

Substitute Environmental Documents for the Machado Lake Trash TMDL

Prepared under the California Environmental Quality Act
(CEQA) Requirements of a Certified Regulatory Program



March 20, 2007

California Regional Water Quality Control Board
Los Angeles Region
320 West 4th Street, Suite 200
Los Angeles, California 90013

TABLE OF CONTENTS

1. EXECUTIVE SUMMARY	4
2. REGULATORY REQUIREMENTS FOR ENVIRONMENTAL IMPACT ANALYSIS OF THE TMDL	7
2.1 EXEMPTION FROM CERTAIN CEQA REQUIREMENTS	8
2.2 CALIFORNIA CODE OF REGULATIONS AND PUBLIC RESOURCES CODE REQUIREMENTS	8
2.3 PROGRAM AND PROJECT LEVEL ANALYSES	9
2.4 PURPOSE OF CEQA	9
3. TMDL OVERVIEW AND PROGRAM OBJECTIVES	11
3.1 INTRODUCTION – LEGAL BACKGROUND	11
3.2 TMDL GOALS AND WATER QUALITY OBJECTIVES	12
4. DESCRIPTION OF ALTERNATIVES	14
4.1 PROGRAM ALTERNATIVES	14
4.1.1 ALTERNATIVE 1 - REGIONAL BOARD TMDL	14
4.1.2 ALTERNATIVE 2 – US EPA TMDL	15
4.1.3 ALTERNATIVE 3 – NO PROGRAM ALTERNATIVE	16
4.1.4 RECOMMENDED PROGRAM ALTERNATIVE	16
4.2 PROJECT LEVEL ALTERNATIVES	17
5. DESCRIPTION OF IMPLEMENTATION ALTERNATIVES	17
5.1 STORM DRAIN SYSTEMS	18
5.1.1 DESIGN OF DEVICES FOR TRASH REMOVAL	18
5.2 STRUCTURAL DEVICES	19
5.2.1 CATCH BASINS AND CATCH BASIN INSERTS	19
5.2.2 VORTEX SEPARATION SYSTEMS	25
5.2.3 TRASH NETS	26
5.2.4 GROSS SOLIDS REMOVAL DEVICES	28
5.3 NON-STRUCTURAL CONTROLS	32
5.3.1 ENFORCEMENT OF LITTER LAWS	32
5.3.2 STREET SWEEPING	32
5.3.3 STORM DRAIN CLEANING	34
5.3.4 PUBLIC EDUCATION	34
5.3.5 TRASH RECEPTACLES	36
5.3.6 PATROL	36
5.3.7 TRASH BAGS	37
5.3.8 COMMUNITY INVOLVEMENT	37
5.3.9 RECYCLING PROGRAM	37
5.3.10 REPORTING SYSTEM	37
5.3.11 STENCIL	37
5.3.12 CONSIDERATION OF PICNIC AREA RELOCATION	37
5.3.13 IMPOSITION OF TRASH TAX	38
5.3.14 COOPERATION OF POTENTIAL SOURCES OF TRASH	38
5.3.15 SURVEILLANCE CAMERA	38

5.3.16 TAX BENEFIT BY ADOPTING WATERBODIES, PARKS, ETC.	38
6. SETTING, IMPACTS, AND MITIGATION	39
6.1 INTRODUCTION	39
6.1.1 APPROACH TO ENVIRONMENTAL SETTING AND IMPACT ANALYSIS	39
6.1.2 PROGRAM LEVEL VERSUS PROJECT-LEVEL ANALYSIS	40
6.1.3 ENVIRONMENTAL SETTING	40
6.2 INSTALLATION, OPERATION AND MAINTENANCE ACTIVITIES FOR TRASH-REDUCTION STRUCTURAL BMPs	42
6.2.1 STORMDRAIN IMPROVEMENT INSTALLATION STAGING AND METHODS	42
6.2.2 MAINTENANCE	44
6.3 SITE SPECIFIC ENVIRONMENTAL ANALYSIS	45
6.3.1 END-OF-PIPE SCREENS	45
6.4. CEQA CHECKLIST AND DETERMINATION	47
6.4.1 ENVIRONMENTAL CHECKLIST	47
6.4.2 DISCUSSION OF ENVIRONMENTAL EVALUATION	54
7 OTHER ENVIRONMENTAL CONSIDERATIONS	119
7.1 CUMULATIVE IMPACTS	119
7.1.1 PROGRAM CUMULATIVE IMPACTS	119
7.1.2 PROJECT CUMULATIVE IMPACTS	120
7.2 GROWTH-INDUCING IMPACTS	121
7.2.1 CEQA GROWTH-INDUCING GUIDELINES	121
7.2.2 TYPES OF GROWTH	122
7.2.3 EXISTING OBSTACLES TO GROWTH	122
7.2.4 POTENTIAL FOR COMPLIANCE WITH THE PROPOSED TMDL TO INDUCE GROWTH.	123
7.3 UNAVOIDABLE SIGNIFICANT ADVERSE IMPACTS	123
8. FINDINGS	124
9. REFERENCES	125

1. EXECUTIVE SUMMARY

The California Regional Water Quality Control Board – Los Angeles Region is the Lead Agency for evaluating the environmental impacts of the proposed Total Maximum Daily Load (TMDL) for trash in the Machado Lake. This Substitute Environmental Document (SED) analyzes environmental impacts that may occur from reasonably foreseeable methods of implementing a TMDL for trash in the Machado Lake (trash TMDL). This SED is based on a proposed trash TMDL that will be considered by the California Regional Water Quality Control Los Angeles Region (Los Angeles Water Board) and, if approved by the Los Angeles Water Board, implemented through an amendment to the Water Quality Control Plan Los Angeles Region (Basin Plan). The proposed trash TMDL is described in the Staff Report, Tentative Board Resolution and Tentative Basin Plan Amendment available on the Los Angeles Water Board website. This SED analyzes foreseeable methods of compliance with the trash TMDL and provides the public information regarding environmental impacts, mitigation, and alternatives in accordance with the California Environmental Quality Act (CEQA).

The SED will be considered by the Regional Board when the Regional Board considers adoption of the trash TMDL as a Basin Plan Amendment. Approval of the SED is separate from approval of a specific project alternative or a component of an alternative. Approval of the SED refers to the process of: (1) addressing comments, (2) confirming that the Regional Board considered the information in the SED, and (3) affirming that the SED reflects independent judgment and analysis by the Regional Board (Section 10590 15090 of CEQA Guidelines (Title 14 of CCR)).

Water quality in the Machado Lake is limited by trash, as documented in current and proposed State of California 303(d) lists of impaired waterbodies. Trash in water causes significant water quality problems and impairs existing beneficial uses of the Machado Lake, including navigation (NAV); non-contact water recreation (REC-2); commercial and sport fishing (COMM); marine habitat (MAR); and rare, threatened, or endangered species (RARE). Wildlife living in the lake and in riparian areas can be harmed by ingesting or becoming entangled in floating trash. Trash which does not float, but which settles, instead, is less obvious. The settleables include glass, cigarette butts, rubber, construction debris and more. Settleables can be a problem for bottom feeders and can contribute to sediment contamination. Some debris (e.g. diapers, medical, and household waste) are a source of bacteria and toxic substances.

Floating debris that is not trapped and removed will eventually end up on the beaches or in the open ocean, repelling visitors away from beaches and degrading coastal waters.

Persistent trash such as plastics is a worldwide problem and trash in the Machado Lake may pollute the Pacific Ocean and distant Pacific beaches for many years. Marine debris has been widely recognized as a threat to the marine environment since the 1970s. Research shows that, despite global treaties to prevent dumping at sea and increasing efforts in developing countries to protect water quality, the quantity of debris in the world's oceans is increasing. For example, the abundance of micro plastics in the North Pacific tripled during the last decade (Moore, et. al, 2005). During the same period, near the coast of Japan, quantities increased by a factor of 10 every two-three years (Haruo and Yuri, 2000).

A 1999 study of marine debris in the Mid-Pacific Gyre, conducted by the Algalrita Marine Research Foundation, collected plankton samples from the ocean surface at various locations throughout the gyre. The results showed the mass of plastic particles collected was six times higher (5,000 g/km²) than the mass of plankton (841 g/km²), although the number of planktonic organisms (1,837,342/km²) was five times the number of plastic pieces. In this study, the most common type of identifiable particle, thin plastic film, accounted for 29% of the total (Moore, et. al, 2001).

Many years of International Coastal Clean-up (ICC) data¹ show definite trends. For example, an average of 60% of the debris items retrieved from beaches on Coastal Clean-up Day in the U.S. is comprised of plastic materials. The primary items of debris from land-based sources on the Pacific Coast collected during the ICC include food wrappers, beverage containers, cigarettes and smoking-related materials. (Sheavely, 2005).

A trash TMDL is required under section 303 of the Clean Water Act and mandated by a Consent Decree between Heal the Bay et al. and the United States Environmental Protection Agency (US EPA). This consent decree requires that all TMDLs for the Los Angeles Region be adopted within 13 years, and prescribes schedules for certain TMDLs. The objective of the trash TMDL is to restore the beneficial uses of the Machado Lake that are currently impaired by trash, in accordance with Clean Water Act section 303(d).

Littering consisting of plastic bags, aluminum cans and paper is a problem at the Machado Lake area. The trash TMDL establishes waste load allocations that will be used to develop effluent limits in National Pollutant Discharge Elimination System (NPDES) storm water permits for discharges to the Machado Lake and its tributaries and estuaries. The TMDL also established compliance metrics based on structural and nonstructural "Best Management Practices" (BMPs) to attain full capture certification by the Los Angeles Water Board. The Regional Board has certified BMPs such as vortex separators, gross solid removal devices, and catch basin inserts and screens as full capture devices. The TMDL establishes load allocations (LAs) to nonpoint sources of pollution that may be implemented through non-structural BMPs and a program of minimum frequency of assessment and collection of trash. In addition, Waste Load Allocations (WLAs) may be issued to additional facilities under Phase II of the US EPA Stormwater Permitting Program.

This SED analyzes three Program Alternatives and two types of Implementation Alternatives (see Sections 4 and 5 of this SED for a description of the alternatives) that encompass actions within the jurisdiction of the Los Angeles Water Board and implementing municipalities and agencies. A No Project Alternative is analyzed to allow decision makers to compare the impacts of approving a proposed alternative and its components compared with the impacts of not approving the proposed alternative. The SED analyzes the potential environmental impacts in accordance with significance criteria widely accepted by municipalities and government agencies in the Machado Lake watershed for CEQA review. The TMDL does not specify types of projects, specific locations, or mitigation measures for those projects. Projects are specified, designed, constructed, operated, and mitigated for by the NPDES permittees.

¹ The ICC data is collected by volunteers on one day each year, and is not a scientific assessment.

Consequently, this environmental analysis is structured in accordance with guidelines for a Tier 1 Program SED rather than a Tier 2 Project SED.

Municipalities and agencies that will implement specific projects and BMPs may use this SED to help with the selection and approval of project alternatives. The implementing municipality or agency will be the lead agency and have responsibility for environmental review of the projects they determine necessary to implement the trash TMDL.

Approval of projects (i.e., project alternatives or components of project alternatives) refers to the decision of either the implementing municipalities or agencies to select and carry out an alternative or a component of an alternative. (Section 5 of this SED summarizes the components that comprise the project alternatives analyzed in this SED). The components assessed at a project level have specific locations that will be determined by implementing municipalities and agencies. The project-level components will be subject to additional environmental review, including review by cities and municipalities implementing trash TMDL projects.

Many of the specific projects and BMPs analyzed in this SED will involve small construction projects and maintenance of trash collection and stormdrain infrastructure. Infrastructure maintenance and urban construction projects generate varying degrees of environmental impacts. The potential impacts can include, for example, noise associated with construction, air emissions associated with vehicles to deliver materials during construction, traffic associated with increased vehicle trips and where construction or attendant activities occur near or in thoroughfares, and additional light and glare. Additionally, maintenance of constructed BMPs such as catch basin inserts or vortex separation systems may involve, for example, such consequences as additional traffic and air emissions from requisite additional street sweeping and additional trash collection, need for additional landfill space to dispose of collected trash, additional risk of flooding if trash collection devices are not properly maintained and so forth. These foreseeable impacts are analyzed in detail in Section 6 of this SED.

To address the environmental and nuisance impacts from these routine and essential activities, public works departments are required to employ a variety of techniques, “best management practices”, and other mitigation measures to minimize the impacts on the environment. Generally accepted and recognized mitigation measures for construction projects on the scale of these maintenance projects include, for example, such actions as the management of traffic by planning construction activities for certain times of the day, development of detailed traffic plans in coordination with police or fire protection authorities; mitigation of excessive noise by planning construction activities for certain times of the day, use of less noisy equipment, use of sound barriers; reduction of air emissions by use of lower emissions vehicles. Numerous agencies such as Caltrans, CASQA, and WERF publish handbooks containing guidance on the selection, siting, design, installation, monitoring, and evaluation of storm water BMPs (Caltrans, 2002, 2003; CASQA, 2003a; CASQA, 2003b; WERF, 2005). These mitigation methods and BMPs are discussed in detail in Section 6 of this SED.

These mitigation measures and best management practices are intended to avoid or minimize site specific impacts, and in many cases they do so to less than significant levels, considering the context of the urbanized baseline conditions. Indeed, typically, the construction of trash collection methods are undertaken by municipalities with a declaration by the relevant agency that their project falls under one or more “categorical

exemptions” from CEQA, that is, projects that the municipality has concluded, and the Resources Agency agrees, do not result in significant adverse environmental impacts.

This SED finds foreseeable methods to comply with the trash TMDL focus on improvements to the stormdrain system and non-structural BMPs in the Machado Lake Trash TMDL area and do not cause significant impacts that cannot be mitigated through commonly used construction and maintenance practices. The SED finds that environmental impacts from the trash TMDL are those impacts related to installation and maintenance of structural BMPs. The SED identifies mitigation methods for impacts with potentially significant effects and finds that those methods can mitigate potentially significant impacts to levels that are less than significant. The SED can be used by implementing municipalities and agencies to expedite any additional environmental analysis of specific projects required to comply with the trash TMDL.

As discussed in this SED, California Water Code section 13360 prohibits the Regional Board from specifying the manner of compliance with the TMDL. Methods of compliance and selection of specific BMPs and associated mitigation measures are the responsibility of the responsible agencies for implementing the trash TMDL.

Many of the mitigation measures identified in the SED are common practices currently employed by agencies when planning and implementing storm water BMPs. Agencies such as Caltrans, the California Stormwater Quality Association (CASQA), and the Water Environment Research Foundation (WERF) publish handbooks containing guidance on the selection, siting, design, installation, monitoring, and evaluation of storm water BMPs (Caltrans, 2002, CASQA, 2003a, CASQA, 2003b, WERF, 2005). Manuals are also available, which describe engineering and administration policies and procedures for construction projects (e.g., Caltrans, 2003a). Since the decision to perform these measures is strictly within the responsibility and jurisdiction of the individual implementing agencies, such measures can and should be adopted by these agencies. (Title 14, California Code of Regulations, Section 15091(a)(2).)

The regulatory requirements and the program objectives for the Machado Lake Trash TMDL are provided in Section 2 and Section 3 respectively. Section 4 discusses the program level alternatives for the trash TMDL and presents implementation alternatives to achieve compliance with the final waste load allocation of zero trash. Section 5 provides a detailed description of implementation alternatives. Section 6 contains site specific environmental impacts (Section 6.3) and the CEQA Checklist and Determination with in-depth analysis of each resource area (Section 6.4). Other environmental considerations are discussed in Section 7. A list of references refer to supporting documentation for this SED.

2. REGULATORY REQUIREMENTS FOR ENVIRONMENTAL IMPACT ANALYSIS OF THE TMDL

This section presents the regulatory requirements for assessing environmental impacts of a TMDL implemented through a Basin Plan Amendment at the Regional Board. This TMDL for trash in Machado Lake is evaluated at a program level of detail under a *Certified Regulatory Program* and the information and analyses are presented in these *Substitute Environmental Documents* as discussed in this section.

2.1 EXEMPTION FROM CERTAIN CEQA REQUIREMENTS

The California Secretary of Resources has certified the State and Regional Boards' basin planning process as exempt from certain requirements of the California Environmental Quality Act (CEQA), including preparation of an initial study, negative declaration, and environmental impact report (California Code of Regulations, Title 14, Section 15251(g)). As the proposed amendment to the Basin Plan is part of the basin planning process, the environmental information developed for and included with the amendment is considered a substitute for an initial study, negative declaration, and/or environmental impact report.

2.2 CALIFORNIA CODE OF REGULATIONS AND PUBLIC RESOURCES CODE REQUIREMENTS

While the "certified regulatory program" of the Regional Board is exempt from certain CEQA requirements, it is subject to the substantive requirements of California Code of Regulations, Title 23, Section 3777(a), which requires a written report that includes a description of the proposed activity, an analysis of reasonable alternatives, and an identification of mitigation measures to minimize any significant adverse environmental impacts. Section 3777(a) also requires the Regional Board to complete an environmental checklist as part of its substitute environmental documents. This checklist is provided in section 6 of this document.

In addition, the Regional Board must fulfill substantive obligations when adopting performance standards such as TMDLs, as described in Public Resources Code section 21159. Section 21159, which allows expedited environmental review for mandated projects, provides that an agency shall perform, at the time of the adoption of a rule or regulation requiring the installation of pollution control equipment, or a performance standard or treatment requirement, an Environmental Analysis of the reasonably foreseeable methods of compliance. The statute further requires that the environmental analysis at a minimum, include, all of the following:

- (1) An analysis of the reasonably foreseeable environmental impacts of the methods of compliance.
- (2) An analysis of reasonably foreseeable feasible mitigation measures to lessen the adverse environmental impacts.
- (3) An analysis of reasonably foreseeable alternative means of compliance with the rule or regulation that would have less significant adverse impacts. (Pub. Resources Code, § 21159(a).)

Section 21159(c) requires that the Environmental Analysis take into account a reasonable range of:

- (1) Environmental, economic, and technical factors,
- (2) Population and geographic areas, and
- (3) Specific sites.

2.3 PROGRAM AND PROJECT LEVEL ANALYSES

Public Resources Code § 21159(d) specifically states that the public agency is not required to conduct a “project level analysis.” Rather, a project level analysis must be performed by the local agencies that are required to implement the requirements of the TMDL (Pub. Res. Code § 21159.2.) Notably, ***the Regional Board is prohibited from specifying the manner of compliance with its regulations*** (Water Code § 13360), and accordingly, the ***actual*** environmental impacts will necessarily depend upon the compliance strategy selected by the local agencies and other permittees.

This Substitute Environmental Document identifies the reasonably foreseeable environmental impacts of the ***reasonably foreseeable*** methods of compliance (Pub. Res. Code, § 21159(a)(1).), based on information developed before, during, and after the CEQA scoping process that is specified in California Public Resources Code section 21083.9 This analysis is a program-level (i.e., macroscopic) analysis. CEQA requires the Regional Board to conduct a program-level analysis of environmental impacts. (Pub. Res. Code, § 21159(d).) Similarly, the CEQA substitute documents do not engage in speculation or conjecture (Pub. Res. Code, § 21159(a).) When the CEQA analysis identifies a potentially significant environmental impact, the accompanying analysis identifies reasonably foreseeable feasible mitigation measures. (Pub. Res. Code, § 21159(a)(2).) Because responsible agencies will most likely use a combination of structural and non-structural BMPs, the SED has identified the reasonably foreseeable alternative means of compliance. (Pub. Res. Code, § 21159(a)(3).)

2.4 PURPOSE OF CEQA

CEQA’s basic purposes are to: 1) inform the decision makers and public about the potential significant environmental effects of a proposed project, 2) identify ways that environmental damage may be mitigated, 3) prevent significant, avoidable damage to the environment by requiring changes in projects, through the use of alternative or mitigation measures when feasible, and 4) disclose to the public why an agency approved a project if significant effects are involved. (Cal. Code Regs., tit. 14, § 15002(a).)

To fulfill these functions, a CEQA review need not be exhaustive, and CEQA documents need not be perfect. They need only be adequate, complete, and good faith efforts at full disclosure. (Cal. Code Regs., tit. 14, § 15151.) The Court stated in *River Valley Preservation Project v. Metropolitan Transit Development Board* (1995) 37 Cal.App.4th 154, 178:

"As we have stated previously, “[our limited function is consistent with the principle that “[t]he purpose of CEQA is not to generate paper, but to compel government at all levels to make decisions with environmental consequences in mind. . . .”” (City of Santee v. County of San Diego (1989) 214 Cal.App.3d 1438, 1448 [263 Cal.Rptr. 340]; quoting *Laurel Heights I*, supra, 47 Cal.3d at p. 393.) “We look ‘not for perfection but for adequacy, completeness, and a good faith effort at full disclosure.’ (Guidelines, §§ 15151.)” (City of Fremont v. San Francisco Bay Area Rapid Transit Dist., supra, 34 Cal.App.4th at p. 1786.)”

Nor does a CEQA require unanimity of opinion among experts. The analysis is satisfactory as long as those opinions are considered. (Cal. Code Regs., tit. 14, § 15151.)

In this document, the Regional Board staff has strived to perform a good faith effort at full disclosure of the reasonably foreseeable environmental impacts that could be attendant with the proposed trash TMDL. Our analysis and conclusions follow.

3. TMDL OVERVIEW AND PROGRAM OBJECTIVES

3.1 INTRODUCTION – LEGAL BACKGROUND

The Total Maximum Daily Load (TMDL) for trash in the Machado Lake was designed to attain the water quality standards for trash in this lake. The TMDL was prepared pursuant to state and federal requirements to preserve and enhance water quality in the Machado Lake. The adoption of a TMDL is not discretionary and is compelled both by section 303(d) of the federal Clean Water Act (33 USC 1313(d)) and by a federal consent decree, *Heal the Bay Inc., et al. v. Browner, et al.* C 98-4825 SBA (United States District Court, Northern District of California, 1999) approved on March 22, 1999.

The California Water Quality Control Plan, Los Angeles Region, also known as the *Basin Plan*, sets water quality standards for surface waters and ground waters in the region. These standards are comprised of designated beneficial uses for surface and ground water, and numeric and narrative objectives necessary to support beneficial uses and the state's antidegradation policy. Such standards are mandated for all waterbodies within the state under the Porter-Cologne Water Quality Act. In addition, the Basin Plan describes implementation programs to protect all waters in the region. The Basin Plan implements the Porter-Cologne Water Quality Control Act (commencing at Section 1300 of the "California Water Code") and serves as the State Water Quality Control Plan applicable to the Machado Lake, also requiring water quality standards for all surface waters as required pursuant to the federal Clean Water Act (CWA).

Section 305(b) of the CWA mandates biennial assessments of the nation's water resources. These water quality assessments are used, with any other available data and information, to identify and prioritize waters not attaining water quality standards. The resulting amalgamation of waters is referred to as the "303(d) List" or the "Impaired Waters List". CWA section 303(d)(1)(C) and (d)(1)(D) require that the state establish TMDLs for each listed water. Those TMDLs, and the 303(d) List itself, must be submitted to USEPA for approval under section 303(d)(2). Section 303(d)(3) requires that the state also develop TMDLs for all waters that are not on the 303(d) List as well, however TMDLs for waters that do not meet the criteria for listing are not subject to approval by USEPA.

TMDLs must be established at a level necessary to attain water quality standards, considering seasonal variations and a margin of safety. The TMDL must also include an allocation of parts of the total allowable load (or loading capacity) to all point sources and to nonpoint sources and natural background, in the form of waste load and load allocations, accordingly. Waste load and load allocations must be assigned for all sources of the impairing pollutant, irrespective of whether they are discharged to the impaired reach or to an upstream tributary. TMDLs are generally established in California through the basin planning process, i.e., an amendment to the basin plan to incorporate a new or revised program of implementation of the water quality standards, pursuant to Water Code section 13242. The process that the Regional Board uses for establishing TMDLs is the same whether under section 303(d)(1) or 303(d)(3).

USEPA's authority over the 303(d) program includes the obligation to approve or disapprove the identification of impaired waters. If any list or TMDL is disapproved, USEPA must establish its own list or TMDL.

As part of California's 1996, 1998, and 2002 303(d) list submittals, the Regional Board identified the Machado Lake as being impaired due to trash.

A consent decree between the USEPA, the Santa Monica BayKeeper and Heal the Bay, represented by the Natural Resources Defense Council (NRDC), was signed on March 22, 1999. This consent decree requires that all TMDLs for the Los Angeles Region, for 1998 listed water, be adopted within 13 years.

The Machado Lake Trash TMDL is a Basin Plan Amendment and is subject to the 2001 provision of the Public Resources Code Section 21083.9 that requires a CEQA Scoping to be conducted for Regional Projects. CEQA Scoping involves identifying a range of project/program related actions, alternatives, mitigation measures, and significant effects to be analyzed in an EIR or its functionally equivalent document. On December 6, 2006 a CEQA Scoping hearing was held to present and discuss the foreseeable potential environmental impacts of compliance with the Machado Lake Trash TMDL. A notice of the CEQA Scoping hearing was sent to interested parties including cities and/or counties with jurisdiction in or bordering the Machado Lake. Input from all stakeholders and interested parties was solicited for consideration in the development of the CEQA document.

These SEDs are being released for public comment accompanying the TMDL staff report, Basin Plan amendment, and tentative resolution for adoption by the Regional Board; these documents should be considered as a whole when evaluating the environmental impacts of implementing the TMDL. When complete, the SED will also include a response to comments on this draft SED.

3.2 TMDL GOALS AND WATER QUALITY OBJECTIVES

The Water Quality Control Plan Los Angeles Region (Basin Plan) designates beneficial uses of waterbodies, establishes water quality objectives for the protection of these beneficial uses, and outlines a plan of implementation for maintaining and enhancing water quality. The proposed amendment would incorporate into the Basin Plan a TMDL for trash in the Machado Lake.

The beneficial uses likely to be impaired by trash include: navigation (NAV), non-contact water recreation (REC2), commercial and sporting fishing (COMM), marine habitat (MAR); and rare, threatened or endangered species (RARE).

The Regional Board's goal in adopting the TMDL is to eliminate the significant water quality impacts caused by trash in waterways. Small and large floatables can inhibit the growth of aquatic vegetation, decreasing spawning areas and habitats for fish and other living organisms. Wildlife living in lakes and in riparian areas can be harmed by ingesting or becoming entangled in floating trash. Trash which does not float, but which settles, instead, is less obvious. The settleables include glass, cigarette butts, rubber, construction debris and more. Settleables can be a problem for bottom feeders and can contribute to sediment contamination. Some debris (e.g. diapers, medical and household waste) are a source of bacteria and toxic substances.

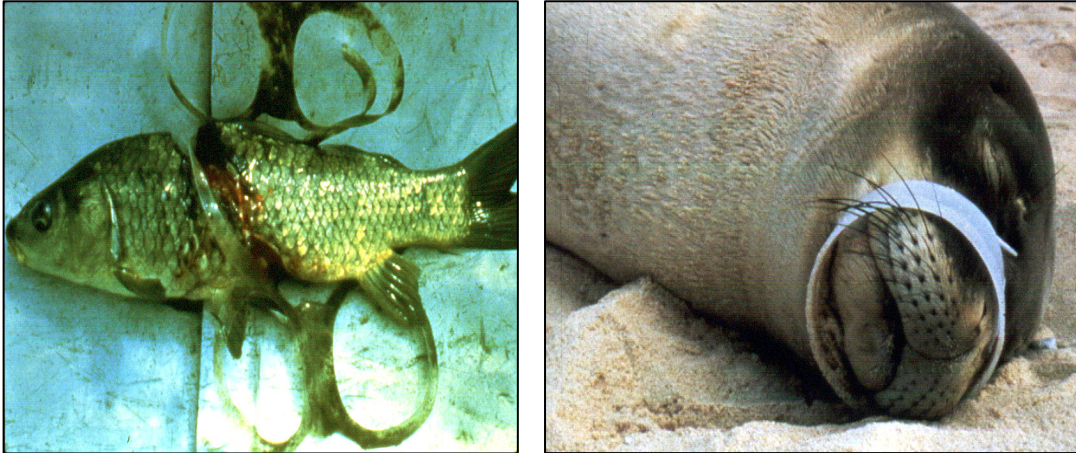

Figure 3-1: Impacts to wildlife from trash

The proposed TMDL sets the numeric water quality targets equal to zero in order to implement the Basin Plan's narrative water quality objectives for trash:

"Waters shall not contain floating materials, including solids, liquids, foams, and scum, in concentrations that cause nuisance or adversely affect beneficial uses."

"Waters shall not contain suspended or settleable material in concentrations that cause nuisance or adversely affect beneficial uses."

For purposes of controlling point source discharges, trash is defined as man-made litter that can be retained by a 5 mm mesh screen. Additionally, a number of "best management practices" (BMPs) have been approved as "full capture devices" because of their expected performance, such that if a responsible agency implements these BMPs, the agency will be deemed in compliance with what will ultimately be a zero waste load allocation, in all drainage areas served by these devices.

The implementation and compliance schedule is designed to accommodate trash reduction efforts that have been conducted by permittees and local agencies. The baseline Waste Load Allocations and load allocations are derived from data collected by City of Calabasas. Responsible jurisdictions must achieve a phased reduction each year from baseline Load and Waste Load Allocation until zero discharge of trash is attained.

4. DESCRIPTION OF ALTERNATIVES

These substitute environmental documents analyze three Program Alternatives that encompass actions within the jurisdiction of the Regional Board and implementing municipalities and agencies. The program alternatives include the trash TMDL as it is proposed for Regional Board adoption; a trash TMDL established by the US EPA, and a No Program Alternative in which a trash TMDL is not implemented. Because a TMDL is required by Section 303(d) of the Clean Water Act and a federal consent decree, the no Program Alternative is analyzed to allow decision makers to compare the impacts of approving a proposed alternative and its components compared with the impacts of not approving a proposed alternative. The specifics of the many projects which would make up a program alternative are discussed in detail in Section 5 and include structural and non structural Best Management Practices (BMPs) that are reasonably foreseeable to be implemented under the trash TMDL program alternatives.

This document does not analyze a “partial” TMDL; for example, a TMDL which would achieve only a 70% or only an 80% reduction in trash. This sort of alternative was considered and rejected because, to the extent that significant adverse environmental impacts would be created by compliance with this proposed TMDL, while a “partial” TMDL would, in fact, have fewer of those environmental impacts associated with compliance (although, also, less environmental benefits of the TMDL), the specific legal requirements of section 303(d) of the Clean Water Act require a level necessary to achieve water quality standards. Thus a “partial” TMDL is unlawful because a partial reduction in trash would not meet water quality standards.

The components assessed at a program level generally are program elements that would be implemented as part of the trash TMDL, but these elements do not have specific locations or design details identified. The components assessed at a project level have specific locations which will be determined by implementing municipalities and agencies. The project-level components will be subject to additional future environmental review, including review by cities and municipalities implementing trash TMDL projects.

4.1 PROGRAM ALTERNATIVES

4.1.1 ALTERNATIVE1 - REGIONAL BOARD TMDL

This program alternative is based on the TMDL that is presently proposed for Regional Board consideration. The TMDL focuses on reduction in sources of trash from municipal stormdrains and highways and assigns wasteloads to stormwater permittees and CalTrans. The TMDL waste load allocations (WLA) are established through an amendment to the Water Quality Control Plan (Basin Plan) and implemented through National Pollutant Discharge Elimination System (NPDES) permits. The Regional Board TMDL provides a program for addressing the adverse impacts of trash through a progressive reduction in trash discharges to the Machado Lake, through an 8 year schedule, which is both reasonable and as short as practicable. The WLAs and the schedule when they are incorporated into the Basin Plan will be considered by the NPDES permit writers when developing permit limits that are adopted in separate actions by the Regional Board.

The proposed TMDL establishes an 8-year plan for progressively reducing the amount of trash that may be discharged to the lake for point sources and a 5-year plan for nonpoint sources. The schedule requires immediate implementation of a baseline waste load allocation and annual reductions of 20% beginning in year 4 until the final numeric target of zero trash discharged is reached. Alternatively responsible jurisdictions may implement a program of minimum frequency of assessment and collection in conjunction with BMPs. For Machado lake, the minimum frequency is once per day.

The TMDL will be implemented primarily through regulatory mechanisms that implement the State Board's 2004 Nonpoint Source Policy, such as conditional waivers. For nonpoint sources, the strategy for attaining water quality standards focuses on assigning Load Allocations (LAs) land owners and agencies in the vicinity of Machado Lake. Waste Load Allocations for point sources will be implemented through the NPDES storm water permits. Waste Load Allocations will be assigned to the Permittees and Co-permittees (hereinafter referred to as Permittees) of the Los Angeles County Municipal Stormwater Permit (MS4) and Caltrans. In addition, Waste Load Allocations may be issued to additional facilities under Phase II of the US EPA Stormwater Permitting Program. Waste Load Allocations assigned under the MS4 permit and the Caltrans permit will be based on a phased reduction from estimated discharges (i.e., baseline) over the compliance period until the final Waste Load Allocation (currently set at zero) is met.

Although the Regional Board cannot mandate the manner of compliance, foreseeable environmental impacts from methods of compliance are well known. During the development of the TMDL, a CEQA scoping meeting was held during which the manner of compliance was discussed. At this meeting, the most reasonable means of compliance were examined. They include structural methods such as catch basin inserts, structural vortex separation devices, end of pipe trash nets, as well as non-structural alternatives such as increased street sweeping, and enforcement of existing litter laws.

This TMDL program alternative anticipates compliance through installation of structural devices (full or partial capture devices in the stormdrain systems), and non-structural methods (institutional controls) as discussed in Section 5. Potential adverse impacts to the environment stem principally from the installation, operation, and maintenance of the full or partial capture devices in the storm drain systems. This document analyzes these impacts and concludes that installation of implementation projects are of relatively short duration and typical of "baseline" construction and maintenance projects that occur presently in the Trash TMDL area. It also concludes that significant impacts can be mitigated or there are alternative means of compliance available.

4.1.2 ALTERNATIVE 2 – US EPA TMDL

This program alternative is based on a TMDL that would be established by the United States Environmental Protection Agency, pursuant to the consent decree, if the Regional Board fails to adopt a Trash TMDL. Because the technical analysis will be very similar to the Regional Board analysis and because the same laws and regulations apply, it is assumed that the technical portions and WLAs of this TMDL Program Alternative will be essentially the same as Program Alternative 1. However, because such a TMDL is not implemented through a Basin Plan amendment, the WLAs will be implemented through NPDES permit limits as the permits are renewed without consideration of a compliance

schedule. Because NPDES permits are renewed every five years, all responsible parties, municipalities and CalTrans, could be required to be in full compliance immediately following the TMDL adoption by USEPA, or within 5 years.

This TMDL program alternative also anticipates compliance through installation of structural devices (full or partial capture devices in the stormdrain systems), and non-structural methods (institutional controls) as discussed in Section 5. Potential adverse impacts to the environment stem principally from the construction and operation of the full or partial capture devices in the storm drain systems. This document analyzes these impacts and concludes that installation of implementation projects are of relatively short duration and typical of “baseline” construction and maintenance projects that occur presently in the Trash TMDL area. It also concludes that significant impacts can be mitigated or there are alternative means of compliance available, and that the benefits of the program outweigh any significant adverse environmental effects.

4.1.3 ALTERNATIVE 3 – NO PROGRAM ALTERNATIVE

This program alternative assumes that neither the USEPA nor the Regional Board implements a trash TMDL. While cities and municipalities could implement BMPs on a discretionary basis, this CEQA analysis is based on the assumption that no additional trash reduction BMPs would be implemented in addition to those that are presently in place. However, the No Project TMDL is contrary to federal and state law and a Court Ordered Consent Decree between citizen plaintiffs and the US Environmental Protection Agency. Therefore, the failure to implement a trash TMDL is unlawful.

In addition, while impact to the environment from construction or maintenance of full or partial capture devices in the stormdrain systems would be avoided in this No Program alternative, No Program would *not* restore beneficial uses to the Machado Lake. Either TMDL Program Alternative will restore beneficial uses in the Machado Lake and attain water quality standards by removing trash from the Machado Lake and its tributaries. As such, either trash TMDL program alternative 1 or 2 represents a benefit to the environment and the No TMDL Program Alternative represents a continued trash impairment of the environment.

4.1.4 RECOMMENDED PROGRAM ALTERNATIVE

This environmental analysis finds that Program Alternative 1 is the most environmentally advantageous alternative.

Alternative 3 is not a feasible alternative because, while it avoids impacts due to discrete installation projects, it allows the trash impairment of the lake and the Los Angeles contribution to the ocean plastics problem to continue. Both program alternatives 1 and 2 will comply with the law and the federal consent decree, remove the large trash impairment from the Machado Lake, and reduce the Machado Lake’s contribution to the ocean plastics pollution problem at the comparatively small environmental cost of small installation projects throughout the watershed.

The key difference between program alternatives 1 and 2 is the establishment of an implementation schedule. While the same WLAs will need to be met and the same technological choices will be available by both alternatives, alternative 1 will allow a measured implementation plan, resulting in full compliance in 8 years. Alternative 2, in

contrast, will require compliance at the time of permit renewal, in all permit cases, in less than 5 years. The environmental impacts due to alternative 2 may be of greater severity as the intensity of implementation actions will be greater to comply with the shorter time frame. The longer schedule of alternative 1 allows for prioritization and planning, more thoroughly mitigated impacts, more appropriately designed, sited and sized structural devices and, therefore, less environmental impact, in general. In addition, prioritization and planning will likely result in more efficient use of funds and lower overall costs.

4.2 PROJECT LEVEL ALTERNATIVES

The program alternatives above present many alternatives and options and do not require any specific projects to achieve compliance. Rather, a project level analysis must be performed by the local agencies that are required to implement the requirements of the TMDL (Pub. Res. Code § 21159.2.). Notably, the Regional Board is prohibited from specifying the manner of compliance with its regulations (Water Code § 13360), and accordingly, the actual environmental impacts will necessarily depend upon the compliance strategy selected by the local agencies and other permittees.

Although the Regional Board cannot mandate the manner of compliance, foreseeable environmental impacts from methods of compliance are well known, as are feasible mitigation measures. During the development of the TMDL, a CEQA scoping meeting was held during which the manner of compliance was discussed. At this meeting, the most reasonable means of compliance discussed included structural methods such as catch basin inserts, structural vortex separation devices, end of pipe trash nets, as well as non-structural alternatives such as increased street sweeping, and enforcement of existing litter laws.

The components assessed at a project level have specific locations which will be determined by implementing municipalities and agencies. The project-level components will be subject to additional future environmental review, including review by cities and municipalities implementing trash TMDL projects. Section 5 of this SED includes an extensive discussion of the project alternatives.

5. DESCRIPTION OF IMPLEMENTATION ALTERNATIVES

This Section of the SED begins with a description of the stormwater system in the Trash TMDL area and a description of the type of sites where structural devices or controls might be placed in compliance with the Trash TMDL. The structural alternatives such as catch basin inserts and vortex separators and the institutional control alternatives such as street sweeping and public education are then discussed.

The Regional Board is prohibited from specifying the manner of compliance with its regulations (Water Code § 13360), and accordingly, the actual compliance strategies will be selected by the local agencies and other permittees. Although the Regional Board does not mandate the manner of compliance, foreseeable methods of compliance are well known. The most likely measures of compliance include structural methods such as catch basin inserts, vortex separation devices, end of pipe trash nets, as well as non-structural alternatives such as increased street sweeping, and enforcement of existing litter laws.

The project-level components will be subject to additional future environmental review. A project level environmental analysis must be performed by the local agencies that are required to implement the requirements of the TMDL (Pub. Res. Code § 21159.2.).

5.1 STORM DRAIN SYSTEMS

Underground storm drains are typically designed to carry the runoff from up to a 10-year storm. Open channels are typically designed to carry the runoff from up to a 50-year storm, and in some cases, this design flow rate is increased to accommodate debris-laden flows. The rate of runoff a drain can safely convey, expressed in cubic feet per second, is called its peak capacity. While a drain's capacity will not diminish over the years, the amount of runoff generated by a given storm event can increase over the years. This potential increase could be due to a number of factors including: an increase in the amount of development and impervious surfaces within the tributary area, and; the addition of smaller upstream tributary drains that deliver runoff more quickly to the collecting drain. The potential for such increases should always be considered in selecting the appropriate structural BMP for a particular site.

Storms are commonly referred to by their "frequency." For example, a 1-year storm, having a long-term probability of happening at least once a year, is a very common occurrence. On the other hand, a 50-year storm event is a much rarer occurrence, with a long-term probability of occurring only once in 50 years. The actual rate of runoff from storms of a given size or frequency depends on a number of factors, including the intensity and duration of the rainfall, the size of the tributary area, the topography, the soil types within the tributary drainage area, and the overall connected imperviousness of the tributary area.

5.1.1 DESIGN OF DEVICES FOR TRASH REMOVAL

The structural devices likely to be used for compliance with the Trash TMDL are devices that will be installed in existing storm drains. Older storm drains may be limited in expansion capability and maintenance right of way and the complying municipalities and agencies must consider these factors when designing and siting new trash devices.

Among factors to consider when designing and siting devices is drain capacity. For instance, if a structural device is to be installed mid-drain, the storm drain system must have sufficient capacity, or the storm drain must be modified to maintain sufficient capacity. Start-of-pipe devices such as catch basin opening screens and excluders or end-of-pipe devices such as trash racks, fabric mesh socks and wire screens, may have less impact on hydraulic drain capacity under certain hydraulic conditions than devices installed mid-pipe. The smaller the amount of flow a retrofitted device or system must treat, the less hydraulic impact it will have on the storm drain system as a whole.

In addition, the definition of "full capture" in the Trash TMDL includes reference to a maximum trash particle size of 5mm. The 5mm size limit is approximately the diameter of a pencil or cigarette butt. A smaller particle size implies a smaller filtering mesh or screen size, and a smaller mesh or screen size implies more resistance to the flow passing through it. When designing and siting devices, assuming that a certain percentage of a screen would be blocked by trash during a storm event, the total area of the screen openings would have to be larger than the area of the drain's cross section by that percentage.

In addition to the requirement of removing litter 5mm and above from flows up to the runoff from a 1-year storm, the design of a trash removal device should take into account reliability and performance sensitivity under varying loads. A trash device should meet the following minimum criteria:

- It must not adversely affect the level of flood protection provided by the drainage system;
- It should be vector-resistant, or not pond water for more than 48 hours after the end of a storm;
- It should not worsen water quality by resuspending trash, sediments, or bacteria, or by leaching heavy metals or semi-volatile organic compounds;
- If it is to be an underground device with access shafts, it must meet or exceed American Public Works Association standards, have ladder rungs, and have the ability to withstand lateral soil pressures;
- It should have no plastic or fiberglass interior parts that would break or shatter in the path of direct flow;
- Its pipes, conduits and vaults should not be more than 32 feet below ground, and should be easily accessible by a vacuum truck hose for clean-out, be reasonably accessible by a qualified maintenance worker, have provisions for confined space entry and safety guard rails around the rim; and
- It should provide means to block off the inflow and tail water backflow to isolate the device for safe maintenance and repair of the unit.

5.2 STRUCTURAL DEVICES

5.2.1 CATCH BASINS AND CATCH BASIN INSERTS

A catch basin or storm drain inlet is an inlet to the storm drain system that typically includes a grate or curb opening where stormwater enters the catch basin and a sump to capture sediment, debris and associated pollutants. They are also used in combined sewer watersheds to capture floatables and settle some solids. Catch basins act as pretreatment for other treatment practices by capturing large particles. The performance of catch basins at removing sediment and other pollutants depends on the design of the catch basin (e.g., the size of the sump), and routine maintenance to retain the storage available in the sump to capture sediment.

Catch basins are used in drainage systems throughout the United States. However, many catch basins are not designed for sediment and pollutant capture. Ideal application of catch basins is as pretreatment to another stormwater management practice. Retrofitting existing catch basins may help to improve their performance substantially. A simple retrofit option of catch basins is to ensure that all catch basins have a hooded outlet to prevent floatable materials, such as trash and debris, from entering the storm drain system.

The performance of catch basins is related to the volume in the sump (i.e., the storage in the catch basin below the outlet). Optimal catch basin sizing criteria, which relates all catch basin dimensions to the diameter of the outlet pipe (D), are shown in Figure 5-1.

Typical dimensions are:

The diameter of the catch basin should be equal to 4D.

The sump depth should be at least 4D. This depth should be increased if cleaning is infrequent or if the area draining to the catch basin has high sediment loads.

The top of the outlet pipe should be 1.5 D from the inlet to the catch basin.

Catch basins can also be sized to accommodate the volume of sediment that enters the system. The study proposed a sizing criteria based on the concentration of sediment in stormwater runoff. The catch basin sump is sized, with a factor of safety, to accommodate the annual sediment load to the catch basin with a factor of safety. This method is preferable where high sediment loads are anticipated, and the optimal design described above is suspected to provide little treatment.

The basic design should also incorporate a hooded outlet to prevent floatable materials and trash from entering the storm drain system (see Figure 5-1). Adding a screen to the top of the catch basin would help capture trash entering the catch basin. To limit the discharge rate downstream of the outlet pipe, a flow restrictor is used and discharge rates can be accurately controlled by slot or orifice dimensions in the riser pipe shielded (see Figure 5-2).

Typical maintenance of catch basins includes trash removal if a screen or other debris capturing device is used, and removal of sediment using a vacuum truck. Operators need to be properly trained in catch basin maintenance. When sediment fills greater than 60% of their volume, catch basins reach steady state. Storm flows may then bypass treatment as well as resuspend sediments trapped in the catch basin. Regular clean-outs can retain the volume in the catch basin sump available for treatment of stormwater flows.

At a minimum, catch basins should be cleaned once or twice per year. Two studies suggest that increasing the frequency of maintenance can improve the performance of catch basins, particularly in industrial or commercial areas. One study of sixty catch basins in Alameda County, California, found that increasing the maintenance frequency from once per year to twice per year could increase the total sediment removed by catch basins on an annual basis. These results suggest that, at least for industrial uses, more frequent cleaning of catch basins may improve removal efficiency. However, the cost of increased operation and maintenance costs needs to be weighed against the improved pollutant removal.

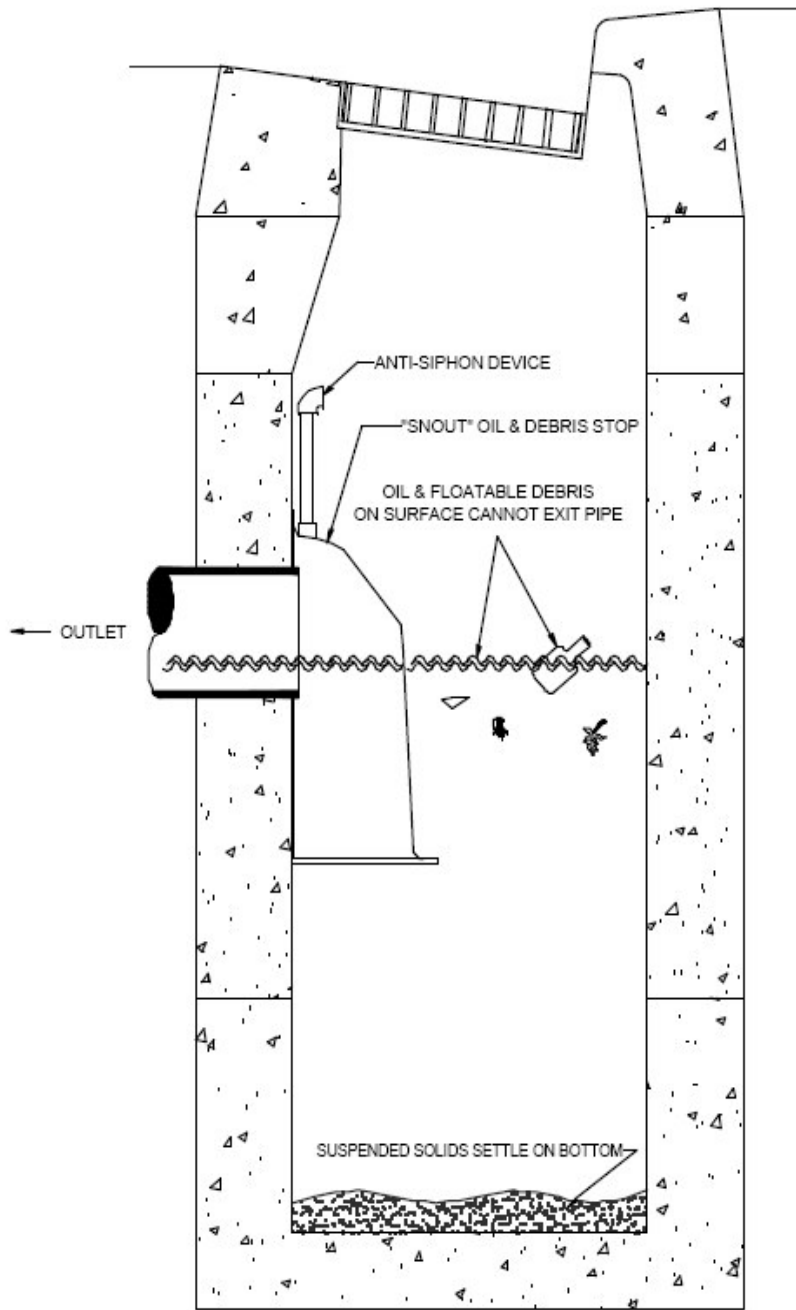
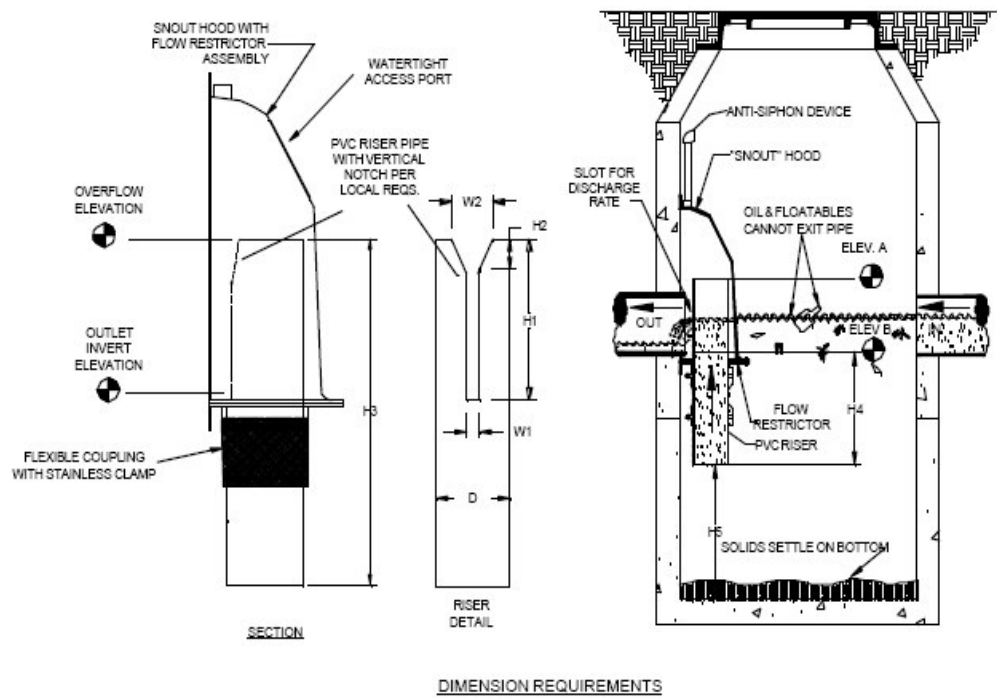

Figure 5-1 A typical cross section of a catch basin.

To minimize re-suspension of fine captured solids, a deep sump with a minimum depth of 4ft, or a depth equal to 4 times the outlet pipe inside diameter is recommended.



D=Riser ID, W1=Slot Width, W2=Notch Width

H1=Slot Length, H2=Notch Length, H3=Riser Length

H4=Submerge Depth, H5=Depth to Bottom

Figure 5-2 In-line catch basin with hood and flow restrictor.

Within a catch basin a "catch basin insert," may also be used to filter runoff entering the catch basin. There are several types of catch basin inserts. One insert configuration consists of a series of trays, with the top tray serving as an initial sediment trap, and the underlying trays comprised of media filters. Another option uses filter fabric to remove pollutants from stormwater runoff. These devices have a very small volume compared to the volume of the catch basin sump, and would typically require very frequent sediment removal. Bench test studies found that a variety of products showed little removal of total suspended solids, partially due to scouring from relatively small (6-month) storm events.

Catch basins can also be perforated metal screens placed horizontally or vertically within a catch basin. There are a multitude of inserts of various shapes and configurations. One device suitable for compliance with the Trash TMDL is a grated plastic box or metal screen that fits directly into the curbside catch basin. As the storm water passes through

the box, trash, rubbish, and sediment remain in the box while storm water exits (see Figure 5-3).

Metal screening inserts can be deployed in a vertical or horizontal configuration within the catch basin for the retention of trash. These inserts maximize much of the existing catch basin volume and concurrently pass through flow. Companies such as American Stormwater, Practical Technologies, and Advanced Solutions are marketing these types of devices.

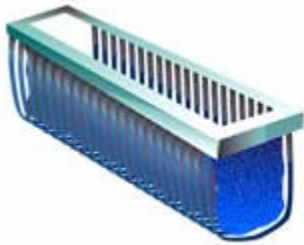

Figure 5-3 Catch basin insert Source:
<http://www.lastormwater.org/WPD/program/TMDLs/tmdls.htm>

Some catch basin screens are designed to open to curb flow in order to reduce the potential for flooding during wet weather. For example American Storm Water has a catch basin screen with an automatic retractable screen (ARS) gate design which can be adjusted to "un-lock" and open up to storm water curb flow from 20% to 60% of curb height. This device which is termed the "Surf Gate" is also designed with a special "locking" application, which keeps children safe and large debris from getting into the catch basin (see Figure 5-4).

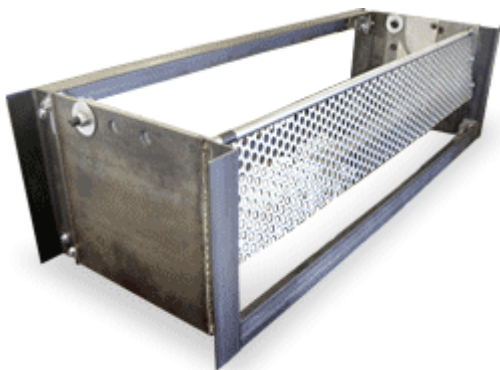

Figure 5-4: Catch basin insert with automatic retractable screen

Source: http://www.americanstormwater.com/Storm_Water_Products/surf_gate.html

Grate inserts are typically found in parking lots, alleys, and sloping streets. Inserts installed in these basins mainly capture trash smaller than an inch due to the standardized grating spacing. Inserts designed for curb opening basins are best suited for capturing larger debris like water bottles and plastics bags, as the opening under the curb may range from four to eight inches.

The City of Glendale creatively modified the catch basin inserts by installing brush-like material over catch basin openings. This material was actually designed as a type of mud flap for use on large trucks and motor homes. The bristles are stiff enough to keep large items from entering the catch basin while allowing the flow of water into the basin. Large debris remain in the street where they would later be removed by street sweeping. To capture smaller debris that passes through the brush, Glendale installed metal mesh in the catch basin above the level of the outlet pipe. The mesh slopes down from the upstream end to the downstream end so that the debris can be flushed with a hose to the downstream end where it can be removed by vacuum trucks through the access hole in the top of the catch basin. The size of the opening is slightly less than 5 mm, so any debris passing through the mesh is allowed by the trash TMDL. Figures 5-5 and 5-6 are pictures of brush installed over the catch basin opening and the metal mesh in the catch basin.



Figures 5-5 Brush installed over the catch basin opening.



Figure 5-6 Metal mesh installed within the catch basin to collect trash not retained by the brush at the inlet.

5.2.2 VORTEX SEPARATION SYSTEMS

Vortex Separation Systems (VSS) units capture almost all trash deposited into a storm drain system. A VSS unit diverts the incoming flow of storm water and pollutants into a pollutant separation and containment chamber. Solids within the separation chamber are kept in continuous motion, and are prevented from blocking the screen so that water can pass through the screen and flow downstream. Solid pollutants including trash, debris and coarse sediments are retained in a centrally located solids catchment chamber with the heavier solids ultimately settling into the base of the unit or sump. This is a permanent device that can be retrofitted for oil separation as well. Outfitting a large drainage with a number of large VSS units may be less costly than using a larger number of small VSS units.

An example of VSS technology is the Continuous Deflective Separation (CDS) unit, developed by CDS Technologies, Inc. (see Figure 5-7). When applied to storm water, the CDS unit is designed to capture and retain sediments, floatable and settleable trash and debris over a wide range of flow conditions (up to 300 cubic feet per second (cfs)). The fine screens used in storm water applications vary in size from 1.2 – 4.7 mm (0.048-0.185 inch). The CDS units are placed underground and are appropriate for ultra urban retrofit situations where space is limited. In general, a CDS unit occupies about 4-1/2 square feet of surface area for each cfs that it treats, with the bulk of the installation being well below grade. The solids can be removed using a vactor truck, a removable basket or a clam shell depending on the user's preference and size of the unit. Based on climate conditions in Southern California, CDS units installed for the trash TMDL can be cleaned once per storm season. For new installations, it is recommended to check the condition of the unit after every runoff event for the first 30 days. Based on the behavior of the unit relative to storm events, inspections can be scheduled on projections using storm events vs. pollutant buildup. For ongoing operation, the unit should be inspected at least once every 30 days during the wet weather season. The floatables should be removed and the sump cleaned when the sump is above 85% full. At least once a year, the unit should be pumped down and the screen carefully inspected for damage and to

ensure that the screen is properly fastened. Detailed information on CDS is provided at <http://www.epa.gov/region01/assistance/ceitts/stormwater/techs/contdeflective.html>.

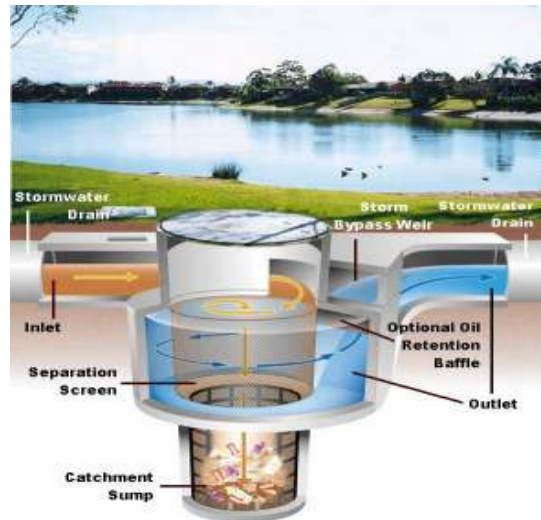

Figure 5-7 CDS unit. (Source: <http://lakes.chebucto.org/SWT/cds.html>)

5.2.3 TRASH NETS

Trash nets are devices using the natural energy of the flow to trap trash, floatables and solids in disposable mesh nets. An example are the trash nets developed by Fresh Creek Technologies, Inc. Three modular models are available from Fresh Creek Technologies, Inc.:

- The *In-Line* Netting TrashTrap[®] model is a modular chamber containing the capture apparatus for holding the disposable nets. The system is installed in-line with the outfall pipe. A prefabricated chamber minimizes site work and cost. In-line units are underground and out of sight, particularly well suited for densely populated locations.
- The *End-of-Pipe* Netting TrashTrap[®] model is installed at the end of the pipe. These units are often installed as a retrofit to an existing outfall structure. When this opportunity exists, the End-of-Pipe system is highly cost effective.
- The *Floating* Netting TrashTrap[®] model is a modular pontoon structure that floats at the end of the outfall. Floating units are an economical solution where site conditions (minimum water depth of two feet and a relatively sheltered site) permit its use. They are often installed with only minor modifications to the existing site.

Model selection and sizing is based on site-specific criteria including peak volume, peak velocity, and trash/floatables volume. Modularity and capacity are achieved by varying the number of nets in the system. Current installations range from single net units to systems with 10 nets handling flows above 3,000 cfs. The standard mesh net will handle

flows up to 30 cfs or 22 million gallons per day (mgd) and velocities up to 5 feet per second at the mouth of the net. A truck with a hoist for changing the nets, and a container for holding the full nets is used for servicing. A crew of two accomplishes the net change out in a matter of a few minutes. Road access to the site is required for the service vehicle.

The *End-of-Pipe* nets are suitable devices for the Trash TMDL because of the low cost, the ease of maintenance, and also because the devices can be relocated after a set period at one location (provided the pipe diameters are the same). With limited funding, installation could be spread over several land uses and lead to valuable monitoring results. For smaller systems the total installation time can be as short as one day. A diagram of end-of-pipe trash net is shown in Figure 5-8.

Because the devices require attachment to the end of a pipe, this can severely reduce the number of locations within a drainage system that can be monitored. In addition, these nets cannot be installed on very large channels (7 feet in diameter is the maximum).

Detailed information on trash nets is provided at http://www.freshcreek.com/products/prod_specs.php?prodID=ntt.

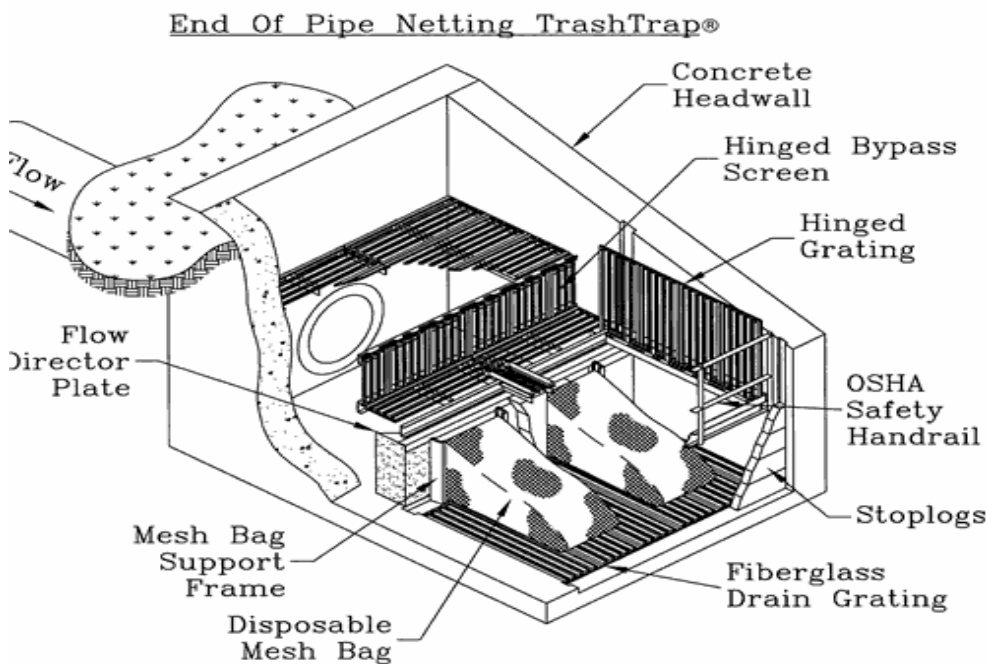

Figure 5-8 End-of-Pipe Trash Net

From: <http://www.freshcreek.com/products.php>

5.2.4 GROSS SOLIDS REMOVAL DEVICES

Several Gross Solids Removal Devices (GSRDs) were developed by the California Department of Transportation (Caltrans) to be retrofitted into existing highway drainage systems or implemented in future highway drainage systems. GSRDs are structures that remove litter and solids 5 mm (0.25 inch nominal) and larger from the stormwater runoff using various screening technologies. Overflow devices are incorporated, and the usual design of the overflow release device is based upon the design storm for the roadway. Though designed to capture litter, the devices can also capture some of the vegetation debris. The devices shown below are generally limited to accept flows from pipes 30 inches in diameter and smaller.

The Caltrans' GSRD Pilot Program consists of multiple phases with each phase representing one pilot study. A pilot study generally consists of one or more devices that are developed from concept, advanced through design and installation, and placed in service for two years of testing to evaluate overall performance. Three types of GSRDs have been shown the most promising: linear radial and two versions using an inclined screen.

Linear Radial Device A Linear Radial Device is shown as in Figure 5-9. This device is relatively long and narrow, with flow entering one end and exiting the other end. It is suited for narrow and flat rights-of-way with limited space. It utilizes modular well

screen casings with 5 mm (0.25-inch nominal) louvers and is contained in a concrete vault, although it also could be attached to a headwall at a pipe outfall. While runoff flows enter into the screens, they pass radially through the louvers and trap litter in the casing. A smooth bottom to convey litter to the end of the screen sections is required, so a segment of the circumference of each screen is unlouvered. The louvered sections have access doors for cleaning with vacuum truck or other equipment. Under most placement conditions the goal would be to capture within the casing one year's volume of litter. This device has been configured with an overflow/bypass for larger storm events and if the unit becomes plugged

Figure 5-9. Linear Radial Device

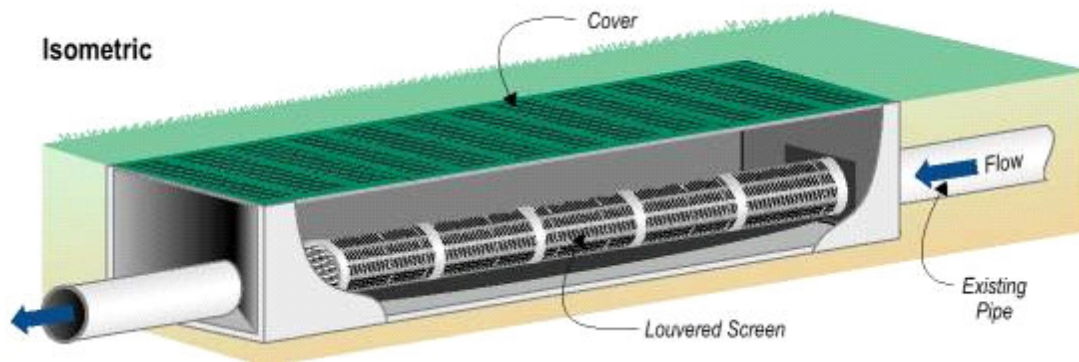

Inclined Screen Devices: Two Inclined Screen Devices have been developed; one is shown in Figure 5-10 and the other as Figure 5-11. Each device requires about 1-meter (3 ft) of hydraulic head and is better suited for fill sections. In the Type 1 device, the storm water runoff flows over the weir and falls through the inclined bar rack. The screen has 5-mm maximum spacing between the bars. Flow passes through the screen and exits via the discharge pipe. The trough distributes influent over the inclined screen. Storm water pushes captured litter toward the litter storage area. The gross solids storage area is sloped to drain to prevent standing water. This device has been configured with an overflow/bypass for larger storm events and if the unit becomes plugged. It has a goal of litter capture and storage for one year. The Type 2 Inclined Screen only comes in a sloped sidewall version.

Isometric

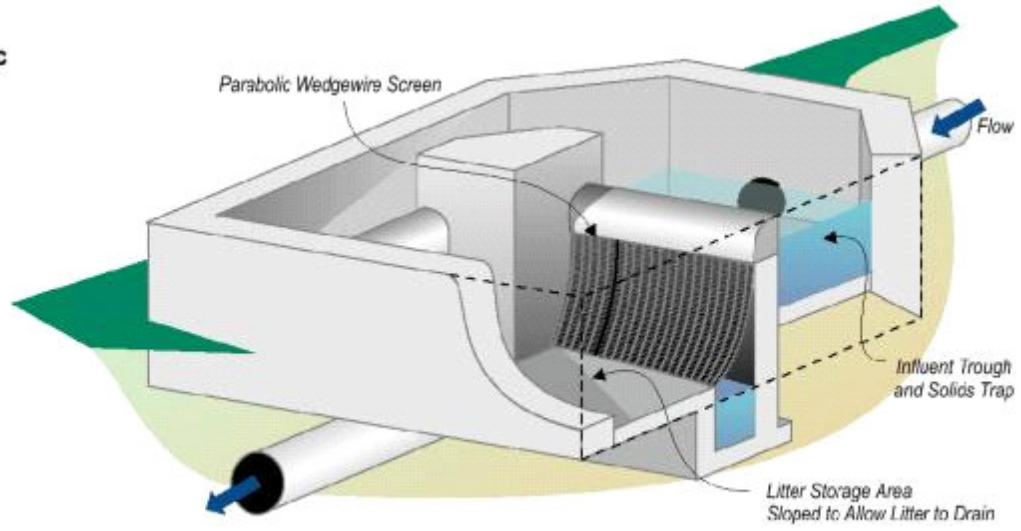

Conceptual Schematic / Not to Scale

Figure 5-10. Inclined Screen Device – Type 1

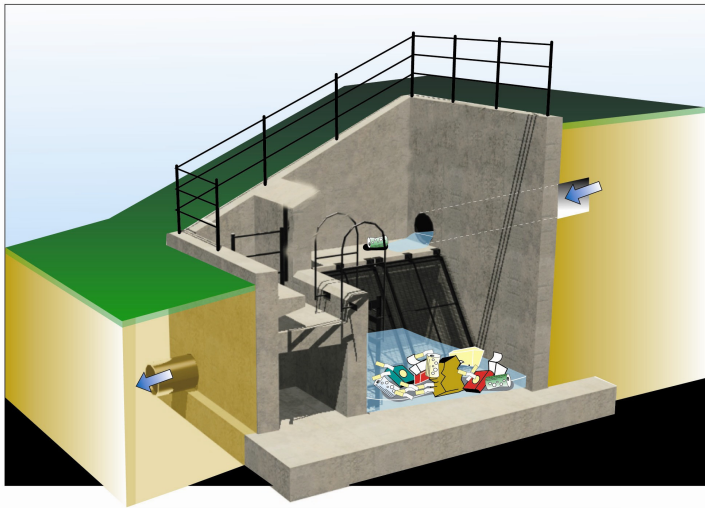
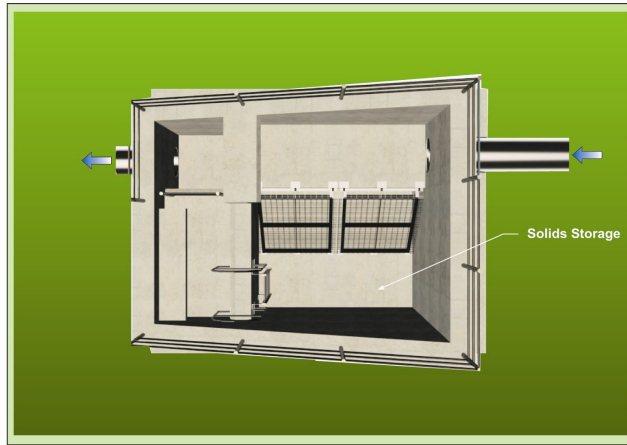
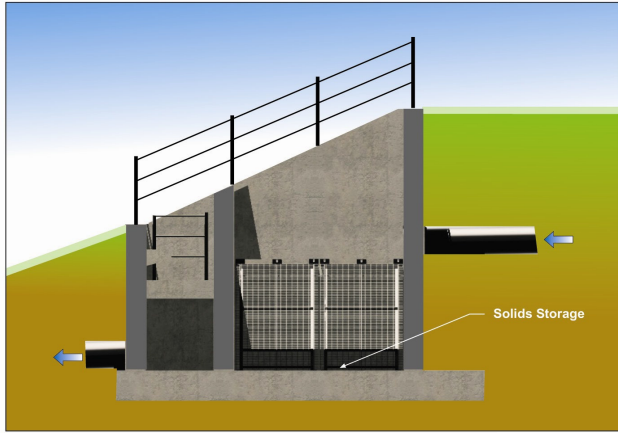

Figure 5-11. Inclined Screen Device – Type 2

5.3 NON-STRUCTURAL CONTROLS

Institutional controls are non-structural methods to control trash loading to the river such as enforcement of existing litter laws, increased street sweeping, and cleaning of storm water conveyance structures, such as catch basins and storm drain inlets. Institutional controls provide several advantages over structural full capture systems. Foremost, institutional controls offer other societal benefits associated with reducing litter in our city streets, parks and other public areas. Institutional controls can typically be implemented in a relatively short period of time. The capital investment required to implement institutional controls is generally less than for full capture systems. However, the labor costs associated with institutional controls may be higher, and institutional controls may be more costly in the long-term (see cost estimates in the Staff Report).

5.3.1 ENFORCEMENT OF LITTER LAWS

Enforcing litter laws in sensitive areas or in areas that generate substantial amounts of litter would eliminate an ultimate source of trash loading to the river. Ordinances that prohibit litter are already in place in most cities. For example, the Los Angeles City Code of Regulations recognizes that trash becomes a pollutant in the storm drain system when exposed to storm water or any runoff and prohibits the disposal of trash on public land:

No person shall throw, deposit, leave, cause or permit to be thrown, deposited, placed, or left, any refuse, rubbish, garbage, or other discarded or abandoned objects, articles, and accumulations, in or upon any street, gutter, alley, sidewalk, storm drain, inlet, catch basin, conduit or other drainage structures, business place, or upon any public or private lot of land in the City so that such materials, when exposed to storm water or any runoff, become a pollutant in the storm drain system. (City Code of Regulations, §64.70.02.C.1(a).)

Ensuring compliance with existing statewide and local litter laws and ordinances would eliminate the substantial adverse environmental and economic impacts from the litter, and the need for additional structural or institutional controls that generate their own nominal adverse environmental impacts.

5.3.2 STREET SWEEPING

Street sweeping minimizes trash loading to the river by removing trash from streets and curbs. Maintaining a regular street sweeping schedule reduces the buildup of trash on streets and prevents trash from entering catch basins and the storm drain system. Street sweeping can also improve the appearance of roadways and urban areas. There are three types of street sweepers: mechanical, vacuum filter, and regenerative air sweepers (US EPA, 2006).



A street sweeper cleans up pollutants and sediments on the street to reduce the amount of pollutants entering receiving waters

Figure 5-12 (Source: US EPA 2006)

Mechanical sweepers use a broom to remove particles from the street curb and a water spray to control dust. The removed particles are carried by a cylindrical broom to a conveyor belt and into a storage hopper (FHWA, 2006).

Vacuum-assisted sweepers also use brooms to remove particles. However, the removed particles are saturated with water and transported by a vacuum intake to the hopper. Vacuum-assisted dry sweepers use a specialized brush that allows the vacuum system to recover almost all particulate matter. A continuous filtration system prevents very fine particulate matter from leaving the hopper and trailing on the street behind the sweeper (FHWA, 2006).

Regenerative air sweepers blow air onto the pavement and immediately vacuum it back to entrain and capture accumulated sediments. A dust separation system regenerates air for blowing back onto the pavement (FHWA, 2006).

No definitive independent studies have yet been staged to determine the best sweeping system (US EPA, 2006). However, it is recommended that local agencies use a combination of street sweeper types to maximize efficiency. (CASQA, 2003a) In the Los Angeles Region, use of certain sweeper types is dictated by South Coast Air Quality Management District Rule 1186, which requires local agencies to acquire or use only PM10 certified sweepers beginning January 1, 2000. Furthermore, Rule 1186.1 requires local agencies to acquire alternative fuel or less polluting street sweepers beginning July 1, 2002. (SCAQMD, 2006)

Increasing the frequency of street sweeping in areas with high traffic volume and trash accumulation will further reduce trash loading to the river. Further consideration should be given to street sweeping before the rainy season begins. A successful street sweeping program includes accurate recordkeeping of curb-miles swept, proper storage and disposal of street sweepings, regular equipment maintenance, and parking policies that restrict parking in problematic areas and notify residents of sweeping schedules. (California of Stormwater Quality Association - CASQA, 2003a)

Using modern and efficient street sweepers may reduce the need for other structural storm water controls and may prove to be more cost-effective than certain structural controls, especially in more urbanized areas with greater areas of pavement (US EPA, 2006).

5.3.3 STORM DRAIN CLEANING

Routine cleaning of the storm drain system reduces the amount of trash entering the river, prevents clogging, and ensures the flood control capacity of the system. Cleanings may occur manually or with eductors, vacuums, or bucket loaders. A successful storm drain cleaning program includes regular inspection and cleaning of catch basins and storm drain inlets, increased inspection and cleaning in areas with high trash accumulation, accurate recordkeeping, cleaning immediately prior to the rainy season to remove accumulated trash, and proper storage and disposal of collected material. (CASQA, 2003a)



Figure 5-13: Catch Basin cleaning (Source: CASQA, 2003a)

As required by MS4 permits, the County of Los Angeles Department of Public Works (DPW) was to prioritize catch basin cleanup by volumes of trash accumulated and to place more trash cans at public transit stops.

5.3.4 PUBLIC EDUCATION

Public education can be an effective implementation alternative to reduce the amount of trash entering the river. The public is often unaware that trash littered on the street ends up in receiving waters.

Community outreach is one way to educate the public about the effects of littering on the quality of receiving waters. Local agencies can provide educational materials to the public via television, radio, and print media, distribution of brochures, flyers, and community newsletters, information hotlines outreach to educators and schools, community event participation, and support of volunteer monitoring and cleanup programs. Storm drain inlet stenciling is another means of educating the public about the direct discharge of storm water to receiving waters and the effects of littering and

dumping on receiving water quality. Stenciling can be conducted in partnership with other agencies and organizations to garner greater support for educational programs (US EPA, 2005).

Under the Los Angeles County Municipal Storm Water Permit, permittees are required to develop and implement an educational storm water and urban runoff outreach program to reach as many County of Los Angeles residents as possible (MS4 permit 01-182). The residential component of this program includes:

- Stenciling of all storm drain inlets with a "No Dumping" message
- Maintenance of a countywide hotline for reporting clogged catch basin inlets and illicit discharges/dumping, faded or lack of catch basin stencils, and general storm water management information
- Outreach and education activities including advertising, media relations, public service announcements, "how to" instructional material, corporate, community association, environmental organization and entertainment industry tie-ins, and events targeted to specific activities and population subgroups
- Culturally diverse educational strategies
- Outreach efforts to residents and businesses related to the proper disposal of cigarette butts
- Participation in local and county-wide educational activities
- Provide assurance that a minimum of 35 million impressions per year are made on the general public about storm water quality via print, local TV access, local radio, or other appropriate media
- Distribution to schools within each School District in the County with materials, including, but not limited to, videos, live presentations, and other information necessary to educate a minimum of 50 percent of all school children (K-12) every 2 years on storm water pollution
- Develop a strategy to measure the effectiveness of in-school educational programs. Develop a behavioral change assessment strategy

The business component of the public education program includes:

- Corporate Outreach to educate and inform corporate managers about storm water regulations, including conferring with corporate management to explain storm water regulations, distribution and discussion of educational material.
- Business Assistance Program to provide technical resource assistance to small businesses to advise them on BMPs implementation to reduce the discharge of pollutants in storm water runoff.

Public Education materials are available through the Erase the Waste campaign, sponsored by the State Water Resources Control Board and Regional Boards. Erase the

Waste is a public education program, working to reduce harmful storm water pollution and improve the environment of the region's coastal and inland communities. The campaign started in Los Angeles County, and materials produced during its three-year run have now been packaged here for state and nationwide use. It is built around the theme, Erase the Waste – a positive, empowering theme that encourages all residents and stakeholders to take ownership of their communities, help reduce and prevent storm water pollution from the local landscape and “become part of the pollution solution.”

Recently made available is the **California Storm Water Toolbox** (State Water Resources Control Board, 2006 (<http://www.waterboards.ca.gov/erasetheWaste/index.html>)), which includes the following tools for residents, community and civic groups, educators, municipalities and public agencies:

- Advertisements, posters, collateral materials and a comprehensive Neighborhood Action Kit in English, Spanish, Chinese, Korean and Vietnamese – a comprehensive “how-to” guide to community-focused pollution prevention
- A landmark Water Quality Service Learning Model for grades 4-6 that meets the state's curriculum standards
- The Water Quality Detectives After School Program, an adapted version of the curriculum for middle school and after school setting
- The California Storm Water Resource Directory, an online inventory of storm water materials developed in partnership with the California Storm Water Quality Association

5.3.5 TRASH RECEPTACLES

Most of trash disposed of on the ground may result from the lack of trash receptacles. Installing trash receptacles can reduce nonpoint source trash loading. The receptacles shall be visible and conveniently reachable for all park users. During the picnic seasons, sufficient trash and hot coal receptacles in the picnic area should be provided. Receptacles shall equip with lids to prevent the wildlife browsing through or the wind re-mobilizing the trash inside. Receptacles may be decorated but shall not cause visual intrusion to the background environment.

Varieties of land uses determine the proper locations and necessary density of the trash receptacles. More receptacles are needed along trails, near park entrances and exits, adjacent to picnic areas or other areas with higher activity frequencies. Sanitation should be maintained to avoid nuisances.

5.3.6 PATROL

Constant patrol is required to promote proper trash disposal concepts to park users and residents. Full time personnel can be designated to patrol the site with information of litter laws and importance of preserving environment. Patrol personnel can also observe trash accumulated in the waterbody surface or on the adjacent areas for immediate cleanup. Timely report is necessary if substantial illegal disposal is found.

The frequency of patrol depends on the critical conditions such as weather and visitations at high seasons. It will also be the duty of these patrol personnel to recommend improvements in the trash collection system as necessary.

5.3.7 TRASH BAGS

Trash bags may be provided at the park entrance for visitors to keep their trash contained. Trash bags should be available at designated locations for park users to collect after their activities or pets.

The concept of trash bags originates from the trash bags offered in the Los Angeles mass transportation system which provides trash bags in the buses for passengers to keep the buses clean. This program may be more effective if it combines with other encouragement. The effectiveness shall be monitored by finding the use of these trash bags in the trash collectors or trash receptacles.

5.3.8 COMMUNITY INVOLVEMENT

Involving communities may be more effective in promoting the importance of protecting water quality and environment. The bonding between residents and community makes community more influential in educating residents of concepts. Communities can organize activities to illustrate that the environmental protection involves each individual's continuous efforts.

5.3.9 RECYCLING PROGRAM

A recycling program can be developed to minimize the trash source in the vicinity of the waterbody of concern. It may require some incentives to encourage park users or residents to bring the recyclable trash to designated locations and keep non-recyclable trash contained.

5.3.10 REPORTING SYSTEM

Patrol personnel, park users, or residents can report accumulation of trash or illegal disposal of trash to the waterbodies and their adjacent areas. Information with a toll-free number can be made available near the waterbodies for timely reporting. The supervising agencies, after receiving reports, should conduct inspection to formulate proper cleanup actions.

5.3.11 STENCIL

Stencils are to remind the residents and park users the importance of maintaining water quality and not to violate the existing ordinances. Signs can be placed in prominent locations where most people will view them, and can contain appropriate symbols as well as clear written messages, and cite the appropriate federal, state and county codes including the largest possible penalty amount for violation of codes.

5.3.12 CONSIDERATION OF PICNIC AREA RELOCATION

Trash found in the waterbodies may be the result of stormwater flushing or wind re-mobilizing the trash originally disposed of around picnic areas. If stormwater or wind is

the dominant factor causing trash impairment, and trash is constantly found near picnic areas, it may be a solution to reconsider the proper location of picnic areas.

The further the picnic area is away from waterbodies, the longer time or more mobilization energy will be needed from stormwater or wind to carry trash to waterbodies of concern. Trash may be picked up before reaching waterbodies. A proper monitoring period to analyze the cause of trash is necessary prior to considering this option.

5.3.13 IMPOSITION OF TRASH TAX

The trash often discovered on or adjacent to the waterbodies is convenient paper or plastic food or beverage containers, plastic bottles, paper plates, aluminum cans, or plastic bags. This trash shares the same characteristics as packaging utilized in the fast food stores. The evidence of trash causing waterbody impairment may be used to justify an increase in retail price of disposable food or beverage packaging to compensate the potential environmental impacts. The additional tax income can contribute to the preventive or cleanup actions for the designated waterbody of concern.

5.3.14 COOPERATION OF POTENTIAL SOURCES OF TRASH

Stores carrying goods considered potential sources of trash to the waterbody or its adjacent areas can advise their patrons to handle the packaging, residuals or any trashable parts in an environmentally friendly manner. Similar to the stencils, signs with clear language containing ordinances and penalty of violation should be posted near the cashier, exit and parking lot.

5.3.15 SURVEILLANCE CAMERA

Surveillance cameras can be installed to monitor the water quality and any illegal disposal which require immediate cleanup. They can also be used to enforce the littering laws if necessary.

5.3.16 TAX BENEFIT BY ADOPTING WATERBODIES, PARKS, ETC.

This concept is adapted from the “adopt a highway” program. The participation from industries in the vicinity of lakes, rivers, or creeks, can help the responsible municipalities and agencies to maintain the cleanliness of the environment, and increase the cleaning frequency. Industries or any entities which contribute resources, time, or effort to keep the environment clean can be encouraged by having tax benefit.

6. SETTING, IMPACTS, AND MITIGATION

6.1 INTRODUCTION

This section presents the environmental setting, impacts, and mitigation, where applicable, for the proposed implementation alternatives evaluated in this draft Substitute Environmental Document (SED). The implementation alternatives for achieving compliance with the Machado Lake trash TMDL are described in detail in Section 5 of this document and again in the TMDL Staff Report. Each of these implementation alternatives have been independently evaluated in this draft SED. The environmental setting for the Machado Lake trash TMDL is discussed in Section 6.1. The installation, operation and maintenance activities associated with the trash TMDL implementation alternatives are discussed in Section 6.2. Section 6.3 discussed site-specific and device-specific environmental impacts from implementing the trash TMDL. Section 6.4 is the environmental checklist, which includes the potential negative environmental impacts of the Implementation Alternatives (see Section 5 for a detailed description of the TMDL Implementation Alternatives).

6.1.1 APPROACH TO ENVIRONMENTAL SETTING AND IMPACT ANALYSIS

Any potential environmental impacts associated with the Machado Lake Trash TMDL depend upon the specific compliance projects selected by the responsible jurisdictions, most of whom are public agencies subject to their own CEQA obligations. (See Pub. Res. Code § 21159.2.) This CEQA substitute document identifies broad mitigation approaches that could be considered at the program level. Consistent with PRC§21159, the substitute document does not engage in speculation or conjecture, but rather considers the reasonably foreseeable environmental impacts of the foreseeable methods of compliance, the reasonably foreseeable feasible mitigation measures, and the reasonably foreseeable alternative means of compliance, which would avoid or reduce the identified impacts.

Within each of the sections listed above, this draft SED evaluates the impacts of each implementation alternative relative to the subject resource area. The physical scope of the environmental setting and the analysis in this EIR is the Machado Lake and surrounded area as shown in Figure 6.1-1. This area is the geographic area for assessing impacts of the different implementation alternatives, because the discharge of trash generated in this area to the lake would be controlled and/or eliminated by any one of or a combination of the implementation alternatives. Also, any potential impacts of implementing the proposed alternatives would be focused in this area.

The implementation alternatives evaluated in this draft SED are evaluated at a program level for impacts for each resource area. An assumption is made that a more detailed project-level analysis will be conducted by all responsible agencies and jurisdictions once their mode of achieving compliance with the trash TMDL has been determined. The analysis in this draft SED assumes that, project proponents will design, install, and maintain implementation measures following all applicable laws, regulations, ordinances, and formally adopted municipal and/or agency codes, standards, and practices. Several handbooks are available and currently used by municipal agencies that provide guidance for the selection and implementation of BMPs (Caltrans, 2002, CASQA, 2003a, CASQA, 2003b, WERF, 2005).

6.1.2 PROGRAM LEVEL VERSUS PROJECT-LEVEL ANALYSIS

As previously discussed, the Regional Board is the lead agency for the TMDL program, while the responsible agencies are the lead agencies for any and all projects implemented, within their jurisdiction, to comply with the program. The Regional Board does not specify the actual means of compliance by which responsible agencies choose to comply with the TMDL. Therefore, the implementation alternatives are mostly evaluated at a program level in this draft SED. The alternatives assessed at a program level generally are projects that would be implemented as part of TMDL compliance, PRC §21159 places the responsibility of project-level analysis on the agencies that will implement the water board's TMDL.

6.1.3 ENVIRONMENTAL SETTING

Machado Lake is located within the Dominguez Channel watershed bordered by Rosecrans and Dominguez Hills with an elevation of 200 feet at the north and east, by Palos Verdes Hills with an elevation of 1,480 feet at the southwest, and by Port of Los Angeles and Port of Long Beach to the south. The lake, formerly known as Harbor Park Lake in Ken Malloy Harbor Regional Park (KMHRP) overseen by Los Angeles City Department of Recreation and Parks, was original used for flood control serving Wilmington and Harbor City areas, and for boating and fishing. KMHRP is west of the Harbor Freeway and East of Vermont Avenue between Tosco Refinery on the south and Pacific Coast Highway on the north.

The 40 acre, averagely 3 feet deep kidney shape Machado Lake runs approximately 3,000 feet north-southerly embracing Harbor Park Municipal Golf course and Los Angeles Harbor College to the east. A marsh area at the north end of the lake that has shallow water less than 1 foot deep or may be dry during summer consists of a large amount of cattails and reed plants. Trails on mostly grassy lawns, a boat house, gardens, parking lots, and where the majority of activities occur, are at the west of the lake. A concrete dam at the south end of Machado Lake separates the lake from a lower wetland which is about 63.5 acres and one of the last wetlands in the Los Angeles. The depth of the lake near the dam is roughly 10 feet. Overall the lake surface is at 10 feet above MSL.

Machado Lake is a receiving body of urban and storm water runoff from storm drain system covering an approximately 20 square mile watershed. Wilmington Drain discharges over 50 percent of the water to Machado Lake at northeast corner. The rest of the water enters the lake through other storm drains including Project No. 77 channel, Harbor City Relief Drain located at the west end of the lake, City of Los Angeles drains for runoff from streets and Harbor Park Municipal Golf Course. Wilmington Drain, Project 77 and Harbor City Relief Drain collect storm water from communities of Harbor City, Lomita, Carson, Torrance and Wilmington, and from Waleria Lake drainage area. In addition, two Project 643 outlets discharge to the wetland area. During the dry season, Machado Lake is replenished via a City of Los Angeles Department of Water And Power (LADWP) potable water pipeline and dry weather runoff.

Water from the lake overflows the dam to the wetland area prior to flowing out to the ocean through the Harbor Outflow located at the southeast corner or the park. The harbor Outflow structure is connected to the West Basin of Los Angeles Harbor.

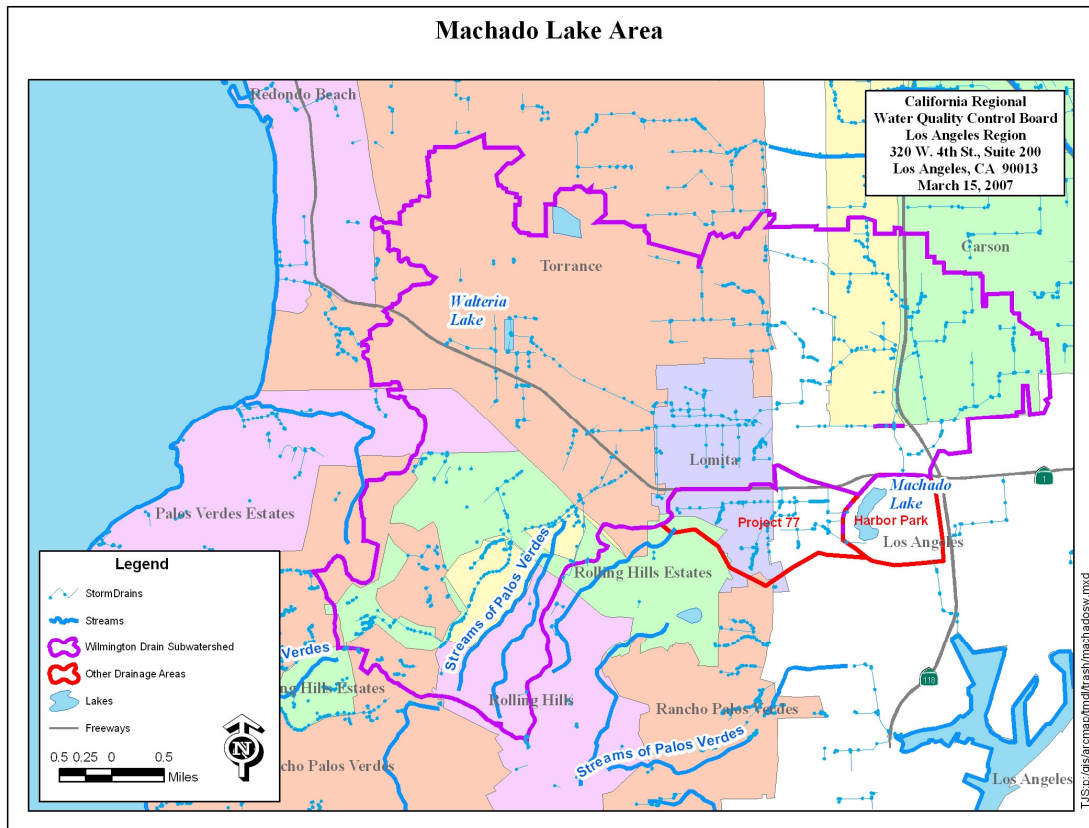

Figure 6.1-1. Machado Lake Trash TMDL area.

6.1.3.1 Beneficial Uses of Machado Lake

The existing beneficial uses of Machado Lake include industrial service supply (IND), navigation (NAV), non-contact water recreation (REC2), commercial and sporting fishing (COMM), marine habitat (MAR); rare, threatened or endangered species (RARE); and shellfish harvesting (SHELL). The potential beneficial use of Machado Lake includes contact water recreation (REC1).

6.1.3.2 Description of the storm drain system

The storm drain system in the Machado Lake Trash TMDL area is a network of underground pipes and open channels that were designed to prevent flooding. Runoff drains from the streets, into the gutters, and enters the system through an opening in the curb called a catch basin. The storm drain system receives no treatment or filtering process and is completely separate from Los Angeles' sanitary sewer system. Most of the storm drain systems in Machado Lake TMDL area are owned and operated by the Los Angeles County Department of Public Works (LACDPW).

Based on hydrology reports and available drawings, the discharging points to Machado Lake are from Wilmington Drain, Project No. 77, and Harbor City Relief Drain. In addition, several of the smaller city of Los Angeles drains are also discharged to Machado Lake. While a number of storm drain systems collect storm water runoff and

flow directly into Machado Lake, there are some storm drain systems that connect to other major drains, such as Walteria lake and the Harbor City Relief Drain, before discharging to the lake. A schematic drawing of the overall drainage system flowing to Machado Lake is shown in Figure 6.1-1.

6.2 INSTALLATION, OPERATION AND MAINTENANCE ACTIVITIES FOR TRASH-REDUCTION STRUCTURAL BMPs

This section discusses the installation, and operation and/or maintenance activities associated with the trash TMDL implementation alternatives. This information should provide a frame of reference in determining potential environmental impacts of these alternatives. Some reasonably foreseeable installation activities for compliance with the trash TMDL would consist of the installation of improvements to the stormdrain system to attain “full capture” certification. These improvements include installation of screens and inserts for catch basins, gross solids removal devices (GSRDs) within the alignment of storm drain pipes, and trash collection nets in stormdrain outlets. Temporary impacts to natural resources from these types of installation activities typically include air pollution from dust and construction equipment, increased runoff and soil-erosion, and installation noise.

Installation of stormdrain improvements to comply with the trash TMDL would be located throughout the developed portion of the Machado Lake Trash TMDL area. The trash TMDL provides approximately eight years to complete the installation of storm drain improvements. The installation would occur at different locations at different periods. Equipment to be installed would include filters, metal screen, fabric nets, and gross solid removal devices. Some of the equipment would be mounted on small steel structures. Equipment weights range from several hundred pounds to 100,000 pounds, therefore the installation rigs would range from small truck-mounted cranes to larger track-mounted units. The equipment would be electrically connected together by cable or by buss (open air copper or aluminum tubes). The installation would be either through the inlets or outlets or with the piping. GSRD station sites would typically be finished with fencing around the site.

6.2.1 STORMDRAIN IMPROVEMENT INSTALLATION STAGING AND METHODS

The following paragraphs describe installation activities and staging for these facilities. The sites proposed for the location of trash TMDL are presently in residential, commercial, or industrial areas. Site preparation would include clearing, grubbing and grading with bulldozers and dump trucks. Access roads would be prepared concurrently with the site operations.

6.2.1.1 Catch Basin Inserts

Improvements to catch basins include concrete work, installation of filters within the catch basins and installation of screens at the catch basin inlets. These activities entail concrete demolition and refinishing and field fabrication methods such as welding and mechanical bolting. These improvements would be located in existing catch basins within existing municipal and agency stormdrain systems. Construction of new catch basins is not required to comply with the TMDL, although damaged catch basins may require replacement. Existing catch basins are located below sidewalks and streets with openings flush with the curb.

Installation tasks for catch basin improvements include:

- Removal of manhole cover and accessing bottom of catch basin and manually inserting prefabricated catch basin inserts in the bottom or interior of the catch basin
- Concrete demolition and removal if the entire catch basin need replacement
- Catch basin installation – this task pertains to catch basins that require replacement
- Concrete drilling and welding – this task is required to install fasteners and bracing for screens and brushes at the storm drain inlets. These screens can be welded onto the installed bracing
- Concrete finishing – to restore site after installation is completed.

Installation of catch basin improvements require the following types of tools: compressor, hand power tools, hand tools, backhoe, welder, light-duty truck. Based on Means Heavy Construction Cost Data, removal and reset of a catch basin can be accomplished at a rate of 7 per day by a three person crew with a backhoe. Conversations with City of Glendale personnel indicate that 2-person crew can install inserts and screens in less than one-day (City of Glendale, 2006).

6.2.1.2 Gross Solid Removal Device and Vortex Separation System Installation

Gross Solid Removal Devices are new installations that are located in transportation rights of way. These devices are typically fabricated off-site and transported to the site for installation. The installation sites are typically not located in areas of sensitive receptors. Installation activities include:

- Site Preparation – a flat area of sufficient size to locate a concrete equipment pad is required. Vegetation removal might be required, as well as placement of a gravel sub-base for the area. The site should be selected for access by an equipment crane, maintenance vehicles and trash collection vehicles.
- Fencing – security fencing is generally preferred for water quality treatment systems located within existing structures in watersheds. Chain link fencing is often selected which involves installation of fence poles. Fence screens are often used in areas where a GSRD causes adverse visual impacts.
- Concrete pad – GSRDs are generally fabricated as modular units that are transported to the site and bolted to a concrete pad. This task involves preparing a level sub-base, placement of rebar and forms, and pouring ready-mix concrete to form a pad of sufficient dimensions to support the GSRDs.
- GSRD placement – the GSRDs are placed onto the concrete pad with an equipment crane and secured with anchor bolts.

- Pipe fitting/connection – the storm drain conveyance piping is connected to the GSRD with standard plumbing connects such as unions or joints. The connections are leak tested.
- Utility service – for GSRDs which require electrical service, wiring from a nearby service connector will be made to a switchbox located on the concrete pad. Appropriate conduit and wiring for outdoor service would be used.

Equipment required to install GSRDs include: equipment crane, concrete mix truck, hand power tools, hand tools, backhoe, and light duty truck. CalTrans provided descriptions of installation of GSRD in the report Phase I Pilot Study – Gross Solid Removal Devices and reported that the installation of GSRDs was straightforward there were no significant environmental impacts due to the installation of GSRD.

6.2.1.3 Trash Nets

Trash nets are installed at the outlets of stormdrains and channels. These locations are typically located within the interior of the stormdrain system where there is limited public access. Installation of trash nets includes field joining techniques and may include concrete repair. The tasks for trash net installation include:

- Preparation of concrete for installation of bracing to hold trash nets. Concrete preparation may entail simple cleaning of the concrete surfaces to patching and resurfacing of areas where the trash nets are to be attached.
- Installation of net bracing – net bracing is typically installed with anchor bolts.
- Attachment of the net to the bracing – simple mechanical devices are used to attach the flexible netting to the metal bracing.

Tools required to install trash netting include: hand power tools, hand tools, backhoe, and light duty truck. Contractors report that the Hamilton Bowl trash nets in Signal Hill and Long Beach were installed in a single day without adverse environmental impacts. Any impacts to air quality from installation equipment would be less than significant for such a short duration, particularly if equipment is tuned and maintained in good working condition to minimize emissions of criteria pollutants and particulates. Potential short-term noise impacts could be mitigated through installation practices such as using noise barriers and modified work hours. These measures are discussed in greater detail in the sections dealing with each specific resource area.

6.2.2 MAINTENANCE

Maintenance includes removing trash from catch basins, GSRDs, and trash nets and providing any mechanical service and repair that may be required. Because each device is limited in the volume of trash that can be collected, it is likely that relatively light-duty trucks can be used. Additionally, there is opportunity to consolidate the trash collected from catch basins, GSRDs and trash nets with other trash to mitigate impacts associated with transport and disposal of trash collected from storm drain improvements.

The impacts from maintenance activities associated with the trash TMDL can be mitigated through modified work hours and dust suppression methods. Spoils resulting

from installation of storm drain improvements would be relatively small in quantity. These spoils would be disposed of by disposal of excess in licensed facilities. Any spoils found to be contaminated with hazardous waste would not be spread within the right-of-way; the disposal of such material is addressed in Hazardous Waste.

6.3 SITE SPECIFIC ENVIRONMENTAL ANALYSIS

Pursuant to Section 21159 of the Public Resources Code, an agency's environmental analysis must include an analysis of a reasonable range of specific sites. The following section includes a discussion of site-specific and device-specific environmental impacts from implementing the trash TMDL. The trash TMDL compliance project discussed below has been implemented by municipalities and public agencies in the Trash TMDL area. All of the projects discussed below were deemed categorically exempt from CEQA analysis by the lead agencies of the corresponding projects, showing that the municipalities and public agencies consider the environmental impacts from implementing these trash TMDL compliance projects to have no reasonable probability of resulting in a significant adverse effect on the environment. An otherwise applicable categorical exemption is not available when the project could result in significant individual or cumulative adverse environmental effects. (14 Cal. Code Regs. § 15300.2.)

The municipality or public agency decisions in designing and siting structural devices may depend on the catchment land use. Site specific BMPs will likely be employed throughout the Trash TMDL area to reduce trash loading to the Machado Lake, and specific BMPs will be best suited to particular land uses. For example, land uses generating large amounts of trash or downstream collection points may be better target areas to implement full capture systems; where as low density residential areas may be better served by simple catch basin inserts.

6.3.1 END-OF-PIPE SCREENS

End-of-pipe screens may be placed on storm drains to prevent large pieces of trash from entering the water body. This BMP device is easy to monitor and mesh size of the screen can be custom sized. The installation of these screens is generally easy and in certain situations can be very easy. The cost is moderate to low and benefit of trash reduction is high (County of Los Angeles, 2004). However, it is critical to properly design the system to prevent a loss of drain capacity, particularly if a small mesh size is selected (County of Los Angeles, 2004). This type of BMP may be best suited to low density residential or park land uses as these areas generate a lower percentage of man-made trash.



Figure 6.3-1. Machado Lake trash screen.



Figure 6.3-2. Machado Lake trash screen.

6.4. CEQA CHECKLIST AND DETERMINATION

6.4.1 ENVIRONMENTAL CHECKLIST

	ENVIRONMENTAL CHECKLIST	Potentially Significant Impact	Less Than Significant with Mitigation Incorporated	Less Than Significant	No Impact
1.	Earth. Will the proposal result in:				
	a. Unstable earth conditions or in changes in geologic substructures?		X		
	b. Disruptions, displacements, compaction or overcoming of the soil?		X		
	c. Change in topography or ground surface relief features?				X
	d. The destruction, covering or modification of any unique geologic or physical features?				X
	e. Any increase in wind or water erosion of soils, either on or off the site?		X		
	f. Changes in deposition or erosion of beach sands, or changes in siltation, deposition or erosion which may modify the channel of a river or stream or the bed of the ocean or any bay, inlet or lake?			X	
	g. Exposure of people or property to geologic hazards, such as earthquakes, landslides, mudslides, ground failure, or similar hazards?			X	
2.	Air. Will the proposal result in:				
	a. Substantial air emissions or deterioration of ambient air quality?		X		
	b. The creation of objectionable odors?		X		
	c. Alteration of air movement, moisture or temperature, or any change in climate, either locally or regionally?				X
3.	Water. Will the proposal result in:				

	ENVIRONMENTAL CHECKLIST	Potentially Significant Impact	Less Than Significant with Mitigation Incorporated	Less Than Significant	No Impact
	a. Changes in currents, or the course of direction or water movements, in either marine or fresh waters?		X		
	b. Changes in absorption rates, drainage patterns, or the rate and amount of surface water runoff?		X		
	c. Alterations to the course of flow of flood waters?		X		
	d. Change in the amount of surface water in any water body?			X	
	e. Discharge into surface waters, or in any alteration of surface water quality, including but not limited to temperature, dissolved oxygen, or turbidity?				X
	f. Alteration of the direction or rate of flow of ground waters?				X
	g. Change in the quantity or quality of ground waters, either through direct additions or withdrawals, or through interception of an aquifer by cuts or excavations?				X
	h. Substantial reduction in the amount of water otherwise available for public water supplies?				X
	i. Exposure of people or property to water related hazards such as flooding or tidal waves?		X		
4.	Plant Life. Will the proposal result in:				
	a. Change in the diversity of species, or number of any species of plants (including trees, shrubs, grass, crops, microflora and aquatic plants)?		X		
	b. Reduction of the numbers of any unique, rare or endangered species of plants?		X		
	c. Introduction of new species of plants into an area, or in a barrier to the normal replenishment of existing species?			X	
	d. Reduction in acreage of any agricultural crop?				X

	ENVIRONMENTAL CHECKLIST	Potentially Significant Impact	Less Than Significant with Mitigation Incorporated	Less Than Significant	No Impact
5.	Animal Life. Will the proposal result in:				
	a. Change in the diversity of species, or numbers of any species of animals (birds, land animals including reptiles, fish and shellfish, benthic organisms, insects or microfauna)?			X	
	b. Reduction of the numbers of any unique, rare or endangered species of animals?		X		
	c. Introduction of new species of animals into an area, or result in a barrier to the migration or movement of animals?		X		
	d. Deterioration to existing fish or wildlife habitat?			X	
6.	Noise. Will the proposal result in:				
	a. Increases in existing noise levels?		X		
	b. Exposure of people to severe noise levels?		X		
7.	Light and Glare. Will the proposal:				
	a. Produce new light or glare?			X	
8.	Land Use. Will the proposal result in:				
	a. Substantial alteration of the present or planned land use of an area?			X	
9.	Natural Resources. Will the proposal result in:				
	a. Increase in the rate of use of any natural resources?				X
	b. Substantial depletion of any nonrenewable natural resource?				X

	ENVIRONMENTAL CHECKLIST	Potentially Significant Impact	Less Than Significant with Mitigation Incorporated	Less Than Significant	No Impact
10.	Risk of Upset. Will the proposal involve:				
	a. A risk of an explosion or the release of hazardous substances (including, but not limited to: oil, pesticides, chemicals or radiation) in the event of an accident or upset conditions?		X		
11.	Population. Will the proposal:				
	a. Alter the location, distribution, density, or growth rate of the human population of an area?				X
12.	Housing. Will the proposal:				
	a. Affect existing housing, or create a demand for additional housing?				X
13.	Transportation/Circulation. Will the proposal result in:				
	a. Generation of substantial additional vehicular movement?		X		
	b. Effects on existing parking facilities, or demand for new parking?		X		
	c. Substantial impact upon existing transportation systems?			X	
	d. Alterations to present patterns of circulation or movement of people and/or goods?			X	
	e. Alterations to waterborne, rail or air traffic?			X	
	f. Increase in traffic hazards to motor vehicles, bicyclists or pedestrians?		X		

	ENVIRONMENTAL CHECKLIST	Potentially Significant Impact	Less Than Significant with Mitigation Incorporated	Less Than Significant	No Impact
14.	Public Service. Will the proposal have an effect upon, or result in a need for new or altered governmental services in any of the following areas:				
	a. Fire protection?		X		
	b. Police protection?		X		
	c. Schools?				X
	d. Parks or other recreational facilities?				X
	e. Maintenance of public facilities, including roads?		X		
	f. Other governmental services?		X		
15.	Energy. Will the proposal result in:				
	a. Use of substantial amounts of fuel or energy?			X	
	b. Substantial increase in demand upon existing sources of energy, or require the development of new sources of energy?			X	
16.	Utilities and Service Systems. Will the proposal result in a need for new systems, or substantial alterations to the following utilities:				
	a. Power or natural gas?			X	
	b. Communications systems?			X	
	c. Water?			X	
	d. Sewer or septic tanks?				X
	e. Storm water drainage?		X		
	f. Solid waste and disposal?		X		
17.	Human Health. Will the proposal result in:				

	ENVIRONMENTAL CHECKLIST	Potentially Significant Impact	Less Than Significant with Mitigation Incorporated	Less Than Significant	No Impact
	a. Creation of any health hazard or potential health hazard (excluding mental health)?		X		
	b. Exposure of people to potential health hazards?		X		
18.	Aesthetics. Will the proposal result in:				
	a. The obstruction of any scenic vista or view open to the public?			X	
	b. The creation of an aesthetically offensive site open to public view?			X	
19.	Recreation. Will the proposal result in:				
	a. Impact upon the quality or quantity of existing recreational opportunities?		X		
20.	Archeological/Historical. Will the proposal:				
	a. Result in the alteration of a significant archeological or historical site structure, object or building?		X		
21.	Mandatory Findings of Significance				
	Potential to degrade: Does the project have the potential to degrade the quality of the environment, substantially reduce the habitat of a fish or wildlife species, cause a fish or wildlife population to drop below self-sustaining levels, threaten to eliminate a plant or animal community, reduce the number or restrict the range of a rare or endangered plant or animal or eliminate important examples of the major periods of California history or prehistory?		X		

	ENVIRONMENTAL CHECKLIST	Potentially Significant Impact	Less Than Significant with Mitigation Incorporated	Less Than Significant	No Impact
	Short-term: Does the project have the potential to achieve short-term, to the disadvantage of long-term, environmental goals? (A short-term impact on the environment is one which occurs in a relatively brief, definitive period of time, while long-term impacts will endure well into the future.)			X	
	Cumulative: Does the project have impacts which are individually limited, but cumulatively considerable? (A project may impact on two or more separate resources where the impact on each resource is relatively small, but where the effect of the total of those impacts on the environment is significant.)			X	
	Substantial adverse: Does the project have environmental effects which will cause substantial adverse effects on human beings, either directly or indirectly?			X	

6.4.2 DISCUSSION OF ENVIRONMENTAL EVALUATION

The analysis of potential environmental impacts is based on the numerous alternative means of compliance available for controlling trash in the Machado Lake in response to the proposed Basin Plan amendment. These include structural methods such as catch basin inserts, structural vortex separation devices, end of pipe trash nets, as well as non-structural alternatives such as increased street sweeping and enforcement of existing litter laws. Potential impacts are discussed below, and it is found that any significant impacts can be mitigated at a project level. Many of the mitigation measures identified are common practices currently employed by agencies when planning and implementing storm water BMPs. Agencies such as Caltrans, CASQA, and WERF publish handbooks containing guidance on the selection, siting, design, installation, monitoring, and evaluation of storm water BMPs (Caltrans, 2002, CASQA, 2003a, CASQA, 2003b, WERF, 2005). The evaluation considers whether the environmental impact indicated will have a substantial, adverse change in any of the physical conditions within the area affected by the activity. In addition, the evaluation discusses environmental effects in proportion to their severity and probability of occurrence.

Pursuant to section 13360 of the Water Code, the Regional Board cannot dictate which compliance measures responsible agencies may choose to adopt or which mitigation measures they would employ to implement the Trash TMDL. However, the Regional Board does recommend that appropriate compliance and mitigation measures as discussed herein, which are readily available and generally considered to be consistent with industry standards, be applied in order to reduce, and if possible avoid, potential environmental impacts, such that there is no significant impact. Since the decision to perform these measures is strictly within the responsibility and jurisdiction of the individual implementing agencies, such measures can and should be adopted by these agencies. (Title 14, California Code of Regulations, Section 15091(a)(2).)

1. **Earth. a.** Will the proposal result in unstable earth conditions or in changes in geologic substructures?

Answer: Less Than Significant with Mitigation Incorporated

Vortex Separation Systems

No impact due to exposure of people to or property to geologic hazards such as rupture of a known earthquake fault, strong seismic ground shaking, liquefaction, or landslides is expected from the implementation of vortex separation systems. Although areas of the watershed are subject to geologic hazards, compliance with standard design and construction specifications and the recommendations of geotechnical studies prepared at the project level would reduce the risk of damage from seismic-related hazards. Furthermore, it is not reasonably foreseeable that responsible agencies would choose to comply with this TMDL through structural means in areas where doing so would result in exposure of people or property to geologic hazards. Rather, it is foreseeable that localities would avoid such compliance measures in lieu of other compliance measures, such as enforcing litter ordinances in sensitive areas.

To the extent that vortex separation systems are installed in areas subject to geologic hazards, such as, ground shaking, liquefaction, liquefaction-induced hazards, or landslides, geotechnical studies prepared as part of the pre-design process would

identify site-specific soil and subsurface conditions and specify design features would keep potential seismic-related impacts within acceptable levels. Compliance with existing regulations, building codes, and standards specifications would also keep potential impacts within acceptable levels. The most appropriate mitigation measure for potential fault rupture hazards is avoidance (i.e., building setbacks), as most surface faulting is confined to a relatively narrow zone a few feet to few tens of feet wide (California Geological Survey, 2002).

Catch Basin Inserts

Catch basin inserts fit directly into curbside catch basins in urbanized areas and require no construction or ground disturbance. There is therefore no potential to impact earth conditions or geologic substructures from this alternative means of compliance.

Trash Nets

Trash nets are installed within the storm drain system either inline or at the end of pipe. Installation requires no ground disturbance which might impact earth conditions or geologic substructures.

Gross Solids Removal Devices (GSRDs)

Like vortex separation systems, gross solids removal devices are inline structural trash removal devices that are implemented in urbanized areas. As such, the project-level impacts on geology and soils resources due to implementation of gross solids removal devices would be similar to the project-level impacts associated with vortex separation systems.

The proposed mitigation measures for gross solids removal devices would be similar to the proposed mitigation measures for vortex separation systems.

Non-Structural BMPs

Non-structural BMPs would involve no change to the physical environment either directly or indirectly and would have no impact on earth conditions or geologic substructures.

1. Earth. b. Will the proposal result in disruptions, displacements, compaction or overcoming of the soil?

Answer: Less Than Significant with Mitigation Incorporated

Vortex Separation Systems

Implementation of the TMDL may result in minor surface soil excavation during installation of vortex separation systems and result in unstable soil. However, most of the relevant areas are already urbanized, and have already suffered soil compaction and hardscaping. Installation of vortex separation systems would occur within the existing storm drain system.

To the extent that any soil is disturbed during installation of vortex separation systems, standard construction techniques, including but not limited to, shoring, piling and soil

stabilization can mitigate any potential impacts. Prior to earthwork, a geotechnical study would be conducted to evaluate geology and soil conditions.

Catch Basin Inserts

Catch basin inserts fit directly into curbside catch basins in urbanized areas and require no construction or ground disturbance. There is therefore no potential to cause disruptions, displacements, compaction or overcoming of the soil from this alternative means of compliance.

Trash Nets

Trash nets are installed within the storm drain system either inline or at the end of pipe. Installation requires no ground disturbance which might cause disruptions, displacements, compaction or overcoming of the soil.

Gross Solids Removal Devices (GSRDs)

Like vortex separation systems, gross solids removal devices are inline structural trash removal devices that are implemented in urbanized areas. As such, the project-level impacts on disruptions, displacements, compaction or overcoming of the soil due to implementation of gross solids removal devices would be similar to the project-level impacts associated with vortex separation systems.

The proposed mitigation measures for gross solids removal devices would be similar to the proposed mitigation measures for vortex separation systems.

Non-Structural BMPs

Non-structural BMPs would involve no change to the physical environment either directly or indirectly and would have no potential to cause disruptions, displacements, compaction or overcoming of the soil.

1. **Earth. c.** Will the proposal result in change in topography or ground surface relief features?

Answer: No impact

Vortex Separation Systems

Vortex separation systems would not be of the size or scale to result in unstable earth conditions, changes in geologic substructures, topography or ground surface relief features, or destruction, covering or modification of any unique geologic or physical features. Typical units occupy about 4-1/2 square feet of plan view area for each cubic foot per second that they treat. The city of Los Angeles has installed a CDS unit in the downtown Los Angeles area that weighs approximately 70.6 tons with a foot print diameter of 18 ft.

Catch Basin Inserts

Catch basin inserts fit directly into curbside catch basins in urbanized areas and require no construction or ground disturbance. There is therefore no potential to impact topography or ground surface relief features from this alternative means of compliance.

Trash Nets

Trash nets are installed within the storm drain system either inline or at the end of pipe. Installation requires no ground disturbance which might result in change in topography or ground surface relief features.

Gross Solids Removal Devices (GSRDs)

GSRDs would not be of the size or scale to result in unstable earth conditions, changes in geologic substructures, topography or ground surface relief features, or destruction, covering or modification of any unique geologic or physical features.

Non-Structural BMPs

Non-structural BMPs would involve no change to the physical environment either directly or indirectly and would have no impact on topography or ground surface relief features.

1. Earth d. Will the proposal result in the destruction, covering or modification of any unique geologic or physical features?

Answer: No impact

Vortex Separation Systems

Vortex separation systems would not be of the size or scale to result in destruction, covering or modification of any unique geologic or physical features. Typical units occupy about 4-1/2 square feet of plan view area for each cubic foot per second that they treat. The city of Los Angeles has installed a CDS unit in the downtown Los Angeles area that weighs approximately 70.6 tons with a foot print diameter of 18 ft. .

Catch Basin Inserts

Catch basin inserts fit directly into curbside catch basins in urbanized areas and require no construction or ground disturbance. There is therefore no potential to result in the destruction, covering or modification of any unique geologic or physical features from this alternative means of compliance.

Trash Nets

Trash nets are installed within the storm drain system either inline or at the end of pipe. Installation requires no ground disturbance which might result in the destruction, covering or modification of any unique geologic or physical features.

Gross Solids Removal Devices (GSRDs)

GSRDs are inline structural trash removal devices that are implemented in urbanized areas. GSRDs would not be of the size or scale to result in destruction, covering or modification of any unique geologic or physical features.

Non-Structural BMPs

Non-structural BMPs would involve no change to the physical environment either directly or indirectly and would have no potential to result in the destruction, covering or modification of any unique geologic or physical features.

1. Earth. e. Will the proposal result in any increase in wind or water erosion of soils, either on or off the site?

Answer: Less Than Significant with Mitigation Incorporated

Vortex separation systems

Wind or water erosion of soils may occur as a short-term impact during installation of vortex separation systems.

To the extent that the installation of vortex separation systems causes an increase in erosion, typical established best management practices would be used during implementation to minimize offsite sediment runoff or deposition. Construction sites are required to retain sediments on site, either under a general construction storm water permit or through the construction program of the applicable MS4 permit—both of which are already designed to minimize or eliminate erosion impacts on receiving water.

Catch Basin Inserts

Catch basin inserts fit directly into curbside catch basins in urbanized areas and require no construction or ground disturbance. There is therefore no potential to result in any increase in wind or water erosion of soils, either on or off the site from this alternative means of compliance.

Trash Nets

Trash nets are installed within the storm drain system either inline or at the end of pipe. Installation requires no ground disturbance which might result in any increase in wind or water erosion of soils, either on or off the site.

Gross Solids Removal Devices (GSRDs)

Like vortex separation systems, gross solids removal devices are inline structural trash removal devices that are implemented in urbanized areas. As such, the project-level impacts on resulting in increase in wind or water erosion of soils, either on or off the site due to implementation of gross solids removal devices would be similar to the project-level impacts associated with vortex separation systems.

The proposed mitigation measures for gross solids removal devices would be similar to the proposed mitigation measures for vortex separation systems.

Non-Structural BMPs

Non-structural BMPs would involve no change to the physical environment either directly or indirectly and would not result in increase in wind or water erosion of soils, either on or off the site.

1. Earth. f. Will the proposal result in changes in deposition or erosion of beach sands, or changes in siltation, deposition or erosion which may modify the channel of a river or stream or the bed of the ocean or any bay, inlet or lake?

Answer: Less than significant

Vortex Separation Systems

Siltation or deposition within the vortex separation systems may occur, resulting in reduction in siltation or deposition in the estuary or within the channels and the concrete lined channels. Reduction in siltation and deposition in the estuary may be considered a positive impact as fine sediments may contain toxic pollutants.

Catch Basin Inserts

Catch basin inserts are gritted and fit directly into curbside catch basins in urbanized areas. There is no potential to result in changes in siltation, deposition or erosion which may modify the bed of the lake.

Trash Nets

Trash nets are installed within the storm drain system either inline or at the end of pipe. The screen size is large enough and there is no potential to result in changes in siltation, deposition or erosion which may modify the bed of the lake.

Gross Solids Removal Devices (GSRDs)

Like vortex separation systems, GSRDs are inline structural trash removal devices that are implemented in urbanized areas. Siltation or deposition within the GSRDs may occur, resulting reduction in siltation or deposition may occur in the lake. Reduction in siltation and deposition in the lake may be considered a positive impact as fine sediments may contain toxic pollutants.

Non-Structural BMPs

Non-structural BMPs would involve no change to the physical environment either directly or indirectly and would not result in changes in siltation, deposition or erosion which may modify the bed of the lake.

1. Earth. g. Will the proposal result in exposure of people or property to geologic hazards, such as earthquakes, landslides, mudslides, ground failure, or similar hazards?

Answer: Less than Significant

Vortex Separation Systems

No impact is expected. Although areas of the watershed are subject to geologic hazards, geotechnical studies prepared at the project level would ensure that treatment facilities or BMPs were not employed in these areas. It is not reasonably foreseeable that responsible agencies would choose to comply with this TMDL through structural means in areas where doing so would result in exposure of people or property to geologic hazards. Rather, it is foreseeable that localities would avoid such compliance measures in lieu of other compliance measures, such as enforcing litter ordinances in sensitive areas.

Catch Basin Inserts

Catch basin inserts fit directly into curbside catch basins in urbanized areas and require no construction or ground disturbance. There is therefore no potential to result in exposure of people or property to geologic hazards, such as earthquakes, landslides, mudslides, ground failure, or similar hazards.

Trash Nets

Trash nets are installed within the storm drain system either inline or at the end of pipe. Installation requires no ground disturbance which might result in exposure of people or property to geologic hazards, such as earthquakes, landslides, mudslides, ground failure, or similar hazards.

Gross Solids Removal Devices (GSRDs)

Installation and operation of GSRDs would not cause or accelerate instability due to on- or off-site landslides, lateral spreading, subsidence, expansive soils, liquefaction, or collapse. GSRDs would not be of the size or scale to result in unstable earth conditions, changes in geologic substructures, topography or ground surface relief features, or destruction, covering or modification of any unique geologic or physical features.

Non-Structural BMPs

Non-structural BMPs would involve no change to the physical environment either directly or indirectly and would not result in exposure of people or property to geologic hazards, such as earthquakes, landslides, mudslides, ground failure, or similar hazards.

- 2. Air. a.** Will the proposal result in substantial air emissions or deterioration of ambient air quality?

Answer: Less Than Significant with Mitigation Incorporated

Vortex Separation Systems

Short term increases in traffic during the construction and installation of VSS devices, short term emissions generated by construction equipments, and long-term increases in traffic caused by ongoing maintenance of these devices (e.g., delivery of materials and deployment of vacuum trucks) are potential sources of increased air pollutant emissions. Maintenance requirements for trash removal devices demonstrate that devices should

be emptied when they reach 85% capacity. VSS devices can be designed so that they need be cleaned only once per storm season. Potential impacts that result in substantial air emissions or deterioration of ambient air quality could occur where facilities are located. However, emission levels for all the pollutants are expected far below the SCAQMD Air Quality Significance thresholds considering the scale of the Trash TMDL program. In case that daily emission exceeds significance threshold, which is unlikely, construction and maintenance for different VSS units can be conducted on different days to reduce emissions rates. Detailed analysis can only be done at project level.

Mitigation measures for increased air emissions due to increased vehicle trips or increased use of construction equipment include: 1) use of construction, and maintenance vehicles with lower-emission engines, 2) use of soot reduction traps or diesel particulate filters, and 3) use of emulsified diesel fuel.

Catch Basin Inserts

Long-term increases in traffic caused by ongoing maintenance of catch basin inserts (e.g., delivery of materials, street sweeping) are potential sources of increased air pollutant emissions. Potential impacts that result in substantial air emissions or deterioration of ambient air quality could occur where facilities are located. Nonetheless, mitigation measures are available to mitigate any potential impacts to air quality due to increased traffic. Mitigation measures could include 1) use of construction, maintenance, and street sweeper vehicles with lower-emission engines, 2) use of soot reduction traps or diesel particulate filters, 3) use of emulsified diesel fuel, 4) use of vacuum-assisted street sweepers to eliminate potential re-suspension of sediments during sweeping activity, and 5) the design of trash removal devices to minimize the frequency of maintenance trips (e.g., design for smaller drainage areas and adjusting screen size to prevent clogging).

Trash Nets

Trash nets are end-of-pipe devices. The installation of trash nets is limited by availability of locations and the size of pipes. Short term increases in traffic during the construction and installation of trash nets and long-term increases in traffic caused by ongoing maintenance of these devices (e.g., replacement of nets) are potential sources of increased air pollutant emissions. After installation, trash nets can be replaced once per year. It is not clear how many trash nets are going to be installed at this point. If the stakeholders make decisions on the numbers of trash nets that are going to be installed, the impacts on air quality caused by installation and maintenance of trash nets could be analyzed at project level. Nevertheless, many fewer trash nets are currently being installed than catch basin inserts, and, anticipating this trend to continue, the impacts of installation and maintenance of trash nets on air quality are expected to be much less than those of catch basin inserts.

Mitigation measures for increased air emissions due to increased vehicle trips or for construction equipment due to the installation of trash nets include: 1) use of construction, and maintenance vehicles with lower-emission engines, 2) use of soot reduction traps or diesel particulate filters, and 3) use of emulsified diesel fuel.

Gross Solids Removal Devices

Short term increases in traffic during the construction and installation of GSRDs and long-term increases in traffic caused by ongoing maintenance of these devices (e.g., replacement of nets) are potential sources of increased air pollutant emissions. Each GSRD was designed to capture annual load of gross solids, which would result in one cleaning per year. GSRDs are currently under pilot studies conducted by Caltrans. It is not clear how many GSRDs are going to be installed at this point. If the stakeholders make decisions on the numbers of GSRDs that are going to be installed, the impacts on air quality caused by installation and maintenance of GSRDs could be analyzed at project level. Nevertheless, many fewer GSRDs are currently being installed than catch basin inserts, and, anticipating these trends to continue, the impacts of installation and maintenance of GSRDs on air quality are expected to be much less than those of catch basin inserts.

Mitigation measures for increased air emissions due to increased vehicle trips or for construction equipment due to the installation of GSRDs include: 1) use of construction, and maintenance vehicles with lower-emission engines, 2) use of soot reduction traps or diesel particulate filters, and 3) use of emulsified diesel fuel.

Increased Street Sweeping

Increased street sweeping would increase traffic and therefore increase air pollutant emissions. Increased street sweeping would not foreseeably be implemented alone for the trash TMDL. It is not clear how often street sweeping would be increased to fulfill the trash TMDL at this point. If the stakeholders make decisions on the frequency of street sweeping, the impacts on air quality caused by increased street sweeping could be analyzed at project level. Nevertheless, the impacts of increased street sweeping have been included in alternatives, such as catch basin inserts, that may also include increased street sweeping.

Other non-structural BMPs

It is possible that workers and vehicles may be required to implement non-structural BMPs. However, non-structural BMPs are not expected to have noticeable impact on air quality for the level of effort that would be required for this relatively small waterbody. For example, to implement a program for minimum frequency of assessment and collection, responsible jurisdiction would need to patrol the lake once per day.

2. Air. b. Will the proposal result in creation of objectionable odors?

Answer: Less Than Significant with Mitigation Incorporated

Vortex Separation Systems

VSS devices may be a source of objectionable odors if design allows for water stagnation or collection of water with sulfur-containing compounds. Storm water runoff is not likely to contain sulfur-containing compounds, but stagnant water could create objectionable odors. Mitigation measures to eliminate odors caused by stagnation could include covers, aeration, filters, barriers, and/or odor suppressing chemical additives. Devices could be inspected to ensure that intake structures are not clogged or pooling

water. During maintenance, odorous sources could be uncovered for as short of a time period as possible. To the extent possible, trash removal devices could be designed to minimize stagnation of water (eg., allow for complete drainage within 48 hours) and installed to increase the distance to sensitive receptors in the event of any stagnation.

Catch Basin Inserts

To the extent improper disposal of, for instance, household wastes result in them being kept on the street or in inserts, and potentially allowing a release of odors, local residents could be exposed to those effects. On balance, however, it is not unfair that the residents of the localities where improper disposal of such materials occurs should suffer those risks rather than allowing the wastes to be conveyed to expose downstream citizens to the cumulative risks of them instead. Nevertheless, to the extent the locality that originated the risk would become newly potentially exposed instead of downstream receptors, those impacts could be potentially significant in those locales. Such impacts could be avoided or mitigated by educating the local community of the effects of improper disposal of such wastes, enforcing litter ordinances, and timely cleaning out inserts.

Trash Nets

Trash trapped in trash nets may be a source of objectionable odors. Mitigation measures to eliminate odors could include covers, aeration, filters, barriers, and/or odor suppressing chemical additives. During maintenance, odorous sources could be uncovered for as short of a time period as possible. Notably, the current conditions result in significant impacts from odor. The impacts from odor could be mitigated by employing alternative structural devices, such as in-line trash nets, or by employing non-structural controls, for instance, increased litter enforcement.

Gross Solids Removal Devices

Trash trapped in GSRDs may be a source of objectionable odors. Mitigation measures to eliminate odors could include covers, aeration, filters, barriers, and/or odor suppressing chemical additives. During maintenance, odorous sources could be uncovered for as short of a time period as possible. The impacts from odor could be mitigated by employing non-structural controls, for instance, increased litter enforcement.

Increased Street Sweeping

Increased street sweeping may increase objectionable odors on street. Nonetheless, mitigation measures are available to mitigate any potential impacts to air quality due to increased street sweeping. Mitigation measures could include 1) use of street sweeper vehicles with lower-emission engines, 2) use of soot reduction traps or diesel particulate filters, 3) use of emulsified diesel fuel, 4) use of vacuum-assisted street sweepers to eliminate potential re-suspension of sediments during sweeping activity.

Other Non-Structural BMPs

It is possible that workers and vehicles may be required to implement non-structural BMPs. However, non-structural BMPs are not expected to have noticeable impact on air quality for the level of effort that would be required for this relatively small waterbody.

2. Air. c. Will the proposal result in alteration of air movement, moisture or temperature, or any change in climate, either locally or regionally?

Answer: No Impact

Foreseeable methods of compliance would not be of the size or scale to result in alteration of air movement, moisture or temperature, or any change in climate, either locally or regionally.

3. Water. a. Will the proposal result in changes in currents, or the course of direction or water movements, in either marine or fresh waters?

Answer: Less Than Significant with Mitigation Incorporated

Vortex Separation Systems

The Vortex Separation Systems may cause a change in current and surface water movement. The stream flow in the lower watershed is highly channelized. As more trash is kept out of the channels, the roughness coefficient may be reduced, which would increase the flow rate in the channel. However, the impact would be less than significant. Vortex separation devices may impede or slow overland flow to storm drains but proper design and maintenance can mitigate this impact. Vortex separation devices may impede or slow overland flow to storm drains but proper design and maintenance can mitigate this impact. The CDS units would not alter the direction or slope of the stream channels in the lower watershed, therefore, no change in the direction of surface water flow will occur.

Gross Solids Removal Devices

The GSRDs units may cause a change in current and surface water movement. The stream flow in the lower watershed is highly channelized. As more trash is kept out of the channels, the roughness coefficient may be reduced which would increase the flow rate in the channel. However, the impact would be less than significant. The GSRDs units would not alter the direction or slope of the stream channels in the lower watershed, therefore, no change in the direction of surface water flow will occur.

Trash nets

Trash nets can be installed at or below grade within existing storm water conveyance structures or retrofitted to an existing outfall structure with only minor modifications. As more trash is kept out of the channels, the roughness coefficient may be reduced which would increase the flow rate in the channel. However, the impact would be less than significant. The Trash nets would not alter the direction or slope of the stream channels in the lower watershed, therefore, no change in the direction of surface water flow will occur.

Catch Basin Inserts

Catch basin inserts are manufactured frames that typically incorporate filters or fabric and placed in a curb opening or drop inlet to remove trash, sediment, or debris. They can also be perforated metal screens placed horizontally or vertically within a catch basin. These devices have less hydraulic effect than the CDS units or the GSRDs, The impacts that result in changes in currents, or the course of direction or water movements, in fresh waters are not significant. Overland flow in the urbanized portion of the watershed is directed primarily to storm drains. Catch basin inserts may alter overland flow to storm drains, but this impact can be mitigated through proper design and maintenance of these inserts.

Non-Structural BMPs

Non-structural BMPs would involve no change to the physical environment either directly or indirectly and would not result in changes in currents, or the course of direction or water movements, in marine or fresh waters. No impact is anticipated. No mitigation measures are required.

3. Water. b. Will the proposal result in changes in absorption rates, drainage patterns, or the rate and amount of surface water runoff?

Answer: Less Than Significant with Mitigation Incorporated

Vortex Separation Systems

The Vortex Separation Systems may cause a significant change in the drainage patterns, rate and amount of surface water runoff. These units may impede or slow overland flow to the storm drain system. Any device installed in a storm drain, especially an older, under-capacity drain could have a negative effect on the drain's ability to convey surface waters including flood waters. This negative impact can be mitigated through design of the CDS units with overflow/bypass structures and by performing regular maintenance of these devices and if necessary enlargement of the storm drain upstream of the device.

Gross Solids Removal Devices (GSRDs)

The GSRDs may cause a significant change in the drainage patterns, rate and amount of surface water runoff. These units may impede or slow overland flow to the storm drain system. Any device installed in a storm drain, especially an older, under-capacity drain could have a negative effect on the drain's ability to convey surface waters including flood waters. This negative impact can be mitigated through design of the GSRDs units with overflow/bypass structures and by performing regular maintenance of these devices and if necessary enlargement of the storm drain upstream of the device.

Trash nets

Trash nets are devices that use the natural energy of the flow to trap trash, floatables and solids in disposable mesh nets. Trash nets can be installed at or below grade within existing storm water conveyance structures or retrofitted to an existing outfall structure with only minor modifications. These units may impede or slow overland flow to the

storm drain system. Any device installed in a storm drain, especially an older, under-capacity drain could have a negative effect on the drain's ability to convey surface waters including flood waters. This negative impact can be mitigated through design of the trash nets with overflow/bypass structures and by performing regular maintenance of these devices and if necessary enlargement of the storm drain upstream of the device.

Catch basin inserts

Catch basin inserts are manufactured frames that typically incorporate filters or fabric and placed in a curb opening or drop inlet to remove trash, sediment, or debris. They can also be perforated metal screens placed horizontally or vertically within a catch basin. These units may impede or slow overland flow to the storm drain system. Any device installed in a storm drain, especially an older, under-capacity drain could have a negative effect on the drain's ability to convey surface waters including flood waters. This negative impact can be mitigated through design of the catch basin inserts with overflow/bypass structures and by performing regular maintenance of these devices and if necessary enlargement of the storm drain upstream of the device.

Non-Structural BMPs

Non-structural BMPs would involve no change to the physical environment either directly or indirectly and would not result in change in the drainage patterns, rate and amount of surface water runoff. No impact is anticipated. No mitigation measures are required.

3. Water. c. Will the proposal result in alterations to the course of flow of flood waters?

Answer: Less Than Significant with Mitigation Incorporated

Vortex Separation Systems

Vortex Separation Systems may result in a potentially significant impact due to flooding hazards if the screens became blocked by trash and debris, preventing the discharge of storm water to the lakes, or if the CDS units are not properly designed and constructed to allow for bypass of storm water during storm events that exceed the design capacity. Any device into a storm drain, especially an older, under-capacity drain could have a negative effect on the drain's ability to convey waters including flood waters. This potential impact can be mitigated through the design of the CDS units with overflow/bypass structures and by performing regular maintenance to prevent the build up of trash and debris. Enlargement of the drain upstream of the device may be required.

Gross Solids Removal Devices

Gross Solids Removal Devices (GSRDs) may result in a potentially significant impact due to flooding hazards if the screens became blocked by trash and debris and prevent the discharge of storm water to the Machado Lake or if the GSRDs are not properly designed and constructed to allow for bypass of storm water during storm events that exceed the design capacity. This potential impact can be mitigated through the design of the GSRDs with overflow/bypass structures and by performing regular maintenance to prevent the build up of trash and debris. Therefore, the exposure of people and property to flooding hazards after mitigation is less than significant.

Trash Nets

Trash nets have less hydraulic effect than the CDS units or the GSRDs, however, flooding is still a potential hazard if the nets became blocked by trash and debris and prevent the discharge of storm water. This potential impact can be mitigated through sizing and designing trash nets to allow for bypass when storm events exceed the design capacity and by performing regular maintenance to prevent the build up of trash and debris.

Catch Basin Inserts

Catch basin inserts have less hydraulic effect than the CDS units or the GSRDs, however, flooding is still a potential hazard if the filters or screens became blocked by trash and debris and prevent the discharge of storm water. This would be of particular concern in areas susceptible to high leaf-litter rates. This potential impact can be mitigated through the use of inserts that are designed with automatic release mechanisms or retractable screens that allow flow-through during wet-weather and by performing regular maintenance to prevent the build up of trash and debris. Any device into a storm drain, especially an older, under-capacity drain could have a negative effect on the drain's ability to convey waters including flood waters. Enlargement of the drain upstream of the device may be required. Certain devices such as trash racks or mesh screens may have less hydraulic effect than in-line treatment devices.

Non-Structural BMPs

Non-structural BMPs would involve no change to the physical environment either directly or indirectly and would not result in alterations to the course of flow of flood waters. No impact is anticipated. No mitigation measures are required.

3. Water. d. Will the proposal result in change in the amount of surface water in any water body?

Answer: Less than significant

Vortex Separation Systems

Vortex Separation Systems do not divert water for other uses and the amount of water in storm drains is not changed. Surface water in the Machado Lake is not likely to change due to the removal of trash.

Gross Solids Removal Devices

Gross Solids Removal Devices (GSRDs) do not divert water for other uses and the amount of water in storm drains is not changed. Surface water in the Machado Lake is not likely to change due to the removal of trash.

Trash Nets

Trash nets do not divert water for other uses and the amount of water in storm drains is not changed. Surface water in the Machado Lake is not likely to change due to the removal of trash.

Catch Basin Inserts

Catch basin inserts do not divert water for other uses and the amount of water in storm drains is not changed. Surface water in the Machado Lake is not likely to change due to the removal of trash.

Non-Structural BMPs

Non-structural BMPs would involve no change to the physical environment either directly or indirectly and would not result in change in the amount of surface water in any water body.

3. Water. e. Will the proposal result in discharge to surface waters, or in any alteration of surface water quality, including but not limited to temperature, dissolved oxygen, or turbidity?

Answer: No Impact

Vortex Separation Systems

Vortex Separation Systems will alter surface water quality by reducing the amount of trash that enters the lake. This reduction will positively impact water quality and associated recreational beneficial uses of surface waters, including water contact and non-contact recreation, and other beneficial uses. Vortex Separation Systems will not foreseeably result in negative impacts to temperature, dissolved oxygen, or turbidity.

Gross Solids Removal Devices

Gross Solids Removal Devices will alter surface water quality by reducing the amount of trash that enters the lake. This reduction will positively impact water quality and associated recreational beneficial uses of surface waters, including water contact and non-contact recreation, and other beneficial uses. Gross Solids Removal Devices will not foreseeably result in negative impacts to temperature, dissolved oxygen, or turbidity.

Trash Nets

Trash nets will alter surface water quality by reducing the amount of trash that enters the lake. This reduction will positively impact water quality and associated recreational beneficial uses of surface waters, including water contact and non-contact recreation, and other beneficial uses. Trash nets will not foreseeably result in negative impacts to temperature, dissolved oxygen, or turbidity.

Catch Basin Inserts

Catch basin inserts will alter surface water quality by reducing the amount of trash that enters the lake. This reduction will positively impact water quality and associated recreational beneficial uses of surface waters, including water contact and non-contact recreation, and other beneficial uses. Catch basin inserts will not foreseeably result in negative impacts to temperature, dissolved oxygen, or turbidity.

Non-Structural BMPs

Non-structural BMPs would involve no change to the physical environment either directly or indirectly and would not result in discharge to surface waters, or in any alteration of surface water quality.

3. Water. f. Will the proposal result in alteration of the direction or rate of flow of ground waters?

Answer: No impact

The direction or rate of flow of ground waters is not likely to change due to compliance with this TMDL. Partial capture devices (i.e., catch basin inserts) and full capture devices (i.e., structural vortex separation devices) would not likely change the direction or rate of flow of ground water because systems would not be installed in areas that are not already developed or at depths that could impact the ground water table.

3. Water. g. Change in the quantity or quality of ground waters, either through direct additions or withdrawals, or through interception of an aquifer by cuts or excavations?

Answer: No impact

The reasonably foreseeable methods of compliance act entirely on surface waters and would not add or withdraw groundwater.

3. Water. h. Will the proposal result in substantial reduction in the amount of water otherwise available for public water supplies?

Answer: No Impact

No impact is foreseeable. The goal of the TMDL is to capture the trash through catch basins or structural BMP devices. Stormwater runoff may be returned to the river without resulting in substantial reduction in the amount of water.

3. Water. i. Will the proposal result in exposure of people or property to water related hazards such as flooding or tidal waves?

Answer: : Less Than Significant with Mitigation Incorporated

Vortex Separation Systems

Vortex Separation Systems may result in a potentially significant impact due to flooding hazards if the screens became blocked by trash and debris and prevent the discharge of storm water to the Machado Lake or if the CDS units are not properly designed and constructed to allow for bypass of storm water during storm events that exceed the design capacity. This potential impact can be mitigated through the design of the CDS units with overflow/bypass structures and by performing regular maintenance to prevent the build up of trash and debris. Therefore, the exposure of people and property to flooding hazards after mitigation is less than significant.

Gross Solids Removal Devices

Gross Solids Removal Devices (GSRDs) may result in a potentially significant impact due to flooding hazards if the screens became blocked by trash and debris and prevent the discharge of storm water to the Machado Lake or if the GSRDs are not properly designed and constructed to allow for bypass of storm water during storm events that exceed the design capacity. This potential impact can be mitigated through the design of the GSRDs with overflow/bypass structures and by performing regular maintenance to prevent the build up of trash and debris. Therefore, the exposure of people and property to flooding hazards after mitigation is less than significant.

Trash Nets

Trash nets have less hydraulic effect than the CDS units or the GSRDs, however, flooding is still a potential hazard if the nets became blocked by trash and debris and prevent the discharge of storm water. This potential impact can be mitigated through sizing and designing trash nets to allow for bypass when storm events exceed the design capacity and by performing regular maintenance to prevent the build up of trash and debris. Therefore, the exposure of people and property to flooding hazards after mitigation is less than significant.

Catch Basin Inserts

Catch basin inserts have less hydraulic effect than the CDS units or the GSRDs, however, flooding is still a potential hazard if the filters or screens became blocked by trash and debris and prevent the discharge of storm water. This would be of particular concern in areas susceptible to high leaf-litter rates. This potential impact can be mitigated through the use of inserts that are designed with automatic release mechanisms or retractable screens that allow flow-through during wet-weather and by performing regular maintenance to prevent the build up of trash and debris. Therefore, the exposure of people and property to flooding hazards after mitigation should be less than significant.

Non-Structural BMPs

Non-structural BMPs would involve no change to the physical environment either directly or indirectly and would not result in exposure of people or property to water related hazards such as flooding or tidal waves. No impact is anticipated. No mitigation measures are required.

4. Plant Life. a. Will the proposal result in change in the diversity of species, or number of any species of plants (including trees, shrubs, grass, crops, microflora and aquatic plants)?

Answer: Less Than Significant with Mitigation Incorporated

Vortex Separation Systems

Vortex separation systems would be implemented in currently urbanized areas. Because these areas are already fully urbanized it is unlikely that the installation of vortex separation systems would cause the removal, disturbance or change in diversity

of any plant species or cause a change or reduction in the number of any unique, rare or endangered species of plants. However, depending on the final location of facilities, potential impacts to biological resources including special-status species and habitat, wetlands, and trees protected under local ordinances or policies could occur where facilities are located. Plant number and species diversity could be maintained by either preserving them prior, during, and after the construction of vortex separation systems or by re-establishing and maintaining the plant communities post construction.

Catch Basin Inserts

Catch basin inserts fit directly into curbside catch basins in urbanized areas where native habitat or special-status species usually are absent. As such, impacts to species diversity and number of species would be avoided. Furthermore, installation of catch basin inserts requires no construction or ground disturbance which could impact species diversity and number of species.

Trash Nets

Trash nets are installed within the storm drain systems either inline or at the end of pipe in urbanized areas where native habitat or special-status species usually are absent. As such, impacts to species diversity and number of species would be avoided. Furthermore, installation of trash nets requires minimal construction and no ground disturbance which could impact species diversity and number of species.

Gross Solids Removal Devices (GSRDs)

Like vortex separation systems, gross solids removal devices are inline structural trash removal devices that are implemented in urbanized areas. As such, the project-level impacts on biological resources due to implementation of gross solids removal devices would be similar to the project-level impacts associated with vortex separation systems.

The proposed mitigation measures for gross solids removal devices would be similar to the proposed mitigation measures for vortex separation systems.

Non-Structural BMPs

Non-structural BMPs would involve no change to the physical environment either directly or indirectly and would have no impact on species diversity and number of species.

4. Plant life. b. Will the proposal result in reduction of the numbers of any unique, rare or endangered species of plants?

Answer: Less Than Significant with Mitigation Incorporated

Vortex Separation Systems

Vortex separation systems would be implemented in currently urbanized areas. Because these areas are already fully urbanized it is unlikely that the installation of vortex separation systems would cause a change or reduction in the number of any unique, rare or endangered species of plants. However, depending on the final location

of facilities, potential impacts to special-status species and habitat, wetlands, and trees protected under local ordinances or policies could occur where facilities are located.

Assuming any unique species are present, plant number and species diversity could be maintained by either preserving them prior, during, and after the construction of vortex separation systems or by re-establishing and maintaining the plant communities post construction.

When the specific projects are developed and sites identified, a search of the California Natural Diversity Database could be employed to confirm that any potentially sensitive plant species or biological habitats in the site area are properly identified and protected as necessary. Focused protocol plant surveys for special-status-plant species could be conducted at each site location, if appropriate. If sensitive plant species occur on the project site mitigation would be required in accordance with the Endangered Species Act. Mitigation measures shall be developed in consultation with the California Department of Fish and Game (CDFG) and the United States Fish and Wildlife Service (USFWS). Responsible agencies should endeavor to avoid compliance measures that could result in reduction of the numbers of any unique, rare or endangered species of plants, and instead opt for such measures as enforcing litter ordinances in sensitive habitat areas, or siting physical compliance measures sufficiently upstream or downstream of sensitive areas to avoid any impacts..

Catch Basin Inserts

Catch basin inserts fit directly into curbside catch basins in urbanized areas where native habitat or special-status species usually are absent. As such, impacts to unique, rare or endangered species of plants would be avoided. Furthermore, installation of catch basin inserts requires no construction or ground disturbance which could impact biological resources.

Trash Nets

Trash nets are installed within the storm drain systems either inline or at the end of pipe in urbanized areas where native habitat or special-status species usually are absent. As such, impacts to unique, rare or endangered species of plants would be avoided. Furthermore, installation of trash nets requires minimal construction and no ground disturbance which could impact unique, rare or endangered species of plants.

Gross Solids Removal Devices (GSRDs)

Like vortex separation systems, gross solids removal devices are inline structural trash removal devices that are implemented in urbanized areas. As such, the project-level impacts on biological resources due to implementation of gross solids removal devices would be similar to the project-level impacts associated with vortex separation systems.

The proposed mitigation measures for gross solids removal devices would be similar to the proposed mitigation measures for vortex separation systems.

Non-Structural BMPs

Non-structural BMPs would involve no change to the physical environment either directly or indirectly and would have no impact to unique, rare or endangered species of plants.

4. Plant life. c. Will the proposal result in introduction of new species of plants into an area, or in a barrier to the normal replenishment of existing species?

Answer: Less than significant

Vortex Separation Systems

It is not reasonably foreseeable that implementation of vortex separation systems would result in the introduction of exotic or invasive plant species into an area. Nor will it result in a barrier to the normal replenishment of existing species. However, in the case that landscaping is incorporated into the specific project design, there is a possibility of disruption of resident native species. The possibility of disruption of resident native species could be avoided or minimized by using only plants native to the area. Use of exotic invasive species or other plants listed in the Exotic Pest Plant of Greatest Ecological Concern in California should be prohibited (CalEPPC, 1999).

Catch Basin Inserts

Catch basin inserts fit directly into curbside catch basins in urbanized areas where native habitat or special-status species usually are absent. As such, impacts that result in introduction of new species of plants, or in a barrier to the normal replenishment of existing species would be avoided. Furthermore, installation of catch basin inserts requires no construction or ground disturbance which could result in introduction of new species of plants into an area, or in a barrier to the normal replenishment of existing species.

Trash Nets

Trash nets are installed within the storm drain systems either inline or at the end of pipe in urbanized areas where native habitat or special-status species usually are absent. As such, impacts that result in introduction of new species of plants, or in a barrier to the normal replenishment of existing species would be avoided. Furthermore, installation of trash nets requires minimal construction and no ground disturbance which could result in introduction of new species of plants, or in a barrier to the normal replenishment of existing species.

Gross Solids Removal Devices (GSRDs)

Like vortex separation systems, gross solids removal devices are inline structural trash removal devices that are implemented in urbanized areas. As such, the project-level impacts on biological resources due to implementation of gross solids removal devices would be similar to the project-level impacts associated with vortex separation systems.

The proposed mitigation measures for gross solids removal devices would be similar to the proposed mitigation measures for vortex separation systems.

Non-Structural BMPs

Non-structural BMPs would involve no change to the physical environment either directly or indirectly and would have no impact that result in introduction of new species of plants, or in a barrier to the normal replenishment of existing species.

4. Plant life. d. Will the proposal result in reduction in acreage of any agricultural crop?

Answer: No impact

Vortex Separation Systems

It is not expected that vortex separation systems will be placed in any area currently engaged in crop production, but will be implemented in already highly urbanized areas and would have no foreseeable impact on the acreage of any agricultural crop.

Catch Basin Inserts

It is not expected that catch basin inserts will be placed in any area currently engaged in crop production, but will be implemented in already highly urbanized areas and would have no foreseeable impact on the acreage of any agricultural crop.

Trash Nets

Trash nets are installed within the storm drain systems either inline or at the end of pipe in urbanized areas. It is not expected that trash nets will be placed in any area currently engaged in crop production, but will be implemented in already highly urbanized areas and would have no foreseeable impact on the acreage of any agricultural crop.

Gross Solids Removal Devices (GSRDs)

Like vortex separation systems, gross solids removal devices are inline structural trash removal devices that are implemented in urbanized areas. It is not expected that gross solids removal devices will be placed in any area currently engaged in crop production, but will be implemented in already highly urbanized areas and would have no foreseeable impact on the acreage of any agricultural crop.

Non-Structural BMPs

Non-structural BMPs would involve no change to the physical environment either directly or indirectly and would have no impact on the acreage of any agricultural crop.

5. Animal Life. a. Will the proposal result in change in the diversity of species, or numbers of any species of animals (birds, land animals including reptiles, fish and shellfish, benthic organisms, insects or microfauna)?

Answer: Less than significant

Vortex Separation Systems

In general, the activities that will take place with the implementation of the full capture trash control devices will be similar in nature to current urban activities that are already

occurring in the watershed. The implementation of additional trash control measures will not foreseeably:

- Cause a substantial reduction of the overall habitat of a wildlife species,
- Produce a drop in a wildlife population below self-sustaining levels, or
- Eliminate a plant or animal community.

It is not reasonably foreseeable that either the construction/implementation or maintenance phase of potential projects will result in a significant impact to general wildlife species adapted to developed environments.

Catch Basin Inserts

Catch basin inserts fit directly into curbside catch basins in urbanized areas. As such, impacts that result in change in the diversity of species, or numbers of any species of animals would be avoided. Furthermore, installation of catch basin inserts requires no construction or ground disturbance which could impact biological resources.

Trash Nets

Trash nets are installed within the storm drain systems either inline or at the end of pipe in urbanized areas. As such, impacts that result in change in the diversity of species, or numbers of any species of animals would be avoided. Trash nets used for the purposes of compliance with the Trash TMDL would not be located within the lake, but rather in the storm drain itself and would not result in a foreseeable deterioration of existing fish habitat. Furthermore, installation of trash nets requires minimal construction and no ground disturbance which could impact biological resources.

Gross Solids Removal Devices (GSRDs)

Like vortex separation systems, gross solids removal devices are inline structural trash removal devices that are implemented in urbanized areas. As such, the project-level impacts on biological resources due to implementation of gross solids removal devices would be similar to the project-level impacts associated with vortex separation systems.

The proposed mitigation measures for gross solids removal devices would be similar to the proposed mitigation measures for vortex separation systems.

Non-Structural BMPs

Non-structural BMPs would involve no change to the physical environment either directly or indirectly and would have no impact that result in change in the diversity of species, or numbers of any species of animals.

5. Animal Life. b. Will the proposal result in reduction of the numbers of any unique, rare or endangered species of animals?

Answer: Less than significant with mitigation incorporated

Vortex Separation Systems

It is possible that direct or indirect impacts to special-status animal species may occur at the project level. Because these animal species are protected by state and/or federal Endangered Species Acts, impacts to them would be considered potentially significant. Even though it is expected that potential projects would occur in previously developed areas it is possible for special-status species to occur in what would generally be described as urban areas. If these species are present during activities such as ground disturbance, construction, and operation and maintenance activities associated with the potential projects, it could conceivably result in direct impacts to special status species including the following:

- Direct loss of a sensitive species
- Increased human disturbance in previously undisturbed habitats
- Mortality by construction or other human-related activity
- Impairing essential behavioral activities, such as breeding, feeding or shelter/refugia
- Destruction or abandonment of active nest(s)/den sites
- Direct loss of occupied habitat

In addition, potential indirect impacts may include but are not limited to, the following:

- Displacement of wildlife by construction activities
- Disturbance in essential behavioral activities due to an increase in ambient noise levels and/or artificial light from outdoor lighting around facilities

The following mitigation measures should be implemented to reduce or avoid potential project-level impacts to unique, rare or endangered species of animals:

Responsible agencies should endeavor to avoid compliance measures that could result in significant impacts to unique, rare or endangered (special-status) species, should any such species be present at locations where such compliance measures might otherwise be performed, and instead opt for such measures as enforcing litter ordinances in sensitive habitat areas. Mitigation measures, however, could be implemented to ensure that potentially significant impacts to special status animal species are less than significant. When the specific projects are developed and sites identified a search of the California Natural Diversity Database could be employed to confirm that any potentially special-status animal species in the site area are properly identified and protected as necessary. Focused protocol animal surveys for special-status animal species will be conducted at each site location.

If special-status animal species are potentially near the project site area, as required by the Endangered Species Act (ESA), two weeks prior to grading or the construction of facilities and per applicable USFWS and/or CDFG protocols, pre-construction surveys to determine the presence or absence of special-status species would be conducted. The

surveys should extend 300 feet off site to determine the presence or absence of any special-status species adjacent to the project site. If special-status species are found to be present on the project site or within the 300 feet buffer area mitigation would be required under the ESA. To this extent mitigation measures would be developed with the USFWS and CDFG to reduce potential impacts. Mitigation can include angling nighttime lighting down and away from potential habitat areas. Furthermore, the use of prismatic glass coverings and cutoff shields is recommended to further prevent light spillover off site.

Catch Basin Inserts

Catch basin inserts fit directly into curbside catch basins in urbanized areas where native habitat or special-status species usually are absent. As such, impacts that result in reduction of the numbers of any unique, rare or endangered species of animals would be avoided. Furthermore, installation of catch basin inserts requires no construction or ground disturbance which could impact biological resources.

Trash Nets

Trash nets are installed within the storm drain systems either inline or at the end of pipe in urbanized areas where native habitat or special-status species usually are absent. As such, impacts to that result in reduction of the numbers of any unique, rare or endangered species of animals would be avoided. Furthermore, installation of trash nets requires minimal construction and no ground disturbance which could impact biological resources.

Gross Solids Removal Devices (GSRDs)

Like vortex separation systems, gross solids removal devices are inline structural trash removal devices that are implemented in urbanized areas. As such, the project-level impacts on biological resources due to implementation of gross solids removal devices would be similar to the project-level impacts associated with vortex separation systems.

The proposed mitigation measures for gross solids removal devices would be similar to the proposed mitigation measures for vortex separation systems.

Non-Structural BMPs

Non-structural BMPs would involve no change to the physical environment either directly or indirectly and would have no impact that result in reduction of the numbers of any unique, rare or endangered species of animals.

5. Animal Life. c. Will the proposal result in introduction of new species of animals into an area, or in a barrier to the migration or movement of animals?

Answer: Less than significant with mitigation incorporated

Vortex Separation Systems

It is not reasonably foreseeable that implementation of vortex separation systems will result in the introduction of a new animal species. In addition, because potential projects

would be established in previously heavily developed areas it is not expected that potential project sites would act as a travel route or regional wildlife corridor. Construction of these facilities would not considerably restrict wildlife movement. A travel route is generally described as a landscape feature (such as a ridgeline, canyon, or riparian strip) within a larger natural habitat area that is used frequently by animals to facilitate movement and provide access to necessary resources (e.g. water, food, den sites). Wildlife corridors are generally an area of habitat, usually linear in nature, which connect two or more habitat patches that would otherwise be fragmented or isolated from one another. It is considered unlikely that vortex separation systems would be constructed in areas such as these.

However, constructed vortex separation systems may potentially impact wildlife crossings. A wildlife crossing is a small narrow area relatively short and constricted, which allows wildlife to pass under or through obstacles that would otherwise hinder movement. Crossings are typically manmade and include culverts, underpasses, and drainage pipes to provide access across or under roads, highways, or other physical obstacles.

Construction activities associated with the implementation of vortex separation systems may impact migratory avian species. These avian species may use portions of potential project sites, including ornamental vegetation, during breeding season and may be protected under the Migratory Bird Treaty Act (MBTA) while nesting. The MBTA includes provisions for protection of migratory birds under the authority of the USFWS and CDFG. The MBTA protects over 800 species including, geese, ducks, shorebirds, raptors, songbirds, and many other relatively common species.

The following mitigation measures should be implemented to reduce or avoid potential project-level impacts to the migration or movement of animals:

If vortex separation systems are implemented at locations where they would foreseeably adversely impact species migration or movement patterns, mitigation measures could be implemented to ensure that impacts which may result in a barrier to the migration or movement of animal is less than significant. Any site-specific wildlife crossings should be evaluated in consultation with CDFG. If a wildlife crossing would be significantly impacted in an adverse manner, then the design of the project should include a new wildlife crossing in the same general location.

If construction occurs during the avian breeding season for special status species and/or MBTA-covered species, generally February through August, then prior (within 2 weeks) to the onset of construction activities, surveys for nesting migratory avian species would be conducted on the project site following USFWS and/or CDFG guidelines. If no active avian nests are identified on or within 200 feet of construction areas, no further mitigation would be necessary.

Alternatively, to avoid impacts, the agencies implementing the TMDL may begin construction after the previous breeding season for covered avian species and before the next breeding season begins. If a protected avian species was to establish an active nest after construction was initiated and outside of the typical breeding season (February – August), the project sponsor, would be required to establish a buffer of 200 feet or as required by USFWS between the construction activities and the nest site.

If active nest for protected avian species are found within the construction footprint or within the 200-foot buffer zone, construction would be required to be delayed within the construction footprint and buffer zone until the young have fledged or appropriate mitigation measures responding to the specific situation are developed in consultation with USFWS or CDFG. These impacts are highly site specific, and assuming they are foreseeable, they would require a project-level analysis and mitigation plan.

Finally, to the extent feasible, responsible agencies should endeavor to avoid compliance measures that could result in significant barriers to the beneficial migration or movement of animals, and instead opt for such measures as enforcing litter ordinances in sensitive areas.

Catch Basin Inserts

Catch basin inserts fit directly into curbside catch basins in urbanized areas where native habitat or special-status species usually are absent. As such, impacts that result in introduction of new species of animals into an area, or in a barrier to the migration or movement of animals would be avoided. Furthermore, installation of catch basin inserts requires no construction or ground disturbance which could impact biological resources.

Trash Nets

Trash nets are installed within the storm drain systems either inline or at the end of pipe in urbanized areas where native habitat or special-status species usually are absent. As such, impacts that result in introduction of new species of animals into an area, or in a barrier to the migration or movement of animals would be avoided. Furthermore, installation of trash nets requires minimal construction and no ground disturbance which could impact biological resources.

Gross Solids Removal Devices (GSRDs)

Like vortex separation systems, gross solids removal devices are inline structural trash removal devices that are implemented in urbanized areas. As such, the project-level impacts on biological resources due to implementation of gross solids removal devices would be similar to the project-level impacts associated with vortex separation systems.

The proposed mitigation measures for gross solids removal devices would be similar to the proposed mitigation measures for vortex separation systems.

Non-Structural BMPs

Non-structural BMPs would involve no change to the physical environment either directly or indirectly and would have no impacts that result in introduction of new species of animals into an area, or in a barrier to the migration or movement of animals.

5. Animal Life. d. Will the proposal result in deterioration to existing fish or wildlife habitat?

Answer: Less than significant

Vortex Separation Systems

Vortex separation systems would not be located within the lake, but rather in the storm drain itself. As such, a foreseeable deterioration of existing fish or wildlife habitat is not anticipated. It is foreseeable, however, that the implementation of the Machado Lake Trash TMDL will considerably improve fish or wildlife habitat by removing trash from the lake.

Catch Basin Inserts

Catch basin inserts fit directly into curbside catch basins in urbanized areas. As such, impacts that result in deterioration to existing fish or wildlife habitat would be avoided.

Trash Nets

Trash nets used for the purposes of compliance with the Trash TMDL would not be located within the lake, but rather in the storm drain itself and would not result in a foreseeable deterioration of existing fish or wildlife habitat.

Gross Solids Removal Devices (GSRDs)

GSRDs would not be located within the lake, but rather in the storm drain itself. As such, a foreseeable deterioration of existing fish habitat is not anticipated. It is foreseeable, however, that the implementation of the Machado Lake Trash TMDL will considerably improve fish or wildlife habitat by removing trash from the lake.

Non-Structural BMPs

Non-structural BMPs would involve no change to the physical environment either directly or indirectly and would have no impacts that result in deterioration to existing fish or wildlife habitat.

6. Noise. a. Will the proposal result in increases in existing noise levels?

Answer: Less than significant with mitigation incorporated

Vortex Separation Systems (CDS Units)

Installation of vortex separation systems would potentially involve removal of asphalt and concrete from streets and sidewalks, excavation and shoring, installation of reinforced concrete pipe, installation of the unit, and repaving of the streets and sidewalks. It is anticipated that installation activities would occur in limited, discrete, and discontinuous areas over a short duration. No major construction activities are anticipated. It is anticipated that excavation, for the purpose of installation, and repaving would result in the greatest increase in noise levels during the period of installation. Table 6.4-1 provides noise levels generated by different machinery that may be used in installing the CDS units. The manufacturer recommends that the unit needs maintenance 2 to 4 times a year depending on amount and frequency of precipitation. Maintenance involves cleaning using vacuum trucks, which would increase ambient noise levels. The increase in noise levels would be dependent on the proximity of sensitive receptors to the site.

Maintenance is also expected to generate 2-4 vehicle trips per year which is not expected to increase ambient noise levels noticeably.

Table 6.4-1: Typical Installation Equipment Noise Emission Levels

Equipment	Maximum Noise Level, (dBA) 50 feet from source	Equipment Usage Factor	Total 8-hr Leq exposure (dBA) at various distances	
			50ft	100ft
Foundation Installation			83	77
Concrete Truck	82	0.25	76	70
Front Loader	80	0.3	75	69
Dump Truck	71	0.25	65	59
Generator to vibrate concrete	82	0.15	74	68
Vibratory Hammer	86	0.25	80	74
Equipment Installation			83	77
Flatbed truck	78	0.15	70	64
Forklift	80	0.27	74	69
Large Crane	85	0.5	82	76

Source; Caltrain, 2004

Contractors and equipment manufacturers have been addressing noise problems for many years, and through design improvements, technological advances, and a better understanding of how to minimize exposures to noise, noise effects can be minimized. An operations plan for the specific construction and/or maintenance activities could be developed to address the variety of available measures to limit the impacts from noise to adjacent homes and businesses. To minimize noise and vibration impacts at nearby sensitive sites, installation activities should be conducted during daytime hours to the extent feasible. There are a number of measures that can be taken to reduce intrusion without placing unreasonable constraints on the installation process or substantially increasing costs. These include noise and vibration monitoring to ensure that contractors take all reasonable steps to minimize impacts when near sensitive areas; noise testing and inspections of equipment to ensure that all equipment on the site is in good condition and effectively muffled; and an active community liaison program. A community liaison program should keep residents informed about installation plans so they can plan around noise or vibration impacts; it should also provide a conduit for residents to express any concerns or complaints.

The following measures would minimize noise and vibration disturbances at sensitive areas during installation:

- Use newer equipment with improved noise muffling and ensure that all equipment items have the manufacturers' recommended noise abatement measures, such as mufflers, engine covers, and engine vibration isolators intact and operational. Newer equipment will generally be quieter in operation than older equipment. All installation equipment should be inspected at periodic intervals to ensure proper maintenance and presence of noise control devices (e.g., mufflers and shrouding).
- Perform all installation in a manner to minimize noise and vibration. Use installation methods or equipment that will provide the lowest level of noise and ground vibration impact near residences and consider alternative methods that are also suitable for the soil condition. The contractor should select installation processes and techniques that create the lowest noise levels.
- Perform noise and vibration monitoring to demonstrate compliance with the noise limits. Independent monitoring should be performed to check compliance in particularly sensitive areas. Require contractors to modify and/or reschedule their installation activities if monitoring determines that maximum limits are exceeded at residential land uses.
- Conduct truck loading, unloading and hauling operations so that noise and vibration are kept to a minimum by carefully selecting routes to avoid going through residential neighborhoods to the greatest possible extent. Ingress and egress to and from the staging area should be on collector streets or higher street designations (preferred).
- Turn off idling equipment.
- Temporary noise barriers shall be used and relocated, as practicable, to protect sensitive receptors against excessive noise from installation activities. Consider mitigation measures such as partial enclosures around continuously operating equipment or temporary barriers along installation boundaries.
- The installation contractor should be required by contract specification to comply with all local noise and vibration ordinances and obtain all necessary permits and variances.

These and other measures can be classified into three distinct approaches as outlined in Table 6.4-2.

Table 6.4-2: Noise Abatement Measures

Type of Control	Description
Source Control	<p><i>Time Constraints</i> – Prohibiting work during sensitive nighttime hours</p> <p><i>Scheduling</i> – performing noisy work during less sensitive time periods</p> <p><i>Equipment Restrictions</i> – restricting the type of equipment used</p> <p><i>Substitute Methods</i> –using quieter equipment when possible</p> <p><i>Exhaust Mufflers</i> – ensuring equipment have quality mufflers installed</p> <p><i>Lubrication and Maintenance</i> – well maintained equipment is quieter</p> <p><i>Reduced Power Operation</i> – use only necessary power and size</p> <p>Limit equipment on-site – only have necessary equipment on-site</p> <p><i>Noise Compliance Monitoring</i> – technician on-site to ensure compliance</p>
Path Control	<p><i>Noise barriers</i> – semi-portable or portable concrete or wooden barriers</p> <p><i>Noise curtains</i> – flexible intervening curtain systems hung from supports</p> <p><i>Increased distance</i> – perform noisy activities further away from receptors</p>
Receptor Control	<p><i>Community participation</i> –open dialog to involve affected parties</p> <p><i>Noise complaint process</i> – ability to log and respond to noise complaints</p>

Adapted from Thalheimer, 2000

Increases in ambient noise levels are expected to be less than significant once mitigation measures have been properly applied.

Catch Basin Inserts

Installation of catch basin inserts should not involve any construction activity or the use of major equipment therefore no significant increase in ambient noise levels is anticipated.

Catch Basin Inserts need to be cleaned regularly. Frequency of cleaning depends on the amount of trash flowing into the insert. Increased street sweeping can decrease the amount of trash, caught by catch basin inserts. Catch basins are cleaned out on varying schedules at a minimum frequency of once a year as a requirement of the MS4 permit. This implementation measure does not require an increase in cleaning frequency above what is already required for existing permits, therefore no significant increase in noise levels are anticipated.

It is not anticipated that ambient noise levels will be adversely affected by the use of catch basin inserts. To the contrary it is expected that since these inserts act to prevent trash from entering the catch basins, the frequency of cleanouts of these basins may be reduced as a result of reduced trash loading. However, in the unlikely event that there should be an increase in noise levels generated by current clean-out practices, the source, path and receptor control measures presented in Table 6.4-2 should be applied.

Trash Nets

Installation of trash nets should not involve any construction activity or the use of major equipment therefore no significant increase in ambient noise levels is anticipated.

Maintenance of the trash nets involves replacing the nets when full or after each major storm event as necessary. Frequency of maintenance would depend on the trash volumes generated in the catchment area of the net. Equipment used to detach and haul away the trash nets may result in temporary increases in ambient noise levels.

In areas where noise levels have the potential to be classified as nuisance, efforts should be made to implement source receptor and path control measures as outlined in Table 6.4-2.

Gross Solids Removal Devices (GSRDs)

GSRD are the trash-reduction BMPs being used by the California Department of Transportation (Caltrans) for highway drainage systems and as such will be located adjacent to freeways and major highways under Caltrans' jurisdiction. Installation of GSRDs would involve activities similar to those for vortex separation system installation. Clean-outs of GRSD systems are expected to occur only once per year. Equipment and/or machinery employed in this exercise may not significantly increase ambient noise levels as the potential sites for these units will already be subject to high traffic noise levels. In addition, increase in noise levels due to clean-outs will be of low frequency and short duration.

In areas where noise levels have the potential to be classified as nuisance, efforts should be made to implement source receptor and path control measures as outlined in Table 6.4-2.

Non-Structural BMPs

Non-structural BMPs are not expected to create any increases in ambient noise levels, hence no mitigation would be required.

6. Noise. b. Will the proposal result in exposure of people to severe noise levels?

Answer: Less than significant with mitigation incorporated

Vortex Separation Systems (CDS Units)

Installation of vortex separation systems would potentially involve removal of asphalt and concrete from streets and sidewalks, excavation and shoring, installation of reinforced concrete pipe, installation of the unit, and repaving of the streets and sidewalks. It is anticipated that installation activities would occur in limited, discrete, and discontinuous areas over a short duration. No major construction activities are anticipated. It is anticipated that excavation, for the purpose of installation, and repaving would result in the greatest increase in noise levels during the period of installation. Table 6.4-1 provides noise levels generated by different machinery that may be used in installing the CDS units. The manufacturer recommends that the unit needs maintenance 2 to 4 times a year depending on amount and frequency of precipitation. Maintenance involves cleaning using vacuum trucks, which would not be expected to increase noise to severe level.

Mitigation has been discussed in 6 (a).

Catch Basin Inserts

Installation of catch basin inserts should not involve any construction activity or the use of major equipment therefore exposure of people to severe noise levels is not anticipated.

Catch Basin Inserts need to be cleaned regularly. Frequency of cleaning depends on the amount of trash flowing into the insert. Increased street sweeping can decrease the amount of trash, caught by catch basin inserts. Catch basins are cleaned out on varying schedules at a minimum frequency of once a year as a requirement of the MS4 permit. This implementation measure does not require an increase in cleaning frequency above what is already required for existing permits, therefore no significant increase in noise levels is anticipated.

Trash Nets

Installation of trash nets should not involve any construction activity or the use of major equipment therefore exposure of people to severe noise levels is not anticipated. Maintenance of the trash nets involves replacing the nets when full or after each major storm event as necessary. Frequency of maintenance would depend on the trash volumes generated in the catchment area of the net. Equipment used to detach and haul

away the trash nets may result in temporary increases in ambient noise levels. However, given the low frequency and short duration of cleanings this impact is not expected to be significant.

Gross Solids Removal Devices

GSRD are the trash-reduction BMPs being used by the California Department of Transportation (Caltrans) for highway drainage systems and as such will be located adjacent to freeways and major highways under Caltrans' jurisdiction. Installation of Gross Solid Removal Devices (GSRDs) would involve activities similar to those for CDS unit installation. Clean-outs of these systems are expected to occur only once per year. Equipment and/or machinery employed in this exercise is not likely to significantly increase ambient noise levels as the potential sites for these units will already be subject to high traffic noise levels. In addition, given the low frequency and short duration of cleanings any further increase in noise levels is not expected to be significant.

In areas where noise levels have the potential to be classified as nuisance, efforts should be made to implement source receptor and path control measures as outlined in Table 6.4-2.

Non-Structural BMPs

Non-structural BMPs are not expected to create any increases in ambient noise levels or exposure of people to severe noise levels; hence, no mitigation would be required.

7. Light and Glare. Will the proposal produce new light or glare?

Answer: Less than significant

Implementation of the proposed Basin Plan amendment is not likely to produce new light or glare because none of the reasonably foreseeable means of compliance involve additional lighting. Should night time construction activities be proposed, or should lighting be used to increase safety around structural BMPs or treatment facilities, potential impacts should be evaluated at the project level. A lighting plan could be prepared to include shielding on all light fixtures and address limiting light trespass and glare through the use of shielding and directional lighting methods, including but not limited to, fixture location and height. Potential mitigation efforts may also include screening and low-impact lighting.

8. Land Use. a. Will the proposal result in substantial alteration of the present or planned land use of an area?

Answer: Less than significant

Vortex Separation Systems

Vortex Separation Systems (i.e. CDS unit) are installed below grade and are appropriate for highly urbanized areas where space is limited. In general a CDS unit occupies about 4-1/2 square feet of plan view area for each cfs of runoff that is treated with the bulk of the plan view area being well below grade. Maintenance of the CDS unit involves the

removal of the solids either by using a vactor truck, a removable basket or a clam shell excavator depending on the design and size of the unit.

The installation of CDS units may require modification of storm water conveyance structures; however, these units would generally be sited below grade and within existing storm drain infrastructure. The installation of CDS units is not expected to result in substantial alterations or adverse impacts to present or planned land use. To the extent that there could be land use impacts at a specify location, these potential land use conflicts are best addressed at the project level. Since, the Regional Board cannot specify the manner of compliance with the TMDL the Regional Board can not specify the exact location of trash removal devices. The various cities that might install these devices will need to identify local land use plans as part of a program-level analysis to ensure that projects comply with permitted use regulations and are consistent with land use plans, general plans, specific plans, conditional uses, or subdivisions.

Construction of CDS units will not result in permanent features such as above-ground infrastructure that would disrupt, divide, or isolate existing communities or land uses. Construction activities could follow standard mitigation methods and BMPs to reduce any potential impact on surrounding land uses and access to all adjacent land uses could be provided during the construction period.

Commentors on previous trash TMDLs have commented that adequate land might be unavailable for multiple structural compliance measures, particularly from this and subsequent TMDLs. The infeasibility of specific compliance measures, however, is not subject to CEQA analysis, absent a showing that such infeasibility could result in alternatives that do have attendant adverse environmental impacts. No evidence or suggestion of such alternatives were voiced, however. Upon inquiry, the issue was admittedly one of cost, rather than environmental degradation, which is not subject to CEQA analysis.

Gross Solids Removal Devices

The Gross Solids Removal Devices (GSRDs) were developed by Caltrans to be retrofitted below grade into existing highway drainage systems or installed in future highway drainage systems. These devices are appropriate for highly urbanized areas where space is limited. The GSRDs can be designed to accommodate vehicular loading. Maintenance of the devices involves the removal of the solids either by using a vactor truck or other equipment.

The installation of GSRDs may require modification of storm water conveyance structures; however, these units would generally be sited below grade and within existing storm drain infrastructure. The installation of GSRDs is not expected to result in substantial alterations or adverse impacts to present or planned land use. To the extent that there could be land use impacts at a specify location, these potential land use conflicts are best addressed at the project level. Since, the Regional Board cannot specify the manner of compliance with the TMDL the Regional Board can not specify the exact location of trash removal devices. The cities that might install these devices will need to identify local land use plans as part of a project-level analysis to ensure that projects comply with permitted use regulations and are consistent with land use plans, general plans, specific plans, conditional uses, or subdivisions.

Construction of GSRDs will not result in permanent features such as above-ground infrastructure that would disrupt, divide, or isolate existing communities or land uses. Construction activities could follow standard mitigation methods and BMPs to reduce any potential impact on surrounding land uses and access to all adjacent land uses could be provided during the construction period.

Trash Nets

Since, trash nets can be installed at or below grade within existing storm water conveyance structures or retrofitted to an existing outfall structure with only minor modifications no adverse impacts are expected on present or planned land use.

Catch Basin Inserts

Since, catch basin inserts can be installed at or below grade within existing storm water catch basins with minor modifications to the storm water conveyance structure no adverse impacts are expected on present or planned land use.

Non-Structural BMPs

Non-structural BMPs would involve no change to the physical environment either directly or indirectly and are not expected to alter present or planned land use.

9. Natural Resources. a. Will the proposal result in increase in the rate of use of any natural resources,

Answer: No impact

Vortex Separation Systems (CDS Units)

Installation and maintenance of CDS Units are not foreseeably likely to significantly increase the rate of use of any natural resources or cause substantial depletion of any nonrenewable natural resource. Installation and maintenance of CDS Units would not require quarrying, mining, dredging, or extraction of locally important mineral resources. Installation and maintenance of CDS Units may consume electricity to operate pumps, etc., but not at levels which would cause impacts. Furthermore, CDS units can be designed to operate hydraulically without the need for pumps.

Catch Basin Inserts

Installation and maintenance of Catch Basin Inserts are not foreseeably likely to significantly increase the rate of use of any natural resources or cause substantial depletion of any nonrenewable natural resource. Installation and maintenance of Catch Basin Inserts would not require quarrying, mining, dredging, or extraction of locally important mineral resources.

Trash Nets

Installation and maintenance of Trash Nets are not foreseeably likely to significantly increase the rate of use of any natural resources or cause substantial depletion of any

nonrenewable natural resource. Installation and maintenance of Trash Nets would not require quarrying, mining, dredging, or extraction of locally important mineral resources.

Gross Solids Removal Devices (GSRDs)

Installation and maintenance of GSRDs are not foreseeably likely to significantly increase the rate of use of any natural resources or cause substantial depletion of any nonrenewable natural resource. Installation and maintenance of GSRDs would not require quarrying, mining, dredging, or extraction of locally important mineral resources. Installation and maintenance of GSRDs may consume electricity.

Non-Structural BMPs

Non-structural BMPs are not expected to result in increase in the rate of use of any natural resources. It is reasonably foreseeable that the regulation would precipitate education about the environmental and economic effects of litter, and thereby stimulate greater efforts to use less disposable materials, and to recycle more, thus reducing the use of resources including natural resources. Increased recycling would be considered a positive environmental impact. (See 15.a.)

9. Natural Resources. b Will the proposal result in substantial depletion of any non-renewable natural resource

Answer: No impact

See 9. a.

10. Risk of Upset Will the proposal involve a risk of an explosion or the release of hazardous substances (including, but not limited to: oil, pesticides, chemicals or radiation) in the event of an accident or upset conditions?

Answer: Less than significant with mitigation incorporated

Vortex Separation Systems

It is reasonably foreseeable that hazards or hazardous materials could be encountered during the installation of vortex separation systems. Contamination could exist depending on the current and historical land uses of the area. The use of hazardous materials (e.g., paint, oil, gasoline) and potential for accidents is also likely during installation.

Trash that is trapped by vortex separation systems could become hazardous to the public or to maintenance workers who collect and transport the trash if it is not handled in a timely manner and disposed of appropriately.

Installation of vortex separation systems could result in the temporary interference of emergency response or evacuation plans if construction equipment, road closures, or traffic interfered with emergency vehicles traveling through the installation area.

As vortex separation systems will be located in urbanized areas, it is not reasonably foreseeable that their installation would expose people to wildland fires. Furthermore,

these are structural trash removal devices that would not serve as residences or places of employment. They would not result in a safety hazard for people residing or working within two miles of public airport or public use airport.

To the extent that installation of vortex separation systems could involve work with or near hazards or hazardous materials, potential risks of exposure can be mitigated with proper handling and storage procedures. The health and safety plan prepared for any project should address potential effects from cross contamination and worker exposure to contaminated soils and water and should include a plan for temporary storage, transportation and disposal of contaminated soils and water. Compliance with the requirements of California Occupational Health and Safety Administration CalOSHA and local safety regulations during installation, operation, and maintenance of these systems would prevent any worksite accidents or accidents involving the release of hazardous materials into the environment, which could harm the public, nearby residents and sensitive receptors such as schools. Systems can be redesigned and sites can be properly protected with fencing and signs to prevent accidental health hazards.

To the extent that trash trapped by vortex separation systems could become hazardous, impacts to maintenance workers and the public could be avoided or mitigated by educating the local community of the effects of improper disposal of such wastes, enforcing litter ordinances, and timely cleaning out inserts and structural controls.

To the extent that installation of vortex separation systems interfered with emergency response or evacuation plans, traffic control plans could be used to manage traffic through installation zones.

To the extent that vortex separation systems become a source of standing water and vector production, design at the project-level can help mitigate vector production from standing water. For example, in the Los Angeles River trash TMDL Regional Board hearing, the City of Los Angeles commented about vector creation and upstream flooding due to head loss. CDS Technologies described mitigation measures that CDS Technologies took in the installation of the CDS units in Los Angeles. Vector creation was mitigated at the project planning phase. The unit was planned to be installed at least 75 feet from inlet and outlet pipes to mitigate vector habitats. The unit was factory sealed to further prevent vector harborage. To mitigate upstream flooding, CDS Technologies redesigned their weir boxes and customized their diversion structures. They increased the surface area of their diversion structures to lower the depth of flow and reduced overall raised water surface. The unit also had a bypass overflow in case flow exceeds treatment capacity. Netting can be installed over devices to further mitigate vector production. Vector control agencies may also be employed as another source of mitigation. Systems that are prone to standing water can be selectively installed away from high-density areas and away from residential housing and/or by requiring oversight and treatment of those systems by vector control agencies.

Catch Basin Inserts

Catch basin inserts fit directly into curbside catch basins in urbanized areas and require no construction or ground disturbance. There is therefore no potential to encounter contaminated soils or groundwater or other hazards from this alternative means of compliance. Since no construction is required, the use of hazardous materials or

potential for construction accidents is unlikely during installation. However, catch basin cleaning and maintenance could pose risks to maintenance workers.

To the extent that catch basin cleaning and maintenance could pose risks to maintenance workers, mitigation measures to avoid these risks include requiring workers to obtain hazardous materials maintenance, record keeping, and disposal activities training, OSHA-required Health and Safety Training, and OSHA Confined Space Entry training.

Trash Nets

Trash nets are installed within the storm drain system either inline or at the end of pipe. There is therefore no potential to encounter contaminated soils or groundwater or other hazards from this alternative means of compliance. Since no construction is required, the use of hazardous materials or potential for construction accidents is unlikely during installation.

Gross Solids Removal Devices (GSRDs)

Like vortex separation systems, gross solids removal devices are inline structural trash removal devices that are implemented in urbanized areas. As such, the project-level impacts related to hazards and hazardous materials due to implementation of gross solids removal devices would be similar to the project-level impacts associated with vortex separation systems.

The proposed mitigation measures for gross solids removal devices would be similar to the proposed mitigation measures for vortex separation systems.

Non-Structural BMPs

Non-structural BMPs would involve no change to the physical environment either directly or indirectly and would have no impact related to hazards, hazardous materials, or human health.

11. Population. Will the proposal alter the location, distribution, density, or growth rate of the human population of an area?

Answer: No impact

Vortex Separation Systems

Vortex Separation Systems (i.e. CDS unit) are installed below grade and are appropriate for highly urbanized areas where space is limited. The installation of CDS units may require modification of storm water conveyance structures. Maintenance of the CDS unit involves the removal of the solids either by using a vacuum truck, a removable basket or a clam shell excavator depending on the design and size of the unit.

Therefore, it is not reasonably foreseeable that the installation and maintenance of CDS units would directly or indirectly induce population growth or displace people.

Catch Basin Inserts

Catch basin inserts fit directly into curbside catch basins in urbanized areas. It is not reasonably foreseeable that the installation and maintenance of catch basin inserts would induce population growth or displace people.

Gross Solids Removal Devices

The Gross Solids Removal Devices (GSRDs) were developed by Caltrans to be retrofitted below grade into existing highway drainage systems or installed in future highway drainage systems. These devices are appropriate for highly urbanized areas where space is limited. The GSRDs can be designed to accommodate vehicular loading. Maintenance of the devices involves the removal of the solids either by using a vactor truck or other equipment.

Therefore, it is not reasonably foreseeable that the installation and maintenance of GSRDs would directly or indirectly induce population growth or displace of people.

Trash Nets

Trash nets are installed within the storm drain system either inline or at the end of pipe. It is not reasonably foreseeable that the installation and maintenance of trash nets would induce population growth or displace people.

Non-Structural BMPs

It is not reasonably foreseeable that non-structural BMPs would induce population growth or displace people.

12. Housing. Will the proposal affect existing housing, or create a demand for additional housing?

Answer: No impact

Vortex Separation Systems

Vortex Separation Systems (i.e. CDS unit) are installed below grade and are appropriate for highly urbanized areas where space is limited. The installation of CDS units may require modification of storm water conveyance structures. These devices can be installed in existing storm drain infrastructure, therefore, no additional land is required nor is there a need to displace existing housing. Maintenance of the CDS unit involves the removal of the solids either by using a vactor truck, a removable basket or a clam shell excavator depending on the design and size of the unit.

Therefore, it is not reasonably foreseeable that the installation and maintenance of CDS units would directly or indirectly affect existing housing, or create a demand for additional housing.

To the extent that these devices, if employed, may conceivably require the displacement of available housing, it is not reasonably foreseeable that the responsible agencies

would install such a device. Rather, an agency would foreseeably opt for non-structural control measures, such as enforcing litter ordinances.

Catch Basin Inserts

Catch basin inserts fit directly into curbside catch basins in urbanized areas. It is not reasonably foreseeable that the installation and maintenance of catch basin inserts would affect existing housing, or create a demand for additional housing.

Trash Nets

Trash nets are installed within the storm drain system either inline or at the end of pipe. It is not reasonably foreseeable that the installation and maintenance of trash nets would affect existing housing, or create a demand for additional housing.

Gross Solids Removal Devices

The Gross Solids Removal Devices (GSRDs) were developed by Caltrans to be retrofitted below grade into existing highway drainage systems or installed in future highway drainage systems. These devices are appropriate for highly urbanized areas where space is limited. The GSRDs can be designed to accommodate vehicular loading. Maintenance of the devices involves the removal of the solids either by using a vactor truck or other equipment.

The installation of GSRDs may require modification of storm water conveyance structures; however, these units would generally be sited below grade and within existing storm drain infrastructure. The installation of GSRDs is not expected to require additional land nor is there a need to displace existing housing.

To the extent that these devices, if employed, may conceivably require the displacement of available housing, it is not reasonably foreseeable that the responsible agencies would install such a device. Rather, an agency would foreseeably opt for non-structural control measures, such as enforcing litter ordinances.

Non-Structural BMPs

It is not reasonably foreseeable that non-structural BMPs would affect existing housing, or create a demand for additional housing.

13. Transportation/Circulation. a. Will the proposal result in generation of substantial additional vehicular movement?

Answer: Less than significant with mitigation incorporated

Vortex Separation Systems

The proposal may result in additional vehicular movement during installation of Vortex Separation Systems. These impacts will be temporary and limited in duration to the period of installation. Maintenance requirements for trash removal devices demonstrate that devices could be emptied when they reach 85% capacity. However, trash removal devices can be designed so that they need be cleaned only once per storm season. The

proposed project would be in conformance with the existing Los Angeles County congestion management plan (CMP), and this impact would be less than significant.

In order to reduce the impact of construction traffic, implementation of a construction management plan for specified facilities could be developed to minimize traffic impacts upon the local circulation system. A construction traffic management plan could address traffic control for any street closure, detour, or other disruption to traffic circulation. The plan could identify the routes that construction vehicles will use to access the site, hours of construction traffic, and traffic controls and detours. The plan could also include plans for temporary traffic control, temporary signage and tripping, location points for ingestion and egress of construction vehicles, staging areas, and timing of construction activity which appropriately limits hours during which large construction equipment may be brought on or off site. Potential impacts could also be reduced by limiting or restricting hours of construction so as to avoid peak traffic times and by providing temporary traffic signals and flagging to facilitate traffic movement.

To the extent that significant adverse traffic impacts occur in a given locality, those effects are already occurring in the Trash TMDL implementation area and should be considered baseline impacts. Nevertheless, to the extent the locality that originated the trash would become newly exposed to increased traffic from the need to properly dispose of trash generated locally instead of downstream jurisdictions, those impacts could be potentially significant in those locales.

Catch Basin Inserts

No construction activity or use of heavy equipment is anticipated for catch basin insert installation. Therefore additional vehicular movement during installation of the catch basin inserts to control trash is unlikely to be significant. Also, it is not anticipated that any such increase will have an adverse effect on traffic and transportation in the watershed, as they would be limited and short-term. With respect to maintenance, catch basins need to be cleaned regularly. Frequency of cleaning depends on the amount of trash flowing in through the insert. Catch basins are cleaned out on varying schedules at a minimum frequency of once a year as a requirement of the MS4 permit. This implementation measure does not require an increase in cleaning frequency above what is already required for existing permits, therefore no significant increase in traffic is anticipated. Impacts from other maintenance activities, such as street sweeping, are not expected to be significant.

Trash Nets

The number of end-of-pipe trash nets installed will be limited by the number of suitable locations within the watershed. Installation and maintenance of trash nets will create similar environmental impacts similar to those of the vortex separation systems.

Mitigation measures to be applied will be the same as those for the vortex separation systems

Gross Solids Removal Devices

Gross Solids Removal Devices are the implementation alternatives developed by Caltrans for trash reduction from roadways. Hence their installation will foreseeably be

limited to rights of way over which Caltrans has jurisdiction. In the Caltrans gross solids removal devices pilot studies, interim cleaning was not required and trash was removed only once per season. The proposed project would be in conformance with the Los Angeles County CMP, and this impact would be a less than significant impact.

Mitigation measures to be applied will be the same as those for the vortex separation systems.

Increased Street Sweeping

The number of trips generated by increased street sweeping will depend of the magnitude of increase in sweeping frequency determined by any responsible agency choosing to use this implementation alternative. It is not anticipated that such increases will have a significant impact on traffic and transportation. However, in the unlikely event that traffic and or transportation systems are negatively compromised, mitigation measures similar to those described for the vortex separation systems could be applied.

Other Non-Structural BMPs

It is not reasonably foreseeable that other non-structural BMPs would result in generation of substantial additional vehicular movement.

13. Transportation/Circulation. b. Effects on existing parking facilities, or demand for new parking?

Answer: Less than significant with mitigation incorporated

Vortex Separation Systems

The proposal may result in alterations to existing parking facilities to incorporate Vortex Separation Systems for trash control.

Vortex Separation Systems can be designed to accommodate space constraints or be placed under parking spaces and would not significantly decrease the amount of parking available in existing parking facilities. Available parking spaces can be reconfigured to provide equivalent number of spaces or provide functionally similar parcel for use as offsite parking to mitigate potential adverse parking impacts.

Catch Basin Inserts

Catch basin inserts fit directly into curbside catch basins in urbanized areas and require no construction or ground disturbance. It is not reasonably foreseeable that Catch basin inserts would have effects on existing parking facilities, or demand for new parking.

Trash Nets

Trash nets are installed within the storm drain systems either inline or at the end of pipe in urbanized areas. It is not reasonably foreseeable that Catch basin inserts would have effects on existing parking facilities, or demand for new parking.

Gross Solids Removal Devices

Impacts and mitigation measures will be the same as those for the vortex separation systems.

Non-Structural BMPs

It is not reasonably foreseeable that non-structural BMPs would have effects on existing parking facilities, or demand for new parking.

13. Transportation/Circulation. c. Will the proposal result in substantial impacts upon existing transportation systems?

Answer: Less than significant

Vortex Separation Systems

The proposal may result in temporary alterations to existing transportation systems during construction of vortex separation systems. The potential impacts are limited and short-term.

Potential impacts could be reduced by limiting or restricting hours of construction so as to avoid peak traffic times and by providing temporary traffic signals and flagging to facilitate traffic movement.

Catch Basin Inserts

Catch basin inserts fit directly into curbside catch basins in urbanized areas and require no construction or ground disturbance. It is not reasonably foreseeable that Catch basin inserts would result in substantial impacts upon existing transportation systems.

Trash Nets

The number of end-of pipe trash nets installed will be limited by the number of suitable locations within the watershed. Installation and maintenance of trash nets will create similar environmental impacts similar to those of the vortex separation systems.

Mitigation measures to be applied will be the same as those for the vortex separation systems

Gross Solids Removal Devices

Gross Solids Removal Devices are the implementation alternatives developed by Caltrans for trash reduction from roadways. Hence their installation will foreseeably be limited to rights of way over which Caltrans has jurisdiction. In the Caltrans gross solids removal devices pilot studies, interim cleaning was not required and trash was removed only once per season. Installation and maintenance of Gross Solids Removal Devices will create similar environmental impacts similar to those of the vortex separation systems.

Mitigation measures to be applied will be the same as those for the vortex separation systems.

Non-Structural BMPs

It is not reasonably foreseeable that non-structural BMPs would result in substantial impacts upon existing transportation systems.

13. Transportation/Circulation. d. Will the proposal result in alterations to present patterns of circulation or movement of people and/or goods?

Answer: Less than significant

See response to "Transportation/Circulation." 13.b., and 13.c.

13. Transportation/Circulation. e. Will the proposal result in alterations to waterborne, rail or air traffic?

Answer: Less than significant

Vortex Separation Systems

The proposal may potentially result in temporary alterations to rail transportation during construction of storm water diversion or treatment facilities. The potential impacts would be limited and short-term.

The potential impacts could be avoided or minimized through siting, designing, and scheduling of construction activities.

Catch Basin Inserts

Catch basin inserts fit directly into curbside catch basins in urbanized areas and require no construction or ground disturbance. It is not reasonably foreseeable that Catch basin inserts would result in alterations to waterborne, rail or air traffic.

Trash Nets

The number of end-of pipe trash nets installed will be limited by the number of suitable locations within the watershed. Installation and maintenance of trash nets will create similar environmental impacts similar to those of the vortex separation systems.

Mitigation measures to be applied will be the same as those for the vortex separation systems

Gross Solids Removal Devices

Gross Solids Removal Devices are the implementation alternatives developed by Caltrans for trash reduction from roadways. Hence their installation will foreseeably be limited to rights of way over which Caltrans has jurisdiction. In the Caltrans gross solids removal devices pilot studies, interim cleaning was not required and trash was removed only once per season. Installation and maintenance of Gross Solids Removal Devices will create similar environmental impacts similar to those of the vortex separation systems.

Mitigation measures to be applied will be the same as those for the vortex separation systems.

Non-Structural BMPs

It is not reasonably foreseeable that non-structural BMPs would result in alterations to waterborne, rail or air traffic.

13. Transportation/Circulation. f. Will the proposal result in increase in traffic hazards to motor vehicles, bicyclists or pedestrians?

Answer: Less than significant with mitigation incorporated

Vortex Separation Systems

The foreseeable methods of compliance may entail short-term disturbances during construction of Vortex Separation Systems. It is not foreseeable that this proposal will result in significant increases in traffic hazards to motor vehicles, bicyclists or pedestrians, especially when considered in light of those hazards currently endured in an ordinary urbanized environment.

The specific project impacts can be mitigated by appropriate mitigation methods during construction. To the extent that site-specific projects entail excavation in roadways, such excavations should be marked, barricaded, and traffic flow controlled with signals or traffic control personnel in compliance with authorized local police or California Highway Patrol requirements. These methods would be selected and implemented by responsible local agencies considering project level concerns. Standard safety measures should be employed including fencing, other physical safety structures, signage, and other physical impediments designed to promote safety and minimize pedestrian/bicyclists accidents.

Catch Basin Inserts

Catch basin inserts fit directly into curbside catch basins in urbanized areas and require no construction or ground disturbance. It is not reasonably foreseeable that catch basin inserts would result in increase in traffic hazards to motor vehicles, bicyclists or pedestrians.

Trash Nets

The number of end-of pipe trash nets installed will be limited by the number of suitable locations within the watershed. Installation and maintenance of trash nets will create similar environmental impacts similar to those of the vortex separation systems.

Mitigation measures to be applied will be the same as those for the vortex separation systems

Gross Solids Removal Devices

Gross Solids Removal Devices are the implementation alternatives developed by Caltrans for trash reduction from roadways. Hence their installation will foreseeably be

limited to rights of way over which Caltrans has jurisdiction. In the Caltrans gross solids removal devices pilot studies, interim cleaning was not required and trash was removed only once per season. Installation and maintenance of Gross Solids Removal Devices will create similar environmental impacts similar to those of the vortex separation systems.

Mitigation measures to be applied will be the same as those for the vortex separation systems.

Non-Structural BMPs

It is not reasonably foreseeable that non-structural BMPs would result in result in increase in traffic hazards to motor vehicles, bicyclists or pedestrians.

14. Public Service. a. Will the proposal have an effect upon, or result in a need for new or altered governmental services in any of the following areas: Fire protection?

Answer: Less than significant with mitigation incorporated

Vortex Separation Systems

There is potential for temporary delays in response times of fire vehicles due to road closure/traffic congestion during installation of the CDS units. To mitigate potential delays the responsible agencies could notify local emergency and police service providers of construction activities and road closures, if any, and coordinate with the local fire protection to establish alternative routes and traffic control during the installation activities. Most jurisdictions have in place established procedures to ensure safe passage of emergency vehicles during periods of road maintenance, construction, or other attention to physical infrastructure, and there is no evidence to suggest that installation of these structural devices would create any more significant impediments than other such typical activities. Any construction activity would be subject to applicable building and safety codes and permits. Therefore, the potential delays in response times for fire vehicles after mitigation are less than significant.

Since, the installation of CDS units will not result in development of land uses for residential, commercial, and/or industrial uses nor will the these units result in increase growth, it is reasonably foreseeable that the CDS units would not result in a need for new or altered fire protection services. In addition, Emergency Preparedness Plans could be developed in consultation with local emergency providers to ensure that the new CDS units will not contribute to an increase in the cumulative demand for fire protection services.

Gross Solids Removal Devices

Gross Solids Removal Devices are the implementation alternatives developed by Caltrans for trash reduction from roadways. Hence their installation will foreseeably be limited to rights of way over which Caltrans has jurisdiction. In the Caltrans gross solids removal devices pilot studies, interim cleaning was not required and trash was removed only once per season. Installation and maintenance of Gross Solids Removal Devices will create similar environmental impacts similar to those of the vortex separation systems.

Mitigation measures to be applied will be the same as those for the vortex separation systems.

Trash Nets

The environmental impacts associated with the installation, maintenance and monitoring of trash nets are similar to those for the CDS and VSS units. Although the delays due to installations will be more localized and of shorter duration since the installation of trash nets is not as complicated as the other structural BMPs. More maintenance may be required depending on the design of these units since, the capacity for trash collection may be limited to the size of the unit.

Catch Basin Inserts

The environmental impacts associated with the installation, maintenance and monitoring of catch basin inserts are similar to those for the trash nets. As with the trash nets, more maintenance may be required depending on the design of these units since, the capacity for trash collection may be limited to the size of the catch basin.

Non-structural BMPs

It is not reasonably foreseeable that non-structural BMPs would result in a need for new or altered governmental services in fire protection.

14. Public Service. b. Will the proposal have an effect upon, or result in a need for new or altered governmental services in any of the following areas: Police protection?

Answer: Less than significant with mitigation incorporated

Vortex Separation Systems

There is potential for temporary delays in response times of police vehicles due to road closure/traffic congestion during installation of the CDS units. To mitigate potential delays the responsible agencies could notify local emergency and police service providers of construction activities and road closures, if any, and coordinate with the local fire protection to establish alternative routes and traffic control during the installation activities. Most jurisdictions have in place established procedures to ensure safe passage of emergency vehicles during periods of road maintenance, construction, or other attention to physical infrastructure, and there is no evidence to suggest that installation of these structural devices would create any more significant impediments than other such typical activities. Any construction activity would be subject to applicable building and safety codes and permits. Therefore, the potential delays in response times for police vehicles after mitigation are less than significant.

Since, the installation of CDS units will not result in development of land uses for residential, commercial, and/or industrial uses nor will these units result in increase growth, it is reasonably foreseeable that the CDS units would not result in a need for new or altered police protection services. In addition, Emergency Preparedness Plans could be developed in consultation with local emergency providers to ensure that the new CDS units will not contribute to an increase in the cumulative demand for police protection services.

Gross Solids Removal Devices

Gross Solids Removal Devices are the implementation alternatives developed by Caltrans for trash reduction from roadways. Hence their installation will foreseeably be limited to rights of way over which Caltrans has jurisdiction. In the Caltrans gross solids removal devices pilot studies, interim cleaning was not required and trash was removed only once per season. Installation and maintenance of Gross Solids Removal Devices will create similar environmental impacts similar to those of the vortex separation systems.

Mitigation measures to be applied will be the same as those for the vortex separation systems.

Trash Nets

The environmental impacts associated with the installation, maintenance and monitoring of trash nets are similar to those for the CDS and VSS units. Although the delays due to installations will be more localized and of shorter duration since the installation of trash nets is not as complicated as the other structural BMPs. More maintenance may be required depending on the design of these units since the capacity for trash collection may be limited to the size of the unit.

Catch Basin Inserts

The environmental impacts associated with the installation, maintenance and monitoring of catch basin inserts are similar to those for the trash nets. As with the trash nets, more maintenance may be required depending on the design of these units since, the capacity for trash collection may be limited to the size of the catch basin.

Non-Structural BMPs

It is not reasonably foreseeable that non-structural BMPs would result in a need for new or altered governmental services in police protection.

14. Public Service. c. Will the proposal have an effect upon, or result in a need for new or altered governmental services in any of the following areas: Schools?

Answer: No impact

Proposed implementation strategies for this TMDL include stormwater best management practices, storm drain diversions and treatment strategies, and pollution prevention. It is not foreseeable that this proposal will have an effect upon, or result in a need for new or altered any school services.

14. Public Service. d. Will the proposal have an effect upon, or result in a need for new or altered governmental services in any of the following areas: Parks or other recreational facilities?

Answer: No impact

It is not foreseeable that this proposal will have a negative impact upon, or result in a need for new or altered governmental services to parks or other recreational facilities.

14. Public Service. e. Will the proposal have an effect upon, or result in a need for new or altered governmental services in any of the following areas: maintenance of public facilities, including roads?

Answer: Less than significant with mitigation incorporated

The proposal will result in the need for increased maintenance of public facilities and, specifically, stormwater treatment or structural BMPs. Non-structural BMPs, such as increased storm drain catch basin cleanings and improved street cleaning, would require additional road maintenance as well. While these requirements may result in increases in maintenance costs, any increase will be outweighed by the resulting overall improvement in water quality and protection of human health. To the extent that significant costs may be imposed upon a given locality, those effects are already occurring in the watershed and should be considered baseline impacts, as they are presently carried by downstream communities. Nevertheless, to the extent the locality that originated the trash would become newly exposed to increased costs from the need to properly dispose of trash generated locally instead of downstream jurisdictions, those impacts could be potentially significant in those locales. On balance, it is not unfair to subject localities to the effects of abating litter generated locally in local storm drains, rather than causing the downstream cities to bear the costs of cleaning up the trash collected from all the upstream cities. Nevertheless, an increased cost of maintenance is not an “environmental” impact that involves a change in the physical environment.

14. Public Service. f. Will the proposal have an effect upon, or result in a need for new or altered governmental services in any of the following areas: other government services?

Answer: Less than significant with mitigation incorporated

The proposal will result in the need for increased monitoring in the Machado Lake, and its tributaries to track compliance with the TMDL. Non-structural BMPs, such as education and outreach, would result in the need for new or altered governmental services. In addition, as described in 14.e., additional maintenance would be required for street sweeping and structural BMP maintenance. Nevertheless, these types of alterations to governmental services are not “environmental” impacts that involve a change in the physical environment.

15. Energy. a. Will the proposal result in use of substantial amounts of fuel or energy?

Answer: Less than significant impact

The foreseeable means of compliance with the proposed Basin Plan Amendment include a mix of non-structural and structural methods to control trash, several of which will require expenditure of fuel or energy. However, compliance should not result in the use of substantial additional amounts of fuel or energy, or a substantial increase in demand upon existing sources of energy, or require the development of new sources of energy.

A full capture vortex separation system would require fuel for heavy equipment and fuel for vacuum trucks maintenance. Other full capture systems and catch basin inserts may require heavy equipment for maintenance in the form of dump trucks. Maintenance requirements for trash removal devices demonstrate that devices should be emptied when they reach 85% capacity. However, trash removal devices can be designed so that they need be cleaned only once per storm season. In the Caltrans gross solids removal devices pilot studies, interim cleaning was not required and trash was removed only once per season. Therefore the proposal is not expected to place substantial increases on existing energy supply.

Responsible agencies may avoid some use of fuel or energy by enforcement of litter laws and institutional controls which could lessen the increase in truck trips and the demand for fuel. The cleaning of catch basin inserts and other full capture systems can coincide with residential and commercial trash pickup schedules to decrease the added vehicle trips for dump trucks. In addition, increased fuel consumption from added street sweeping could also be mitigated by the gradual installation of full capture systems, decreasing the need for added street sweeping.

15. Energy. b. Will the proposal result in a substantial increase in demand upon existing sources of energy, or require the development of new sources of energy.

Answer: Less than significant impact

See response to "15. Energy. a."

16. Utilities and Service Systems. a. Will the proposal result in a need for new systems, or substantial alterations to the following utilities: power or natural gas?

Answer: Less than significant impact

The installation of full or partial trash capture systems would not require or result in the construction of new energy production or transmission facilities. These trash capture systems do not require power for operation. However; there is the limited potential that power or natural gas lines may conflict with the installation of a full capture trash system at specific locations; although with careful placement of the full capture trash system this issue should be avoided. It is not anticipated that the implementation of full or partial trash capture systems will require substantial alterations to power or natural gas utilities.

16. Utilities and Service Systems. b. Will the proposal result in a need for new systems, or substantial alterations to the following utilities: communications systems?

Answer: Less than significant impact

Implementation of this TMDL will require new trash control structures. It is anticipated that construction and maintenance crews will use various communication systems such as, telephones, cell phones, and radios. These types of communication devices and systems are used daily by the construction and maintenance personnel as part of regular business activities. It is not expected that the implementation full or partial trash capture systems would create undue stress on the established communication systems and will not require substantial alterations to the current communication system or a new communication system.

16. Utilities and Service Systems. c. Will the proposal result in a need for new systems, or substantial alterations to the following utilities: water?

Answer: Less than significant impact

Potential projects associated compliance with the Machado Lake TMDL will not result in the need for a new or substantial alteration to water supply utilities. The implementation of the Machado Lake TMDL will not result in the development of any large residential, retail, industrial or any other development projects that would significantly increase the demand on the current water supply facilities or require new water supply facilities.

16. Utilities and Service Systems. d. Will the proposal result in a need for new systems, or substantial alterations to the following utilities: Sewer or septic tanks?

Answer: No impact

Implementation of the Machado Lake trash TMDL involves a progressive reduction in trash discharges to Machado Lake through structural BMPs, enforcement of existing litter laws, and institutional controls. These strategies to reduce trash are not related to the sewer system and will not affect Publicly-Owned Treatment Works (POTWs) nor will they impact any septic tank systems. The implementation of the trash TMDL will not result in the need for a new or alterations to existing sewer or septic tank systems. The structural BMPs that may be implemented as part of the trash TMDL such as catch basin inserts will be implemented to update the storm drain system and reduce trash to Machado Lake. The storm drain system is completely separate from the sewer system and septic tank systems; thus the sewer and septic systems will not be impacted.

16. Utilities and Service Systems. e. Will the proposal result in a need for new systems, or substantial alterations to the following utilities: storm water drainage?

Answer: Less than significant with mitigation incorporated

Vortex Separation Systems

Vortex Separation Systems (i.e. CDS unit) are devices designed to allow the incoming flow of urban runoff or storm water to pass through the device while capturing trash and other debris within the unit. These types of devices may result in a potentially significant impact due to flooding hazards if the screens became blocked by trash and debris and prevent the discharge of storm water to the Machado Lake or if the CDS units are not properly designed and constructed to allow for bypass of storm water during storm events that exceed the design capacity. This potential impact can be mitigated through the design of the CDS units with overflow/bypass structures and by performing regular maintenance to prevent the build up of trash and debris. The CDS units may cause a significant change in the drainage patterns, rate and amount of surface water runoff. These units may impede or slow overland flow to the storm drain system. Any device installed in a storm drain, especially an older, under-capacity drain could have a negative effect on the drain's ability to convey surface waters including flood waters. This negative impact can be mitigated through design of the CDS units with overflow/bypass structures and by performing regular maintenance of these devices and if necessary enlargement of the storm drain upstream of the device.

The CDS units may cause a change in current and surface water movement. The stream flow in the lower watershed is highly channelized. As more trash is kept out of the channels, the roughness coefficient may be reduced which would increase the flow rate in the channel. However, the impact would be less than significant. The CDS units would not alter the direction or slope of the stream channels in the lower watershed, therefore, no change in the direction of surface water flow will occur.

Overall, the significant amount of installation required by full capture systems will substantially alter the storm water drainage system. These alterations will have a positive environmental impact with the resulting reduced pollutant loads from urban and storm water runoff.

Gross Solids Removal Devices

Gross Solids Removal Devices (GSRDs) are devices designed to allow the incoming flow of urban runoff or storm water to pass through the device while capturing trash and other debris within the unit. These types of devices may result in a potentially significant impact due to flooding hazards if the screens became blocked by trash and debris and prevent the discharge of storm water to Machado Lake or if the GSRDs are not properly designed and constructed to allow for bypass of storm water during storm events that exceed the design capacity. This potential impact can be mitigated through the design of the GSRDs with overflow/bypass structures and by performing regular maintenance to prevent the build up of trash and debris. Therefore, the exposure of people and property to flooding hazards after mitigation is less than significant.

The GSRDs may cause a significant change in the drainage patterns, rate and amount of surface water runoff. These units may impede or slow overland flow to the storm drain system. Any device installed in a storm drain, especially an older, under-capacity drain could have a negative effect on the drain's ability to convey surface waters including flood waters. This negative impact can be mitigated through design of the GSRDs units with overflow/bypass structures and by performing regular maintenance of these devices and if necessary enlargement of the storm drain upstream of the device.

The GSRDs units may cause a change in current and surface water movement. The stream flow in the lower watershed is highly channelized. As more trash is kept out of the channels, the roughness coefficient may be reduced which would increase the flow rate in the channel. However, the impact would be less than significant. The GSRDs units would not alter the direction or slope of the stream channels in the lower watershed, therefore, no change in the direction of surface water flow will occur.

Trash Nets

Trash nets are devices that use the natural energy of the flow to trap trash, floatables and solids in disposable mesh nets. Trash nets can be installed at or below grade within existing storm water conveyance structures or retrofitted to an existing outfall structure with only minor modifications. These devices have less hydraulic effect than the CDS units or the GSRDs, however, flooding is still a potential hazard if the nets became blocked by trash and debris and prevent the discharge of storm water. This potential impact can be mitigated through sizing and designing trash nets to allow for bypass when storm events exceed the design capacity and by performing regular maintenance

to prevent the build up of trash and debris. Therefore, the exposure of people and property to flooding hazards after mitigation is less than significant.

Catch Basin Inserts

Catch basin inserts are manufactured frames that typically incorporate filters or fabric and placed in a curb opening or drop inlet to remove trash, sediment, or debris. They can also be perforated metal screens placed horizontally or vertically within a catch basin. These devices have less hydraulic effect than the CDS units or the GSRDs, however, flooding is still a potential hazard if the filters or screens became blocked by trash and debris and prevent the discharge of storm water. This would be of particular concern in areas susceptible to high leaf-litter rates. This potential impact can be mitigated through the use of inserts that are designed with automatic release mechanisms or retractable screens that allow flow-through during wet-weather and by performing regular maintenance to prevent the build up of trash and debris. Therefore, the exposure of people and property to flooding hazards after mitigation should be less than significant.

Non-Structural BMPs

It is not reasonably foreseeable that non-structural BMPs would negatively impact hydrology or water quality.

16. Utilities and Service Systems. f. Will the proposal result in a need for new systems, or substantial alterations to the following utilities: solid waste and disposal?

Answer: Less than significant with mitigation incorporated

Compliance with the Machado Lake Trash TMDL will require that significant amounts of waste, that would otherwise enter storm drains, will be collected by institutional controls and structural methods for collecting trash, or by source control and proper litter disposal by citizens in upstream locales. Based on landfill capacity in the Los Angeles region there appears to be ample availability to receive trash that would be collected as part of compliance with the Machado Lake Trash TMDL. It is not anticipated that trash collected as part of the Machado Lake Trash TMDL would cause the landfills to exceed their permitted capacity.

To the extent that decreases in available landfill space may be imposed upon a given locality or local region, those effects are already occurring elsewhere in the watershed as a result of the improper disposal of trash, and such effects should be considered baseline impacts, as they are presently carried by the downstream communities. On balance, it is not unfair to require localities to dispose of trash generated locally rather than causing the downstream cities to dispose of this solid waste. Notably, any such impacts could be avoided considerably if the responsible agencies would control trash locally. Although, based on the capacity of landfill space in the Los Angeles area it is not anticipated that the collected trash will cause an exceedance of permitted landfill capacity. Furthermore, it is reasonably foreseeable that the regulation would precipitate education about the environmental and economic effects of litter, and thereby stimulate greater efforts to use less disposable materials, and to recycle more, thus reducing the use of resources including natural resources. Increased recycling would be considered a positive environmental impact.

In addition to trash collected as part of compliance with the TMDL there will be construction debris generated by the installation of structural BMPs. Existing landfills in the area do have adequate capacity to accommodate this limited amount of construction debris. In addition, the County of Los Angeles and many municipalities have construction and demolition debris recycling and reuse programs. Recycling and reuse of construction and demolition material has been shown to considerably reduce the amount of debris sent to landfills. According to the County of Los Angeles, except under unusual circumstances, it is feasible to recycle or reuse at least 50% of construction and demolition debris (LADPW, 2006). Impacts on the disposal of solid waste would be less than significant.

A new solid waste and disposal system is not required by the Basin Plan Amendment.

17. Human Health. a. Will the proposal result in creation of any health hazard or potential health hazard (excluding mental health)?

Answer: Less than significant with mitigation incorporated

Vortex Separation Systems

It is reasonably foreseeable that hazards or hazardous materials could be encountered during the installation of vortex separation systems. Contamination could exist depending on the current and historical land uses of the area. Depending on their location, vortex separation systems could be proposed in areas of existing oil fields and/or methane zones or in areas with contaminated soils or groundwater. The use of hazardous materials (e.g., paint, oil, gasoline) and potential for accidents is also likely during installation.

Trash that is trapped by vortex separation systems could become hazardous to the public or to maintenance workers who collect and transport the trash if it is not handled in a timely manner and disposed of appropriately.

Installation of vortex separation systems could result in the temporary interference of emergency response or evacuation plans if construction equipment, road closures, or traffic interfered with emergency vehicles traveling through the installation area.

As vortex separation systems will be located in urbanized areas, it is not reasonably foreseeable that their installation would expose people to wildland fires. Furthermore, these are structural trash removal devices that would not serve as residences or places of employment. They would not result in a safety hazard for people residing or working within two miles of public airport or public use airport.

To the extent that installation of vortex separation systems could involve work with or near hazards or hazardous materials, potential risks of exposure can be mitigated with proper handling and storage procedures. The health and safety plan prepared for any project should address potential effects from cross contamination and worker exposure to contaminated soils and water and should include a plan for temporary storage, transportation and disposal of contaminated soils and water. Compliance with the requirements of California Occupational Health and Safety Administration Cal/OSHA and local safety regulations during installation, operation, and maintenance of these systems would prevent any worksite accidents or accidents involving the release of hazardous

materials into the environment, which could harm the public, nearby residents and sensitive receptors such as schools. Systems can be redesigned and sites can be properly protected with fencing and signs to prevent accidental health hazards.

To the extent that trash trapped by vortex separation systems could become hazardous, impacts to maintenance workers and the public could be avoided or mitigated by educating the local community of the effects of improper disposal of such wastes, enforcing litter ordinances, and timely cleaning out inserts and structural controls.

To the extent that installation of vortex separation systems interfered with emergency response or evacuation plans, traffic control plans could be used to manage traffic through installation zones.

To the extent that vortex separation systems become a source of standing water and vector production, design at the project-level can help mitigate vector production from standing water. For example, in the Los Angeles River trash TMDL Regional Board hearing, the City of Los Angeles commented about vector creation and upstream flooding due to head loss. CDS Technologies described mitigation measures that CDS Technologies took in the installation of the CDS units in Los Angeles. Vector creation was mitigated at the project planning phase. The unit was planned to be installed at least 75 feet from inlet and outlet pipes to mitigate vector habitats. The unit was factory sealed to further prevent vector harborage. To mitigate upstream flooding, CDS Technologies redesigned their weir boxes and customized their diversion structures. They increased the surface area of their diversion structures to lower the depth of flow and reduced overall raised water surface. The unit also had a bypass overflow in case flow exceeds treatment capacity. Netting can be installed over devices to further mitigate vector production. Vector control agencies may also be employed as another source of mitigation. Systems that are prone to standing water can be selectively installed away from high-density areas and away from residential housing and/or by requiring oversight and treatment of those systems by vector control agencies.

Catch Basin Inserts

Catch basin inserts fit directly into curbside catch basins in urbanized areas and require no construction or ground disturbance. There is therefore no potential to encounter contaminated soils or groundwater or other hazards from this alternative means of compliance. Since no construction is required, the use of hazardous materials or potential for construction accidents is unlikely during installation. However, catch basin cleaning and maintenance could pose risks to maintenance workers.

To the extent that catch basin cleaning and maintenance could pose risks to maintenance workers, mitigation measures to avoid these risks include requiring workers to obtain hazardous materials maintenance, record keeping, and disposal activities training, OSHA-required Health and Safety Training, and OSHA Confined Space Entry training.

Trash Nets

Trash nets are installed within the storm drain system either inline or at the end of pipe. There is therefore no potential to encounter contaminated soils or groundwater or other hazards from this alternative means of compliance. Since no construction is required,

the use of hazardous materials or potential for construction accidents is unlikely during installation.

Gross Solids Removal Devices (GSRDs)

Like vortex separation systems, gross solids removal devices are inline structural trash removal devices that are implemented in urbanized areas. As such, the project-level impacts related to hazards and hazardous materials due to implementation of gross solids removal devices would be similar to the project-level impacts associated with vortex separation systems.

The proposed mitigation measures for gross solids removal devices would be similar to the proposed mitigation measures for vortex separation systems.

Non-Structural BMPs

Non-structural BMPs would involve no change to the physical environment either directly or indirectly and would have no impact related to hazards, hazardous materials, or human health.

17. Human Health. b. Will the proposal result in exposure of people to potential health hazards?

Answer: Less than significant with mitigation incorporated

See response to 17 Human Health a.

20. Aesthetics. a. Will the proposal result in the obstruction of any scenic vista or view open to the public?

Answer: Less than significant impact

Vortex Separation Systems

Vortex Separation Systems (VSSs) are subsurface devices and therefore installing them at a particular location is unlikely to result in an impairment of scenic and opens views to the public. Since these units will be installed within already existing storm drain network, it is also not foreseeable that the installation of VSSs may substantially damage scenic resources and/or degrade the existing visual character or quality of any particular location and its surroundings. It is not foreseeable that the installation activities associated with siting CDS units would result in any substantial adverse effect on the scenic vistas of the location. However, in the unlikely event that such activities should create aesthetically offensive impacts, these can be mitigated with screening and other construction BMPs. Screening can be used to reduce temporary impacts from aesthetically offensive installation activities. An illustration of location with VSS device installed is shown in Figure 6.4-1.

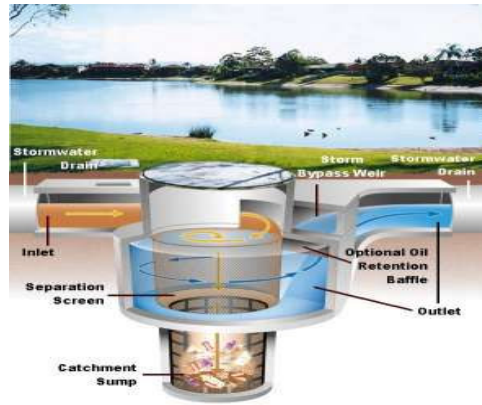

Figure 6.4-1. Illustration of location with VSS device installed.

Catch Basin Inserts

Catch basin inserts will have less than significant impact on any scenic vista or view open to the public. Curbside catch basin inserts are roadside devices. Installation of catch basin inserts would not foreseeably obstruct scenic vistas or opens views to the public. Once completed, catch basin inserts will not result in an impairment of scenic and opens views to the public. Figure 6.4-2 shows a catch basin insert device with accumulated debris.



Figure 6.4-2. A catch basin brush insert with accumulated debris

Trash Nets

Installation of in-line trash nets would not foreseeably obstruct scenic vistas or open views to the public as their installation will be limited to locations within the storm drain system and not in open channels. Once completed, trash nets will not result in an impairment of scenic and open views to the public. Figure 6.4-3 shows a location with trash nets installed.



Figure 6.4-3. Picture of end-of-pipe trash net containing trash.

Gross Solids Removal Devices

GSRDs are subsurface devices and, as such, would not foreseeably obstruct scenic vistas or open views to the public after installation. To the extent that a particular GSRD unit at a particular site could obstruct scenic views, such impacts could be avoided by employing non-structural controls at such locations instead, for instance, increased litter enforcement.



Figure 6.4-4. Location with GSRD Installation.

Non-Structural BMPs

Non-structural BMPs is unlikely to result in an impairment of scenic and opens views to the public.

18. Aesthetics. b. Will the proposal result in the creation of an aesthetically offensive site open to public view?

Answer: Less than significant

Vortex Separation Systems

Vortex Separation Systems (VSSs) are subsurface devices and therefore installing them at a particular location is unlikely to result in the creation of an aesthetically offensive site open to public view after installation. The creation of an aesthetically offensive site during installation can be mitigated with standard architectural and landscape architectural practices such as screening and landscaping. Many structural BMPs can be designed to provide habitat, recreational areas, and green spaces in addition to improving storm water quality.

Vandalized structures may become an aesthetically offensive site. Vandalism, however, already exists to some degree in most if not all, urbanized areas, and adding several new structures is not of itself likely to have any impact upon current vandalism trends, any more than adding any other public structure.

Catch Basin Inserts

Installation of catch basin inserts is a quick process and would not likely create an aesthetically offensive site to the public during installation. Catch basin inserts

themselves are unlikely to create an aesthetically offensive site after installation because they are installed at street level. That notwithstanding, the creation of an aesthetically offensive site could be mitigated by improving the aesthetic characteristics of that device. Trash accumulated outside of the catch basin inserts could create an aesthetically offensive site. Increased street sweeping and enforcement of litter laws may mitigate this adverse effect and even cause a positive impact by removing visible trash.

Trash Nets

Trash nets may create an aesthetically offensive site to the public during installation. The effects are less than significant with mitigation incorporated. The creation of an aesthetically offensive site during installation can be mitigated with screening and other construction BMPs. End-of-Pipe trash nets are surface devices and would create an aesthetically offensive site after installation. The creation of an aesthetically offensive site could be mitigated by employing alternative structural devices, such as in-line trash nets, or by employing non-structural controls, for instance, increased litter enforcement.

Trash nets may become a target of vandalism. Vandalized structures may become an aesthetically offensive site. Improved lighting and enforcement of current vandalism regulations may decrease the instance of vandalized structures. Vandalism, however, already exists to some degree in most if not all, urbanized areas, and adding several new structures is not of itself likely to have any impact upon current vandalism trends, any more than adding any other public structure. Trash nets will have less than significant impact on any scenic vista or view open to the public, by virtue of their location.

Gross Solids Removal Devices (GSRDs)

GSRDs are subsurface devices and, as such, would not foreseeably obstruct scenic vistas or open views to the public after installation. To the extent that a particular GSRD unit at a particular site could obstruct scenic views, such impacts could be avoided by employing non-structural controls at such locations instead, for instance, increased litter enforcement.

During installation, however, GSRDs may create an aesthetically offensive site to the public. The creation of an aesthetically offensive site during installation can be mitigated with screening and other construction BMPs. Standard architectural and landscape architectural practices can be implemented to reduce impacts from aesthetically offensive structural impacts. Any effects should be less than significant impact with mitigation incorporation.

GSRDs may become a target of vandalism. Vandalized structures may become an aesthetically offensive site. Vandalism, however, already exists to some degree in most if not all, urbanized areas, and adding several new structures is not of itself likely to have any impact upon current vandalism trends, any more than adding any other public structure.

Non-Structural BMPs

Non-structural BMPs would not create an aesthetically offensive site. Rather, this alternative would pose a positive aesthetic impact by reducing visible trash, instead.

19. Recreation. a. Will the proposal result in impact on the quality or quantity of existing recreational opportunities?

Answer: Less than significant with mitigation incorporated

Vortex Separation Systems

The CDS units will be installed below grade in existing storm drain systems, which should not require additional land. Therefore, it is not reasonably foreseeable that park land, recreational or open space areas will be needed for the installation of the CDS units. In addition, implementation of the Machado Lake Trash TMDL is designed to improve the quality of the Machado Lake. This will create a positive impact and increase recreational opportunities.

It is reasonably foreseeable that installation of the CDS units may temporarily impact the usage of existing recreational sites. Structural BMPs and subsurface devices and will only pose temporary impairment to recreational opportunities. For instance, bike lanes may be temporarily unavailable during installation of structural BMPs or parking locations for recreation facilities may be impacted. Mitigation measures include the incremental installation of the CDS units in storm drains located in parks, bike lanes, and other recreational sites to avoid impairment of the entire site. The responsible agency may also redesign the CDS units to be less obtrusive or choose a less disruptive implementation strategy such as a non-structural alternative.

Gross Solids Removal Devices

The GSRD units will be installed below grade in existing storm drain systems, which should not require additional land. Therefore, it is not reasonably foreseeable that park land, recreational or open space areas will be needed for the installation of the GSRD units. In addition, implementation of the Machado Lake Trash TMDL is designed to improve the quality of the Machado Lake. This will create a positive impact and increase recreational opportunities.

It is reasonably foreseeable that installation of the GSRD units may temporarily impact the usage of existing recreational sites. Structural BMPs and subsurface devices and will only pose temporary impairment to recreational opportunities. For instance, bike lanes may be temporarily unavailable during installation of structural BMPs or parking locations for recreation facilities may be impacted. Mitigation measures include the incremental installation of the GSRD units in storm drains located in parks, bike lanes, and other recreational sites to avoid impairment of the entire site. The responsible agency may also redesign the GSRD units to be less obtrusive or choose a less disruptive implementation strategy such as a non-structural alternative.

Trash Nets

Since, trash nets can be installed at or below grade within existing storm water conveyance structures or retrofitted to an existing outfall structure it is reasonably foreseeable that additional land will not be required. Therefore, there will not be a significant impact to the quality or quantity of existing recreational opportunities. In addition, implementation of the Machado Lake Trash TMDL is designed to improve the quality of the Machado Lake. This will create a positive impact and increase recreational opportunities.

It is reasonably foreseeable that installation of the trash nets may temporarily impact the usage of existing recreational sites as was the case with the other structural BMPs. Mitigation measures include the incremental installation of the trash nets in storm drains located in parks, bike lanes, and other recreational sites to avoid impairment of the entire site.

Catch Basin Inserts

Since, catch basin inserts can be installed at or below grade within existing storm water catch basins it is reasonably foreseeable that additional land will not be required. Therefore, there will not be a significant impact to the quality or quantity of existing recreational opportunities. In addition, implementation of the Machado Lake Trash TMDL is designed to improve the quality of the Machado Lake. This will create a positive impact and increase recreational opportunities.

It is reasonably foreseeable that installation of the catch basin inserts may temporarily impact the usage of existing recreational sites as was the case with the other structural BMPs. Mitigation measures include the incremental installation of catch basin inserts located in parks, bike lanes and other recreational sites to avoid impairment of the entire site.

Non-Structural BMPs

It is not reasonably foreseeable that non-structural BMPs would impact the quality or quantity of existing recreational opportunities. In addition, implementation of the Machado Lake Trash TMDL is designed to improve the quality of the Machado Lake. This will create a positive impact and increase recreational opportunities throughout the watershed.

20. Archeological/Historical. Will the proposal result in the alteration of a significant archeological or historical site structure, object or building?

Answer: Less than significant with mitigation incorporated

Vortex Separation Systems

Vortex separation systems would be installed in currently urbanized areas where ground disturbance has previously occurred. Because these areas are already fully urbanized it is unlikely that their implementation would cause a substantial adverse change to historical or archeological resources, destroy paleontological resources, or disturb human remains. However, depending on the final location of facilities, potential impacts

to cultural resources could occur. The site-specific presence or absence of these resources is unknown because the specific locations for vortex separation systems will be determined by responsible agencies at the project level. Installation of these systems could result in minor ground disturbances, which could impact cultural resources if they are sited in locations containing these resources and where disturbances have not previously occurred.

Upon determination of specific locations for vortex separation systems, responsible agencies should complete further investigation, including consultation with Native American tribes, to make an accurate assessment of potential to affect historic, archaeological, or architectural resources or to impact any human remains. If potential impacts are identified, mitigation measures could include project redesign, such as the relocation of facilities outside the boundaries of archeological or historical sites. According to the California Office of Historic Preservation, avoidance and preservation in place are the preferable forms of mitigation for archeological sites. When avoidance is infeasible, a data recovery plan should be prepared which adequately provides for recovering scientifically consequential information from the site. Studies and reports resulting from excavations must be deposited with the California Historical Resources Regional Information Center (California Office of Historical Preservation, 2006).

Catch Basin Inserts

Catch basin inserts fit directly into curbside catch basins in urbanized areas and require no construction or ground disturbance. There is therefore no potential to impact cultural resources from this alternative means of compliance.

Trash Nets

Trash nets are installed within the storm drain system either inline or at the end of pipe. Installation requires no ground disturbance which might impact cultural resources.

Gross Solids Removal Devices (GSRDs)

Like vortex separation systems, gross solids removal devices are inline structural trash removal devices that are implemented in urbanized areas. As such, the project-level impacts on cultural resources due to implementation of gross solids removal devices would be similar to the project-level impacts associated with vortex separation systems.

The proposed mitigation measures for gross solids removal devices would be similar to the proposed mitigation measures for vortex separation systems.

Non-Structural BMPs

Non-structural BMPs would involve no change to the physical environment either directly or indirectly and would have no impact on cultural resources.

21. Mandatory Findings of Significance.

21. Mandatory Findings of Significance. a. Does the project have the potential to degrade the quality of the environment, substantially reduce the habitat of a fish or wildlife species, cause a fish or wildlife population to drop below self-sustaining levels,

threaten to eliminate a plant or animal community, reduce the number or restrict the range of a rare or endangered plant or animal or eliminate important examples of the major periods of California history or prehistory?

Answer: Less than significant with mitigation incorporated

The California Legislature and the Secretary of Resources have determined that certain kinds of impacts are necessarily “significant” and thus automatically require preparation of an EIR or an EIR level of analysis to effectuate CEQA’s substantive mandate. Thus, the purpose of mandatory findings of significance is to remove an agency’s discretion to not adopt an EIR in some specific circumstances, and to ensure that agencies do not avoid the requirements to make necessary findings, to modify projects, and to adopt statements of overriding consideration.

When an initial study concludes that any of these impacts may occur, the lead agency must prepare an EIR, rather than a negative declaration. This lead agency however, is not obligated to prepare an EIR, and the checklist is not an initial study, but rather, a component of the Regional Board’s substitute environmental documents, as required by CEQA and Water Board regulations.

Without implementation of recommended mitigation measures, potentially significant environmental impacts, such as impacts to air, noise, and transportation, can result from implementation projects. However, it is reasonably foreseeable that local agencies will implement the proposed mitigation measures to reduce these potential impacts to less than significant levels.

21. Mandatory Findings of Significance. b. Does the project have the potential to achieve short-term, to the disadvantage of long-term, environmental goals?

Answer: Less than significant

This TMDL is directed to long-term environmental goals, and does not sacrifice long-term for short-term benefit. Rather, the proposed trash TMDL is designed to achieve long-term environmental goals, most notably in improved water quality in the waters of the Region, and this document recognizes that in achieving these long-term goals, short-term impacts may result, as discussed in more detail above, as well as elsewhere in this document.

21. Mandatory Findings of Significance. c. Does the project have impacts which are individually limited, but cumulatively considerable?

Answer: Less than significant with mitigation incorporated

Each compliance measure is expected to have nominal environmental impacts if performed properly. However this TMDL will require many individual projects to comply region-wide, which may have potential program-level, and project-level, cumulative effects upon the region. These impacts are discussed in detail in this document.

21. Mandatory Findings of Significance. d. Does the project have environmental effects which will cause substantial adverse effects on human beings, either directly or indirectly?

Answer: Less than significant with mitigation incorporated

Without implementation of recommended mitigation measures, potentially significant environmental impacts, such as impacts to air, noise, and transportation, can result from implementation projects. In some cases, mitigation measures even if performed may not reduce the impacts to less than significant levels. The significance of these impacts is discussed in detail above, as well as elsewhere in this document.

7 OTHER ENVIRONMENTAL CONSIDERATIONS

This section evaluates several other environmental considerations of reasonably foreseeable methods of complying with the trash TMDL, specifically:

7.1. Cumulative Impacts of the Program Alternatives (as required by CEQA Guidelines Section 15130);

7.2. Potential Growth-Inducing Effects of the Program Alternatives (as required by CEQA Guidelines Section 15126); and

7.3. Unavoidable Significant Impacts (as required by CEQA Guidelines Section 15126.2).

7.1 CUMULATIVE IMPACTS

Cumulative impacts, defined in Section 15355 of the CEQA Guidelines, refer to two or more individual effects, that when considered together, are considerable or that increase other environmental impacts. Cumulative impact assessment must consider not only the impacts of the proposed TMDL, but also the impacts from other municipal and private projects, which would occur in the watershed during the period of implementation.

The areas of cumulative impacts analyzed in this section include: 1) the Program level cumulative impacts and 2) the Project level cumulative impacts. On the program level, the impacts from multiple TMDLs, if exist, are analyzed. On the project level, while the full environmental analysis of individual projects are the purview of the implementing municipalities of agencies, the cumulative impact analysis included here entails consideration of construction activities occurring in the vicinity of one another as a result of other projects being built in the same general time frame and location. The Trash TMDL projects, if occurring with other construction projects, could contribute to temporary cumulative noise and vibration effects that would not occur with only one project.

7.1.1 PROGRAM CUMULATIVE IMPACTS

Currently there are no other TMDLs adopted for the Machado Lake. However, when other TMDLs will be adopted in the future, the programmatic cumulative impacts would be analyzed in the SED documents for those TMDLs. For compliance with the Machado Lake TMDL, full capture systems must be designed to treat the peak flow rate resulting from a one-year, one-hour storm, at a minimum. Some trash removal systems for compliance with this TMDL have a secondary benefit; the catch basin improvements and gross solids removal systems developed by Caltrans and discussed in section 5 of this

SED also remove sediments and other pollutants. Therefore, the potential implementation strategies discussed in this SED for the trash TMDL may contribute to the implementation of other TMDLs for the Machado Lake in the future. Likewise, implementation of other TMDLs in the Machado Lake may contribute to the implementation of this trash TMDL.

7.1.2 PROJECT CUMULATIVE IMPACTS

Specific TMDL projects must be environmentally evaluated and cumulative impacts considered as the implementing municipality or agency designs and sites the project. However, as examples, TMDL projects and other construction activities may result in cumulative effects of the following nature:

Noise and Vibration - Local residents in the near vicinity of installation and maintenance activities may be exposed to noise and possible vibration. The cumulative effects, both in terms of added noise and vibration at multiple Trash TMDL installation sites, and in the context of other related projects, are not considered cumulatively significant due to the temporary nature of noise increases. Noise mitigation methods including scheduling of construction or trash device installation are available as discussed in the checklist. In addition, the fact that trash BMP installation activities are being conducted in the same vicinity as other projects will not make mitigation methods less implementable.

Air Quality - Implementation of the Trash TMDL Program may cause additional emissions of criteria pollutants and slightly elevated levels of carbon monoxide during construction or trash device installation activities. The TMDL, in conjunction with all other construction activity, may contribute to the region's non-attainment status during the installation period. SCAQMD prepared the Air Quality Management Plan (AQMP) (2003) to bring the region into compliance with the National Ambient Air Quality Standards as set by the EPA under the Clean Air Act Amendments (1990). The AQMP is essentially designed to address the cumulative air pollutants released into the South Coast Air Basin (SCAB). Because these installation -related emissions are temporary, and because the AQMD addresses cumulative air pollution in the SCAB, compliance with the TMDL would not result in long-term significant cumulative air quality impacts. In the short term, cumulative impacts could be significant if the combined emissions from the individual TMDL projects exceed the threshold criteria for the individual pollutants.

Transportation and Circulation - Compliance with the trash TMDL involves installation activities occurring simultaneously at a number of surface sites in the Trash TMDL area. Installation of trash devices may be occurring in the same general time and space as other related or unrelated projects. In these instances, surface construction activities from all projects could produce cumulative traffic effects which may be significant, depending upon a range of factors including the specific location involved and the precise nature of the conditions created by the dual construction activity. Special coordination efforts may be necessary to reduce the combined effects to an acceptable level. Overall, significant cumulative impacts are not anticipated because coordination can occur and because transportation mitigation methods including are available as discussed in the checklist. In addition, the fact that trash device installation activities are being conducted in the same vicinity as other projects will not make mitigation methods less implementable.

Public Services - The cumulative effects on public services in the Trash TMDL study area would be limited to traffic inconveniences discussed above. These effects are not considered cumulatively significant as discussed above.

Aesthetics - Construction activities associated with other related projects may be ongoing in the vicinity of one or more Trash TMDL construction sites. To the extent that combined construction activities do occur, there would be temporary adverse visual effects of less than cumulatively significant proportions as discussed in the checklist.

7.2 GROWTH-INDUCING IMPACTS

This section presents the following:

- 7.2.1) an overview of the CEQA Guidelines relevant to evaluating growth inducement,
- 7.2.2) a discussion of the types of growth that can occur in the Machado Lake Watershed,
- 7.2.3) a discussion of obstacles to growth in the watershed, and
- 7.2.4) an evaluation of the potential for the TMDL Program Alternatives to induce growth.

7.2.1 CEQA GROWTH-INDUCING GUIDELINES

Growth-inducing impacts are defined by the State CEQA Guidelines as:

The ways in which a proposed project could foster economic or population growth, or the construction of additional housing, either directly or indirectly, in the surrounding environment. Included in this are impacts which would remove obstacles to population growth. Increases in the population may tax existing community service facilities, requiring construction of new facilities that could cause significant environmental effects... [In addition,] the characteristics of some projects.. .may encourage and facilitate other activities that could significantly affect the environment, either individually or cumulatively. It is not assumed that growth in any area is necessarily beneficial, detrimental, or of little significance to the environment.

(CEQA Guidelines, Section 15126.2(d)).

Growth inducement indirectly could result in adverse environmental effects if the induced growth is not consistent with or accommodated by the land use plans and growth management plans and policies. Local land use plans provide for land use development patterns and growth policies that encourage orderly urban development supported by adequate public services, such as water supply, roadway infrastructure, sewer services, and solid waste disposal services.

Public works projects that are developed to address future unplanned needs (i.e., that would not accommodate planned growth) could result in removing obstacles to population growth. Direct growth inducement would result if, for example, a project involved the construction of new wastewater treatment facilities to accommodate populations in excess of those projected by local or regional planning agencies. Indirect

growth inducement would result if a project accommodated unplanned growth and indirectly established substantial new permanent employment opportunities (for example, new commercial, industrial, or governmental enterprises) or if a project involved a construction effort with substantial short-term employment opportunities that indirectly would stimulate the need for additional housing and services. Growth inducement also could occur if the project would affect the timing or location of either population or land use growth, or create a surplus in infrastructure capacity.

7.2.2 TYPES OF GROWTH

The primary types of growth that occur within the Trash TMDL area are:

- 1) development of land and
- 2) population growth (Economic growth, such as the creation of additional job opportunities, also could occur; however, such growth generally would lead to population growth and, therefore, is included indirectly in population growth.)

Growth in land development

Growth in land development is the physical development of residential, commercial, and industrial structures in the Trash TMDL area. Land use growth is subject to general plans, community plans, parcel zoning, and applicable entitlements and is dependent on adequate infrastructure to support development.

Population Growth

Population growth is growth in the number of persons that live and work in the Trash TMDL area and other jurisdictions within the boundaries of the area. Population growth occurs from natural causes (births minus deaths) and net emigration to or immigration from other geographical areas. Emigration or immigration can occur in response to economic opportunities, life style choices, or for personal reasons.

Although land use growth and population growth are interrelated, land use and population growth could occur independently from each other. This has occurred in the past where the housing growth is minimal, but population within the area continues to increase. Such a situation results in increasing population densities with a corresponding demand for services, despite minimal land use growth.

Overall development in the County of Los Angeles is governed by the County of Los Angeles General Plan, which is intended to direct land use development in an orderly manner. The General Plan is the framework under which development occurs, and, within this framework, other land use entitlements (such as variances and conditional use permits) can be obtained. Because the General Plan guides land use development and allows for entitlements, it does not represent an obstacle to land use growth. The cities within the Trash TMDL area also have plans which direct land use development.

7.2.3 EXISTING OBSTACLES TO GROWTH

Obstacles to growth could include such things as inadequate infrastructure, such as an inadequate water supply that results in rationing, or inadequate wastewater treatment

capacity that results in restrictions in land use development. Policies that discourage either natural population growth or immigration also are considered to be obstacles to growth.

7.2.4 POTENTIAL FOR COMPLIANCE WITH THE PROPOSED TMDL TO INDUCE GROWTH.

Direct Growth Inducement

Because the reasonably foreseeable methods of compliance with the proposed trash TMDL focus on non-structural BMPs and improvements to the storm drain system which is located throughout the urbanized portion of the Trash TMDL area, the trash TMDL would not result in the construction of new housing and, therefore, would not directly induce growth.

Indirect Growth Inducement

Two areas of potential indirect growth inducement are relevant to a discussion of the proposed TMDL: (1) the potential for compliance with the TMDL to generate economic opportunities that could lead to additional immigration, and (2) the potential for the proposed TMDL to remove an obstacle to land use or population growth.

Installation of trash devices to comply with the proposed TMDL would occur over a 8-year time period. Installation and maintenance spending for compliance would generate jobs throughout the region and elsewhere where goods and services are purchased or used to install trash devices. Based on the above annual construction cost estimates, the alternatives would result in direct jobs and indirect jobs. The creation of jobs in the region is considered a benefit.

Although the construction activities associated with the trash TMDL would increase the economic opportunities in the area and region, this construction is not expected to result in or induce substantial or significant population or land use development growth because the majority of the new jobs that would be created by this construction are expected to be filled by persons already residing in the area or region, based on the existing surplus of unemployed persons in the area and region. SCAG estimates that the SCAG region had over 405,000 unemployed persons.

The second area of potential indirect growth inducement is through the removal of obstacles to growth. As discussed above, no obstacles exist to land use or to population growth in the watershed.

7.3 UNAVOIDABLE SIGNIFICANT ADVERSE IMPACTS

Section 15126.2(c) of the CEQA Guidelines requires a discussion of potential significant, irreversible environmental changes that could result from a proposed project. Examples of such changes include commitment of future generations to similar uses, irreversible damage that may result from accidents associated with a project, or irretrievable commitments of resources. Although the proposed TMDL would require resources (materials, labor, and energy) they do not represent a substantial irreversible commitment of resources.

In addition, implementation of the TMDL will have substantial benefits to water quality and will enhance beneficial uses. Enhancement of the recreational beneficial uses (both water contact recreation and non-contact water recreation) will have positive social and economic effects by decreasing potential trash hazards and increasing the aesthetic experience at beaches, parks around the lake, and other recreation areas. In addition, habitat carries a significant non-market economic value. Enhancement of habitat beneficial uses will also have positive indirect economic and social benefits. Section 6 of this SED identifies the anticipated environmental effects for each resource area, identifies mitigation measures for potentially significant impacts, and determines that impacts after implementation of mitigation are insignificant.

8. FINDINGS

On the basis of this initial evaluation and staff report for the TMDL, which collectively provide the required information:

I find the proposed Basin Plan amendment could not have a significant effect on the environment.

I find that the proposed Basin Plan amendment could have a significant adverse effect on the environment. However, there are feasible alternatives and/or feasible mitigation measures that would substantially lessen any significant adverse impact. These alternatives are discussed above and in the staff report for the TMDL.

I find the proposed Basin Plan amendment may have a significant effect on the environment. There are no feasible alternatives and/or feasible mitigation measures available which would substantially lessen any significant adverse impacts. See the attached written report for a discussion of this determination.

DATE:

Jonathan S. Bishop

Executive Officer

9. REFERENCES

American Stormwater. 2006. American Storm Water: Products - Surf Gate. [http://www.americanstormwater.com/Storm Water Products/surf_gate.html](http://www.americanstormwater.com/Storm%20Water%20Products/surf_gate.html). Accessed November, 2006.

California Department of Conservation, California Geological Survey. 2002. Guidelines for Evaluating the Hazard of Surface Fault Rupture – Note 49.

California Exotic Pest Plant Council (CalEPPC). 1999. Exotic Pests Plants of Greatest Ecological Concern, October, 1999. ucce.ucdavis.edu/files/filelibrary/5319/4898.pdf.

California Office of Historical Preservation. 2006. Proprietary data.

California Regional Water Quality Control Board Los Angeles Region. 2001. Order No. 01-182: Waste Discharge Requirements for Municipal Storm Water and Urban Runoff Discharges within the County of Los Angeles, and the incorporated Cities Therein, Except the City of Long Beach. December 13, 2001.

California Stormwater Quality Association (CASQA). 2003a. California Stormwater BMP Handbook: Municipal. January 2003. <http://www.cabmphandbooks.com>.

California Stormwater Quality Association (CASQA). 2003b. California Stormwater BMP Handbook: New Development and Redevelopment. January 2003. www.cabmphandbooks.com.

CDS Technologies. 2006 Stormwater In-line Units. <http://www.cdstech.com/stormwater/inlineunit.htm>. Accessed February, 2007.

Cities of Burbank, Glendale, La Canada Flintridge and Pasadena (Four Cities). 2005. Letter to the Regional Board: Request for Full Capture System Certification for the Los Angeles River Trash Total Maximum Daily Load. February 16, 2005.

City of Glendale. 2006. Personal communication with Environmental Program Manager, City of Glendale Department of Public Works. October 2, 2006.

City of Los Angeles Stormwater Program Website. 2006. <http://www.lastormwater.org/WPD/program/TMDLs/tmdls.htm>. Accessed November 2006.

Federal Highway Administration (FHWA). 2006. Storm Water Best Management Practices in an Ultra-Urban Setting: Selection and Monitoring. <http://www.fhwa.dot.gov/environment/ultraurb/index.htm>.

Fresh Creek Technologies, Inc.. 2006. The Fresh Creek Netting TrashTrap® Systems, <http://www.freshcreek.com/products.php>. Accessed December, 2006.

Los Angeles Regional Water Quality Control Board (LARWQCB). 1994. Water Quality Control Plan for the Los Angeles Region (Basin Plan).

Moore, C. J., Moore, S.L., Leecaster, M. K., Weisberg, S.B. 2001. A Comparison of Plastic and Plankton in the Pacific Central Gyre. *Marine Pollution Bulletin*, 42 (2001):1297-1300.

Moore, C. J., Lattin, G. L., Zellers, A. F. 2005. Density of Plastic Particles found in zooplankton trawls from Coastal Waters of California to the North Pacific Central Gyre. In Proceedings of the Plastic Debris Rivers to Sea Conference, September 7-9, 2005. www.plasticdebris.org.

Sheavely, Seba. 2005. Beach Debris-Characterized through the International Coastal Cleanup & the U.S. National Marine Debris Monitoring Program. In Proceedings of the Plastic Debris Rivers to Sea Conference, September 7-9 2005. www.plasticdebris.org.

Soil & Water Conservation Society of Metro Halifax. 2006. Select features of the CDS (Continuous Deflective Separation) Technologies Inc. <http://lakes.chebucto.org/SWT/cds.html>. Accessed November 2006.

South Coast Air Quality Management District (SCAQMD) webpage. 2006. <http://www.aqmd.gov/ceqa/handbook/signthres.doc>. Accessed October, 2006.

South Coast Air Quality Management District. 2006. Regulation XI - Source Specific Standards. Rule 1186.1 - Less-Polluting Sweepers. <http://www.aqmd.gov/rules/reg/reg11/r1186-1.pdf#>.

State of California Department of Transportation (Caltrans). 2002. Storm Water Quality Handbooks: Project Planning and Design Guide. September 2002, revised July 2005. <http://www.dot.ca.gov/hq/oppd/stormwtr/>.

State of California Department of Transportation (Caltrans). 2003a. Construction Manual. December 2003.

State of California Department of Transportation (Caltrans). 2003b. Phase I: Gross Solids Removal Devices Pilot Study: 2000-2002. Final Report October 2003. CTSW-RT-03-072.31.22.

State of California Department of Transportation (Caltrans). 2003c. BMP Retrofit Pilot Program. Final Report January 2004. CTSW - RT - 01 - 050.

State of California Department of Transportation (Caltrans). 2005. Division of Environmental Analysis. http://www.dot.ca.gov/hq/env/stormwater/ongoing/gsrp_pilot_study/index.htm -Website updated: December 22, 2005.

State Water Resources Control Board. 2006. California Water Boards - Erase the Waste Campaign. California Storm Water Toolbox. <http://www.waterboards.ca.gov/erasethewaste/index.html>

Superior Court of the City and County of San Francisco, No.316912 (*102 Cal.App.4th 656, Division T*), September 30, 2002. San Franciscans Upholding the Downtown Plan, et al. v. City and County of San Francisco, et al.

Swift, Camm Emeritus Natural History Museum of Los Angeles County, California Academy of Sciences. Personal communication. May 20, 2000.

Thalheimer, E. 2000. Construction Noise Control Program and Mitigation Strategy at the Central Artery Tunnel Project. Noise Control Engineering Journal. 48(5) Sept-Oct.

U.S. Department of Transportation Federal Transit Administration, and the Peninsula Corridor Joint Powers Board. 2004. Caltrain Electrification Program –San Francisco to Gilroy: Environmental Assessment/Draft Environmental Report. April, 2004.

U.S. EPA. 2005. Stormwater Phase II Final Rule - Public Education and Outreach Minimum Control Measure Fact Sheet. EPA 833-F00-005.

United States Environmental Protection Agency (US-EPA). 2006.
<http://www.epa.gov/region01/assistance/ceitts/stormwater/techs/contdeflective.html>
Accessed November 2006.

United States Environmental Protection Agency (US-EPA9). 2006. National Menu of Stormwater Best Management Practices, Catch Basin Inserts.
<http://cfpub.epa.gov/npdes/stormwater/menuofbmps/index.cfm>. Accessed November 2006.

Water Environment Research Foundation (WERF). 2005. Critical Assessment of Stormwater Treatment and Control Selection Issues. Project No. 02-SW-1
<http://www.werf.org/AM/Template.cfm?Section=Research&Template=/CustomSource/Research/ResearchProfile.cfm&ReportId=02-SW-1&CFID=707181&CFTOKEN=54086235>.