



Evaluation and Monitoring of Seepage and Internal Erosion

Interagency Committee on Dam Safety (ICODS)

FEMA P-1032 / May 2015



FEMA

Evaluation and Monitoring of Seepage and Internal Erosion

Interagency Committee on Dam Safety (ICODS)

Federal Emergency Management Agency

Cover photo: Upper Red Rock Site 20, Oklahoma – dam failure from seepage along poor lift joints in highly dispersive clay soil embankment.

May 2015

Acronyms and Abbreviations

°	degree(s)
AC	alternating current
ADAR	Airborne Data Acquisition and Registration
ADAS	Automated Data Acquisition System
AFP	annual failure probability
ANCOLD	Australian National Committee on Large Dams
APF	annualized probability of failure
ARMS	Army Remote Moisture System
ASCE	American Society of Civil Engineers
ASDSO	Association of State Dam Safety Officials
ASTM	American Society for Testing and Materials
CCR	capacitively coupled resistivity
cm	centimeter(s)
CMP	corrugated metal pipe
cm/s	centimeters per second
DC	direct current
DVC	data validation criteria
EAP	Emergency Action Plan
ECD	electric current distribution
EM	electromagnetic
EPA	United States Environmental Protection Agency
ERT	electrical resistivity tomography
FEMA	Federal Emergency Management Agency
FERC	Federal Energy Regulatory Commission
FOV	field of view
ft ³ /s	cubic feet per second
GHz	gigahertz
GIS	Geographic Information System
gpm	gallons per minute
GPS	Global Positioning System
Guidelines	Federal Guidelines for Dam Safety
HET	Hole Erosion Test
ICODS	Interagency Committee on Dam Safety
ICOLD	International Commission on Large Dams
IR	infrared
JET	Jet Erosion Test
L/min/yr	liters per minute per year
LiDar	Light Detection and Ranging
LL	life loss
LSI	Langlier Saturation Index
m	meter(s)
mm	millimeter(s)

m/s	meters per second
NASA	National Aeronautics and Space Administration
NHD	net head dissipated
NIMS	National Incident Management System
nm	nanometer(s)
NRCS	Natural Resources Conservation Service
OMB	Office of Management and Budget
PAR	population at risk
PFM	potential failure mode
PFMA	potential failure modes analysis
PI	plasticity index
PVC	polyvinyl chloride
Reclamation	Bureau of Reclamation
ROC	rate of change
SAR	synthetic aperture radar
SP	self-potential
SRP	system response probabilities
TADS	Training Aids for Dam Safety
Task Group	ICODS Task Group on Internal Erosion
TDS	total dissolved solids
TLS	terrestrial laser scanning
USACE	U.S. Army Corps of Engineers
USDA	United States Department of Agriculture
USGS	U.S. Geological Survey
USSD	United States Society on Dams (formerly United States Committee on Large Dams)

Symbols

- A The percentage of soil passing the No. 200 sieve, fines content.
- C_u Coefficient of uniformity, as determined from a grain size analysis, equal to the ratios D₆₀ / D₁₀, where D₆₀ and D₁₀ are the particle diameters corresponding to 60 and 10 percent finer on the cumulative gradation curve, respectively
- C_z Coefficient of curvature (also coefficient of gradation), as determined from a grain size analysis, calculated from the relationship:

$$C_z = D_{30}^2 / (D_{60} * D_{10})$$

- Where D₆₀, D₃₀, and D₁₀ are the particle diameters corresponding to 60, 30, and 10 percent finer on the cumulative gradation curve, respectively
- D₁₀ The particle size diameter in millimeters of the 10th percentile passing grain size
- D₆₀ The particle size diameter in millimeters of the 60th percentile passing grain size
- D₈₅ The particle size diameter in millimeters of the 85th percentile passing grain size
- D_{15B} The particle size diameter in millimeters of the 15th percentile passing grain size of the base soil
- D_{85B} The particle size diameter in millimeters of the 85th percentile passing grain size of the base soil
- D_{15F} The particle size diameter in millimeters of the 15th percentile passing grain size of the filter
- e Void ratio
- i Gradient, the ratio of head loss over the distance that head loss occurs ($\Delta h / \Delta d$)
- i_{cr} Critical gradient
- k Soil permeability
- S_{pg} Specific gravity

β	Slope angle
ϕ	Drained angle of internal friction
γ_b	buoyant unit weight of the soil
γ_w	unit weight of water

Note: Historically, the symbols “d” and “D” have been used in filter research and some design manuals. The meanings of those symbols were:

- d Particle diameter of the base soil
- D Particle diameter of the filter

Conversion Factors

To the International System of Units (SI) (Metric)

Pound-foot measurements in this document can be converted to SI measurements by multiplying by the following factors:

Multiply	By	To obtain
acre-feet	1233.489000	cubic meters
cubic feet	0.028317	cubic meters
cubic feet per second	0.028317	cubic meters per second
cubic yards	0.764555	cubic meters
degrees Fahrenheit	$(^{\circ}\text{F}-32)/1.8$	degrees Celsius
feet	0.304800	meters
feet per second	0.304800	meters per second
gallons	0.003785	cubic meters
gallons	3.785412	liters
gallons per minute	0.000063	cubic meters per second
gallons per minute	0.063090	liters per second
inches	2.540000	centimeters
mils	0.000025	meters
mils	0.025400	millimeters
pounds	0.453592	kilograms
pounds per cubic foot	16.018460	kilograms per cubic meter
pounds per square foot	4.882428	kilograms per square meter
pounds per square inch	6.894757	kilopascals
pounds per square inch	6894.757000	pascals
square miles	2.589988	square kilometers
tons	907.184700	kilograms

Preface

Internal erosion through and under embankments poses one of the greatest threats to satisfactory performance of these type of water retention structures. This document addresses various processes of internal erosion that can occur in soils and how that erosion can, in some cases, result in failure of a dam or levee. Considerations for identifying and understanding potential failure modes and risks related to internal erosion of embankment and foundation materials are presented to aid practitioners in identifying conditions that adversely affect dam safety. Various monitoring methods that can be used to detect evidence of internal erosion as well as methods for long-term performance monitoring are also presented. Possible emergency response actions for short-term risk reduction and numerous approaches of long-term mitigation of internal erosion risks are included.

This document addresses evaluation and monitoring of seepage and internal erosion in an effort to collect and disseminate information and experience that is current and has a technical consensus. It is recognized, though, that the study of internal erosion continues to evolve and that not all phases of the process are completely understood. While research continues into these processes, this document attempts to present the best understanding based on current Federal agency practice. Hence, very recent or new, unproven technologies are not discussed. The authors also acknowledge that there are some minor variations in practice for evaluation and monitoring of seepage and internal erosion among the various Federal agencies. They have tried to focus on what they judged to be the “best practice” and included that judgment in this document. Therefore, this document may be different than some of the various participating agencies’ own internal practices.

Procedures and guidance for “best practices” concerning the evaluation and monitoring of seepage and internal erosion are provided. Currently available information was reviewed, and when detailed documentation existed, it was cited to avoid duplicating available materials. The authors have strived not to reproduce information that was readily accessible in the public domain and attempted to condense and summarize the vast body of existing information and provide a clear and concise synopsis of this information. This document is intended for use by personnel familiar with embankment dams and levees, such as designers, inspectors, construction oversight personnel, engineering geologists, and dam safety engineers.

The particular design elements and site conditions of each embankment dam are unique, and as such, no single publication can cover all of the requirements and conditions that can be encountered during evaluation and analysis. Therefore, it is critically important that embankment dams be analyzed by engineers experienced with all aspects of their performance.

The users of this document are cautioned that sound engineering judgment should always be applied when using references. The authors have strived to avoid referencing any material that is considered outdated. However, the user should be aware that certain portions of references cited may have become outdated in regards to methodology or philosophy. While these references still may contain valuable information, users should not automatically assume that the entire reference is suitable for use.

The Interagency Committee on Dam Safety (ICODS) sponsored development of this document. ICODS, which was established in 1980, encourages the implementation and maintenance of effective Federal programs, policies, and guidelines to enhance dam safety and security. ICODS serves as the permanent forum for the coordination of Federal activities in dam safety and security. The Federal Emergency Management Agency (FEMA) chairs ICODS. Agencies that allocated significant resources to development of this document include the U.S. Department of the Interior's Bureau of Reclamation (Reclamation), Federal Energy Regulatory Commission, Natural Resources Conservation Service (NRCS), and U.S. Army Corps of Engineers (USACE).

The primary authors of this document are Kevin Richards, P.E. (USACE), Ben Doerge, P.E. (NRCS), Mark Pabst, P.E. (USACE), Dennis Hanneman, P.E. (Reclamation), and Tim O'Leary, P.E. (USACE). The technical editor for this document was Sharon Leffel (Reclamation), and the illustrator was Cynthia Gray (Reclamation).

Initial peer review of this document has been provided by Doug Boyer, P.E., P.G. (USACE), Bill Engemoen, P.E. (Reclamation), Gregg Scott, P.E. (USACE), and Dan Osmun, P.E. (Reclamation).

A number of additional engineers and technicians provided input in preparation of this document, and the authors appreciate their efforts. The authors also extend their appreciation to the following agencies and individuals for graciously providing additional reviews, information, and permission to use their materials in this publication.

Authors of the draft FEMA Seepage Manual, which was discontinued as a stand-alone document, deserve particular thanks because much of their work was incorporated into this ICODS document (Part 3 - Identifying and Monitoring Seepage and Internal Erosion). Authors of the FEMA draft document include Randy Welch, Ben Doerge, Noah Vroman, Tommy Lee, Mark Pabst, Jarrod Durig, and staff members from the Engineer Research and Development Center. Randy Welch also assisted with development of this ICODS document.

Bill Engemoen, P.E. (Reclamation), the primary author of Reclamation's updated Seepage Design Standard provided a draft of the document for the team's use. Information from the draft document was used in portions of chapter 3 (parts of Section 3.5 –Vertical Seepage Paths – Heave and Blowout) as well as some of the discussion and several case studies included in Chapter 10 – Long-term Remediation Methods.

The authors would also like to acknowledge the generous contributions of published materials for the Case Histories appendix from: the International Commission on Large Dams, U.S. Society on Dams, Dr. John H. Schmertmann, Hydroplus, GEI Consultants, Larry Von Thun, Missouri University of Science and Technology, and the Association of State Dam Safety Officials.

The material presented in this document has been prepared in accordance with recognized engineering practices. The guidance in this document should not be used without first securing competent advice with respect to its suitability for any given application. The publication of the material contained herein is not intended as representation or warranty on the part of individuals or agencies involved or any other person named herein. This information is suitable for any general or particular use, but it does not promise freedom from infringement of any patent or patents. Anyone making use of this information assumes all liability from such use.

Any use of trade names and trademarks in this document is for descriptive purposes only and does not constitute endorsement. The information contained herein regarding commercial products or firms may not be used for advertising or promotional purposes and is not to be construed as an endorsement of any product or firm.

Contents

Page

Part I – Overview of Internal Erosion Processes

Chapter 1 – Introduction

1.1	Background.....	1-1
1.2	Purpose.....	1-1
1.3	Scope.....	1-2
1.3.1	Part 1 – Overview of Internal Erosion	1-2
1.3.2	Part 2 – Risk-informed Approach to the Evaluation of Internal Erosion.....	1-2
1.3.3	Part 3 – Identifying and Monitoring Seepage and Internal Erosion	1-3
1.3.4	Part 4 – Remediation Methods for Internal Erosion	1-3
1.4	References.....	1-3

Chapter 2 – Background

2.1	Historical Context and Evolution of Practice	2-1
2.2	Failure Statistics.....	2-3
2.3	Notable Failures and Incidents.....	2-5
2.4	References.....	2-6

Chapter 3 – Mechanics of Internal Erosion

3.1	Introduction to Internal Erosion.....	3-1
3.2	Internal Erosion – Mechanisms	3-2
3.2.1	Concentrated Leak Erosion.....	3-2
3.2.1.1	Differential Settlement.....	3-2
3.2.1.2	Hydraulic Fracture	3-3
3.2.1.3	Interruptions in Fill Placement.....	3-7
3.2.1.4	Frozen Lifts.....	3-7
3.2.1.5	Pervious Lift in an Impervious Core.....	3-7
3.2.1.6	Desiccation.....	3-7
3.2.1.7	Dispersion	3-9
3.2.1.8	Geologic Defects in the Foundation	3-11
3.2.1.9	Earthquake-induced Cracking.....	3-11
3.2.2	Backward Erosion Piping	3-12
3.2.2.1	Investigations in Horizontal Seepage.....	3-14
3.2.3	Internal Instability (Suffusion/Suffosion).....	3-17
3.2.4	Stoping.....	3-21
3.2.5	Saturation Failure/Sloughing	3-24
3.3	Biologic Activity (Animal and Vegetation).....	3-25
3.4	Aging Effects	3-25
3.4.1	Drainage Systems.....	3-25
3.4.2	Conduits	3-26
3.5	Vertical Seepage Paths – Heave and Blowout.....	3-26
3.5.1	Heave – High Exit Gradients in a Cohesionless Soil.....	3-26

	Page
3.5.2	Blowout – Uplift of a Confining Soil Layer 3-28
3.5.3	Implications of High Exit Gradients and Uplift Pressures..... 3-31
3.6	Horizontal Seepage Paths – Scour and Backward Erosion..... 3-32
3.7	References..... 3-33

Part 2 - Risk-based Approach to the Evaluation of Internal Erosion

Chapter 4 – Potential Failure Modes

4.1	Introduction..... 4-1
4.2	Internal Erosion Potential Failure Modes 4-2
4.2.1	Potential Failure Mode Categories..... 4-3
4.2.2	Failure Mode Development and Descriptions 4-3
4.3	Conceptual Framework Conducive to Potential Failure Modes Analysis 4-6
4.3.1	Phases of Internal Erosion 4-6
4.3.2	Phase 1 – Initiation..... 4-7
4.3.2.1	Factors Increasing the Likelihood of Initiation..... 4-8
4.3.2.2	General Classification of Soil Erodibility..... 4-11
4.3.2.3	Laboratory Tests for Classification of Soil Erodibility..... 4-13
4.3.3	Phase 2 – Continuation 4-14
4.3.3.1	Function of Filters and Their Importance 4-14
4.3.3.2	Cementation and Cohesion in Filters..... 4-15
4.3.3.3	Assessment of Filters in Existing Dams 4-16
4.3.3.4	Additional Considerations for Continuation..... 4-17
4.3.4	Phase 3 – Progression 4-18
4.3.4.1	Continuous Stable Roof and/or Sidewalls 4-19
4.3.4.2	Constriction or Upstream Zone Fails to Limit Flows 4-20
4.3.4.3	No Self-healing Provided by Upstream Zone 4-21
4.3.5	Phase 4 – Breach..... 4-22
4.4	Failure Mode Screening and Ranking..... 4-25
4.5	Risk Management Factors in the Potential Failure Modes Analysis 4-26
4.5.1	Major Findings and Understandings..... 4-26
4.5.2	Interim Risk Reduction Measures..... 4-26
4.5.3	Potential Changes to Instrumentation and Monitoring, and Operation/ Maintenance Procedures 4-26
4.5.4	Updating the Emergency Action Plan Following a Potential Failure Modes Analysis..... 4-27
4.5.5	Recommendation of Additional Studies and Other Activities..... 4-27
4.6	Concluding Remarks Regarding the Potential Failure Modes Analysis Process..... 4-28
4.7	References..... 4-28

Chapter 5 – Risk Evaluation

5.1	Introduction	5-1
5.2	General	5-3
5.3	Risk Assessment	5-4
5.3.1	Event Sequences	5-4
5.3.2	Qualitative or Semiquantitative Risk Assessments	5-7
5.3.3	Quantitative Risk Assessment	5-8
5.3.3.1	Historical Rates	5-9
5.3.3.2	Subjective Probability Estimates	5-9
5.4	Risk Management	5-11
5.5	References	5-12

Part 3 – Identifying, Monitoring, and Addressing Internal Erosion**Chapter 6 – Seepage Detection and Investigation Methods**

6.1	Visual Detection Methods	6-1
6.1.1	Introduction	6-1
6.1.2	Surface Discharges	6-4
6.1.3	Surface Deformations	6-8
6.1.4	Video Inspections of Conduits and Penetrations	6-9
6.1.5	Photography	6-10
6.1.6	Inspection Reporting	6-12
6.2	Non-visual Detection and Investigation Methods	6-13
6.2.1	Introduction	6-13
6.2.2	Surface Monitoring Systems	6-13
6.2.3	Dye Tracing	6-15
6.2.4	Temperature	6-16
6.2.5	Electrical Resistivity and Self-potential Methods	6-18
6.2.5.1	Electrical Resistivity	6-18
6.2.5.2	Self-potential Method	6-19
6.2.6	Electromagnetic Profiling	6-19
6.2.6.1	General Considerations	6-19
6.2.6.2	Example Electromagnetic Profiling Method	6-21
6.2.7	Remote Sensing Applications	6-22
6.2.7.1	Early Detection of Potential Seepage Locations	6-24
6.2.7.2	Detecting Seepage Discharge Locations	6-27
6.3	Intrusive Methods	6-27
6.4	References	6-28

Chapter 7 – Seepage Collection and Measurement

7.1	Introduction	7-1
7.1.1	Water Quantity and Quality	7-2
7.1.2	Pressure Measurement	7-2

	Page
7.2	Best Practices 7-2
7.2.1	Criticality of Seepage Location..... 7-2
7.2.2	System Selection, Design, and Installation..... 7-3
7.2.2.1	Layout Considerations 7-5
7.2.2.2	Installation Considerations..... 7-6
7.2.2.3	Automated Data Acquisition Systems 7-7
7.2.2.4	Early Detection and Warning..... 7-8
7.2.3	Seepage Collection..... 7-8
7.2.3.1	Ditches and Channels..... 7-9
7.2.3.2	Drains 7-10
7.2.3.3	Wells 7-12
7.2.4	Seepage Measuring Devices 7-15
7.2.4.1	Water Level – Staff Gages, Pressure Transducers, Manometers, Chart Recorders 7-16
7.2.4.2	Seepage Flow Rate..... 7-17
7.2.4.3	Pressure - Piezometers 7-21
7.2.5	Water Quality Measurement 7-34
7.2.5.1	Turbidity 7-34
7.2.5.2	Dissolved Solids..... 7-35
7.2.5.3	Corrosion Potential 7-35
7.2.6	Maintenance Issues 7-37
7.3	References..... 7-38

Chapter 8 – Seepage Performance Monitoring

8.1	General..... 8-1
8.2	Frequency of Monitoring 8-2
8.2.1	Monitoring Requirements for Extreme Events 8-3
8.3	Processing, Proofing, and Presenting Data 8-4
8.4	Alarm Levels..... 8-6
8.5	Analysis of Data..... 8-7
8.5.1	Introduction..... 8-7
8.5.2	Evaluating Geologic and Time Lag Effects on Seepage Paths 8-7
8.5.3	Detecting Changes and Trends 8-8
8.5.3.1	Gradual Changes 8-10
8.5.3.2	Abrupt Changes 8-12
8.5.3.3	Trends Analysis 8-13
8.5.4	Uses of Piezometer Data 8-17
8.5.5	Predicting Piezometer Readings at Higher Reservoir Levels 8-19
8.5.5.1	Graphical Extrapolation 8-19
8.5.5.2	Differential Head Ratio..... 8-20
8.5.5.3	Seepage Modeling..... 8-22
8.6	Aging Impacts 8-22
8.7	References..... 8-23

Part 4 – Emergency Response and Remediation Methods for Internal Erosion

Chapter 9 – Emergency Response and Interim Measures

9.1	Introduction	9-1
9.2	Pre-event Planning	9-1
9.3	Emergency Action Plan	9-2
9.4	Incident Detection and Initial Evaluation	9-4
9.4.1	Internal Erosion Detection	9-4
9.4.2	Initial Assessment and the Decision Point	9-5
9.4.2.1	Immediate Emergency Requiring Aggressive Response	9-6
9.4.2.2	Incidents that Allow Time for Further Evaluation	9-7
9.5	Emergency Response Alternatives	9-7
9.5.1	Immediate Actions	9-8
9.5.1.1	Emergency Reservoir Drawdown	9-8
9.5.1.2	EAP Implementation	9-9
9.5.1.3	Take Other Appropriate Actions as Needed	9-9
9.5.1.4	Other Immediate Actions	9-9
9.5.2	Non-immediate Actions	9-9
9.5.2.1	Reservoir Restriction	9-10
9.5.2.2	Increased Monitoring Frequency	9-11
9.5.2.3	Install Additional Instrumentation	9-11
9.5.3	Interim Measures	9-11
9.6	Post-event Evaluations and Report	9-12
9.7	General Recommendations	9-12
9.8	References	9-12

Chapter 10 – Long-term Remediation Methods

10.1	General	10-1
10.2	Role of Risk in the Evaluation of Remediation Alternatives	10-1
10.3	Description of Alternative Remediation Methods	10-1
10.3.1	Cutoffs	10-2
10.3.1.1	Sheet Pile Walls	10-2
10.3.1.2	Secant Pile Walls	10-3
10.3.1.3	Slurry Walls	10-3
10.3.1.4	Grouting	10-5
10.3.1.5	Geomembranes	10-6
10.3.1.6	Upstream Blanket	10-7
10.3.1.7	Upstream Cutoff Trench	10-8
10.3.2	Seepage Collection	10-8
10.3.2.1	Chimney Drains	10-9
10.3.2.2	Toe Drains	10-10
10.3.2.3	Blanket Drains	10-11
10.3.3	Filters	10-11
10.3.3.1	General Considerations	10-11

	Page
10.3.3.2	Filter Diaphragms 10-13
10.3.4	Pressure Reduction..... 10-16
10.3.4.1	Relief Wells 10-17
10.3.4.2	Trench Drains..... 10-18
10.3.4.3	Drainage Galleries 10-20
10.3.5	Reduction of Piping Potential 10-21
10.3.5.1	Flattening Slopes/Berms 10-21
10.3.5.2	Increasing Tailwater Elevation 10-21
10.3.5.3	Soil Stabilization..... 10-23
10.3.5.4	Excavate and Replace 10-23
10.3.6	Crack Stoppers 10-24
10.3.6.1	Granular Barriers 10-24
10.3.6.2	Geotextile Barrier..... 10-26
10.3.6.3	Other Considerations During Remediation..... 10-28
10.3.7	Other Methods 10-28
10.3.7.1	Replace Dam..... 10-28
10.3.7.2	Breach/Decommissioning..... 10-29
10.4	Evaluation/Selection of Remediation Method 10-31
10.4.1	Cost Considerations 10-31
10.4.2	Risk Reduction..... 10-32
10.4.2.1	Initiation Prevention..... 10-32
10.4.2.2	Continuation Prevention 10-32
10.4.2.3	Progression Stop 10-33
10.4.3	Combined Cost/Risk Reduction Analysis..... 10-33
10.5	References..... 10-35

Tables

Table	Page
2-1	Summary of embankment failures (Foster et al. 1998)..... 2-4
4-1	Erosion resistance of soils (Sherard 1953)..... 4-12
4-2	Erosion resistance (from concentrated leaks) of soils related to classification and dispersivity (Fell et al. 2008) 4-12
4-3	No erosion boundary for the assessment of filters of existing dams (after Foster and Fell 2001) 4-16
4-4	Excessive and continuing erosion criteria (Foster 1999; Foster and Fell 1999, 2001) 4-16
4-5	Probability of a soil being able to support a roof (Fell et al. 2008) 4-20
6-1	Generalized comparisons of commercially available remote sensing technology and applicability to embankment seepage detection and monitoring 6-25
8-1	Criteria for post-earthquake inspections of USACE dams (USACE 2014)..... 8-4

Figures

Figure		Page
3-1	Examples of dam cracking (adapted from Sherard 1963)	3-4
3-2	Example of stress arching and hydraulic fracture at a conduit	3-6
3-3	Suspected hydraulic fracture at Ochoco Dam near the intake tower that was subsequently filled with reservoir sediments	3-6
3-4	Examples of winter construction at embankment dams prior to removal of snow and ice contamination. (<i>Top</i>) Blue blanket is insulated to prevent freezing of underlying soils. (<i>Bottom</i>) Placement of fill on improperly prepared frozen ground, snow, and ice	3-8
3-5	Upper Red Rock Site 20 Dam internal erosion through dispersive soils.....	3-9
3-6	Illustration of backward erosion piping showing the fully formed pipe connected from downstream to upstream	3-12
3-7	Deltares small-scale laboratory test apparatus	3-15
3-8	Deltares large-scale field test (Van Beek)	3-15
3-9	Overhead view of piping progression in small-scale tests by Deltares.....	3-16
3-10	Suffusion mechanism.....	3-18
3-11	Grading envelopes of some broadly graded soils with no self-filtering (adapted from Sherard 1979; FEMA 2011).....	3-20
3-12	Soils susceptible to suffusion (adapted from Wan and Fell 2004)	3-21
3-13	Vertical stoping of void from erosion of Zone 1 soil into the bedding planes, joints, and karst solution features in the foundation.	3-22
3-14	Sinkhole at Willow Creek Dam.	3-22
3-155a	Sinkhole in crest of a dam in Montana	3-23
3-155b	Excavation of the sinkhole shown in previous photograph revealed original toe drain below the sinkhole	3-23
3-16	Illustration of how downstream sloughing due to saturation could lead to dam failure.	3-24
3-17	Illustration of types of sand boils (Von Thun).....	3-28
3-18	Definition sketch for the Total and Effective Stress Methods	3-30
4-1	Example PFM: Stages 1, 2, and 3 of a “through foundation” failure mode	4-4
4-2	Example PFM: Stages 4, 5, and 6 of a “through foundation” failure mode	4-4
4-3	Example PFM: Stage 7 of a “through foundation” failure mode.....	4-4
4-4	Illustration of filtering at a crack	4-15
4-5	Criteria for excessive erosion boundary (Foster and Fell 2001).....	4-17
4-6	Example of a dam that experienced gross enlargement, but the reservoir drained before erosion progressed to the point of crest collapse.	4-22
4-7	Fontenelle Dam, which nearly breached by sloughing	4-23
4-8	Maximum section of Minidoka Dam. The downstream rockfill zone withstood significant flows when the core overtopped during construction.	4-24
4-9	Sallacoa Dam experienced a large sinkhole from internal erosion into a karst foundation.	4-24
6-1	Visual observation of failure mode in progress	6-3

Figures (continued)

Figure		Page
6-2	Seepage discharge where the typical grass growth has been retarded in the saturated soil environment and where other vegetation species are becoming dominant.....	6-5
6-3	Presence of phreatophytic vegetation (willow trees and cattails) in an established seepage discharge location approximately 200 feet below the downstream toe.....	6-6
6-4	Visual markers (flagging) map the areal extents and spreading of surface seepage discharges (seeps)	6-6
6-5	Illustration of sand boil formation near the downstream toe and potential backward erosion piping failure mode in the foundation.	6-7
6-6	Sinkhole that developed on the upstream face of a dam due to piping and internal erosion of the embankment into the foundation.....	6-8
6-7	Surface deformation indicative of animal activity observed on the downstream slope	6-9
6-8	Surface erosion (gully).....	6-10
6-9	Photograph shown without a visual reference or scale to establish the plant's size.	6-12
6-10	Example of excessive or continuous crest settlement indicating a deteriorating condition likely due to piping or internal erosion.	6-15
6-11	Seepage water discharge locations (flagged with red markers) are more evident during the winter due to water temperature differences.....	6-16
6-12	Temperature measurements in piezometer sensors 035:1, 045:1, and 060:1 located in a Swedish dam foundation (bedrock). Temperature sensor 060:1 indicates seepage flow at this location due to its higher seasonal temperature variation (after Johansson et al. 2007)	6-17
6-13	Electrical resistivity imaging and self-potential plots for right abutment of earth embankment with karstic foundation.	6-20
6-14	Electromagnetic survey layout to investigate seepage in a typical embankment. The dashed yellow lines represent the idealized electric current between the two electrodes. (Courtesy of Willowstick Technologies)	6-21
6-15	Typical response ratio map. (Courtesy of Willowstick Technologies).....	6-22
6-16	Electric current distribution model showing zone of leakage in an embankment foundation. The view shown is a profile along the centerline of the embankment, looking upstream. (Courtesy of Willowstick Technologies).....	6-23
7-1	Reclamation's decision tree for instrumentation review (Reclamation 2009).....	7-4
7-2	Simple seepage flow rate measurement illustration.....	7-9
7-3	Illustrative seepage collection and measurement system installed on the foundation surface under the downstream shell of an embankment dam (after ANCOLD, 1983).....	7-10
7-4	Chimney and blanket drain inside a homogeneous-fill dam on an impervious foundation.	7-11
7-5	Typical toe drain detail (adapted from the Bureau of Reclamation [1990]; footnotes refer to the source document.).....	7-11

Figures (continued)

Figure		Page
7-66a	Isometric view of toe drain inspection well basic components (Pabst 2007b)	7-13
7-66b	Closer view of components in the bottom of a typical toe drain inspection well. Optional baffle at the end of the inlet pipe is not shown. In order for the weir to function properly, a head drop distance across the weir no less than one pipe diameter of the largest pipe penetrating the well is required (Pabst 2007b)	7-13
7-7	Toe drain cleanout access features (not to scale) (Pabst 2007b)	7-14
7-8	Observation well (USACE 1995)	7-14
7-9	Relief well seepage outflow. Although relief wells are not typically installed for the primary purpose of seepage water monitoring, their outflow can be collected, measured, and evaluated similar to open piezometers or observation wells	7-15
7-10	Staff gage indicates reservoir water level (elevation).....	7-16
7-11	Weir types	7-17
7-12	Automated V-notch weir system (after Soil Instruments, Ltd.).....	7-18
7-13	Plan and elevation views of a concrete (cast-in-place) Parshall flume. (Courtesy of USDA-NRCS).....	7-19
7-14	Cup-type velocity meter. (Photo courtesy of USDA-NRCS)	7-21
7-15	Open system piezometer installed in a borehole (after USACE [1995]). A slotted well screen as shown on figure 7-8 is often used instead of the porous filter as illustrated here.....	7-22
7-16	Closed-system piezometer installed in a borehole using conventional borehole sealing components	7-23
7-17	Pneumatic piezometer pressurized with nitrogen gas. The gage measures differential pressure (after ASCE [2000]).....	7-24
7-18	Vibrating wire piezometer. (Courtesy of Geokon, Inc.)	7-25
7-199a	Illustration of a multi-level closed-system piezometer installed in the traditional manner. All piezometers can be installed using this method. Although the element dimensions are not scaled in this illustration, they are specifically provided in design and construction details.....	7-29
7-19b	Illustration of a multi-level closed-system piezometer installed using the conventional method. All diaphragm-type piezometers can be installed using this method, but it is most commonly recommended by vibrating wire piezometer manufacturers. Although the element dimensions are not scaled in this illustration, they are specifically provided in design and construction details	7-29
7-199c	Single open- or closed-system piezometer installation using the direct-push method. Multi-level sensor installation is also possible with this method.....	7-29
7-20	Approximate response times for selected piezometer types installed in confined, fully pressurized influence zones (after Terzaghi and Peck 1967)	7-32

Figures (continued)

Figure	Page
8-1	Conceptual illustration of a seepage drain flow rate response plot. The flow rate from drain #2 varies significantly from that in drain #1 as the reservoir level increases, indicating a seepage anomaly or other phenomenon occurring in the drain #2 collection area 8-10
8-2	Time history plot of reservoir level overlaid with piezometer 5 and 6 data. In this plot, the pore pressures measured by piezometer 5 (in red) are not influenced by changes in reservoir levels, but are related to changes in regional groundwater. In contrast, the pore pressures measured by piezometer 6 (in blue) show minimal time lag response to reservoir level changes 8-11
8-3	Weir response and raw fit (ASDSO 2010)..... 8-15
8-4	Weir parsed 1973–1983, 1983–1997, and 1997–2009 (ASDSO 2010)..... 8-15
8-5	Weir parsed and corrected for lag (ASDSO 2010). 8-16
8-6	Weir parsed and corrected for lag and creep (ASDSO 2010)..... 8-16
8-7	Example groundwater contour map produced by mapping software from existing data collected from piezometers 8-18
8-8	Graphical extrapolation of piezometric elevation versus reservoir elevation plot 8-20
8-9	Definition sketch for differential head ratio for blanket-aquifer foundation. 8-21
8-10	Differential head ratio versus time for a piezometer during first filling (vertical axis units for “Pool Rise” curve are in feet)..... 8-22
10-1	Geomembrane cutoff with sand filter on Reach 11 Dike, Arizona. (Photo courtesy of Reclamation) 10-7
10-2	Simple cross section showing a chimney used in a new dam or an old dam with an extended chimney..... 10-9
10-2	Simple cross section showing a chimney added to the downstream slope of an existing dam. 10-9
10-3	Typical one-stage (left) and two-stage (right) toe drains in a trapezoidal trench..... 10-11
10-4	Pressure washing joints and fractures in bedrock prior to dental grouting and covering with a blanket under the downstream shell of a dam. (Photo courtesy of NRCS) 10-12
10-5	Typical filter diaphragm addition around a conduit near the centerline of a dam (outlet for filter diaphragm not shown)..... 10-14
10-6	Example of filter diaphragm (with drainage zone) around a conduit near the downstream toe of a dam 10-14
10-7	Recommended detail of a filter diaphragm extending across the entire width of an opening excavated through a dam (details of conduit cradle not shown) 10-15
10-8	Failure of an earth embankment in Louisiana along the principal spillway conduit, looking upstream toward riser. Notice damaged anti-seep collars on conduit. (Photo courtesy of NRCS, Louisiana)..... 10-16
10-9	Typical relief well installation for blanket-aquifer foundation 10-17

Figures (continued)

Figure	Page
10-10	Relief well locations at Canby Creek, R-1 Dam, in Minnesota with blanket-aquifer foundation. (Drawing courtesy of NRCS, Minnesota) 10-18
10-11	Typical trench drain details – (a) drain at downstream toe of dam; (b) drain under downstream slope of dam with horizontal drainage layer (after USACE 1993) 10-19
10-12	Trench drain parallel to outlet channel of dam at Canby Creek, R-1 Dam 10-20
10-13	Safety factor determination for a layered blanket with a seepage berm 10-22
10-14	Sandbags placed around a sand boil to increase tailwater level as part of a temporary risk reduction measure. (Photo courtesy of USACE, Missouri Valley Division) 10-23
10-15	Granular barrier on centerline of a cracked embankment in a normally dry dam (barrier should extend at least to the maximum pool elevation) 10-25
10-16	Inclined granular barrier near downstream slope of a cracked embankment in a normally dry dam 10-25
10-17	Filter design for silt earthfill with 2-inch-wide cracks 10-26
10-18	Construction of geotextile barrier in Olmitos-Garcias No. 2 Dam in south Texas. The downstream side of the embankment is shown. Left – geotextile being backfilled in foundation trench. Right – geotextile on back slope of dam prior to backfilling. (Photos courtesy of NRCS, Texas) 10-27
10-19	Construction of a geotextile/aggregate chimney filter in Florence Dam in Arizona. Geotextile drape is on right (downstream) side of trench. (Photo courtesy of NRCS, Arizona) 10-27
10-20	Cross section of Cañon C-4 Dam showing crack stopper feature (“structural filter”) beneath upstream impervious zone with non-standard use of geotextile (the purple dashed line is geotextile)..... 10-28
10-21	Seepage-caused slope instability near outlet of principal spillway conduit, Little Washita No. 13, Oklahoma (1979). (Photo courtesy of NRCS, Oklahoma)..... 10-30
10-22	Sinkhole in reservoir area of Little Washita No. 13, Oklahoma. (Photo courtesy of NRCS, Oklahoma) 10-30
10-23	Combined portrayal of alternative cost and risk reduction. 10-34

Appendices

Appendix

- 1 Case Histories of Dam Failures from Internal Erosion

Part 1

Overview of Internal Erosion Processes

CHAPTER 1 – INTRODUCTION

1.1 Background

Internal erosion occurring at Federal (and non-Federal) embankment dams and levees poses a threat of failure and potential risk to public safety. In fact, a study conducted by the University of New South Wales (Foster et al. 1998) shows that 54 percent of the world-wide embankment dam failures post-1950 were the result of internal erosion. Various Federal agencies may use different methods and procedures for monitoring and measuring seepage, identifying and quantifying the probability of failure and risk due to internal erosion, and identifying, evaluating and implementing risk reduction measures for internal erosion. This document presents a summary of current Federal practices for monitoring and measuring seepage, identifying potential failure modes (PFMs) related to internal erosion, assessing risk related to internal erosion, and remediating internal erosion. Other documents, such as the Bureau of Reclamation (Reclamation)-U.S. Army Corps of Engineers (USACE) *Dam Safety Risk Analysis Best Practices Training Manual*, provide more detailed “how-to” information for conducting a risk analysis.

The USACE, Reclamation, Federal Energy Regulatory Commission, Federal Emergency Management Agency, Natural Resources Conservation Service, and the International Commission on Large Dams have been actively involved in developing best practices related to internal erosion and risk-informed approaches. The various Federal agencies currently apply risk-informed decisionmaking using different methodologies or internal policies. These practices range from a formal risk analysis to informal methods based on engineering judgment and have evolved based on the unique dam inventories, regulatory framework, and specific agency needs and resources.

1.2 Purpose

The Interagency Committee on Dam Safety (ICODS) Task Group on Internal Erosion (Task Group) was tasked with developing an overview of current practices for dam safety analysis and decision making relative to monitoring and measuring seepage as well as summarizing the current state of knowledge with respect to PFMs and remediation procedures for internal erosion. The objective of this manual is to collect the various Federal efforts on this subject and provide a summary and practical information for the dam safety profession. It is not the purpose of this document to impose a specific risk-informed approach to dam safety on all Federal agencies.

1.3 Scope

ICODS provided the Task Group with the following items as topics in preparing this manual:

- Best practices for monitoring and measuring seepage as well as evaluating seepage
- Evaluating PFMs related to internal erosion
- Best practices for quantifying the risk posed by internal erosion
- Best practices for internal erosion remediation measures

To address the above items, this manual has been divided into four parts to provide a logical flow through the subject matter. Appendix 1 is included to provide some case histories of internal erosion incidents, failures, risk assessments, and examples of remediation of internal erosion problems.

1.3.1 Part 1 – Overview of Internal Erosion

This section begins with a historical context for the subject of piping and internal erosion, including embankment failure statistics; the role of notable failures, such as Teton Dam,¹ and the evolution of how internal erosion has been evaluated and treated by dam engineers. A conceptual overview of various mechanisms of internal erosion is discussed. The often inconsistent terminology that has historically been used for internal erosion-related phenomena is presented and defined so that a common set of terms can be established for the purposes of this manual. The overall intent is to improve the understanding of internal erosion processes.

1.3.2 Part 2 – Risk-informed Approach to the Evaluation of Internal Erosion

Identifying and understanding PFMs for internal erosion of embankment and foundation materials is critical to effective and efficient monitoring, evaluation, and mitigation of internal erosion. PFMs are categorized according to the location of the seepage pathway in order to facilitate subsequent evaluation. When it is necessary to further evaluate PFM based on their potential risk to infrastructure and people, a risk analysis can be used to help inform decision makers. Risk analysis is a rapidly changing field that is currently undergoing development at several Federal agencies. The level and detail of risk analysis depends largely on the types of dams and range of potential impacts within an agency or corporate dam portfolio, and there are many valid approaches that can be employed. Some may use a simple screening process to identify the PFMs at each dam that have the greatest potential for damage or loss. Others may do a more detailed and rigorous risk analysis to rationally allocate the best use of expenditures using the risk-informed approach. There really is no “one-size-fits-all” approach to risk analysis in the current state of the practice, but chapter 5 presents some of the basic aspects of performing a risk analysis.

¹ For additional details, see Case 1 – Teton Dam and Fontenelle Dam, in appendix 1 (Seminal Case Histories).

1.3.3 Part 3 – Identifying and Monitoring Seepage and Internal Erosion

This section covers practices for seepage-related monitoring, including visual observations, geophysical investigations, instrumentation, and remote sensing. Practices related to seepage monitoring are discussed, including system selection, design, and installation; seepage collection measures; seepage measuring devices, including both flow rate and pressure; water quality measurement; and performance monitoring considerations, including frequency of monitoring, alarm levels, and analysis of data. The use of seepage-related observations and measurement to identify PFMs is emphasized.

Long-term performance monitoring is also discussed as well as the concepts of interpretation and processing of data, presentation of monitoring results, and development of a cogent life-cycle monitoring program.

1.3.4 Part 4 – Remediation Methods for Internal Erosion

A number of actions are possible during an emergency; however, not all actions may produce the desired results depending on the situation. This section presents some common emergency response methods that have been successfully employed when seepage issues developed. Possible interim measures that may be necessary to ensure the safety of a project under distress are also discussed. These measures may be required for some time until a permanent fix can be designed and constructed.

Numerous approaches and remediation measures exist to address or reduce risks related to internal erosion. Some measures are more successful than others, and each has advantages and disadvantages depending on a number of factors. This section provides general guidance on various long-term internal erosion remediation approaches that can be considered, including: cutoffs, collection, filters, pressure reduction, and other approaches such as dam replacement or decommissioning.

Common, innovative, and emerging alternatives are also presented and discussed. The alternatives are compared and contrasted, and general guidance is provided on advantages and shortcomings of each. Alternatives are also discussed from a risk reduction approach.

A list of available documents related to internal erosion remediation methods is also included.

1.4 References

Foster, M.A., M. Spannagle, and R. Fell (1998). "Report on the Analysis of Embankment Dam Incidents." *UNICIV Report No. R-374*, University of New South Wales, Sydney, Australia.

CHAPTER 2 – BACKGROUND

2.1 Historical Context and Evolution of Practice

Dam failures due to internal erosion have occurred from the earliest days to modern times. Early designs of dams were more prone to internal erosion failures until experience was gained. Early dams did not incorporate any defensive measures for underseepage, such as cutoff walls or extended seepage paths. The early designs for dams mostly consisted of narrow masonry or timber crib structures, often founded on sand, with no cutoffs and earthen dams. Colonel Clibborn (1902) performed experiments using non-cohesive sand after a number of weir (diversion dam) structures failed from internal erosion in India in the late 1800s. These tests led to his prediction of failure of the Narora Weir by internal erosion. This may also be one of the earliest cases of rudimentary risk analysis being employed to assess internal erosion for a number of structures from an analysis to predict internal erosion. These early experiments were published and contributed to the understanding of the importance of the hydraulic gradient in the design of water-retaining structures.

Bligh (1910, 1911a, 1911b, 1913) developed an empirical approach to the design of water-retaining structures after studying a limited number of dam failures by internal erosion, most of which were low-head structures. His design method utilized the concept of head losses along a seepage line that followed the outline of the submerged portions of a structure, including cutoff walls. Bligh's method recognized the importance that composition and grain size have on a soil's susceptibility to internal erosion. Bligh's empirical approach was later improved by Lane (1934), who studied over 200 dams and developed a very similar empirical method. Lane's method recognized that seepage along horizontal planes is less inhibited than vertical seepage and he therefore weighted the lengths of the seepage paths accordingly in his design method. Although controversial, both Lane and Bligh's methods are still used by some engineers today and rely on the concept that seepage is assumed to concentrate along a soil-structure boundary and the susceptibility to internal erosion being dictated by the soil's characteristics. While potentially useful for conservative design of concrete dams founded on soil and spillway apron lengths, the method has not found much use in risk analyses. Lane (1934) discusses the controversy between the concepts of intergranular seepage versus seepage along structural contacts, and the discussion continues to this day. Terzaghi (1929) emphasized that unpredictable geologic defects can be a primary cause of internal erosion and that seepage theory alone cannot always predict behavior.

Forchheimer (1886, 1914) described use of the flow net method in groundwater hydraulics to assess the direction and rate of seepage. This analytical method complements Darcy's (1856) evaluation of seepage through granular materials, and the resulting Darcy's Law can be used with Forchheimer's flow nets to determine the pore pressures and discharge rates of seepage through granular materials. The method is useful as it is based on site-specific geometric variations and their impact on the hydraulic gradient. Shortly after these developments, Terzaghi (1922) performed experiments in "piping" (internal erosion) that led to development of an early

defensive measure against piping—the filter/weighted berm. He had also observed levees along the Mississippi River that exhibited boils and was interested in assessing seepage in cofferdams in relation to the changes in the effective stress brought about by altered seepage gradients during construction. Terzaghi had developed the concept of effective stress and developed a theoretical factor of safety. This method was applicable for non-cohesive soil subjected to vertical seepage. An example of the use of this failure criterion for the interior floor of a cellular cofferdam was presented in Terzaghi's seminal text book, *Erdbaumechanik* (1925). Terzaghi's failure criterion was later used for the downstream toes of embankment dams using a factor of safety based on a critical hydraulic gradient.

At about the same time that Lane was developing his method, Harza (1934) recognized the importance of uplift forces to the overall stability of dams. These developments led to changes in the way dams were designed after the 1930s, with the recognition of the importance of seepage and stability of structures from underseepage, uplift, and internal erosion, and with the addition of defensive measures such as foundation cutoff walls, drains, filters, and weighted berms. Casagrande (1937) was one of the early proponents of the use of flow nets for evaluation of seepage through dams. It is interesting to note that even prior to these developments of sound engineering theory, dam designers had recognized the importance of constructing dams with impervious cores from trial and error (Jansen 1983). Masonry structures that were in common use in early dams were found to be prone to leakage over time and would often be designed with a clay puddle core to reduce seepage through the structure.

Construction of large embankment dams, which required large amounts of material to construct, utilized the concept of the clay puddle core to allow construction of the dam from mostly coarse materials, which are generally more available at many dam sites. Many of these hydraulic-fill dams were constructed with rockfill shells around clay-puddle cores. After numerous internal erosion incidents in the early 1900s, Terzaghi introduced the concept of drainage elements, which helped to protect fine materials subject to intergranular seepage. Sherard et al. (1972, 1973, 1976) found that hydraulic fracturing and dispersive soils contributed to development and failure by internal erosion. Sherard et al. (1984) evaluated Terzaghi's filter criteria in the 1980s to assess its applicability for design of filters with regard to preventing erosion associated with concentrated leaks in silts and clays, including dispersive clays.

In both Australia and in the United States, problems developed with dams that were constructed with dispersive soils. Dams constructed of dispersive soils were found to be susceptible to failure from the infiltration of rain, leading to development of erosion tunnels and shafts (jugs) through the dam. Failure of dams from erosion of dispersive soils is similar in some respects to the failure of dams by external influences such as rodents burrowing tunnels and plants creating new pathways for concentrated seepage through dams, which can flood and erode further during high-water events (or first filling). It was found that dams constructed of dispersive soils are very susceptible to failure by concentrated seepage and required special design considerations and monitoring. A number of tests are available for testing the dispersivity of soils (Jones 1981; ASTM 2013). Modern dams are now designed with filters as a defensive measure against various forms of internal erosion, including dams constructed of dispersive soils. However, many dams that are still in service were constructed prior to these design improvements and do

not include defensive measures for the prevention of internal erosion. A more complete discussion of the development and current practice with filter criteria is presented in Filters for Embankment Dams (Federal Emergency Management Agency, 2011).

In the late 1970s, researchers began to understand another internal erosion process that could lead to excessive seepage and failure by internal erosion (Kézdi 1979; Kovács 1981). This process, known as internal instability (suffusion/suffosion), occurs in soils that are gap or broadly graded and non-self filtering. It has more recently been recognized that this form of internal erosion can occur at very low hydraulic gradients (Adel et al. 1988; Skempton and Brogan 1994; Richards 2008). Such soils are termed internally unstable, and there are simple methods for evaluating the internal stability of soils based on sieve analyses (Kézdi 1979; Kenny and Lau 1985; Skempton and Brogan 1994; Åberg 1993).

Dam designs have been increasingly modified to add defensive measures for seepage control and internal erosion. Methods have also evolved as the complexity and varieties of processes leading to internal erosion have become better understood. Work is still ongoing to develop better methods for the assessment of backwards erosion¹ piping potential and internal erosion potential from concentrated leaks; however, the practice has come a long way in addressing the various risks posed by internal erosion.

2.2 Failure Statistics

A number of studies have been made of the failure of embankment dams in the last several decades (Foster et al. 2000; Richards and Reddy 2007). These studies consistently show that seepage-related failures of dams comprise about one-half of all dam failures. Bonala and Reddi (1998) report that about one-quarter of internal erosion failures can be attributed to poor filter design. Richards and Reddy (2007) reviewed case histories of dam failures in the United States using the National Performance of Dams Program database and found that nearly one-third of internal erosion failures may be associated with backward erosion piping. About 50 percent were found to fail from internal erosion along conduits and internal erosion into or along foundation contacts. The statistics of dam failures are generally problematic in that there is not a universal understanding or common language to describe the complexity of internal erosion failure modes. In addition, internal erosion research and understanding have been evolving over time; but published reports of dam failures by internal erosion are often missing critical information necessary for proper classification of the failure mode (Richards and Reddy 2007).

Foster et al. (1998, 2000) undertook a study of dams worldwide and found 46.1 percent of all embankment dam failures can be attributed to internal erosion. Of these failures, 30 percent were due specifically to internal erosion through the embankment, about 15 percent were due to internal erosion through the foundation, and the remaining 1.5 percent were from the embankment into the foundation. For dam failures associated with internal erosion through the embankment, they found that one-half of those were along a conduit or other structure.

¹ Refer to chapter 3 for a definition of terms used within this document.

Foster et al. (1998) conducted a study on embankment dam incidents for large dams² up to 1986 from the International Committee on Large Dams (ICOLD) World Register, which includes a database of 11,192 dams. These dams cover a broad range of age, embankment type, construction techniques, and foundation conditions. Foster et al. developed a table (table 2-1) to show the number of embankment dam failures for different modes of failure:

Table 2-1.—Summary of embankment failures (Foster et al. 1998)

Mode of failure	Number of cases		Percent failures (where known)	
	All failures	Failures in operation	All failures	Failures in operation
Overtopping	46	40	35.9	34.2
Spillway/gate	16	15	12.5	12.8
Subtotal	62	55	48.4	47.0
Piping through embankment	39	38	30.5	32.5
Piping through foundation	19	18	14.8	15.4
Piping from embankment into foundation	2	2	1.6	1.7
Subtotal	59	57	46.1	48.7
Slides	7	5	5.5	4.3
Earthquake/liquefaction	2	2	1.6	1.7
Unknown	8	7		
Total number of failures	136	124		

From their study, the piping (seepage-induced erosion) failure mode accounts for almost one-half of the embankment failures. Furthermore, the results from their study indicate that about 1 in 200 dams fail due to piping and 1 in 60 dams experienced a piping incident.

Of the piping failures, the majority occur through the embankment. About one-half of all piping failures are associated with conduits. Conduits are sources for discontinuities and are difficult to properly compact around.

For piping through the embankment, Foster et al. (1998) show that nearly 50 percent of the failures occurred during the first filling and 64 percent within the first 5 years of operation. For piping through the foundation, nearly 25 percent of the failures occurred during first filling and

² ICOLD (1974) defines a large dam as a dam that is more than 49 feet (15 meters) in height (measured from the lowest point in the valley to the crest of the dam) or any dam between 32.8 feet (10 meters) and 49 feet (15 meters) with either has a crest length more than 1,640 feet (500 meters), 810 acre-feet (1 million cubic meters), or 70,000 cubic feet per second (2,000 cubic meters per second).

75 percent within the first 5 years of operation. First filling is considered the first true test of the embankment dam under hydraulic loading conditions. If a dam is poorly constructed or contains flaws and defects, first filling will likely expose these weaknesses. However, some piping failures can develop slowly over time (such as internal erosion into a karstic foundation). As indicated earlier, nearly 25 percent of failures occur after 5 years of operation.

The Bureau of Reclamation (Reclamation) undertook a study of internal erosion incidents of their embankment dams in Engemoen and Redlinger (2009). These “incidents” differ from “failures” in other studies since complete failure was not achieved. The study defined an incident as an “Observation of a failure mode or potential failure mode in progress in which failure is prevented by natural causes such as self-healing or by human intervention.” Of the 220 embankment dams in the study, it was found that almost one-quarter had some type of internal erosion-related incident. Of those, about 70 percent were found to be through the foundation, 12 percent into drains, 8 percent through the embankment, 7 percent from the embankment into the foundation, and 5 percent into or along a conduit. Also of interest in this study is the age of the structures that have had internal erosion incidents. The Reclamation inventory shows that about 35 percent of incidents occur in the first 5 years of the structure life, with the remaining 65 percent occurring after 5 years. Of this 65 percent, some have occurred as much as 80 years after original construction. It was also noted that one-third of the incidents occurred prior to 1976 and two-thirds occurred after 1976. The greater number of incidents in recent decades could be attributable to the increasing age of the dams and increased scrutiny since the advent of the Dam Safety Act. However, Regan (2009) found that the rate of dam failures continues at the same pace even after the Dam Safety Act. However, this may partially be due to better reporting of incidents in recent decades.

2.3 Notable Failures and Incidents

There are a number of notable dam failures and incidents specifically related to internal erosion. Some of the more instructive failures (and incidents) are covered at various points throughout this manual, but are listed below:³

- Teton Dam (1976) – Internal erosion of embankment core along jointed bedrock foundation (and/or hydraulic fracturing of the silt core) with stopping failure of the embankment.
- Quail Creek Dike (1988) – Internal erosion of embankment core due to extensive foundation-contact seepage exacerbated by multiple phases of foundation grouting and hydraulic fracturing.
- A.V. Watkins Dam (2006) – Emergency remedial measures required due to backward erosion piping through the foundation soils under very low hydraulic gradient.

³ For additional details, see the case histories in appendix 1.

- A number of dams (1960s in Australia, 1970s Oklahoma) – Failure of dams constructed of dispersive soils.
- Walter Bouldin Dam (1975) – Failure of dam by internal erosion into the foundation.
- Wister Dam (1949) – Near failure in dispersive embankment soils triggered by differential settlement cracking over the original stream channel.
- Fontenelle Dam (1964 and 1965) – Near failure of embankment due to internal erosion of embankment core due to extensive seepage along the embankment/foundation contact.
- Black Rock Dam (1909) – Internal erosion of foundation soils below a basalt caprock due to excessive seepage and unprotected seepage exit. Caused a 9-foot lowering of the abutment and near-breach.

2.4 References

- Åberg, B. (1993). “Washout of Grains from Filtered Sand and Gravel Materials,” *ASCE Journal of Geotechnical Engineering*, 119(1):36–53.
- Adel, D.H., K.J. Bakker, and M.K. Breteler (1988). “Internal stability of minestone,” *Proc. Int. Symp. Modelling Soil-Water-Structure Interaction*, Balkema, Rotterdam, pp. 225–231.
- ASTM Standard D4647/D4647M-13, 2013, “Standard Test Methods for Identification and Classification of Dispersive Clay Soils by the Pinhole Test,” ASTM International, West Conshohocken, PA, 2013, DOI:10.1520/D4647_D4647M-13.
- Bligh, W.G., “Dams, Barrages and Weirs on Porous Foundations,” *Engineering News*, Vol. 64, No. 26, December 29, 1910, pp. 708-710.
- _____, Reply to “Sheet Piles as a Means of Decreasing Permeability of Porous Foundations,” Fielding, J.S., *Engineering News*, Vol. 65, No. 4, January 26, 1911, p. 109.
- _____, “Weirs on porous foundations and with pervious floors,” *Engineering News*, Vol. 65, No. 15, April 13, 1911, pp. 444-445.
- _____, “Lessons from the failure of a weir and sluices on porous foundations,” *Engineering News*, Vol. 69, No. 6, February 6, 1913, pp. 266-270.
- Bonala, M.V.S. and L.N. Reddi (1998). “Physicochemical and Biological Mechanisms of Soil Clogging: An Overview,” *ASCE Geotechnical Special Publication No. 78*, pp. 43–68.
- Casagrande, A. (1937). “Seepage through dams,” *J. New England Water Works Assoc.*, Vol. 51, No 2, pp. 131–172.

- Clibborn, J. (1902). “Experiments on the passage of water through sand,” Govt. of India, Central Printing Office, Technical Paper No. 97.
- Darcy, H. (1856). “Les fontaines publiques de la Ville de Dijon, Dalmont, Paris.
- Engemoen, W. and C.G. Redlinger (2009). “Internal Erosion Incidents at Bureau of Reclamation Dams,” 29th Annual USSD Conference, Nashville, Tennessee.
- Federal Emergency Management Agency (2011). “Filters for Embankment Dams – Best Practices for Design and Construction,” Federal Emergency Management Agency, pp. 332.
- Forcheimer, P. (1886) “Über die Ergiebigkeit von Brunnenanlagen und Sickerschlitzten,” Zeitschrift, Architekten und Ingenier-Verein, Hannover, Vol. 32, No. 7, pp. 539–564.
- _____(1914). *Hydraulik*, Leipzig.
- Foster, M., M. Spannagle, and R. Fell (1998). Report on the analysis of embankment dam incidents. UNICIV Report No. R-374, School of Civil and Environmental Engineering, The University of New South Wales.
- Foster M., R. Fell, and M. Spannagle (2000). “The statistics of embankment dam failures and accidents,” Canadian Geotechnical Journal, Vol. 37, Issue 5, pp. 1000–1024.
- Harza, L.F. (1934). “Uplift and seepage under dams on sand: Proceedings of the ASCE, Vol. 60, No. 7, pp. 967–1000.
- International Commission on Large Dams (1974). “Lessons from Dam Incidents,” Paris, France.
- Jansen, R.B. (1983). “Dams and Public Safety,” Water Resources Technical Publication, U.S. Department of the Interior, Bureau of Reclamation, pp. 1332.
- Jones, J.A.A. (1981). “The nature of soil piping: a review of research,” BGRG research monograph 3, Norwich:Geo Books.
- Kenney, T.C. and D. Lau (1985). “Internal stability of granular filters,” Canadian Geotechnical Journal, Ottawa, Canada, Vol. 22, pp. 215–225.
- Kézdi, Á. (1979). Soil Physics Selected Topics - Developments in Geotechnical Engineering 25, Elsevier Scientific Publishing Company, Amsterdam, pp. 1–160.
- Kovács, G. (1981). “Developments in Water Science - Seepage Hydraulics,” Chapter 3.2, Elsevier, pp. 349–379.
- Lane, E.W. (1934). “Security from under-seepage masonry dams on earth foundations,” Transactions ASCE, Vol. 60, No. 4, pp. 929–966.

- Regan, P.J. (2009). "An Examination of Dam Failures vs. Age of Dams," 2009 Conference Proceedings, 29th Annual USSD Conference, Nashville, Tennessee, U.S. Society on Dams, Denver, Colorado.
- Richards, K.S. (2008). "Piping Potential of Unfiltered Soils in Existing Levees and Dams," Ph.D. Dissertation, University of Illinois at Chicago, Chicago, Illinois, pp. 334.
- Richards, K.S. and Reddy, K.R. (2007). "Critical appraisal of piping phenomena in earth dams," Bulletin Engineering Geology Environment, Vol. 66, pp. 381-402.
- Sherard, J.L. (1973). "Embankment dam cracking," in Embankment-Dam Engineering – Casagrande Volume, ed. Hirschfeld, R.C. and S.J. Poulos, John Wiley & Sons, New York, pp. 271–353.
- Sherard, J.L., R.S. Decker, R.S., and N.L. Ryker (1972), "Piping in Earth Dams of Dispersive Clay," Proceedings, Specialty Conference on Performance of Earth and Earth-Supported Structures, Purdue University, Indiana, American Society of Civil Engineers, Vol. 1, Part 1, pp. 589–626.
- Sherard, J.L., L.P. Dunnigan, and R.S. Decker (1976). "Identification and nature of dispersive soils," Journal of the Geotechnical Engineering Division, Proceedings ASCE, 102(GT4), pp. 287–301.
- Sherard, J.L., L.P. Dunnigan, and J.P. Talbot (1984). "Filters for Silts and Clays," Journal of Geotechnical Engineering, ASCE, Vol. 110, No. 6, pp. 701–718.
- Skempton, A.W. and J.M. Brogan (1994). "Experiments on piping in sandy gravels," Geotechnique, Vol. 44, Issue 3, pp. 449–460.
- Terzaghi, K., "Der Grundbruch an Stauwerken und seine Verhütung (The failure of dams by piping and its prevention)," Die Wasserkraft, Vol. 17, 1922, pp. 445-449. Reprinted in "From theory to practice in soil mechanics," John Wiley and Sons, New York, 1960.
- Terzaghi, K. (1925). "Erdbaumechanik," Franz Deuticke, Vienna.
- Terzaghi, K. (1929). "Effect of minor geologic details on the safety of dams," Amer. Inst. Min. and Met. Engrs. Tech. Publ. 215, pp. 31–44.

CHAPTER 3 – MECHANICS OF INTERNAL EROSION

3.1 Introduction to Internal Erosion

Internal erosion, as used in this document, refers to erosion/detachment of soil particles below the ground surface due to the flow of subsurface water. The term piping is also used as a general term to describe removal of soil from earthen structures, as is internal erosion. Terminology has evolved since at least the late 1800s, when Col. Clibborn (1897) used the term piping to describe the formation of a clear channel through sand from blow-out and subsequent washing out of material “from the gentlest of horizontal currents.” As more was learned about soil erosion beginning in the 1960s additional terminology was added, such as internally unstable soils and dispersive soils to describe other internal erosion mechanisms. More recently, as a result of numerous failures, the term internal erosion has supplanted the term piping as the all-inclusive term per international practice. The term “internal erosion” has thus been adopted in this document to include all forms of removal of soil particles from within earthen structures and their foundations.

The term “internal erosion” encompasses a variety of more specific terms that are found in literature. Some of the terms that have been used include concentrated leak erosion, scour, seepage erosion, piping, backward erosion piping, internal instability, suffusion, suffosion, internal migration, contact erosion,¹ heave, blowout, tunneling, jugging, and saturation failure. Most of these terms are intended to convey information about how the erosion initiates or progresses, but many of the terms have had various meanings to different individuals and organizations. As a practical matter of necessity, many of these terms are defined and used in this chapter. However, emphasis is placed on developing an understanding of the internal erosion processes that could occur at a particular dam from reservoir filling and initiation of erosion all the way through to the worst possible outcome, dam failure.

The remainder of this chapter provides a summary of the current understanding of the mechanics of internal erosion as practiced by many Federal agencies. Some topics and terminology presented herein are not universally agreed upon, and others are actively being studied to increase the state of knowledge regarding the mechanics of internal erosion. Consequently, the information presented is a “snapshot in time.” The most important currently recognized physical mechanisms are discussed first, followed by a conceptual framework that is conducive to a potential failure modes analysis, which is discussed in chapter 4.

¹ The term “contact erosion” has recently been proposed as a special case of internal erosion in which high seepage flows through a granular soil erode adjacent fine-grained soils. In this document, no further reference is made to that term because it is considered to be a form of concentrated leak erosion, described in section 3.2.1.

3.2 Internal Erosion – Mechanisms

Four internal erosion mechanisms are defined in this chapter, including concentrated leak erosion (section 3.2.1), backward erosion piping (section 3.2.2), internal instability (section 3.2.3), and stoping (section 3.2.4). For concentrated leak erosion, many of the more common possible causes of a defect leading to a concentrated leak are described in several subsections.

3.2.1 Concentrated Leak Erosion

Concentrated leak erosion, also referred to as scour, seepage erosion, or tractive force erosion, can occur when preferential flow paths develop in earth embankments, their foundations, or at contacts between the fill and concrete structures or bedrock. In this mechanism of internal erosion, soil particles are detached by slaking along the preferential flow path (e.g., along the walls of an open crack in the soil or other defect), and the soil is subsequently eroded by water flowing at relatively high velocity (compared to the lower velocity of flow in intergranular flow). The eroded particles are then carried through the preferential flow path to the filter face or other downstream exit. Most soils are subject to erosion from this mechanism. Concentrated leak erosion is responsible for the majority of catastrophic dam failures due to internal erosion.

Defects such as cracks or other flaws in an embankment or foundation might not immediately result in concentrated seepage. It is possible that pore pressure induced by direct pool head pressure or elevated natural groundwater may buildup within, beneath, or upstream of an impervious layer or zone can lead to forces capable of moving material from and breaching the impervious layer from hydraulic fracture or blowout. Once the impervious materials are breached, a concentrated leak could rapidly develop along a flaw or geologic defect that previously did not have sufficient velocity to detach soil particles. See section 3.5 for a more detailed discussion on heave and blowout.

Potential flaws that can lead to concentrated leak erosion in embankment dams or foundations must be considered. Major causes of these defects are presented in the following sections (also refer to section 4.3.2 for additional considerations).

3.2.1.1 Differential Settlement

All embankment dams will settle to some degree during and after construction. Not all of this settlement will be uniform, and differential settlement to some degree should be expected in every dam. When the foundation profile is irregular and the depth of fill varies, differential settlement will occur. When the differential settlement is large enough, cracks can form in areas of tensile stress. Typically, these will be transverse cracks that could potentially be continuous through the core and are therefore of most concern. Longitudinal cracks may develop due to differing foundation conditions beneath the core and shells and/or due to differences in elastic moduli of the zones. Longitudinal cracks are generally of lesser concern, but could potentially allow reservoir water to access two separate transverse cracks that would not otherwise be continuous from upstream to downstream. Additionally, dams founded on collapsible soil

deposits can settle after the reservoir fills. If wetting occurs during first filling, or during a flood event for flood control impoundments, the settlement can be large and dramatic. A good description of the mechanics of cracking in embankment dams was provided by Sherard (1963), and several figures adapted from that reference are included on figure 3-1(a–d).

Cracking is more likely in brittle materials such as soils with fine-grained materials compacted to high density and dry of optimum moisture content. Although cracks are usually considered to be more likely to occur in an embankment, differential settlement within the foundation soils could cause cracks in foundation soils.

3.2.1.2 Hydraulic Fracture

Conditions can be present in embankment dams in which the induced hydrostatic pressure acting upon or within the earthfill is greater than the minor principal stress plus tensile strength of the soil (tensile strength is small in soil when compared to other engineering materials [e.g., concrete, steel]). Sherard (1986) documented the role of hydraulic fracturing in numerous failures and incidents involving embankments of fine-grained soils. Murdoch et al. (1991) demonstrated that hydraulic fractures can be formed in saturated, fine-grained soil (silty clay). This condition is most likely to exist or develop along structures such as conduits, walls, vertical rock faces in foundations, and other locations where stresses could be low. For older dams, it was not uncommon to excavate a trench in the foundation, construct an outlet works conduit in that trench, and place earthfill around the conduit. When little space was available between the outside of the conduit and the trench wall, compaction was difficult and performed with light hand-operated equipment. In some cases, fill was placed by hydraulic methods. In either case, low-density, low-strength fill more susceptible to hydraulic fracture was more likely to result.

In addition to poor compaction, low confining stress conditions can be exacerbated or caused by unfavorable geometry that can prevent the full stress from overlying fill from being transferred to a conduit or other structure backfill, or fill placed in or adjacent to sharp changes in foundation profile. For conduits, this can occur when the overlying fill arches from the trench side slope to the top of the conduit. The full overburden of the dam will not be “felt” by the fill between the conduit and trench wall. In this situation, it is possible for the hydrostatic pressure to exceed the lateral stress in the conduit backfill. The same phenomenon can occur next to overhanging or near vertical rock excavation surfaces or embedded structures. Figure 3-2 illustrates stress arching that could occur at a conduit.

Hydraulic fracturing has been suggested to possibly have played a role in the failure of Teton Dam, which featured a very narrow, steep-sided cutoff trench backfilled with low plasticity soil.² It is believed that an example of hydraulic fracturing occurred at Ochoco Dam in Oregon (figure 3-3)³. The suspected hydraulic fracture was observed in an excavation near the intake tower and upstream portion of the outlet works conduit during dam safety modifications in the 1990s.

² The other prevailing theory is that concentrated leaks developed through the poorly treated bedrock discontinuities, and the seepage attacked, or eroded, the silt cutoff trench fill soils (i.e., scour along the foundation contact with the embankment fill).

³ For additional information, see Case 1 – Teton Dam and Fontenelle Dam, (Seminal Case Histories) and Case 1 – Ochoco Dam, (Other Case Histories) in appendix 1.

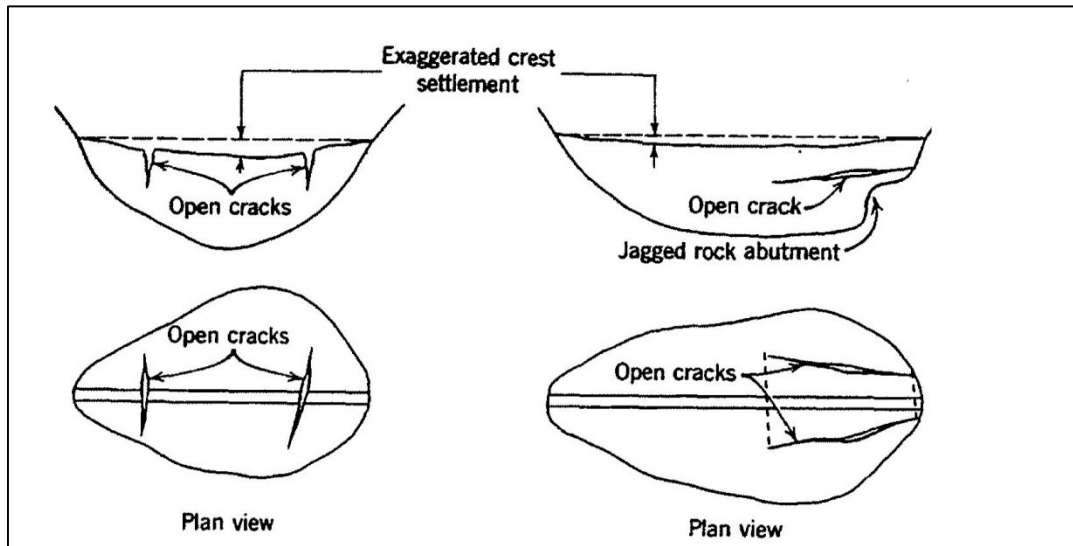

Figure 3-1a.—Examples of transverse and longitudinal differential settlement cracks.

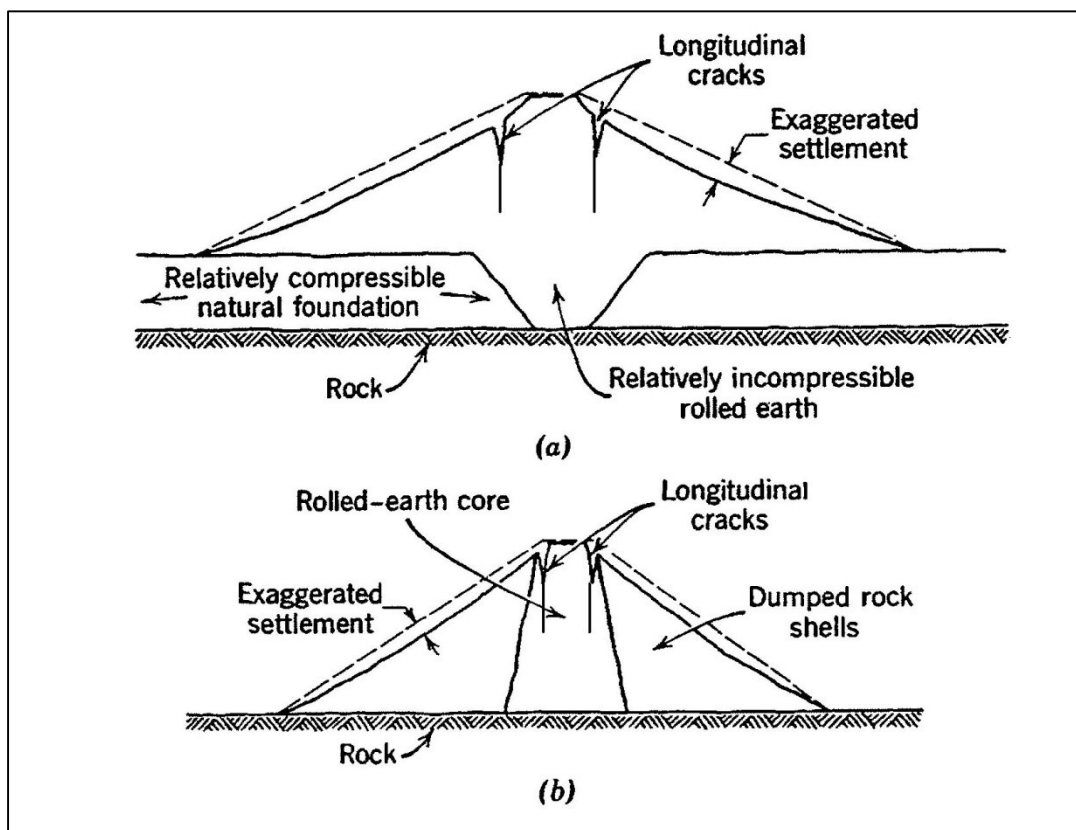

Figure 3-1b.—Longitudinal cracks. (a) Cracking caused by differential foundation settlement. (b) Cracking caused by differential settlement between embankment sections of dumped rock and rolled earth.

Figure 3-1.—Examples of dam cracking (adapted from Sherard 1963).

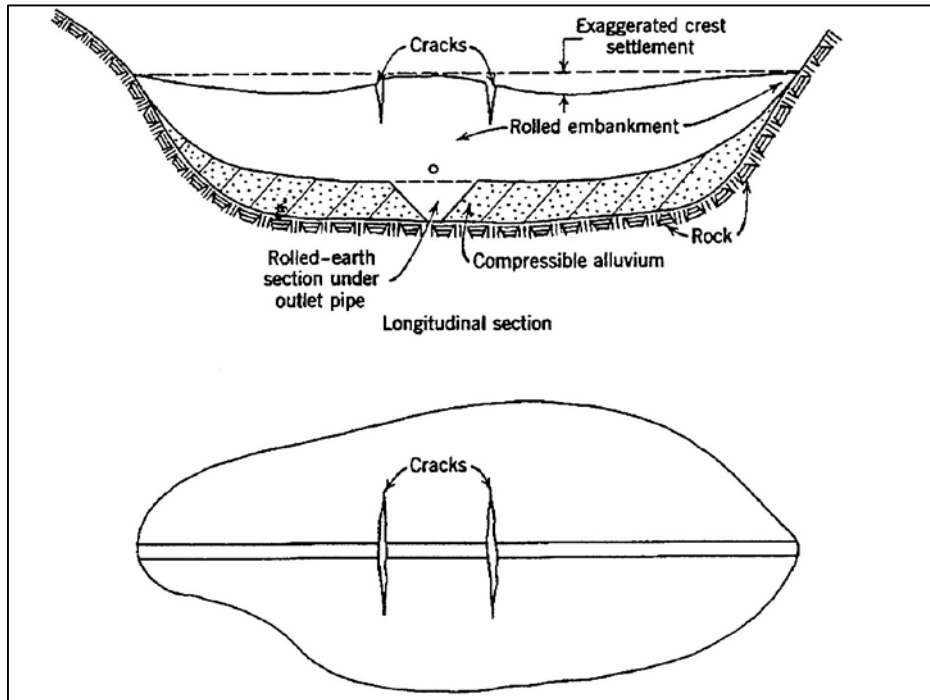

Figure 3-1c.—Cracking due to differential settlement between natural foundation soil and rolled-earth support under outlet pipe (or other discontinuity in the foundation).

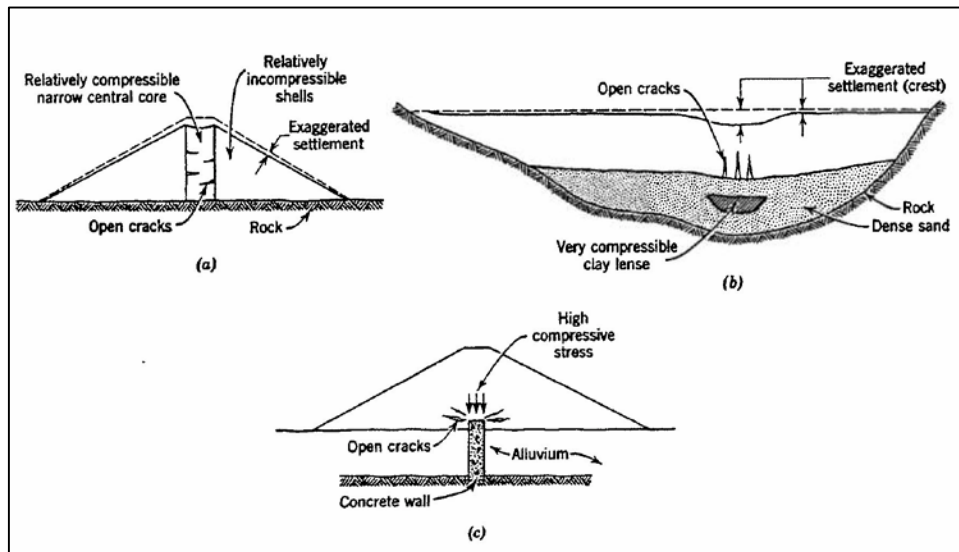

Figure 3-1d.—Internal embankment cracking.

Figure 3-1 (continued).—Examples of dam cracking (Sherard 1963).

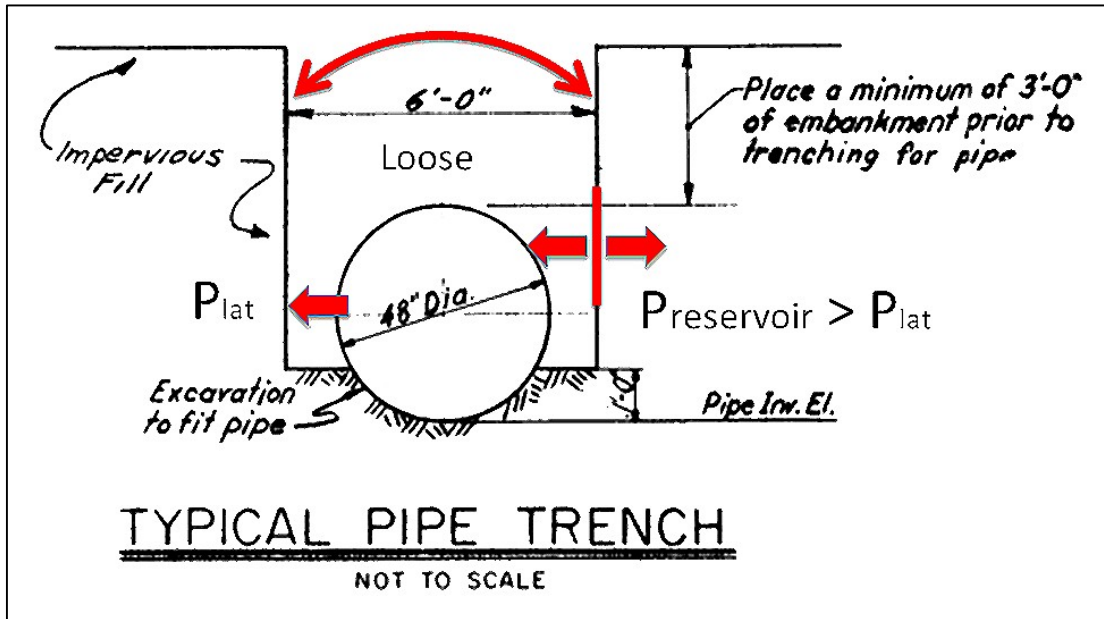

Figure 3-2.—Example of stress arching and hydraulic fracture at a conduit.



Figure 3-3.—Suspected hydraulic fracture at Ochoco Dam near the intake tower that was subsequently filled with reservoir sediments.

Hydraulic fracturing in embankments or foundations can also be caused by drilling or grouting activities. This phenomenon became a significant concern after several documented incidents were discussed in a paper by Sherard (1973). In this situation, the pressure in the drill or grout fluid exceeds the confining pressure in the surrounding fill. A crack then forms from the source of the pressure (drill or grout hole) outward and might be capable of extending upstream to downstream or possibly exacerbating an existing flaw. For this reason, drilling and grouting operations through the core of a dam are generally avoided or undertaken only with careful provisions to minimize drilling fluid pressures (Bruce and Davis 2005).

3.2.1.3 Interruptions in Fill Placement

For larger projects or at sites with short construction seasons, it may not be possible to construct the embankment without interruption. Contractual problems can also lead to construction being shutdown. These interruptions can lead to a weathered work surface that, if not addressed when the construction restarts, can result in an improperly bonded contact between the new and old fill. This poor bonding can also result in preferential seepage paths where a concentrated leak may develop.

3.2.1.4 Frozen Lifts

In some cases, construction during winter is unavoidable. Similar to *Interruption in Fill Placement* described above, if the top lifts are allowed to freeze, a defect in the earthfill can result. Freezing may occur during temporary shutdown when the contractor chooses not to work until warmer weather returns or during winter shutdown when work is stopped for several months. Earthfill correctly placed and compacted originally will be damaged due to freezing action and will no longer have the properties of the specified lift. Ice and snow may also become mixed with the surface lifts of soil. Frost-damaged and ice-contaminated materials should be removed and replaced when better weather conditions return. Frost-susceptible soils such as silts and fine sands are of particular concern because ice lenses may form within them. Frost-damaged soils may be prone to development of preferential seepage paths and concentrated leaks. Examples of winter construction are shown on figure 3-4.

3.2.1.5 Pervious Lift in an Impervious Core

Due to improper or absent construction inspection, material not meeting gradation requirements could be placed in the impervious core, resulting in pervious lifts. With inadequate controls during placement, core materials susceptible to segregation may also result in pervious lifts. Usually, for this problem to result in a dam safety deficiency, the practice would have to occur over an extended period of time and would need to have sufficient upstream to downstream continuity. It is more likely to have upstream to downstream continuity at the top of the dam where the zones are narrower.

3.2.1.6 Desiccation

When soils possessing some degree of plasticity are allowed to dry, they will undergo a reduction in volume, which can result in cracks. Desiccation cracking is of particular concern with clays of higher plasticity. For embankment dams in which the core is present at the top of the dam, cracks may form in the crest. If the cracks, or network of cracks, are continuous upstream to downstream, internal erosion can occur when the reservoir next reaches the crack(s). Desiccation cracking is of particular concern in arid/hot areas such as the Western United States due to evaporation. Capillary action in fine-grained soils and extended duration of low reservoir levels may increase the potential for desiccation cracking.



Figure 3-4.—Examples of winter construction at embankment dams prior to removal of snow and ice contamination. (Top) Blue blanket is insulated to prevent freezing of underlying soils. (Bottom) Placement of fill on improperly prepared frozen ground, snow, and ice.

3.2.1.7 Dispersion

A number of dam failures occurred in Australia in the 1960s. Investigations into the cause of these failures identified a potential problem with dams constructed of dispersive soils. A conference was held in Australia to discuss this issue, and a number of papers were published describing the issue and recommending testing of soils to determine their dispersivity. Approximately 10 years later, several dams (Little Wewoka, Upper Boggy Creek Site 53, Upper Red Rock Site 20 [figure 3-5], and others) began failing in the United States.⁴ These dams were located in areas with dispersive soils, many in Mississippi and Oklahoma. Investigations were conducted, and a conference was held in Chicago in 1976 (ASTM 629, 1979) to discuss this issue and to review the Australian's experience. It was determined that dispersive soils were also responsible for these dam failures in the United States. A number of papers resulted from these events, and Terzaghi's filter criteria were reviewed to determine if standard filter designs could be used to address internal erosion in dams constructed with dispersive soils. It was determined that some adjustments were warranted to Terzaghi's filter design criteria with the addition of soil categories (Sherard et al. 1984), and as a result, a new design method for filters was adopted by U.S. Federal agencies. Actual testing of dispersive base soils was not done until Foster and Fell looked at it 25 years later, resulting in further minor adjustments to filter criteria for dispersive soils (Federal Emergency Management Agency [FEMA] 2011; Foster and Fell 2001).



Figure 3-5.—Upper Red Rock Site 20 Dam internal erosion through dispersive soils.

⁴ For additional information, see appendix 1.

3.2.1.7.1 Dispersive Process

Jones (1981) provides an excellent review of the issues and processes related to dispersive soils. It should be noted that dispersive soils, often thought to be concentrated in the American Southwest, can form in nearly any climate or geographic region. Internal erosion in dispersive soils is the result of degradation of an embankment due to the interaction of fresh water with dispersive clays in the soil. Due to the geochemical imbalance of soil pore water high in sodium with rain and surface water high in calcium, the dispersive clay interlayer binding forces are degraded, and clay particles are easily detached and entrained in seepage water. The effect is similar to dissolving a solid, but the clay particles entrained in the water remain in a solid state and suffuse through the soil with the seepage water. It is thought that internal erosion in dispersive soils is most severe in unsaturated soil. Soil within a long-established phreatic zone equilibrates with the chemistry of seepage water; however, this may not always be the case.

3.2.1.7.2 Failure Mode in Dispersive Soils

Internal erosion in dispersive soils is especially of concern in embankments prone to concentrated leak erosion (e.g., desiccation cracking or hydraulic fracturing), which often fail on first filling (Sherard 1972). Any uncontrolled seepage associated with embankments constructed of dispersive soils is cause for alarm because these embankments do not behave as embankments constructed of non-dispersive soils.

Tunnels and jugs are common features observed in dispersive soils caused by rainfall and erosion due to runoff, and the process has been discussed in detail by a number of Australian and New Zealand workers (Jones 1981). The presence of tunnels and jugs often occurs after a heavy, intense rainfall, and the speed and degree to which the embankment erodes is significantly higher than in embankments not constructed of dispersive soils. Tunneling occurs within the vadose zone and is due to chemical dispersion of clay soils from rainwater passing through open cracks or natural conduits. Jugging occurs when a jug-shaped vertical cavity forms in a soil by vertical movement of water and progressive erosion and widening of cracks or vertical tunnels. If left untreated, tunneling or jugging in dispersive soils can lead to dam failures similar to the tunneling activities of animals or penetration by tree roots. Development of tunnels and jugs could also exacerbate one of the forms of internal erosion presented earlier in this chapter.

3.2.1.7.3 Identification of Dispersive Soils

There are some characteristic erosion patterns in embankments subjected to this type of internal erosion. Vertical shafts with widened rounded voids at the shaft bottom form, which are termed jugs. Water flows along horizontal planes and forms tunnels similar to horizontal rodent holes. Deep rills dropping into jugs may form on the crest and upper slopes of a dam constructed of dispersive soils. This results in an embankment exhibiting an interconnected network of tunnels and jugs. Similar kinds of erosion patterns have also been observed in embankments constructed from loess soils.

A number of laboratory and field tests are available to assess the dispersivity of a soil, although the recommendation is to not rely on any one test. Due to the highly variable spatial distribution of dispersive soils, sampling must be done very carefully to fully assess the full range of possible

soils present at a site. In the U.S., engineers typically use the crumb test (ASTM D6572), double hydrometer test (ASTM D4221), and the pinhole test (ASTM D4647) developed by Sherard in cooperation with the Soil Conservation Service (later renamed the Natural Resources Conservation Service) for this purpose. Dispersive soils are typically clays containing total dissolved solids (TDS) greater than about 1.0 milliequivalent per liter, with sodium comprising about 50 percent or more of the TDS. A chemical test is also available to determine the exchangeable sodium percentage in the soil pore water (Soil Survey Staff 1996 and Seilsepour et al. 2009)

3.2.1.8 Geologic Defects in the Foundation

Foundation defects have been the root cause of some historic dam failures and incidents such as Teton Dam, Fontenelle Dam, and Quail Creek Dike⁵. Foundation cleaning, preparation, and treatment are critical aspects of dam construction that often receive inadequate attention or concern. Some of the more common geologic conditions that may contribute to development of preferential seepage paths include openly fractured or jointed foundation soils or rock, open-work gravel or gap-graded soil foundations, karst or other geologic anomalies (such as lava tubes) that provide concentrated leaks through the foundation. The presence of soluble minerals or dispersive soils may also impact a dam's performance. Regional-scale anomalies such as earth fissures due to groundwater or petroleum extraction can also create concentrated leaks within a dam foundation. Hence, an engineering geologist should be included on the design and construction teams to assess foundation conditions. Caution should be exercised during design and construction to address these conditions through positive cutoffs, filtered seepage collection, and/or meticulous foundation inspection and preparation. If unknown or untreated geologic conditions exist within the foundation or inadequate foundation preparation measures were taken during construction, then concentrated leak erosion could develop along the foundation contact with the embankment or entirely through the foundation.

3.2.1.9 Earthquake-induced Cracking

Shaking at a dam site caused by earthquake loading can aggravate many of the factors discussed above, which may lead to cracking of an embankment dam or foundation. When embankment dams are affected by a large earthquake, they often settle and spread in the upstream and downstream directions. Many exhibit longitudinal cracking, and some exhibit transverse cracking. A few examples include Austrian Dam (Harder et al. 1991 and Forster and MacDonald 1998), Guadeloupe Dam (Harder et al. 1991), and Lexington Dam (Fong and Bennett 1995).

Pells and Fell (2002) evaluated case history data from embankment dams not subjected to liquefaction and found dams that settled more than about 1.5 percent of the dam height were virtually certain to exhibit transverse cracking in the upper part of the embankment; dams that settled between 0.5 and 1.5 percent of the dam height had about a 20 percent chance of transverse cracking; and dams that settled between 0.2 and 0.5 percent of the dam height had about a 5 percent chance of transverse cracking. If liquefaction occurs, the deformations are

⁵ For additional details on these dams, see appendix 1.

likely to be large, and the likelihood of cracking is greater. If the dam does not overtop as a result of seismic-induced liquefaction, concentrated leak erosion through these cracks could develop.

3.2.2 Backward Erosion Piping

Backward erosion piping (also referred to herein as piping) is erosion that initiates at an exit point and progresses backward (upstream) toward the reservoir. Particles of soil are carried away by the seepage until eventually a tunnel, or pipe, is formed from the downstream exit point to the reservoir. Unlike concentrated leak erosion, a discrete flaw through the embankment or a geologic defect in the foundation is not a necessary condition to initiate backward erosion. A continuous layer susceptible to piping, beneath a layer or structure capable of forming a roof, is required for backward erosion piping. An unfiltered exit point is required for this type of erosion to initiate. If geologic or dam conditions are such that a defect exists (or develops) that increases pore pressures within the dam or foundation, gradients at the seepage exit could increase sufficiently to initiate backward erosion piping where none had been observed previously. Embankment dams and other structures without a positive cutoff to bedrock (through which significant head loss is typically achieved) founded on cohesionless soil deposits are most susceptible to piping through the foundation. In some cases, embankments with unusually high gradients and/or cohesionless or low-plasticity cores could also be of concern for piping. An illustration of backward erosion piping through a soil foundation is presented on figure 3-6.

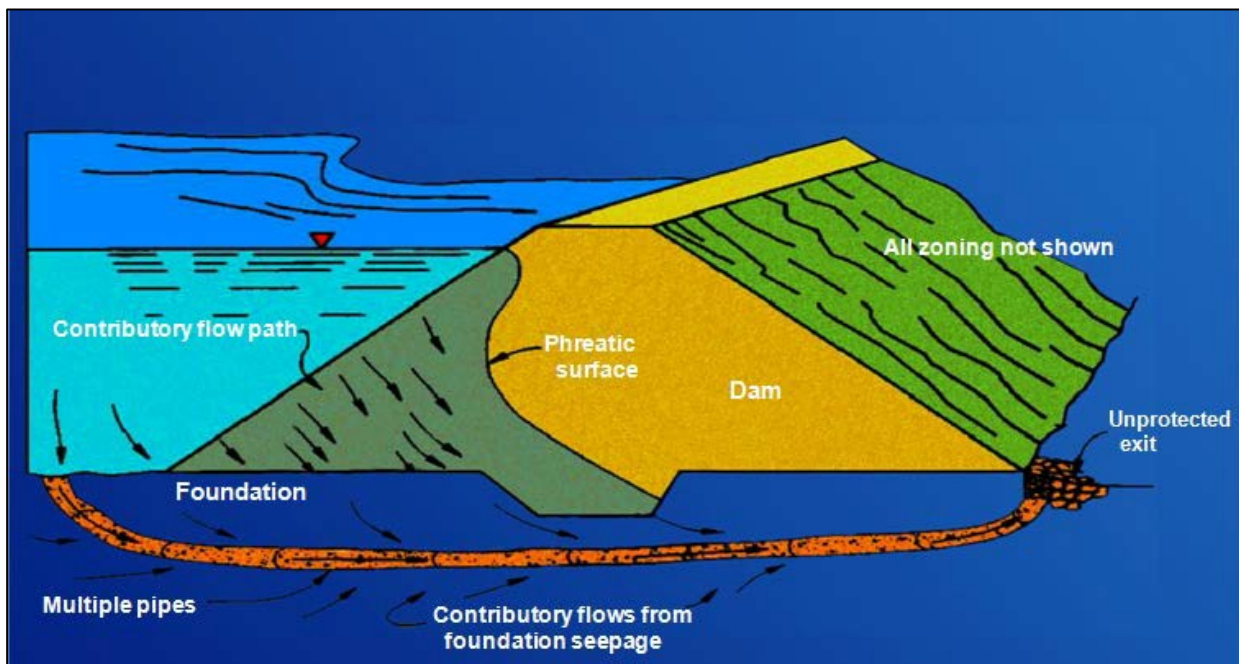

Figure 3-6.—Illustration of backward erosion piping showing the fully formed pipe connected from downstream to upstream.

Backward erosion piping could begin if no filters are present, downstream materials are too coarse to provide particle retention, or if the filter or downstream materials could sustain a crack. It is also possible that an unfiltered exit could be created if heave or blowout occurs at the downstream toe of the dam. Guidance for assessing heave or blowout conditions at the toe of a dam is provided in section 3.5. A word of caution is necessary here: Terzaghi's (1948) factor of safety against heave (vertical upward flow) was not intended to apply to backward erosion piping as understood today. There are many other factors that influence the potential for backward erosion that were not included in Terzaghi's special case for heave.

Unfiltered seepage paths through a dam and foundation could exist at the free face of the downstream slope, at the toe of a dam, or farther downstream. Other potential unfiltered exits include coarser soils (whether in the foundation or adjacent embankment zones), bedrock discontinuity apertures, cracks or open joints in concrete structures (particularly outlet works conduits), and drains (toe drains or underdrains), etc. If adequate filters exist to safely control the seepage and prevent erosion, backward erosion piping will not initiate.

For backward erosion piping to initiate, a seepage exit condition must exist (i.e., the phreatic surface daylights on the downstream slope of the embankment, or the groundwater at the downstream toe rises to the ground surface). The gradient under which backward erosion could initiate depends on the particle size and plasticity of the soils under consideration. The gradients required to initiate piping in plastic silts and clays with plasticity indices (PI) greater than about 7 are usually not achieved in conventional embankment dams or embankment dam foundations. However, there are some cases (Zaslavsky and Kassiff 1965) where backward erosion piping has developed after long periods of time under atypically high gradients in cohesive soils. For cohesionless soils, or very low plasticity soils (PI less than about 7), seepage velocities from much lower gradients can initiate backward erosion piping. Therefore, typically only cohesionless or very low plasticity materials are considered susceptible to backward erosion piping. The localized seepage exit gradient and seepage velocity must be high enough to mobilize particle movement for backward erosion to initiate. For soils with low uniformity coefficients (C_u) and a low PI, the gradient required to advance a pipe to the reservoir can be much less than the critical gradient required to initiate heave (zero effective stress condition). Particle movement can occur under much lower gradients for horizontal seepage and vertically downward seepage than for vertically upward seepage as discussed later in this chapter.

The gradient/seepage velocity in cohesionless soils that initiates piping is dependent on uniformity of particle size, mass and size of particles, and density. Soils comprised of particles of fine, uniformly graded sand with no cohesive binder (typically classified as SP or SP-SM in the Unified Soil Classification System) are very susceptible to being detached because of low particle mass and lack of interparticle attraction. Larger sand particles or gravels are more resistant to particle detachment because of their greater mass. Well-graded sands are more resistant to backward erosion piping because the small particles most susceptible to detachment cannot easily migrate through the soil body to the discharge face because they are blocked by larger particles in the mass. Soils that have been compacted or otherwise are naturally dense usually have more resistance to backward erosion piping (FEMA 2011).

3.2.2.1 Investigations in Horizontal Seepage

Studies of the mechanics of backward erosion piping began in the early part of the 20th century. Terzaghi (1922, 1939), Lane (1934), and Sherard et al. (1963) presented models of internal erosion in which particles are progressively dislodged from the soil matrix through tractive forces produced by intergranular seepage at an exit point. The mobilizing tractive forces are countered by the shear resistance of grains, weight of the soil particles, and filtration. The erosive forces are greatest where flow concentrates at an exit point, and once soil particles are removed by erosion, the magnitude of the erosive forces increases due to the increased concentration of flow into the developing pipe. The tractive force causing this type of erosion is directly proportional to the velocity of intergranular flow and, therefore, depends on the Darcy velocity and hydraulic gradient through the soil.

Research conducted by Geo Delft, which is now part of a Dutch organization called Deltares, through small- and large-scale piping tests indicated that low horizontal gradients could initiate piping (lower than the critical gradient calculated by Terzaghi's classical equation). Figure 3-7 shows the Deltares small-scale laboratory test apparatus, and figure 3-8 shows the large-scale field test. Progression of piping in the small-scale test is illustrated on figure 3-9. A conceptual "piping" model was proposed by Sellmeijer (1988), which was later updated by Weijers and Sellmeijer (1993), to estimate the critical gradient to initiate and progress backward erosion piping for dikes in the Netherlands. Based on the results of small, medium, and large-scale tests described in Van Beek et al. (2010), Sellmeijer et al. (2011) extended and updated this model and proposed an equation for the critical gradient required to advance a pipe toward the reservoir. The researchers noted that particle uniformity and particle size play a major role in initiation of piping and that less gradient is needed for piping to occur with more uniformly graded and smaller particle sizes. These researchers found that an equilibrium state is possible after initial development of pipes that did not progress to the upstream source of driving head (reservoir). By incrementally increasing the head, a critical/threshold head is reached, and the pipe erodes quickly to the upstream side. Erosion initiated, but did not progress, at heads that were 40 to 60 percent of the critical head needed for piping to both initiate and progress all the way upstream.

Research by Schmertmann (2000) also found that initiation of piping did not always progress to complete formation of a pipe from downstream to upstream. The term "critical gradient" is used in much of the recent literature to describe the threshold gradient at which piping both initiates and progresses to the upstream side given that a continuous roof exists. This should not be confused with the traditional use of the term "critical gradient" for vertically upward seepage at the toe of a dam that has been previously discussed. This behavior is in contrast to a previous belief that once initiated, backward erosion piping will accelerate to failure provided a roof is present. The actual behavior has been shown to be more complex than this simple model assumed.

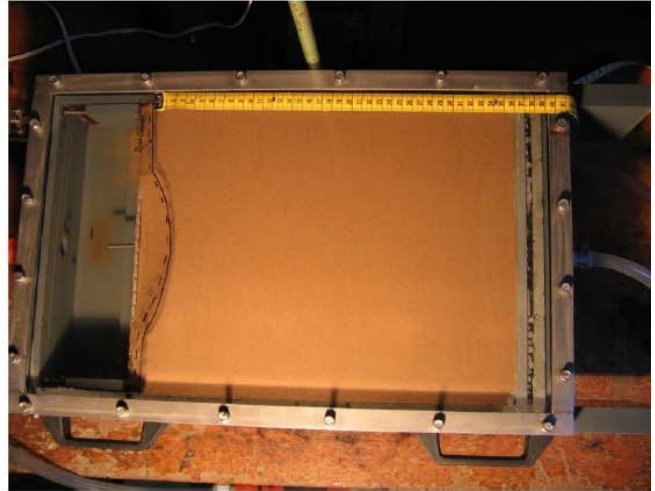
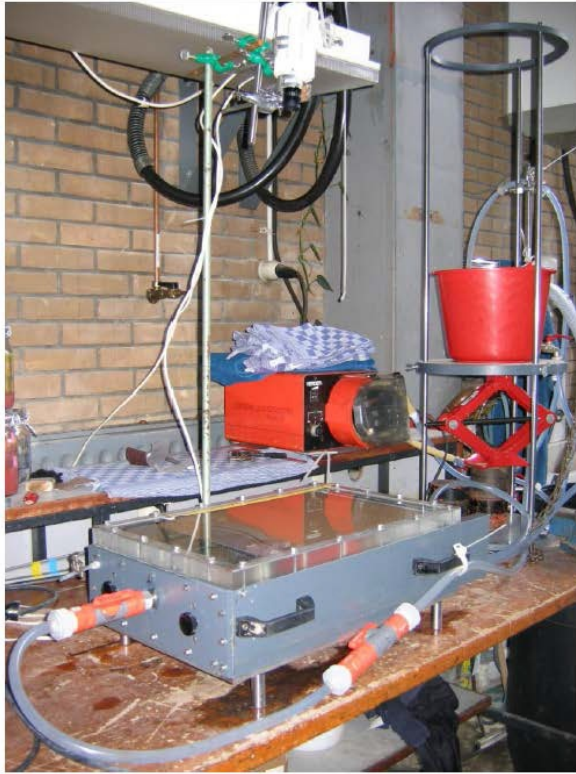

Figure 3-7.—Deltares small-scale laboratory test apparatus.



Figure 3-8.—Deltares large-scale field test (Van Beek).

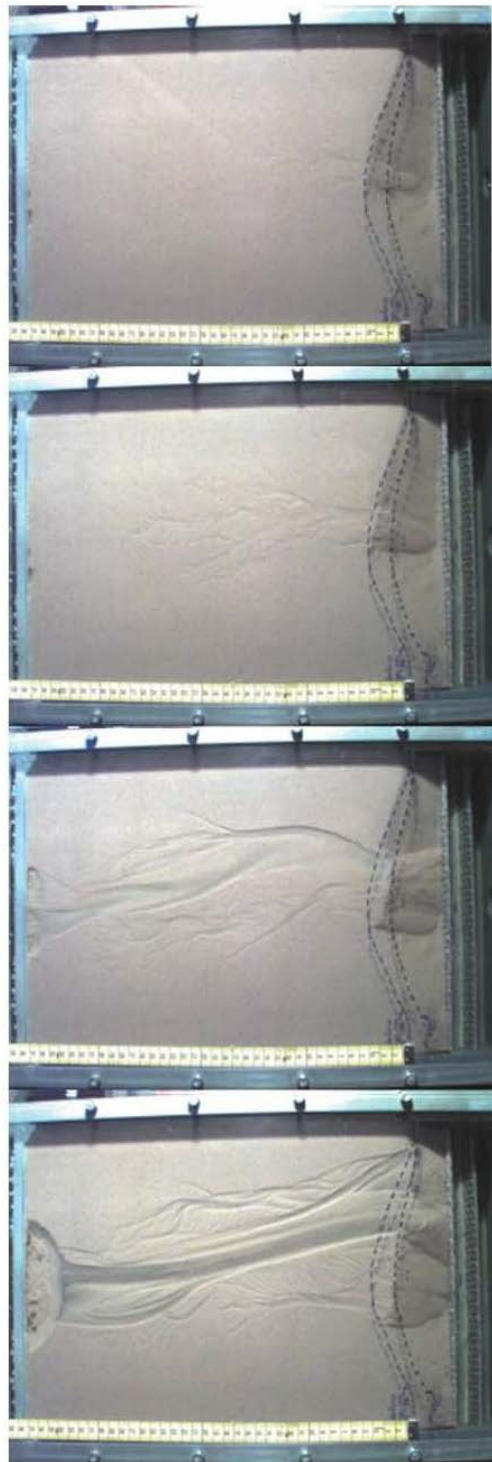

Figure 3-9.—Overhead view of piping progression in small-scale tests by Deltares.

Schmertmann (2000) compared water velocities required to initiate erosion for two soils that were tested for both scour in open channel flow (external erosion) and piping (internal erosion). The results showed the velocity required for external erosion (i.e., scour in a channel bottom) was 40 to 90 times that required for piping. He explained the difference by considering the three-dimensional aspects at the “pipe head” and found that the soil at that point could be in a “quick” condition, resulting in localized sloughing and transport under essentially zero effective stress. The tests were fairly conclusive, indicating that it takes much smaller velocities to move soil in a piping situation than in the bottom of an open flow channel. It should be noted that sufficient velocity and flow rate are needed to carry particles away from the pipe head once detached. Research by Townsend et al. (1988) and Schmertmann (2000) identified a minimum gradient for piping in clean, fine, uniform sands. Based on their laboratory tests, this type of sand was found to experience backward erosion piping at a minimum gradient of 0.08. This appears to model a fairly severe scenario in that a highly erodible soil was used and a roof consisting of a plexiglass plate was used above it.

These studies suggest that the more broadly (well) graded the material is, some self-healing action occurs, and higher gradient is needed for piping. It is speculated that the larger particles filter the smaller particles (bridging), and higher gradients are needed to move the larger particles.⁶

In a majority of field conditions, coarser soils will likely be encountered, and a natural roof may not form along the entire seepage path. However, it should be pointed out the piping experienced at A.V. Watkins Dam⁷ in 2006 involved materials and conditions quite similar to the model used by Schmertmann and Townsend in that a hardpan layer formed a continuous roof, and a horizontal exit into a drainage channel was present at the site. Back calculation of the conditions at A.V. Watkins Dam indicated that the average gradient was also approximately 0.06 (Hanneman 2011).

3.2.3 Internal Instability (Suffusion/Suffosion)

Suffusion and suffosion are internal erosion mechanisms that can occur with internally unstable soils. Internally unstable soils are either gap or broadly graded soils without self-filtering capability. Suffusion and suffosion processes are similar, and there are some inconsistencies in international published literature on their definitions and descriptions. The following definitions are used here:

⁶ Note that filter design criteria are based on the D15 size of the base soil with no regard for the shape of the gradation curve above the D15 size (i.e., there is no consideration as to whether the base is uniformly or broadly graded).

⁷ For additional details, see Case 3 – A.V. Watkins Dam and the Florida Power and Light Dike, in appendix 1 (Seminal Case Histories).

- Suffusion is a form of internal erosion that involves selective erosion of finer particles from a skeleton of coarser particles that are in point-to-point contact in such a manner that the finer particles are removed through the voids between the larger particles by seepage flow, leaving behind a soil skeleton formed by the coarser particles. Suffusion typically involves little or no change in volume of the soil mass. Suffusion can occur at hydraulic gradients less than the Terzaghi critical gradient in cases of vertical flow. Suffusion also occurs at low hydraulic gradients from horizontal flow due to the fact that effective stresses are carried largely by the coarser particles. (This phenomenon is sometimes referred to as suffusion in literature.) (See figure 3-10.)

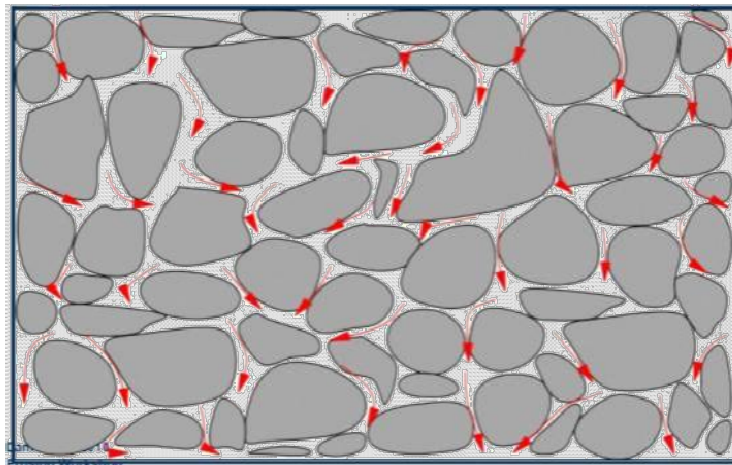

Figure 3-10.—Suffusion mechanism.

- Suffusion is a form of internal erosion that initially involves selective erosion of finer particles in a mix with coarser particles, but at higher gradients also involves movement of medium size particles. The volume of finer particles is such that the coarser particles are “floating” within the finer matrix and are not in point-to-point contact. Suffusion involves a decrease in volume of the soil mass. The effective stresses are carried by all the particles, and suffusion occurs at higher hydraulic gradients than suffusion. (This phenomenon is sometimes referred to as suffusion in literature.)

In order for either the suffusion or suffusion process to occur, several physical conditions must exist. First, the material gradations are internally unstable such that they do not self-filter. In addition, a combination of hydraulic conditions (seepage velocity) and stress conditions must be favorable enough for erosion to initiate. If a material is judged to be internally unstable, suffusion or suffusion is not a given. For example, the seepage velocity through internally unstable soils might be too low, or the confining stresses might be very high in the case of suffusion.

For suffusion to occur, the size of the fine soil particles must be smaller than the size of the constrictions between larger particles, which form the basic skeleton of the soil. The amount of fine soil particles also must be less than enough to fill the voids. In addition, the velocity of the flow through the matrix must be high enough to overcome stresses and move the fine soil

particles through the constrictions between the larger particles (Wan and Fell 2004). Seepage erosion of the finer fraction through the coarser skeleton will result in a higher permeability and no volume change in the material being subject to suffusion.

Broadly graded transition zones in some older embankments are sometimes considered to act as filter zones. Gradation of these zones often does not meet current criteria for internal stability. Caution should be used when assuming that these zones protect core material because the transition zone may be prone to suffusion. Suffusion within transition zones results in a loss of filter compatibility because the gradation becomes coarser. Once an open framework develops through suffusion, the transition zone may not retain base (core) materials. This process can result in one of several internal erosion mechanisms, including backwards erosion piping, stoping, or scour (concentrated leak erosion) of adjacent soils. In such cases, there may be no volume change in the transition material but significant volume change in the core.

The key question when evaluating if materials may be subject to suffusion is, “When are the coarser particles in point-to-point contact?” If they are not in contact, suffusion is not possible, but suffusion might be possible. Factors such as the shape of the particle size distribution curve, the maximum particle size, and the percentages of sand and fines will influence whether the coarser particles are in point-to-point contact. For example, for some silt-sand-gravel mixtures, approximately 80–85 percent gravel is needed for the gravel to be in point-to-point contact. For poorly graded materials (e.g., missing some sand gradations), the percent of coarse materials needed to be in point-to-point contact may be as low as 65 percent (Wan and Fell 2004).

Compared to suffusion, suffosion requires a more extreme combination of seepage velocity and gradient to initiate particle movement because the in-situ stresses imposed on the finer fraction particles by the surrounding soils must be overcome for erosion to occur. After suffosion starts and some of the finer particles are removed, the confining stresses may be lowered, enabling further suffosion to occur. The suffosion process has been observed in dams, although the process is characterized by high localized gradients (>4) that do not typically occur in dams with broad cores (Fell et al. 2008). Note that soils susceptible to suffosion are also generally susceptible to segregation during construction. The degree to which segregation may have played a role in case histories of suffosion is unknown.

Several researchers have proposed various methods for evaluating whether materials may be internally unstable (Kezdi 1979; Kenney and Lau 1985, 1986; Burenkova 1993). Li and Fannin (2008) reviewed current methods for assessing internal stability and recommended improvements. Wan and Fell (2004) concluded some methods were too conservative (i.e., indicated internally unstable when tested stable). Wan and Fell (2004) developed a probabilistic method for evaluating the probability of internal instability.

Based on empirical studies, Sherard (1979) developed a band for potentially internally unstable soils based on gradation, which is useful for screening purposes (figure 3-11). Sherard obtained data on a variety of soils that were judged to be internally unstable and plotted a band around these gradations as shown on figure 3-11. Soil gradations plotting within this band are

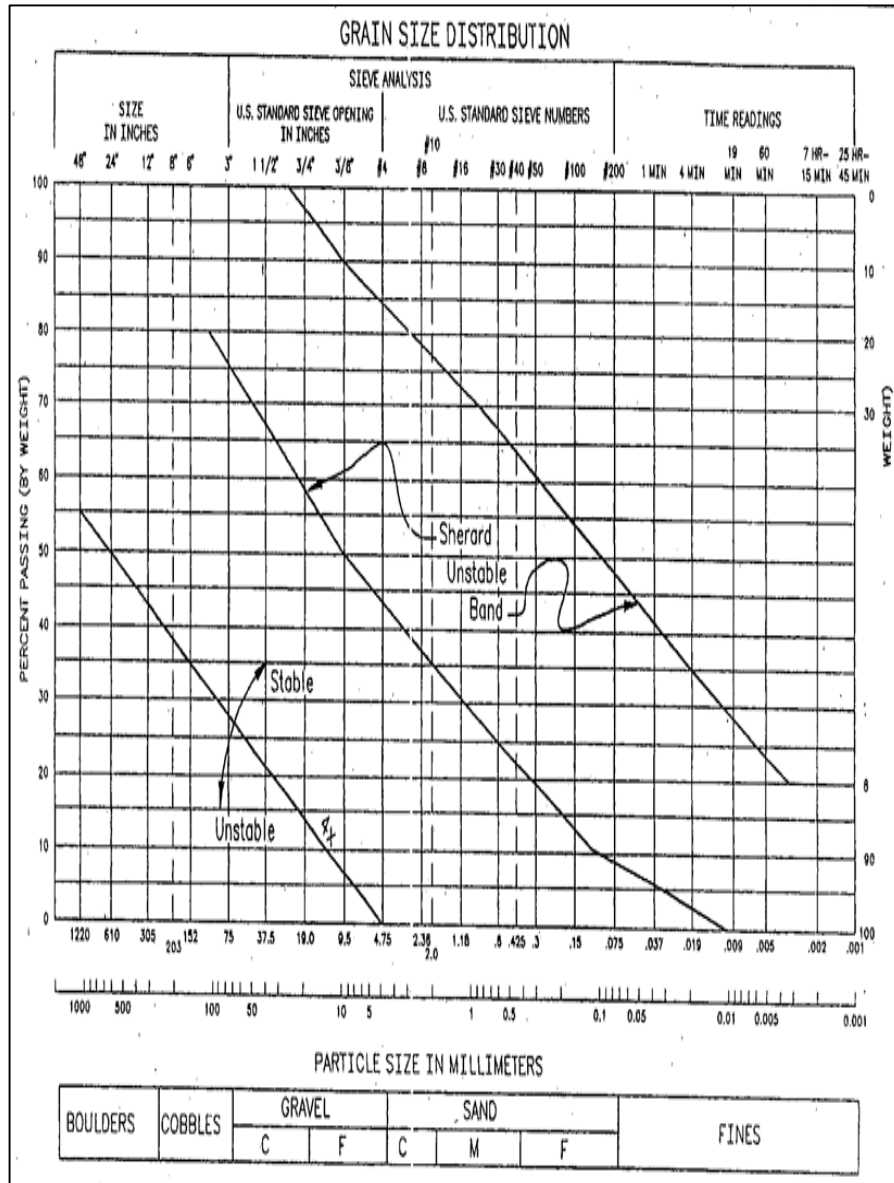

Figure 3-11.—Grading envelopes of some broadly graded soils with no self-filtering (adapted from Sherard 1979; FEMA 2011).

potentially internally unstable. Sherard found three factors that may increase the likelihood of internal instability: (1) materials placed against a smooth surface such as a pipe or a wall, (2) material that overlies a uniformly graded coarse material, and (3) materials subject to a high seepage velocity.

Coarse-graded and gap-graded soils, such as those shown schematically on figure 3-12, are susceptible to suffusion. They should be checked for self-filtering capability by comparison of the fine versus the coarse fractions using standard filter criteria (Kézdi 1979; Kovács 1981; Skempton and Brogan 1994).

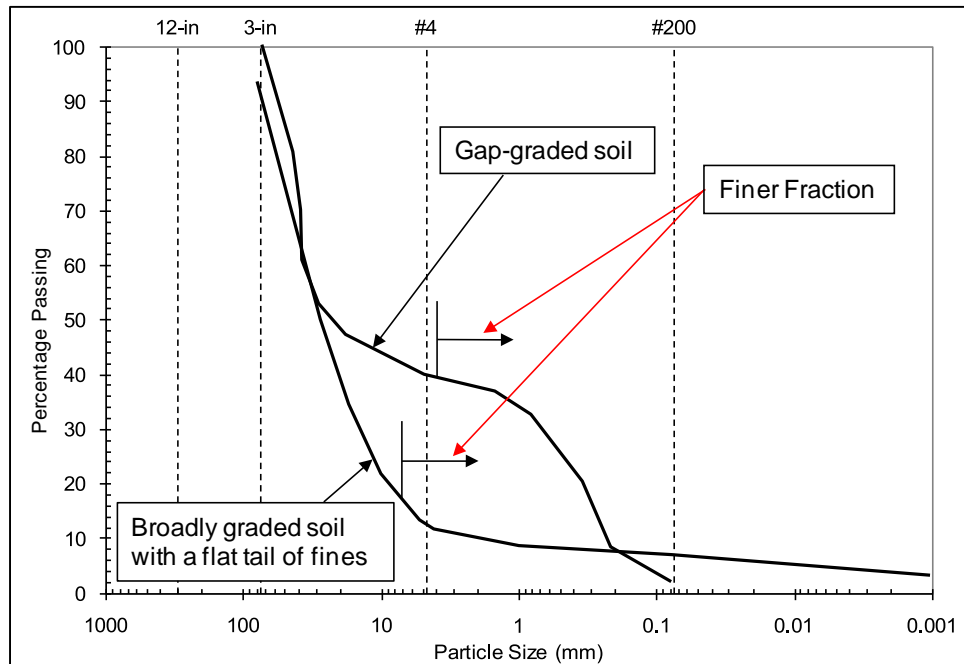

Figure 3-12.—Soils susceptible to suffusion (adapted from Wan and Fell 2004).

3.2.4 Stopping

Stopping can occur when the soil is not capable of sustaining a stable roof. Soil particles are eroded at an unfiltered exit and a void grows until the temporary roof can no longer be supported, at which time the roof collapses. This mechanism is repeated progressively, causing the void to enlarge and migrate vertically upward (figure 3-13). These voids can develop in both the saturated and unsaturated environments and typically result in formation of a sinkhole on the surface of the embankment.

Stopping frequently initiates at points of obvious filter incompatibility such as improperly designed or damaged drains, cracks or weepholes in conduits, or areas (often in reservoir) where fine-grained soils overlie or are adjacent to coarse-grained soils. Generally, stopping is thought to be much less likely to lead to dam failure than concentrated leak erosion or backward erosion piping because the stopping does not migrate toward the reservoir and there is usually time to intervene once a sinkhole is observed on the surface. It is common to see sinkholes develop somewhere above the point where the erosion is initiating. These sinkholes may be located in relatively benign areas such as in the reservoir floor or at downstream drains. Stopping has the potential to develop into a failure mode by creating a large sinkhole that could cause overtopping failure. It may also compromise the embankment by serving as a repository for eroded soil or water, increasing pore pressures within the downstream portion of the embankment, or by shortening seepage paths and possibly triggering backward erosion or blowout. For these reasons, stopping should be taken very seriously. The Bureau of Reclamation's (Reclamation) cataloging of internal erosion incidents has indicated that internal migration (stopping) may have been the fundamental mechanism in about one-third of that agency's dam-related internal erosion incidents.

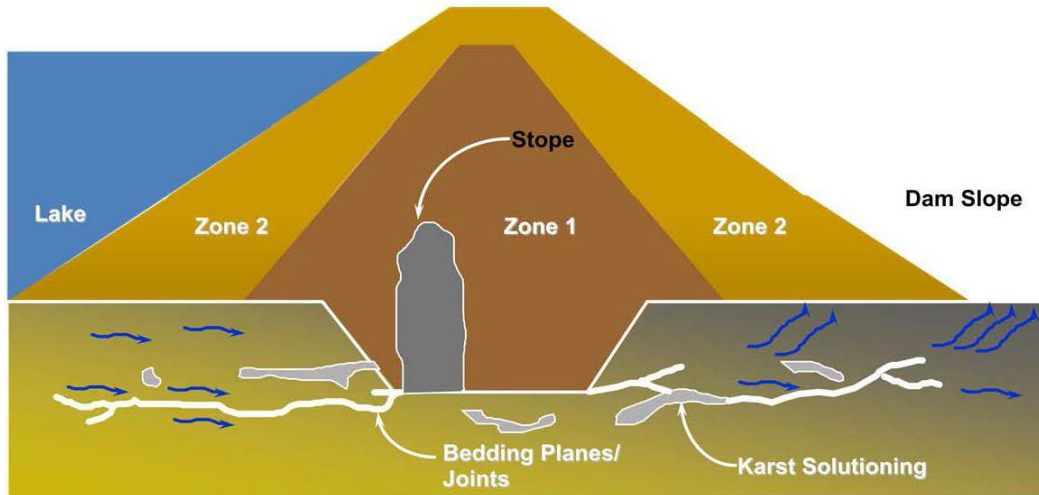

Figure 3-13.—Vertical stoping of void from erosion of Zone 1 soil into the bedding planes, joints, and karst solution features in the foundation.

There are many examples of stoping incidents. A large sinkhole (figure 3-14) developed suddenly in the crest of Willow Creek Dam⁸ due to this process, which took nearly 40 years to manifest. Another dam in Montana experienced a sinkhole on its crest due to internal erosion into a toe drain. The toe drain was original construction that was left in place after a downstream dam raise. The modified dam crest was located above the original toe drain, which served as an unfiltered exit (figure 3-15(a–b)).

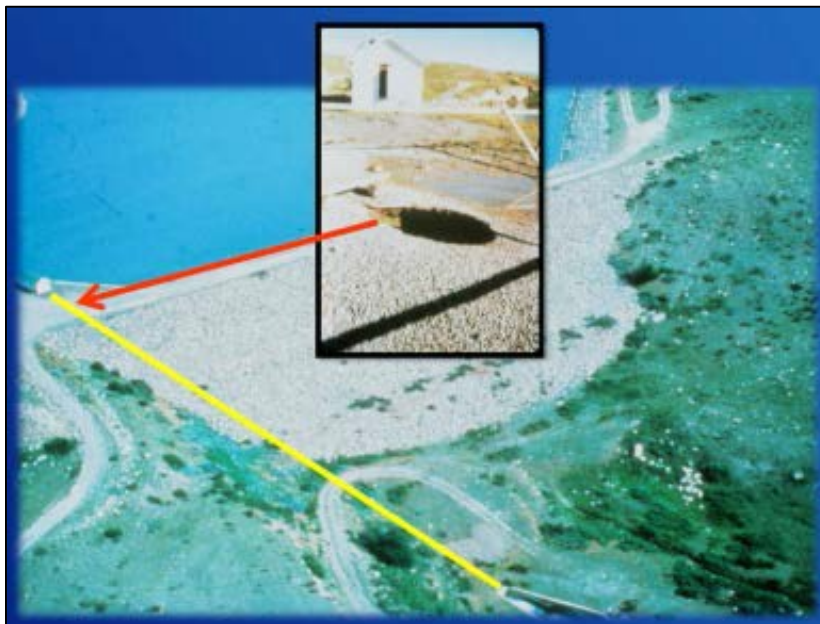

Figure 3-14.—Sinkhole at Willow Creek Dam.

⁸ For additional information, see Case 4 – Willow Creek Dam, in appendix 1 (Other Case Histories).



Figure 3-15a.—Sinkhole in crest of a dam in Montana.



Figure 3-15b.—Excavation of the sinkhole shown in previous photograph revealed original toe drain below the sinkhole.

A sinkhole also developed in the Clearwater Dam⁹ in 2003 from stoping into an untreated karst feature in the foundation or a feature originally soil filled, but over time was cleaned out by internal erosion. Photographs of this incident are depicted in figure 6-6 in chapter 6.

3.2.5 Saturation Failure/Sloughing

Some embankment dams were constructed with relatively steep downstream slopes. Such slopes may remain stable for decades as long as the phreatic line remains low on the downstream face of the dam. However, if the reservoir level rises to an unprecedented level and the lower portion of the embankment becomes more saturated, moving the phreatic line higher up on the downstream face of the dam, the downstream slope may begin sloughing. This is common in sand embankments constructed by dumping or spreading the fill with a monitor during the original construction in which the final outer slopes may be near the unsaturated angle of repose. In such dams, when shallow sloughing occurs, it may concentrate flow within the embankment toward the sloughed area. If enough seepage is present within the slough, it may wash away the sloughed material, allowing the oversteepened scarp to slough again. The process may continue in a step-wise fashion toward the reservoir until a breach is formed through the dam. Figure 3-16 illustrates the process.

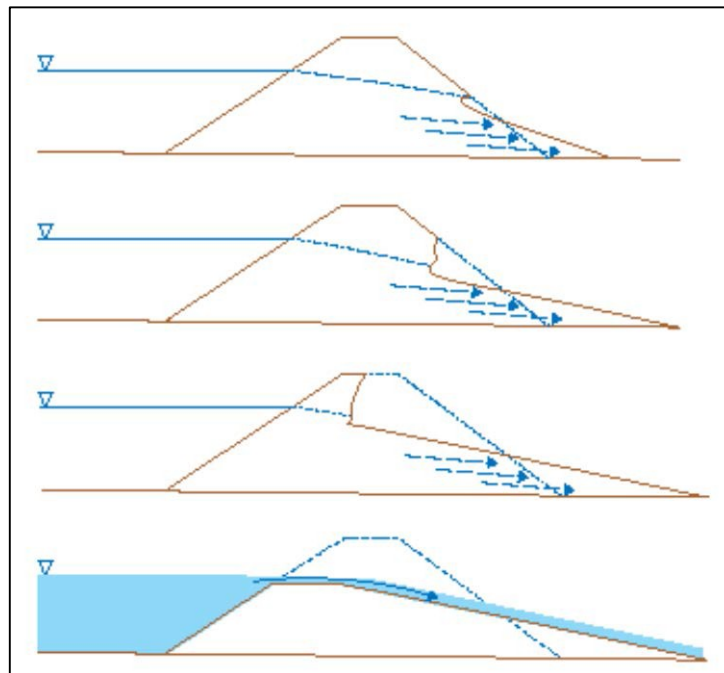

Figure 3-16.—Illustration of how downstream sloughing due to saturation could lead to dam failure.

⁹ For additional information, see Case 5 – Clearwater Dam, in appendix 1 (Other Case Histories)

While the process just described is similar to one of the common internal erosion breach mechanisms discussed later (i.e., sloughing/unraveling), it is primarily a function of the slope stability and increased seepage through the dam. Once a slough is initiated, measures should be taken as soon as possible to place filter material and stabilize the sloughed area to prevent continuation and progression to failure. Other areas of the downstream slope may also need to be buttressed to prevent the appearance of new sloughs, especially if the reservoir level is continuing to rise.

3.3 Biologic Activity (Animal and Vegetation)

Many State dam safety agencies and FEMA have published guidance on maintenance of vegetation on embankment dams (FEMA 473, 2005; FEMA 534, 2005). Numerous incidents have occurred due to improper maintenance of vegetation and animal activity on levees and embankment dams. For example, the Truckee Canal¹⁰ is thought to have failed as a result of burrowing animals. Burrowing animals weaken embankments by providing shortened seepage paths and voids. Heavy vegetative cover provides habitat for burrowing animals, and the root systems can also lead to internal erosion. Large trees can topple and also result in breach of a dam or levee. Proper vegetative and animal maintenance is required to address these potential failure modes.

3.4 Aging Effects

3.4.1 Drainage Systems

When drainage systems deteriorate with age, their seepage collection efficiency decreases, thus impacting long-term measurement and monitoring capabilities. Typical problems resulting from deteriorating drainage systems may include the following:

- (a) Decreasing cross section of the drainage area reduces the flow capacity while potentially increasing the water pressure.
- (b) Increased potential for crack development due to increased water pressure, which provides additional seepage flow paths. Additional flow paths enhance the likelihood of internal erosion.
- (c) Water conduit pipes may corrode, break, or have blockage that allows water to leak into the surrounding soil strata or circumvent the designed filter media locations. Pore water pressures may develop in the soil strata, and increased water pressure within preferential flow paths may initiate internal erosion and piping development.

¹⁰For additional information, see Case 6 – Truckee Canal, in appendix 1 (Other Case Histories).

3.4.2 Conduits

The condition of conduits changes with time, so there can be an aging concern. Metal conduits, such as corrugated metal pipe (CMP), have a limited life span and are prone to long-term deterioration. Concrete conduits may have a longer life span, but also are prone to aging effects such as freeze/thaw deterioration, scour, cracking, corrosion of reinforcement, settlement, and deterioration of water stops. Conduits can also become deformed by long-term settlement or poor design and excessive loading, which can lead to internal erosion either from embankment materials entering the conduit or fluids entering the embankment through holes in the conduit. Settlements due to pipe deformations can also lead to cracking in the embankment. A proper monitoring program is necessary to periodically assess the condition of conduits to address these potential issues before they become a problem. For more information refer to FEMA 484 (2005).

3.5 Vertical Seepage Paths – Heave and Blowout

The preceding paragraphs have focused on internal erosion mechanisms, the initiation of which generally depend on horizontal or non-vertical gradients and flow paths. This section discusses the impact of vertical seepage gradients and uplift pressure. Evaluation of seepage forces and pore pressures at the downstream toe of an embankment is complicated and requires careful consideration of site conditions. Simplified formulae for estimating exit (vertical) gradients and safety factors can be easily misused without an understanding of the specific “failure mechanism” being considered. Furthermore, for a condition at the downstream toe to progress and develop into an internal erosion mechanism, which results in breach of an embankment, requires additional considerations. The following paragraphs discuss the issues and factors involved in evaluating the criticality of seepage conditions at the downstream toe of an embankment.

An important point to keep in mind when addressing exit gradients or uplift pressures is that the flows and gradients being considered are typically *vertical*, or at least nearly so, for the vast majority of cases. Internal (*horizontal*) gradients, which are typically associated with piping or internal erosion potential along a more horizontal path, are distinctly different than vertical exit gradients and are discussed separately in section 3.2.2 on backward erosion piping.

3.5.1 Heave – High Exit Gradients in a Cohesionless Soil

Terzaghi and Peck (1967) defined “heave” in the context of upward flow on the dewatered side of a sheet pile cofferdam embedded in sand. Heave is described as a sequence of characteristic phenomena that occur at the point when the upward flow reduces the effective stress in the sand to zero. First, the water flowing through the sand can straighten and widen without meeting any resistance because the sand is in the quick, or fluid-like, condition. The resulting loosening and volume increase of the sand adjacent to the sheet pile wall greatly increases its permeability, attracting additional flow to this zone, and the top surface of the sand rises. Finally, “the sand

starts to boil, and a mixture of water and sand rushes from the upstream side of the sheet piles toward the zone where the boiling started” (Terzaghi and Peck 1967). The hydraulic gradient at which the effective stress becomes zero is termed the critical gradient.

While Terzaghi understood piping due to heave as occurring suddenly at the precise moment when the gradient reaches the critical gradient, the phenomenon is likely more complex than that. Arguably, the transition from intergranular flow through the body of sand to fluid flow of the sand/water mixture is also more gradual than described by Terzaghi. As the gradient increases from zero to the critical gradient, the state of effective stress in the sand transitions from that at geostatic conditions to zero. The straightening and widening of flow channels without resistance and the loosening of the sand should theoretically be able to begin as soon as the excess pore pressure exceeds the lateral confining stress in the sand, as in hydraulic fracturing. In sand, the upward gradient required for this condition to occur is well below the critical gradient (Doerge 2012). Therefore, piping failure can be seen as the process beginning with the initial rearrangement of the sand particles and a change in void ratio and ending with the flushing of the sand from under the sheet pile wall. To be consistent with Terzaghi’s original intent, the term “heave” should be applied only to cohesionless soils.

Sand boils are a manifestation of areas where the critical exit gradient has been reached in cases of vertical upward seepage. The critical gradient (i_{cr}) is most commonly expressed as the ratio of the buoyant unit weight of the soil (γ_b) to the unit weight of water (γ_w):

$$i_{cr} = \gamma_b / \gamma_w$$

An alternate form of this equation, *assuming the foundation soil is saturated*, utilizes the specific gravity (G) and the void ratio (e) of the soil:

$$i_{cr} = (G-1)/(1+e)$$

In cohesive soils (plastic clays), interparticle attractions create bonds between particles that make it less likely for individual particles to be easily moved. Laboratory tests have shown that while sands can typically move or become quick under an upward gradient of around 1.0, clay particles may not move until threshold gradients are significantly higher. Thus, any type of critical gradient in cohesive soils would be difficult to measure, would vary widely among such soils (due to such variables as percentage of clay fines, type of clay minerals, water content, and density), and should definitely not be calculated by the above equation. This is discussed in more detail later.

For the case of cohesionless soils, the factor of safety with respect to exit gradients is generally defined as the ratio of the critical gradient (i_{cr}) to the predicted or measured exit gradient (i_e):

$$FS = i_{cr}/i_e$$

The value of i_e is typically determined by seepage analyses for dams with no piezometric data or by evaluating piezometric data at existing dams if available. Depending on the state of

knowledge about a given site condition, there can be significant uncertainty with the estimated values of gradients (and the resulting calculated factor of safety). Heterogeneous foundation soils can complicate the estimate of the critical gradient. Insufficient instruments (piezometers) at multiple locations at the downstream toe can lead to an inability to accurately measure actual exit gradients. For new facilities or untested conditions, seepage models may be the only basis of estimating exit gradients. The difficulties associated with modeling natural foundation soils and accurately assigning permeability values definitely leads to uncertainties in the calculation of gradients. For these reasons, a conservative factor of safety should be used when assessing any threat of high exit gradients. Historically, practitioners have used a wide variety of acceptable factors of safety in seepage-related problems depending on the uncertainty in the parameters used in the analysis. A safety factor of 3.0 to 4.0 has been considered reasonable by some agencies. It should be recognized that factor of safety estimates are only one of several things that influence risk-informed decisions, and ultimately, the adequacy of an existing dam is determined considering all the events that would be necessary to cause failure.

The term “boil” is frequently used in connection with heave. Because soils are seldom homogenous, flow may be concentrated in localized areas, resulting in concentrated seepage paths. Boils will often appear at locations of concentrated flow. While particle movement may be evident in these boils, there may be no continuous removal of soil if the material “rolls” in a steady state condition (i.e., particles simply rise and fall within the boil). The soil stratigraphy also plays an important role in the seriousness of boils. However, boils in any state can be an alarming condition, as a slight increase in gradient may result in rapid development of backward erosion piping (Pabst et al. 2013). Von Thun (1996) observed sand boils as possibly falling into one of three categories depending on the amount and source of fines entrained in the effluent: (1) no problem, (2) possible problem, and (3) big problem as illustrated on figure 3-17.

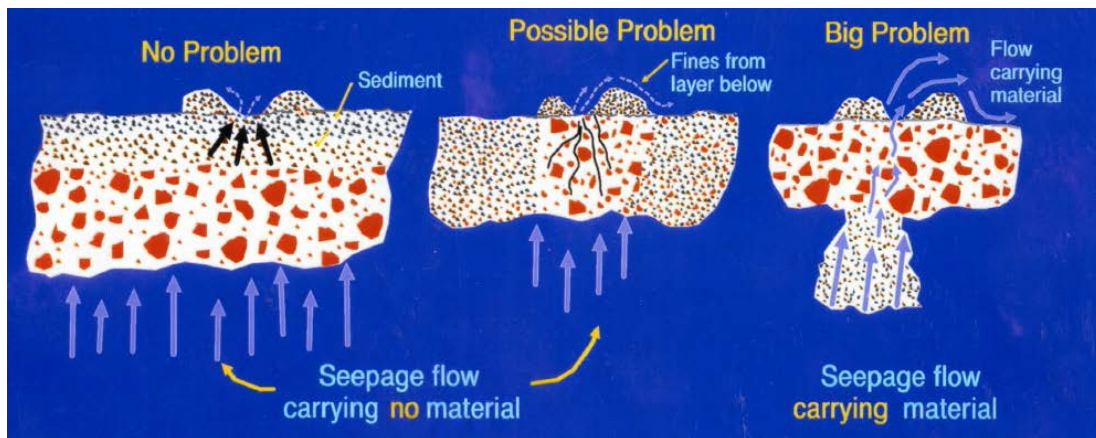

Figure 3-17.—Illustration of types of sand boils (Von Thun).

3.5.2 Blowout – Uplift of a Confining Soil Layer

Dam foundations consisting of a low-permeability surface layer underlain by a more pervious layer can develop high uplift (artesian) pressures acting on the upper (confining) layer. This type of foundation is often referred to as a “blanket-aquifer” foundation. “Blowout” (or rupture) of

the confining layer will occur at the downstream toe of an embankment if the seepage pressure in the pervious layer is sufficiently high. The formation of the rupture in the confining layer can produce an exit gradient condition at the top of the pervious layer, which can lead to quick conditions and sand boils as described in section 3.5.1 above. A rupture of the confining layer also constitutes an unfiltered exit for material from the pervious layer. If the velocity of flow through the rupture is high enough to transport particles from the pervious layer to the surface, then the potential for void formation and even backward erosion piping may exist. This section will examine the mechanics of blowout and present methods to analyze it.

The confining layer (or blanket) typically consists of fine-grained soils, often having some degree of cohesion. The behavior of cohesive soils (clays) subject to upward flow is quite different from that of non-cohesive soils (sands). In particular, clay particles are held together by electrochemical forces (i.e., cohesion) and are not as easily detached from the soil mass as sand grains are from a layer of sand. Therefore, the ability of cohesive soil to resist uplift consists of two components: one due to its weight (similar to non-cohesive soils) and another due to its tensile strength. However, no widely accepted method for quantifying the contribution of tensile strength exists, and it is typically neglected in uplift analyses.

Uplift on cohesive blankets has typically been analyzed by comparing the weight of the soil with the upward seepage force and determining a safety factor equal to the ratio of the two. Two different methods are found in the literature for analyzing uplift on confining layers: the “Total Stress Method” and the “Effective Stress Method.” As implied by the respective names, the stresses acting on the blanket are stated in terms of total stresses in the first method and effective stresses in the second. In the Total Stress Method, the factor of safety against uplift is calculated as the total downward pressure exerted by the weight of the confining layer divided by the upward water pressure at the base of the layer, while the Effective Stress Method uses the buoyant or effective weight of the soil and the net piezometric head acting on the blanket (see definition sketch and equations on figure 3-18). Note that Duncan et al. (2011) proposed that the pressure force on the ground surface due to any tail water be subtracted from the driving water pressure force in the denominator in the Total Stress Method equation rather than adding it to the resisting weight in the numerator. With the Effective Stress Method, tail water reduces the net head acting across the confining layer by the depth of the tail water. As a caution, since tail water increases safety with respect to uplift, tail water should only be included in an analysis if it is certain to be present at all times under consideration.

A comparison of the two methods is presented here. Text books and technical literature are not always completely clear in defining whether one method or the other is preferred, or even in distinguishing between the two approaches. Federal agencies also differ on which method to use. Reclamation (2012b) recommends using the Total Stress Method, while the U.S. Army Corps of Engineers (USACE) (2005a) and Natural Resources Conservation Service (NRCS) (1979) specify the Effective Stress Method.

Doerge (2009) presented a detailed evaluation of the physical/mathematical basis of both the Total and Effective Stress Methods. The Effective Stress Method treats soil as a two-phase medium in which the stresses are carried by the soil skeleton, while the Total Stress Method effectively treats soil as a solid, completely impermeable material. For a given set of conditions,

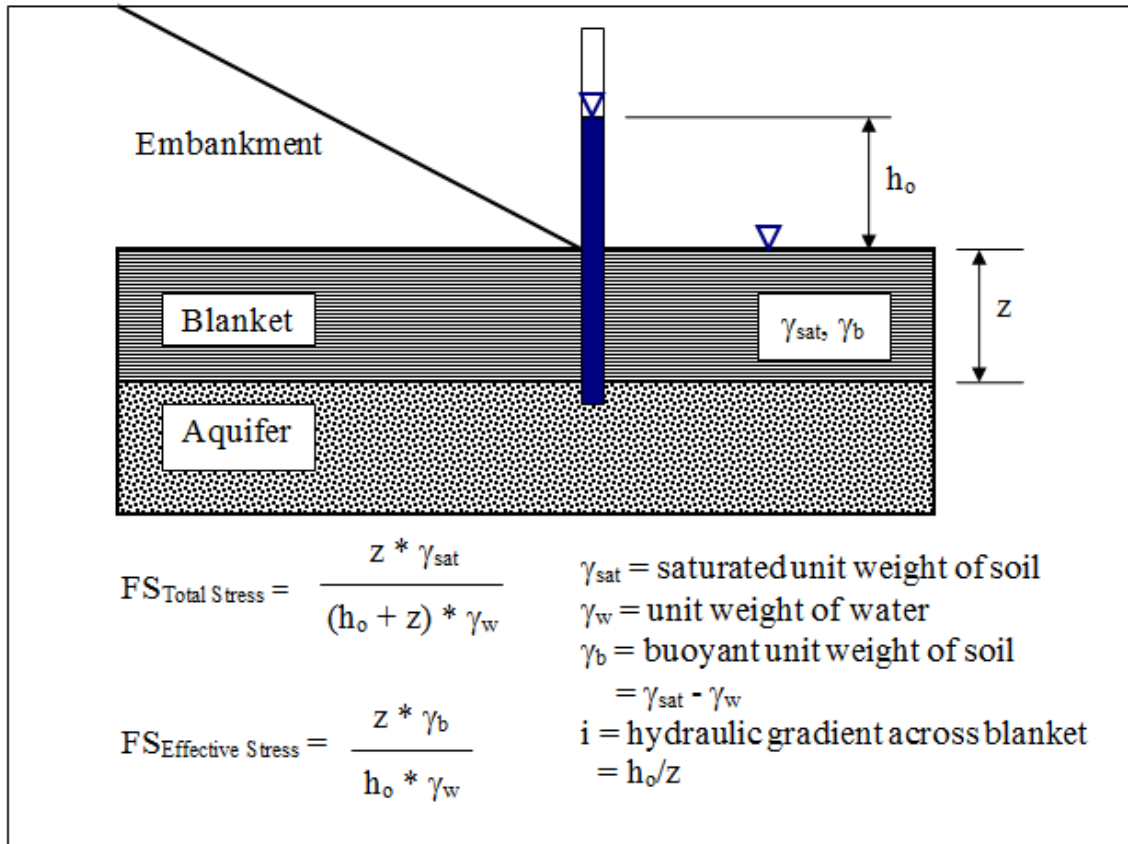

Figure 3-18.—Definition sketch for the Total and Effective Stress Methods.

the safety factor for the Total Stress Method is numerically lower than that for the Effective Stress Method, though both yield a value of 1.0 when the upward gradient equals the critical gradient, i_{cr} , as defined in the previous section. For saturated conditions with no upward flow, the Effective Stress Method yields an infinite safety factor, as would be expected since the driving force is zero, while the Total Stress Method yields a safety factor of about two (γ_{sat}/γ_w).

Both methods may be used to analyze uplift on confining layers as long as the method used is clearly identified and consistent with anticipated field conditions. The basic equations for both methods are formulated for saturated, steady seepage conditions as shown on figure 3-18. However, both methods can be adapted to analyze partially saturated and layered confining layers as well (Doerge, 2009). The Total Stress Method may be used in cases where the pore pressure below a confining layer rises rapidly compared to the rate at which the flow within the layer can adjust to the pore pressure increase. A shortcoming of both methods is that neither takes into account the contribution of the tensile strength of the soil to resist uplift on the confining layer.

In the broader context of a potential failure modes analysis, it is important to keep in mind that blowout (or rupture) of a confining layer at the downstream toe of an embankment does not

necessarily imply total failure of the structure. Blowout represents only the initiation stage of internal erosion because it simply provides formation of an unfiltered outlet by which soil particles may be lost from the foundation. Many other factors related to erosion and sediment transport must be considered to determine whether complete failure by dam breach may ultimately occur.

Implicit in both the Total and Effective Stress Methods is the assumption that failure due to upward seepage forces is by a lifting of the soil since both compare the upward seepage force with the resisting weight of the soil. However, the actual mechanism for blanket rupture may be by hydraulic fracturing rather than by lifting or other mechanisms suggested in the literature. Doerge (2012) postulated that upward seepage forces can produce the conditions required for the blanket soil to hydraulically fracture. Hydraulic fracturing occurs in soil when the excess pore pressure exceeds the lateral confining stress in the soil plus the tensile strength, if any, of the soil (Hubbert et al. 1957). Doerge (2012) showed that hydraulic fracturing can occur at pore pressures well below what is required to “lift” the soil.

It should be noted that both safety factor methods for analyzing uplift as well as any predictions for the onset of hydraulic fracturing are theoretical. They treat the confining layer as totally uniform in all its properties, including thickness, unit weight, tensile strength, and lateral earth pressure coefficient. Natural soil blankets, however, are subject to variations in all these parameters. They may also contain various defects, which can greatly reduce the blanket’s resistance to blowout. The significance of such defects will generally increase as the thickness of the confining layer decreases. Clearly, rupture of the confining layer and the resulting sand boils will appear first at locations where the resistance is the least, such as at defects or thinner/weaker spots in the confining layer. However, it is important to note that the presence of defects is not required for sand boils to form by hydraulic fracturing.

3.5.3 Implications of High Exit Gradients and Uplift Pressures

If analyses described above indicate the potential for seepage gradients to approach the critical gradient or for uplift pressures to be near the resisting overburden pressures, it is possible that the embankment and foundation may experience sand boils (in a cohesionless foundation) or possibly cracking of a low permeability confining layer. Soil conditions at a site are usually variable, and the calculations presented above are for idealized conditions. Defects such as cracks, roots, penetrations (such as fence or utility poles), burrows, thinning, etc., may affect the performance of confining layers. Seepage flow could be concentrated through the crack that develops (blowout/uplift), where sand boils manifest (heave), or where defects exist. Evaluations should focus on the potential for an internal erosion process to develop as described elsewhere in this chapter. Perhaps the most obvious failure mechanism to consider is that these events might then lead to progressive backward erosion and ultimate dam breach.

3.6 Horizontal Seepage Paths – Scour and Backward Erosion

Whereas the previous sections on exit gradients focused primarily on vertical gradients, this discussion focuses on internal gradients through an embankment or foundation, which are generally horizontal or often nearly so in many (if not most) cases of internal erosion failure mechanisms. Although formulae exist for computing factors of safety for conditions of critical exit (vertical) gradients, there is much more uncertainty when it comes to determining critical internal (horizontal) gradients. This uncertainty comes from the variables and differing conditions inherent in lengthy seepage flow paths through embankment or foundation soils. It is possible to estimate an overall average gradient for a seepage path given an upstream piezometer and a downstream piezometer. However, the internal gradients are likely quite different at various places along the seepage pathway since natural, or even engineered, soils can be highly variable. The seepage path is undoubtedly not a straight line and likely meanders considerably with seepage flows experiencing different amounts of head losses along the way. It is extremely unlikely that sufficient piezometers would be located in a number of critical locations along a seepage pathway in or beneath a dam to accurately measure the piezometric pressures at key points in a critical (weak link) flow path. Furthermore, it is exceedingly difficult to accurately assess how the soils along an entire seepage pathway will respond to seepage gradients. Laboratory tests can provide insights into how a relatively small segment of representative soil will behave under various hydraulic gradients, and these studies suggest that key factors like soil plasticity, grain size, and uniformity are important parameters in determining the potential for internal erosion. In actual field conditions, both soils and gradients are expected to vary in most instances.

These complex variables, as well as many other physical or chemical factors that play a role in an internal erosion process, help explain why there is no widely accepted means to determine the factor of safety against internal erosion or backward erosion piping. Rather than using deterministic safety factors, some agencies typically use available laboratory testing, research, and empirical evidence to probabilistically estimate internal erosion potential in risk analyses (also see chapters 4 and 5).

An interesting case history is Wister Dam¹¹ in Oklahoma, where internal erosion may have occurred in the dispersive clays comprising the embankment under gradients as low as 0.02 (Casagrande 1950). In the case of Wister Dam, the internal erosion probably occurred as a result of cracking due to differential settlement and/or possibly hydraulic fracturing rather than piping.

It is worth reinforcing the concept that the critical internal gradient that might lead to the initiation of internal erosion may be as low as 0.02 to 0.08 for particularly susceptible soils. These critical internal (horizontal) gradients are much lower than the “rule of thumb” critical gradient of 1.0 often assumed for exit (vertical) gradients.

¹¹ For additional details, see Case 6 – Wister Dam, Little Wewoka, Upper Boggy Creek Site 53, Upper Red Rock Site 20, and Others, in appendix 1 (Seminal Case Histories).

Seepage that exits the embankment or foundation at a sloping exit face can more easily detach particles than seepage that is exiting the ground vertically upward. A paper by O’Leary et. al., (2013) summarizes errors in previously published equations for particle detachment at sloping exit faces and provides suggested approaches to evaluate the hydraulic conditions for the initiation and progression of backward erosion piping.

3.7 References

- American Society of Civil Engineers (1975). Sedimentation Engineering, ASCE Manuals and Reports on Engineering Practice - No. 54.
- American Society for Testing and Materials (ASTM) (1977). *Dispersive Clays, Related Piping, and Erosion in Geotechnical Projects*, ed. J.L. Sherard and R.S. Decker, ASTM Special Technical Publication 623, ASTM International, Philadelphia, PA. <http://www.astm.org>
- Bjerrum, L., J.K. Nash, R.M. Kennard, and R.E. Gibson (1972). Hydraulic Fracturing in Field Permeability Testing, *Géotechnique* 22 (2):319–332.
- Bruce, D.A. and J.P. Davis (2005). Drilling through Embankment Dams: The State of the Practice, USSD 2005 Conference, Salt Lake City, Utah, June 6–10.
- Bureau of Reclamation (Reclamation) (2012a). *Design Standards No. 13, Embankment Dams*, “Chapter 5: Protective Filters,” U.S. Department of the Interior, Bureau of Reclamation, Technical Service Center, Denver, Colorado.
- _____ (2012b). *Design Standards No. 13, Embankment Dams*, Chapter 8: Seepage, U.S. Department of the Interior, Bureau of Reclamation, Technical Service Center, Denver, Colorado.
- Burenkova, V.V. (1993). “Assessment of suffusion in non-cohesive and graded soils.” Filters in Geotechnical and Hydraulic Engineering (Proc., 1st International Conference “Geo-Filters,” Karlsruhe, Germany), Balkema, Rotterdam, 357–360.
- Casagrande, A. (1950). Notes on the Design of Earth Dams, *Journal of the Boston Society of Civil Engineers*, Vol. xxxvii, No. 4.
- Doerge, B.C. (2009). Total or Effective Stress Analysis for Uplift – Which One to Use? Presentation at the ASDSO Annual Conference, Hollywood, Florida.
- _____ (2012). Failure Modes of Cohesive Soil Subject To Flow: A Dam Failure Case Study, Presentation at the ASDSO Annual Conference, Denver, Colorado.
- Duncan, J. M., B. O’Neil, T. Brandon, and D. R. VandenBerge (2011). “Evaluation of Potential for Erosion in Levees and Levee Foundations,” CGPR Report No. 64, Virginia Polytechnic Institute and State University.

Environment Canterbury (2011). The Solid Facts About Christchurch Liquefaction. Available at: <http://ecan.govt.nz/publications/General/solid-facts-christchurch-liquefaction.pdf>.

Federal Emergency Management Agency (FEMA) (2011). *Filters for Embankment Dams – Best Practices for Design and Construction*, Federal Emergency Management Agency, October 2011, Washington, D.C.. Available at: <http://www.fema.gov/library>

_____(2012). Federal Emergency Management Agency, “History of Graded Filters” presentation by J. Schmertmann, National Emergency Training Center, Emergency Management Institute, National Dam Safety Program Technical Seminar No. 19 - Filters, Drains, and Geotextiles in Dams and Levees, Emmitsburg, Maryland.

Fell, R., M.A. Foster, J. Cyganiewicz, G.L. Sills, N.D. Vroman, and R.R. Davidson (2008). *Risk Analysis for Dam Safety: A Unified Method for Estimating Probabilities of Failure of Embankment Dams by Internal Erosion and Piping*, URS Australia, New South Wales, Sydney, Australia.

Federal Emergency Management Agency (FEMA) 473 (2005a). Federal Emergency Management Agency, Technical Manual for Dam Owners: Impacts of Animals on Earthen Dams.

FEMA 484 (2005b). Federal Emergency Management Agency, Technical Manual: Conduits through Embankment Dams.

FEMA 534 (2005c). Federal Emergency Management Agency, Technical Manual for Dam Owners: Impacts of Plants on Earthen Dams.

Fong, F.C. and W.J. Bennett (1995). Transverse Cracking on Embankment Dams due to Earthquakes, Association of State Dam Safety Officials, Western Regional Meeting.

Foster, M.A., R. Fell, N. Vroman, J. Cyganiewicz, G. Sills, and R. Davidson (2008). “Seepage and Piping Toolbox – Continuation, Progression, Intervention and Breach,” 28th Annual USSD Conference in Portland Oregon, Denver, Colorado.

GEER (2011). Post-Earthquake Reports, Darfield, New Zealand. Available at: http://www.geerassociation.org/GEER_Post%20EQ%20Reports/Darfield%20New%20Zealand_2010/GEER_Darfield_2010_11-14-2010_Chapter%204.pdf. Access on March 6, 2012.

Hanneman, D.L. (2011). “Recent examples of backward erosion piping, internal erosion along a conduit, and embankment cracking at Bureau of Reclamation dams,” paper prepared for 2011 European Working Group on Internal Erosion meeting in Brno, Czech Republic.

Hubbert, J.K. and D.G. Willis (1957). Mechanics of Hydraulic Fracturing, Transactions AIME, 210:153–168.

- Jones, J.A.A. (1981). The nature of soil piping: a review of research, BGRG research monograph 3, Norwich: Geo Books, 1981.
- Kenney, T.C. and D. Lau (1985). Internal stability of granular filters, *Canadian Geotechnical Journal*, Vol. 22, 215–225.
- _____(1986). Closure to: internal stability of granular filters, *Canadian Geotechnical Journal*, Vol. 23, 420–423.
- Kezdi, A. (1979). *Soil physics – selected topics*, Elsevier Scientific, Amsterdam.
- Kovács, G. (1981). *Seepage Hydraulics*, Elsevier Scientific, Amsterdam, 349–379.
- Lane, K.S. (1947). Discussion of Middlebrooks, T.A. and W. H. Jarvis (1946) Relief Wells for Dams and Levees, *Transactions, ASCE*, Paper No. 2327, 112:1321–1399.
- Li, M. and R.J. Fannin (2008). Comparison of two criteria for internal stability of granular soil, *Canadian Geotechnical Journal*, Vol. 45, 1303–1309.
- McCook, D.K. (2004). A Comprehensive Discussion of Piping and Internal Erosion Failure Mechanisms, Presentation at the ASDSO Annual Conference, Phoenix, Arizona.
- Murdoch, L.C., G. Losonsky, P. Cluxton, B. Patterson, I. Klich, and B. Braswell (1991). Feasibility of Hydraulic Fracturing of Soil to Improve Remedial Actions, EPA/600/S2-91/012.
- Natural Resources Conservation Service (NRCS) (1979). *The Mechanics of Seepage Analyses*, Soil Mechanics Note SMN-7.
- Netherlands Technical Advisory Committee on Flood Defences (1999, draft English version 2002). *Technical Report on Sand Boils (Piping)*. Rijkswaterstaat, Road and Hydraulic Engineering Institute. Delft, The Netherlands.
- Pabst, M., B. Robbins, W. Engemoen, D. Hanneman, C. Redlinger, and G. Scott (2013). Heave, Uplift, & Piping at the Toe of Embankment Dams. Association of State Dam Safety Officials, *Journal of Dam Safety* Vol. 11, Issue 2, ISSN 1944–9836.
- Pells, S. and R. Fell (2002). *Damage and Cracking of Embankment Dams by Earthquakes and the Implications of Internal Erosion and Piping*, UNICIV Report No. R-406, School of Civil and Environmental Engineering, The University of New South Wales.
- O’Leary, T., N. Vroman, C. Williams, and M. Pabst (2013). Critical Horizontal Seepage Gradients. Association of State Dam Safety Officials, *Journal of Dam Safety*, Vol. 11, Issue 3.

- Schmertmann, J.H. (2000). “The no-filter factor of safety against piping through sands.” Judgment and Innovation: The Heritage and Future of the Geotechnical Engineering Profession, Geotechnical Special Publication No. 111, American Society of Civil Engineers, Reston, Virginia, 65–132.
- Seilsepour, M., M. Rashidi, and B.G. Khabbaz (2009). “Prediction of Soil Exchangeable Sodium Percentage Based on Soil Sodium Adsorption Ratio,” American-Eurasian J. Agric. & Environ. Sci. 5(1): 01–04, IDOSI Publications, 2009, ISSN 1818–6769. Available at: https://eprints.usq.edu.au/5778/2/Seilsepour_Rashidi_Khabbaz_2009_PV.pdf
- Sellmeijer, J.B. (1988). “On the mechanism of piping under impervious structures.” Ph.D. Thesis, Delft University of Technology, Delft, The Netherlands.
- Sellmeijer, J.B., H. López de la Cruz, V.M. van Beek, and J.G. Knoeff (1972). Piping in earth Dams of Dispersive Clay, Proceedings, Specialty conference on Performance of Earth and Earth-Supported Structures, Purdue University, Indiana, American Society of Civil Engineers, Vol. 1, Part 1, 589–626.
- _____(1973). Embankment Dam Cracking, from *Embankment-Dam Engineering*, pp. 271–353, John Wiley and Sons, Inc., New York.
- _____(1979). “Sinkholes in dams of coarse, broadly graded soils.” Trans., 13th ICOLD Congress, International Commission on Large Dams, New Delhi, India, Vol. 2, 25–35.
- _____(1986). Hydraulic Fracturing in Embankment Dams, ASCE Journal of Geotechnical Engineering, 112(10):905–927.
- _____(2011). “Fine-tuning of the backward erosion piping model through small-scale, medium-scale and IJkdijk experiments.” European Journal of Environmental and Civil Engineering, 15(8), 1139–1154.
- Sherard, J.L., R.J. Woodward, S.F. Gizienski, and W.A. Cleavenger (1963). *Earth and Earth-Rock Dams*, John Wiley and Sons, Inc.
- Sherard, J.L., L.P. Dunnigan, and J.R. Talbot (1984). “Basic properties of sand and gravel filters.” Journal of Geotechnical Engineering, American Society of Civil Engineers, 110(6), 684–700.
- Sills, G.L. and C.B. Groves (2008). The Development of Piping in Levee Foundations, Presentation at the Floodplain Management Association Annual Meeting, San Diego, California.
- Skempton, A. W. and J.M. Brogan (1994). “Experiments on piping in sandy gravels.” Géotechnique, 44(3), 449–460.

- Soil Survey Staff (1996). *Soil Survey Laboratory Methods Manual*, Soil Survey Investigations Report 43, Version 3.0, U.S. Government Printing Office, Washington, D.C.
- Terzaghi, K. (1939). *Soil Mechanics: A New Chapter in Engineering Science*, Institution of Civil Engineers.
- Terzaghi, K. and R.B. Peck (1948). *Soil Mechanics in Engineering Practice*, John Wiley and Sons, New York.
- _____(1967). *Soil Mechanics in Engineering Practice*, Second Edition, John Wiley and Sons, Inc., New York.
- Townsend, F.C., D. Bloomquist, J.M. Shiau, R. Martinez, and H. Rubin (1988). Analytical and Experimental Investigation of Piping and Filter Design for Sands, Report to the Bureau of Reclamation, University of Florida, Department of Civil Engineering, Gainesville, Florida.
- Turnbull, W.J. and C.I. Mansur (1959). Design of Control Measures for Dams and Levees, *Journal of the Soil Mechanics and Foundations Division, ASCE*, paper No. 2217.
- U. S. Army Corps of Engineers (USACE) (2005a). *Embankment Seepage Control*, Engineer Manual EM 1110-2-1901.
- _____(2005b). *Design Guidance for Levee Underseepage*. CECW-EG, Technical Letter No. 1110-2-569.
- Van, M.A., A.R. Koelewijn, and F.B.J. Barends (2005). Uplift Phenomenon: Model, Validation, and Design, *International Journal of Geomechanics*, 5(2):98–106.
- Van Beek, V.M., H.T.J. Bruijin, J.G. Knoeff, A. Bezuijen, and U. Förster (2010). “Levee failure due to piping: A full-scale experiment.” *Geotechnical Special Publication No. 210 (Proc., 5th International Conference on Scour and Erosion, San Francisco, California)*, American Society of Civil Engineers, Reston, Virginia, 283–292.
- Von Thun, L. (1996). Understanding Seepage and Piping Failures – the No. 1 Dam Safety Problem in the West. *ASDSO Western Regional Conference, Lake Tahoe*.
- Wan and Fell (2004). Experimental Investigation of Internal Instability of Soils in Embankment Dams and Their Foundations, UNICIV Report No. R-429, School of Civil and Environmental Engineering, The University of New South Wales.
- Weijers, J.B.A. and J.B. Sellmeijer (1993). A new model to deal with the piping mechanism, *Filters in Geotechnical and Hydraulic Engineering (Proc., 1st International Conference Geo-Filters)*, Balkema, Rotterdam, 349–376.
- Zaslavsky, D. and G. Kassiff (1965). Theoretical Formulation of Piping Mechanism in Cohesive Soils, *Geotechnique* v 15.

Part 2

Risk-based Approach to the Evaluation of Internal Erosion

CHAPTER 4 – POTENTIAL FAILURE MODES

4.1 Introduction

A failure mode is a unique set of conditions and/or sequence of events that could result in dam failure. For dam safety, failure is defined as an event characterized by the uncontrolled release of impounded water. For any level of evaluation and/or risk analysis, it is essential to have a thorough understanding of the potential failure mode (PFM) and to fully describe the sequence of events from initiation to breach and uncontrolled reservoir release and/or significant loss of operational control. A potential failure modes analysis (PFMA) is used by the U.S. Army Corps of Engineers (USACE), Bureau of Reclamation (Reclamation), Bureau of Indian Affairs, National Park Service, and Federal Energy Regulatory Commission (FERC) to identify and describe PFMs. A number of other Federal, State, and private sector entities have also used or are considering the use of the PFMA process.

A PFMA is a method of analysis in which particular defects and initiating conditions are postulated, and the full range of effects of the defect or the initiating condition on the system are evaluated. A PFMA is normally a facilitated identification and evaluation of PFMs for a dam by a diverse team of individuals who are qualified by experience and education to evaluate the dam. It is based on a review of available data and information, firsthand input from field and operational personnel, site inspections, completed engineering analyses, discussion of known issues/problems, a general understanding of dam characteristics, and an understanding of the consequences of failure. Guidance for performing PFMA is provided in chapter 14 of the FERC's *Engineering Guidelines*, Reclamation's/USACE's *Dam Safety Risk Analysis Best Practices Training Manual*, and Appendix K of USACE's ER 1110-2-1156, *Safety of Dams – Policy and Procedures*.

Since the methods of failure are identified, described, and evaluated on their credibility and significance, a PFMA can lead to a significant increase in dam safety awareness, a more efficient risk analysis process, identification of additional information or analyses that would be useful in understanding the failure mode, and effective development of performance monitoring and risk-reduction opportunities, and others. How this information is used will vary with the needs of each organization and follow-on risk analysis activities. For some organizations, the level of detail obtained from a PFMA may be sufficient to identify situations in which urgent action is needed.

The success of failure mode development is directly related to the level of understanding of the dam. For this reason, a thorough review of all background information on the dam, including design, construction, site conditions, geology, and performance is required in order to develop the failure modes. Often an important piece of information, such as a construction photograph of steps in a foundation surface or a report of a depression (sinkhole) thought to be benign, will lead to development of key failure modes.

In addition to reviewing of all records associated with a project, a site examination should be done. This examination should be attended by onsite personnel who are familiar with the day-to-day operation and performance of the structure. It is also highly beneficial if other members of the PFMA team are able to visit the site. Oftentimes field staff has information that does not exist in written reports or correspondence that can be useful during the PFM analysis. Onsite staff may have explanations for project oddities, whose purpose is unclear, and information about prior performance incidents that were not fully documented. These personnel also know reservoir operation procedures and have information about specific actions that were taken during previous flood events or internal erosion incidents.

All members of the PFMA team should review the historic documents sufficiently to become thoroughly familiar with the dam prior to the PFMA meeting. Typically, two or more experienced team members are responsible for a very detailed review of all dam safety records to determine which documents should be provided to the rest of the team. For large projects or projects that have a large amount of data, additional reviewers may be needed. This group should discuss amongst themselves what information has been found and where dead ends were encountered. The group should also communicate with the “responsible engineer” or “lead engineer” about incomplete data areas or unclear historical information.

Today, the most common methodology used to perform a probabilistic analysis for dam safety is the PFMA/risk analysis process (Von Thun 1999). While the process is executed continuously, it is presented in this manual in two separate chapters. The PFMA portion of the process is presented in this chapter, and the risk analysis portion is presented in chapter 5. As described later, the PFMA process can be considered the qualitative portion of the analysis, and the RA is the quantitative portion – although the process provides enough flexibility that qualitative and quantitative methods can be used in both.

4.2 Internal Erosion Potential Failure Modes

Internal erosion mechanisms, as described in chapter 3, can be thoroughly evaluated through the PFMA. Through research and practice it has been found that there are common categories of failure modes as described in the next section. It is important to note that those categories are not failure modes themselves, and estimators should not be limited by these categories. Actual failure modes are specific to location and mechanism of failure. As described later, failure mode descriptions are effective in helping the team envision the failure process and are critical for effective risk analysis. The current state of knowledge with respect to some of the failure modes is evolving as are the methodologies being employed in the PFMA process. However, the common goal is to assess all failure modes using the current state-of-practice in order to help prioritize dam safety investigations, monitoring, and remedial actions.

4.2.1 Potential Failure Mode Categories

When considering internal erosion relative to embankment dams, it is helpful to subdivide this rather complex issue by the general location of the potential failure path into the four categories shown below. Von Thun (1996) originally proposed this breakdown with items 1, 2, and 3 below, with item 4 considered as a subset of any of the first three categories. A separate category is presented in this document to emphasize the importance, and often relatively higher risks, associated with embankments and foundations that have embedded structures in them.

- (1) Internal erosion through the embankment
- (2) Internal erosion through the foundation
- (3) Internal erosion of embankment into the foundation or along the embankment/foundation contact
- (4) Internal erosion along or into embedded structures

Specific failure modes will stem from consideration of these categories and will include the location and pathway (i.e., flow path through a specific embankment zone or geologic unit). As an example, consider a dam that is founded half on sand and half on clay. For the “through foundation” category, it would be preferred to identify one failure mode for the sand foundation and one for the clay. A similar line of reasoning could be used for areas of a dam that have varying performance history. Perhaps no differentiation can be made in the foundation conditions but it is known that a specific area downstream from the dam always shows sand boils once the reservoir reaches a certain elevation. A failure mode could then be developed for the area where the sand boils are seen and another failure mode for areas where sand boils have not been observed. Then, during risk analysis (see chapter 5), the importance of this performance can be considered for each of the two failure modes.

4.2.2 Failure Mode Development and Descriptions

Because the internal erosion type of failure process is a function of seepage, it is beneficial to post cross sections of the dam during the team meeting so seepage paths can be discussed. In addition to the embankment zones and foundation conditions, the cross section should include the reservoir levels under consideration, piezometric information for those reservoir elevations, and downstream performance information such as location of sand boils, artesian pressure, etc. The seepage pathway should also be drawn on the cross section. Typically, as this is done the group will discuss the merits of why a failure may take a particular direction. This cross section helps to stimulate discussion among team members and to ensure that all members envision the same failure process. During the report preparation phase, these cross sections can be more formally produced and also used in presentations during the review and approval process of the study. Experience has shown that a clear understanding of the failure mode is essential for an orderly progression through the review and approval process. Poorly understood or poorly

portrayed failure modes have led to review comments that required the team to reconvene again and develop more clearly defined failure modes. An example of a failure mode illustrated on a cross section is given on figures 4-1, 4-2, and 4-3.

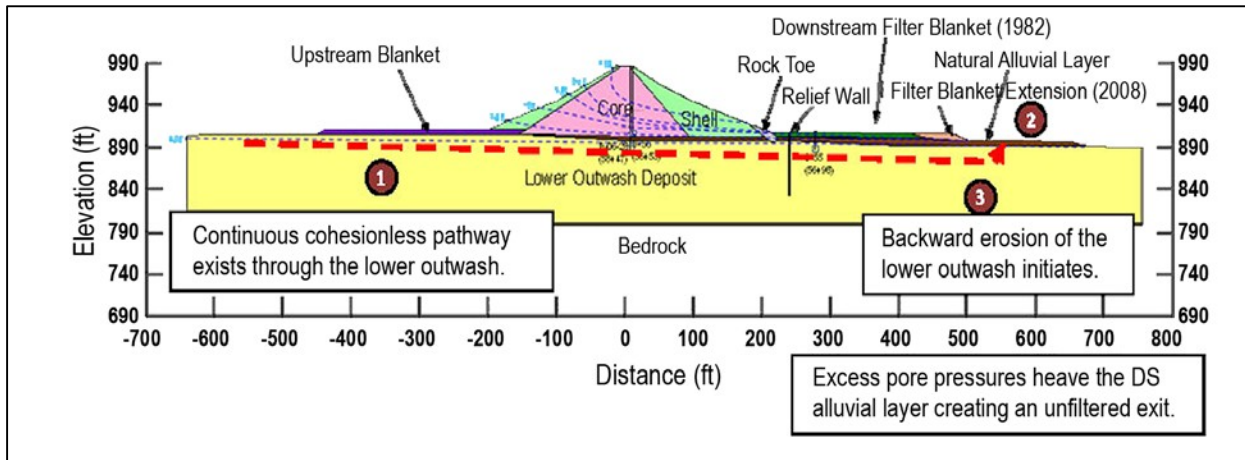

Figure 4-1.—Example PFM: Stages 1, 2, and 3 of a “through foundation” failure mode.

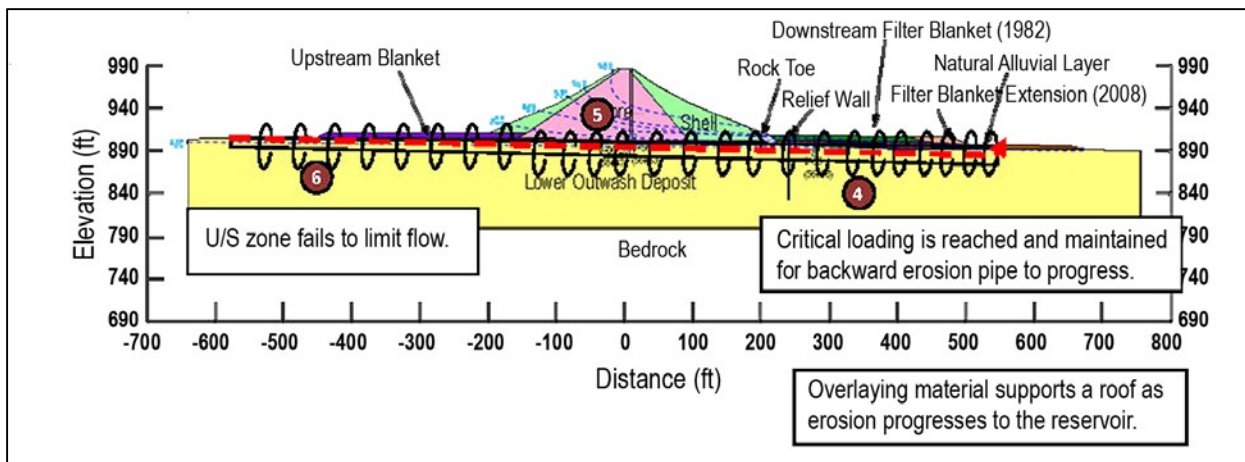

Figure 4-2.—Example PFM: Stages 4, 5, and 6 of a “through foundation” failure mode.

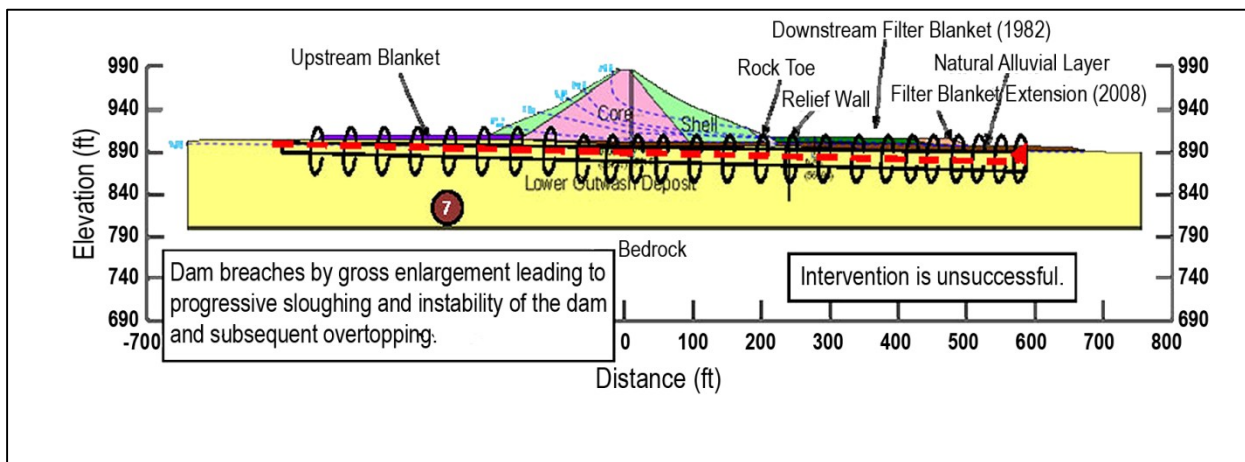

Figure 4-3.—Example PFM: Stage 7 of a “through foundation” failure mode.

A list of PFMs is then developed. Once the team agrees on a given failure path, a narrative is written that describes that failure mode. A trial narrative can be written and displayed on a marker board or projection screen for all to see. The facilitator or a selected team member can write the initial failure mode description. The team then discusses the wording of the failure mode in a dialogue similar to what was done for the cross-section development. Internal erosion risk analysis addresses catastrophic failures (breach of the embankment and loss of reservoir), and therefore, the failure mode description must culminate in that scenario. All team members should be in agreement with the revised and final failure mode description. If agreement cannot be reached, it may be that an additional failure mode requires development to satisfy all team members' concerns.

The failure mode description typically consists of three parts as described below:

- *Initiator*: This is the loading or physical condition that leads to initiation of the PFM (e.g., increases in reservoir level due to flooding perhaps exacerbated by a debris-plugged spillway, strong earthquake ground shaking, malfunction of a gate, or an increase in internal water pressures due to drain plugging).
- *Failure Progression*: This includes the step-by-step process needed to lead to the breach or uncontrolled release of the reservoir. The location(s) where the dam is most vulnerable and the failure is most likely to develop should be highlighted (e.g., the path through which materials would be transported in a piping scenario, the location of breach).
- *Breach*: The expected magnitude of the breach or uncontrolled release of the reservoir is also part of the description. This includes the breach mechanism and how rapid and large the expected breach would be. Defining these breach characteristics aids in assessing the impacted areas and available time to implement emergency actions, such as warnings and evacuations, to mitigate the potential consequences of failure.

Developing a descriptive failure mode takes some practice, and initial efforts typically leave out important information. Below is an example of an unacceptable and acceptable failure mode description.

- *Unacceptable (insufficient detail)*: Piping through the foundation.
- *Acceptable*: A backward erosion piping internal erosion failure mode initiates at the downstream toe of the dam between sta. 1+50 and 3+00 when the reservoir rises sufficiently to increase exit gradients in an area of prior poor performance (sand boil), and seepage flows begin to concentrate at this location. As soil is removed from the upper silty sand layer, a pipe begins to form beneath the embankment due to roof support from the overlying sandy clay embankment. The pipe progresses upstream with increasing gradient at the erosion point due to decreasing seepage path length. Flow within the developing pipe is sufficient to transport the eroding particles to the unfiltered exit at the downstream toe. The piping channel eventually engages the reservoir at the upstream toe of the embankment, which allows a significant increase in flow rate. This

increased flow rate results in pipe enlargement and erosion up into the embankment. The erosion channel continues to increase in size until the overlying fill collapses into it, resulting in overtopping and formation of a breach. Flow from the reservoir is no longer constrained as conduit flow and is now open channel flow. Overtopping flows erodes the embankment and increases the breach size by widening until the flow velocity is low enough to eliminate further scour. The flow continues, leading to large-scale flooding and life loss downstream until the reservoir is empty.

The reasons for completely describing the PFMs are to: (1) ensure the team has a common understanding of the failure mode, (2) document the PFM for future reference and use and (3) facilitate subsequent development of an event tree when a risk analysis is done.

4.3 Conceptual Framework Conducive to Potential Failure Modes Analysis

During a PFMA exercise, factors that influence the likelihood of internal erosion are qualitatively or semiquantitatively evaluated, and an overall likelihood of failure is assessed based on the specific characteristics at the project. In order to assist this process, a table of the more likely and less likely factors that influence internal erosion from initiation through development of a breach is developed. These more likely/less likely factors are elicited from a team of professionals who very familiar with the project and have unique qualifications and experience to make these judgments. This section discusses some of the criteria and factors that are typically used during a PFMA to assess the likelihood of failure from internal erosion.

4.3.1 Phases of Internal Erosion

To better understand how internal erosion develops and conditions under which it is a significant concern, it is useful to break the process into distinct phases that can be more easily evaluated. Internal erosion failures in dams have been described as a four-phase process consisting of initiation, continuation, progression, and breach (Fell et al. 2004).

- (1) *Initiation*: Initiation of erosion occurs when the energy of water flowing through a dam or its foundation is sufficient to detach particles.
- (2) *Continuation*: Continuation occurs if no filter exists along the seepage path or a large enough “repository” for the eroded materials exists for erosion to continue. The various materials comprising the dam and foundation are evaluated for their ability to filter the eroded particles. If filtering occurs, then the erosion process stops.

- (3) *Progression*: In the progression phase, the erosion pathway enlarges to form a continuous void or “pipe” through the embankment or foundation. Soils surrounding the seepage path must be able to support a pipe without collapsing (some forms of internal erosion do not necessarily require “progression” as defined here). Flow through the seepage path or pipe must be sufficient to maintain velocities capable of detaching particles and carrying them downstream through the unfiltered exit without self-healing (movement of materials into the seepage path that chokes off further migration of material, in effect creating a localized filter).
- (4) *Breach*: Assuming intervention is either not attempted or is unsuccessful, the dam can breach by several different mechanisms, including gross enlargement of the developing pipe, loss of freeboard due to crest collapse, sinkhole formation, progressive sloughing of the downstream slope, and/or slope instability.

All four phases, described in greater detail below, are necessary for dam failure to occur for internal erosion processes that pose the most significant threats to dam safety: concentrated leak erosion and backward erosion piping. Some forms of internal erosion such as internal instability, stoping, and tunneling/jugging do not necessarily require the progression phase as defined above and may have unique initiation and continuation factors. However, these types of internal erosion processes usually develop slowly, often resulting in sinkholes, cloudy seepage, or other signs that typically provide enough time for detection and mitigation. Nevertheless, these forms of internal erosion should be taken seriously, as there is a real possibility that the process could lead to dam failure.

4.3.2 Phase 1 – Initiation

Erosion initiates within a soil mass when seepage forces are sufficient to move soil particles away from their original location in the dam or foundation. Concentrated leak erosion (also frequently referred to as “scour”¹) can occur when the reservoir rises to a level that provides enough energy to increase flow velocities along a preferential flow path, such as a crack or other defect, so that soil particles are detached from the soil surface. A rise in reservoir level also can cause increased pore pressures and intergranular seepage that can lead to heave, blowout and/or backward erosion piping. Other types of erosion that can initiate within a dam or foundation include internal instability, internal migration, saturation failure/sloughing, and tunneling/jugging. Additional considerations for the initiation of internal erosion processes mentioned above, as well as potential impacts of animal activity, vegetation, and dispersive soils are presented in sections 3.2 through 3.4. Key seepage concepts related to heave and blowout that could initiate erosion are discussed in section 3.5.

Once erosion initiates, it could develop rapidly into a dam breach within a few days or even hours. It is also possible for the erosion to only occur episodically, possibly taking many

¹ “Scour” is a term that has typically been used to describe surface or external erosion. It is used in this document with reference to internal erosion and the similar mechanism of particle detachment due to flowing water that also occurs in external erosion.

decades to manifest into a problem. It could be that erosion only occurs when the reservoir reaches a threshold elevation, which might only exist for a short period annually, or perhaps might not be reached except during flood events. (It is also possible that the erosion is not able to progress upstream for reasons discussed above and in chapter 3.)

Observation of clear seepage does not necessarily mean that there is no internal erosion concern. Sediment transport could be occurring, but it might not be visible if materials are eroding slowly, or it could be that the observation was made during a period of no active erosion. Examiners should look for evidence of past erosion episodes such as silt or sand deposits at or downstream of seepage exit points. Internal erosion should be considered a possibility for any case of uncontrolled seepage (i.e., seepage not collected through an engineered filter drain). Evidence of internal erosion could go unnoticed for many years if seepage exits occur in swift water, under thick brush or rockfill zones, into conduits, etc. Initially, seepage can be minimal and clear, with the flow gradually increasing and becoming visibly turbid, and rapidly escalating into a very threatening situation.

Erosion may or may not occur upon first filling. The absence of evidence of internal erosion upon first filling by no means implies that a structure is “safe” from new erosion initiating. It is one performance characteristic that must be considered in an evaluation of the potential for internal erosion. Internal erosion incidents have occurred after many decades (in some cases more than 80 years) of apparently successful performance (Engemoen 2011).

4.3.2.1 Factors Increasing the Likelihood of Initiation

A primary mechanism for internal erosion initiation is through flaws (e.g., cracks, high permeability layers, areas of low confining stress, etc.) in the embankment core or foundation. Conditions that may lead to an increased likelihood of a flaw existing through the dam are summarized below and include considerations for embedded structures (compiled from Fell et al. 2008). Many of the factors summarized below are discussed in more detail in section 3.2.

- Wide benches or “stair steps” in the upper to middle portion of the abutment profile can lead to transverse cracking from differential settlement.
- Steep abutments near the top of the dam can lead to transverse cracking from differential settlement.
- Very steep abutments and a narrow valley can cause “arching” of the soil across the valley, leading to a reduction in vertical confining stress within the dam and increased potential for cracking due to hydraulic fracturing (i.e., pore pressures exceed confining stress).
- Fell et al. (2008) suggest that differential settlement between the shell and the core (if deformability of the materials differ) can lead to “dragging and transverse shearing” of the core. However, more typically, this type of differential settlement leads to longitudinal cracks at the interface between the two materials.

- Different foundation conditions (deformability) across the profile can lead to differential settlement and cracking of the dam core.
- Low-density, fine-grained loess soils or weakly cemented “desert” soils present within the foundation may collapse upon wetting, leading to differential settlement or hydraulic fracturing through the low density material, and transverse cracking through the embankment.
- Dessication of the embankment material can lead to transverse cracking through the upper part of the core.
- Excessive settlements as a percentage of the dam height (i.e., more than about 4 percent during construction or about 1 percent at 10 years post-construction) increases the chances of transverse cracking – even lesser settlements may lead to cracking in particularly brittle soils. Note that cracking is often masked; case histories suggest that such cracking can go unnoticed for years and even decades.
- An irregular foundation contact surface, possibly with overhanging rock features, or sloppy or loose foundation soil conditions upon embankment placement can lead to inadequate compaction and a pervious channel along the dam-foundation contact.
- Poor core density due to lack of formal compaction, lack of compaction control, or excessively thick compacted lifts can result in pervious layers through the core.
- Seasonal shutdowns or placement in freezing weather can lead to a pervious layer through the core if not properly treated (i.e., frozen material and dessication cracking was not removed and the surface thoroughly scarified with good moisture control upon re-compaction). In the unlikely event that post-shutdown construction results in lower modulus material in comparison to the underlying embankment, differential settlement of the overlying embankment can lead to transverse cracking in that portion.
- The presence of a conduit through the core of a dam creates a potential high permeability pathway due to the potential for inadequate density or compaction, especially if one or more of the following conditions are also present:
 - A round conduit with no concrete encasement in which it is difficult to get good compaction under the haunches (on the underside).
 - The presence of seepage cutoff collars, which are difficult to get good compaction around and against.
 - Cracks or open joints in the conduit, or corrugated metal pipe, which is subject to corrosion deterioration and through-going holes into which embankment core material can be washed.

- Steep and narrow trench into which the conduit was placed, which makes compaction difficult and creates the potential for arching of soil across the trench, leaving a low-density zone susceptible to hydraulic fracturing.
- A stiff conduit projecting into a brittle embankment also creates the potential for differential settlement above and adjacent to the conduit and the potential for cracking.
- Presence of frost-susceptible soils in which ice lenses can form, particularly when these materials are adjacent to conduits or other structures that could increase the possibility of freezing conditions (e.g., Anita Dam²).
- If a spillway passes through the embankment such that the core is compacted against the spillway wall, difficulties in compacting against the wall (especially if vertical or counterforted), and settlement away from the wall parallel to the abutment, can potentially lead to a high permeability zone or small gap adjacent to the wall.
- For composite concrete/embankment dams, vertical faces, overhangs, and changes in slopes of the concrete section (against which the embankment core is compacted) can lead to higher permeability seepage paths, especially if post-construction embankment settlements are large.
- Direct observations such as observed transverse cracks in the crest of the dam, or concentrated seepage or wet areas on the downstream face of the dam, adjacent to an outlet works conduit or adjacent to a spillway wall could be indications that a flaw may extend through the dam.
- Evidence of sinkholes or depressions (especially along the alignment of a penetrating outlet works conduit) could be indications that material has moved by means of seepage flows.
- Rodent holes and root balls, if not properly treated, can be locations for internal erosion to initiate. Rodents may burrow into dry areas of an embankment when the reservoir is low, but these areas may be exposed to the reservoir as it rises. Similarly, decaying root systems can form pathways for piping initiation.

The following conditions may indicate an increased likelihood of internal erosion through the foundation or from the embankment into the foundation:

- A low-permeability confining layer at the toe of the dam beneath which high artesian pressures exist, which increases the chance of blowout.
- Sand boils observed in the channel downstream of the dam, which could be indications of material movement associated with a foundation seepage path, especially if material is moving out away from the boils.

² For additional details, see Case 7 – Anita Dam, in appendix 1 (Other Case Histories).

- Open joints, seams, faults, shears, bedding planes, solution features, or other discontinuities in the rock foundation at the contact with the dam core into which core material can erode, especially if the following also apply:
 - There was no or questionable foundation surface treatment performed during construction in the way of dental concrete or slushgrout.
 - The effectiveness of foundation grouting is questionable due to grout holes being parallel to open discontinuities, widely spaced holes with uncertain closure, uncaulked surface leaks during grouting, and/or little pore-pressure drop across the grout curtain as measured by piezometers.
 - The discontinuities are open or perhaps filled with erodible silty or sandy material. Wider discontinuities are more problematic than narrow ones.
 - The discontinuities trend upstream to downstream across the foundation, providing a pathway for reservoir seepage.
- Poor cleanup, or lack of cleanup, at the core-foundation rock surface can lead to a low density or erodible pathway at the contact.
- Ridges and valleys formed by excavation along geologic features (e.g., tilted bedding planes forming an irregular surface) that trend upstream to downstream, into which compaction is difficult, can lead to low-density pathways near the dam-rock contact.
- Embankment core material placed against the downstream slope of a cutoff trench cut into pervious gravels with no intervening filter leaves an interface through which core material can be eroded.
- A narrow steep-walled cutoff or outlet conduit trench forms a location where arching of core material placed into the trench can lead to a low-density zone in the core susceptible to transverse hydraulic fracturing. This can be problematic if there is a pathway downstream through which the core material can erode.
- Highly permeable foundation materials that can transmit significant flow capable of eroding material at the base of the dam and carrying it downstream.

4.3.2.2 General Classification of Soil Erodibility

A key consideration in evaluating the potential for erosion initiation is the erodibility of the embankment core and/or foundation materials. The chance of erosion initiating is much higher in highly erodible soils. Sherard (1953) published an early erosion resistance classification,

which is still useful in evaluating the likelihood of erosion, and is shown in table 4-1³ (Note: the lower the number, the greater the erosion resistance). Fell et al. (2008) also categorized erosion resistance based on fines content (table 4-2) for cases of concentrated leaks. Note that plasticity and amount of fines plays a key role in erodibility.

Table 4-1.—Erosion resistance of soils (Sherard 1953)

Greatest piping resistance Category 1	Plastic clay, (PI>15), well compacted
	Plastic clay, (PI>15), poorly compacted
Intermediate piping resistance Category 2	Well-graded material with clay binder, (6<PI<15), well compacted
	Well-graded material with clay binder, (6<PI<15), poorly compacted
	Well-graded, cohesionless material, (PI<6), well compacted
Least piping resistance Category 3	Well-graded, cohesionless material, (PI<6), poorly compacted
	Very uniform, fine cohesionless sand, (PI<6), well compacted
	Very uniform, fine, cohesionless sand, (PI<6), poorly compacted

Table 4-2.—Erosion resistance (from concentrated leaks) of soils related to classification and dispersivity (Fell et al. 2008)

Erosion soil group	Soil classification*
1. Extremely erodible	All dispersive soils; Sherard pinhole classes D1 and D2**; or Emerson Crumb Class 1 and 2 AND SM with <30% fines
2. Highly erodible	SM with >30% fines; SC with <30% fines;* ML; SC with >30% fines;*** CL-ML
3. Moderately erodible	CL; CL-CH; MH; CH with liquid limit <65%
4. Erosion resistant	CH with liquid limit >65%

* ASTM D2487, Standard Practice for Classification of Soils for Engineering Purposes (Unified Soil Classification System).

** ASTM D4647, Standard Test Methods for Identification and Classification of Dispersive Clay Soils by the Pinhole Test.

*** Apparent discrepancy in original publication.

³ The summary table is for backward erosion piping and does not apply to cracks or concentrated leaks. It also does not specifically cover all soil types, but table 8 in Sherard's 1953 thesis provides additional information that may be useful for those cases.

Based on a recent examination of Reclamation incidents (Engemoen 2011), it is estimated that 87 percent of cases of internal erosion at Reclamation embankments has been associated with soils of no to low plasticity and only 13 percent associated with soils having a PI greater than 6 or 7. Dispersive soils are not addressed in table 4-1, but they can be highly erodible even though they may possess moderate to high plasticity.

4.3.2.3 Laboratory Tests for Classification of Soil Erodibility

Laboratory tests such as the Hole Erosion Test (HET), Jet Erosion Test (JET), and Rotating Cylinder Test can be used to evaluate the critical shear stress needed to initiate erosion (detachment of particles). These tests provide information on the erosion resistance of the tested soil. A detachment rate coefficient can be calculated that relates the change in erosion rate to the change in applied excess stress. Detachment rate coefficients calculated from these tests are typically not consistent with each other. Based on the value of detachment rate coefficient, the soil can be categorized into degrees of erodibility. Wahl (2010) compared the HET and JET and concluded that the HET is desirable for internal erosion issues, but the JET can be applied to a wider range of soils.

The HET (Wan and Fell 2004) is performed using an undisturbed tube sample or a soil specimen compacted into a Standard Proctor mold. A 1/4"-diameter hole is pre-drilled through the axis and placed into the testing apparatus. Water flows through the hole under a hydraulic head that is incrementally increased until erosion occurs. When the threshold for erosion is reached, head is held constant, and the test is continued for as long as flow can be maintained. The change in the flow rate during the test is measured as the hole erodes and enlarges. Measurements of the initial and final diameter of the erosion hole are used to compute the time history of the applied shear stress and the erosion rate. The collected data enable calculation of the detachment rate coefficient. Erosion index categories for the HET include: 1-extremely rapid, 2-very rapid, 3-moderately rapid, 4-moderately slow, 5-slow, and 6-very slow.

The submerged JET was developed at the Agricultural Research Service Hydraulic Engineering Research Unit, Stillwater, Oklahoma (Hanson and Cook 2004). The JET simulates a situation of scour of a soil surface (i.e., surface erosion) due to a perpendicular impinging jet and produces a process similar to a headcut or overfall. The test is run with a constant jet pressure produced by a 1/4"-diameter nozzle. The depth of scour beneath the jet is measured over time and is used to estimate the critical shear stress and detachment rate coefficient. JET categories are: very erodible, erodible, moderately resistant, resistant, and very resistant.

Arulanandan, Loganathan, and Krone (1975) developed a rotating cylinder test to assess the erodibility of clay soils. Their device was based on the original design prepared by Masch, Espey, and Moore (1963). The method provides the critical shear stress required to initiate erosion and allows evaluation of other factors that affect erodibility, such as the pore and eroding fluid compositions. It was found that the erodibility of dispersive soils is particularly influenced by the chemical compositions of pore and eroding fluids. The test consists of two concentric cylinders with a water-filled annular space of 0.5 inch. The soil sample is mounted on the inner cylinder and remains stationary throughout the test. The outer cylinder rotates at speeds up to

1,500 rotations per minute and induces shear in the fluid that surrounds the soil sample. The soil sample is mounted on a bearing, and rotation of the soil is resisted by a mandrel and mechanical load. Slight rotation of the soil sample during the test is measured with a torque indicator and is used to measure of the applied hydraulic shear stress. Hence, the amount of shear stress is computed as a function of the torque being applied to the soil sample. The erosion rate is measured as the difference in weight of the sample before and after the applied shear stress. Due to the procedure for this test, only saturated soils are tested. Arulanandan et al. found that a critical hydraulic shear stress exists for surficial erosion of clay soils, below which there is little to no erosion. When the hydraulic shear stress exceeds this threshold, the erosion rate increases linearly with increasing shear stress. The method is applicable for cases in which fluid flow is in direct contact with a soil surface (i.e., surface erosion) and can only be used with cohesive saturated soils that will retain their shape during the test.

4.3.3 Phase 2 – Continuation

Continuation is the phase of the internal erosion process in which a lack of filters, or the presence of inadequate filters, allows erosion of the core or foundation to continue. When considering the potential for continuation at a particular dam, the downstream embankment zones and foundation materials are evaluated to assess their ability to provide filtering. The way in which filters function and a procedure to evaluate materials that were not designed according to modern filter criteria are discussed below.

4.3.3.1 Function of Filters and Their Importance

As discussed above, soil particles can be detached by concentrated flow along a preferential flow path (e.g., along the walls of a crack in the soil) or by intergranular seepage initiating backward erosion piping at an unfiltered exit. Eroded particles are then either carried to an unfiltered exit, in which case a dangerous condition may exist, or the eroded particles could be carried to a filter (whether intentionally designed as such or not). Modern filter criteria were developed to protect against internal erosion of all types.

The FEMA Filter Manual (2011) provides a thorough review of the subject of filter design and construction. Figure 4-4 illustrates the way in which a filter works to prevent internal erosion from a concentrated leak (Sherard et al. 1984). Figure 4-4(a) shows eroding soil in the crack is caught at the filter face, stopping flow in the crack. High gradients cause hydraulic fracturing from the crack to the adjacent filter. Figure 4-4(b) shows eroding soil from a crack has been caught at the filter face, and hydraulic fracturing from high gradients between water in the crack and the adjacent filter has caused some widening of the filter cake near the crack. On figure 4-4(c), eroding soil from the crack has been caught at the filter face, and hydraulic fracturing from the high gradients between water in the crack and the adjacent filter has caused further widening of the filter cake until the gradient is reduced. The filter cake having a very low permeability covers the width of the crack and some distance on each side of the crack. The

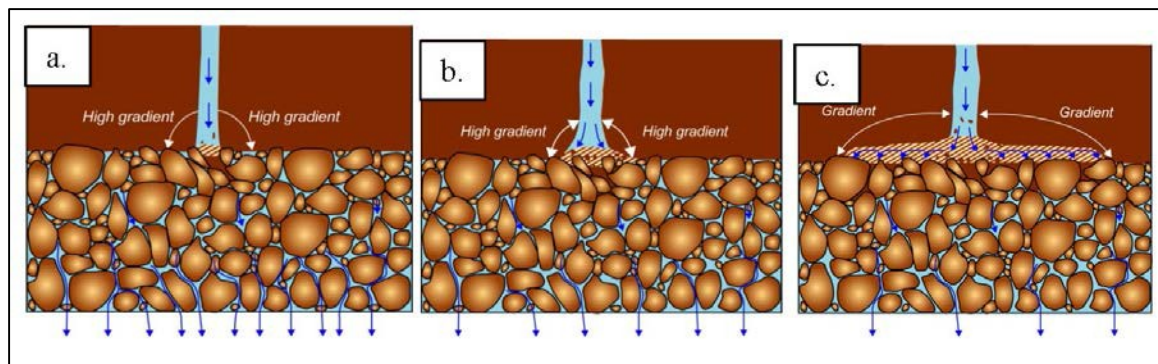

Figure 4-4.—Illustration of filtering at a crack.

remaining filter is open for collecting seepage flow through the pores of the soil between cracks. The presence of filters and drains also helps to control pore pressures within the embankment and foundation.

While it seems obvious that filters placed in new dams or as part of dam safety modifications should be designed in accordance with modern filter criteria, the presence of a relatively modern filter (i.e., since about the mid-1980s and depending on the design organization) does not necessarily guarantee successful performance. Both design **and** construction of filters are critical to ensure that the filter performs its function of providing both particle retention and drainage. In some cases, the potential for filter cracking or coarse zones due to segregation during placement may be of sufficient concern that adequate filtering is not certain. Dams designed and constructed before modern filter criteria were developed may or may not include zones that meet current design standards.

4.3.3.2 Cementation and Cohesion in Filters

Filters that develop cementation or contain too many fines (>5 percent) are susceptible to cracking, and the crack could remain open even upon saturation by seepage. Eroded core materials could be transmitted through the crack to an unfiltered location downstream. It is important to ensure that commercial or borrow sources for filters do not contain materials that are susceptible to cementation (carbonates, volcanic ash, silicates, etc.). A number of filters developed cementation after being placed into service for as little as 1 year (e.g., Ochoco Dam⁴ in Oregon). When modifications were being constructed at Natural Resources Conservation Service (NRCS) dams in Arizona, it was discovered that cementation had developed in some filters.

Testing for filter material quality is described in the FEMA Filter Manual (2011), and the Modified Sand Castle Test is described in Rhinehart et al. (2012).

⁴For additional details, see Case 1 – Ochoco Dam, in appendix 1 (Other Case Histories).

4.3.3.3 Assessment of Filters in Existing Dams

New dams or major new modifications should use filters designed in accordance with current filter criteria (FEMA 2011). In some cases, filters in existing dams are evaluated for filter compatibility as part of a dam safety review. Foster and Fell (2001) provide a method to evaluate filter compatibility in existing dams for materials that may not meet current filter design criteria (tables 4-3 and 4-4). This situation is relatively common at many older dams where the downstream zone was not designed to be a state-of-the-art filter, yet may exhibit beneficial filtering effects. The procedure involves the concept of a “continuing erosion boundary” as well as “excessive erosion” and “no erosion” boundaries.

Table 4-3.—No erosion boundary for the assessment of filters of existing dams (after Foster and Fell 2001)

Base soil category	Fines content ¹	Design criteria of Sherard and Dunnigan (1989)	Range of D ₁₅ F for no erosion boundary from tests	Criteria for no erosion boundary
1	≥ 85%	$D_{15}F \leq 9 D_{85}B$	6.4 – 13.5 $D_{85}B$	$D_{15}F \leq 9 D_{85}B$ (2)
2	40 – 85%	$D_{15}F \leq 0.7 \text{ mm}$	0.7 – 1.7 mm	$D_{15}F \leq 0.7 \text{ mm}$ (2)
3	15 – 40%	$D_{15}F \leq (40 - \text{pp}\% 0.075 \text{ mm}) \times (4 D_{85}B - 0.7) / 25 + 0.7$	1.6 – 2.5 $D_{15}F$ of Sherard and Dunnigan design criteria	$D_{15}F \leq (40 - \text{pp}\% 0.075 \text{ mm}) \times (4 D_{85}B - 0.7) / 25 + 0.7$
4	< 15%	$D_{15}F \leq 4 D_{85}B$	6.8 – 10 $D_{85}B$	$D_{15}F \leq 4 D_{85}B$

- Notes: (1) The fines content is the percent finer than 0.075 mm after the base soil is adjusted to a maximum particle size of 4.75 mm.
 (2) For highly dispersive soils (Pinhole classification D1 or D2 or Emerson Class 1 or 2), it is recommended to use a lower $D_{15}F$ for the no erosion boundary. For soil group 1 soils, suggest using the lower limit of the experimental boundary (i.e., $D_{15}F \leq 6.4 D_{85}B$). For soil group 2 soils, suggest using $D_{15}F \leq 0.5 \text{ mm}$. The equation for soil group 4 would be modified accordingly.

Table 4-4.—Excessive and continuing erosion criteria (Foster 1999; Foster and Fell 1999, 2001)

Base soil	Proposed criteria for excessive erosion boundary	Proposed criteria for continuing erosion boundary
Soils with $D_{95}B < 0.3 \text{ mm}$	$D_{15}F > 9 D_{95}B$	For all soils: $D_{15}F > 9 D_{95}B$
Soils with $0.3 D_{95}B < 2 \text{ mm}$	$D_{15}F > 9 D_{90}B$	
Soils with $D_{95}B > 2 \text{ mm}$ and fines content > 35%	$D_{15}F >$ the $D_{15}F$ value, which gives an erosion loss of 0.25 g/cm ² in the CEF test (0.25 g/cm ² contour line on figure 4-5)	
Soils with $D_{95}B > 2 \text{ mm}$ and fines content < 15%	$D_{15}F > 9 D_{85}B$	
Soils with $D_{95}B > 2 \text{ mm}$ and fines content 15–35%	$D_{15}F > 2.5 D_{15}F$ design, where $D_{15}F$ design is given by: $D_{15}F$ design = $(35 - \text{pp}\% 0.075 \text{ mm}) \times (4 D_{85}B - 0.7) / 20 + 0.7$	

Criteria are directly applicable to soils with $D_{95}B$ up to 4.75 mm. For soils with coarser particles, determine $D_{85}B$ and $D_{95}B$ using grading curves adjusted to give a maximum size of 4.75 mm.

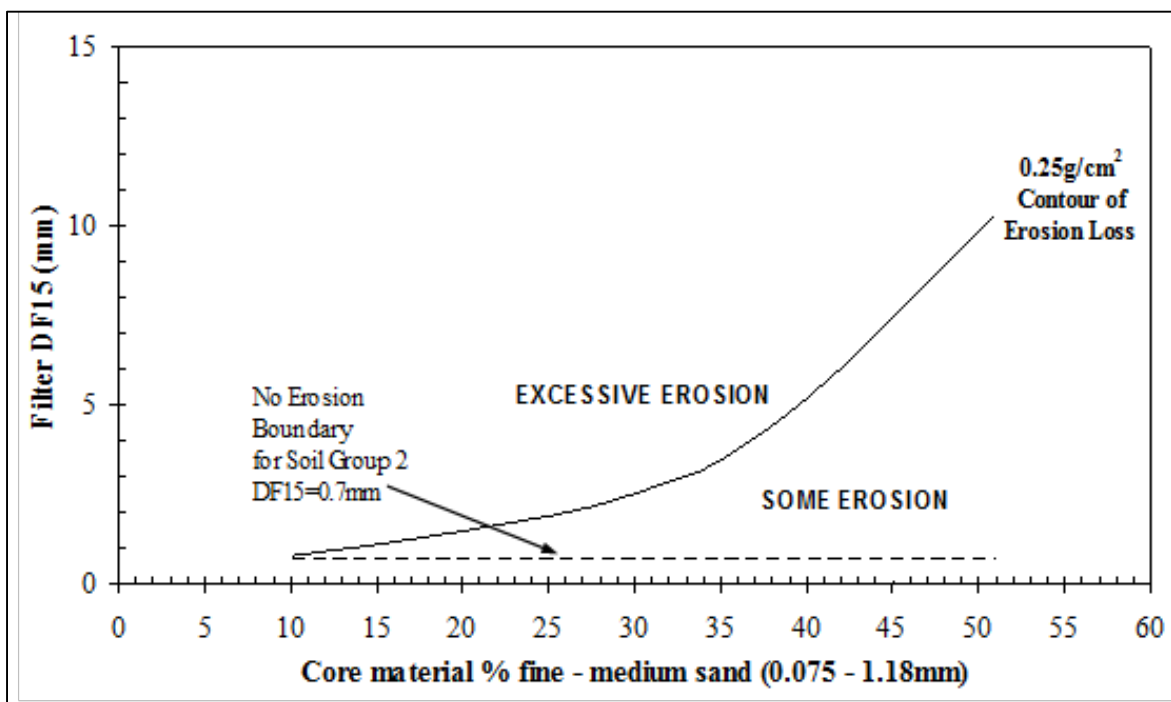

Figure 4-5.—Criteria for excessive erosion boundary (Foster and Fell 2001).

4.3.3.4 Additional Considerations for Continuation

Additional considerations for the continuation phase of the internal erosion process include:

- Assess whether or not the exit is truly open or continuous. Open zones in shell materials and alluvial materials need to be continuous to an open face. Bedrock joints/fractures need to be continuous to an open face and not covered by alluvium (unless the alluvium is too coarse to provide filtering). In some cases where extensive void spaces may exist in rockfill zones, coarse soils, or bedrock, an open exit may not be needed, but sufficient “storage space” for eroded fines must be available.

If segregation is judged to be a significant concern, the chances of a concentrated leak or flaw lining up with a continuous segregated layer need to be included in the assessment.

- Cracks in conduits or apertures in bedrock potentially serve as “filters.” The estimated effective opening sizes are used as a means of evaluating whether these types of features will allow continuation of erosion. There currently is no universally accepted guidance for evaluation of this. However, Fell et al. (2005) suggest the aperture size cannot be greater than D_{85} to D_{96} of the adjacent soil depending on the erosion boundary under consideration.

- Reclamation’s filter design standard (chapter 5) (2012) can be used for evaluation of filter compatibility of drainpipe perforations, and it suggests that in order to prevent erosion into the opening, the aperture size must be less than the D_{50} of the soil material closest to the pipe. Since these criteria are used for design, they are likely conservative unless the particles are flat.
- Poorly designed or filtered structure underdrains, toe drains, or weepholes into which embankment materials can be carried should be evaluated using similar “opening size” considerations where applicable.
- Be cognizant of the number of samples used to evaluate filter compatibility. For example, if only one or two samples are available for each zone and only from borrow sources, care must be taken in drawing conclusions from the data.
- Consider reviewing the borrow source and placement information. It may be that different portions of the embankment were placed using different borrow areas or zones within a borrow area. Thus, some areas may have predominantly finer core material (or coarse filter material), and these areas should be evaluated using information specific to those areas, and not the average conditions.
- Evaluate if the filter gradations are susceptible to suffusion.
- Research by the USACE and Reclamation (Redlinger et al. 2012) found that single-stage uniform sand filters are prone to cracking when densely compacted, but do not crack if loosely placed. Two-stage filters with a gravel stage are robust with respect to cracking and self-healing.

4.3.4 Phase 3 – Progression

Progression is the process of developing and enlarging an erosion pathway through the core or foundation. The progression phase can be subdivided into three separate processes for concentrated leak erosion and backward erosion piping modes of internal erosion: (1) formation of a continuous stable roof and/or sidewalls through the core, (2) the possibility that flows are limited by a constriction or an upstream zone, and (3) the potential for an upstream zone to provide self-healing. These three considerations are commonly used, but in some cases, other factors may also need to be considered for the progression phase. The progression phase includes all steps after continuation and prior to breach with the exception of intervention.

If the internal erosion process is stoping, tunneling/jugging, internal instability or other mechanisms that do not necessarily require formation of a pipe that connects to the reservoir,

the progression phase as defined above would be handled differently. Currently, there is no commonly accepted practice for evaluation of progression for these other internal erosion processes, although specific factors should be developed for the process being considered.

4.3.4.1 Continuous Stable Roof and/or Sidewalls

Formation of a continuous roof through the core or foundation is dependent on the soil conditions or presence of structures above the potentially erodible soils. Therefore, conduits, spillways, walls, and other concrete structures can form a roof along an identified potential internal erosion pathway. Interbeds of “hardpan” or caliche also constitute potential roofs for underlying soils that are not capable of supporting a roof by themselves. Absent these conditions, the capability of the soil to support a roof is dependent mainly on the properties of the soil being eroded.

A 2008 report (Fell et al. 2008) summarized work by Foster (1999) and Foster and Fell (1999) that evaluated case histories and found that the two most important factors for roof formation are the fines content and whether or not the soil is saturated. Soils with fines contents greater than about 15 percent were found to be likely to hold a roof regardless of the plasticity (whether non-plastic or plastic). Other factors found to have an influence include the degree of compaction (loose soil less likely to support a roof) and reservoir operation (cyclic reservoir levels were more likely to cause collapse than constant levels). Research by Park (2003)⁵ showed that sandy gravel with 5 to 15 percent non-plastic fines collapsed quickly when saturated. Park also found that sandy gravel with 5 percent cohesive fines collapsed after some time, but very slowly with 15 percent cohesive fines. Based on these studies, table 4-5,⁶ reproduced from Fell et al. (2008), provides guidance on the likelihood a soil will be able to support a roof, absent overlying harder materials. Although the table was developed for use with quantitative risk analysis, which is beyond the scope of this chapter, the table provides a sense for which soil types and conditions roofing is likely or not.

For concentrated leak erosion that occurs high in the embankment (e.g., cracks in crest or gap adjacent to spillway wall), a roof is not necessarily a requirement for the process to progress. It is possible that the sidewalls could collapse and prevent further progression rather than collapse of a roof material.

The presence of a structure or hard layer and soil properties are primary factors to consider in roof formation. Some other factors include soil variability along the seepage path, the length of the seepage path, and stress arching.

⁵ Park’s research was related to cracking in filters. Some of the test results were considered applicable to the potential for roof formation of soils.

⁶ The probabilities presented in this table are not based on rigorous analysis and should be considered for informational purposes only. These numbers are not universally accepted.

Table 4-5.—Probability of a soil being able to support a roof (Fell et al. 2008)

Soil classification	Percentage fines	Plasticity of the fines	Moisture condition	Likelihood of supporting a roof
Clays, sandy clays (CL, CH, CL-CH)	> 50%	Plastic	Moist or saturated	0.9+
ML or MH	> 50%	Plastic or non-plastic	Moist or saturated	0.9+
Sandy clays, gravely clays, (SC, GC)	15% to 50%	Plastic	Moist or saturated	0.9+
Silty sands, Silty gravels, Silty sandy gravel (SM, GM)	> 15%	Non-plastic	Moist Saturated	0.7 to 0.9+ 0.5 to 0.9+
Granular soils with some cohesive fines (SC-SP, SC-SW, GC-GP, GC-GW)	5% to 15%	Plastic	Moist Saturated	0.5 to 1.0 0.2 to 0.5
Granular soils with some non-plastic fines (SM-SP, SM-SW, GM-GP, GM-GW)	5% to 15%	Non-plastic	Moist Saturated	0.05 to 0.1 0.02 to 0.05
Granular soils, (SP, SW, GP, GW)	< 5%	Non-plastic Plastic	Moist and saturated Moist and saturated	0.0001 0.001 to 0.01

Notes: (1) Lower range of probabilities is for poorly compacted materials (i.e., not rolled), and upper bound for well- compacted materials.

(2) Cemented materials give higher probabilities than indicated in the table. If soils are cemented, use the category that best describes the particular situation.

4.3.4.2 Constriction or Upstream Zone Fails to Limit Flows

There are some cases in which internal erosion can progress to the point where the dam core or foundation is eroded through, but a flow constriction at any point along the path, an upstream zone, or facing element limits the flow from the reservoir to the point where erosion is arrested and a breach will not form. This is contingent upon the upstream zone being stable under the flows and having small enough openings to limit flows through the zone to levels that would prevent further erosion of the core. In essence, the flow is limited so that shear stresses are insufficient to detach soil particles.

Examples of constrictions may include concrete or sheet pile walls within the embankment or that fully penetrate foundation soils, which greatly increase the chance of success for this event. Modern concrete walls (crossing the internal erosion pathway, typically extending into rock) that are thought to be in good condition have the best chance for success. Steel sheet pile walls may be less effective under poor driving conditions. Concrete or steel membranes, soil-cement slope

protection, geomembranes, or other linings on the upstream face of the dam can be effective in limiting flows, depending on their condition, but potential erosion of the underlying support for the facing may be an issue.

For failure modes that involve seepage paths through bedrock discontinuities, the flow could be limited by the aperture of those discontinuities. Similarly, failure modes in which the seepage flows into a crack or joint in concrete, such as an outlet works conduit, the flow may be limited. However, flow velocities could be quite high through an open bedrock joint, which could lead to stoping.

Fell et al. (2008) suggest that, for upstream soil zones, the success of the zone in limiting flows is highly dependent on whether the mechanism leading to a flaw in the core is also present in the upstream zone, with its ability to support a roof or crack of secondary importance. If the potential for the flaw to extend through the upstream zone is high, and the potential for the upstream zone to support a roof or crack is high, then there is reduced likelihood this mechanism will be successful. If the upstream zone will not support a roof, then these materials could collapse into the pipe. If the upstream zone contains large particles that are not capable of being transported downstream through the developing pipe, they could possibly reduce velocities enough to prevent further erosion. However, in erodible soils, erosion around the edges of the filled erosion path is likely and generally little benefit would be given to this possibility. The possibility of flow limitation may occur early when the defect is relatively small or later in the process when the pipe is larger.

4.3.4.3 No Self-healing Provided by Upstream Zone

Upstream granular zones have been observed to help supply crack-stopping materials and contribute to self-healing. If a pipe progresses through the core of the dam, and there is an upstream zone that can collapse into the “pipe” (i.e., is not capable of supporting a crack or a roof) and then is filtered against a downstream transition zone or constriction along the seepage path, internal erosion could be arrested and would not lead to breach of the dam. The likelihood of success is difficult to evaluate, but it increases with thicker upstream zones, the presence of truly cohesionless materials, a variety of particle sizes, and the presence of a downstream shell or constriction that will provide a “stop” for these materials that wash into and through the core.

Consideration should be given to whether the self-healing will occur early when the defect is small. In general, it is more likely to self-heal earlier in the process when sand size particles could be carried to downstream zones by relatively low flows. Gravel and larger-sized particles need high flows to be transported, so by the time flows are large enough to transport these sizes, significant enlargement of the erosion pathway may have already occurred. A documented example of this type of self-healing is in a case history for Matahina Dam⁷ in New Zealand (Gillon and Newton 1991). Self-healing has also been observed at Suorva Dam in Sweden (Nillson 2005) and at Uljua Dam in Finland (Kuusiniemi 1991).

⁷ For additional details, see Case 3 – Matahina Dam, in appendix 1 (Other Case Histories).

4.3.5 Phase 4 – Breach

Assuming intervention is either not attempted or is unsuccessful, a dam can breach by several different mechanisms. The type of breach depends on the internal erosion process being considered, embankment type, and specific failure mode being considered. The following breach mechanisms are typically considered.

- *Gross Enlargement*: If the erosion pathway, or “pipe,” connects to the reservoir, rapid erosion and enlargement of the pipe could develop until the crest collapses into the pipe. If the amount of crest drop is greater than the available freeboard, overtopping of the embankment could quickly lead to a breach. It is also possible that if overtopping does not occur, the embankment could be severely damaged and breach could still occur by concentrated flow through cracks. Examples of gross enlargement include Teton Dam and Anita Dam.⁸ Figure 4-6 shows a dam that experienced gross enlargement, but the reservoir drained out before the pipe enlarged enough to cause the crest to collapse. If the likely breach mechanism for a PFM is breach by gross enlargement, as opposed to sinkhole development or sloughing, a breach is generally more likely to occur. If the downstream shell is unable to support a roof, sloughing/unraveling would be the more likely breach mechanism.



Figure 4-6.—Example of a dam that experienced gross enlargement, but the reservoir drained before erosion progressed to the point of crest collapse.

⁸ For additional details, see Case 1 – Teton Dam and Fontenelle Dam, (Seminal Case Histories) and Case 7 – Anita Dam, (Other Case Histories) in appendix 1.

- *Sloughing/Unraveling*: In situations where the downstream zone is not capable of sustaining a roof, over-steepening of the downstream slope due to progressive slumping can eventually lead to complete loss of freeboard. Soil particles are eroded and a temporary void grows near the downstream face until a roof can no longer be supported, at which time the void collapses. This mechanism is repeated progressively until the core is breached or the downstream slope is oversteepened to the point of instability. Unraveling refers to progressive removal of individual rocks by large seepage flows through a downstream rockfill zone.

Reclamation's Fontenelle Dam in Wyoming nearly breached in 1965 by sloughing (figure 4-7), but the breach process occurred slowly enough so that the reservoir water surface was able to be lowered over the span of several days and arrest the breach. In contrast, Hell Hole Dam, a rockfill structure in California, failed from overtopping during construction in 1964, but handled a flow of about 13 cubic feet per second per foot before small slides and erosion began to progressively occur at the toe. Once this began, failure occurred within about 3½ hours (Leps 1973). The core of Reclamation's Minidoka Dam overtopped during construction (1904 to 1906), and the downstream rockfill zone withstood flows estimated up to 1,000 cubic feet per second. The water surface elevation was 8 feet below the normal water surface when the core overtopped. Figure 4-8 shows the maximum section of Minidoka Dam, which is approximately 80 feet high.



Figure 4-7.—Fontenelle Dam, which nearly breached by sloughing.

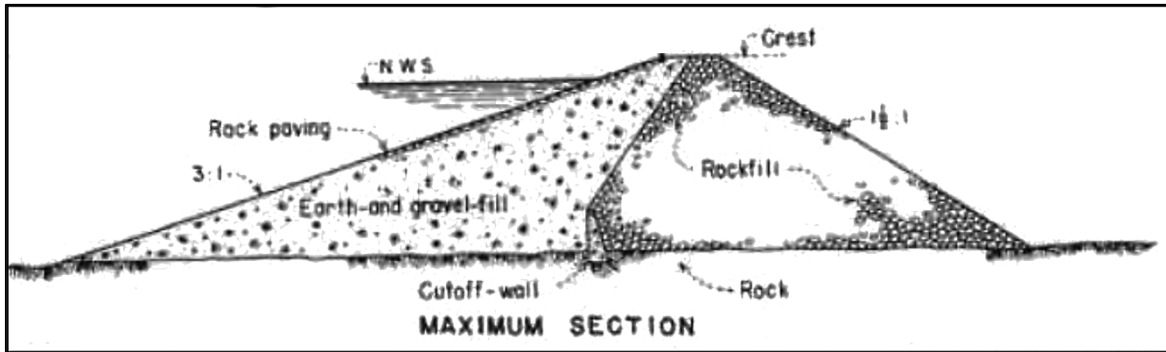

Figure 4-8.—Maximum section of Minidoka Dam. The downstream rockfill zone withstood significant flows when the core overtopped during construction.

- Sinkhole Development:* This mechanism refers to stoping of material upward, creating a sinkhole or depression in the crest that drops below the reservoir level. For breach to occur, the sinkhole would need to be large enough to lead to overtopping. USACE’s Wolf Creek Dam⁹ was constructed over karst features and has experienced numerous sinkholes. Due in part to concern that sinkholes may lead to potential breach, major mitigation measures have been undertaken. Sallacoa Dam¹⁰ also experienced formation of a large sinkhole for similar reasons (figure 4-9).



Figure 4-9.—Sallacoa Dam experienced a large sinkhole from internal erosion into a karst foundation.

⁹ For additional details, see Case 10 – Wolf Creek Dam and Mississinewa Dam, in appendix 1 (Seminal Case Histories).

¹⁰ For additional details, see Case 8 – Sallacoa Creek Watershed, Site No. 77 Dam, in appendix 1 (Other Case Histories).

- *Slope Instability*: Internal erosion could cause high pore pressures in the foundation or embankment, resulting in reduced shear strength and slope failure. Breach could occur if the failure surface either intersects the reservoir or the slope deformations are significant enough that the remnant can't resist the reservoir load. This is generally not considered to be a very likely breach mechanism for most dams although it is possible.

One or more of the above breach mechanisms may occur during the breach process, and it is generally not necessary to know precisely which mechanism(s) would occur. However, risk estimates should typically be developed considering the most likely breach mechanism(s). There are a few cases where once failure has initiated and progressed, and intervention has been unsuccessful, complete breach of the dam did not necessarily follow. Reclamation's Great Plains dams often have on the order of 50 feet of freeboard under normal conditions. If the operative breach mechanism was stoping (forming a sinkhole near the crest) or progressive slumping and erosion at the toe of the dam, the large freeboard may prevent failure by keeping the sinkhole above the reservoir surface or by formation of a "berm" at the downstream slope from the slumped material that ultimately arrests breach development. In addition to large freeboard, other factors that have led to a reduced probability of complete breach include a concrete corewall to nearly full dam height (which is capable of retaining the reservoir even if a "pipe" or sinkhole develops). In the case of internal instability of core material, not only must the finer particles be washed through the coarser materials, but the remaining fraction must sustain enough flow such that it is also completely eroded. It is also possible that a small reservoir volume may empty through an opened seepage path before complete dam breach can occur.

Breach mechanisms vary in their time to fully develop and catastrophically release the reservoir, and the intervention node should consider the potential time available based on the breach mechanism being considered.

4.4 Failure Mode Screening and Ranking

During the brainstorming section of the PFMA, the team should be encouraged to envision as many failure modes as they can since a risk analysis will only be as good as the failure modes considered. Some case histories have demonstrated that the failure mode leading to an incident was never considered by the team. Typically, teams will produce as many as several dozen failure modes during the brainstorming session, but clearly not all failure modes will be credible. Therefore, a qualitative evaluation procedure can be used to rank the failure modes and screen those that are considered of most concern and significant contributors to the overall risk profile of the project. After the PFMs have been identified, there are a number of tools and methods that should be employed to screen projects based on the specific failure modes and consequences at a site (see chapter 5 for more details). The specific rationale for excluding failure modes from further consideration should be well documented in the PFMA report. Additional investigations or studies may be necessary before a PFM can be properly assessed.

4.5 Risk Management Factors in the Potential Failure Modes Analysis

Risk management decisions are often made after the PFMA is completed. In some agencies, and under some situations, the immediate risk management decision may be to further study the issue with a full risk analysis. This might be necessary to ensure expensive repairs or dam modifications are based on accurate risk assessments and that limited funds are used for the best purpose. In other instances, the PFMA may be enough to inform decisionmakers about the risk of internal erosion so that decisions can be made without an additional risk analysis. The PFMA report should include additional information to help inform the decisionmakers about the risks at a project.

4.5.1 Major Findings and Understandings

At the conclusion of a PFMA, much information has been developed about a project. Some of the information is obtained during the extensive reading of historical documents and preparation for the exercise. It is not uncommon to uncover institutional knowledge about a project that was long forgotten. Key failure modes and factors that influence the failure mode can be discovered, which might drive later decisions regarding monitoring and instrumentation. Hence, one of the critical aspects of a PFMA is capturing all this information before the team disbands. This is done with preparation of a list of the major findings and understandings. Everyone on the team will contribute to the list, and it should provide all the critical information related to the project that was found to influence PFMs and its vulnerabilities.

4.5.2 Interim Risk Reduction Measures

There may be a need to institute interim risk reduction measures if a PFMA uncovers active failure modes, or failure modes that have a high likelihood of occurring under future loading conditions. A wide range of PFMs will be considered in the PFMA, and most, if not all of these, will usually be eliminated from immediate concern. However, there may be cases in which immediate or near-term measures are needed to help mitigate the risk of failure until more permanent measures can be developed and implemented. Immediately following a PFMA, the team should assess the critical failure modes for the project and make recommendations if interim risk reduction measures are warranted and what interim measures should be considered.

4.5.3 Potential Changes to Instrumentation and Monitoring, and Operation/Maintenance Procedures

Once a PFMA has identified the most critical failure modes for a project, the instrumentation and monitoring program will likely need to be updated. Instrumentation and monitoring are typically

developed to perform routine health monitoring and monitoring of specific concerns. There may be instrumentation at a project that is monitoring a specific concern that was found to have a very low likelihood of failure after a more detailed and thorough evaluation was conducted with a PFMA. Some instrumentation may no longer be needed. There may be new failure modes found that have high priority for monitoring that require installation of new instrumentation. The PFMA report should highlight the PFMs of concern, and this information should be used to help focus future field inspections by informing personnel of the most critical areas and failure modes at the project. This is a good training opportunity for field personnel, in that the PFMA report should discuss not only the critical failure modes, but also explain how and where the indications of an active failure mode may appear in the field, and explain why it is a specific concern at that site. The PFMA may also inform staff regarding critical operation and maintenance (O&M) activities related to PFMs. O&M requirements should be reviewed following a PFMA and recommendations made to address specific failure modes in cases where routine O&M activities are needed to help mitigate the risk.

4.5.4 Updating the Emergency Action Plan Following a Potential Failure Modes Analysis

As with the instrumentation and monitoring, and O&M activities, a PFMA will inform emergency action planning. The Emergency Action Plan (EAP) should be updated so that it accurately reflects the key risks that have been identified for the project. This may require stockpiling materials that meet certain filter criteria and identifying contractors with special equipment or skills to address anticipated failure modes during an emergency. Other activities and modifications may be required in the EAP to monitor, evaluate, address, and warn of the types of failures considered most likely to develop at the project. The PFMA should be used to assist in review of the EAP and can help inform necessary changes to the EAP to minimize the consequences and/or risk of failure.

4.5.5 Recommendation of Additional Studies and Other Activities

Finally, conducting a PFMA will identify areas where specific information is lacking in order to adequately characterize risk at a project. Obtaining the additional information may result in either lowering the concern, or in some cases, the additional information may result in the need for a heightened awareness of a PFM. The PFMs that are in need of additional information to adequately assess them should be identified by the PFMA team, and recommendations should be made as to what specific information is needed. Decisionmakers can then determine if additional funding is necessary for studies or other activities to address the knowledge gaps.

4.6 Concluding Remarks Regarding the Potential Failure Modes Analysis Process

A PFMA can take a week or less to complete. It is a good opportunity for newer staff to get up to speed on a project as well as for senior staff to review the current status, recent and past performance, and identify specific risks associated with a project. The PFMA will identify key failure modes that are more likely to occur at a project based on the site-specific characteristics. It will also identify interim risk reduction measures that can be taken to address key risks, inform the instrumentation and monitoring programs, help prioritize O&M activities, and highlight areas where key information or knowledge gaps exist. The PFMA will help prioritize followup activities and will lead to better management of risks associated with a single project and in aggregate with a portfolio of projects. Recent experience with PFMA's, both in the private sector and at Federal projects, has proven the value in performing PFMA's, and in some cases, immediately helped avoid dam failures. The PFMA can be done for relatively little cost and is a proven method for managing risk. In some cases, an agency or dam owner may be unwilling to invest in a major dam modification just based on a PFMA and may request a more indepth and detailed picture of the risk be developed. In those cases, a full risk analysis may be warranted, which is the topic of the next chapter.

4.7 References

- Arulanandan, K., P. Loganathan, and R.B. Krone (1975). "Pore and Eroding Fluid Influences on Surface Erosion of Soil," *Journal of the Geotechnical Engineering Division, ASCE*, pp. 51–66.
- Bischoff, John A., T.C. MacDonald, and T.M. Wilson (1985). *Rehabilitation of an Old Hydraulic Fill Dam for Stability Against Earthquakes*, International Committee on Large Dams, Lausanne, France.
- Bureau of Reclamation and U.S. Army Corps of Engineers (2011). *Dam Safety Risk Analysis Best Practices Training Manual, Version 2.2 (April 2011)*, U.S. Department of the Interior, Bureau of Reclamation, Technical Service Center, Denver, Colorado.
<http://www.usbr.gov/ssle/damsafety/Risk/methodology.html>.
- Engemoen, W.O. (2011). "Bureau of Reclamation experiences with internal erosion incidents." *Proc., Internal Erosion in Embankment Dams and Their Foundations*, European Working Group of ICOLD, Brno, Czech Republic.
- Fell, R., C.F. Wan, and M. Foster (2004). *Methods for estimating the probability of failure of embankment dams by internal erosion and piping – piping through the embankment. UNICIV Report No. R-428, The University of New South Wales, Sydney, Australia.*

- Fell, R., P. MacGregor, D. Stapledon, and G. Bell (2005). *Geotechnical Engineering of Dams*, Balkema, Leiden, ISBN 041536440x.
- Fell, R., M.A. Foster, J. Cyganiewicz, G.L. Sills, N.D. Vroman, and R.R. Davidson (2008). *Risk Analysis for Dam Safety: A Unified Method for Estimating Probabilities of Failure of Embankment Dams by Internal Erosion and Piping*, URS Australia, New South Wales, Sydney, Australia.
- Fell, R., M. Foster, R. Davidson, J. Cyganiewicz, G. Sills, and N. Vroman (2008). *A Unified Method for Estimating Probabilities of Failure of Embankment Dams by Internal Erosion and Piping*. UNICIV Report R 446, The School of Civil and Environmental Engineering, the University of New South Wales, Sydney, Australia 2052. ISBN:85841 413 9.
- Foster, M.A. (1999). "The probability of failure of embankment dams by internal erosion and piping." Ph.D. Thesis, University of New South Wales, Sydney, Australia.
- Foster, M.A. and R. Fell (1999). "Assessing embankment dam filters that do not satisfy design criteria." UNICIV Report No. R-376, University of New South Wales, Sydney, Australia.
- ____ (2001). "Assessing embankment dam filters that do not satisfy design criteria." *Journal of Geotechnical and Geoenvironmental Engineering*, American Society of Civil Engineers, 127(5), 398–407.
- Foster, M.A., R. Fell, and M. Spannagle (1998). "Analysis of Embankment Dam Incidents," UNICIV Report No. R-373, The University of New South Wales, Sydney, Australia.
- Gillon, M.D. and C.J. Newton (1991). "Abutment Repairs at Matahina Dam," ICOLD 17th Congress, Vienna.
- Hanson, G.J. and K.R. Cook (2010). "Apparatus, test procedures, and analytical methods to measure soil erodibility in situ," *Applied Engineering in Agriculture*, Vol. 20, No. 4, pp. 455–462.
- Kuusiniemi, R. (1991). "Internal Erosion of the Uljua Earth Dam," 17th International Congress on Large Dams, ICOLD.
- Leps, T.M. (1973). "Flow through Rockfill," in: *Embankment Dam Engineering* (R.C. Hirschfield and S.F. Poulos, eds.), John Wiley & Sons Inc., New York, pp. 87–97.
- Masch, F.D., W.H. Espey, Jr., and W.L. Moore (1963). "Measurements of the Shear Resistance of Cohesive Sediments," *Proceedings of the Federal Inter-Agency Sedimentation Conference*, Agricultural Research Service, Publication No. 970, Washington, D.C., p. 151.
- Nilsson, A. (2005). "The Susceptibility of Internal Erosion in the Suorva Dam," *Workshop on Internal Erosion and Piping of Dams and Foundations*, Aussois, France.

- Park, Y. (2003). “Investigation of the ability of filters to stop erosion through cracks in dams.” Ph.D. Thesis, Virginia Polytechnic Institute and State University, Blacksburg, Virginia.
- Redlinger, C., C. Rudkin, D. Hanneman, and W. Engemoen (2012). “Lessons Learned from Large-Scale Filter Testing,” Sixth International Conference on Scour and Erosion, Paris, France.
- Rhinehart, R., M. Pabst, B. Jackson, and K. Ngozi-Bullock (2012). A Test for Cementation Potential of Granular Filter Material, Sixth International Conference on Scour and Erosion, Paris, France.
- Sherard, J.L. (1953). “Influence of Soil Properties and Construction Methods on the Performance of Homogeneous Earth Dams.” Technical Memorandum No. 645, Bureau of Reclamation, Denver, Colorado.
- Sherard, J.L. and L.P. Dunnigan (1989). “Critical Filters for Impervious Soils,” *Journal of Geotechnical Engineering*, ASCE 115(7), 927-947.
- U.S. Department of Homeland Security, FEMA (2011). *Filters for Embankment Dams*, U.S. Department of Homeland Security, FEMA, Washington, D.C., <http://www.fema.gov/library>.
- Von Thun, J.L. (1996). “Understanding Seepage and Piping Failures - the No. 1 Dam Safety Problem in the West,” Association of State Dam Safety Officials, Western Regional Conference, Lake Tahoe, Nevada, April.
- _____(1999). “Background on Philosophy and Technical Rationale for Reclamation’s Dam Safety Public Protection Guidelines,” Memorandum to Chuck Hennig and Risk Cadre Members, Bureau of Reclamation, Technical Service Center, Denver, Colorado.
- Wahl, T.L. (2010). “A Comparison of the Hole Erosion Test and Jet Erosion Test,” Joint Federal Interagency Conference on Sedimentation and Hydrologic Modeling.
- Wan, C.F. and R. Fell (2004). “Investigation of rate of erosion of soils in embankment dams,” *Journal of Geotechnical and Geoenvironmental Engineering*, ASCE Vol. 130, No. 4, pp. 373–380.

CHAPTER 5 – RISK EVALUATION

5.1 Introduction

Risk-informed methodologies have been used in the safety assessment of many high-consequence industries since the 1960s, including the nuclear power and liquefied natural gas industries and Federal regulatory agencies such as the United States Environmental Protection Agency, U.S. Food and Drug Administration, and Federal Aviation Administration. Risk-informed decision making is also used in dam safety evaluations in the United States, Canada, Australia, and New Zealand, and it is being developed for use in England, Sweden, France, and The Netherlands. A risk-informed decision process can also be used to evaluate internal erosion problems and can be particularly useful for complex issues related to seepage. Expenditures can be better prioritized to address the highest risk internal erosion concerns using this process.

As a result of the failure of Teton Dam,¹ President Carter issued a memorandum in 1977 to the heads of Federal agencies involved in dam safety that included a directive that “the following items should be investigated: the means of inclusion of new technological methods into existing structures and procedures; the degree to which probabilistic or risk-based² analysis is incorporated into the process of site selection, design, construction, and operation. . .” (reproduced in Federal Emergency Management Agency [FEMA] 2004).

In response to President Carter’s memorandum, FEMA published the Federal Guidelines for Dam Safety (Guidelines) in 1979 (FEMA 2004). The stated purpose of the Guidelines is to “enhance national dam safety.” The Guidelines charge those administering the Guidelines with recognizing “that the achievement of dam safety is through a continuous, dynamic process in which guidelines, practices, and procedures are examined periodically and updated. Technical procedures need to change with technological advancement, and management should ensure that observed deficient practices are corrected and that successful practices are duplicated.” The Guidelines recognized the use of risk-informed methodologies as “a relatively recent addition to the tools available for assessing dam safety” while stating “with further refinement and improvement, risk-based analyses will probably gain wider acceptance in the engineering profession and realize potential as a major aid to decision making in the interest of public safety.” The Guidelines also encourage Federal agencies to “perfect techniques for evaluating

¹ For additional details, see Case 1 – Teton Dam and Fontenelle Dam, in appendix 1 (Seminal Case Histories).

² FEMA recently provided updated guidance on the use of the terms “risk-informed” and “risk-based” (FEMA 2015). The term “risk-based” is used in this document only when quoting earlier FEMA documents. The Bureau of Reclamation and the U.S. Army Corps of Engineers use the term “risk-informed” for the decisionmaking process. FEMA (2015) states that dam safety decisions should be risk-informed, not risk-based. FEMA (2015) provides the following clarification:

- a. Risk-informed dam safety decisionmaking implies that decisions are made considering risk estimates and many other contributing factors that might include confidence in the risk estimates, risk uncertainty, deterministic analyses, and the overall dam safety case in addition to other local or regional considerations.
- b. Risk-based dam safety decisionmaking implies that a comparison of a risk estimate to risk criteria is the basis for decisionmaking.

the probability of possible deficiencies causing dam failures and estimating the potential losses due to such a failure.” Specifically, the Guidelines state: “on existing dams, a risk-based analysis should be considered in establishing priorities for examining and rehabilitating the dams, or for improving their safety.” Furthermore, “the agencies should individually and cooperatively support research and development of risk-based analysis and methodologies as related to the safety of dams. This research should be directed especially to the fields of hydrology, earthquake hazard, and potential for dam failure. Existing agency work in these fields should be continued and expanded more specifically into developing risk concepts useful in evaluating safety issues.”

The U.S. Department of the Interior’s Bureau of Reclamation (Reclamation), the owner and designer for Teton Dam, has subsequently been a leader in the United States for the development of risk-informed methodologies for use in dam safety evaluations. Reclamation’s efforts helped to focus attention and research in the United States on internal erosion case histories and methodologies for evaluating the probability of failure from internal erosion. In 2005, the U.S. Army Corps of Engineers (USACE) began to develop a risk-informed decision making process based on work previously done by Reclamation, and the devastating effects of Hurricane Katrina provided renewed emphasis on these efforts. Over the past few years, the USACE, in cooperation with Reclamation and the Federal Energy Regulatory Commission (FERC), has developed a series of policy and procedure documents that guides the use of risk-informed decision making and evaluation of internal erosion within USACE. In 2007, the USACE and Reclamation signed a joint dam safety risk management charter to outline the mutual framework for cooperation by the USACE and Reclamation for dam safety risk management activities. Reclamation sister agencies within the U.S. Department of the Interior (Bureau of Indian Affairs, Bureau of Land Management, National Park Service, U.S. Fish and Wildlife Service, etc.) are also exploring risk methodologies, and the level of integration varies amongst them. Other government agencies (FERC, FEMA), as well as some State dam safety programs, are also investigating integration of detailed risk methodology into their programs. These programs continue to quickly evolve, and the specific agency should be contacted for the latest practice in risk analysis methodology.

This chapter primarily addresses risk analysis methodology, which is the first part of what is typically a two-part process. In the **risk assessment**³ phase, technical staff estimates event probabilities and then calculates annualized failure probability and consequences for the failure modes as well as the total risk estimate. The second phase involves “decision makers,” usually management, who interprets the results and decides which course of action to take. A **risk management** phase generally follows the risk assessment phase (Office of Management and Budget 1995, 2007). The risk assessment portion of the process is covered in some detail in this chapter, but a discussion of risk management is beyond the scope of this manual (although an example is provided at the end of this chapter). For a detailed description of risk framework (risk management and public protection guidelines), see Reclamations’ Interim Dam Safety Public Protection Guidelines (2011), and USACE’s ER 1110-2-1156 Safety of Dams Policy and

³ The use of terminology is not consistent among agencies. Reclamation and FEMA (2015) use the term risk analysis for the initial phase, while USACE and the Office of Management and Budget refer to it as risk assessment. Reclamation and FEMA (2015) use the term risk assessment for the decisionmaking phase.

Procedures (2014). It should be noted that risk methodology continues to evolve, and material in this manual will likely be superseded as time goes on. It is recommended that the reader contact the referenced agencies directly to ensure that the latest guidelines are on hand.

Risk analysis has been in development for use in dams for about 15 years in Federal agencies and has undergone significant change during recent history. This is still a developing field that has not been universally adopted by all Federal agencies. However, particularly for dam portfolio management in which a large number of projects must be maintained, risk is a valuable method for prioritizing expenditures of limited resources. The process of preparing and conducting a potential failure modes analysis (PFMA) and risk analysis has proven to be highly beneficial and instructive about the potential safety issues for a dam. Risk analysis is not a substitute for ongoing inspections, monitoring, or training. These activities must continue in order to ensure the safety of all dams, regardless of the outcome of previous risk analysis. Risk analyses need to be updated if conditions at a dam change. A risk estimate is an evaluation that represents a snapshot in time based on the conditions at the dam, the state of practice, and the understanding of potential failure modes (PFMs).

5.2 General

Risk is defined as the probability of a loss occurring in a given time period (annually). The annual probability associated with the loading is addressed by the first component of the equation. For internal erosion failure modes, this component will be the annualized probability for a given reservoir level. The second component of the equation represents the conditional probability of failure (or system response probability) for the reservoir level identified in the first component. The last component represents the consequences (e.g., life loss or economic damages) due to failure only.¹ The first two components have likelihoods or probabilities associated with them, and the product of these two components is the annual probability of failure (APF or f). The consequences typically address life loss (LL or N), although some organizations or specific studies use monetary property loss or environmental damage for this component. The “risk” is then the annualized life loss (ALL). The equation then reduces to an algebraic form of:

$$ALL = APF \times LL \quad \text{or} \quad ALL = f \times N \quad (2)$$

¹ Note that the focus of this document is on the second component of the equation. This document does not specifically address the first component, although its development is straightforward. The last component of the equation, consequences, is beyond the scope of this document. See Reclamation (2014) and Needham, et al. (2010) for additional information.

Stakeholders will have different information needs for their dam safety decisions (e.g., information that may play an essential role in a dam owner's decision making process may not be needed by a regulator who oversees the dam owner's decision outcomes). Because the information needs of organizations vary widely, it is not feasible for a single risk management approach to meet the needs of all organizations. Similarly, it is not feasible for a single failure mode assessment approach to meet the needs of all risk assessments. The risk evaluation may be quantitative or qualitative, it may consider only a discrete loading event (e.g., normal water level or an operating basis earthquake with a coincident normal water level), or it may consider the full range of reservoir or seismic loading. For quantitative risk analysis, the individual event probabilities in an event tree, discussed in the following sections, are multiplied together to get the APF. The method of assigning likelihood or probability must also be considered in the context of the risk assessment. The following sections provide an overview of practices for dam safety risk assessment. Referenced documents should be consulted for additional details.

5.3 Risk Assessment

As described in the previous section, risk is the product of the event probabilities for a given event tree and life loss. In the simplest form, single value estimates are made for each event and result in a single point estimate of the risk. This procedure does not address uncertainty, and more elaborate methods can be used to capture that uncertainty. The general practice is to gather a team and elicit probability estimates from that group. In this process, there are many people involved who have widely varying backgrounds related to dams, construction, remediation, technical background, engineering, mathematics, and practical experience. A detailed discussion of uncertainty and its estimation is beyond the scope of this manual, but the following sections provide an overview of the subject.

Methods of quantitative probability estimation (adapted from Vick, 2002) are presented below. As described in the following sections, some analytic methods, such as Monte Carlo analysis, are common among several of the techniques. While the first four techniques are practiced to some degree within the profession, the most widely used at this time is subjective probability, and it is presented in the greatest detail in this manual. The following are common techniques that may be used during the risk assessment and are discussed in more detail in the following paragraphs:

- Historical failure rates (e.g., frequency-based statistics)
- Subjective probability (i.e., engineering judgment)
- Reliability analysis (e.g., Taylor series expansion or Monte Carlo simulation)
- Bayes' theorem (i.e., adjustment of frequency data for site-specific factors)

5.3.1 Event Sequences

Event sequences (event trees) are typically developed to help quantify risk at critical steps of the failure process leading to dam breach. An event tree can be thought of as a graphical representation of a failure mode. The "nodes" of the tree represent a decision point (a split in the

event tree) and are the various events that could occur and, in turn, the various events that could follow from each preceding event. An event tree allows a systematic approach to diagram the steps and conditions that will determine the risk associated with an embankment dam. It also provides a mechanism to think through the process of the events that can cause failure of the dam and the consequences resulting from the failure. Event trees can be used as a tool to understand and evaluate internal erosion failure modes regardless of the level of analysis. A unique event tree can be constructed for each specific internal erosion failure mode. Event trees are very beneficial for dissecting an issue on a dam and understanding the sequence of events that must happen to initiate an internal erosion failure mode that ultimately leads to failure and consequences (life loss or property damage). While event trees are typically prepared during a full risk analysis, they also can be developed during a PFMA (see chapter 4) to help better understand the various factors that may influence a particular failure mode and to help in the evaluation and ranking of PFMs.

Shown below is an example sequence of events for an internal erosion failure mode used to develop an event tree. The example includes eight events (other event trees have been used that include additional or fewer events). Ultimately, it is the responsibility of the team to agree on the nature of the event tree for the particular PFM under study.

Sequence of Events Leading to Failure

1. Reservoir at or above threshold level?
2. Erosion initiates (erosion begins)?
3. Unfiltered exit exists?
4. Roof forms to support a pipe?
5. Upstream zone fails to limit flows (e.g., throttled flow)?
6. Self-healing does not occur?
7. Intervention unsuccessful?
8. Dam breaches?

This sequence of events can be illustrated as an event tree in which each event has either a “yes” or “no” answer as illustrated below. During a quantitative risk analysis (discussed in section 5.3.3), the probability of a “yes” occurring would be assigned to each event.

Below is a short description of each event. Note that these events, with the exception of intervention, are thoroughly discussed in “Section 4.3, Conceptual Framework Conducive to Potential Failure Modes Analysis.” Also see chapter 24 of the Reclamation/USACE *Best Practices for Risk Analysis* document for a more detailed explanation of these events and typical considerations that are used for each.

Example Generic Event Tree

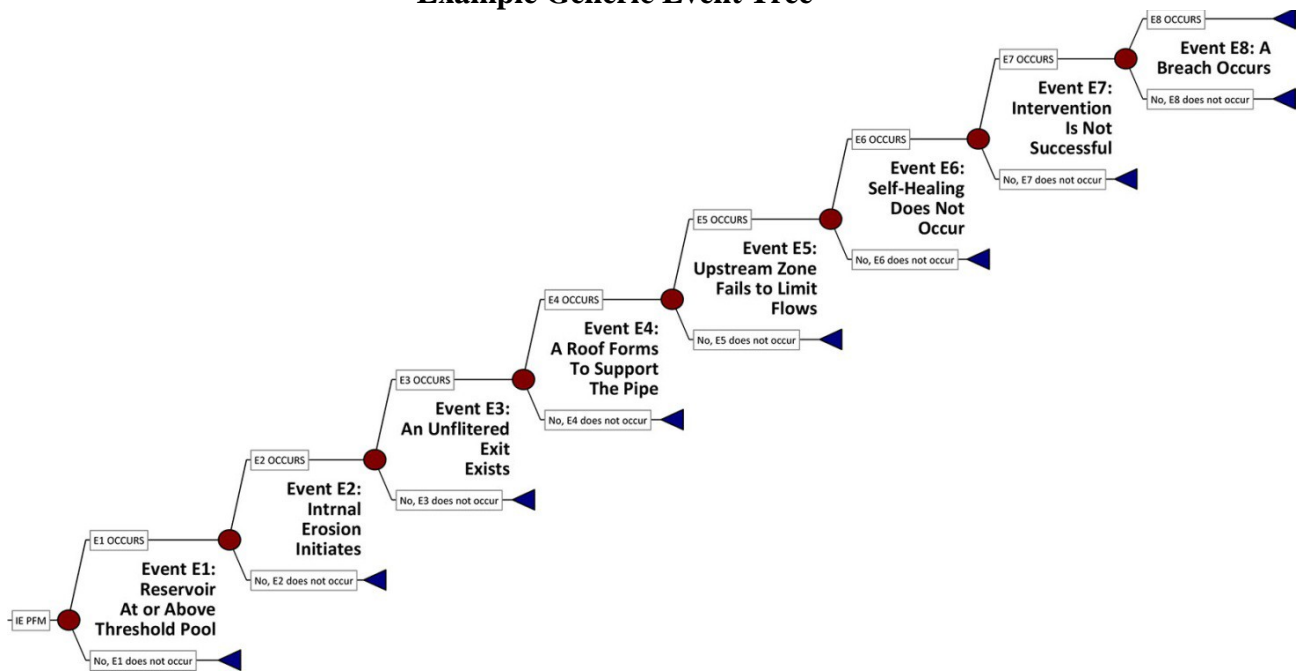

Event 1 – Considered the “loading” event. An estimation is made for a given range of reservoir level, and the recurrence of that reservoir level is determined from historic reservoir operating history plotted as the reservoir level exceedance curve (chapter 4, *Dam Safety Risk Analysis Best Practices Training Manual*) (Reclamation-USACE 2011).

Event 2 – This event considers the likelihood that a continuous seepage path exists AND that erosion would begin or has occurred along the failure path. This is the “initiation” phase of internal erosion discussed in chapter 3. These probabilities can be based on historic initiation rates of a particular inventory of dams or on analytical methods. For example, Reclamation uses their database of dams, which are located in the Western United States, with some structures that have been in service for over 100 years. The reader is directed to chapter 24 of the *Dam Safety Risk Analysis Best Practices Training Manual* for a more detailed explanation of these data and considerations that are needed for the specific project that is under consideration. Other databases (private or public) may be available (Foster and Fell 1990).

Event 3 – The existence of a filtered exit is considered at this node. While the common design elements such as chimney filters and toe drains are included for this node, consideration can also be given to “zones of opportunity” that might meet particle retention requirements. This is the “continuation” phase of internal erosion discussed in chapter 3.

Event 4 – The ability of a soil to support a roof is evaluated at this node and is essentially an estimate of the material properties of the soils along the failure path. Soil plasticity is typically used as a gauge of the capability of the material to support a roof. This is a component of the “progression” phase of internal erosion discussed in chapter 3.

Event 5 – This event allows for an estimate of the probability that the flow in the erosion pathway can be limited. Flow can be limited when the flow path is through a crack or joint in a concrete structure such as the wall of an outlet works conduit or the concrete deck⁵ on the upstream face of a dam. In these cases, the concrete is erosion resistant, and flow will be throttled at these locations. Another example includes flow through an upstream rockfill. If the rock sizes are sufficiently large, they cannot be eroded even at very large flow rates.⁶ This is a component of the “progression” phase of internal erosion discussed in chapter 3.

Event 6 – Also known as the self-healing node, here consideration of the soil properties along the failure path are estimated for their self-healing potential (i.e., the possibility of movement of upstream materials into the seepage path that chokes off further migration of material, in effect creating a localized filter). Broadly graded shells are more likely to perform this way. This is a component of the “progression” phase of internal erosion discussed in chapter 4.

Event 7 – This event provides for an estimate of the probability that intervention will NOT be successful in preventing failure of the dam. Typical intervention measures include draining the reservoir, backfilling a sinkhole/whirlpool at the entrance location, and placing an emergency blanket on the downstream area of discharge.

Event 8 – The probability estimate for this event includes consideration of whether a full depth breach forms. This event includes gross enlargement of the piping channel to the point where the overlying fill collapses into it. At this point, the flow past the dam transitions from pipe flow to open channel flow. Estimating in this node also includes the enlargement of the breach both laterally and downward. This is a component of the “breach” phase of internal erosion discussed in chapter 3.

The actual event tree used by the team will vary depending upon the specific failure mode under consideration. Each branch of the event tree can be evaluated quantitatively or qualitatively. The principle advantage of event trees is the thorough understanding gained regarding the sequence of events that must happen to initiate the failure mode and the resulting failure and consequences.

5.3.2 Qualitative or Semiquantitative Risk Assessments

In some cases, qualitative or semiquantitative risk assessments may be appropriate. The USACE uses such a procedure for its Periodic Assessment Program, which is part of its routine dam safety activities (Reclamation-USACE 2012). The following basic steps for qualitative or semiquantitative risk assessments are suggested:

⁵ Steel, wood, asphaltic concrete, and other types of upstream diaphragms are also included.

⁶ For additional information, see flow through rockfill analysis by Bischoff (1985).

- Review the basic statistics for the dam and photographs of key features if available.
- Review available flood-frequency hazard curves.
- Review available seismic hazard curves and design ground motions of the dam.
- Review available breach inundation studies for non-breach, sunny-day, and flood scenarios.
- Conduct a PFMA to identify and fully describe PFMs based on an evaluation of a dam's vulnerabilities.
- Qualitatively or semiquantitatively assess the risk.

Typically, the risk assessment is performed in conjunction with the PFMA. After the list of potential failure modes is developed, the following steps are followed for each identified PFM:

- Document the pertinent background information (geometry, geology, design, construction, etc.)
- Document the pertinent performance history (observations, instrumentation, etc.)
- Fully describe the PFM from initiation to breach
- Document factors that make the PFM more or less likely to occur and highlight key pieces of evidence
- Assess the failure likelihood category, rationale, and confidence (described in more detail below)
- Assess the consequences category, rationale, and confidence (described in more detail below)
- Plot the PFM in the appropriate cell of the risk matrix (described in more detail below)
- Discuss recommendations for operation and maintenance, surveillance, instrumentation, interim risk reduction measures, etc.

5.3.3 Quantitative Risk Assessment

In the following sections, quantitative risk assessment is generally described. A more detailed description of this method is described in *Best Practices in Dam and Levee Safety Risk Analysis* (Reclamation-USACE 2012).

5.3.3.1 Historical Rates

Several researchers (Foster et al. 1998, 2000; Engemoen and Redlinger 2009; Engemoen 2011; ICOLD 1974, 1983, 1995) have collected failure rate data based on loading condition, dam type, and failure mode. Some have assessed a given dam by comparison to the most similar dam type and assumed the probability of failure based on the failure rate for an agency's inventory of dams. The statistics of historical failures and embankment dam incidents can provide some insight when estimating the likelihood of a flaw existing in the embankment. However, risk assessments based on a database of failure case histories are dependent on the quality, completeness, and appropriateness of the database employed and, therefore, possibly prone to error. Therefore, these failure rates must be used with caution and only in cases with very similar site-specific conditions.

5.3.3.2 Subjective Probability Estimates

Due to many unknowns associated with geotechnical engineering and dam engineering in particular, the subjective probability method has become popular in estimating the probability of failure and the associated uncertainty. Typically, there is insufficient or inadequate statistical information, or appropriate models for calculating probabilities do not exist. In order to make quantitative risk estimates, it then becomes necessary to judge the likelihood of various events or conditions. The probabilities are estimated or assigned using subjective, degree-of-belief probability methods. A subjective probability estimate is the numerical value or range of values when incorporating uncertainty, judged to be believable based upon the available evidence for a specific event (i.e., node in the event tree). Typically, it is best if more than one estimator is involved in making the estimates, and that is the standard practice at several organizations at this time. Therefore, this is typically accomplished in a team setting where "synergy" enhances and draws out the breadth of experience brought to the table by a group of individuals qualified to make the estimates. Team members can enter into discussions that will allow the group as a whole to arrive at a more comprehensive estimate than each individual could on their own. A better understanding of the PFM is often obtained through the process of debate needed to assign (and defend) a probability estimate for a node. Both USACE and Reclamation use a form of team elicitation in their probability estimates. Team elicitation is a systematic process of posing questions to a panel of experienced individuals to get their knowledgeable opinion on a specific event (i.e., node of an event tree) so that its probability can be assessed. A facilitator is used, usually the same individual from the PFMA described in chapter 4. Similar to the role for the PFMA, the facilitator is an individual knowledgeable and experienced in both embankment dam performance related to seepage and risk methodology. The facilitator guides the group through the event tree process and confirms that the resulting probability estimates are in agreement with the team's engineering judgment. The facilitator is also responsible of ensuring appropriate risk methodology techniques have been followed and state of the practice engineering reasoning has been used.

The importance that team members have a mutual understanding of the failure mode and event tree cannot be stressed enough. A thorough understanding, or at least agreement, of the mechanics of each node is also required among team members. It is not uncommon during an

elicitation that one member will account for a mechanism in one node while another member will assign it elsewhere. Estimators “spreading” their estimates around in this manner can dilute the results and make it difficult to identify which mechanism and nodes are the major contributors to the risk.

In estimating the probabilities for a given event (node) of an internal erosion PFM, likely and unlikely factors that influence the individuals are produced by the team.⁷ An example form is presented on the following page. Once all members have had an opportunity to add their factors, the team is asked which of the factors are the most influential or important to them. The factors considered to be most significant by the team are then highlighted, in bold typeface, as shown in the form.

Once the factors have been obtained, the nodal probability estimates are made. This is accomplished by asking the team members individually what their estimate is. There are three categories from which estimates can be taken:

- *Measured*: These include probability estimates based on collected data. One example would be reservoir level data through time.
- *Historical*: Probability estimates can be based on historical failure rates for similar event processes within a failure mode.
- *Verbal Descriptors*: A method by which verbal estimates are translated into numerical values. Example: “It is six of one or half a dozen of the other.” = 0.5 (neutral).

Due to the abstract nature of verbal descriptors and their relative new use in dam safety engineering, some background will be presented. Several verbal probability mapping schemes have been proposed, including Barneich et al. (1996) and Vick (2002). Reclamation (2003) adopted a verbal mapping scheme for most of the subjective probability estimates based primarily on experiments reported by Reagan et al. (1989) and summarized by Vick (2002). The current USACE and Reclamation guidance is available in the latest version of the *Dam Safety Risk Analysis Best Practices Training Manual* (Reclamation-USACE 2011).

Although probability mapping of verbal descriptors provides a common framework for the team making probability estimates, there are no defensible relationships between such mapping schemes to “absolute” probability. Each mapping scheme results in a different end probability estimate if applied to a given event tree. There is no standard for weighing the evidence against a subjective scale and no way to ensure consistency from study to study. Although the probability estimates are typically made in a team setting, they can be very easily affected by individual biases or the biases of the strongest team member. These must be recognized, and it is the role of the facilitator to minimize their impacts to the estimates. Even if the same team evaluated all dams in an organization’s portfolio, the basis of their experience will change

⁷ Factors that can be argued as being both more and less likely (neutral) can also be shown as illustrated on the bottom of the table.

Node 2: Initiation of Internal Erosion PFM R2-3: IE Through Embankment		Res El.: 14.6 ft (5-yr) Condition: Baseline
<u>More Likely Factors</u>		<u>Less Likely Factors</u>
<ul style="list-style-type: none"> • Variable fill throughout embankment • Embankment fill may contain high permeability/loose zones (sands, gravels, shells, limestone, cobbles, boulders) due to fill and dragline excavation of geological materials from borrow areas for approximately 12,000 feet on the eastern portion of the reach (becomes more uniform toward the western portion) • No compaction in 1930's construction, little compaction in 1960's construction • Silt and sand materials in embankment are erodible • Sands are poorly graded • Wet landside toe area has made mowing difficult (Sta. 2915+00 to Sta. 2955+00 and 3140+00 to Sta. 3350+00) 		<ul style="list-style-type: none"> • No known embankment seepage observed exiting the face in this reach for this reservoir elevation • Average gradient is less than 0.02 hydraulic (assuming tailwater in landside toe swale local is at elevation 10 ft) • There is some cementation and/or plasticity in the fill, potentially from shell material, which may provide some erosion resistance • Past erosion on lakeside face stood vertically, observed at 5-foot depth in Reach 1 (see photo 18 in the Final Construction Report); this suggests some plasticity, which may provide some erosion resistance • Gravels, cobbles, boulders are not erodible • Landside portion of the seepage path would need to go through the 1960's material, which is better compacted and more resistant to erosion • Limerock berm was placed at landside toe near Sta. 3140+00 to Sta. 3350+00 • Flow path is long
	<u>Neutral</u>	
<ul style="list-style-type: none"> • Fines content unknown • Instrumentation report showed some head loss within the embankment between the lake and centerline based on piezometers at R2-1, R2-2, R2-3 and R2-4; appeared to be performance issues for some periods based on readings being above reservoir level [13] 		
Probability	Low: 2×10^{-4} Best: 6×10^{-4} High: 1×10^{-3}	

after each dam is evaluated. Therefore, an inherent difficulty with this method is achieving consistency to be used even in a relative sense. Vick (2002) describes many of these biases in detail.

5.4 Risk Management

Upon completion of the risk assessment, the results are supplied to decision makers so risk management can be performed. While the risk assessment provides the quantitative estimate of the probability of failure for a dam and the “case” that defends those values, it does not draw any conclusion about what actions should be taken, (i.e., additional exploration or analysis, dam modification, etc.). In practice, these decisions are typically made by agency managers who weight the results from the individual studies against the inventory of structures

within the agency's inventory of dams. Another tool used to manage these inventories is a rating system that ranks the individual features against one another. The USACE uses Dam Safety Action Classification, while Reclamation uses the Dam Safety Priority Rating system.

5.5 References

- Baecher, G.B. (2007). *Length Effects in Levee System Reliability*, Summary of Discussions from Louisville, Kentucky, meeting July 18–20, 2007.
- Baecher, G.B. and J.T. Christian (1982). "Statistical methods in site characterization," *Reliability Theory and Its Application in Structural and Soil Engineering*, Santa Barbara Engineering Foundation, pp. 463–492.
- Barneich, J., D. Majors, Y. Moriwaki, R. Kulkarni, and R. Davidson (1996). "Application of Reliability Analysis in the Environmental Impact Report (EIR) and Design of a Major Dam Project," *Geotechnical Special Publication No. 58*, American Society of Civil Engineers, New York, Vol. 2, pp. 1367–1382.
- Bayes, T. (1764). "An Essay Toward Solving a Problem in the Doctrine of Chances," *Philosophical Transactions of the Royal Society of London*, 53, 370–418.
- Bischoff, John A., T.C. MacDonald, and T.M. Wilson (1985). Rehabilitation of an Old Hydraulic Fill Dam for Stability Against Earthquakes, International Committee on Large Dams, Lausanne, France.
- Bureau of Reclamation (Reclamation) (2003), "Guidelines for Achieving Public Protection in Dam Safety Decision Making," Denver, Colorado.
- _____(2011). "Interim Public Protection Guidelines," Denver, Colorado.
- Bureau of Reclamation (Reclamation) and U.S. Army Corps of Engineers (USACE) (2007). "Joint Dam Safety Risk Management Charter," August 17.
- _____(2011). *Dam Safety Risk Analysis Best Practices Training Manual*, Version 2.2, (April 2011), U.S. Department of the Interior, Bureau of Reclamation, Technical Service Center, Denver, Colorado. <http://www.usbr.gov/ssle/damsafety/Risk/methodology.html>.
- _____(2012). *Best Practices in Dam and Levee Safety Risk Analysis*, published jointly by the U.S. Department of the Interior, Bureau of Reclamation and U.S. Army Corps of Engineers, December 3, 2012.
- _____(2014). *RCEM – Reclamation Consequence Estimating Methodology, Interim Guidelines for Estimating Life Loss for Dam Safety Risk Analysis*, (February 2014), U.S. Department of the Interior, Bureau of Reclamation, Technical Service Center, Denver, Colorado.

- Douglas, K.J., M. Spannagle, and R. Fell (1998). “Analysis of Concrete and Masonry Incidents,” UNICIV Report No. R-373, The University of New South Wales, Sydney, Australia.
- Engemoen, W.O. (2011). “Bureau of Reclamation experiences with internal erosion incidents.” *Proc., Internal Erosion in Embankment Dams and Their Foundations*, European Working Group of ICOLD, Brno, Czech Republic, 11–18.
- Engemoen, W.O. and C.G. Redlinger (2009). “Internal erosion incidents at Bureau of Reclamation dams.” *Proc., 29th USSD Annual Meeting and Conference*, United States Society on Dams, Nashville, Tennessee, 731–745.
- Federal Emergency Management Agency (FEMA) (2004). *Federal Guidelines for Dam Safety*, FEMA 93.
- _____(2015). *Federal Guidelines for Dam Safety Risk Management*, FEMA P-1025.
- Foster, M.A., R. Fell, and M. Spannagle (1998). “Analysis of Embankment Dam Incidents,” UNICIV Report No. R-374, The University of New South Wales, Sydney, Australia.
- _____(2000). “The statistics of embankment dam failures and accidents,” *Canadian Geotechnical Journal*, National Research Council Canada, 37(5), 1000–1024.
- Graham, W.J. (1999). “A procedure for estimating loss of life caused by dam failure.” Report DSO-99-06, U.S. Department of the Interior, Bureau of Reclamation, Denver, Colorado.
- Hatem, G.A. (1985). “Development of a Data Base on Dam Failures in the U.S. – Preliminary Results,” Thesis, Stanford University, Palo Alto, California.
- Hill, P., D. Bowles, P. Jordan, and R. Nathan (2003). “Estimating overall risk of dam failure: Practical considerations in combining failure probabilities.” *Bulletin No. 127*, Australian National Committee on Large Dams, 63–72.
- International Commission on Large Dams (ICOLD) (1974). *Lessons from Dam Incidents*, International Commission on Large Dams, Paris, France.
- _____(1983). *Deterioration of Dams and Reservoirs*. International Commission on Large Dams, Paris, France.
- _____(1995). *Dam Failures – Statistical Analysis*, Bulletin No. 99, International Commission on Large Dams, Paris, France.
- McClelland, D.M. and D.S. Bowles (2002). “Estimating Life Loss for Dam Safety Risk Assessment: A Review and New Approach,” Institute for Water Resources, U.S. Army Corps of Engineers, Alexandria, Virginia.

Needham, J.T., Y. Seda-Sanabria, and David S. Bowles (2010). “Consequence estimation for critical infrastructure risk management.” *Proc., 30th USSD Annual Meeting and Conference*, United States Society on Dams, Sacramento, California, 477–491.

Office of Management and Budget (OMB) (1995). Memorandum for Regulatory Working Group, Principles for Risk Analysis (1995), http://georgewbush-whitehouse.archives.gov/omb/inforeg/regpol/jan1995_risk_analysis_principles.pdf

Reagan, R., F. Mosteller, and C. Youtz (1989). “Quantitative Meanings of Verbal Probability Expressions,” *J Applied Psychology*, Vol. 74, No. 3, pp. 433–442.

Swain, R.E., J.F. England, K.L. Bullard, and D.A. Raff (2006). “Guidelines for Evaluating Hydrologic Hazards,” U.S. Department of the Interior, Bureau of Reclamation, Denver, Colorado.

U.S. Army Corps of Engineers (USACE) (2010). “Hydrologic Engineering Center Flood Impact Analysis software (HEC-FIA),” Version 2.1 Beta, Davis, California.

_____(2011). “Design of I-Walls,” EC 1110-2-6066, Appendix I: Length Effects in Levee System Reliability, Washington, D.C.

_____(2014). “Safety of Dams – Policy and Procedures,” ER 1110-2-1156, Washington, D.C., Draft.

U.S. Geological Survey (USGS) (2002). National and Regional Seismic Hazard Maps. U.S. Department of the Interior, U.S. Geological Survey, Earthquake Hazards Program <http://earthquake.usgs.gov/research/hazmaps/index.php>

_____(2007). Updated Principles for Risk Analysis, September 19, 2007 http://www.whitehouse.gov/sites/default/files/omb/assets/regulatory_matters_pdf/m07-24.pdf

Vick, S.G. (2002). *Degrees of Belief: Subjective Probability and Engineering Judgment*, American Society of Civil Engineers, Reston, Virginia.

Von Thun, J.L. (1985). “Application of Statistical Data from Dam Failures and Accidents to Risk-Based Decision Analysis on Existing Dams,” Bureau of Reclamation, Denver, Colorado.

Whitman, R.V. (1984). “Evaluating calculated risk in geotechnical engineering.” *J. Geotechnical Engineering*, ASCE, Reston, Virginia, Vol. 110 (2):45–188.

Part 3

Identifying, Monitoring, and Addressing Internal Erosion

CHAPTER 6 – SEEPAGE DETECTION AND INVESTIGATION METHODS

6.1 Visual Detection Methods

6.1.1 Introduction

Most potential failure modes (PFMs) related to seepage at dams have initially been detected by visual observation. Even untrained observers have detected obvious seepage anomalies. Visual inspection of seepage consists of visually detecting or observing wet spots, depressions, or other evidence of seepage. While instrumentation is very important in assessing the overall stability of a dam, nothing is as important as effective visual inspection. In addition to the capability of visually monitoring seepage outflow locations and quantity, visual inspection is often the primary step in detecting surface geometry aberrations such as localized deformations in the slope or crest. Methods and equipment to facilitate visual observation of seepage should be considered during embankment dam design.

Regular surveillance (monitoring) by trained personnel (inspectors, engineers, operators, etc.) is essential to detect and evaluate seepage. Without knowing the dam's history, the owner and/or the inspector has no idea whether the seepage condition is developing or represents a steady state. The same inspector(s) should ideally be used for each inspection to establish familiarity with the embankment structure and thus enable better detection of changes at the dam site. The inspector(s) should always look for increases in seepage flow and investigate any evidence of seepage flow carrying soil particles. In addition to conducting proper surveillance techniques, trained personnel are essential for data collection, reporting, and evaluation. These topics are addressed later in this manual, and various resources are available to assist in these endeavors. For example, the Department of Homeland Security through the Federal Emergency Management Agency (FEMA) and the Association of State Dam Safety Officials (ASDSO) offers freely available dam safety monitoring software on the ASDSO Web site: www.damsafety.org.

Personnel who perform visual observations should be given basic dam safety training, which should include common causes of dam failures and incidents, identification of signs of potential seepage problems by visual observation, and actions to be taken when unusual conditions, signs of potential problems, or emergency conditions occur. State agencies as well as the U.S. Army Corps of Engineers (USACE) and other Federal dam agencies, such as the Bureau of Reclamation (Reclamation), provide such training. Reclamation also provides a series of videotapes and workbooks known as Training Aids for Dam Safety (TADS).

Some potential visual signs for various internal erosion mechanisms are described in the table below.

Internal erosion mechanism	Process at work	Possible visual cues ¹
Backward erosion piping	Erosion starting at an exit point, moving into the dam opposite the direction of seepage	A concentrated leak from a saturated embankment toe with exit velocity sufficient to move soil materials. Most likely to appear in an area with high exit gradients, and in noncohesive soils.
Concentrated leak erosion	Erosion due to concentrated leakage along the bedrock/embankment contact surface	Concentrated leakage from the abutment groin near the bedrock surface, possibly accompanied by sinkhole formation.
Concentrated leak erosion	Erosion due to concentrated leakage along a structure/embankment contact	Concentrated leakage from the contact area between a structure (e.g., conduit or spillway wall), possibly accompanied by sinkhole formation.
Concentrated leak erosion	Erosion through cracks in the embankment from differential settlement cracking	Concentrated leakage from the embankment, near a structural penetration or near a steep break in slope of the underlying foundation. May be accompanied by vortices where the crack intercepts the reservoir. Can progress particularly rapidly if embankment also contains dispersive soil.
Internal instability (suffusion)	Erosion of fines from a gap-graded foundation soil, between geologic units, or into poorly designed granular filters	Diffuse or concentrated, increasing leakage carrying or redepositing a select gradation of fines leaving an openwork foundation gravel or cobbles, or into a poorly designed filter or drain. May be accompanied by linear depressions following drain lines, or slowly developing depressions in the embankment or abutments.
Concentrated leak erosion	Tunneling and jugging due to dispersion of clay-soil	Telltale signs are related to the identification of dispersive soils, such as occurrence of jugging and rill-erosion after intense rainfall. When reservoir levels rise, multiple and rapidly increasing discharge from springs on the downstream slope of the embankment may occur. May form a horizontal line of many springs along lift lines in some cases.
Heave or blowout	<p>Heave – Vertical hydraulic gradient exceeds effective stress of overlying pervious material</p> <p>Blowout – Vertical hydraulic gradient exceeds total stress of overlying impervious material</p>	<p>Boils with or without sand cones. May be accompanied by sinkholes migrating toward the reservoir if boils progress to backward erosion.</p> <p>Both processes may result in an unfiltered exit, but may not necessarily lead to failure unless accompanied by backward erosion or slope failure.</p>

¹ Particularly if leakage is observed to be carrying away or redepositing soil near the exit.

Dam failure risk issues should be used to help guide the dam owner's allocation of resources for seepage monitoring. For example, only visual monitoring may be required for low-hazard potential dams (FERC 2006), but for higher hazard dams, using greater instrumentation and monitoring efforts, as well as more frequent visual monitoring, may be able to further reduce a risk by identifying unusual or unsatisfactory performance due to seepage problems that could not be found through visual monitoring alone. Effective surveillance can provide for early warning and may influence potential life loss and increase time for intervention. These impacts may ultimately help reduce the risks for internal erosion failure modes.

Seepage is usually monitored by using techniques and instrumentation that quantify seepage parameters (flow rate, quantity, velocity, elevation, phreatic surface, and water quality) within the embankment, abutments, or foundation. Measuring seepage parameters is accurate only if the instrumentation is properly located. If new seepage begins at a site and is not collected for measurement, in-place measuring devices located elsewhere may not detect the potential problem. Seepage volumes may actually decrease at adjacent measurement locations, leading the dam owner to believe the dam is operating normally (Indiana Department of Natural Resources 2003). Even when all visible seepage is being measured, additional seepage may be occurring in locations where it cannot be observed.

In November 2006, a local landowner riding a horse noticed seepage and soils exiting from the cut slope of the south drain on the A.V. Watkins Dike¹ in northern Utah (Demars et al. 2009). He called authorities, and the Bureau of Reclamation began emergency drawdown of the reservoir and 24-hour monitoring. Figure 6-1 illustrates the failure mode that was in progress when the first responders arrived.



Figure 6-1.—Visual observation of failure mode in progress.

¹ For additional details, see Case 3 – A.V. Watkins Dam and the Florida Power and Light Dike, in appendix 1 (Seminal Case Histories).

In addition to erosion into the south drain, first responders also found excessive seepage (~570 to 760 liters per minute or 150 to 200 gallons per minute), sand boils, and erosion at the toe of the dam. Emergency action to transport filter and drainage materials was implemented immediately. Filter sand was initially placed over the sand boils, but was washed away due to high exit velocities. Gravel materials were then placed over the sand boils until the flow velocities were reduced enough to allow placement of the filter sand. A large berm of 13 centimeters (cm) (5-inch) minus pit-run material was then placed over the filter and gravel. Erosion, however, continued into the south drain. A second berm was then pushed into the reservoir in an attempt to plug upstream entrance locations of the seepage. This effectively stopped further erosion of soil into the south drain, and the failure mode was prevented from progressing any further. An upstream ring dike was constructed in the incident area to reduce risks in the interim period until a permanent fix could be implemented. Dam failure would have been likely if the emergency actions had not been taken.

6.1.2 Surface Discharges

Surface discharges are generally classified as either seeps or boils. A seep is generally a wet spot or area detected on the ground surface. Seeps discharge on the downstream slope, toe, abutment face, or other downstream location where the seepage flow path's hydraulic (total) head (phreatic surface) intersects the atmosphere. The term "head" is typically used to describe the energy potential expressed as an equivalent vertical column of fresh water. Total head equals the sum of velocity, pressure, and elevation heads. The term "hydraulic head" is often used instead of "total head" when the velocity head is assumed to be negligible. At the seep exit face, the seepage discharge velocity head is generally negligible, and the pressure head is atmospheric (i.e., zero relative pressure), thus the total head equals the elevation head. If the seepage discharge is more active than just a wet spot (e.g., a "boil"), the velocity head is not negligible. The seepage gradient equals the change in total head with distance along the seepage flow path.

Seeps that occur during the annual vegetation growth season are easily detected by changes in vegetation type, growth rate, size, and color at those locations. Depending on the water content of the surface soil (or depth of standing water) in the seep vicinity, evidence of the seepage may include slightly denser grass or the presence of cattails and small brush. Tree growth may emerge if the seep locations are not maintained by regular grass cutting. Figure 6-2 illustrates a seepage discharge at the dam toe where usual grassy vegetation growth is curtailed because of the saturated soil condition. Figure 6-3 illustrates a seepage discharge downstream from the dam toe where the vegetation growth has matured into phreatophytic woody shrubs and trees.

Emerging surface seeps are harder to detect if there are no visual surface anomalies such as increased vegetation growth. Often a seep is indicated by a change in vegetation type (phreatophyte) or lushness. Non-visual techniques discussed later in this chapter may be performed to identify and delineate surface seeps if the perceived threat warrants additional investigation. Monitoring the surface seeps may be as simple as flagging their location and areal spread as illustrated on figure 6-4. In this illustration, the yellow flags mark the initial seepage discharge boundary, and subsequent lateral spreading is tracked with red flags. The location of the flags should be photographed, measured and mapped, and ultimately a decision made



Figure 6-2.—Seepage discharge where the typical grass growth has been retarded in the saturated soil environment and where other vegetation species are becoming dominant.

regarding appropriate followup action. It is important to identify and document the visible seepage locations, turbidity, the quantity and content of seepage flow, the size of the wet area, the reservoir level, and the type of vegetation to enable subsequent comparisons that are made during followup inspections.

If the seepage flow path gradient increases due to an increase in the total head (e.g., if the reservoir rises), a seep may be a precursor to internal erosion initiation and subsequent progression to a breach failure. If soil particles emerge at the seepage discharge location, internal erosion may be occurring, and its progression must be measured, monitored, evaluated, and stopped.

Boils are also surface seepage discharges, but their presence could be an indicator of incipient erosion initiation or subsequent progression. Boils generally occur during high-head events, and



Figure 6-3.—Presence of phreatophytic vegetation (willow trees and cattails) in an established seepage discharge location approximately 200 feet below the downstream toe.

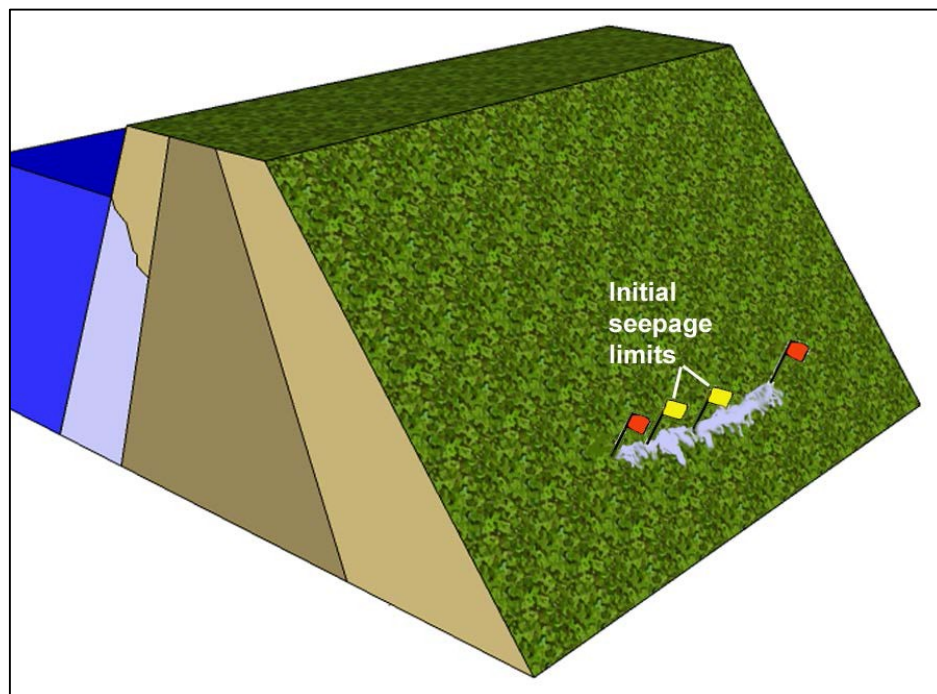

Figure 6-4.—Visual markers (flagging) map the areal extents and spreading of surface seepage discharges (seeps).

their presence indicates that preferential internal seepage flow paths may have formed between the reservoir and the discharge point and/or that a heave or blowout condition may have developed. As opposed to a seep, a boil has a discharge velocity head that is greater than the ground surface elevation (i.e., the total head is greater than the elevation head), and therefore, the flow may have enough energy to erode and/or transport soil particles.

Due to the higher velocity, the boil transports soil particles through the preferential flow path and deposits the coarser-grained particles at the seepage discharge point where the velocity decreases. For this reason, boils are often referred to as “sand boils.” Figure 6-5 illustrates this phenomenon.

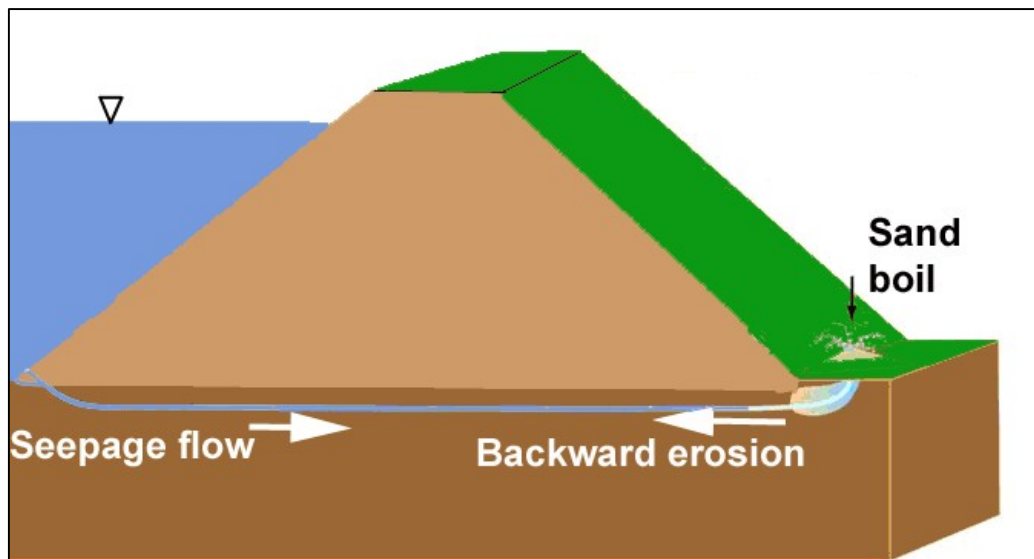

Figure 6-5.—Illustration of sand boil formation near the downstream toe and potential backward erosion piping failure mode in the foundation.

It is vitally important to identify and document the boil location, the quantity and content of seepage flow, and the size and areal spread of the boil area, and the reservoir level. A boil containing soil particles may be indicative that some degree of internal erosion has occurred. The effluent's particle size distribution (gradation) and color may be indicative of the material source. The erosion may have the potential to subsequently progress, particularly if the hydraulic gradient increases, and control measures may be immediately required to prevent a breach failure. Subsequent loading may trigger the internal erosion associated with boils at lower heads or advance into other geologic material that may behave differently.

At the same time, site-specific factors might prevent the failure mode from developing (as discussed in chapters 3 and 4). At some sites, the presence of boils, especially pinhole boils with no particle movement, may not be a significant concern due to the particular site geology. Details of a particular incident must be carefully considered, as the stability of the boil can be affected by other factors.

6.1.3 Surface Deformations

Surface deformations that develop during the dam's lifespan may or may not be indications of subsurface seepage causing internal erosion or foundation subsidence. There may be many explanations other than internal erosion that can cause similar deformations. Examples of surface deformations include depressions, sinkholes, slumps, cracks, and cavities. Surface deformation detection is especially critical at dam sites with karstic foundations of limestone or other soluble bedrock. Surface deformations occurring above conduits or penetrations usually indicate that prompt action is required because of the high likelihood that internal erosion is actively occurring. Figure 6-6 illustrates a seepage-induced problem evidenced by a sinkhole appearing on the upstream slope. Internal erosion from the embankment into the foundation was found to be the culprit in this case. Sinkholes may also develop below the reservoir level, where their development is hidden from view, unless a whirlpool forms over the hole. Underwater inspections by divers can also be used to locate sinkholes in the reservoir.

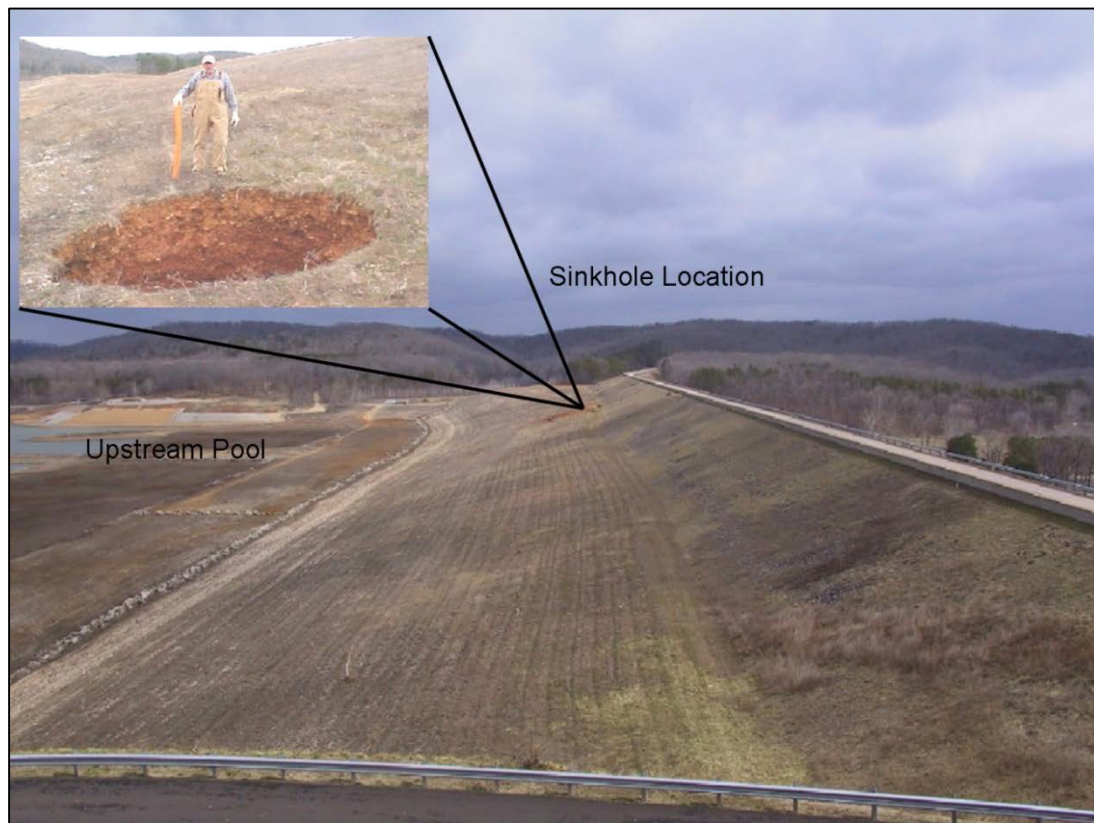

Figure 6-6.—Sinkhole that developed on the upstream face of a dam due to piping and internal erosion of the embankment into the foundation.

If internal erosion is occurring, at some point it can be expected that deformation of the structure will occur. However, because of arching action, it is unclear at what point the internal erosion will cause deformations. In some instances, detection of surface deformations might allow for

intervention that could prevent a dam breach, such as crest subsidence related to stoping of core material. However, in other cases, deformations may only be detected when the erosion and piping has fully developed and the dam is near breach, such as the sudden appearance of a backward erosion piping tunnel on the upstream slope of the dam. Therefore, the benefit of detecting internal erosion by measuring surface deformations may be limited.

Surface deformations that are caused by factors other than internal erosion may also be observed. Animal (rodent) burrows, collapsed corrugated metal pipes, and decomposing organic layers are examples of observable defects that may be precursors to seepage-induced incidents or failures.

Figure 6-7 illustrates a small rodent burrow found in the downstream shell of an embankment dam. Figure 6-8 illustrates surface-erosion features (gullies) that also were not caused by internal seepage processes but could eventually become a preferential flow path if not repaired. A series or group of rodent holes may be an indication of low stress or cracked zones in the fill, as rodents tend to dig where it is easiest.



Figure 6-7.—Surface deformation indicative of animal activity observed on the downstream slope.

6.1.4 Video Inspections of Conduits and Penetrations

Recent advances in digital camera technology packaged in downsized systems allow video inspection of smaller conduit pipe diameters. This trend will likely continue, thus providing an appropriate means to closely inspect and periodically monitor any small-diameter appurtenance or pipe for potential blockage or leakage.



Figure 6-8.—Surface erosion (gully).

Robotic and endoscopic systems are useful for inspecting conduits and penetrations too small or unsafe for personnel entry. Specialty vendors and suppliers are available for purchasing or renting these rapidly evolving technologies. The FEMA (2005) conduit manual should be consulted for more detailed information.

6.1.5 Photography

Early detection of seepage-induced abnormalities relies heavily on visual inspections supplemented with photographic documentation and video imagery collection and interpretation. Webcams (Web-accessible cameras) can be positioned anywhere on the dam site and can transmit images at given time intervals for periodic review and time lapse imaging. The equipment components are usually installed in an instrumentation remote sensing package, but the required maintenance for such equipment can be expensive.

Photographs provide time-stamped records that are invaluable for periodic seepage detection, monitoring, and evaluation. Photography taken for the purpose of augmenting periodic inspection report forms is increasingly common. Due to the advent of digital formats, attaching digital photographs is readily accommodated if the inspection form is generated from a computer with word processing software. Attaching a hardcopy print is also readily accommodated if the inspection form is manually filled out and filed for future reference.

There are several details to be aware of when taking photographs for the purposes of record-keeping and long-term seepage monitoring:

- (a) Shoot from a consistent location. Select a location and angle from which a picture is periodically taken. Periodic changes are then readily documented.
- (b) Be aware of lighting and shadows cast on the subject. Avoid glare from water surfaces, and select the camera height and angle providing maximum clarity, resolution, and sharp focus.
- (c) Provide a linear scale for reference on each picture. The photographer will have a concise idea of the subject's dimensions, but the viewer will not be able to discern those dimensions unless there is a relative or absolute reference scale included in the picture. Figure 6-9 shows an example of a picture taken without a reference scale (the reader has no idea of the relative size of the subject).
- (d) Take more than one picture since the aphorism, "a picture is worth a thousand words," is generally true.

As visual inspection enters the digital age, portable computers, hand-held data collection devices, mobile telephones, and digital cameras are increasingly being utilized for gathering field information and transferring that information to centralized data bases. The quickest method to provide real-time photographic evidence of an emerging sand boil is to simply snap a digital image (picture) or movie on a hand-held cellular telephone and transmit it anywhere in the world. Global Positioning System (GPS) data may also be combined with the digital picture output to enable geo-referencing of an emerging sand boil location.

Digital technology has progressed to the point that manually filling in an inspection report form and attaching a photograph will ultimately be replaced with digital data collection, entry, and report output techniques. As portable computers and hand-held devices have become commonly accepted as inspection reporting tools, the visual inspection process is adapting to accommodate those technologies.

A Geographic Information System (GIS) integrates photographic imagery with dam geometry, spatial orientation, soil information, physical feature attributes, and numerous other aspects at a given dam site. Although GIS technology is becoming commonplace in land-use planning, infrastructure development, and other civil work applications, it has not been robustly utilized for existing embankment dams except for specific project applications. The ability to map detected seepage outflow locations is a potential application of GIS technology.



Figure 6-9.—Photograph shown without a visual reference or scale to establish the plant's size.

Although not yet developed for dam applications, tools that integrate digital videography, GIS mapping, GPS coordinates, and inspection reporting in a single hand-held package are available. For example, coastal dike structures are being periodically inspected using a hand-held integrated system (CHL-ERDC-Hammer™) that enables mobile inspection monitoring and expedited reporting by one individual at the field site. The visual attributes of the structure may be geo-referenced, mapped, photographed day or night, and the generated inspection report may be wirelessly transmitted in real time (Federal Laboratory Consortium, 2009). Such technology may be particularly useful for dam owners with multiple dam inventories or inspection agencies responsible for multiple dam inspections.

It should be noted that technology is changing quickly, and photographs can be obtained aerially (balloon, remote-controlled planes, or helicopters), in an economic fashion. Additionally, software is available, and being developed, with 3-D capabilities and filtering

and measuring functions that have vastly improved the field of photogrammetry and the ability to characterize and monitor dams. Improved accuracy can now be achieved for surface deformation monitoring using either terrestrial or aerial digital photogrammetry. There are a number of references available to help select a specific photogrammetric method for a particular application.

6.1.6 Inspection Reporting

Visual inspection results should always be recorded to fulfill the proper reporting requirements identified for each dam in the context of PFMs. Visual inspection frequency is either suggested or mandated depending on the dam classification and owner. Inspection reporting is generally performed using a hard copy report format that is completed by inspection personnel.

State dam safety offices usually have inspection checklists for use by dam owners. Specific inspection reporting requirements and personnel qualifications vary by State. Most Federal agencies responsible for dams have also developed checklists.

Most States and Federal agencies require a licensed professional engineer to conduct regular dam inspections and sign the inspection reports. The engineer must be competent in items relating to dam investigation, design, construction, and operation of the type of dam being inspected, and they must understand the effects of adverse dam incidents and failures and the potential cause of failures. The text of the inspection report should be concise and provide all relevant dam and dam-related facts, findings, conclusions, recommendations, and data. Each

report should contain clear, color photographs, with each photograph indicating the date it was taken and the appropriate dam reference number (State or Federal). If the visual inspection checklist was completed as part of the inspection, it should accompany the inspection report.

6.2 Non-visual Detection and Investigation Methods

6.2.1 Introduction

Geophysical and other non-visual detection and monitoring techniques have successfully been used to detect subsurface seepage. Historically, the dam engineering profession has been skeptical or cautious regarding the effectiveness of using geophysical techniques for investigating seepage (FEMA 2000), but their usage will undoubtedly increase as the confidence in their usage increases (i.e., as they are proven capable based on additional case histories). Instead, direct information concerning seepage flow paths and potential subsurface voids is preferred. Methods such as microgravity (ASTM 2005a; Rybakov et al. 2001), electrical resistivity (ASTM 2005b, 2005c, 2005d), ground-penetrating radar (Hoover 2003), and temperature differentials (Birman 1986; Welch 1997) have been applied in diverse fields from petroleum prospecting to archaeology, and they are also useful for embankment dam applications.

Monitoring programs should always be developed considering the PFMs that have been identified for the project. In a risk-informed context, instrumentation programs that were previously installed may not be suitable or justified.

6.2.2 Surface Monitoring Systems

Surface monitoring systems may be utilized for PFMs related to development of sinkholes or void formation (internal erosion or stoping) and differential settlement and its resulting PFMs (cracking and internal erosion). Surface monitoring has also been used to prevent failures from karstic-related failure modes (such as at Mississinewa Dam).

Traditional surface deformation measurement and subsequent monitoring is achieved using a survey crew with a level and rod. Technology advances such as GPS and total station instrumentation have made deformation mapping more efficient and less labor intensive. GPS, pseudolites, and robotic total stations monitor individual points and are capable of around-the-clock monitoring. Synthetic aperture radar (SAR) and light detection and ranging (LiDAR) systems can monitor an entire embankment surface and possibly will be candidates for permanent installation and continuous monitoring efforts in the foreseeable future.

Terrestrial laser scanning techniques for sub-centimeter accuracy and three-dimensional surface mapping are gaining favor for mapping structural deformations, although they have yet to be widely applied on embankment dams. These high-resolution techniques allow three-dimensional

deformation measurements, including displacement vectors and rotations (Monserrat and Crosetto 2008). Autonomous operation of stand-alone equipment with wireless networking capabilities allow around-the-clock remote monitoring of surface deformation changes in selected locations at a dam site.

The deformation monitoring systems can be used in conjunction with one another. As an example, multiple sensors were installed to monitor dam surface deformations at Diamond Valley Lake Dam in California. At that dam, 8 robotic total stations, 232 concrete monitoring prisms, and 5 GPS stations were installed to monitor the dam continuously and automatically. The instruments were all linked to a central processing system that performed the automated measurements and data processing (Szostak-Chrzanowski et al. 2008).

GPS instrumentation is becoming very popular for a variety of reasons. GPS receivers provide true three-dimensional measurements and have excellent long-term stability. The receiver hardware, wireless radio hardware, and solar-powered hardware have solid-state electronic components that are reliable and well suited to automation. The signal coverage from the GPS satellites is continuous, so around-the-clock measurements are readily available. Fixed GPS stations can be quickly installed and have small footprints. However, in areas such as deep canyons where dams are often located, GPS cannot track as many satellites, and the accuracy is diminished, especially in the vertical direction. In this case, pseudolites, ground-based transmitters that use GPS signals, can be used to supplement and improve accuracy in such locations (Dai et al. 2001).

In 2002, a GPS monitoring system capable of 1-millimeter accuracy was installed at the USACE Seattle District's Libby Dam in Montana. Six GPS monitoring stations were located along the crest of the dam to measure horizontal and vertical motion, and a GPS reference station was located on each side of the dam to provide differential correction information. Each station was self-contained and independent from the existing electrical and mechanical systems at the dam site. The entire installation was completed in about 3 weeks at a cost of just under \$150,000 (2002 dollars), including the GPS and radio hardware. All eight GPS stations were powered by photovoltaic equipment and communicated to a desktop computer in the Seattle District Office (400 miles distant) via a digital radio network. Processing software collected raw data from all eight GPS stations and computed positioning and deformation information in real time. Managing the output data from the system proved to be the most difficult challenge for this project (Rutledge and Meyerholtz 2005).

Surveys along the crest of an embankment can provide early warning of internal erosion and piping. Typically, a dam should not settle more than 1 percent of its height over the life of the structure. If the dam has settled more than 1 percent, this would indicate that possibly weak zones exist within the dam's foundation or that the dam was poorly constructed. Excessive settlement of the dam in the valley can lead to overtopping of the embankment, while large differential settlements can lead to cracking. Crest surveys are typically taken annually during the first several years after the dam has been constructed to monitor settlement. The rate of settlement should decay continuously with time. Once settlement has slowed or stopped, the surveys may be taken at reduced frequency, say every 5 years. However, if unexpected movement is suspected or begins to occur, then annual surveys may be needed. Figure 6-10

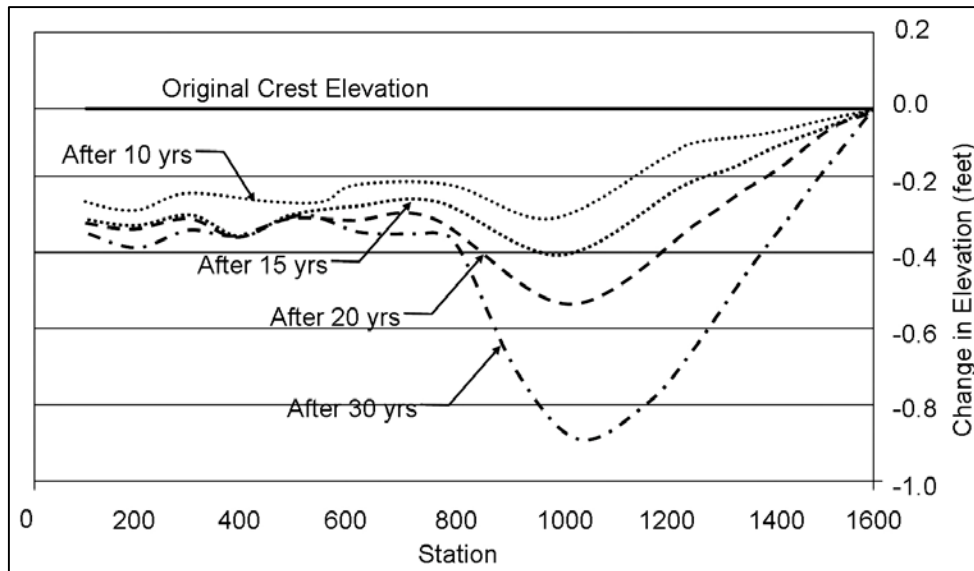

Figure 6-10.—Example of excessive or continuous crest settlement indicating a deteriorating condition likely due to piping or internal erosion.

shows an actual dam that had relatively minor settlement during the first 10 years of operation, but began to experience excessive settlement after 20 years. This information warned the dam owners and dam safety engineers that a serious internal erosion and piping issue was occurring. The dam was founded on a karstic foundation.

6.2.3 Dye Tracing

Dye testing can be used to investigate seepage paths within the embankment, abutments, or foundation. Its primary purpose is to demonstrate connectivity between seepage entry and exit points and to measure flow velocities. Colored or fluorescence-induced dye chemicals are injected into boreholes, observation wells, or released at specific locations in the reservoir. The downstream seepage is detected using dye tracing techniques and equipment. Dye tracing tests are very important if fractured or karst geological formations are present in the abutments or foundation because of the potential for open cracks or other continuous seepage pathways. High seepage flow rates are indicative of such preferential pathways, and their location may be detected by dye testing. The time required for the dye to travel from the upstream inlet location to the downstream discharge location is a direct indicator of the seepage velocity.

Fluorescent dyes such as rhodamine and fluorescence-detecting instruments (fluorimeters) are utilized to identify or confirm seepage flow paths. A field fluorimeter instrument detects very low concentrations of fluorescent dyes. Standardized dye trace test procedures have been established by ASTM (ASTM 2003), the United States Environmental Protection Agency (Quinlin 1992), and the U.S. Geological Survey (USGS) (Kilpatrick and Wilson 1989), and several dye trace studies performed in karst geology have been published (Mull et al. 1988; Van Dike 1985). An experienced engineering geologist should be consulted during planning for dye tests.

6.2.4 Temperature

As water flows from its supply source into the dam or foundation materials, its temperature will change. Typically, deeper water is insulated from air temperature changes and remains at a relatively constant temperature. Influx of water from rivers or lakes will be reflected by temperature changes. Figure 6-11 shows seepage discharge locations that are easily identified during wintertime when the temperature difference between surface water and subsurface seepage is highest.



Figure 6-11.—Seepage water discharge locations (flagged with red markers) are more evident during the winter due to water temperature differences.

Water temperature measurements have been used since the 1950s to monitor dams for seepage by manually measuring water temperatures in standpipes. The temperature method uses seasonal temperature variations in both the air and the temperature of the reservoir water to monitor seepage. These seasonal temperature changes are able to be detected in the water seeping through it. The magnitude of the seasonal temperature variations in the dam are correlated to the amount of water seeping through it (Johansson et al. 2007).

Temperature measurement started to gain acceptance in the 1990s when fiber optic cables were developed to detect thermal changes along the length of the cable. By embedding these optical fiber cables in an embankment dam, temperature measurements can be taken across the entire length of the embankment and evaluated for seepage. In addition to monitoring temperature, the optical fibers can also measure strain (deformation). Temperature and strain are measured by pulses of laser light traveling through the optical fiber. A detector measures how the laser light is scattered as it travels down the optical fiber. The scattering characteristics of the laser light

will be dependent upon the temperature and strain along the entire fiber. Using this method, the entire fiber is a sensor, and measurement points can be taken every 1 meter along the fiber up to 10 kilometers in length (Parker et al. 1997; Johansson et al. 2007).

Strain measurements are directly observed along the fiber length and need no further processing. Temperature measurements require more processing to identify areas of high seepage because temperature is an indirect measurement of seepage flow. Areas of high seepage can be identified by large seasonal temperature variations along the optical fiber. The seepage volume can be computed from thermal process calculations. Figure 6-12 illustrates how post-processed fiber optic data can readily indicate areas with seepage anomalies. On this figure, sensor 060:1 (bold dashed line) exhibits the highest seepage rate when compared to the other sensors.

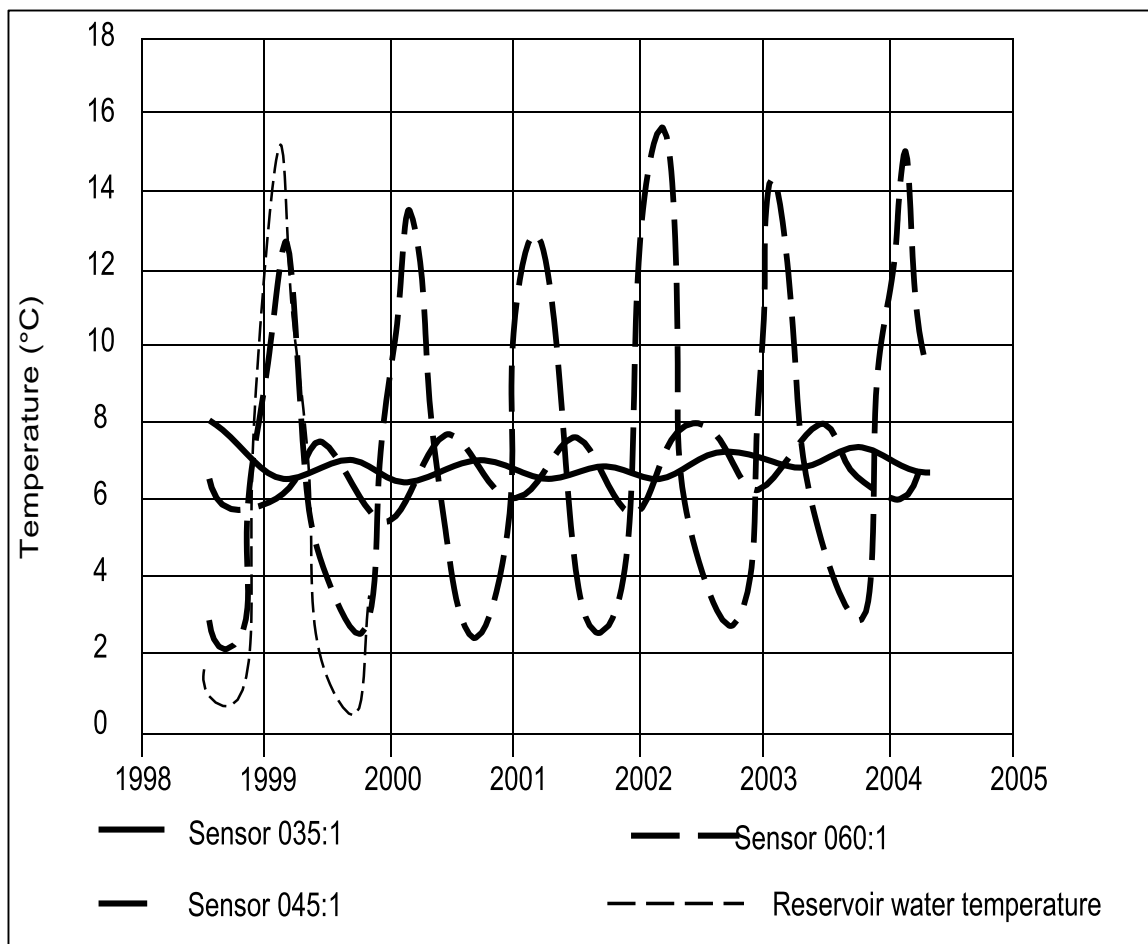

Figure 6-12.—Temperature measurements in piezometer sensors 035:1, 045:1, and 060:1 located in a Swedish dam foundation (bedrock). Temperature sensor 060:1 indicates seepage flow at this location due to its higher seasonal temperature variation (after Johansson et al. 2007).

Fiber optic cable has been installed in about 40 Swedish dams with twice as many in other worldwide locations. Installation in existing dams is typically scheduled concurrently when new toe berms with toe drains are constructed (Johansson et al. 2007). A common installation location for the fiber optic cable is the downstream toe. The optical fiber is placed upslope and upstream of the drainage system. Before water enters the drains, the temperature is measured to see which sections of the drain are collecting the most seepage. Installations are also in vertical standpipes (piezometers) to obtain temperature profiles, which allow an effective way of measuring the seepage flow at different elevations. By combining data from a line of standpipes along the dam, good coverage of the seepage flow can be achieved over the entire dam. The total installation cost can be on the order of \$20 per meter of cable (Johansson and Watley 2005).

The frequency of data collection is determined based on analysis of initial reference measurements made after final installation. Measurements will probably be performed each third year at some dams, while others will be measured several times per year. Measurements may be performed within several months during some periods of the year to observe temperature variations as the reservoir levels change (Johansson et al. 2007).

Fiber optic temperature technology is designed for detecting and monitoring slow and small changes in seepage; thus, it is useful for long-term monitoring on a yearly seasonal timeframe. Since temperature variation measurements indicate seepage anomalies, this technology may not be viable in areas of the world where there is limited seasonal temperature variation. In addition, installation of this system in existing dams is limited to the crest, toe, or vertical standpipes because it would not be possible to embed the fiber into the dam without major reconstruction efforts (Johansson 2006). Comparing resistivity to fiber optic temperature measurements at a dam site in Norway, it was concluded that resistivity measurements (63 electrodes placed on the crest of the dam at a spacing of approximately 2/3 meter) were not as precise as direct temperature measurements using fiber optic cables, and the resistivity data required more processing.

6.2.5 Electrical Resistivity and Self-potential Methods

6.2.5.1 Electrical Resistivity

Resistivity profiling is another non-invasive technique for mapping the locations of potential seepage paths. Anomalies in resistivity exist in the subsurface for any structure. This structure can be a clay-, water-, or air-filled void or fracture zone (Butler and Llopis 1990). Resistivity profiles have been used successfully to detect seepage paths in dams (Panthulu 2001).

The ability of soil (and rock) to conduct an electrical current is termed electrical conductivity, and the inverse is termed the electrical resistivity. Ohm's law states for a linear isotropic medium, the static voltage field is directly proportional to the product of the current density and soil resistivity. Geophysical resistivity methods rely on the intrinsic electrical resistance of all materials and on the resistance contrasts between them. The resistivity of earth materials is determined by injecting electrical current into the ground and measuring the resulting potential difference.

Water saturation (moisture content) near dams and levees is not a constant. As a result, the electrical resistivity associated with water is a transient property. For example, internal erosion involves washout of fine particles from the dam's core, and this process initially increases the resistivity of the core material by increasing the porosity. However, the initial increase is counteracted by a decrease in resistivity as the porosity is filled by conductive water. Similarly, as lake levels rise, the upstream shell of the dam will saturate, decreasing electrical resistivity, increasing the permeability to water, and increasing the flow of water into the dam core. As lake levels decrease, the dam shell will dewater, increasing the resistivity of shell materials. Soil and rock characteristics include the amount and interconnectivity of minerals; distribution, size, and interconnectedness of pores; and clay content. For example, silicate mineral conductivity is very low, while most clays and shales are quite conductive. Heath et al. (2009) and others provide details about the use of electrical resistivity for dam seepage investigations.

6.2.5.2 Self-potential Method

The self-potential (SP) method has proven to be a useful tool to monitor seepage in the subsurface (Butler and Llopis 1990; Panthulu 2001; Al-Saigh and Mohammed 1994). Fluid flow generates an electric potential that is recorded by a survey line at the surface. Comparing SP surveys from different reservoir levels can reveal seepage flow paths (Corwin 1989; Brosten et al. 2005).

The detection and delineation of seepage paths is facilitated by conducting resistivity profiling in conjunction with self-potential surveys. SP and resistivity profiles are the most common geophysical techniques used for dam seepage monitoring (Brosten et al. 2005). Figure 6-13 illustrates the use of both methods to identify possible seepage paths in a dam abutment. On figure 6-13, the surveys were conducted at the contact between the embankment and the right abutment, and profiles were oriented parallel to the embankment centerline. Where a zone of low resistivity coincides with a relatively low value in self-potential, such as at Station 200, a possible seepage path is indicated. Performing resistivity and self-potential profiles along several lines across the abutment permits a quasi-three dimensional view of the seepage pattern to be obtained.

6.2.6 Electromagnetic Profiling

6.2.6.1 General Considerations

Electromagnetic (EM) profiling can also be used to detect subsurface materials. Seepage paths can be identified by low or high conductivities since air-filled features produce low conductivities and water or clay-filled features produce high conductivities (Brosten et al. 2005). The EM profile can (1) be conducted without contact to the ground, (2) cover large areas quickly, and (3) produce continuous spatial data (as opposed to sections). Disadvantages include a limited depth (15 feet) and interference from metal objects or nearby electrical sources (Butler and Llopis 1990).

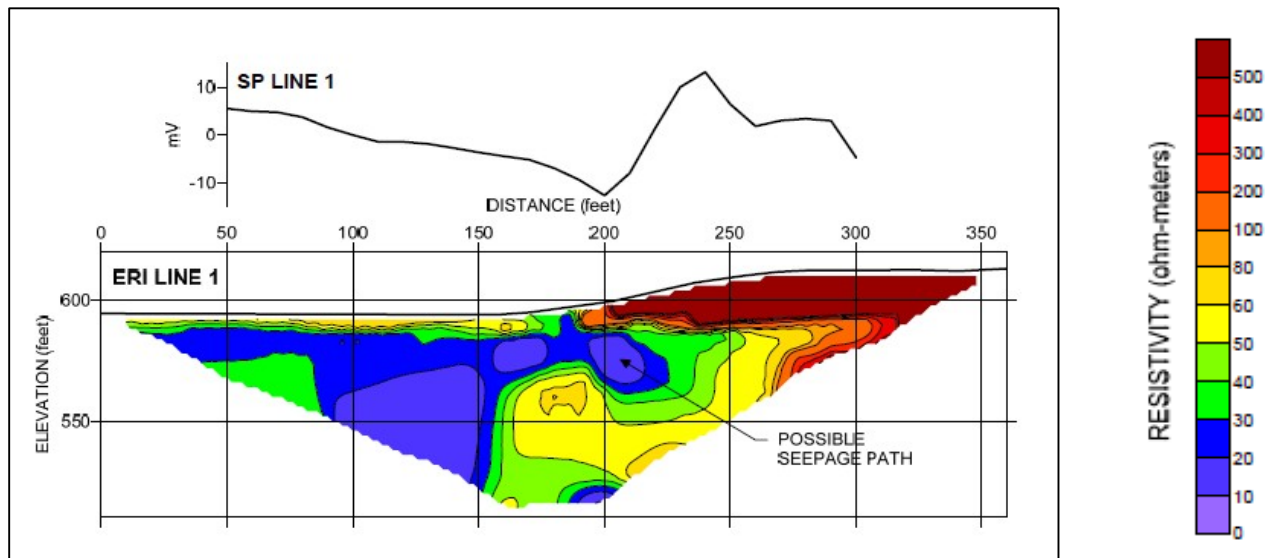

Figure 6-13.—Electrical resistivity imaging and self-potential plots for right abutment of earth embankment with karstic foundation.

The EM profiling technique is non-intrusive and can be performed on dams without the need to core drill, excavate, or de-water. Another advantage is the technology can be very selective in correlating the survey results to known and existing seeps or sources of groundwater seepage. Real-time monitoring of seepage flow distribution patterns through earthen dams can also be accomplished, but quantity and quality of seepage flow are not directly measured with this technology. The seepage mapping provided by this technology can be helpful in interpreting data from existing monitoring devices as well as identifying locations for installing additional monitoring devices and/or seepage remediation measures.

EM profiling can be used at most sites provided that great care is taken to minimize natural and manmade magnetic interference. It is also important to understand the site hydrogeology and to characterize the presence of clay layers in the soils, power lines, buried cables, or other weak electrical conductors. Other potential influences on EM profiling are changes in water conductivity due to changing ion concentrations, widening of the water stream (sheet flow versus channel flow), or other related changes in the groundwater surface (Montgomery and Kofoed 2001).

As stated in the above paragraphs, EM profiling and other geophysical methods use an indirect method to interpret subsurface conditions. Interpretations based on geophysical methods should be confirmed with other information, and users should be aware that there can be significant limitations in these methods because of site stratigraphy and other factors.

6.2.6.2 Example Electromagnetic Profiling Method

A tool was specifically developed to detect and map dam seepage flow paths using EM responses of induced electrical currents (Montgomery and Kofoed 2001). Willowstick Technologies (2009) has developed a proprietary method (AquaTrack™) for mapping seepage using electromagnetic profiling. This is an example of an EM method that conducts electricity through water-bearing subsurface strata and measures the surface magnetic fields generated by the subsurface electrical currents. Figure 6-14 shows a typical survey layout for the investigation of an embankment dam.

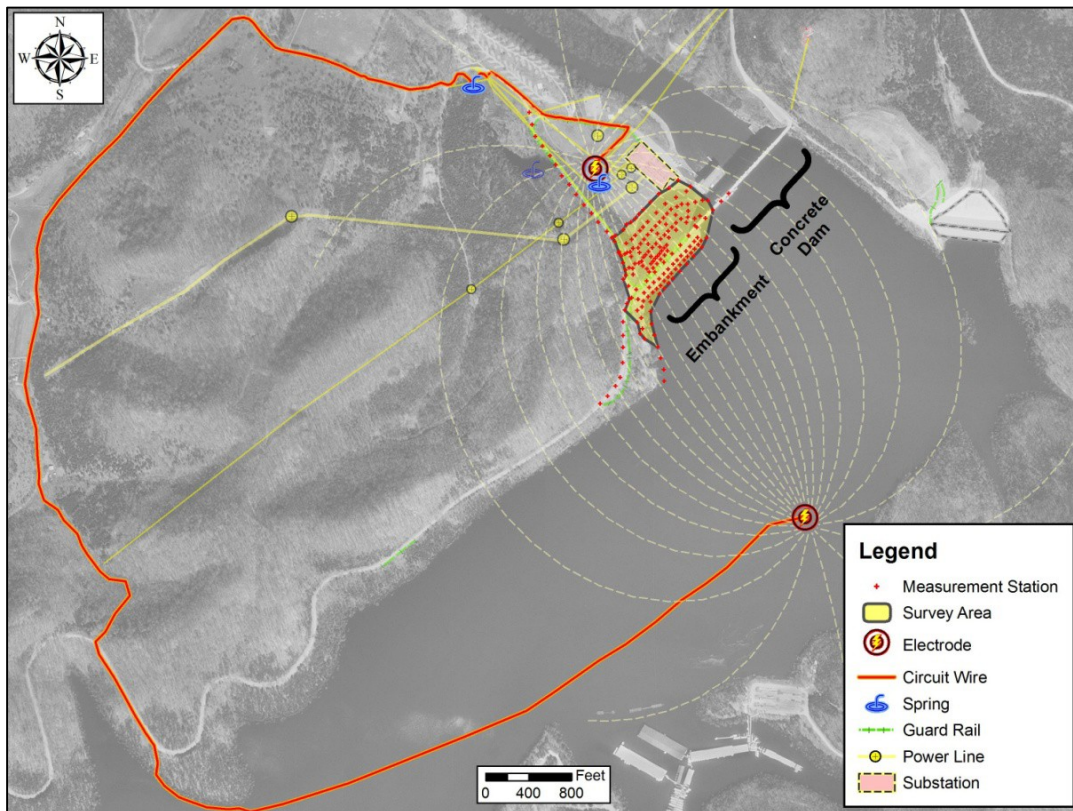

Figure 6-14.—Electromagnetic survey layout to investigate seepage in a typical embankment. The dashed yellow lines represent the idealized electric current between the two electrodes. (Courtesy of Willowstick Technologies)

Predicted magnetic field response assuming homogeneous conditions is compared with measured (actual) magnetic field response. By dividing the measured magnetic field by the predicted magnetic field model, a ratio response map (figure 6-15) is created, which removes electric current bias from the data and better highlights areas of anomalous electric current flow (greater or lesser than predicted). On figure 6-15, the white shaded contours (where the ratio is approximately 1:1) represent areas where the electric current is equivalent to that predicted by the homogeneous model. Areas shaded purple indicate electric current flow is less than predicted, and areas shaded green indicate electric current flow is greater than predicted. Areas with higher than predicted current flow suggest preferential water flow paths. Because magnetic

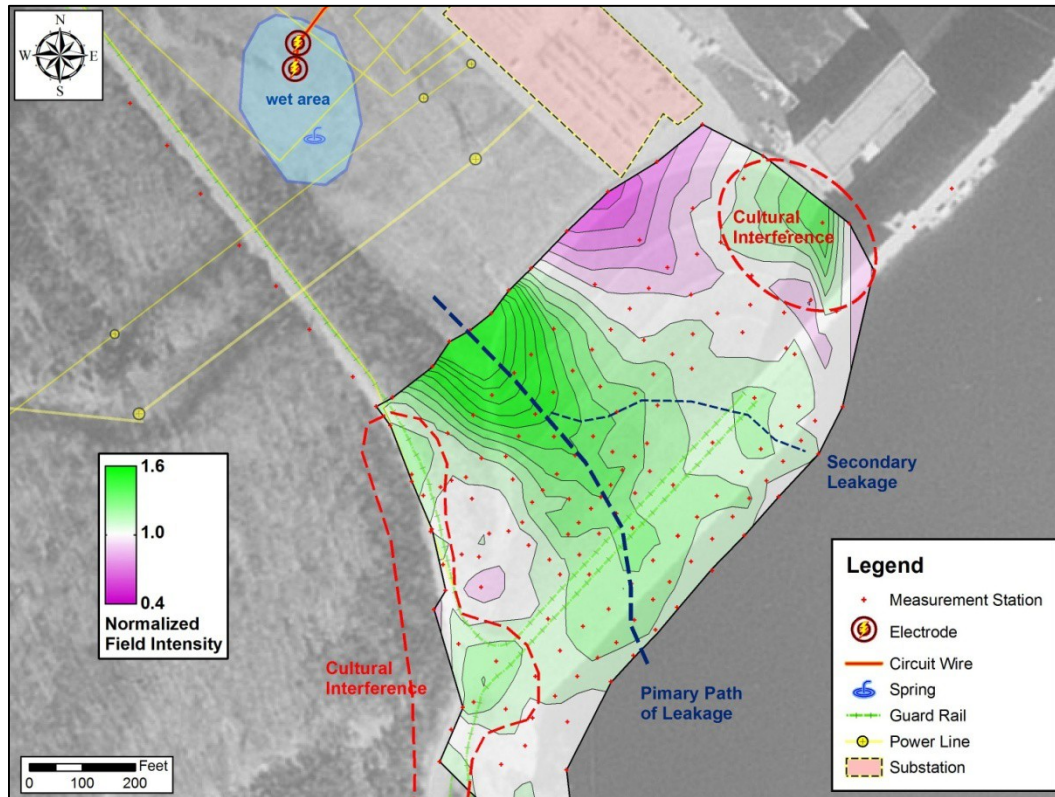

Figure 6-15.—Typical response ratio map. (Courtesy of Willowstick Technologies)

field measurements can only be obtained on the earth's surface, it is difficult to identify the depth of preferential electric current flow from the “footprint” map alone. For this reason, the data are subjected to an inversion algorithm (mathematical model) designed to predict the electric current distribution in three dimensions through the subsurface study area. The inversion model is referred to as an electric current distribution (ECD) model. Figure 6-16 present an example of a three-dimensional view of the ECD model created from these survey data. Zones of increasing electrical current correspond to preferential water flow paths as shown by green shading on figure 6-16.

6.2.7 Remote Sensing Applications

At its most fundamental level, “remote sensing” is the process of visual inspection and monitoring of an embankment dam and all its appurtenances. One example of remote visual inspection is using GoogleEarth™ satellite-based imagery to view a dam site. Since onsite visual inspection and monitoring is required during the entire life cycle of the dam structure, remote sensing is presently not an option to replace onsite inspection. On a more advanced level, remote sensing is a methodology for acquiring visible-light spectral data as well as multi-spectral (visible, near-infrared, infrared, ultraviolet, and other electromagnetic/radio frequency spectrums) data from collection platforms physically removed from the dam site. Remote

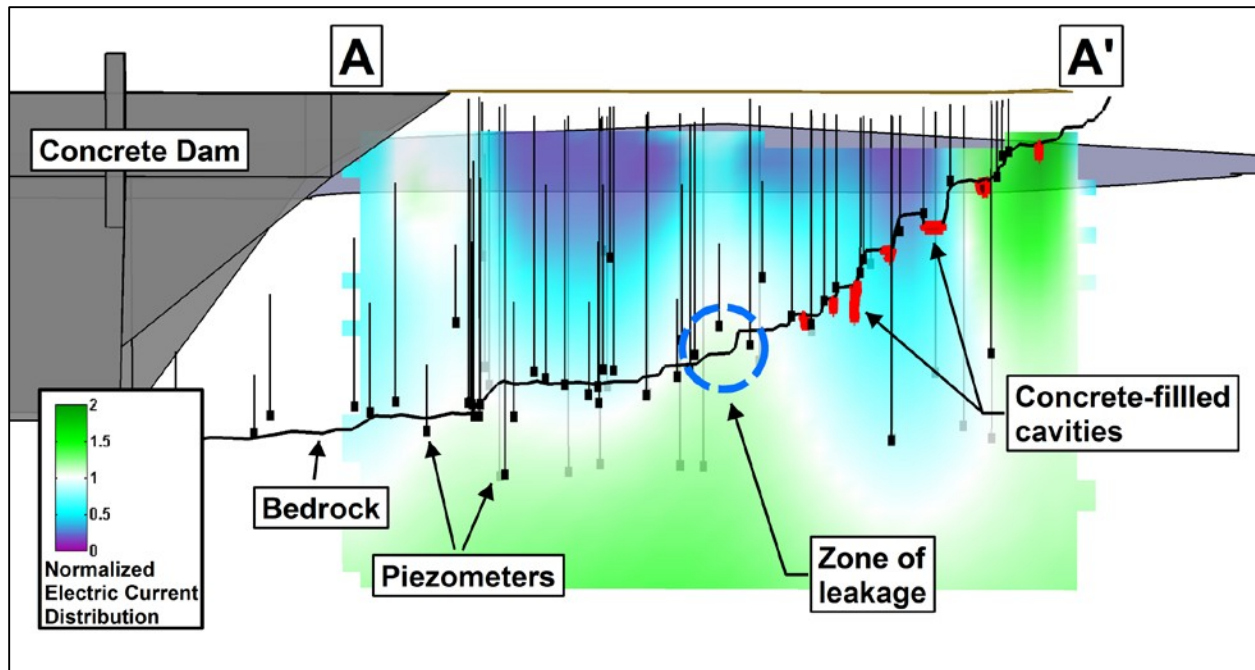

Figure 6-16.—Electric current distribution model showing zone of leakage in an embankment foundation. The view shown is a profile along the centerline of the embankment, looking upstream (courtesy of Willowstick Technologies).

sensing data collection methods typically utilize aircraft and satellite over flights, but terrestrial-based technologies are increasingly being utilized to augment onsite inspections. Remote sensing for dam structure and seepage monitoring remains an emerging technology mostly due to cost and turnaround (timeliness) issues, but data acquisition, post-processing, and interpretation techniques are continuously being enhanced.

Although visual inspection by trained personnel is the most effective method of detecting and monitoring seepage, it has practical limitations. Unless the observer is at the dam site around the clock, a seepage problem visual predecessor (such as surface deformation or sinkholes) or an abnormal seepage outflow event may remain undetected until the next periodic visual inspection. Also, some dam sites are remote or have lengthy embankments that are labor intensive to inspect. Even with remote monitoring (unmanned dam site instrumentation), abnormalities may not be identified until the remote observations are coupled with onsite visual or offsite (remote) sensing data.

Some of the practical limitations of visual inspection also apply to remote sensing data collection and interpretation. Remote sensing is episodic, is not available around the clock, nor is it capable of real-time information interpretation and inch-scale resolution (not included are the classified national intelligence entities with geostationary satellite systems targeted to non-U.S. landmasses and delivering real-time imagery).

Commercially available (lower resolution) remote sensing technology has been demonstrated to be useful for embankment seepage detection and monitoring applications. Seepage location

detection via airborne remote sensing has been demonstrated over the past few decades. Surface deformation mapping from airborne- and terrestrial-based collection platforms is an indirect approach to subsurface seepage detection. Commercially available remote sensing applications for early detection of potential seepage locations and time-based remote monitoring of seepage development have yet to be specifically applied to embankment dams. Table 6-1 provides generalized comparisons of commercially available remote sensing applicable to seepage detection and monitoring.

6.2.7.1 Early Detection of Potential Seepage Locations

Early detection of potential seepage problems using non-invasive technologies such as remote sensing currently relies on emerging techniques and equipment usage that has yet to be demonstrated in embankment dam seepage applications. Similar to geophysical technology acceptance, remote sensing technology will have to be proven to demonstrate a high degree of confidence in its results prior to its general acceptance by the dam engineering profession.

6.2.7.1.1 Surface Soil Moisture Content Changes

Techniques for measuring soil moisture content using commercially available airborne and satellite remote sensing datasets have been demonstrated for enabling soil moisture content measurements in the top few centimeters of soil. However, the potential of those techniques for early detection or long-term monitoring of probable dam seepage locations has yet to be fully exploited by either commercial or governmental entities.

Soil moisture content has been measured using remote sensing technology utilizing a wide range of frequencies within the electromagnetic spectrum, from low-frequency radio waves all the way up to gamma rays. Successful measurement depends upon the type of reflected or emitted radiation. Weidong et al. (2002) described reflectance frequency as a function of volumetric moisture content for a variety of soil types. Engman (1991) discussed the advantages and disadvantages of using gamma radiation techniques, visible/near-infrared (IR) techniques, IR techniques, and microwave techniques for remote sensing of soil moisture content.

Passive and active microwave techniques work best for detecting soil moisture content since there is a large contrast between the dielectric properties of liquid water and dry soil emitted in the microwave frequencies. Microwaves readily penetrate cloud cover and, to a lesser extent, vegetation cover. Microwave radiometers typically use the L-band (1.42 gigahertz (GHz) frequency; 21-centimeter [cm] wavelength), but higher frequencies up to about 89 GHz (0.3 cm wavelength) have been used.

Mattikalli et al. (1998) discussed an application of airborne-based passive microwave radiometry to derive spatial distribution of surface soil moisture and saturated hydraulic conductivity for an agricultural watershed. Schmugge (1998) discussed several airborne passive microwave radiometry experiments conducted over crop and grasslands specifically for delineating surface soil moisture. Typical ground resolution was approximately 200 meters. Lacava et al. (2005) showed that passive microwave satellite data can be useful for detecting soil wetness variations

Evaluation and Monitoring of Seepage and Internal Erosion

Table 6-1.—Generalized comparisons of commercially available remote sensing technology and applicability to embankment seepage detection and monitoring

Attribute	Imagery band						
	Microwave (radar)			IR/near-IR	Laser	LiDAR	Visible (photo)
	Sensor platform	Scatterometer	Passive modes				
Satellite	No	Yes	Yes	Yes	No	No	Yes
Airborne	Yes	Yes	Yes	Yes	No	Yes	Yes
Terrestrial	No	No	Yes	Yes	Yes	Yes	Yes
Detects soil moisture content	Yes	Yes	Yes	Yes, indirectly	No	No	No
Detects surface deformation	No	No	Yes	No	Yes	Yes	Yes
Detects seepage outflow	No	No	No	Yes	No	No	Yes
Quantifies seepage rate	No	No	No	No	No	No	No
Has dam site-scale resolution ¹	Yes	Yes	Yes	Yes	Yes	Yes	Yes
Time-based monitoring capability ²	Fair	Good	Good	Poor	Good	Good	Fair
Penetrates non-woody vegetation cover ³	Good	Fair	Fair	Good (depends on density)	Poor	Good	Poor
Dam-related case histories?	None	None	One ¹	Several	Some ⁴	Some ⁴	Most common

¹ Depends on sensor platform, imagery data processing, and interpretation resolutions. In general, satellite-based imagery has lowest resolution.

² Depends on sensor platform, imagery data processing, and interpretation turn-around timing. Airborne data are collectable on an as-needed basis, but satellite data collection depends on the orbital path and sensor targeting priority.

³ Depends on data processing models to neutralize (filter) vegetation attributes.

⁴ Deformation related only.

with time and space, albeit for a regional area of interest. Remote sensing applications for detecting surface soil moisture changes as a function of time on a small local scale (such as a dam site) have not been found in the public domain literature, but such technology would be particularly useful for remotely detecting downslope phreatic line exposure, as an example.

Active microwave techniques using satellite-based synthetic aperture radar (SAR) combined with empirical and physical model algorithms have been developed to provide higher resolution soil moisture estimates (Santanello et al. 2007). However, even with high-resolution imagery (1 to 25 meters), studies have shown generally poor relationships between modeled and measured soil moisture contents. Wigneron et al. (2003) and Thoma et al. (2008) describe the various modeling approaches enabling better correlations between measured and modeled moisture.

The Army Remote Moisture System (ARMS) exploits satellite-based SAR imagery and links it to GIS and land information system modeling and data assimilation to obtain volumetric soil moisture contents with ground resolution less than 100 meters (Tischler et al. 2007). The satellite-based ARMS was developed to provide the U.S. Army with soil property information useful for construction engineering and other tactical-scale applications.

Another microwave radiation method for estimating soil moisture content utilizes scatterometers operating in the P-band (430 megahertz, wavelength 68 cm). The advantage of scatterometers is they can be mounted on light aircraft (i.e., Cessna-type aircraft) at a much lower cost than the operation of SAR. Scatterometer data must be calibrated against ground-obtained soil moisture measurements. Geo-referencing was done using GPS, and three-dimensional mapping of the volumetric soil moisture content contours was produced.

6.2.7.1.2 Surface Deformations due to Seepage

Surface depressions caused by internal erosion (or settlement) aberrations may be detected and monitored using remote sensing technology. LiDAR surveys are conducted from airborne or terrestrial platforms. Radar (radio detecting and ranging) surveys are conducted from terrestrial, airborne, or satellite platforms typically using SAR sensor technology. Deformation and subsidence rates as low as a few millimeters per year are detectable using differential SAR interferometry (also called InSAR) collected from a satellite or airborne platform. Two SAR images acquired from slightly different flyover or orbit paths at different times are combined to detect deformation changes. Strozzi et al. (2001) discussed this technique and its demonstrated applications for SAR imagery collected from the European Remote Sensing satellites ERS-1 and ERS-2. This technique did not work well over vegetated (tree) areas, but was more applicable to urban areas having sparse tree cover.

Airborne-collected radar data allow for more precise targeting and higher spatial resolution. The National Aeronautics and Space Administration (NASA) acquired a commercially available dataset captured with the Airborne Data Acquisition and Registration (ADAR) 5500, which has wavelength bands similar to the first four Landsat bands. This sensor was capable of producing imagery and mosaics referenced to 1:24,000-scale national map accuracy standards, with 1-meter resolution (Goward et al. 2008).

Terrestrial laser scanning (TLS) techniques for subcentimeter resolution surveys and three-dimensional mapping are gaining increased interest. These techniques allow for three-dimensional deformation measurements, including displacement vectors and rotations (Monserrat and Crosetto 2008). Alba et al. (2006) describe a TLS application for mapping

and periodic monitoring of millimeter-level deformation at a large concrete dam near Milan, Italy. They stated that TLS is more “operational” than terrestrial SAR even though terrestrial SAR could produce similar deformation maps.

6.2.7.2 Detecting Seepage Discharge Locations

In addition to visual and photographic methods, remote sensing technology is useful for detecting seepage discharge occurring before or after surface deformations (sinkholes) are evident. Early detection of potential seepage anomalies is possible using thermal infrared imagery.

Thermal energy from the emissive thermal IR spectrum wavelengths is analyzed to detect surface moisture patterns. IR wavelengths of 8 to 14 micrometers (microns) detect radiated heat much more effectively than other wavelengths. IR technology has been found to be useful for delineating water or wet soil because water maintains a more constant temperature than rock or soil (i.e., water has a diurnal radiant temperature that is less temporally variable than rock or soil). Wet soil has less radiant temperature variability than dry soil (Myer 1975). Within the terminology of the electro-optics community, an IR band with wavelengths greater than 700 nanometers (nm) is typically divided into several classes based on properties. Near-IR (700–1,100 nm reflective) behaves like visible light. Short-wave IR (1,100–2,500 nm) is reflective with negligible emissive component. Mid-wave IR (2,500–7,000 nm, combined reflective and emissive) is used for high-temperature industrial measurements. Long-wave IR (7,000–1,5000 nm, all emissive, negligible reflective) is used for thermal measurements in ambient temperature ranges. Mid-wave and long-wave are collectively referred to as thermal IR (Sabol 2009).

Visual interpretation of thermal IR and near-IR imagery allows one to readily detect standing water bodies or wet soil. Thermal imagery collected during night-time hours will show those entities as “hot spots,” brighter than surrounding materials, and conversely for day-time imagery. Near-IR wavelengths (0.7 to 1 micron) are useful for detecting solar energy reflections, and wet soil reflects less solar energy than does dry soil. Near-IR imagery collected during day-time hours shows water bodies and wet soil as darker colors (black and dark gray). Near-IR and thermal IR imagery collected during a sunny day following a cold night allows maximum detectability of wet soil because of a wet soil’s high IR (thermal) differential radiance and high near-IR (solar) absorption.

Case histories related to the above methods have been published by a number of authors (Link, 1970; Fisher, 1973; Nickels et al., 1991; Banks et al., 1996; Washburn 2002; West and Hahn 1996).

6.3 Intrusive Methods

Geotechnical or geological borings and cores may be taken to help define the hydrogeology of a site during evaluation of seepage-related PFMs. Test pits are also often used to allow sampling for gradation analysis. Cone Penetration Test drill rigs also may be employed for site

characterization work and may be needed to define the stratigraphy at a site. Caution should be used during acquisition of data with intrusive methods to ensure that the embankment dam and foundation are not damaged. More information regarding these commonly used methods may be obtained from a number of sources (USACE, ER 1110-1-1807).

6.4 References

Alba, M., L. Fregonese, F. Prandi, M. Scaioni, and P. Valgoi (2006). “Structural monitoring of a large dam by terrestrial laser scanning,” *Intl Archives of Photogrammetry, Remote Sensing and Spatial Information Sciences*, Vol. 36 (Part 5), unpaginated CD ROM.

Al-Saigh, N.H. and Z.S. Mohammed (1994). “Detection of water leakage from dams by self-potential method,” *Engineering Geology* 37(2):115–121.

American Society for Testing and Materials (ASTM) (2003). *Standard Test Method for Open-Channel Measurement of Time of Travel Using Dye Tracers*. D5613-94(2003). Subcommittee: DI9.07, Book of Standards Vol. 11.02. American Society for Testing and Materials.

____ (2005a). *Standard Guide for Using the Gravity Method for Subsurface Investigation*. D6430-99(2005). Subcommittee: DI8.0I, Book of Standards Vol. 04.09. American Society for Testing and Materials.

____ (2005b). *Standard Guide for Use of the Time Domain Electromagnetic Method for Subsurface Investigation*. D6820-02. Subcommittee: DI8.01.02, Book of Standards Vol. 04.09. American Society for Testing and Materials.

____ (2005c). *Standard Guide for Using the Frequency Domain Electromagnetic Method for Subsurface Investigations*. D6639-01. Subcommittee: DI8.0I, Book of Standards Vol. 04.09. American Society for Testing and Materials.

____ (2005d). *Standard Guide for Conducting Borehole Geophysical Logging: Electromagnetic Induction*. D6726-0I. Subcommittee: DI8.0I, Book of Standards Vol. 04.09. American Society for Testing and Materials.

Banks, W.S.L., R.L. Paylor, and W.B. Hughes (1996). “Using thermal-infrared imagery to delineate groundwater discharge,” *Ground Water* Vol. 34, No. 3, pp. 434–443.

Birman, J.H. (1986). *Thermal Monitoring of Leakage Through Dams*, Las Vegas, Nevada, USA, ASCE, New York, New York, USA.

Blumberg, D.G., V. Freilikher, I.V. Lyalko, L.D. Vulfson, A.L. Kotlyar, V.N. Shevchenko, and A.D. Ryabokononko (2000). “Soil moisture (water-content) assessment by an airborne scatterometer: The Chernobyl disaster area and the Negev desert,” *Remote Sensing of Environment*, Vol. 71 pp. 309–319.

- Brosten, T.R., J.L. Llopis, and J.R. Kelley (2005). "Using Geophysics to Assess the Condition of Small Embankment Dams," ERDC/GSL TR-05-17. U.S. Army Corps of Engineers Research and Development Center, Vicksburg, Mississippi.
- Butler, D.K. and J.L. Llopis (1990). "Assessment of Anomalous Seepage Conditions," Stanley H. Ward, Geotechnical and Environmental Geophysics Society of Exploration Geophysicists, 2:153–173.
- Corwin, R.F. (1989). "Geotechnical Applications of the Self Potential Method; Report 3, Development of Self-potential Interpretation Techniques for Seepage Detection," Technical Report REMR-GT-6, U.S. Army Engineers Waterways Experiment Station, Vicksburg, Mississippi.
- Dai, L., J. Wang, C. Rizos, and S. Han (2001). "Applications of Pseudolites in Deformation Monitoring Systems," 10th FIG International Symposium on Deformation Measurements, Orange, California, pp. 11–22.
- Demars, B., C. Pledger, and B. Barrett (2009). "A.V. Watkins Dam Modification: Cement-Bentonite Slurry Cutoff Wall," Conference Proceedings, 29th Annual Meeting and Conference, Nashville, United States Society on Dams.
- Engman, E.T. (1991). "Applications of microwave remote sensing of soil moisture for water resources and agriculture," *Remote Sensing of Environment* 35:213–226.
- Federal Laboratory Consortium (FLC) (2009). "Handheld apparatus for mobile mapping and expedited reporting," in: *Technology for Today*, published by Universal Technical Resource Services, Inc., p. 39.
- Federal Emergency Management Agency (FEMA) (2000). National Dam Safety Program Research Needs Workshop: Seepage Through Embankments, FEMA 535. Denver, Colorado.
- _____(2005). Technical Manual: Conduits through embankment dams, FEMA 484.
- Federal Energy Regulatory Commission (FERC) (2006). Engineering Guidelines for the Evaluation of Hydropower Projects.
<http://www.ferc.gov/industries/hydropower/safety/guidelines/eng-guide.asp>
- Fisher, P.R. (1973). *Thermal imaging in reservoir leakage analysis*, Office of the Chief of Engineers, Washington, D.C. 20 p. and Appendix.
- Goward, S.N., L.W. Underwood, M.G. Fearon, R. Fletcher, J.B. Garvin, G. Hurtt, J. Jensen, M. Nolan, K. Holekamp, M. Pagnutti, R.E. Ryan, T. Stanley, T.E. Frisbie, and W. Swearingen (2008). "NASA's earth science use of commercially available remote sensing data," *Photogrammetric Engineering and Remote Sensing*, 74(2):139–146.

- Heath, G, C. Scott, and A. Schafer (2009). “Electrical Resistivity Methods for Dam Seepage Characterization and Monitoring,” Idaho National Engineering Laboratory.
- Hoover, R.A. (2003). “Geophysical Choices for Karst Investigations,” in: *Proceedings of the 9th Multidisciplinary Conference on Sinkholes and the Engineering Impacts of Karst*, Huntsville, Alabama.
- Indiana Department of Natural Resources (2003). Indiana Dam Safety Inspection Manual. *Indiana Department of Natural Resources Dam Safety Inspection Manual* http://www.in.gov/dnr/water/files/Part-2-Dam_Safety_Manual.pdf
- Johansson, S. (2006). “Fiber-optics to detect seepage and internal erosion in embankment dams.” *International Journal on Hydropower and Dams*, 13(5), p. 94.
- Johansson, S. and D. Watley (2005). “Optical illusions,” *International Waterpower & Dam Construction*, Vol. 57, No. 1, ISSN 0306-400X, pp. 22–23 and 25.
- Johansson, S., P. Sjudahl, and H. Cooney (2007). “Seepage Monitoring in Embankment Dams Using Distributed Temperature Sensing in Optical Fibers – Experiences from Some Swedish Dams,” *International Symposium on Modern Technology of Dams – The 4th EADC Symposium*, Cengdu, China, pp. 564–571.
- Kilpatrick, E.A. and J.E. Wilson (1989). “Measurement of time of travel in streams by dye tracing,” USGS Office of Surface Water Technical Memorandum No. 89.17.
- Lacava, T., V. Cuomo, E.V. Di Leo, N. Pergola, F. Romano, and V. Tramutoli (2005). “Improving soil wetness variations monitoring from passive microwave satellite data: The case of April 2000 Hungary flood,” *Remote Sensing of Environment*, Vol. 96, pp. 135–148.
- Link, L.E., Jr. (1970). “Aerial infrared survey of the Walter F. George Lock and Dam, Chattahoochee River, Alabama-Georgia,” *Miscellaneous Paper M-70-3*, U.S. Army Engineer Waterways Experiment Station, Vicksburg, Mississippi. 34 p.
- Mattikalli, N.M., E.T. Engman, L.R. Ahuja, and T.J. Jackson (1998). “Microwave remote sensing of soil moisture for estimation of profile soil properties,” *Intl. Journal of Remote Sensing*, Vol. 19, No. 9, pp. 1751–1767.
- Montgomery, J.R. and V.O. Kofoed (2001). “Mapping, tracking, and monitoring flow paths through earthen dams,” in: *Dam Safety 2001, the 18th annual conference of the Association of State Dam Safety Officials, held September 9–13, 2001, in Snowbird, Utah*: Lexington, Kentucky: Association of State Dam Safety Officials.
- Monserrat, O. and M. Crosetto (2008). “Deformation measurement using terrestrial laser scanning data and least squares 3D surface matching,” *Journal of Photogrammetry and Remote Sensing*, Vol. 63, Issue 1, pp. 142–154.

- Mull, D.S., T.D. Lieberman, J.L. Smoot, and L.H. Woosley (1988). "Application of dye-tracing techniques for determining solute-transport characteristics of ground water in karst terrains," EPA 904/6-88-001. U.S. Environmental Protection Agency, Region IV. Atlanta, Georgia.
- Myer, V.I. (1975). "Crops and soils," in: *Manual of Remote Sensing*, American Society of Photogrammetry, Falls Church, Virginia, pp. 1715–1813.
- Nickels, K., S. Grant, and D. Christensen (1991). A Seepage Investigation. *Water Engineering and Management* 138(1):16–17.
- Panthulu, T.V. (2001). "Detection of seepage paths in earth dams using self-potential and electrical resistivity methods," *Engineering Geology* 59(3-4):281–295.
- Parker, T.R., M. Farhadiroushan, V.A. Handerek, and A.J. Rogers (1997). "A Fully Distributed Simultaneous Strain and Temperature Sensor Using Spontaneous Brillouin Backscatter," *IEEE Photon. Tech. Lett.* Vol. 9, No. 7, p. 979.
- Quinlin, J.F. (1992). "Ground-Water Monitoring in Karst Terrains: Recommended Protocol and Implicit Assumptions," EPA/600/-89/050. U.S. Environmental Protection Agency, Environmental Monitoring Systems Laboratory. Las Vegas, Nevada.
- Rybakov, M., V. Goldshmidt, L. Fleischer, and Y. Rotstein (2001). "Cave detection and 4-D monitoring; a microgravity case history near the Dead Sea," *The Leading Edge*, 20(8):896-900.
- Rutledge, D.R. and S.Z. Meyerholtz (2005). "Using the Global Positioning System (GPS) to monitor the performance of dams." *Geotechnical News*, 23(4), pp. 25–28.
- Sabol, B. (2009). Personal communication.
- Santanello, J.A. Jr., C.D. Peters-Lidard, M.E. Garcia, D.M. Mocko, M.A. Tischler, M.S. Moran, and D.P. Thoma (2007). "Using remotely-sensed estimates of soil moisture to infer soil texture and hydraulic properties across a semi-arid watershed," *Remote Sensing of Environment*, Vol. 110, pp. 79–97.
- Schmugge, T. (1998). "Applications of passive microwave observations of surface soil moisture," *Journal of Hydrology*, Vol. 213, pp. 188–197.
- Strozzi, T., U. Wegmuller, L. Tosi, G. Bitelli, and V. Spreckels (2001). "Land subsidence monitoring with differential SAR interferometry," *Photogrammetric Engineering and Remote Sensing*, 67(11):1261–1270.

- Szostak-Chrzanowski, A., A. Chrzanowski, M. Massiera, M. Basanowski, and C. Whitaker (2008). “Study of a Long-term Behavior of Large Earth Dam Combining Monitoring and Finite Element Analysis Results,” 13th FIG International Symposium on Deformation Measurements and Analysis, Lisbon, Portugal.
- Thoma, D.P., M.S. Moran, R. Bryant, M.M. Rahman, C.D. Holifield Collins, T.O. Keefer, R. Noriega, I. Osman, S.M. Skrivin, M.A. Tischler, D.D. Bosch, P.J. Starks, and C.D. Peters-Lidard (2008). “Appropriate scale of soil moisture retrieval from high resolution radar imagery for bare and minimally vegetated soils,” *Remote Sensing of Environment*, Vol. 112, pp. 403–414.
- Tischler, M., M. Garcia, C. Peters-Lidard, M.S. Moran, S. Miller, D. Thoma, S. Kumar, and J. Geiger (2007). “A GIS framework for surface-layer soil moisture estimation combining satellite radar measurements and land surface modeling with soil physical property estimation,” *Environmental Modeling and Software*, Vol. 22, pp. 891–898.
- Van Dike, J.E. (1985). “Movement of shallow groundwater in the Perryville Karst Area, Southeastern Missouri,” Miscellaneous Publication Number 44. Missouri Department of Natural Resources. Rolla, Missouri.
- Washburn, G.R. (2002). “Use of infrared remote sensing for the detection of potential seepage sites along the Erie Canal,” Thesis (M.S.) - State University of New York, College of Environmental Science and Forestry, Syracuse, New York. 82 p.
- Weidong, L., F. Baret, G. Xingfa, T. Qingxi, Z. Lanfen, and Z. Bing (2002). “Relating soil surface moisture to reflectance,” *Remote Sensing of Environment*, Vol. 81, pp. 238–246.
- Welch, L R. (1997). “Thermal monitoring of seepage at Fontenelle Dam, Atlanta, Georgia, USA,” ASCE, New York, New York, USA.
- West, H.W. and C. Hahn (1997). “Feasibility study of using remote sensing to detect seep, boils, and other problems in the levee system,” unpublished presentation, U.S. Army Corps of Engineers Waterways Experiment Station, Vicksburg, Mississippi.
- Wigneron, J.P., J.C. Calvet, T. Pellarin, A.A. Van de Griend, M. Berger, and P. Ferrazzoli (2003). “Retrieving near-surface soil moisture from microwave radiometric observations: current status and future plans,” *Remote Sensing of Environment*, Vol. 85, pp. 489–506.
- Willowstick Technologies (2009). Internet Website
<http://www.willowstick.com/technology.html>

CHAPTER 7 – SEEPAGE COLLECTION AND MEASUREMENT

This chapter addresses the importance of collecting, measuring, and monitoring seepage as related to the safety of earth dams. It also provides best practices for performing these functions. Three main areas of seepage-related observations will be considered: (1) seepage quantity and flow rate, (2) water levels and pressures, and (3) seepage water quality attributes.

7.1 Introduction

Observations related to seepage through an earth embankment or its foundation may give an early indication of the nature, location, and severity of potential failure modes (PFMs) that may already have initiated or could initiate at higher reservoir levels. For example, vigorously flowing sand boils discharging sediment near the downstream toe of an embankment may indicate that backward erosion piping in the foundation has already initiated and that it has the potential for rapid progression. Likewise, concentrated, clear seepage at an abutment groin may be an indication of a preferential flow path through the abutment, which could provide an avenue for internal erosion at higher gradients.

Seepage collection and monitoring systems should be designed with all failure modes in mind that may reasonably be anticipated at a particular structure site, given its unique geologic characteristics and design features. Ideally, all needed seepage measurement and monitoring systems should already be in place and available to collect seepage information from the first filling on, but of course new seepage areas can emerge at any time. Once water is impounded in the reservoir, all seepage-related phenomena should be evaluated with reference to PFMs of which they could be indicators. Early identification of PFMs that may be at work can facilitate the undertaking of emergency or remedial actions that need to be performed on short notice.

Measuring seepage quantity and quality provides several important benefits:

- (1) *Comparison with Design:* Measurements of actual seepage can be compared with seepage rates assumed or calculated during design to evaluate whether the dam and its various seepage control systems are functioning as intended (e.g., a foundation cutoff system or an embankment or foundation drain).
- (2) *Identifying Changes with Time:* The appearance of unexpected seepage or changes in seepage quantity or quality over time can alert the dam owner to potential problems occurring within the embankment or foundation and allow for the implementation of corrective measures in a timely manner.

7.1.1 Water Quantity and Quality

Both seepage water quantity and quality are important indicators of seepage-related problems. Unexpectedly large flows or flows that vary with time, particularly increasing flows, are of serious concern. Seepage water that can be collected and measured can also be tested for water quality attributes such as turbidity, dissolved solids, and corrosion potential. Flow containing suspended soil particles (sediment) is indicative that piping and/or internal erosion processes are taking place. Comparison of dissolved solids content between reservoir and seepage water may be used as an indicator of dissolution of bedrock in the foundation or abutments and therefore of creation of preferential flow paths potentially conducive to internal erosion or other hazards.

Additionally, seepage water chemistry may adversely affect the integrity of instrumentation or other structural features. For example, relief well screens can be corroded by overly acidic water, leading to loss of filter pack and foundation materials into the well. The screens can also become clogged with chemical precipitates if the water is sufficiently rich in minerals, resulting in increased foundation pressures and/or increased maintenance requirements.

7.1.2 Pressure Measurement

By measuring seepage pressures in the embankment and foundation, the structure's response to the hydraulic loading of the reservoir can be characterized. Pressure is typically measured using piezometers or observation wells. From pressure measurements, seepage direction can be estimated, the location of the phreatic surface can be estimated, and seepage gradients can be calculated at critical locations such as the downstream toe of the embankment. The effectiveness of both cutoffs and drainage features can be verified from pressure measurements. Changes in pressure at a given location with time (either increases or decreases) can be indicators of various kinds of distress, including internal erosion. Finally, pressures observed at normal pool levels can be extrapolated to estimate those for extreme reservoir loadings such as the probable maximum flood.

7.2 Best Practices

7.2.1 Criticality of Seepage Location

The location where seepage emerges from the structure or the surrounding terrain is highly significant and provides valuable insight into where seepage-related problems may be located and which PFMs may be operating. Typical locations where seepage may exit include: downstream toe areas, abutment groins, downstream embankment slopes and abutment surfaces, principal spillway pipe joints, plunge pools, outlet channels, and pre-existing springs.

The relation between reservoir level and downstream seepage flow can help pinpoint the inlet area in the reservoir or if the flow is even coming from the reservoir. For example, downstream springs may flow only when the reservoir exceeds a certain elevation. Inlet features include:

exposed bedrock in the pool areas, rock joints and bedding planes, incomplete upstream blankets, pervious layers exposed in upstream channels, and sinkholes. Flow may also be coming from more than one source. Therefore, it is critically important to consider the location of the seepage in the design and installation of the monitoring system.

7.2.2 System Selection, Design, and Installation

Seepage collection, measurement, and monitoring systems can be planned and designed either during initial design of a new dam or during the operation phase of an existing dam, typically after the appearance of unexpected or problem seepage. In both cases, system selection, design, and installation of the seepage monitoring system involves a team effort of all personnel at a given dam site and should address all the site's unique conditions and operational requirements. These factors include (Indiana Department of Natural Resources 2003):

- (a) Identifying seepage flow paths and discharge locations depending on reservoir level and dam design features
- (b) Defining specific collection and measurement locations and spatial layouts
- (c) Defining collection and measurement instrumentation purposes
- (d) Selecting instrumentation types, makes, and models (including standalone, remotely monitored, system operational, and compatibility planning)
- (e) Planning for data collection procedures and frequency (including calibration schedules)
- (f) Planning for data validity checking and data evaluation procedures
- (g) Life cycle cost estimating

In addition to those items listed above, risk should also be a key consideration. Selection of instrumentation and preparation of a monitoring program should be tied to specific failure modes and the relative risk associated with them. It is not practical to spend limited resources monitoring failure modes that have a very low probability of occurrence or that would result in minimal consequences when other failure modes may be more probable and may have significantly greater potential impacts. Risk analysis, engineering methods, and case histories were not well developed when most dams were constructed, and the original project instrumentation may therefore not adequately address all failure modes associated with internal erosion. Many Federal agencies have been addressing this deficiency with implementation of a potential failure modes analysis and risk analysis to determine the most likely failure modes with the greatest potential impact and to assess the older monitoring systems to ensure they are adequately monitoring the critical PFMs. Instrumentation is also being periodically reassessed, and modifications to monitoring programs are continually being made as experience

is gained in the performance of a dam. The Bureau of Reclamation (Reclamation) utilizes a decision tree to assist with periodic assessments of instrumentation programs (figure 7-1) that incorporates risk.

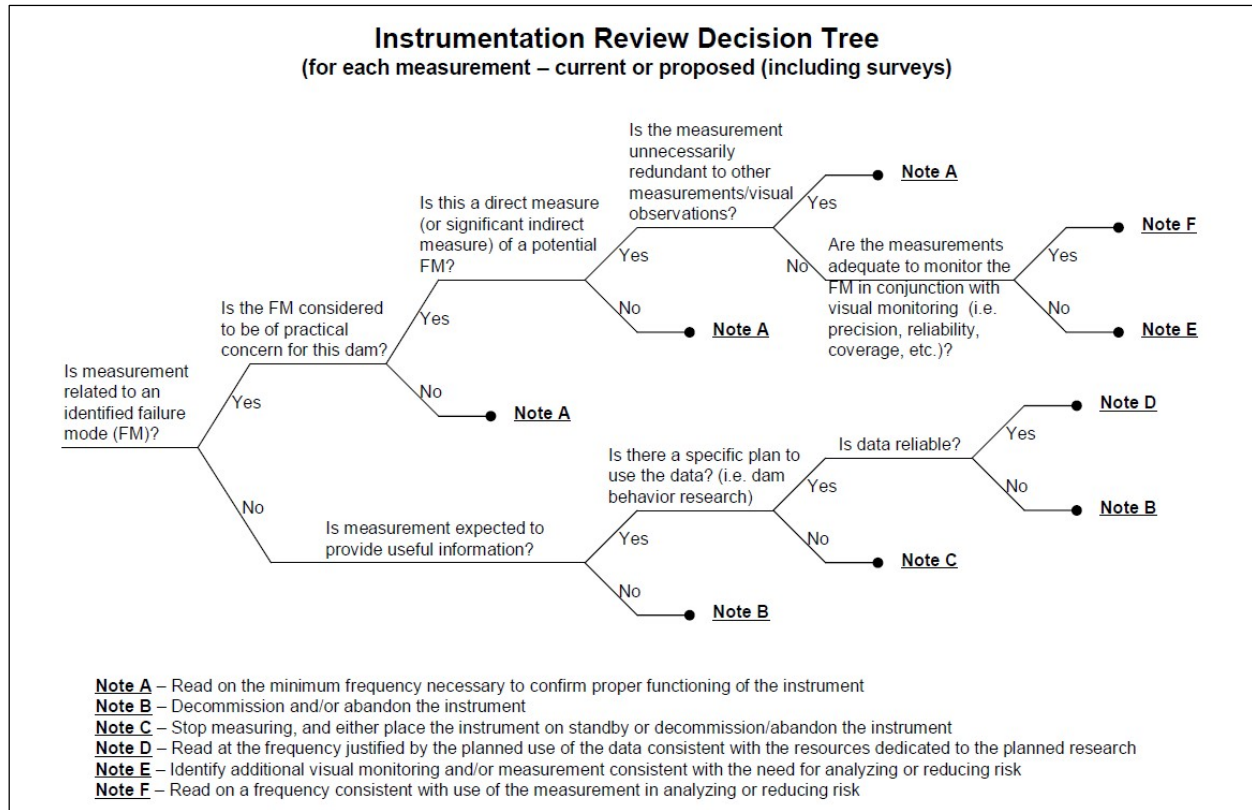

Figure 7-1.—Reclamation’s decision tree for instrumentation review (Reclamation 2009).

Typical locations for collecting and measuring seepage flow are channels and ditches, drain outlet pipes, well outlets, and drainage galleries. Pipe flow can be diverted into an inspection well or other enclosure where instrumentation can be easily accessed for inspection yet remain protected from freezing, vandalism, or other damage. The primary measurement devices used to quantify seepage volume and flow rates collected in open channels, ditches, or drain outlets are weirs, flumes, and calibrated containers. The primary measurement devices used to quantify seepage volume and flow rates in pipes are velocity meters and pressure transducers within tube-type flow meters. Installing and operating the optimum system at a dam site is dependent on expected function, cost, local climate, reliability, and required accuracy. Provisions for monitoring and collecting sediment are also necessary.

The bottom of the inspection well is separated into several bays. Divider walls are used to make these bays. The number of bays depends on the number of inlet and outlet pipes and the required flow measurements. The walls should be constructed out of metal, which will offer flexibility if changes are required at a later date. The upstream bay serves as the sediment trap and will also act as a quieting pool prior to flow passing through the weir or flume. Depending on the amount of flow entering this bay, a baffle may be needed to aid in quieting the flow. The bottom of this

bay should be painted white with waterproof paint to aid in the detection of sediment in the bottom of the bay. The flow then passes through the measurement device consisting of a flume or weir. While weirs are more economical and require less space, they can be difficult to meet the approach requirements for quiet flow. Flumes typically are a better flow measurement scheme for inspection wells since they produce more consistent readings through a larger flow range. Downstream from the weir/flume is the discharge bay, which has no special requirements. As mentioned previously, the number of inlet and outlet pipes is dependent on the overall drain system layout. The simplest arrangement is one pipe in and one pipe out (Pabst 2007b)

Considerations for seepage collection and measurement systems at dams are somewhat different than those for irrigation water measuring systems because dam seepage flows are generally much smaller than typical irrigation flows. An important concern in system selection is choosing the proper one that is capable of consistently accurate measurements at low flow rates.

Another factor to consider is the expected duration of seepage monitoring. For permanent systems, all components should be of durable, corrosion-resistant materials and should have an expected life span and other performance features that are consistent with the overall structure. However, when systems are only temporarily needed for seepage problem identification (or design of remedial measures), then simpler, less permanent devices, such as removable plastic flumes or temporary installations for using calibrated catch containers, may be appropriate. Temporary devices will obviously capture sediment only when the seepage flow is being measured and may miss sediment that is transported in an episodic manner.

7.2.2.1 Layout Considerations

The location of anticipated or actual seepage sources will dictate system layout. Wherever possible, seepage flows should be collected for measurement as close to their point of origin as possible to allow for the separate measurement of flows from each individual source and to minimize infiltration and evaporation losses, erosion, and mixing of flow from separate sources. For example, seepage emanating from the downstream slope of an embankment dam should be channeled away from the slope and directed through a pipe or weir for flow measurement. Seepage collection and measurement systems should be designed so that individual sources (e.g., drain outlets, surface runoff, springs, etc.) can be separately measured. This may require measures to prevent portions of the flow from escaping under or around the collection system and measurement instrumentation. Sediment traps should be protected from surface runoff.

Seepage collection and measuring devices should be located to avoid interfering with or damaging other components of the structure. For example, drilling operations should be carefully planned so as to avoid compromising existing features such as filters, drains, pipes, utilities, and cutoffs. On existing structures, as-built drawings should be reviewed prior to installing any new features.

Knowing the expected head and tail water conditions is essential in the design and installation of weirs and flumes, which have specific requirements on minimum length and size of the approach and discharge channel for proper flow measurement. Flow meters also have requirements regarding the length of straight pipe upstream and downstream from the meter.

Piezometers provide point readings of water pressure. Therefore, careful thought must go into locating piezometers such that all critical locations are covered and so that valid interpolation between measuring locations is possible. Piezometers are typically located in lines or grids as well as at individual points of interest. Locations for piezometers depend on the PFM and may include: (1) in lines from upstream to downstream; (2) along the downstream toe; (3) along the outlet channel; (4) in confined aquifers, especially where the confining layer is thinner; (5) in drains and other embankment zones; (6) between relief wells; and (7) in seep areas. Multiple (“nested”) piezometers may be installed at different depths at the same location so that vertical gradients can be measured. An appropriately spaced and designed array of piezometers may be used to develop groundwater contours.

Piezometers should generally not be installed in the dam core unless there are very compelling reasons for such an installation location. Piezometers located in the upstream and downstream shells can usually provide sufficient information, and those locations are much safer due to their lower risk for creating seepage flow paths. Care should also be taken against building potential seepage defects into embankments by properly locating piezometer instrumentation conduit and tubes. Instrumentation elements may be routed in a transverse direction through pervious zones such as blanket drains and coarse fill, but never through the embankment impervious core (Federal Emergency Management Agency [FEMA] 2000).

7.2.2.2 Installation Considerations

Some considerations for permanent seepage monitoring installations are:

- Use durable, corrosion-resistant materials such as concrete, galvanized steel, and stainless steel. Corrugated metal pipes should not be used for drainpipes in seepage collection systems because of their record of deterioration.
- Provide all-weather instrumentation enclosures.
- Provide automated instrumentation for higher risk sites and if regular inspection or site access issues are problems.
- Provide year-round accessibility for sample collection, instrument calibration, and maintenance activities.
- Protect all equipment from vandalism and animal damage (e.g., the tops of piezometers should be installed inside metal guard pipes with locking covers). Wells should also have locking caps and guard pipes for protection against vehicle and mowing equipment damage.

Excavation at the downstream toe of an embankment may be hazardous unless the reservoir is drawn down or the excavation is appropriately dewatered. Subsurface vertical or horizontal drilling with fluids can potentially damage existing structures by initiating hydraulic fracturing, which can lead to internal erosion and dam breaching. Drilling can also intercept and damage filter zones in embankments, subsurface drains, underground utilities, or other structures.

Installation of redundant measurement instruments provides for the useful purpose of verifying and evaluating unusual data readings. It may be more cost effective to install redundant instrumentation to account for the possibility of malfunction, than to replace inoperable instruments at a later date, depending on access and equipment costs. For example, vibrating-wire piezometer transducers are relatively inexpensive and are occasionally installed in pairs when appropriate to provide continuity of data if one of the transducers should fail (Federal Energy Regulatory Commission [FERC] 2006).

7.2.2.3 Automated Data Acquisition Systems

An Automated Data Acquisition System (ADAS) includes systems that can monitor the performance of a dam without human intervention (American Society of Civil Engineers [ASCE] 2000). The ADAS is becoming increasingly popular in dam applications due to increased safety concerns and advances in hardware/software (United States Committee on Large Dams [USCOLD] 1993). The systems can range from simple automated instrument readings, to a complete monitoring system that combines instrument measurements and warning systems. Examples of fully automated systems are discussed in Marrilley and Myers (1996) and Welch and Fields (1999).

Specific details of an ADAS can be found in International Commission on Large Dams (ICOLD) (2000) and ASCE (2000). Here, the focus will be on the need for automation of dam instrumentation on monitoring and important issues associated with designing an ADAS. Considerations for use of an ADAS include the following (USCOLD 1993):

- (1) The condition of the dam
- (2) Adverse foundation conditions
- (3) Downstream hazards
- (4) Design or construction deficiencies of the existing structure
- (5) Performance and operation concerns
- (6) Number and type of instruments
- (7) Future personnel resources available for instrumentation monitoring
- (8) The political and environmental setting

These points are in addition to budgetary constraints. Of great importance, as with all seepage monitoring issues, is the risk associated with a dam. Higher risks and specific PFMs may warrant the need for an ADAS.

In cases where economics alone don't dictate, the responsible party, usually the dam owner, is encouraged to create a weighted matrix of above items 1–8 with several weight factor scenarios to help determine the need for an ADAS. Only the professional person(s) most familiar with the specific issues or gravity of each of the issues can best determine the importance of each of the items. Cost, labor, and time saved (to gain notification of data and potentially an alarm level) should also be weighed along with the above items.

Even with thorough instrumentation and a complete ADAS, the system does not take the place of routine visual inspections. An ADAS requires instruments of the right type, in the right place, and having proper personnel able to interpret and respond to an ADAS warning. Exclusive use of an ADAS is not ideal, as it relies heavily on instrumentation and on the assumption that all processes will go exactly as planned. Most failure scenarios occur as a compounding process of unplanned events. The strength of an ADAS for most installations is to relieve personnel of the duties to take and record readings of particular instruments and to help provide a better operating history and measure of the dam's performance through automated tabulation and data storage/retrieval. The ADAS does not take the place of evaluating the instrumentation data or the overall performance of the dam (USCOLD 1993). An ADAS is simply gathering the information from the instrumentation. Thus, the ability to predict the performance of the dam, even with an ADAS, is limited to the information provided by instrumentation. As previously discussed, instruments only provide points of information for a dam. Many dam failures may not have been preventable even with an ADAS. At the same time, an ADAS can serve as a temporary risk reduction measure by permitting virtually continuous monitoring of a developing seepage-related incident. Data collected from an ADAS can also be easily interfaced with Web-based applications to make "live" monitoring data more widely available through the Internet.

7.2.2.4 Early Detection and Warning

An ADAS can also be tied to early warning systems for public notification. Automated monitoring systems need to be designed so that they measure parameters that can clearly provide adequate warning. For example, functional relationships (reservoir surface elevation, discharge and precipitation versus inflow) are means to extrapolate rates of change in reservoir pool level. Other applications, such as tail water level monitors that are sometimes used for early warning, will often not provide adequate advance warning to the population at risk (e.g., the alarm would come too late). By contrast, piezometers in the downstream shell of a dam may, in the right situation, provide a sensitive measure of changing conditions (FEMA 2000). Caution is needed while designing such systems to eliminate false alarms.

7.2.3 Seepage Collection

Seepage collection systems should be designed to facilitate seepage and sediment collection and measurement at each dam site. All appreciable seepage quantities should be collected for measurement whether the seepage emanates from inside the dam gallery, through any filter or drain outlet, on a downstream slope, or from any other location at the dam site. Choosing where to collect and measure seepage depends on the dam type, foundation conditions, and local seepage conditions.

Seepage flows may emerge at unexpected locations where no measurement equipment is present. For example, springs or boils may form at a downstream location. In such cases, the flow should be controlled so that appropriate measurements can be made (e.g., spring flow can be collected into a ditch and routed to a weir for measurement).

7.2.3.1 Ditches and Channels

Channels or ditches are the simplest approach to collecting seepage and diverting it to a measurement point. It should be noted that excavating ditches downstream from a dam can increase the chance of failure of the dam by increasing the gradient beneath it. Ditches should only be excavated after careful evaluation by a qualified engineer. To avoid this potential hazard, properly filtered drains should be used for seepage collection instead of ditches wherever possible.

Figure 7-2 illustrates a collection ditch designed to divert water into a simple flow control structure that enables measurement of the seepage flow rate using a bucket and stopwatch.

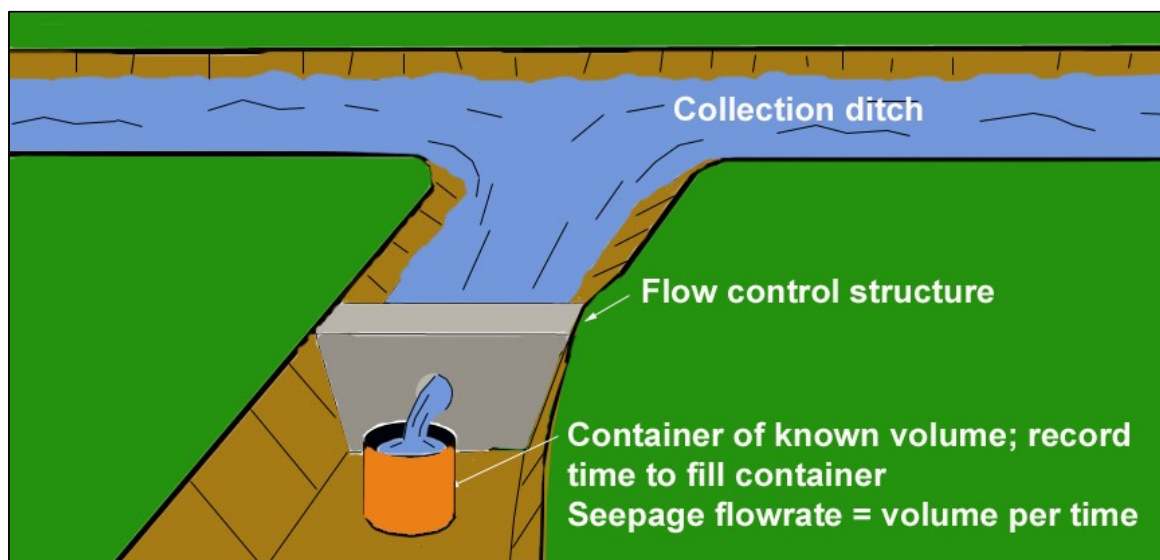

Figure 7-2.—Simple seepage flow rate measurement illustration.

Seepage collection ditches should be designed with adequate grade to provide enough elevation head for the measurement weirs or flumes to operate properly. Similarly, pipe outlets from drains or wells should be raised off the ground sufficiently to allow room for a calibrated catch container to capture all the flow. However, surface water runoff may influence flow measurements unless flow is directed away from the ditch. Additionally, sediment traps are not practical in this application.

Ditches should be designed so they are easily monitored by visual observation. In addition to being readily accessible, they also should enable visual detection of sediments in the seepage effluent. One method is to paint the conveyance channel (e.g., exposed concrete) a color that

contrasts with the color of the sediment. The contrasting color allows easier visual observation of sediment particles suspended in the effluent stream. If the flow rate is high enough to flush sediments through the system, then an additional settling area should be installed.

7.2.3.2 Drains

Drains are a design feature constructed specifically for seepage control and collection, so they typically are an integral part of the embankment structure. Drain systems may also be added after the embankment is constructed to control the seepage and reduce the likelihood of internal erosion or piping. All drainage systems should be monitored for seepage flow rate, quantity, and water quality attributes. This goal serves the dual purposes of checking for adequate drainage performance (by comparing actual to expected attributes) and detecting potential seepage problems. Figure 7-3 illustrates an elaborate layout of filter and drain elements integrated in the downstream slope and located at strategic points for intercepting and controlling seepage flow.

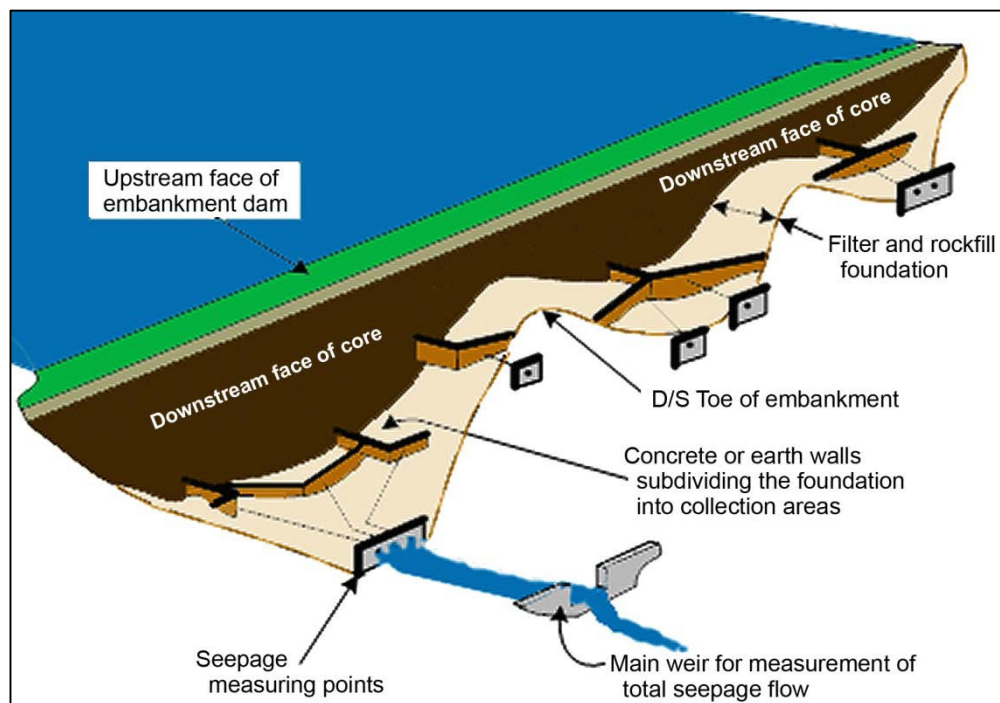

Figure 7-3.—Illustrative seepage collection and measurement system installed on the foundation surface under the downstream shell of an embankment dam (after ANCOLD, 1983).

7.2.3.2.1 Blanket Drains

Blanket drains are designed embankment dam features that provide for controlling the seepage flow path in pervious material while containing (filtering) excessive soil particle movement in the seepage flow path. Blanket drain design and construction guidelines are listed in other

published documents (FEMA 2011).¹ If seepage collection pipes are designed within the internal blanket drains, it must be recognized that the collection pipes may collapse, become plugged with soil materials or roots, or be damaged by site investigation drilling. Any such detrimental impacts to the seepage collection system will affect the seepage monitoring effort and may eventually affect dam safety. Figure 7-4 illustrates a simple blanket drain layout for intercepting seepage in a homogeneous fill over an impervious foundation.

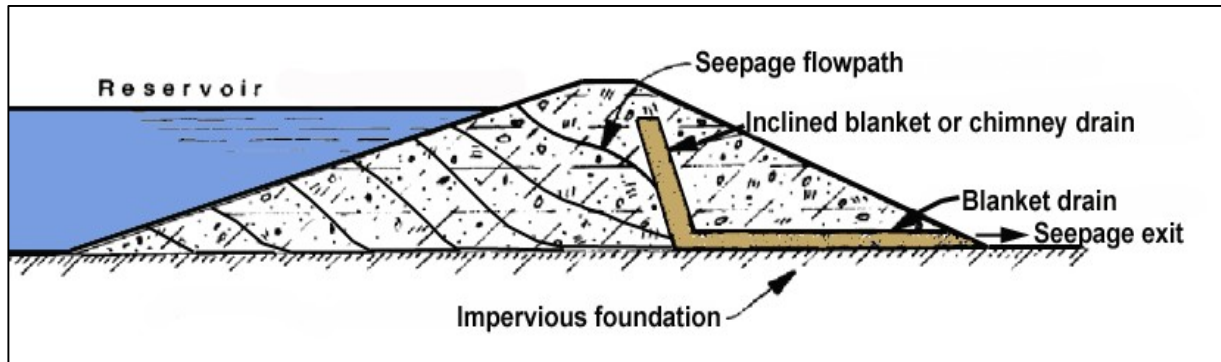

Figure 7-4.—Chimney and blanket drain inside a homogeneous-fill dam on an impervious foundation.

7.2.3.2.2 Toe Drains

Figure 7-5 illustrates a typical toe drain design detail that ties the blanket drain into the seepage collection system.

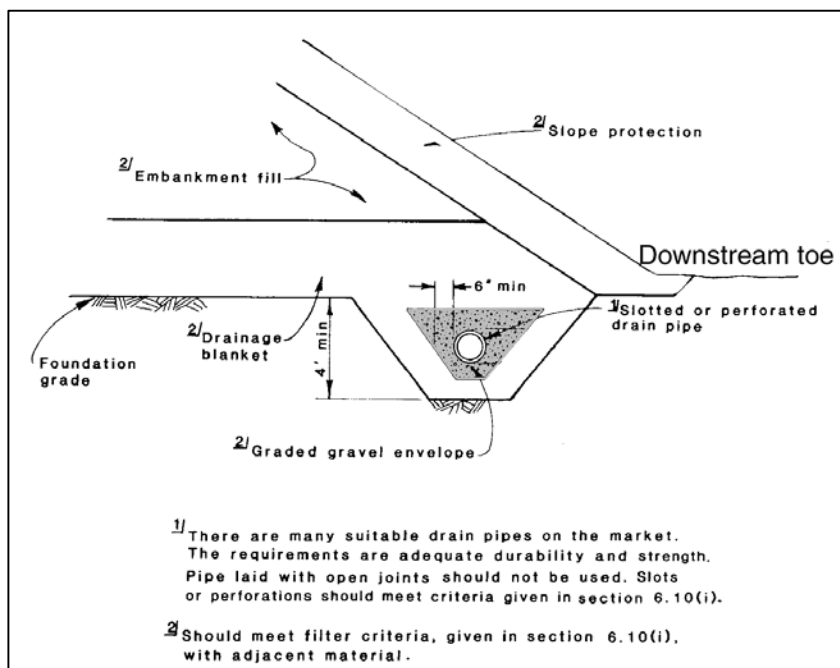

Figure 7-5.—Typical toe drain detail (adapted from the Bureau of Reclamation [1990]; footnotes refer to the source document.)

¹ See chapter 10 for further discussion of blanket drains.

Modern best practice for the design of toe drains in embankment dams includes access for inspection and maintenance in order to ensure the drain system is functioning as intended. Inspection is typically achieved with video cameras, and maintenance can be performed by cleaning with jetting tools. In addition to inspection and maintenance, access to drain systems is also used to measure flow and trap sediment in the interest of monitoring performance over time. Sediment traps are used to detect whether or not soil is moving into the drain. When sediment-laden flow enters the trap, the flow velocity reduces, allowing the sediment to drop out of the flow. Flow measurements are used to discern whether the seepage performance of the dam is changing with time for a given reservoir elevation. These measurements should be taken and recorded on a regular basis, especially after cleaning to ensure that no damage occurred, as part of the dam monitoring program. Comparing data for equivalent loading (reservoir level) and load path (rising or falling reservoir) will indicate whether or not the performance is constant through time.

Access to toe drain systems can be separated into two categories: inspection wells and clean outs. Inspection wells (figures 7-6a and -6b) provide entry by personnel, contain flow measurement instrumentation, and allow inspection at the junction of several drains. Cleanouts provide indirect access to the toe drain system by remote video and jetting equipment and are much less expensive to construct than inspection wells. Figure 7-7 illustrates cleanout access features.

Comprehensive details regarding drains, drainage filters, and pipes are available in various technical publications. For example, FEMA 484 (FEMA 2005), FEMA P-675 (FEMA 2007), and FEMA (2011) technical manuals provide detailed information and guidance for embankment dam drains, filters, and seepage water conveyance conduits. McCook and Pabst (2006) and Pabst (2007a, 2007b) provide detailed guidance on drainage pipe selection, design, and installation aspects. The reader is strongly encouraged to obtain detailed guidance from those and other related documents freely available for download on the Internet (e.g., <http://www.damsafety.org> and <http://www.fema.gov>).

The use of geotextiles in seepage collection drains varies widely among dam owners and operators. As a general rule, geotextiles are not recommended for inaccessible locations that are critical to dam safety, primarily because of concerns over clogging. Geotextiles placed in safety-critical yet accessible locations must be accessible, repairable, or replaceable in an appropriate length of time before dam safety becomes a critical issue. These criteria may change in the future as long-term in-situ geotextile performance data are accepted (FEMA 2000). Other countries (China, France, and Germany) are utilizing geotextiles where they are inaccessible but not safety critical.

7.2.3.3 Wells

7.2.3.3.1 Observation Wells

Observation wells are typically vertical pipes with a slotted section at the bottom or a tube with a porous filter tip at the bottom as illustrated on figure 7-8. They are usually installed in boreholes with a seal at the ground surface to prevent surface water from entering the borehole.

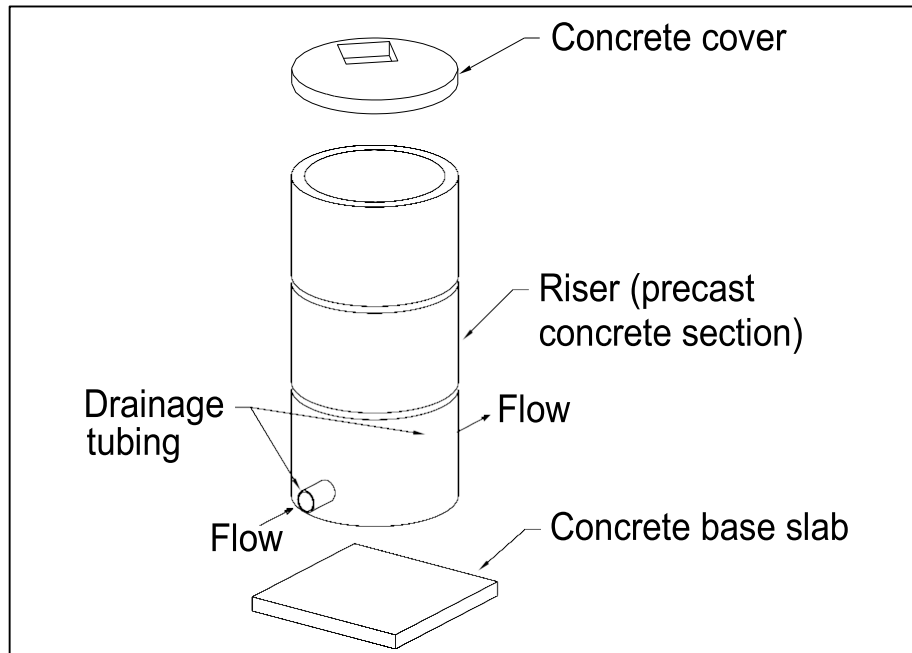

Figure 7-6a.—Isometric view of toe drain inspection well basic components (Pabst 2007b).

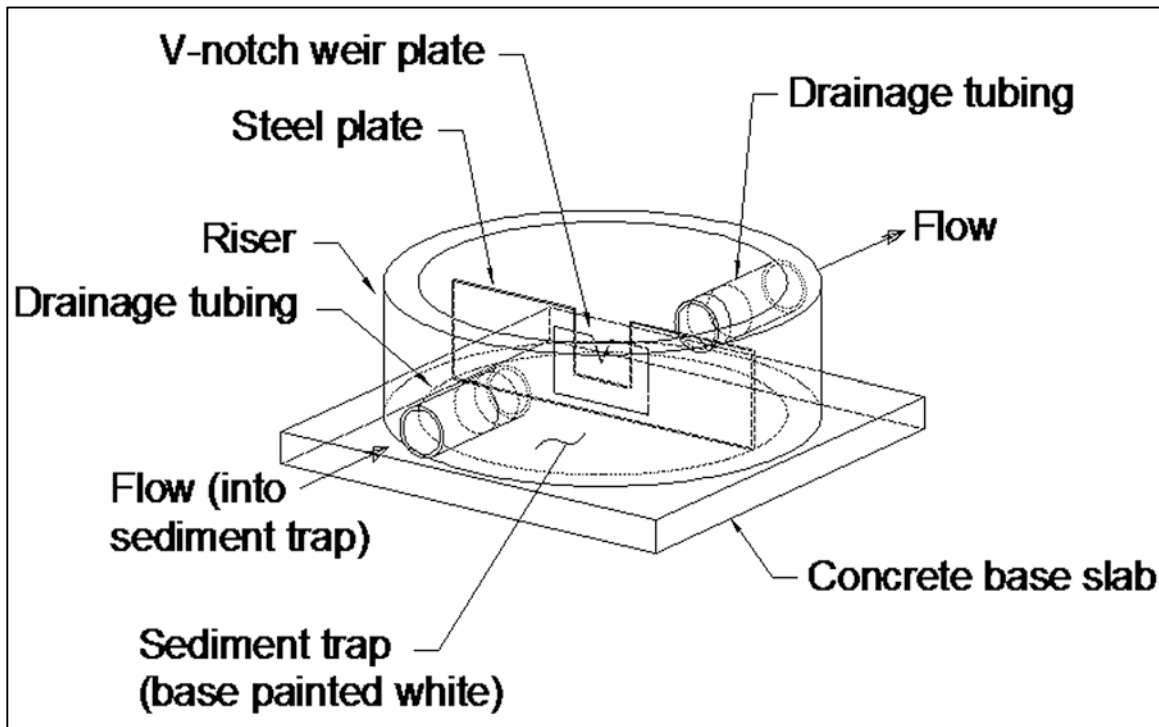

Figure 7-6b.—Closer view of components in the bottom of a typical toe drain inspection well. Optional baffle at the end of the inlet pipe is not shown. In order for the weir to function properly, a head drop distance across the weir no less than one pipe diameter of the largest pipe penetrating the well is required (Pabst 2007b).

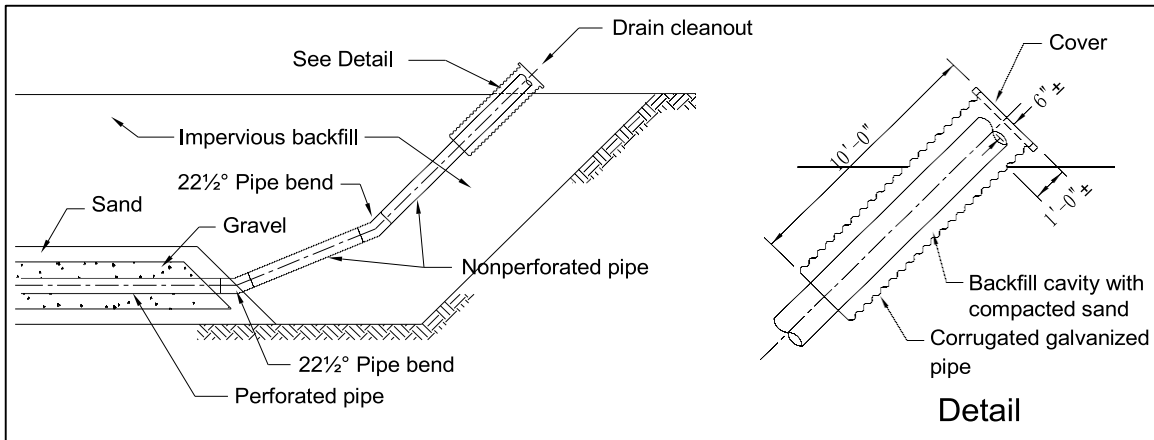

Figure 7-7.—Toe drain cleanout access features (not to scale) (Pabst 2007b).

The depth to the water level is measured by lowering a weighted tape or an electronic probe into the pipe or they can be instrumented by putting a pressure transducer in the hole. Observation wells can also be used to sample groundwater for water quality testing.

Observation well screens or tips are appropriate only in a uniform, pervious layer such as sandy material. In a stratified material, an uncased borehole or observation well pipe may allow a vertical hydraulic connection between strata. As a result, the water level in the well may

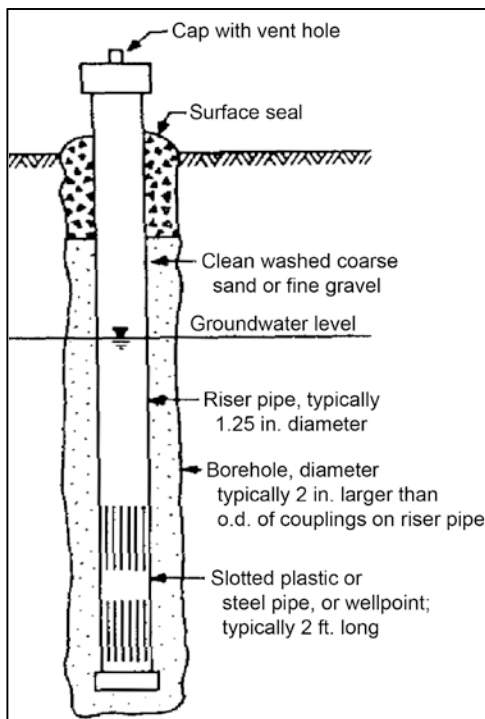

Figure 7-8.—Observation well (USACE 1995).

result from a combination of the water pressure and permeability in all strata intersected by the borehole or well pipe. Thus, observation well data may not accurately measure the actual water pressures within key areas of the dam, foundation, or abutment strata.

Unlike the observation well, which shows an overall height of water from multiple layers, a piezometer indicates the water pressure in the particular layer in which the piezometer screen or sensor is located. Piezometers are also better to use for water samples, as there is no confusion about which strata the water originated from. The components of open standpipe observation wells are identical in principle to components of open standpipe piezometers if there are subsurface seals to isolate the subsurface zone of interest. Water elevation in the isolated zone(s) may be determined by sounding with a water level indicator such as a manual water level gage, a pressure transducer placed in the standpipe below the lowest piezometric level, or with a sonic transducer.²

² See section 7.2.4.3 for a detailed discussion of piezometers.

7.2.3.3.2 Relief Wells

Relief wells also function as observation wells, but their primary purpose is to reduce the hydraulic head at selected locations along the seepage flow path.³ Figure 7-9 shows a relief well discharge where the seepage water could be collected if necessary.

Relief wells for dams have specific problems associated with the plugging of the filter packs or the accumulation of bacteria or carbonates (USACE 1995). It is often necessary to install piezometers adjacent to relief wells to measure and monitor the pressure increases associated with clogged wells. Relief wells typically require regular maintenance for long-term proper functioning, including re-development, chemical treatments, and disinfection.



Figure 7-9.—Relief well seepage outflow. Although relief wells are not typically installed for the primary purpose of seepage water monitoring, their outflow can be collected, measured, and evaluated similar to open piezometers or observation wells.

7.2.4 Seepage Measuring Devices

Three kinds of seepage measurements are typically made: (1) water level, (2) flow rate, and (3) pressure. The devices used for each of these measurements are discussed in the following sections.

It is important to monitor the water level in the reservoir and the downstream channel or pool regularly to determine the quantity of water in the reservoir and its level relative to the regular outlet works and the emergency spillway. The water level is also used to compute water pressure and pore pressure; the amount of seepage is usually directly related to the reservoir level. It is also important to establish the normal or typical flow through the outlet works so that any effect from reservoir operations to piezometric readings, especially in the area of the spillway or outlet works, is properly evaluated.

The most commonly used types of seepage measuring systems are weirs, flumes, and calibrated catch containers. Other devices include in-line flow meters, velocity or current meters, pitot tube velocity meters, and pressure transducers to measure water levels. A comprehensive reference on commonly used water measurement devices is Reclamation's *Water Measurement Manual* (Reclamation 2001). This manual is geared primarily toward measurement of irrigation flows, which are generally much larger than seepage flows. Some measuring devices,

³ See chapter 10 for further discussion of relief wells.

particularly weirs, are more conducive to collecting sediment. Details of the installation, operation, and maintenance of water measurement methods and devices are also described in the following publications (included in the references):

- (1) *Embankment Dam Instrumentation Manual*, Bureau of Reclamation, Government Printing Office, February 1987.
- (2) *Guidelines for Instrumentation and Measurements for Monitoring Dam Performance*, American Society of Civil Engineers, September 2000.
- (3) *Instrumentation of Embankment Dams and Levees*, EM 1110-2-1908, U.S. Army Corps of Engineers, June 1995.

7.2.4.1 Water Level – Staff Gages, Pressure Transducers, Manometers, Chart Recorders

The difference in total head between the reservoir and outlet channel (tail water) surfaces provides the potential energy driving seepage development. These water levels should be

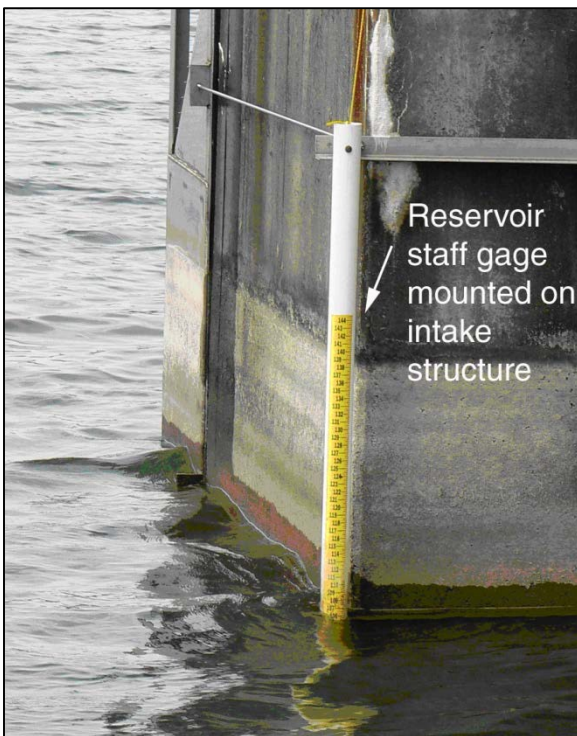

Figure 7-10.—Staff gage indicates reservoir water level (elevation).

measured and evaluated with the corresponding seepage measurement data. Water levels may be measured by simple elevation gages (either staff gages or numbers painted on permanent, fixed structures in the reservoir, as illustrated on figure 7-10), or by electronic water level sensing devices. Staff gages are the simplest method for measuring reservoir and tail water levels, as they are generally reliable and durable. The stage data is collected by visual inspection and recording. There are also numerous chart recorders, encoders, manometers, and pressure transducers commercially available, and their selection should be based on the specific site conditions and data recording requirements.

For automated water level monitoring, a float and recorder, ultrasonic sensor, bubbler, or other instrumentation is necessary. Sediment deposition can change the water level device calibration and cause inaccurate measurements. Water level devices subjected to sedimentation should be periodically re-calibrated (FERC 2006).

7.2.4.2 Seepage Flow Rate

7.2.4.2.1 Weirs

Weirs fall into two general categories: sharp-crested and broad-crested. Sharp-crested weirs measure lower flows more accurately than broad-crested weirs and are preferred for measurement of seepage flows. The most commonly used weirs for seepage measurement are the V-notch weir, the rectangular weir, and the trapezoidal (Cipolletti) weir (Reclamation 2001), with the V-notch being the most widely used. Figure 7-11 illustrates these weir types.

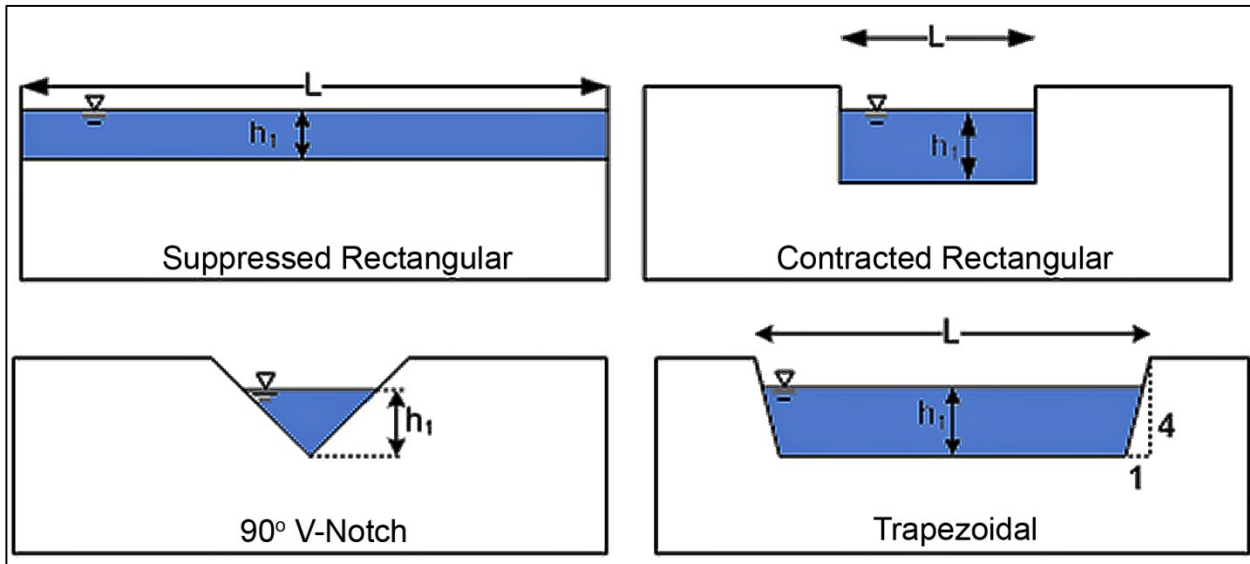

Figure 7-11.—Weir types.

The V-notch weir is well suited for measuring small flows typically encountered in seepage monitoring on dams. The notch angle can range from about 20 to 100 degrees. The narrower notch angles allow for the accurate measurement of lower flow rates. The Kindsvater-Shen equation (Reclamation 2001) for fully contracted V-notch weirs of any angle between 25 and 100 degrees is:

$$Q = 4.28 C_e \tan(\theta/2) h_{1e}^{2.5}$$

where:

- Q = Discharge over weir in cubic feet per second (ft³/s)
- C_e = Effective discharge coefficient, which is a function of θ
- h₁ = Head on weir in feet
- h_{1e} = h₁ + k_h
- k_h = Head correction factor, which is a function of θ
- θ = Angle of V-notch

The simpler Cone equation (Reclamation 2001) is commonly used for the 90-degree V-notch weir:

$$Q = 2.49 h_1^{2.48}$$

where:

Q = Discharge over weir in ft³/s
 h₁ = Head on weir in feet

Similar discharge equations are often available from specific weir manufacturers based on their own calibration and testing.

The minimum flow rate that can be accurately measured with a V-notch weir is about 4 gallons per minute (gpm). For comparison, the minimum flow rate for the smallest (i.e., 6-inch wide) rectangular or Cipolletti weir is about 70 gpm. For flow rates less than 4 gpm, a calibrated catch container (see section 7.2.4.2.3) should be used to permit more accurate measurement. The head on the upstream side of the weir should be measured outside of the weir's drawdown zone. Furthermore, the water surface downstream from the weir must be at least 0.2 foot below the bottom of the notch to ensure that the nappe springs free of the weir plate. Therefore, the designer of the weir installation must carefully consider the amount of available head, as well as tail water conditions, so that the weir will function properly at the desired flow rate.

Many types and sizes of V-notch weirs are available commercially, including pre-manufactured assemblies with built-in stilling boxes. Weirs are readily automated by installing vented pressure transducers to accurately measure water levels. The transducer data may be input into a data logger for manual retrieval, or in more complex systems, the data may be transmitted to a distant location. Figure 7-12 illustrates such a system.

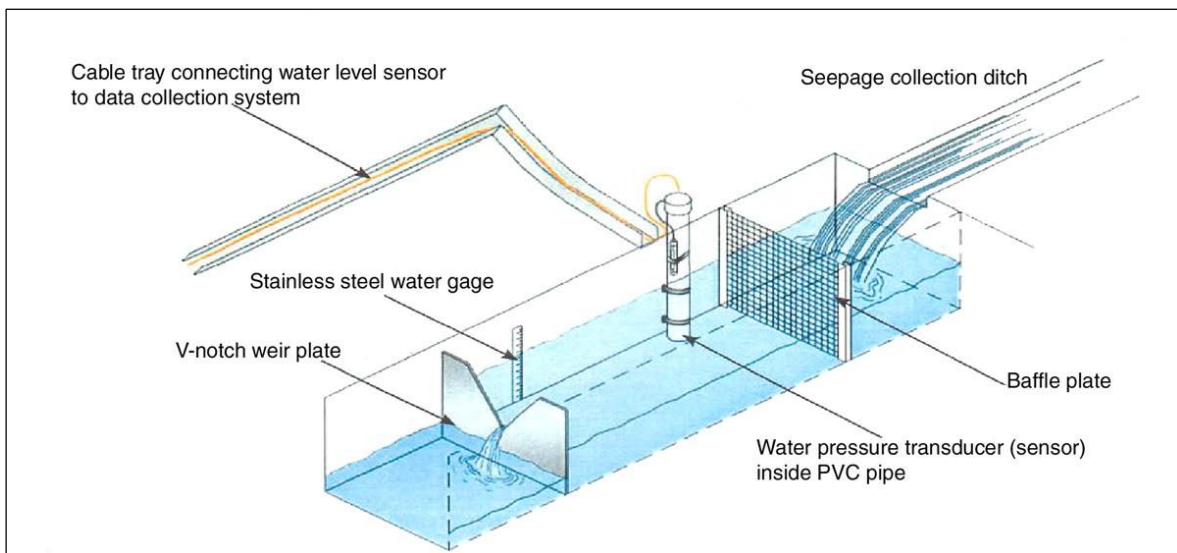

Figure 7-12.—Automated V-notch weir system (after Soil Instruments, Ltd.)

7.2.4.2.2 Flumes

Flumes are specially shaped open channel flow sections that cause the flow to accelerate and, under proper circumstances, pass through critical depth. For flow in this condition, an accurate relationship between the upstream (and sometimes downstream) stage of the water and the discharge through the flume exists. Flumes are classified as either long- or short-throated.

Flumes are typically used for higher flow rates than weirs. One reason for this is that flumes require substantially less head to operate than weirs of equal width. Another advantage of flumes is that they can operate with a relatively high degree of submergence, in contrast to weirs. Therefore, when relatively large seepage flows must be measured, or for flatter channels, flumes are preferred over weirs. Small flumes are also capable of measuring extremely low flows. At the low end of the range, for example, the discharge from a 1-inch throat width Parshall flume with a head of 0.05 foot is about 1.3 gpm (United States Department of Agriculture [USDA]-Natural Resources Conservation Service [NRCS] 1973). No practical upper limit exists for flume discharge. Flumes tend to be self-flushing and are therefore not effective at trapping sediment.

A commonly used flume for water measurement is the Parshall flume (figure 7-13). Other types of flumes include the H-flume, ramp flume, and cutthroat flume (Reclamation 2001). Long-throated flumes have several significant advantages over short-throated flumes, including: greater accuracy, simpler construction, and greater tolerance of submergence. Each type of flume typically has a rating table developed for it, which relates discharge to upstream head and degree of submergence.

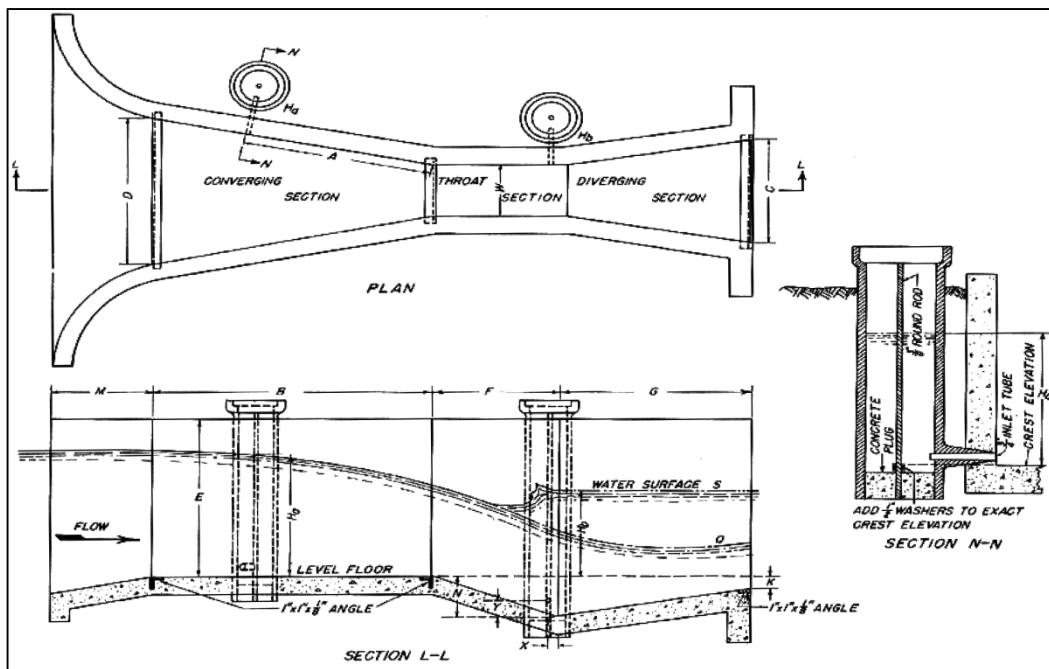

Figure 7-13.—Plan and elevation views of a concrete (cast-in-place) Parshall flume. (Courtesy of USDA-NRCS).

7.2.4.2.3 Calibrated Catch Containers

Calibrated containers are reliable for low flows and are inexpensive, but they have limited application because they require a free-falling flow; they are not accurate for large flows; and they are labor intensive. The use of calibrated catch containers to monitor flow involves measuring the time it takes to catch and fill a container of known volume with flowing water. The volume caught divided by the elapsed time equals the flow rate. This method is often referred to as the “bucket-and-stopwatch” method. Calibrated catch containers are particularly useful for measuring low flows, and extremely low flow rates can be measured accurately. The maximum flow rate is limited by the size of the container that can be maneuvered quickly into and out of the flow or into which flow can readily be diverted. Calibrated containers are generally appropriate for flows less than about 0.003 cubic meter per second (50 gpm) (FERC 2006).

The water must have a free discharge with sufficient vertical clearance that the catch container may be placed under the jet and capture all of it with no splash or spillage. Containers may range in size from 1 pint (or smaller) up to 5 gallons. Containers above 5 gallons in capacity become too heavy to handle easily. Flow rates above about 50 gpm cannot be accurately measured by this method due to relatively large errors involved with measuring short time intervals and to the tendency of the water jet to splash from the container as it approaches being full. Tipping-bucket rain gages may be useful for automating the measurement of small, free discharges.

7.2.4.2.4 Flow Meters

Flow meters are used when the flow is inside a closed pipe. Numerous types and sizes of flow meters are commercially available. The anticipated flow rate and pressure at the meter location should be matched to the recommended operating range for flow rate and pressure specified by the manufacturer for the meter selected. Propeller- and turbine-type flow meters perform well, but can be prone to clogging with sediment.

7.2.4.2.5 Velocity (Current) Meters

Velocity meters are used to measure flow rate in unengaged open channels of essentially any size and shape, and are more accurate for larger flows (i.e., where the size of the meter is small relative to the size of the channel cross section). Several types of velocity meters are commercially available. These devices are used to measure the velocity of flow at various points in the cross section in order to compute the total flow rate by the continuity equation:

$$Q = A_{\text{total}} \times V_{\text{avg}} = \Sigma (A_i \times V_i)$$

where:

- Q = Discharge
- A_{total} = Total area of flow
- V_{avg} = Average velocity of flow
- A_i = Incremental area of flow
- V_i = Average velocity of flow for incremental area, A_i

Detailed information on the use of velocity meters is presented by Reclamation (2001) or is available from the manufacturers of the various meters. Figure 7-14 shows a cup-type velocity meter.

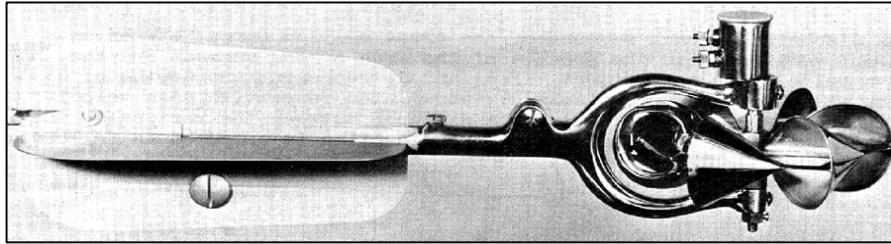

Figure 7-14.—Cup-type velocity meter. (Photo courtesy of USDA-NRCS).

7.2.4.3 Pressure - Piezometers

As water moves through pores in the soil, rock, or concrete as well as through cracks, joints, and fissures, head loss occurs and the pressure of the water at a given location acts uniformly in all planes and is called pore water pressure. The upward force (called uplift pressure) has the effect of reducing the effective weight of the dam and can reduce dam stability. Pore water pressure in an embankment dam, foundation, or abutment reduces the soil shear strength and may contribute to internal erosion that could even progress to failure. Pore water pressure is generally a function of the water level in the reservoir and can be monitored with piezometers.

Commonly used types of piezometers include: open standpipe, hydraulic, pneumatic, and vibrating wire. The selection of which type to use is made based on intended use, cost, and availability. A qualified dam safety professional should be consulted to evaluate the requirements, select the type, and supervise the installation of piezometers.

Because the sensing zone of a piezometer is smaller than that of an observation well, it has the ability to measure smaller changes in the water level and has a more rapid response to changes of water pressure in the embankment. Piezometers can be installed in the embankment or foundation at any elevation, but are not advisable for the dam core. For a detailed discussion of advantages and disadvantages of the various types of piezometers, the reader is referred to Dunicliff (1993).

7.2.4.3.1 Open Standpipe Piezometers

Open standpipe piezometers are the most commonly used type of instrument in large embankment dams. The components of open standpipe piezometers (illustrated on figure 7-15) are identical in principle to observation well components, with the addition of subsurface seals that isolate the zone of interest. Readings can be made by sounding with a water level indicator or by placing a pressure transducer in the standpipe below the lowest piezometric level.

Open standpipe piezometers are typically made of polyvinyl chloride (PVC) Schedule 40 pipe with 3-inch outside diameter and 0.010-inch slotted screen width. The smaller the pipe diameter, the quicker the piezometer can respond to changes in pore pressure. The screen length varies based on the size of the subsurface zone of interest. The annular space around the screen is filled with clean quartz filter sand (usually passing between sieve size numbers 20 through 40).

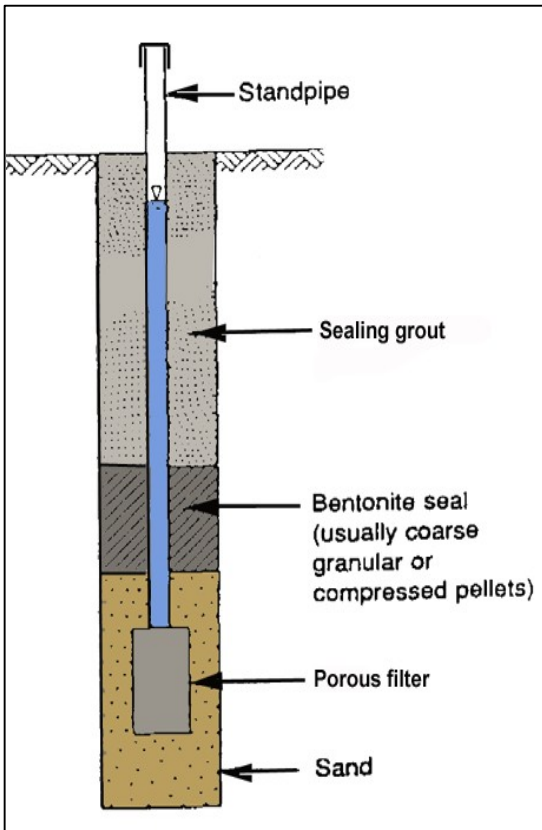

Figure 7-15.—Open system piezometer installed in a borehole (after USACE [1995]). A slotted well screen as shown on figure 7-8 is often used instead of the porous filter as illustrated here.

Bentonite pellets fill the annular space above the sand filter, and cement grout fills the annular space above the bentonite seal, extending to the ground surface. Alternatively, the annular space can be backfilled with bentonite pellets to the ground surface. The exposed PVC pipe is usually protected by steel casing with a hinged locking cap. A flush-mount casing and protective cap are required for roadways. The American Society for Testing and Materials and various States also have standards for construction of monitoring wells.

Some *advantages* of a standpipe piezometer system are:

- (1) Simplicity of design with no mechanical or electrical components.
- (2) They can be installed in deep boreholes with conventional sand and bentonite borehole sealing or may be direct-pushed in shallow depths.
- (3) A groundwater sample may be retrieved. This advantage is unique to open-system piezometers.
- (4) They have the potential for longer life than other types of piezometers.

Some *disadvantages* are:

- (1) Since their response to water head variations is comparatively slow, they are generally beneficial for obtaining long-term readings in high permeability strata (greater than approximately 10^{-4} cm/s) or in places where the relative response time is considered adequate and it is desired to install an instrument with a longer life than another type of piezometer.
- (2) Water level readings are useful only in near-vertical down hole installations; other inclinations are feasible using a Bourdon gage readout, provided there is sufficient pressure to raise the water up to the gage.

- (3) They are susceptible to damage from, or may interfere with, construction, maintenance, recreation, and other operations.
- (4) They may be exposed to freezing temperatures.

7.2.4.3.2 Hydraulic Piezometers

Unlike the observation well or open standpipe that directly indicate the water height above the screened interval or porous filter, a closed system, or hydraulic piezometer indicates the water pressure exerted on a sensor or transducer. The closed piezometer system measures the water pressure entering the porous filter stone. The pressure is transmitted through water-filled tubes leading from each piezometer to the terminal well at the downstream toe of the embankment. The pressure is read on pressure gages located in the terminal well. Several installation options are available with closed-system piezometers.

Conventional borehole sealing isolates the sensor (illustrated on figure 7-16), the borehole may be fully grouted using a bentonite-cement mix (depending on the sensor manufacturer's instructions), or the sensor may be direct-pushed to the desired depth (again depending on the sensor manufacturer's instructions).

Some *advantages* of a hydraulic piezometer system are:

- (1) They are simple devices for remotely measuring positive or negative pore pressures.
- (2) They are reliable and accurate in long-term use.
- (3) They have fast response to pressure changes.
- (4) No electronic components ensures long-term reliability.

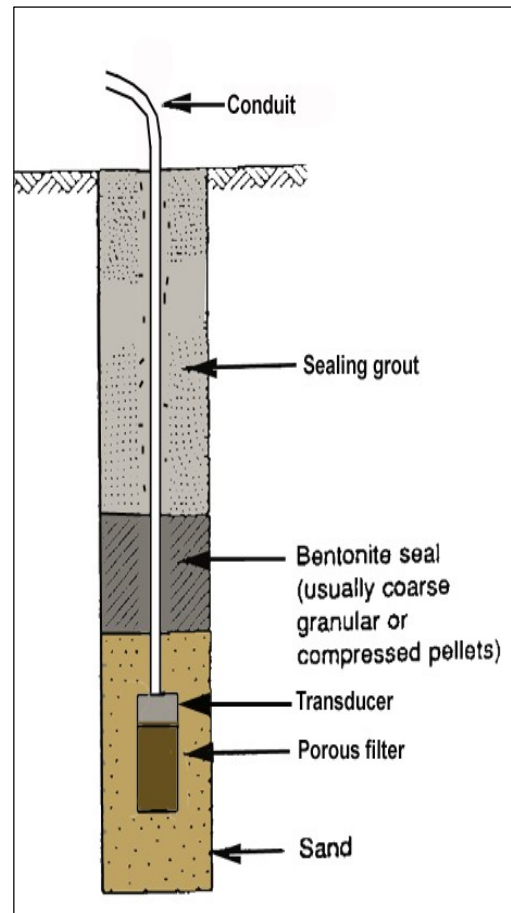

Figure 7-16.—Closed-system piezometer installed in a borehole using conventional borehole sealing components.

Some *disadvantages* are:

- (1) Tube flushing may be required to remove sediment or mineral deposits in the piezometer liquid.
- (2) The water in the tubes may be exposed to freezing and be damaged.
- (3) The drainage of terminal wells needs to be maintained below frost depth.
- (4) Trenches may create transverse seepage paths through core or abutments.
- (5) Tubes may deteriorate with time.
- (6) High maintenance requirements for the gages.

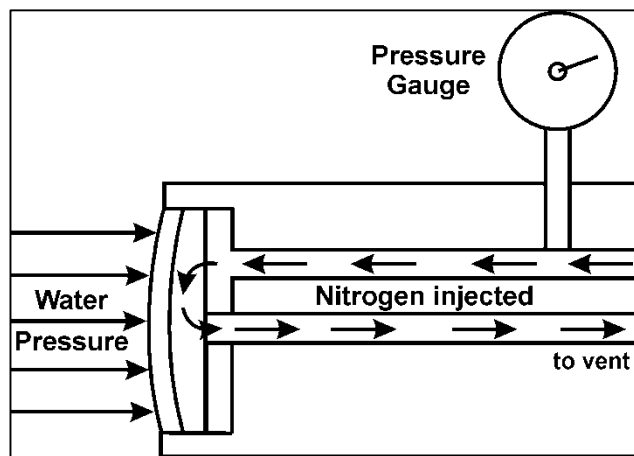

Figure 7-17.—Pneumatic piezometer pressurized with nitrogen gas. The gage measures differential pressure (after ASCE [2000]).

7.2.4.3.3 Pneumatic Piezometers

Pneumatic piezometers (illustrated on figure 7-17) utilize the principle of differential gas pressure. A filter is added to separate the flexible diaphragm from the material in which the piezometer is to be installed.

The sensor consists of a porous filter element integral to a diaphragm-type pressure transducer. Water pressure acts on one side of the diaphragm and gas pressure acts on the other. Compressed nitrogen gas from the indicator flows down the input tube to increase gas pressure on the diaphragm. When gas pressure exceeds water pressure, the diaphragm is forced away from the vent

tube, allowing excess gas to escape via the vent tube. When the return flow of gas is detected at the surface, the gas supply is shut off. Gas pressure in the piezometer decreases until water pressure forces the diaphragm to its original position, preventing further escape of gas through the vent tube. When gas pressure equals water pressure, the pneumatic indicator shows the pressure gage reading. A twin tube connects the transducer to the pneumatic terminals of a data logger or readout panel.

Some *advantages* are:

- (1) Pneumatic piezometers are small, accurate, and reliably designed with a track record over 30 years of use.
- (2) The diaphragm senses very small volume changes, therefore ensuring a fast response.

- (3) The elevation of the tubing in relation to the readout panel is not critical. Newer tubing is strong and flexible and can be installed in lengths up to 500 meters.
- (4) They can be installed horizontally or vertically.

Some *disadvantages* are:

- (1) High cost.
- (2) Limitation on distance between tip and readout unit.
- (3) Installation oversight for prevention of kinked tubing.
- (4) Trenches may create transverse seepage paths through core or abutments.
- (5) More training and skill needed on the part of the person taking the readings.
- (6) More difficult (complex) to automate.
- (7) Some instances of poor reliability.

The piezometer may be suspended in a standpipe, placed in a borehole sealed in the traditional manner, placed in a borehole encapsulated in bentonite-cement grout, or direct-pushed similar to a cone penetrometer. Manufacturers' instructions typically mention the conventional borehole sealing manner (sand, bentonite, and grout), but at least one manufacturer indicates their pneumatic piezometers may be fully encapsulated in bentonite-cement grouted boreholes.

7.2.4.3.4 Vibrating Wire Piezometers

Vibrating wire piezometers (illustrated on figure 7-18) are based on the use of an electromagnetic current-inducting transducer that responds to pressure changes. Permanent embedded installation arrangements are similar to those of other piezometer installations. Special heavy-walled versions are available for installation in compacted fills, with a sturdy enclosure to ensure that the instrument responds only to changes in pore water pressure, and not to the total stresses acting on the housing.

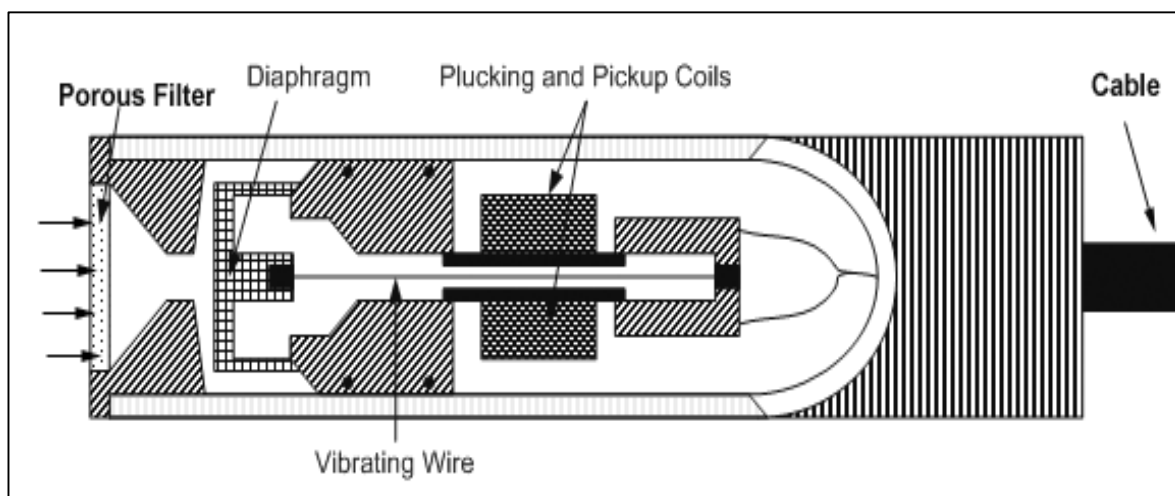

Figure 7-18.—Vibrating wire piezometer. (Courtesy of Geokon, Inc.).

The vibrating wire piezometer converts water pressure to a frequency signal via a diaphragm, a tensioned steel wire, and an electromagnetic coil. The piezometer is designed so that a change in pressure on the diaphragm causes a change in tension of the wire. When excited by the electromagnetic coil, the wire vibrates at its natural frequency. The vibration of the wire in the proximity of the coil generates a frequency signal that is transmitted to the readout device or data logger. The data logger and/or post-processing software processes the signal, applies calibration factors, and displays a reading in the desired engineering units.

Vibrating wire piezometers (sensors) are frequently used in long-term monitoring of embankment dams. They are often installed in open wells, open standpipe piezometers, in soft, shallow soils (generally less than 40 feet) using direct-push installation from a small-tracked or four-wheeled machine, or directly buried in the embankment. Direct-push/burial installations offer a potentially substantial cost savings from reduced installation time and material usage. Large embankment dams usually benefit from traditional open standpipe piezometers and wells, and smaller dams would benefit from the direct-push cost savings compared to traditional open well and standpipe piezometers. Two sensors are often installed for redundancy at each location while the equipment is onsite. There is a cost savings with direct-push installations in that no filter pack, riser pipe, or sealing grout are needed. However, once they are placed, the direct push sensors are not serviceable.

Some *advantages* of vibrating wire piezometers are:

- (1) They have high resolution and accuracy, typically providing a resolution of 0.025 percent of full scale. Some manufacturers' equipment contains automated calibration systems.
- (2) They are not adversely affected by wet conditions.
- (3) They offer rapid response to changes in pore water pressure whether they are grouted in, direct-pushed into cohesive soils, or embedded in a conventional sand filter zone.
- (4) The signal transmission is reliable over long distances with properly shielded cable.
- (5) Most include a temperature sensor.
- (6) They are compatible with most automated data collection systems.

Some *disadvantages* are:

- (1) High cost if long runs of cable are required.
- (2) Experienced installation oversight required for proper installation and commissioning.
- (3) Trenches may create transverse seepage paths through core or abutments.
- (4) Calibration, data logging, and equipment issues (long-term maintenance and reliability concerns).

- (5) Can be damaged by lightning.
- (6) Service life is limited and instruments cannot be easily replaced unless installed in a standpipe.

7.2.4.3.5 Piezometer Filters

Piezometer filters are vitally important components that require special considerations for installation, and their selection depends on the intended purpose and location of the piezometer. The primary purpose of piezometer filters is to prevent soil from impacting or conveying high stress to the piezometer diaphragm while allowing pore water to pass freely through to the diaphragm.

Low air entry filters easily allow passage of both air and water and are useful for installations in either saturated soil or unsaturated soil that is not extremely low in permeability. These coarse-grained filter elements are also selected for open standpipe piezometers installed in unsaturated soils.

High air entry filters are useful on piezometers installed in unsaturated, very low permeability soil because their fine-grained elements define high water-air pressure differentials that serve to prevent air from entering the filter. Water saturation of high air entry filters requires a more controlled procedure, which includes removing the filter from the piezometer, placing the dry filter in a container, and applying a vacuum. The filter is then gradually saturated with de-aired water.

For very low permeability soils, especially when the pore water pressure effect upon shear strength is a concern, piezometer filters should be water saturated when installed in accordance with the specific manufacturers' literature. Filters can readily be saturated with water prior to installation by soaking in water to fully saturate the filter pores. If the piezometer filter does not remain saturated with seepage water, pneumatic and vibrating wire piezometers cannot be relied upon for monitoring long-term pore water pressures. For long-term piezometer installations, the filter saturation is uncertain because soil gas (air) may enter the filter. The pressure and time required to obtain saturation depend on the soil type, degree of compaction, and degree of initial saturation. Since the embankment fill may remain unsaturated for a prolonged period of time after the reservoir is filled, and may never become fully saturated, soil gas (air) may be entrapped in the filter. The presence of air in the filter effectively reduces the pore water pressure reading by the transducer. Pore air pressure may remain significantly higher than pore water pressure for a substantial length of time, thus adversely affecting the output of the transducer whose filter requires full water saturation for proper operation. In addition, the selected filter must not be damaged during installation and must be sturdy enough to resist deformation.

Twin-tube hydraulic piezometers allow for flushing of the filter and cavity with de-aired liquid, thereby ensuring that pore water pressure alone is measured. Unvented piezometers may require correction for barometric pressure if an accuracy greater than ± 1 foot is needed. Open standpipe piezometers are typically chosen for long-term reliable measurement of pore water pressure. For

short-term applications, the choice may include open standpipe, hydraulic, pneumatic, or vibrating wire piezometers. Economic considerations and measurement accuracy issues will help determine which type of piezometer is chosen.

7.2.4.3.6 Piezometer Installation Methods

There are generally four piezometer installation methods:

- (1) The ***embankment method*** is simply placing the sensor into the subsurface using the manufacturer's directions to orient the sensor in a horizontal or vertical position as the embankment is being constructed. This method does not apply to retrofit installations.
- (2) The ***sand filter method*** is used when the piezometer is installed in a pre-drilled borehole in which a sand filter is placed around the sensor positioned at the specified depth. A bentonite plug is placed on top of the sand filter, and the remainder of the borehole is then filled with a bentonite-cement grout. Figure 7-19a illustrates the conventional manner of installation in a borehole. Installations of multiple closed-system piezometers in the same borehole are more susceptible to hydraulic communication between levels than installations where each piezometer is set in its own borehole due to leakage through the seals and backfill between levels.
- (3) The ***grout-in method*** is used when the piezometer is installed in a pre-drilled borehole and the borehole is filled with a bentonite-cement grout after positioning the sensor down hole. This method is particularly useful when multi-point measurements are required in a single borehole. Figure 7-19b illustrates a multi-level sensor installation in a bottom-grouted borehole. Though the transducer is fully encased in grout, the permeability of the grout is high enough to allow the very small amount of water to pass through that is required for the transducer to sense the pressure change.

Borehole grouting mixtures to fully encapsulate piezometer sensors are listed by the piezometer manufacturers. They recommend mixing cement with the water before adding bentonite powder. A neat cement (Portland cement and water with no bentonite) is not recommended because of its higher permeability (about 1×10^{-3} centimeters per second [cm/s]). Cement-bentonite grout yields laboratory permeability values of about 5×10^{-8} cm/s. Bentonite-chip seals used in conventional installations have a laboratory permeability value of about 1×10^{-9} cm/s. The amount of bentonite is adjusted to produce a grout with the consistency of heavy cream. If the grout is too thin, the solids and the water will separate. If the grout is too thick, it will be difficult to pump (McKenna 1995).

- (4) The ***push-in method*** uses a direct-push installation similar to a cone penetrometer and is used in soft cohesive soil. The piezometer must be monitored during installation to ensure that it is not over-pressured as it is pushed in. Figure 7-19c illustrates a piezometer installed by direct-pushing into the subsurface. The push is terminated when the sensor reaches the zone of interest.

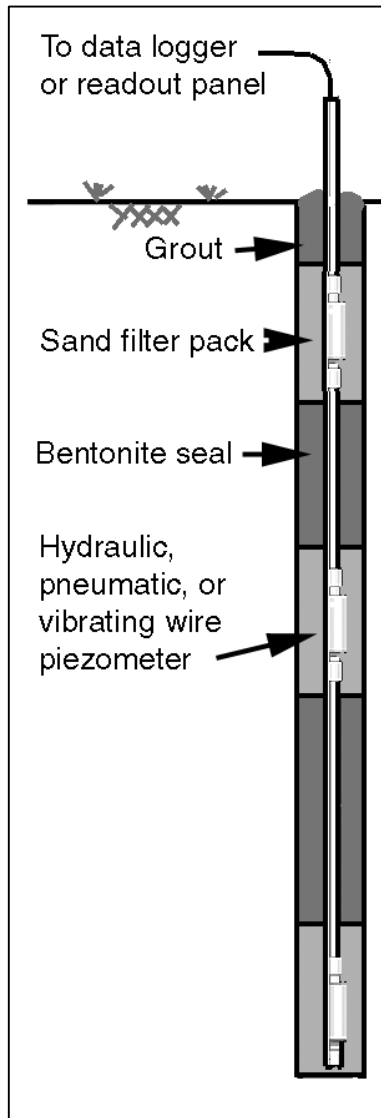

Figure 7-19a.—Illustration of a multi-level closed-system piezometer installed in the traditional manner. All piezometers can be installed using this method. Although the element dimensions are not scaled in this illustration, they are specifically provided in design and construction details.

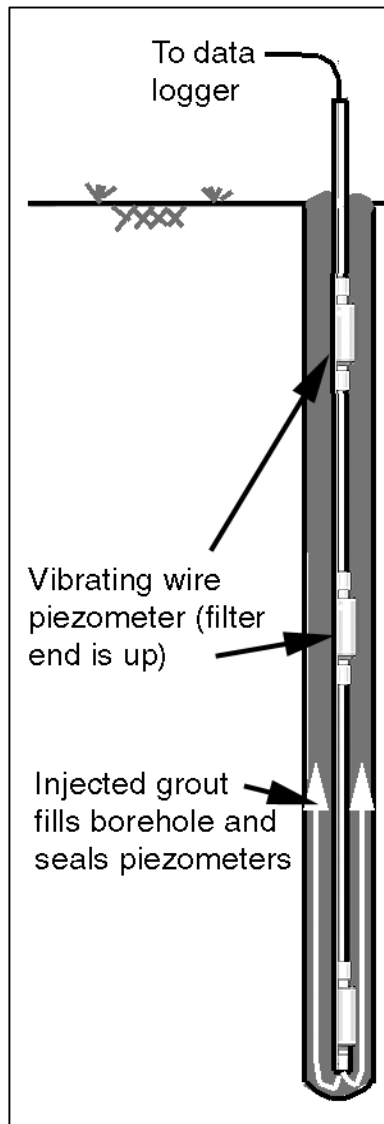

Figure 7-19b.—Illustration of a multi-level closed-system piezometer installed using the conventional method. All diaphragm-type piezometers can be installed using this method, but it is most commonly recommended by vibrating wire piezometer manufacturers. Although the element dimensions are not scaled in this illustration, they are specifically provided in design and construction details.

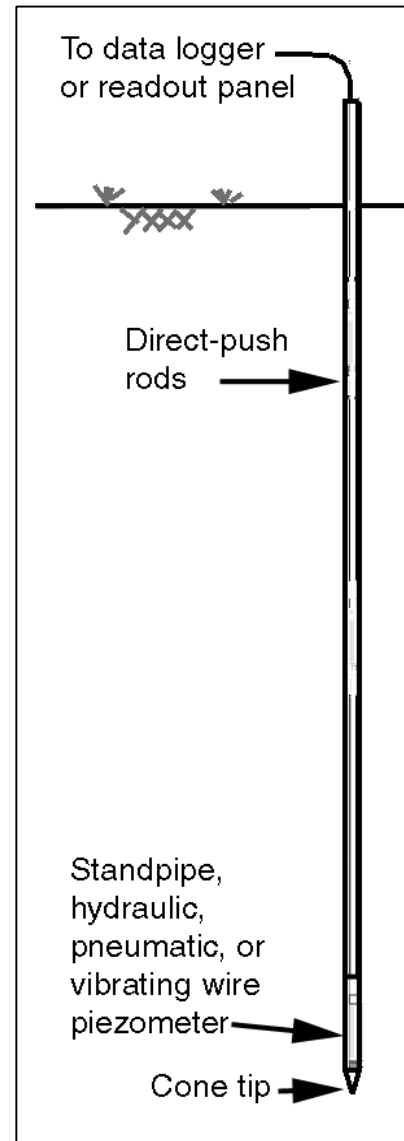

Figure 7-19c.—Single open- or closed-system piezometer installation using the direct-push method. Multi-level sensor installation is also possible with this method.

Multi-level piezometers are used to monitor pore-water pressure at different zones in the borehole. The piezometers are assembled in-line and installed down hole. Signal cables or tubing are routed to the surface through the placement pipe. The borehole is then sealed in the conventional manner or filled with a bentonite-cement grout, using the placement pipe or other method to deliver the grout. When the grout cures, each piezometer is isolated from the zones above and below it, but is responsive to changes in pore-water pressures at its own elevation, because the filtered tip is in direct contact with the soil.

Advantages of grouting the whole borehole instead of using the conventional sand filter method include:

- (1) Placing sensors at their intended depth may be difficult with the traditional method, and the difficulty increases with the number of sensors. With the multi-level system, piezometers are installed in-line with a placement pipe. The pipe controls the elevation and relative spacing of the piezometers.
- (2) Placement of sand filter zones and bentonite seals with the traditional method is time consuming and uncertain. The grout-in method entirely eliminates sand filters and bentonite seals.
- (3) Signal cables or tubing from the piezometers pass through the seals that isolate the various intake zones in the traditional method. The cables can form preferential flow channels for migration of water between zones and are likely to be twisted or damaged. With a multi-level system having a placement pipe, signal cables or tubing from each piezometer run to the surface through the placement pipe. The placement pipe is then filled with grout.

Some *disadvantages* are:

- (1) It may be easier to transport sand and bentonite sealing chips instead of a grout reservoir and pump if the installation is in a remote area.
- (2) Grout may crack due to ground movements, which could lead to higher macroporosity and communication between piezometers in multi-level installations. This is especially true of piezometer tips installed near a shear zone.
- (3) A grouted-in installation may not be practical for a very high permeability soil where excessive grout may be lost in the voids. The method is suitable for moderately high permeability soils such as sands and sandy gravels.
- (4) The permeability of the grout must be equal to or lower than the surrounding soil zone permeability in almost all situations.

7.2.4.3.7 Piezometer Installation Lag Time

The time required to establish equalization of pore water pressures after installing or flushing a piezometer is known as the installation time lag. When pore water pressures change, the time required for water to flow to or from the piezometer to create equalization is the hydrostatic time lag. The hydrostatic time lag is dependent primarily on the permeability of the soil and/or encapsulating grout, type and dimensions of the piezometer, and changes in pore water pressure.

The volume of flow required for pressure equalization at a diaphragm piezometer is extremely small, and the hydrostatic time lag is very short. For an open standpipe piezometer, the time lag may be reduced by providing a large intake area and reducing the diameter of the riser pipe, thereby reducing flow required for pressure equalization. Hydrostatic time lag is not significant when piezometers are installed in highly pervious soils such as coarse sands.

McKenna (1995) showed that for different piezometer sensors installed in a borehole with surrounding soil zone permeability of 10^{-7} cm/s, the flow volumes and hydrostatic time lags were not much different if the borehole was fully encapsulated with a bentonite-cement grout having permeability of 10^{-8} cm/s when compared to sensors installed in the conventional manner (sand filter and bentonite sealant). Closed-system diaphragm-type (i.e., pneumatic and vibrating wire) sensors installed in grouted boreholes required about 0.0001 cc volume to equalize a 100-centimeter (cm) head of water, with a response time of less than 10 seconds. Open-system piezometers installed in the conventional manner required about 500 cc to equalize a 100-cm head of water, with a response time of about 10 days. When encapsulated in a grouted borehole, their response time increased up to 10 months.

An estimate of the hydrostatic time lag helps when selecting the proper type of piezometer for given subsurface conditions at a given site. The time order of magnitude required for 90 percent response of several types of piezometers installed in confined, fully pressurized influence zones are illustrated on figure 7-20. Per Dunnicliff (1993), the 90 percent response is considered reasonable for most practical purposes since the 100 percent response time is infinite. The response time of open standpipe piezometers can be estimated from equations developed by Penman (1961), shown also in Terzaghi and Peck (1967).

7.2.4.3.8 Piezometer Maintenance

Observation wells are similar to open standpipe piezometers except they have no seals to isolate soil strata. Observation well maintenance is practically the same as that for open standpipe piezometers.

If the water level rises above the frost line in open standpipe piezometers or observation wells, a non-toxic low-freezing point fluid should be added to protect from freezing. The difference in specific gravities of the low-freezing-point fluid and the in-situ pore water must be taken into account in adjusting the hydrostatic pressure shown by the piezometer or well.

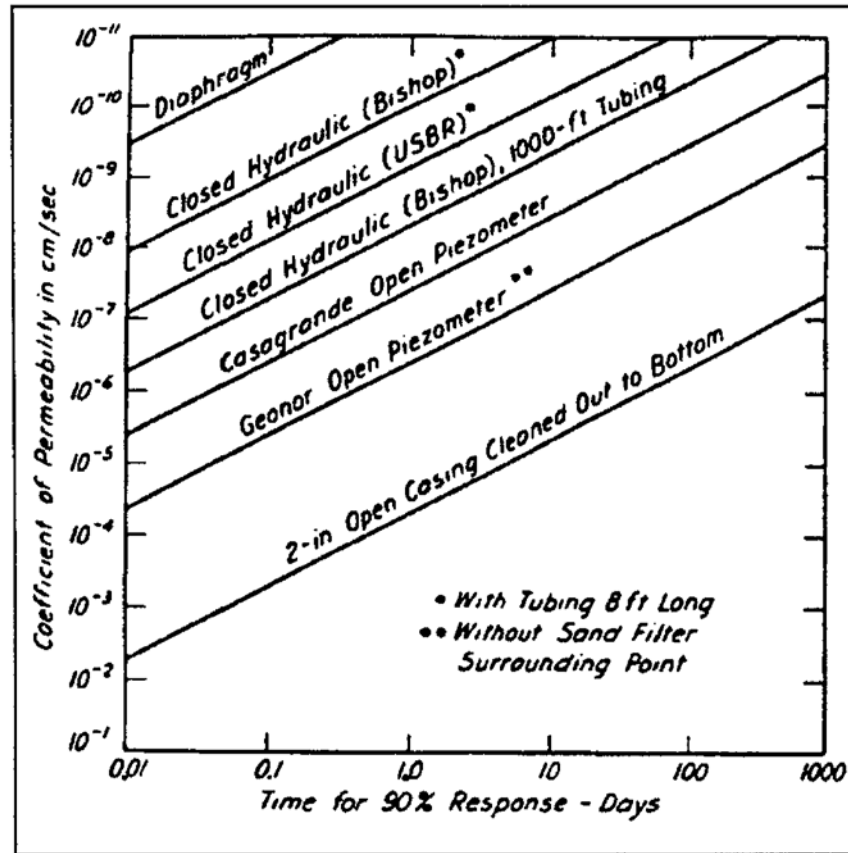

Figure 7-20.—Approximate response times for selected piezometer types installed in confined, fully pressurized influence zones (after Terzaghi and Peck, 1967).

The hydrostatic time lag, or response time, of each open standpipe piezometer should be measured by performing a rising or falling head test at the time of installation. In low permeability soils, piezometer response can be obtained by adding or removing water in increments and observing the rate of rise or fall prior to complete equalization. In any case, resulting information should be verified whenever the piezometer appears to indicate a change in the response rate to reservoir level changes. Also, piezometers should be periodically checked to determine if the tips contain sediments. If sediments deep enough to interfere with probe readings or low enough in permeability to significantly reduce piezometer response time are detected, they should be flushed and removed. Similarly, regularly scheduled disinfecting treatments are generally required in hydraulic piezometers to prevent or kill bacterial growth in the tubing. Care should be taken to avoid introducing contaminants into the piezometer (USACE 1995). To determine the appropriate period for the various aspects of piezometer maintenance, the recommendations of the manufacturer(s) and/or an instrumentation specialist should be followed.

Maintenance evaluation for twin-tube hydraulic piezometers is based on comparisons of current readings with previous readings to observe trends. Under normal conditions, the two gages will indicate equal pressures. If not, then maintenance flushing followed by rehabilitation, or gage

replacement, is needed. The tubes and gages should be observed for presence of bubbles and water clarity. Sediment or mineral deposits may be present in the piezometer liquid. When flushing is performed, the discharge water should be checked for gas, sediment, or mineral deposits.

Twin-tube hydraulic piezometer maintenance includes flushing with de-aired liquid to clean the lines of any mineral deposits and to remove accumulated gas bubbles from the tubing and manifold system. When de-airing a piezometer, water under pressure may flow through the filter into the surrounding soil, causing excess pore water pressure in the soil that requires time to dissipate. Vacuum should be applied to one tube while de-aired water under the minimum pressure needed to dislodge and move the air bubbles is applied to the other tube in order to minimize or eliminate the buildup of pore water pressure in the surrounding soil when de-airing piezometers. The system should be checked frequently for blockage and/or presence of gas. Sediment and mineral deposits must be flushed from the system because these deposits will eventually plug and neutralize the instrumentation. Pressure gages should be periodically checked by comparison to a more precise and accurate master gage. Master gages and individual gages should be maintained and recalibrated. Inaccurate or damaged gages should be replaced. Protection from freezing is required, preferably by heating the terminal structure. Maintenance of the heating equipment and control of moisture in the terminal structure will also be required. Flushing procedures, pressure calculations, and other maintenance issues are described in further detail by Dunicliff (1993).

Pneumatic piezometer instruments and readings should be observed to detect substandard performance indicating that maintenance is needed. Unusual readings, sticking flow meters, evidence of moisture, leaking gas sounds, and valve malfunctioning are typical symptoms indicating that maintenance is needed. Pressure gages in pneumatic piezometer readout units occasionally require calibration recording. Flow meters will occasionally have to be cleaned to remove moisture or other residue. Tubing may occasionally have to be flushed with dry nitrogen gas to evaporate moisture from the tubing, and O-rings and valves will need replacement if leaks are detected.

Vibrating wire and most other pressure transducers are available with non-vented and vented cable options. Sensors with vented cables must use manufacturer's or other approved desiccant traps to prevent condensation and/or small insects and spiders from getting into the vent tube and blocking the barometric compensation. Use of manufacturer's suggested desiccant tube housing assemblies with proper desiccant maintenance (change outs are usually needed every 6 months to a year) is very effective at eliminating vent tube blockages from moisture and small spiders.

Non-vented or sealed piezometer transducers may require corrections for barometric pressure if high accuracy is needed. At sea level, uncorrected barometric pressure reading inaccuracies can range up to 1.5 feet of hydraulic head over a 36-hour period during low to high atmospheric pressure changes. Thus, barometric corrections for sealed sensors or the use of vented sensors (with desiccant assemblies) that self-compensate for barometric changes are recommended.

7.2.4.3.9 Piezometer Limitations

Piezometers provide valuable information regarding seepage measurement and evaluation if the instruments are correctly installed, maintained, and their data are accurately interpreted. Their limitations must be recognized—they provide location-specific data. It is not likely that piezometer tips will be located at exactly the correct locations (e.g., at a defect such as a crack or in a high permeability thin layer) to provide direct data regarding piping, since piping channels are often relatively long and narrow features in an embankment dam (FEMA 2000). For example, if the piezometer tip is installed in a localized sand pocket, the piezometric head will be measured within that sand pocket, and the measurement cannot simply be extrapolated into a fine-grained strata above it.

An open standpipe piezometer is the first choice for saturated soils, but the limitations associated with extending the standpipe through embankment fill may impact their location within lower embankment fill layers. When these constructability limitations are unacceptable, other piezometer types must be chosen. For short-term applications (i.e., during a typical construction period), the choice is generally between pneumatic and vibrating wire piezometers. Selection will depend on the site factors, the designer's confidence in one type or the other, and cost comparisons. As opposed to borehole drilling and piezometer installations, direct push-in piezometer types are also available.

7.2.5 Water Quality Measurement

Seepage water quality measurements detect changes in suspended sediment concentrations (turbidity), changes in dissolved solid concentrations (mineral dissolution), and corrosion potential. Suspended solids are indicative of the internal erosion process that physically transports soil particles. Mineral dissolution is a chemical process that mainly occurs when certain foundation or abutment bedrock materials are present. In rare instances, the presence of either suspended or dissolved solids may indicate that erosion and piping are taking place that may progress to dam failure. Additionally, the water chemistry may deleteriously affect the integrity of instrumentation if the water is either too alkaline or too acidic.

7.2.5.1 Turbidity

Eroded material (suspended solid particles) may be detrimental to the performance of a dam if the transported particles create internal voids or cause structural deficiencies. A method to detect if seepage is eroding material is to measure the water quality for presence of suspended soil particles. Turbidity is a measure of how much light is adsorbed or reflected in a given quantity of seepage water. Zero turbidity indicates the water is clear (i.e., no soil particles are present). Quantitatively measuring turbidity values can determine if seepage is causing piping or erosion of material. To detect episodic erosion, turbidity monitoring must be continuous.

The presence of soil particles suspended in water can be simply determined by visual inspection. A simple visual description would note the seepage water as being clear or cloudy. The suspended sediments will usually be the larger particles (silt, sand, small gravel) that settle

to the bottom of a water jar sample. An increase in the cloudiness may indicate that the water is carrying soil with it as it travels through the dam, which is indicative of internal erosion. An evaluation of the turbidity and sediment should be made to observe any change between inspections. The easiest method for comparing changes is to collect a sample of the water in a quart jar marked with the date collected. A different jar should be used until five or six samples have been collected. Then, the jars can be reused, starting with the one containing the oldest sample. All the jars should be shaken when a new sample is collected. In this fashion, each new sample can be compared with the previous samples to observe any change in the visual cloudiness or turbidity. The sediment collected in the bottom of the jars can be weighed and sieved for a more accurate measurement and sediment classification.

Turbidity-measuring instruments (turbidimeters) can also be used to accurately quantify the concentration of suspended sediment (soil particles) in seepage water. The United States Environmental Protection Agency (EPA) uses turbidimeters for drinking water, and they are described in detail in *Guidance Manual for Compliance with the Interim Enhanced Surface Water Treatment Rule: Turbidity Provisions* (EPA 1999). Turbidimeters are limited because they must be calibrated for changing sediment size distribution (ASCE 2000). Problems with the formation of films on surfaces of mirrors and lenses may also be encountered with these meters. Emerging technologies include the use of laser diffraction to determine sediment size distribution and concentration. Advancements of this technology for coastal environments are described in Agrawal and Pottsmith (1999, 2004).

7.2.5.2 Dissolved Solids

Water-soluble rocks and minerals such as gypsum, anhydrite, calcite, and dolomite are not uncommon, especially in the Western U.S. (Reclamation 2005). These chemical constituents are often found in embankment dam foundations and abutments, and their solubility in seepage water may cause problems due to internal void formation. The void spaces formed by mineral dissolution can lead to greater hydraulic conductivity and the formation of preferential flow paths in the foundation or abutment. If the seepage progresses, internal void enlargement (or formation of new voids) may occur. The resulting internal erosion, piping, or structural defects may eventually contribute to embankment dam failure.

If the embankment dam is sited over foundation materials that potentially contain water-soluble minerals, a seepage water sampling, testing, and evaluation system could be included as part of the seepage monitoring effort. Seepage chemistry investigations are interdisciplinary and require collaboration among chemists, geologists, and engineers. Reclamation (2005) provides details for conducting seepage water quality monitoring (see USBR Seepage Water Chemistry Manual, Technical Report DSO-05-03, December 2005, for additional information).

7.2.5.3 Corrosion Potential

In addition to potentially dissolving certain foundation materials as discussed above, seepage water chemistry may also affect the proper functioning of pipe conduits, steel screens,

instrumentation, or other items exposed to seepage water for an extended period of time. For example, if the seepage water contains calcium carbonate, calcareous deposits (scale) may form on those items exposed to the water. Pipe conduit scale buildup due to calcareous deposits will eventually restrict the flow. Likewise, an instrument placed in a seepage measurement flume may have scale buildup, which will eventually affect the instrument's functioning and seepage measurement accuracy.

Conversely, if the pH is low, the seepage water may corrode certain metals exposed to the flow of water over a period of time. The NRCS recommends that steel pipe and appurtenances have a protective interior lining if the pH of the water is below 6.5 (USDA-NRCS 2001). However, a pH above 6.5 is not necessarily a guarantee that no corrosion will occur. Experience by the NRCS in the Western United States has shown that extremely pure water derived from snowmelt can produce severe corrosion in unlined steel pipelines. Besides pH, other variables, including dissolved oxygen, chlorides, and sulfate ions influence the corrosion of steel. Aluminum can corrode quickly in a high pH environment.

To determine water's scaling (or conversely, its corrosive) tendency, several indices or formulas have been developed over the years, with each considering different variables of water's chemistry. The most common index is the Langlier Saturation Index (LSI), developed by Langlier in 1936. The LSI considers the effects of calcium, total alkalinity, dissolved solids, and temperature to arrive at a computed formula value. The computed value is then simply subtracted from the water's pH value. If the result is positive, then the water will potentially develop mineral deposits (scale). If the result is negative, the water will tend to dissolve calcium carbonate (i.e., be corrosive). If the result is zero, the water is "balanced" and should not deleteriously affect any exposed objects such as instrumentation. The LSI has been widely used as an indicator of both corrosion and deposition potential even though it is only a measure of the water's ability to dissolve calcium carbonate. The LSI is calculated by the following equation:

$$\text{LSI} = \text{pH} - \text{pH}_s$$

where:

pH = pH of the water

pH_s = pH of the water at saturation with calcium carbonate

A value of LSI greater than about +0.5 or +1.0 indicates the tendency toward deposition of calcium carbonate, while a value less than about -0.5 or -1.0 indicates a tendency toward no deposition of calcium carbonate and possibly corrosion.

Other indices that focus on the potential for deposition include the Ryznar Saturation Index, Puckorius Scaling Index, Stiff-Davis Index, and Oddo-Tomson Index. Indices intended to more directly reflect corrosion potential include the Singley Index, Riddick Index, and Larson-Skold Index.

The corrosivity of the water to be conveyed in the seepage collection and monitoring system should be checked in order to identify potential corrosion problems. If the water is corrosive, then protective measures should be considered. These measures may include linings or coatings, using non-corrosive materials such as plastic or stainless steel, or installing cathodic protection (sacrificial anodes or external electric power) on susceptible metallic elements. The potential of the water to produce deposition of chemical precipitates (scale) should also be checked.

7.2.6 Maintenance Issues

Seepage must be regularly monitored to determine if it is increasing, decreasing, or remaining constant as the reservoir level fluctuates. A seepage flow rate that does not change relative to the reservoir water level may be an indication of internal erosion problems, or it may simply be due to a clogged drain. Proper operation and maintenance of all seepage collection and measurement elements should be a high priority since any change in seepage quantity or water quality may indicate potential problems. Periodic maintenance will help eliminate measurement system uncertainties when evaluating these changes. Whenever possible, installed elements should be accessible for maintenance. If, after final installation, an instrument or device will not be accessible for maintenance, multiple instruments or devices should be considered to provide redundancy.

Regular inspection of drainage outlets, collection pipes, channels, ditches, weirs, flumes, etc., is necessary to initiate routine maintenance to remove any debris, vegetation, or sediment that obstructs flow. Observation and relief wells also require regular inspections and maintenance to prevent screened interval fouling and riser pipe impediments due to biological growths, water chemistry byproducts, and physical clogging.

Weirs and flumes must be properly installed, operated, and maintained if they are to measure water accurately. They should be checked periodically to verify that they are level and plumb. Vegetation and sediment accumulations should be removed as necessary to maintain the proper dimensions of the approach channel. Staff gages should be replaced when worn or hard to read. Checks should be made to verify correspondence of the weir or flume crest elevation with the zero reading on the staff gage. Regular calibration of measuring devices is recommended. Inspections should be performed to detect any leakage under or around the structure. Following any repairs or modifications, the weir or flume should be rechecked to verify that it is still level and plumb. Inspections should also verify that weir notches are not nicked, dented, or otherwise damaged.

A routine of regular maintenance, operability testing, and calibration of all instrumentation should be established. The maintenance and calibration procedures and periodic frequency are typically provided in the manufacturer's technical information sheets and should be followed unless there is suitable justification to alter them.

7.3 References

Agrawal, Y.C. and H.C. Pottsmith (1999). “Instruments for particle size and settling velocity observations in sediment transport,” *Xibei Gongye Daxue Xuebao/Journal of Northwestern Polytechnical University* 17(3):89–114.

_____(2004). “LISST laser diffraction sensors advance sediment monitoring,” *Sea Technology* 45(8):33–38.

American Society of Civil Engineers (ASCE) (2000). *Guidelines for Instrumentation and Measurements for Monitoring Dam Performance*, American Society of Civil Engineers.

Australian National Committee on Large Dams (ANCOLD) (1983). “Guidelines for Dam Instrumentation and Monitoring Systems.”

Bureau of Reclamation (Reclamation) (1987). *Embankment Dam Instrumentation Manual*. Superintendent of Documents, United States Government Printing Office. Washington, DC.

_____(1990). *Design Standards No. 13, Embankment Dams*, Chapter 11: Instrumentation. U.S. Department of the Interior, Bureau of Reclamation, Technical Service Center, Denver, Colorado.

_____(2001). *Water Measurement Manual*. U.S. Department of the Interior, Bureau of Reclamation, Technical Service Center, Denver, Colorado.

_____(2005). “Seepage Water Chemistry,” Dam Safety Technology Development Program Technical Report DSO-05-03, U.S. Department of the Interior, Bureau of Reclamation, Technical Service Center, Denver, Colorado, 164 p.

_____(2009). *Comprehensive Facility Review 2009 Guidelines*.

Dunnicliff, J. (1993). *Geotechnical Instrumentation for Monitoring Field Performance*, John Wiley & Sons. New York, New York.

Federal Emergency Management Agency (FEMA) (2000). National Dam Safety Program Research Needs Workshop: Seepage Through Embankments, FEMA 535. Denver, Colorado.

_____(2005). Technical Manual: Conduits through embankment dams, FEMA 484.

_____(2007). Technical Manual: Plastic Pipe Used in Embankment Dams: Best Practices for Design, Construction, Problem Identification and Evaluation, Inspection, Maintenance, Renovation, and Repair, FEMA P-675.

_____(2011). Filters for embankment dams: Best practices for design and construction.

- Federal Energy Regulatory Commission (FERC) (2006). Engineering Guidelines for the Evaluation of Hydropower Projects.
<http://www.ferc.gov/industries/hydropower/safety/guidelines/eng-guide.asp>
- Indiana Department of Natural Resources (2003). Indiana Dam Safety Inspection Manual.
Indiana Department of Natural Resources Dam Safety Inspection Manual
http://www.in.gov/dnr/water/files/Part-2-Dam_Safety_Manual.pdf
- International Commission on Large Dams (ICOLD) (2000). Bulletin 118, Automated dam monitoring – Guidelines and case histories.
- Marilley, J.M. and B.K. Myers (1996). “Making an Automated Monitoring System Work at Tolt Dam,” *Hydro Review* 15(6).
- McCook, D.K. and M. Pabst (2006). “Pipes in drain systems: Are they a necessary evil?,” in: *Dam Safety 2006, the 23rd annual conference of the Association of State Dam Safety Officials, held September 10–14, 2006, in Boston, Massachusetts*: Lexington, Kentucky: Association of State Dam Safety Officials.
- McKenna, G.T. (1995). “Grouted-in installation of piezometers in boreholes,” *Canadian Journal of Geotechnical Engineering* Vol. 32, April, pp. 355–363.
- Pabst, M. (2007a). “Getting water into pipes - not as easy as it seems,” in: *Dam Safety 2007, the 24th annual conference of the Association of State Dam Safety Officials, held September 9–13, 2007, in Austin, Texas*: Lexington, Kentucky: Association of State Dam Safety Officials.
- _____(2007b). “Design and construction of access features for toe drains,” in: *Dam Safety 2007, the 24th annual conference of the Association of State Dam Safety Officials, held September 9–13, 2007, in Austin, Texas*: Lexington, Kentucky: Association of State Dam Safety Officials.
- Penman, A.D.M. (1961). “A study of the response time of various types of piezometers,” in: *Proceedings, Conference on Pore Pressures and Suction in Soils*. Butterworth, London.
- Terzaghi, K. and R.B. Peck (1967). *Soil Mechanics in Engineering Practice*, John Wiley & Sons. New York, New York.
- United States Committee on Large Dams (USCOLD) (1993). General Guidelines and Current U. S. Practice in Automated Performance Monitoring of Dams.
- United States Department of Agriculture-Natural Resource Conservation Service (USDA-NRCS) (1973). *National Engineering Handbook*, Section 15, Irrigation, Chapter 9, Measurement of Irrigation Water.
- _____(2001). *National Handbook of Conservation Practices*, 2001.

United States Environmental Protection Agency (EPA) (1999). Guidance Manual for Compliance with the Interim Enhanced Surface Water Treatment Rule: Turbidity Provisions. EPA-815-R-99-010.

U.S. Army Corps of Engineers (USACE) (1995). *Instrumentation of Embankment Dams and Levees*. EM 1110-2-1908.

Welch, L.R. and P.E. Fields (1999). “Integrated automation of the New Waddell Dam performance data acquisition system,” *ASTM Special Technical Publication 1358*:285–297.

CHAPTER 8 – SEEPAGE PERFORMANCE MONITORING

8.1 General

Performance monitoring should be focused on those areas where potential failure modes (PFMs) are most likely to occur. Supplemental instrumentation and observation systems may be needed if the existing system is inadequate. Performance of seepage barriers, drainage and collection features, and the associated measuring systems should be compared to the designer's predictions to ensure the dam is performing as expected. Commonly documented predictions (based on the designer's assumptions) include the pressure drops across seepage barriers, uplift on the base of the dam, the general dissipation of seepage in the body of the dam and in the foundation, and the amount of flow that will pass through conveyance features. When problem seepage occurs, instrumentation reading frequency is increased until permanent remedial measures have been completed and their effectiveness verified.

Monitoring may be a permanent or interim risk reduction measure. Instruments are installed during original construction or added as experience is gained from operations. Each instrument should address a specific, identifiable risk. Seepage can result in a number of different PFMs, each of which may require a different instrument configuration. Hence, it is important to understand the most critical, site-specific failure modes when designing a monitoring system. This is often accomplished with a potential failure modes analysis or risk analysis. The monitoring program should be continually re-evaluated during the life of a project using a risk-informed approach, as the risk profile that was considered previously may change over time as experience is gained. A systematic, risk-based evaluation of the monitoring program ensures that instrumentation is monitoring the critical PFMs, and it can influence the decision about whether obsolete instrumentation should be retired or replaced.

Often the process of seepage evaluation involves little or no input from actual measurements because most dams include few if any flow or pressure measuring devices. Where there are no seepage measurements, evaluations of dam behavior must be based upon visual observations such as pool level versus observed seepage along the downstream toe coupled with knowledge of the design and construction. However, to aid judgment, most reviewers of dam performance welcome the opportunity to utilize actual measurements of key parameters. This is especially true for larger dams. Measurements provide supporting evidence for evaluation conclusions. Of course, measurements by themselves have little meaning. It is only when properly analyzed that measurements provide useful information. Only with evaluated measurements can a reviewer of seepage data make informed judgments on whether or not there are early indications of a problem.

Effective analysis has its roots in the planning and layout of a monitoring program that is centered around informative parameters and appropriate monitoring frequencies. Inappropriate parameters and inadequate monitoring frequencies can seldom be overcome in the analysis

process. Effective analysis involves integrating measurements with engineering and geological data. Thus, a well-developed understanding of the design intent, construction, and foundation is needed.

Dams that have been in operation for some time probably have had analyses and examinations performed on them in the past. Engineers performing evaluations of the dam's ability to control seepage should be familiar with those results and with all available records of reservoir operation and the response of the dam as indicated by observations and measurements of seepage flow and pressure. Most importantly, the establishment of a baseline visual seepage record, with the accompanying pool level data, is critical when comparing reports of new seepage or seepage that is transporting materials. Evaluation is necessary to confirm that the location of piezometers is adequate based on knowledge of failure modes; it should be understood it is unlikely that an instrument will be located directly in a failure pathway. Hence, visual monitoring is required.

8.2 Frequency of Monitoring

For effective analysis, seepage data must be collected at the appropriate frequency. Obviously, seepage measured only when the reservoir is at low levels would not indicate an internal erosion problem associated only with high reservoir levels. When there is concern for the possibility for quickly developing failure modes, monthly seepage readings and observations would not significantly reduce the risk of operation. Observation and reading frequencies must be determined in light of dam design, reservoir operation, labor requirements, instrument capabilities, parameter variability, level of risk associated with the flows and pressures being monitored, and a good understanding of the PFMs being monitored.

Reporting, screening, and re-reading must also be performed in a timely manner. The first step after data collection is field screening for obvious reading and recording errors. Bad readings should be retaken as soon as possible to prevent having an erratic data record. As soon as the data are screened they should be processed or transmitted to processors who will also screen for questionable and/or less obvious errors. Following up on erroneous readings that get past these early stages is expensive and a waste of resources. Such followup activities should be minimized.

The frequency of instrument readings or making observations at a dam depends primarily on the PFM, but may also include the following factors:

- (1) Hazard to life and property downstream from the dam
- (2) Height of the dam
- (3) Amount of water impounded by the dam
- (4) Age of the dam
- (5) Frequency and amplitude of reservoir water level fluctuation
- (6) Presence of suspected or observed dam performance anomalies (e.g., internal erosion)
- (7) Level of effort required to take a reading (e.g., manual versus an Automated Data Acquisition System [ADAS])

More frequent readings are usually taken during first-filling, high reservoir water levels, and after significant floods and earthquakes. Visual observations should be made during each visit to the dam and not less than monthly. Several Federal agencies and individuals have proposed seepage monitoring schedules based on a number of factors. Seepage monitoring schedules have been developed by the Australian National Committee on Large Dams (ANCOLD), International Committee on Large Dams (ICOLD), Bureau of Reclamation (Reclamation), U.S. Army Corps of Engineers (USACE), and the Federal Energy Regulatory Commission (FERC). These schedules are not based on a higher risk failure mode, which would require more intensive monitoring.

Monitoring frequency depends on the risk and consequences associated with a dam and the period of operation. More monitoring is required during first filling because the structure is untested, and unknown defects may exist. Therefore, the following stages are suggested intervals for monitoring instruments during the first filling (ICOLD 1988) as found in Penman and Sharma (1999):

- When water reaches about a quarter the total height
- When water reaches the mid height
- When water level is about three-fourths the total height
- As the water increases in steps of 2 meters, but the measurement interval does not exceed a month

Visual inspection is often the most valuable information type and should be conducted at a higher frequency than manual reading(s) of any dam instrument. Instrument readings are limited to the location at which they are installed. Visual inspections are better able to assess the overall performance of the dam and also can determine the need for the installation of more instrumentation.

8.2.1 Monitoring Requirements for Extreme Events

Extreme events, such as floods and earthquakes, can increase the risk of internal erosion and failure because they induce additional stresses on the structure. Therefore, dams require increased monitoring during and following extreme events, including both visual inspections and evaluation of instrument readings and measurements. The appropriate frequency for such monitoring depends on site-specific conditions and should be set by a qualified engineer familiar with all aspects of the site. The monitoring requirements for extreme events should be documented in the instrumentation/monitoring plan as well as in the Emergency Action Plan (EAP).

As an example, the U.S. Army Corps of Engineers' criteria for post-flood/earthquake inspections are given in USACE (2014) and USACE (1979). Special inspections are required during and after any unusually large flood or after the occurrence of a significant earthquake (USACE 2014). An earthquake is considered significant if it causes damage or if it meets the criteria reproduced in table 8.1.

Table 8.1—Criteria for post-earthquake inspections of USACE dams (USACE 2014)

Earthquake magnitude	Epicenter distance from the dam (miles) (Inspect dam if epicenter is within this distance to the dam)
4.5	10
5.0	50
6.0	75
7.0	125
8.0	200

8.3 Processing, Proofing, and Presenting Data

Processing involves reduction of the data to values that can be more readily visualized in terms of dam behavior and reservoir operation. Most flows are reduced to gallons per minute, or for large flows, to cubic feet per second; however, small flows may be shown as gallons per hour. Occasionally, flow readings from special meters require no reduction, but usually they are depth, pressure, or time interval readings, which need to be reduced to other units. In these cases, it is useful to have expected limits tabulated in raw-reading form for quick checking in the field. Pressures are often reduced from depth measurements that directly yield piezometric elevation, but they are generally more useful when reduced to units of pressure such as pounds per square inch. Reduced data, too, will need to be inspected by a knowledgeable reviewer for input and/or calculation errors.

Interpretation and evaluation can be performed on different levels. At a basic level, they involve the review of manual or computerized methods of processing data to produce quantities or engineering units. Basic graphic displays show the variations with other performance parameters or time. At a higher but less frequently used level, evaluation may additionally include elements such as displaying pressure distributions, including investigative techniques, calculating safety factors, and assessing risk. At whatever level, data processing, presentation, and analysis must be performed by personnel having appropriate knowledge and experience. Processing procedures are always an important aspect. Processing data is often considered to be a routine undertaking, but the results can be very misleading if the processing is not adequately and accurately performed.

Reviewers of seepage data should have a well-founded background in dam design, construction, operation, and behavior. A geotechnical engineering background with an understanding of geology and hydraulics is particularly useful. Along with that background should go an understanding of the limitations and working principles of water flow, quality, and pressure measuring instruments. Discrete measurements are seldom informative; usually, they trend in response to reservoir level, and it takes qualified reviewers to spot those trends.

Dam safety training should be given to all personnel who collect, process, and/or evaluate seepage data. The training should include identification of potential seepage problem indicators and actions to be taken when unusual conditions, signs of potential problems, or emergency conditions occur. Some Federal dam agencies provide dam safety training. As an example, Reclamation provides a series of videotapes and workbooks known as Training Aids for Dam Safety (TADS), also available free of charge from the Federal Emergency Management Agency (FEMA) Publications Warehouse (<http://www.fema.gov/library/>). State dam safety organizations also provide such training.

Most often the conclusion of an effective evaluation consists of communicating results to decisionmakers. Typically, data and analyses from which conclusions are based must be presented graphically along with or on drawings that show the location of measurements and/or observations. Reports should be adequate to allow qualified engineers who are not familiar with the dam not only to understand the findings and their basis but also to develop independent conclusions.

Reduced data are most easily reviewed when displayed graphically. Graphs facilitate the communication of analysis results and can summarize an entire data history or illustrate the details of a particular time period or loading. Displays of reduced data need to be proofread to ensure that appropriate scales and groupings are used. A too-small scale can easily flatten out a record to make it look as though no significant responses have occurred. A too-large scale will reduce the amount of data that can be conveniently shown. Having many variables on a graph, such as a cluster of drain flows, can result in visual chaos from which it is difficult to determine trends and to detect early changes in behavior. Similar difficulties arise when the record shown is very long. Readings from piezometers and flow measurements should be grouped such that all those on a particular display have something in common such as location, geologic unit, drainage feature, or behavior. Of course, displays should correctly show the identification of parameters measured, instruments used, and the associated locations. Often it is helpful to graph the same data in different ways. Graphs of flow against time, for example, are not as useful at illustrating key reservoir elevations as are graphs of reservoir elevation versus flow. It is also important to show on time plots the times when physical changes are made that impact the instruments (e.g., installation of nearby drains, grouting, changing a weir plate, etc.).

Data processing should also include keeping a log of all visual observations of seepage behavior. Most seepage-related problems at dams have been detected visually. Even not so well-trained observers have detected obvious seepage anomalies. Related to that, the best analysis of processed data will be performed by reviewers that have seen the condition of the dam, the measurement locations, and the condition of flow measuring devices.

Graphs that show the piezometric and/or hydraulic head profiles through the dam cross section as a function of reservoir water elevation should be generated as the data are collected. Seepage drain discharge flow rates and water quality measurements also should be graphed as functions of reservoir water elevation. These graphs should be maintained to readily show the piezometer and observation well measurement histories. The graph formats should be designed in such

a way as to make them easily updated after each measurement, enabling the observer to graphically see the relationships between the current reading and historical readings. Additional guidelines for constructing time versus reading graphs are listed in FERC (2006), Chapter 14, Appendix J.

Measurements should be compared to anticipated piezometric levels. Any deviations from the expected level should be further investigated. To help spot deviations, statistical analysis can be utilized to develop empirical relationships between piezometer readings, rainfall data, and reservoir elevations. Piezometric data should be compared to reservoir level and precipitation amounts. Piezometric level is usually responsive to reservoir level. Changes in piezometric level without a change in reservoir level could indicate a seepage erosion and piping problem or may simply indicate abnormal rainfall infiltration into shallow (less than 20-foot depth) piezometers. Short- and long-term plots of reservoir levels versus piezometric levels should be constructed in a manner that enables accurate comparison to seepage quantity measurements (Mangney 2006).

8.4 Alarm Levels

An alarm level associated with a seepage monitoring measurement is the reading that, when equaled or exceeded, generates subsequent action. This subsequent action could include verifying the initial reading, performing an immediate site inspection, lowering the reservoir, or implementing the EAP.

Alarm levels may be set based on prior analysis (e.g., the piezometer readings at which the upward hydraulic gradient corresponds to a minimum allowable safety factor for uplift). They may also be based on comparisons of historically measured normal (background) and high pool-based piezometric responses. A higher degree of professional engineering judgment (more stringent limits) is thus required until more operating data are obtained to justify relaxing or altering limits.

Expected piezometric and instrument limits and alarm levels should consist of a minimum of high and low static (physical) limits, high and low statistical responses bands, and rate(s) of rise and fall where applicable for a given instrument type. An ADAS can assist in determining/refining these levels as larger historical datasets are more easily attained with an ADAS in place.

Implementation of alarm levels is best achieved with a complete ADAS. The focus of an ADAS has been on additional features (beyond basic data collection) to fully automated data plotting and event notification, as the software and technology have evolved extensively from 2000 to the present with computer/Internet growth. Multiple affordable telemetry options, including email, cellular text, landline, and satellite are also employed in many current ADAS applications.

8.5 Analysis of Data

8.5.1 Introduction

Evaluation and analysis of seepage monitoring data serves two main purposes: (1) to compare actual performance with predicted or expected performance and (2) to identify trends related to time, reservoir level, and other variables. In both cases, the main objective is to identify potential dam safety issues as early as possible.

8.5.2 Evaluating Geologic and Time Lag Effects on Seepage Paths

Effective seepage evaluation cannot be performed without understanding the site geology, regional meteorology, construction history, and performance history. Geologic elements include how foundation material properties determine groundwater hydrology and include topography, geologic structure, and stratigraphy. Meteorological elements include seasonal climate variations, precipitation, and temperature. Construction elements include the type of design, design assumptions, construction methods, construction equipment, and as-built construction records. Performance history elements include previous evaluations, exam reports, data records, reservoir operation records, and any incident records. Unless one understands the dam, one cannot be certain of the expected, recognize the unusual but satisfactory, be alerted to the problematical, and may not be able to distinguish the alarming in a timely fashion. The best reviews are performed by qualified individuals that have seen the site and pertinent structural features.

Topography is generally a function of the patterns of surface and groundwater movements acting over time. Those movements, in conjunction with the resulting ground contours, greatly affect the distribution and conveyance of water below, but near, the ground surface at a dam site. An understanding of the variations of seepage beneath a dam cannot be developed without visualizing how small basins near the dam will capture and feed runoff to the groundwater table or how low elevation troughs will direct the drainage flow path. Also, steep-walled valleys may have developed relief joints that can convey water past the dam.

Geologic structure, of course, is also a factor in topography. Beneath the surface and in some instances in contrast with the surface topography, synclines will concentrate and direct seepage flow. An anticline often contains joints parallel to its axis that can significantly affect the direction of flow. Formations that are connected to higher elevations can induce groundwater pressure that is greater than that introduced into the foundation by the reservoir.

Stratigraphy will generally include layers of different hydraulic conductivity and transmissivity. Permeability relative to water can vary over six or seven orders of magnitude and more. Gravelly and sandy layers will readily convey water, while silty and clayey layers may reduce flow or confine seepage in such a way as to allow pressures to reach high levels. A rock joint's in-plane orientation may have a very high permeability, while the same joint's cross-plane

orientation may have a much lower permeability. In instances where the soil is dry or unsaturated, the movement of water through the interstitial pore spaces can vary substantially and is dependent on the surface tension (matric suction) of the soil. The variation is especially significant when compared to the estimated velocities calculated using the saturated permeability. This is an important issue to consider in stability evaluations on flood water retention basins and levees or for analyzing the response of dams undergoing a first filling or seismic loading, especially in liquefaction evaluations at saturation levels below 85 percent.

Seasonal climate variations, principally precipitation, often have significant effects on groundwater levels. Dam leakage in the case of pervious rockfill embankments and concrete dams having open joints can also be noticeably affected by precipitation. Seasonal variations in ambient temperature cause joints in concrete dams to open in winter and close in the summer. Thus, a concrete dam that has a higher summer reservoir surface may experience greater leakage during the winter when the reservoir surface is low.

Each observation well, piezometer, and seepage drain measurement reading must be compared to previous readings. Any changes in the readings should be evaluated. If the readings appear normal for what can be expected for the reservoir water elevations, the normal monitoring program can be continued. If the profile appears unusual, then it may indicate a potentially dangerous situation, and a qualified dam safety professional must be consulted to discuss the results.

As discussed in chapter 7, most piezometers require some movement of pore water to or from the device to activate the measuring mechanism. When pore water pressures change, the time required for water to flow to or from the piezometer to create equalization is the hydrostatic time lag, which is dependent on the permeability of the soil, type, and dimensions of the piezometer, in addition to the pore water pressure changes. The volume of flow required for pressure equalization in a closed-system piezometer is very small, and the hydrostatic time lag is very short. Time lag may be longer for an open standpipe piezometer. Field measurements of time lag may be obtained by comparing reservoir level fluctuations with piezometer readings.

8.5.3 Detecting Changes and Trends

All seepage collection, measurement, and monitoring data will follow trends such as seasonal fluctuations, variation with reservoir or tail water elevations, time-history variations, or combinations thereof. Statistical analysis may be useful for detecting trends obscured by scatter, but such analyses do not substitute for common sense and judgmental experience.

New data should be compared to antecedent data for detection of inconsistent patterns or possible erroneous data. Instrument readings that deviate from established trends should be verified by updated readings on a more frequent basis. Erroneous readings should be so noted on original data records and then removed from data summary tables and plots (FERC 2006) unless it is recognized as a recurring error that is not fully understood.

The cause of anomalous seepage may be identified through simple plots of the seepage monitoring data. A case study involved a 187-foot-high embankment dam located in an urban area of California where an increased amount of seepage was noted in the toe drain. The owner notified dam safety personnel that the toe drain flow rate had increased from a normal range of 10 to 60 gallons per minute up to an estimated 400 gallons per minute. The drain was at the upstream toe and conveyed the seepage collected by the drainage zone beneath an upstream impervious lining. Evaluation of reservoir level, toe drain, under drain, and observation well data showed that only the toe drain flow rate was anomalous. The reservoir level fluctuation was strongly correlated to the toe drain flow rate fluctuation. As a result, the normal flow rate was determined for a range of reservoir elevations by plotting toe drain flow rate versus reservoir elevation. This plot was used to identify the seepage anomaly. The plot showed that over a 6-week period, the flow rate increased from 3 times to 10 times the normal flow rate. The flow rate decreased, and then effectively stopped, as the reservoir was drawn down. An evaluation of the data by qualified engineers did not reveal the location of the anomaly, but engineering judgment was utilized to eventually locate the problem, which was a 5-inch-diameter hole in the upstream lining (Smith 1986).

Numerically tabulated data are useful for detecting trends, evaluating seepage anomalies, or comparing design values to actual values, especially when the data are statistically analyzed. Graphic plots of the data enable visual comparisons to be made between actual and predicted parameters. Plots also provide a visual means to detect data acquisition errors, to determine periodic trends or cyclical effects, to compare parameters between instruments, and to determine instrumentation maintenance needs. Plotting enables data to be readily compared with events that cause changes in the data, such as construction activities or environmental changes. Plotting also provides a visual means to evaluate unanticipated performance and confirm unsatisfactory performance issues.

A response plot displays the reservoir elevation versus the parameter change (e.g., the piezometric head may change as a function of reservoir elevation, and this data can easily be plotted on an XY chart). Drainage outflow volume is another parameter that may change with reservoir elevation. Figure 8-1 illustrates how such a graph enables detection of seepage trends as the reservoir elevation fluctuates.

A time history plot displays time versus the parameter value. Parameters such as water level, seepage flow rate, pore water pressure, deformation, water quality (temperature, turbidity, and dissolved solids concentrations) can be plotted as functions of time. Figure 8-2 illustrates a time history plot of piezometric head seasonal variations. Dual Y-axis time history plots allow the additional plotting of a second parameter such as pool elevation, tail water elevation, or rainfall amount. Smaller positional plots are often used to show time histories at particular locations. Locations of where data are collected typically are indicated with cross-section, profile, or plan views.

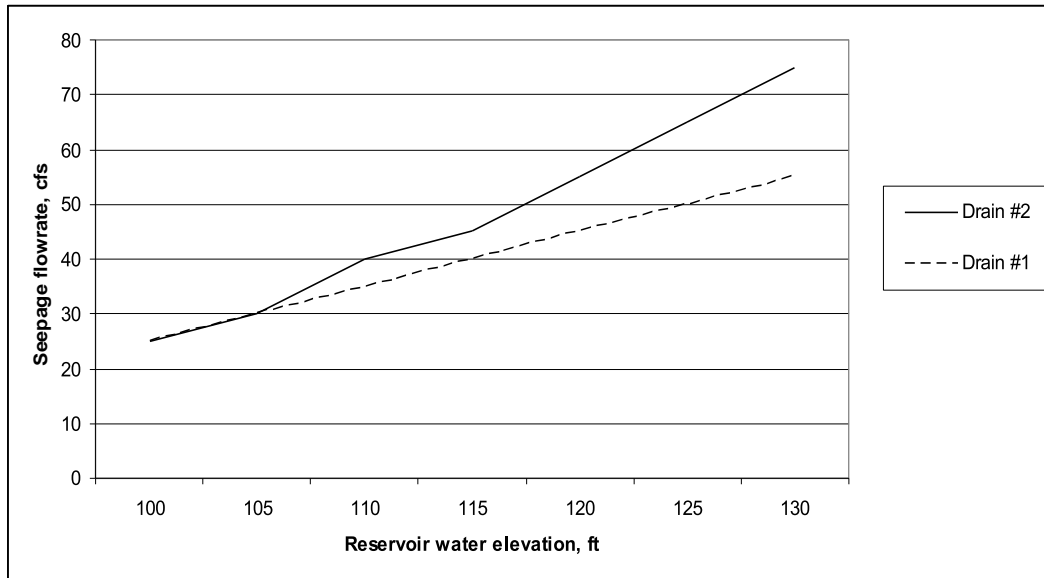

Figure 8-1.—Conceptual illustration of a seepage drain flow rate response plot. The flow rate from drain #2 varies significantly from that in drain #1 as the reservoir level increases, indicating a seepage anomaly or other phenomenon occurring in the drain#2 collection area.

8.5.3.1 Gradual Changes

Gradual changes of seepage conditions can indicate increased or decreased permeability of the system or active internal erosion. Gradual changes include the following:

- (1) Increasing or decreasing trends in piezometric levels
- (2) Increasing or decreasing trends in seepage volumes
- (3) Increasing numbers of wet areas or seeps downstream from the dam
- (4) Gradual changes in seepage effluent water quality

Long-term and short-term piezometric levels and seepage volumes should be plotted with reservoir levels and inspected for increasing or decreasing trends. It is important to note that increases or decreases in piezometric level or seepage volumes can be caused by deteriorating dam conditions. Levels should be compared with anticipated seepage water pressures and volumes. Assigning specific threshold or action levels is unique to each PFM. Using monitoring data along with other observations and measurements will help in assessing the overall dam performance.

Increases in the number or sizes of wet areas downstream can indicate poor dam performance. These wet areas should be noted during visual inspections. Wet areas indicate that excess seepage that is not being collected or measured is occurring. They may be indications of active erosion and piping, but are not the same as sinkholes, which are described later. Action and threshold levels for the number and sizes of wet areas are unique to the particular dam site.

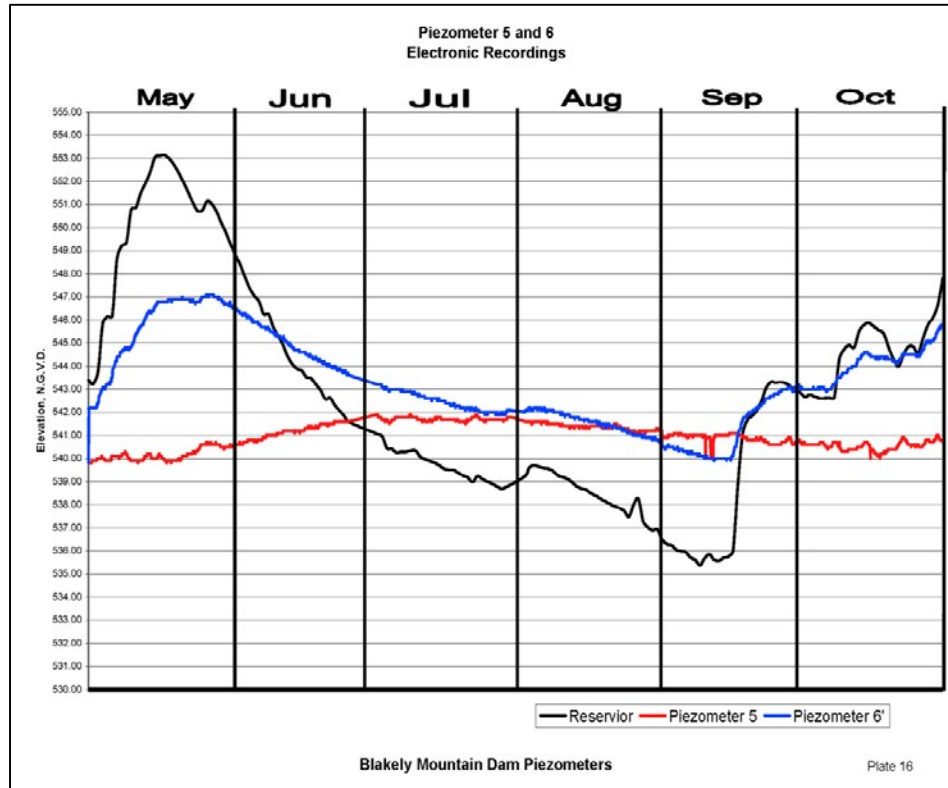

Figure 8-2.—Time history plot of reservoir level overlaid with piezometer 5 and 6 data. In this plot, the pore pressures measured by piezometer 5 (in red) are not influenced by changes in reservoir levels, but are related to changes in regional groundwater. In contrast, the pore pressures measured by piezometer 6 (in blue) show minimal time lag response to reservoir level changes.

Decreases in piezometric levels or seepage volumes can be functions of a lower sustained water level or the natural sedimentation process. Dams create lower velocities of flow than the rivers and streams they impound. It can be anticipated that some amount of sedimentation and silting may occur during the lifetime of the dam. This could cause a general decrease in piezometric levels or seepage volumes as pathways become clogged with sediment. Drainage resulting from internal erosion can cause similar decreases.

Gradual changes and trends in piezometric levels, seepage volumes, and wet areas can be indications of unsatisfactory dam performance. The decision to take immediate action or monitor the situation further, after taking into account the risks and consequences associated with the dam, is the responsibility of the dam owner.

Gradual changes in seepage water turbidity may be visually observed (without using a turbidimeter) as described in chapter 7. The flow rate and visual clarity (turbidity) of sampled seepage water should be recorded from each periodic dam inspection. If seepage problems are suspected or begin to be observed, a qualified dam safety professional should be contacted. Note that internal erosion may be episodic and that the above sampling method may easily miss such episodes.

8.5.3.2 Abrupt Changes

Abrupt changes in seepage are generally more serious and require swifter action than gradual changes in seepage. Internal erosion and piping may not be detected until they are almost fully developed, and piping can develop and initiate a breach in less than 3 hours for highly erodible sand and adverse conditions (Fell et al. 2005). If erosion and piping are detected, action should be taken quickly.

The following visual indicators signal that abrupt changes in seepage may be occurring:

- (1) Presence of rapidly developing sinkholes
- (2) Increases or decreases in seepage water turbidity or dissolved solids concentration
- (3) Abrupt changes in piezometric levels
- (4) Abrupt changes in collected seepage flow rates or volumes

The formation of sinkholes and cloudy seepage water are definitive indicators that erosion or piping has occurred. Soil is being removed by the seepage water at some location within the dam, foundation, abutment, or seepage collection system. All instances of sinkholes or turbidity increases in seepage water should be promptly investigated. It should be noted that the cessation of apparent change does not necessarily indicate that erosion has ceased, as internal erosion can be episodic. The following is a quote from the National Dam Safety Program Research Needs Workshop: Seepage Through Embankment Dams (FEMA 2000):

“After extensive discussion, a general consensus was reached that piping can often be an episodic phenomenon. That is, piping with muddy or turbid seepage may occur for some period of time, after which the pipe collapses or stabilizes for some period of time, only to be followed later by another episode of active piping. It may take many repeated episodes of piping before the phenomenon progresses to failure of the dam. The importance of this understanding of the piping phenomenon is that the observation of clear seepage does NOT necessarily mean that there is no piping problem. It could simply be the case that the observation was made during a period of no active piping. Piping should be considered a possibility for any case of uncontrolled seepage. Inspectors should also look for evidence of past piping episodes (e.g., silt or sand deposits at or downstream from seepage exit points).”

Sinkholes along the embankment are potentially a concern, as they indicate material is being removed from the dam. However, sinkholes often appear first on the downstream face or crest and may not intercept the reservoir or lower the crest below the reservoir level until a later stage if timely action is not taken after the first appearance. Abrupt changes in piezometric levels or seepage flow rates (or volumes) can be the result of a number of factors. If abrupt changes in those readings having no apparent cause (i.e., no reservoir level changes or recent rainfall events), they should be investigated quickly. In all cases, these types of abrupt seepage change

indicators should be further investigated. The corrective action taken for all these types of imminent erosion indicators range from simply increasing the frequency of monitoring to immediately drawing down the reservoir level.

8.5.3.3 Trends Analysis

Trends analysis involves evaluation and correlation of instrumentation monitoring data in an attempt to identify performance changes in or around an instrument. It can be performed for any routine performance monitoring data, but is particularly useful for piezometric and weir flow data for evaluating internal erosion PFMs. Trends analysis can be used to assess instrument reliability, correlate readings with the reservoir level, identify anomalous dam behavior or instrument readings, determine instrument lag time, identify gradual changes in dam performance, and predict future performance (Garner and Vazinkhoo 2007). The latter is of particular importance to assessing the incremental risk due to internal erosion PFMs for reservoir loadings above the pool of record.

Trends analysis usually involves plotting the piezometer/weir data in two ways: (1) time-history plot where the piezometer/weir data are plotted with the stimulus or driver (usually reservoir level) against time and (2) correlation plot where the piezometer/weir data are plotted against the stimulus (e.g., piezometer/weir reading versus reservoir level). Time-history plots are more common because of how the data are collected and recorded over time. Often, the performance of the dam is apparent from the time-history plot, especially for a reservoir whose annual loading does not vary significantly from year to year (e.g., nearly filled every year for hydropower or water supply). However, correlation plots illustrate some aspects of the response of embankment dams better than time-history plots (Gall 2008).

The stimulus for time-history plots is typically the reservoir level, but piezometer/weir readings could also be influenced by tailwater levels, surface water runoff from precipitation, regional groundwater levels fed from an uphill source, or a combination thereof. Raw data collection and initial plotting should include tailwater and precipitation, if available, to help discern such influences. On a typical time-history plot, the piezometer/weir reading and reservoir level are plotted along the y-axis and time along the x-axis. The data on the time-history plots should be reviewed and parsed (i.e., separated) for “windows in time” to improve correlation. Factors to consider when parsing the data include the initial saturation phase during first filling of the reservoir, changes in reservoir operation, major modifications to the embankment or its foundation, and changes in observed performance after high pool events or drought. For example, correlations based on the entire period of record for a piezometer/weir are not appropriate for forecasting future performance if a seepage berm (i.e., a major modification) was installed 10 years ago that altered the performance. Time-history plots are also useful in identifying time-lag in the response of an instrument to loading as well as creep (or drift) in which an instrument gradually increases or decreases over time at consistent reservoir levels.

On correlation plots, the reservoir level is typically plotted along the x-axis and the piezometer/weir level along the y-axis. Each point represents an instrument-reservoir reading for a moment in time. Correlation plots are particularly useful where reservoir water levels vary significantly. If the piezometer/weir level is influenced only by the reservoir level and no significant lag is present, the data points will plot in nearly a straight line (correlation line). If the piezometer/weir level is influenced by and lags behind the reservoir level, the points scatter along a sloped line. On correlation plots, the lag for a certain reservoir level is expressed as the deviation in piezometer/weir level from the correlation line. It is expressed in feet for piezometric levels or flow for weirs rather than time as on the time-history plots (Gall 2008).

Curve-fitting to the raw or corrected data can be used to mathematically define the correlation line, forecast future performance, and help establish action levels as part of a performance monitoring program. The coefficient of determination (R^2) is used to statistically evaluate the strength of the correlation (i.e., how well a regression line fits a dataset). It ranges from 0 to 1.0 and provides an indication of the reliability of the fitted trend and the accuracy of the forecast. An R^2 value near 1.0 indicates a good fit to the data, while an R^2 closer to 0 indicates a poor fit to the data. Generally, as the difference between the piezometer/weir reading and the reservoir level becomes larger, the correlation becomes weaker, resulting in a flatter slope of the correlation line. The slope of the correlation line can vary from a “perfect” or one-to-one correlation (i.e., the piezometer/weir reading equals the reservoir level, resulting in a 45-degree line for equal scales on both axes) to no correlation (i.e., the piezometer/weir level is constant regardless of the reservoir level, resulting in a horizontal line). Random scattering is indicative of a different stimulus such as surface water runoff, aquifer fed from an uphill source, or tailwater level variation (Gall 2008).

The correlation and its usefulness in assessing performance is improved when the instrumentation data are parsed and corrected for lag and creep as shown on figures 8-3 through 8-6. In this example from the Association of State Dam Safety Officials (ASDSO) (2010), the raw fit of the weir flows over the entire period of record resulted in an R^2 value of 0.28 as shown on figure 8-3. Based on a review of the weir flows over time, three distinct periods of performance characteristics were observed: (1) flows increased at 76 liters per minute per year (L/min/yr) until July 1983, (2) flows decreased at 9.8 L/min/yr from July 1983 to May 1997, and (3) flows decreased at 6 L/min/yr from May 1997 to present. Flows increased slightly when the reservoir levels were above elevation 2180. Lag time was 15 days prior to 1983 and was unchanged at 23 days since 1983. By parsing the data into three time intervals as shown on figure 8-4, the R^2 values for the resulting correlations are improved to 0.64, 0.30, and 0.39, respectively. By correcting for lag as shown on figure 8-5, the R^2 values for the resulting correlations are improved to 0.65, 0.40, and 0.51, respectively. Lastly, by correcting for creep as shown on figure 8-6, the R^2 values for the resulting correlations are improved to 0.73, 0.41, and 0.52, respectively. With corrections for parsing, lag, and creep in the trends analysis, the weir flows correlated well with the reservoir levels.

Normalizing instrumentation data can also be useful in trends analysis and forecasting future performance. One such method is the theoretical concept of net head dissipated (NHD) that

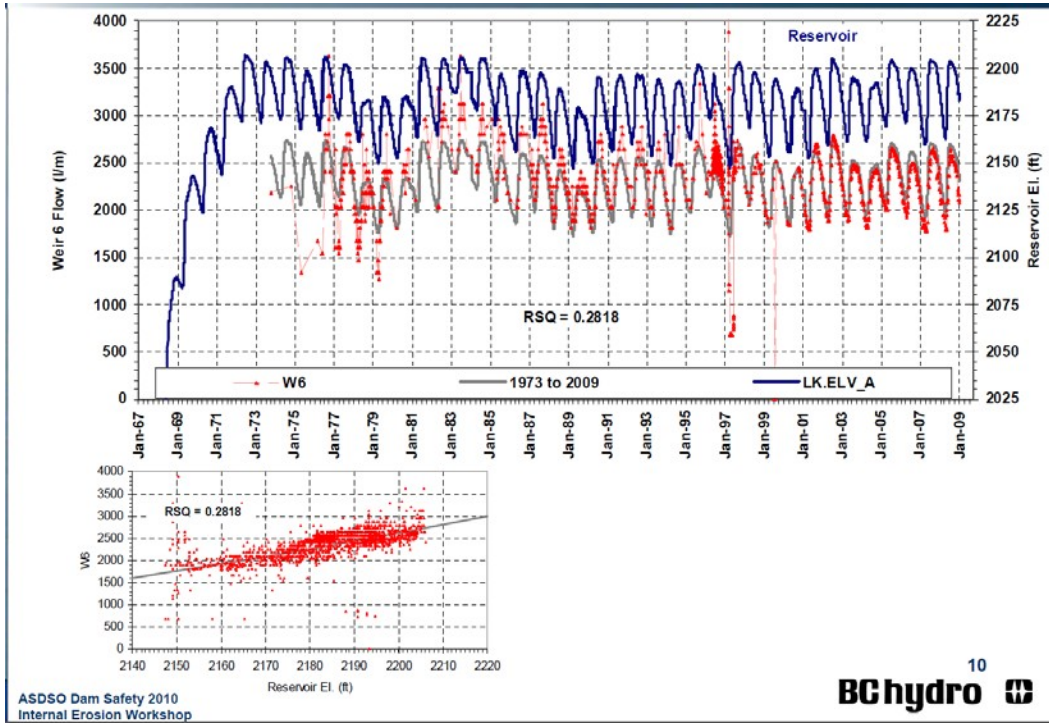

Figure 8-3.—Weir response and raw fit (ASDSO 2010).

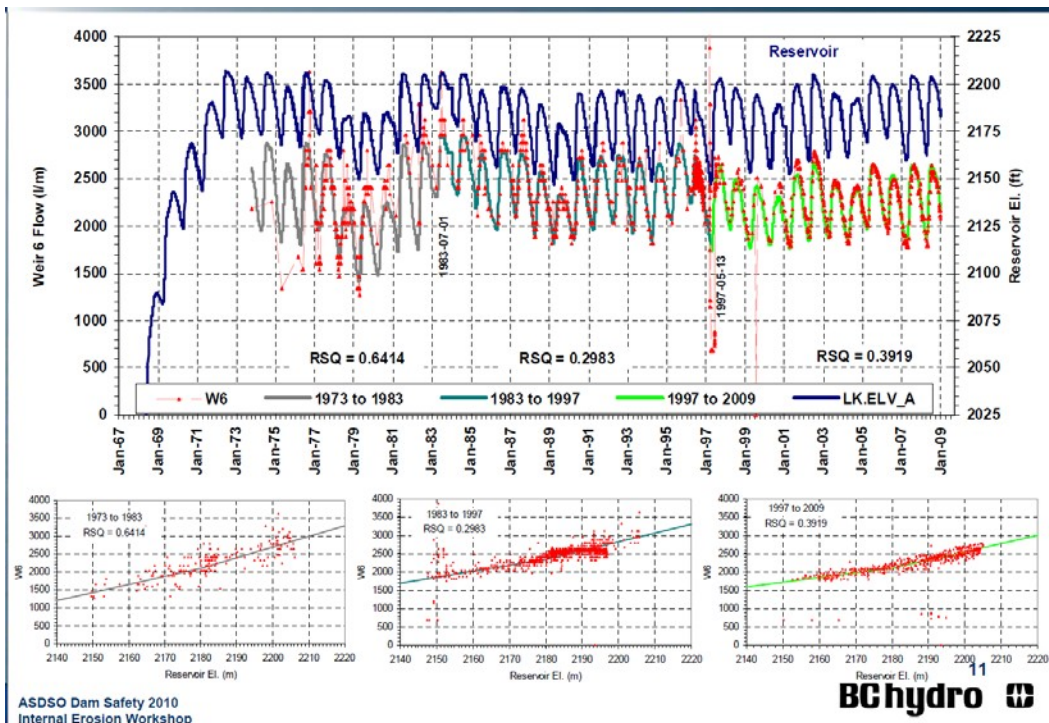

Figure 8-4.—Weir parsed 1973–1983, 1983–1997, and 1997–2009 (ASDSO 2010).

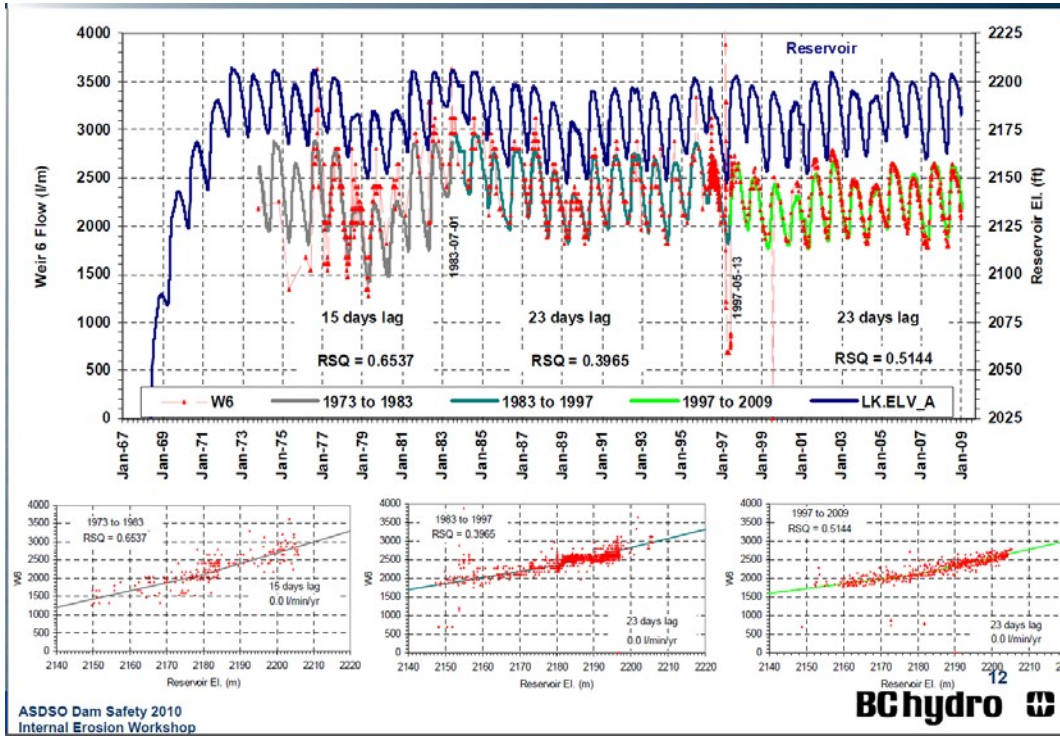

Figure 8-5.—Weir parsed and corrected for lag (ASDSO 2010).

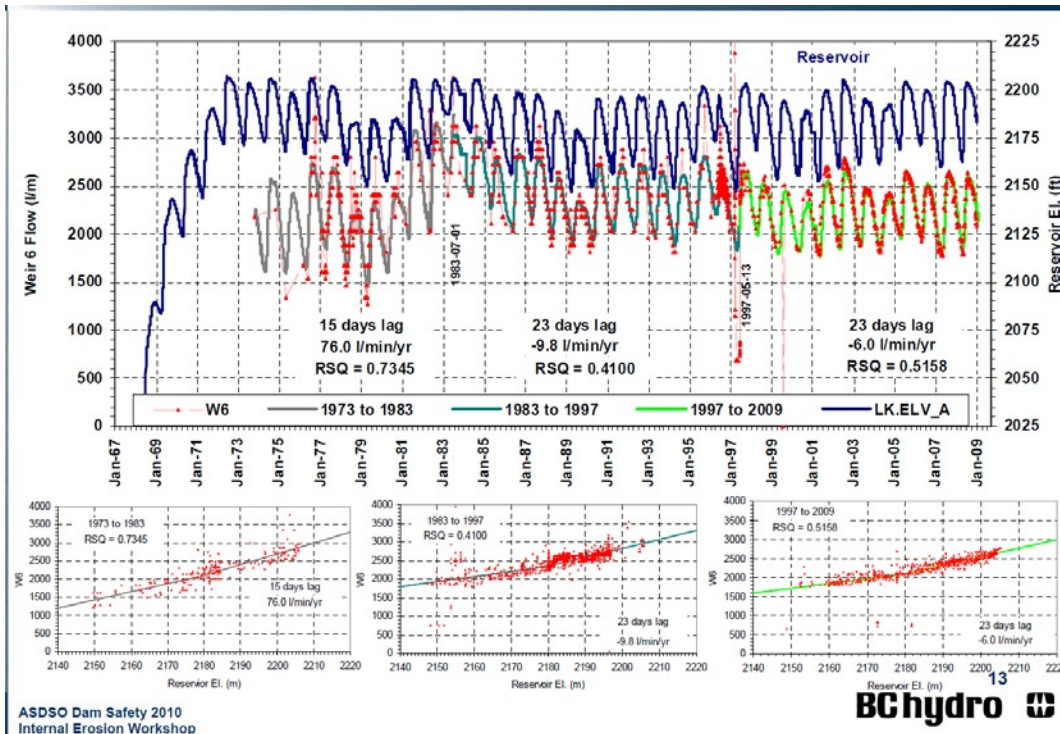

Figure 8-6.—Weir parsed and corrected for lag and creep (ASDSO 2010).

statistically normalizes piezometer data at all reservoir-tailwater combinations. NHD values can be computed using the measured piezometer reading, reservoir elevation, and tailwater elevation as shown in the equation below:

$$\text{Net head dissipated (NHD)} = \frac{\text{Reservoir elevation} - \text{Piezometric elevation}}{\text{Reservoir elevation} - \text{Tailwater elevation}}$$

When evaluating NHD values, decreasing piezometric levels are reflected by increasing NHD values and vice versa. NHD values should remain constant through time (at steady-state hydrostatic condition) unless boundary conditions change (e.g., installation or change in efficiency of relief wells, upstream silting of seepage entrances, construction activity, clogging of toe drains, piping) (Guy et al. 2006); in which case, the aforementioned adjustments by parsing and correcting for lag and creep can be made. It may also be useful to consider the net head felt (n) or differential head ratio (DHR), as discussed in the next section. The DHR is the complement of the NHD, and $\text{DHR} = 1 - \text{NHD}$.

8.5.4 Uses of Piezometer Data

Piezometer data can be used in several ways to define seepage conditions at the dam site. A single piezometer measures water pressure at a specific location. If multiple piezometers are installed in a single borehole, then the average hydraulic gradient between any two piezometer locations can be calculated. Similarly, in the case of a surface blanket of low permeability soil over an aquifer, the gradient across the blanket can be calculated if a piezometer is installed just below the blanket and the tailwater elevation on the top of the blanket is known. From the thickness and unit weight of the blanket and the piezometric head across the blanket, the factor of safety against uplift can be determined by the methods presented in chapter 3.

Piezometer data can also be used to delineate contours of the groundwater elevation, say, in the area downstream from the dam. The contours represent the phreatic surface within an unconfined aquifer or the potentiometric surface within a confined aquifer. A sufficient number of piezometers must be installed in the area of interest so that interpolations between data locations accurately represent actual conditions. Boundary conditions must also be understood to properly interpret the instrument readings and for input into seepage models. Also, care should be taken to ensure that all piezometers used to create the contours are located within the same stratum. Contour maps of groundwater elevation can be used to determine the direction and pattern of flow in plan view and to identify areas of high gradients, concentrations of flow, and potential problem areas (figure 8-7). After initial contour plots are developed, locations where additional piezometers are needed may become apparent.

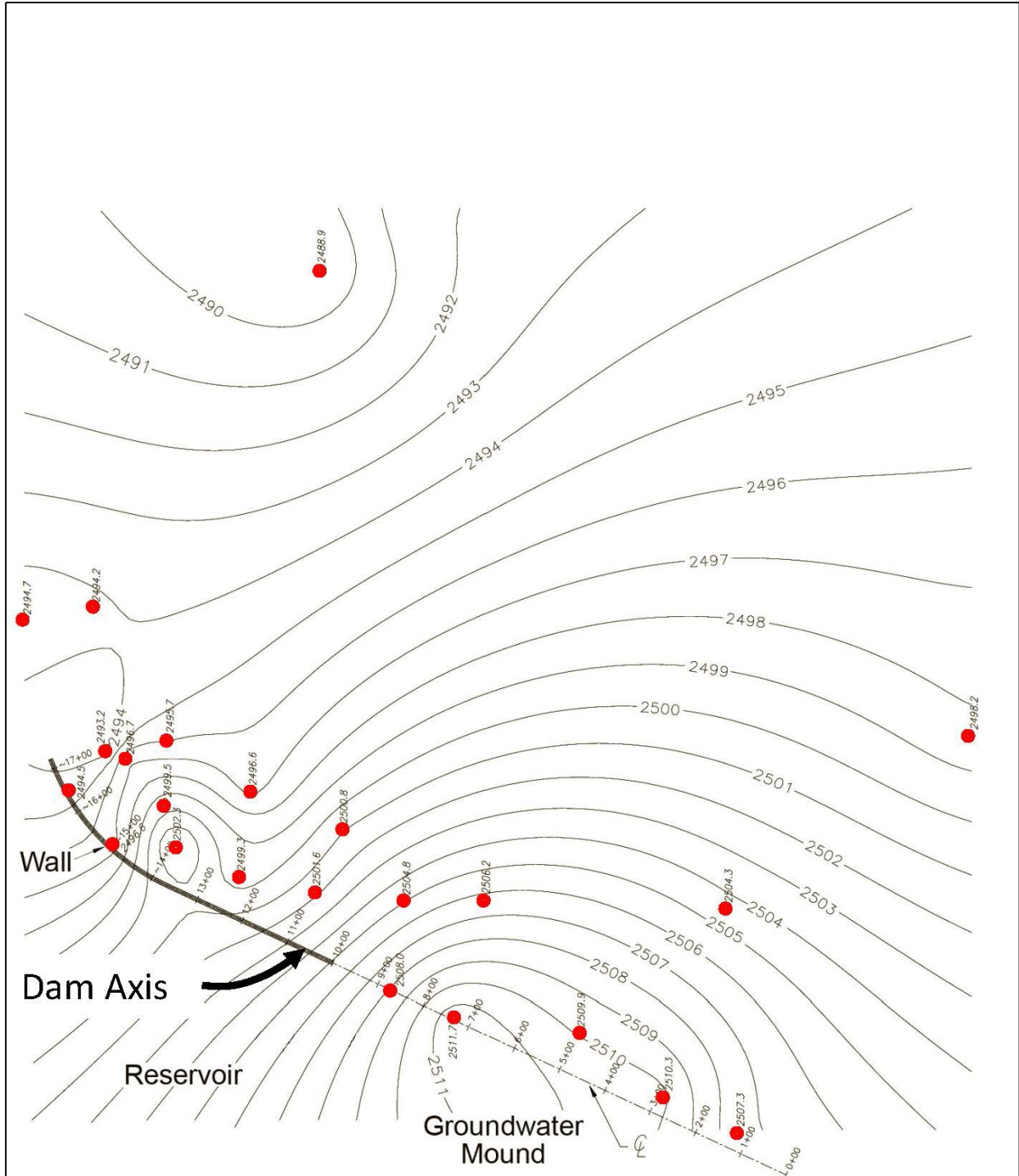

Figure 8-7.—Example groundwater contour map produced by mapping software from existing data collected from piezometers.

8.5.5 Predicting Piezometer Readings at Higher Reservoir Levels

Piezometer readings at lower reservoir levels can be used to predict what the readings will be at reservoir levels not yet experienced, such as at the emergency spillway crest or at the top of dam. Such projections are valuable in evaluating the safety of the structure under extreme loading conditions. However, it must be remembered that these projections represent only point values at the piezometer location(s) themselves. To reasonably assure safety at all locations, sufficient piezometers must be installed so that extrapolations can be made with confidence over the entire area of interest. Caution must be exercised when using linear extrapolations because the behavior may become non-linear at higher reservoir levels due to opening of joints, etc.

Three methods for predicting piezometer readings at higher reservoir levels are presented below:

- (1) Simple graphical extrapolation of piezometric elevation versus reservoir elevation
- (2) Mathematical extrapolation based on trends analysis (non-linear) or differential head ratio (linear)
- (3) Computer seepage modeling

While predictions can be made, it is highly unlikely that piezometers will be located at the critical location (i.e., weak link or defect) in the seepage pathway. Therefore, care must be taken to not get a false sense of confidence if the piezometric data look good because the controlling seepage water may be elsewhere.

8.5.5.1 Graphical Extrapolation

The simplest method to predict piezometric elevations for higher reservoir levels from those observed at lower levels (e.g., during the first filling) is graphical extrapolation of a plot of piezometric elevation versus reservoir elevation. An example of such a plot is shown on figure 8-8, where the piezometric elevations at both the emergency spillway crest and at the top of dam are estimated. Obviously, this method cannot be used until enough piezometer readings at various pool levels have been obtained to permit reliable extrapolation of the data. Readings taken at initial pool levels may need to be disregarded until the plot takes on a linear trend, such as when a minimum pool level is required either to fully charge the dam foundation or to overcome regional artesian pressure in the foundation.

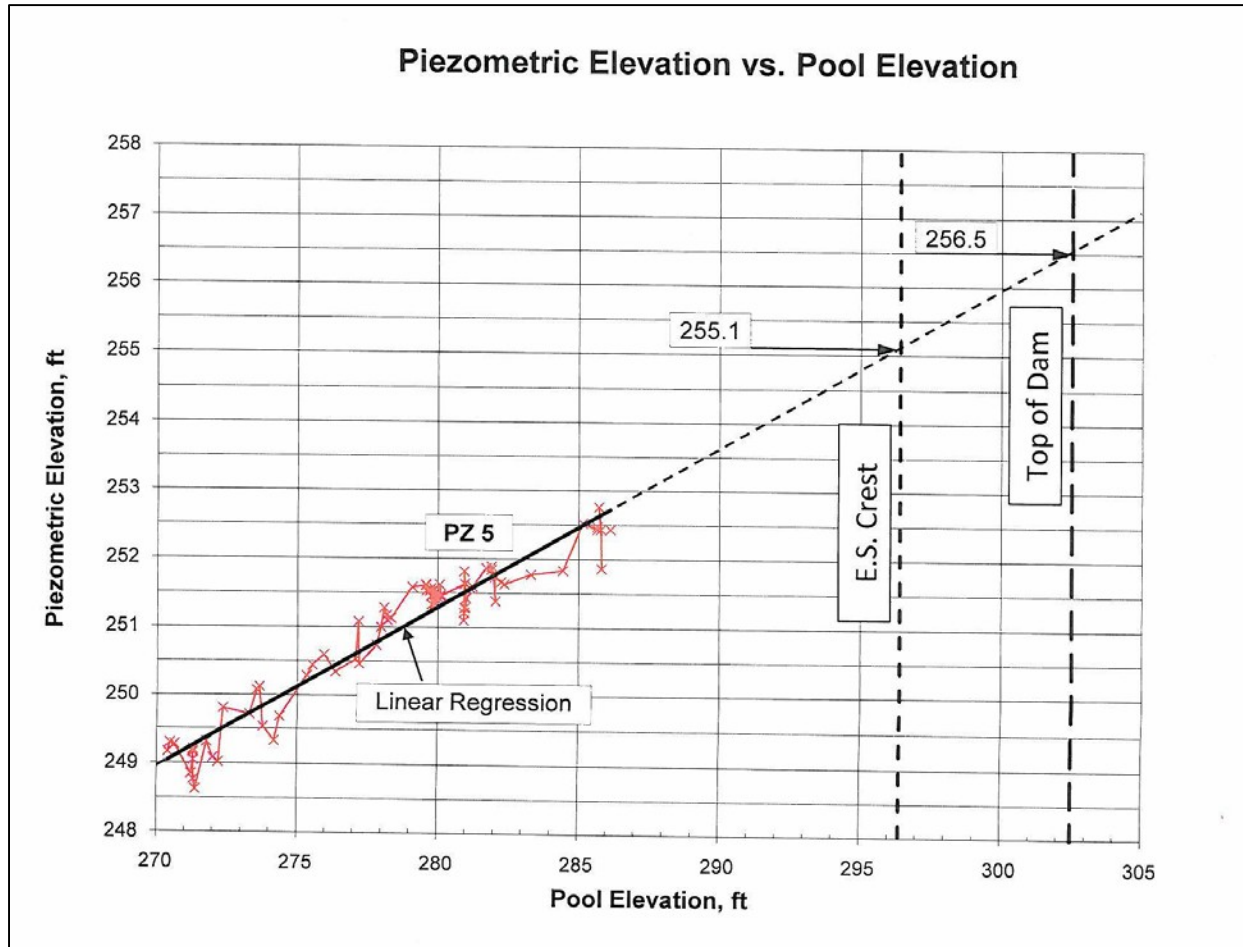

Figure 8-8.—Graphical extrapolation of piezometric elevation versus reservoir elevation plot.

8.5.5.2 Differential Head Ratio

The concept of differential head ratio (DHR) may also be used to predict piezometric levels at higher reservoir levels. This approach is based on the concept that the piezometric elevation at a given location (i.e., at a piezometer) represents an equipotential line in the flow net that defines the flow pattern between the reservoir and the downstream boundary conditions and that the shape of the flow net does not change with fluctuations in the reservoir and/or tailwater levels. Therefore, DHR remains constant at a given piezometer location for all reservoir levels. The differential head ratio can be calculated directly using the following equation:

$$\text{Differential head ratio (DHR)} = \frac{\text{Piezometric elevation} - \text{Tailwater elevation}}{\text{Pool elevation} - \text{Tailwater elevation}}$$

where the terms are illustrated on figure 8-9. Since the DHR remains constant for all pool levels, it can be used to mathematically calculate the piezometric elevation at a piezometer for any reservoir level, provided that the corresponding tailwater elevation is known.

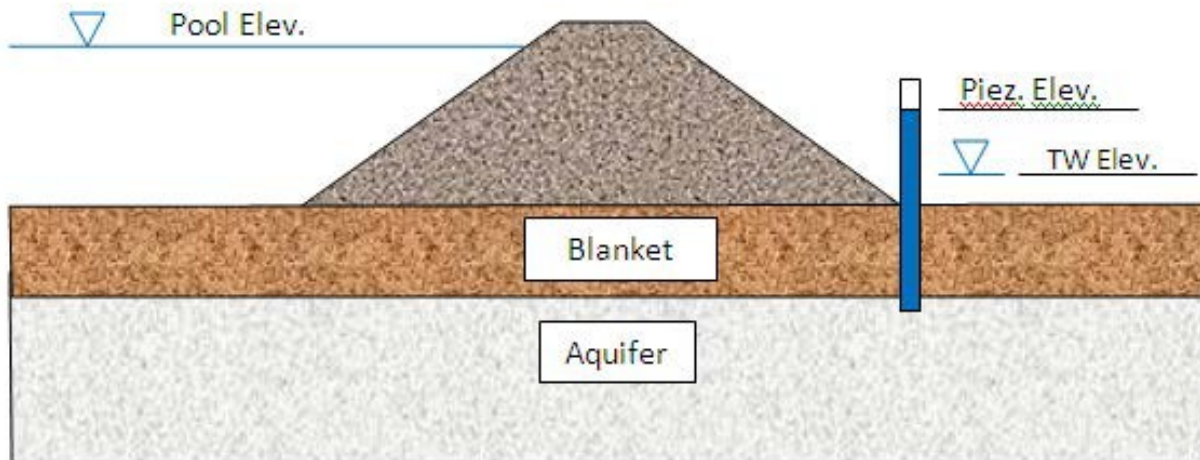

Figure 8-9.—Definition sketch for differential head ratio for blanket-aquifer foundation.

On figure 8-10, a plot of DHR (as percent) versus time for an actual piezometer (piezometer 5) is shown for the first filling of a reservoir. Once a certain reservoir level was reached and the foundation was fully charged, it can be seen that the DHR remained relatively constant at about 20.4 percent. The variation in the data may be the result of such environmental factors as precipitation and barometric pressure fluctuations. For a top of dam elevation of 302.5 and a corresponding tailwater elevation of 244.0, the piezometric elevation in piezometer 5 when the pool is at the top of dam is calculated as follows:

$$\text{Piezometric elevation} = (20.4/100) (302.5 - 244) + 244 = 255.9$$

One advantage of the DHR over the graphical extrapolation method is that it is not necessary to have piezometer readings over a wide range of reservoir levels to be able to make projections to higher reservoir levels. This would apply in the case where a new piezometer is installed after the reservoir has already filled to the permanent pool level. It should be kept in mind that the DHR at a given piezometer could increase at some higher reservoir level if a new seepage entry area is reached by the pool. Additionally, the relationship between reservoir level and piezometer reading may be linear at lower reservoir levels but non-linear at higher levels due to opening of joints and other causes. Therefore, caution should be exercised when using linear extrapolations based on DHR. Also, it is critical that piezometer readings be obtained whenever the reservoir exceeds normal pool so that the validity of extrapolations based on DHR can be checked.

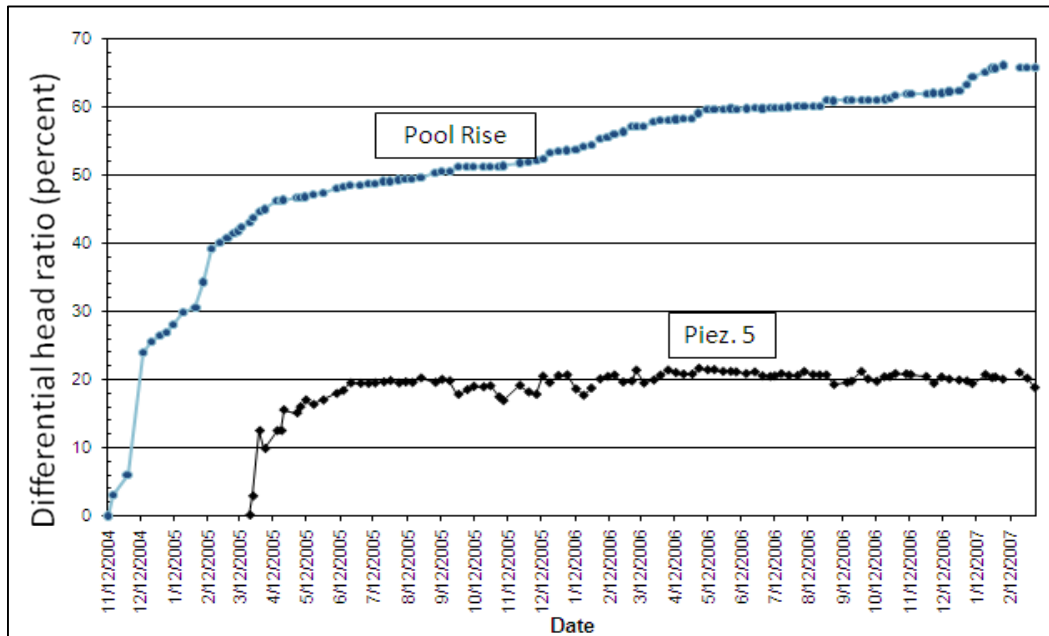

Figure 8-10.—Differential head ratio versus time for a piezometer during first filling (vertical axis units for “Pool Rise” curve are in feet.)

8.5.5.3 Seepage Modeling

Computer seepage modeling may also be used to predict piezometric levels at higher reservoir levels. Seepage modeling software, such as SEEP/W, may be used to create a model of the seepage conditions at a given dam site for various reservoir levels. The model is calibrated using observed data at reservoir levels up to the normal pool. Seepage conditions at higher reservoir levels can then be estimated simply by changing the upstream and downstream head boundary conditions in the model as appropriate. It should be noted that the accuracy of the projections is dependent on how accurately the model captures the complexity of the actual conditions at the site, such as variations in thickness, permeability, and anisotropy of the various foundation strata. Foundation deformations that may accompany higher pools can also affect the permeability, flow, and pressures that are not accounted for in a seepage analysis. Furthermore, if additional entry areas in the reservoir come into play at levels above the normal pool, then the seepage model may give non-conservatively low estimates of seepage rates and pressures at these higher reservoir levels.

8.6 Aging Impacts

Long-term deterioration primarily affects the seepage drainage system components. Instrumentation equipment may also suffer aging effects if not properly maintained and replaced as needed. Granular filter media, conduit pipes, well screens, mechanical fittings, and geotextiles are other drainage system components subject to aging and long-term deterioration effects (FEMA 2000, 2005).

Deterioration may include:

- (1) Material corrosion, physical breakage, or blockage
- (2) Mineral deposition and encrustation
- (3) Bacterial or algal growth
- (4) Filter media cementation
- (5) Gravel pack siltation
- (6) Damage from repeated maintenance activities
- (7) Vandalism
- (8) Tree root encroachment
- (9) Animal activity

Many, but not all, of the forms of deterioration listed above will tend to cause piezometric levels to gradually rise; for example, siltation of relief well filter packs or biological clogging of drain outlets. If gradual increases in piezometric levels are observed, all possible aging effects should be considered when evaluating the piezometer readings rather than assuming that faulty instruments are to blame. Visual inspections can be invaluable in identifying operative aging effects.

8.7 References

- Association of State Dam Safety Officials (ASDSO) (2010). "Specialty Workshop: Identification, Monitoring and Repair of Piping Damage to Dams," ASDSO Dam Safety 2010 Conference, Seattle, Washington.
- Federal Emergency Management Agency (FEMA) (2000). National Dam Safety Program Research Needs Workshop: Seepage Through Embankments, FEMA 535. Denver, Colorado.
- _____(2005). Federal Guidelines for Dam Safety: Hazard Potential Classification for Dams, FEMA 535. Denver, Colorado.
- Federal Energy Regulatory Commission (FERC) (2006). Engineering Guidelines for the Evaluation of Hydropower Projects. <http://www.ferc.gov/industries/hydropower/safety/guidelines/eng-guide.asp>
- Fell, R., P. MacGregor, D. Stapledon, and G. Bell (2005). Geotechnical Engineering of Dams, A.A. Balkema.
- Gall, E.B. (2008). "Using correlation plots for dam safety analysis," Hydro Review, 27(3).
- Garner, S.J. and Vazinkhoo, S. (2007). "Analysis of conventional monitoring and cross-hole seismic data for detection of internal erosion in an earthfill dam" Proc. 7th ICOLD European Club Dam Symposium, Freising, Germany, September.

Guy, E., T. Calhoun, G. Alford, and C. Barry (2006). “Relief wells rehabilitation at Alum Creek and Dillon Dams,” Proc., 2006 Annual Conference, Association of State Dam Safety Officials.

International Commission on Large Dams (ICOLD) (1988). Dam Monitoring General Considerations. Bulletin 60.

Mangney, A. (2006). Owner’s Instrumentation Submittals. Dam Surveillance and Monitoring Workshop, USSD.

Penman, A.D.M. and V.M. Sharma (1999). Instrumentation, Monitoring and Surveillance Embankment Dams, A.A. Balkema/Rotterdam/Brookfield.

Smith, D.W., Jr. (1986). “Surveillance measurements within California’s Dam Safety Program,” Division Procedures Manual, California Department of Water Resources Division of Safety of Dams, Sacramento, California.

U.S. Army Corps of Engineers (USACE) (1979). *Reporting Earthquake Effects*. ER 1110-2-1802.

_____(2014). *Safety of Dams – Policy and Procedures*. ER 1110-2-1156.

Part 4

Emergency Response and Remediation Methods for Internal Erosion

CHAPTER 9 – EMERGENCY RESPONSE AND INTERIM MEASURES

9.1 Introduction

This chapter focuses specifically on emergency actions that should be taken as a result of an internal erosion incident. As demonstrated in statistics, incidents and dam failures due to internal erosion are a constant concern and occur with high frequency every year. A dam owner should never assume that since they have never had an incident related to internal erosion that they are free from such concerns.

Dam safety risks can increase dramatically and quickly during dam incidents. Properly managing these risks can make the difference between a controlled situation and a full dam failure that results in major consequences, including loss of life. Emergencies require real-time, high-priority responses regardless of what day or time it is.

The following paragraphs discuss several components of planning for emergencies—pre-event planning, an Emergency Action Plan (EAP), and interim measures. This chapter is not meant to be a substitute for site-specific EAPs; it is only a brief overview of the subject and may not be specifically applicable to every situation. The reader may find more detailed references on this topic in the Federal Guidelines for Dam Safety: Emergency Action Planning for Dam Owners (Federal Emergency Management Agency [FEMA] (2004a).

9.2 Pre-event Planning

Prior to any incident occurring at a dam, particularly internal erosion for purposes of this chapter, the dam owner should have completed a risk assessment, either through a general assessment of risk, a potential failure modes analysis, or a risk analysis. The results of the risk assessment can be used to inform what incidents might be likely to occur and can assist with preparations for potential emergencies in addition to general emergency planning. With proper advance planning and monitoring, it may be possible to intervene if internal erosion problems are detected quickly and develop slowly enough. Dam owners should be aware that first filling (e.g., initial impoundment, record pool elevations, or filling after dam modifications) is a critical period. Pre-event planning is an important tool that may help with intervention efforts. It can be done following a risk assessment for a variety of failure modes and may be incorporated into the Operations Manual, Standard Operating Procedures, EAP, or as a separate plan.

There is no standard practice in regard to pre-event planning. The degree and level of pre-event planning will depend to a large extent on anticipated consequences, ability to lower the reservoir, and value of the project assets. A typical plan might:

- Identify the responsible person for overall plan implementation.
- List technical resources and technical experts who can be consulted during an emergency, including 24-hour/365 days per year contact information.
- Identify the procedures that will be implemented during the decision making process (e.g., if senior managers will be involved in the final decisions, their names, and 24-hour/365 days per year contact information).
- List names and contact information for local sources of material, haulers, and local heavy equipment contractors that are available on very short notice during an emergency. More than one potential source for each of these should be identified in advance if possible. In some cases, dam owners will maintain pre-existing contracts for these emergency services.
- Identify what types and gradations of materials may be needed to address an internal erosion problem at your site. In some cases, preliminary designs for emergency repairs are prepared in advance.
- Identify outlet capacities, downstream channel capacities, and a plan for emergency reservoir drawdown.

Pre-identified individual(s) who are familiar with each dam in their inventory and who could contribute to an emergency response are critical to a good dam safety program. The size of the team and technical background will vary depending on the size and complexity of the inventory of dams. Dam decisionmakers should rely on, and have immediate access to, technical specialists to make informed decisions. Technical specialists can be a great aid during an incident, as they can review and understand the implications of design and construction information, compare past performance with the current event to see if the risks are increasing, help define heightened monitoring programs or identify explorations that should be conducted, and quickly review failure modes and risks to see what risk reduction actions need to be taken.

Pre-event planning does not require much time or resources and it can make the difference between having a dam safety incident versus a dam failure when an internal erosion problem develops.

9.3 Emergency Action Plan

The primary purpose of an EAP is to identify the scope of possible impact of a dam failure and to lay out all the information necessary to efficiently implement evacuations and other actions needed during an emergency at a dam. The EAP will clearly identify the local and State jurisdictions impacted by a dam failure and who is responsible for protecting the public in each jurisdiction. Contact information is provided, and the dam owner is usually responsible for making the initial notifications during an emergency. The EAP can be implemented during any

type of emergency, but can be particularly instrumental when an internal erosion problem is developing, especially if the decision to warn and evacuate is carefully thought out and planned in advance of this type of emergency. Most EAPs will typically have several different alert levels to allow the emergency responders to take an appropriate stance depending on conditions at the dam. These alert levels may be similar to the following:

- *Condition D*: Non-emergency condition is occurring at the project, such as abnormally high flood flows, but conditions for the dam are within normal operating parameters. No actions required other than routine flood related activities; this information is for emergency management agency flood planning purposes.
- *Condition C*: There is a static situation at the dam we are evaluating. Due to its seriousness, it is warranted to alert the authorities to standby in case of any change in status but that there is presently no need to implement evacuation. (“Ready”)
- *Condition B*: A hazardous condition is now developing. Efforts are underway to control the situation. Emergency responders should prepare to mobilize on short notice; command and control elements should mobilize as needed to follow conditions as they develop. (“Set”)
- *Condition A*: Dam failure is imminent. Immediate actions required, and emergency responders should mobilize now. (“Go”)

EAPs are updated on a frequent basis and may be tested periodically through tabletop and functional exercises. It is recommended that an internal erosion problem be considered as a dam failure scenario at these exercises to familiarize the responders with the time element and uncertainties that may be involved with such an incident.

As mentioned above, many dam owners will have a sub-plan in the EAP to address the owner’s internal procedures based on pre-event planning. This may not be required by all Federal agencies, but is a good idea to consider since it will help ensure that the dam owner’s organization is also well informed and prepared during an emergency. The EAP is typically prepared by an owner to facilitate warning local emergency responders during an emergency, to identify the potential impacted areas, and to supplement the emergency responder’s plans for addressing an emergency at the dam. However, it might be good practice to include the dam owner’s pre-event planning in the EAP so everyone involved in an incident understands the potential owner-actions that may need to be supported during an emergency. For example, during an internal erosion incident, there may need to be truck traffic routes left open to the dam if filter-berm material is needed at the dam.

All projects with a high downstream hazard potential should have an EAP, and one is also recommended for projects with a significant downstream hazard potential. Some projects with low downstream hazard potential may have EAPs if roads or other infrastructure may be impacted and would require intervention from local emergency management agencies. EAPs are further discussed in FEMA (2004).

9.4 Incident Detection and Initial Evaluation

Internal erosion incidents are typically identified by a dam owner's personnel during routine monitoring or by the public. New seepage or a sudden change in seepage conditions may occur, which alerts those most familiar with the dam of a potential problem. Depending on the magnitude of the change, a technical specialist may be called, and decisionmakers may be notified to determine follow-up actions. In other cases, the changed condition may be so extreme that the EAP is immediately activated. Other times, the situation may fall between these two extremes, and the dam owner may not be sure what steps to take. This section discusses some of the factors that may be involved during an internal erosion incident and some factors that may be considered when making decisions on how best to proceed. When people's lives may potentially be at risk, it is important to be prepared in advance to determine the best course of action that will minimize loss of life. While this chapter provides information that might be useful to the decision maker, we have to caution that there is no standard response or formula that can be applied to every internal erosion incident, as every incident is unique. Some initial questions that might be asked to initially assess a situation might include the following:

- What failure mode is potentially occurring, and has this risk been previously assessed?
- Has internal erosion initiated (i.e., has particle transport or turbidity been observed)? If so, do we have a pre-event plan of action for internal erosion?
- Is it likely to continue and lead to failure (is the seepage rate increasing, are sinkholes forming, etc.)?
- What is the potential downstream impact if the condition leads to failure?
- Can the reservoir be rapidly drawn down, and is there enough time to evacuate downstream residents if the condition becomes critical?

Internal erosion is likely to develop at a number of key locations as discussed in chapter 3, and detection efforts should be focused on those areas.

9.4.1 Internal Erosion Detection

Detection of internal erosion is done with visual and instrumented monitoring. Chapter 6 discusses the various procedures and tools available for detecting and assessing internal erosion problems. Since internal erosion can be a situation in which the problem gradually progresses and worsens as time passes, it is a failure mode that is amenable to treatment if early detection is made.

While many dam owners have invested heavily in detection equipment and hardware to monitor seepage at their dams, many times the weak link in such systems is the human factor. It is

critical to train new personnel in the importance of seepage monitoring and dam safety and the proper way to take measurements from the equipment used to detect seepage issues. They should also be trained to recognize the visual signs of internal erosion, such as the accumulation of soil around seepage exits, surging seepage, the change in turbidity or quantity of seepage, or the sudden appearance of seepage at a new location. They should also be trained on the potential failure modes that have been specifically highlighted for the project, instrumentation and monitoring thresholds, and the design and construction vulnerabilities that are specific to the facility. The majority of internal erosion failures occur from seepage around the outside of conduits, and this fact should be known by those responsible for daily visual inspections of dams.

It is not unusual for the person taking the measurements and doing daily visual inspections to not be the same person responsible for interpreting the data. This can be a weak link, especially if the data are not being immediately checked for accuracy or the visual observations are not being conveyed to the engineers in a timely fashion. It is the dam owner's responsibility to ensure these human factors do not jeopardize the project.

As previously mentioned, seepage problems are not static problems, and early detection is critical. The best practice for early detection is to have personnel who are responsible for conducting the observations and interpreting the readings to either be present when the readings are taken or to evaluate the data a short time after the readings or observations are made.

Once an adverse reading or observation is made, the information should be passed immediately to the appropriate decision makers and/or technical staff. This may require notification beyond normal business hours. Once the manager has been notified, he is tasked with making an informed decision on how next to proceed. This decision is extremely time-critical, as it affects the time and level of effort to respond to a potentially rapidly developing problem and can significantly impact the outcome.

9.4.2 Initial Assessment and the Decision Point

Once the decision maker has been notified of a change in seepage condition, an assessment of the situation must be made on short notice and a determination made regarding the appropriate actions to take. The decision maker should determine if it is an immediate emergency requiring an aggressive response or something that is progressing slowly, which allows time for further evaluation.

Incidents and emergencies are real-time, high-pressure events. People responding to internal erosion events often need to take quick action to prevent dam failure. In some cases there may be time to consult with experienced dam safety program and technical staff, but this is not always the case.

9.4.2.1 Immediate Emergency Requiring Aggressive Response

There are a number of ways that internal erosion may be expressed. In some cases, the physical manifestation may provide clues as to the possible magnitude of the problem. The following observations may indicate an immediate emergency is developing, requiring immediate action by the dam owner. Please note that this is not an all-inclusive list (there may be other signs of an immediate emergency that are not listed here) and is not a substitute for proper training.

- A sinkhole has developed on the slope or crest of the dam or in the abutments and is observed to be enlarging.
- Turbid or sandy seepage is exiting an embankment, abutment, or foundation (this might be located some distance downstream from the dam or within the dam itself).
- A depression is actively developing on the embankment slope or abutments.
- Turbid or sandy seepage is exiting from the annular space from around the outside of a conduit that penetrates an embankment dam.
- Seepage is discharging from a point with increasing rate (or may be fluctuating with overall average increasing rate).
- Seepage is exiting so fast that it is eroding the embankment or foundation at its exit point.
- A sudden increase in turbid or sandy flow from within a conduit that penetrates the dam.
- Previously stable boils begin discharging soil as the reservoir level rises, and the reservoir is continuing to rise.
- Any uncontrolled seepage from embankments constructed of dispersive soils.
- Turbid or sandy seepage begins exiting rock joints at high flows or from under or adjacent to spillways or other structures.
- Sudden, unexplained change in instrumentation readings.
- Whirlpools are developing in the reservoir.

As discussed above, there can be a number of other critical scenarios that would indicate an immediate emergency that are not listed.

9.4.2.2 Incidents that Allow Time for Further Evaluation

Not every new seepage outbreak is an immediate emergency. All dams have seepage that passes under the dam or through the abutments. This occurs because groundwater levels are near reservoir level on the upstream side of the dam and near tailwater downstream from the dam. Hence, the overall natural gradient drives seepage through, under, or around the dam. Normal annual variations in the phreatic surface can be driven by natural fluctuations of infiltration and regional groundwater flow patterns. All of these conditions may result in new seepage exiting the embankment, foundation, or abutments at slow rates that may be considered benign. However, seepage that is not considered an immediate dam safety concern should be carefully investigated, evaluated, and monitored until it has been confirmed that it is benign. Conditions may change, especially during times of high headwater or low tailwater, and benign seepage may become an immediate dam safety concern if not properly treated. Some characteristics of the physical manifestation of the seepage may be clues that the seepage is presently stable and not progressing to internal erosion. In these cases, there may be time to do a thorough investigation and develop a long-term plan for addressing the issue. Please note that there are no set rules in this regard, and there can be exceptions depending on the situation.

9.5 Emergency Response Alternatives

Depending on the level of concern, appropriate actions must be taken to address an internal erosion incident. As was discussed above, some incidents may not appear to be an immediate emergency, but warrant further investigation. Other incidents may indicate a rapidly deteriorating condition that needs to be addressed immediately. An engineer with technical expertise in this area is needed to help determine what actions are appropriate when an internal erosion concern develops.

The first rule of thumb when decisions need to be made in response to a dam incident is to “do no harm.” There are actions that people can take that can inadvertently make the problem worse, and the following are some examples (not meant to be all inclusive):

- A local equipment operator may put clay on top of a seep in order to stop the seepage – this could raise the pressures within the dam and cause more severe seepage blowout or slope instability. Construction of a filter/drainage berm would normally be a better course of action in this case to control the seepage.
- A drainage ditch is dewatered near the downstream toe of a dam for maintenance or other reasons, triggering internal erosion at the dam.
- Excavation is done near the toe of the dam, increasing seepage through the foundation and triggering heave or blowout.
- A contractor hydraulically fractures the core of a dam while installing a new piezometer or performing other investigations.

- A contractor drills through a confining layer into an artesian aquifer, causing a sand boil at the toe of the dam.
- Grouting to reduce seepage triggers large rock or soil slope failure due to increased uplift pressures.
- Grouting in an embankment or foundation resulted in roof formation or a changing seepage path that promotes internal erosion.

Prompt contact with dam experts will help ensure that any action results in a reduction of risks to the dam and helps prevent failure.

9.5.1 Immediate Actions

Assuming it has been decided that the internal erosion incident is progressing and immediate action is required, there are a number of possible steps that may be taken at this stage. Some possible activities during and after an emergency follow and may be not be implemented in the order shown depending on the situation:

- Initiate the EAP
- Begin reservoir drawdown if needed
- Take other appropriate actions as needed to address the problem
- Mobilize the contractor in accordance with the pre-event action planning
- Mobilize the response team in accordance with the pre-event action planning
- Implement additional risk reduction measures as needed
- Collect the entire necessary project data needed to evaluate the condition
- Complete site inspections, follow-up investigations, and desk studies

The following paragraphs describe some of these steps in more detail. They are not listed in any specific order and may be implemented in the manner most appropriate for your emergency. Other steps may also be possible, which are not listed here.

9.5.1.1 Emergency Reservoir Drawdown

Drawing down the reservoir in an emergency may help to reduce the hydraulic forces driving internal erosion, which may slow it down or even arrest it. It also may help mitigate some of the potential downstream damages by reducing the amount of retained water in the event of an uncontrolled breach of the dam. If a flaw exists at a certain elevation, drawing down the reservoir to an elevation below the flaw removes the emergency. In rare cases, it may be necessary to induce a controlled breach of the dam in an area where the breach will be naturally restricted (e.g., on a rocky abutment area) rather than allowing the internal erosion to induce a deeper, wider breach in a more critical area. The authorities should be notified as soon as

possible after the decision to drawdown the reservoir has been made, and local emergency management agencies, radio, television stations, as well as the National Weather Service should be notified, as well as people living on or near the river just downstream from the dam so they are aware of the reason the reservoir levels are dropping, can take appropriate actions to ensure their safety, and can communicate the information to the general public.

9.5.1.2 EAP Implementation

The uncontrolled progression of internal erosion generally warrants activation of *Condition A* of an EAP if the progression will lead to breach of the dam and a significant uncontrolled release. Each situation must be evaluated individually, but it will take time to implement the EAP. The earlier the authorities are alerted, the more likely it will be a successful evacuation. However, evacuations come with a cost. Persons have been injured or even killed while evacuating due to an emergency, so activation of *Condition A* should always be well founded.

9.5.1.3 Take Other Appropriate Actions as Needed

- Close gates as needed to reduce loading in problem areas
- Place sandbags around sand boils
- Place emergency filter material and stability berms over seepage areas (USACE 1993)

The work involved to save a dam can proceed concurrently with the above steps. If the project has a pre-event action plan, and it can be safely implemented, contractors should be mobilized to execute the plan. Temporary mitigation of internal erosion often involves placing temporary filters and seepage berms at the exit points. This may include placing a staged filter with gravels to slow seepage to facilitate placement of fine filter material.

9.5.1.4 Other Immediate Actions

In accordance with the pre-event action planning, additional actions should be taken, as time allows, to develop and implement a better system for stabilizing the situation. Other specific actions that might be taken are site/situation specific and may include lowering the reservoir, increasing the tailwater elevation, or other measures determined to be safe responses to the immediate seepage condition.

9.5.2 Non-immediate Actions

As discussed above, there are some situations that may not be an immediate emergency, but should be further investigated and addressed in a timely fashion. In such cases, interim risk reduction measures may be taken concurrent with investigating the incident (USACE 2011;

O’Leary 2009). While these investigations are ongoing, interim measures are often required to ensure conditions do not change or deteriorate into an immediate emergency. In addition to possibly activating *Condition B* of the EAP, a few of the actions that might be taken are discussed below:

- Implement reservoir restriction if needed
- Perform interim monitoring and surveillance and prepare an interim monitoring and surveillance plan
- Collect project data needed to fully evaluate the condition
- Complete follow-up studies and investigations
- Develop a long-term plan of action
- Implement a long-term plan of action
- Complete the post-event evaluation and report

9.5.2.1 Reservoir Restriction

As a precaution, the reservoir may be drawn down and kept at a restricted pool-elevation to reduce the hydraulic forces that may lead to progression of internal erosion. The purpose of a reservoir restriction is to provide a safe operating reservoir level that is maintained for the vast majority of time and maintained at that level through non-damaging run-of-river releases to restore the reservoir to restricted level as quickly as reasonable. A reservoir restriction may not be necessarily treated as a “not to exceed” level in some cases. Rather, the intent of a reservoir restriction may be to reduce the frequency of the reservoir exceeding a certain level as well as the duration of the reservoir above that level. Reservoir restrictions usually require advance public notification and coordination with State, Federal, and local agencies.

The reservoir should be drawn down in a controlled manner so as not to strand fish or boaters, endanger downstream residents, and to ensure the reservoir slopes and embankment slopes do not become unstable. To ensure there is adequate time to complete the necessary investigations, the reservoir levels may need to be restricted for some time after the incident. A reservoir restriction plan should be developed to communicate the length of time the reservoir will be drawn down. Once the investigations and remediation activities are completed and it has been determined it is safe to raise the reservoir to its normal level, a refilling plan should be coordinated in advance with State, Federal, and local agencies.

9.5.2.2 Increased Monitoring Frequency

Immediately after a potential internal erosion problem has been identified, an increased level of surveillance should be implemented. The details of the plan will depend on the condition that has been discovered, but may consist of any or all of the following and additional activities not listed:

- *Increased frequency of visual surveillance.* It may be necessary to mobilize 24-hour shifts for hourly or continuous monitoring throughout the day and night depending on the rate of progression of the problem. The frequency of the visual surveillance may be decreased as the risk is better understood.
- *Increased frequency of instrumentation readings and evaluations.* If piezometers, weirs, and other dam safety instrumentation are already present, readings should be taken and evaluated more frequently to monitor changing conditions and help to understand the problem.
- *Additional temporary monitoring instruments may be required.* Since a change in conditions is likely, additional, temporary instrumentation or monitoring stations may need to be established to customize the monitoring program for the specific condition that is of immediate concern.

9.5.2.3 Install Additional Instrumentation

Additional long-term monitoring instrumentation may be required as part of the long-term plan of action. The type and location of the new instrumentation will need to be established after investigations have been completed. At the onset, more long-term measurements may need to be taken until the performance of the instruments, effectiveness of any repairs, and threshold levels can reasonably be established.

9.5.3 Interim Measures

There are a number of interim measures that may be implemented depending on the type of problem. For example, if boils appeared and there is concern of long-term migration of soil, sandbag ring dikes may be employed around the boils to raise the water surface and decrease the hydraulic driving force. The ring dikes will also allow installation of a temporary flume to monitor seepage rates. The area inside the ring dike can be periodically cleaned out to measure the amount of soil and rate of accumulation. For concentrated leaks on slopes or abutments, temporary Parshall flumes may be installed to monitor the rate of discharge and for observing if any soil is being transported with the seepage. Sediment traps may also be constructed for monitoring the volume of sediment being transported from concentrated leaks. In situations where the seepage is too significant for monitoring, temporary seepage berms may be constructed in accordance with pre-event action planning.

9.6 Post-event Evaluations and Report

Much experience can be gained from incidents. It is important therefore to follow-up after an incident to determine what lessons may be learned and how the incident response might be improved. A debriefing of all those involved in the incident is recommended. Those who were involved should all have an opportunity to make recommendations as to what might have been done differently to improve the overall response. External and emergency management agencies should also be consulted to see if communications can be improved and to determine if modifications need to be made to the EAP or pre-event action plans. All the information should be documented in a report. This report will be invaluable in the future as the institutional knowledge can be preserved. During future training exercises, the incident report should be reviewed by new personnel working on the project so they become familiar with the types of incidents that might occur at their project and the appropriate response.

9.7 General Recommendations

The National Incident Management System (NIMS) outlines procedures to be used for managing all types of incidents (FEMA 2013). This document is the nationally recognized standard required of all Federal agencies for management of incidents on Federal lands and at Federal facilities. It is recommended that this document and the NIMS Web site (www.fema.gov/emergency/NIMS) be reviewed by those responsible for dams.

9.8 References

- Federal Emergency Management Agency (FEMA) (2004). Federal Guidelines for Dam Safety: Emergency Action Planning for Dam Owners. April.
<http://www.fema.gov/library/viewRecord.do?id=1672>
- _____(2013). National Incident Management System (NIMS).
www.fema.gov/emergency/NIMS
- O’Leary, T. (2009). *Interim Risk Reduction Measures for Dam Safety*, ASDSO Journal of Dam Safety, Vol. 7, Iss. 1, Art. 3, Association of State Dam Safety Officials, Lexington, KY.
<http://www.damsafety.org/resources/bookstore/product.aspx?p=71d71c52-ec31-448b-8218-6f95afc56127&catId=280e6f32-3ea9-4947-9080-9ae3213b76c2&prodId=91fbc793-713a-400d-92ec-846c51230be7>.
- U.S. Army Corps of Engineers (USACE) (1993). Seepage Analysis and Control for Dams, EM-1110-2-1901.
http://publications.usace.army.mil/publications/eng-manuals/EM_1110-2-1901_pflsec/EM_1110-2-1901.pdf.

_____ (2014). Safety of Dams – Policy and Procedures, ER 1110-2-1156, Chapter 7 – Interim Risk Reduction Measures for Dam Safety, pp 7-1–7-12
http://publications.usace.army.mil/publications/eng-regs/ER_1110-2-1156/ER_1110-2-1156.pdf

CHAPTER 10 – LONG-TERM REMEDIATION METHODS

10.1 General

After monitoring and risk evaluations are completed, and a dam safety issue has been identified, a decision may be made to remediate the risk during the risk management phase. There is a wide variety of potential remediation techniques to address internal erosion concerns. Various Federal agencies may employ more or less of these depending on their particular dam inventory. There are no general standards other than design standards that pertain to the design of new dams, but those concepts can also be used for remediation of existing dams. The following discussion provides information about the various remediation methods that have been employed and may be of use to dam owners. The methods discussed pertain specifically to remediating internal erosion problems.

10.2 Role of Risk in the Evaluation of Remediation Alternatives

Once the decision has been made to remediate, there are generally a number of alternatives possible to achieve the desired risk reduction. The potential failure modes analysis and evaluation of risk should have identified the primary concerns with respect to internal erosion failure modes. The remediation method selected to address that failure mode will likely be different depending on the failure mode. For example, remediation for heave will be different than remediation for potential concentrated leak erosion through a cracked core of dispersive soil. In order to select the remediation method, one must understand what is driving the risk and focus to reduce that risk. Potential risk reduction measures can be evaluated by comparing the residual risk after implementation. The goal is to achieve the maximum risk reduction for the minimum cost and to quantify (based on risk) the most effective method to reduce risk as early as possible in the event tree.

10.3 Description of Alternative Remediation Methods

Seepage that may potentially cause internal erosion through and under embankment dams is addressed in two ways: (1) blocking or stopping the flow and (2) intercepting or collecting the flow in a controlled manner. Each method can be used independently, or both methods can be used in conjunction with one another. Whether to use one method or both is usually a function of cost and other constraints such as the existence of a reservoir pool that cannot easily be drawn down in the case of an existing dam. No single answer can be given on the best approach to follow since site conditions, access, performance, and a host of other conditions vary greatly from site to site. The next two major sections present techniques available for each of these methods.

10.3.1 Cutoffs

A wide variety of cutoff types exists, including earth zones and blankets, structural barriers, membranes, and grout-modified zones. Generally, cutoffs are located between the reservoir and the centerline of the dam. Wherever practical, cutoffs should fully penetrate pervious zones and be keyed into a low permeability layer within the foundation. Partially penetrating cutoffs are generally less effective and may require additional seepage control measures downstream from the cutoff. Design issues related to cutoffs include high gradients across the cutoff, erodibility of the cutoff material, filter compatibility with the material immediately downstream from the cutoff, and how to accommodate possible leaks in the cutoff system. Documentation for many older cutoff walls is often poorly preserved or never collected, which hinders future dam safety evaluations. This highlights the importance of collecting and maintaining good as-built information about cutoff walls in the project records. A good summary of seepage cutoff methods in common use for levees and dams is provided by Bruce (2013).

10.3.1.1 Sheet Pile Walls

Cutoffs can be constructed of interlocking driven piles that form a continuous, relatively impermeable wall. Early pile walls in embankments consisted of tongue and groove timber piles (commonly known as Wakefield Piling), and occasionally an older dam with one of these walls will be encountered. However, timber pile walls are no longer in use.

Rolled steel is the most typical type of sheet pile wall in use today, and vinyl and composite (such as fiber reinforced polymer) sheet piles are a relatively new development that are receiving wider use. These products consist of individual panels of various weights, stiffness, and cross-sectional configuration.

A key feature is the interlocking joints along the edges of the sheets that allow a continuous wall to be formed. The sheets are typically driven into the ground by special equipment, while jetting is sometimes used to facilitate penetration. Sheet piles can be an effective and economical means of constructing a cutoff wall, particularly at relatively shallow depths and if located in soils with a minimum of large-size particles. However, these types of walls do have limitations and difficulties and may not be suitable for use as a permanent critical or sole line of defense against seepage. Dense soils, cobbles, or any obstruction can result in damaging the piles, difficulties in achieving effective interlocks, or difficulties advancing to full depth.

It is not uncommon to see some leakage at the interlocks, but in some cases, these joints may clog from migration of fines over time. There are also a number of products and proprietary interlocks that are used to improve the seal at interlocks. Preferably, the wall can be keyed into an impermeable layer in the foundation. Otherwise, the effects of having only a partial cutoff must be considered.

Composite sheet pile walls were used by the Bureau of Reclamation (Reclamation) to minimize seepage on Tarheel Dam and Fourth Creek Dam, which are small Bureau of Indian Affairs facilities in Oregon. Another example is at a levee project in Maasland, Netherlands (PRWeb 2013).

10.3.1.2 Secant Pile Walls

Secant pile cutoff walls are not nearly as common as other walls, but can be considered as a potential means of constructing cutoff walls. These walls consist of circular columns in drilled holes that are backfilled with concrete. By overlapping and keying in adjacent columns, a continuous wall can be constructed. A secant pile cutoff wall was constructed at Reclamation's Lake Tahoe Dam (Reclamation 2012) and Wolf Creek Dam¹ (USACE 2011) to minimize seepage through the embankment and foundation, respectively.

10.3.1.3 Slurry Walls

Cutoff walls constructed by slurry trench methods can effectively cut off seepage in the embankment and/or foundation of dams. For new dams, slurry trench cutoff walls have been used as the impermeable water barrier for an embankment (instead of an impervious earth core) or have been used as a foundation cutoff when the bedrock (or other suitable impermeable layer) is relatively deep such that a traditional cutoff trench excavation is very costly. On existing dams, slurry trench cutoff walls have been used to reduce seepage through embankments, soil foundations, and rock foundations.

Slurry wall construction can be separated into two categories: continuous and panel construction. The continuous trench method is generally performed for shorter walls (generally no more than 60 feet deep) and where excavation conditions are easy. The panel method is used for deeper walls and where excavation conditions are more difficult. The continuous method is generally less costly than the panel method, and each is described in more detail later in this section.

Slurry wall cutoffs are constructed by excavating relatively narrow trenches, typically 2 to 5 feet in width, with bentonite slurry pumped into the excavation to support the trench sidewalls and prevent collapse during construction. Pre-grouting has been used to reduce the potential for slurry loss for cutoff wall installation in karst terrain. A major benefit of the slurry wall method is that cutoffs can be installed without dewatering the foundation, which typically results in a lower cost as compared to open excavation. The relative impermeability of a slurry cutoff wall results in part from the slurry forming a filter cake against both sidewalls of the trench.

To keep the slurry approximately level and within a couple of feet of the top of the excavated trench, the working surface must be kept level. For relatively level ground (and depending on

¹ For additional details, see Case 10 – Wolf Creek Dam and Mississinewa Dam, in appendix 1 (Seminal Case Histories).

the nature of the backfill), the trench can be kept open for a significant distance. On sloping ground, a series of stepped working surfaces are needed, and increments of the wall are constructed separately with overlaps into previously constructed segments. Equipment used to excavate these cutoff walls can include excavators, clamshells, and specially constructed rock milling machines designed to cut through rock as well as soil.

Slurry trenches using the panel construction method have been excavated to depths of approximately 400 feet or more, which is considered by some to be a practical limit. However, specialty contractors claim to have the capability to go deeper, and refinements in technology may lead to greater depths being common.

The type of backfill that is used for a particular application is dependent on the strength that is needed for the wall. Originally, slurry trench cutoff walls were typically constructed of soil-bentonite backfill. The excavated soils, usually saturated with slurry, are cast to the side of the trench. These materials are then sluiced with more bentonite slurry, additional fines added if needed to help ensure low permeability, and the materials are then worked with dozers to produce a well-mixed soil-bentonite backfill. This backfill is then dozed back into the trench where it forms a sloping backfill that follows behind the excavation operation.

Another backfill method has been to add cement to the bentonite slurry to form a low-strength backfill with no soil component. In this method, the cement-bentonite slurry is typically mixed in a separate pond and then pumped through a tremie pipe to the bottom of the excavated trench where it displaces the trench slurry used to stabilize the walls. Ultimately, the cement-bentonite mixture hardens, forming a wall with an unconfined compressive strength estimated to typically range from 15 to 30 pounds per square inch, depending on cement content. A cement bentonite wall was used at A.V. Watkins Dam (Bliss and Dinneen 2008; Reclamation 2011a).

One of the limitations of these two types of slurry trench cutoff walls is the low-strength backfill. Because of the narrow trench, significant arching occurs such that the backfill typically does not experience the weight of the overlying materials and, thus, is in a low stress condition. This makes soil-bentonite, and cement-bentonite to a lesser extent, potentially subject to hydraulic fracturing. Another concern with these types of walls is blowout under high gradient. Because a slurry trench cutoff wall is relatively impermeable, there will be a high gradient across the trench. If a cutoff wall intercepts a pervious coarse zone, there is the potential that the high gradients could initiate internal erosion of the backfill into the coarse foundation layer downstream. To improve the resistance of the backfill to hydraulic fracturing or blowout, cement can be added to a soil-bentonite mixture to create a soil-cement-bentonite backfill. Mixing of this backfill becomes more complicated than in a traditional soil-bentonite operation, and may require a pugmill.

Another type of cutoff wall constructed by slurry trench methods is the concrete diaphragm wall. With this method, the trench is usually excavated in panels, and then the slurry is displaced by tremied concrete. A variation of this method is the use of “plastic” concrete, which has a bentonite component. Plastic concrete is thought to be less brittle than conventional concrete, and its stiffness is more compatible with the surrounding soils. For additional strength, reinforcement steel “cages” can be constructed and lowered into the excavation prior to

concrete placement to create a reinforced concrete wall. Unreinforced concrete cutoff walls were constructed at Reclamation’s Navajo and Fontenelle Dams² (Reclamation 2011a) as part of dam safety modifications.

There are two typical locations for a slurry trench cutoff wall in an embankment – at the upstream toe or through the crest. For the upstream location, the cutoff wall typically ties into an upstream blanket. Advantages of this location include a reduction of gradients, pore pressures, and seepage flows beneath most of the embankment; a wider working surface; the possibility of making future repairs if the reservoir can be drawn down; and keeping a potentially low-strength vertical element considerably away from most of the embankment. A disadvantage of the upstream location is that the reservoir must be drained or lowered in order to perform the work. When the slurry wall is located through the crest of the dam, which tends to be the more common location when modifying a dam, it has the significant advantage of minimizing both foundation and embankment seepage. However, the expense of treating the embankment must be borne even if the embankment is already sound from a seepage standpoint.

For both new and existing dams, seepage analyses can be used to model the potential effectiveness of these features and help determine the optimum locations, depths, and extent of the walls. In the design of slurry trench cutoff walls, it is important to recognize that very high gradients will exist across these thin walls, at the base of the wall, and at the ends of the walls. Consequently, special attention needs to be paid to ensuring that the walls are founded in competent materials that will be able to withstand the potential erosive effects of high gradients at these locations. When this type of feature ties into an existing embankment core, additional care should be taken to ensure that this connection is similarly well protected against internal erosion.

10.3.1.3.1 Case History

On Canby Creek, Structure R-1,³ in Minnesota, a soil-bentonite slurry trench was installed near the upstream toe of the embankment to reduce pressures at the downstream toe within a regional artesian aquifer of glacial lake-laid sands. The slurry trench was tied into the upstream impervious zone of the embankment. The trench was partially effective, but was unable to fully cut off the flow and pressure coming around the dam through one of the abutments. Therefore, additional pressure relief measures were required to completely remediate the structure (see section 10.3.4.2 below). This case history underscores the importance of providing a complete cutoff with continuous key-in along both the base and the sides of the slurry wall.

10.3.1.4 Grouting

Grout curtains in rock may be used to reduce seepage, but as a seepage cutoff feature their effectiveness varies greatly depending on geologic conditions. Although grouting can be dependable for reducing total seepage flow through the foundation, a single “window” in the

² For additional details, see Case 10 – Navajo Dam, (Other Case Histories) and Case 1 – Teton Dam and Fontenelle Dam, (Seminal Case Histories) in appendix 1.

³ For additional details, see Case 11 – Canby Creek, R-1 Dam, in appendix 1 (Other Case Histories).

curtain can allow a shorter flow path with concentrated seepage. Neat cement grout is most commonly used in grouting applications, but is generally reserved for grouting in rock foundations containing joints and fractures.

Similar to the caution on cutoff walls, a successful grout curtain can lead to very high gradients across the top of the grout cap or at the embankment/foundation contact. Careful foundation treatment measures such as slush grouting, dental concrete, and foundation filters at the downstream face of the cutoff trench are necessary to ensure that there are no unfiltered exits for seepage that may have the potential to cause erosion of the core.

Grouting should only be done in embankment material using extreme caution due to the possibility of hydraulic fracturing. It should be noted that grouting an existing embankment of foundation soils can actually make matters worse. Grouting under reservoir head can be dangerous. The grout moves downstream with the flowing water and may set up at a downstream location. This backs pressures up behind the location of the grout set and may lead to high water pressures and potential instability in unexpected areas.

A detailed discussion of grouting can be found in Reclamation (1984) and U.S. Army Corps of Engineers (USACE) (1984, 2013 [in print]).

10.3.1.5 Geomembranes

Geomembranes can be used in lieu of an impervious soil zone to cut off seepage through an existing dam. The geomembrane can be installed on the upstream slope of the embankment,⁴ generally with a protective cover layer, or it can be installed in an excavation near the centerline of the dam. Since geomembranes can be damaged during installation, provisions should be included to provide a line of defense against any such leaks, such as filters or drains downstream from the geomembrane. Other design issues involved with geomembrane cutoffs include:

- Potentially high gradients across the geomembrane
- Providing suitable key-in around the periphery of the geomembrane
- Constructability issues related to seaming geomembrane panels together to form a continuous barrier
- Quality assurance testing of geomembrane seams

10.3.1.5.1 Case History

Reclamation constructed a geomembrane cutoff wall at Reach 11 Dikes⁵ in Arizona. The cutoff consisted of both an impermeable barrier and a sand filter to mitigate the potential for internal erosion failure of the cracked flood protection dikes (figure 10-1). A trench was excavated

⁴ Known as a diaphragm design.

⁵ For additional details, see Case 18 – Reach 11 Dikes, in appendix 1 (Other Case Histories).



Figure 10-1.—Geomembrane cutoff with sand filter on Reach 11 Dike, Arizona.
(Photo courtesy of Reclamation)

through the crests of the embankments, supported by biodegradable slurry. Stiff geomembrane panels of 80 mil high-density polyethylene were lowered into the trench. Interlocks similar to those on sheet piles enabled the construction of a continuous wall. The trench was then backfilled with filter sand (by tremie pipe) as an extra measure of protection against internal erosion. In principle, the biodegradable slurry completely decomposes and leaves no trace of an impermeable filter cake, thus permitting a filter to be an effective second line of defense. Since Reach 11 is a flood control feature, it is not loaded on an annual basis. As of the preparation of this manual, the structure had not been loaded; therefore, the performance of the repair has not been evaluated.

10.3.1.6 Upstream Blanket

Upstream soil blankets are a horizontal extension of the embankment water barrier (usually an earthfill core) and can be used to cut off seepage entry areas in the reservoir. As with other seepage reduction measures, these features are geared toward lengthening the seepage path in the foundation, thereby reducing seepage quantity and pressures.

Blankets are relatively simple to design and construct and can be effective in controlling seepage. Possible disadvantages with using upstream blankets include:

- Need to lower reservoir during construction
- Difficulty in locating all permeable entry areas.
- Lack of suitable low permeability soil for the blanket
- Relatively high cost if the entire reservoir area must be blanketed
- Reduction in available storage volume in the reservoir

Relatively impermeable soil materials are frequently used in an upstream blanket, although geomembranes or chemical grouting can be economical alternatives when suitable materials are not readily available. Because a high gradient will typically occur across an upstream blanket, it is important to ensure that blanket materials cannot pipe into the underlying foundation. This can be accomplished by designing a transition or filter material beneath the impermeable soil that meets particle retention criteria for the blanket and the foundation. The use of a geomembrane instead of low-permeability soil may eliminate the need for an underlying filter, although a bedding layer and a protective cover will be needed to protect the geomembrane both during construction and during future operation. Since an upstream blanket is constructed of low-permeability materials, it does not have to be particularly thick (several feet to 10 feet, depending on the reservoir head). The length to which the blanket extends upstream is generally more important and can be assessed by numerical seepage analysis. Design considerations for upstream blankets can be found in Reclamation (1992) and Reclamation (1987). Design considerations for geomembrane blankets can be found in Reclamation (1992).

10.3.1.7 Upstream Cutoff Trench

If seepage through the foundation or abutments is excessive, an upstream cutoff trench can be used. The upstream cutoff is normally connected to an upstream impermeable zone in the embankment to provide a continuous barrier to seepage. The cutoff should be continuously keyed into a relatively impermeable foundation stratum for maximum effectiveness. If the depth to such an impermeable layer is great, or if extensive dewatering is needed to excavate the trench, then a slurry trench cutoff may be preferable. Otherwise, design and construction of an upstream cutoff is relatively straightforward. One disadvantage of the upstream cutoff trench is that the reservoir must be lowered or drained or cofferdams installed in order to excavate and backfill the trench in the dry. The design of an upstream cutoff should include consideration of the potential for high gradients through the cutoff and filter compatibility between the cutoff backfill and the in-place foundation material.

10.3.2 Seepage Collection

This section will address design elements in dam remediation that protect against internal erosion by safely collecting seepage from the embankment, foundation, or abutments and conveying it to an outlet. Seepage collection is performed by the use of filter and drain elements since these elements must be able to freely pass water while preventing the movement of soil particles. Both functions (water collection/conveyance and particle retention) play central roles in protecting against internal erosion and are normally considered together. However, for the purposes of this manual, these two functions will be discussed separately. This section will focus on design elements whose primary function is to collect and convey seepage (i.e., drains), while the following section will focus on elements whose primary function is soil retention (i.e., filters). It should be noted that modern practice is to include a two-stage element (filter/drain) when needed for capacity.

10.3.2.1 Chimney Drains

To control seepage through an existing embankment, a chimney drain is typically used. The chimney drain should extend to intercept any preferential seepage paths such as from transverse cracking or poorly bonded lifts. Seepage can be concentrated at any level of the embankment. For existing dams, where the chimney drain does not extend full height to protect against cracking, trenching can be performed from the crest to create a new filter that extends to the chimney drain as shown on figure 10.2a.

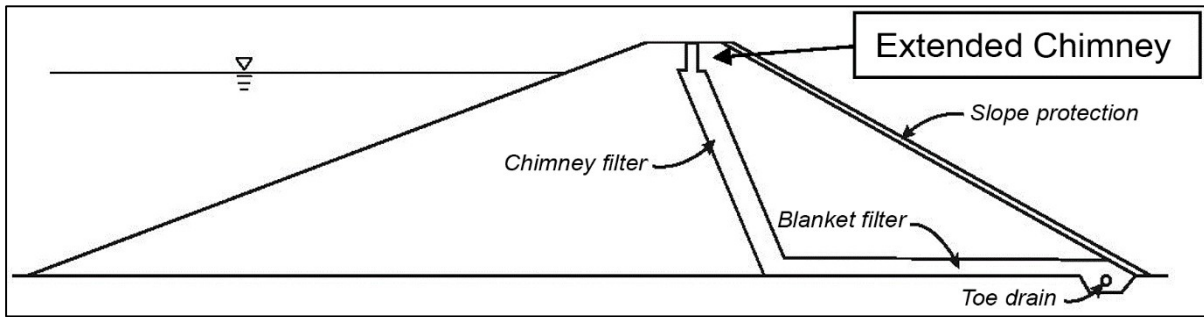

Figure 10-2a.—Simple cross section showing a chimney used in a new dam or an old dam with an extended chimney.

There are slight differences of these applications between new construction and modification to existing dams. For new construction, the chimney would be placed near the centerline of the dam for central core designs, whereas the addition of a chimney to an existing dam would require removal of a large portion of the existing embankment to obtain this location. The central location is desirable to maximize the confining stress on the chimney as well as to minimize hydrostatic pressure, thereby improving shear strength in the downstream shell.

Modifications to existing dams will typically locate the chimney further downstream than what would be used for new construction (figure 10.2b). When chimneys are located downstream, sufficient overburden must be provided to protect against blowout, conservatively assuming that full reservoir head may act on the drain. In a similar manner, a blanket added to an existing dam would be shorter since the chimney it connects to is further downstream.

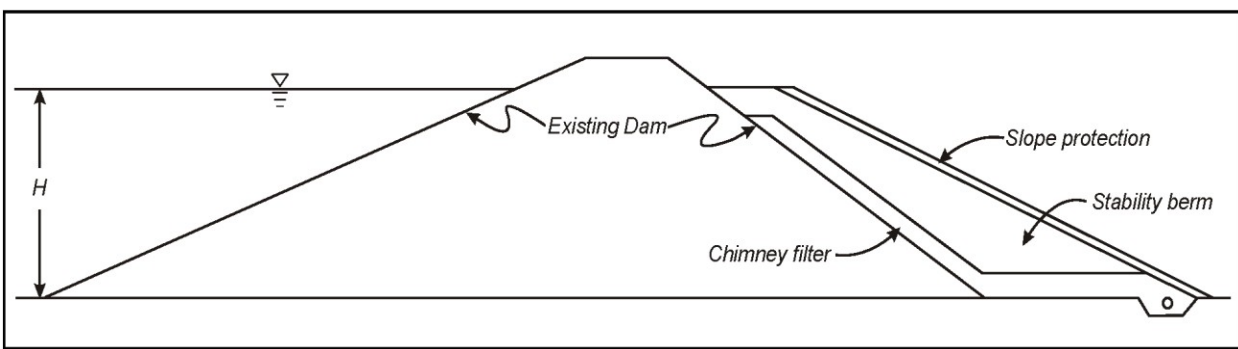

Figure 10-2b.—Simple cross section showing a chimney added to the downstream slope of an existing dam.

Installation of chimney or finger drains at existing dams can be a safety concern because it involves excavation of the downstream shell of the dam. Construction of the drain will require consideration of stability of the excavation during construction and may require a drawdown for safety.

10.3.2.2 Toe Drains

As implied by the name, toe drains are typically constructed at or near the downstream toe of the embankment. A typical toe drain is shown on figure 10-2a. The purpose of a toe drain is to collect seepage from two sources: (1) the chimney/blanket drains and (2) foundation seepage below the dam (underseepage). Toe drains placed on dam abutments will also collect abutment seepage. The toe drain may be keyed into the foundation somewhat to facilitate the collection of underseepage through pervious layers near the ground surface. If the pervious layer is blanketed to a significant depth by a layer of lower permeability soil, then a trench drain will be used instead of a toe drain. Trench drains are discussed in section 10.3.4.2 below.

When a toe drain is added to an existing dam, the hydrostatic pressure near the downstream toe will normally be reduced, while the upstream head due to the reservoir is unchanged. The result will be an increase in the overall hydraulic gradient under the dam, which can increase the chance for particle movement over the pre-existing conditions. This points out the importance of having a good filter design and construction for a trench drain.

Toe drains should consist of a perforated pipe surrounded by a gravel drain which, itself, is surrounded by a sand filter. This arrangement is known as a two-stage toe drain. An example of a two-stage toe drain is presented on figure 10-3. While foundation conditions may vary, this arrangement is considered the minimum necessary for an effective drain. Toe drains should normally be placed close enough to the toe of the dam to permit replacement at a future date, should that become necessary. For further details on toe drain design and construction, the reader is referred to Federal Emergency Management Agency (FEMA) (2011).

In the case of pervious foundations, the importance of collecting seepage and, more importantly, reducing pressure, cannot be overemphasized. Gradation of a toe drain should be checked to make sure the filter will not act as a barrier to any of the foundation units contacted by the drain. If the filter layer is not permeable enough, it can cause a detrimental elevation in the hydrostatic pressures under the dam. This problem can generally be avoided following the recommendations given in FEMA (2011).

Open ditches have been constructed to provide drainage at the toe of a dam. In general practice, this should be avoided if possible, as it may result in heave along the ditch floor or lead to backward erosion initiation in the sides of the ditch as occurred at A.V. Watkins (Reclamation 2011a) and at the Florida Power and Light Dike (Simmons 2006; Schmertmann 2012).

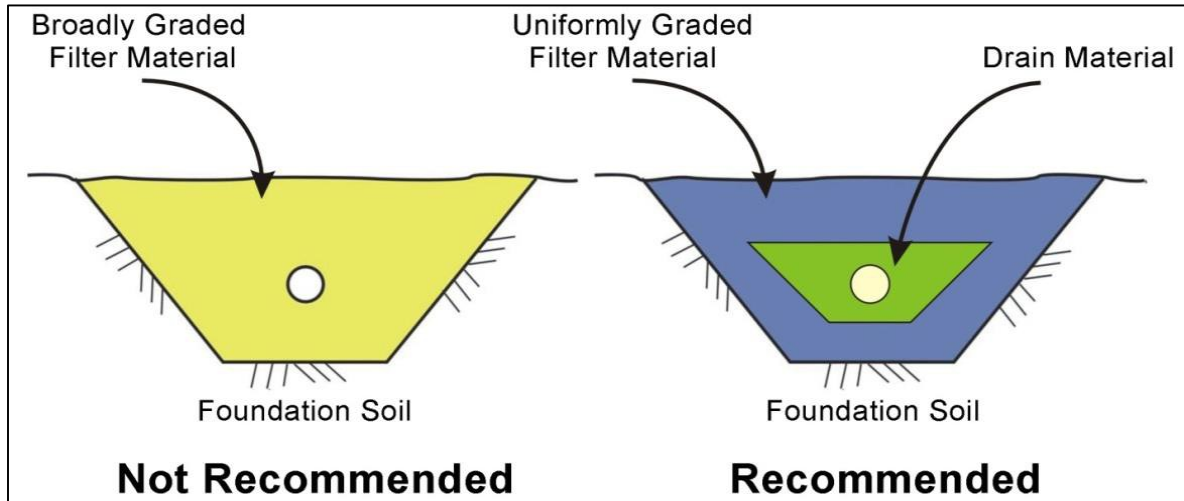

Figure 10-3.—Typical one-stage (left) and two-stage (right) toe drains in a trapezoidal trench.

10.3.2.3 Blanket Drains

Blankets may be included in embankment designs both to collect seepage from foundation horizons and to provide an outlet for seepage collected by a chimney drain. The use of blanket drains in remediation situations could involve the removal of significant portions of the embankment to expose the foundation layer(s) to be blanketed such as over fractured bedrock under the downstream side of the embankment. If a zone of new fill is to be added on the downstream side of an existing embankment, say, for a downstream raise of the embankment or for the addition of a chimney drain/filter, then a blanket drain can readily be included under the new fill (see figure 10-2b). Abutment seepage can be collected by the use of blanket drains, provided adequate cover is provided to prevent blowout.

Blankets must provide filter compatibility between foundation soils or bedrock that is not filter compatible with the overlying embankment. A properly designed blanket will protect finer embankment soils from piping into underlying coarser foundation soils or bedrock with joints and fractures as shown on figure 10-4. It can also protect foundation soils from piping into a coarser overlying embankment zone.

10.3.3 Filters

10.3.3.1 General Considerations

Filters may be used to remediate earth embankments that have experienced cracking or which were not originally equipped with lines of defense against cracking. Embankment cracking can be caused by various factors, including desiccation, differential settlement, foundation collapse, and subsidence. Cracking can be either transverse or longitudinal relative to the axis of the dam. Transverse cracks pose a greater threat to dam safety because they provide a direct pathway for uncontrolled flow from the reservoir to the downstream face of the embankment, leading to the

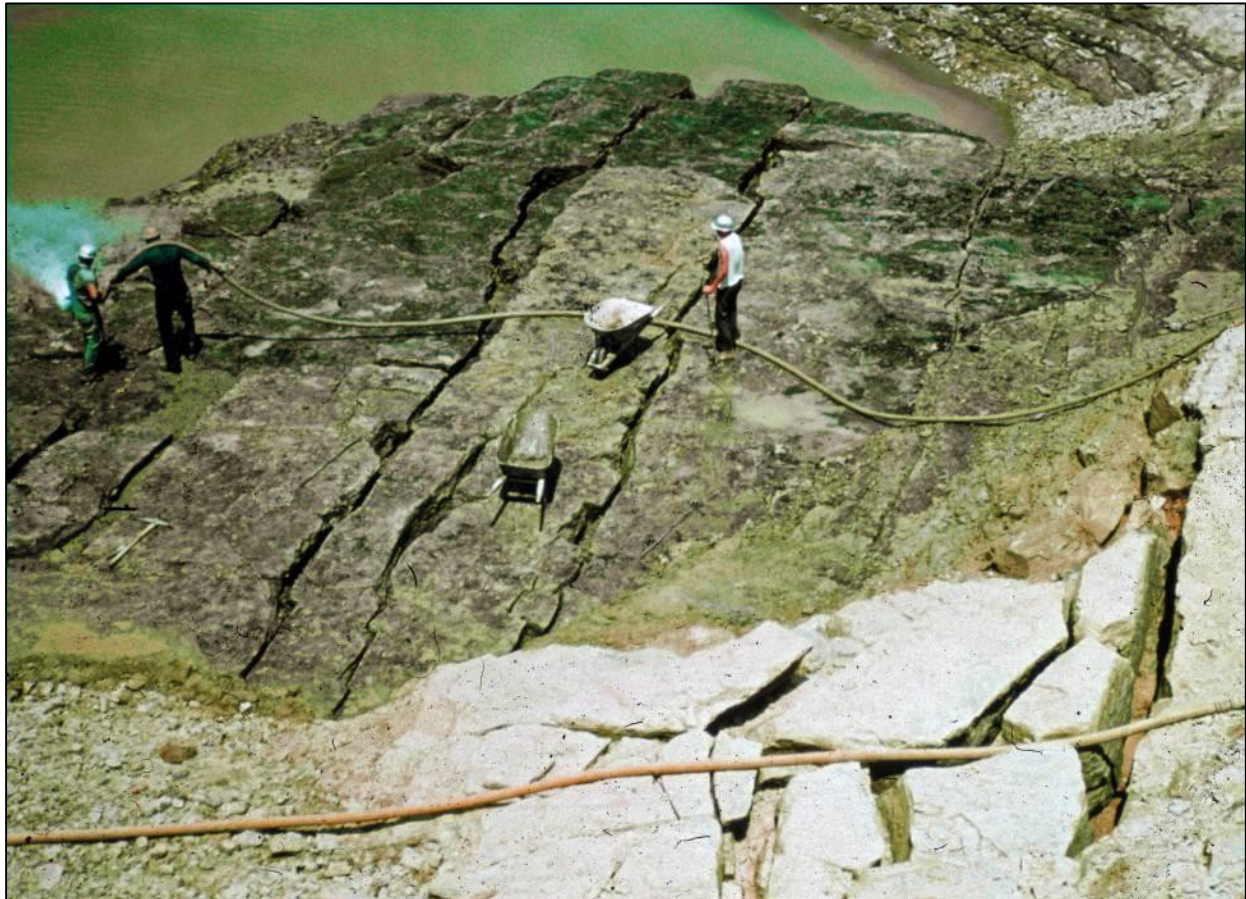

Figure 10-4.—Pressure washing joints and fractures in bedrock prior to dental grouting and covering with a blanket under the downstream shell of a dam. (Photo courtesy of NRCS)

potential for internal erosion and possibly contributing to dam failure (Doerge 2010). However, longitudinal cracks cannot be considered benign either, since they can connect otherwise discontinuous cracks and create additional flow pathways through the dam.

Extensive research by the Soil Conservation Service in the 1980s demonstrated that granular filters are effective in controlling internal erosion in cracks through earth embankments (Sherard and Dunnigan 1985). Soil eroded from the walls of a crack is trapped at the upstream filter face, forming a “filter cake” or seal. The filter is able to withstand high gradients, provided there is sufficient soil cover over the filter to resist the accompanying uplift forces. This research yielded filter criteria for fine- and coarse-grained soils (United States Department of Agriculture-Natural Resources Conservation Service [USDA-NRCS] 1994), which form the basis for the filter criteria currently used by the major Federal dam building agencies (USACE 1993; Reclamation 2007). For detailed guidance on filter design, the reader is referred to FEMA (2011).

To form a line of defense against internal erosion through cracks, the filter zone must transect the entire portion of the embankment subject to cracking. If cracks may exist anywhere in the embankment, such as with cracking due to desiccation or differential settlement, the filter zone

must extend from abutment to abutment and from the maximum potential water level in the reservoir down to the bottom of the potentially cracked zone. In the case of desiccation cracking, the cracks are typically limited to the embankment. But in the case of cracking due to foundation collapse or subsidence, the cracks may extend down into the foundation as well.

In other cases, the cracking may be confined to a localized area (e.g., the zone of differential settlement cracking in the vicinity of the principal spillway conduit). Here, a smaller filter zone, called a *filter diaphragm*, is placed around the conduit and extended outward such that all potential cracks due to the presence of the conduit will be intercepted. Filter diaphragms will be discussed in the following sections.

10.3.3.2 Filter Diaphragms

Modern best practice calls for filter diaphragms around any conduits through earth embankments in place of traditional anti-seep collars (FEMA 2005). A filter diaphragm is basically a type of chimney filter in the embankment that provides protection against internal erosion in the immediate vicinity of the conduit. The filter diaphragm surrounds a conduit passing through the embankment, and its purpose is to intercept intergranular seepage along the embankment/conduit interface and prevent piping of those soils, as well as intercepting cracks in the surrounding earthfill that could be caused by differential settlement of the embankment due to the presence of the conduit. It should be noted that when a full chimney is used in an embankment cross section, it will surround the conduit, and a separate filter diaphragm is not needed.

When existing dams without filter diaphragms are remediated, the installation of a filter diaphragm should be considered. This is especially recommended where the characteristics of the fill are conducive to cracking (low plasticity soils) or to internal erosion (dispersive soils). If the embankment itself has been performing satisfactorily, then a full chimney filter may not be needed as part of the remediation.

10.3.3.2.1 Location of Filter Diaphragms

Two locations are generally used for adding a protective filter around existing conduits: the preferable location is near the centerline of the dam, but locations near the downstream toe are also acceptable. The centerline location is preferable since the greater overburden stress will provide greater confining stress to keep the filter in contact with the conduit and will have greater resistance to hydraulic fracturing. A cross section of a typical filter addition near the centerline of a dam is shown on figure 10-5. Adding a filter diaphragm near the centerline of the dam may require removal of a significant portion of the embankment, including the crest. If reservoir operation is to be maintained during construction, this method may not be acceptable.

Diaphragms can also be added to downstream locations, but sufficient overburden is required to overcome any “blowout” concerns. Assuming a seepage path exists along the existing conduit and full reservoir head may act at the filter diaphragm, sufficient overburden is required to overcome this hydrostatic pressure. This can be accomplished by placing a stability berm over the filter diaphragm. Assuming the density of the berm is twice the density of water, the berm

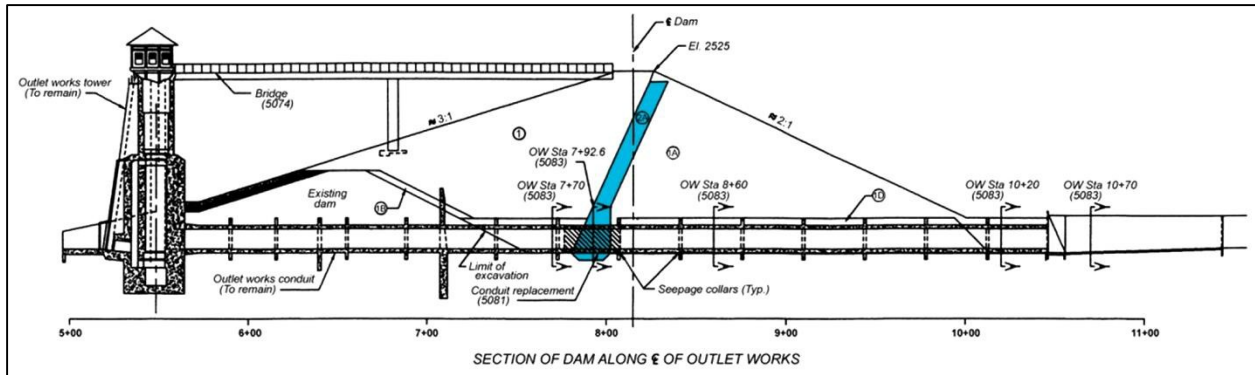

Figure 10-5.—Typical filter diaphragm addition around a conduit near the centerline of a dam (outlet for filter diaphragm not shown).

height should be one-half of the reservoir height. A cross section of a typical filter addition near the downstream toe of a dam is shown on figure 10-6. Where a dam is raised by adding fill on the downstream side, a filter diaphragm can easily be added between the existing and new fill.

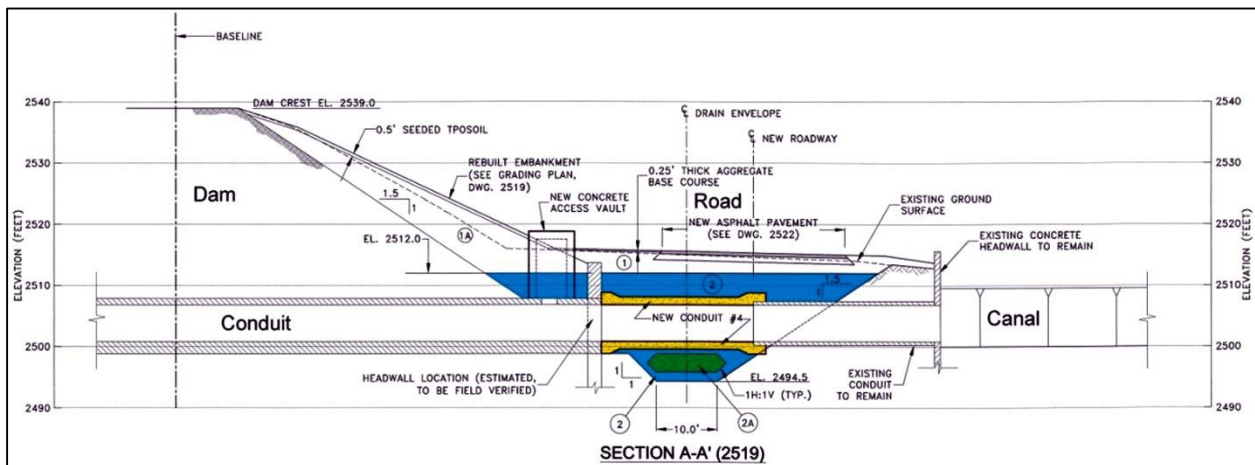

Figure 10-6.—Example of filter diaphragm (with drainage zone) around a conduit near the downstream toe of a dam.

10.3.3.2.2 Dimensions of Filter Diaphragms

Filter diaphragms added to existing structures should normally be constructed with the same dimensions as appropriate for new embankments. Detailed criteria for the dimensions of filter diaphragms are given in FEMA (2005). In cases where an opening is excavated in the dam, such as when the original conduit is being replaced, extension of the diaphragm to encompass the entire width of the opening is recommended (figure 10-7) if the fill materials are low in plasticity (prone to cracking) or dispersive (highly erodible).

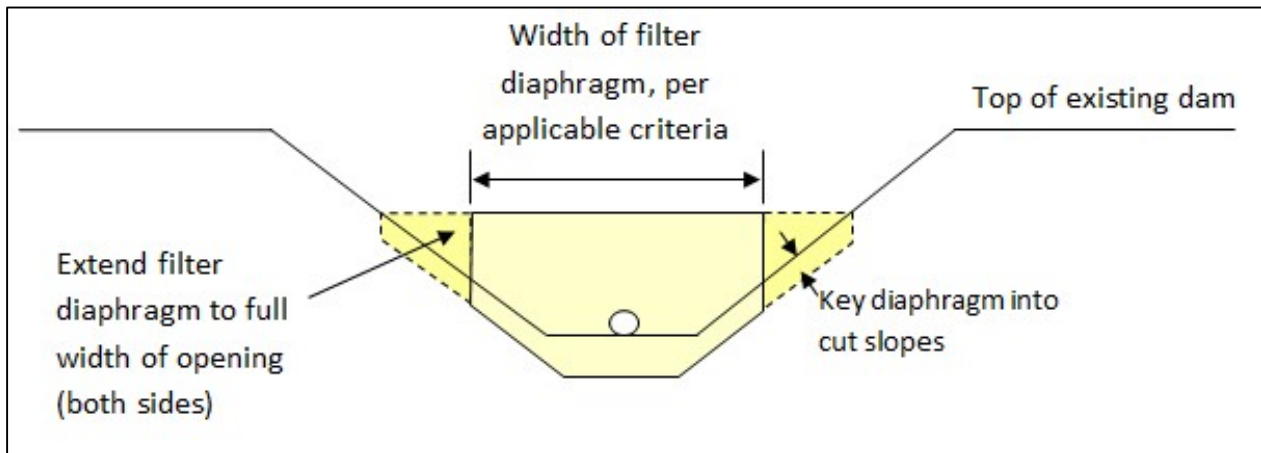

Figure 10-7.—Recommended detail of a filter diaphragm extending across the entire width of an opening excavated through a dam (details of conduit cradle not shown).

10.3.3.2.3 Construction Considerations for Adding Filter Diaphragms

Conduits on soil foundations require filter protection around the entire conduit. Exposing a conduit and adding a filter to only the sides and top will leave the foundation under the conduit unprotected. Piping channels can form under conduits; this is an ideal location for such development since the conduit will act as a roof for the piping channel. Therefore, a reliable method for filter placement and compaction under the conduit is also needed since any gap or low-density areas will render the protection useless. Poorly compacted filter material is subject to settlement, and this could result in a void forming directly under the conduit. However, overcompacted filter material that contains excessive fines may be prone to cracking.

In the interest of providing intimate contact between the filter and the bottom of the conduit, as well as achieving proper compaction of the filter material, it is recommended that a section of the conduit be removed and re-constructed after filter placement. For detailed guidance on adding filter diaphragms around existing conduits, the reader is referred to FEMA (2011).

10.3.3.2.4 Filter Diaphragms Around Other Appurtenant Structures

Filter diaphragms can be placed around other structures that penetrate the embankment to provide protection against internal erosion. Such structures include chute spillways, navigation locks, outlet works stilling basins, and power houses. Normally the diaphragm will be installed during original construction of the structure. Placing a diaphragm around an existing structure would require removal of a portion of the structure to permit the placement of the filter material under it. For further information on filter diaphragms for other appurtenant structures, the reader is referred to FEMA (2011).

10.3.3.2.5 Case History

Figure 10-8 shows the failure of a small dam in Louisiana consisting of dispersive soil, presumably due to cracking and concentrated leak erosion in the vicinity of the principal spillway conduit. Failure occurred during the first filling. It is noteworthy that metal anti-seep collars were used on the original conduit instead of a filter diaphragm. An opening was excavated through the embankment to access the conduit, and a filter diaphragm was installed around the conduit. The diaphragm extended across the full width of the opening and was successful in mitigating the problem.



Figure 10-8.—Failure of an earth embankment in Louisiana along the principal spillway conduit, looking upstream toward riser. Notice damaged anti-seep collars on conduit. (Photo courtesy of NRCS, Louisiana)

10.3.4 Pressure Reduction

Dams and levees can require remediation to limit foundation pressures to safe levels, either because uplift-related distress has already been observed (e.g., sand boils, heave, or blowout), or instability has been observed (e.g. slumps or slides), or one of these is predicted at higher reservoir levels based on projections from instrumentation data. Situations in which remediation for pressure reduction may be required include: confined aquifer conditions, incomplete cutoff of foundation alluvium, and natural artesian conditions. Typically, the most critical location for foundation pressures is at the toe of the embankment. However, other locations can be more critical (e.g., where confining blankets become thinner or absent altogether, such as in swales or excavations).

Pressure reduction can be accomplished by the installation of drainage features, including *relief wells* and *trench drains*. Typically, relief wells are used when high-pressure conditions are too deep to address with a trench drain. Trench drains are preferred though, due to the greater surface area they have and their subsequent greater ability to intercept seepage. These two measures are discussed below.

10.3.4.1 Relief Wells

Relief wells are effective for reducing foundation pressures by increasing seepage flow and thereby increasing head loss in the foundation between the reservoir and the well location. For uniform foundations, relief wells are typically installed in a line along the toe of the dam. Drawdown is at its maximum at the well locations, and the goal of the design is to maintain the piezometric surface at an acceptable level at the midpoint between adjacent wells. Figure 10-9 shows a typical relief well installation for a confined aquifer. For design of relief wells, the reader is referred to Reclamation (1977), USACE (1963), USACE (1993), and USACE (2000).

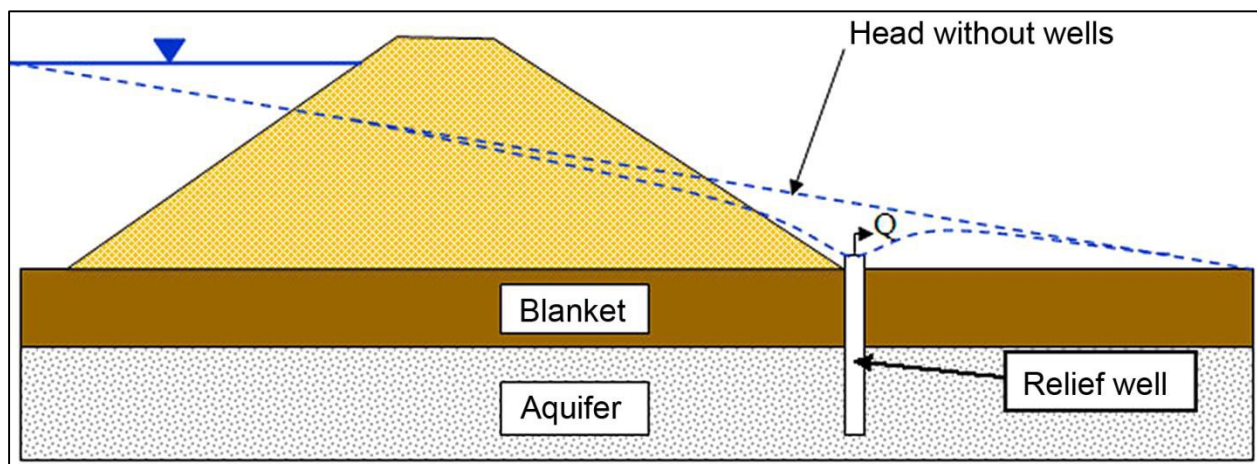

Figure 10-9.—Typical relief well installation for blanket-aquifer foundation.

The *advantages* of using relief wells for remedial seepage control include:

- Installation is quick and requires relatively little right-of-way.
- Wells can often be installed without draining the pool or providing extensive dewatering.

The *disadvantages* of using relief wells for remedial seepage control include:

- Clogging potential for filter packs and well screens.
- Susceptibility to iron ochre
- Relatively small area of influence per well.
- High operation and maintenance requirements.

- Increased seepage losses from reservoir.
- Control of erosion and flooding from discharge water required.

10.3.4.1.1 Case History

Figure 10-10 shows Canby Creek, Structure R-1, in Minnesota where a number of relief wells were installed on a remedial basis to control seepage pressures beneath a low-permeability confining layer. Note that wells were installed both at critical locations near the toe of the dam as well as along the outlet channel. The excavation required to construct the outlet channel reduced the thickness of the confining layer overlying an artesian aquifer and made the outlet channel the most critical location for uplift. Immediately following installation of the wells, the required pressure relief was obtained. However, within a few years, the performance of the wells began to drop off due to clogging of the filter packs with fine silt particles from the aquifer formation. Re-development was performed on a periodic basis, but did not reverse a gradual decline in the effectiveness of the wells. Eventually the relief wells were abandoned in favor of other seepage control measures requiring less maintenance, including a trench drain (see section 10.3.4.2 below) and a structure to increase tailwater in the outlet channel (see section 10.3.5.2 below).

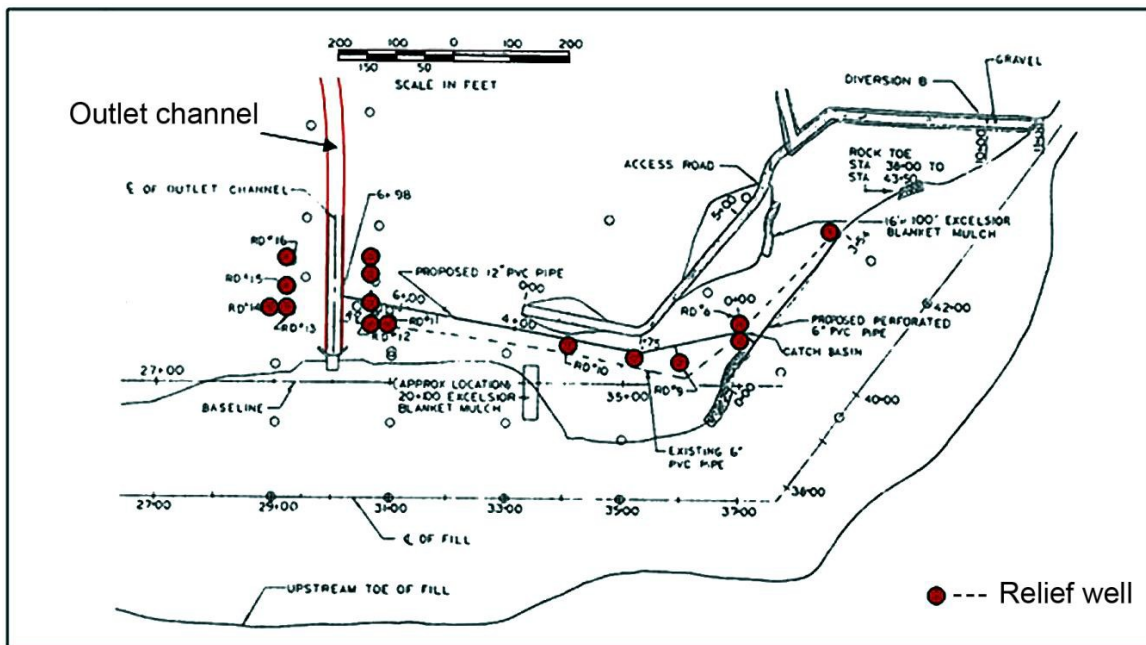

Figure 10-10.—Relief well locations at Canby Creek, R-1 Dam, in Minnesota with blanket-aquifer foundation. (Drawing courtesy of NRCS, Minnesota)

10.3.4.2 Trench Drains

Where a full cutoff of the foundation is infeasible, seepage can be controlled using a trench drain near the downstream toe of the dam. A trench drain may be used to control seepage and pressure with either a blanket-aquifer situation or where a pervious foundation is present without a surface

blanket. Trench drains are more effective at draining shallower pervious foundations where the trench can penetrate well into the pervious zone. If the pervious layer is very deep, underseepage can bypass the trench and emerge downstream from the trench. In these situations, relief wells may be more effective at intercepting the underseepage. Complex geology in the foundation may render a trench drain ineffective unless properly designed. The depth, location, and design of the trench drain must take these complexities into account for the drain to be effective.

Trench drains typically are placed at the downstream toe of the embankment (as shown on figure 10-11a), but may also be placed a short distance upstream of the toe in conjunction with a blanket drain outlet (as shown on figure 10-11b). The downstream toe location is typically used in remediation situations. The drains are normally installed in open trenches for shallow applications. The slurry trench method may be needed for deeper trenches.

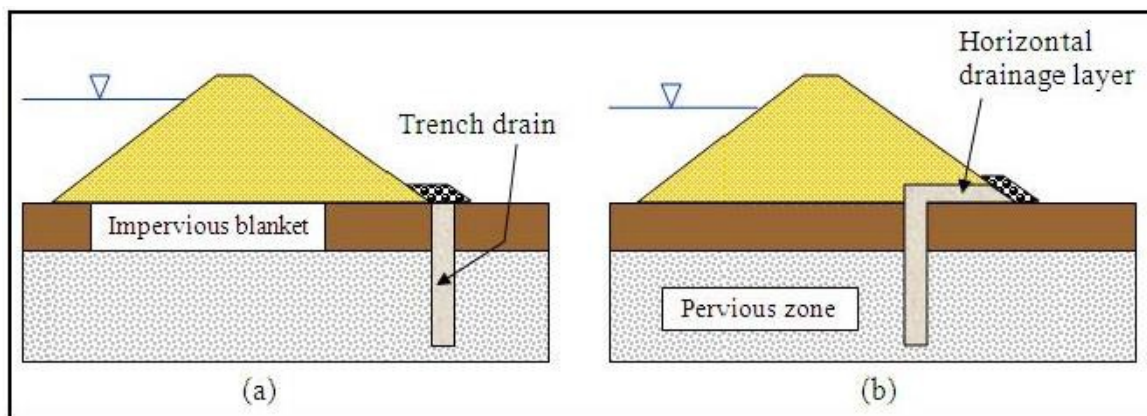

Figure 10-11.—Typical trench drain details – (a) drain at downstream toe of dam; (b) drain under downstream slope of dam with horizontal drainage layer (after USACE1993).

10.3.4.2.1 Installing Trench Drains with the Slurry Trench Method

When a trench drain is required at the downstream toe of a dam, a high water table or confined aquifer can make the installation difficult. A method that can be used to install a trench drain under such conditions is the slurry trench method. The use of a slurry trench seems counterintuitive since slurry trenches are often used to construct cutoff walls through dams.

The use of a bentonite slurry is also contrary to constructing a drainage element that provides high permeability relative to the surrounding foundation. To overcome these obstacles, a slurry trench method was developed using a degradation technology (Fisk et al. 2001). In this method, a synthetic biopolymer or other organic admixture, such as guar gum, is used in place of the bentonite admixture used in typical slurry trench applications. These admixtures are mixed with water to produce a slurry that stabilizes the trench long enough to place the filter or drain backfill. Biodegradation of the slurry then occurs, permitting the trench to act as a flow interceptor. Shortcomings of this method are that the trench cannot be visually inspected, and the trench backfill cannot be compacted.

This method has received limited use; therefore, it does not have a well-established track record and should be used with caution. There are known cases where drains installed with this slurry trench method have been unsuccessful possibly due to caving, mixing, or segregation during construction.

10.3.4.2.2 Case History

A trench drain may also be placed adjacent to other linear features where pressure reduction is needed. For example, for the dam shown on figure 10-10, the critical location for uplift was in the outlet channel where the confining layer thickness was a minimum. Therefore, a trench drain was placed parallel to the channel to provide the required pressure relief. The trench extended from near the toe of the dam to a point downstream where uplift was no longer a concern. The drain outlet was placed at the downstream end of the trench to provide the greatest possible drawdown of the piezometric surface. A check structure was also installed in the outlet channel to permanently elevate the water surface and thus reduce even more of the uplift acting on the blanket in the channel bottom. A schematic drawing of the trench drain along the outlet channel is shown on figure 10-12.

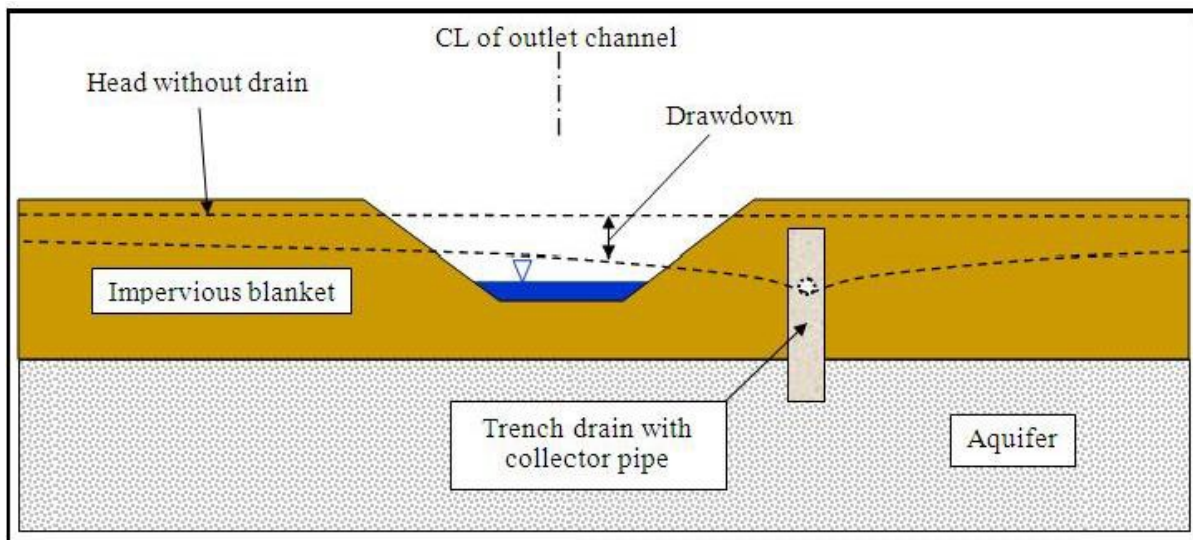

Figure 10-12.—Trench drain parallel to outlet channel of dam at Canby Creek, R-1 Dam.

10.3.4.3 Drainage Galleries

Drainage galleries are frequently used in concrete dams, dam abutments, and occasionally in earth embankments. Two examples of earth dams with a drainage gallery are Soldier Creek and Navajo Dams (Reclamation 2011a). The potential for the use of drainage galleries or adits (horizontal tunnels) for seepage collection in earth embankments is probably quite limited, but may be feasible in some instances.

10.3.5 Reduction of Piping Potential

A variety of other remediation methods can be used to reduce the potential for backward erosion piping within the foundation of the embankment. These methods rely on either reducing the overall hydraulic gradient under the embankment or improving or replacing foundation materials susceptible to piping. Examples of these methods will be discussed in the following sections.

10.3.5.1 Flattening Slopes/Berms

Flattening downstream embankment slopes and providing berms can be an effective way of lengthening the seepage path through an embankment or its foundation and thus reducing seepage. In addition, downstream berms provide a means of increasing safety factors against uplift or instability due to high pore pressures in the foundation. They can also function as seepage control measures when filters and drains are incorporated into their design. Since the piezometric level in the foundation typically decreases in the downstream direction, the downstream extent of the berm is determined as that point at which the excess piezometric head can be safely resisted by just the weight of the in-place soil materials at grade.

10.3.5.1.1 Case History

Franklin County Dam in Mississippi was built on a blanket-aquifer foundation (illustrated on figure 10-9). Zones of excess uplift were identified in the area downstream from the dam from piezometer readings. Additional fill was placed over these zones to provide enough resisting weight over the confining layer such that an adequate safety factor against uplift was achieved in all locations. The design of the additional berms was based on a comparison of the resisting effective stresses acting on the confining blanket with the driving uplift acting on the blanket at maximum reservoir head (Doerge 2009). Figure 10-13 illustrates how the safety factor against uplift is calculated for a seepage berm over a partially saturated confining blanket. The subscripts “m” and “b” refer to the moist and buoyant unit weights of the soils above and below the groundwater level, respectively.

10.3.5.2 Increasing Tailwater Elevation

Increasing the tailwater level on the downstream side of a dam reduces the potential for piping by decreasing both the exit gradient in the downstream area as well as the overall gradient under the embankment. Placing sandbags around a sand boil to elevate the tailwater level on the boil (figure 10-14) is a common flood-fighting practice. If the outlet channel of a dam is a critical location for uplift, then installing a hydraulic structure in the channel to permanently raise the water level can be a non-invasive, low-cost measure to control uplift. The effects of greater submergence on the conduit and any outlet structures must be considered in the remediation design. The water control structure must also be designed to survive the highest flows to which it may be subjected.

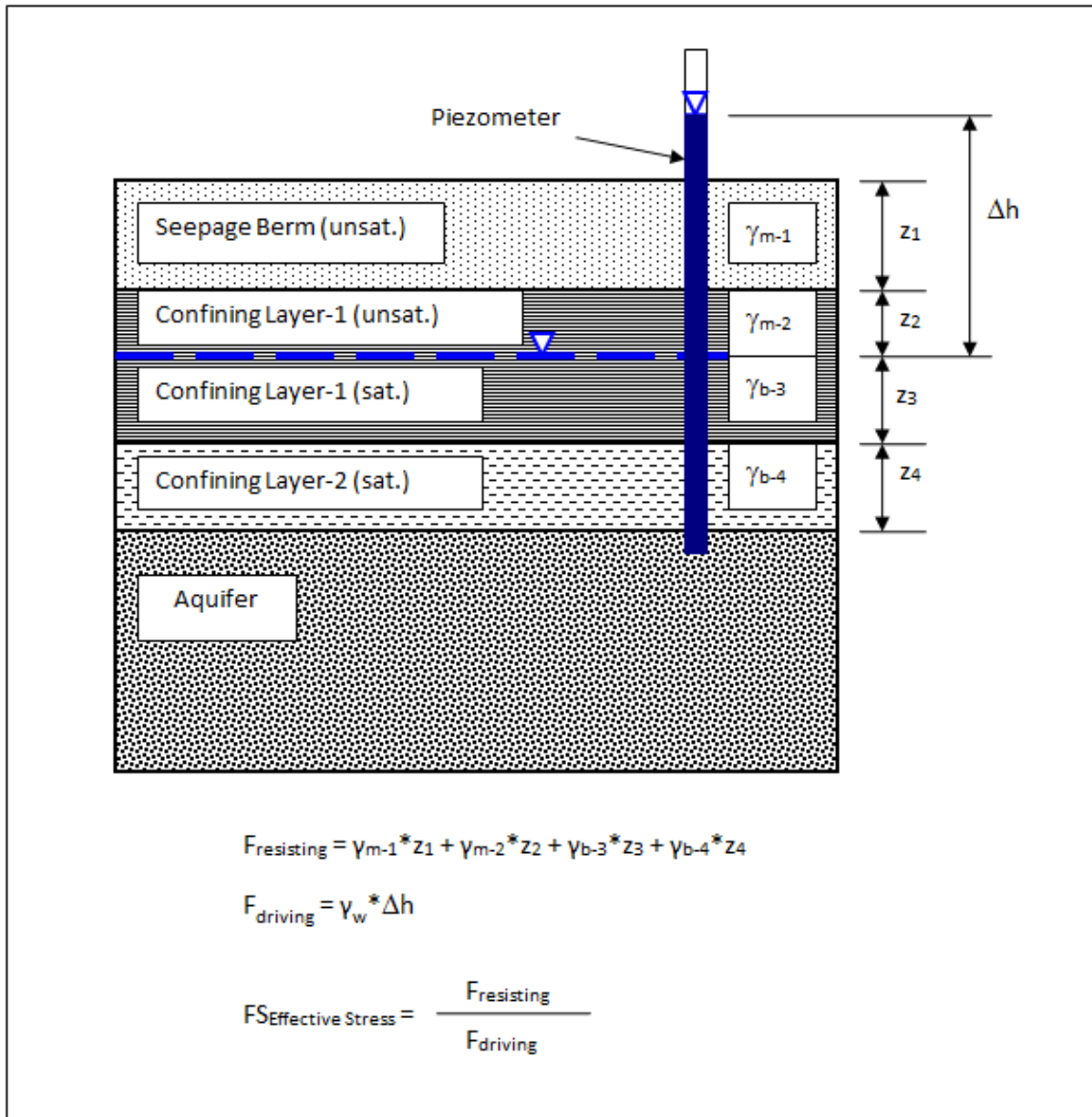

Figure 10-13.—Safety factor determination for a layered blanket with a seepage berm.

This method was used on Herbert Hoover Dike⁶ in Florida, which has a downstream ditch conveniently located and easily blocked using check dams whenever additional tailwater depth is needed. Increasing tailwater elevation provides the following benefits:

- Puts backpressure on the seepage exit
- Allows for measurement of flow with an outlet pipe
- Allows for observation of soil movement
- Allows for monitoring the size of the seepage exit

⁶ For additional details, see Case 9 – Herbert Hoover Dike, in appendix 1 (Other Case Histories).



Figure 10-14.—Sandbags placed around a sand boil to increase tailwater level as part of a temporary risk reduction measure. (Photo courtesy of USACE, Missouri Valley Division)

10.3.5.3 Soil Stabilization

Jet-grouted columns and soil mixing methods have been used as a foundation improvement method to treat foundations subject to liquefaction. However, they are sometimes considered as a seepage-reduction alternative. The jet grouting method consists of inserting a special injection pipe into the ground to the desired bottom of the treatment. The pipe is slowly raised while it simultaneously rotates and injects a grout mixture into the foundation soils, creating a grouted column. Soil mixing methods use similar techniques to create “cemented” columns or barriers. By overlapping these columns, or putting in a closely spaced grid of columns, most of the foundation can be treated. In general, these types of walls would pose concerns as a sole defensive measure to reduce seepage or prevent internal erosion because it is envisioned to be difficult to create a fully continuous wall—there may be some chance that a “window” exists. The potential for the columns to crack would also need to be evaluated.

10.3.5.4 Excavate and Replace

In some cases, it may be feasible or necessary to excavate problem zones and replace them with other suitable materials. This approach is probably more suited to new construction than remediation. The feasibility of the excavate-and-replace method on a given project would have to be based on a thorough consideration of all relevant site-specific features.

10.3.6 Crack Stoppers

In remediation of cracked earth embankments, it is sometimes desired to install measures to prevent existing or potential cracks from propagating into previously uncracked zones. Such measures are referred to as “crack stoppers.” The crack stopper must be self-healing or otherwise capable of preventing cracks from propagating through it. The design of the crack stopper must address filter compatibility with both the adjacent earthfill material and any cracks that may exist in the fill. It must also be able to safely accommodate any displacements that may occur in the fill accompanying future crack formation.

Crackstoppers are especially relevant in the case of seismic offset. In seismically active areas, it may be possible that the dam will experience differential offsets of several feet. These offsets can come from two sources. The first results from large displacements caused by liquefiable foundation or embankment materials or poorly compacted fill. The second involves embankments overlying an active fault. The estimation of the magnitude of either type of offset is beyond the scope of this manual, but a conservative factor of safety for filter width should be used. Consideration should also be given to the cracking potential of the filter material itself. In cases where it is believed that the probability of filter cracking is non-trivial, crackstoppers can be used as an additional defense. Generally as crackstopper elements become coarser, as in the case of a uniformly graded gravel, the probability to sustain a crack diminishes. Where cracking is expected to be severe, multiple crackstopper zones can be used: one gravel and one with cobble-sized gradations.

10.3.6.1 Granular Barriers

Granular barriers for crack remediation can be placed in a vertical trench excavated on the centerline of the existing embankment as shown on figure 10-15, or they can be placed on or near the downstream slope of the embankment as shown on figure 10-16. In both cases, sufficient cover must be provided over the filter so that stability against uplift is provided, assuming full pool head is acting on the upstream side of the filter. The barrier is conservatively assumed to be completely sealed by a filter cake and must be designed to satisfy filter criteria. The downstream location may be preferred if large excavation depths would be required to construct the centerline barrier.

The key design consideration for a granular barrier in a cracked earth embankment is, understandably, filter compatibility with the adjacent fill material as well as with all existing and future cracks in the fill and foundation. This presents a challenge to the designer, as these two requirements work in opposition to each other. Figure 10-17 illustrates this problem, where a granular filter is to be designed for a fine-grained soil (silt) that has 2-inch-wide cracks in it. Designing the filter for compatibility with the silt, a relatively small D15 size (0.7 millimeter) is needed. However, designing for compatibility with the cracks, a D50 of at least 2 inches is needed to prevent sloughing of the filter material into existing or potential cracks. This will help to ensure the overall stability and integrity of the filter. The resulting envelope (dashed lines) describes a broadly graded filter that may have problems with segregation and internal stability. Methods to address this design challenge are presented in the following sections.

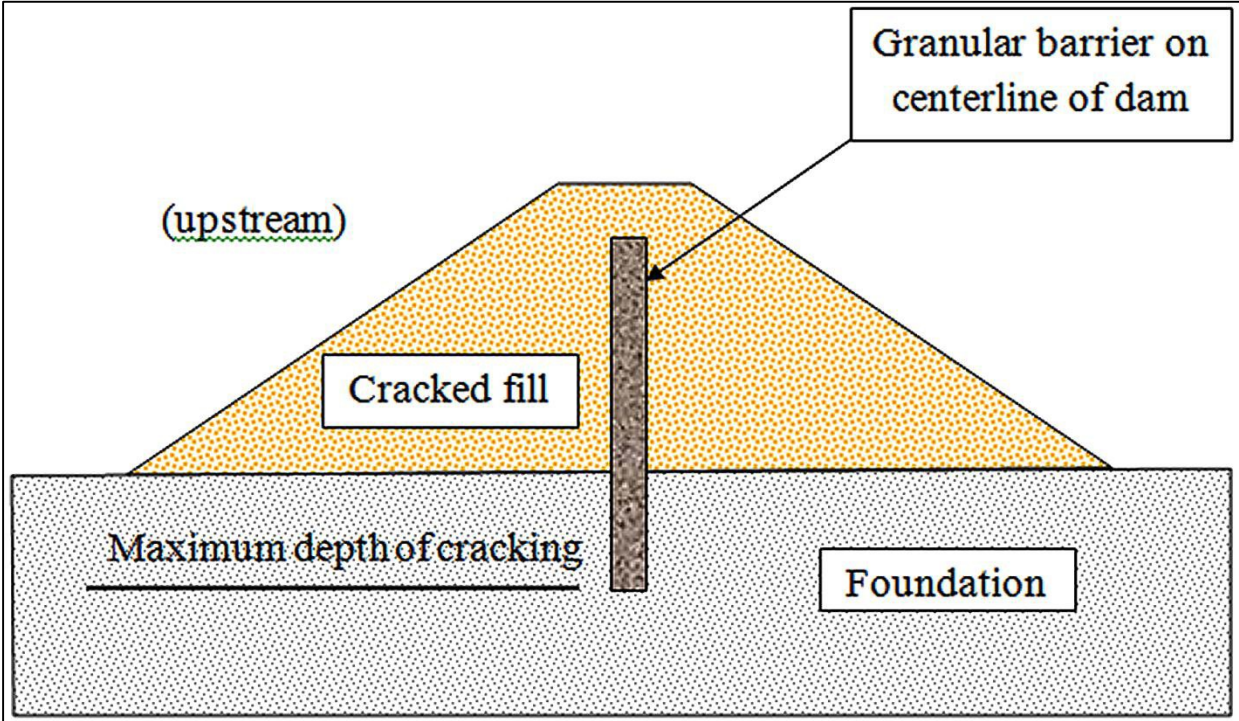

Figure 10-15.—Granular barrier on centerline of a cracked embankment in a normally dry dam (barrier should extend at least to the maximum pool elevation).

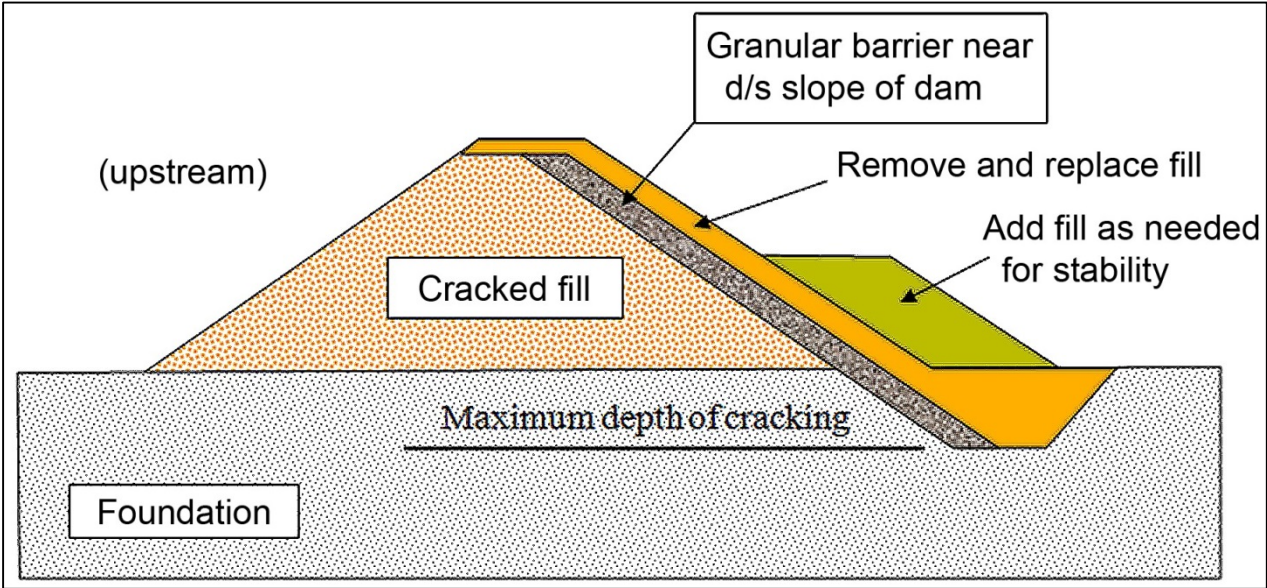

Figure 10-16.—Inclined granular barrier near downstream slope of a cracked embankment in a normally dry dam.

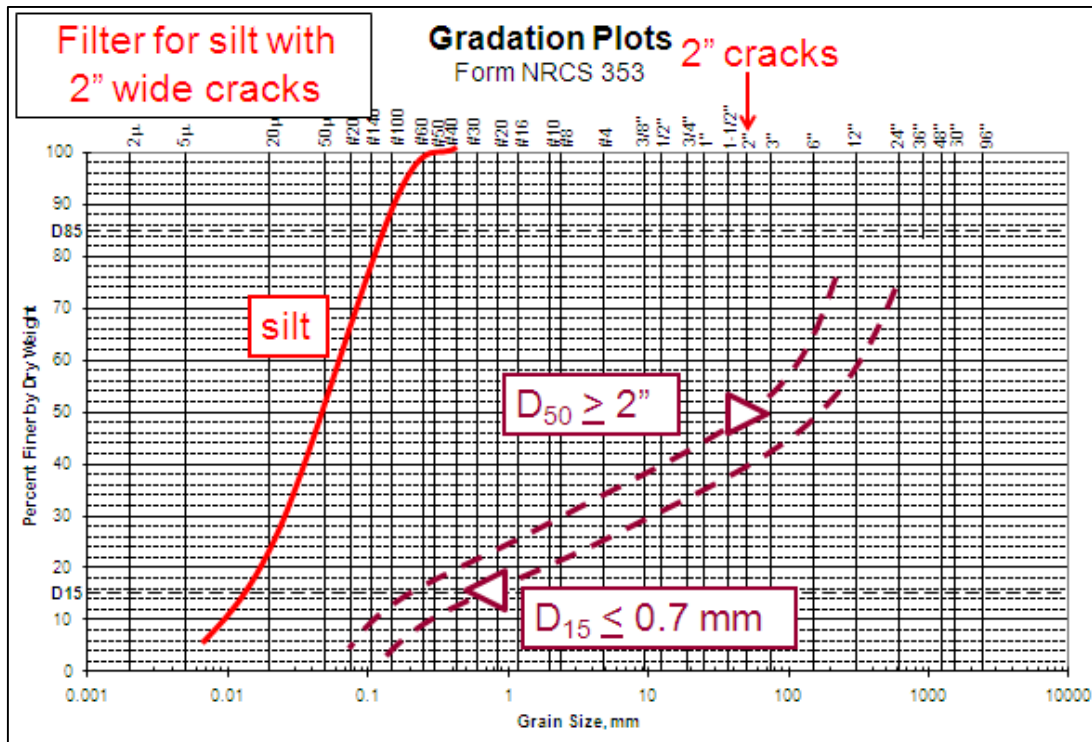

Figure 10-17.—Filter design for silt earthfill with 2-inch-wide cracks.

10.3.6.2 Geotextile Barrier

Under certain circumstances, barriers for remediation have also been constructed using geotextiles in place of granular filter materials (Doerge 2010). If a geotextile is used as the sole element in the barrier, then it must be designed to be able to span any open cracks in the fill. Figure 10-18 shows a geotextile barrier under construction in the Olmitos-Garcias No. 2 Dam⁷ in south Texas. A heavy (16 ounce per square yard) non-woven geotextile was used in this project.

Geotextiles are not recommended for use in drainage features within earth embankments because of their potential for clogging (FEMA 2011). But, in this case, the geotextile’s sole function was particle retention, so clogging would not have posed a problem for the structure.

10.3.6.2.1 Case History 1

To overcome the problems illustrated on figure 10-17, a geotextile can be used in conjunction with a granular chimney filter. In Florence Dam⁸ in southern Arizona (Doerge 2010), a geotextile was draped on the downstream face of the centerline trench prior to backfilling the trench with appropriately graded granular filter material (figure 10-19). In this case, the

⁷ For additional details, see Case 12 – Olmitos-Garcias No. 2 Dam, in appendix 1 (Other Case Histories).

⁸ For additional details, see Case 13 – Florence Dam, in appendix 1 (Other Case Histories).



Figure 10-18.—Construction of geotextile barrier in Olmitos-Garcias No. 2 Dam in south Texas. The downstream side of the embankment is shown. Left – geotextile being backfilled in foundation trench. Right – geotextile on back slope of dam prior to backfilling. (Photos courtesy of NRCS, Texas)

geotextile served to span existing or future cracks in the fill and retain the filter material within the filter trench. The geotextile is theoretically not required below the depth where cracks become narrow enough to be filter compatible with the filter material itself.

10.3.6.2.2 Case History 2

Figure 10-20 shows a crack stopper feature that was used in a highly cracked homogeneous earthfill dam in Colorado, the Cañon C-4 Dam⁹ (Doerge 2010). This particular arrangement, particularly the use of geotextiles, should not be considered a standard section. It was uniquely developed for this particular case of a dry dam where potential clogging of the geotextile was not an issue. The dam contained numerous cracks, both transverse and longitudinal, as the result of differential settlement exacerbated by collapse in the foundation alluvium. In the remediation, the upstream portion of the embankment was removed down to the underlying bedrock. On the resulting slope, a “structural filter” was placed, which consisted of an 18-inch-thick sandwich of a sand-cobble mixture between two layers of heavy non-woven geotextile. The geotextile provided filter compatibility between the various materials and any cracks in the fill. The heavy



Figure 10-19.—Construction of a geotextile/aggregate chimney filter in Florence Dam in Arizona. Geotextile drape is on right (downstream) side of trench. (Photo courtesy of NRCS, Arizona)

⁹ For additional details, see Case 14 – Cañon C-4 Dam, in appendix 1 (Other Case Histories).

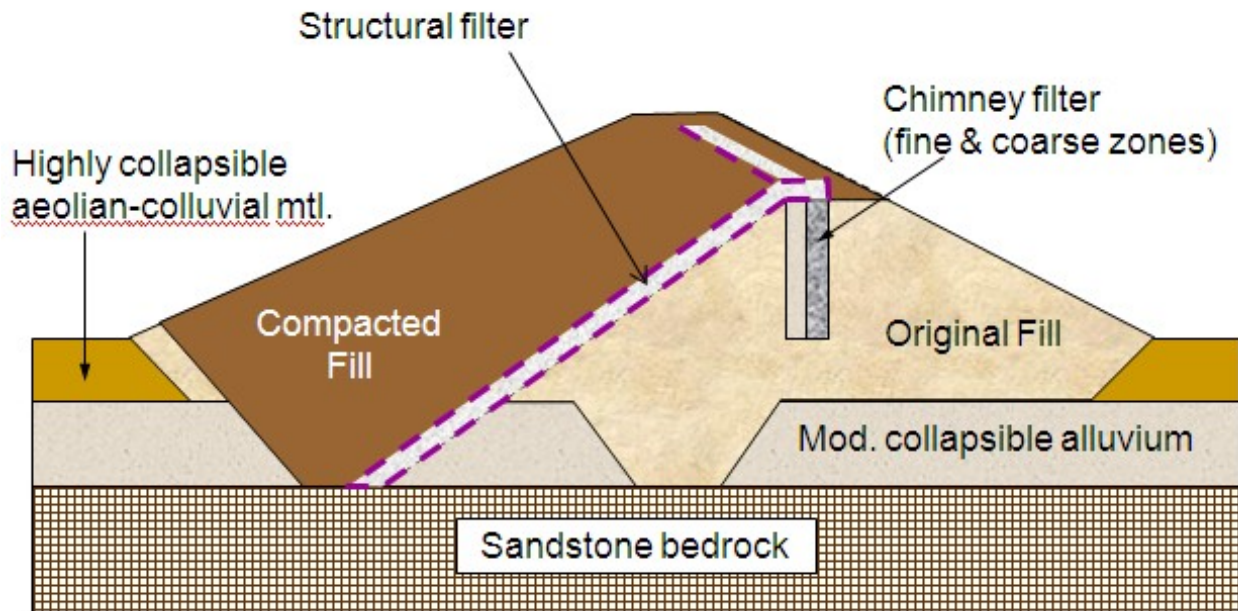

Figure 10-20.—Cross section of Cañon C-4 Dam showing crack stopper feature (“structural filter”) beneath upstream impervious zone with non-standard use of geotextile (the purple dashed line is geotextile).

geotextile was selected to provide adequate strength and ductility in case the foundation experienced any new deformation related to additional collapse of the foundation alluvium. The cobbles were designed to bridge across the widest cracks in the fill (up to 5 inches in width), using the same approach as for sizing a filter pack adjacent to slotted pipe (USACE 1993). Besides acting as a crack stopper, the structural filter also functioned like a chimney filter as a line of defense against internal erosion in any existing or future cracks in the upstream impervious zone, say, by desiccation.

10.3.6.3 Other Considerations During Remediation

As with new construction, care must be taken to clean, map, and treat any newly exposed foundation areas. Foundation treatment may consist of removal of loose material, slush grouting, filling of cracks, placement of dental concrete, and all the other care that would be taken during new construction.

10.3.7 Other Methods

10.3.7.1 Replace Dam

For some existing dams, it may be technically or financially advantageous to replace it rather than to remediate it. In such cases, the new dam would be designed and constructed according to

applicable current criteria, and any modifications needed to safely retire the existing dam from service would be performed. When the replacement is built downstream, the existing dam can then be used as a cofferdam for the new construction. Each situation would be handled on a case-by-case basis.

10.3.7.2 Breach/Decommissioning

In some cases, the most feasible way to remediate a dam with seepage or other problems is to breach or completely remove it. Reasons why decommissioning may be the preferred over the remediation option include the following:

- It is technically or financially unfeasible to properly remediate the dam.
- The dam causes undesirable effects, such as preventing fish migration.
- The dam no longer provides the benefits for which it was constructed (e.g., an old mill pond after the mill has ceased operation).
- The dam has become inconsistent with surrounding land use.

Dam decommissioning typically requires comprehensive planning and the involvement of all affected stake holders. Planning should consider such factors as: (1) environmental effects, (2) sediment disposal, (3) geomorphic effects, (4) permitting issues, (5) social considerations (including recreation), and (6) preservation of historic structures.

10.3.7.2.1 Case History

An example of a dam that was decommissioned to remediate seepage problems is Little Washita No. 13 Dam,¹⁰ a flood control dam in Oklahoma with gypsiferous foundation soils. The homogeneous earth embankment was 34 feet high and was constructed in the late 1970s. Following initial construction, the seepage resulting from the impounding of the reservoir began to dissolve the gypsum salts present in the foundation. This process greatly increased the seepage through the foundation and caused slope stability problems in the outlet basin and on the downstream slope of the embankment (figure 10-21). Various remedial actions were taken, including flattening slopes, installing drainage features, as well as several rounds of foundation grouting. The measures were temporarily effective, but the seepage problems reappeared following continued solutioning within the foundation. Sinkholes have been observed in the reservoir area on many occasions (figure 10-22). Finally, it was decided that the only permanent solution was to breach the dam and decommission it.

¹⁰ For additional details, see Case 15 – Little Washita No. 13 Dam, in appendix 1 (Other Case Histories).



Figure 10-21.—Seepage-caused slope instability near outlet of principal spillway conduit, Little Washita No. 13, Oklahoma (1979). (Photo courtesy of NRCS, Oklahoma)



Figure 10-22.—Sinkhole in reservoir area of Little Washita No. 13, Oklahoma. (Photo courtesy of NRCS, Oklahoma)

10.4 Evaluation/Selection of Remediation Method

When considering engineering aspects of modification alternatives, the two major evaluation factors are cost and risk reduction. Risk reduction is a somewhat new concept stemming from risk analysis methodology used for problem solving of dam safety issues. The precursor to risk-reduction analysis was what engineers termed “technical adequacy.” Technical adequacy is typically expressed in non-quantitative terms, whereas risk reduction is quantified. The two methods are not mutually exclusive, and engineering judgment is used in both. In Reclamation’s dam safety program, the goal in alternative selection is to find “the lowest cost technically acceptable alternative.” This simple rule is effective in eliminating low-cost measures that won’t work (provide insufficient risk reduction) and expensive measures that are overly conservative (provide excess risk reduction). An effective alternative selection procedure should adhere to this model and identify an alternative between these two extremes.

There are other evaluation factors that may be used for alternative evaluation such as environmental considerations, real estate, impacts on other projects within the system, etc. These factors are beyond the scope of this document; the following sections will address only the cost and risk reduction considerations.

10.4.1 Cost Considerations

Cost analysis has long been used by the engineering profession in selecting alternatives for final design and construction. Typically, costs are developed at several distinct stages in the design process such as at preliminary, appraisal, and feasibility-level designs. Alternative selection typically occurs during feasibility-level design, and selection of preferred alternatives should be done with caution at earlier design stages due to pitfalls intrinsic with those early cost estimates. As an example, an organization may decide to make an alternative selection during the *appraisal* stage due to schedule constraints. The selection is made, and as planned, an exploration program is completed during the feasibility stage. The results of that exploration program show that conditions are worse than first envisioned, and the modification cost will be much greater than first estimated. In this situation, the selected alternative may no longer be the best options for the site.

When evaluating cost estimates, it is important to keep in mind the volatility of those estimates. Typically, conventional construction methods result in less volatility than “new technologies” or methods proposed by specialty contractors (proprietary methods). The disadvantage with proprietary methods is the lack of competition between bidders, where sole source acquisition is an extreme example. Volatility can also arise for proprietary methods when contractor claims are made for “changed conditions.” Such a claim may be made by a contractor when the proprietary methods encounter a new site condition in which it is unsuccessful.

Cost estimates are just that—final construction cost will certainly be higher or lower than the original estimate. To address this variability, Reclamation has undertaken a program of

providing low, best, and high estimates for all alternatives. The range of estimates is made by applying uncertainty factors, and the designer varies assumptions on best and worst site conditions discovered after construction begins. Also during this analysis, economic conditions can be factored in that address the level of competitiveness amongst bidders.

10.4.2 Risk Reduction

The technical merit of an alternative can be measured using risk analysis techniques. In the risk analysis method, a given failure mode is broken down into distinct components that lead to complete failure of the dam and loss of the reservoir. These components are then strung together to replicate the failure progression, also known as an event tree. The condition of the dam is evaluated using the usual risk analysis methodology (Reclamation 2011b; USACE 2011) known at the *baseline* condition. Next, each alternative is evaluated and compared to the baseline condition. The difference between the two risk estimates is the amount of risk reduction. When alternatives are evaluated in a risk context, judgment is made as to how the alternative addresses typical event tree nodes. Typically, three nodes are revised as described in the following sections.

10.4.2.1 Initiation Prevention

The initiation node primarily addresses the condition of the dam and the likelihood that a pre-existing defect exists through which internal erosion will initiate. This node is largely subjective and based on historical performance data of dams worldwide. Additionally, Reclamation has developed a set of statistics for its inventory (see chapter 2). Judgment would also be made on the effectiveness of a given alternative in addressing a concentrated flow path. As an example, a concentrated flow path, such as a piping channel in a foundation, may be more confidently addressed by the use of a protective downstream filter than some form of in-situ treatment such as grouting under the dam. The difference in confidence of these methods results in differing probability estimates for this node.

10.4.2.2 Continuation Prevention

This nodal estimate addresses whether a protective filter is present along the seepage path. Obviously, when protective filters are incorporated into an alternative, it will decrease the probability for this node. Common issues that are considered with filter and/or drainage systems is whether gradient is increased and whether the filter acts as a barrier to the most pervious foundation layers. These considerations will affect the uncertainty of the probability estimate as well as the estimate itself.

10.4.2.3 Progression Stop

Progression, or advancement, of a piping seepage path is portrayed by three separate event nodes: roof forms, upstream zone fails to fill a crack, and constriction or upstream zone fails to limit flows. Since the potential for a roof to form is a function of the cohesion or plasticity of the soil (or other geologic/structural features), it is unlikely that alternatives will alter this node. One way an embankment modification could alter this node is if a section of the dam was removed and replaced with non-plastic material that could not sustain a roof.

Alternatives that include two-stage filters (choke filter) can be used to address the crack filling node. Choke filters in this instance can also be thought of as reverse filters since the flow of water is from the filter into the base soil. As a piping conduit progresses upstream through the core, it encounters a sand filter element that erodes into the crack, thus choking off the flow. For redundancy, a second layer of gravel can be added for conditions when the sand passes through large piping conduits. A variation of this alternative is to utilize large material (cobbles and boulders) that will fall into very large piping conduits. While this material may not fill the conduit, it can throttle the flow, resulting in a more controlled release of the reservoir. This will result in a reduction of probability of failure of the constriction node.

10.4.3 Combined Cost/Risk Reduction Analysis

The results from cost estimates and risk reduction for each alternative as described in the previous sections can now be combined for analysis. The easiest way to conduct this analysis is by using a modified f-N plot as shown on figure 10-23. In this example the total baseline risk (i.e., the dam prior to modification) is plotted. It is seen from the figure that the annual failure probability (AFP) is about 4×10^{-4} , and the estimated loss of life is seven. Two alternatives were developed using two different modification approaches to the dam. A risk reduction exercise was performed for Alternative A, and the AFP was estimated at 1×10^{-5} . In a similar manner, Alternative 2 was studied, and the AFP was almost one order of magnitude lower than Alternative A ($\text{AFP} = 1.5 \times 10^{-6}$). These values are then plotted on the f-N plot. A cost estimate was made for each alternative (\$7 million for Alternative 1 and \$8 million for Alternative 2). These values are then added to the plot as shown. This figure can then be used to make a judgment on which alternative to select. For this example, it is noticed that both alternatives provide sufficient risk reduction and would therefore be technically adequate. It is also noticed that it costs about \$7 million to achieve a reduction of about one and a half orders of magnitude for the AFP. Spending an additional \$1 million provides an additional one order of magnitude reduction in AFP. Other considerations would include the potential for increase in downstream population and the attendant increase in the population at risk with time. If this dam were near an urban area, over a few decades it may be possible for the estimated loss of life to increase from 7 to more than 100. If this were the case, Alternative 1 would provide insufficient risk reduction, and Alternative 2 would be preferred.

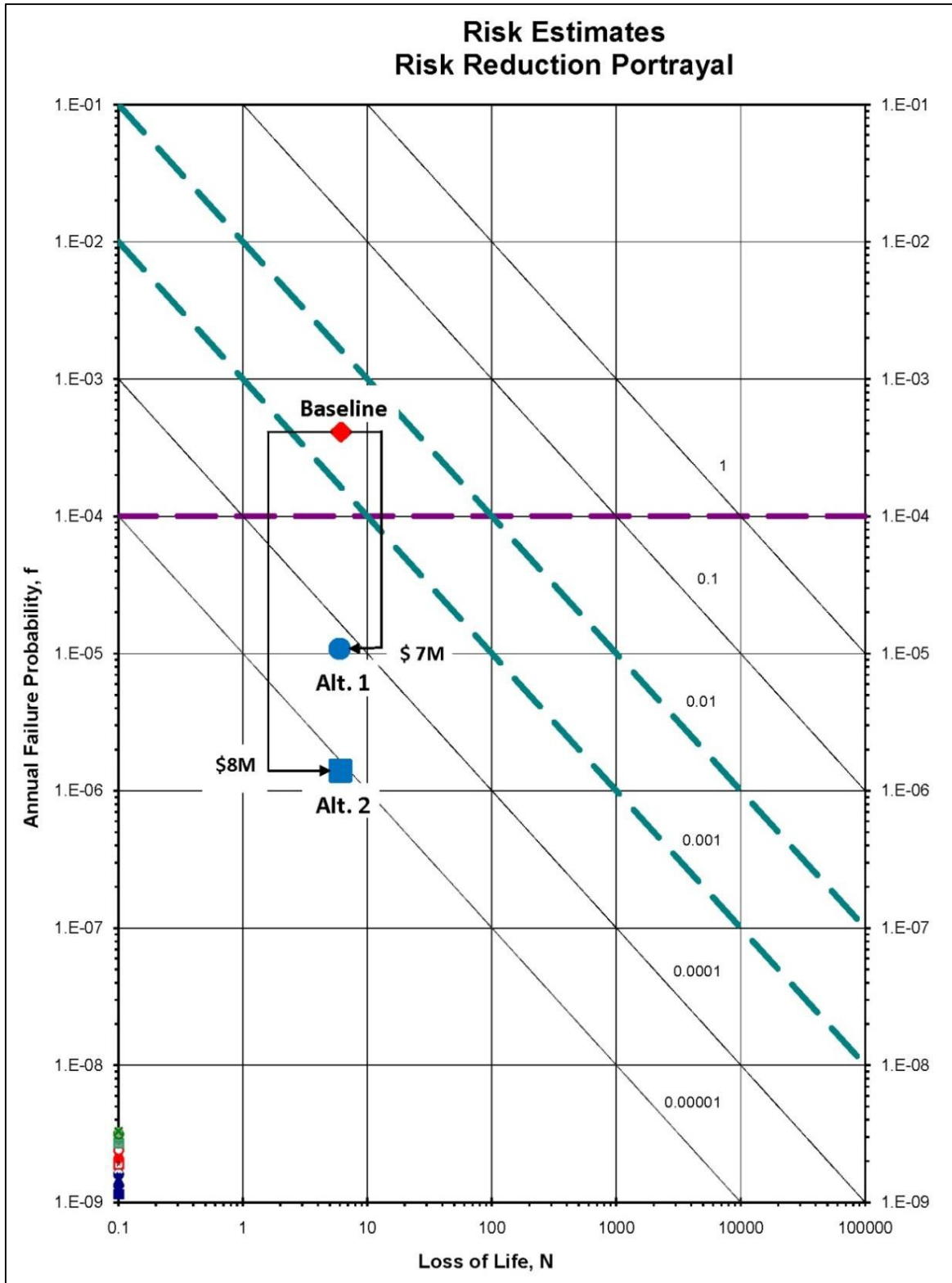

Figure 10-23.—Combined portrayal of alternative cost and risk reduction.

10.5 References

- Baker (2011). The Fontenelle Dam Incident: The Investigation, Likely Causes, and Lessons (Eventually) Learned, Association of State Dam Safety Officials, Annual Conference, Washington, D.C.
- Bliss, M. and E.A. Dinneen (2008). Emergency Remedial Actions at A.V. Watkins Dam, IPENZ Proceedings of Technical Groups 33/1.
- Bruce, D. (2013). “Seepage Cut-offs for Levees and Dams: The Technology Review,” Geosystems, L.P., Venetia, Pennsylvania
<http://www.geosystemsbruce.com/v20/biblio/256%20Seepage%20Cut-Offs%20for%20Levees%20and%20Dams%20-%20The%20Tech%20Review.pdf>
- Bureau of Reclamation (Reclamation) (1977). *Groundwater Manual*.
- _____(1984). *Policy Statements for Grouting*, ACER Technical Memorandum No. 5.
- _____(1987). *Design of Small Dams*.
- _____(1992). *Design Standards No. 13, Embankment Dams*, Chapter 2: Embankment Design, U.S. Department of the Interior, Bureau of Reclamation, Technical Service Center, Denver, Colorado.
- _____(2007). *Design Standards No. 13, Embankment Dams*, Chapter 5: Protective Filters, U.S. Department of the Interior, Bureau of Reclamation, Technical Service Center, Denver, Colorado.
- _____(2011a). *Reclamation’s Seepage Barrier Experience – A cursory Scoping Study*, MERL Report Number 2001-42.
- _____(2011b). *Dam Safety Protection Guidelines (Interim)*.
- _____(2012). *Design Standards No. 13, Embankment Dams*, Chapter 8: Seepage, U.S. Department of the Interior, Bureau of Reclamation, Technical Service Center, Denver, Colorado.
- Doerge, B.C. (2009). *Total or Effective Stress Analysis for Uplift – Which One to Use?*, 2009 ASDSO Conference.
- _____(2010). *Using Geotextiles to Repair Cracked Earth Dams*, 2010 ASDSO Conference.
- Federal Emergency Management Agency (FEMA) (2005). *Technical Manual: Conduits Through Embankment Dams*, FEMA 484.

- ____ (2011). *Technical Manual: Filters for Embankment Dams: Best Practices for Design and Construction*.
- Fisk, G., J. Gagliardi, and S. Day (2001). Slurry Trench Construction of a Vertical Filter at Wasco Dam, 21st USSD Annual Meeting and Lecture Proceedings.
- PRWeb (2013). “Revolutionary Composite Sheet Piling Used for Dike Repair Project in Holland”
http://www.prweb.com/releases/composite_sheet_piling/dike_repair/prweb556336.htm.
- Schmertmann (2012). “History of Graded Filters,” presentation at FEMA Emergency Management Institute, Emmitsburg, Maryland.
- Sherard, J.L. and L.P. Dunnigan (1985). “Filters and Leakage Control in Embankment Dams,” *Proceedings, Symposium on Seepage and Leakage from Dams and Impoundments*, ASCE, Denver, Colorado, pp. 1–31.
- Simmons, R. (2006). “Breach of much smaller dike a hint of Lake O catastrophe,” Palm Beach Post News, May 15, 2006.
- United States Department of Agriculture-Natural Resource Conservation Service (USDA-NRCS) (1994). *National Engineering Handbook*, Part 633, Chapter 26, Gradation Design of Sand and Gravel Filters.
- U.S. Army Corps of Engineers (USACE) (1963). *Design of Finite Relief Well Systems*, EM 1110-2-1905.
- ____ (1984). *Grouting Technology*, EM 1110-2-3506.
- ____ (1993). *Seepage Analysis and Control for Dams*, EM 1110-2-1902.
- ____ (2000). *Design and Construction of Levees*, EM 1110-2-1913.
- ____ (2014). *Safety of Dams – Policy and Procedures*, EM 1110-2-1156.
- ____ (2011). “Wolf Creek Dam Foundation Remediation – Barrier Wall Installation Methods,” USACE Infrastructure Conference 12–17 June 2011. http://www.usace-isc.org/presentation/Geotech%20and%20Materials%20I/Barrier%20Wall%20Installation%20-%20Wolf%20Creek_Lopez_Jose.pdf
- ____ (2013). *Grouting Technology*, EM 1110-2-3506 (revision in print).

**APPENDIX 1 –
CASE HISTORIES OF DAM FAILURES FROM
INTERNAL EROSION**

APPENDIX 1 – CASE HISTORIES OF DAM FAILURES FROM INTERNAL EROSION

Seminal Cast Histories

Case	Page
1 Teton Dam and Fontenelle Dam	A1-7
2 Quail Creek Dike	A1-23
3 A.V. Watkins Dam and Florida Power and Light Dike.....	A1-33
4 Walter Bouldin Dam	A1-43
5 East Branch Dam	A1-49
6 Wister Dam, Little Wewoka, Upper Boggy Creek Site 53, Upper Red Rock Site 20, and Others	A1-53
7 Black Rock Dam	A1-67
8 Narora Weir.....	A1-75
9 Balderhead Dam (and other glacial-moraine core dams).....	A1-79
10 Wolf Creek Dam and Mississinewa Dam.....	A1-97

Other Case Histories

Case	Page
1 Ochoco Dam	A1-123
2 Red Rock Dam.....	A1-127
3 Matahina Dam	A1-131
4 Willow Creek Dam	A1-137
5 Clearwater Dam.....	A1-143
6 Truckee Canal.....	A1-149
7 Anita Dam.....	A1-169
8 Sallacoa Creek Watershed, Site No. 77 Dam.....	A1-173
9 Herbert Hoover Dike	A1-179
10 Navajo Dam.....	A1-217
11 Canby Creek, R-1 Dam	A1-225
12 Olmitos-Garcias No. 2 Dam.....	A1-229
13 Florence Dam.....	A1-235
14 Cañon C-4 Dam.....	A1-241
15 Little Washita No. 13 Dam	A1-251
16 Red Willow Dam.....	A1-263
17 Horsetooth Reservoir.....	A1-275
18 Reach 11 Dikes	A1-285
19 Clam Lake Project.....	A1-293

The following case histories are instrumental to the understanding of the various processes that are responsible for dam failures from internal erosion and remediation methods currently being employed. They are not intended to be exhaustive, as many of these case histories have been well documented in more detail in the literature. References are provided for each case, allowing the reader an opportunity to learn more about the specific aspects of that case. The case histories are divided into two general groups: seminal case histories and other case histories. The terminology used in some of the case histories is not always consistent with the definitions presented in the main text of this document (refer to chapter 3, section 3.1).

Seminal Case Histories

1. Teton Dam (1976) and Fontenelle Dam (1965) – Internal erosion along jointed bedrock foundation and/or hydraulic fracturing of the silt core with progression of stoping.
2. Quail Creek Dike (1988) – Failure of Quail Creek Dike resulted because embankment materials placed on the foundation, including overburden left in place, were not adequately protected from seepage erosion. Efforts to grout the seepage may have exacerbated the problem.
3. A.V. Watkins Dam (2006) and the Florida Power and Light Dike (1979) – Emergency remedial measures were required at the A.V. Watkins Dam, and a breach occurred at the Florida Power and Light (FPL) Dike due to backward erosion piping through the foundation. The backward erosion occurred under very low hydraulic gradients.
4. Walter Bouldin Dam (1975) – The Walter Bouldin Dam may have failed by internal erosion through the foundation, although it will never be known with certainty what caused the breach. This case history highlights the difficulties in documenting the root causes of dam failure, and points out the importance of three-dimensional details in the design of seepage control systems, and how construction activities and reservoir operations may compromise the effectiveness of such systems.
5. East Branch Dam (1957) – Muddy water began discharging at a rate of about 10 cubic feet per second (ft^3/s) from the rock toe drain of the East Branch Dam after 4½ years (yr) of operation. The dam was constructed with a wide impervious core. A large cavity was found in the core that was assessed to be the result of a crack through the impervious core over the right abutment. The incident was attributed to differential settlement over abutment irregularities and inadequate grout treatment of the abutment.
6. Wister Dam (1949), Little Wewoka, Upper Boggy Creek Site 53, Upper Red Rock Site 20, and Others – In Wister Dam, a near failure occurred in dispersive soils triggered by differential settlement cracking over the original stream channel. Additional dam failures, in dams constructed of similar materials, in Australia and Oklahoma in the 1960s and 1970s resulted in better appreciation of the high potential for cracking, hydraulic fracturing, and rapid erosion in dams constructed of dispersive clay soils.

7. Black Rock Dam (1909) – Internal erosion of foundation soils below a basalt caprock due to excessive seepage and unprotected seepage exit, which caused a 9-foot (ft) lowering of the abutment and near breach.
8. Narora Weir (1898) – The first case in which the newly developed hydraulic gradient theory was used to predict the failure of a dam.
9. Balderhead Dam (and other glacial-moraine core dams) – Internal erosion causing depressions and sinkholes in embankments constructed with cores of broadly graded, internally unstable, glacially derived soils. In dams with thin cores, arching and hydraulic fracturing may have exacerbated the problem.
10. Wolf Creek Dam (2013) and Mississinewa Dam (1988) – Ineffectiveness of partial cutoffs in karst foundations and the use of hydromill and secant wall technology for installation of deep cutoffs to address problems with karst.

Other Case Histories

1. Ochoco Dam – Ochoco Dam experienced seepage from the right abutment during first filling, and the dam was repaired in 1921 and again in 1950 to address the abutment seepage. Sinkholes and erratic piezometer readings occurred in 1985, and a turbid flow of 3,600 gallons per minute (gpm) occurred from the drains in 1995 accompanied by a significant rise in pore pressure within the embankment. The increased flow was probably related to a 10-ft-diameter sinkhole that appeared on the upstream slope.
2. Red Rock Dam – Red Rock Dam was constructed on geologic strata with significant gypsum beds. Grouting during the original construction was extensive and confirmed the presence of significant voids due to dissolution of the gypsum deposits in the left side of the dam and in solutioned limestone in the right side. Remedial grouting was performed in 1994, which included a test program to assess acceptable drilling methods to prevent hydrofracturing the impervious embankment from grouting operations.
3. Matahina Dam – Matahina Dam was constructed on a hard, volcanic rock foundation. During first filling in 1967, an increase in cloudy seepage was observed from the drainage blanket. A couple weeks later, a large area of subsidence was noted in the dam crest immediately downstream from the core, near the right abutment. During the investigation, it was found that cracking in the core over a hard foundation ledge, and the presence of grout seams caused by leakage from grout holes cased through the body of the dam, “aggravated the position.” The dam performed well after repairs, until after a large earthquake occurred March 2, 1987. On December 17, 1987, an area of subsidence appeared on the left abutment, 9 months after the earthquake, with characteristics similar to the 1967 incident that occurred in the right abutment.

4. Willow Creek Dam – A sinkhole developed at the dam crest in 1996 due to internal erosion into and around the outlet works tunnel. The incident required emergency corrective actions, including reservoir drawdown and embankment reconstruction.
5. Clearwater Dam – The reservoir experienced the pool of record in May 2002. The following January in a period of low pool, a sinkhole opened up on the upstream embankment face above the pool elevation. It is believed that the sinkhole pipe developed below the dental treatment through a karst feature that was originally soil filled but, over time, was cleaned out by erosion.
6. Truckee Canal – At approximately 4:00 a.m. on January 5, 2008, the downhill embankment of the Truckee Canal failed at approximate canal Station (Sta.) 714+00, releasing water into the town of Fernley, Nevada. The canal drained through the breach from both the upstream and downstream directions. Reportedly, water flowed through the breach for up to 9 hours (hr), and water depths of up to 8 ft occurred in some locations, with water depths of 1 to 4 ft common throughout the housing developments. Based on available information, it appears that animal burrowing is the most likely of the plausible potential failure modes (PFMs).
7. Anita Dam – Anita Dam failed from internal erosion along an unfiltered outlet conduit on March 26, 1997. The failure began with a small amount of seepage at the outlet pipe, which accelerated to failure due to the presence of dispersive clay.
8. Sallacoa Creek Watershed, Site No. 77 Dam – After 35 yr of incident-free operation, a 65-ft-diameter sinkhole appeared without warning on the downstream slope of the embankment. Subsequent drilling and electrical resistivity surveys revealed that the limestone bedrock under the dam contained an extensive system of voids and solution cavities. The sinkhole was formed by stoping of overburden soil and embankment fill into these cavities. Remediation was judged to be economically unfeasible, and the decision was made to decommission the dam.
9. Herbert Hoover Dike – Seepage-related concerns and the overall length of Herbert Hoover Dike have resulted in significant challenges and investigations into cost-effective methods to address the risk of internal erosion. Portions of the dike have already been remediated with seepage cutoff walls, and there is an ongoing effort to address other reaches of the dike. Two papers are provided for this project: (1) a paper utilizing the deterministic approach for evaluation of remediation alternatives and (2) a paper utilizing the risk analysis process for evaluation of remediation alternatives.

10. Navajo Dam – Approximately 1 yr after the commencement of reservoir storage, seepage was noted on the left abutment in the downstream groin area and on the right abutment near the embankment-abutment contact. The seepage fluctuated with the reservoir level and steadily increased through the following years. Maximum measured seepage in the summer of 1973 was 664 gpm through the left abutment and 1,037 gpm through the right abutment. A concrete diaphragm wall through the embankment and extending deep into the left abutment was the selected remedial treatment for the left abutment. A drainage tunnel system was selected as the appropriate remedial treatment for the right abutment.
11. Canby Creek, R-1 Dam – A high-downstream-hazard potential earthfill dam founded on artesian, lacustrine-sand overlain by an impermeable glacial till. This case history provides an example of remediation methods for foundation drainage problems (relief wells, slurry trench, and trench drain installation).
12. Olmitos-Garcias No. 2 Dam – This case history demonstrates the use of geotextiles to remediate a severely cracked, low-head earthen dam founded on collapsible soil.
13. Florence Dam – Florence Dam, constructed by the Natural Resources Conservation Service (NRCS) in 1965, is located in Pinal County Arizona. It has a history of transverse and longitudinal cracking attributed to desiccation. This case history discusses the nature of the cracking and describes how the dam was remediated with a centerline filter-trench with geotextile filter on the downstream side of the trench.
14. Cañon C-4 Dam – This case history is somewhat similar to the Olmitos-Garcias No. 2 Dam case history. It describes the remediation of a highly distressed embankment using geotextiles and a sand filter on the upstream slope of the dam. The distress was caused by differential settlement from collapsible soil in the foundation.
15. Little Washita No. 13 Dam – Located in Grady County, Oklahoma, Little Washita No. 13 Dam experienced excessive underseepage due to the presence of a gypsiferous foundation (Whitehorse Group of Upper Permian Age) and alluvial soils with very high (40–60 percent) soluble salt content and subsequent development of sinkholes through the foundation. Excessive seepage triggered progressive sloughing of the downstream slope, but the problem was corrected before the dam failed. Subsequent development of sinkholes required further evaluations that ultimately recommended: (1) decommission the site or (2) accept the chance that breach could occur during a flood event.
16. Red Willow Dam – Dam safety modifications were required in 2011 to address internal erosion through cracks in the embankment. The modification included a two-stage chimney filter and drain system and installation of a filter and drain around the outlet works and spillway conduits, in the discharge basin, and a toe drain along the toe of the embankment. A double-sided geo-net composite was used in the chimney filter construction and is the first use of a geo-net composite by the Bureau of Reclamation (Reclamation).

17. Horsetooth Reservoir – After 40 yr of uneventful operation, excessive seepage appeared below the dam, and a number of sinkholes appeared near (and in) the reservoir. Modifications were required between 2001 and 2003 to address PFMs related to internal erosion issues and excess foundation seepage. Modification included the addition of a two-stage chimney filter and drain system downstream from the core. An impervious blanket consisting of a geomembrane, geotextiles, and an impervious clay layer was placed in the reservoir upstream of the left abutment to control seepage through the Forelle limestone and other Lykins units beneath the embankment.
18. Reach 11 Dikes – The Reach 11 flood detention dikes are part of the Hayden-Rhodes Aqueduct, located in central Arizona, and consist of four separate embankments with a total length of 15 miles (mi). The dikes experienced severe cracking, excessive erosion by rills, gullying, and tunnel erosion from intense rainfall due to the presence of dispersive soils in the embankment materials. The embankments were modified by deep slurry trenching and installation of a vertical high-density polyethylene (HDPE) geomembrane barrier wall and a tremie-backfill sand filter to mitigate internal erosion concerns.
19. Clam Lake Project – The Clam Lake Project is a flood-retarding embankment constructed from broadly graded glacial till between 1974 and 1977. Although the project has a 10-ft-wide downstream chimney drain, it was designed based on the total gradation of the base embankment soils, which was the practice at the time. Current NRCS practice would require regrading the filter based on the portion of base soil passing the No. 4 sieve. After close evaluation of the site characteristics and embankment construction, it was determined that internal erosion at Clam Lake was a remote probability.

SEMINAL CASE HISTORIES

Case 1 – Teton Dam and Fontenelle Dam

Teton Dam

Most dam engineers are familiar with the Teton Dam failure. Teton Dam was located on the Teton River, a tributary of Henrys Fork of the Snake River in Fremont County of eastern Idaho. The dam, located 3 mi northeast of Newdale, Idaho, was a 305-ft-high zoned earthfill structure with a crest length of 3,100 ft, including the spillway, and a crest elevation of 5332 ft. The total impoundment capacity was 288,250 acre-ft, with an active capacity of 200,000 acre-ft. A three-gated, chute-type spillway was located on the right abutment along with an auxiliary outlet works and access shaft. The main river outlet was located in a tunnel in the left abutment. The power and pumping plant were located in a steel-framed building at the base of the left abutment of the dam. The powerplant consisted of two 10,000-kilowatt (kW) generators with a provision to install a third unit in the future. The pumping plant facilities included six pumping units – two rated at 7.35 ft³/s and four rated at 14.7 ft³/s. The rated head was 323 ft. Water from the pumping plant was to be delivered into the Fremont Pump Canal.

On June 5, 1976, the Teton Dam structure failed during initial filling, resulting in a complete breach of the reservoir. The reservoir elevation at the time of failure was 5301.7; the reservoir was filling at about 3 ft per day. At full reservoir capacity of 288,250 acre-ft, the water surface elevation would have been 5320 ft. The river outlet works and powerplant were not fully operational at the time of the dam failure.

Teton Dam failed during first filling, marking the first and only failure of a Reclamation embankment dam. However, the failure was similar to an incident that occurred 11 yr earlier at Fontenelle Dam where excessive seepage through highly jointed foundation rock led to erosion of highly erodible core material during initial filling (see next case history in this section). Figure 1 shows Teton Dam after the subsequent failure. Figure 2 shows a section of the dam through the abutment areas where the embankment dam was founded on fractured bedrock. Contributing factors in the failure of Teton Dam included the use of highly erodible low plasticity fines in the core, the lack of filters in the core key trench, and insufficient treatment of open joints in the bedrock foundation.

The Zone 1 embankment fill was constructed of aeolian silt (loess), which was known to be erodible, but due to its low permeability and proximity to the dam was chosen to be used for the core material. The Zone 2 shell material surrounding the silt core was composed of sand, gravel, and cobbles. On the abutments above elevation 5100, a cutoff trench with side slopes of 0.5H:1.0V was excavated into bedrock with a 30-ft-wide base as shown on figure 2. Transition filter zones were not provided between the silt core and bedrock or in areas where the silt core was in contact with alluvium or the sand/gravel/cobble fill. In the areas of the cutoff trench, the core material placed against rock was to be compacted wet of optimum for a 2-ft zone in contact with the rock. Compaction was done with hand compactors and rubber-tired rollers.

Evaluation and Monitoring of Seepage and Internal Erosion

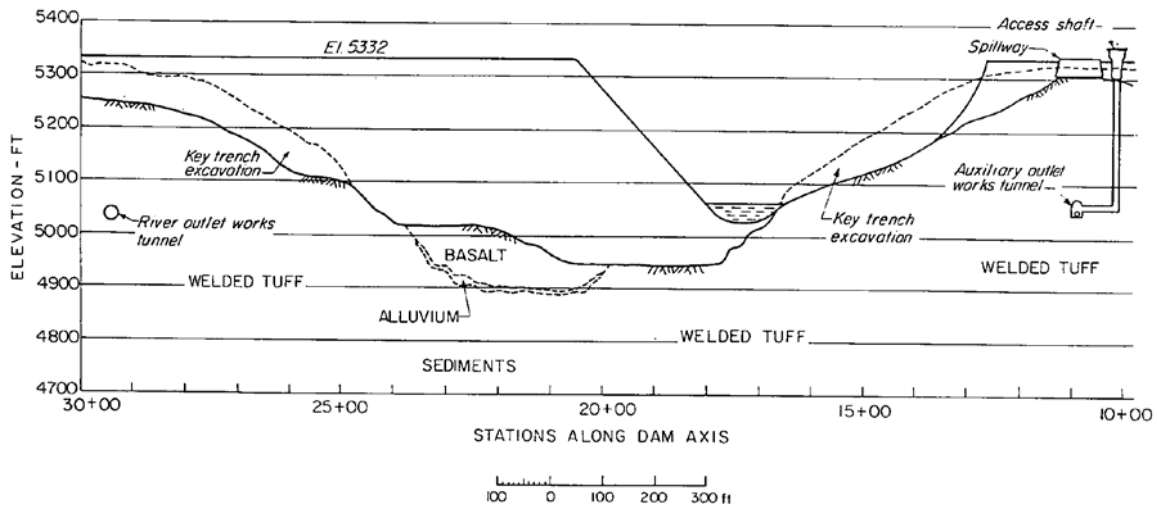

Figure 1.—Profile of Teton Dam following failure from internal erosion at the right abutment (Independent Panel to Review Cause of Teton Dam Failure 1976).

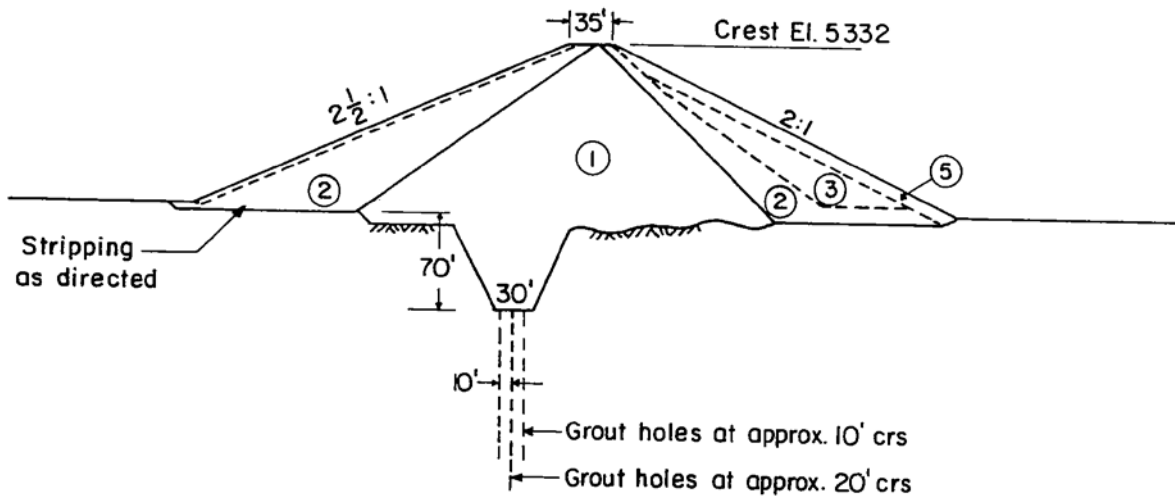

Figure 2.—Typical cross section for abutments where embankment core (silt with some clay and gravel) is founded directly on jointed rhyolite.

A 70-ft-deep excavation was made in the bedrock at the right abutment for the cutoff trench. There was a lack of foundation shaping and treatment in the cutoff trench. No shotcrete, dental concrete, or slush grout was used in the floors or walls of the cutoff excavation. Widely open joints were sealed with bucket grouting, and a grout cap was placed along the cutoff trench floor for installation of the grout curtain. Fine materials used in the core of the dam were placed against untreated bedrock. A grout curtain was installed the full length of the dam with grout holes on a single line. Grout holes of the primary curtain were spaced 10 ft apart. The grout curtain extended to depths of as much as 300 ft, and split spacing was used where needed.

Barrier grout holes were also installed to prevent excessive grout flow from the main, single-row grout curtain. The barrier grout holes were placed on 20-ft centers and were located in rows 10 ft upstream and 10 ft downstream from the main curtain. The barrier holes were not intended to seal the foundation but just limit excessive grout flows from the main curtain grouting. A 23-hole grouting test program was performed in the left abutment prior to installation of the grout curtain, which found that only two holes took all the grout planned for the entire test (15,700 sacks of cement). The majority of the grout was placed in the top 70 ft with grout daylighting 300 ft downstream from the grout holes. Also important was the finding that one leak between 30 and 70 ft could not be grouted to refusal (Seed and Duncan 1981). These findings resulted in a decision to excavate a 70-ft-deep key trench in the abutments above elevation 5100.

Reports were prepared by an independent panel and a Government panel to review the cause of the failure of Teton Dam. A number of reasons postulated how a defect in the core of the right abutment cutoff trench came about. Some theorized the failure resulted from the fill becoming frozen during winter shutdown due to the presence of a wet lift of material discovered in the right abutment following the failure. Another theory (supported with stress analysis) found low confining stresses from arching in the narrow cutoff trench in the abutment, which could have resulted in hydraulic fracturing and cracking, causing seepage through the cutoff trench (figures 3 and 4). Others have hypothesized that the grout curtain was inadequate to cut off seepage through the highly fractured foundation (figure 5) or possible hydraulic separation at the base of the key trench. However it occurred, excessive abutment seepage exited along the bedrock-embankment contact on the downstream side of the dam, leading to soil erosion and gross enlargement of the erosion pathway that eventually breached the dam. Note that sloughing of the downstream, sinkholes, and eventually the collapse of the crest all occurred during the breach process, but gross enlargement is considered to have been the primary breach mechanism.

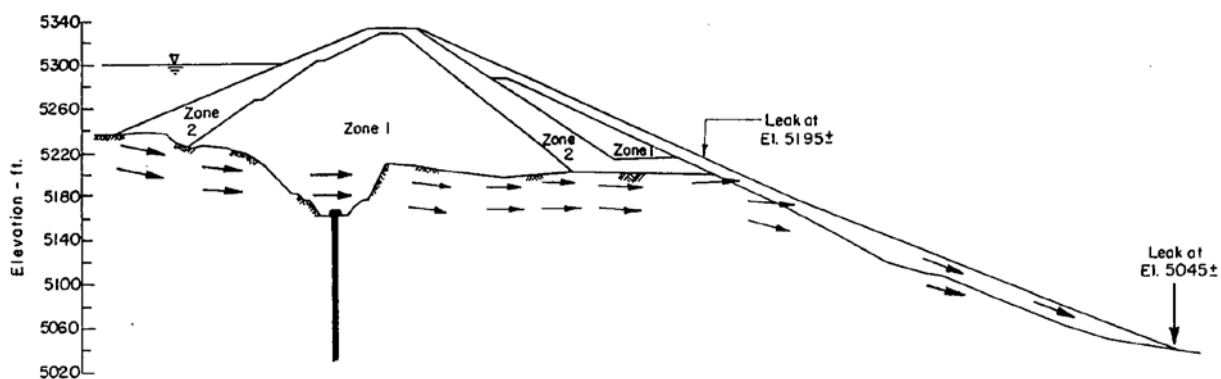

Figure 3.—Postulated path for seepage through the abutment cutoff trench (Independent Panel to Review Cause of Teton Dam Failure 1976).

It is critical to recognize that the joints, fractures, and openings in the downstream wall of the cutoff trench and the remaining foundation downstream from the trench were severely incompatible with respect to filtering and retention of the very fine-grained, erodible core



Figure 4.—Narrow, 70-ft-deep abutment cutoff trench. Man shown for scale (photo courtesy of James Wright 2007).



Figure 5.—Deep, highly fracture zone under the right abutment cutoff trench. Joints were generally open, some as much as 2 inches.

material as well as the silt infillings in some of the joints themselves. Although special compaction of the core material was specified within the confines of the core trench, it would have been virtually impossible to construct a perfect core without defects to overcome these conditions. Greater focus should have been on proper foundation treatment and construction of filter protection for the core trench walls and silt infillings.

After careful review and participation in the indepth investigations that occurred following the failure of Teton Dam, Seed and Duncan (1981) succinctly summarized the key lessons learned:

1. It is important to recognize how quickly a dam failure may occur due to internal erosion and piping of erodible construction materials. For this reason, it is essential to fill the reservoir slowly under fully controlled conditions and to have available a means for lowering the water level rapidly (e.g., a low-level outlet) if problems develop.
2. The problem of foundation and abutment treatment for high embankment dams on rock foundations remains one of the most critical aspects of dam design. If the contact surfaces between the impervious core and the jointed rock at the Teton site had been appropriately sealed and a filter layer had been provided to prevent movement of core material into any voids that may have inadvertently remained unsealed, the piping that led to failure of the dam could not have occurred. Sealing of the core-foundation contact and the provision of adequate filter and drainage systems are essential elements of all earth dams.
3. The principle of multiple lines of defense, long advocated by Arthur Casagrande, should never be neglected because there are many unknown circumstances that may arise during construction, such as the use of unexpected types of fill in the borrow areas at the Teton site, which can jeopardize the best designs.
4. While every effort should be made to ensure that an earth dam is built in accordance with the design specifications, materials and conditions not anticipated by the designer may arise during construction, which will lead to incorporating materials into the embankment that are of lower quality than those envisaged by the designer. This possibility should be recognized in the design and provisions made both to minimize the possibility and also to ensure the safety of the dam in spite of such occurrences.
5. It is the opinion of all investigating panels that the occurrence of the main “wet seam” at Teton Dam could not be related to the failure that ultimately occurred. However, under other conditions, such as the occurrence of the design earthquake, the unknown presence of the wet seam could have been the trigger mechanism that led to a major slide – an occurrence that would have been a source of mystery to the designers and to the profession as a whole. It is essential that detailed construction records be kept on fill material placed so that all aspects of embankment performance may be fully understood.
6. No matter how successful a design agency or group may be, it is extremely desirable that designs of major dams be reviewed by an independent group of engineers to ensure that no possible design deficiency has been overlooked.
7. Instrumentation designed to monitor the performance of earth dams should be incorporated in all major structures so that any evidence of malfunctioning can be detected at an early stage and remedial action taken to prevent failure.

8. It is virtually impossible to provide a tight grout curtain in highly jointed rock with a single row of grout holes, and it is equally difficult to seal all rock defects near the rock surface no matter how carefully and skillfully the grouting procedures may be performed.
9. It is essential that the designer of an earth dam remain in close contact during the entire period of construction of the dam so that unanticipated conditions may be recognized and the design modified, as appropriate, to mitigate any hazards that the new conditions may introduce.
10. Abrupt changes in geometric configuration or material stiffness in an embankment dam can lead to stress distributions that will greatly facilitate the occurrence of hydraulic separation or hydraulic fracturing. Such abrupt changes should be avoided.
11. While low stresses facilitate the occurrence of hydraulic fracturing, this phenomena can only occur if there are discontinuities present in the soil that will permit the development of tensile stresses in the soil. Such discontinuities include existing cracks in the soil, zones of loose soil adjacent to rock joints, cavities and voids in the embankment soil, and irregular zones of high permeability embedded within less pervious materials.

The 1976 failure of Teton Dam caused approximately \$1 billion in economic losses and the lives of 14 individuals. This failure, following so closely to the failure of Buffalo Creek Dam in 1972 (125 lives lost), led to the creation of U.S. Federal Guidelines concerning the safety of dams in 1979 and Executive Order 12148 from President Carter directing the Federal Emergency Management Agency (FEMA) to coordinate Federal dam safety efforts.

References

- Independent Panel to Review Cause of Teton Dam Failure (1976). "Report to U.S. Department of the Interior and State of Idaho on Failure of Teton Dam," Bureau of Reclamation, Denver, Colorado.
- Seed, H.B. and Duncan, J.M. (1981). "The Teton Dam Failure – A Retrospective Review," Proceedings of the Tenth International Conference on Soil Mechanics and Foundation Engineering, Stockholm, Sweden, June 1981, pp. 1–20.
- U.S. Department of the Interior Teton Dam Failure Review Group (1980). "Failure of Teton Dam, Final Report," Bureau of Reclamation, Denver, Colorado.

Fontenelle Dam

Fontenelle Dam is located on the Green River 24 mi southeast of La Barge, Wyoming. The reservoir has a surface area of 8,058 acres and is 20 mi in length when full with a shoreline of approximately 56 mi. The total capacity of the reservoir is 345,360 acre-ft. The primary features of Fontenelle Dam include the embankment, spillway, outlet works, access roads, and powerplant. A zoned earthfill structure, the embankment is 139 ft high with a crest length of 5,421 ft and a volume of 5,265,000 cubic yards (yd³) of material. The spillway consists of an uncontrolled crest, open chute, and stilling basin with a design capacity of 20,200 ft³/s. Fontenelle Powerplant is located adjacent to the toe of the dam, with the power penstock branching from the river outlet works. The powerplant consists of one 10,000-kW generator and one 16,000-horsepower hydraulic turbine.



Figure 1.—Fontenelle Dam (Google Earth, July 5, 2009).

Fontenelle Dam is founded on the Laney Shale Member of the Green River Formation. In the area surrounding the dam site, the Lower to Middle Eocene sedimentary rocks of the Green River Formation consist of the thinly bedded calcareous sandstones, siltstones, shales, and minor beds of limestone. Individual beds range from less than a foot to several tens of feet in thickness. Bedding dips at very low angles (1 to 2 degrees) downstream and from the right toward the left abutment. The soluble minerals gypsum, thenardite, and analcite are reported in drill hole core logs above the groundwater in both abutments. These minerals occur primarily as fracture fillings and coatings on open joints and in bedding plane layers.

Three main discontinuity sets have been measured and described at the site: (1) bedding plane joints, (2) vertical to near vertical tectonic joints, and (3) near vertical relief jointing predominantly within the massive sandstone units. The bedding plane joints are evident within

the platy siltstone and fissile shale units. The near vertical relief jointing occurs predominantly within the massive sandstone units and within an area bordering the steep abutments. Because of its uniformly massive characteristics, the sandstones, particularly in the right abutment, respond to stress by breaking along fractures, which generally extend the full thickness of the unit and continue laterally for a considerable distance. These stress relief joints form in the most massive rock due to removal of lateral support. The stress results in deep open joints that roughly parallel the abutment and extend at least to the bottom of the sandstone units. These open joints were also encountered in the spillway inlet excavation, and one was exposed in the spillway chute. They attain an open width of up to 1 ft and are generally vertical and roughly parallel to the abutment contours.

A cutoff trench was excavated approximately 50 ft upstream of the dam axis throughout most of the dam. The bottom width is generally 80 ft but tapers to 20 ft at the left (east) abutment. The slopes of the cutoff trench were excavated on a 1.5H:1V slope. The maximum depth of the trench is 28 ft. The majority of the cutoff trench had a depth of approximately 15 ft. Excavation for a grout cap ranged from zero to 7 ft but generally a 5-ft depth was considered adequate. Foundation preparation of the excavated bedrock surface below the embankment was performed to stabilize the exposed foundation surfaces that are susceptible to loss of strength and slaking from exposure and to provide adequate bond of the embankment materials to the foundation. Shale in the foundation that tended to weather and air slake badly on exposure required a coating of bituminous material to preserve the surfaces. Foundation preparation provisions included final shaping of the rock at the foundation surface. Foundation grouting originally consisted of curtain grouting to reduce seepage through the foundation bedrock. The curtain grouting was performed across the valley and extended to a maximum depth of 110 ft into bedrock. All foundation curtain grouting was performed using 2-in-diameter pipes placed normal to the slope and embedded in a grout cap. The grout cap is a continuous 3-ft-wide by 3-ft-high concrete cap placed in the center of the cutoff trench. Grouting pressures were 1 pound per square inch (lb/in²) per foot of depth to the packer plus 15 lb/in². Pressures were reduced when foundation uplift occurred.

The central core of the embankment was constructed of impervious material (Zone 1) consisting of a mixture of clay, silt, sand, and gravel. The core is flanked both upstream and downstream with free-draining sand, gravel, and cobbles (Zone 2). Incorporated within the downstream Zone 2 portion of the embankment is a zone of miscellaneous material (Zone 3) obtained from required excavation. The upstream face of the dam is sloped at 3H:1V and is protected by a 5-ft-thick blanket of riprap from the dam crest to a 15-ft-wide berm at elevation 6480. The downstream face of the dam is sloped at 2H:1V and has no slope protection. A concrete diaphragm wall was constructed from 1985 to 1988 from the crest of the dam into the foundation rock along the entire length of the dam to correct the dam safety deficiency of seepage and internal erosion instability. Fontenelle Dam was designed by Reclamation in the late 1950s to make use of readily available materials in the immediate vicinity of the dam site. The Zone 2 portion of the embankment provides a drainage zone for removal of seepage from the embankment. Filter criteria were not applied to the use of Zone 2 as a filter for Zone 1 material. The Zone 2 material provides drainage that would keep Zone 3 dry and thereby aid in the stability of the embankment (figure 2).

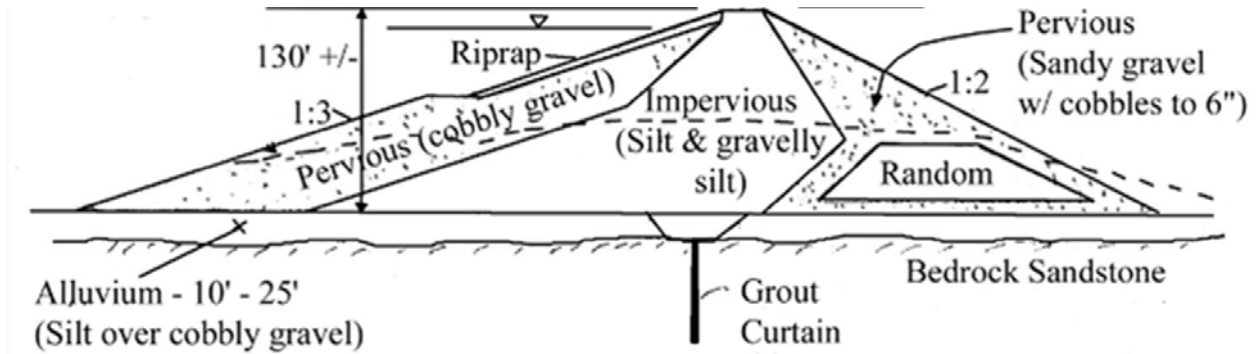

Figure 2.—The dam is founded on fractured bedrock in abutments and on alluvium in the valley.

September 1965 Incident

Fontenelle Dam nearly failed during first filling in 1965, and the incident has some similarities to the Teton Dam failure that occurred in 1976. Upon first filling at Fontenelle Dam, seepage appeared in a borrow area 2,000 ft downstream. As the reservoir continued to fill, seepage appeared from bedrock in the rock cut for the spillway on the right abutment and from a cliff on the left side of the valley 0.6 mi downstream. In the summer of 1965, sloughing of the backfill material adjacent to the left side of the spillway chute occurred. It was believed that the sloughing was caused by saturation of the spillway chute backfill caused by water flowing through a crack in the sandstone parallel to the valley wall and exiting through cracks perpendicular to the valley wall. These sloughs were repaired by installing a 12-inch perforated corrugated metal drainpipe parallel to the spillway wall and embedding the pipe in gravel.

On the morning of September 3, 1965, a wet spot appeared near the left side of the spillway on the downstream slope of the embankment at about mid-height at elevation 6458 (figure 3). The reservoir filled rapidly under flood conditions and was about 1.6 ft above the spillway crest at the time. By mid-afternoon, water was flowing from the area, causing erosion and sloughing. By evening, the flow from the wet area of the embankment was estimated at 5 ft³/s.



Figure 3.—First appearance of sinkhole, with drainage.

The flow increased to about 21 ft³/s by the morning of September 4, and an estimated 10,500 yd³ of material had eroded from the embankment. All outlets, including the east and west canals, were opened full to draw down the reservoir. The erosion created a larger cone-shaped hole, with steep sides, that was migrating toward the crest

and enlarging as it went. Sloughing from the steep sides continued at an alarming rate. In an effort to prevent further erosion, rock for upstream slope protection was taken from a storage pile near the dam and was dumped into the hole.

On the morning of September 5, it appeared that the flow rate was stabilized and that the erosion had stopped. However, it appeared that the dumped rock partially plugged the opening from which the flow was coming. This plugging forced the water to exit at higher elevations, causing additional sloughing at these higher levels.

A series of violent surges occurred in the flow in the afternoon of September 5, and the flow was much more sediment laden than previously. At that time, the rock dumping was stopped. By evening, the flow again appeared to have stabilized.

On the morning of September 6, the flow remained stable. However, later that afternoon, an area on the dam crest about 20 ft in diameter, with its center near the upstream edge of the crest, suddenly collapsed with a drop of approximately 33 ft (figure 4a). Bedrock was exposed on the abutment side of the newly created cavity, and water appeared to be issuing from cracks in the rock. Heavy rock was dumped into the hole to stabilize the area against further collapse (figure 4b). A cross section at the sinkhole locations is shown on figure 4c.



Figure 4a.—20-ft-diameter sinkhole on upstream side of dam crest. (Standing near the edge of a large sinkhole while hanging onto a rope is considered extremely dangerous and is not recommended.)



Figure 4b.—The sinkhole migrated in the upstream direction, expanding in size, as material progressively caved from the sides and was washed out of the bottom (stopping).

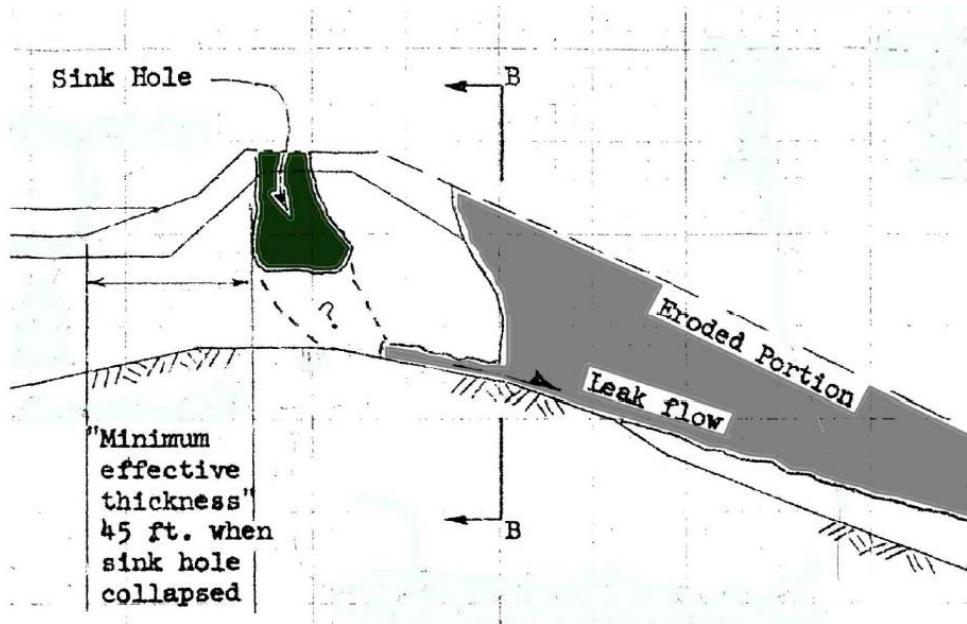

Figure 4c.—Section through embankment at sinkhole location. Note approximately only 45 ft of embankment was retaining the reservoir.

After the September 6 collapse, there were no additional slides. By continued operation of the various reservoir outlets, the reservoir level continued to drop at the approximate rate of 4 ft per day, and the flow from the leak gradually decreased and eventually stopped when the reservoir reached about 48 ft below the spillway crest. At that point, observation of the near failure indicated that the seepage flow came out of the bedrock through open cracks.

A number of intersecting open joints, some up to 3/4 in wide, were observed in the bedrock of the right abutment following the near failure. The primary cause of the near failure was associated with the inadequate grouting or overly optimistic grouting expectations and the presence of numerous stress relief joints and a prominent horizontal plane of leakage within the bedrock that were not adequately sealed (figure 5).

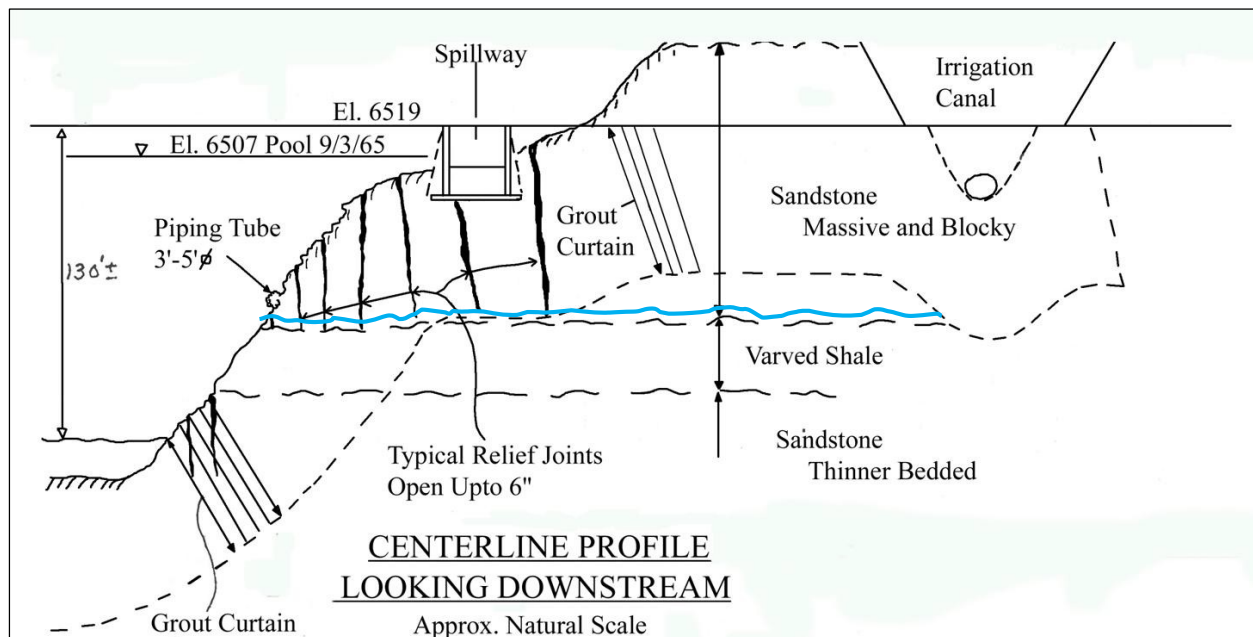

Figure 5.—Section into the right abutment, showing vertical stress relief joints and prominent horizontal leakage plane (top of Varved Shale).

In hindsight, an obvious key factor in the near failure, in addition to the lack of sufficient treatment of open joints and bedding planes in the bedrock foundation, was the lack of an internal filter and drainage zone that would render seepage through both the foundation and embankment harmless with respect to the removal of soil particles and the buildup of pore pressures. A couple of key details are that the average Zone 1 core material in the dam is reported as being a SC-CL with 13 percent (%) plus No. 4 material and having a liquid limit of 31 and a plasticity index (PI) of 13.

However, the core material remaining after the near breach in the abutment area was generally described as a well-graded mixture of sandy gravel and silt. Perhaps the core was constructed with soils that were internally unstable. No crack in the core was noticed during close inspection of the piping channel through Zone 1. Zone 2 materials described as select sand, gravel, and

cobbles, as well as the materials in the miscellaneous zone sloughed during this incident, and the incident that occurred 4 months prior, and were easily removed by the concentrated seepage. Other contributing factors of the near failure included:

- The steep abutment made shallow grouting difficult to perform because low pressures were necessary to prevent movement of the foundation.
- The steep abutment encouraged differential settlement and cracking of the embankment.
- The steepness of the abutment, along with irregularities and overhangs in the rock, made it difficult to achieve a good embankment bond to the abutment.
- Lack of slush grouting and dental concrete, and the presence of deep open joints and bedding planes within the foundation, allowed a substantial amount of water to seep through the foundation and along the embankment-abutment contact.
- The silty, Zone 1 soil (low permeability embankment core) was highly erodible.

Modifications were undertaken to repair the right side of the foundation and embankment. Repairs included remedial grouting of the foundation and reconstruction of the embankment. In addition, supplemental grouting of the foundation was performed on the left abutment where cracking of the embankment had been observed above the East Canal outlet works. The supplemental grouting was performed to repair the rock foundation and re-establish the original grout curtain as well as extend the grout curtain in the right abutment and left abutment. In the right abutment, both blanket and curtain grouting were performed.

Embankment repairs included stripping the surfaces of previously placed embankment and excavation of a keyway, stripping the right abutment, excavating a cutoff trench, excavating drainage trenches, and placing and compacting embankment materials. Foundation treatment required that loose materials be removed from the abutment contacts and that sharp irregularities be reduced to provide satisfactory foundation contours. In addition, the foundation was properly cleaned so that a good bond between foundation and embankment could be achieved.

Zone 1, Zone 2, and rock blanket materials were used in reconstructing the embankment. Zone 1 and Zone 2 material and placement specifications were similar to those of the original construction. The rock blanket consisted of a 5-ft horizontal layer placed at the downstream Zone 2 to abutment contact. The blanket consisted of 1/4- to 4-in material.

A 12-in-diameter toe drain was installed in the location of the original right side toe drain. In addition, the existing 12-in drain adjacent to the left spillway wall was extended further up the slope.

1982 Seepage Incident

The reservoir filled to spilling for the second time in 1982. Significant amounts of seepage were noted below the left (east) side of the dam and along the toe of the dam in several locations. The reservoir was restricted, and several years of investigations followed. Investigations identified a silt core susceptible to internal erosion by seepage and lack of a properly designed granular filter zone.

1985–88 Concrete Cutoff Wall Construction

Due to seepage observations and slope stability analyses in the 1980s, two phases of cutoff wall construction were performed. First, in 1985, a test section was constructed to evaluate the effectiveness and ability to construct a concrete cutoff wall through the embankment and foundation materials. Second, the majority of the cutoff wall was constructed in those areas not completed by the test section. The wall was constructed from approximate dam Sta. 12+50 to Sta. 66+00. The wall penetrated the upper 10 to 20 ft of bedrock, which was known to be more intensely fractured and pervious from various explorations and from grout takes (figure 6). The wall was constructed through the East Canal outlet works, and considerable effort was made to tie into the river outlet works. Additional grouting was performed from inside the river outlet works conduit to block seepage paths under the conduit in the vicinity of the wall's intersection with the conduit. Strict alignment and vertical control were included as major objectives in construction control, and extensive core sampling was conducted to verify concrete integrity, strength, and accuracy of placement. Porous tube piezometers, vibrating wire piezometers, inclinometers, embankment measurement points, cutoff wall measurement points, and survey piers were installed.

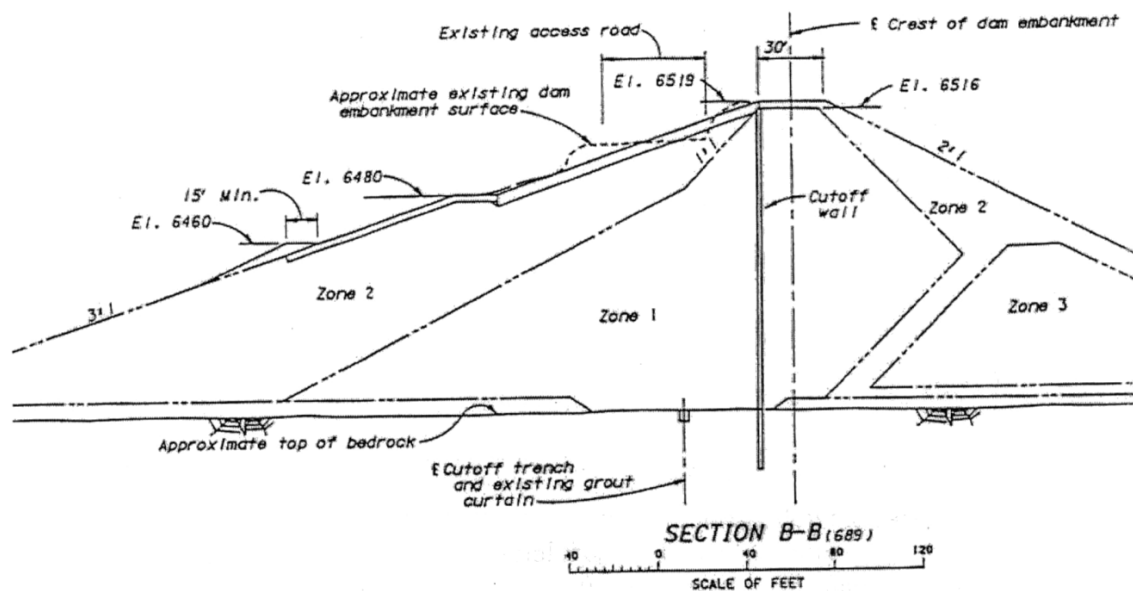

Figure 6.—Cutoff wall installation.

Design and construction methods in use at the time of the 1960's construction of the dam do not conform to present practice. This includes the lack of slush grouting and dental concrete, the absence of filters at the embankment-foundation contact, excessive grouting pressures, and steep abutment slopes. These deficiencies caused a first filling seepage, and internal erosion induced a near-failure event that required emergency reservoir evacuation and significant repairs to the foundation and embankment, with additional dam modification using a continuous concrete diaphragm wall parallel to the dam axis to control seepage. The dam and reservoir have performed well since acceptance of the core wall in 1989.

References

- Baker, M.E. (2011). "The Fontenelle Dam Incident: The Investigation, Likely Causes, and Lessons (Eventually) Learned," Association of State Dam Safety Officials, Annual Conference, Washington, D.C., September 2011.
- Bureau of Reclamation (Reclamation) (2013). "Fontenelle Dam, Wyoming," draft paper prepared for International Commission on Large Dams case histories publication (in print).

Case 2 – Quail Creek Dike¹

Quail Creek Reservoir was impounded by Quail Creek Dam and Quail Creek Dike (figure 1a) and is located in the southwestern corner of Utah. The dike failed near midnight on New Year's Eve, January 1989, releasing 25,000 acre-ft of water into the Virgin River near Hurricane, Utah. The breach was preceded by concentrated leakage in one area on December 31, 1988, which increased throughout the day. The leakage began to increase rapidly at about 8:20 p.m. and was estimated to be about $70 \text{ ft}^3/\text{s}$ by 10:30 p.m., at which time the leakage changed from a vertical orientation to a horizontal orientation and began to erode the toe of the dike. A large slough occurred at 11:00 p.m., and as more material was eroded, sloughing progressed until the dike was completely breached at 12:30 a.m. on January 1, 1989. Peak discharges from the breach were estimated to be up to $66,000 \text{ ft}^3/\text{s}$. Although no life loss was incurred, there was about \$12 million in damages to downstream agricultural land.

The maximum height of the dike is about 78 ft with a crest width of 20 ft and an overall length of about 1,980 ft. The breach was approximately 140 ft wide and 80 ft deep (figure 1b). The foundation for this earthen dam consisted of dipping beds of sedimentary rock that strike almost perpendicular to the axis of the dike (figure 2). The construction of Quail Creek Reservoir took place in 1984, about 8 yr after the failure of Teton Dam, yet there were few additional measures taken to address the potential for concentrated leakage from constructing an earthen embankment on a rock foundation. The dam was constructed as a zoned earth embankment with a 10-ft cutoff trench (figure 3).

The dike foundation is composed of sedimentary beds of the Moenkopi Formation. The Moenkopi Formation is Lower Triassic in age and was deposited in tidal, nearshore, and shallow marine environments. It typically contains thinly bedded mudstones and sandstones with secondary gypsum and, in the area of the dike, contained limestone-dolomite, gypsum beds, and other salt-rich sediments (Catanach et al. 1989). The dike was constructed on the flank of a large anticline where arching of the thin-bedded sediments created minor faulting, folding, and jointing of beds.

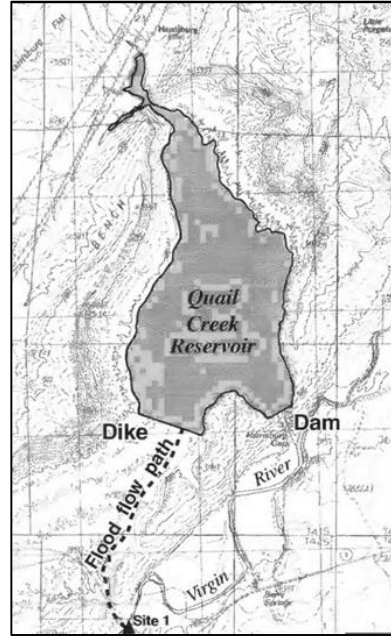

Figure 1a.—Quail Creek Reservoir.



Figure 1b.—Breach through Quail Creek Dike.

¹ The majority of this material was adapted from J.L. Von Thun (2012).



Figure 2.—The breach of the dike is located on the right limb of a large anticline where the rock outcrop extends beneath the dam in an upstream- downstream orientation.

Although the PFM of “piping through the dam” was protected against in the original design of the embankment, the failure mode of “piping at the dam foundation contact through the cutoff trench” was not adequately addressed. This latter potential piping failure mode is evident in the design cross section. Zone 1 (sandy silt and silty sand) was erodible and could support a pipe. The foundation key trench extended through open, highly permeable, highly weathered rock. The trench was protected on the bottom with a layer of Zone 2 clay material, which was a very good plastic, non-erodible, quite impermeable clay. However, the sides of the cutoff trench were neither filtered nor protected with the clay. Thus, a potential flow path was

constructed, allowing seepage from the reservoir into Zone 3 gravel, into the weathered rock foundation, and then through the key trench (Zone 1) with a free exit for Zone 1 into the weathered rock and/or into the Zone 3 gravel in the downstream shell. This allowed for possible tunnel formation at the dam foundation contact, leading to seepage erosion, expansion of the tunnel, and collapse of the dam. This mode was very similar to the actual failure mode for the dam.

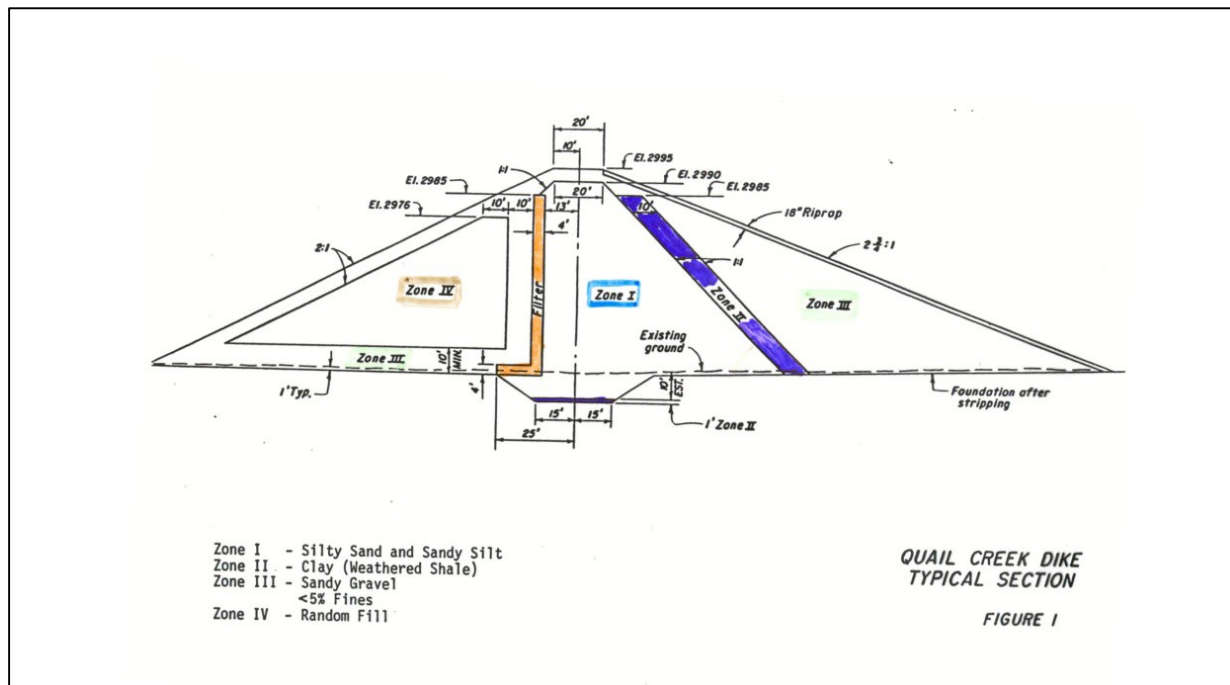

Figure 3.—Design cross section through the dike showing zones and cutoff trench.

During construction, an important field modification was made to the dike. Due to the uneven surface across the dipping sedimentary beds in the right abutment, the contractor was allowed to place a leveling course of erodible Zone 1 material to assist with embankment construction. The dam design cross section in these intermediate “valley” sections now contained an unprotected, unfiltered Zone 1 layer, extending from upstream to downstream in the low swales of the outcrop and consisting of erodible sandy silt and silty sand with enough plasticity to hold a pipe.

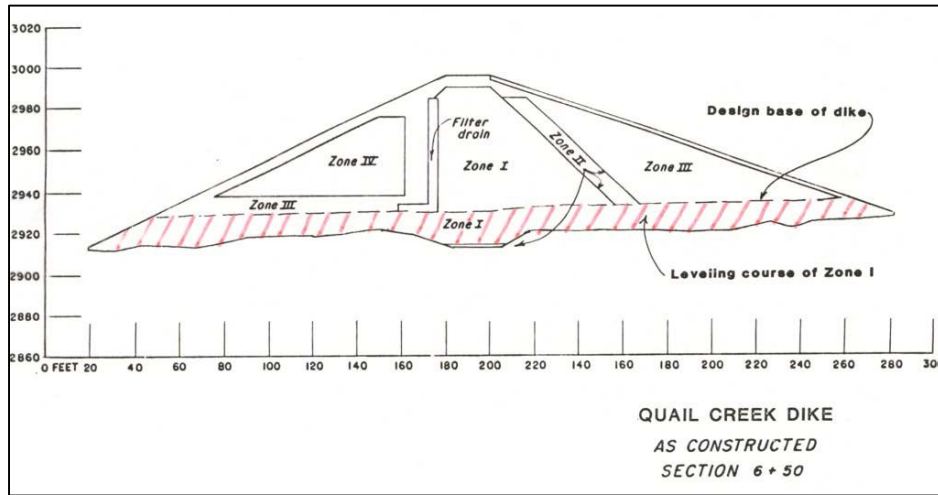

Figure 4.—As-built cross section.

Foundation grouting was the selected remediation after excessive leakage occurred during first filling in 1985, 4 yr prior to the breach (figure 5).



Figure 5.—Excessive leakage during first filling.

A timeline plot of the reservoir level and grouting period shows that most of the grouting took place with a nearly full reservoir (figure 6a) and that the grouting significantly affected piezometric pressures near the base of the dam (piezometers are shown on figure 6b). Grout is present in defects in the bedrock, extending well downstream, as visually observed in the path scoured by the breach flow. Grout travel in the foundation toward the downstream would be expected, as it would be pushed downstream by the seepage water. What might have been feared but not necessarily expected was the evidence of grout throughout the dam remnant. The “foundation” grouting that had been done by drilling through the dam had found pathways back into the dam, fracturing the dam and filling seams in the dam with grout nearly to the crest of the dam.

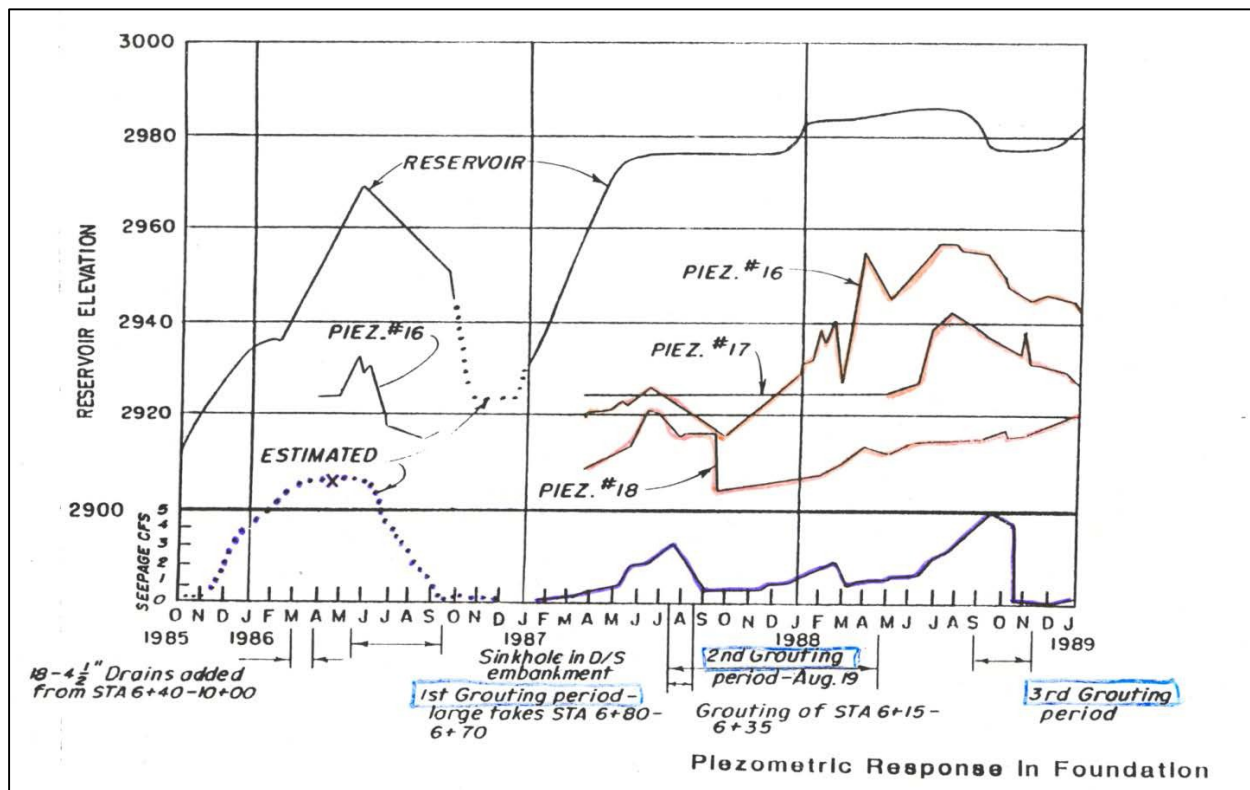

Figure 6a.—Grouting (1985–89). Note the increase in piezometric levels and quantity of seepage after second grouting period.

The head in piezometer 17 reaching a high of 2,942 ft in July gives a head differential of 29 ft over a distance of about 120 ft. Considering that there is a free exit in the 5-ft-deep toe trench results in another 5 ft of head differential. A gradient/head loss of 34 ft over 120 ft ($34/120 = 0.28$) in this silty sand, sandy silt material was great enough to initiate piping.

The piezometric response in the piezometers also illustrates a common insight—the potential development of and the initiation of piping may be indicated by either rising piezometric levels or falling levels. The response of piezometers 16, 17, and 18 and the measured seepage flows

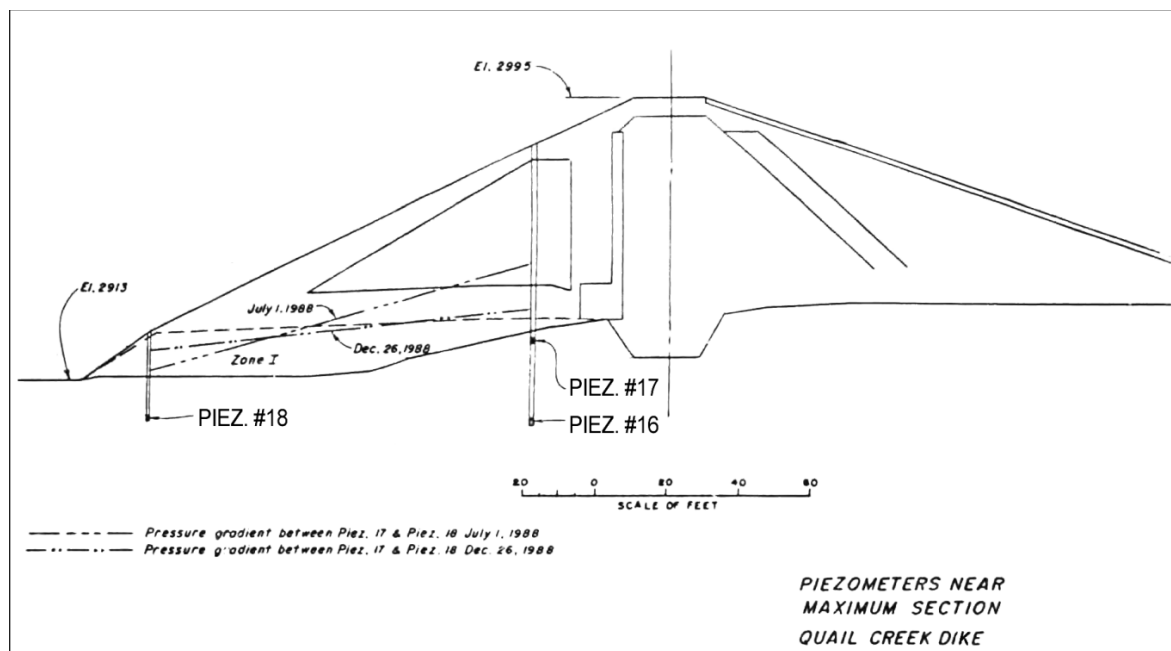

Figure 6b.—Location of piezometers 16–18.

showed that piping channels had probably developed in earnest back to near the axis by August 1988. At that time, the pipes provided pressure relief, and the pressures at the axis began to drop. As the pipes progressed, increasing flow caused the pressures at piezometers 17 and 18 to gradually rise from October 1987 to August 1988. Additional grouting was performed in September 1988. This third round of grouting appeared successful in lowering pressures in piezometers 16 and 17 but may have only redirected the foundation seepage as pressure continued to rise in piezometer 18. The increasing pressure in piezometer 18 at the toe of the dam eventually led to the sudden increase in leakage in a concentrated leak area and erosion of the dam.

Dike Performance

Reservoir filling began in April 1985. During March 1986, eighteen 4.5-in-diameter drain wells were installed between Sta. 6+40 and 10+00, and the following month, plans were prepared for pressure grouting the dike foundation and adding a drainage blanket and berm due to excessive seepage through the foundation. By May 1986, the remediation work had begun, and flow from the dike was estimated to be $6.3 \text{ ft}^3/\text{s}$, with the major seepage occurring at Sta. 6+50 and Sta. 3+00 downstream from the toe. After grouting was completed in September 1986, the seepage had decreased to about $0.3 \text{ ft}^3/\text{s}$, and the following month, a decision was made to install an upstream cutoff at the dike in October 1986. The upstream cutoff and partial blanketing a distance 500 ft upstream of the upstream toe was completed by December 1986.

Substantial seepage developed near Sta. 6+00 the following summer during the period from June – July 1987. Additional grouting was ordered, which was completed by April 1988. During this grouting effort, it was determined that the main seepage was occurring near the contact between Sta. 6+15 and 6+35, and that it was difficult to cut off. A decision was made to grout the left abutment.

Seepage increased to about 5 ft³/s during the summer of 1988, and some turbidity was noted in the seepage. A third round of grouting was ordered. During this effort, the main source of seepage was found on September 21, 1988, to be 130 ft beneath the crest of the dike (approximately 40 ft below the foundation contact). After extensive effort, the seepage was stemmed, but the grouting required several Redi-mix trucks pumping grout through 125 ft of casing. By November 18, 1988, the deep grouting was stopped, and seepage was estimated to be between 0.1 to 0.7 ft³/s, but increased turbidity was noted.

As noted in the Independent Review Panel report (Catanach et al. 1989):

“Based on eyewitness accounts, the first indication of the potential failure was on December 31, 1988, with the observed upward flow of discolored water around an observation pipe located at about Sta. 5+90 (see figures 7 and 8). Equipment and materials were mobilized to place a gravel filter over the seep area. Despite continued efforts to control the flow, the volume increased to an estimated 70 cfs at about 10:30 p.m. when the flow changed from vertical to horizontal from a rapidly growing cavity at the toe. At this point, personnel and equipment were removed and an emergency downstream evacuation was ordered. At about 11:30 p.m., a wedge of the downstream slope about 50 ft wide and extending about one-third of the way up the slope dropped down. Continuing embankment caving toward the reservoir crossed the dike crest and breached the dike, releasing the reservoir at about 12:30 a.m. on January 1, 1989. By 1:00 p.m. on January 1, about 25,000 acre-ft of water had drained from the reservoir, resulting in a breach about 300 ft wide and 80 to 90 ft deep.”

Based on the evidence gathered and the witnessing of the failure development, the following failure mode was postulated (figure 9):

1. High leakage/seepage flow occurred through the foundation of the dam. This flow entered upstream and dropped in elevation as it proceeded under the dam, leaving the dam cross section above the cutoff essentially unaffected. (It is conceivable that this leakage could have stabilized with time, but it is also possible that it could have eroded out a high-capacity tunnel through the foundation that could have resulted in loss of the reservoir.)
2. A “free exit” toe trench was dug at the toe of the dam and filled with coarse rock, increasing the gradient and providing a free exit for escape of soil material. This toe trench exacerbated the “free exit” condition that already existed. The PFM existed without it, and it is likely that failure would have resulted even if the toe trench had not been built. However, the likelihood of intervention and avoidance of failure would have increased without it.

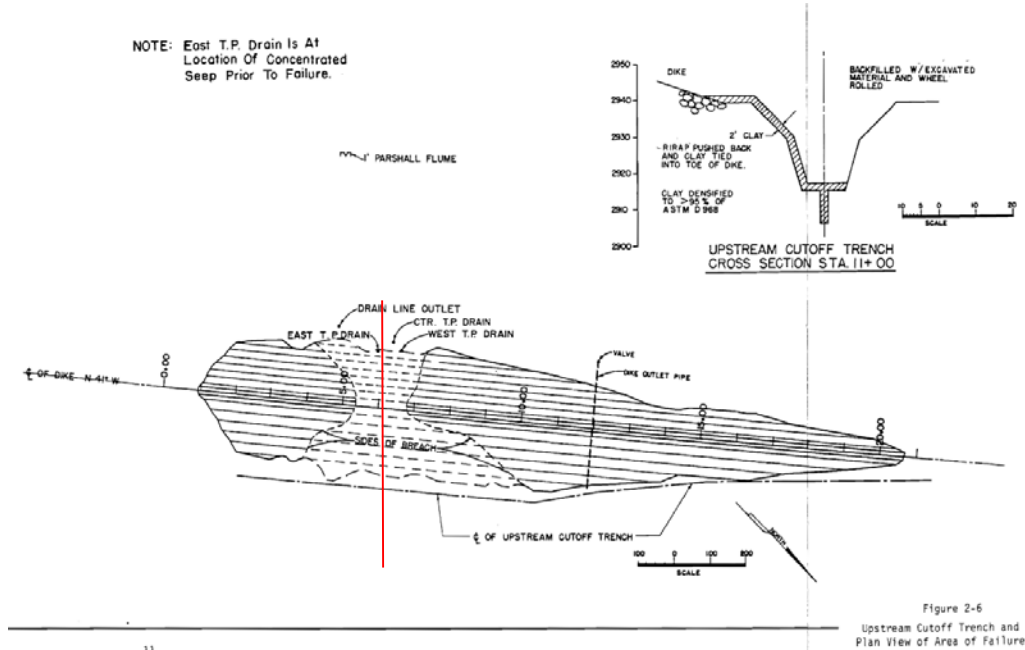

Figure 7.—Plan view of breach area.

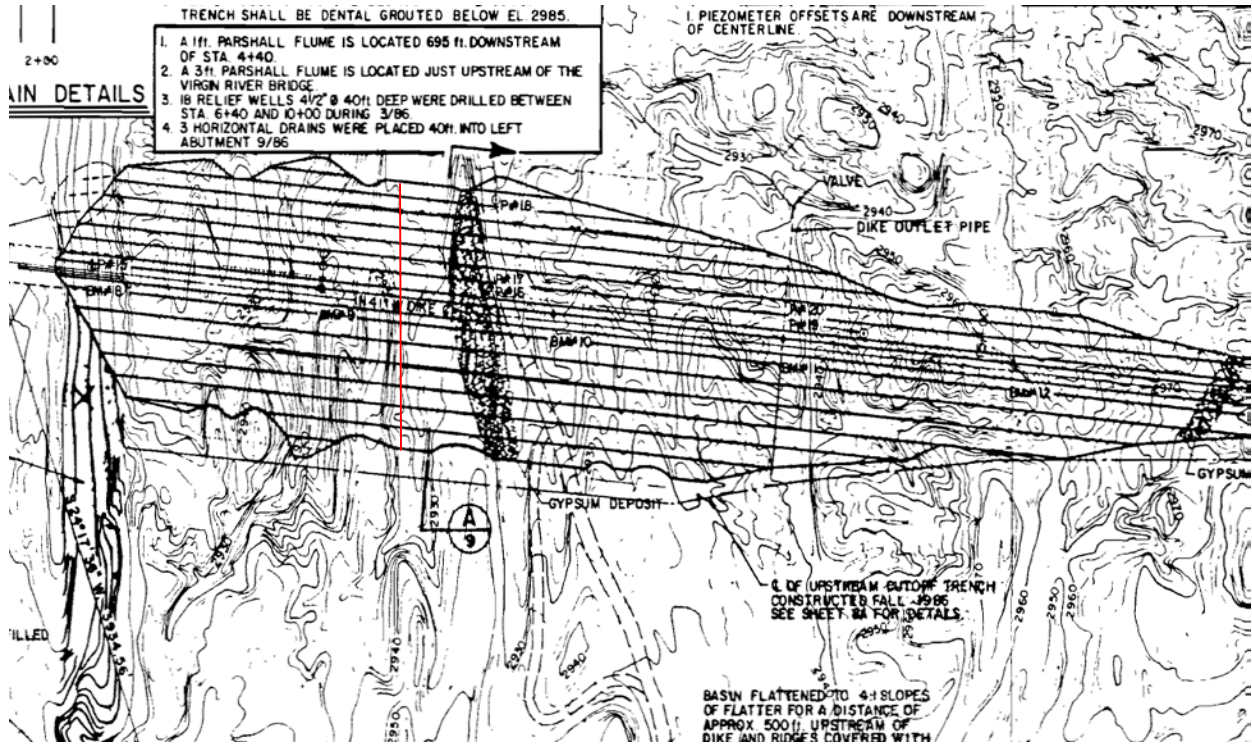

Figure 8.—The breach occurred in an area to the left of a prominent gypsum deposit where steep slopes were present in the bedrock foundation. (Approximate centerline of breach shown with redline).

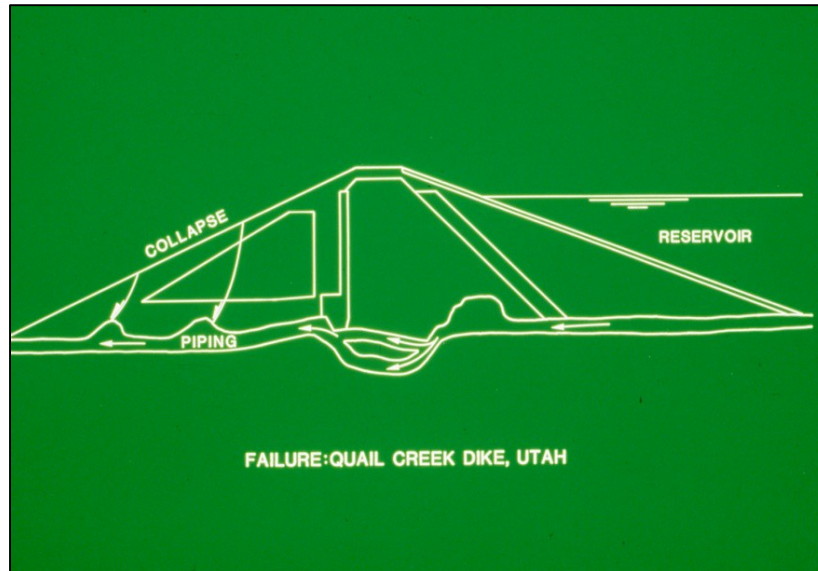

Figure 9.—Postulated failure mode.

3. Grouting the foundation forced the water level up to the Zone 1 leveling material, and the resulting high pressures provided a gradient through this material that was great enough to initiate erosion in the Zone 1 material.
4. Erosion continued through the Zone 1 leveling material until it reached the reservoir. It appears that it took approximately 6–9 months for the pipes to advance from the toe to the reservoir through this material.
5. Seepage erosion along the pipe in the Zone 1 leveling material, once it reached the reservoir, led to progression and rapidly expanded the tunnel and increased the discharge. The upstream-downstream continuity of this fill material and its relative erodibility allowed this development to occur very rapidly and preclude intervention.
6. The dam collapsed into the eroded tunnel, and the high discharge was able to carry away the collapsing material through progressive sloughing, until the breach occurred.

After investigations were completed by the Independent Review Team following the failure, the following lessons learned (or “relearned and reinforced”) were reported to Governor Bangerter:

1. The primary conclusion is that failure resulted because embankment materials placed on the foundation, including overburden left in place, were not protected from seepage erosion.
2. Geologic conditions at the site with thinly bedded, highly gypsiferous sediments striking upstream and downstream and with a shallow dip toward the left abutment (southeast) were extremely challenging and deserved special consideration in design.

3. Fractures in the form of three major near vertical joint sets were present in the foundation and permitted significant seepage flow; foundation exploration was not designed or complete enough to fully detect seepage problems associated with these joints.
4. The early assumption that there would be little or no seepage through the dike foundation below the shallow cutoff was not valid and had a profound effect on design of seepage erosion protection.
5. Highly fractured, pervious rock and erodible overburden was left in place upstream and downstream from the cutoff, permitting seepage along the foundation contact.
6. Upstream-downstream trending hogback ridges were left in place with intervening valleys filled from upstream toe to downstream toe with unprotected and erodible Zone 1 material in intimate contact with open conduits in the fractured, pervious rock foundation.
7. The presence of considerable gypsum in the foundation was not the primary cause of failure; however, as time passed, the solutioning of gypsum allowed increased volume and velocity of seepage near the contact, thus hastening the erosion process.
8. Remedial grouting was not a long-term solution for seepage control of this foundation as demonstrated by the shifting locations of seepage emergence during grouting and sporadic outbreaks of new seepage after completion of each episode of remedial grouting.
9. There is piezometric and field evidence that remedial grouting restricted downstream drainage channels in the rock foundation, increasing hydraulic pressure against the embankment-foundation contact, enhancing conditions for piping at the contact.
10. Filter criteria were not met in the downstream toe drain, which was invaded by eroded fine-grained material; the toe drain may have accelerated (but did not cause) failure by providing a closer uncontrolled exit for eroded materials than the original uncontrolled seepage exits.
11. There is no indication that seepage through the dike embankment or the quality of its construction contributed to the failure.

References

- Catanach, R.B., R.L. James, A.L. O'Neill, and J.L. Von Thun (1989). "Investigation of the Cause of Quail Creek Dike Failure - Report of Independent Review Team," Association of State Dam Safety Officials, Lexington, Kentucky, 1989, pp. 1–217. <http://www.damsafety.org/media/Documents/DownloadableDocuments/QuailCreekFailureRept.pdf>

Von Thun, J.L. (1990). "The Quail Creek dike failure," Proc., Dam Foundation Engineering, 10th Annual USCOLD Lecture, United States Committee on Large Dams, New Orleans.

Von Thun, J.L. (2012). Personal communication (USACE-RMC Internal Erosion Workshop).

Case 3 – A.V. Watkins Dam and the Florida Power and Light Dike

A.V. Watkins Dam

A.V. Watkins Dam is located on the eastern edge of the Great Salt Lake. It is a U-shaped, zoned earthfill structure more than 23 kilometers (km) (14.5 mi) long and 11 meters (m) (36 ft) high at its maximum section. The offstream reservoir impounded by the dam stores approximately 265 million cubic meters (m³) (215,000 acre-ft) of water. Very soft, highly organic lacustrine clay and silt deposits (Lake Bonneville Clay) exist beneath the entire reservoir area and are hundreds to thousands of meters thick. About 2/3 of the dam nearest the Great Salt Lake is founded directly on these soft soils. To ensure static stability, the dam was constructed in stages between the years of 1957 and 1964 to allow for consolidation and dissipation of pore pressures within the foundation soils. The remaining 1/3 of the dam is founded on sand, silty sand, and silt deposits to depths up to 9 m (30 ft). This area, located in the southeastern portion of the dam, is where the backward erosion piping incident occurred that nearly resulted in a dam breach. At this location, the embankment is 7.3 m (24 ft) high, and the hydraulic height is 4.6 m (15 ft). Figure 1 illustrates the typical dam section in the vicinity of the incident. (Figures in this section were obtained from a paper [Bliss and Dinneen 2008] prepared soon after the incident.)

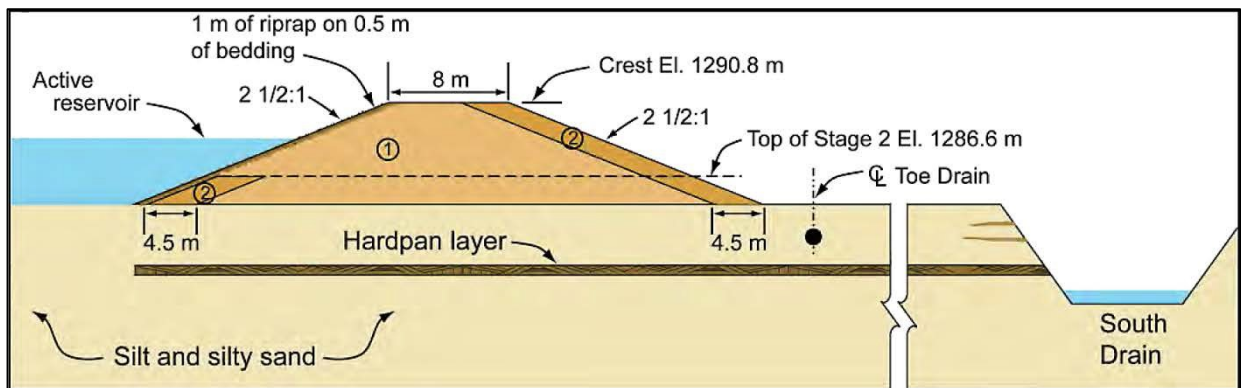

Figure 1.—A.V. Watkins Dam – section in vicinity of the incident (not to scale).

In November 2006, a local landowner riding a horse noticed seepage and soils exiting from the cut slope of the South Drain. He called authorities, and Reclamation began emergency drawdown of the reservoir and 24-hr monitoring. Figure 2 illustrates the failure mode that was in progress when the first responders arrived, and figure 3 shows sediments eroded into the South Drain. Figure 4 is an aerial view of the western portion of the dam that indicates the incident location.

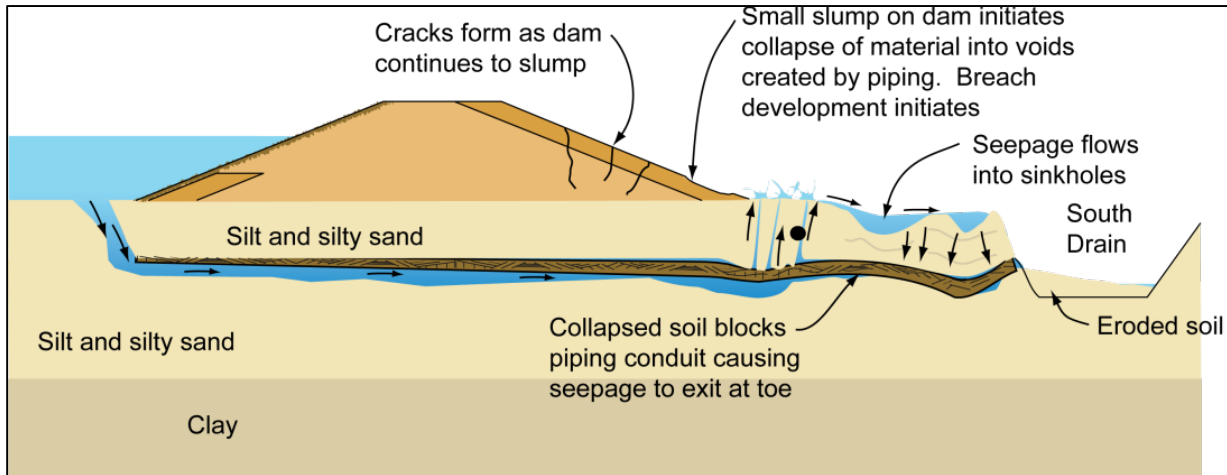

Figure 2.—Failure mode in progress (not to scale).



Figure 3.—Eroded sediments in South Drain first noticed by neighboring landowner.



Figure 4.—Aerial view of the western portion of the dam showing the incident location in relation to the South Drain and feedlot.

In addition to erosion into the South Drain, first responders also found excessive seepage (≈ 570 to 760 liters per minute or 150 to 200 pm), sand boils, and erosion at the toe of the dam. Emergency action to transport filter and drainage materials was implemented immediately. Filter sand was initially placed over the sand boils but was washed away due to high exit velocities. Gravel materials were then placed over the sand boils until the flow velocities were reduced enough to allow placement of the filter sand. A large berm of 13-centimeter (cm) (5-in) minus pit-run material was then placed over the filter and gravel. Erosion, however, continued into the South Drain. A second berm was then pushed into the reservoir in an attempt to plug upstream entrance locations of the seepage (figure 5). This effectively stopped further erosion of soil into the South Drain, and the failure mode was prevented from progressing any further. An upstream ring dike was constructed in the incident area to reduce risks in the interim period until a permanent fix could be implemented. Dam failure would have been likely if the emergency actions had not been taken.

The incident occurred under a very low hydraulic gradient. The estimated average gradients at the time of the piping incident were calculated to be 0.06 for a seepage path beneath the hardpan exiting into the South Drain and 0.08 for a seepage path immediately beneath the embankment exiting at the downstream toe. Detailed investigations were conducted after the piping incident. Based on these investigations, the key factors that caused or may have contributed to the incident include:



Figure 5.—Erosion into the South Drain did not stop until an upstream berm of gravel and pit-run material was pushed into reservoir.

- (1) Highly erodible foundation materials
 - (2) Unfiltered horizontal seepage exit into a small canal
 - (3) Hardpan layer(s) that acted as a roof over the developing pipe
 - (4) Gradient increase due to drought conditions and reduced toe drain capacity
 - (5) Animal burrows may have shortened the seepage path beneath the hardpan
- (1) **Erodible Foundation Soils:** Investigations in the incident area showed that the embankment is founded on relatively continuous deposits of fine sand and silty sand approximately 6 m (20 ft) thick. The sandy deposits are underlain by a discontinuous layer of silt and silty sand that varies from 1.5 to 2 m (5 to 6.5 ft) thick to a depth of 9 m (30 ft), below which lays the soft lacustrine clay.
 - (2) **Unfiltered Horizontal Seepage Exit:** The South Drain was constructed prior to the dam to lower the shallow water table and intercept surface runoff to facilitate construction of the dam embankment. Foundation seepage can exit unfiltered out of the cut slope for the South Drain. A backward erosion process is much more likely to initiate when a horizontal seepage exit is present, relative to the typical situation where the ground surface is flat and seepage exits more or less vertically.
 - (3) **Hardpan:** Layers of carbonate and carbonate-cemented sand known as “hardpan” exist in the upper 3 m (10 ft) of fine to silty sand deposits (figure 6). The hardpan is at least partially continuous in the southeast reach of the dam. In the immediate area of the incident, there are two distinct layers of hardpan that are generally only 5 to 10 cm (2 to



Figure 6.—Hardpan that formed a roof for the developing pipe.

4 in) thick. The layers of hardpan thicken to about 0.75 m (2.5 ft) to the south of the incident area, and the hardpan thins out and eventually disappears completely to the north of the incident area. The thick deposit of hardpan appears in several layers along the banks of the South Drain and required blasting to excavate during construction of the South Drain.

- (4) **Increase in Hydraulic Gradient:** Despite construction of the South Drain, the water table beneath the dam rose quickly during first reservoir filling. When the reservoir was approximately 0.6 m (2 ft) from full, numerous wet areas appeared at the downstream toe in the southeast portion of the dam. These wet areas ranged from 100 to 300 m (300 to 1,000 ft) in length, with some sections described as “becoming quick.” The reservoir was lowered, and approximately 5.8 km (19,000 ft) of toe drains were constructed to control the seepage. The toe drains consisted of 20-cm (8-in) diameter, open joint, concrete pipe surrounded by gravel placed 4.6 m (15 ft) downstream and parallel to the toe of the dam. The invert of the toe drain was 1 to 1.3 m (3 to 4 ft) below the ground surface. Outfalls spaced at 300-m (1,000-ft) centers discharged collected water into the South Drain.

Construction of the toe drains lowered the local water table sufficiently to prevent seepage from being observed at the ground surface for many years. However, slowly over the decades, portions of the toe drains apparently became plugged, and the effectiveness diminished based on video inspections of the toe drains performed after the incident. Indications of decreased toe drain performance were first identified in the 1980s. Prior to the 2006 incident, there were boggy areas and cattail vegetation growing along the toe of the dam, indicating that seepage continued at shallow depths. A gradual increase in gradients due to partial or complete loss of the primary defense (toe drain) may have been just enough to initiate backward erosion in a metastable condition. However, it is not clear to what degree the loss of toe drain effectiveness played in the incident.

Drought conditions that existed in years leading up to the incident may also have allowed higher gradients to develop. Flows in the South Drain were likely lower than in previous years due to the drought (records are not kept). Gradients into the South Drain may have been highest when the drought ended and the reservoir began to fill to levels not experienced for several years. Similar to reduced toe drain function, it is not clear how much of a factor this was in the incident.

- (5) **Animal Burrows:** Examination of the South Drain cut slope revealed many significant animal burrows, including some below the hardpan, using the hardpan as a roof. These burrows were most likely excavated when the flows were depressed in the South Drain through drought years from approximately 2000–05, coinciding with low reservoir levels. Removal of soils and any tunneling activity toward the reservoir would shorten the seepage path and increase the gradient, thereby increasing the potential to initiate backward erosion.

A cement-bentonite (C-B) wall was designed to mitigate the potential for internal erosion through the foundation and to allow full reservoir storage. The minimum 76-cm (30-in) wide C-B wall was constructed during the summer and fall of 2008 and extends for a length of 8 km (5 mi). It was constructed from the crest, through the embankment, and into the clay deposits that underlie the sandy materials. As a result, the C-B wall also mitigates the potential for internal erosion through the embankment in this dam reach. The C-B wall was expected to provide practically complete seepage cutoff because it was extended a minimum of 5 ft into impermeable clay. Post-construction monitoring of piezometric levels indicates a very effective cutoff was achieved. A vertical filter trench and toe drain were also included in the immediate incident area.

In summary, unfiltered seepage exited horizontally into the South Drain, and a hardpan layer, continuous from the bank of the South Drain to the upstream side of the dam, formed a roof for the pipe. The developing pipe may have slowly worked its way toward the reservoir over many years. Gradual reduction in toe drain effectiveness and/or animal activity beneath the hardpan might have contributed to the initiation of erosion by allowing hydraulic gradients to increase. Dam failure was averted by emergency actions and interim repairs that included filters, an upstream ring dike, and a toe drain in the incident area. A cement-bentonite wall constructed in 2008 mitigated the potential for backward erosion piping in this portion of the dam and foundation.

References

- Bliss, M. and E.A. Dinneen (2008). Emergency Remedial Actions at A.V. Watkins Dam, IPENZ Proceedings of Technical Groups 33/1.
- Hanneman, D.L. (2011). “Recent examples of backward erosion piping, internal erosion along a conduit, and embankment cracking at Bureau of Reclamation dams,” paper prepared for 2011 European Working Group on Internal Erosion meeting in Brno, Czech Republic.

Florida Power and Light Dike

A case history similar to the A.V. Watkins Dam is the failure of the FPL cooling dike in 1979. The FPL cooling pond is located between Indiantown, Florida, and Lake Okeechobee (figure 1) and was constructed in 1977. The 7,000-acre pond is approximately 4.75 mi long and 3.2 mi wide and is impounded by a 17.5 mi-long ring dike. The dike is approximately 35 ft high with a crest elevation of 50.0 ft. The upstream slope is 2H:1V and is protected with horizontal slabs of soil-cement. The downstream slope is 3H:1V. The dike is a homogenous embankment without filters and is composed of compacted earth made up of sand. There is a 12-ft-wide, 3-ft-high stability berm at its downstream toe. A 3-ft-deep drainage ditch with 5H:1V side slopes is located 10 ft beyond the stability berm. The dam is keyed 3 ft into the foundation. A section of the embankment is shown on figure 2.

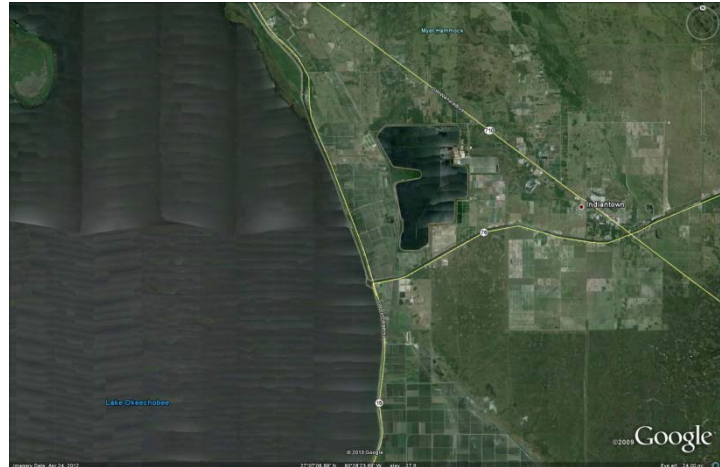

Figure 1.—Location of the FPL cooling pond (Google, 2012).

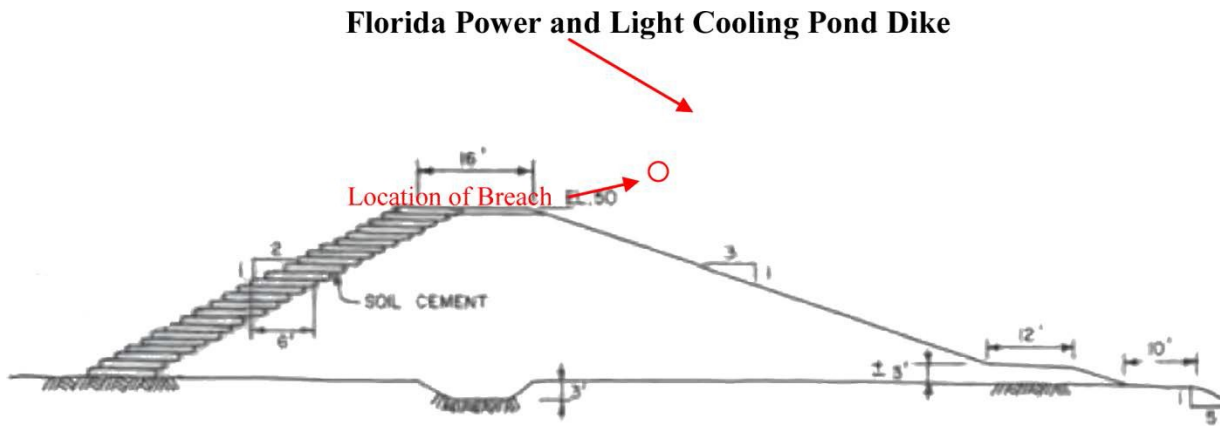

Figure 2.—Typical section of the FPL cooling pond dike (Schmertmann 2012).

Lake Okeechobee formed about 6,000 years ago after sea level receded. Presently, low ridges are present east of Hoover Dike that are thought to be former shoreline deposits of mid-Holocene age. These deposits are composed of medium to fine-grained quartz sand, interbedded with shells and organics, superimposed upon peat and muck deposits typical of the Everglades (Gallagher 2001).

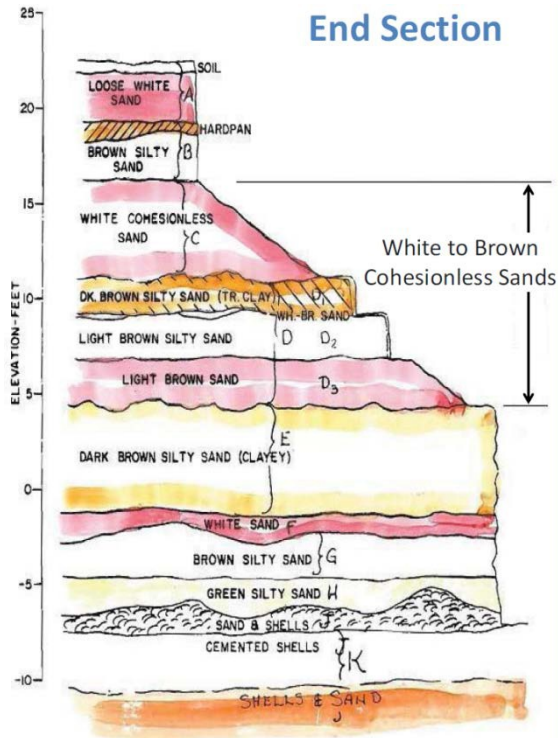

Figure 3.—Stratigraphy in the area of the FPL Dike (note that the dike foundation is at about elevation 15.0) (Schmertmann 2012).

Figure 3 is a typical stratigraphic section for the area of the FPL Dike (Schmertmann 2012), which shows the foundation is composed predominately of sand, with areas of relatively thin hardpan, and shell deposits.

Important to note is the presence of a railroad borrow pit and the L65 Canal in the southwest quadrant of the project site. The layout of these features, and the breach that occurred there, are shown on figures 4 and 5.

The breach occurred on October 30, 1979, with a water level of 37.0 in the cooling pond. As described by Schmertmann (2012), the breach occurred 2.8 days after water level in the L65 canal inadvertently dropped 5 ft due to lock failure at the canal outlet. Approximately 1 day after the canal level dropped 5 ft, the water level in a railroad borrow pit, closer to the dike, dropped about 1 to 3 ft. The next day, the FPL Dike failed from backward erosion piping. The resulting breach was 600 ft wide. The railroad borrow pit was located about 300 ft from the toe of the dam.

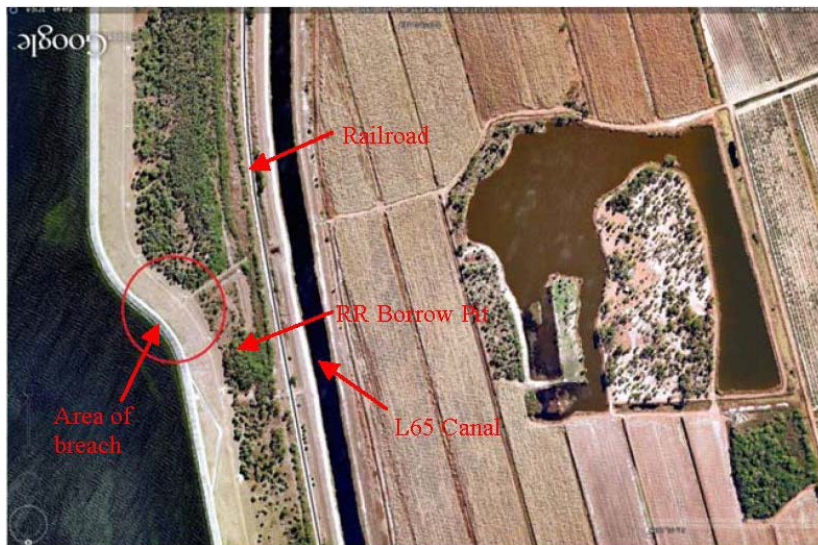

Figure 4.—Layout of borrow pit and L65 Canal.



Figure 5.—Same area after breach.

Subsequent modeling (figure 6) and other evaluations found that when the water level in the borrow pit dropped, it resulted in a very slight net increase in the exit gradient for seepage through the foundation of the dam (3 ft/300 ft or +0.01), resulting in a total exit gradient of approximately 0.06. The exit gradient in this area was already quite low (≈ 0.05) prior to the drop in water level in the railroad borrow pit. Due to the geometry of the area, flow was also concentrated into the area of the borrow pits. The dike failure is attributed to backward erosion piping through the fine-medium sands in the foundation. Hardpan layers assisted with the formation of a roof for the piping.

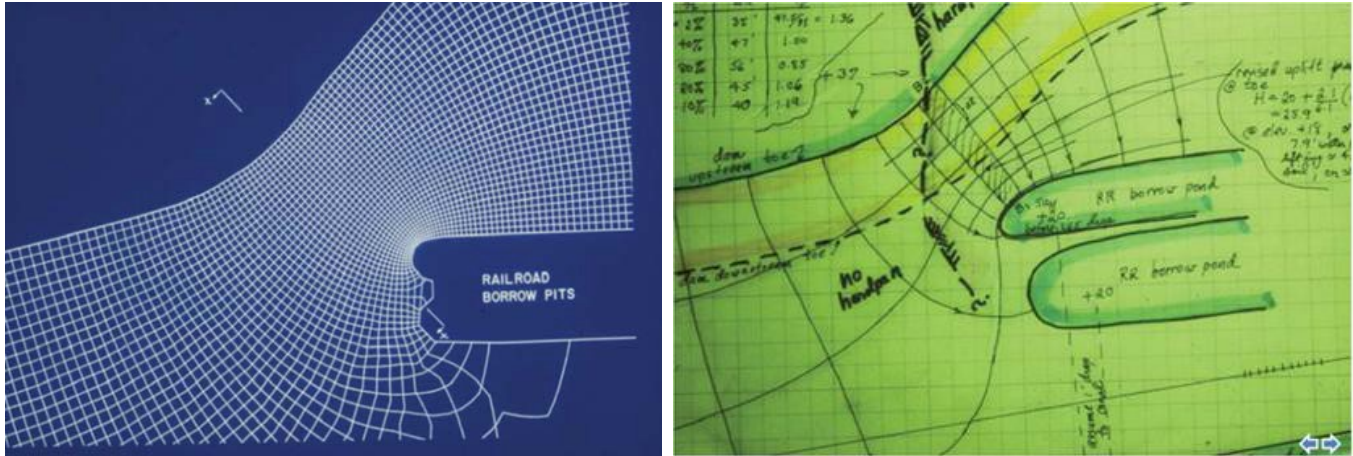

Figure 6.—Groundwater model of horizontal flow and an early sketch of the flownet with the extent of the hardpan-roof shown (Schmertmann 2012).

The important lessons learned from this case history, as with A.V. Watkins Dam, are that very low exit gradients can induce backward erosion piping given the right conditions and that there is potential vulnerability for dams founded on erodible materials to unexpected drops in tailwater levels in nearby ditches and pits.

The recommended repair section is shown on figure 7 and included a filtered foundation drain and an enlarged, flattened embankment toe slope.

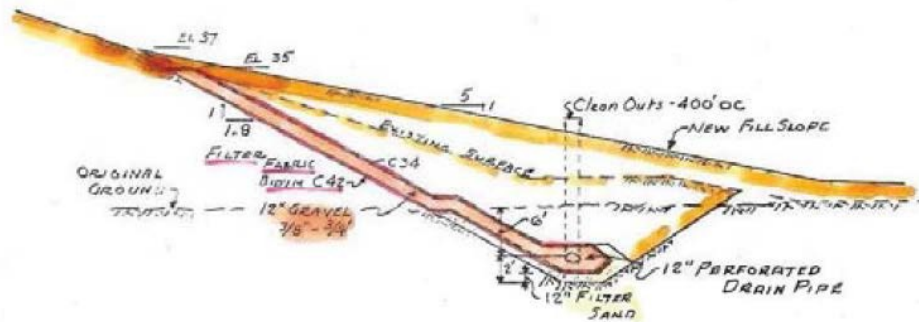

Figure 7.—Proposed repair section (Schmertmann 2012).

References

- Gallagher, J. (2001). "Mid-Holocene Age for Natural Lake Okeechobee Shoreline?," Session No. 106, GSA Annual Meeting, November 5–8, 2001, Geological Society of America.
- Schmertmann, J.H. (2012). "History of Graded Filters," presentation at FEMA NDSP Annual Conference, Emmittsburg, Maryland.

Case 4 – Walter Bouldin Dam¹

Walter Bouldin Dam, an earthfill structure near Wetumpka, Alabama, failed in 1975. The collapse was attributed by some to internal erosion in the downstream shell from potential deficiencies in the internal drainage. In 1976, a Federal Power Commission (FPC) administrative law judge² reviewing the failure criticized the performance of both the contractor and the power company inspectors during construction but added that, from the evidence, he could not point to a single cause of the 91-m (300-ft) long breach. Four factors leading to the dam's failure, according to an FPC regional report, were a weakened foundation, a weakened embankment caused by a 1972 slide in the area of the breach, steep embankment slopes, and poorly compacted fill.



Figure 1.—Walter Bouldin Dam, intake, powerhouse, and tailrace canal (Google Earth, November 1, 2014).

¹ Jansen, R.B. (1983). "Dams and Public Safety – A Water Resources Technical Publication," Bureau of Reclamation, Denver, Colorado, pp. 227–229.

² "Dam Failure Inquiry," *Engineering News-Record*, September 2, 1976.

Background

Walter Bouldin Dam is located near Wetumpka, Alabama, and was constructed from 1963–67. The purpose of the project was hydropower generation. Earthen embankments (dikes) were constructed to form a “forebay pond.” Water is conveyed to the forebay pond through a power canal from nearby Jordan Lake (figure 2). Two dikes flank the intake structure at the south end of the forebay pond. A tailrace canal was excavated into Cretaceous silty sands, and the intake structure and powerhouse are founded on underlying schist. The approximately 165-foot-high embankments were constructed with defensive seepage measures consisting of a 10-foot-thick upstream impervious blanket that lined the forebay pond floor and covered the upstream slope to the crest of the dam and a 3-foot-thick downstream drainage blanket that runs from the toe of the dike to the centerline (figure 3). The tailrace canal was cut into alluvium and Cretaceous sands and lacked filters to stabilize the foundation or backfill (figure 4) and was overlain with unfiltered riprap in the immediate area of the powerhouse. Rockfill on the upstream slope and riprap on the downstream slope provide erosion protection. Relief wells and a French drain were added later to address seepage issues at the toe of the dam near the intake structure. A grout curtain (figure 5), extending through alluvium and into the underlying fine Cretaceous sand, was also installed beyond the end of the sheet pile cutoff to address excessive seepage at the intake structure. The grout curtain reportedly had little effect on the foundation seepage and also may have damaged the foundation when it was installed (Leps 1988).

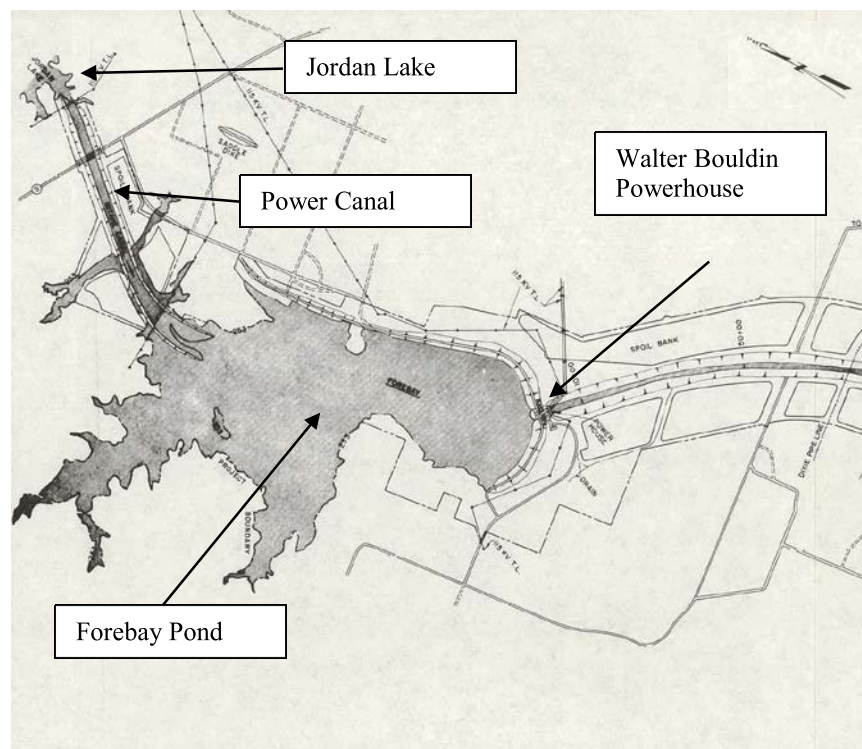

Figure 2.—Walter Bouldin forebay pond, powerhouse, and power canal from Jordan Lake (modified from FERC 1978).

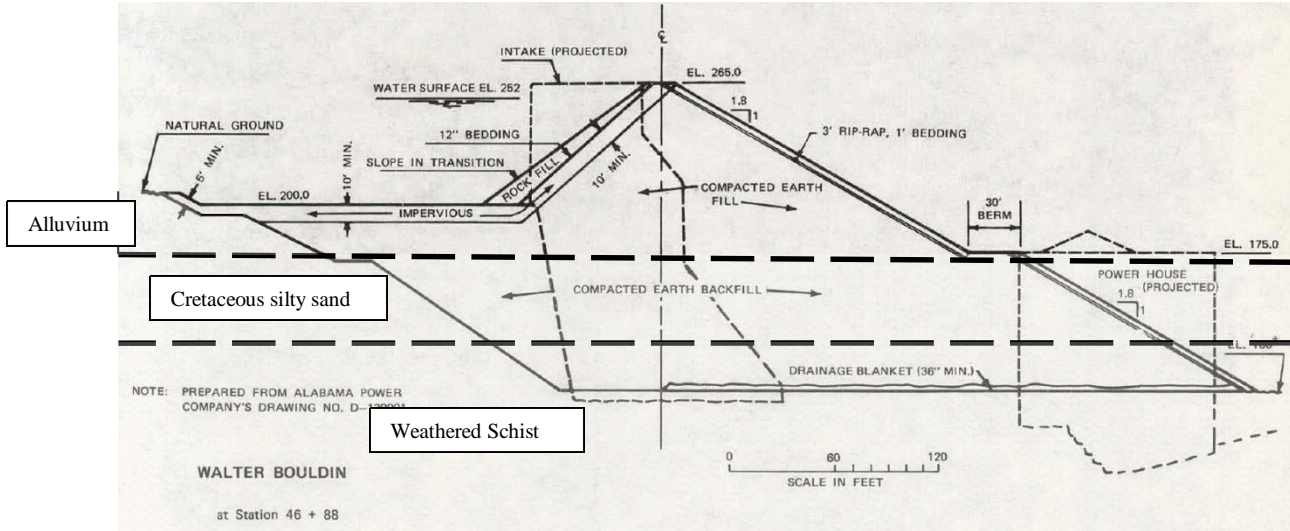

Figure 3.—Typical dike section in area where breach occurred (modified from FERC 1978).

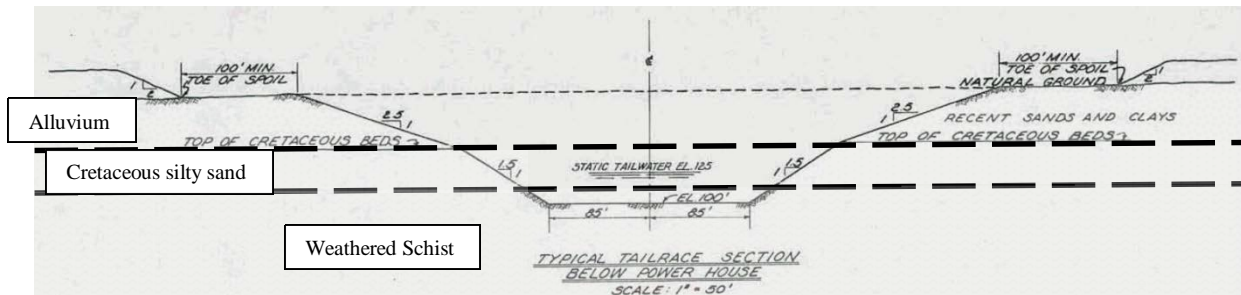

Figure 4.—Geology and construction of tailrace canal, just below the powerhouse (FERC 1978).

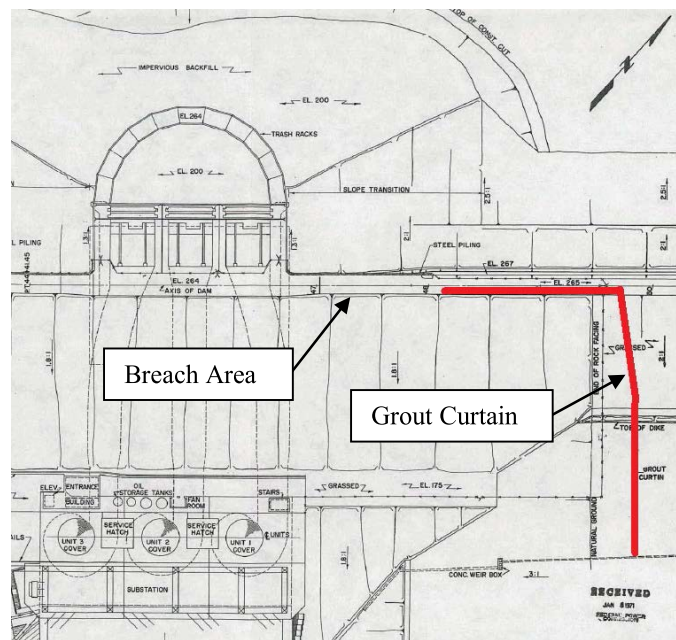

Figure 5.—Left side of intake structure and grout curtain (red line) in area of breach (modified from FERC 1978).

The borrow source for the embankment material was from the forebay pond area. The earth fill placement was to be graded from an impervious fill at the upstream slope to more permeable fill being placed at the downstream toe. Post-failure field investigations of the embankment found that the impervious blanket consisted of reddish brown, sandy, lean clay and clayey sand, and that the downstream zone of the dikes was constructed with well-graded granular material. However, sand and gravel lenses were observed in the impervious blanket, clay lenses had been placed in the rockfill, and impervious lifts were observed in the pervious downstream shell. Lift thicknesses greater than 12 inches and excessive moisture contents were also found in the constructed embankment, which led investigators to conclude that there were inadequate earthwork specifications and controls during construction of the embankments. Overall, the investigation found the constructed zoning to be excellent in preventing through-embankment seepage.

A 30- to 40-foot section of the upstream slope of the embankment had previously sloughed in 1972 in the oversteepened (1.3:1) section where the left embankment abuts the concrete intake structure (figure 6). The sloughing occurred when the reservoir was drawn down 10 feet in a 7-hour period and was attributed to rapid drawdown slope failure. Other performance issues included the presence of springs and excessive foundation seepage below the toe of the embankment in the area where the breach occurred. The seepage required remediation, which included installation of relief wells and a French drain.

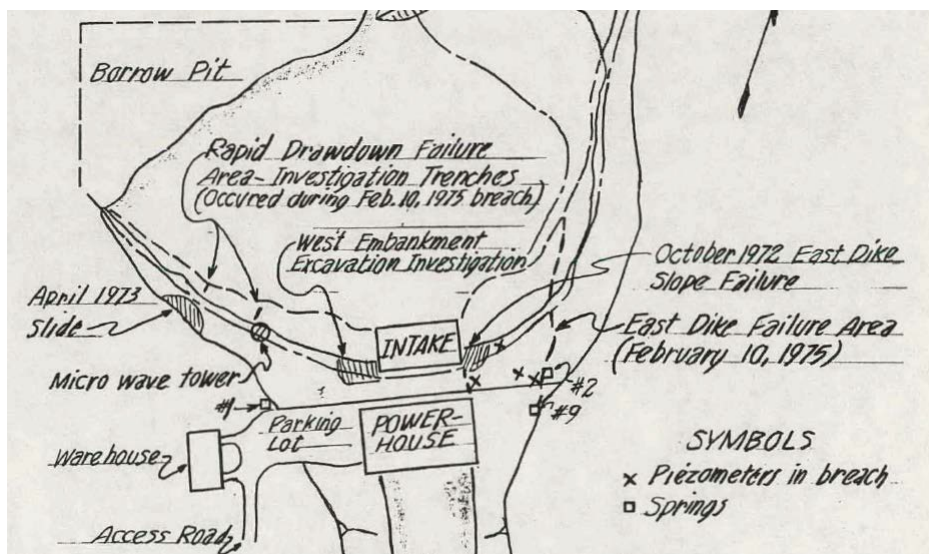

Figure 6.—Sketch showing area of October 1972 slope failure. Also note areas of springs and piezometers in the breach area (FERC 1978).

Dike Failure

The left dike breached without warning in the early morning hours of February 10, 1975. The final breach was approximately 300 feet wide, and over 165 feet deep, scouring into the alluvial and Cretaceous sand foundation materials adjacent to the intake structure (figure 7). The breach took approximately 4.5 hours. As described in the after action report, the “...Erosion at the

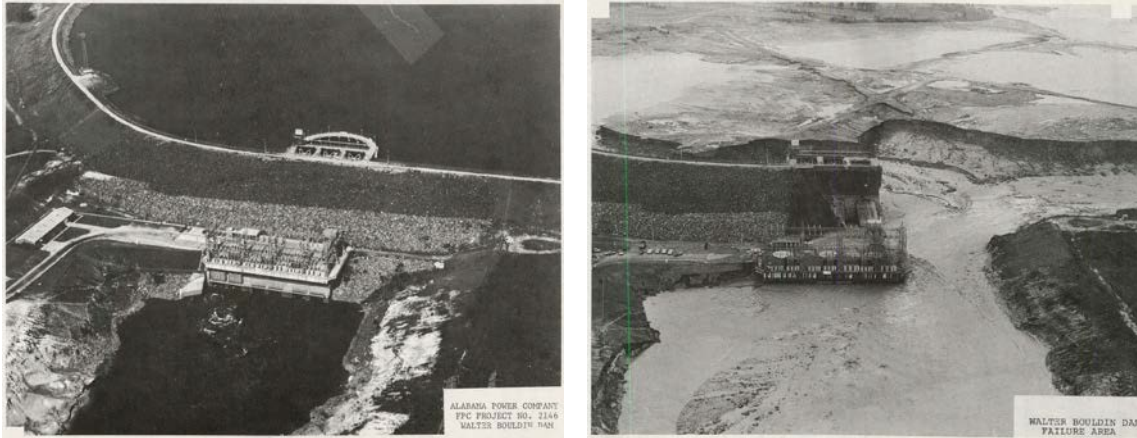

Figure 7.—Before and after photographs of the Walter Bouldin dike failure (FERC 1978).

breach extended vertically downward to remove a significant volume of the foundation and the backfill at the east end of the concrete structure” (FERC 1978). The initiation of the breach is not well documented, as observations were hampered by darkness and the fact that the lights at the crest of the dam went out early; however, eyewitness accounts describe a shallow trough-like slump, possibly 25 feet deep, which developed near the crest (FERC 1978). This “slump” has been interpreted as being due to slope failure of the upstream slope, leading to overtopping of the embankment. The “trough-like slump” may also be interpreted as a feature of internal erosion and stoping (i.e., large sinkhole). Unfortunately, there was no evidence remaining after the breach to support either argument, so the actual cause of the breach remains controversial.

Conclusions

The exact cause of failure of Walter Bouldin Dam remains controversial. As described by Thomas Leps (1988):

“With reference to the cause of failure, it is unfortunately true that the total washout of the breached area occurred at night when observation was impossible, and removed virtually all conclusive evidence. Hence, there is no real proof of a probable single cause. My assessment, however, is that because there was no drawdown event in the forebay during February 9 to trigger an upstream slope failure, and there was no physical distress evident at the dike crest as late as 8 hr before the first notice of failure, it is most probable that the dike failed initially by foundation piping in the highly erodible Cretaceous Formation, followed by collapse of the crest into the quickly enlarging “pipe.”

The findings of the FPC focused on past performance of the slopes and the limited eyewitness accounts:

“Observations of the initial action triggering the failure were hampered by darkness and the fact that the lights along the crest went out early during the beginning of the break. There was general agreement among early eyewitness accounts, however, that a shallow trough-like slump, possibly 25 feet deep, developed at the top of the embankment near the intake structure. Water was heard coming through the upper portion of the dike. The breach developed fairly rapidly, eroding from the top down...It was concluded that the accident most likely occurred by a failure of the upstream slope near the east end of the intake structure.”

A second theory was also presented by Commission staff that there may have been an insufficient bond between the impervious clay material in the dike and the concrete intake structure, resulting in internal erosion along this contact. Relatively poorer soil compaction was attained in this area, which may have contributed to the internal erosion. This failure mode was possibly indicated by dark stains that were observed on the concrete in this area. The theory was subsequently thrown out in favor of the slope failure theory, after further investigation found that the concrete staining was not related to algae.

The relative importance of the grout curtain, poor earthwork specifications and controls, steep upstream slope, and lack of foundation and embankment filters in the tailrace area may never be fully known. However, failure of Walter Bouldin Dam should highlight the importance of continually detecting, assessing, and addressing poor performance at dams, preferably utilizing potential failure modes analysis, allowing for better risk-informed decisions.

References

- Federal Energy Regulatory Commission (1978). “Report to the Federal Energy Regulatory Commission: Walter Bouldin Dam Failure and Reconstruction,” Report No. DOE/FERC-0017, September 1978.
- Leps, T.M. (1988). “The Walter Bouldin Dam Failure,” in *Advanced Dam Engineering for Design, Construction, and Rehabilitation*, Ed. Robert B. Jansen, Springer, pp. 53–57.

Case 5 – East Branch Dam

The East Branch Dam is located near Johnsonburg, on the east branch of the Clarion River, in Elk County, Pennsylvania. It impounds 64,300 acre-ft of water from a 72-mi² drainage area and is used principally for flood control and recreation. The dam was constructed in 1952 by the U.S. Army Corps of Engineers (USACE). The dam has a structural height of 184 ft and is 1,725 ft long (figure 1).

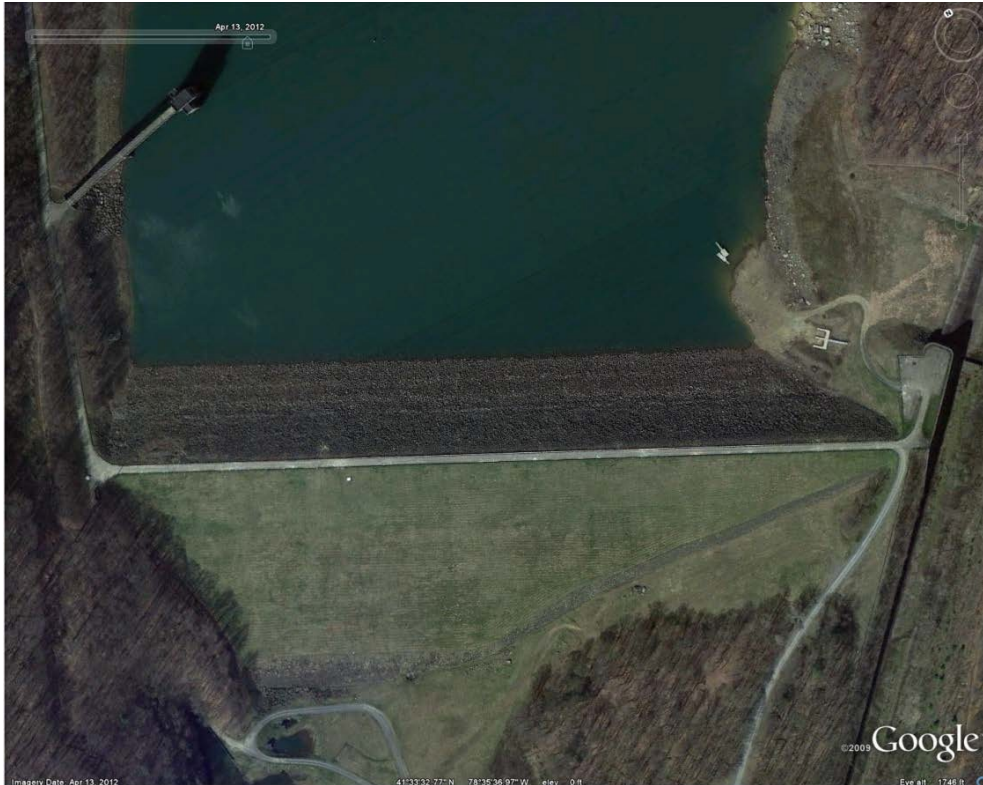

Figure 1.—East Branch Dam – the incident occurred over the steep, right abutment (Google Earth, April 13, 2012).

East Branch Dam, 1957 Incident

The most serious seepage caused by abutment irregularities occurred at East Branch Dam in Pennsylvania. This 56-m-high earth dam was constructed with an impervious core of clayey silt plus shale fragments, flanked on each side by random shells of silt and clay containing processed shale, siltstone, and sandstone. A horizontal rock drain surrounded by a filter layer extended from the downstream edge of the core to the downstream toe at the foundation line. The right abutment had an irregular slope with a general inclination of 1.5H:1V. This area was grouted through a 2.4-m-wide concrete grout cap with a double line of holes on 1.5-m centers to a maximum depth of 49 m.

On May 8, 1957, approximately 4½ yr after the dam was placed in operation, muddy water was detected flowing from the downstream rock toe drain. A weir was installed to measure the flow. The initial reading indicated a discharge of 270 liters per second (L/s) (9.5 ft³/s). Twelve hr after the installation of the weir, the flow had increased to 291 (L/s) (10.3 ft³/s). The outlet gates were opened to draw down the reservoir at a rate that would not exceed bank full capacity of the stream below the dam. Samples of the seepage water were tested and found to contain 200 parts per million (ppm) of solids. Drilling was started through the crest in the vicinity of Sta. 8+00 on the supposition that the leakage might be coming from a hillside spring. Drilling was continued for several days before one of the drill holes that had been dry “blew in” and the cavity in the core was located. By this time the solids content in the seepage water had increased to 1,000 ppm. Dye introduced into the drill hole began to appear in the seepage water within 1 hr. Continued drilling in the immediate area disclosed a large cavity in the core, which was thoroughly mapped by further drilling. The cavity was irregular in shape, roughly 3 to 4.5 m wide and 4.5 to 6 m high. Its cross section at Sta. 8+33 is shown on figure 2.

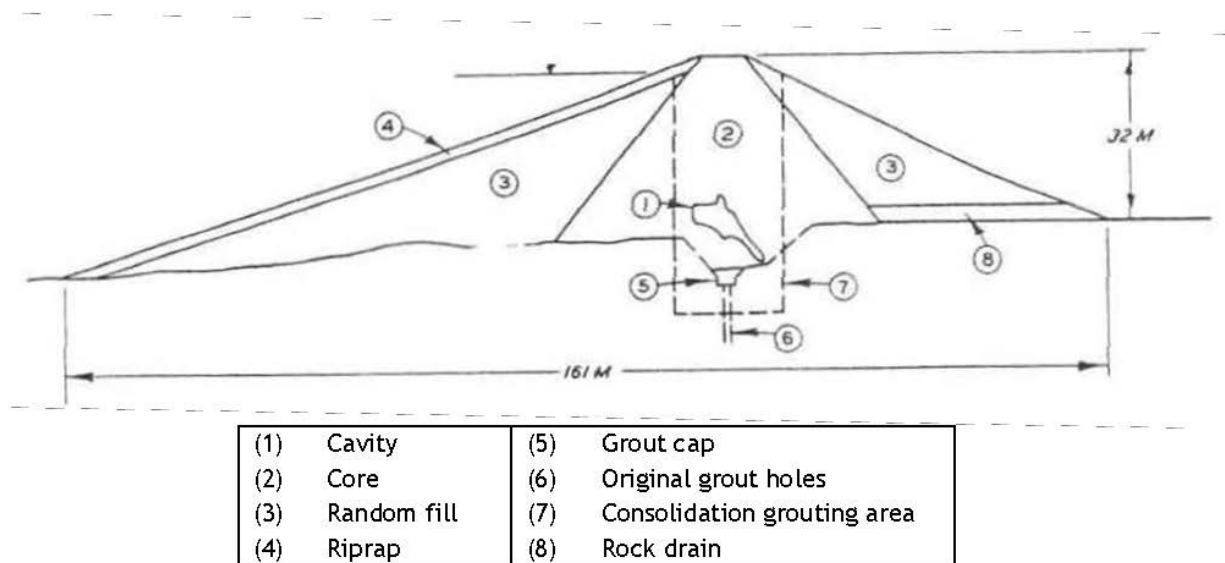

Figure 2.—Section of East Branch Dam showing cavity (Bertram 1967).

Grouting of the cavity was done with a cement and sand mortar grout introduced under gravity flow. After the cavity had been grouted, the random drill holes put down during the exploration were also grouted. A program of consolidation grouting on 1.5-m centers was undertaken from 7.5 m downstream from the centerline to 7.5 m upstream of the centerline between Sta. 7+90 and Sta. 8+65. This drilling and grouting was carried 5 m below the elevation of the grout cap. A provision was made for the installation of 18 piezometers both upstream and downstream from the repaired area. In filling the large cavity, a total of 831 bags of cement and 46.7 m³ of sand were used. A permanent weir and a gage house were constructed, and a recording type of gage was installed. Readings of both the weir and the piezometers were taken as the reservoir filled and regularly thereafter. The project has been operated successfully since these repairs were made, and seepage has been reduced to 7 L/s.

The size of the cavity and of its vertical extension indicate that a crack in the core preceded the piping of the core material. The location of the cavity in relation to the abutment is shown on figure 3. There had been a construction road up the abutment crossing the centerline at Sta. 8+42. From Sta. 8+42 to Sta. 8+20 at the hillside edge of the road cut, the slope was very steep. In all probability, this discontinuity in the abutment slope produced a sufficient differential settlement of the core to create a crack. It is also possible that the grout cap and the narrow grouted zone permitted full reservoir pressure on the crack from open joints and from cracks in the rock on the upstream side of the grout curtain. The eroded material was probably carried into the rock drain downstream through further open joints in the rock. Consequently, this failure may well be blamed on differential settlement aggravated by inadequate grout treatment of the abutment.

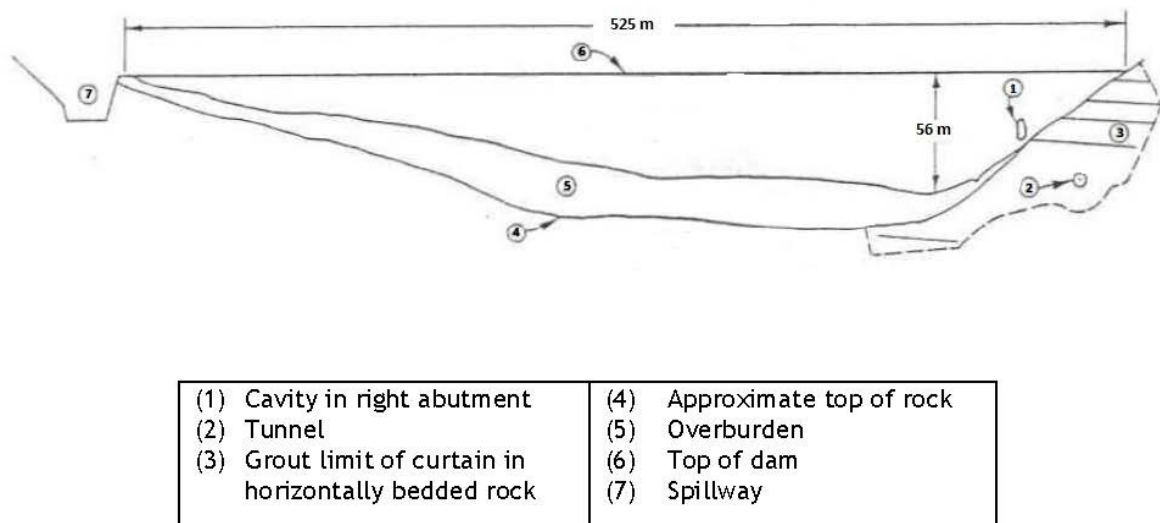

Figure 3.—Profile of East Branch Dam. Note location of cavity in the right abutment.

Project Update¹

As part of a risk management approach to improving public safety, the USACE classified East Branch Dam as Dam Safety Action Class (DSAC) II after a screening-level risk analysis. East Branch Dam is considered to have unconfirmed (potentially unsafe) issues, which merit further study and analysis, largely because it has a history of seepage-related problems, including the serious episode in 1957 that required lowering the lake until repairs could be made. There have been no observed changes in seepage conditions or performance of the dam in the time since repairs were completed. The dam functioned safely during the record pool event in 1972 resulting from Hurricane Agnes. As a result of the DSAC II classification, the Pittsburgh District has implemented interim risk reduction measures to reduce the risk to the public.

¹“Dam Failure Inquiry,” *Engineering News*

These measures include increased monitoring, 24/7 staffing, updating emergency operation plans, reducing the water level in the reservoir to relieve pressure on the dam, and stockpiling emergency materials onsite.

These and other short-term actions allow the USACE to operate the dam to meet public safety objectives while investigating long-term repairs. The approved long-term risk reduction plan for East Branch Dam consists of constructing a concrete cutoff wall within the existing embankment and foundation. The first construction contract for improving the access road to the dam was awarded in September 2011. Field explorations were completed in March 2012 to provide information to design the cutoff wall. New instrumentation installation was completed in June 2012. A scope of work is under development to automate a number of existing and new instruments to enhance monitoring during construction. The cutoff wall contract solicitation was announced on May 10, 2013. Completion of the cutoff wall in 2017–18 is funding dependent.

References

Bertram, G.E. (1967). “Experience with Seepage Control Measures in Earth and Rockfill Dams,” Proceedings 9th ICOLD Congress, Istanbul, Turkey, Vol. III, 1967, pp. 91–109.

Case 6 – Wister Dam, Little Wewoka, Upper Boggy Creek Site 53, Upper Red Rock Site 20, and Others

Wister Dam

Wister Dam is located approximately 2 mi south of Wister, Oklahoma. The dam is located on the Poteau River at river mile 61 and forms Wister Lake. It was constructed and is currently maintained and operated by the USACE. The main part of the dam is made up of a rolled earthfill embankment that is 5,700 ft long, has an average height of 70 ft above the streambed, a maximum height of 99 ft, and a crest width of 25 ft. Wister Lake is also retained by a 2,400-ft-long rolled earthfill dike located just south of the primary embankment. The dike has a maximum height of 40 ft and a crest width of 25 ft. Outbound water flows are primarily released through two 14 by 15-ft, 10-in semielliptical concrete conduits. The flows are regulated by a reinforced gate tower containing six 7 by 12-ft tractor-type vertical lift gates and have a maximum release capacity of 14,800 ft³/s. There is an emergency spillway located in a ridge that makes up the right abutment of the primary embankment. It is 600 ft wide and has a maximum release capacity of 113,500 ft³/s. Elevations of key features of the dam can be seen on figure 1.

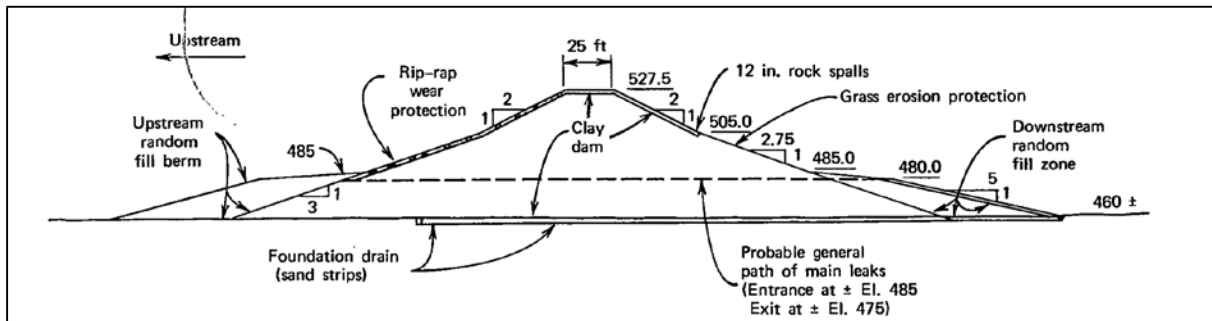

Figure 1.—Section through Wister Dam.

Constructed between 1947 and 1948, the dam almost failed on first filling in January 1949. The dam was constructed as a homogeneous clay embankment that was compacted slightly dry of optimum moisture content. Since the dam was also constructed of dispersive soils, the embankment fill was highly erodible, susceptible to cracking in the dry state, and generally very unforgiving of any defects that allowed seepage into the dam due to the dispersive, highly erodible nature of the soils.

A rapid filling event occurred from January 23–27, 1949, after heavy precipitation. A small concentrated leak appeared on January 30, 1949, a few feet above the toe of the downstream random berm where the old river channel exits from beneath the dam. A number of additional leaks appeared, more or less, along a horizontal line extending for a length of 600 ft on the downstream face of the dam at about the same elevation as the first observed leak. The total leakage increased to about 20 ft³/s by February 3, 1949, and a vortex appeared in the reservoir near where the abandoned Poteau River channel enters the dam foundation on the upstream side of the dam (figure 2). Horizontal tunnels were discovered in the upstream slope that were about 2 ft in diameter, and as the reservoir level was lowered below these tunnels, the seepage exiting

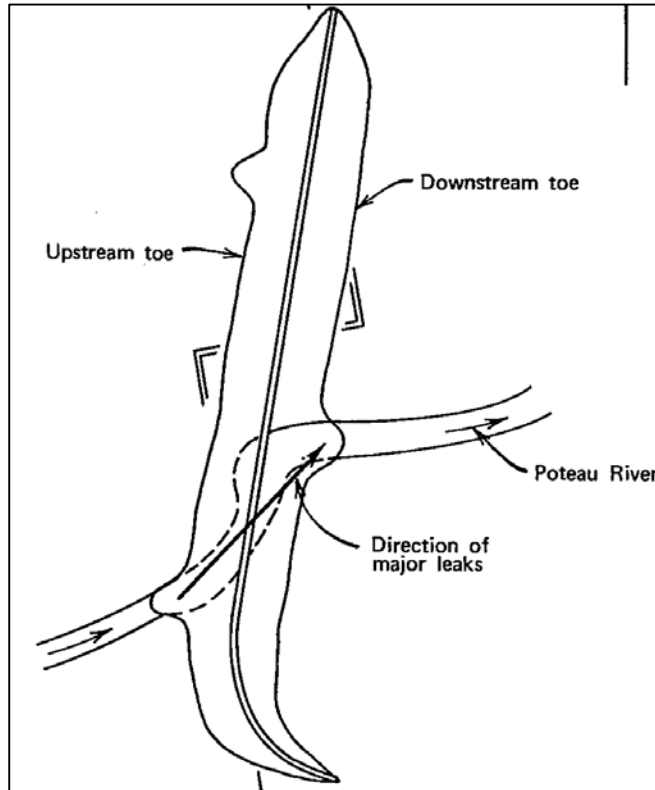

Figure 2.—Plan view of Wister Dam (after Bertram 1967).

the downstream face stopped. A characteristic type of erosion (tunnels and jugs) from rainfall was observed on the downstream slope of the dam, with jugs up to several feet in diameter (figure 3).

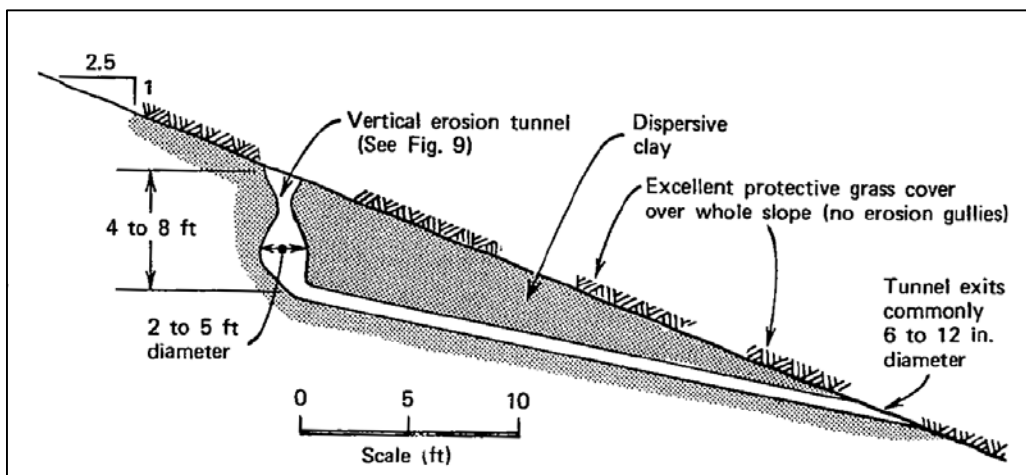

Figure 3.—Peculiar rainfall erosion tunnels (horizontal) and jug (vertical, jug-shaped void) observed on downstream slope of Wister Dam. These features are common in embankments constructed of dispersive soils.

As reported by Sherard et al. (1972) and Jones (1981), erosion tunnels are started when rainfall enters drying (or other) cracks in dispersive soils. Tunnel erosion is common in the area of Wister Dam, near southern Oklahoma. Sherard concluded that it was probable that the leak in Wister Dam broke through a differential settlement crack but also said that hydraulic fracturing may have assisted in the crack development. As a result of this incident, Sherard recommended that chimney filters be employed in low homogeneous dams, except in cases where failure would not cause loss of life or important property damage. The Wister Dam embankment soil was found to by Sherard to fall within Zone 1 (highly prone to dispersive erosion) based on the chemistry of the soil (figure 4). More case histories related to dispersive soils are provided in the next section.

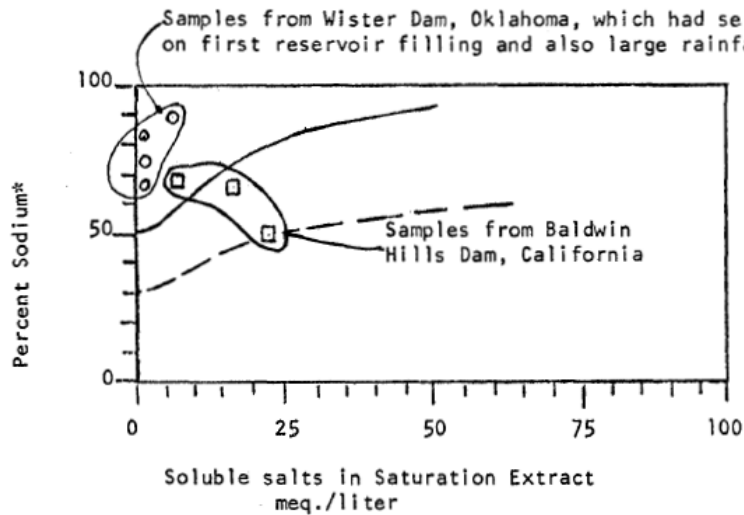

Figure 4.—Dispersive characteristics of Wister Dam (Sherard 1972).

Geologic and Geotechnical Site Conditions

The majority of the subsurface explorations used in the analysis of the Wister Dam internal erosion event were primarily carried out before the construction of the dam and immediately after the seepage event took place. The initial foundation exploration program consisted of 66 rock core borings, 181 auger borings, 1 undisturbed boring, and 3 test pits advanced in the dam abutments and along the center line of the dam. In addition to the pre-construction exploration, at least one additional soil boring was advanced through the centerline of the dam down to rock at the time of the 1949 seepage event in the area near the right abutment (referred to as "Hole A"). Laboratory testing was done on material from the test pits, the undisturbed boring, and on potential borrow samples. The subsurface explorations indicate that the overburden material left in place under the footprint of the dam mainly consists of sandy clayey silt and sandy silty clay with thin lenses of fine sand. The materials appear to be mostly alluvial deposits that have a maximum thickness of 38.4 ft and an average thickness of 28 ft. There is no cutoff trench excavated into the overburden soils. Topography in the area of Wister Dam can be generally characterized as generally mountainous, having valley slopes that are steep and rocky. The topography in the specific vicinity of the dam site has formed from differential erosion of

the severely folded and faulted hard sandstones and softer shales of the Ouachita Mountains as a result of anticline and synclinal deformation. The ridges and valleys have an east-west trend, parallel to the general strike of the anticlines and synclines that dominate the area. The sediments in the immediate area of Wister Dam dip approximately 28 degrees to the north (USACE 1949a).

A complicating factor in the internal erosion event that took place at Wister Dam is the possibility that dispersive soils were used as fill material. Wister, Oklahoma, is located in a region within the United States where dispersive soils have been positively identified in other projects. Dispersive soils are considered to be highly erodible materials because they have a reduced cation exchange capacity, making the individual clay particles not as tightly bound to each other, so they easily disperse when exposed to water (Davies and Lacey 2009). Double hydrometer, pinhole testing, and crumb testing (ASTM D4221, D4647, and D6572, respectively) were performed on soil samples collected from borings performed during a recent investigation of the outlet works and the abutting embankment material. Results of the testing indicate that about 30% of the soils tested display strongly dispersive characteristics with at least another 30% being moderately dispersive.

Construction

Construction on Wister Dam began in April of 1946 and was substantially complete in November 1948. The main embankment of the dam was built in stages, with the majority of the embankment being constructed to full height except for a closure section covering the old Poteau River bed. This extended from Sta. 2+00A to Sta. 14+00A and was constructed last. A typical cross section of the primary embankment was shown on figure 1. It is a zoned earthfill embankment with upstream and downstream slopes ranging from 2H:1V to 3H:1V. The main part of the embankment is made up of impervious fill material defined in contract documents as overburden materials taken from the site or borrow areas (sandy clayey silt and sandy silty clay) with a mixture of no more than 20% shale material. The impervious fill was placed in 6-in lifts that were compacted by eight passes of a sheepsfoot roller. Construction records indicate the impervious materials were primarily placed within -6 to +1% of optimum water content and within -4 to +3% of the standard Proctor compaction test. Aside from the previously described foundation drains, there are no designated filter or drainage zones.

Upon completion of the outlet works and the main body of the primary embankment, cofferdams were constructed at the upstream and downstream ends of the embankment closure section to divert the flow of the Poteau River through the outlet works. After unwatering was complete, impervious fill material was placed in the bottom of the old riverbed. It is assumed that typical impervious fill placement procedures consisting of 6-in lifts compacted by eight passes of a sheepsfoot roller were used to fill the old riverbed. Profiles of the bedrock at the site indicate that the bottom of the riverbed approximately coincides with the top of competent bedrock.

Internal Erosion Event

From January 23 to 27, 1949, approximately 2 months after completion of the closure section in the main embankment of Wister Dam, 8.43 in of rain fell in the Wister Dam watershed. By January 28, the reservoir crested, remained there for about 12 hr, and then slowly began to fall. Between the period of January 30 to February 3, multiple seeps were observed on the downstream slope of the dam from Sta. 1+06 to 14+40, all within an approximate elevation range of 470 to 475 ft. Measurements of the cumulative discharge through the seeps indicated that seepage flow through the embankment was increasing despite the fact that the reservoir level was dropping. On February 3, a sinkhole appeared on the upstream slope of the embankment at Sta. 2+12 and elevation 485 ft. On that same day, dye was introduced into the upstream sinkhole and emerged approximately 13 minutes later out of the initial seep at Sta. 9+09. The straight line distance between the two points is approximately 715 ft. An elevation difference of 10 ft between the upstream entrance and downstream exit provides an average gradient of just over 1.1 between the two points. Over the next 4 days, two additional upstream seepage entrances opened up at similar elevations. Dye introduced to these upstream entrances emerged downstream in approximately 30 minutes. Granular material was placed in the seepage entrances, reducing the flow of discharge by about 1/3. On February 7, the reservoir level fell below the elevation of the seepage entrances, essentially stopping seepage through the embankment.

Conclusions

As can usually be said of nearly any industry where disasters or, as in this case, near disasters occur, there were multiple events working either in tandem or in series that lead to the near failure of Wister Dam. All the available information on this case history, including design and construction records, past subsurface explorations carried out before and since the internal erosion event, and previous investigations on the partial failure, were re-examined in an effort to better understand the near failure of Wister Dam. The authors believe that the phenomenon that caused the initial downstream seep to form was different from the mechanism that caused the dam to progress to a more widespread internal erosion incident that led to multiple downstream seeps across the face of the closure section and nearly failed the dam.

It is postulated that the event was initiated by a differential settlement crack that formed along the south side of the former Poteau River bed from the upstream end of the embankment closure to the downstream end. As one of the remediation measures taken immediately after the near failure event in 1949, a row of sheet pile was driven across the upstream slope of the closure section. Further research of the remediation methods revealed that the sheet pile driver kept good records, making it possible to construct a detailed profile of the bedrock along the sheet pile alignment based on where each sheet pile met refusal. The sheet pile toe profile agrees with the rock profile used in the design except in one significant area. The design bedrock profile indicates that the area between the old Poteau River and the right abutment has a shallow bedrock surface very near the surface of the embankment foundation (indicated by the gray triangle-shaped area on figure 5-5a and the gray marbled material on figure 5-5b). However,

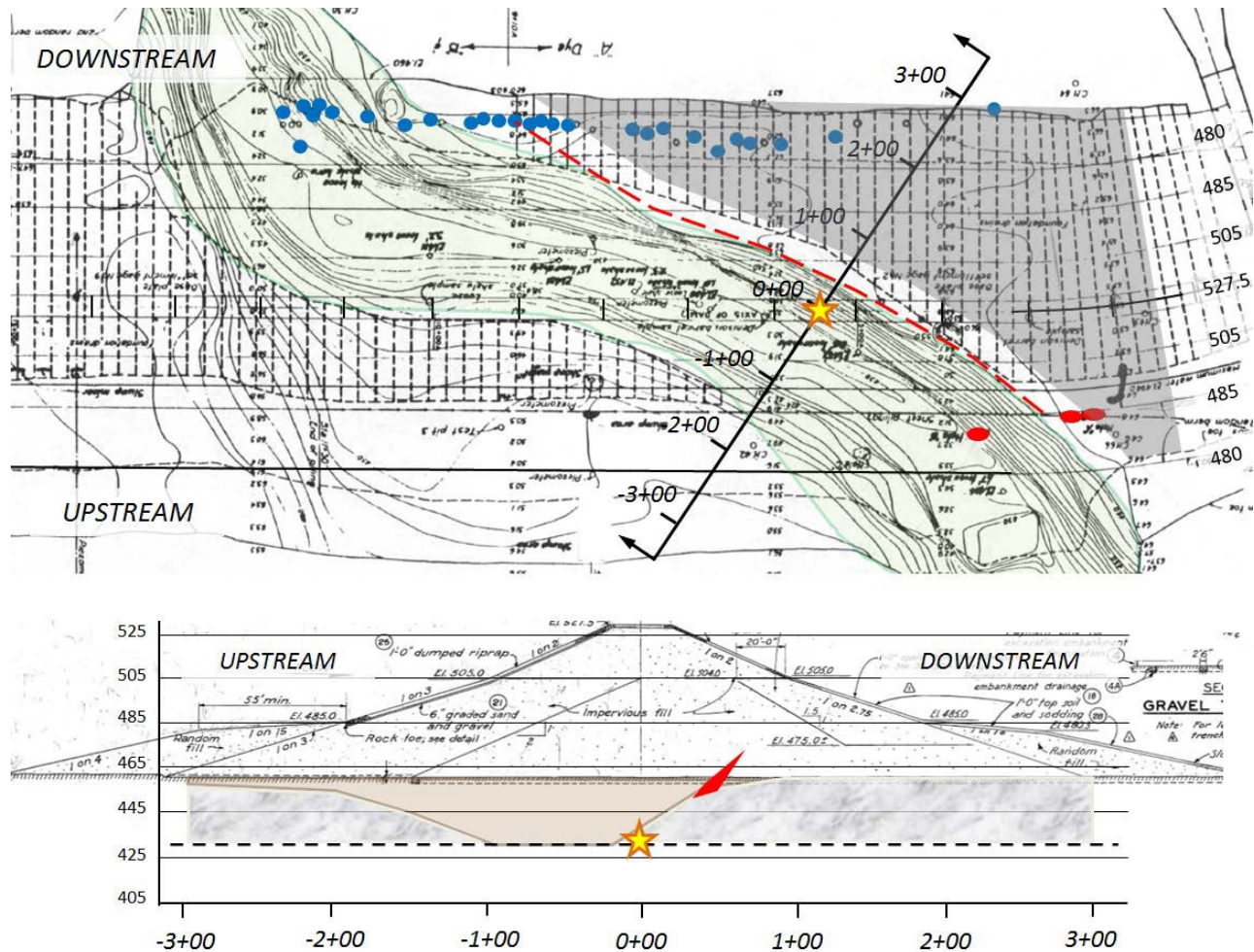

Figure 5-5a.—(Top) depicts the closure section of the dam in plan view. Figure 5-5b (bottom) is a cross-sectional view corresponding to a cross-section cut shown on figure 5-5a. The star in both figures corresponds to the same location.

when the sheet pile profile is compared to the originally assumed bedrock profile, it becomes apparent that the depth to bedrock in this area is actually similar to what it is in the center of the valley (approximately elevation 430 ft).

A comparison of the sheet pile tip elevation profile to topographic maps of the Poteau River indicates that the bottom of the riverbed was essentially running along the top of bedrock. Therefore, any fill placed within the confines of the old riverbed (shown as the light brown area on figure 5-5b) was placed on or near bedrock and was not subject to foundation settlement. In addition, this was well-compacted impervious fill placed at or near optimum water content that would be subject to minimal consolidation. Between the old riverbed and the right abutment, however, there was approximately 30 ft of relatively compressible alluvial foundation soil left in place. When this area was subsequently loaded under the weight of 45 ft of new embankment material, the triangle of alluvial material bordered by the old Poteau River to the north and dipping bedrock to the south settled more than the stiffer, well-compacted fill material placed within the riverbed. As the area continued to settle, a continuous crack formed along the south

side of the riverbed at some elevation above the foundation excavation (shown as the red dotted line in the plan view on figure 5-5a and the red triangular flaw on figure 5-5b). When the reservoir rose for the first time in January of 1949, water entered the crack and made its way downstream.

Over the course of the next 2 days, the authors theorize the reservoir pressure opened up the downstream segments of the differential settlement crack by hydraulically fracturing areas of low stress, eventually emerging at the downstream face. Once free water was inside the embankment and under the full pressure of the reservoir, additional failure mechanisms, such as desiccation, a poorly compacted or wet zone, or saturation settlement paired with hydraulic fracturing, likely opened the additional seeps along the downstream face of the closure section. The presence of dispersive soils in much of the fill material could have accelerated the development of each potential failure mechanism. Had the reservoir not fallen below the elevation of the seepage entrances when it did, full breach of the embankment could have occurred.

The effects of the 1949 internal erosion event at Wister Dam cannot be overstated. With regard to the Wister Dam Project, the occurrence of uncontrolled seepage emerging from the downstream face of the dam during its first filling was not only the single most hazardous event in the dam's history but also was the impetus for the addition of significant improvements and redundancies to the dam. The repercussions of the Wister Dam internal erosion event on the dam building community were significant as well. Arthur Casagrande considered the events at Wister Dam so disturbing that he felt it his duty to call it to the attention of the profession and did so in his 1950 paper to the Boston Society of Engineers. It disturbed him greatly that a dam made out of "clay which is compacted at optimum moisture content (did) not possess the ability to follow even small differential settlements without cracking" (Casagrande 1950). The events at Wister Dam also led James L. Sherard to the belief "that near failure of the Wister Dam by piping is one of the more important single experiences to guide present thinking about the evolution of leakage control design measures" (Sherard 1986) – specifically, that no dams should be designed without the inclusion of redundancy measures such as a well-designed filter and drain. A review of the events at Wister Dam yield several recommendations concerning the design, construction, and operation of dams.

1. Even well-built embankment dams composed of clayey materials placed at or near the optimum water content are susceptible to flaws (especially if the clay is highly erodible material such as dispersive clay). All dams should be designed with redundancy measures such as filters and drains in place.
2. A thorough subsurface exploration program and geotechnical/geologic analyses should be aggressively pursued before the design of any major earth-founded project.
3. Potential fill or foundation materials should always be tested for the presence of dispersive soils, particularly in regions where these materials are known to exist. Such materials should be appropriately lime treated to remove their dispersive properties.
4. Flood-fighting methods should be in place should an event outside the normal operation of a dam occur. Had the reservoir not had the ability to be drawn down at a rather rapid rate (2 ft per day), Wister Dam may have breached.

References

- Bertram, G.E. (1967). "Experience with Seepage Control Measures in Earth and Rockfill Dams," Proceedings 9th ICOLD Congress, Istanbul, Turkey, Vol. III, 1967, pp. 91–109.
- Casagrande, A. (1950). "Notes on the Design of Earth Dams." Boston Society of Civil Engineers, Boston, MA.
- Cochrane, Victor H. (1946). Specifications for Construction of Dam, Arkansas River Watershed, Wister Dam, Poteau River, Oklahoma. Tulsa, OK: U.S. Army Corps of Engineers; January 1946. Serial No. 34-066-46-48.
- Davies, Stephen and Alison Lacey (2009). Farmnote 386: Identifying Dispersive Soils [Pamphlet]. South Perth WA, Australia: Western Australian Agriculture Authority, November 2009.
- Jones, J.A.A. (1981). "The Nature of Soil Piping: A Review of Research," GeoBooks, Cambridge, UK.
- Redlinger, Charles, P.E. and Andy Hill, P.E. (2013). "Second Look: The 1949 Wister Dam Internal Erosion Event," USACE Risk Management Center, Denver, CO.
- Sherard, J.L. (1986). "Hydraulic Fracturing in Embankment Dams," Journal of Geotechnical Engineering, Vol. 112, No. 10, October, 1986.
- Sherard, J.L., R.S. Decker, and N.L. Ryker (1972). "Piping in Earth Dams of Dispersive Clay," Proceedings of the Specialty Conference on Performance of Earth and Earth-Supported Structures, American Society of Civil Engineers, June 1972, pp. 589–626.
- U.S. Army Corps of Engineers (USACE) (1959). Waterways Experiment Station, Review of Soils Design Construction and Performance Observations, Wister Dam Oklahoma. Vicksburg, MS; June 1959. Technical Report No. 3-508.
- U.S. Army Corps of Engineers, Tulsa District (1949a). Completion Report, Construction of Wister Dam and Appurtenances, Poteau River, Leflore County, Wister, Oklahoma. Tulsa, OK, May 1949. Contract No. W-34-066-eng-387.
- _____(1949b). Report of Seepage and Remedial Work, Wister Dam, Poteau River, Oklahoma. Tulsa, OK, June 1949.
- _____(1950). Report on Additional Investigation in Connection With Remedial Work at Wister Dam, Wister, Oklahoma. Tulsa, OK, January 1950.

Little Wewoka, Upper Boggy Creek Site 53, Upper Red Rock Site 20, and Others

A study was conducted in 1971 by the NRCS after 11 dams in Oklahoma failed by internal erosion (Sherard 1972). It was known that most of the failed dams were constructed within a geographic area of Oklahoma in which clayey soils are susceptible to erosion termed "dispersive piping." A similar problem was also known to exist in north-central Mississippi where a considerable number of NRCS dams were experiencing vertical tunnel erosion from rainfall. Three of these Mississippi dams failed upon first filling. Sherard (1972) noted that similar dam failures have also occurred in Australia and Israel where dispersive soils were common. Of the more than 3,000 Australian structures known to have been constructed of dispersive soils, approximately 8% failed by rapid progressive erosion of spontaneous leaks (Sherard 1972). Sherard plotted the soil chemistry from many of these case histories and other notable failures and observed four zones could be defined based on dam performance (figure 6).

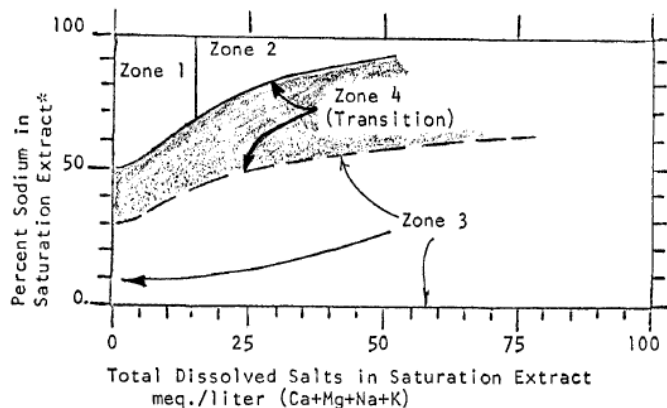

Zones 1 and 2 include nearly all of the clay samples from dams which failed by breaching in Oklahoma and Mississippi. Samples generally have high dispersion when tested in the laboratory. Highly erodible clays.

Zone 1 includes all samples from 16 clay dams which were damaged by tunnel erosion from rainfall in Venezuela, Oklahoma, Mississippi, Arkansas, Tennessee and Texas.

Zone 3 includes the test results for most of the "control" samples. Probable range of ordinary, erosion resistant clays.

Zone 4 is the transition zone. Most samples in this zone had low dispersion when tested in the laboratory. The lower boundary of the Zone is not well established by the data.

SUMMARY OF CORRELATION BETWEEN CHEMICAL TEST RESULTS
AND DAM PERFORMANCE EXPERIENCE

Figure 6.—Plot of dam performance and soil dispersive characteristics.

The Oklahoma case histories studied by Sherard were found to be related to geographic occurrence of dispersive soils (figure 7). A short summary of the Oklahoma case histories follows (Wister was discussed above). For more detailed information and photographs see Sherard (1972).

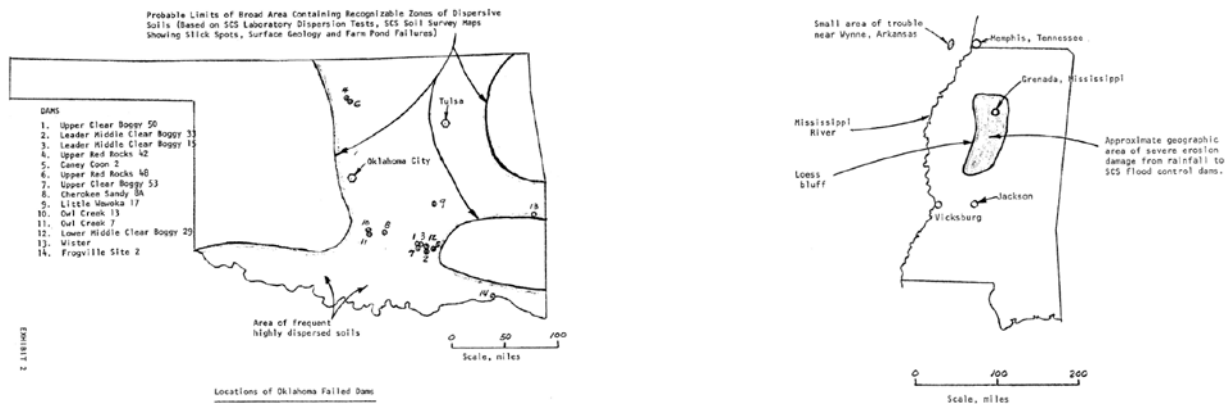

Figure 7.—Oklahoma and Mississippi geographic areas with a history of dam failures related to occurrence of dispersive soil.

Upper Clear Boggy Creek 50 – The dam is a 28-ft-high embankment constructed of soil with 60–80% passing the No. 200 sieve and a PI of 7–18 (liquid limits from 22–35). The dam was constructed in May 1970. First filling of the 1,005 acre-ft reservoir was done on October 9, 1970, which was followed by failure on October 15, 1970. There were no eye witnesses to the failure, but the failure is thought to be the result of differential settlement cracks caused by a rapid change in depth of the underlying bedrock and high sensitivity to seepage due to the presence of highly dispersive soils. Soil Conservation Service (SCS) dispersion tests yielded high values of 100%. The conduit was not involved in the breach.

Leader Middle Clear Boggy Creek 33 – The dam is a 23-ft-high embankment constructed of soil with 50–75% passing the No. 200 sieve and a PI of 11–27 (liquid limits from 27–48). The dam was constructed in September 1963. First filling of the 370 acre-ft reservoir occurred in 1964, and the dam failed on October 14, 1969. The failure occurred following rapid reservoir filling on October 13, 1969. Two independent tunnels developed simultaneously about 90 ft apart. The largest tunnel was 8 ft high and 15 ft wide. It is thought that the breach may have been a result of drying cracks eroding from rainfall. Previous jugging, with jugs up to 4 ft in diameter, were observed several years in the area of the failure prior to the failure. SCS dispersion tests yielded high values of 82%. The conduit was not involved in the breach.

Leader Middle Clear Boggy Creek 15 – The dam is a 25-ft-high embankment constructed of soil with 50–80% passing the No. 200 sieve and a PI of 7–32 (liquid limits from 22–50). The dam was constructed in 1965. First filling of the 270 acre-ft reservoir began May 26, 1965, and the dam failed the same day. The dam was subsequently repaired but failed a second time on June 1, 1968. The two breaches were 100 ft apart. The 1965 failure occurred as an arch-like tunnel, 3 ft high and 15 ft wide, through the base of the dam along the ground level. The 1968

breach occurred as a 3-ft-diameter circular tunnel passing through the bottom of the dam at an elevation from 2–5 ft above the foundation. The conduit was not involved in either breach. In both cases, dispersive soils were listed as a contributing factor. The 1968 failure was also attributed to possible desiccation cracks or differential settlement due to a rapid change in depth of bedrock. The entire upstream slope of the dam was treated with lime in 1970 due to severe jugging. When inspected by Sherard in January 1971, it was noted that the downstream slope was badly eroded, with frequent jugs up to 18-in diameter, in spite of an excellent grass cover. SCS dispersion tests yielded high values of 92 and 88%.

Upper Red Rock Creek 42 – The dam is a 23-ft-high embankment constructed of soil with 65–90% passing the No. 200 sieve and a PI of 9–18 (liquid limits from 28–35). The dam was constructed in December 1966. First filling of the 385 acre-ft reservoir began June 20, 1967, with failure occurring the same day. Failure began with an observation of a small leak (about a 1-in diameter) just below the bottom of the outlet conduit. The reservoir was completely empty 24 hr later. An erosion tunnel had formed along the right side of the conduit (at the upstream end), which crossed over to the left side of the conduit near the centerline of the dam and extended to the downstream face of the dam. The erosion tunnel was approximately 3 ft high by 6 ft wide and was entirely within embankment fill. The failure was attributed to piping along the sides and bottom of the conduit. The 18-in-diameter conduit did not have concrete bedding or a cradle, and it was thought that inadequate bonding of conduit with bedding or backfill, or displacement of the pipe during backfilling, contributed to the leakage. Moderate jugging was observed on both the upstream and downstream slopes during the 1971 inspection, with jugs up to a 12-in diameter. SCS dispersion tests yielded a high value of 41% (from only four tests).

Caney Coon Creek 2 – The dam is a 50-ft-high embankment constructed of soil with 60–75% passing the No. 200 sieve and a PI of 0–18 (liquid limits from 20–32). The dam was constructed on November 16, 1964, with first filling of the 8,500 acre-ft reservoir occurring on November 17, 1964. The dam failed less than 2 days later on November 19. The entire failure was witnessed. Two independent tunnels formed about 125 ft apart at the downstream toe. The first tunnel appeared at 10 a.m. on November 19, 1964, as a small leak from a 6-in-diameter area, occurring along the contact between the dam and rock abutment along the line of the municipal water supply conduit. The leak increased to 25 ft³/s over the next 7 hr, and the diameter of the discharge area also increased to an 18-in diameter. By the following morning (November 20, 1964), the tunnel had increased in size to 15 ft in diameter, discharging an estimated 50–75 ft³/s. The second tunnel appeared on November 20, 1964, and increased to 10 ft in diameter over the next 2 days. The first tunnel was attributed to piping into cracks in the rock abutment, differential settlement cracks due to settlement at the steep abutment, or from differential settlement of natural and compacted soils around the conduit trench. The second tunnel was attributed to differential settlement cracks from differing thicknesses and compressibility of the foundation soils and a concentrated leak in the foundation alluvium. The tunnels were also attributed to the highly dispersive soils and layers of cohesionless sandy silt in the upper foundation. SCS dispersion tests yielded high values of 91 and 79%.

Upper Red Rocks 48 – The dam is a 22-ft-high embankment constructed of soil with 75–85% passing the No. 200 sieve and a PI of 12–22 (liquid limits from 30–42). The dam was constructed on November 2, 1964, with first filling of the 394 acre-ft reservoir on November 16,

1964. The dam failed approximately 24 hr later on November 17, 1964. The reservoir emptied before the failure was discovered on November 18, 1964; hence, the exact timing of the failure is unknown. The failure occurred as a 10-ft-diameter tunnel through the dam, located just a few feet from the conduit. During reconstruction, it was found the conduit was still surrounded by intact compacted embankment, over a length of 50 ft, near the center of the embankment. There were no obvious causes cited for failure of the dam; however, the embankment was compacted dry of optimum, and the foundation soils were also generally dry. During Sherard's 1971 inspection, isolated jugs of 6-in diameter were observed in the vicinity of the conduit. SCS dispersion tests yielded high values of 55 and 32%.

Upper Clear Boggy 53 – The dam is a 26-ft-high embankment constructed of soil with 60–90% passing the No. 200 sieve and a PI of 12–25 (liquid limits ranged from 25–40). The dam was constructed on November 2, 1964, with first filling of the 360 acre-ft reservoir on June 16, 1964. The dam failed 2 days later on June 18, 1964. As with many of the other cases, there were no eye witnesses to the failure, but it was known that the reservoir emptied within 24 hr of the first leak. An erosion tunnel formed on the left side of the conduit, just above its top, on the upstream slope and crossed over the conduit and emerged on the right side on the downstream slope. The tunnel had a diameter of about 10 ft near the dam axis, with the tunnel axis about 8–12 ft away from the right side of the conduit. The erosion tunnel was completely confined within the fill section of the dam. Causes for the failure were attributed to differential settlement cracks, caused by the bedrock being present in the foundation on one side of the erosion tunnel and alluvium in the foundation on the other side, and compacted fill in the trench of the conduit. It was also attributed to the fill being compacted dry of optimum and highly dispersive, with potential for drying cracks and poor bond between compacted layers. SCS dispersion tests yielded high values of 63 and 59%.

Cherokee Sandy Creek 8A – The dam is a 27-ft-high embankment constructed of soil with 75–90% passing the No. 200 sieve and a PI of 38–52 (liquid limits from 55–75). The dam was constructed on January 22, 1963, with first filling of its 633 acre-ft reservoir on May 6, 1964. The dam failed about 9 days after first filling, on May 15, 1964. The failure began with a leak that entered the upstream slope near the high water line, migrated down to near the original ground surface, travelled along the base of the dam horizontally, and then flowed upward, emerging on the downstream slope about 5 ft above the toe. The tunnel was gradually eroded along this path, reaching a diameter of about 8 ft. It took about 48 hr for the initial leak to appear after the reservoir hit its high mark. Once the leak appeared, it took another 48 hr to release the main volume of the reservoir. The conduit was not involved in the failure. Failure was attributed to drying cracks in the embankment or foundation, differential settlement cracking due to variable compressibility of foundation soils (the erosion tunnel occurred over the old stream channel), or difficulty in compacting the clay. It was also noted that the material is highly dispersive clay. SCS dispersion tests yielded high values of 100%.

Little Wewoka Creek 17 – The dam is a 40-ft-high embankment dam constructed of soil with 40–70% passing the No. 200 sieve and a PI of 5–17 (liquid limits from 20–32). The dam was constructed on May 14, 1960. First filling of its 2,043 acre-ft reservoir occurred on May 19, 1960, and the dam failed about 2 days later on May 21, 1960. The failure sequence was observed, initiating with a small leak from an approximate 6-in-diameter area as a trickle of

water at 8 a.m. This initial leak occurred on the downstream slope, in line with the conduit, but about 15 ft above the conduit. By the middle of the day, the erosion tunnel had enlarged to 10 ft in diameter, and the entire reservoir was evacuated before the end of the day. The erosion tunnel collapsed, leaving a 47-ft-wide breach with near vertical sides, and the conduit exposed the full length of the bottom of the breach. The failure was attributed to differential settlement cracks related to a rapidly increasing depth of bedrock in the vicinity of the failure or from the difference in compressibility of the natural foundation soil and compacted fill in the trench under the conduit. It was also noted that the embankment contained highly dispersive soils and that rapid reservoir filling may have contributed to the failure. SCS dispersion tests yielded high values of 100 and 51%. During the 1971 inspection, “bad” erosion was observed in the form of jugs and saps on the downstream slope near the conduit. Jugs with 12-in-diameter openings were also noted in isolated areas for the full length of the dam. It was noted that these erosion features developed in spite of the excellent grass cover.

Owl Creek 13 – The dam is a 24-ft-high embankment constructed of soil with 60–70% passing the No. 200 sieve and a PI of 12–18 (liquid limits from 30–40). The dam was constructed on January 6, 1957. First filling of the 124 acre-ft reservoir occurred on May 17, 1957, and the dam failed about 2 days later on May 19, 1957. The failure was not observed, but the erosion tunnel remaining after the failure ran along the right side of the conduit. The erosion tunnel was about 18 ft in diameter with its bottom near the same elevation as the invert of the conduit. The erosion tunnel exposed the conduit its full length. Failure was attributed to differential settlement cracks due to rapidly increasing depth to bedrock. It was also noted that the embankment was compacted dry of optimum and with low density. An inadequate bond was suspected between the backfill and the conduit, and it was thought that there were potential drying cracks present, and that the presence of highly dispersive soils contributed to the failure. SCS dispersion tests yielded high values of 63 and 43%.

Owl Creek 7 – The dam is a 24-ft-high embankment constructed of soil with 50–75% passing the No. 200 sieve and a PI of 10–25 (liquid limits from 25–50). The dam was constructed on March 19, 1957. First filling of the 205 acre-ft reservoir occurred on May 17, 1957, with failure occurring less than 2 days later on May 19, 1957. The reservoir was evacuated before the first inspection occurred on May 20, 1957. An erosion tunnel was found to have entered the right abutment about 80 ft upstream of the dam, travelling in the downstream direction until reaching the cutoff under the dam. The tunnel then turned 90 degrees and travelled parallel to the cutoff trench for 60 ft, where it encountered the outlet conduit, after which the tunnel exited the downstream toe, crossing over the conduit from the right to the left side. The tunnel was 4 ft in diameter in the natural ground of the abutment and increased to 15 ft in diameter in the fill at the centerline of the dam. The bottom of the erosion tunnel was about 3 ft lower than the invert of the conduit. Only the downstream half of the conduit was exposed by the erosion tunnel. The cause of the failure was attributed to piping into cracks in the shale of the right abutment and seepage through a possible old landslide in the abutment area. Differential settlement may have also occurred from the differing compressibility of the natural foundation soils and the compacted earth in the trench under the conduit. Drying cracks may have also contributed, and it was thought that there may have been a poor bond or poor compaction of the soil around the conduit. SCS dispersion tests yielded high values of 81 and 78%.

Lower Middle Clear Boggy Creek 29 – The dam is a 23-ft-high embankment constructed of soil with 30–70% passing the No. 200 sieve and a PI of 2–13 (liquid limits ranging from 19–30). The dam was constructed on September 29, 1962, with first filling of the 258 acre-ft reservoir occurring in 1963. A serious incident occurred about 7 years later in 1970, but the dam did not fail. The reservoir was only at high levels twice since constructed: once in 1969 and once in 1970. The 1970 event resulted in a leak of dirty water exiting the downstream slope over the conduit but about 10 to 12 ft above the conduit. After it flowed a short time, the leak stopped, which was thought to be in response to lowering the reservoir pool. When the site was inspected in 1971, it was noted that “it was difficult to distinguish the leakage tunnel from the many erosion jugs on the slope.” No formal investigation was made, so there are no theories regarding the cause of this incident. However, the 1971 inspection observed the slopes and crest of the dam were badly damaged by jugs and that the jugging in this dam was more severe than observed at any of the other dams in the study area. It was also noted that the excellent grass cover helped to prevent formation of erosion gullies but had little effect of jugging. It was noted that there were so many jugs on the slopes of the dam that it was dangerous to walk on the surface. The jug openings varied from 6 to 18 in. SCS dispersion tests yielded high values of 58 and 46% but were taken from a limited number of tests (eight).

References

- Sherard, J.L. (1972). “Study of Piping Failures and Erosion Damage from Rain in Clay Dams in Oklahoma and Mississippi.” Report prepared for U.S. Department of Agriculture Soil Conservation Service, NRCS. 214 p.

Case 7 – Black Rock Dam¹

Black Rock Dam

Black Rock Dam, originally named Zuni Dam, is a historic embankment dam built by the Indian Irrigation Service of the Bureau of Indian Affairs (BIA) between 1904 and 1908, on the Zuni River. Ancient basalt lava flows cover the area of the dam site and initially impounded the Zuni River in a shallow lake. The impounded water eventually undermined the basalt, forming the gorge and dam site. The intensely jointed basalt, overlain by several feet of unconsolidated surficial deposits, form the upper 30 to 40 ft of the abutments. The basalt is underlain by erodible, discontinuous beds of silty and clayey sands and gravels, and clay. The dam is a combination embankment, consisting of a downstream rockfill section and an upstream hydraulic earthfill section (figure 1). The dam is 80 ft high (structural height of 110 ft), and has a crest length of 780 ft. The original spillway was constructed by excavating a channel in the left abutment, basalt, and lining the channel with concrete and masonry.

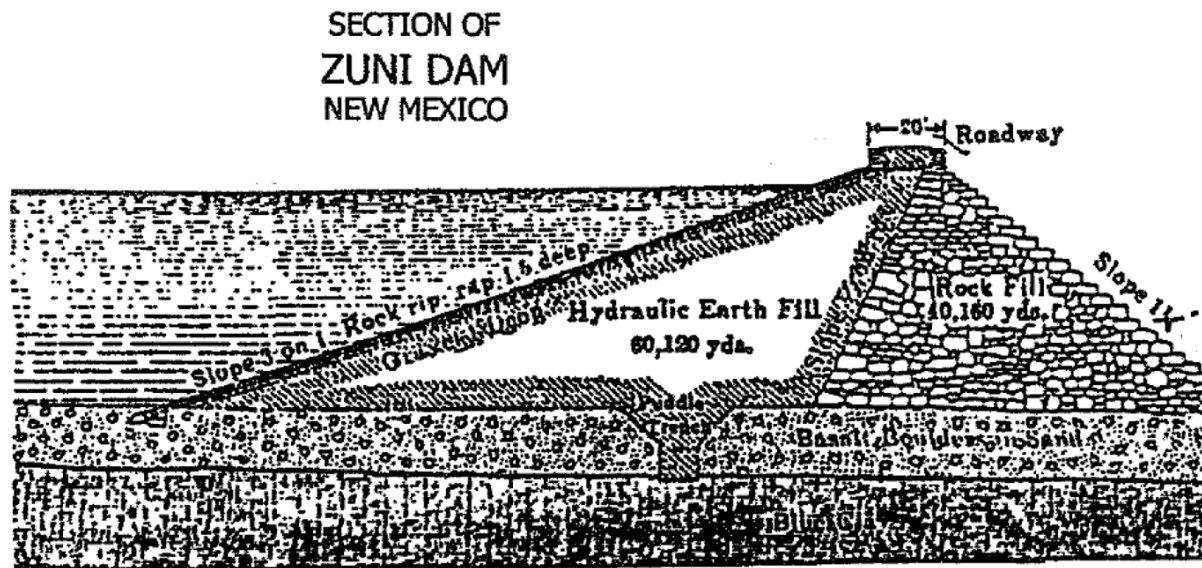

Figure 1.—Black Rock Dam maximum section.

During first filling in 1909, reservoir water flowed through fractures in the basalt at rates up to 5,000 ft³/s, eroding the underlying deposits, which resulted in settlements of up to 10 ft of the basalt blocks, partial collapse of the spillway structure, and near failure of the left abutment of the dam. A new concrete and masonry spillway structure and a masonry and steel sheet pile cutoff wall were built in 1909–12. Exposed basalt was also blanketed with earthfill. Despite these attempts to limit flows through the basalt, the dam nearly failed from erosion in the left abutment in 1932 and again in 1936.

¹ Modified and reprinted with permission from USSD, GEI Consultants, and Hydroplus (Hydroplus.com).

More recent inspections by Reclamation under their Safety Evaluation of Existing Dams (SEED) program classified Black Rock Dam as high hazard and identified significant dam safety deficiencies of uncontrolled seepage through the abutments. In addition to safety deficiencies, the reservoir has experienced heavy sedimentation, which has reduced the design storage volume of 15,000 acre-ft to about 2,600 acre-ft today.

Seepage Remediation

Seepage of reservoir water through fractures in the basalt in the upper portions of the abutments, and the subsequent erosion of underlying soil, had caused near failure of the dam on at least two occasions (figure 2). Preventing water from entering the basalt is a key consideration for improving the safety of the dam. The left and right abutment stratigraphy is similar and consists of several feet of eolian silty sand deposits over 15 to 30 ft of fractured basalt, over interbedded alluvial sands and gravels, and clays (figure 3). At normal storage levels, most of the basalt is exposed to reservoir water. The valley between the abutments was eroded into the material below the basalt.



Figure 2.—Black Rock Dam near failure, 1909; spillway is in the foreground.

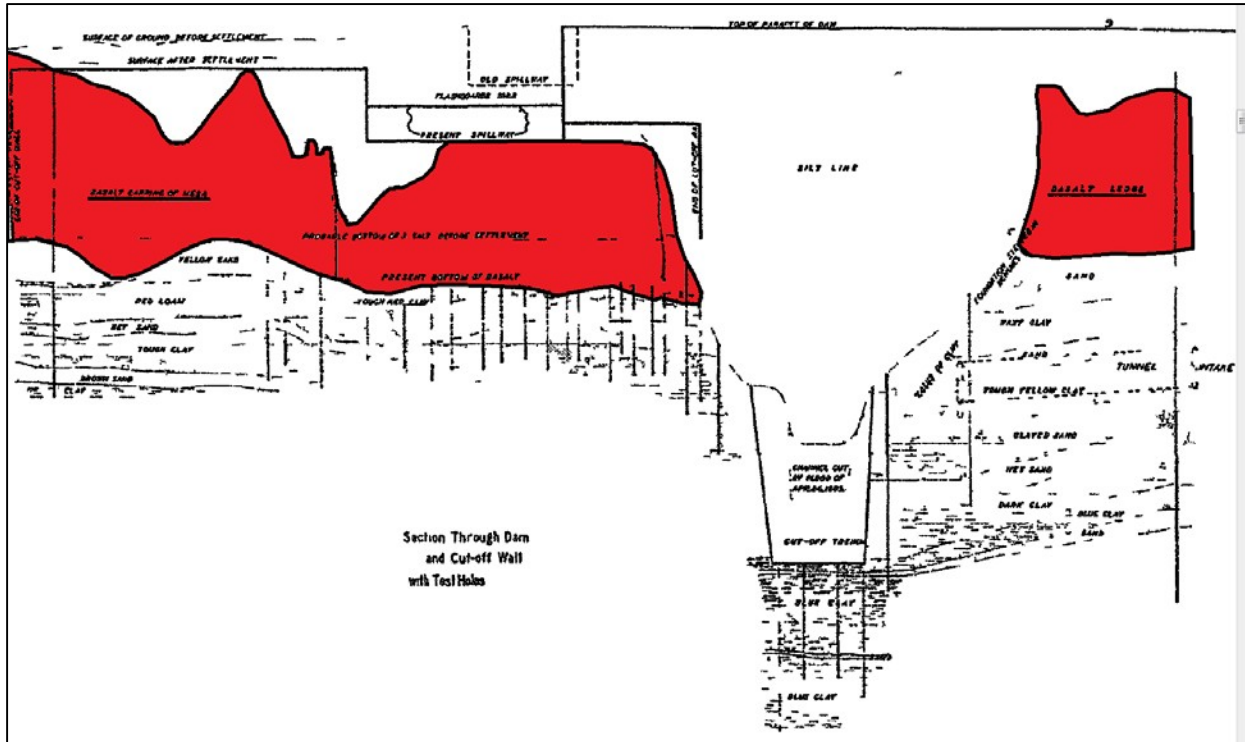

Figure 3.—Profile through the axis of the dam, looking downstream (red strata is fractured basalt, overlying sand and clay soils).

Any seepage control measure would have to extend horizontally into each abutment and either tie into the hydraulic fill of the dam or extend across the upstream face of the dam.

The dam is operated by the BIA. Under auspices of the Indian Self Determination Act, Public Law 93-638, the Pueblo of Zuni contracted with the BIA to administer the design and construction of the needed safety improvements. The Pueblo of Zuni selected GEI Consultants for design and engineering services and Laguna Construction Company, owned by the Pueblo of Laguna, as a construction contractor. Design began in 1996. The first phase of construction began in early 1998 and was scheduled to be completed in August 2001.

Alternatives

Several alternatives for reducing and controlling seepage were considered, which included covering the basalt with impervious material, grouting of the basalt blocks, a horizontal impervious blanket, and a vertical cutoff trench.

Covering the upstream faces of the basalt with impervious material or grouting the fractures in the basalt would seem like an obvious first step in reducing flows through the basalt. However, water could then flow through the permeable soils beneath the basalt and exit in an upward direction into the basalt fractures downstream from the impervious layer or grout curtain, where erosion of soils and settlement of the abutment would continue. An impervious liner extending

several hundred feet horizontally into the reservoir could lengthen the seepage path, reducing gradients to safer levels. Construction of this liner would be very difficult due to the sediments in the reservoir. The sediments are very soft, and construction of the liner on the sediments would be difficult and costly. Removal and disposal of sediments beneath a horizontal liner would also be difficult and costly.

A vertical cutoff trench could extend into the soils underlying the basalt, reducing seepage flows and gradients to safe levels, and could be constructed with minimum excavation of reservoir sediments. A soil-bentonite filled cutoff constructed by slurry trench methods was the selected alternative.

Design

The depth and horizontal extent of the cutoff trench was selected after seepage modeling of alternatives using the SEEP/W computer program. The silts below the basalt were categorized as either sand or clay based on descriptions of split spoon samples obtained from borings. Six soil types were modeled as shown in table 1. The cutoff trench was modeled as soil 7.

Table 1.—Seep/W model parameters

Soil description	Depth (ft)	Hydraulic conductivity (cm/second)
1. Silty sand	0–12	5×10^{-4}
2. Basalt	12–35	5×10^{-3}
3. Sand	35–45	5×10^{-3}
4. Clay	45–52	5×10^{-8}
5. Silty sand	52–84	5×10^{-3}
6. Clay	84–150	5×10^{-8}
7. Cutoff trench	Varies	5×10^{-7}

Borings had been made in both abutments. Boring logs indicated that water loss in the basalt was significantly higher in the left abutment than in the right abutment. This correlated well with incidents at the dam where relatively small amounts of seepage and settlement observed on the right abutment compared to the high seepage and settlements observed on the left abutment. The model computed the phreatic surface, equipotential lines, and the total seepage flow rate (for comparison) through the profile.

Existing conditions were modeled without a cutoff trench, and the calculated phreatic surface was compared to groundwater levels observed during drilling. The comparison showed a satisfactory correlation between the calculated and measured values. The effectiveness of various cutoff wall configurations was evaluated by comparing the reduced seepage rate reduction to the results of this initial model.

A 5-ft-wide cutoff trench was selected, extending 500 ft into the right abutment, 575 ft into the left abutment, and 65 ft below the modeled bottom of the basalt. Continuous construction of a single trench was more economical and effective than tying two trenches into the hydraulic fill of the dam. The trench therefore extends across the upstream face of the dam, about 50 ft from the crest, adding about 200 ft to the length of the trench.

In order to construct the cutoff trench, trenches in each abutment had to be excavated through the basalt to expose the underlying soil. The trenches were designed to be as narrow as possible. The trenches were excavated by blasting, with side slopes of 0.5 to 1, and a nominal bottom width of 10 ft (figure 4). Open fractures in the exposed downstream face of the basalt were manually filled with grout. The trenches were then backfilled with compacted clay, with filter material against the downstream face of the basalt, to a constant elevation, providing a work platform 20-ft wide for the slurry trench construction. The slurry trench was constructed to 75 ft below the work platform.

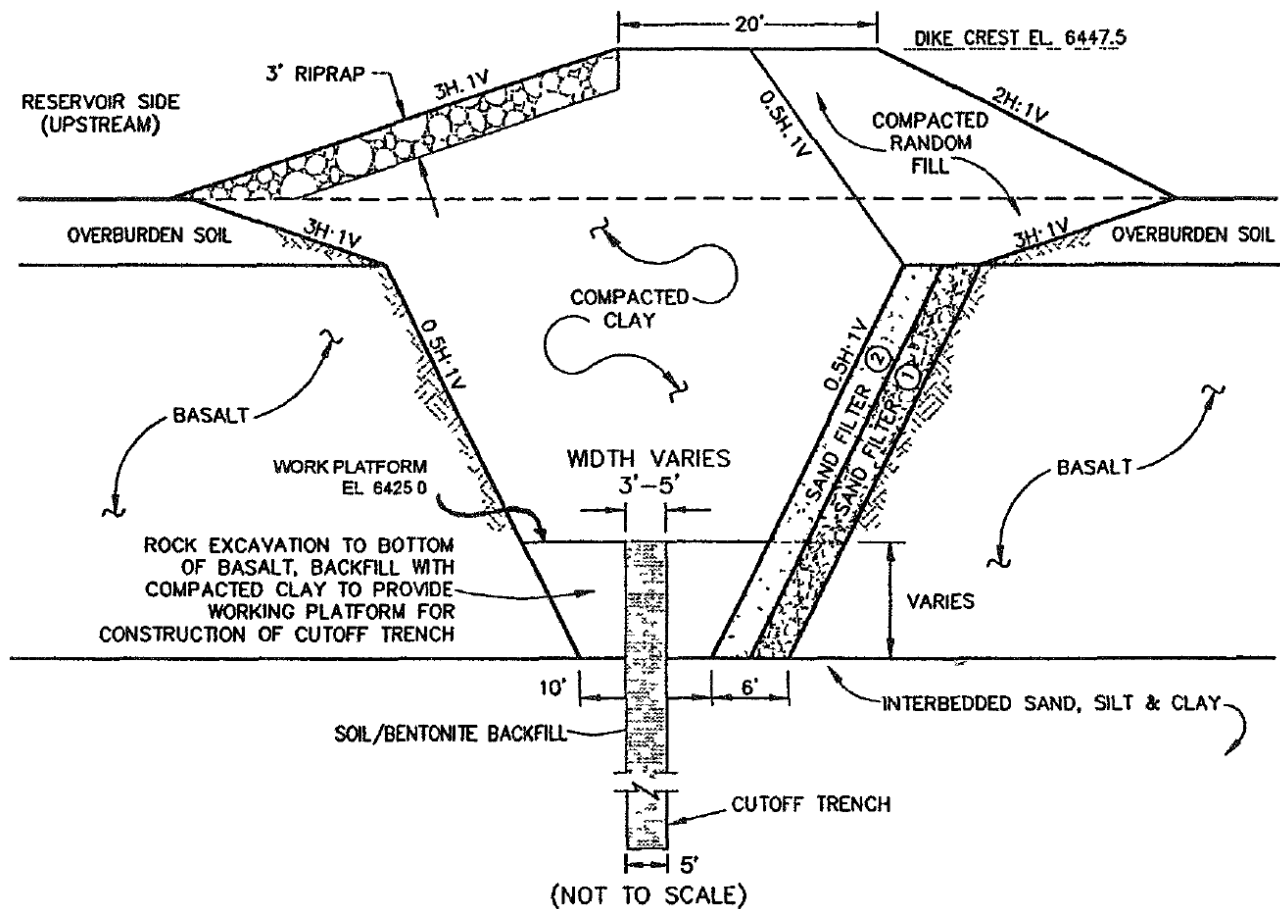

Figure 4.—Typical cutoff trench section.

Once the cutoff trench was constructed, the remainder of the trenches in basalt were backfilled with clay and filter material. Because of expected settlement of the soil-bentonite material in the cutoff trench, which could potentially form a void below the clay backfill, the backfill was not placed until several months after completion of the slurry trench. Settlement measurements were taken of the cutoff trench backfill at seven locations along the trench during this period. Settlements were generally 0.8 to 1.2 ft at 180 days. Because the alignment of the cutoff trench is upstream of the dam, the top of the clay backfill is below the elevation of the dam crest. Dikes were constructed on the clay backfill, above the cutoff trench, with a crest elevation equal to the dam crest, and riprap was placed on the upstream face of the dikes.

Tying it All Together

The cutoff trench and dikes greatly reduces reservoir water flowing through the basalt abutments of the dam. The auxiliary spillway on the left abutment is formed by lowering a section of the left dike and excavating a discharge channel downstream. Auxiliary spillway discharges would flow over the cutoff trench and downward into the basalt. To prevent this, the auxiliary spillway is lined with a HDPE liner. The liner is tied into a cutoff trench and extends to a point near the downstream end of the auxiliary. To complete the seal, the liner also extends across the service spillway and is tied into the hydraulic fill of the dam (figures 5 and 6).

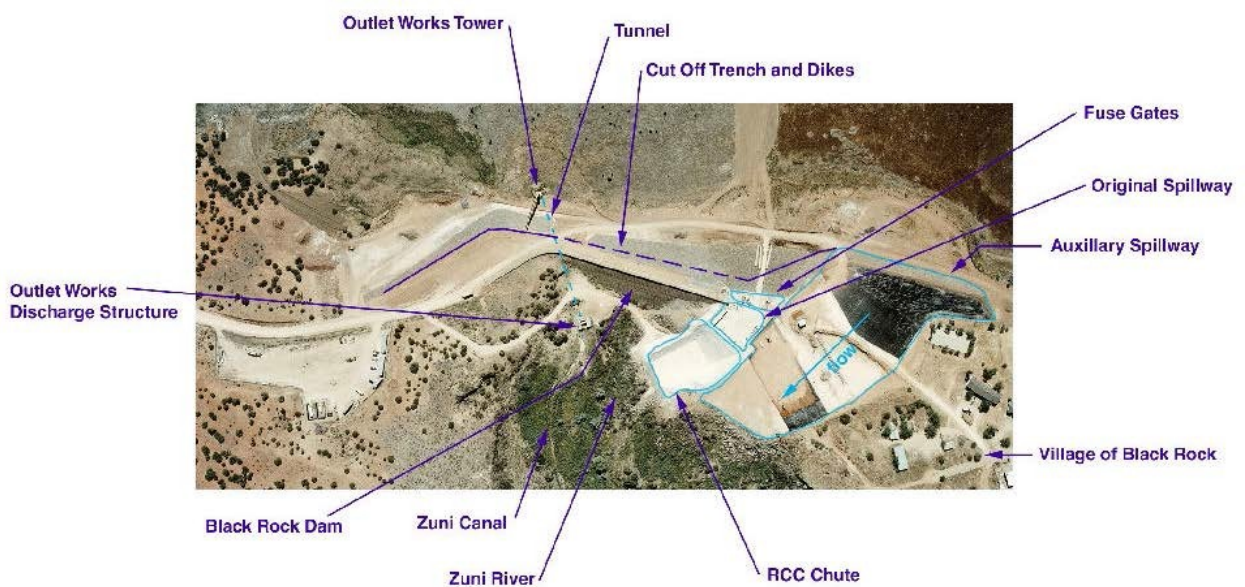

Figure 5.—Plan view of repairs to Black Rock Dam.

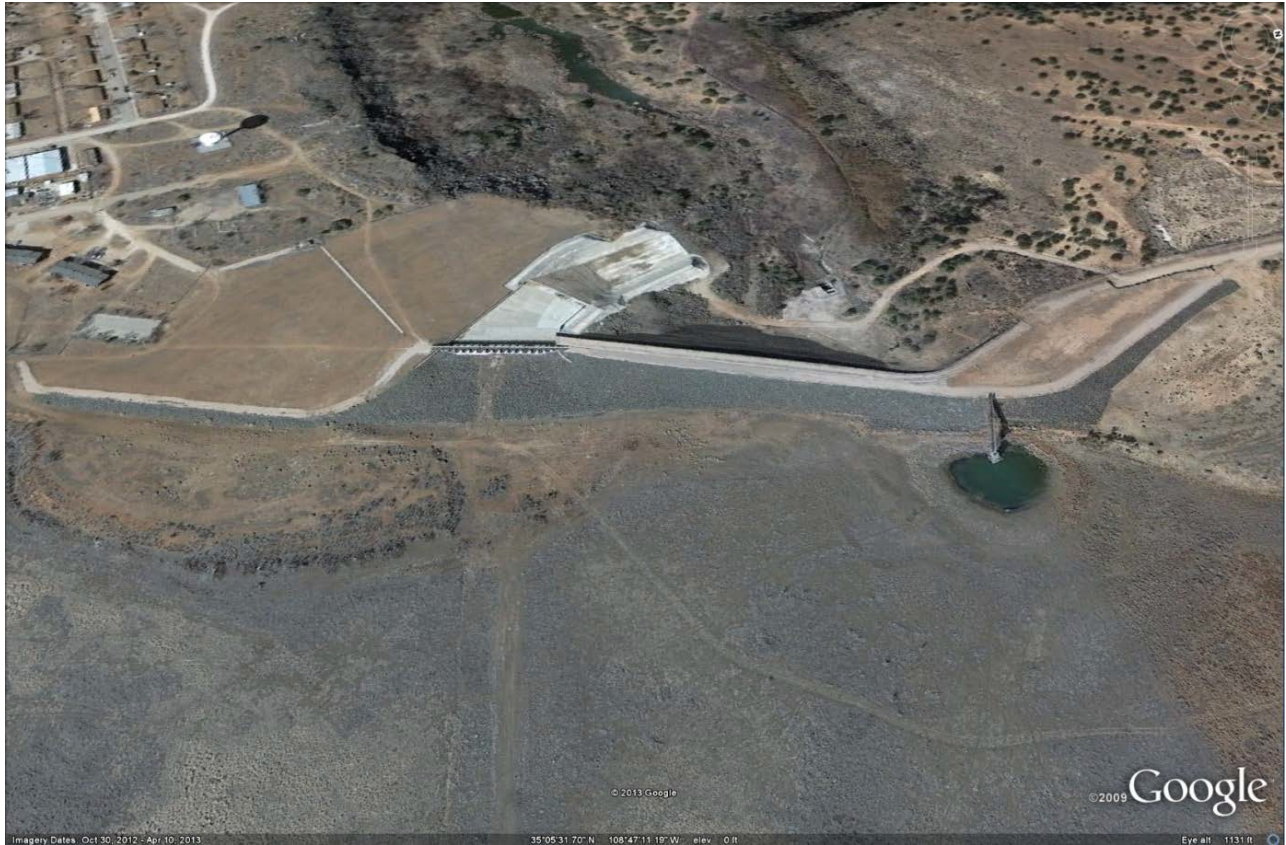

Figure 6.—Oblique view of modified Black Rock Dam (Google Earth, October 30, 2012).

References

Kocahan, H.T. and G.M. Taylor (2002). “Rehabilitation of Black Rock Dam – Seepage & Inadequate Spillway,” ASDSO Dam Safety 2002.

Taylor, G.M., D. Mahooty, and J. Rayssiguier (2001). “Historic Dam – Modern Upgrade,” 21st USSD Annual Meeting and Lecture, Denver, July 30 – August 3, 2001.

Case 8 – Narora Weir

The Narora weir, the diversion dam for the Lower Ganges irrigation canal system in India (figure 1), was constructed in 1877. The Lower Ganges canal system has 440 mi of main and branch canals and 2,700 mi of distributaries (Buckley 1905). A masonry structure, the crest of the Narora weir is 10 ft above the normal low water level of the river and 4,200 ft long (figure 2). The Narora weir is founded on fine micaceous sand described as being almost as fine as flour (Buckley 1905). The left abutment is composed of “light friable soil” of lowland khadir land, and the right bank, the bhangar highland, is formed of strong, red sand and clay. Due to the unavailability of local stone, the Narora weir was constructed of brick rather than stone masonry.

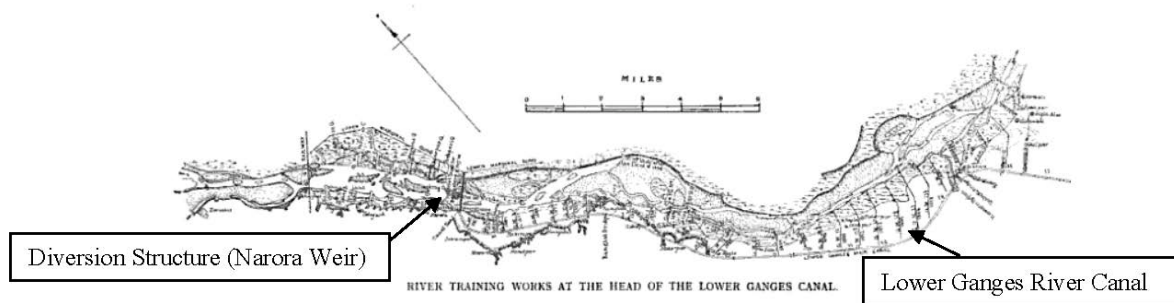

Figure 1.—Diversion of Lower Ganges River for irrigation.

The Narora weir failed the spring of 1898 during a period of high flow. The concrete and stone stilling basin was damaged over a 350-ft-wide section, and failure has been attributed to hydraulic forces related to the high flows (Chanson 2000), but early workers attributed the failure to “piping” (Bligh 1907). Ultimately, the failure of Narora weir was instrumental in the development of early piping theory (Bligh 1910), which eventually led to the understanding that piping and heave are influenced by both the hydraulic head and foundation conditions at a dam.

Prior to the collapse of the Narora weir, failure of the Khanki weir on the Chenab Canal (India) had prompted the Government of India to fund research by Lt. Col. J. Clibborn, Principal of Thomason College. The results of his 1885–86 investigation of the Khanki Weir led to Lt. Col. Clibborn’s prediction of the collapse of Narora weir, which apparently was the first case in which piping was recognized as an engineering concern (Jones 1981). Lt. Col. Clibborn’s study utilized a horizontal tube, 120 ft long with an inner diameter of 2 ft, tightly packed with sand from the Khanki weir site. A 20-ft-tall standpipe was affixed at one end (filled from a cistern on the College roof) to provide hydraulic head to the horizontal pipe. The tail end of the pipe emptied into a sandbox with a 5-ft drop curtain. Piezometric pressures were measured with pressure gages along the length of the tube at 10-ft intervals. The experiments were to determine

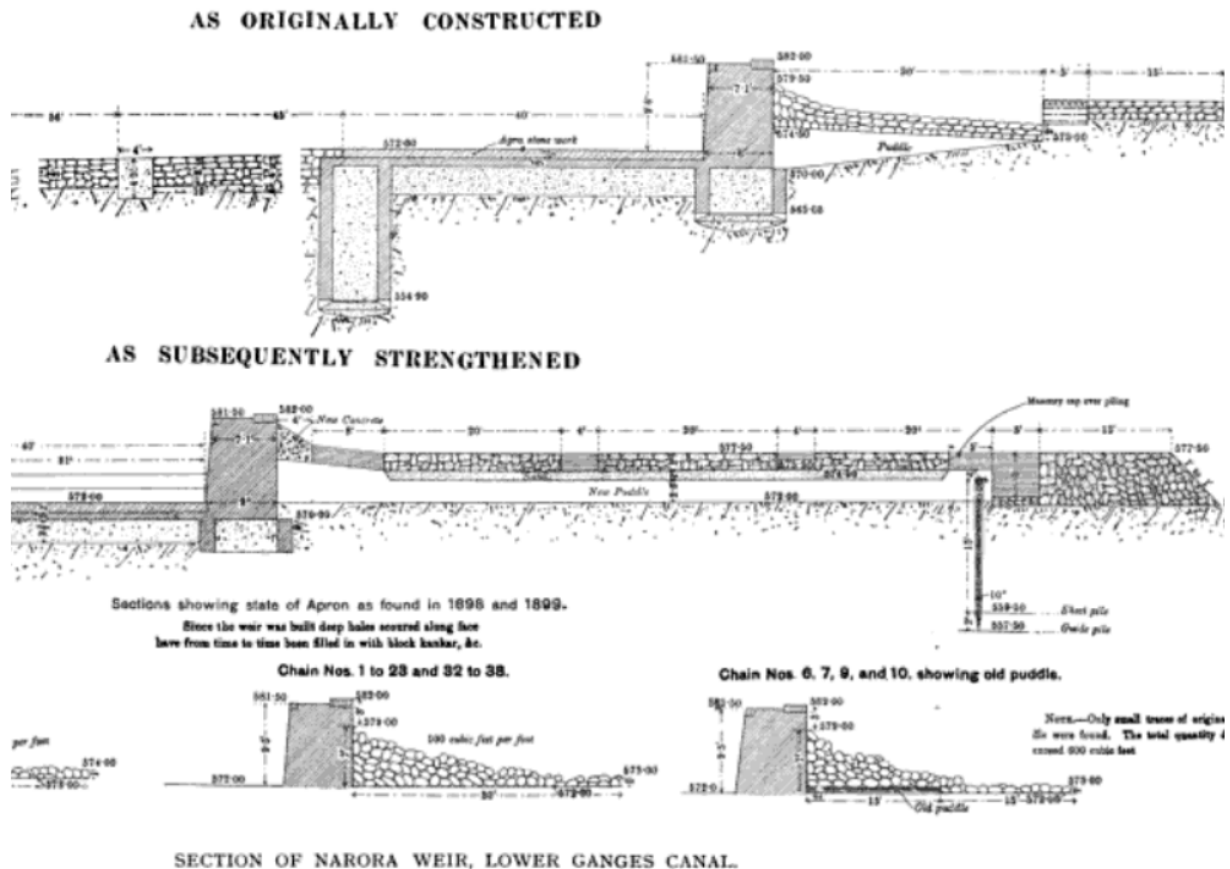

Figure 2.—Pre-failure and repaired sections of Narora weir (Buckley 1905). Note how the seepage path was significantly lengthened in the repaired section and the addition of an upstream, sheet pile cutoff wall.

(1) how the sand influenced hydrostatic pressures at different distances, (2) the quantity of discharge of water through the sand under different heads at different distances, (3) the pressures needed to blow sand through orifices, and (4) the useful effect of curtain walls. As described by Lt. Col. Clibborn:

“When carrying out these experiments, it became evident that intermediate springs in a floor are great aids to the formation of long continuous cavities for currents to act along. As far as could be seen, what happens is that, first the very fine particles are washed out of the main body of sand along the line of least resistance; then the current increasing in force as the intervals between particles get greater owing to this washing of the material, larger particles are moved and carried away until in time the heaviest particles can be moved, and a clear channel is formed for the current of water to work in; this of course leads eventually to a subsidence of the structure or stratum above.”

A number of recommendations came out of Lt. Col. Clibborn's work:

1. When a large work is to be built, an experiment should be conducted on the material forming the foundation to determine the minimum width of floor (apron) that will stand the maximum head of water.
2. The width of the masonry body (dam) and the thickness of the floor (apron) should be 125% over that required to withstand uplift pressures.
3. A perfect curtain (cutoff) should be added of moderate depth.
4. Upstream of the work should be protected by a puddle apron (covered with concrete) at least the same width as the floor (downstream apron), with special care being taken for the joint with the floor. This upstream apron will materially reduce the upward pressure and tendency to sand draw.
5. A loose (not grouted) pitching (gravel/stone) should be provided under the floor (apron).

J.S. Beresford (1902), Chief Engineer, Punjab Irrigation District, was prompted by Lt. Col. Clibborn's experiments to suggest that field tests be performed to assess the actual percolation pressure at the Narora weir on March 27, 1897. The original Narora weir had an unusually short apron section (40 ft). The results from this test are shown on figure 3.

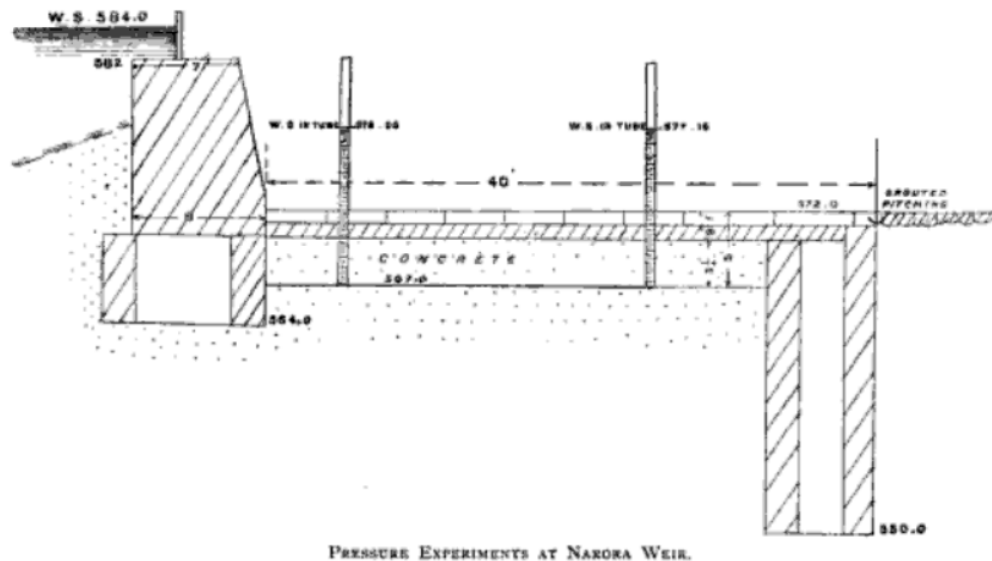

Figure 3.—Results of 1897 pressure tests at Narora weir.

Based on these results, which indicated unacceptable levels of uplift and marginal stability of the apron (and potential for piping as documented by Lt. Col. Clibborn), additional tests were ordered, and possible strengthening of the work or reducing percolation pressures were under

consideration. However, on March 29, 2 days after the above test was conducted, 600 to 700 ft of the apron was “blown up,” and approximately 200 ft of weir was lost (Beresford 1901). The failure did not occur in the same area where the above test was performed; hence, the test holes did not contribute to the failure (Beresford, 1901). As described by Beresford:

“...the failure of the Khanki weir gave great prominence to the subject of percolation water pressure discussed by Colonel Clibborn in his note on the Roorkee experiments of 1896, and some of the valuable practical suggestions contained in that note.”

As later described by Bligh (1910), the gradient under the original Narora weir was 1:11 or steeper. Bligh noted that under this gradient, the work stood for 20 yr, but was always in a state of unstable equilibrium, with the floor most likely in a state of tension. He also observed that shortly before the failure, test borings revealed that the floor was then entirely undermined and was only held up or supported against collapse by the hydrostatic pressure. Bligh proposed that when the spring 1898 flood occurred, first a portion of the apron was washed out, increasing the gradient to 1:9.5, after this the whole floor was blown up. The subsequent repairs to Narora weir increased the percolation factor from 9.5 to 15.7, at which the safety was assured (Bligh 1910). Bligh’s assignment of acceptable percolation factors for fine micaceous sand foundations was cited on the experiences with Narora and the Khanki weirs.

The turn of events described above and early research of Lt. Col. Clibborn led to Bligh (1910) developing acceptable percolation factors using empirical studies based on India’s experience with weirs. Bligh’s percolation factors were later refined with Lane’s (1934) weighted creep rule.

References

- Beresford, J.S. (1902). “Notes on Narora Weir,” Technical paper 97.
- Bligh, W.G. (1907). “The Practical Design of Irrigation Works,” D. Van Nostrand Company, NY. (<http://books.google.com>)
- _____. (1910). “Dams, Barrages and Weirs on Porous Foundations,” Engineering News, American Society of Civil Engineers, Vol. 64, No. 26, pp. 708–710.
- Buckley, R.B. (1905). “The Irrigation Works of India,” Spon & Chamberlain, 123, Liberty Street, NY. (<http://books.google.com>)
- Chanson, H. (2000). “A Review of Accidents and Failures of Stepped Spillways and Weirs,” Proc. Instn. Civ. Engrs. Water and Maritime Engrg., UK, Vol. 142, December, pp. 177–188 (ISSN 0965-0946).
- Jones, J.A.A. (1981). “The Nature of Soil Piping: A Review of Research,” GeoBooks, Cambridge, UK.
- Lane, E.W. (1934). “Security from Under-Seepage – Masonry Dams on Earth Foundations,” Proceedings of ASCE, Vol. 60, No. 7, pp. 929–966.

Case 9 – Balderhead Dam (and other glacial-moraine core dams)

Sherard (1979) observed that sinkholes commonly form in dams constructed of broadly graded soils such as glacial or alluvial materials. The sinkholes were postulated to occur from fine soil particles migrating out of the compacted soil mass, exiting through cracks in the foundation or through filters that were too coarse to retain the eroded fines. He cited a number of case histories to support his hypothesis: Balderhead, Hyttejuvet, Yards Creek Upper Reservoir, Viddalsvatn, Messaure, Seitevare, Bastusel, and Churchill Falls Dykes. Many of the examples cited were constructed from widely graded soils consisting of cobbles down to clay-sized particles and were constructed in areas with glacial borrow materials. Some of the case histories cited by Sherard are described in more detail below in addition to a dam on Brodhead Creek, USA.

Great Britain Dams with Moraine Cores

Balderhead Dam

Balderhead Dam (figure 1) is a 157-ft-high, 3,000-ft-long rolled-earth dam with a 222,000 yd³ boulder-clay core and 2,508,000 yd³ of shale fill forming the shoulders (Kennard et al. 1967). It is located on the River Balder in Tees Valley, in northern England, United Kingdom, and was constructed between 1961 and 1964 and went into service in 1965. The dam is founded on bedrock of the Yoredale sequence consisting mostly of Carboniferous shale with occasional horizontal thin sandstone, limestone, and coal seams. However, areas on the lower slopes of the valley contain boulder-clay glacial drift deposits that were left in place during construction of the dam.



Figure 1.—Aerial view of 3,000-ft-long Balderhead Dam (Google Earth), which was the tallest earthfill dam in England when constructed.

The original design concept was to use compacted shale fill in the shoulders of the dam and use boulder-clay glacial drift in the core, and that over time, the shale fill would disintegrate into clay. A 5-ft-wide filter of crushed limestone was constructed on the downstream side of the clay core to prevent seepage into the shale fill on the downstream side of the dam (figure 2). A concrete cutoff extends into the shale foundation and a short distance into the core along the centerline of the core, with a single-line grout curtain extending below the concrete cutoff.

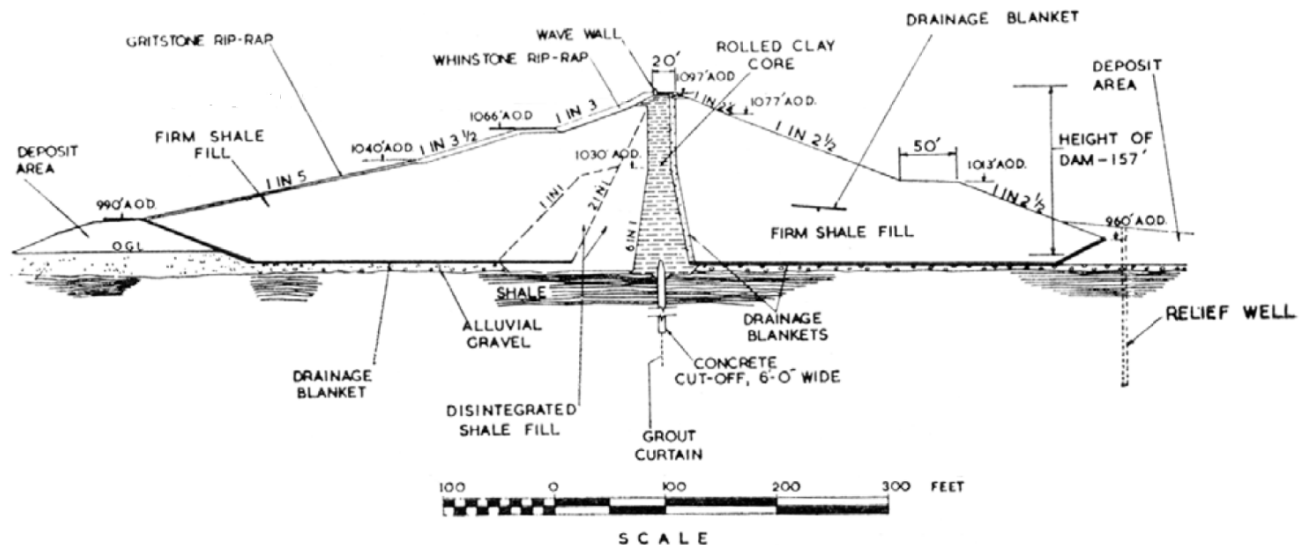

Figure 2.—Section of Balderhead Dam (Kennard et al. 1967).

Extensive testing was performed on the shale borrow material that confirmed satisfactory fill could be obtained using 6-in maximum size material compacted in 9-in layers. It was thought that 95 percent Proctor density could be obtained from the shale material, with compacted density ranging from 130–135 pounds per cubic foot (lb/ft^3). While the constructed shale fill would have a moisture content of 7 percent, the disintegrated shale was projected to have a moisture content of 14% (Kennard et al. 1967). The shale fill was compacted in 8-in lifts with a grid roller to an elevation of 304 m and placed in 31-in lifts and compacted with a vibratory roller on the remainder of the dam. The core material was well-graded material from clay size to 3-ft- diameter boulders. Overall, the core was composed of 20 percent fines less than 0.002 mm. Stones exceeding about 6-in size were culled at either the borrow site or after placement on the dam, and the core material was moistened and compacted in 7-in lifts with a taper-foot roller. However, later excavation of the core during remediation found that the core contained stones up to about a 6-in size, with some being flat boulders with maximum dimensions up to about 2 ft (Vaughn et al. 1970). The filter was designed to have a ratio of three between the 15 percent size of the filter and the 85 percent size of the core based on a 2-cm maximum size in the core; however, due to segregation and variations of the placed materials, this ratio may be as high as six (Vaughn et al. 1970). Important factors in the design are the relatively thin clay core and the difference in mechanical behavior between the clay core and adjacent shale-rock and crushed limestone zones.

The clay core settled more than the shale shoulders, particularly over areas with boulder-clay foundation, and some transverse arching action may have developed within the core due to the differential settlement characteristics of the core and shells of the dam.

As the reservoir was first filled, a small quantity of barely colored water was visible at Balderhead Dam. The reservoir began filling in October 1964, and seepage was measured at approximately 10 L/s in the main underdrain during the first 6 months of filling. The seepage increased to about 25 L/s after the reservoir was filled and held steady at this rate for 6 months. In August 1966, seepage gradually increased to over 50 L/s over a 4-month period. By the end of January 1967, a small depression appeared in the crest above the filter drain at Sta. 286. A second, larger sinkhole (about 3 m wide) appeared at the upstream boundary of the core at Sta. 317 in April 1967. The second sinkhole triggered an order to lower the reservoir, and as the reservoir was being lowered, local crest settlements were observed at Stations 215, 287, 317, 370 and 450. After the appearance of sinkholes, it was determined that eroded fines had entered the downstream filter, which was too coarse to properly filter the core. The piezometers showed no unusual readings during the incident except for two piezometers in the upstream shell, which showed an unusual decrease in piezometric level that corresponded to increases in seepage. Subsurface investigations were subsequently conducted, and a soft, damaged core was found to depths of 18 m between Sta. 316 to Sta. 461. The cross-sectional area of damaged core is shown below on figure 3. The area where horizontal seepage was occurring through the core (elevation 308 to 317) corresponds to an area where the core was placed dry of optimum.

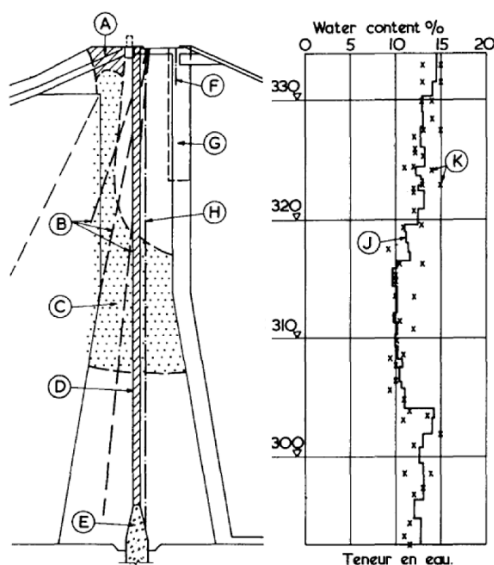

Fig. 3

Section of core at chainage 317 m.

- (A) Depression at crest.
- (B) Raking grout holes.
- (C) Zone of erosion damage.
- (D) Diaphragm wall.
- (E) Concrete cut-off.
- (F) Filter flushing hole.
- (G) Trial pit.
- (H) Grout holes with tubes-à-manchettes.
- (J) Placement water content.
- (K) Proctor optimum water content.

Figure 3.—Area of damaged core, investigations of the large- diameter sinkhole at Sta. 317, and subsequent placement of diaphragm wall and grout holes.

Based on the settlement of the crest as the reservoir was drawn down, and the other evidence, it was determined that cracking was probably assisted by a form of hydraulic fracture due to the increasing reservoir pressure during first filling in combination with localized lowering of confining stresses due to arching action of the differential settlement. This interpretation was based on discussions with Dr. Bjerrum and Mr. Kjaernsli of the Norwegian Geotechnical Institute from similar experience at Hyttejuvet Dam (Kjaernsli and Torblaa 1968). As described by Vaughn et al. (1970):

“The existence of low earth pressures in the Balderhead core may be deduced from the behavior of the piezometers at Ch. 385 during construction. In the lower part of the core, where the pressure cells showed high earth pressures, the construction pore pressures increased at a rate of 50 to 70% of the nominal overburden pressure. In the upper part the rate of increase was 15 to 20%. This difference is greater than can be explained by variations in moisture content, suggesting that the earth pressures in the upper part (where damage was found) were low.”

An extensive concrete cutoff wall was installed by the slurry trench method to address the cracked core. The concrete mix contained 12% Portland cement, 2.5% bentonite, and 85.5% 1.2-cm aggregate with a water to solids ratio of 24%. Since the diaphragm wall was to be constructed with the reservoir 75% full, and the core was soft and damaged, consolidation grouting was performed in the core prior to excavation of the slurry trench. During grouting, the filter zone was continuously flushed and the effluent turbidity monitored (Vaughn et al. 1970). Refilling the reservoir was completed on March 30, 1969. Close monitoring of settlements, pressure cells, strain gages, piezometers, and seepage during refilling did not indicate any significant issues. A complex set of 69 angled piezometers were installed in the upstream shell for long-term monitoring for the reappearance of leakage through the core.

References

- Kennard, M.F., J.L. Knill, and P.R. Vaughn (1967). “The geotechnical properties and behavior of Carboniferous shale at the Balderhead Dam,” *Quarterly Journal of Engineering Geology and Hydrogeology*, Vol. 1, pp. 3–24, DOI 10.1144. <http://qjgeh.lyellcollection.org/content/1/1/3.short>
- Kjaernsli, B. and I. Torblaa (1968). “Leakage through Horizontal Cracks in the Core of Hyttejuvet Dam,” Norwegian Geotechnical Institute, Publication No. 80, 1968.
- Sherard, J.L. (1979). “Sinkholes in dams of coarse, broadly graded soils,” *Commission Internationali Des Grands Barrages, Treizieme Congres des Grands Barrages, New Delhi*, pp. 25–35.
- Vaughan, P.R., D.J. Kluth, M.W. Leonard, and H.H.M. Pradoura (1970). “Cracking and Erosion of the Rolled Clay Core of Balderhead Dam and the Remedial Works Adopted for Its Repair,” *The Transaction of the Tenth International Congress on Large Dams, Montreal, Canada, International Commission on Large Dams, Paris, France, June 1–5, 1970*, pp. 73–93.

Scandinavian Dams with Glacial-moraine Cores

A more recent study of internal erosion incidents at European dams was undertaken by the European Working Group of ICOLD in 2004 (Charles 2004). Although it was found that internal erosion incidents involving sinkholes and turbid leakage are relatively common in Scandinavian dams with moraine cores, it was found that these incidents rarely led to failure. However, several serious incidents were reported to have occurred. The following two case histories are examples of Scandinavian dams constructed with a core of soil borrowed from glacial-moraines (Hyttejuvet Dam) and constructed on top of a glacial moraine (Seitevare Dam).

Hyttejuvet Dam (Norway)

Hyttejuvet Dam, constructed during 1964–65 in Norway, experienced an abrupt increase (from 2 to 63 L/s) in concentrated leakage of turbid water (0.1 gram per liter) during first filling in the summer of 1966 when the reservoir was nearly full (elevation 740). Subsequent investigations found that the leakage was due to hydraulic fracturing of the core (Sherard 1973), which was due to arching in the core and development of a horizontal settlement crack.

The core of the dam is composed of widely graded glacial-moraine material, consisting of gravelly, clayey sand (PI = 6), with a similar gradation as at Balderhead Dam (Sherard 1973). The core was compacted wet of optimum, in 9- to 10-in-thick layers, with a crawler tractor. This resulted in a dry density range between 97 and 103% of standard American Association of State Highway Officials maximum density. A design change was made between the 1964 and 1965 construction season to reduce the thickness of the core due to concerns over measured pore pressures within the core (Sherard 1973).

Narrow central cores are common in Norway; the 305-ft-high Hyttejuvet Dam has a core-to-foundation contact width of only 75 ft, and the core narrows to 13 ft in the uppermost 66 ft (Jansen 1988). The dam has a crest length of about 1,312 ft. Figure 1 is a cross section through Hyttejuvet Dam that shows the various zones that were employed, and figure 2 shows the gradations for Zones 1, 2, and 3.

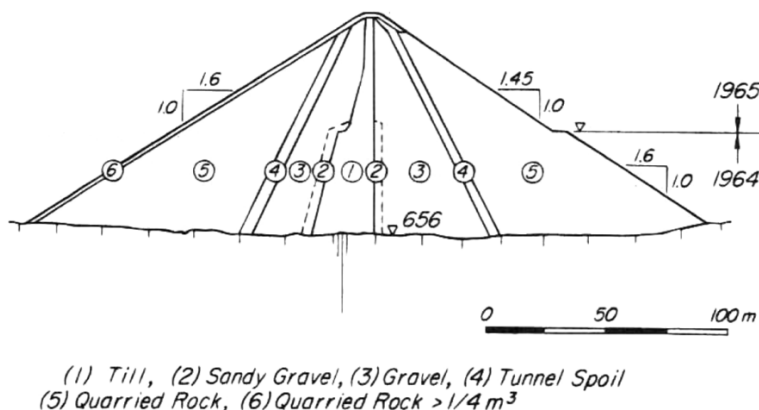

Figure 1.—Cross section of Hyttejuvet Dam. Note sharp transitions in width of Zone 1 from base to top (Terzaghi et al. 1996).

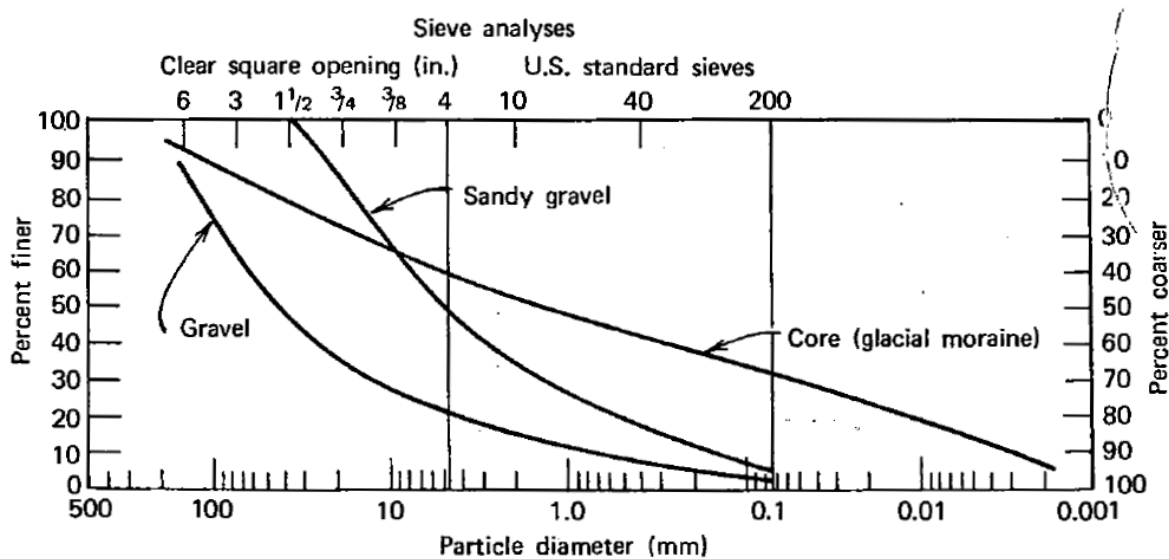

Figure 2.—Gradations for Zones 1, 2, and 3 materials (after Kjaernsli and Torblaa 1968; Sherard 1973).

It has been recognized that narrow zones of compressible material (such as the Zone 1 till in Hyttejuvet Dam) abutting less compressible material (such as the Zone 3 gravels in Hyttejuvet Dam) may lead to development of internal stresses and transverse cracking (Terzaghi et al. 1996). This might especially occur where a sharp transition may occur in the section properties, which could lead to concentrated stresses. For dams with pervious shells as in Hyttejuvet Dam, settlement-stress induced transverse cracking could lead to hydraulic fracturing through the core, especially where the dam experiences high heads and the core is thin. As reported by Sherard (1973), pressure cell measurements in the core of Hyttejuvet Dam measured only 14 tons per square meter (tons/m^2) prior to filling the reservoir versus an expected 40 tons/m^2 based on the expected weight of overburden. Some of the stress must have been transferred to the shoulders through arching. During filling of the reservoir, internal stress within the core only increased to 23 tons/m^2 , still less than the expected overburden pressure. Boring investigations conducted after the incident found a zone of lost circulation within the core, at an elevation between 730 and 740, in the upper portion of the core approximately where the core width transitions to its narrowest.

During the 1960s and 1970s, a number of serious incidents were reported in dams with thin cores: Hyttejuvet, Balderhead, Yards Creek, Matahina, Churchill Falls Dykes, and Viddalsvatn. These incidents involved the appearance of sinkholes with sediment-laden discharges. The subsequent investigations focused on transverse cracks through the cores as the primary problem (American Society of Civil Engineers 1986).

Jansen (1988) noted two lessons learned regarding Hyttejuvet Dam:

1. Care should be exercised to ensure compatibility of settlement in the core and adjacent rockfill zones.
2. A filter zone of closely graded material not prone to segregation during placement should be used.

Foster and Fell (1999) evaluated the performance of the cores of dams by looking at the D15 of the filters and percent fine-medium sand within base soil (see figure 2). They found that the cores of Hyttejuvet and Brodhead Dams fell well above the no-erosion boundary and were consistent with other dams with known poor filter performance. Hyttejuvet and Brodhead Dams were expected to have erosion loss rates of approximately 0.4 gram per square centimeter (g/cm^2) and 0.18 g/cm^2 , respectively (FEMA 2000).

Based on the above studies, the appearance of sinkholes at Hyttejuvet Dam was attributed to hydraulic fracturing and subsequent erosion through the till core (Sherard 1973). The lack of a proper filter resulted in excessive erosion through the core.

References

- American Society of Civil Engineers (ASCE) (1986). “Terzaghi Lectures: 1974–1982,” ASCE Publications, ASCE, pp. 415–416.
- Charles, J.A. (2004). “Internal Erosion in European Embankment Dams,” European Working Group on internal erosion in embankment dams, Building Research Establishment, Garston, Watford, United Kingdom.
- Federal Emergency Management Agency (FEMA) (2000). “The National Dam Safety Program – Research Needs Workshop: Seepage through Embankment Dams,” FEMA. <http://www.fema.gov/library>
- Foster, M.A. and R. Fell (1999). “Assessing embankment dam filters that do not satisfy design criteria.” UNICIV Report No. R-376, University of New South Wales, Sydney, Australia.
- Jansen, R.B. (1988). “Advanced Dam Engineering for Design, Construction, and Rehabilitation,” Springer.
- Sherard, J.L. (1973). “Embankment Dam Cracking,” in Embankment Dam Engineering, Hirschfeld and Poulos (eds.). John Wiley & Sons, New York, NY, pp. 271–353.
- Terzaghi, K., R.B. Peck, and G. Mesri (1996). Soil Mechanics in Engineering Practice. 3rd Edition, John Wiley & Sons, New York.

Seitevare (Sweden)

Seitevare Dam, located in northern Sweden, impounds water for the Seitevare Power Plant (figure 1) in the highest reaches of the river Lilla Lule älv. The dam is 1,450 m long with a maximum height of 106 m. At the time the dam was constructed (late 1960s), it was becoming common practice in Sweden to construct new embankment dams with a curved form in plan view (Nilsson 1967); hence, Seitevare has a horizontal radius of 2,000 m. The right abutment is located on pervious glacial deposits. A 540-m-long, 10-m-high saddle dike is close to the right terminus of the main dam. The dam impounds 1,750 million m³ over an area of 82 square km at maximum pool.



Figure 1.—The Seitevare Dam consists of a powerhouse, overflow spillway, main dam, and saddle dike. The right abutment was constructed on a glacial moraine.

Seitevare Dam is a zoned earth and rockfill dam (figure 2). The foundation bedrock is granite that has an 8-m-wide fractured zone aligned with the valley axis that required grouting. The grout curtain is a three-row curtain with two rows to depths of 6 and one to 15 m. The pressure grouting program was designed after foundation pressure testing and was designed to treat the fracture zone passing beneath the dam. It was determined that general slush grouting of the foundation was not needed. The powerhouse became operational in 1967.

Dam construction practice in Sweden at the time Seitevare Dam was constructed utilized available materials for the cores of the dam to keep costs low (Nilsson 1967). Glacial-moraine materials, sometimes mixed with other sources of material to achieve low permeability, were used in the cores of many dams. Cores were typically constructed in lifts of 60–70 cm, with a maximum allowed particle size of up to 2/3 the height of the lift, and compacted with vibratory rollers if dry and with four to six passes of D6 tractors when wet. Similar procedures were followed for placement of filter zones. Construction of rockfill dams was often completed under winter conditions. The rockfill was not dumped, rather it was placed in 1- to 2-m-thick

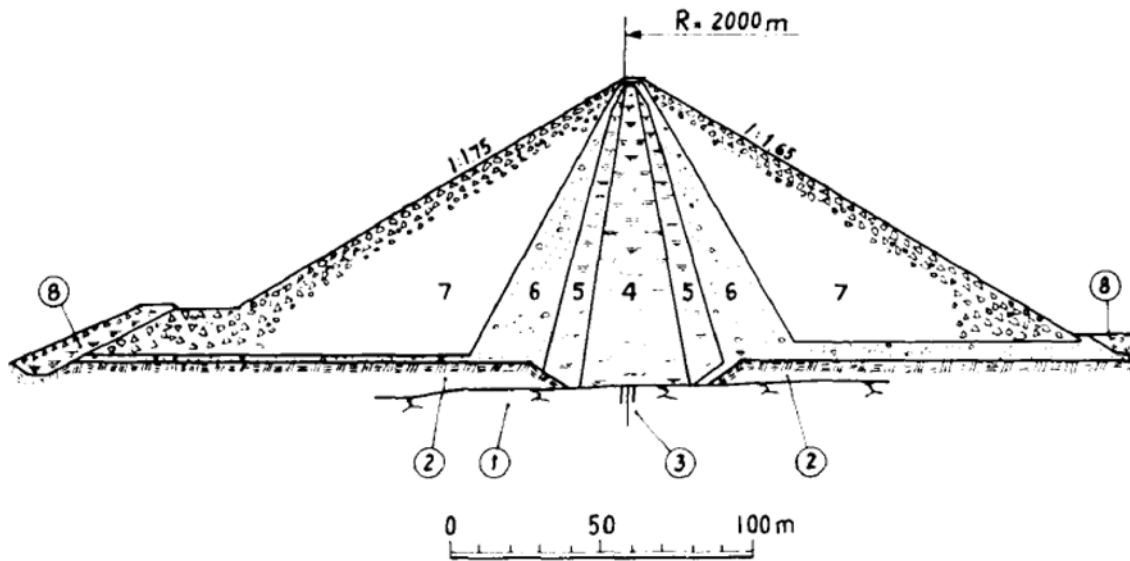

Fig. 4
Cross-section of the Seitevare dam.

- | | |
|----------------------------|--------------------------|
| (1) Rock. | (5) Transition material. |
| (2) Pervious earth. | (6) Filters. |
| (3) Grout curtain. | (7) Rock fill. |
| (4) Impervious earth core. | (8) Cofferdam. |

Figure 2.—Seitevare Dam is a zoned earth and rockfill embankment founded on bedrock and soil (Nilsson 1967). The toe berm was designed with a height of 0.2 times the dam height.

lifts, flushed with water, and compacted. Using these methods, vertical settlements on the order of 0.1% of the dam height were observed in the cores of dams, and for rockfill up to 0.3%, after 5 yr of service (Nilsson 1967). Hence, for Seitevare settlement on the order of 0.106 m (≈ 4.1 in) would be typical for the core, and up to 0.318 m (≈ 12 in) might be expected for the rockfill shells.

In the riverbed and for a length of 450 m into the right abutment, foundation preparation consisted of removal of overburden to bedrock where the height of the dam was more than 20 m. Natural, glacial-moraine and sediment deposits were left in place from about Sta. 2+050 to the end of the embankment (Bernell and Scherman 1970). The Swedish State Power Board was constructing many dams in mountainous areas at the time and had found that construction of dams on homogeneous moraine deposits was possible without any special treatments. If seepage developed through the foundation materials, it was more cost effective to make repairs than to incorporate significant seepage cutoff features into the original design. Their experience showed that it was rare that significant seepage problems developed in the moraine deposits. Seitevare Dam was one of the exceptional cases, where pervious gravel layers, located within the moraine deposits, concentrated seepage through the foundation.

Several months after the dam was constructed and put into service, concentrated leakage (springs) appeared beyond the toe of the dam over a length of about 50 m, close to Sta. 2+050. This was in the area where the dam was constructed on top of the native moraine materials and where the rock foundation had been grouted. Investigations determined that the excessive seepage was due to the presence of a highly pervious zone of “eroded” gravels near the bedrock contact (figure 3), with possible communication to highly fractured bedrock. Additional grouting was performed (figure 4).

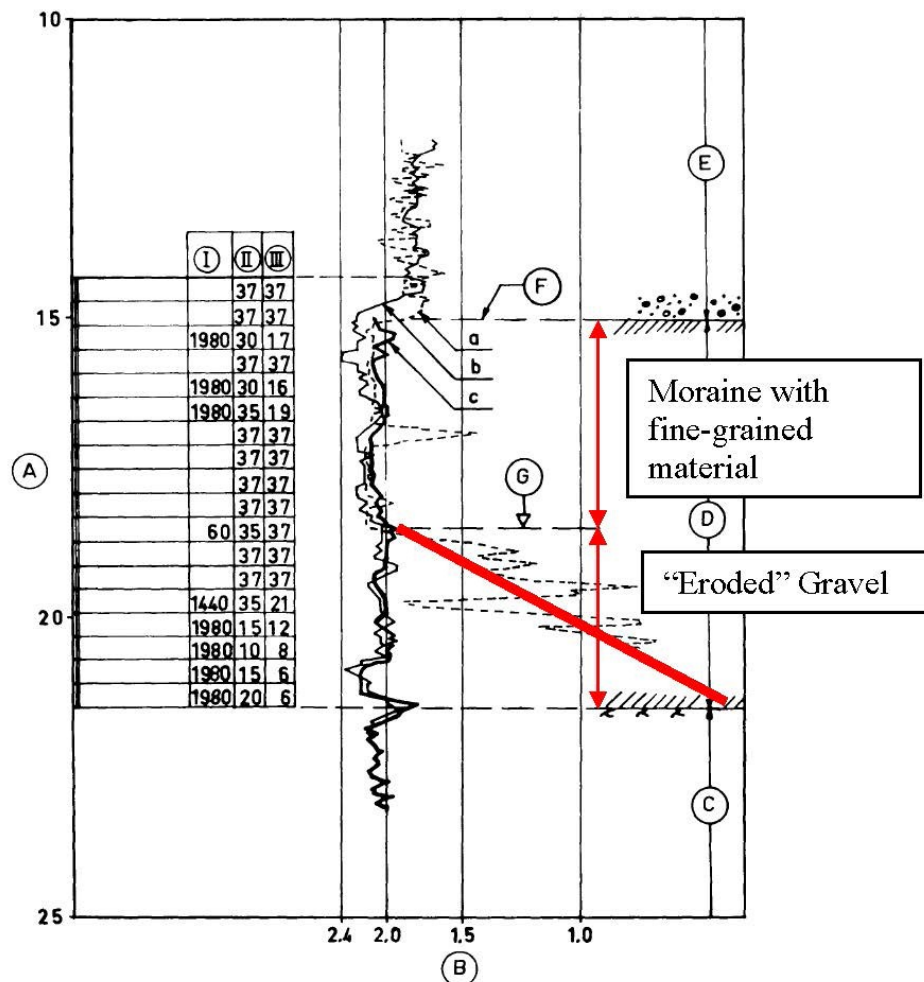

- (a) Initial Nuclear-Density Log (prior to grouting)
- (b) Nuclear-Density Log after first stage grouting
- (c) Nuclear-Density Log after second-stage grouting
- (E) Dam Fill (filter zone)
- (D) Glacial Sediments
- (C) Bedrock

Figure 3.—Nuclear-density log of grout hole at Sta. 2+117. Red line shows fining-upward “eroded” basal gravel deposit (modified from Bernell and Scherman 1970). For the soil grouting, total grout-take [liters] is shown in column I, initial grout pressure [kilograms per square centimeter] is shown in column II, and final grout pressure is shown in column III. Rock grouting not shown.

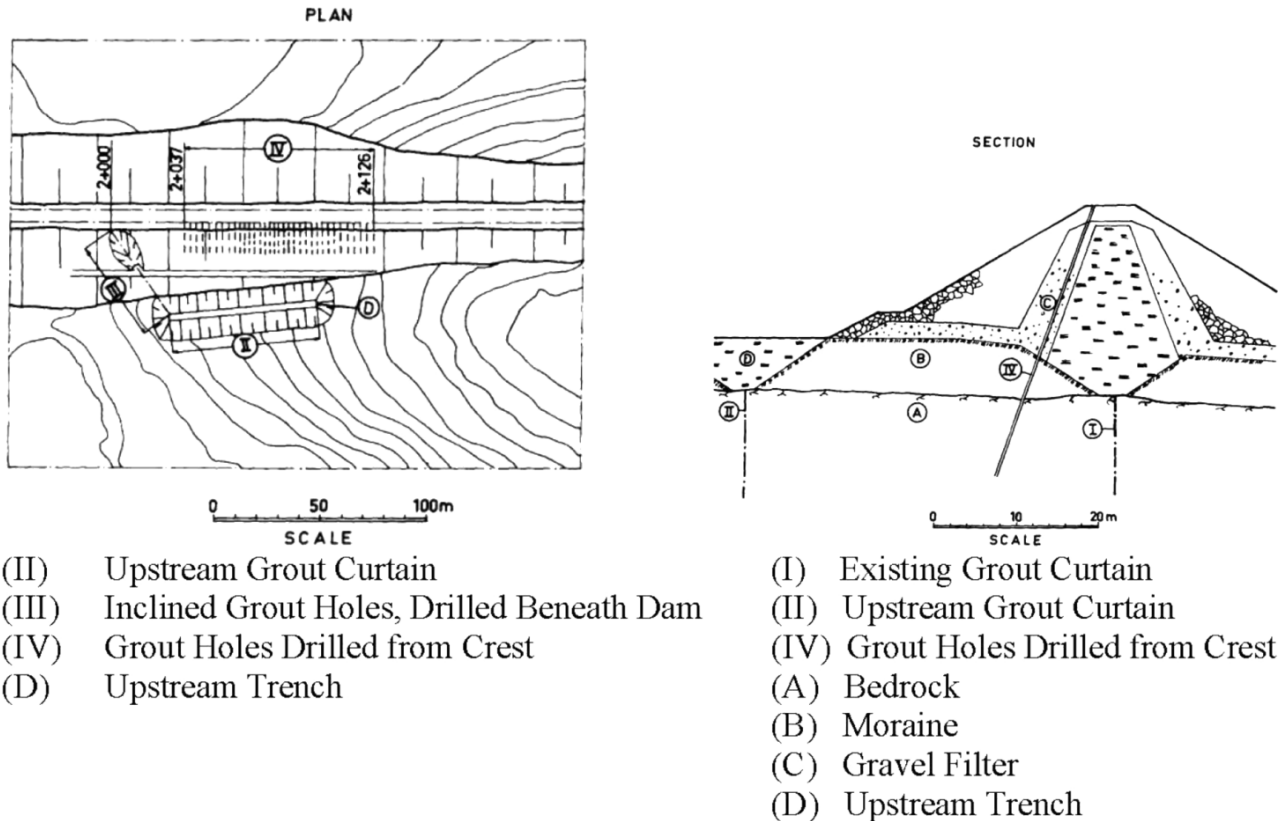

Figure 4.—Plan and section of remedial grouting (Bernell and Scherman 1970).

In the upstream trench, the grout holes extended 15 m into the foundation and were spaced 3 m apart. A second phase of grouting was performed from the crest of the dam, between Sta. 2+037 and Sta. 2+126, to reduce the permeability of the pervious, basal sediments and to seal fractures deeper in the bedrock. The second phase required separate grout holes for the bedrock grouting and for grouting the basal-gravel deposits. Special care was taken during grouting not to damage the existing embankment (Bernell and Scherman 1970).

During a risk analysis (Bartsch and Gustafsson 2000), all PFMs were reconsidered, given the performance history of the dam and known conditions, and only three possible failure scenarios were found plausible: (1) overtopping during high floods, (2) wave erosion during periods of high reservoir and high winds, and (3) internal erosion during water levels near or above the maximum water level. Leakage and internal erosion were ultimately determined to contribute the least to the overall project risk.

References

- Bartsch, M. and A. Gustafsson (2000). "Risk Analysis of the Seitevare Rockfill Dam," Twentieth International Congress on Large Dams, September 19–22, 2000, Beijing, China, International Commission on Large Dams, Paris, France, pp. 607–624.
- Bernell, L. and K.A. Scherman (1970). "Application of Nuclear Testing to Quality Control of Grouting Procedures," Tenth International Congress on Large Dams, June 1–5, 1970, Montreal, Canada, International Commission on Large Dams, Paris, France, pp. 1–15.
- Nilsson, T. (1967). "Swedish National Committee on Large Dams," Ninth International Congress on Large Dams, September 4–8, 1967, Istanbul, Turkey, International Commission on Large Dams, Paris, France, pp. 811–830.

United States Dams with Moraine Cores

Brodhead Creek Watershed Project (Pennsylvania)

U.S. Soil Conservation Service (now the NRCS) Dam PA 463 (also known as the Leavitt Branch Dam or Brodhead Dam) is located near Canadensis, Monroe County, Pennsylvania. It impounds floodwaters of the Leavitt Branch of Brodhead Creek and was constructed in 1976. The dam is about 850 ft long and 88 ft high with a crest width of 26 ft (figure 1). Talbot (1986) cites Brodhead Dam as a case history that demonstrates problems that may be encountered when broadly graded soils have been used to construct earth dams. The issue is related to internally unstable soil, acting in concert with embankment cracking, leading to preferential erosion of the fine portion of the soil (suffusion). Filters were commonly designed for the total gradation of these widely or gap-graded soils and, therefore, may not be capable of filtering the finer, mobile-fraction of the soil.



Figure 1.—Brodhead Dam, on a tributary to Brodhead Creek, Pennsylvania (Google Earth, 2013).

Brodhead Dam was constructed from broadly graded, non-plastic, silty sand with gravel, cobbles, and boulders on a shale and silty-shale bedrock foundation. It was to be divided into Zone 1 and Zone 2 fill. The embankment was to be a homogeneous embankment, composed predominantly of Zone 1 sandy silt, prepared by raking and removal of cobbles and boulders (which were used as Zone 2 slope protection on the upstream slope). The dam has an internal drainage system consisting of drainage fill placed on the downstream slope of the cutoff trench excavation. A trench drain was placed two-thirds the distance from the centerline to the downstream toe, and a blanket drain was constructed under a portion of the dam in contact with the abutment (National Dam Inspection Program 1979). Seepage from the drains is directed through three pipes to the downstream toe.

In the spring of 1984, while SCS studies had progressed to testing broadly graded soils, “selective” internal piping was discovered in Brodhead Dam (Talbot 1986). A high, floodwater storage event had occurred on April 18, 1984. On May 4, 1984, a 12-ft-diameter sinkhole was

observed at Sta. 4+13 on the downstream side of the embankment about 160 ft downstream from the centerline. During the investigation, it was found that the embankment fill was internally unstable with fines and fine sands suffusing out of the embankment, leaving coarse sand and gravel behind. Water entering the fill from the steep, jointed, and fractured bedrock in the left abutment was thought to have caused the internal erosion. The October 17, 1978, Phase I Inspection of the dam for the USACE suggested the dam had a design deficiency in the filter drainage system, with fines being observed exiting the ends of the drainpipes. The filter requirements for the project were designed using SCS criteria in effect at the time (Soil Mechanics Note No. 1, dated May 1, 1968). Figure 2 (Talbot 1986) shows the relevant gradations. The SCS design criteria required the filter be designed using a gradation curve for base material finer than 1 in (SCS 1984).

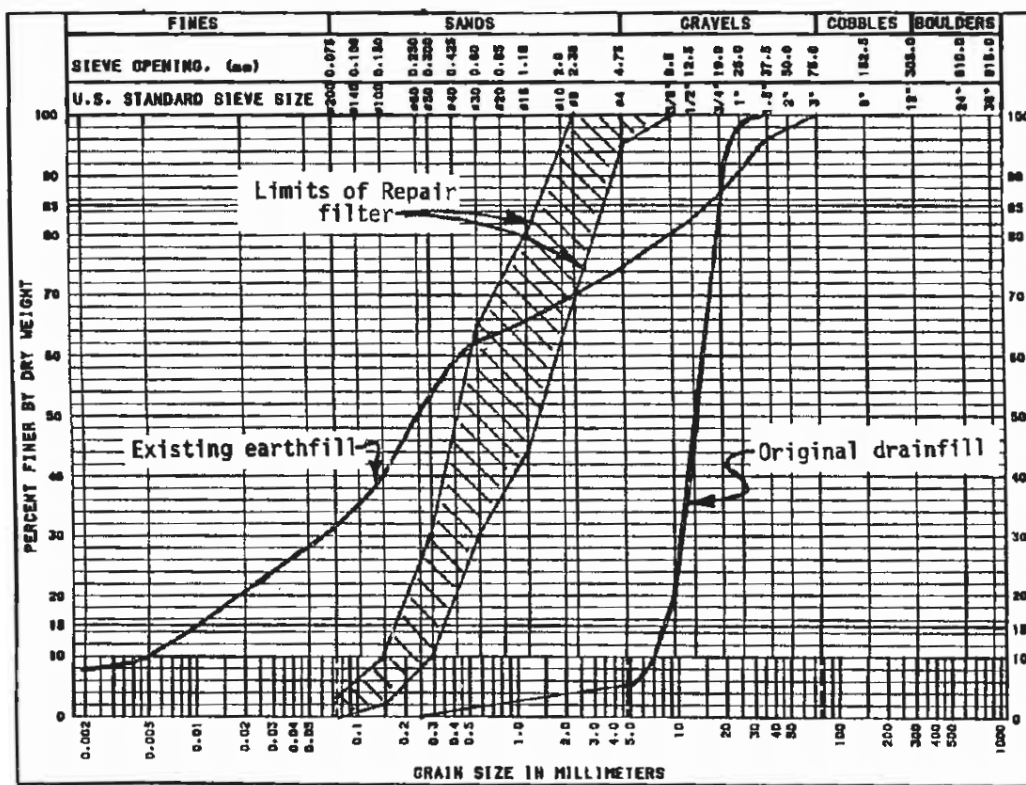

Figure 2.—Brodhead Dam grain size distribution curves for earthfill, original drainfill, and repair filter.

Subsequent back-hoe investigations found “tunnel-like” voids extending toward the centerline of the dam. Other sinkholes and tunnels were found during further excavation, with the largest void 7 ft in diameter and 28.5 ft deep. The sinkholes were located near the steep left abutment, and it was confirmed that they formed from migration of fine soil into inadequately filtered drainage fill of the blanket drain and drain within the cutoff trench (figure 3). The blanket drain in this area consisted of gravel located on bedrock from the abutment contour elevation of 1180 ft to about 20 ft downstream from the centerline of the dam and extending downstream 210 ft to a 12-in drainpipe at Sta. 5+25.

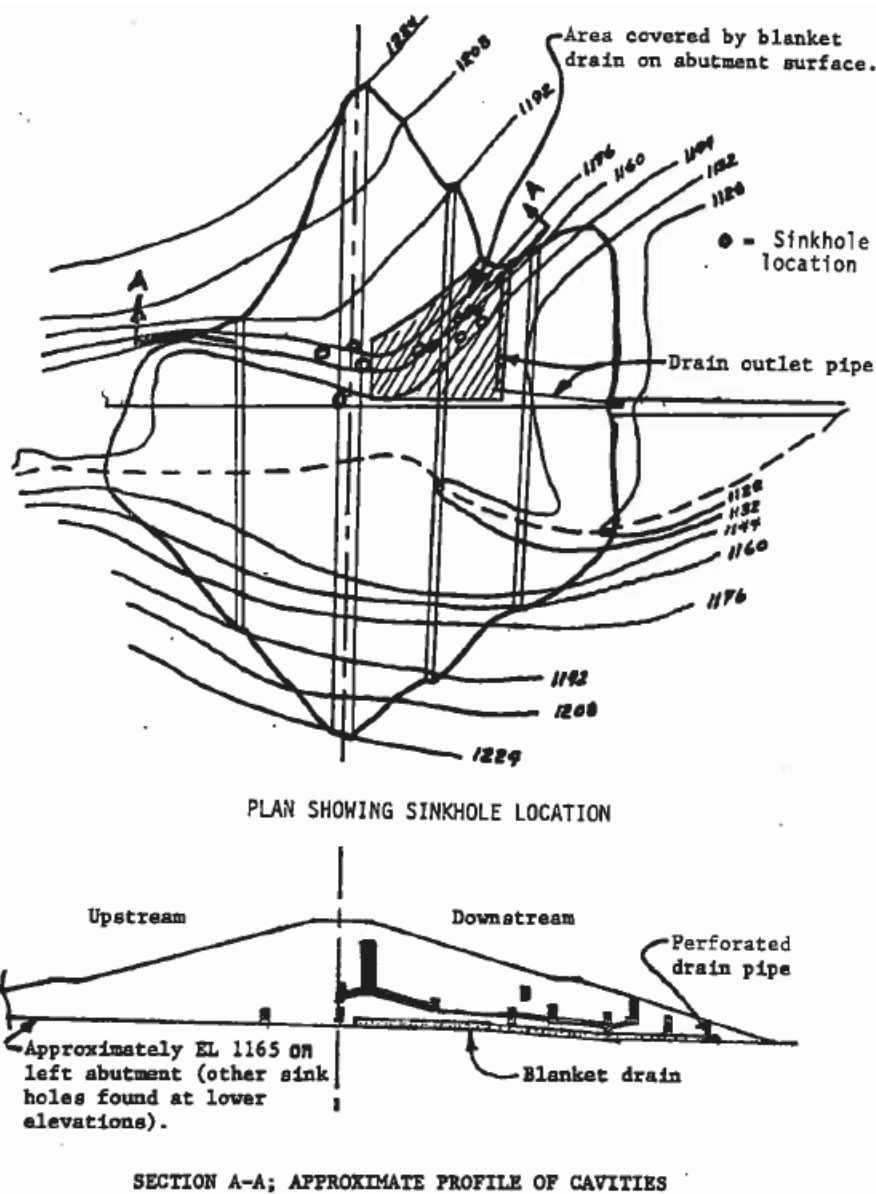

Figure 3.—Plan and section views of sinkhole occurrence in Brodhead Dam (Talbot 1986).

Based on the above information, it was concluded that voids and open gravel and cobble zones were created in the embankment from the washing of fines and fine sand from the soil mass. The fines and fine sands were deposited in the drainage fill materials, and some of the fines may have washed through drains and discharged into the downstream channel. The cavities were enlarged upward by caving of the ceiling (currently this is termed stoping). The following factors were considered to contribute to the problem:

1. An embankment was constructed with broadly graded material consisting of 30% fines, 50% sand, and 20% gravel with approximately up to 15–20% cobbles and boulders.
2. The steep left abutment may produce differential settlement and possible tension cracks within the embankment fill.
3. Rapid filling of the reservoir may have created optimum conditions for hydraulic fracturing of the embankment.
4. Jointed and fractured bedrock in the left abutment may have resulted in a short path through the embankment to the drains.
5. The dam contains a filter with large enough voids to permit fines and fine sand to pipe into it.
6. Soil Mechanics Note 1, issued May 1, 1968, does not adequately address broadly graded soils.

Note that for gap-graded materials, prone to internal instability, the design of the filter should have been based on the mobile fraction of the base material rather than the total fraction. Had the filter design taken into account the internal stability of the base soil, the incident may have been avoided.

Recommended repairs consisted of the following:

1. Treat the steep, left rock abutment to reduce potential for seepage through the rock and reduce the rock slope to 1:1 or flatter. Abrupt changes in slope should be avoided. Dental grout should be used to fill any overhanging or vertical rock faces, open joints, and fractures.
2. Eliminate the potential for piping of fines and fine sand by either removing the drainage fill or protecting it with a properly design filter.
3. Rebuild the embankment to its original specifications but use revised zoning and fill placement requirements.
4. Install a chimney drain across the entire valley from the foundation to within 2–3 ft of the top of the dam. Filter gradation should conform to Sherard's 1979 paper, "Sinkholes in Dams of Coarse, Broadly Graded Soils."

As reported by Talbot (1986), the result of the SCS studies on filters, and experiences using broadly graded soil, caused the criteria for the design of filters to be modified as recommended in Sherard and Dunnigan (1985). Also, the SCS began placing more emphasis on the use of filters in dams where there is a potential for cracking and included the use of diaphragm filters around conduits and other structures. The diaphragm filters were to replace the use of traditional antiseep collars.

References

- National Dam Inspection Program (NDIP) (1979). National Dam Inspection Program, Soil Conservation Service, Project Abstract, Accession Number: ADA072900, <http://oai.dtic.mil>
- Sherard, J.L. (1979). “Sinkholes in Dams of Coarse Broadly Graded Soils,” 13th ICOLD Congress, India, Vol. II, pp. 25–35.
- Sherard, J.L. and L.P. Dunnigan (1985). “Filters and Leakage Control in Embankment Dams,” in Seepage and Leakage from Dams and Impoundments, Proceedings of a Geotechnical Engineering Division Symposium in Denver, Colorado, May 5, 1985, R.L. Volpe and W.E. Kelly (eds.), American Society of Civil Engineers, New York, NY, pp. 1–30.
- Soil Conservation Service (SCS) (1984). “Engineering Report, Brodhead Creek Watershed Project - August 7, 1984,” U.S. Department of Agriculture, Soil Conservation Service.
- Talbot, J.R. (1986). “Filter Failure in an Embankment Constructed of Broadly Graded Soil: SCS Experience,” SCS Internal Report, April 1986 (SCS report adapted from: Talbot, J.R. and D.C. Ralston, Earth Dam Seepage Control, SCS Experience, in Seepage and Leakage from Dams and Impoundments, R.L. Volpe and W.E. Kelly (eds.), American Society of Civil Engineers, 1985, pp. 44–65.

Case 10 - Wolf Creek Dam and Mississinewa Dam

Wolf Creek Dam¹

Background

In 1968, approximately 17 year after first being impounded, wet areas, muddy flows in the tailrace, and sinkholes in the downstream toe of the embankment signaled serious foundation seepage problems at Wolf Creek Dam. The Nashville District of the USACE began an emergency investigation, instrumentation, and grouting program that were generally credited with saving the dam. Data generated revealed an extensive interconnected network of solution features in the limestone foundation and inadequate foundation treatment measures taken during construction.

It was decided grouting alone could not be relied upon as a long-term solution in such geology. Thus, from 1975 through 1979, a concrete cutoff wall was installed through the embankment and into the rock foundation. Since that time, the project has been closely monitored. Based on instrumentation readings, investigations, and visual observations, it became apparent seepage had found new pathways through features left untreated by the first wall. The Nashville District is installing a new wall upstream of the existing wall to a greater depth and lateral extent to cut off remaining seepage paths.

Location

Wolf Creek Dam is located at Mile 460.9 of the Cumberland River in south central Kentucky near Jamestown as shown on figure 1.

Project Purpose

Wolf Creek Dam and Lake Cumberland, which it impounds, provide flood control, navigation, hydropower, recreation, water supply, and water quality benefits for the basin.

General Description of Project Features

Wolf Creek Dam is a combination concrete gravity and earthfill structure. The 1,796-ft-long concrete section ties into the left abutment and extends across the old river channel toward the right abutment. It has a maximum height of 258 ft above founding level. The concrete dam contains a control section constructed in the old river channel, a powerhouse to the right of that, and non-overflow sections on either end. The control section contains a spillway with ten 50- by 37-ft Tainter gates and six four- by six-ft low-level sluices. The powerhouse contains six

¹ Reprinted with permission from International Commission on Large Dams.

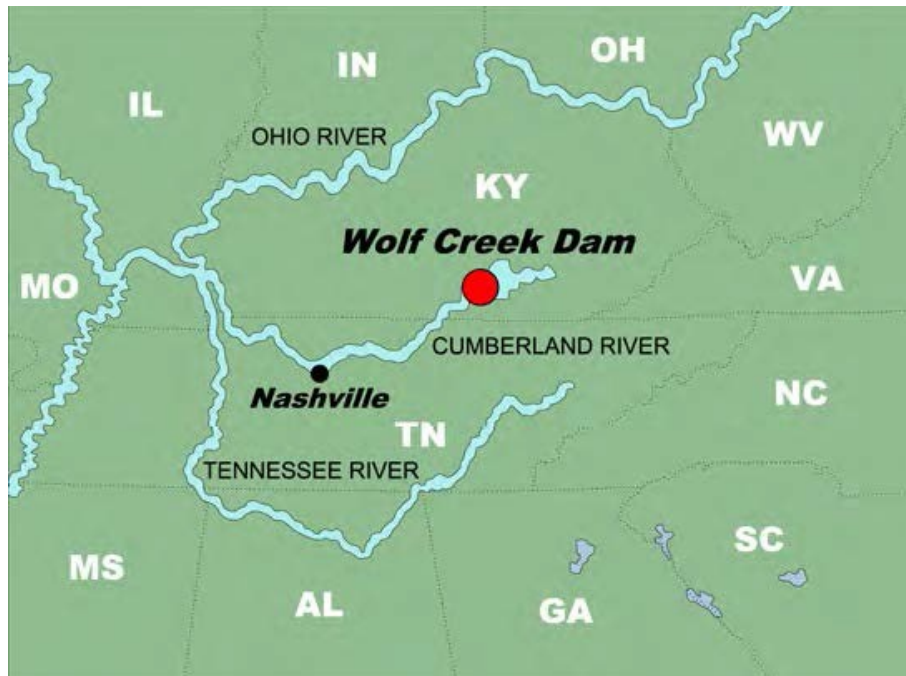

Figure 1.—Location map.

turbines rated at 45,000 kW each. From the end of the concrete gravity section, a non-zoned compacted clay embankment with a maximum height of 215 ft above top of rock extends 3,940 ft across the valley to the right abutment. U.S. Highway 127 traverses the dam. There are limited outlets (six penstocks and six sluices) for emergency drawdown of the reservoir. An overview of the dam is shown on figure 2.



Figure 2.—Overall view of the dam showing extent of the existing and new cutoff walls.

The project normally stores approximately 4 million acre-ft of water with up to 6 million acre-ft of water at its maximum storage.

Embankment

The embankment, which is the focus of the rehabilitation, wraps around the right non-overflow section of the concrete portion of the dam and extends 3,940 ft across the valley floor to tie into the right abutment. Except for random fill in the upstream and downstream toe, the embankment is composed of fairly homogenous, well-compacted, low-plasticity clay that has performed well. However, several design and construction deficiencies as they relate to foundation seepage have led to the serious problems at the project. Neither the original subsurface investigations nor the interpretation of the data were sufficient to identify the extent of the solution features or their impacts on performance. The techniques used for treating the features lacked permanence.

With the exception of the seepage cutoff trench, there was no foundation treatment beneath the embankment in the original construction. Except for the area over the cutoff trench and the tie-in to the masonry section, the embankment was constructed over alluvial soils, which vary in thickness from a few feet to 40 ft. This prevented inspection of the majority of the rock and required the alluvium to function as part of the embankment. In addition, the alluvium contains sand and gravel layers and lenses that are more easily eroded and have higher permeability. A 2-ft-thick drainage blanket was placed over the alluvium to collect and remove water as the material was consolidated by the embankment loading. This construction predated formal filter criteria.

The seepage cutoff trench was designed along the upstream toe of the embankment. During construction of the trench, a solution feature was intercepted running generally along the planned trench alignment, and the decision was made to use the existing solution feature as the trench as shown on figure 3. This feature, and thus the trench, turned and tied back into the masonry portion of the dam at the juncture of end monolith 37 and the embankment.

The trench was of inadequate depth and width (10 ft at the bottom) to prevent seepage, and the fill was poorly compacted. Several large caves and numerous other solution features of varying size intercepted the trench at generally right angles. The sidewalls of the trench were not shot smooth or laid back to allow for tight contact between the fill and rock. Placement and compaction, often by hand, were therefore attempted on rough, vertical walls; in solution features; and under rock overhangs. Obtaining tight compaction and impervious fill against the sidewalls and in intercepting solution features was not considered important. The trench is so narrow and steep sided that bridging of the embankment is very likely.

The trench steps down in several vertical steps, or benches, which were left in place, as it moves from the right abutment to its tie-in at monolith 37. These hard steps are potential locations of differential settlement in the trench fill that could cause cracking in the fill. Typically, these steps also coincided with solution features crossing the trench. Thus, concentrated flow in solution features may occur at cracks in the trench fill, which provide an avenue for through seepage.



Figure 3.—View of solution feature in cutoff trench excavation.

Site Geology

The Cumberland Valley in the dam site area is a broad, deep entrenchment cut in nearly level argillaceous limestones and shales of Ordovician, Devonian, and Mississippian age. Although no faulting is present at the site, relatively close-centered jointing is prevalent and follows two well-defined joint sets. Solutioning along these near vertical joints of the limestone has occurred over millions of years. Water infiltration along these vertical features has exacerbated the solutioning activity along bedding features as well. The exploration programs and foundation preparation for the masonry dam and core trench revealed a rock foundation riddled with solutioned features ranging in size from a few inches to 40 ft in vertical dimension along the joints. The interconnected nature of the karst system has been well documented by the foundation preparation during construction through the various exploration programs, pool responsive piezometers, and wet areas downstream from the dam. These open features within the rock mass have been variably filled or partially filled with residual and alluvial deposits of sands, silts, and clays.

Post-construction Performance

The project was operated with few visible distress signs until 1967. This period was prior to the current dam safety program and before any performance monitoring instrumentation was installed in the dam.

Right Downstream Wet Areas

The earliest anomalies observed were wet areas near the downstream toe toward the right abutment. First identified in 1962, these areas became too wet to mow by 1967. In 1967, a small sinkhole was found near the embankment toe in the general vicinity of the wet areas. It was dug out to a depth of approximately 7 ft without encountering rock and was backfilled with crushed rock.

Muddy Flows and Sinkholes

Muddy flows were observed in the river approximately 150 ft downstream from the powerhouse on October 7, 1967. In March and April 1968, two sinkholes developed near the downstream toe above the switchyard in the wraparound area. The sinkholes developed to a maximum size of approximately 13 ft in diameter and extended to top of rock approximately 40 ft below the surface. The second sinkhole was approximately 26 ft upslope of the first sinkhole.

Seepage Modifications

Initial Barrier Wall

Responding to the near dam failure in 1968, the district embarked on an emergency exploration and grouting program from 1968 to 1970. Because grouting through the clay-filled features was not considered a permanent fix in this type of geology, it was concluded a concrete wall was needed for the long-term reliability of the embankment and foundation. Two walls were recommended and subsequently installed between 1975 and 1979. One was located downstream between the switchyard and tailrace to protect the switchyard foundation from eroding as a result of the tailwater surging during power generation. This wall has performed this purpose well. The second wall was located at the crest of the embankment along the dam axis. The performance of this wall is the concern, as seepage around, under, and through the wall is occurring.

The bottom of the wall varied in its termination depth and was only carried approximately two-thirds of the distance toward the right abutment, both of which contributed to the problems experienced today. The wall extended toward the right abutment to Sta. 57+50. This left the remainder of the dam from Sta. 57+50 to Sta. 74+00 treated only with grout. Regarding the depth, there are areas in which the wall extended only slightly below major solution features.

Post-wall Performance

Since completion of the wall in 1979, the district has been monitoring various indicators of performance. A variety of instrumentation has been installed over the years. In addition, observation of physical manifestations of the foundation seepage problems in the embankment and downstream areas is done routinely. Subsurface investigations and other indicators of distress confirm features still exist that have not been cut off. Over time, seepage has found these new paths under and around the ends of the wall and is once again increasing.

Current Barrier Wall Construction

The Nashville District conducted an extensive major rehabilitation evaluation study that resulted in the selection of a new concrete barrier cutoff wall. This new wall starts immediately upstream of the right-most concrete monoliths and runs the length of the embankment into the right abutment for a total length of approximately 4,200 ft. It is being constructed to a depth that is deeper than the deepest sections of the original wall and as much as 75 ft deeper than the majority of the original wall. The location of the barrier wall is shown on figure 2. The wall profile and cross section are shown on figures 4 and 5. The founding depth will be well below the zone of solutioning. With a minimum 2-ft thickness, a depth extending up to 275 ft, and a total surface area of the face of approximately 980,000 square feet (ft²), the Wolf Creek barrier wall is unlike any other previously constructed around the world and represents a milestone in barrier wall construction.

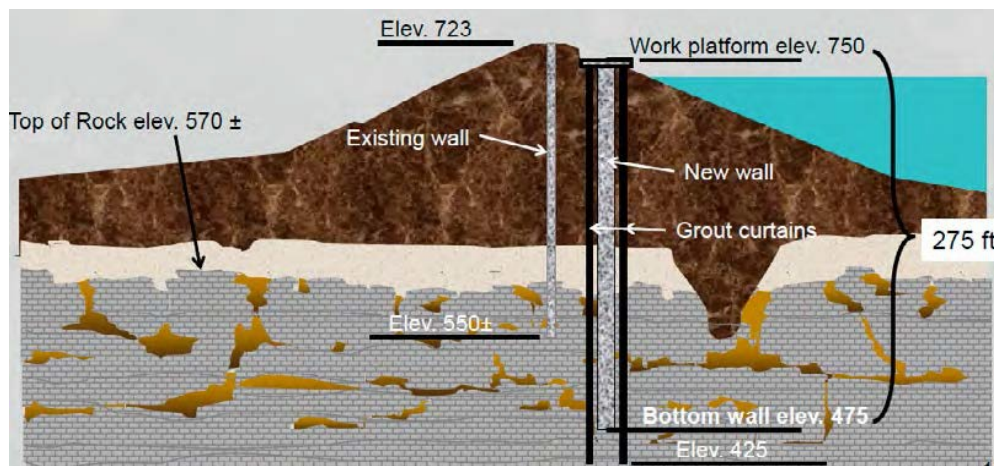

Figure 4.—Embankment cross section with barrier wall.

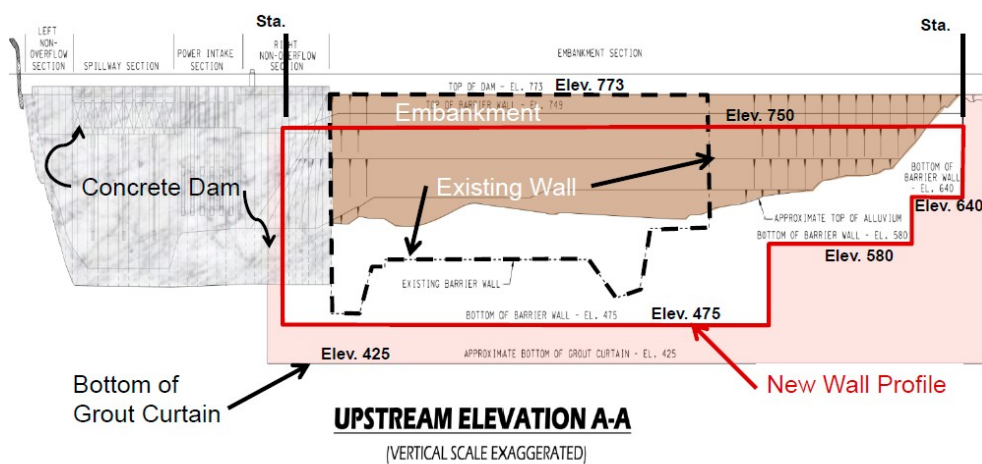

Figure 5.—Profile of barrier wall.

The new wall is being installed from a work platform constructed on the upstream face of the dam as shown on figures 6 and 7. The top elevation of the platform is 750 ft, and the design depth of the wall is to elevation 475 ft, making a total depth of wall in embankment and foundation rock of 275 ft. As much as 110 ft of that length is in the limestone foundation.



Figure 6.—View of working platform on upstream slope.

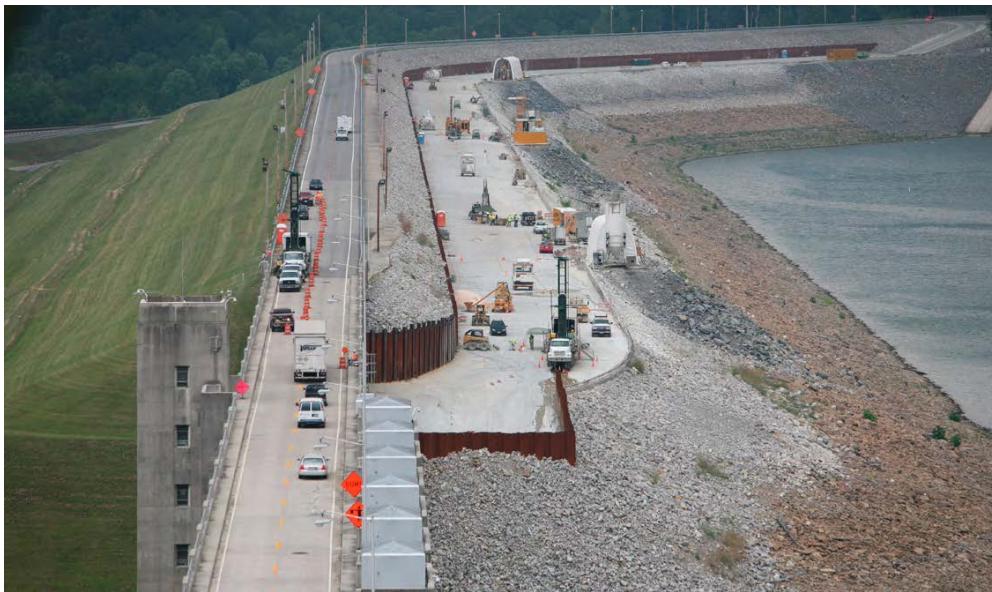

Figure 7.—View of working platform from left side.

To protect the earth embankment against the effects of construction activities, a 6-ft-wide protective concrete embankment wall was first constructed along the entire length of the embankment as shown on figure 8. Ranging from 110 to 225 ft deep, this wall was installed through the embankment and keyed 2 ft into rock. It is 40 ft upstream of the original wall completed in 1979 and defines the alignment of the new barrier wall. This wall was built in 9-ft segments using a hydromill as shown on figure 9.

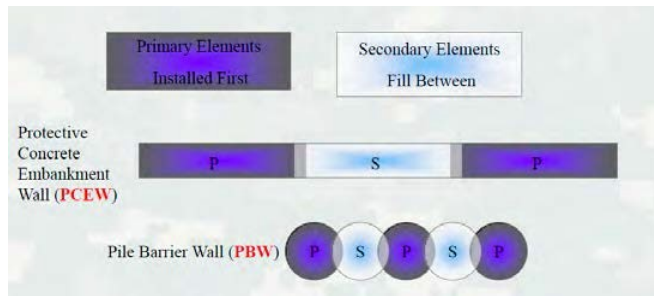

Figure 8.—Barrier wall configuration.



Figure 9.—View of hydromill construction.

The final barrier wall consists of 50-in-diameter overlapping (secant) piles. The minimum wall thickness is 2 ft. Verticality of these piles is critical to achieving continuity in the wall. The maximum deviation between two pile centers that can be tolerated and still achieve the minimum overlap is 9 in. The first step is to drill an 8-in-diameter pilot hole through the embankment wall and into the rock below using directional drilling equipment and techniques as shown on figure 10. As each pilot hole is advanced, crews use an underground magnetic tracking system to monitor verticality in real time and make adjustments as necessary.

Excavation for the full-size pile begins with predrilling through the embankment wall to enlarge the pilot holes. Drill rigs advance the oversized secant piles to approximately 150 ft through the embankment wall depending on the depth of the embankment wall. For this task, a special 52-in-diameter drill with a leading stinger was developed that follows the pilot hole, thus guiding the pile drilling as shown on figure 11.

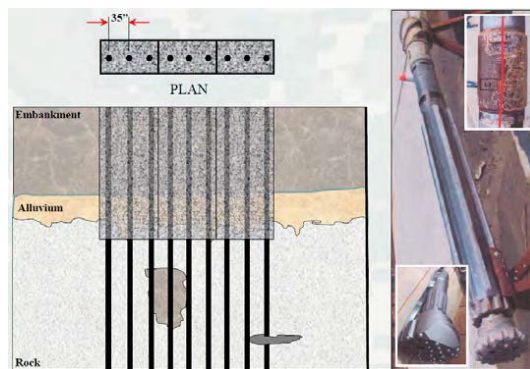

Figure 10.—Pilot hole construction.

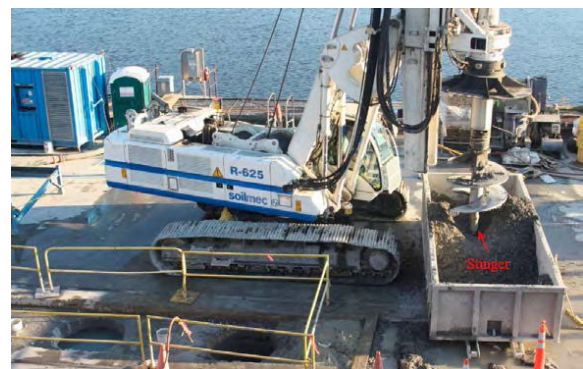

Figure 11.—Secant pile wall construction.

From the bottom of the embankment wall, reverse circulation drill rigs drill the remainder of the 50-in-diameter piles into the underlying limestone rock as much as 100 ft for total wall depths reaching 275 ft as shown on figure 12.



Figure 12.—Secant pile wall construction with reverse circulation drill.

Construction

USACE awarded the barrier wall contract to Treviicos-Soletanche Joint Venture based on its best-value proposal. The joint venture is led by Boston-based Treviicos, the North America subsidiary of Trevi, headquartered in Italy. Soletanche Construction, a subsidiary of Soletanche-Bachy of France, is the other partner.

Cost

The contract amount for the barrier wall construction was \$340 million.

References

U.S. Army Corps of Engineers (USACE) (2013). “Wolf Creek Dam, Kentucky,” prepared by USACE-Nashville District for ICOLD 2013 Congress, ICOLD, Paris, France.

Mississinewa Dam²

Introduction

The Mississinewa Dam is a USACE Dam located in northern Indiana on the Mississinewa River, just above its confluence with the Wabash River, approximately 65 air mi northeast of Indianapolis, Indiana. The Mississinewa Lake project consists of an 8,100-ft-long embankment, consisting of compacted impervious earthfill, and having a maximum height of 140 ft. The embankment was completed in 1967, and the dam was placed in full operation in 1968.

During construction of the outlet works and left abutment, karstic limestone was found to be prevalent. As a result, an impervious cutoff trench with dental treatment into competent limestone was required in these areas. Unfortunately, construction of the right abutment was nearly complete by the time the left abutment foundation was fully characterized. Thus, the right embankment was founded on glacial outwash materials overlying karstic limestone.

In 1988, project personnel noticed a depression in the guardrail on the right embankment. Re-evaluation of the data from the surface displacement monuments confirmed that 300–400 ft of the dam was continuing to settle about 0.035-ft per year. By 1999, the crest elevation in the settlement zone was approximately 0.8 ft lower than the initial crest elevation after construction and showed no signs of stopping. Two aluminum slope inclinometers, in the area of distress, were destroyed as a result of the dam settlement. Subsurface investigations revealed a 25-ft-deep, clay-filled solution feature beneath the settlement zone. As a result, operational restrictions were placed on the structure until foundation remediation could be performed.

The recent remediation consisted of a 2,600-ft long, concrete cutoff wall extending down at least 148 ft into competent limestone. The cutoff wall was installed with the use of clam shells and hydromills. During construction, several problems arose, including sudden slurry loss and solution features, which were much deeper than expected. A grouting program was initiated in advance of the cutoff wall installation to explore conditions in front of the hydromill and to help reduce the risk of sudden slurry loss.

Project Description

The Mississinewa Dam is located in Indiana on the Mississinewa River, 7.1 mi above its confluence with the Wabash River. The project is in northeastern Indiana approximately 65 air miles northeast of Indianapolis, Indiana, and 8 mi southeast of Peru, Indiana, on the Wabash-Miami County line (figures 1 and 2). The purposes of the USACE-owned and operated project are flood control, water quality, water supply, and recreation.

² Modified and reprinted with permission from Association of State Dam Safety Officials.

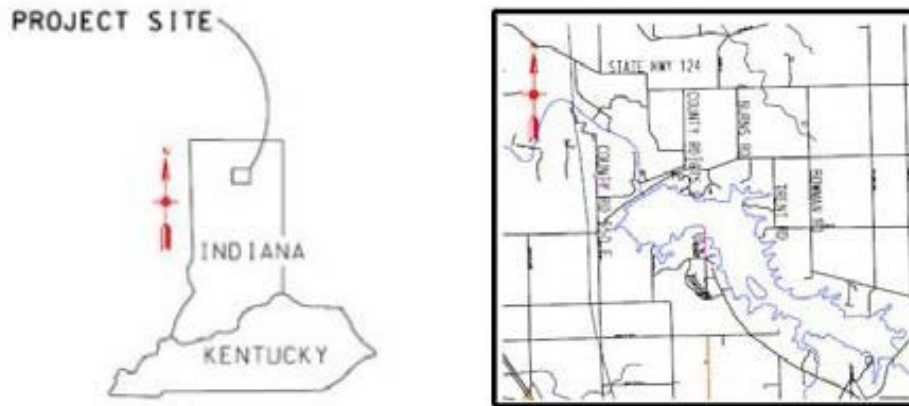

Figure 1.—Site location.



Figure 2.—Oblique view of dam (Google Earth, February 27, 2012).

The project consists of an 8,100-ft-long earthfill embankment, having a maximum height of 140 ft, with a gate-controlled outlet works along the base of the left abutment. There is a 1,550-ft-wide uncontrolled, open cut spillway 1 mi to the east of the right abutment at elevation 779. The dam embankment consists of compacted impervious fill with a downstream compacted random fill section and a top elevation of 797. The top of the dam is 36 ft wide to accommodate a county road.

Mississinewa Dam has a total flood storage capacity of 368,400 acre-ft at spillway crest, which is equivalent to 8.54 in of runoff from the upstream drainage area of 809 square miles (mi²). The reservoir area is irregularly shaped, and at spillway crest level, the pool would reach upstream approximately 31 mi, covering 12,830 acres. The State of Indiana, Department of Natural Resources, operates boating, fishing, and camping facilities along the southern portion of the reservoir. A seasonal wildlife refuge is operated from October 1 to January 15.

Site Geology

The subsurface of the Mississinewa Valley is dominated by ancient glacial activity. During the Pleistocene, the Mississinewa Valley was a tributary of the now-buried Teays River Valley. As a result of heavy erosion, the ancient Mississinewa River cut much deeper into the valley than the existing river valley. The ancient Mississinewa River cut through the Liston Creek Member and into the Mississinewa Member. The Liston Creek Member was laid bare during glacial highstands and shows weathered tops, incised valleys, and solutioned joints and bedding planes. In the present valley area, nearly all bedrock is covered by glacial or fluvial sediments.

The bedrock surface topography near the centerline of the dam varies from elevation 675 to 720 under the right abutment and falls off to 620 under the Mississinewa Valley. The cross section of the bedrock surface reveals a deep and moderately wide, incised channel (see figure 8). The bedrock surface on the right side forms a broad terrace before stepping up to a terrace. During the course of remediation, the foundation rock was divided into the three reaches depending on top-of-rock elevation. They were the “Upper Terrace” from Sta. 25+00 to Sta. 31+00, the “Lower Terrace” from Sta. 31+00 to Sta. 43+00 and the “Deep Valley” section from Sta. 43+00 to Sta. 51+00. Weathering of the bedrock varies from 3 to 15 ft under the Upper Terrace, from 0–10 ft along the Lower Terrace, and from 0 to 5 ft in the Deep Valley section under the Mississinewa River. The bedrock bedding is horizontal.

Two members of the Wabash Formation are present at the dam site. In ascending order, they are the Mississinewa and Liston Creek Members, both of Silurian age. In addition, the Red Bridge Bed, part of the Liston Creek Member, is observable in rock cores.

- The Mississinewa Member is a blue-gray, hard, fine-grained crystalline to highly argillaceous silty limestone to an argillaceous dolomitic siltstone and silty dolomite, which is fairly calcareous in places. It is found in various shades of gray and is dense, fine grained, and appears massive in unweathered exposures. The highly disseminated nature of the clays and calcite crystals create a unit that weathers in a shale-like manner. The bedding ranges from 0.4 to 1.0 ft in the top 5 ft, becoming massive with depth. The Mississinewa Member contains reef facies. This member appeared resistant to solutioning and deemed suitable to key the cutoff wall.

- The Red Bridge Bed is a light-colored, fine-grained, glauconitic, thin, argillaceous to dolomitic limestone that commonly weathers reddish-brown. This 6-in to 6-ft-thick bed directly overlies the Mississinewa Member and defines the base of the Liston Creek Member. At the dam site it is found to range from 2 ft thick to nearly absent. The Red Bridge Bed is prone to solutioning along bedding planes as evident from horizontal communication between grout holes and exploratory borings. Water losses were common in this bed both during exploratory drilling and grout-related drilling.
- The Liston Creek Member is a gray, hard, fine- to medium-grained crystalline limestone, containing a high amount of bonded and nodular chert, with a 0.2- to 1.0-ft thinly bedded structure. This severely weathered and partially solutioned member was the main unit of distress and required extensive grouting pretreatment in advance of the cutoff wall installation. The Liston Creek was highly weathered along bedding planes, joints, and the upper surface, and it commonly showed water losses and core losses during drilling. Portions of the Liston Creek were unweathered, and pre-bid rock testing showed unconfined compressive strengths as high as 25,000 pounds per square inch (psi) for this unit.

Construction History

An understanding and appreciation of the construction history, problems encountered during construction and emergency impoundment, and remedial actions after critical events, give clues as to the possible mechanisms for the anomalous settlement observed at the crest of the structure. A site layout of the project can be found on figure 3.

Some of the construction milestones:

- During the outlet works construction, two large solution channels were discovered.
- The right embankment was completed to elevation 780 by November 1964 while the solution channels were being cleaned and grouted on the left abutment.
- The valley section and left abutment was constructed together to the same elevation as the right embankment, and the entire length of the dam was completed to crest elevation 797 by fall 1966.

Outlet Works

During construction of the outlet works, excavations and borings made for the conduit foundation encountered limestone highly interconnected by clay-filled seams and joints. All construction records indicate a highly jointed, open bedded, and fractured foundation. The two large, vertical, clay-filled solution channels were oriented at near 90 degrees to the centerline of the conduit. Solution channels were blasted, excavated, pressure grouted, then filled with dental concrete.

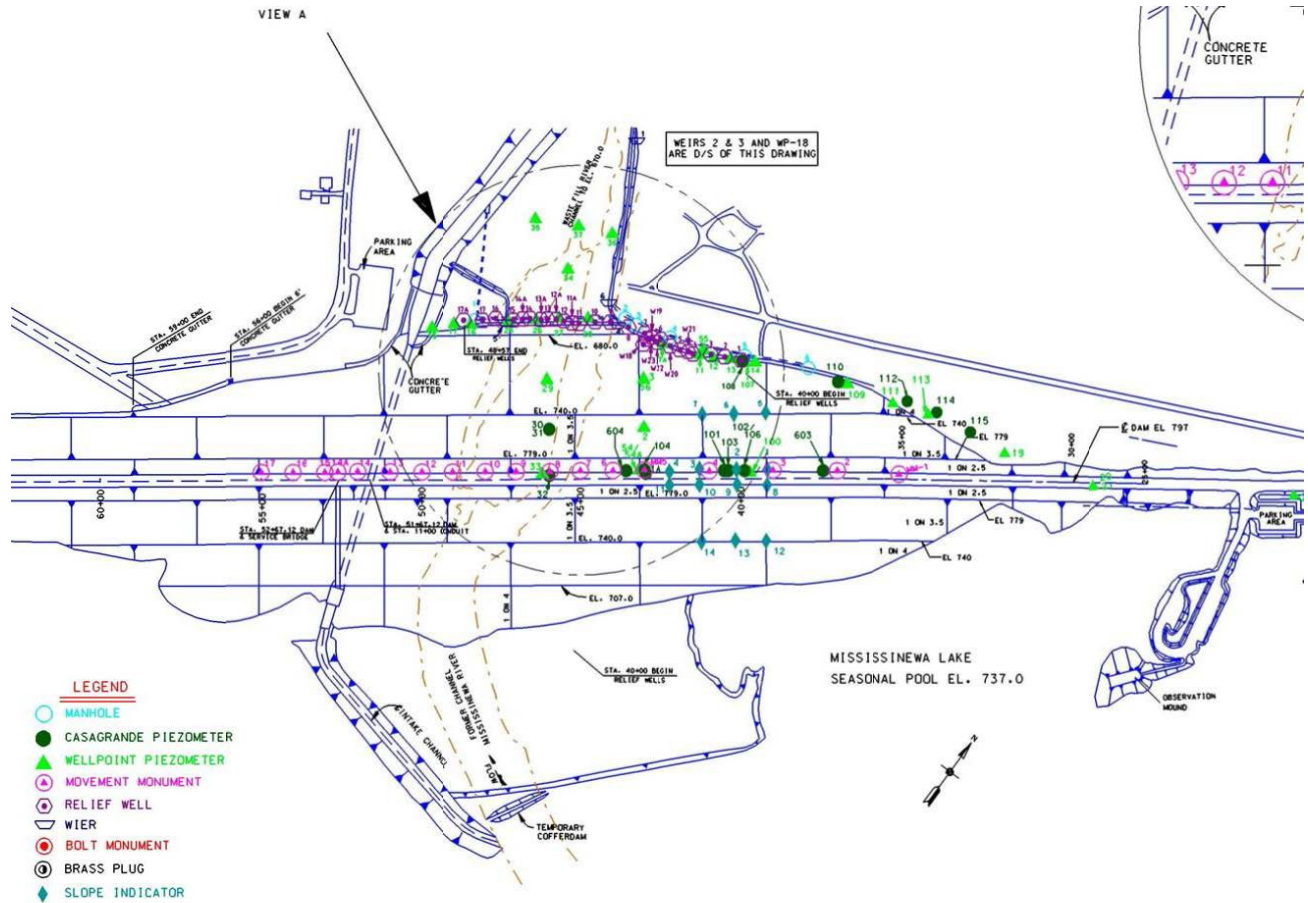

Figure 3.—Mississinewa dam site.

Right Abutment

The right abutment was prepared by clearing, grubbing, and stripping of topsoil. The right abutment extends from the river's edge at Sta. 44+00 to Sta. 15+00. In June 1964, a 6.0-ft-deep and 10.0-ft-wide inspection trench was excavated along the centerline on the right abutment. This extended from Sta. 15+20 to approximately 45+30. Sandy, silty clay was exposed from Sta. 15+20 to Sta. 38+00, with occasional pockets of water bearing sands and gravel between Sta. 34+00 and Sta. 36+00. The lower portion of the trench between Sta. 38+00 and Sta. 45+30 contained only water-bearing sand and gravel. Selected fill was used to stop the water flow; however, no further investigative work was initiated. Before the cutoff trench was constructed for the left abutment, placement of the right embankment proceeded. No cutoff trench to bedrock was installed in the right abutment.

According to the plans, the abutments were to be built with 5H:1V slopes, to approximately elevation 732 in the first season (1965), and to at least elevation 752 by the second season (1966). After a review of archived construction photographs, the right abutment was in fact

begun in July 1964 and taken to elevation 780 by the middle of November 1964. A portion of the sloping and horizontal sand drain, with a top elevation of 779, was installed during this construction. To the right of Sta. 42+00, this drain does not exist.

Left Abutment

In response to the solution channel found in the conduit excavation, a 30-ft-wide cutoff trench was added to the design. In October 1964, the cutoff trench was begun between dam centerline Sta. 50+80 to Sta. 57+50 and excavated 7.0 ft into bedrock. In addition, the solution channel uncovered during conduit construction was excavated on both sides of the conduit and was found to be over 600 ft long (figure 4) and at an approximate 15-degree angle to the dam centerline. A second solution channel of similar vertical depth was excavated for nearly 200 ft before exiting the side of the vertical bedrock face. All exposed solution channels were blasted, cleaned, filled with concrete, and topped with select fill. After these large solution channels were uncovered, the original cutoff trench was extended to Sta. 75+00. This trench extension was 15.0 ft wide down to top of rock with no removal of weathered rock. No further solution channels were uncovered.



Figure 4.—View of solution feature in cutoff trench of the left abutment.

Additional grouting holes, oriented 20 degrees toward the abutment on 20-ft spacing and extending 40 ft below top of rock, were added. This grout line extended out to Sta. 75+00 as well. In addition, on both sides of the conduit, three lines of grout holes were drilled toward the conduit centerline. Even though some of the grout borings were determined to be interconnected, there was no mention of large grout takes or problems while grouting the curtain. The cutoff trench was completed in September 1965, and the abutment was constructed to grade with the valley section of the dam.

Dam Performance

The Mississinewa Dam was placed into emergency operation on December 9, 1966, soon after the dam was complete, but previous to the project being placed into service. During this period, the relief well system in the valley bottom (between Sta. 44+00 and Sta. 48+00) began to flow, and minor seepage had developed along the embankment toe and up the right abutment. On December 14, the Project Engineer discovered a small boil about 6 ft upstream of relief well No. 7 (Sta. 43+00), at approximately elevation 678.

During the course of 2 weeks, the pool reached its highest elevation to that point (elevation 741.9), and the boil had become 12- to 14-in diameter. During this time, muddy water and mud balls ranging from a 3/8- to 1/2-in diameter were carried by a flow of 20–25 gpm (figure 5). Seepage was also noted in a gravel pit located approximately 400 ft downstream from the embankment toe. An area of approximately 2 acres on the right riverbank about 700 ft downstream from the toe was saturated with seepage water.



Figure 5.—Conditions during the boil event of 1966.

After the boil event, there was much concern over the fact that the right abutment foundation had no treatment, especially after the solution features were found to be so large and common. In an effort to spot treat the right abutment foundation, a single-line grout curtain was attempted between Sta. 40+00 to Sta. 45+00 along the upstream toe of the completed right embankment. These borings were designed to be oriented at 20 degrees toward the right abutment at 20-ft spacing; however, the curtain was inadvertently angled 20 degrees toward the river. Large grout takes were experienced in these primary holes at relative elevations of 667+, 654+, and 647+. During pressure testing, pressures used on these initial holes were somewhat high, ranging from 1.0 to 2.0 lb per linear ft. These were lowered due to the high grout takes and fear of hydraulic jacking. Grouting operations proceeded, with open-hole conditions encountered frequently. Grout takes were “soaring,” and grout pressures of 5 lb were difficult to obtain. In many areas, spacing was reduced to 2.5-ft quaternary holes, yet no appreciable reduction in permeability was attained. An example of the takes experienced in this effort was communicated in a Memorandum dated September 14, 1967, “The hole at Sta. 40+60 had a total take of 1,762 bags of cement, 17 ft³ of flyash, and 561 ft³ of sand.” Grouting was halted after several times the initial cost estimate was spent with no reduction in permeability.

Other remediation efforts included an upstream seepage blanket and additional relief wells on the right abutment. Subsequently, the dam went into operation with no functional anomalies noted until 1988. In 1988, project personnel made the keen observation that the guardrail running

along the county road on the crest had a slight dip in it. This area was surveyed and inspected and was in fact significantly lower than the rest of the crest. This area of differential settlement was contained in a 400-ft stretch between Sta. 38+00 to Sta. 42+00. By 1999, a total of 0.85 ft of settlement had been experienced in the area, as compared to the 0.25 ft of post-construction settlement in the rest of the crest (figure 6). Also by 1999, two slope inclinometers, which had been placed in the settlement area to capture lateral movement, had been destroyed (figure 7). The instruments had been crushed by internal stresses developing in the embankment due to the settlement and deformation.

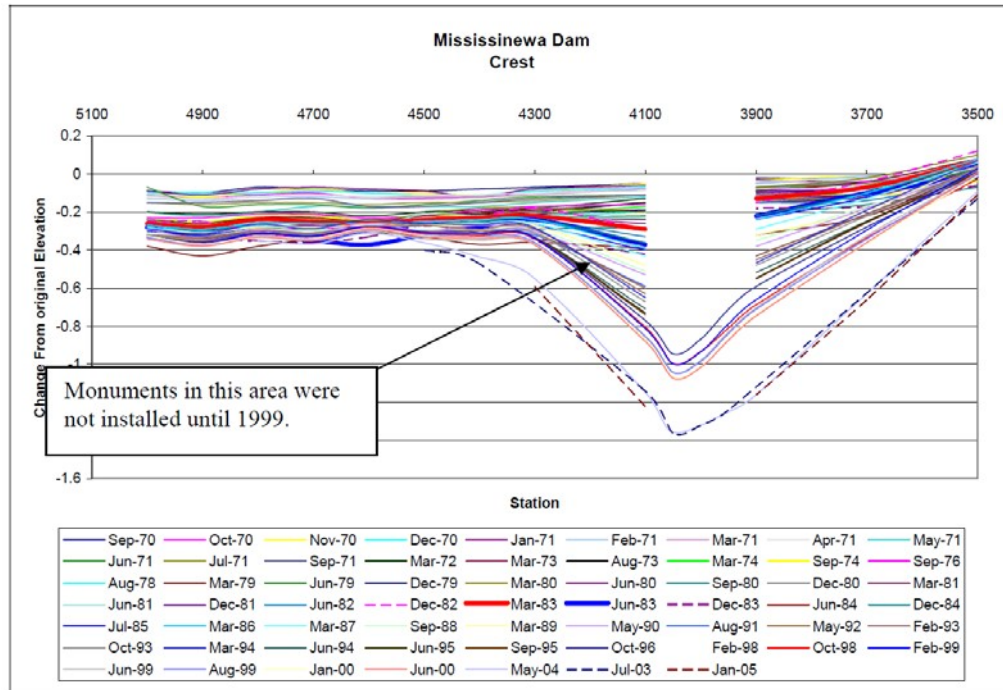

Figure 6.—Plot of survey elevations showing reach of high differential settlement.

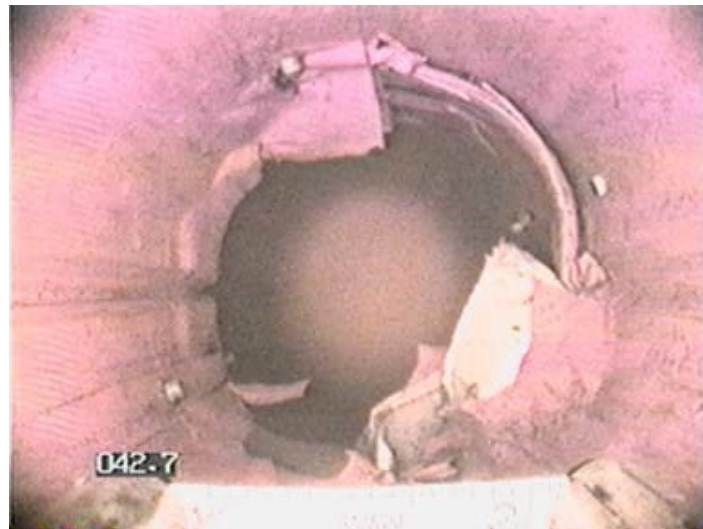

Figure 7.—Crushed inclinometer.

Based on an evaluation of the construction records, subsurface investigations, instrumentation analyses, and other observations, the Louisville District concluded that Mississinewa Dam was experiencing a progressive failure of the foundation, which could lead to embankment failure. This failure was being caused by the movement of materials from the overburden foundation into openings in the rock that have resulted from ancient solutioning of the limestone foundation rock. As these materials moved into the openings in the rock, they removed the support for the overlying embankment. The embankment sagged into the opening created by the migrating foundation materials, and these embankment deformations then progressed upward until they were observed as differential settlement of the crest. The threat was that embankment materials would begin to migrate into the openings in the rock, causing conditions to deteriorate very quickly to a point in which the stability of the structure was threatened. Because of the overall uncertainty regarding the exact conditions under which the embankment was performing and the state of progressive failure, reservoir restrictions were implemented.

Pool restrictions, while necessary, were very difficult on both State run facilities around the reservoir as well as private businesses that depended on the recreational use of the reservoir.

Ninety-six additional movement markers were installed in four lines on both upstream and downstream embankment slopes in August 1999. Also, 23 thermistors were installed along the downstream toe of the right abutment. Finally, between November 1999 and January 2000, 18 exploratory borings were drilled along the dam centerline to define the deep paleo-valley in the mid-section of the dam and to help better define the foundation characteristics.

The geotechnical borings revealed increasingly negative and alarming information about the bedrock. These borings confirmed that portions of the Liston Creek limestone had solutioned into a very soft, wet clay and limestone mix having very low blow counts. One boring encountered an approximate 24-ft solution feature incised into the top of rock. It was very common to find open bedding planes, solutioned widened joints, clay seams, and open voids within the Liston Creek formation. In general, these borings confirm the existence of pathways for seepage and foundation material transport.

Interim risk reduction measures were prepared that included a two-level response plan tied to pool elevations. The plan required increased surveillance, onsite personnel, material supply and equipment mobilization, lighting, and other actions that would be required.

Rehabilitation Alternatives

The construction methods used during building Mississinewa Dam were not adequate in meeting current state-of-the-art construction criteria. The foundation conditions that exist on the right abutment at Mississinewa would be treated very differently if the project were designed and constructed using modern criteria. The treatment methods used for the solution-widened joints found in the left abutment of Mississinewa may have met the current criteria. On the right abutment, however, the rock surface was never exposed for inspection and treatment. It then was a fairly simple justification as to how the foundation for the right abutment was unacceptable from the standpoint of providing adequate defenses against migration of the embankment or

overburden foundation materials into the underlying rock. Thus, the need for a rehabilitation technique was required. A Major Rehabilitation Report was submitted to USACE Headquarters, and money was appropriated for the construction effort in 2000.

The Major Rehabilitation Report outlined the plan for remediation of the foundation under Mississinewa Dam. The options considered were: (1) replace the structure, (2) install a grout curtain, or (3) install a concrete cutoff wall. Replacing the structure was not a cost-effective solution. Since the foundation was so poor and it had damaged the embankment through time, it was imperative to have a complete and positive cutoff to protect against seepage through the embankment and foundation. As a result, grouting was deemed to not be a complete positive cutoff to seepage, but more of a method of reducing seepage. A concrete cutoff wall was selected as the recommended plan. It was deemed that the cutoff wall would safely maintain future flood storage pools and prevent the progressive deterioration of foundation conditions.

The concrete cutoff wall was designed to extend approximately 2,600 ft along the length of the center valley section and the right embankment. It would extend to depths ranging from 148 to 180 ft, penetrating 5 ft below the contact between the two limestone formations (figure 8).

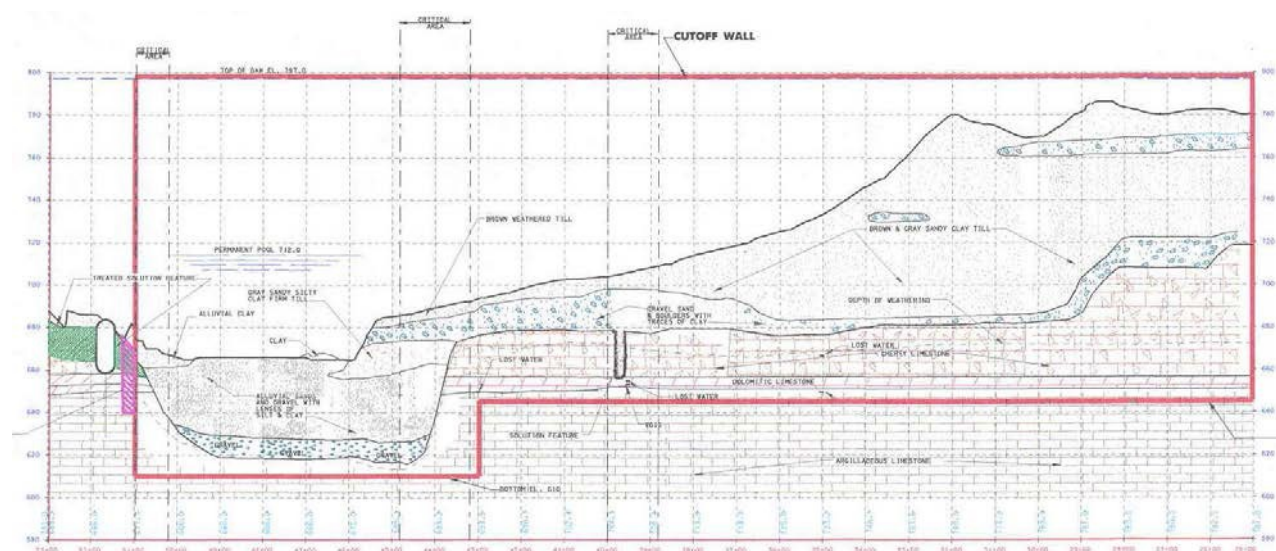

Figure 8.—As-designed cutoff wall profile. Red line denotes the designed extent of the newcutoff wall. Vertical exaggeration is 5X.

Cutoff Wall Construction

The concrete cutoff wall construction project was awarded to a Joint Venture of Bencor Corporation, Dallas, Texas, USA, and Petrifond Foundation Company, Montreal, Quebec, Canada, in September 2001.

Many items of work were required before actual installation of the cutoff wall could commence. Because a county road occupied the construction zone on top of the dam, a detour road had to be constructed to re-route traffic below the dam for the duration of the project. In order to

accommodate cutoff wall excavation equipment, support equipment, and the flow of spoil and concrete trucks, the county road on top of the right half of the dam had to be widened from 32 to 68 ft. This was accomplished by installing a temporary work platform constructed of continuously driven sheet piles on the upstream face. An adequately large spoil disposal area in the form of a large ravine was provided in the upstream entrance of the open cut emergency spillway. Spoil and rock cuttings were placed in the spillway ravine. Used bentonite slurry was solidified in settling ponds located in the floor of the spillway and then transported, placed, and compacted into the ravine.

The cutoff wall began at Sta. 25+00 and was continuous to Sta. 51+00. Between Sta. 51+00 and Sta. 51+30 was a short grout tie-in section to the original conduit dental treatment. The centerline of the wall was located approximately 10 ft downstream from the dam centerline. The further downstream the wall was located, the more room cranes and other equipment would have to work. However, the wall was positioned far enough upstream to preserve all downstream instrumentation, which would have been destroyed had the work platform been constructed on the downstream edge. Depending on geology, the depth of the wall varied. From Sta. 25+00 to Sta. 38+08, the wall was either 148 or 152 ft deep. At this depth, the wall completely bisected the Liston Creek limestone and was keyed a minimum of 3 to 7 ft into the Mississinewa limestone. Between Sta. 38+08 to Sta. 39+88, defined as the “deep feature,” the wall varied between 152 and 230 ft. From Sta. 39+88 to Sta. 43+00, again, the wall varied in depth between 148 and 160 ft. From Sta. 43+00 to the end-of-project Sta. 51+00, defined as the Deep Valley,

the wall was 185 ft deep. Here the wall bisected and isolated the alluvial-filled Deep Valley section with 5 ft of embedment into the Mississinewa limestone. The only sequencing of excavation work dictated by contract specifications was a 100-ft test section at Sta. 25+00 to Sta. 26+00. The test section had to be completed, a report submitted, and procedures accepted prior to construction of the remaining 2,500 linear feet of cutoff wall.



Figure 9.—Typical hydromill configuration.

Two principal pieces of excavation equipment were used during cutoff wall construction: a clamshell and a hydromill (figure 9). The clamshell rig was a CMV TL50 80-ton crawler crane with a 150-ft telescoping-kelly Casagrande KRC 2-180 Hydraulic Clamshell Grab. The clamshell bucket was capable of making a 10-ft by 30-in bite. An 8-ft by 30-in bucket was also available for closure panels. About 0.5 ft was removed per bite. The excavation rate was approximately 20 feet per hour, but decreased

with depth. The contractor attempted to maintain excavation verticality by the “frontman” (a laborer) using a 4-ft carpenter’s level applied to the x-y sides of the Kelly and minor deviation corrections made in leveling of the rig. In difficult overburden soils where cobbles or boulders could be encountered, the contractor had onsite heavy-duty cable clamshell buckets and 27-ft, 12-ton chisels. The cable clamshells and chisels were used with conventional cranes. The

TL-50's mechanical reliability was good during the project, with minor breakdowns such as blown hydraulic lines. Over the course of the project, Government inspectors began to question the inherent verticality of this excavation method.

Rock excavation was performed using a Casagrande K3L hydromill. Weighing in at approximately 35 tons, the 50-ft-long hydromill was a two-part assembly mounted to a 100-ton crawler crane. The lower portion contained the hydraulic motors, cutting wheels, and slurry return Soletanche suction pump. The upper portion functioned as a guide frame for alignment. The four cutting wheels were paired (two each) with a drive chain, allowing for independent rotational speed and torque control of the wheel pairs. Arrayed on the cutting wheels were shank-mounted carbide tip cutting teeth. Worn teeth were replaced at regular intervals, typically twice a shift, but at least once a shift. The configuration, number, and style of teeth could be changed to suit rock conditions. Milling rates were very dependent upon rock conditions ranging from highs in decomposed to highly weathered Liston Creek to lows in unweathered, high chert-content Liston Creek. At times, the hydromill was used in both overburden and rock. This machine was prone to breakdowns without significant preventative maintenance. With an experienced operator, this machine was capable of maintaining excellent verticality in overburden or rock.

The contractor developed a panel schedule dividing the cutoff wall into 26- and 25-ft "primary panels" separated by 9-ft "closure panels." These were theoretical widths, and due to machine widths of approximately 10.5 ft, the closure panels ended up being 10.5 ft as placed. Excavation and concrete backfilling of the primary panels occurred first, then excavation and concrete backfilling of the secondary panels. The specifications placed a restriction on the total length of open excavation, along with permissible separation between open panels. Therefore, panel construction was non-linear. Specifically, no individual open panel could exceed 30 ft in length, the total footage of all open panels could not exceed 90 ft, and there had to be 90 ft of separation between any open panels. Later in the job, the 90-ft rule was relaxed when primary panel(s) had been placed between open excavations.

Generally, excavation proceeded with overburden excavation to top of rock with the TL-50. Once rock was reached, the hydromill was introduced and the panel taken to the desired depth. Bentonite slurry was introduced when the excavation was 10 ft deep, and a constant slurry head was maintained at all times during excavation to prevent sidewall failure. The primary panel was subdivided into three "bites." Bites B-1 and B-3 were 10-ft-deep bites at opposite ends of the panel, leaving an intermittent 5- or 6-ft Bite B-2 standing as a pillar separating Bites B-1 and B-3. After overburden excavation, the hydromill was introduced into Bites B-1 and B-3 and the panel partially milled approximately 10 ft to create a "seating" slot for alignment control. The freestanding B-2 bite functioned as a guide for the mill to control alignment and to prevent the mill from walking off station. With the seating slots complete, Bite B-2 was removed. Milling proceeded with taking Bites B-1, B-2, and B-3 to full depth. After completion of the primary panels and concrete backfilling, the intervening 9-ft closure panel was excavated in a like manner in a single bite. Note that the mill is 10.5 ft wide, and by milling through a 9-ft panel between primary panels on each side, an overlapping watertight joint between panels was created.

The contractor was required to complete a 100-ft test section between Sta. 25+00 and Sta. 26+00. This location was chosen for the test section because it was deemed a non-critical area of the dam. The purpose of the test section was to demonstrate the suitability and performance of the contractor's equipment, procedures, production rates, quality control plan conformity, and overall methodologies. Successful completion of the test section, along with a written report, was required prior to moving forward with the remainder of the production, utilizing the approved work platform.

After completion of the work platform, excavation of the cutoff wall test section began on April 4, 2002. The contractor had planned on 26-ft primary panels. The closure panels would be 9 ft between primaries and 10 ft when completed. On the first bite of the first primary panel at 70 ft, 30 ft of slurry were suddenly lost. Further slurry loss was prevented with the addition of extra slurry and hay bales. When Bites B-1 and B-3 had reached top of rock, the hydromill began excavating on Bite B-1. On April 13, milling to 84 ft, approximately 9 ft into rock, a 100% sudden and complete slurry loss occurred. Approximately 30,000 gallons of slurry were lost, leading to the simultaneous collapse of the panel excavations. It is supposed that once the slurry in the first bite was lost, the slurry head in the second panel forced the sand and gravel layer plug between the two bites to blow out. Once breached, the slurry from the third bite was lost through the same feature that just caused the first bite slurry loss. At this point, a 26-ft-wide and approximately 75- to 85-ft-depth excavation into the dam embankment was open and unsupported. The emergency slurry loss plan prevented total collapse of the panel. The response of the contractor initiating emergency panel backfill procedures prevented significant embankment damage; however, the fact that the slurry loss happened at all temporarily halted the project. No further excavation was conducted until response procedures were reviewed and a revised slurry loss plan implemented.

Once excavation was continued, a single-bite panel on the opposite end of the test section was made. A small slurry loss occurred in the sand and gravel layer above the top of rock. This was easily controlled by on-hand resources, and rock milling began on this single-bite panel. A rapid and 100% slurry loss then occurred during milling in rock. The improved slurry loss plan was successfully implemented using pre-staged emergency backfill material. The contractor elected to re-excavate this panel two more times with the identical results of 100% sudden slurry loss at the same depth. All cutoff wall excavation was stopped to study the problem and develop a solution.

Grouting Program

The sudden slurry losses during installation of the cutoff wall lead to loss of excavation stability and severe cave in of the panels. The Government directed the prime contractor to implement a pre-treatment program in the test section to see if the slurry loss could be slowed, if not stopped, so that installation of the panels could continue.

The design philosophy of the grouting program was to prevent total and complete sudden slurry losses and not the partial loss of slurry due to natural filtration or loss into other minor rock features. To rationally establish the performance for grouting, the performance basis was a

compromise of assigning the required residual permeability and the dimensions of the grouted zone in order to achieve an acceptable average slurry loss. The acceptable design was such that leakage rates for fresh slurry would be manageable with the prime contractor’s slurry reserves.

From the loss analysis, the target residual permeability of 10-Lugeons or less within a grouted zone encompassing the cutoff wall and 5 ft beyond each side was determined to provide acceptable performance. In order to accomplish this target residual permeability, a double row grout curtain with final split-spaced holes on 5-ft centers was chosen (figure 10). After initial problems with upstage methods, and the potential for lost tooling, the program was grouted downstage on 12-ft centers. Thus, it was composed of two lines, an upstream “A-line” located 4 ft upstream of the centerline of the cutoff wall and the downstream line “B-line” within the guidewall. The joint orientation of the bedrock allowed for both lines to be oriented in the same direction instead of opposing each other. This was beneficial in eliminating costly and expensive fan hole sections at bedrock shelf breaks. Hole spacing was set forth with primaries on 20-ft centers, secondaries split to 10 ft, and tertiary at 5 ft. A few quaternary holes and the verification holes were split spaced on 3-ft centers.

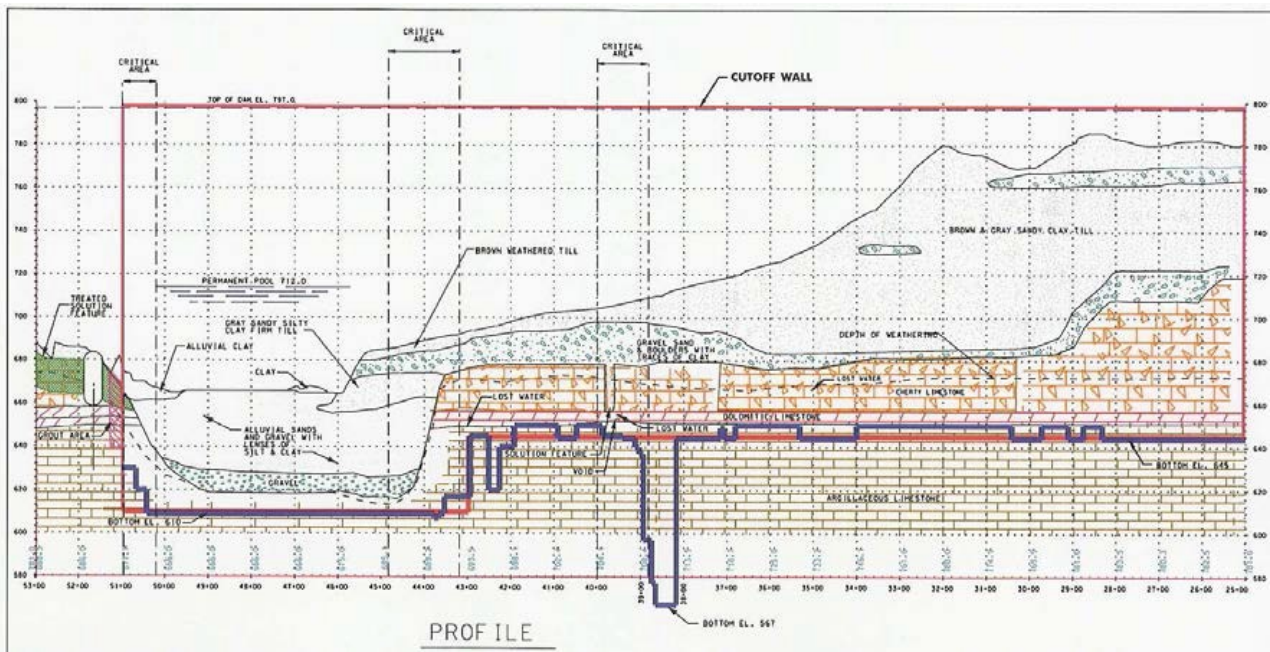

Figure 10.—Final cutoff wall profile. The blue line shows the revised bottom depths of the cutoff wall as extended during construction. Vertical exaggeration is 5X.

After the grouting program was successfully completed, the cutoff wall installation began again. The remaining panels were installed without incident of sudden slurry losses. In addition, since the grouting was conducted with such closely spaced holes, it was easier to characterize the top of rock elevations, conditions, and any other geologic features in the subsurface. Since the grouting appeared successful, the grouting was approved for continuation across the rest of the cutoff wall length.

For the production section grouting, a few changes were made. A sonic drill was modified to allow it to drill 2 ft downstream from the guidewall to prevent the possible loss of drilling steel within the cutoff wall alignment. The hole spacing was changed to 24-ft primaries, 12-ft secondaries, and 6-ft tertiaries. A methodology was established that allowed changes, including upstage grouting in areas with higher-quality bedrock, and different refusal criteria.

With the test section completed and analyzed, the grouting was conducted until it progressed far enough ahead to allow cutoff wall construction. During a period of time, both pretreatment of the remaining section of cutoff wall as well as cutoff wall production were progressing simultaneously. No significant slurry losses were encountered at any time during the production sections. Limited pretreatment data were used to modify the depth of the cutoff wall. In some locations, the wall was nominally raised a few feet, and in other locations, the wall was extended in depth to cut off the “deep feature,” which was incised deep into the Mississinewa Member. The Liston Creek Member was entirely cut off throughout the length of the wall. The cutoff wall was finished on April 5, 2005.

Observations During Construction

Below the settlement area, two features were found. One was a U-shaped solution feature, through the entire Liston Creek Member, oriented 5 degrees from the dam centerline, and was discovered on both grout lines. A second feature was the so-called “deep feature,” which was found on the upstream grout line (only) for a limited extent laterally.

The “deep feature” merits further discussion. This erosion/solution feature was discovered with the use of grout-related drilling in the settlement area. Inspectors were surprised when sonic drilling, on the upstream grout line, continued almost 80 ft beyond normal top-of-rock without significant resistance. The feature was confirmed as filled with well-sorted or poorly graded sand. This sand was not well consolidated, and sonic boreholes intersecting this feature were gravity-filled with significant quantities of flow-fill-concrete. Core drilling in this feature also revealed travertine (as in stalagmites) as well. No previous drilling, including multiple grout holes on the left abutment and geotechnical borings in the right abutment, showed solutioning within the Mississinewa Member. The most puzzling aspect of this deep feature is that it only occurs on one grout line. The grout lines are dam-axis parallel, with one upstream and one downstream. Quite a lot of extra drilling was done on the downstream grout line where the feature was not encountered. If the feature had terminated at the Liston Creek-Mississinewa boundary, the feature could be assumed to be another solution feature. If the feature had stopped at the depth of the Deep Valley, it could be assumed as a buried paleo-ravine. However, it continued beyond both of these depths. The current collaborative hypothesis for this deep feature is that it represents a plunge pool, showing mechanical erosion from water falling at the Liston Creek-Mississinewa boundary onto the Mississinewa unit. It was decided to extend the cutoff wall up to 230 ft deep to cover the area of the deep feature (see figure 10).

In the areas of the deep feature, the panels were limited to 10-ft-wide single-bite panels. There were additional modifications to the hydromills to reach these depths not anticipated at the beginning of the job.

Overall Project Assessment

Overall, the cutoff wall appears to be working as intended and appears to be installed with good quality. The early setbacks of sudden slurry loss in the test section were dealt with appropriately by pre-grouting previous to the cutoff wall installation. After the grouting, the cutoff wall installation proceeded with no significant slurry loss. The test section verticality questions lead to the use of more methods and more frequent verticality and continuity measurements to ensure success of the cutoff wall closure. As a secondary assurance, the piezometer lines located on both sides of the cutoff wall were reacting as one would expect after the cutoff wall installation.

The piezometers on the reservoir side of the wall have increased by approximately 20 ft, while the piezometers on the downstream side of the wall have dropped approximately 15 ft. The relief wells in the valley center, which relieve the deep-buried sands and gravels, will be monitored during the upcoming seasonal pool period to see if flow has dramatically reduced. The reservoir pool was put back into full operation in the spring of 2005. All instrumentation appears to be acting properly, and the project as a whole appears to be working within the designed parameters. Detailed observations will be required for the next few seasons to ensure that the dam behaves as intended, as it has undergone a complex rehabilitation. Any unusually high elevation pool events will require particularly scrutinizing observation to watch how the structure behaves under unusual loading.

It is important to note that the project was a success in the light of working with the local communities, county agencies, and State of Indiana agencies. The local residences and businesses were very understanding of the requirement to rehabilitate the structure from a dam safety standpoint. Public meetings and constant communication with those folks helped to minimize hardship due to disrupting the area for several years. The local county agencies were very helpful in transitioning the county roads during construction and helped with utility disruptions. The State of Indiana was also very amenable to working with the USACE, even though it meant several seasons of major disruptions to several boating and recreation areas under their operation.

Acknowledgements

The authors would like to thank Timothy Flaherty, onsite project geologist, for not only his work at the project to make it successful, but also contributions to this paper, and Steve Hornbeck, former District Geologist, for his critical roles in characterizing the problem, designing the rehabilitation, and ensuring quality during construction.

References

Henn, K.E. and B.E. Brosi (2005). "Mississinewa Dam Settlement Investigation and Remediation," Dam Safety 2005, the 22nd annual conference of the Association of State Dam Safety Officials, September 23–27, 2005, Orlando, Florida, Association of State Dam Safety Officials, Lexington, Kentucky.

OTHER CASE HISTORIES

Case 1 – Ochoco Dam

Ochoco Dam impounds a 46,500-acre-ft reservoir on the Crooked River near Prineville, Oregon (figure 1). The dam was constructed of hydraulic fill from 1918 to 1920. The dam is 120 ft high and 950 ft long with an inlet-tower and a cut and cover tunnel outlet works arrangement. An excavated, uncontrolled, concrete-lined emergency spillway is provided on the left abutment adjacent to the fill section. The left abutment is composed of alluvial fan/talus complex, and the right abutment and center-right portions of the dam were founded on an ancient landslide complex. The landslide complex contains open joints in rock blocks and coarse, open-work rubble zones with voids varying in size from 1/4 to 6 in and free of infilling. Post-construction excavations into the dam confirmed the dam was constructed with a fine-grained, laminated puddle core with an interlayered sand and gravel shell on the downstream side of the core. Outer zones of the embankment fill contain coarse-grained rock from 3- to 12-in diameter.



Figure 1.—Oblique view of Ochoco Dam, Oregon.

Seepage issues appeared shortly after first filling in 1921, with 43 ft³/s total seepage exiting primarily from numerous springs at the toe of the dam, but also through the embankment. Sinkholes were discovered within the landslide deposits in the right abutment after lowering the reservoir. Sinkholes were filled with sluiced fines, which reduced the total seepage to 28 ft³/s after the reservoir was filled in 1922. Sluicing of fines at the right upstream abutment was redone in 1947 after sinkholes reappeared in the same general area as the 1922 sinkholes. The

dam was subsequently raised 6 ft, and an impervious zone was constructed in the upper part of the dam. An outer shell of pervious material consisting of sand and gravel was placed on the downstream slope, and a zone of rockfill was placed downstream from the new pervious zone in 1950. A new toe drain system was placed at the toe of the original dam and covered with the new pervious shell. A new, 3-ft-thick riprap layer was also placed on the upstream face of the dam after the old material was stripped off. A new, 5-ft-thick impervious blanket was also placed from the right abutment groin for a distance of 450 ft upstream. No major incidents occurred following this major rehabilitation until 1989.

The reservoir experienced drought and severe drawdown in the fall of 1988. When the reservoir filled during spring of 1989, seepage through the right abutment increased significantly, and there was an alarming 20-ft increase in piezometric levels in a piezometer screened in an interval near the embankment-foundation contact of the right abutment. New sinkholes also appeared along the shoreline upstream of the dam, which were confirmed to be conveying water rapidly downstream. It was thought that internal erosion was occurring along the dam/foundation contact, which led to an immediate 21-ft drawdown being ordered. The visible sinkholes were repaired in the fall of 1989, and additional piezometers were installed where the internal erosion was suspected to be occurring. The following year (1990), an impervious membrane was used to temporarily seal the upstream area of the right abutment where the sinkholes were found, as further remedial measures were being considered. During this timeframe, it was also noted that the outlet conduit, which also passes through the right abutment landslide, had settled and that there had been significant erosion of embankment materials into the conduit. Unfortunately, when the reservoir was restored to its normal pool elevation, it was determined that the membrane was not performing as designed.

Further dam safety modifications were subsequently completed by May 1995, which consisted of excavating the upstream surface of the embankment and a deep interceptor drainage trench parallel to the upstream toe of the dam, and backfilling with zones of impervious earthfill, filter, and drain material (Zones 1, 2, and 3, respectively, on figure 2).

The reservoir was filled about 2 weeks following completion of the above modification. During the refilling, seepage increased to about 3,600 gpm ($8 \text{ ft}^3/\text{s}$) in the main seepage weir, and turbid flow was observed over an 8-hr period. Piezometric levels rose in the area of the conduit in an area downstream from the modifications. Sinkholes were discovered on the upstream face of the dam in the vicinity of the outlet works pipe where it had been extended during the course of the dam safety modifications. The sinkhole was sluiced with cinders, which significantly reduced the leakage. Subsequent forensic investigations of the hydraulic fill discovered a zone of open-work rock, which was hydraulically connected with fill materials along the outlet works. A second sinkhole was also discovered near the foundation with the paleo-landslide material that had not yet migrated to the surface through the repairs (red circle on figure 2). The open-work rock was subsequently covered with choke stone and filter, and the embankment was reconstructed by the end of 1995. Additional relief drains were also added to the outlet works conduit. Refilling of the reservoir began again in 1996.

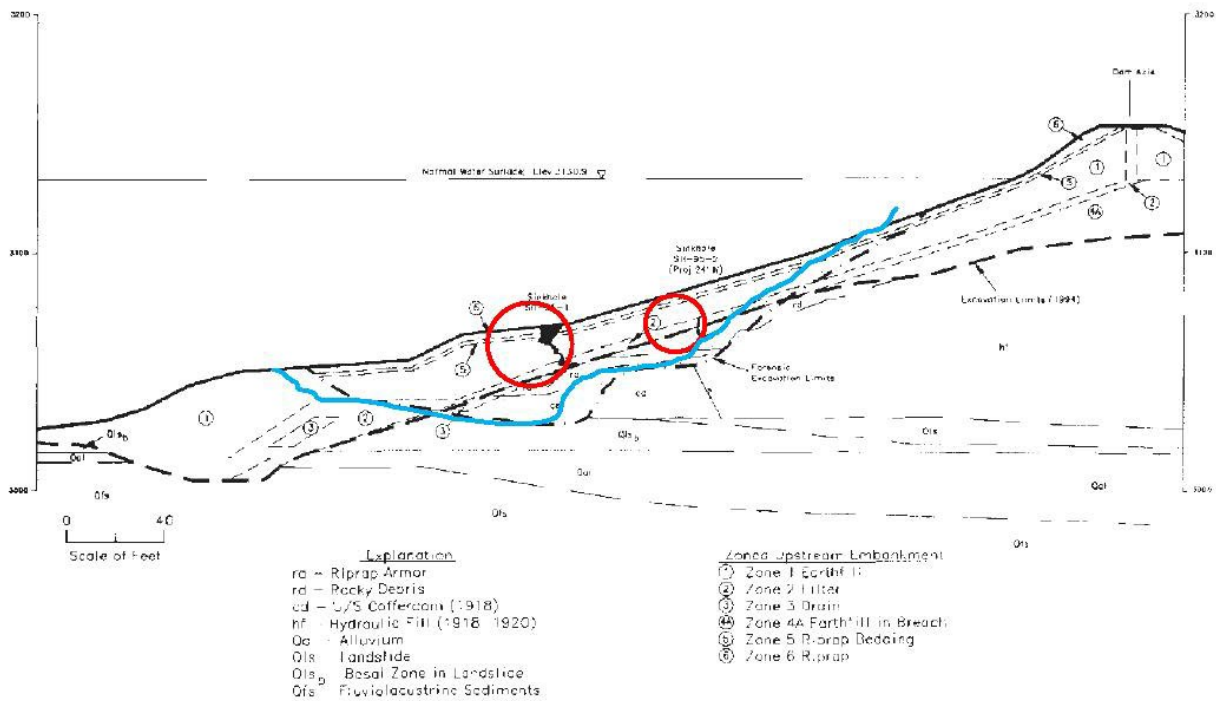

Figure 2.—1995 dam raise and upstream slope modifications. Depth of forensic excavation (blue line) and sinkholes that developed upon refilling (red circles). Limits of 1995 construction excavation are shown with the dashed, black line.

In 1998, after the reservoir was back in operation, an increased amount of sand or gravel was observed in the sediment traps in a few of the seepage monitoring weir boxes. Material was entering the older drainpipes and being carried downstream to the weir boxes. The toe drains were examined by video cameras, and sand and gravel were observed in the drains. The majority of the toe drains that were installed in 1949–50 were removed and replaced with new drainpipe. In areas where the toe drains were not removed, they were retrofitted with a perforated inner sleeve. Weir boxes were also replaced and inspection wells and cleanouts were added to aid in the inspection of the drains. The phreatic surface was lowered along the right abutment after the replacement of the toe drains.

Ochoco Dam is now a heavily instrumented and monitored dam. There are 28 porous tube piezometers, 17 vibrating wire piezometers, 9 seepage monitoring locations, 16 outlet works tunnel uplift pressure monitoring locations, 3 inclinometers, 16 embankment surface measurement points in 3 lines, and 73 structural measurement points in the outlet works tunnel and spillway. Inspection checklists are used every month, and since completion of the multiple phases of construction, no new seepage problems have been identified. Ochoco Dam has returned to normal operation after the successful completion of construction and reservoir filling.

References

- Carter, B.H. and R.A. Link (1998). "Safety of Dams Modification of Ochoco Dam Crooked River Project, Oregon," Fourth International Conference on Case Histories in Geotechnical Engineering, Missouri University of Science and Technology, pp. 469–475.
- Bureau of Reclamation (1983). "SEED Report on Ochoco Dam, Crooked River Project, Oregon," Bureau of Reclamation, Denver, Colorado, pp. 1-45.
- _____(2007). "Comprehensive Facility Review – Ochoco Dam, Crooked River Project, Pacific Northwest Region," Bureau of Reclamation, Denver, Colorado, November 2007.
- _____(2000). "Completion of Embankment Modifications," Bureau of Reclamation, Denver, Colorado, February 2000.
- _____(1998). "Construction Geologic Report for Safety of Dams Modifications, Ochoco Dam and Spillway, Crooked River Project, Oregon," Volume 1, Bureau of Reclamation, Denver, Colorado, June 1998.
- _____"Final Construction Report – Ochoco Dam Modifications," Bureau of Reclamation, Denver, Colorado, undated.
- _____(1983). "Project Data Book, Crooked River Project, Pacific Northwest Region," Bureau of Reclamation, Denver, Colorado, 1983.

Case 2 – Red Rock Dam

The Lake Red Rock Project was constructed in 1969 on the Des Moines River as a flood control project by the USACE and is located in Marion County near Pella, Iowa. The dam consists of a 5,700-ft, 110-ft-high, rolled earth embankment with an integral gated spillway (figure 1). The dam impounds a 1,624,970-acre-ft reservoir from a drainage area of 12,323 mi².



Figure 1.—Oblique view of Red Rock Dam (Google Earth, September 11, 2011).

The embankment is founded on glacial outwash and sand and clay alluvium deposits up to about 30 ft thick that rest unconformably on bedrock. The spillway is founded directly on bedrock, which in the valley consists of St. Louis Limestone of the Meramec Series, Late-Mississippian aged. St. Louis Limestone contains beds of sandstone, limestone, clay, gypsum, and dolomite in the area of the dam (figure 2). The upland areas around the reservoir are underlain by rocks of the Cherokee Group. The upper boundary of the Mississippian in southeastern Iowa is an erosional surface that is unconformably overlain by the Cherokee Group, Pennsylvanian aged. St. Louis Limestone is a micritic limestone with a lower zone of brown, arenaceous dolostone that contains a high percentage of anhydrite and gypsum. St. Louis Limestone is known to have a highly brecciated texture as a result of dissolution of the evaporates (Avcin and Koch 1979).

The embankment is constructed of homogeneous impervious fill, with a downstream chimney drain and random fill shell (figure 3). The impervious fill is a medium to very stiff clay (CL) with a PI of 16–38. The embankment was constructed between 90 and 115% of optimum moisture content and compacted to greater than 90% of optimum density. The impervious fill

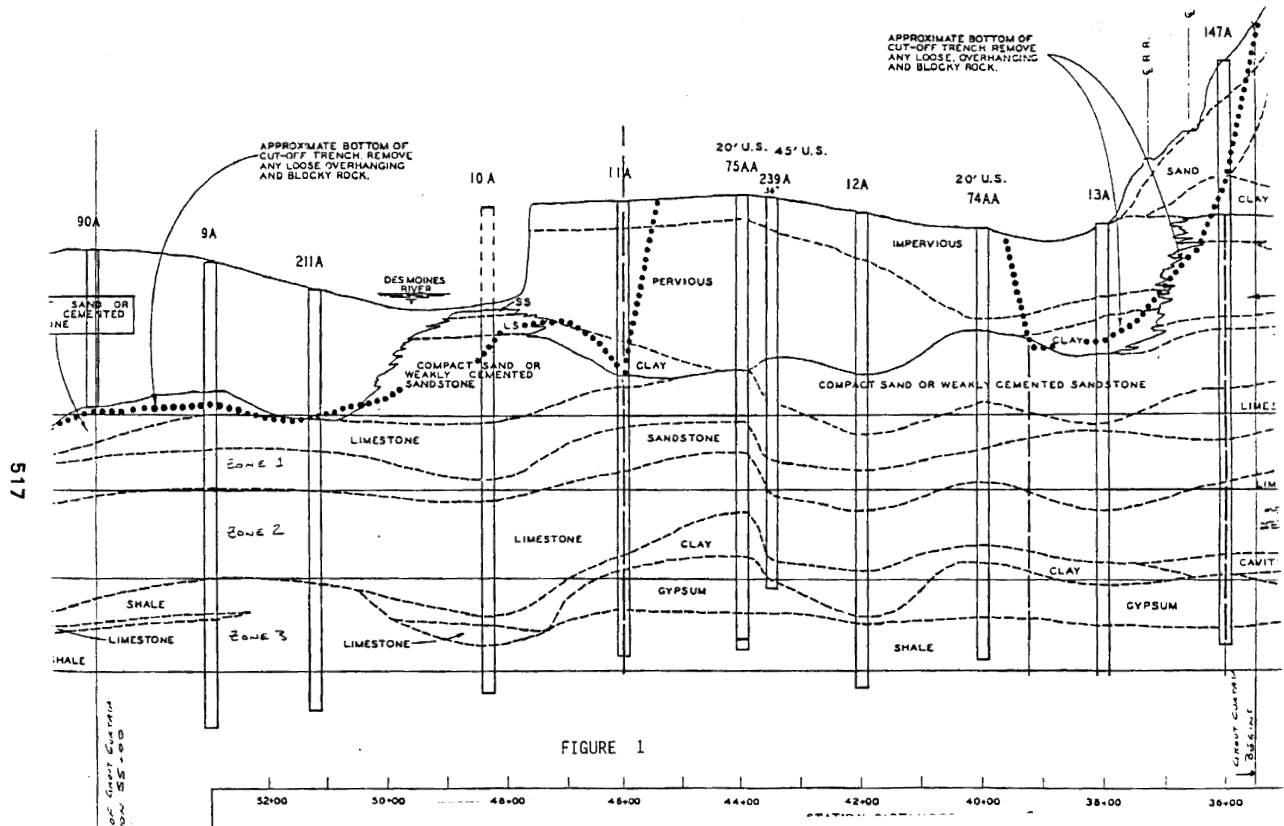

Figure 2.—Geologic section along the dam axis (Carr 1996). Note location of gypsumbeds.

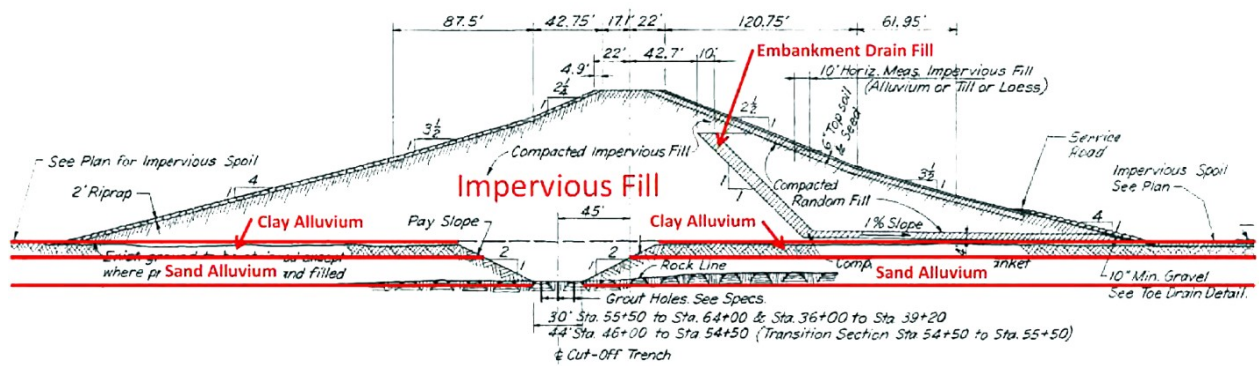

Figure 3.—Section through Red Rock Dam showing embankment zones.

was placed on top of the alluvium, except in the core trench, where it is directly on bedrock. The chimney drain is composed of fine to medium poorly graded sand. The drain contains from 9 to 10% fines with a sand content from 84 to 87%. A three-row grout curtain was originally installed from the core trench to treat solution cavities in the limestone and gypsum beds.

Remedial grouting was required in the 1990s. For the remedial grouting, the foundation was divided into three zones (see figure 2), with special grouting requirements specified for each zone.

Since the dam was constructed, there had been indications of potential foundation distress, particularly in the area of the left abutment, where phreatic levels in piezometers indicated increasingly higher levels tied to pool elevations. During installation of the original three-row grout curtain, extremely high volumes of grout were placed throughout the length of the dam (Carr 1996). The original grouting filled cavernous solution cavities in the right abutment and filled a partially solutioned gypsum lens that extends from under the left abutment to about Sta. 47+00 (see figure 2). However, due to concerns related to increasing piezometric levels, it was thought that additional dissolution of gypsum or internal erosion would result in unacceptable increases in underseepage quantity and pore pressure at the base of the dam.

A decision was made to perform remedial grouting in 1991, which began with a test grouting program over a 1,110-ft length of the dam, from Sta. 25+00 to Sta. 36+00, and extending 500 ft into the left abutment. Following this test section, a second phase of more extensive grouting was done in 1994–97 (Carr 1996). The second phase of grouting was done with three-stage grout holes and required angled holes to intercept and enhance the original grout curtain. Angled holes were required since the cutoff trench is located about 45 ft upstream of the dam centerline. It was the preferred method, over construction of a grouting platform on the upstream slope, and required drilling vertically from the crest of the dam to a specified depth, where the hole was then drilled at an angle of 14 degrees from vertical to intercept the old grout curtain. The Phase 2 work also overlapped the area that was grouted during the Phase 1 test program. The grout holes were cased through the embankment to top of rock and were drilled to a vertical depth of 167 ft. All primary and secondary grout holes were drilled and casing installed with a primary spacing of 10 ft and split spacing of 5 ft. Drilling through the embankment was done with augers, using water to assist in cutting removal. The water used for augering apparently was not an engineered fluid; as described by the contractor, the water was circulated through a mud pit, “making its own drilling fluid.” After each of the primary and secondary holes were augered to top of rock, the holes were filled with the drilling fluid, and casing was lowered into the hole, followed by grouting the annular space with the displacement method.

Issues developed during installation of the casings. Loss of drilling fluid occurred while augering through the embankment, and because of the presence of the “weathered” or poorly cemented sand at top of rock, flowing sand was also encountered at the bottom of the auger holes. There was concern that installation of the grout casings could result in hydrofracturing the embankment, and efforts were made to coordinate within the USACE to determine the best practices for this type of work at the time. The USACE is currently modifying its drilling guidance to more effectively address this specific concern. The new guidance severely restricts drilling into embankments because of numerous experiences with drilling fluid that damages otherwise competent impervious fill sections of dams.

As a result of the coordination that was done during the 1994 grouting work, three methods were tested that would minimize damage to the embankment from drilling fluids:

1. Use a roller bit and a mud engineer to design and control drilling fluid. This method failed and was abandoned after repeated attempts resulted in continued loss of circulation.
2. Use a dual drill string system consisting of a 6-in-outer-diameter rod and an inner NWJ drill rod. Drilling mud circulated down the NWJ rod and returned through the annular space in the 6-in outer string. This method also failed and was abandoned after continued loss of circulation.
3. Use hollow-stem augers. This method was found to be the safest method for drilling into the impervious fill but required high-torque equipment and limited the holes to vertical (no angled holes). The vertical limitation required that a drilling platform (berm) be constructed on the upstream face of the dam. Details of the drilling and socketing into top of rock and the casing installation procedure are discussed in Carr (1996).

After casings were set into the top of rock, rock drilling commenced with rotary drill equipment. Each hole was pressure tested prior to grouting. Three-stage grouting proceeded from top to bottom as the drilling progressed. The top zone included the socket and casing, the center zone was in the gypsum and solutioned limestone zones, and the last stage was in the deepest strata consisting of the lower portion of solutioned material and dolomitic limestone. Grout mixes varied from 3:1, 1:1, 1:1, and heavier sand mixes, and grout pressures were controlled by a programmable controller with maximum pressures at 40 psi in the last stage (Carr 1996).

The grouting work was successful in lower piezometric levels, and no problems have been noted since completion of the remedial grouting.

References

- Avcin, M.J. and D.L. Koch (1979). "The Mississippian and Pennsylvanian (Carboniferous) Systems in the United States-Iowa," Geological Survey Professional Paper 1110-M, U.S. Geological Survey.
- Carr, P. (1996). "Remedial Grouting, Phase II Red Rock Dam Pella, IA," Dam Safety 1996, the 13th annual conference of the Association of State Dam Safety Officials, September 8-11, 1996, Seattle, Washington, pp. 511-516.

Case 3 – Matahina Dam

Matahina Dam is an 86-m-high, 400-m-long zoned earth and rockfill dam constructed in 1966 (figures 1 and 2). The dam is located upstream of the small community of Lake Matahina, on the Rangitaiki River, North Island, New Zealand. The project is also equipped with a spillway, penstocks and powerhouse, and diversion and dewatering tunnels. These features are located on a rock spur that makes up the left abutment of the dam. The rock spur contains two drainage tunnels and a grout curtain (Gillon 1988).



Figure 1.—Oblique view of Matahina Dam (Google Earth, September 9, 2011).

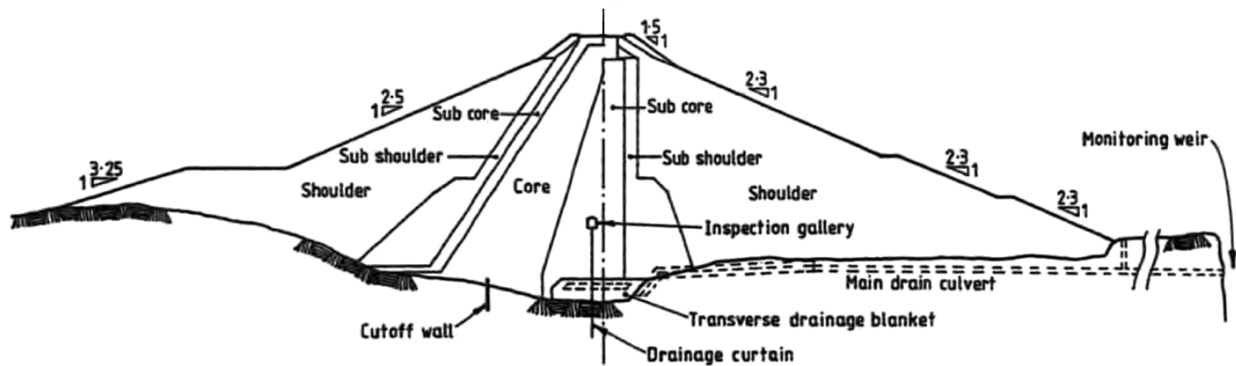

Figure 2.—Matahina embankment section (Gillon 1988).

The dam is located in a river gorge cut through a regional ignimbrite sheet (volcanic pyroclastic flow deposit) into underlying Tertiary-aged compact gravels, sands, and silty clays (Gillon 1988). The dam foundation contains open joints within the ignimbrite, and splinter faults from the Waiohau fault occur within the dam foundation. During preparation of the foundation, a number of ledges and projections were left in place along the steep abutment areas. The core of the dam was constructed with a residual clay-gravel soil of low plasticity that is weathered greywacke (Galloway 1970). Upstream and downstream transition zones are provided to separate the clay core from the outer rockfill shoulders. The transition zones consist of crushed volcanic rock, described as “fines and softer strippings from the ignimbrite rockfill” (Gillon 1988), and are relatively rigid as compared to the clay core. The rockfill consists of compacted ignimbrite stone. An extensive drainage blanket is provided along the foundation downstream from the core, supplemented with a gallery, drainage curtain, and drain culvert as shown on figure 2. A short cutoff wall extends from the base of the core into the foundation. Discharge from the drainage system is monitored at a monitoring weir.

January 1967 Incident

During first filling of the reservoir in January 1967, an area of subsidence appeared immediately downstream from the core over the right abutment. The subsidence was preceded 2 weeks earlier by an increase in discharge from the dam drains from 70 to 560 L/s. An interesting thing occurred at this point: the seepage decreased from a cloudy 560 L/s to a clear, steady 250 L/s. A decision was made at that point to allow the reservoir to continue to rise. Everything seemed normal for the next couple weeks, until the subsidence appeared, which triggered immediate efforts to lower the reservoir.

The subsidence area was 3 m wide and 6 m long at the surface and was estimated to be about 40 m³ in volume (Galloway 1970). Subsequent investigations found the subsidence was the surface expression of a “chimney” (i.e., sinkhole) of disturbed material estimated to be 6 m wide, 12 m long, and 15 m deep. The sinkhole ran laterally through the crushed volcanic transition zone, and vertically from the abutment contact up to the crest of the dam, with the clay core forming the upstream limit of the sinkhole. During close inspection of the walls of the sinkhole, a soft, wet area was discovered in the core just below a projection of the rock abutment. Mixed transition zone material and soft core material was found in this soft, wet area. Two-in-thick (50-mm) grout seams were also observed in the exposed walls of the sinkhole, indicating this area may have also been damaged during grouting. The grout was thought to have been from either cased grout holes that were placed through the embankment or from leakage during construction from under the grout cap. While the total volume of the “chimney” disturbed by the sinkhole was estimated at 750 m³, it was estimated that only about 40 m³ of material actually eroded into the abutment contact. The factors that contributed to the incident were enumerated as follows (Galloway 1970):

1. An area of severe cracking in the core
2. Rather rigid transition zone materials (crushed volcanic rock)

3. Segregation of rockfill at the abutment contact
4. Rapid rising of the reservoir (1.5 m per day) at the critical level

Galloway (1970) theorized that a crack formed in the core about 15 m below the crest of the dam, where the rock “projection” had been left in the steep abutment face, and that the crack extended about 1.5 m above the abutment contact. When the reservoir was raised above the elevation of the crack, the downstream transition zone became charged with reservoir water. The increased gradient caused transition zone material to begin washing out along the abutment-rock shell contact where there was a pocket of loose rockfill and a boulder that allowed voids to form from segregation during placement. The upstream transition zone possibly collapsed into the crack (resulting in the mixed transition zone and core material observed under the rock projection in the abutment contact), sealing it and reducing the cloudy leakage from 560 L/s to clear leakage of 250 L/s. It then took about 2 weeks for the void to migrate from the loose rockfill at the abutment contact up to the crest of the dam, forming the 40 m³ depression observed in the crest. This incident has been cited as an example of a dam where an upstream zone prevented progression from developing into a breach (Gillon 2007).

The area of disturbed/mixed core was plugged with a mix of sand/gravel/bentonite, and the sinkhole back-filled with washed sand and gravel. The core was grouted with a cement-bentonite mix, and the reservoir refilled without further incident (Galloway 1970; Gillon 1988). The repair was monitored with observation wells to ensure satisfactory performance of the repairs, and the dam performed well until 1987.

December 1987 Incident

Another internal erosion incident occurred at Matahina Dam that involved both the left and right abutments about 21-yr after the first incident occurred in the right abutment. A factor that contributed to the second incident was the occurrence of the 6.3 magnitude (ML) Edgecumbe earthquake in the Bay of Plenty (figure 3) on March 2, 1987. The epicenter was only 23 km from Matahina Dam. Strong-motion accelerometers at Matahina Dam recorded a crest level acceleration of 0.42 g and a mid-height acceleration of 0.48 g. The ground motions at the dam triggered about 4 in (100 mm) of settlement of the crest, 10 in (250 mm) of movement downstream (Gillon 1988), and 32 in (800 mm) of settlement in the upstream rockfill.

During an inspection of the dam following the earthquake, transverse cracks and settlement near the abutments with increased drainage from the left abutment rock spur and minor increased flow from the drainage blanket were found. Moderate spreading occurred in the crest of the dam, and deformation was also noted in the rockfill shoulders. The increased seepage from the left abutment was turbid. A decision was made to draw down the reservoir to the minimum operating level and implement additional investigations and monitoring to assess the extent of the damage. Close attention was paid to the monitoring because of the past incident and known propensity for formation of cracks in the dam core as a result of differential settlement. In addition to monitoring the existing instrumentation, geophysical methods, surface trenching, and air-flushed drill holes were also employed to determine the extent of the cracks and damage to the dam.

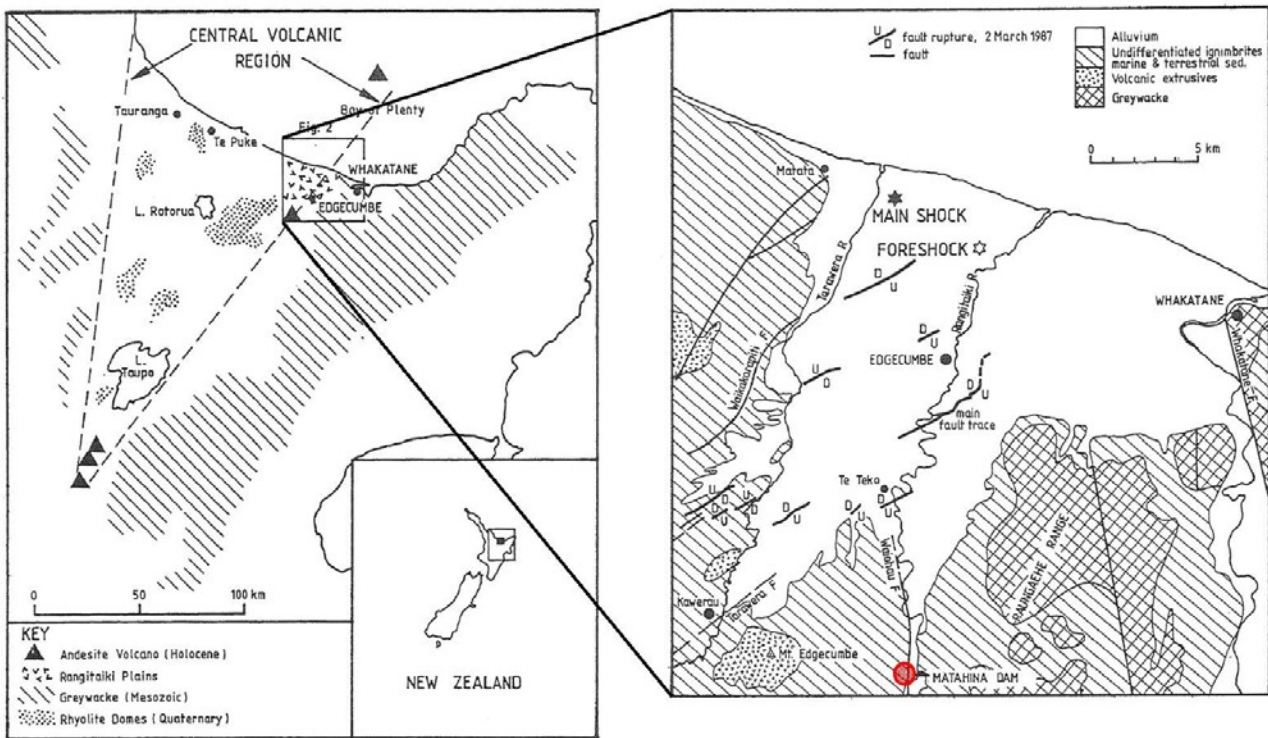

Figure 3.—Location of Edgcumbe earthquake, geology, epicenters, and fault locations (Gillon 1988). Location of Matahina Dam is shown with red circle.

With the use of trench investigations, transverse cracking was found to be shallow, and a large cavity in the same area of the right abutment as the 1967 sinkhole was discovered in line with the foundation anomaly but upstream of the core (figure 4). After discovery of the new cavity, two shafts were drilled to investigate the previous repairs to the right abutment. The sinkhole discovered on December 17, 1987, about 9 months after the earthquake, confirmed that internal erosion had occurred and was continuing (Centre for Energy Advancement through Technological Innovation [CEATI] 2010). After four inclined borings were drilled into the left abutment, high inflows downstream from the core were found. Twelve piezometers were installed in the left abutment, and anomalously high pore pressures were measured. Surveys confirmed that there was continuing settlement of the dam and left abutment spur several weeks after the earthquake (Gillon 1988). Seepage from the left abutment increased four-fold immediately following the earthquake and continued to rise for at least 8 months. The conclusion drawn from the investigations was that the core in the left abutment had experienced cracking and erosion similar to that experienced previously in the right abutment, although it could not be determined with certainty if the condition existed prior to the earthquake (Gillon 1988).

The dam was repaired in 1988 to address the issues related to cracking in the two abutment areas. However, more extensive repairs were implemented 10 yr later after further assessment of seismicity. These later repairs addressed the potential for internal erosion and seismic deformations for the entire dam (CEATI 2010).



Figure 4.—Internal erosion in the dam core (Amos and Gillon, 2007).

The final repairs incorporated a leakage- and deformation-resistant downstream filter and buttress (figure 5). The leakage-resistant buttress was designed to control post-earthquake leakage through a ruptured core. The wide filter, transition, and drainage zones were designed to remain functional after anticipated displacements following a magnitude 7.2 (Mw) earthquake. The seismic remediation work was completed in 1998 (Amos and Gillon, 2007).

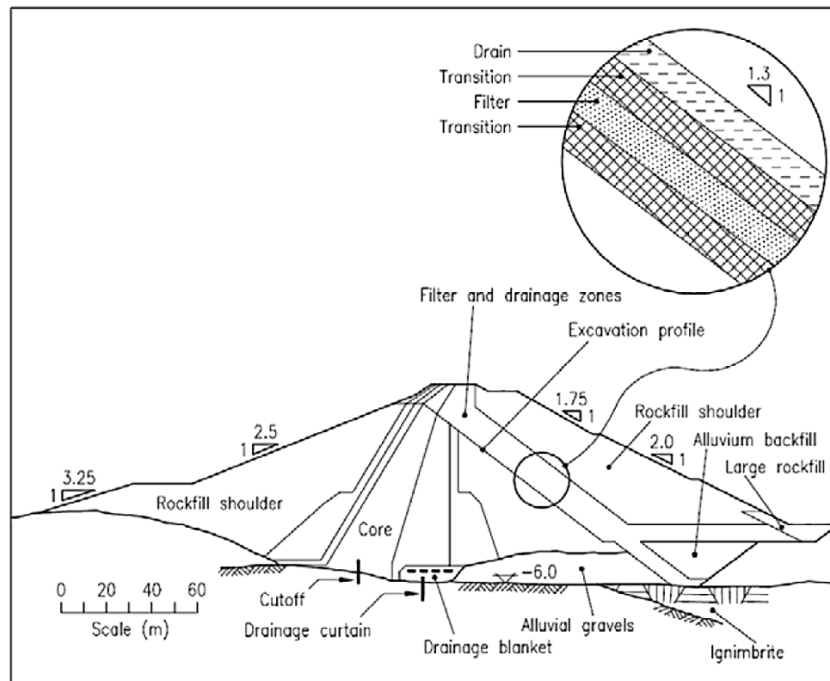

Figure 5.—Repair section for Matahina Dam (Amos and Gillon 2007).

References

- Amos, P. and M. Gillon (2007). “Dams and Earthquakes in New Zealand,” Proceedings of First Turkish Dam Safety Symposium, May 2007 <http://www.vncold.vn/Modules/CMS/Upload/13/Documents/120620/3DamwatchVietnam09paper08.pdf>
- Centre for Energy Advancement through Technological Innovation (CEATI) (2010). “Lest we forget: learning from international dam incidents,” in Water Power Magazine, International Water Power & Dam Construction, Kent, UK.
- Galloway, J.H.H. (1970). “Subsidence and Piping in Matahina Dam, Rangitaiki River, Rotorua, New Zealand,” Transactions of the Tenth International Congress on Large Dams, Montreal, Canada, June 1–5, 1970, International Commission on Large Dams, Paris, France, Vol. VI, pp. 769–771.
- Gillon, M.D. (1988). “The Observed Seismic Behavior of the Matahina Dam,” Proceedings: Second International Conference on Case Histories in Geotechnical Engineering, June 1–5, 1988, St. Louis, Missouri, Paper No. 4.29.
- ____ (2007). “Re-evaluation of internal erosion incidents at Matahina Dam, New Zealand,” in Fell, R. and J.J. Fry (eds.), *Internal Erosion of Dams and their Foundations*, Taylor and Francis, pp. 115–132.

Case 4 – Willow Creek Dam¹

Willow Creek Dam is an earthfill structure on Willow Creek near Augusta, Montana (figure 1). In addition to storing water from Willow Creek, the reservoir is fed from the Sun River through the Willow Creek Feeder Canal. The structure is 93 ft high, has a crest length of 650 ft, and contains 275,000 yd³ of material. An open spillway channel 700 ft wide at the ground surface has a capacity of 10,000 ft³/s. The outlet works tunnel runs through the right abutment. The reservoir has a capacity of 32,400 acre-ft of water. Geology at the dam site consists of Cretaceous age bedrock of the Two Medicine Formation (horizontal bedded, decomposed to soft shales and siltstones prone to slaking, and fine-grained sandstones) overlain by Pleistocene glacial moraine deposits and recent alluvium and colluvium along the channel of Willow Creek. The sandstones are moderately hard to hard, and high-angle jointing is prominent and leads to formation of blocky, tabular fragments. Glacial moraine deposits in the area are quite coarse and generally consist of sand and gravel with minor amounts of cobbles, boulders, and silt and clay fines. Alluvium along the creek channel is a highly variable mixture of material ranging in size from clay fines to boulders. A thin layer of material at the base of the dam, identified as alluvium, is composed of mostly cobbles and gravel with almost no fines. Glacial deposits form the foundation of the dikes and spillway.



Figure 1.—Photograph of the Willow Creek Dam and gate house (Reclamation).

¹ Portions of this report are from Reclamation (2013), reprinted with permission from International Commission on Large Dams (with minor revisions).

The Willow Creek Project consists of a main dam and three small freeboard dikes. The main dam is a homogeneous earthfill structure. The dam was originally constructed between 1907 and 1911, and modified in 1917 when the dam crest was raised 2 ft, and again in 1941 when the dam crest was raised 12 ft to its current level. The upstream face of the dam has a slope of 3H:1V and is protected with a 3-ft-thick layer of well-graded riprap.

The outlet works consists of an intake structure, a 201-ft-long, 54-in-diameter concrete-lined upstream tunnel; a gate shaft; a gate house; a 429-ft-long, 54-in-diameter concrete-lined downstream tunnel; and a stilling basin. There is one 4-ft-square emergency slide gate, one 4-ft 6-in square regulating slide gate, and an access/wet well shaft to each gate from the control house on the dam crest. The current discharge capacity of the outlet works is approximately 350 ft³/s.

Milestones associated with Willow Creek Dam include the following:

- First storage reservoir for Reclamation's Sun River Project in Montana, with the main dam now over 100 years old (first completed in 1911).
- The grass-lined emergency spillway became the subject of one of the first documented uses of risk-based decision analysis by Reclamation in 1981. No dam safety modifications were determined to be justified at that time based on an estimate of low downstream incremental damages in the event of a breach by erosion.
- A sinkhole developed at the dam crest in 1996, due to piping into and around the outlet works tunnel, requiring emergency corrective actions, including reservoir drawdown and embankment reconstruction.
- The first use by Reclamation of cured-in-place pipe (CIPP) for an outlet works tunnel lining, in 1997, using a technology originally developed 20 years earlier for lining sewer pipes.

Right Abutment

Dam safety modifications were completed in 1996 and 2000. The 2000 modifications included removal of the downstream rockfill slope protection, excavation of potentially liquefiable foundation materials at the downstream toe, and construction of a downstream filtered berm buttress with toe drain system to control seepage and reduce liquefaction concerns during a major seismic event. The downstream face of the modified dam now has a grass cover, with a slope of 2H:1V above and below the top of the berm, at elevation 4116.0 (figure 2). A portion of the downstream tunnel was lined with CIPP in 1997 following a piping incident (see below). A new air vent pipe and concrete gate house were also provided for the outlet works at that time.



Figure 2.—Willow Creek Dam after 1996 and 2000 repairs (Google Earth, December 31, 2005).

On June 28, 1996, a sinkhole was discovered on the crest of Willow Creek Dam about 50 ft downstream from the gate house (Reclamation 2013). Emergency investigations determined that embankment material had been piping into a large cavity surrounding the outlet works tunnel at the location of a tunnel collapse in 1958 (figures 3 and 4). In addition, some material had been piping into the tunnel through weep holes drilled through the concrete lining to provide pressure relief. Emergency repairs were undertaken in the fall of 1996 to excavate the right abutment area, backfill the sinkhole cavity with grout, pressure grout the foundation, place a filter on the dam foundation contact, replace the embankment, and construct an upstream berm to provide a longer seepage path through the abutment. Designs were also undertaken to repair the outlet works, including the addition of a new air vent (constructed in June 1997), a partial tunnel lining (constructed in August 1997), a new trashrack structure, a new gate house, and guard gate repairs.

As part of the process to repair the sinkhole in 1996, the reservoir was drawn down, and a portion of the right abutment was excavated to within about 12 ft of the crown of the tunnel in the vicinity of the sinkhole. A layer of fractured sandstone separated the excavation from the tunnel crown. A total of 374 yd³ of lean concrete grout was tremied into the void around the tunnel and brought up to about elevation 4087. After letting the grout set up, lean backfill concrete was placed to fill the excavation to the foundation surface at elevation 4110. Pressure grouting of the bedrock was also performed along an 80-ft length of the tunnel. A total of 32 grout holes, with an average length of 35 ft each, were drilled, water tested, and grouted at mostly low pressures of around 5 lb/in², with an average grout take of 0.2 bag per linear ft. Filter sand was placed over the exposed bedrock surface in the bottom of the excavation, and the excavated embankment fill was replaced and recompacted. As a precaution, an upstream berm was constructed to provide 100-yr flood protection in the event the embankment construction could not be completed before winter. The berm extended 240 ft across the right abutment groin,



Figure 3.—View from top of dam after excavation was complete.



Figure 4.—Looking into sinkhole from foundation contact.

with a 2H:1V upstream slope. The earthfill was placed and compacted in horizontal lifts. The berm resulted in a wider embankment crest, increasing the potential seepage path within the embankment and along the tunnel upstream of the sinkhole location.

Continued concern for the long-term stability and structural integrity of the downstream tunnel lining, and the potential for renewed piping of earth materials through open cracks and joints (despite the grouting performed in 1996), resulted in the consideration of potential tunnel lining

options. A structural lining was determined necessary for the first 100 ft of tunnel downstream from the regulating gate located directly below the dam embankment crest. This would include the location of a tunnel lining collapse in 1958 during maximum releases, the sinkhole location, a significant longitudinal crack in the tunnel lining along the crown, and the primary sources of continuing seepage from open joints and cracks. Since the configuration of the outlet works tunnel and stilling basin was not suitable for installation of a rigid lining (e.g., steel or HDPE), flexible linings were investigated. A CIPP lining was selected for final design in 1997, consisting of a flexible, resin-impregnated, needled polyester felt tube that is inflated under hydrostatic head and cured by the circulation of heated water. The pulled-in-place method of ASTM F1743 was adopted for this application. For the design of the CIPP lining, the existing concrete tunnel lining was assumed to be in a “fully deteriorated” condition and subject to internal pressure under maximum discharge conditions, with an external fill height of 10 ft on the crown, an external hydrostatic head of 10 ft on the invert, and a maximum internal pressure of 20 lb/in². An epoxy vinyl ester resin was selected over a polymer resin for greater strength and longevity, with an initial flexural strength of 5,000 lb/in² for external loads, and an initial tensile strength of 3,000 lb/in² for internal loads. The final design thickness of the CIPP lining was 1.06 in. Installation of the CIPP lining took only 1 week to complete. The most recent examination found the instrument-based performance of Willow Creek Dam to be satisfactory.

References

Bureau of Reclamation (Reclamation) (2013). “Willow Creek Dam, Montana,” prepared for 2013 ICOLD Congress, International Commission on Large Dams, Seattle, Washington.

Case 5 – Clearwater Dam

Clearwater Dam is located on the Black River in Wayne and Reynolds Counties in southeast Missouri (figure 1). It is a 154-ft-tall and 4,225-ft-long embankment dam that was completed in 1948 (figure 2). During construction, a cutoff trench was excavated to the foundation rock. Some large solution features (figure 3) were revealed and treated with dental concrete and grouting. Only the rock in the cutoff trench was exposed and treated.



Figure 1.—Location of Clearwater Lake (Krizanich 2007).

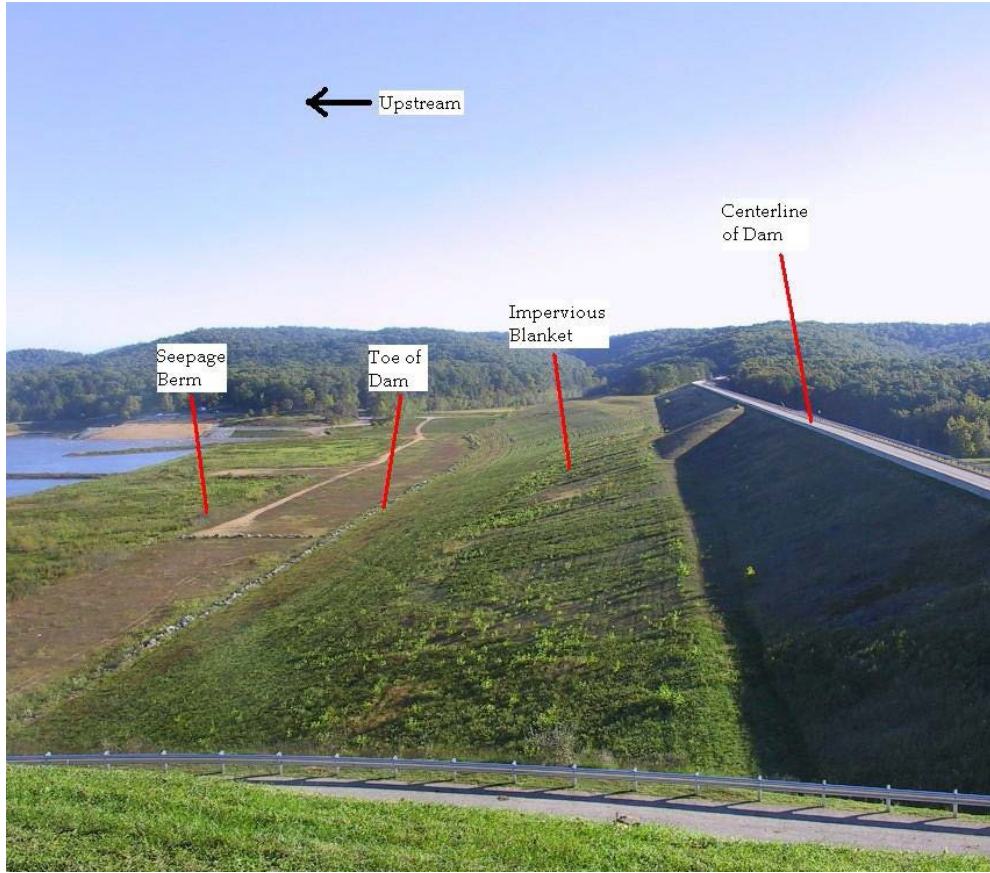

Figure 2.—Upstream slope and impervious blanket, Clearwater Dam (USACE 2004).



Figure 3.—Solutioned dolomite observed in cutoff trench.

The project is underlain by bedrock of the Eminence-Potosi Formation (figure 4).

Black River Basin Geology

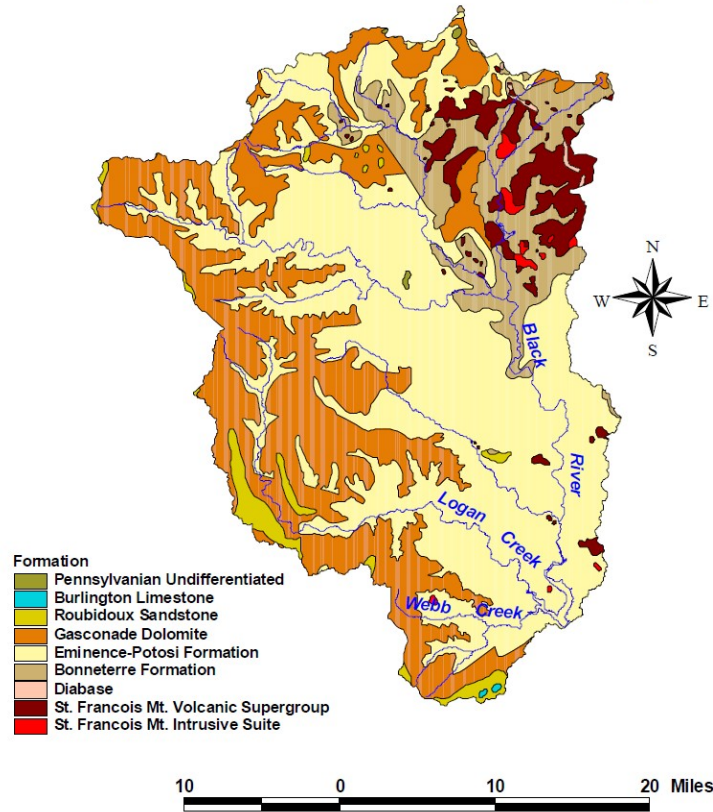

Figure 4.—Extent of the Eminence-Potosi bedrock in the Black River Basin (Krizanich 2007).

Seepage problems at Clearwater Dam were detected and became pronounced as early as 1950 shortly after impoundment. Several modifications have been made to control seepage, including temporary changes to the operation and management of the lake and construction of a seepage berm in 1989. However, seepage problems continued affecting the long-term structural integrity of the dam. Since the embankment was constructed on highly porous rock, there was a concern of possible movement of material beneath the structure, without observable exterior evidence.

The reservoir experienced the pool of record in May 2002. The following January in a period of low pool, a sinkhole (figure 5) opened up on the upstream embankment face above the pool elevation. It is believed that the sinkhole pipe developed below the dental treatment through a karst feature that was originally soil filled but over time was cleaned out by erosion (figure 6). It is also possible the pipe eroded the core above the dental treatment into an untreated feature and bypassed the treated cutoff trench. Following the incident, the dam was placed under a pool restriction until major repairs could be implemented.



Figure 5.—Sinkhole through upstream impervious blanket.

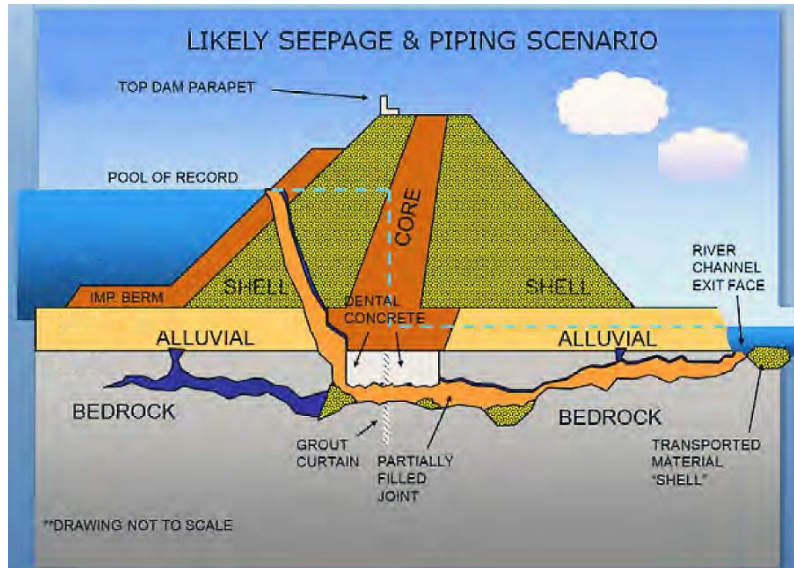

Figure 6.—Conceptual model for underseepage with stoping into the upstream slope.

The project was subsequently evaluated with a screening level risk assessment and assigned a Dam Safety Action Classification (DSAC) 1 rating in the USACE rating system, indicating it as a high-priority project. The critical failure mode was internal erosion through karst solution features with stoping into the upstream slope (see figure 6).

The no action, dam removal, and structural measures were considered to remediate the dam. Potential structural measures considered included: (1) only extending the upstream impervious blanket, (2) constructing a cement-bentonite slurry wall into bedrock along a line 500 ft upstream of the toe of the dam and extending the existing impervious blanket to the top of the dam, and (3) installing a concrete cutoff wall through the embankment and into the foundation. It was determined that the concrete cutoff wall was the best alternative for treating the karstic foundation. The repairs were let in two contracts as described in the solicitation:

“Clearwater Major Rehabilitation Project Phase II primarily consists of the construction of a concrete cutoff wall that penetrates through Clearwater Dam embankment and clay core and into bedrock. The cutoff wall shall be aligned between the existing A and B grout curtain lines that have been completed as part of Phases I and Ib. The separation between these two grout lines is 10 ft. The contract also includes, but is not limited to, widening of the existing construction platform, design and construction of a haul road leading from the spillway to the upstream face of the embankment and extension of the existing seepage blanket. The extension shall be a minimum of 6 ft thick and shall be roller compacted in lifts from the existing surface to the top of the dam.”

The concrete cutoff wall was placed along the centerline of the dam using a hydromill, at a total depth of 230 ft over a length of 4,300 ft of the dam, with a minimum 6-in overlap between panels (figures 7 and 8).

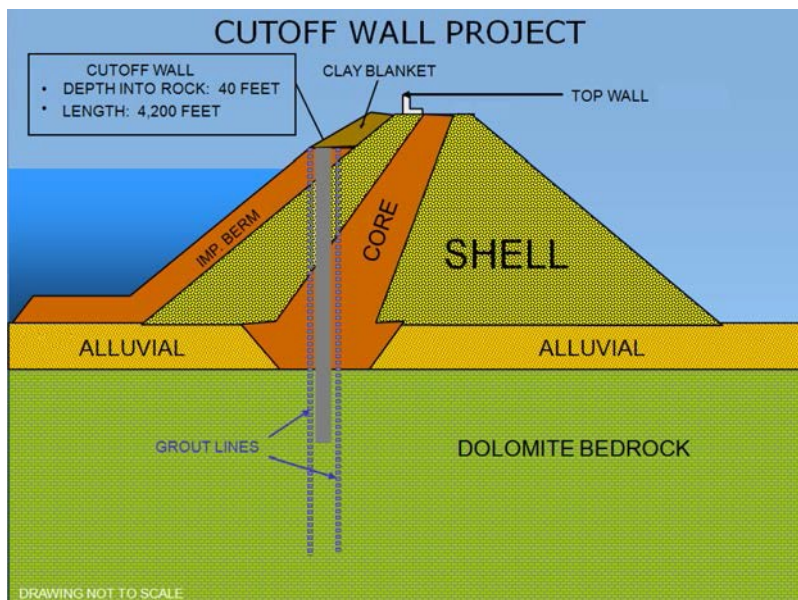

Figure 7.—Cutoff wall extended 40 ft into the dolomite.

Post-construction evaluations found that the cutoff wall is performing as intended with a reduction in measured seepage quantities and reductions in recorded piezometric levels. Review of quality assurance/quality control (QA/QC) test results from the construction confirm that the

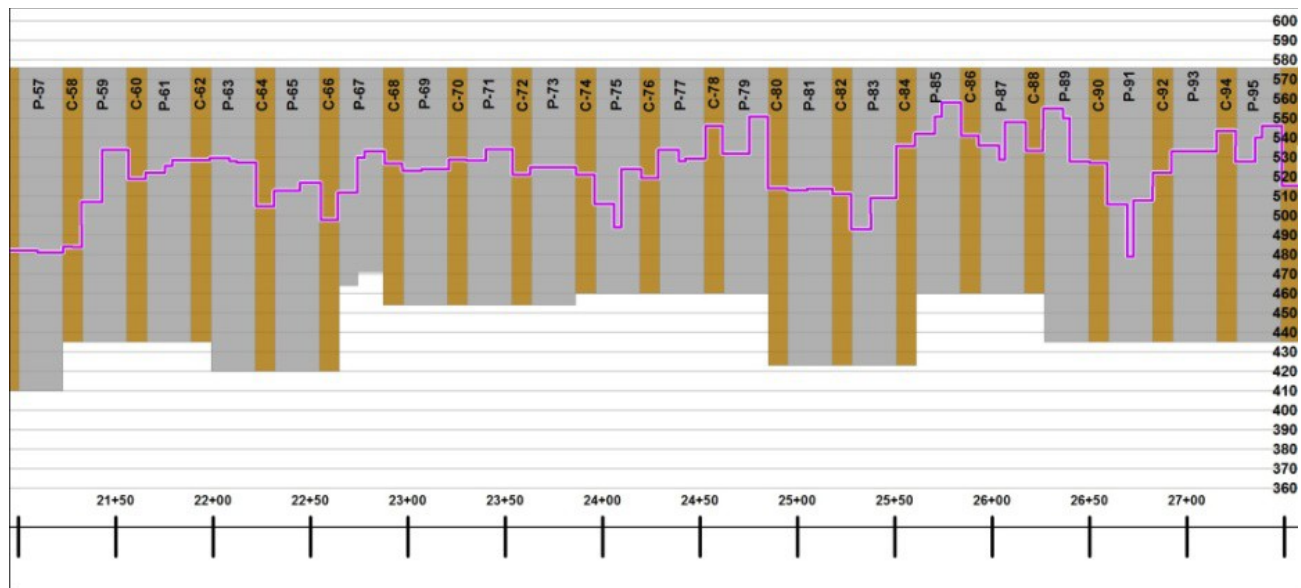

Figure 8.—Total depths for installed cutoff panels.

cutoff wall was installed in accordance with the plans and specifications and has good integrity. The USACE is currently re-evaluating the DSAC rating for this project with consideration for the anticipated performance of the new cutoff wall.

References

- Krizanich, G.W. (2007). “An Investigation of Lead and Other Metal Contaminants in the Sediments of Clearwater Lake, Missouri,” Dissertation of Doctor of Philosophy, University of Missouri-Rolla, Rolla, Missouri.
- U.S. Army Corps of Engineers (USACE) (2004). “Clearwater Dam Major Rehabilitation Study – Clearwater Lake, Missouri, Draft Environmental Assessment,” USACE Little Rock District, Little Rock, Arkansas.

Case 6 – Truckee Canal¹

Introduction

At approximately 4:00 a.m. on January 5, 2008, the downhill embankment of the Truckee Canal failed at approximate canal Sta. 714+00, releasing water into the town of Fernley, Nevada. The canal drained through the breach from both the upstream and downstream directions.

Reportedly, water flowed through the breach for up to 9 hr, and water depths of up to 8 ft occurred in some locations, with water depths of 1 to 4 ft common throughout the housing developments.

No fatalities occurred as a result of the flooding. Damages were estimated to be approximately \$50 million.

Prior to January 4, 2008, the Truckee Carson Irrigation District (TCID) had been diverting water through the canal at an approximate daily rate of 370 ft³/s. A storm event in the Reno/Sparks area on January 4, 2008, generated 1.91 in of precipitation, which resulted in significant increases in the Truckee River flows and diversions into the Truckee Canal. Based on data from a U.S. Geological Survey (USGS) gauging station about 4 mi upstream of the breach site, it is estimated that the flow in the canal was approximately 750 ft³/s at the time the breach occurred.

This paper will present (1) technical information pertinent to the failure, (2) investigations of the canal and breach site, and (3) the PFMs to help explain the cause of the failure.

Background

The Truckee Canal is a part of Reclamation's Newlands Project. The canal was designed and constructed by Reclamation in 1903 and is approximately 30 mi long. In 1926, operation and maintenance of the canal was contracted to the TCID. The Truckee Canal transports water that is diverted from the Truckee River at Derby Diversion Dam into Lahontan Reservoir and provides irrigation along its length. Intervening irrigation, check structures, turnouts, and smaller canals have been built as the project was developed. The Gilpin Wasteway (upstream of Fernley) is used to divert water back into the Truckee River if necessary. The Carson River also flows into Lahontan Reservoir and helps fill it.

In recent years, Reclamation's role has been to determine the amount of water that may be diverted into the canal, to monitor TCID's maintenance activities, and to provide dam safety related services for Lahontan Dam.

¹ Paul et al. (2008) (revised with minor edits and reprinted with permission from Association of State Dam Safety Officials.

Description of the Incident

Based on reports of 911 calls summarized by TCID, the canal failed at approximately 4:00 a.m. on January 5, 2008.

The following narrations were summarized from those reports.

The first call was from a local emergency dispatcher and occurred at approximately 4:26 a.m., indicating that there was a problem at the dam. The project engineer drove from his house toward the Truckee Canal but was stopped near Cook Lane by local emergency responders because of flooding of the road.

The engineer proceeded to call others within TCID to confirm that the canal had indeed failed. While TCID had already implemented some procedures to minimize flows, they then implemented other responses to limit further flooding. Summarizing these procedures: flows into the canal at Derby Dam were stopped, the Gilpin Wasteway was changed to divert all canal flows back into the river, and the Fernley Check, about 1,800 ft upstream of the failure location, was eventually closed when it was judged safe to do so.

Closing of the Fernley Check, accomplished at about 8:00 to 8:30 a.m., stopped the flows out of the upstream side of the canal that were flowing into the breach – although some leakage at the Fernley Check may have been continuing. Additionally, some flows were continuing from the downstream side of the canal through the breach. TCID then completed the temporary plugging (figure 1) of the breach with earthen material, finally stopping all flows from the breach at about 4:00 p.m.

Typical Canal Operations

The decision to approve the diversion and amount of water from the Truckee River into the Truckee Canal throughout a water year is made by Reclamation; it is made based on available water and other factors and does not consider the operational condition of the canal.

Once Reclamation makes an approval, it is up to TCID to monitor flows in the Truckee River and make day-to-day decisions on the amount of flows to divert at Derby Dam – including making actual diversions.

Summarized as follows are the typical operational scenarios:

- When there is a wet year in the drainage basin that feeds Lahontan Dam, high flows in the Carson River will typically occur. Since the Carson also fills Lahontan Dam, the Truckee Canal is normally only used when Carson River Flows are low.



Figure 1.—Photo of the breach during early phases of temporary breach repair on the morning of January 5, 2008. Normal canal flow is from left to right in this photo. The breach is being filled by pushing fine-grained soil into the gap in the canal embankment. Some of the scour of the canal bottom can be seen along with some scour of the area immediately downstream from the breach. The pipeline shown is an abandoned natural gas pipeline that had been buried in the canal embankment. The pipe remained in place after the breach despite eroding all support provided by the original embankment.

- During the irrigation season, typically April through October, the canal is operated in a “checked up” condition, which means that no flows into Lahontan Reservoir are made, and all check structures are closed. This essentially fills the canal to its highest level, and irrigation releases are made (with the depletions filled by a small amount of diversion at Derby Dam). Typically, the least freeboard occurs during the checked up condition (freeboard about 1½ ft at breach location).
- During the non-irrigation season (November through March), the canal is used to fill Lahontan Reservoir if Reclamation has approved the diversion of flows. The diversion of a base flow of water is typical, and if there is a heavy rainfall event in the upper Truckee River runoff basin, the increased diversion to catch a “spike” of Truckee River flow is made.

Canal Operations Just Prior to Failure

As shown on figure 2, for about 2 months prior to the January 5, 2008, failure, a base flow of about 350 ft³/s was being diverted into the canal. No substantial irrigation releases were being made anywhere along the canal.

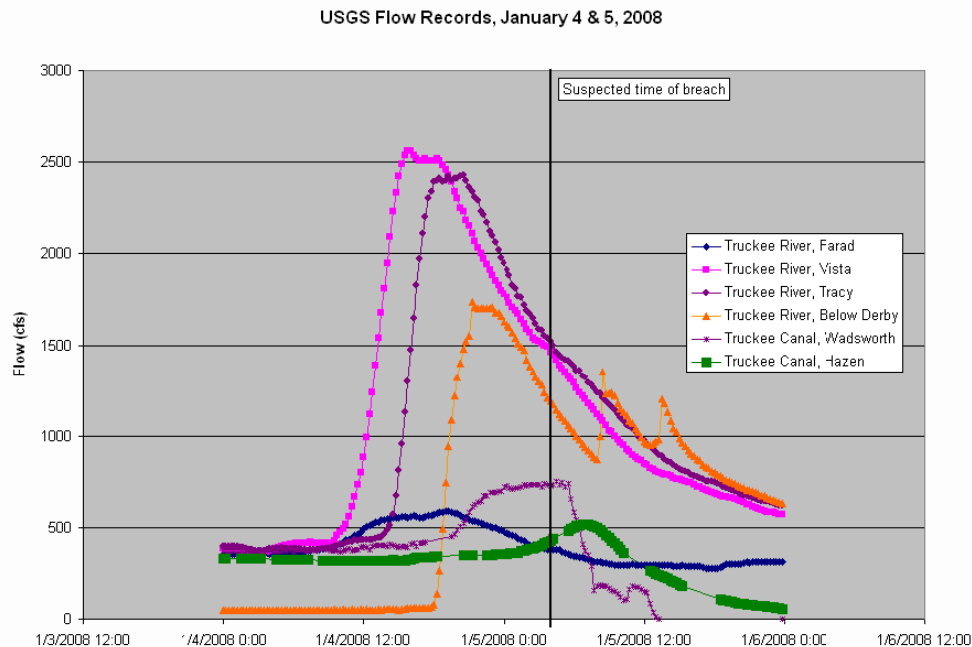

Figure 2.—Flow observations at USGS gages during event. The flow gage at Wadsworth is the gage apparently considered by TCID as the one that gives the flow history closest to the 2008 breach site.

Beginning about Thursday, January 3, 2008, TCID personnel determined, from weather predictions, that a significant rainfall event could cause a large flow in the Truckee River in a few days. On Thursday and Friday (January 3–4), TCID personnel were preparing to divert this large flow should it occur. Activities included some last minute maintenance of equipment, staffing of facilities, and a review of operating criteria and contact information.

Monitoring of weather reports on Friday evening indicated that, indeed, the Truckee River was rising substantially – even unusually fast. Diversions were increased at Derby Dam to capture the flows with a maximum diversion of 650 ft³/s at about 7:15 p.m. on Friday. TCID personnel then monitored the canal flows through the canal system and the performance of the facilities to these flows. This monitoring continued until about 2:00 am on Saturday morning. The final inspection included a visit to the Fernley Check structure at about 1:15 a.m. on Saturday morning. Nothing unusual was reported.

Later evaluations by Reclamation indicated that the likely flow in the Truckee Canal at the breach location was about 750 ft³/s.

Historic Performance

Since original construction, 1903, nine breaches of the Truckee Canal have occurred:

1. April 18, 1918 (related to construction activities)
2. December 10, 1919
3. January 2, 1921 (approximate canal Sta. 513+00)
4. December 13, 1951
5. January, 1957
6. 1959
7. January 1, 1975 (reported due to ice blockage)
8. December 19, 1996 (reported due to animal burrowing)
9. January 5, 2008 (approximate canal Sta. 714+00)

Breach incident Nos. 7, 8, and 9 were all located in or very near the town of Fernley. This record of other incidents apparently does not specify the PFM or its location.

Breach incident No. 7 was reported by TCID to be due to the formation of an “ice dam,” which caused a backup of water, leading to overtopping and breach.

Description of Site Conditions Following the Breach

During the breach event, water from the Truckee Canal flowed from both upstream and downstream in the canal through the breach for at least 9 hr. Water eroded through the left embankment of the canal (which was about 8 ft high in this area) and downcut into the foundation beneath the embankment an additional 9½ ft, for a total erosion depth of about 17½ ft (figure 3).

At the breach site, the invert of the canal was exposed to a vortex of swirling water as canal water from both upstream and downstream met. Due to this turbulence, a scour hole was eroded into the invert of the canal about 12 ft deep. The elevation of the invert of the canal before the breach can best be approximated from a Light Detection and Ranging (LiDar) survey of the canal at about elevation 4185, and the deepest scour was to about elevation 4173.

As the volume of flow through the breach decreased with time, the scour hole filled with a mix of loose canal sediment (mostly medium grain-sized sand), water weeds, and trash. This material was removed from the scour hole and the foundation exposed prior to canal embankment reconstruction.

Breach Description

The site of the breach was located about 1,800 ft downstream from the Fernley Check. Figure 4 shows the approximate dimensions of the breach.



Figure 3.—View through the breach toward Fernley, Nevada. The downstream breach face cut into the left canal embankment is 17½ ft high.

The breach flows traveled directly through a very slight natural drainage and then near a few homes about 1,000 ft downstream from the breach. They then flowed into a topographic low within Fernley where the majority of house flooding occurred.

Of possible importance was the comment by the project engineer that it appeared to him that the breach had developed to full height upon his arrival. He did not notice any remnant of the embankment in the breach that would cause a “waterfall” looking flow through the breach. Such a remnant may have allowed ruling out of foundation piping PFMs.

Based on the verbal report of the project engineer, the dimensions shown on figure 6 were substantially wider than that first noticed upon his arrival at the breach site at least 45 minutes after the breach had occurred (figure 5), which would suggest the widening to the final size occurred sometime between 4:45 and 6:30 a.m.

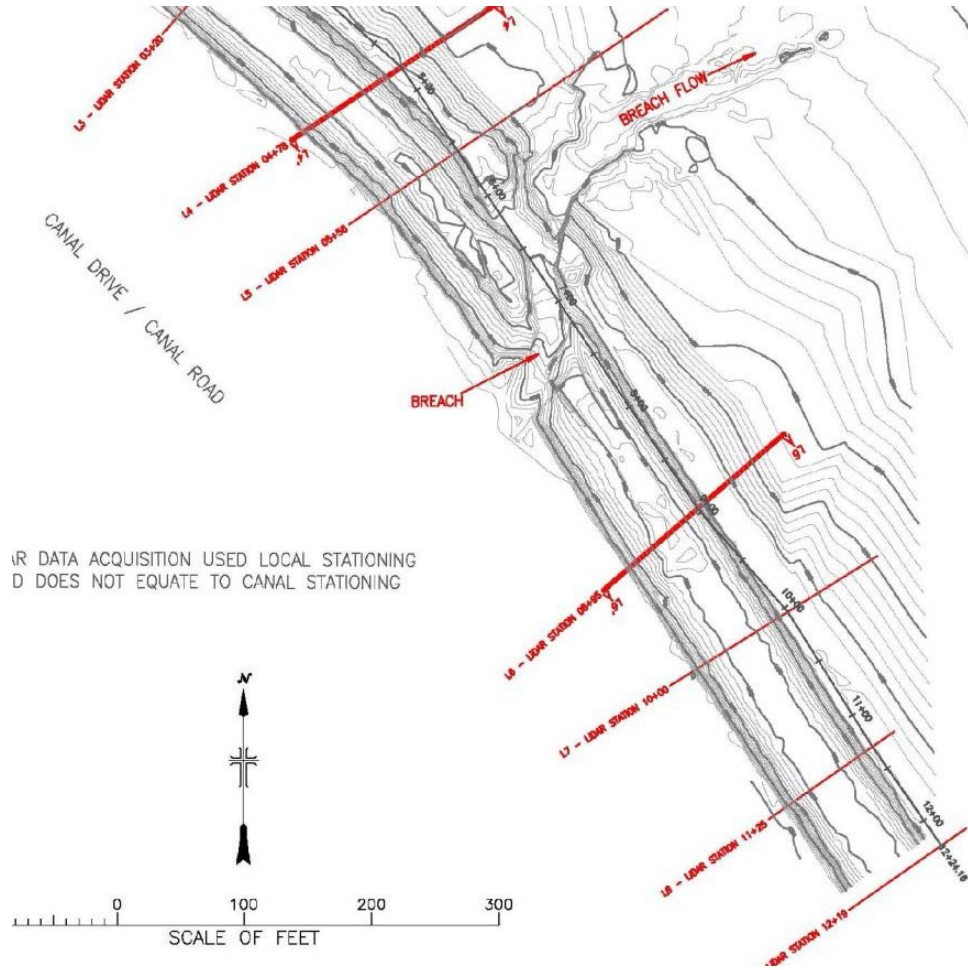

Figure 4.—LiDar survey of breach area after temporary repairs were made (provided by Mid-Pacific Region).

Weather Conditions

During Friday, January 4, records show that a large amount of rain fell on the town of Fernley.

“On the day before the breach, there was a significant weather event in the area. The storms brought 1.91 in of total precipitation to the Reno area just to the west of Fernley, primarily in the form of heavy rain between 10:00 a.m. and 2:00 p.m., followed by snow throughout the afternoon and evening (as recorded at the Reno Airport, based on National Weather Service Daily Summary).”



Figure 5.—Earliest photos showing breach (estimated time about 6:30 a.m. on January 5, 2008) (photos by Walt Winder, TCID).

This heavy rainfall would make it unlikely that local town citizens would have seen the conditions at the eventual breach location in the daylight hours of January 4 prior to the failure. There are no known reports of the condition of the breach site late on the day of January 4. In summary, it does not appear that the early signs of failure were noticed.

Based on a verbal report from the project engineer, the rainfall of the night of January 4 had changed to snow during the early hours of January 5. He indicated an inch or two of snow had been deposited in the area by the time the breach occurred. At about 5:30 a.m., he indicated the snow ended, followed by clearing and sunshine.

Geology

The foundation geology at the breach site consists of two principal geologic units. The lowermost unit consists of Quaternary Age Alluvial Fan Deposits (Qf). Overlying the alluvial fan deposits are Quaternary Age Lahontan Lakebed Sediment (Ql).

Lahontan Lakebed Sediment (Ql)

Glacial Lake Lahontan covered much of western Nevada in late Pleistocene times. Sediment from this lake is present today throughout the Fernley area as thick deposits of laterally extensive, massively bedded, cohesive, fine-grained silt and clay interbedded with thin beds of silty sand. At the January 5, 2008, breach site, the Truckee Canal is a cut-and-fill structure, with the cut portion being within Lahontan Lakebed Sediment (Ql).

Alluvial Fan Deposits (Qf)

Underlying the lakebed sediment (Ql) are thick alluvial fan deposits (Qf). At the breach site, these alluvial fan deposits are composed mostly of poorly graded gravel with silt, sand, and cobbles (GP-GM)sc to cobbles with poorly graded gravel with sand. The gradation of material in these deposits changes rapidly both laterally and with depth.

In the area of the canal breach, fine-grained lakebed sediment is underlain by coarse-grained alluvial fan deposits (figure 6). At the breach site, scour by rushing water eroded down through fine-grained lakebed sediment, forming the invert of the canal, exposing, and removing up to several feet of coarse alluvial fan deposits (Qf).

The details of original construction of this stretch of the canal were not located. Given that the original construction occurred in the early 1900s, it is likely that such details no longer exist.

Based on visual observations of the walls of the breach section, this section of the canal was constructed as about an 8-ft-high embankment directly on foundation materials. The embankment is homogeneous with no slope protection on either the waterside or landside. As

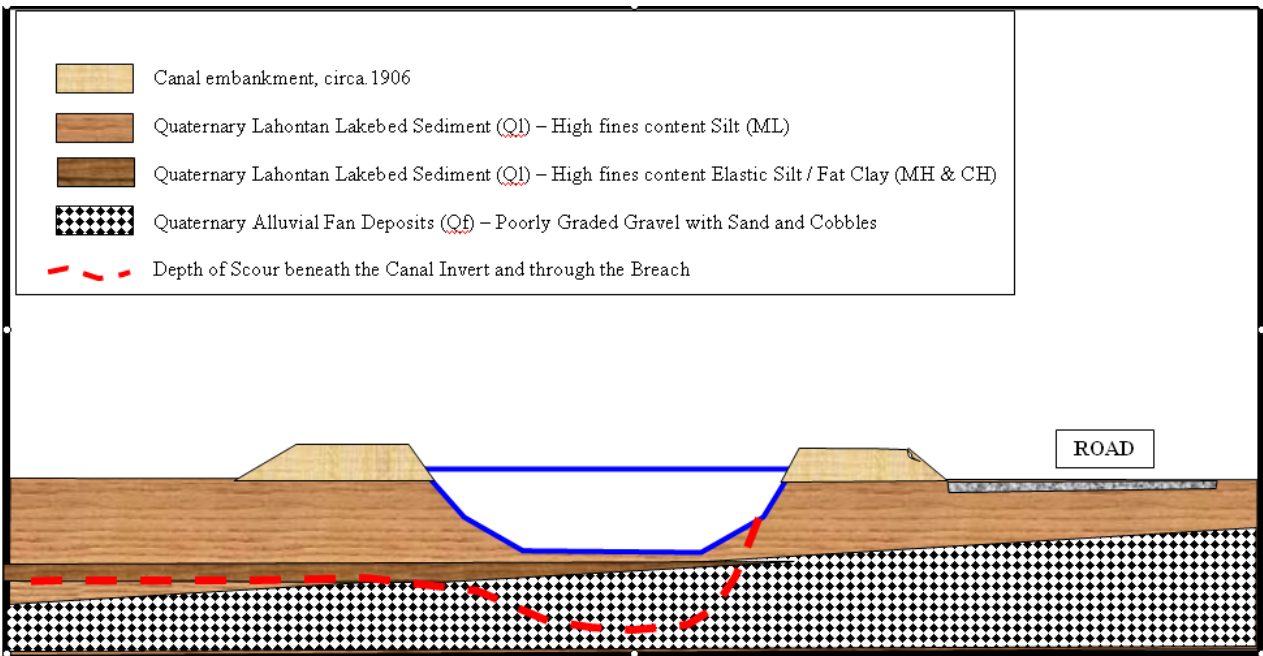

Figure 6.—Sketch of cross section of the Truckee Canal looking downstream at Sta. 714+00 prior to the breach on January 5, 2008 – not to scale. Dashed, red line shows the depth of scour during the breach event.

noted during recent geologic studies, it appeared that some material had been excavated from within the canal over the last 100 yr and deposited on the crest and landside slopes of the embankment (noted as “dredged” materials on figure 7).

The physical properties of the canal embankment are given in table 1.

Table 1.—Some of the canal embankment physical properties measured at the breach site

Hole Number		Inplace Densities		PROJECT	Newlands					FEATURE	Truckee Canal-Fernley Breach			DATE	February 6, 2003		SHEET	2 OF 5	
IDENTIFICATION		DEPTH (Feet)		LAB CLASSIFICATION	PARTICLE - SIZE FRACTION IN PERCENT					CONSISTANCY LIMITS			SPECIFIC GRAVITY			IN-PLACE UNIT WT.		COMPACTION TEST	
SAMPLE NUMBER	From	To	Fines < .075		Sand #200 to #4	Gravel #4 to 3inch	Cob-bles 3 inch to 5inch	Over-size > 5inch	Liquid Limit %	Plasti-city Index %	Field Moisture %	PLUS NO. 4	Bulk	Appar-ent	Absorp-tion %	Total Dry Unit Weight lbs/ft³	-#4 "D" Value	Max. Dry Unit Wt lbs/ft³	Opti-mum Moisture %
1-13-A-1R (Density#1)	4	5	ML	98.9	1.1	0.0	0.0	0.0	NP	NP	35.5				80.4	82.3	97.7	21.6	
1-18-A-1R (Density#2)			CL	86.8	10.3	2.9	0.0	0.0	41.3	18.1	29.9				78.2	79.9	97.9	20.8	
1-18-A-2R (Density#3)			(ML)s	81.3	17.6	1.1	0.0	0.0	38.5	13.0	28.5				66.9	70.0	95.5	25.6	
1-23-A-1R (Density#4)	3.5		(CL)s	83.1	15.5	1.4	0.0	0.0	39.9	15.3	32.2				70.8	75.3	94.0	25.5	
1-23-A-2R (Density#5)	6		SM	36.8	54.5	8.7	0.0	0.0	NP	NP	12.8	2.53		4.1	95.7	82.3	116.3	14.2	
1-23-A-3R (Density#6)	9	10	CH	97.8	2.2	0.0	0.0	0.0	52.7	27.8	45.8				65.0	73.2	88.8	30.2	
1-24-A-1R (Density#7)			ML	98.7	1.3	0.0	0.0	0.0	44.0	14.2	39.0				70.6	76.3	92.5	28.2	
NP = Non-Plastic																			



Figure 7.—Downstream view of the Truckee Canal breach. Dashed, black line is the approximate contact between the canal embankment and in-place lakebed deposits (Q1) composed primarily of silt with sand (ML)s and elastic silt (ML) with minor sandy lenses. Center-left is an abandoned Sierra Pacific Power gas pipeline.

There are two distinct geologic units exposed in the final excavation at the scour hole area. The upper unit is fine-grained Lahontan Lakebed Sediment (Q1b) composed mostly of high-fines content silt and clay with minor sand and is estimated to have a low to very low relative permeability. Underlying the lakebed sediment are coarse alluvial fan deposits (Qf) composed mostly of poorly graded gravel with sand and cobbles (figure 8). The coarse deposits are estimated to have a moderate to high relative permeability.

Discussion of Potential Failure Modes

Because most of the evidence that caused the breach of the Truckee Canal on January 5, 2008, was washed away during the event, it will likely never be possible to determine, with certainty, the actual failure mode that caused the failure. Information provided in the following discussion was gathered primarily during the period January 11–18, 2008, including during the site inspections and interviews by the “Forensic Team” contracted by Reclamation shortly after the incident.

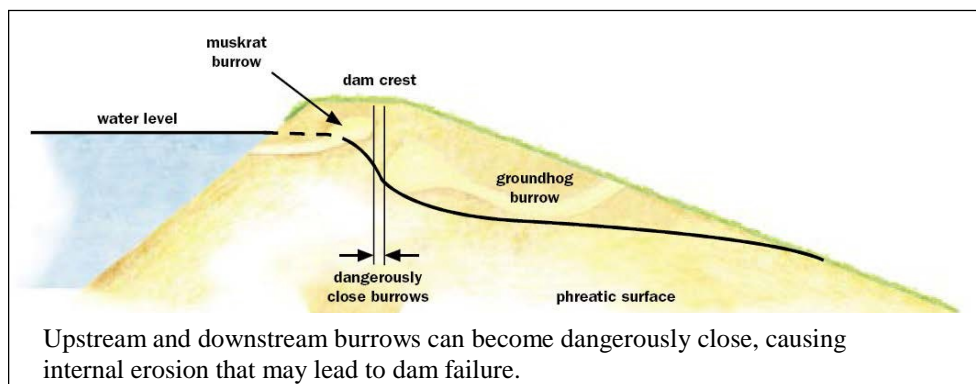
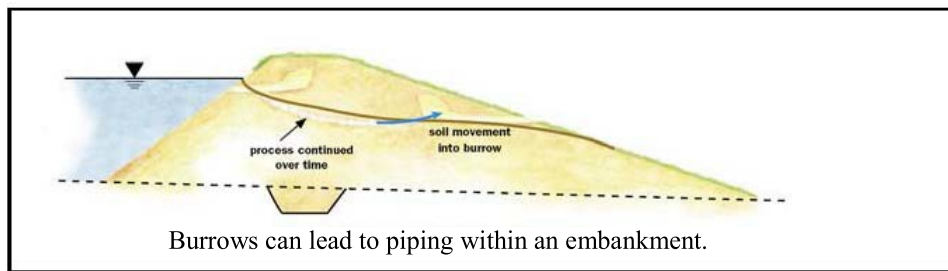
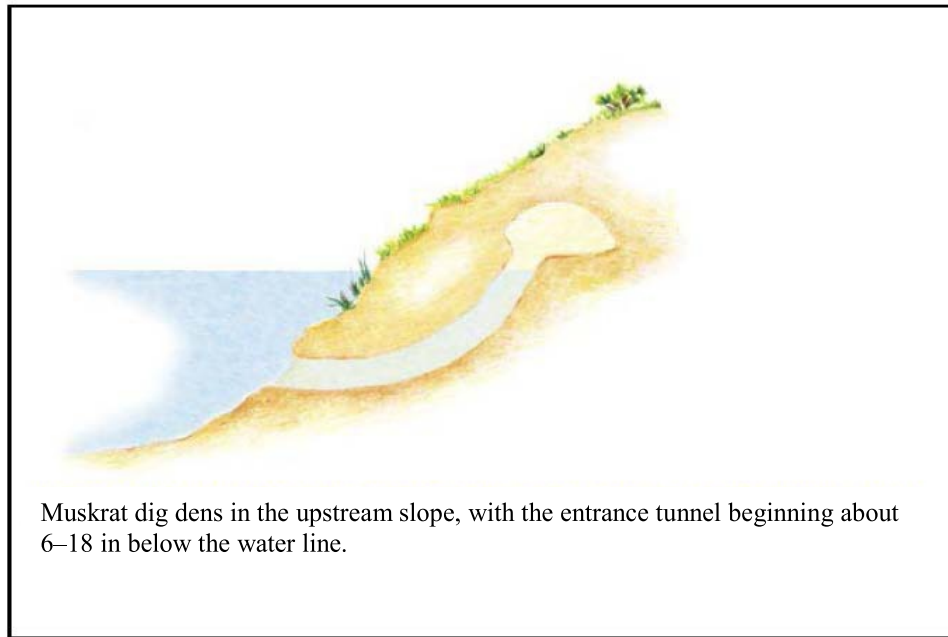

Figure 8.—View to the southwest (toward the right side canal embankment) of the final excavation of the scour hole site.

Based on information provided in later sections of this report, the most likely PFM is considered to be the following:

- **PFM 1 (Animal Burrowing):** The many months of steady flows in the canal at $350 \text{ ft}^3/\text{s}$ may induce animals (muskrats, beavers, and ground squirrels) to burrow into the canal from the waterside toward the landslide at the breach location. As may be typical, the burrowing could start just below the water line and then possibly trend above the phreatic level within the embankment. The burrowing could continue toward the landside until it reaches close to or completely through to the landside. Then, the “surge” of water from increased diversions from Derby Dam reaches the breach site and its burrows. This water rise could cause the burrow to fill with water, possibly causing the animal to burrow deeper toward the landside to escape the rising water if it has not yet burrowed completely through. This flooded burrow could cause water to either flow directly out of the landside canal face or close to it and eventually break through as the water rises further. This flowing water could erode the sidewalls of the burrow, causing the walls to enlarge. Eventually, the canal embankment crest could collapse into the burrow once it widened sufficiently, causing a catastrophic release of canal flows.

The following sketches are from a FEMA manual (FEMA 2005) and illustrate some possible muskrat burrowing patterns.



There are other PFMs that may be relevant. For completeness, some of these other PFMs were also considered in this report. In the end, they were judged to be much less likely than PFM 1. These less likely failure modes can be described as follows (in no particular order):

- **Hydrologic PFM 2 (Overtopping):** Releases into the Truckee Canal at Derby Dam are made. The flows could exceed the canal capacity at the breach site and possibly nowhere else. Heavy, local runoff may also add some water into the canal, causing flows to possibly increase further. Some constrictions in the canal prism may exist due to prior slumping of canal banks, possible buildup of silt or weeds, or possible ice damming. These constrictions could occur in the area of the breach site. The flows at the breach site could then overtop the canal embankment crest. The overtopping flows could have caused erosion to start at the “landside” toe of the embankment. This erosion may move into the embankment, eventually causing catastrophic breach.
- **Internal Erosion PFM 3 (Decaying Tree Roots):** Large trees may have grown near the crest of the canal embankment from either the water or landsides. Their roots may have grown through the embankment to the opposite side. The trees then may have either died from natural causes or were cut down, leaving their roots in place to decay. The roots may decay sufficiently that a hole resulted and may have been completely through the embankment. Shortly on or before the breach of January 5, 2008, the canal water surface rises, flooding these holes. If the holes extend through or mostly through the embankment, water may have started to flow through the embankment directly out of the landside canal face. This flowing water could then erode the sidewalls of the root holes, causing them to enlarge. Eventually, the canal embankment crest could collapse into the root hole once it widened sufficiently, causing a catastrophic release of canal flows.
- **Internal Erosion PFM 4 (Flaw Exists Through Embankment):** A flaw could exist within the canal embankment capable of leading to concentrated seepage. The list of possible flaws might include:
 - Possible cracking of the embankment soil near the canal crest due to desiccation or freeze/thaw.
 - Possible differential settlement due to an irregular foundation profile or settlement of foundation materials.
 - Possible poor compaction during original construction that leads to a loose lift that can collapse upon wetting – possibly leaving a void. An embankment lift surface was possibly left to dry for a period of time during construction and not properly treated before restarting construction. This layer could then possibly have cracks or be of low density that could collapse upon wetting and leave a possible void. One of these potential flaws could penetrate completely through the embankment. When the canal water surface rises on January 5, 2008, water may have then flowed through the flaw. This flowing water could erode the sidewalls of the flaw, causing it to enlarge. Eventually, the crest might collapse into the widened hole, causing a catastrophic release of canal flows.

- **Internal Erosion PFM 5 (Flaw Exists at Embankment-Foundation Contact):** During original construction, the original ground surface beneath the footprint of the canal embankment may not have been stripped of organic materials, or there may have been pre-existing cracks. The organic materials could eventually decompose, possibly leaving a void, or the cracks in the foundation were not treated if they existed. Either of these may have been of sufficient width to transmit enough seepage so that if it were concentrated at the base of the embankment, it might erode the overlying embankment. This flowing water could then possibly erode the sidewalls of the flaw, causing it to enlarge. Eventually, the crest could collapse into the widened hole, causing a catastrophic release of canal flows.
- **Internal Erosion PFM 6 (Erosion of Foundation Material):** The foundation beneath the canal embankment at the breached section may have had a crack system that formed prior to original construction, or the material itself could be sufficiently pervious to allow enough seepage that, if of sufficient volume, it could begin backward erosion piping (BEP) of the foundation materials. BEP occurs when the soil particles at the landside toe begin to wash away with the erosion continuing in a backward direction (toward the water in the canal.) This could then lead to the formation of a hole completely through to the canal that could allow water to rush through. Conversely, seepage through a possible pre-existing crack system in the siltstone can erode the siltstone itself, causing the cracks to widen. The BEP or crack-widening process could be a slow process that may have deposited material at the canal toe, forming sand boils. It is remotely possible that none of these sand boils are seen in previous inspections. The erosion process could continue unchecked and eventually increase to the point where large seepage flows could begin to undermine the canal embankment, causing it to possibly drop into the piping channel, which could lead to breach and catastrophic release of the canal flows.
- **Instability PFM 7 (Slumping of Canal Embankment):** The canal embankment slopes may have become unstable. This could have resulted if they were originally constructed with too steep of slopes, water flow in the canal over time may have eroded the slopes and oversteepened them, or the heavy rainfall events just prior to the breach may have caused the waterside canal slope to fail. Conversely, a high phreatic water surface may have built up in the canal embankment, possibly causing instability that could lead to a slump of the landside slope of the canal. The slumping of the slope could have caused a drop in the canal crest that may have allowed the embankment to be overtopped, which could have led to a catastrophic release of the canal flows.

Muskrat Hole Investigations

A few days after the breach, an informal inspection of the canal embankment revealed a series of animal burrows located a few hundred feet downstream from the breach. A tape inserted into one of the burrows penetrated to an approximate horizontal distance of 11 ft. On the landside of the canal, almost directly across from the burrow, a fresh delta of sand was found with a collapse feature noted on the canal face.

To determine the conditions in the crest of the canal embankment, investigations conducted of the muskrat activity were documented in a report. As discussed in that report, a grout program was implemented that injected a Stratathane™ and water mixture under low pressure into the burrow area. The area was later excavated. Observations indicate that a “cast” of portions of a burrow warren had been made. It indicated that the series of burrows, dens, and voids had penetrated to within a few feet of the landside of the canal bank very close to the collapse feature area. From all of this, it can be reasonably surmised that the burrowing had been occurring in the months prior to the failure when the canal had been flowing at an approximately steady rate of about 350 ft³/s. When the canal flows were sharply increased the morning of January 5, the burrows would have flooded with a few feet of hydraulic head. This increase in water head likely caused concentrated seepage from the landside face of the canal embankment, which started the erosion process. The fresh deposit of sand below the collapsed feature and nearly directly in line with the animal burrows appears to be evidence that erosion had started. It is likely that the erosion would have progressed and caused a failure if the breach had not happened just upstream with the resulting drop in water surface.

Some photos from that report follow (figures 9–11).

Summary and Conclusions

A small section of the Truckee Canal failed on the morning of January 5, 2008. Almost 600 homes were flooded, but no fatalities occurred.

As is usual for failures of most earthen embankments, the act of breaching and subsequent high outflows washed away crucial evidence that may have allowed exact identification of the cause of the failure. Thus, the actual cause will likely never be known.

Judging based on available information, it would appear that animal burrowing is the most likely of the plausible PFMs. Most of the burrowing could have occurred during the months prior to failure when steady flows in the canal were occurring. This could have produced conditions adequate (low flow velocity, only small changes in water level) for animals to begin their burrowing. A near-constant water level could have encouraged the animals to start burrowing just below the water line and then burrow up, above the phreatic water level within the embankment, probably very far into the embankment or possibly completely through it. There is some evidence from inspections that burrowing well into the canal embankment has occurred in many other areas of the Truckee Canal. It is also possible that the burrow(s) from the waterside at the breach site were, by chance, aligned with other burrows from the landside, forming a through-going connection.

The 2–3 ft rapid rise in the water level on the morning of January 5 could then have flooded the burrow, causing concentrated seepage to another burrow or directly out of the embankment. The rise in water level may also have caused water pressures very near the downstream slope –



Figure 11.—View of canal embankment prior to investigations showing three muskrat burrow entrances on the waterside and the location of a collapse feature (feature not visible) on the landside. The burrow entrance appeared to be located a foot or so below the approximate 350 ft³/s flow line.



Figure 10.—View of partial excavations of canal embankment crest following grouting with Stratathane™. Features that were found grouted have been painted with orange paint.

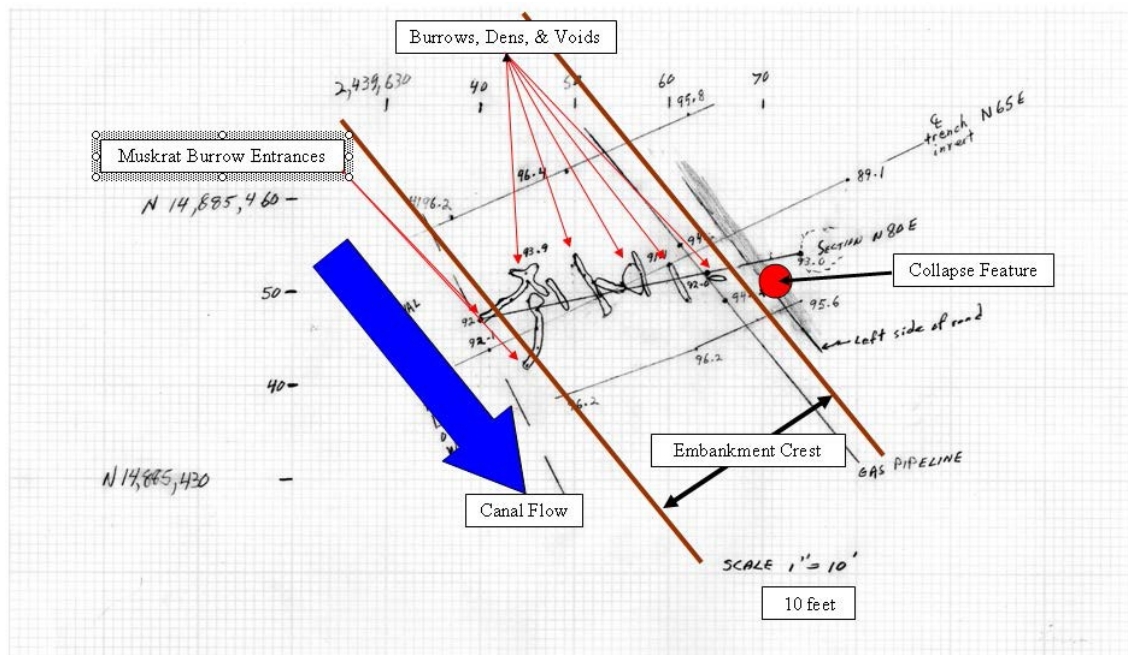

Figure 11.—Map of features found during muskrat investigations.

depending on the extent of actual penetration of the embankment by animal burrows. Pressures near the downstream slope could cause it to leak and eventually result in a fully penetrating concentrated leak or “pipe.”

Once concentrated seepage started, poorly compacted canal embankment materials, of which the canal embankment was built, may have eroded rapidly. Re-molded specimens of canal fill material were tested to have an estimated I_{HET} (erosion rate index from Hole Erosion Test) value of about 1–2, a number indicative of high erodibility. The erodible nature of the embankment material could have allowed rapid failure of the embankment – possibly as quick as the 4 hr (minimum) between observations of the canal the morning of January 5 by TCID personnel. Once failure occurred, the breach could then widen substantially, resulting in possible increasing outflow. No defensive measures to address potential piping issues (e.g., sand filters, gravel drains) were included in the original, 1903 design.

Investigations at a series of muskrat holes a few hundred feet downstream from the breach (Sta. 716+50) seem to verify this as the likely PFM. “Grouting” the area with Stratathane™, followed by excavation, revealed that the burrows appeared to be capable of staying open with substantial diameter for a portion of their length. The average diameter of this grouted burrow was on the order of 4 in – possibly capable of large, erosive seepage velocities with even a small amount of hydraulic head supplied from the waterside. A collapse feature was noticed along with a delta of sand that had been deposited on the landside of the canal toe in the immediate vicinity of the burrow. It could be that erosion was underway at this location. It is possible that this area would have soon failed if the breach did not happen just upstream, causing a drop in the water surface.

References

- Bureau of Reclamation (Reclamation) (2008a). "Truckee Canal Breach, Sta. 716+50, Muskrat Burrow Investigations," Newlands Project, Lahontan Basin Area Office, Nevada, Bureau of Reclamation, March 2008.
- _____(2008b). Technical Memorandum No. MERL-08-6, "Results of Laboratory Physical Properties and Hole Erosion Tests, Truckee Canal Embankment Breach," Newlands Project, Bureau of Reclamation, Technical Service Center, Denver, March 2008.
- Paul, D.B, J. Cyganiewicz, C. Slaven, and J. France (2008). "Potential Failure Modes for the Truckee Canal at Fernley Nevada," Dam Safety 2008, Association of State Dam Safety Officials, Lexington, Kentucky, JDS-Vol. 7, Issue 4, Article 1.
- Federal Emergency Management Agency (FEMA) (2005). "Technical Manual for Dam Owners, Impacts of Animals on Earthen Dams," FEMA Document #473, September 2005.

Case 7 – Anita Dam¹

Anita Dam was constructed in 1996 with a height of 36 ft, a crest width of 14 ft, and a crest length of 1,012 ft. It impounds a 1,210 acre-ft reservoir (figure 1) on an unnamed tributary to the East Fork of Battle Creek in a rural area near Zurich, Montana, and retains water from a 15-square-mi area for irrigation. The dam was equipped with a 36-in-diameter steel outlet conduit, as the principal spillway, and two unlined spillways located on the reservoir rim to pass extreme floods. The embankment is constructed of CL material that was found to be dispersive and is a homogeneous fill with upstream riprap protection. The conduit was equipped with antiseep collars and supported by flowable fill; no diaphragm filter was provided. This case history illustrates an embankment failure by internal erosion of dispersive clay fill despite the use of seep collars.

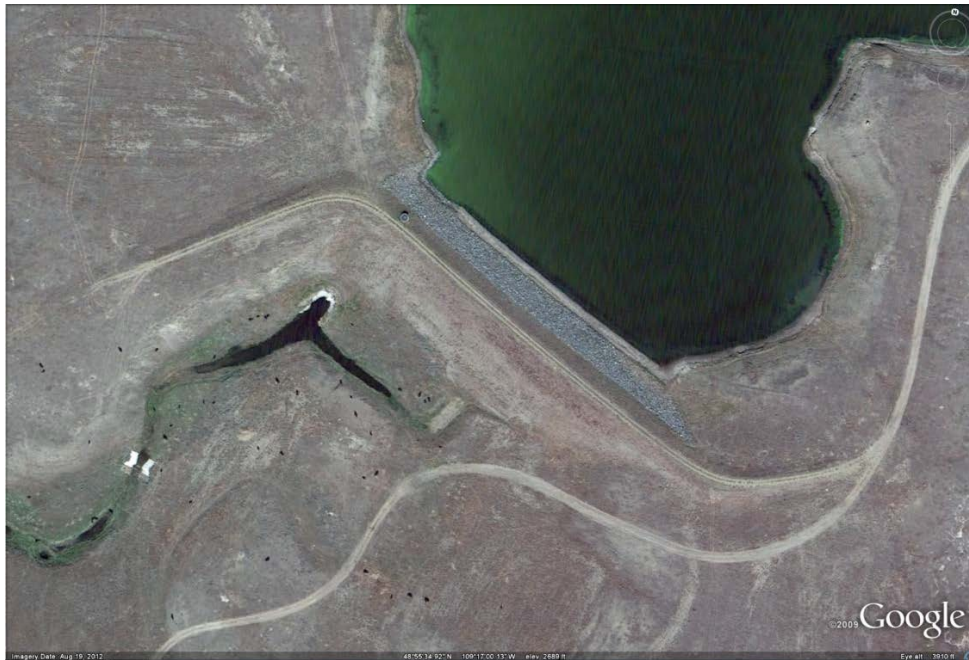

Figure 1.—Aerial view of Anita Dam (Google Earth, August 19, 2012).

On March 26, 1997, the Anita Reservoir dam embankment suffered major piping erosion along the outlet pipe, which resulted in the rapid discharge of almost 800 acre-ft of water through and along the outlet pipe in about 36 hr. There was no injury or loss of life and only minor property damage downstream; however, four families were evacuated downstream as a precautionary measure. The unusual spring flooding throughout the drainage presented a much more serious risk of injury or loss than the failure of Anita Dam. (The drainage area into Anita Reservoir is only 4% of the east fork of Battle Creek and about 1% of the total Battle Creek drainage.)

¹ Except for the first paragraph, reprinted Executive Summary of the incident, Bureau of Land Management (November 13, 1997) and supplemented with material from FEMA (2005).

Anita Dam, located in the Havre Resource Area, Lewistown District, about 5 mi from the Canadian border, was built under the Prairie Potholes Joint Venture with Reclamation and Ducks Unlimited. The dam was designed by the Bureau of Land Management (BLM) and constructed by a contractor in 1996. Anita Dam was classified as a low-hazard dam.

The reservoir is not on a live stream, and was anticipated to be filled over a 3-yr period. But a large snowpack and warm weather throughout the area and into Canada caused the reservoir to be filled in only 4 days. Before the principal spillway (a standpipe) began flowing, water piped through the embankment along the outlet works and caused rapid failure of the dam (figure 2). Although the embankment did not collapse, it was necessary to open the outlet gate and drain the reservoir. BLM personnel were onsite monitoring the situation until the reservoir was drained.



Figure 2.—Discharge of water from internal erosion adjacent to conduit (top photograph) and erosion of fill from around seep collars at upstream end of conduit (bottom photograph) taken after the reservoir emptied.

A Board of Inquiry was convened at the request of the BLM Montana State Director. The board visited the site the week after the failure and interviewed the people who witnessed the failure and participated in the emergency actions. Individuals involved in the design and construction process were also interviewed, and files were reviewed.

A series of soil samples from the dam area were tested, and a review of current dam design criteria was performed. The board evaluated the criteria and procedures used by BLM personnel as well as the effectiveness of the emergency actions taken in response to the developing failure. In addition, a literature search of previous dam failures nationwide was performed to compare similarities and causes.

The board concluded that the cause for failure was piping, initiated by a small flow path along the outlet pipe through the dam embankment. This flow path need only have been a fraction of an inch and could have been started by settlement, pipe rotation, freeze-thaw, or inadequate pipe compaction. It was discovered that the dam was constructed of a dispersive clay material, which looks like “regular” clay material but goes into colloidal suspension in water and very rapidly loses cohesiveness. This both accelerated the failure and precluded the possibility of the piping void healing itself. The dam design lacked redundancy to avoid this type of failure. The dispersive clay problem can be remedied by adding calcium chloride to the soil and/or by installing a sand filter in the embankment. These actions would preclude a similar failure.

As cited in the literature following failure of this dam (FEMA 2005), the cause of the failure was probably due to a combination of the presence of dispersive clay fill; hydraulic fracture; presence of antiseep collars, leading to poor compaction around the conduit, use of flowable backfill rather than a continuous concrete conduit support; and lack of a filter and drain around the conduit at the downstream portion of the embankment. Also, it was noted that cold air flowing through the conduit may have created ice lenses adjacent to the conduit that could have provided a path for concentrated seepage.

References

- Bureau of Land Management (BLM) (1997). EMS Transmission 11/13/97 – Information Bulletin No. 98-18, Bureau of Land Management, Washington, DC.
- Federal Emergency Management Agency (FEMA) (2005). Technical Manual: Conduits through Embankment Dams, Federal Emergency Management Agency, Washington, DC.

Case 8 – Sallacoa Creek Watershed, Site No. 77 Dam

Sallacoa No. 77 is a single-purpose NRCS flood control dam. It was constructed in 1973 in Gordon County in northwest Georgia. The maximum height of the dam is 48 ft, and the crest length is 720 ft. The drainage area is 935 acres, and the storage capacity is 431 acre-ft. The embankment consists of a zoned fill with a fine-grained central core (MH soil) and more permeable outer shells (SM soil and weathered shale). The foundation consists of weathered shale over interbedded shale and limestone. The dam's cutoff trench bottomed on the limestone. A foundation trench drain was installed across the entire valley section near the downstream toe.

Geologic Site Conditions

The 1968 geologic investigation identified numerous problems with the site suggestive of karst activity, including sinkholes, springs, frequent loss of circulation water and/or rod drop during drilling, numerous mud/soft soil-filled joints, and very high permeabilities in the bedrock on the right abutment. However, no large, open caverns were detected. A 50-ft-diameter sinkhole was observed on the left abutment near the outlet of the emergency spillway (figure 1). In a dye test, dye introduced on the right abutment surfaced 1/4 mi downstream.

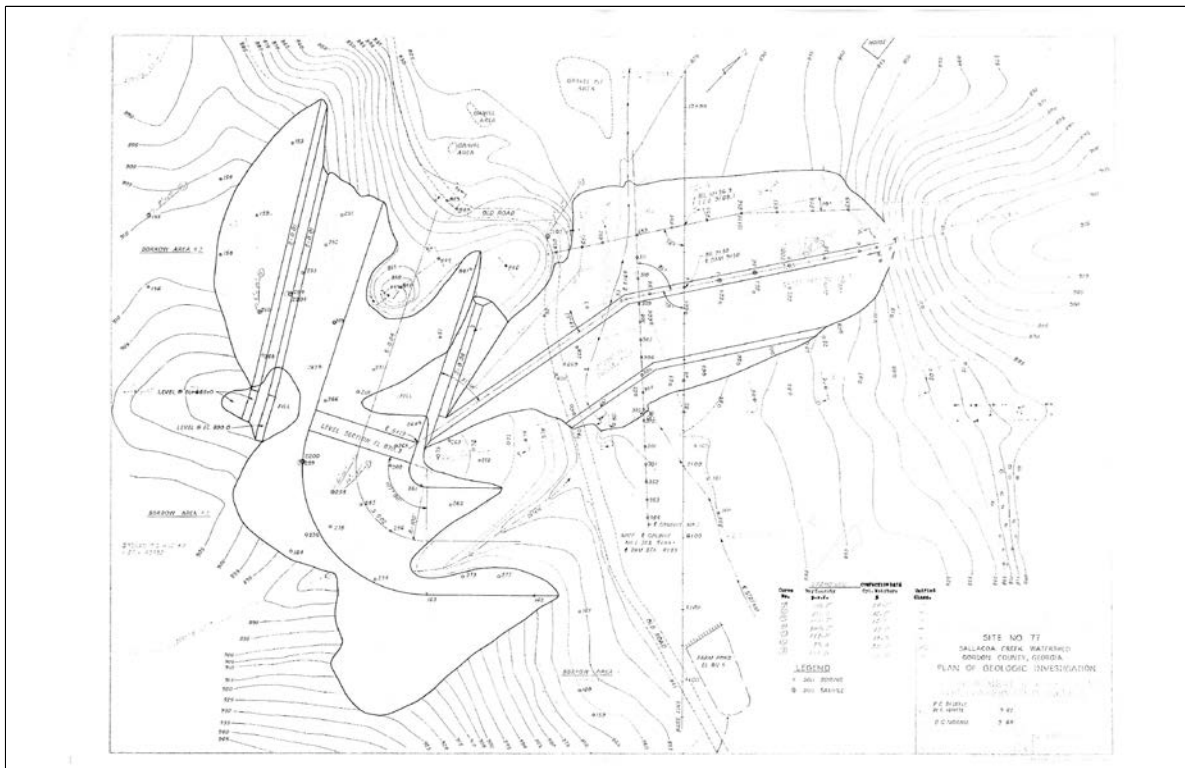

Figure 1.—Plan view of Sallacoa No. 77 from 1968 geologic investigation drawings. Note the pre-existing sinkhole at the outlet end of the emergency spillway on the left abutment.

Appearance of Sinkhole on Downstream Slope of Dam

After 35 yr of operation, a large sinkhole developed very suddenly on the downstream slope of the dam (figure 2). On April 10, 2008, the dam was observed to be in normal condition. On April 11, a landowner downstream from the dam noticed a large “brown spot” on the downstream slope of the dam near the eventual location of the sinkhole. On April 12, the presence of the sinkhole was confirmed. Upon examination of the structure by engineers and emergency personnel, the low stage gate was opened to drain the reservoir as a precautionary measure.



Figure 2.—Aerial view of the sinkhole on the downstream slope of the dam. Photo was taken after the reservoir had been drained.

The sinkhole was approximately 65 ft in diameter and 40 ft deep. It was located about 100 ft to the right (looking downstream) of the principal spillway conduit. Groundwater was present in the bottom of the sinkhole, and the elevation of the bottom was several feet below the invert of the core trench and therefore was in in-place bedrock. The bottom of the sinkhole was about 10 ft below the collector pipe in the foundation trench drain. The pipe showed no signs of flow.

The large volume of the sinkhole (approximately 5,000 yd³) indicated that a very large system of voids existed under the dam. The failure appears to be a classic case of stoping of foundation

and embankment soil into large openings in the underlying karst foundation. The two major joint lineaments associated with the drainage pattern in the watershed were found to intersect at the very location of the sinkhole, indicating that this spot was the site of preferential groundwater flow and, therefore, karst solutioning activity.

Subsequent Investigations

Following the appearance of the sinkhole, additional geologic investigations were performed to further characterize the subsurface conditions at the dam site and to provide the basis for developing repair alternatives. First, an electrical resistivity (ER) survey was performed, followed by additional drilling on the embankment.

Electrical Resistivity Survey

The ER survey consisted of six lines of electrodes parallel to, and three lines perpendicular to, the dam centerline, respectively (figure 3). The survey identified a number of large “anomalous” (highly conductive) areas suggestive of water- or mud-filled cavities in the limestone bedrock, including at the site of the 2008 sinkhole. Figure 4 is an ER profile that shows a large conductive area adjacent to the sinkhole. The ER profiles also depict a large, elongated feature that generally confirms the presence of a solution feature associated with the pre-existing sinkhole in the emergency spillway. The profiles suggest that a “roof” of more competent rock overlies more open limestone deeper in the formation. In some cases, fingers of conductive material (likely fractures) penetrate this roof and suggest areas of past, present, or future sinkhole activity. The findings of the ER survey strongly suggest that sufficiently large amounts of void space are available within the deeper limestone to explain the loss of the large amount of soil from the 2008 sinkhole.

Additional Drilling

First, three boreholes were advanced from the embankment crest using a hollow-stem auger with mud-rotary drilling methods. Standard penetration test (SPT) samples were obtained at 5-ft intervals, and the holes were terminated at refusal. This occurred at or just into the partially weathered bedrock below the cutoff trench invert. The embankment fill was found to be uniform and well compacted, with blow counts generally ranging between 10 and 20 blows per foot (uncorrected). Next, 40 boreholes were advanced at various locations within the embankment footprint using an air percussion drill rig (note that current practice would not allow the use pneumatic drilling in a water-retaining embankment in this way). The additional drilling program was performed to verify the results of the ER survey and to provide for further characterization of the foundation materials and conditions. In the air percussion drilling, measurable open or water/mud-filled voids/seams were encountered in 27 of 40 of the borings. In one borehole located about 100 ft left of the 2008 sinkhole, a rod drop of 34 ft was measured, indicating a very large open void, joint, or cavity. Frequent loss of air pressure was experienced

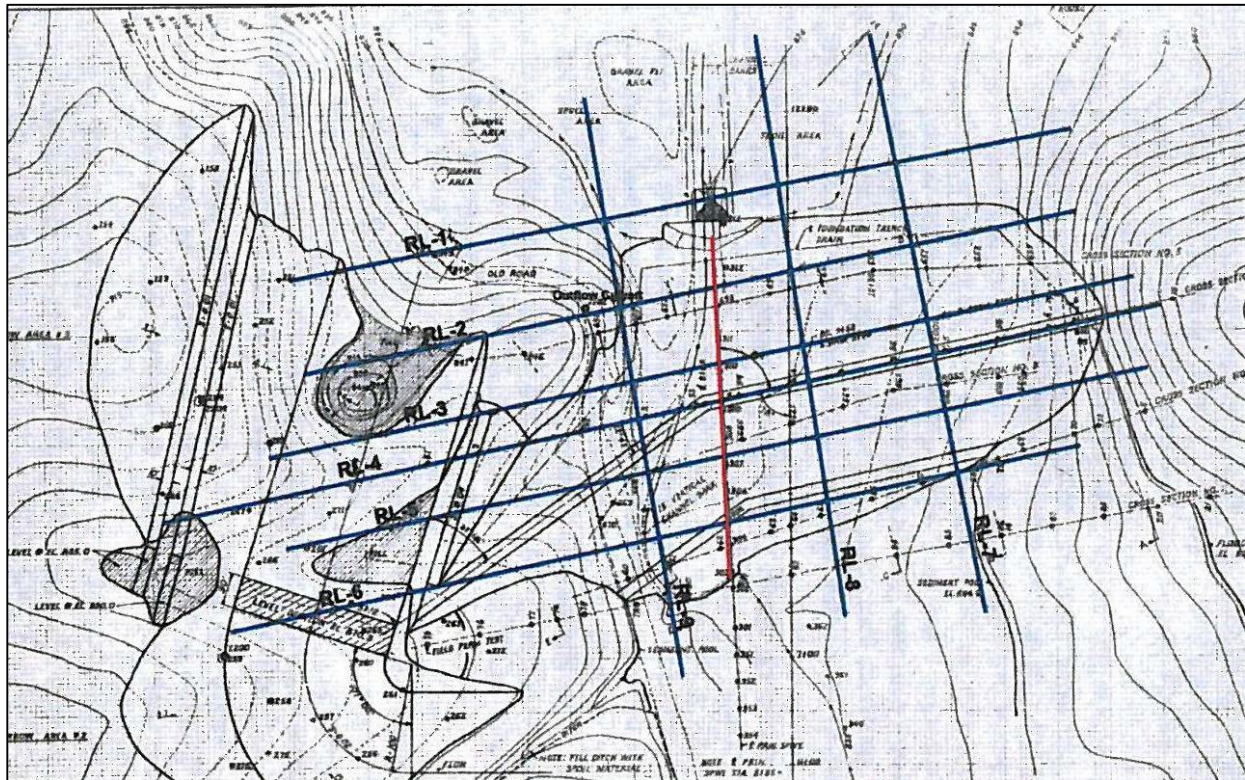

Figure 3.—Plan view of dam showing lines of electrodes (in blue) used in the ER survey. The approximate location of the 2008 sinkhole is shown in red. The straight, red line is the principal spillway alignment.

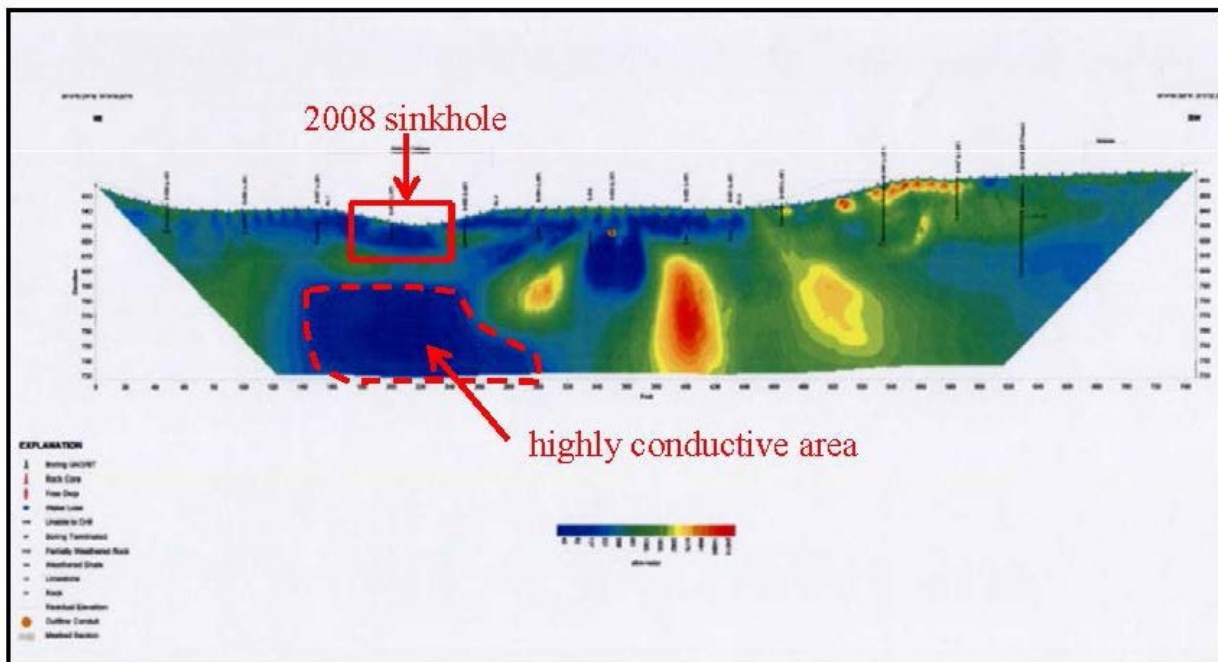

Figure 4.—ER profile adjacent to 2008 sinkhole (Line RL-2 on figure 3). Dark blue area (in dashed, red outline) indicates a highly conductive zone at the sinkhole location. The green area above the conductive zone suggests a “roof” layer.

during drilling, suggesting numerous voids and openings in the bedrock. In a number of cases while drilling on the embankment, air or water was observed to escape from areas both upstream and downstream from the embankment, demonstrating a degree of continuity within the system of voids in the bedrock foundation under the dam.

Conclusion

In general, the drilling program confirmed the findings of the ER survey; namely, that an extensive system of underground voids exists under the dam. This system of voids is conducive to the formation of sinkholes by stoping, especially since a more competent “roof” layer appears to be present. The extent to which seepage from the reservoir formed new cavities or enlarged existing cavities in the foundation cannot be determined. However, the additional head from the reservoir acting on the groundwater flow regime under the dam likely accelerated the rate of stoping at the sinkhole location. Because of the extensive nature of the system of voids under the dam, it was determined that achieving a positive cutoff of seepage under and around the dam by grouting would be economically unfeasible. Therefore, the decision was made to decommission the dam by breaching it.

Case 9 – Herbert Hoover Dike^{1, 2}

Paper 1 – Deterministic Approach to Dam Remediation

Introduction

Herbert Hoover Dike (HHD) encircles Lake Okeechobee (the second largest freshwater lake wholly within the United States) in south central Florida (figure 1). The HHD was originally authorized in response to hurricanes of 1926 and 1928 and was constructed in two general phases over the course of more than 30 yr. The first phase was constructed in the 1930s and resulted in approximately 84 mi of embankment. Construction was carried out by a combination of dipper and hydraulic dredges, with blasting required in some areas (figure 2). Containment dikes were constructed within the footprint, and dredged materials were pumped to fill them as they were periodically raised and narrowed in accordance with the design template. Unfortunately, no engineering or construction records can be located from the original 1930's construction, so several uncertainties remain regarding decisions that were made.

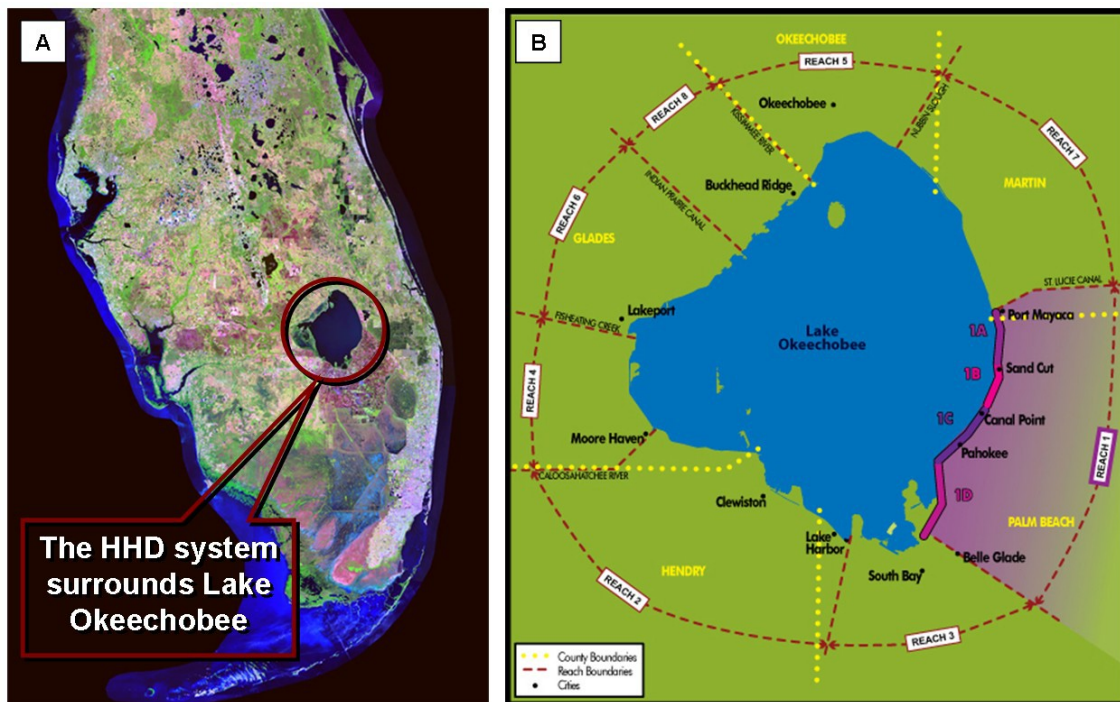

Figure 1.—Satellite view of south-central Florida (A) and a map view of the HHD project reaches (B). The focus of this paper, Reach 1A (4.9 mi long), is located between Port Mayaca and Sand Cut and is within the 22.5-mi-long Reach 1.

¹ Davis et al. (2009), reprinted with permission from United States Society on Dams (formerly United States Committee on Large Dams).

² Editor's note – Subsequent to publication of the 2009 paper, the USACE performed a risk assessment to further assess and prioritize proposed mitigation measures for internal erosion at the HHD; preliminary results of the risk assessment are provided in paper 2 for comparison.

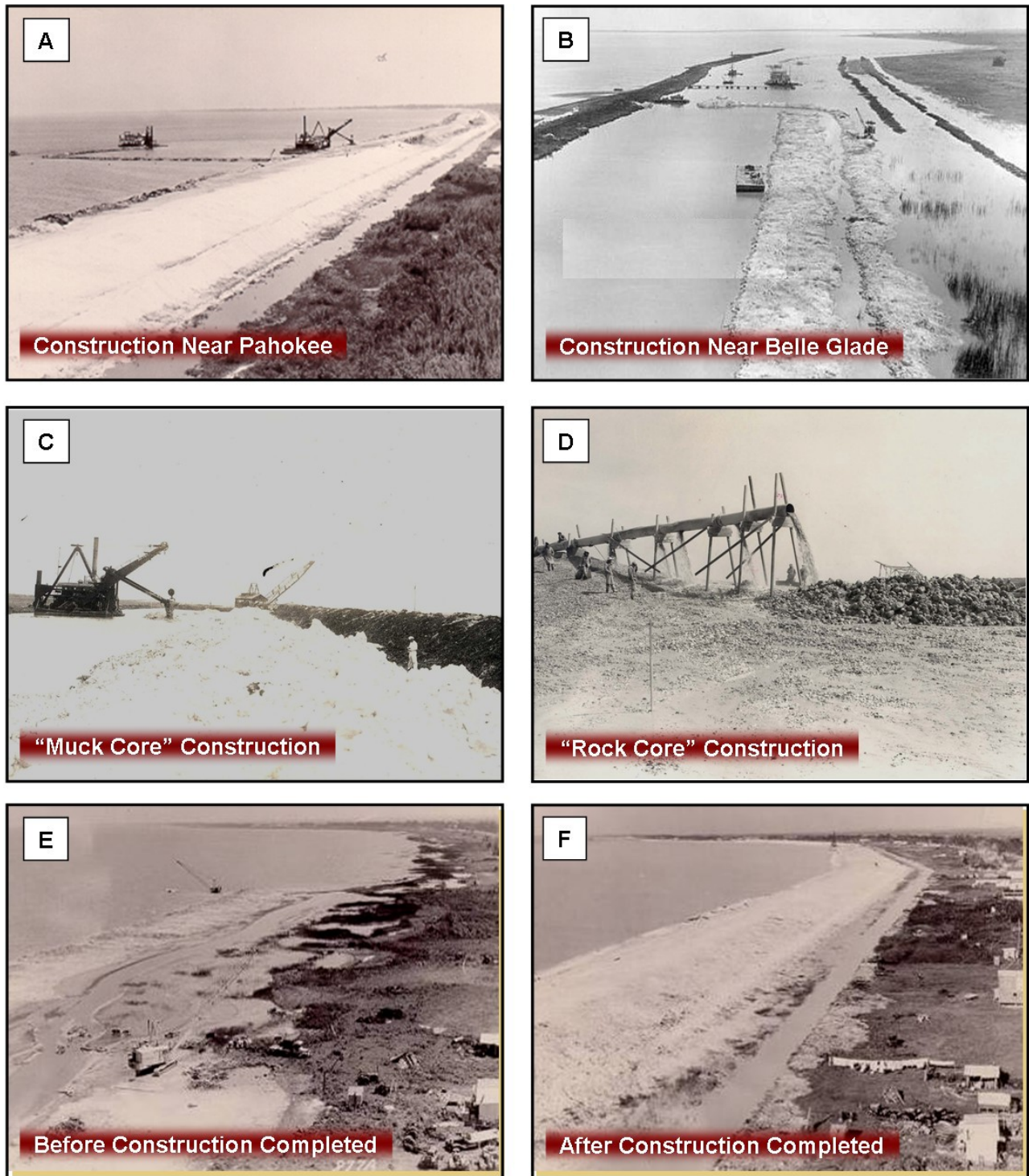

Figure 2.—Historical photographs (taken during the 1930s) of original dike construction via hydraulic dredge and dragline: (A) construction near Pahokee, (B) construction near Belle Glade showing alignment through marshy area, (C) and (D) evidence of “muck and rock core” being incorporated into the dike during construction, and (E) and (F) before and after completion of construction views (looking toward the northeast) from the top of the Pahokee water tower; note the toe ditch landward of the dike embankment in (F).

During the 1950s, several reports were prepared in which the hydrometeorological impacts to Lake Okeechobee from hurricanes, lake surges, and wave runup were studied. Through this work, it was concluded that the design storm would be equivalent to a Category 3 storm crossing the lake. The second phase of construction was performed during the 1960s utilizing construction techniques similar to those of the first phase. The original dike was raised, and the remaining lake perimeter was enclosed, resulting in the current HHD configuration (final length of 143 mi). Outlet works having sufficient capacity to pass the standard project flood (SPF) were not built during either phase of HHD construction.

Concerns due to seepage (and related slope) instability at HHD have been documented since the early 1980s. They became more pronounced during the mid- to late 1990s when two nearly back-to-back high water events served to demonstrate the need for an immediate rehabilitation effort. During these events, the lake crested, and numerous sinkholes, seeps, pipes, and boils were observed (figure 3) primarily along the nearly 50 mi that comprises Reaches 1, 2, and 3 and were subsequently addressed with remedial measures. A significant reason for seepage concerns at HHD arises from the lack of hydraulic controls. Lake Okeechobee is operated according to a regulation schedule, but water managers lack the control needed to release enough water during high inflow periods. The outlet capacity is dwarfed by large inflows during high lake events, as no emergency spillway exists, and water continues to accumulate within the lake. To put the volume in perspective, each 1-ft increase of lake elevation roughly corresponds to 450,000 acre-ft (or 19.6 billion ft³) of water. The ability to regulate lake stages is further hampered by seepage-related concerns that exist for lake stages within the regulation schedule (i.e., normal hydrologic events). Ditches at the toe of HHD (see figure 2), historically constructed to remove excess water from adjacent agricultural lands, are problematic. Their geometry increases instability potential, and they are connected to drainage canals that fluctuate with harvest seasons and the needs of independent drainage districts that operate several large pump stations. No continuous features exist at HHD to relieve excess pore pressures, control seepage, or arrest material piping during elevated lake levels.

Remedial Design Criteria and Methods

Due to its history of excessive seepage during normal hydrologic events, potential for loss of life, and lack of seepage control/cutoff features, HHD was ranked as an urgent and compelling project by the USACE Screening Portfolio Risk Assessment process (Halpin and Ferguson 2007). This paper provides overviews of HHD seepage-related aspects, design approaches for remedying concerns along the 4.9-mi-long Reach 1A of HHD (see figure 1), and current rehabilitation alternatives. Reach 1A is in the 22.5-mi-long Reach 1 of HHD authorized for major rehabilitation.

Seepage Design Criteria

Given challenges associated with applying existing design criteria to HHD, project-specific seepage and slope stability remedial design criteria were developed and approved (USACE



Figure 3.—Representative photographs of prior seepage erosion conditions at HHD near Lake Harbor. Downstream area seepage distresses were observed during events having a ~30-yr return period: (A) sinkhole formation in crest, (B) heave of downstream toe caused by upward seepage flow - surveyrod was easily embedded 4 ft deep, (C) piping at downstream toe of dike, and (D) saturation of landward toe and embankment slope.

2008). For example, traditional USACE seepage guidance describes a factor of safety (FS) based on the use of a maximum allowable exit gradient of 0.5 for saturated unit weights of blanket material greater than or equal to 110 pounds per cubic foot (lb/ft^3). However, since blanket materials that surround HHD are much lighter than $110 \text{ lb}/\text{ft}^3$, use of the cited maximum allowable exit gradient for remedial designs at HHD would lead to unconservative designs. HHD project-specific remedial design criteria require that for the SPF, minimum steady-state seepage (effective stress uplift) FS values of at least 3.0 at the dike toe, and of at least 1.6 at and beyond a distance of 150 ft landward of the dike toe be obtained. Also required is the obtainment of minimum transient seepage (effective stress uplift) FS values of at least 1.5 at these same locations (i.e., everywhere landward of the dike) for the maximum surcharge pool. This event is simulated as a static lake elevation rising (due to storm-related wind setup) over a 12-hr period. For risk management and decisionmaking purposes, design FS values are also calculated and reported for the maximum (or extreme) pool. At this elevation, overtopping

would begin to occur on the western side of Lake Okeechobee; an ongoing hydrologic frequency analysis study is scheduled to determine the probable maximum flood (PMF) for Lake Okeechobee later this year. Through design evaluations performed to date, it has been found that when deterministic seepage FS values (i.e., FS values against subsurface erosion initiation) meet the above criteria that calculated FS values for the maximum pool have been greater than unity.

Embankment and Subsurface Conditions

Based on available as-constructed information and subsequent extensive exploration and testing, the HHD embankment generally consists of a heterogeneous mixture of lightly compacted to dense, fine to medium carbonate, quartz, clayey, and silty sands; shells; organic soils; and peat. Other materials encountered are limestone and sandstone gravels, cobbles, and occasional small boulders. As an exception, pockets of high concentrations of limestone cobbles and boulders can be found within the embankment. These coarse pockets vary in length and thickness and can either have voids between the cobbles or can be filled with a matrix of sand and gravel; filled pockets are known to be highly permeable. Typical dimensions of the HHD embankment in Reach 1A are a crest width of 14 ft, a base width of 250 ft, a lakeside slope of 1V:6H, a landside slope of 1V:3H, and a crest height above ground surface of about 25 ft (at an elevation of 36 ft).

The HHD soils are highly variable in the vertical direction, generally consisting of a (often-present) lightweight continuous blanket of organic materials at the surface overlying foundation sands with variable amounts of silt and several limestone and sandstone strata with variable thicknesses and extents (figure 4). Where the continuous blanket is present at HHD, subsurface conditions are generally referred to as a “blanket aquifer” foundation case, whereas without a blanket, conditions are referred to as a “non-blanket aquifer” case. Toward the southern end of Reach 1A, the organic blanket has an average thickness of 10 ft, while the underlying foundation (part of the regional surficial aquifer system and referred to as the “site aquifer”) has an average thickness of 180 ft. Beneath this sequence is the Hawthorn Group, which ranges from 400 to 750 ft thick in the Okeechobee Basin (Scott 1998) and serves as a basal confining unit for the site aquifer. The Hawthorn Group consists of detrital clays, silts, and mudstones, and regionally it serves as the intermediate confining unit that separates the surficial aquifer system from the upper zones of the Floridan Aquifer System. Consolidated site aquifer strata consist of poorly and well-cemented sand and shell and range from nearly impermeable to highly permeable. The poorly cemented rock is often easily penetrated via split-spoon and was therefore historically often misclassified as sand with limestone fragments. In Reach 1A of HHD, consolidated strata are present extensively between elevations of 5 and -20 ft. They (along with surrounding sands) were exposed in the lake bottom during initial HHD construction dredging. This exposure created a direct conduit for seepage into the foundation and decreased the effective seepage path distance beneath HHD. Seepage entrance conditions, the highly variable and relatively pervious embankment and foundation, the low weight and relatively impervious landward surficial blanket, and the lack of seepage control/cutoff features result in HHD seepage concerns.

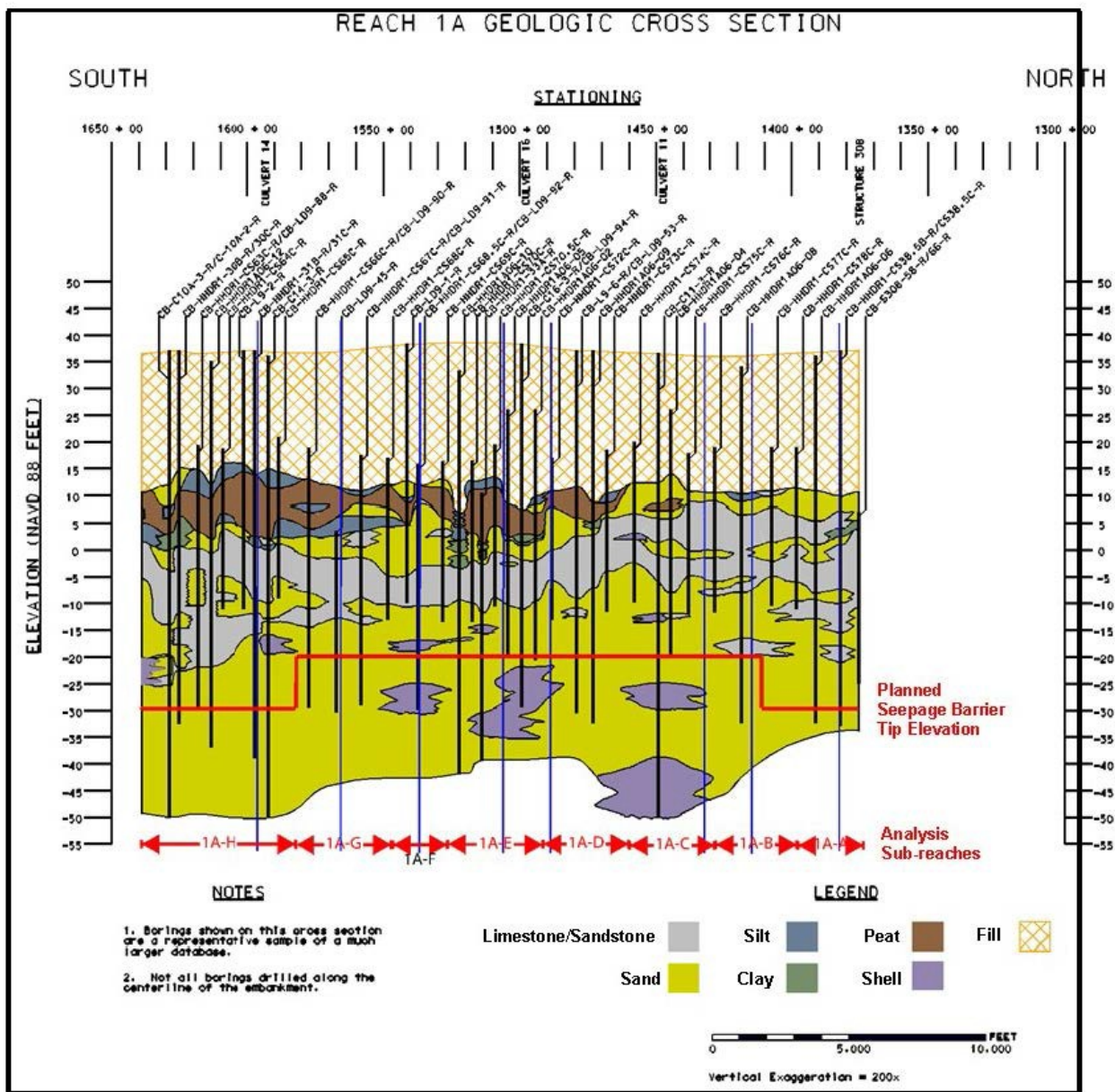

Figure 4.—Generalized geologic cross section (constructed using a representative sample of borings from a larger database) along the 4.9-mi-long Reach 1A atHHD.

Seepage Design Properties

To assist in the selection of hydraulic design properties for the Reach 1A foundation materials, a constant rate pumping test was performed landward of Sta. 1485+29 during September 2008 when the lake was at a constant elevation. The pumping well was installed 250 ft landward of the dike crest, and lines of three monitoring wells were installed in four orthogonal directions at increasing radial distances of 15, 40, and 100 ft. Pumping was conducted at a constant rate of 108 gpm for 1.25 days, with drawdown data recorded in all wells. Measured drawdown data are shown on figure 5; monitoring wells MW-6 through MW-9 were located

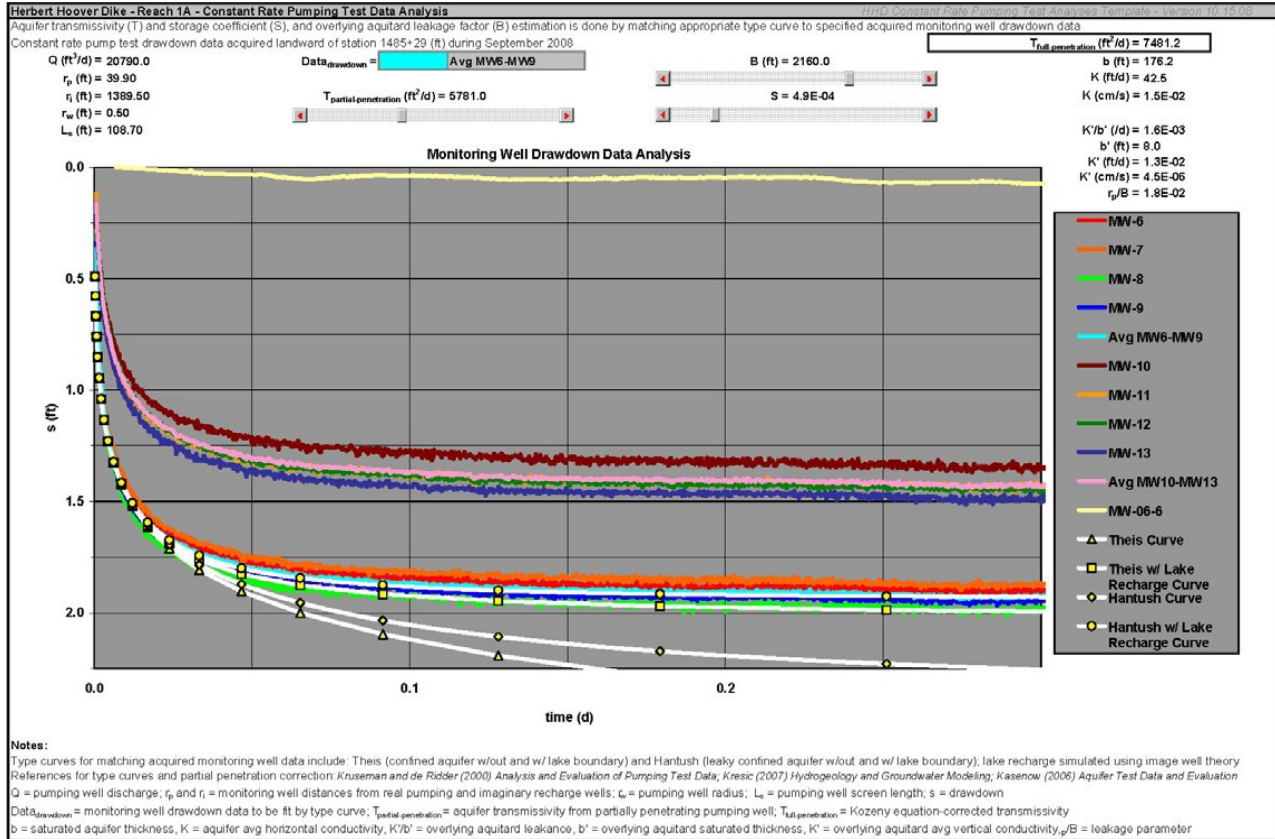

Figure 5.—Data analysis from a constant rate pumping test conducted at Sta. 1485+29, with a resultant aquifer transmissivity of 7,481 square feet per day). Monitoring wells MW-6 through MW-9 were located 40 ft from the pumping well in orthogonal directions. Radial distances of MW-10 through MW-13 were 100 ft, while MW-06-6 (background well) was 1,825 ft from the pumping well. Lake recharge effects were modeled with the hydraulic boundary (effective seepage entrance location) 700 ft from the pumping well.

40 ft from the pumping well, while MW-10 through MW-13 were located 100 ft from the pumping well. Different theoretical drawdown curves were attempted to be matched to all drawdown data to estimate average hydraulic properties (with foundation transmissivity being the parameter of most interest for Reach 1A seepage analyses). As seen on figure 5, which focuses on a curve representing the average drawdown at a radial distance of 40 ft, at a time of less than 0.1 day drawdown, data begin to depart from the theoretical Theis and Hantush-Jacob (labeled as Hantush) solutions, which is indicative of recharge and leaky system effects. Such effects have historically been noted during pumping tests performed along the southern perimeter of Lake Okeechobee (USGS 1971).

Using image well theory and superposition, the lake recharge boundary was considered to create modified (“lake recharge”) Theis and Hantush curves (note that the Hantush curve also considers leakage from the overlying blanket with a standing water table), which are seen to more closely approximate observed drawdown (figure 5). Prior to testing, ambient groundwater gradients, measured across the monitoring well layout, when back-projected, indicated that the location of the effective hydraulic recharge boundary was 700 ft upstream of the pumping well (which

equates to the location of the borrow pit dredged during initial dike construction). It was concluded that the drawdown data were best modeled by fitting the (“lake recharge”) Hantush curve to acquired drawdown data. The calculated average transmissivity value was adjusted (using the Kozeny approach) to account for partially penetrating characteristics of the well network to yield an average foundation transmissivity of 7,481 square feet per day. This transmissivity equates to an average foundation hydraulic conductivity of 42.5 feet per day (or 0.015 centimeter per second). Previously, the average hydraulic conductivity of the shallow (surficial) aquifer in Palm Beach County, Florida, was estimated (based on correlation of subsurface geophysical and lithologic logs with aquifer and lab tests data) to range from 1.0 to 130.0 feet per day (USGS 1977). The average value determined during the Reach 1A pump test lies within this range, and more specifically lies within a range of 10.0 to 60.0 feet per day, which was referred to as a relatively moderate to high conductivity range for the shallow aquifer in the USGS study. This range was further described in the study to be typical for the shallow aquifer where it consisted of sand and gravel, well-sorted coarse sand, sandy shell beds or sandy coquina, and/or solutionalized calcareous sandstone or limestone with openings filled with sand.

The average transmissivity obtained from pump testing (see figure 5) is considered more reliable than the other available hydraulic conductivity estimates (e.g., from other field tests, lab tests, and correlations with grain size); however, it can be directly used only at the pump test location and possibly at other locations where borings indicate very similar conditions. Subsurface conditions vary considerably over Reach 1A as indicated by the geologic cross section shown on figure 4.

The average transmissivity from pump testing could arguably be directly employed to construct a seepage model consisting of a single homogenous foundation layer at the pumping test location. However, the accuracy of using a single foundation layer could be questionable when subsurface strata have significantly differing properties and when modeled remedial alternatives only partially penetrate the foundation. It was desired (given potential increased accuracy and benefits obtainable, especially when modeling rehabilitation alternatives) to increase the level of model detail with regard to subsurface stratification by incorporating additional existing subsurface data into the model and to utilize the pump testing results as a basis for an approach to improve model construction capability at other locations in Reach 1A (where pump testing had not been performed). Therefore, a unique approach was taken that utilized material classifications logged in the pumping well boring in conjunction with existing hydraulic conductivity data for material classifications across Reach 1A and the entire HHD project. When possible and deemed appropriate, hydraulic conductivity values used in parameter spreadsheets and (after adjustment) in seepage models were selected from values from field tests (such as slug and dilatometer) and laboratory conductivity tests on representative samples. Correlations of hydraulic conductivity with grain size testing were supplementally used to estimate hydraulic conductivity for some material classifications for which field and laboratory data have not been obtained and for soil classifications where these data were considered to be anomalous and the correlations more reliable. A “living” database that includes all geotechnical laboratory testing for the project has been developed. The hydraulic conductivity and grain size parameters for correlations were obtained from a statistical summary from this database.

On figure 6, a cumulative foundation transmissivity curve has been generated utilizing material classifications from the Reach 1A pumping well along with material conductivity distributions in the project database. The percentile value of all existing (lognormal) soil conductivity distributions employed was adjusted to 65 in order to yield a cumulative transmissivity value equivalent to that determined through pump testing. Once this calibration was achieved, a second model curve (figure 6) was manually fit to the initially generated cumulative transmissivity curve. The points defining this model curve were positioned at the major slope inflection points of the initial curve; sharp breaks in the curve slope represent significant changes in foundation conductivity occurring with depth and the horizon elevations of regions to be used in seepage models. The inverse of model segment slopes is indicative of relative hydraulic conductivity. Each “aquifer zone” or foundation stratum approximated by this model curve is typically comprised of multiple (logged) material classifications having similar effective conductivity, which are now represented for design analysis purposes as a single homogeneous layer. Conductivities for each idealized stratum were then calculated by employing typical equations used for determining the effective horizontal and vertical conductivities of an equivalent homogeneous and anisotropic formation (the aquifer zone) from an input array of assumed layered homogeneous and isotropic formations (the individual logged material classifications comprising each aquifer zone). Once this approach was developed and calibrated for the pumping well material classifications and field-measured cumulative transmissivity, the 65 percentile value for soil conductivity distributions was then utilized (with location-specific boring data) for the development of the other Reach 1A analysis profiles and their design hydraulic conductivity values. Additional pump tests are being conducted at other Reaches of the HHD project. Material classifications from borings made at the pumped wells for these tests will be evaluated with the above method to compare and hopefully further verify that the approach can be effectively employed to predict the site aquifer transmissivity with reasonable accuracy from borings, with only a few pump tests needed for verification.

Seepage design values of saturated density for Reach 1A were generally selected based on 33-percentile values for fine-grained soils found mostly in blanket zones and on 50-percentile values for coarse soil and rock found mostly in aquifer zones. A smaller density value is more conservative (than a larger value) for uplift computations in blanket zones. At least within the range of plausible design values, results of stability analyses are less sensitive to the density of aquifer materials. The densities of inorganic materials encountered in Reach 1A are similar to typical inorganic materials at most other projects; however, the peat (Pt) and organic silt (OH and OL) that comprise much of the blanket zone material are much less dense at HHD (figures 6 and 7) than inorganic materials for which most seepage analysis design guidance documents were written. Encountered peat, when not completely saturated, was frequently lighter than water, and the organic-rich blanket zones at HHD provide much less resistance to uplift pressures (i.e., their tolerance against excess head and heaving is much less) than alluvial blankets commonly found at most other projects. Such low tolerance for excess uplift pressures in lightweight organic blanket materials has been documented in two other known case histories (Marsland 1961; Interagency Performance Evaluation Task Force 2007). In Reach 1A, design challenges caused by the small amount of allowable excess head were compounded along some analysis profiles by a landward ground surface elevation (further downstream than a proposed remedial alternative) that was lower than the ground surface elevation at the dike toe. In some

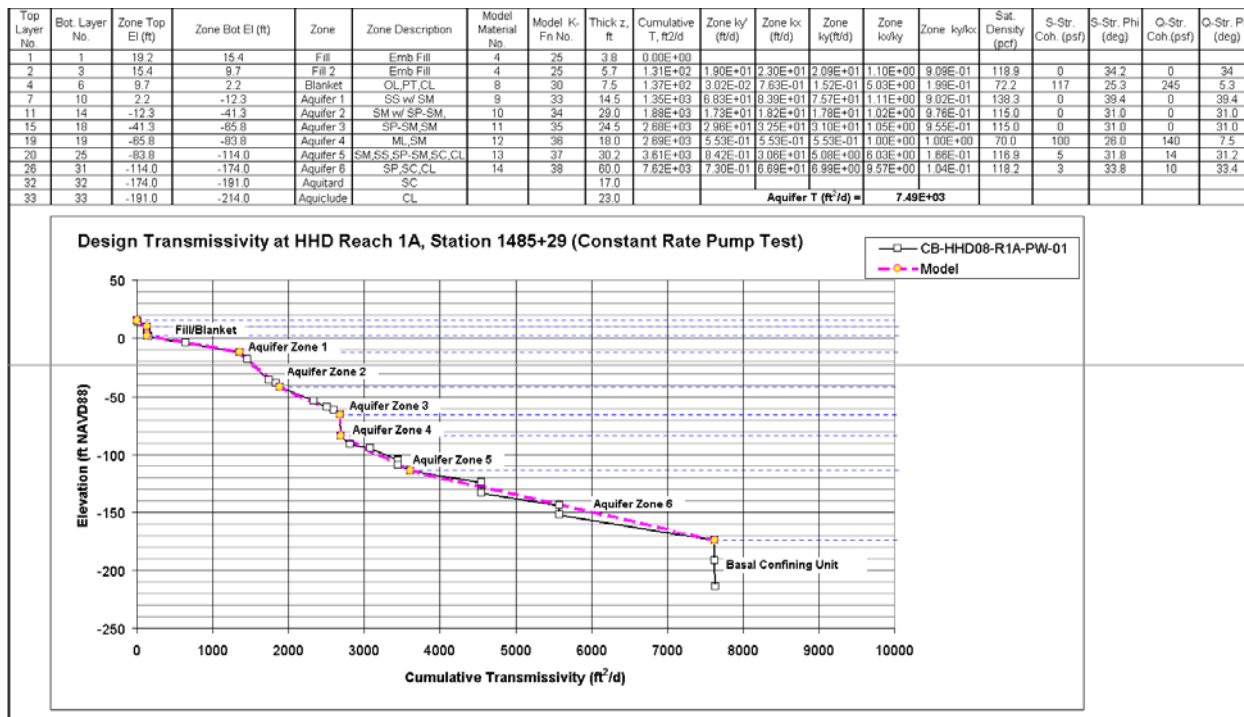

Figure 6.—Soil properties and model regions summary at Sta. 1485+29. The cumulative aquifer transmissivity (T) curve is based on classifications of soils logged in the pumping well used for constant rate testing (see figure 5). It was constructed primarily based on existing conductivity data from field tests and grain size correlations, with the soil distributions’ design percentile value adjusted such that the cumulative T at this station matched that determined from pump testing. A model curve was fit to the cumulative T curve in order to select vertical limits of foundation strata and their composite hydraulic properties.

respects, evaluating and designing to accommodate seepage affects downstream from a proposed remedial solution for design loading conditions (as required by the HHD design criteria) agrees with the USACE intent of applying resilience and robustness concepts.

Seepage Design Analyses

Seepage and slope stabilities were evaluated for base and remedial feature conditions through the use of two-dimensional (2D) finite element models; the modeling programs employed were SEEP/W and SLOPE/W (GEO-SLOPE International 2004). Soil profiles representative of conditions for Reach 1A were constructed (using the methods described above) along transects (at Stations 1383+00, 1413+00, 1428+00, 1488+00, 1505+00, 1537+00, 1568+00, and 1601+00) perpendicular to the geologic cross section (see figure 4). Each profile (selected as representative of subsurface conditions across a Reach 1A station range) was built using investigation-derived topographic and subsurface data (discussed above). Model topography was defined based on conventional survey data at and near the dike, LiDar data landward of the dike, and as-built construction drawings beyond the lakeshore. The following discussion focuses on subsurface characteristics, seepage analysis approaches, modeling results, and proposed remedy design concepts primarily using Sta. 1568+00 (a blanket aquifer condition case) as an

Appendix 1 - Case Histories of Dam Failures from Internal Erosion

Herbert Hoover Dike - Reach 1A - Profile 1AG										Final Seepage and Slope Stability Analyses - Template - Version 11.17.09								
Station Range: 1547+00 to 1581+00 (ft), representative cross-section for this range is located at station 1568+00										Total station range feet: 3400.0								
Design Material Property Values for Seepage and Slope Stability Analyses											Q - Strength		S - Strength		Y _{sat} (pcf)	Y _v (pcf)	i _{sv}	i _{ch}
Material	Model color	Kx (ft/d)	Ky (ft/d)	Ky/Kx	Kx/Ky	Ke (ft/d)	Q - Strength		S - Strength		Y _{sat} (pcf)	Y _v (pcf)	i _{sv}	i _{ch}				
		(cm/s)	(cm/s)			(cm/s)	φ (deg)	c (psf)	φ (deg)	c (psf)								
Embankment Fill (SP-SM, w/ GP-GM and SHELL)	Gold	8.50E+00 3.0E-03	4.25E+00 1.5E-03	5.0E-01	2.0E+00	6.01E+00 2.1E-03	30.0	0.0	30.0	0.0	110.0	47.6	0.76	0.44				
Blanket Zone 1 (CH, w/ SP)	Brown	2.23E+00 7.9E-04	1.17E+01 4.1E-05	5.2E-02	1.9E+01	5.10E-01 1.6E-04	3.0	802.0	25.8	440.0	93.4	31.0	0.50	0.24				
Blanket Zone 2 (CL, ML, PT, w/ SP)	Brown	8.99E-01 3.2E-04	3.94E+01 1.4E-04	4.4E-01	2.3E+00	5.95E-01 2.1E-04	7.0	169.0	25.7	102.0	70.2	7.8	0.13	0.06				
Aquifer Zone 1 (SS, SP-SM)	Light Yellow	7.53E+01 2.7E-02	6.97E+01 2.5E-02	9.3E-01	1.1E+00	7.25E+01 2.6E-02	37.7	0.0	37.7	0.0	133.6	71.2	1.14	0.88				
Aquifer Zone 2 (SP-SM, SM)	Gold	2.88E+01 1.0E-02	2.69E+00 9.5E-04	9.3E-02	1.1E+01	8.80E+00 3.1E-03	31.0	0.0	31.0	0.0	115.0	52.6	0.84	0.51				
Aquifer Zone 3 (SP-SM, SP)	Light Yellow	5.29E+01 1.9E-02	4.82E+01 1.7E-02	9.1E-01	1.1E+00	5.05E+01 1.8E-02	32.2	0.0	32.2	0.0	116.5	54.1	0.87	0.55				
Aquifer Zone 4 (SM, SC)	Gold	1.39E+01 4.9E-03	4.99E+00 1.6E-03	3.6E-01	2.8E+00	8.33E+00 2.9E-03	31.0	0.0	31.0	0.0	115.0	52.6	0.84	0.51				
Aquifer Zone 5 (LS, SS, SM)	Light Yellow	6.08E+01 2.1E-02	5.19E+01 1.8E-02	8.5E-01	1.2E+00	5.62E+01 2.0E-02	38.6	0.0	38.6	0.0	136.1	73.7	1.18	0.94				
Aquifer Zone 6 (SM, SP-SM, SC, w/ CL)	Gold	1.70E+01 6.0E-03	2.98E+00 1.0E-03	1.7E-01	5.7E+00	7.09E+00 2.5E-03	29.8	25.0	30.8	8.0	114.0	51.6	0.83	0.49				
Aquifer Zone 7 (SP)	Light Yellow	9.32E+01 3.3E-02	9.32E+01 3.3E-02	1.0E+00	1.0E+00	9.32E+01 3.3E-02	35.0	0.0	35.0	0.0	120.0	57.6	0.92	0.65				
Aquifer Zone 8 (SC, SP, w/ CL)	Gold	3.68E+01 1.3E-02	3.55E+00 1.3E-03	9.6E-02	1.0E+01	1.14E+01 4.0E-03	31.5	22.0	32.4	7.0	116.1	53.7	0.86	0.55				
Aquifer Zone 9 (SP)	Light Yellow	9.32E+01 3.3E-02	9.32E+01 3.3E-02	1.0E+00	1.0E+00	9.32E+01 3.3E-02	35.0	0.0	35.0	0.0	120.0	57.6	0.92	0.65				
Cutoff Wall (Cement-bentonite-soil mix)	Magenta	2.80E-03 9.9E-07	2.80E-03 9.9E-07	1.0E+00	1.0E+00	2.80E-03 9.9E-07	NA	NA	45.0	3000.0	145.0	82.6	1.32	1.32				
Upstream Blanket Fill (SM)	Rose	2.83E-01 1.0E-04	1.42E+01 5.0E-03	5.0E-01	2.0E+00	2.00E-01 7.1E-05	31.0	0.0	31.0	0.0	115.0	52.6	0.84	0.51				
Filter Sand (Specified construction material)	Light Blue	1.00E+02 3.5E-02	1.00E+02 3.5E-02	1.0E+00	1.0E+00	1.00E+02 3.5E-02	NA	NA	33.0	0.0	115.0	52.6	0.84	0.55				
Graded Gravel (Specified construction material)	Turquoise	3.00E+03 1.1E+00	3.00E+03 1.1E+00	1.0E+00	1.0E+00	3.00E+03 1.1E+00	NA	NA	35.0	0.0	120.0	57.6	0.92	0.65				
Filter Pack (Developed relief well filter pack)	Pale Blue	2.85E+02 1.0E-01	1.43E+02 5.0E-02	5.0E-01	2.0E+00	2.02E+02 7.1E-02	35.0	0.0	35.0	0.0	120.0	57.6	0.92	0.65				
Relief Well Screen (Slotted stainless steel)	Red	5.70E+02 2.0E-01	1.10E+07 3.9E+03	1.9E+04	5.2E-05	7.92E+04 2.9E+01	NA	NA	NA	NA	NA	NA	NA	NA				
Relief Well Riser (Stainless steel)	Violet	2.80E-03 9.9E-07	2.80E-03 9.9E-07	1.0E+00	1.0E+00	2.80E-03 9.9E-07	NA	NA	NA	NA	NA	NA	NA	NA				

Model Color Index Table for Embankment, Blanket, and Foundation Materials				Model Color Index Table for Remedial Construction Materials			
Color	Ke (cm/s) Range	XLS Color	Red, Green, Blue #s	Color	Type	XLS Color	Red, Green, Blue #s
Light Yellow	>=	36	255, 255, 204	Magenta	Cutoff Wall	7	255, 0, 255
Yellow	5.50E-03 to	27	255, 255, 0	Rose	Upstream Blanket Fill	38	255, 153, 204
Gold	1.00E-03 to	44	255, 204, 0	Light Blue	Filter Sand	34	204, 255, 255
Light Orange	5.50E-04 to	45	255, 153, 0	Turquoise	Graded Gravel	8	0, 255, 255
Brown	1.00E-04 to	53	153, 51, 0	Pale Blue	Filter Pack	37	153, 204, 255
	<=	9	128, 0, 0	Red	Relief Well Screen	3	255, 0, 0
				Violet	Relief Well Riser	13	128, 0, 128

Figure 7.—Sta. 1568+00 seepage and slope stability values used in design analyses (see figures 8, 9, 10, and 11). Relief well regions were represented by adjacent material property strengths in models and are therefore listed as NA. See text for discussion.

example. The design material properties for this profile are shown on figure 7, and the base condition profile is shown on figure 8. As mentioned above, the borrow pit in this profile contributes to seepage concerns in Reach 1A; it was created during initial dike construction dredging. Model profiles include idealized strata and material zones, with material properties assumed to be homogenous within each stratum or material. As discussed, properties assigned to idealized strata are composite values based on the thicknesses, classifications, and properties of associated component layer classifications.

The load cases modeled for each soil profile in Reach 1A included events associated with the highest historical lake level, the SPF, the maximum surcharge pool represented by transient wind setup on top of the SPF (as from a hurricane), and the maximum (or extreme) pool. Boundary conditions were applied with controlling pool elevations defined by upstream gauge readings from the maximum historic pools and as defined by hydraulic model predictions for events not previously experienced. The downstream tail water elevation in the existing toe ditch (for base condition case) or in a newly constructed swale (for remedial alternative cases) was defined as the elevation of the top of the ditch or swale. Although having the ditch or swale full may increase the calculated FS at this location, historic downstream gauge readings indicate such features will most likely be full under design loads, and modeling these features as full is

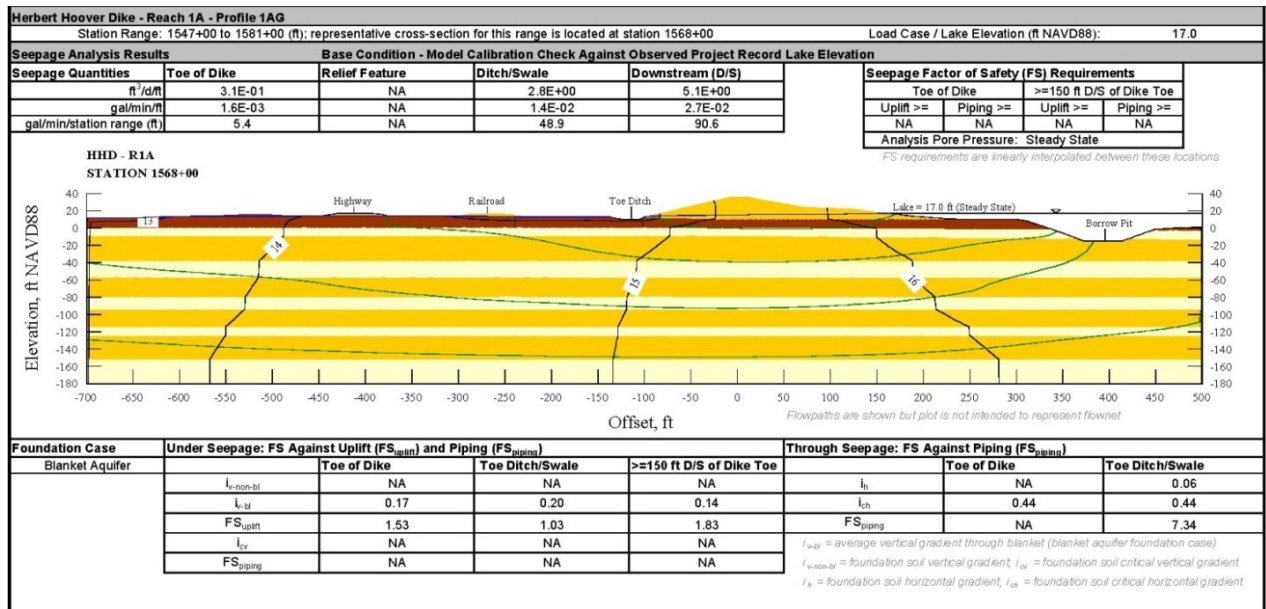

Figure 8.—Sta. 1568+00 base condition soil profile and seepage modeling results (using design values on figure 7) for the highest historical pool (lake elevation of 17 ft). The resultant factors of safety against subsurface erosion initiation are above unity at the dike toe and landward of the toe ditch, but approximately at unity in the toe ditch, which agrees with past observations.

conservative; when full, the resultant phreatic elevation and uplift pressures downstream from these features will be higher. Finite element models were not tightly calibrated to past instrumentation data (as none exist in Reach 1A); however, a calibration check against past observed conditions was performed for each profile. As shown on figure 8, which contains base condition modeling results for the Sta. 1568+00 profile under the highest historical lake level, calculated FS values against subsurface erosion initiation are above unity at the dike toe and landward of the toe ditch but approximately at unity in the toe ditch.

These results agree with past observations for the record pool elevation, in that seepage and related erosion initiation were not observed at the dike toe or landward of the toe ditch, but were periodically observed (where dense vegetation did not prevent observation) near this station in the toe ditch. Occasionally (for other Reach 1A profiles), the vertical blanket conductivity was slightly adjusted to better calibrate resultant FS values to past observations for the record pool elevation.

Reach 1A models were used to calculate head distribution, seepage quantities, and FS values (see figure 8) against initiating heaving of the downstream blanket and piping of foundation materials. In the context of a continuum model for seepage-induced failure discussed in recent literature (Halpin and Ferguson, 2007), such initiation would generally be followed on an event tree by erosion continuation (erosion movement up gradient toward the water source), erosion progression (seepage quantity increase and erosion feature enlargement), and breach formation (massive erosion followed by pool loss). Although HHD design criteria (USACE 2008) do not require probabilistic analyses, it can generally be stated that for the base condition in Reach 1A, it is expected that once erosion initiates, continuation will occur since foundation soils are

erodible, filters or a cutoff to arrest erosion are not present, and materials capable of acting as a pipe roof are present. Specifically, the FS values on figure 8 represent results from effective-stress uplift (FSuplift) and piping (FSpiping) calculations.

The FSuplift values were calculated consistent with the approach described in McCook (2007). His paper provides an effective stress equation for calculating FS against uplift for a case when tail water is at the ground surface, but since tail water elevation (in the existing toe ditch or in a newly constructed swale) is projected to exceed the ground surface in Reach 1A during high lake events, this was considered during calculations. Where tail water was projected at or above the ground surface, FSuplift was calculated as the product of the buoyant blanket soil density and the blanket thickness divided by the product of the density of water and the difference between the total head at the blanket base and the tail water elevation. Where non-blanket aquifer conditions are present in Reach 1A, FSpiping values were calculated (instead of FSuplift values) by dividing the material's vertical critical gradient by the measured vertical exit gradient. For both foundation cases in Reach 1A, FSpiping values were also calculated at the dike toe and toe ditch slopes where horizontally emerging seepage occurred through granular embankment or foundation materials. In this case, FSpiping was calculated by dividing the material's horizontal critical gradient (taken as the product of the material's vertical critical gradient and friction angle tangent; USACE 1997) by the measured horizontal exit gradient. Values returned as "NA" during FS computations indicate the lack of any excess head or emerging seepage.

Remedial Design Results and Alternatives

Employing the above-described analytical approaches, numerous alternatives for remedying seepage deficiencies in Reach 1A of HHD have been evaluated and are still being further considered and optimized as part of the overall design analyses. The final selected remedy will be that which most effectively reduces the risk associated with unsatisfactory performance for the authorized project loadings. To address embankment through-seepage concerns and assist toward addressing underseepage concerns, a partially penetrating seepage/piping barrier ("cutoff wall") through the embankment and near-surface consolidated strata is currently a required component of all remedial alternatives. This feature would not restrict all groundwater significant flow, but is intended to "cutoff" pre-existing piping pathways and internally unstable materials within the embankment, as well as in near-surface, consolidated and often quite pervious foundation strata. The barrier will extend to a variable depth along Reach 1A (see figure 4) to fully penetrate near-surface consolidated strata but would not fully penetrate the foundation. Constructing it through the entire site aquifer would adversely impact regional groundwater and would be more costly than alternatives that couple the partially penetrating barrier with landward seepage control features. A second required component of all remedial alternatives currently is the filling in (with a granular material) of the existing landward toe ditch, the geometry of which is problematic.

A number of remedy components were coupled with the partially penetrating seepage barrier and toe ditch filling and were evaluated through finite element modeling and spreadsheet computations to determine their potential for remedying HHD seepage deficiencies. These included constructing a landward ("full-length") seepage berm (having a length of 16 times the

dike height or 400 ft), constructing a landward (“partial-length”) seepage berm (having a length of 4 times the dike height or 100 ft), installing a toe drain with pumps in conjunction with the partial-length berm, installing sand drains with the partial-length berm, installing a relief trench (comprised of sand or sand with a gravel core) with the partial-length berm, installing relief wells with the partial-length berm, and constructing an upstream, relatively impervious blanket with the partial-length berm. Generally, analyses and engineering judgment have indicated that non-blanket aquifer conditions, where present, will require only the construction of the landward partial-length seepage berm (along with the partially penetrating seepage barrier and toe ditch filling) to meet remedial design criteria. Where blanket aquifer conditions exist, evaluations have determined a pore pressure relief system is required in conjunction with the seepage barrier, toe ditch filling, and partial-length seepage berm.

The discussion of details from results of all design analyses is beyond the scope of this paper. However, for illustrative purposes of why a remedy component providing pore pressure relief is necessary for blanket aquifer conditions at HHD, deterministic modeling results from Sta. 1568+00 for the full-length seepage berm option at the maximum possible static pool are shown on figure 9.

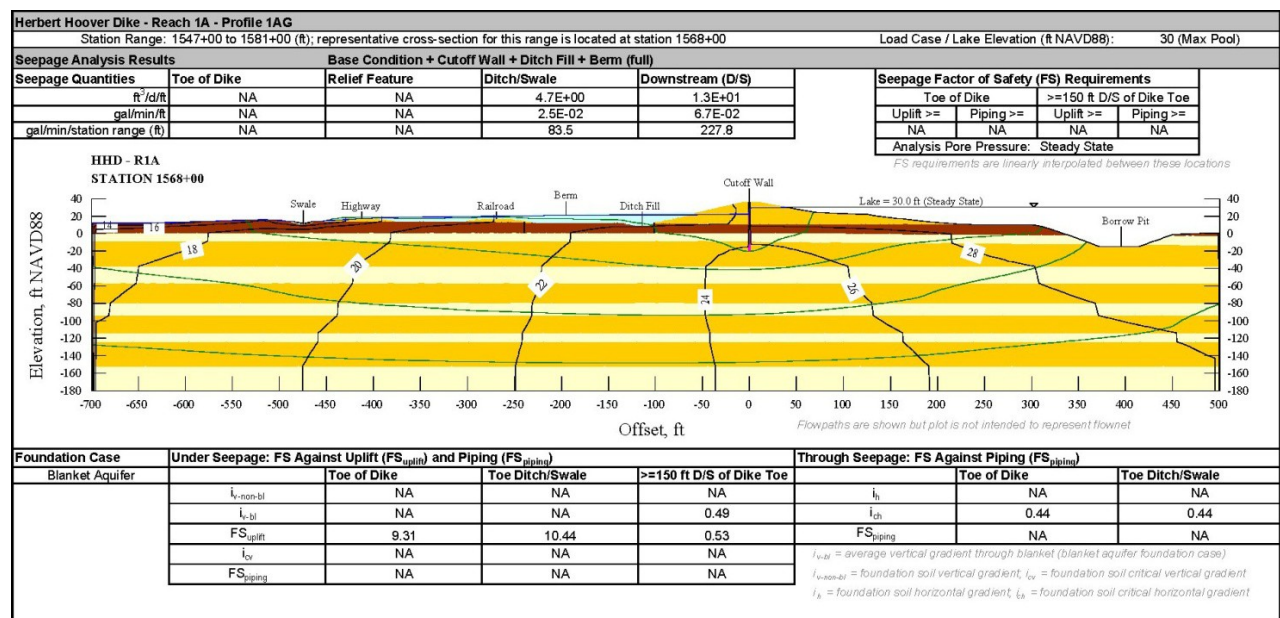

Figure 9.—Sta. 1568+00 soil profile and seepage modeling results (using design values on figure 7) for the maximum possible static pool. The profile includes a partial-depth seepage/piping barrier through the embankment and a 400-ft-long seepage berm. The resultant factor of safety against subsurface erosion initiation beyond the berm toe is less than unity.

These results show that while desirable FS values are obtained at the dike toe and former (now filled in) toe ditch location, an FS value against subsurface erosion initiation of less than unity still exists beyond the berm toe. The thickness and relatively impervious nature of the continuous organic-rich blanket does not allow enough dissipation of foundation head with increasing distance downstream such that the relatively light weight of the blanket can provide adequate resistance to remaining uplift pressure beyond the berm toe. It could be argued that a

berm of greater length could be constructed to obtain a desirable FS at its toe; however, the construction of an excessively long berm would become increasingly costly, not only in terms of dollars, but in terms of real estate and environmental impacts as well. It could also be argued that with increasing distance downstream, the initiation of subsurface erosion beyond a berm toe would be less likely to result in actual dike failure; however, project-specific remedial design criteria do not include such probabilistic analyses and currently require target deterministic FS values to be obtained everywhere downstream.

Seepage analyses indicated that three types of pore pressure relief systems (coupled with the partially penetrating seepage barrier, toe ditch filling, and landward, partial-length seepage berm) provide the potential for adequately reducing uplift pressures and allowing remedial design criteria to be met.

- The first such system consists of a 3-ft-diameter toe drain surrounded by graded gravel and filter sand regions, located at the toe of the partial-length berm, and (in the case of Sta. 1568+00) at an elevation of 7.5 ft. This alternative will result in the downstream phreatic surface being drawn down such that remaining uplift pressures beyond the toe drain are not excessive. For the toe drain to be as effective in practice as it is when modeled (as a perfectly efficient drain), it will need to be actively pumped (e.g., via end-line pump stations) so that the phreatic elevation near the drain will not rise above elevation 7.5 ft. For design pools, it is projected that without active pumping, it will rise above elevation 7.5 ft, as tail water in the drainage swale will submerge the toe drain by up to 6 ft.
- The second relief system alternative does not require pumping and consists of a laterally continuous relief trench located at the berm toe. Shown on figure 10 are modeling results (from Sta. 1568+00) for this option (a 5-ft-wide, gravel core trench) at the maximum surcharge design pool. These results indicate that this remedy option will meet design requirements provided that it can be properly constructed as designed to a depth of 90 ft.
- The third relief system alternative does not require pumping either and consists of relief wells having a proper depth and spacing combination. Shown on figure 11 are (2D) modeling results (from Sta. 1568+00) for a fully penetrating (12-in-diameter) relief well, which demonstrate that when modeled as laterally continuous, such a feature would meet design requirements. Separate spreadsheet design analyses that consider three-dimensional (3D) effects have been performed consistent with relief well design guidance (USACE 1992). These have determined that fully penetrating relief wells would need to be spaced on 100-ft centers to meet remedial design criteria, whereas wells penetrating 75% of the site aquifer hydraulic conductivity would require 50-ft spacing. If installed, a maintenance program will be designed, implemented, and refined as needed to ensure that the well efficiency used in analyses for design pools and discharges does not deteriorate over time.

Evaluation and Monitoring of Seepage and Internal Erosion

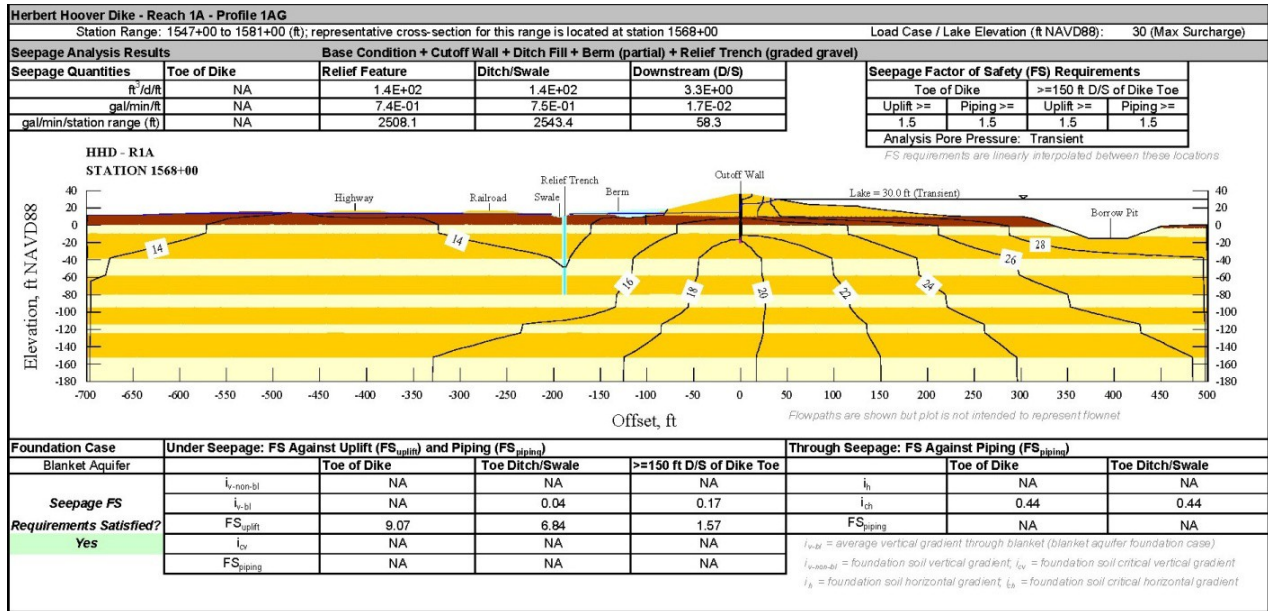

Figure 10.—Sta. 1568+00 soil profile and seepage modeling results (using design values on figure 7) for the maximum surcharge design case (transient lake elevation rise over a 12-hr period). The profile includes a partial-depth seepage/piping barrier through the embankment, a 100-ft-long seepage berm, and a continuous 90-ft-deep, 5-ft-wide, two-stage (with gravel core) relief trench located at the berm toe. Resultant factors of safety against subsurface erosion initiation satisfy design requirements.

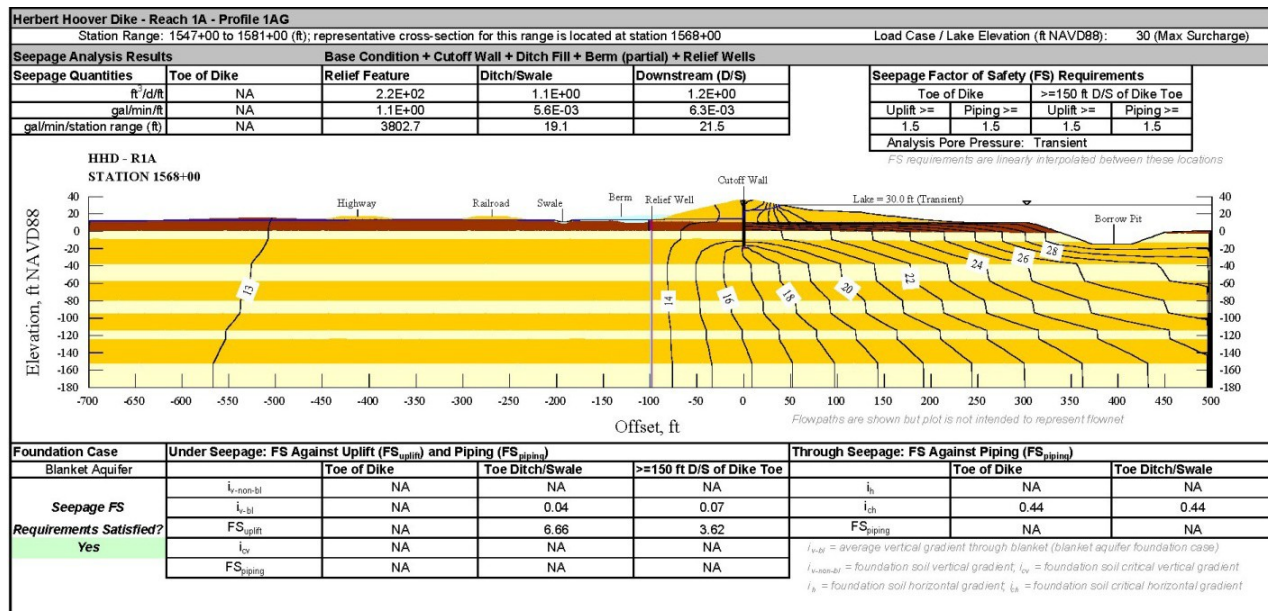

Figure 11.—Sta. 1568+00 soil profile and seepage modeling results (using design values on figure 7) for the maximum surcharge design case (transient lake elevation rise over a 12-hr period). The profile includes a partial-depth seepage/piping barrier through the embankment, a 100-ft-long seepage berm, and a system of fully penetrating relief wells (on 100-ft centers, determined by a separate 3D analysis) at the dike toe. Resultant factors of safety against erosion initiation satisfy design requirements.

Conclusions

As part of the remedial design work for Reach 1A at HHD, deterministic analyses have been performed to assess existing conditions and formulate solutions that are in compliance with approved technical guidelines and site-specific (seepage and slope stability) design criteria. Based on analyses, current remedy design concepts will require the construction of two primary components: (1) a partial-depth seepage/piping barrier (“cutoff wall”) through the embankment and near-surface consolidated strata and (2) a landward seepage berm coupled with an often necessary pore pressure relief system. In general, non-blanket aquifer conditions, where present, will require a landward seepage berm, whereas blanket aquifer conditions, where present, will also require a pore pressure relief (pumped toe drain, gravity relief trench, or gravity relief well) system. The required depth of the cutoff wall (from the embankment crest) will vary from 55 to 65 ft in Reach 1A depending on near-surface foundation conditions. The landward seepage berm will have a required length of four times the dike height (e.g., a length of 100 ft where the dike is 25 ft tall) and will have thicknesses of 5 and 2 ft at the dike and berm toes, respectively. Necessary depths (as well as spacings of non-continuous relief wells) for pore pressure relief system features where they are required in Reach 1A will vary with subsurface conditions. For the example cross-section analyses presented in this paper, the required depth of a continuous gravel core relief trench located at the seepage berm toe is 90 ft, and the required spacing of fully penetrating relief wells located at the dike toe is 100 ft. The optimal location (e.g., at the dike or berm toe) for installing pressure relief system features is being further evaluated, and final remedy selection for Reach 1A will be based on additional (e.g., sensitivity and probabilistic) analyses, economic calculations, and socioeconomic impact considerations, which are being performed. With the final remedy, a robust instrumentation system will be installed to allow real-time monitoring of performance conditions and further verification of design assumptions during future high water events.

The final design report for Reach 1A was scheduled for 2009 completion, with environmental policy compliance and construction scheduled to be phased over the following several years. Coincident with design work, construction of the partial-depth cutoff wall is underway, and interim risk reduction measures have been developed in accordance with USACE (2007). Several measures have been implemented already, such as in-filling of miles of toe ditches, stockpiling of granular material for possible flood-fighting, removal of obstructive vegetation, and pool reduction through both natural and regulatory processes. Work toward implementation of additional measures continues.

References

- Davis, J.R., E.D. Guy, and R.L. Nettles (2009). Herbert Hoover Dike Seepage Remedial Design Concepts, 29th Annual USSD Conference, Nashville, Tennessee, April 20–24, 2009, U.S. Society on Dams, Denver, Colorado, pp. 685–706.
- GEO-SLOPE International (2004). Seepage Modeling with SEEP/W, 398 p. and Stability Modeling with SLOPE/W. 332 p.

- Halpin, E. and K. Ferguson (2007). USACE Dam Safety: Program Status and Lessons in Transitioning to Risk Informed Approaches, *The Journal of Dam Safety*, Vol. 5, pp. 24–36.
- Interagency Performance Evaluation Task Force (IPET) (2007). Performance Evaluation of the New Orleans and Southeast Louisiana Hurricane Protection System, Vol. 5, app. 8.
- Kasnow, M. (2006). *Aquifer Test Data: Analysis and Evaluation*, Water Resources Publications. 344 p.
- Kresic, N. (2007). *Hydrogeology and Groundwater Modeling*, CRC Press, 807 p.
- Kruseman, G. and N. de Ridder. (2000). *Analysis and Evaluation of Pumping Test Data*, International Institute for Land Reclamation and Improvement. 377 p.
- Marsland, A. (1961). A Study of a Breach in an Earthen Embankment Caused by Uplift Pressures, *Int. Soil Mechanics Foundation Engineering Conference*, Vol. 2, pp. 663–668.
- McCook, D. (2007). A Discussion of Uplift Computations for Embankments and Levees, *The Journal of Dam Safety*, Vol. 5, pp. 30–39.
- Scott, T. (1988). The Lithostratigraphy of the Hawthorn Group (Miocene) of Florida. *Florida Geological Survey Bulletin No. 59*. 148 p.
- U.S. Army Corps of Engineers (USACE) (1992). *Design, Construction, and Maintenance of Relief Wells*, EM 1110-2-1914.
- _____(1997). *Seepage and Stability Analysis of Herbert Hoover Dike*, Report GL-97-2.
- _____(2007). *Interim Risk Reduction Measures for Dam Safety*, EC 1110-2-6064.
- _____(2008). *Herbert Hoover Dike Loadings and Factors of Safety for Use in Seepage and Stability Analyses*. 9 p.
- U.S. Geological Survey (USGS) (1971). *Seepage Beneath Hoover Dike, Southern Shore of Lake Okeechobee, Florida*, Report of Investigations No. 58.
- _____(1977). *Hydraulic Conductivity and Water Quality of the Shallow Aquifer, Palm Beach County, Florida*, Water-Resources Investigations 76–119. Paper 2 – Risk-informed Approach to Dam Remediation.

Paper 2³ – Risk-informed Approach to Dam Remediation

USACE Risk-informed Evaluation

The USACE has undertaken a risk-informed evaluation methodology for its inventory of dams and levees over approximately the last 10 yr. In early 2005, an initial screening identified the six highest risk USACE dams, of which Herbert Hoover Dike is one. Later that same year, a greater emphasis was put on these efforts after the life loss and damage associated with Hurricane Katrina occurred. Subsequent to this tragedy, adjustments were made to the dam safety program to prioritize all USACE structures with life safety consequences on an equal, nationwide basis to allow decisionmakers the ability to determine where and how funds should most effectively be utilized to reduce risk within the inventory. In response, the USACE began to evaluate its portfolio of flood control structures using a more exhaustive risk assessment methodology. This approach analyzes structures from a failure mode and consequence perspective and has had success in other industries and government organizations. Analyzing structures in this way and comparing the results to a set of tolerable risk guidelines (TRG) helps to understand, prioritize, and appreciate the urgency of dam or levee safety issues that exist within the USACE's inventory. Though the potential for economic, environmental, historic, and cultural consequences are considered in a risk assessment, the life safety consequences remain paramount.

Tolerable risk guidelines have been set by USACE to provide a suggested guideline for justifying the need for risk reduction efforts. The primary TRG is that of annualized life loss, of which the value is the product of the annual probability of the failure times the life loss consequences. The TRG for annualized life loss is 1×10^{-3} except in cases of life loss numbers greater than 1,000. The annual probability of failure (APF) of the dam is the secondary TRG and is set at a value of 1×10^{-4} or 1 in 10,000 chance of failure per year. Other TRGs consider societal and individual risk. Failure modes that are below the annualized life loss and APF TRG limits may warrant monitoring and perhaps other risk reduction actions that are reasonable and prudent to satisfy the principle of reducing the risk to “as low as reasonably practical” (ALARP). The ALARP principle is a means to judge the reasonableness of further risk reduction. The ALARP principle states that risk reduction measures should be implemented until no further risk reduction is possible without considerable capital investment or other resource expenditure that would be grossly disproportionate to the amount of risk reduction achieved.

HHD Area Description and Consequences

HHD spans five counties (Glades, Hendry, Martin, Okeechobee, and Palm Beach) in Florida around Lake Okeechobee. There are several population centers located around the dam's perimeter, immediately downstream from the structure, as shown on figure 1. HHD had previously been separated into eight reaches based on a benefit/cost analysis. The reaches

³ Reprinted with permission from: Herbert Hoover Dike – Risk Analysis Update for a 143-mile Long Dam in South Florida, Mark Pabst, J. Williams, B. Davis, J. Davis, J. Drayton, J. France, R. Grove, A. Hill, J. Kendall, C. Papiernik, and J. Wright, ASDSO National Conference, September 2013.

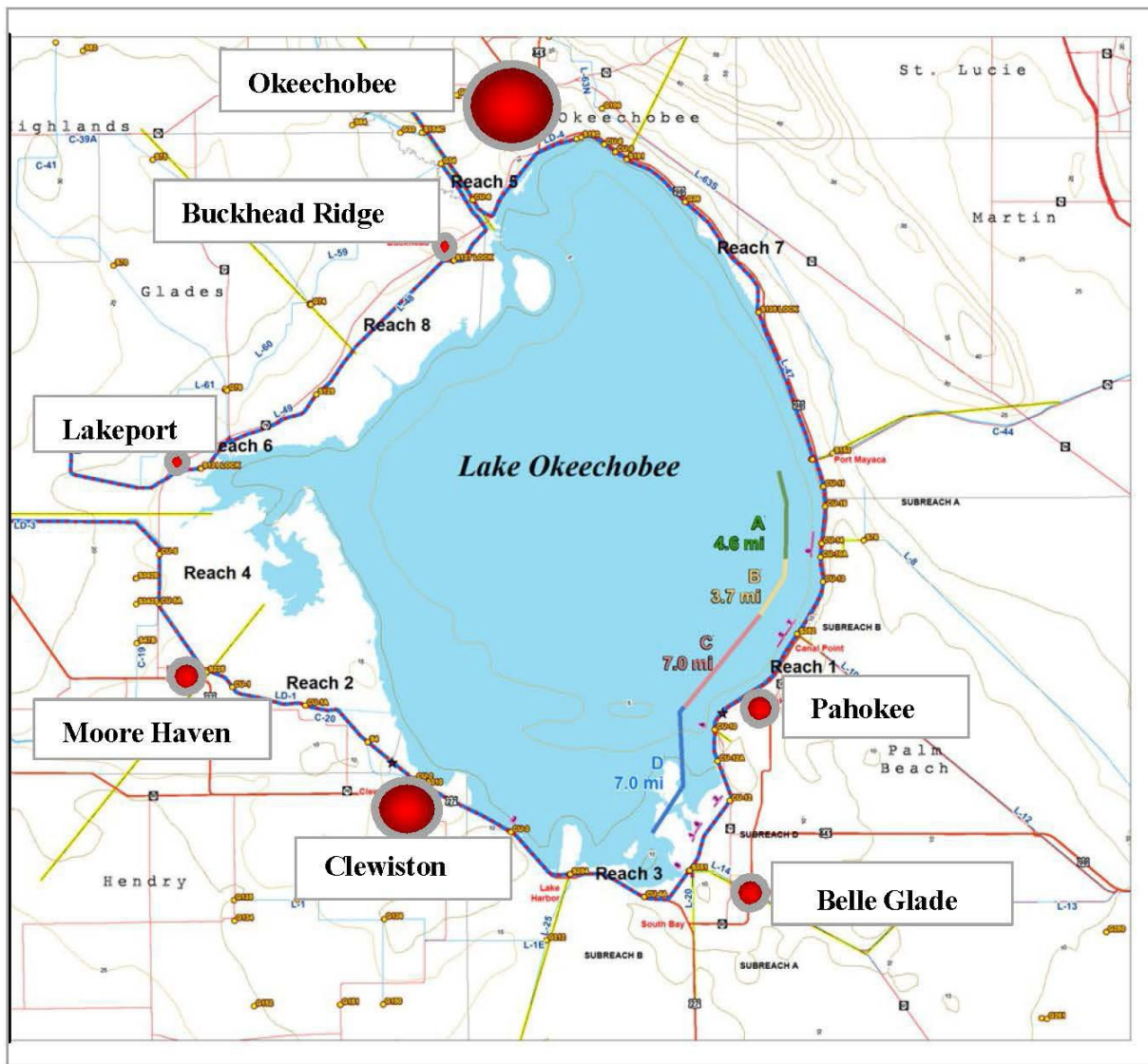

Figure 1.—Population centers and reach designations around Lake Okeechobee.

were numbered in accordance to their perceived urgency for repair, with Reach 1 considered to be the most critical and Reach 8 being the least critical. The various reaches are shown on figure 1. Reaches 1, 2, 3, and 6 were further subdivided into consequence boundaries based on differences in model parameters.

Regional topography in the area has a gentle slope toward the southeast, generally creating drainage flow into the reservoir from the northwest, which naturally flowed out of the reservoir toward the southeast prior to construction of HDD. As previously described, the inflow and outflow of the dam is atypical in that the inflow drastically dwarfs the outflow capacity. Figure 2 shows the locations of inflow conduits to the lake (blue arrows) and outflow structures from the lake (green arrows). Based on the size of the structure, topography, and numerous waterways

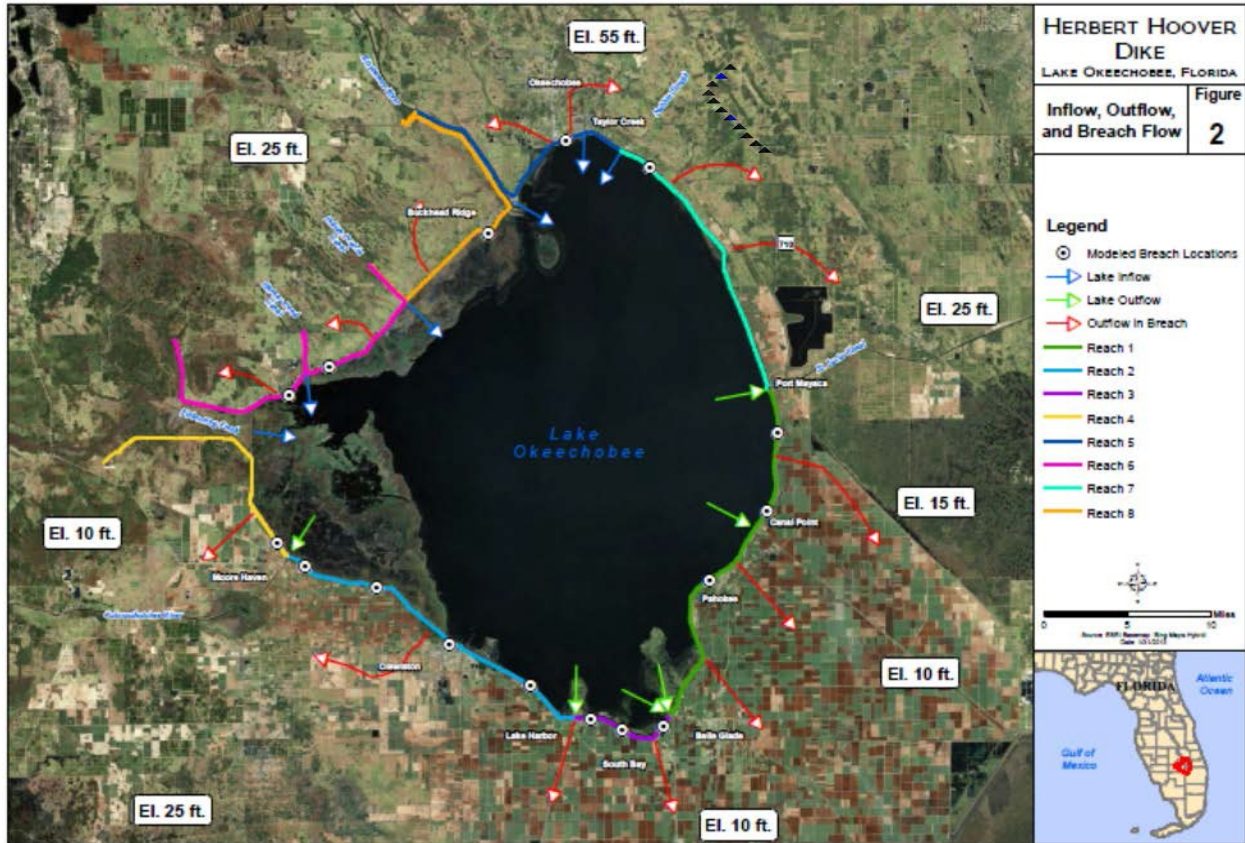

Figure 2.—Lake Okeechobee with general topography, primary inflow/outflow sources, and breach flow.

surrounding the dam, breach flows under failure scenarios do not follow a single water course as in typical dams. Breach flows would spread across broad areas. Numerous breach locations were evaluated around the dam, placed at locations that would yield conservative estimates for population at risk (PAR), considering locations of waterways and changes in topography that affect direction and depth of breach flow. Modeled breach locations and general outflow directions are also shown on figure 2 (red arrows).

In order to estimate the consequences of a dike failure, a number of hydraulic inputs were developed: depth grids, arrival time grids, duration grids, and hazard area boundaries. The process of computing loss of life within HEC-FIA is to identify the PAR for a given event and then divide this PAR into those who are cleared from the danger area, those caught evacuating, and those not mobilized. These divisions are based on a number of factors, including time of issuance of warning relative to the flood wave arrival time, mobilization, and distance to a “safe zone.”

As the recurrence drops to more frequent levels in the range of 50 to 100 yr, the life loss is again significantly reduced.

Risk Approach and Methodology

The greatest challenges associated with performing a risk assessment on the HHD were the scale of the structure and its associated variability. As was previously discussed, HHD is approximately 143 mi long and is constructed on various geologic deposits that comprise widely varying materials having differing material properties (strength, stiffness, permeability, etc.). Additionally, several different construction practices were used to construct the dam, and the geometry of the embankment and adjacent canals along the toe vary significantly along the alignment. In addition, the established tolerability guidelines were developed based on more typical dam structures, with lengths less than a mile and well-defined downstream breach flood paths. These challenges needed to be addressed when developing an approach to applying a risk assessment to the entire length of the dike.

To overcome these challenges, the dam was further delineated into manageable segments, with each segment considered as an independent structure. The eight reaches previously described were further divided into these 26 segments based on differences in geology, dike geometry, and downstream consequences (some segment boundaries resulted from previously delineated reach boundaries). Reach and segment delineations are summarized on figure 3. Segment numbering begins in Reach 3 and proceeds clockwise around the lake (in plan). Unlike the original designation of the reaches, the number designations of the segments do not have any correlation to risk or consequence values.

The team of risk estimators assembled for HHD included a diverse panel, representing geotechnical, geologic, structural, and construction disciplines, as well as a range in dam safety experience that is both project specific and industry wide. Makeup of the team varied for different sessions and failure modes depending on the specifics of the failure mode being discussed and applicability of their experience and expertise to that particular failure mode.

Risk Assessment Process

The team followed the general methodology previously developed by the USACE and the U.S. Department of the Interior, Reclamation, for dam safety risk assessment and failure probability estimation. In performing a risk assessment, a team's goal is to consider qualitative information in order to quantify the risks with numbers that can be easily compared. Therefore, the risk assessment process followed the following general steps:

Qualitative Assessment:

- *PFMs*: Upon convening, the team brainstormed and listed all PFM's that it could identify.

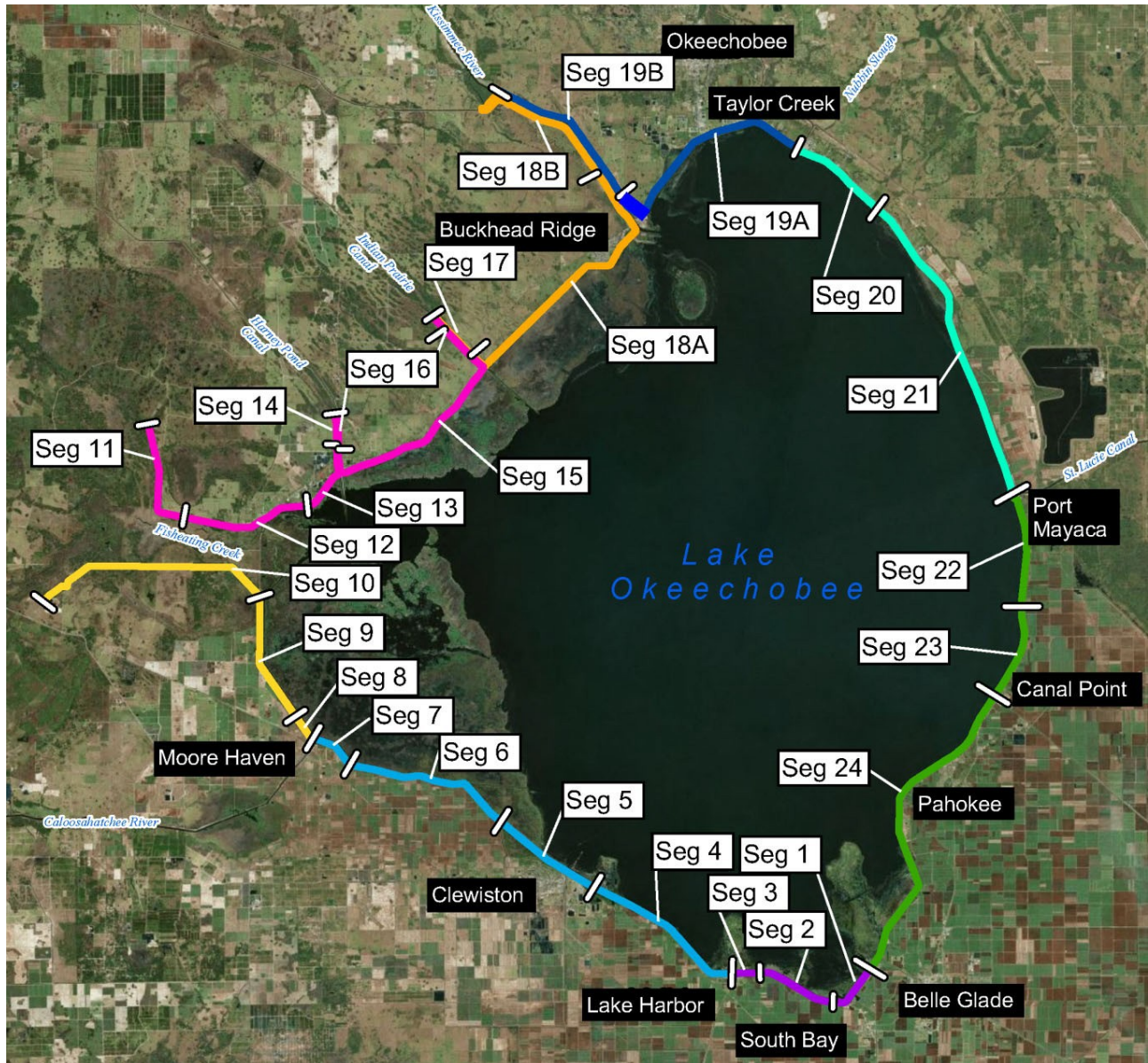

Figure 3.—HHD risk segment delineation.

- *Considerations:* The team then discussed considerations for each failure mode, taking into account the conditions and series of events needed for the PFM to occur.
- *Screening:* Based on the above considerations, the team narrowed the PFM list down to the more likely or “more credible” PFMs.
- *Ranking:* The more credible PFMs were then further discussed and ranked in order to identify which of them the team considered more likely to occur as compared to others. The team then assessed the ranked PFMs on a quantitative basis, generally beginning with the highest ranking and working downward.

Quantitative Assessment:

- *Event Trees*: Each PFM considered in the quantitative assessment was defined by the team in greater detail, identifying the sequence of logical events necessary for the PFM to begin, continue, and ultimately cause dam failure. Each step in the logical sequence is considered a node in the event tree for the PFM.
- *Factors*: The team listed factors that make each node in the event tree more or less likely to occur. These factors were developed based on specific characteristics of the dam (geometry, embankment materials, foundation materials, and seepage gradients), past performance, results of analyses, knowledge of dam operations, experience with other dams under similar conditions, etc.
- *Numeric Estimates*: The team then estimated probabilities of occurrence for each node in the event tree.

This process was then repeated for each of the 26 segments of HHD. The following provides further detail regarding the quantitative risk estimation process.

Two numerical values employed in this study to gage the quantitative level of risk at HHD are APF and annualized life loss (i.e., “risk”). To compute the APF and the annualized loss of life, the following equations were used and were accumulated by summation over the entire range of possible reservoir levels for each individual failure mode:

$$\text{Annual probability of failure} = (\text{Probability of the loading}) \times (\text{Probability of failure given the loading})$$

$$\text{Annualized loss of life} = (\text{Probability of the loading}) \times (\text{Probability of failure given the loading}) \times (\text{Adverse consequences given the failure})$$

Where:

- Probability of loading is the annual probability that the chosen load or load range will occur.
- Probability of failure given the loading is the likelihood that the dam will fail under the specific load or load range.
- Adverse consequences given the failure is expressed in terms of the estimated number of lives lost given a dam failure.

The probabilities of occurrence were estimated. For example, the event tree for internal erosion failure modes had the following sequence of events:

- ↳ Reservoir rises to a certain elevation
 - ↳ Erosion initiates
 - ↳ Erosion continuation (lack of filtering)
 - ↳ Progression step 1 (roof forms to support a pipe)
 - ↳ Progression step 2 (upstream zone fails to fill crack)
 - ↳ Progression step 3 (constriction or upstream zone fails to limit flows)
 - ↳ Unsuccessful intervention
 - ↳ Breach (uncontrolled release of the reservoir)

Some event probabilities (e.g., reservoir elevation) were based on available probability estimates (e.g., hydrologic recurrence curves). Other event probabilities were estimated by the team, guided in part by the verbal probability descriptors given in Reclamation’s *Dam Safety Risk Analysis Best Practices Training Manual* (Reclamation 2010) as summarized below.

Verbal descriptor	Probability value
Virtually certain	0.999
Very likely	0.99
Likely	0.9
Neutral	0.5
Unlikely	0.1
Very unlikely	0.01
Virtually impossible	0.001

The probability for each event to occur was considered independent of the other events, and efforts were made to ensure that factors and considerations were not assessed multiple times for different nodes within each PFM. The estimators considered each node assuming that all prior nodes had occurred, that is a probability of 1 for prior nodes, regardless of the probability values that had been estimated by the team for prior nodes. In general, the nodes were considered to be sequential in time; that is, the second node occurs after the first, the third node occurs after the second, etc. The one exception is the “unsuccessful intervention” node, which is placed very late in the event tree. The team considered this node to be able to “float” in time; that is, intervention could have occurred early in the development of the failure mode and, if successful, could have prevented further development of the failure mode.

Each estimator initially provided a reasonable low and reasonable high estimate of probability for each node, and then these estimates were discussed by the team to reach team consensus estimates of reasonable low and reasonable high probabilities for the node in question. The range between the reasonable low and reasonable high was a function of the level of uncertainty the team had for a given node. For this risk assessment, it was assumed that for each node the probability density function (PDF) for each node was uniform between the reasonable low and reasonable high estimates. For this PDF, the arithmetic average of the two estimates is also the median value and was referred to as the “best estimate” value for the node probability. The reasonable low and reasonable high values define the uncertainty of the probability value assigned to each node by the risk estimators. This uncertainty is helpful in identifying PFM event node probability estimates that may be able to be improved with further information not available at the time of the risk assessment and could suggest where further investigation or analysis would be helpful.

The product of all nodal probabilities within an event tree, except for the load probability, is the system response probability (SRP) and is a measure of the likelihood of dam failure for a given PFM assuming a specific loading has occurred. The SRP is an assessment of the condition of the dam and its response to a particular loading. Each PFM event tree was considered for multiple loading conditions, which vary depending on the failure mode. After SRPs were developed for several loading conditions (e.g., various reservoir levels), a system response curve was developed in the form of SRP versus loading (e.g., probability of failure versus reservoir level for hydrologic loading). The probability of the loading node occurring is based on recurrence values of certain events or conditions. The APF takes flood recurrence into account and is estimated by combining the probabilities of the loads and the SRPs for the PFM in a numerical process. The numerical process consists of multiplying the probability of a load range (e.g., probability the reservoir is between two specific elevations) times an average or representative SRP for that load range, repeating this process for all possible load ranges, and then summing the resulting probabilities. The APF is a measure of the likelihood of dam failure for a given PFM occurring in a given year. Annualized life loss estimates were calculated similarly by multiplying the APF for a reservoir range times an average or representative estimate of life loss for that reservoir range, repeating the process for all possible load ranges and then summing the resulting annualized life loss values. APF and annualized life loss values were calculated for this study using three methods: DAMRAE, @Risk, and SimRiskCalc, as discussed further below.

The computer program DAMRAE, Version 2.1.1.2, developed for USACE by the Utah Water Research Laboratory at Utah State University and USACE Reemployed Annuitant Cadre Engineers and Economists, was one method used to perform the risk calculations, including APF and annualized life loss. The PFMs evaluated were judged to be non-mutually exclusive in that all or any one of the failure modes could occur in the same segment under the same hydrologic loading. Therefore a common-cause adjustment was applied to the SRPs so the probability of loading was only accounted for once in the calculation.

Additionally, in order to address the numeric uncertainty of the study, the computer programs PrecisionTree v5.7 and @Risk v5.7 were utilized, both of which were developed by Palisade Corporation. Lastly, SimRiskCalc, an Excel spreadsheet application, was used to calculate APF

and annualized life loss from the SRP relationship, the life loss estimates, and the reservoir elevation recurrence curve (France and Pabst 2013). The computation procedure is a simplified numerical integration process using linear interpolation and is beneficial during team meetings, as it provided real time results.

Risk Assessment Results and Findings

As described above, the risk assessment process for HHD consisted of both qualitative screening and quantitative assessment of PFMs. The team started with over 40 PFMs for the first reach analyzed, Reach 3. These were qualitatively screened down to two general failure modes considered the most crucial for the dam: (1) internal erosion through the embankment and (2) internal erosion through the foundation. Additional failure modes associated with overtopping and overwash are still being evaluated by the team. Additionally, failure modes associated with a few selected structures were also estimated. A comprehensive risk assessment of failure modes associated with all structures and conduit penetrations in the dam is currently in process. Consideration of the two primary failure modes led to quantitative risk estimations for 60 failure modes representing baseline (existing) conditions along the 8 reaches (26 segments) of the dam alignment. These 60 failure modes represent internal erosion through the embankment, through the foundation, and along selected structures for varying geometries and geologic conditions in the segments along the dam alignment. Figure 4 shows an idealized schematic of one of the quantified failure modes.

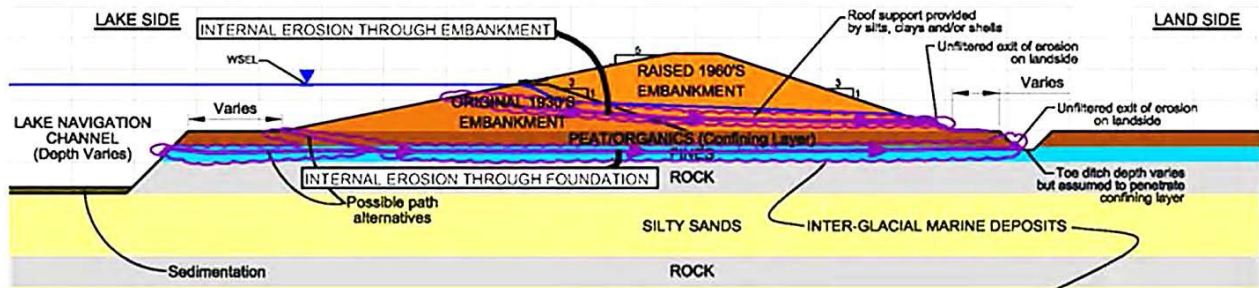

Figure 4.—Idealized failure mode cross section.

Quantitative Risk Results

Quantitative risk estimates were developed for the 60 viable failure modes using the previously described procedure. Twenty-seven of the 60 baseline failure modes plot above the TRG for APF (i.e., APF greater than 1×10^{-4}), and 26 of the 60 baseline failure modes plot above the annualized life loss TRG (i.e., annualized life loss greater than 1×10^{-3}) as shown on figure 5.

Presenting Risk to Understand Contributors

Figure 5 is the f-N diagram commonly used in risk assessments and summarizes the results for HHD; however, caution should be used when reviewing risk results plotted on an f-N diagram. Close attention needs to be paid to the loading condition of the failure mode, risk accumulation, and source software that produces the plot. The plotted point for an individual failure mode results from summing accumulated risk over several loading ranges, and it is not possible to discern which load range contributes the most risk when presented in this format. In addition, various software applications compute and accumulate risk differently. Programs such as DAMRAE compute a weighted average for the probability of failure and loss of life interpolated over the load range. In this case, it is easy to believe that there is an error between plots and tables since there is an appearance that the values do not agree, when in fact, it is the computed weighted average that results in the confusion.

Because f-N diagrams do not show loading contributions, new presentation methods were developed that illustrate the contribution to risk from: (1) reservoir loading, (2) APF, and (3) individual failure modes. Figure 6 is a modified f-N diagram plotting the APF and loss of life for one failure mode at different reservoir levels. It can be seen from the example that the majority of the risk comes from the 1,150-yr pool level.

Another way to visualize the contribution of reservoir load to the risk is shown on figure 7, which is a bar chart showing the percentage of the total that each reservoir level contributes to the total APF and annualized loss of life risk for a particular failure mode. Also shown is the “weighted life loss”⁴ that indicates the increasing consequences of increasingly large floods and subsequent inundations depths.

Total estimated risk for HHD was not computed because it is erroneous to accumulate risk across multiple downstream populations. Therefore, each segment was considered by the team as an individual risk entity, and risks were summed only within each segment. Risk was plotted though along the dam alignment to evaluate differences among the various segments. Figure 8 shows the annualized loss of life risk along the alignment plotted separately for each of the two primary failure modes: internal erosion through the embankment and internal erosion through the foundation. Also plotted on this figure is the total annualized loss of life risk for each segment, which is the sum of the annualized life loss risks for the two primary failure modes. This figure demonstrates how the risk varies along the alignment. It also shows which failure mode dominates the risk in each segment. It can be seen that internal erosion through the foundation generally controls the risk, with the exception of segments 9–12, where the sandy foundation and lack of a cohesive shallow layer reduces the probability of roof support within the foundation.

⁴ “Weighted life loss” differs from “life loss” in that it is back-calculated from the final annualized life loss calculation. This is done since a number of “life loss” values are used in the preceding calculations, but a single value is desired for clarity when illustrating the total risk.

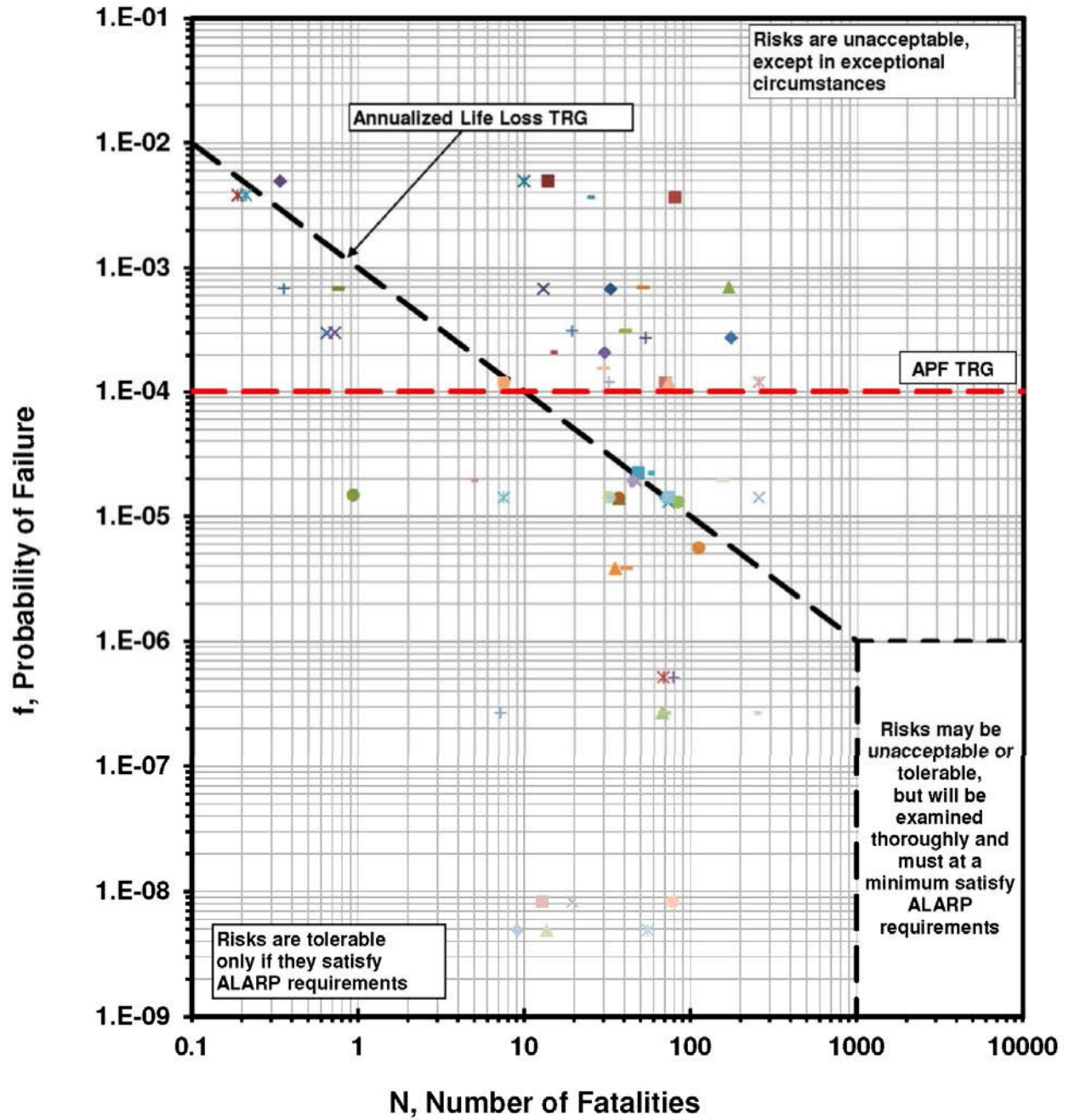

Figure 5.— f - N plot of baseline risk estimates.

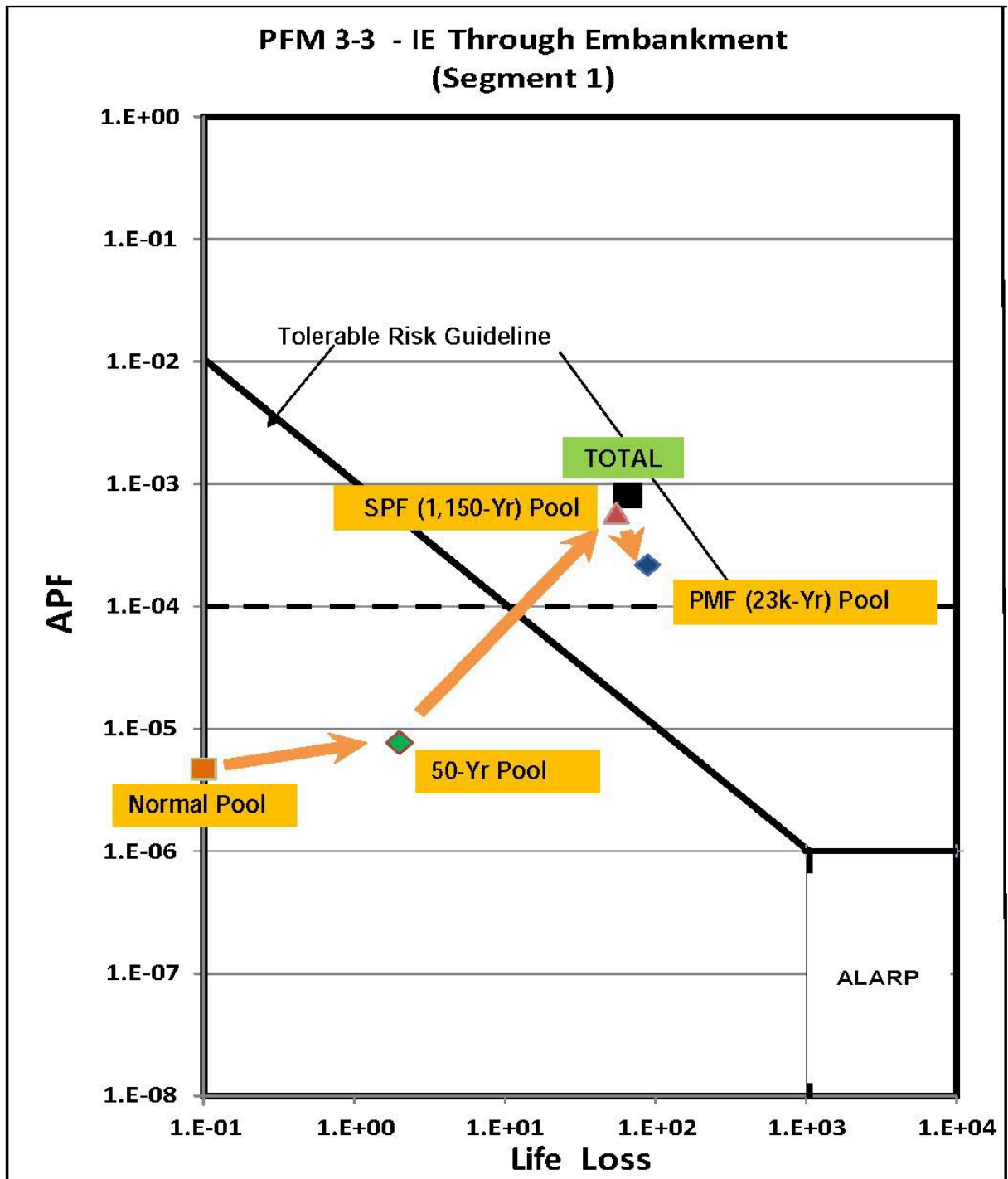

Figure 6.—Typical risk path by reservoir level for individual failure mode.

Risk Contributions by Reservoir Range
 Reach 3 Segment 1
 PFM R3-3 Internal Erosion Through Embankment (FIA)

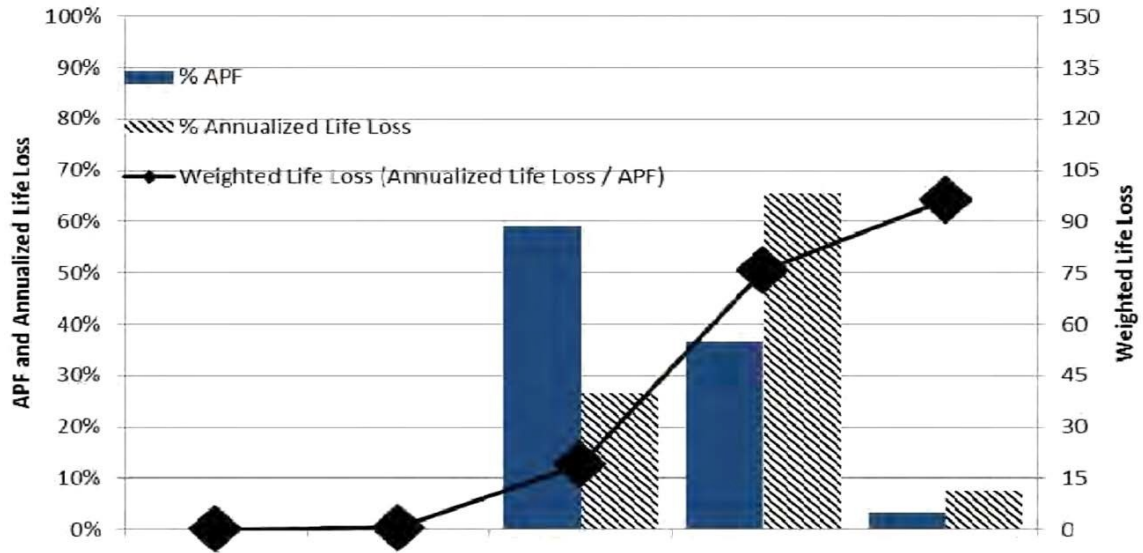

Figure 7.—Typical risk contribution by reservoir range.

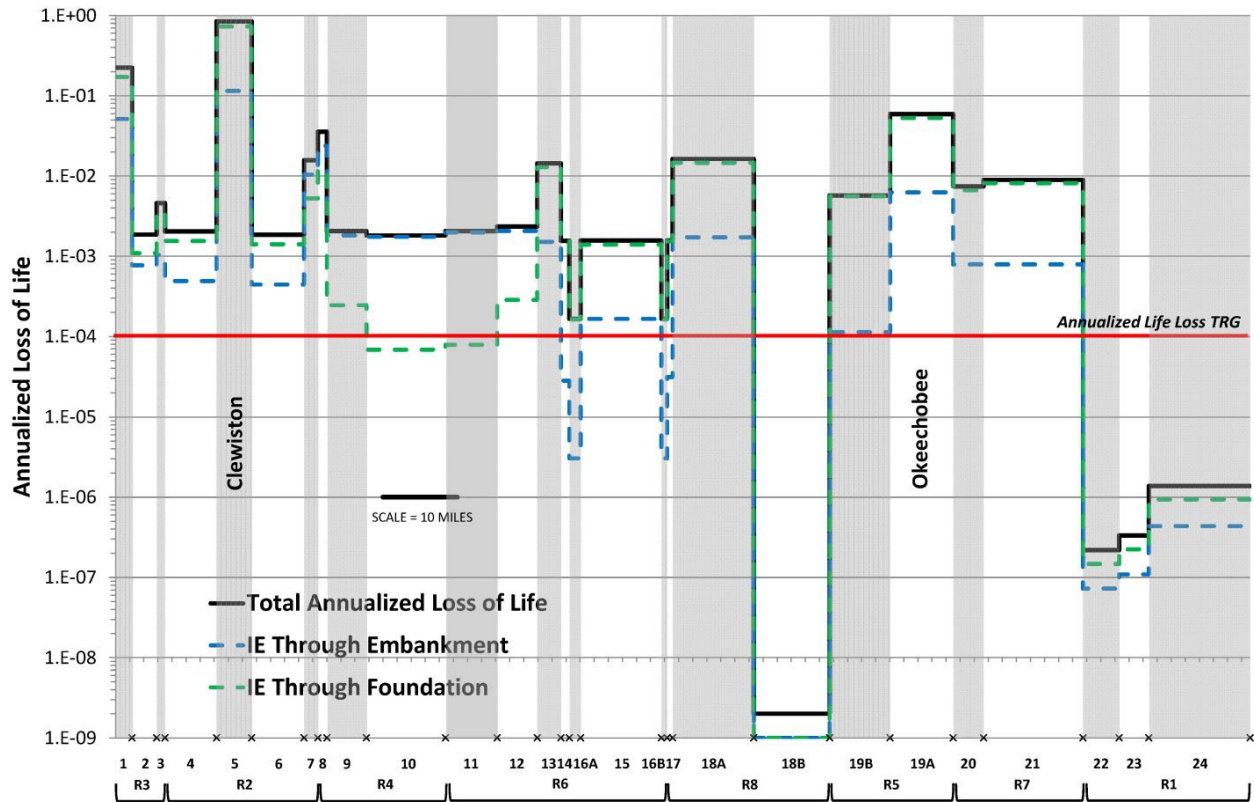

Figure 8.—Risk results by failure mode along dam alignment.

Prioritizing Risk

Figure 9 presents the variations of three values along the dam alignment: APF, annualized loss of life (“risk”), and weighted loss of life.⁵ The weighted loss of life was computed by dividing the total annualized loss of life by the APF, thus producing a weighted average for all reservoir levels. As can be seen on figure 9, baseline risk estimates for 21 of the 26 segments exceed the defined TRGs for either APF or annualized loss of life risk. Risk was very sensitive to consequence estimates and boundaries. Several of the segments were more heavily influenced by life loss estimates than by the condition of the dam. This is demonstrated where APFs are below the TRG, while annualized life loss exceeded the TRG.

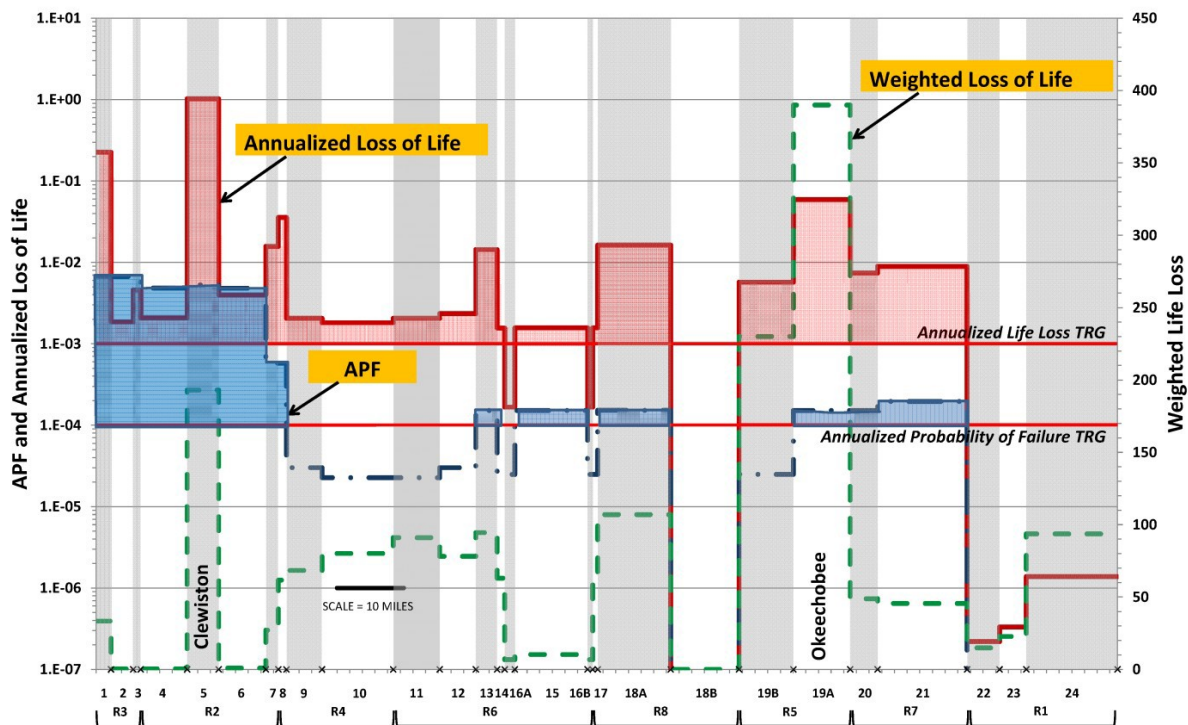

Figure 9.—Risk analysis results by segment along dam alignment.

In total, over 120 mi of the dike (over 80%) have internal erosion failure modes with estimated risks above TRGs. The rehabilitated Reach 1, where a cutoff wall was recently constructed, accounts for over half of the remaining 20% of the alignment for which estimated risks are below TRG; portions of tie-back embankments (those extending along water courses flowing into the lake) account for the other half.

⁵ Weighted life loss is the average of the life loss estimates based on life loss values at various reservoir levels. Since the recurrence of the reservoir levels differs, the value is weighted to give greater importance to those levels that occur more often (i.e., lower reservoir levels).

It is not practical to undertake repair of the more than 120 mi of dam with risks exceeding TRGs due to annual budget limitations. Therefore, the segments needed to be prioritized. The quantified risk results were compared in relative terms to prioritize the segments. That is, the areas with the greatest potential for risk reduction can be identified for decisionmakers. Although TRGs for both APF and annualized loss of life have been established, the annualized loss of life risk is generally considered the priority for decisionmaking. Segments were divided into risk tiers based on highest to lowest annualized loss of life, which aided in the determination of where risk reduction efforts would be most effective. For example, segments with annualized loss of life above 10^{-1} were considered tier 1, and segments with annualized loss of life between 10^{-2} and 10^{-1} were considered tier 2, and so on. The segments falling within these top two tiers are shown graphically on figure 10 and in plan view on figure 11. Remaining segments with risks above TRGs are prioritized in lower tiers.

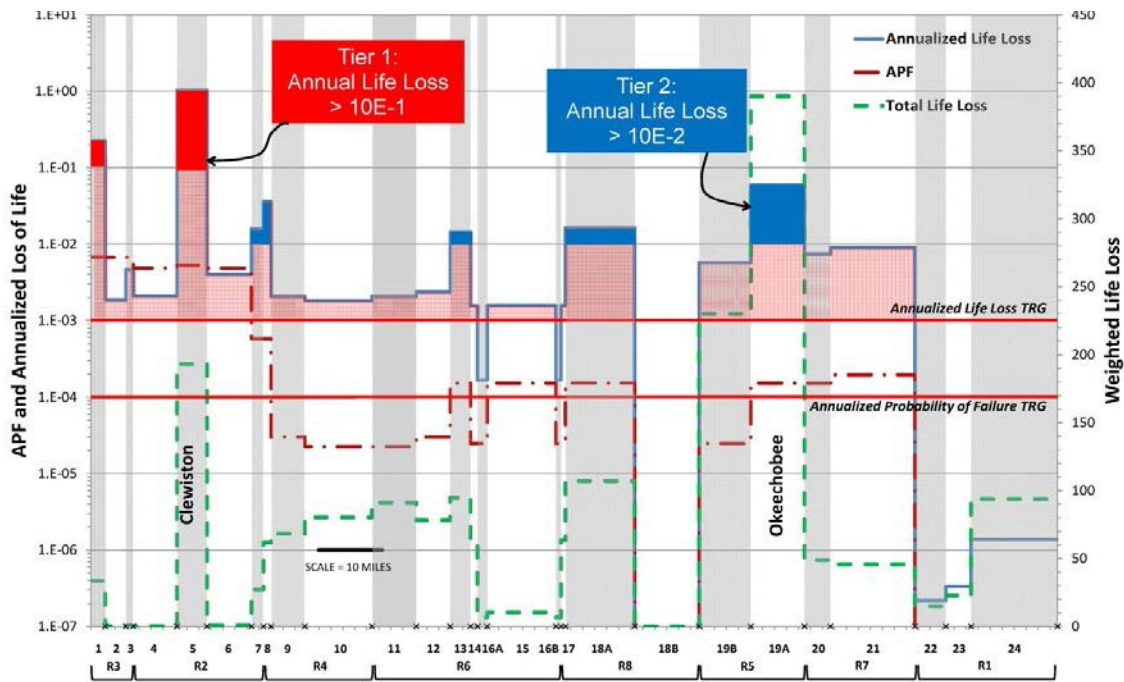

Figure 10.—Risk prioritization for 143-mi Long Dam.

Qualitative versus Quantitative Risk Results

Although most engineers tend to gravitate toward the numeric and graphical results of the quantitative risk assessment, decisionmakers need to understand the story behind the numbers. “Making the case” to support the numeric results is a critical component of presenting risk analysis results. A qualitative description of the reasoning behind the results provides a basis for decisionmakers to either support or question the results. Furthermore, explaining the risk in a narrative format helps identify the key contributors that need to be addressed. Following is an example of a qualitative description of risk results for one such failure mode.

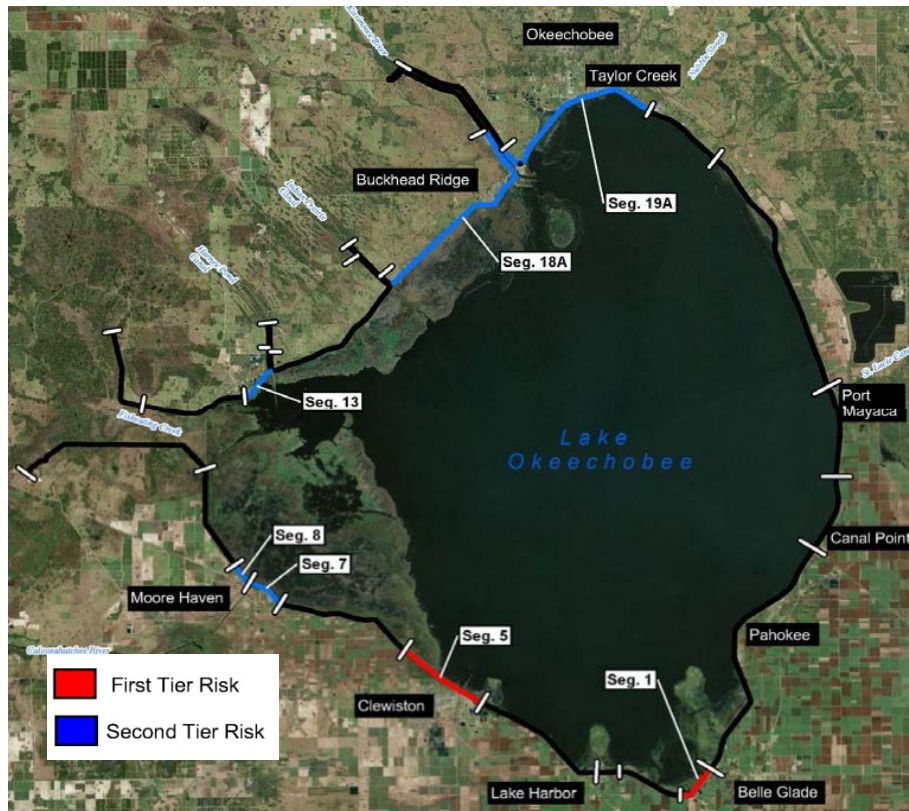

Figure 11.—Risk prioritization in plan view.

Example Qualitative Risk Result:

PFM R2-3 – Internal erosion through embankment in Reach 2

Reservoir loading in the range (just above pool of record [POR]) the SPF is the largest contributor to APF. Reservoir loading in the range from the SPF to the PMF is the largest contributor to risk. This difference in load ranges contributes to the APF. The poor quality of the fill (non-plastic hydraulic fill) and poor construction methods (no to little compaction), with little quality control, contribute to embankment material inconsistency and the presence of loose material. No known performance issues have shown wet areas on the landside slope, but conditions are similar to Reach 3, where poor performance has been observed. Any reservoir fill above the POR will be first fill conditions for the embankment, greatly increasing the uncertainty in how the structure will behave under such loading. No protective measures, such as filters, are present within the embankment to prevent internal erosion. Past events have shown the embankment capable of holding a vertical face and the presence of some cohesive soils suggests that roof support is possible. Corrective measures have been successful in addressing historic performance, and it is thought that intervention will be effective at lowering the probability of failure.

The team developed the qualitative results through the process of identifying factors that make the identified failure modes more or less likely. Complete, but concise, tables that summarize these factors are important. Based on the risk results for HHD, it was found that the following

key factors most influenced the estimated probabilities of failure: (1) foundation geology, (2) geometry (i.e., the presence of landside ditches at the toe of the dam providing horizontal exit for seepage), (3) previous performance, and (4) flood loading. Internal erosion through the foundation generally had higher probabilities of failure than through the embankment. Failure modes with the highest APFs are those in segments that had a shallow cohesive layer that would support a roof. Previous incidents of seepage, cloudy boils, and evidence of initiation of piping at some locations influenced the team to estimate relatively high probabilities of erosion initiation for reservoir water levels at or above the historic pool of record. The team estimated substantially higher probabilities of failure under elevated flood pools.

Conclusions

A risk analysis of the existing condition of a 143-mi-long, high-hazard dam was completed by a panel of engineers and geologists using an elicitation process. Estimating and presenting risks for such a long structure presented several challenges, which included:

- Extrapolating available geotechnical data over long distances and the inherent uncertainties this caused
- Accounting for variable PARs along the structure
- Delineating areas with the highest risk
- Portraying the analysis that explains the risk to the public in a straightforward fashion

These challenges were met by dividing the dam into segments that were considered by the team to represent separable structures or risk entities. This limited the variability of geology, geometry, consequences, and other risk factors within a given segment. Risk was estimated individually for each segment and then compared relatively across the entire 143-mi dam. Because about 80% of the 143-mi dam had quantitative risk estimates that exceeded established TRGs, the relative level of risks among segments was used as a prioritization tool. By comparing the segments based on relative magnitude of risk, the reliance on absolute TRG values that have been based on much shorter dams was diminished. The risk priority areas can be used by decisionmakers to apply funding first in areas where the greatest risk reduction can be achieved as expeditiously as possible.

In order to assist the decisionmakers, both quantitative and qualitative risk results were developed. The quantitative results provide numeric estimates for ranking, while the qualitative results provide the understanding and justification behind those estimates, as well as identifying key deficiencies that need to be addressed.

Due to the length of the structure, several uncertainties were considered by the team while estimating probabilities and risk, which included:

- The quantity and quality of geotechnical data varied greatly along the dam.
- Due to the length of the dam, spacing between test holes was significant. Numerous investigations conducted over the history of the project resulted in variations in procedures and data quality.
- Delineations of consequence areas with variable assumptions lead to distinct boundaries with significantly different life loss values. This leads to uncertainty as to the actual consequence numbers in areas close to the segment boundaries.

Additional studies were identified by the team that would reduce some of the uncertainty and perhaps affect the risk results. These included obtaining additional geotechnical data through SPT borings, cone penetration tests, excavated test pit and trenches, and detailed logging of excavations during ongoing construction to replace culvert penetrations through the embankment. These would reduce the uncertainty applied by the team in estimating probabilities at higher reservoir elevations and provide performance data at locations where none previously existed. The next step in this project is to refine the baseline risk estimates based on the additional data described above. Furthermore, risk reduction provided by various rehabilitation alternatives is being estimated to aid in identifying the most efficient repair options. Based on the results of this study, HHD remains one of the USACE's highest priority Safety of Dams projects.

References

- Bureau of Reclamation (Reclamation) (2010). *Dam Safety Risk Analysis Best Practices*, Technical Service Center, Denver, Colorado.
- F.C. Townsend, J.H. Schmertmann, T.J. Logan, T.J. Pietrus, and Y.W. Wong (1982). "An Analytical and Experimental Investigation of a Quantitative Theory for Piping in Sand, Final Research Report for Florida Power and Light Company," Department of Civil Engineering, EIES, College of Engineering, University of Florida. 100 p.
- France, John W. and Mark W. Pabst (2013). "SimRiskCalc – A Spreadsheet Implementation for Simplified Risk Analysis Calculations," Association of State Dam Safety Officials (ASDSO) Dam Safety 2013; Providence, Rhode Island, September 9–12, 2013.
- Jacksonville District (1975). "Letter Report: Rehabilitation of Structure 154," USACE, Jacksonville, Florida, August 1975.
- _____(2000). "Herbert Hoover Dike Major Rehabilitation Evaluation Report," USACE, Jacksonville, Florida, November 2000.

South Florida Water Management District (1979). "Florida Power and Light Dike Failure and its Impact on Project Facilities," South Florida Water Management District, West Palm Beach, Florida, November 1979.

U.S. Army Corps of Engineers (USACE) (2011). "Safety of Dams – Policy and Procedure, ER-1110-2-1156," Department of the Army, Washington, DC, October 2011.

Case 10 – Navajo Dam

Construction of Navajo Dam began in July 1958, and it was dedicated on September 15, 1962. The nearly 3/4-mi-long dam (figure 1) stands 402 ft (123 m) high with a crest length of 3,648 ft (1,112 m). Nearly 26 million yd³ (19.8 million m³) of selected cobbles, gravel, sand, and clay taken from 16 borrow areas beside the San Juan River and along valley benches were used in construction of the rolled earthfill embankment. Navajo Reservoir extends 35 mi (56 km) up the San Juan River, 13 mi (21 km) up the Pine River, and 4 mi (6 km) up the Piedre River. When full, the surface area of the reservoir is 15,610 acres (6,317 hectares), with a total capacity of 1,708,600 acre-ft (2,107 million m³).



Figure 1.—Navajo Dam and spillway (Google Earth, June 30, 2005).

Bedrock is the Tertiary age San Jose Formation (formerly the Wasatch Formation), which underlies the dam and reservoir and crops out in the general area. Bedrock is an ancient alluvial deposit primarily consisting of relatively flat-lying, massive sandstone, which ranges in thickness from about 25 to 75 ft. The sandstone is interbedded with shale and siltstone lenses, which are generally 1 to 20 ft thick with lateral extents less than 450 ft.

The alluvium is composed of unconsolidated gravel, sand, and silt. The alluvium includes an upper fine-grained interval overlying a coarser (sandy gravel) interval. A cutoff trench was excavated through the alluvial materials to “sound rock” for the full length of the dam beneath

the Zone 1 core. The maximum depth of this excavation was 55 ft, and the average was approximately 22 ft. Under the Zone 2 areas of the embankment, the upper fine-grained silty sand portions of the alluvium were removed, and the embankment was placed on the underlying sandy gravel deposits. Only light stripping occurred under the extreme upstream and downstream limits of the embankment.

Navajo Dam was constructed across a sharp incised meander of the San Juan River. The left abutment is formed by the erosion of the outside edge of the meander. The differential erosion of the interbedded shale and sandstone on the left abutment causes step-like cliffs common to both abutments. The right abutment is the narrow weathered bedrock nose of the inside of the meander and is directly exposed to the reservoir. The upstream side of this bedrock nose is near vertical and moderately jointed at 5- to 10-foot intervals. As shown on figure 2, the right abutment foundation extends for a significant distance beneath the embankment. Regional fracturing at the dam site is generally widely spaced. Local fracturing is relief jointing caused by lateral stress relief due to downcutting of the San Juan River, ranging from intermediate to closely spaced. Additionally, there are bedding planes, which form joints. Fractures and joints interconnect, creating a highly permeable secondary seepage system beneath the embankment.



Figure 2.—Right abutment of Navajo Dam, looking downstream.

Foundation treatment included blanket grouting and a single-row grout curtain with primary, secondary, and tertiary grout holes up to 260 ft deep. The blanket grouting used 145 grout holes and averaged 3.82 sacks/ft of hole. Grout takes in the left abutment averaged 4.7 sacks/ft over 14,000 ft of hole. Grout takes in the right abutment averaged only 0.46 sack/ft of hole, but the grout holes were mostly vertical and probably did not efficiently intersect the relief joints.

The dam is a rolled, zoned earthfill embankment. The dam features a wide central core (Zone 1) of impervious material, flanked by transition zones (Zone 2) upstream and downstream from the core. Zone 2 transitions to upstream and downstream shells (Zone 3) that are comprised of sand, gravel, cobbles, and boulders. The dam has a crest length of 3,648 ft, structural height of 402 ft, and a total embankment volume of 26,840,863 yd³. The upstream face of the embankment has slopes that vary from 5H:1V near the toe to 2-1/2H:1V near the crest. The downstream face of the embankment has slopes varying from 5H:1V near the toe to 2H:1V near the crest. The upstream face of the embankment is protected with a 3-ft-thick layer of riprap. Zone 2 sand and gravel provides downstream slope protection. The impervious core is founded on rock. The remainder of the embankment is founded on river alluvium. The dam is now highly instrumented with a variety of surface measurement points, vertical cross-arm devices, inclinometers, twin-tube hydraulic piezometers, porous-tube piezometers, slotted-pipe piezometers, vibrating-wire piezometers, and seepage weirs.

Approximately 1 yr after the commencement of reservoir storage, seepage was noted on the left abutment at elevation 5830 in the downstream groin area and on the right abutment near the embankment/abutment contact. The seepage fluctuated with the reservoir level and steadily increased through the following yrs. Maximum measured seepage in the summer of 1973 was 664 gpm through the left abutment and 1,037 gpm through the right abutment. Reclamation engineers concluded, and independent consultants affirmed, that the potential for failure due to subsurface piping was significant enough to require structural modification. The PFMs identified were internal erosion of the Zone 1 core material into and/or along the untreated joints and cracks in the foundation bedrock. Extensive modifications were made to the dam during 1987 and 1988 to alleviate seepage conditions at the abutments. The modifications included: construction of a downstream drainage tunnel in the right abutment from which drain holes were drilled to near the impervious fill to foundation contact, and construction of a concrete diaphragm or cutoff wall at the left end of the dam.

Left Abutment Diaphragm Wall

A 436-ft-long, 400-ft (maximum) deep, and 32-in nominal width concrete diaphragm wall was installed in the left abutment to cutoff seepage. The wall was constructed in 8-ft panels by using a "Hydrofraise" (rock mill) (figures 3 and 4) to excavate a slurry-filled trench to the specified length and depth and then backfilling the panel by introducing concrete at the bottom (figure 5) of the trench until it was filled with concrete. At the time (1987-88), the Hydrofraise used at Navajo Dam was the largest ever built. The Hydrofraise was 90 ft tall, which was 40 ft taller than previous models, and weighed 30 tons. Some 28-day compressive strengths for the diaphragm concrete reached 5,000 lb/in². The typical concrete mix (per yd³) was: water at 207 lb; cement at 363 lb; and pozzolan at 155 lb; sand at 1,261 lb; and gravel (aggregate) at 1,915 lb. The concrete diaphragm wall was intended to control or drive the seepage deeper into the abutment at the contact between the impervious core and the foundation sandstone. This modification greatly reduced the potential for internal erosion of the impervious core material into the fractured sandstone. Piezometer readings and seepage measurements show that this has occurred. The seepage rate through the left abutment has been greatly reduced from pre-wall conditions and the seepage pressures downstream from the concrete diaphragm wall are significantly less than pre-wall conditions.

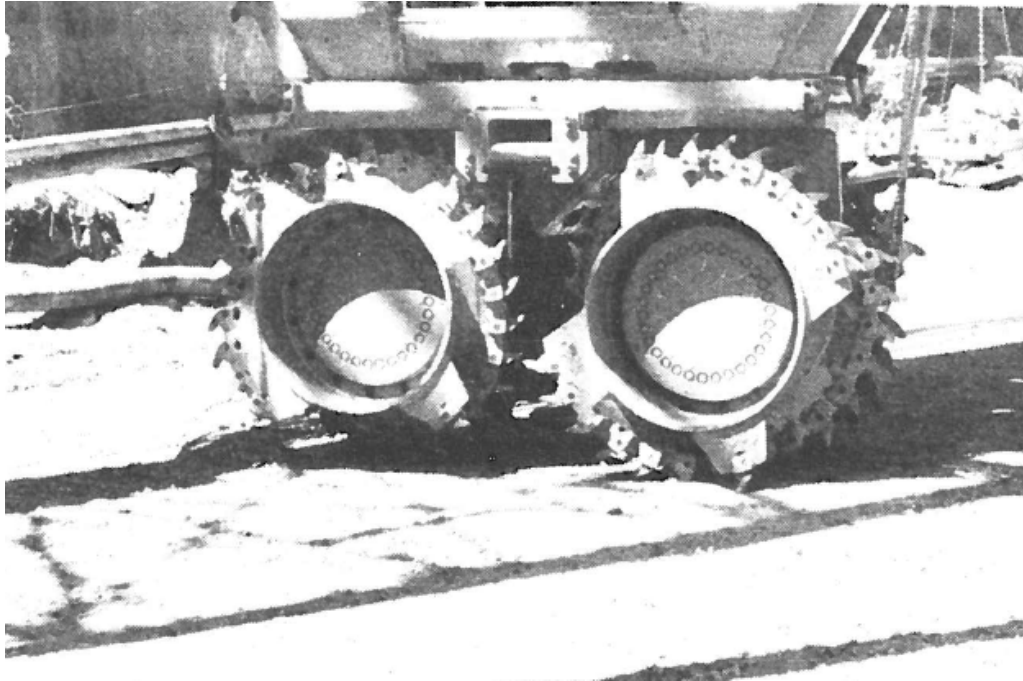

Figure 3.—View of Hydrofraise cutting heads.



Figure 4.—View of Hydrofraise being maneuvered and lowered for panel excavation.

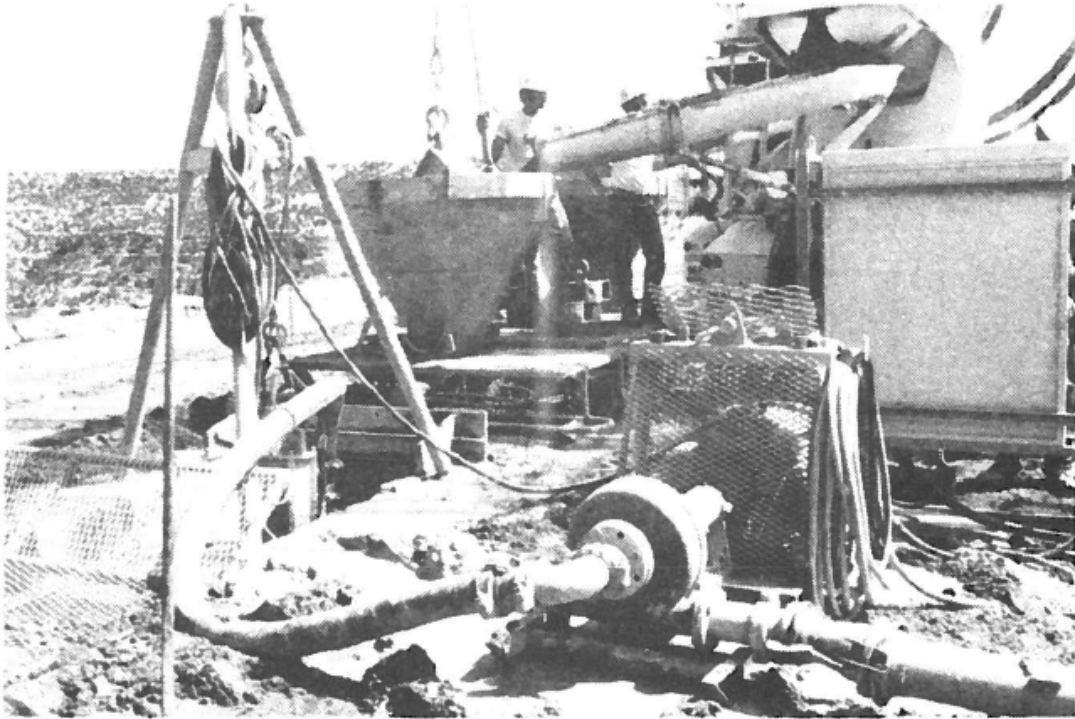

Figure 5.—Concrete placement for cutoff wall panel. Pump in foreground removes displaced bentonite from trench.

Large slurry losses were encountered during construction, which occurred at a rate of 23 inches per minute. In one case, 120 yd³ of sand and gravel were dumped into the excavation to stop them. In one instance, it was estimated that 380 yd³ of slurry were lost.

Right Abutment Drainage Tunnel

The right abutment drainage tunnel is a concrete-lined modified horseshoe-shaped tunnel that is 9 ft high and 12 ft wide within a lower sandstone unit. The tunnel extends 800 ft into the right abutment, then at a large chamber makes an approximate 90-degree bend to the left (looking upstream of the portal), and continues generally parallel to the dam crest for about 300 ft (figure 6). Drain holes ranging from 103 to 623 ft long were drilled from the parallel portion of the drainage tunnel between March and June 1988. The drain holes were drilled toward the grout curtain and were inclined from -2.7 degrees (downward) to +73 degrees (upward) to a target tip location about 20 ft below the embankment-rock contact (figure 7). A total of 46 drains were planned. The drain holes were finished with a 2-in inside-diameter Schedule 80 PVC pipe with 0.02-in slots and butyl-rubber packers (truncated-cone shaped attached to the PVC pipe with stainless-steel bands) at 30-ft intervals. If fines were encountered in the seepage flowing back down the drill hole, then a 1-in-diameter slotted PVC pipe fitted with Mirafi 140 filter fabric (geotextile) wrapped around the pipe was to be installed inside the 2-in PVC pipe. Only a few of the drains may have included the filter fabric wrapped slotted PVC pipe; most of

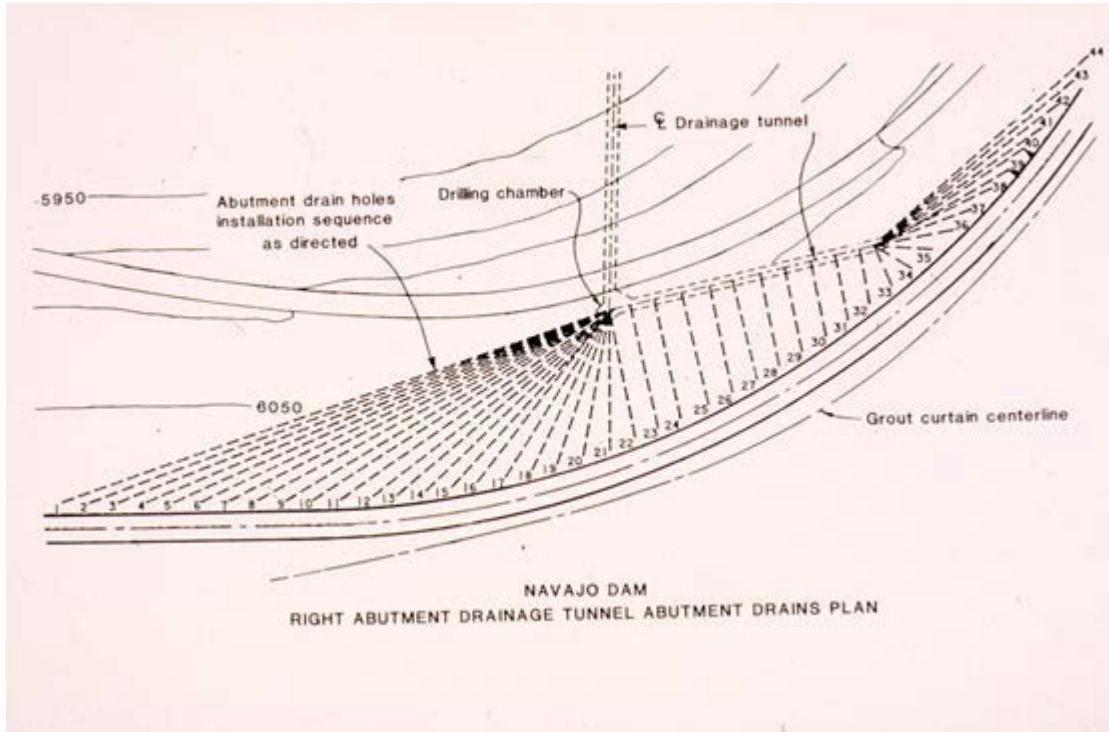

Figure 6.—Right abutment drainage tunnel plan.

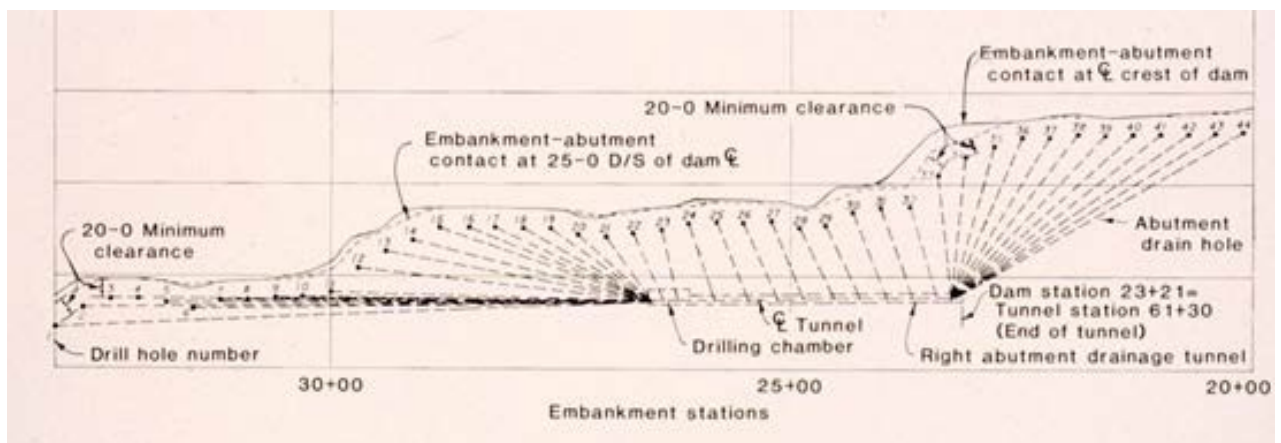

Figure 7.—Drain hole profile along centerline of dam crest.



Figure 8.—High flows and sand washing into drain hole No. 45.

the drains consist of only the slotted PVC pipe. High seepage flows (up to 750 gpm) were encountered when drilling the last 15 drains (drain Nos. 32 to 46 located toward the left end). In one instance, large amounts of sand were washed into the hole (figure 8). Because of the very large seepage inflows washing sand and shale particles from the holes, four holes were grouted off and one was fitted with a valve and its flow shut off. An additional four holes were not drilled.

Prior to the modification, the total seepage measured at the right abutment was up to about 1,200 gpm. The total seepage flow from the drainage tunnel system generally ranges up to about 800 gpm with a maximum of about 400 gpm collected on the right abutment groin. A filtered toe drain was also installed along the right groin of the dam embankment to filter and collect this seepage. The drainage tunnel system was intended to reduce seepage pressures in the foundation sandstone in the vicinity of the impervious core-sandstone contact. In most areas, this goal was achieved. Upon completing the modification, piezometric pressures within the right abutment were not reduced beneath the embankment foundation contact in all areas. For this reason, an extensive array of instrumentation, an automated data logger, and an early warning system were installed at Navajo Dam to (1) monitor the behavior of the embankment and foundation, (2) provide advanced warning for the development of PFMs, and (3) provide notification to the downstream population in the event of an emergency.

As expected, the total right abutment seepage has increased because of the construction of the drainage tunnel system, but the right abutment seepage is now judged to be adequately controlled. The drainage tunnel system probably increased the gradient and the quantity of seepage through the right abutment, but piezometers did show that seepage pressures were reduced near the impervious core contact with the foundation sandstone.

References

Bureau of Reclamation (2010). "Comprehensive Facility Review, Navajo Dam, Colorado River Storage Project, Upper Colorado Region," U.S. Department of the Interior, Bureau of Reclamation, Technical Service Center, Denver, CO, March 2010.

_____(1966). "Technical Record of Design and Construction, Navajo Dam and Reservoir," U.S. Department of the Interior, Bureau of Reclamation, Denver, CO, November 1966.

_____(2012). "Instrumentation Issue Evaluation, Navajo Dam," U.S. Department of the Interior, Bureau of Reclamation, Technical Service Center, Denver, CO, March 2012.

Case 11 – Canby Creek, R-1 Dam¹

Canby Creek, R-1 Dam (figure 1) is an NRCS-designed dam constructed in 1985, with a maximum structural height of 70 ft, in a glacial outwash area of Yellow Medicine County, Minnesota. The dam impounds a reservoir with a maximum storage capacity of 6,100 acre-ft from a drainage area of 26 mi².



Figure 1.—Oblique view of Canby Creek, R-1 Dam (Google Earth, October 2, 2012).

The foundation is composed of clay and glacial outwash materials, with a surface layer of clay underlain by an aquifer under artesian pressure. In 1986, as the pool was being filled, boils occurred in the channel downstream from the dam (McCook 2000). Significant quantities of sand were being deposited, and the flow from the boils was increasing as the pool elevation increased. The pool was lowered, and additional relief wells were installed on both sides of the outlet channel. The dam's original design had some relief wells but not enough to prevent the boils that developed. The boils diminished in activity, and quick conditions ceased when the additional relief wells began to function. However, within a year, the flows from the wells decreased, and piezometric levels rose as the relief wells became less efficient from silt and sand plugging and other causes.

¹ McCook (2000) article, reprinted with permission from Association of State Dam Safety Officials (with minor revisions).

Since then, relief well maintenance has been a continued problem. The wells eventually clog after each cleaning, and the reduced efficiency causes rises in piezometric levels. The relief well fittings have become loose with repeated surging, and the NRCS began a study in 1993 to determine a more permanent solution to the uplift pressures that would require less maintenance. While the relief wells have essentially prevented boil development, a concern is that, in the future, the maintenance might be abandoned, and the structure could be less safe.

In 1994, a deep slurry trench cutoff was installed along the front embankment toe. The slurry trench cost was in excess of \$1 million. While somewhat effective, it did not reduce the piezometric levels downstream enough to provide adequate safety factors against heaving. The slurry trench caused the combined flow in relief wells to decrease by about 50%, but sand boils still developed in the channel downstream when the relief wells were shut off for testing (figure 2).



Figure 2.—Boils in outlet channel at Canby Creek, R-1 Dam, Minnesota.

Further performance evaluations found that the piezometers responded more to changes in relief well efficiency than to changes in pool level, which indicated that some of the source of piezometric pressure is from abutment seepage as opposed to underseepage from the reservoir. When the reservoir was lowered in 1994 to install the upstream cutoff wall, the drop in pool level was over 30 ft, but several piezometers only responded by dropping an average of about 2.7 ft. When the pool was refilled, the average response or rise in piezometers was similar. This response was used to predict future changes in piezometric levels if the pool filled to the auxiliary spillway crest.

Based on uplift calculations and projections of piezometric levels at higher pool levels, it was determined that additional sand boils would occur if the efficiencies of the existing wells continued to decline without continued maintenance. It was likely that if relief wells were

abandoned (or inadequately maintained), and a high pool stage occurred, piping of the underlying sands into the outlet channel would resume. Although piping of subterranean soil at a magnitude sufficient to cause subsidence of the embankment, or formation of a backward-erosion pipe, was judged to be minimal, the risk was not considered acceptable considering the size and hazard class of this structure.

Several alternatives to the continued maintenance of relief wells were developed. Alternatives proposed by previous studies at the project were also considered. The alternatives discussed here are as follows:

1. No Action – Discontinue maintenance of the wells. Based on prior observations, the piezometric levels to the left and right of the outlet channel could increase by as much as 2 to 3 ft if the pool level increased by 9 ft (to the auxiliary spillway). Significant boil development would probably recur in soils along the outlet channel bottom, with some quick conditions likely as well. Slope instability in the outlet channel side slopes could also occur.
2. Continue to rehabilitate the relief wells at the site on a regular basis using the same techniques that were used in the past. Mechanical problems with pipes and fittings will probably become more severe, and some wells will probably be damaged beyond repair or abandoned.
3. Continue to rehabilitate the relief wells on a regular basis but consider alternative techniques to provide a longer-lasting effect. Alternatives could include methods to reduce biofouling and chemical encrustation. A specialist was contracted to provide recommendations for other treatments, but reduced efficiencies ensued even after implementing the recommendations of the consultant.
4. Pond water in the outlet channel to reduce the differential pressure causing boil development. This alternative was chosen, in addition to alternative 5 below, for remedial design. A low-water weir consisting of graded rockfill and a clay core was constructed to create a backwater in the outlet channel.
5. Install a deep, continuous trench drain along both sides of the outlet channel for a distance downstream where boils have occurred. This option was implemented, together with option 4.
6. Install a large number of additional relief wells parallel to the outlet channel, on both sides, within the area where boils have previously been observed.

In 1998, a remedial contract costing about \$140,000 was implemented. It consisted of two parts. The first was a low-water weir located 500 ft downstream. Creating a permanent backwater in the channel downstream reduces the uplift pressures on the clay layer. Calculations showed that 4 ft of ponded water in the channel increased the safety factor against uplift for a given reservoir head from about 0.74 to 1.1. The second measure to prevent piping of the underlying sands

through the clay blanket was a deep trench drain installed along the outlet channel of the dam (figure 3). The trench penetrated through the clay blanket at least 2 ft into the underlying sand aquifer and was as much as 15 ft deep. It extended about 250 feet downstream from the embankment toe. Installing the trench drain required well points to dewater the excavation without lowering the pool. Piezometric levels dropped appreciably after installing the trench drain and have remained at lower levels even though the relief wells have not been further rehabilitated since 1998. The repair is considered a success.



Figure 3.—Trench drain installation at Canby Creek, R-1 Dam.

The Canby Creek R-1 site demonstrates that uplift pressures in deep sand aquifers overlain by clay layers are a difficult problem to solve. Relief wells require continued maintenance that is both expensive and potentially destructive to the wells. If granular filters can be installed directly on the underlying foundation with deep trenches, this method is likely to be more effective and long lasting. Using ponding techniques downstream is an economical method of reducing uplift pressures. Simple spreadsheet calculations can demonstrate the needed level of ponding. Slurry trench methods depend on a fully penetrating cutoff for maximum effectiveness. Partially penetrating cutoffs may provide a limited benefit at a considerable expense.

References

McCook, D.M. (2000). "Canby Creek, Site R-1, Minnesota," in *Three Seepage Case Histories, Dam Safety 2000*, the 17th annual conference of the Association of State Dam Safety Officials, September 27–29, 2000, Providence, Rhode Island.

Case 12 – Olmitos-Gracias No. 2 Dam¹

Structure Data

Purpose	Flood control
Hazard classification	Low hazard
Drainage area	31.8 mi ² (total), 20.3 mi ² (uncontrolled below Olmitos- Gracias No. 1 Dam)
Permanent storage	None (dry structure)
Original embankment type	Homogeneous earthfill dam of slightly to moderately plastic clays (CL) and clayey sands (SC)
Foundation	Alluvium consisting of slightly to moderately plastic clays (CL) and clayey sands (SC) over claystone
Maximum embankment height	21 ft
Embankment length	4,600 ft
Seepage cutoff	Rolled earth cutoff trench, up to 9 ft deep
Embankment drainage	None
Principal spillway conduit	36-in-diameter reinforced concrete pipe
Emergency spillway	Earth spillway, 400 ft wide
Date of original construction	1963
Date of repair work	2002

Investigation

Olmitos-Gracias No. 2 Dam is located in Starr County in the southern tip of Texas (figure 1). Numerous cracks and sinkholes were discovered in the embankment during a 1999 inspection. The cracks were both transverse and longitudinal. The sinkholes had formed through erosion of soil into cracks and were found on both the upstream and downstream slopes and on the crest (figure 2). One 3-in-diameter hole was measured to be over 25 ft deep. Insects and animals, including badgers, were using the cracks and holes to facilitate burrowing into the embankment. Numerous mesquite trees were found growing on the embankment, and mesquite roots had penetrated into many open cracks to considerable depths.

¹ Reprinted with permission, Ben Doerge, NRCS.

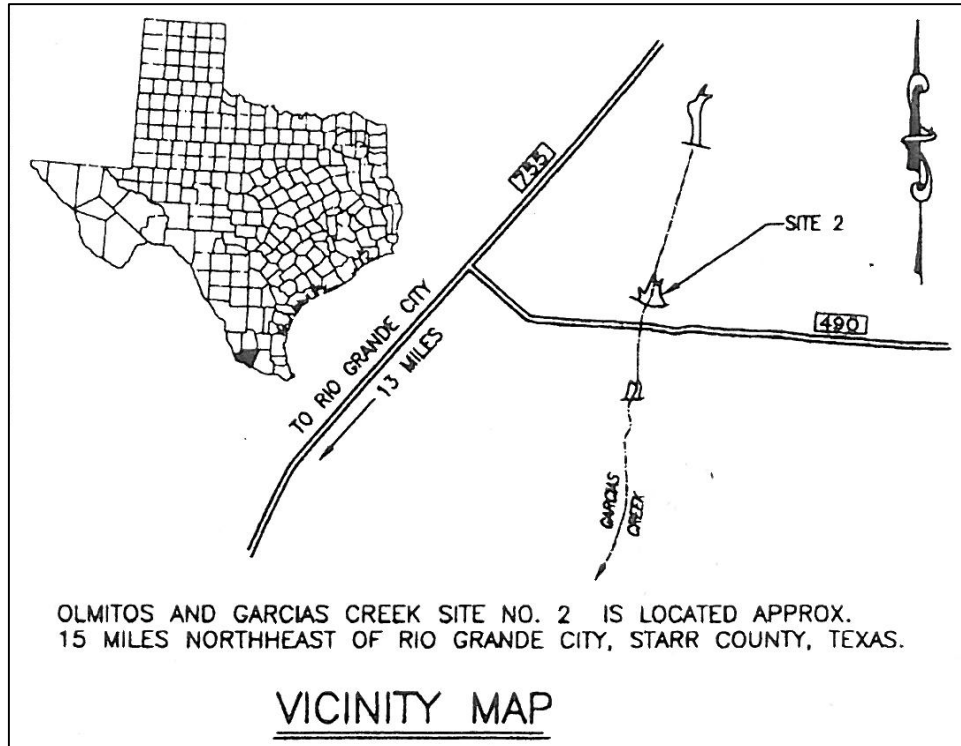

Figure 1.—Location map, Olmitos-Garcias No. 2 Dam.



Figure 2.—Large crack in embankment, Olmitos-Garcias No. 2 Dam.

Soils investigations upstream and downstream from the embankment discovered that the alluvium in the foundation was low in density (1.4 grams per cubic centimeter) and contained pinholes ranging in diameter from 1/16 to 1/4 in. Test pit excavations revealed that the cracks tended to increase in width with depth, up to a width of 2 in. This finding indicated that the top of the embankment was in compression while the bottom was in tension, suggesting that the embankment foundation had experienced subsidence. Screening procedures based on density and other index properties indicated that the top 12 to 14 ft of the foundation alluvium contained collapsible materials. Based on all the evidence, it was concluded that the cause of the cracking was the collapse of the foundation upon wetting during periodic storage of water in the reservoir following runoff events.

Several large-scale infiltration tests were performed from the top of the embankment to determine the extent of the cracking. Three 15-ft-deep test pits were excavated into the top of the embankment and filled with gravel. Both transverse and longitudinal cracks were observed in the walls of the pits. Water was pumped into each pit at a rate of 775 gpm until the pit was full or reached a constant level. In all cases, the pits emptied very quickly, and generally little or no flow emerged from either the upstream or downstream slopes adjacent to the pit. Following the infiltration tests from the top of the dam, two test pits were excavated near the downstream toe of the dam to a depth of 16 ft to determine if seepage waters had migrated downstream and below the surface of the dam. No sign of seepage water or the dye introduced into the upper test pits was found at either location.

Design

Based on the results of the infiltration tests and other observations at the site, it was clear that an extensive system of cracks had developed in both the embankment and the foundation alluvium. Furthermore, the geologic investigations indicated that the top 2 to 3 ft of the claystone in the foundation was highly fractured. Therefore, it was determined that the barrier to control the possible downstream migration of soil particles needed to extend from the top of the embankment down to unfractured claystone and from abutment to abutment. Three barrier alternatives were considered (NRCS 2002):

- Chimney filter on the downstream slope of the embankment and into the foundation
- Impermeable barrier in the upstream slope of the embankment and into the foundation
- Geotextile placed in the downstream slope and into the foundation

For reasons of economy and constructability, the geotextile option was chosen. A non-woven, needle-punched geotextile was selected for its filtering and elongation properties. A 16-ounce fabric was specified in order to provide adequate tensile strength to span existing cracks or cracks that may develop throughout the life of the structure. Good resistance to root penetration was also desired. At the same time, operation and maintenance guidelines were developed to include control of mesquite and other woody vegetation on the embankment.

The geotextile was placed deep enough within the embankment to ensure stability against internal, hydraulic uplift pressures even if the geotextile became fully sealed and was able to maintain full reservoir head on its upstream side. An additional stability berm was installed to the approximate mid-height of the embankment at the downstream toe (figure 3). The geotextile did not need to function as a drain, so no outlets were required. Its primary purpose was to stop the migration of any soil particles through the dam by its filtering function.

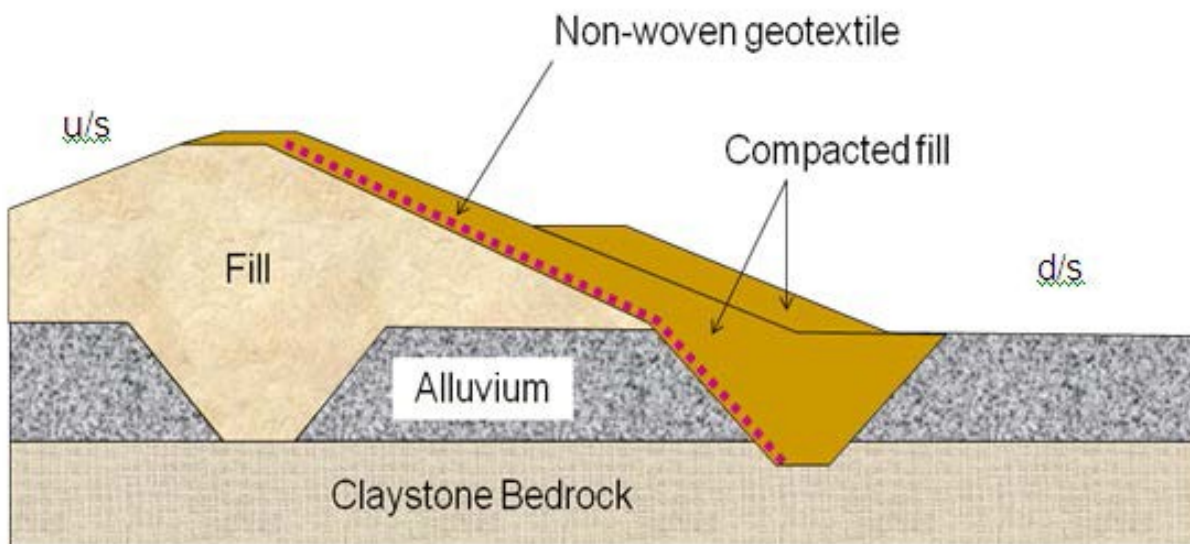

Figure 3.—Typical cross section, Olmitos-Garcias No. 2 dam repair.

Construction

The outside 12 ft (measured horizontally) of the 2.5H:1V downstream slope were removed, and a trench with a 12-ft bottom width was excavated down to competent claystone. The subgrade for the geotextile was smoothed by dragging a flat metal frame over the slope surfaces using a tractor and cables (figure 4). Then, the geotextile was placed on the slope, beginning at the bottom of the foundation trench and extending to within 1 ft of the top of the dam. Finally, the trench was backfilled, and the slope and stability berm were constructed with compacted earthfill (figures 5 and 6). In the vicinity of the principal spillway conduit, the geotextile within the foundation trench was replaced with a vertical trench filled with flowable fill (figure 7).

The construction went smoothly, and the only change recommended by the construction staff was to construct the subgrade slope for the geotextile at a constant 2.5H:1V slope rather than at a 1H:1V slope in the foundation trench and a 2.5H:1V slope above the natural ground elevation. This would reportedly have made wrinkle-free placement of the geotextile easier.



Figure 4.—Smoothing geotextile subgrade with metal frame, Olmitos-Garcias No. 2 Dam.



Figure 5.—Backfilling foundation trench, Olmitos-Garcias No. 2 Dam.



Figure 6.—Fill placement against geotextile, Olmitos-Garcias No. 2 Dam.

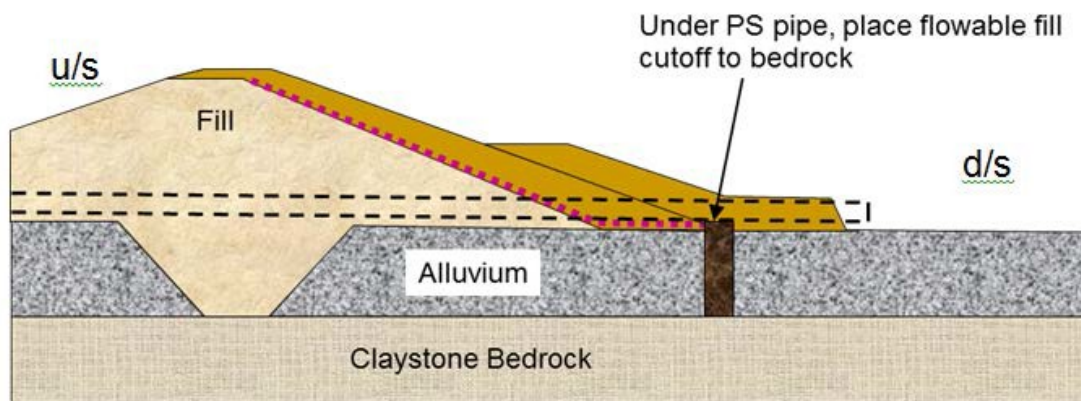

Figure 7.—Principal spillway conduit detail, Olmitos-Garcias No. 2 Dam. Geotextile (dashed, pink line) is tied into a flowable fill cutoff under pipe.

References

- Doerge, B.C. (2010). Using Geotextiles to Repair Cracked Earth Dams. Presentation at Association of State Dam Safety Officials (ASDSO) Annual Conference, Seattle, Washington.
- Natural Resources Conservation Service (NRCS) (2002). Design Folder, Olmitos-Garcias Watershed, Site No. 2 Repair.

Case 13 – Florence Dam¹

Structure Data

Purpose	Flood control
Hazard classification	High hazard
Drainage area	61.1 mi ²
Permanent storage	None (dry structure)
Original embankment type	Homogeneous earthfill dam of moderately plastic clays (CL) and clayey sands (SC)
Foundation	Alluvium consisting of moderately plastic clays (CL) and clayey sands (SC) and silty sands (SM)
Maximum embankment height	26 ft
Embankment length	5.1 mi
Seepage cutoff	Upstream rolled earth cutoff trench
Embankment drainage	None
Principal spillway conduit	42-in-diameter reinforced concrete pipe
Emergency spillway	Earth spillway, 400 ft wide
Date of original construction	1965
Date of repair work	2005

Investigation

Florence Dam is located southeast of Phoenix, Arizona, in Pinal County (figure 1). Cracking was first observed at Florence Dam in 1971 following a documented case of impoundment of flood water. In 1977, cracking in Florence Dam was investigated by means of three test pits (SCS 1978). In 1982, additional trenching with water testing was performed (SCS 1982). Cracking of the homogeneous earthfill embankment consists largely of transverse cracks, but several longitudinal cracks have also been observed. The transverse cracks range in width from hairline to 2 in and are generally widest at the surface and decrease in width with increasing depth. The transverse cracks are visible at the crest and are seen for nearly the entire length of the dam, with four large concentrations covering 25% of the total length. This cracking pattern is consistent with tensile cracking due to desiccation.

The maximum depth of cracking observed at any NRCS dam in Arizona is about 22 ft, and the maximum depth at which cracks become hairline is 11 ft (NRCS 2004a). The cracking in

¹ Reprinted with permission, Ben Doerge, NRCS.

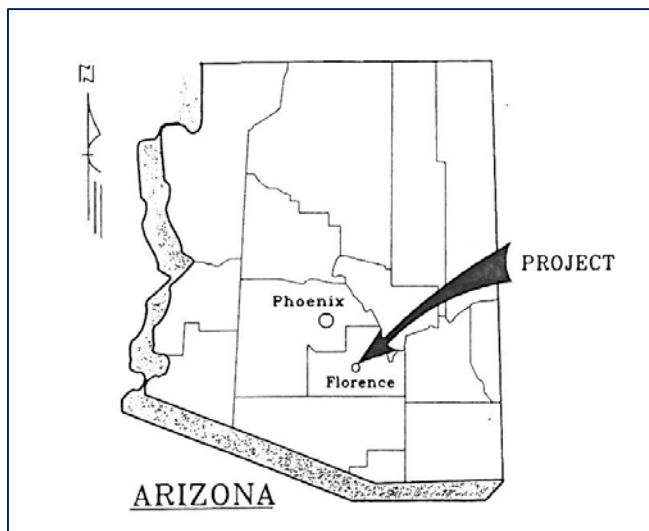

Figure 1.—Location map, Florence Dam.

Florence Dam is thought to be primarily due to desiccation, but some cracking due to collapse has also been suspected by some investigators (NRCS 2004b). Collapsible materials have been found in the foundation outside the footprint of the dam, but engineering judgment determined that its effect upon the existing structure was not significant enough to require mitigation.

In 2004, 15 test pits were excavated along the upstream toe of the embankment to the depth corresponding to the anticipated depth of the proposed centerline filter trench. The purpose of these test pits was to verify that the proposed trench would intercept all cracks through the embankment and

foundation and to assess collapse potential of foundation soils. In all 15 test pits, no cracks were found in the foundation soils. This finding supported the conclusion that the transverse cracking was confined to the embankment.

Design

The repair consisted of a centerline trench filled with filter material to intercept any suspended soil particles being transported through cracks in the embankment. The 2 ft-wide trench would be excavated to a maximum depth of 31 ft, or 9 ft deeper than the deepest cracks observed in any Arizona dam investigated by the NRCS/SCS. At this depth, the trench penetrated a minimum of 1 ft below the stripped ground line along the centerline of the dam. The filter material was designed to be a broadly graded mixture of sand and gravel in order to give it excellent self-healing properties. It was also less prone to bulking than more uniform sand material. However, the broadly graded nature of the filter material identified segregation during placement as a significant concern to be addressed by QA/QC during construction.

A non-woven geotextile was designed to be placed against the upper 11 ft of the downstream trench wall prior to filling the trench with filter material, with an additional 4 ft secured to the top of the dam with securing pins (figure 2). The top of the filter was terminated at a depth of 1 ft below top of dam to allow for 1 ft of fine-grained soil cover over the filter. The primary purpose of the geotextile was to mitigate downstream movement of filter material into any cracks in the trench wall with a width that exceeded the filter material's D50 size (1.19 to 4.76 mm). The filter material was not designed to be coarse enough to bridge across cracks as wide as those observed at Florence Dam (up to 2 in wide). Since cracks narrow to hairline below a depth of 11 ft, the cracks below this depth are expected to be thin enough to be bridged over by the filter material's D50 size. Cracks wider than this below a depth of 11 ft are unlikely based on

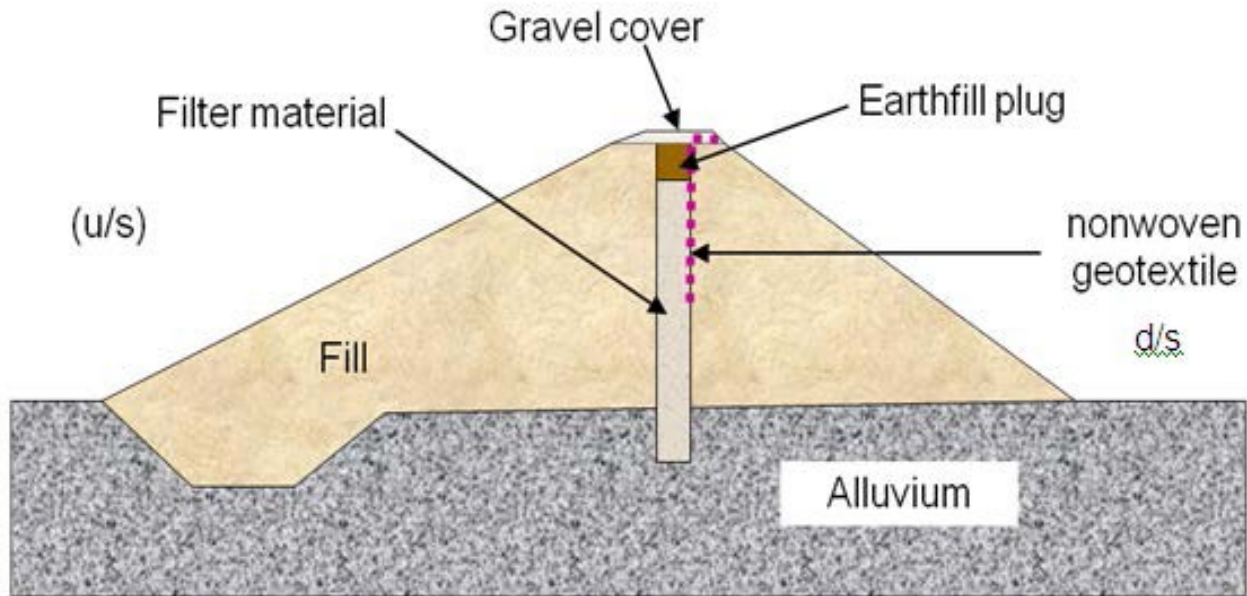

Figure 2.—Typical cross section, Florence Dam repair.

historical observations of cracks. Coverage with geotextile to a depth of 11 ft over the entire length of the embankment was considered reasonable due to the distribution of transverse cracking identified along the length of the crest (NRCS 2004a).

For the geotextile to perform its intended function, it must have adequate tensile strength to withstand the forces acting on it. No proven method for analyzing a geotextile's ability to span open cracks has appeared in the technical literature. Therefore, the designer developed a method to check the adequacy of the geotextile (NRCS 2004a). This method is based on consideration of the stresses acting on a failure plane in the filter material at the time of formation of a new crack. It is assumed that a failure plane must develop in the filter material for a crack to form. The stresses acting on the failure plane in the filter are conservatively assumed to be completely transferred to the geotextile (i.e., with no slippage). The resulting tensile stresses acting on the geotextile are compared to the ultimate tensile strength. The tensile capacity of the geotextile in the vicinity of the crack is estimated to be equal to the ultimate tensile load from an ASTM D4632 Grab Tensile Test.

The design calculations showed that a 6-ounce non-woven geotextile would be adequate to survive the formation of a 2-in-wide crack. The maximum tensile load was calculated to be at a depth of 10 ft.

Construction

The construction consisted of four main steps: (1) excavation of the centerline trench, (2) placement of the geotextile drape on the downstream face of the trench, (3) placement

of the filter material in the trench to within 1 ft of the top, and (4) placement of 1 ft of compacted earthfill over the trench and covering the embankment crest with 3 in of gravel. The two major challenges with construction were excavation of the 25-ft-deep trench in dry, partially cemented earthfill and blending and placing the broadly graded filter material without segregation. The trench was successfully excavated with both hydraulic excavators (figure 3) and a Case CX 290 trencher. No instability of the trench occurred between trench excavation and placement of the filter material. The gradation of the filter material was equivalent to a 50-50 mix of ASTM C33 Fine Aggregate for Concrete and ASTM C33 No. 57 gravel. The grading and blending of the filter material was accomplished using a screening machine and an auger-type mixer/elevator (figure 4). Placement of the filter material in the trench was performed using a tremie pipe to control segregation (figure 5). An 18-in overlap between adjacent sections of geotextile was used.



Figure 3.—Trenching and operation, Florence Dam.



Figure 4.—Screening machine (right) and mixer/elevator (left) for processing filter material, Florence Dam.



Figure 5.—Placing filter material with tremie, Florence Dam.

References

- American Society for Testing and Materials (ASTM) International (2010). "Test Method for Grab Breaking Load and Elongation of Geotextiles (D 4632)." Annual Book of Standards, Section Four, Volume 4.13. ASTM International. West Conshohocken, PA.
- Doerge, B.C. (2010). Using Geotextiles to Repair Cracked Earth Dams. Presentation at Association of State Dam Safety Officials (ASDSO) Annual Conference, Seattle, Washington.
- Natural Resources Conservation Service (NRCS) (2004a). Design Folder, Florence Dam Repair.
- _____(2004b). Technical Assistance Report, Florence Dam Repair.
- Soil Conservation Service (SCS) (1978). "Cracking of Earth Dams in Arizona," Internal Memorandum.
- _____(1982). "Crack Investigation, Florence Retarding Structure, Florence Watershed," Internal Memorandum.

Case 14 - Cañon C-4 Dam¹

Background

Cañon C-4 Dam is a homogenous embankment 40 ft in total height and 500 ft long at the crest, located above Cañon City, Colorado (figure 1). The original construction was in 1971 for the single purpose of surge retention and, for that reason, has an ungated outlet. The original construction also included a cutoff trench that extends to bedrock and a vertical filter drain that feeds into a toe drain system.

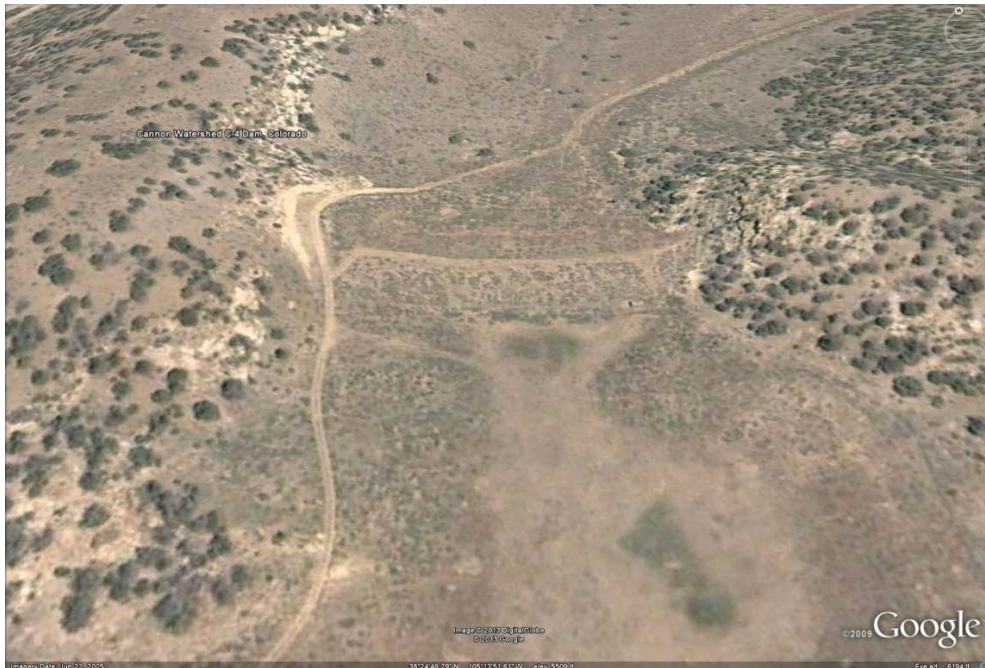

Figure 1.—Oblique view of Cañon C-4 Dam, looking downstream (Google Earth, June 22, 2005).

During a 2004 inspection, over 50 holes and cavities were discovered in the crest of the dam that varied in size from 1/2 in to 3 ft in diameter and with depths up to 13 ft (USDA, 2004). Visible distress on the original embankment included extensive longitudinal and transverse cracking. Most of this distress occurred on the crest and upstream side, but some transverse cracks extended through the embankment. These cracks were suspected of interconnecting into a network of voids within the embankment. Constructed in an arid climate with lean clays having a low PI, the embankment material was found to be extremely hard but highly erodible. A filled reservoir would have subjected the distressed embankment to internal erosion, quickly producing a catastrophic failure. A breach order was imposed on this embankment by the Colorado Division of Water Resources.

¹ Modified and reprinted with permission from Rex Stambaugh, P.E (2007), An unusual restoration for a highly distressed embankment, ASDSO Dam Safety Conference, 2007.

Investigations concluded that the primary cause of the cracking was differential settlement resulting from insufficient removal of collapsible foundation material during its construction. From the pattern and location of surface distress, it was believed that the upstream portion of the collapsible foundation material was more consolidated than within the downstream foundation due to the protection of an existing cutoff trench beneath the dam's axis.

Beneath the large holes on the embankment surface (figure 2), cracks were found to be as much as 5 in wide (figure 3), and to the depths investigated, virtually all cracks maintained their widths. Consolidation of the collapsible foundation material was believed to be the source of the cracks, and it was confirmed that these cracks did not extend through the collapsible material. The compaction effort was within the requirements of the original specifications. Though the dam site had experienced years of drought, desiccation cracking was found to be insignificant.



Figure 2.—Holes observed in crest.



Figure 3.—Up to 5-in-wide cracks under holes.

This dam had not yet achieved maximum retention, but it was believed that the few opportunities for water retention produced a wetting front, which moved through the upstream extents of the collapsible foundation material. This periodic water movement caused successive episodes of collapse of those materials, which was manifested as a succession of cracks extending to the embankment surface.

When the wetting front reached the cutoff trench, the high differential settlement gradient between consolidated and formerly unconsolidated materials created a well-defined longitudinal crack along the upstream edge of the cutoff trench, extending up to the embankment crest. The condition of the downstream side of the embankment suggested that the wetting front did not reach any downstream collapsible material. Figure 4 illustrates the condition of the original embankment as determined by the investigation.

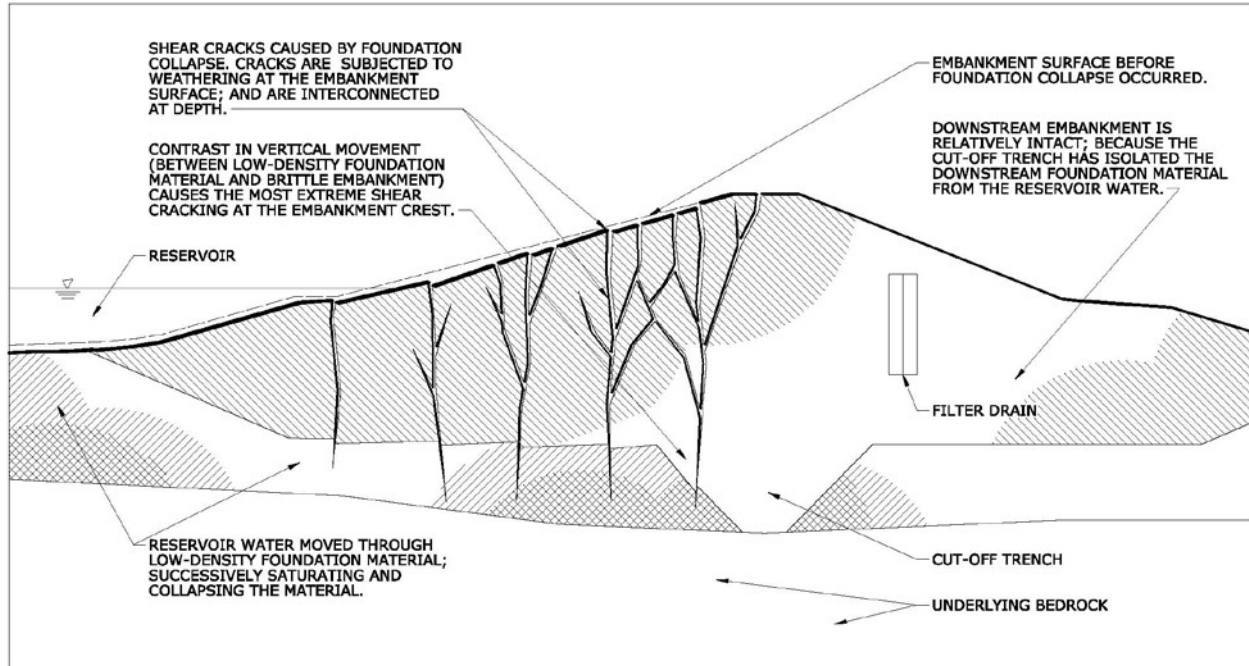

Figure 4.—The original embankment at maximum section.

Restoration

A decision was made to restore rather than breach Cañon C-4 Dam. The intent of the restoration was to remove as much of the existing upstream embankment as practical, replacing it with a reconstituted zone of clay. The remaining existing embankment now serves as a buttress for this reconstituted material. Structurally bridging the remaining and any future cracks, as well as preventing the propagation of these cracks into the reconstituted material, was determined to be necessary at the interface of the restoration. Figure 5 shows the configuration of the restoration, which was done to the upstream side of the original embankment.

Upstream/Downstream Restoration Comparisons

An upstream restoration isolates free reservoir water from the embankment interior. A downstream restoration would allow reservoir water to pass through much of the embankment via existing cracks, directing reservoir pressures against a smaller downstream soil mass. For the same amount of earth moved, a downstream restoration would be inherently less stable, with higher pressure gradients.

Preventing direct flow into the embankment cracks also reduces the deterioration of those cracks, prevents any additional collapsing of the foundation, and eliminates the probability of reservoir water finding any unknown location of compromised integrity within the undisturbed

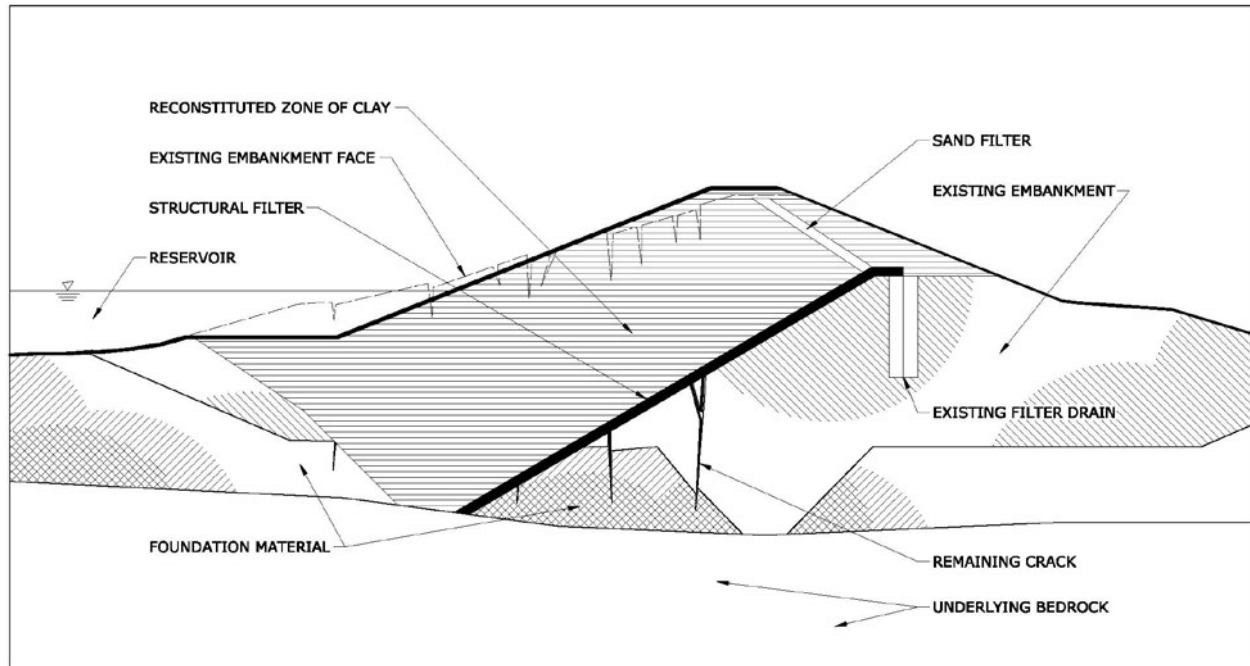

Figure 5.—The restored embankment at maximum section.

embankment, abutment, or foundation. The continued performance of an upstream restoration would be more favorable following a foundation collapse and the cracking of the embankment that would likely result.

An upstream restoration avoids the existing toe drain system and any complicated detailing around the existing outlet structure. The existing inlet structure was far enough from the embankment that it was not impacted by the earthwork.

Excavation

A significant portion of the embankment was excavated through the zone of collapsed foundation material to the bedrock foundation and abutments, providing a cutoff trench with a 15-ft minimum width. This width provided an adequate area for bedrock treatment, provided space for the movement of construction equipment, and met the Occupational Safety and Health Administration minimum requirement for an open excavation.

The configuration of the excavation minimized the cost of the project, removed as much of the distressed embankment and unconsolidated foundation material as possible, and provided a required level of construction safety. The excavated embankment surface had a slope of 1.7H:1V, and the upstream limit of excavation had a combination of 1H:1V and 1.5H:1V slopes.

Surface Treatments

The exposed bedrock was inspected and, as needed, treated with grout. It was anticipated that any cracks intersecting the excavated surface would be concealed by the movement of excavation equipment, and the restoration would span any remaining or future cracks. However, the design included a procedure to fill any cracks encountered on the excavated surface. This procedure prescribed a repeated cycle of filling exposed cracks with dry, rounded sand, using water sparingly to wash the sand as deeply as possible. This sand was intended to be used as a best effort to buttress the sides of the cracks and reduce further unconsolidation of the adjacent embankment material.

Bentonite, flowable fill concrete, and soil cement were also considered for fill materials. Bentonite was not specified because it would shrink and develop its own cracks within the desiccated environment. Flowable fill concrete and soil cement were too rigid for the surrounding embankment material and would have provided a high density gradient along its surfaces, which could ultimately aggravate internal erosion.

Structural Filter Design

The structural filter is a relatively thin system that is built up from geotextiles, two layers of sand, and a feature labeled the composite zone. In addition to filtering, the structural filter impedes the propagation of existing and future cracks from the original embankment to the restored embankment and structurally bridges any existing or future cracks within the remaining embankment. Filtering and impeding the propagation of cracks require little explanation, but structurally bridging cracks is described briefly.

The cracks were found to be variable in size, with a maximum width of around 5 in. Structural bridging to span these cracks was specified to be a cobble gradation with an average size equal to the 5-in crack width. Because the collapsible foundation material had undergone some consolidation, any future cracks were expected to be smaller than the existing cracks.

Reclamation directs the gradation requirement of filter material around perforated pipe by stating that the D85 of the filter material shall be equal to or greater than twice the maximum pipe opening (Reclamation 1987a). This standard was also used for determining the gradation of these cobbles.

An analogy was made between the pipe perforations and the relative inferiority of the cracked clay, with consideration for the variability of crack width in contrast to a maximum pipe opening, the extremely hard condition of the cracked clay, and the designed absence of flowing water. The Reclamation standard was used in lieu of the NRCS standard, the latter requiring the D85 to match or exceed the maximum pipe opening (NRCS 1994).

To achieve filter compatibility between the cobble material and the overlying clay, a series of soil zones transitioning between the cobbles and the overlying clay was considered

(Reclamation 1987b). The high cost, potential of compromised quality, difficulty of inspection, and limited space within the embankment for such a multiple-zoned system prompted the design of the composite zone.

The composite zone bridges any embankment cracks but also has filter compatibility with the overlying embankment clay. This dual function is achieved by infilling the voids of a cobble matrix with sand of the required filter compatibility. The cobble matrix within the composite zone should be as identical as possible to the cobble without the in-filled sand.

In addition to the D50 and D85 requirements above, the maximum and minimum sizes of cobble material were specified. The maximum limited the cobble material to a manageable size, the minimum provided voids between cobbles for the in-filling of the sand, and both delineated a uniform gradation.

The specified gradation of the cobble material was as follows:

Opening size	Percent passing
15 in	100
10 in	70–85
5 in	30–50
3 in	0–30

The composite zone has a thickness of 18 in. An underlying geotextile prevents the in-filled sand from sifting down into any embankment cracks. Above this composite zone, an overlying geotextile protects the integrity of the reconstituted zone of clay against voids within the composite zone, caused by quality shortcomings in the in-filled sand placement, or loss of the in-filled sand containment. Between the composite zone and the geotextiles, sand placements protect the geotextiles from excess stress and punctures from the cobbles; a 2-in placement lies beneath the overlying geotextile, and a 4-in placement lies above the underlying geotextile. The 4-in sand layer also disperses the loading from the cobbles, thus reducing the loading at any embankment cracks. This assembly is the structural filter, which has a total thickness of 24 in and is illustrated on figure 6.

Drainage from the structural filter can only occur through existing cracks within the original embankment and only through those cracks above the downstream toe. Because the embankment is used exclusively for surge retention, the quantity of seepage and volume of any impoundment insignificantly affect foundation consolidation and slope stability.

Sand Filter Design

The entire embankment profile is protected by either one of two filtering configurations. Above the structural filter, a sand filter extends upward to intercept any distress caused by transverse cracks, a void formation within the composite zone, or any movement from below. A layer of geotextile was also placed along the downstream edge of this sand filter.

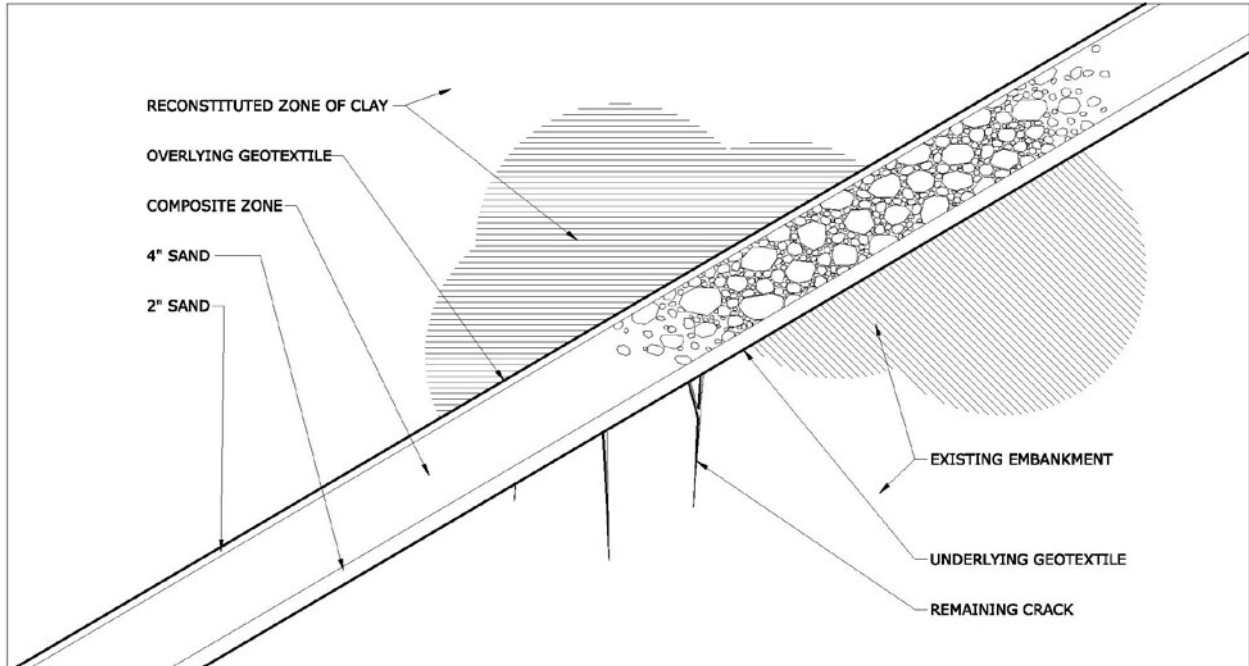

Figure 6.—Section showing the structural filter.

At its closest point to the restored embankment surface, the sand filter is covered by 2 ft of reconstituted clay for protection and to prevent the entry of precipitation. Because the sand filter was not designed to be a drain, clogging of the geotextile was not considered to be detrimental.

Structural Filter Construction

It was anticipated that the construction of the composite zone would be the most difficult aspect of the restoration because it involved the use of untried methods; therefore, the specification was written to allow the contractor freedom to use any method of choice to build this feature. To ensure that the contractor's methods would produce the design intent, specifications were written to require the contractor to construct a mockup (test fill) of the structural filter for approval prior to construction.

The techniques, equipment, materials, and methods used to construct the approved mockup were duplicated for the construction of the structural filter. The approved mockup remained in place for the duration of construction to serve as a reference template for the quality control of the construction.

Several mockups were constructed before one finally received approval (figure 7). The contractor's method of choice for building the composite zone was to mix and place proportions of cobble and sand using a front-end loader. The use of vibrating equipment and hand placement were found to be unnecessary. The approved composite zone had a cobble to sand ratio of



Figure 7.—Constructing the mockup.

4:1 by volume. Approval was based on the highest proportion of cobbles to sand possible, the degree of contact between the cobbles by visual inspection, the absence of voids between cobbles, and the ability of the composite to transfer an impact through the cobble material. Impact was delivered using the side of a front-end loader bucket.

The Underlying Geotextile

Without containment, a small amount of sand would be able to sift out of the structural filter and into underlying embankment cracks. An underlying geotextile was specified to provide this containment. Since the cobble matrix would structurally bridge these cracks, and would also contain most of the in-filled sand, the underlying geotextile was designed to support a column of sand equal to the thickness of the structural filter over a maximum span of 5 in (figure 8). Long-term creep in the geotextile was desirable to accommodate any movement created by future cracks as long as the geotextile continued to support its design load. Therefore, the specified geotextile was polypropylene instead of polyester. The tensile strength of a woven material was desirable but the greater ability of a non-woven material to elongate was more desirable. Because the structural filter was not required to drain, clogging was not considered to be detrimental. The strength of the specified geotextile was sufficient to preclude the need for geogrid reinforcement.



Figure 8.—Placement of geotextile, rockfill, and sand on upstream face (prior to placement of overlying geotextile).

The Overlying Geotextile

As a filtration material, the overlying geotextile was designed to remain intact despite any shifting around voids within the composite zone or subsidence around any crack. The projection of any distress through the geotextile was difficult to quantify, but it was assumed that the overlying geotextile should be required to span a 5-in void. Because the structural filter was not designed to be a drain, clogging was not considered to be detrimental. A non-woven geotextile was chosen because it contains two separate mechanisms of elongation, stretching of the plastic fibers, and movement of the fibers within the fabric matrix. The specified geotextile was the same as for the underlying geotextile.

A geomembrane was considered for this material, but was determined to be less desirable than a geotextile, because it has a characteristically lower friction coefficient, it had less allowable elongation, and it required a higher level of care during installation.

Reconstituted Zone of Clay

The dry climate, the moisture content of the original embankment, and the infrequency of reservoir impoundment dictated that the embankment restoration should preclude the use of clays with a high PI. Though highly erodible, the lean clays of the original embankment showed little

distress due to desiccation. Therefore, the excavated clays of the original embankment were reused for this zone. The compaction effort was preferred to be dry of optimum to further reduce any desiccation cracking at the expense of higher porosity.

An effort was made to place material with the highest PI immediately against the treated bedrock surface in order to provide lower seepage velocities at this wetter location. The surfaces of the restoration were seeded and mulched, and a livestock fence was built around the site.

Conclusion

The restoration of Cañon C-4 Dam is an unusual but effective method to extend the duration of protection to the residents of Cañon City. The embankment's use for surge retention, the availability of specific soil materials, and the dry climate of southern Colorado contributed to the feasibility of this design.

References

- Bureau of Reclamation (1987a). Design Standard 13 Chapter 5.12; U.S. Department of the Interior, Bureau of Reclamation, May 13, 1987.
- _____(1987b). Design Standard 13 Chapter 5.8, Bureau of Reclamation, May 13, 1987.
- Colorado Department of Natural Resources (CODNR) (1994). Dam Safety Project Review Guide, Dam Safety Branch, Division of Water Resources, Office of the State Engineer, Department of Natural Resources, Denver, Colorado, September 23, 1994.
- Koerner, R.M. (1997). Designing with Geosynthetics, 4th edition, Section 3.2.6.
- Natural Resources Conservation Service (NRCS) (1994). National Engineering Handbook, Part 633.26, Table 26.7, October 1994.
- U.S. Department of Agriculture (USDA) (2004). Engineering Report, USDA-NRCS, May 10, 2004.

Case 15 – Little Washita No. 13 Dam

Little Washita No. 13 Dam is 34 ft high and 1,150 ft long (figure 1). It is located on Charlie Creek in Grady County, Oklahoma. It impounds up to 282 acre-ft of storage. Construction of the Little Washita River No. 13 was completed in April 1978. The site periodically exhibited signs of deteriorating conditions caused by solutioning of gypsiferous foundation soils.



Figure 1.—Little Washita No. 13 (Google Earth, February 5, 1995).

The foundation is the Rush Springs formation, part of the Whitehorse group of upper Permian age. The site was characterized as consisting of rounded hills and deep incised stream channels filled with low-plasticity soils that contain excessive amounts of gypsum salts. The alluvial soils are derived from the overlying Cloud Chief Formation, which is largely eroded in the watershed above the site. Bedrock is very deep on the left side of the stream channel and is relatively shallow on the right side. Bedrock is soft, massively bedded, poorly cemented sandstone. The geology report does not describe any gypsum beds in the site area, but descriptions of the Rush Springs and Whitehorse group formations in Oklahoma Geologic information shows that beds of gypsum are common. A soil mechanics report prepared in November 1975 showed alluvial soils contained from 40–60% soluble salt content. The report did not address potential problems from the high soluble salt contents in the foundation soils other than recommending a drain be installed.

Shortly after construction, the reservoir filled to the sediment pool elevation, which is a maximum of about 20 ft deep in the stream channel and about 6 ft deep in the flood plain areas. Soon after impounding water, severe sloughing of the side slopes of the plunge basin developed

from excessive seepage. A purchase order was issued in June 1978 for installing a drain system on the sides of the plunge pool. A perforated, plastic drain was installed at about an 8-ft depth, apparently confined to an area near the plunge pool.

The sloughing problem reoccurred, and problems were noted in a trip report by Mavis Jones, dated May 4, 1979. Figures 2–4 show the problems observed in May 1979. After this, the area downstream was apparently reworked, and a more extensive foundation drain was installed. Documentation is lacking on the details of the repairs done at this time, but apparently the main effort was directed at providing a drain on the right side of the plunge pool, extending up the right abutment. The drain may have wrapped around the plunge pool and may have extended some distance to the left of the pool. The pictures of the failure shown below indicate that the damaged foundation area was to the right of the plunge pool, but documentation on this repair is minimal. It is well known that a drain was added on the left side of the flood plain area in the 1993 repair discussed in following sections.



Figure 2.—Sloughing of plunge pool in May 1979.



Figure 3.—Sloughing of downstream area near plunge pool.



Figure 4.—Sloughing of downstream area observed in May 1979.

In September 1987, severe seepage was again noted by the landowner, and NRCS was notified. Extensive seepage was occurring from multiple points downstream, particularly on the left side of the flood plain. The slide gate on the riser was opened and the lake level drawn down. As the lake level was lowered, flow reduced in the seepage outbreak areas. Sinkholes were observed in the pool area after the lake level was lowered. By October 5, 1987, the lake level was about 10 ft lower.

Subsidence was observed in the upstream berm, which aligned with a concentrated seepage area downstream from the embankment. Figure 5 shows seepage observed downstream from the embankment in September 1987.



Figure 5.—Seepage occurring downstream from embankment in September 1987.

An NRCS geologist investigated the problems at the site in April 1988. The geologist's report noted two sinkholes near the upstream toe, near Sta. 4+80 and Sta. 5+75. The report also noted that two sinkholes had recently occurred on the downstream berm, near Sta. 4+96 and Sta. 5+13. Thirteen drill holes were implemented along the centerline of the dam, between Sta. 4+50 and Sta. 5+85. A defined cavity, or tunnel, was thought to have been encountered while drilling a hole at Sta. 4+95. Six cubic yards of grout were injected into the hole at a depth of about 35 ft. The hole probably would have accepted more grout than this, but the initial batch of grout set up before more grout could be delivered. Loss of circulation occurred while wash boring, but dye introduced into the holes did not show up at seepage discharge points.

Soil samples were obtained from several holes in the foundation. Tests showed foundation alluvial samples were high in soluble salts. Soluble salt percentages up to 30% were measured.

An engineering report was prepared in August 1988. The report attributed the excessive seepage to preferential flow paths developing through the gypsiferous foundation soils (figure 6). It was determined that development of flow paths occurred from dissolution of the soluble salts in the foundation. The report recommended a cutoff barrier extending downward to at least elevation 1246 (about 6 ft below the zone of lost circulation in the 1988 investigation), a foundation drain, and repair of the sinkholes.



Figure 6.—Tunnel outlet downstream from Sta. 5+50, March 8, 1988.

Alternatives considered included:

- No action – the predicted result was that continued tunneling would result in eventual breach of the structure.
- Breaching the dam and vegetating the disturbed areas.

- Repairing the dam by excavation and replacement, adding a toe drain, and repairing sinkholes.

A repair was designed that consisted of an extensive repair of sinkholes, pressure grouting sinkholes, using a slurry trench to install a cutoff to a depth of about 30 ft, and adding 250 ft of toe drain.

A preliminary design report was prepared and dated November 1990. The report addressed:

- Installing a cutoff trench to elevation 1246 (about 6 ft below a zone of lost circulation in the 1988 geologic investigation – also about 20 ft below flood plain elevation). Based on recommendations of the State Geotechnical Engineer, a cement-bentonite slurry trench was planned. Plans called for removing the top 10 ft of embankment to provide a working platform.
- Removing sinkhole features and tunnels.
- Adding a foundation drain between Sta. 3+70 and Sta. 6+30.
- Gravity grouting of drill holes along the centerline of dam.

A decision was made to proceed with a modified repair scheme that only employed grouting from drill holes and adding a foundation drain. Plans show a total of 41 grout holes were planned between Sta. 4+00 and Sta. 6+00.

In August and September of 1993, grouting along the centerline was implemented. According to job diaries, a total of 1,824 ft of grout holes were drilled and 24 yd³ of gravity grout injected into holes. A 350-ft-long foundation drain was installed. After the repair, the lake was once again allowed to fill to the sediment pool elevation.

In early 2005, the landowner noted that the lake level was about 2 ft below normal pool, which was unusual, and that discharge from the foundation drain on the left side of the plunge pool was flowing at an alarming rate. NRCS State Office personnel visited the site in mid- and late February 2005.

Evaluations and Recommendations (2006)

The problem with this site is one of a deteriorating foundation condition under the earthen embankment. Continued solutioning of gypsiferous soils in the foundation of the dam will in all likelihood lead to larger sinkholes developing in the upstream pool area and under the embankment if the reservoir is allowed to refill with no other action taken. A cycle of sinkhole development and flushing of cave-in materials will probably lead to larger passageways under the dam.

Eventually, if unchecked, this process could result in sections of the dam either developing a tunnel through the fill or a section of the crest subsiding into underground sinkholes. If the embankment in this deteriorated condition were subjected to flood storage following large rainfalls, a breach would possibly occur. The effect of this would be to flood areas in the inundation map downstream from the site. The site has been classified as a low hazard dam, so it is unlikely that any damage other than property damage would occur.

Several options for proceeding with decisions on this site were proposed. They are discussed below in no order of preference. After each option is a brief discussion of the advantages and disadvantages.

Option A – Decommission Dam

One option for dealing with the problems at this site is to decommission the structure. This would involve construction to remove the riser, principal spillway conduit and appurtenances, and a portion of the embankment so the structure will not detain water. The soil removed from the embankment could be used to fill in the auxiliary spillway and borrow areas and provide fill on which to construct measures that would control the grade from the upstream pool to the channel below.

Advantages

This option removes any hazard associated with potential dam breaches. There would be no yearly maintenance costs and no future repair costs associated with this option.

Disadvantages

The site would no longer function as a flood-retarding embankment, and annualized damages from periodic flood events would occur. The site would no longer accumulate and retard sediment delivery downstream. The county road downstream from the site would probably be impacted during flood events. The benefit of having a sediment pool of water for livestock water and recreational purposes would be lost under this option.

Option B – Provide for Permanently Dry Pool

Under this option, the gate that drains the sediment pool would be kept permanently open. Additional earthwork would be required to grade the entire pool for drainage to this low spot so as not to impound any water in low spots. Additional earthwork would be needed to provide an even grade for the stream through the site area, adjusting any overfall areas. The inlet for the pipe would probably also require modification to add a scour pad and trash guard feature as well as altering the slide gate to provide a permanent opening.

Advantages

This option is very inexpensive. It partially addresses the continued solutioning of foundation soils from stored hydrostatic heads in the reservoir. Used in conjunction with other repair options discussed in following sections, it could increase the longevity of any other repairs.

Disadvantages

Even without any stored water in the pool, groundwater flow will probably continue to solutionize the foundation under the dam and in the pool area. Providing a dry pool would be a partial contribution to any other repair options, but as a stand-alone option, it would furnish limited protection against continued deterioration. The benefit of having a permanent pool of water for livestock water and recreational purposes would be lost under this option.

Option C – Construct a Cutoff Barrier Under the Embankment

Under this option, a barrier would be constructed under the embankment or at the upstream toe of the dam to intercept water seeping under the embankment. Several options are available, some of which were considered in previous repairs to the site. Options include a slurry trench (either a soil-bentonite or a cement-bentonite type), a grout curtain, a rolled fill cutoff trench, or a chemical grout curtain. The primary problem with a barrier at the site is that it would likely be ineffective because a barrier should tie to a relatively impervious lower boundary for any effectiveness.

Figure 7 illustrates the effect that a cutoff barrier has on seepage quantities under an embankment. It shows that even if 90% of a foundation horizon is intercepted with an effective cutoff, the reduction in flow is only 34%. The foundation on the left side of the stream channel where all of the problems with this site have occurred consists of very deep alluvial soils with high soluble salt content. Even if a cutoff could be extended to underlying bedrock, the bedrock at this site is permeable poorly cemented sandstone. No impervious layer exists at the site to found a barrier on.

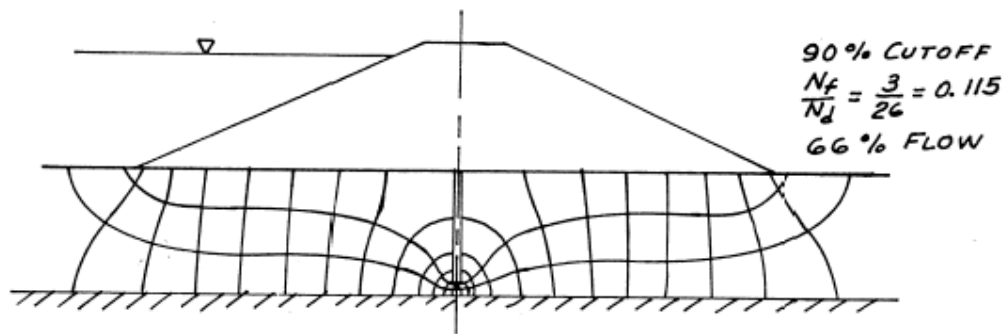

Effect of Partial Cutoffs Beneath Dams

Figure 7.—Illustration of ineffectiveness of partial cutoff barriers.

Figure 8 shows the same conceptual information in a slightly different form. It is from Reclamation's Design Standards No. 13, chapter 8.

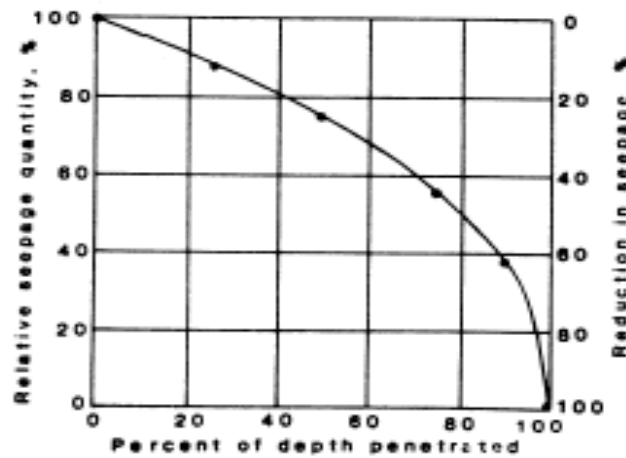

c. RELATIONSHIP BETWEEN QUANTITY OF SEEPAGE AND DEPTH OF PARTIAL CUTOFF (after CEDEGREN^[23])

Figure 8.—Chart showing relationship between seepage quantity and percent of foundation intercepted with cutoff barrier.

Advantages

This option could provide a modest reduction in groundwater flow under the dam. In conjunction with a dry pool, it would probably reduce the frequency and severity of the development of sinkholes over the remainder of life of the dam.

Disadvantages

A cutoff barrier that were deep enough to provide significant benefits would be very expensive. Estimates of the cost of cement-bentonite cutoff trenches on small jobs are as high as \$40/ft² of wall. If you assume a wall at least 40 ft deep extending between Sta. 3+00 and Sta. 6+50, the cost could be over \$500,000. Grouting of soil foundations is not reliable, and only existing features would likely accept grout. Grout would not address future solutioning of soils that do not presently have cavities in them. A grout curtain would not be effective in the long term, as has already been demonstrated with a previous repair attempt. This option would require the option of a dry reservoir, which has attendant disadvantages.

Option D - Provide Additional Foundation Drainage

The drain on the left side of the flood plain was installed as part of the repairs done in early 1993. Based on pictures taken during site visits in February 2005, the capacity of the drain is insufficient to convey all the seepage. Photographs of the drain in the plunge pool show water jetting from the pipe. A larger pipe installed inside a larger gravel section of drainfill would probably allow more of the seepage to be collected and conveyed in a controlled manner to the plunge pool and subsequently to the constructed outlet channel.

Advantages

This option is relatively low cost. Used in conjunction with other options (like a dry pool), it will reduce the seepage emerging downstream in the flood plain. This would reduce maintenance costs and provide a better appearance for the site.

Disadvantages

A larger drainage system would significantly increase underseepage by shortening flow paths. The increased seepage quantities are likely to increase the rate of solutioning of foundation soils and lead to larger and more rapidly developing sinkholes in the foundation.

Recommendations

It was the opinion of the National Design, Construction, and Soil Mechanics Center for the NRCS reviewers that the problems on this site would continue without some treatment. Even if a dry pool was provided, continued circulation of groundwater would probably produce additional sinkholes upstream of the dam and under the dam. Periodic caving of the sinkholes would likely involve the embankment and eventually could lead to an embankment that could not store a flood event without developing a breach in the dam. At the same time, realistic repair alternatives are difficult to formulate. Without expenditures well in excess of a half million dollars, very little improvement in long-term performance is predicted.

The only practical alternatives were to:

- Decommission the site
- Accept the chance that the site could breach during a flood event

The downstream area consists primarily of pasture and range and a county road downstream. A breach analysis was recently performed according to information from the Oklahoma staff, and the house located downstream from the site is not at risk either from a dam failure or from flooding that is likely if the site is decommissioned.

Several other sites in Oklahoma have similar geologic conditions, and some of them have experienced the development of sinkholes and downstream seepage, problems similar to those at this site. Gypsum can be highly soluble, and cavities can develop quickly both in bedrock layers and in soil horizons rich in gypsum (figures 9 and 10). Treating existing cavities is feasible, but little can be done with existing technology to address cavities that are likely to develop in the future.



Figure 9.—Sinkholes in reservoir bottom.



Figure 10.—Large sinkhole in reservoir.

Sites on gypsiferous foundations often have a repetitive cycle of problems and repairs similar to those at this site. On other sites in Oklahoma where similar conditions have resulted in repetitive repairs, careful economic analyses should be performed to evaluate whether future reductions in flood benefits outweigh the likely high cost of continued periodic repairs to the sites. Those sites should be evaluated to determine if conditions are similar to those at Little Washita No. 13 where intercepting seepage water that is creating the problem is difficult or impractical. At sites where continued seepage cannot be addressed with reasonably economical approaches, consideration should be given to draining those pools, maintaining the sites as dry structures to minimize the attack on the gypsiferous foundations.

The dam was eventually decommissioned and the damaged channel area stabilized with stone (figure 11).

The flood plain agricultural land and the county road would be impacted either by a breach in the dam or in the scenario in which the dam is decommissioned.



Figure 11.—Little Washita No. 13 site today (Google Earth, October 31, 2012).

References

- Natural Resource Conservation Service (NRCS) (2006). Technical Assistance Report, USDA-NRCS, Fort Worth, Texas.
- Soil Conservation Service (SCS) (1988). Engineering Report dated August 19, 1988, USDA-SCS, Grady County, Oklahoma.

Case 16 – Red Willow Dam

Red Willow Dam is located on the confluence of Red Willow Creek and Spring Creek in southwestern Nebraska. The dam was constructed between 1960 and 1962 and modified between 2011 and 2013. The primary features of the design and construction of Red Willow Dam include the embankment, outlet works, and spillway (figure 1). The dam crest is 3,159 ft long with a structural height of 126 ft. The upstream face slopes at 2.5H:1V from the crest to elevation 2600.0, then at 3H:1V to a 20-ft-wide berm at elevation 2550.0, then at 4H:1V to the reservoir floor. The upstream dam face is protected by 2½ to 3 ft of riprap on 12 in of gravel bedding. The dam impounds a reservoir of 27,303 acre-ft to the active storage level and has a total storage capacity of 78,829 acre-ft.



Figure 1.—Red Willow Dam.

Red Willow Dam was originally designed and constructed as an unzoned embankment of compacted silt derived from local loess deposits. The modified homogenous design was dictated by scarcity and, thus, a high cost of sand, gravel, and rock in the area. A 5-ft-thick drainage blanket, designated as Zone 2, was designed under most of the downstream side of the dam, beginning 110 ft downstream from the dam centerline, below elevation 2570 to provide for drainage to lower the phreatic line. The dam design did not include a cutoff trench due to the depth of materials required for removal. The drain material extended to a toe drain located near the downstream toe. Use of miscellaneous fill (Zone 3) was permitted at both the upstream and downstream toes of the dam. Shortly after original construction was complete, nine relief wells were installed near the downstream toe in 1966 and 1969 due to seepage and high exit gradients downstream of the toe of the embankment.

A pseudo-upstream seepage blanket was constructed out to 1,400 ft upstream of the dam centerline in which the foundation was rolled using a 50-ton pneumatic-tired roller. The results of compacting with a 50-ton roller were unsatisfactory, and ultimately a sheepsfoot roller was used for this seepage blanket. Approximately 2.5 to 3.5 ft of embankment settlement was observed at the dam during construction. The design would not meet current state of practice. However, this design was typical to the period and area in which the dam was constructed (see figure 2 for typical cross section).

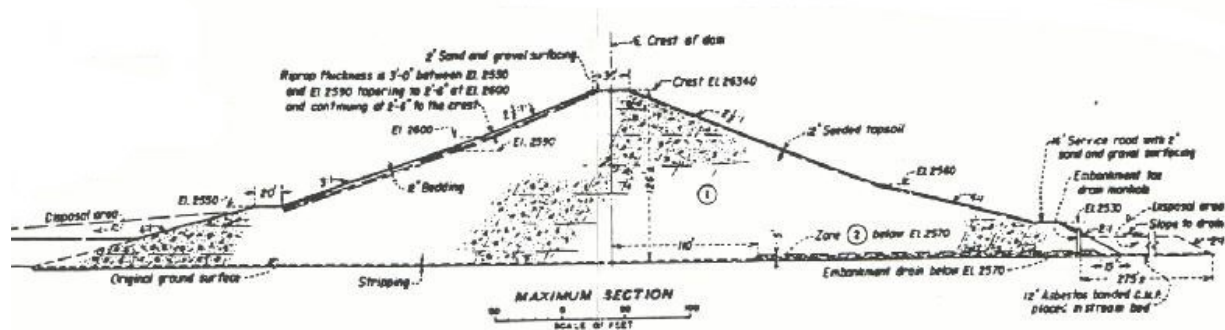

Figure 2.—Typical cross-section of Red Willow Dam.

Embankment materials are comprised of low plasticity silts (average PI of the embankment soils is 3 based on testing from original construction). Foundation materials consist of loess deposits on both abutments overlying the Ogallala Formation, described as variably cemented and consisting primarily of sands. Valley deposits reportedly consist of both sands and silts, with the upper portion being mostly silt. It appears that the valley silts may be either loess or at least partially reworked loess, as they have low densities and settlement characteristics similar to that of the Peorian Loess.

The outlet works and spillway are conduits located near each other at the right abutment of the dam. Both were reportedly founded primarily on competent Ogallala Formation (figure 3). As was typical for 1960's era Reclamation dams, both conduits feature cutoff collars and no filter envelopes, although the horizontal drainage blanket extends over the outlet works conduit and partially up the abutments.

In the fall of 2009, Reclamation was performing subsurface investigations and installing piezometers in the vicinity of the outlet works to obtain data to better evaluate the PFM of internal erosion into the outlet works stilling basin underdrains and/or voids in the foundation near the stilling basin. While performing these investigations, a sinkhole was discovered on the downstream face of the dam along the alignment of the outlet works (test pit #1 is figure 4). Trenches and test pits revealed the presence of additional sinkholes and embankment cracking (test pits #2 and #3 on figure 4). Discovery of the sinkholes and embankment cracking, in combination with the earlier concerns, led to emergency investigations and actions to better define the threat to the dam. In addition to drilling and test pitting to gather more data,

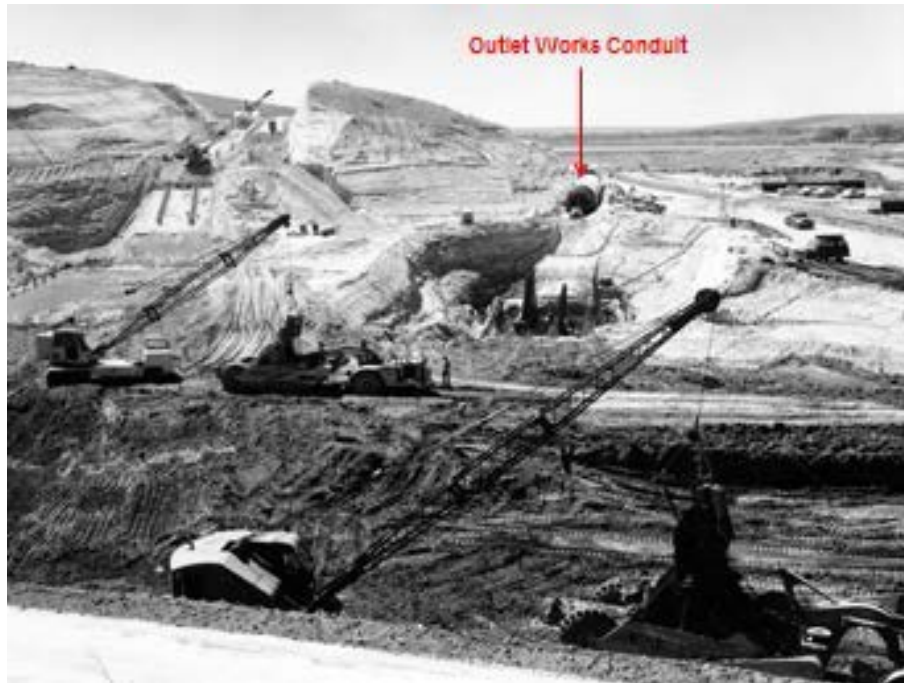

Figure 3.—Construction photo showing outlet works notched into firm Ogallala Formation.



Figure 4.—Photo showing locations of observed cracking in the embankment.



Figure 5.—Representative cracking in the embankment observed in test pit #2. Dye was poured into the sinkholes to aid in tracing the cracks. Cracks were typically 1/4 to 1 in wide.

interim risk reduction measures included stockpiling sand and gravel materials for use as potential emergency filters, 24-hr monitoring, and lowering the reservoir by approximately 20 ft to the dead pool elevation. Figure 5 shows the typical cracking observed.

It is believed that the cracking resulted from differential settlement in the foundation due to unfavorable bedrock geometry and compressible foundation soils. The bedrock profile dips sharply downward just left of the conduit, and to the right of the conduit, the foundation was excavated at a 1H:1V slope. Compressible, low-density silt foundation soils left of the conduit settled up to 4 ft elsewhere in the dam (where measurements were obtained). The embankment soils are brittle and are not capable of withstanding much differential settlement without cracking. The combination of these conditions created the potential for low stress conditions and tension cracks. In addition to embankment cracking near the outlet works, cracks were also discovered in the embankment near the diversion channel, which was excavated with 1H:1V slopes and filled with compacted embankment, leaving compressible silts on either side of the filled in diversion. All of the cracks observed have an upstream-downstream orientation. A nearly horizontal hole with a 6- to 8-in-diameter was observed near the bottom of the sinkhole at a depth of about 4 ft. Maximum apertures of cracks in the vicinity of the outlet works conduit were about 1/2 and about 1 in at the old channel.

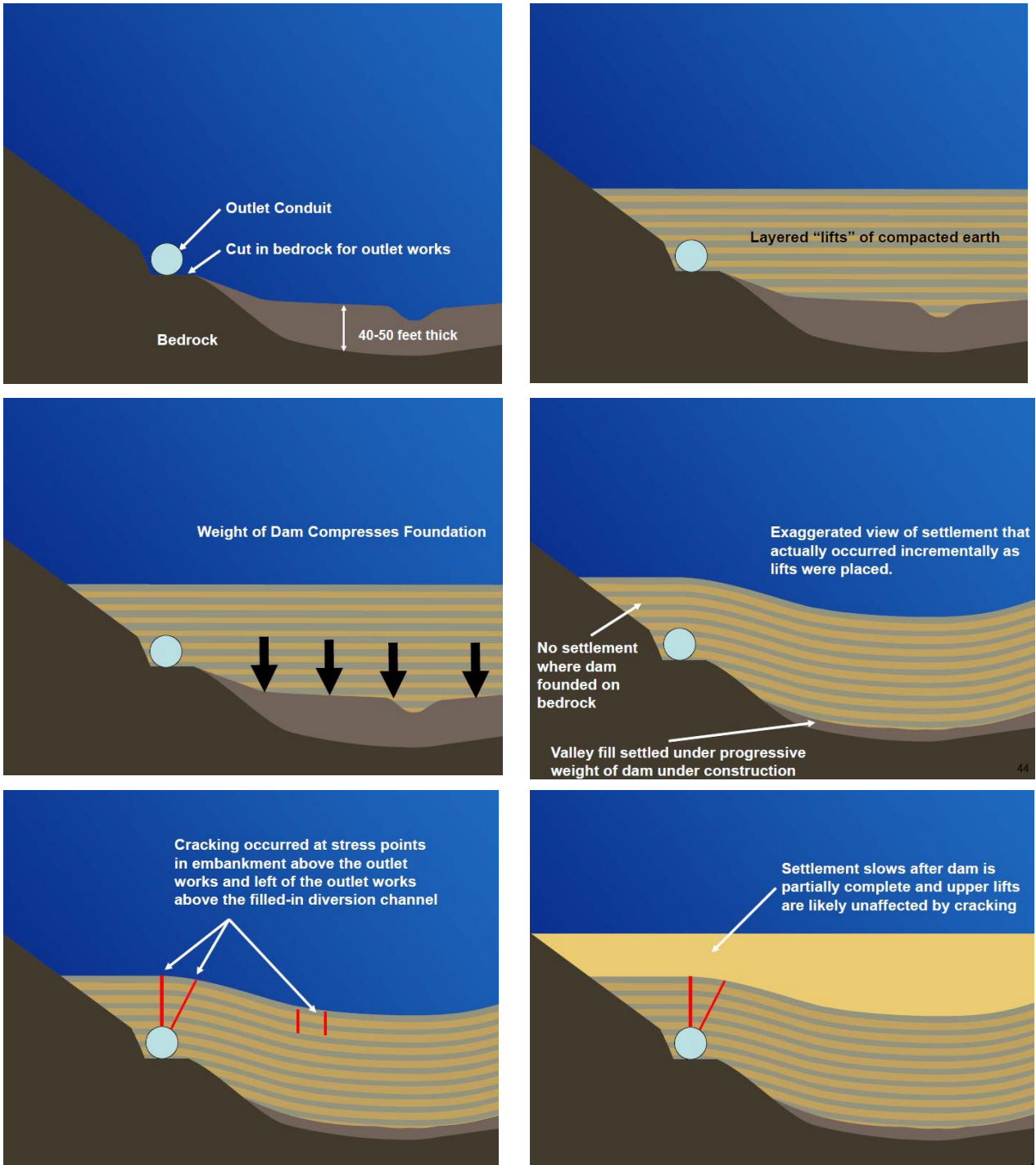

Figure 6. —Conceptual illustration of cracking mechanism.

Although no active erosion was observed in this case history, risks were estimated to warrant expedited actions to correct dam safety deficiencies. Final designs were developed, and construction began in the fall of 2011 and was completed in 2013. Modification of the embankment, as shown on figure 7, consisted of excavating the downstream face of the dam at a 2H:1V slope down to the existing 5-ft-thick horizontal sand blanket, removing the existing corrugated metal toe drain pipe and replacing it with a new toe drain system constructed in approximately the same location as the original, placing a two-sided geo-net composite on the excavated surface, placing a two-stage chimney filter/drain above the geo-net composite, placing a geotextile above the two-stage filter/drain, and finally placing a berm/buttruss above the geotextile as shown on figures 7, 12, and 13.

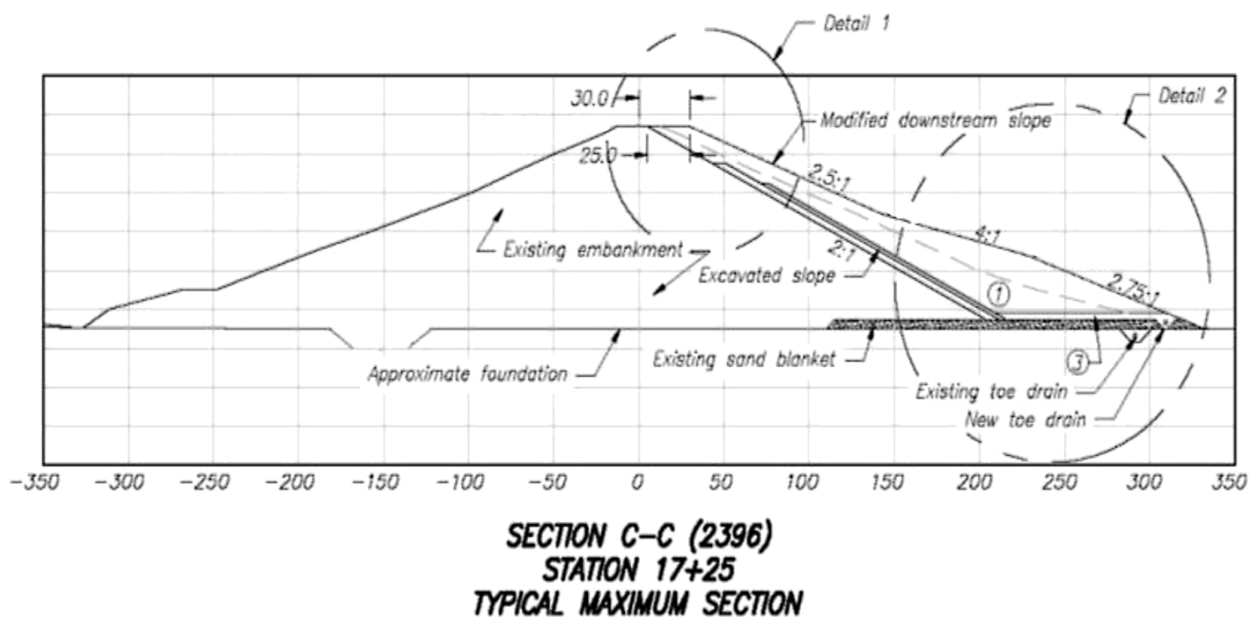

Figure 7.—Cross section of modified Red Willow embankment.

As originally designed, the new two-stage chimney filter and drain was to consist of an 8-ft-wide (measured horizontally) fine sand (Zone 2) filter with a 4-ft-wide (measured horizontally) coarse sand (Zone 2A) drain. Due to the difficulty of procuring acceptable Zone 2A material, the contractor was allowed to use No. 67 coarse aggregate gravel (Zone 3) material in place of Zone 2A. During the final design process, the designers actually preferred the gravel more than the coarse sand; however, due to the difficulty and costs expected in obtaining/hauling the gravel (it was not available in the expected quantities locally), investigation indicated that coarse sand was available locally and would be cheaper. As it turned out, during construction, the contractor was hauling the coarse sand (Zone 2A) from over 150 mi anyway, and it was more expensive than the No. 67 Zone 3 gravel. Allowing the contractor to use gravel instead of coarse sand was of benefit to both parties.

A double-sided geo-net composite was also placed against the excavated embankment upstream of the chimney filter/drain, and a geotextile fabric was placed on the downstream side of the

coarse drain and above the gravel drain materials in the base of the excavation as a separator to prevent migration of fines from the miscellaneous Zone 1 berm embankment into the drainage material.

The double-sided geo-net composite was installed over the entire excavated slope for the full length of the embankment. The material was anchored into a trench along the crest and then rolled down the excavated slope to the base of the excavation. Figure 8 below is a photo of the geo-net composite used in the modifications, and figure 9 shows the typical installation, rolling the panels from the dam crest.



Figure 8.—Geo-net composite – 5-mm biaxial HDPE geo-net, 16 ounces per square yard (oz/yd^2) geotextile bottom layer, 6 oz/yd^2 geotextile top layer (photo above does not show the top [downstream] geotextile).



Figure 9.—Typical installation of geo-net composite on downstream face of embankment.

The geo-net composite was incorporated into the design to span existing cracks and mitigate any new cracks caused by additional loading of the berm/buttress from extending continuously through the new embankment section. In addition, the geo-net composite was thought to prevent loss of the new chimney sand filter material into any open cracks that exist on the excavated embankment surface. The geo-net composite also acts as the primary filter/drain in the very upper portions of embankment, above elevation 2615 (see figure 12), which would only experience reservoir loading during relatively remote hydrologic events.

In order to prevent degradation of the geo-net composite due to ultraviolet breakdown, it was specified that the geo-net be covered within 30 days of placement. This posed a unique problem due to the embankment construction sequence and large area of geo-net composite materials to be covered. Ultimately, the contractor used a 6-in layer of sand to protect the exposed geo-net. A telebelt conveyor system was used to ensure coverage of the entire exposed composite as shown on figure 10.



Figure 10.—Telebelt used from dam crest to protect geo-net composite.

The use of geo-net composite materials in Reclamation dams is not common practice. Red Willow Dam is the first Reclamation dam to use the geo-net composites as identified. Federal guidelines prohibit the use of geosynthetics as a primary filter/drain. For this reason, a two-stage filter/drain was constructed below elevation 2615 to serve as the primary filter/drain. The use of a geo-net composite as the primary filter/drain above elevation 2615 is unconventional, but due to the low likelihood of the reservoir exceeding this elevation, the designers decided there was very little risk in not continuing the chimney filter/drain above this elevation. Because the drain materials were imported from a long distance, stopping the two-stage filter at this elevation also had an economic benefit for the project – by limiting quantities, a cost savings was achieved. A total of 70,000 square yards of geo-net composite was installed of the downstream excavation as shown on figure 11 below.



Figure 11.—Aerial photo of Red Willow Dam showing geo-net installation and protection with sand.

A downstream stability berm and buttress was designed to overlay the chimney filter/drain since known cracks in the embankment that run perpendicular to the alignment of the dam could potentially be continuous from the upstream to downstream, thereby acting as an open conduit. There is the possibility that the filter at the end of these potential open cracks could become clogged with soil particles and cause full reservoir head pressure to be pushed up against the two-stage filter system. It was thought that the potential for all of these hypothetical events to line up and cause a blowout at the downstream face of the dam was unlikely. However, it was decided that sizing the downstream berm and buttress so that it could resist an “open crack” blowout from full reservoir head at any point along the downstream face of the dam would be beneficial based on its conservatism. The downstream slope of the modified embankment has a 15-ft crest extension beyond the original downstream crest edge as shown on figure 12.

From this point, the downstream edge of the embankment slopes down at a 2.5H:1V slope to elevation 2589. From elevation 2589 down to 2567.5, the surface of the berm and buttress flattens out to a 4H:1V slope. At elevation 2567.5, the surface slopes down to a 2.75H:1V slope to the toe of the embankment as shown on figure 13.

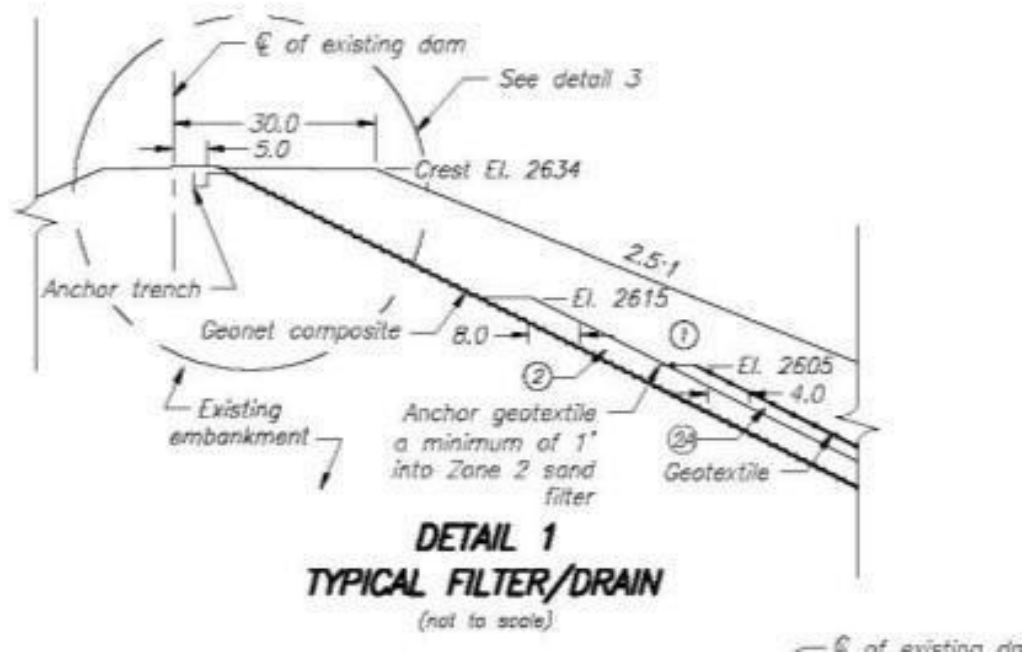

Figure 12.—Crest detail of embankment modifications.

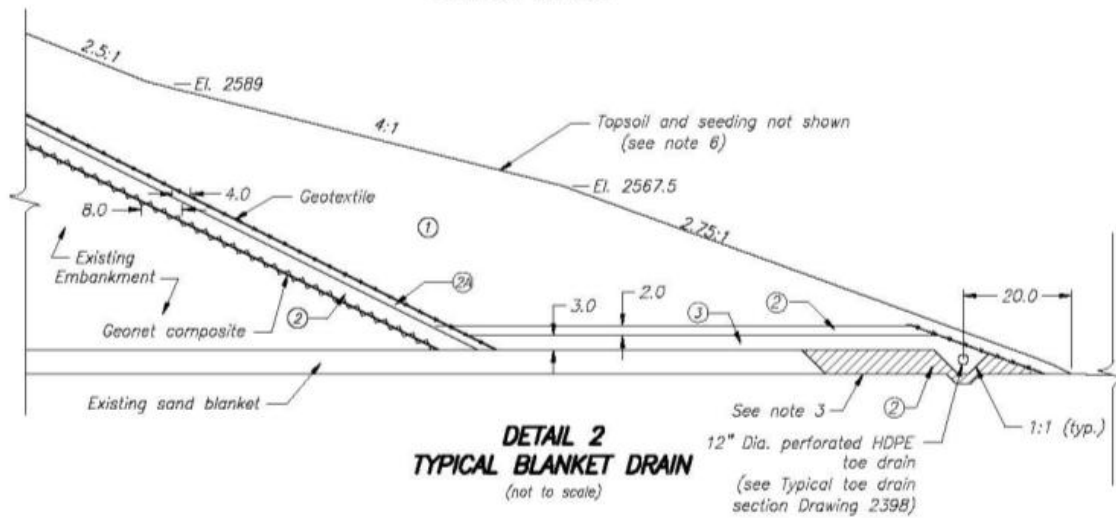

Figure 13.—Section showing downstream berm configuration.

Substantial completion of the modification occurred on December 13, 2013; however, there is little to report regarding performance since only 2–3 additional ft of water has been stored in the reservoir (as of summer 2014) due to downstream release requirements

References

Bureau of Reclamation (Reclamation) (2013). “Red Willow Dam, Nebraska,” ICOLD Congress, 2013, ICOLD, Seattle, Washington.

_____(1976). Design of Small Dams, Denver, Colorado.

_____(1994). Embankment Dams Design Standards No.13, Denver, Colorado.

_____(2012). Comprehensive Review – Red Willow Dam, Denver, Colorado.

_____(2014). Embankment Modification Designs Technical Memorandum – Red Willow Dam, Denver, Colorado.

Hanneman, D.L. (2011). “Recent examples of backward erosion piping, internal erosion along a conduit, and embankment cracking at Bureau of Reclamation dams,” paper prepared for 2011 European Working Group on Internal Erosion meeting in Brno, Czech Republic.

Case 17 – Horsetooth Reservoir

Horsetooth Reservoir is situated in a narrow north-south valley between hogbacks of the front range just west of Fort Collins, Colorado (figure 1). The reservoir contains 156,735 acre-ft of water and is 6.5 mi long. The project consists of five embankments: Horsetooth Dam (figure 2), Satanka Dike, Soldier Canyon Dam, Dixon Canyon Dam, and Spring Canyon Dam. The project has no spillway but is equipped with two low-level outlet works (one at Horsetooth Dam and a much smaller one [90 ft³/s at normal pool] at Soldier Canyon Dam). The outlet works have a combined discharge capacity of 2,590 ft³/s at normal pool.



Figure 1.—Horsetooth Reservoir. Horsetooth Dam is the dam at the far left end of the reservoir in the above photograph.



Figure 2.—Oblique view of Horsetooth Dam and Satanka Dike (looking south).

Horsetooth Dam

Horsetooth Dam is located on the northern end of Horsetooth Reservoir and has a structural height of 158 ft, a crest elevation of 5444 ft, and a crest length of 1,615 ft. Horsetooth Dam is a zoned earthfill structure consisting of a wide central Zone 1 core comprised of clays and sandy clays. As a result of modifications, the structure now incorporates an internal two-stage chimney filter and drain system downstream from the Zone 1 core that extends to the top of the normal reservoir water level. The upstream face slopes at 3H:1V from the crest to the toe of the dam. The upstream shell consists of a combination of Zone 2 (rock fines), Zone 3 (sand, gravel, and cobbles), and Zone 4 (rockfill). The downstream face of the dam is sloped at 2.5H:1V to the top of the 145-ft-wide stability berm at elevation 5350 and then slopes at 2H:1V to the downstream toe. The downstream shell consists of Zone 3 (sand, gravel, and cobbles). Satanka Dike is adjacent to the left abutment of Horsetooth Dam and has a structural height of 33 ft.

After 40 years of uneventful operations, seepage was observed on the downstream left abutment of Horsetooth Dam in October 1990. Prior to this observation, several sinkholes were observed in the South Bay campground at the south end of the reservoir in 1989. The appearance of these features led to a concern that similar sinkholes could be possible within the footprint of Horsetooth Dam. As a result of the sinkhole observations, a drilling program to investigate the foundation conditions at Horsetooth Dam was undertaken to better define subsurface conditions. Several drill holes to obtain samples of the bedrock were completed with the installation of piezometers to monitor water pressures in the foundation. The piezometers were equipped with data loggers to obtain frequent water level readings. For the subsequent 10 years of monitoring, both the quantity of surface seepage and the water pressures within the foundation bedrock steadily increased with time for similar reservoir water surface elevations. A comprehensive evaluation of the seepage behavior was undertaken, and data gathered were utilized in a quantitative risk analysis to evaluate the risks posed to the downstream public by the increasing seepage. Risk analysis played a primary role in determining not only the PFMs and associated risk, but also guided how the modifications were selected based on overall risk reduction.

Considering the results from the risk analysis (which indicated risks that exceeded Reclamation guidelines) and the fact that the dams were over 50 years old and not designed to today's state of practice, Reclamation decided to pursue structural modifications. Various structural alternatives were considered in detail, and the evaluation process included the use of Value Engineering teams and a review by independent consultants. In addition, the various alternatives were evaluated by a risk analysis team to determine the amount of risk reduction achieved by each modification alternative. Ultimately, the following corrective actions were selected: (1) to address the internal erosion PFMs at each of the Horsetooth Reservoir Dams, construct a two-stage chimney filter and drain system to provide a filtered exit for any seepage exiting through the Zone 1 core and along the foundation contact; (2) to address the seismic PFMs at each of the Horsetooth Reservoir Dams, excavate the foundation alluvium at the downstream toe to remove potentially liquefiable material and replace the excavated material with compacted embankment and construct a stability berm at the downstream toe area to provide adequate stability in the event that foundation liquefaction occurs in the alluvium that remained beneath the Zone 1 core of the dam; and (3) to address the bedrock seepage through the Forelle limestone and

surrounding bedrock units at Horsetooth Dam, construct a concrete cutoff wall. Figure 3 shows the typical embankment modification design at all dams, while figure 4 shows the location of the planned slurry trench cutoff wall at Horsetooth Dam.

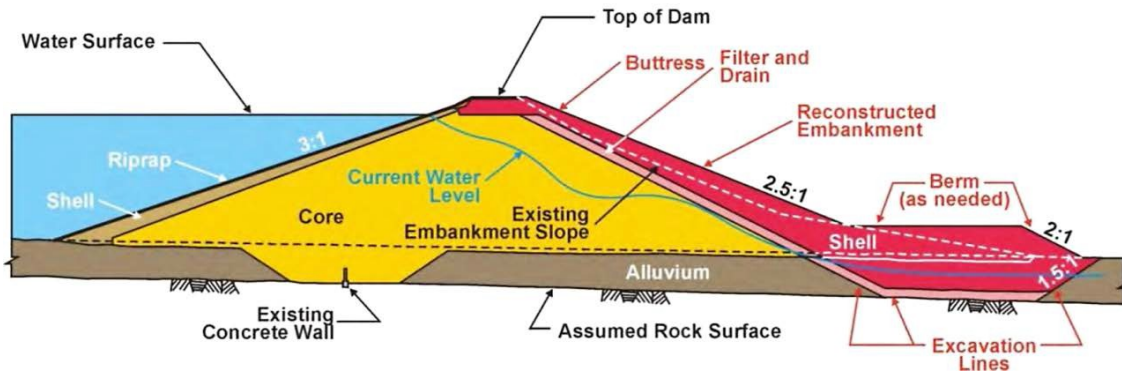

Figure 3.—Filter and berm modification at all Horsetooth Reservoir dams.

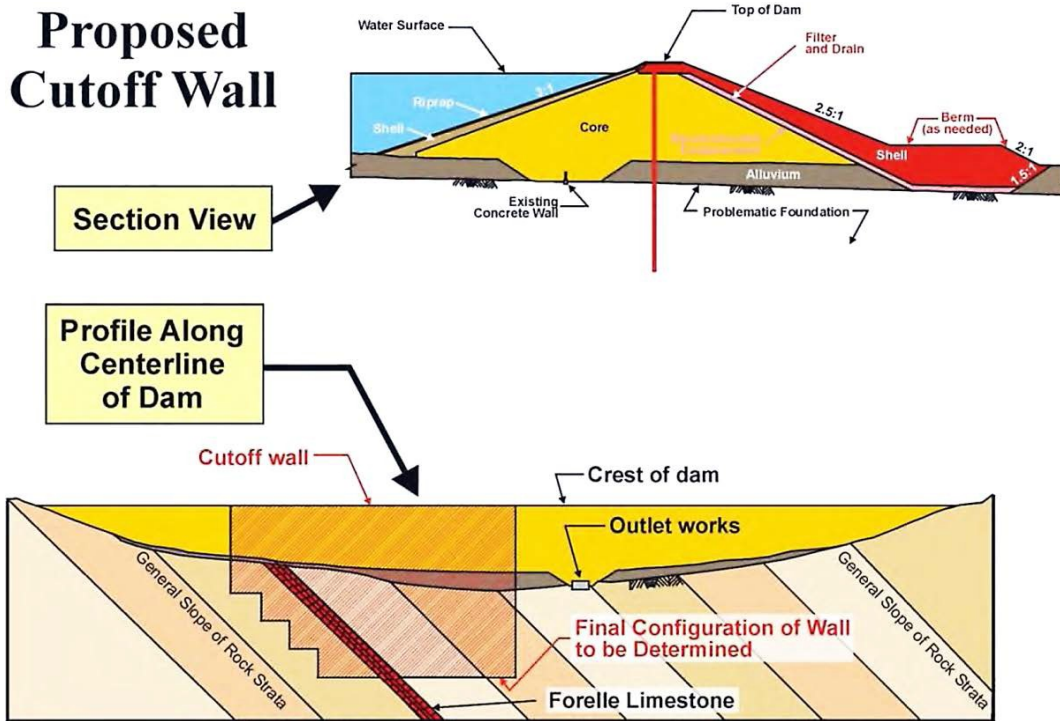

Figure 4.—Proposed cutoff wall location at Horsetooth Dam.

During the summer and fall of 2000, the reservoir water surface was drawn down to investigate conditions along the upstream toe of Horsetooth Dam and to lower the reservoir water surface in preparation for construction of the filter and drain modification. Because of embankment stability concerns during construction, the reservoir water surface was restricted. As the reservoir drawdown reached elevation 5335, a sinkhole was observed on the upstream left abutment groin as shown on figure 5. As the reservoir water surface decreased below this elevation, the piezometers showed significantly decreased water levels in the foundation. To test the effects of the seepage entrance on the piezometric levels in the foundation, a gravity head water test was conducted. Water was pumped from the reservoir to the sinkhole. The purpose of the test was to estimate the flow capacity of the conduit/fracture network and to provide an indication of the continuity of the entrance condition to the Forelle limestone member. The vibrating wire piezometers were connected to data loggers that recorded readings every 15 minutes. The piezometers with influence zones in the Forelle limestone responded immediately, indicating a direct connection to the seepage entrance point. Water testing for a 24-hr period with the reservoir drawn down indicated that the seepage conduits could sustain a steady flow of approximately 2.2 ft³/s.



Figure 5.—Observed sinkhole at upstream left groin of Horsetooth Dam.

Since the reservoir water surface would fill during construction of the filter and drain modification and cover the sinkhole area, a temporary repair of the sinkhole was constructed. Design of a concrete cutoff wall at Horsetooth Dam had not been completed. A separate construction contract to construct the concrete cutoff wall was being prepared. In general, a conservative approach was taken in the treatment of the sinkhole in that several barriers at the entrance of reservoir water into the foundation were provided. The treatment consisted of grouting through the opening in the rock, placement of lean concrete over the seepage conduits, followed by placement of Zone 3 (sand, gravel, and cobbles) over the concrete to provide a pad for placement of a geomembrane and a 5-ft clay cap. The area covered by the geomembrane was approximately 80 by 100 ft.

The effect of the sinkhole repair on the piezometric levels in the bedrock was evaluated after the reservoir filled in the spring of 2001. Comparison of piezometric levels prior to sinkhole repair with water levels after repair indicated decreases in water levels in all piezometers. Decreases in piezometer water levels ranged from 20 to 65 ft. As a result of the evaluation of the effects of the temporary repairs on piezometric levels and seepage gradients within the bedrock, Reclamation decided to construct a more extensive upstream impervious blanket to cover the pervious bedrock units in the reservoir area immediately upstream of the dam in lieu of a concrete cutoff wall. In addition, there were concerns that a cutoff wall could drive seepage down to a massive gypsum layer within the foundation and initiate solutioning. The upstream impervious blanket consisted of a geomembrane covered by 5 ft of soil cover. The area covered by the geomembrane is approximately 300 by 800 ft. The location and installation of the upstream blanket are shown on figure 6.

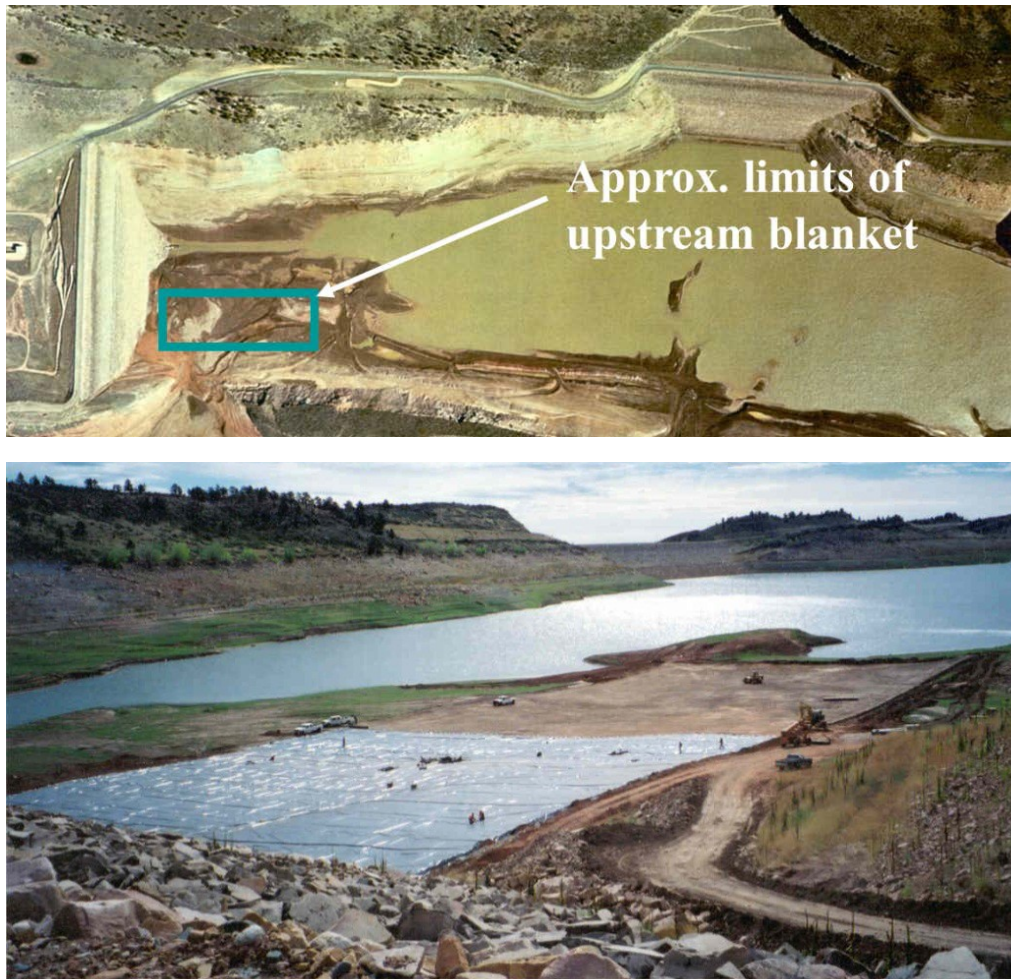

Figure 6.—Upstream blanket constructed at Horsetooth Dam.

The remediation feature on the left abutment of Horsetooth Dam was unique due to the difficulty in defining the problematic seepage feature, extensive exploration and monitoring required to better understand the nature of the increased seepage emitting from Horsetooth Dam prior to remediation, and the use of risk analysis to define PFMs and predict the risk posed to populations downstream. Furthermore, the decision to construct an impervious blanket in the upstream basin in lieu of a concrete cutoff wall to reduce bedrock seepage was perhaps one of the most discussed aspects of the modification design, and it received confirmation from the water district and Reclamation's board of independent consultants prior to implementation. Among the reasons for this decision were the potential for a deep cutoff wall to do harm by driving seepage into soluble gypsum within the foundation, the fact that both features serve to lengthen the seepage path, and the extreme difference in estimated cost (\$750,000 for the blanket versus \$50 million for the cutoff wall).

Due to the changing conditions observed in the visual observations and instrumentation data at Horsetooth Dam, it is important for dam safety professionals to recognize the importance of a careful monitoring program and regular evaluation of visual behavior and instrumented data. At Horsetooth Dam, changed conditions were taken seriously and evaluated thoroughly. In addition, all potential impacts of a proposed corrective action should be carefully considered. At Horsetooth Dam, the design team determined that a cutoff may not be an effective mitigation measure and could potentially lead to worsening conditions. The construction activities were completed between 2001 and 2003 with no major adverse issues. Figures 7–10 show construction activities at all four dams. An unexpected seepage feature at Horsetooth Dam was discovered prior to construction, as outlined above, which prompted a change in the previously selected preferred alternative to construct a concrete cutoff wall. The design change significantly reduced the anticipated total project cost.



Figure 7.—Construction of downstream filter and berm at Horsetooth Dam.



Figure 8.—Foundation cleanup and construction of downstream filter and berm at Spring Canyon Dam.



Figure 9.—Excavated downstream embankment and foundation at Soldier Canyon Dam.



Figure 10.—Completed downstream modification at Dixon Canyon Dam.

The original Horsetooth Reservoir dams appear to have been well constructed, inspected, and tested. In addition, the recent modification design and construction was thorough and well done. Careful surveillance and instrument monitoring during the refilling of the reservoir through the present indicates that the embankments and foundations meet or exceed the designer's expectations. Instrumentation for the Horsetooth Reservoir dams include 15 seepage monitoring points, 64 piezometers, a multipoint extensometer, 193 embankment measurement points, and regular ongoing visual inspection reports.

Piezometers located within the Forelle limestone unit are displaying an extremely linear response to the reservoir, and it is clear that the combination of the upstream sinkhole repair and the addition of the upstream blanket have dramatically reduced the entrance point for seepage in the Forelle and related Lykins units. Figure 11 represents the typical behavior of these piezometers. These modifications have brought the embankments to modern state-of-practice structures that continue to perform well today and pose very low risks to the public.

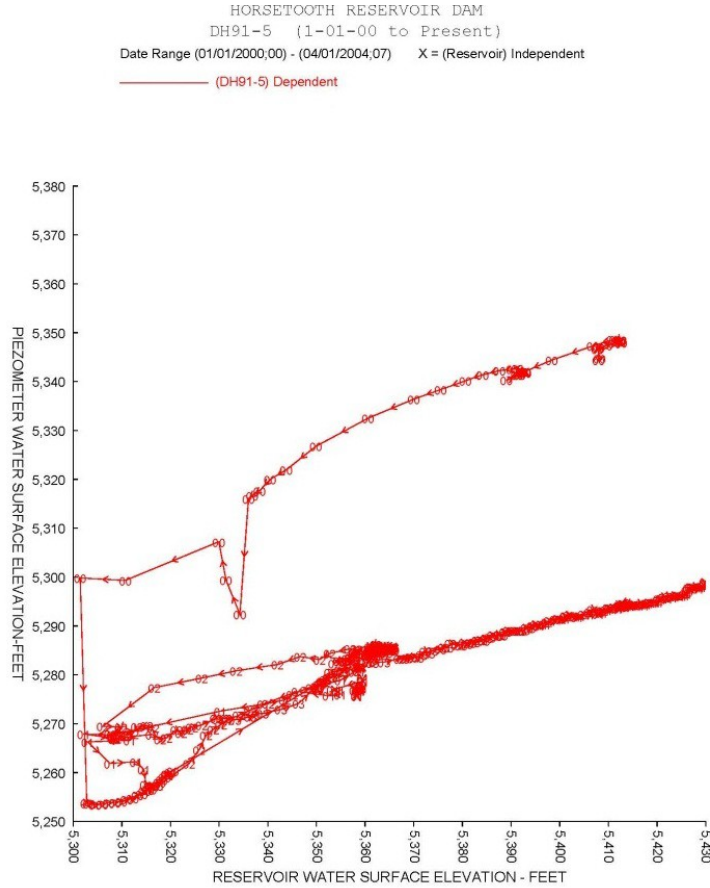

Figure 11.—Typical piezometric behavior at Horsetooth Dam.

References

- Bureau of Reclamation (Reclamation) (2013). “Horsetooth Reservoir Dams, Colorado,” 2013 ICOLD Congress, ICOLD, Seattle, Washington.
- _____(1987). Design of Small Dams, 3rd ed., Denver, Colorado.
- _____(1994). “Design Standards No. 13, Embankment Dams,” Denver, Colorado.
- _____(2007). “Report of Construction Horsetooth Dam,” Great Plains Region, December 28, 2007.
- Engemoen, William (2001). “Assessing the Dam Safety Risks of the Horsetooth Reservoir Dams,” 21st USSD Conference, Denver, Colorado.
- Kiene, Allen, Ronald Pearson, and Roger Torres (2001). “Discovery, Assessment, and Treatment of Sinkholes at Horsetooth Dam,” 21st USSD Conference, Denver, Colorado.

Case 18 – Reach 11 Dikes

The Reach 11 flood detention dikes are part of the Hayden-Rhodes Aqueduct, a feature of the Central Arizona Project, located in the northern Phoenix and Scottsdale metropolitan areas (figure 1). The dikes protect the aqueduct from stormwater runoff by attenuating flows in detention basins that were designed to store the PMF. The detention basins are dry under normal conditions. The dikes are parallel to the aqueduct and consist of four separate embankments that have a total length of approximately 15 mi. Each of the four dikes is a homogeneous compacted earth embankment. The side slopes of the dikes transition between 2½H:1V and 4H:1V over distances varying from every 500 to every 1,500 ft; the transformation occurs in such a fashion that the downhill slope is steepest when the uphill slope is most gradual, and vice versa, and was included in the design to produce an aesthetic effect. There is no slope protection on the dikes other than natural vegetation.

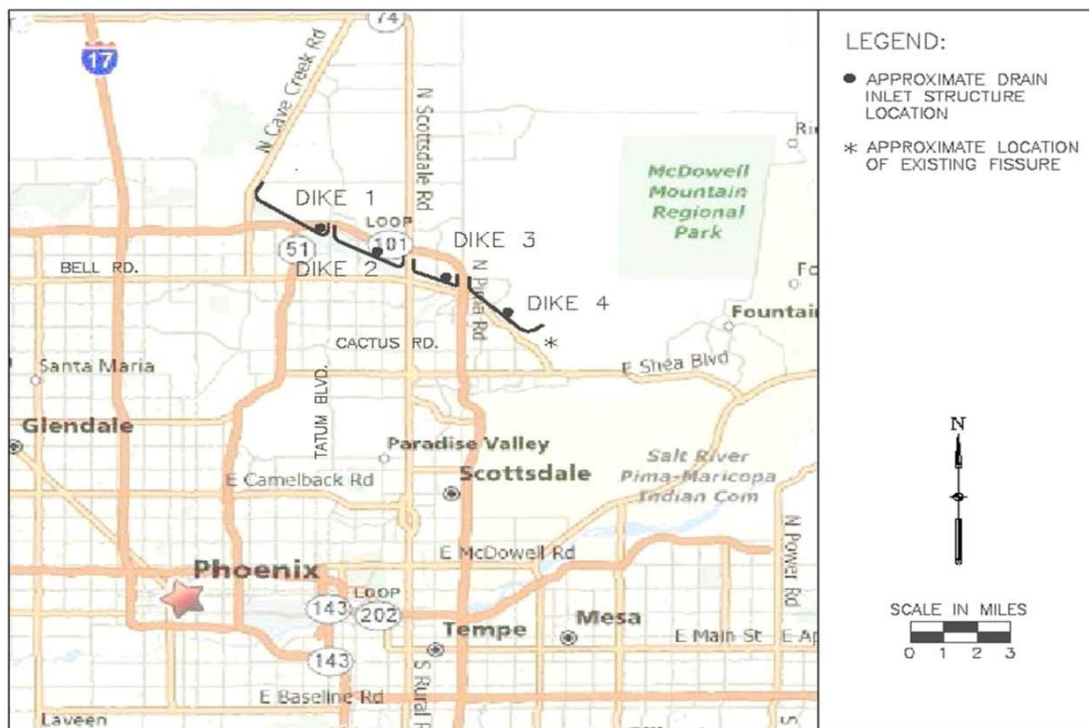

Figure 1.—Location of Reach 11 Dikes.

The dikes trend southeasterly across Paradise Valley, a structural basin containing thick accumulations of quaternary fluvial and lacustrine sedimentary deposits. All four dikes are founded on the uppermost sequence of these deposits, divided into two subunits: basin fill and alluvial fan deposits. Pre-construction investigations and geologic mapping of the excavated canal prism disclosed several soil types. The basin fill deposits consist of variable mixtures of silty sand, clayey sand, and sandy silt with numerous pockets, lenses, and stringers of loose, relatively clean, poorly graded sand. The alluvial fan deposits are coarser, consisting primarily of silty gravel to gravelly sand containing cobbles to 12-in diameter.

Occurring near the eastern margin of the Union Hills, the beginning of Dike 1 is founded on 5 to 8 ft of basin fill deposits overlying coarser alluvial fan deposits. Foundation materials become progressively finer as the dikes trend easterly away from the Union Hills source area. Investigations along the eastern two-thirds of Dike 1, all of Dikes 2 and 3, and the western end of Dike 4 revealed only basin fill deposits, which are mostly uncemented to weakly cemented. From the western end of Dike 4 heading southeast, the foundation materials significantly increase in the percentage of gravel and oversize particles and also in the degree of caliche cementation. The eastern, approximate 2 mi of Dike 4 are founded entirely on coarse-grained alluvial fan deposits that originated from the nearby McDowell Mountains.

Over the life of the dikes, very significant transverse and horizontal cracking has been seen along the crest of the dikes, especially Dikes 1, 2, and 3. In addition, large sinkholes have formed along the alignment of these cracks, and erosion outlet tunnels have appeared on the slopes of the dikes. Figures 2 and 3 illustrate show the observed features. Typically, these features have been seen after significant rainfall events, which have temporarily stored up to 8 ft of water against the dikes, and the water was allowed to evaporate and/or infiltrate into the foundation. Field investigations have revealed that some of these cracks extended completely through the dike embankments. Laboratory testing of dike and foundation materials also revealed that approximately 40% of the soils tested were classified as D-1 dispersive soils. Vertical strains over 20% were seen in laboratory tests of foundation samples at the effective vertical overburden stress imposed on the soils by the embankment. According to research done on the prediction of field collapse of soils due to wetting, in the basin and range provinces of the Southwest, collapsible soil deposits are primarily wind deposited, weakly cemented silty sands, sandy silts, and clayey sands of low plasticity. The majority of the basin fill deposits under Dikes 1, 2, and 3 fit these soil types.



Figure 2.—Typical longitudinal cracking observed on crest of Reach 11 Dikes.



Figure 3.—Typical severe erosion of dispersive embankment soils comprising Reach 11 Dikes.

Geotechnical exploration and laboratory testing programs were developed in 1988 and completed in 1989 to address the severe cracking and erosion problems. The objective of these investigations was to identify the causes of the cracks, determine if the dikes could be safely operated under normally expected loading conditions in their current state, and recommend alternatives to correct any deficiencies. The conclusions from these investigations are summarized below:

1. Foundation pre-treatment prior to construction of the dikes, consisting of pre-wetting and surface compaction of foundation materials, was only effective to relatively shallow depths. Undisturbed samples of foundation soils beneath the dike embankment indicated that in-place dry densities are low and decrease rapidly with depth.
2. Trenching on the dike crests and in-place moisture determinations showed that desiccation of dike materials had occurred to a depth of 3.5–4.0 ft. Desiccation cracking was relatively widespread, but cracks were generally hairline in width and consistently spaced approximately 18 in apart at each trench location.
3. Large, deep, longitudinal, diagonal, and transverse cracks in Dikes 1, 2, and 3 were caused by differential settlement of foundations due to low in-place densities and infiltration of water (figure 4). Longitudinal cracks can be correlated to areas having retained water during past rains.
4. Historical events have shown that the dike embankment materials are highly erosive and dispersive. Laboratory testing on embankment samples indicated that approximately 40% of the materials tested were classified as D-1 dispersive.
5. Failure of the dikes is likely in the event of either brief or sustained storage from rains. During field investigations, transverse and horizontal cracks were observed to extend through some of the crests to depths exceeding 16 ft. During the construction to modify the dikes, cracks were noted that extended completely through the dikes to the foundation. Due to the erosive and/or dispersive properties of the materials, and based on the extensive erosion of the dikes during rainstorms, it was determined that seepage flowing through cracks would quickly erode the dike material and cause breaching.

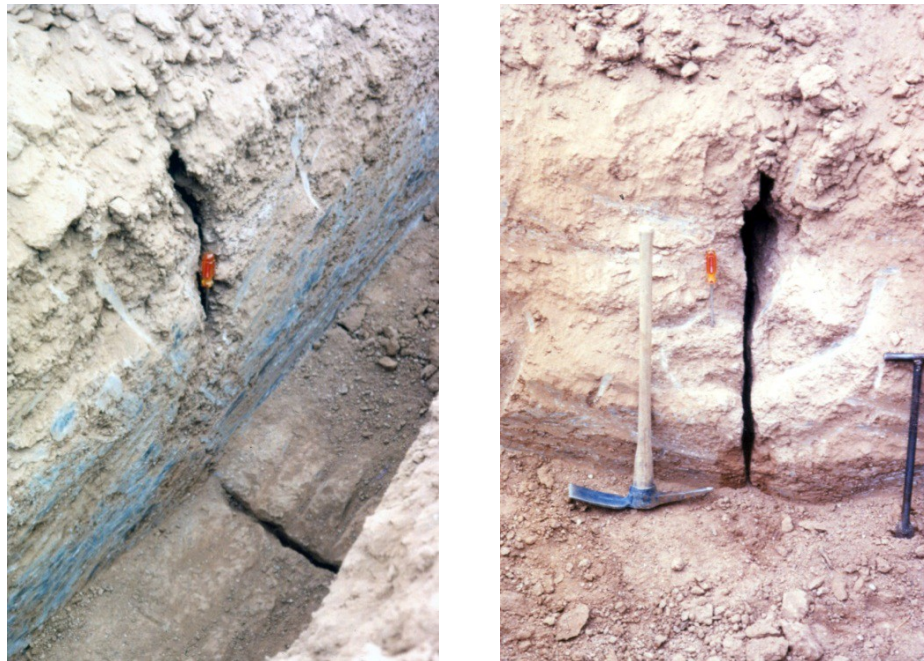

Figure 4.—Transverse cracks observed in test pits.

Because of the presence of erodible and dispersive soils, the design team eliminated options that did not include a soil filter. However, since some deep gullies could form in the dike, a downstream filter was likely to be subject to eventual erosion. The downstream filter would also potentially be exposed to high seepage gradients at the downstream toe from concentrated flow through transverse cracks, which could erode the filter. The conclusion was that a vertically placed filter zone (drainage trench with finger drains) through the centerline of the dike offered the best protection from future erosion, would require the smallest volume of filter material for construction, and was the least costly solution. The design concept is illustrated on figure 5.

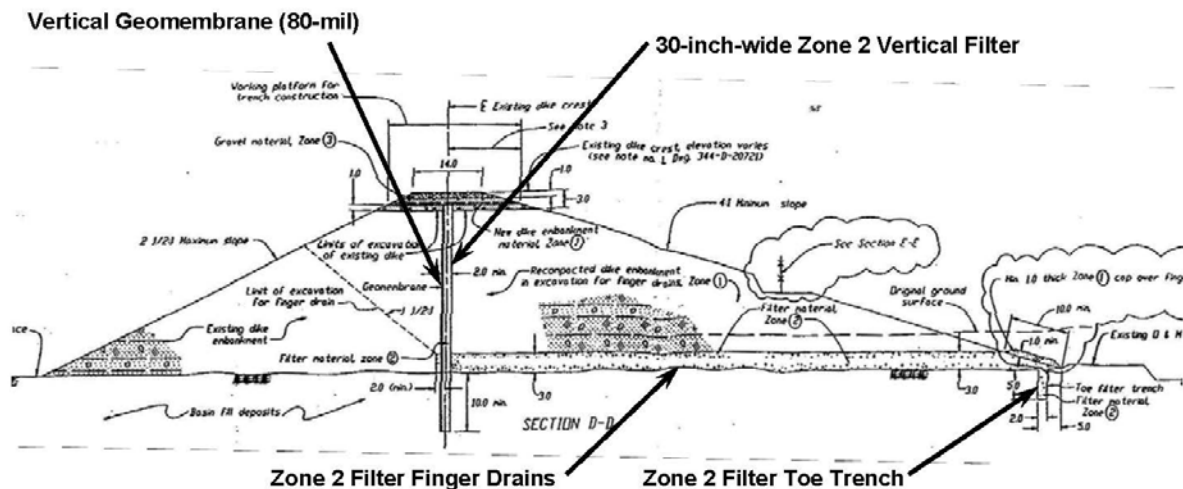

Figure 5.—Dike section highlighting key aspects of the modification design.

Excavation and placement of filter zone materials was accomplished by the slurry trench method. A biodegradable slurry was selected to prevent contamination of the filter zone material with residual materials that would occur with conventional slurry (typically bentonite). A biodegradable slurry, such as a natural guar gum or a synthetic biopolymer, will break down naturally over time or can be chemically broken down using a weak chlorine solution and flushed out of the filter zone material, leaving a free-draining filter zone in place.

There also was concern for high seepage gradients across the vertical filter zone that could wash filter material into a downstream crack. To prevent this, a vertical barrier wall was included against the upstream wall of the trench. The vertical barrier wall material selected for installation in the trench was an interlocking, jointed HDPE geomembrane, commonly referred to as a curtain wall. The curtain wall was installed in the biopolymer trench before placement of the filter zone material. Each panel consisted of a 26-ft-wide, 80-mil-thick HDPE section attached to 160-mil-thick joint sections. Panels were installed by being placed onto steel frames that were then lifted vertically by crane so that each panel could then be inserted into the biopolymer-supported trench alongside the previous panel with the use of an interlocking joint section (figure 6). Each joint section contained an expandable hydrophilic seal extending the full depth of the panel. The full continuity of each joint was verified through copper wiring within each joint extending the full length of the panel. When the panel was fully inserted, an electrical circuit was created when the wires made contact at the bottom of the trench. The electric circuit could be verified by instrumentation at the crest of the dike. The backfill in the trench is ASTM C-33 concrete sand, which was tremied into the slurry-filled trench. The sand meets filter gradation requirements for the embankment and foundation materials. Figures 7–9 are construction photos.

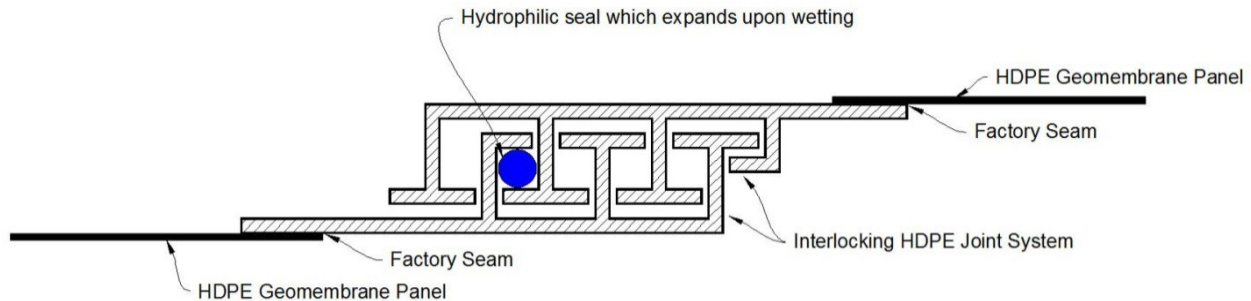

Figure 6.—Joint detail showing connection of adjacent vertical geomembrane panels.

A large test section 1,100 feet in length was constructed in the most heavily cracked area. The section was heavily instrumented (observation wells, porous tube piezometers, and settlement/deflection points) and was filled to the PMF level (3 ft below the crest) and impounded for 30 days. The following observations resulted from evaluation of the test section construction and performance during ponding:

1. The curtain wall is an effective watertight vertical barrier wall.
2. Installation of a curtain wall can be done to depths of at least 50 ft.
3. Deep vertical trenching, supported by biopolymer fluid, can be an effective means of placing both a HDPE barrier wall and filter zone materials.
4. A test section is recommended to better define construction procedures and understand the behavior of the biopolymer fluid being used.
5. Trenching with biopolymer fluids is most effective in finer-grained soils. Where groundwater depths are shallow, the particular site conditions should be carefully evaluated to assure effective trench support.



Figure 7.—Excavation of trench using biopolymer slurry. Steel frame was used to install the geomembrane panels.



Figure 8.—Transport of geomembrane panel by crane using steel frame.



Figure 9.—Installation of geomembrane panel in the trench adjacent to previously placed panel.

Based on the results of the test section construction and monitoring, the contractor was awarded part 2 of the contract to complete modifications to the full 12.5 mi of dike. Construction was begun in December 1993 and completed approximately in February 1995, almost 6 months ahead of schedule. This method of installation proved to be a cost-effective and efficient way of creating a deep seepage barrier.

Portions of the dikes outside the original test section area have not been subjected to significant reservoir head since construction was completed, but they appear to be performing as expected under current conditions.

References

Bliss, M. and P.T. Burnette (1995). "Reach 11 Dikes Modification: A Vertical Barrier Wall of HDPE Geomembrane," Proc. Geosynthetics '95, IFAI, pp. 147–160.

Bureau of Reclamation (Reclamation) (2013). "Reach 11 Dikes, Arizona," ICOLD Congress, 2013, ICOLD, Seattle, Washington.

_____(1998). Water Operation and Maintenance Bulletin No. 186, Denver, Colorado.

_____(2013). Comprehensive Review – Reach 11 Dikes, Denver, Colorado.

Case 19 – Clam Lake Project¹

Clam Lake Dam is a 94-ft-high, 985 ft-long flood-retarding embankment constructed between 1974 and 1977 near Cold Spring, Massachusetts (figure 1). The embankment was constructed of broadly graded glacial till soil with low plasticity fines. The dam impounds a maximum storage of 3,840 acre-ft from a 10.5-mi² drainage area.

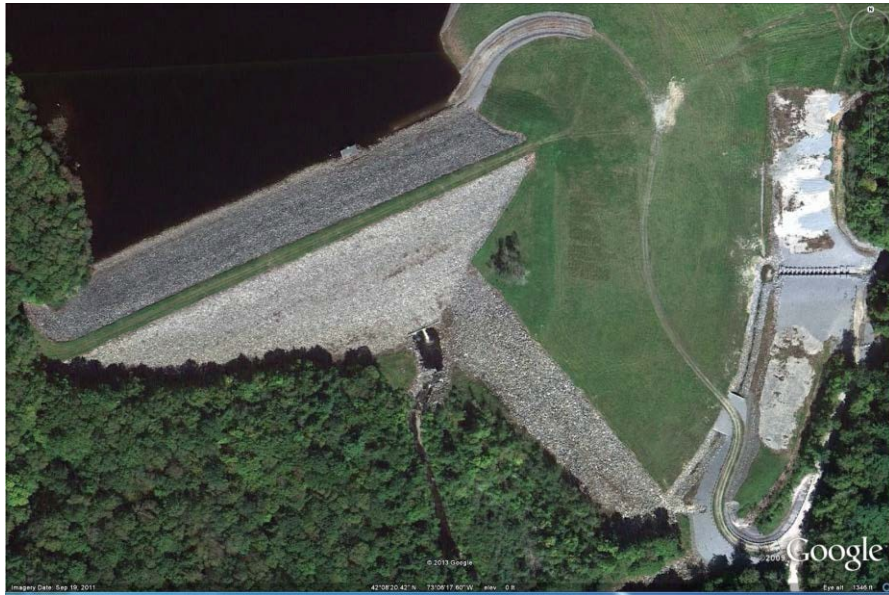

Figure 1.—Clam Lake Dam.

Problems experienced at other dams, constructed of similar soils, prompted concern over the safety of this site. The structure has an embankment chimney drain and downstream blanket drain. However, the design of the drain was based on the total gradation of the base embankment soils, as was the practice at the time. Current filter design would use re-graded base soil curves with particles larger than the # 4 sieve omitted from the gradation used for designing the filter. The designed drain fill was much coarser than a current design would obtain.

Many successful dam projects have cores or homogeneous construction consisting of coarse, broadly graded soils without fine sand filters. Problems discussed by Sherard (1979) have occurred only on a small fraction of the total number of dams built using such soils. Sinkhole development and internal erosion in dams with coarse broadly graded soils appears to develop only when an unfavorable combination of the following conditions exists (McCook 2000).

1. Thin core, usually vertical
2. Downstream filter of coarse sand and gravel with little or no fine sand sizes
3. Steep or jagged rock foundation not adequately sealed
4. Rapid reservoir filling

¹ McCook (2000) article, reprinted with permission from Association of State Dam Safety Officials (with revisions).

The unlikely and likely factors were assessed to evaluate the likelihood of internal erosion and sinkholes developing at Clam Lake are summarized as follows:

Unlikely Factors

- There are no sharp breaks in either the surface ground profile or the bedrock profile in the foundation at Clam Lake. This reduces the probability of hydraulic fracturing of the fill. Without hydraulic fracturing, the overly coarse drain fill gradation has less serious implications.
- The bedrock surface was probably thoroughly cleaned and dental grouted during construction, reducing the likelihood of erosion of earthfill in contact with the bedrock, even with an overly coarse drain fill.
- No seepage with turbid water, either in springs or in water emanating from the drain system at the site, has been noted.
- A reservoir head of over 20 ft has occurred above the only appreciable profile change in the bedrock. This should have been high enough to induce hydraulic fracturing, and no problems occurred.
- Sinkhole development and internal erosion have usually developed in the first few years of reservoir operations, and none have occurred in the 22-yr history of Clam Lake.

Likely Factors

- The broadly graded glacial till embankment soils plot within a band of soils identified as being susceptible to internal erosion.
- Current filter criteria show that the filter gradation used in the blanket and chimney drain zones is too coarse to filter fines from the embankment soils should internal erosion occur.
- The reservoir has not filled rapidly to a high stage in a single event. Although the site has stored water to significant heights during its life, no single event test has occurred. It is impossible to be 100% certain that sinkholes will not develop when previous hydraulic heads of this magnitude have not occurred.
- The reservoir has been empty for long periods. For practical purposes, future fillings are similar to first fillings that have caused problems at other sites.

Sinkhole development at the Clam Lake site during higher pool stages caused by hydraulic fracture of the fill and attendant internal erosion is a remote probability. Even if sinkholes

develop, erosion sufficient to breach the embankment is a remote probability. Because sinkhole development progresses from a downstream exit point upstream, considerable erosion would be required to breach the embankment. The likelihood that the pool would remain at a high enough level to allow an erosion tunnel to reach the pool water is remote. Sherard's study noted that no breaches have occurred subsequent to sinkhole development. While the drain fill in the chimney and blanket drain zones at Clam Lake are too coarse to meet current filter criteria, the likelihood that internal erosion caused by intergranular seepage through the embankment is remote. The perceived problems at Clam Lake do not warrant excavation and replacement of the filter zones. The site should be carefully monitored after storm events that could induce high pool stages. If sinkholes occur near the crest of the dam, and a high pool level exists at the time, emergency action plans should be initiated.

Embankments constructed of broadly graded soils like those at the Clam Lake project pose special evaluation problems. Sites built of broadly graded soils before current filter criteria were applied may have overly coarse drainage zones and should be studied in detail to evaluate potential problems. The potential for hydraulic fracturing is an important factor that should be considered. Another important factor is whether areas of the foundation with potential for significant differential settlement have been exposed to first filling of the reservoir stages. Unless all of the factors likely to cause internal erosion and sinkholes are present, sites with these types of soils are unlikely to develop significant problems.

References

- McCook, D.M. (2000). "Clam Lake Project, Massachusetts," in Three Seepage Case Histories, Dam Safety 2000, the 17th annual conference of the Association of State Dam Safety Officials, September 27–29, 2000, Providence, Rhode Island.
- Sherard, James L. (1979). "Sinkholes in Dams of Coarse, Broadly Graded Soils," Transactions, 13th Congress on Large Dams, Vol. 2, pp. 25–35, New Delhi, India.



FEMA

FEMA P-1032
Catalog No. 15120-2