

STORM WATER POLLUTION PREVENTION PLAN

DUTRA HAYSTACK LANDING ASPHALT FACILITY SONOMA COUNTY, CALIFORNIA (PETALUMA AREA)

PREPARED FOR COMPLIANCE WITH THE
NATIONAL POLLUTANT DISCHARGE ELIMINATION SYSTEM (NPDES)
GENERAL PERMIT FOR STORM WATER DISCHARGES
ASSOCIATED WITH CONSTRUCTION ACTIVITY
WATER QUALITY CONTROL ORDER: 99-08-DWQ

Prepared for:

Dutra Group

2350 Kerner Blvd., Suite 200
San Rafael, California 94901
(415) 258-6873

Prepared by:

CSW/Stuber-Stroeh Engineering Group, Inc.

45 Leveroni Court
Novato, California 94949
(415) 883-9560

Prepared on:

July 29, 2014

TITLE PAGE

PROJECT NAME: Dutra Haystack Landing Asphalt Facility

PROJECT ADDRESS: 3355 Petaluma Boulevard
Petaluma, CA 94952

OWNER: Dutra Group

OWNER=S ADDRESS: 2350 Kerner Blvd., Suite 200
San Rafael, CA 94901

OWNER=S PHONE: (415) 258-6846

CONTRACTORS:

Site Work: Dutra Group

Building Contractor: Dutra Group

WASTE DISCHARGE IDENTIFICATION NO.: TBD

CONTACT: Ross Campbell/Aaron Johnson
Dutra Group
1000 Point San Pedro Road
San Rafael, CA 94901

CONTACT PHONE: (415) 258-6846

EMERGENCY PHONE: Ross Campbell: (415) 720-3984
Aaron Johnson: (415) 721-1391

CERTIFICATION PAGE

OWNER=S CERTIFICATION

Preparer:

I certify under penalty of law that this document and all attachments were prepared under my direction or supervision in accordance with a system designed to assure that qualified personnel properly gather and evaluate the information submitted. Based on my inquiry of the person or persons who manage the system or those persons directly responsible for gathering the information, the information submitted is to the best of my knowledge and belief, true, accurate, and complete. I am aware that there are significant penalties for submitting false information, including the possibility of fine and imprisonment for knowing violations.

Signed: _____

Date: _____

Title: Brian Peer, Project Manager

AMENDMENTS

Amendment No.	Location	Description	Reason	Sections Amended	Amended By	Amendment Date

TABLE OF CONTENTS

- I. Title Page
- II. Certification Page
- III. Amendments
- IV. Table of Contents
- V. Introduction
- VI. Source Identification
 - A. Topography Map
 - B. Site Map
- VII. Narrative Descriptions
 - A. Site Estimates and Description of On-site Soil
 - B. Pollutants Likely to be Present in Storm Water Discharges
 - C. Toxic Materials
 - D. Erosion and Sediment Control Practices
 - E. Non-Storm Water Management
 - F. Maintenance, Inspection and Repair of Structural Controls
 - G. Spill Prevention and Control
 - H. Post-Construction Storm Water Management
 - I. Personnel Training
 - J. List of Contractors / Subcontractors
 - K. Updates
 - L. Other Plans
- VIII. Monitoring
 - A. General Plan Summary
 - B. Site Inspections
 - C. Compliance Certification
 - D. Non-compliance Reporting
 - E. Records

IX Attachments

1. Schedule
2. Training
3. Points of Contact
4. Contractors/Subcontractors
5. Site Inspection Record
6. Notice of Intent

X Plans

- a. Figure 1 - Vicinity Map
- b. EC1 - Erosion Control Plan

INTRODUCTION

The Project is located at 3355 Petaluma Boulevard South in Petaluma, California. The site is located between the Petaluma River and Petaluma Boulevard South in a rectangular shaped lot consisting of approximately 37 acres. The facility will take delivery of aggregate and sand from the existin Shamrock site via a conveyor system over the Barton property, above the railroad tracks, and over the Haystack property. The aggregate will be either processed into a finished asphalt product or sold as virgin aggregate material to the public. Material will be deposited from the conveyor system to stockpiles on the NE side of Area “C” at the proposed facility. See the vicinity map to further describe the Project location, Figure 1 (F1).

In 2005, minor clearing and grubbing of existing vegetation occurred in the SE portion of Area “C” and the Barton property along Petaluma River. Gravel fill was put down to allow for temporary storage of future asphalt plant equipment. Currently, the project area is vacant.

VI. SOURCE IDENTIFICATION

This section provides a geographical description of potential sources that are likely to add significant quantities of pollutants to storm water discharges, or may result in non-storm water discharges from the construction site.

A. TOPOGRAPHY MAP

Figure 1 depicts the project site on a portion of the Petaluma U.S.G.S. quadrangle map.

The area within 1/4 mile of the site has been indicated along with the expected point of discharge to Petaluma River. The existing storm water runoff discharges by sheet flow to a ditch system that eventually drains to the Petaluma River. Waters that could potentially be impacted by onsite pollutants include the Petaluma River and ultimately San Pablo Bay.

B. SITE MAP

The attached plans, EXH-43 and EXH-43b, at a scale of 1"=100' provides greater detail of the storm water controls at the construction site. The following items are shown on the site map:

1. Areas of soil disturbance.
2. Surface water locations.
4. Location of control practices used during construction.
5. Planed paved areas and buildings.
6. Location of post-construction control measures. This includes areas of hydro seeding, drainage structures, etc.

The site contractor will designate the following areas:

1. Areas used to store soils, materials and wastes.
2. Vehicle and equipment storage areas.
3. Concrete truck wash-out areas.

VII. NARRATIVE DESCRIPTIONS

A. SITE ESTIMATES AND DESCRIPTION OF ON-SITE SOIL

Size of Project Site:	35+/- Acres
Size of Disturbed Area:	7.5+/- Acres
Size of Post-Construction Impervious Area:	5.21 Acres

Impervious Area as a Percentage of the Construction Site:

Before Construction: 0.0%
 After Construction: 75.0%

Runoff Coefficient of the Site:

Before Construction: 0.35
 After Construction: 0.40

Onsite Soil:

The onsite soils in the vicinity of the proposed temporary facility consists of Sandy Silt, medium brown, very moist, soft, low plasticity, with approx. 20% fine to medium-grained sand. Additional data is available in the Geotechnical Investigations prepared by Miller Pacific Engineering Group in August 12, 2004.

Adjacent Land Uses:

The Dutra Haystack Landing Asphalt Facility project is bound on the west by Petaluma Boulevard South and Highway 101, and on the east by a commercially zoned area with residences along the bank of the Petaluma River. A recycling facility is also in the vicinity.

B. POLLUTANTS LIKELY TO BE PRESENT IN STORM WATER DISCHARGES

POLLUTANT	SOURCE
<p><u>Petroleum Products</u></p> <p>Diesel, Asphaltic Oil, No.2 Fuel Oil, Gear Lube, Motor Oil, Waste Oil, Used Oil Filters and Grease</p> <p>Asphalt</p> <p>Gravel, Construction Aggregate</p>	<p>Trucks and vehicles.</p> <p>N/A</p> <p>Repair to existing roadway</p>
<p><u>Lime and Sodas</u></p> <p>Concrete</p>	<p>N/A</p>

POLLUTANT	SOURCE
<u>Metals</u>	N/A
<u>Chlorinated Solvents</u>	N/A
<u>Other Organic Compounds</u>	N/A
Pesticides	N/A
Herbicides	N/A
<u>Sedimentation</u>	Disturbance to existing vegetation
<u>Trash</u>	N/A

C. TOXIC MATERIALS

Not Applicable

D. EROSION AND SEDIMENT CONTROL PRACTICES

1. General Practices

§ **Straw Bale Dikes:** Placed as backup to silt fence, and appropriate points where more weight than standard fiber roll is required.

§ **Fiber Rolls:** Placed along contours in graded areas on the uphill side of all silt fences.

§ **Water Conservation:** Water for construction purposes is to be trucked in.

2. Soil Stabilization Practices

The following soil stabilization practices will be used to preserve existing vegetation and to re-vegetate open graded areas on the construction site. The practices will be installed by the Contractor in accordance with the schedule provided below and with the attached plans. Also refer to the *Erosion and Sediment Control Field Manual*, Pages 37 to 43.

§ **Silt Fences:** Black synthetic construction fencing will be installed around all designated wetland areas to prevent sediment runoff from disturbed soils into water courses.

§ **Hydro mulching:** Primarily used as a temporary or permanent measure for stabilizing disturbed areas. Evenly apply straw mulch over the site and stabilize the mulch in place with tackifier.

3. Practices to Reduce the Tracking of Sediment onto Public and Private Roads

The following control practices will be employed to reduce the tracking of sediment onto public and private roads. These practices will help prevent the deposition of sediments into local storm drains. The production of air-borne dust is addressed in the next Section. Also see the attached plans and the *Erosion and Sediment Control Field Manual*, Pages 51 to 52.

§ **Stabilized Construction Entrance:** Driveway paving will be installed at the project entrance by no later than *October 1, 2005*, thus providing an effective means of minimizing the tracking of mud and dirt onto public roads by construction vehicles. Where the existing road meets new pavement, a stabilized construction entrance will be created per the detail in the Erosion Control Drawings.

4. Wind Erosion

The following BMPs will generally stabilize the exposed surfaces and thereby minimize suspended or tracked dust particles. See the *Erosion and Sediment Control Field Manual*, Pages 45 to 49, for additional information.

§ **Dust Control:** The principal construction phase deterrent to wind erosion is the spraying of water onto dirt surfaces in order to adhere soil particles and minimize wind transport and loss. The Contractor will spray water from a mobile tank truck with mounted sprinkler, applying water at non-erosive rates to avoid causing any runoff. This practice is typically discontinued during the rainy season, except during extended periods of dry weather. It is applied in areas where vehicles are tracking, such as future streets, roads, and driveways.

If the need arises because of extreme winds, other methods will be used to control dust such as tarps or other blanket materials to protect graded areas or stockpiles from wind exposure. In order to stabilize blanket materials place heavy objects like rocks on the corners.

Other methods for stabilizing exposed dirt are the establishment of temporary or permanent vegetation, and the installation of impervious surfaces, such as paving and gutters.

- § **Sweeping:** The following BMP will serve to remove sediments from hard surfaces within and adjacent to the site. This BMP is applicable on a year-round basis, as long as traffic is entering and leaving the site.

The Contractor will periodically sweep paved areas to remove dirt and debris from the pavement. Onsite sweeping will occur in areas where vehicular traffic is entering from unpaved areas to paved areas. These areas will be swept before each significant predicted rain event, and periodically, as needed, during extended dry periods. Sweeping equipment must have a collector system to avoid depositing debris in the storm drain system. Collected debris may be deposited into areas of open soil, as long as the debris consists mainly of soil material. Otherwise, the collected debris will be disposed of with trash.

5. Practices to Minimize Contact with Storm Water

The following BMPs will serve to minimize contact of construction vehicles, equipment, and materials with storm water. For additional information, refer to the *Erosion and Sediment Control Field Manual*, Pages 97-99. The site map indicates the location of the on-site fueling area.

- § **Vehicle and Equipment Service:** In order to prevent and control leaks from equipment and vehicles and to minimize to possibility of toxic pollutant discharge, the following have been implemented:

- < No major maintenance/repair for equipment/vehicles is allowed inside the site. Equipment/vehicles that need maintenance are transported off site.
- < For minor equipment maintenance, drip pans and drip cloths will be used if it is necessary to drain and replace fluids on-site.
- < Onsite vehicles and equipment will be inspected regularly for leaks and, if necessary, will be repaired immediately.
- < Segregate and recycle wastes, such as greases, used oil or oil filters, antifreeze, cleaning solutions, hydraulic and transmission fluids.
- < No onsite fuel storage tanks will be allowed.
- < No vehicle or equipment washing will occur on-site.

§ **Material Delivery, Handling and Storage:** Small fuel tanks, chainsaw gas, waterproofing, epoxy, mortar, sacks of cement, form release agents, detergents, concrete compounds and glues, are not anticipated to be needed for this project.

6. Construction Material Loading and Unloading

§ Loading and unloading areas for the stockpiles and asphalt facility are designated on the attached plans. Loading and unloading areas are located away from storm drains, to limit the possibility of contaminating runoff through accidental spills.

7. Waste Management and Disposal

The following BMPs will provide techniques for waste disposal practices that will reduce or prevent the discharge of pollutants to storm water. Where applicable, the BMPs are shown on the attached plans, and are also described in the *Erosion and Sediment Control Field Manual*, Pages 91 to 111.

§ **Handling and Disposal of Concrete and Cement:** The following practices have or will be implemented to eliminate discharges to gutters, storm drains, and watercourses:

< No concrete work is anticipated as part of this work.

§ **Sanitary/Septic Waste Management:** Portable toilets are currently being leased from a licensed company that has a waste disposal permit. Units are services regularly as needed. Facilities are inspected for leaks on a weekly basis. Post construction a facility will be provided to employees in the Controller trailer.

§ **Solid Waste Management:** No on-going activity will occur under the current work.

8. Preconstruction Control Practices

Preconstruction practices which were aimed at reducing sediment and other pollutants in storm water discharges included: site design to avoid import and export dirt to and from areas away from site, establishment of a temporary stabilized construction entrance to minimize excess dirt from entering Petaluma Boulevard South.

9. Schedule

See Temporary Timeline following Figure 1 - Vicinity Map.

E. NON-STORM WATER MANAGEMENT

The General Permit prohibits the discharge of non-storm water liquid and waste, with the exception of certain authorized non-storm water discharges. These discharges include irrigation of vegetation and erosion control measures, pipe flushing and testing, street cleaning and water sprayed for dust control, and de-watering of excavations. These discharges must meet the following conditions:

- § Discharged water must be necessary for the performance and completion of the project;
- § The discharge is infeasible to eliminate;
- § The discharge complies with BMPs as described below; and,
- § The discharge does not cause or contribute to a violation of water quality standards.

The following BMPs will be utilized to limit and control non-storm water discharges at the temporary asphalt facility. In no case may polluted water be discharged to the Petaluma River.

- § Minimize risk of causing pollution from non-storm water discharges by avoiding any such discharges and by ensuring there are sediment control measures installed between the location of discharge and the location of entry into the storm drain or creek system.
- § Conserve water by minimizing the amounts of water used for dust control.
- § Clean streets by sweeping rather than by washing, where possible; using only the minimum water necessary to control dust.
- § Locate non-storm water discharges so they will not flow over areas of disturbed soil, potentially causing erosion.
- § One-time discharges shall be monitored during the time that such discharges are occurring. The Superintendent or a designated, qualified person, will ensure that no materials are discharged in quantities which will have an adverse effect on storm drain systems or the Petaluma River.
- § Chlorinated water used to disinfect water pipes may not be discharged to the storm water system. All chlorinated water shall be discharged to the sanitary sewer system or otherwise properly disposed of off-site.

F. MAINTENANCE, INSPECTION AND REPAIR OF STRUCTURAL CONTROLS

Structural controls require on-going inspection, maintenance and repair. Inspections will be performed in accordance with the procedures described in Paragraph VIII.B of this SWPPP. Maintenance and repair shall be conducted as required, and as determined by the inspections. Refer to pages 116-118 of the *Erosion and Sediment Control Field Manual* for more information.

The Contractor must also be prepared to respond to any failure of the structural controls. The Site Superintendent will be responsible for inspection, maintenance and repair procedures. Emergency contacts are listed in the attachment. The following materials will be maintained on-site in sufficient quantities to immediately rectify any problems:

- § Fiber rolls with pickets or spikes;
- § Silt Fences with pickets;
- § Construction entrance.

G. SPILL PREVENTION AND CONTROL

This section describes measures to prevent, control and clean-up spills. Clean up of spills should be immediate, automatic and routine. A trained staff member, or a licensed cleaning company should perform the clean up. Emergency contact numbers are listed in the attachment. For more information refer to pages 95-96 of the *Erosion and Sediment Control Field Manual*.

1. Minor Spills

Minor spills are likely to be controlled by on-site personnel. After contacting local emergency response agencies, the following actions should occur upon discovery of a minor spill:

- § Contain the spread of the spill.
- § If the spill occurs on paved or impermeable surfaces, clean-up using Adry@ methods (i.e., absorbent materials, cat litter and/or rags).
- § If the spill occurs in dirt areas, immediately contain the spill by constructing an earthen dike. Dig up and properly dispose of contaminated soil.
- § If the spill occurs during rain, cover the impacted area to avoid runoff.
- § Record all steps taken to report, contain, and clean-up the spill.

2. Major Spills

Major spills are unlikely to be controlled by on-site personnel. On-site personnel should not attempt to control major spills until the appropriate and qualified emergency response staff has arrived at the site. In addition to local authorities, notify the State Office of Emergency Services (OES) at (800) 852-7550. For spills of federal reportable quantities, also notify the National Response Center at (800) 424-8802. A written report should be sent to all notified authorities.

H. POST-CONSTRUCTION STORM WATER MANAGEMENT

This section describes the control practices utilized to reduce pollutants in storm water discharges after all construction phases are complete. These control practices are primarily related to the design of the project, as opposed to the structural controls used during the construction phase. At the Haystack Landing asphalt facility post construction control practices will be maintained by the Owner.

I. PERSONNEL TRAINING

All contractors and sub-contractors, superintendents and foremen will be trained on the prevention of storm water pollution and the implementation of the SWPPP. Initial training will occur prior to the start of each trades= construction at the site, and will continue and be reinforced at the weekly Superintendent=s safety meetings.

Documentation of formal training is included in the attachment.

J. LIST OF CONTRACTORS / SUBCONTRACTORS

A list of all contractors and subcontractors responsible for implementing the SWPPP is included at the attachment. The information provided includes the company=s name, address and telephone number, along with a contact name and telephone number. This list will be maintained and updated on-site as appropriate.

K. SWPPP UPDATES

The discharger shall amend this SWPPP whenever there is a change in construction or operations which may affect the discharge of significant quantities of pollutants to the Petaluma River or ground waters. This SWPPP must also be amended if the measures described herein are not achieving the general objectives of reducing pollutants in storm water discharges. The Regional Water Quality Control Board or the County of Sonoma may also require the discharger to amend this SWPPP.

All amendments shall be numbered and listed on the Amendment Page, and acknowledged by signature thereon. For each amendment entered on the Amendment Page, include a brief amendment description, describing as appropriate the location, reason for change, and modifications involved. The attached Erosion Control Sheet, X, , provides a grid system for identifying locations within the project site.

Amendments are expected to occur as needed, and will be entered free-hand on this document. For example, the individual erosion control plans for the site based on the current site status and current schedule. Over the course of the winter, the schedule may change and, in turn, this SWPPP will change accordingly. These changes can be entered on the SWPPP by felt-tip pen, free-hand, and recorded as an amendment in the blank space on the third page of the Plan. Formal written amendments may also be issued, as needed, and will be recorded in the same manner.

L. OTHER PLANS

- § Storm Water Pollution Prevention Plan with Monitoring Program and Reporting Requirements for the Dutra Haystack Landing Asphalt Facility, prepared by CSW/Stuber-Stroeh Engineering Group, Inc., October 2005.
- § Erosion and Sediment Control Field Manual, prepared by The California Regional Water Quality Control Board, San Francisco Bay Region, 2002.
- § Included by reference are all construction plans, drawings and maps for the Dutra Haystack Landing Asphalt project.

VIII. MONITORING

A. GENERAL SUMMARY

Under the General Permit, all dischargers are required to conduct inspections of the construction site prior to anticipated storm events and after actual storm events. During extended storm events, inspections must be made during each 24-hour period. The goals of these inspections are:

1. To identify areas contributing to storm water discharge;
2. To evaluate whether measures to reduce pollutant loadings identified in the SWPPP are adequate and properly installed and functioning in accordance with the terms of the General Permit; and,
3. Whether additional control practices or corrective maintenance activities are needed.

Equipment, materials and workers must be available for rapid response to failures and emergencies as described above. All corrective maintenance to BMP=s shall be

performed as soon as possible, allowing for appropriate worker safety. Also refer to the *Erosion and Sediment Control Field Manual*, Pages 119 to 122, for additional information.

B. SITE INSPECTIONS

The Superintendent or his designated representative will conduct a site inspection before each anticipated storm event, after each actual storm event, and at least once every 24-hours during extended storm events. The name and contact number of the assigned inspection personnel is listed in the attachment. (To be provided by the Project Superintendent.)

Pre-storm inspections are to ensure that BMPs are properly installed and maintained.

Post-storm inspections are to assure that the BMPs have functioned adequately. Each inspection shall include all structural and non-structural BMPs installed at the site. Each inspection shall evaluate existing BMPs for adequacy and proper implementation, and shall evaluate whether additional BMPs are required to maintain compliance with the terms of the General Permit.

Each site inspection shall be recorded using the form provided in the attachment. If all BMPs are in place, properly maintained, and properly functioning, then the Inspection Report shall be completed indicating the same. Otherwise, the Inspection Report shall include the locations and nature of any corrective measures taken. *A grid system is provided on the enclosed Plan Sheet EC1 to assist in identifying the location of BMPs for the Report.* These Inspection Reports shall be maintained on-site in accordance with Paragraph E, below.

C. COMPLIANCE CERTIFICATION

The Owner is required to submit an Annual Certification that construction activities at Dutra Haystack Landing Asphalt Facility are in compliance with the requirements of the General Permit and this SWPPP. This certification will be based in part upon the site inspections described above. Certification must be completed by July 1st of each year, and submitted no later than August 31st of each year, or as requested by the Regional Board. The Regional Board will provide a form and format for the Annual Certification.

D. NON-COMPLIANCE REPORTING

The Owner=s Representative shall report any instances of non-compliance with the terms of the General Permit and this SWPPP to the Regional Water Quality Control Board. Non-compliance would include such actions as accidental spills or failures of structural controls. Corrective measures shall be implemented immediately following discovery that water quality standards may have been compromised. The

notification shall be submitted to the Regional Board within thirty days. The notification shall identify the non-compliance event, including an initial assessment of any impact cause by the event; describe the actions necessary to achieve compliance; and include a time schedule (subject to modifications by the Regional Water Quality Control Board) indicating when compliance will be achieved.

E. RECORDS

Records of all inspections, Compliance Certifications, and Non-Compliance Reporting must be retained for a period of at least three (3) years from the date generated. With the exception of Non-Compliance Reporting, the Owner is not required to submit these records to the Regional Board. Upon completion of the project=s construction and termination of coverage under the General Permit, all records shall be retained by the Owner with a copy of the final SWPPP.

IX. TERMINATION

A. TRANSFERS

Coverage under the General Permit is non-transferable. A new owner of an on-going construction activity must submit a new NOI in accordance with the requirements of the General Permit to be authorized to discharge under the General Permit. An owner who sells property covered by the General Permit shall inform the new owner of the duty to file an NOI and shall provide the new owner with a copy of this SWPPP.

B. TERMINATION OF COVERAGE

The Owner may terminate coverage for a portion of the Dutra Haystack Landing Asphalt Facility Project under the General Permit when ownership of a portion of the project has been transferred, or when a phase of the project has been completed. To terminate coverage for a portion of the project, the Owner must submit a Change of Information form (COI) with a revised site map that clearly identifies the newly delineated site.

To terminate coverage under the General Permit for a complete project, the Owner must submit to the Regional Water Quality Control Board a Notice of Termination form (NOT). The construction project is considered complete only when the following conditions have been met:

- § There is no further potential for construction related storm water pollution;
- § All elements of the SWPPP have been completed;
- § Construction materials and waste have been disposed of properly;

- § The site is in compliance with all local storm water management requirements; and,
- § All disturbed areas of the construction site have been stabilized.

Final stabilization has occurred when all soil disturbing activities are completed and either a uniform vegetative cover with 70% coverage has been established, or equivalent stabilization measures have been employed. Equivalent stabilization measures include the use of such BMPs as erosion control blankets, reinforced channel liners, or other erosion resistant soil coverings or treatments.

CONSTRUCTION SCHEDULE

Actual versus targeted progress will be monitored routinely and corrective actions will be taken by the Project Superintendent to ensure that the above schedule is met.

A graphic schedule covering paving activities is attached.

POINTS OF CONTACT

Agencies:

Bay Area Regional Water Quality Control Board
Hossain Kazemi (510) 622-2300

Sonoma County Permit and Resource Management Department
Ken Ellison (707) 565-1928

Owner:

Owner=s Representative: Dutra Group
Ross Campbell (415) 720-3984

CSW/Stuber-Stroeh Engineering Group, Inc.
Al Cornwell (415) 892-4763

Contractor:

Dutra Group
Ross Campbell: (415) 720-3984
Aaron Johnson: (415) 721-1391

Other Contractors:

CONTRACTORS / SUBCONTRACTORS
Company Names, Contact Names and Telephone Numbers

This list is to be updated by Owner=s Rep / Contractor as required.

PRE-STORM & POST-STORM INSPECTION REPORT

TYPE OF INSPECTION	LOCATION OR COORDINATE	BMP=S IMPLEMENTED	STATUS	ACTIONS TAKEN	WEATHER CONDITIONS	DATE AND TIME OF INSP.	INSP. BY
G Before Rainfall G During Rainfall G After Rainfall	G Street G Lots _____	G Silt Fence G Fiber Rolls G Gravel Bags G Mulch _____	G Good G Marginal G Unacceptable _____		G Clear G Cloudy G Rainy _____		
G Before Rainfall G During Rainfall G After Rainfall	G Street G Lots _____	G Silt Fence G Fiber Rolls G Gravel Bags G Mulch _____	G Good G Marginal G Unacceptable _____		G Clear G Cloudy G Rainy _____		
G Before Rainfall G During Rainfall G After Rainfall	G Street G Lots _____	G Silt Fence G Fiber Rolls G Gravel Bags G Mulch _____	G Good G Marginal G Unacceptable _____		G Clear G Cloudy G Rainy _____		
G Before Rainfall G During Rainfall G After Rainfall	G Street G Lots _____	G Silt Fence G Fiber Rolls G Gravel Bags G Mulch _____	G Good G Marginal G Unacceptable _____		G Clear G Cloudy G Rainy _____		
G Before Rainfall G During Rainfall G After Rainfall	G Street G Lots _____	G Silt Fence G Fiber Rolls G Gravel Bags G Mulch _____	G Good G Marginal G Unacceptable _____		G Clear G Cloudy G Rainy _____		

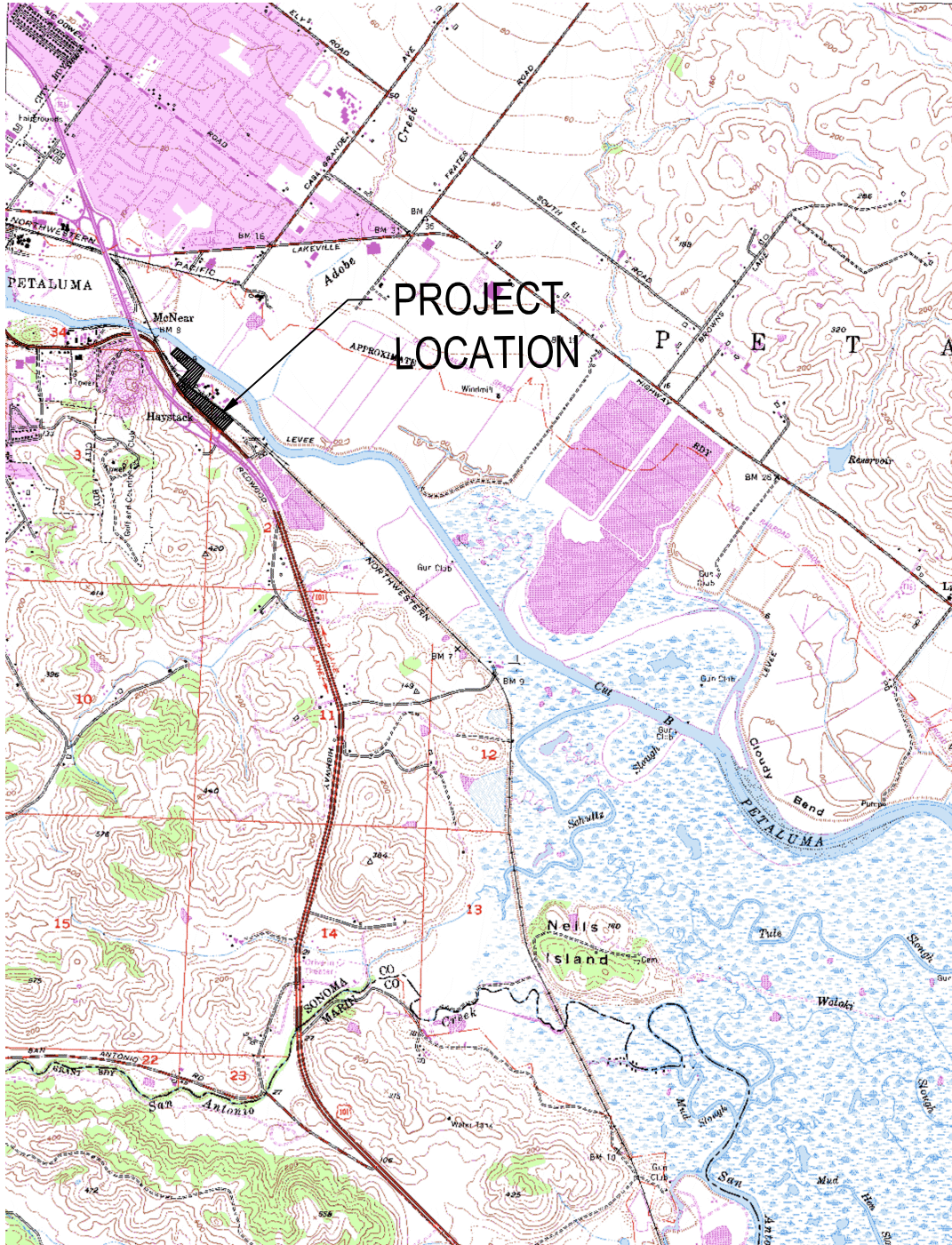

CSW ST2

CSW/Stuber-Stroeh Engineering Group, Inc.
 Civil & Structural Engineers | Surveying & Mapping | Environmental Planning
 Land Planning | Construction Management | Landscape Architecture
 45 Leveroni Court tel: 415.883.9850
 Novato, CA 94949 fax: 415.883.9835

© 2008

Rev. X

Job No. 591302

Date: 04-14-11

Scale: nts















DUTRA HAYSTACK ASPHALT FACILITY USGS MAP OVERALL SITE PLAN

SONOMA

FIGURE 1

CALIFORNIA

EROSION CONTROL LEGEND

- EXISTING
-  CONSTRUCTION FENCING
 -  FIBER ROLLS
 -  SILT FENCING
 -  SWALE OR DITCH
 -  CONSTRUCTION ENTRANCE
 -  PERMANENT 3-STEP HYDROSEED
 -  STRAW AND TACKIFIER
 -  DIRECTION OF FLOW OR SLOPE
 -  EXISTING DIRECTION OF FLOW OR SLOPE
 -  CONCRETE WASHDOWN AREA
 -  DELIVERY AREA
 -  NON HAZARDOUS STORAGE
 -  STORM INLET PROTECTION
 -  PORTABLE TOILET WITH LINER

-  TIRE WASH
-  VEHICLE FUEL STORAGE

NOTES:

- THESE FEATURES SHALL REMAIN IN PLACE UNTIL FINAL STABILIZATION IS DETERMINED BY THE QSP.
- CONTRACTOR SHALL APPLY LINEAR SEDIMENT CONTROLS ALONG THE TOE SLOPE, FACE OF SLOPE AND AT THE GRADE BREAKS OF EXPOSED SLOPES TO COMPLY WITH THE FOLLOWING SHEET FLOW LENGTH CATEGORIZED BY SLOPE PERCENTAGE:

SLOPE PERCENTAGE	SHEET FLOW LENGTH NOT TO EXCEED
0-25%	20 FEET
25-50%	15 FEET
OVER 50%	10 FEET

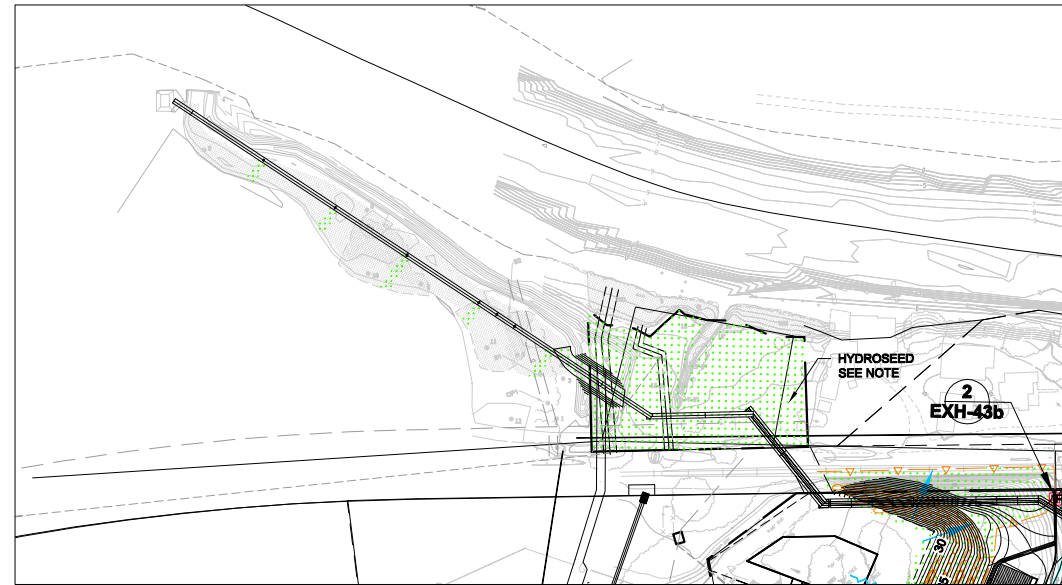

LANDING WAY WETLAND

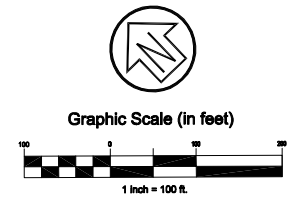
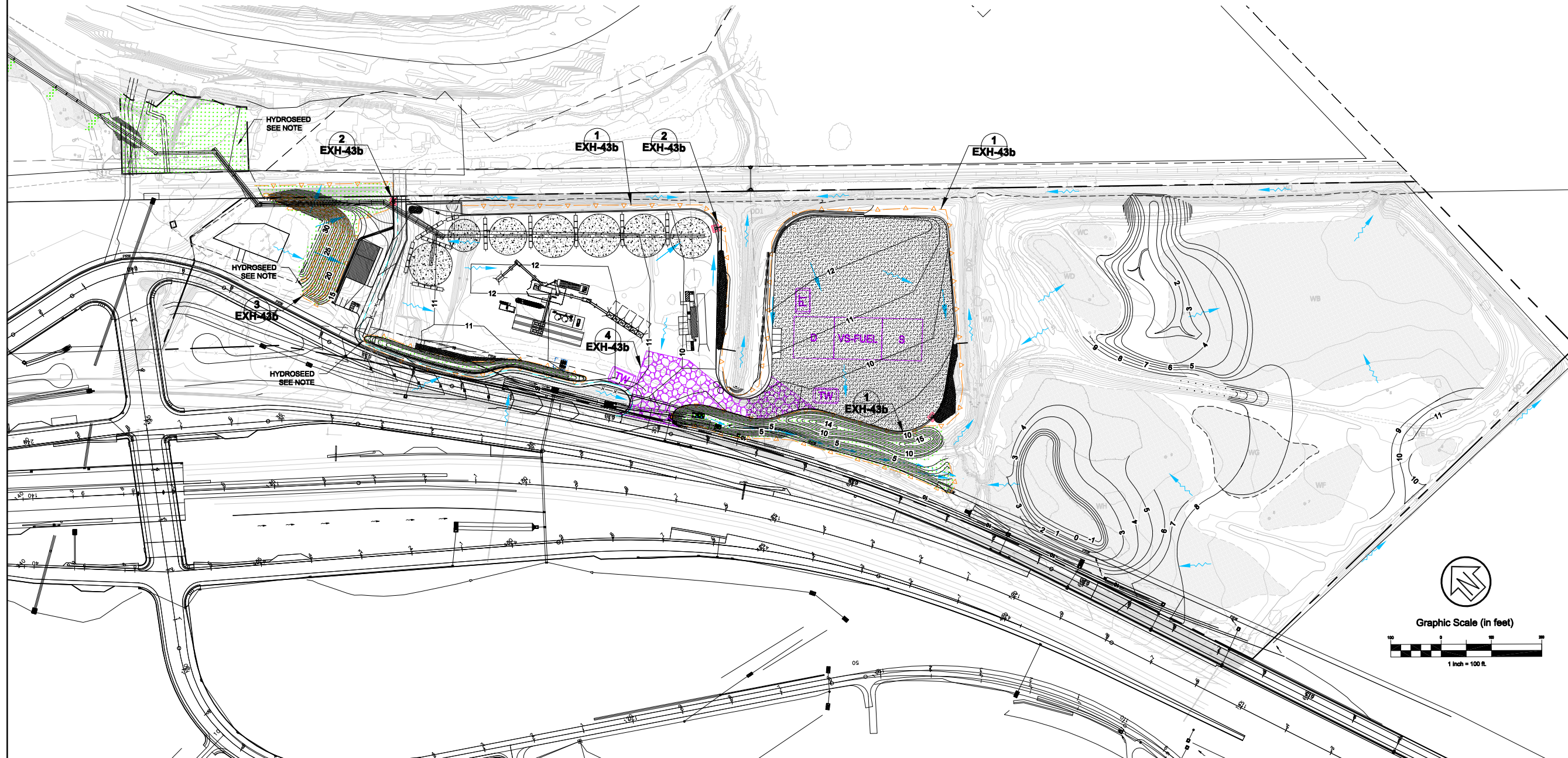

CSW ST 2

CSW/Stuber-Stroeh
Engineering Group, Inc.
45 Leveroni Court
Novato, CA 94949
tel: 415.883.9850
fax: 415.883.9855

Civil & Structural Engineers
Surveying & Mapping
Environmental Planning
Land Planning
Construction Management
Landscape Architecture

© 2008

Rev	Date	Description	Designed	Drawn	Checked
1	2013-12-11	ADDITIONAL REVISION BASED ON JULY 23, 2012	RSW	RSW	AGC
			RSW	RSW	AGC

DUTRA HAYSTACK LANDING
AND PORTION OF LANDING WAY
PRELIMINARY EROSION CONTROL PLAN
DUTRA GROUP

City Of
County Of
Sonoma
State Of
California

Prepared Under the Direction of:

Sheet
EXH-43

Scale: 1" = 100'
Date: 05-08-12
File: 591302-C3D
Plan File: D-4862

P:\2013\0508\0508_2013\EROSION CONTROL PLAN\EROSION CONTROL PLAN.dwg, 11/23/14, 4:00 PM, agc, 1/23/15

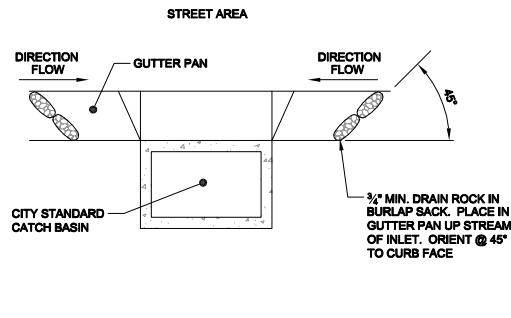

5 GRAVEL BAG FILTER AT GUTTER IN TRAFFIC AREAS
SCALE: NTS

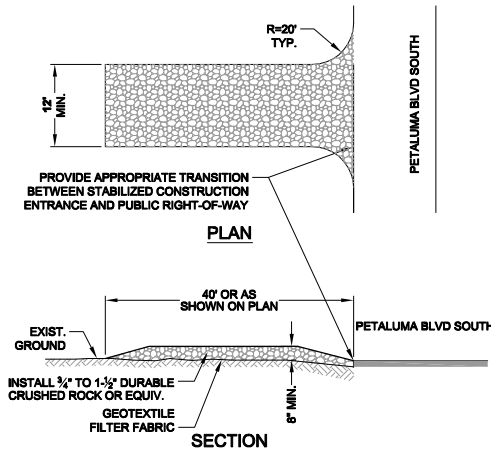

4 TEMPORARY STABILIZED CONSTRUCTION ENTRANCE
SCALE: NTS

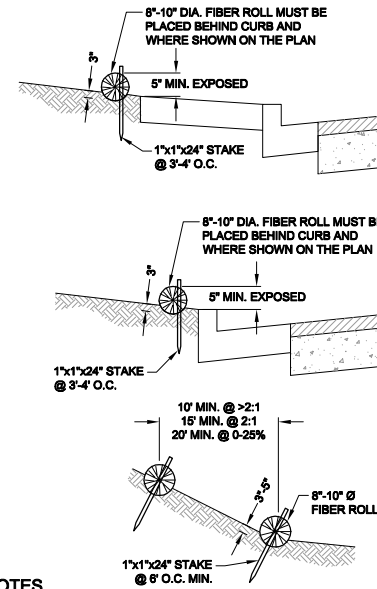

3 FIBER ROLL INSTALLATION DETAILS
SCALE: NTS

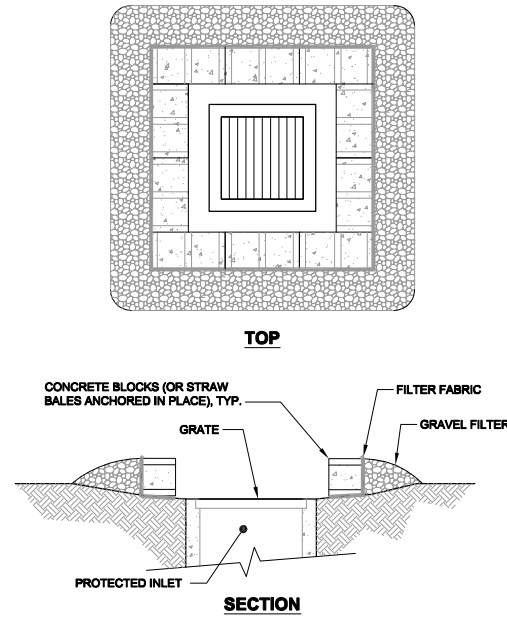

2 INLET PROTECTION DETAIL
SCALE: NTS

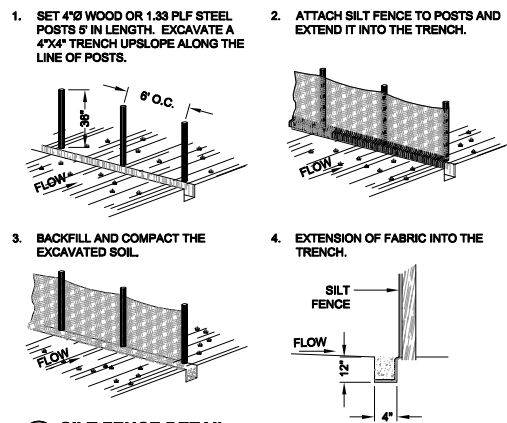

1 SILT FENCE DETAIL
SCALE: NTS

EROSION PREVENTION AND SEDIMENT CONTROL NOTES:

- PERFORM EROSION PREVENTION AND SEDIMENT CONTROL IN ACCORDANCE WITH THE LATEST EDITION OF APPENDIX CHAPTER 33 OF THE CALIFORNIA BUILDING CODE, APPLICABLE SONOMA COUNTY REGULATIONS, A SECTION 20 OF THE CALTRANS STANDARD SPECIFICATIONS.
- THE APPROVED PLANS SHALL CONFORM TO THE EROSION PREVENTION AND SEDIMENT CONTROL BEST MANAGEMENT PRACTICES CONTAINED IN THE LATEST EDITIONS OF THE FOLLOWING PUBLICATIONS OR AN EQUIVALENT BEST MANAGEMENT PRACTICE:
EROSION AND SEDIMENT CONTROL FIELD MANUAL BY THE SAN FRANCISCO BAY REGIONAL WATER QUALITY CONTROL BOARD;
MANUAL OF STANDARDS FOR EROSION AND SEDIMENT CONTROL MEASURES BY THE ASSOCIATION OF BAY AREA GOVERNMENTS;
CONSTRUCTION SITE BEST MANAGEMENT PRACTICES MANUAL BY CALTRANS;
STORMWATER BEST MANAGEMENT PRACTICE HANDBOOK BY THE CALIFORNIA STORMWATER QUALITY ASSOCIATION;
- IF DISCREPANCIES OCCUR BETWEEN THESE NOTES, MATERIAL REFERENCED HERE OR MANUFACTURER'S RECOMMENDATIONS, THEN THE MOST PROTECTIVE SHALL APPLY.
- THE OWNER IS RESPONSIBLE FOR OBTAINING AND COMPLYING WITH THE NATIONAL POLLUTANT DISCHARGE ELIMINATION SYSTEM (NPDES) GENERAL PERMIT NO. CAS000002 WASTE DISCHARGE REQUIREMENTS FOR DISCHARGES OF STORM WATER RUNOFF ASSOCIATED WITH CONSTRUCTION ACTIVITY DISTURBING LAND EQUAL TO OR GREATER THAN ONE ACRE. CONSTRUCTION ACTIVITIES INCLUDE, BUT ARE NOT LIMITED TO CLEARING, GRADING, EXCAVATION, STOCKPILING, AND RECONSTRUCTION OF EXISTING FACILITIES INVOLVING REMOVAL AND REPLACEMENT.
- PRESERVATION OF EXISTING VEGETATION SHALL OCCUR TO THE MAXIMUM EXTENT PRACTICABLE OUTSIDE LIMITS OF GRADING.
- THE OWNER IS RESPONSIBLE FOR PREVENTING STORM WATER POLLUTION GENERATED FROM THE CONSTRUCTION SITE YEAR ROUND. THE OWNER MUST IMPLEMENT AN EFFECTIVE COMBINATION OF EROSION PREVENTION AND SEDIMENT CONTROL ON ALL DISTURBED AREAS DURING THE RAINY SEASON (OCTOBER 15 - APRIL 15).
- EROSION PREVENTION AND SEDIMENT CONTROL MEASURES SHALL BE INSPECTED BY THE OWNER AND THE CONTRACTOR BEFORE FORECASTED STORM EVENTS AND AFTER ACTUAL STORM EVENTS TO ENSURE MEASURES ARE FUNCTIONING PROPERLY. STORM EVENTS PRODUCE AT LEAST 1 INCH OF PRECIPITATION IN A 24 HOUR PERIOD. EROSION PREVENTION AND SEDIMENT CONTROL MEASURES THAT HAVE FAILED OR ARE NO LONGER EFFECTIVE SHALL BE PROMPTLY REPLACED. EROSION PREVENTION AND SEDIMENT CONTROL MEASURES SHALL BE MAINTAINED UNTIL DISTURBED AREAS ARE STABILIZED.
- CHANGES TO THE EROSION PREVENTION AND SEDIMENT CONTROL PLAN MAY BE MADE TO RESPOND TO FIELD CONDITIONS. CHANGES SHALL BE NOTED ON THE PLAN WHEN MADE.
- DISCHARGES OF POTENTIAL POLLUTANTS FROM CONSTRUCTION SITES SHALL BE PREVENTED USING SOURCE CONTROLS TO THE MAXIMUM EXTENT PRACTICABLE. POTENTIAL POLLUTANTS INCLUDE, BUT ARE NOT LIMITED TO: SEDIMENT, TRASH, NUTRIENTS, PATHOGENS, PETROLEUM HYDROCARBONS, METALS, CONCRETE, CEMENT, ASPHALT, LIME, PAINT, STAINS, GLUES, WOOD PRODUCTS, PESTICIDES, HERBICIDES, CHEMICALS, HAZARDOUS WASTE, SANITARY WASTE, VEHICLE OR EQUIPMENT WASH WATER AND CHLORINATED WATER.
- ENTRANCE(S) TO THE CONSTRUCTION SITE SHALL BE MAINTAINED IN A CONDITION THAT WILL PREVENT TRACKING OR FLOWING OF POTENTIAL POLLUTANTS OFFSITE. POTENTIAL POLLUTANTS DEPOSITED ON PAVED AREAS WITHIN THE COUNTY RIGHT-OF-WAY, SUCH AS ROADWAYS AND SIDEWALKS, SHALL BE PROPERLY DISPOSED OF AT THE END OF EACH WORKING DAY OR MORE FREQUENTLY, AS NECESSARY.
- EXPOSED SLOPES SHALL BE PROTECTED BY USING EROSION PREVENTION MEASURES TO THE MAXIMUM EXTENT PRACTICABLE, SUCH AS ESTABLISHING 70% VEGETATION COVER, HYDROSEEDING, STRAW MULCH, GEOTEXTILES, PLASTIC COVERS, BLANKETS OR MATS.
- WHENEVER IT IS NOT POSSIBLE TO UTILIZE EROSION PREVENTION MEASURES, EXPOSED SLOPES SHALL EMPLOY SEDIMENT CONTROL DEVICES, SUCH AS FIBER ROLLS AND SILT FENCES. FIBER ROLLS AND SILT FENCES SHALL BE TRENCHED AND KEYED INTO THE SOIL AND INSTALLED ON CONTOUR. SILT FENCES SHALL BE INSTALLED APPROXIMATELY 2 TO 5 FEET FROM TOE OF SLOPE.

- HYDROSEEDING SHALL BE CONDUCTED IN A THREE STEP PROCESS. FIRST, EVENLY APPLY SEED MIX AND FERTILIZER TO THE EXPOSED SLOPE. SECOND, EVENLY APPLY MULCH OVER THE SEED AND FERTILIZER. THIRD, STABILIZE THE MULCH IN PLACE. APPLICATIONS SHALL BE BROADCASTED MECHANICALLY OR MANUALLY AT THE RATES SPECIFIED BELOW. SEED MIX AND FERTILIZER SHALL BE WORKED INTO THE SOIL BY ROLLING OR TAMPING. IF STRAW IS USED AS MULCH, STRAW SHALL BE DERIVED FROM WHEAT, RICE OR BARLEY AND BE APPROXIMATELY 6 TO 8 INCHES IN LENGTH. STABILIZATION OF MULCH SHALL BE DONE HYDRAULICALLY BY APPLYING AN EMULSION OR MECHANICALLY BY CRIMPING OR PUNCHING THE MULCH INTO THE SOIL. EQUIVALENT METHODS AND MATERIALS MAY BE USED ONLY IF THEY ADEQUATELY PROMOTE VEGETATION GROWTH AND PROTECT EXPOSED SLOPES.

HYDROSEEDING MIX	SEED TYPE	SEEDING RATE (POUNDS PER ACRE, LBS/ACRE)
BELOW ORDINARY HIGH WATER MARK:	UMBRELLA SEDGE	5.0
	CREeping SPIKERUSH	15.0
	CALIFORNIA LOOSESTRIPE	5.0
	OLNEY'S BULRUSH	5.0
	BROAD-LEAF CATTAIL	5.0
ABOVE ORDINARY HIGH WATER MARK:	BROAD-LEAF WATER-PLANTAIN	5.0
	CALIFORNIA BROME	12.5
	MEADOW BARLEY	10
	CREeping WILD RYE	5.0
	CALIFORNIA POPPY	2.5
	SKY LUPINE	4.0
	WHITE YARROW	0.5

- SEED MIX SHALL BE APPLIED AT A MINIMUM RATE OF 42 POUNDS PER ACRE.
 - NATIVE GRASS SEED SHALL BE FROM GENETIC STOCK DERIVED FROM THE REGION OF THE PROJECT SITE.
 - FERTILIZER SHALL BE 7-2-1 BOISOL MIX OR EQUAL AND APPLIED AT A RATE OF 1000 POUNDS PER ACRE.
 - JUTE MATTING AND/OR STRAW SHALL BE PLACED OVER HYDROSEED MIX TO PREVENT WINTER EROSION. THE STRAW SHALL BE APPLIED AT A RATE OF TWO TONS PER ACRE.
 - FOLLOWING THE SPREADING OF STRAW, AN ORGANIC TACKIFIER SUCH AS M-BINDER SHALL BE SPRAYED OVER THE STRAW USING THE TECHNIQUES AND APPLICATION RATE SPECIFIED BY THE MANUFACTURER
- THE OWNER SHALL PROTECT STORM DRAIN INLETS FROM POTENTIAL POLLUTANTS UNTIL DRAINAGE CONVEYANCE SYSTEMS ARE FUNCTIONAL AND CONSTRUCTION HAS BEEN COMPLETED.
 - ENERGY DISSIPATORS SHALL BE INSTALLED AT STORM DRAIN OUTLETS WHICH MAY CONVEY STORM WATER FLOW LEADING TO SOIL EROSION.
 - SOIL AND MATERIAL STOCKPILES SHALL BE PROPERTY PROTECTED TO MINIMIZE SEDIMENT AND POLLUTANT TRANSPORT FROM THE CONSTRUCTION SITE.
 - SOLID WASTE, SUCH AS TRASH, DISCARDED BUILDING MATERIALS AND DEBRIS, SHALL BE PLACED IN DESIGNATED COLLECTION AREAS OR CONTAINERS. THE CONSTRUCTION SITE SHALL BE CLEARED OF SOLID WASTE DAILY, OR AS NECESSARY, AND REGULAR REMOVAL AND PROPER DISPOSAL SHALL BE ARRANGED.
 - A CONCRETE WASHOUT AREA, SUCH AS A TEMPORARY PIT, SHALL BE DESIGNATED TO CLEAN CONCRETE TRUCKS AND TOOLS. AT NO TIME SHALL CONCRETE PRODUCTS AND WASTE BE ALLOWED TO ENTER COUNTY WATERWAYS SUCH AS CREEKS OR STORM DRAINS.
 - PROPER APPLICATION, CLEANING AND STORAGE OF POTENTIALLY HAZARDOUS MATERIALS, SUCH AS PAINTS AND CHEMICALS, SHALL BE CONDUCTED TO PREVENT THE DISCHARGE OF POLLUTANTS.
 - WHEN UTILIZED, TEMPORARY RESTROOMS AND SANITARY FACILITIES SHALL BE LOCATED AND MAINTAINED TO PREVENT THE DISCHARGE OF POLLUTANTS.
 - APPROPRIATE VEHICLE STORAGE, FUELING, MAINTENANCE AND CLEANING AREAS SHALL BE DESIGNATED AND MAINTAINED TO PREVENT DISCHARGE OF POLLUTANTS.

POLLUTION CONTROL NOTES:

- THE SITE WILL BE ROUGH GRADED IN ACCORDANCE WITH THE GRADING PLANS PREPARED BY CSWST2. FUTURE FINISH GRADING SHALL DIRECT ALL STORM WATER RUNOFF TO THE INLETS SHOWN ON THIS PLAN.
- IF SIGNIFICANT SEDIMENT OR OTHER VISUAL SYMPTOMS OF IMPURITIES ARE NOTICED IN THE STORM WATER, CONTACT THE CIVIL ENGINEER IMMEDIATELY.
- CONTRACTOR IS RESPONSIBLE FOR INSPECTION AND RESTORATION OF ALL ASPECTS OF THIS PLAN. SEDIMENT ON SIDEWALKS AND GUTTERS SHALL BE REMOVED BY SHOVEL OR BROOM AND PLACED IN A STOCKPILE.
- ALL DUMPSTERS OR OTHER TRASH STORAGE ENCLOSURES SHALL BE UTILIZED SOLELY FOR NON-HAZARDOUS MATERIALS.

- ALL EMPLOYEES, CONTRACTORS, AND SUBCONTRACTORS ARE RESPONSIBLE FOR CONFORMING TO THE ELEMENTS SHOWN ON THIS PLAN OR RELATED DOCUMENTS. ANY CONTRACTOR PLANNING TO DO WORK ON-SITE SHALL BE RESPONSIBLE FOR OBTAINING AND REVIEWING ALL SWPPP INFORMATION FROM OWNER PRIOR TO START OF WORK AND EDUCATING ALL OF THEIR EMPLOYEES OR SUBCONTRACTORS AS TO THE CONTENTS OF THIS SWPPP.
- THE CONTRACTOR IS RESPONSIBLE FOR OBTAINING ALL PERMITS AND FILING ALL PLANS WITH RELATED AGENCIES ASSOCIATED WITH THEIR WORK. THIS SHALL INCLUDE, BUT NOT BE LIMITED TO, PERMITS FOR STORAGE OF HAZARDOUS MATERIALS, BUSINESS PLANS, PERMITS FOR STORAGE OF FLAMMABLE LIQUIDS, GRADING PERMITS, OR OTHER PLANS OR PERMITS REQUIRED BY THE COUNTY OF SONOMA, OR OTHER AGENCIES. ALL PROPERTY OWNERS, CONTRACTORS, OR SUBCONTRACTORS WORKING ON-SITE ARE INDIVIDUALLY RESPONSIBLE FOR OBTAINING AND SUBMITTING ANY BUSINESS PLANS OR PERMITS REQUIRED BY CITY, STATE OR LOCAL AGENCIES.
- CONTRACTOR MAY RELOCATE STORAGE, DELIVERY, OR WASH-OUT AREAS, TO SUIT THEIR OPERATIONS. RELOCATED LOCATION TO BE SHOWN ON PLANS MAINTAINED AT JOBSITE. CONTACT CIVIL ENGINEER FOR ANY PLAN REVISIONS. PLAN REVISIONS SHALL BE SUBMITTED TO THE COUNTY IF REQUESTED. CONTRACTOR TO MAINTAIN SECONDARY CONTAINMENT AS NECESSARY TO PROHIBIT POLLUTION AND TOXIC MATERIALS FROM ENTERING THE STORM DRAIN SYSTEM.
- THIS PLAN TO BE USED IN CONJUNCTION WITH THE WRITTEN REPORT OF STORM WATER POLLUTION PREVENTION SUBMITTED BY CSWST2

URBAN RUNOFF POLLUTION NOTES:

- STABILIZE ALL DENUDED AREAS AND MAINTAIN EROSION CONTROL MEASURES CONTINUOUSLY BETWEEN OCTOBER 15TH AND APRIL 15TH
- REMOVE SPOILS PROMPTLY AND AVOID STOCKPILING OF FILL MATERIALS WHEN RAIN IS FORECAST. IF RAIN THREATENS, STOCK-PILED SOILS AND OTHER MATERIALS SHALL BE TARPED, AT THE REQUEST OF THE COUNTY ENGINEER.
- STORE, HANDLE AND DISPOSE OF CONSTRUCTION MATERIALS AND WASTES SO AS TO PREVENT THEIR ENTRY TO THE STORM DRAIN SYSTEM. CONTRACTOR MUST NOT ALLOW CONCRETE, WASHWATERS, SLURRIES, PAINT OR OTHER MATERIALS TO ENTER CATCH BASINS OR TO ENTER SITE RUNOFF.
- USE FILTRATION OR OTHER MEASURES TO REMOVE SEDIMENT FROM DEWATERING EFFLUENT.
- NO CLEANING, FUELING OR MAINTAINING VEHICLES ON SITE SHALL BE PERMITTED IN ANY MANNER THAT ALLOWS DELETERIOUS MATERIALS TO ENTER CATCH BASINS OR TO ENTER SITE RUNOFF.
- USE OF PESTICIDES AND/ OR FERTILIZERS SHALL BE APPLIED AND CONTROLLED TO PREVENT POLLUTION RUNOFF.
- IN THE EVENT GRADING OPERATIONS ARE SUSPENDED BY WEATHER CONDITIONS AND IF THE STORM DRAIN SYSTEM IS INCOMPLETE, INSTALL ADDITIONAL ROCK FILTERS AND OTHER FACILITIES AS DIRECTED BY THE COUNTY AND THE ENGINEER.
- CONTRACTOR TO RELOCATE CONCRETE WASHDOWN, VEHICLE STORAGE DELIVERY, AND NON HAZARDOUS WASTE AREAS AS NECESSARY TO FACILITATE THEIR OPERATION AND PROMOTE POLLUTION CONTROL.

Rev	Date	Description	Drawn	Checked
1	2013-12-11	ADDITIONAL REVISION BASED ON JULY 23, 2012	RSW	AGC

DUTRA HAYSTACK LANDING AND PORTION OF LANDING WAY
EROSION CONTROL NOTES
DUTRA GROUP

City Of
County Of
Sonoma
State Of
California

Prepared Under the Direction of:

Sheet
EXH-43b
Scale: NTS
Date: 12-11-2013
File: 591302-C3D
Plan File: D-4862