

Central Valley Dairy Representative Monitoring Program Year 8 Annual Report (2019)



Part II of V

Prepared by



Luhdorff & Scalmanini
Consulting Engineers

April 1, 2020

Attachment A

Attachment A1.	Tables 3-1 to 3-6 from Year 5 CVDRMP Annual Report
Attachment A2.	Hydrograph Series of Groundwater Level Elevation
Attachment A3.	Hydrograph Series of Depth to Groundwater
Attachment A4.	Group Hydrographs
Attachment A5.	Map Series of Water Level Elevation Contour Maps (2019) <ul style="list-style-type: none">□ <i>Central Area East Side:</i> MEN, ANC, BET, DIE, DUR, FG1, BEA, COT, SAN, GEN, TRO, PLS, CAE, ROB, WOO□ <i>Central Area West Side:</i> ANT, COR, FG2, GOD, MAC and NUN, MOO, TON□ <i>North Area:</i> BRE, CRE, MTS□ <i>South Area:</i> AUK, DLF, ELK, ZZI, HOL, HYN, JAD, LON, ADO, MAL, MAP and ZON, RIC, SIE, SO2, SOJ
Attachment A6.	Apparent Horizontal Gradients Between a Selection of Well Pairs
Attachment A7.	Specific Conductance and Total Dissolved Solids Concentrations in Groundwater, Time Series Plots
Attachment A8.	Nitrogen Components Concentrations in Groundwater, Time Series Plots
Attachment A9.	General Mineral Concentrations in Groundwater, Time Series Plots
Attachment A10.	Groundwater Chemical Characteristics – Bar Charts
Attachment A11.	Groundwater Chemical Characteristics – Stiff Diagrams
Attachment A12.	Groundwater Chemical Characteristics – Piper Diagrams
Attachment A13.	Ordinary Least Squares Regression (OLSR) – Total Nitrogen and TDS (2012-2019) including Q1/Q3 and Q2/Q4 Trendlines
Attachment A14.	Ordinary Least Squares Regression (OLSR) – Total Nitrogen and TDS (2012-2019) including Q1, Q2, Q3, Q4 Trendlines

Attachment A1

Tables 3-1 to 3-6 from Year 5 CVDRMP Annual Report

**Table 3-1
Soil Properties at Monitored Dairies, Central Valley Dairy Representative Monitoring Program – Year 5 Annual Report**

Dairy and Soil Survey Map Unit Name	Map Unit Symbol	Physical Soil Properties							Chemical Soil Properties							Soil Features					
		Percent Passing Sieve Number				Clay (%)	Organic Matter (%)	K _{sat(min)} (in/hr)	Available Water Capacity			Cation Exchange Capacity (meq/100g)	pH (pH-units)	Salinity (mS/cm)	CaSO ₄			Kind -	Restrictive Layer Depth		Land Form
4 4.76 mm	10 1.68 mm	40 0.42 mm	200 0.074 mm	60 inch profile (in)	60 inch profile (in)				60 inch profile (in)	CaCO ₃ (%)	2H ₂ O (%)				SAR -	to Top (in)	Thickness (in)				
MEN [Eastern Stanislaus Area, California (CA644)]																			CVDRMP Central Area – East Side		
Dinuba Sandy Loam, Slightly Saline-Alkali, 0 to 1 percent slopes	DwA	100	95-100	69-100	33-85	7-18	0.0-1.0	0.06-0.20	0.07-0.11	5.4	3.8-9.6	7.4-9.0	4.0-8.0	0	0	0-5	-- data not available --	Alluvial fans	Alluvium derived from granite		
Waukena Sandy Loam, Slightly Saline-Alkali, 0 to 1 percent slopes	WdA	100	95-100	69-81	33-43	10-18	0.0-3.0	0.06-0.20	0.10-0.12	6.6	7.2-17	6.6-8.4	4.0-8.0	0-5	0	0-20	-- data not available --	Basin-floor remnants	Alluvium derived from granite		
ANC [Merced Area, California (CA648)]																			CVDRMP Central Area – East Side		
Delhi Loamy Sand, 0 to 3 percent slopes	DdA	100	100	40-80	5-35	0-5	0.0-1.0	5.95-19.98	0.05-0.10	4.8	1.0-5.0	6.1-7.8	0	0	0	0	-- data not available --	Sand sheets	Wind modified sandy alluvium derived from granite		
Dinuba Sandy Loam, Slightly Saline-Alkali, 0 to 1 percent slopes	DrA	100	95-100	70-85	35-60	7-18	0.0-1.0	0.06-0.20	0.10-0.13	7.2	5.0-10	7.9-8.4	4.0-8.0	0	0	0-5	-- data not available --	Alluvial fans	Alluvium derived from granite		
Hilmar Loamy Sand, Slightly Saline-Alkali, 0 to 3 percent slopes	HhA	100	100	50-100	15-85	0-15	0.0-1.0	0.06-0.20	0.06-0.17	7.7	1.0-5.0	7.3-9.6	4.0-8.0	0-5	0	0-5	-- data not available --	Fan skirts	Wind modified sandy alluvium derived from granite over silty alluvium derived from granite		
Waukena Fine Sandy Loam, Strongly Saline-Alkali, 0 to 1 percent slopes	WcA	100	95-100	50-90	30-50	8-30	0.0-1.0	0.06-0.20	0.06-0.15	6.1	5.0-20	7.8-9.6	4.0-30.0	0-5	0	5-20	-- data not available --	Basin-floor remnants	Alluvium derived from granite		
BET [Merced Area, California (CA648)]																			CVDRMP Central Area – East Side		
Delhi Sand, 0 to 3 percent slopes	DfA	100	100	40-80	5-35	0-5	0.0-1.0	5.95-19.98	0.05-0.10	4.3	1.0-5.0	6.1-7.8	0	0	0	0	-- data not available --	Sand sheets	Wind modified sandy alluvium derived from granite		
Delhi Sand, Silty Substratum, 0 to 3 percent slopes	DgA	100	100	40-80	5-50	0-15	0.0-1.0	1.98-5.95	0.05-0.15	6.3	1.0-5.0	6.1-7.8	0	0	0	0	-- data not available --	Alluvial plains, valleys	Wind modified sandy alluvium derived from granite		
Dello Sand, 0 to 1 percent slopes	DkA	100	100	50-70	5-20	0-7	0.0-1.0	5.95-19.98	0.06-0.08	4.2	1.0-5.0	6.6-8.4	0.0-2.0	0	0	0	-- data not available --	Depressions	Alluvium derived from granite		
Dello Sand, Slightly Saline-Alkali, 0 to 1 percent slopes	DoA	100	100	50-70	5-20	0-7	0.0-1.0	5.95-19.98	0.06-0.08	4.2	1.0-5.0	6.6-8.4	4.0-8.0	0	0	0-5	-- data not available --	Depressions	Alluvium derived from granite		
Dune Land, 0 to 3 percent slopes	DuA	100	100	50-80	0-25	0-1	0.0-0.1	5.95-19.98	0.03-0.05	2.5	-	-	0	0	0	0	-- data not available --	Alluvial fans	Eolian deposits		
Dune Land, 3 to 8 percent slopes	DuB	100	100	50-80	0-25	0-1	0.0-0.1	5.95-19.98	0.03-0.05	2.5	-	-	0	0	0	0	-- data not available --	Alluvial fans	Eolian deposits		
Hilmar Sand, 0 to 3 percent slopes	HoA	100	100	40-100	5-85	0-15	0.0-1.0	0.06-0.20	0.05-0.17	7.3	1.0-5.0	7.3-9.6	2.0-4.0	0-5	0	0	-- data not available --	Fan skirts	Wind modified sandy alluvium derived from granite over silty alluvium derived from granite		
DIE [Madera County, California (CA651)]																			CVDRMP Central Area – East Side		
Chino Clay Loam, Moderately Saline-Alkali, 0-1 percent slopes	CebA	100	100	85-100	60-85	18-35	0.5-3.0	0.20-0.57	0.11-0.15	7.8	15-25	7.4-8.4	8.0-16.0	0-10	0	5-10	-- data not available --	basin floors	Alluvium derived from granite		
Chino Clay Loam, Slightly Saline-Alkali, 0-1 percent slopes	CeaA	100	100	85-100	60-85	18-35	0.5-3.0	0.20-0.57	0.15-0.20	10.3	15-25	6.6-8.4	4.0-8.0	0-10	0	0-5	-- data not available --	Basin floors	Alluvium derived from granite		
Chino Loam, Slightly Saline-Alkali, 0-1 percent slopes	CgaA	100	100	85-100	60-85	18-35	0.5-3.0	0.20-0.57	0.15-0.19	10.2	15-20	6.6-8.4	4.0-8.0	0-10	0	0-5	-- data not available --	Basin floorers	Alluvium derived from granite		
Fresno and El Peco Fine Sandy Loams, Slightly Saline-Alkali, 0-1 percent slopes - El Peco	FeaA	100	95-100	70-95	35-60	7-25	0.0-1.0	0.00-0.00	0.00-0.10	1.8	5.0-15	7.8-9.6	4.0-8.0	0-5	0	0-5	Duripan	24-30	0-3	Fan remnants	Alluvium derived from granite
- Fresno		100	95-100	60-95	35-65	10-35	0.0-1.0	0.00-0.00	0.00-0.12	1.9	5.0-20	7.8-9.6	4.0-8.0	1-10	0	0-20	Duripan	18-24	0-3		
Fresno and El Peco Fine Sandy Loams, Moderately Saline-Alkali, 0-1 percent slopes - El Peco	FebA	100	95-100	70-95	35-60	7-25	0.0-1.0	0.00-0.00	0.00-0.10	1.8	5.0-15	7.8-9.6	8.0-16.0	0-5	0	0-10	Duripan	24-30	0-3	Fan remnants	Alluvium derived from granite
- Fresno		100	95-100	60-95	35-65	10-35	0.0-1.0	0.00-0.00	0.00-0.12	1.9	5.0-20	7.8-9.6	8.0-16.0	1-10	0	0-20	Duripan	18-24	0-3		
Fresno and El Peco Loams, Moderately Saline-Alkali, 0-1 percent slopes - El Peco	FfbA	100	95-100	70-95	35-60	7-25	0.0-1.0	0.00-0.00	0.00-0.12	2.0	5.0-20	7.8-9.6	8.0-16.0	0-5	0	0-10	Duripan	24-30	0-3	Fan remnants	Alluvium derived from granite
- Fresno		100	95-100	60-95	35-65	10-35	0.0-1.0	0.00-0.00	0.00-0.12	2.1	5.0-20	7.8-9.6	4.0-16.0	1-10	0	0-20	Duripan	18-24	0-3		

**Table 3-1
Soil Properties at Monitored Dairies, Central Valley Dairy Representative Monitoring Program – Year 5 Annual Report**

Dairy and Soil Survey Map Unit Name	Map Unit Symbol	----- Physical Soil Properties -----							----- Chemical Soil Properties -----							Soil Features						
		Percent Passing Sieve Number				Clay (%)	Organic Matter (%)	K _{sat(min)} (in/hr)	Available Water Capacity		Cation Exchange Capacity (meq/100g)	pH (pH-units)	Salinity (mS/cm)	CaSO ₄			Kind -	Restrictive Layer Depth		Thickness (in)	Land Form	Parent Material
		4 4.76 mm	10 1.68 mm	40 0.42 mm	200 0.074 mm				60 inch profile (in)	60 inch profile (in)				CaCO ₃ (%)	2H ₂ O (%)	SAR -		to Top (in)				
DIE [Madera County, California (CA651)] - Continued																					CVDRMP Central Area – East Side	
Fresno and El Peco Loams, Slightly Saline-Alkali, 0-1 percent slopes - El Peco	FfaA	100	95-100	70-95	35-60	7-25	0.0-1.0	0.00-0.00	0.00-0.12	2.0	5.0-20	7.8-9.6	4.0-16.0	0-5	0	0-5	Duripan	24-30	0-3	Fan remnants	Alluvium derived from granite	
- Fresno		100	95-100	60-95	35-65	10-35	0.0-1.0	0.00-0.00	0.00-0.12	2.1	5.0-20	7.8-9.6	4.0-16.0	1-10	0	0-20	Duripan	18-24	0-3			
Fresno and El Peco Loams, Strongly Saline-Alkali, 0-1 percent slopes - El Peco	FfcA	100	95-100	70-95	35-60	7-25	0.0-1.0	0.00-0.00	0.00-0.12	2.0	5.0-20	7.8-9.6	8.0-30.0	0-5	0	0-15	Duripan	24-30	0-3	Fan remnants	Alluvium derived from granite	
- Fresno		100	95-100	60-95	35-65	10-35	0.0-1.0	0.00-0.00	0.00-0.12	2.1	5.0-20	7.8-9.6	4.0-30.0	1-10	0	0-20	Duripan	18-24	0-3			
Grangeville Fine Sandy Loam, over Traver Soils, Slightly Saline-Alkali, 0-1 percent slopes	Gda	100	95-100	60-95	25-60	8-25	0.0-6.0	0.20-0.57	0.07-0.16	7.2	5.0-15	7.4-8.4	4.0-8.0	0-1	0	0-5	-- data not available --			Alluvial fans	Alluvium derived from granite	
DUR [Eastern Stanislaus Area, California (CA644)]																					CVDRMP Central Area – East Side	
Dinuba Fine Sandy Loam, Slightly Saline-Alkali, 0-1 percent slopes	DpA	100	95-100	69-100	33-85	7-18	0.0-1.0	0.06-0.20	0.07-0.11	5.4	3.8-9.6	7.4-9.0	4.0-8.0	0	0	0-5	-- data not available --			Alluvial fans	Alluvium derived from granite	
Dinuba Sandy Loam, Moderately Saline-Alkali, 0-1 percent slopes	DxA	100	95-100	69-100	33-85	7-18	0.0-1.0	0.06-0.20	0.07-0.11	5.4	3.8-9.6	7.4-9.0	8.0-16.0	0	0	0-5	-- data not available --			Alluvial fans	Alluvium derived from granite	
Fresno Fine Sandy Loam, Moderately Saline-Alkali, 0-1 percent slopes	FrA	100	95-100	75-100	34-85	10-35	0.0-1.0	0.00-0.00	0.00-0.12	3.7	7.6-27	7.8-9.6	4.0-16.0	0-5	0	0-20	Duripan	38-40	0-3	Fan remnants	Alluvium derived from granite	
Hanford Sandy Loam, 0-3 percent slopes	HdA	95-100	86-100	61-82	28-44	7-18	0.0-1.0	1.98-5.95	0.11-0.15	8.1	5.5-15	6.1-7.8	0	0	0	0	-- data not available --			Alluvial fans	Alluvium derived from igneous rock	
Waukena Fine Sandy Loam, Moderately Saline-Alkali, 0-1 percent slopes	WbA	100	95-100	69-97	33-44	10-18	0.0-3.0	0.06-0.20	0.08-0.10	5.4	7.2-17	7.8-9.0	8.0-18.0	0-5	0	0-20	-- data not available --			Basin-floor remnants	Alluvium derived from granite	
FG1 [Merced Area, California (CA648)]																					CVDRMP Central Area – East Side	
Delhi Sand, 0 to 3 percent slopes	DfA	100	100	40-80	5-35	0-5	0.0-1.0	5.95-19.98	0.05-0.10	4.3	1.0-5.0	6.1-7.8	0	0	0	0	-- data not available --			Sand sheets	Wind modified sandy alluvium derived from granite	
Delhi Sand, 3 to 8 percent slopes	DfB	100	100	40-80	5-35	0-5	0.0-1.0	5.95-19.98	0.05-0.10	4.3	1.0-5.0	6.1-7.8	0	0	0	0	-- data not available --			Sand sheets	Wind modified sandy alluvium derived from granite	
Dinuba Sandy Loam, 0 to 1 percent slopes	DpA	100	95-100	70-85	35-60	7-18	0.0-1.0	0.06-0.20	0.10-0.13	7.2	5.0-10	6.6-8.4	0.0-4.0	0	0	0	-- data not available --			Alluvial fans	Alluvium derived from granite	
Grangeville Loam, 0 to 1 percent slopes	GbA	100	95-100	60-100	35-80	8-20	0.0-6.0	0.57-1.98	0.12-0.17	8.6	5.0-15	6.1-8.4	0.0-2.0	0-2	0	0	-- data not available --			Alluvial fans	Alluvium derived from granite	
Grangeville Loam, Slightly Saline-Alkali, 0 to 1 percent slopes	GcA	100	95-100	60-100	35-80	8-20	0.0-6.0	0.57-1.98	0.12-0.17	8.6	5.0-15	6.6-8.4	4.0-8.0	0-2	0	0-5	-- data not available --			Alluvial fans	Alluvium derived from granite	
Hanford Fine Sandy Loam, Channeled, 0 to 8 percent slopes	HcB	100	95-100	60-90	30-50	8-18	0.0-1.0	1.98-5.95	0.08-0.12	6.3	5.0-10	6.6-7.3	0	0	0	0	-- data not available --			Alluvial fans	Alluvium derived from granite	
- Columbia	HcB	100	95-100	60-90	30-50	8-18	0.0-2.0	1.98-5.95	0.08-0.12	6.3	5.0-10	6.1-7.8	0	0	0	0	-- data not available --			Flood plains	coarse-loamy alluvium derived from igneous, metamorphic, and sedimentary rock	
Hanford Fine Sandy Loam, Moderately Deep and Deep Over Sand, 0 to 1 percent slopes	HbA	85-100	75-100	40-75	5-50	0-18	0.0-1.0	1.98-5.95	0.04-0.15	6.2	5.0-10	6.6-7.3	0	0	0	0	-- data not available --			Alluvial fans	Alluvium derived from igneous rock	
Riverwash	Rf	80-100	75-100	30-70	0-20	0-5	0.0-0.1	5.95-19.98	0.03-0.06	2.9	---	---	0	0	0	0	-- data not available --			Basin floors	Gravelly alluvium	

**Table 3-1
Soil Properties at Monitored Dairies, Central Valley Dairy Representative Monitoring Program – Year 5 Annual Report**

Dairy and Soil Survey Map Unit Name	Map Unit Symbol	----- Physical Soil Properties -----							----- Chemical Soil Properties -----							Soil Features					
		Percent Passing Sieve Number				Clay (%)	Organic Matter (%)	K _{sat(min)} (in/hr)	Available Water Capacity		Cation Exchange Capacity (meq/100g)	pH (pH-units)	Salinity (mS/cm)	CaSO ₄			Kind -	Restrictive Layer Depth		Land Form	Parent Material
		4 4.76 mm	10 1.68 mm	40 0.42 mm	200 0.074 mm				60 inch profile (in)	60 inch profile (in)				CaCO ₃ (%)	2H ₂ O (%)	SAR -		to Top (in)	Thickness (in)		
BEA [Merced Area, California (CA648)]																			CVDRMP Central Area – East Side		
Delhi Sand, 3 to 8 percent slopes	DfB	100	100	40-80	5-35	0-5	0.0-1.0	5.95-19.98	0.05-0.10	4.3	1.0-5.0	6.1-7.8	0	0	0	0	- - data not available - -	Sand sheets	Wind modified sandy alluvium derived from granite		
Delhi Loamy Sand, 0 to 3 percent slopes	DdA	100	100	40-80	5-35	0-5	0.0-1.0	5.95-19.98	0.05-0.10	4.8	1.0-5.0	6.1-7.8	0	0	0	0	- - data not available - -	Sand sheets	Wind modified sandy alluvium derived from granite		
Dello Sand, Slightly Saline-Alkali, 0 to 1 percent slopes	DoA	100	100	50-70	5-20	0-7	0.0-1.0	5.95-19.98	0.06-0.08	4.2	1.0-5.0	6.6-8.4	4.0-8.0	0	0	0-5	- - data not available - -	Depressions	Alluvium derived from granite		
Hilmar Loamy Sand, Slightly Saline-Alkali, 0 to 3 percent slopes	HhA	100	100	50-100	15-85	0-15	0.0-1.0	0.06-0.20	0.06-0.17	7.7	1.0-5.0	7.3-9.6	4.0-8.0	0-5	0	0-5	- - data not available - -	Fan skirts	Wind modified sandy alluvium derived from granite over silty alluvium derived from granite		
Hilmar Loamy Sand, Poorly Drained, Slightly Saline-Alkali, 0 to 1 percent slopes	HfA	100	100	50-100	15-85	0-15	0.0-1.0	0.06-0.20	0.06-0.17	1.8	1.0-5.0	7.3-9.6	4.0-8.0	0-5	0	0-5	- - data not available - -	Fan skirts	Wind modified sandy alluvium derived from granite over silty alluvium derived from granite		
Hilmar Sand, Slightly Saline-Alkali, 0 to 3 percent slopes	HpA	100	100	40-100	5-85	0-15	0.0-1.0	0.06-0.20	0.05-0.17	7.3	1.0-5.0	7.3-9.6	4.0-8.0	0-5	0	0	- - data not available - -	Fan skirts	Wind modified sandy alluvium derived from granite over silty alluvium derived from granite		
COT [Merced Area, California (CA648)]																			CVDRMP Central Area – East Side		
Delhi Sand, 0 to 3 percent slopes	DfA	100	100	40-80	5-35	0-5	0.0-1.0	5.95-19.98	0.05-0.10	4.3	1.0-5.0	6.1-7.8	0	0	0	0	- - data not available - -	Sand sheets	Wind modified sandy alluvium derived from granite		
Delhi Sand, 3 to 8 percent slopes	DfB	100	100	40-80	5-35	0-5	0.0-1.0	5.95-19.98	0.05-0.10	4.3	1.0-5.0	6.1-7.8	0	0	0	0	- - data not available - -	Sand sheets	Wind modified sandy alluvium derived from granite		
Dello Sand, 0 to 1 percent slopes	DkA	100	100	50-70	5-20	0-7	0.0-1.0	5.95-19.98	0.06-0.08	4.2	1.0-5.0	6.6-8.4	0.0-2.0	0	0	0	- - data not available - -	Depressions	Alluvium derived from granite		
Dello Sand, Slightly Saline-Alkali, 0 to 1 percent slopes	DoA	100	100	50-70	5-20	0-7	0.0-1.0	5.95-19.98	0.06-0.08	4.2	1.0-5.0	6.6-8.4	4.0-8.0	0	0	0-5	- - data not available - -	Depressions	Alluvium derived from granite		
Dune Land, 3 to 8 percent slopes	DuB	100	100	50-80	0-25	0-1	0.0-0.1	5.95-19.98	0.03-0.05	2.5	-	-	0	0	0	0	- - data not available - -	Alluvial fans	Eolian deposits		
Fresno Loam, Poorly Drained Variant, Strongly Saline-Alkali, 0 to 1 percent slopes	FoA	100	95-100	60-95	35-65	10-35	0.0-1.0	0	0.00-0.12	2.3	5.0-20	7.8-9.6	4.0-30.0	0-5	0	0-20	- - data not available - -	Flood plains	Alluvium derived from granite		
Hilmar Sand, 0 to 3 percent slopes	HoA	100	100	40-100	5-85	0-15	0.0-1.0	0.06-0.20	0.05-0.17	7.3	1.0-5.0	7.3-9.6	2.0-4.0	0-5	0	0	- - data not available - -	Fan skirts	Wind modified sandy alluvium derived from granite over silty alluvium derived from granite		
Hilmar Sand, Poorly Drained, 0 to 1 percent slopes	HkA	100	100	40-100	5-85	0-15	0.0-1.0	0.06-0.20	0.05-0.17	7.3	1.0-5.0	7.3-9.6	2.0-4.0	0-5	0	0	- - data not available - -	Fan skirts	Wind modified sandy alluvium derived from granite over silty alluvium derived from granite		
Hilmar Sand, Poorly Drained, Moderately Saline-Alkali, 0 to 1 percent slopes	HmA	100	100	40-100	5-85	0-15	0.0-1.0	0.06-0.20	0.05-0.17	7.3	1.0-5.0	7.3-9.6	8.0-16.0	0-5	0	0-10	- - data not available - -	Fan skirts	Wind modified sandy alluvium derived from granite over silty alluvium derived from granite		
Hilmar Loamy Sand, 0 to 3 percent slopes	HgA	100	100	50-100	15-85	0-15	0.0-1.0	0.06-0.20	0.06-0.17	7.7	1.0-5.0	7.3-9.6	2.0-4.0	0-5	0	0	- - data not available - -	Fan skirts	Wind modified sandy alluvium derived from granite over silty alluvium derived from granite		
Hilmar Loamy Sand, Poorly Drained, Slightly Saline-Alkali, 0 to 1 percent slopes	HfA	100	100	50-100	15-85	0-15	0.0-1.0	0.06-0.20	0.06-0.17	1.8	1.0-5.0	7.3-9.6	4.0-8.0	0-5	0	0-5	- - data not available - -	Fan skirts	Wind modified sandy alluvium derived from granite over silty alluvium derived from granite		
SAN [Merced Area, California (CA648)]																			CVDRMP Central Area – East Side		
Atwater Loamy Sand, 0 to 3 percent slopes	AfA	100	100	50-75	15-50	2-18	0.0-1.0	1.98-5.95	0.07-0.13	5.8	1.0-10	6.1-7.3	0	0	0	0	- - data not available - -	Dunes, dunes	Sandy alluvium derived from granite		
Delhi Loamy Fine Sand, 0 to 3 percent slopes	DbA	100	100	40-80	5-35	0-5	0.0-1.0	5.95-19.98	0.05-0.10	4.8	1.0-5.0	6.1-7.8	0	0	0	0	- - data not available - -	Sand sheets	Wind modified sandy alluvium derived from granite		
Delhi Loamy Sand, 0 to 3 percent slopes	DdA	100	100	40-80	5-35	0-5	0.0-1.0	5.95-19.98	0.05-0.10	4.8	1.0-5.0	6.1-7.8	0	0	0	0	- - data not available - -	Sand sheets	Wind modified sandy alluvium derived from granite		

**Table 3-1
Soil Properties at Monitored Dairies, Central Valley Dairy Representative Monitoring Program – Year 5 Annual Report**

Dairy and Soil Survey Map Unit Name	Map Unit Symbol	----- Physical Soil Properties -----							----- Chemical Soil Properties -----							Soil Features					
		Percent Passing Sieve Number				Clay (%)	Organic Matter (%)	K _{sat(min)} (in/hr)	Available Water Capacity		Cation Exchange Capacity (meq/100g)	pH (pH-units)	Salinity (mS/cm)	CaSO ₄			Kind -	Restrictive Layer Depth		Land Form	Parent Material
		4 4.76 mm	10 1.68 mm	40 0.42 mm	200 0.074 mm				60 inch profile (in)	60 inch profile (in)				CaCO ₃ (%)	2H ₂ O (%)	SAR -		to Top (in)	Thickness (in)		
SAN [Merced Area, California (CA648)] - Continued																			CVDRMP Central Area – East Side		
Fresno Loam, Strongly Saline-Alkali, 0 to 1 percent slopes	FsA	100	95-100	60-95	35-65	10-35	0.0-1.0	0	0.00-0.12	2.3	5.0-20	7.8-9.6	4.0-30.0	0-5	0	0-20	-- data not available --	Fan remnants	Alluvium derived from granite		
Fresno Loam, Moderately Saline-Alkali, 0 to 1 percent slopes	FrA	100	95-100	60-95	35-65	10-35	0.0-1.0	0	0.00-0.12	2.3	5.0-20	7.8-9.6	4.0-16.0	0-5	0	0-20	-- data not available --	Fan remnants	Alluvium derived from granite		
Fresno Loam, Poorly Drained Variant, Moderately Saline-Alkali, 0 to 1 percent slopes	FnA	100	95-100	60-95	35-65	10-35	0.0-1.0	0	0.00-0.12	2.3	5.0-20	7.8-9.6	4.0-16.0	0-5	0	0-20	-- data not available --	Flood plains	Alluvium derived from granite		
Hilmar Sand, 0 to 3 percent slopes	HoA	100	100	40-100	5-85	0-15	0.0-1.0	0.06-0.20	0.05-0.17	7.3	1.0-5.0	7.3-9.6	2.0-4.0	0-5	0	0	-- data not available --	Fan skirts	Wind modified sandy alluvium derived from granite over silty alluvium derived from granite		
Hilmar Loamy Sand, 0 to 3 percent slopes	HgA	100	100	50-100	15-85	0-15	0.0-1.0	0.06-0.20	0.06-0.17	7.7	1.0-5.0	7.3-9.6	2.0-4.0	0-5	0	0	-- data not available --	Fan skirts	Wind modified sandy alluvium derived from granite over silty alluvium derived from granite		
Hilmar Loamy Sand, Slightly Saline-Alkali, 0 to 3 percent slopes	HhA	100	100	50-100	15-85	0-15	0.0-1.0	0.06-0.20	0.06-0.17	7.7	1.0-5.0	7.3-9.6	4.0-8.0	0-5	0	0-5	-- data not available --	Fan skirts	Wind modified sandy alluvium derived from granite over silty alluvium derived from granite		
Landlow Silty Clay Loam, 0 to 1 percent slopes	LeA	100	95-100	90-100	80-95	30-60	0.0-2.0	0.00-0.06	0.13-0.17	9.1	25-50	6.6-8.4	0.0-4.0	0-5	0	0	-- data not available --	Basin Floors	Alluvium derived from igneous, metamorphic and sedimentary rock		
Landlow Silty Clay Loam, Slightly Saline-Alkali, 0 to 1 percent slopes	LfA	100	95-100	95-100	80-95	30-60	0.0-2.0	0.00-0.06	0.09-0.17	7.5	25-50	7.4-9.0	4.0-8.0	0-5	0	0-5	-- data not available --	Basin Floors	Alluvium derived from igneous, metamorphic and sedimentary rock		
Lewis Silty Clay Loam, Slightly Saline-Alkali, 0 to 1 percent slopes	LoA	100	95-100	60-100	50-95	15-60	0.0-1.0	0	0.00-0.18	3.1	10-50	7.9-9.6	0.0-16.0	1-5	0	0-20	-- data not available --	Fan remnants	Alluvium derived from igneous, metamorphic and sedimentary rock		
Snelling Sandy Loam, 0 to 3 percent slopes	SnA	90-100	75-100	50-90	25-50	5-30	0.0-1.0	0.20-0.57	0.08-0.18	8.4	5.0-20	6.1-8.4	0.0-2.0	0	0	0	-- data not available --	Fan remnants	Alluvium derived from granite		
Snelling Sandy Loam, 3 to 8 percent slopes	SnB	90-100	75-100	40-90	25-50	5-30	0.0-1.0	0.20-0.57	0.08-0.18	8.4	5.0-20	6.1-8.4	0.0-2.0	0	0	0	-- data not available --	Basin-floor remnants	Alluvium derived from granite		
GEN [Eastern Stanislaus Area, California (CA644)]																			CVDRMP Central Area – East Side		
Chualar Sandy Loam, 0-3 percent slopes	CaA	84-100	63-100	46-90	22-51	10-25	0.0-2.0	0.20-0.57	0.10-0.15	7.9	7.6-20	6.1-7.8	0	0	0	0	-- data not available --	Fan remnants	Alluvium derived from igneous, metamorphic and sedimentary rock		
Delhi Loamy Sand, Moderately Deep over Clay, 0-3 percent slopes	DfA	100	100	76-100	26-91	0-60	0.0-1.0	0.06-0.20	0.06-0.16	6.2	0.1-35	6.1-7.8	0	0	0	0	-- data not available --	Sand sheets	Wind modified sandy alluvium derived from granite		
Delhi Sand, 0-3 percent slopes	DhA	100	100	76-81	26-31	0-5	0.0-1.0	5.95-19.98	0.06-0.10	4.8	0.1-4.2	6.1-7.8	0	0	0	0	-- data not available --	Sand sheets	Wind modified sandy alluvium derived from granite		
Delhi Sand, 3-8 percent slopes	DhB	100	100	76-81	26-31	0-5	0.0-1.0	5.95-19.98	0.06-0.10	4.8	0.1-4.2	6.1-7.8	0	0	0	0	-- data not available --	Sand sheets	Wind modified sandy alluvium derived from granite		
Dinuba Fine Sandy Loam, 0-1 percent slopes	DmA	100	95-100	69-100	33-85	7-18	0.0-1.0	0.06-0.20	0.10-0.13	7.2	3.8-9.6	6.6-8.4	0.0-4.0	0	0	0	-- data not available --	Alluvial fans	Alluvium derived from granite		
Dinuba Sandy Loam, 0-1 percent slopes	DrA	100	95-100	69-100	33-85	7-18	0.0-1.0	0.06-0.20	0.10-0.13	7.2	3.8-9.6	6.6-8.4	0.0-4.0	0	0	0	-- data not available --	Alluvial fans	Alluvium derived from granite		
Dinuba Sandy Loam, Slightly Saline-Alkali, 0-1 percent slopes	DwA	100	95-100	69-100	33-85	7-18	0.0-1.0	0.06-0.20	0.07-0.11	5.4	3.8-9.6	7.4-9.0	4.0-8.0	0	0	0-5	-- data not available --	Alluvial fans	Alluvium derived from granite		
Hanford Sandy Loam, 0-3 percent slopes	HdA	95-100	86-100	61-82	28-44	7-18	0.0-1.0	1.98-5.95	0.11-0.15	8.1	5.5-15	6.1-7.8	0	0	0	0	-- data not available --	Alluvial fans	Alluvium derived from igneous rock		
Hanford Sandy Loam, Moderately Deep over Silt, 0-1 percent slopes	HdpA	87-100	66-100	47-100	22-89	7-30	0.0-1.0	0.20-0.57	0.11-0.18	8.9	5.5-23	6.1-7.8	0	0	0	0	-- data not available --	Alluvial fans	Alluvium derived from igneous rock		
Oakdale Sandy Loam, 0-3 percent slopes	OaA	95-100	81-100	61-86	17-45	5-18	0.0-2.0	1.98-5.95	0.08-0.15	7.3	2.6-9.6	6.1-7.3	0	0	0	0	-- data not available --	Fan remnants	Alluvium derived from granite		

**Table 3-1
Soil Properties at Monitored Dairies, Central Valley Dairy Representative Monitoring Program – Year 5 Annual Report**

Dairy and Soil Survey Map Unit Name	Map Unit Symbol	----- Physical Soil Properties -----							----- Chemical Soil Properties -----							Soil Features					
		Percent Passing Sieve Number				Clay (%)	Organic Matter (%)	K _{sat(min)} (in/hr)	Available Water Capacity		Cation Exchange Capacity (meq/100g)	pH (pH-units)	Salinity (mS/cm)	CaSO ₄			Kind (in)	Restrictive Layer Depth to Top (in)	Thickness (in)	Land Form	Parent Material
		4 4.76 mm	10 1.68 mm	40 0.42 mm	200 0.074 mm				60 inch profile (in)	60 inch profile (in)				CaCO ₃ (%)	2H ₂ O (%)	SAR (-)					
GEN [Eastern Stanislaus Area, California (CA644)] - Continued																			CVDRMP Central Area – East Side		
Tujung Loamy Sand, 0-3 percent slopes	TuA	91-100	71-100	53-81	18-31	0-5	0.0-1.0	5.95-19.98	0.05-0.10	4.3	0.1-4.2	6.1-7.8	0	0	0	0	-- data not available --	Alluvial fans	Sandy alluvium derived from granite		
TRO [Madera Area, California (CA651)]																			CVDRMP Central Area – East Side		
Grangeville Fine Sandy Loam, over Traver Soils, 0-1 percent slopes	GcA	100	95-100	60-95	25-60	8-26	0.0-6.0	0.20-0.57	0.07-0.16	7.2	5.0-15	6.6-8.4	0.0-4.0	0-1	0	0-5	-- data not available --	Alluvial fans	Alluvium derived from granite		
Grangeville Fine Sandy Loam, Slightly Saline-Alkali, 0-1 percent slopes	GbA	100	95-100	60-95	25-50	8-18	0.0-6.0	1.98-5.95	0.08-0.15	6.3	5.0-15	6.6-8.4	4.0-8.0	0-1	0	0-5	-- data not available --	Alluvial fans	Alluvium derived from granite		
Traver Loam, Moderately Saline-Alkali, 0-1 percent slopes	TnA	100	95-100	65-90	35-60	10-25	0.0-1.0	0.57-1.98	0.08-0.13	6.6	5.0-15	7.4-9.6	8.0-16.0	1-5	0	5-20	-- data not available --	Fan remnants	Alluvium derived from granite		
Traver Loam, Slightly Saline-Alkali, 0-1 percent slopes	TmA	100	95-100	65-90	35-60	10-25	0.0-1.0	0.57-1.98	0.08-0.13	6.6	5.0-15	7.4-9.6	4.0-8.0	1-5	0	0-20	-- data not available --	Fan remnants	Alluvium derived from granite		
Traver Loam, Strongly Saline-Alkali, 0-1 percent slopes	ToA	100	95-100	65-90	35-60	10-25	0.0-1.0	0.57-1.98	0.08-0.10	5.4	5.0-15	7.4-9.6	16.0-30.0	1-5	0	5-20	-- data not available --	Fan remnants	Alluvium derived from granite		
Tujung Loamy Sand, 0-3 percent slopes	TwA	60-100	50-95	20-70	0-25	0-5	0.0-1.0	5.95-19.98	0.04-0.10	3.9	1.0-5.0	6.1-7.8	0	0	0	0	-- data not available --	Alluvial fans	Sandy alluvium derived from granite		
Visalia Sandy Loam, 0-3 percent slopes	VdA	80-100	75-100	50-70	35-50	8-18	0.0-4.0	1.98-5.95	0.10-0.16	7.9	5.0-15	6.5-7.8	0	0	0	0	-- data not available --	Alluvial fans	Alluvium derived from granite		
Wunje Very Fine Sandy Loam, Slightly Saline-Alkali, 0-1 percent slopes	WuA	100	100	95-100	60-95	8-18	0.0-1.0	0.57-1.98	0.10-0.14	7.2	5.0-10	7.8-9.6	4.0-8.0	0	0	0	-- data not available --	Flood plains	Alluvium derived from granite		
PLS [Merced Area, California (CA648)]																			CVDRMP Central Area – East Side		
Delhi Sand, 0 to 3 percent slopes	DfA	100	100	40-80	5-35	0-5	0.0-1.0	5.95-19.98	0.05-0.10	4.3	1.0-5.0	6.1-7.8	0	0	0	0	-- data not available --	Sand sheets	Wind modified sandy alluvium derived from granite		
Dinuba Sandy Loam, 0 to 1 percent slopes	DpA	100	95-100	70-85	35-60	7-18	0.0-1.0	0.06-0.20	0.10-0.13	7.2	5.0-10	6.6-8.4	0.0-4.0	0	0	0	-- data not available --	Alluvial fans	Alluvium derived from granite		
Dinuba Sandy Loam, Slightly Saline-Alkali, 0 to 1 percent slopes	DrA	100	95-100	70-85	35-60	7-18	0.0-1.0	0.06-0.20	0.10-0.13	7.2	5.0-10	7.9-8.4	4.0-8.0	0	0	0-5	-- data not available --	Alluvial fans	Alluvium derived from granite		
Hilmar Sand, 0 to 3 percent slopes	HoA	100	100	40-100	5-85	0-15	0.0-1.0	0.06-0.20	0.05-0.17	7.3	1.0-5.0	7.3-9.6	2.0-4.0	0-5	0	0	-- data not available --	Fan skirts	Wind modified sandy alluvium derived from granite over silty alluvium derived from granite		
Hilmar Loamy Sand, 0 to 3 percent slopes	HgA	100	100	50-100	15-85	0-15	0.0-1.0	0.06-0.20	0.06-0.17	7.7	1.0-5.0	7.3-9.6	2.0-4.0	0-5	0	0	-- data not available --	Fan skirts	Wind modified sandy alluvium derived from granite over silty alluvium derived from granite		
CAE [Merced Area, California (CA648)]																			CVDRMP Central Area – East Side		
Delhi Sand, 0 to 3 percent slopes	DfA	100	100	40-80	5-35	0-5	0.0-1.0	5.95-19.98	0.05-0.10	4.3	1.0-5.0	6.1-7.8	0	0	0	0	-- data not available --	Sand sheets	Wind modified sandy alluvium derived from granite		
Delhi Loamy Sand, Silty Substratum, 0 to 3 percent slopes	DeA	100	100	40-80	5-50	0-15	0.0-1.0	1.98-5.95	0.05-0.15	6.4	1.0-5.0	6.1-7.8	0	0	0	0	-- data not available --	Sand sheets	Wind modified sandy alluvium derived from granite		
Dune Land, 0 to 3 percent slopes	DuA	100	100	50-80	0-25	0-1	0.0-0.1	5.95-19.98	0.03-0.05	2.5	-	-	0	0	0	0	-- data not available --	-	-		
Dello Sand, 0 to 1 percent slopes	DkA	100	100	50-70	5-20	0-7	0.0-1.0	5.95-19.98	0.06-0.08	4.2	1.0-5.0	6.6-8.4	0.0-2.0	0	0	0	-- data not available --	Depressions	Alluvium derived from granite		
Hilmar Loamy Sand, Slightly Saline-Alkali, 0 to 3 percent slopes	HhA	100	100	50-100	15-85	0-15	0.0-1.0	0.06-0.20	0.06-0.17	7.7	1.0-5.0	7.3-9.6	4.0-8.0	0-5	0	0-5	-- data not available --	Fan skirts	Wind modified sandy alluvium derived from granite over silty alluvium derived from granite		

**Table 3-1
Soil Properties at Monitored Dairies, Central Valley Dairy Representative Monitoring Program – Year 5 Annual Report**

Dairy and Soil Survey Map Unit Name	Map Unit Symbol	----- Physical Soil Properties -----							----- Chemical Soil Properties -----							Soil Features					
		Percent Passing Sieve Number				Clay (%)	Organic Matter (%)	K _{sat(min)} (in/hr)	Available Water Capacity		Cation Exchange Capacity (meq/100g)	pH (pH-units)	Salinity (mS/cm)	CaSO ₄			Kind (in)	Restrictive Layer Depth to Top (in)	Thickness (in)	Land Form	Parent Material
		4 4.76 mm	10 1.68 mm	40 0.42 mm	200 0.074 mm				60 inch profile (in)	60 inch profile (in)				CaCO ₃ (%)	2H ₂ O (%)	SAR (-)					
ROB [Eastern Stanislaus Area, California (CA644)]																			CVDRMP Central Area – East Side		
Dinuba Sandy Loam, Slightly Saline-Alkali, 0 to 1 percent slopes	DwA	100	95-100	69-100	33-85	7-18	0.0-1.0	0.06-0.20	0.07-0.11	5.4	3.8-9.6	7.4-9.0	4.0-8.0	0	0	0-5	-- data not available --	Alluvial fans	Alluvium derived from granite		
Hilmar Sandy Loam, 0 to 1 percent slopes	HfA	100	100	72-95	5-77	0-15	0.0-1.0	0.06-0.20	0.06-0.17	7.2	0.1-7.6	7.3-9.6	0.0-8.0	0-5	0	0	-- data not available --	Fan skirts	Wind modified sandy alluvium derived from granite over silty alluvium derived from granite		
WOO [San Joaquin County, California (CA077)]																			CVDRMP Central Area – East Side		
Acampo Sandy Loam, 0-2 percent slopes	101	0-100	0-100	0-80	0-50	7-18	0.0-3.0	0.00-0.00	0.00-0.14	5.6	15-20	6.1-8.4	0.0-2.0	0	0	0	Duripan	40-60	0-20	Fan terraces	Alluvium derived from granite
DeVries Sandy Loam, Drained, 0-2 percent slopes	149	0-100	0-100	0-85	0-50	7-18	0.0-3.0	0.00-0.00	0.00-0.14	3.5	5.0-15	6.6-8.4	0.0-2.0	0-3	0	0	Duripan	20-40	4-17	Rims on basin floors	Alluvium derived from mixed rock sources
Tokay Fine Sandy Loam, 0-2 percent slopes	256	100	95-100	50-85	25-50	8-18	0.0-3.0	1.98-5.95	0.10-0.15	7.8	8.0-14	6.1-8.4	0.0-2.0	0	0	0	-- data not available --	Fan skirts	Alluvium derived from granitic rock sources		
ANT [Stanislaus County, California, Western Part (CA642)]																			CVDRMP Central Area – West Side		
Pedcat Clay Loam, 0 to 2 percent slopes	331	100	100	75-100	50-95	27-50	0.0-1.0	0.01-0.06	0.09-0.16	6.7	10-37	6.6-9.0	0.0-16.0	1-15	0	0-50	-- data not available --	Alluvial fans	alluvium derived from sedimentary rock		
Vernalis Loam, 0 to 2 percent slopes	122	100	95-100	80-100	55-80	18-30	0.5-2.0	0.60-2.00	0.14-0.18	9.6	15-24	6.6-8.4	0.0-2.0	0-5	0	0-5	-- data not available --	Alluvial fans	Alluvium from mixed rock		
Vernalis-Zacharias Complex, 0 to 2 percent slopes, Rarely Flooded	126	100	95-100	80-100	55-85	18-35	0.5-2.0	0.20-0.60	0.14-0.18	10	15-28	6.6-8.4	0.0-2.0	0-5	0	0-5	-- data not available --	Alluvial fans	Alluvium from mixed rock		
- Zacharias	126	85-100	75-100	60-90	50-80	25-35	0.0-2.0	0.20-0.60	0.13-0.19	9.7	17-27	6.1-7.8	0	1-2	0	0	-- data not available --	Alluvial fans	Alluvium from mixed rock		
COR [Merced County, California, Western Part (CA647)]																			CVDRMP Central Area – West Side		
Chinvar Loam	153	40-100	35-100	25-95	15-75	10-30	0.0-3.0	0.57-1.98	0.07-0.16	7.4	5.0-20	7.4-8.4	0.0-8.0	0-3	0	5-13	-- data not available --	Alluvial fans	alluvium derived from sedimentary rock		
Pedcat Loam, 0 to 2 percent slopes	234	100	100	75-100	50-95	18-50	0.0-1.0	0.00-0.06	0.09-0.14	6.6	10-30	6.1-9.0	8.0-16.0	0-3	0	13-60	-- data not available --	Fan Aprons	alluvium derived from sedimentary rock		
Pedcat Clay, 0 to 2 percent slopes, Severely Eroded	237	100	100	75-100	50-95	30-50	0.0-1.0	0.06-0.20	0.09-0.13	6.6	15-30	7.9-9.0	8.0-16.0	0-3	0	13-60	-- data not available --	Drainageways	alluvium derived from sedimentary rock		
Pedcat Clay Loam, Leveled, 0 to 2 percent slope	236	100	100	75-100	50-95	27-50	0.0-1.0	0.00-0.06	0.09-0.16	6.7	15-30	6.6-9.0	8.0-16.0	0-3	0	13-60	-- data not available --	Fan Aprons	alluvium derived from sedimentary rock		
FG2 [Merced County, California, Western Part (CA647)]																			CVDRMP Central Area – West Side		
Dos Amigos Clay Loam, Partially Drained	168	100	95-100	85-100	50-95	30-50	0.0-2.0	0.00-0.06	0.09-0.20	8.6	5.0-30	7.9-8.4	0.0-16.0	20-35	0-10	0	-- data not available --	Alluvial fans	alluvium derived from sedimentary rock		
Dos Amigos Clay, Partially Drained	169	100	95-100	85-100	50-95	30-50	0.0-2.0	0.00-0.06	0.09-0.17	8.3	5.0-30	7.9-8.4	0.0-16.0	20-35	0-10	0	-- data not available --	Alluvial fans	alluvium derived from sedimentary rock		
Pedcat Clay Loam, Leveled, 0 to 2 percent slopes	236	100	100	75-100	50-95	27-50	0.0-1.0	0.00-0.06	0.09-0.16	6.7	15-30	6.6-9.0	8.0-16.0	0-3	0	13-60	-- data not available --	Fan Aprons	alluvium derived from sedimentary rock		
GOD [Merced County, California, Western Part (CA647)]																			CVDRMP Central Area – West Side		
Henmel Clay Loam, Partially Drained	192	100	100	60-100	35-95	15-45	0.0-3.0	0.06-0.20	0.10-0.19	9.3	10-25	7.9-9.0	0.0-2.0	0-5	0	0-10	-- data not available --	Fan aprons	alluvium derived from sedimentary rock		
Pedcat Clay Loam, Leveled, 0 to 2 percent slopes	236	100	100	75-100	50-95	27-50	0.0-1.0	0.00-0.06	0.09-0.16	6.7	15-30	6.6-9.0	8.0-16.0	0-3	0	13-60	-- data not available --	Fan Aprons	alluvium derived from sedimentary rock		
Woo Loam, 0 to 2 percent slopes	274	80-100	75-100	65-95	50-75	18-35	0.5-2.0	0.20-0.57	0.14-0.19	10	10-15	6.6-8.4	0.0-2.0	1-10	0	0	-- data not available --	Alluvial fans	alluvium derived from sedimentary rock		
MAC and NUN [Merced County, California, Western Part (CA647)]																			CVDRMP Central Area – West Side		
Trulaa Silty Clay, Partially Drained	258	90-100	90-100	80-100	65-95	30-65	0.0-2.0	0.00-0.06	0.12-0.16	8.2	20-50	7.9-8.4	4.0-8.0	0-10	0	0-50	-- data not available --	Basin floors	alluvium derived from sedimentary rock		
Woo Clay Loam, Wet, 0 to 2 percent slopes	279	100	95-100	75-100	50-90	18-45	0.0-2.0	0.06-0.20	0.14-0.19	10.2	10-25	6.6-8.4	0.0-4.0	1-10	0	0	-- data not available --	Alluvial fans	alluvium derived from sedimentary rock		

**Table 3-1
Soil Properties at Monitored Dairies, Central Valley Dairy Representative Monitoring Program – Year 5 Annual Report**

Dairy and Soil Survey Map Unit Name	Map Unit Symbol	----- Physical Soil Properties -----							----- Chemical Soil Properties -----							Soil Features					
		Percent Passing Sieve Number				Clay (%)	Organic Matter (%)	K _{sat(min)} (in/hr)	Available Water Capacity		Cation Exchange Capacity (meq/100g)	pH (pH-units)	Salinity (mS/cm)	CaSO ₄			Kind (in)	Restrictive Layer Depth to Top (in)	Thickness (in)	Land Form	Parent Material
		4 4.76 mm	10 1.68 mm	40 0.42 mm	200 0.074 mm				60 inch profile (in)	60 inch profile (in)				CaCO ₃ (%)	2H ₂ O (%)	SAR (-)					
MOO [Stanislaus County, California, Western Part (CA642)]																			CVDRMP Central Area – West Side		
Bolfar-Columbia Complex, 0 to 2 percent slopes, Rarely Flooded	245	100	100	60-100	35-80	18-35	0.0-2.0	0.20-0.60	0.12-0.17	8.5	5.0-28	7.4-8.4	0.0-4.0	0-2	0	0	-- data not available --	Flood plains	Alluvium derived from granite		
- Columbia	245	100	95-100	40-95	5-50	0-18	0.0-2.0	0.60-2.00	0.05-0.15	7.1	0.0-16	6.1-8.4	0	0	0	0	-- data not available --	Flood plains	Alluvium derived from granite		
Columbia Fine Sandy Loam, Channeled, Partially Drained, 0 to 2 percent slopes, Frequently Flooded	153	100	100	80-95	35-50	8-18	0.0-2.0	2.00-6.00	0.10-0.12	6.6	5.0-16	6.1-7.8	0	0	0	0	-- data not available --	Flood plains	Alluvium from mixed rock		
Dos Palos-Bolfar Complex, 0 to 2 percent slopes, Occasionally Flooded	170	100	100	80-100	50-95	30-60	0.0-3.0	0.06-0.20	0.09-0.15	7.4	5.2-52	7.4-8.4	0.0-4.0	1-15	0	0	-- data not available --	Flood plains	Alluvium derived from granite		
- Bolfar	170	100	100	80-100	35-80	18-35	0.0-2.0	0.20-0.60	0.12-0.17	8.8	5.0-28	7.4-8.4	0.0-4.0	0-2	0	0	-- data not available --	Flood plains	Alluvium derived from granite		
Elsalado Loam, 0 to 2 percent slopes	274	95-100	90-100	75-90	35-65	8-18	0.0-1.0	0.60-2.00	0.14-0.16	9	6.2-15	7.4-8.4	0.0-2.0	1-15	0	1-5	-- data not available --	Alluvial fans	Alluvium derived from sandstone-shale		
Pedcat Clay Loam, 0 to 2 percent slopes, Rarely Flooded	330	100	100	75-100	50-95	27-50	0.0-1.0	0.01-0.06	0.09-0.16	6.7	10-37	6.6-9.0	0.0-16.0	1-15	0	0-50	-- data not available --	Alluvial fans	alluvium derived from sedimentary rock		
Vernalis Loam, 0 to 2 percent slopes	122	100	95-100	80-100	55-80	18-30	0.5-2.0	0.60-2.00	0.14-0.18	9.6	15-24	6.6-8.4	0.0-2.0	0-5	0	0-5	-- data not available --	Alluvial fans	Alluvium from mixed rock		
Vernalis Clay Loam, 0 to 2 percent slopes	125	100	95-100	80-100	55-85	18-35	0.5-2.0	0.20-0.60	0.14-0.18	10	15-28	6.6-8.4	0.0-2.0	0-5	0	0-5	-- data not available --	Alluvial fans	Alluvium from mixed rock		
TON [Merced County, California, Western Part (CA647)]																			CVDRMP Central Area – West Side		
Deldota Clay, Partially Drained	167	100	95-100	90-100	75-95	30-50	0.0-3.0	0.06-0.20	0.15-0.18	9.9	2.0-7.0	7.4-8.4	0.0-2.0	20-40	1-20	0	-- data not available --	Terraces	Residuum weathered from sedimentary rock		
Dos Amigos Clay Loam, Partially Drained	168	100	95-100	85-100	50-95	30-50	0.0-2.0	0.00-0.06	0.09-0.20	8.6	5.0-30	7.9-8.4	0.0-16.0	20-35	0-10	0	-- data not available --	Alluvial fans	alluvium derived from sedimentary rock		
Pedcat Loam, 0 to 2 percent slopes	234	100	100	75-100	50-95	18-50	0.0-1.0	0.00-0.06	0.09-0.12	6.6	10-30	6.1-9.0	8.0-16.0	0-3	0	13-60	-- data not available --	Fan Aprons	alluvium derived from sedimentary rock		
Pedcat Clay Loam, Leveled, 0 to 2 percent slopes	236	100	100	75-100	50-95	27-50	0.0-1.0	0.00-0.06	0.09-0.16	6.7	15-30	6.6-9.0	8.0-16.0	0-3	0	13-60	-- data not available --	Fan Aprons	alluvium derived from sedimentary rock		
Volta Clay Loam	265	100	100	90-100	70-95	27-50	0.0-1.0	0	0.00-0.17	6	15-25	7.4-9.0	0.0-8.0	1-10	0	0-30	-- data not available --	Fan Aprons	alluvium derived from sedimentary rock		
Volta Clay Loam, Partially Drained	266	100	100	90-100	70-95	30-50	0.0-1.0	0	0.00-0.17	6.2	15-25	7.4-9.0	0.0-8.0	1-10	0	0-30	-- data not available --	Fan Aprons	alluvium derived from sedimentary rock		
BRE [Tehama County, California (CA645)]																			CVDRMP North Area		
Altamont Clay, Terrace, 0-3 percent slopes	AcA	100	95-100	80-100	70-95	35-60	0.5-3.0	0.06-0.20	0.14-0.18	7.9	25-50	6.1-8.4	0.0-2.0	0-10	0	0	-- data not available --	Hills	Residuum weathered from sedimentary rock		
Arbuckle Gravelly Loam, 0-3 percent slopes	AvA	35-80	30-75	15-65	10-50	12-30	0.0-1.0	0.20-0.57	0.04-0.15	7.6	5.0-20	5.6-7.3	0	0	0	0	-- data not available --	Terraces	Alluvium derived from metamorphic and sedimentary rock		
Arbuckle Gravelly Loam, Clayey Substratum, Channeled - Arbucle Riverwash	Ay	55-100	50-100	45-95	35-90	12-60	0.0-1.0	0.06-0.20	0.10-0.16	7.9	5.0-30	5.6-7.3	0	0	0	0	-- data not available --	Terraces	Alluvium derived from metamorphic and sedimentary rock		
Corning Gravelly Loam, 3-8 percent slopes	CwB	60-90	50-75	35-75	25-60	10-55	0.0-1.0	0.00-0.06	0.04-0.14	2.5	5.0-35	5.1-7.3	0	0	0	0	Abrupt textural change	21-36	-	Terraces	Alluvium derived from metamorphic and sedimentary rock
Hilgate Loam, 0-3 percent slopes	HgA	80-100	75-100	70-100	55-95	10-45	0.0-1.0	0.00-0.06	0.05-0.18	2.9	10-35	5.6-7.8	0	0	0	0	Abrupt textural change	17	22	Terraces	alluvium derived from sedimentary rock
Kimball Gravelly Loam, 0-3 percent slopes	KoA	65-80	60-75	50-70	35-65	15-60	0.0-3.0	0.00-0.06	0.08-0.17	1.7	10-35	5.6-6.6	0	0	0	0	Abrupt textural change	11	49	Terraces	Alluvium derived from sedimentary rock

**Table 3-1
Soil Properties at Monitored Dairies, Central Valley Dairy Representative Monitoring Program – Year 5 Annual Report**

Dairy and Soil Survey Map Unit Name	Map Unit Symbol	----- Physical Soil Properties -----							----- Chemical Soil Properties -----							Soil Features					
		Percent Passing Sieve Number				Clay (%)	Organic Matter (%)	K _{sat(min)} (in/hr)	Available Water Capacity		Cation Exchange Capacity (meq/100g)	pH (pH-units)	Salinity (mS/cm)	CaSO ₄			Kind (in)	Restrictive Layer Depth to Top (in)	Thickness (in)	Land Form	Parent Material
		4 4.76 mm	10 1.68 mm	40 0.42 mm	200 0.074 mm				60 inch profile (in)	60 (in/in)				CaCO ₃ (%)	2H ₂ O (%)	SAR (-)					
CRE [Glenn County, California (CA021)]																				CVDRMP North Area	
Arbuckle Gravelly Loam, Clayey Substratum, 0-2 percent slopes	Ar	55-100	50-100	45-95	35-90	12-60	0.0-2.0	0.06-0.20	0.10-0.16	7.6	5.0-20	5.6-7.3	0	0	0	0	Strongly contrasting textural stratification	60	-	Terraces	Alluvium derived from conglomerate
Cortina Very Gravelly Sandy Loam	Czr	30-60	25-55	15-50	0-15	0-25	0.0-1.0	1.98-5.95	0.03-0.11	2.8	1.0-10	5.6-7.3	0	0	0	0	Strongly contrasting textural stratification	-	-	Alluvial fans	Gravelly alluvium
Hillgate Clay Loam, 0-3 percent slopes	HI	95-100	90-100	80-100	60-95	27-45	0.0-1.0	0.00-0.06	0.05-0.19	2.7	15-35	5.1-7.3	0	0	0	0	Abrupt textural change	-	-	Terraces	Alluvium derived from sedimentary rock
Hillgate Loam, 0-2 percent slopes	HgA	80-100	75-100	70-100	55-95	10-45	0.0-1.0	0.00-0.06	0.05-0.18	2.5	10-35	5.1-7.3	0	0	0	0	Abrupt textural change	-	-	Terraces	Alluvium derived from sedimentary rock
Myers Clay, 0-3 percent slopes	MzrA	100	100	90-100	80-95	40-60	0.5-2.0	0.06-0.20	0.14-0.16	9.0	30-50	6.1-8.4	0.0-2.0	0	0	0	- - data not available - -	-	-	Alluvial fans	Alluvium derived from sedimentary rock
Tehama Silt Loam, Water Table, 0-2 percent slopes	Tn	90-100	85-100	80-100	60-95	15-35	0.0-2.0	0.06-0.20	0.14-0.19	10.6	10-25	5.6-8.4	0.0-2.0	0-5	0	0	- - data not available - -	-	-	Terraces	Alluvium derived from metamorphic and sedimentary rock
MTS [Glenn County, California (CA021)]																				CVDRMP North Area	
Arbuckle Gravelly Sandy Loam, 0-2 percent slopes	As	35-80	30-75	15-65	10-50	10-30	0.0-2.0	0.20-0.57	0.04-0.15	5.4	5.0-20	5.6-7.3	0	0	0	0	- - data not available - -	-	-	Terraces	Alluvium derived from conglomerate
Hilgate Loam, 0-2 percent slopes	HgA	80-100	75-100	70-100	55-95	10-45	0.0-1.0	0.00-0.06	0.05-0.18	2.5	10-35	5.1-7.3	0	0	0	0	Abrupt textural change	-	-	Terraces	Alluvium derived from sedimentary rock
Tehama Loam, Deep to Gravel, 0-3 percent slopes	Tb	30-100	25-100	15-100	0-95	0-35	0.0-2.0	0.20-0.57	0.02-0.19	7.9	1.0-25	5.6-8.4	0.0-2.0	0-5	0	0	Strongly contrasting textural stratification	-	-	Terraces	Alluvium derived from metamorphic and sedimentary rock
Tehama Silt Loam, 0-3 percent slopes	Tm	90-100	85-100	80-100	60-95	15-35	0.0-2.0	0.06-0.20	0.14-0.19	10.6	10-25	5.6-8.4	0	0-5	0	0	- - data not available - -	-	-	Terraces	Alluvium derived from metamorphic and sedimentary rock
AUK [Tulare County, Western Part, California (CA659)]																				CVDRMP South Area	
Biggriz-Biggriz, Saline-Sodic, Complex, 0-2 percent slopes - Biggriz	104	100	95-100	75-95	40-80	18-33	0.3-1.0	0.20-0.60	0.12-0.17	9.3	10-20	7.4-9.6	0.0-4.0	1-10	0-1	1-13	- - data not available - -	-	-	Fan remnants	Alluvium derived from granitic rock sources
- Biggriz, saline-sodic		100	95-100	75-95	40-80	18-33	0.3-1.0	0.20-0.60	0.10-0.13	7.2	10-20	7.9-9.6	4.0-8.0	1-10	0-1	13-200					
Colpien Loam, 0-2 percent slopes	108	100	100	50-90	40-80	10-31	0.2-3.0	0.20-0.60	0.10-0.21	10.7	10-20	6.6-8.4	0.5-4.0	0-5	0	1-12	- - data not available - -	-	-	Fan remnants	Alluvium derived from granitic rock sources
DLF [Tulare County, Western Part, California (CA659)]																				CVDRMP South Area	
Akers-Akers, Saline-Sodic, Complex, 0-2 percent slopes - Akers	101	100	95-100	70-90	40-70	8-18	0.1-1.0	0.60-2.00	0.13-0.21	9.7	5.0-15	7.4-8.4	0.0-4.0	1-10	0-2	1-12	- - data not available - -	-	-	Fan remnants	Alluvium derived from granitic rock sources
- Akers, Saline Sodic		100	95-100	70-90	40-70	8-18	0.1-1.0		0.12-0.20		5.0-15	7.4-9.0	2.0-8.0	1-10	0-2	1-30					
Colpien Loam, 0-2 percent slopes	108	100	100	50-90	40-80	10-31	0.2-3.0	0.20-0.60	0.10-0.21	10.7	10-20	6.6-8.4	0.5-4.0	0-5	0	1-12	- - data not available - -	-	-	Fan remnants	Alluvium derived from granitic rock sources
Crosscreek-Kai Association, 0-2 percent slopes - Crosscreek	109	60-100	50-100	35-90	20-70	18-35	0.1-1.0	0.01-0.06	0.06-0.18	7.8	5.0-10	6.6-9.9	1.0-12.0	1-10	1-5	1-13	Duripan	40-60	-	Fan remnants	Formed by the chemical and mechanical alteration of the kai series which originally formed in alluvium derived from granitic rock
- Kai		100	100	60-100	35-90	0-35	0.1-0.8	0.01-0.06	0.10-0.21	0.9	5.0-20	6.6-11.0	0.0-16.0	0-10	0	4-80	Natric	4-12	-		
- Kai																	Duripan	20-40	-		
Flamen Loam, 0-2 percent slopes	116	85-100	75-100	65-90	40-80	18-30	1.0-3.0	0.06-0.20	0.10-0.19	6.6	10-20	6.1-8.4	0.0-2.0	0-2	0	1-12	Duripan	40-60	-	Fan remnants	Alluvium derived from granitic rock sources
Nord Fine Sandy Loam, 0-2 percent slopes	130	100	100	25-95	20-70	2-18	0.1-2.0	0.60-2.00	0.05-0.15	7.2	5.0-15	6.6-8.4	0.0-2.0	0-4	0	2-10	- - data not available - -	-	-	Flood plains, alluvial fans	Alluvium derived from mixed

**Table 3-1
Soil Properties at Monitored Dairies, Central Valley Dairy Representative Monitoring Program – Year 5 Annual Report**

Dairy and Soil Survey Map Unit Name	Map Unit Symbol	----- Physical Soil Properties -----							----- Chemical Soil Properties -----							Soil Features						
		Percent Passing Sieve Number				Clay (%)	Organic Matter (%)	K _{sat(min)} (in/hr)	Available Water Capacity		Cation Exchange Capacity (meq/100g)	pH (pH-units)	Salinity (mS/cm)	CaSO ₄			Kind (in)	Restrictive Layer Depth to Top (in)	Thickness (in)	Land Form	Parent Material	
		4 4.76 mm	10 1.68 mm	40 0.42 mm	200 0.074 mm				60 inch profile (in)	60 inch profile (in)				CaCO ₃ (%)	2H ₂ O (%)	SAR (-)						
ELK [Tulare County, Western Part, California (CA659)]																				CVDRMP South Area		
Calgro-Calgro, Saline-Sodic, Complex, 0-2 percent slopes - Calgro		105	65-100	55-100	25-80	10-50	2-18	0.0-1.0	0.01-0.20	0.04-0.18	3.6	5.0-15	7.4-8.4	0.0-4.0	0-2	0	1-12	Duripan	20-40	-	Fan remnants	Alluvium derived from granitic rock sources
- Calgro, Saline-sodic			65-100	55-100	25-80	10-50	2-18	0.0-1.0	0.01-0.20	0.02-0.16	3.0	5.0-15	7.9-11.0	2.0-16.0	1-4	0	13-100	Duripan	20-40	-		
Crosscreek-Kai Association, 0-2 percent slopes - Crosscreek		109	60-100	50-100	35-90	20-70	18-35	0.1-1.0	0.01-0.06	0.06-0.18	7.8	5.0-10	6.6-9.9	1.0-12.0	1-10	1-5	1-13	Duripan	40-60	-	Fan remnants	Formed by the chemical and mechanical alteration of the kai series which originally formed in alluvium derived from granitic rock
- Kai			100	100	60-100	35-90	0-35	0.1-0.8	0.01-0.06	0.10-0.21	0.9	5.0-20	6.6-11.0	0.0-16.0	0-10	0	4-80	Natric	4-12	-		
- Kai																		Duripan	20-40	-		
Quonal-Lewis Association, 0-2 percent slopes - Quonal		132	60-100	50-100	45-100	40-100	18-50	0.1-1.0	0.01-0.06	0.08-0.17	5.4	15-40	7.4-9.6	0.0-8.0	1-10	1-5	0-50	Duripan	40-60	-	Fan remnants	Formed by the chemical and mechanical alteration of the kai series which originally formed in alluvium derived from granitic rock
- Lewis			100	95-100	60-100	50-95	15-60	0.1-1.0	0.01-0.06	0.06-0.18	0.9	10-20	7.9-9.6	4.0-40.0	1-8	0	13-100	Natric	2-6	-		
- Lewis																		Duripan	20-40	-		
ZZI [Kings County, California (CA031)]																				CVDRMP South Area		
Kimberlina Fine Sandy Loam, Saline-Alkali		130	80-100	75-100	40-70	25-50	6-18	0.5-1.0	0.20-0.57	0.02-0.08	3.0	5.0-10	7.9-8.4	4.0-8.0	0-5	0	15-25	- - data not available - -		Alluvial fans	Alluvium derived from igneous and sedimentary rock	
Lakeside Clay Loam, Drained		135	80-100	75-100	60-95	50-80	10-35	0.5-2.0	0.20-0.57	0.08-0.15	7.0	10-20	6.6-9.0	4.0-16.0	1-5	0	2-35	- - data not available - -		Rims on basin floors	Alluvium derived from igneous and sedimentary rock	
HOL [Tulare County, Western Part, California (CA659)]																				CVDRMP South Area		
Biggriz-Biggriz, Saline-Sodic, Complex, 0-2 percent slopes - Biggriz		104	100	95-100	75-95	40-80	18-33	0.3-1.0	0.20-0.60	0.12-0.17	9.3	10-20	7.4-9.6	0.0-4.0	1-10	0-1	1-13	- - data not available - -		Fan remnants	Alluvium derived from granitic rock sources	
Biggriz, saline-sodic			100	95-100	75-95	40-80	18-33	0.3-1.0	0.20-0.60	0.10-0.13	7.2	10-20	7.9-9.6	4.0-8.0	1-10	0-1	13-200					
Colpien Loam, 0-2 percent slopes		108	100	100	50-90	40-80	10-31	0.2-3.0	0.20-0.60	0.10-0.21	10.7	10-20	6.6-8.4	0.5-4.0	0-5	0	1-12	- - data not available - -		Fan remnants	Alluvium derived from granitic rock sources	
Gambogy-Biggriz, Saline-Sodic, Association, Drained, 0-2 percent slopes - Gambogy		118	95-100	90-100	55-100	30-80	8-35	0.5-3.0	0.20-0.60	0.10-0.17	8.3	5.0-20	7.4-8.4	0.0-4.0	0-3	0-1	1-12	- - data not available - -		Flood plains, alluvial fans	Alluvium derived from granitic rock sources	
- Biggriz			100	95-100	75-95	40-80	18-33	0.3-1.0	0.20-0.60	0.10-0.13	7.2	10-20	7.9-9.6	4.0-8.0	1-10	0-1	13-200					
HYN [Tulare County, Western Part, California (CA659)]																				CVDRMP South Area		
Nord Fine Sandy Loam, 0-2 percent slopes		130	100	100	25-95	20-70	2-18	0.1-2.0	0.60-2.00	0.05-0.15	7.2	5.0-15	6.6-8.4	0.0-2.0	0-4	0	2-10	- - data not available - -		Flood plains, alluvial fans	Alluvium derived from mixed	
Tagus Loam, 0-2 percent slopes		137	100	100	60-90	35-65	10-18	0.1-2.0	0.60-2.00	0.12-0.15	8.4	5.0-15	7.4-9.0	0.0-2.0	0-10	0	0-12	- - data not available - -		Fan remnants	Alluvium derived from granitic rock sources	
JAD [Tulare County, Western Part, California (CA659)]																				CVDRMP South Area		
Colpien Loam, 0-2 percent slopes		108	100	100	50-90	40-80	10-31	0.2-3.0	0.20-0.60	0.10-0.21	10.7	10-20	6.6-8.4	0.5-4.0	0-5	0	1-12	- - data not available - -		Fan remnants	Alluvium derived from granitic rock sources	
Crosscreek-Kai Association, 0-2 percent slopes - Crosscreek		109	60-100	50-100	35-90	20-70	18-35	0.1-1.0	0.01-0.06	0.06-0.18	7.8	5.0-10	6.6-9.9	1.0-12.0	1-10	1-5	1-13	Duripan	40-60	-	Fan remnants	Formed by the chemical and mechanical alteration of the kai series which originally formed in alluvium derived from granitic rock
- Kai			100	100	60-100	35-90	0-35	0.1-0.8	0.01-0.06	0.10-0.21	0.9	5.0-20	6.6-11.0	0.0-16.0	0-10	0	4-80	Natric	4-12	-		
- Kai																		Duripan	20-40	-		

Table 3-1
Soil Properties at Monitored Dairies, Central Valley Dairy Representative Monitoring Program – Year 5 Annual Report

Dairy and Soil Survey Map Unit Name	Map Unit Symbol	----- Physical Soil Properties -----							----- Chemical Soil Properties -----							Soil Features					
		Percent Passing Sieve Number				Clay (%)	Organic Matter (%)	K _{sat(min)} (in/hr)	Available Water Capacity		Cation Exchange Capacity (meq/100g)	pH (pH-units)	Salinity (mS/cm)	CaSO ₄			Kind -	Restrictive Layer Depth		Land Form	Parent Material
		4 4.76 mm	10 1.68 mm	40 0.42 mm	200 0.074 mm				60 inch profile (in)	60 inch profile (in)				CaCO ₃ (%)	2H ₂ O (%)	SAR -		to Top (in)	Thickness (in)		
LON [Kings County, California (CA031)]																			CVDRMP South Area		
Cajon Sandy Loam	104	90-100	85-100	40-70	5-35	0-18	0.5-1.0	1.98-5.95	0.06-0.12	5.1	1.0-15	7.4-8.4	0.0-2.0	0	0	0	-- data not available --	Alluvial fans	Alluvium derived from igneous and sedimentary rock		
Excelsior Sandy Loam	112	100	100	50-90	30-70	5-18	0.5-1.0	0.06-0.20	0.05-0.12	6.0	5.0-10	7.9-9.6	0.0-16.0	0-5	0	0-80	-- data not available --	Alluvial fans	Alluvium derived from igneous and sedimentary rock		
Kimberlina Fine Sandy Loam, Saline-Alkali	130	80-100	75-100	40-70	25-50	6-18	0.5-1.0	0.20-0.57	0.02-0.08	3.0	5.0-10	7.9-8.4	4.0-8.0	0-5	0	15-25	-- data not available --	Alluvial fans	Alluvium derived from igneous and sedimentary rock		
Wasco Sandy Loam, 0-5 percent slopes	174	80-100	75-100	45-80	25-50	8-18	0.5-1.0	1.98-5.95	0.08-0.13	6.4	5.0-10	6.1-8.4	0.0-2.0	1-5	0	0	-- data not available --	Alluvial fans	Alluvium derived from sandstone		
ADO [Eastern Fresno Area, California (CA654)]																			CVDRMP South Area		
Hanford Sandy Loam	Hc	100	95-100	50-75	30-40	7-18	0.0-1.0	1.98-5.95	0.10-0.15	7.8	5.0-10	6.1-7.3	0	0	0	0	-- data not available --	Alluvial fans, flood plains	Granitic alluvium		
Hesperia Fine Sandy Loam	Hsr	100	95-100	50-100	35-90	5-30	0.0-1.0	0.06-0.20	0.10-0.18	7.8	5.0-15	6.1-8.4	0.0-2.0	0-5	0	0	-- data not available --	-	Granitic alluvium		
Hesperia Fine Sandy Loam, Moderately Deep	Hst	100	95-100	50-100	35-90	5-30	0.0-1.0	0.06-0.20	0.10-0.18	8.5	5.0-15	6.1-8.4	0.0-2.0	0-5	0	0	-- data not available --	Alluvial fans, fan skirts	Granitic alluvium		
Hesperia Fine Sandy Loam, Moderately Deep, Saline-Alkali	Hsy	100	95-100	50-100	35-90	5-30	0.0-1.0	0.06-0.20	0.08-0.15	6.9	5.0-15	7.9-9.0	4.0-8.0	0-5	0	0-5	-- data not available --	Alluvial fans, fan skirts	Granitic alluvium		
Hesperia Sandy Loam, Moderately Deep, Saline-Alkali	Hsn	100	95-100	50-100	35-90	5-30	0.0-1.0	0.06-0.20	0.08-0.15	6.9	5.0-15	7.9-9.0	4.0-8.0	0-5	0	0-5	-- data not available --	Fan skirts, abandoned channels on alluvial fans	Granitic alluvium		
MAL [Kings County, California (CA031)]																			CVDRMP South Area		
Kimberlina Fine Sandy Loam, Saline-Alkali	130	80-100	75-100	40-70	25-50	6-18	0.5-1.0	0.20-0.57	0.02-0.08	3.0	5.0-10	7.9-8.4	4.0-8.0	0-5	0	15-25	-- data not available --	Alluvial fans	Alluvium derived from igneous and sedimentary rock		
Kimberline Saline-Alkali-Garces Complex - Kimberlina	132	80-100	75-100	40-70	25-50	6-18	0.5-1.0	0.20-0.57	0.02-0.08	3.0	5.0-10	7.9-8.4	4.0-8.0	0-5	0	15-25	-- data not available --	Alluvial fans	Alluvium derived from igneous and sedimentary rock		
- Garces		100	100	60-100	35-85	10-35	0.5-1.0	0.00-0.06	0.05-0.16	1.3	5.0-20	7.4-9.6	2.0-16.0	0-5	0	10-30	Natric	-	-		
Nord Fine Sandy Loam	147	100	100	60-95	35-70	10-18	0.5-2.0	0.57-1.98	0.10-0.15	7.6	5.0-15	6.6-8.4	0.0-2.0	0-5	0	0	-- data not available --	Flood plains	Alluvium derived from igneous rock; alluvium derived from sedimentary rock		
MAP [Eastern Fresno Area, California (CA654)]																			CVDRMP South Area		
Calhi Loamy Sand, 0-3 percent slopes	CfA	100	100	50-90	5-35	0-8	0.0-1.0	5.95-19.98	0.05-0.08	4.1	1.0-5.0	7.4-9.0	0.0-4.0	1-5	0	0	-- data not available --	Dunes on Fan skirt	Eolian deposits derived from granitic alluvium		
Dello Sandy Loam	Dn	100	100	50-80	5-50	0-18	0.0-1.0	1.98-5.95	0.04-0.13	4.5	1.0-10	6.6-8.4	0.0-2.0	0	0	0	-- data not available --	Depressions on flood plains, depressions on alluvial fans			
Grangeville Fine Sandy Loam	Gf	100	95-100	60-95	35-60	8-18	0.5-6.0	1.98-5.95	0.12-0.15	8.3	5.0-15	6.1-8.4	0.0-2.0	0	0	0	-- data not available --	Alluvial fans, flood plains	Recent granitic alluvium		
Grangeville Fine Sandy Loam, Hard Substratum	Gn	100	95-100	50-75	35-50	8-18	0.5-6.0	0.01-0.14	0.00-0.15	5.2	5.0-15	6.6-8.4	0.0-2.0	0	0	0	Duripan	24-60	4-17		
Grangeville Fine Sandy Loam, Hard Substratum, Saline-Alkali	Go	100	95-100	50-75	35-50	8-18	0.5-6.0	0.01-0.14	0.00-0.13	4.0	5.0-15	7.4-8.4	4.0-16.0	0	0	0-5	Duripan	24-60	4-17		
Grangeville Fine Sandy Loam, Saline-Alkali	Gg	100	95-100	60-95	35-60	8-18	0.5-6.0	0.57-1.98	0.12-0.15	8.3	5.0-15	7.4-9.0	4.0-8.0	0	0	0.5	-- data not available --	Alluvial fans, flood plains	Recent granitic alluvium		
Grangeville Fine Sandy Loam, Sandy Substratum	Gm	85-100	75-100	40-75	5-50	0-18	0.0-6.0	1.98-5.95	0.04-0.15	6.2	1.0-15	6.6-8.4	0.0-2.0	0	0	0	-- data not available --	Alluvial fans, flood plains	Recent granitic alluvium		
Traver Fine Sandy Loam	Tt	100	95-100	65-90	35-50	8-25	0.0-1.0	0.06-0.20	0.06-0.13	5.3	5.0-15	7.4-9.6	4.0-16.0	1-5	0	0-20	-- data not available --	Fan skirts	Granitic alluvium		
Traver Sandy Loam	Tr	100	100	65-90	35-50	8-25	0.0-1.0	0.06-0.20	0.06-0.13	5.3	5.0-15	7.4-9.6	0.0-16.0	1-5	0	0-20	-- data not available --	Fan skirts	Granitic alluvium		
Tujung Loamy Sand, 0-3 percent slopes	TzbA	90-100	75-95	40-70	5-25	0-5	0.0-1.0	5.95-19.98	0.05-0.10	4.2	1.0-5.0	6.1-7.3	0	0	0	0	-- data not available --	Flood plains, alluvial fans	Granitic alluvium		

**Table 3-1
Soil Properties at Monitored Dairies, Central Valley Dairy Representative Monitoring Program – Year 5 Annual Report**

Dairy and Soil Survey Map Unit Name	Map Unit Symbol	----- Physical Soil Properties -----							----- Chemical Soil Properties -----							Soil Features					
		Percent Passing Sieve Number				Clay (%)	Organic Matter (%)	K _{sat(min)} (in/hr)	Available Water Capacity 60 inch profile (in/in)	Cation Exchange Capacity (meq/100g)	pH (pH-units)	Salinity (mS/cm)	CaCO ₃ (%)	CaSO ₄ 2H ₂ O (%)	SAR (-)	Kind (-)	Restrictive Layer Depth to Top (in)		Thickness (in)	Land Form	Parent Material
		4 4.76 mm	10 1.68 mm	40 0.42 mm	200 0.074 mm																
ZON [Eastern Fresno Area, California (CA654)]																			CVDRMP South Area		
Calhi Loamy Sand, 0-3 percent slopes	CfA	100	100	50-90	5-35	0-8	0.0-1.0	5.95-19.98	0.05-0.08	4.1	1.0-5.0	7.4-9.0	0.0-4.0	1-5	0	0	-- data not available --	Dunes on Fan skirt	Eolian deposits derived from granitic alluvium		
Delhi Sand, 0-3 percent slopes	DeA	100	100	40-80	5-10	0-5	0.0-1.0	5.95-19.98	0.05-0.10	4.7	1.0-5.0	6.1-7.3	0	0	0	0	-- data not available --	Dunes on fan remnants	Eolian deposits derived from granitic alluvium		
Dello Loamy Sand	Dm	100	100	50-80	5-35	0-10	0.0-1.0	5.95-19.98	0.04-0.10	4.1	1.0-5.0	6.6-8.4	0.0-2.0	0	0	0	-- data not available --	Depressions on flood plains, depressions on alluvial fans	Granitic alluvium		
Dello Sandy Loam	Dn	100	100	50-80	5-50	0-18	0.0-1.0	1.98-5.95	0.04-0.13	4.5	1.0-10	6.6-8.4	0.0-2.0	0	0	0	-- data not available --	Depressions on flood plains, depressions on alluvial fans	Granitic alluvium		
Grangeville Fine Sandy Loam	Gf	100	95-100	60-95	35-60	8-18	0.5-6.0	1.98-5.95	0.12-0.15	8.3	5.0-15	6.1-8.4	0.0-2.0	0	0	0	-- data not available --	Alluvial fans, flood plains	Recent granitic alluvium		
Grangeville Fine Sandy Loam, Hard Substratum, Saline-Alkali	Go	100	95-100	50-75	35-50	8-18	0.5-6.0	0.01-0.14	0.00-0.13	4.0	5.0-15	7.4-8.4	4.0-16.0	0	0	0-5	Duripan	24-60	4-17	Valleys	Recent granitic alluvium
Grangeville Fine Sandy Loam, Sandy Substratum	Gm	85-100	75-100	40-75	5-50	0-18	0.0-6.0	1.98-5.95	0.04-0.15	6.2	1.0-15	6.6-8.4	0.0-2.0	0	0	0	-- data not available --	Alluvial fans, flood plains	Recent granitic alluvium		
Grangeville Sandy Loam, Saline-Alkali	Gd	100	95-100	60-95	35-60	8-18	0.5-6.0	0.57-1.98	0.10-0.13	7.2	5.0-15	7.4-9.0	4.0-8.0	0	0	0-5	-- data not available --	Alluvial fans, flood plains	Recent granitic alluvium		
Grangeville Sandy Loam, Sandy Substratum	Ge	85-100	75-100	40-75	5-50	0-18	0.0-6.0	1.98-5.95	0.04-0.15	6.2	1.0-15	6.6-8.4	0.0-2.0	0	0	0	-- data not available --	Alluvial fans, flood plains	Recent granitic alluvium		
Traver Fine Sandy Loam	Tt	100	95-100	65-90	35-50	8-25	0.0-1.0	0.06-0.20	0.06-0.13	5.3	5.0-15	7.4-9.6	4.0-16.0	1-5	0	0-20	-- data not available --	Fan skirts	Granitic alluvium		
Tujunga Loamy Sand, 0-3 percent slopes	TzbA	90-100	75-95	40-70	5-25	0-5	0.0-1.0	5.95-19.98	0.05-0.10	4.2	1.0-5.0	6.1-7.3	0	0	0	0	-- data not available --	Flood plains, alluvial fans	Granitic alluvium		
Tujunga Sand, 0-3 percent slopes	TzaA	90-100	75-95	40-70	5-25	0-5	0.0-1.0	5.95-19.98	0.05-0.08	4.2	1.0-5.0	6.1-7.3	0	0	0	0	-- data not available --	Flood plains, alluvial fans	Granitic alluvium		
RIC [Kern County, California, Southwest Part (CA691)]																			CVDRMP South Area		
Bakersfield Fine Sandy Loam, Drained, 0-1 percent slopes	101	100	95-100	64-100	17-93	2-27	0.1-3.0	0.57-1.98	0.05-0.22	9.9	1.8-22	6.1-8.4	0.5-5.0	0-3	0	2-12	-- data not available --	Flood plains	Alluvium derived from granitoid		
Bakersfield Sandy Loam, Partially Drained, 0-1 percent slopes	102	100	95-100	64-100	17-93	2-27	0.1-3.0	0.57-1.98	0.05-0.22	9.9	1.8-22	6.1-8.4	1.0-10.0	0-3	0	5-80	-- data not available --	Flood plains	Alluvium derived from granitoid		
Granoso Sandy Loam, 0-2 percent slopes, Overwash	123	85-100	85-100	61-86	8-42	4-12	0.1-0.9	1.98-5.95	0.04-0.15	4.9	2.8-9.1	7.4-8.4	0.1-2.0	0-3	0	1-4	-- data not available --	Alluvial fans, flood plains	Alluvium derived from mixed		
Old River Loam, Partially Drained, Sodic, 0-1 percent slopes	251	100	91-100	52-100	27-98	6-50	0.1-4.0	0.01-1.98	0.06-0.22	7.9	5.0-39	7.4-9.0	2.0-15.0	0-4	0-5	2-30	-- data not available --	Flood plains	Alluvium derived from granitoid rock		
SIE [Tulare County, Western Part, California (CA659)]																			CVDRMP South Area		
Hanford Sandy Loam, 0-2 percent slopes	124	85-100	75-100	40-75	15-50	5-18	0.1-1.0	2.00-6.00	0.07-0.15	6.6	5.0-15	5.6-7.8	0.0-2.0	0-2	0	0-7	-- data not available --	Flood plains, alluvial fans	Alluvium derived from granitic rock sources		
Nord Fine Sandy Loam, 0-2 percent slopes	130	100	100	25-95	20-70	2-18	0.1-2.0	0.60-2.00	0.05-0.15	7.2	5.0-15	6.6-8.4	0.0-2.0	0-4	0	2-10	-- data not available --	Flood plains, alluvial fans	Alluvium derived from mixed		
Tujunga Loamy Sand, 0-2 percent slopes	138	90-100	75-95	35-50	10-25	0-5	0.1-0.8	6.00-20.00	0.02-0.08	3.1	0.0-5.0	6.1-7.3	0	0	0	0	-- data not available --	Flood plains	Alluvium derived from granite		
SO2 [Eastern Fresno Area, California (CA654)]																			CVDRMP South Area		
Delhi Loamy Sand, 0-3 percent slopes	DhA	100	100	50-80	20-30	0-5	0.0-1.0	5.95-19.98	0.05-0.10	4.8	1.0-5.0	6.1-7.3	0	0	0	0	-- data not available --	Dunes on fan remnants	Eolian deposits derived from granitic alluvium		
El Peco Fine Sandy Loam	Ed	100	100	70-95	35-85	7-25	0.0-1.0	0.00-0.01	0.00-0.10	1.8	5.0-15	7.8-9.6	8.0-16.0	0-5	0	0-5	Duripan	20-40	0-3	Fan skirts	Granitic alluvium
El Peco Sandy Loam	Ec	100	100	70-95	35-85	7-25	0.0-1.0	0.00-0.01	0.00-0.10	1.8	5.0-15	7.8-9.6	8.0-16.0	0-5	0	0-5	Duripan	20-40	0-3	Fan skirts	Granitic alluvium
Greenfield Sandy Loam, 0-3 percent slopes	GtA	95-100	90-100	50-75	30-50	7-18	0.00-1.0	1.98-5.95	0.10-0.16	8.0	5.0-15	6.1-7.8	0	0	0	0	-- data not available --	Alluvial fans	Granitic alluvium		

**Table 3-1
Soil Properties at Monitored Dairies, Central Valley Dairy Representative Monitoring Program – Year 5 Annual Report**

Dairy and Soil Survey Map Unit Name	Map Unit Symbol	----- Physical Soil Properties -----							----- Chemical Soil Properties -----							Soil Features					
		Percent Passing Sieve Number				Clay (%)	Organic Matter (%)	K _{sat(min)} (in/hr)	Available Water Capacity		Cation Exchange Capacity (meq/100g)	pH (pH-units)	Salinity (mS/cm)	CaSO ₄			Kind -	Restrictive Layer Depth		Land Form	Parent Material
		4 4.76 mm	10 1.68 mm	40 0.42 mm	200 0.074 mm				60 inch profile (in/in)	(in)				CaCO ₃ (%)	2H ₂ O (%)	SAR -		to Top (in)	Thickness (in)		
Hesperia Fine Sandy Loam, Moderately Deep	Hst	100	95-100	50-100	35-90	5-30	0.0-1.0	0.06-0.20	0.10-0.18	8.5	5.0-15	6.1-8.4	0.0-2.0	0-5	0	0	-- data not available --	Alluvial fans, fan skirts	Granitic alluvium		
Hesperia Sandy Loam	Hsd	100	95-100	50-100	35-90	5-30	0.0-1.0	0.06-0.20	0.10-0.18	7.8	5.0-15	6.1-8.4	0.0-2.0	0-5	0	0	-- data not available --	Alluvial fans	Granitic alluvium		
Hesperia Sandy Loam, Moderately Deep	Hsm	100	95-100	50-100	35-90	5-30	0.0-1.0	0.06-0.20	0.10-0.18	8.5	5.0-15	6.1-8.4	0.0-2.0	0-5	0	0	-- data not available --	Alluvial fans	Granitic alluvium		
Hesperia Sandy Loam, Moderately Deep, Saline-Alkali	Hsn	100	95-100	50-100	35-90	5-30	0.0-1.0	0.06-0.20	0.08-0.15	6.9	5.0-15	7.9-9.0	4.0-8.0	0-5	0	0-5	-- data not available --	Fan skirts, abandoned channels on alluvial fans	Granitic alluvium		
SOJ [Eastern Fresno Area, California (CA654)]																			CVDRMP South Area		
Delhi Loamy Sand, 0-3 percent slopes	DhA	100	100	50-80	20-30	0-5	0.0-1.0	5.95-19.98	0.05-0.10	4.8	1.0-5.0	6.1-7.3	0	0	0	0	-- data not available --	Dunes on fan remnants	Eolian deposits derived from granitic alluvium		
Delhi Sand, 0-3 percent slopes	DeA	100	100	40-80	5-10	0-5	0.0-1.0	5.95-19.98	0.05-0.10	4.7	1.0-5.0	6.1-7.3	0	0	0	0	-- data not available --	Dunes on fan remnants	Eolian deposits derived from granitic alluvium		
Dello Loamy Sand	Dm	100	100	50-80	5-35	0-10	0.0-1.0	5.95-19.98	0.04-0.10	4.1	1.0-5.0	6.6-8.4	0.0-2.0	0	0	0	-- data not available --	Depressions on flood plains, depressions on alluvial fans	Granitic alluvium		
Hesperia Sandy Loam	Hsd	100	95-100	50-100	35-90	5-30	0.0-1.0	0.06-0.20	0.10-0.18	7.8	5.0-15	6.1-8.4	0.0-2.0	0-5	0	0	-- data not available --	Alluvial fans	Granitic alluvium		
Hesperia Fine Sandy Loam	HsR	100	95-100	50-100	35-90	5-30	0.0-1.0	0.06-0.20	0.10-0.18	7.8	5.0-15	6.1-8.4	0.0-2.0	0-5	0	0	-- data not available --	-	Granitic alluvium		

Data Source: USDA NRCS Soil Survey Geographic Database (SSURGO)

With the exception of Ksat(min), numerical values and ranges pertain to a 60-inch soil profile and may integrate properties of multiple soil horizons.

Detailed parameter descriptions for dairies in the Central Area (except DIE, DUR, GEN, TRO, and WOO) are provided in the Year 1 Annual Report (LSCE, 2013a). Detailed parameter descriptions for the remaining dairies are provided in the Evaluation of Representativeness (LSCE, 2013b).

Table 3-2
Summary of Nine Basic Soil Properties at Monitored CVDRMP Dairies
Central Valley Dairy Representative Monitoring Program – Year 5 Annual Report

Dairy Farm	Predominate Soil Types	Clay Content (%) by weight)	Organic Matter Content (%) by Weight)	$K_{sat(min)}$ (in/hr)	Available water capacity (in)	CEC (meq per 100g)	Salinity (mS/cm)	CaCO ₃ Content (% by Weight)	Gypsum Content (% by Weight)	pH
Central Area – East Side										
MEN	sandy loams, slightly saline-alkali (DwA, WdA)	7 - 18	0 - 3.0	0.06 - 0.20	5.4 - 6.6	3.8 - 17	4.0 - 8.0	0 - 5	0	6.6 - 9.0
ANC	loamy sands (DdA, HhA), slightly saline-alkali	0 - 15	0 - 1.0	0.06 - 19.98	4.8 - 7.7	1.0 - 5.0	0 - 8.0	0 - 5	0 - 5	6.1 - 9.6
BET - Production area	sands, slightly saline-alkali (DfA)	0 - 15	0 - 1.0	0.06 - 19.98	2.5 - 7.3	1.0 - 5.0	0 - 8.0	0 - 5	0	6.1 - 9.6
BET - Fields	sand (HoA) and dune land (DuA)	0 - 1	0 - 0.1	5.95	2.5	1.0 - 5.0	0	0	0	6.1 - 9.6
DIE	loams, slightly and moderately saline-alkali (CgaA, Ffa/b/cA)	2 - 35	0 - 3.0	0.00 - 0.57	2.0 - 10.2	5.0 - 20	4.0 - 30.0	0 - 10	0	6.6 - 9.6
DUR	fine sandy loams, slightly and moderately saline-alkali (DpA, WbA)	7 - 18	0.0 - 3.0	0.06 - 0.20	5.4	3.8 - 9.6	4.0 - 18.0	0 - 5	0	7.4 - 9.0
FG1	sands (DfA), sandy loams (HcB), loams (GcA), slightly saline-alkali	0 - 20	0 - 6.0	0.06 - 19.98	4.3 - 8.6	1.0 - 15	0 - 8.0	0 - 2	0	6.1 - 8.4
BEA	sands (HpA) and loamy sands (HfA), slightly saline-alkali	0 - 15	0.0 - 1.0	0.06 - 19.98	1.8 - 7.7	1.0 - 5.0	0 - 8.0	0 - 5	0	6.1 - 9.6
COT	sands (DfA, HoA), loamy sands (HgA), and loam (FoA), slightly to strongly saline-alkali	0 - 35	0.0 - 1.0	0.00 - 19.98	1.8 - 7.7	1.0 - 20	0 - 30.0	0 - 5	0	6.1 - 9.6
SAN	sands (DoA), loamy sands (HgA), sandy loams (SnA), and silty clay loams (LoA), slightly to strongly saline-alkali	0 - 60	0.0 - 2.0	0 - 19.98	2.3 - 9.1	1.0 - 50	0 - 30.0	0 - 5	0	6.1 - 9.6
GEN	sandy loams (DrA, OaA)	5 - 18	0.0 - 2.0	0.06 - 5.95	7.2 - 7.3	2.6 - 9.6	0 - 4.0	0	0	6.1 - 8.4
TRO	loamy sand (TwA); loam, strongly saline-alkali (ToA); and fine sandy loam (GcA)	0 - 26	0.0 - 6.0	0.20 - 19.98	3.9 - 7.2	1.0 - 15	0 - 30.0	0 - 5	0	6.1 - 9.6
PLS	sandy loams (DpA, DrA), slightly saline-alkali	7 - 18	0.0 - 1.0	0.06 - 0.20	7.2	5.0 - 10	0 - 8.0	0	0	6.6 - 8.4
CAE	sands (DuA, DfA) and loamy sands (DeA and HhA), slightly saline-alkali	0 - 15	0.0 - 1.0	0.06 - 19.98	2.5 - 7.7	1.0 - 5.0	0 - 8.0	0 - 5	0	6.1 - 9.6
ROB	sandy loam (DwA) and loamy sand (HfA), slightly saline-alkali	0 - 18	0.0 - 1.0	0.06 - 0.20	5.4 - 7.2	0.1 - 9.6	0 - 8.0	0 - 5	0	7.3 - 9.6
WOO	sandy loam (101) and fine sandy loam (256)	7 - 18	0.0 - 3.0	0.00 - 5.95	5.6 - 7.8	8.0 - 20	0.0 - 2.0	0	0	6.1 - 8.4

Table 3-2
Summary of Nine Basic Soil Properties at Monitored CVDRMP Dairies
Central Valley Dairy Representative Monitoring Program – Year 5 Annual Report

Dairy Farm	Predominate Soil Types	Clay Content (% by weight)	Organic Matter Content (% by Weight)	$K_{sat(min)}$ (in/hr)	Available water capacity (in)	CEC (meq per 100g)	Salinity (mS/cm)	CaCO ₃ Content (% by Weight)	Gypsum Content (% by Weight)	pH
Central Area – West Side										
ANT	loam (122) and clay loam (331)	18 - 50	0.0 - 2.0	0.01 - 2.0	6.7 - 9.6	10 - 37	0 - 16.0	0 - 15	0	6.6 - 9.0
COR	loam (234) and clay (237)	18 - 50	0.0 - 1.0	0.01 - 0.20	6.6	10 - 30	8.0 - 16.0	0 - 3	0	6.6 - 9.0
FG2	clay loam (168) and clay (169)	27 - 50	0.0 - 2.0	0.00 - 0.06	6.7 - 8.6	5.0 - 30	0.0 - 16.0	0 - 35	0 - 10	6.6 - 9.0
GOD	loam (274) and clay loam (192, 236)	15 - 50	0.0 - 3.0	0.00 - 0.57	6.7 - 10	10 - 30	0.0 - 16.0	0 - 10	0	6.6 - 9.0
MAC	silty clay (258) and clay loam (279)	18 - 65	0.0 - 2.0	0.00 - 0.20	8.2 - 10.2	10 - 50	0.0 - 8.0	0 - 10	0	6.6 - 8.4
NUN	silty clay (258) and clay loam (279)	18 - 65	0.0 - 2.0	0.00 - 0.20	8.2 - 10.2	10 - 50	0.0 - 8.0	0 - 10	0	6.6 - 8.4
MOO	loam (122) and clay loam (330)	18 - 50	0.0 - 2.0	0.01 - 2.00	6.7 - 9.6	10 - 37	0.0 - 16.0	0 - 15	0	6.6 - 9.0
TON	clay loam (168, 236, 266)	27 - 50	0.0 - 2.0	0.00 - 0.06	6.2 - 8.6	5.0 - 30	0.0 - 16.0	1 - 35	0 - 10	6.6 - 9.0
North Area										
BRE	loam (HgA), gravelly loam (KoA), clay (AcA)	10 - 60	0.0 - 3.0	0.00 - 0.20	1.7 - 7.9	10 - 50	0 - 2.0	0 - 10	0	5.6 - 8.4
CRE	loam (HgA), clay loam (HI), and clay (MzrA)	10 - 60	0.0 - 2.0	0.00 - 0.20	2.5 - 9.0	10 - 50	0 - 2.0	0	0	5.1 - 8.4
MTS	gravelly sandy loam (As), loam (HgA), and silt loam (Tm)	10 - 45	0.0 - 2.0	0.00 - 0.57	2.5 - 10.6	5.0 - 35	0	0 - 5	0	5.1 - 8.4
South Area										
AUK	loam, saline-sodic (104); loam (108)	10 - 33	0.2 - 3.0	0.20 - 0.60	9.3 - 10.7	10 - 20	0.0 - 4.0	0 - 10	0 - 1	6.6 - 9.6
DLF	fine sandy loam (130), and loam (116 and 109)	0 - 35	0.1 - 3.0	0.01 - 2.00	0.9 - 7.8	5.0 - 20	0.0 - 16.0	0 - 10	0 - 5	6.1 - 11.0
ELK	silty clay and silty clay loam (132), and sandy loam, saline-sodic (106)	2 - 60	0.0 - 1.0	0.01 - 0.20	0.9 - 5.4	5.0 - 40	0.0 - 16.0	0 - 10	0 - 5	7.4 - 11.0
ZZI	fine sandy loam (130)	6 - 18	0.5 - 1.0	0.20 - 0.57	3	5.0 - 10	4.0 - 8.0	0 - 5	0	7.9 - 8.4
HOL	loam, saline-sodic (118)	8 - 35	0.3 - 3.0	0.20 - 0.60	7.2 - 8.3	5.0 - 20	0.0 - 8.0	0 - 10	0 - 1	7.4 - 9.6
HYN	fine sandy loam (130), loam (137)	2 - 18	0.1 - 2.0	0.60 - 2.00	7.2 - 8.4	5.0 - 15	0.0 - 2.0	0 - 10	0	6.6 - 9.0
JAD	loams (108 and 109)	0 - 35	0.1 - 3.0	0.01 - 0.60	0.9 - 10.7	5.0 - 20	0.0 - 16.0	0 - 10	0 - 5	6.6 - 11.0
LON	fine sandy loam (130), and sandy loam (112)	5 - 18	0.5 - 1.0	0.06 - 0.57	3.0 - 6.0	5.0 - 10	0.0 - 16.0	0 - 5	0	7.9 - 9.6
ADO	fine sandy loams (Hsy and Hst)	5 - 30	0.0 - 1.0	0.06 - 0.20	6.9 - 8.5	5.0 - 15	0.0 - 8.0	0 - 5	0 - 5	6.1 - 9.0
MAL	fine sandy loams (132 and 147)	6 - 35	0.5 - 2.0	0.00 - 1.98	1.3 - 7.6	5.0 - 20	0.0 - 16.0	0 - 5	0	6.6 - 9.6

Table 3-2
Summary of Nine Basic Soil Properties at Monitored CVDRMP Dairies
Central Valley Dairy Representative Monitoring Program – Year 5 Annual Report

Dairy Farm	Predominate Soil Types	Clay Content (% by weight)	Organic Matter Content (% by Weight)	$K_{sat(min)}$ (in/hr)	Available water capacity (in)	CEC (meq per 100g)	Salinity (mS/cm)	CaCO ₃ Content (% by Weight)	Gypsum Content (% by Weight)	pH
MAP	fine sandy loams (Gf and Gm) and sandy loam (Dn)	0 - 18	0.0 - 6.0	1.98 - 5.95	4.5 - 8.3	1.0 - 15	0.0 - 2.0	0	0	6.1 - 8.4
ZON	fine sandy loam (Gg), sandy loam (Dn), loamy sand (TzbA)	0 - 18	0.0 - 6.0	0.57 - 19.98	4.2 - 4.5	1.0 - 15	0.0 - 8.0	0	0	6.1 - 9.0
RIC	loam, partially drained (251); sandy loam, partially drained (102); fine sandy loam, drained (101)	2 - 50	0.1 - 4.0	0.01 - 1.98	7.9 - 9.9	1.8 - 39	0.5 - 15.0	0 - 4	0 - 5	6.1 - 9.0
SIE	sandy loams (124 and 130)	2 - 18	0.1 - 2.0	0.60 - 6.00	6.6 - 7.2	5.0 - 15	0.0 - 2.0	0 - 4	0	5.6 - 8.4
SO2	sandy loams (Ec and Hsd)	5 - 30	0.0 - 1.0	0.00 - 0.20	1.8 - 7.8	5.0 - 15	0.0 - 16.0	0 - 5	0	6.1 - 9.6
SOJ	loamy sand (DhA), sandy loam (Hsd)	0 - 30	0.0 - 1.0	0.06 - 19.98	4.8 - 7.8	1.0 - 15	0.0 - 2.0	0 - 5	0	6.1 - 8.4

Data Source: USDA NRCS Soil Survey Geographic Database (SSURGO)

Detailed parameter descriptions for dairies in the Central Area (except DIE, DUR, GEN, TRO, and WOO) are provided in the Year 1 Annual Report (LSCE, 2013a). Detailed parameter descriptions for the remaining dairies are provided in the Evaluation of Representativeness (LSCE, 2013b).

Table 3-3
Forage Crops, Irrigation Systems, and Water Sources
Central Valley Dairy Representative Monitoring Program – Year 5 Annual Report

CVDRMP Area	Dairy	Corn	Oats	Wheat	Alfalfa	Sudan	Triticale	Pasture	Sorghum	Irrigation System	Water Source	
Central Area – East Side	MEN	✓	✓		✓	✓	✓			b/b	sw	
	ANC (1)	-	-	-	-	-	-	-	-	-	-	
	BET	✓	✓							b/b	sw/gw	
	DIE	✓		✓					✓	b/b	gw	
	DUR	✓	✓		✓					b/b	sw	
	FG1	✓	✓							f/b	sw	
	BEA (1)	-	-	-	-	-	-	-	-	-	-	-
	COT	✓	✓	✓					✓	b/b	gw	
	SAN	✓	✓		✓				✓	b/b	gw	
	GEN	✓	✓	✓				✓		b/b	sw	
	TRO	✓		✓	✓					b/b	gw	
	PLS	✓	✓		✓		✓			b/b	sw/gw	
	CAE	✓	✓				✓			b/b	sw	
	ROB	✓	✓	✓	✓	✓	✓			b/b	sw/gw	
WOO	✓	✓			✓		✓		f/b	gw		
Central Area West Side	ANT	✓	✓							f/b	sw	
	COR (1)	-	-	-	-	-	-	-	-	-	-	
	FG2	✓	✓		✓	✓				f/b	sw	
	GOD	✓	✓		✓	✓				f/b	sw	
	MAC	✓	✓							f/b	sw	
	NUN	✓	✓		✓	✓				f/b	sw	
	MOO	✓		✓	✓		✓		✓	f/b	sw/gw	
TON	✓	✓		✓					f/b	sw/gw		
North Area	BRE (2)	✓								cp	gw	
	CRE							✓		flood	sw	
	MTS	✓		✓	✓		✓			b/b	gw	
South Area	AUK	✓		✓						b/b	sw/gw	
	DLF	✓		✓	✓			✓		b/b	sw/gw	
	ELK	✓		✓	✓					f/b	sw/gw	
	ZZI	✓		✓	✓		✓			b/b	sw/gw	
	HOL (1)	-	-	-	-	-	-	-	-	-	-	
	HYN	✓		✓	✓					f/b	sw/gw	
	JAD	✓		✓						f/b	sw/gw	
	LON	✓		✓	✓					f/b	sw/gw	
	ADO (1)	-	-	-	-	-	-	-	-	-	-	-
	MAL	✓			✓		✓		✓	f/b	sw/gw	
	MAP	✓		✓						f/b	sw/gw	
	ZON	✓		✓						f/b	sw/gw	
	RIC	✓	✓	✓	✓					cp	sw/gw	
	SIE	✓		✓	✓	✓				f/b	sw/gw	
SO2	✓		✓	✓	✓	✓	✓	✓	f/b	sw/gw		
SOJ	✓		✓						f/b	gw		

(1) Fields are not monitored at this dairy farm.

(2) Winter crop is rye.

Irrigation Systems: summer crop/winter crop, b=border, f=furrow, cp=center pivot

Water Sources: sw=surface water, gw=groundwater (bold indicates main water source)

**Table 3-4
Infrastructure and Management Practices, Corrals**

Central Valley Dairy Representative Monitoring Program – Year 5 Annual Report

Dairy	Corral ID	Maintenance and Manure Removal [†]
MEN	Open Cow Corrals	corrals slope southward; manure removal in spring and fall using front end loader
	Open Heifer Corrals	same
ANC	Exercise Pens	corrals sloped east and west to flush lanes; manure removal in fall using scraper and front end loader; fill dirt added as necessary; cows are in freestalls Nov-Mar
	Open Cow Corrals	corrals moderately sloped; scraped regularly during dry periods; manure removal in spring and fall using scraper and front end loader; fill dirt added as necessary; cows are in freestalls Nov-Mar
	Open Heifer Corrals	same
BET	Exercise Pens	corrals scraped and re-graded as needed; manure removal in spring and fall using scraper and front end loader; fill dirt added as necessary; cows locked out during wet season
	Open Cow Corrals	same
	Open Heifer Corrals	same
DIE	Exercise Pens	corrals scraped weekly or as needed and graded as needed; manure removal twice a year; no fill dirt used
	Open Cow Corrals	same
	Open Heifer Corrals	same
DUR	Exercise Pens	graded, scraped in summer months as needed, piled and then removed with a front end loader or recycled for bedding, fill dirt added as needed
	Open Cow Corrals	same
	Open Heifer Corrals	same
FG1	Exercise Pens	manure scraped monthly into piles using scraper; removed in fall using front end loader; graded twice a month in dry months; fill dirt added as necessary; cows locked out during wet season
	Open Cow Corrals	same
	Open Heifer Corrals	same
BEA	Corrals	sloped 1.5 - 3.0%; manure removal in spring and fall using scraper and front end loader; fill dirt added and compacted as necessary
COT	Corrals	sloped 1.5 - 3.0%; manure removal in spring and fall using scraper and front end loader; fill dirt added and compacted as necessary
SAN	Corrals	sloped 1.5 - 3.0%; manure removal in spring and fall using scraper and front end loader; fill dirt added and compacted as necessary
GEN	Exercise Pens	corrals are sloped to drain to surrounding flush lanes; re-graded in summer season; manure removal in spring and fall using scraper and front end loader; use stockpiled compost to fill and re-slope as needed; cows locked out during wet season
	Open Cow Corrals	same
	Open Heifer Corrals	same
TRO	Exercise Pens	corrals sloped to drains near fencelines; continuously scraped during dry months; manure removal in spring and fall using Carryall scraper and front loader; fill dirt and fly ash added as needed; cows locked out during wet season
	Open Cow Corrals	same
	Open Heifer Corrals	same

Table 3-4

Infrastructure and Management Practices, Corrals

Central Valley Dairy Representative Monitoring Program – Year 5 Annual Report

Dairy	Corral ID	Maintenance and Manure Removal [†]
PLS	Open Cow Corrals	corrals are sloped to the fencelines or center of corrals to drains; somewhat flat and needs regrading; corrals are scraped twice a month with a box spreader and/or drag scraper; manure is scraped to the center of the corral and used for mounds; manure is removed spring and fall (or more frequently) with box scraper and loader; fill dirt added in the summer and compacted with loader bucket
	Open Heifer Corrals	same
CAE	Exercise Pens	all cows are kept in barns year round; no manure to removed from corrals; no access to corrals for grading; no fill dirt needed
	Open Cow Corrals	same
	Open Heifer Corrals	manure from heifer corrals removed in spring and fall
ROB	Exercise Pens	corrals are sloped at a 3:1 ratio; graded and maintained throughout year as needed; spring tooth used 2-3 times per week in summer months to maintain corrals; manure removal between the months of May and October using scraper; cows locked out during wet season
	Open Cow Corrals	same
	Open Heifer Corrals	same
WOO	Exercise Pens	manure scraped into a pile using scraper twice a year in dry season; removed using front end loader; fill dirt added as needed
	Open Cow Corrals	same
	Open Heifer Corrals	same
ANT	Corrals	corrals slopes are scraped once a year, no fill added
COR	Exercise Pens	corrals are sloped to drain to nearby flushlanes; regraded in summer; manure removal June & October using scraper and front end loader; fill compost used to re-grade as necessary
	Open Cow Corrals	same; cows locked out during wet season
	Open Heifer Corrals	same; cows locked out during wet season
FG2	Exercise Pens	manure scraped monthly into a pile using scraper; removed using front end loader in fall; fill dirt added two times per year as needed; cows locked out during wet season
	Open Cow Corrals	corrals graded twice per month during dry season, bi-weekly removal of manure in summer for bedding; cows locked out during wet season
	Open Heifer Corrals	Corrals graded twice per month during dry season, bi-weekly removal of manure in summer for bedding; cows locked out during wet season
GOD	Exercise Pens	during dry season, corrals are scraped and harrowed monthly and manure is removed 3 times per year; cows locked out during wet season
	Open Cow Corrals	same
MAC	Exercise Pens	relatively flat; eastern and western corrals moderatly sloped to the south; manure removed in spring and fall as needed; during summer months, corrals are scraped and harrowed 3 times per week using scraper and front end loader; cows locked out during wet season
	Open Cow Corrals	same
	Open Heifer Corrals	same
NUN	Exercise Pens	manure removal in spring and fall using scraper and front end loader; corrals graded twice a month during dry months; cows locked out during wet season
	Open Cow Corrals	same
	Open Heifer Corrals	same

**Table 3-4
Infrastructure and Management Practices, Corrals**

Central Valley Dairy Representative Monitoring Program – Year 5 Annual Report

Dairy	Corral ID	Maintenance and Manure Removal [†]
MOO	Exercise Pens	scraped regularly during summer months to maintain slope integrity; manure removal in spring and fall using scraper and front end loader; cows locked out during wet season
	Open Cow Corrals	same
	Open Heifer Corrals	same
TON	Exercise Pens	corrals sloped to drains near fencelines; manure removal in spring using Carryall scraper; fill dirt added as necessary; cows locked out during wet season
	Open Cow Corrals	corrals sloped to drains near fencelines; manure removal in spring and fall using Carryall scraper; fill dirt added as necessary
	Open Heifer Corrals	same
BRE	Exercise Pens	corrals are adequately sloped, corrals are scraped and leveled in fall, manure is removed in spring and fall with a front load scraper, fill dirt added as needed; cows locked out during wet season
	Open Cow Corrals	same
	Open Heifer Corrals	northern heifer corrals well sloped, southern heifer corrals moderately sloped
CRE	Exercise Pens	corrals are well sloped to sump drains below ground level; regraded as necessary; manure scraped into piles in corrals and removed during spring and fall
	Open Cow Corrals	same
	Open Heifer Corrals	same
MTS	Exercise Pens	corrals have adequate slope and good drainage; manure removal twice per year by commercial manure removal; no fill dirt used
	Open Cow Corrals	same
	Open Heifer Corrals	same
AUK	Exercise Pens	corrals are sloped to paved lanes or drains; corrals are groomed regularly to dry and remove manure; manure scraped into piles in spring and fall then removed after the harvest
	Open Cow Corrals	same
	Open Heifer Corrals	same
DLF	Open Cow Corrals	corrals are concrete with 1% slope, corrals are flushed using recycled water to a pipeline directed to lagoon
ELK	Corrals	slopes in corrals are maintained by grooming and manure management as needed
ZZI	Open Cow Corrals	corrals are floated weekly; manure is scraped into piles and removed with loader, fill dirt added in fall as needed.
	Open Heifer Corrals	same
HOL	Exercise Pens	corrals are sloped to paved lanes or drains; corrals are groomed regularly to dry and remove manure; manure scraped into piles in spring and fall then removed after the harvest
	Open Cow Corrals	same
	Open Heifer Corrals	same
HYN	Open Cow Corrals	corrals slope southward; manure removal spring and fall using front end loader; no fill dirt added
	Open Heifer Corrals	same
JAD	Corrals	corrals are sloped to the east and west and flow to the north; corrals are scraped and cleaned on an ongoing basis to maintain corral slope; manure is removed on an ongoing basis

**Table 3-4
Infrastructure and Management Practices, Corrals**

Central Valley Dairy Representative Monitoring Program – Year 5 Annual Report

Dairy	Corral ID	Maintenance and Manure Removal [†]
LON	Exercise Pens	corrals scraped weekly or as needed and graded as needed; manure removal twice a year; no fill dirt used
	Open Cow Corrals	same
	Open Heifer Corrals	same
ADO	Exercise Pens	corrals are sloped to paved lanes or drains; corrals are groomed regularly to dry and remove manure; manure scraped into piles in spring and fall then removed after the harvest
	Open Cow Corrals	same
	Open Heifer Corrals	same
MAL	Corrals	primary slope is to the south, secondary slope is to the east and west; slopes in corrals are maintained by grooming and manure management as needed
MAP	Exercise Pens	corrals scraped weekly or as needed and graded as needed; manure removal twice a year; no fill dirt used
	Open Cow Corrals	same
	Open Heifer Corrals	same
ZON	Exercise Pens	corrals scraped weekly or as needed and graded as needed; no compaction; manure removal twice a year; no fill dirt used
	Open Cow Corrals	same
	Open Heifer Corrals	same
RIC	Exercise Pens	corrals have 2% primary slope 0.5% secondary slope; drainage to concrete lane; corrals regraded as needed; manure removed as needed, scraped into piles and loaded into dump wagon; fill dirt stockpiled on site; compacted using water and heavy equipment
	Open Cow Corrals	same
	Open Heifer Corrals	same
SIE	Exercise Pens	corrals scraped weekly or as needed and graded as needed; manure removal twice a year; no fill dirt used
	Open Cow Corrals	same
	Open Heifer Corrals	same
SO2	Exercise Pens	corrals sloped east and west; manure removal spring and fall using pull type scraper; no fill dirt used
	Open Cow Corrals	same
	Open Heifer Corrals	same
SOJ	Open Cow Corrals	corrals slope southward; manure removal spring and fall using front end loader; fill dirt and ash added to maintain corral integrity and slope (ash only added to three corrals each year)
	Open Heifer Corrals	same

[†] CVDRMP discontinued annually updating observations of slope maintenance and ponding due to their subjectivity.

Table 3-5
Infrastructure and Management Practices, Liquid Manure Lagoons and Settling Basins
Central Valley Dairy Representative Monitoring Program – Year 5 Annual Report

Dairy	Lagoon ID	Year of Construction	Lagoon Construction Details	Soil ‡	Mechanical Separator	Earthen Depth (ft)	Method of Cleaning [#]
MEN	Pond 1	1970's	earthen, no records	sandy loam 7-18	no	15	dilution/agitation
	Pond 2	1990's	earthen, no records			8	dewatered/excavation
	Pond 3	1990's	earthen, no records			6	dilution/agitation
	Pond 4	1990's	earthen, no records			12	dilution/agitation
ANC	WWS 1	1993	earthen, no records	loamy sand 0-15	yes	13	pumped out during irrigation; use of slurry tankers and excavators to remove solids as needed but not done on regular basis
	WWS 2	1993	earthen, no records			13	pumped out during irrigation; use of slurry tankers and excavators to remove solids as needed but not done on regular basis
BET	WWS	2000	earthen, no records	sand 0-15	no	14	agitation
	SSB North	2000	earthen, no records			4	excavation
	SSB South	2000	earthen, no records			4	excavation
DIE	WWS N	2001	clay lined, no records	loams 7-35	yes	18	excavation approximately once a year
	SSB N1	2001	clay lined, no records			6	excavation approximately once a year
	SSB N2	2001	clay lined, no records			8	excavation approximately once a year
	SSB N3	2001	clay lined, no records			11	excavation approximately once a year
	SSB N4	2001	clay lined, no records			10	excavation approximately once a year
	WWS S	1997	clay lined, no records			31	excavation approximately once a year
	SSB S1	1997	clay lined, no records			10	excavation approximately once a year
	SSB S2	1997	clay lined, no records			12	excavation approximately once a year
	SSB S3	1997	clay lined, no records			5	excavation approximately once a year
SSB S4	1997	clay lined, no records	8	excavation approximately once a year			
DUR	Lagoon	1970s	earthen, no records	sandy loams 7-35	yes	15	agitation and pumping, excavation every 2 year to remove solids
FG1	WWS 1	1979	earthen, no records	loam 8-20	yes	14	agitation during irrigation; annual excavation for sand removal

Table 3-5
Infrastructure and Management Practices, Liquid Manure Lagoons and Settling Basins
Central Valley Dairy Representative Monitoring Program – Year 5 Annual Report

Dairy	Lagoon ID	Year of Construction	Lagoon Construction Details	Soil ‡	Mechanical Separator	Earthen Depth (ft)	Method of Cleaning [#]
BEA	WWS	2001	earthen, no records	sand & loamy sand 0-15	no	-	dilution and pumped out
	SSB1	2001	earthen, no records			6	excavation
	SSB2	2001	earthen, no records			6	excavation
	Horseshoe	2001	earthen, no records			6	excavation
COT	WWS	2003	earthen, no records	sand 0-5, loamy sand 0-15	yes	24	none
	Digester	2003	earthen, no records			24	none
	North SSB	1980's	earthen, no records			10	dilution and pumped out
	South SSB	1980's	earthen, no records			10	dilution and pumped out
SAN	WWS	2001	earthen, no records	loam 10-35	no	25	dilution and pumped out
	SSB1	2001	earthen, no records			5	excavation
	SSB2	2001	earthen, no records			5	excavation
	SSB3	2001	earthen, no records			5	excavation
	SSB4	2001	earthen, no records			5	excavation
GEN	Lagoon #1	1972	earthen, no records	sandy loam 7-18	no	18	agitation/pump out
	Lagoon #2	1989	earthen, no records			18	agitation/pump out
	SSB1	2002	earthen, no records			10	excavation annually
	SSB2	2002	earthen, no records			10	excavation annually
TRO†	WWS East	1992	soil resting report concludes sub-soils meet 10/10 design standard (Technicon, 1992)	sand 0-8 and loam 8-26	yes	28	agitation; mechanical separator
	WWS West	1992				28	agitation; mechanical separator
PLS	SSB	1980's	earthen, no records	sandy loam 7-18	yes	13	auger removes solids from basin; additional cleaning only if auger breaks
	WWS	1960's	earthen, no records			15	dilution/agitation; excavated once
CAE	WWS	1998	earthen, no records	dune land 0-1	no	15	none
	SSB 1	2004	earthen, no records			7	excavation
	SSB 2	2004	earthen, no records			7	excavation
ROB	WW1	1975	earthen, no records	sandy loam 7-18, loamy sand 0-15	no	11	agitation
	WW2	2003	earthen, no records			11	agitation
	SSB1	1993	earthen, no records			4	typically dried out annually; excavation
	SSB2	1993	earthen, no records			4	typically dried out annually; excavation

Table 3-5
Infrastructure and Management Practices, Liquid Manure Lagoons and Settling Basins
Central Valley Dairy Representative Monitoring Program – Year 5 Annual Report

Dairy	Lagoon ID	Year of Construction	Lagoon Construction Details	Soil ‡	Mechanical Separator	Earthen Depth (ft)	Method of Cleaning [#]
WOO†	WWS 2	~1980	earthen, no records	loam 8-18	yes	10	agitation; pumped out
	WWS 3	~1980	earthen, no records			12	agitation; pumped out
	SSB	~1980	earthen, no records			10	excavation
ANT	WW1	~2002	earthen, no records	loam 18-30	yes	15	pumped out during irrigation
	WW2	~1980	earthen, no records			15	pumped out during irrigation
	SSB1	~1990	earthen, no records			14	excavation as needed
	SSB2	~1990	earthen, no records			14	excavation as needed
COR	WWS	2001	earthen, no records	loam 18-50, clay 30-50	no	9	none
	SSB	2001	earthen, no records			9	excavation
	Sand Trap	1998	earthen, no records			4	excavation
FG2	SSB 1	1970	earthen, no records	clay loam 27-50	no	12	excavation
	SSB 2	2003	earthen, no records			12	has not required cleaning
	WWS	2002	earthen, no records			11	dilution, agitation and excavation when needed
GOD	WWS	2005	earthen, no records	loam 18-35	no	13	regular agitation during irrigation events with slurry removal using tankers on a 3-year cycle (field applied using direct injection contractor in fall)
	SSB 1	2005	earthen, no records			12	top crust of separated solids is typically excavated 3 times per year
	SSB 2	2005	earthen, no records			12	top crust of separated solids is typically excavated 3 times per year
MAC	WWS	1979	earthen, no records	clay loam 18-45, silty clay 30-65	yes	17	dilution/agitation; dried annually in previous years
NUN	WWS 1	1981	earthen, no records	silty clay 30-65	yes	8	agitation
	WWS 2	1986	earthen, no records			8	agitation and pumped into slurry trucks

Table 3-5
Infrastructure and Management Practices, Liquid Manure Lagoons and Settling Basins
Central Valley Dairy Representative Monitoring Program – Year 5 Annual Report

Dairy	Lagoon ID	Year of Construction	Lagoon Construction Details	Soil ‡	Mechanical Separator	Earthen Depth (ft)	Method of Cleaning [#]
MOO	WWS 1	2003	10/10 design standard; lagoon soil report (The Twining Laboratories, 2003)	loam 18-30	no	9	dilution/agitation
	SSB 1	2003				9	dried annually; slurry tankers/excavation
	SSB 2	2003				9	dried annually; slurry tankers/excavation
TON	WWS 1	1972	earthen, no records	clay loams 27-50	no	13	agitation
	WWS 2	1990	earthen, no records			8	excavation
	SSB	2000	earthen, no records			14	excavation
BRE†	Holding Pond 1	2004	engineered	loams 10-60 and clay 35-60	yes	10	dried and cleaned with loader
	Holding Pond 2	~1989	earthen, no records			10	excavated as needed; slurry tanker used to remove solids
	Settling Pond 1	2004	engineered			8	do not clean- count on continuous flow
	Settling Pond 2	2004	engineered			8	do not clean- count on continuous flow
	Settling Pond 3	2004	engineered			8	do not clean- count on continuous flow
	Settling Pond 4	2004	engineered			8	do not clean- count on continuous flow
Heifer Pond	2004	engineered	10	pump out and dry; slurry tankers used to remove solids			
CRE†	WWS 1	~1980	earthen, no records	loam 10-45 and clay 40-60	no	8	have not been cleaned in over a decade; no solid accumulation observed
	WWS 2	~1980	earthen, no records			9	
	SSB 1	~1980	earthen, no records			8	
	SSB 2	~1980	earthen, no records			8	
	SSB 3	~1980	earthen, no records			8	
	SSB 4	~1980	earthen, no records			8	
	SSB 5	~1980	earthen, no records			3	
	SSB 6	~1980	earthen, no records			4	
MTS†	Lagoon #1	1994	earthen, no records	loams 10-45	no	30	agitation
	SSB1	1994	concrete lined, no records			4	concrete, cleaned by loader as needed
	SSB2	1994	concrete lined, no records			4	concrete, cleaned by loader as needed
AUK	Lagoon	1999	earthen, no records	Biggriz-Biggriz 18-33	no	20	pumping and dipping as needed
	SSB 1	1999	earthen, no records			~20	pumping and dipping as needed
	SSB 2	1999	earthen, no records			~20	pumping and dipping as needed
	SSB 3	1999	earthen, no records			~20	pumping and dipping as needed
	SSB 4	1999	earthen, no records			~20	pumping and dipping as needed

Table 3-5
Infrastructure and Management Practices, Liquid Manure Lagoons and Settling Basins
Central Valley Dairy Representative Monitoring Program – Year 5 Annual Report

Dairy	Lagoon ID	Year of Construction	Lagoon Construction Details	Soil ‡	Mechanical Separator	Earthen Depth (ft)	Method of Cleaning [#]
DLF	North Lagoon	2001	engineered clay liner	sandy loam 2-18	no	40	dilution/agitation
	South Lagoon	2001	engineered clay liner		no	40	dilution/agitation
	SSB North	2001	engineered clay liner		no	35	excavated 4-5 times per year
	SSB South	2001	engineered clay liner		no	35	excavated 4-5 times per year
ELK	Pond 1	2000	earthen, no records	Quonal- Lewis Association 18-50	No	14	excavated once a year
	SSB 1	2000	earthen, no records			13	excavated once a year
	SSB 2	2000	earthen, no records			13	excavated once a year
	SSB 3	2000	earthen, no records			13	excavated once a year
	SSB 4	2000	earthen, no records			13	excavated once a year
ZZI	Pond 1	1970's	earthen, no records	sandy loam 6-18	standpipe	35	cleaned every 4-5 years, agitation slurry removed by tank loads
	Pond 2	2000	earthen, no records			20	cleaned every 4-5 years, agitation slurry removed by tank loads
	SSB	1970's	earthen, no records			12	cleaned quarterly with crane
HOL	Storage #1	2000	earthen, no records	Gambogy- Biggriz 8- 35	no	20	has never required cleaning
	Storage #2	2000	earthen, no records			35	has never required cleaning
	SSB 1 through 6	2000	earthen, no records			12	excavated twice a year
HYN	Pond 1	1990s	earthen, no records	sandy loam 2-18	yes	17	dilution; agitation
	Pond 2	1990s	earthen, no records			19	dewatered/excavation
JAD†	WWS	1973	earthen, no records	loam 10-31	yes	20	cleaned as needed
	SSB 1	1973	earthen, no records			20	excavation
	SSB 2	2001	earthen, no records			20	excavation
LON	WWS 1	1970s	earthen, no records	sandy loam 6-18	yes	17	agitation/pumping, excavation as needed
	WWS 2	2010	Tier 2 lagoon with 60-mil HDPE liner; CQA documentation (Ausenco Vector, 2010)			30	agitation/pumping, excavation as needed
	WWS 3	1970s	earthen, no records			21	agitation/pumping, excavation as needed
	SSB 1	1970s	concrete, no records			6	concrete, cleaned by loader as needed
	SSB 2	1970s	concrete, no records			7	concrete, cleaned by loader as needed

Table 3-5
Infrastructure and Management Practices, Liquid Manure Lagoons and Settling Basins
Central Valley Dairy Representative Monitoring Program – Year 5 Annual Report

Dairy	Lagoon ID	Year of Construction	Lagoon Construction Details	Soil ‡	Mechanical Separator	Earthen Depth (ft)	Method of Cleaning [#]	
ADO	Storage #1	ina	earthen, no records	sandy loam 5-30	yes	-	Dairy and lagoons closed and dismantled in 2013-14	
	Storage #2	2006	Tier 2 single 60-mil HDPE liner installed in 2006 adjacent to earthen lagoon; approved CQA Report (Provost and Pritchard, 2006)			32		
MAL	WWS	2005	two lagoons with 40-mil HDPE liners; construction report (Striatus Engineering, 2005)	Kimberlina-Garces 6-18	yes	18		agitation/pumping, excavation as needed
	SSB	2005				18		excavation
MAP	WWS 1	~2002	earthen, no records	sandy loams 0-18, loamy sand 0-8	no	24		excavation twice per year or when needed
	WWS 2	~2002	earthen, no records			24		excavation twice per year or when needed
	SSB	~2003	concrete, no records			8	concrete, cleaned by loader weekly	
	SSB	~2003	concrete, no records			8	concrete, cleaned by loader weekly	
ZON	Heff WWS	~1980	earthen, no records	sandy loam 8-18, loamy sand 0-5	no	12	not used for wastewater storage	
	WWS	~1974	1-ft thick engineered clay-liner (10/10 design standard); soil report (Anderson, 1990) states that west lagoon will be rebuilt in 1991; these lagoons were combined to one single lagoon; adjacent to settling basin			20	excavated approximately every 6-8 years	
	SSB	1970's	earthen, no records			14	excavated approximately every 5-6 years	
RIC	Pond 1	1999	lagoons constructed in 1999 with partial clay liners to cover sandy areas (10/10 design standard); lagoon soil report (Soils Engineering Inc., 1999)	sandy loam 2-27	yes	6	only crust is removed so liner is not disturbed	
	Pond 2					6		
	Pond 3					6		
	SSB 1	1999	earthen, no records			6	dry and excavate every 5 years	
	SSB 2	1999	earthen, no records			6	dry and excavate every 5 years	
SIE	WWS	~1989	earthen, no records	sandy loam 5-18	no	20	agitation, PTO tractor pump, dilution; excavation every 5 years or as needed	

Table 3-5
Infrastructure and Management Practices, Liquid Manure Lagoons and Settling Basins
Central Valley Dairy Representative Monitoring Program – Year 5 Annual Report

Dairy	Lagoon ID	Year of Construction	Lagoon Construction Details	Soil ‡	Mechanical Separator	Earthen Depth (ft)	Method of Cleaning [#]
SO2	Pond 1	late 1980s	1 to 2-ft thick engineered clay liner (imported material); construction report (True Engineering, 1989)	sandy loam 5-30	yes	30	dilution; agitation
	SSB 1	1988	concrete lined, no records			6	cleaned with a loader ~every 3 weeks
	SSB 2	1988	concrete lined, no records			6	cleaned with a loader ~every 3 weeks
SOJ	Pond 1 N	1970s	earthen, no records	loamy sand 0-5	yes	17	dewatered/excavation
	Pond 2 S	1990s	engineered clay liner (10/10 design standard); lagoon soil testing report by Soil Conservation Service (1994)			20	dewatered/excavation

free = freeboard

† Groundwater conditions are not monitored beneath the liquid manure lagoon(s) at this dairy.

‡ Soils mapped by SSURGO within the footprint of the liquid manure lagoon(s) including range of clay content in percent by weight.

The 10/10 design standard refers to California Code of Regulations Title 27, which requires that retention ponds receiving waste from confined animal facilities be underlain by soils that contain at least 10% clay and not more than 10% gravel.

CVDRMP discontinued annually updating observations of minimum waste depth, berm maintenance, and weed and pest control due to their subjectivity.

Table 3-6

Summary of Dairy Farm Information, Central Valley Dairy Representative Monitoring Program – Year 5 Annual Report

CVDRMP Area	Dairy	Mature Milk Cows (head)				Animal Housing			Soils (1)			Annual Precipitation (inches)			Depth to First Encountered Groundwater (feet)			Crops and Crop Rotations					Irrigation Systems				Irrigation Water Sources		Pond Construction					
		<500	500-999	1,000-2,000	>2,000	Freestall	Open Lot	Combination	Sandy	Loamy	Clayey	<10	10-16	>16	<50	50-100	>100	Corn/Oats	Corn/Wheat	Other Winter Crops (2)	Alfalfa	Pasture	Furrow/Border	Border/Border	Center Pivot	Flood	Surface Water	Ground-Water (4)	Plastic Lined	Fully Clay Lined	Less than Fully Clay Lined (3)			
		Central Area – East Side	MEN			✓			✓	✓			✓			✓			✓		✓				✓			✓					✓	
ANC					✓		✓	✓			✓			✓			na	na	na	na	na	na	na	na	na	na	na				✓			
BET				✓			✓	✓			✓			✓			✓						✓			✓	✓				✓			
DIE					✓		✓	✓	✓		✓			✓	✓	✓		✓					✓			✓					✓			
DUR			✓				✓	✓	✓		✓			✓			✓						✓			✓					✓			
FG1				✓			✓	✓	✓		✓			✓			✓						✓			✓					✓			
BEA					✓		✓	✓			✓			✓			na	na	na	na	na	na	na	na	na	na	na	na			✓			
COT					✓		✓	✓	✓		✓			✓			✓	✓				✓				✓					✓			
SAN					✓		✓	✓	✓	✓		✓			✓		✓			✓	✓				✓						✓			
GEN				✓			✓	✓	✓		✓			✓			✓	✓	✓					✓		✓					✓			
TRO					✓		✓	✓	✓		✓			✓	✓			✓						✓			✓	na	na	na		✓		
PLS	✓						✓	✓	✓		✓			✓			✓			✓	✓				✓	✓					✓			
CAE			✓				✓	✓			✓			✓			✓							✓		✓					✓			
ROB				✓			✓	✓	✓		✓			✓			✓	✓	✓	✓				✓		✓	✓					✓		
WOO	✓					✓	✓	✓		✓			✓			✓			✓	✓		✓			✓		na	na	na		✓			
Central Area West Side	ANT		✓				✓	✓	✓				✓			✓						✓			✓						✓			
	COR		✓				✓	✓	✓				✓			na	na	na	na	na	na	na	na	na	na	na	na				✓			
	FG2				✓		✓	✓	✓				✓			✓			✓	✓			✓			✓					✓			
	GOD			✓			✓	✓	✓				✓			✓			✓	✓			✓			✓					✓			
	MAC		✓				✓	✓	✓				✓			✓							✓			✓					✓			
	NUN			✓			✓	✓	✓				✓			✓			✓	✓			✓			✓					✓			
	MOO			✓			✓	✓	✓				✓				✓	✓	✓	✓			✓			✓	✓				✓			
TON				✓		✓	✓	✓				✓			✓			✓	✓			✓			✓	✓				✓				
North Area	BRE			✓			✓	✓					✓	✓	✓		✓						✓			✓	na	na	na		✓			
	CRE		✓				✓	✓	✓				✓	✓							✓				✓		na	na	na		✓			
	MTS		✓				✓	✓	✓				✓	✓	✓		✓	✓	✓				✓			✓	na	na	na		✓			
South Area	AUK				✓		✓	✓	✓	✓				✓			✓						✓			✓	✓				✓			
	DLF				✓	✓	✓	✓		✓				✓	✓		✓			✓	✓			✓		✓	✓				✓			
	ELK				✓		✓	✓				✓					✓					✓			✓	✓					✓			
	ZZI		✓				✓	✓	✓					✓			✓			✓	✓			✓		✓					✓			
	HOL				✓	✓	✓	✓	✓							na	na	na	na	na	na	na	na	na	na	na	na	na			✓			
	HYN			✓			✓	✓	✓								✓						✓			✓	✓				✓			
	JAD			✓			✓	✓	✓								✓						✓			✓	✓	na	na	na		✓		
	LON			✓			✓	✓	✓								✓						✓			✓	✓				✓			
	ADO	Ceased operation in 2013							✓	✓		✓				na	na	na	na	na	na	na	na	na	na	na	na	na	na	na	na	na	na	na
	MAL				✓		✓	✓	✓						✓					✓	✓			✓			✓	✓				✓		
	MAP			✓			✓	✓	✓									✓					✓			✓	✓					✓		
	ZON				✓		✓	✓	✓									✓					✓			✓	✓		✓			✓		
	RIC				✓		✓	✓	✓								✓							✓		✓	✓					✓		
	SIE			✓			✓	✓	✓														✓			✓	✓					✓		
SO2			✓			✓	✓	✓														✓			✓	✓			✓		✓			
SOJ		✓				✓	✓	✓									✓					✓			✓						✓			

na (not applicable, i.e., pertinent management unit is not monitored)

(1) Soil categories are intended to broadly group predominantly sandy soils of high permeability, predominantly clayey soils of low permeability, and intermediate soils. Loams may occur in all categories.

(2) Sudan, triticale, sorghum, milo, barley, rye.

(3) Includes (a) ponds constructed in compliance with CCR, Title 27, which proscribes ponds to be lined with or underlain by soils that contain at least 10% clay and not more than 10% gravel, including ponds with partial clay liners and ponds without constructed clay liners, and (b) ponds constructed as earthen pits without consideration of soil texture.

(4) Two check marks indicate chief water source.

Attachment A2

Hydrograph Series of Groundwater Level Elevation

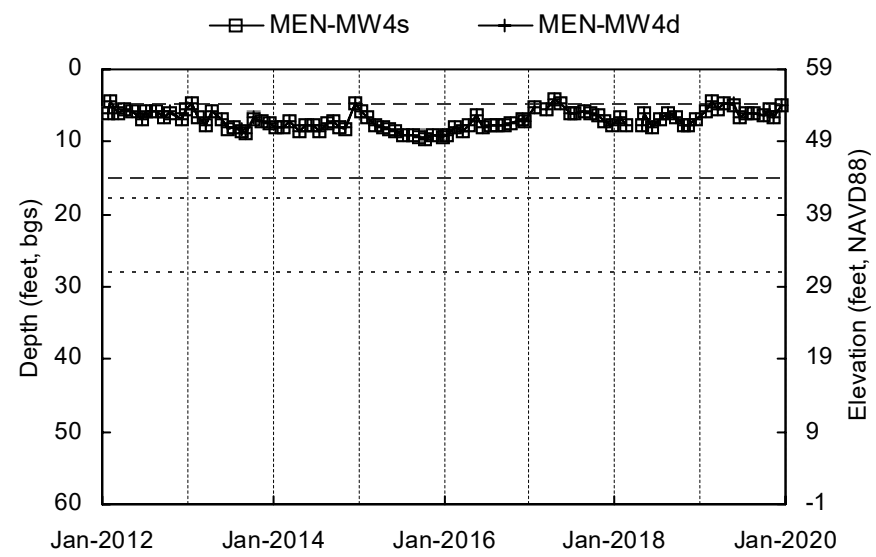
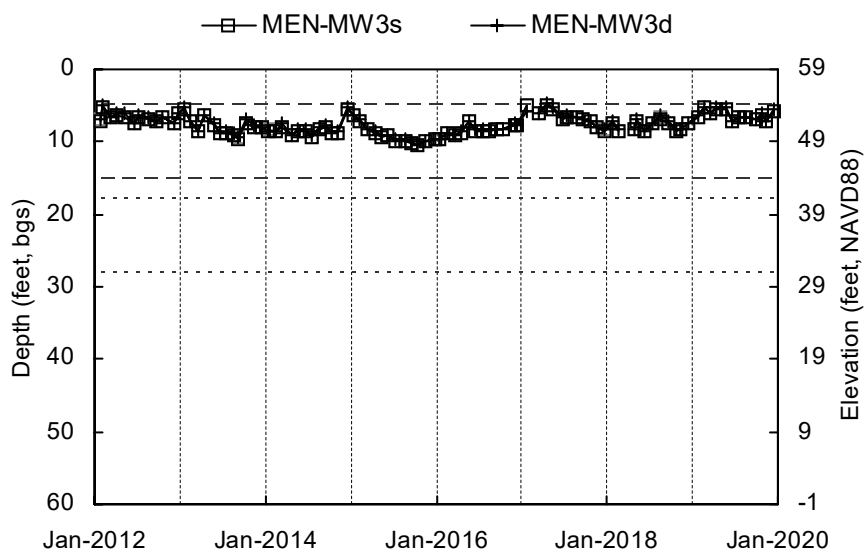
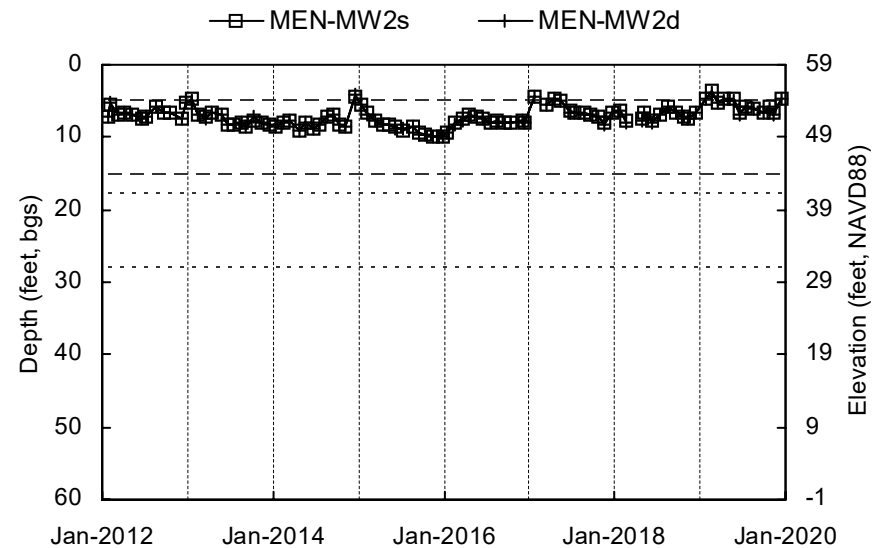
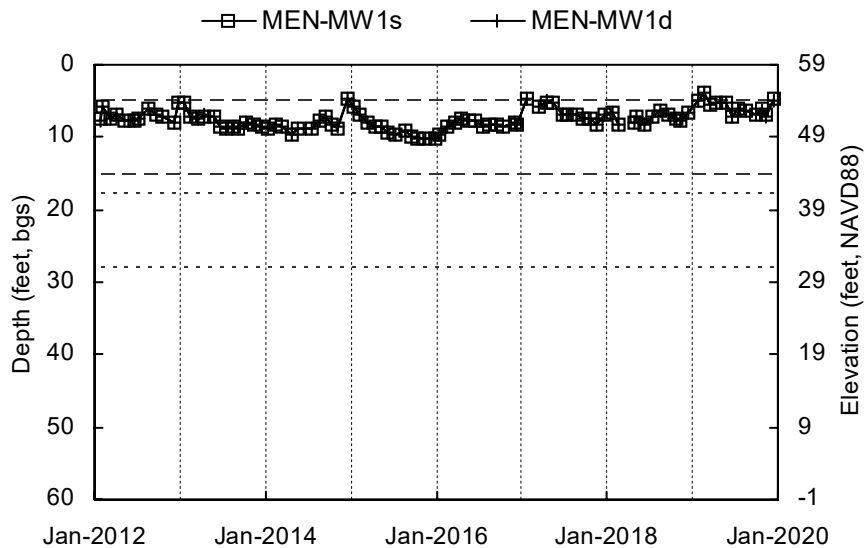

Shallow Well Screened Interval
 Deep Well Screened Interval
 Elevation scale shown to the nearest integer.

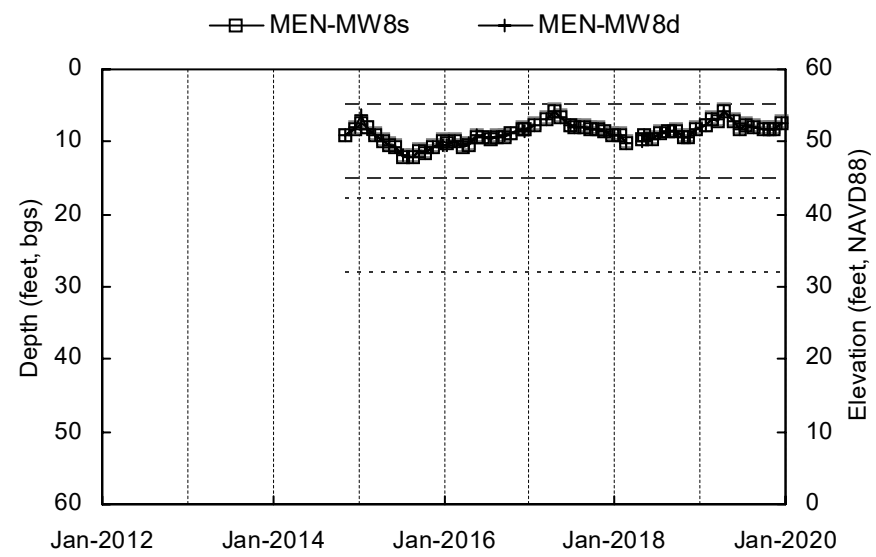
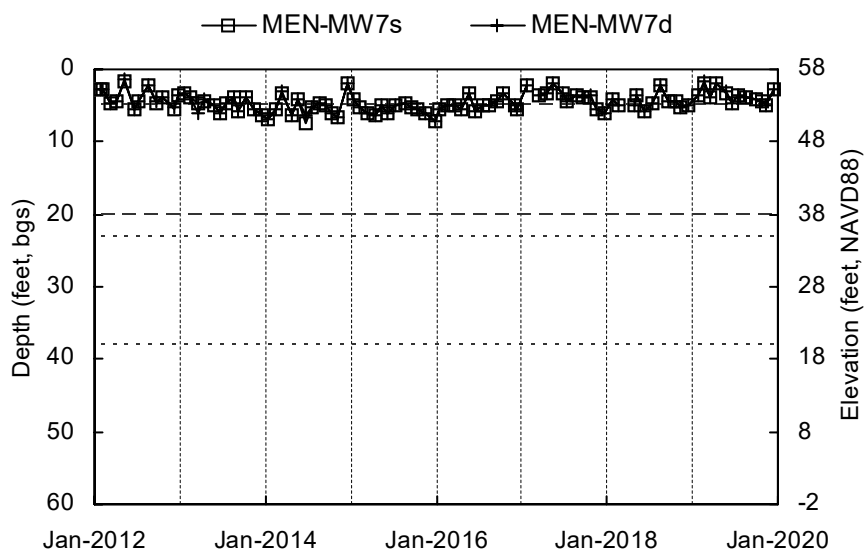
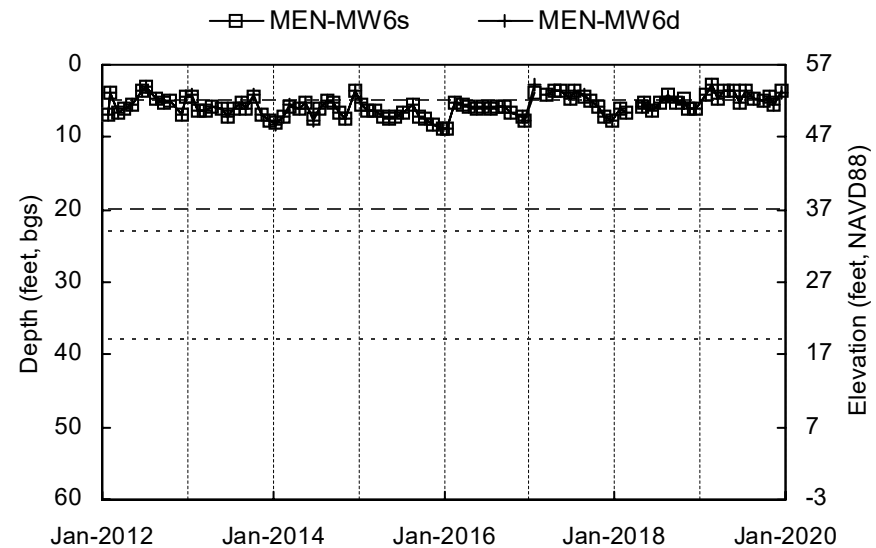
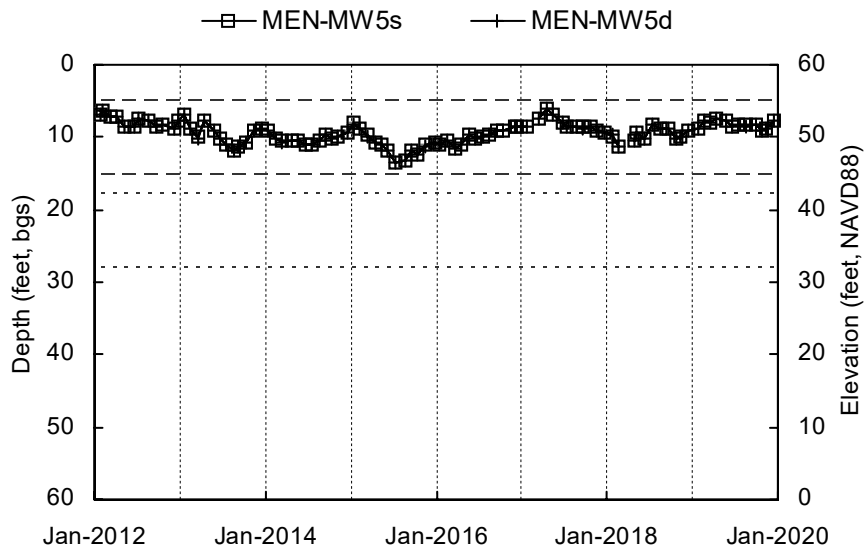

Shallow Well Screened Interval
 Deep Well Screened Interval
 Elevation scale shown to the nearest integer.

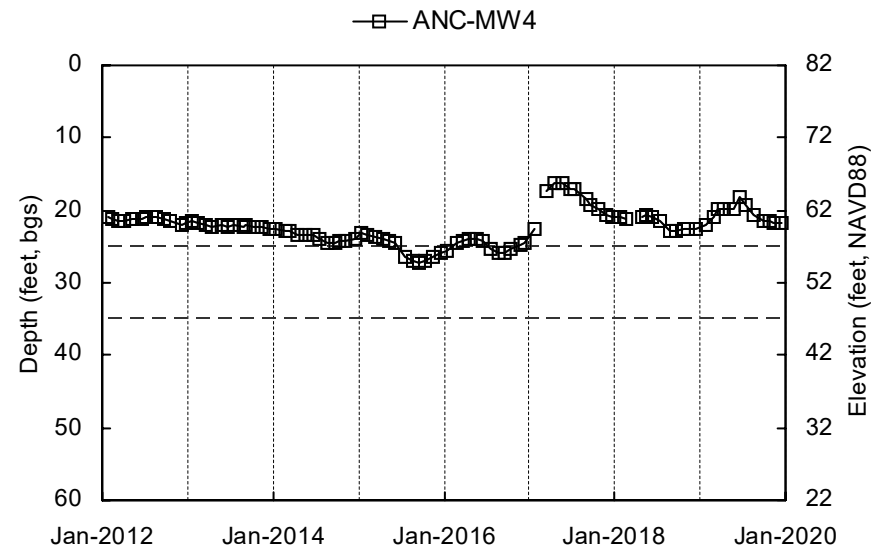
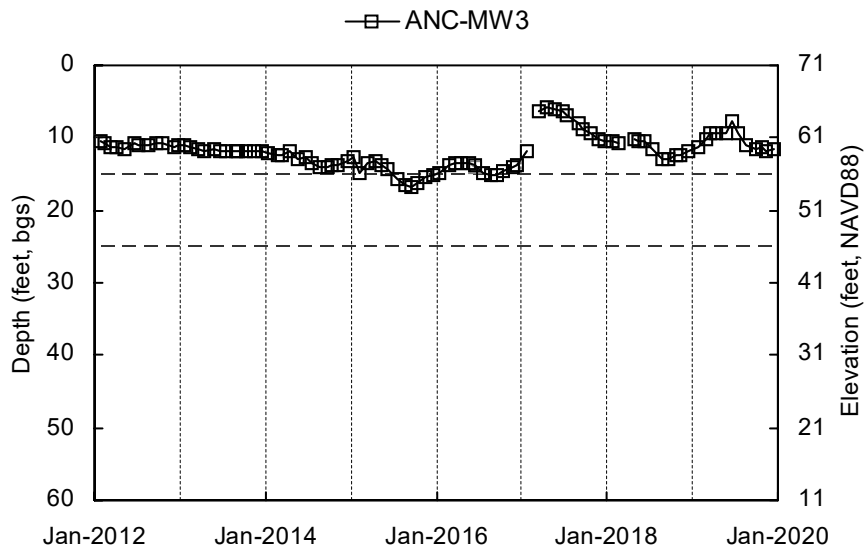
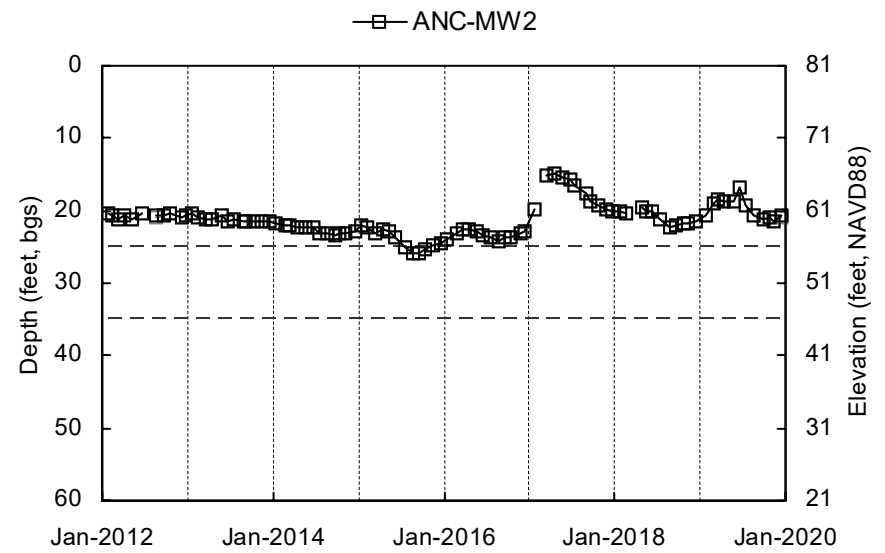
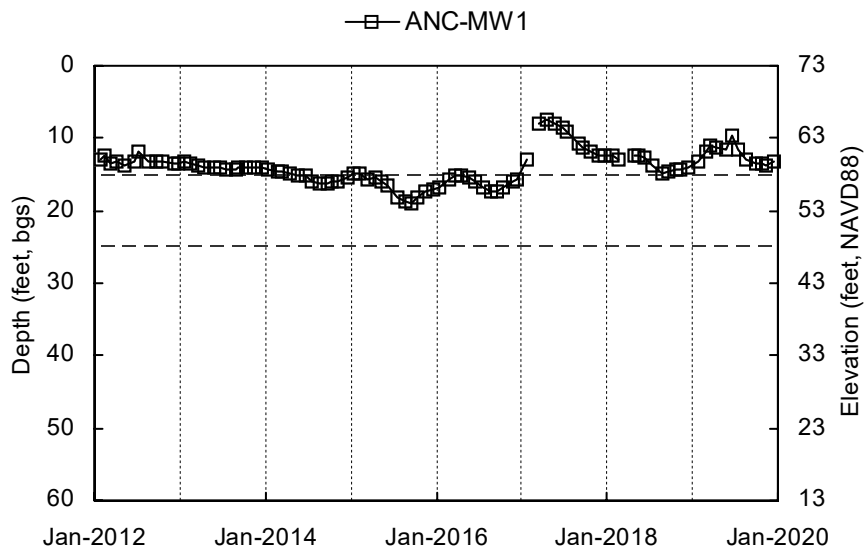

Shallow Well Screened Interval
 Deep Well Screened Interval
 Elevation scale shown to the nearest integer.

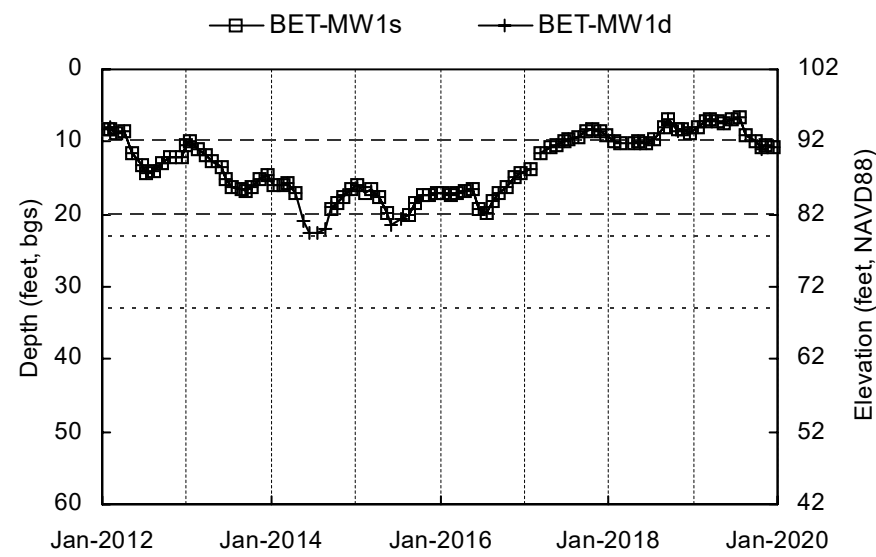
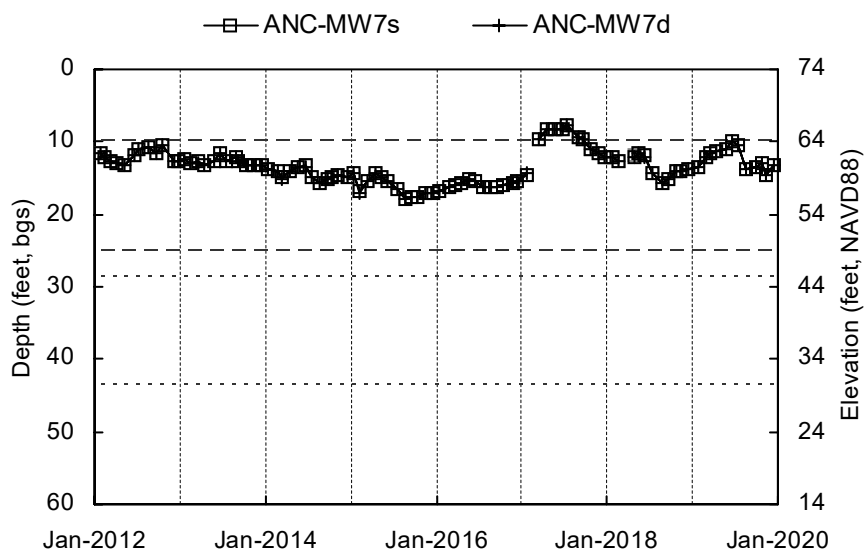
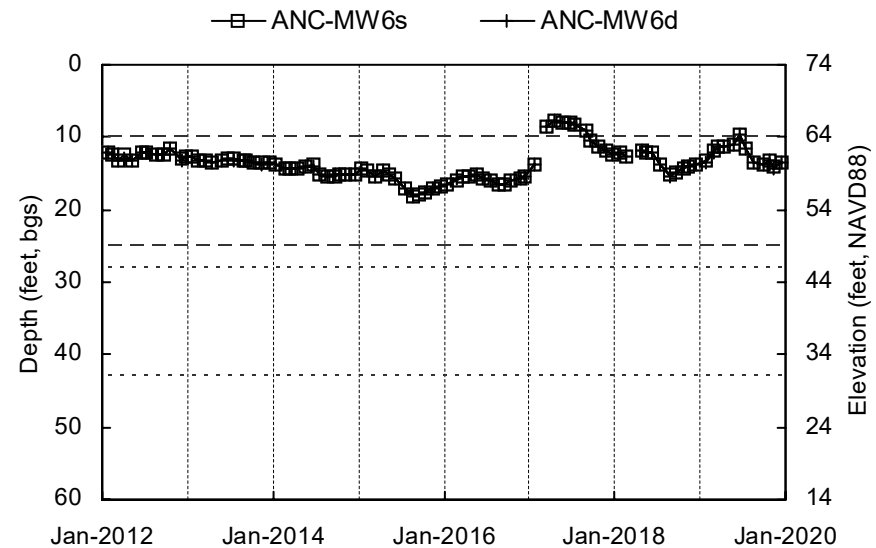
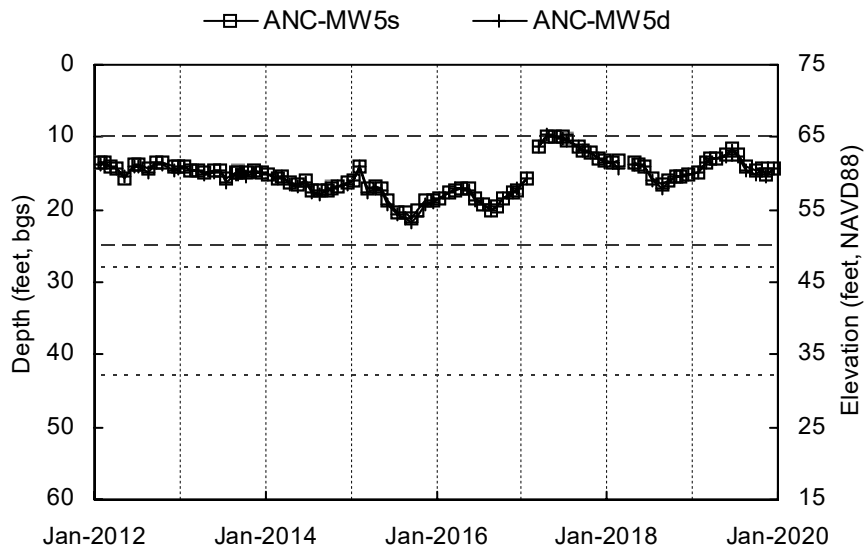

Shallow Well Screened Interval
 Deep Well Screened Interval
 Elevation scale shown to the nearest integer.

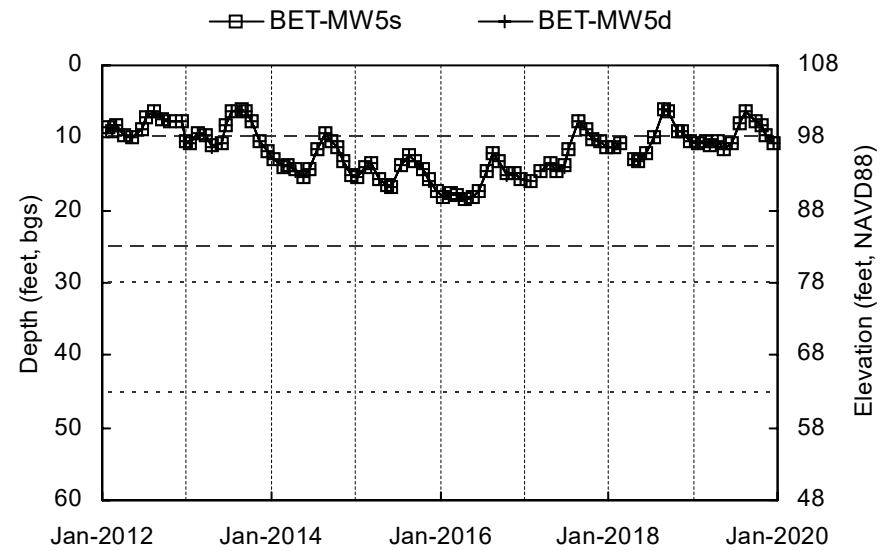
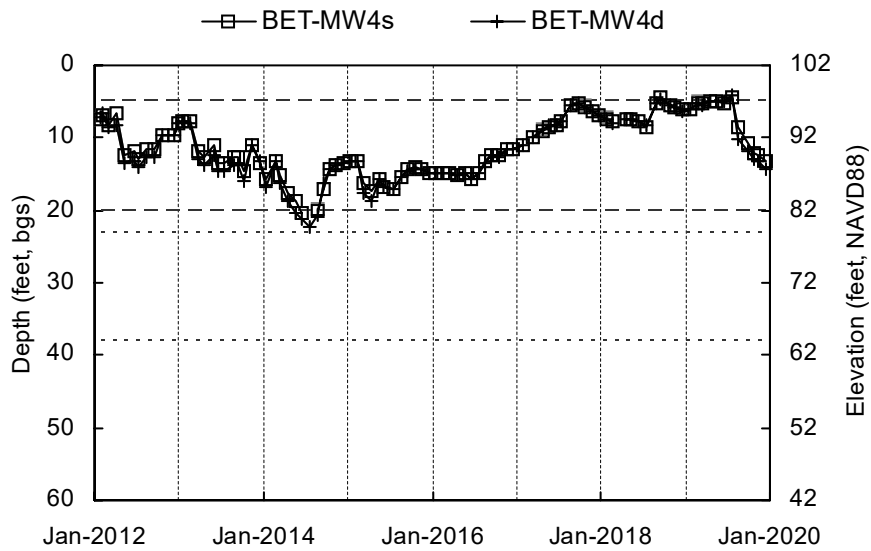
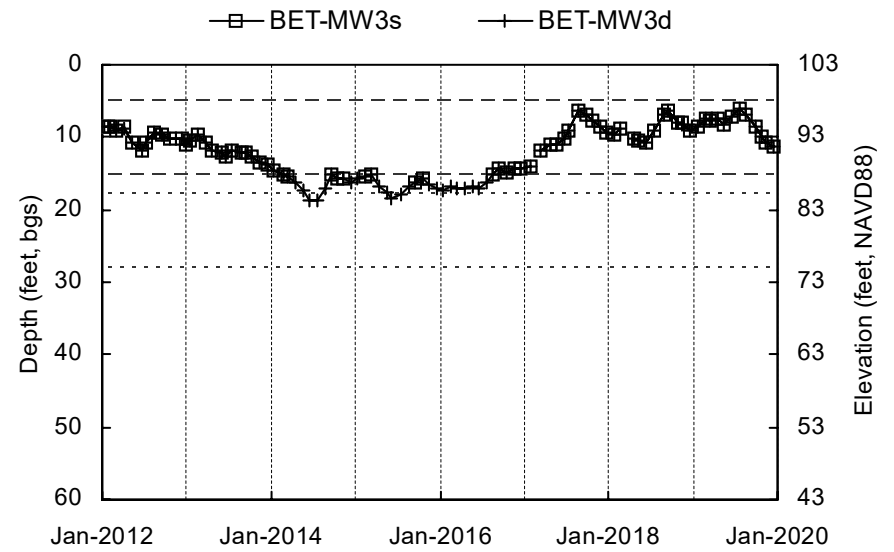
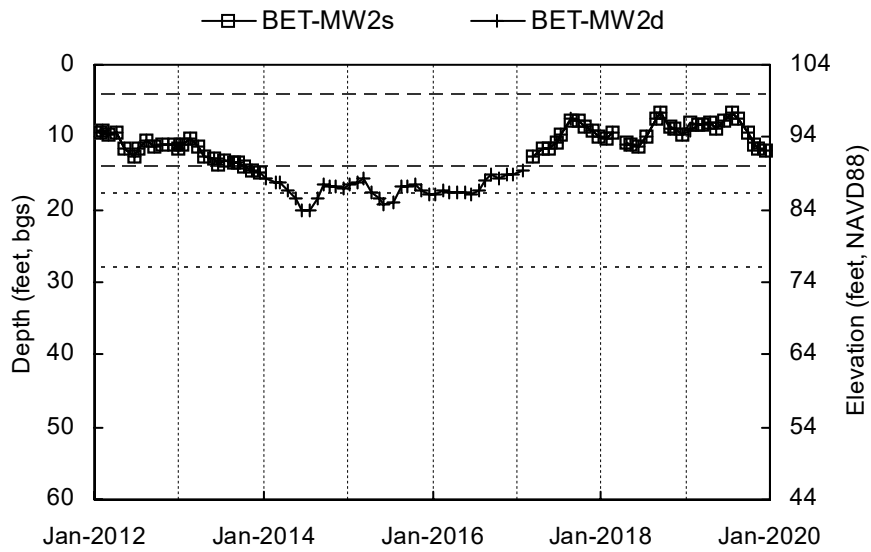

Shallow Well Screened Interval
 Deep Well Screened Interval
 Elevation scale shown to the nearest integer.

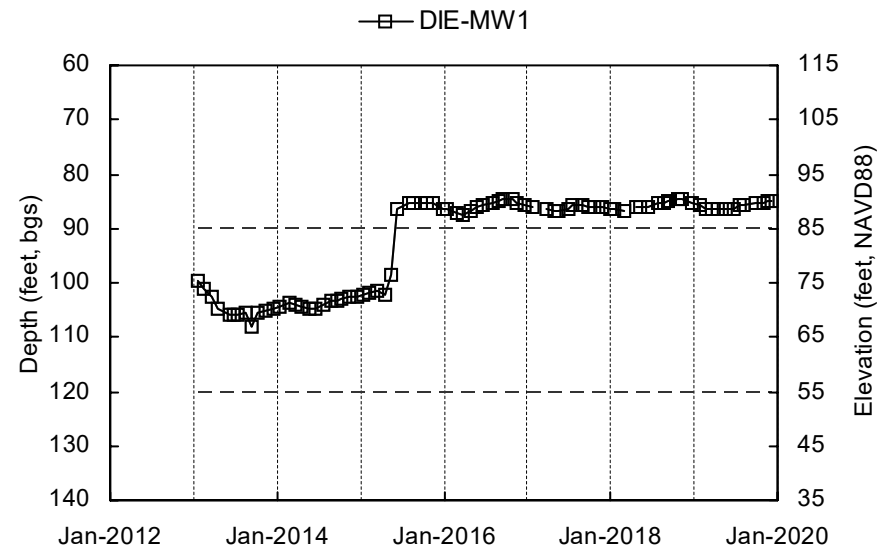
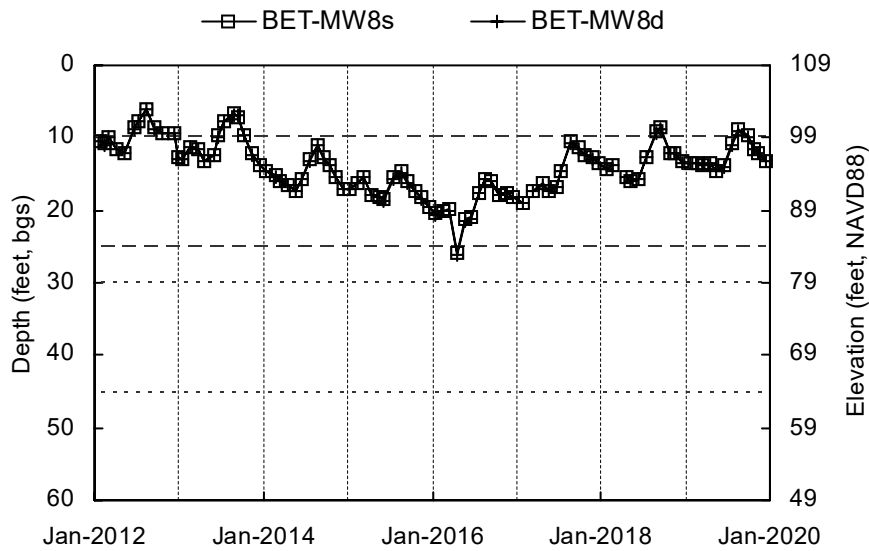
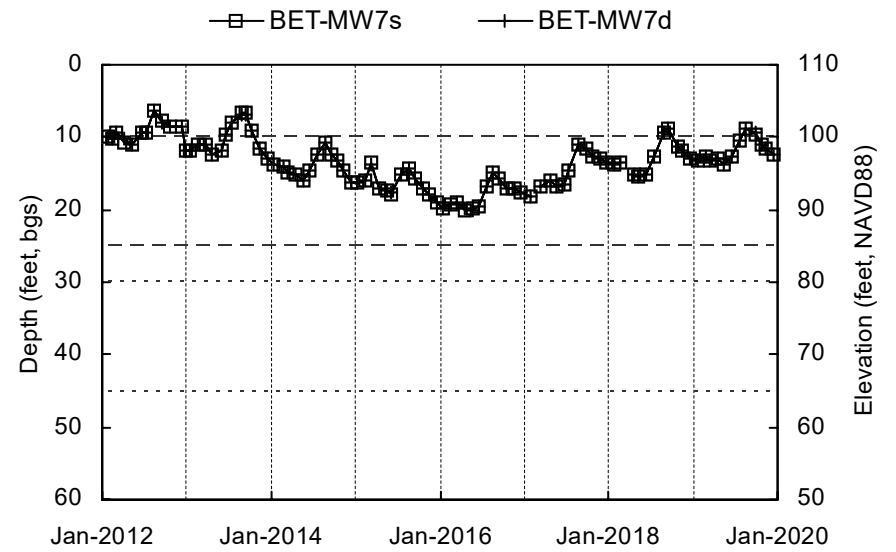
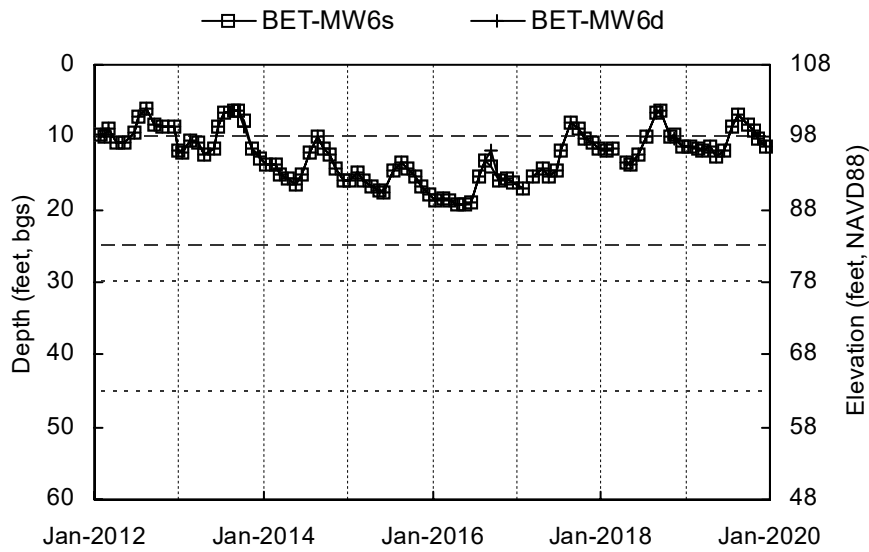

Shallow Well Screened Interval
 Deep Well Screened Interval
 Elevation scale shown to the nearest integer.

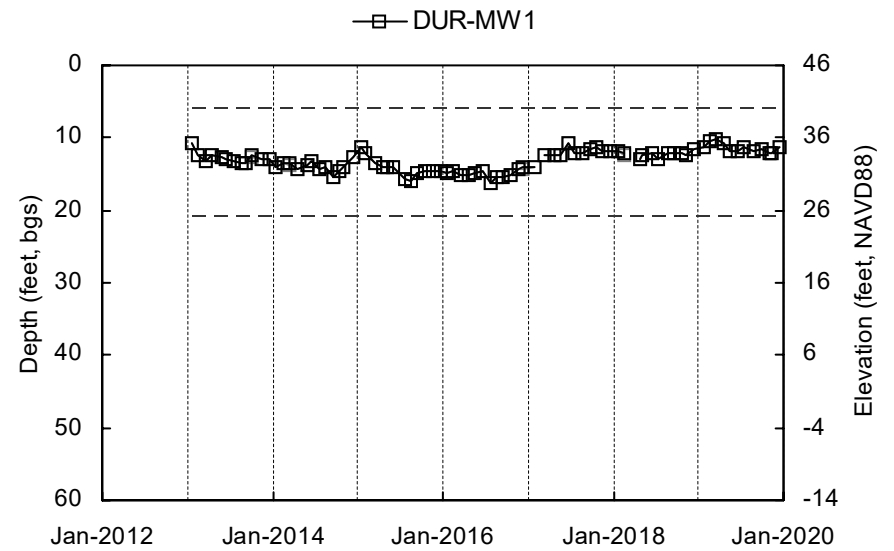
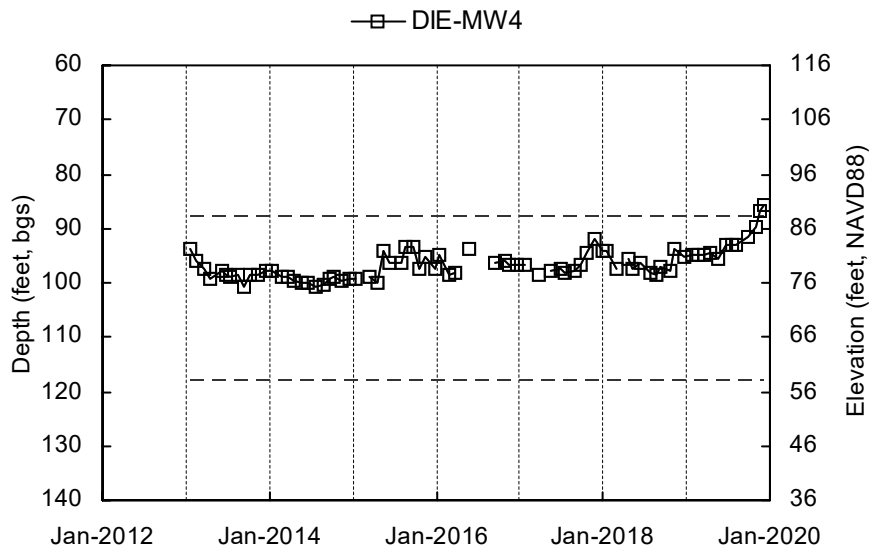
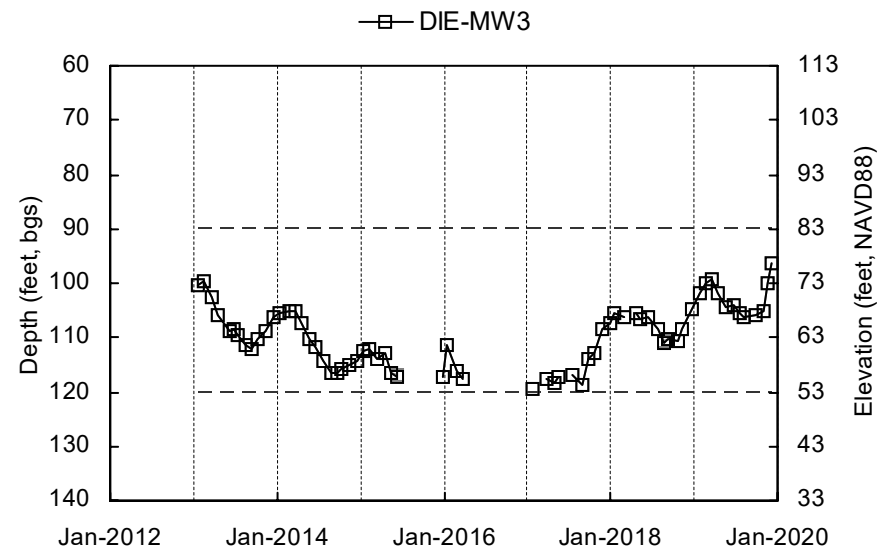
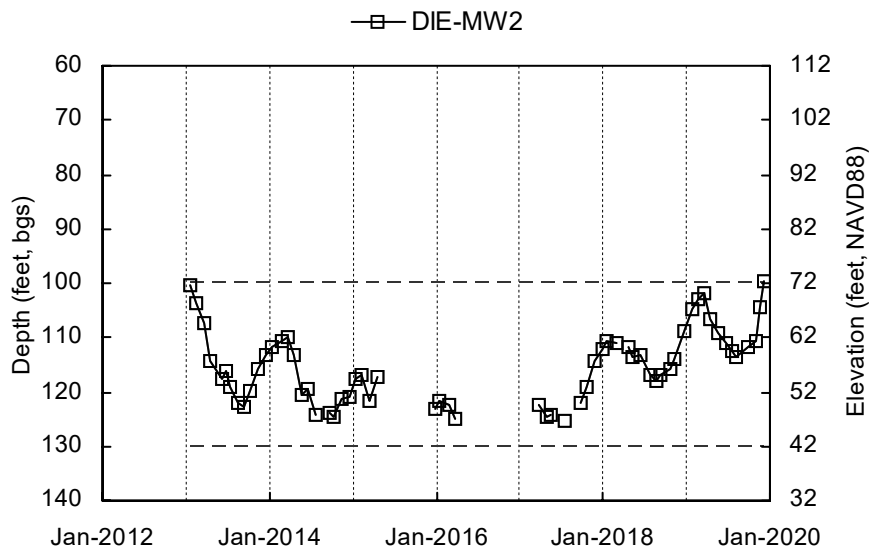

Shallow Well Screened Interval
 Deep Well Screened Interval
Elevation scale shown to the nearest integer.

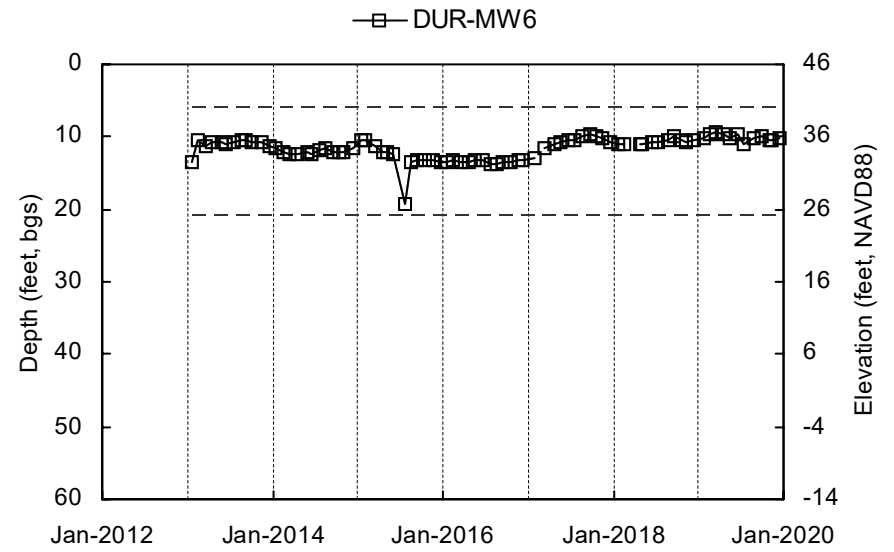
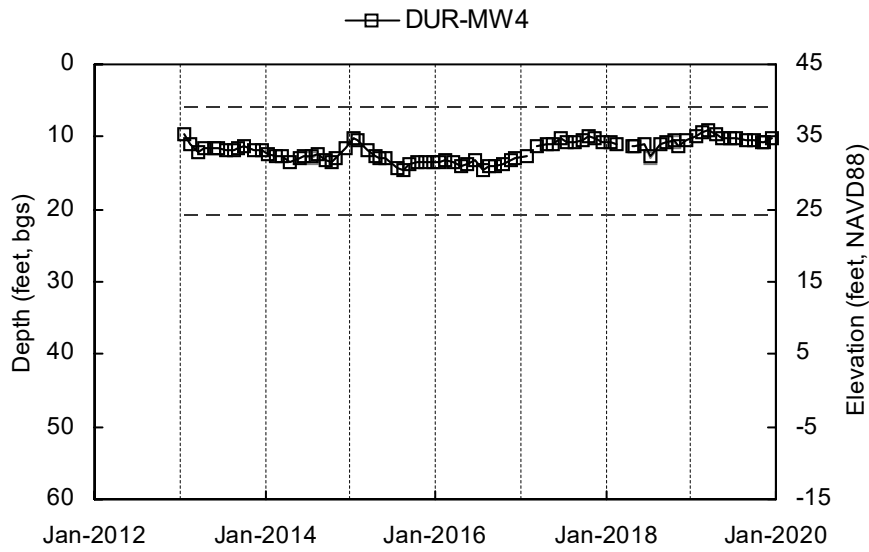
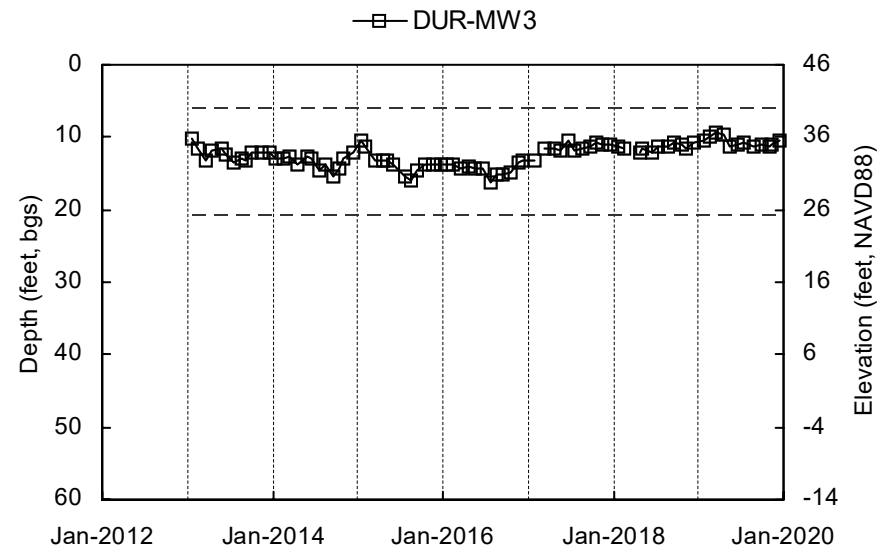
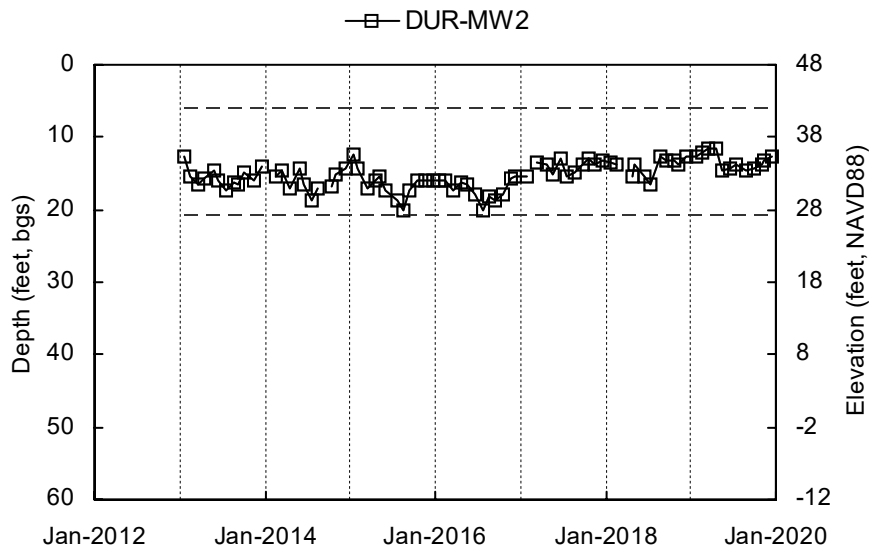

Shallow Well Screened Interval
 Deep Well Screened Interval
 Elevation scale shown to the nearest integer.

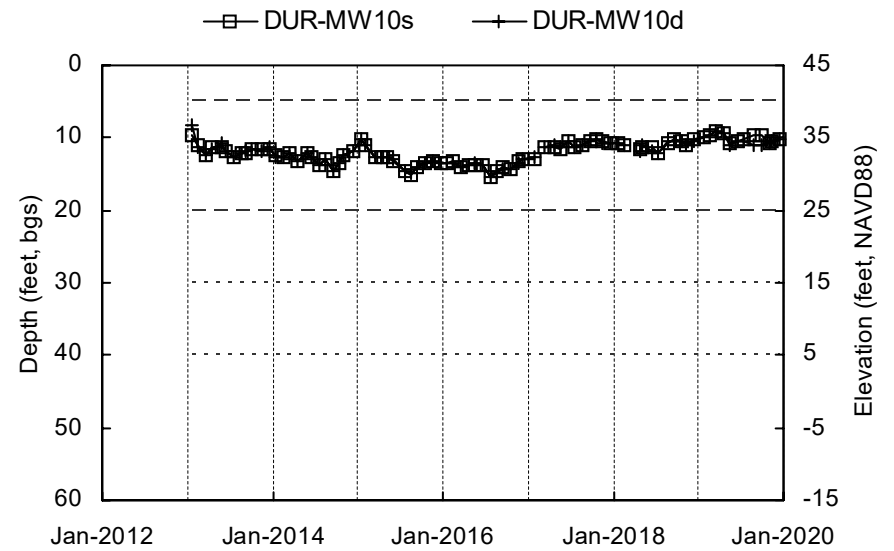
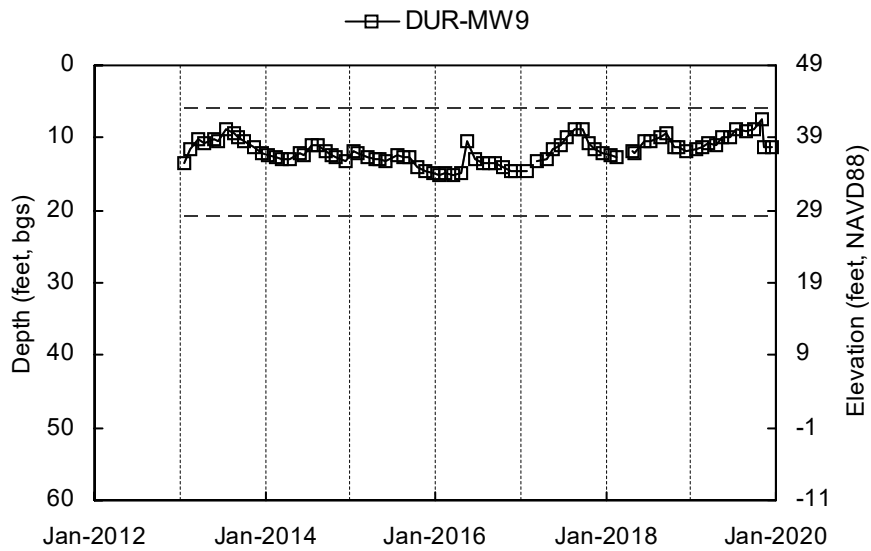
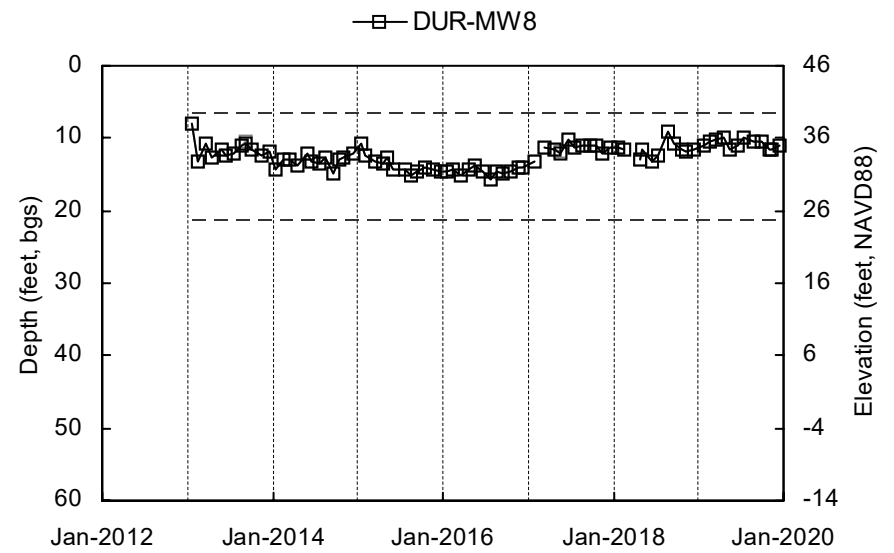
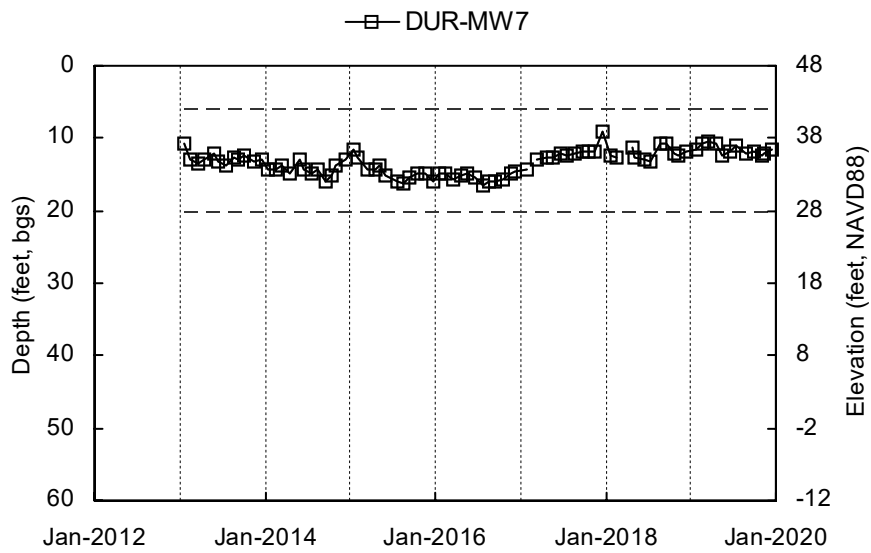

Shallow Well Screened Interval
 Deep Well Screened Interval
 Elevation scale shown to the nearest integer.

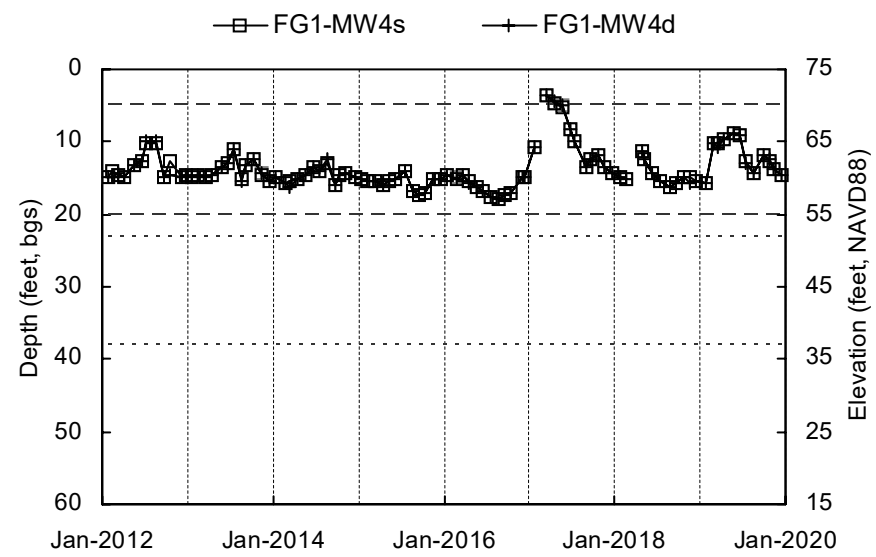
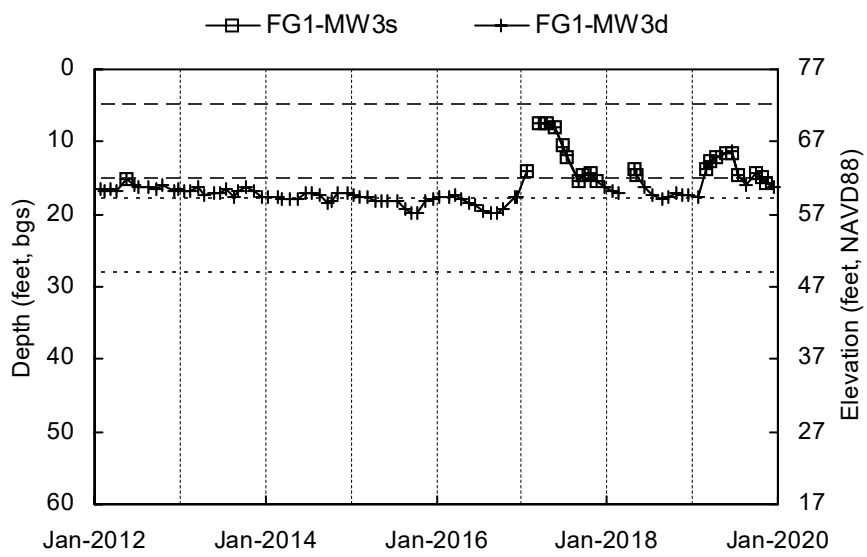
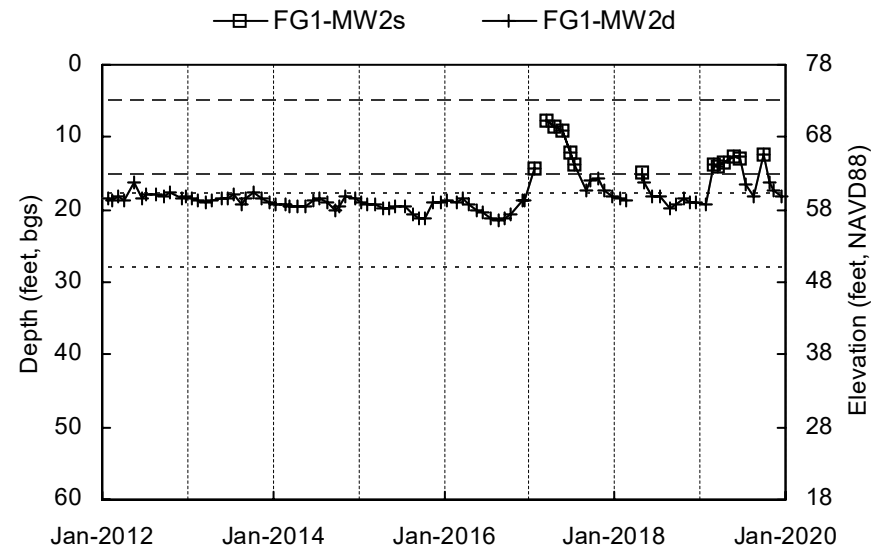
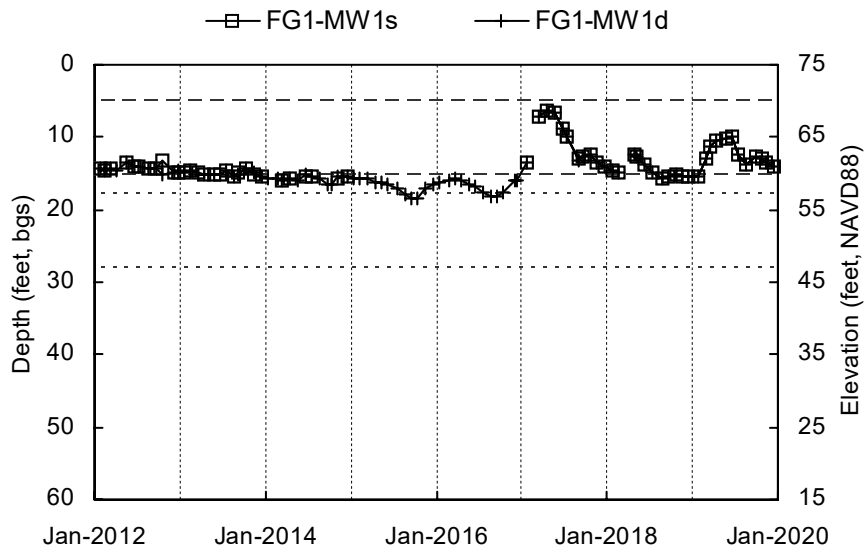

Shallow Well Screened Interval
 Deep Well Screened Interval
 Elevation scale shown to the nearest integer.

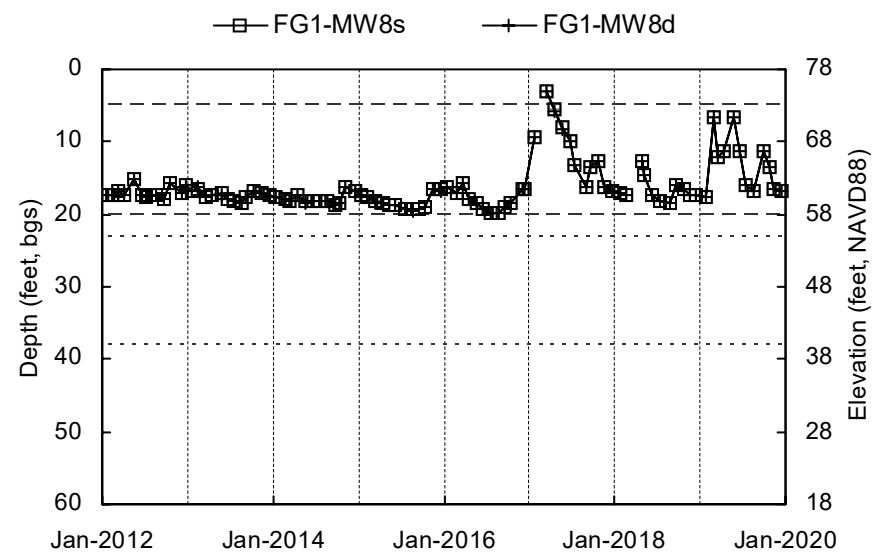
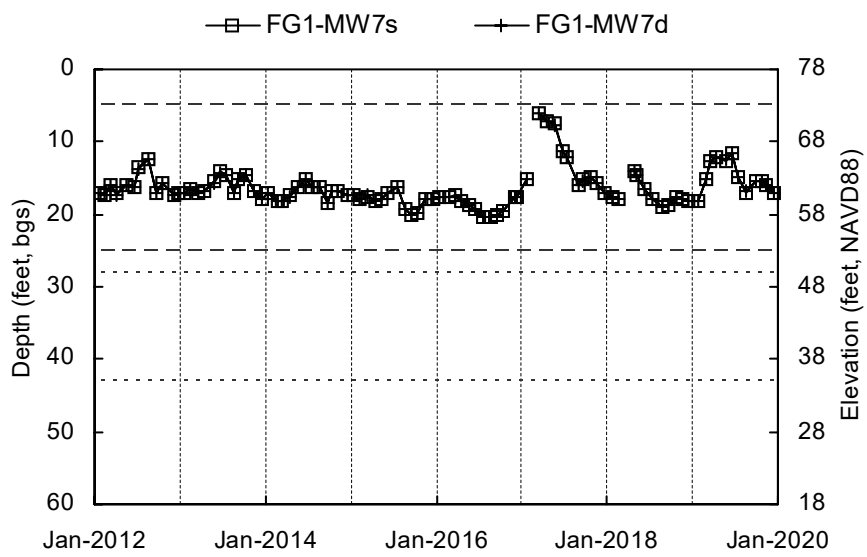
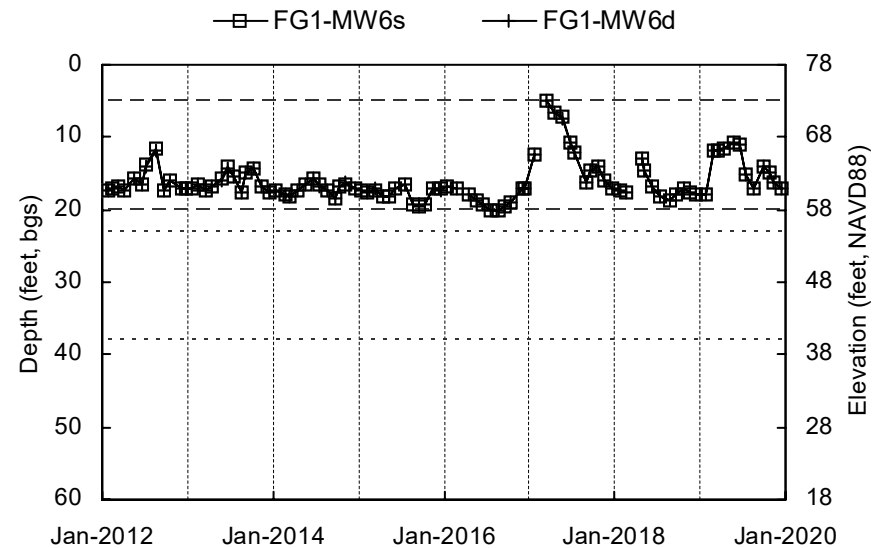
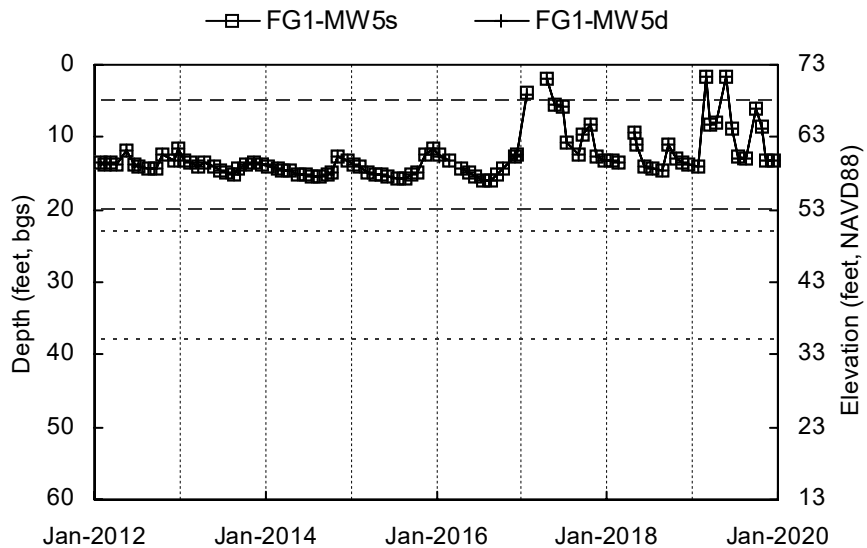

— — — Shallow Well Screened Interval Deep Well Screened Interval
 Elevation scale shown to the nearest integer.

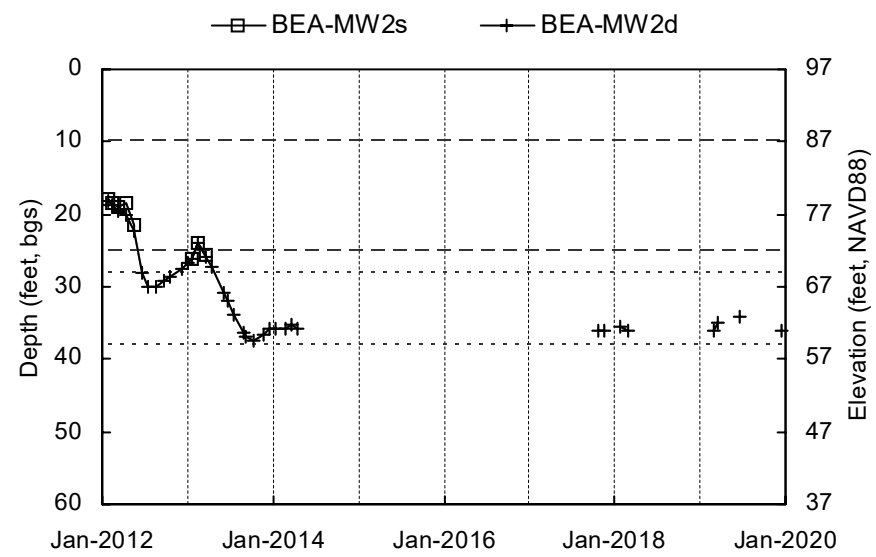
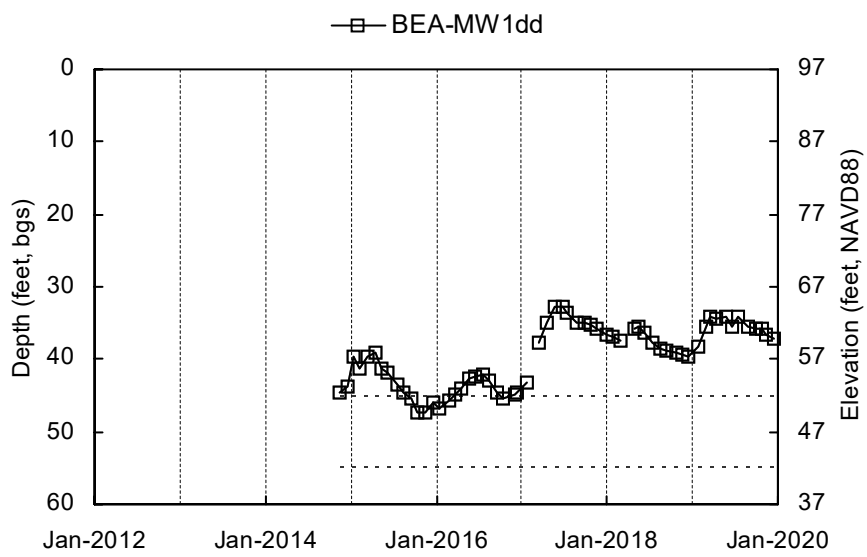
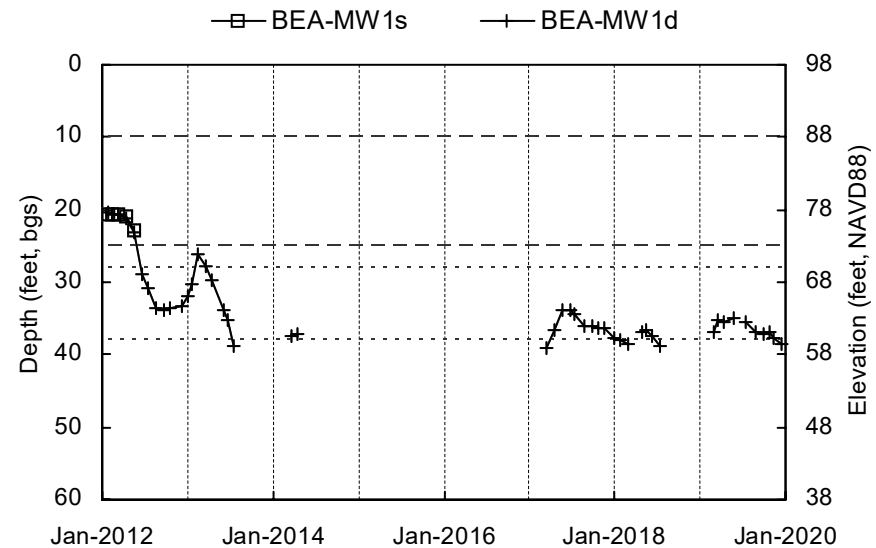
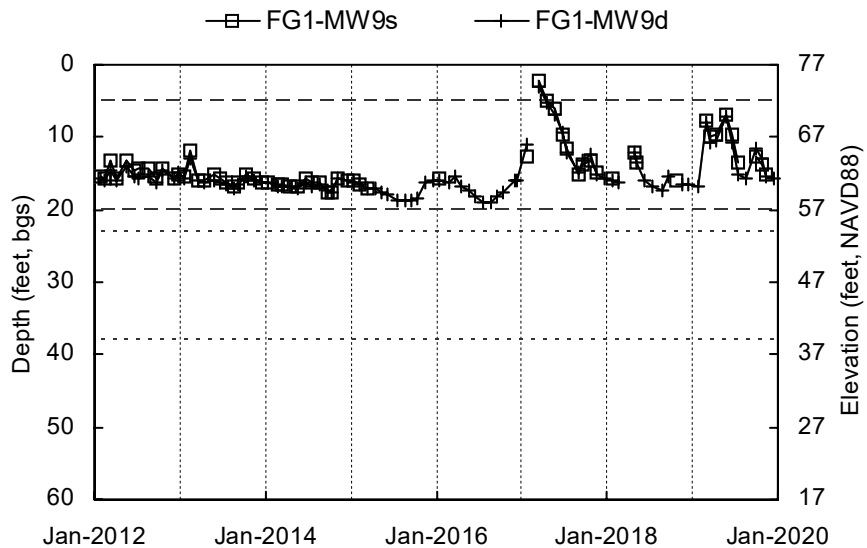

Shallow Well Screened Interval
 Deep Well Screened Interval
 Elevation scale shown to the nearest integer.

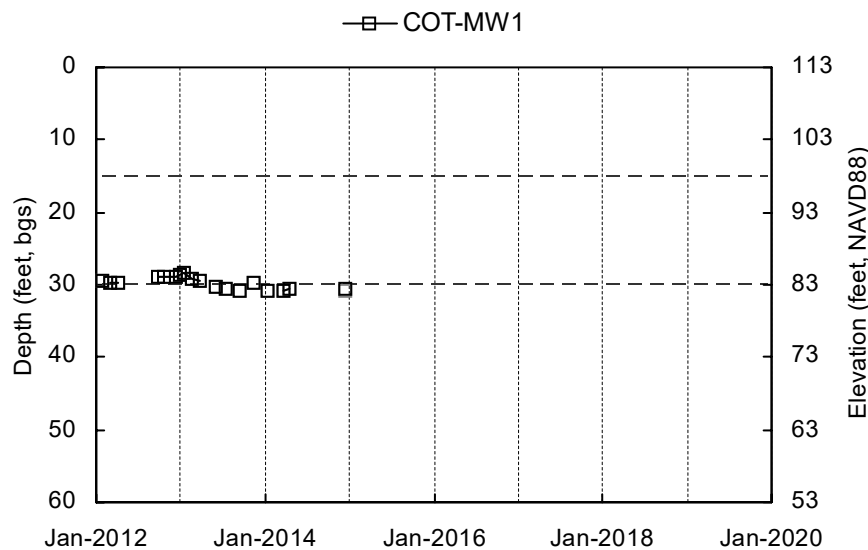
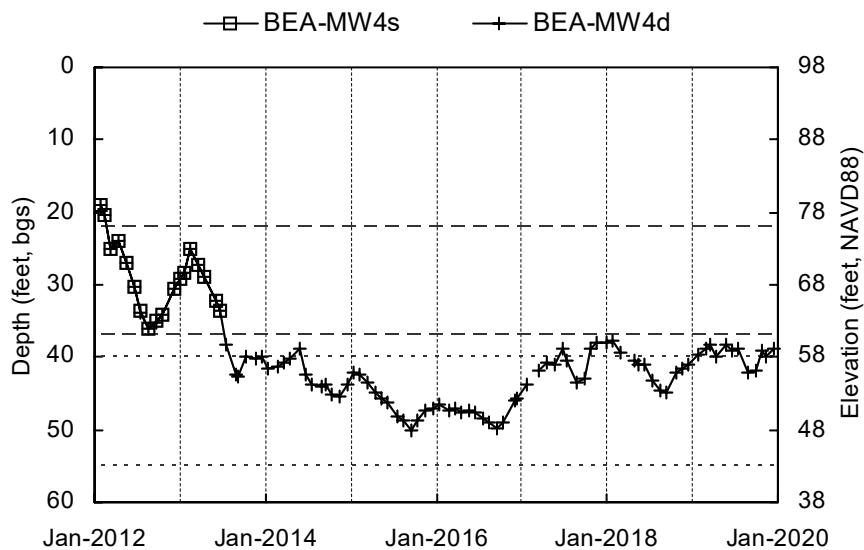
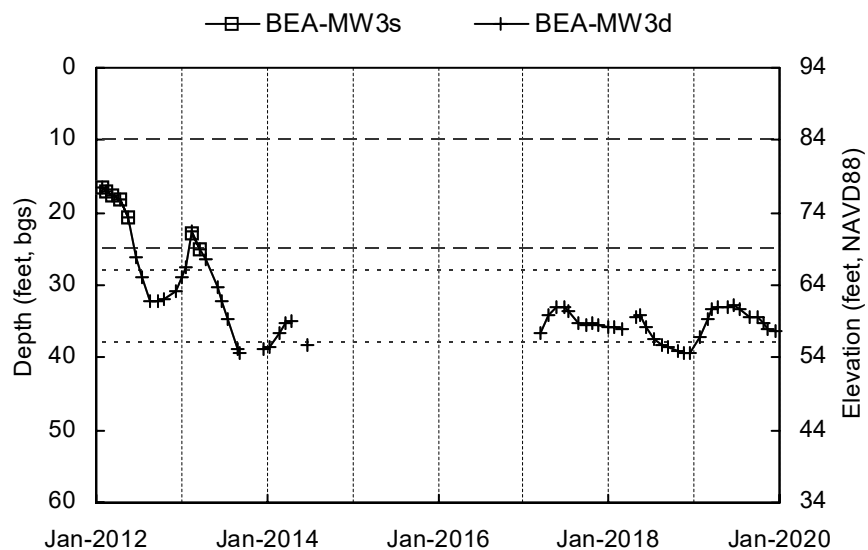
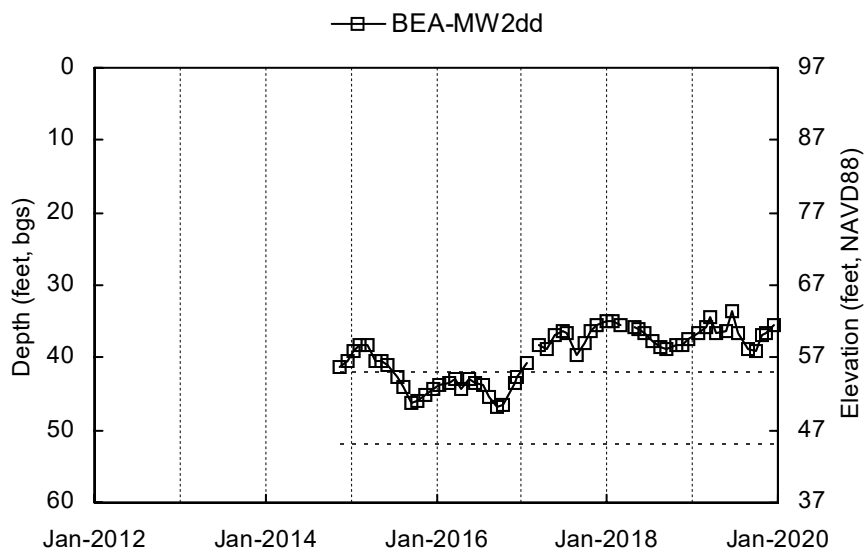

Shallow Well Screened Interval
 Deep Well Screened Interval
 Elevation scale shown to the nearest integer.

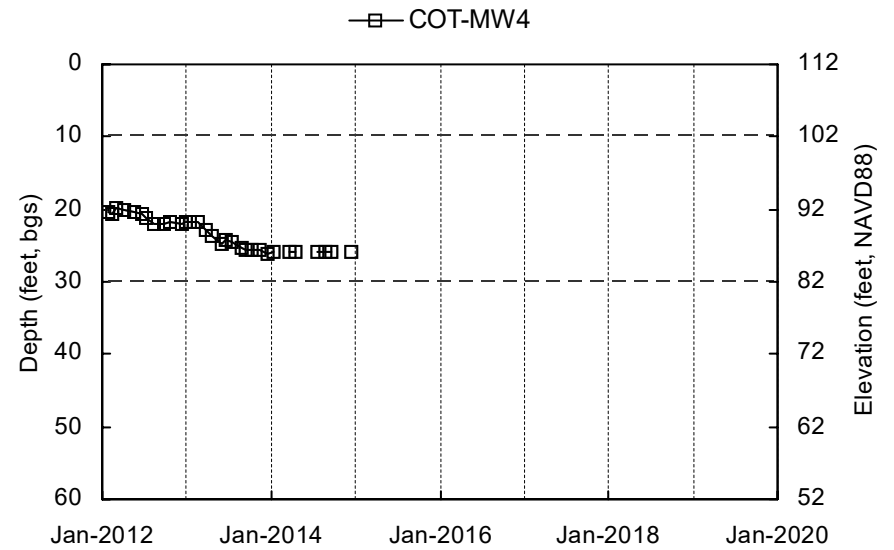
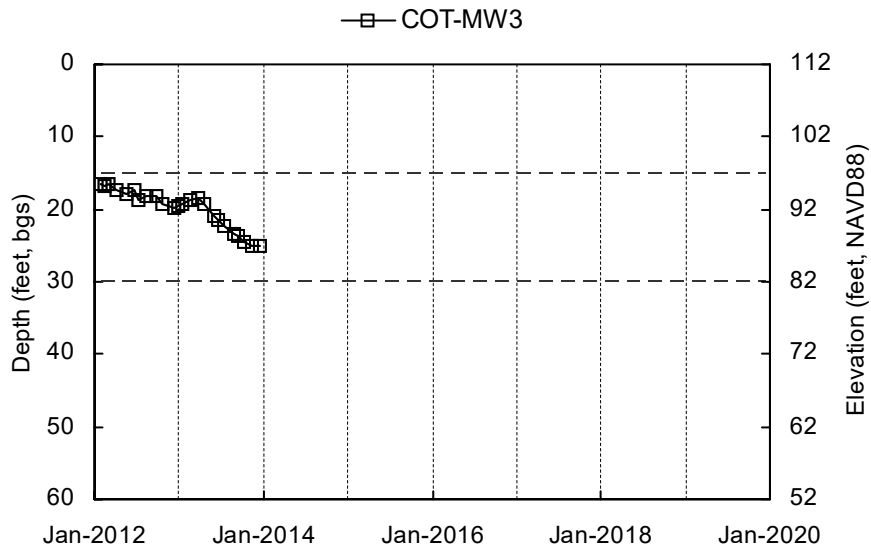
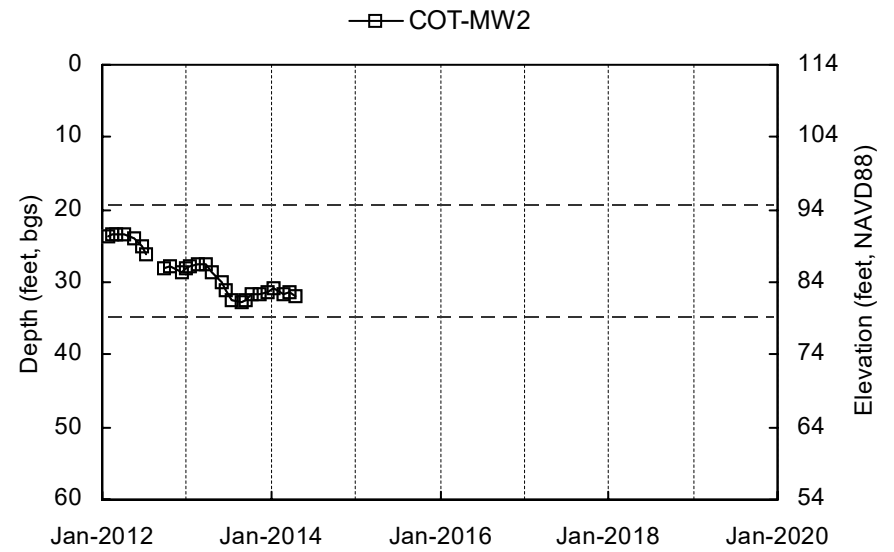
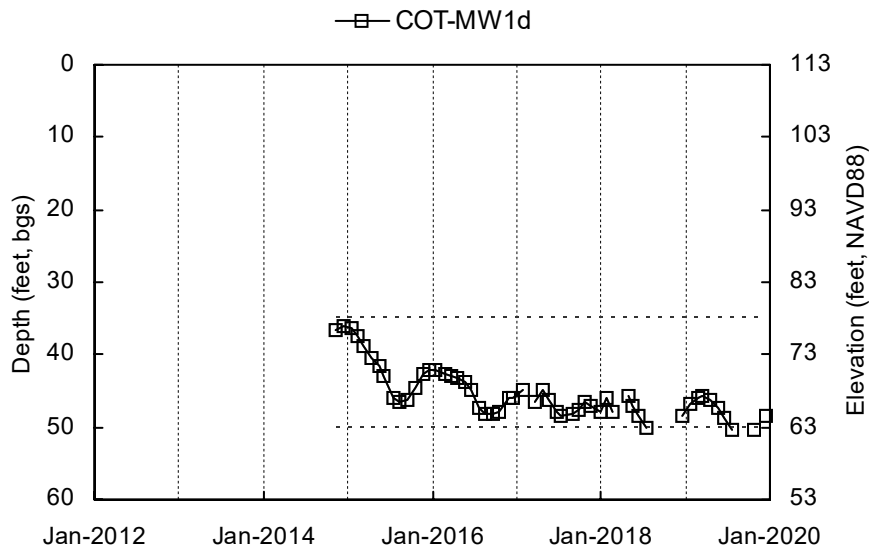

— — — Shallow Well Screened Interval Deep Well Screened Interval
 Elevation scale shown to the nearest integer.

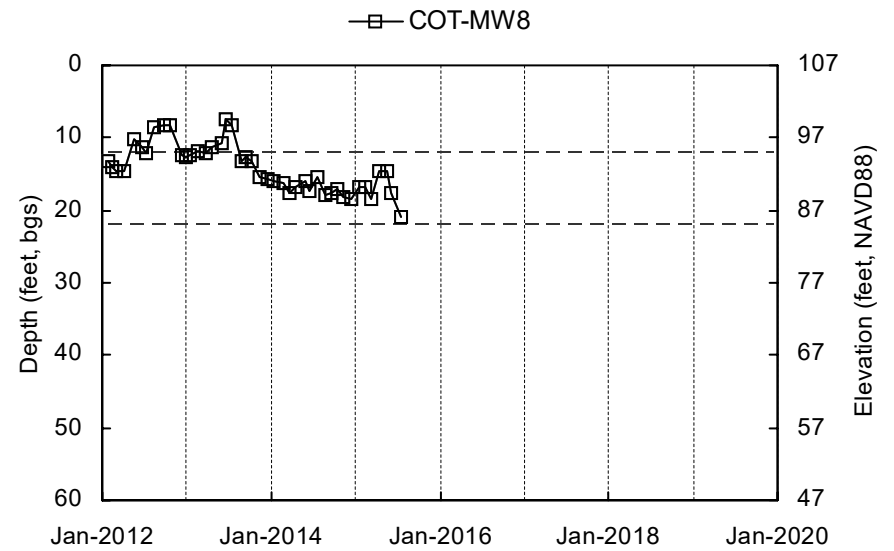
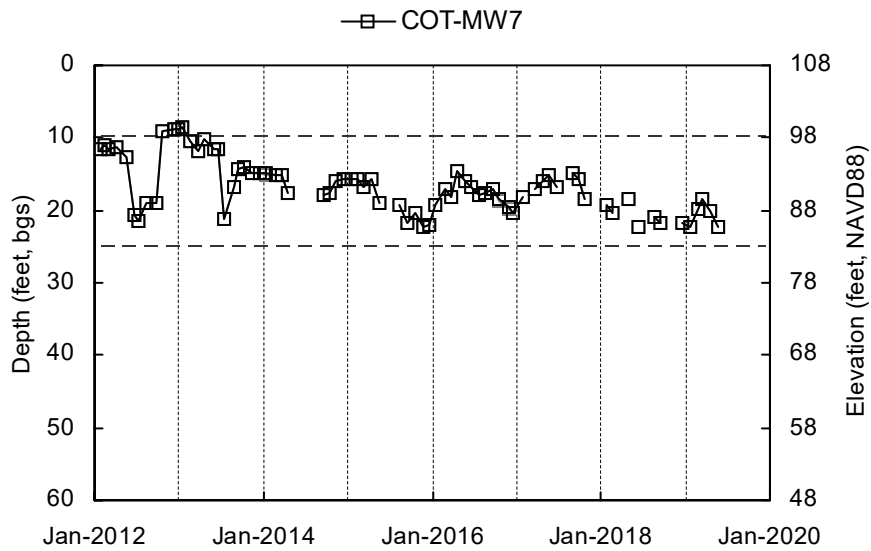
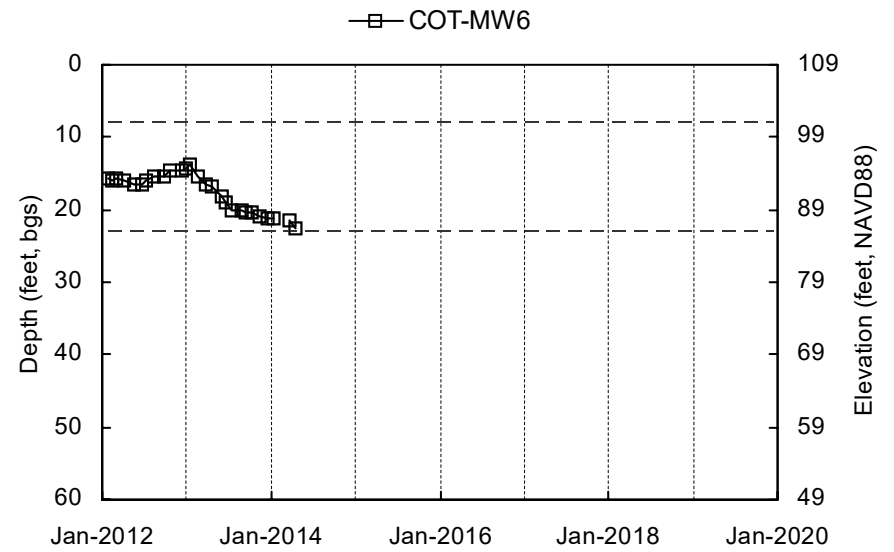
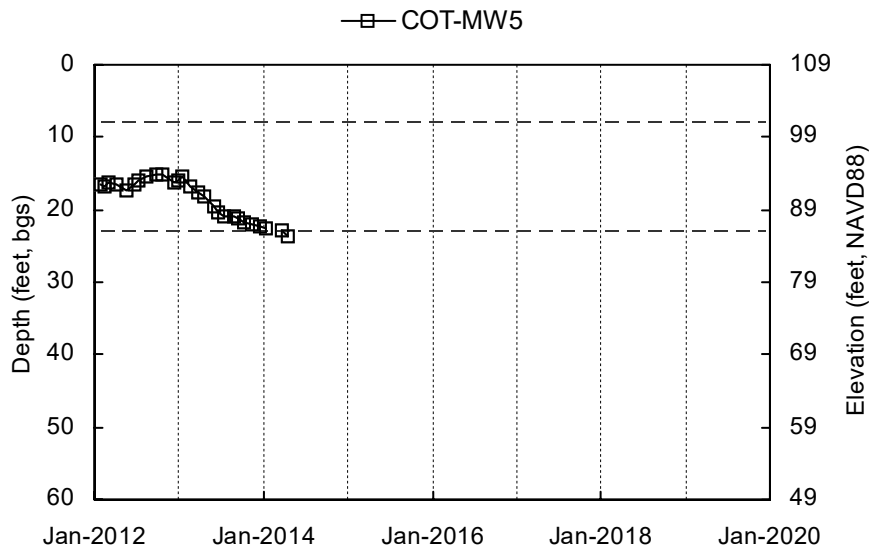

— — — Shallow Well Screened Interval Deep Well Screened Interval
 Elevation scale shown to the nearest integer.

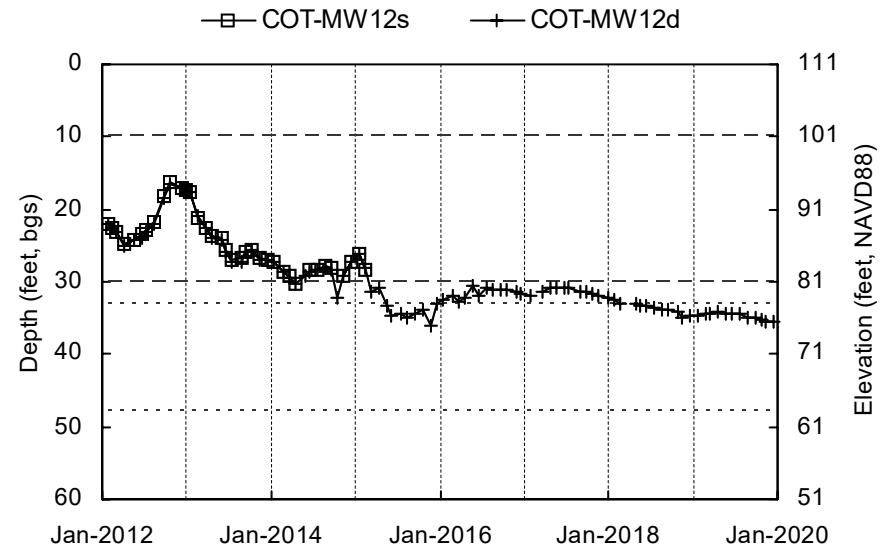
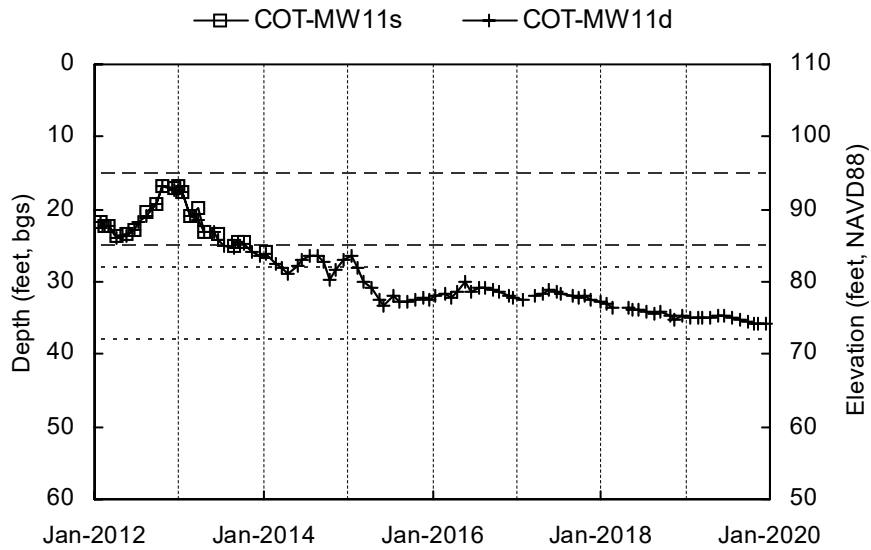
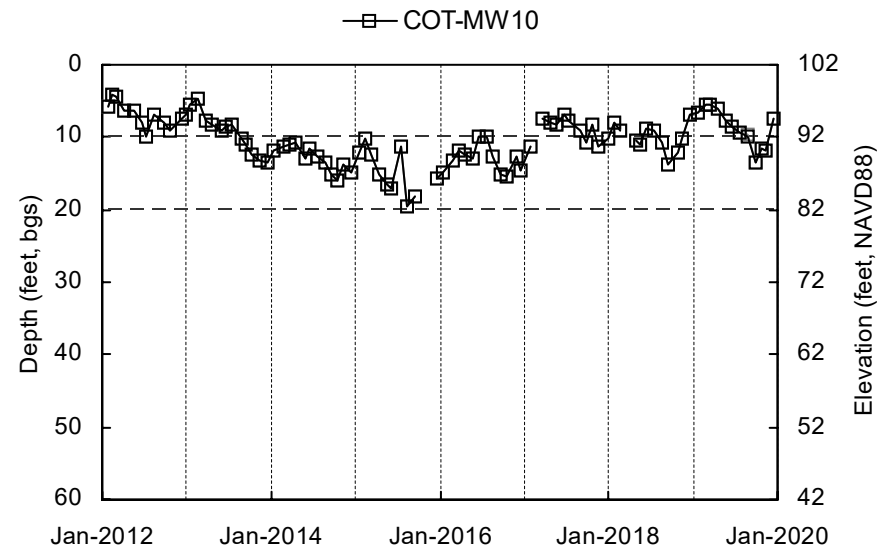
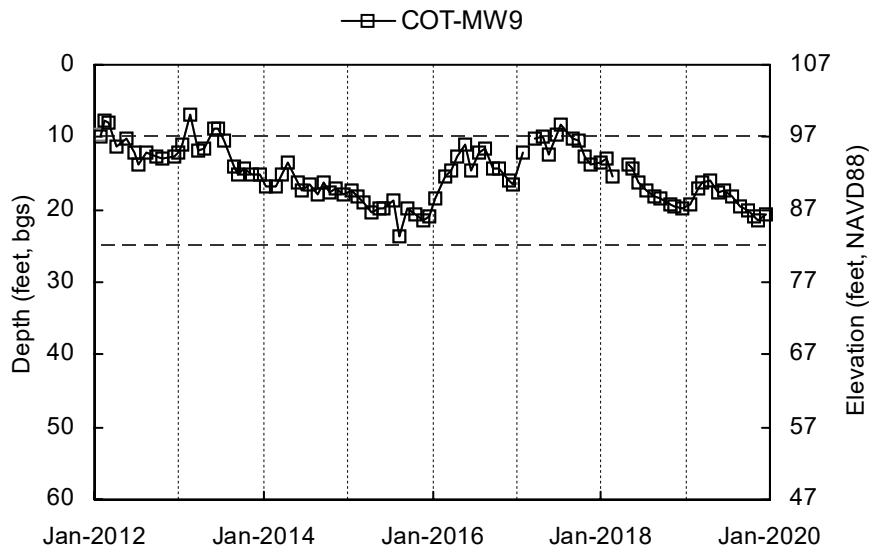

— — — Shallow Well Screened Interval Deep Well Screened Interval
 Elevation scale shown to the nearest integer.

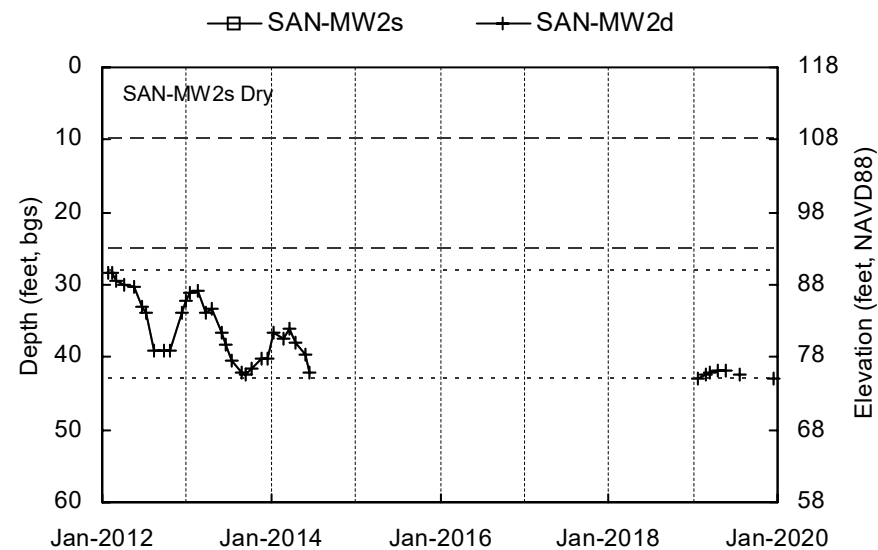
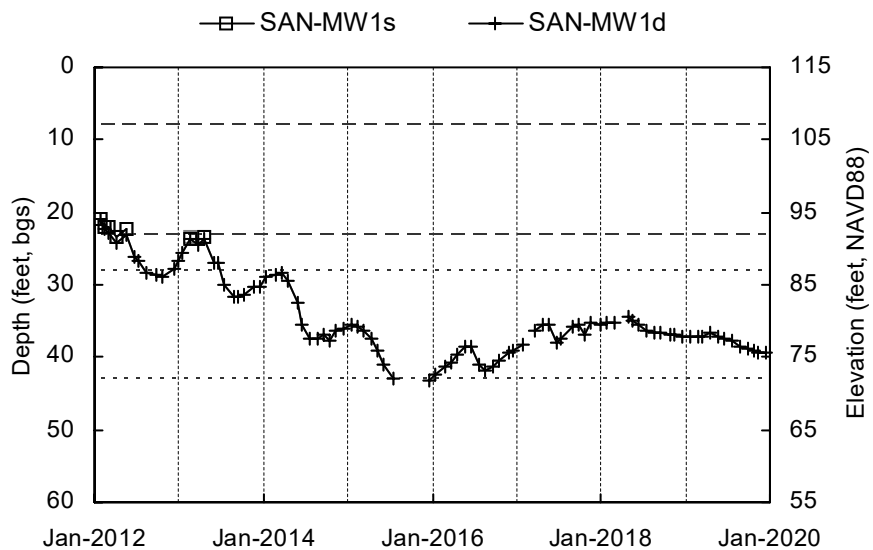
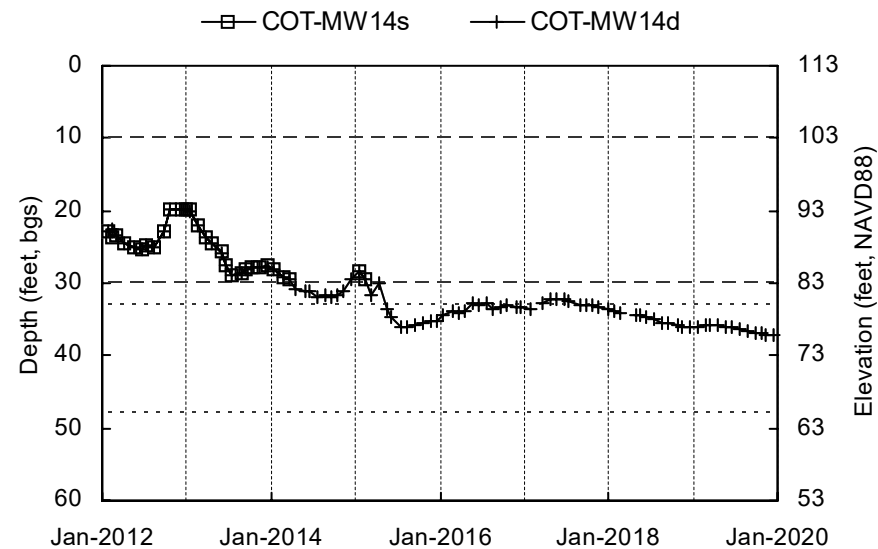
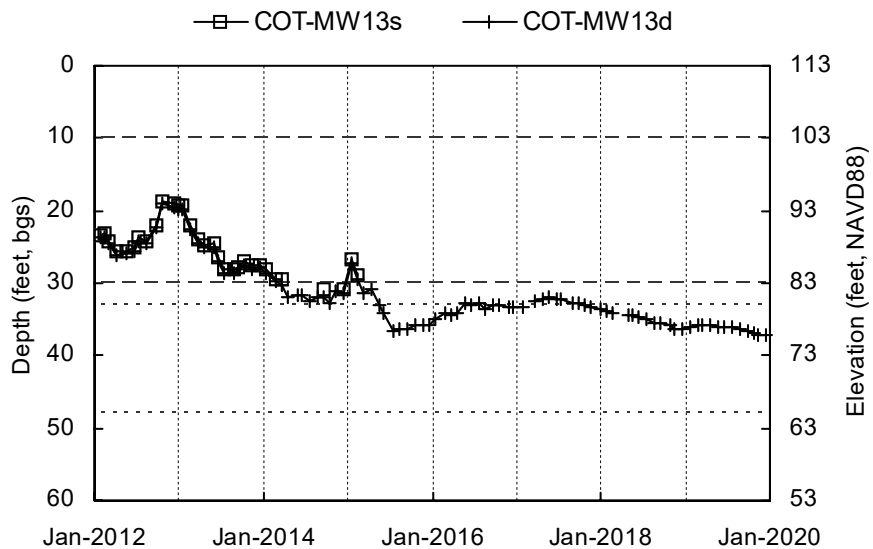

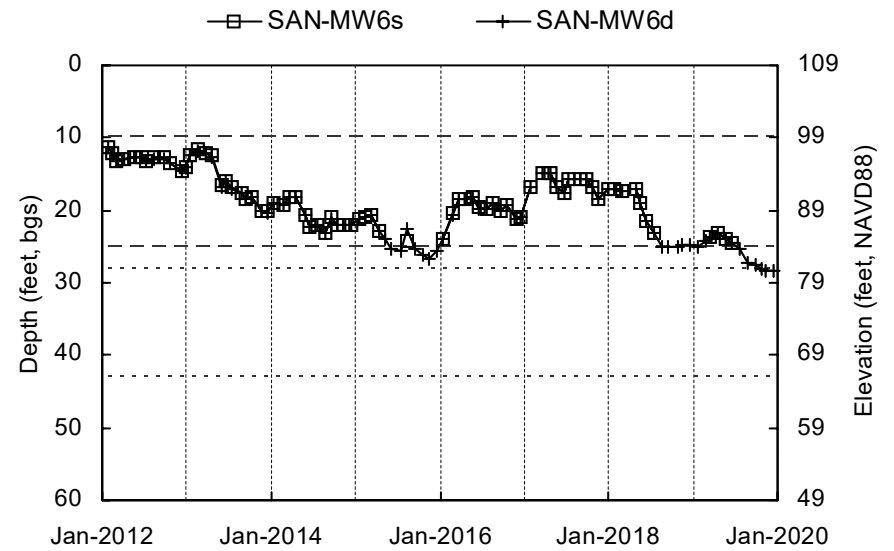
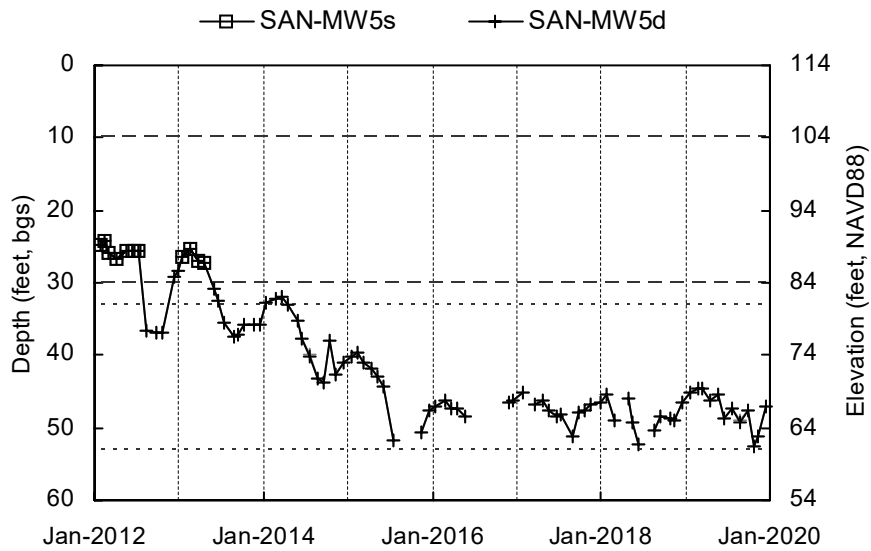
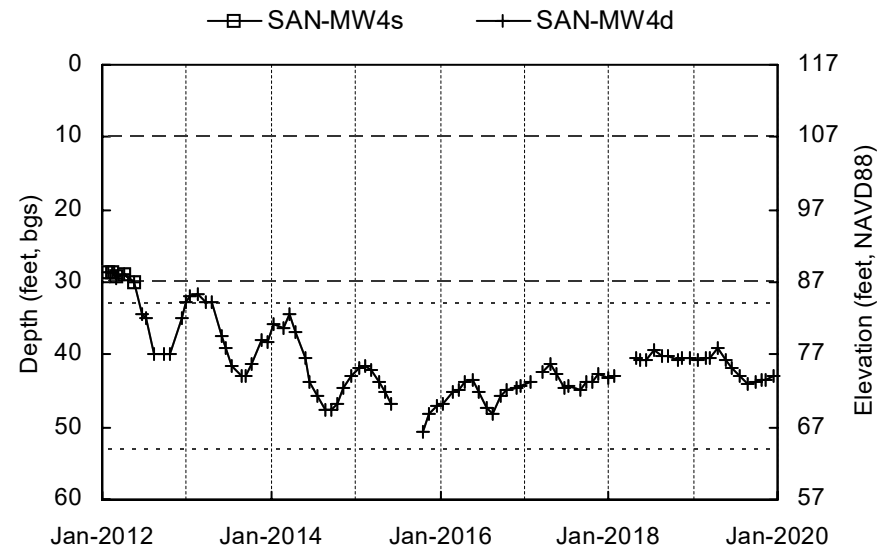
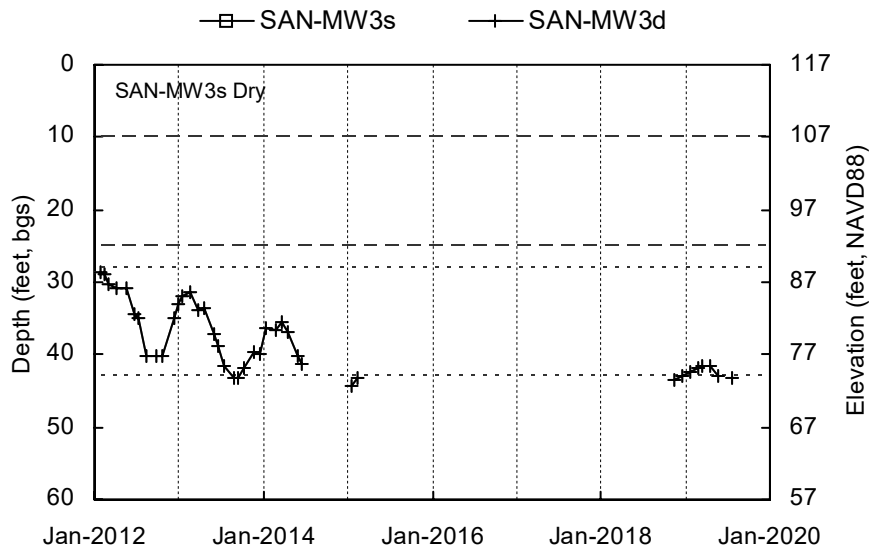

— — — Shallow Well Screened Interval Deep Well Screened Interval
 Elevation scale shown to the nearest integer.

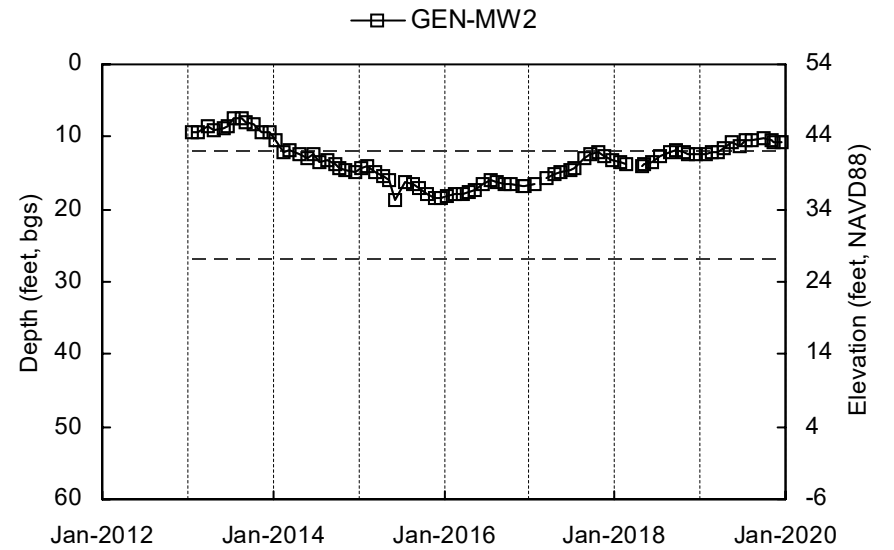
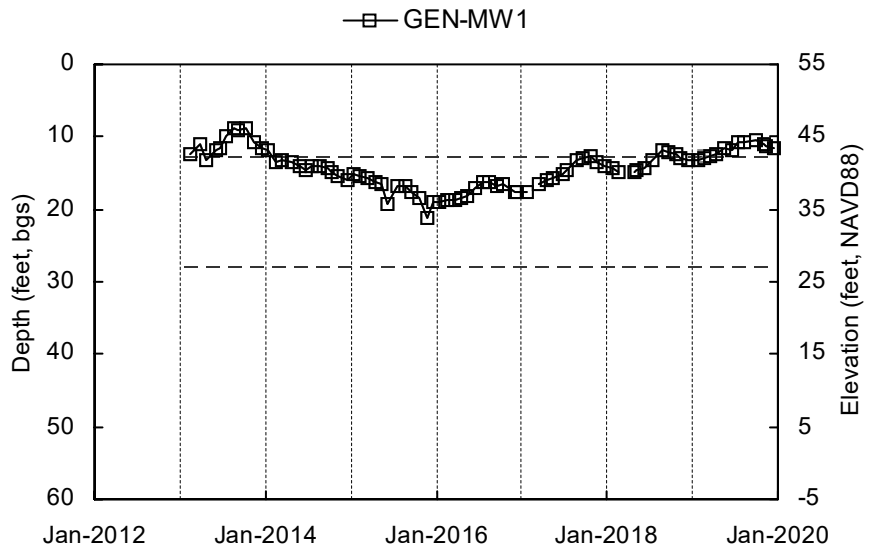
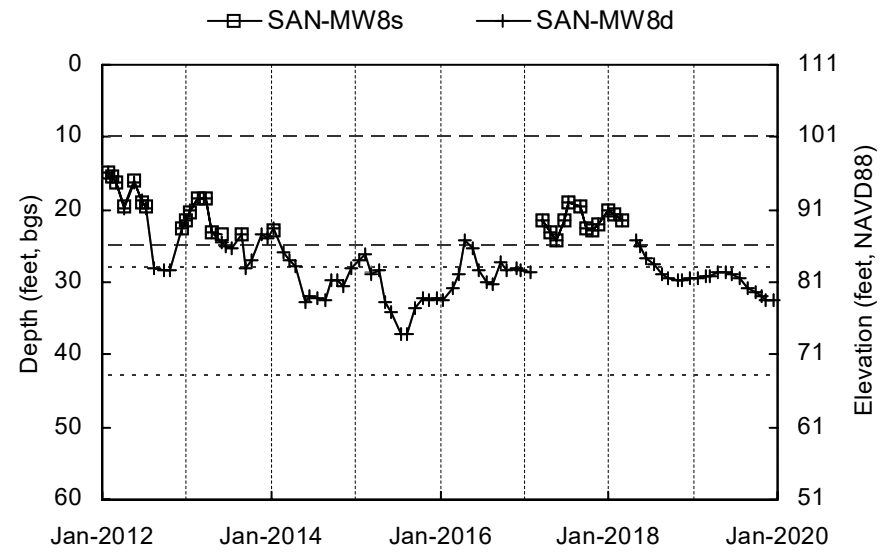
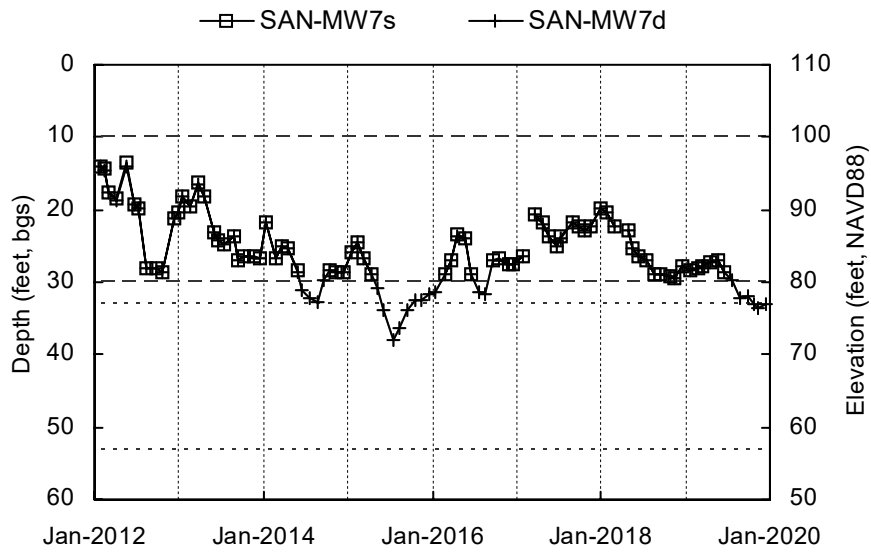

— — — Shallow Well Screened Interval Deep Well Screened Interval
 Elevation scale shown to the nearest integer.

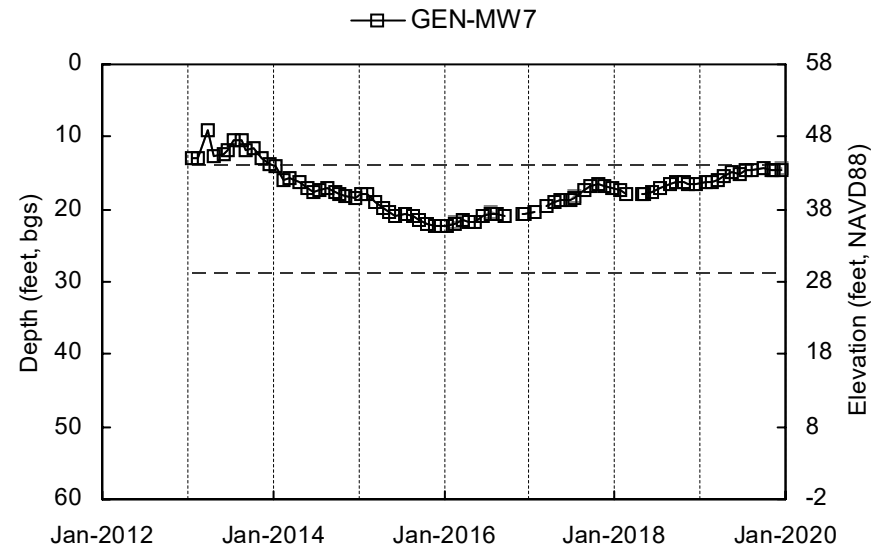
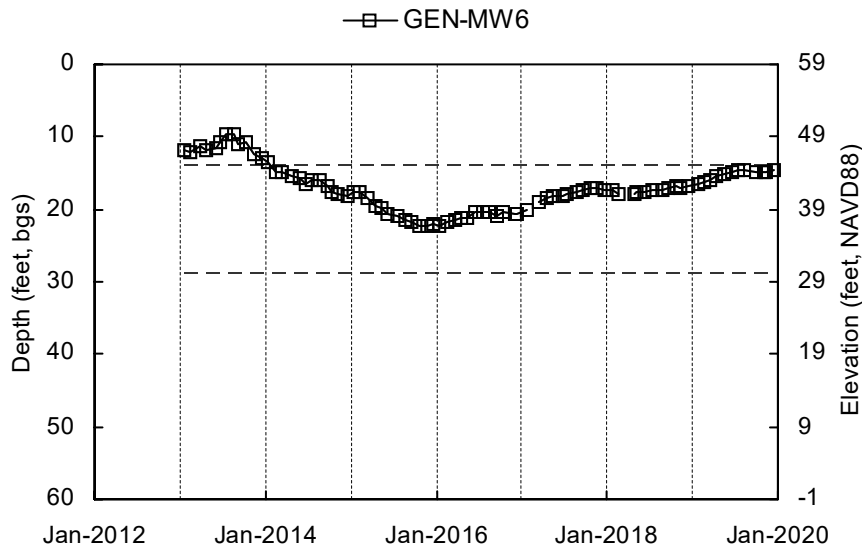
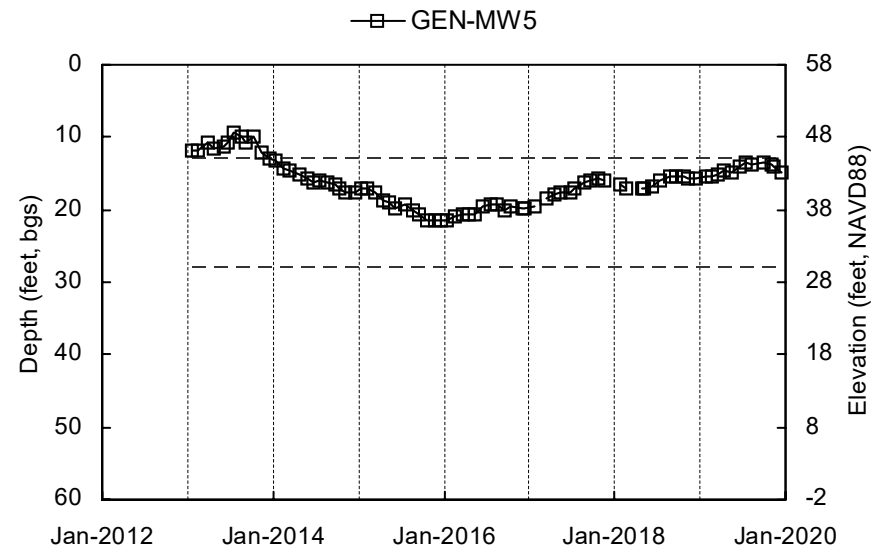
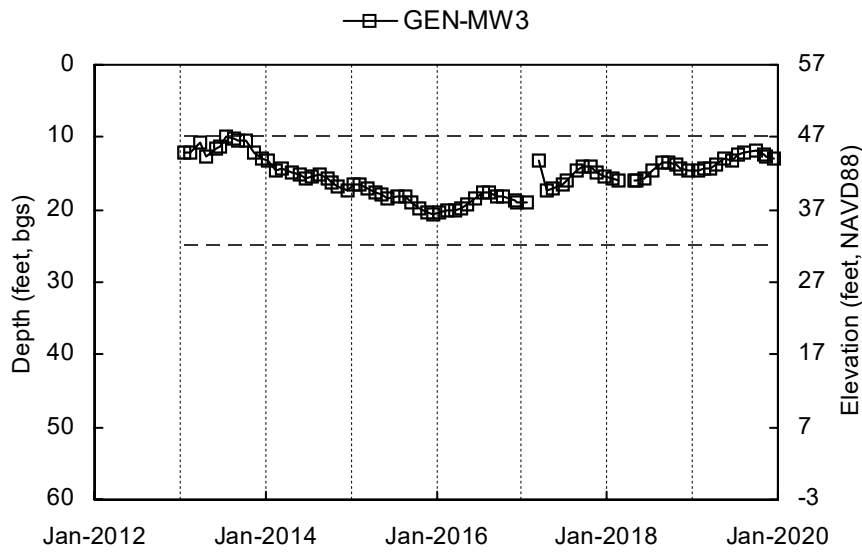

Shallow Well Screened Interval Deep Well Screened Interval
 Elevation scale shown to the nearest integer.

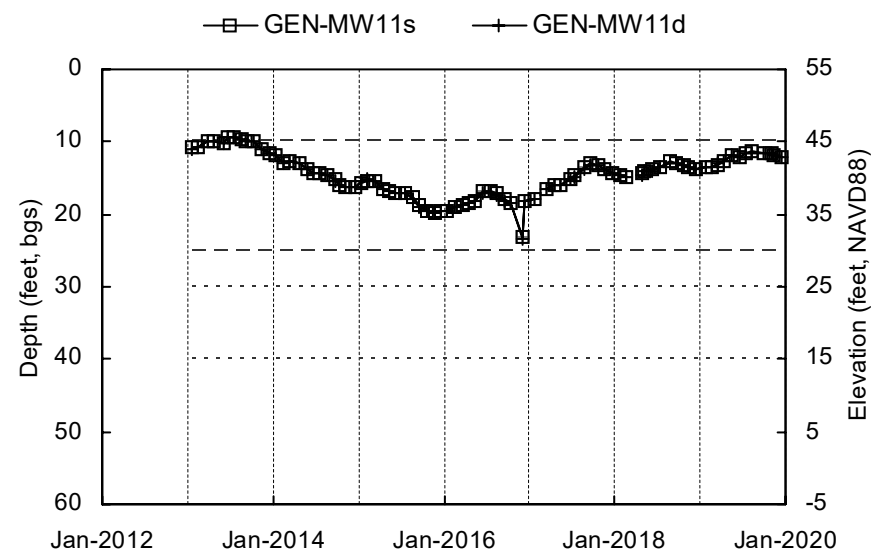
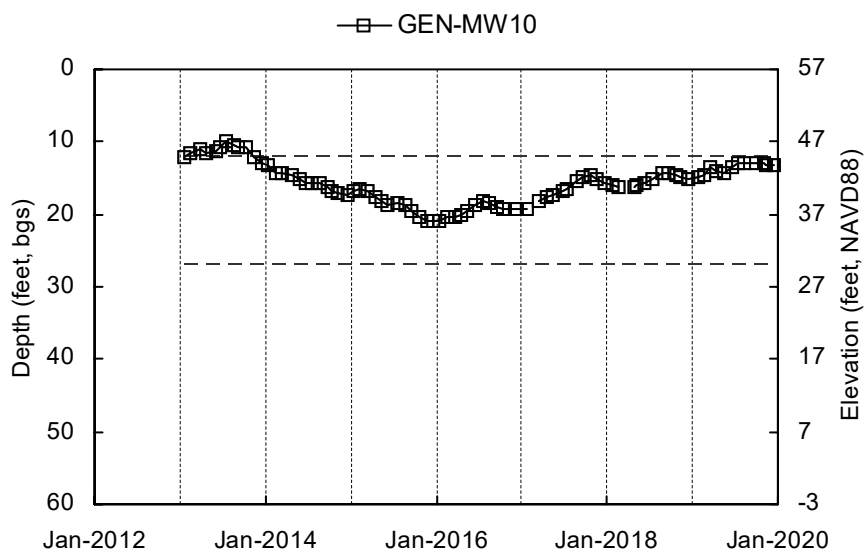
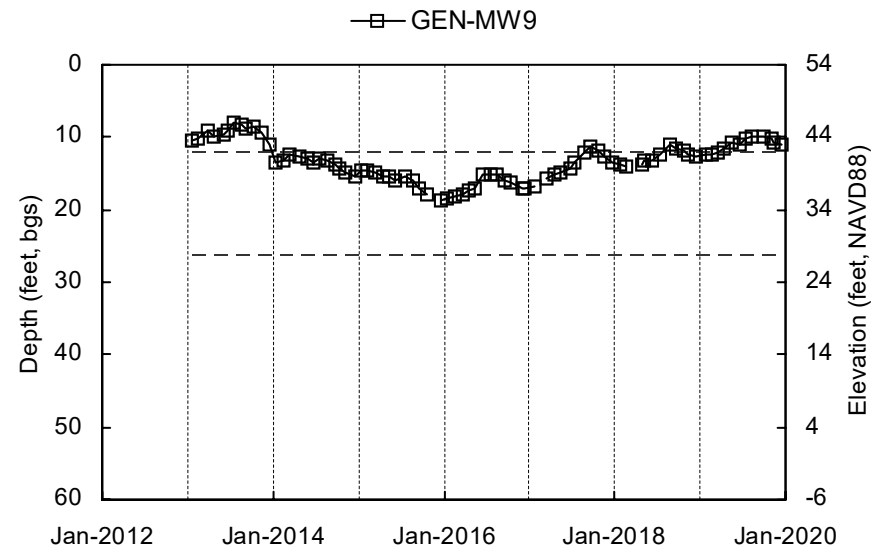
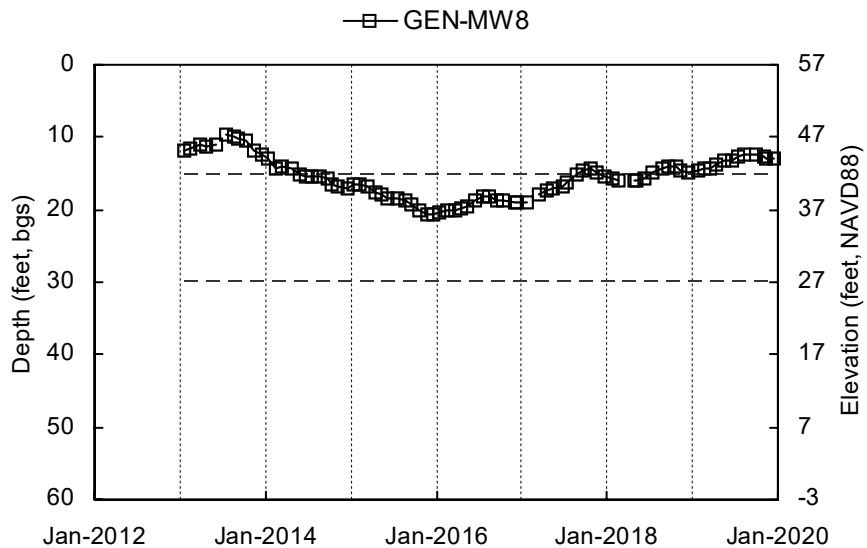

Shallow Well Screened Interval
 Deep Well Screened Interval
 Elevation scale shown to the nearest integer.

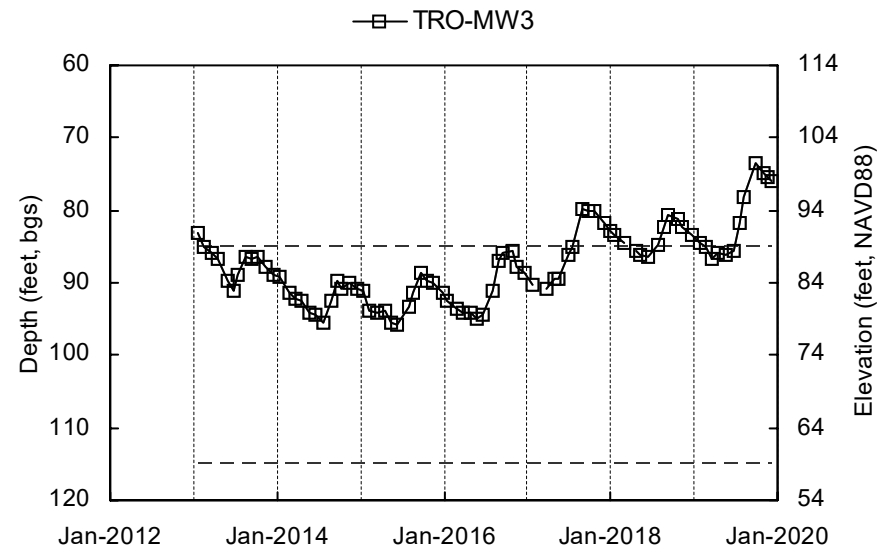
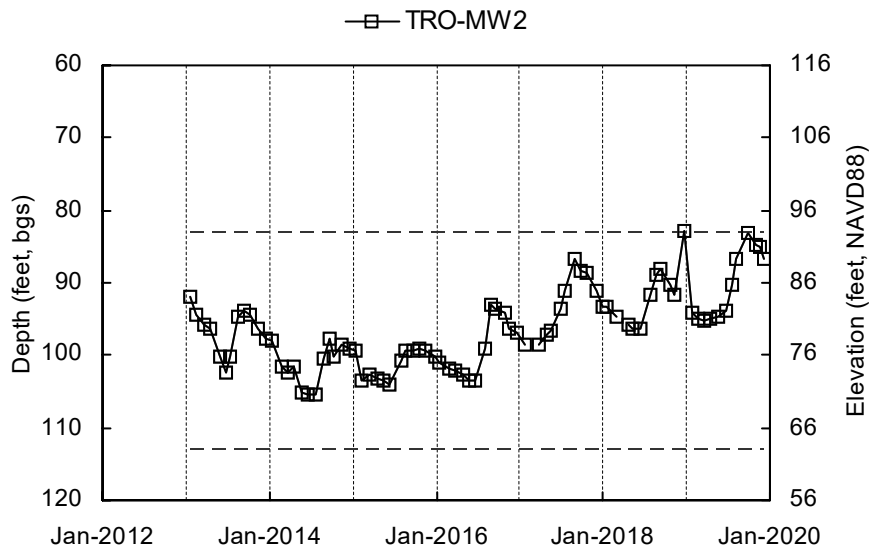
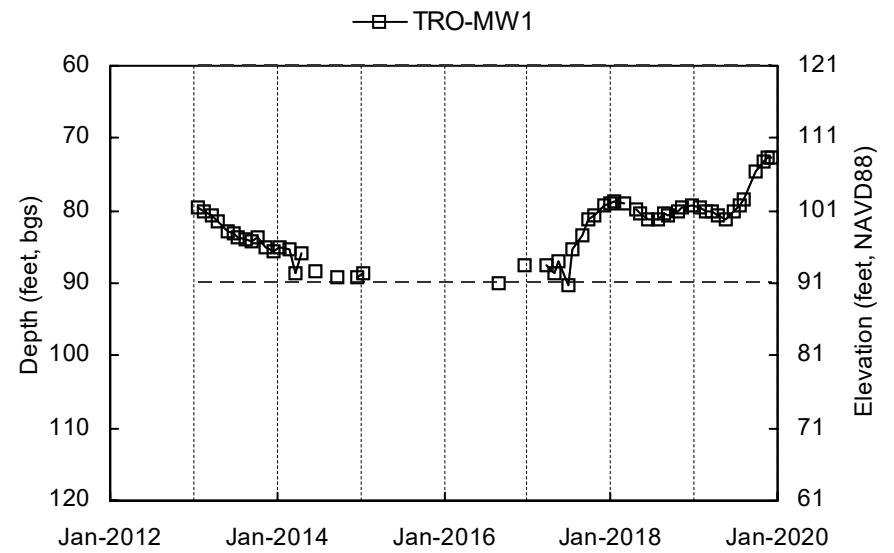
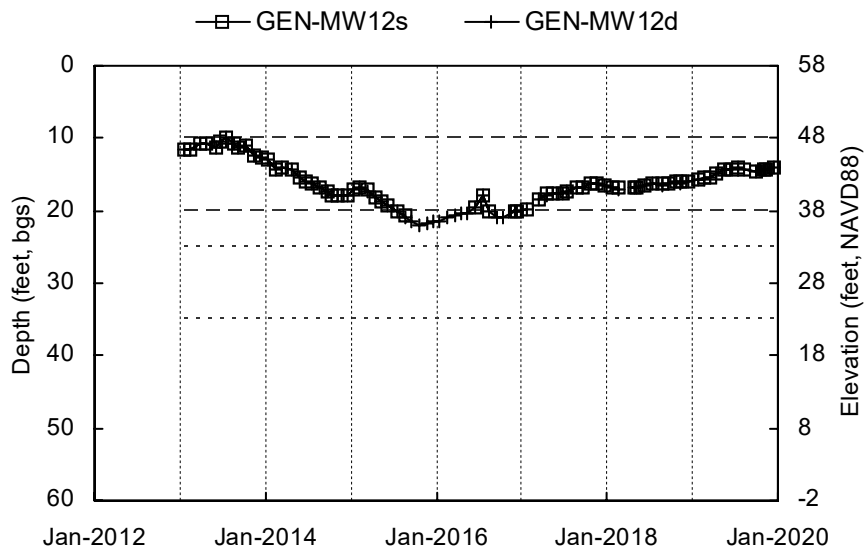

Shallow Well Screened Interval
 Deep Well Screened Interval
 Elevation scale shown to the nearest integer.

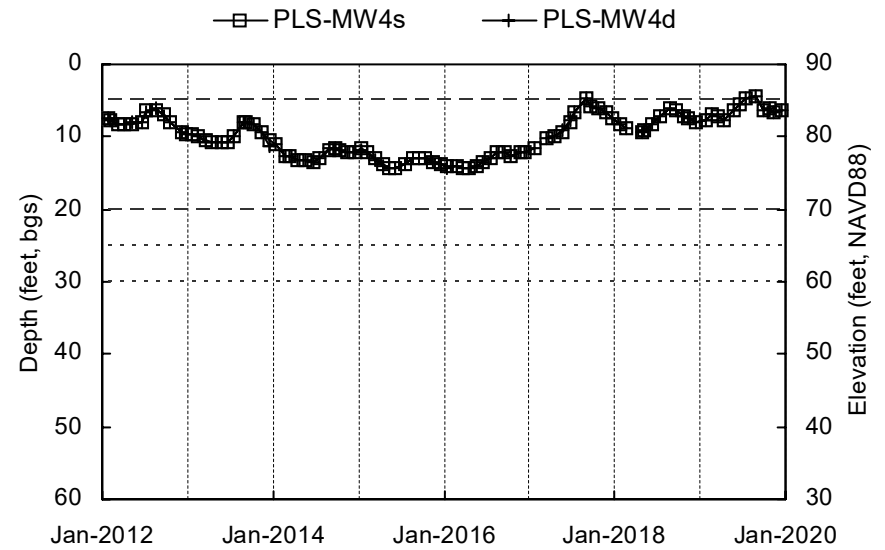
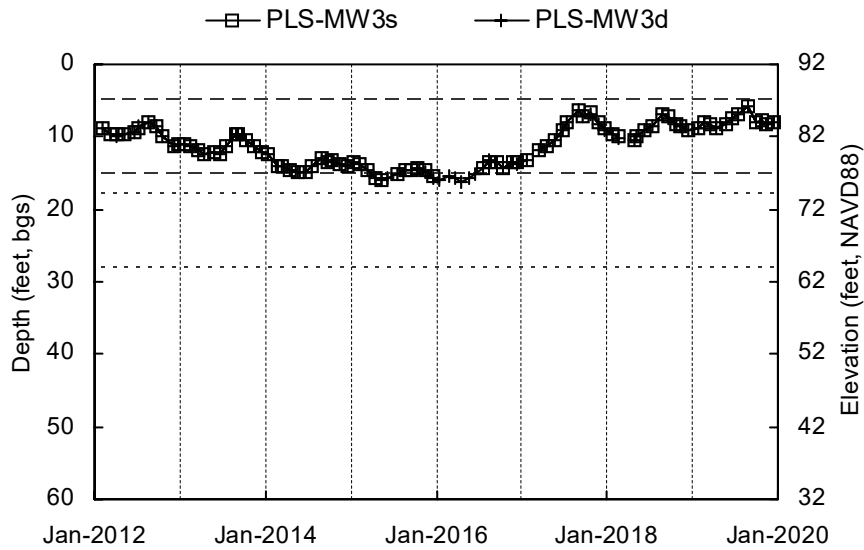
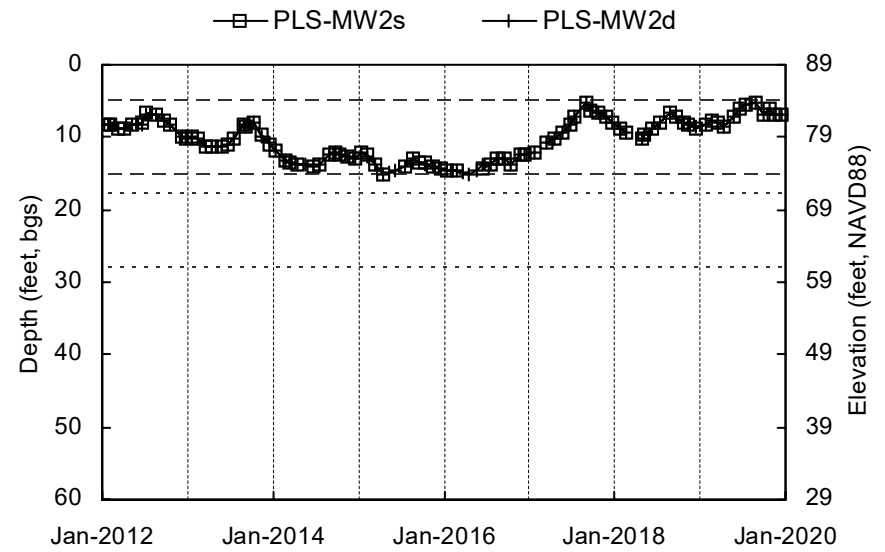
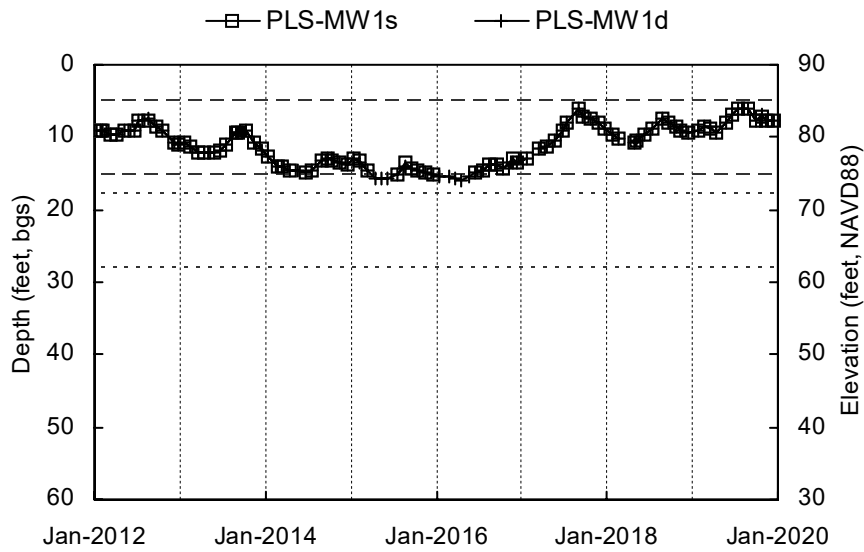

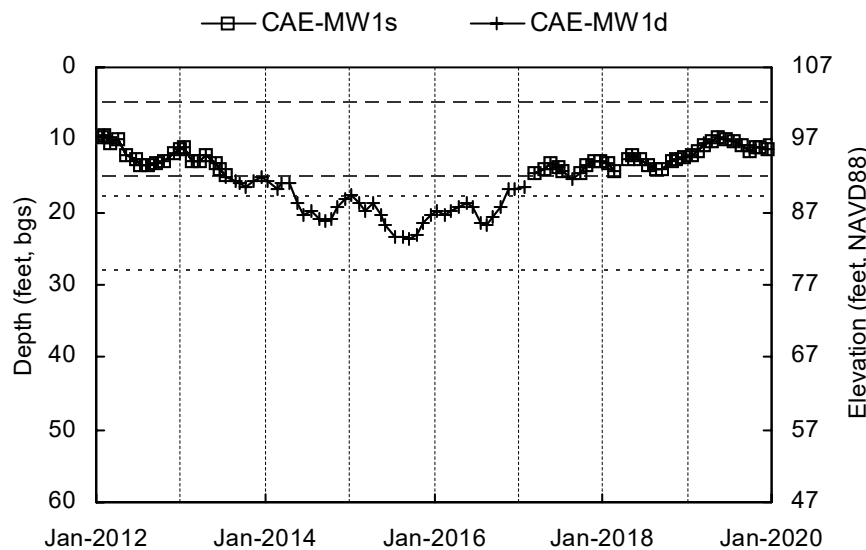
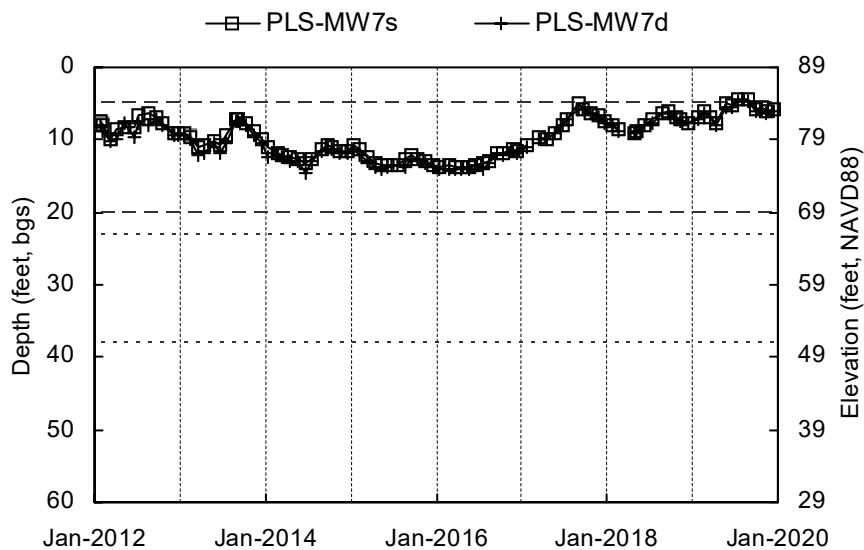
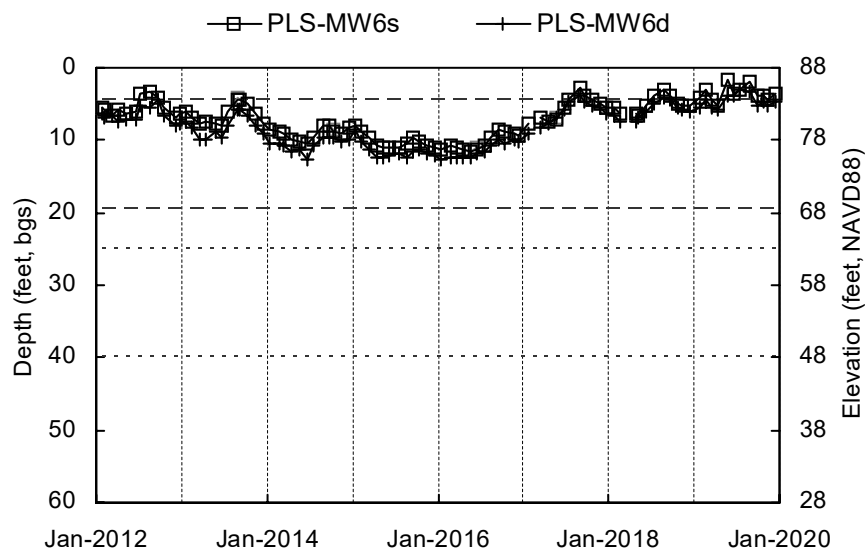
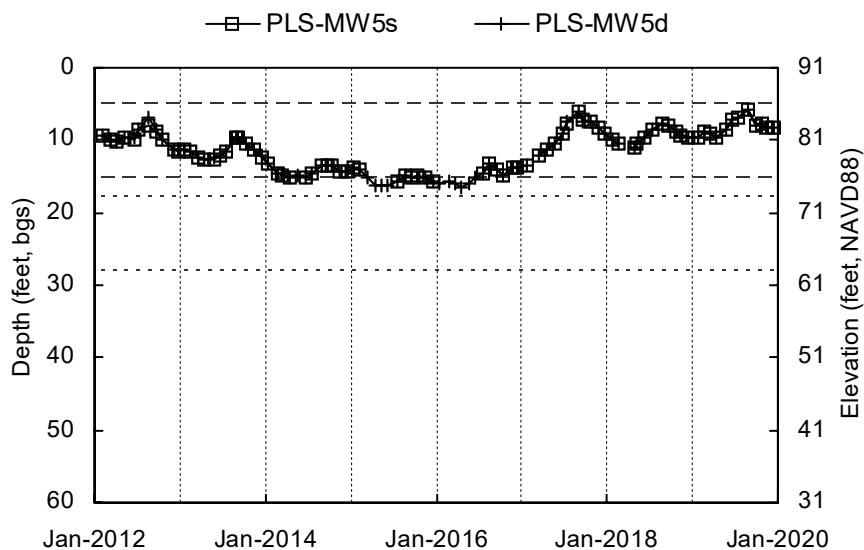

— — — Shallow Well Screened Interval Deep Well Screened Interval
 Elevation scale shown to the nearest integer.

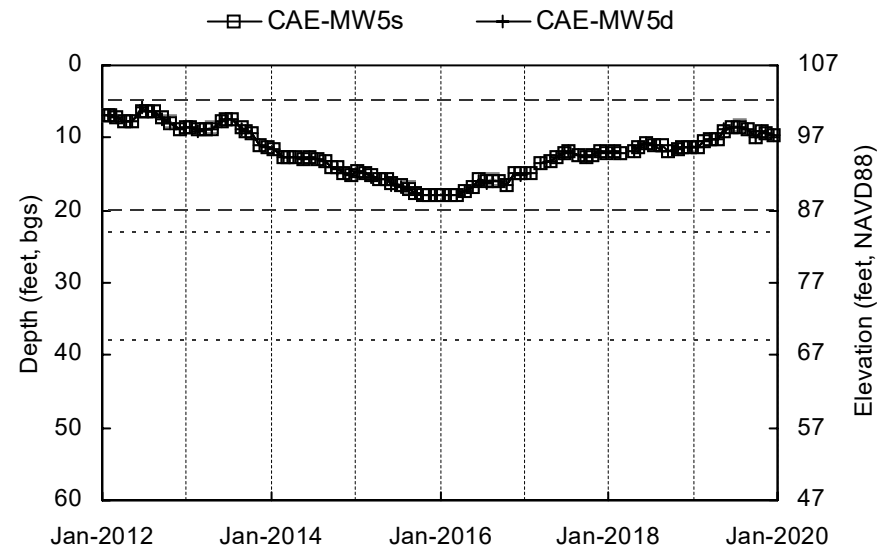
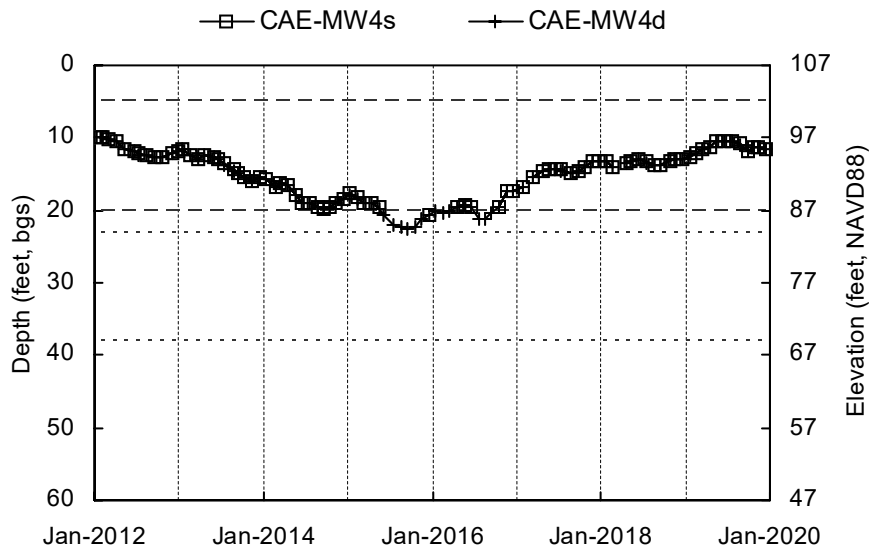
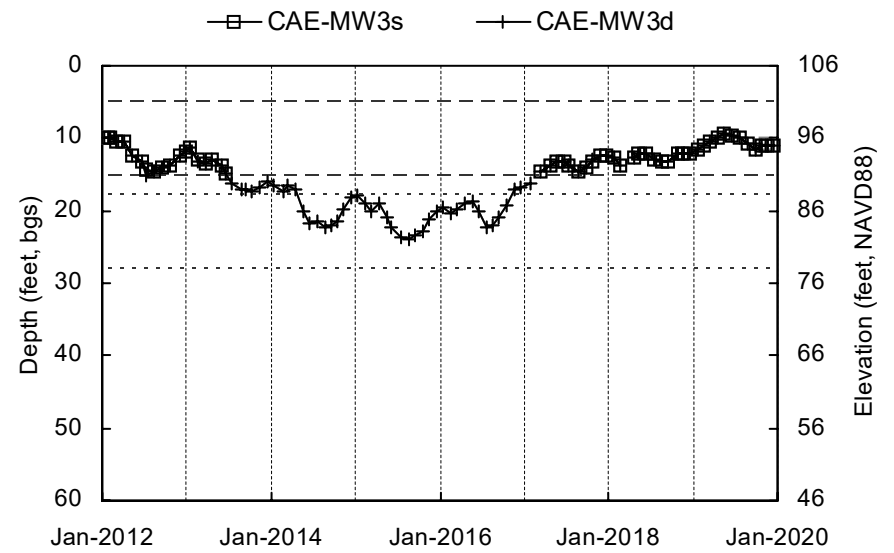
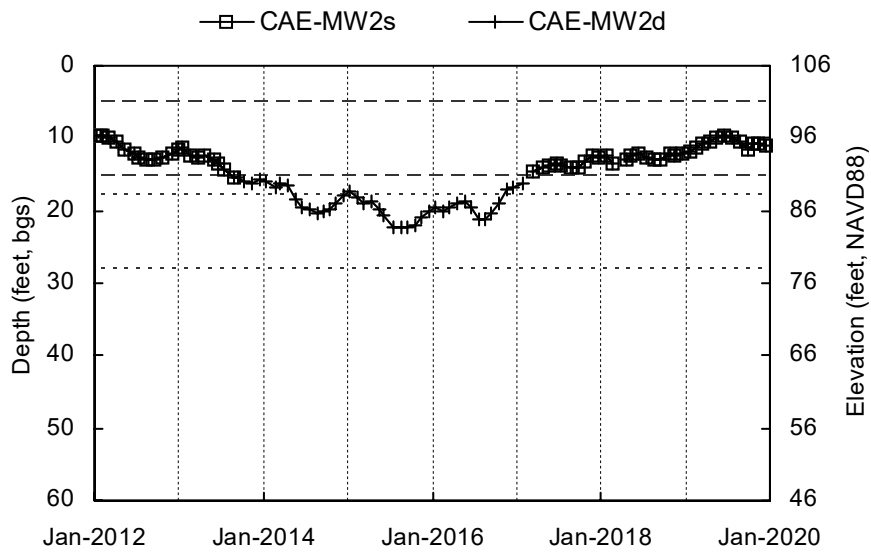

Shallow Well Screened Interval
 Deep Well Screened Interval
 Elevation scale shown to the nearest integer.



 Shallow Well Screened Interval
  Deep Well Screened Interval
 Elevation scale shown to the nearest integer.

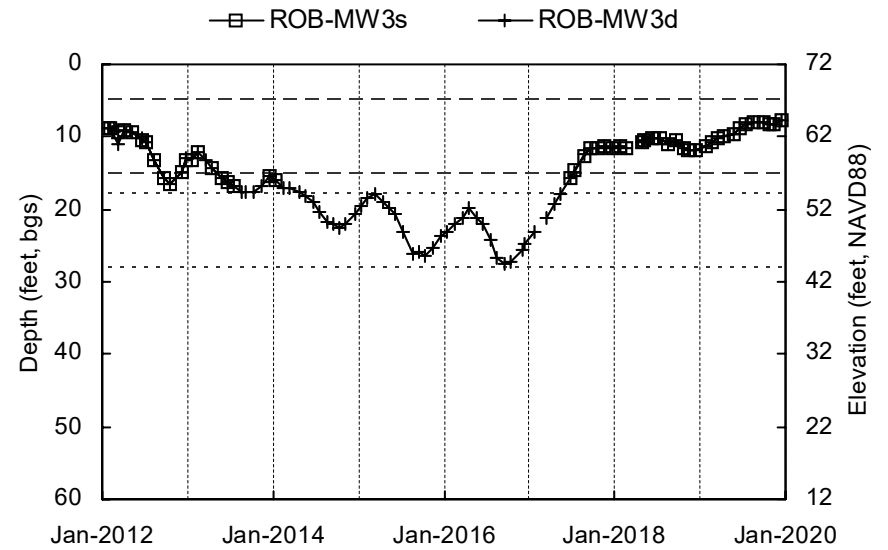
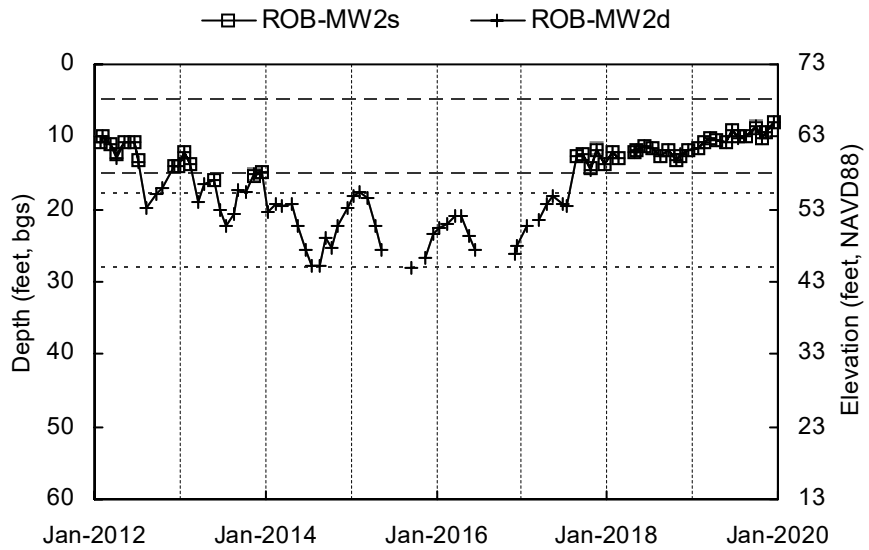
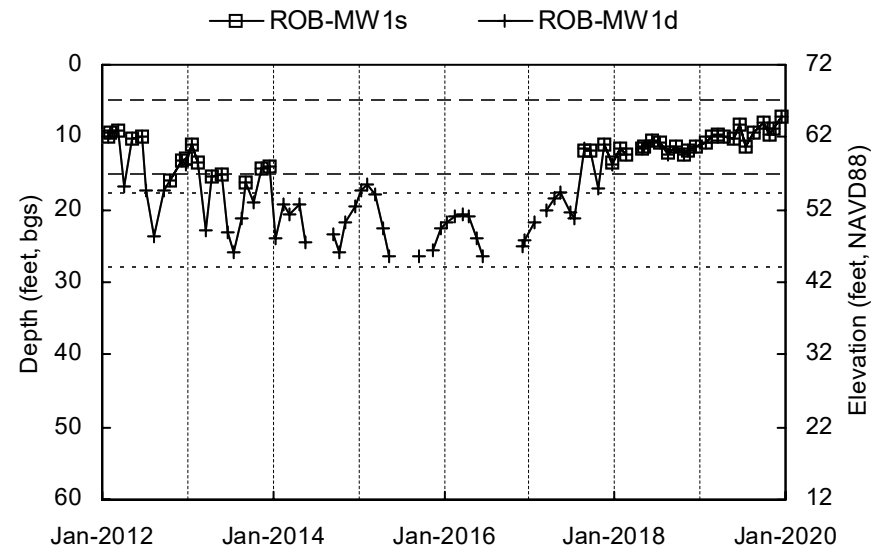
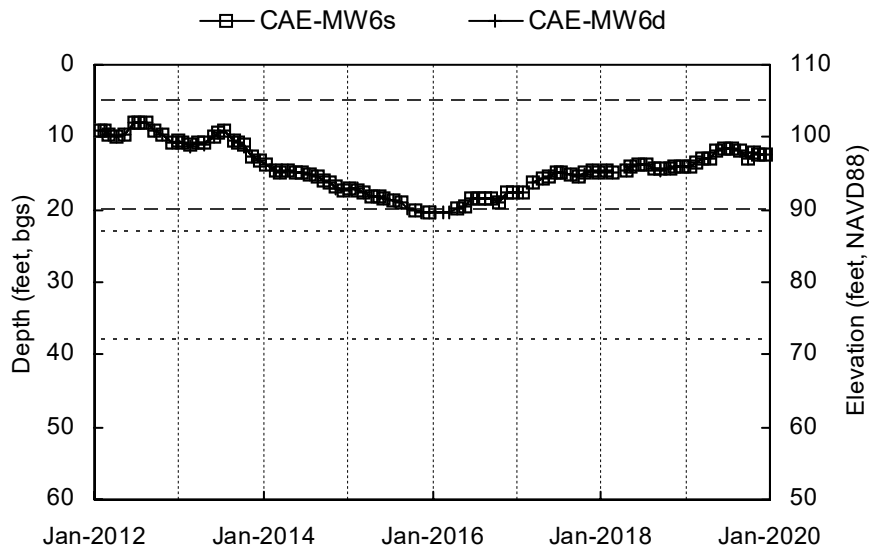

Shallow Well Screened Interval
 Deep Well Screened Interval
 Elevation scale shown to the nearest integer.

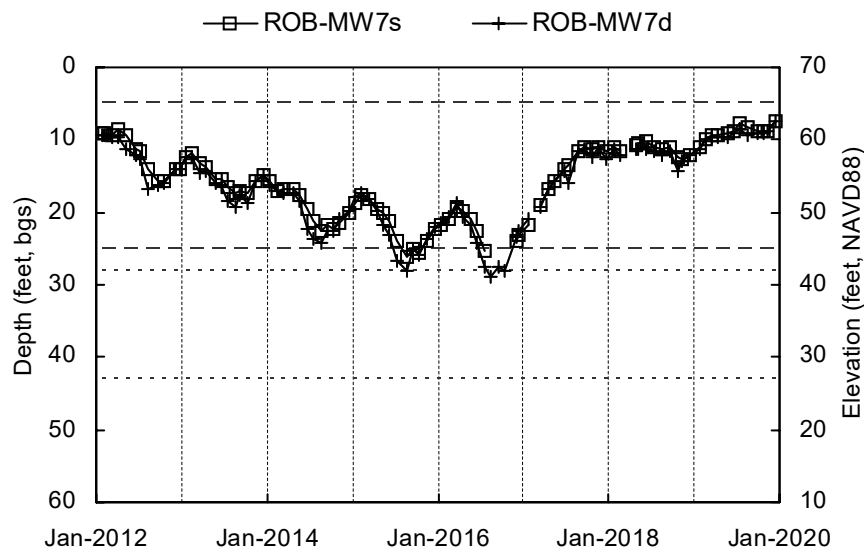
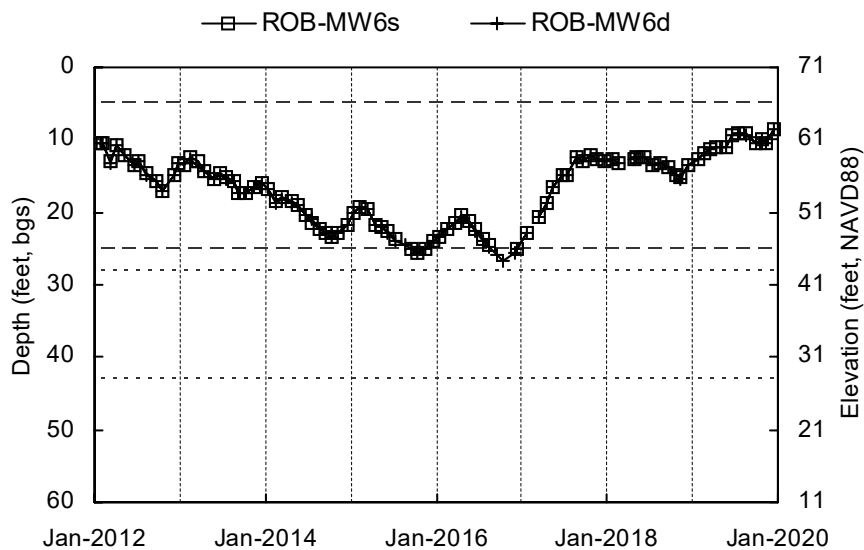
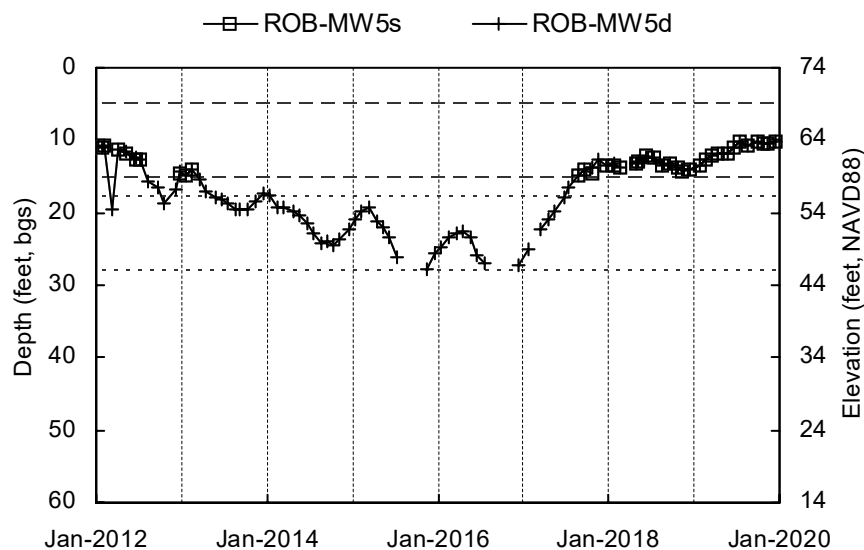
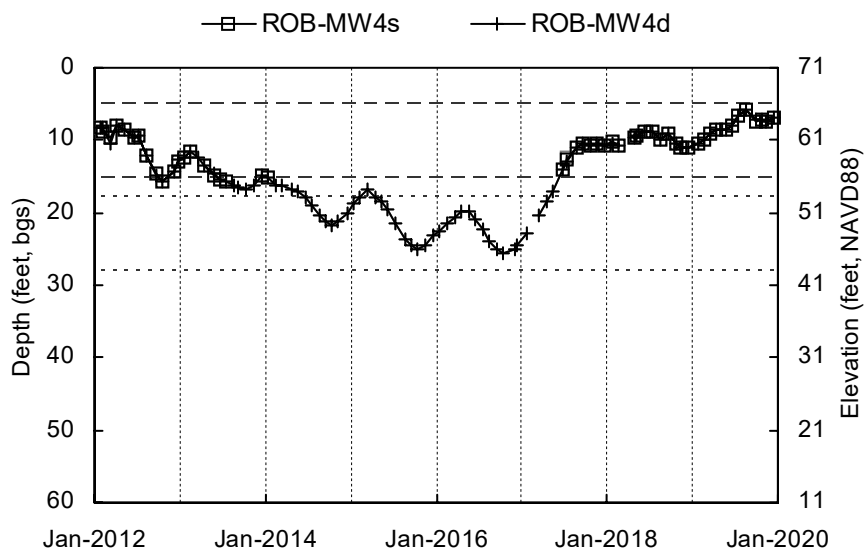

Shallow Well Screened Interval Deep Well Screened Interval
 Elevation scale shown to the nearest integer.

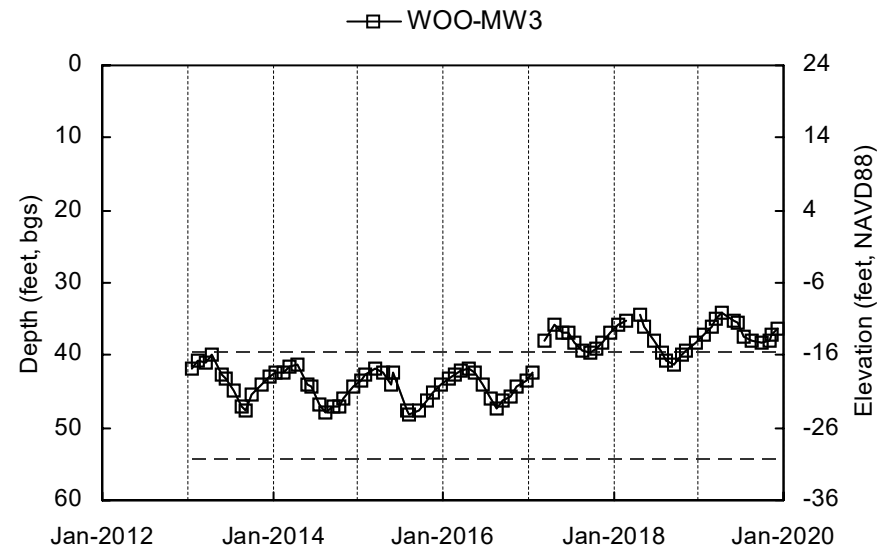
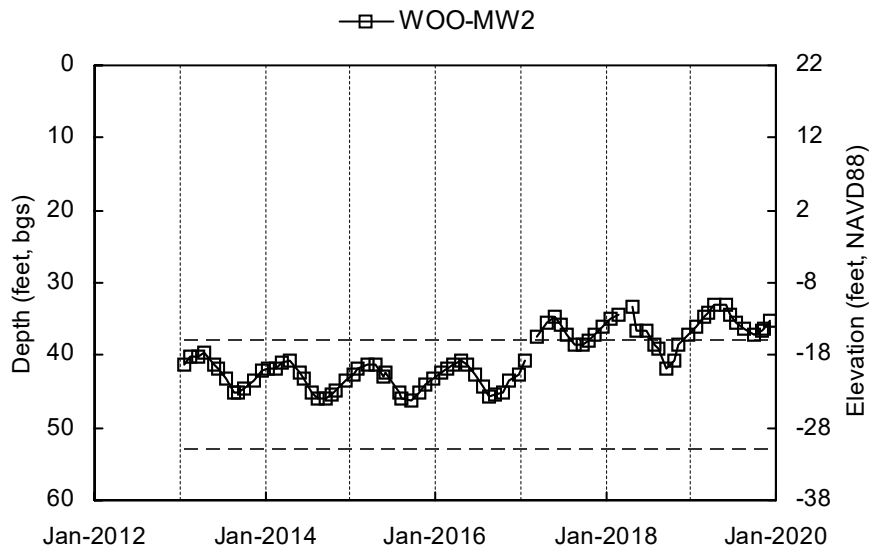
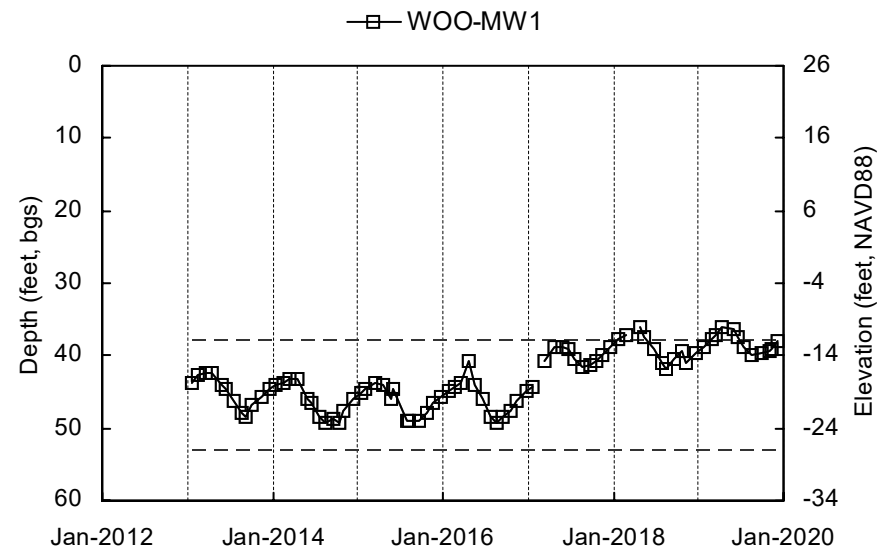
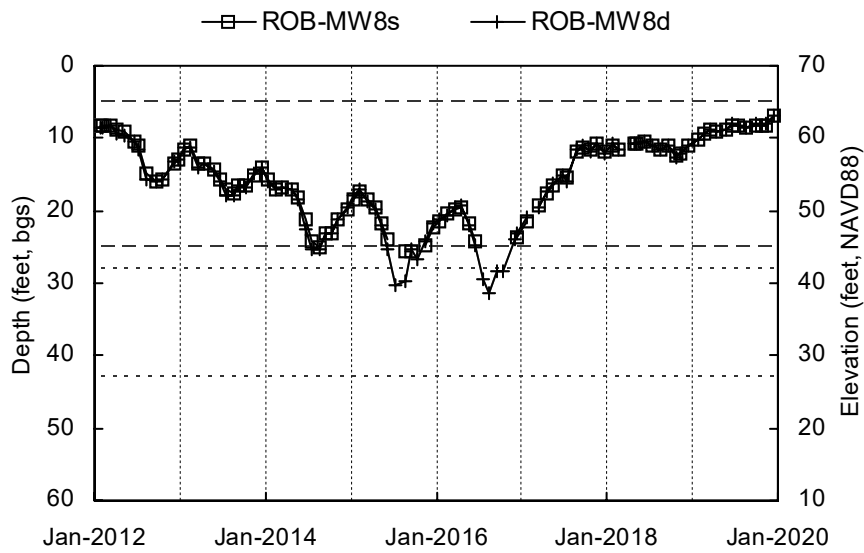

Shallow Well Screened Interval
 Deep Well Screened Interval
 Elevation scale shown to the nearest integer.

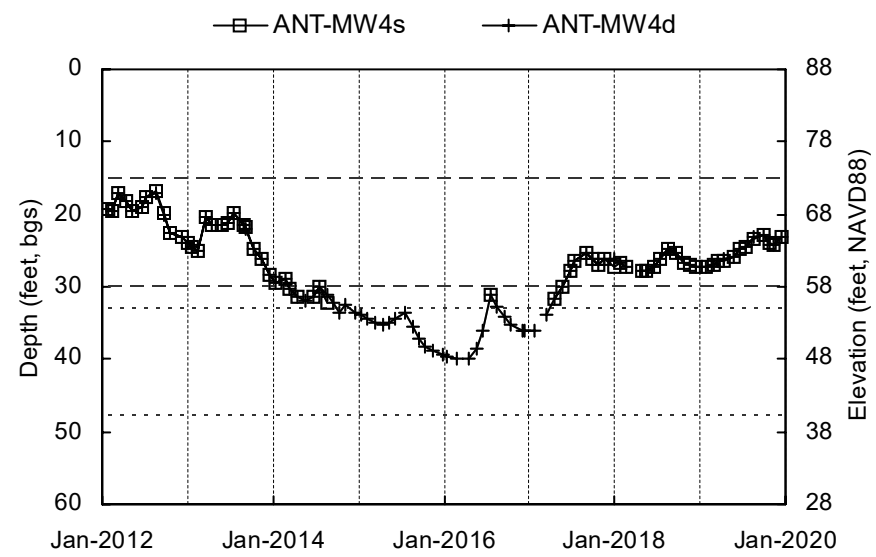
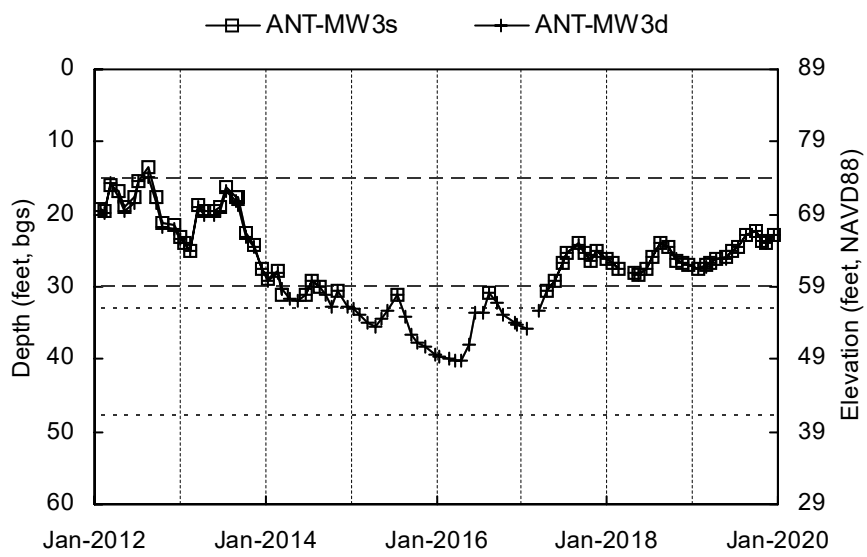
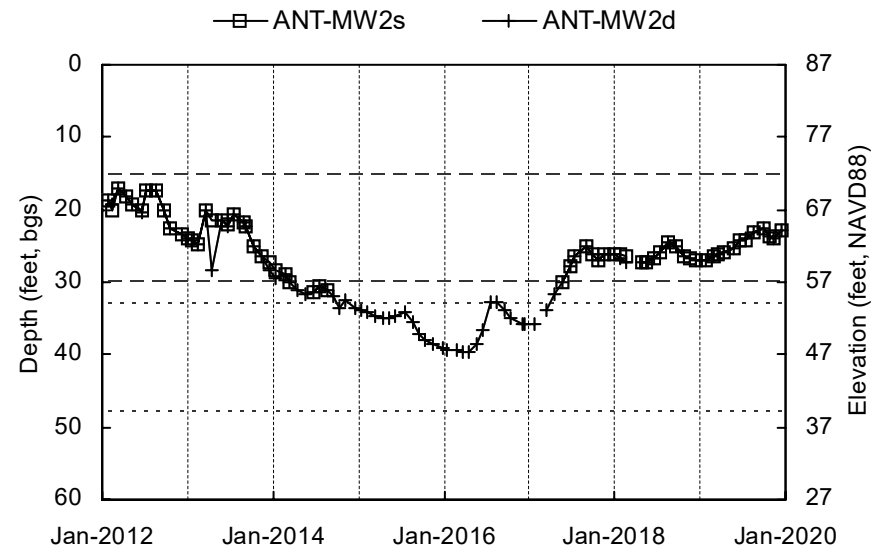
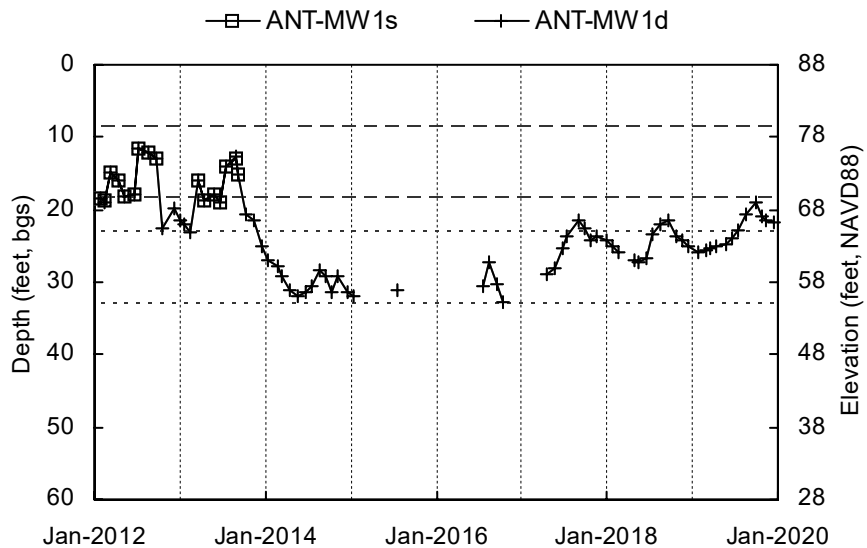

Shallow Well Screened Interval
 Deep Well Screened Interval
 Elevation scale shown to the nearest integer.

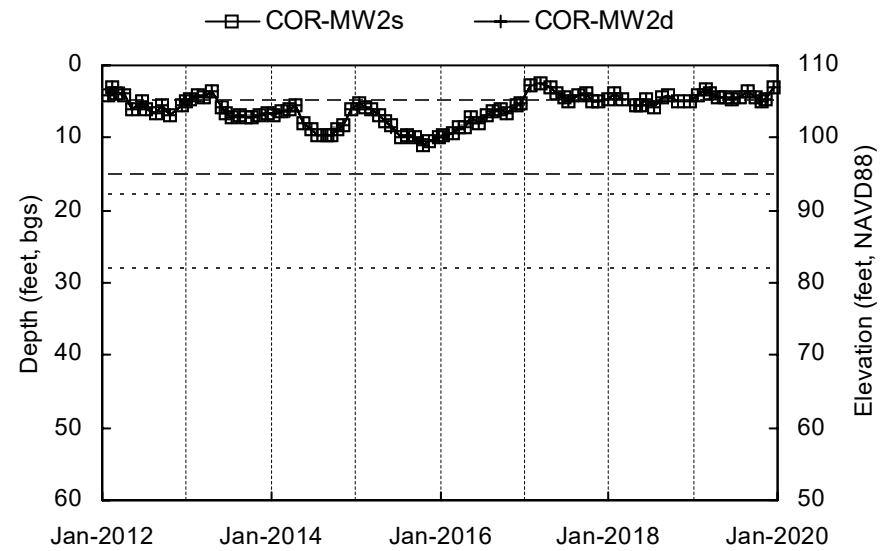
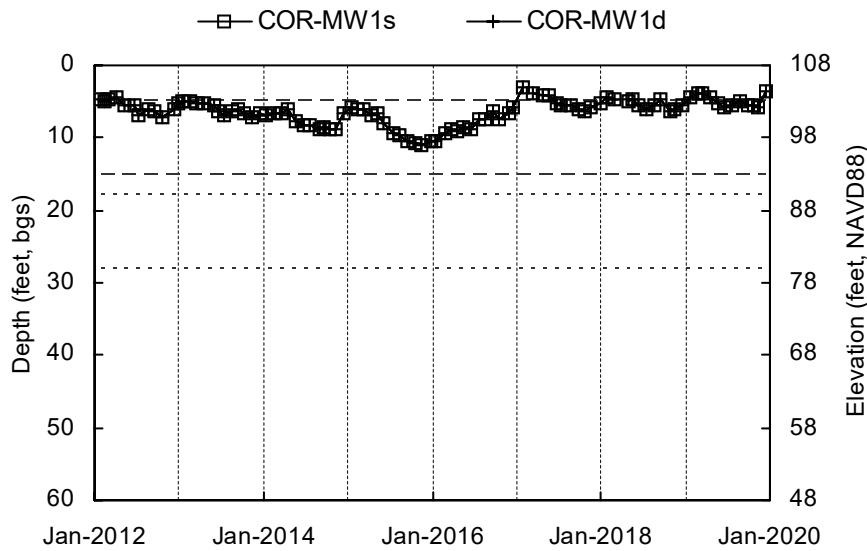
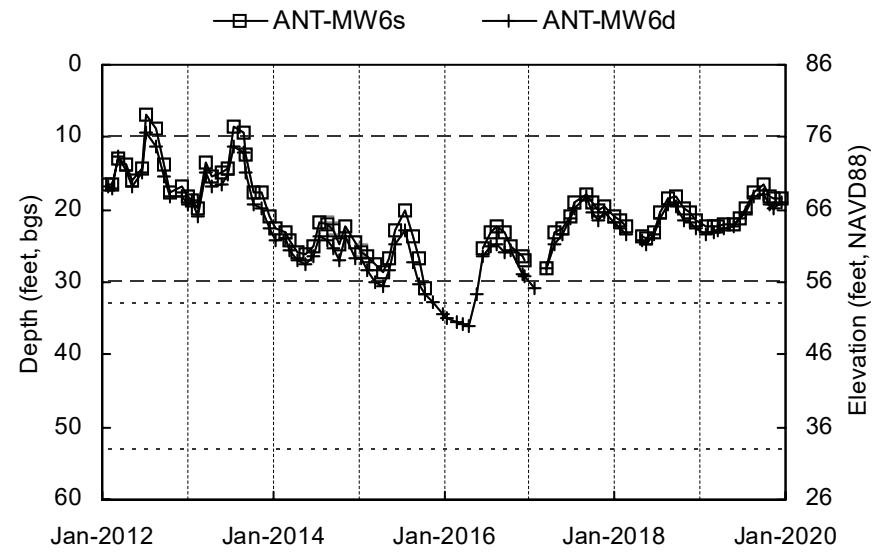
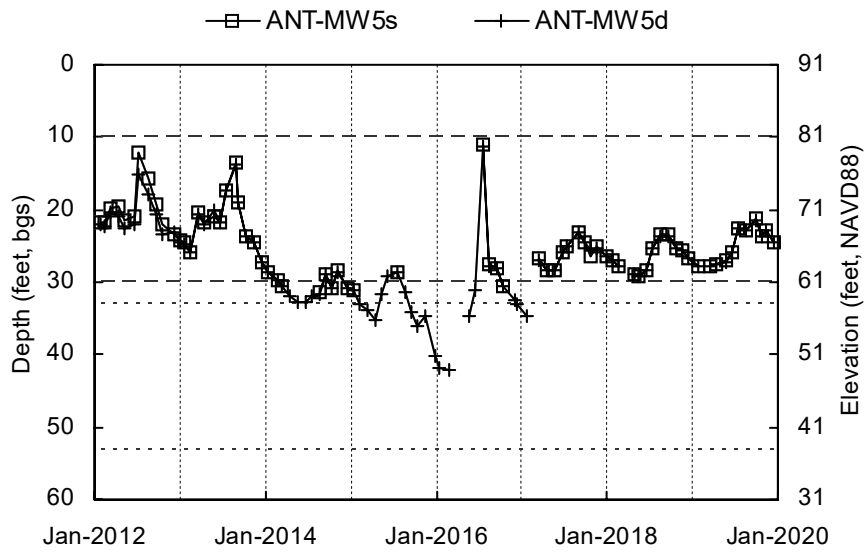

Shallow Well Screened Interval
 Deep Well Screened Interval
 Elevation scale shown to the nearest integer.

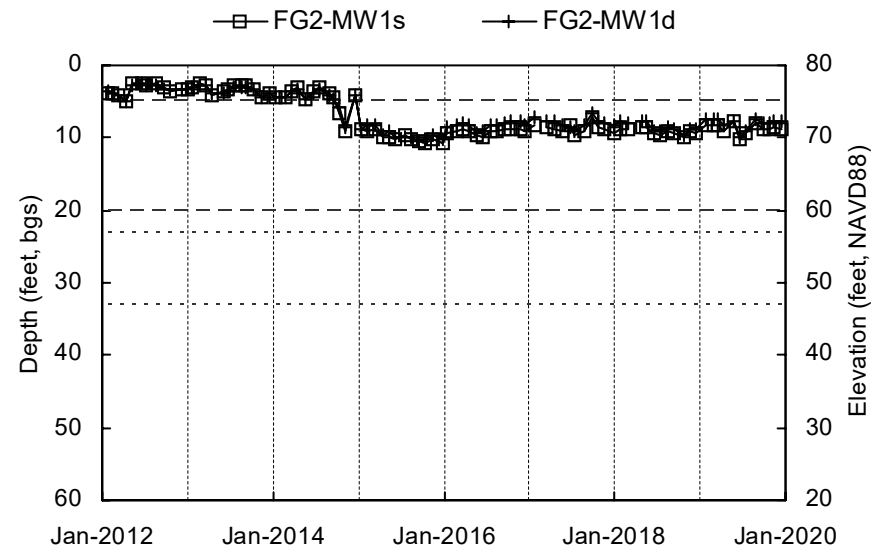
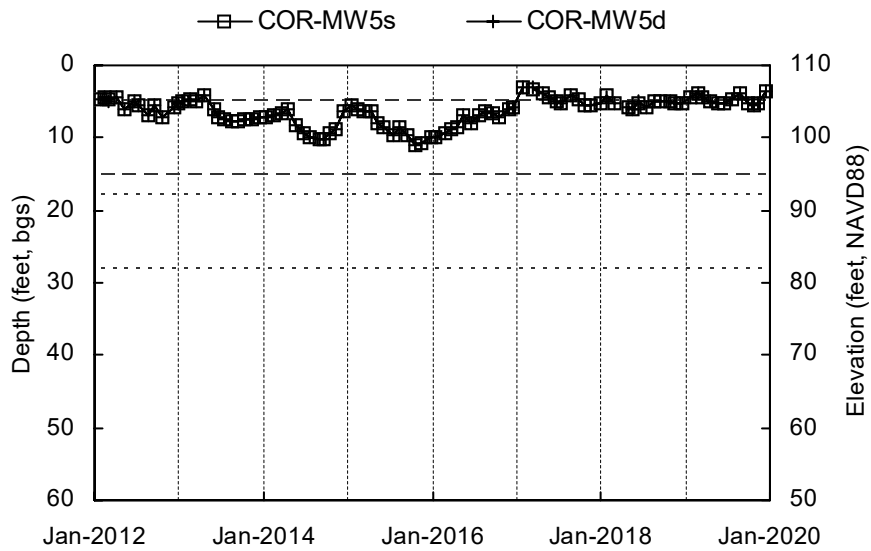
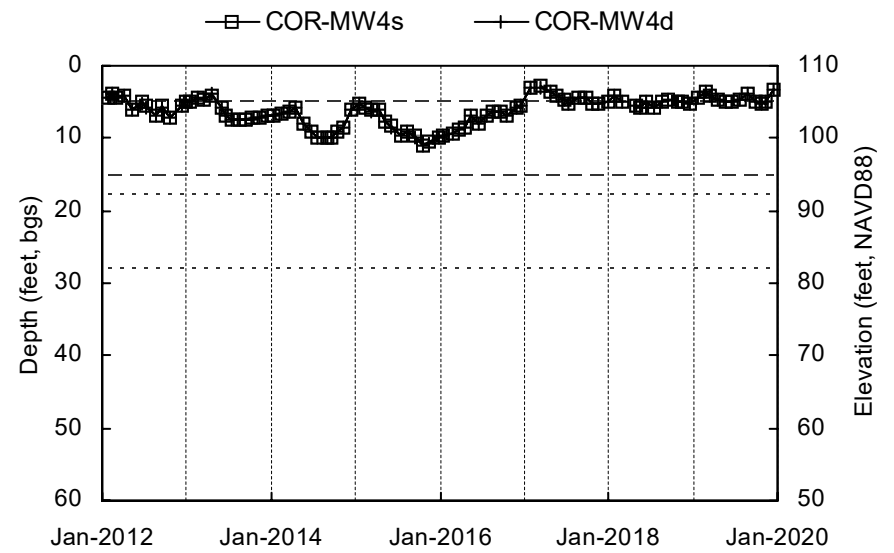
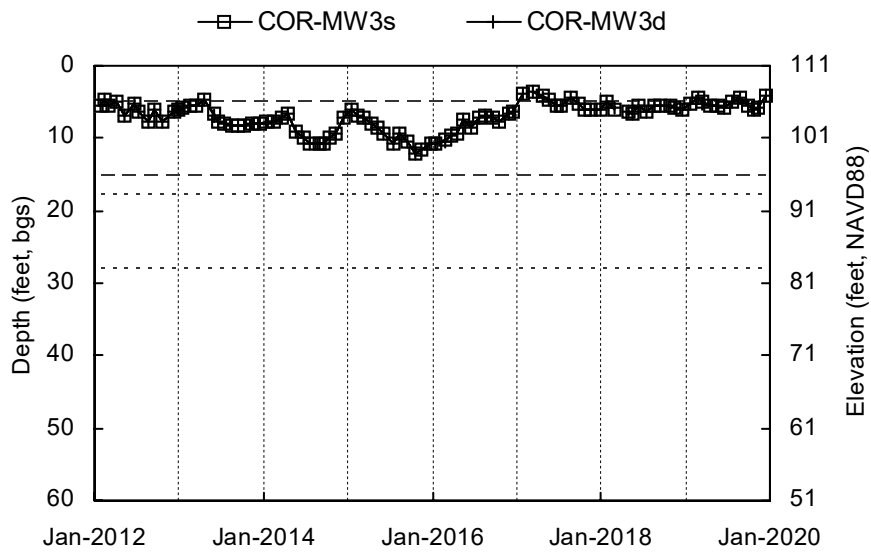

Shallow Well Screened Interval
 Deep Well Screened Interval
Elevation scale shown to the nearest integer.

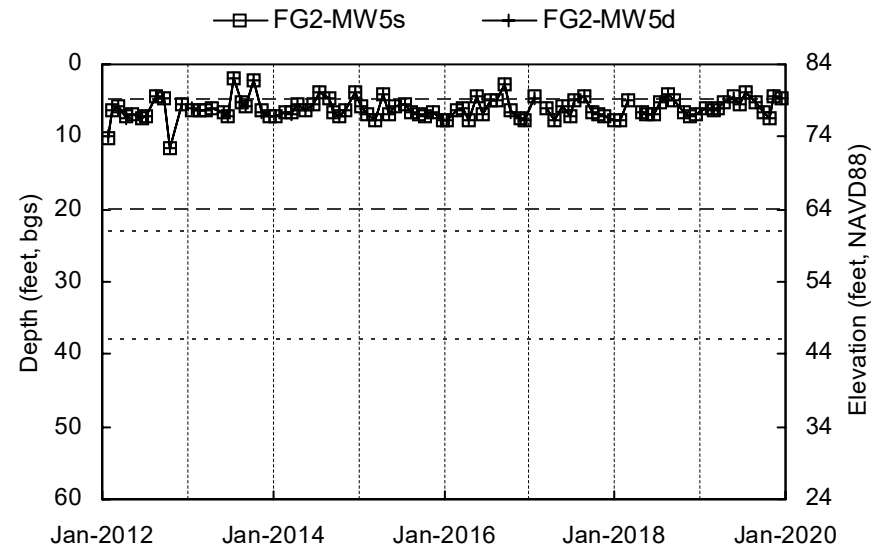
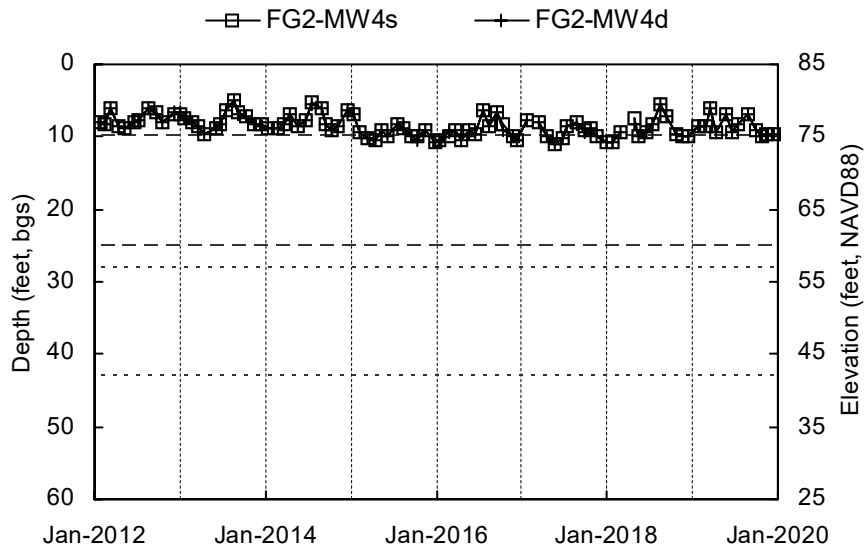
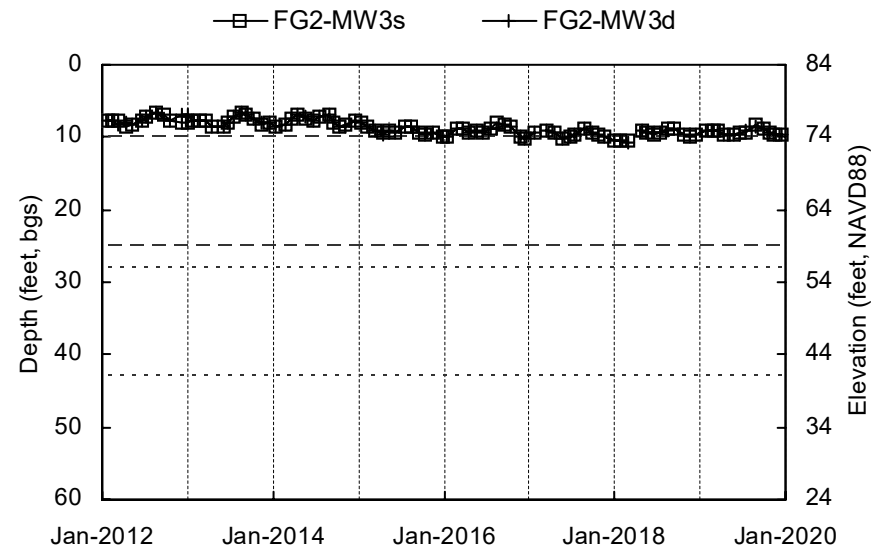
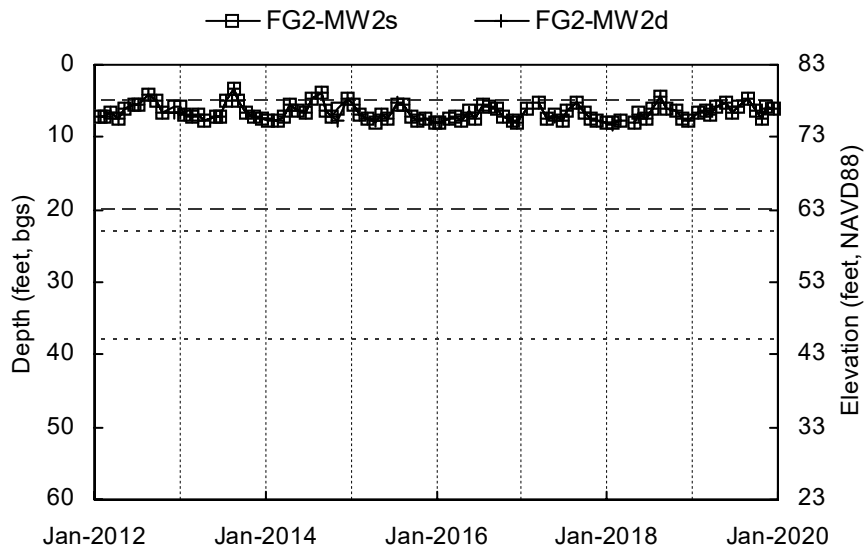

Shallow Well Screened Interval
 Deep Well Screened Interval
 Elevation scale shown to the nearest integer.

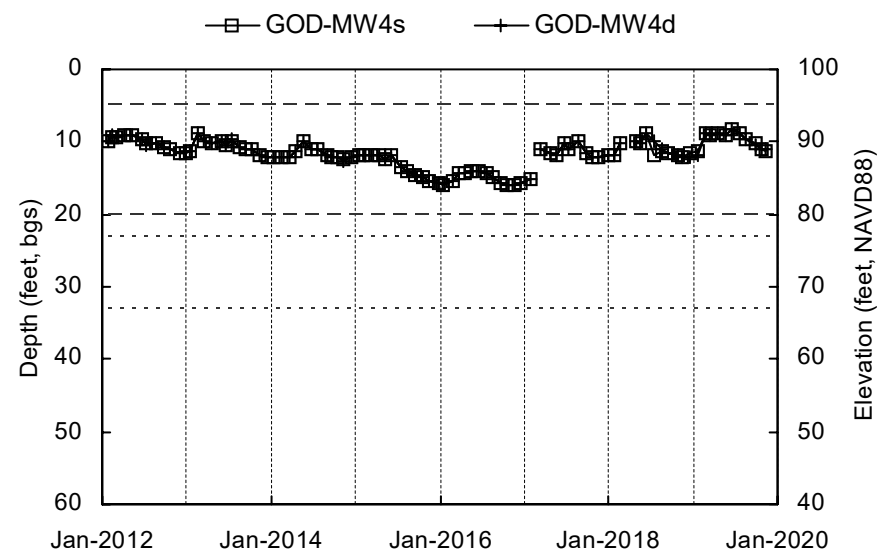
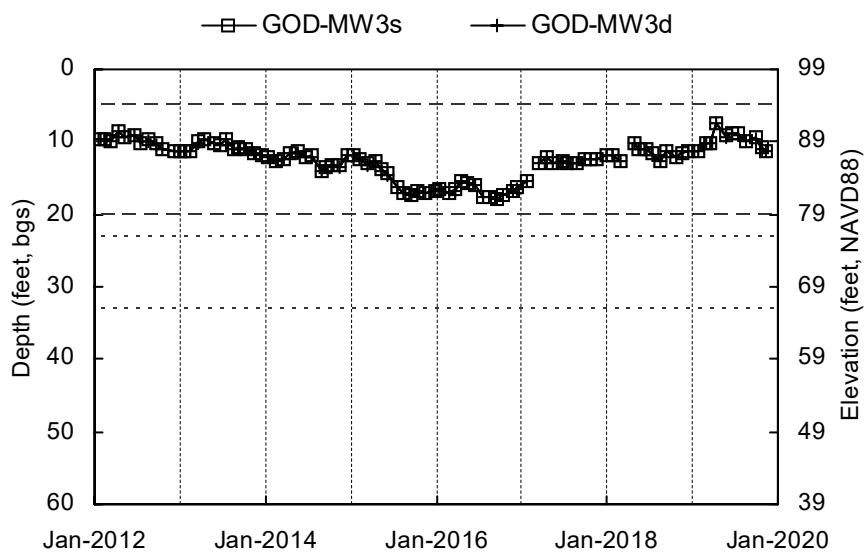
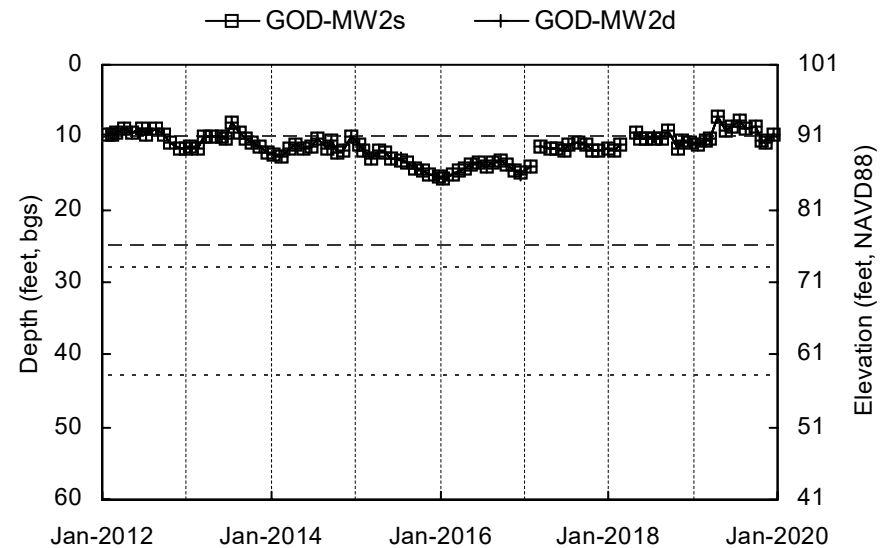
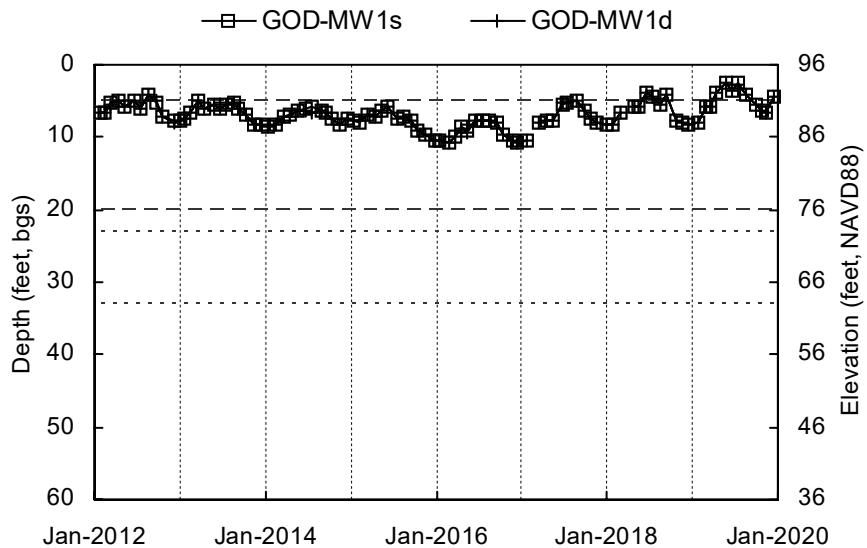

Shallow Well Screened Interval
 Deep Well Screened Interval
 Elevation scale shown to the nearest integer.

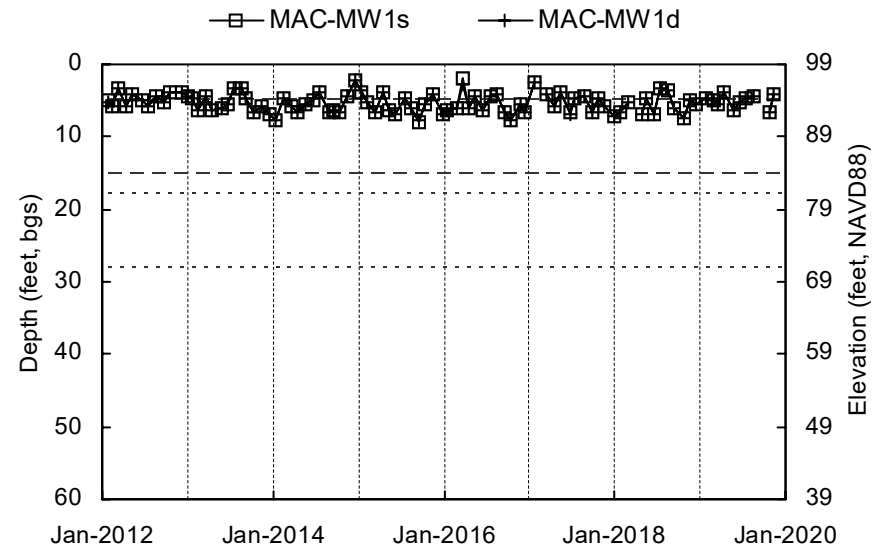
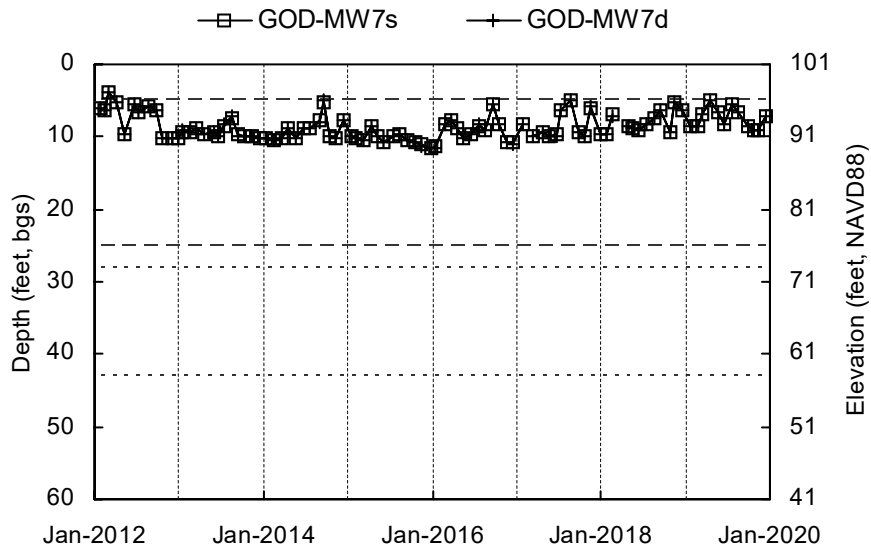
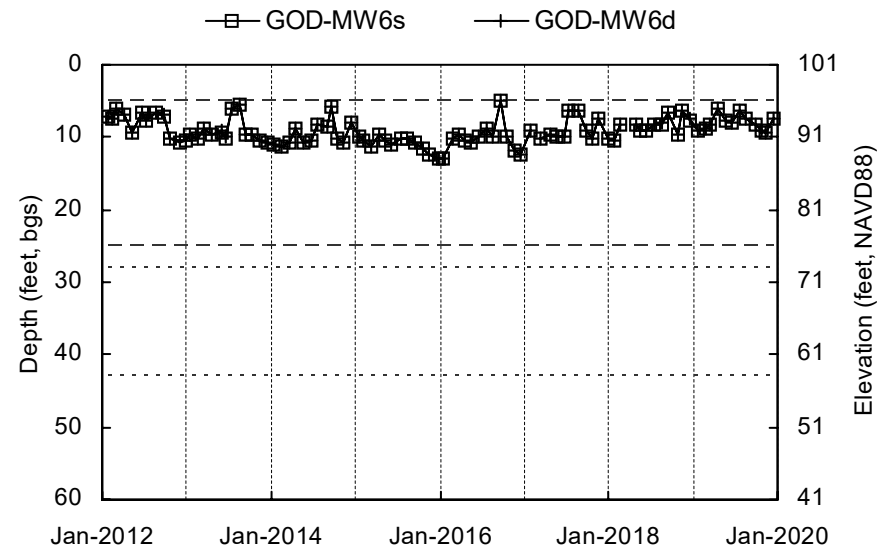
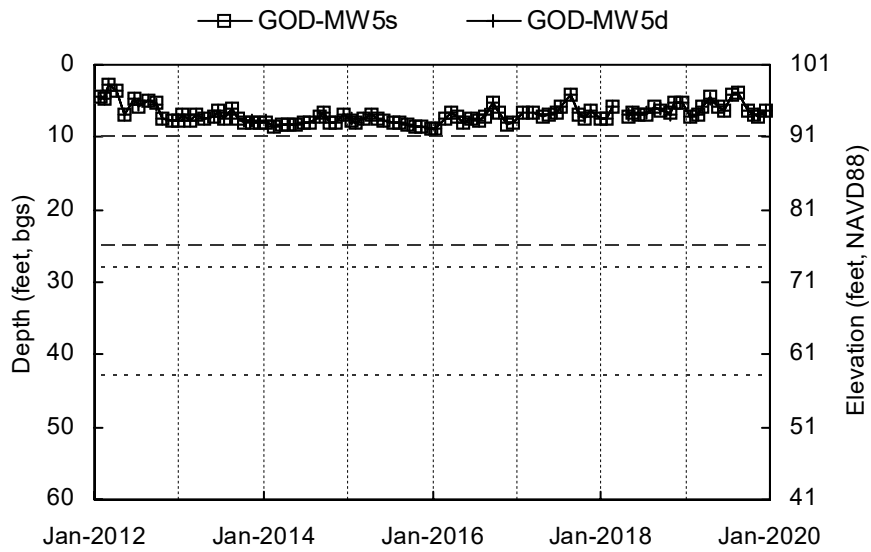

Shallow Well Screened Interval
 Deep Well Screened Interval
 Elevation scale shown to the nearest integer.

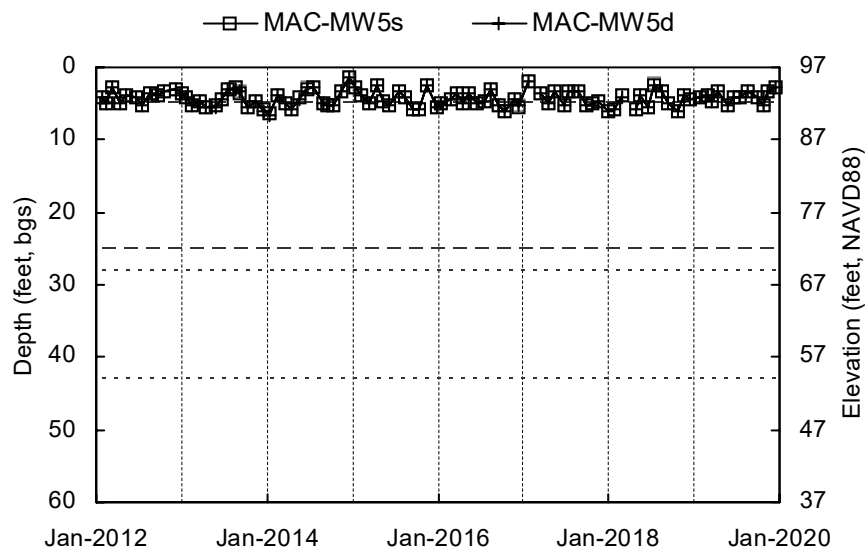
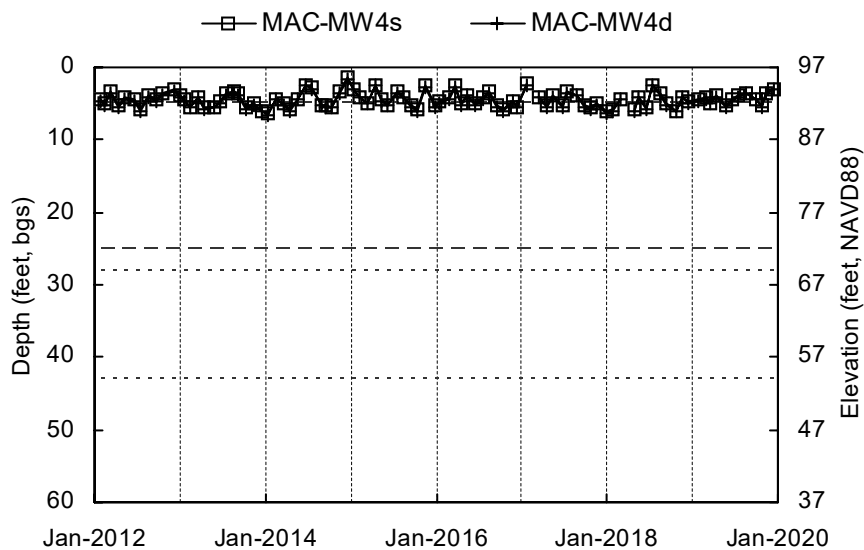
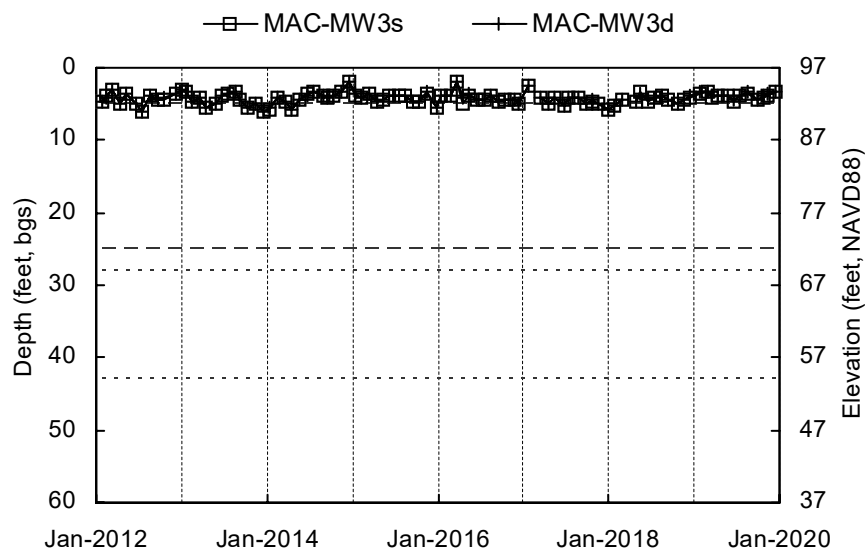
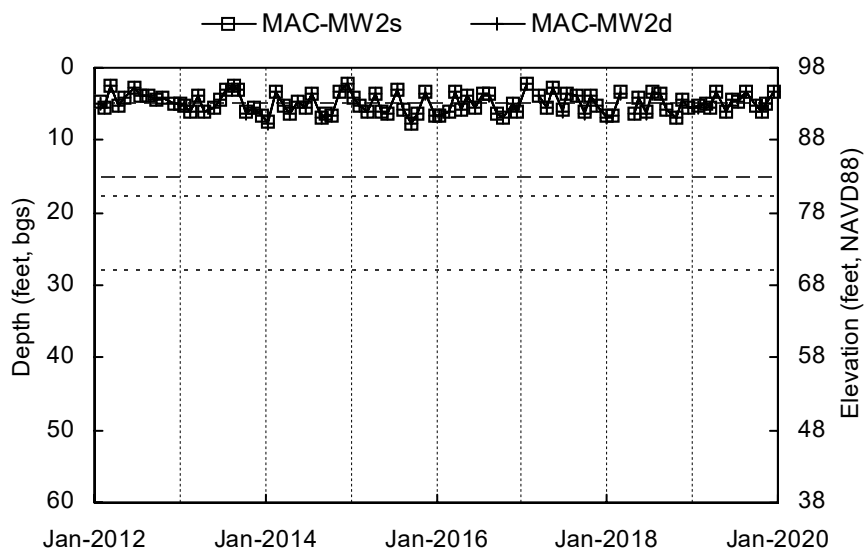

Shallow Well Screened Interval
 Deep Well Screened Interval
 Elevation scale shown to the nearest integer.

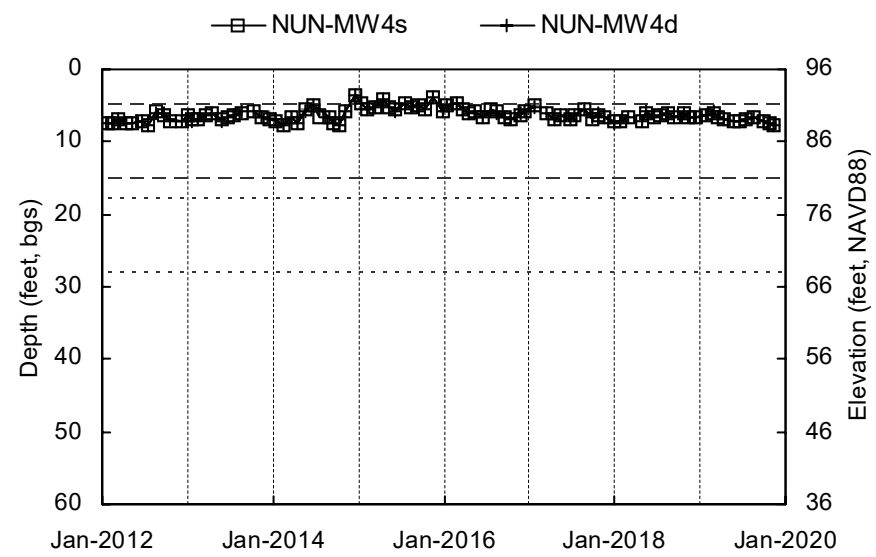
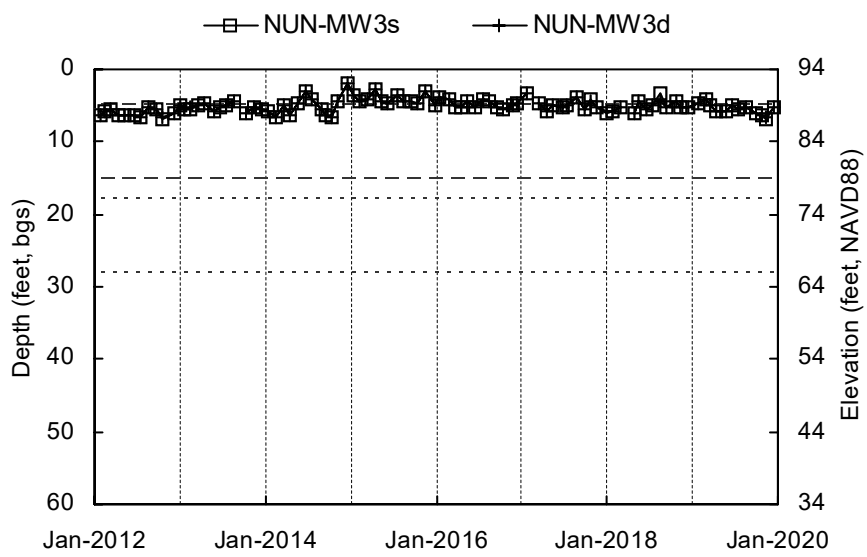
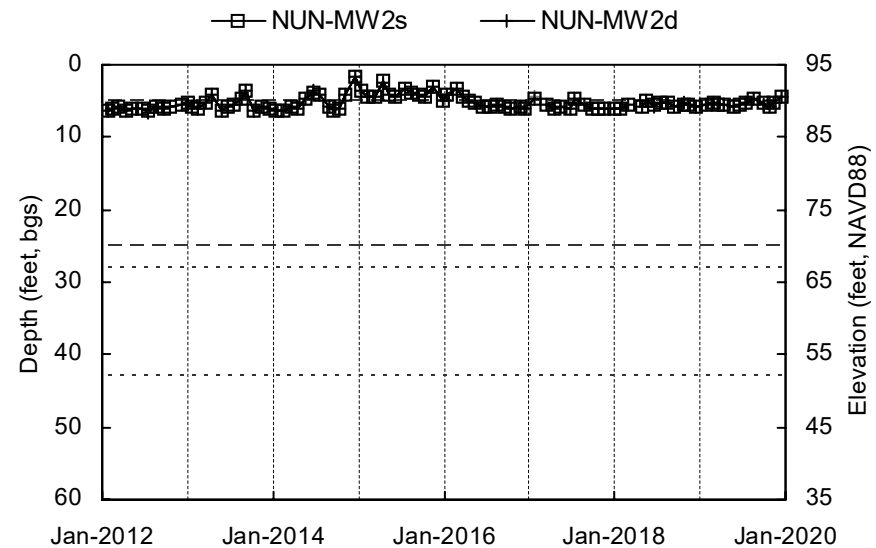
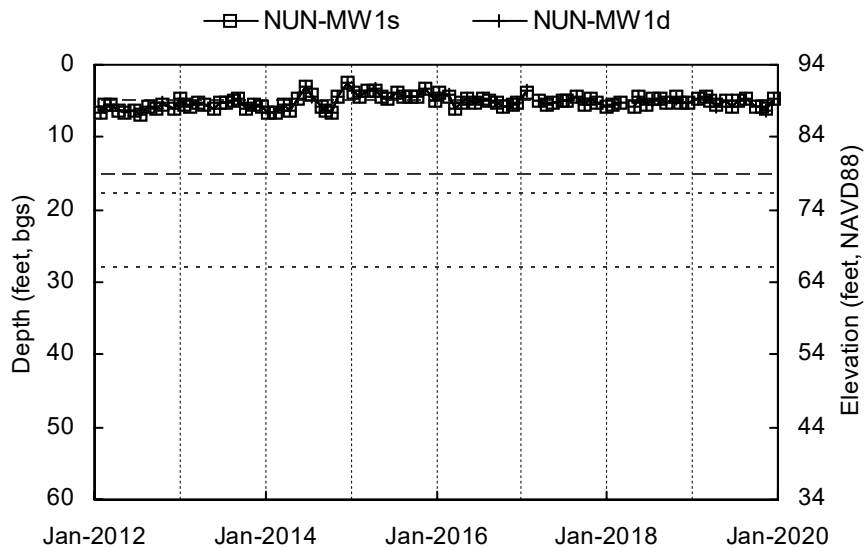

Shallow Well Screened Interval
 Deep Well Screened Interval
 Elevation scale shown to the nearest integer.

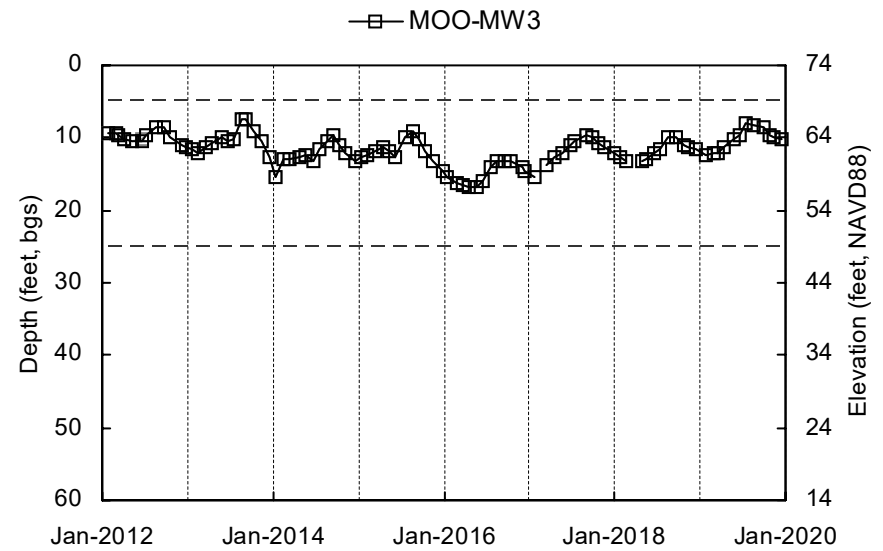
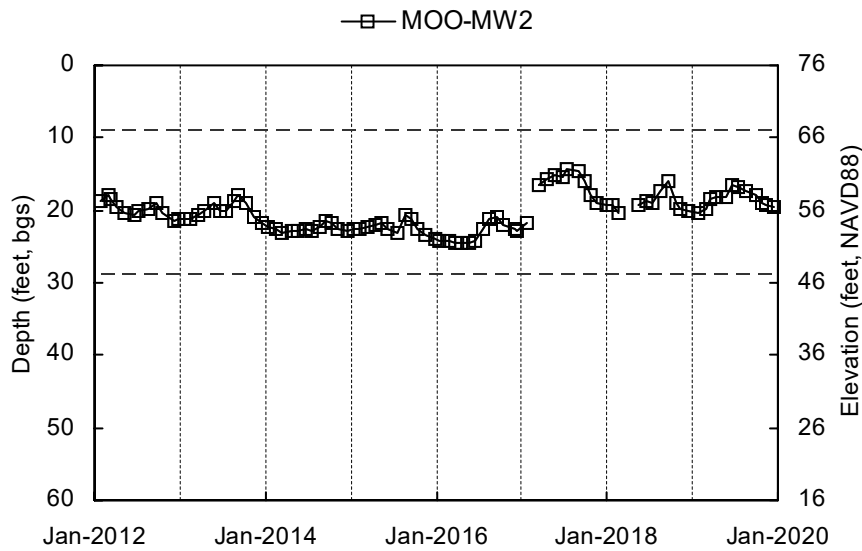
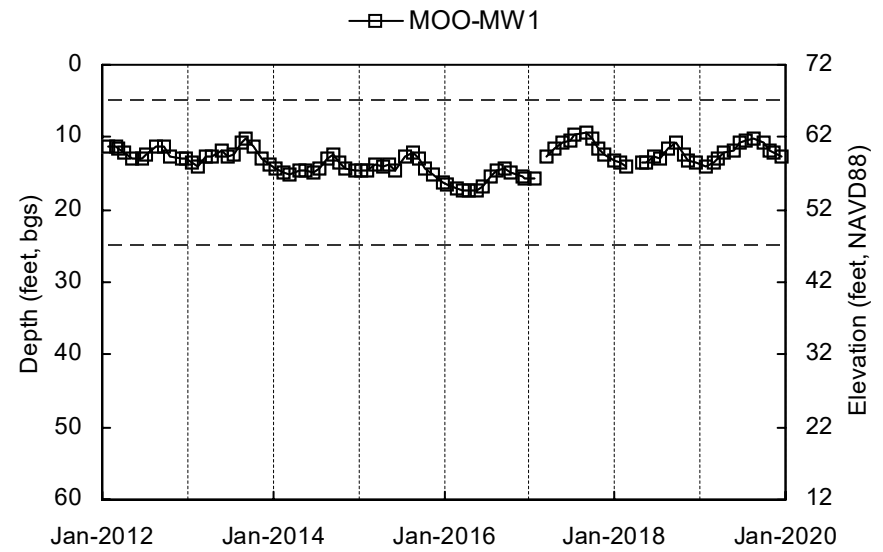
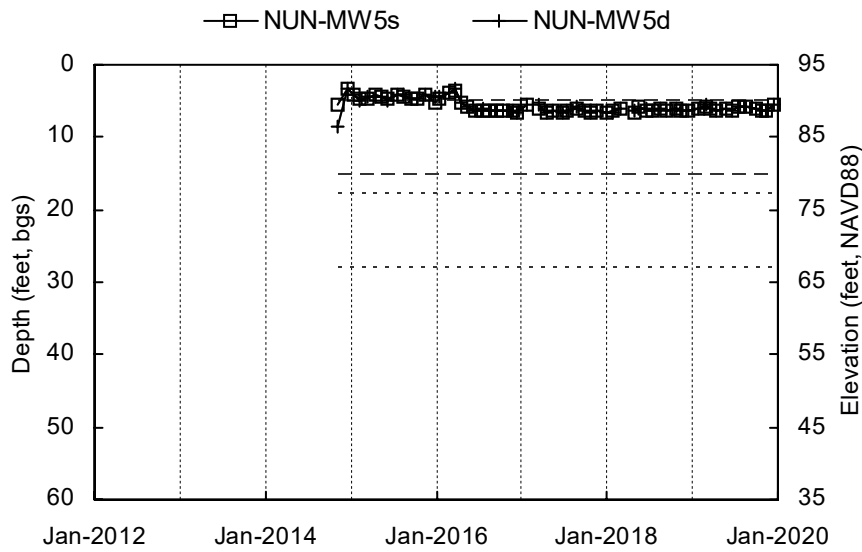

— — — Shallow Well Screened Interval Deep Well Screened Interval
 Elevation scale shown to the nearest integer.

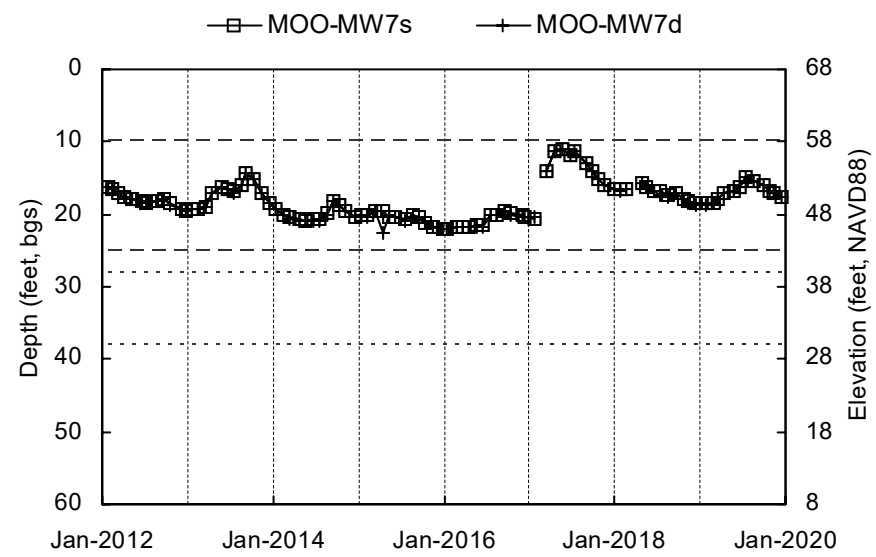
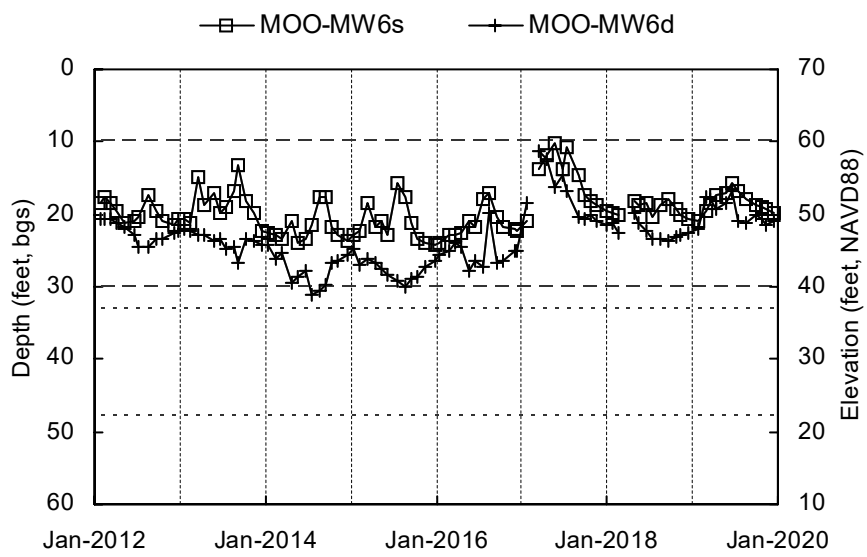
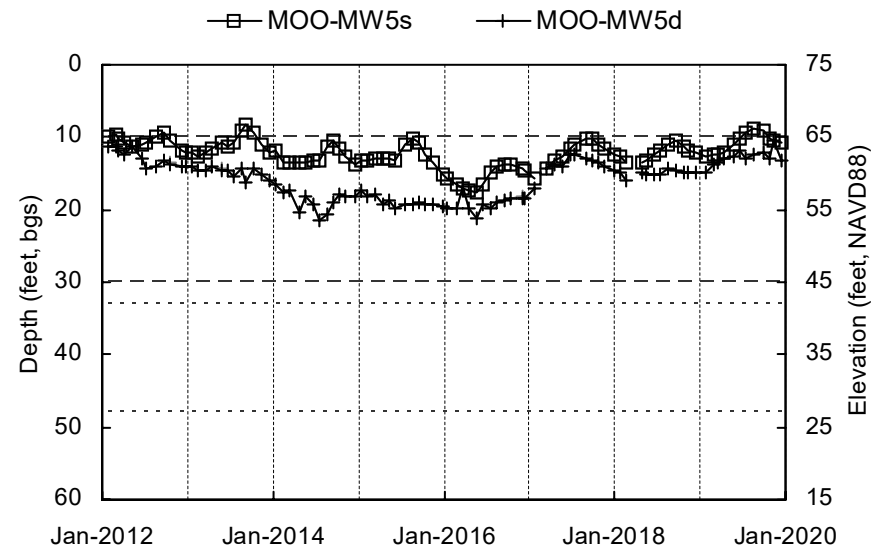
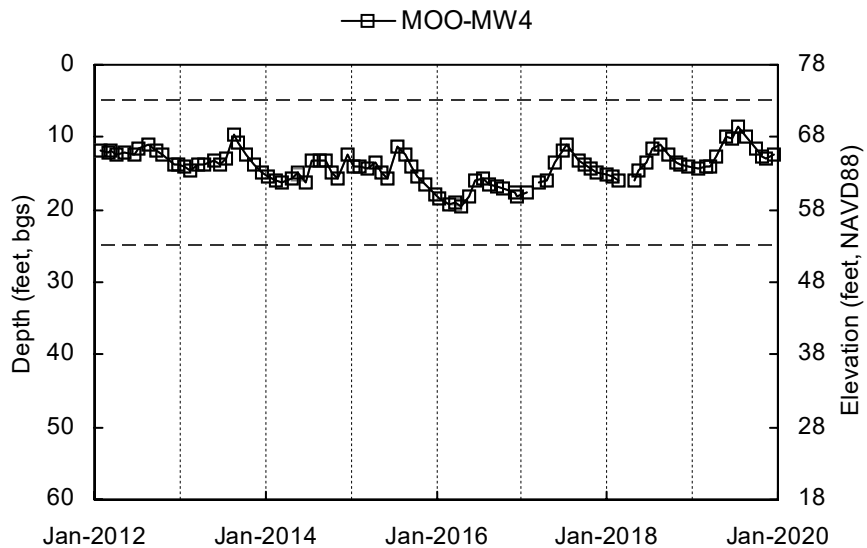

Shallow Well Screened Interval
 Deep Well Screened Interval
 Elevation scale shown to the nearest integer.

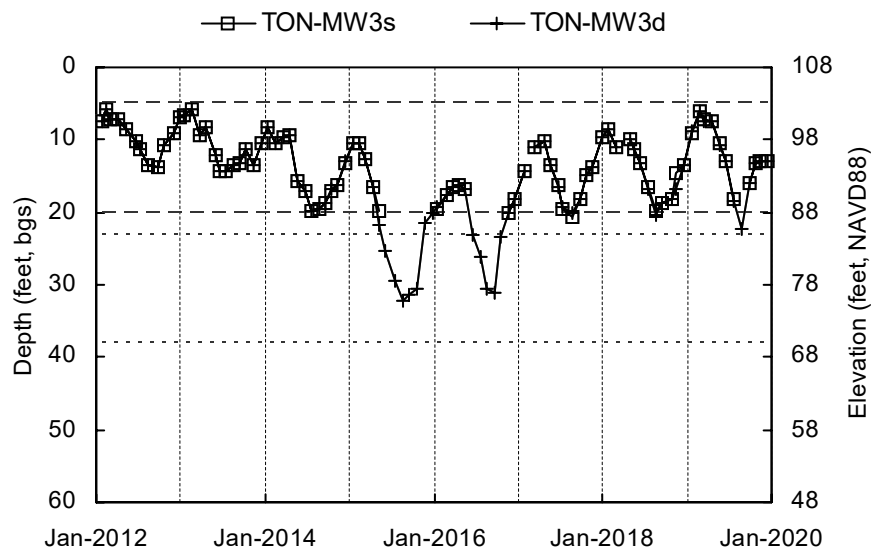
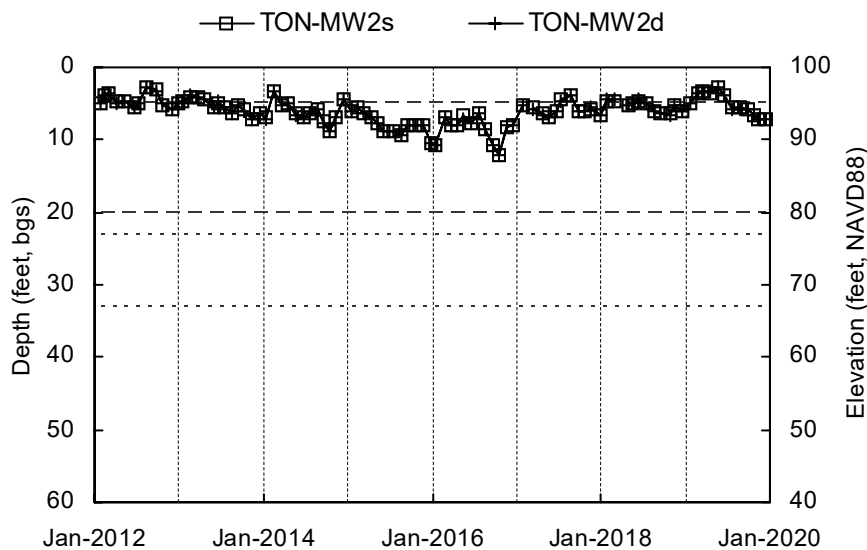
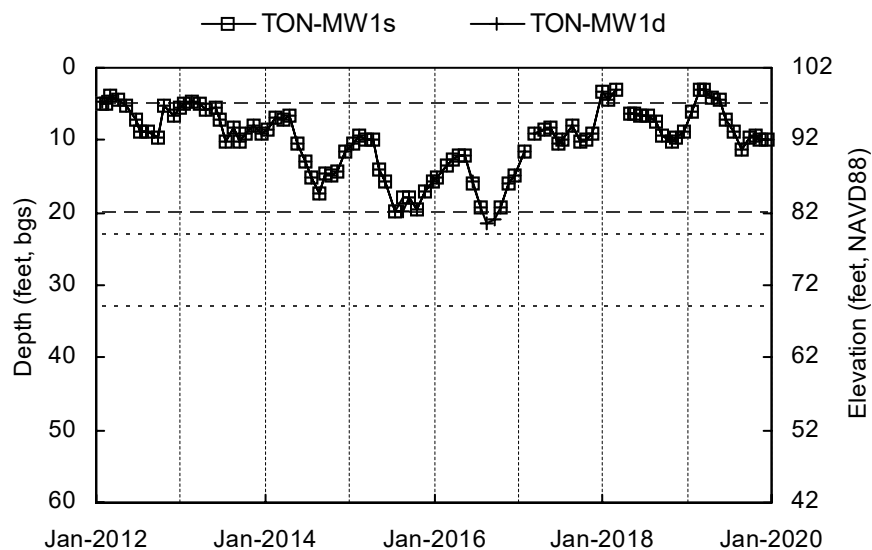
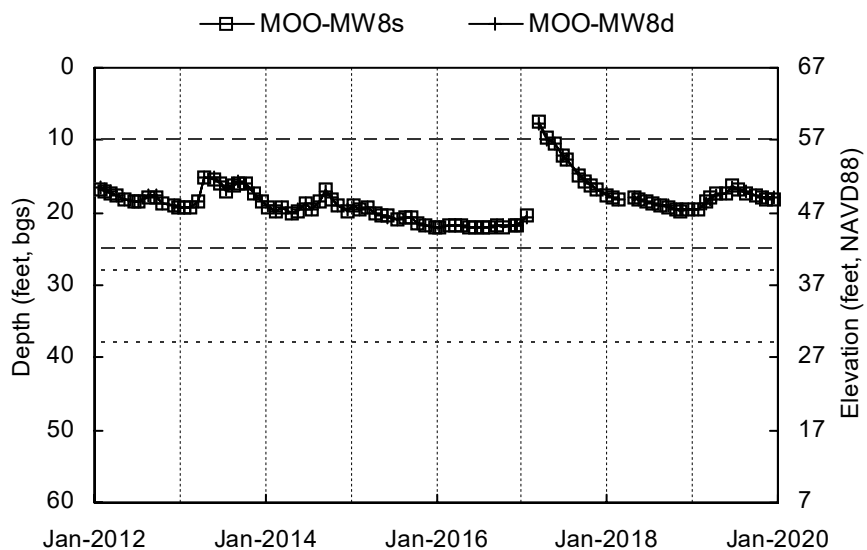

Shallow Well Screened Interval
 Deep Well Screened Interval
 Elevation scale shown to the nearest integer.

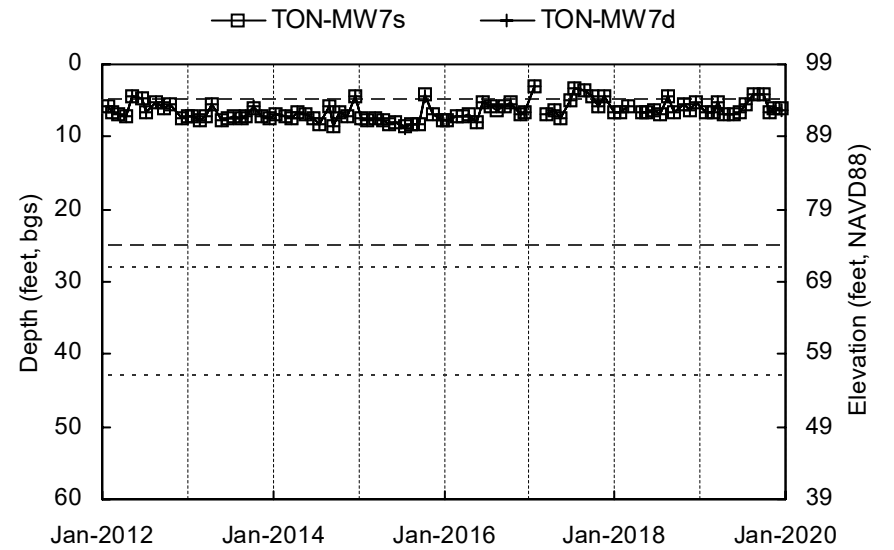
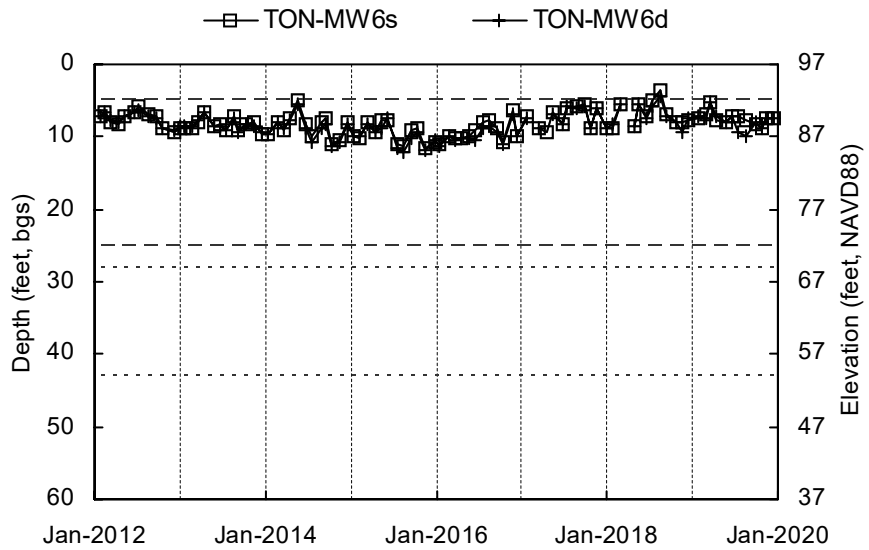
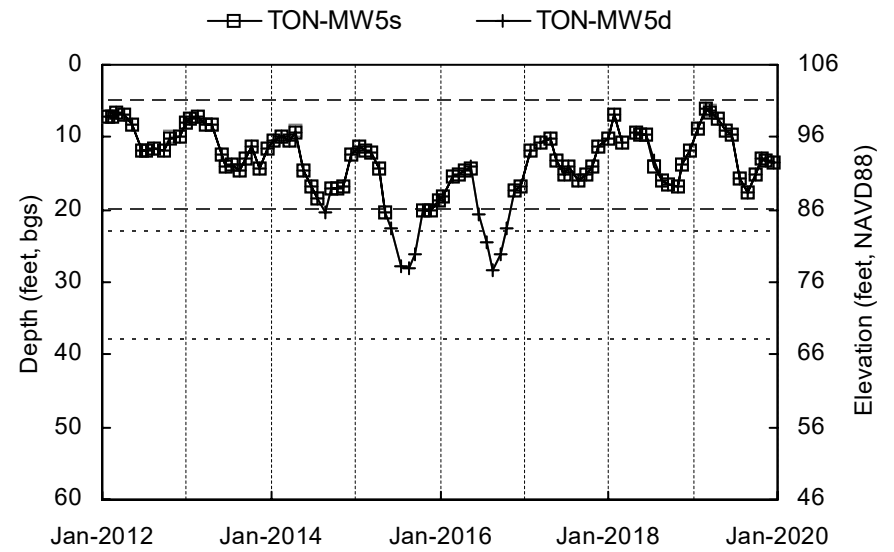
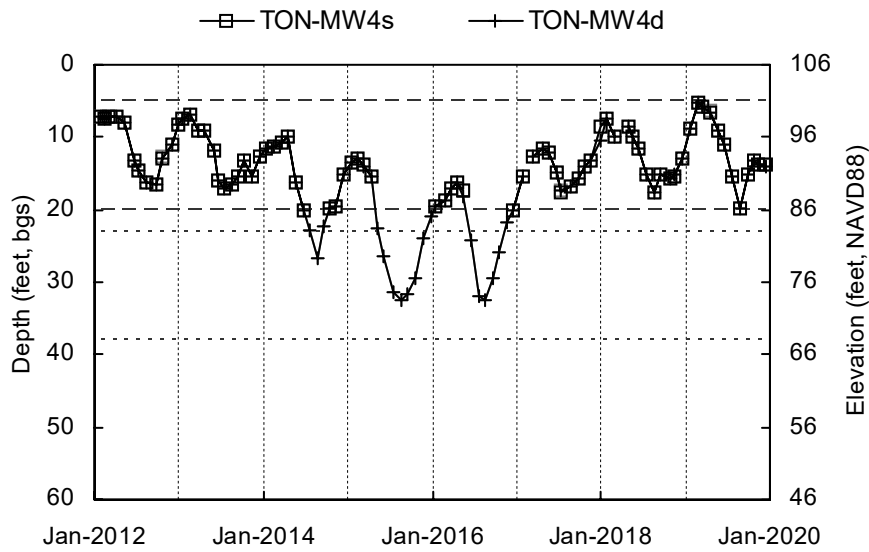

Shallow Well Screened Interval
 Deep Well Screened Interval
 Elevation scale shown to the nearest integer.

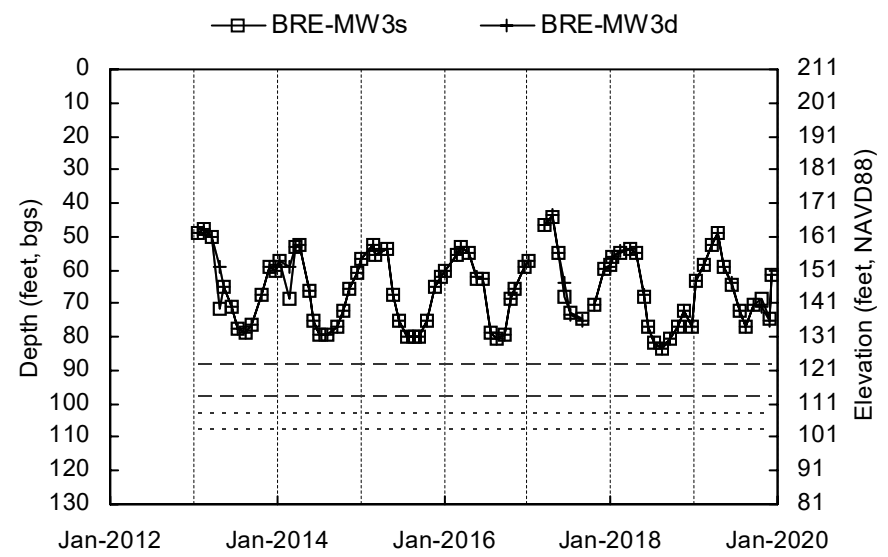
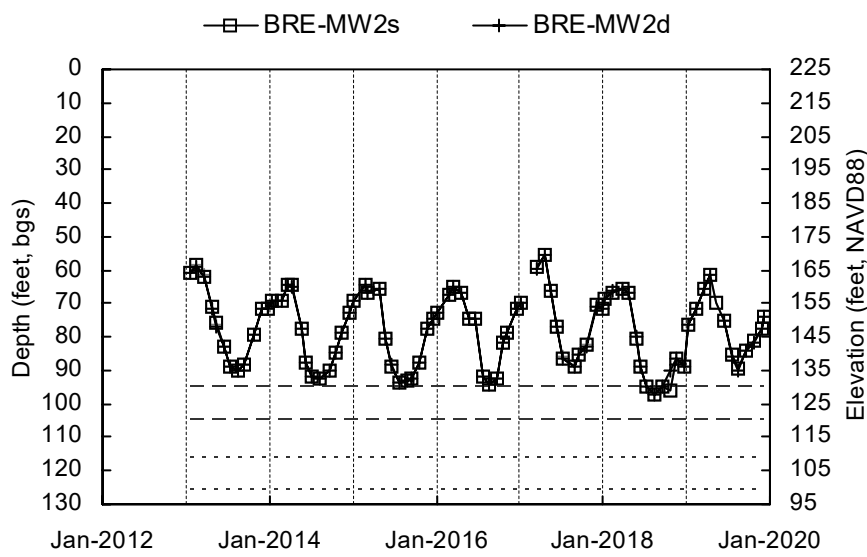
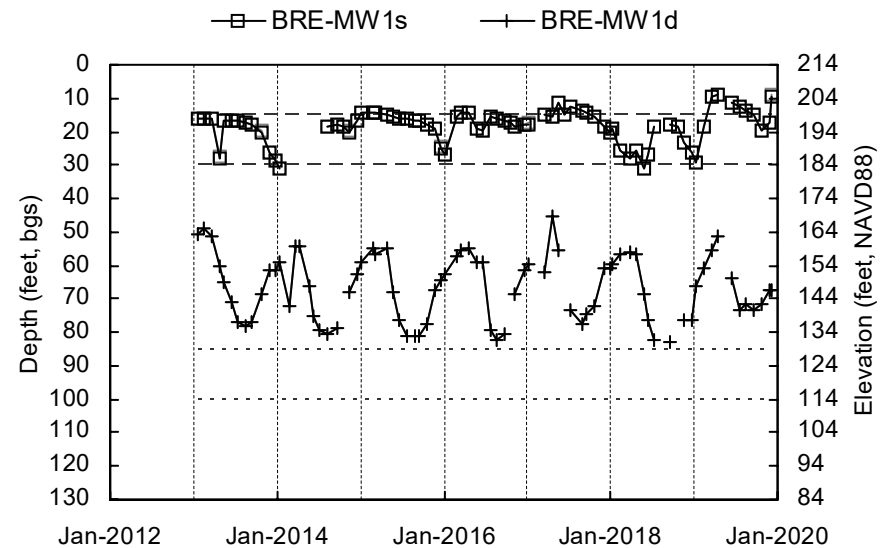
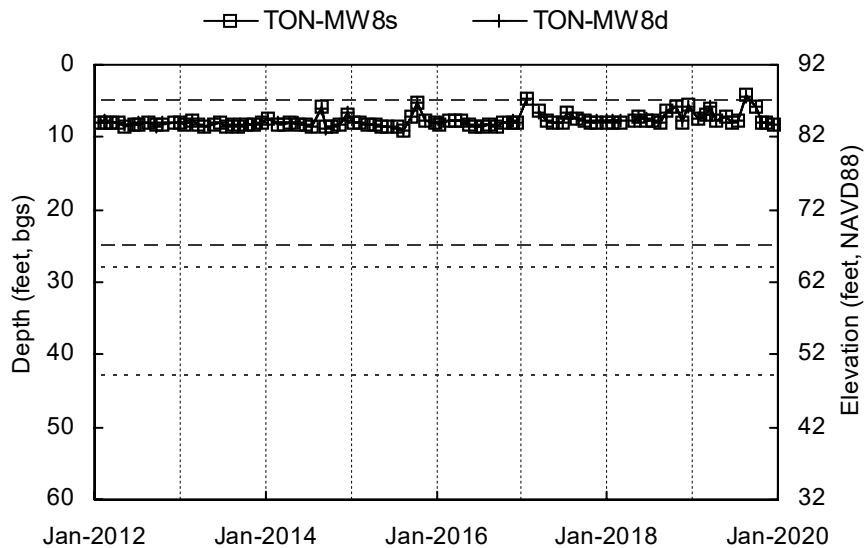

Shallow Well Screened Interval
 Deep Well Screened Interval
Elevation scale shown to the nearest integer.

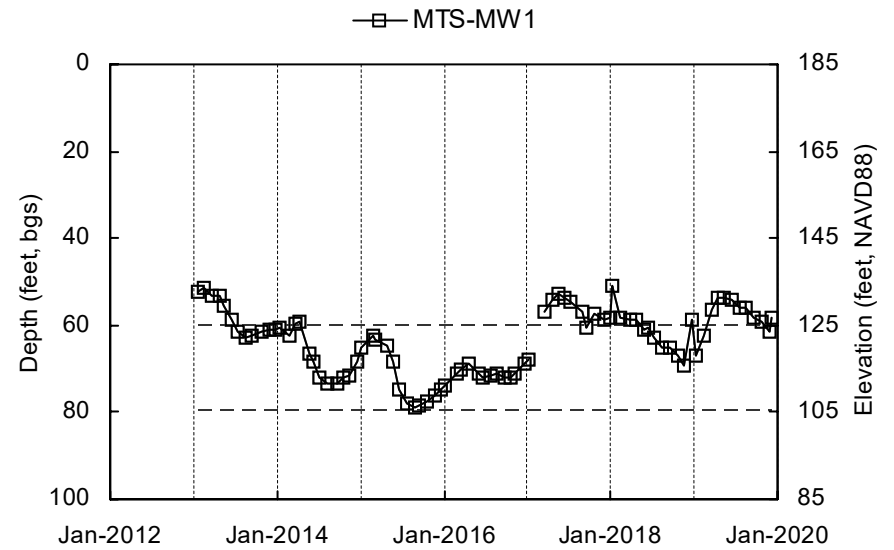
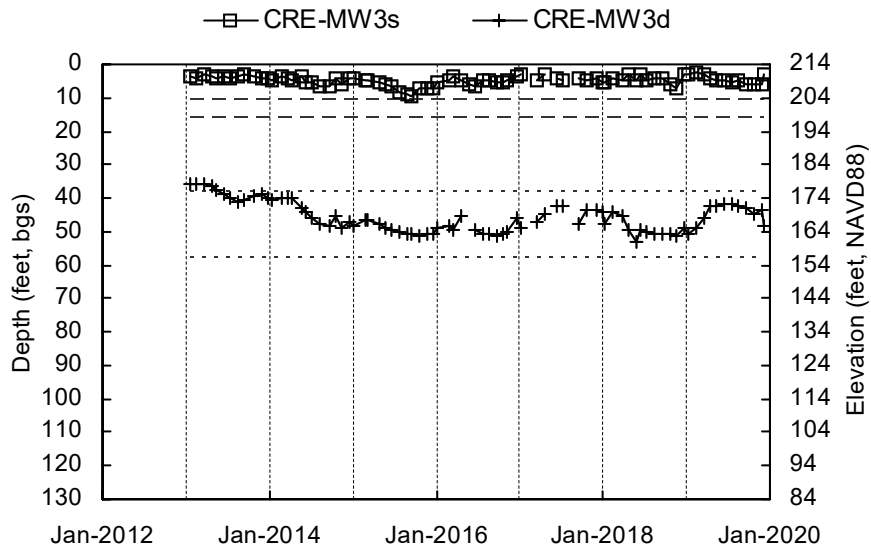
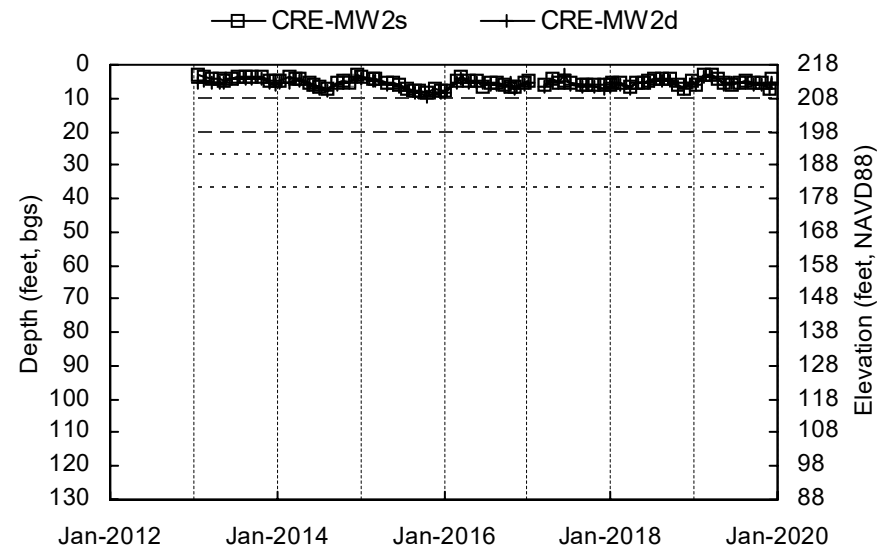
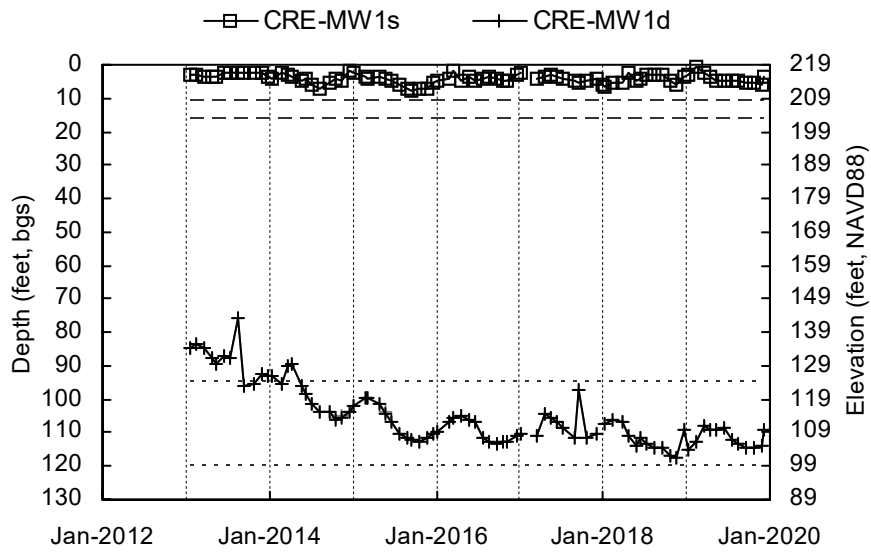

Shallow Well Screened Interval
 Deep Well Screened Interval
 Elevation scale shown to the nearest integer.

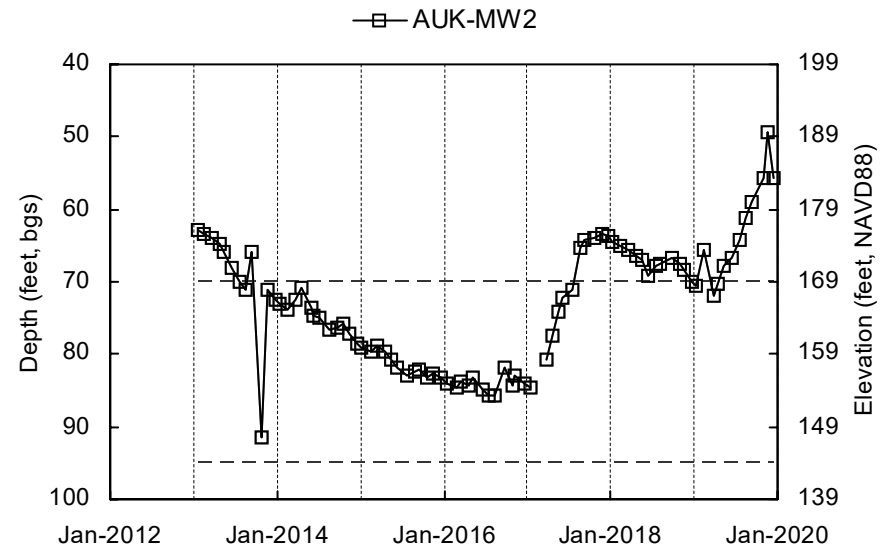
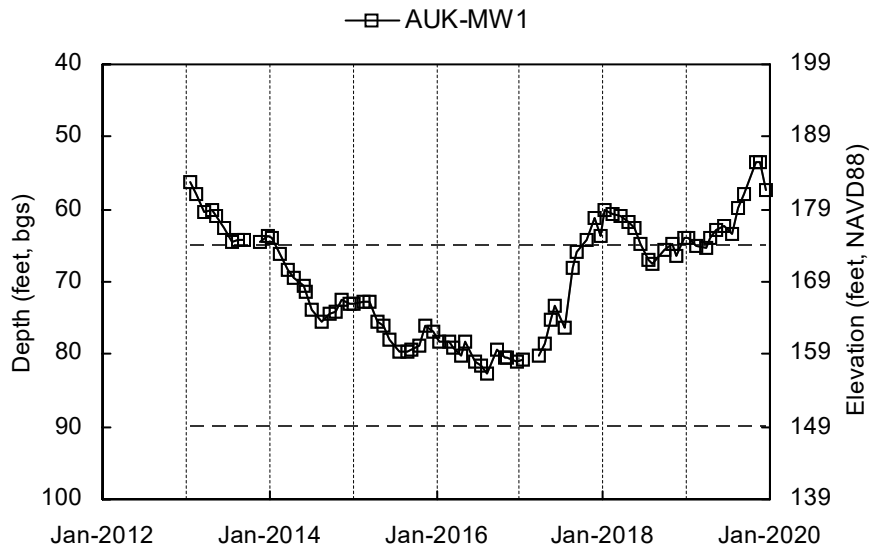
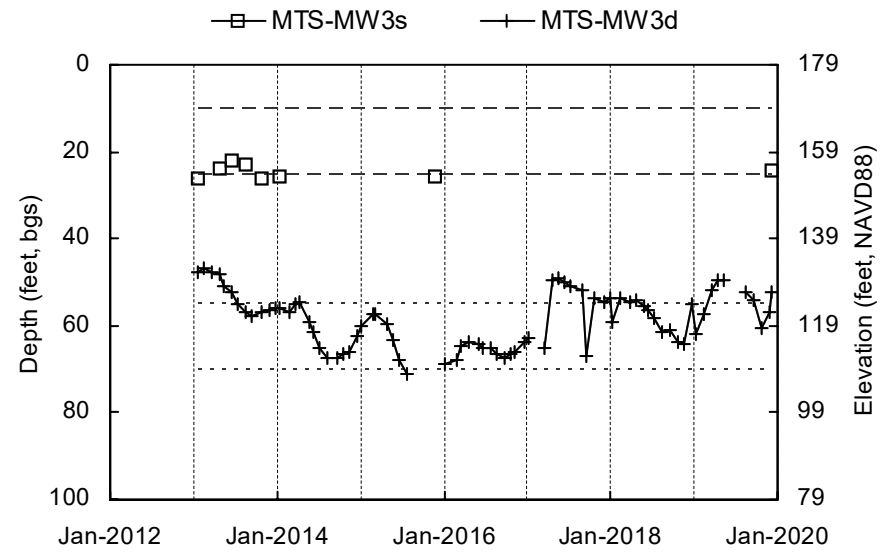
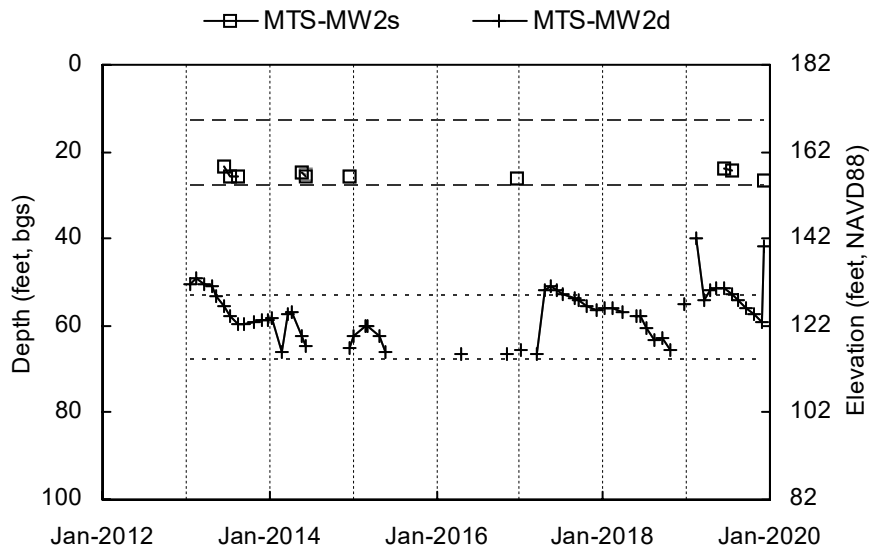

— — — Shallow Well Screened Interval Deep Well Screened Interval
 Elevation scale shown to the nearest integer.

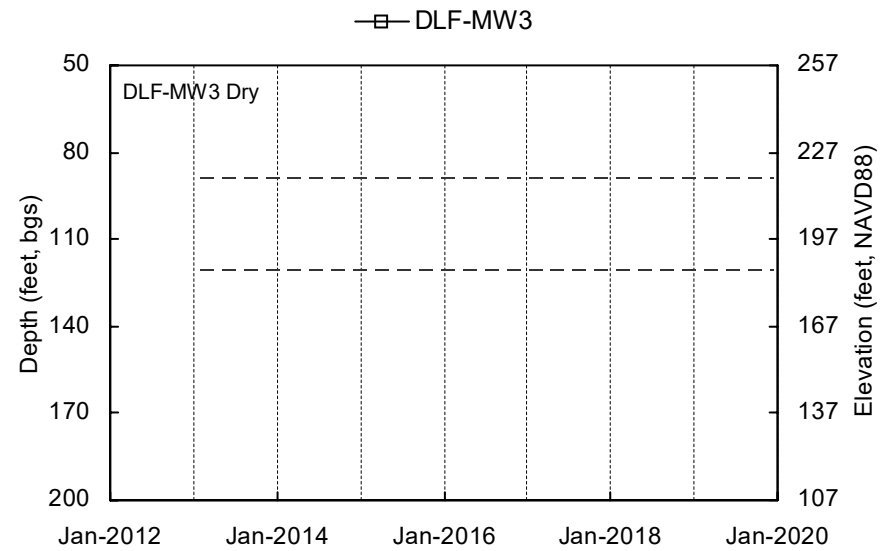
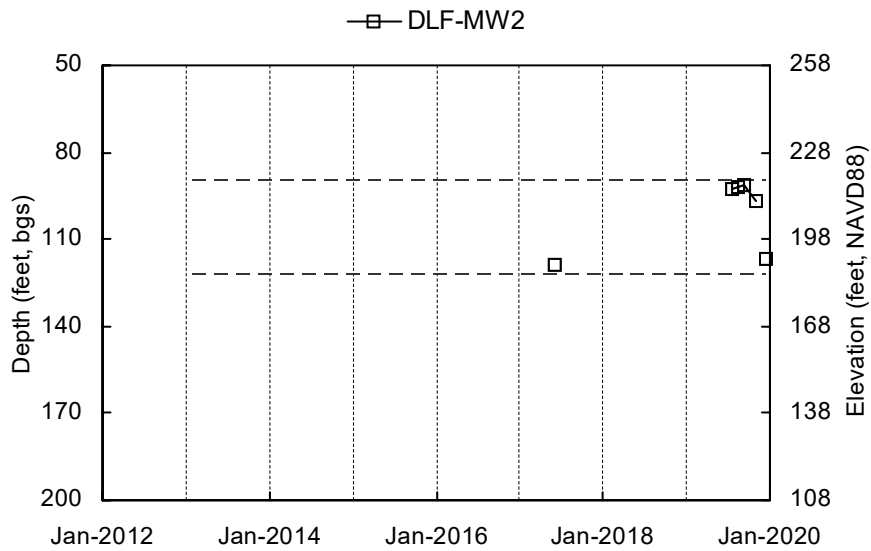
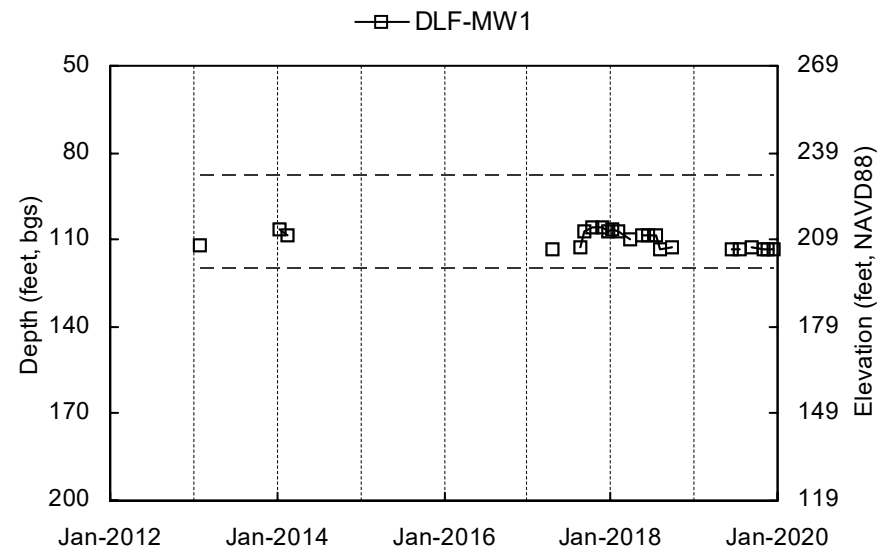
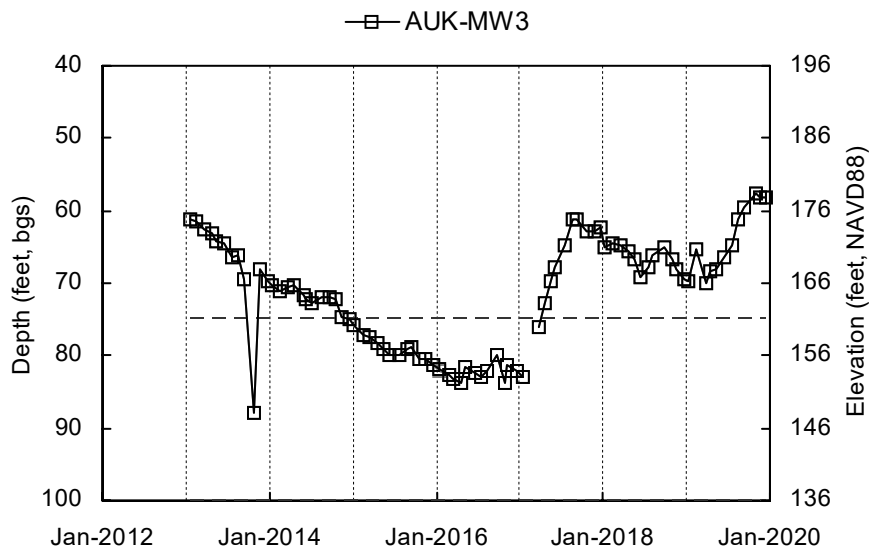

— — — Shallow Well Screened Interval Deep Well Screened Interval
 Elevation scale shown to the nearest integer.

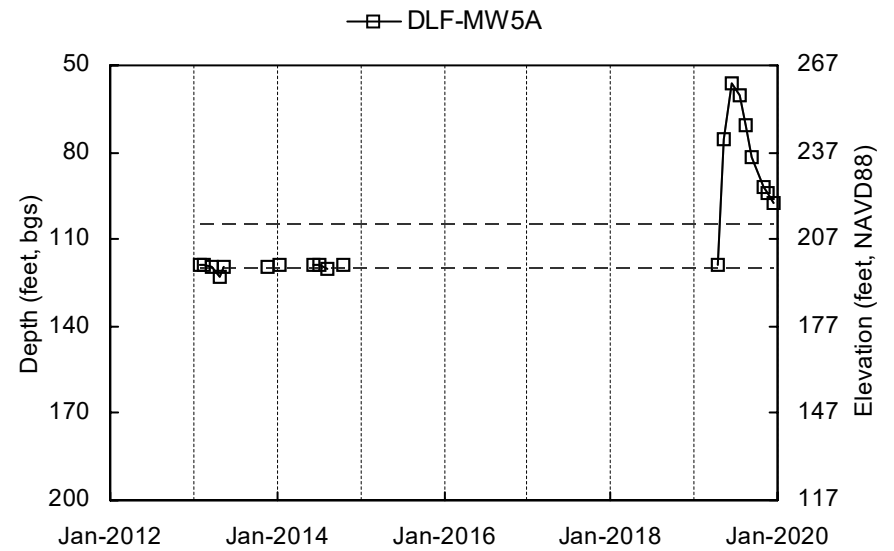
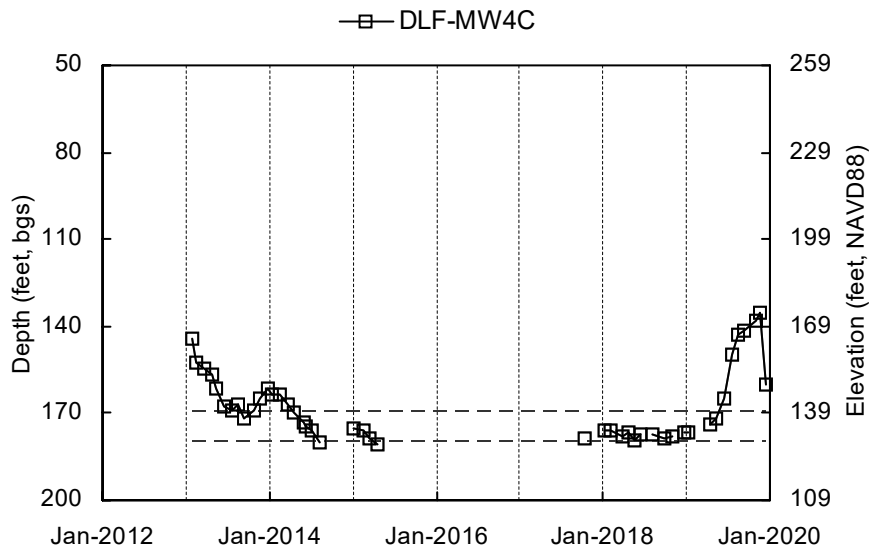
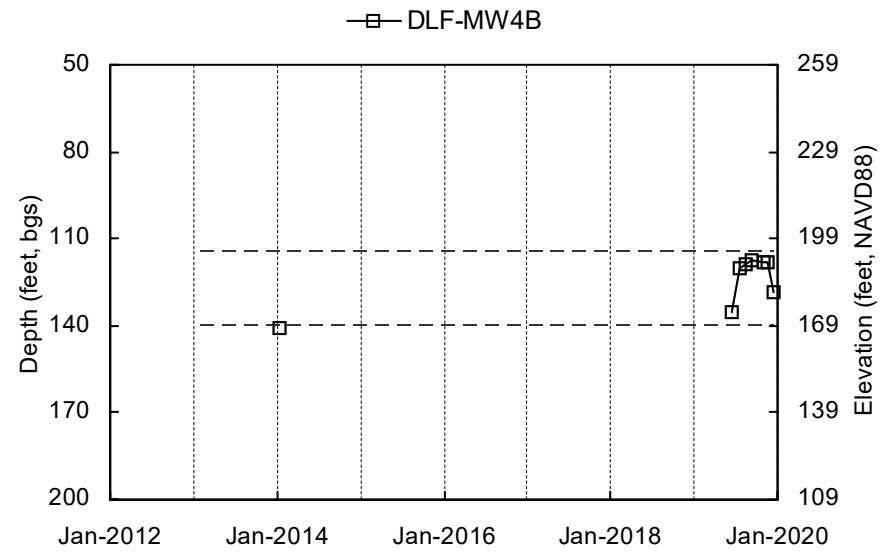
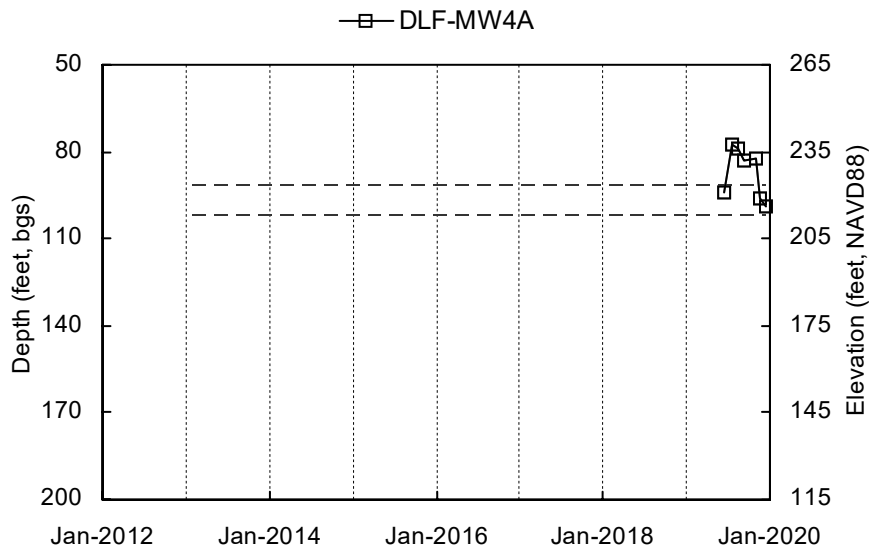

— — — Shallow Well Screened Interval Deep Well Screened Interval
 Elevation scale shown to the nearest integer.

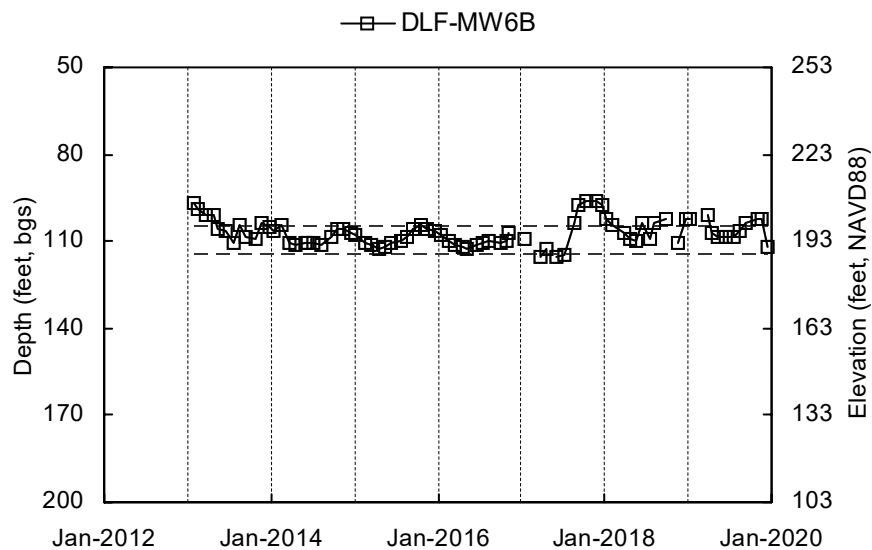
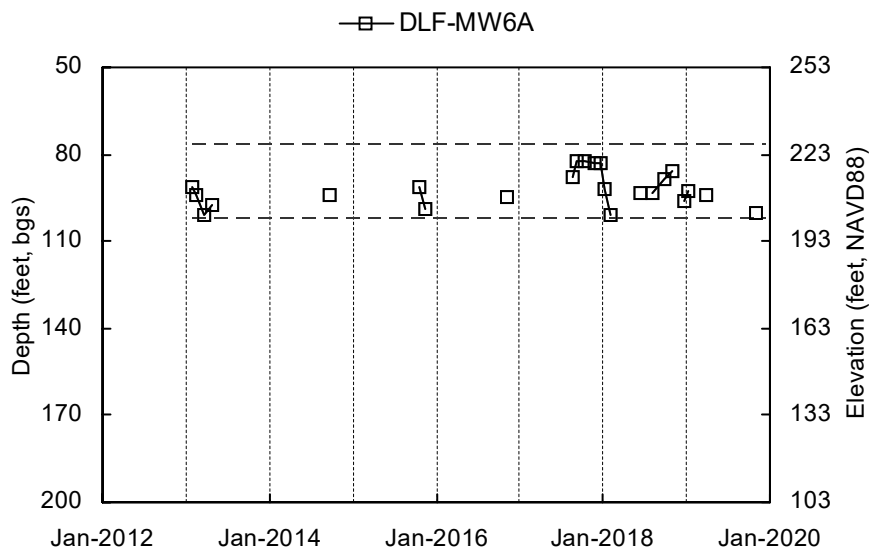
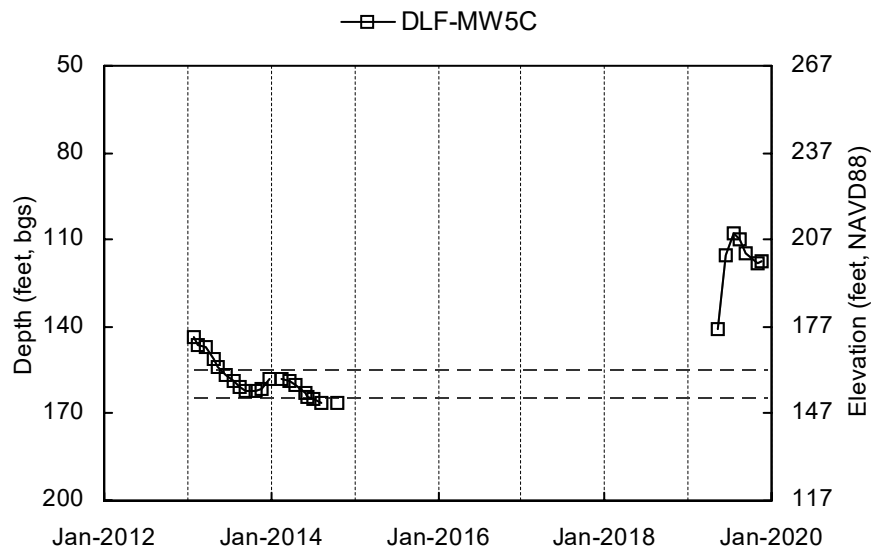
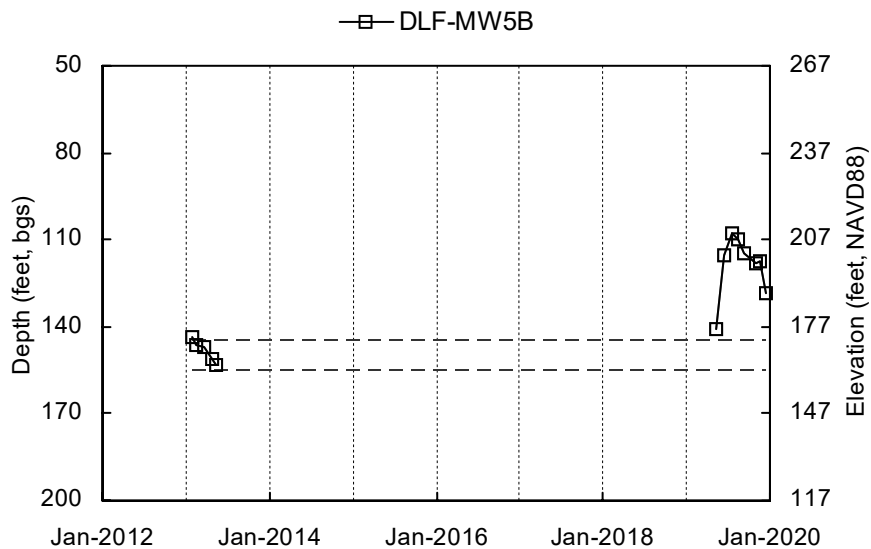

— — — Shallow Well Screened Interval Deep Well Screened Interval
 Elevation scale shown to the nearest integer.

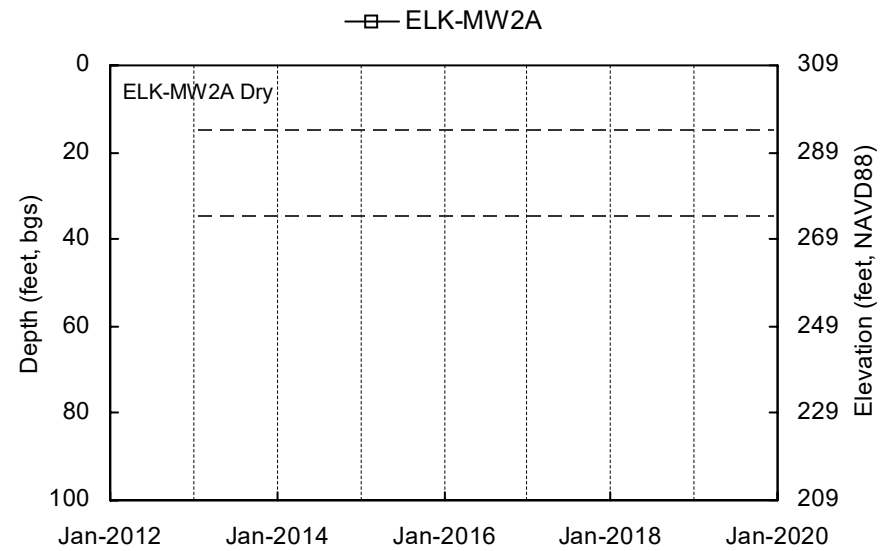
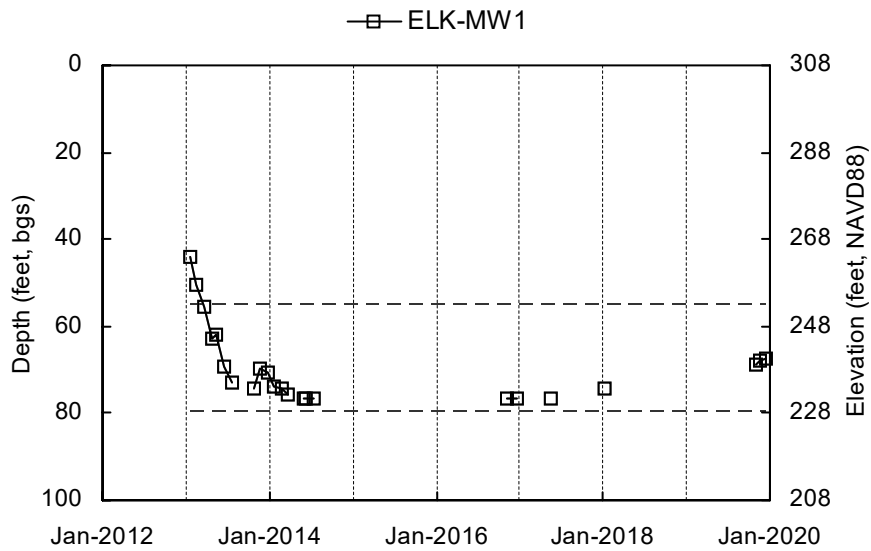
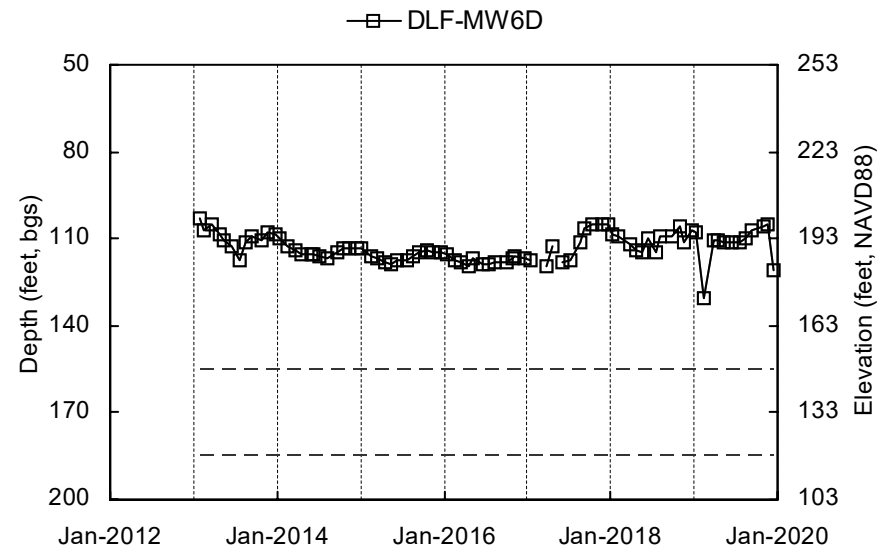
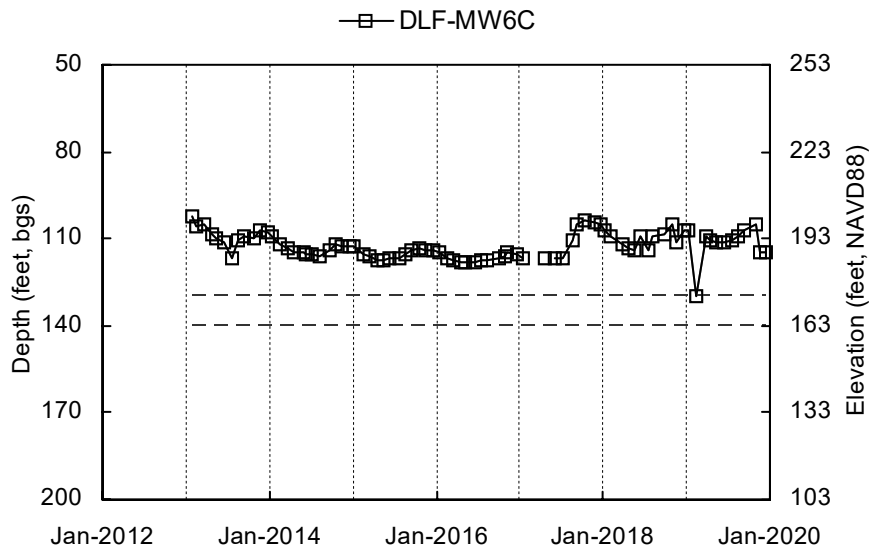

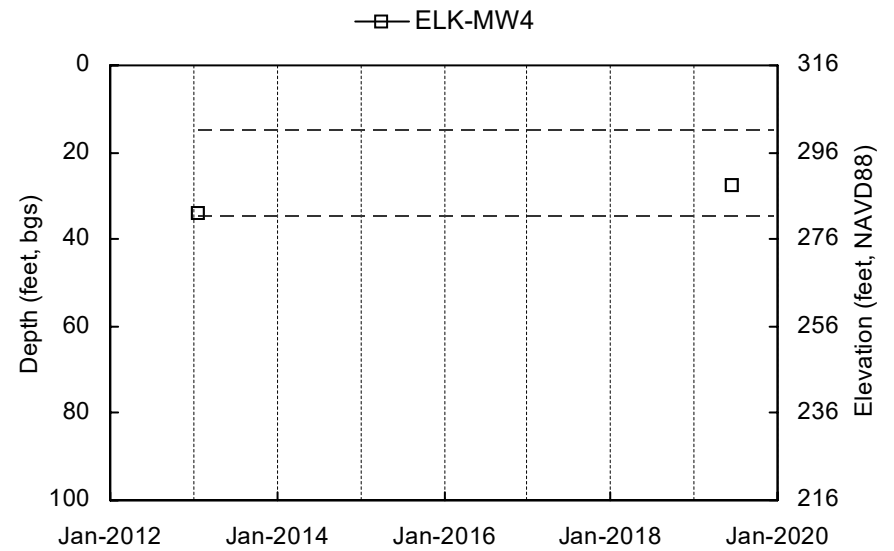
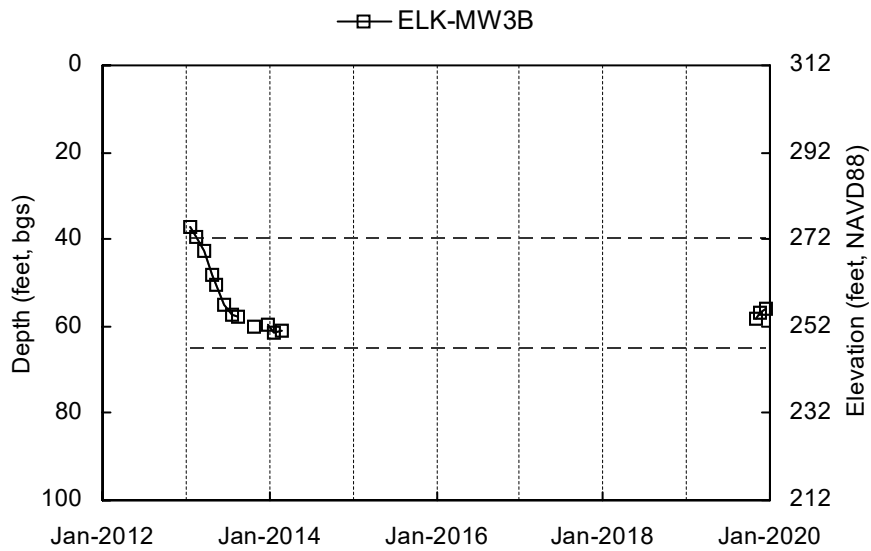
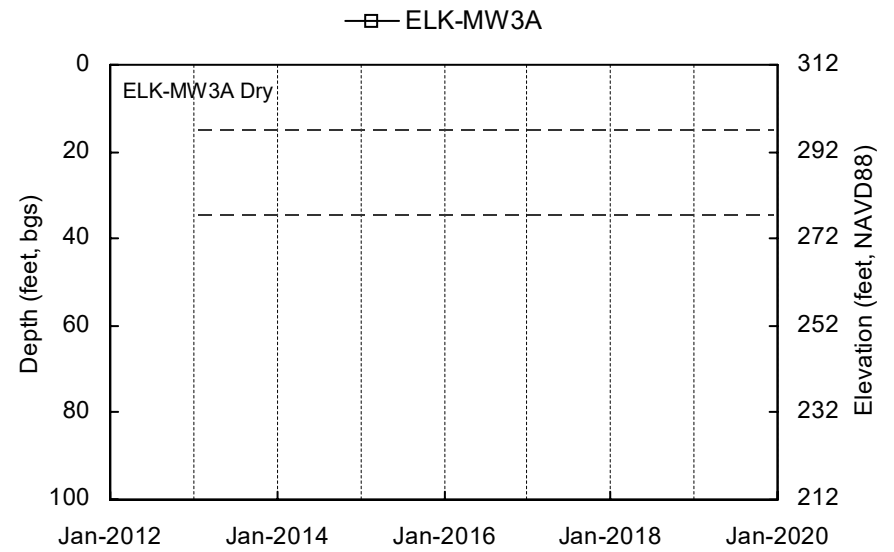
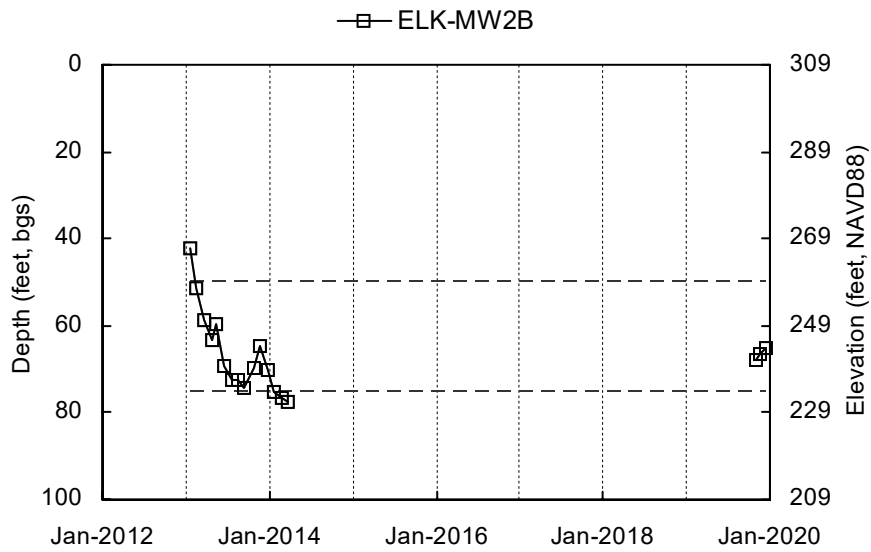

Shallow Well Screened Interval Deep Well Screened Interval
 Elevation scale shown to the nearest integer.

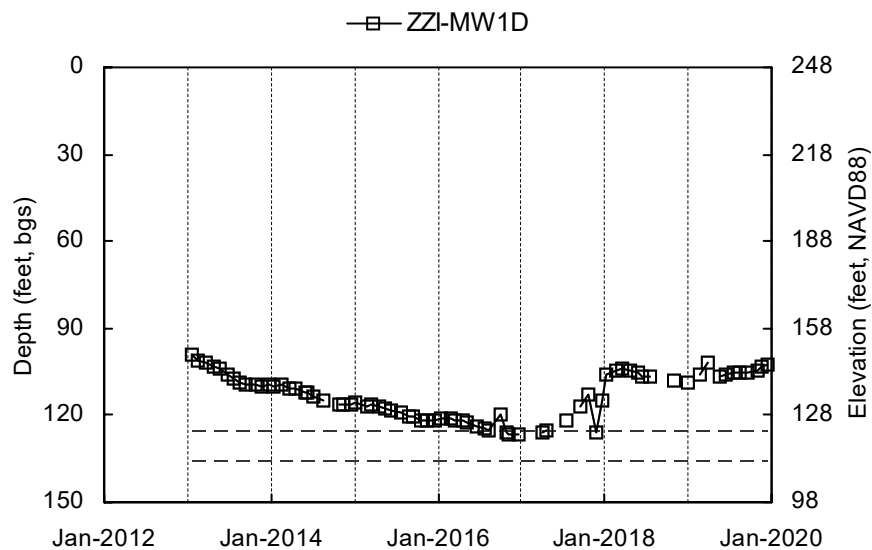
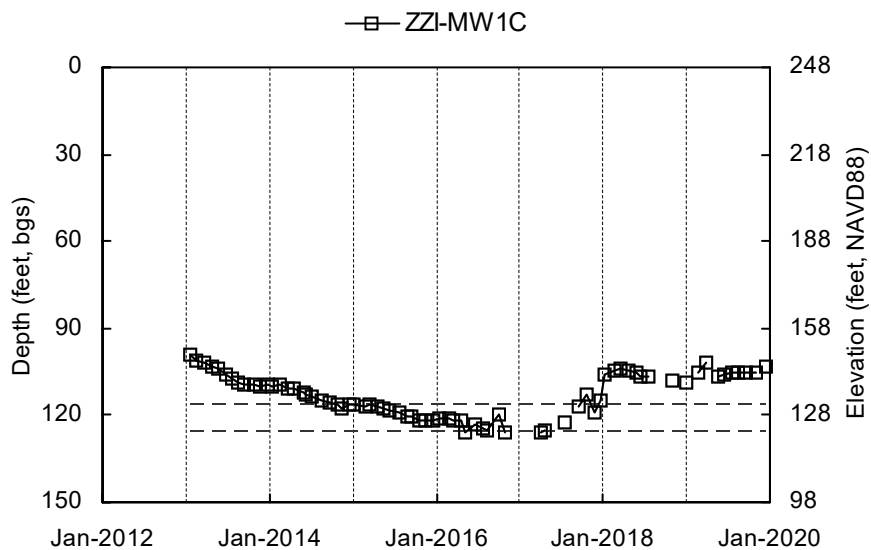
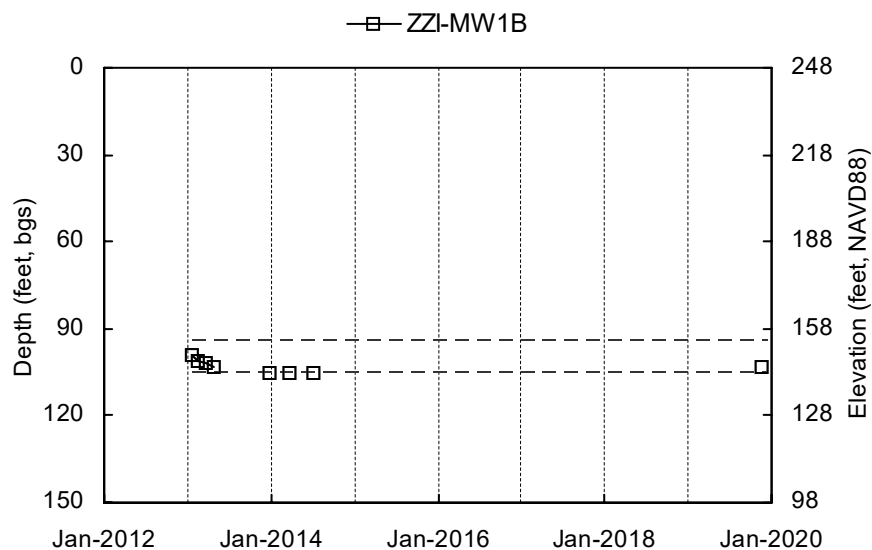
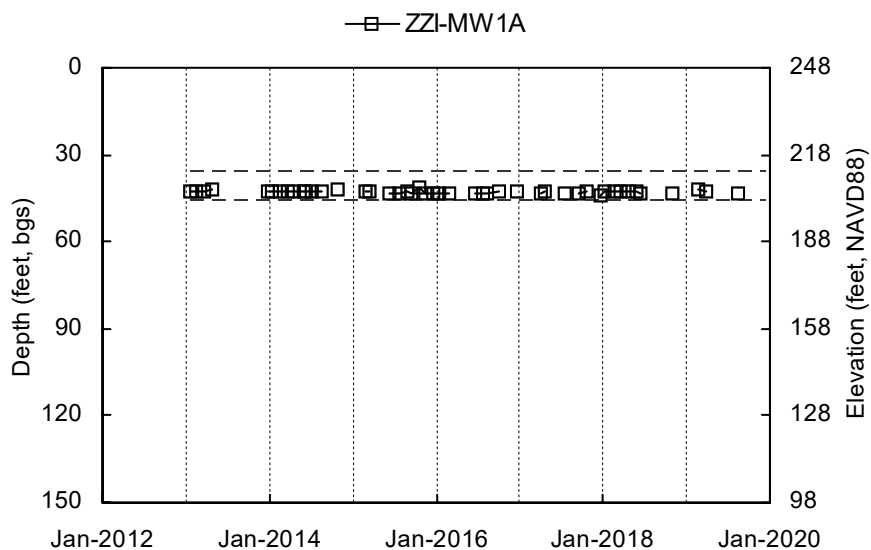

Shallow Well Screened Interval
 Deep Well Screened Interval
 Elevation scale shown to the nearest integer.

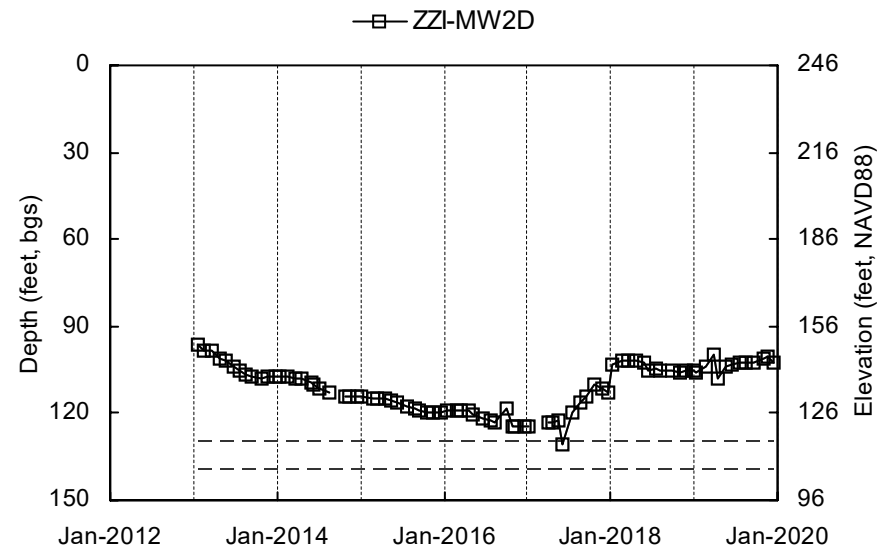
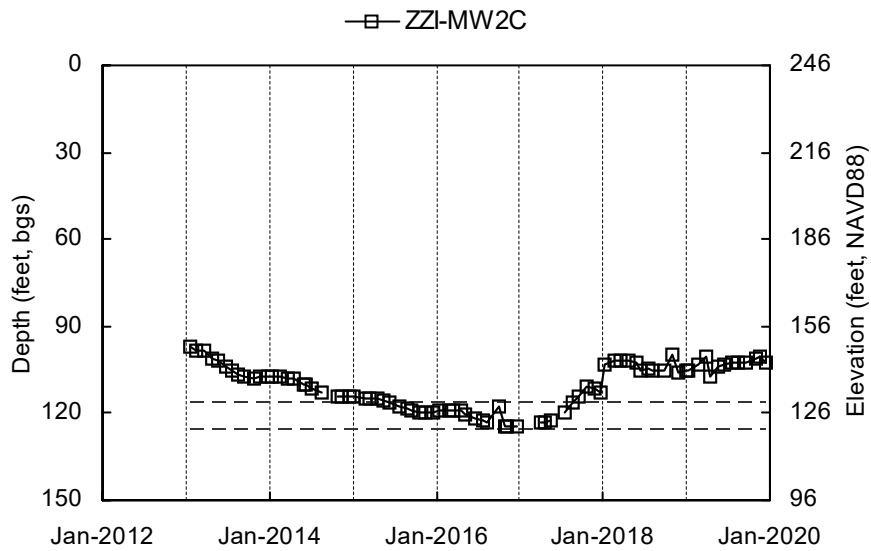
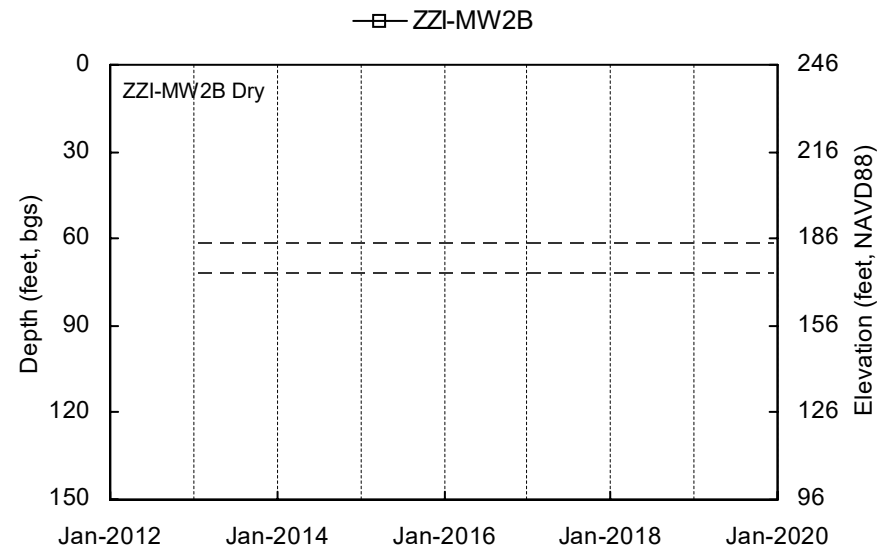
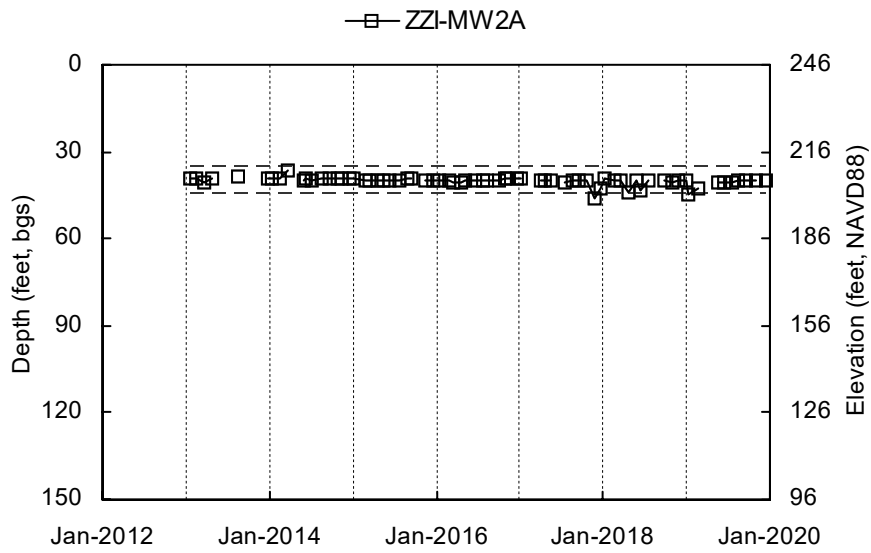

Shallow Well Screened Interval
 Deep Well Screened Interval
 Elevation scale shown to the nearest integer.

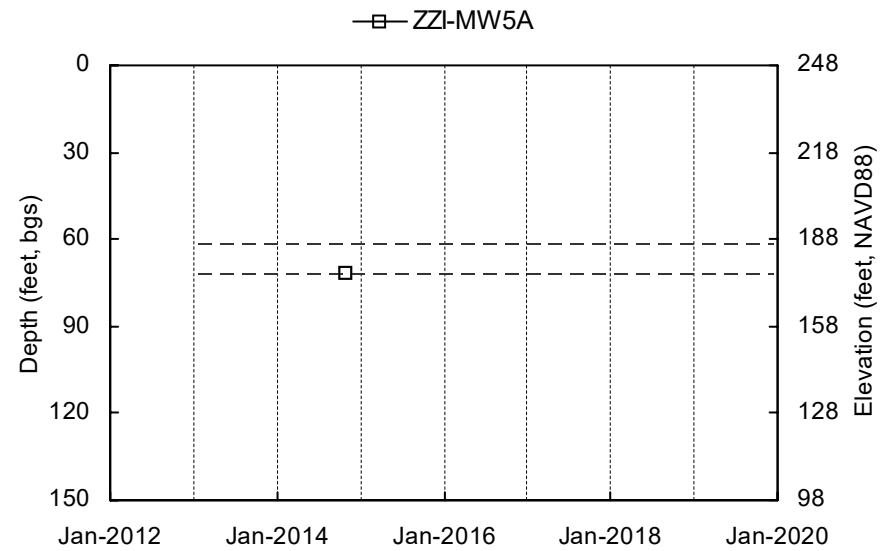
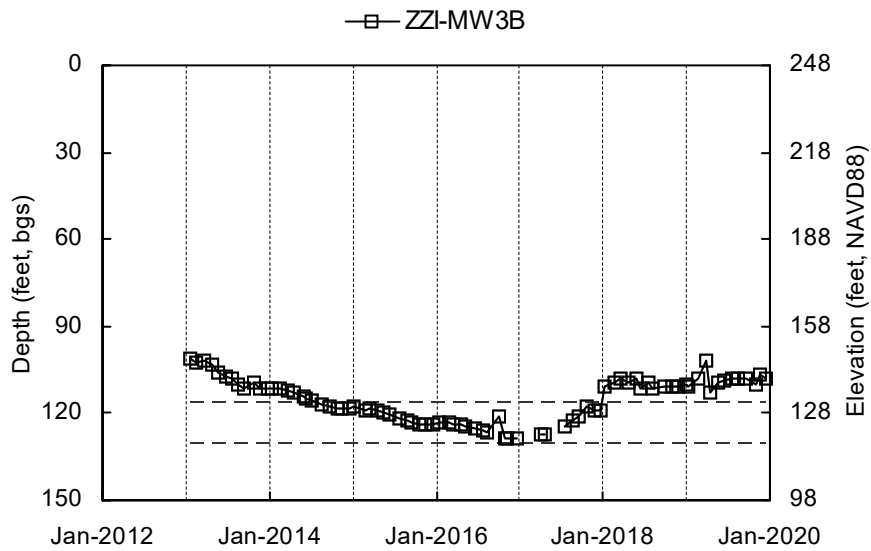
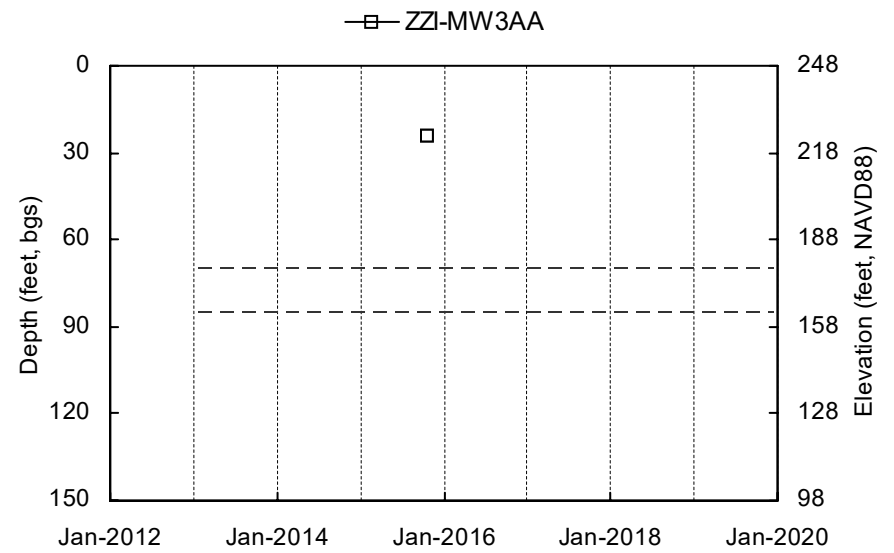
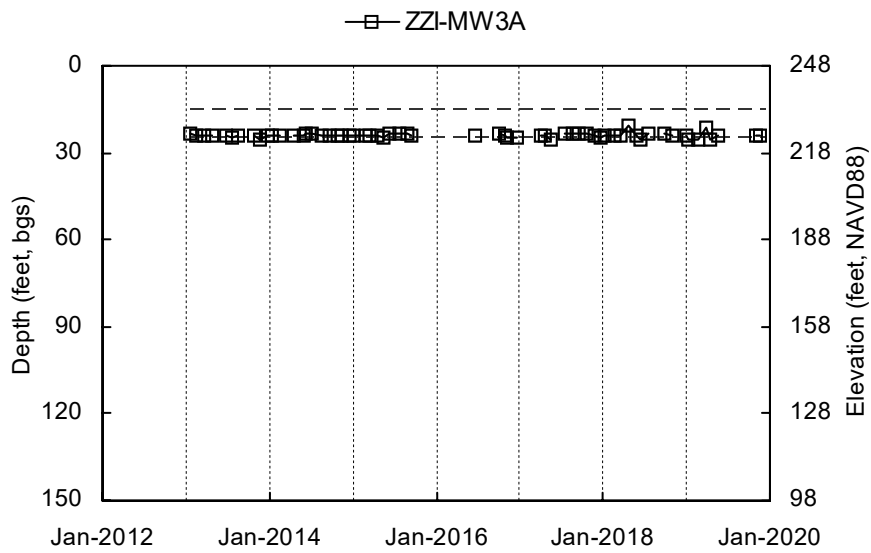

Shallow Well Screened Interval
 Deep Well Screened Interval
 Elevation scale shown to the nearest integer.

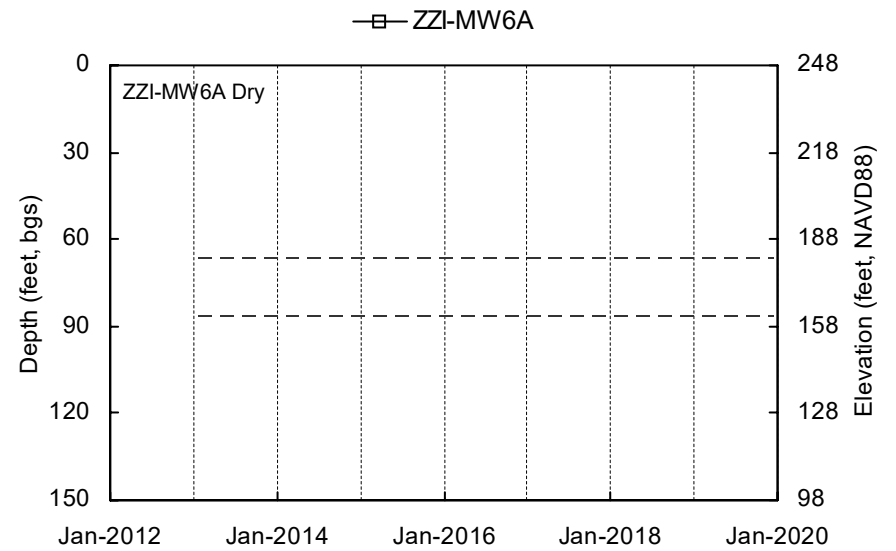
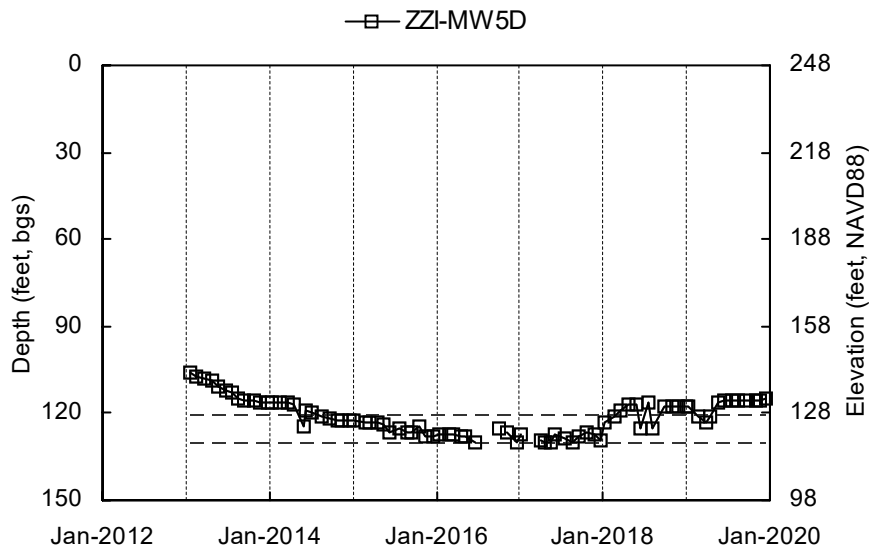
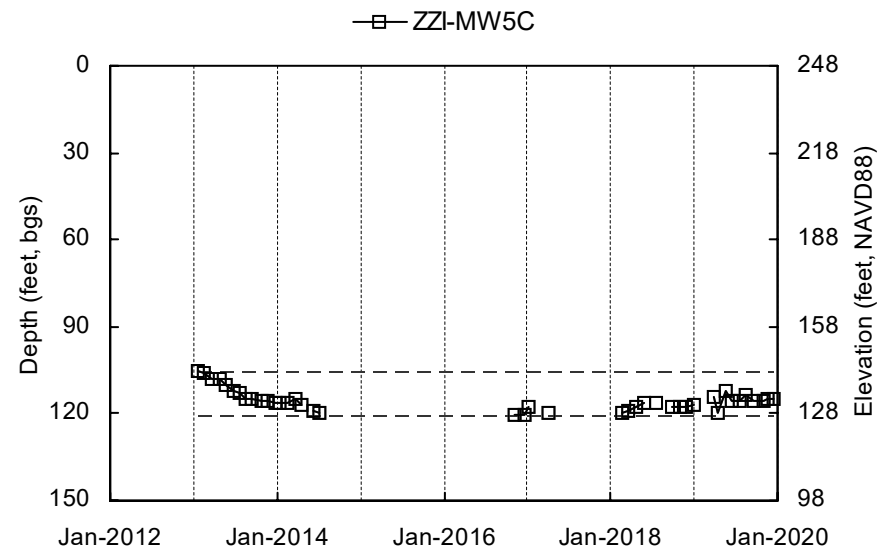
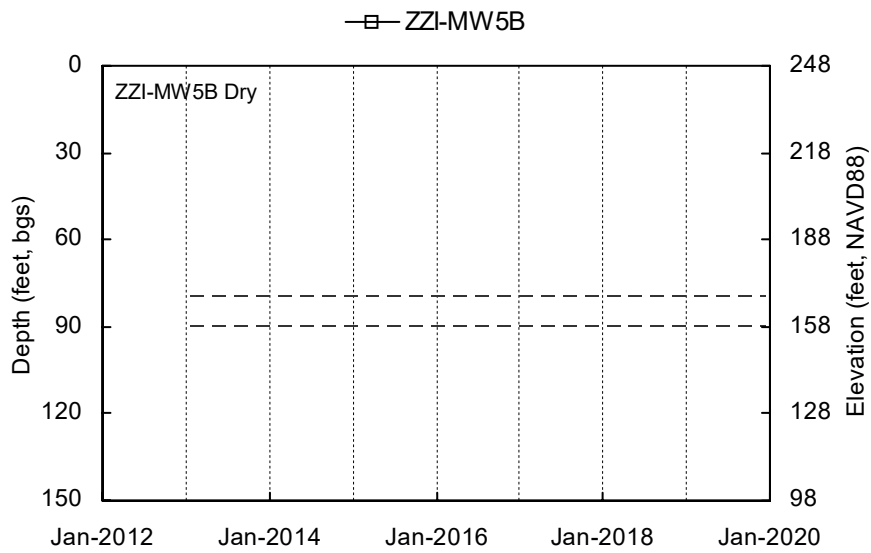

Shallow Well Screened Interval Deep Well Screened Interval
Elevation scale shown to the nearest integer.

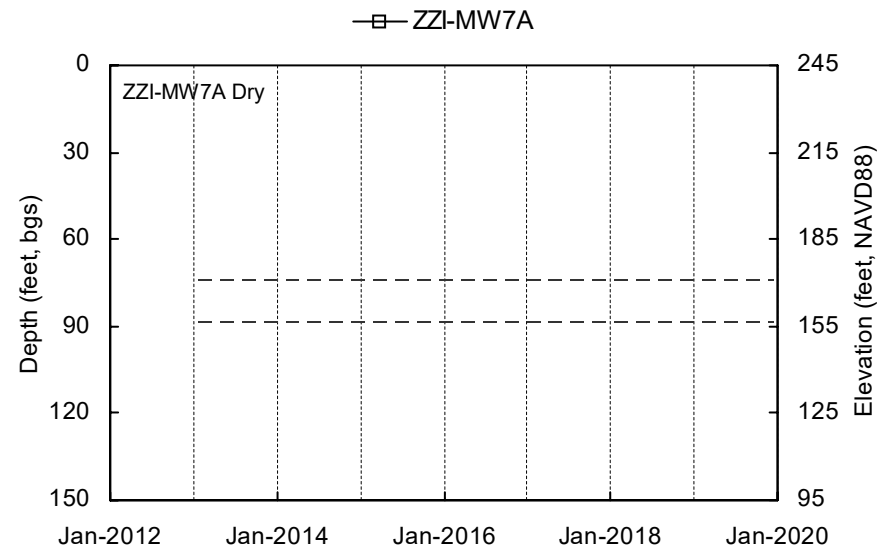
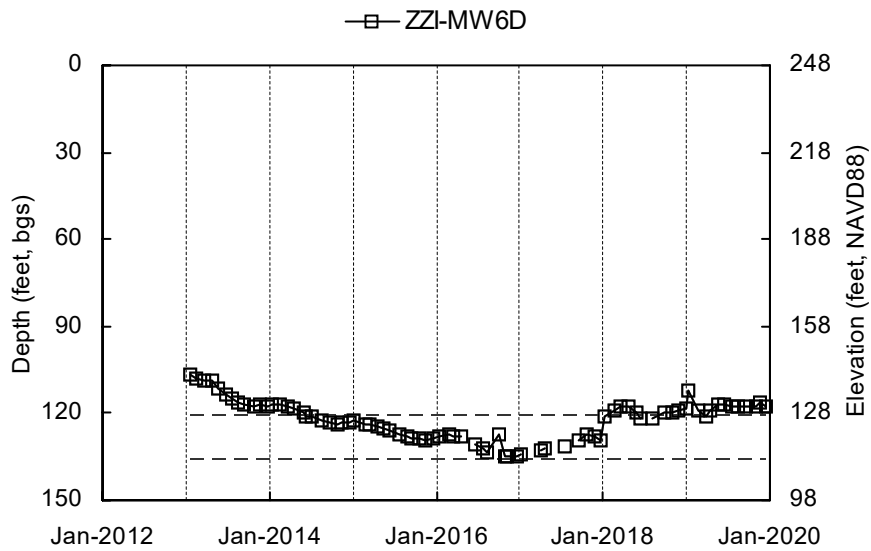
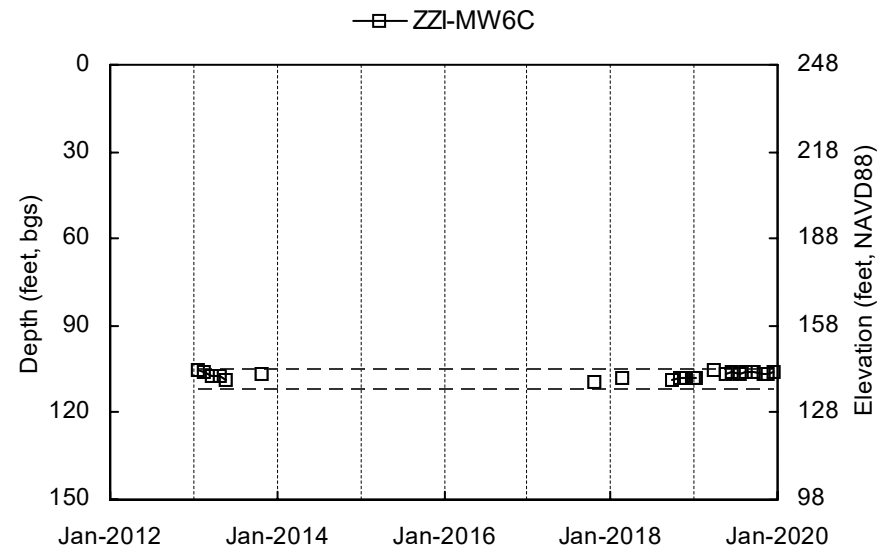
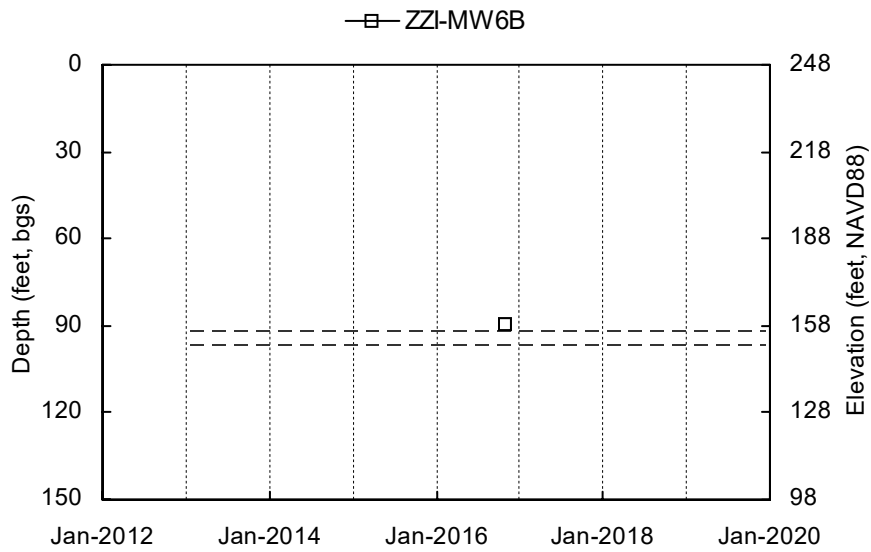

Shallow Well Screened Interval Deep Well Screened Interval
 Elevation scale shown to the nearest integer.

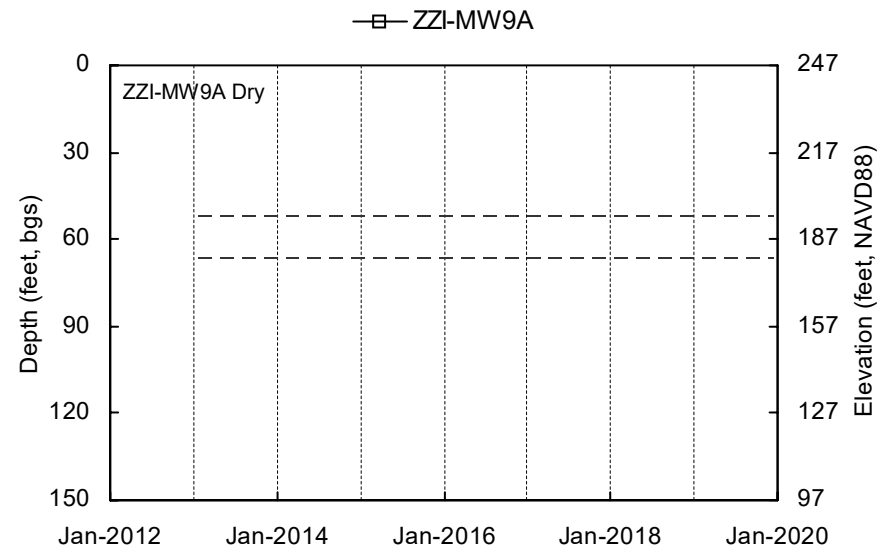
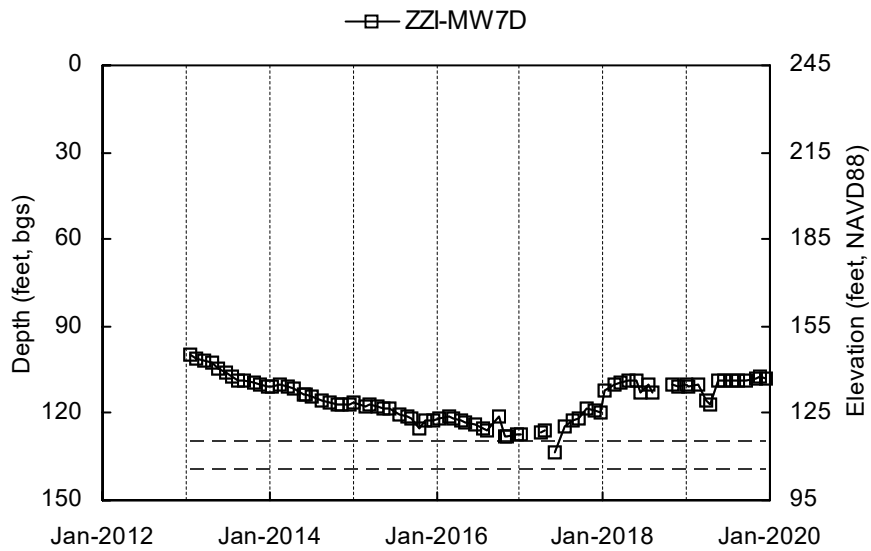
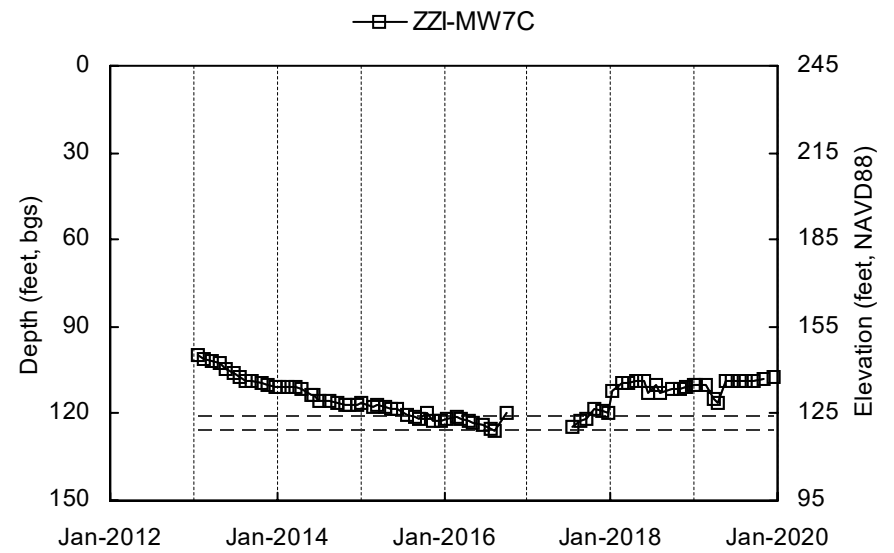
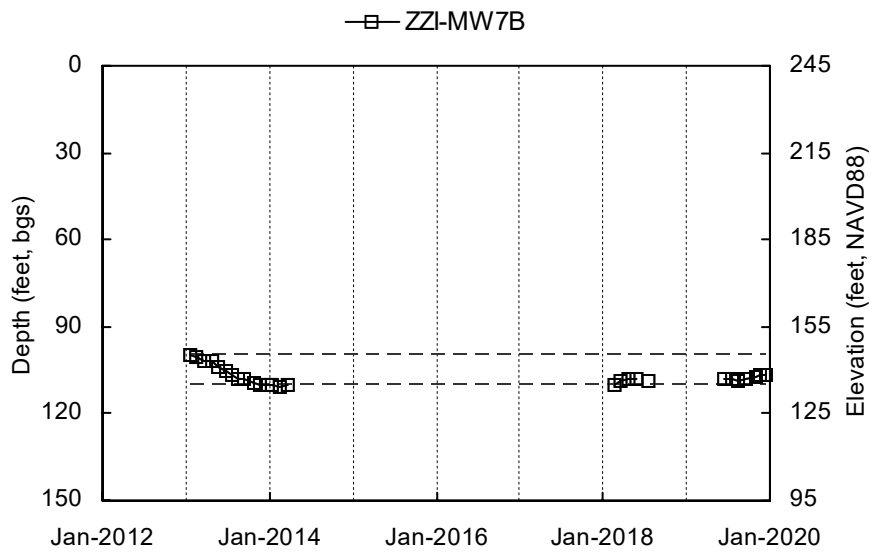

Shallow Well Screened Interval Deep Well Screened Interval
 Elevation scale shown to the nearest integer.

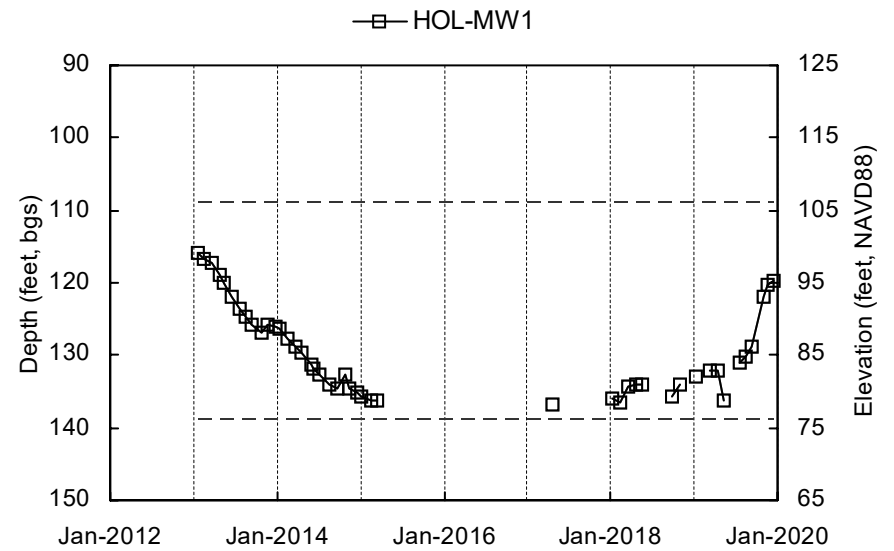
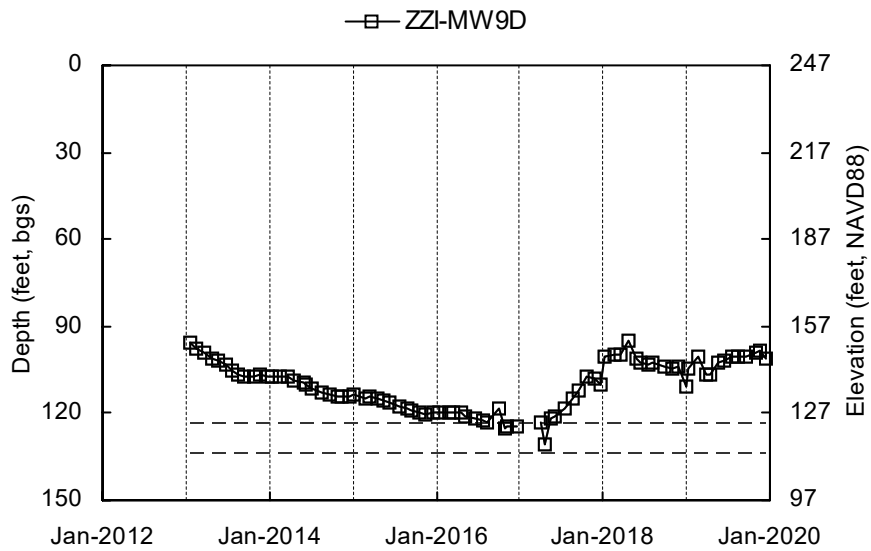
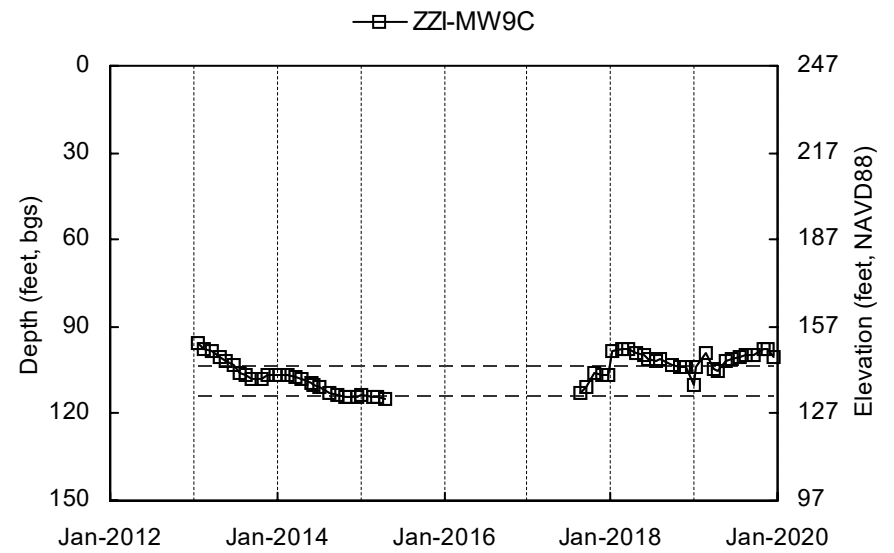
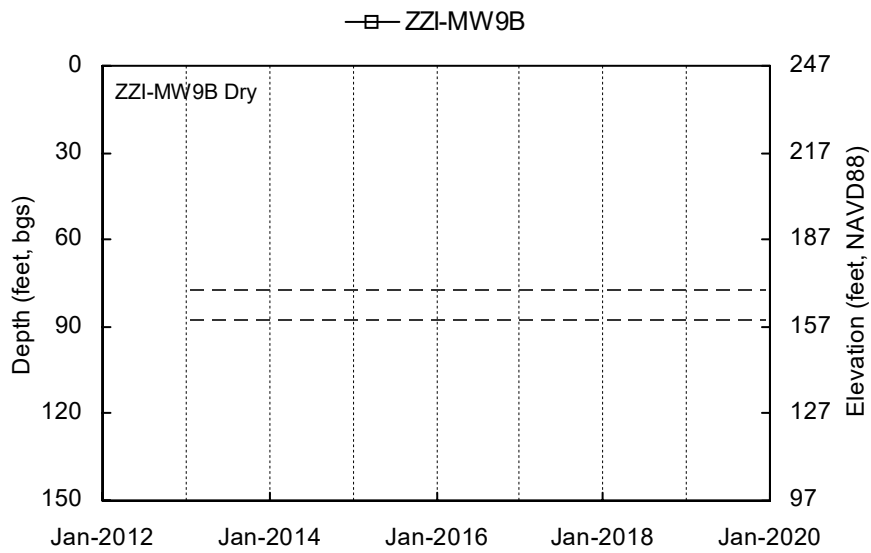

Shallow Well Screened Interval
 Deep Well Screened Interval
 Elevation scale shown to the nearest integer.

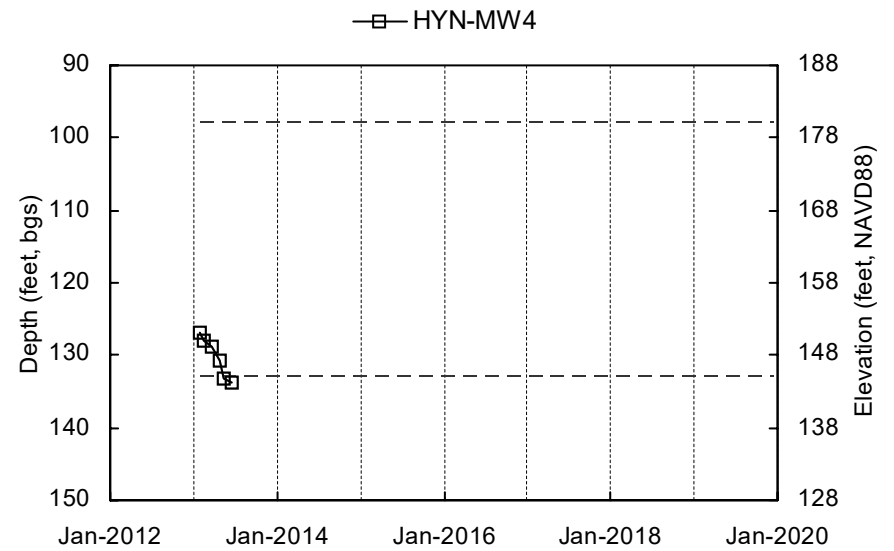
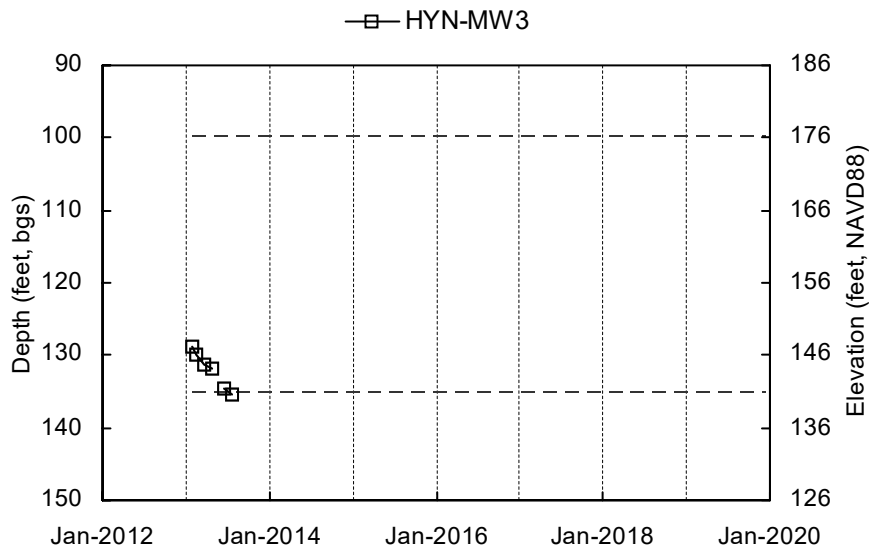
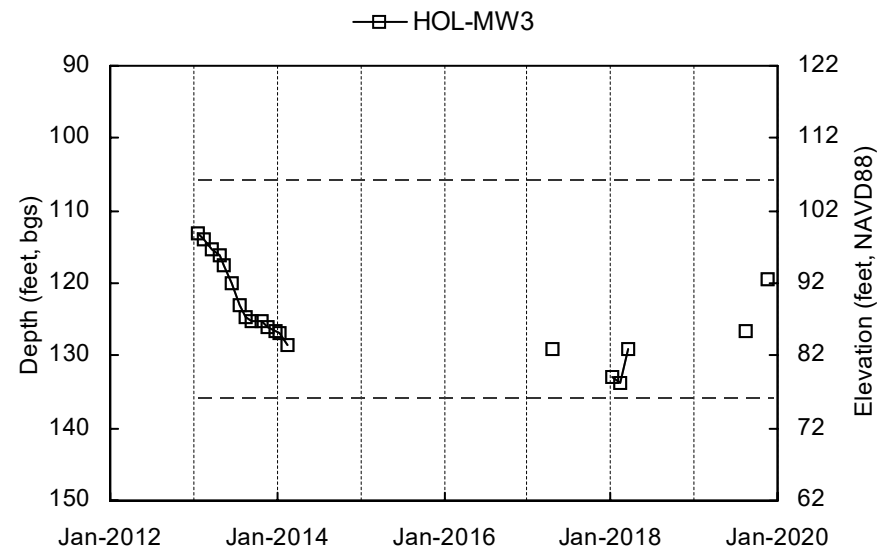
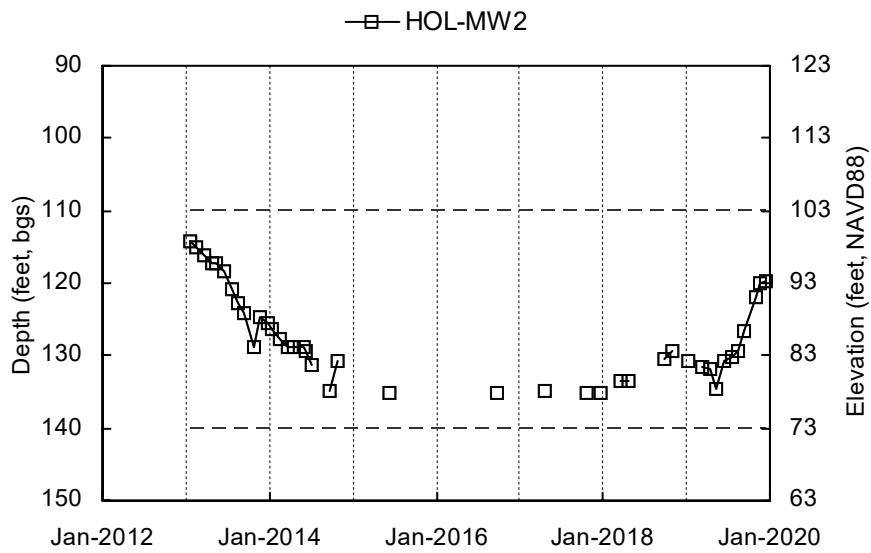

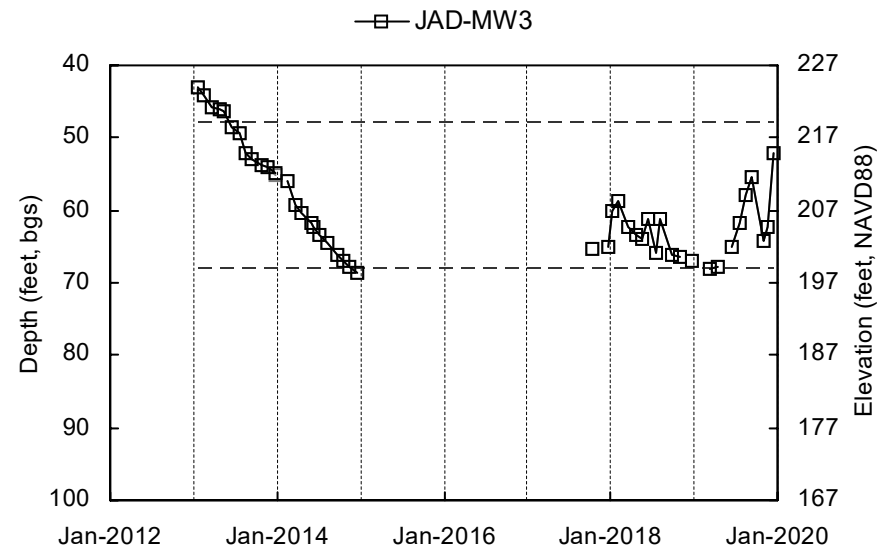
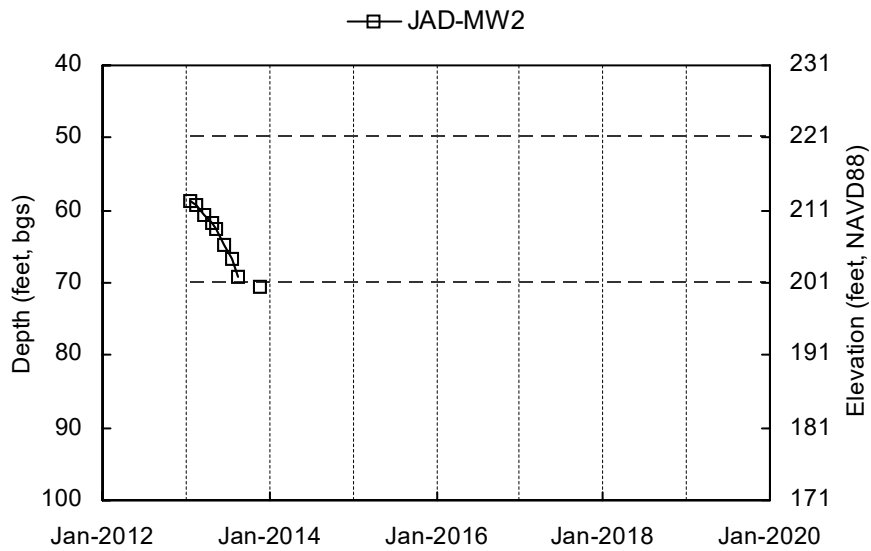
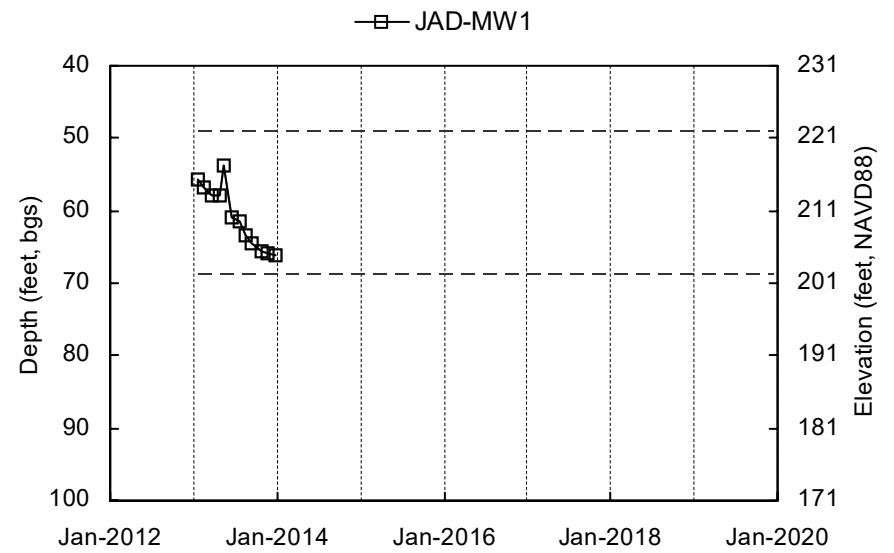
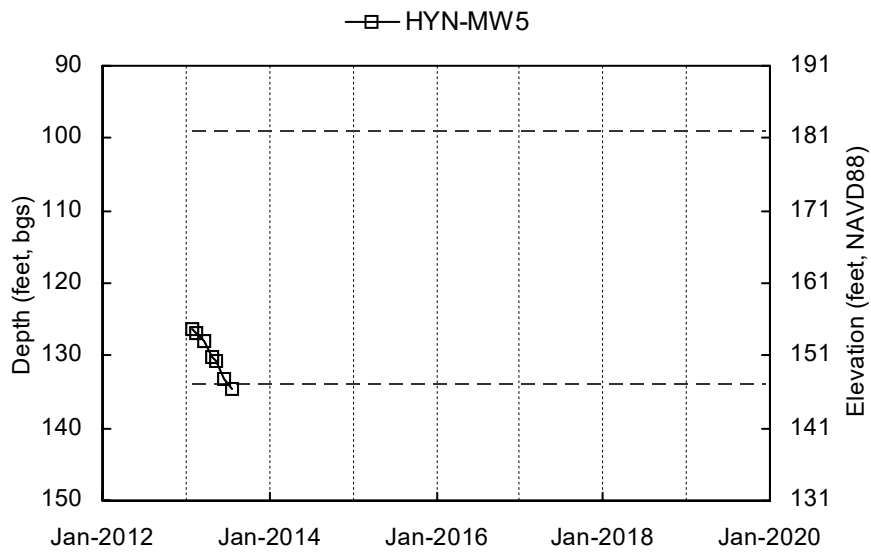

Shallow Well Screened Interval Deep Well Screened Interval
Elevation scale shown to the nearest integer.

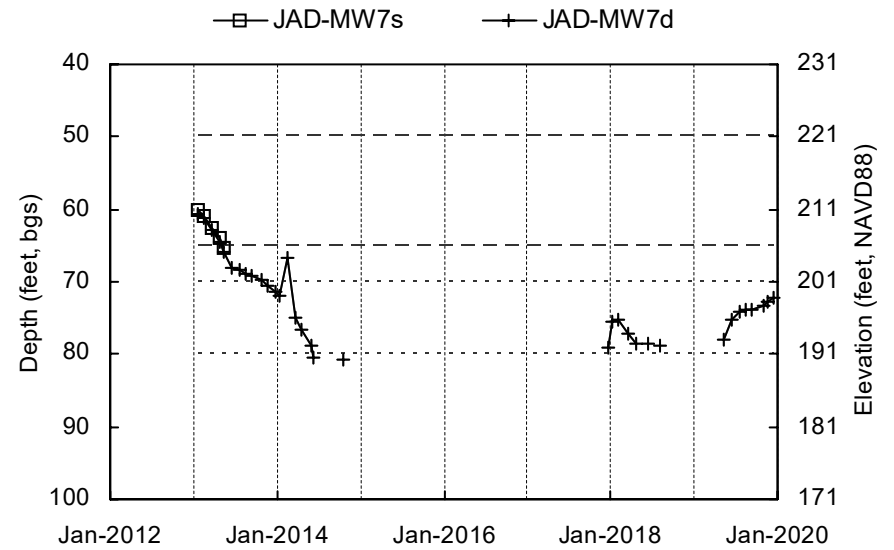
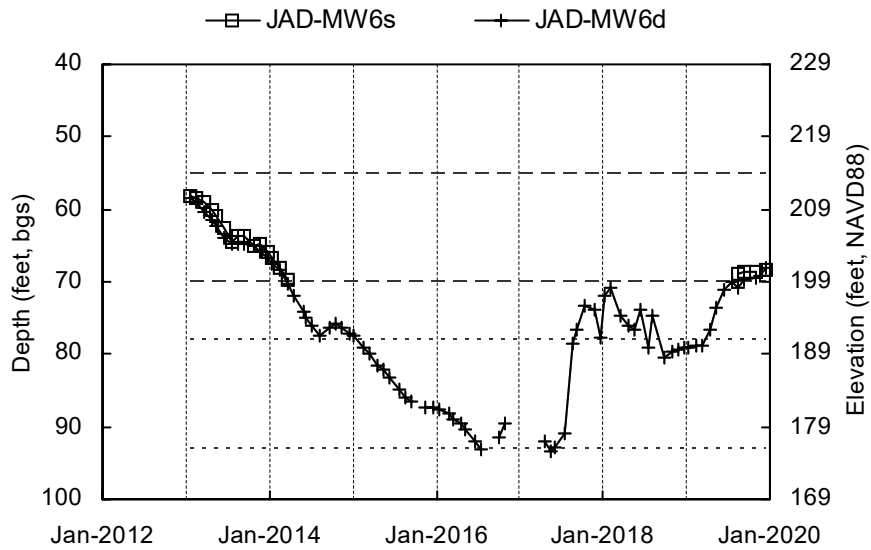
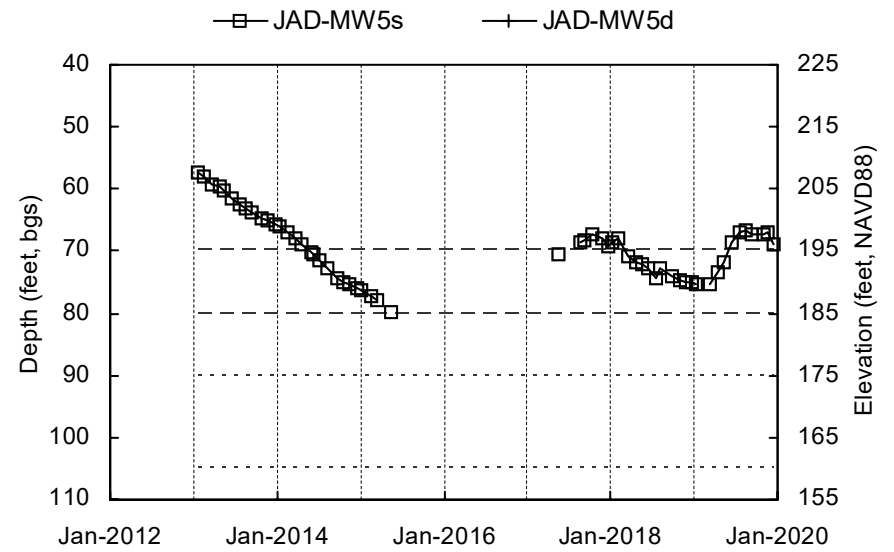
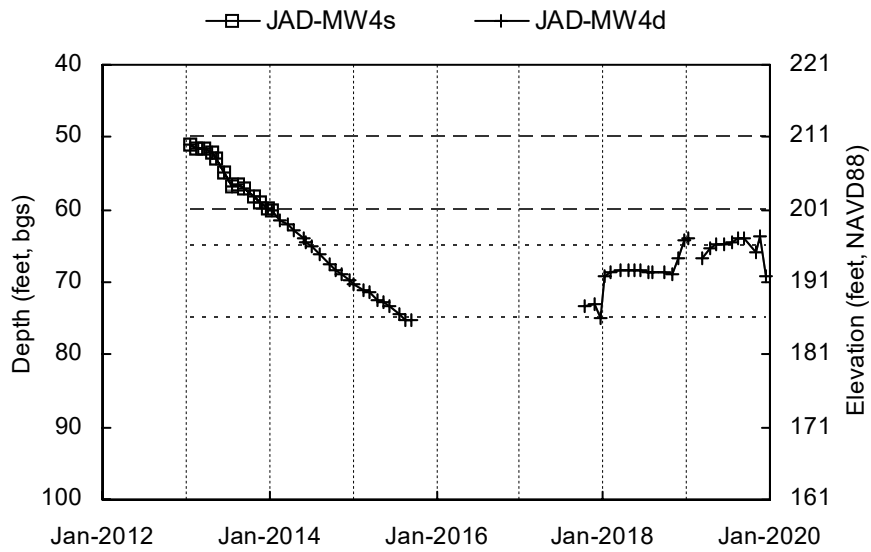

— — — Shallow Well Screened Interval Deep Well Screened Interval
 Elevation scale shown to the nearest integer.

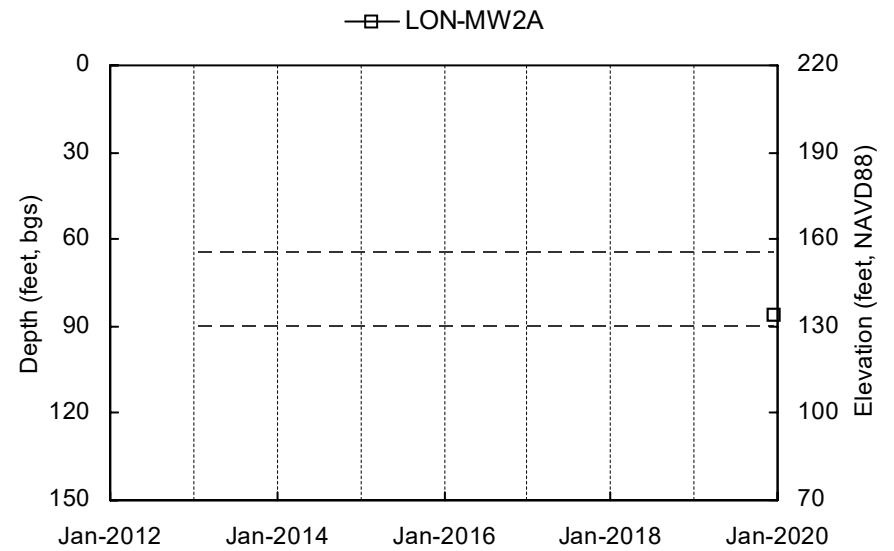
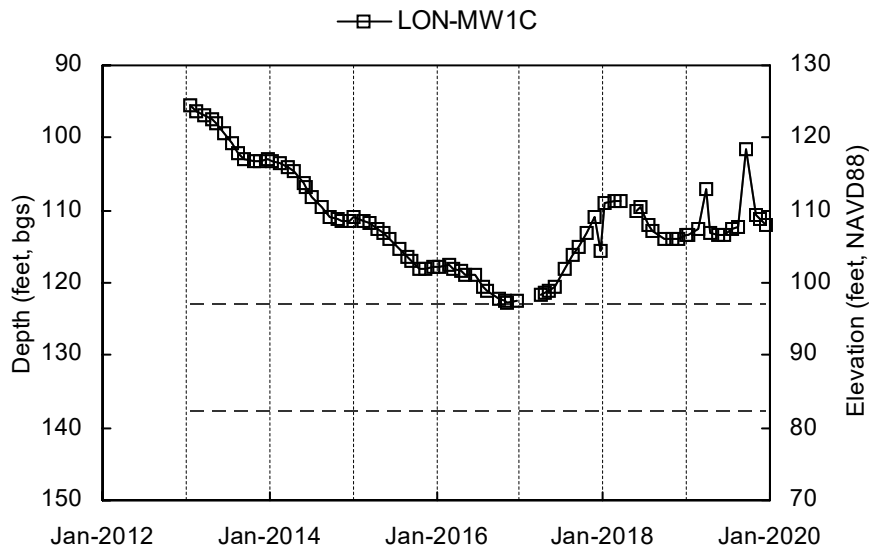
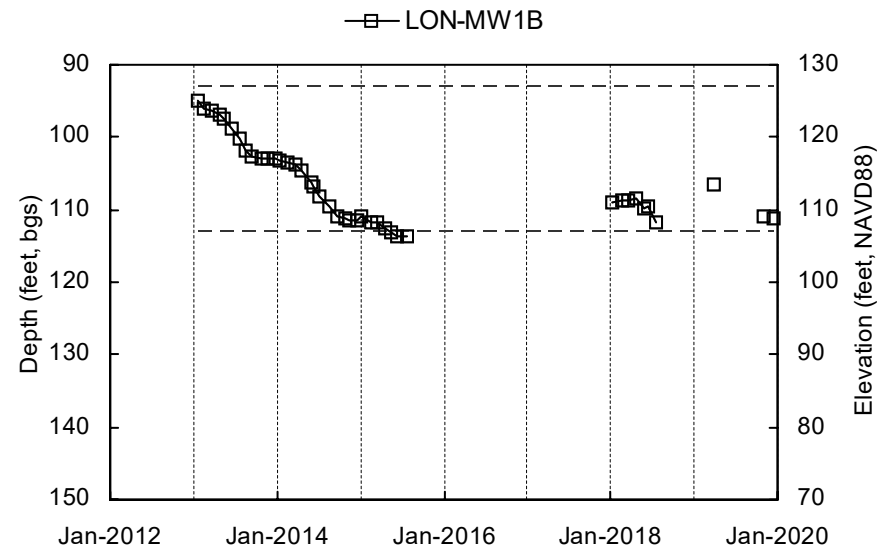
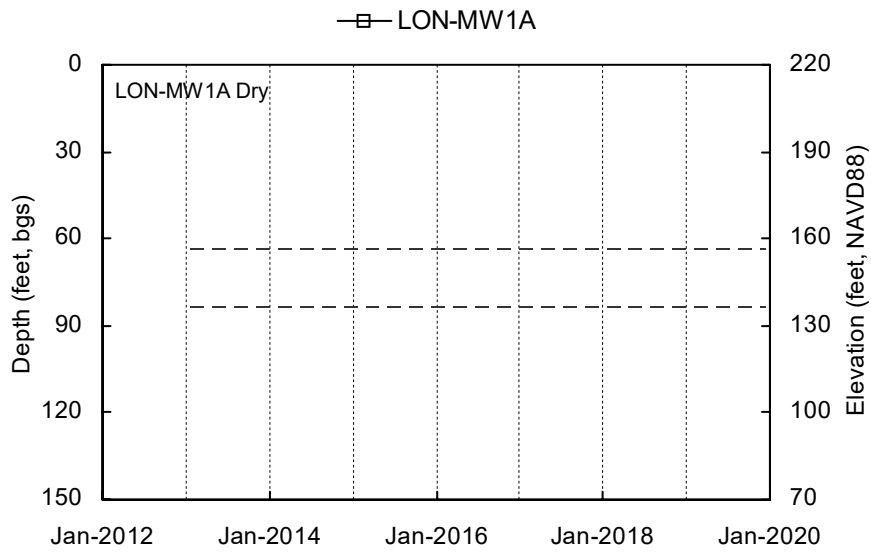

Shallow Well Screened Interval Deep Well Screened Interval
 Elevation scale shown to the nearest integer.

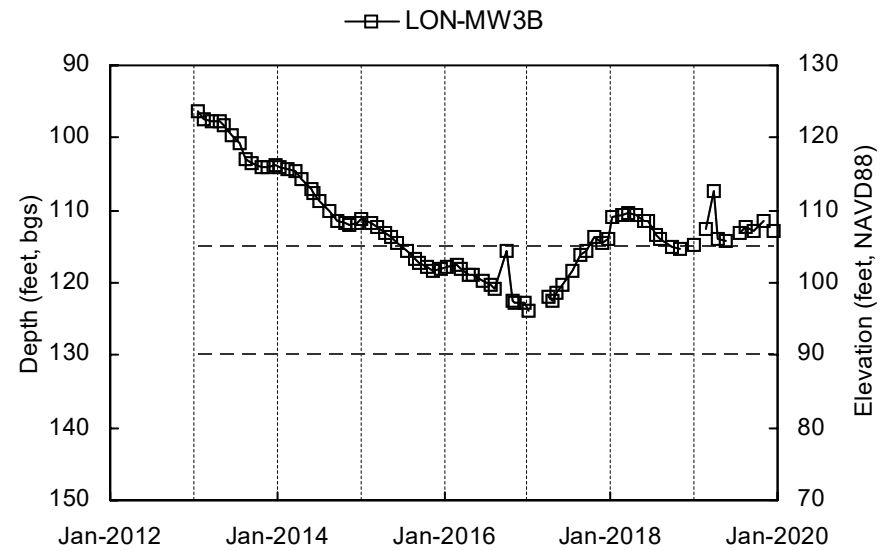
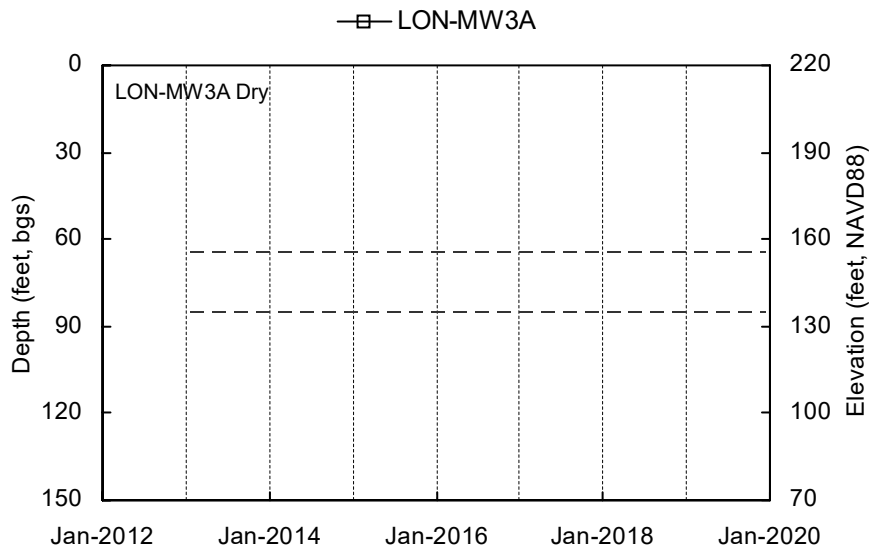
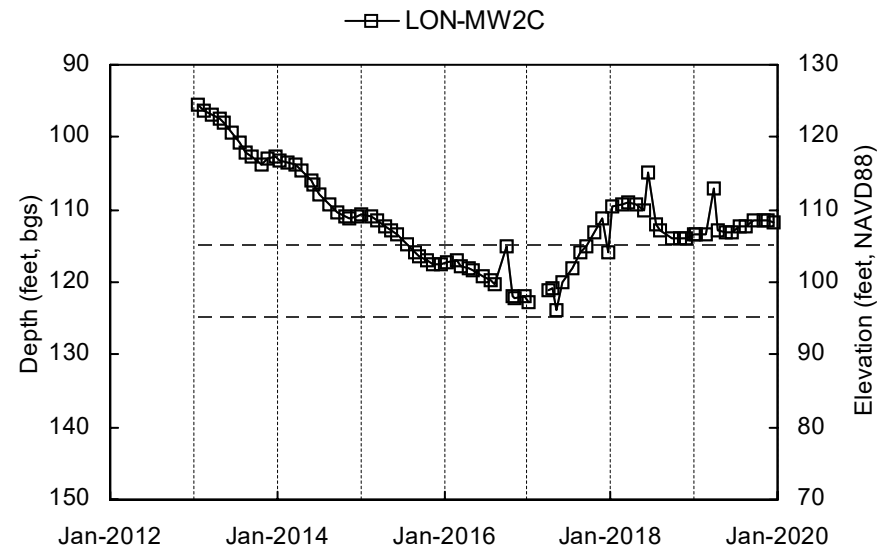
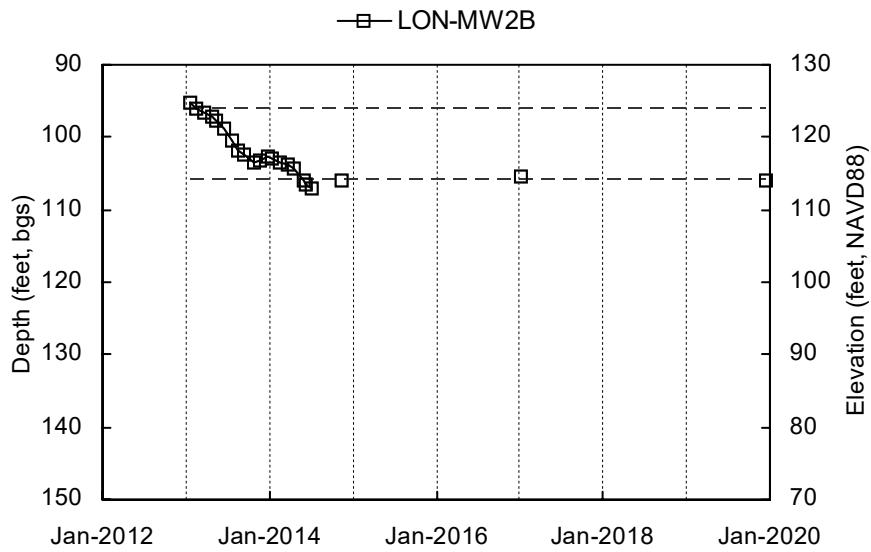

Shallow Well Screened Interval
 Deep Well Screened Interval
 Elevation scale shown to the nearest integer.

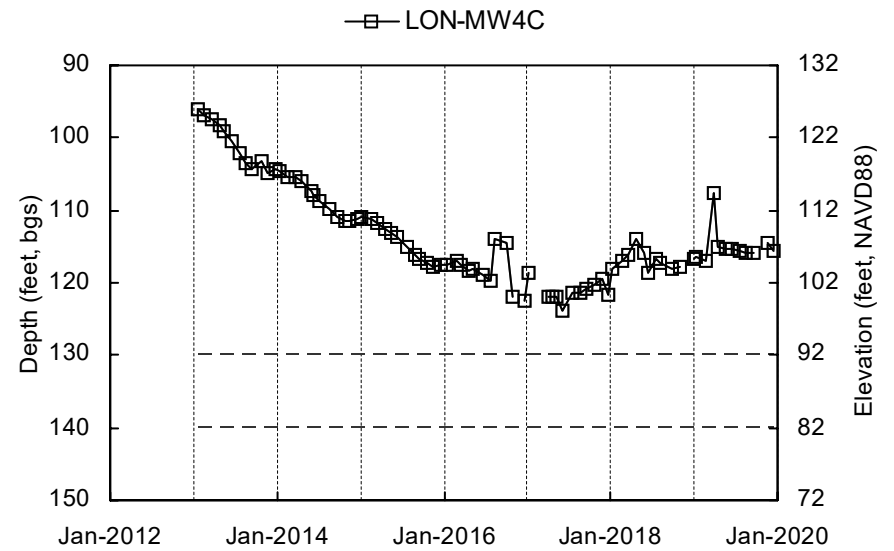
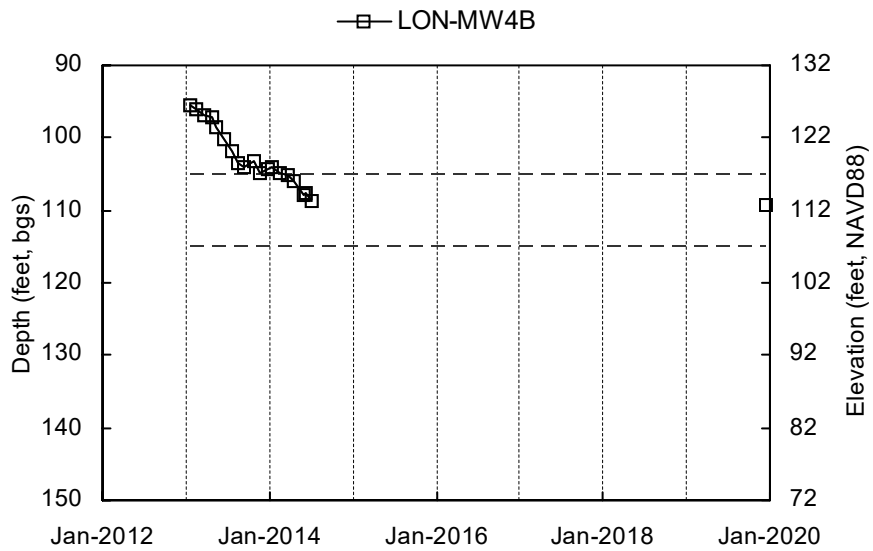
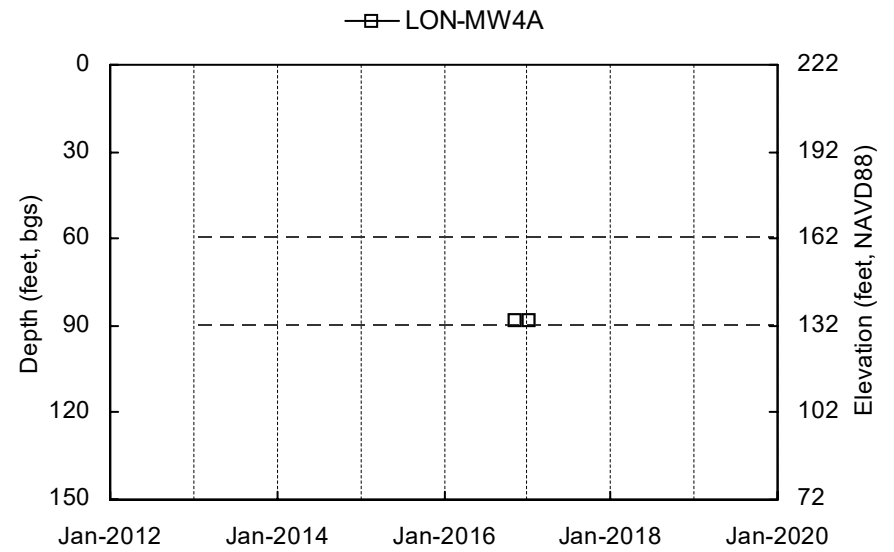
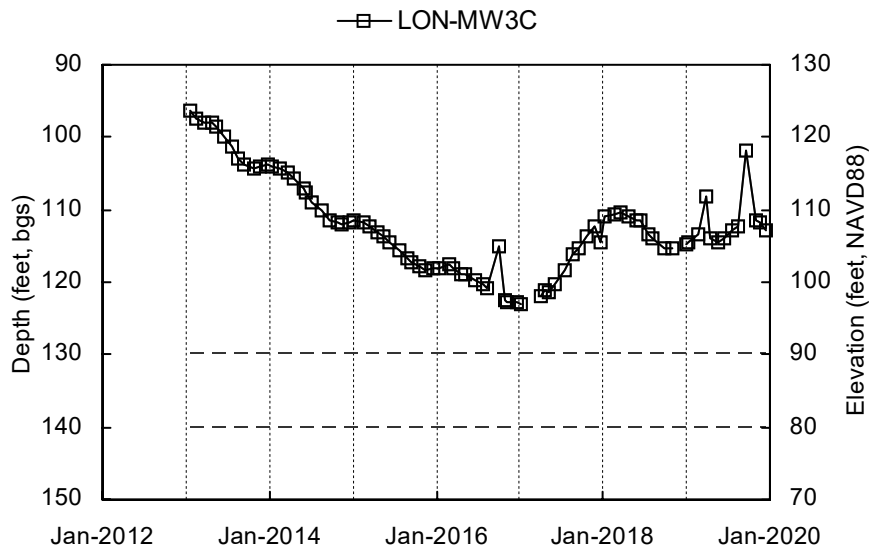

Shallow Well Screened Interval Deep Well Screened Interval
Elevation scale shown to the nearest integer.

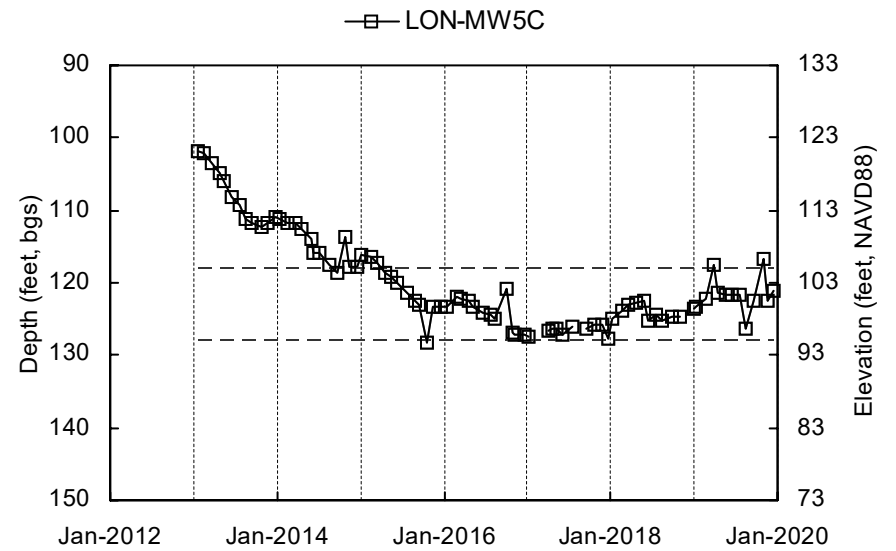
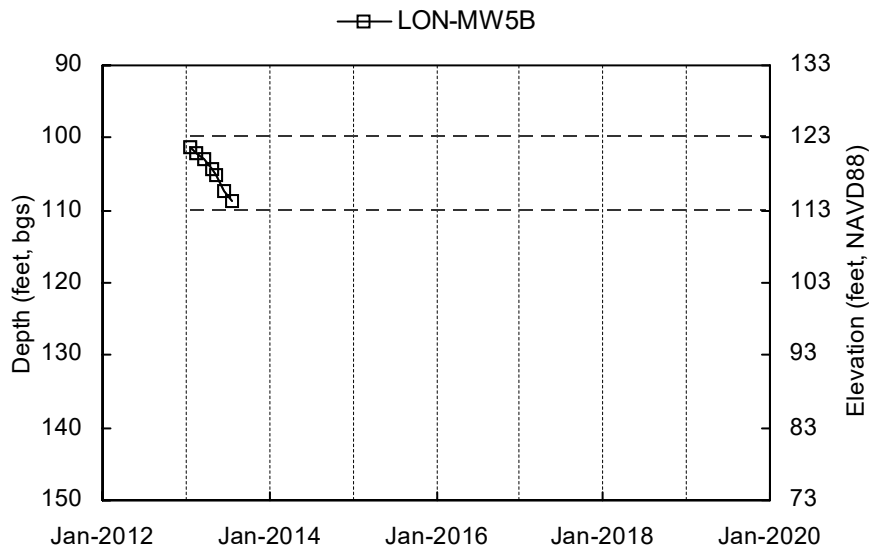
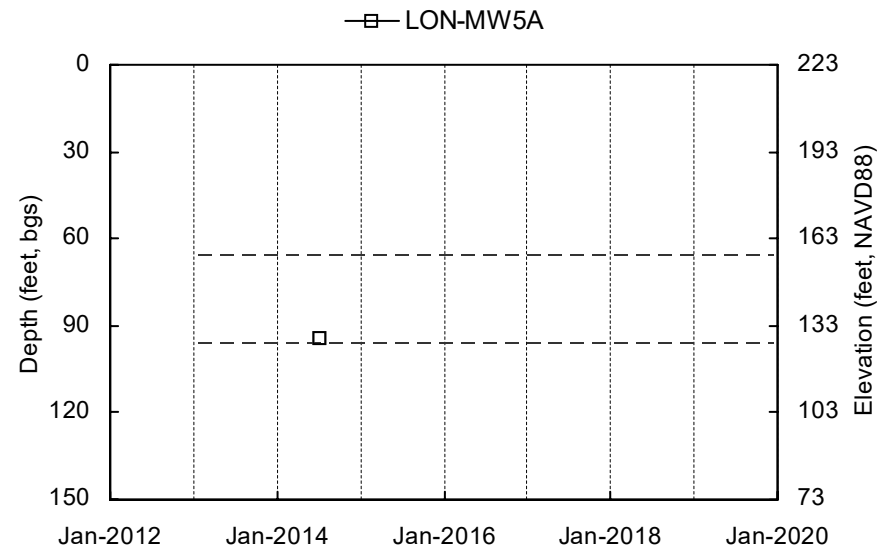
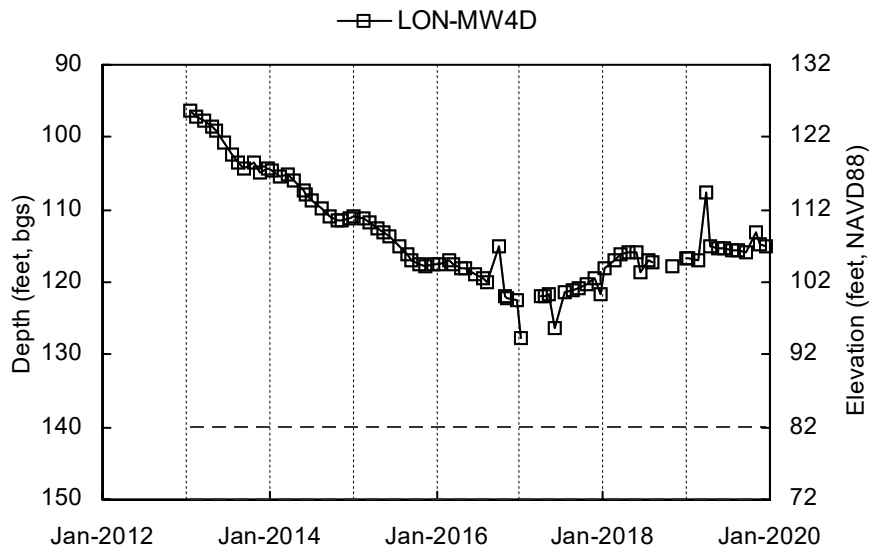

Shallow Well Screened Interval
 Deep Well Screened Interval
 Elevation scale shown to the nearest integer.

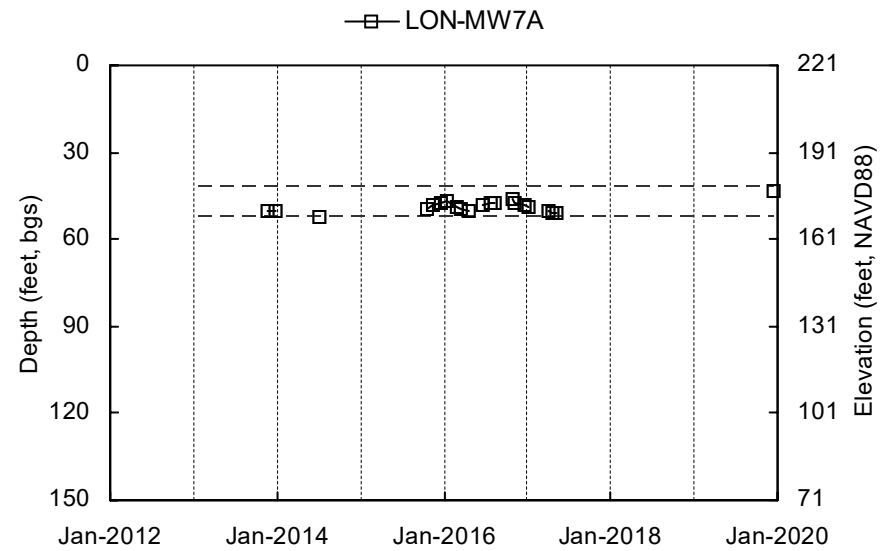
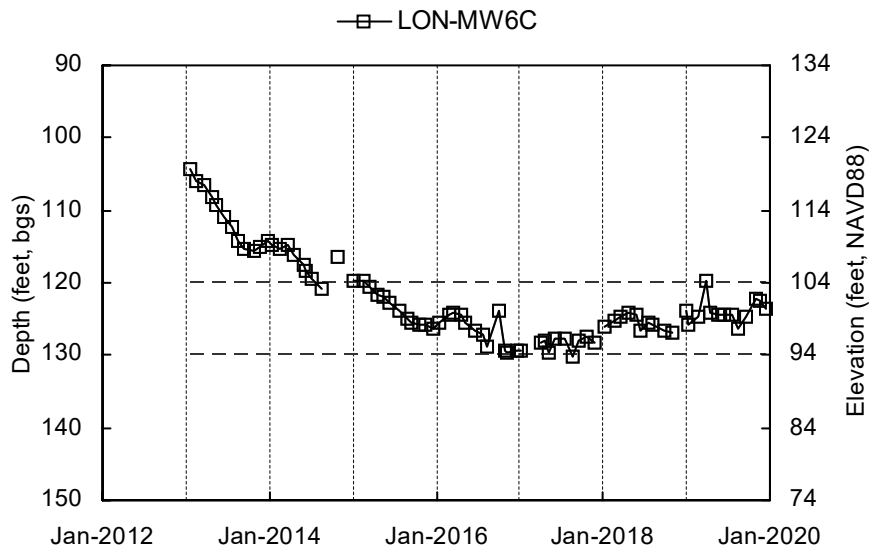
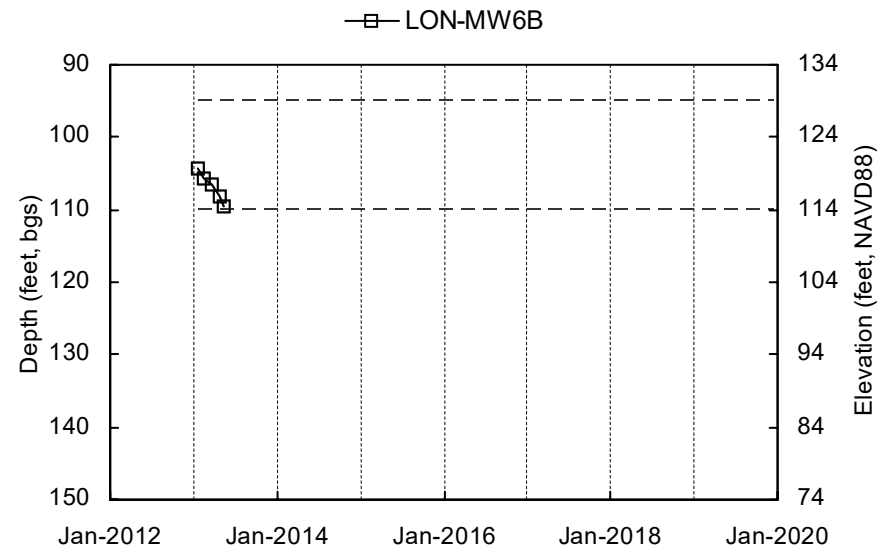
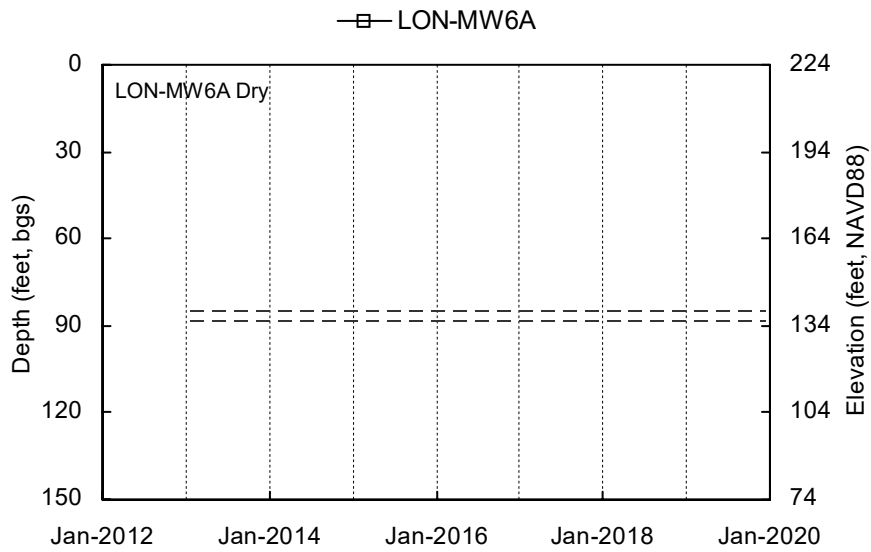

Shallow Well Screened Interval Deep Well Screened Interval
Elevation scale shown to the nearest integer.

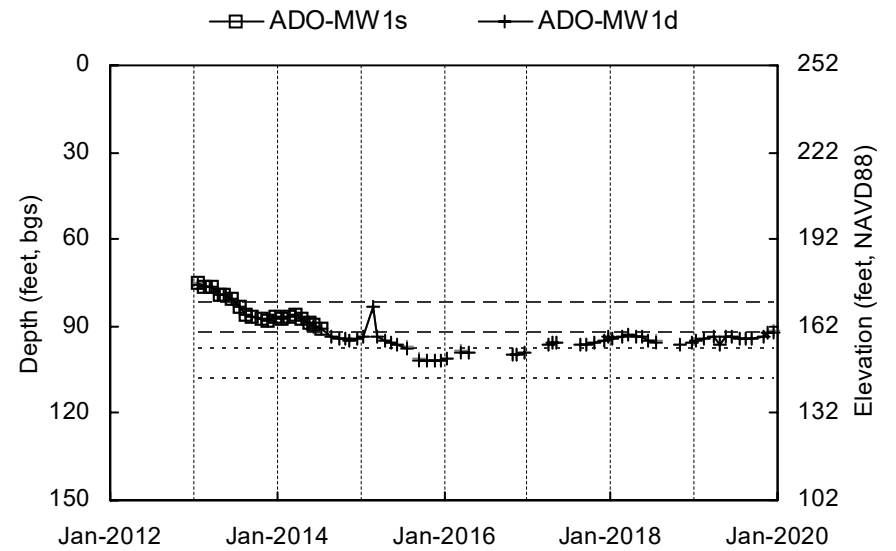
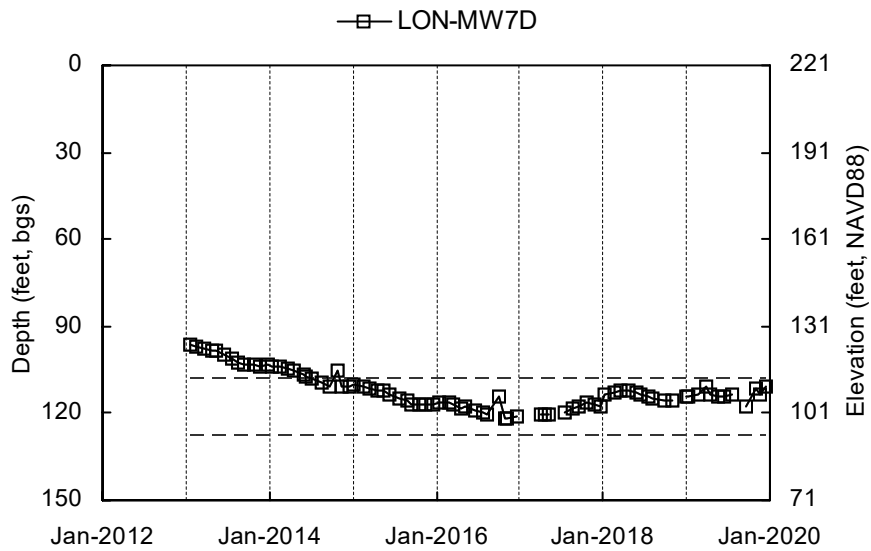
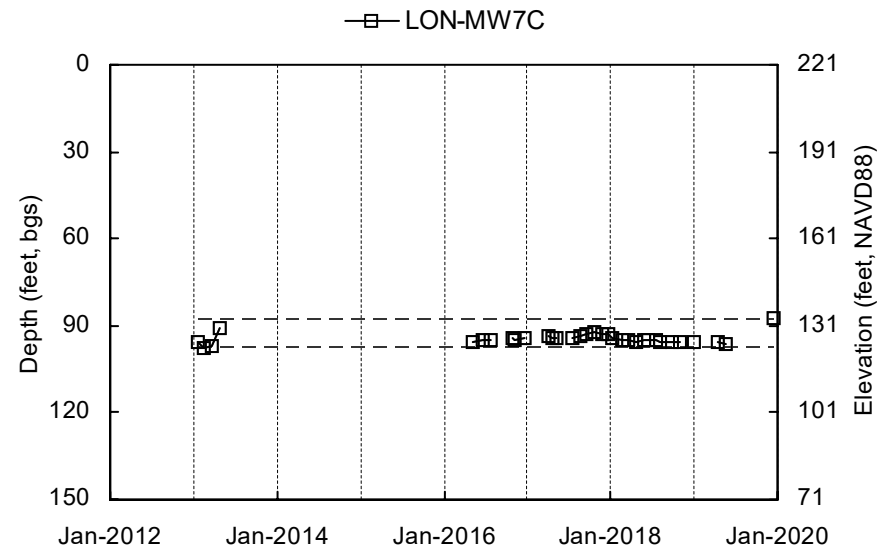
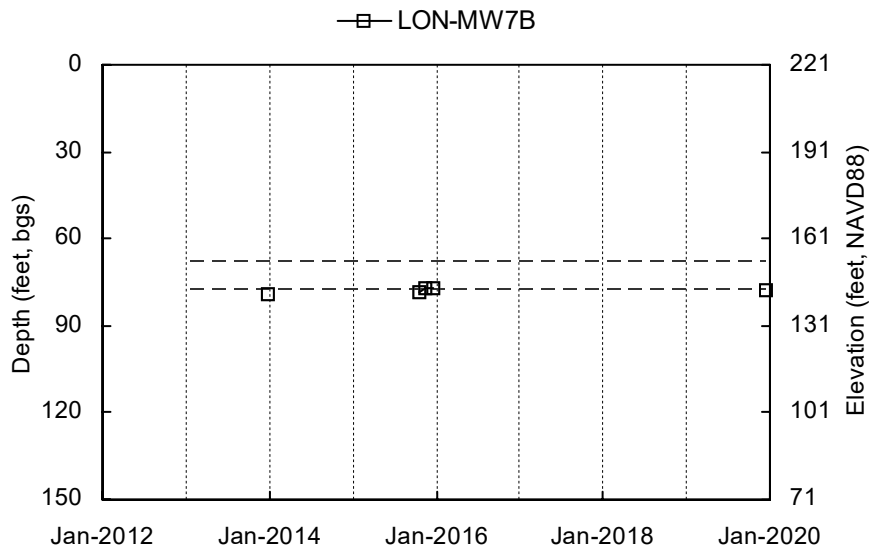

Shallow Well Screened Interval
 Deep Well Screened Interval
 Elevation scale shown to the nearest integer.

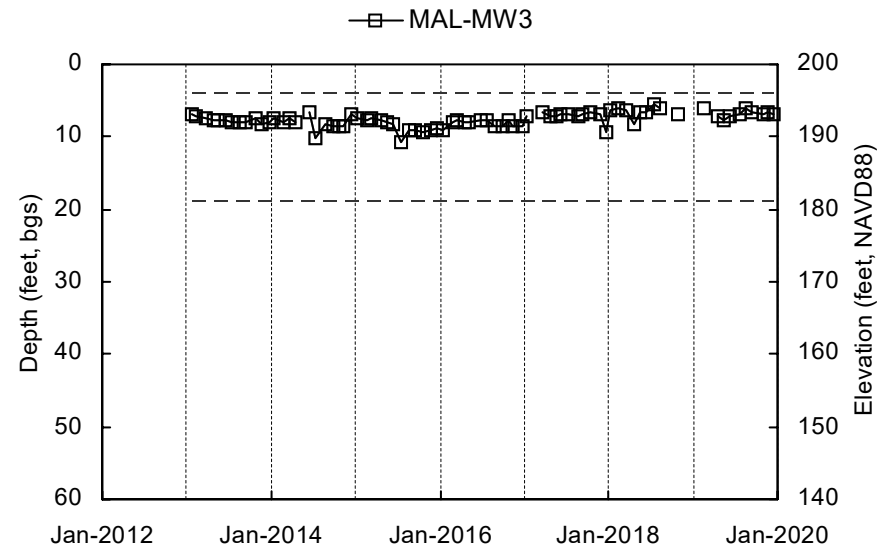
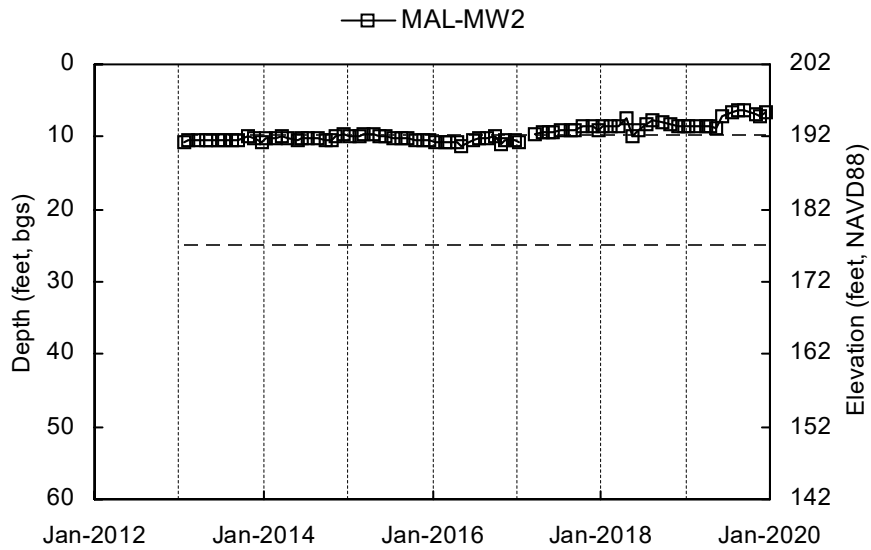
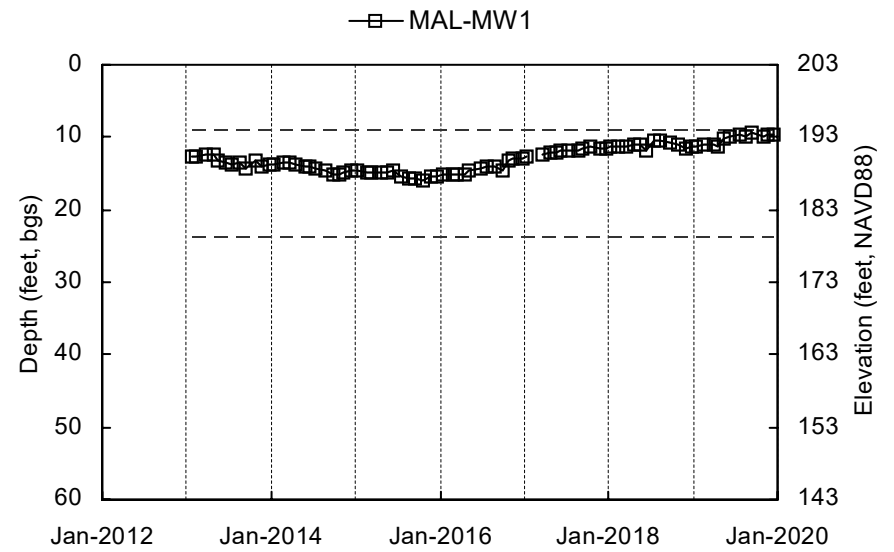
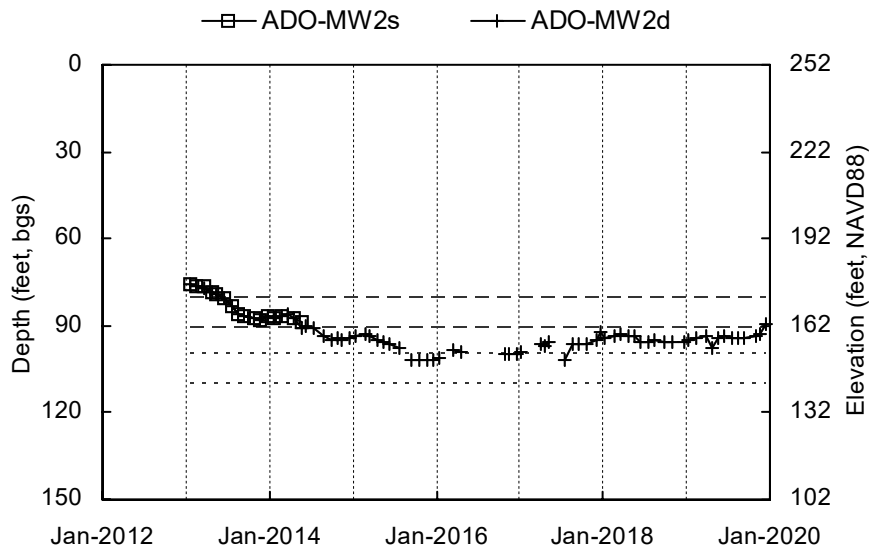

Shallow Well Screened Interval
 Deep Well Screened Interval
 Elevation scale shown to the nearest integer.

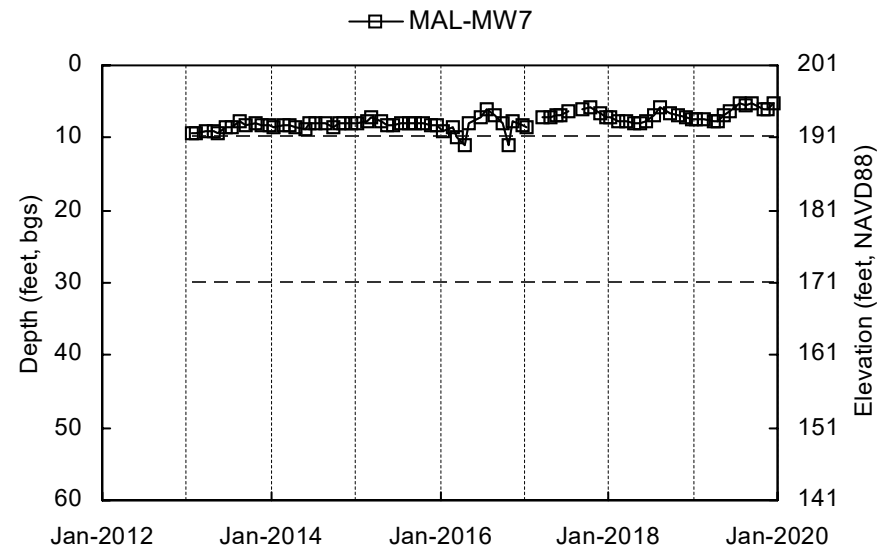
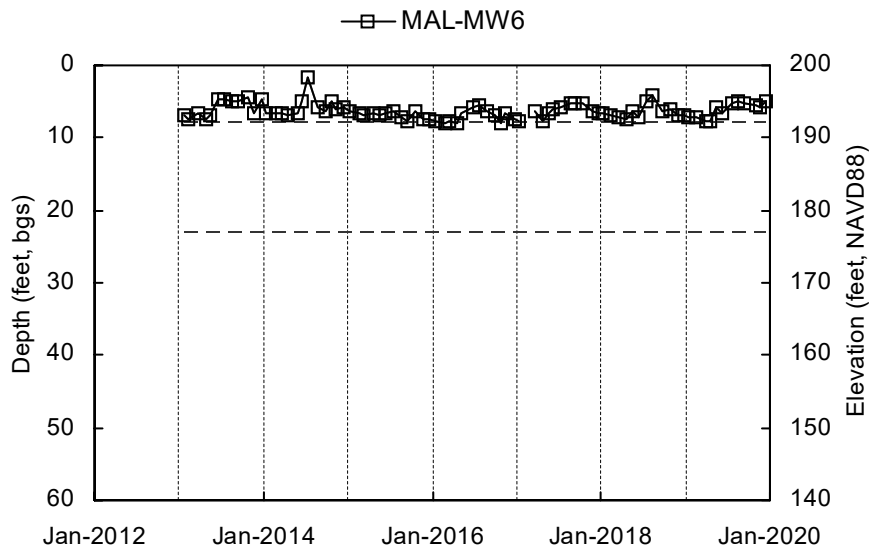
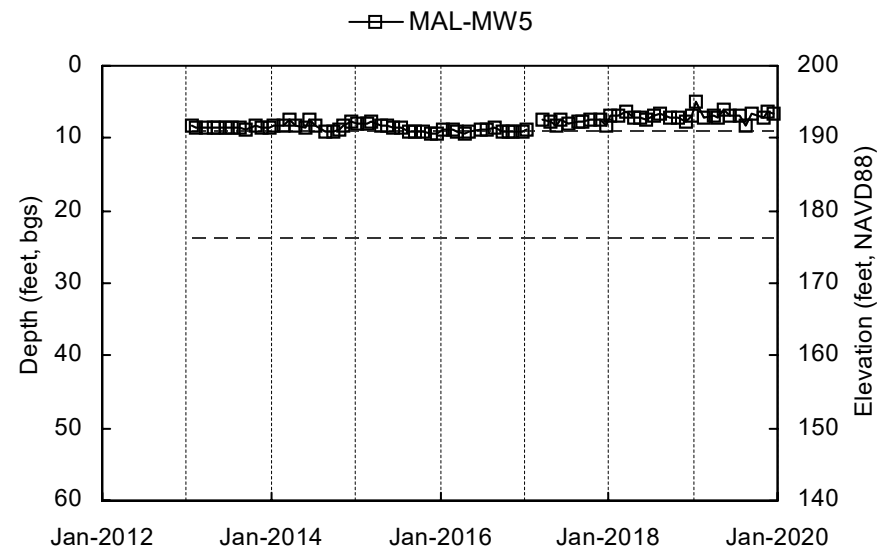
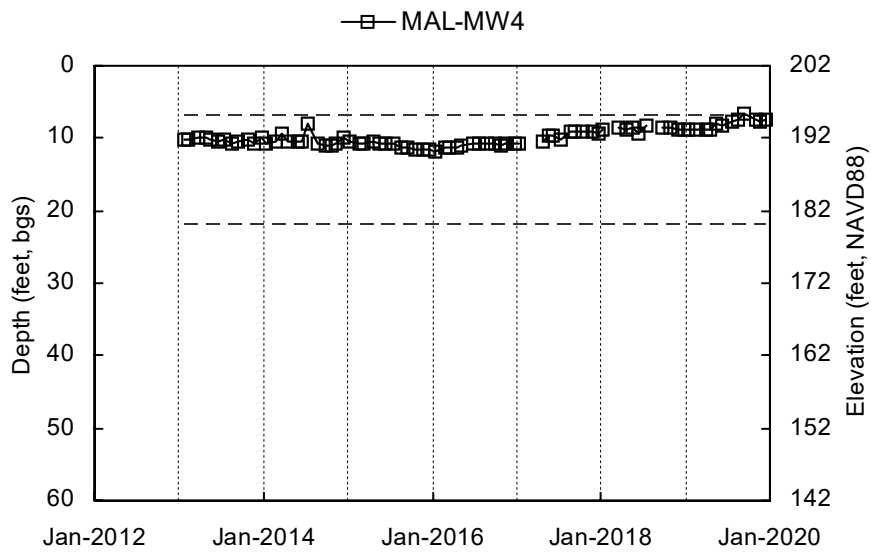

Shallow Well Screened Interval
 Deep Well Screened Interval
 Elevation scale shown to the nearest integer.

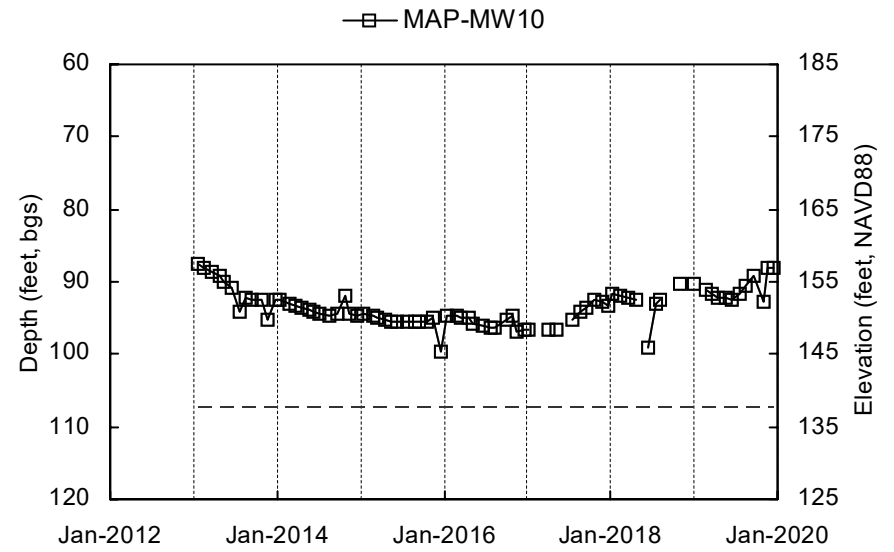
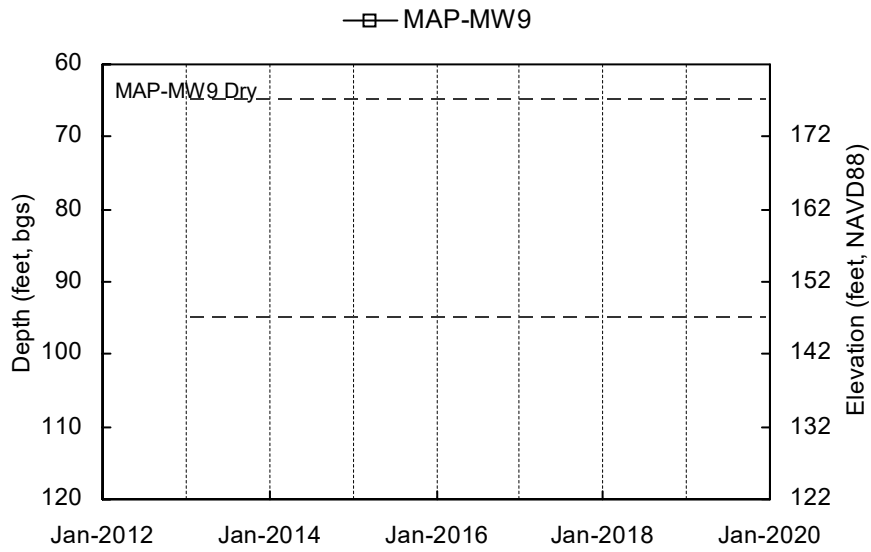
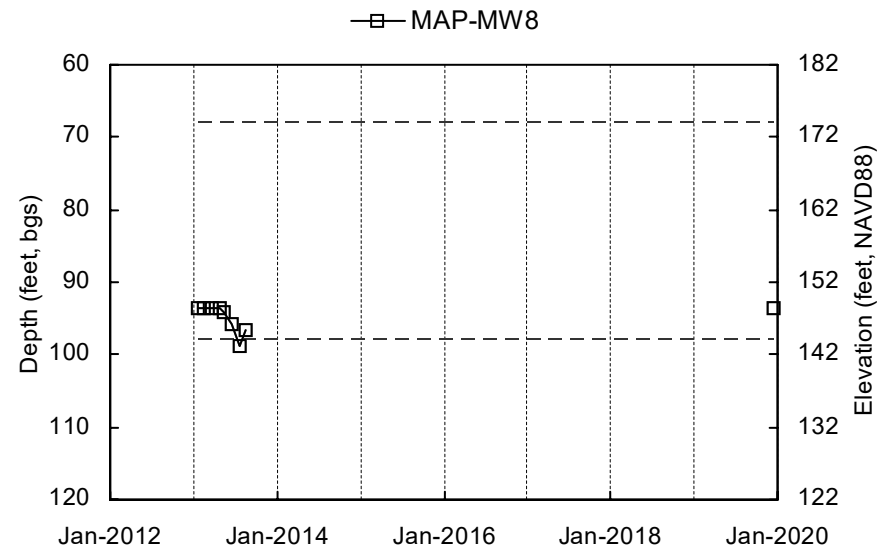
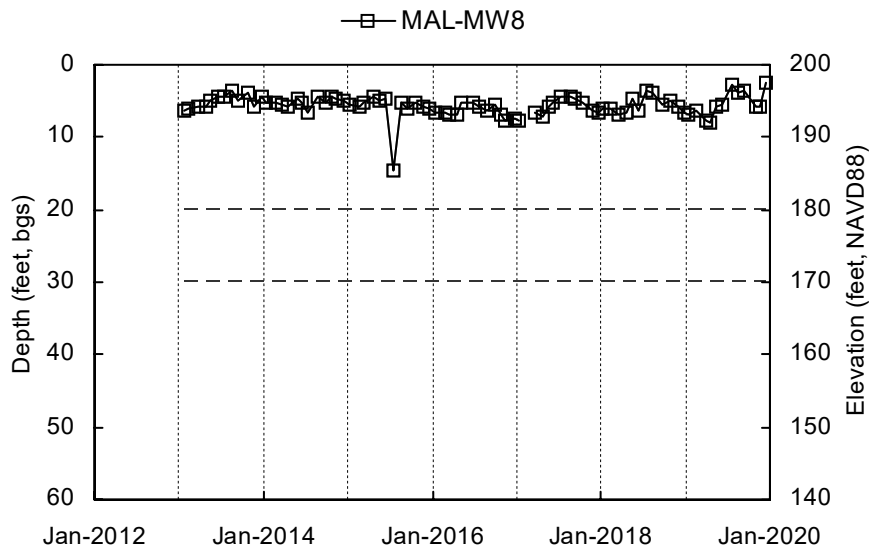

— — — Shallow Well Screened Interval Deep Well Screened Interval
 Elevation scale shown to the nearest integer.

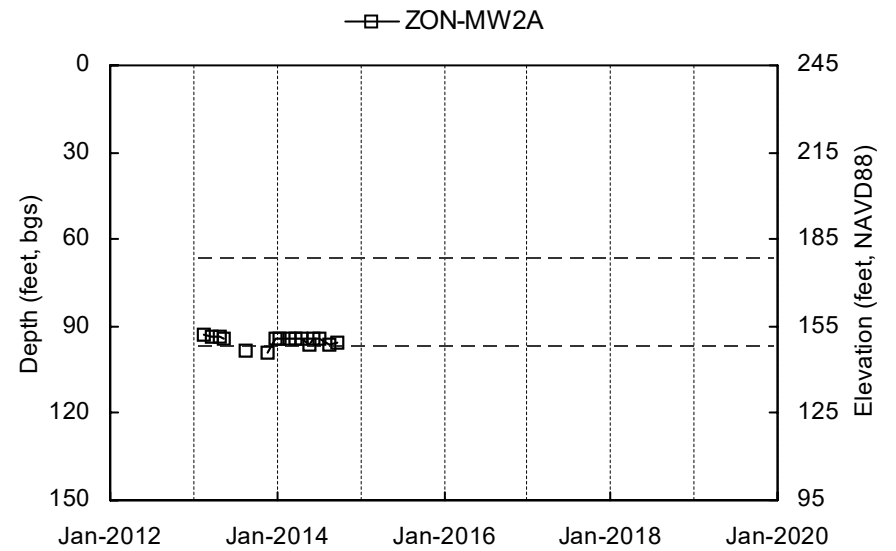
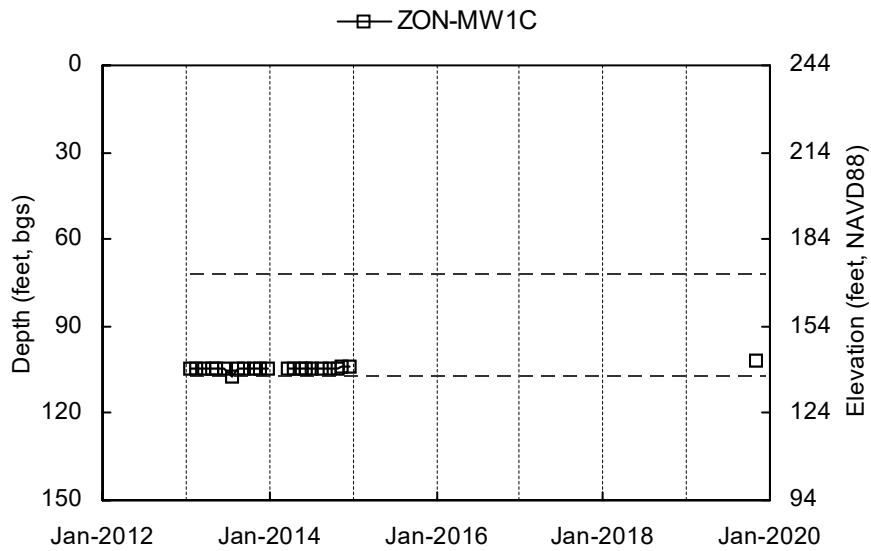
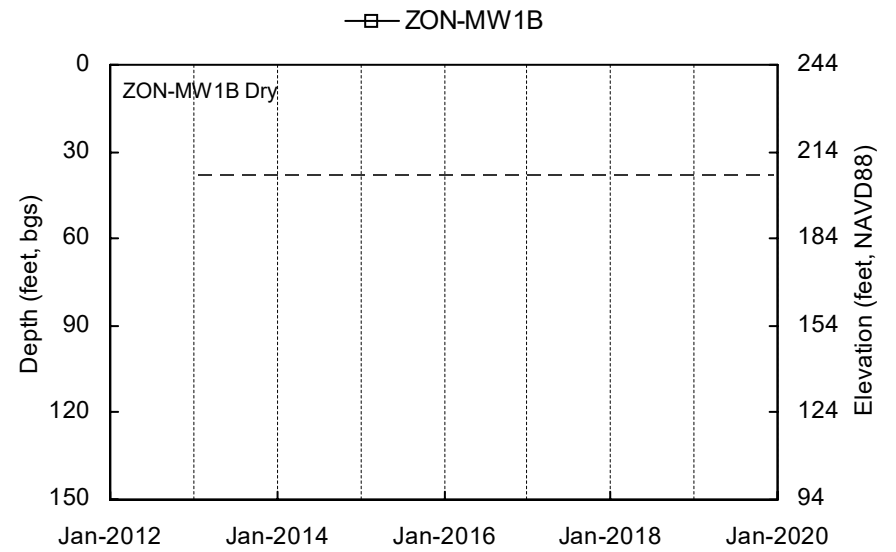
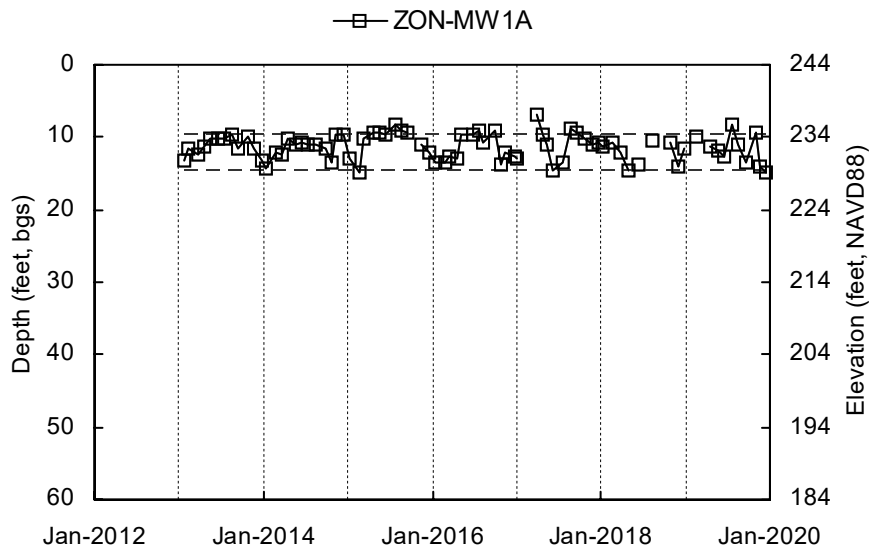

Shallow Well Screened Interval
 Deep Well Screened Interval
 Elevation scale shown to the nearest integer.

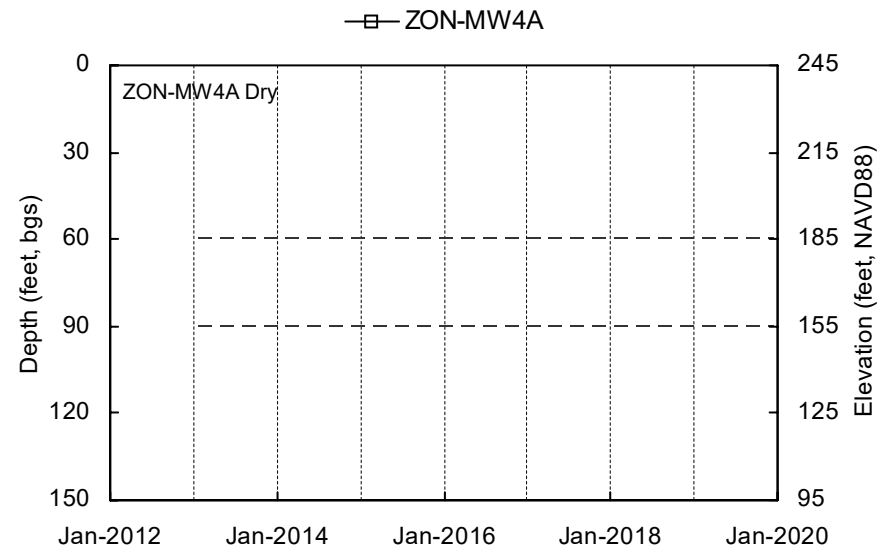
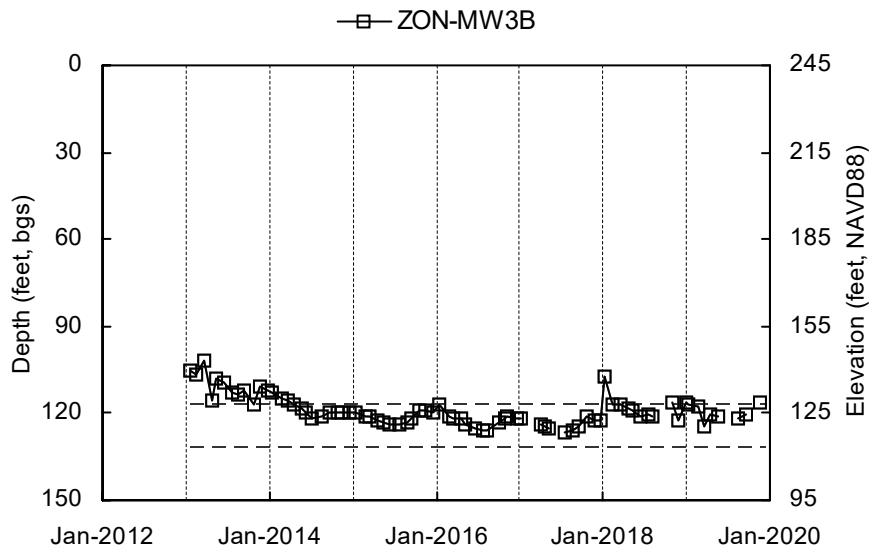
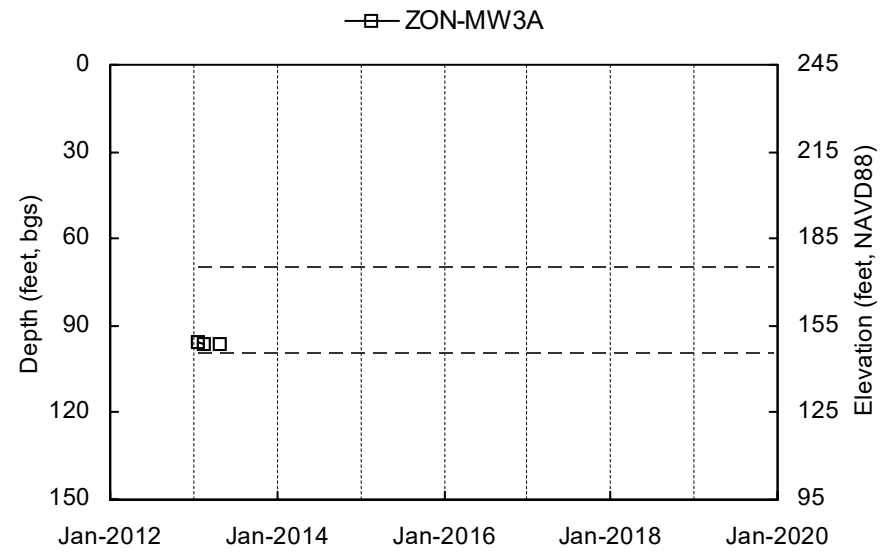
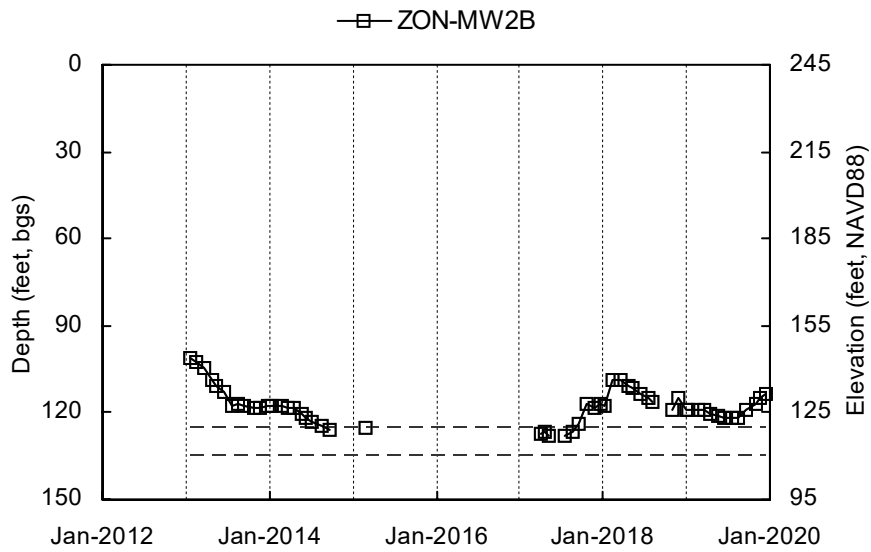

Shallow Well Screened Interval
 Deep Well Screened Interval
 Elevation scale shown to the nearest integer.

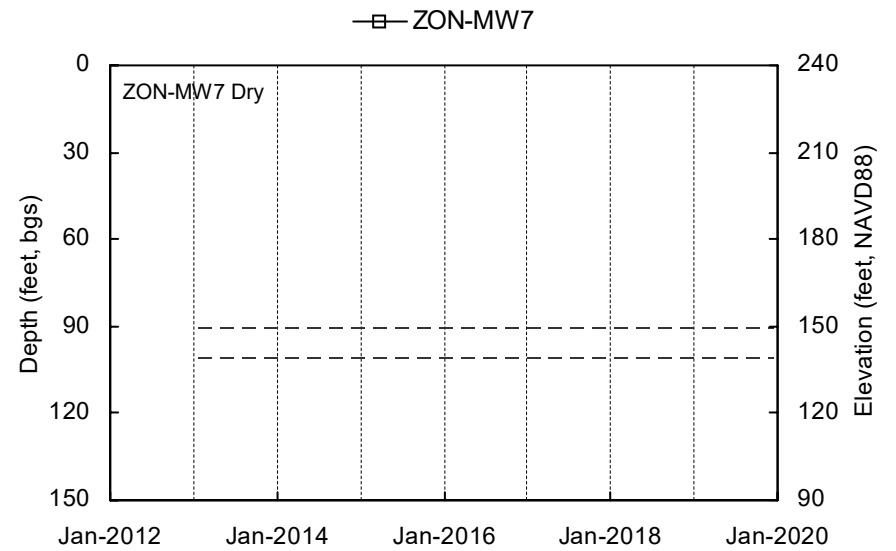
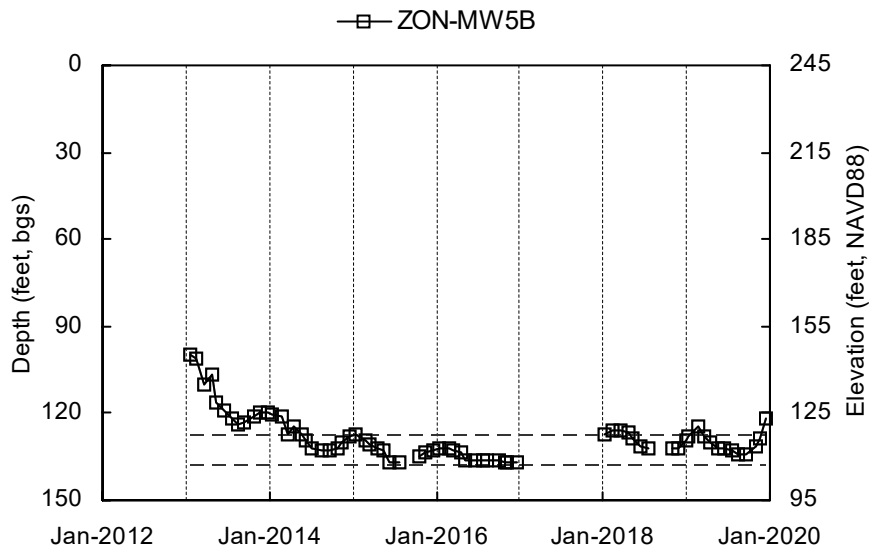
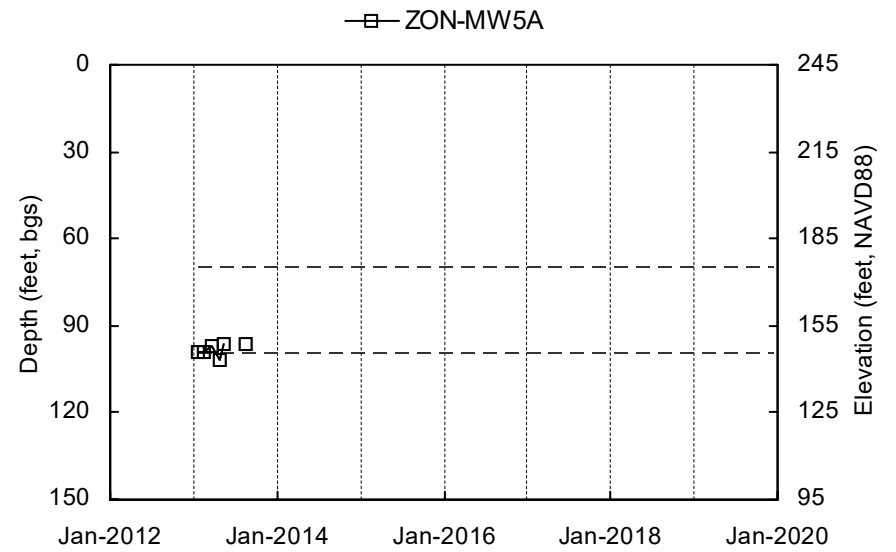
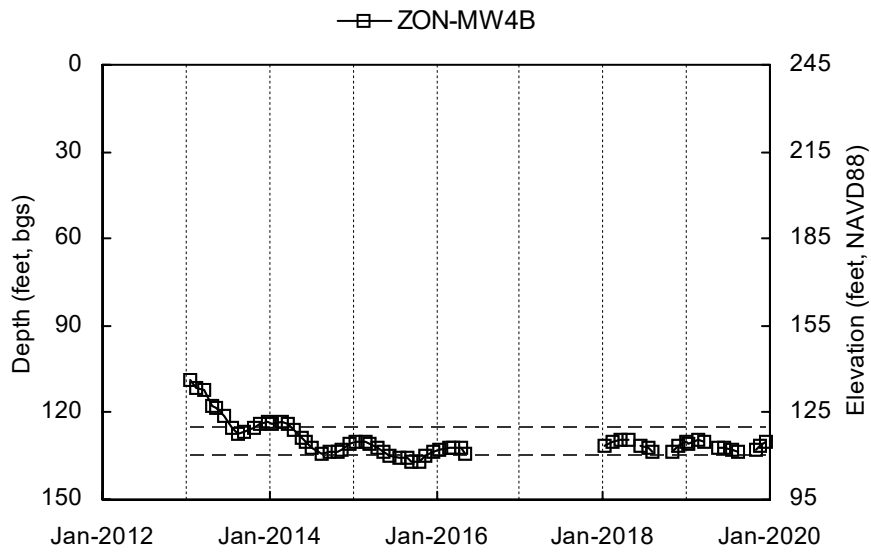

Shallow Well Screened Interval Deep Well Screened Interval
 Elevation scale shown to the nearest integer.

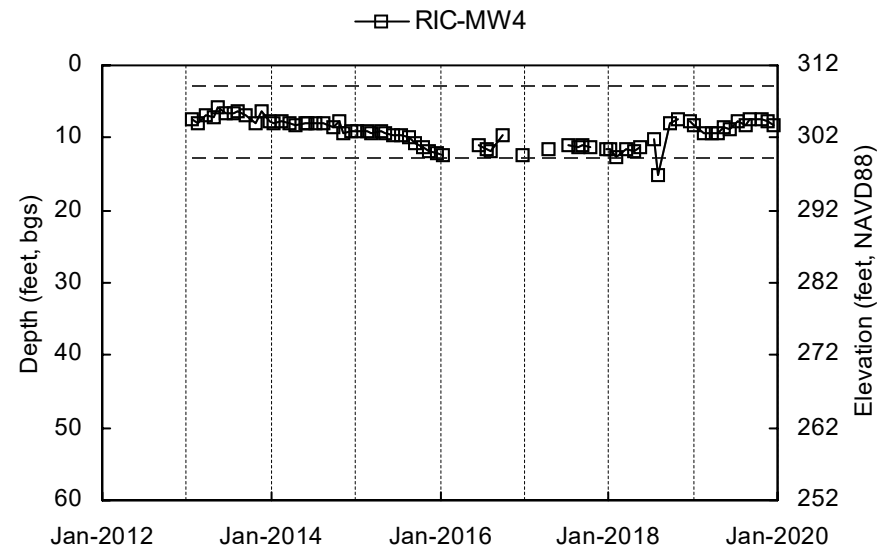
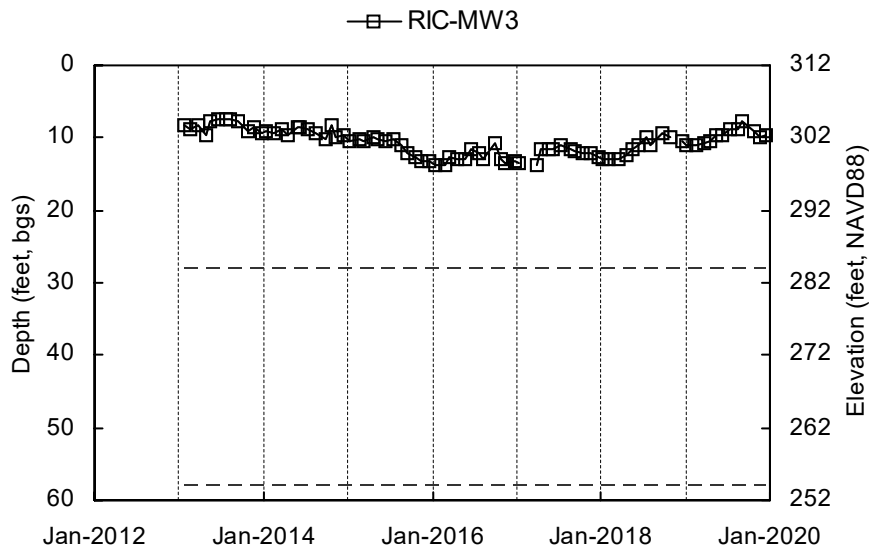
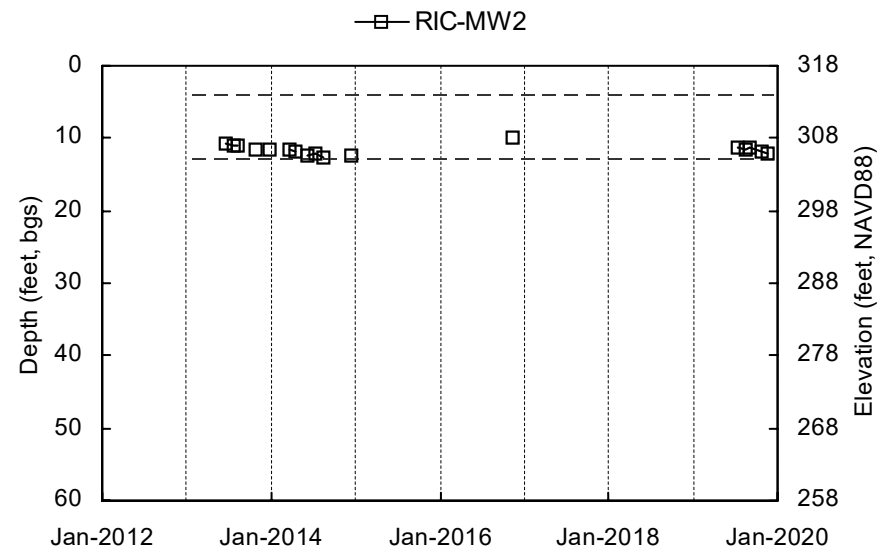
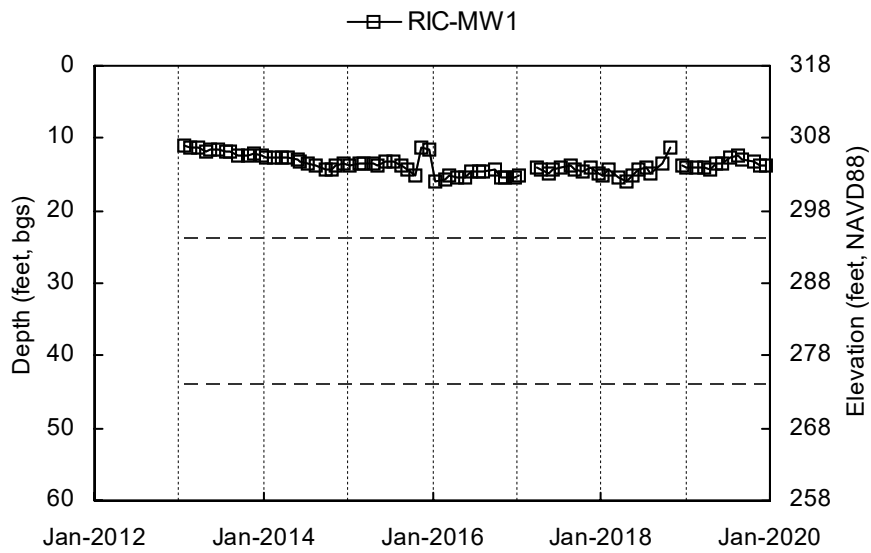

Shallow Well Screened Interval Deep Well Screened Interval
Elevation scale shown to the nearest integer.

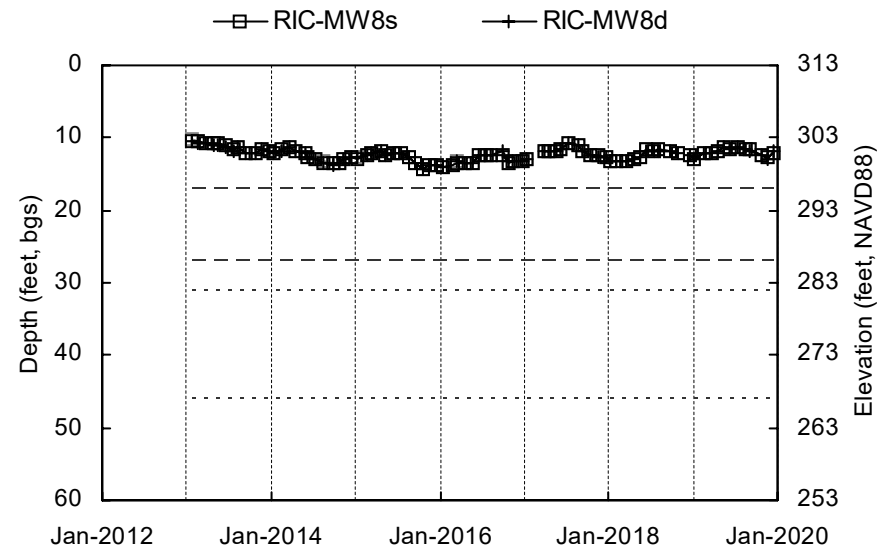
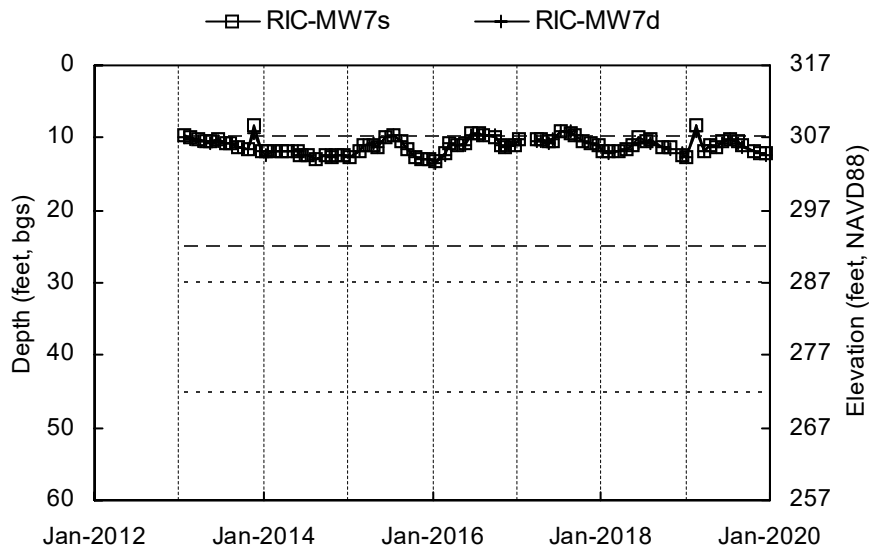
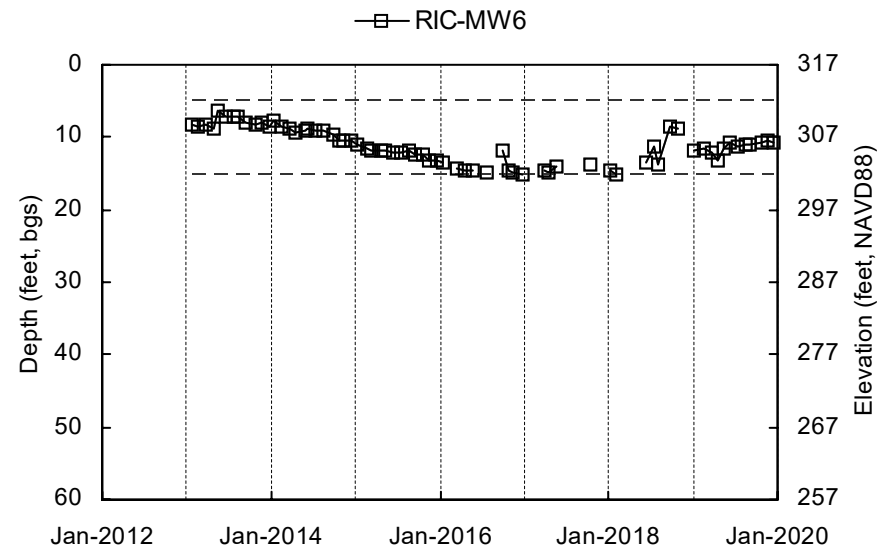
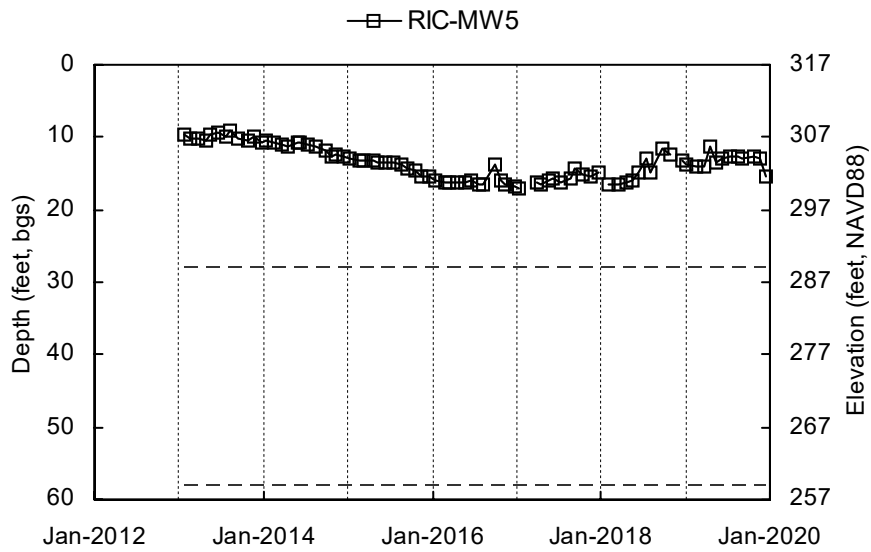

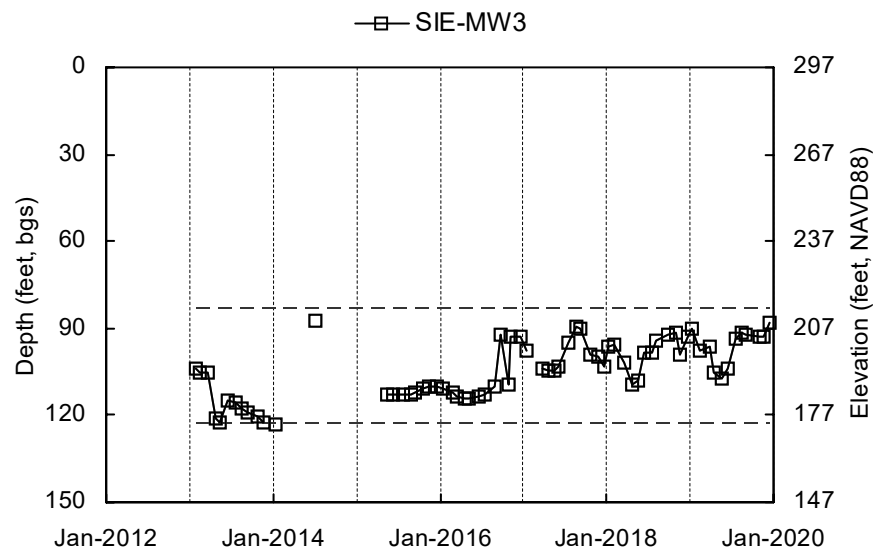
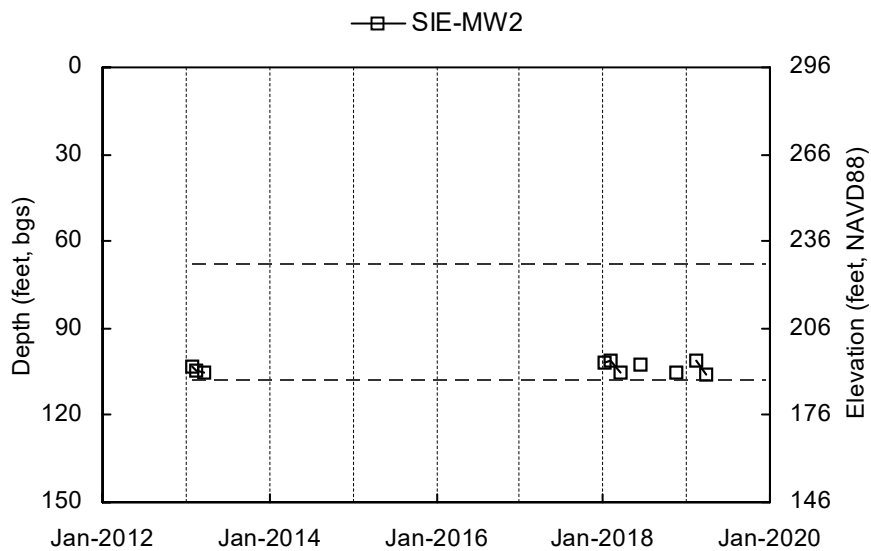
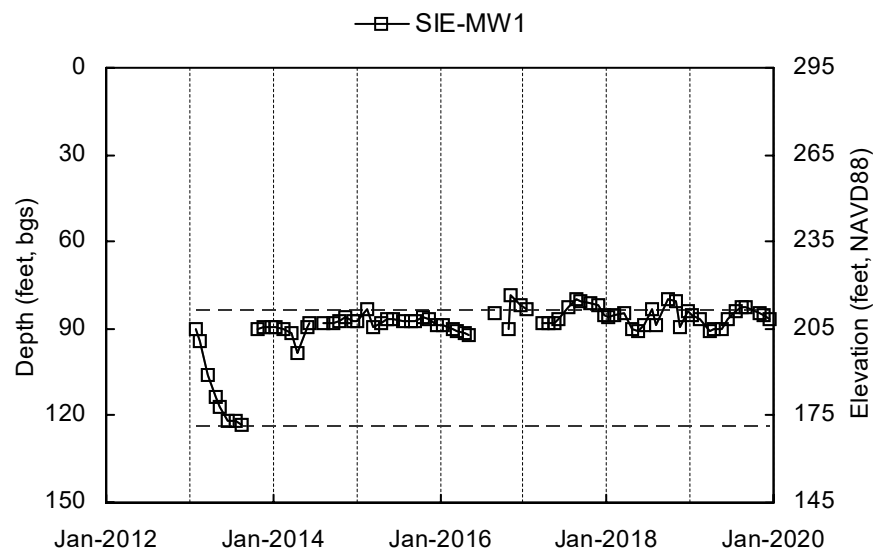
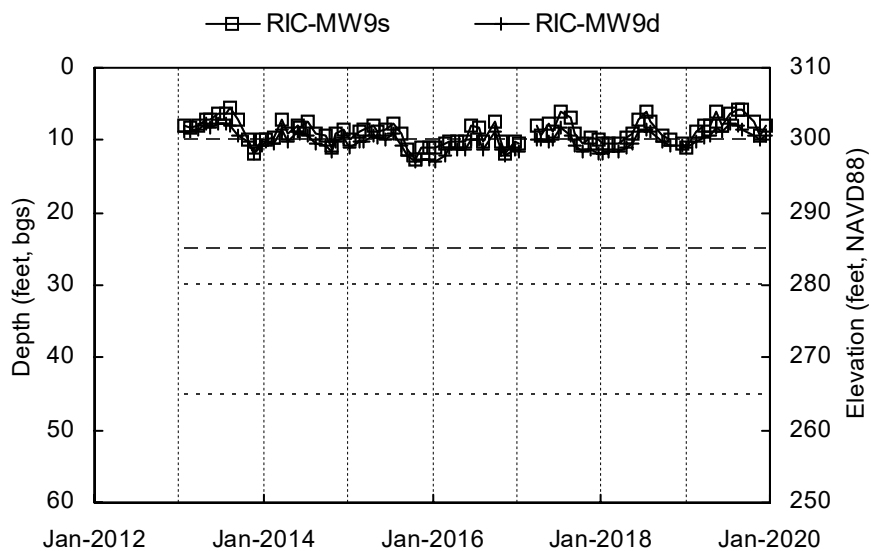

Shallow Well Screened Interval
 Deep Well Screened Interval
Elevation scale shown to the nearest integer.



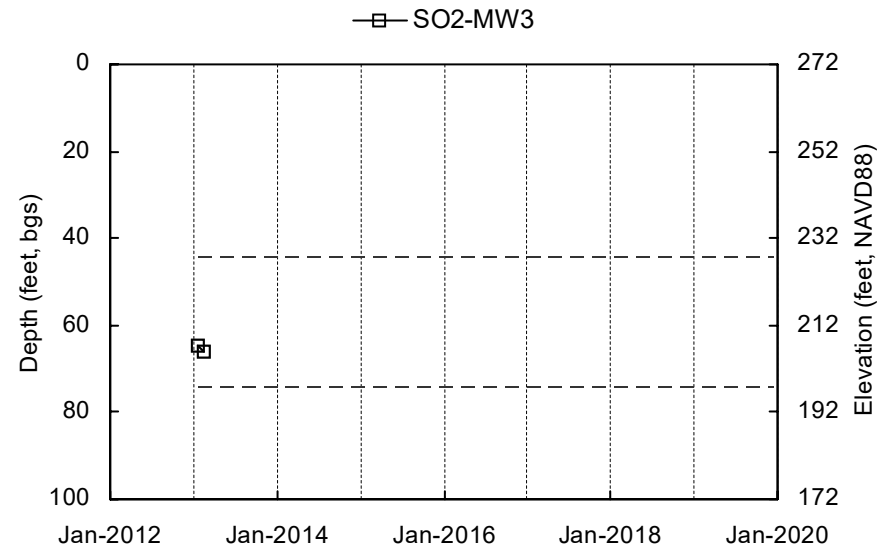
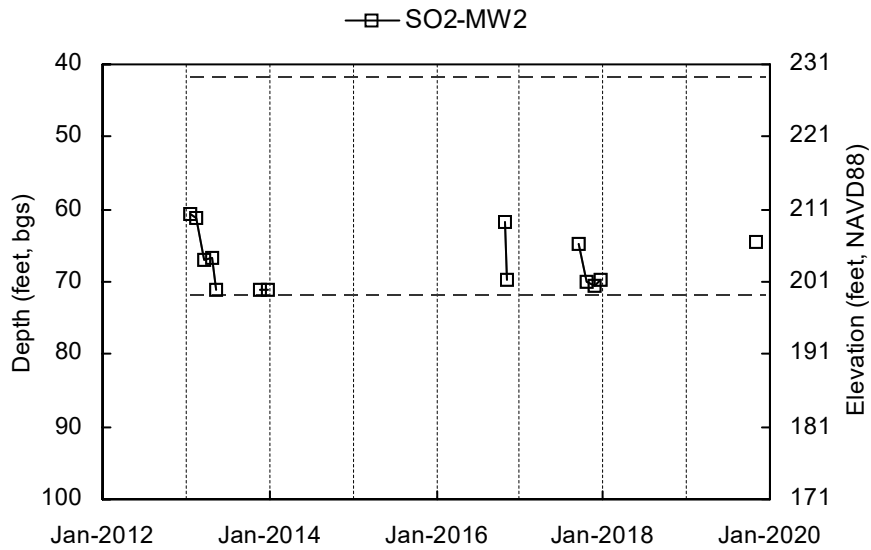
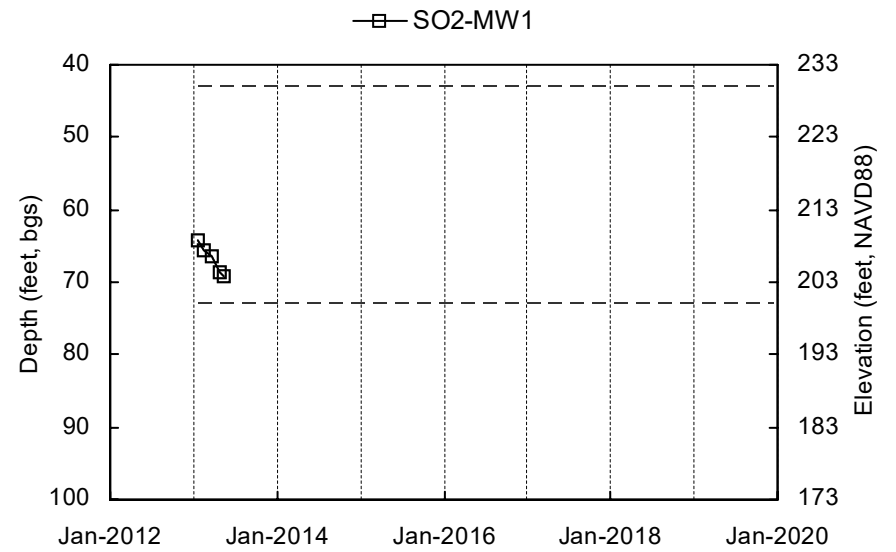
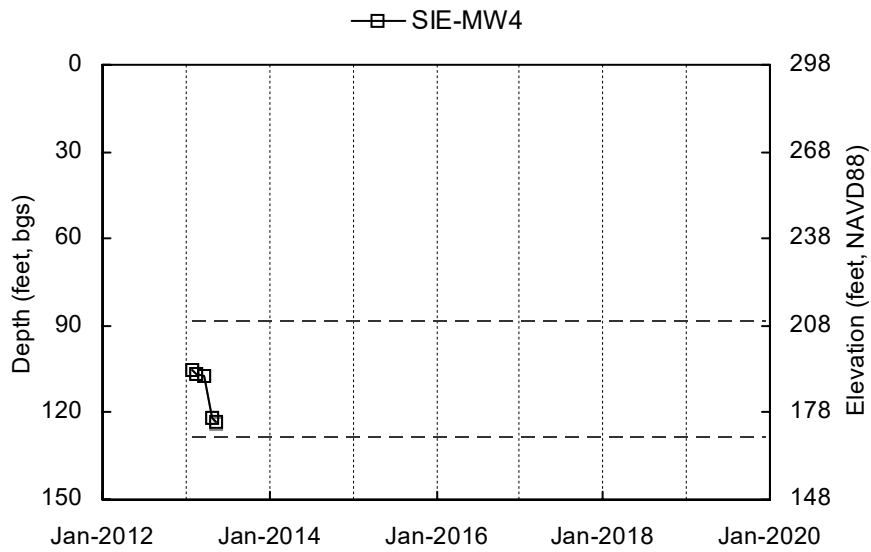

Shallow Well Screened Interval
 Deep Well Screened Interval
 Elevation scale shown to the nearest integer.



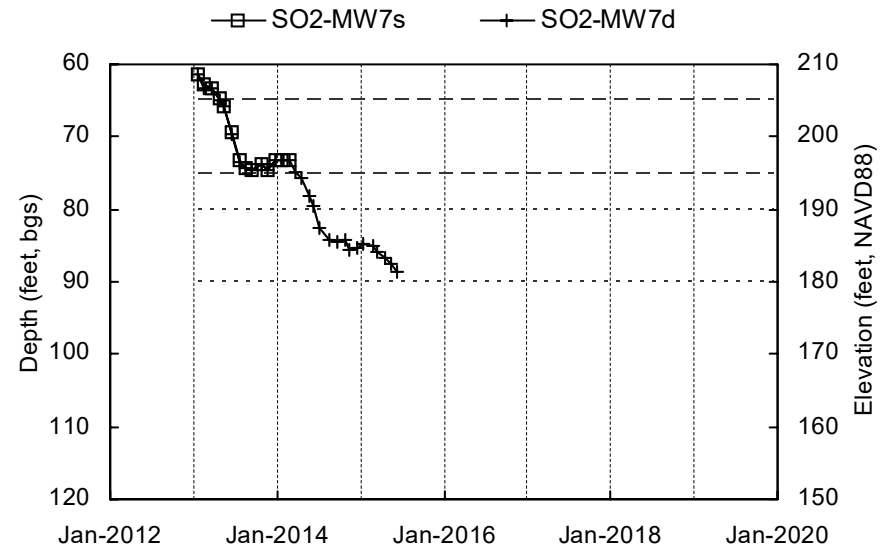
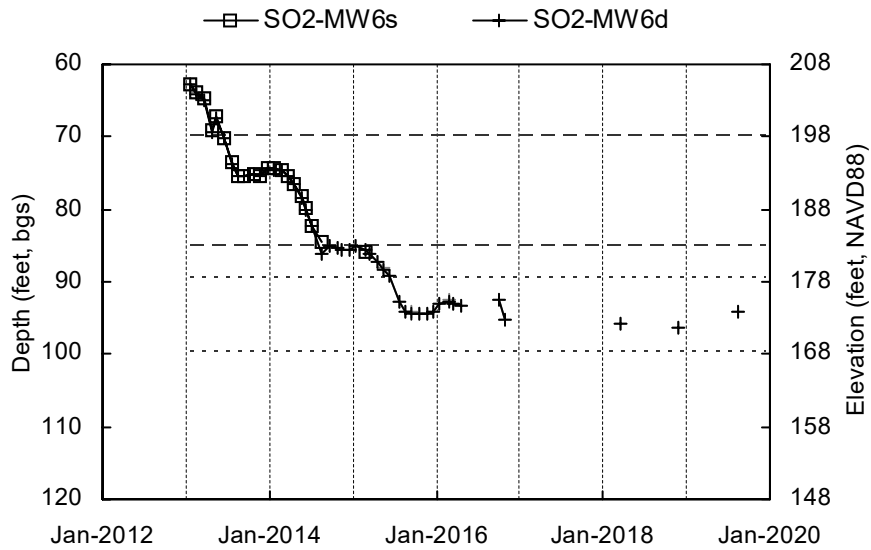
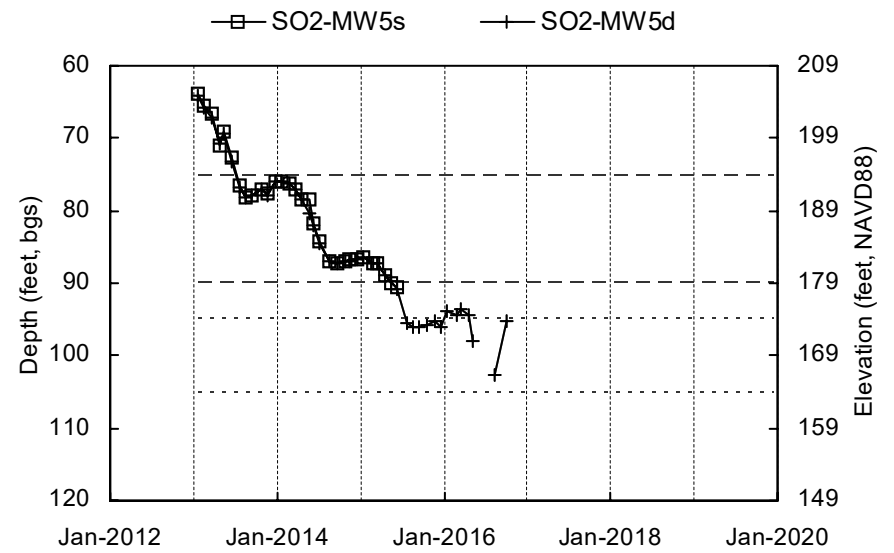
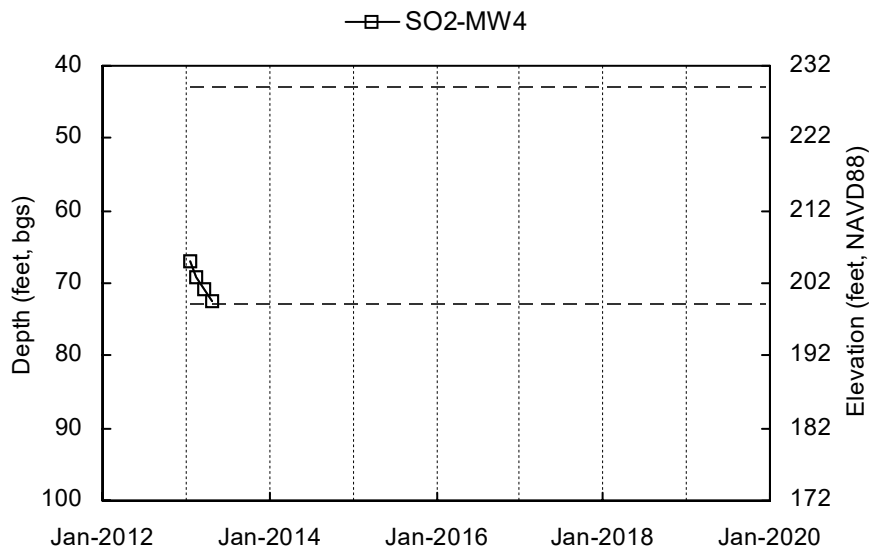

 Shallow Well Screened Interval
  Deep Well Screened Interval
 Elevation scale shown to the nearest integer.



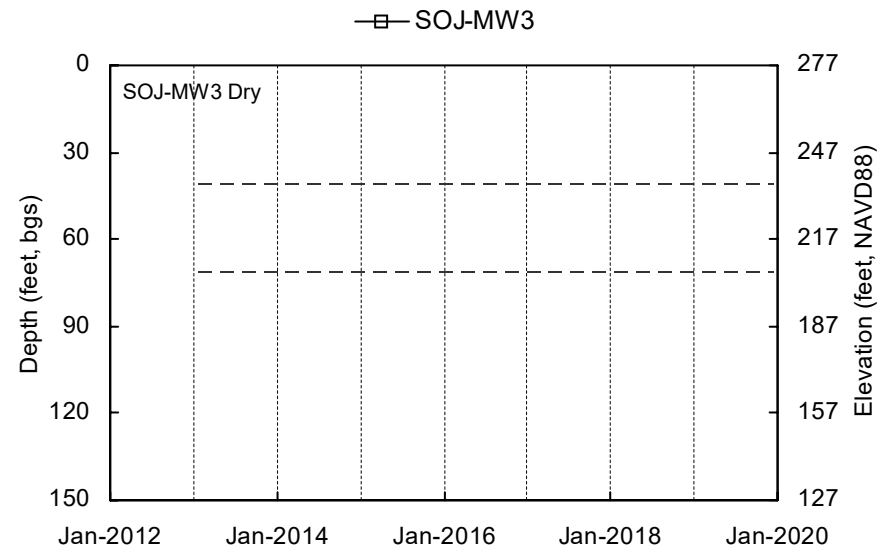
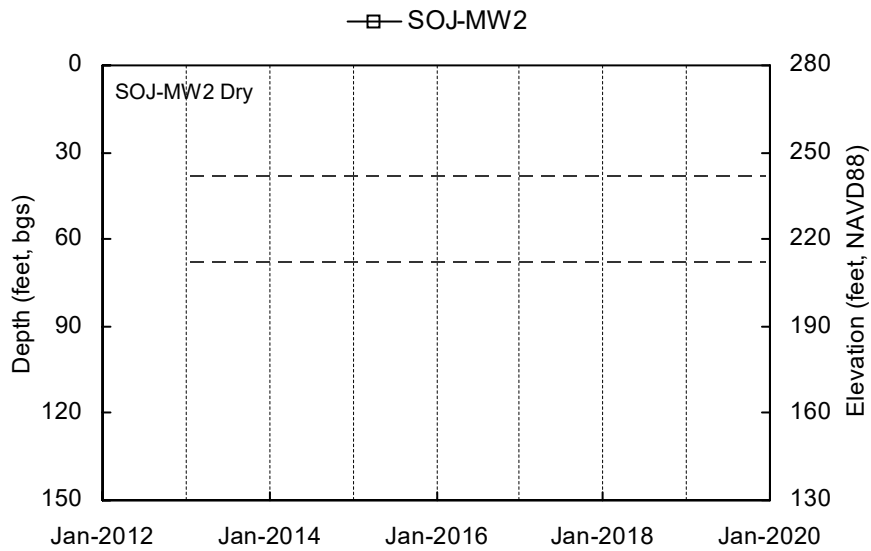
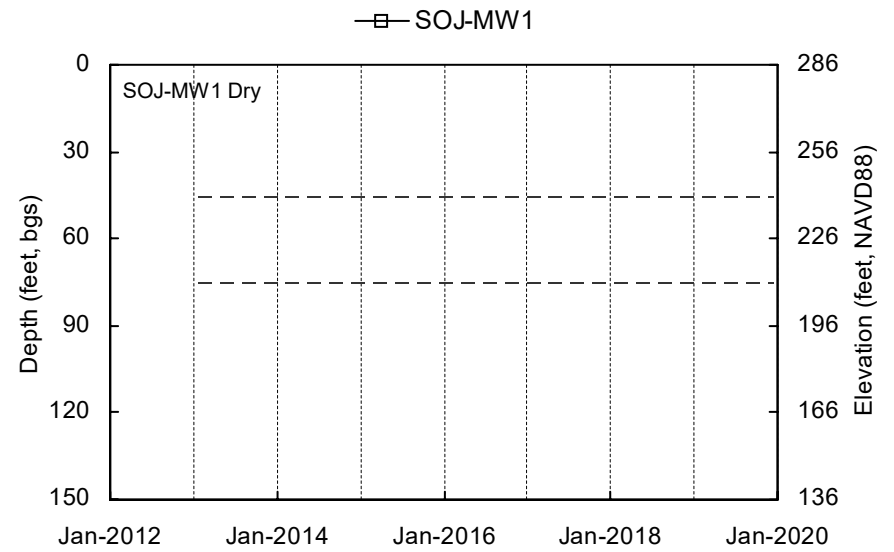
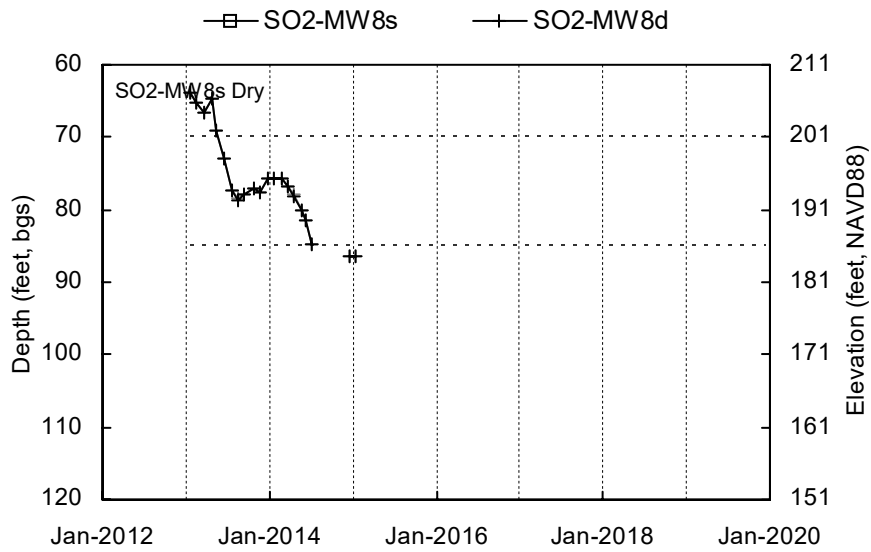

 Shallow Well Screened Interval
  Deep Well Screened Interval
 Elevation scale shown to the nearest integer.

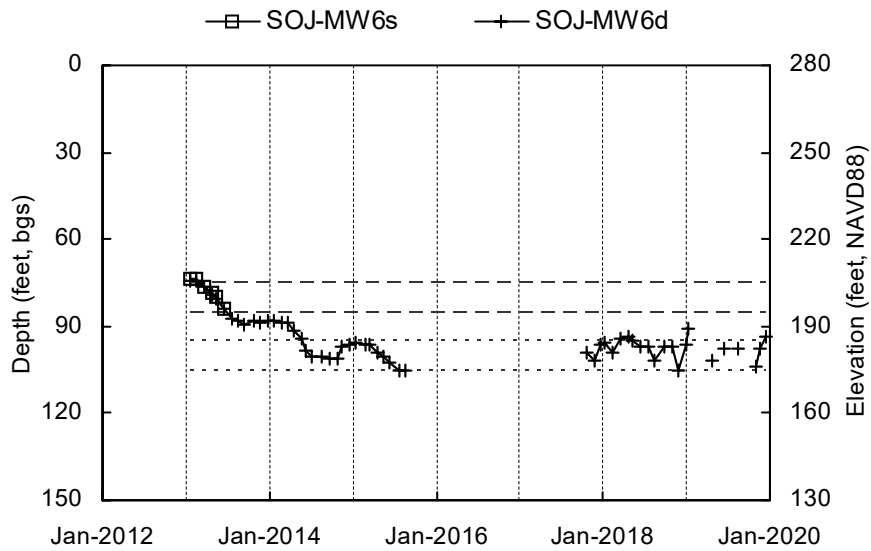
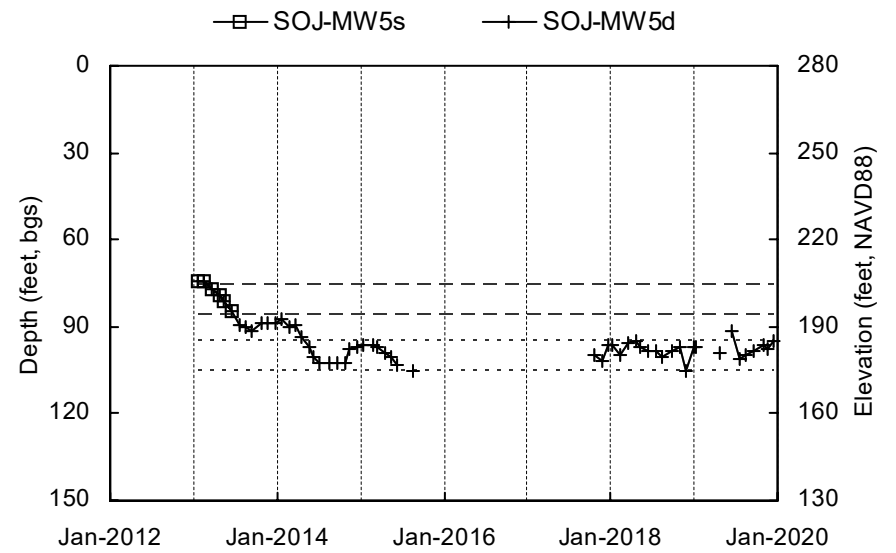
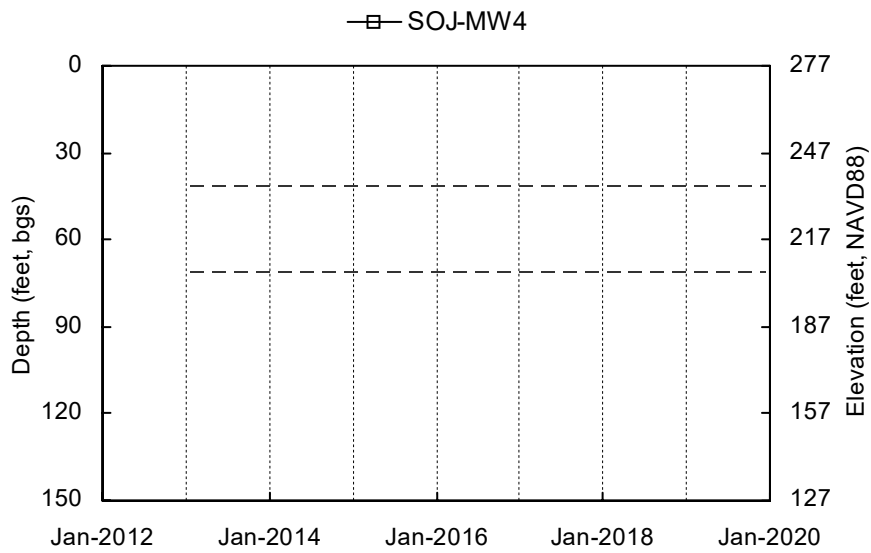

 Shallow Well Screened Interval
  Deep Well Screened Interval
 Elevation scale shown to the nearest integer.



 Shallow Well Screened Interval
  Deep Well Screened Interval
 Elevation scale shown to the nearest integer.

Attachment A3

Hydrograph Series of Depth to Groundwater

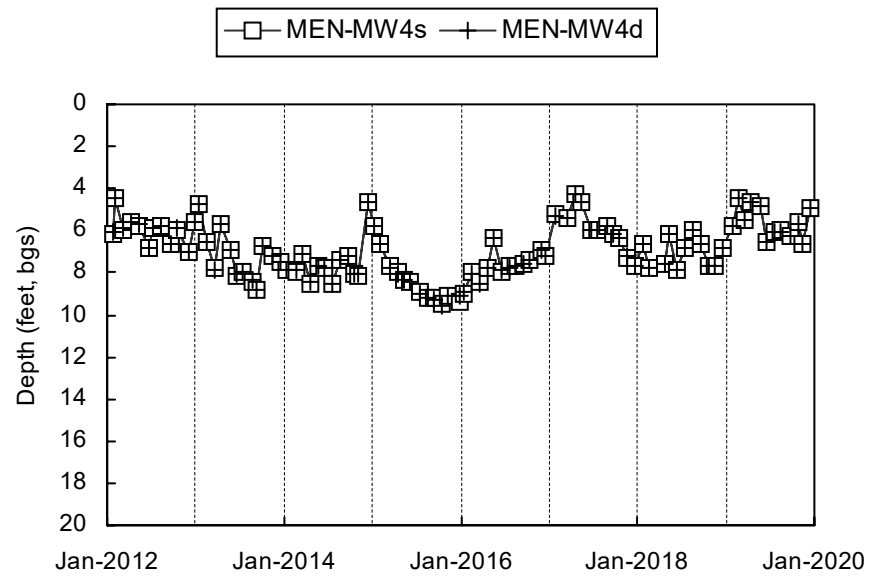
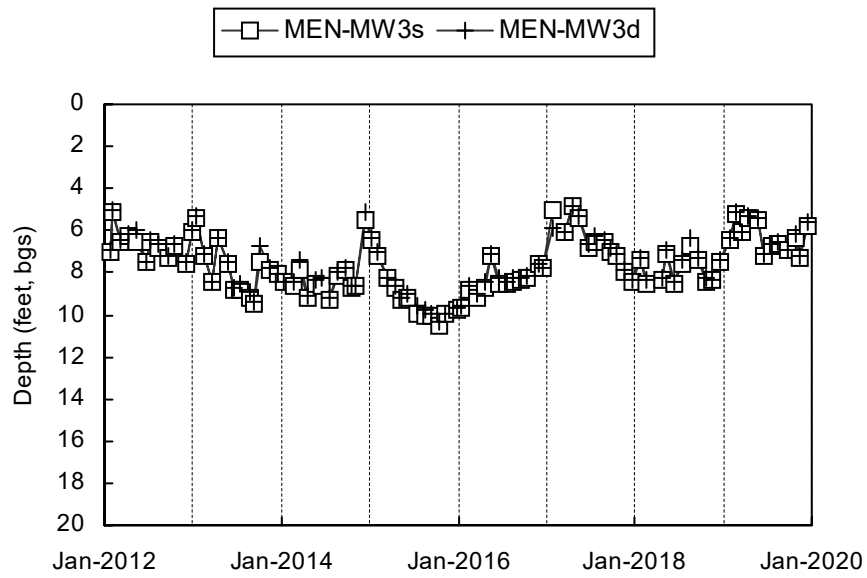
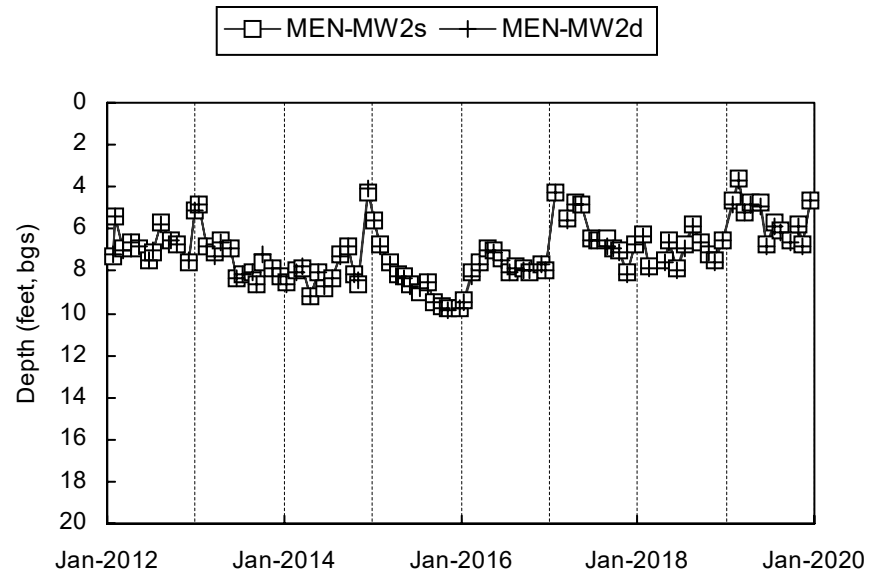
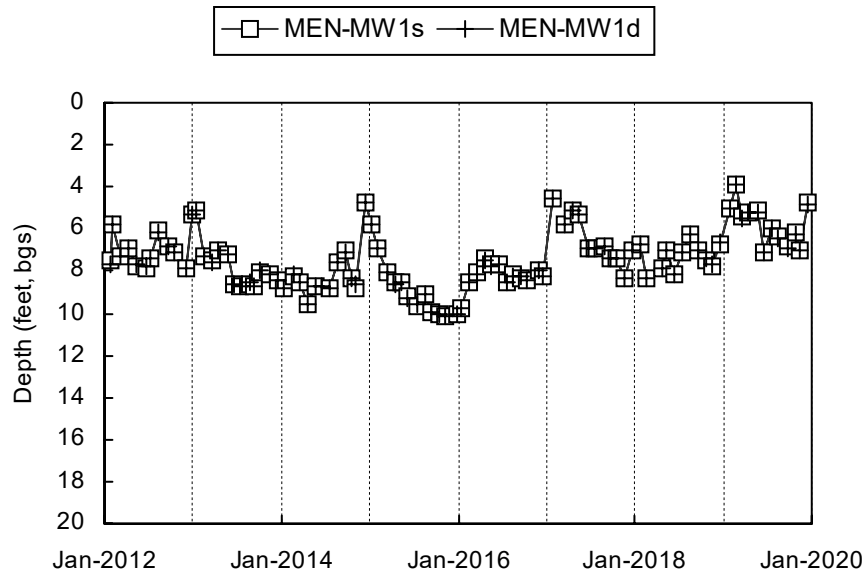

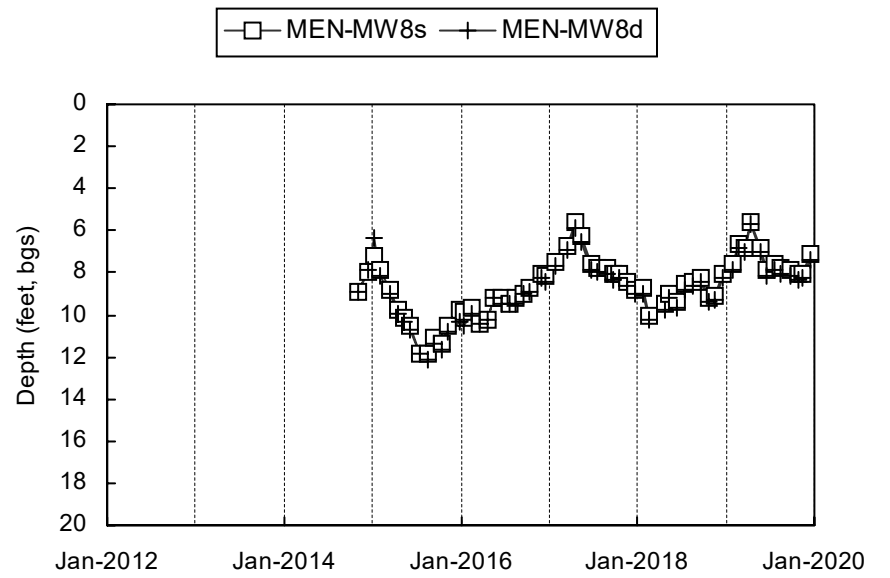
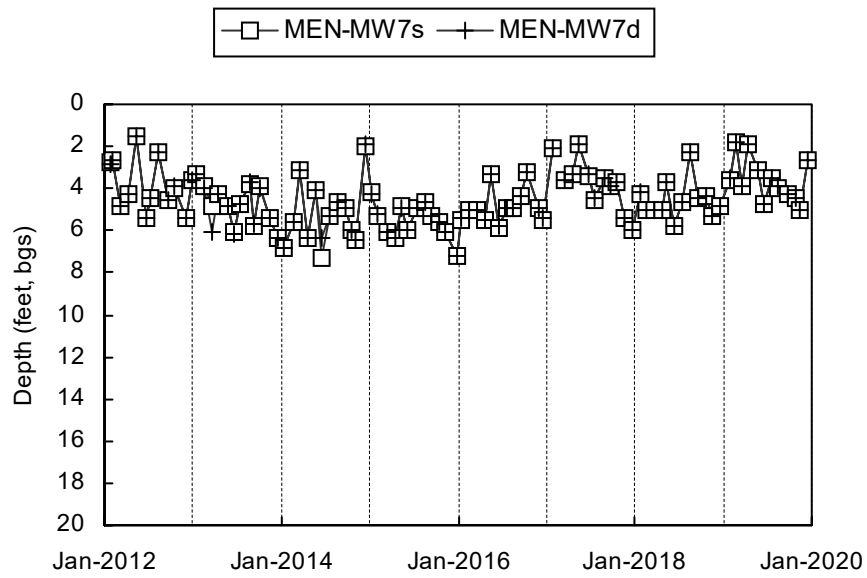
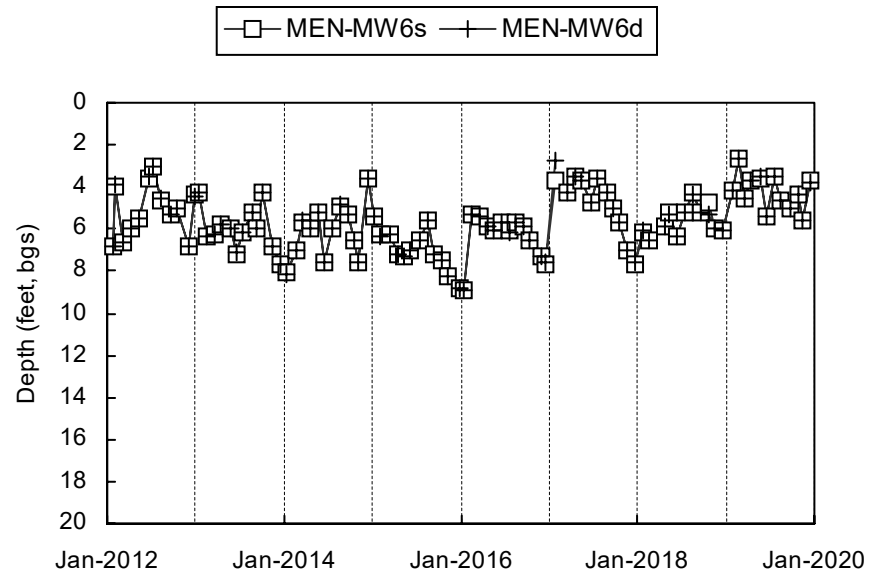
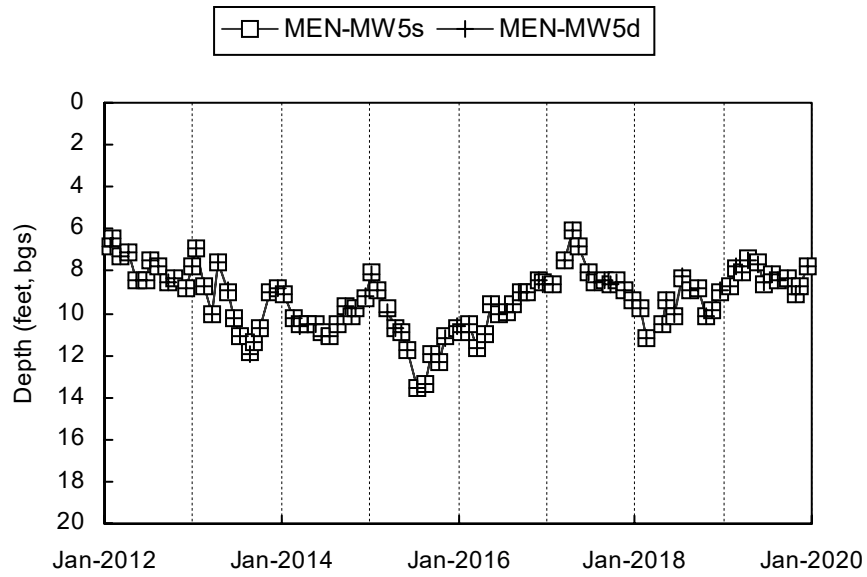

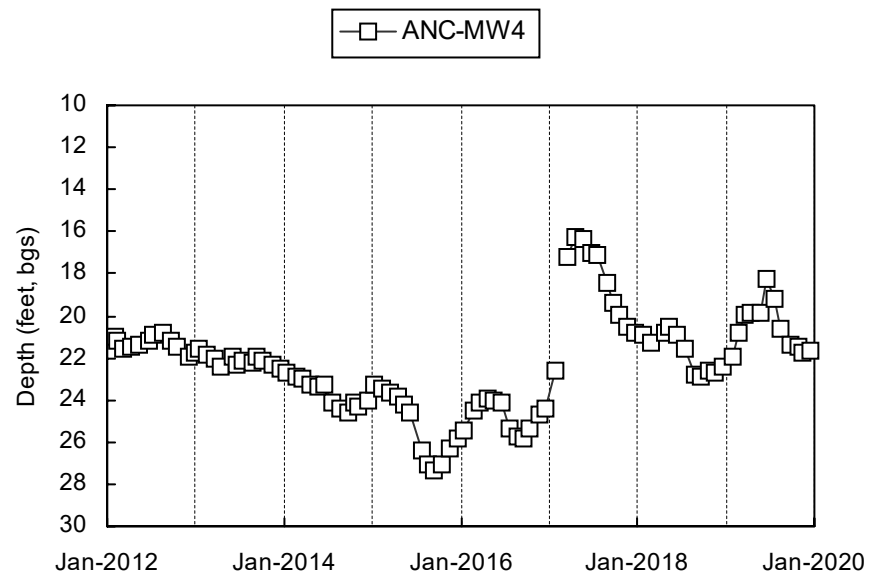
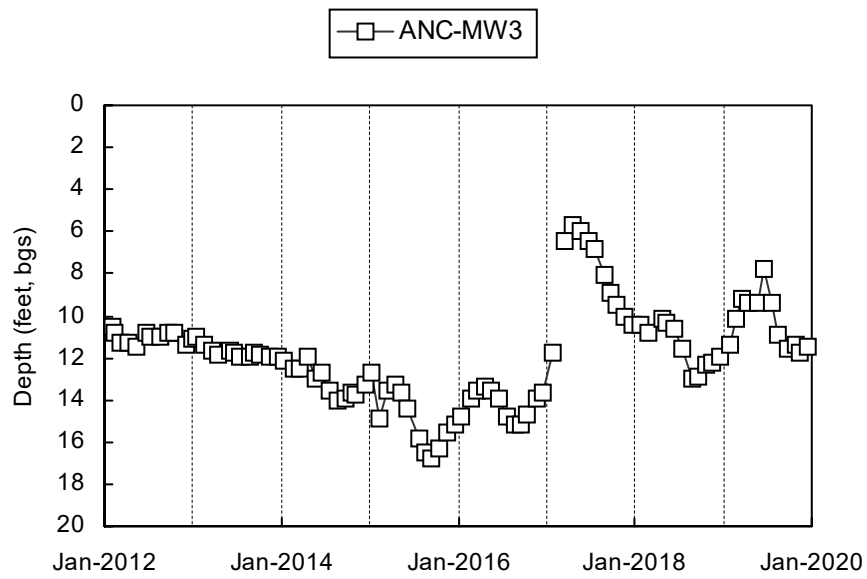
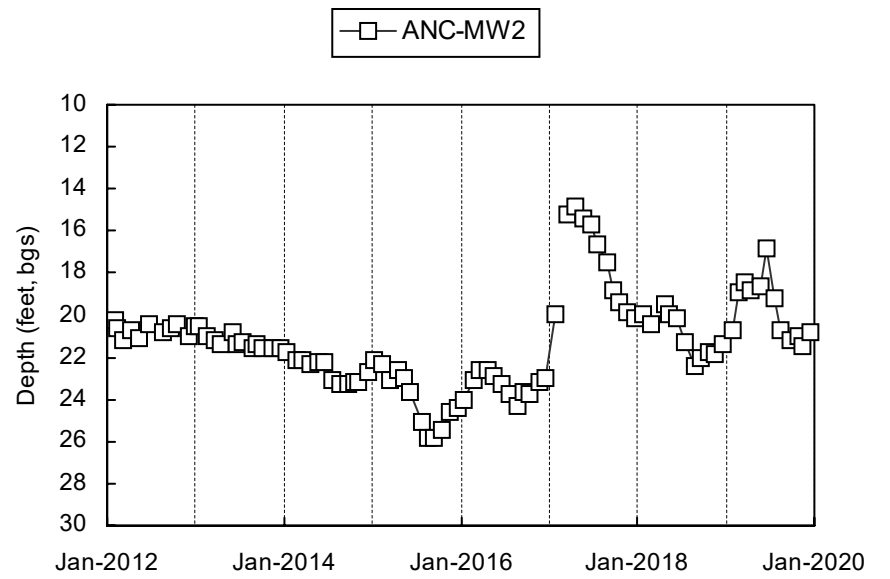
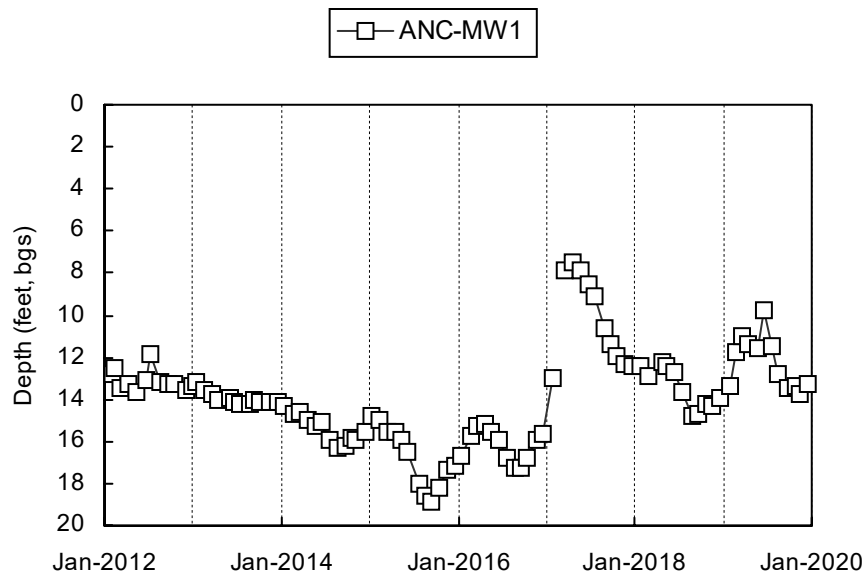

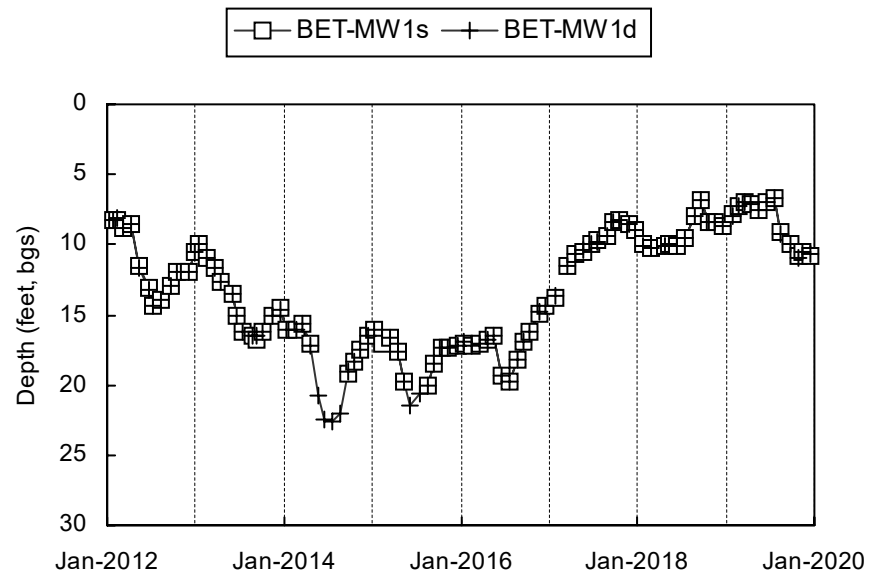
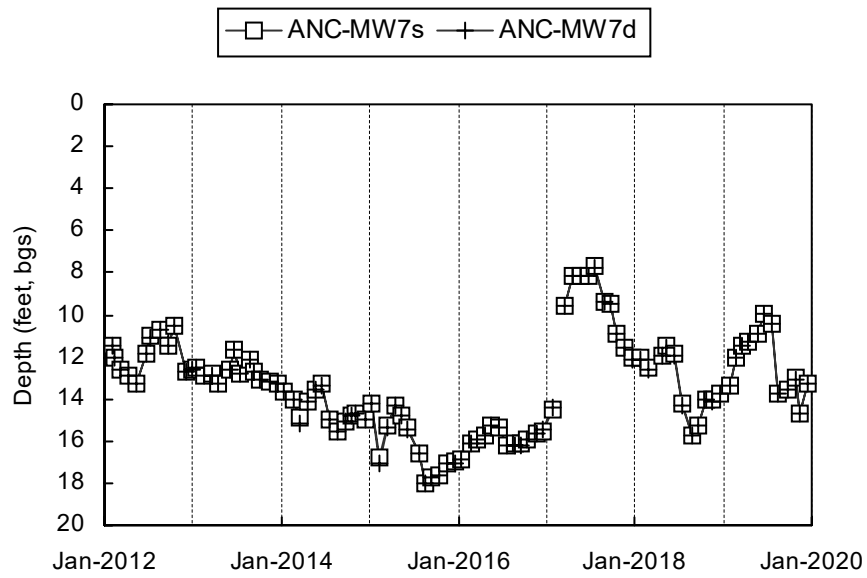
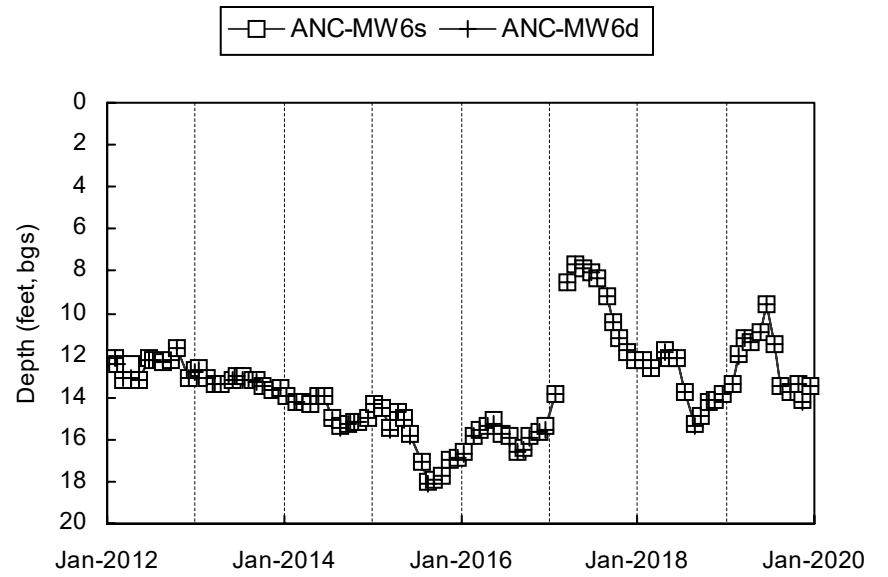
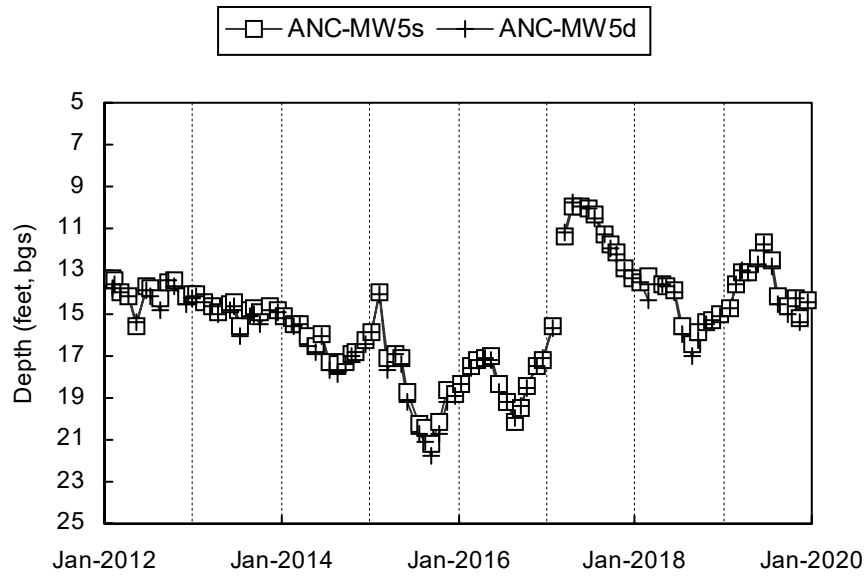

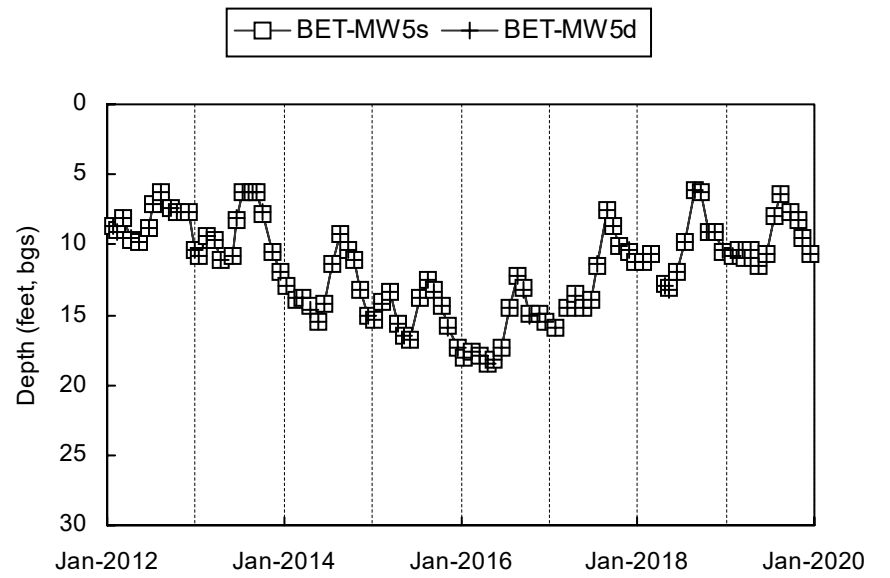
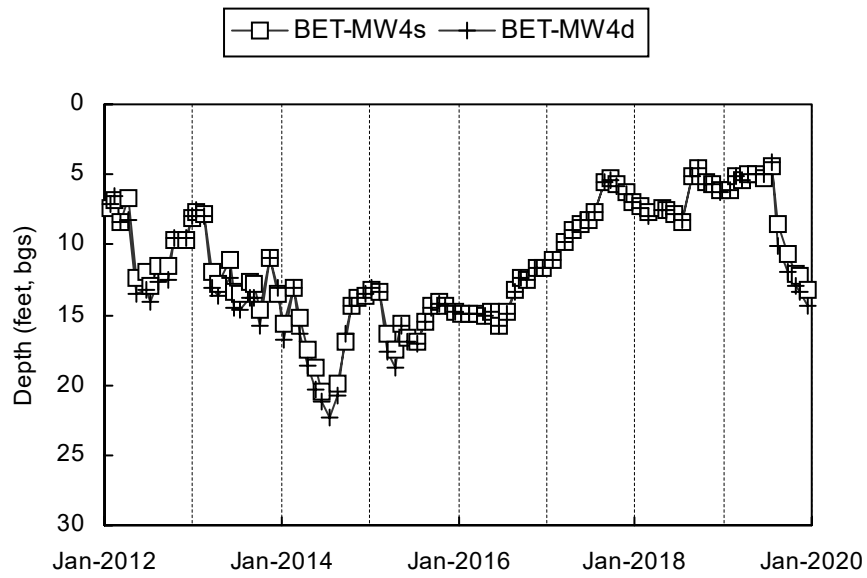
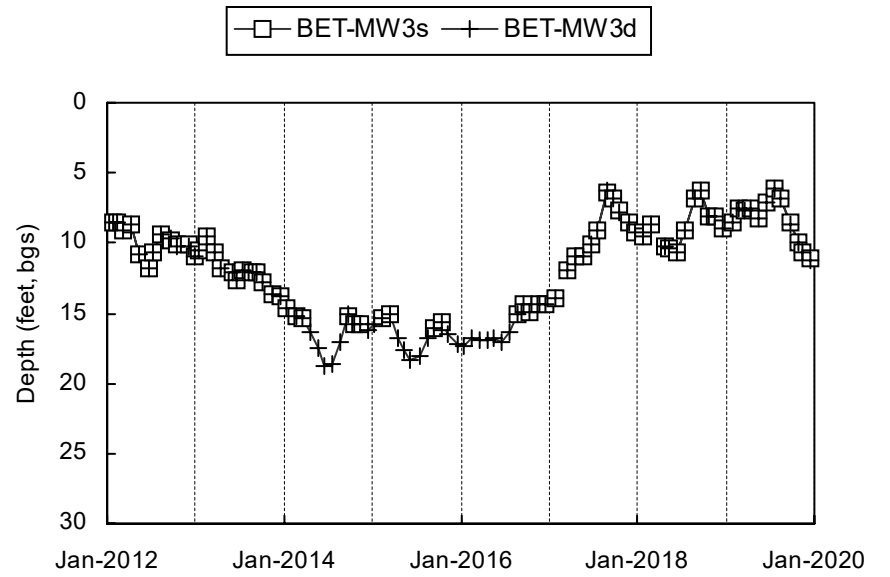
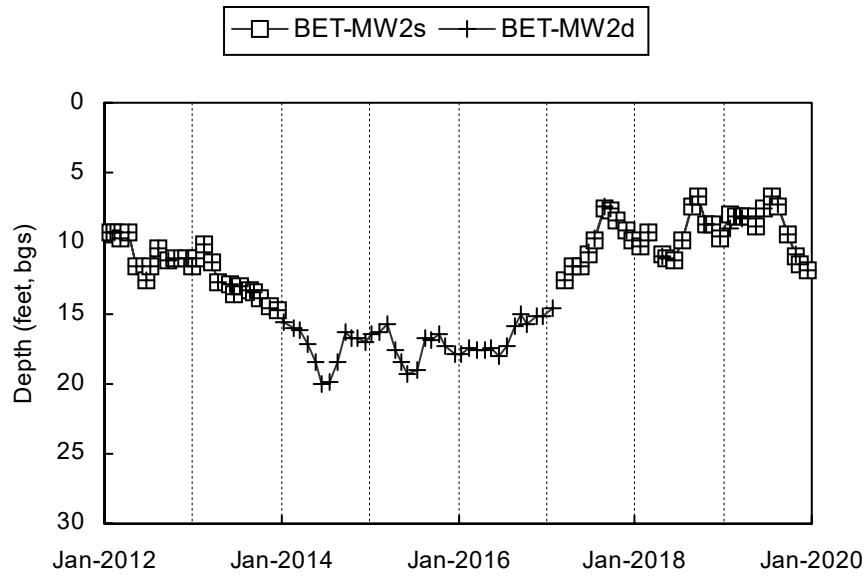

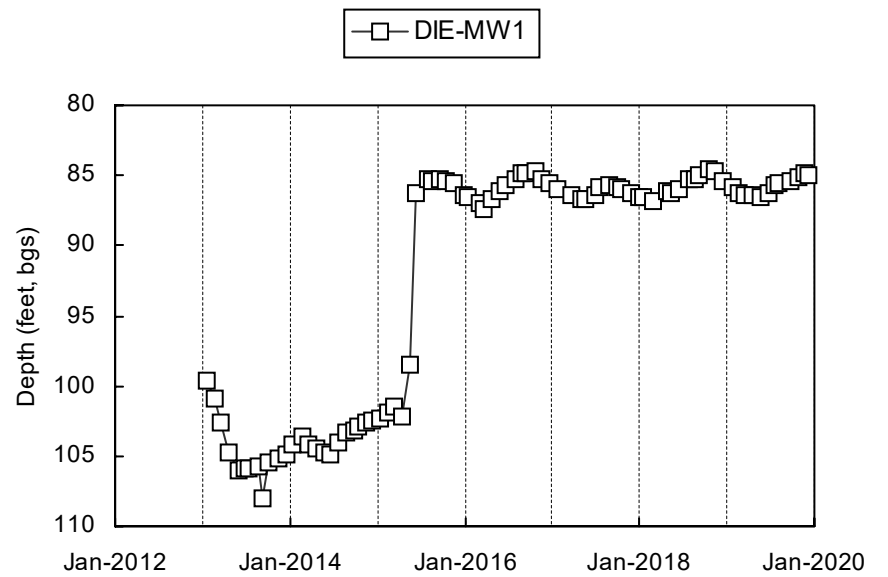
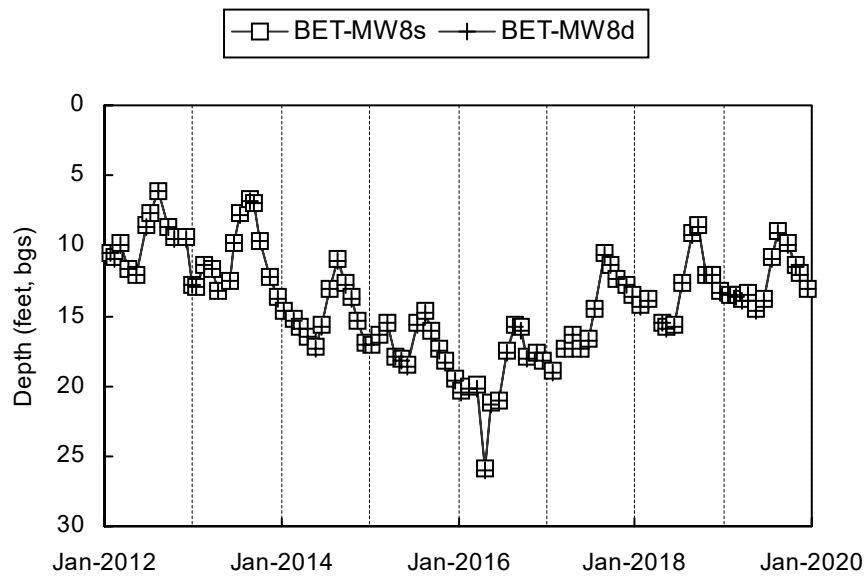
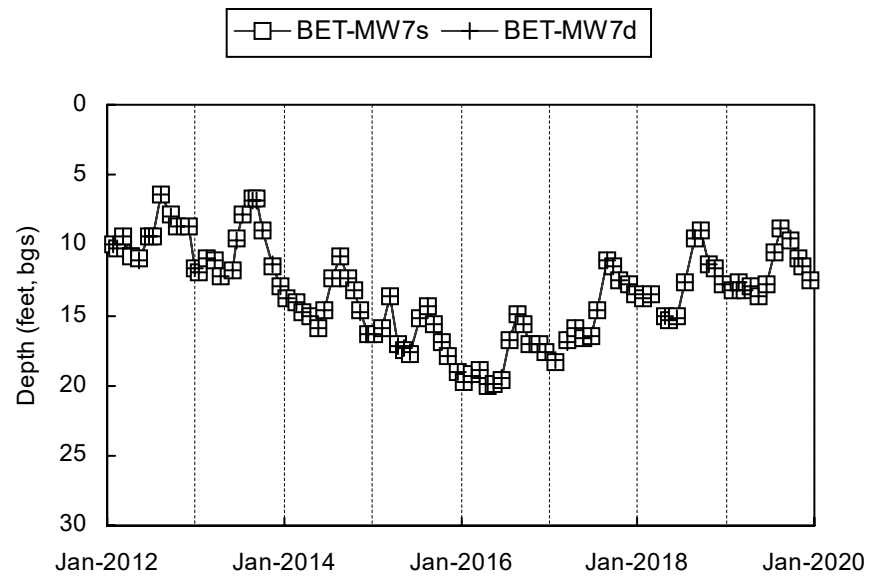
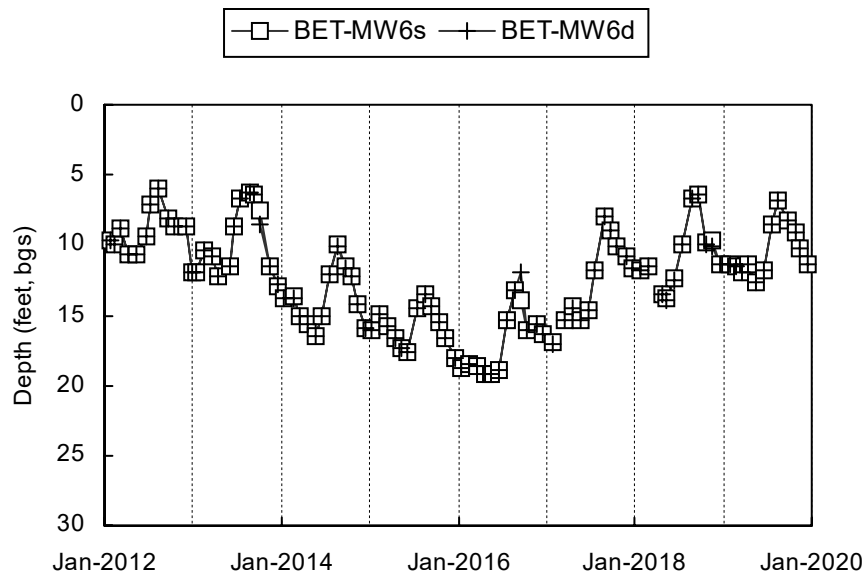

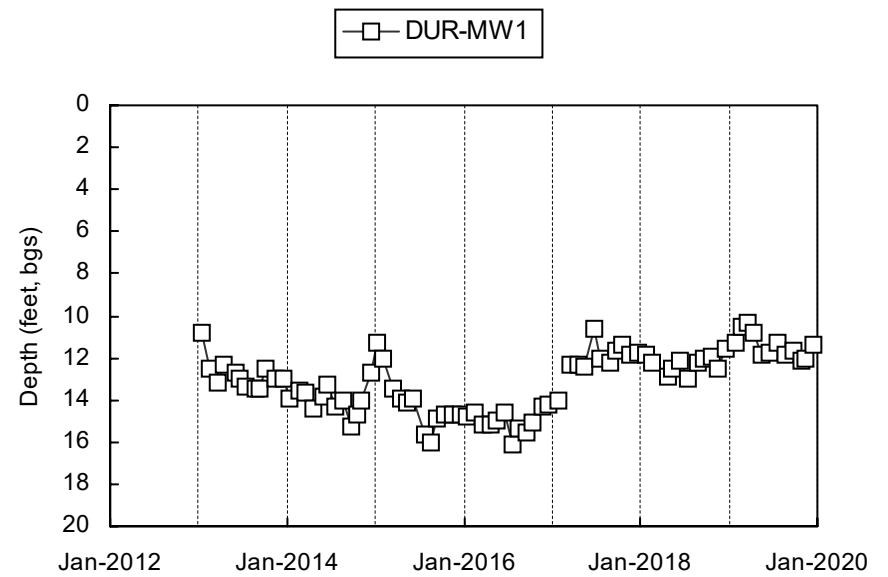
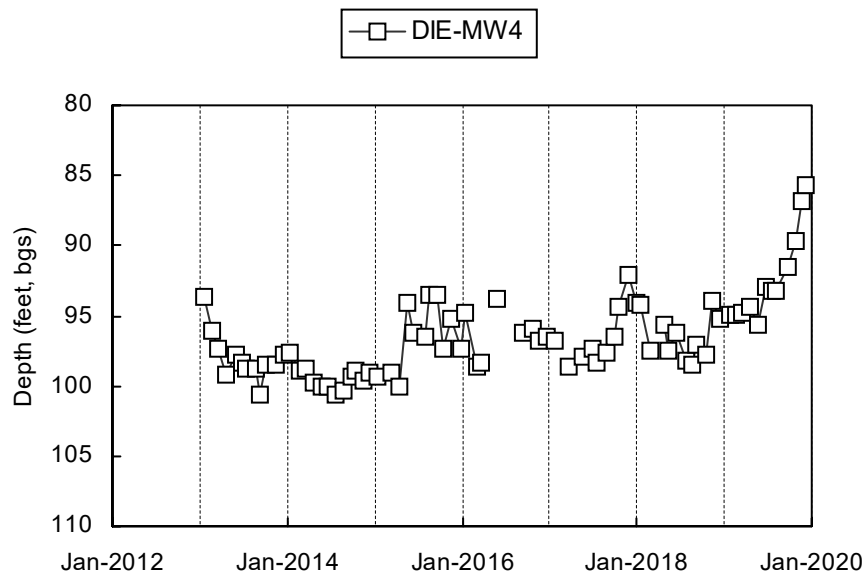
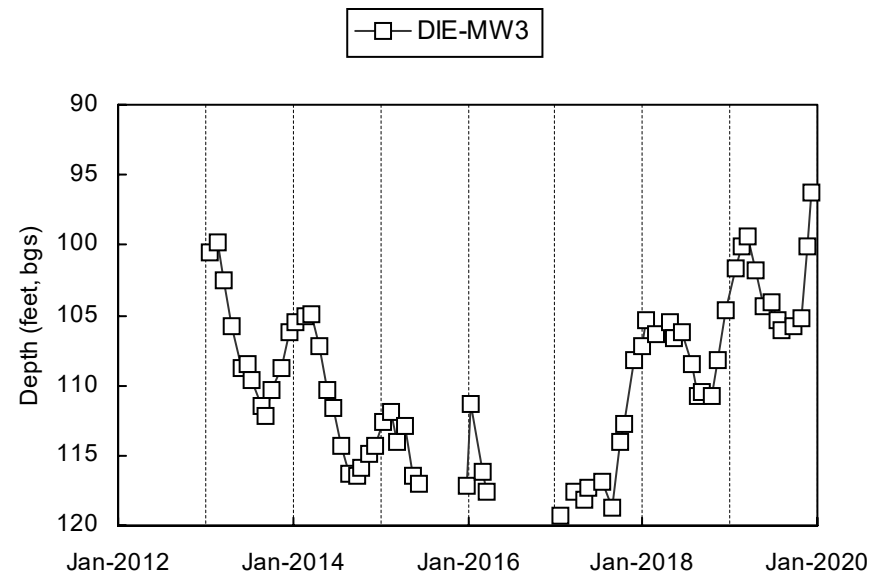
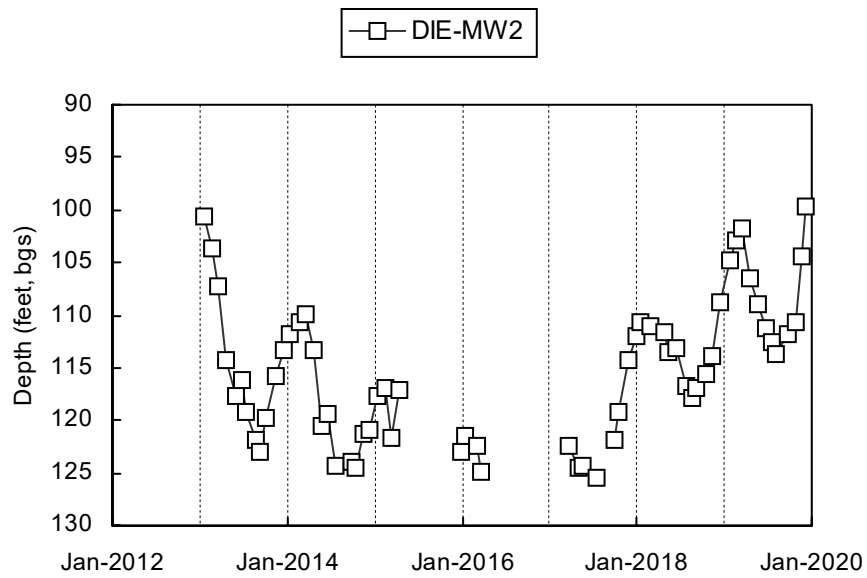

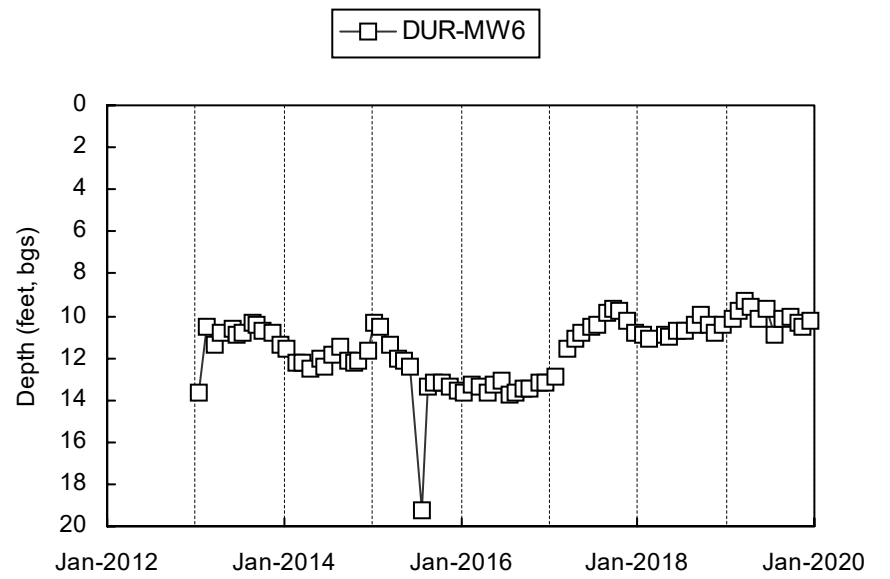
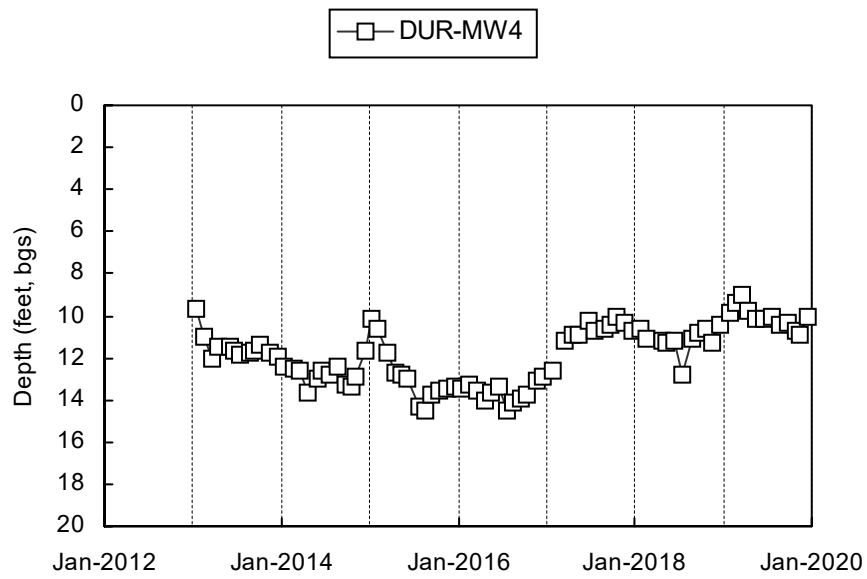
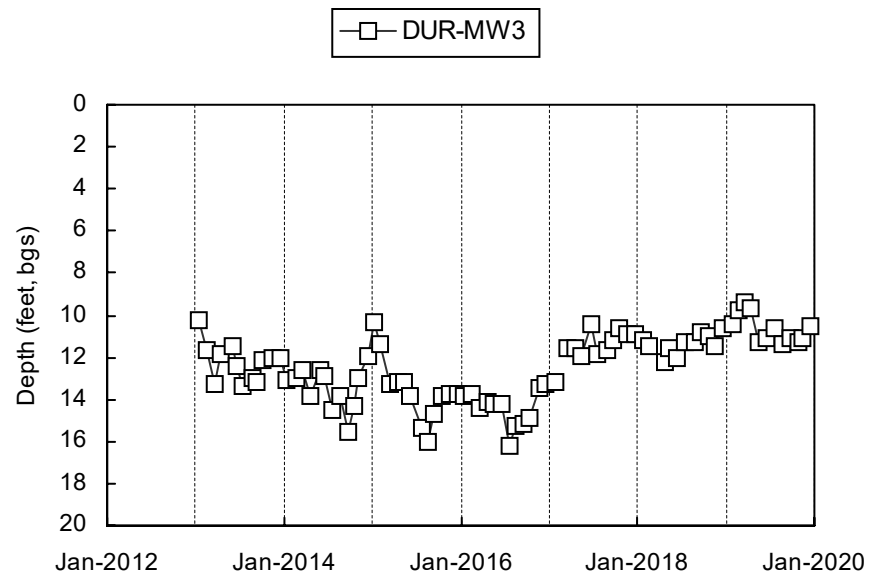
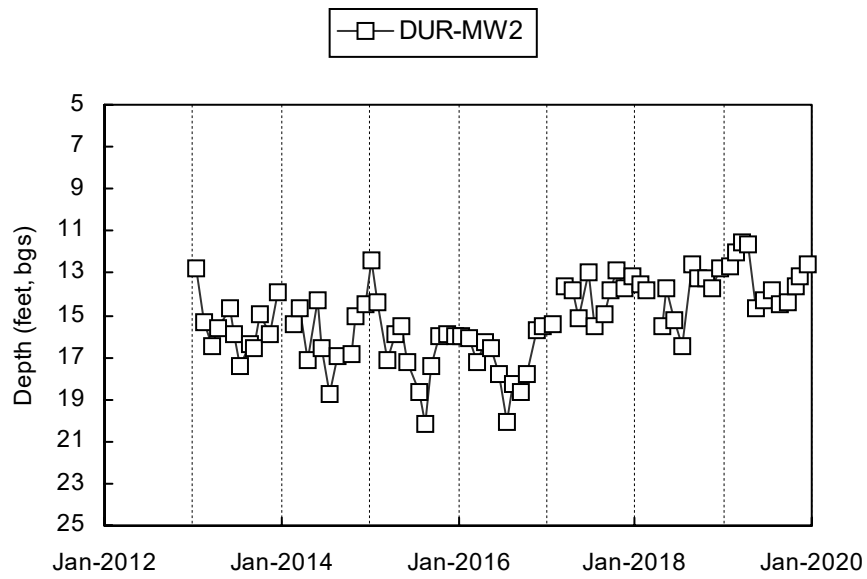

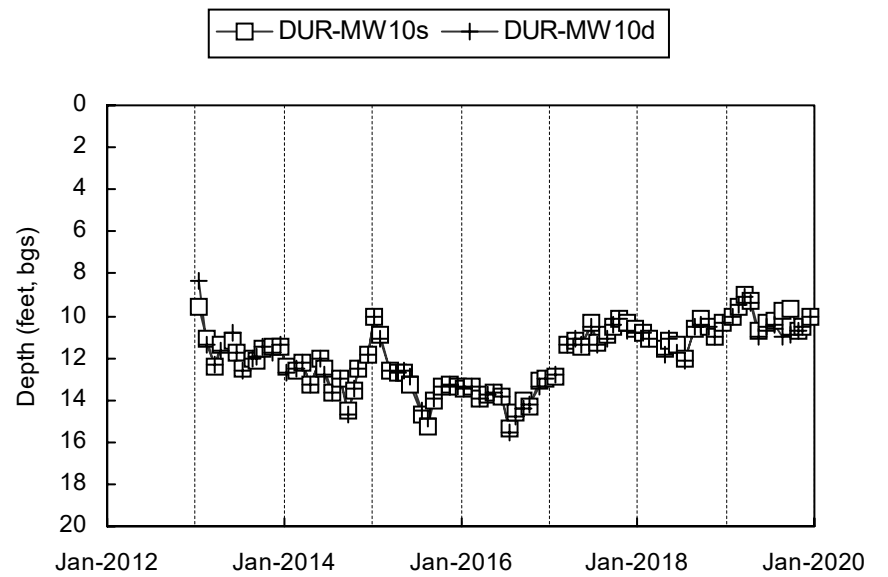
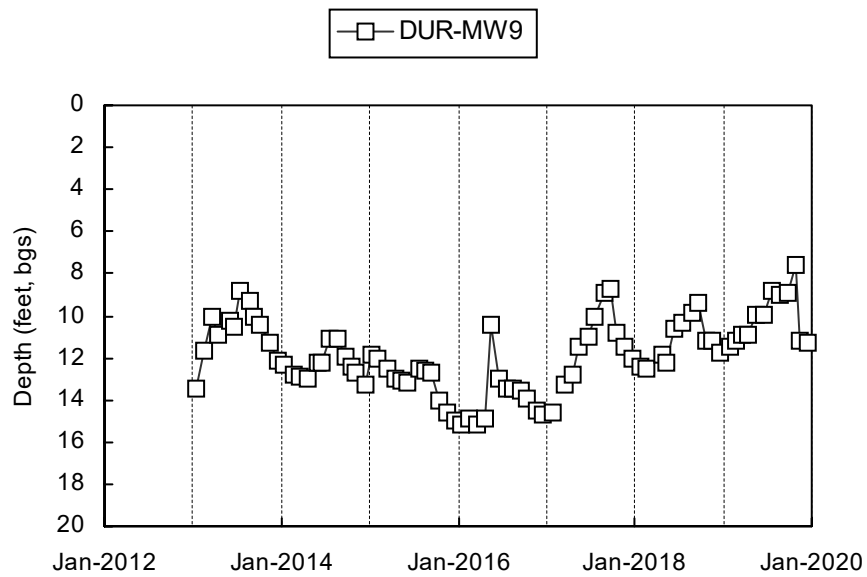
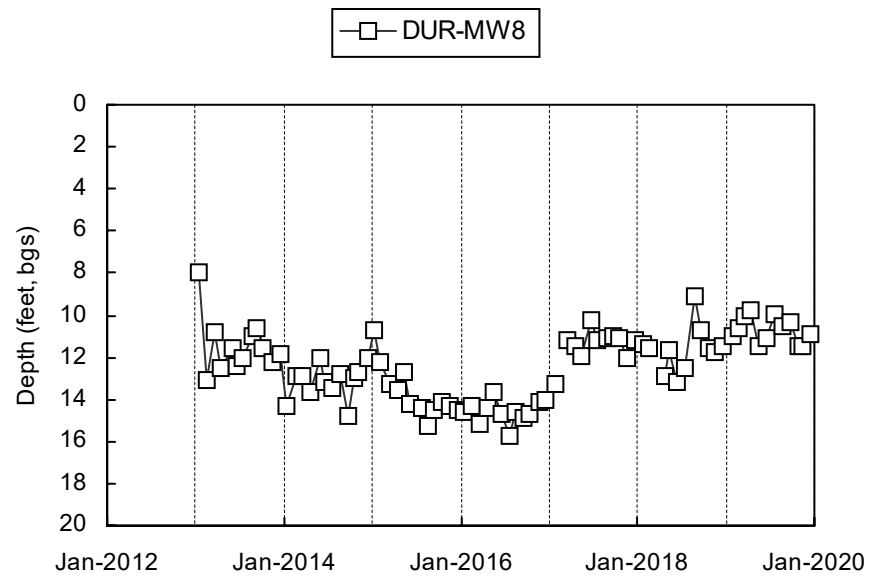
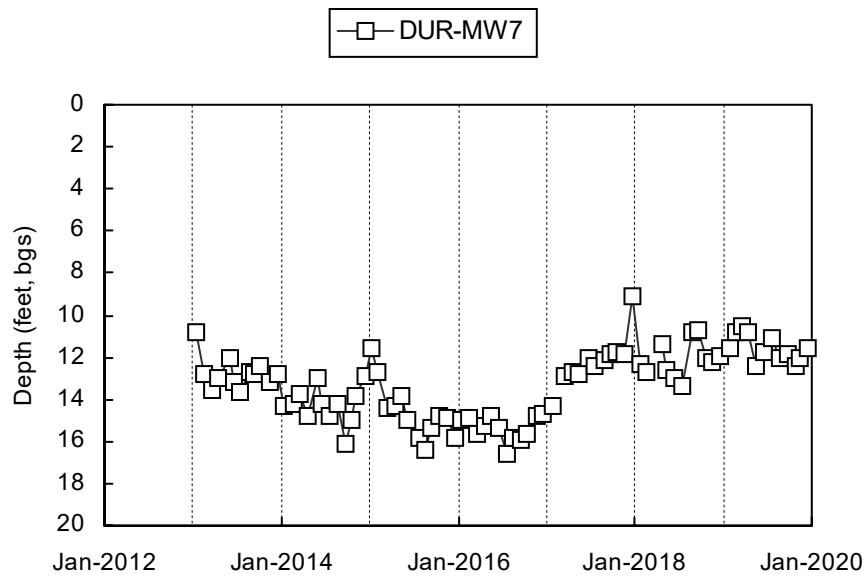

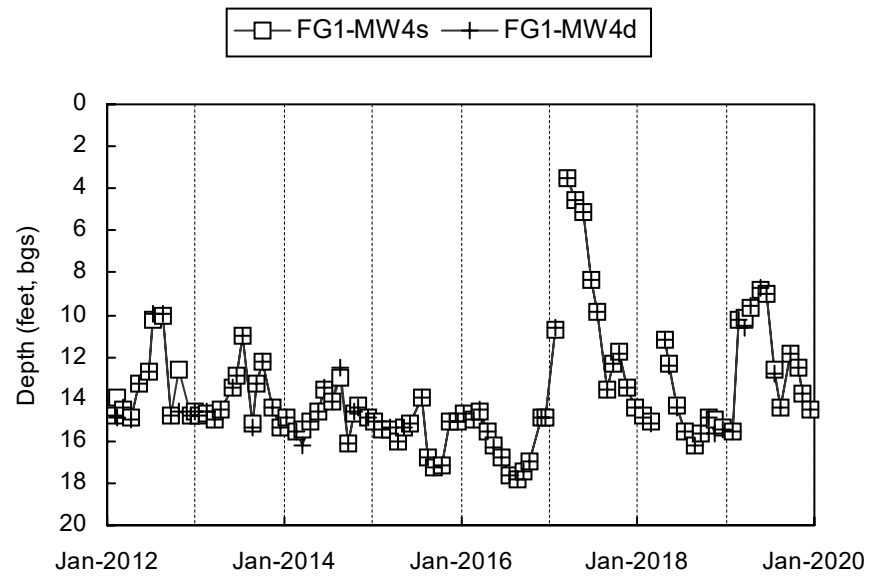
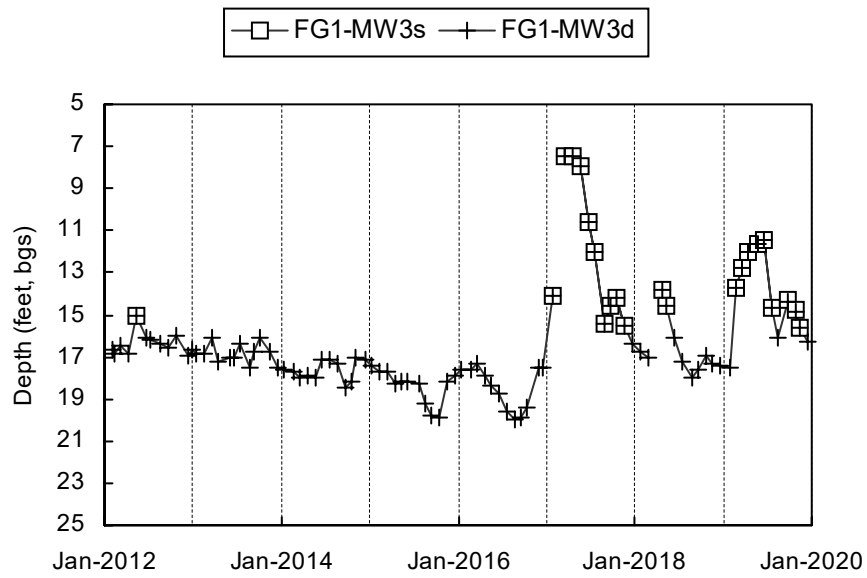
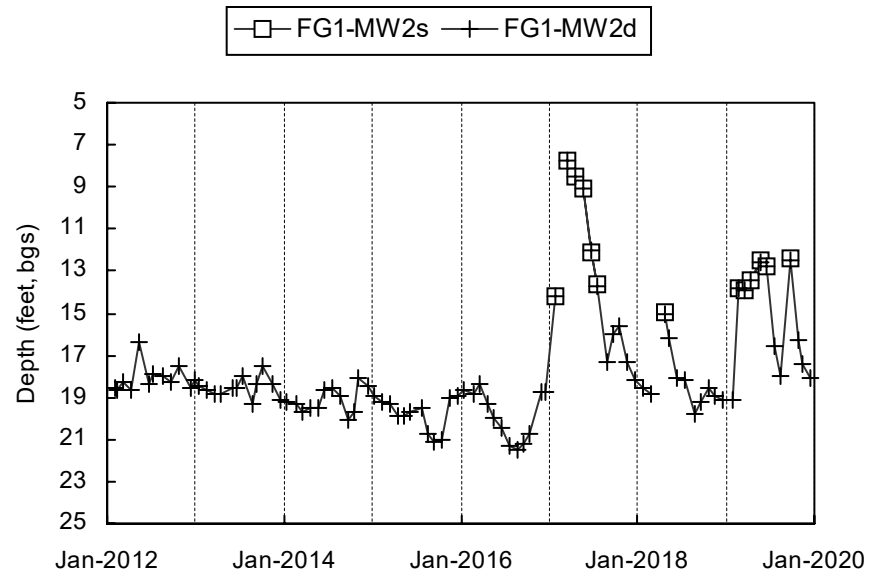
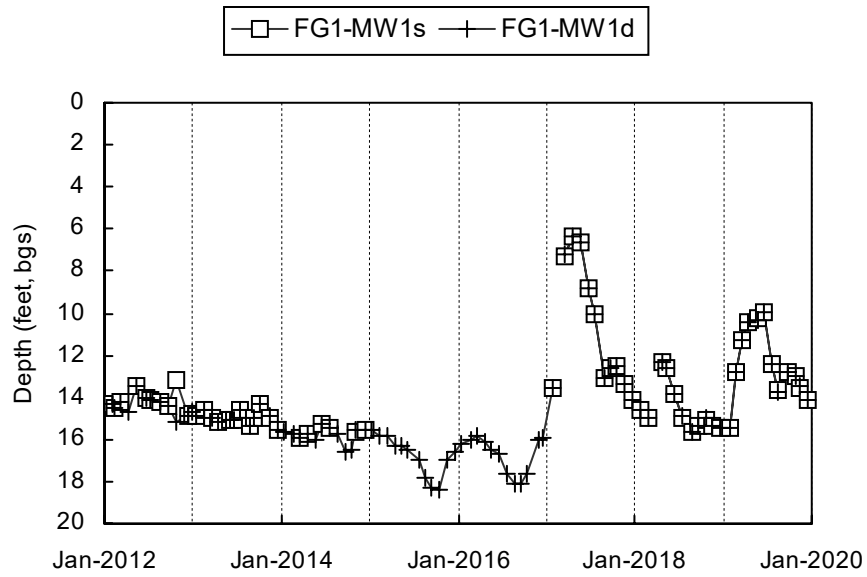

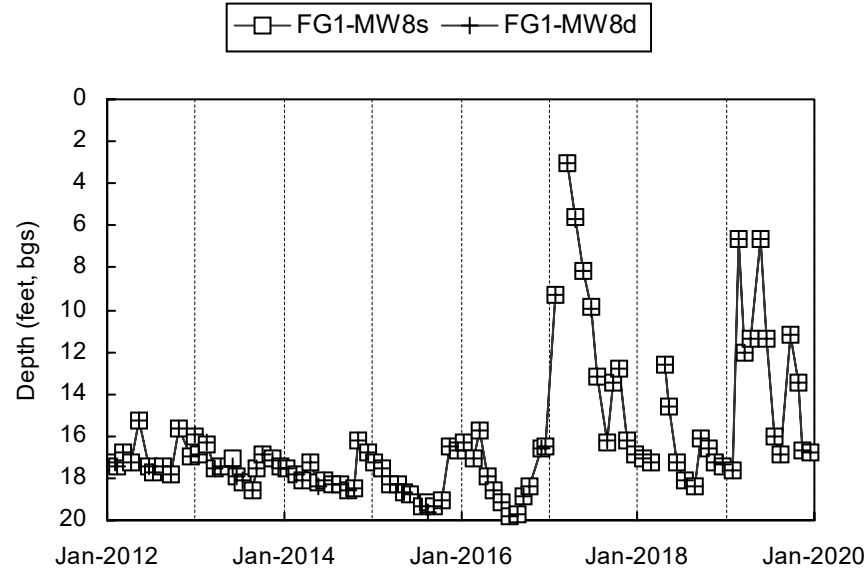
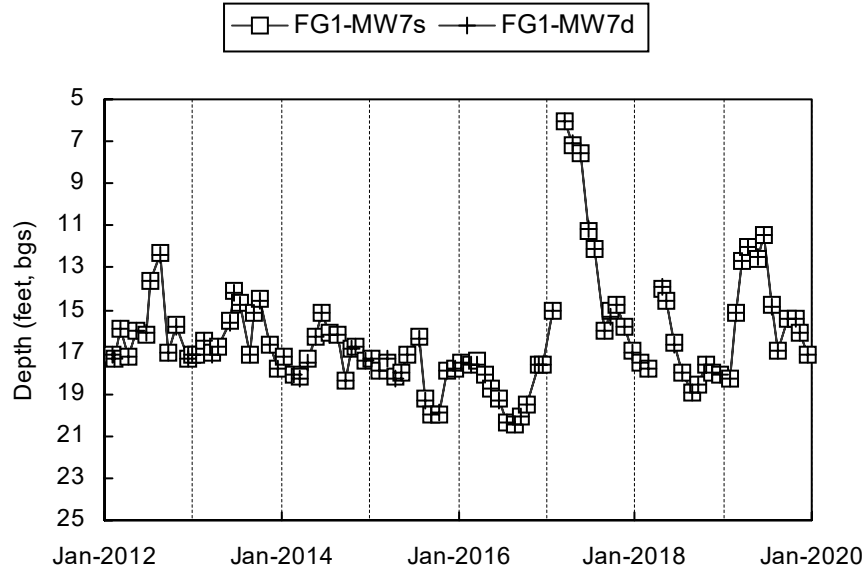
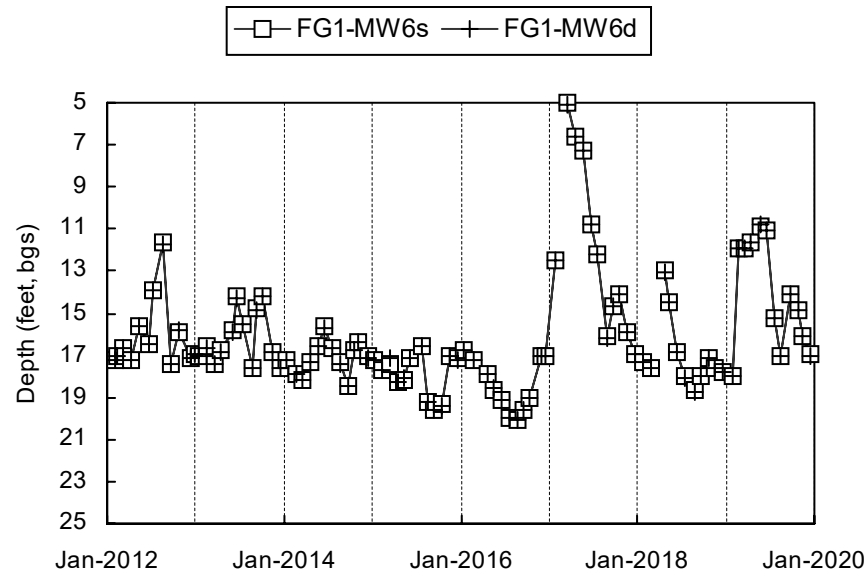
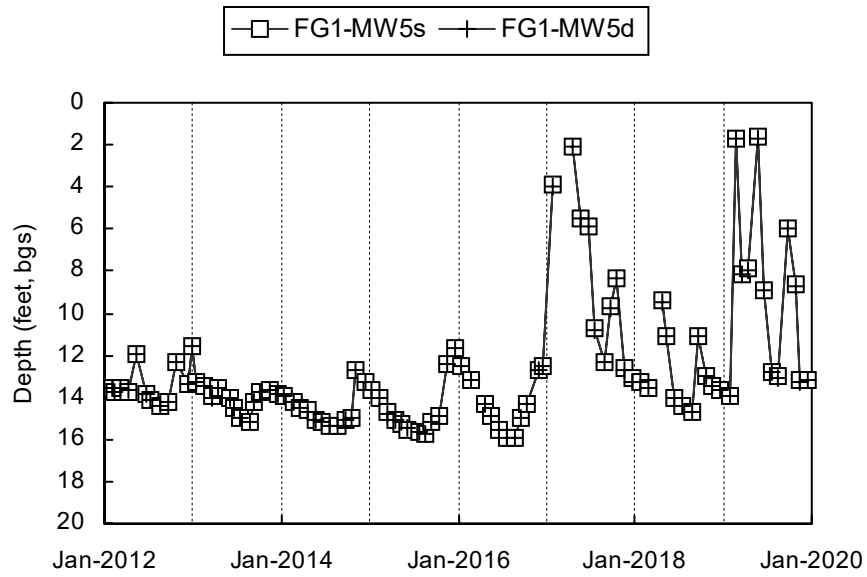

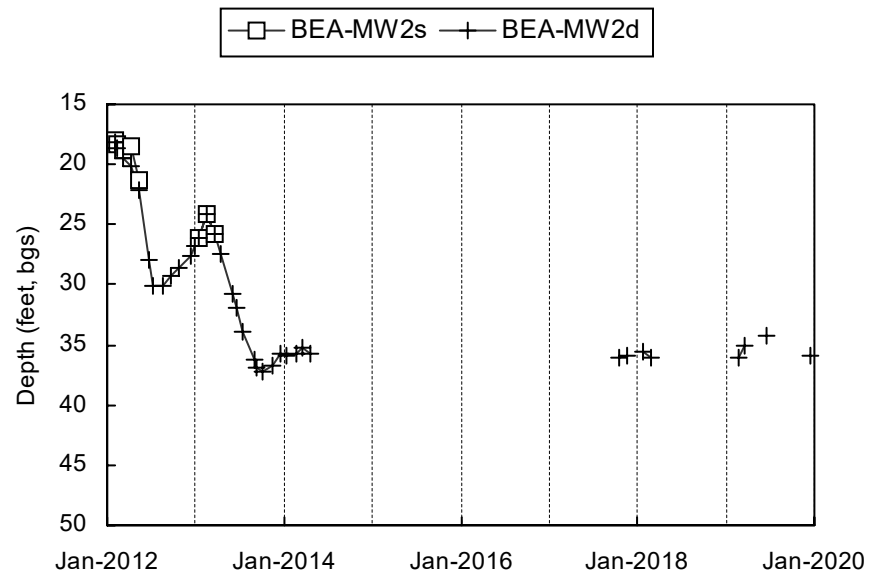
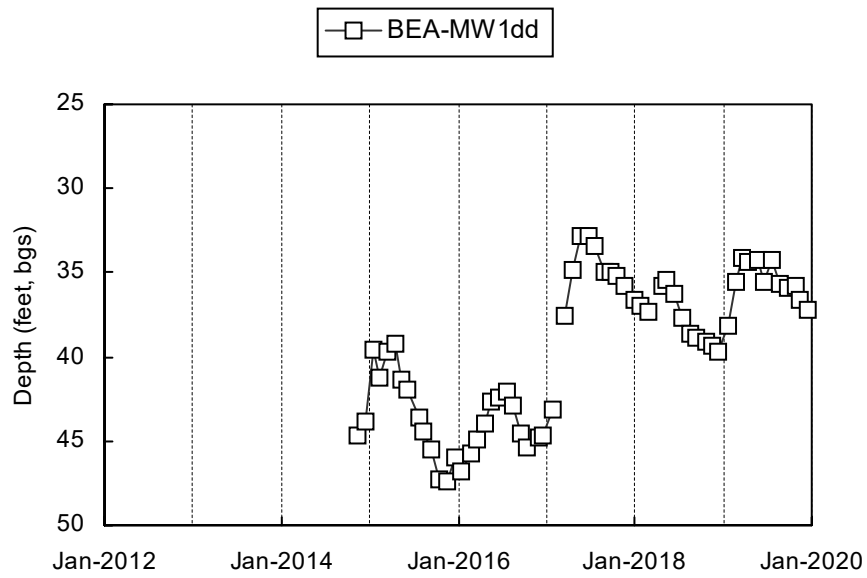
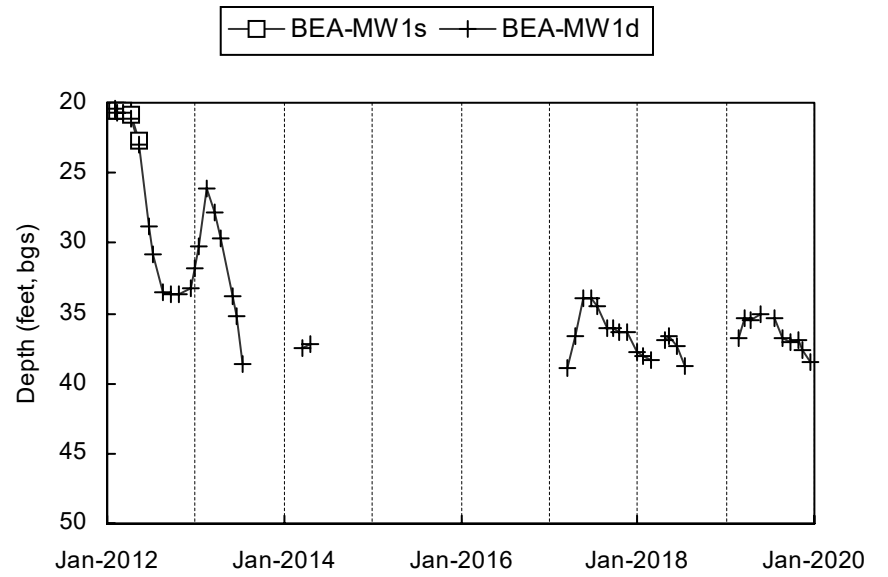
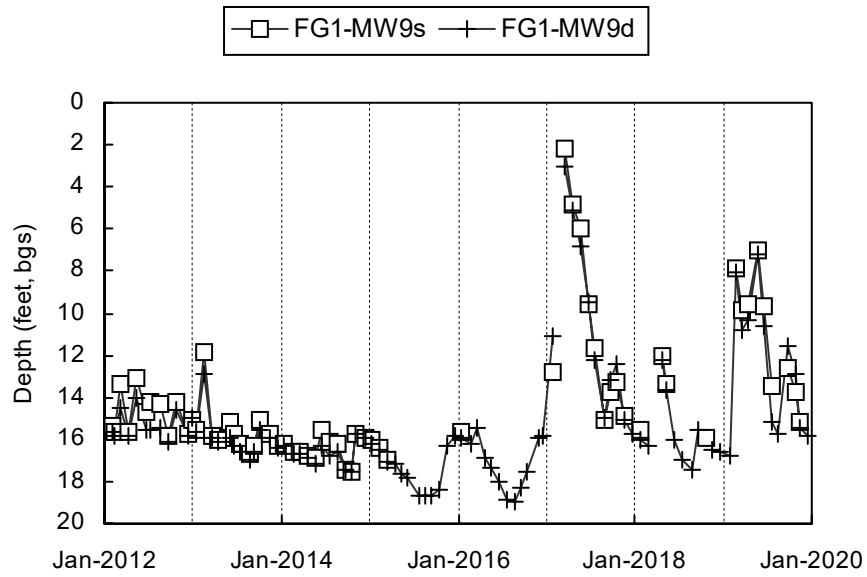

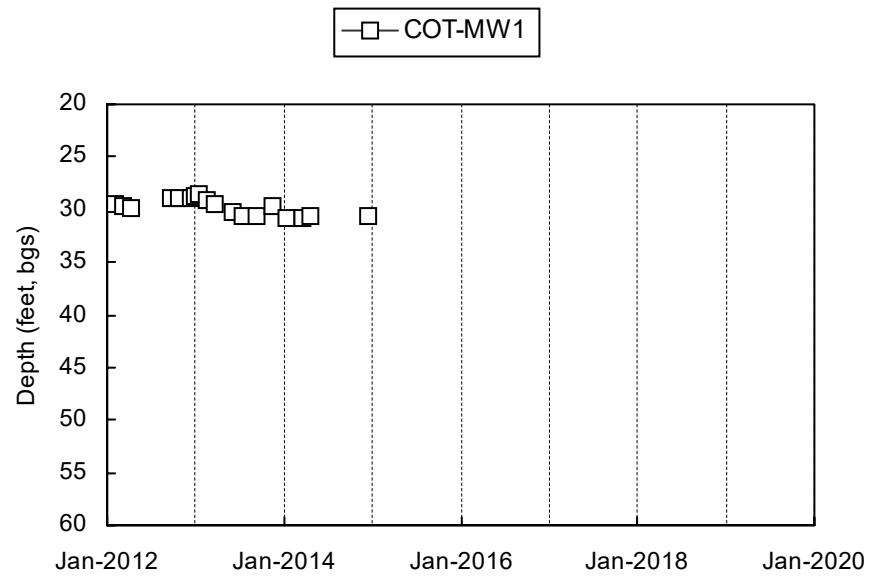
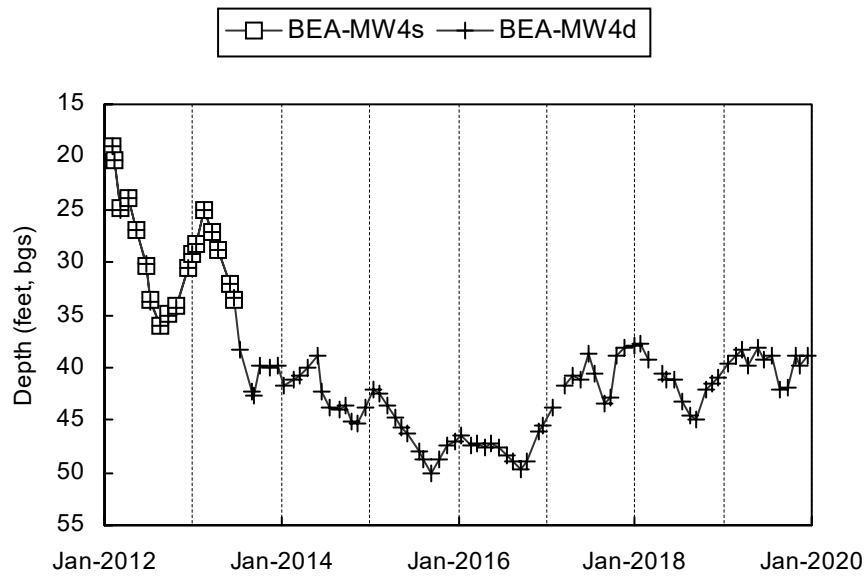
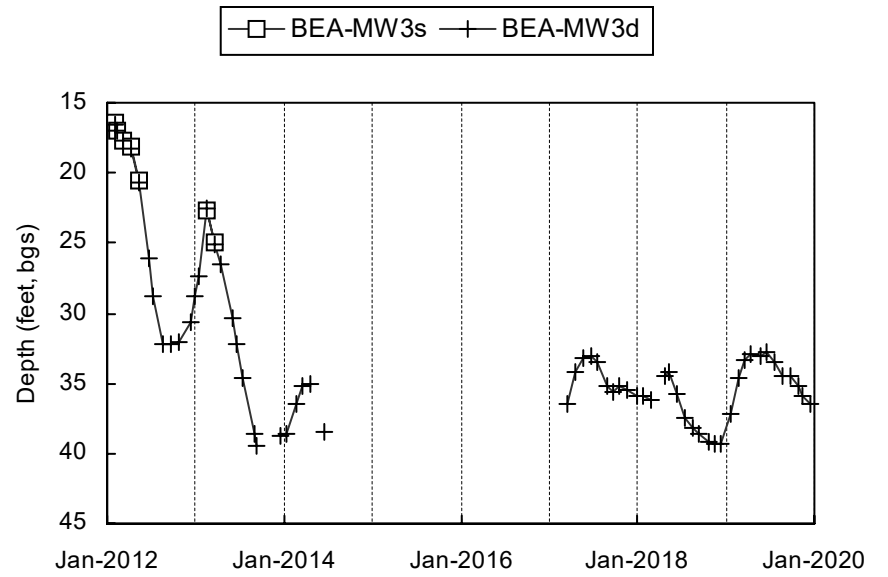
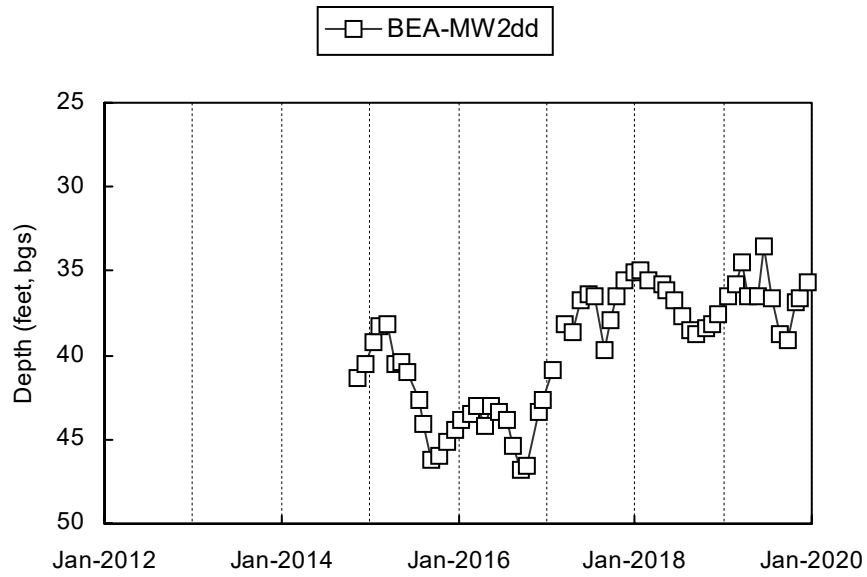

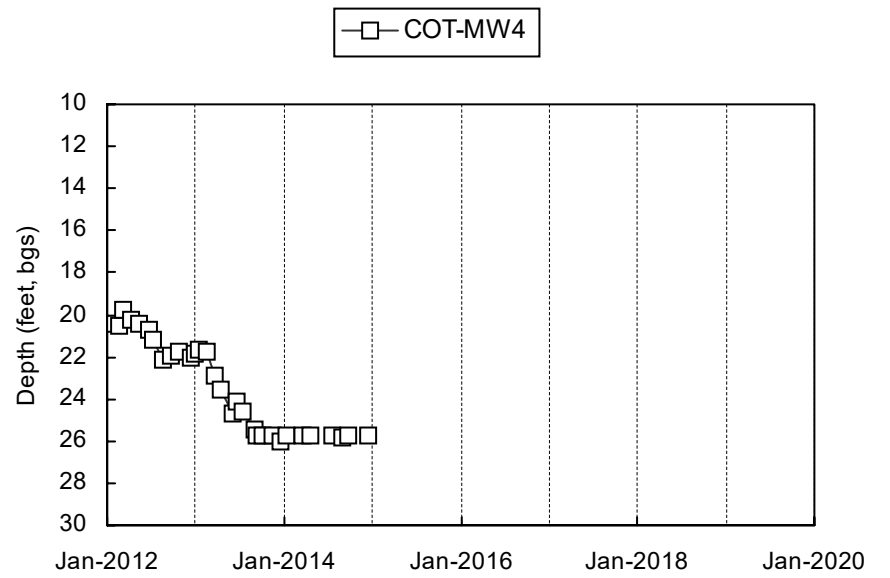
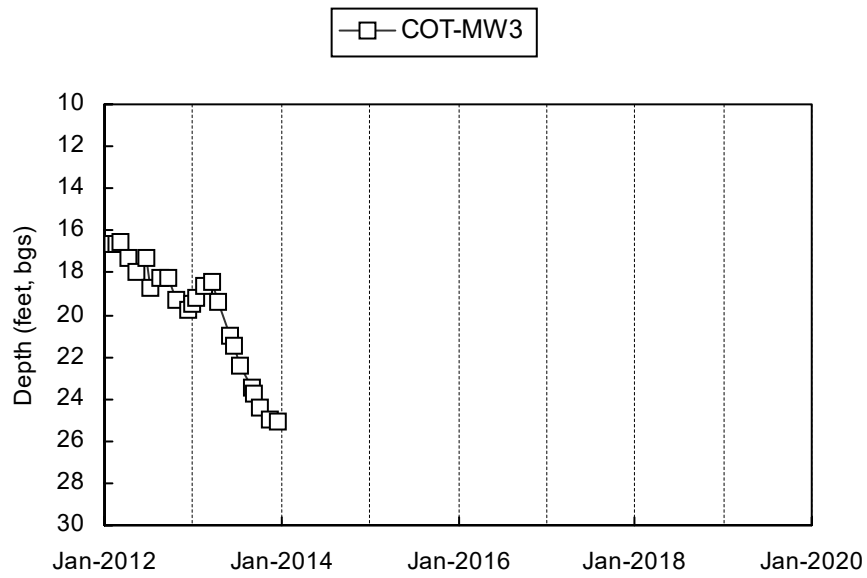
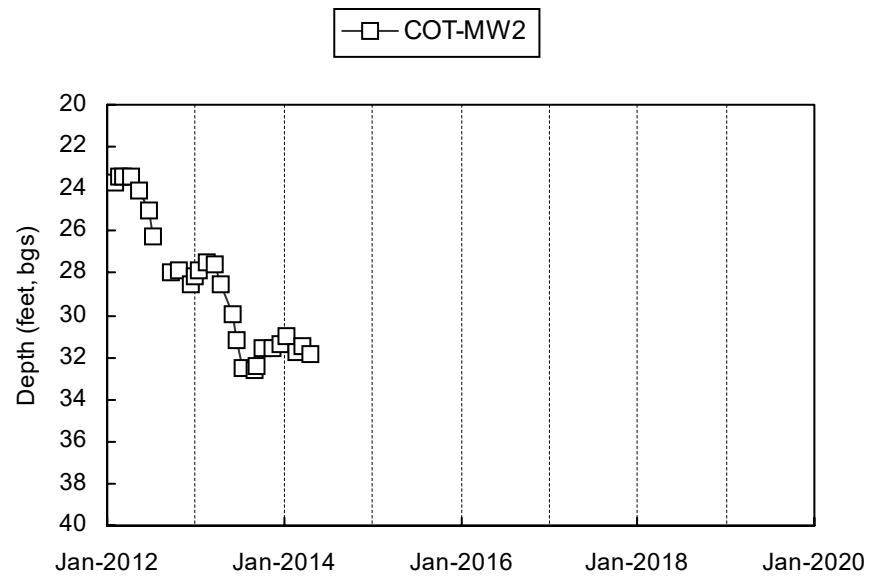
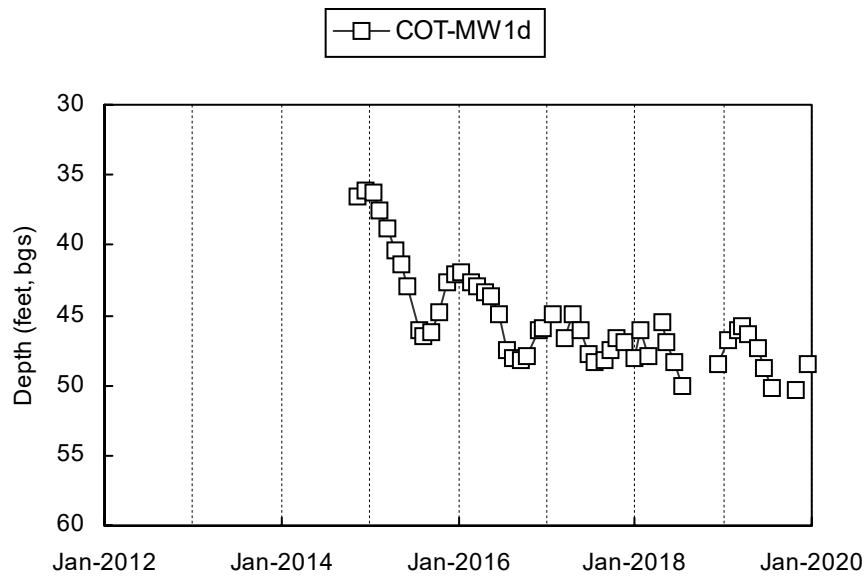

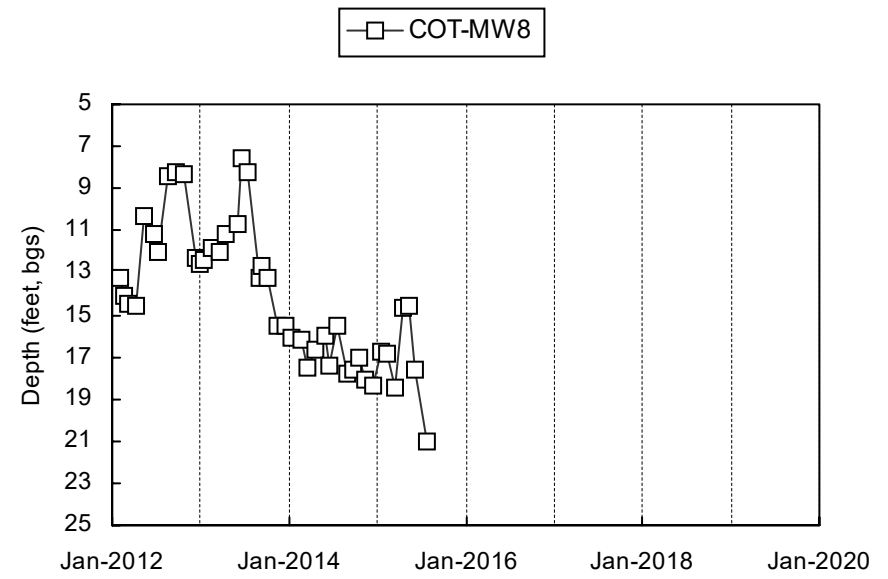
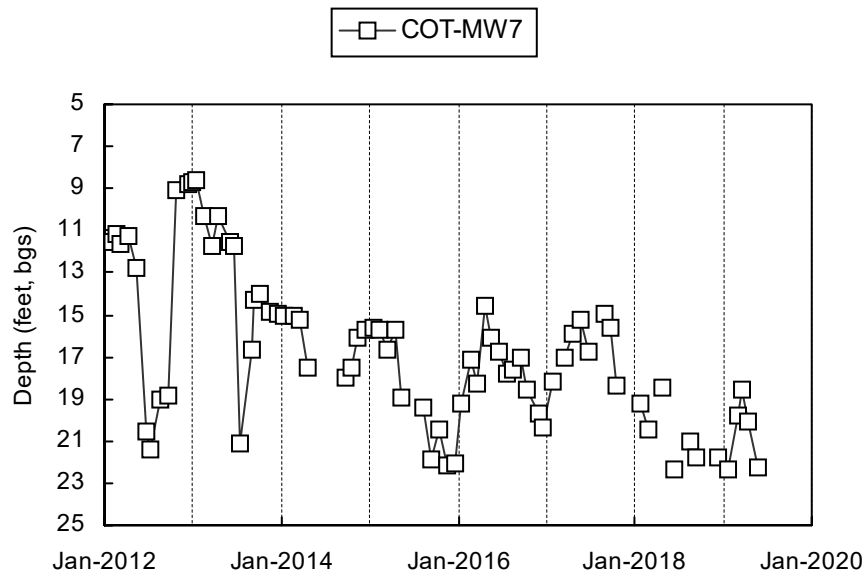
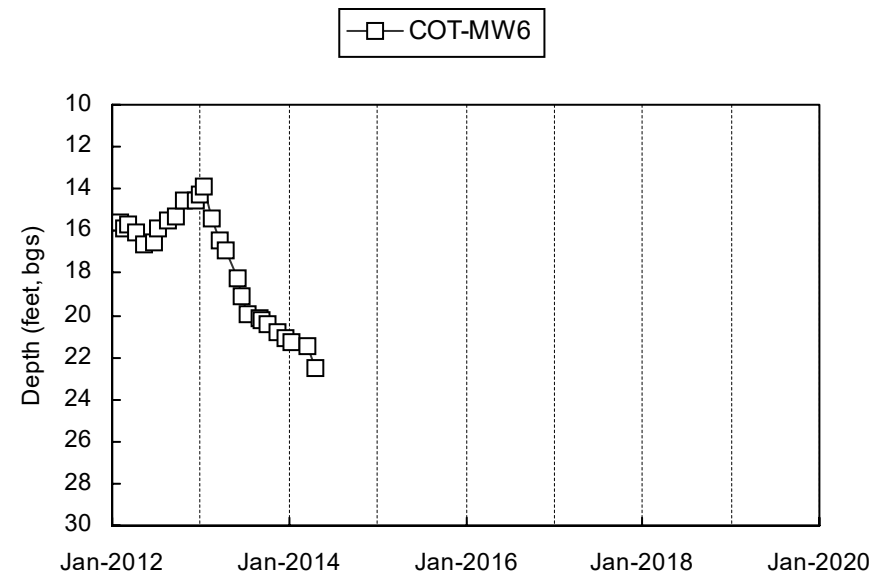
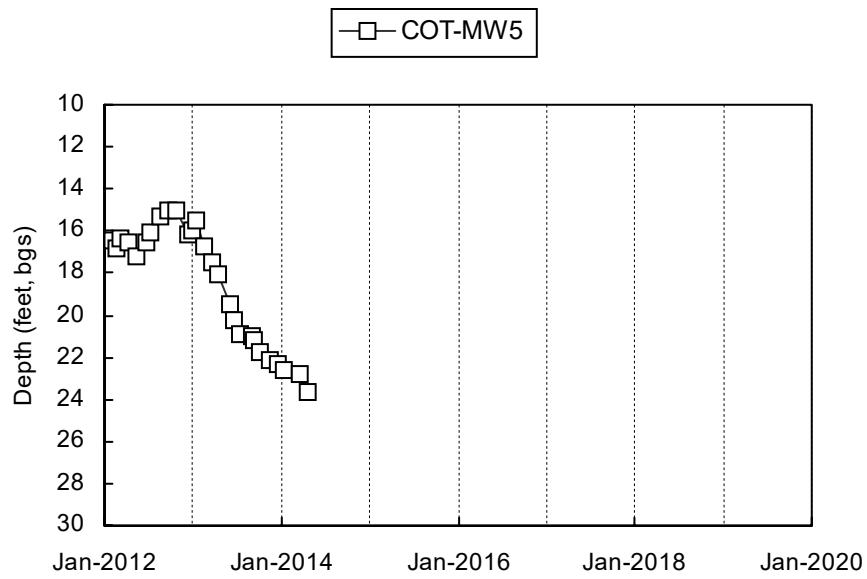

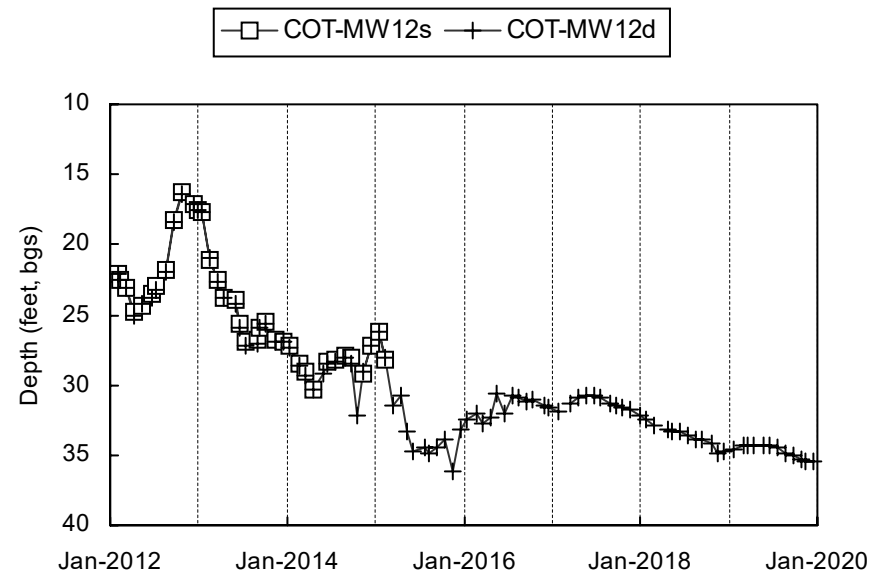
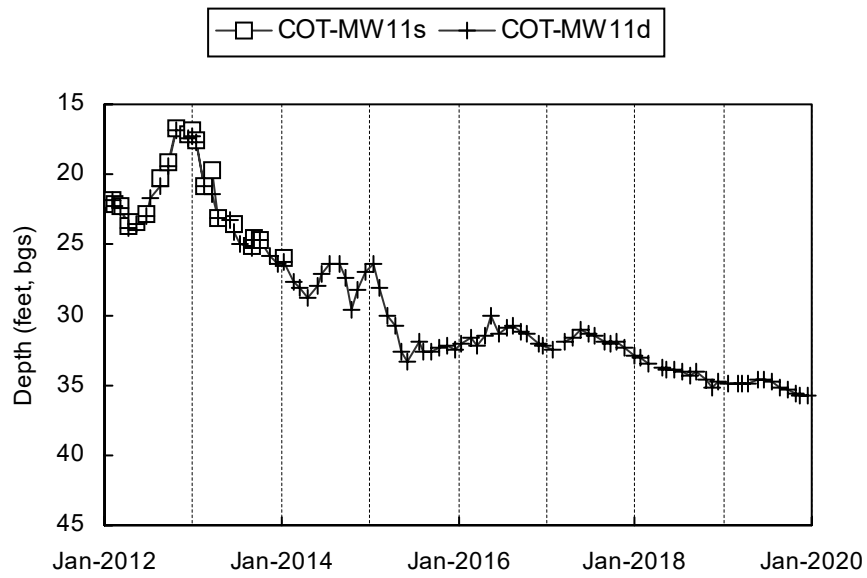
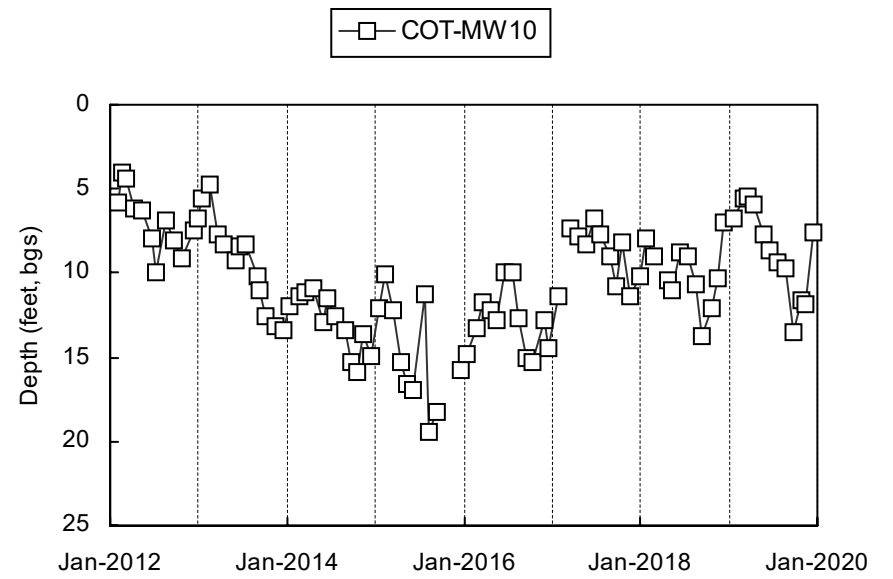
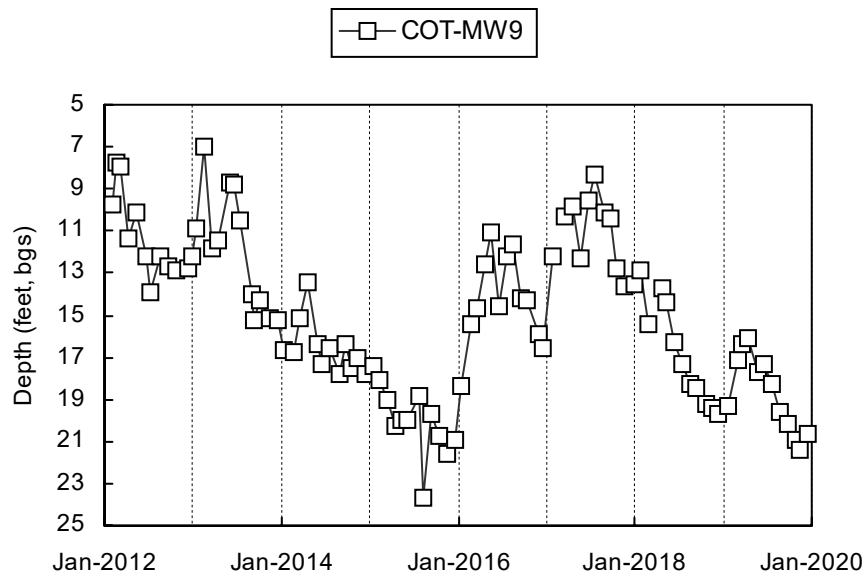

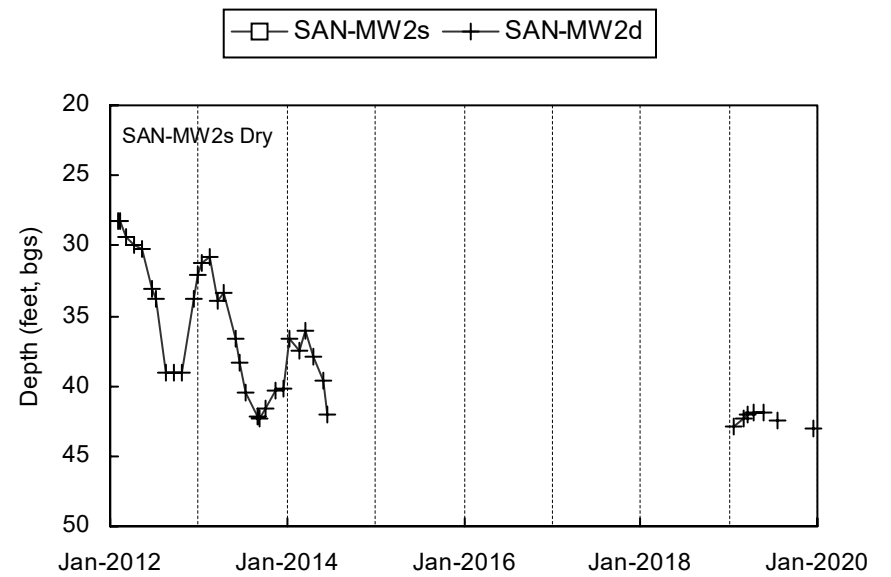
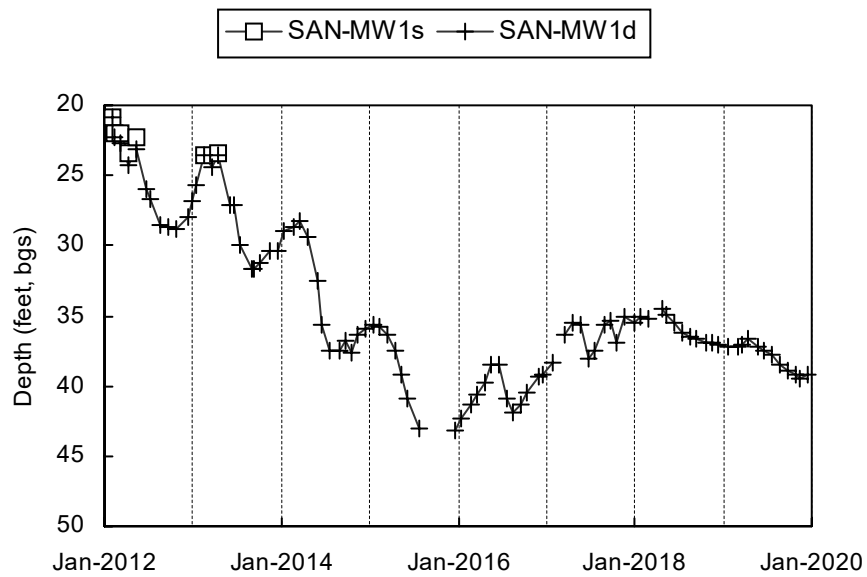
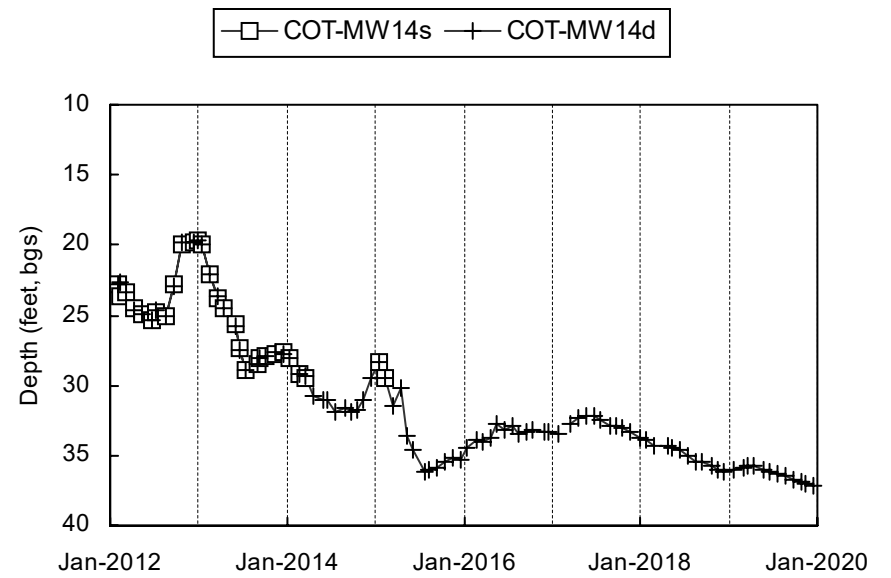
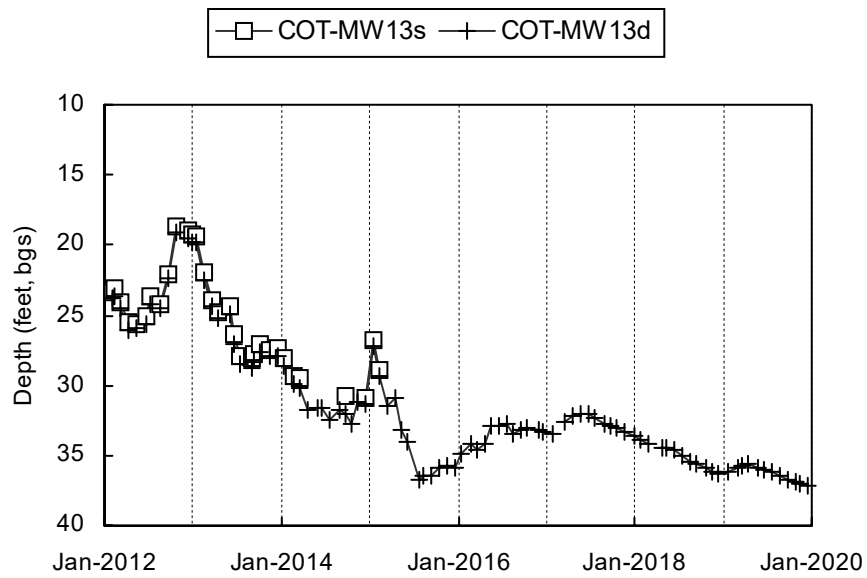

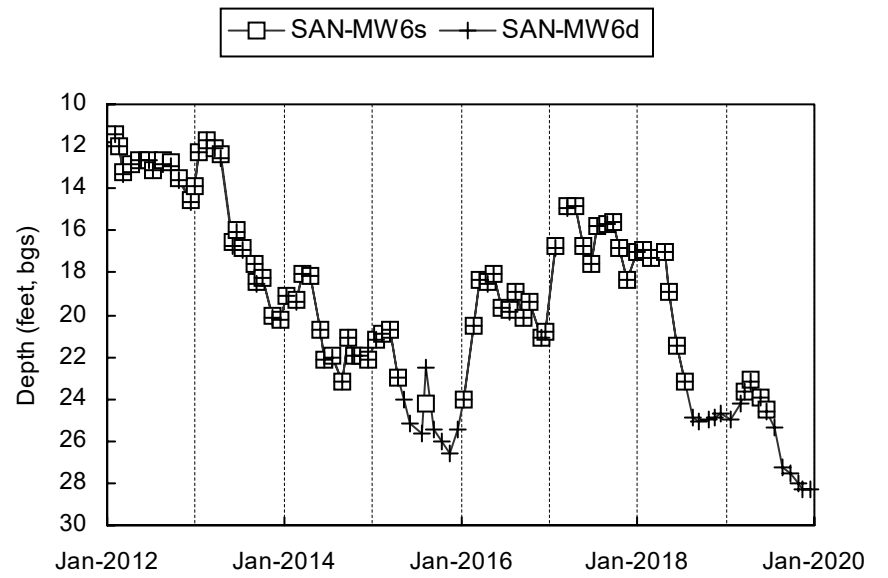
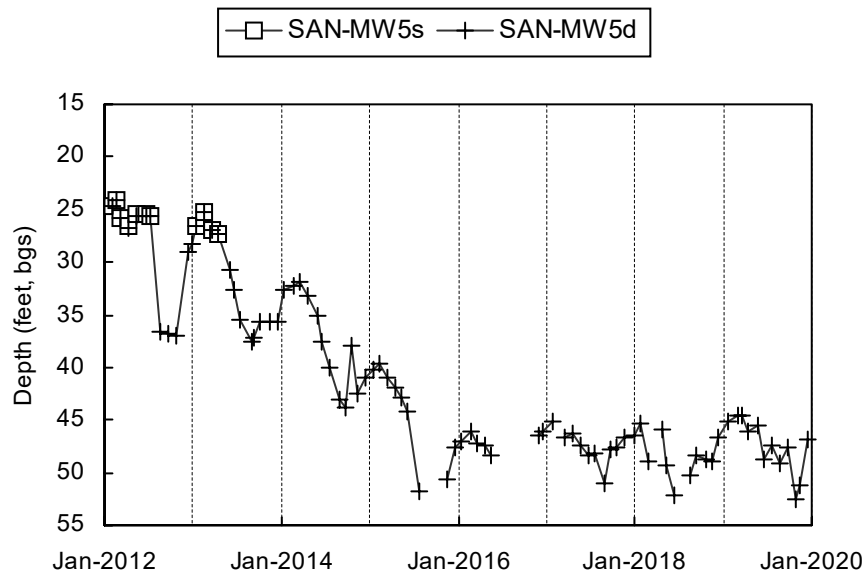
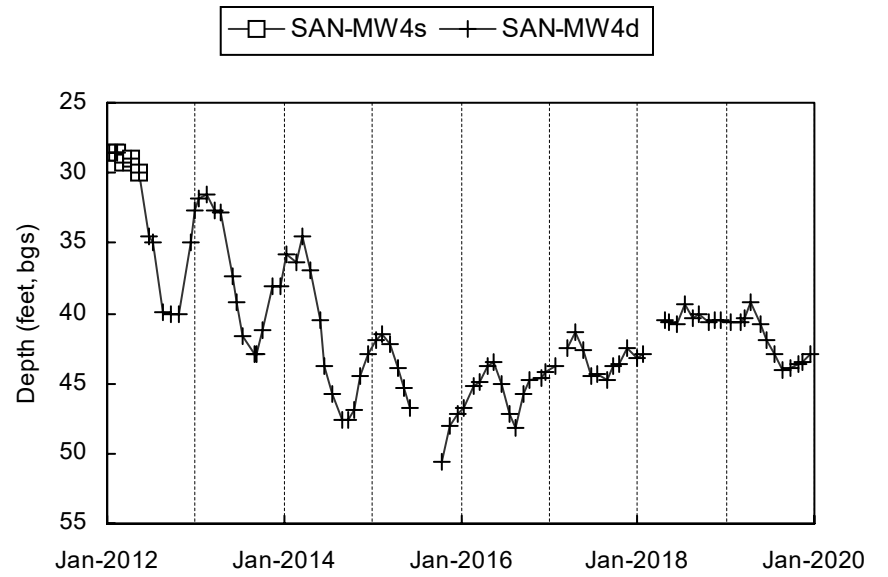
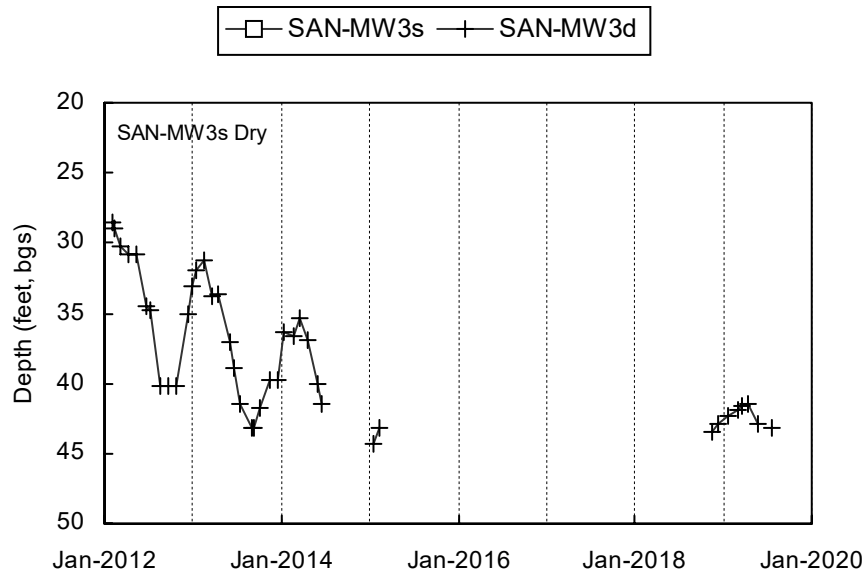

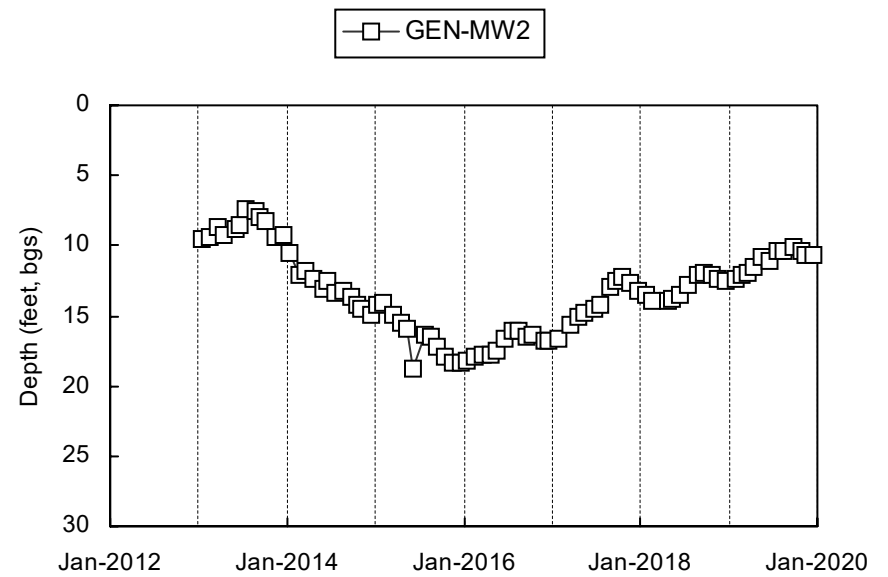
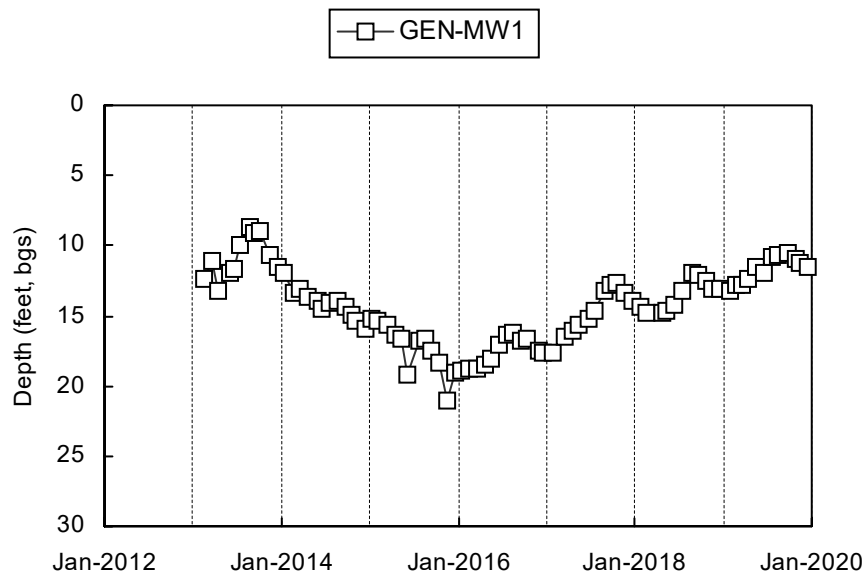
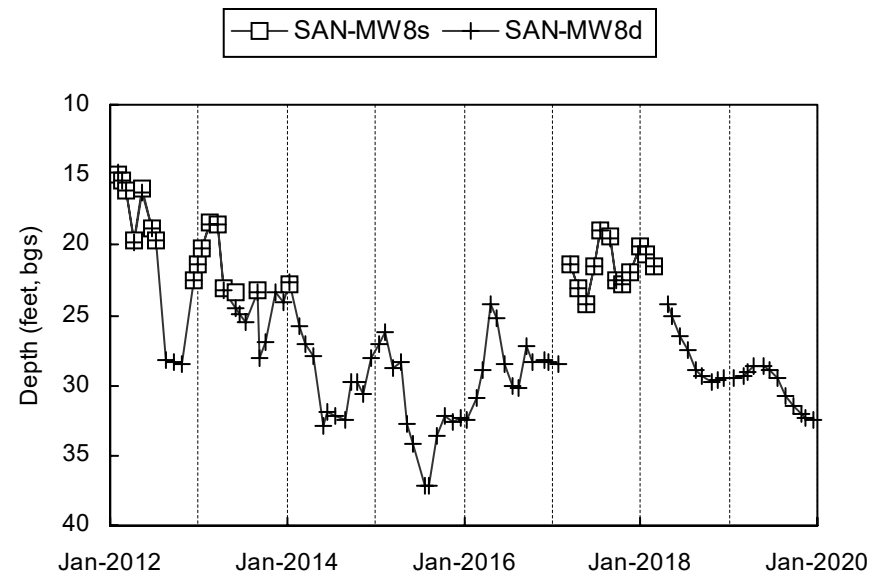
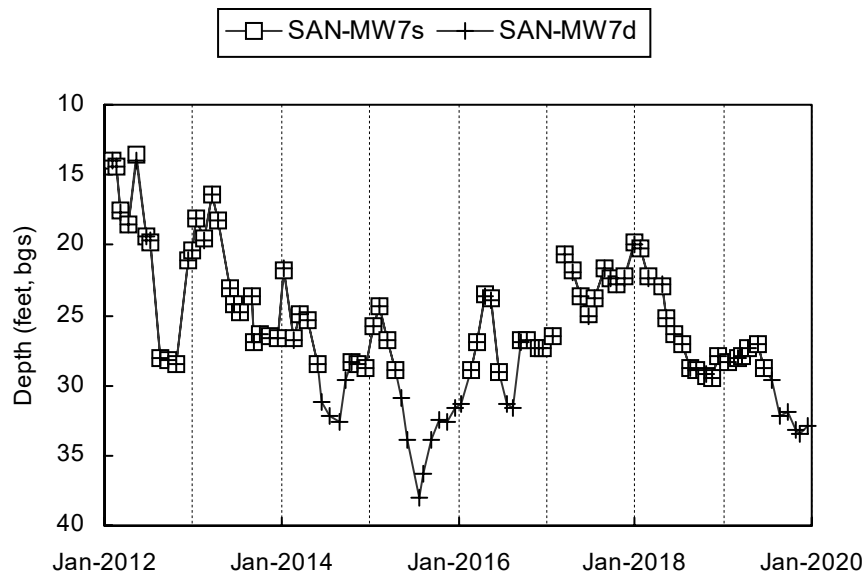

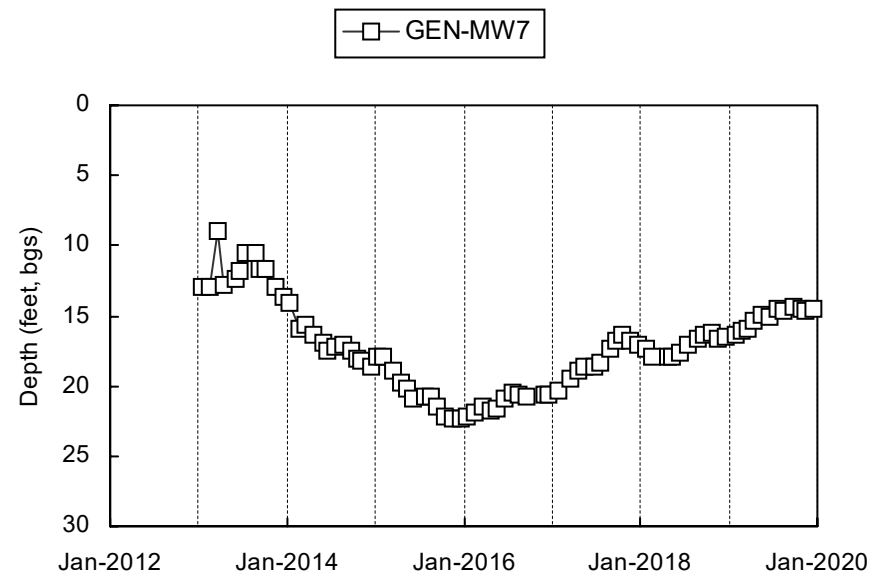
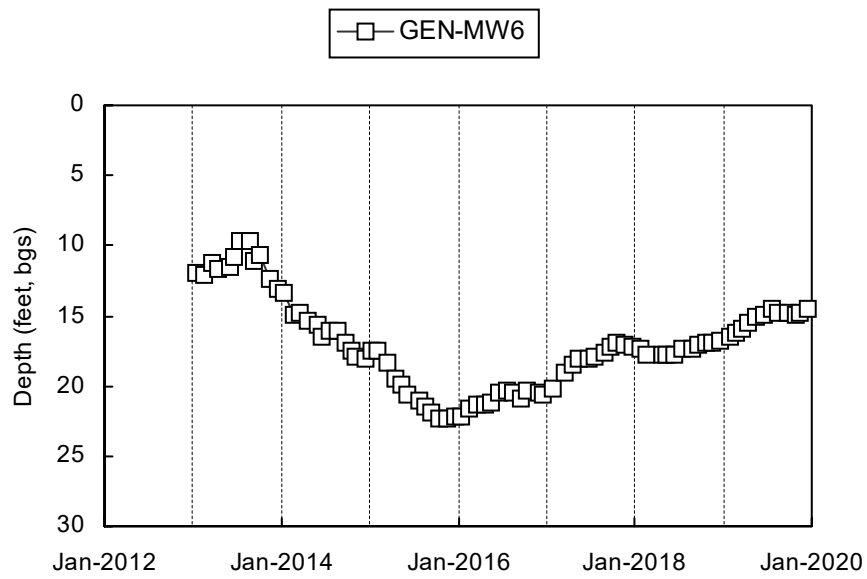
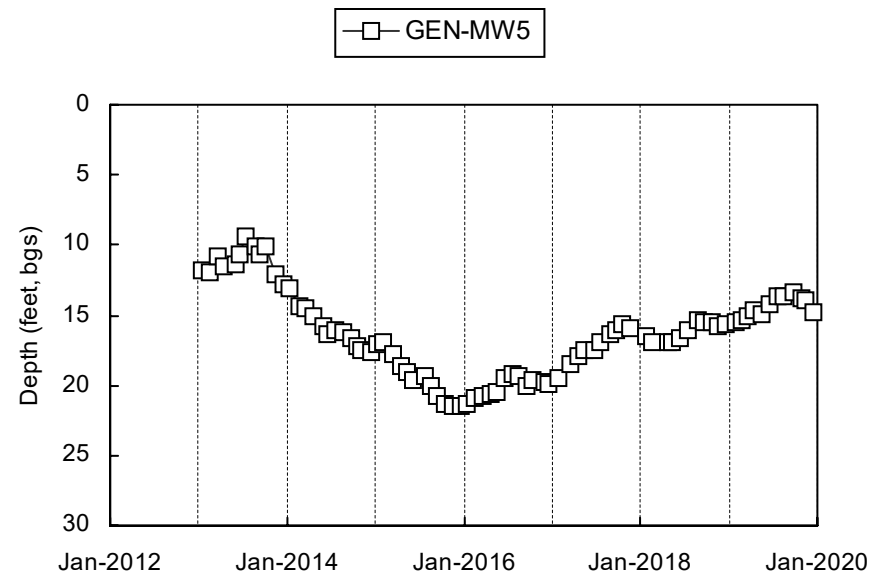
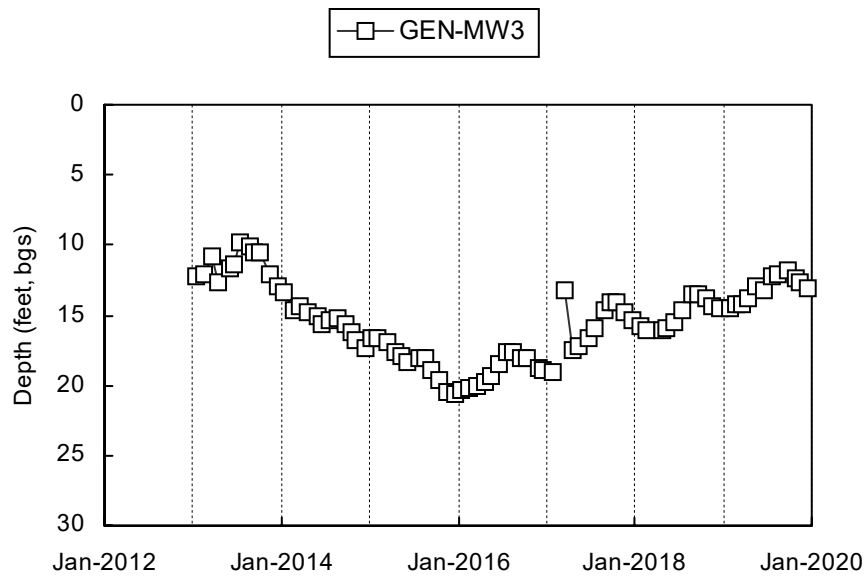

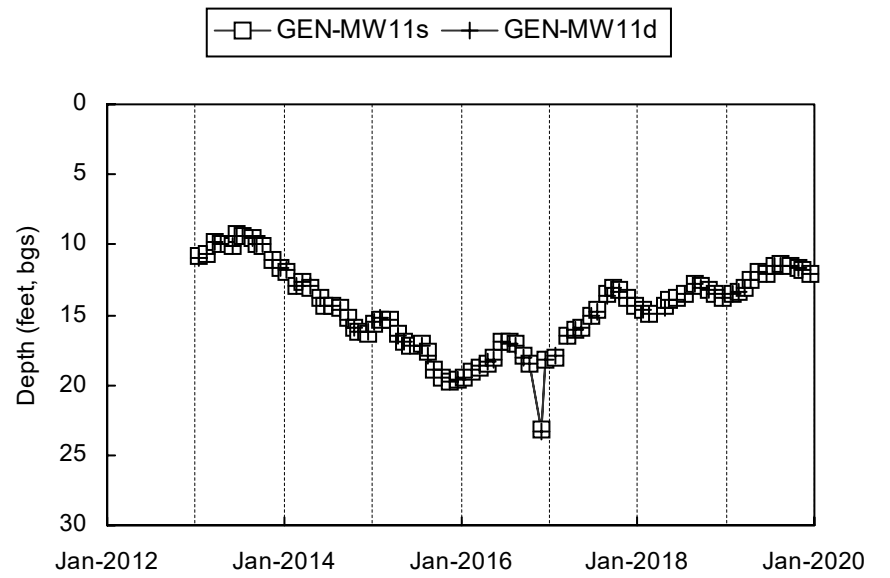
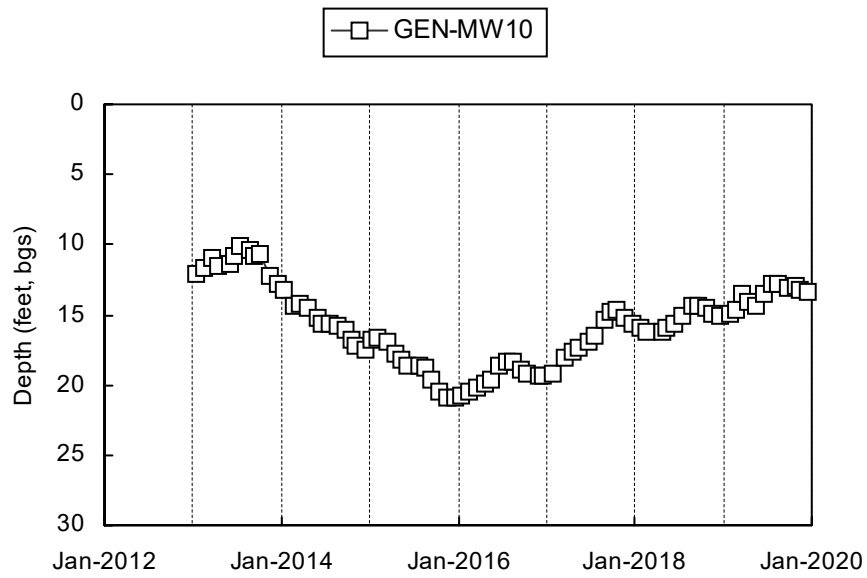
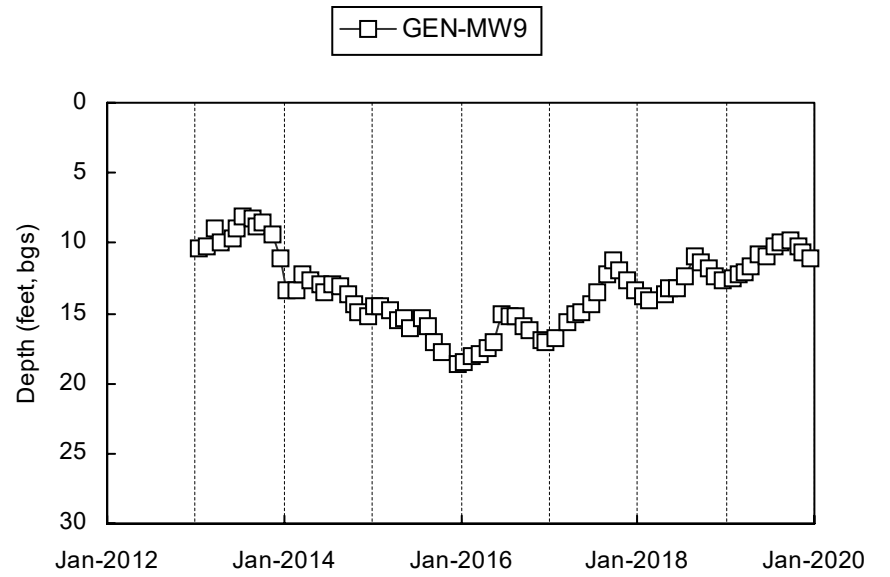
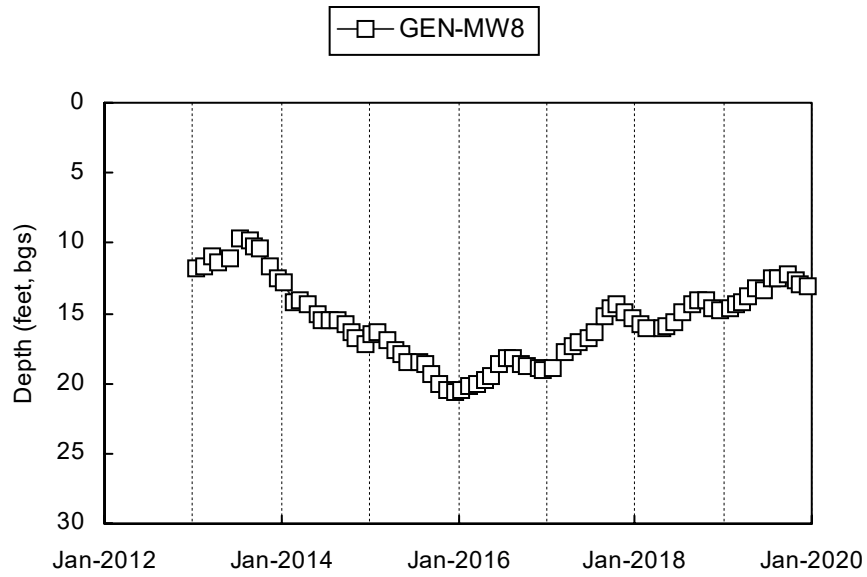

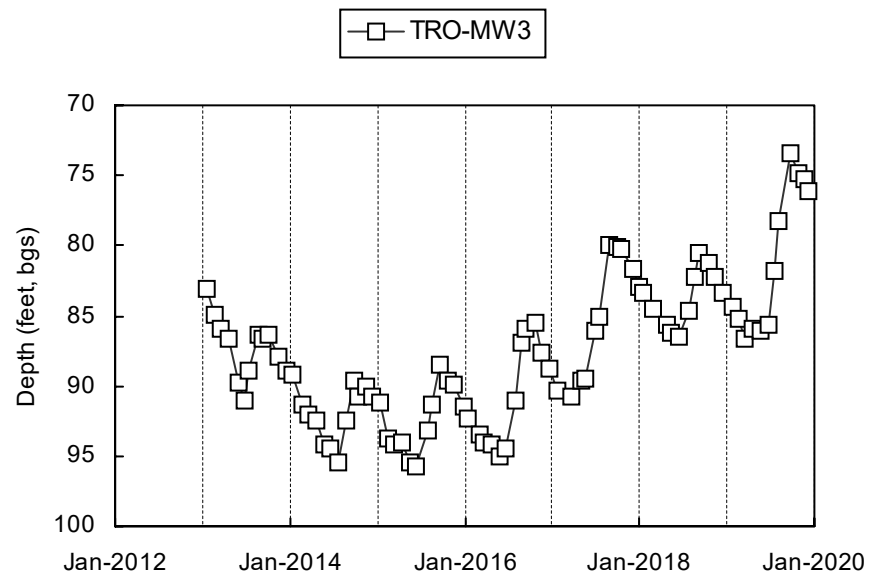
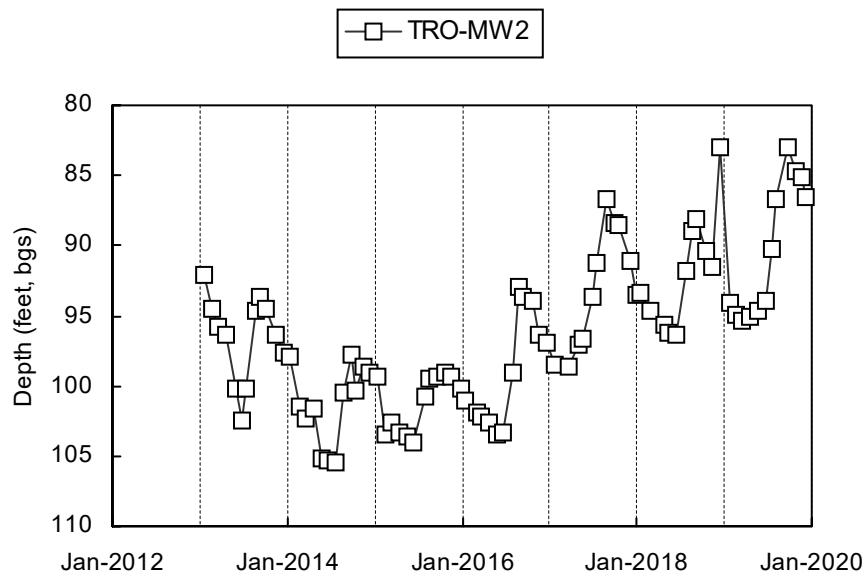
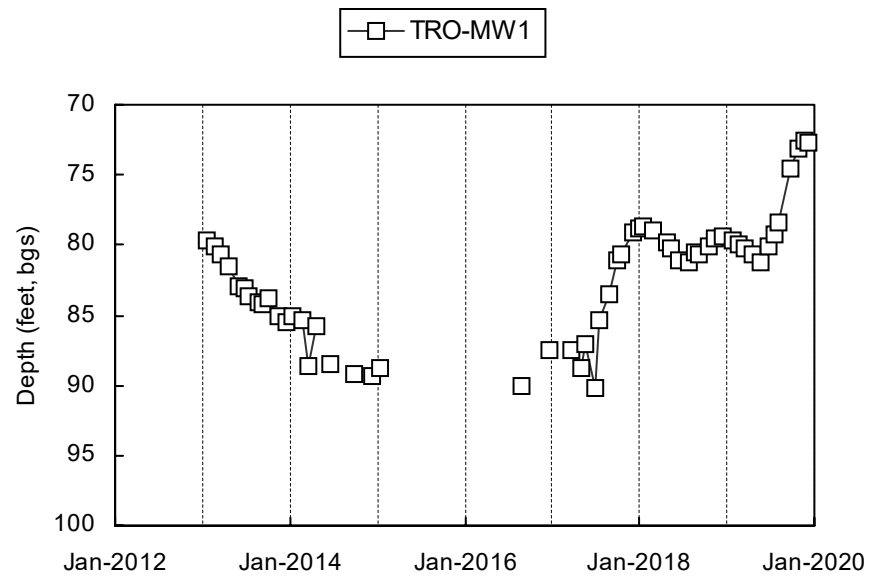
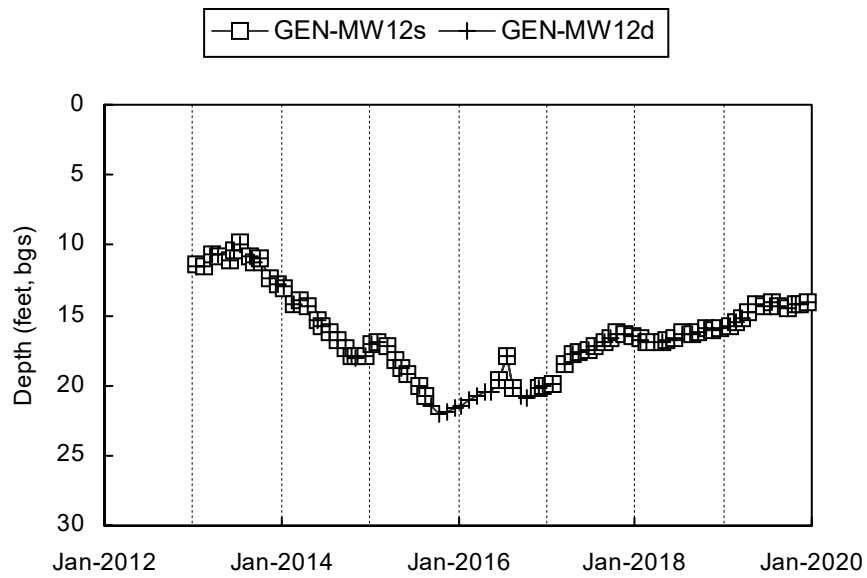

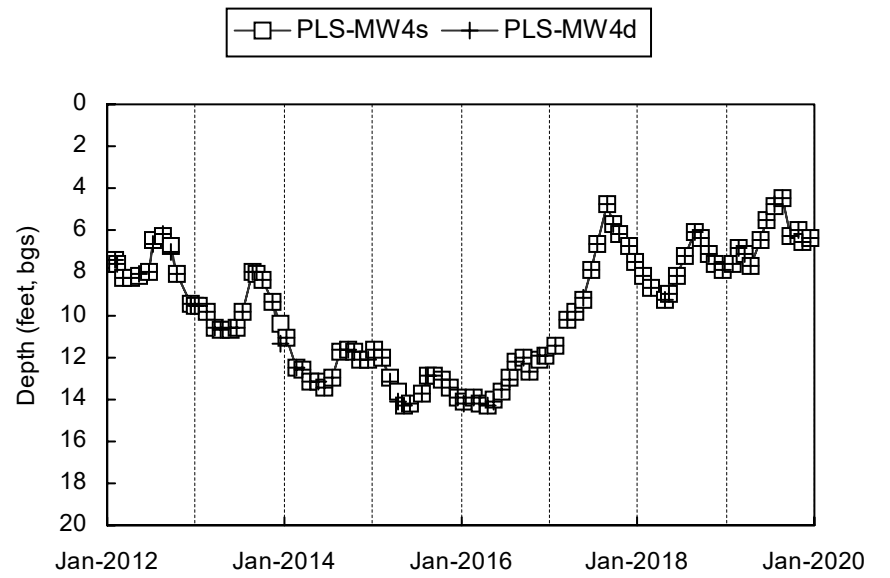
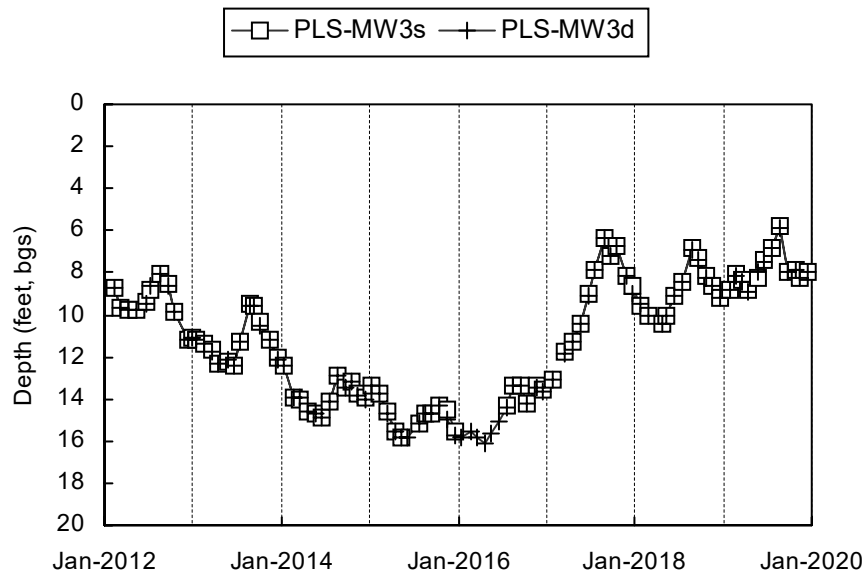
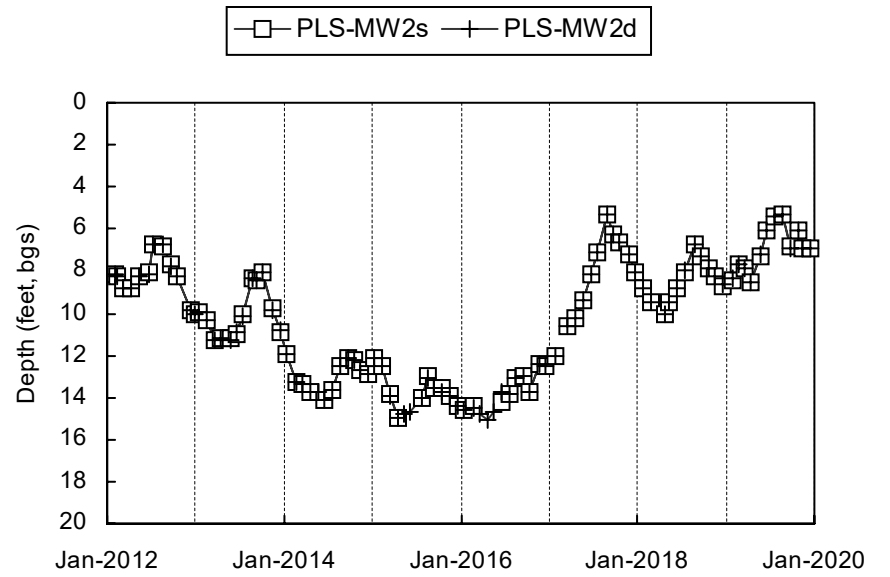
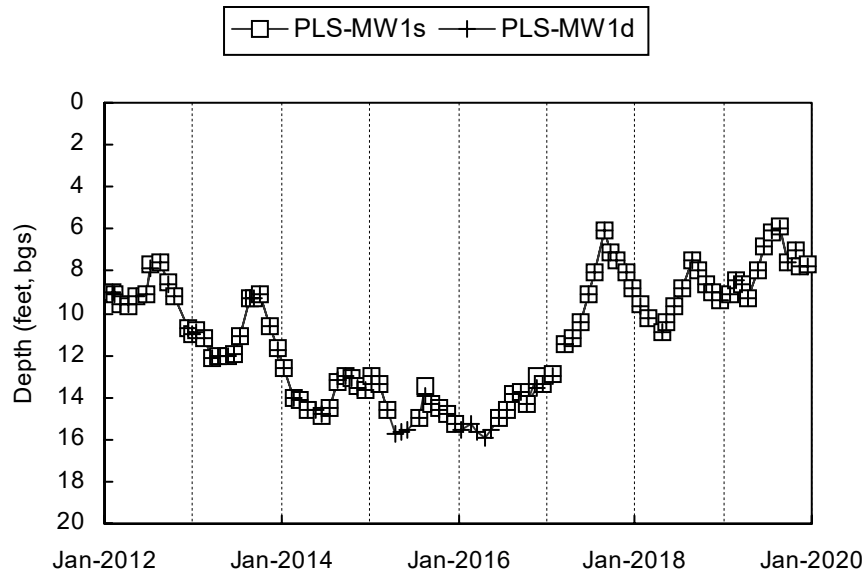

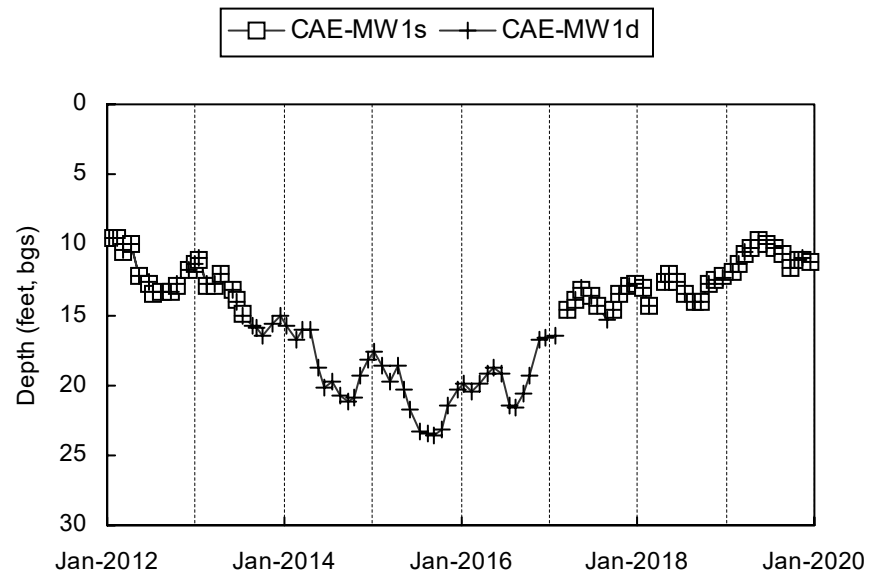
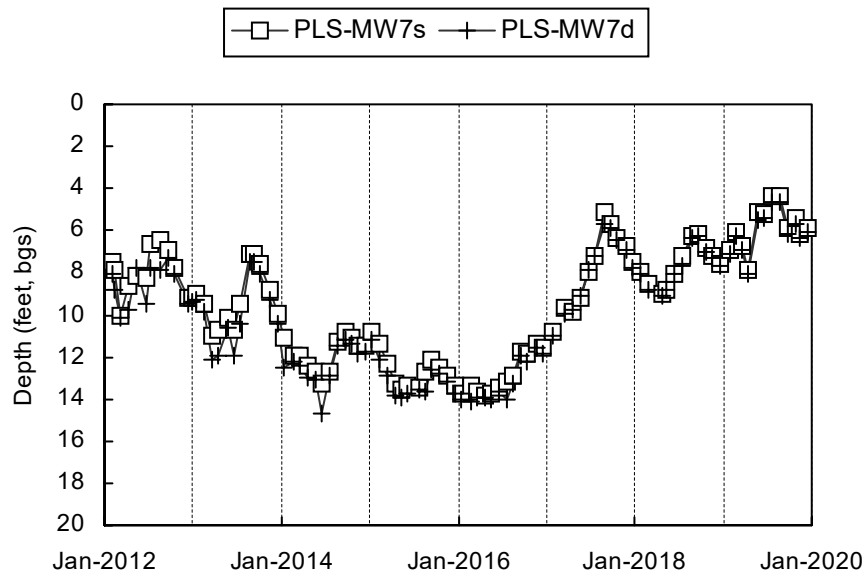
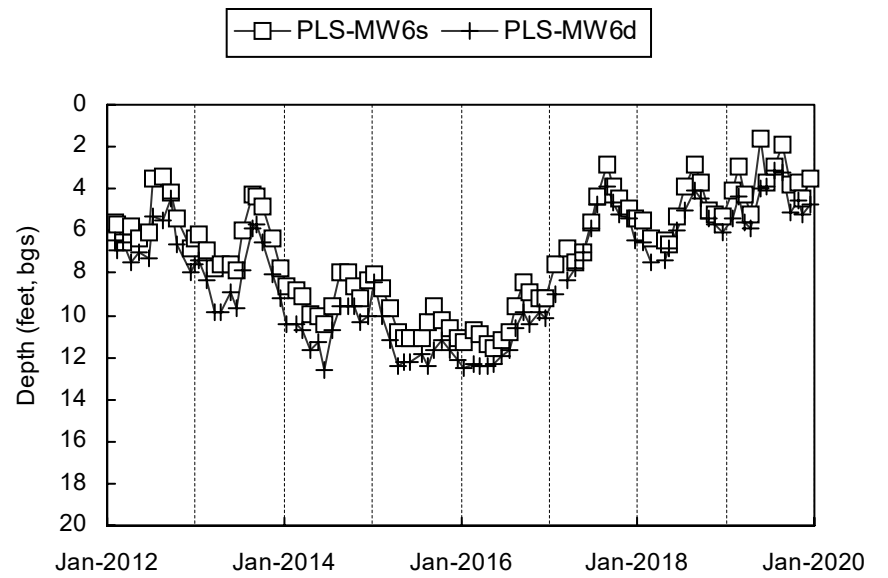
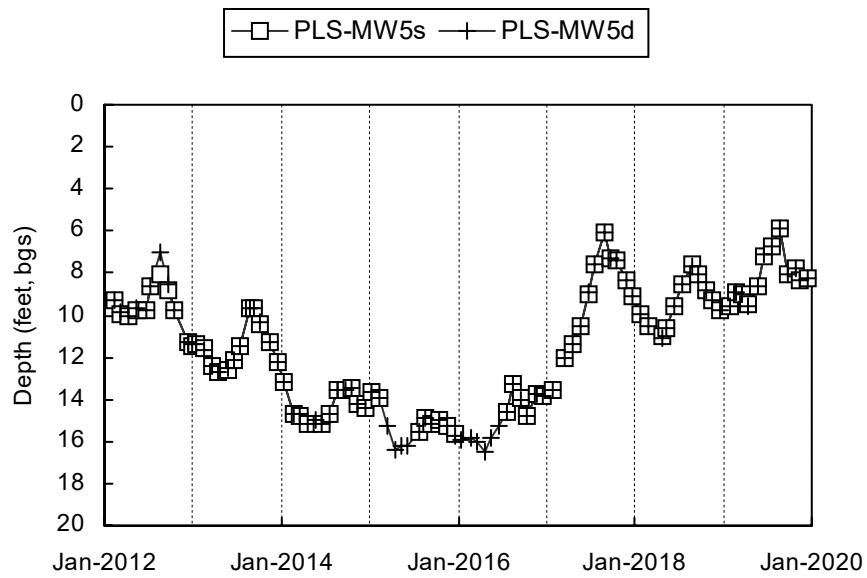

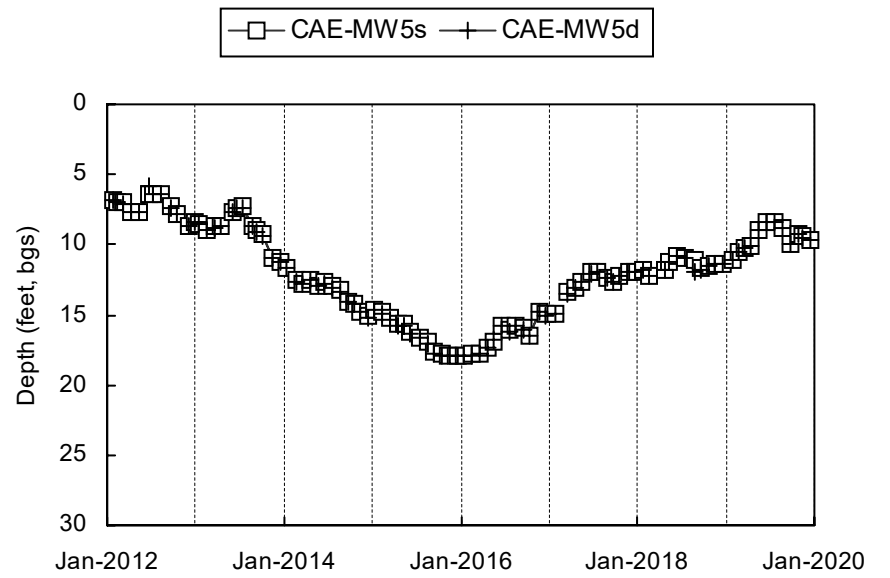
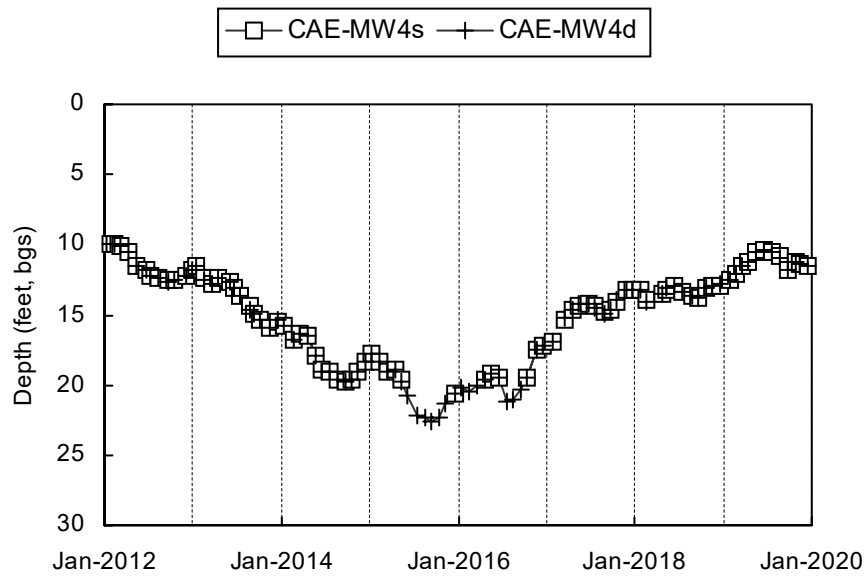
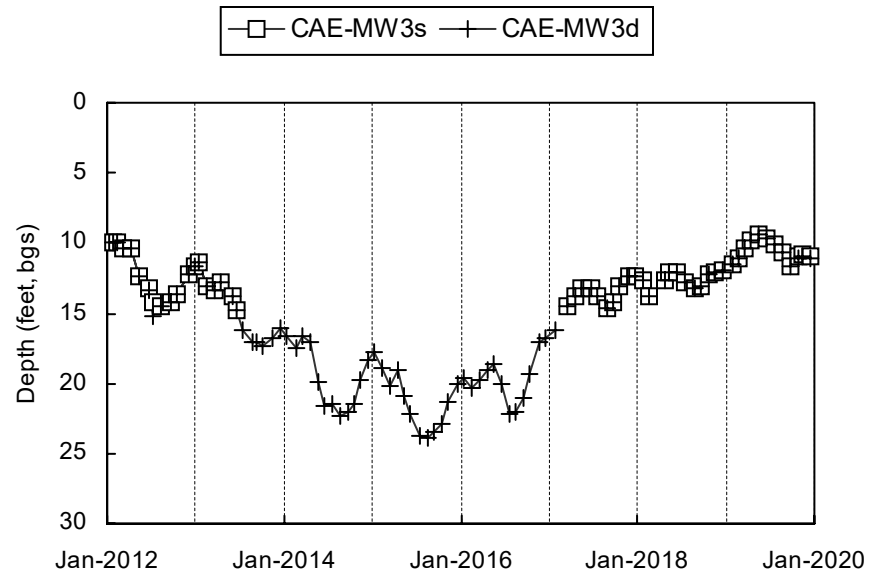
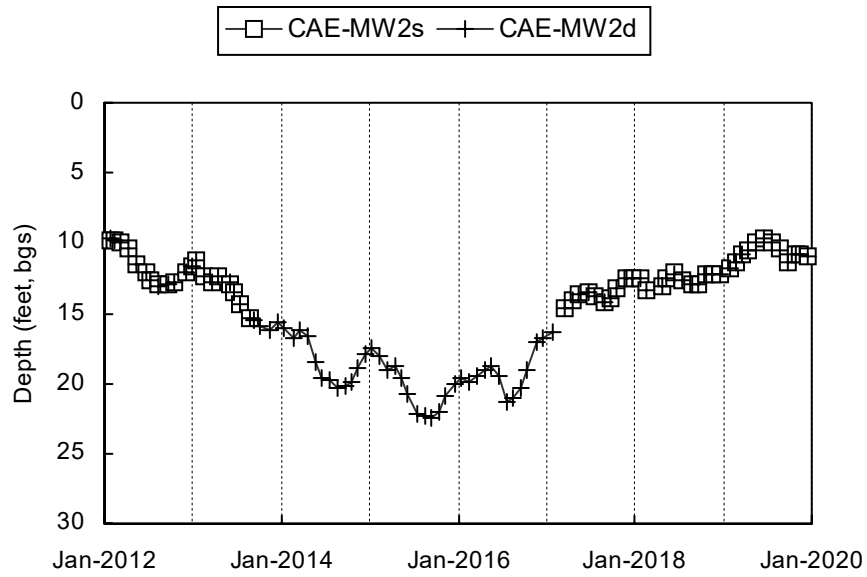

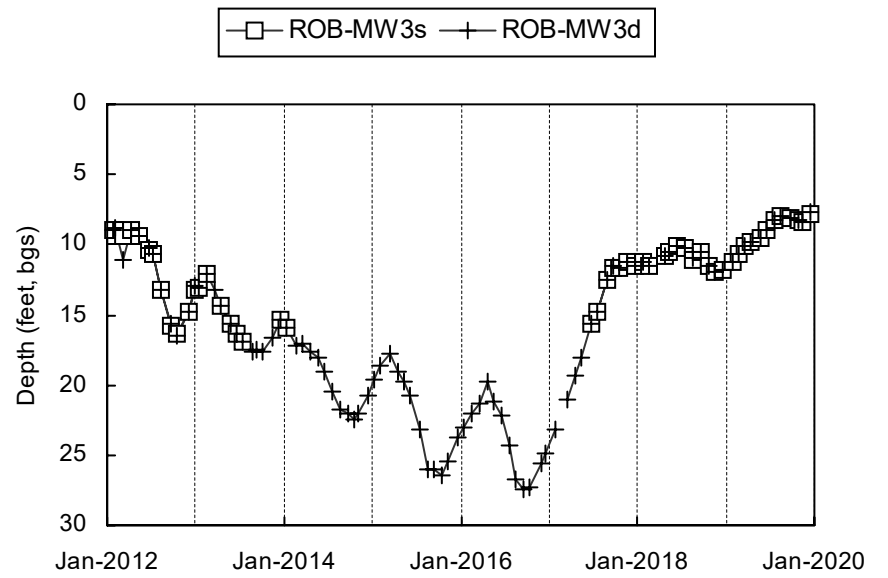
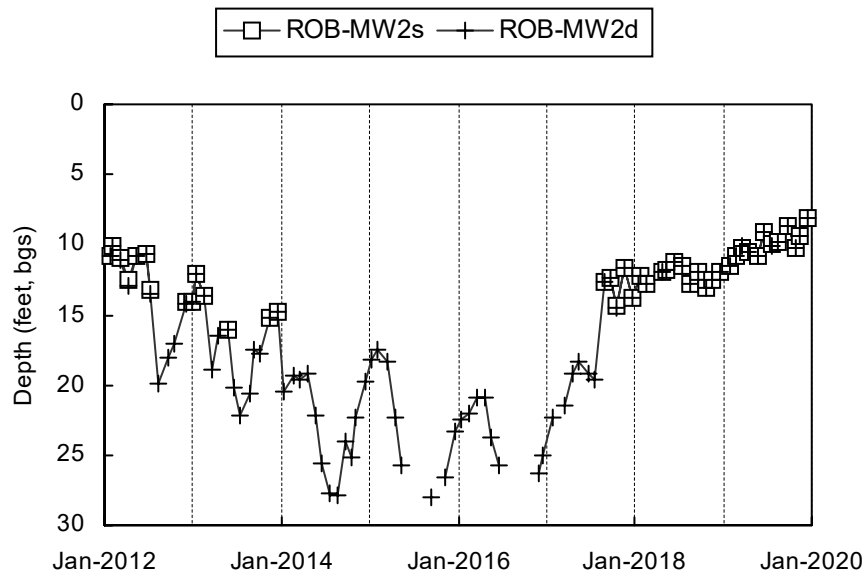
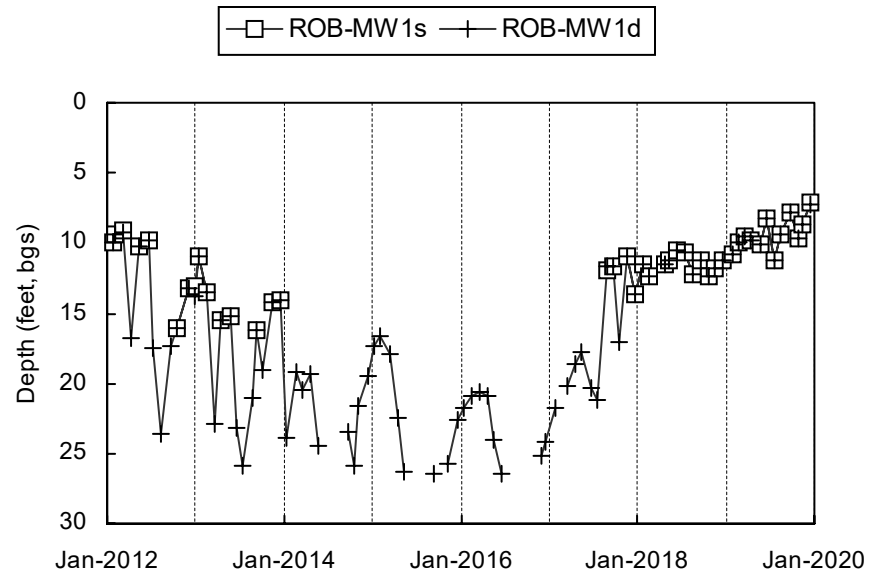
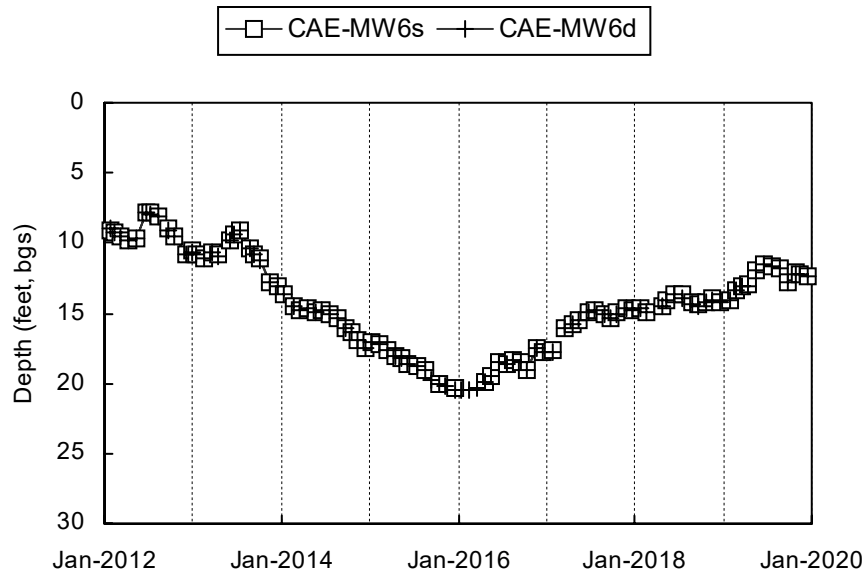

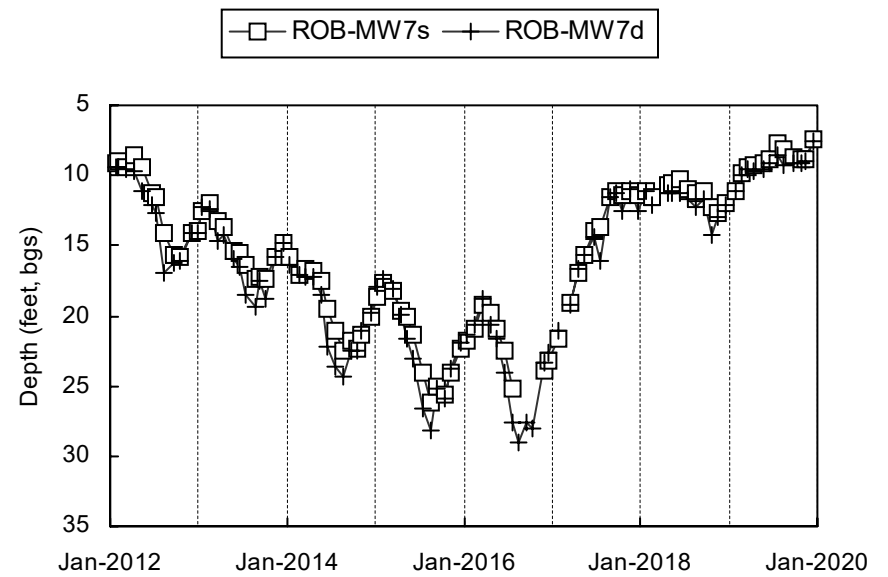
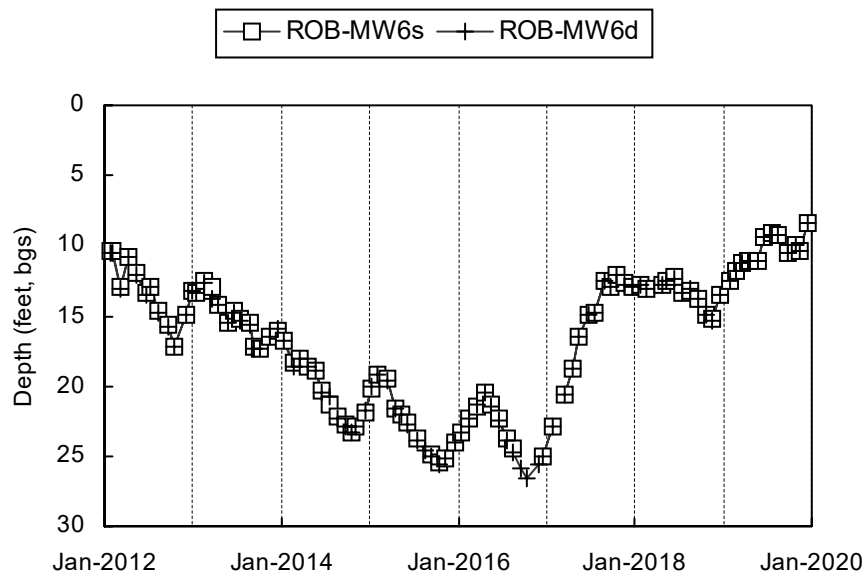
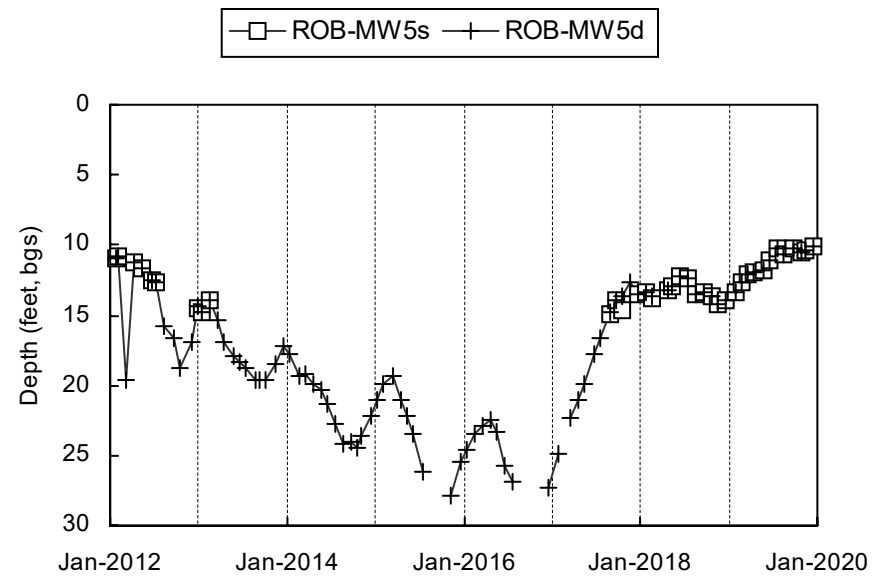
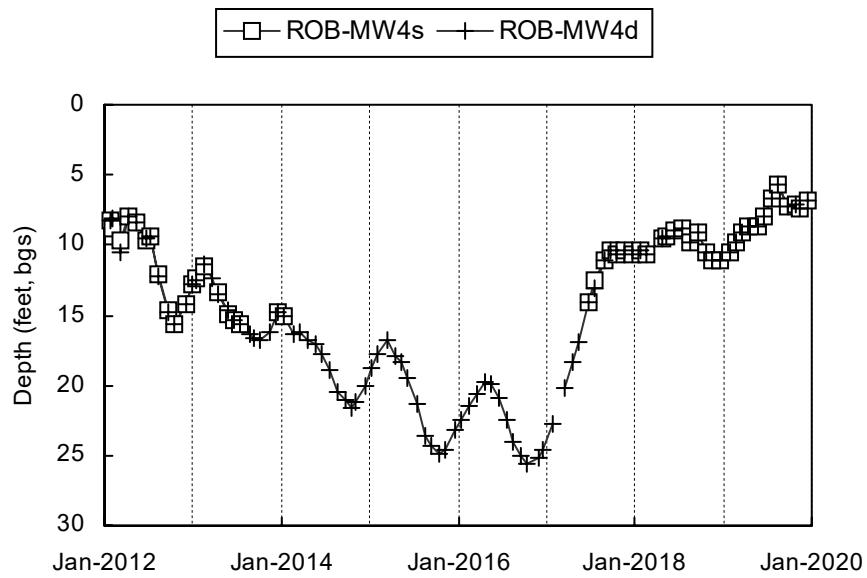

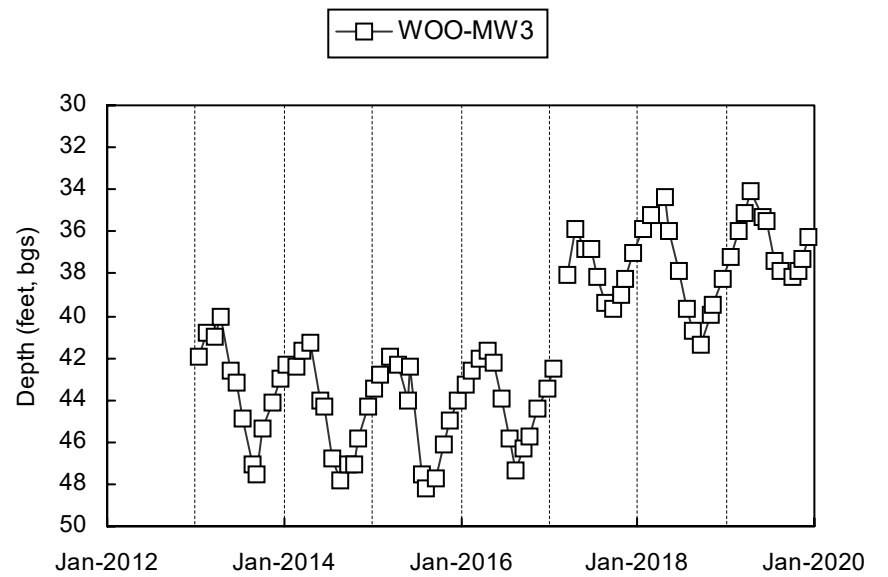
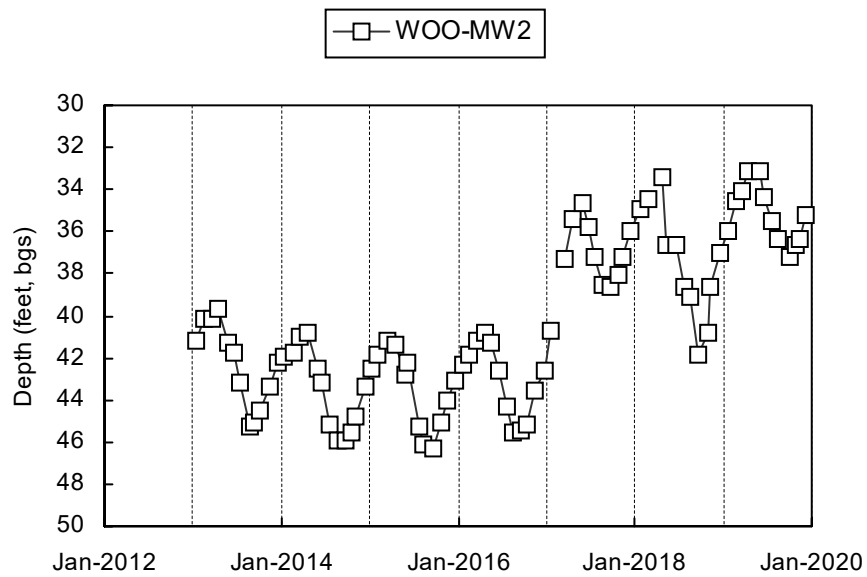
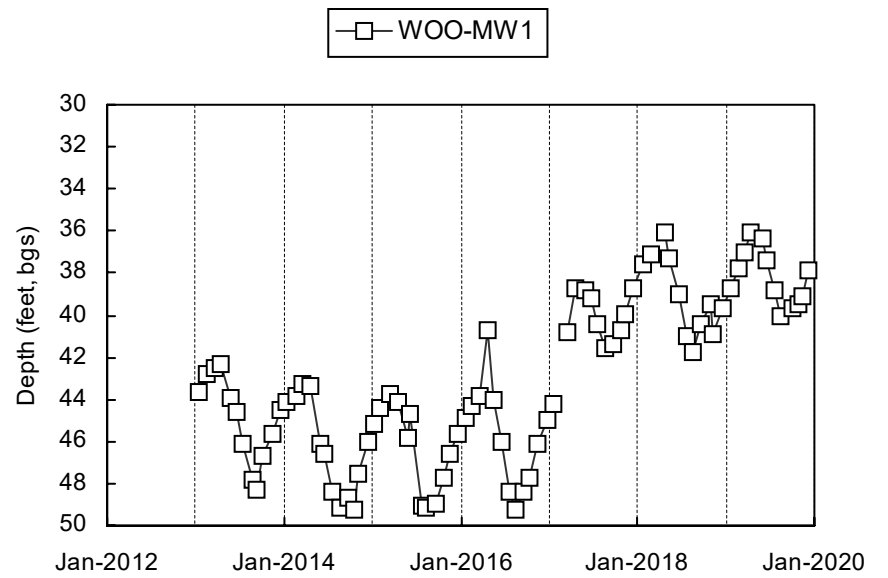
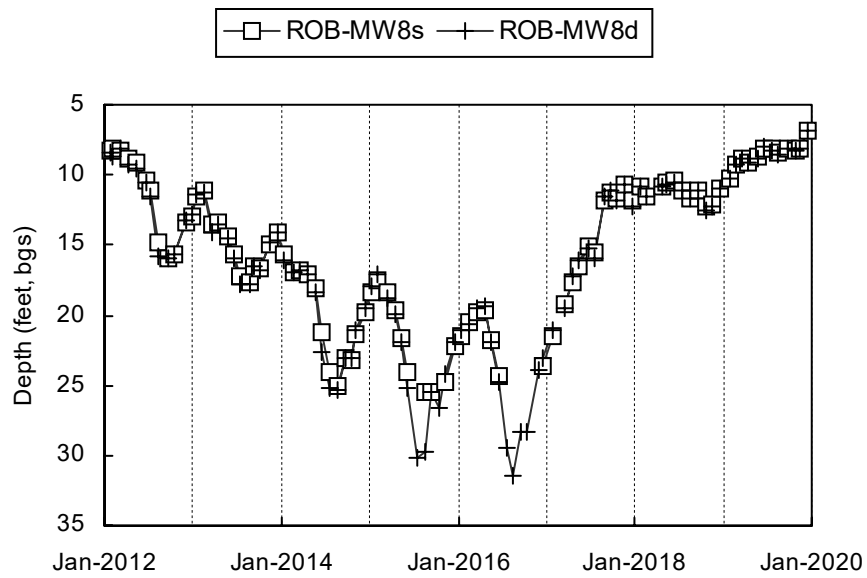

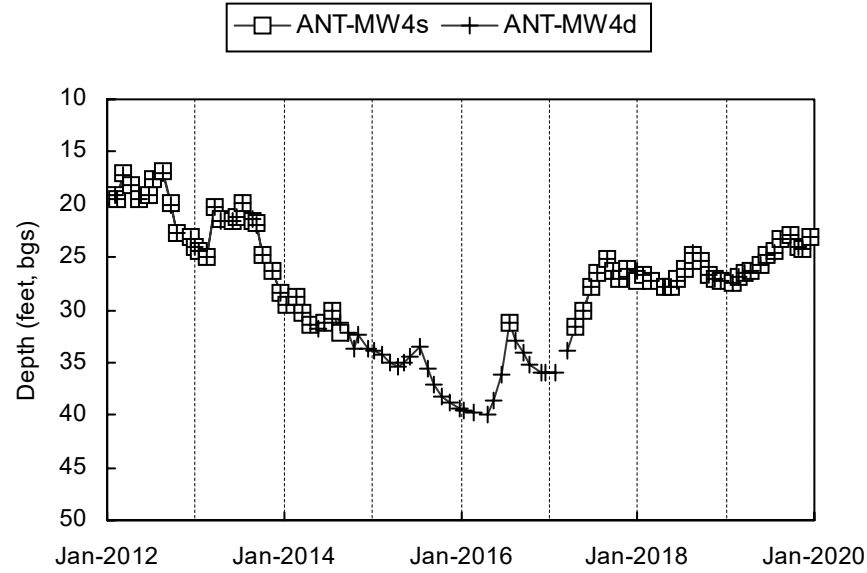
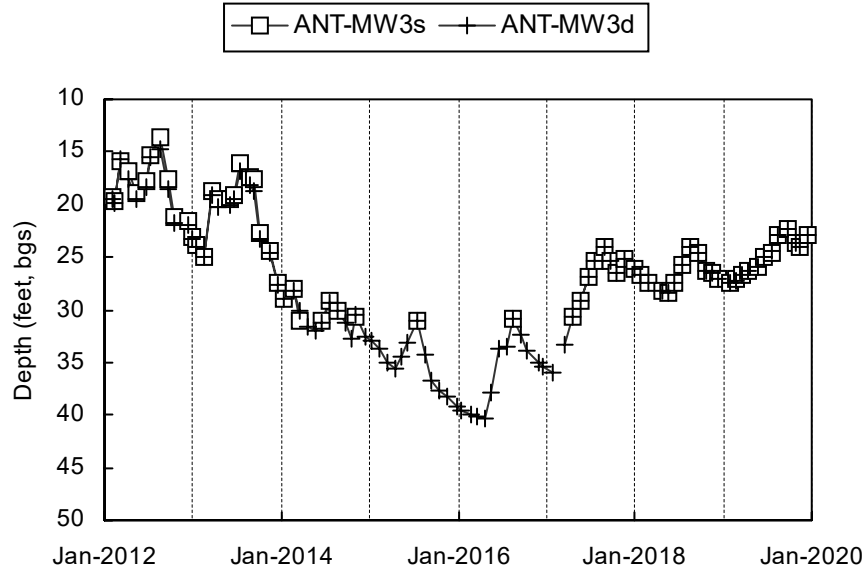
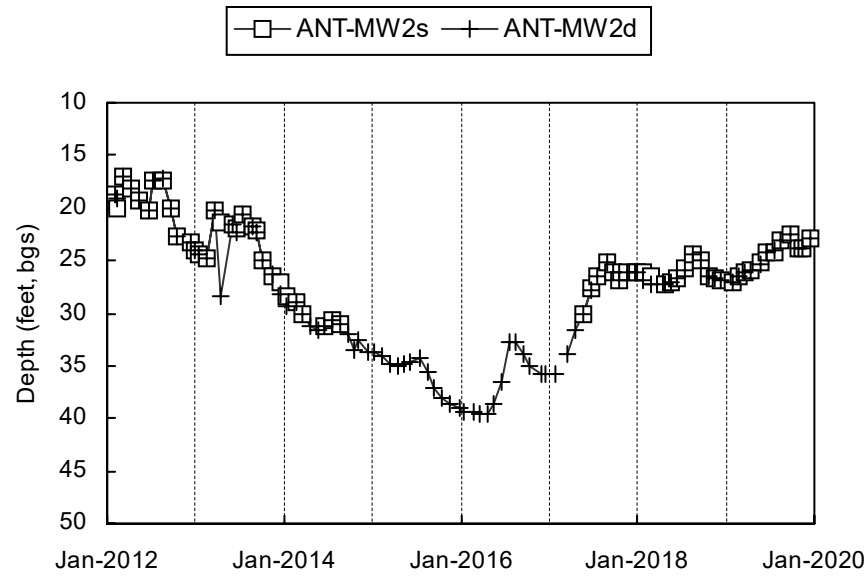
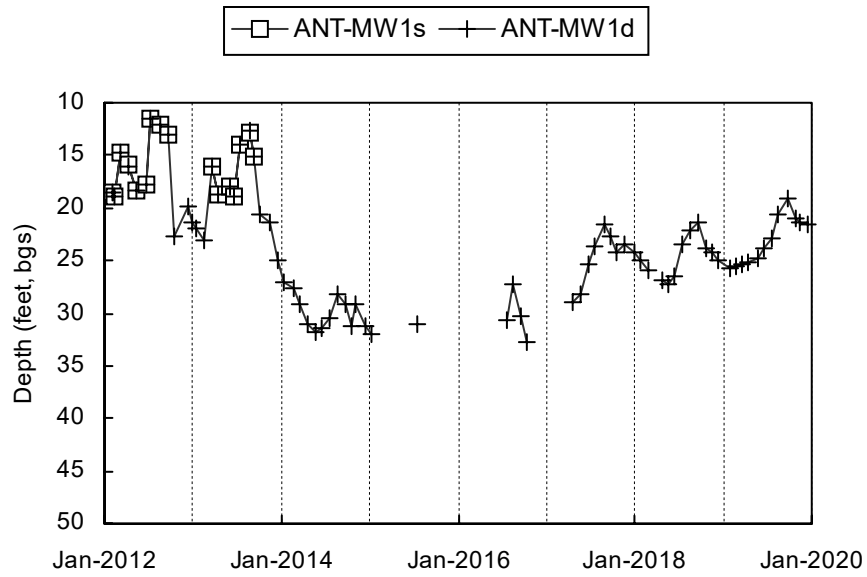

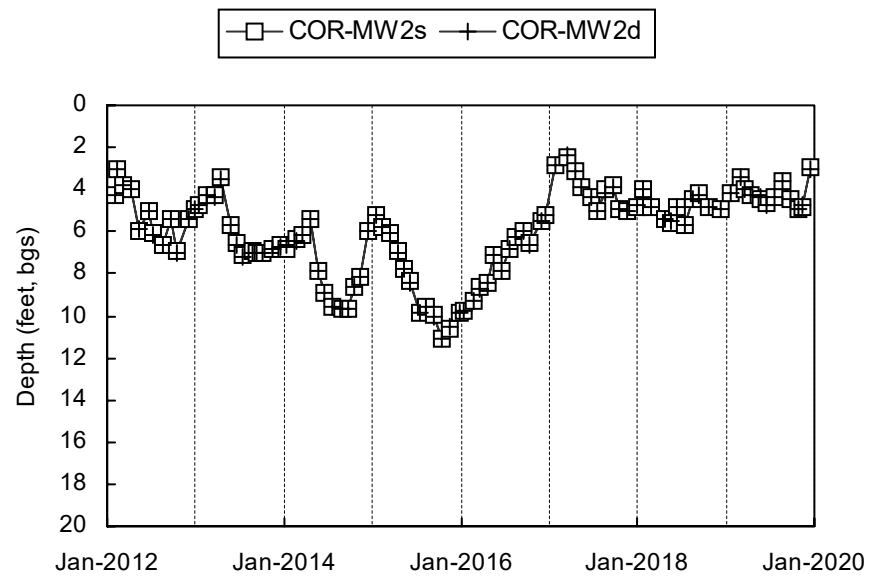
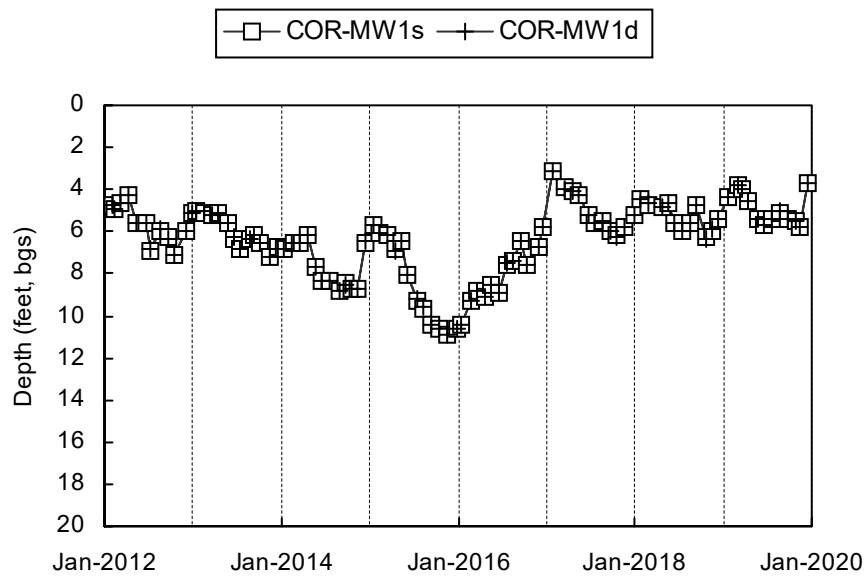
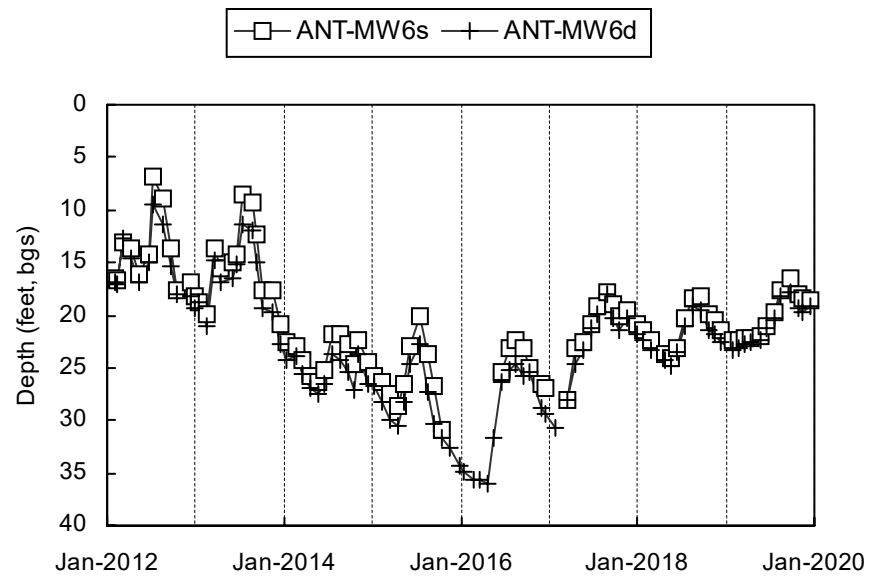
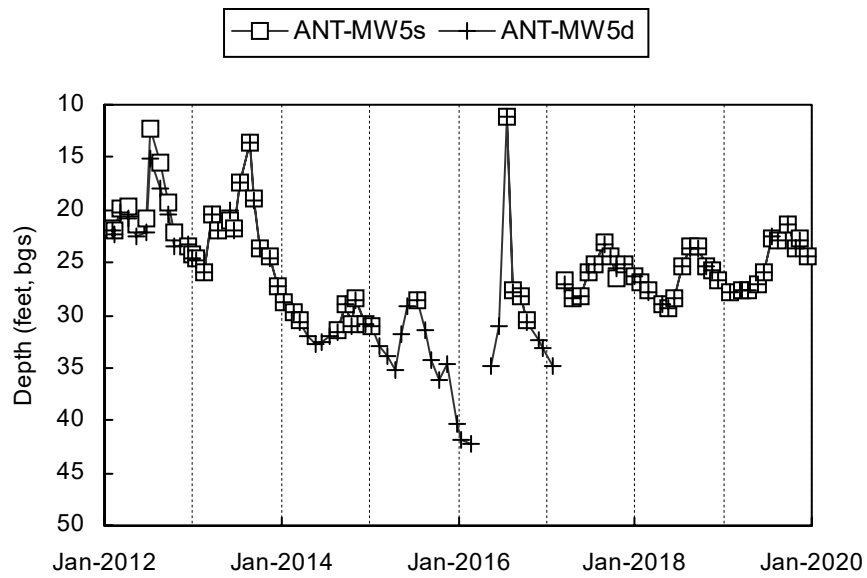

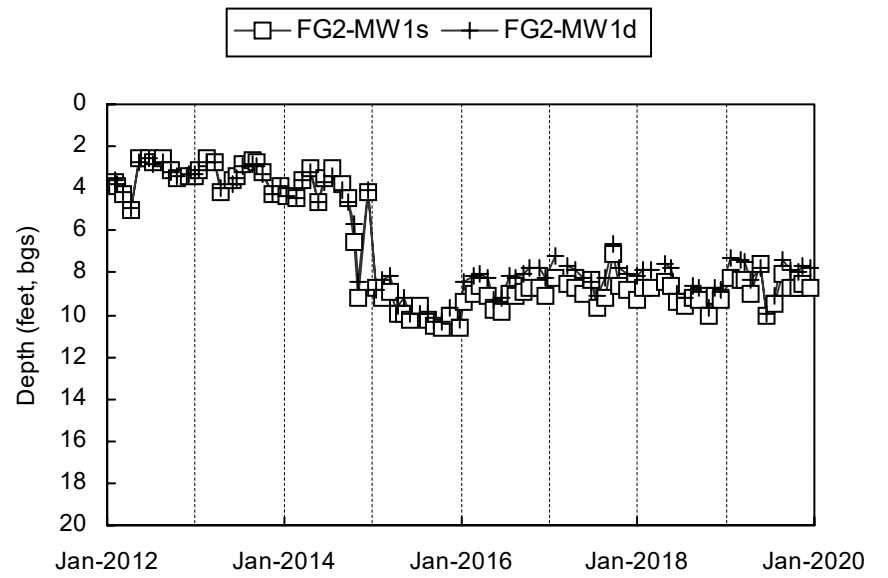
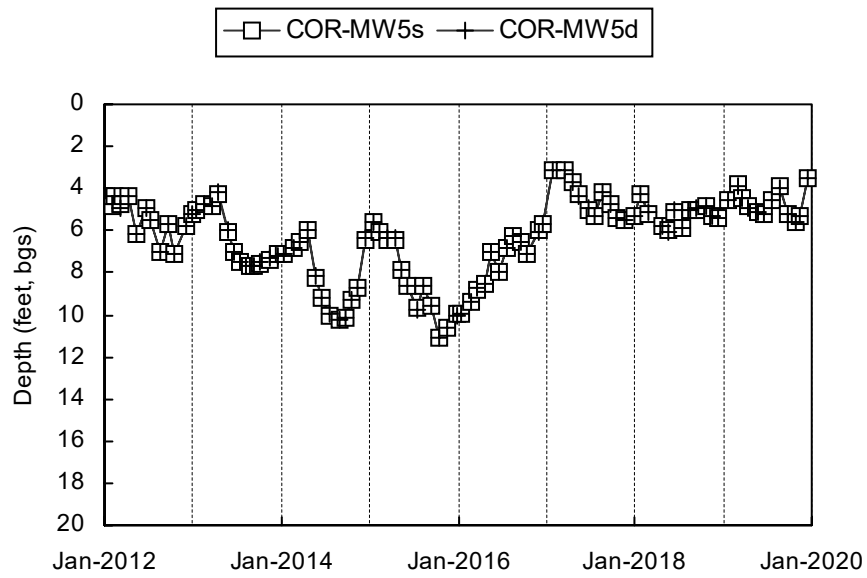
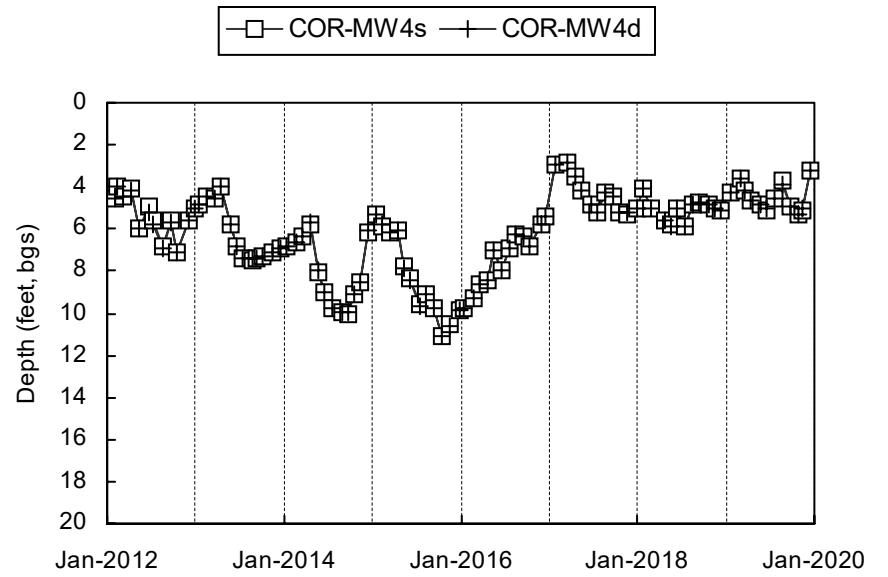
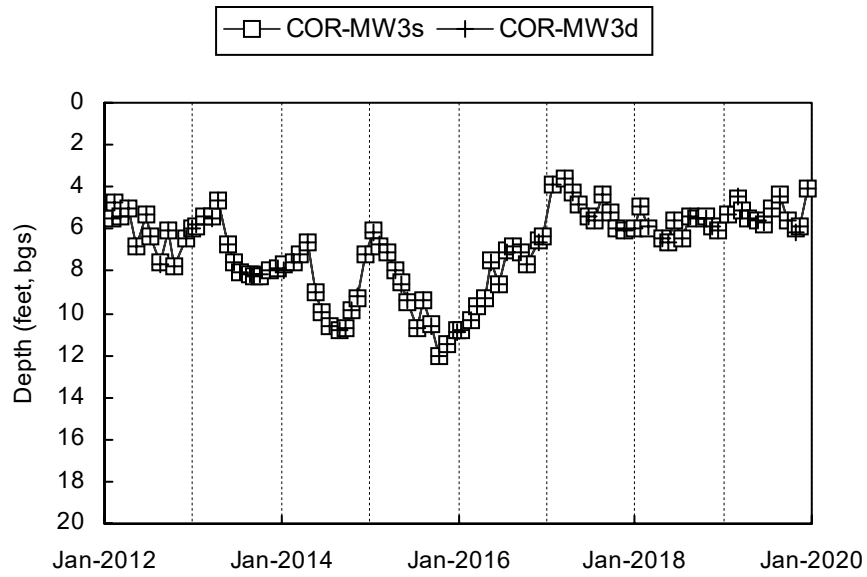

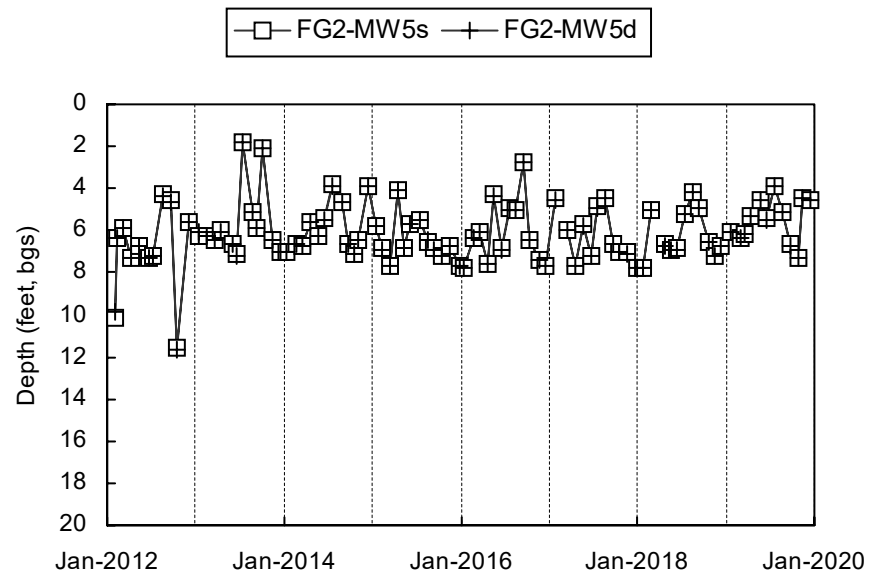
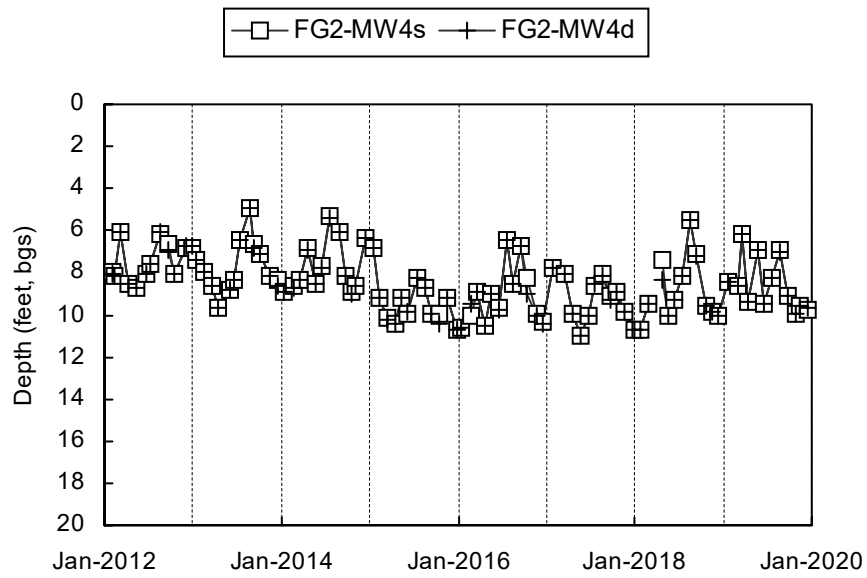
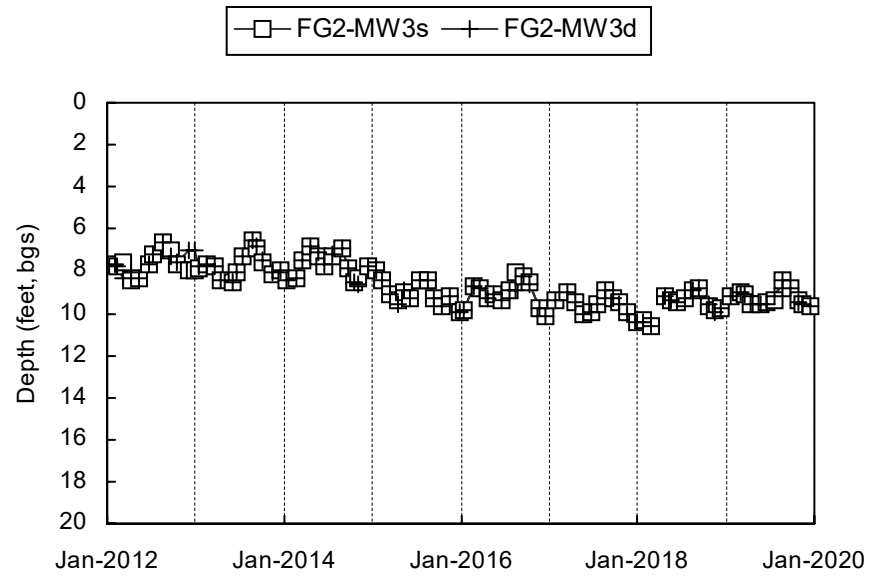
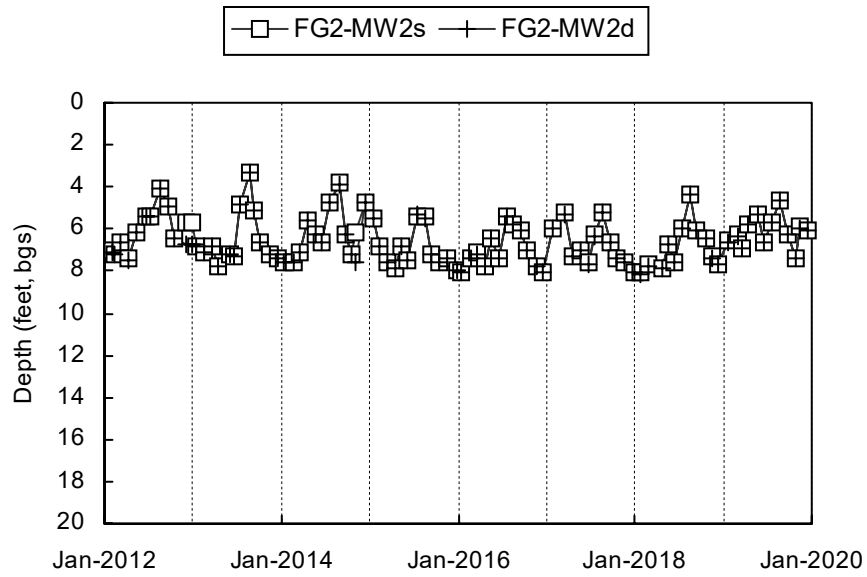

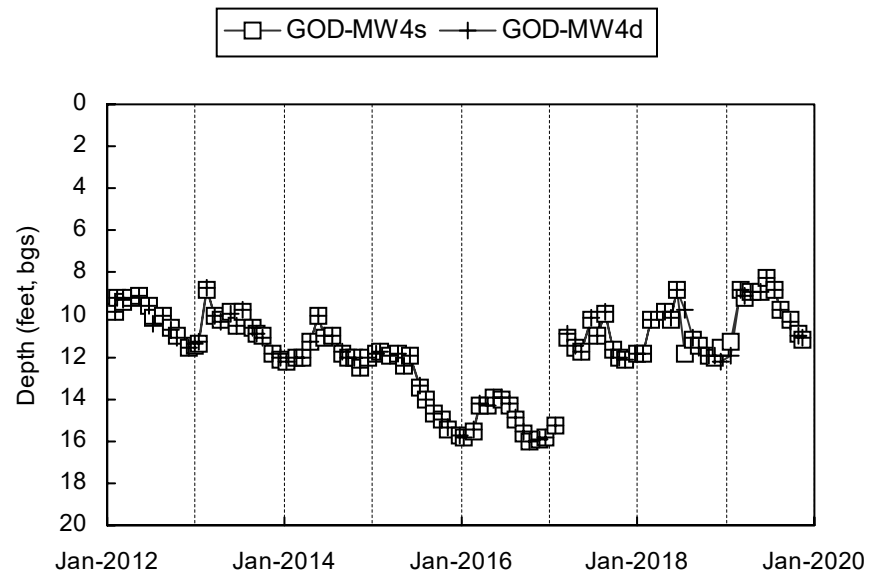
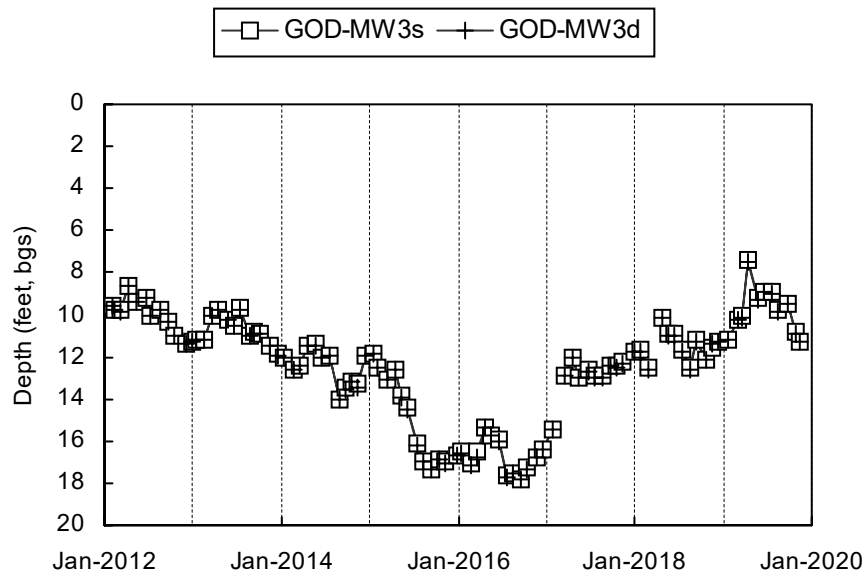
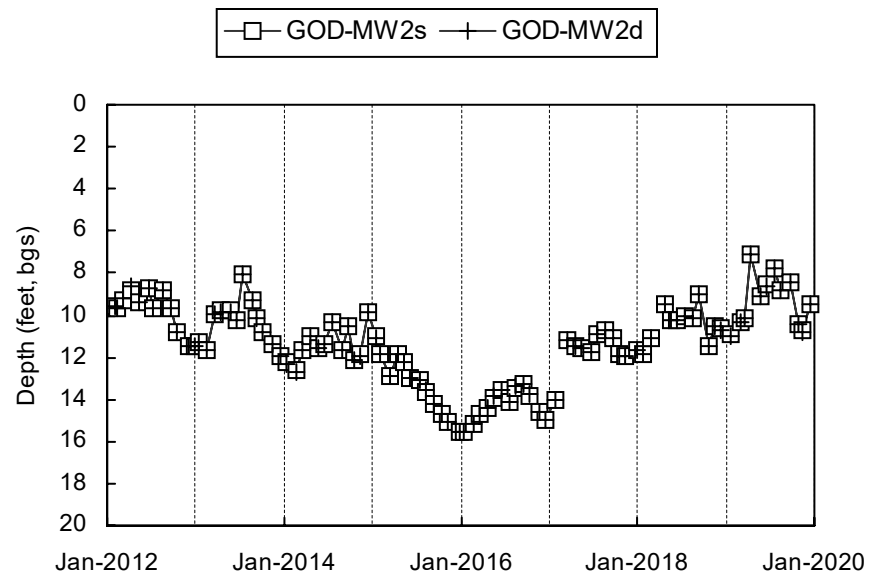
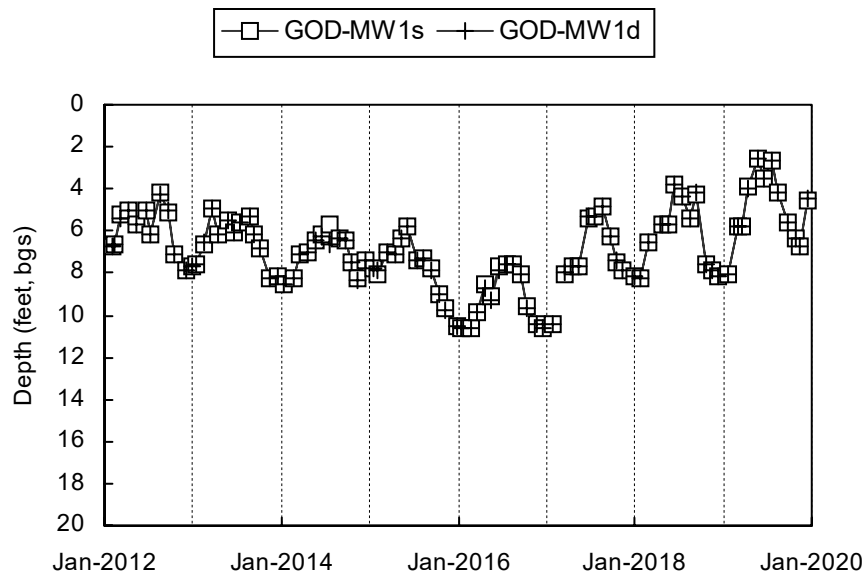

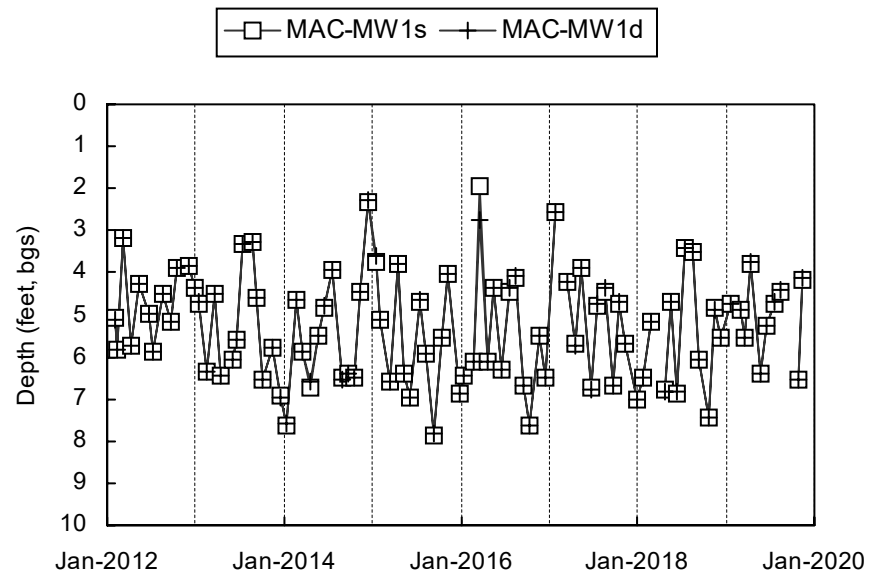
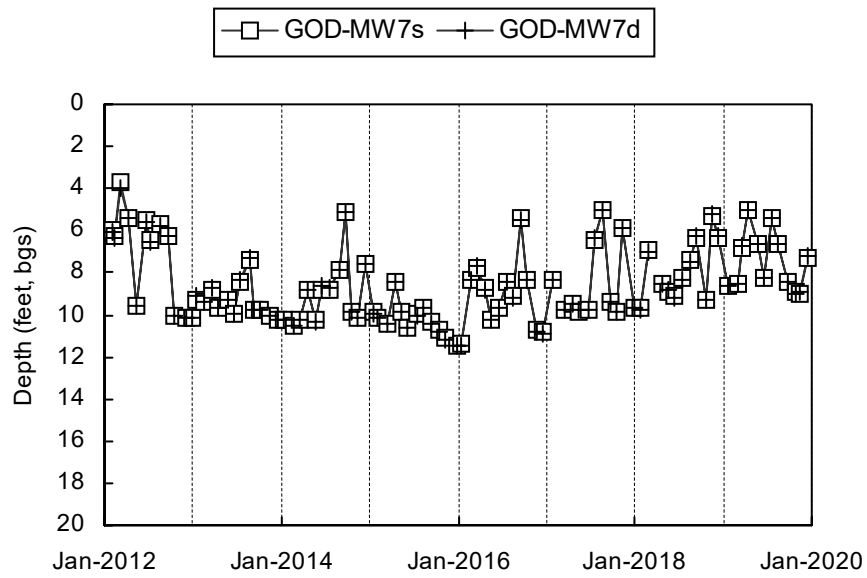
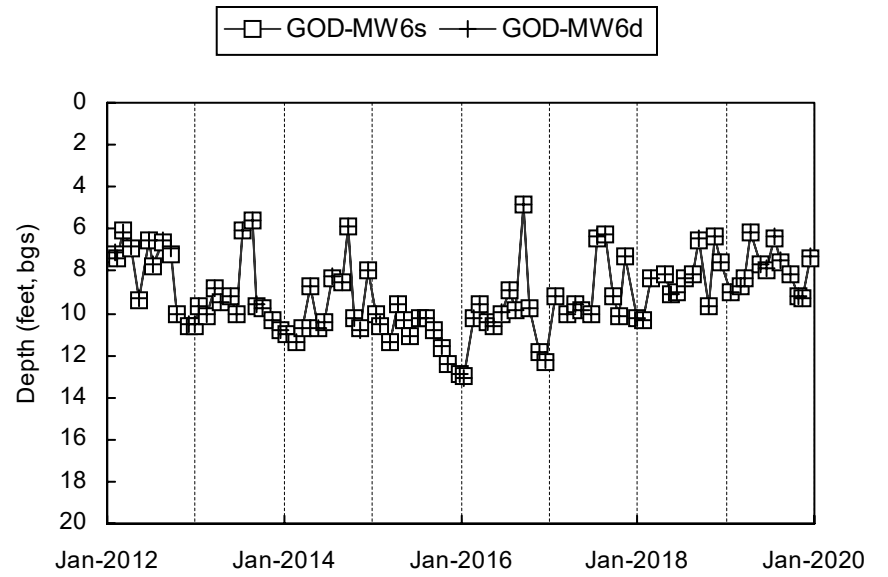
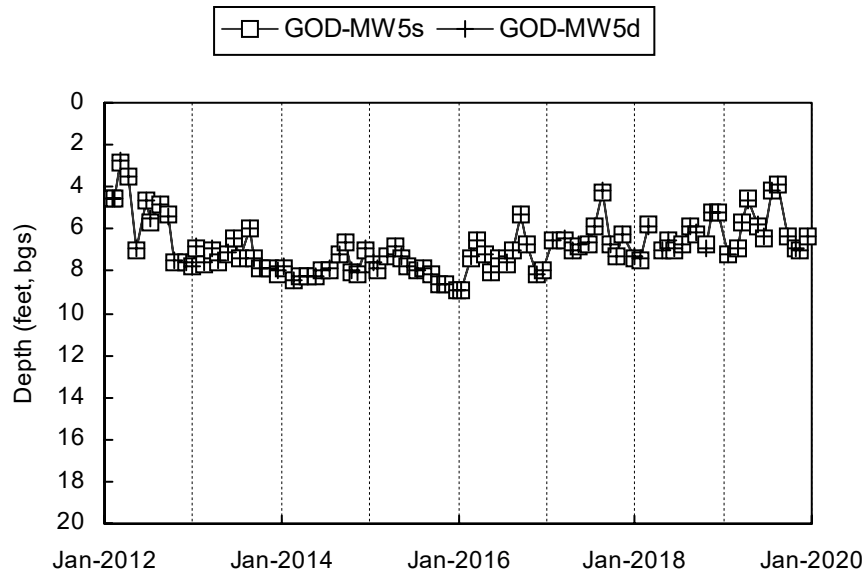

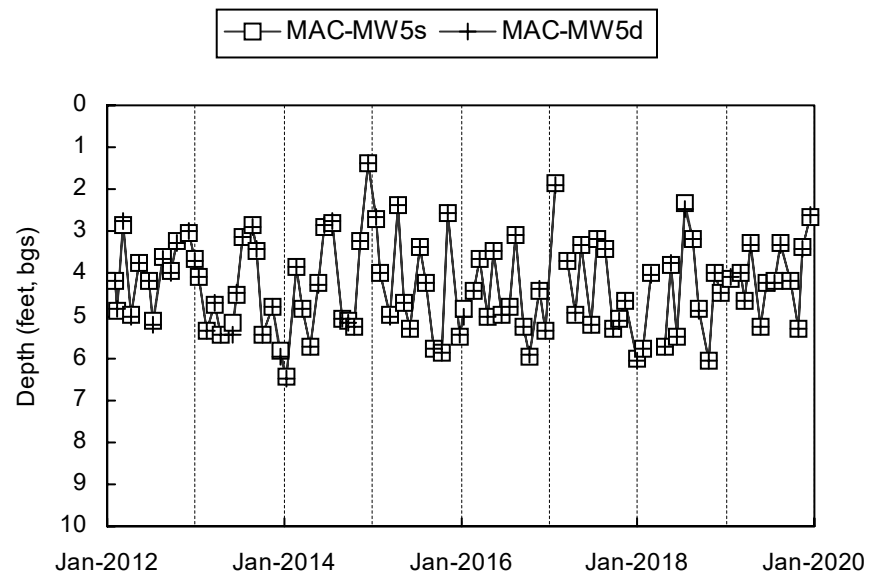
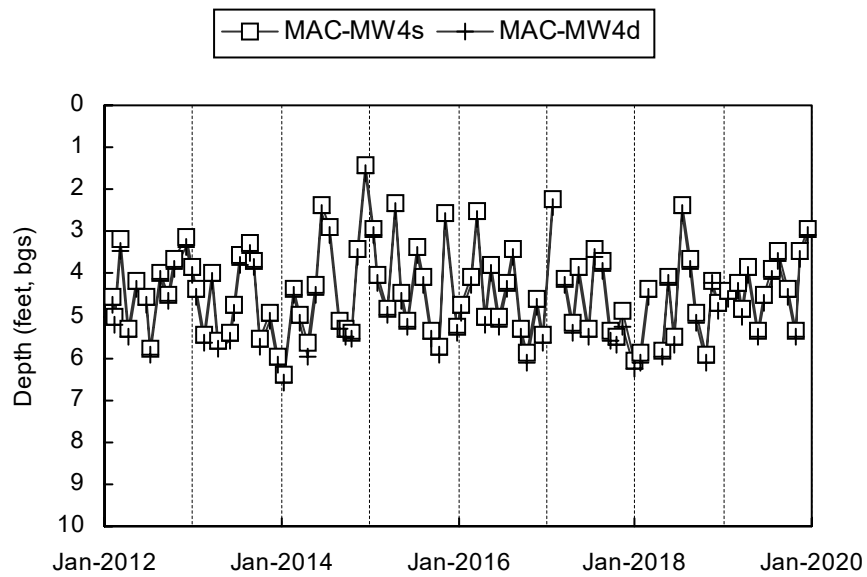
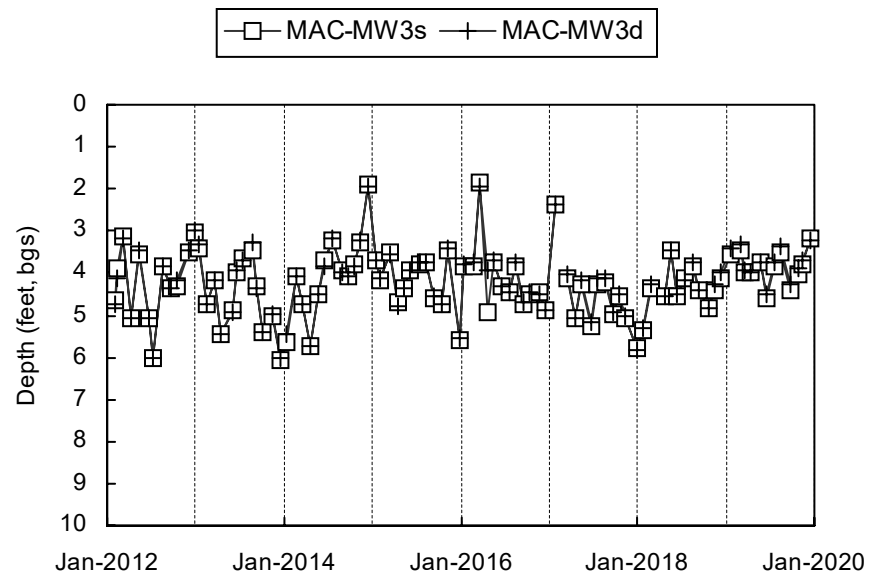
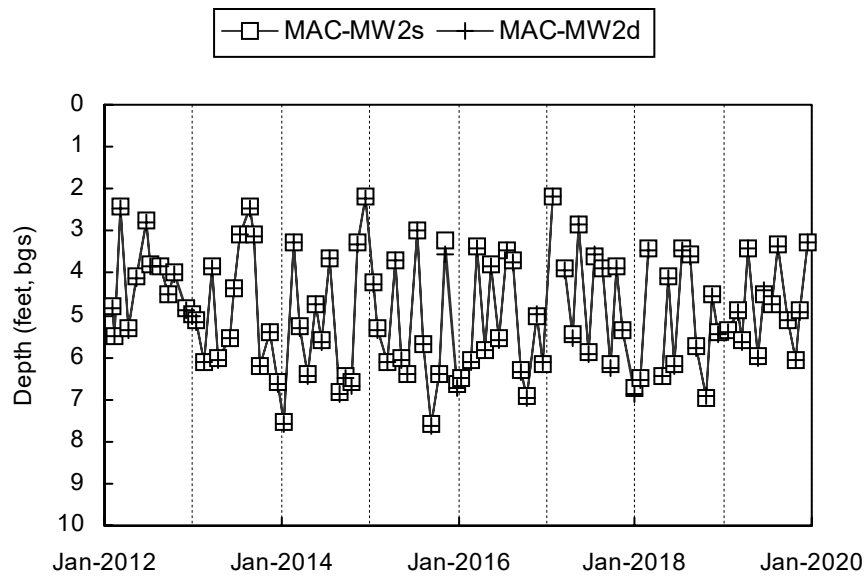

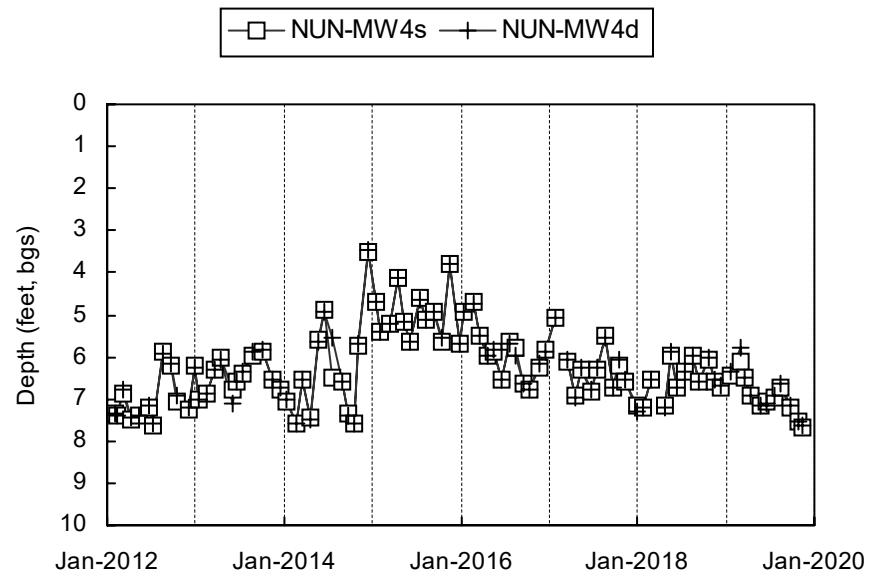
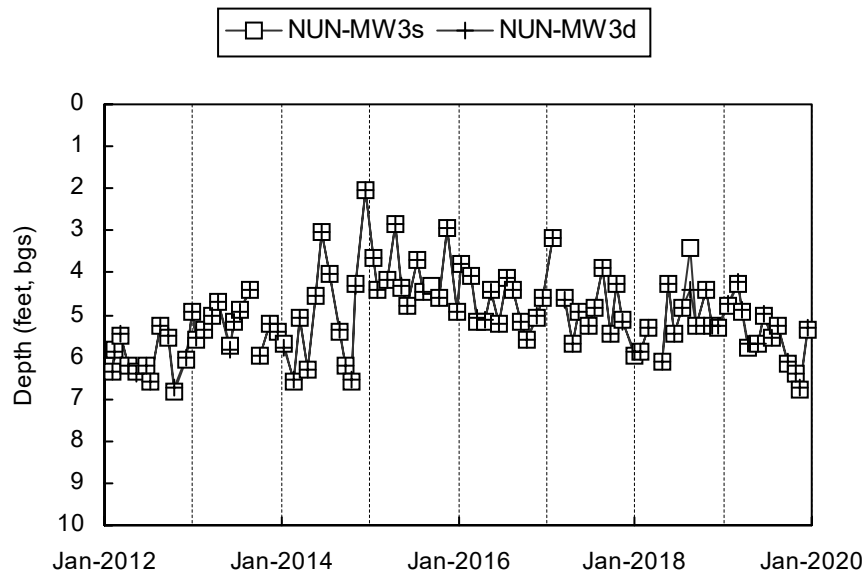
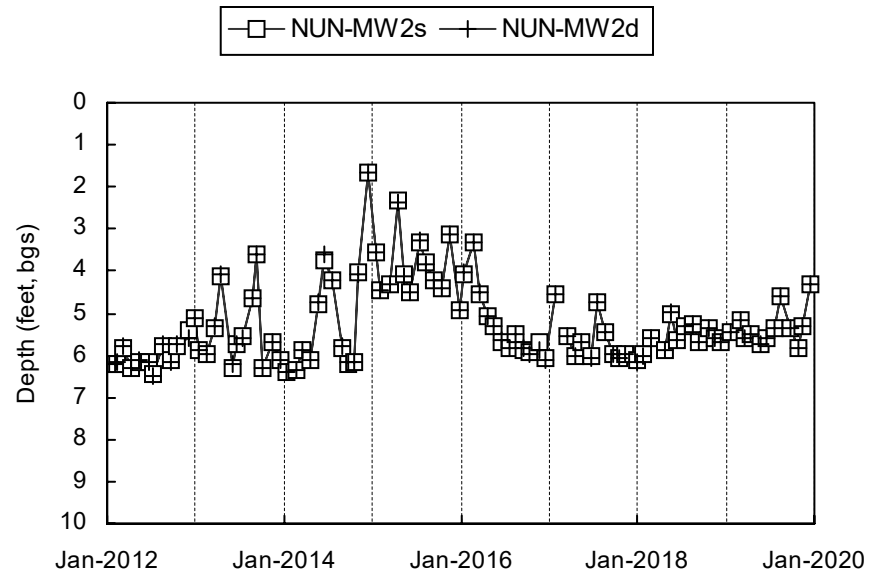
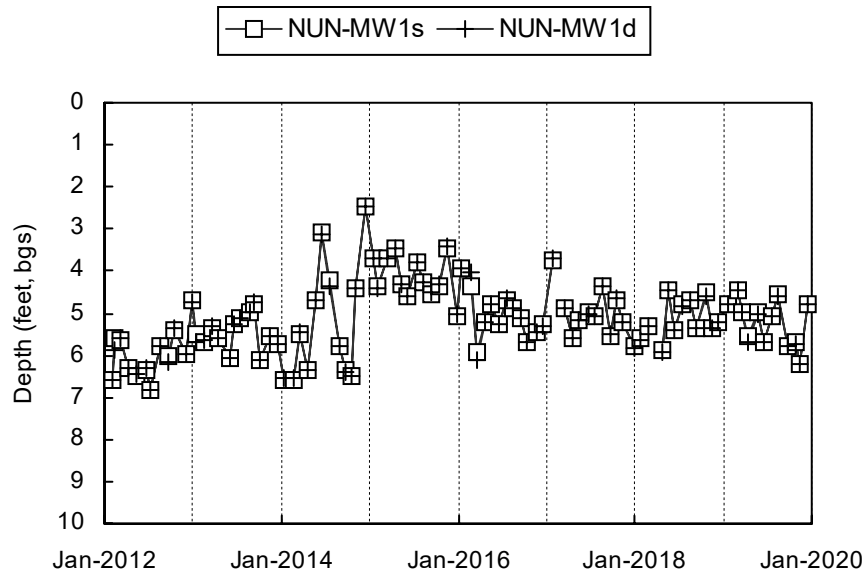

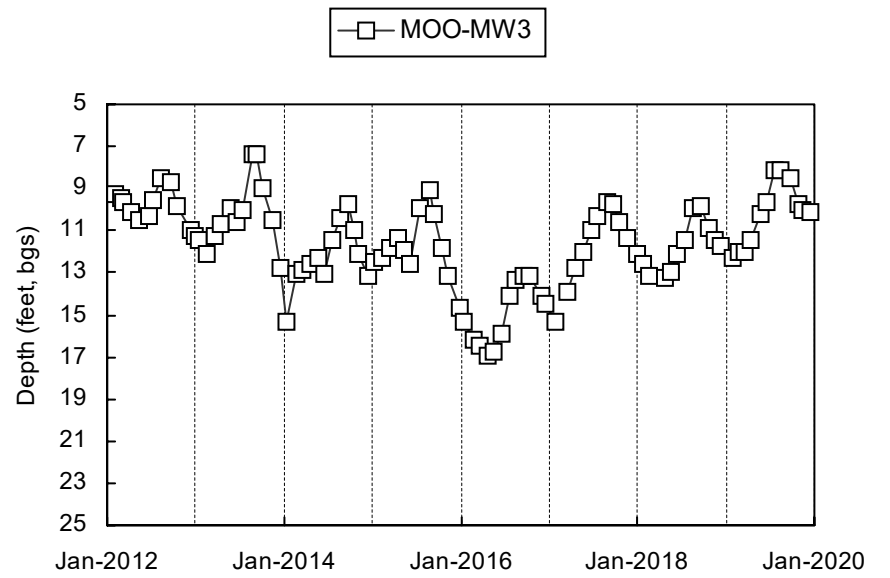
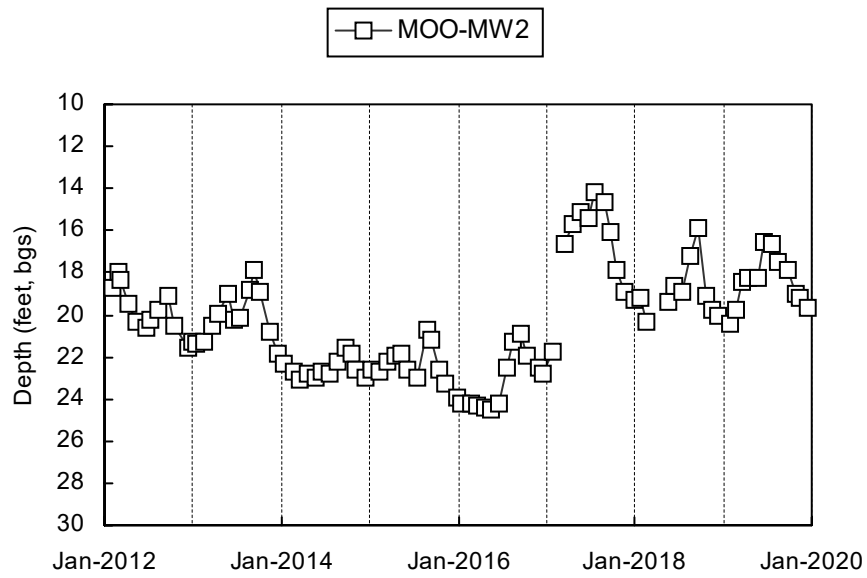
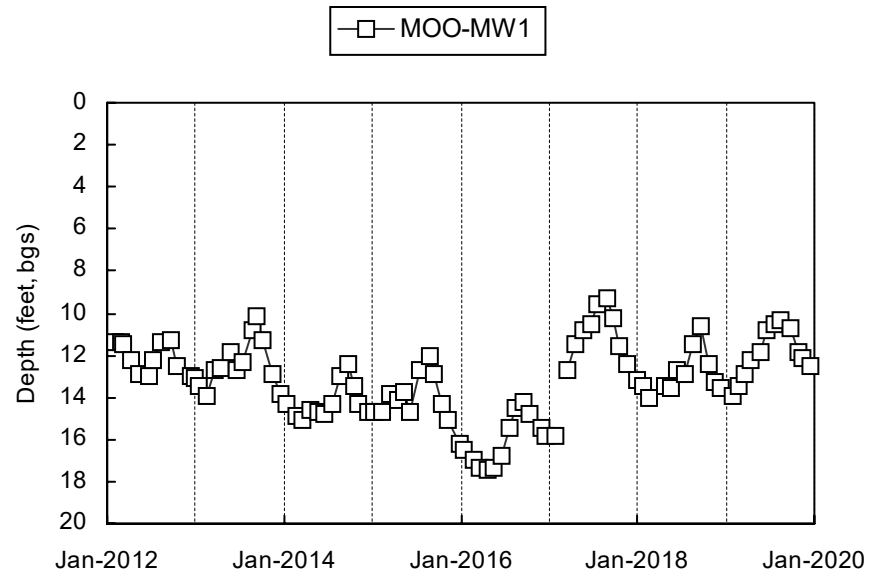
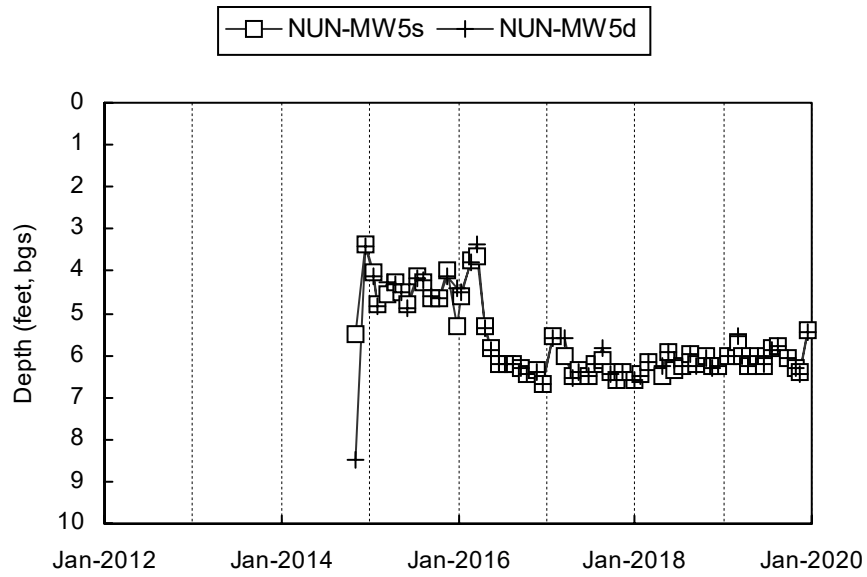

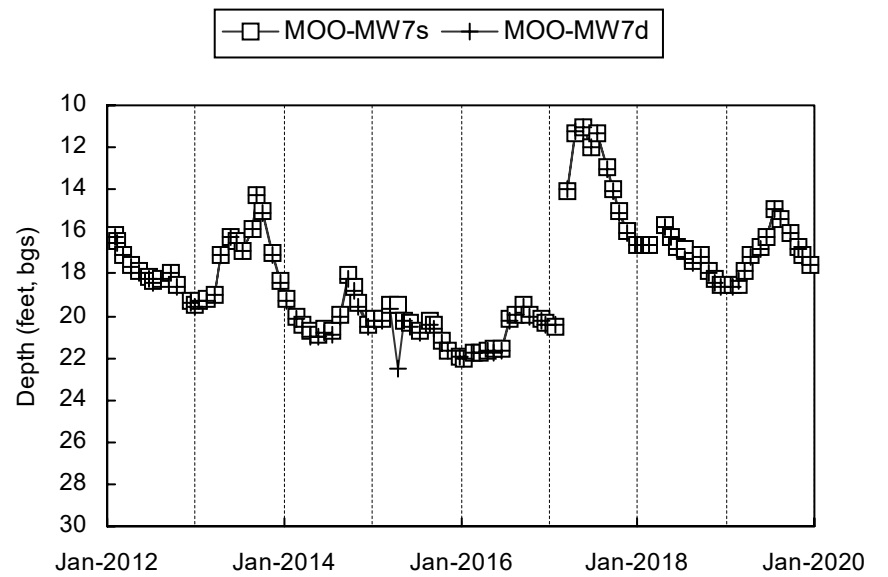
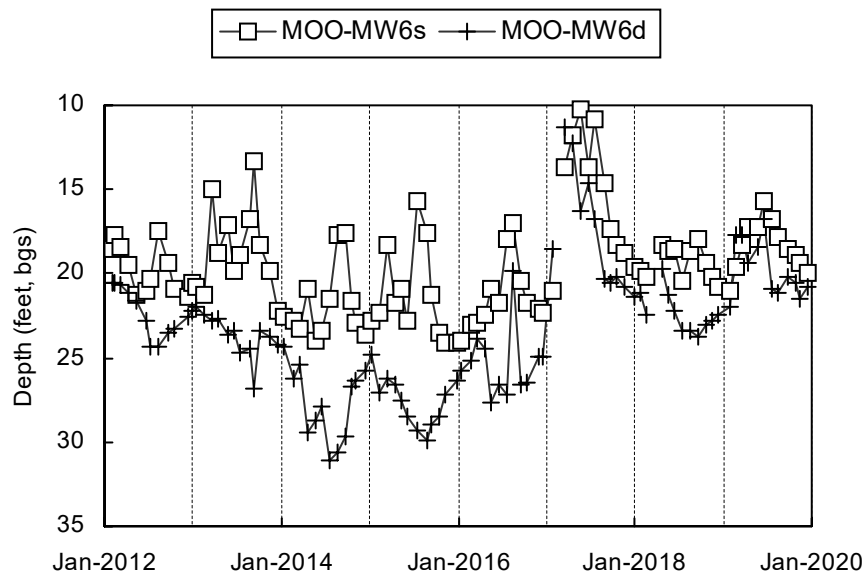
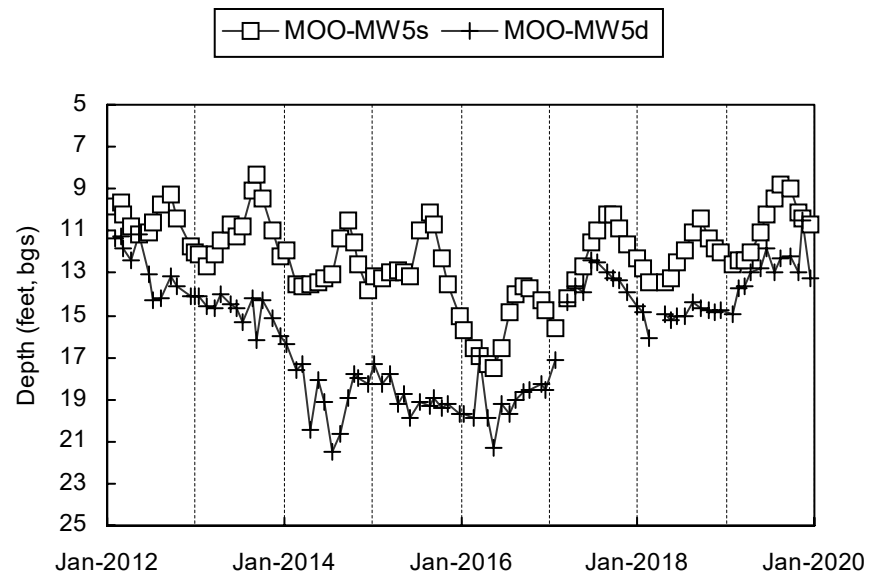
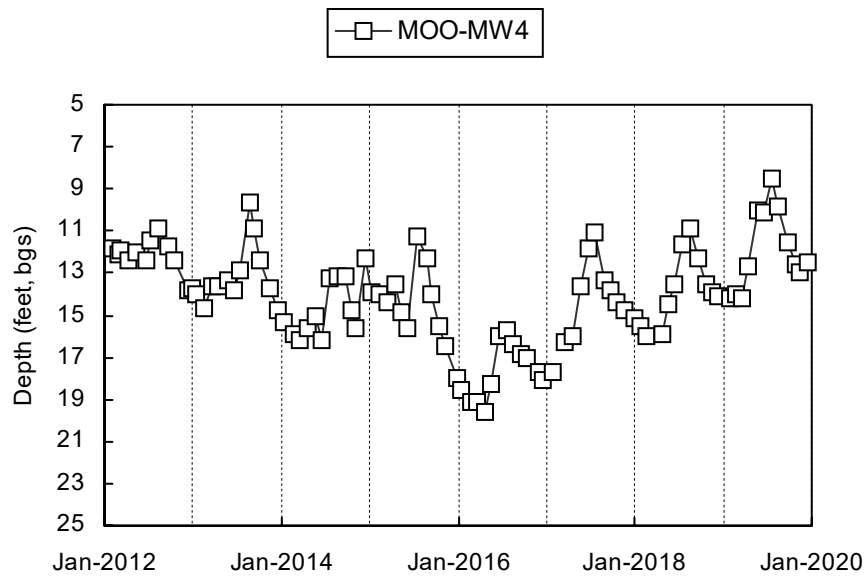

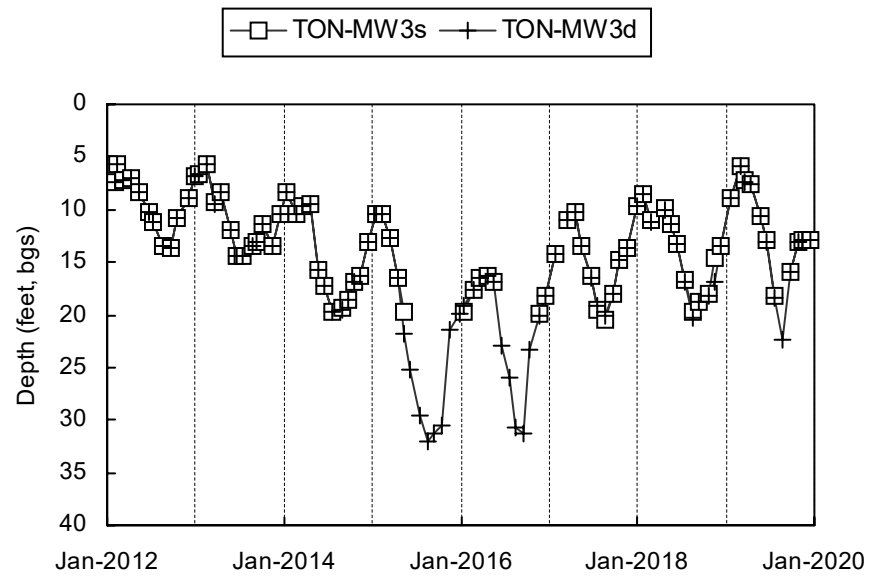
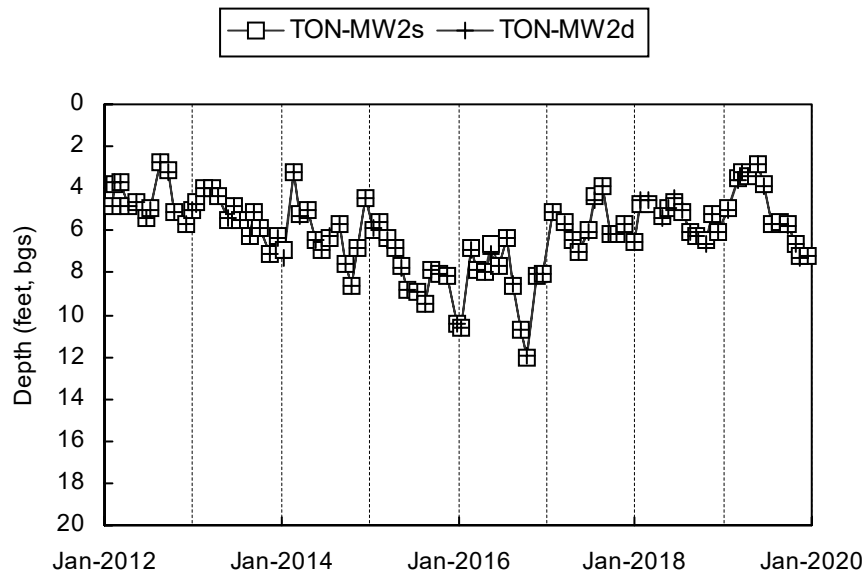
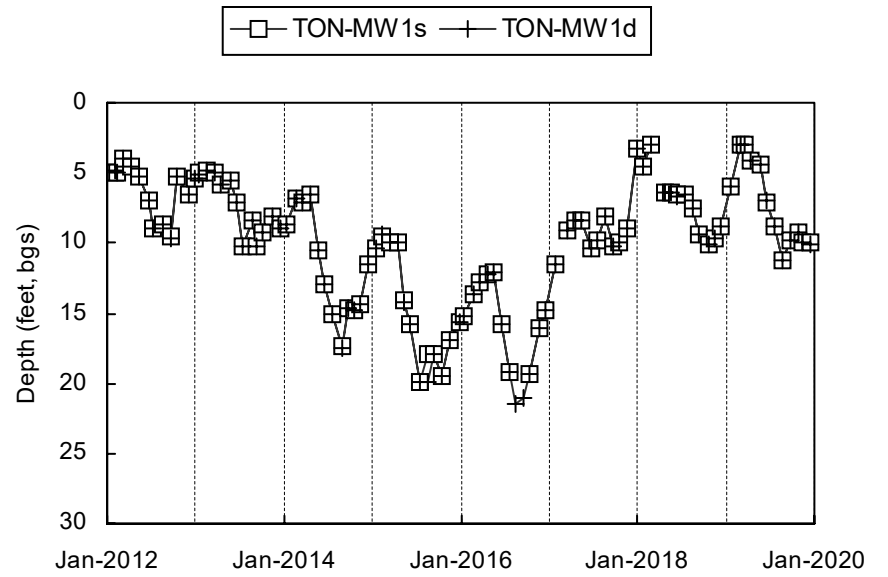
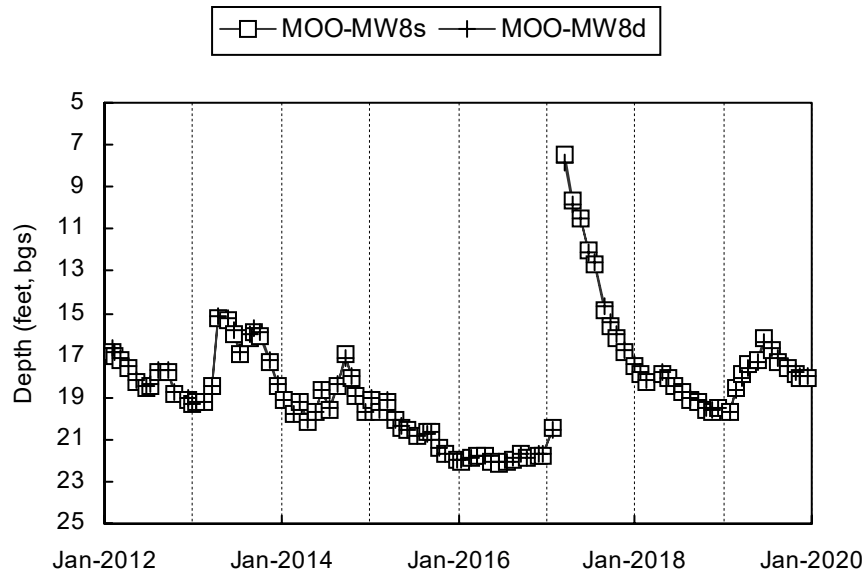

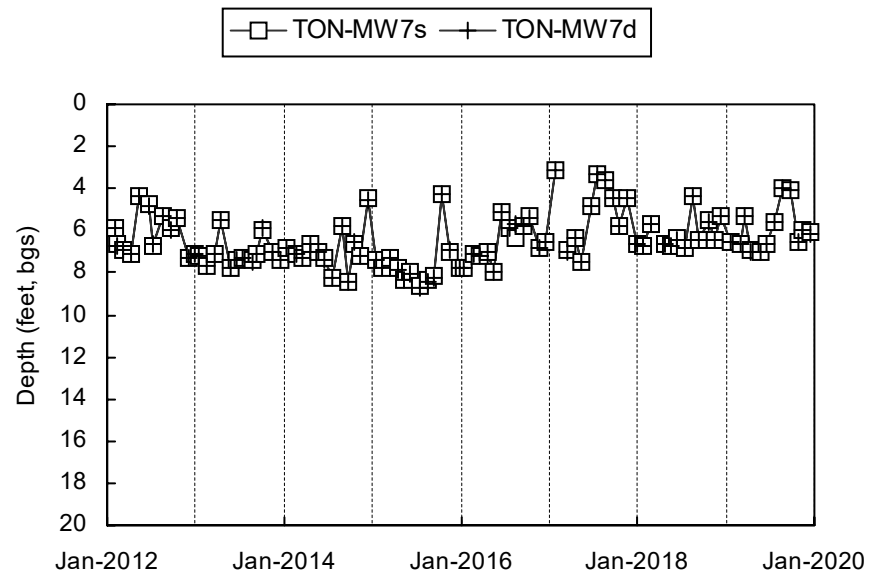
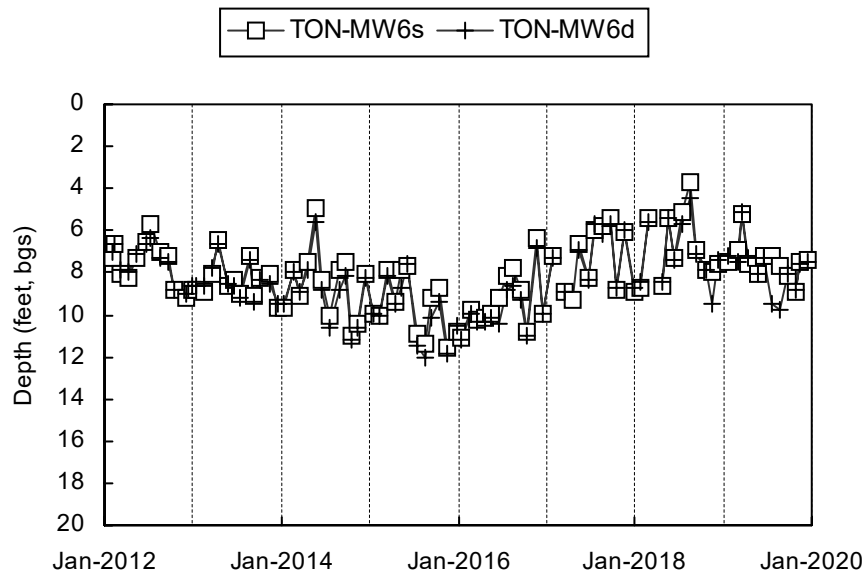
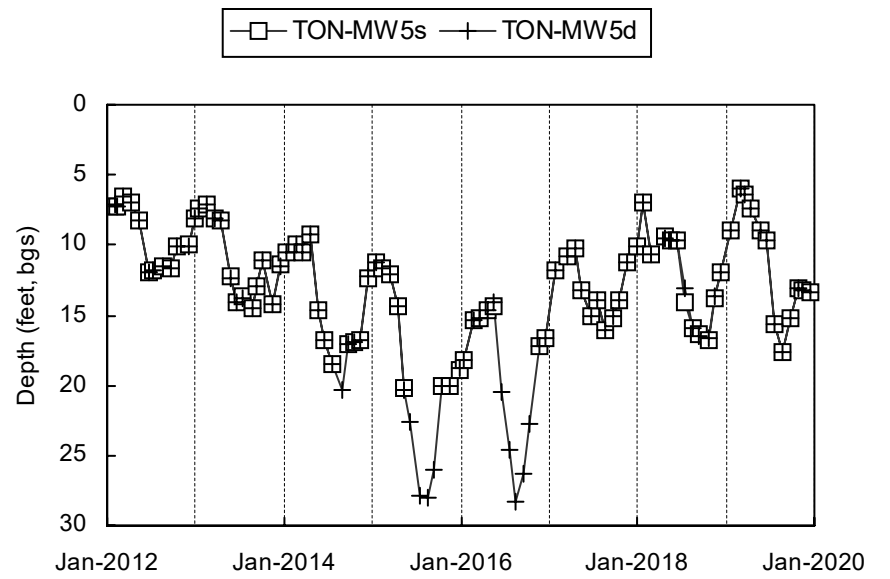
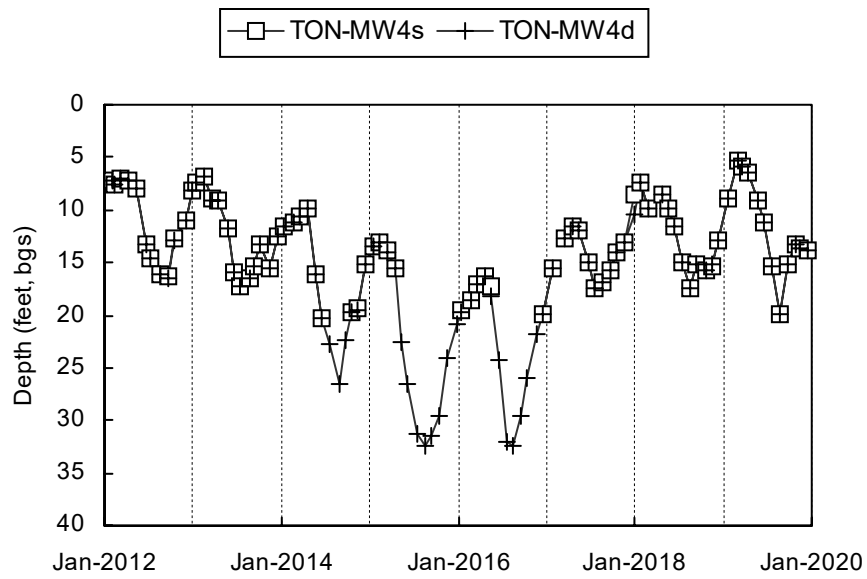

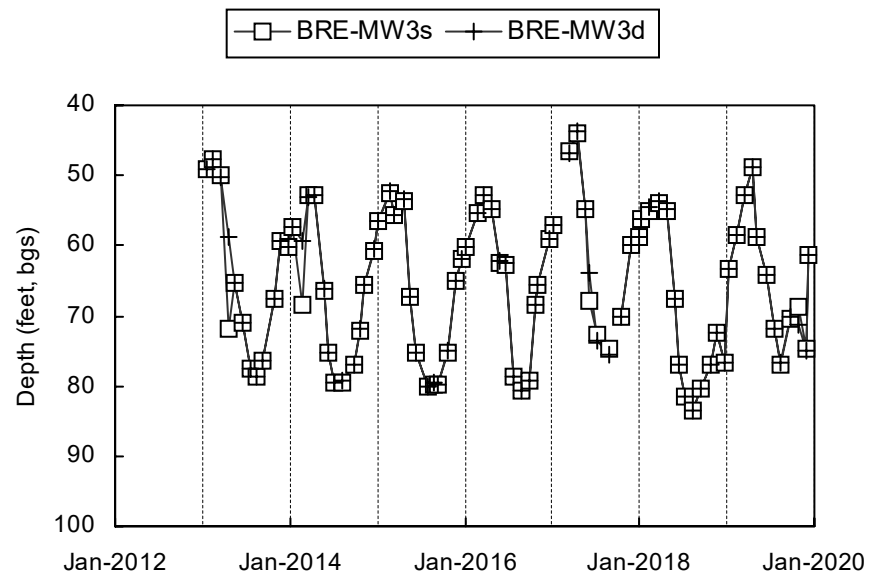
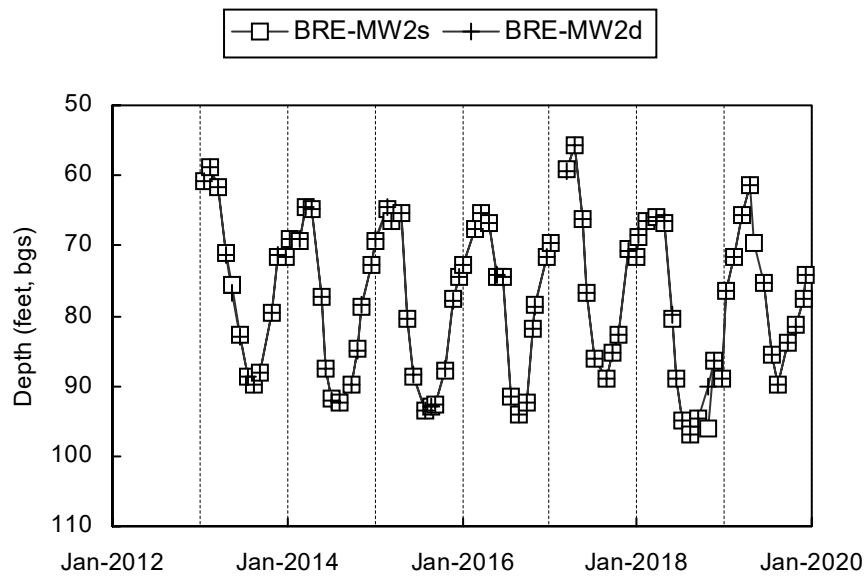
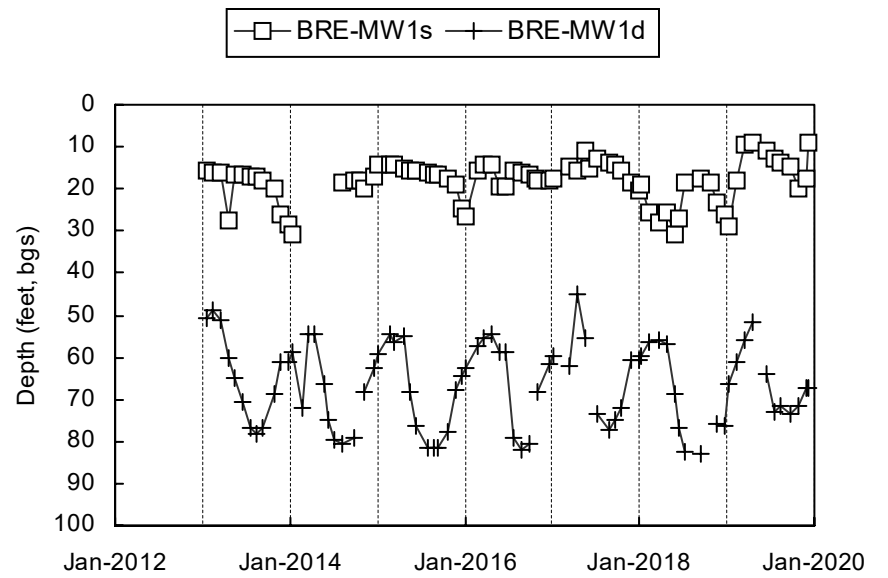
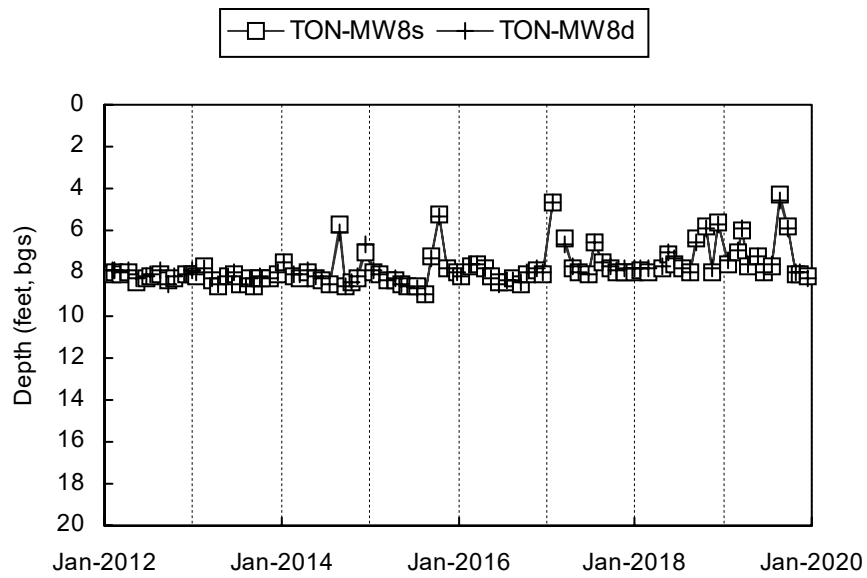

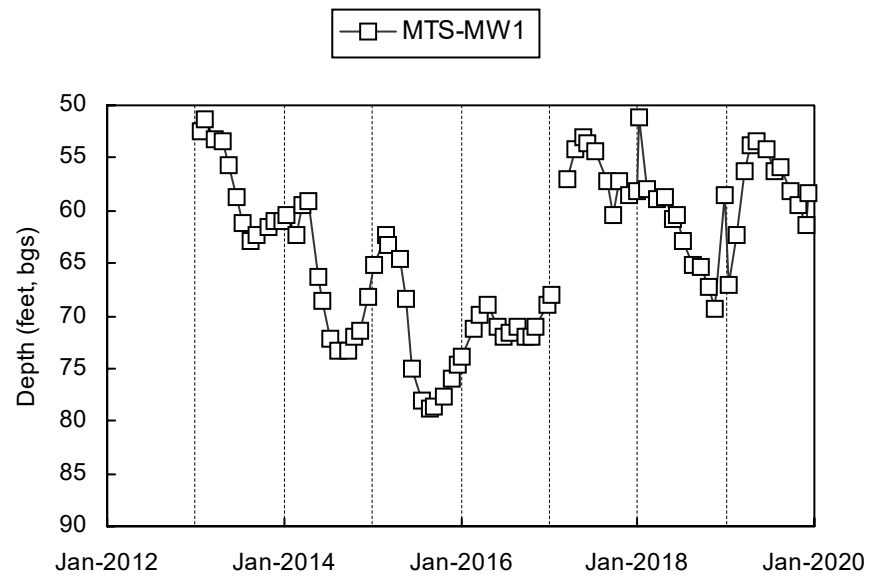
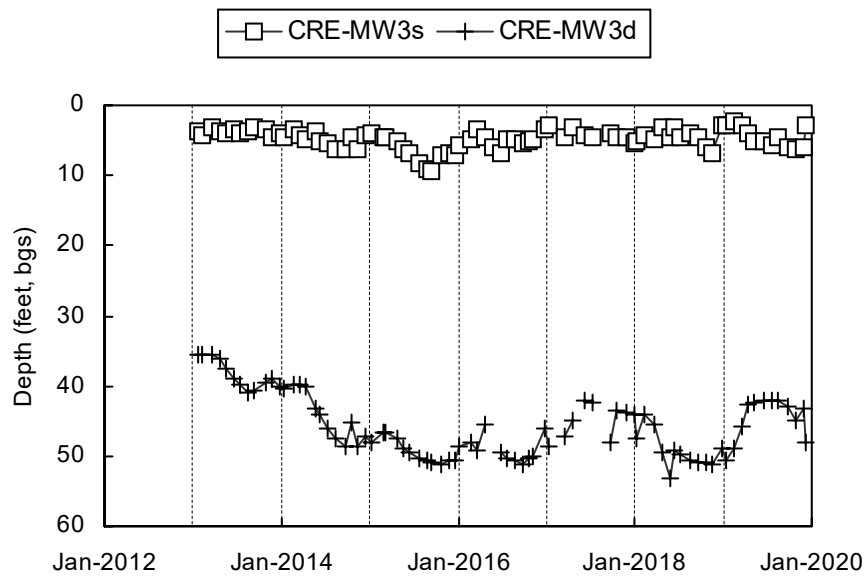
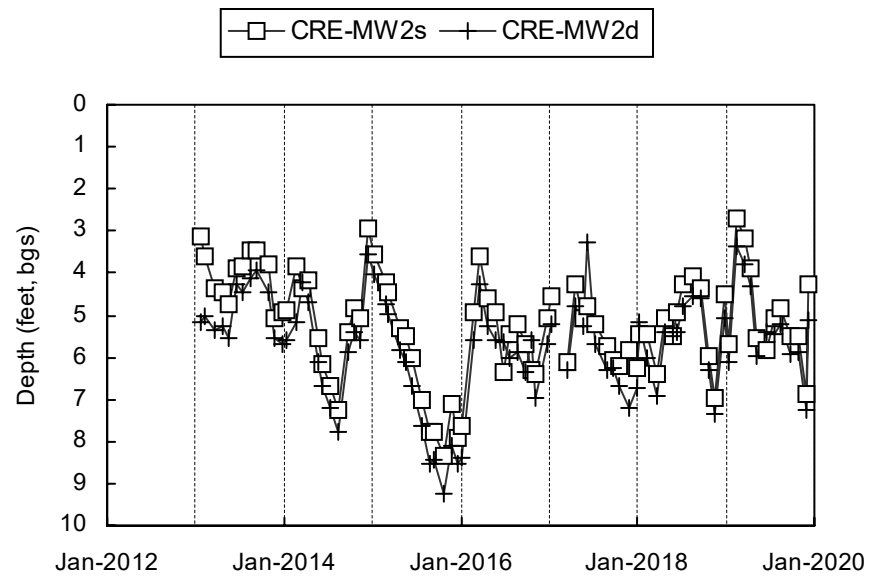
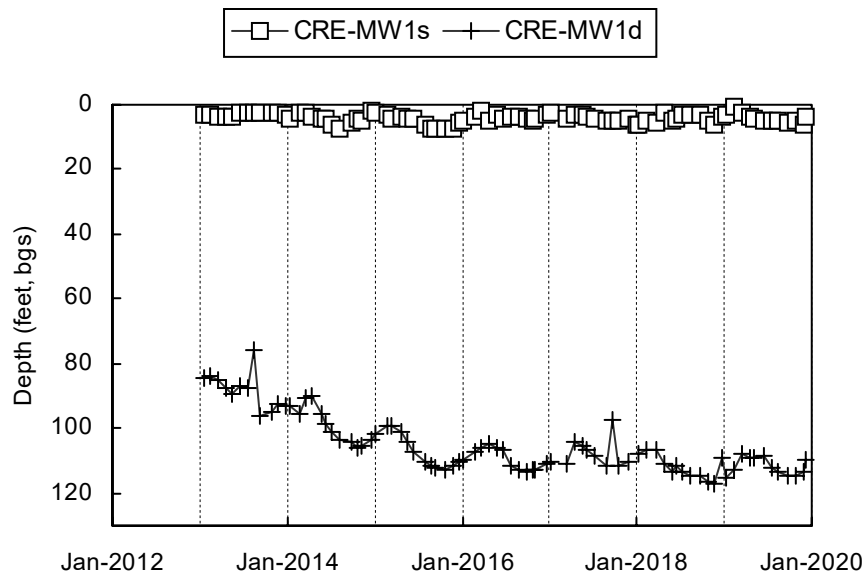

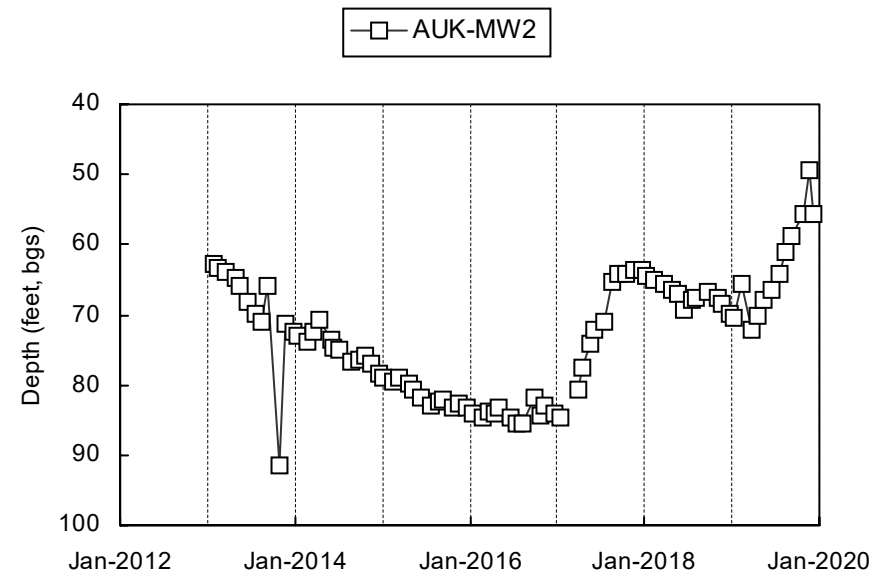
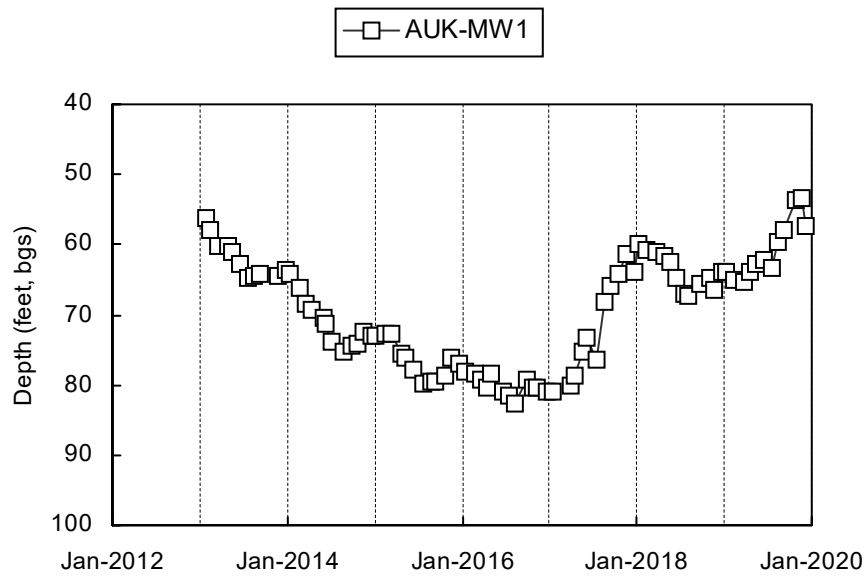
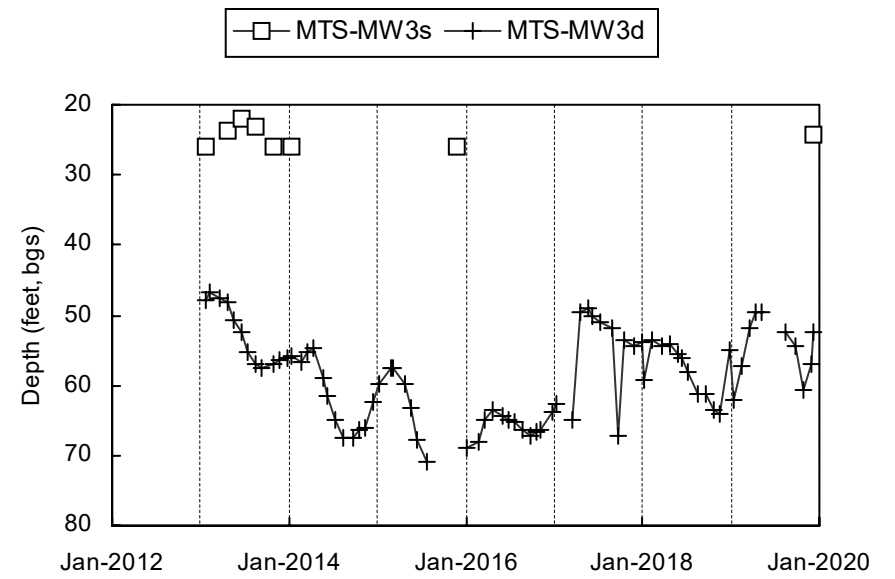
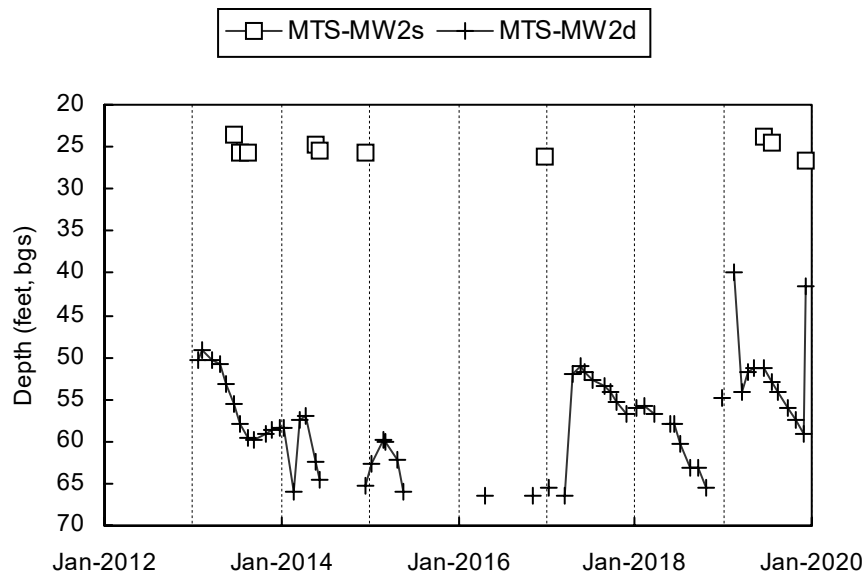

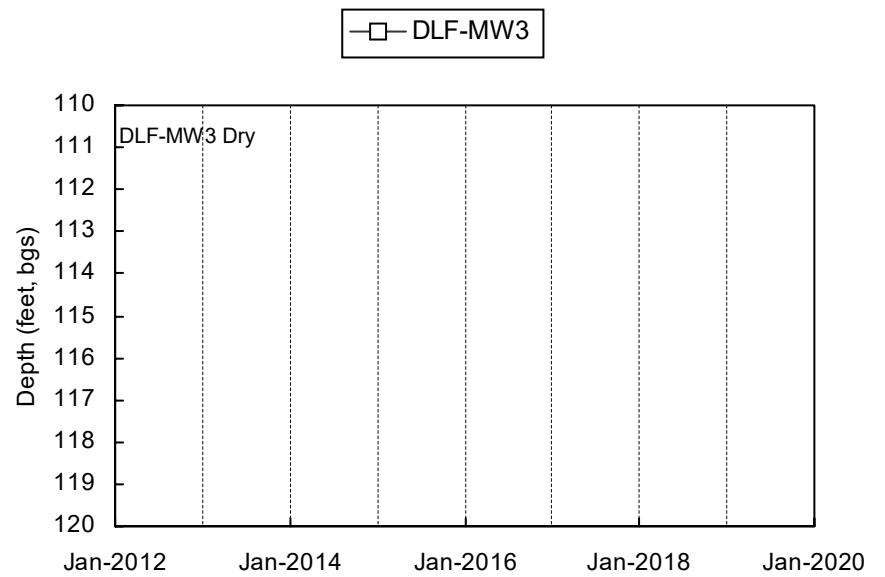
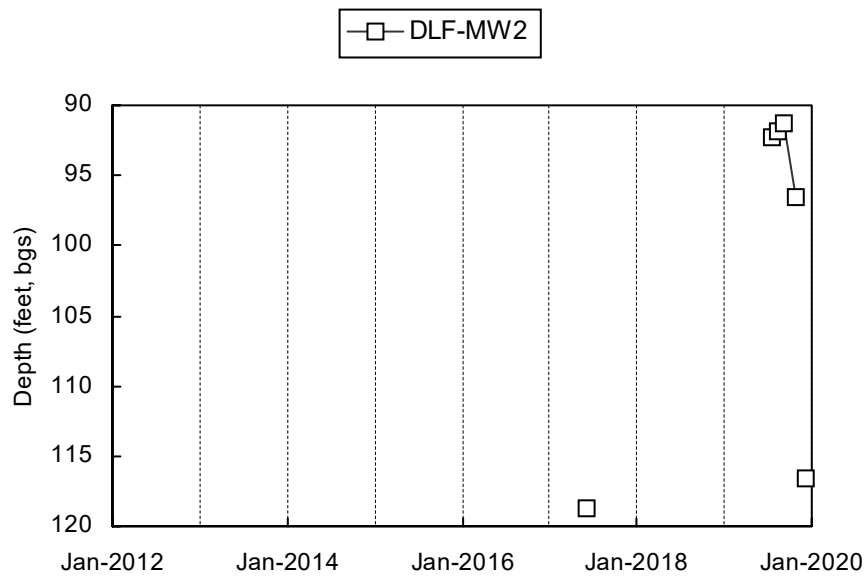
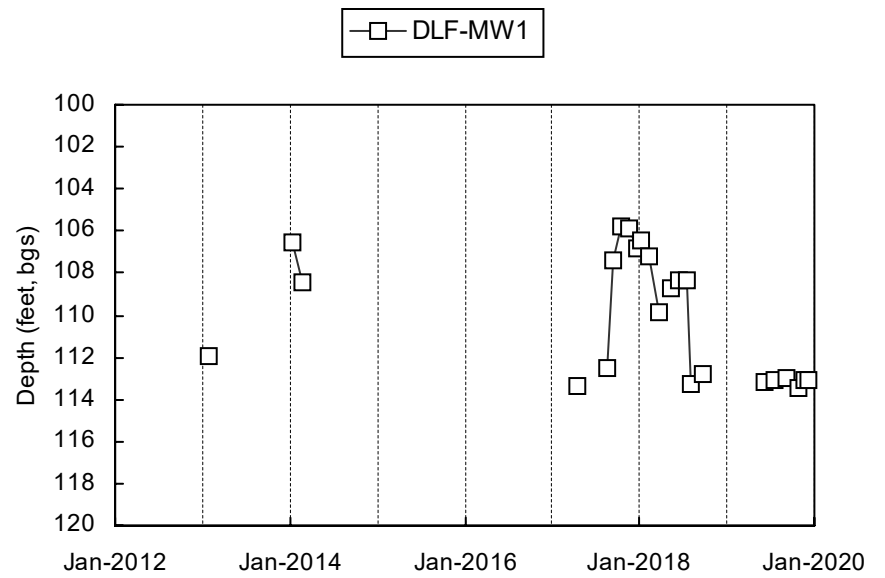
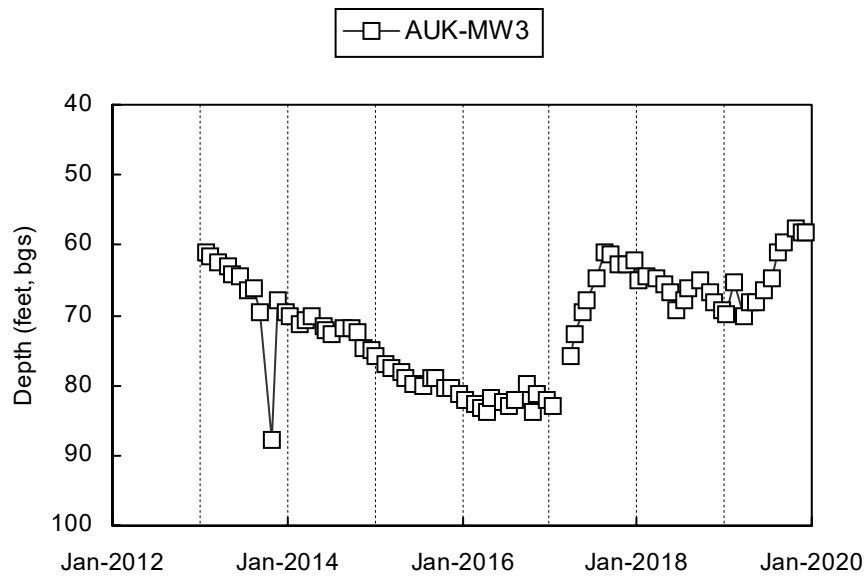

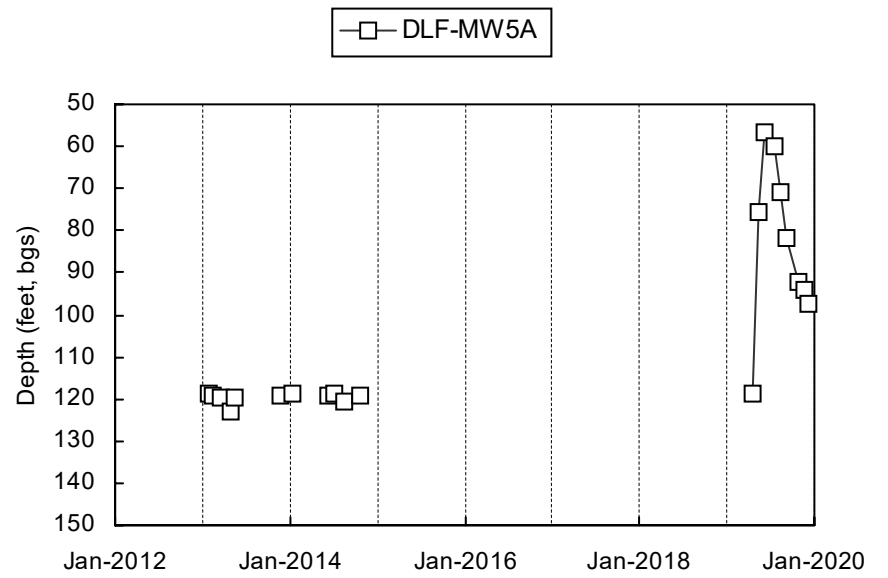
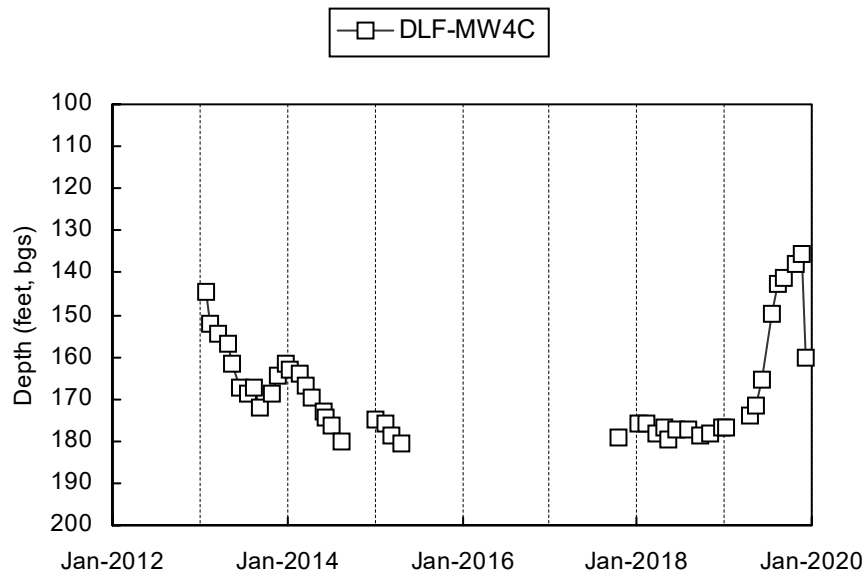
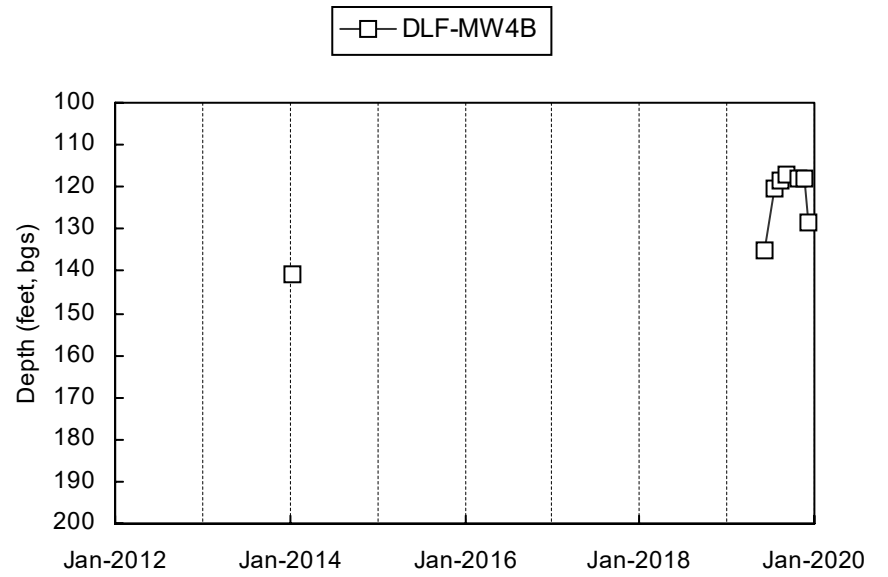
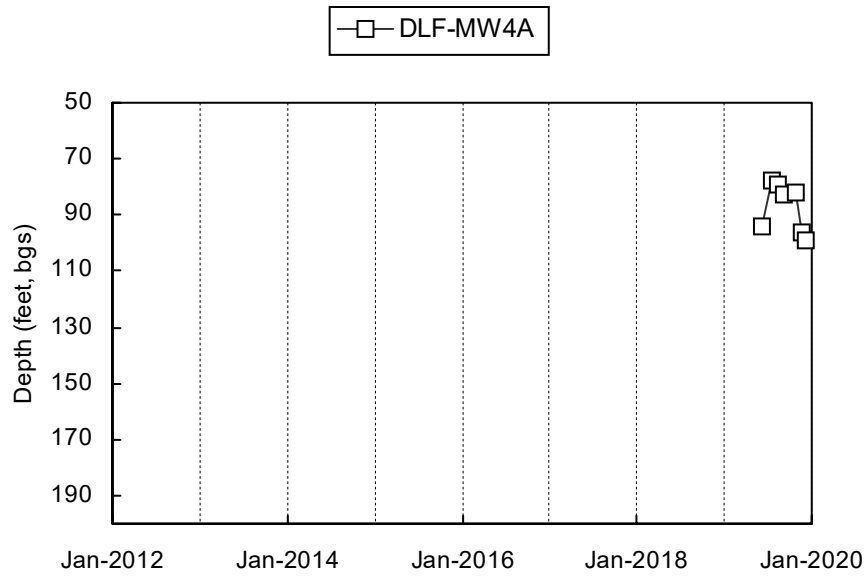

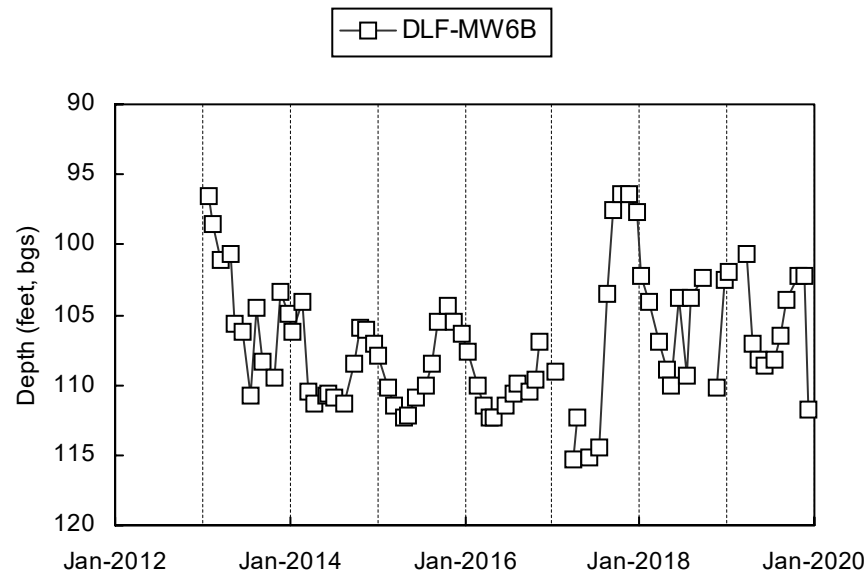
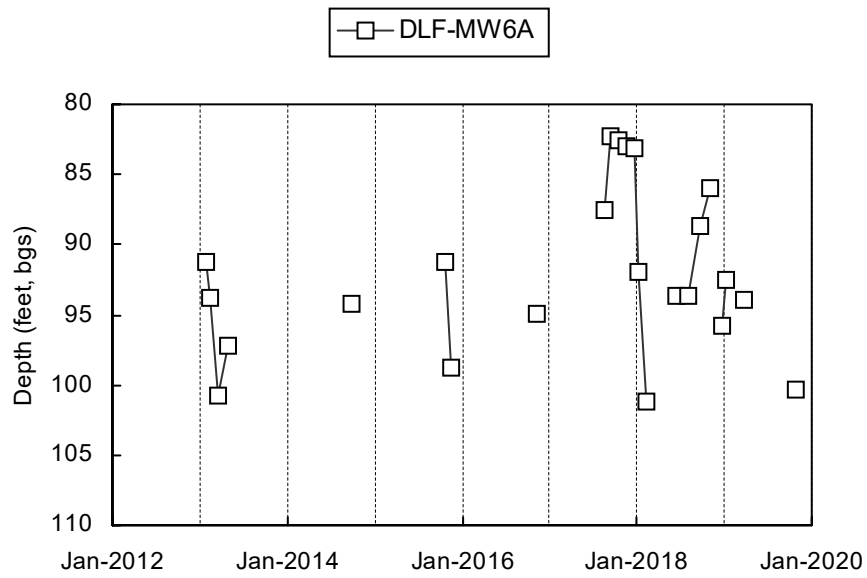
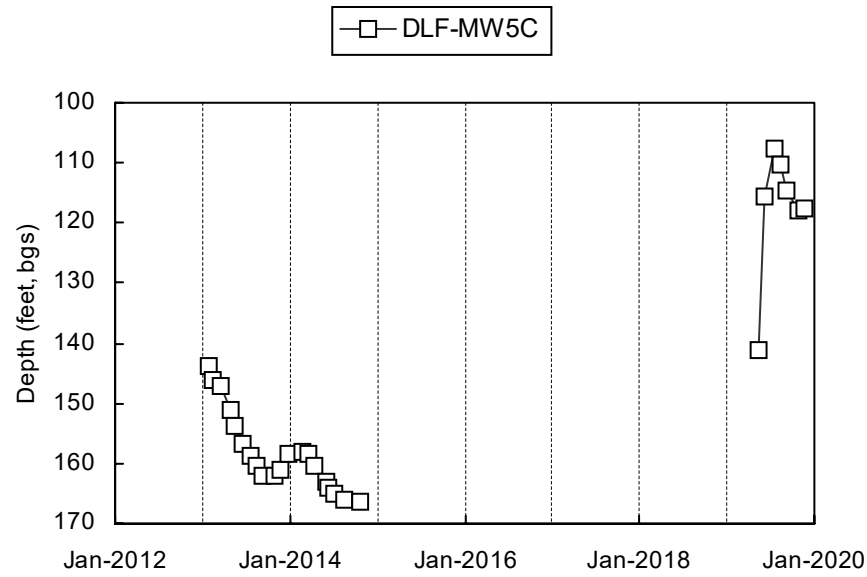
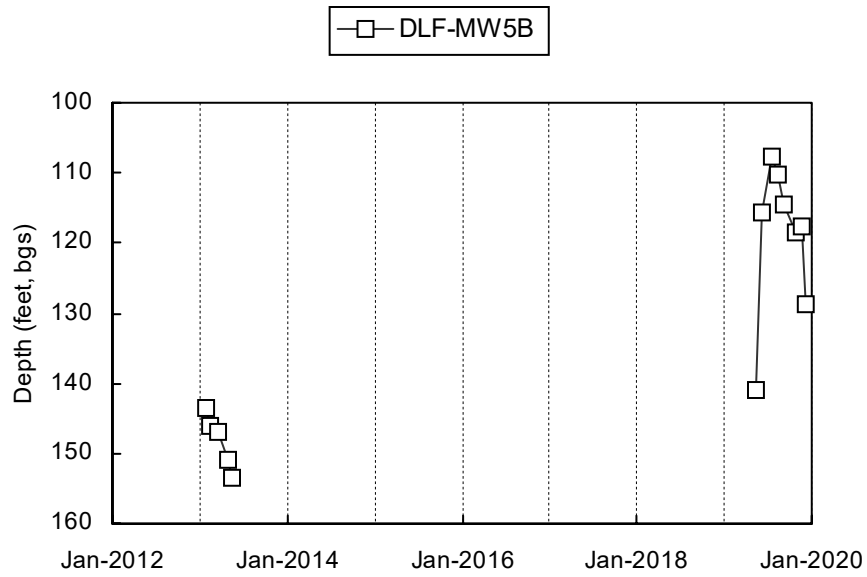

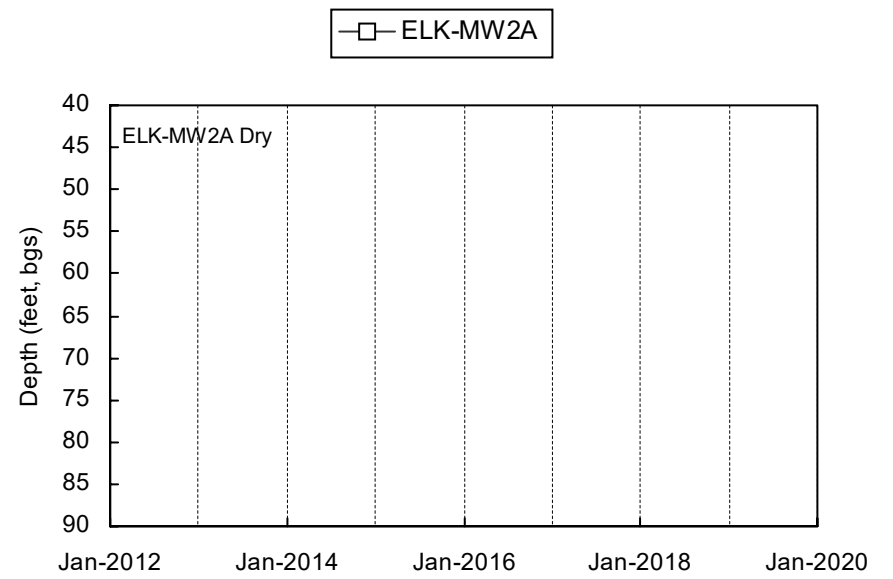
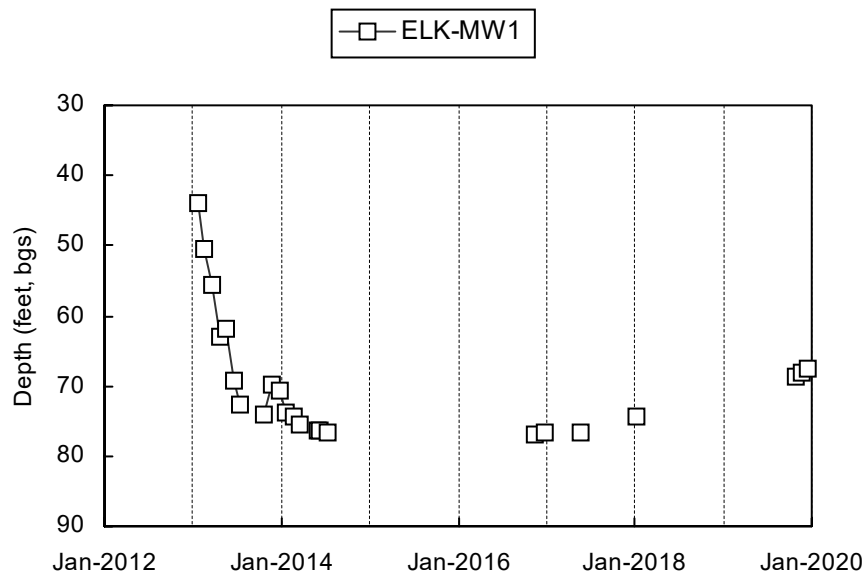
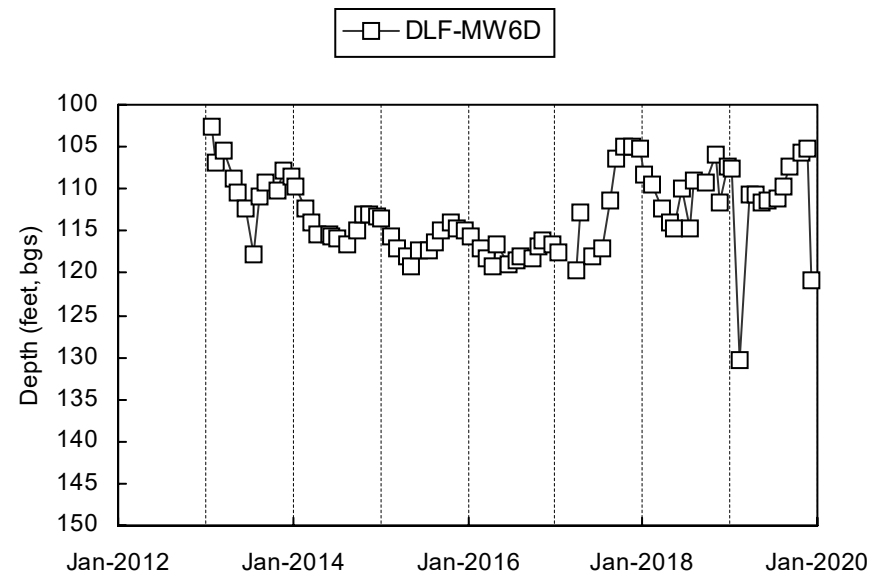
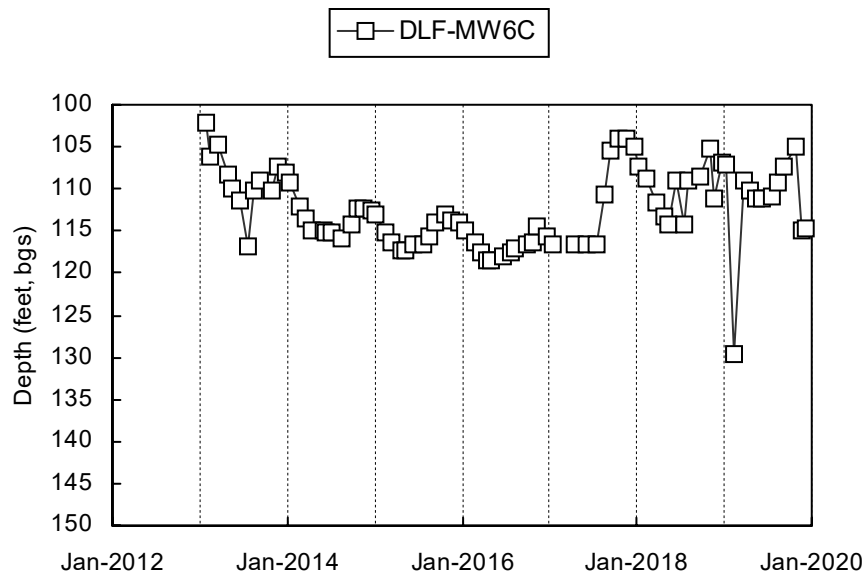

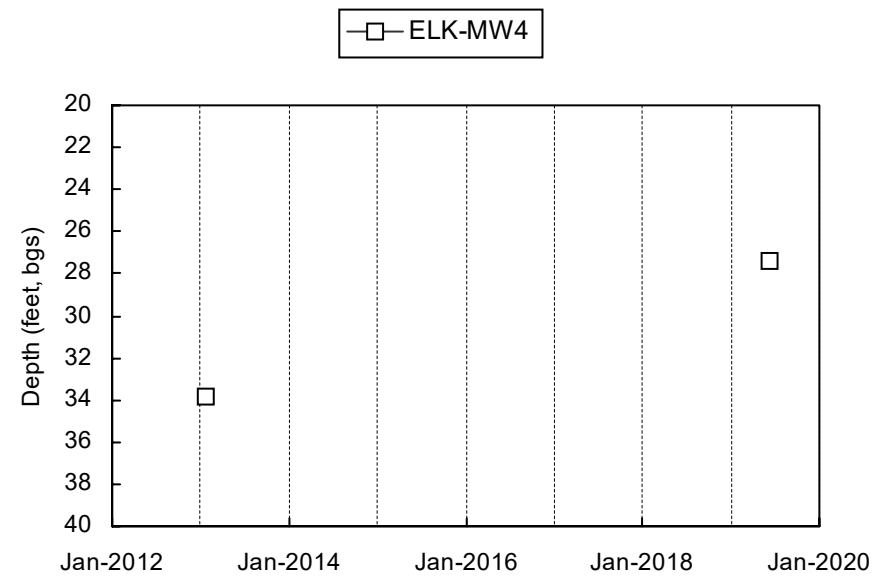
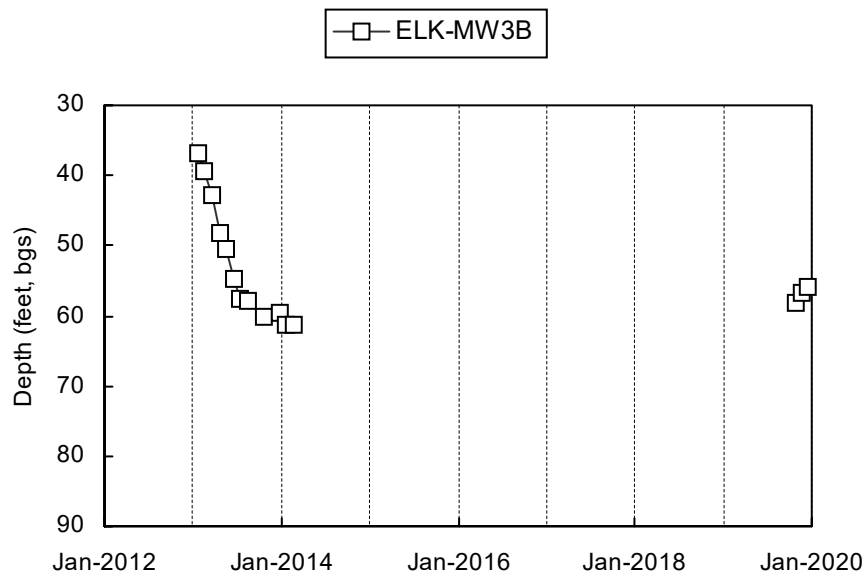
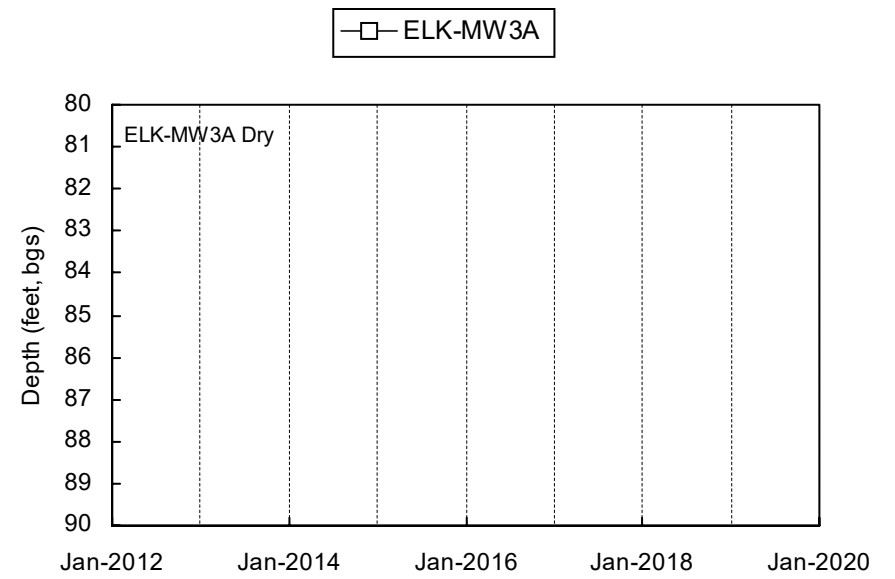
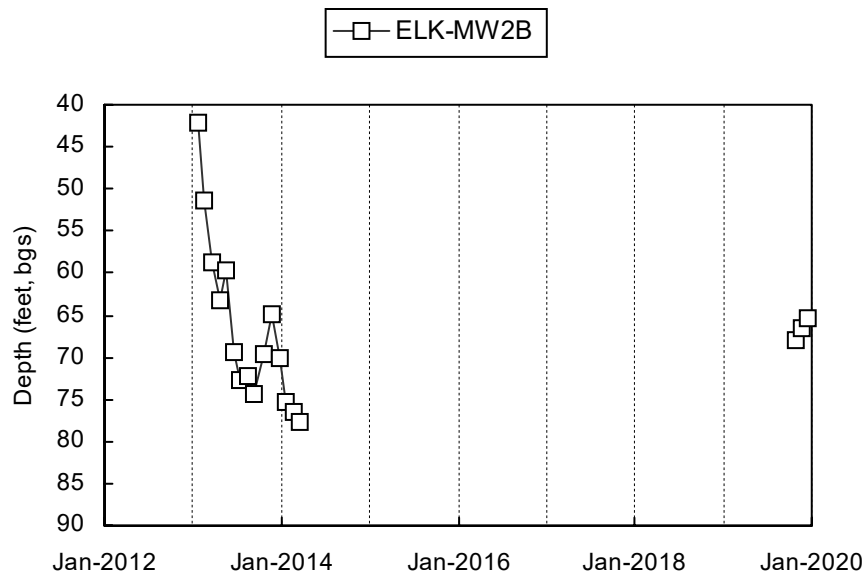

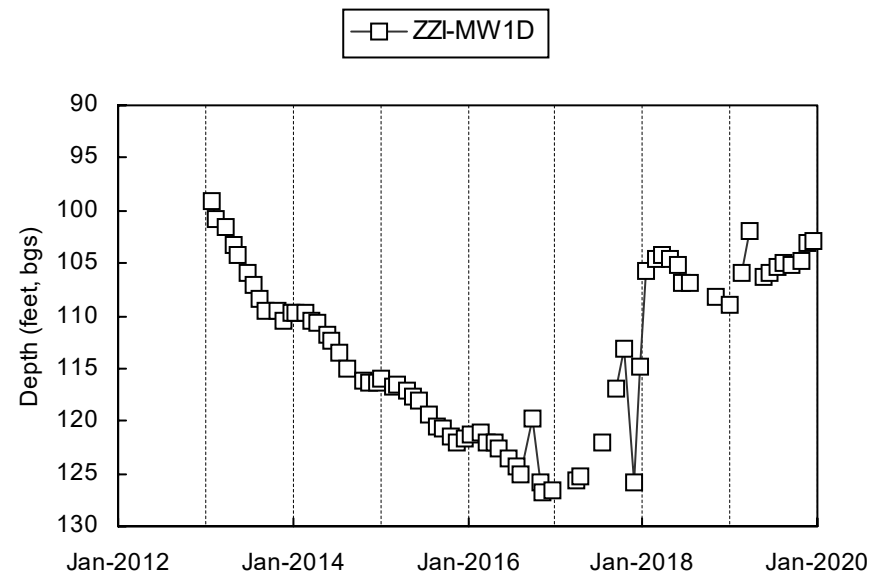
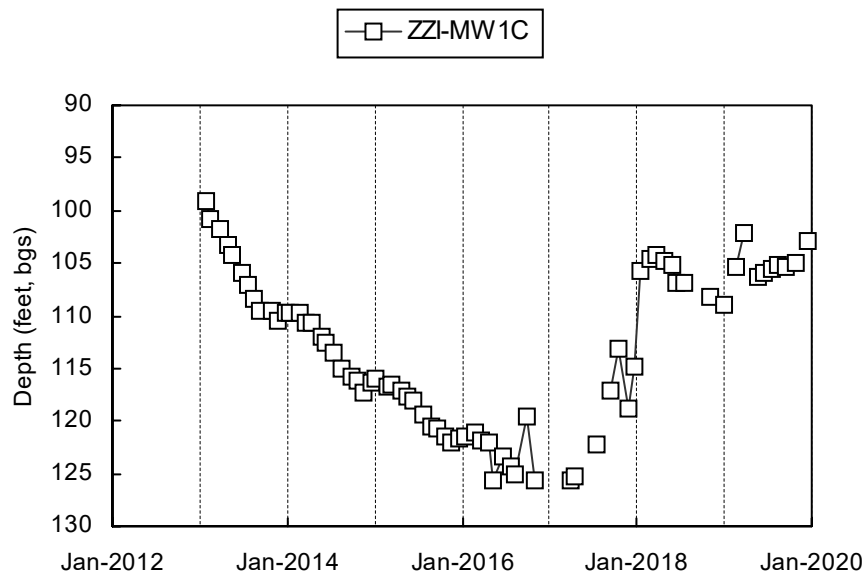
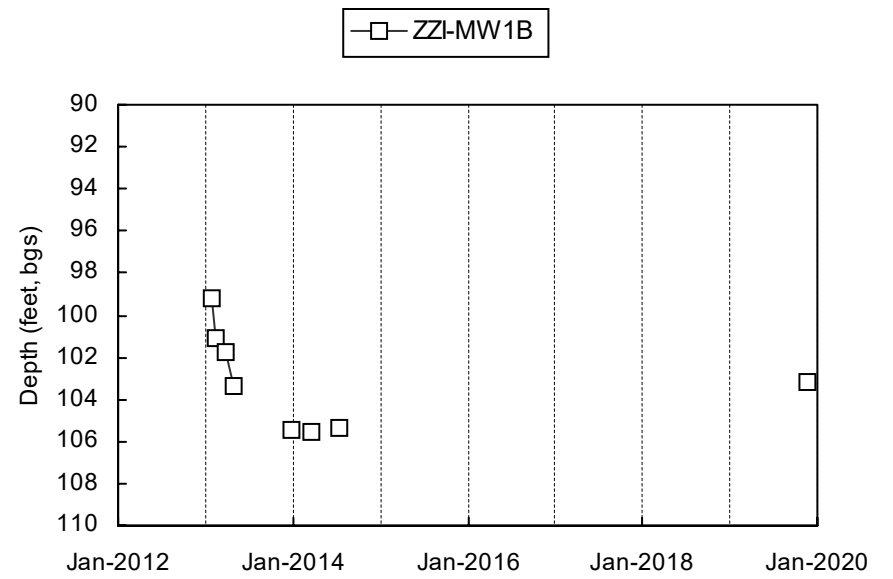
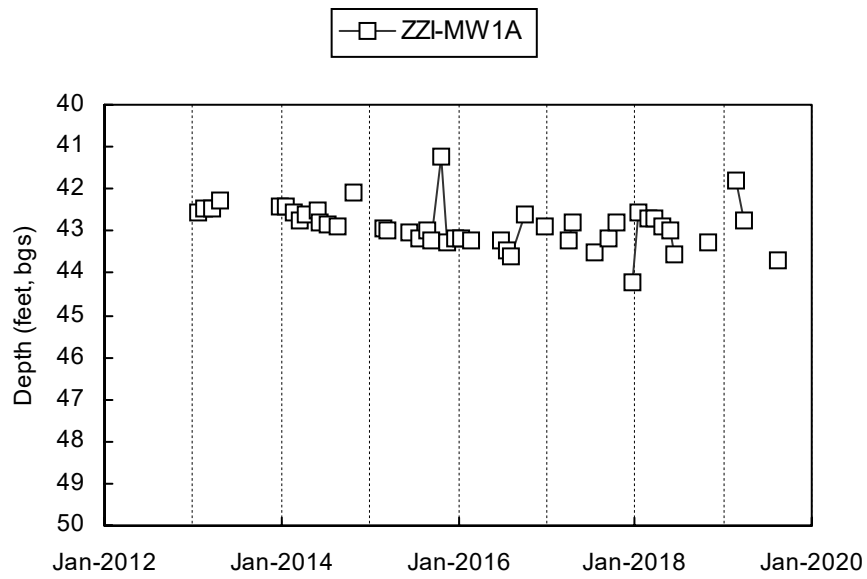

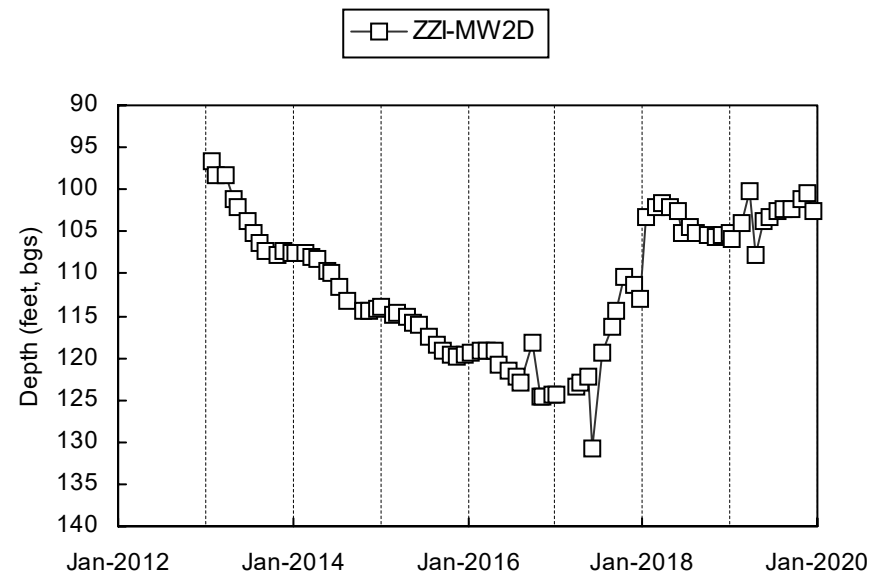
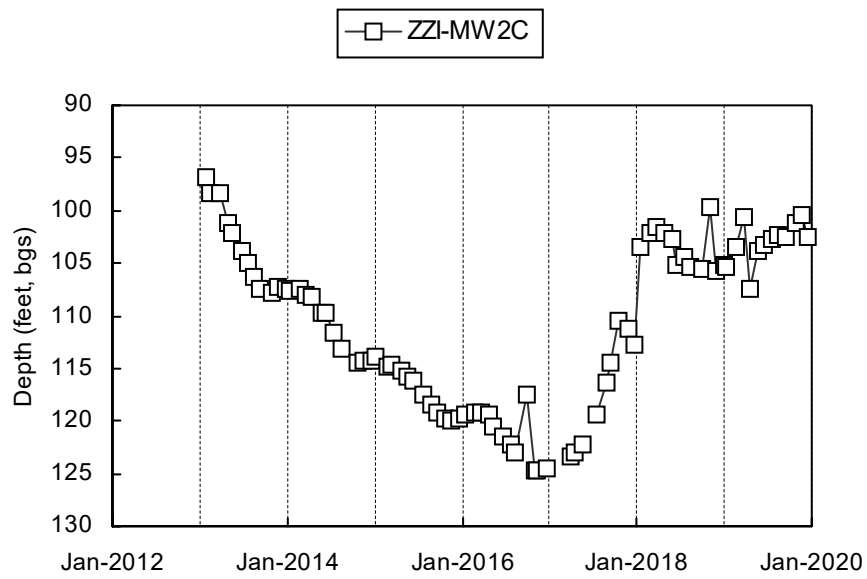
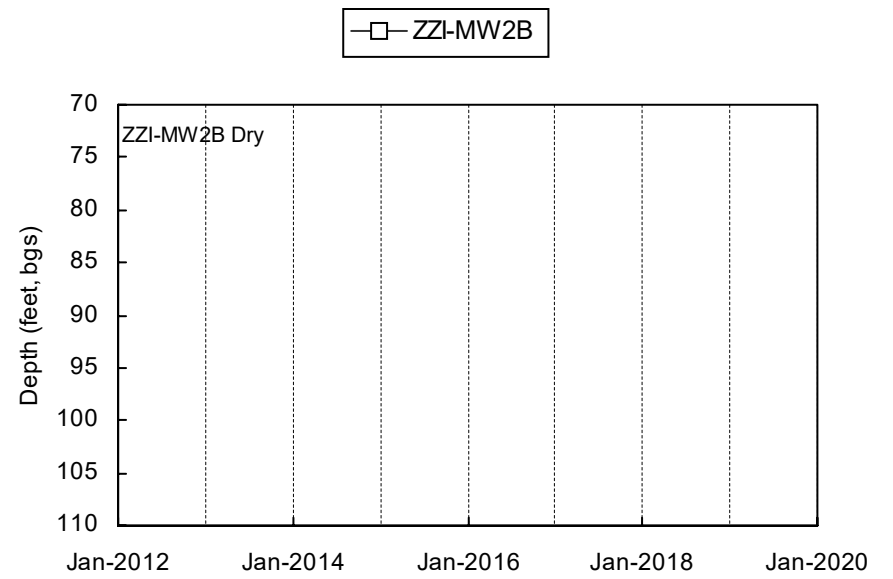
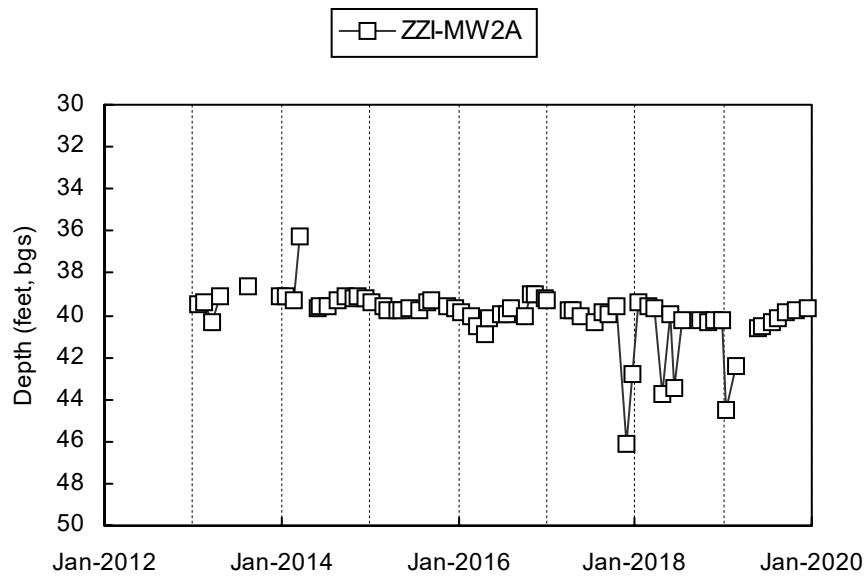

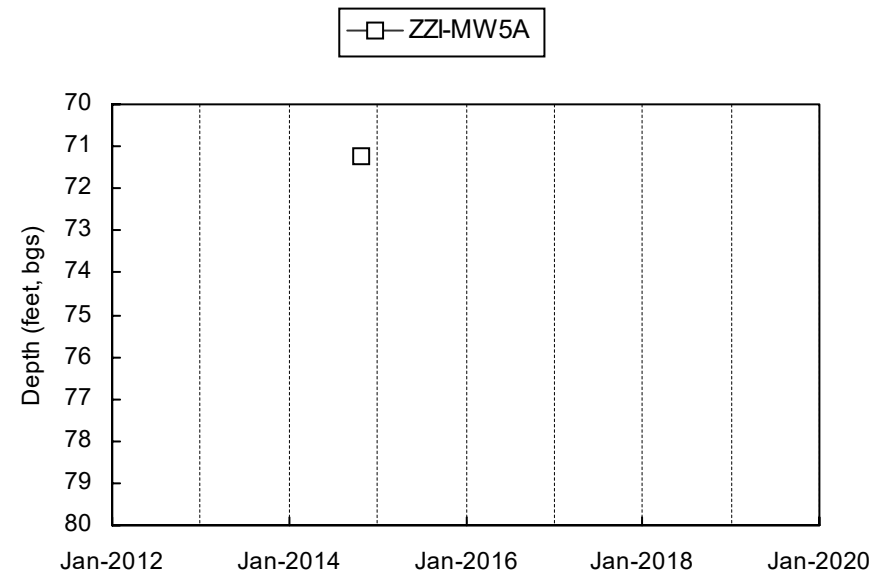
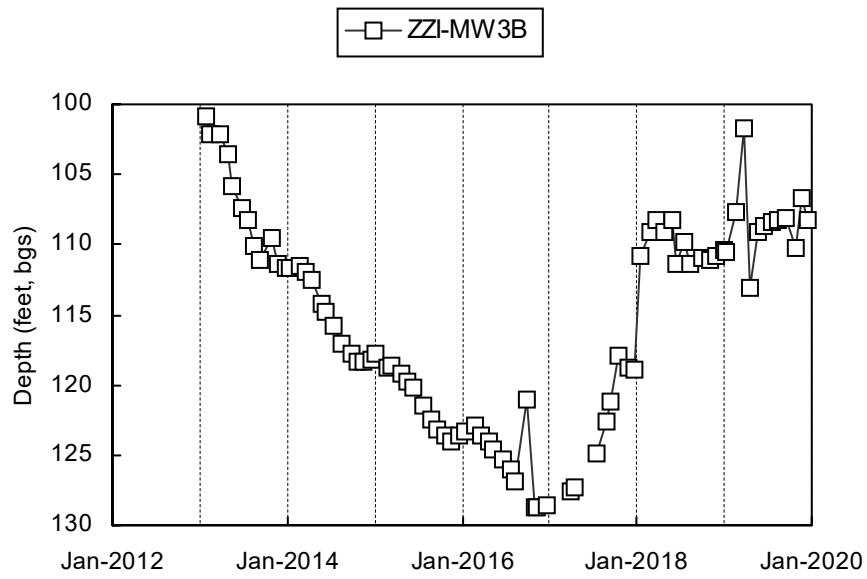
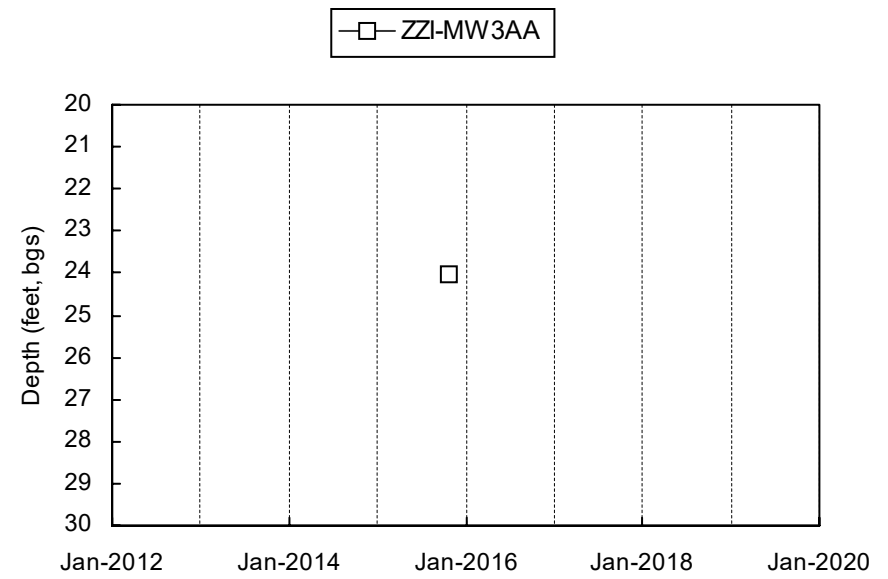
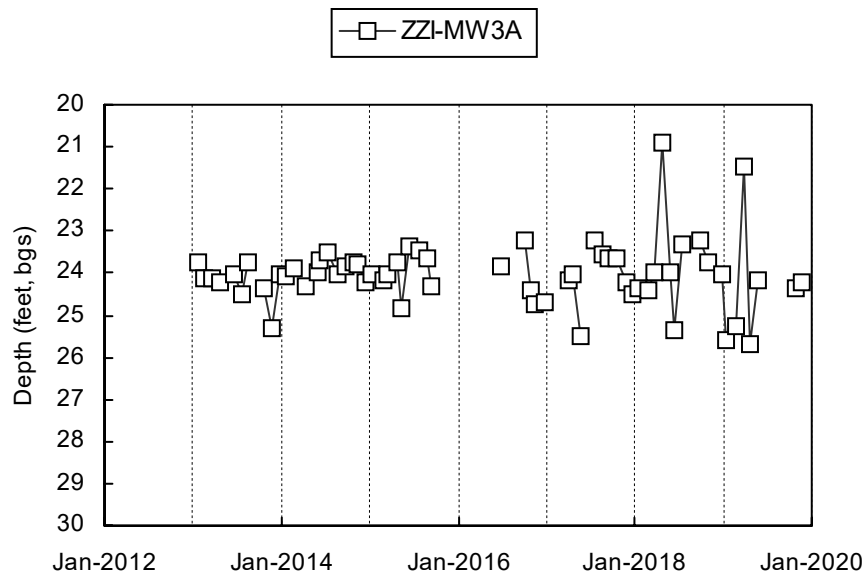

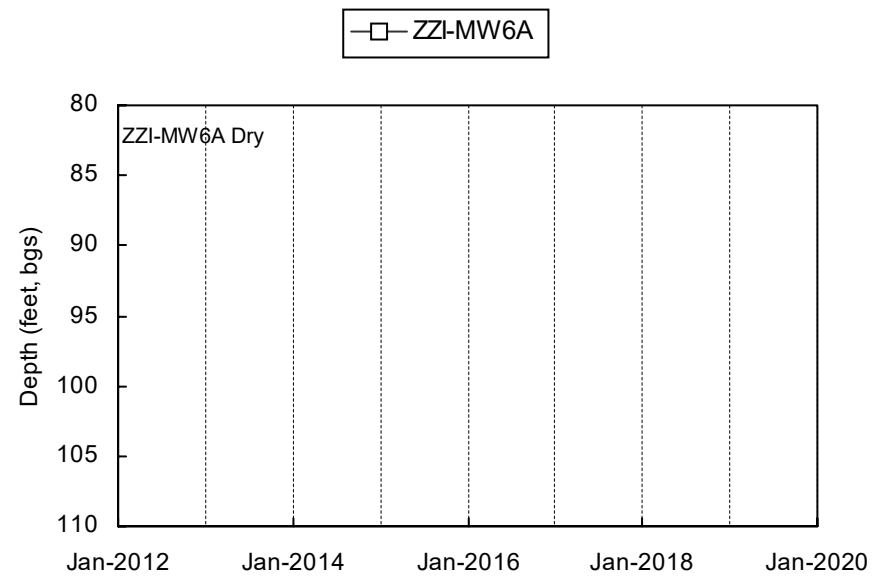
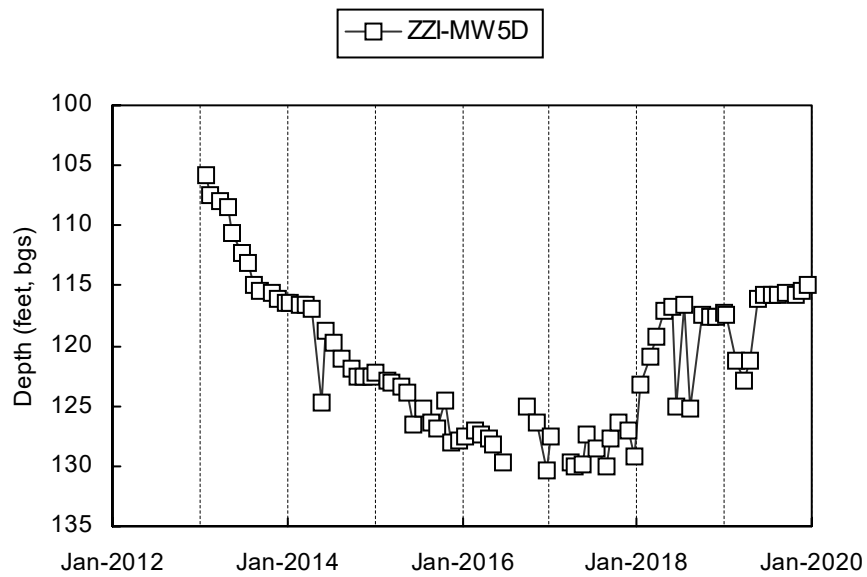
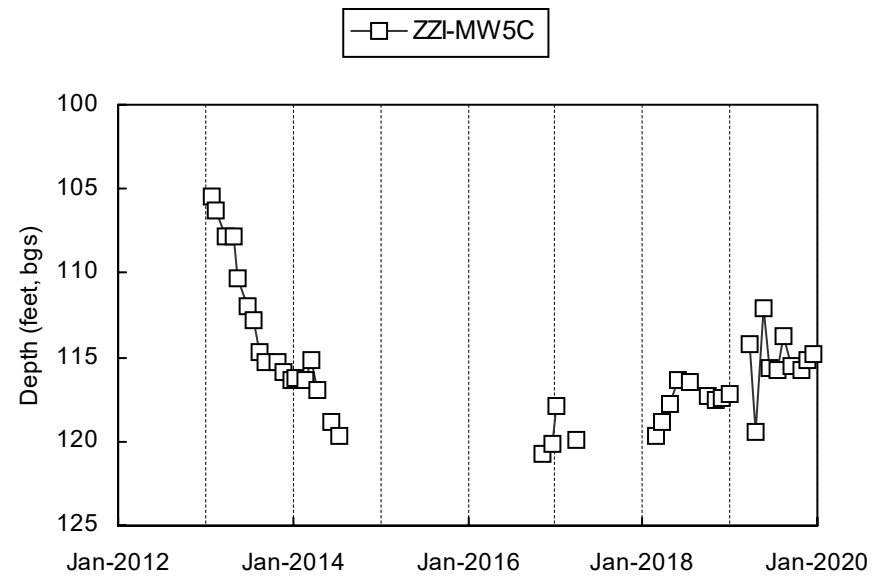
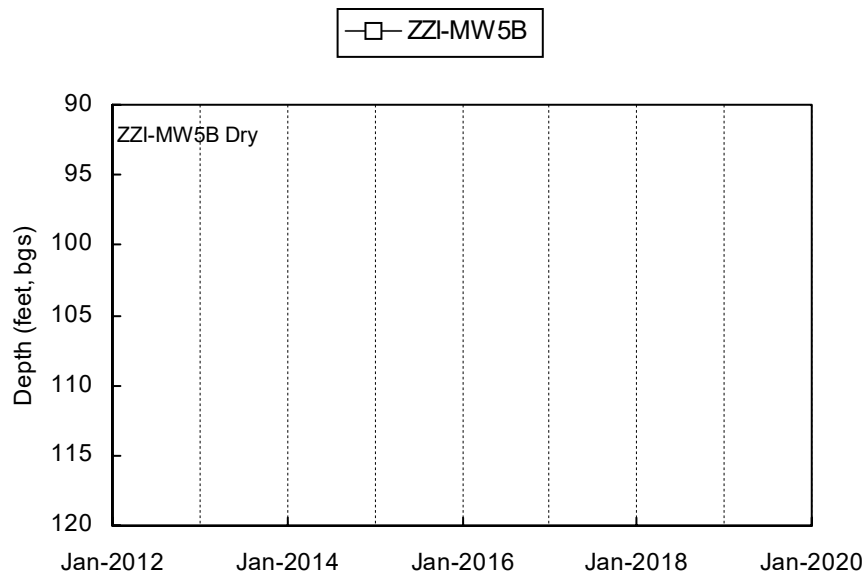

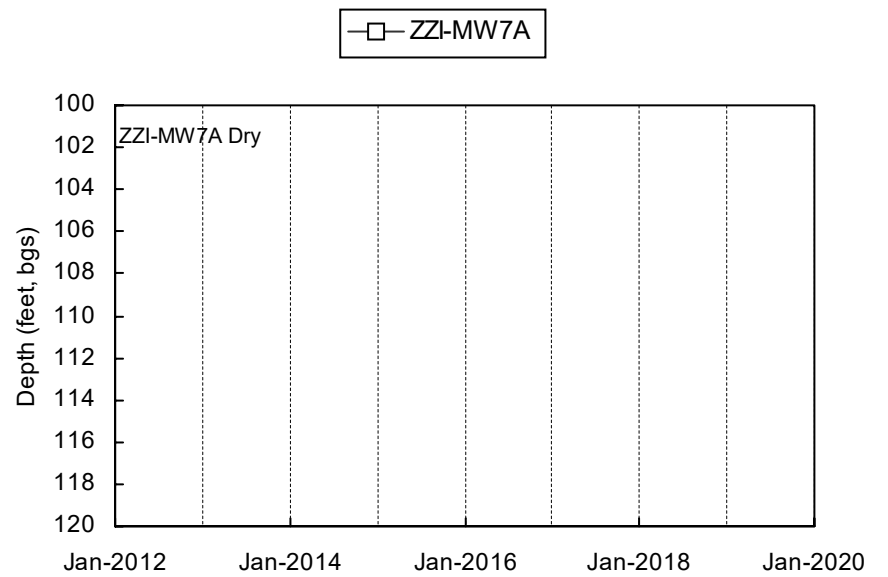
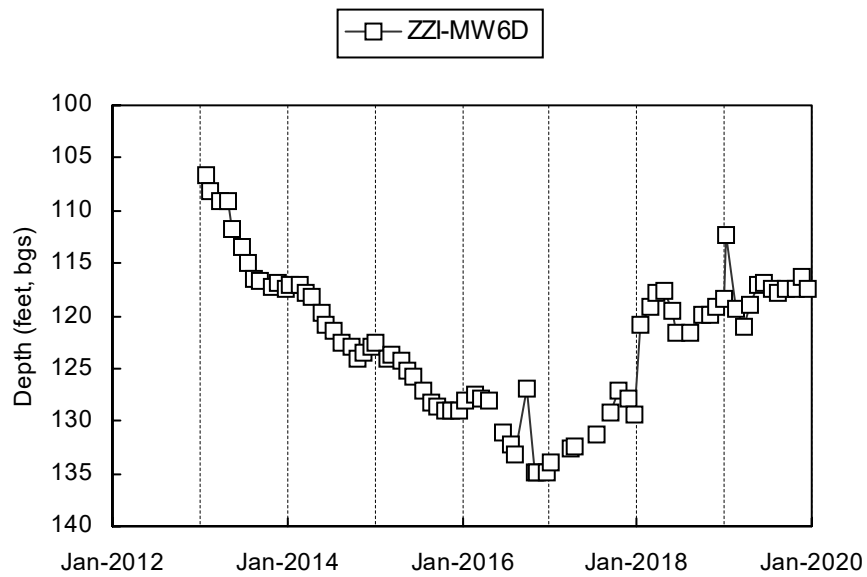
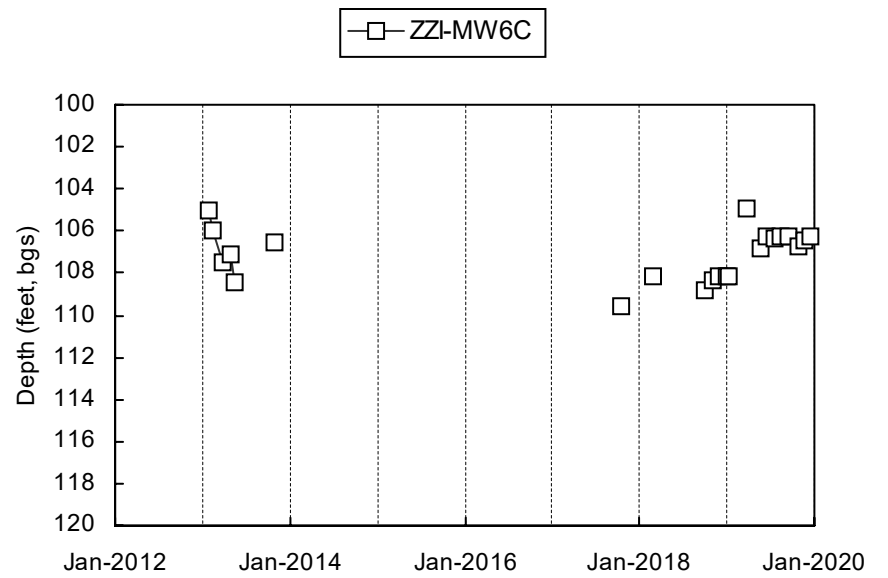
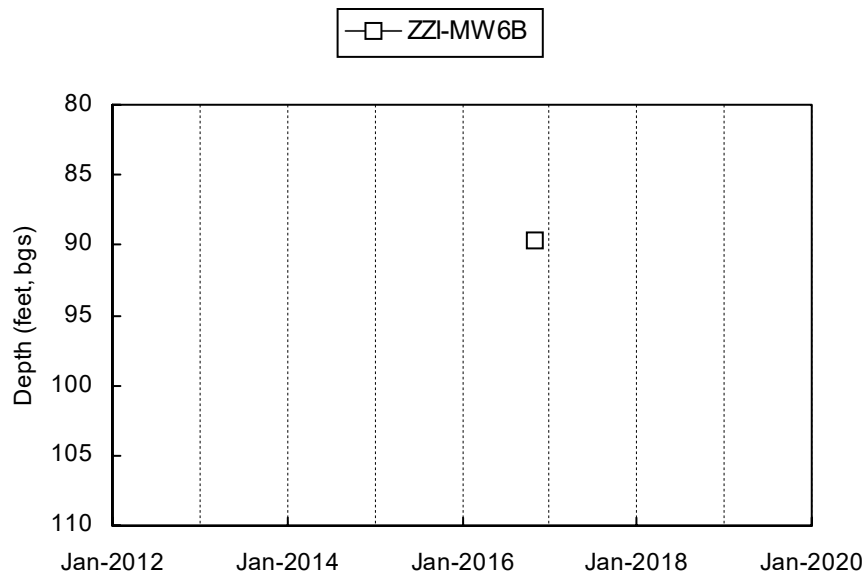

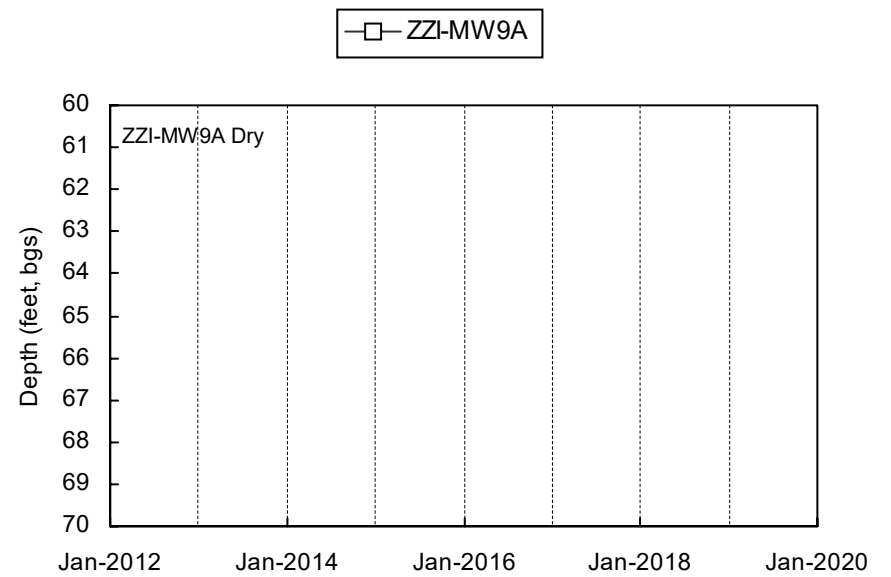
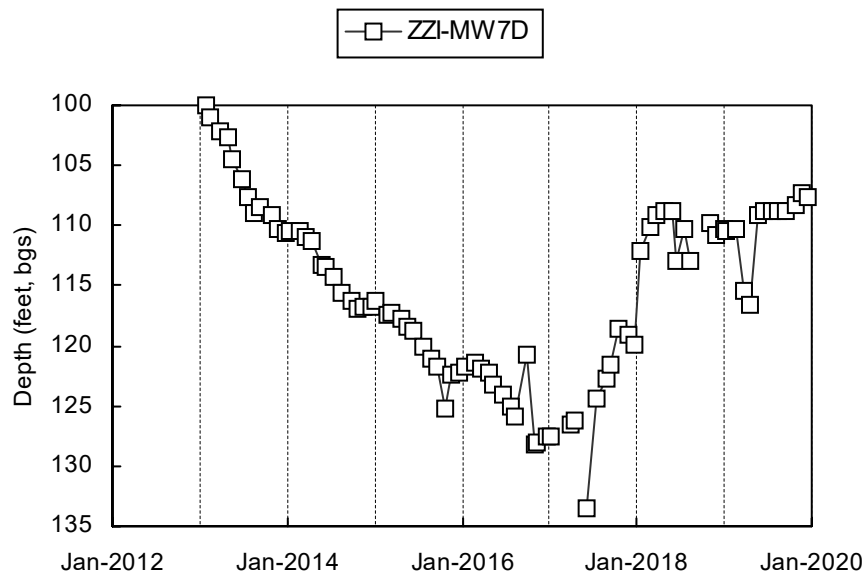
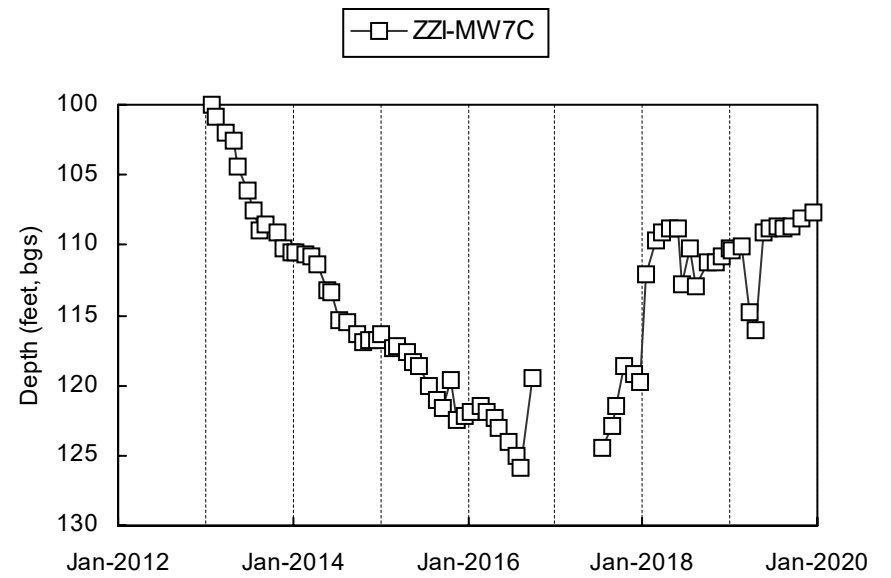
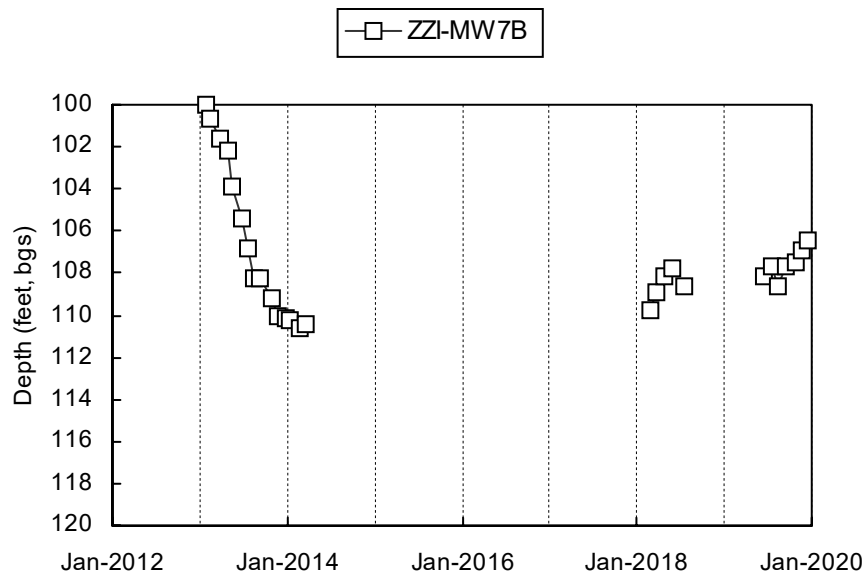

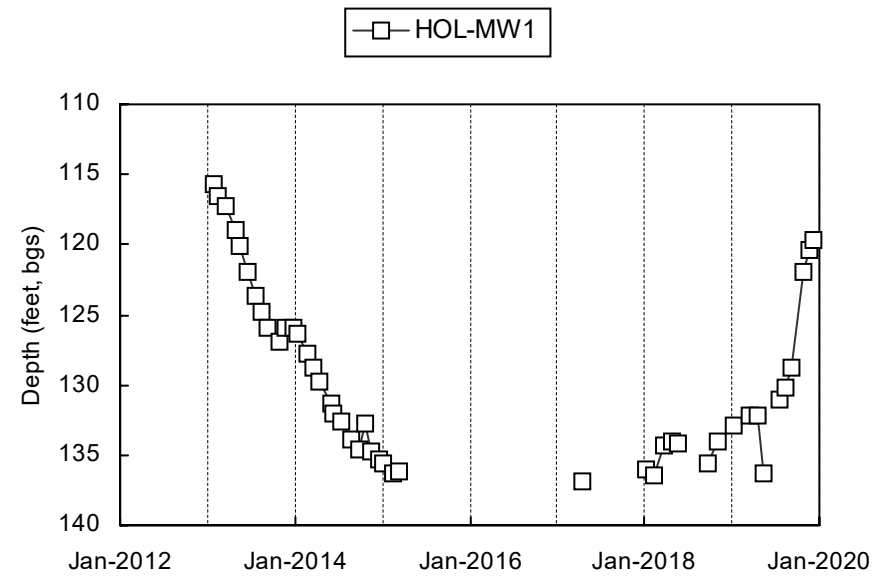
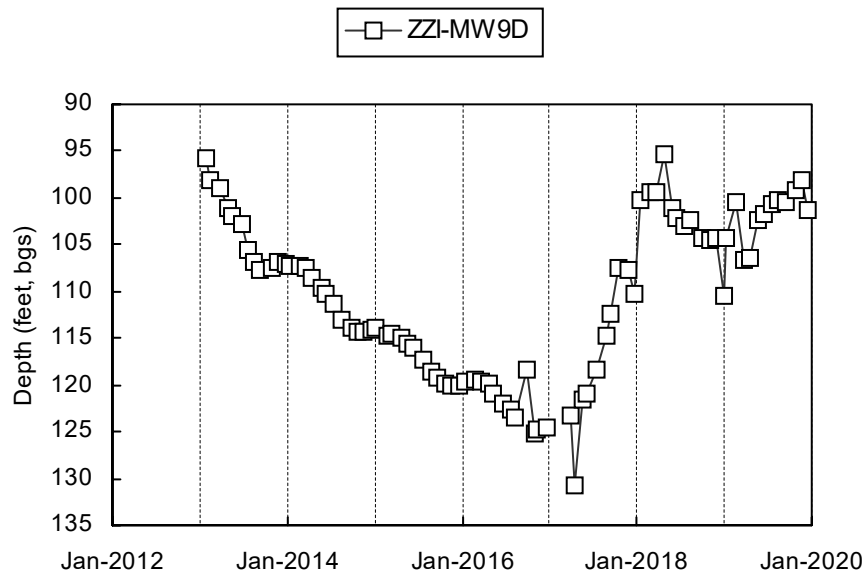
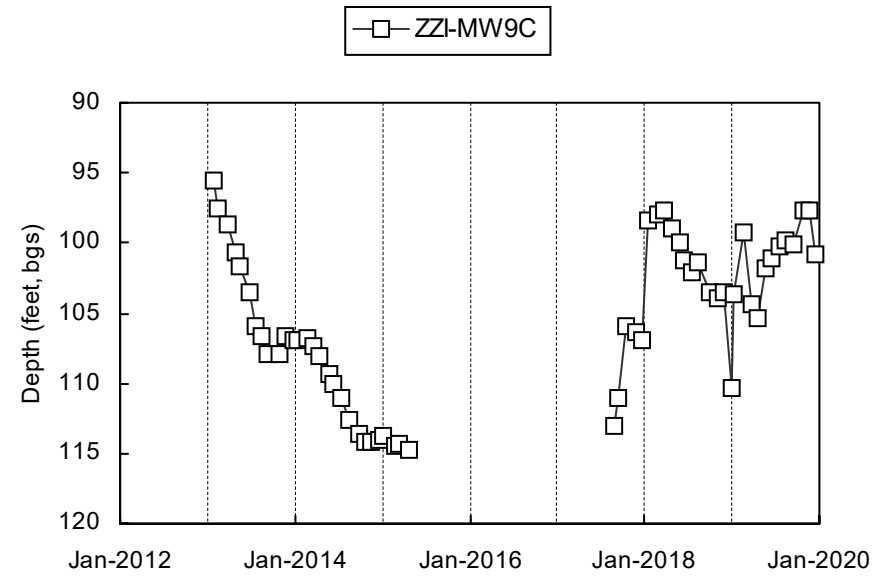
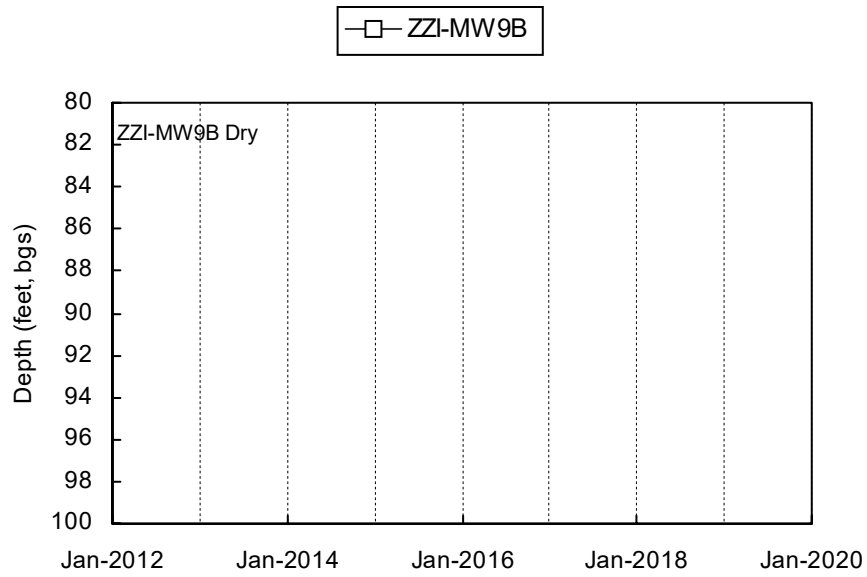

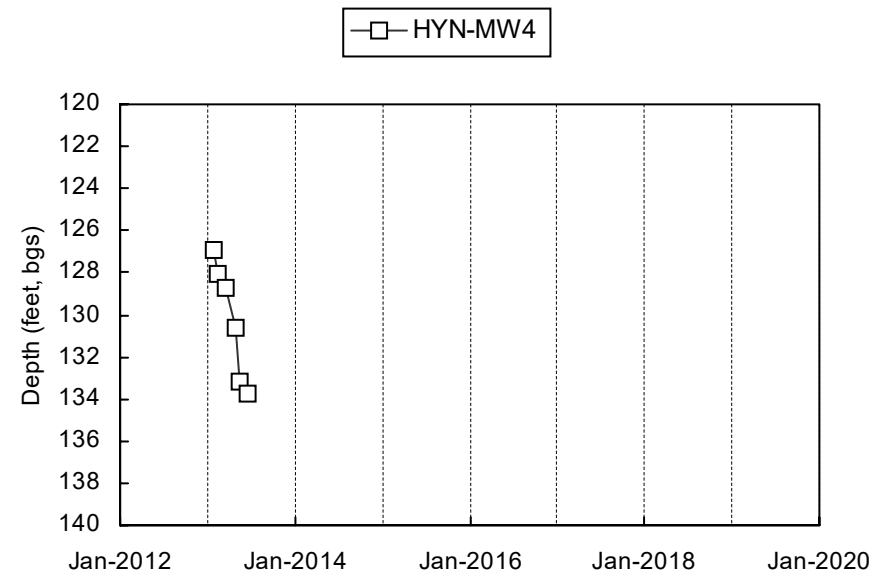
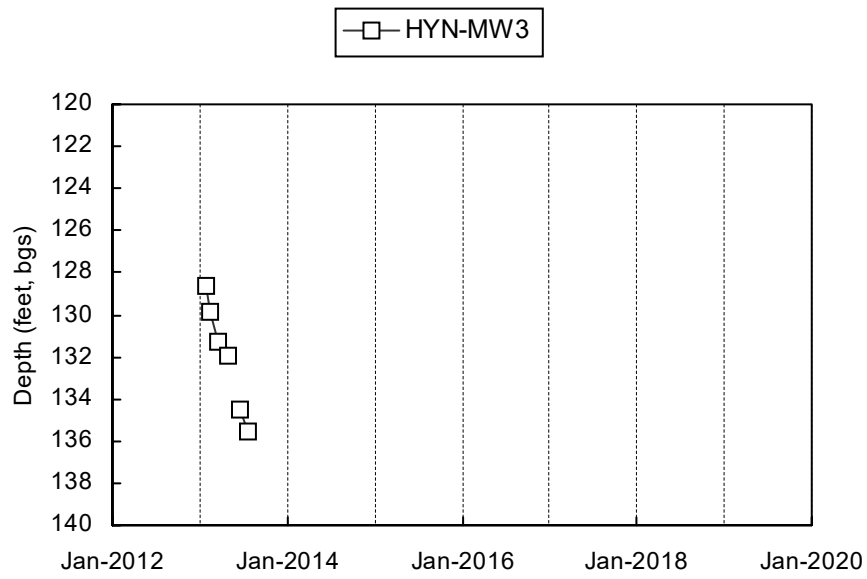
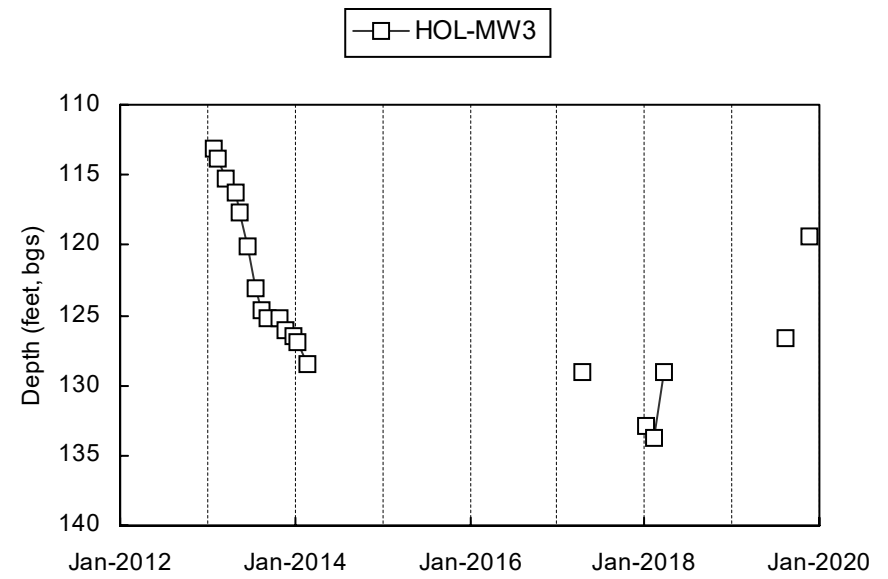
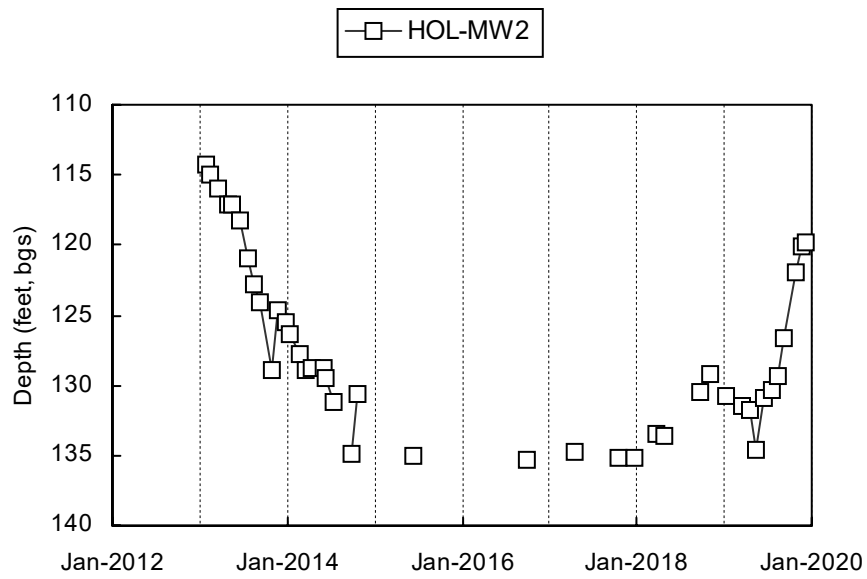

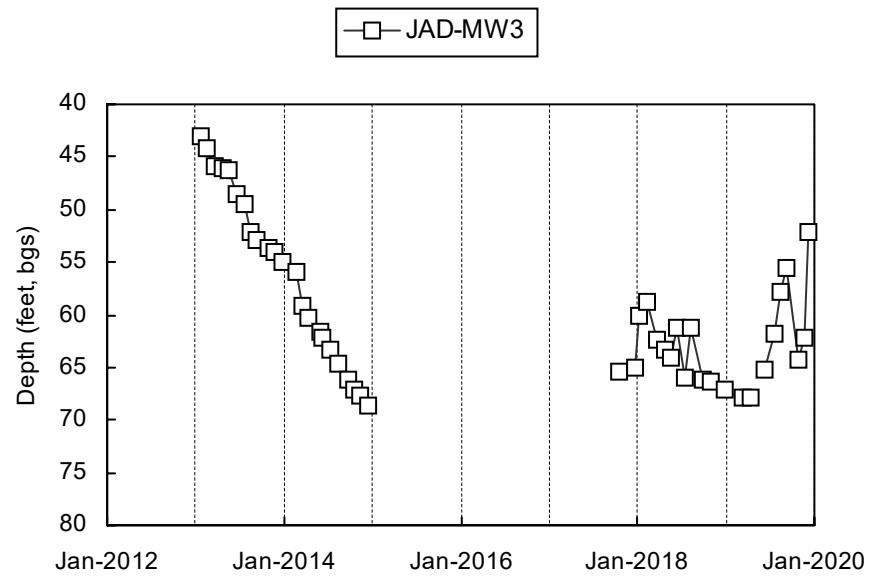
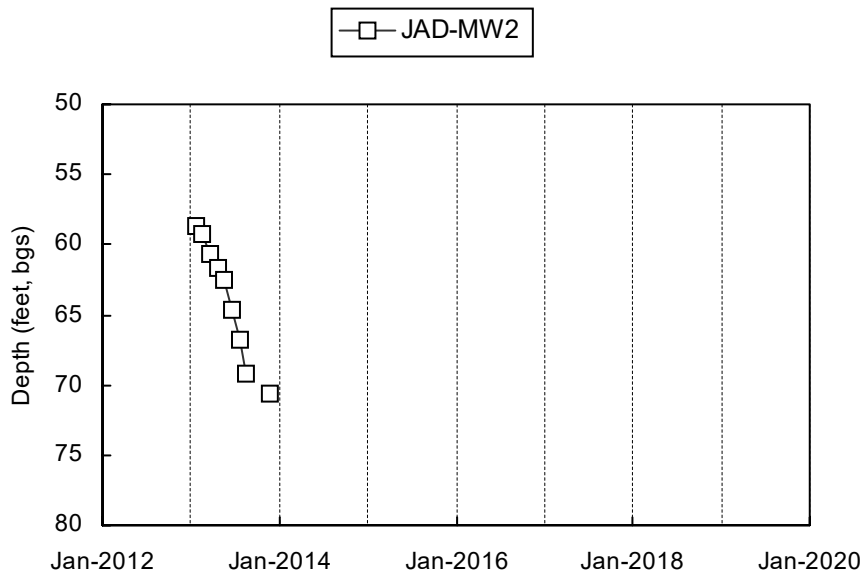
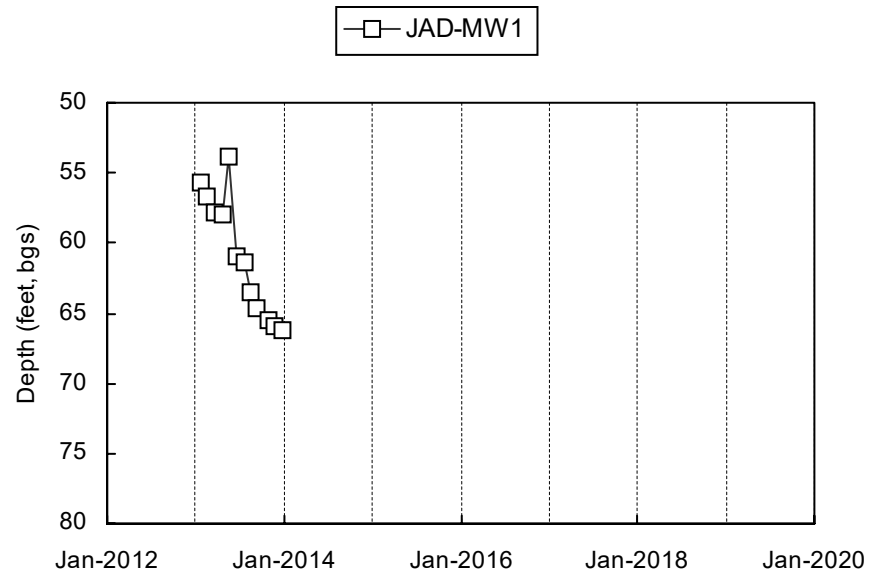
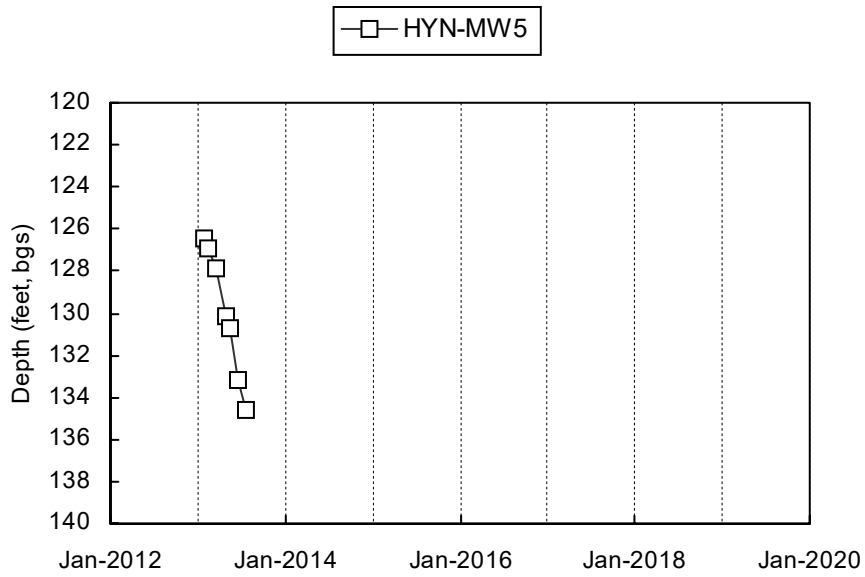

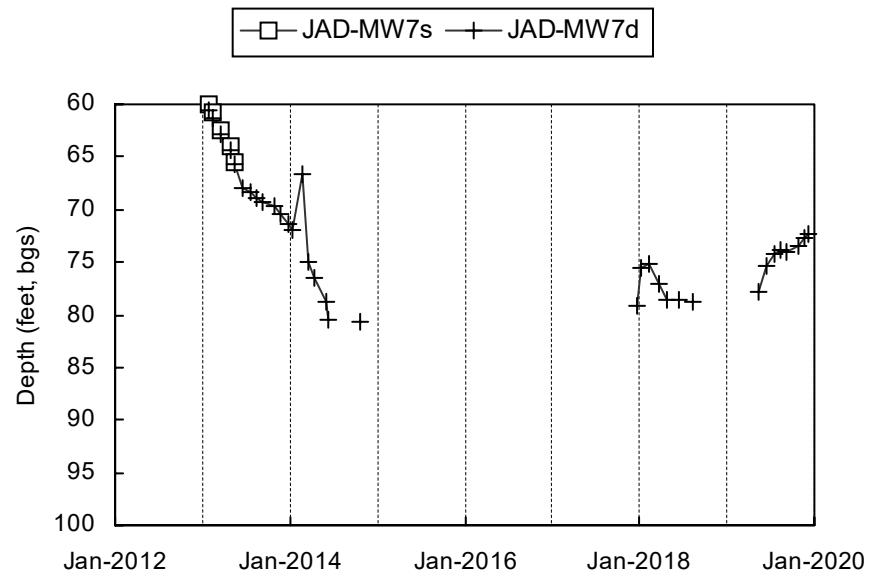
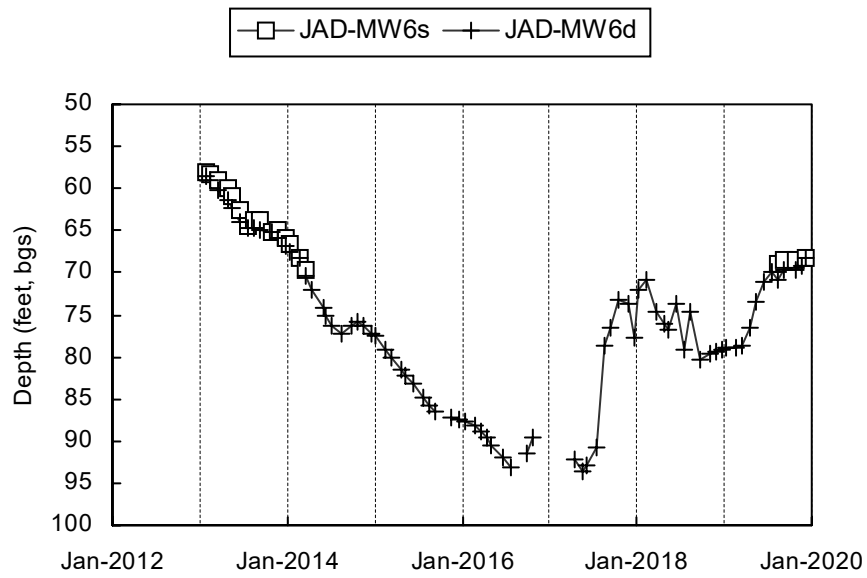
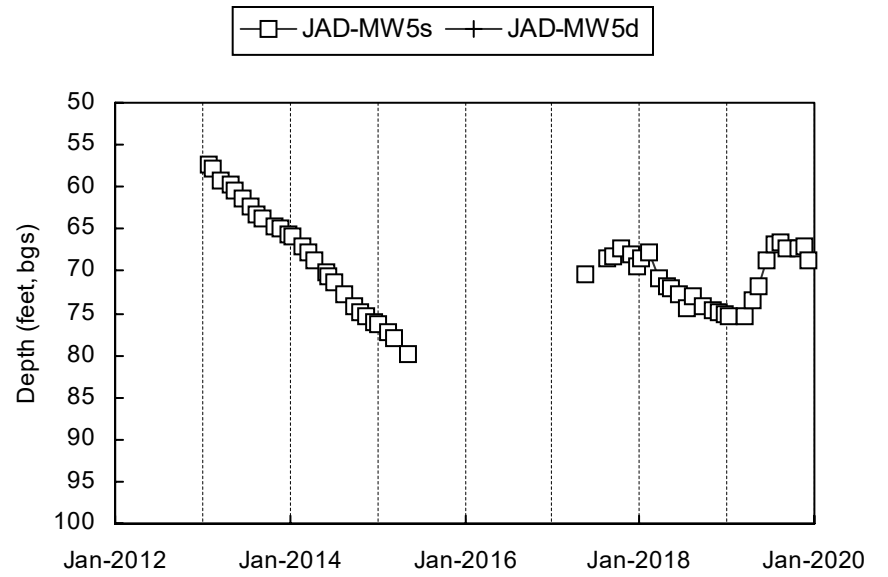
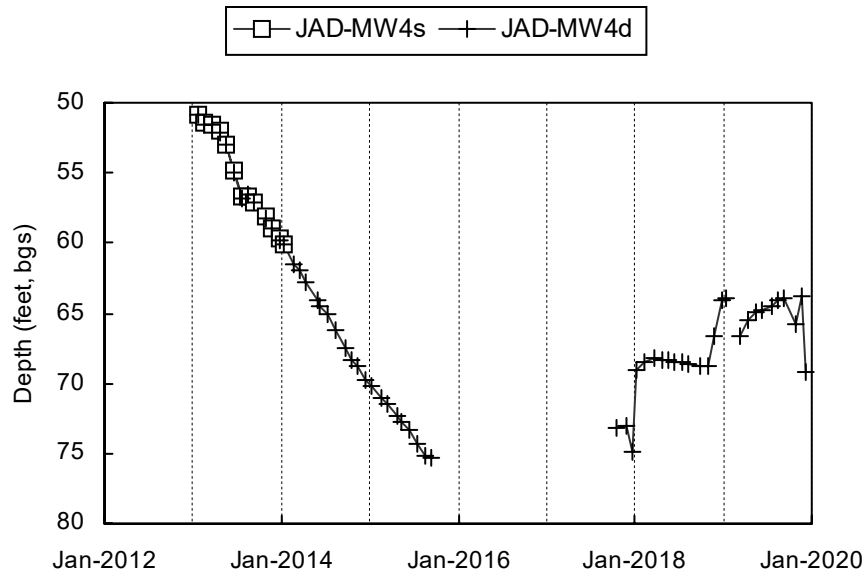

—□— LON-MW1A

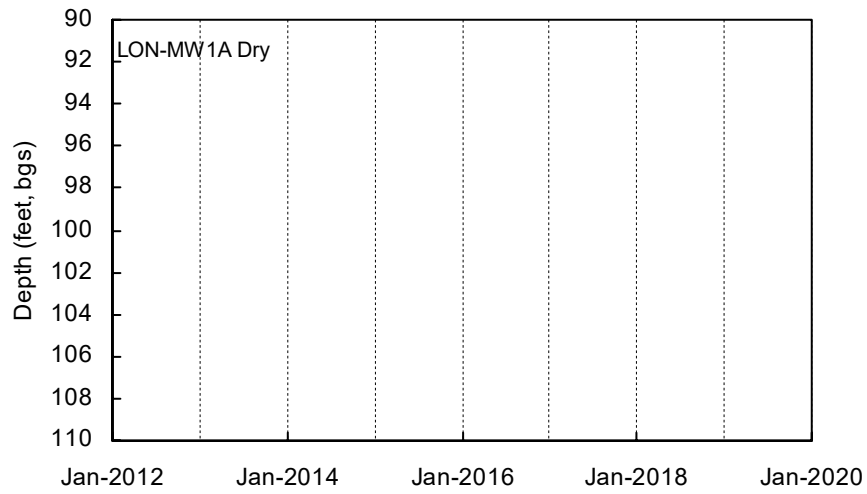

—□— LON-MW1B

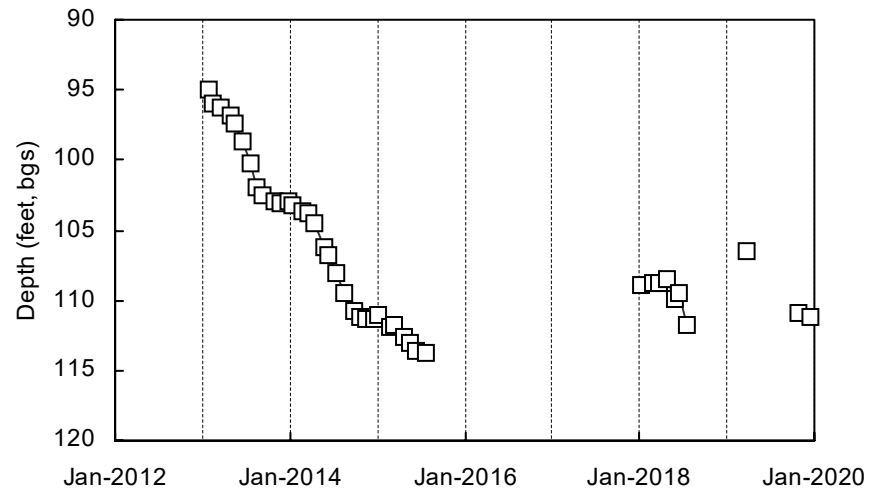

—□— LON-MW1C

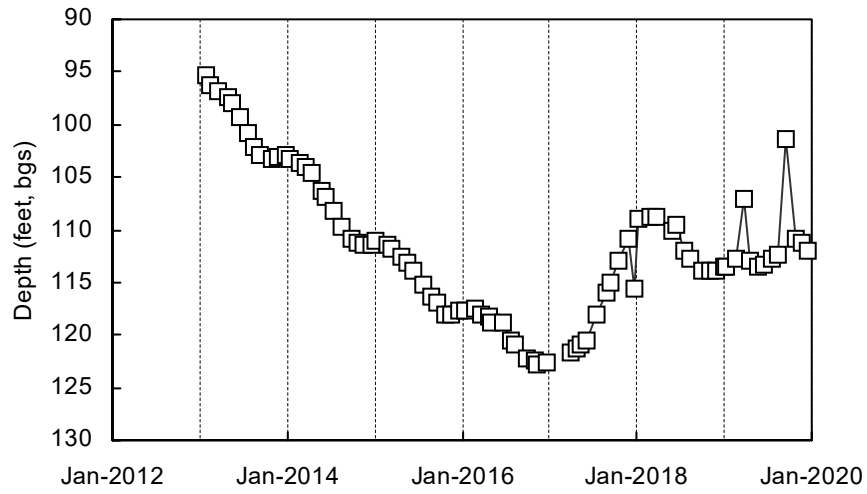

—□— LON-MW2A

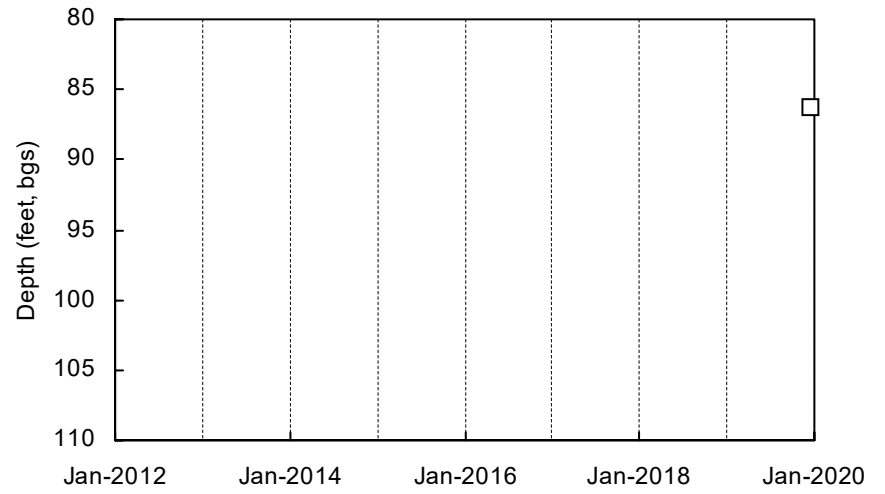

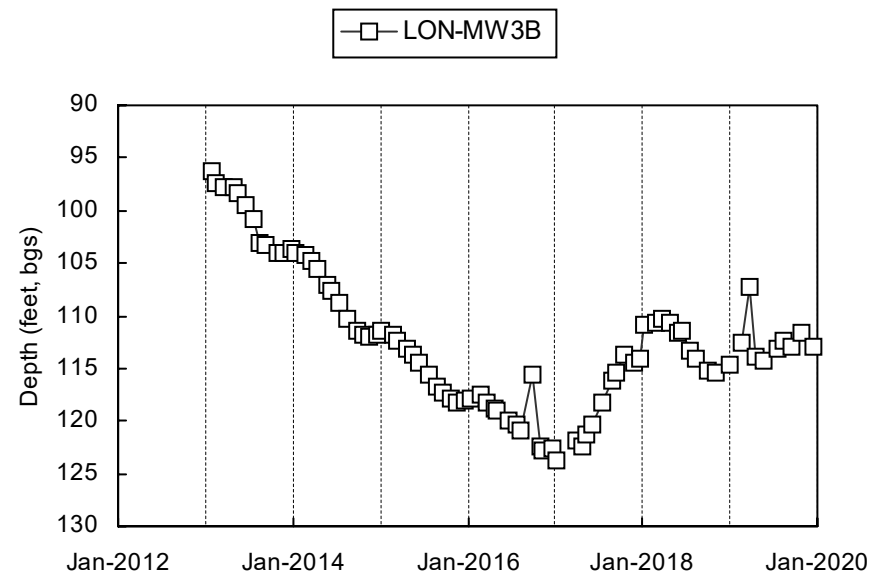
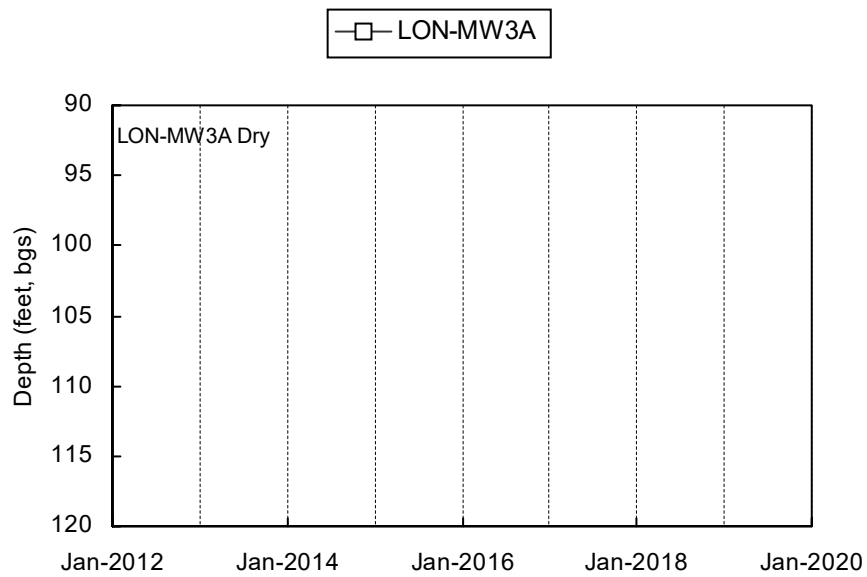
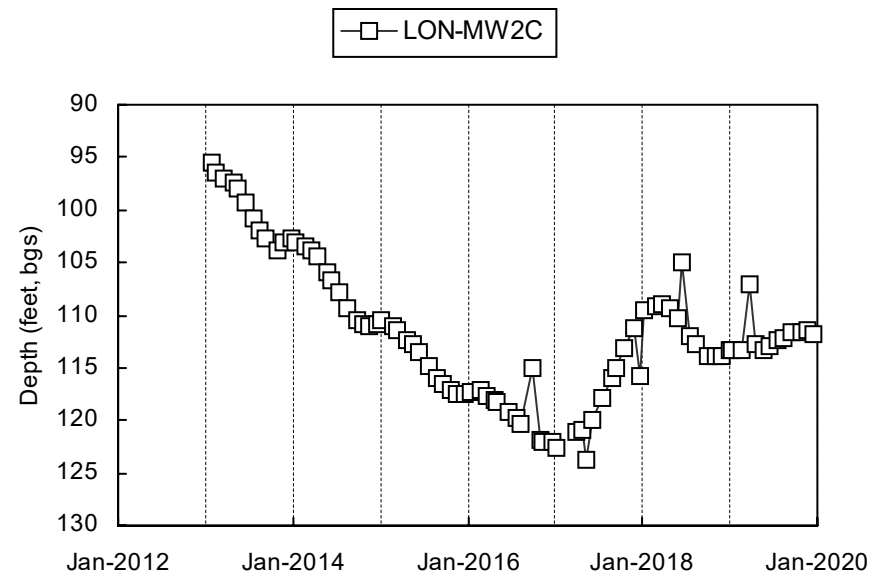
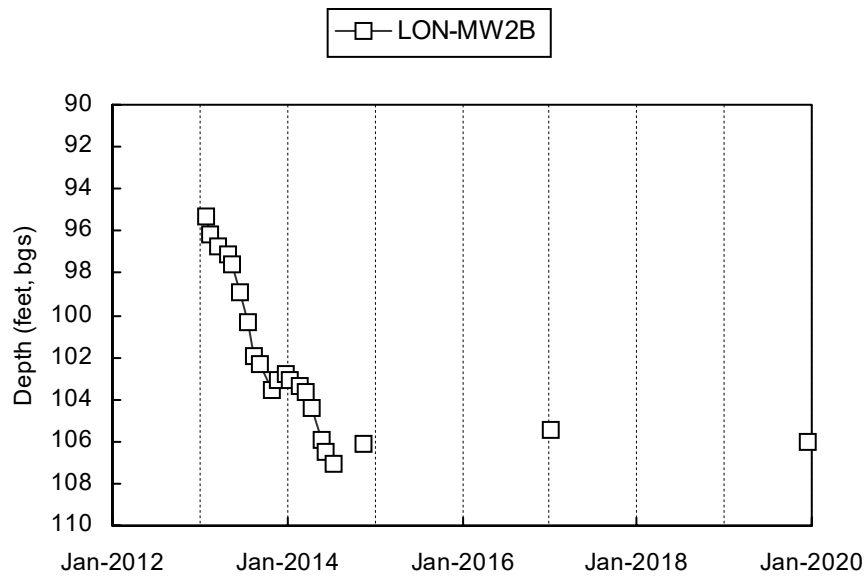

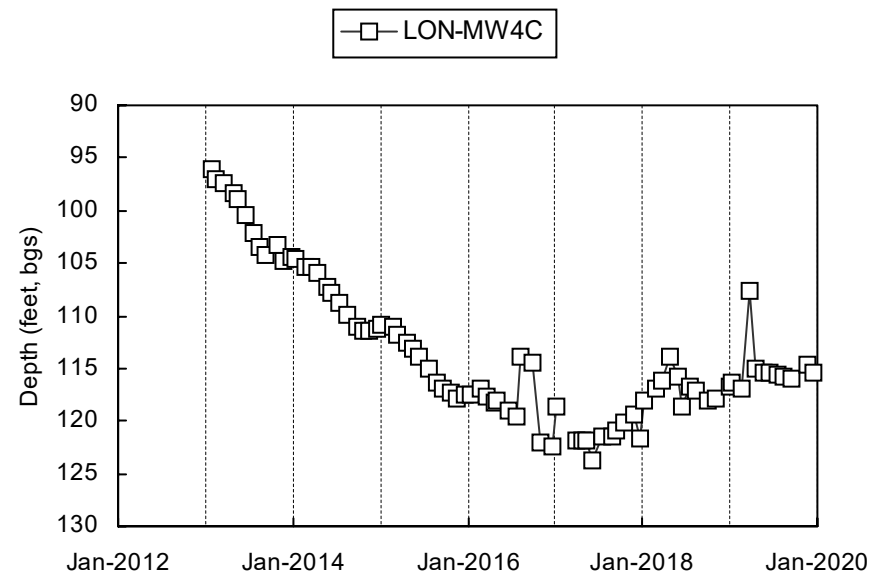
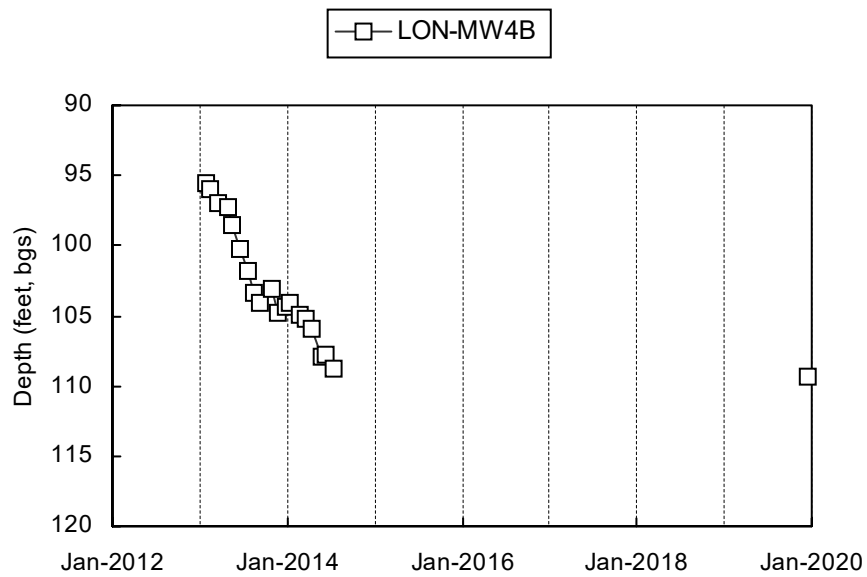
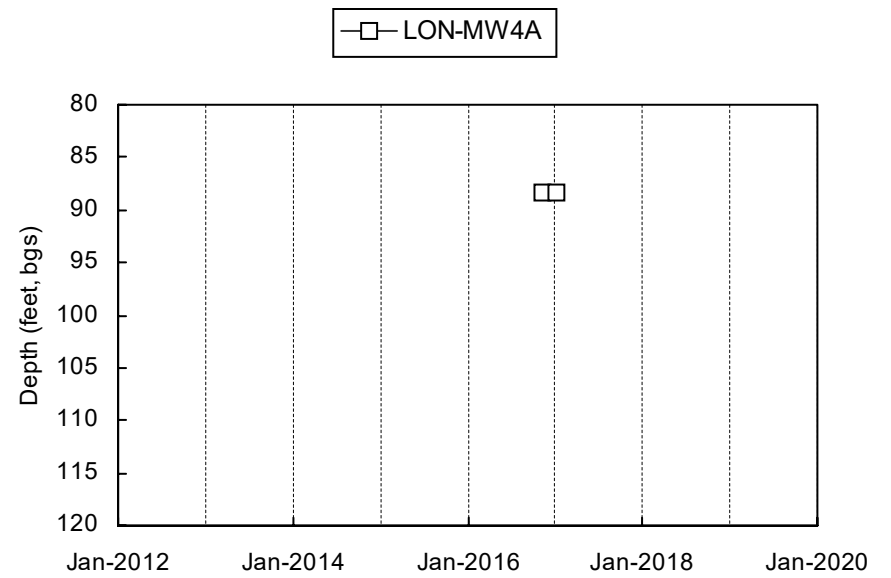
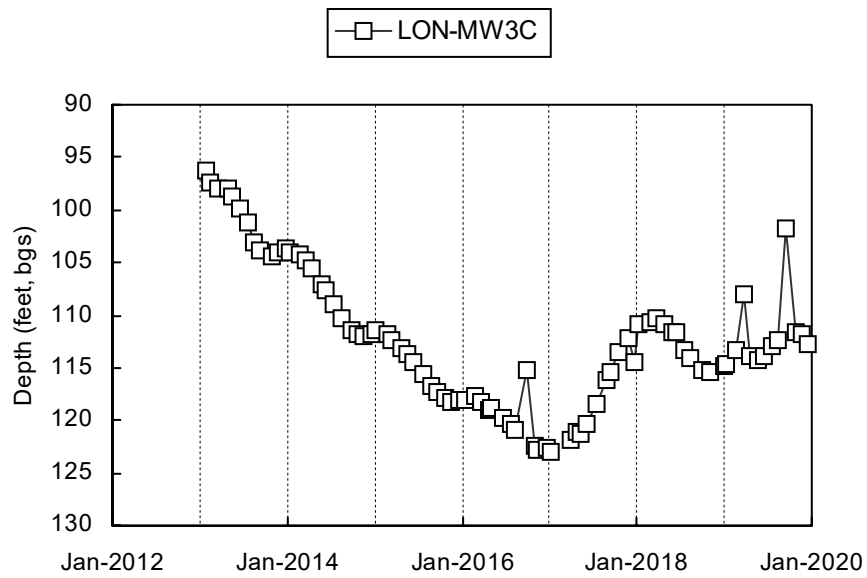

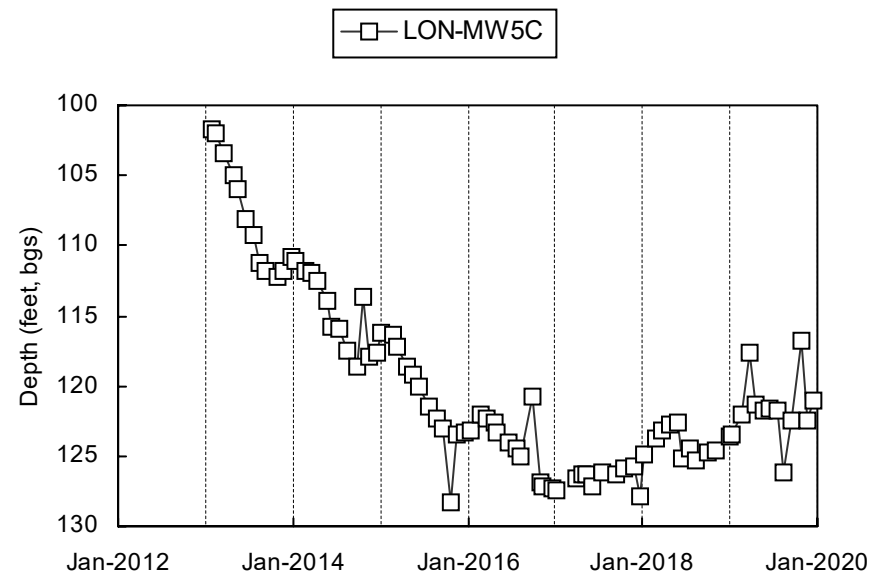
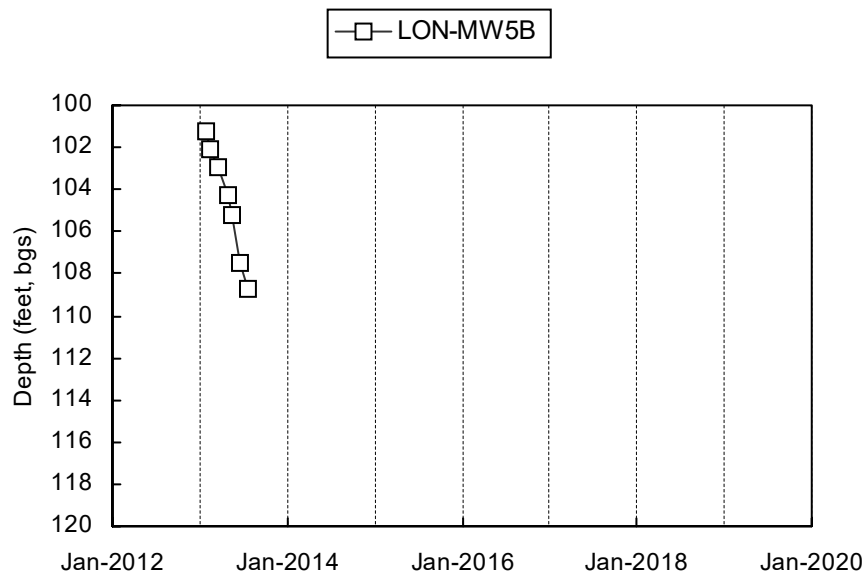
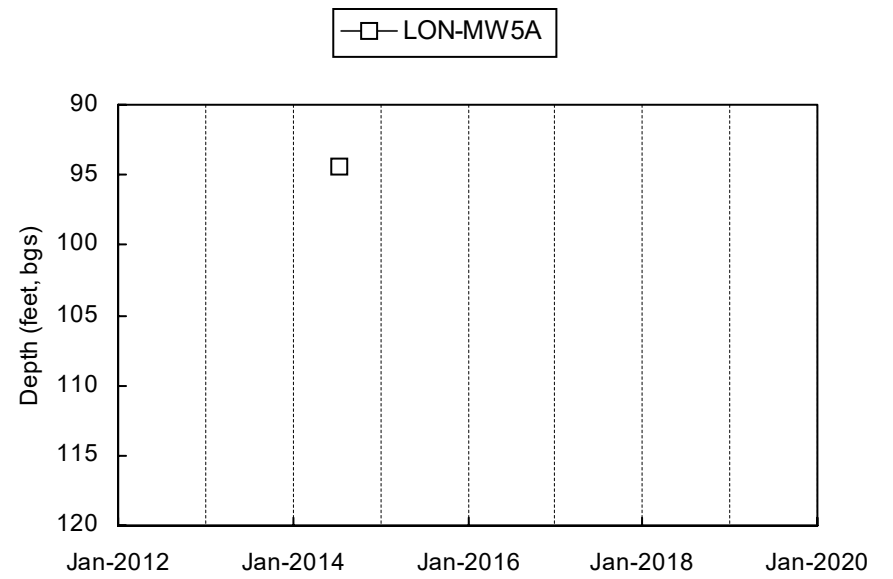
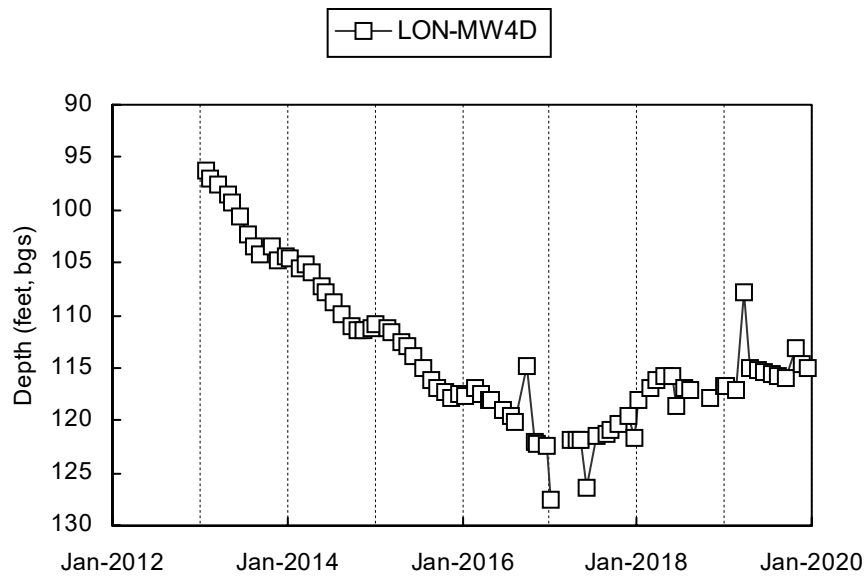

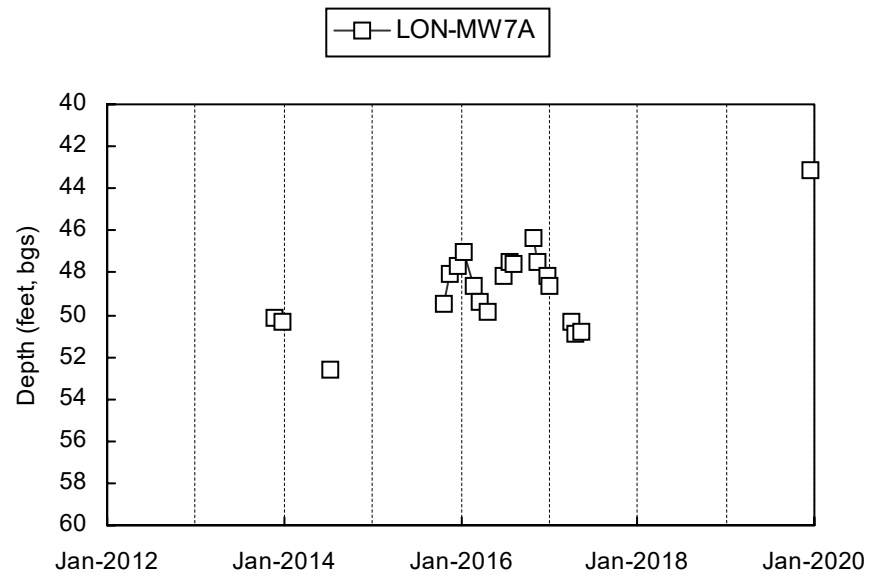
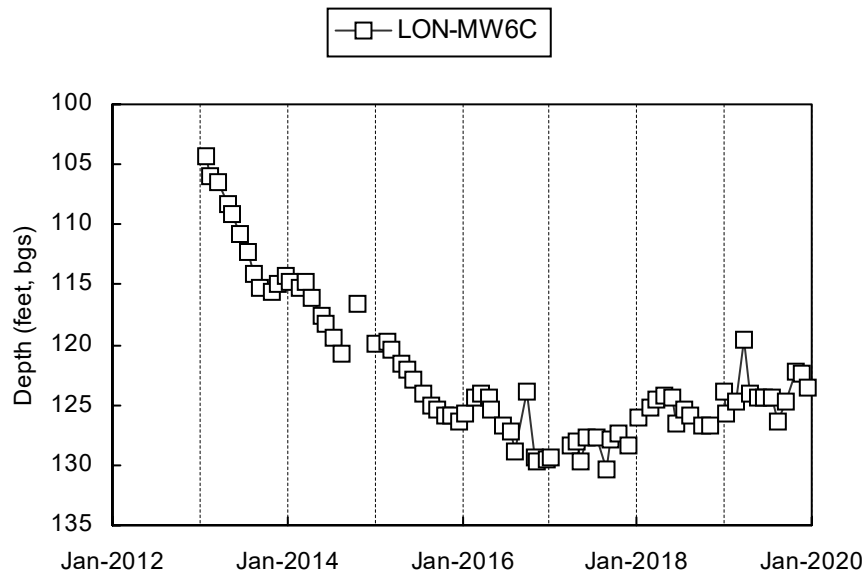
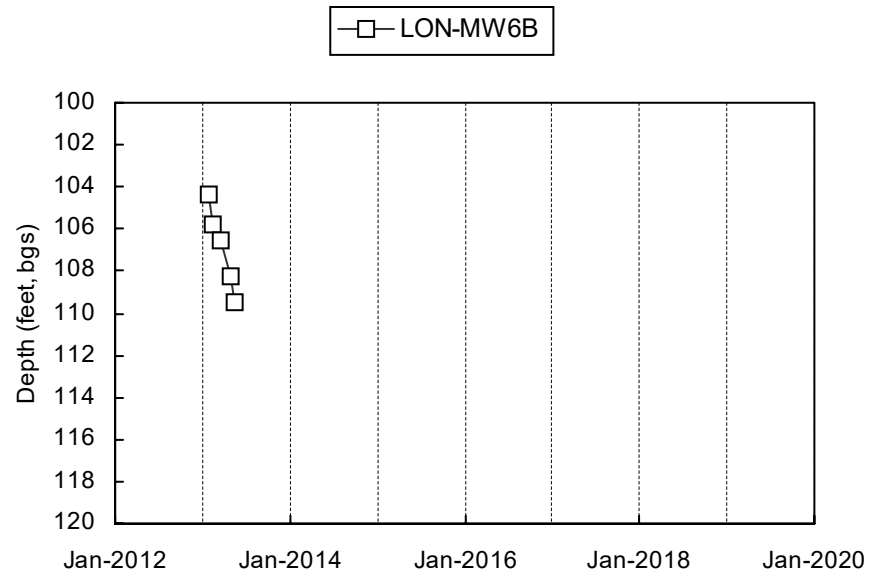
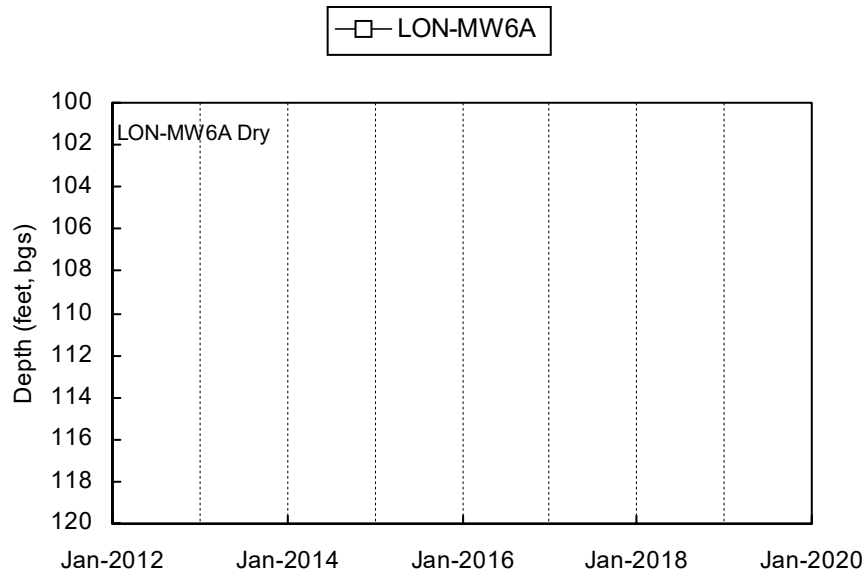

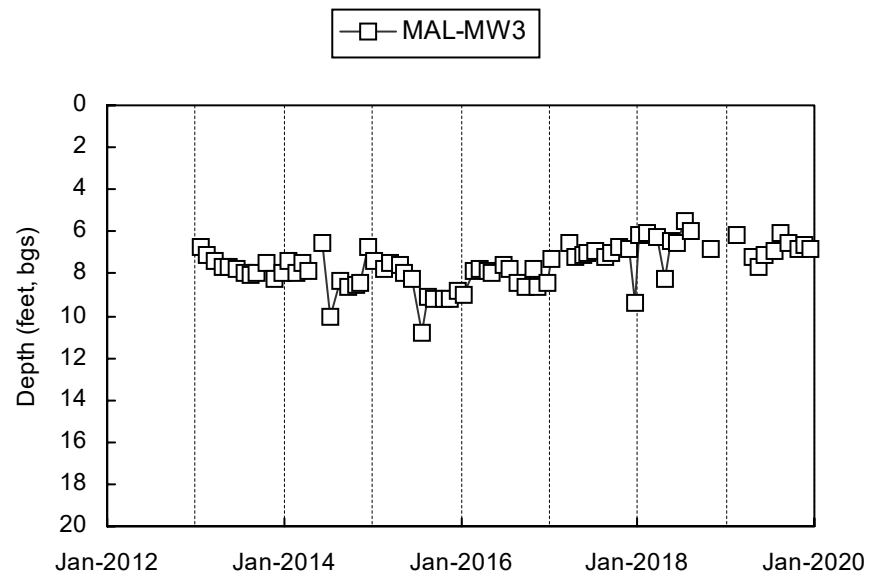
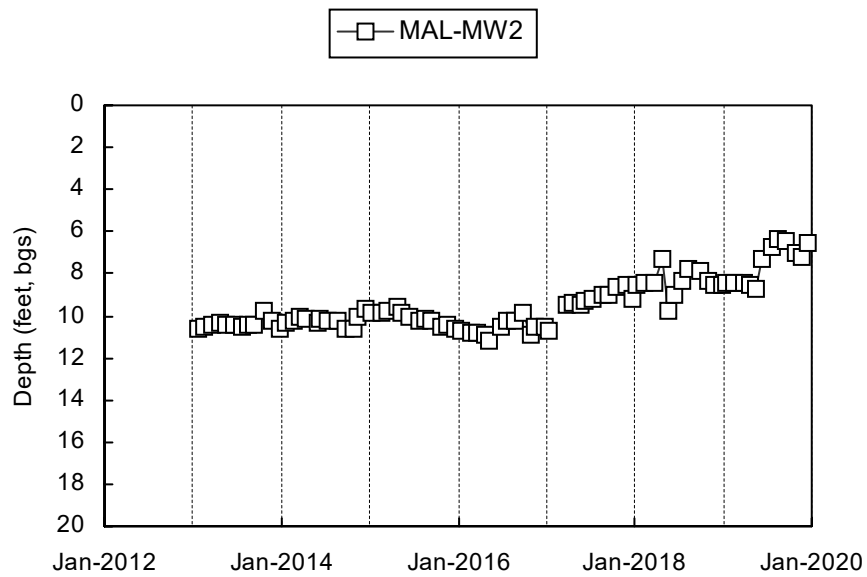
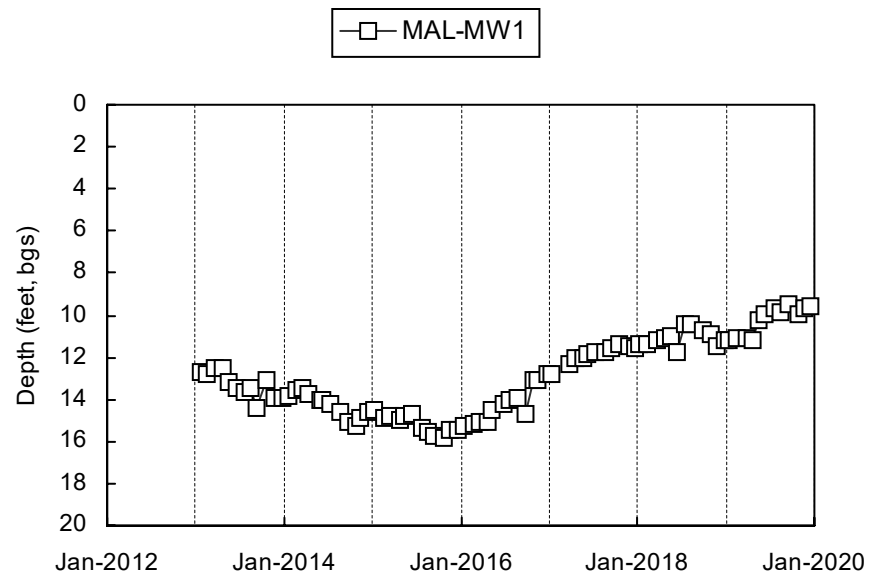
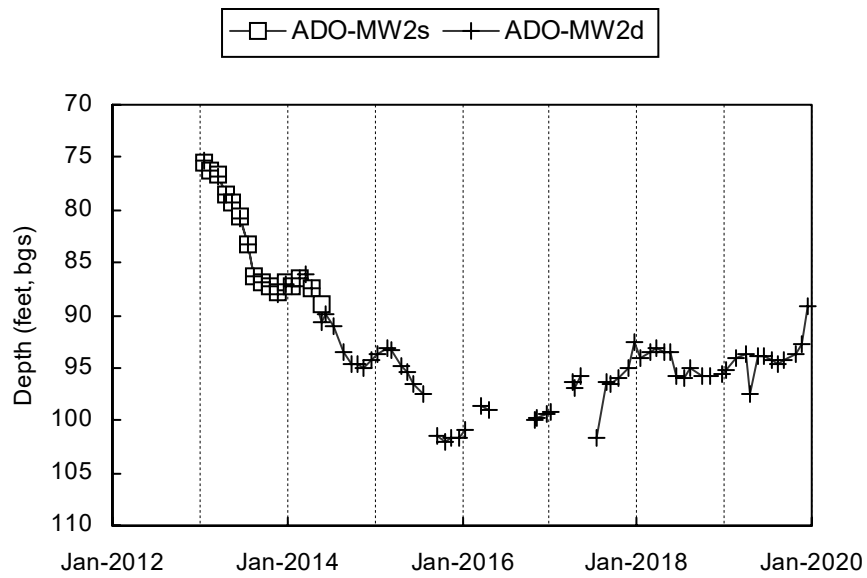

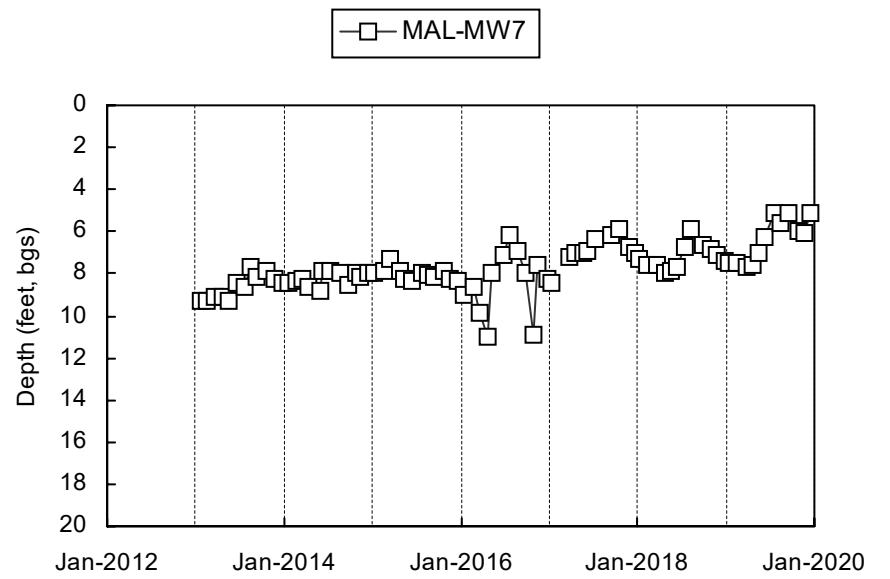
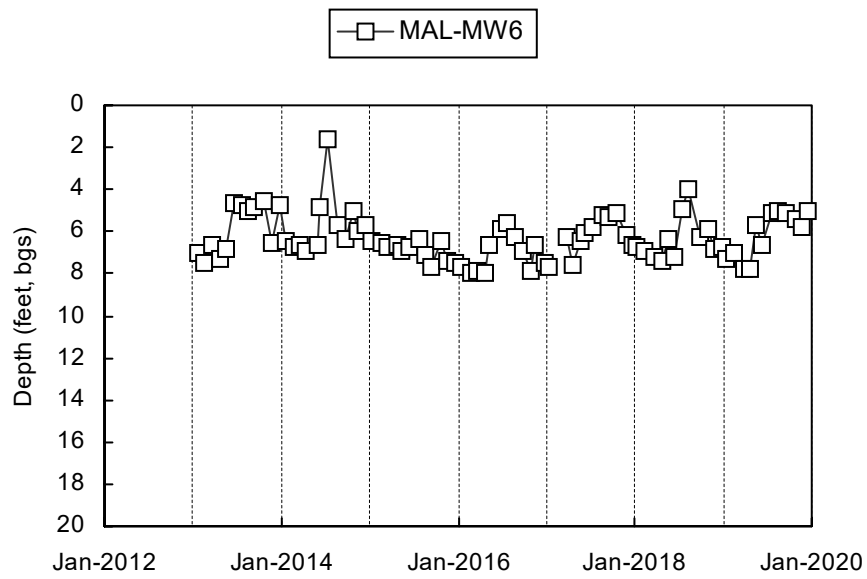
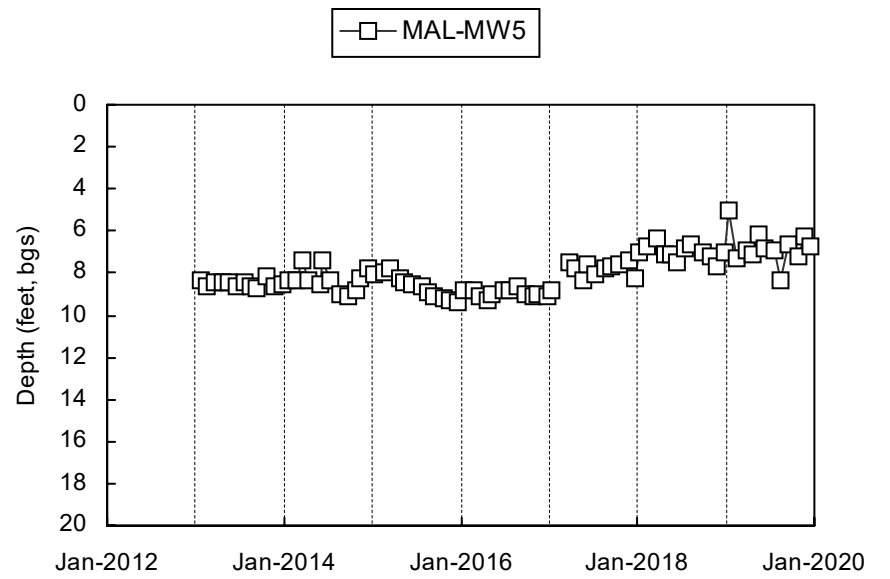
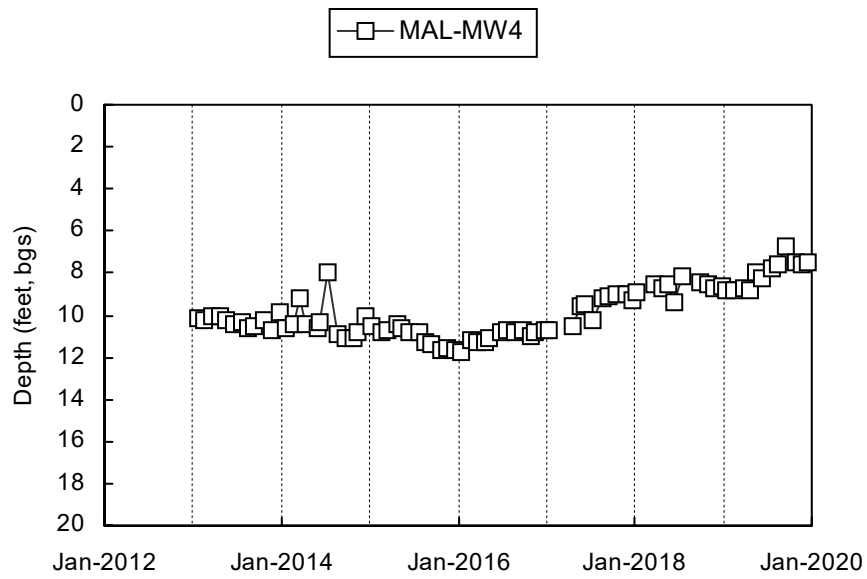

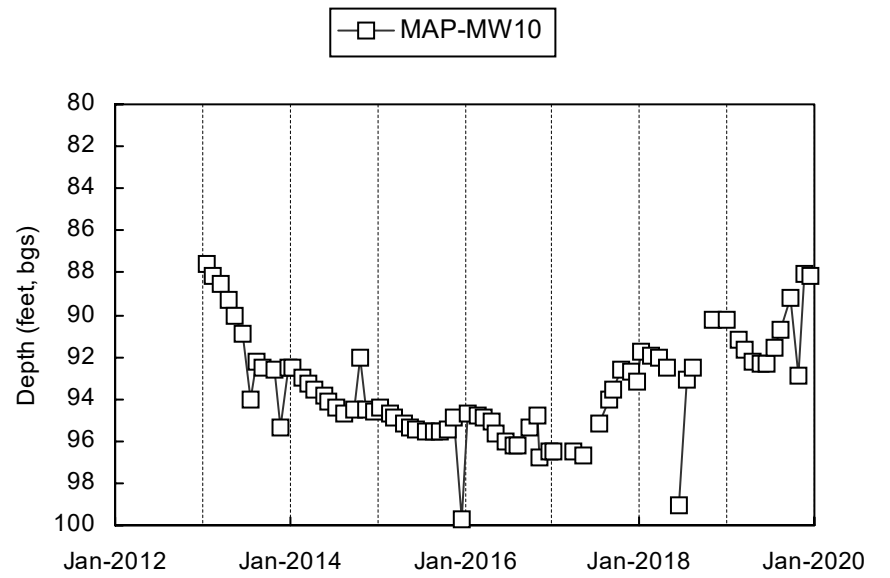
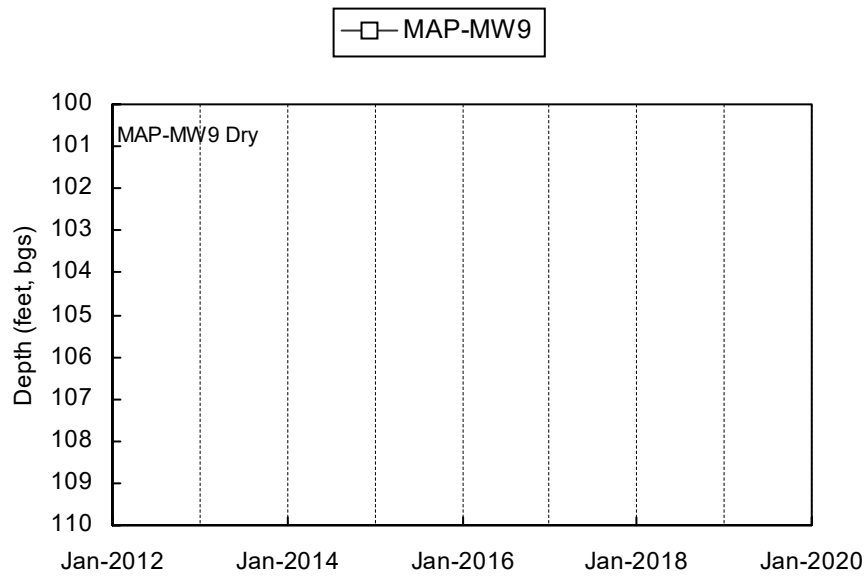
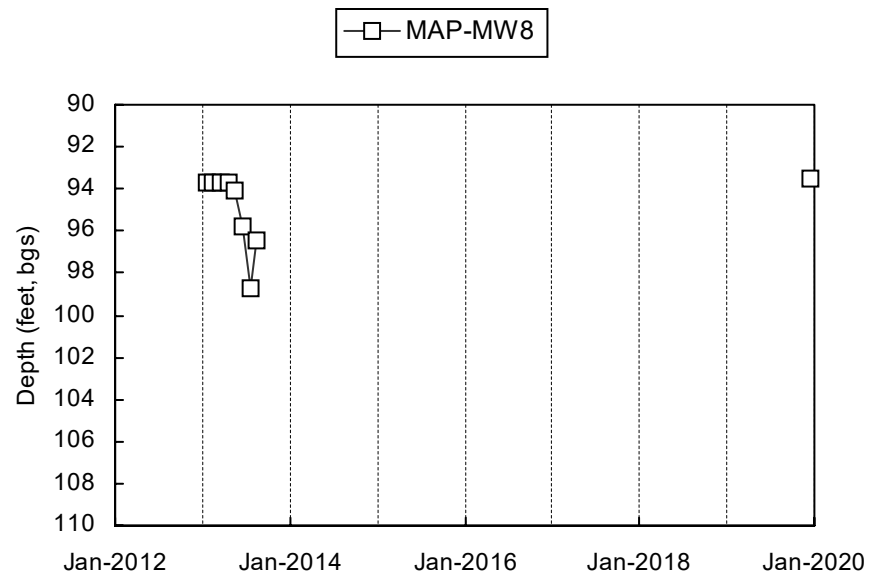
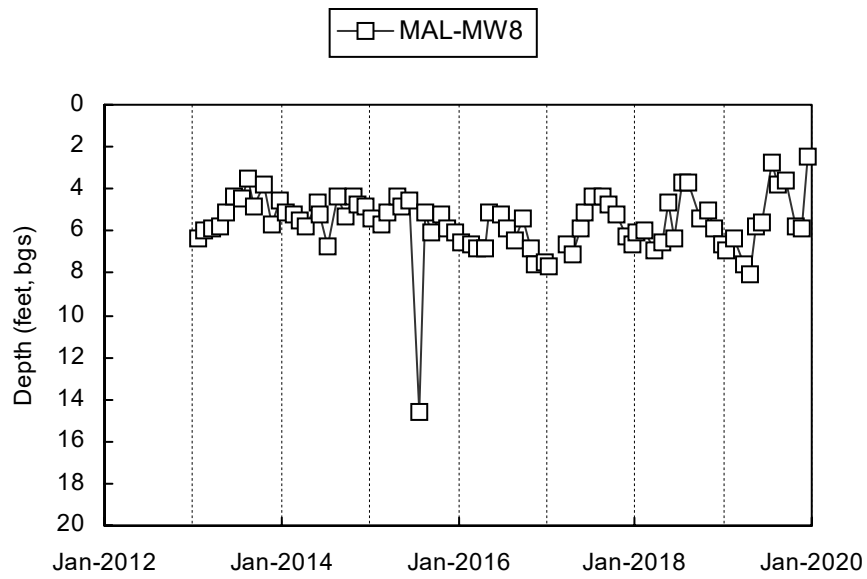

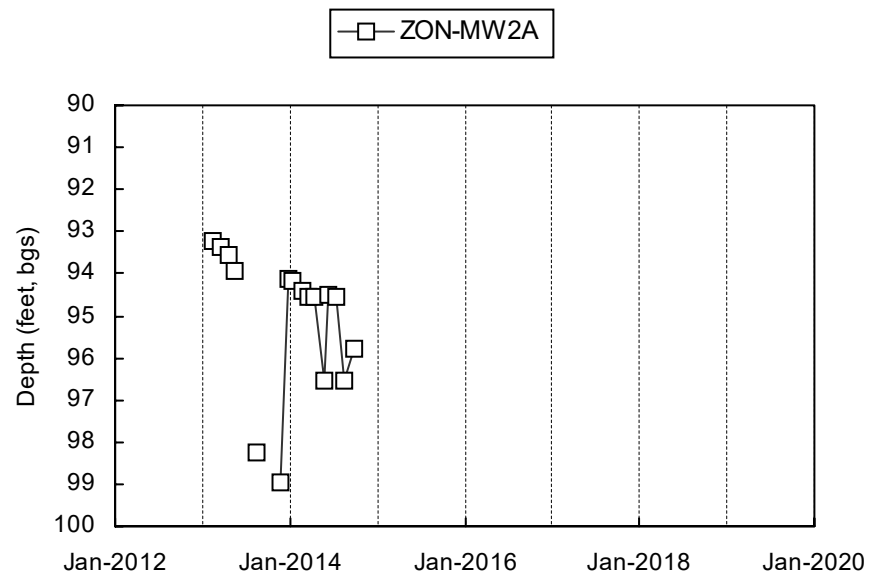
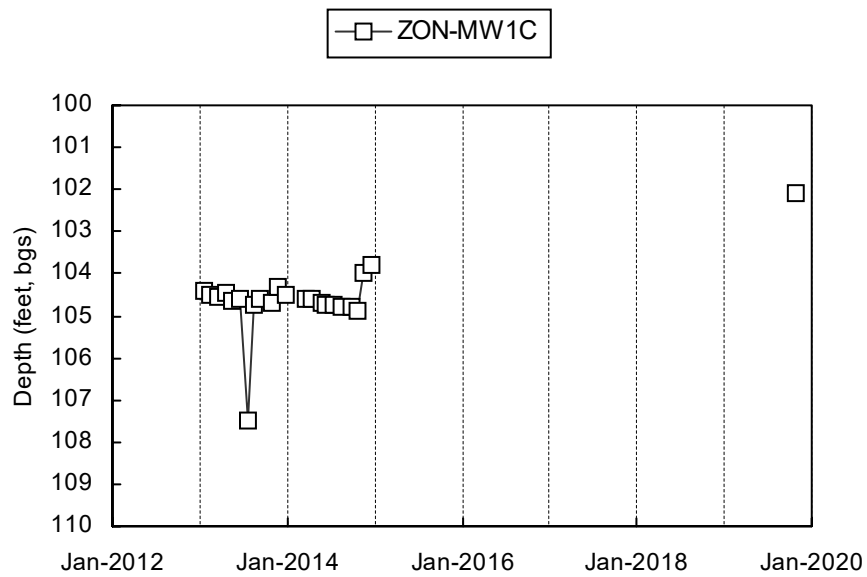
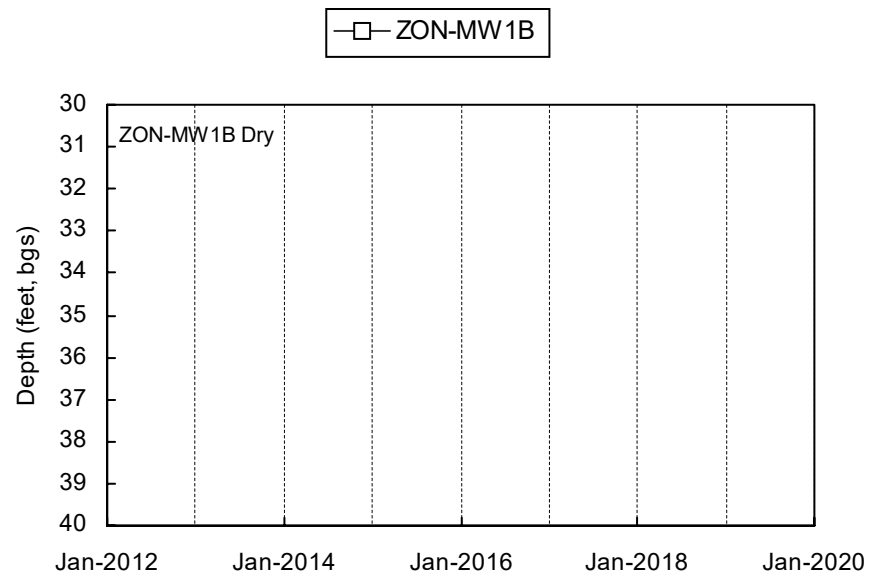
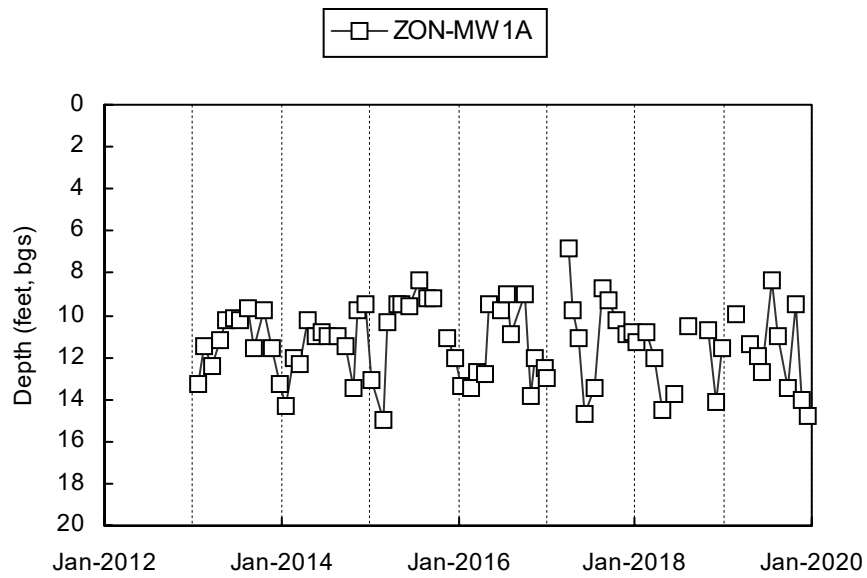

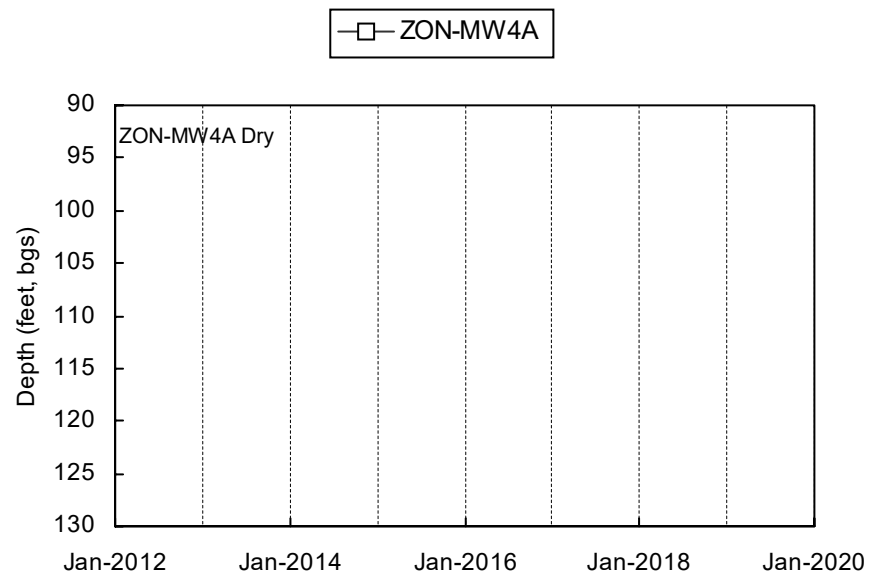
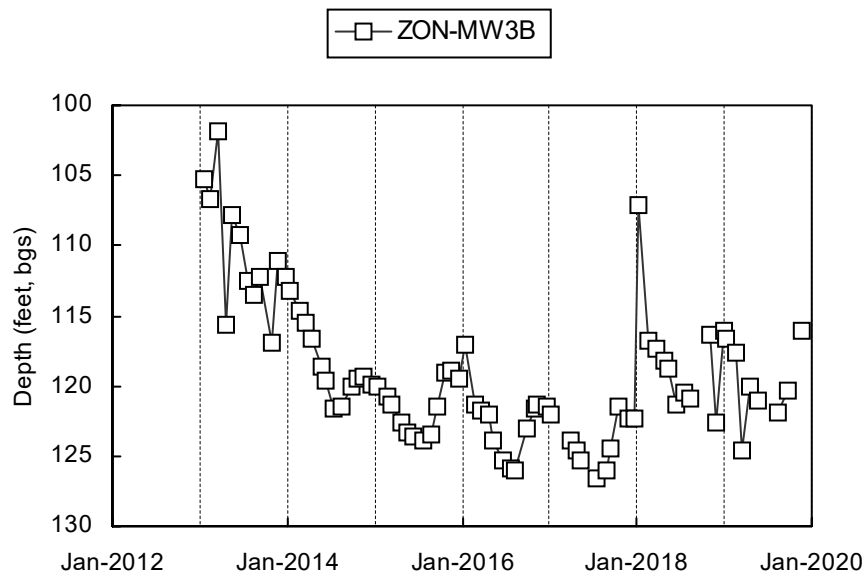
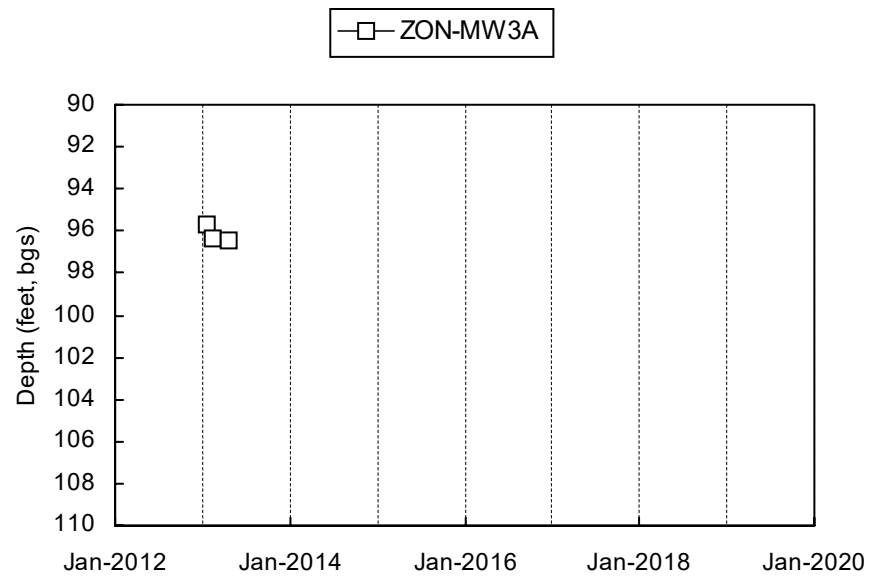
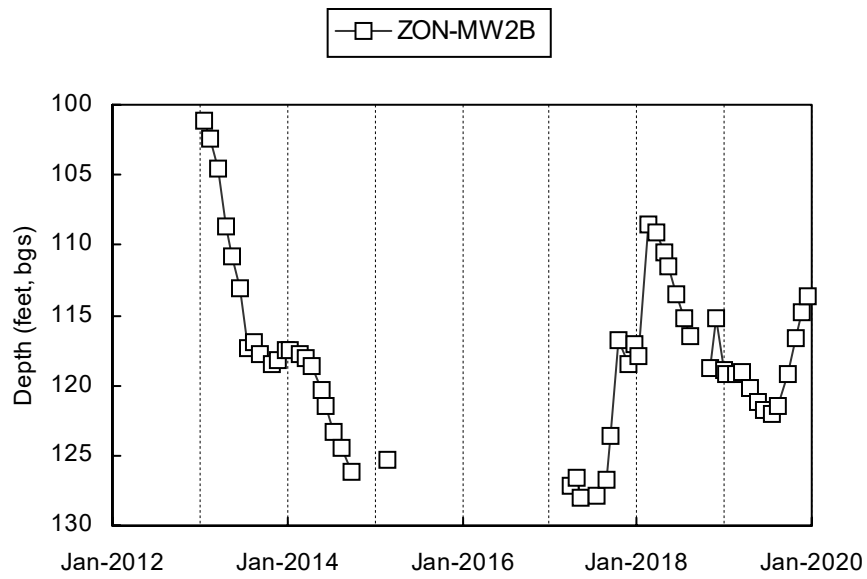

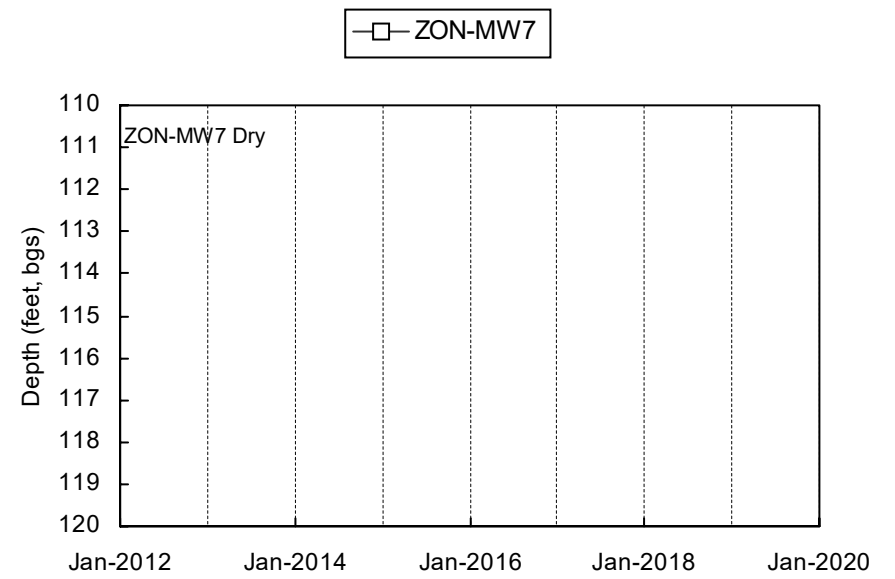
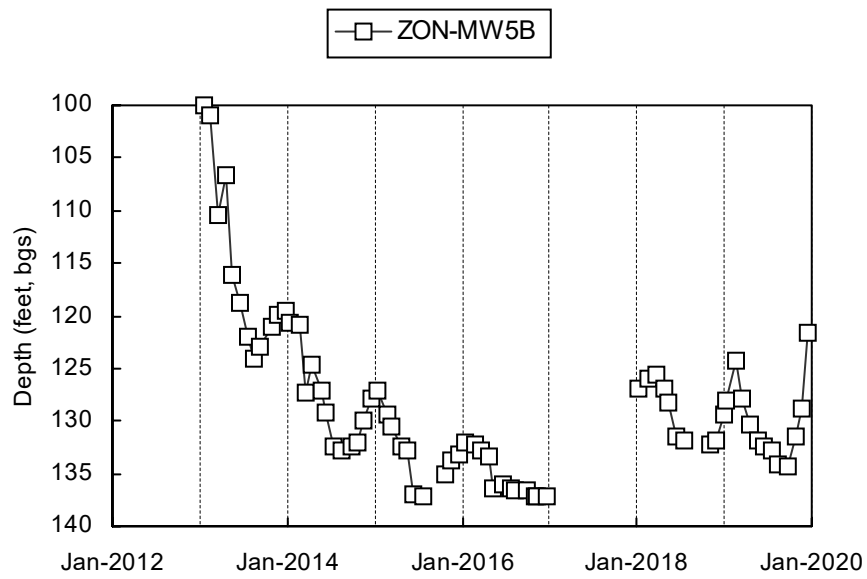
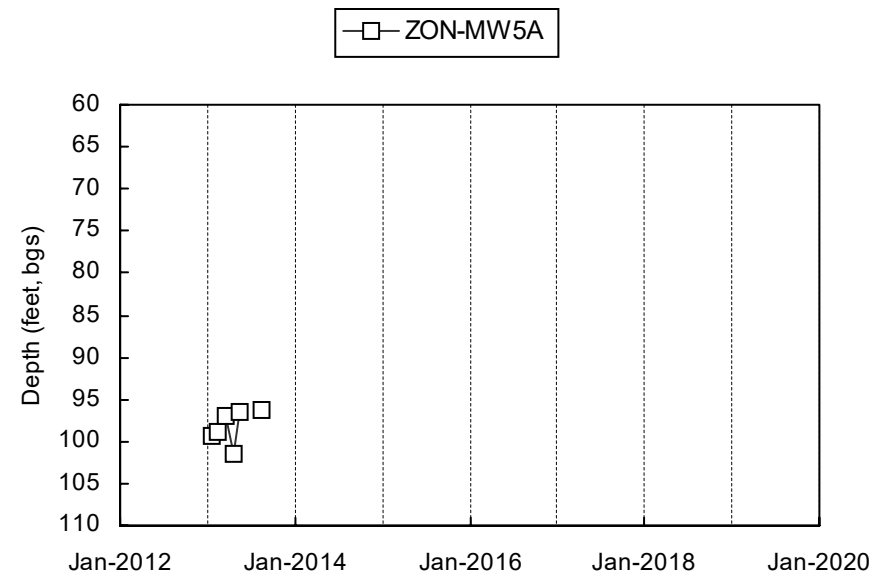
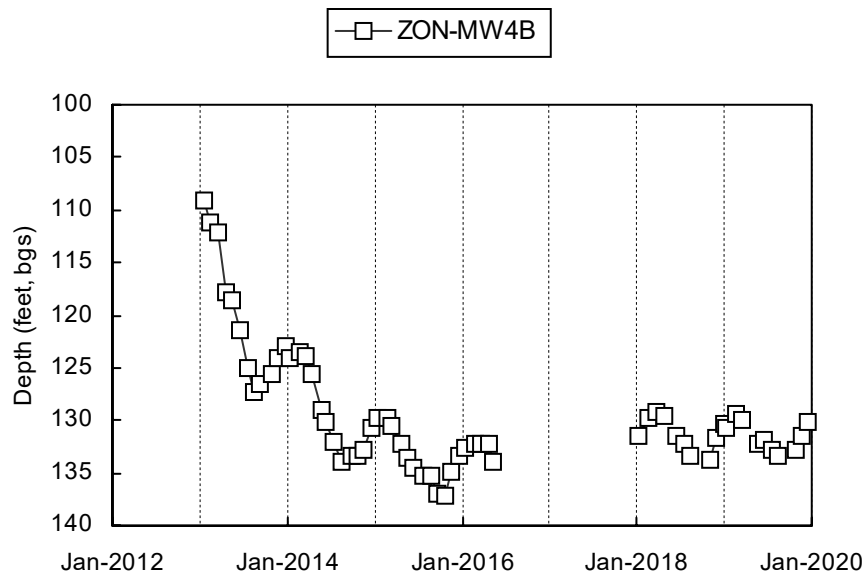

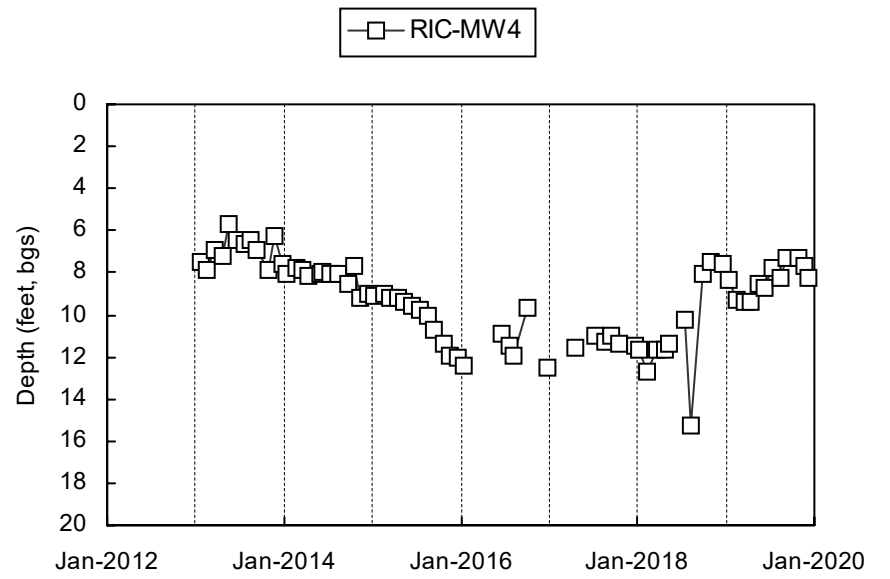
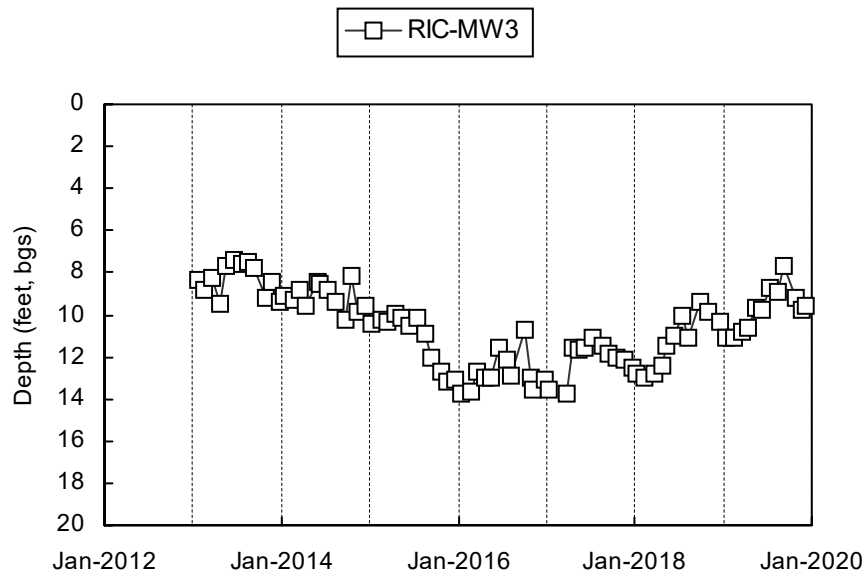
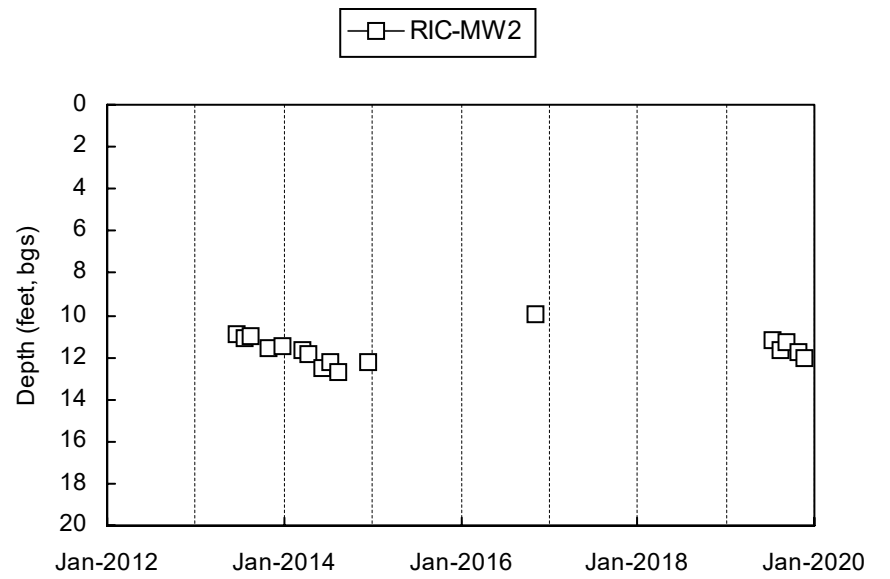
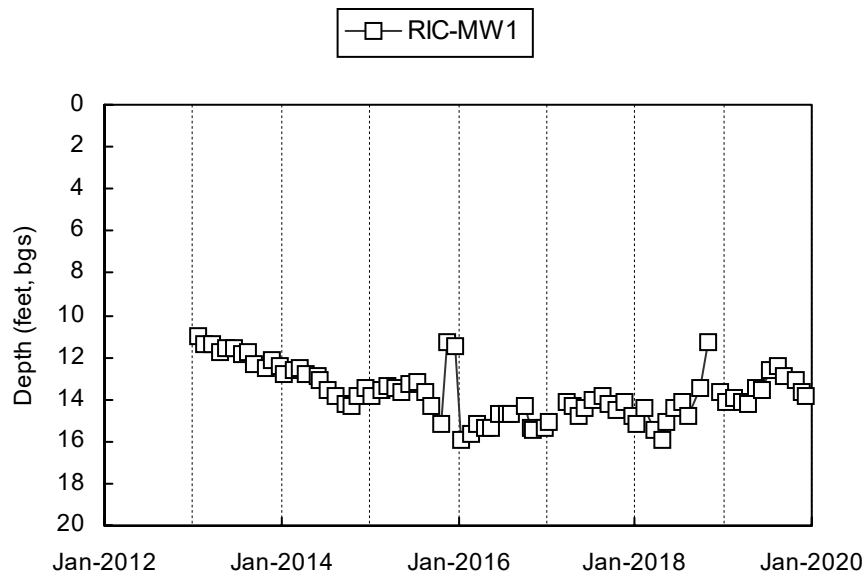

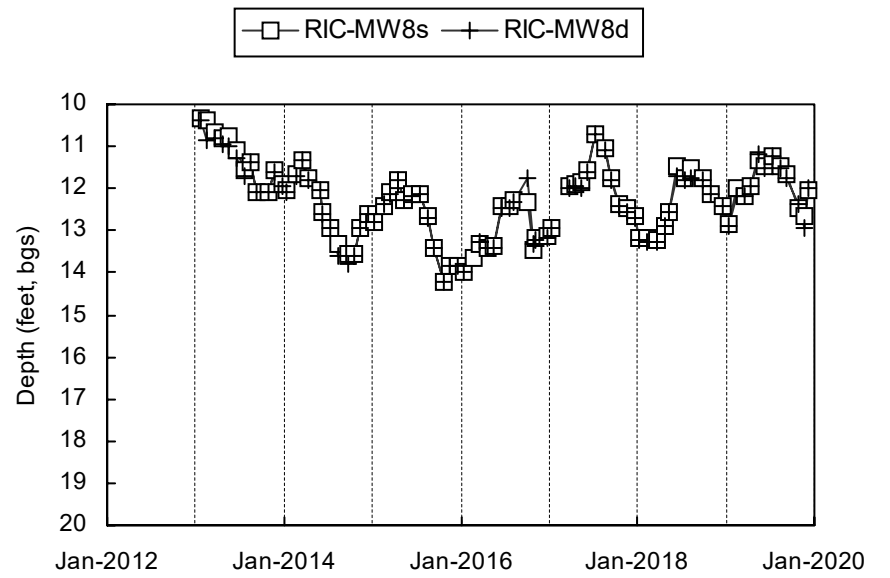
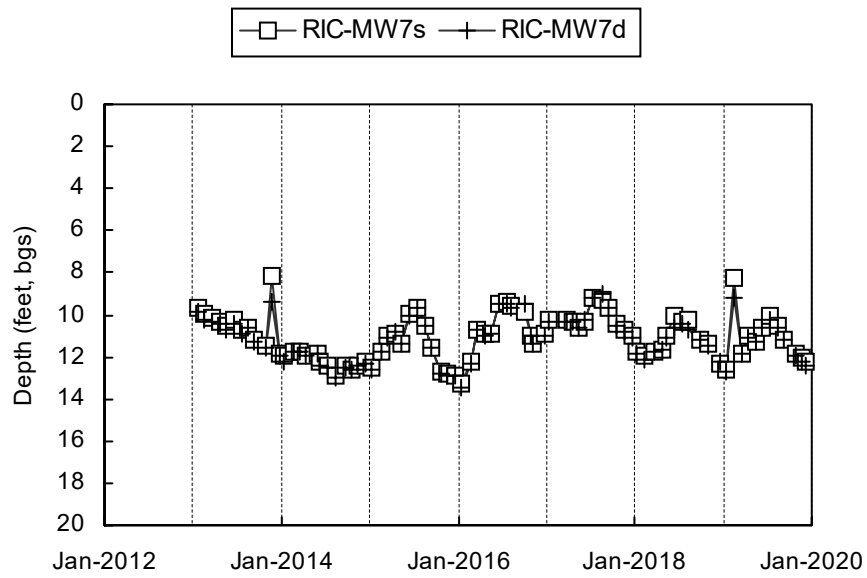
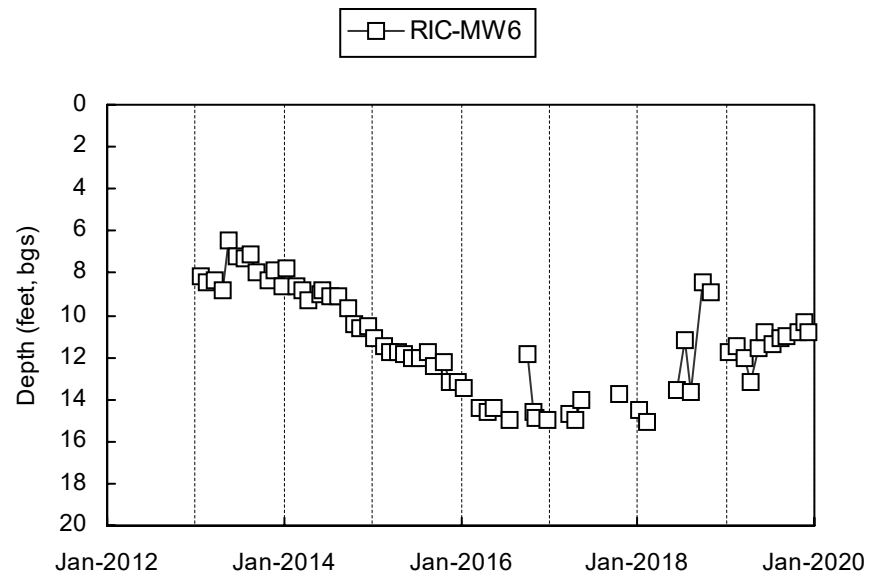
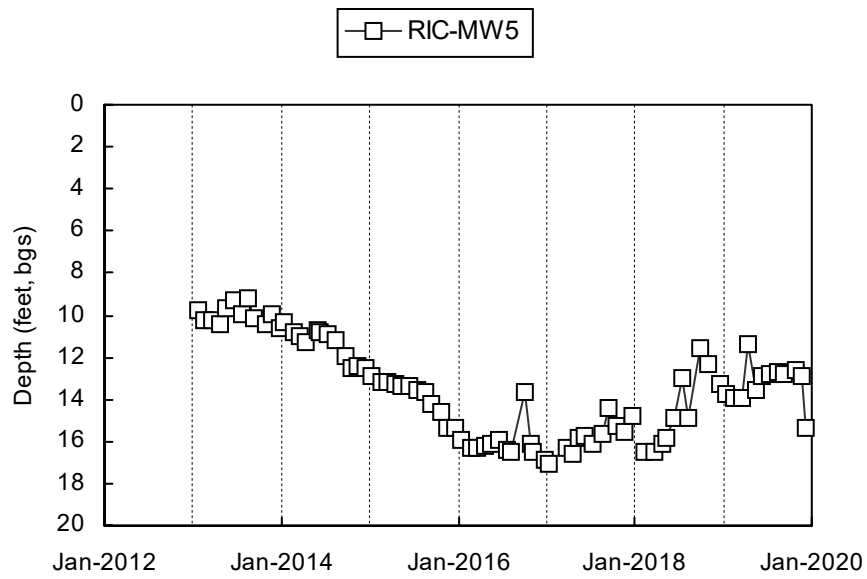

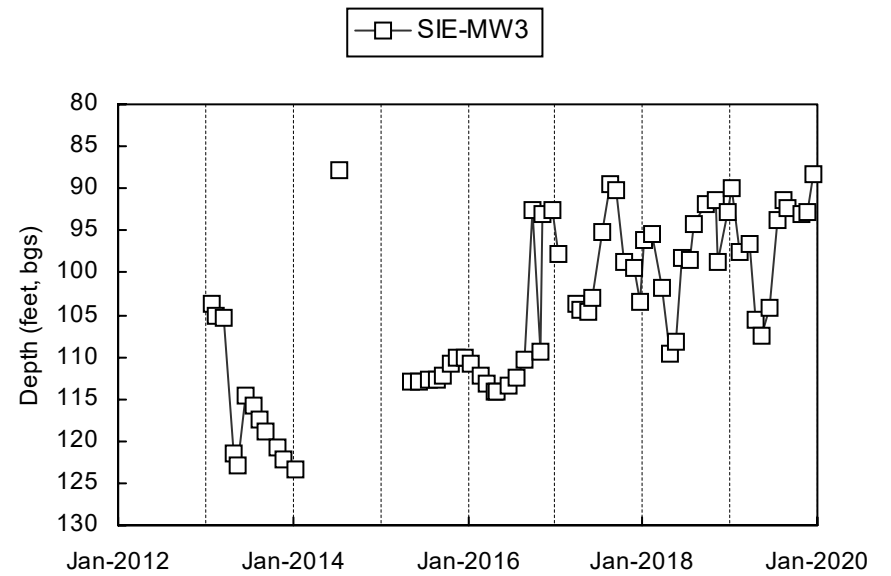
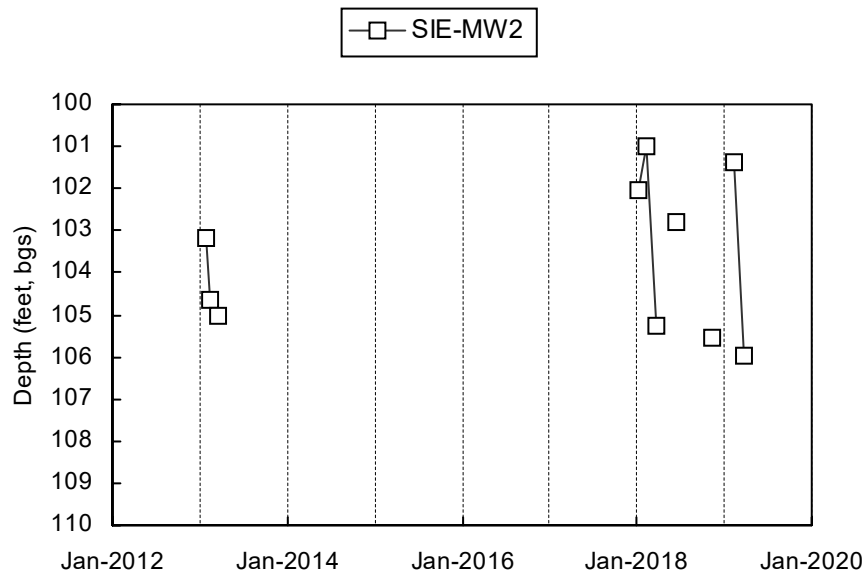
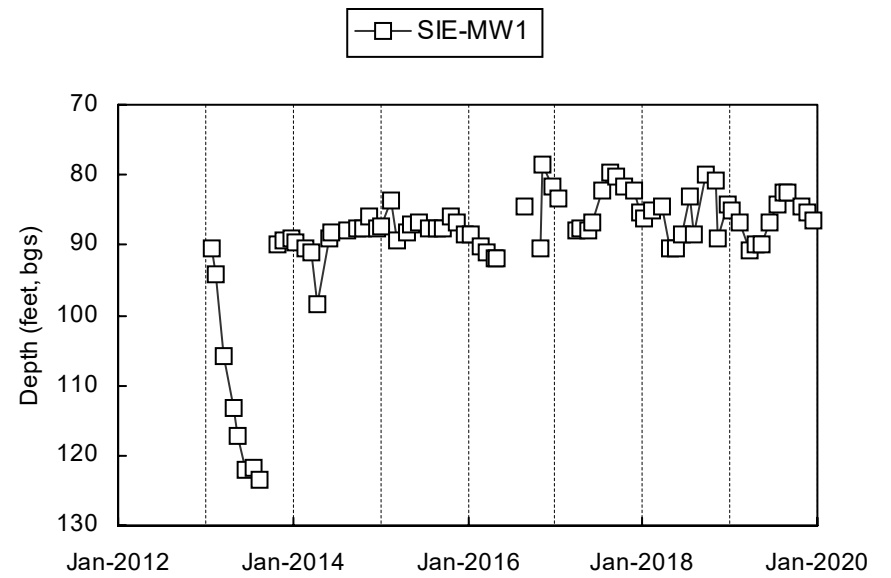
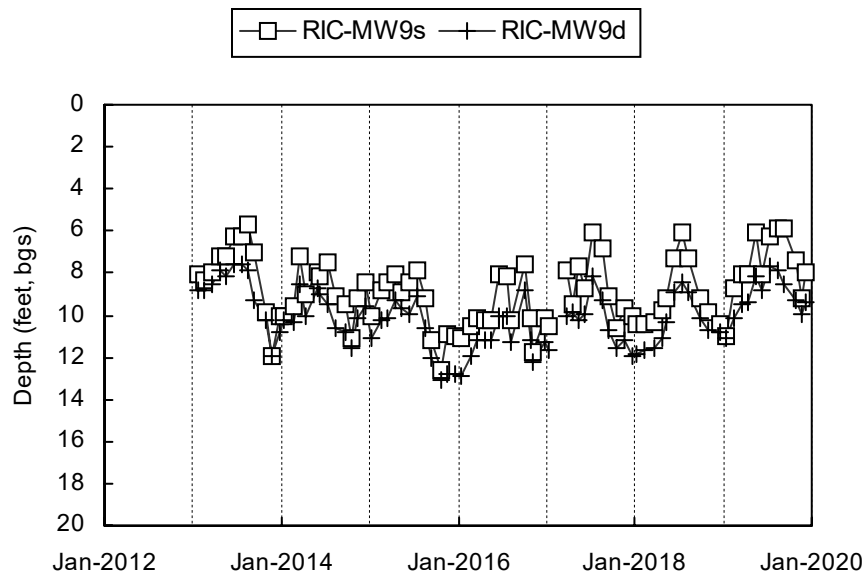

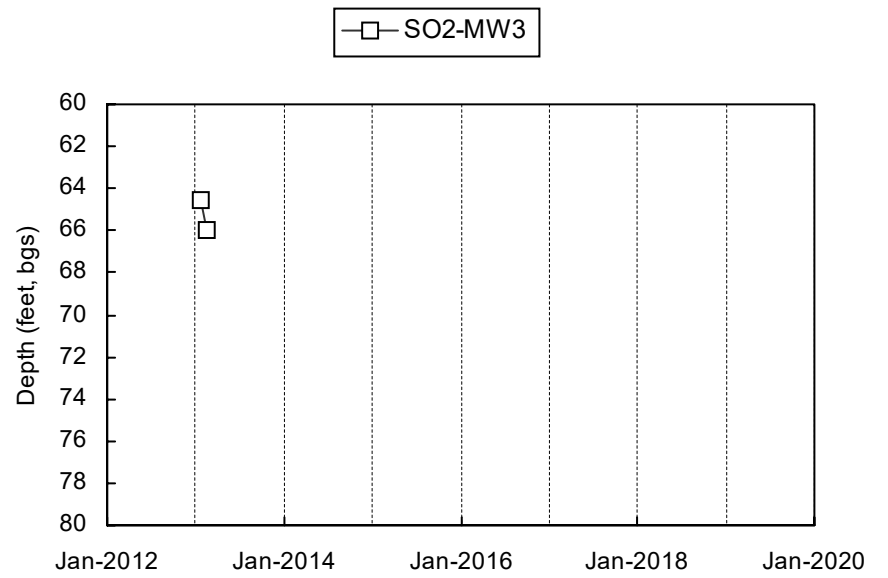
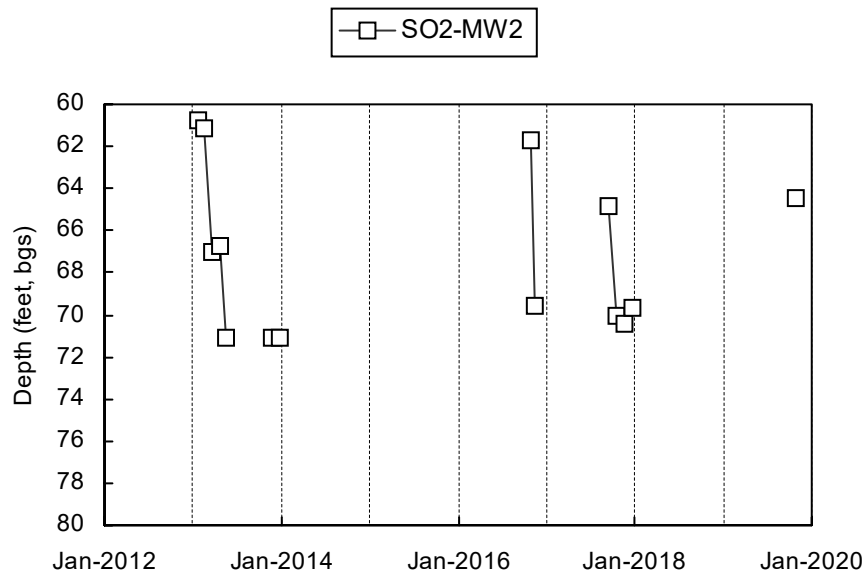
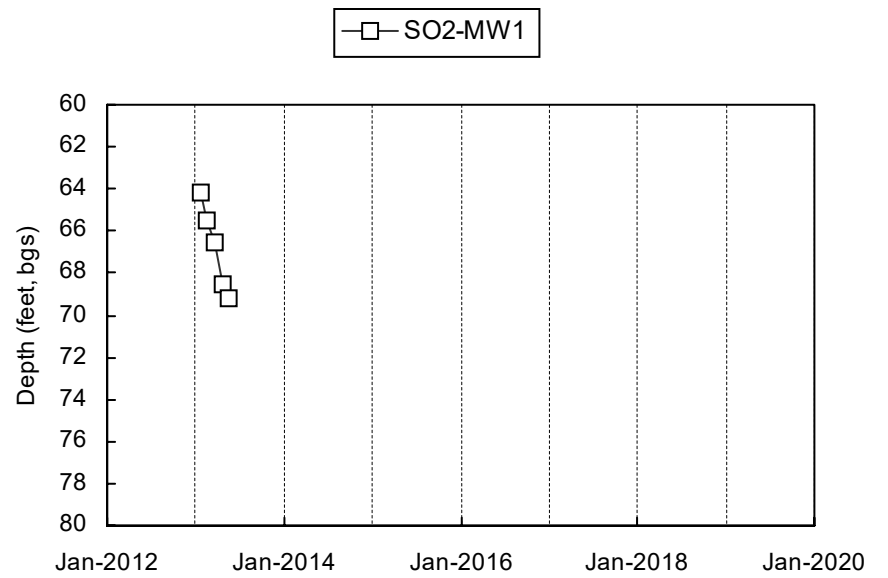
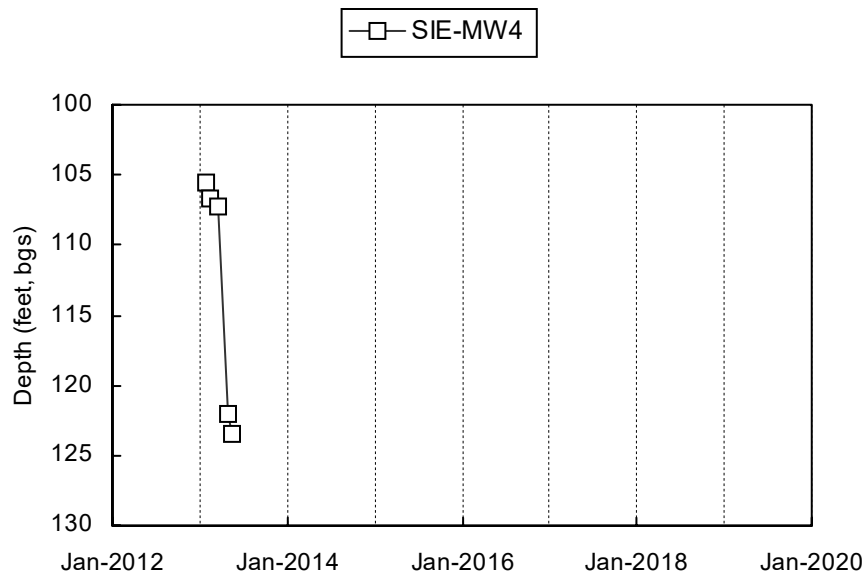

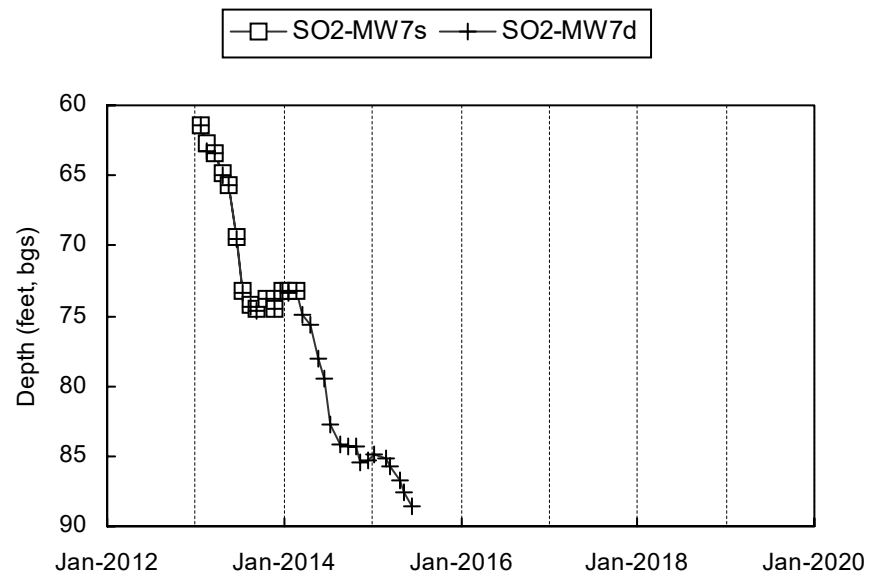
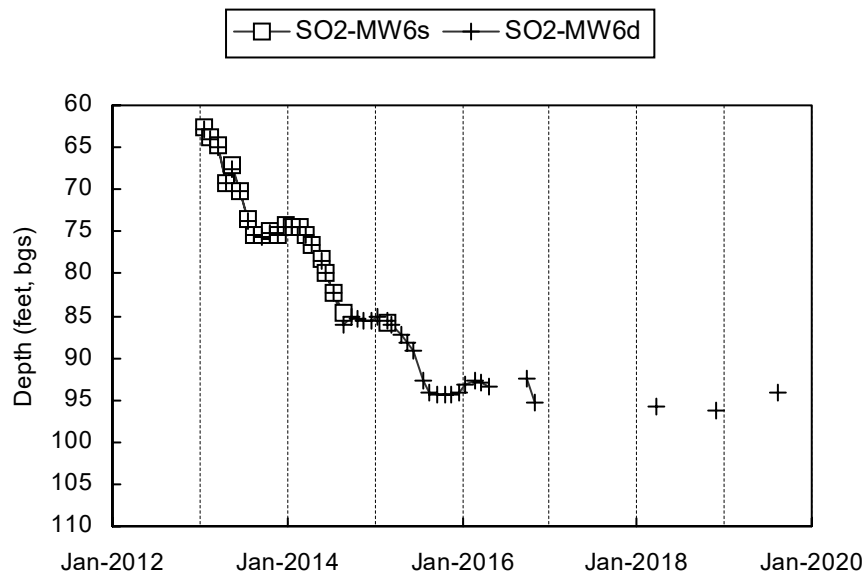
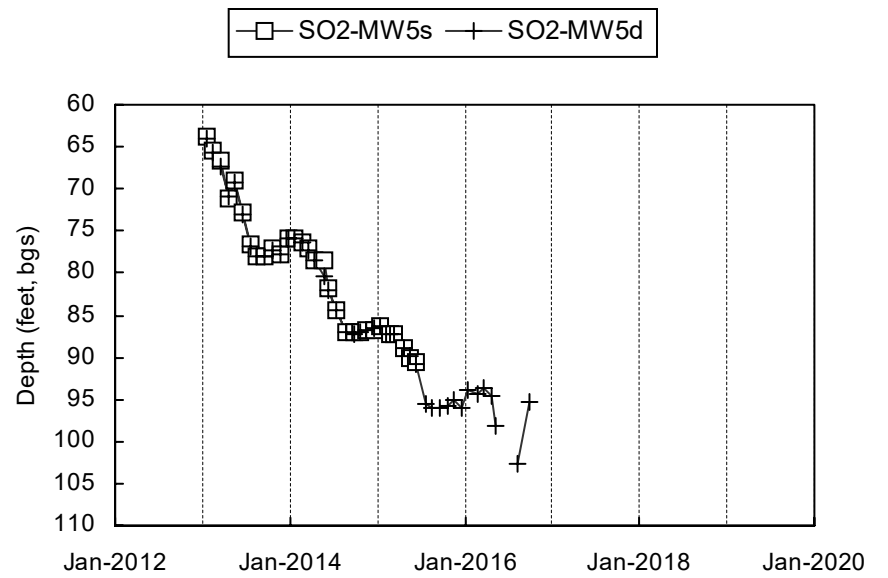
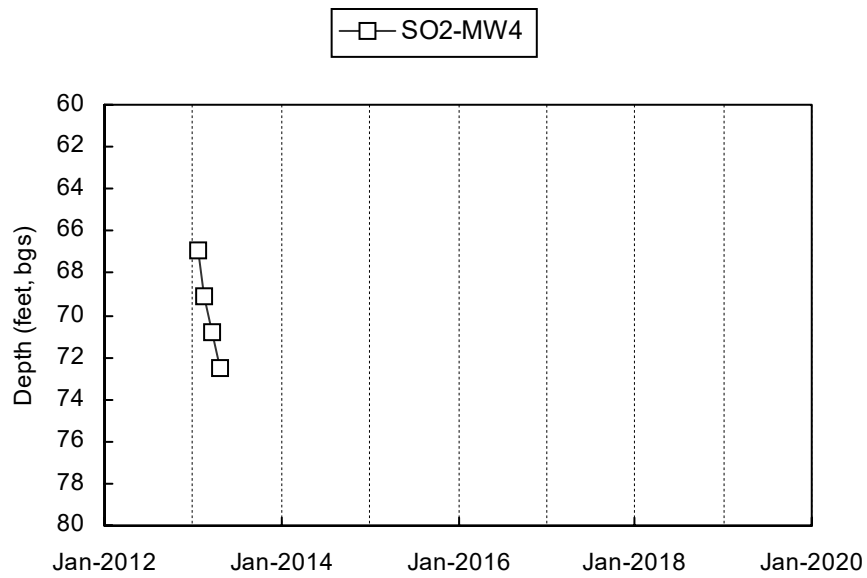

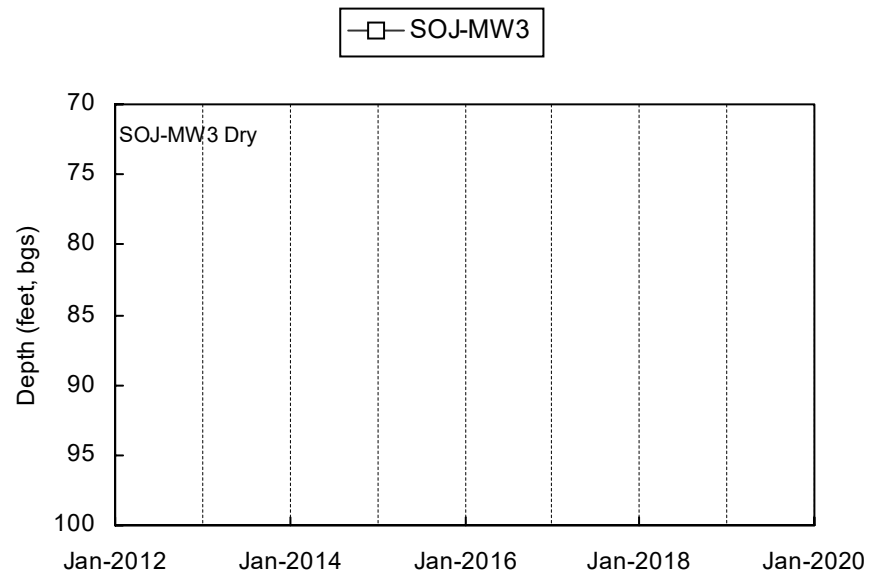
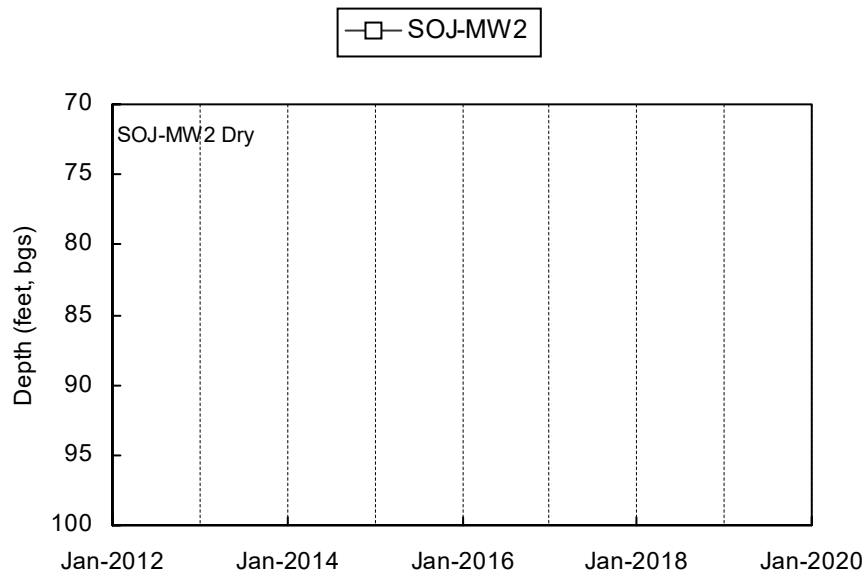
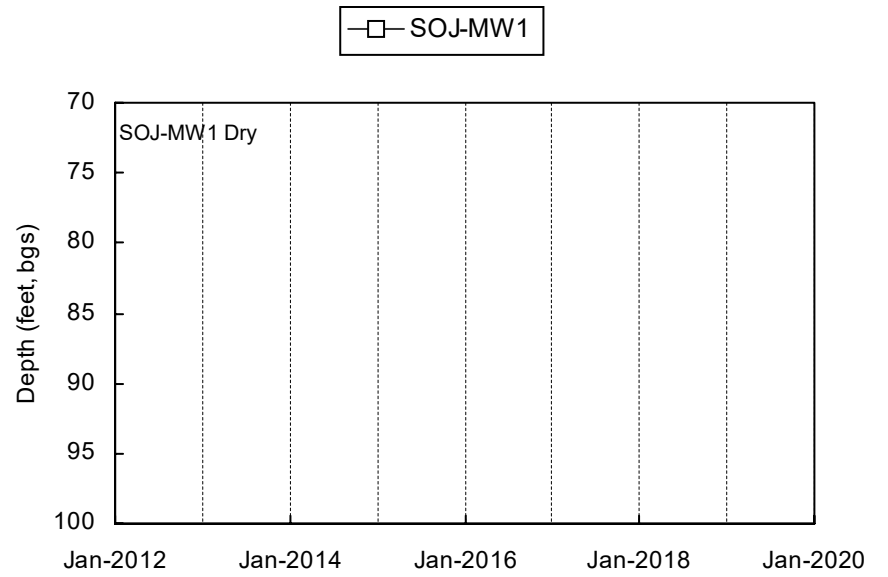
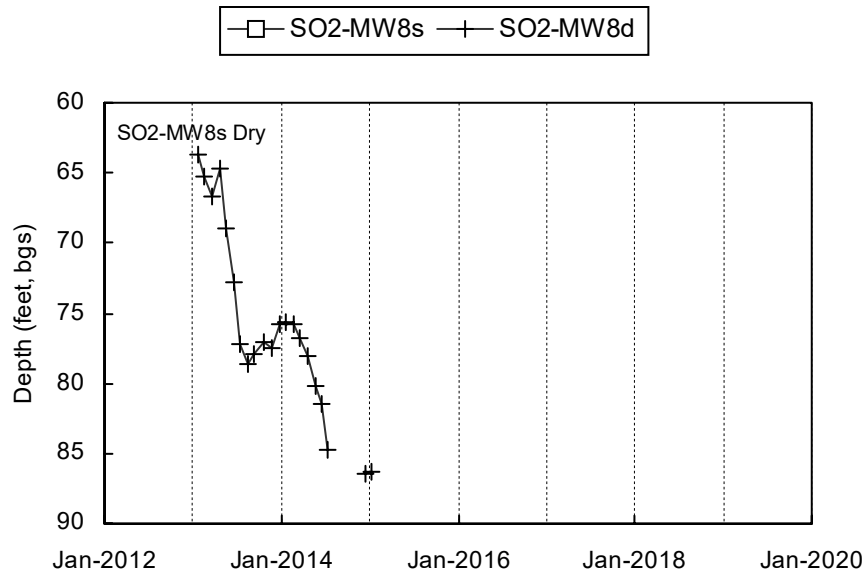

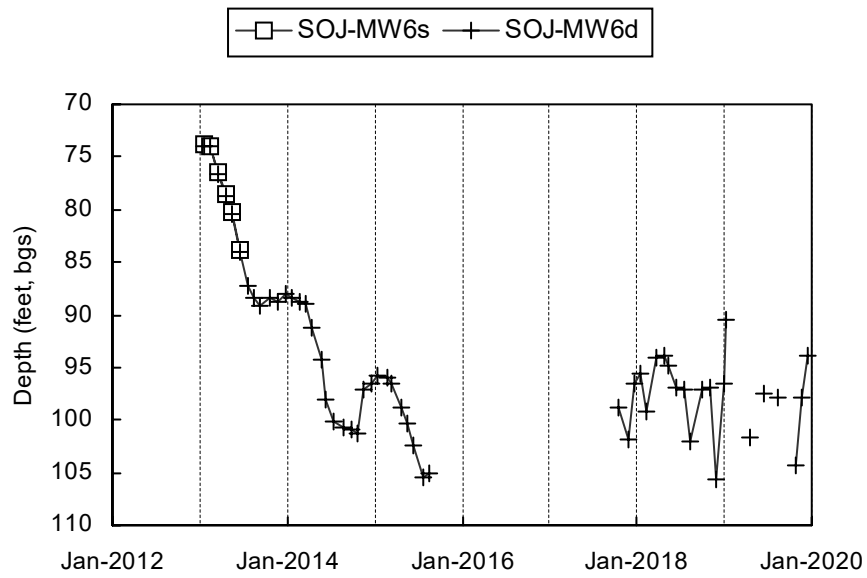
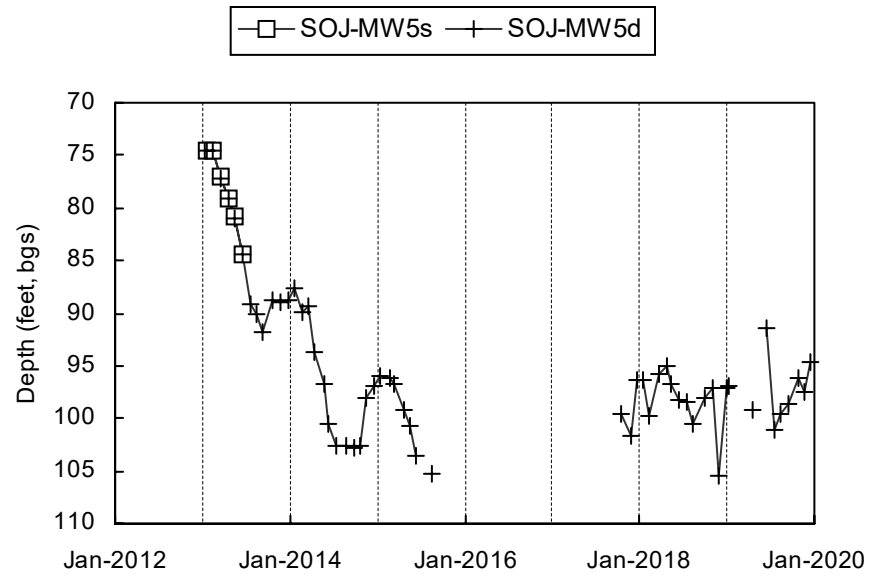
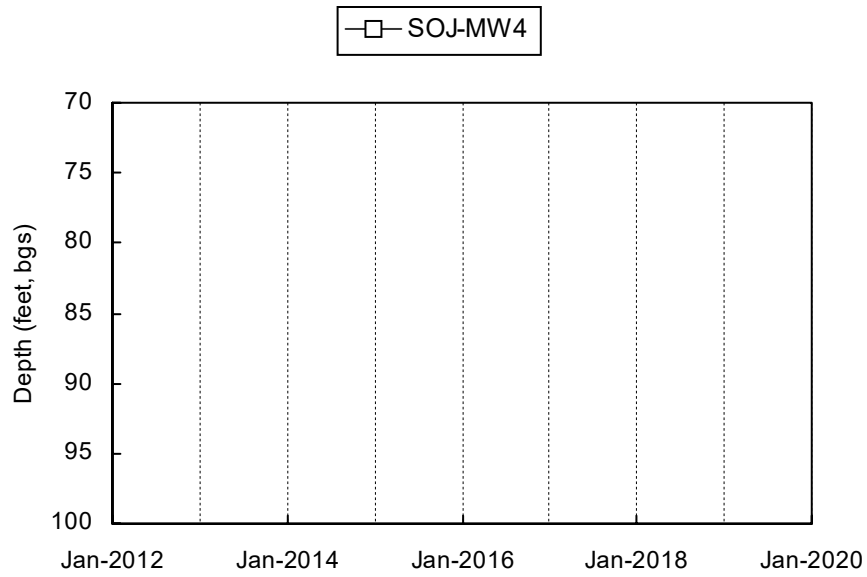

Attachment A4

Group Hydrographs

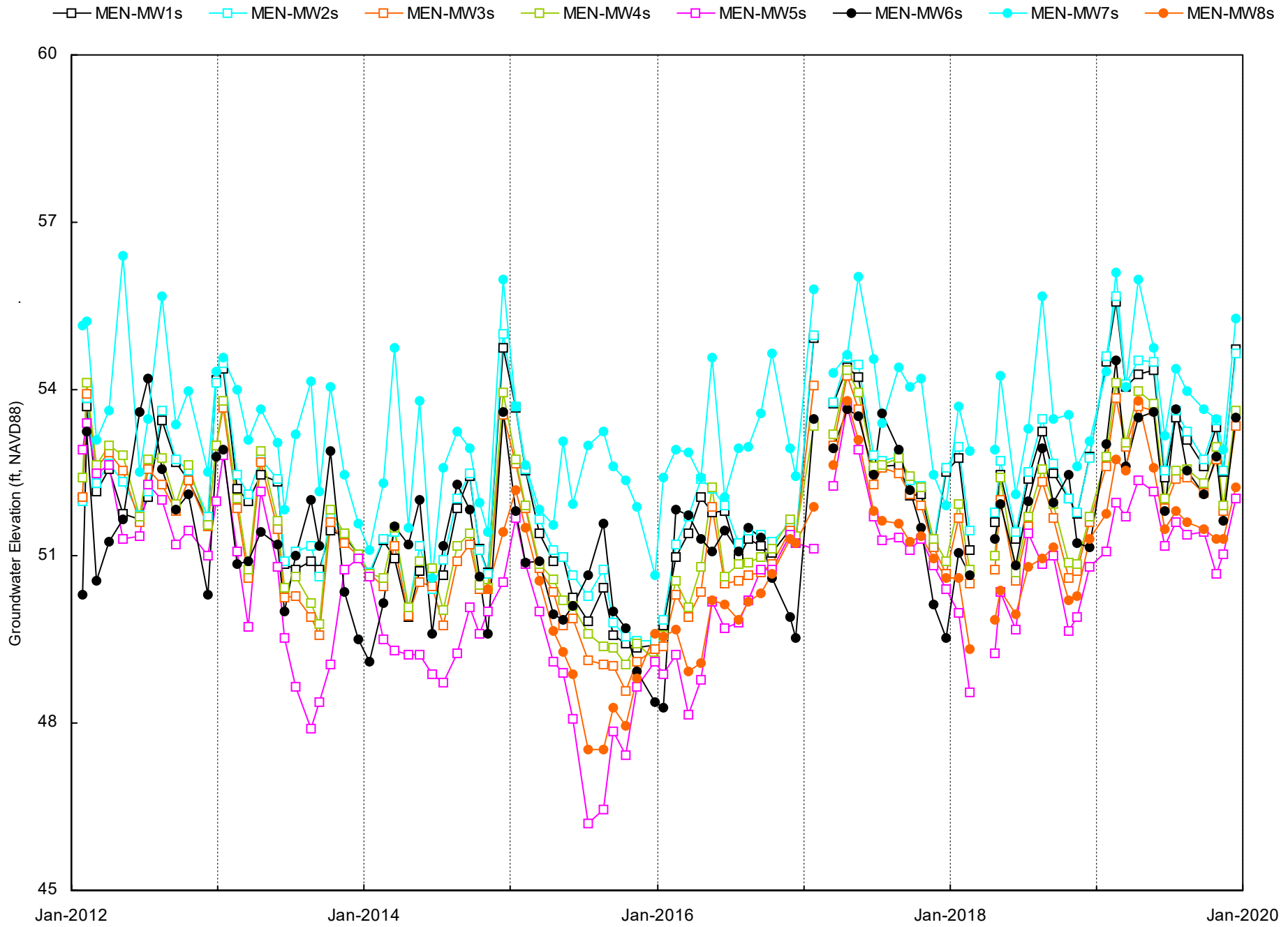

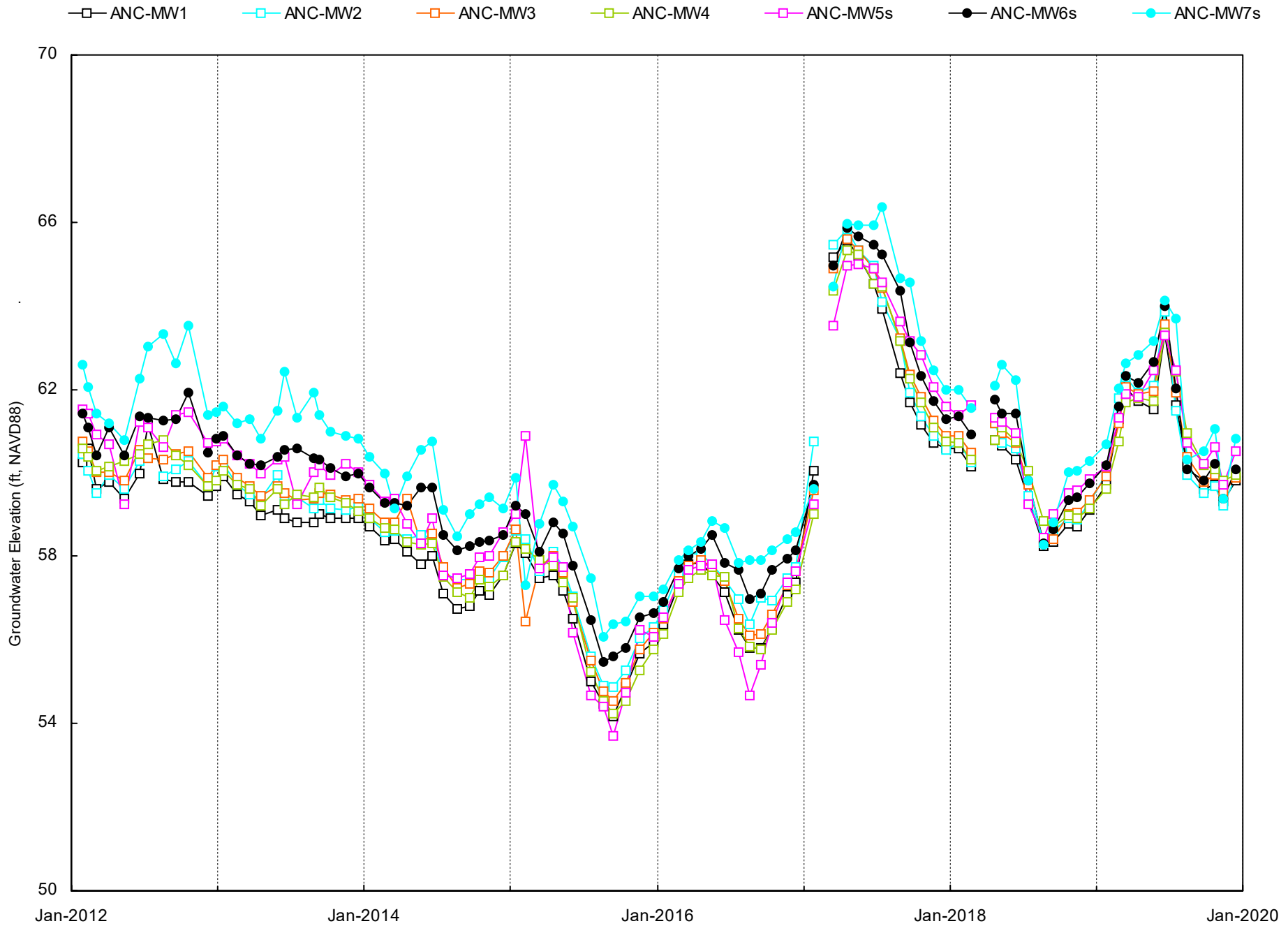

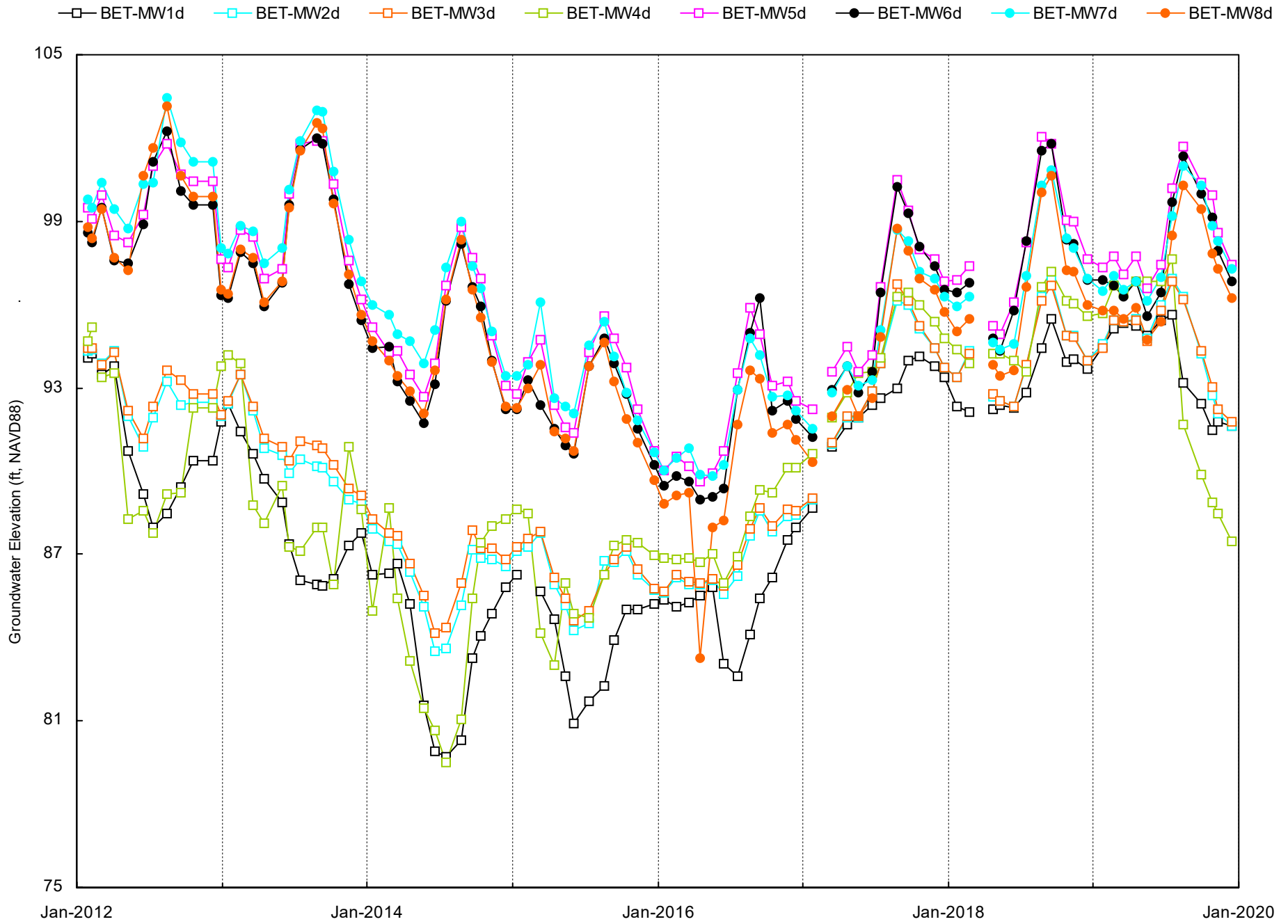

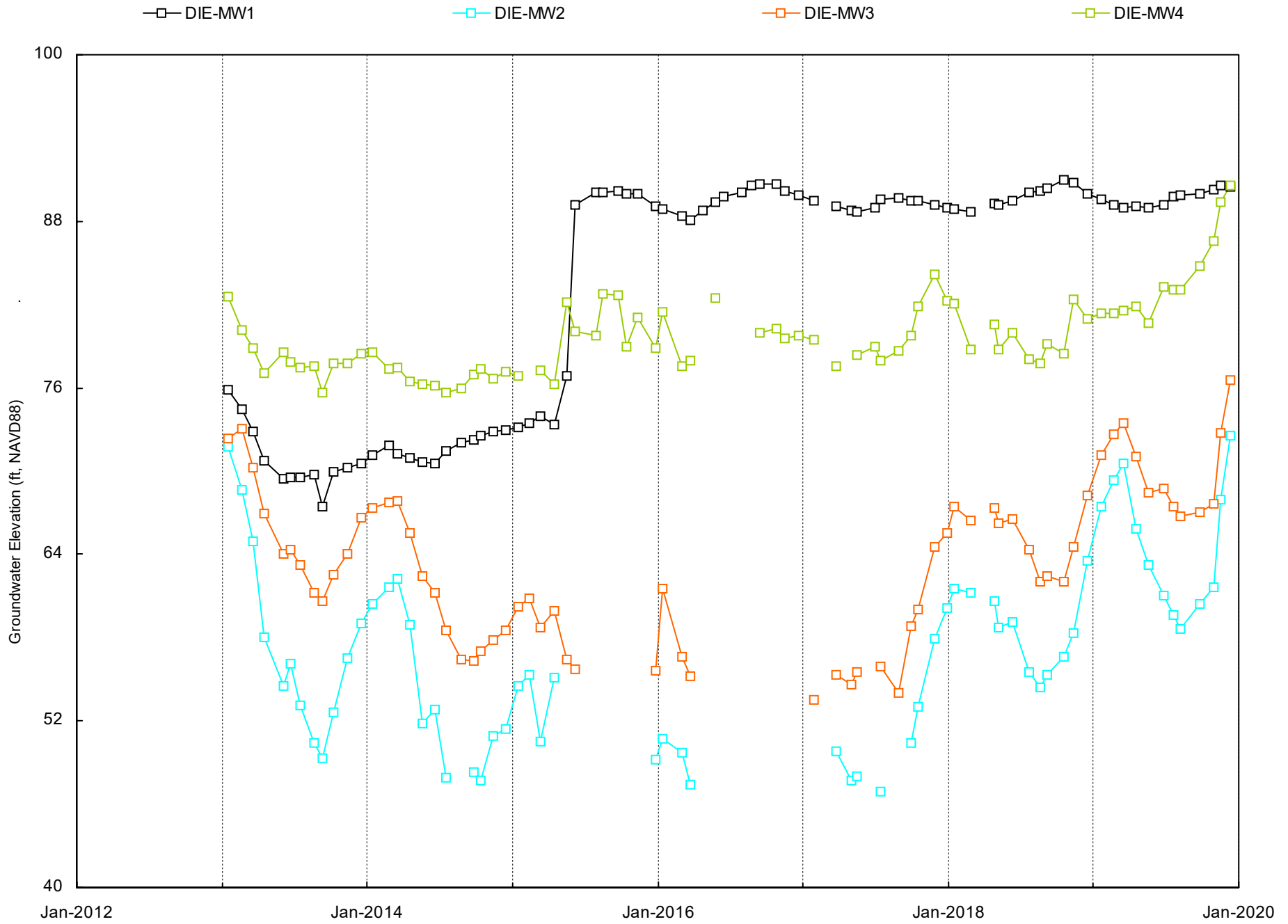

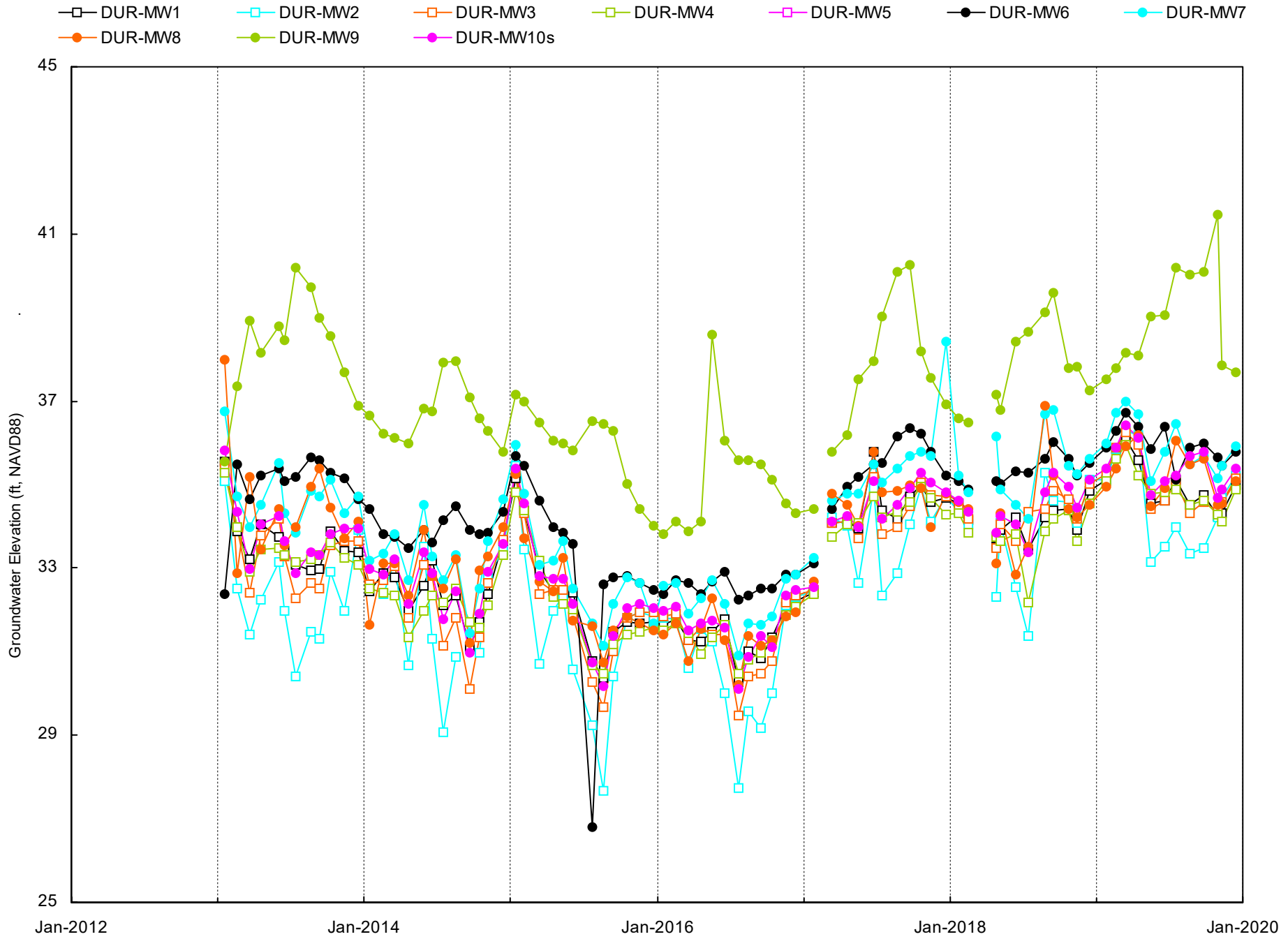

—□— FG1-MW1d —□— FG1-MW2d —□— FG1-MW3d —□— FG1-MW4d —□— FG1-MW5d —●— FG1-MW6d —●— FG1-MW7d —●— FG1-MW8d —●— FG1-MW9d

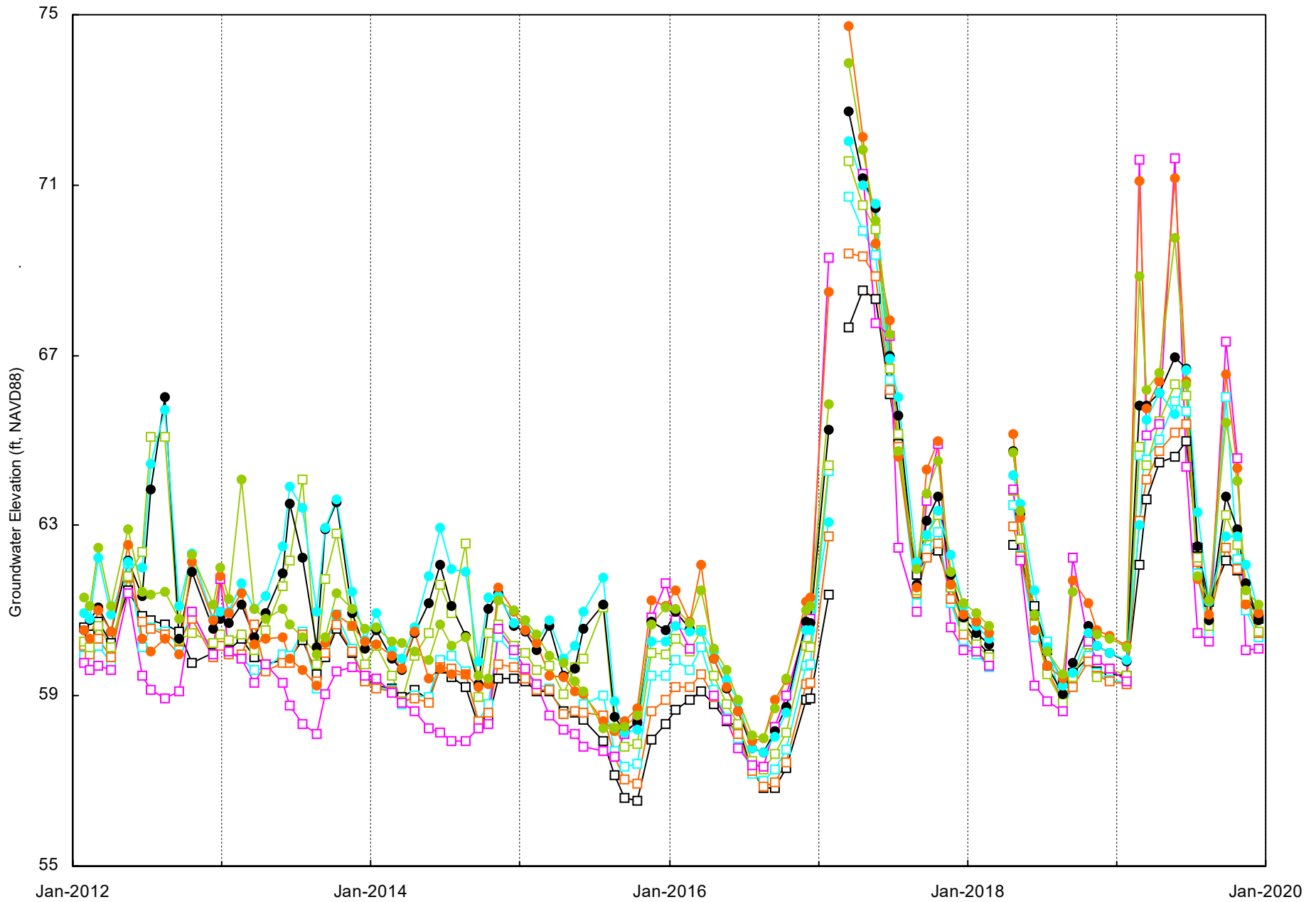



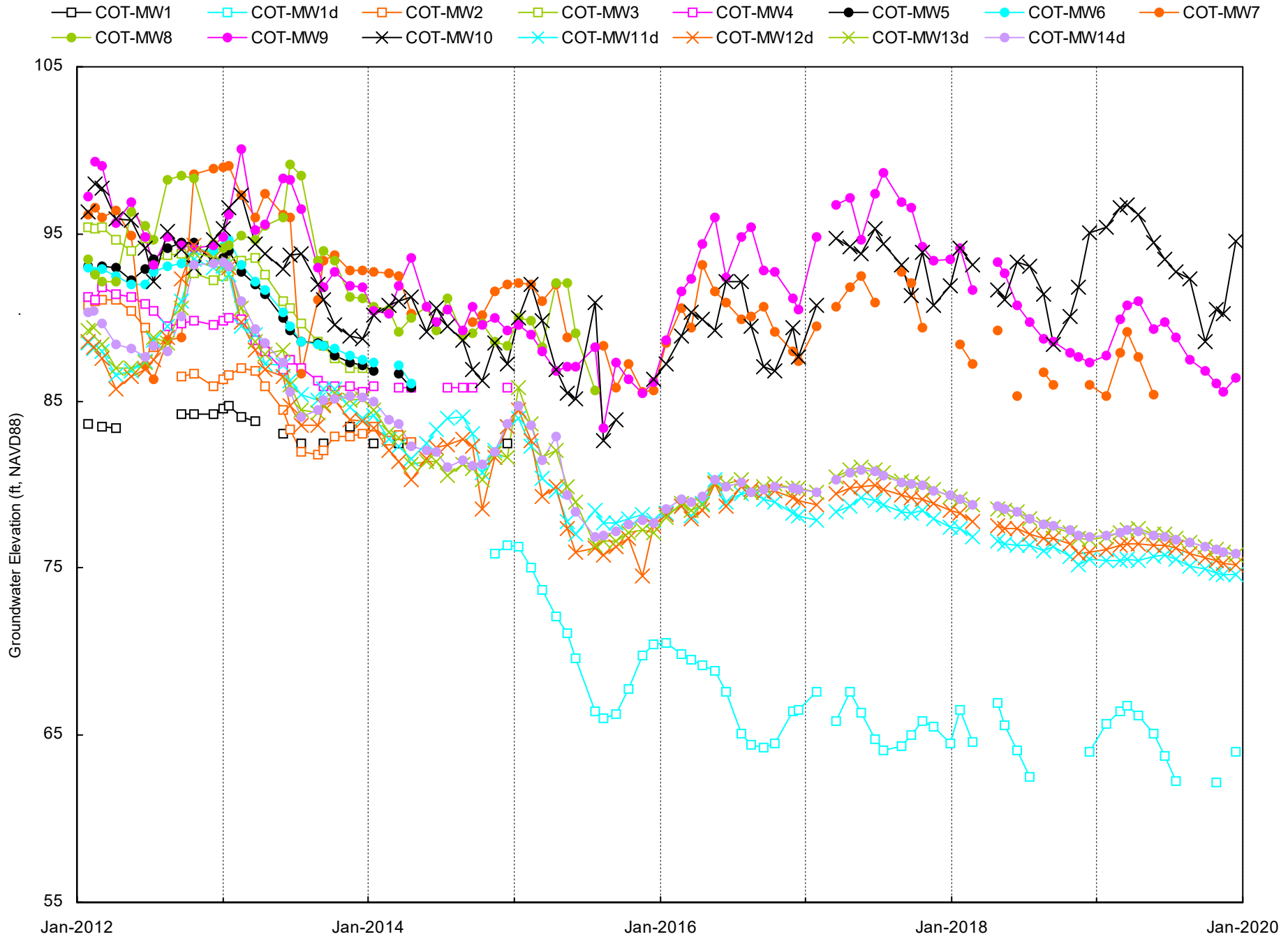

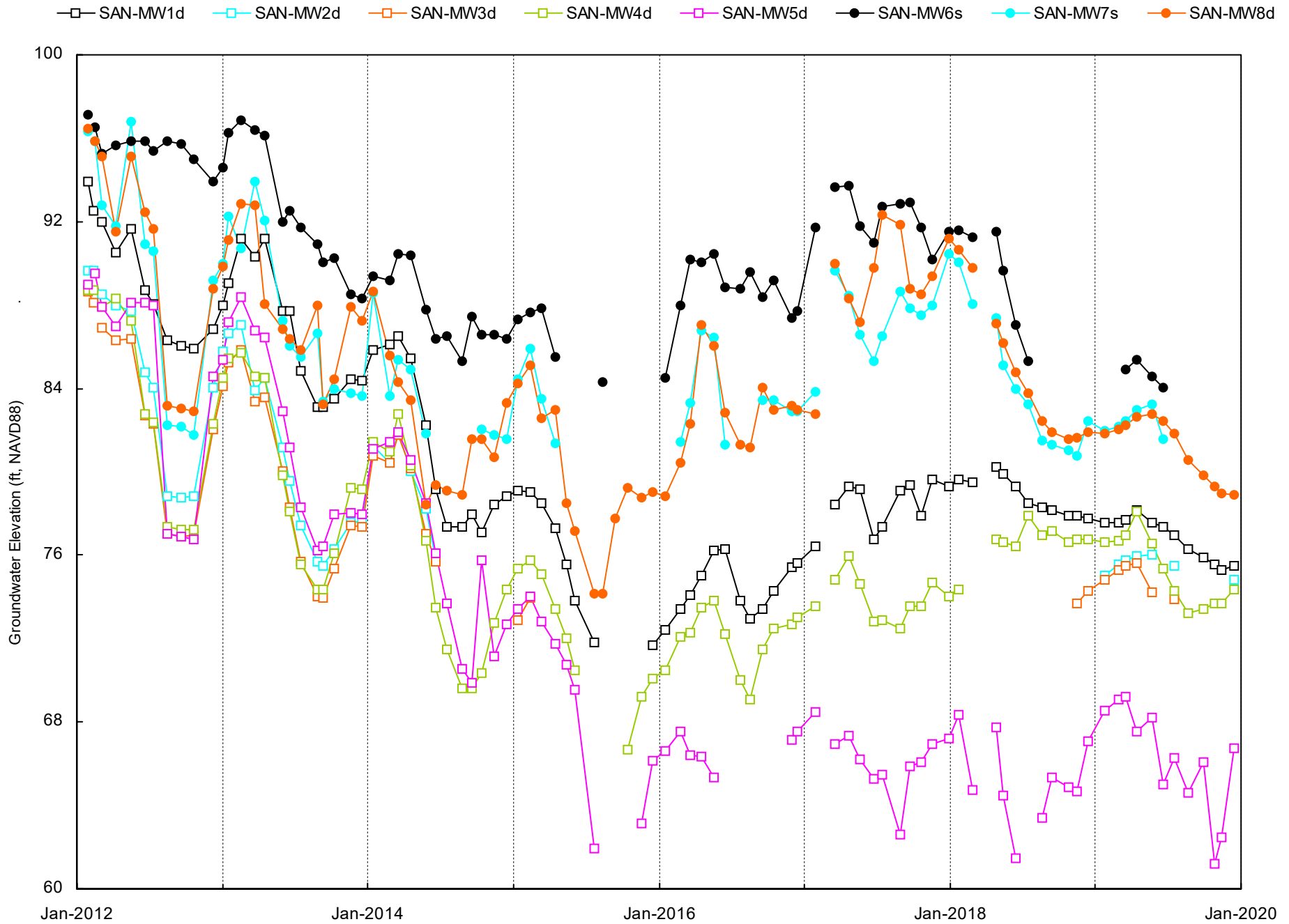

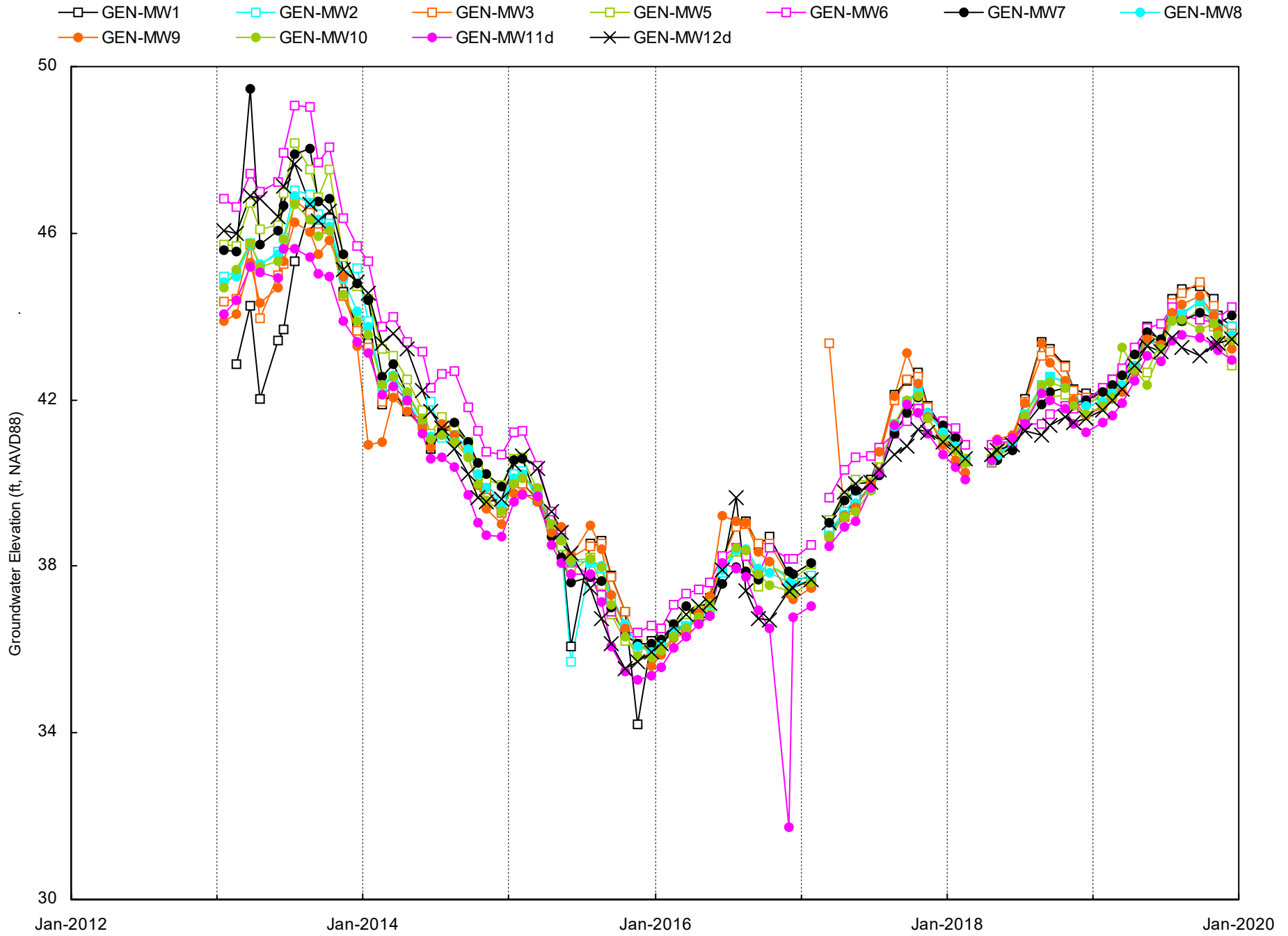

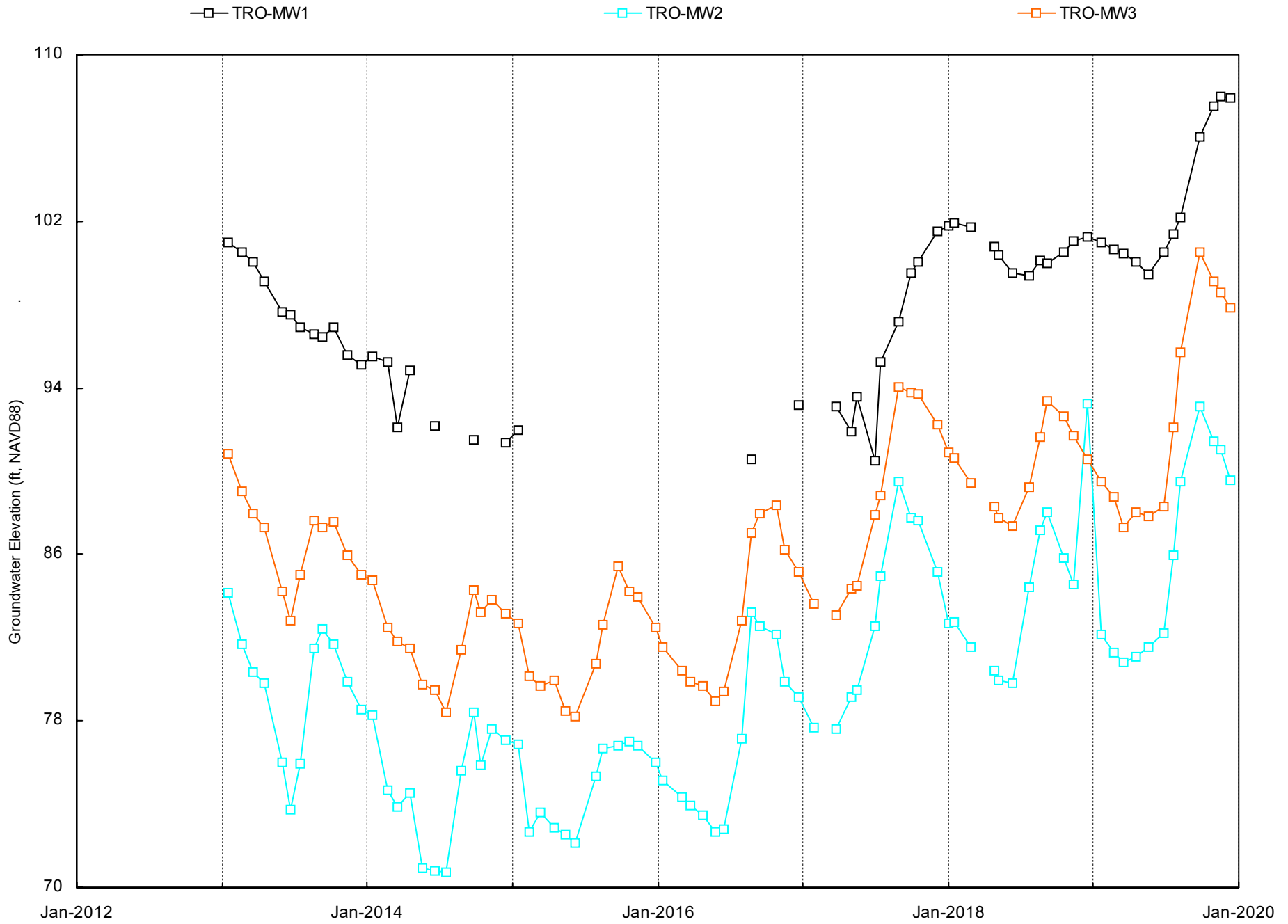

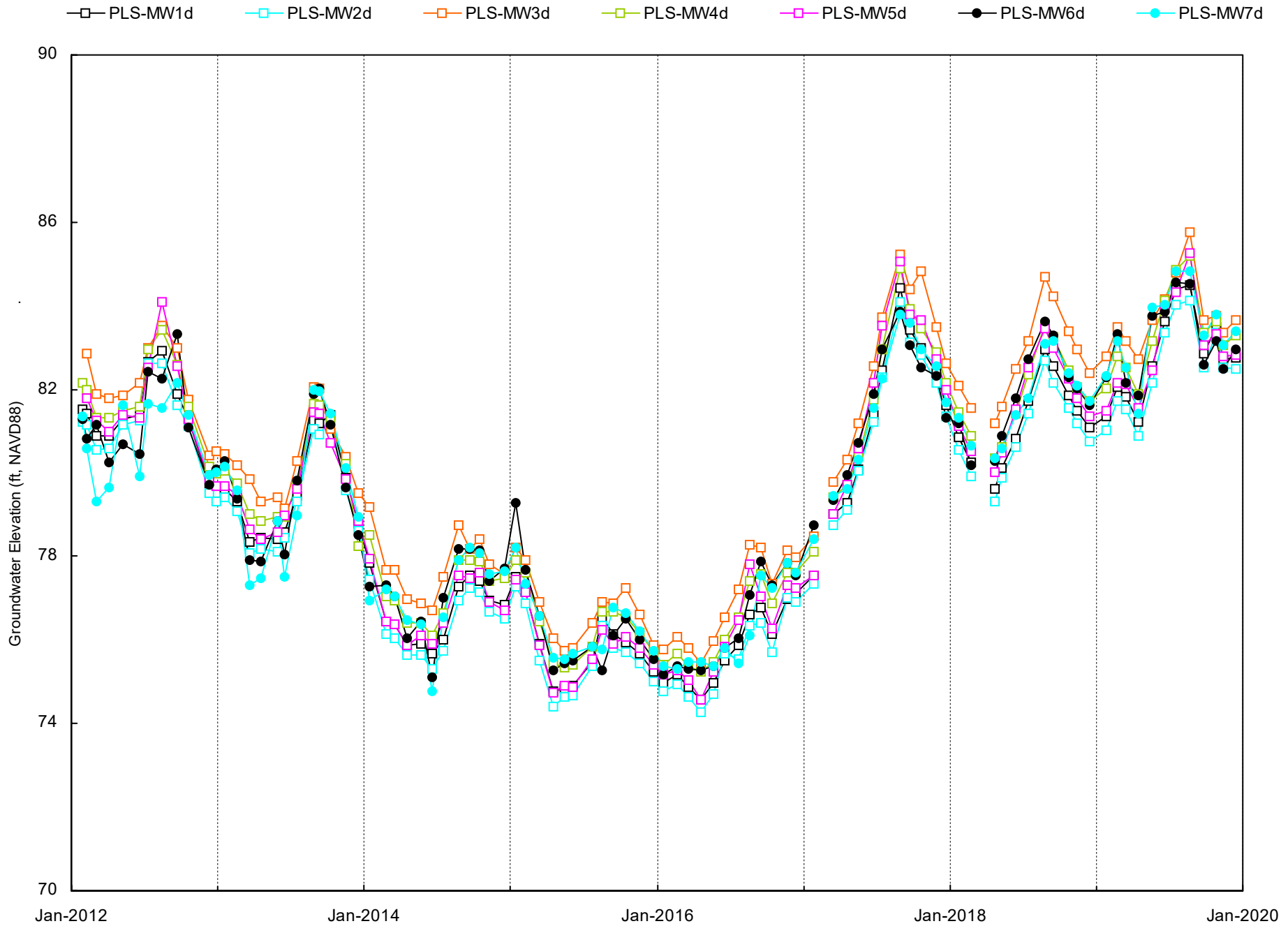

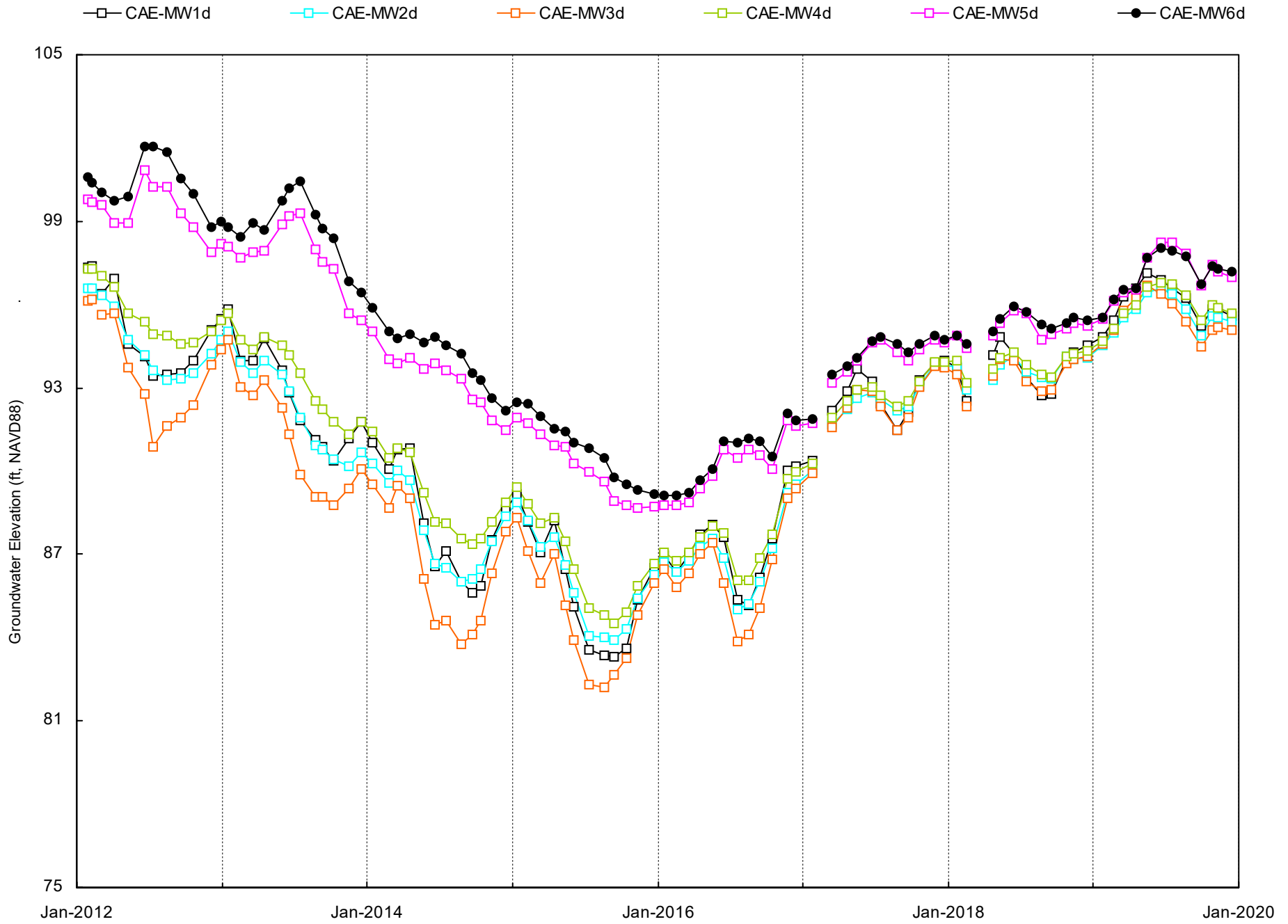

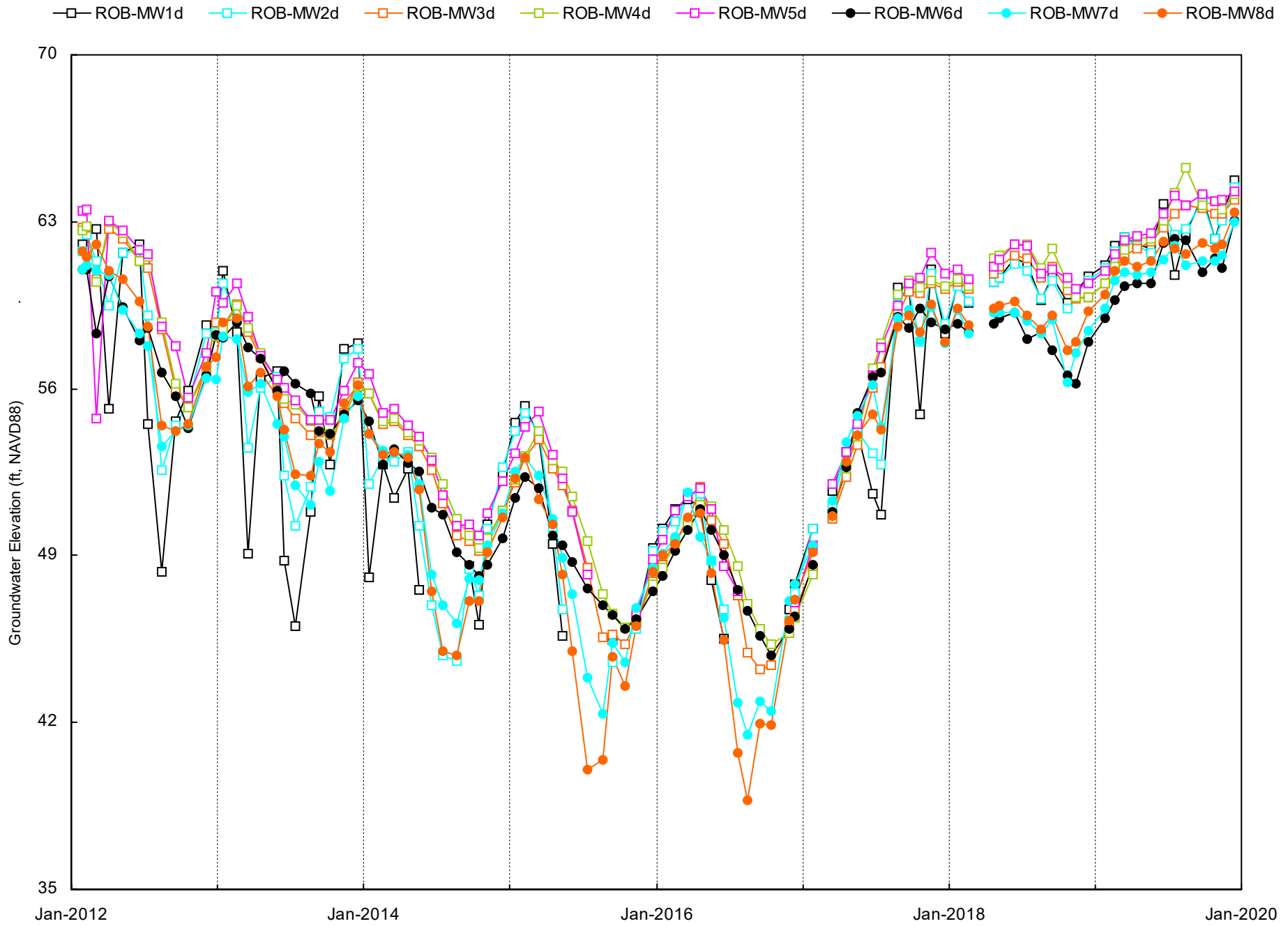

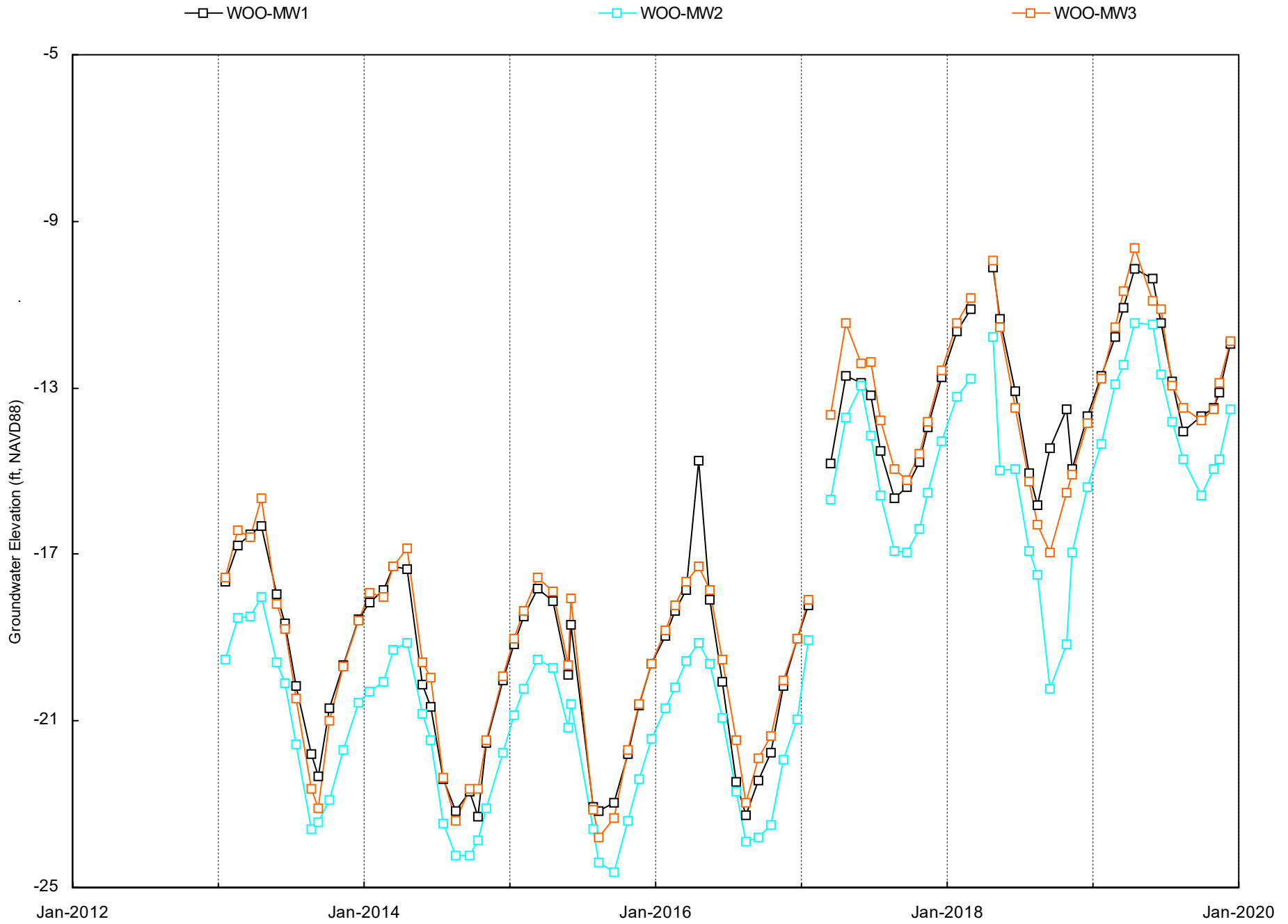

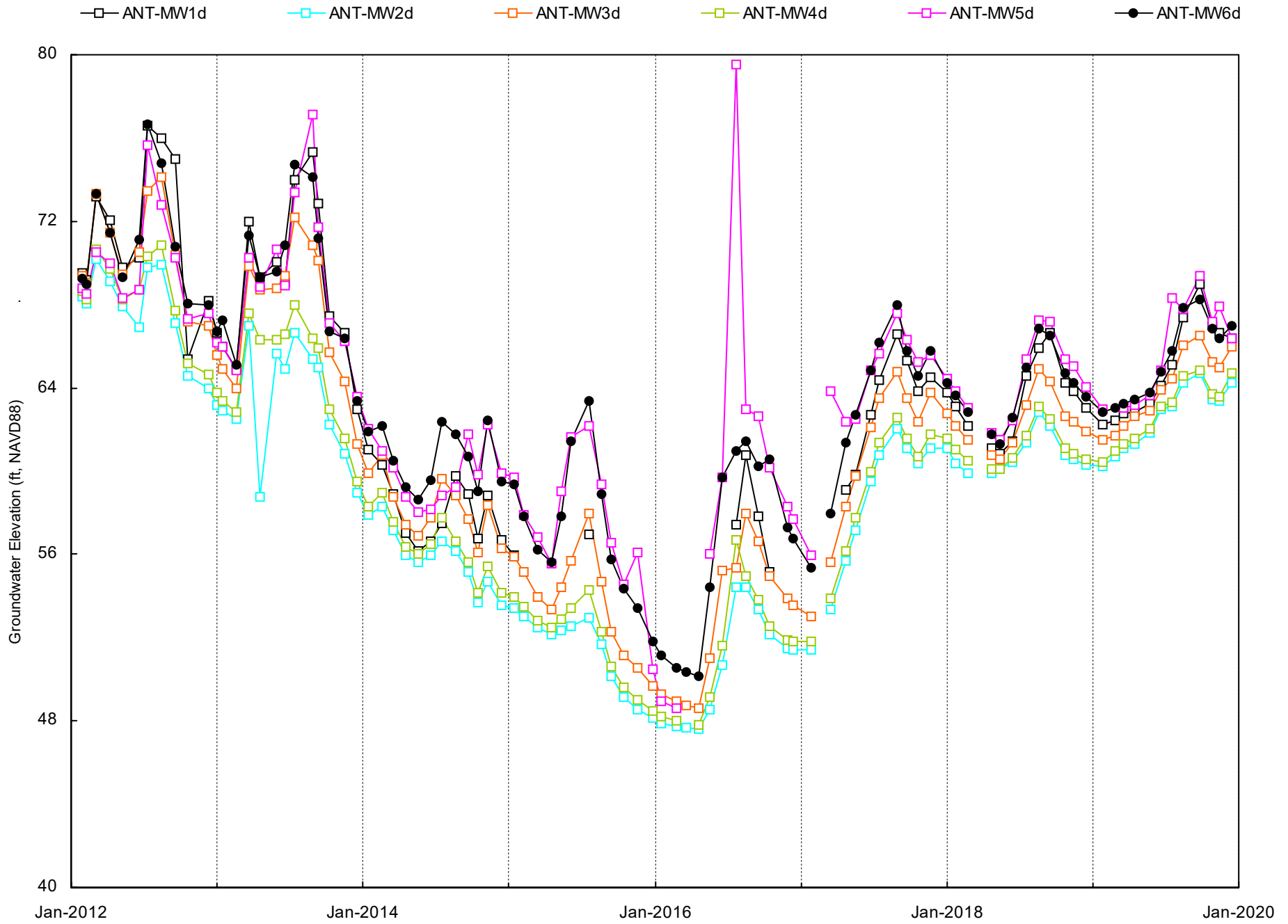

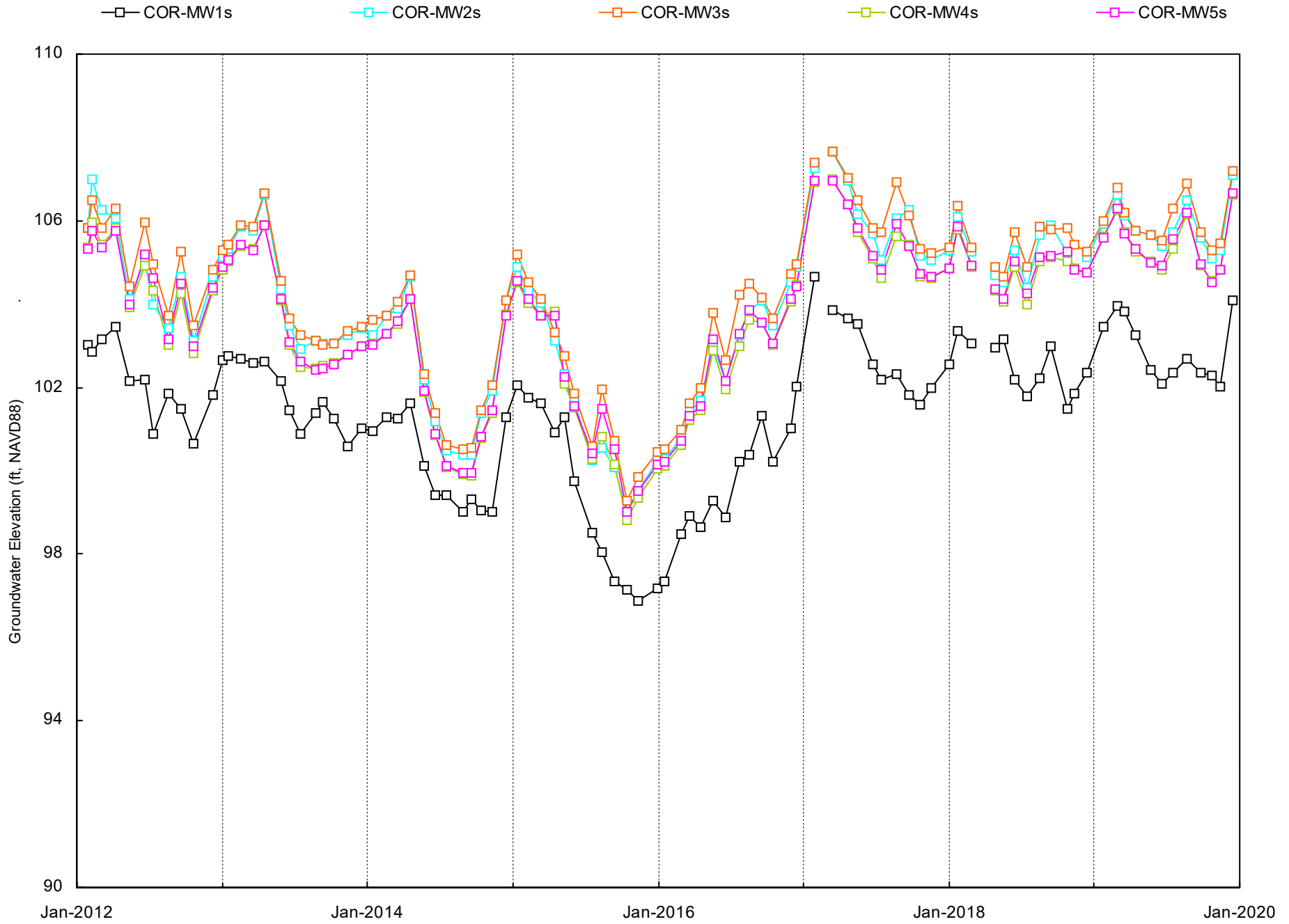



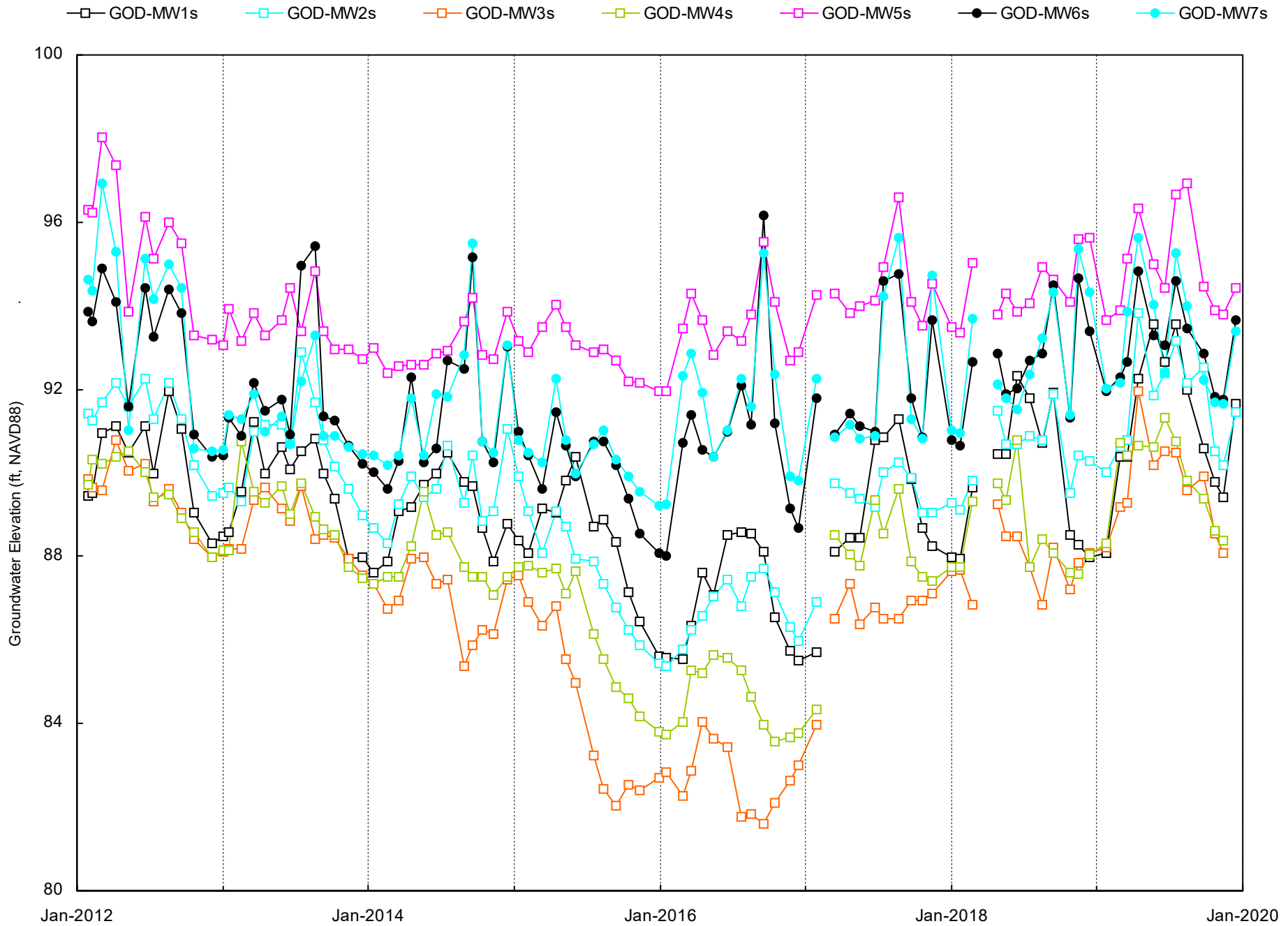

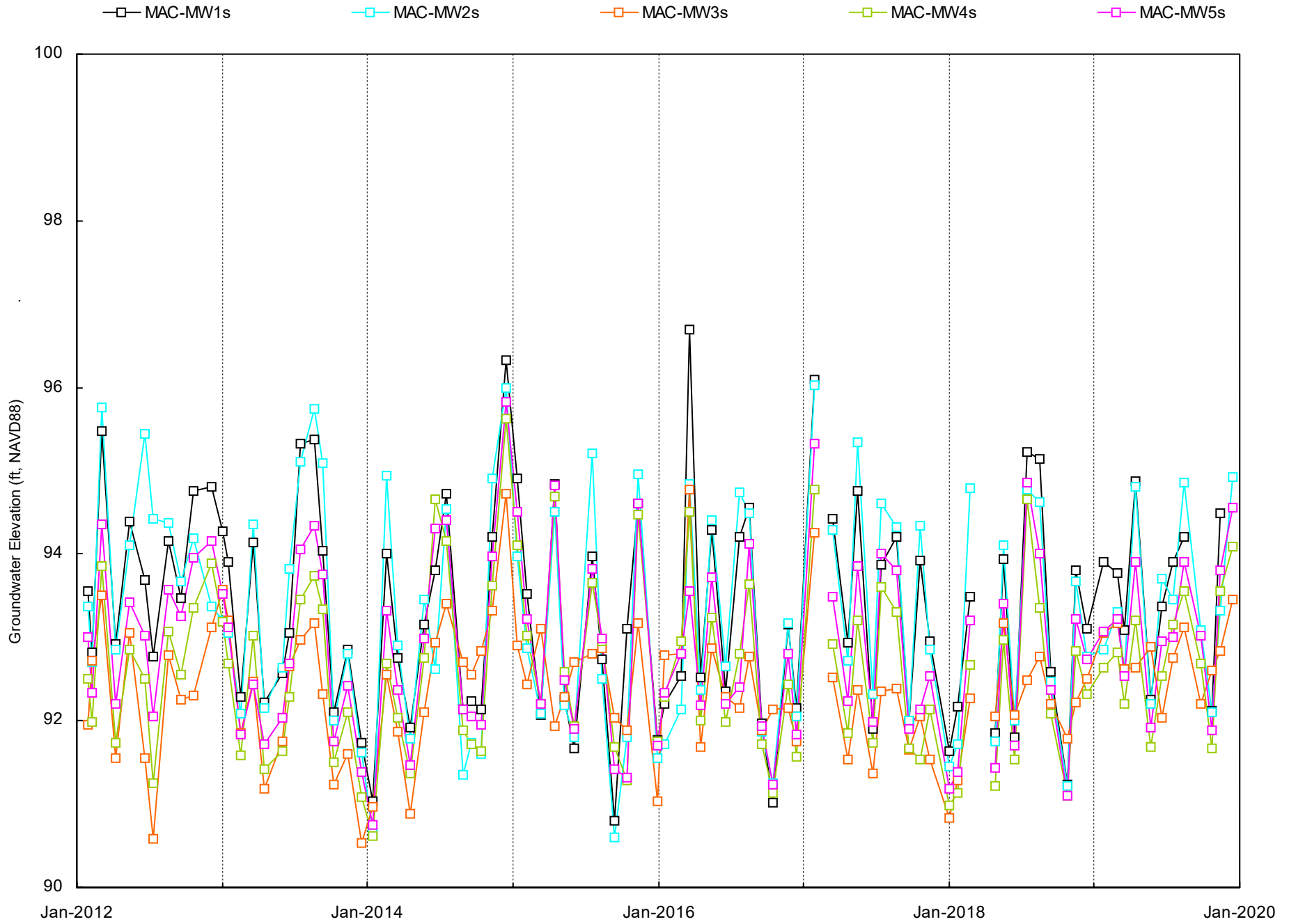

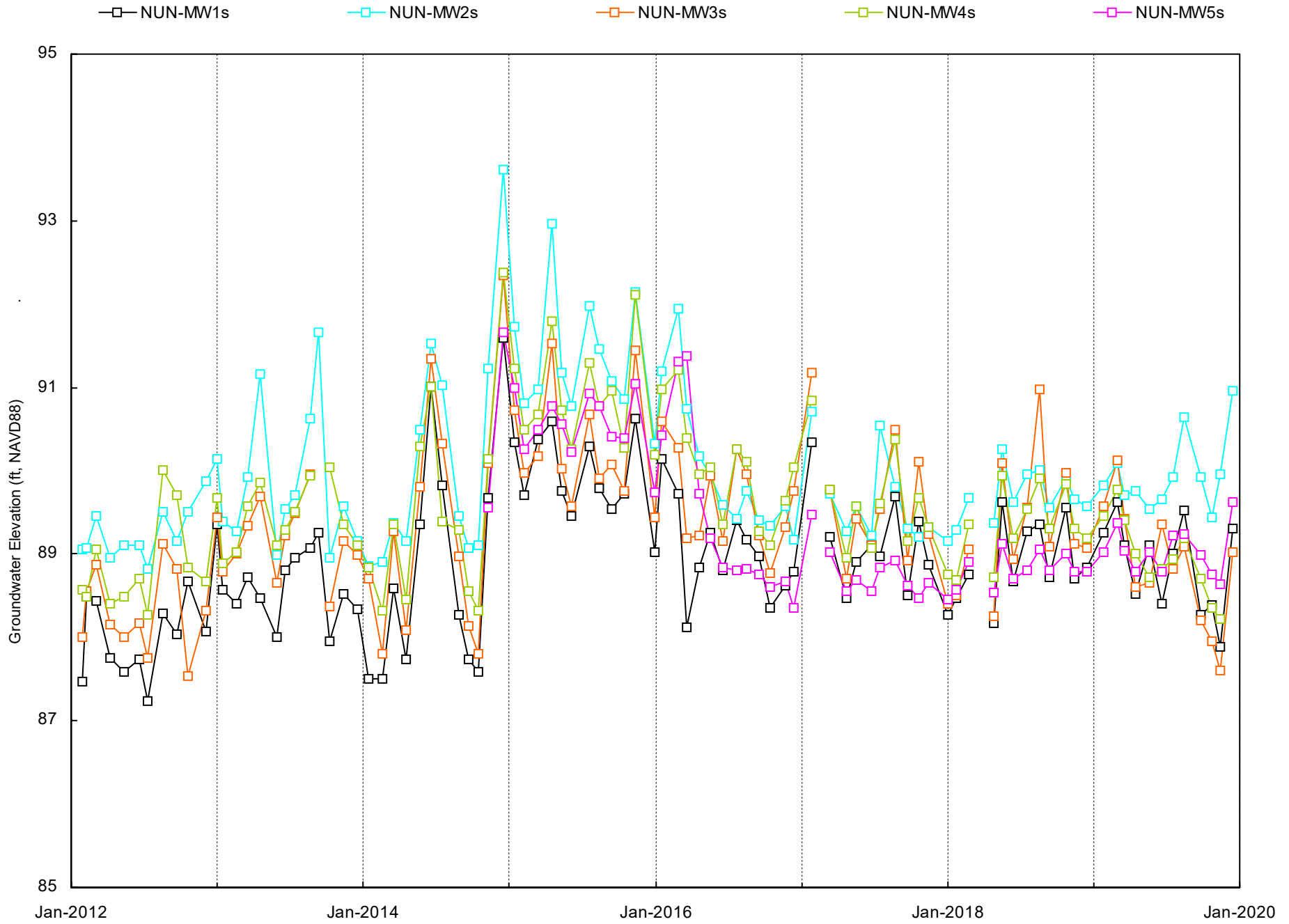

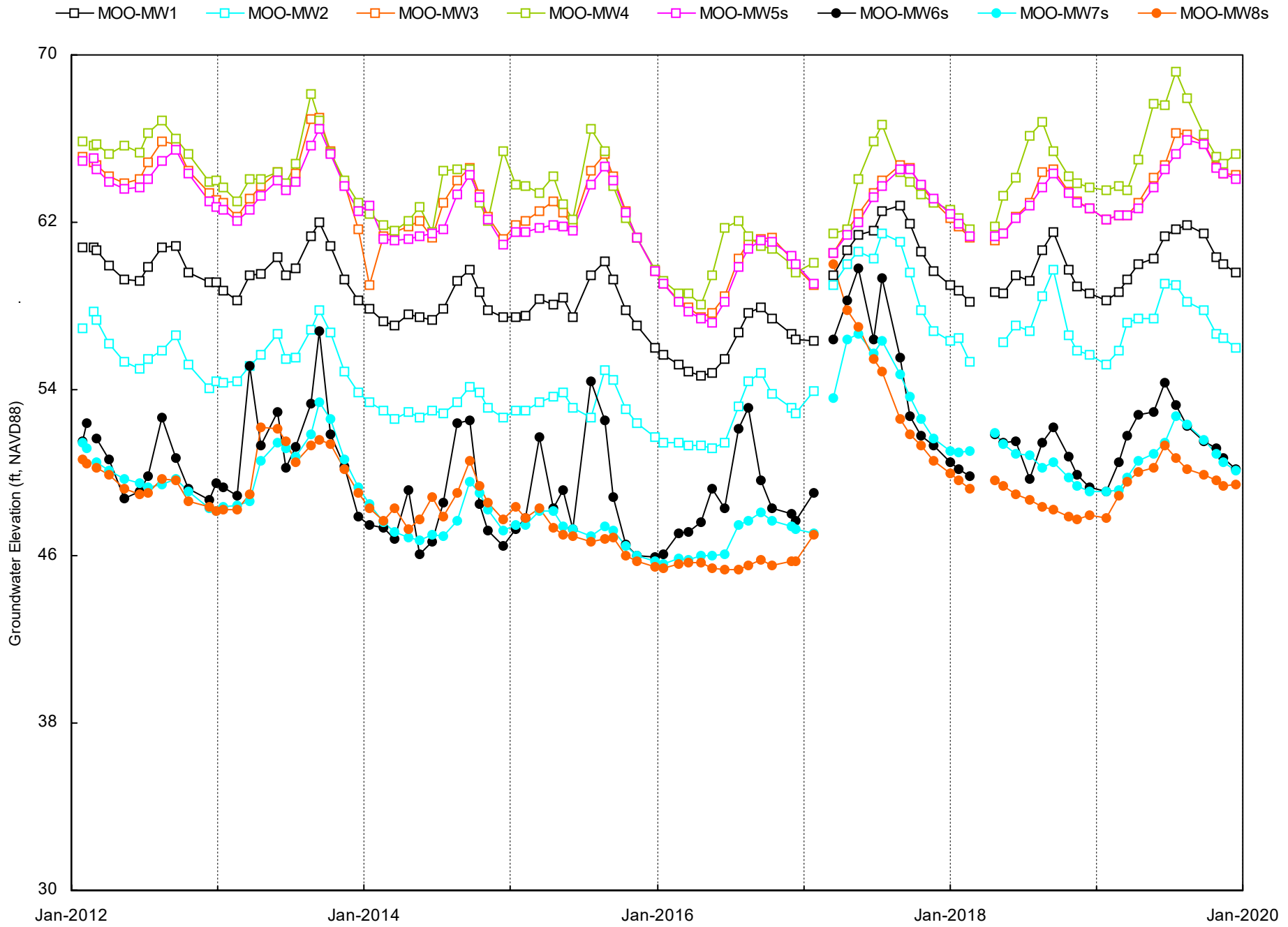

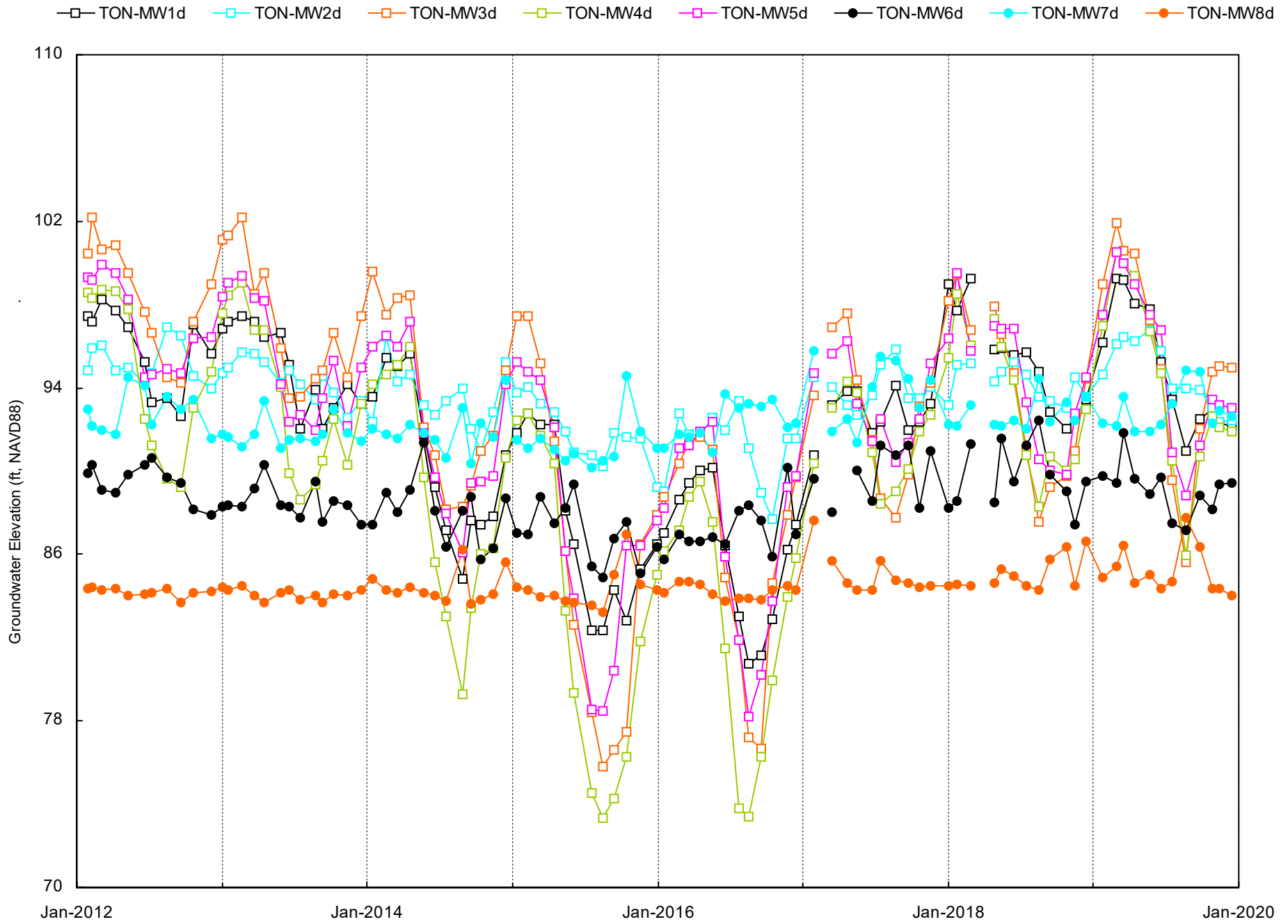

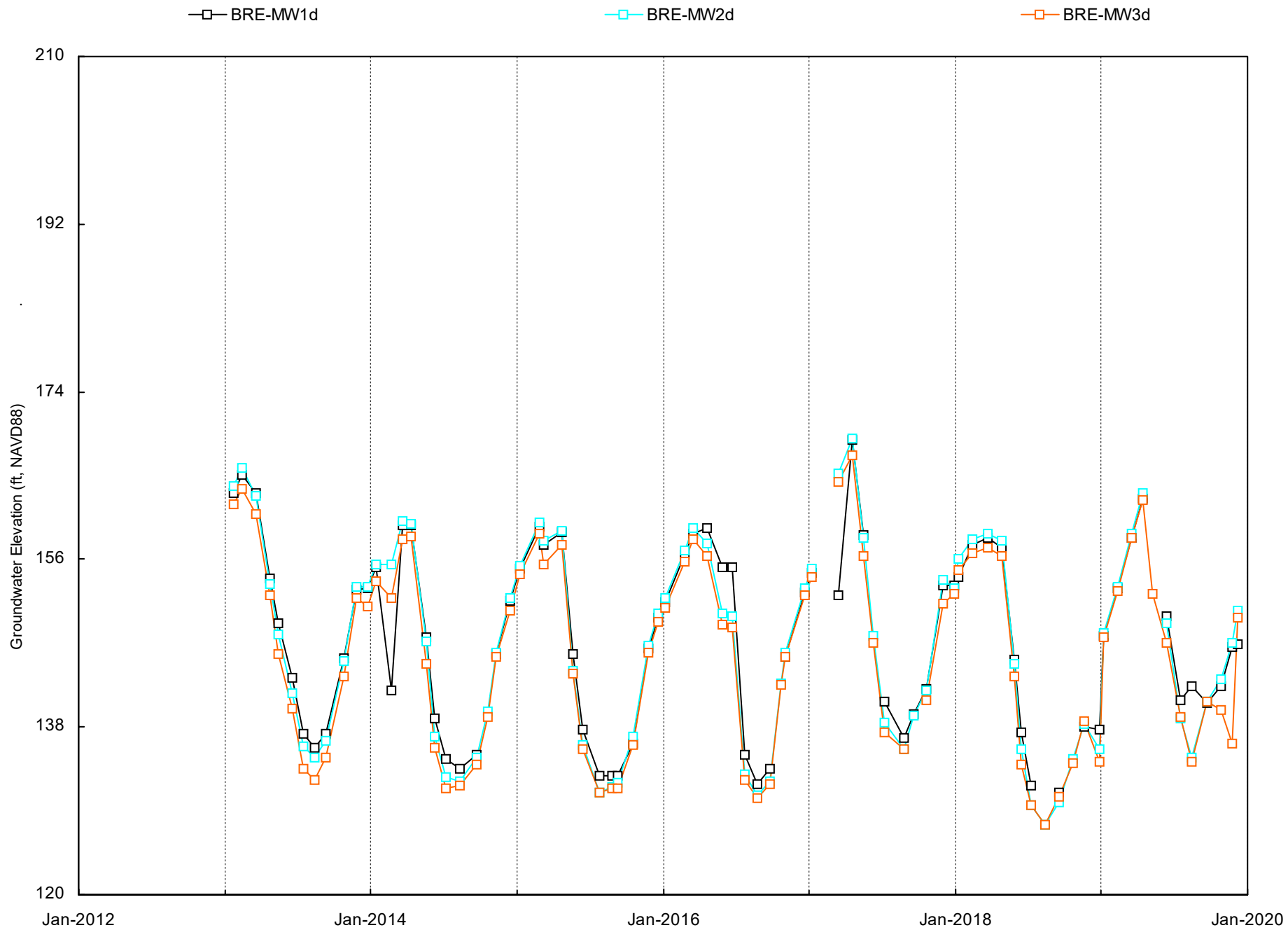

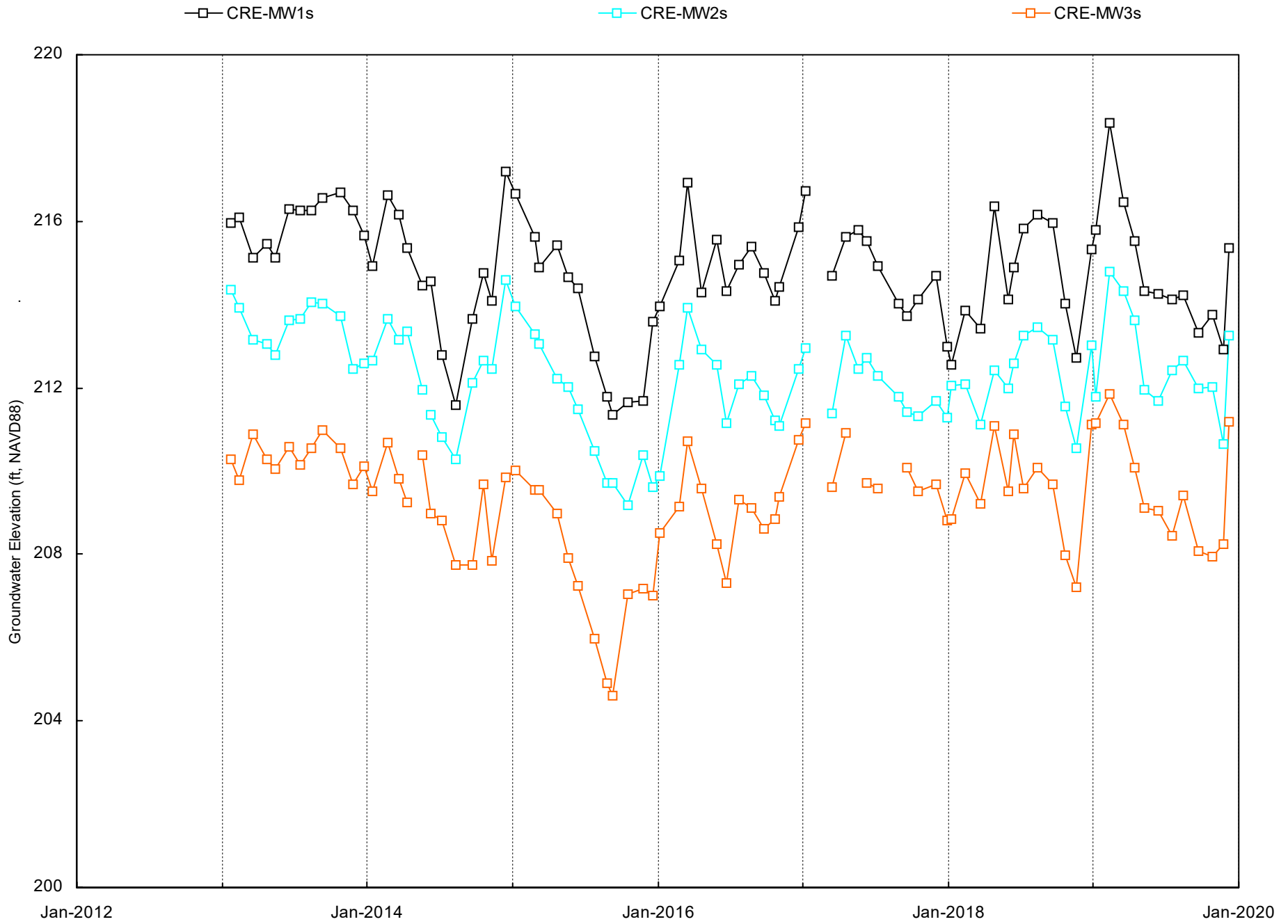

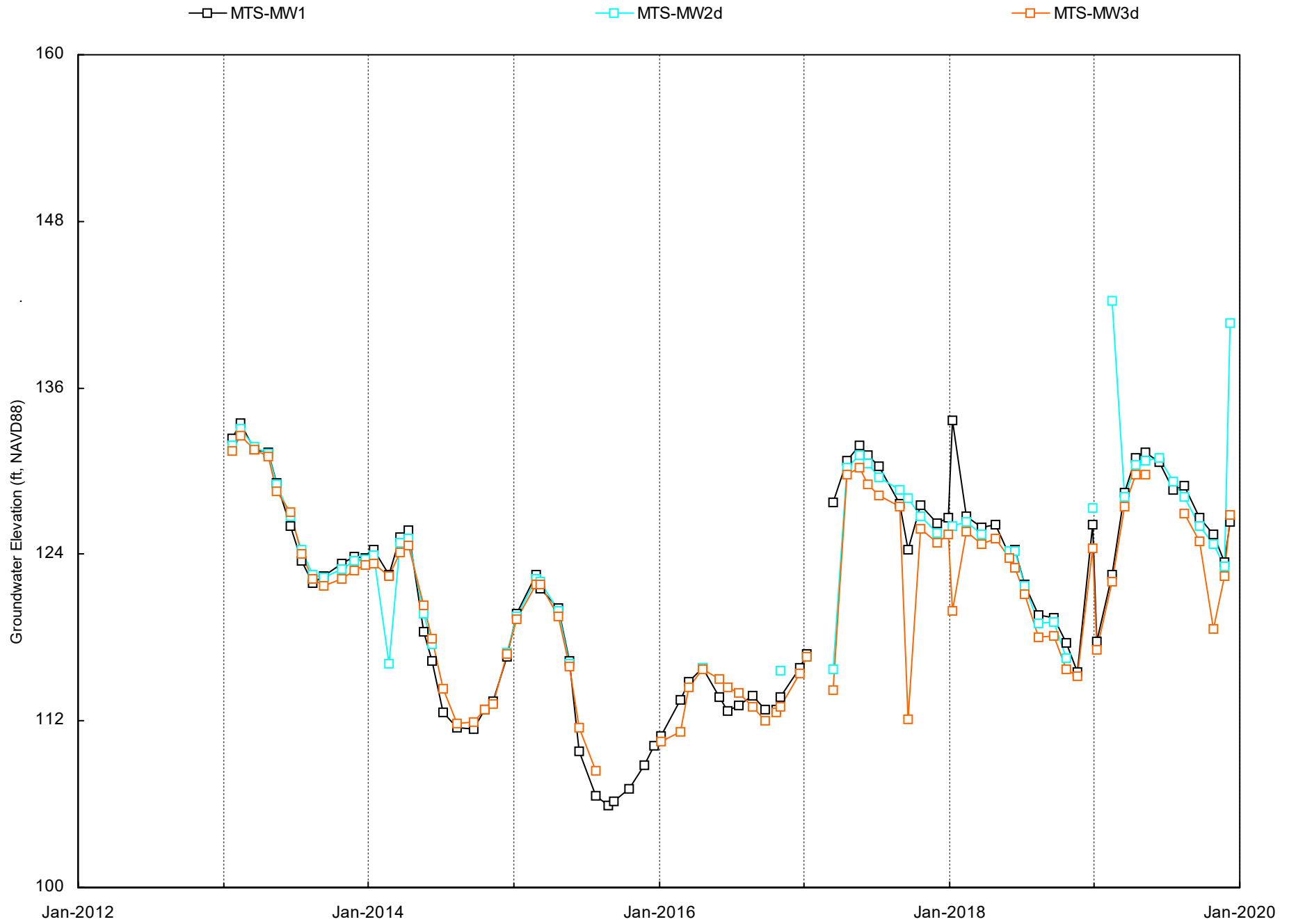

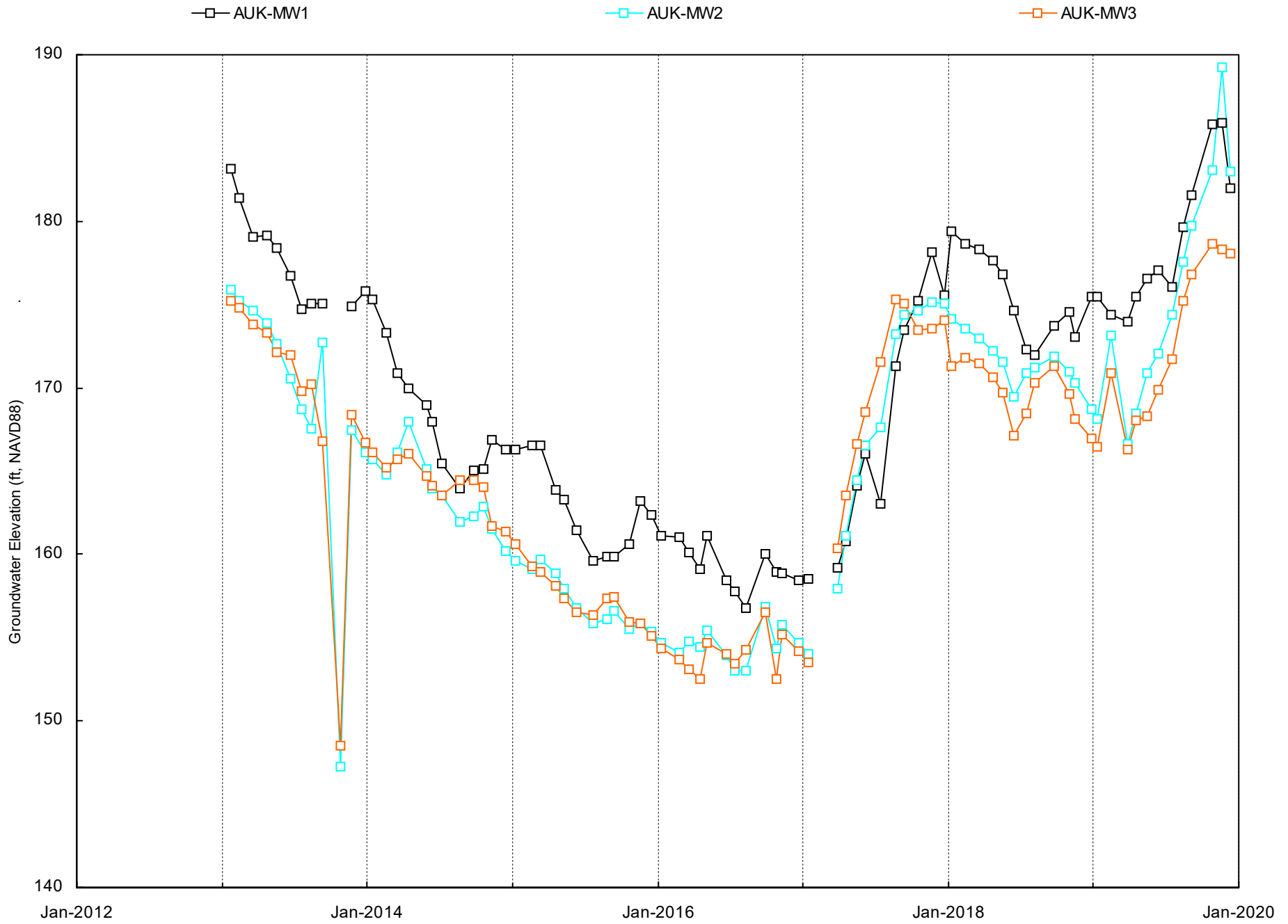

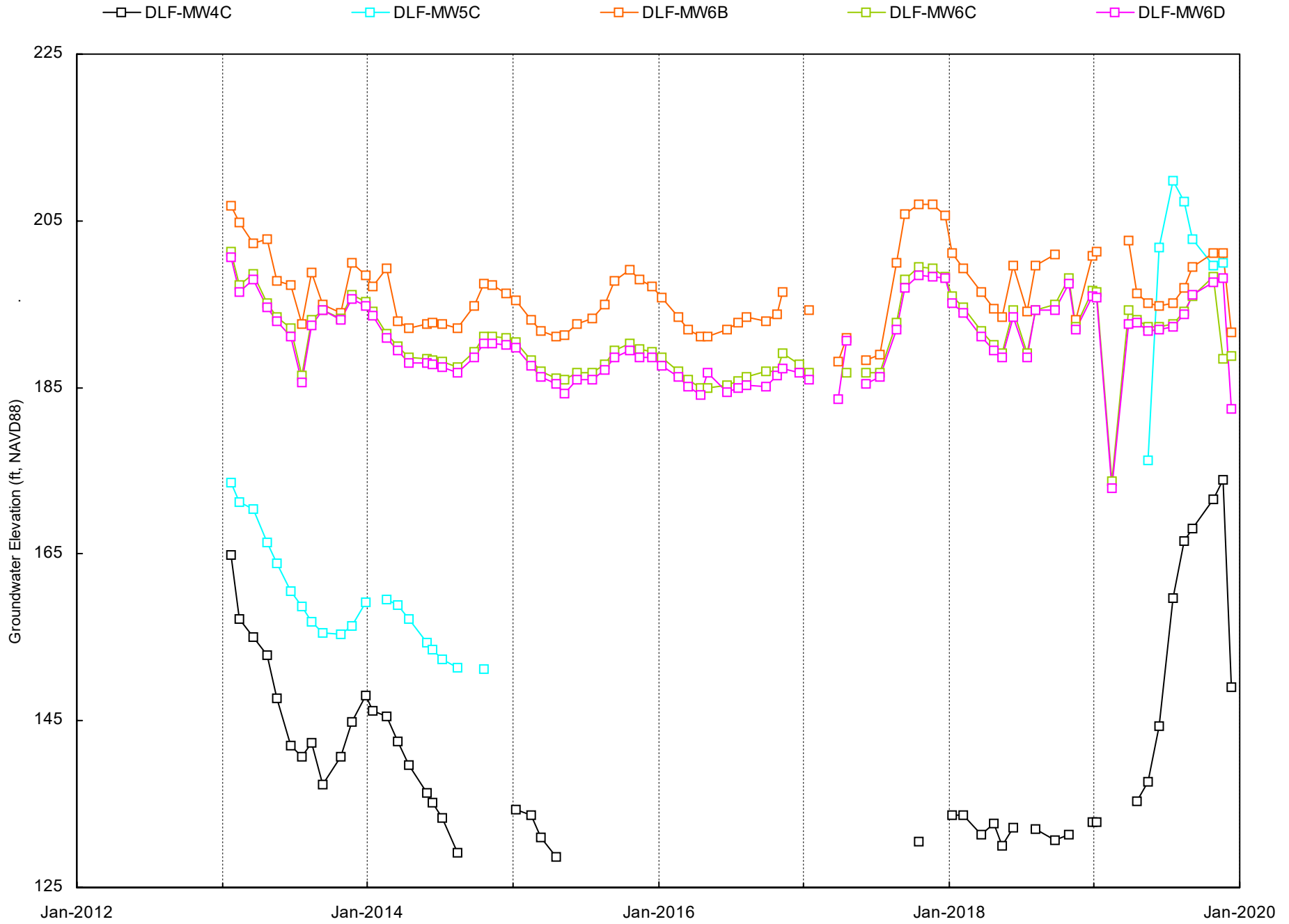

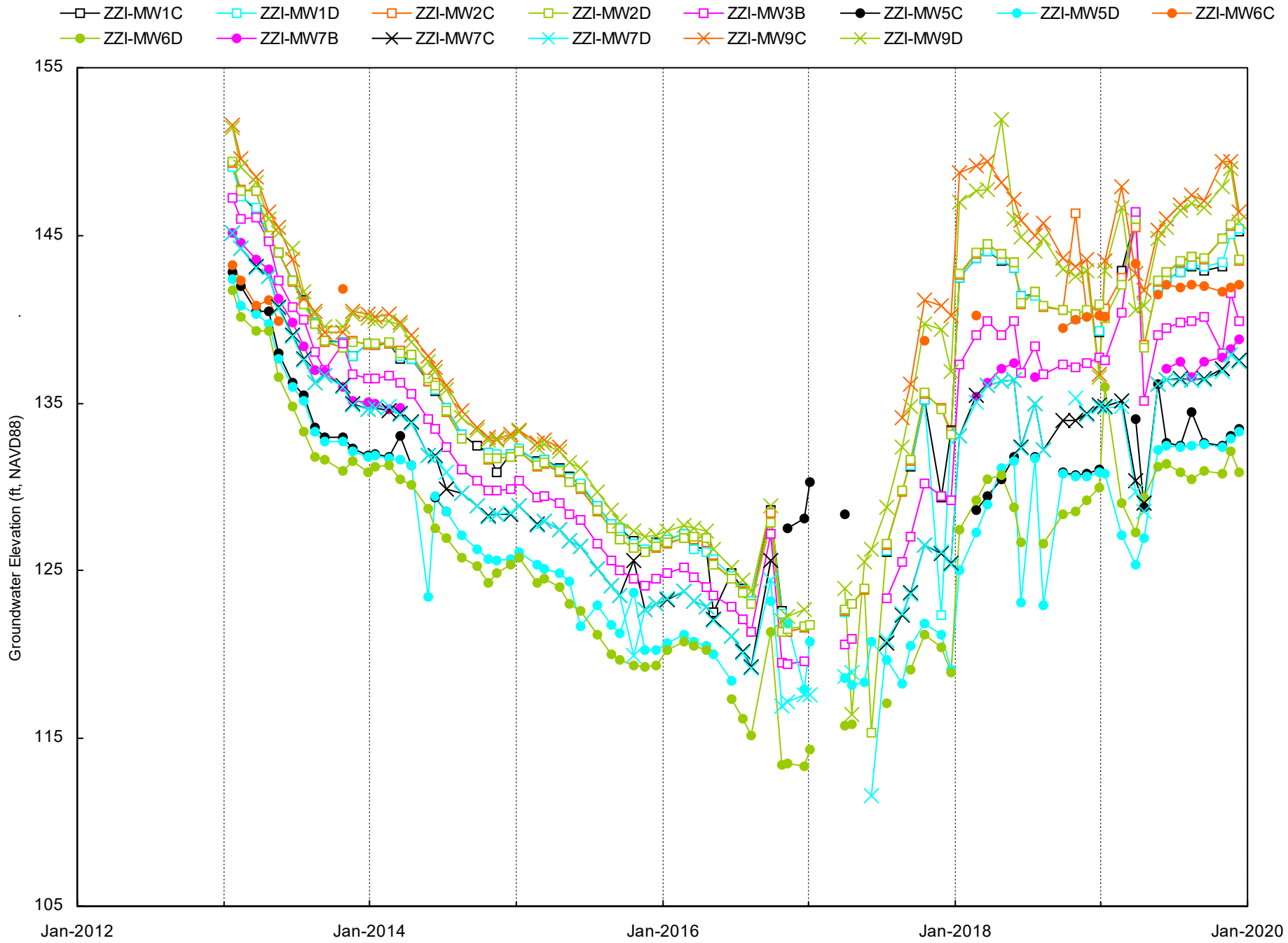

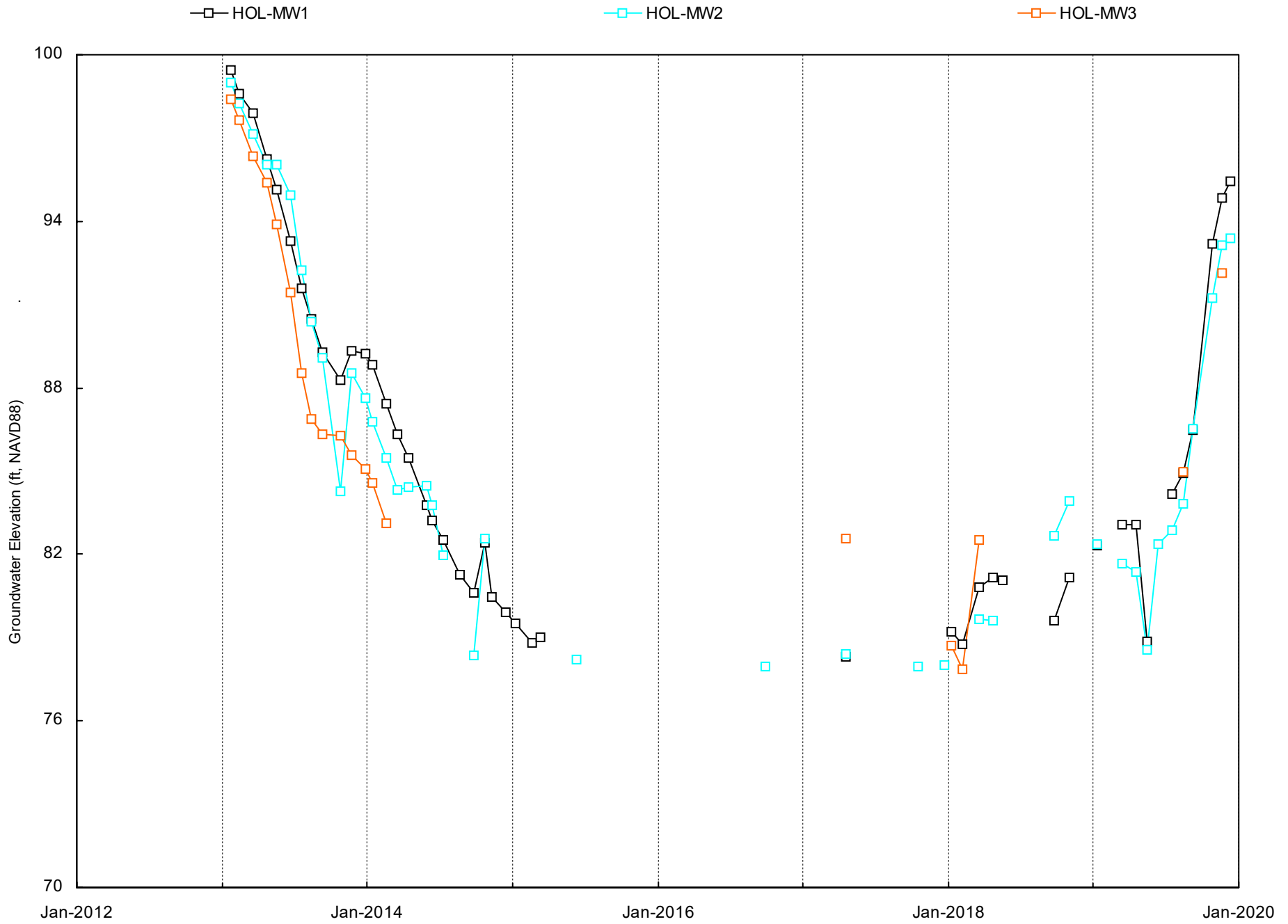

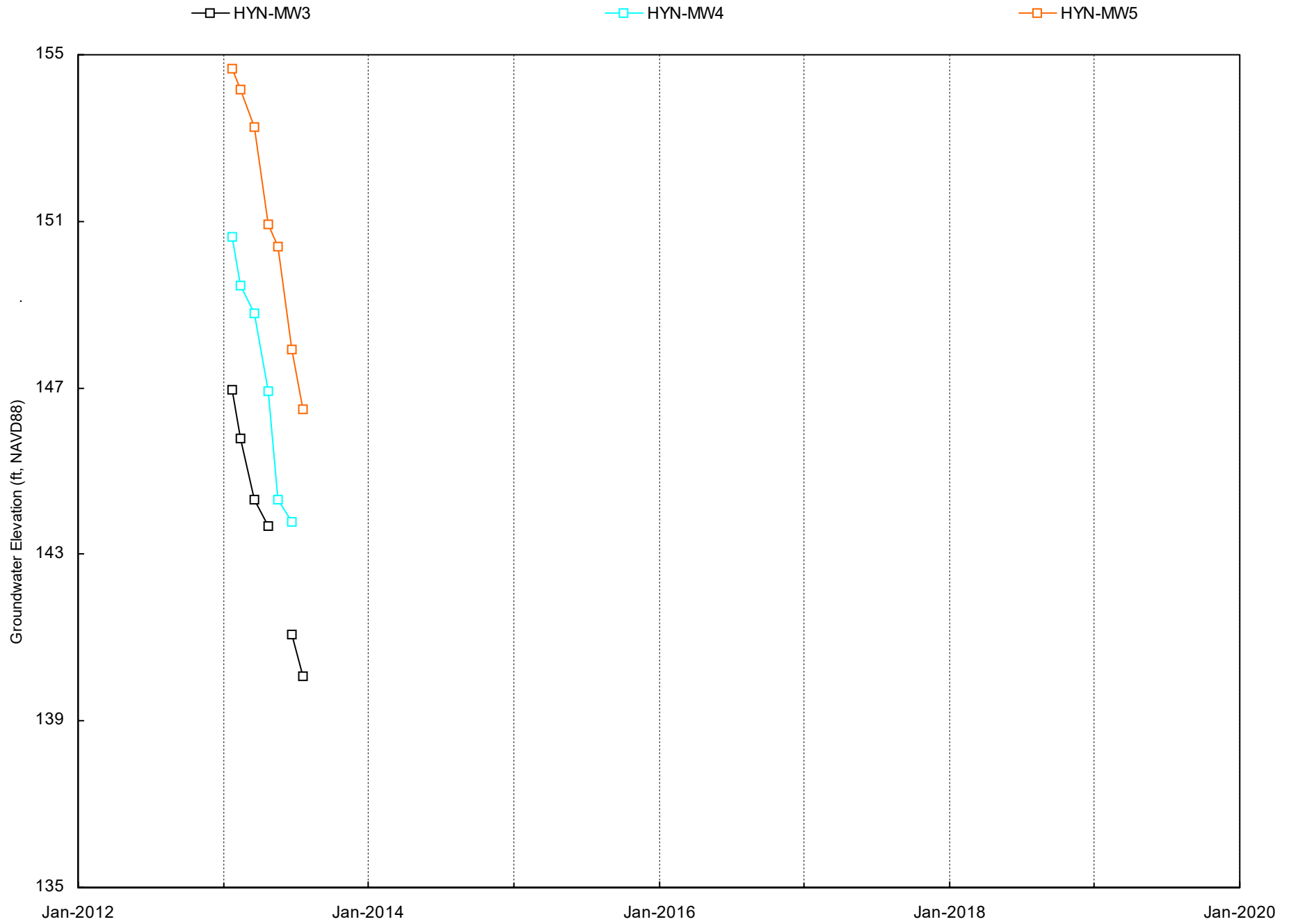

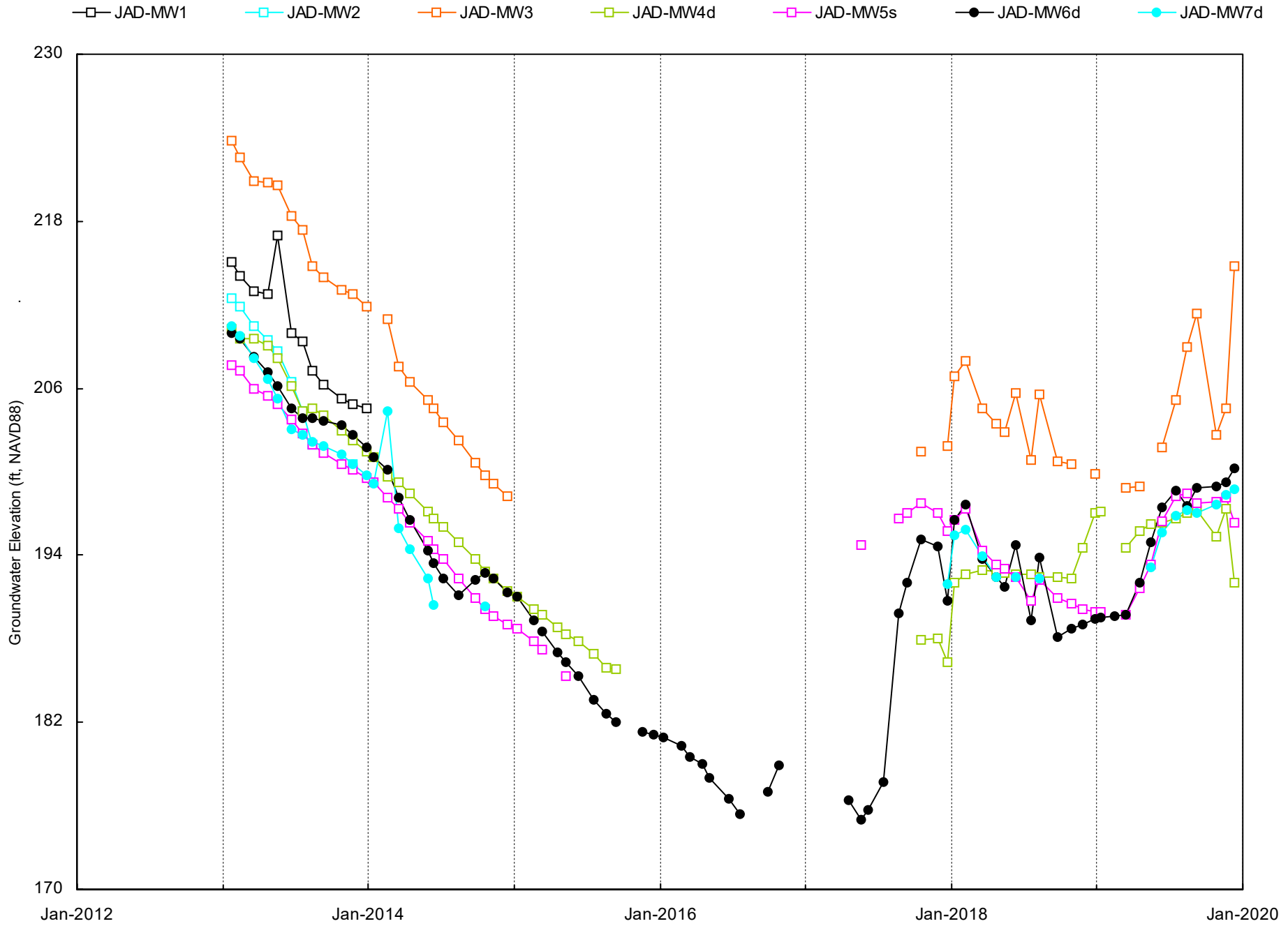

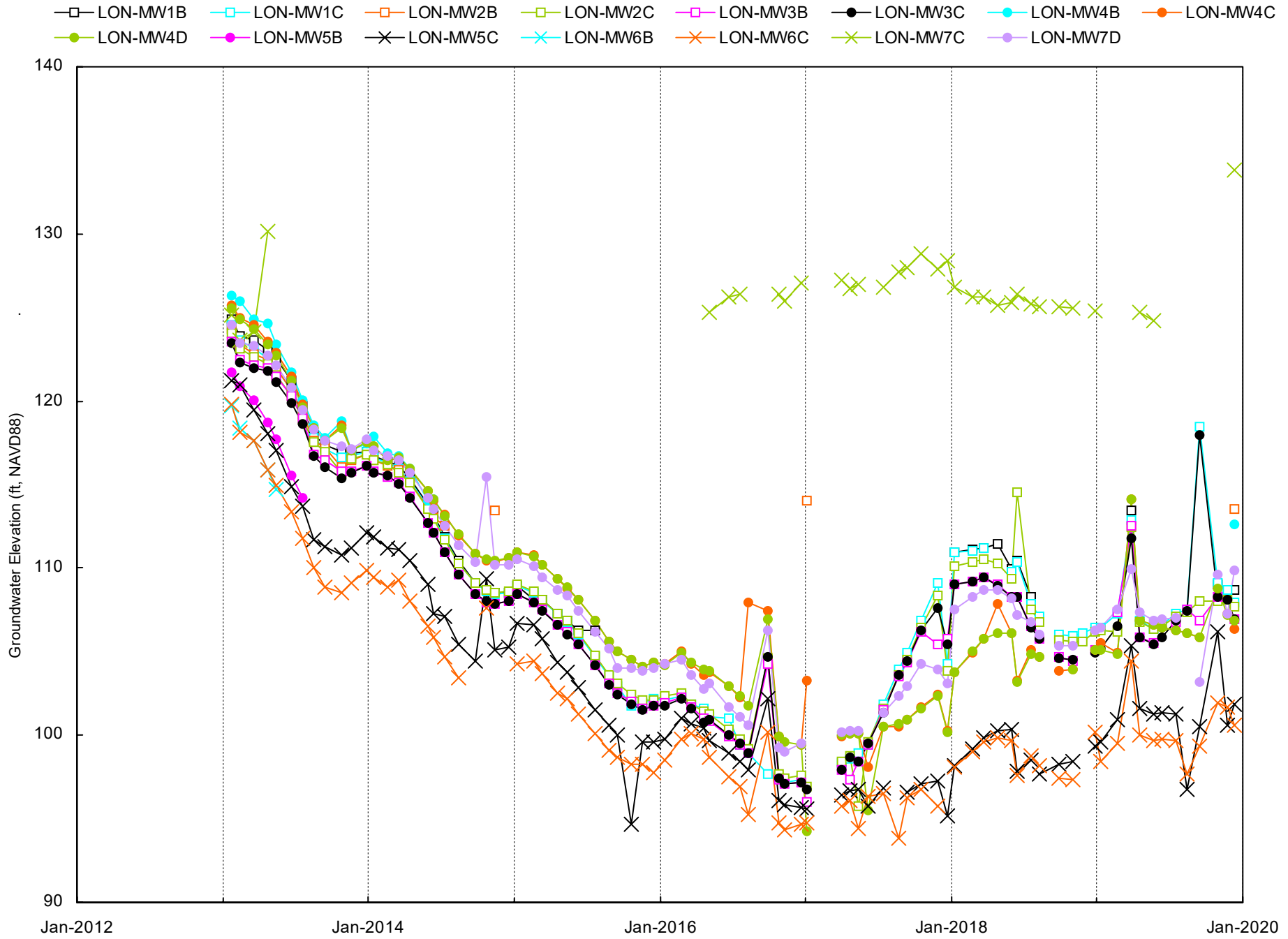

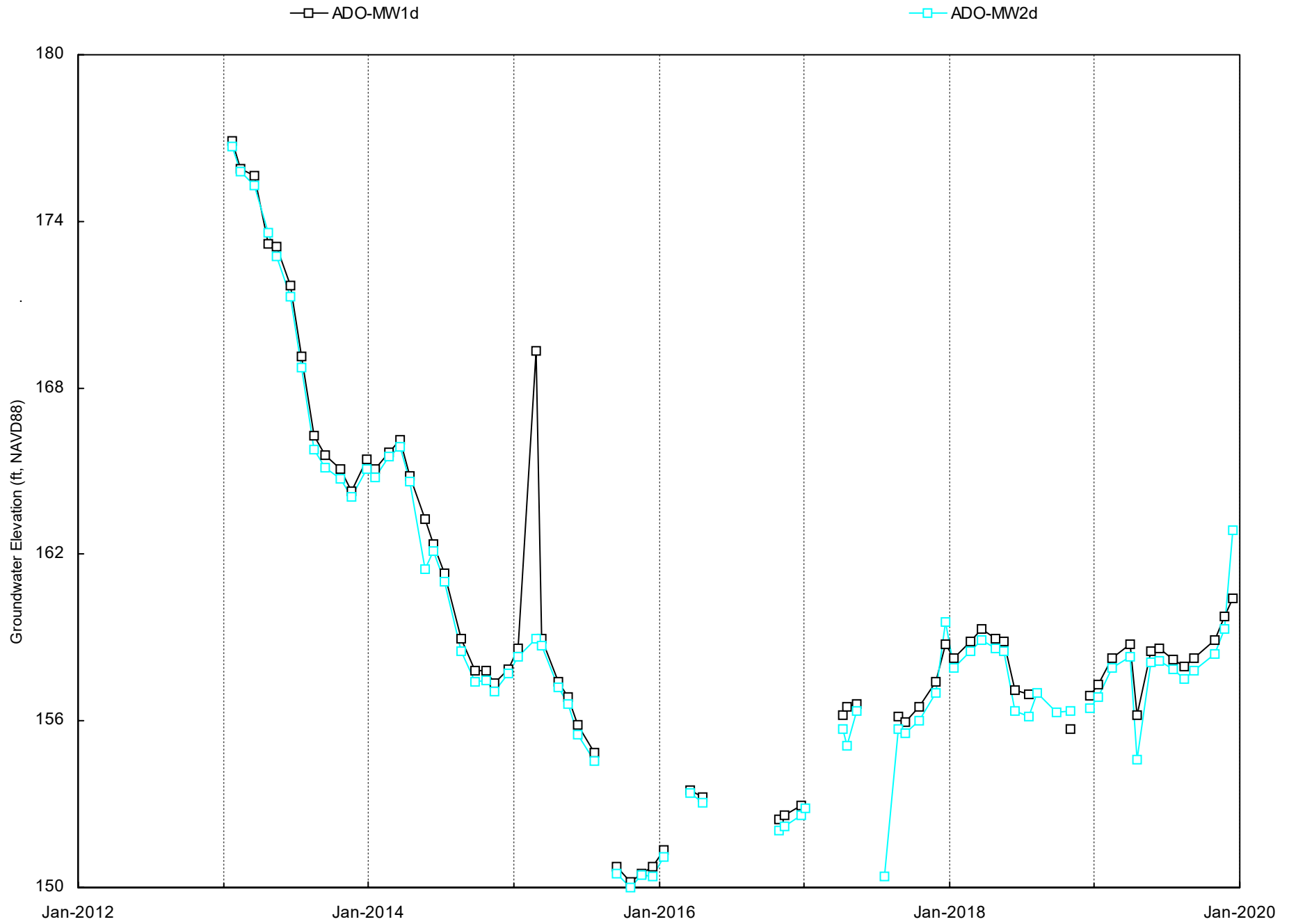

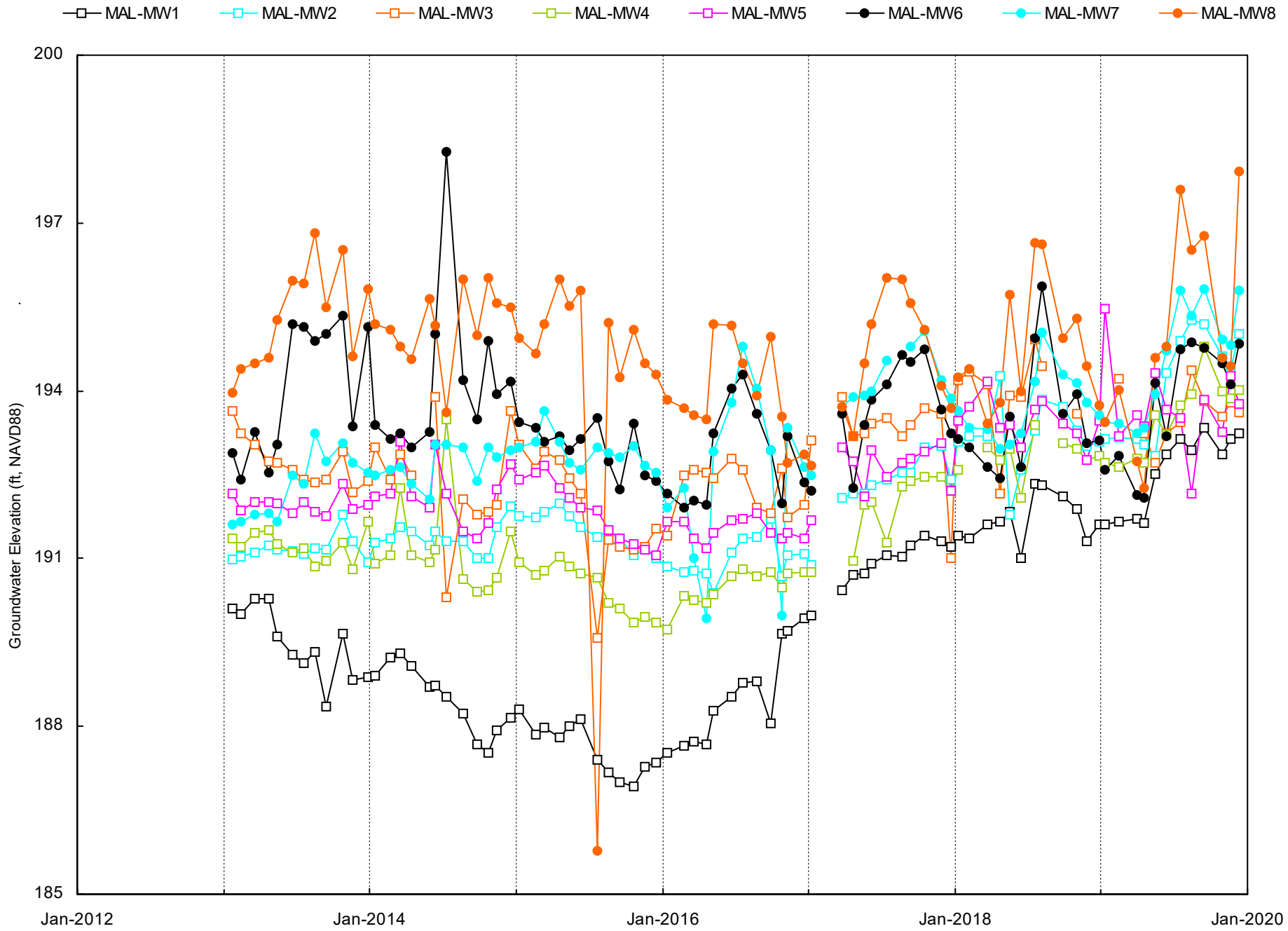

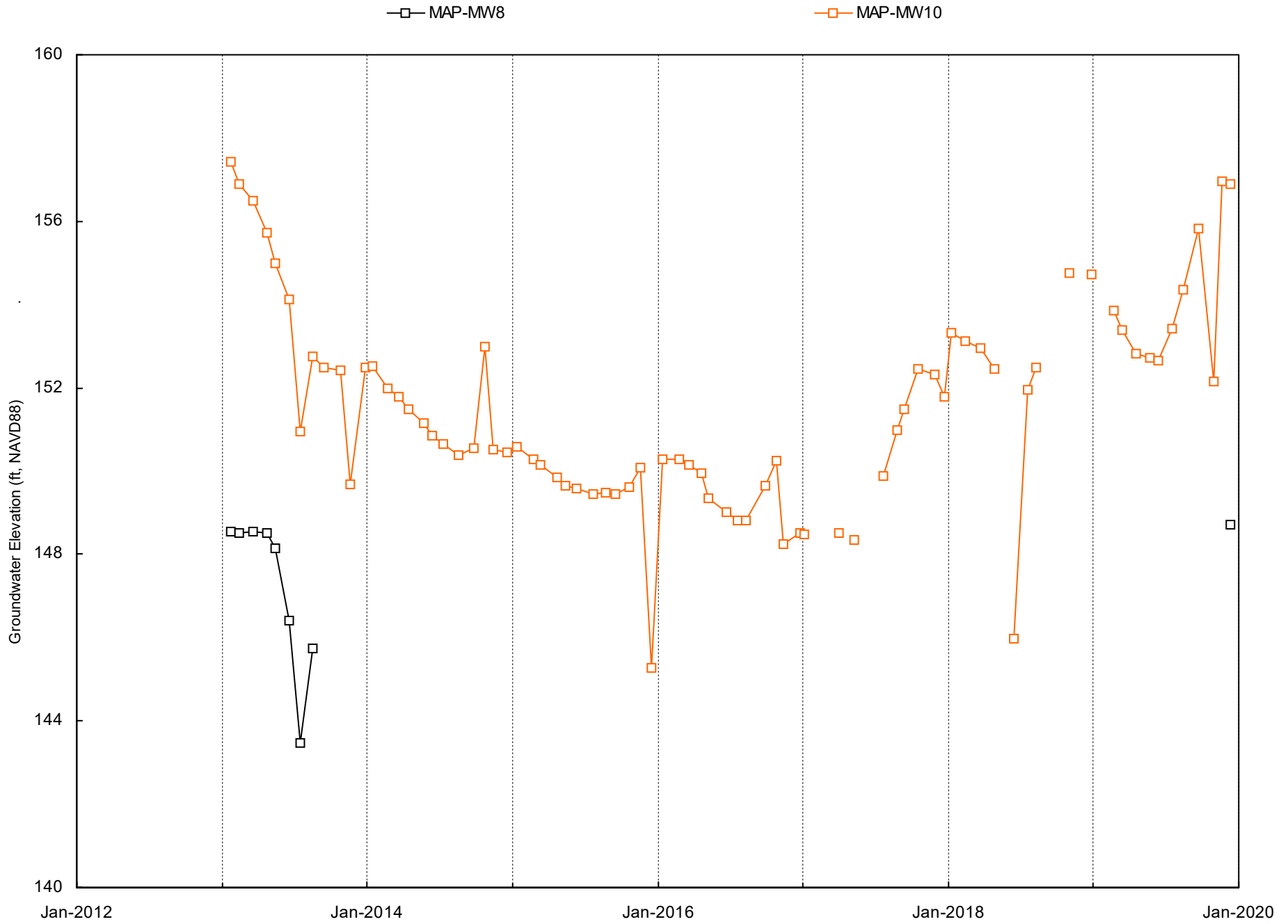

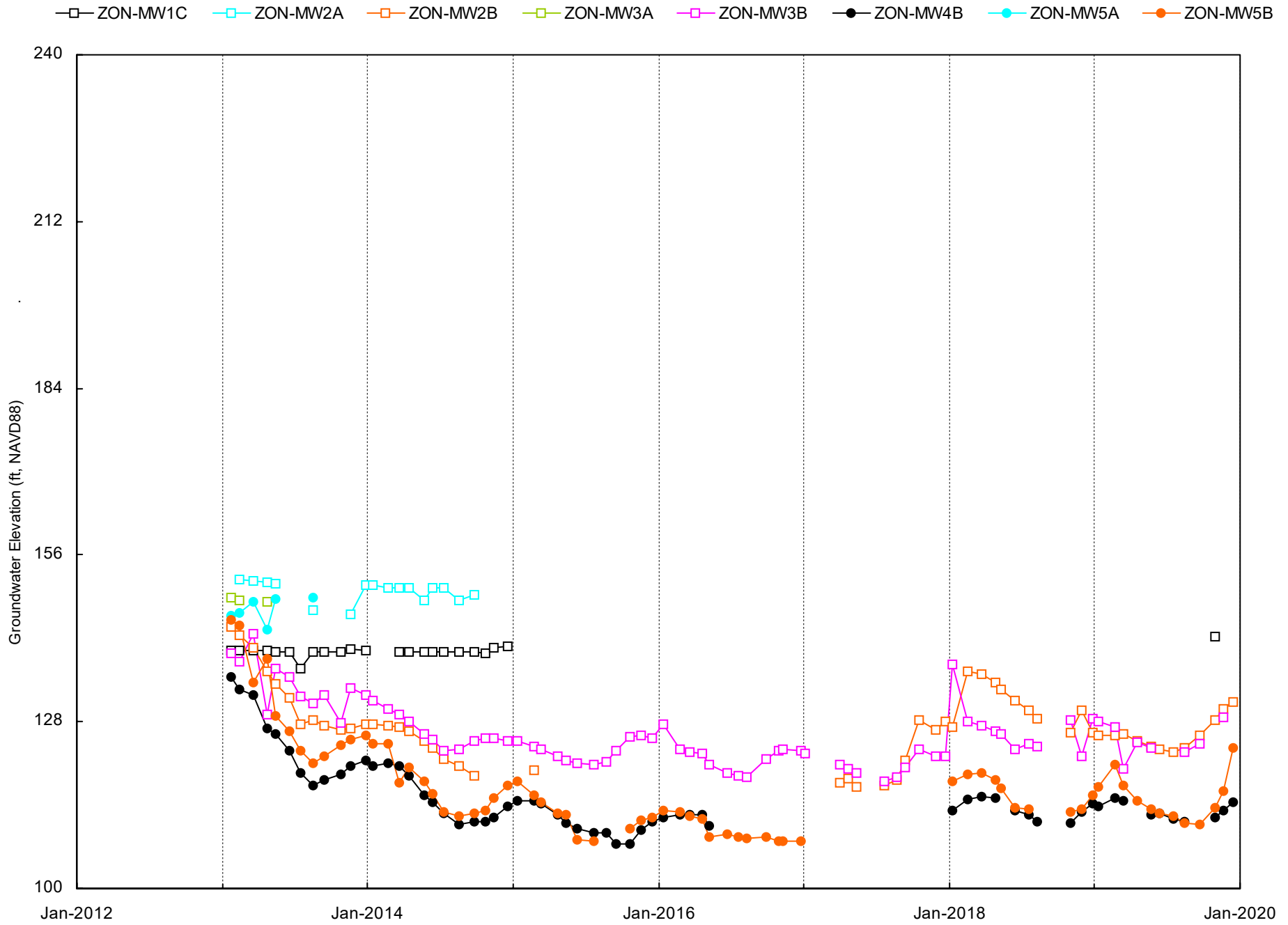

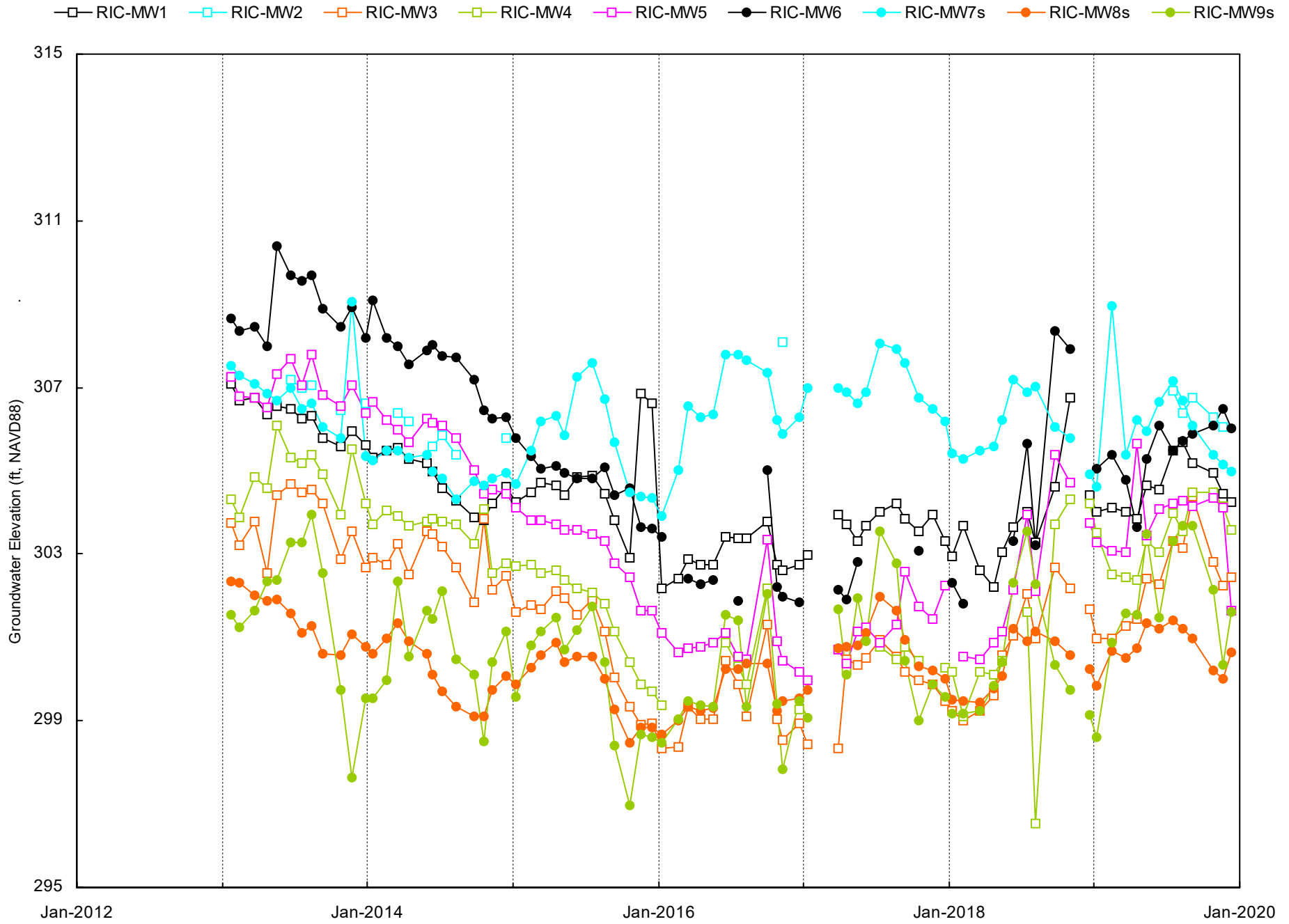

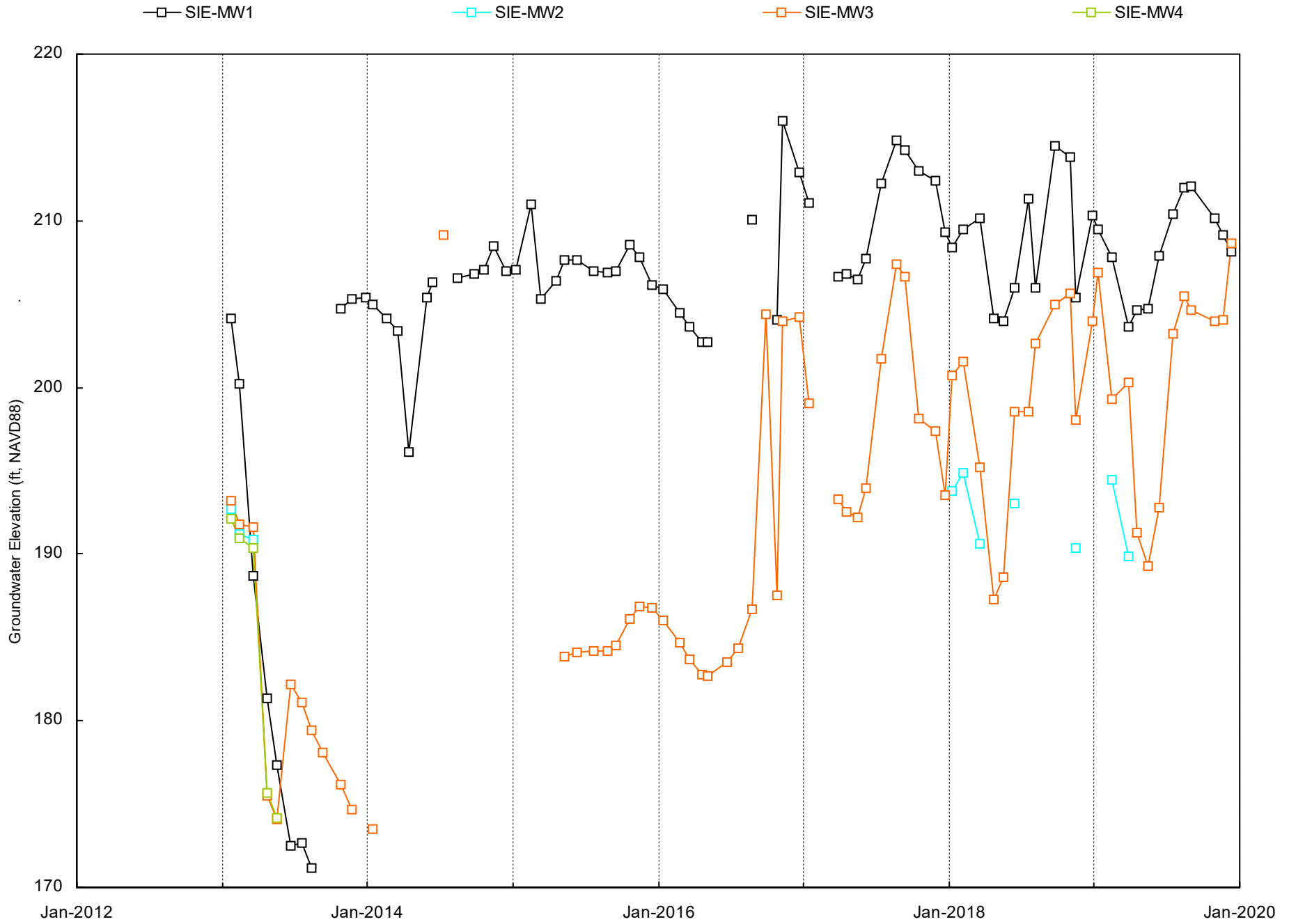

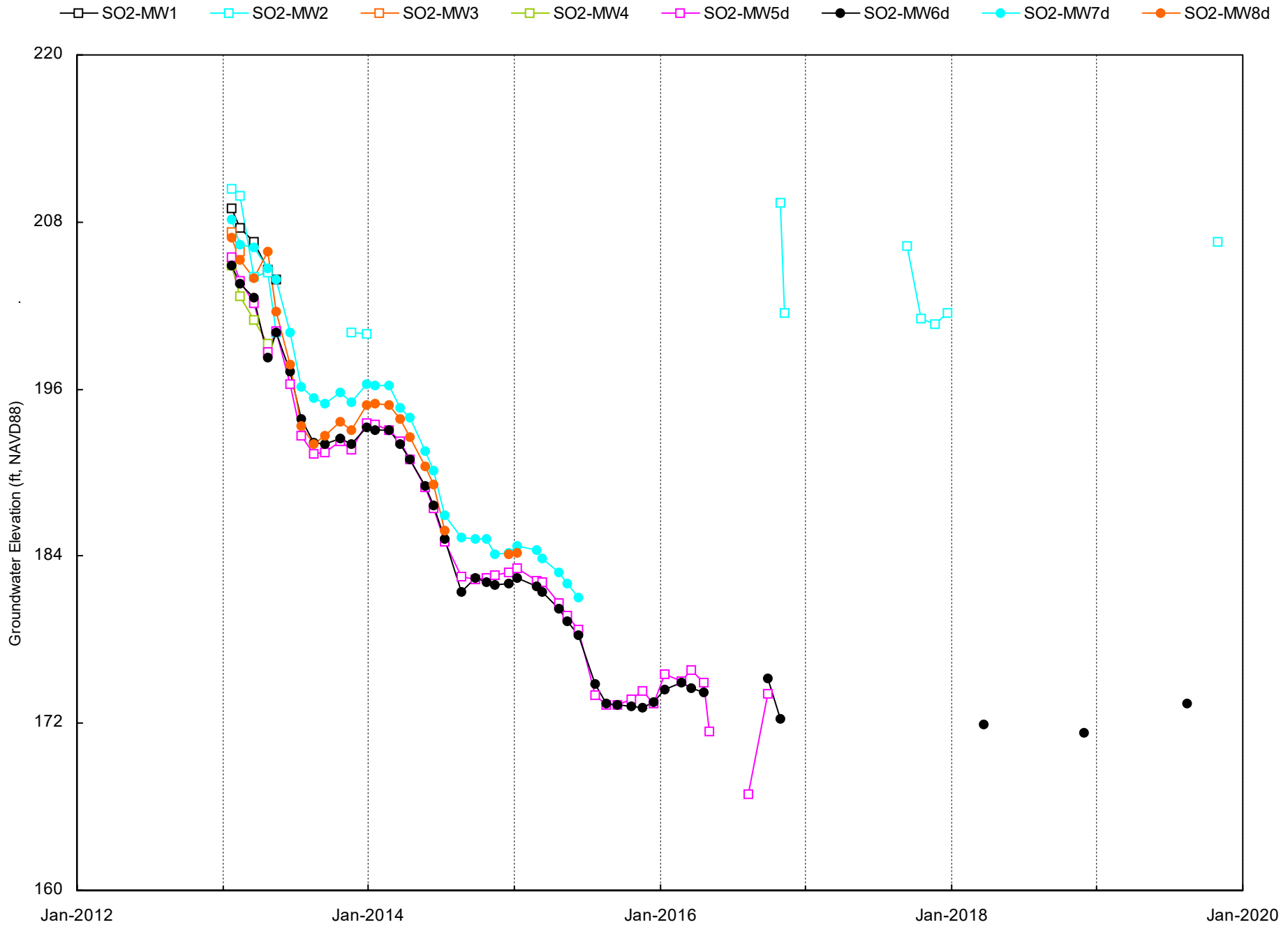

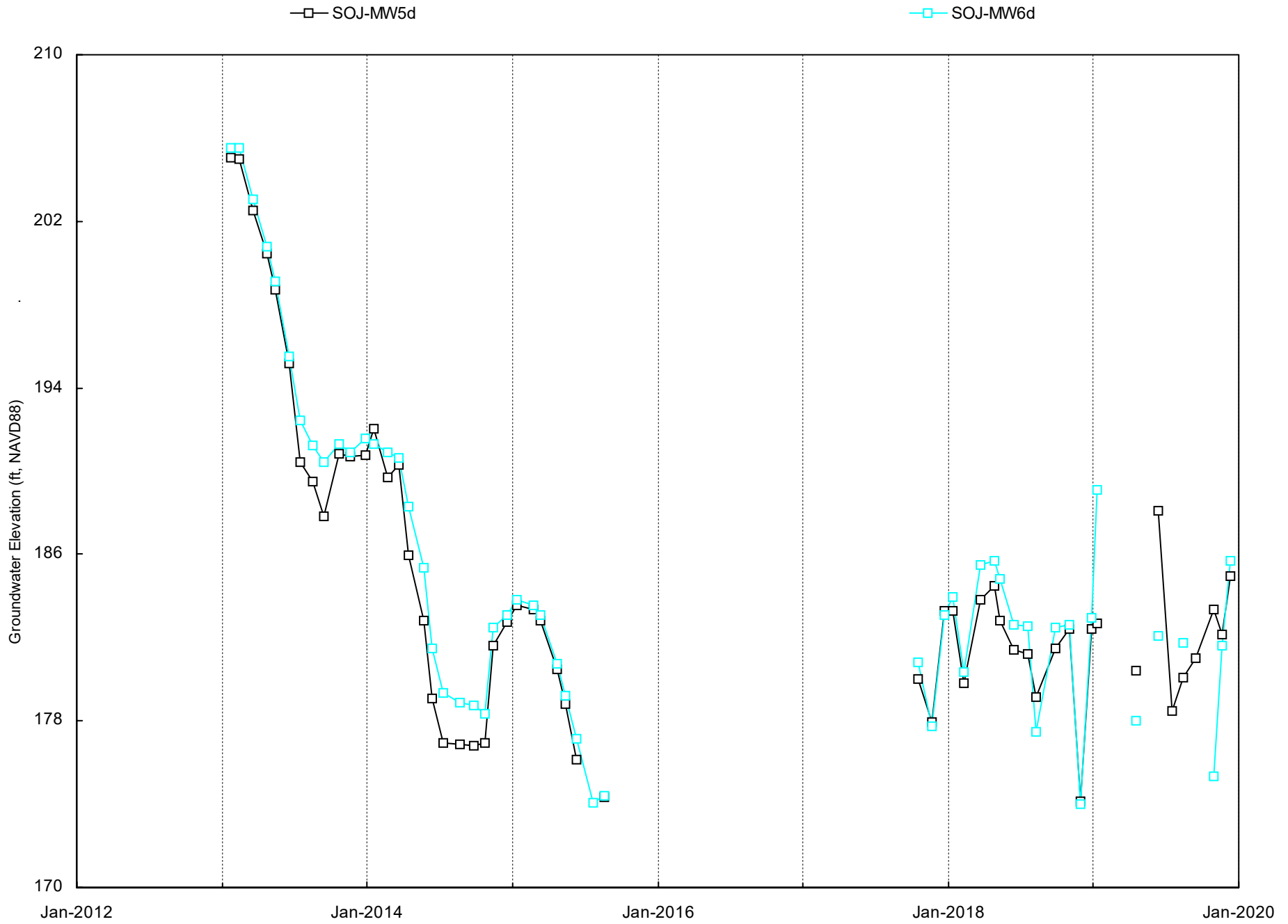

Attachment A5

Map Series of Water Level Elevation Contour Maps (2019)

MEN

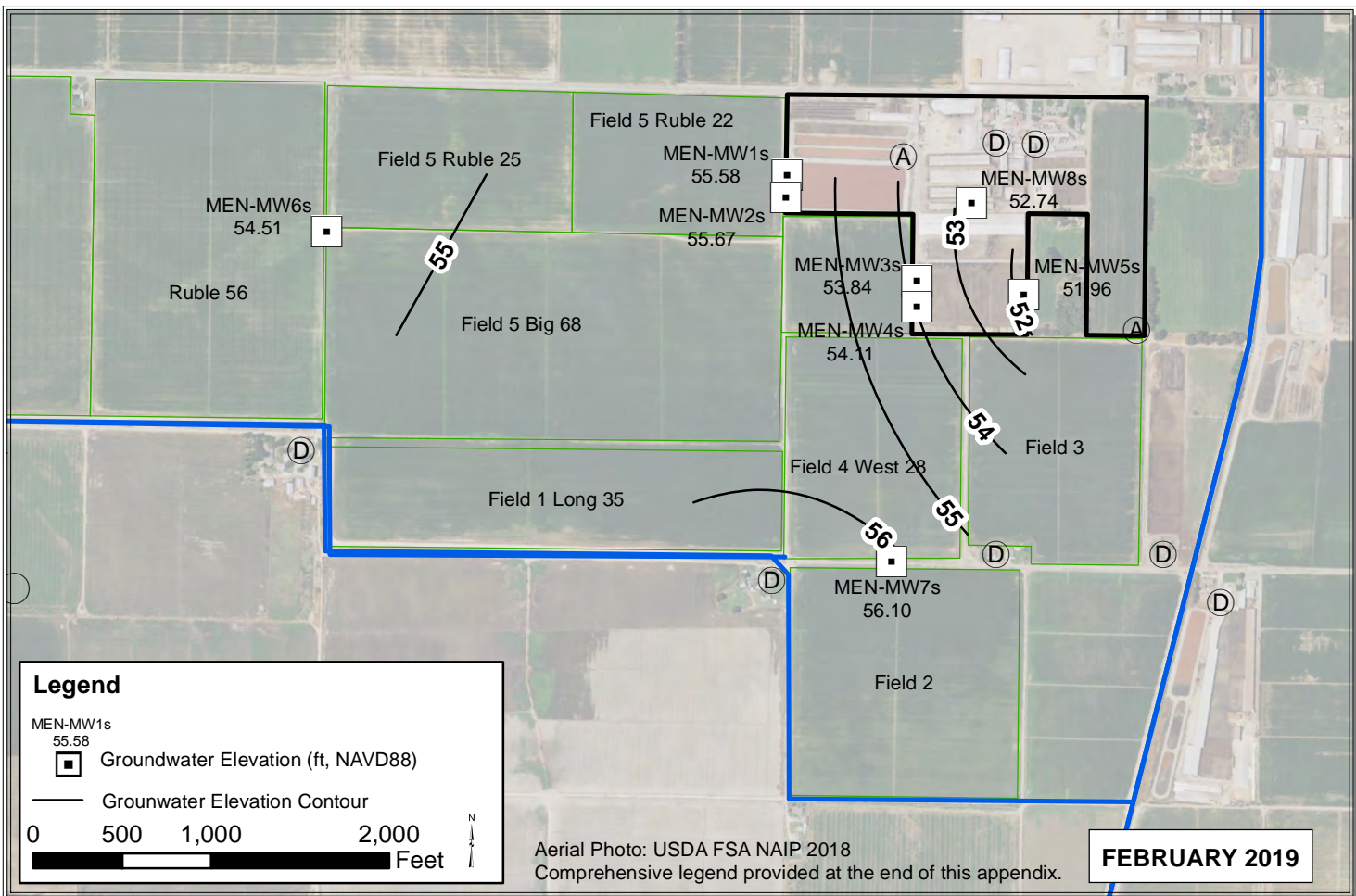
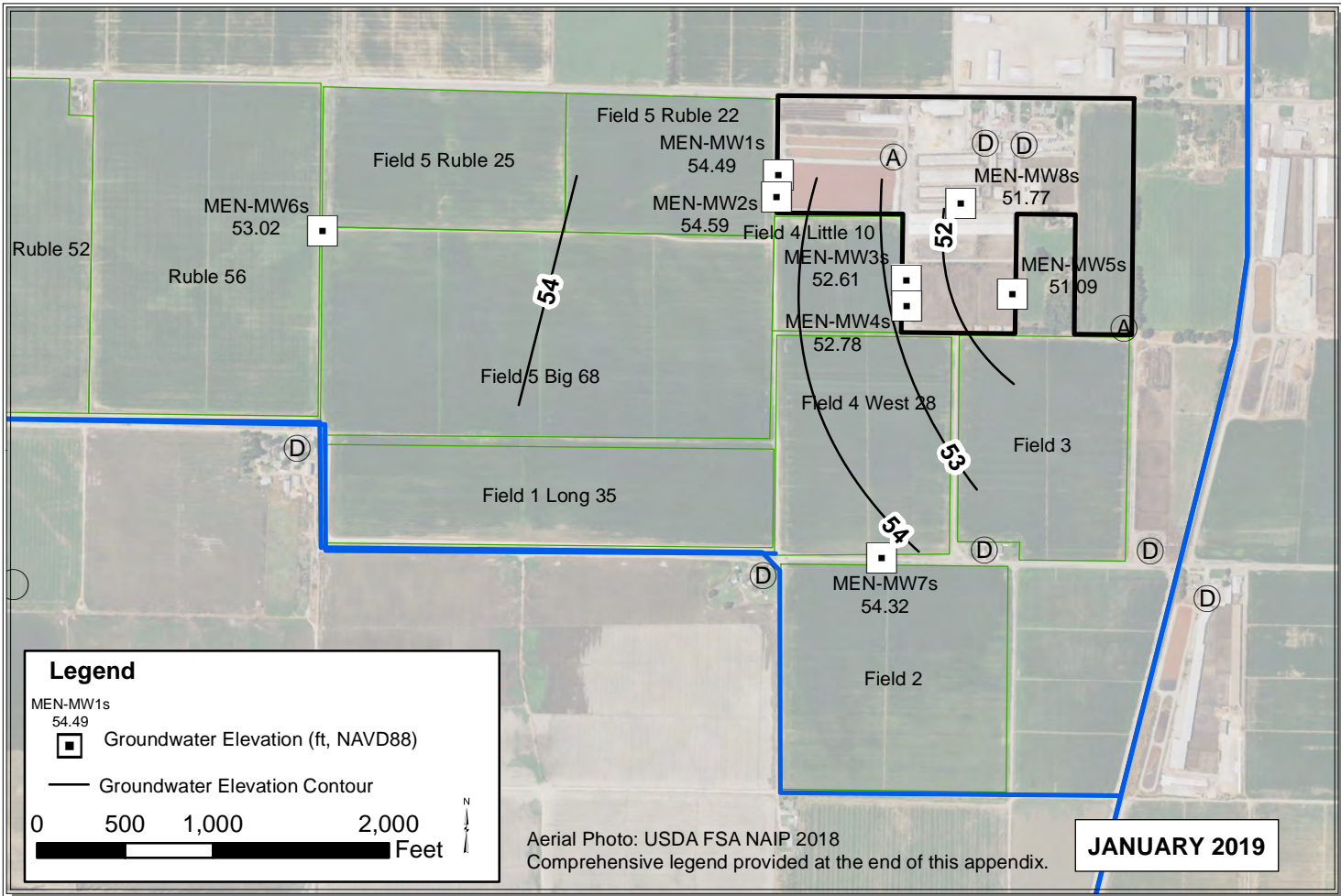

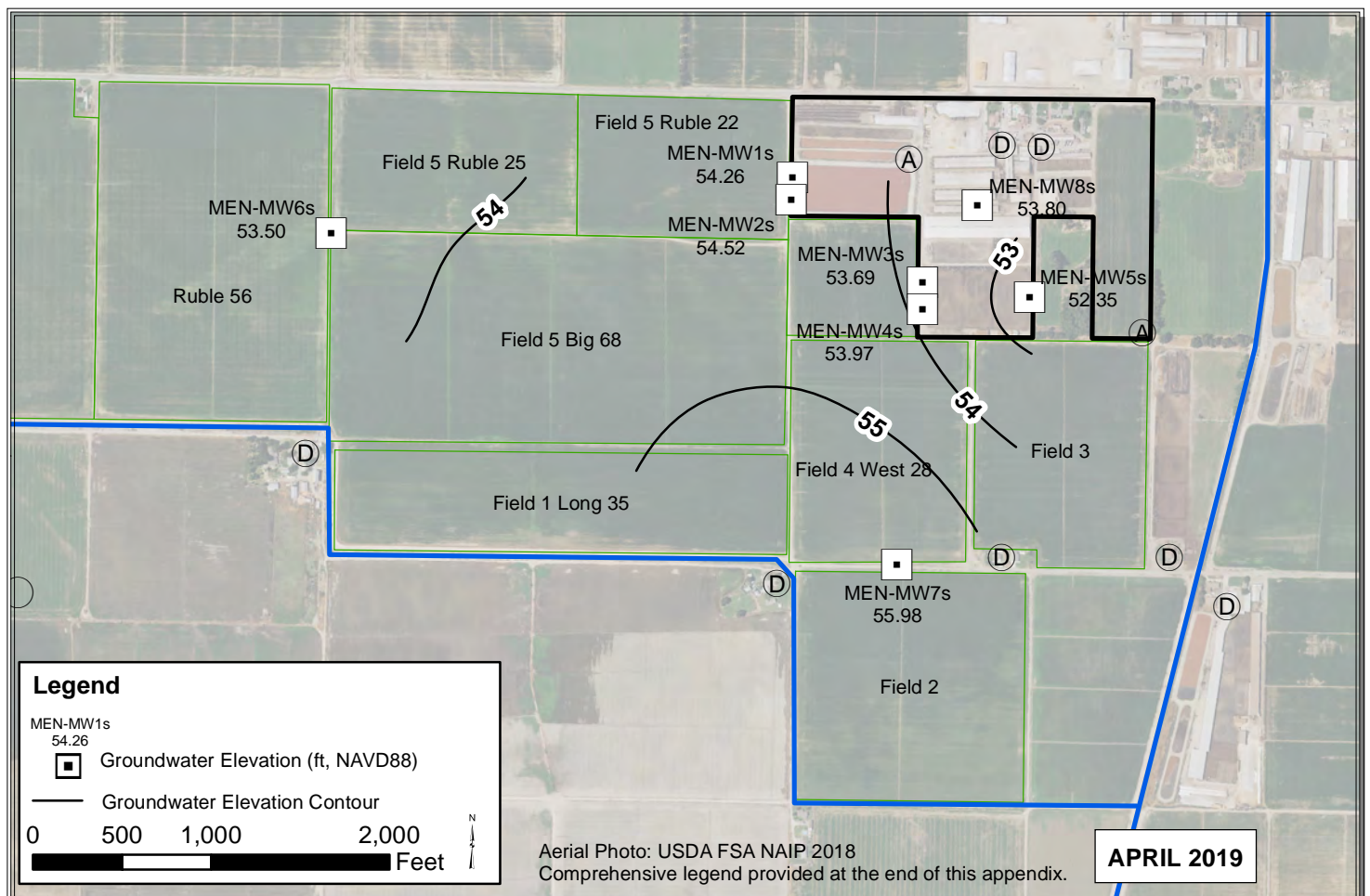
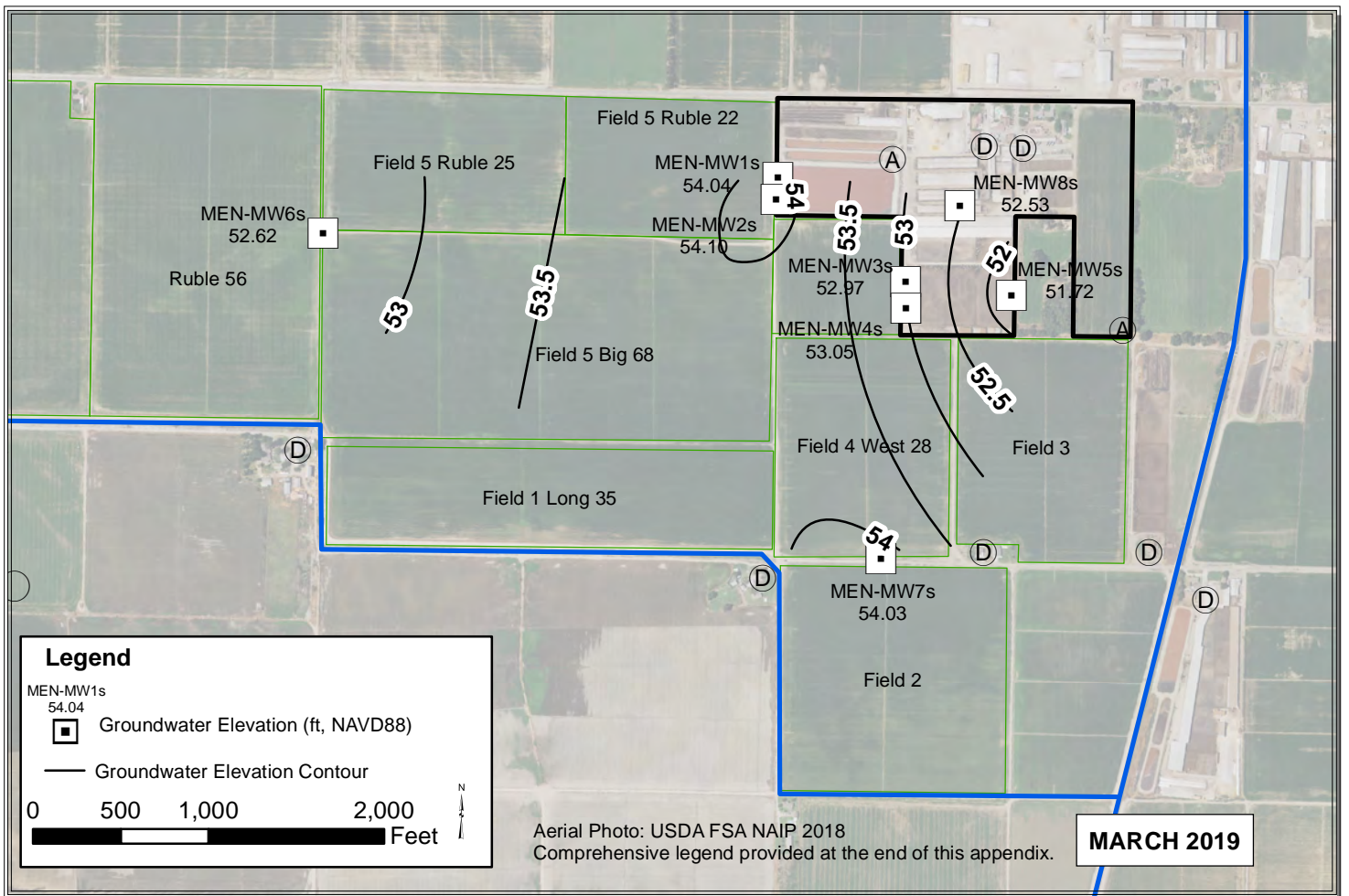

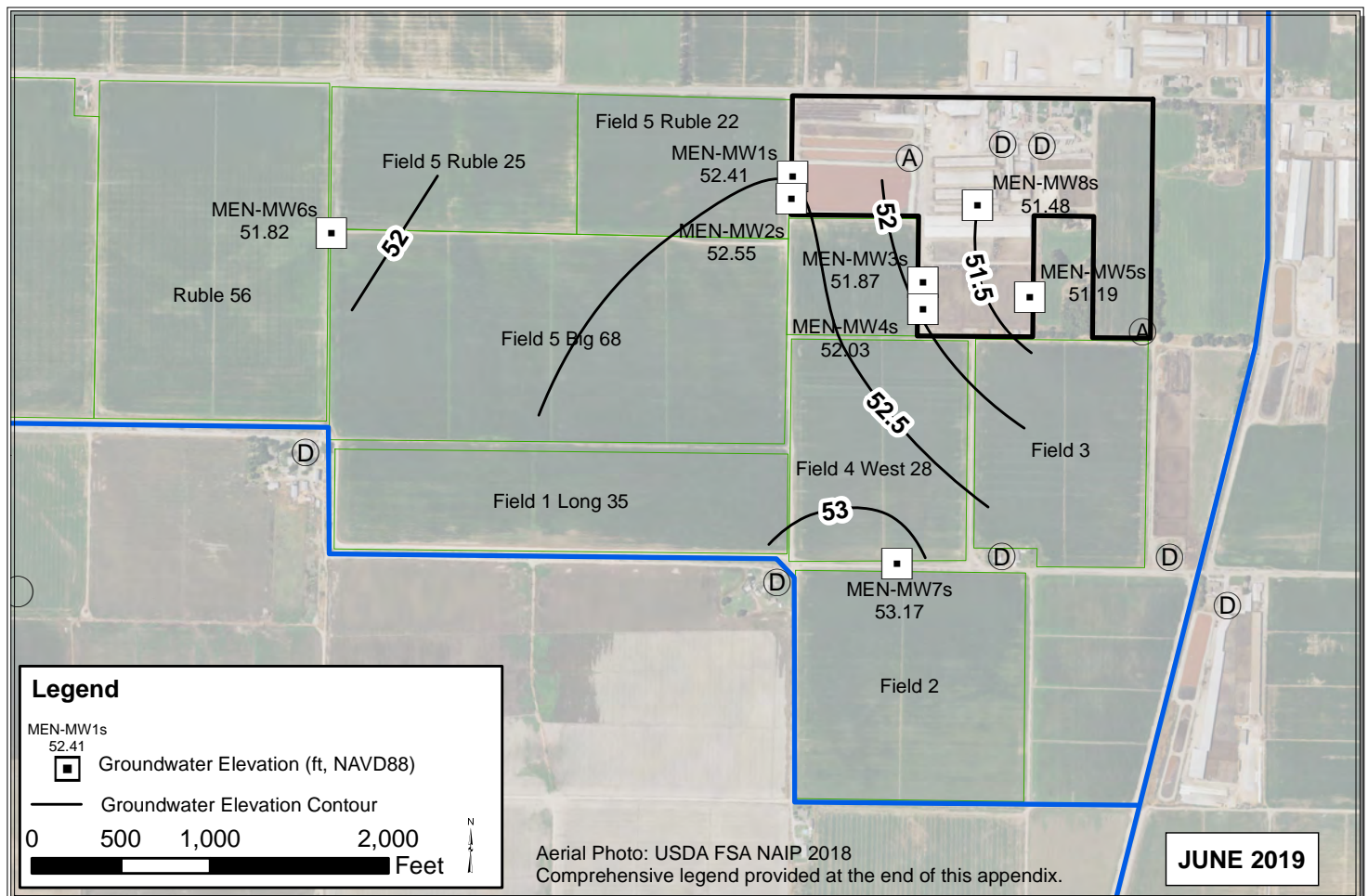
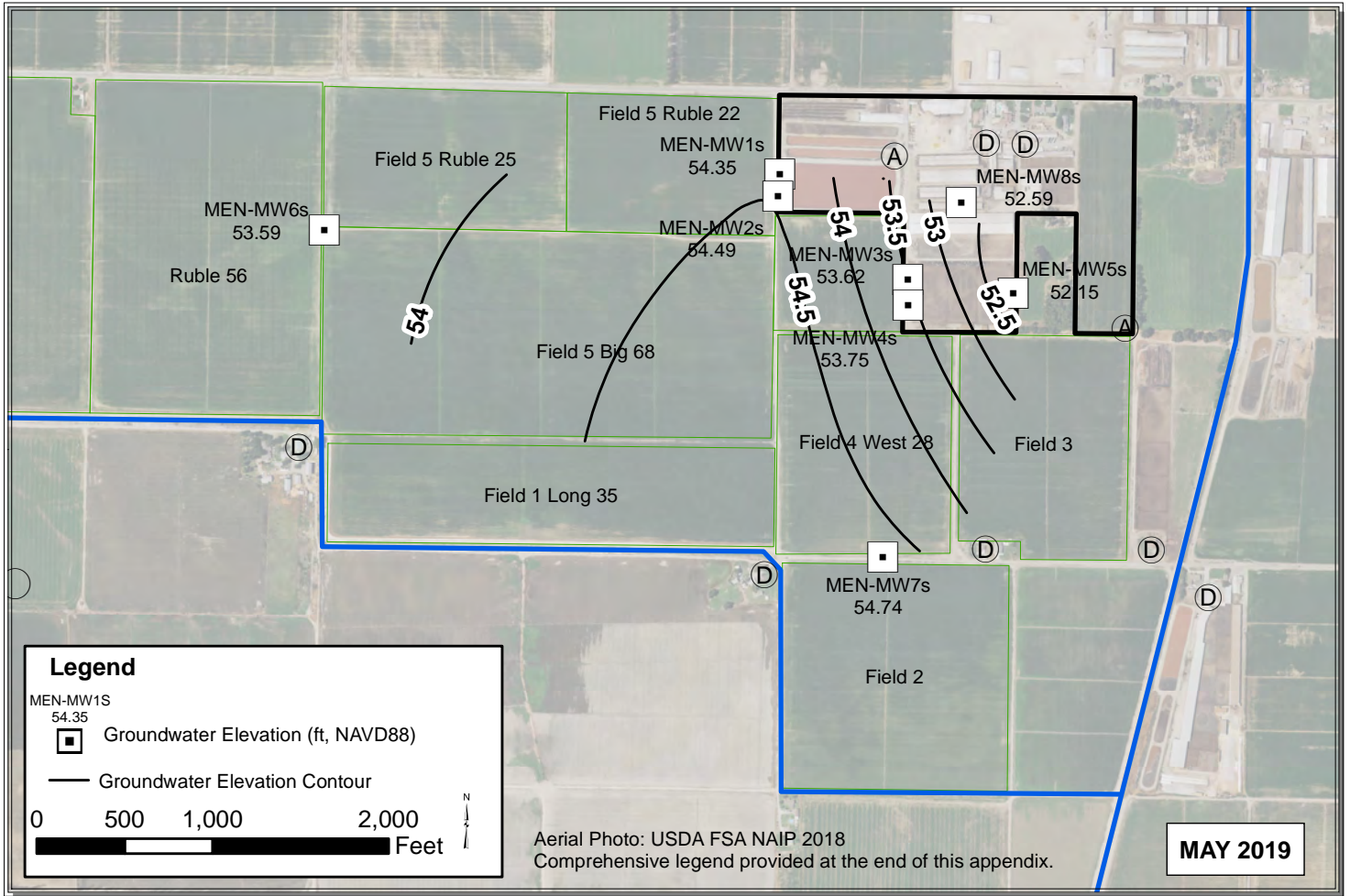

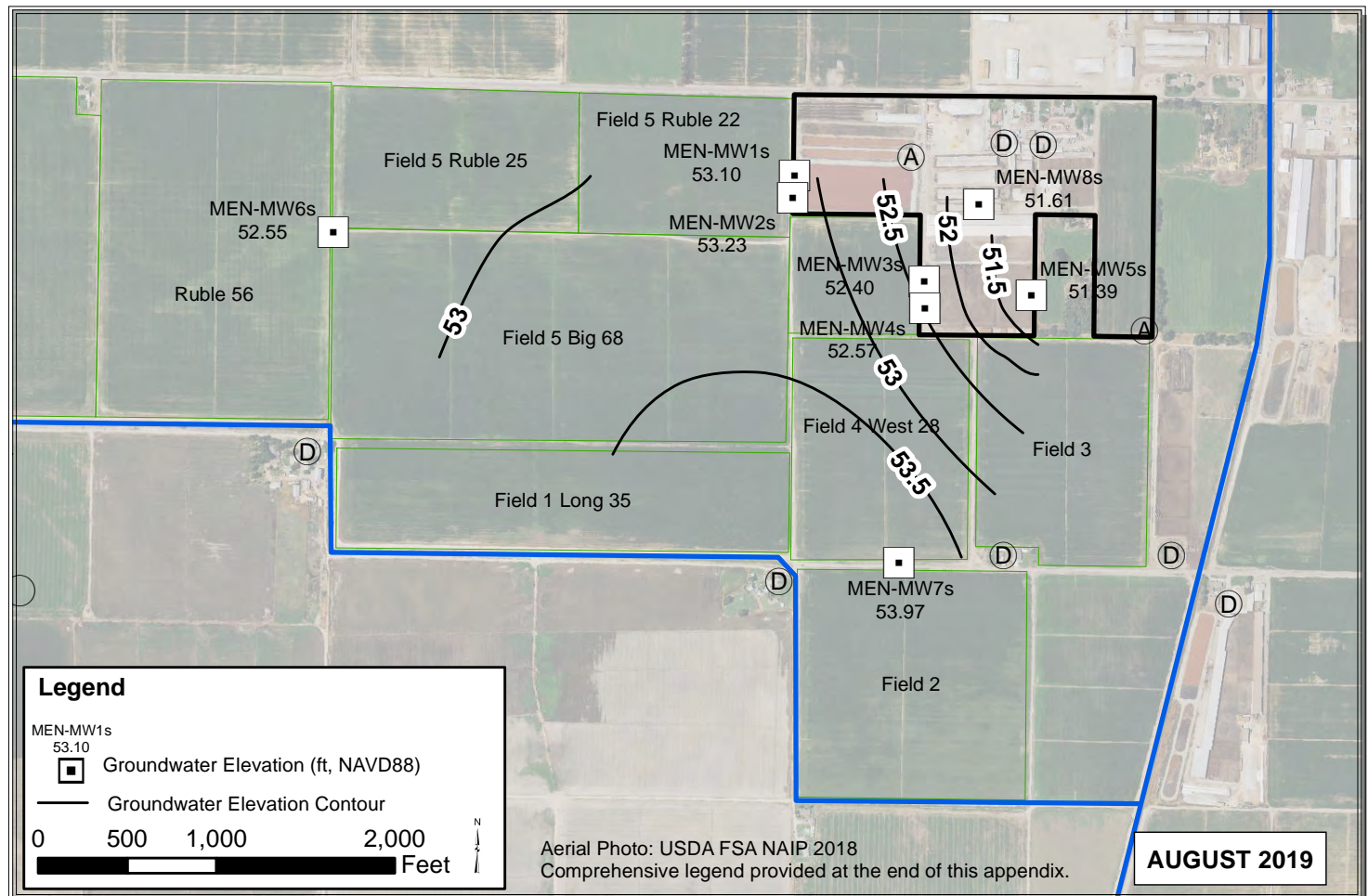
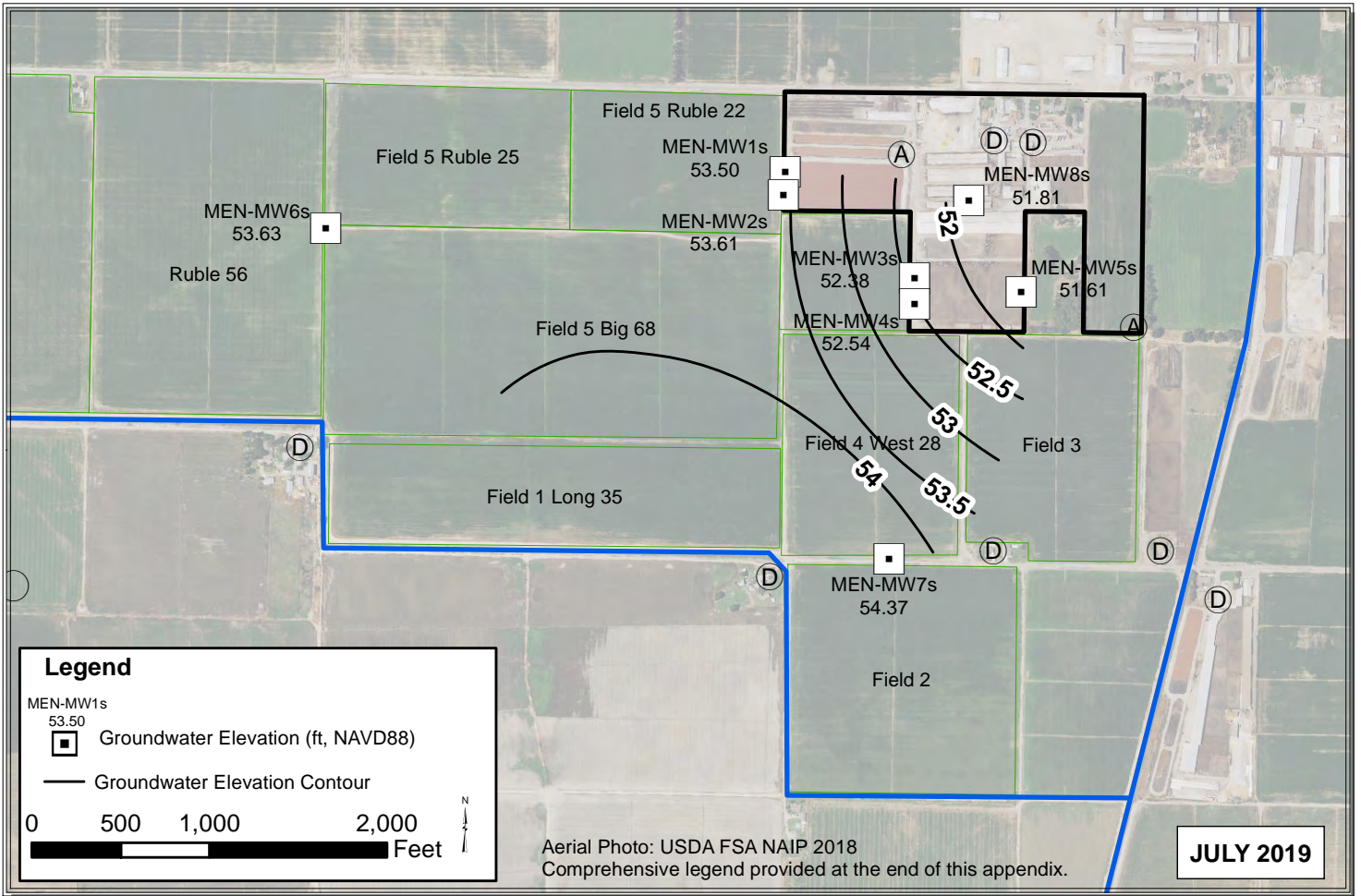

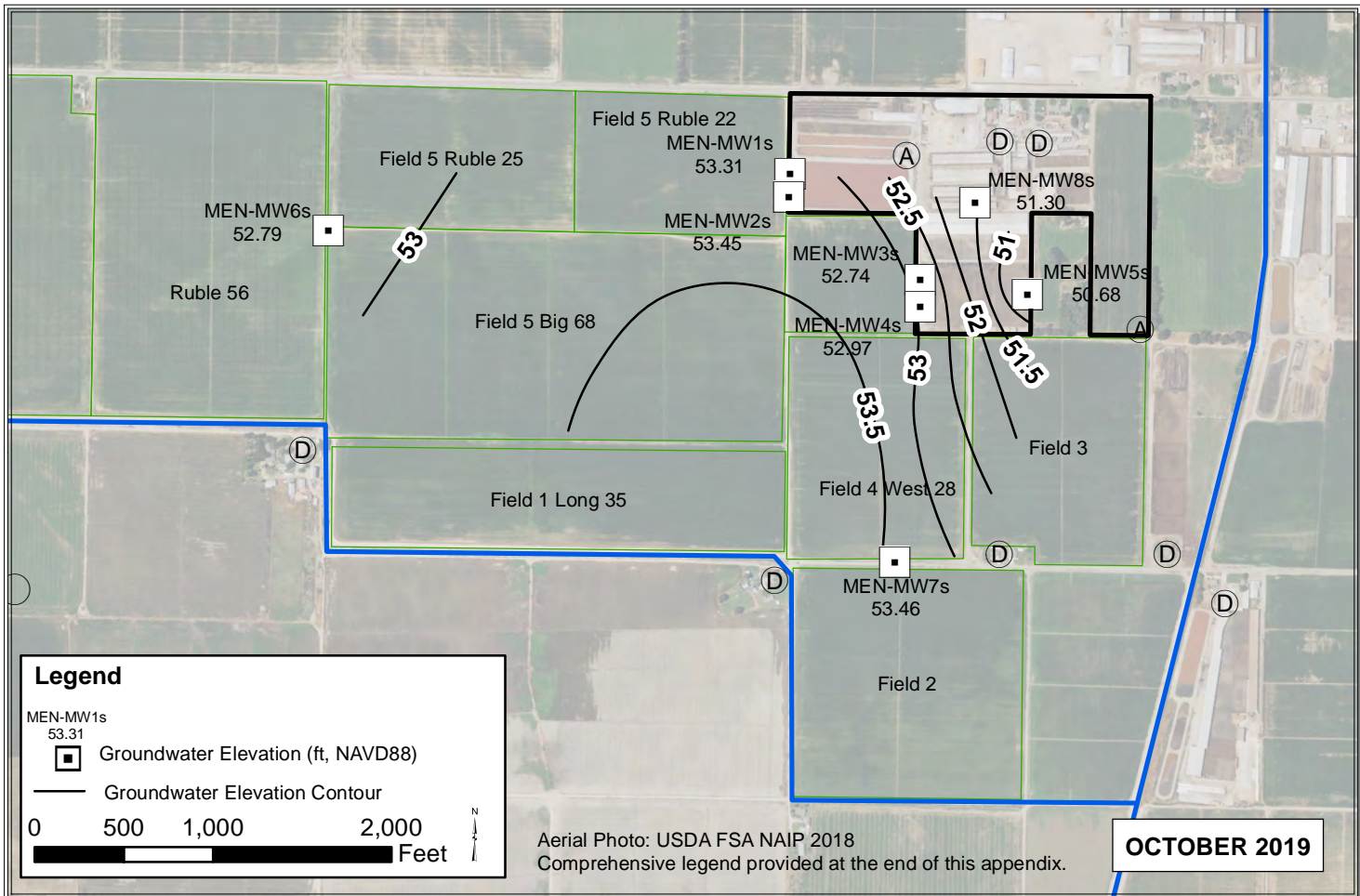
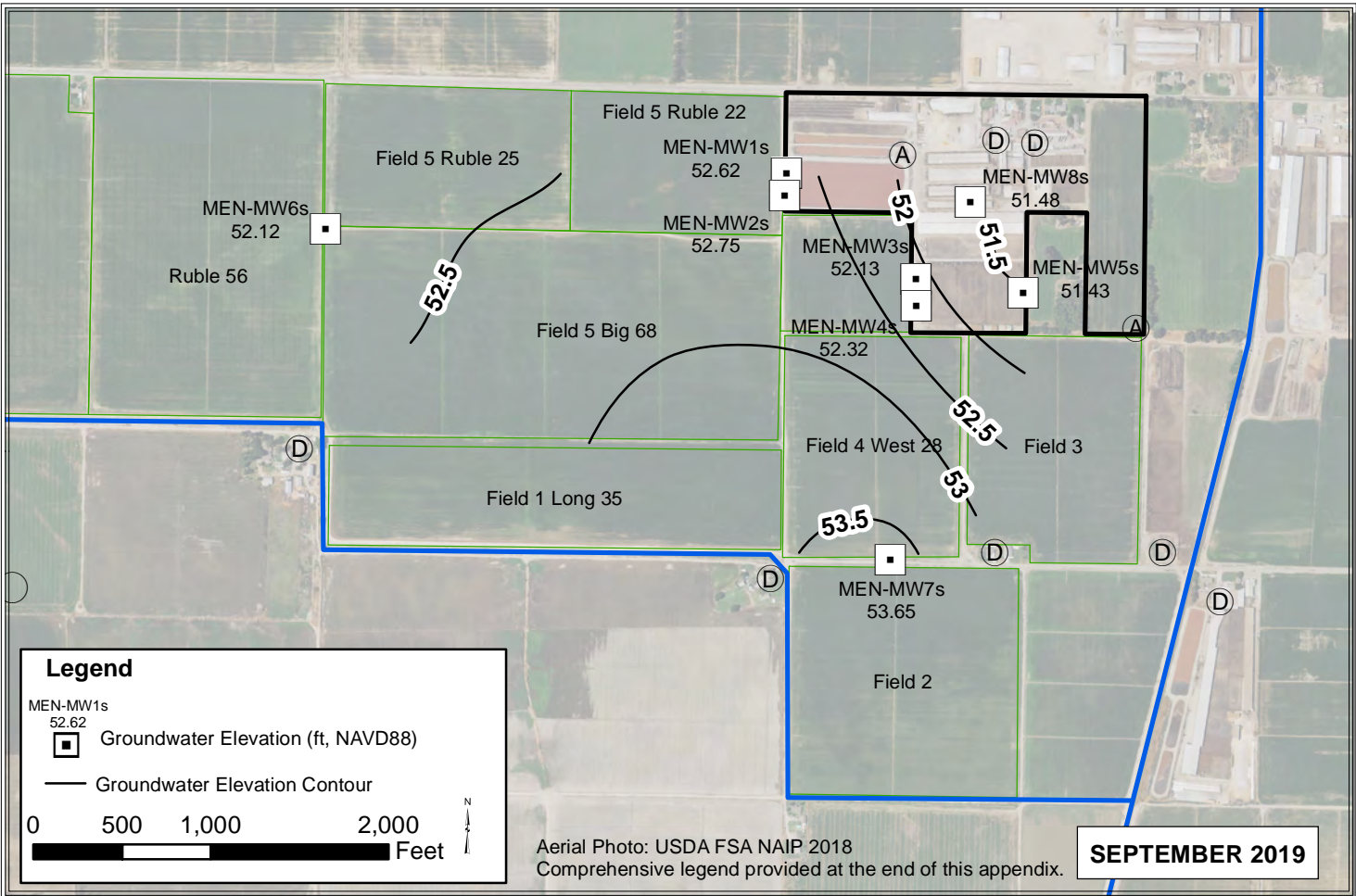

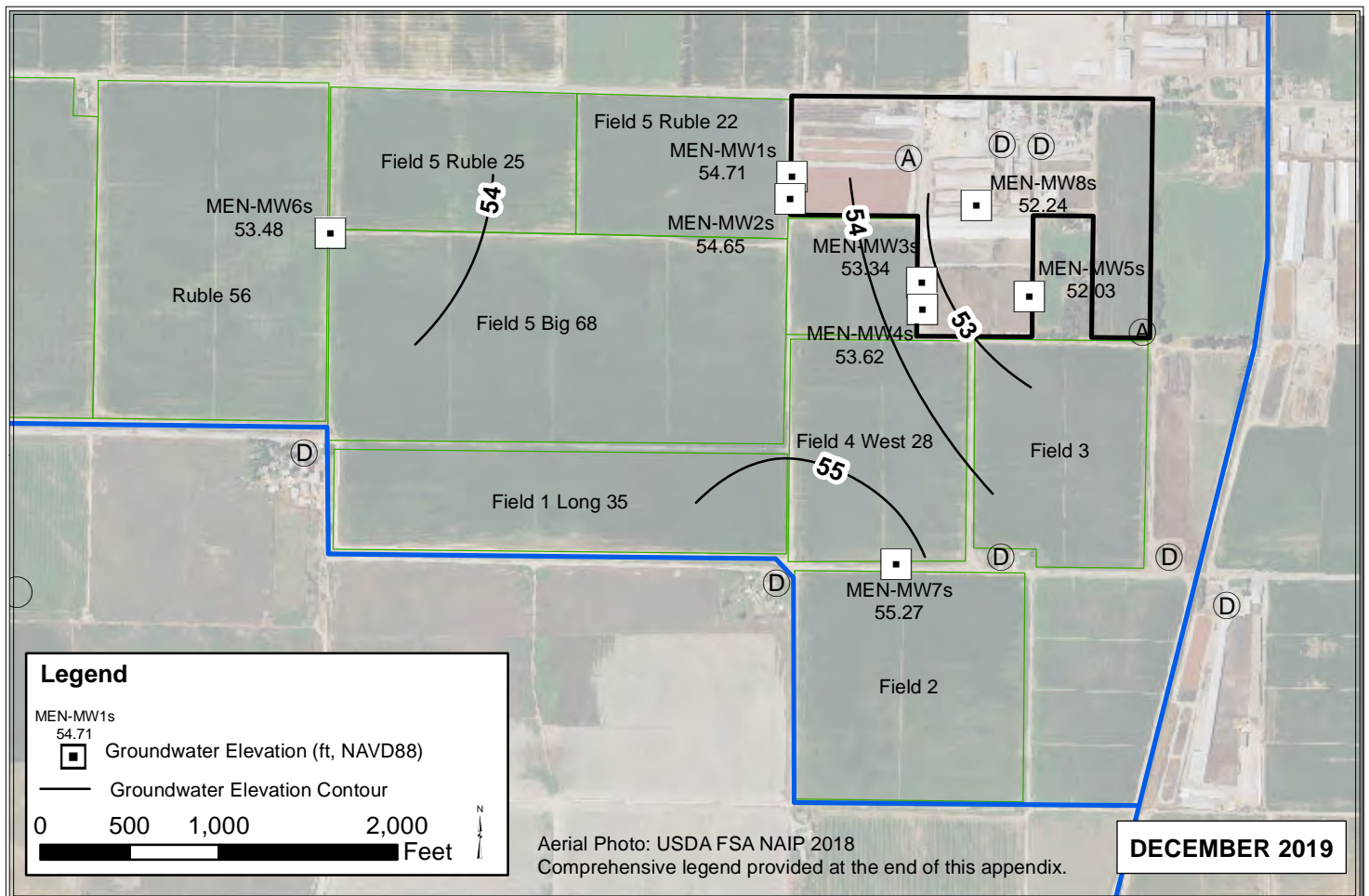
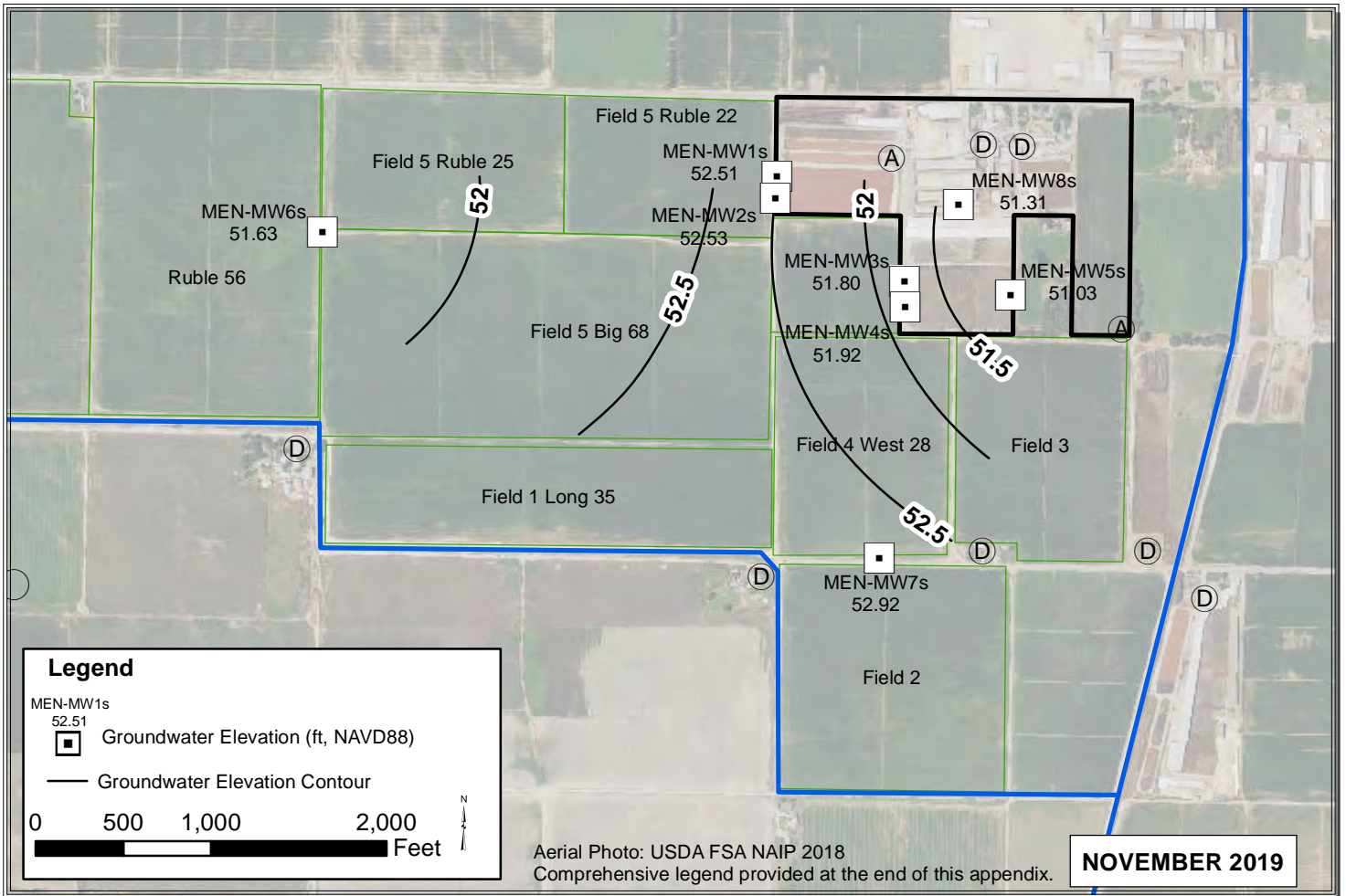

ANC

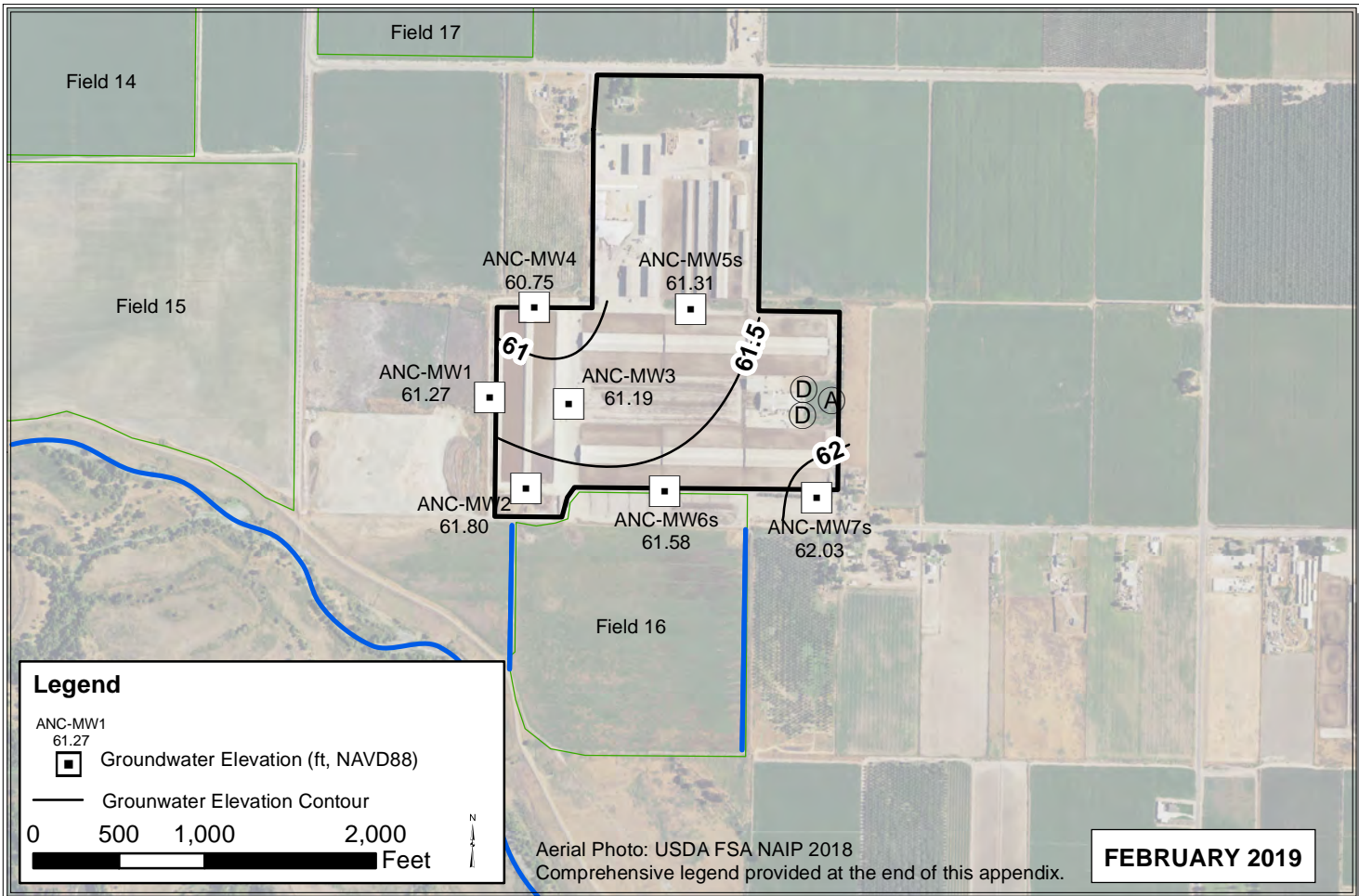
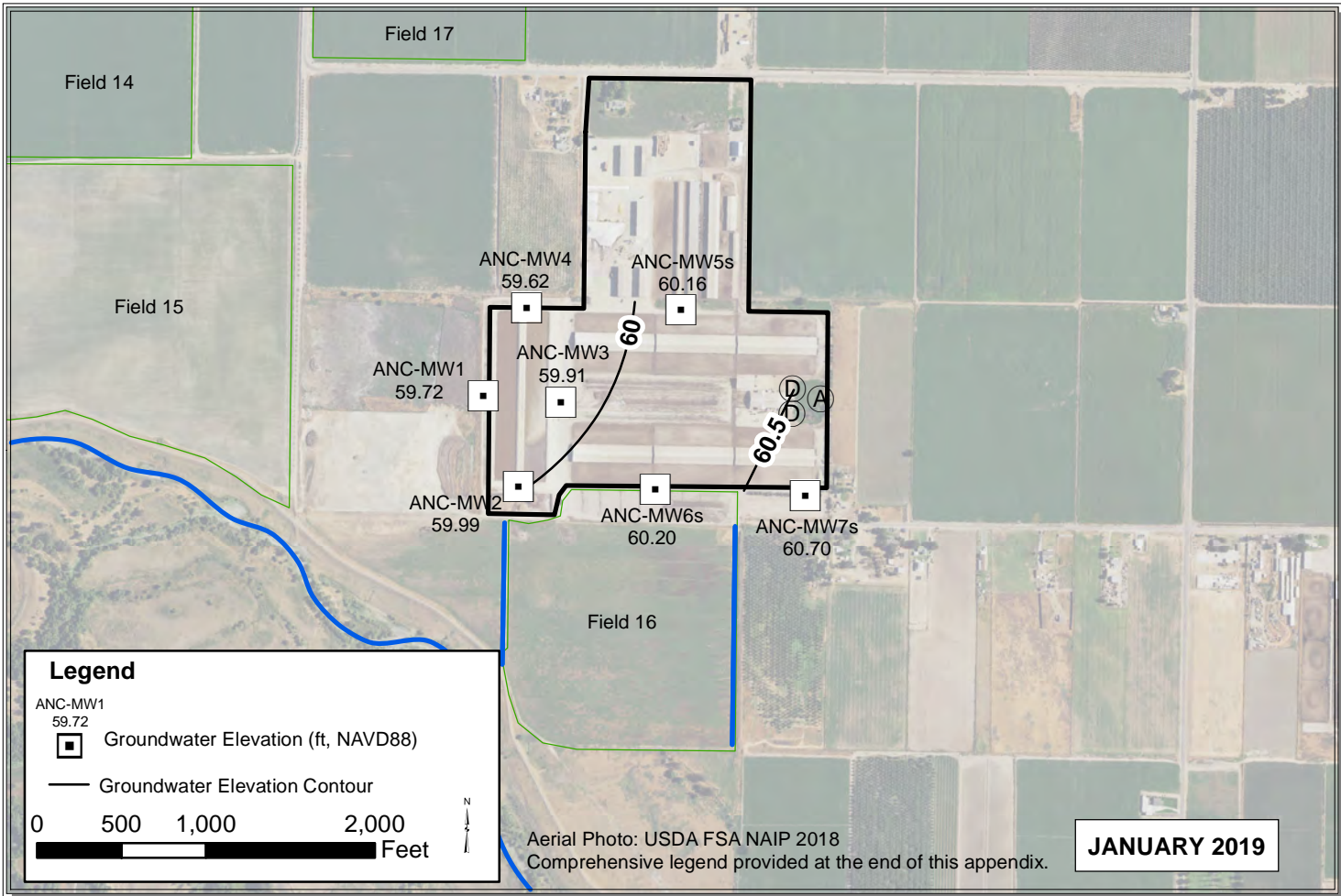

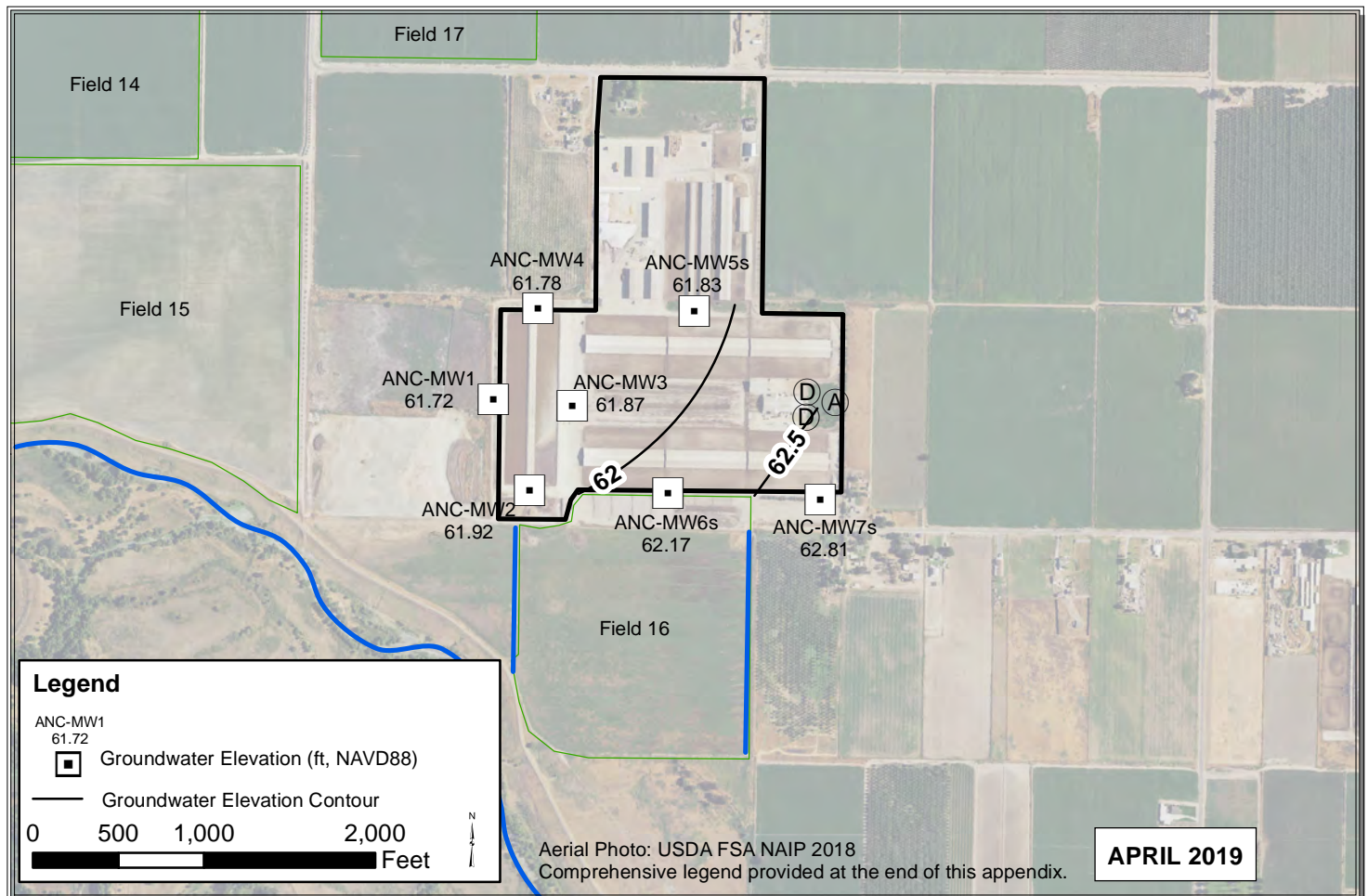
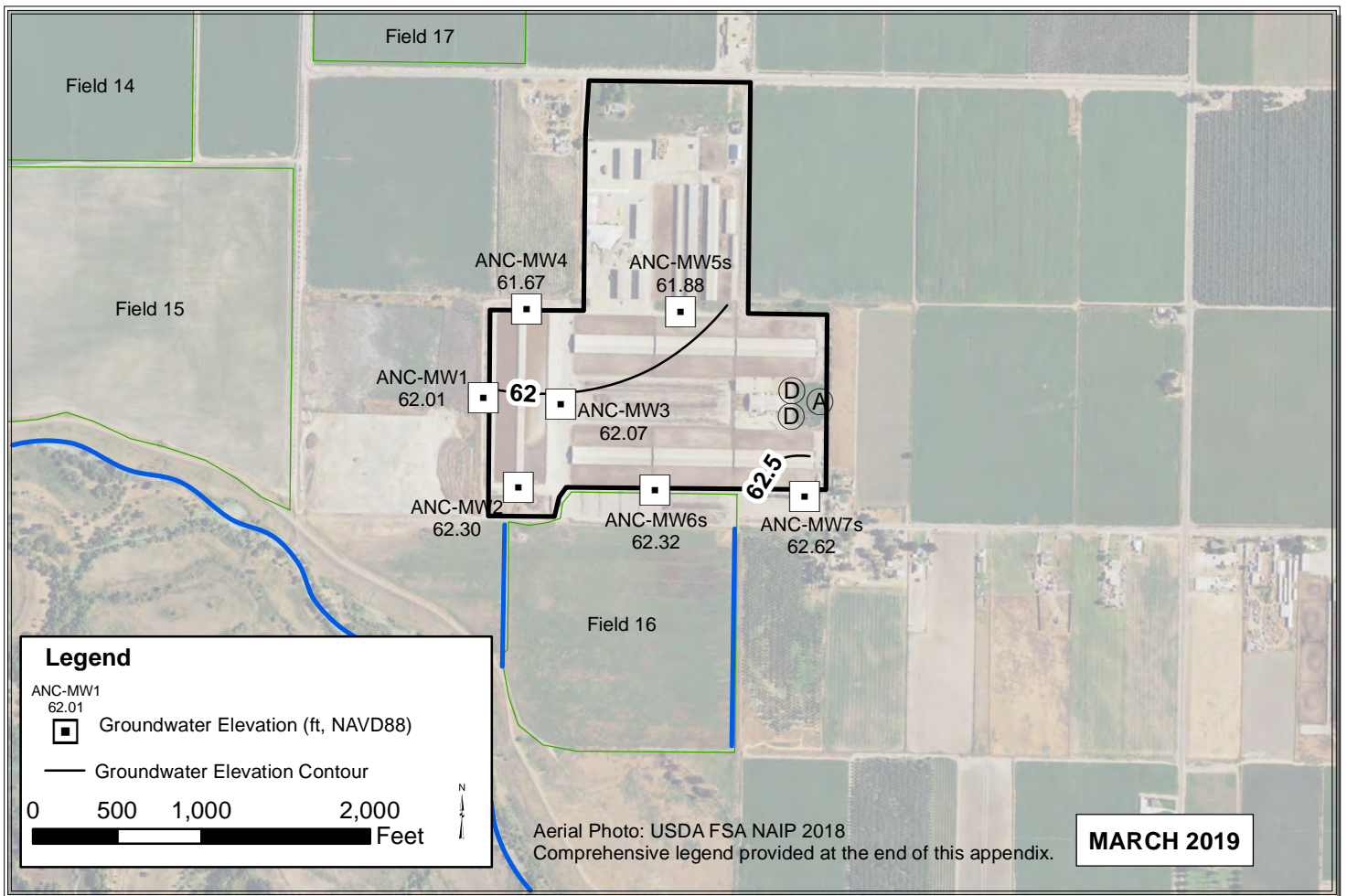

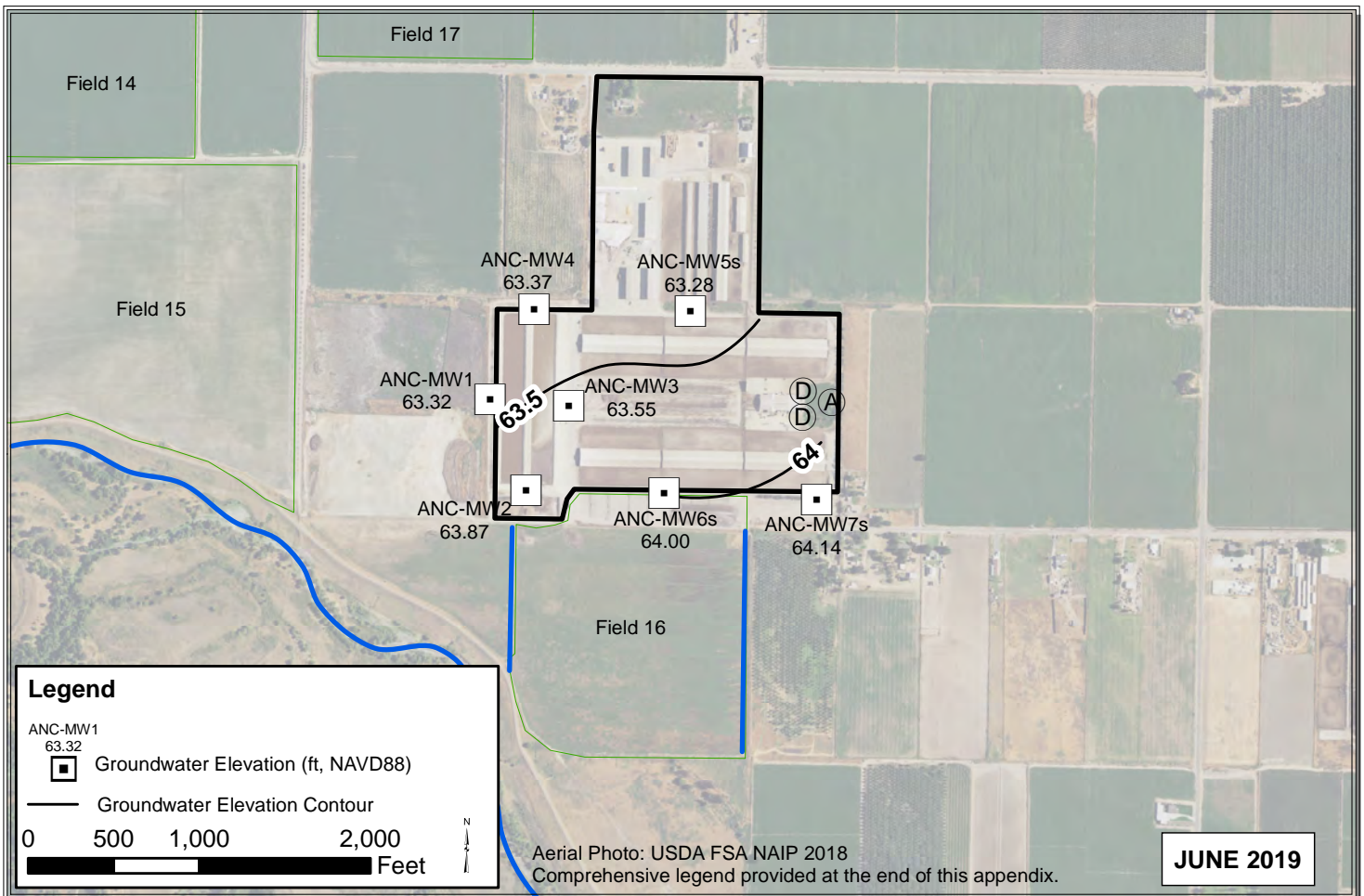
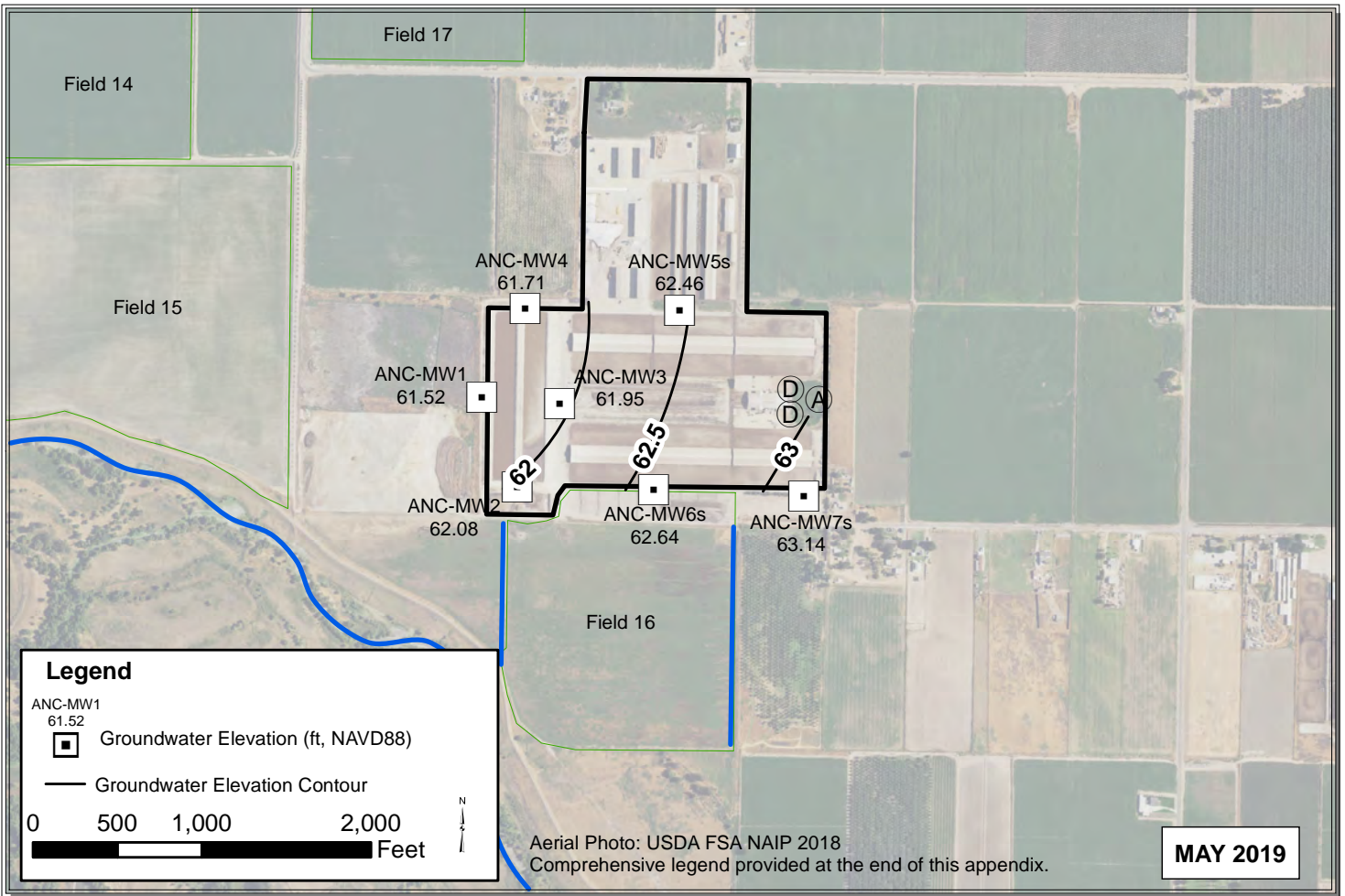

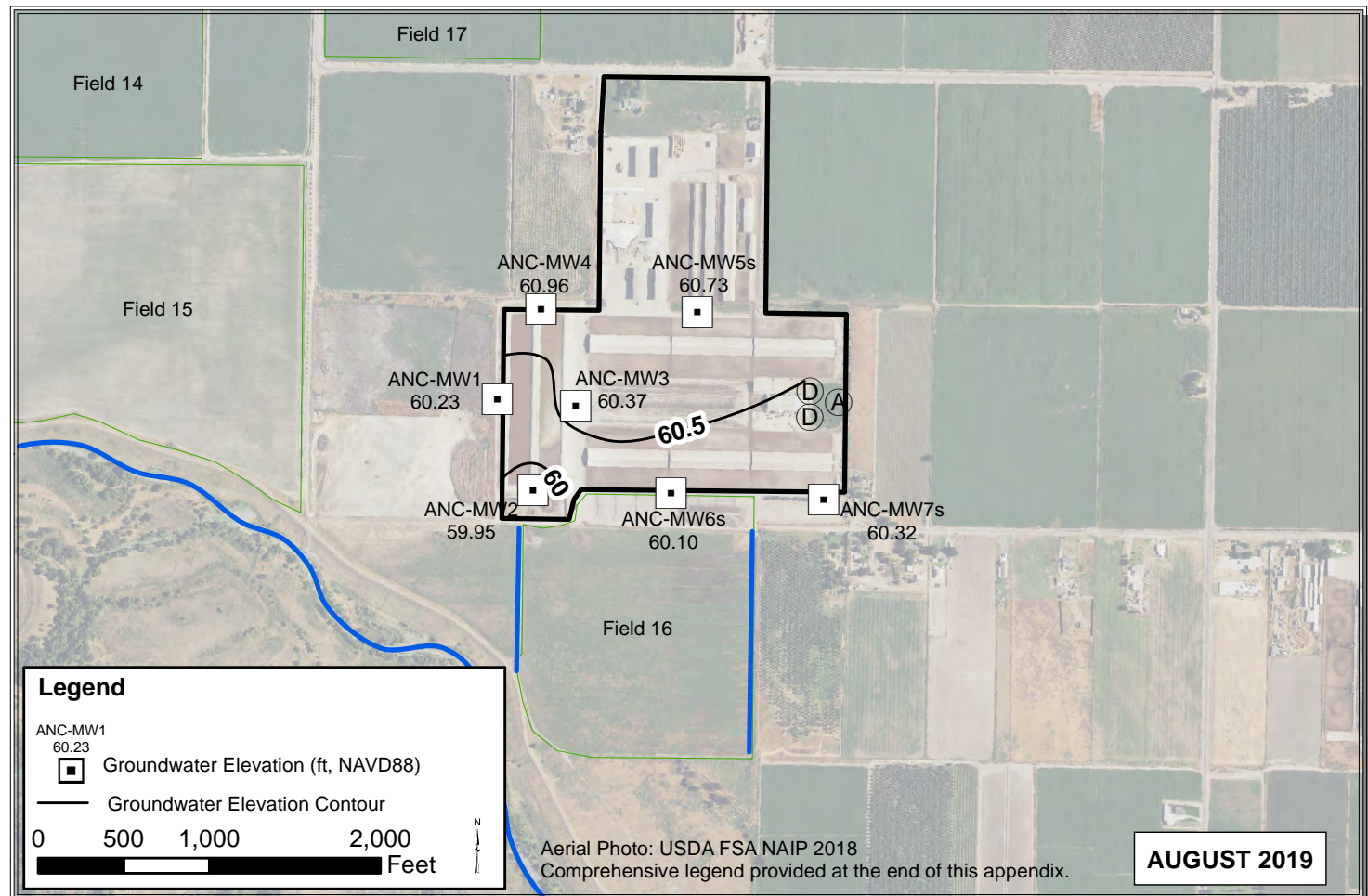
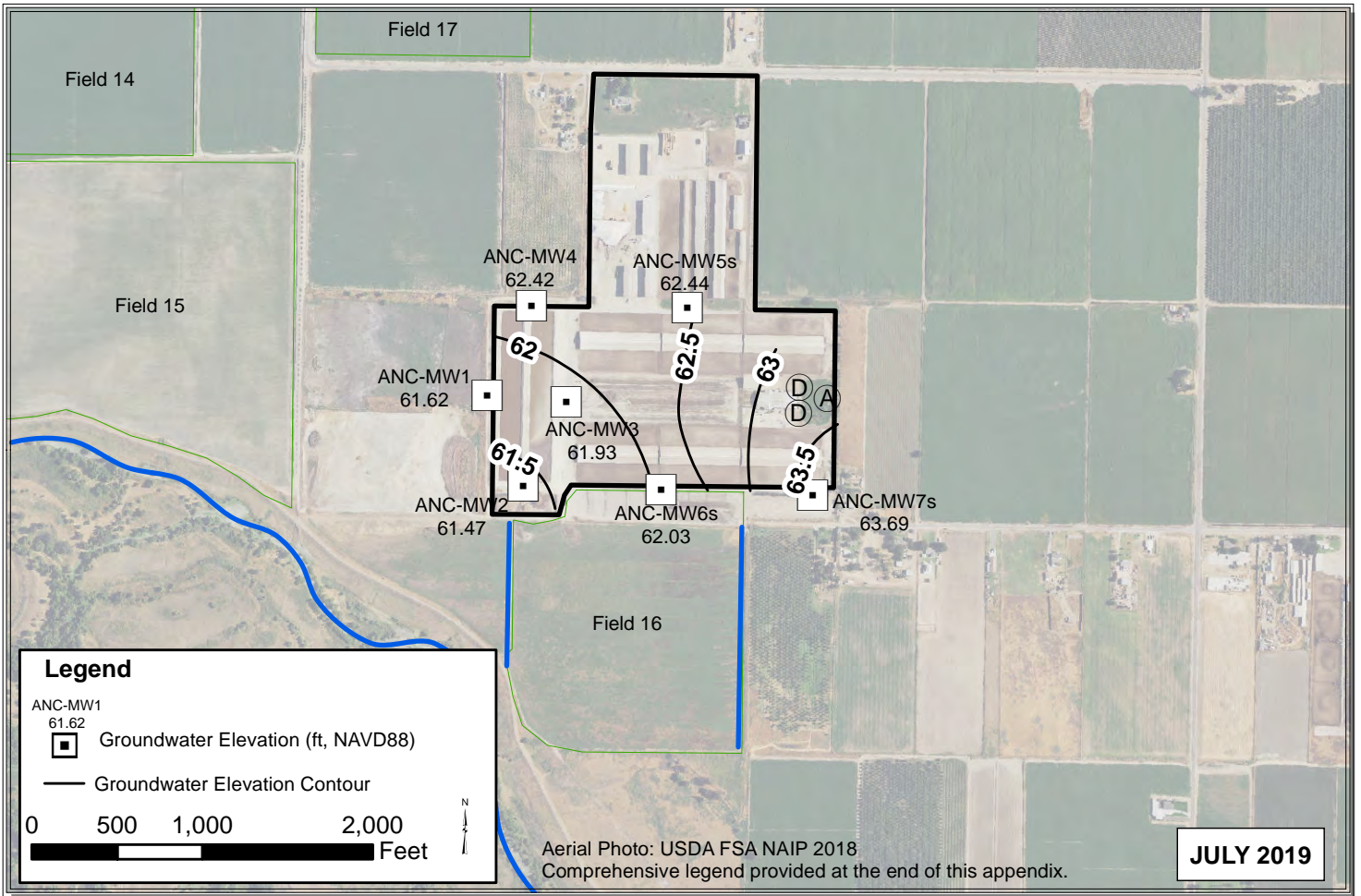

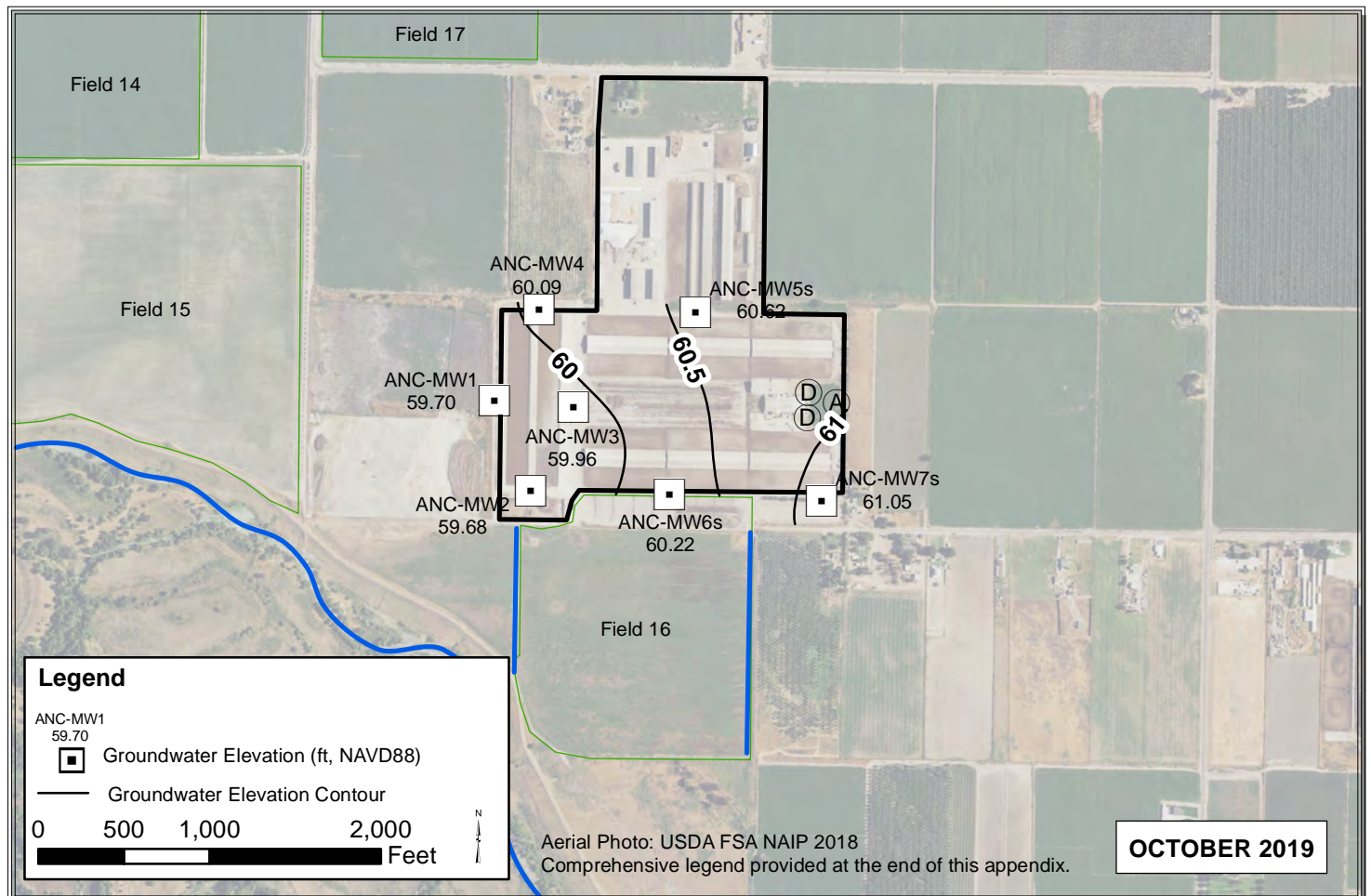
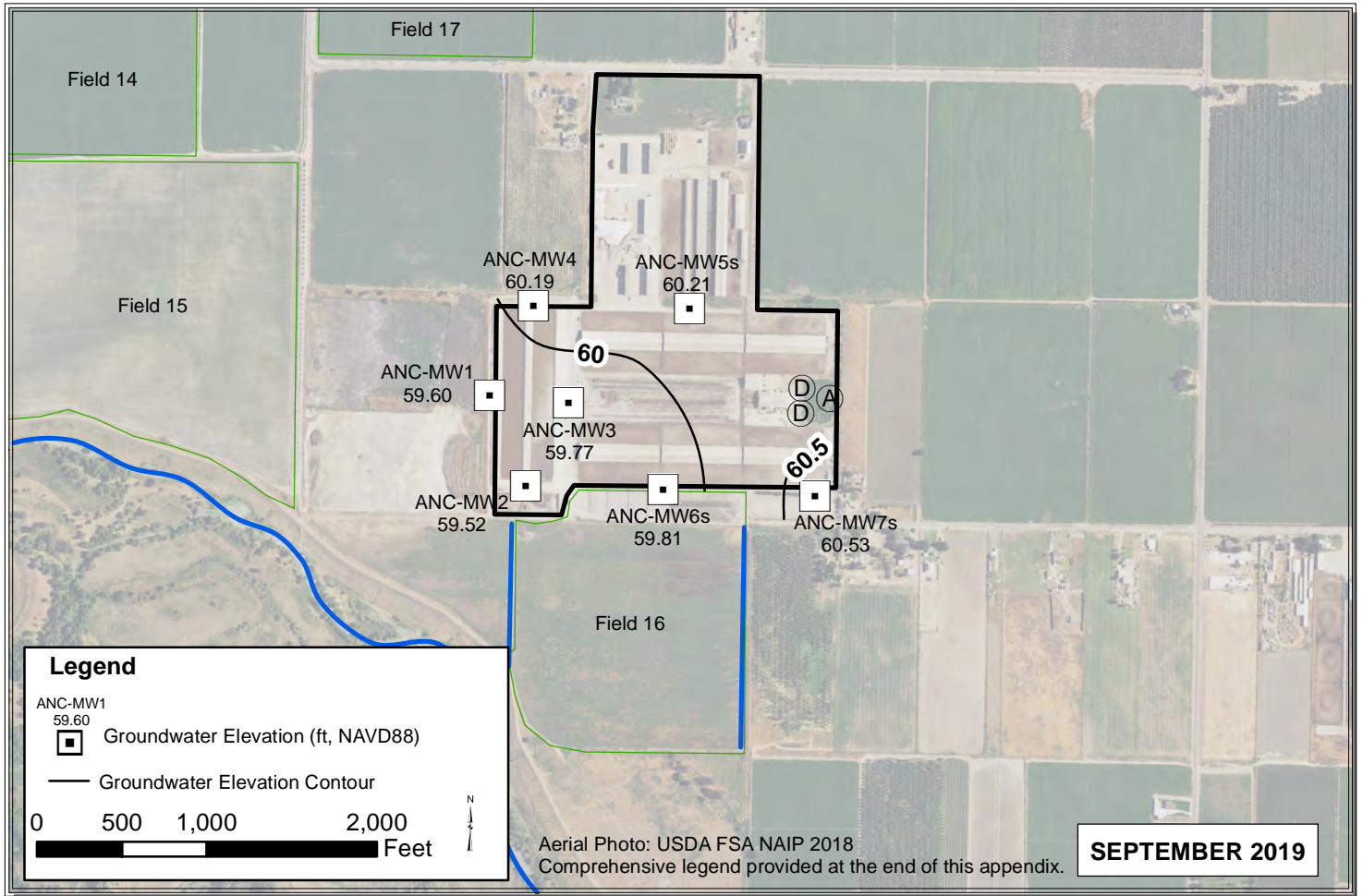

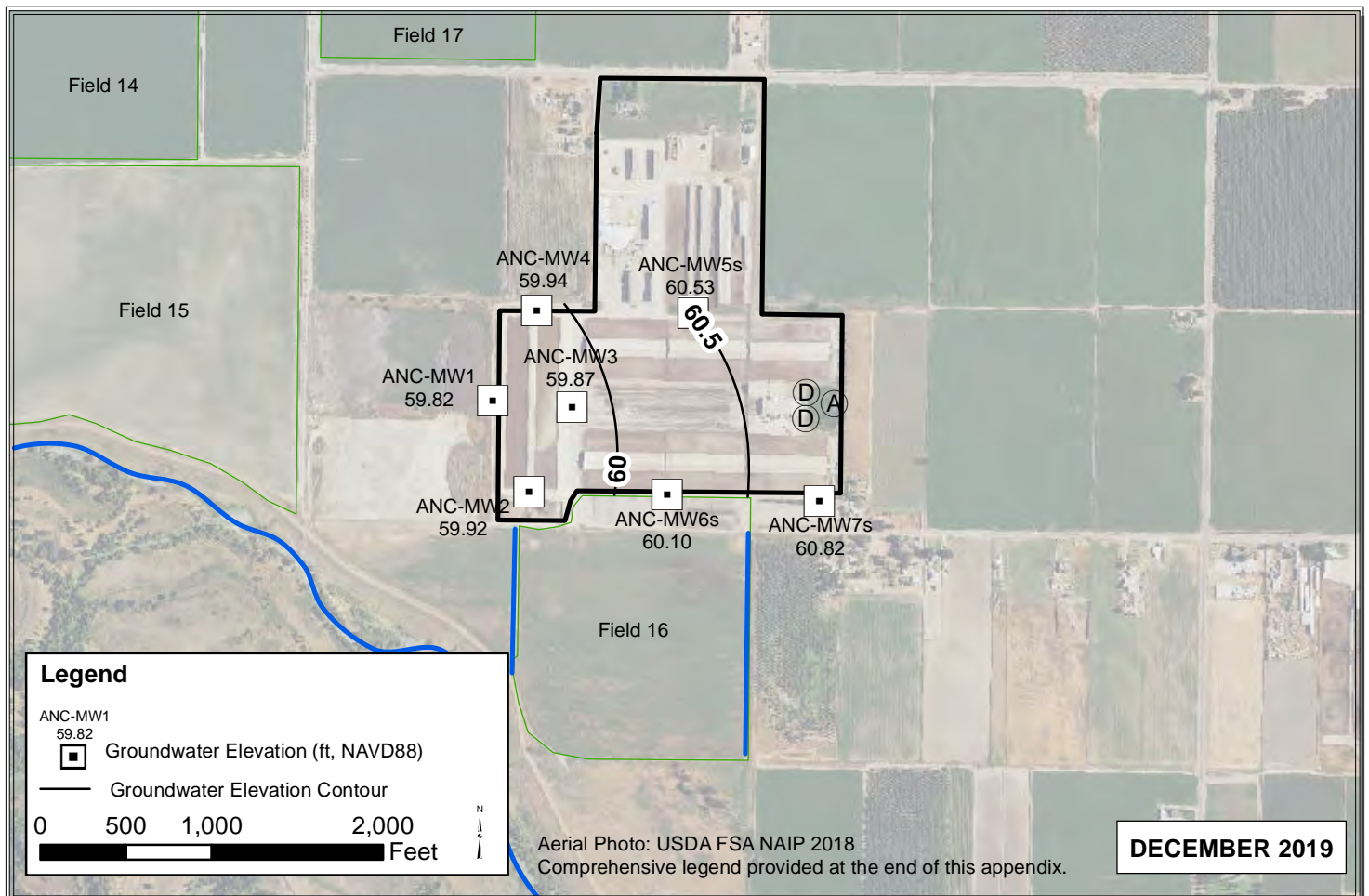
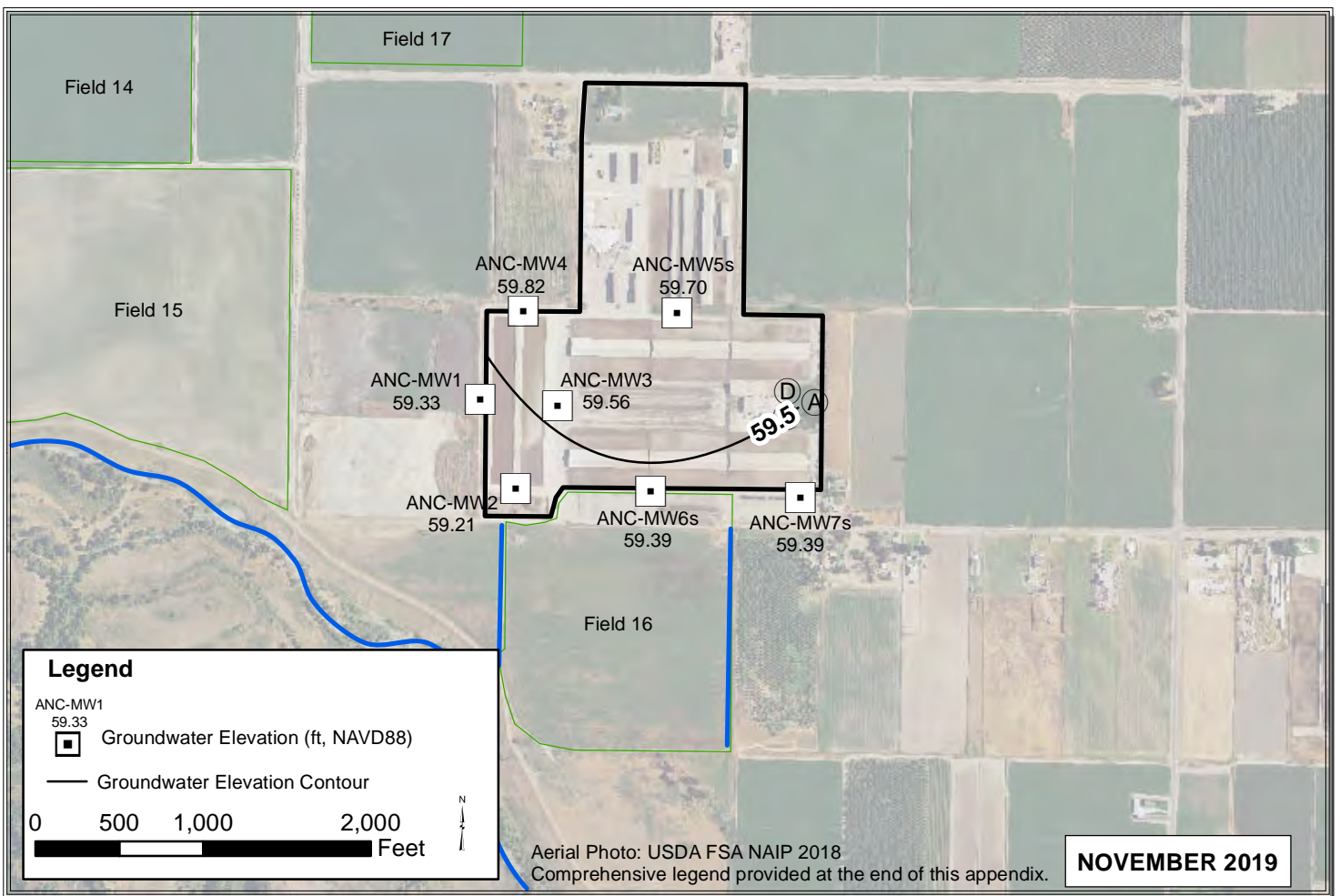

BET

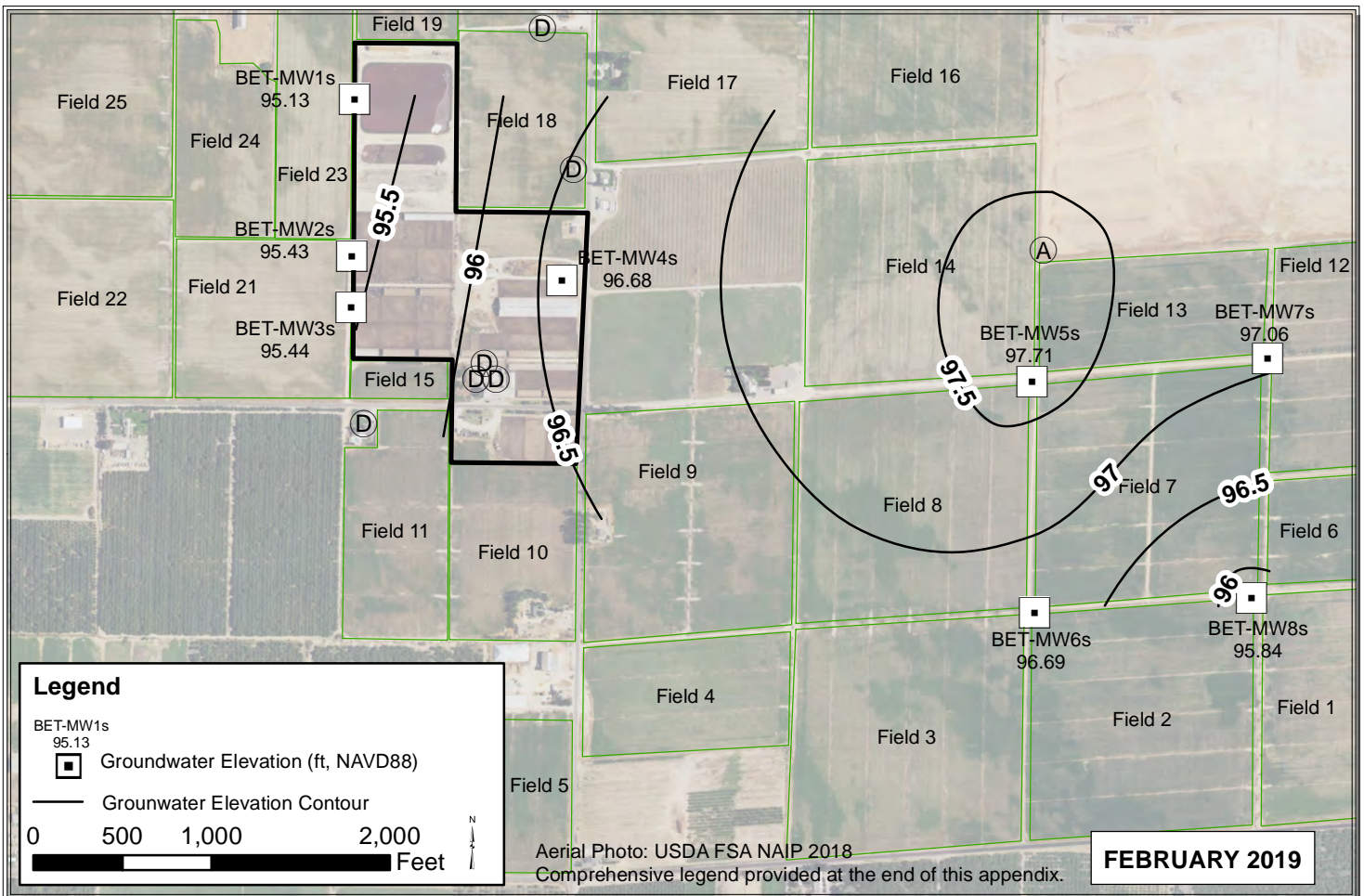
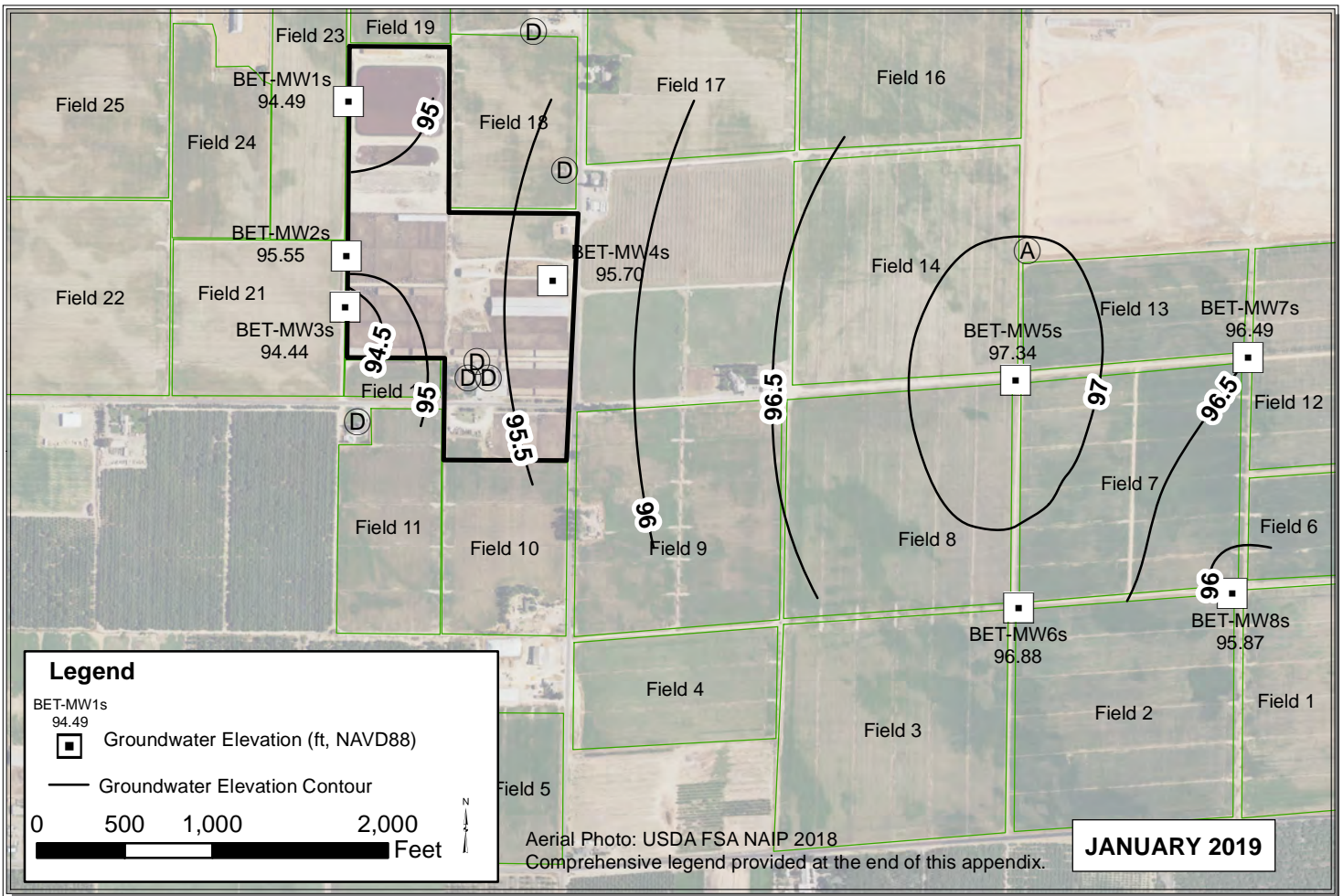

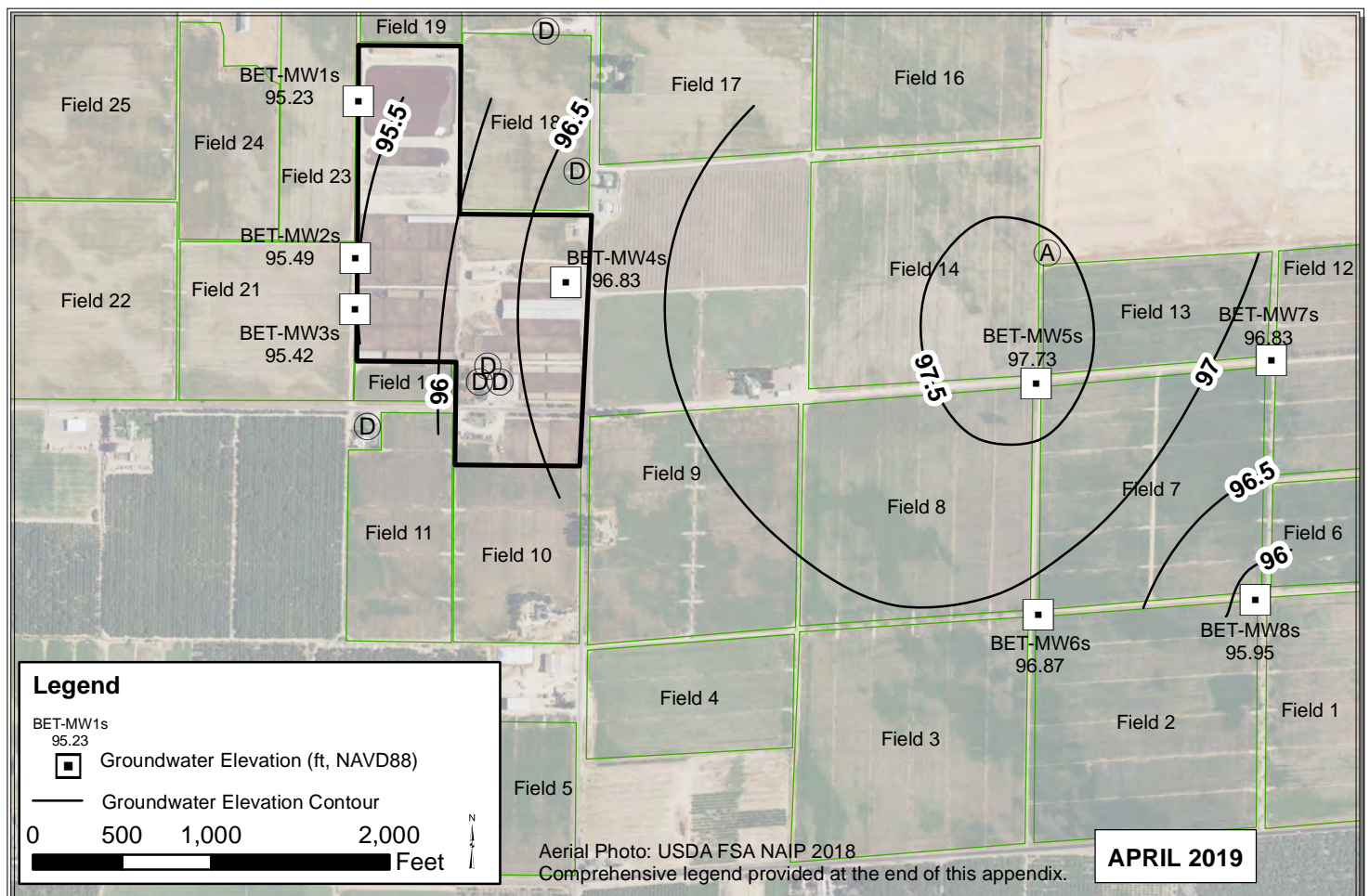
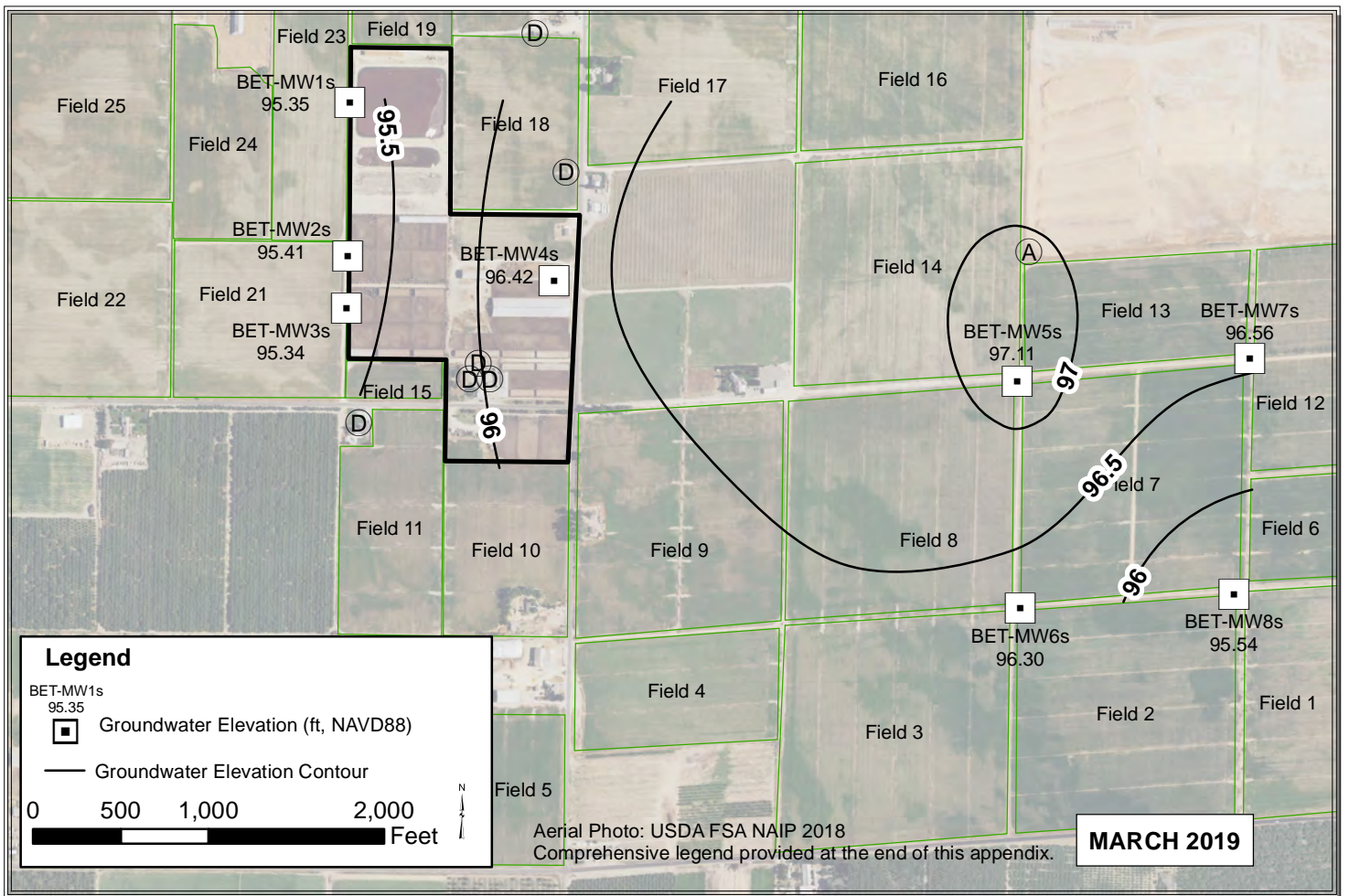

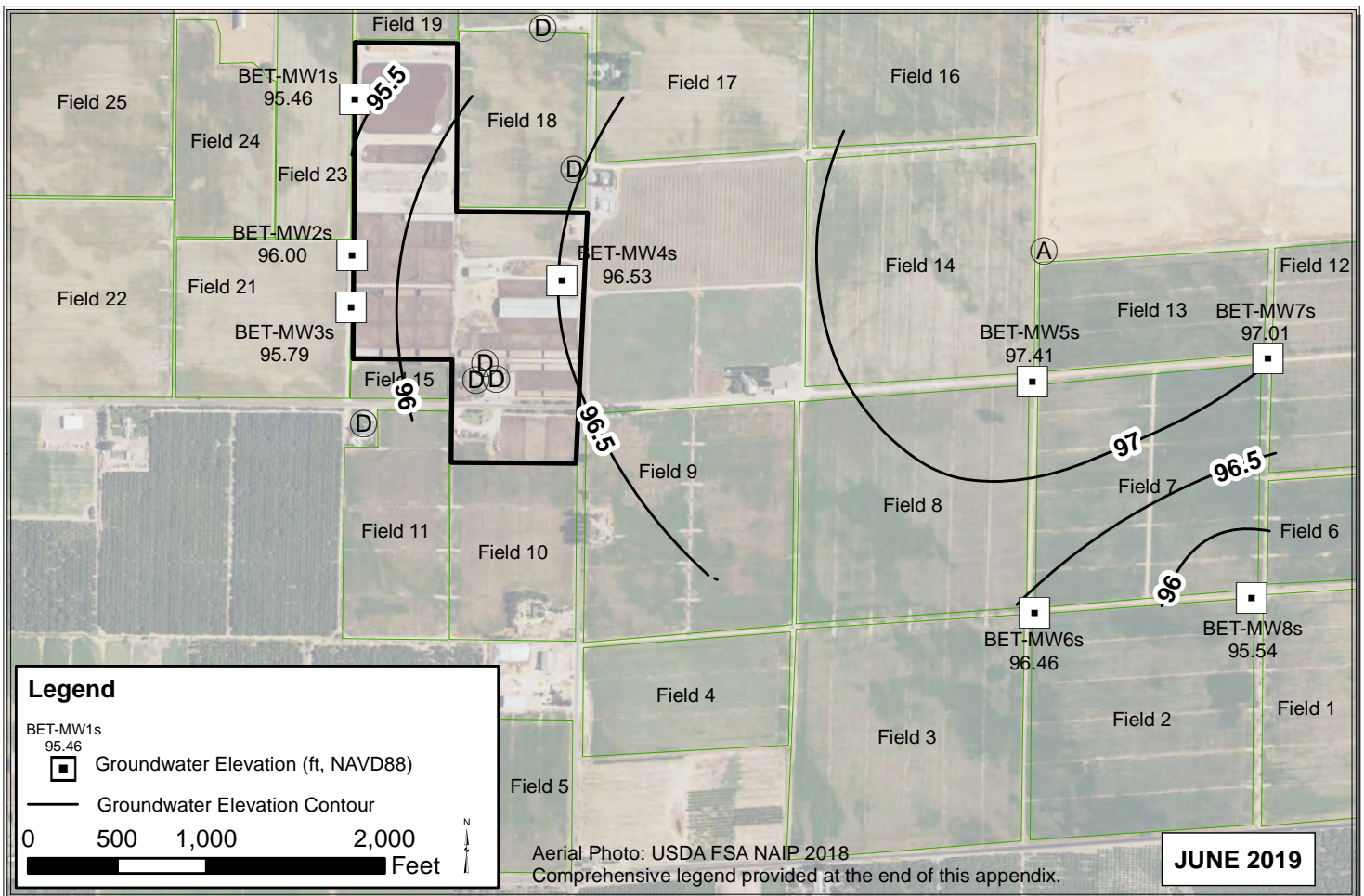
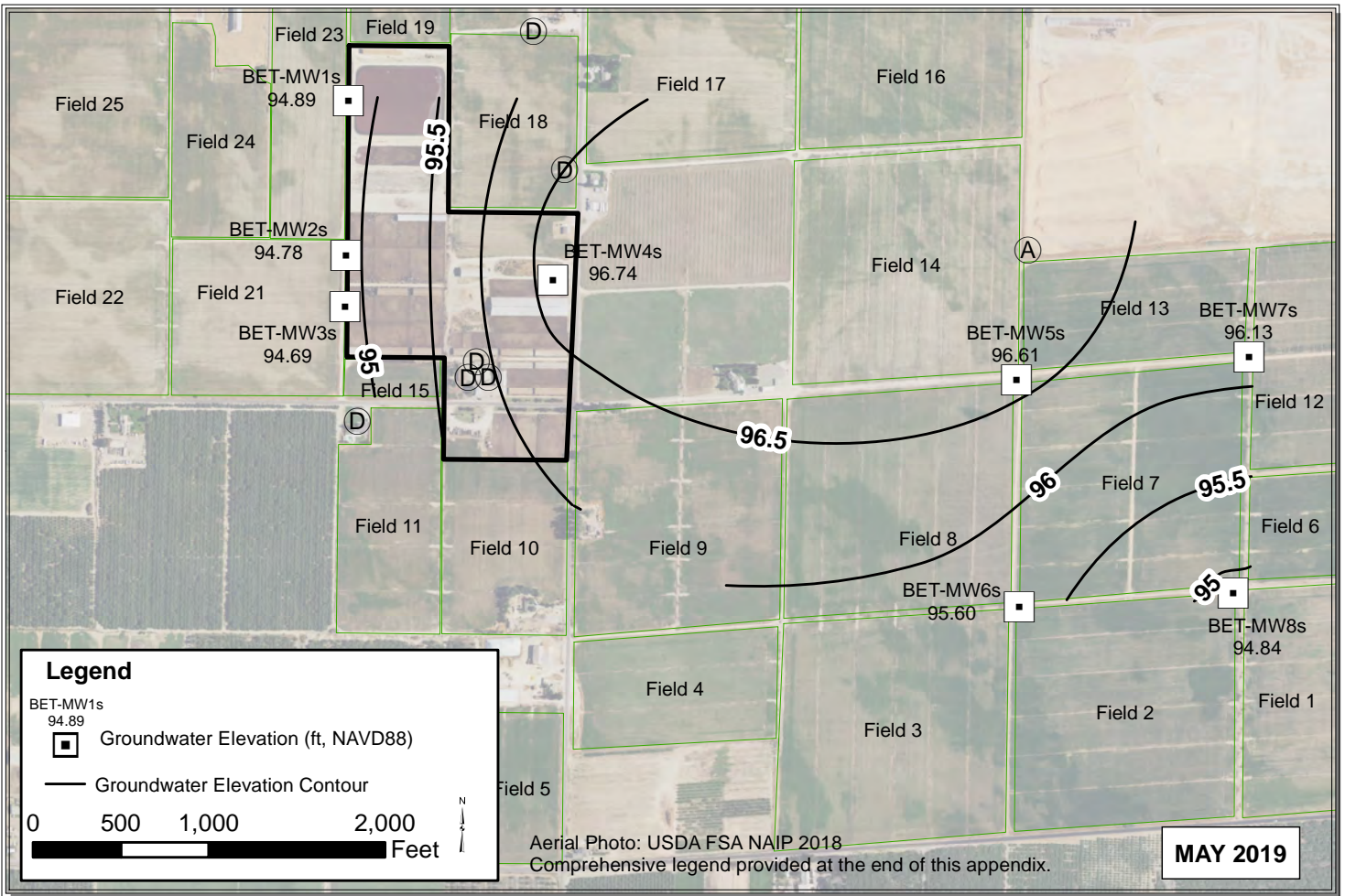

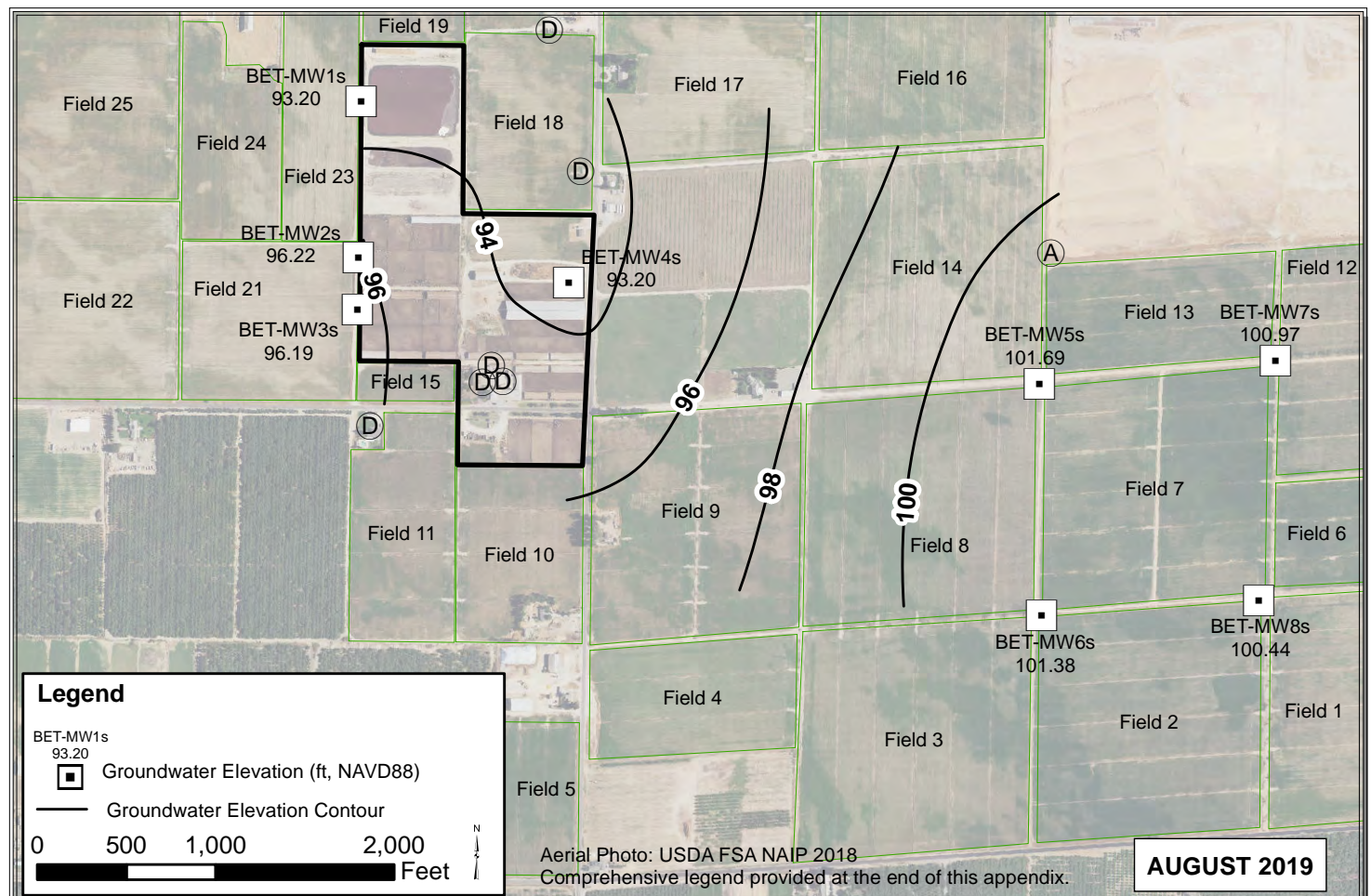
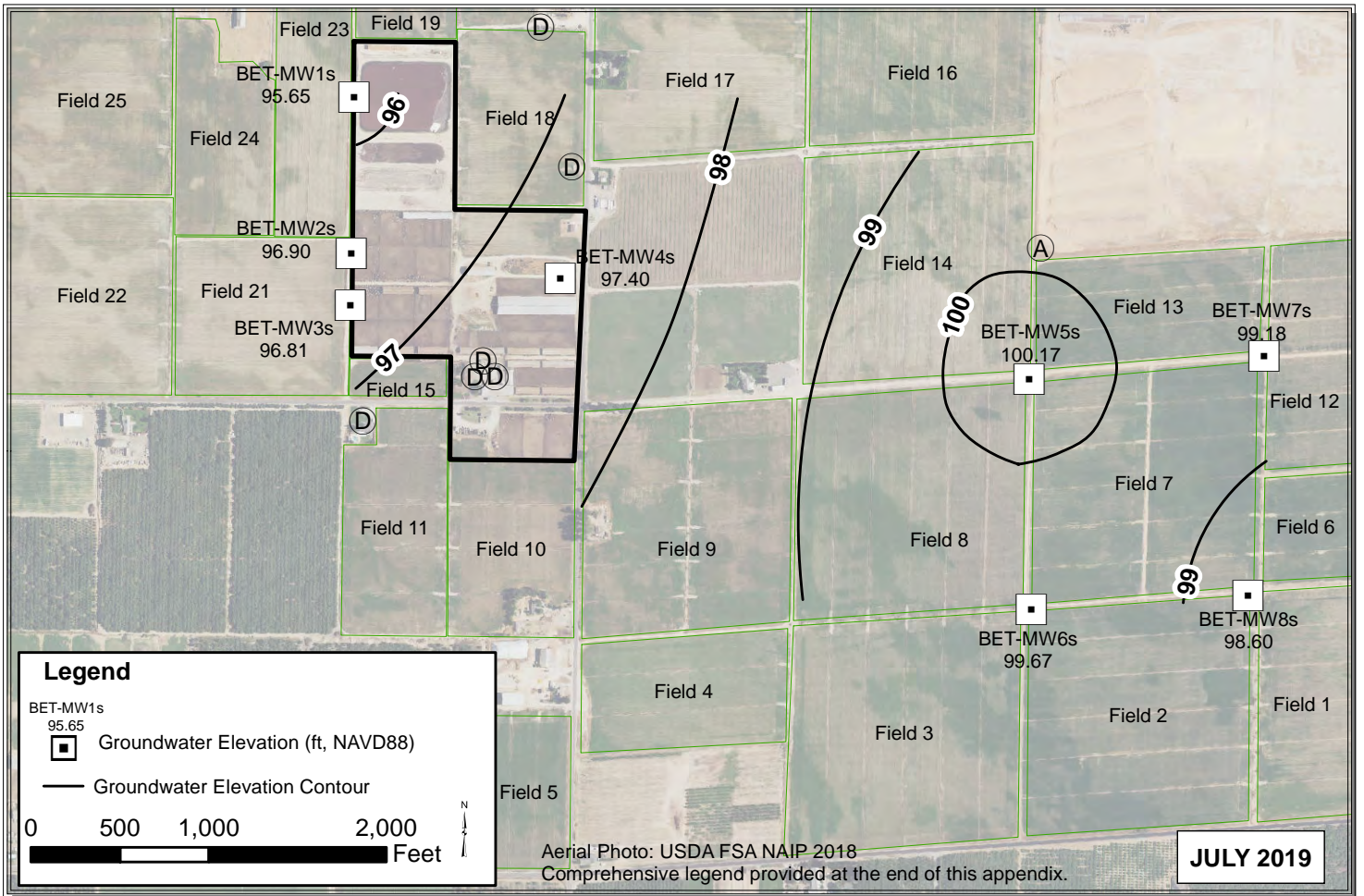

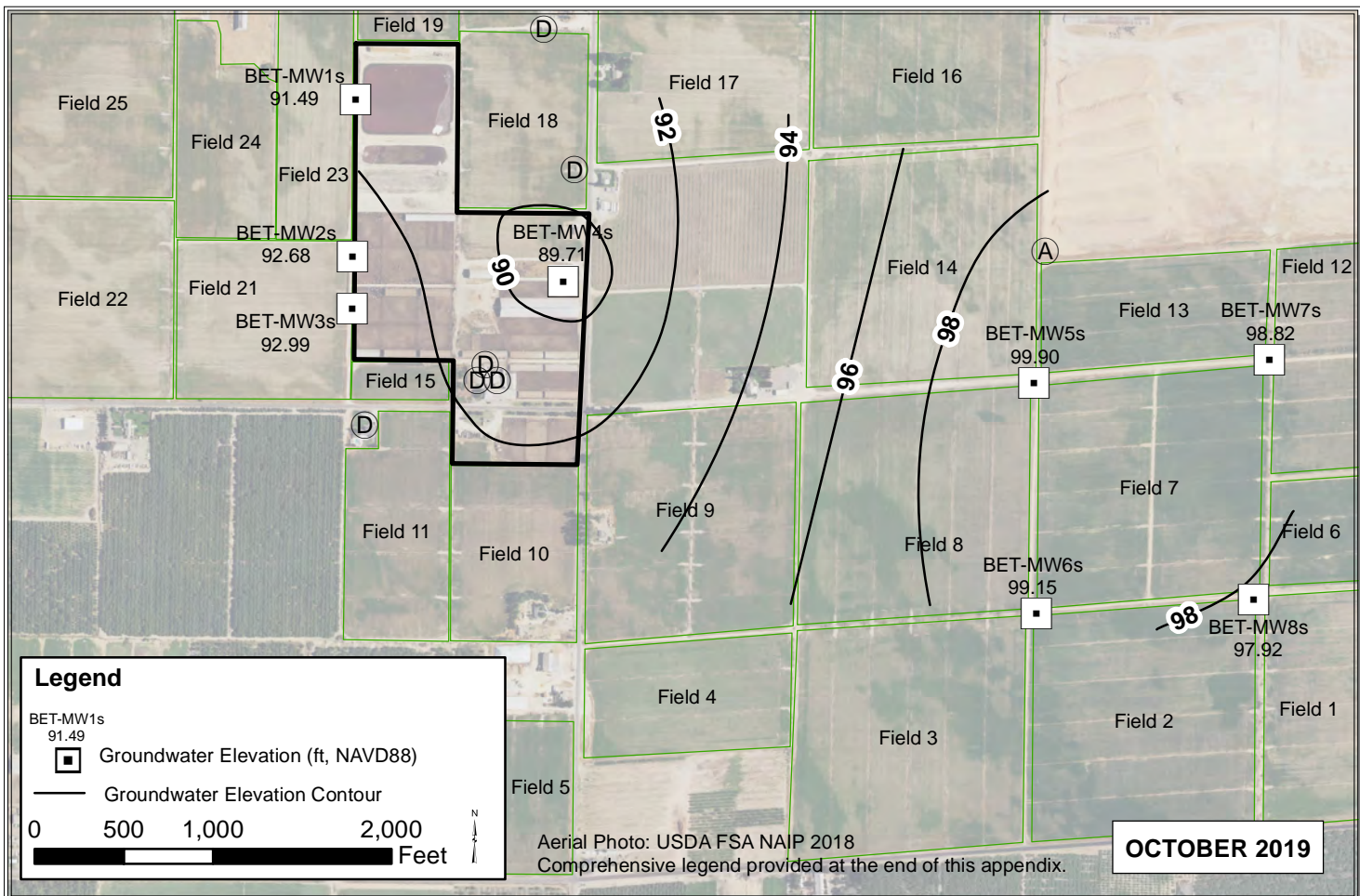
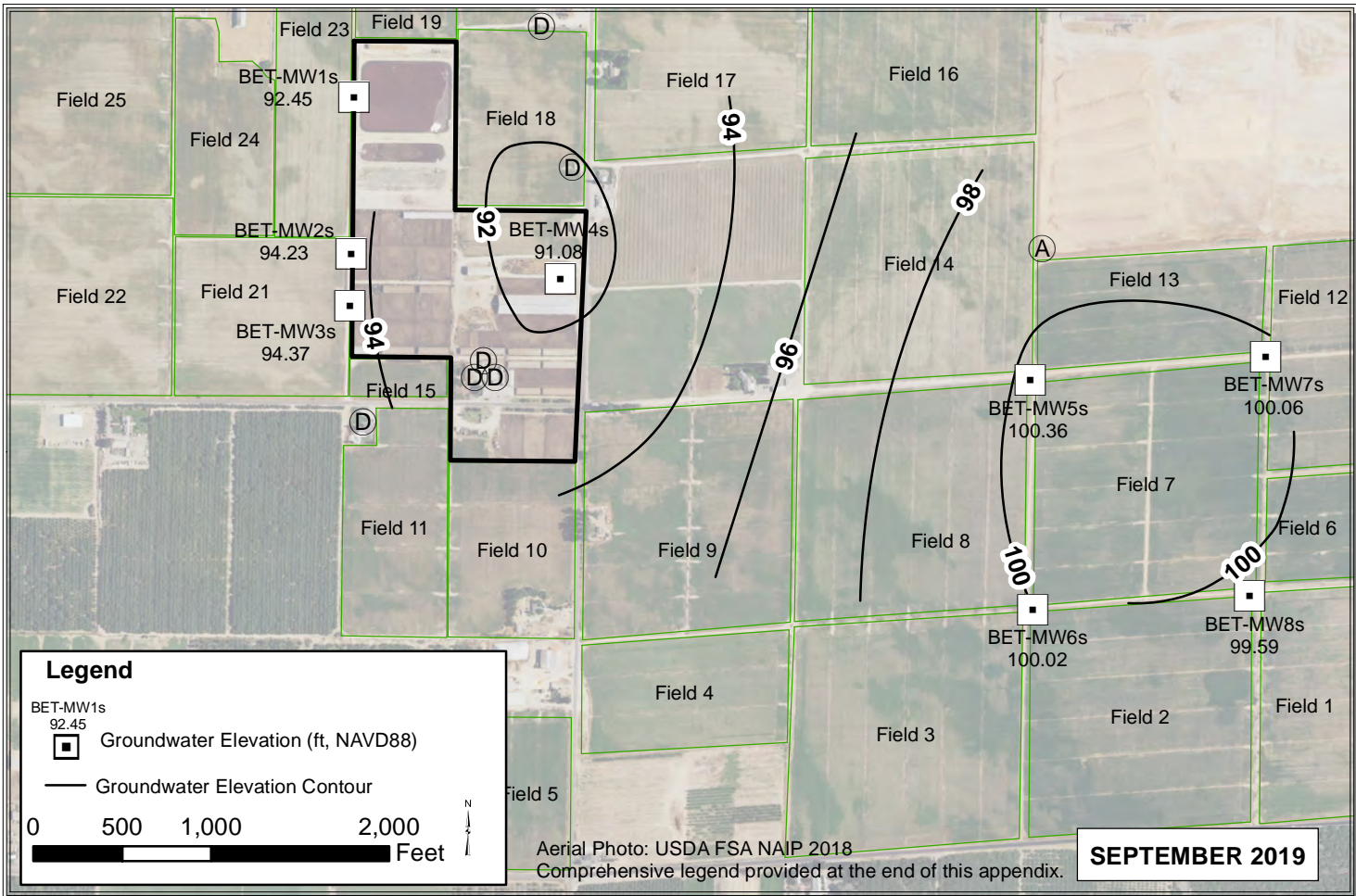

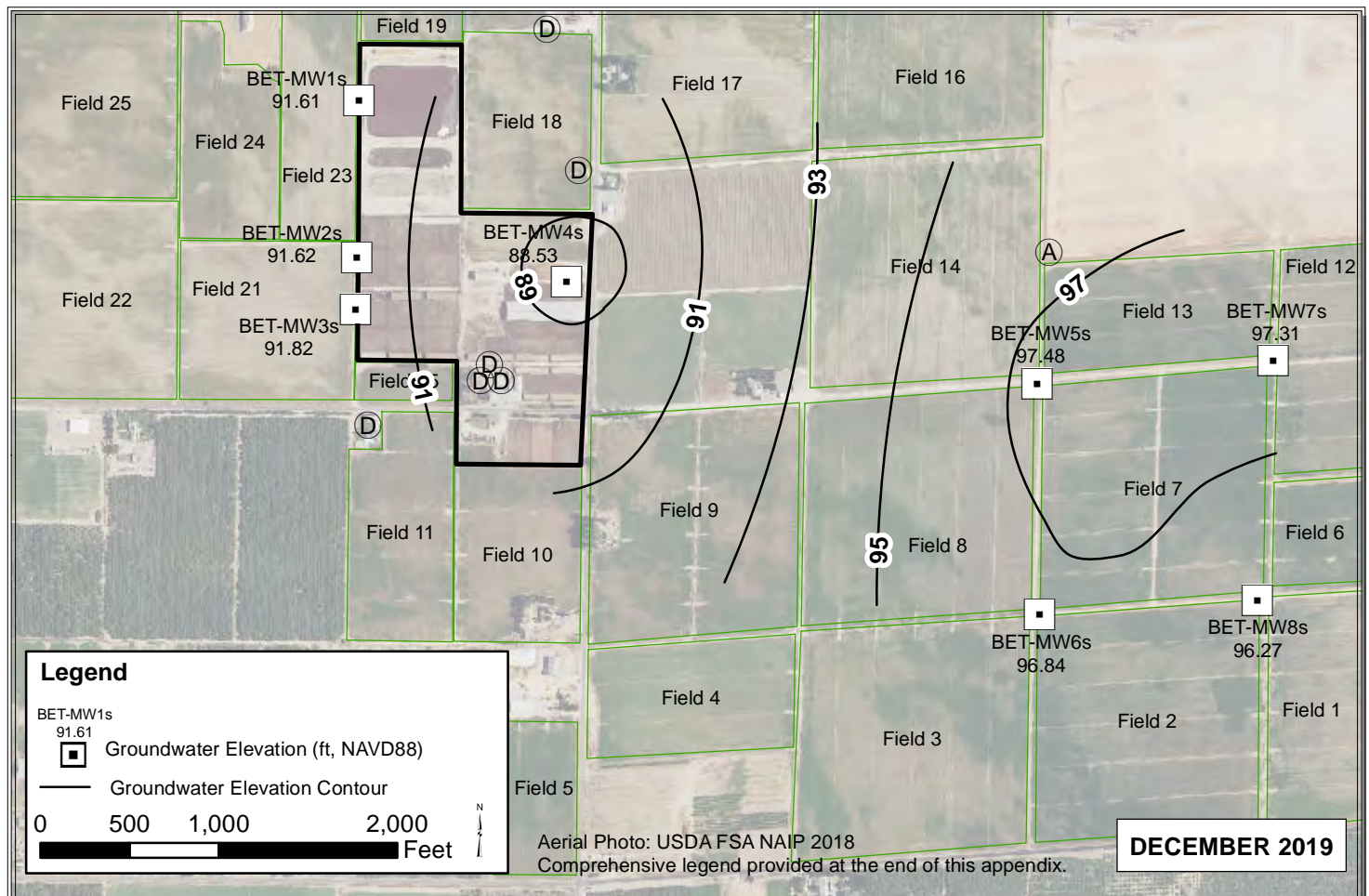
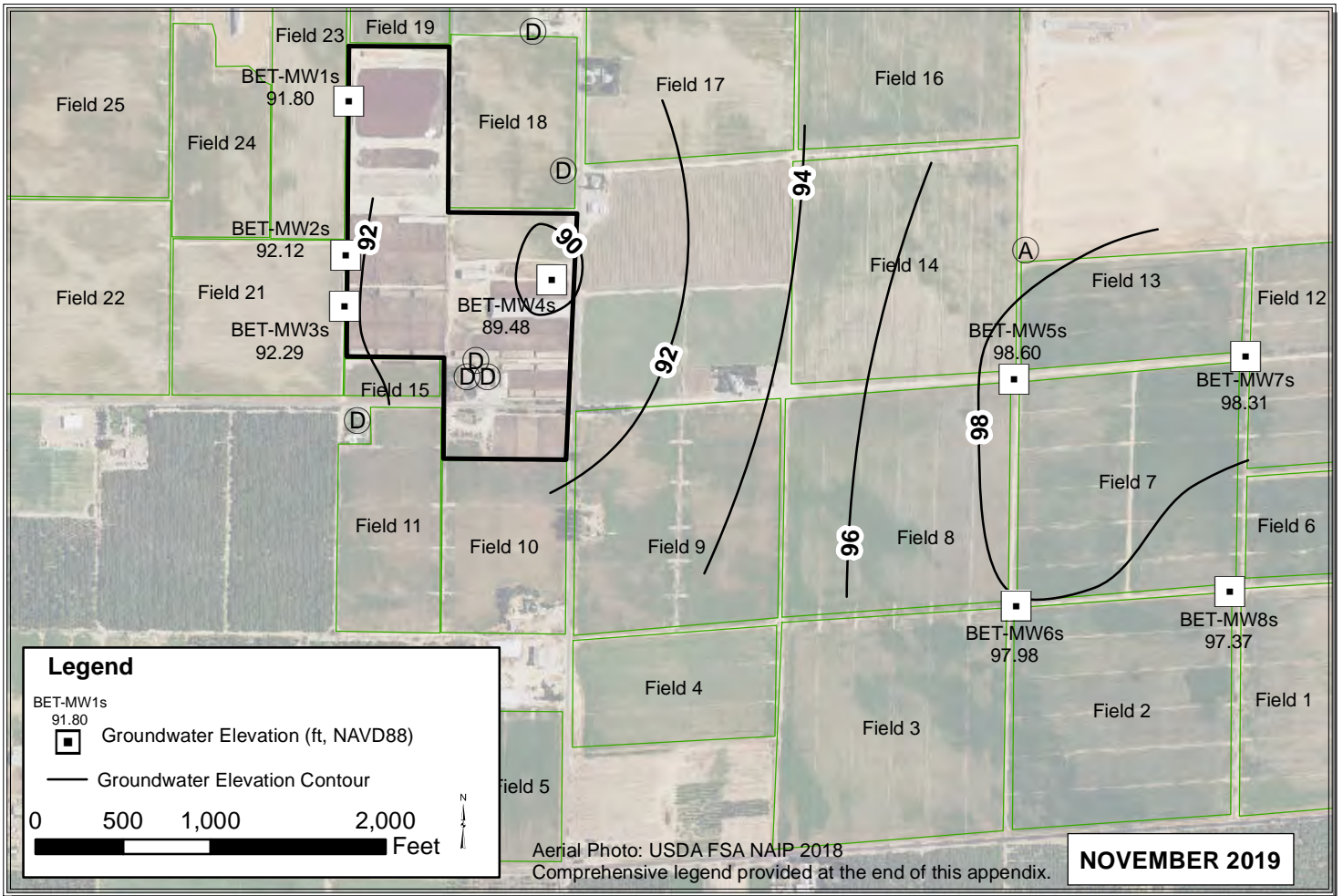

DIE

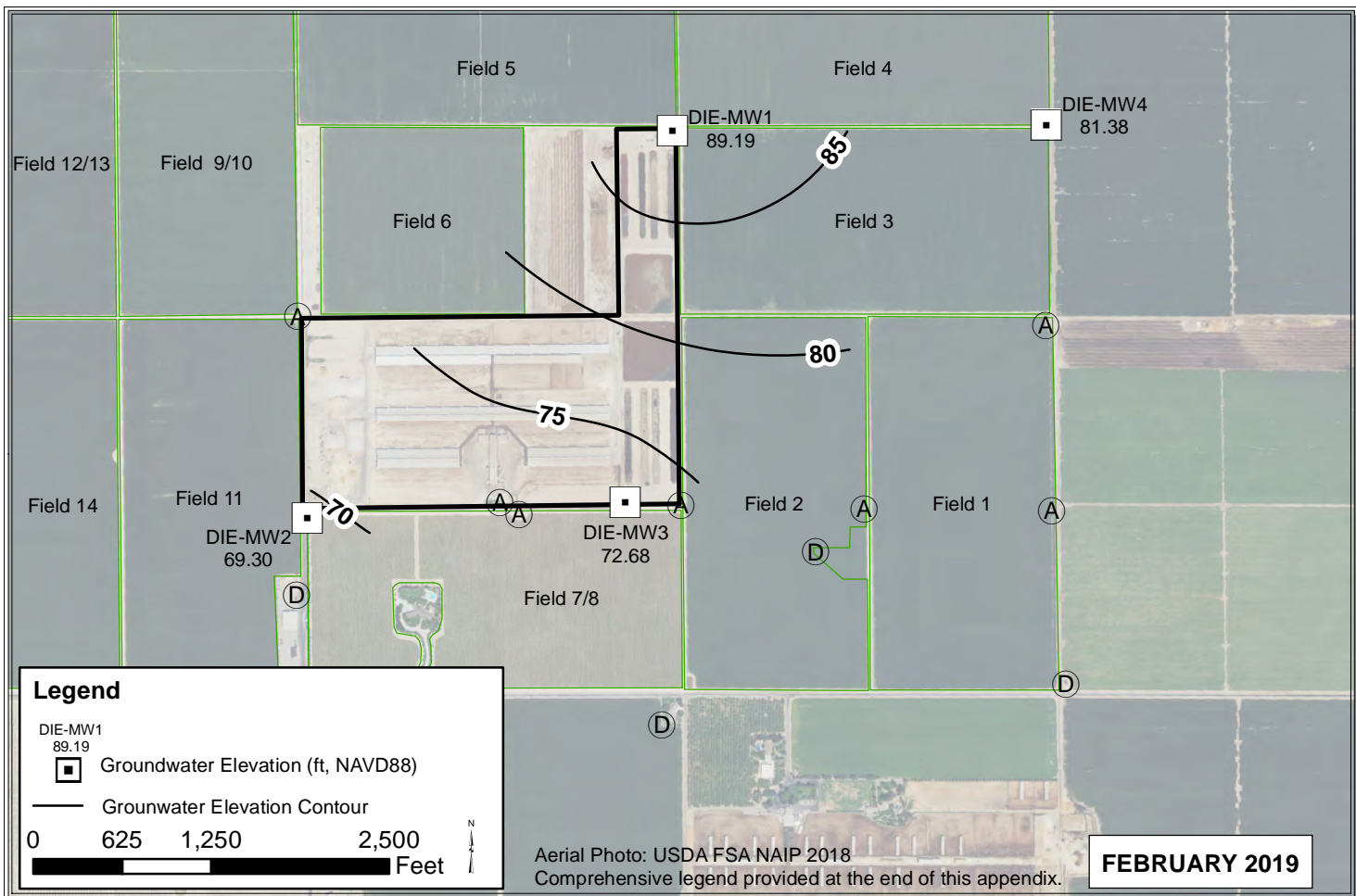
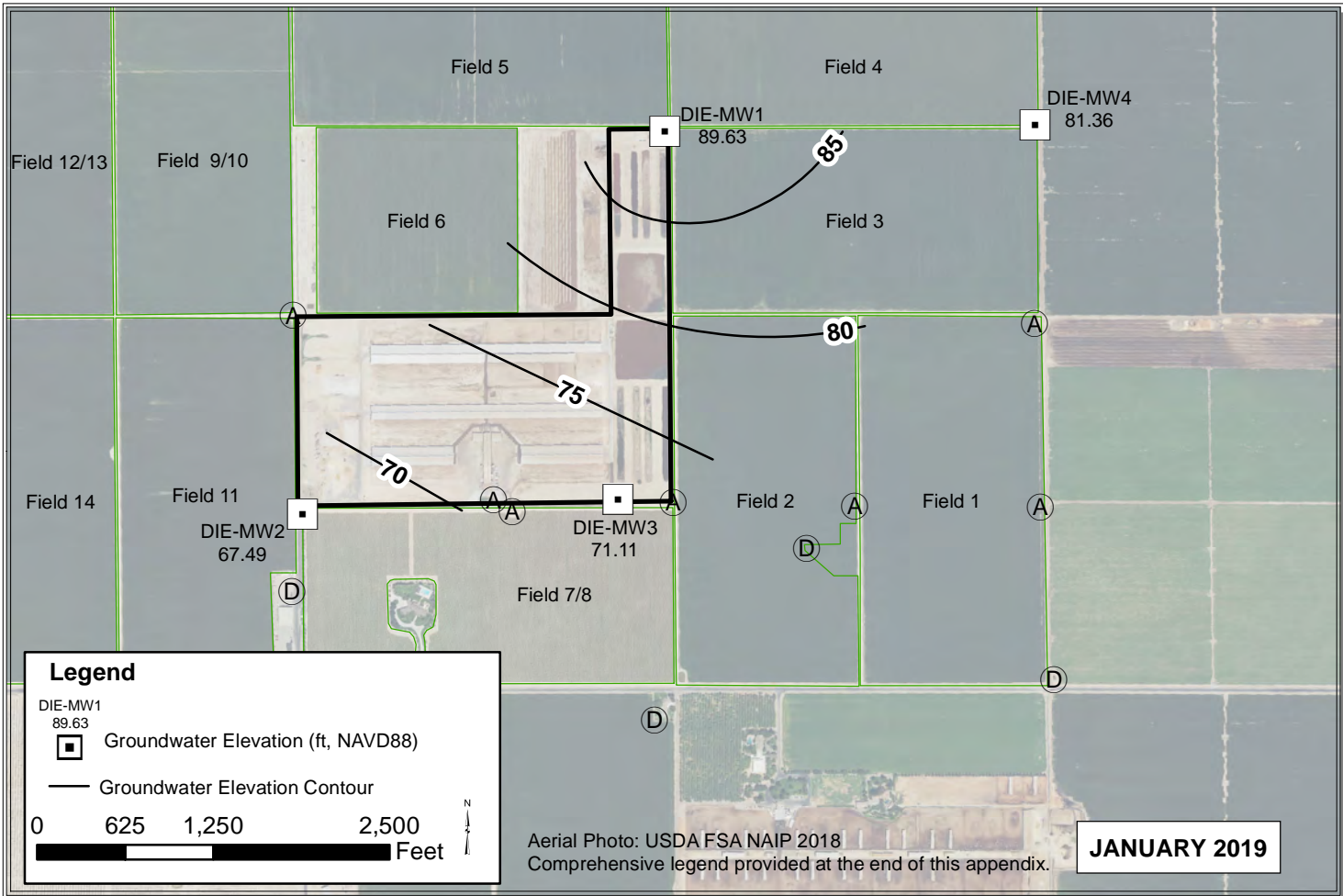

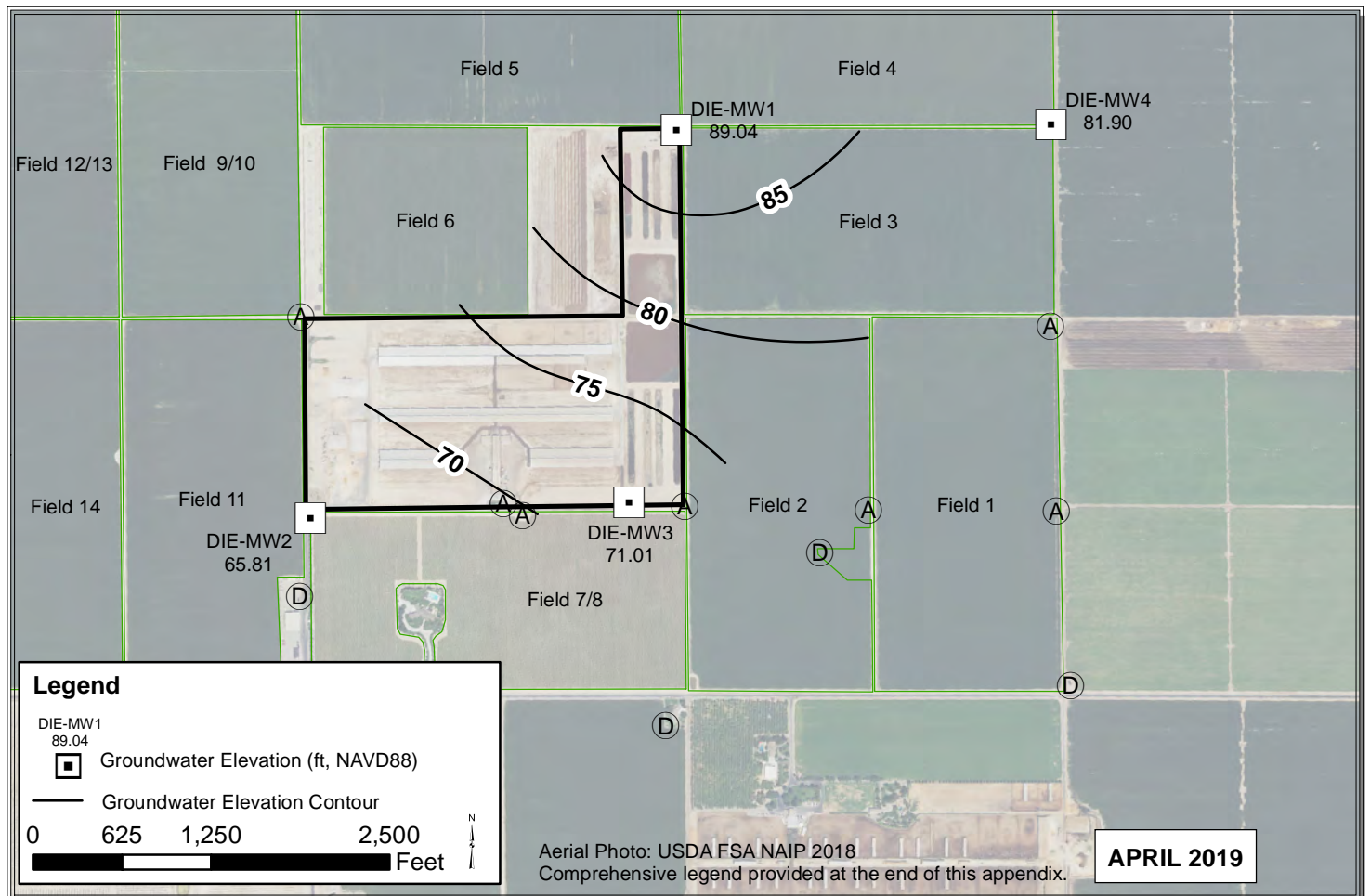
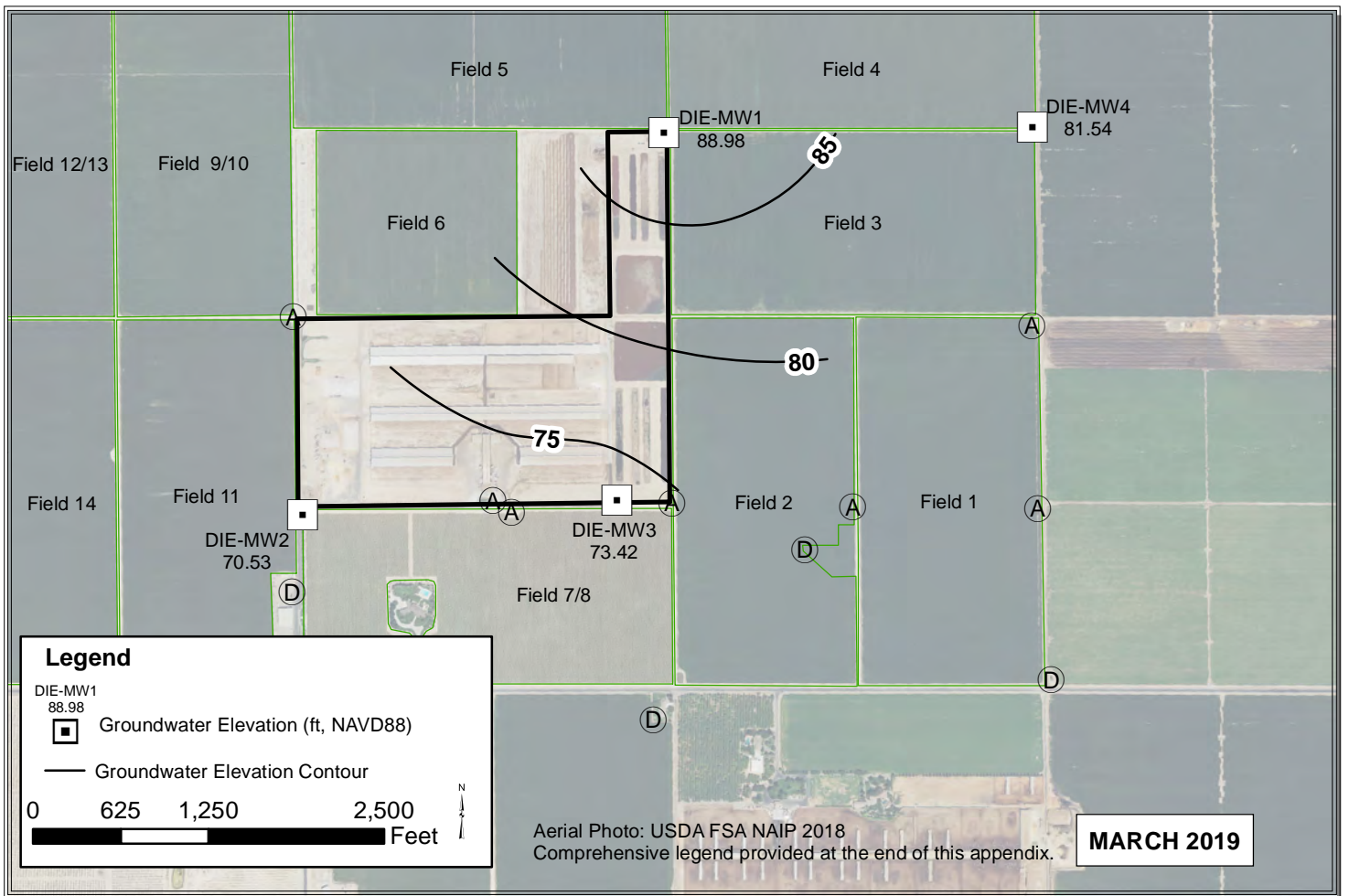

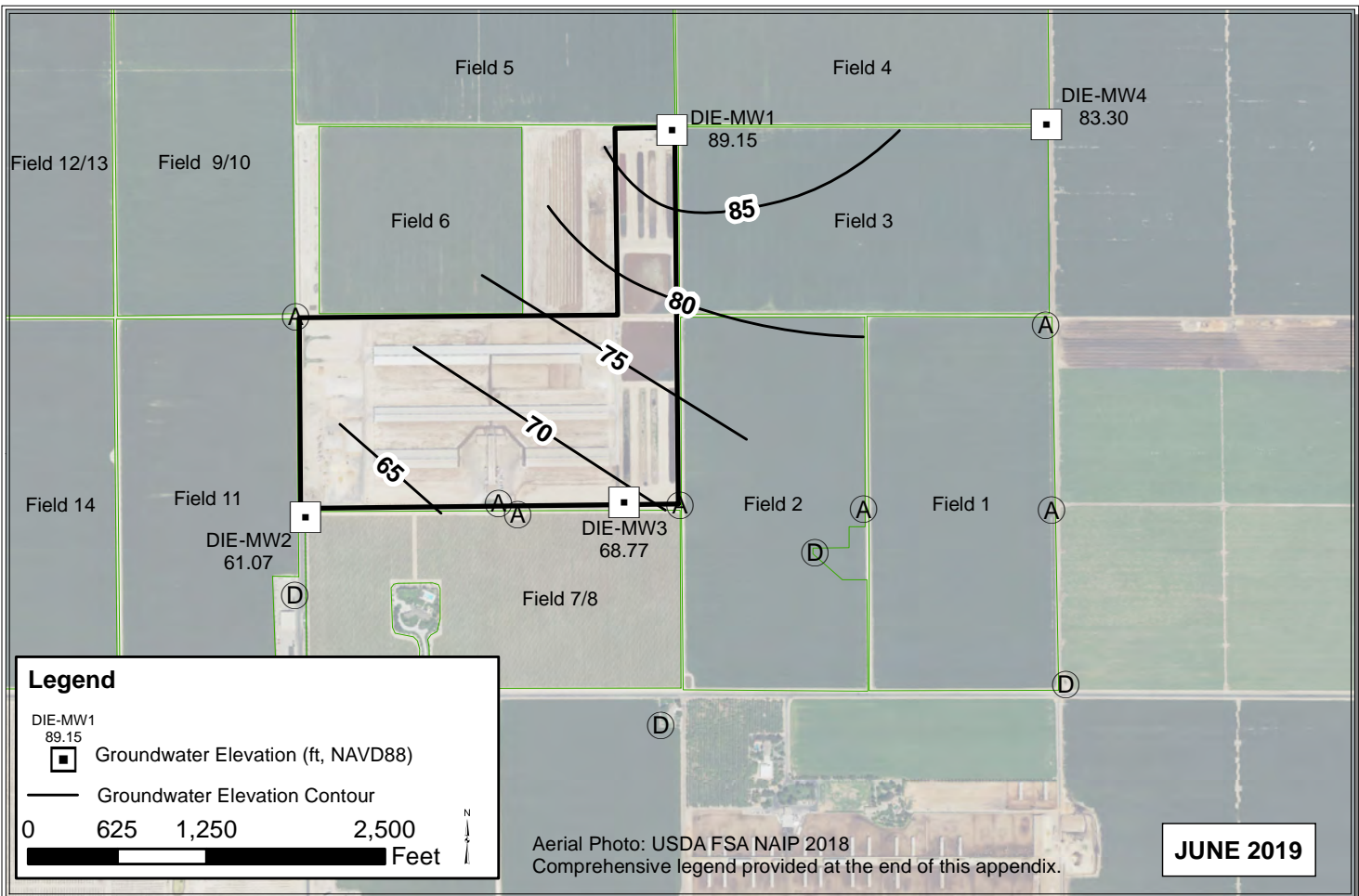
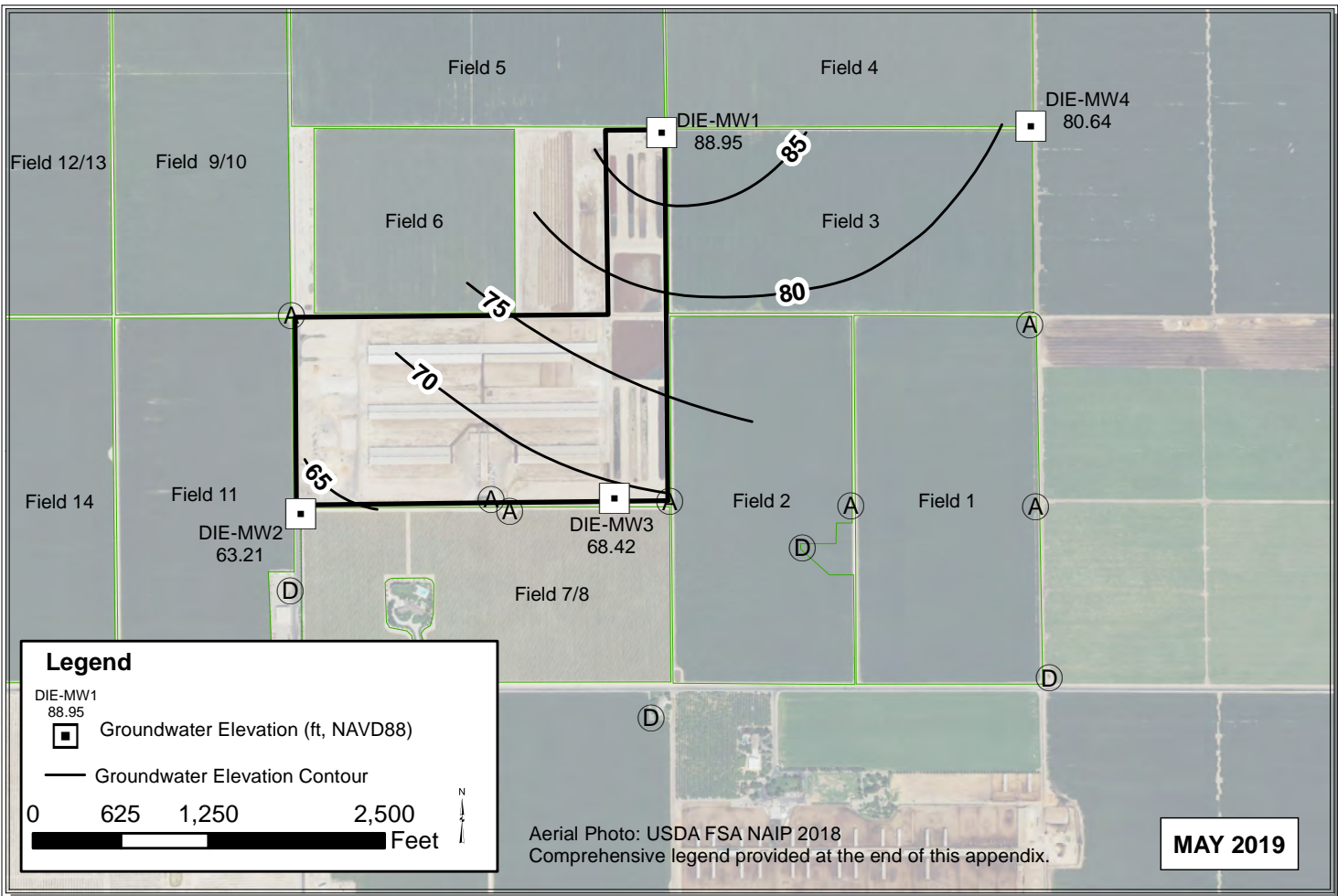

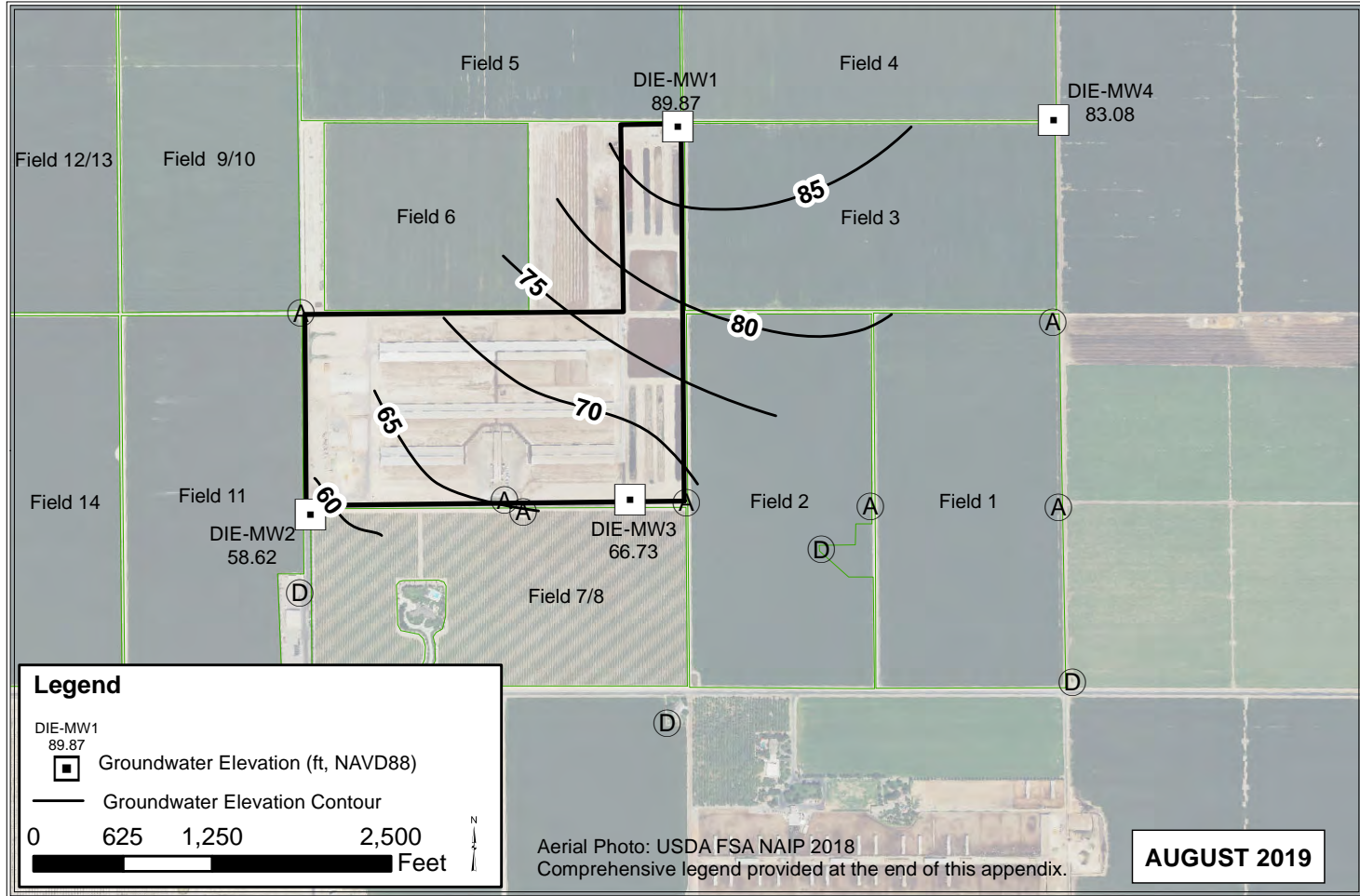
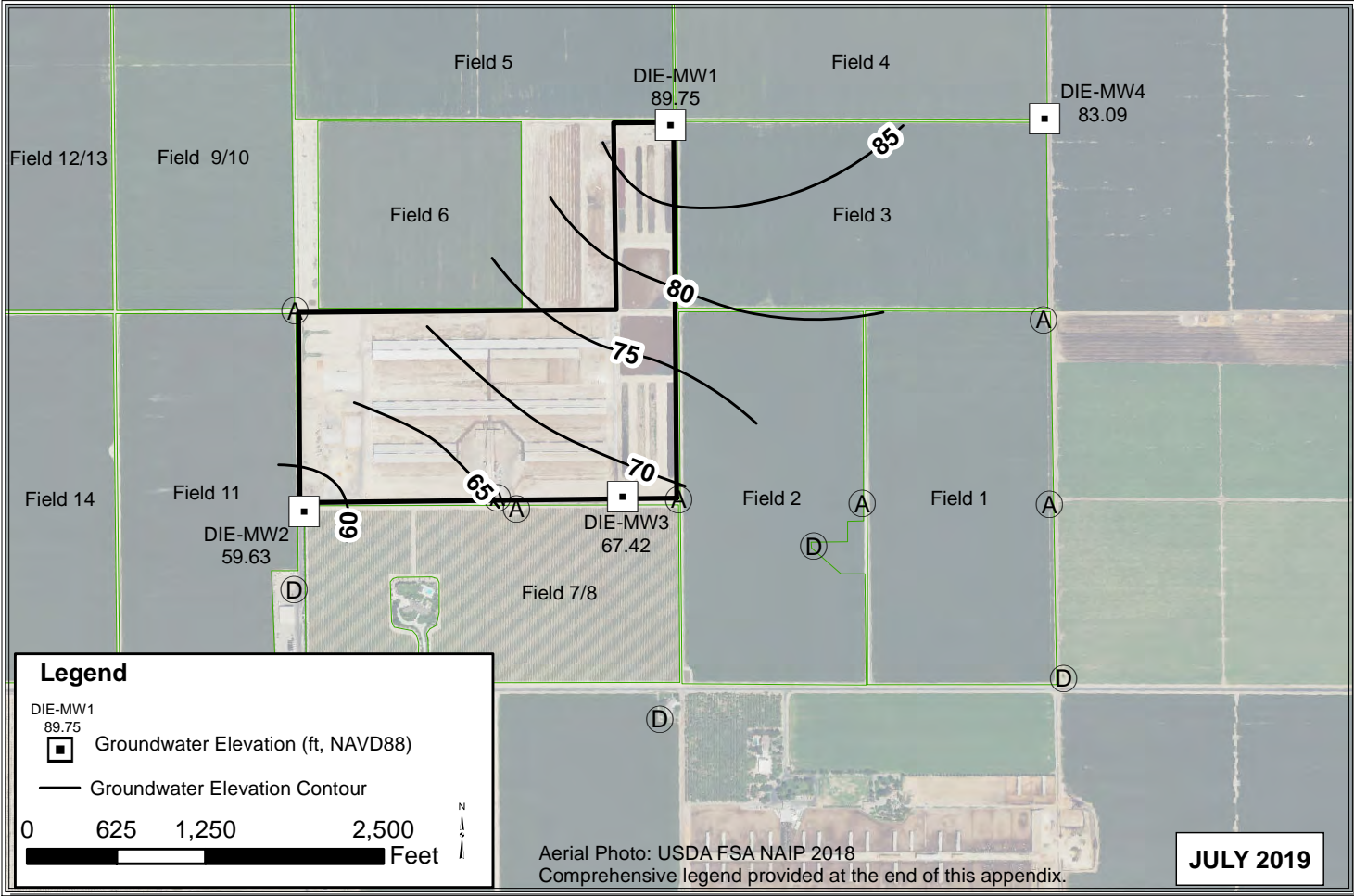

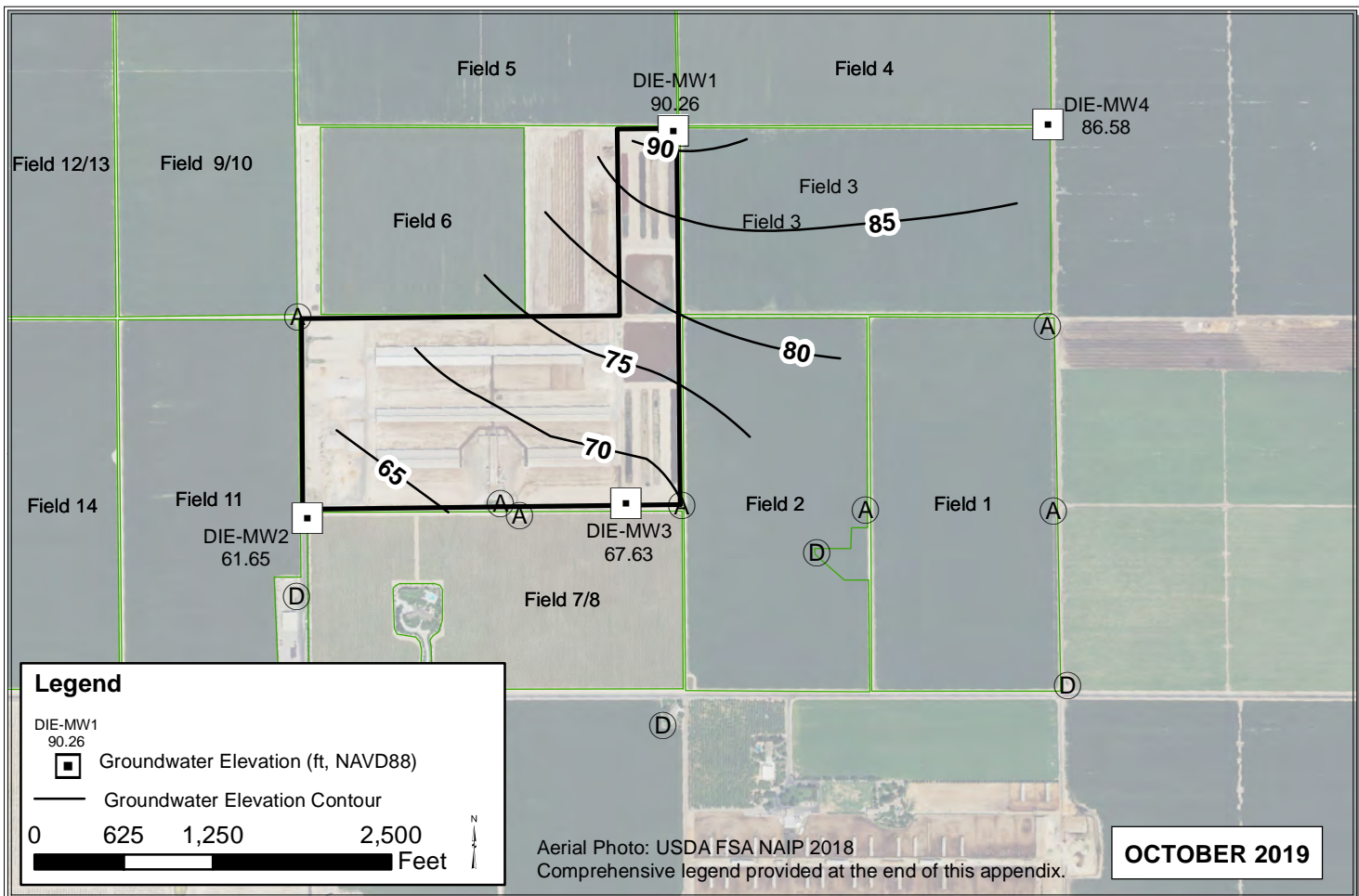
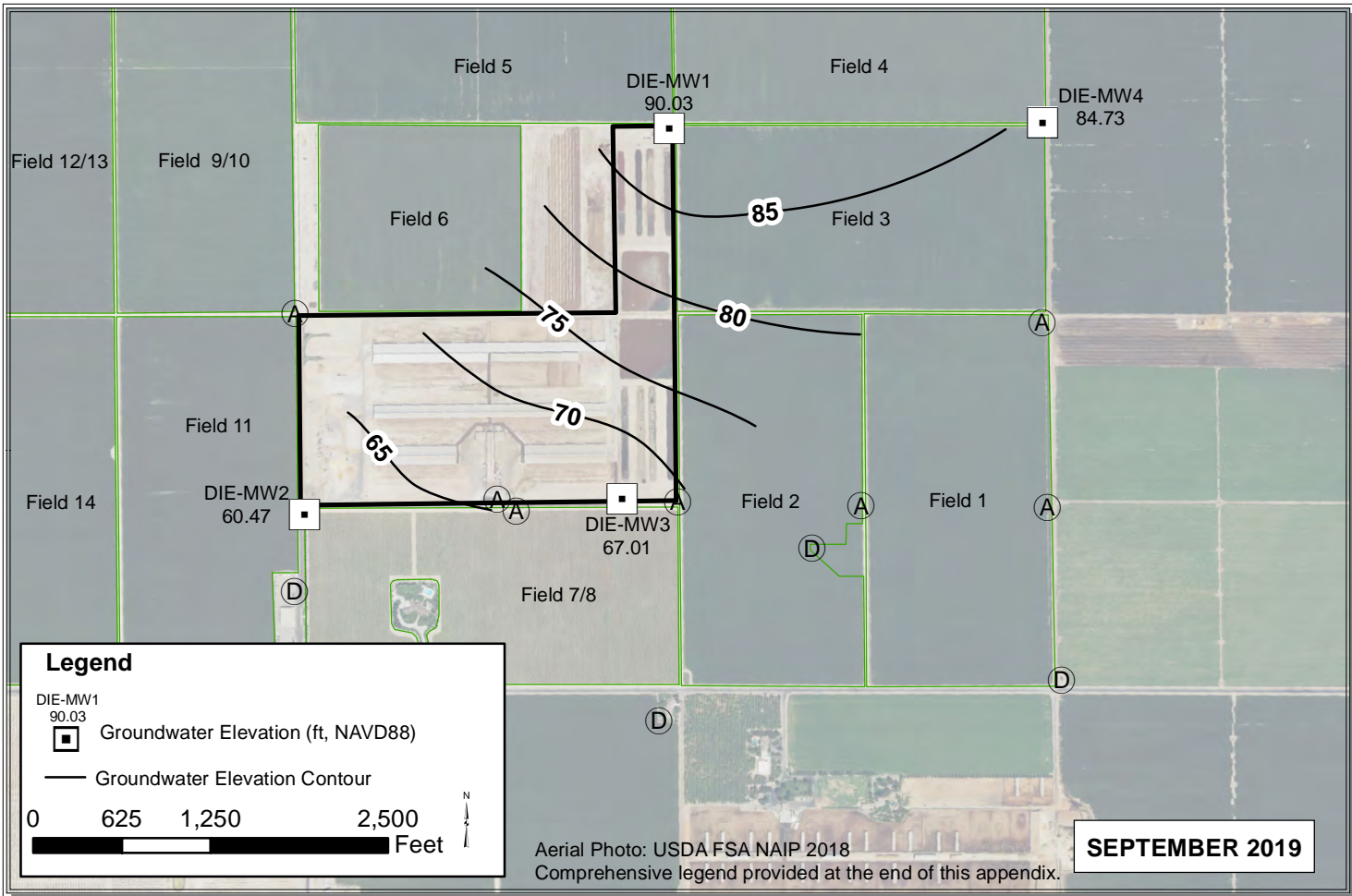

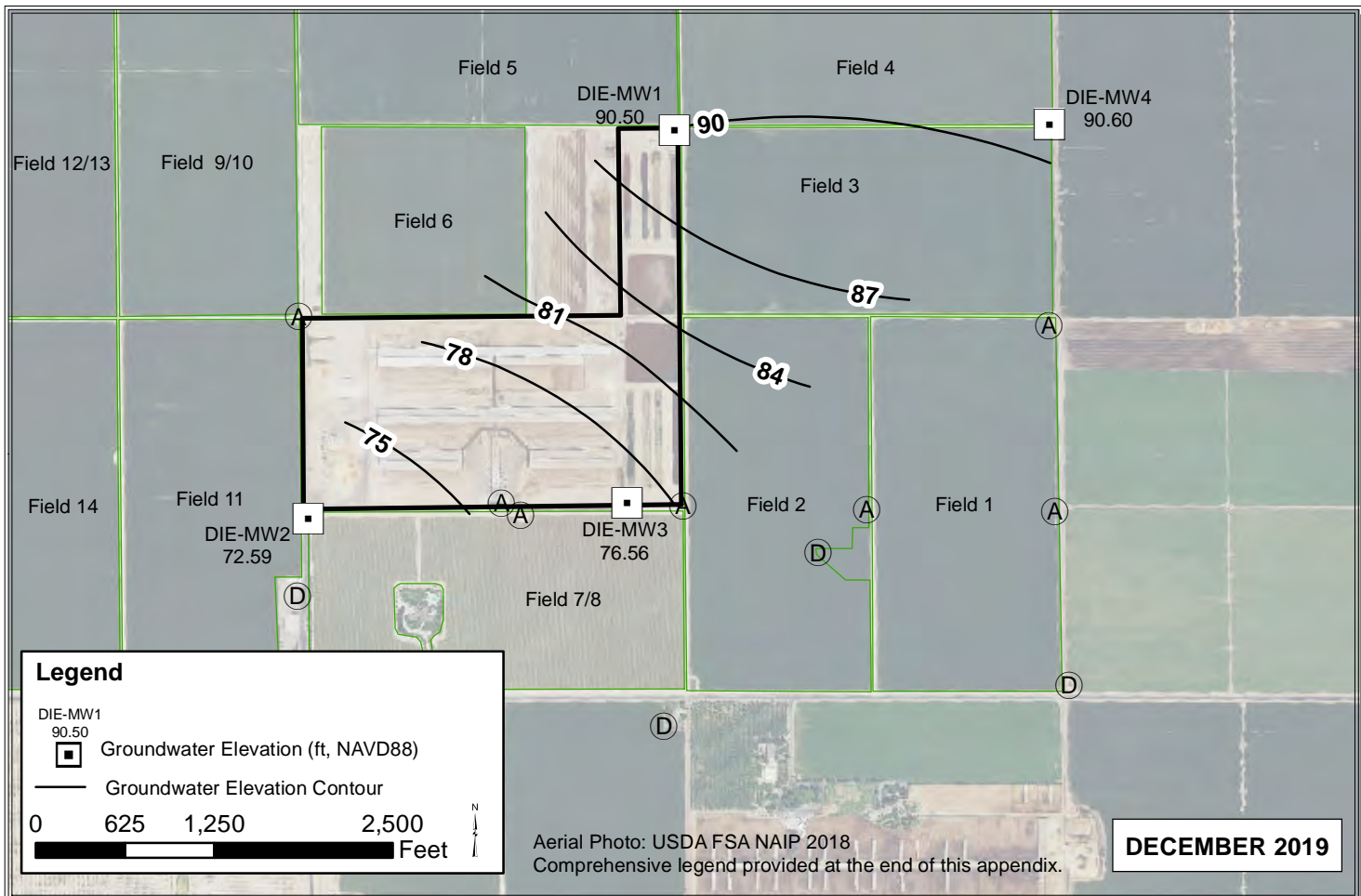
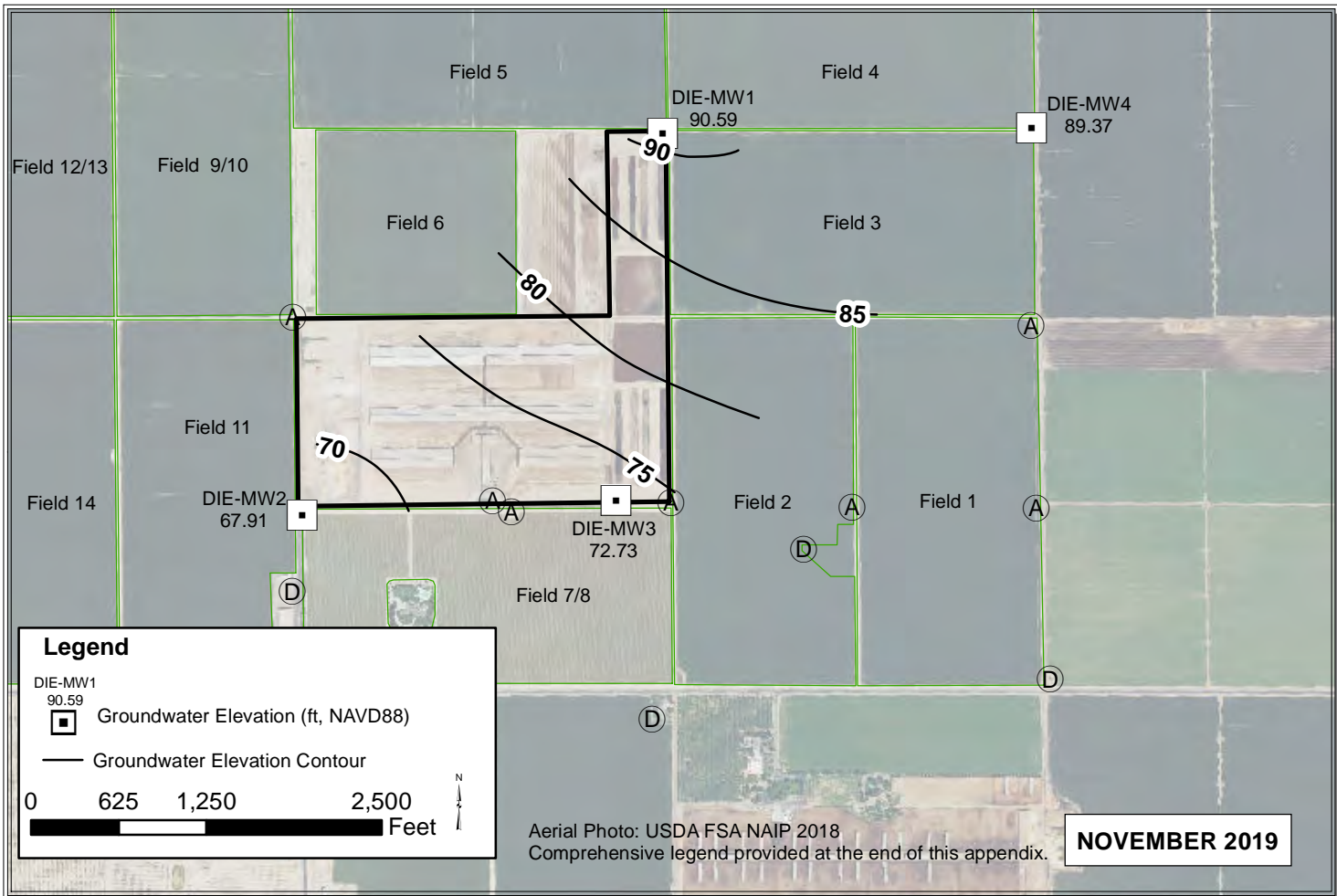

DUR

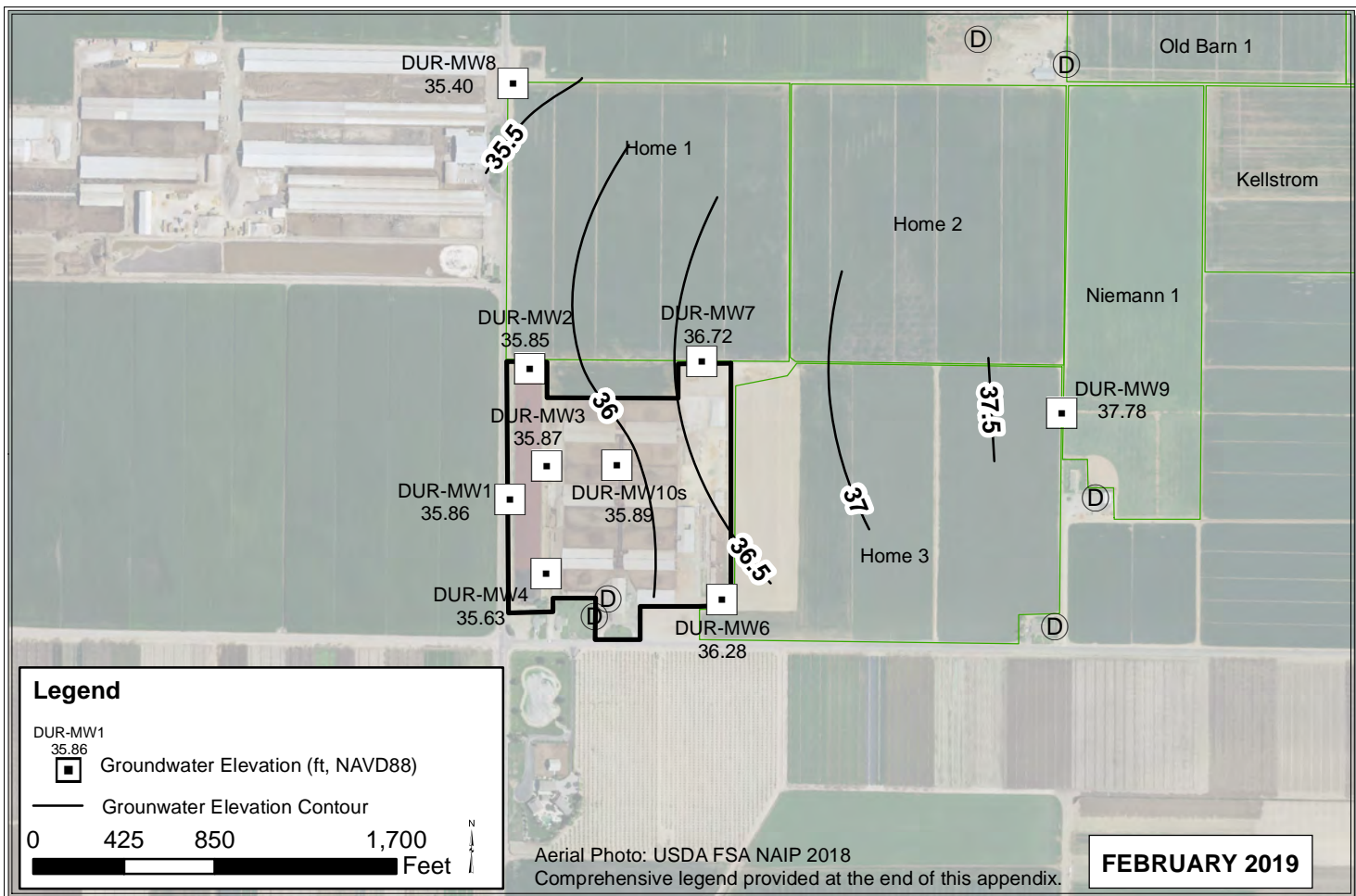
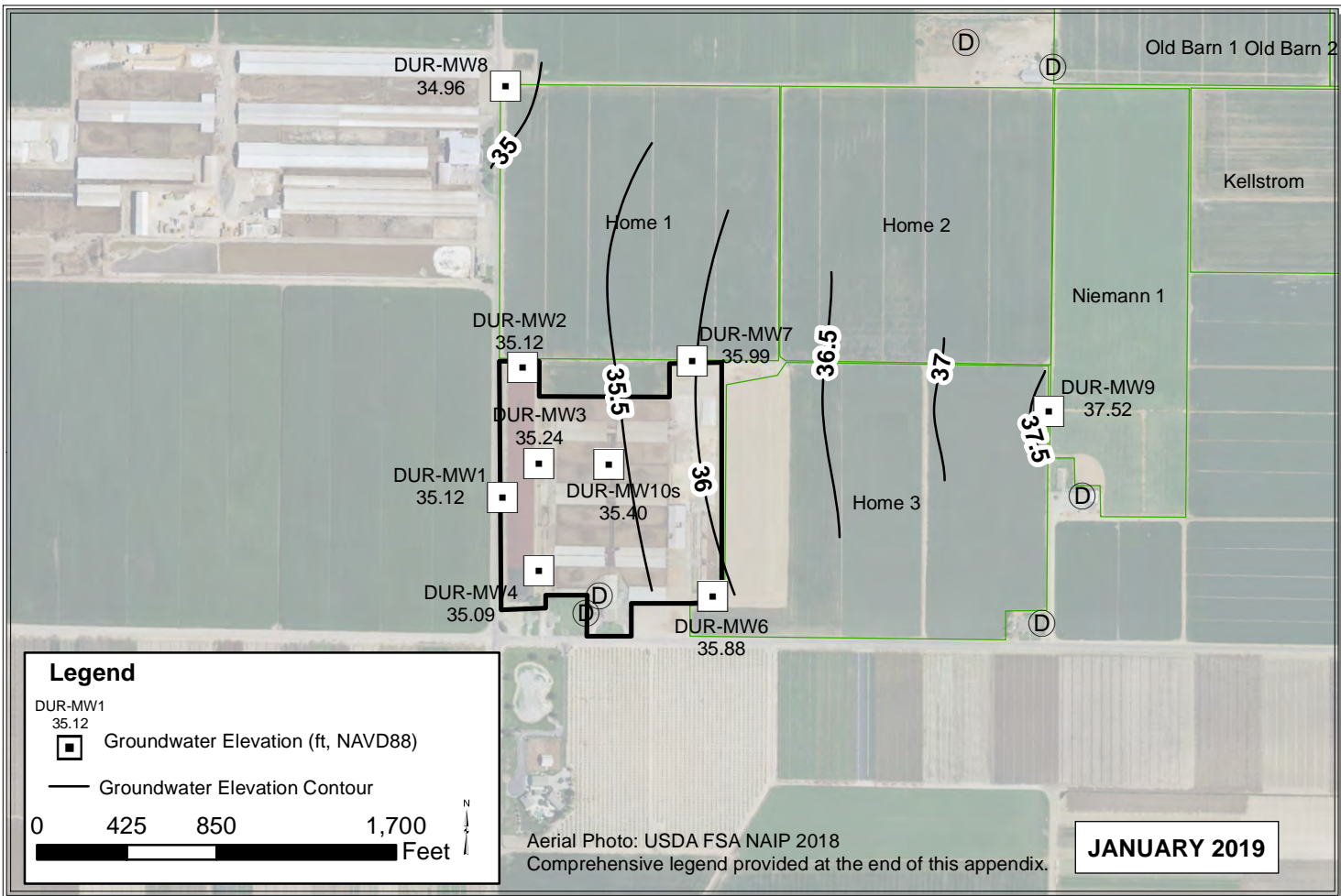

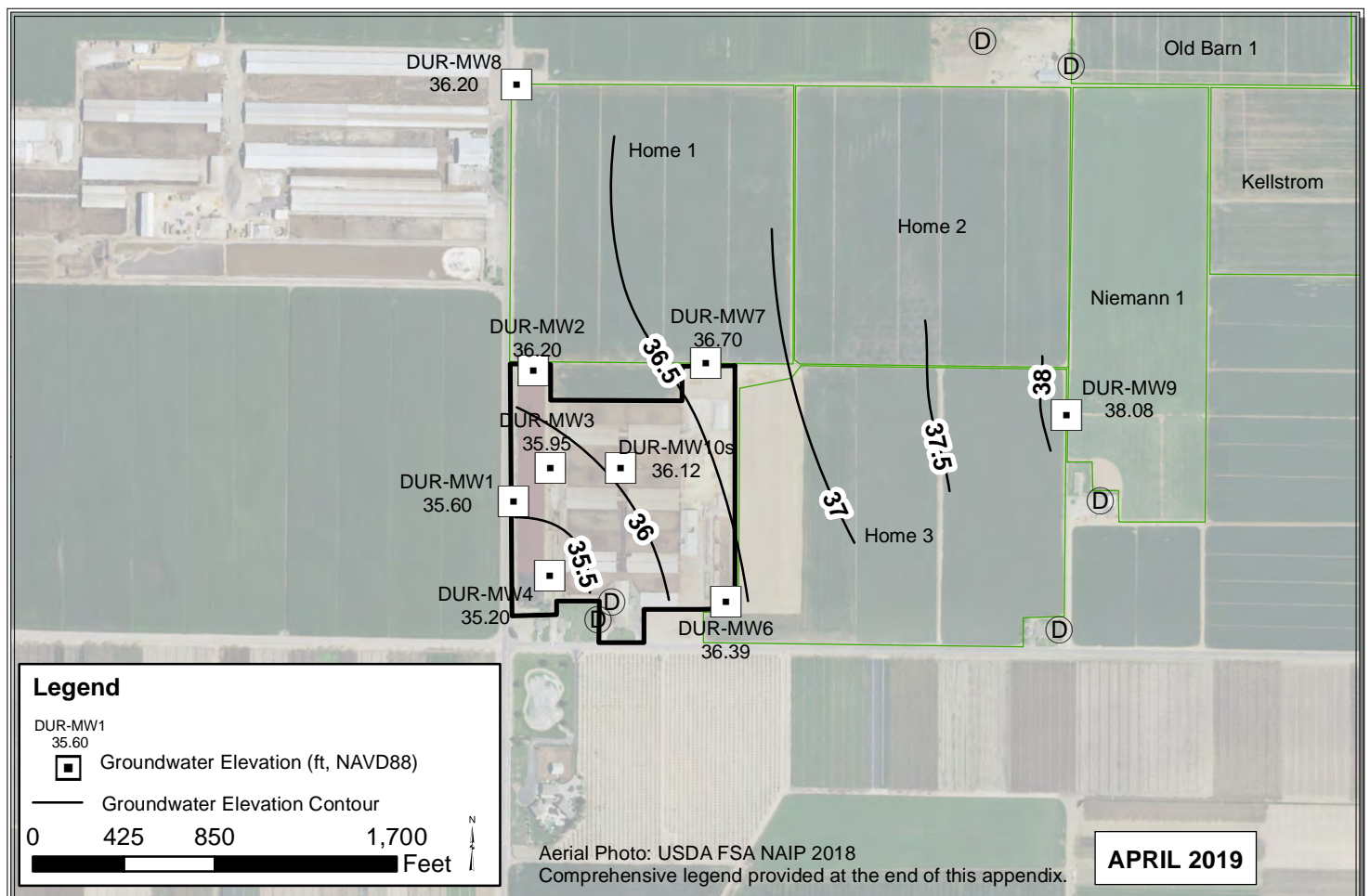
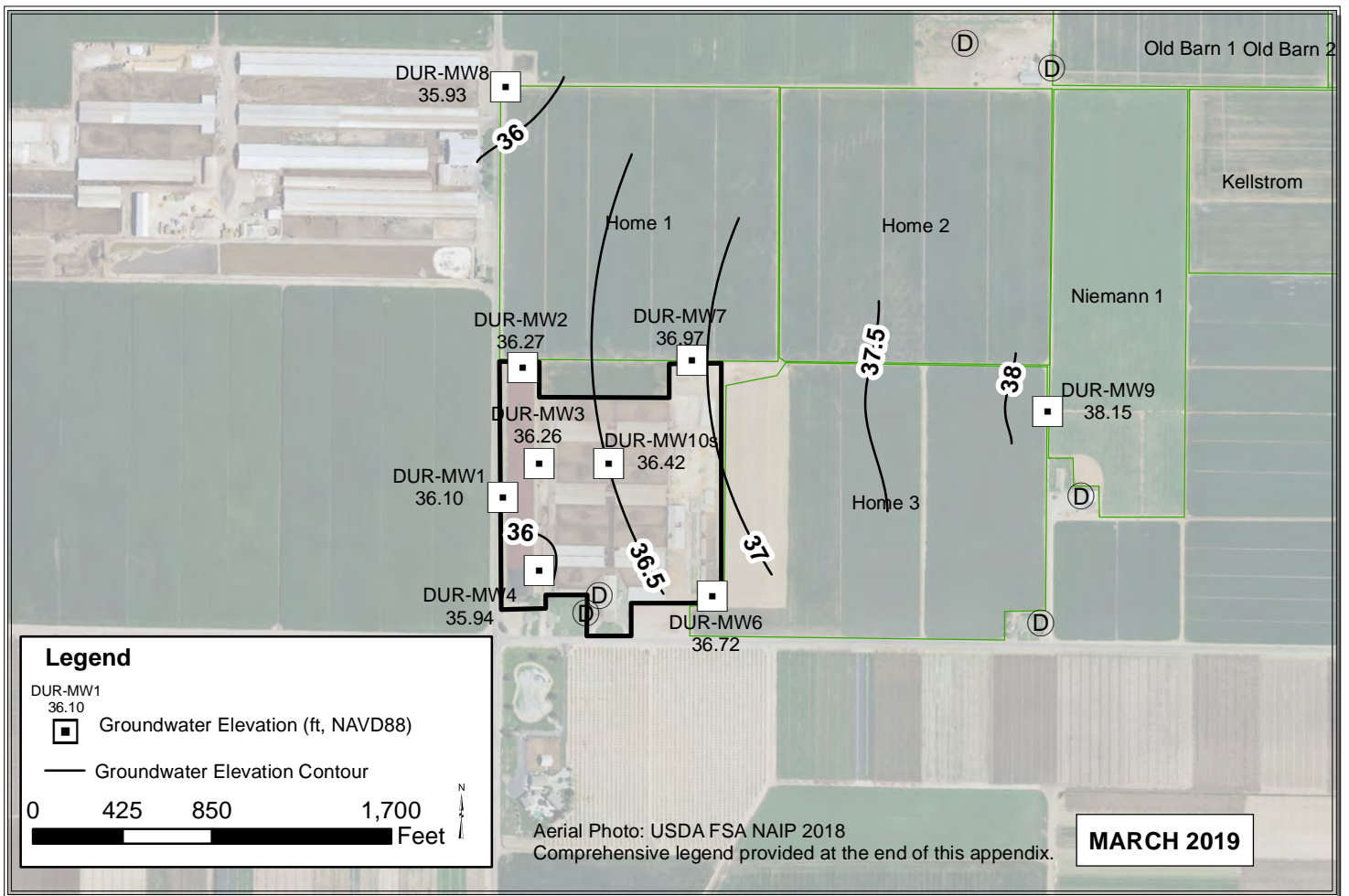

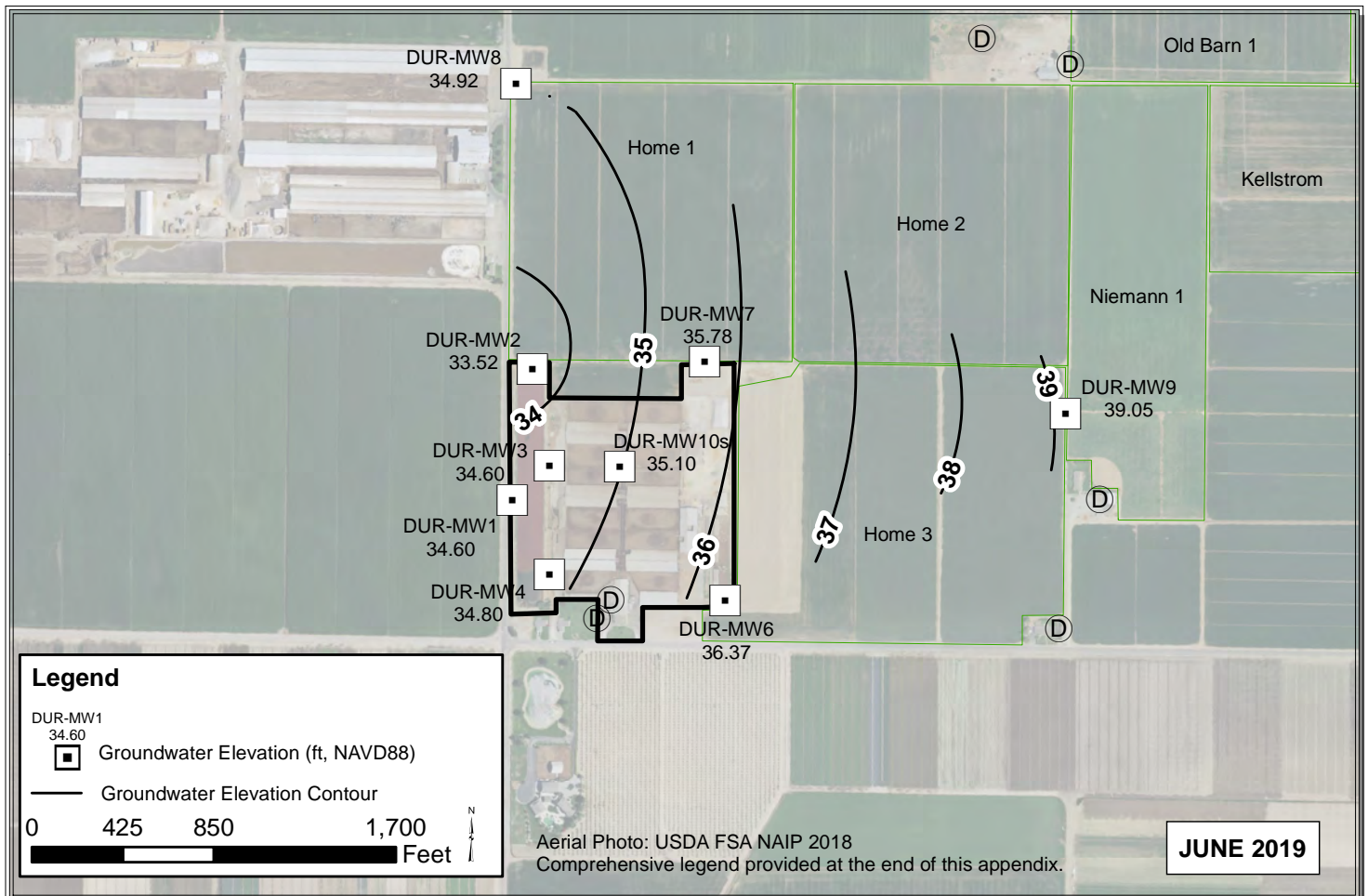
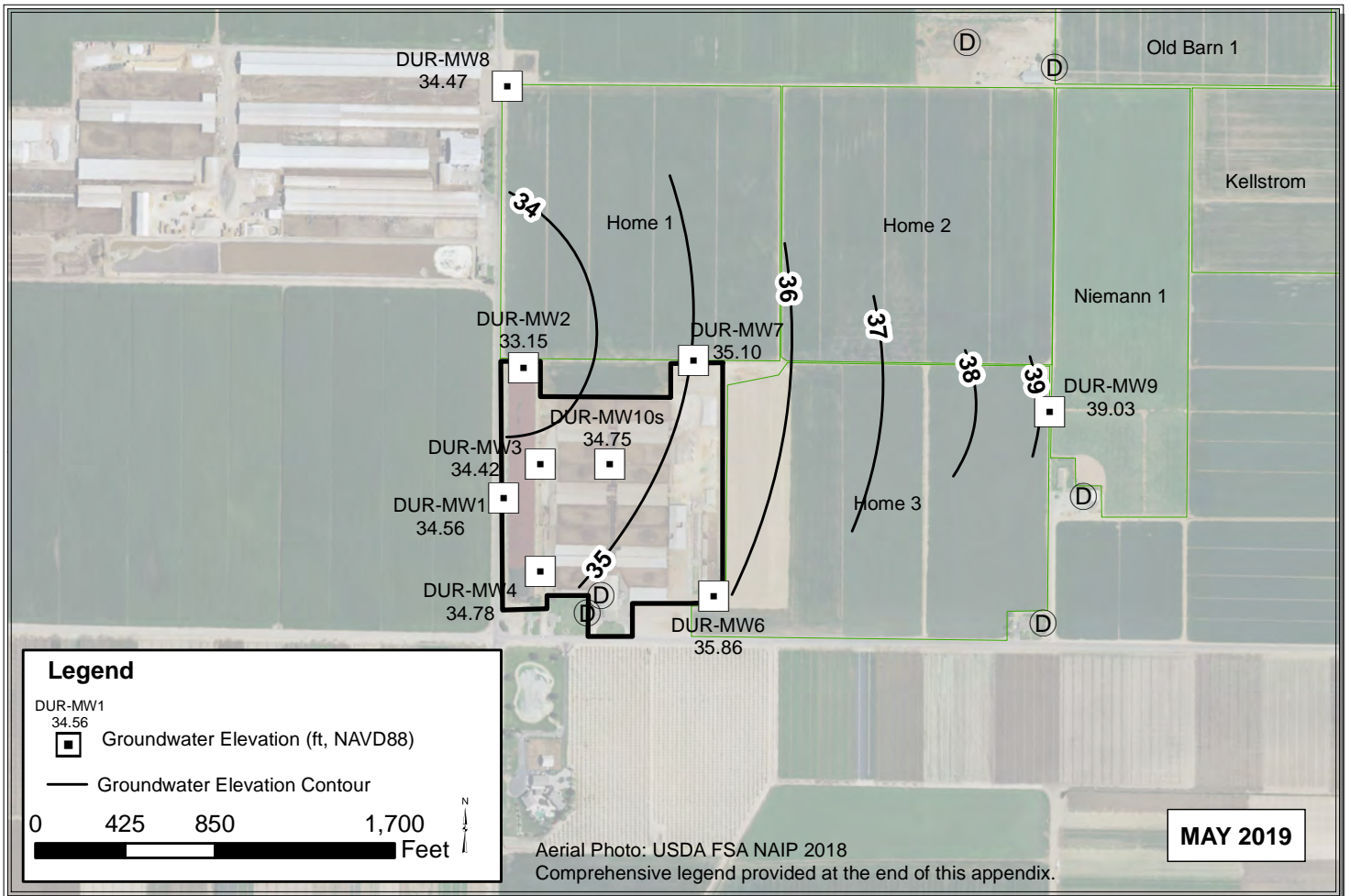

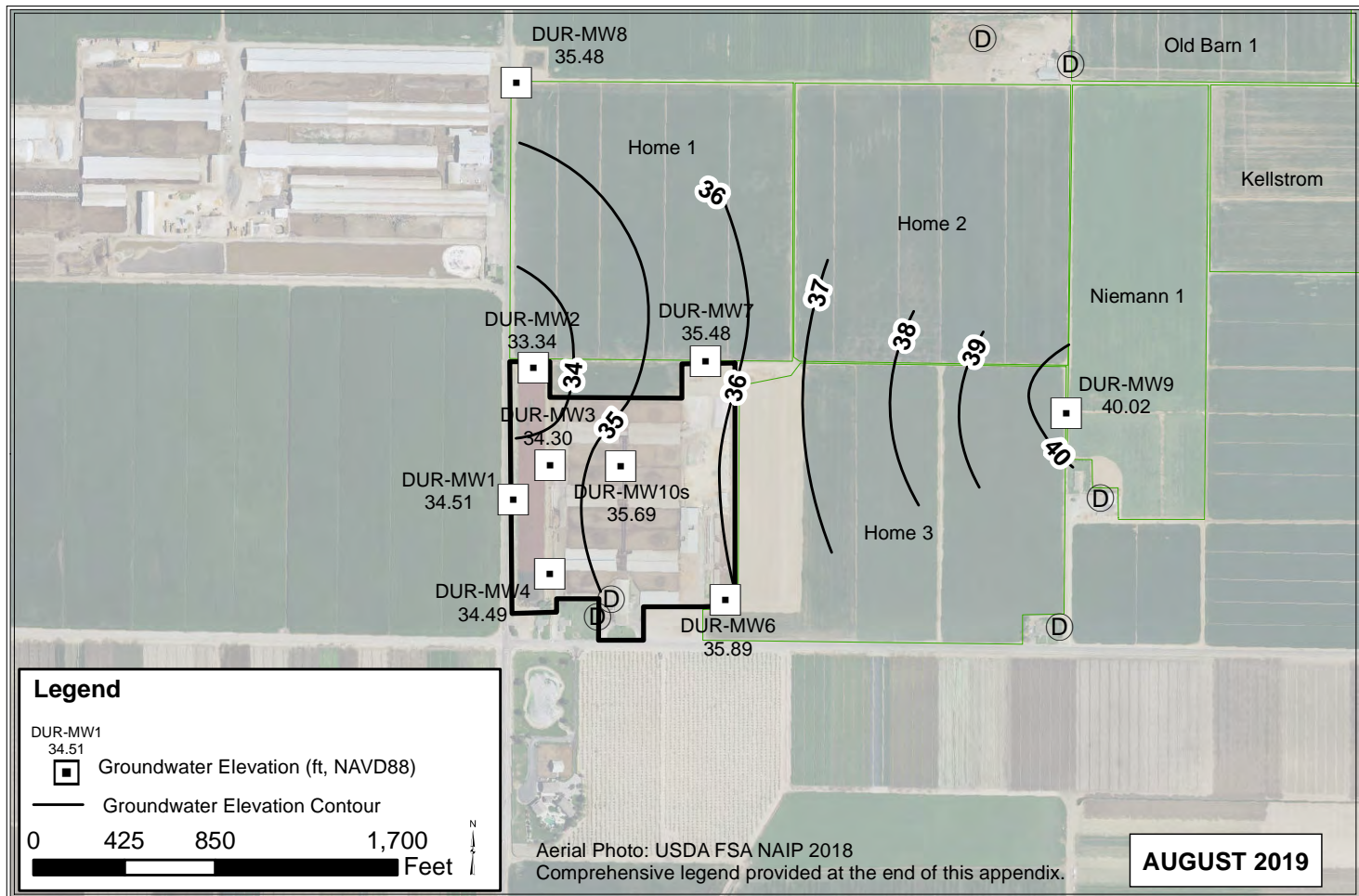
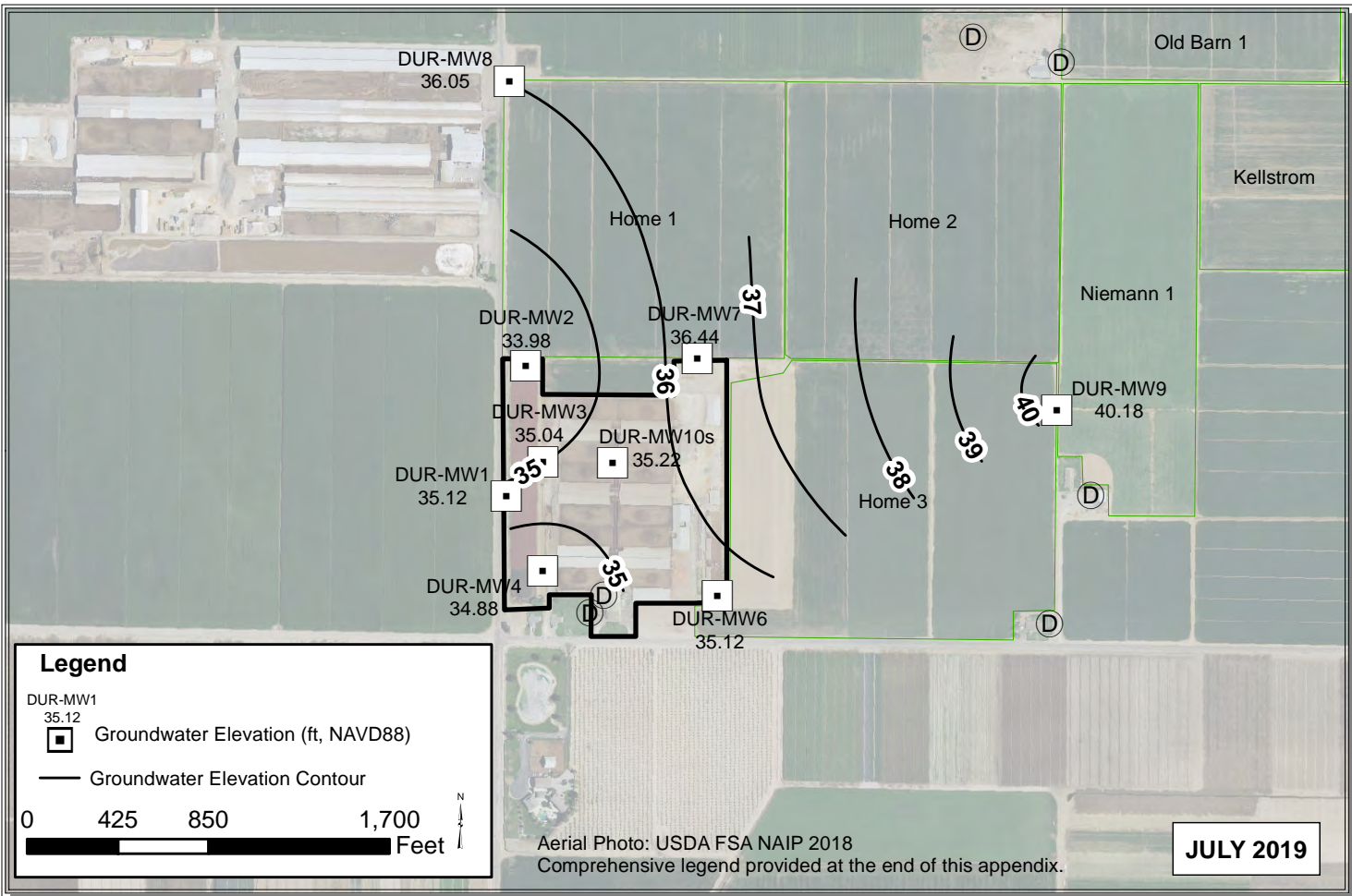

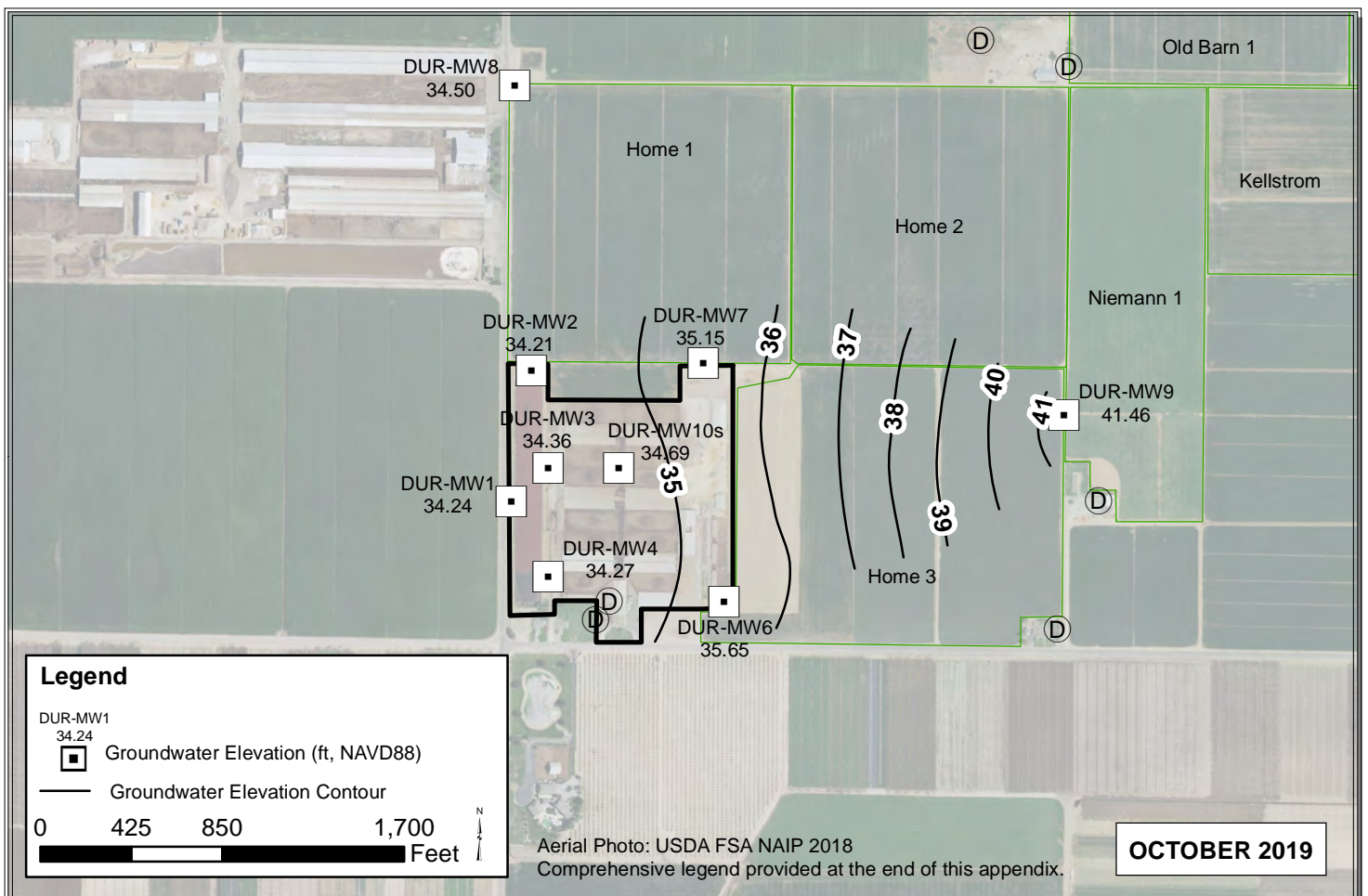
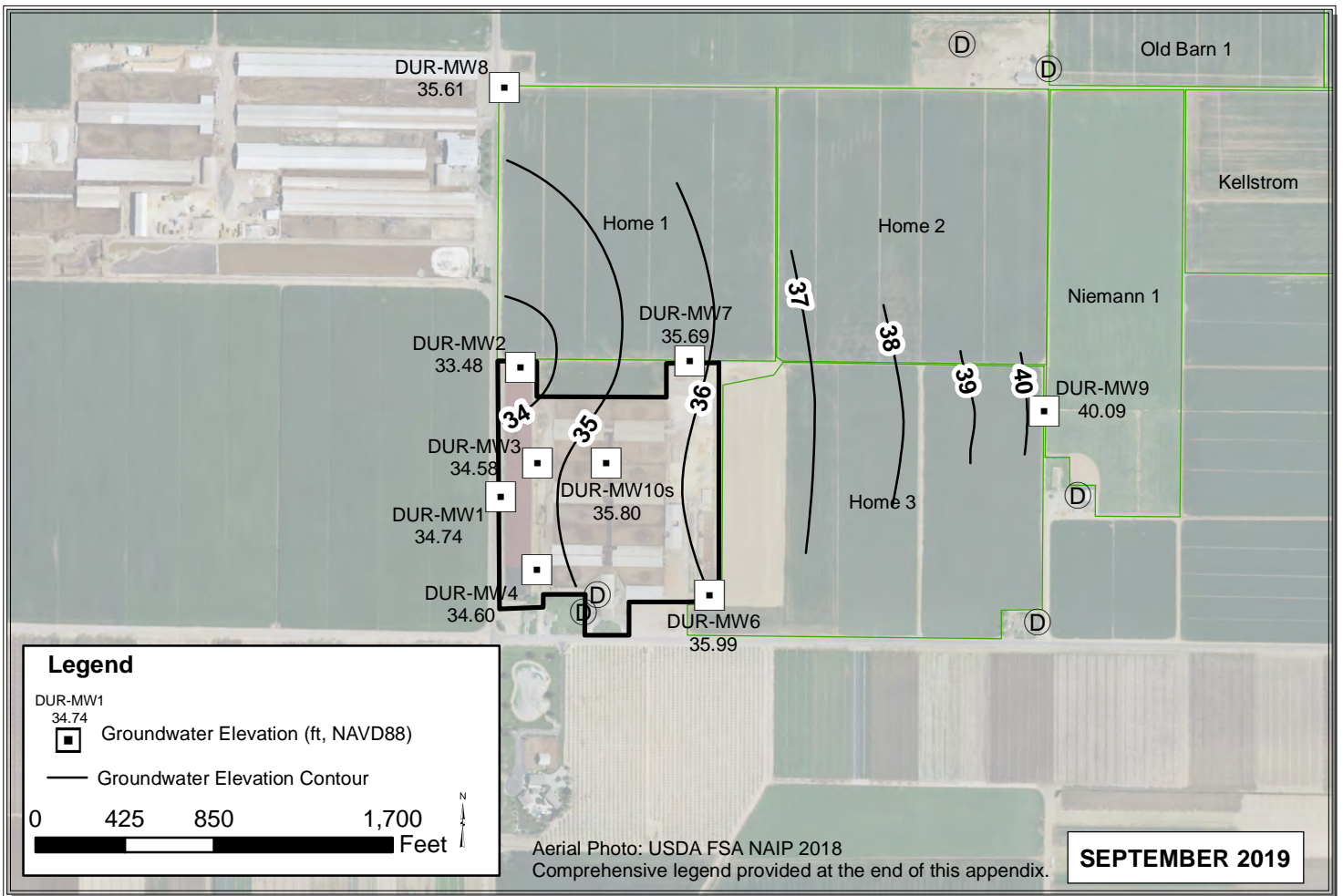

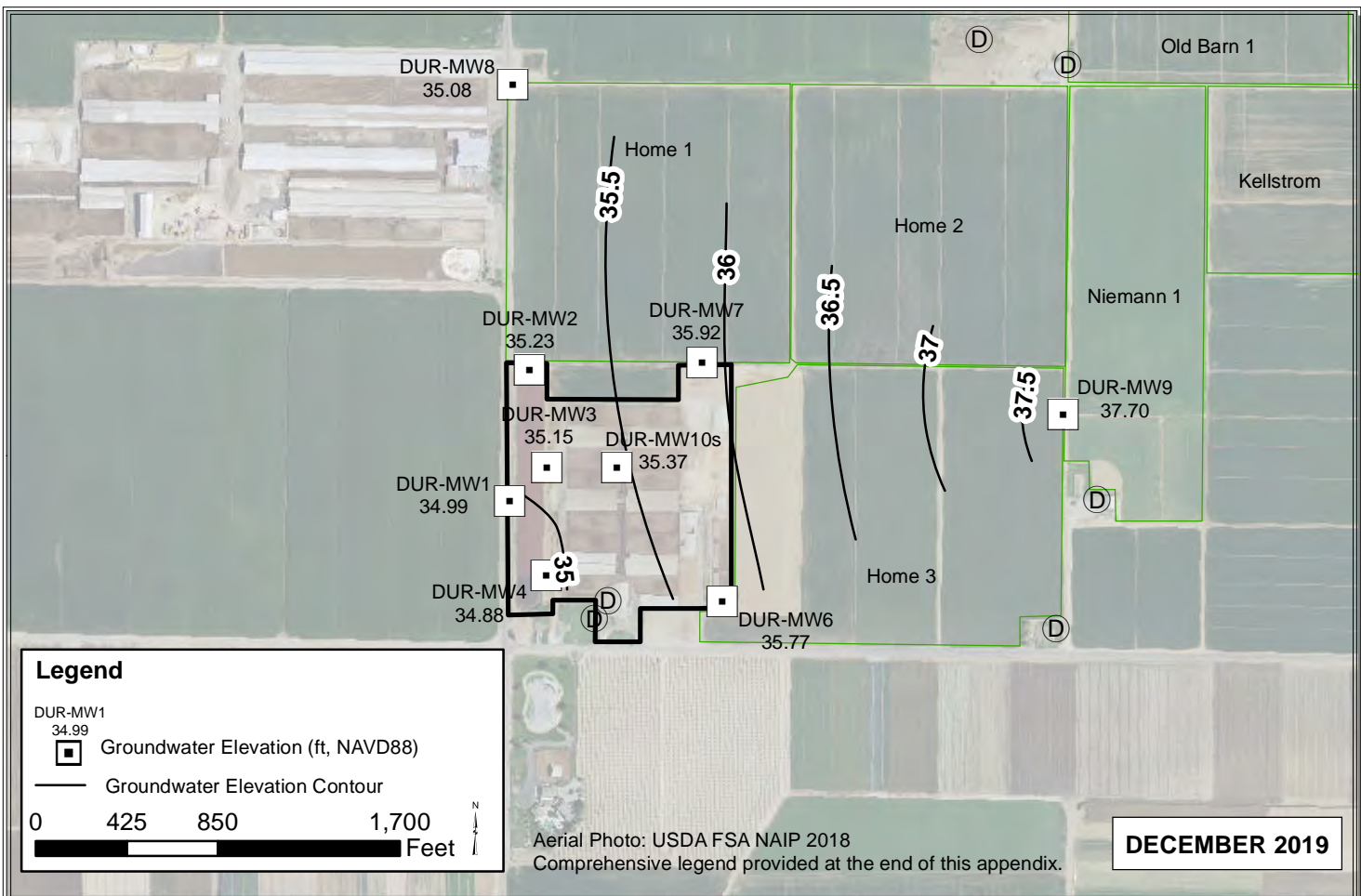
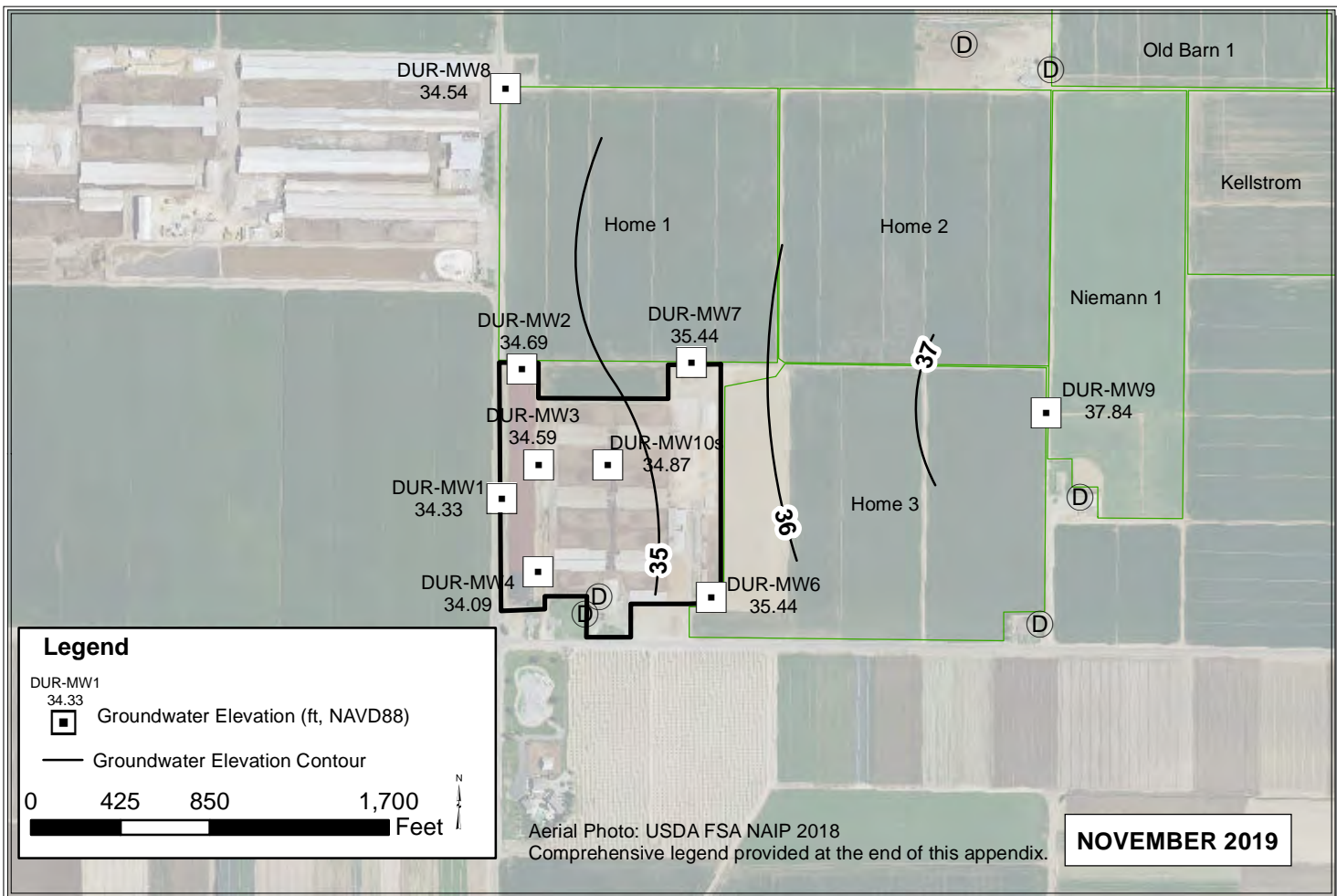

FG1

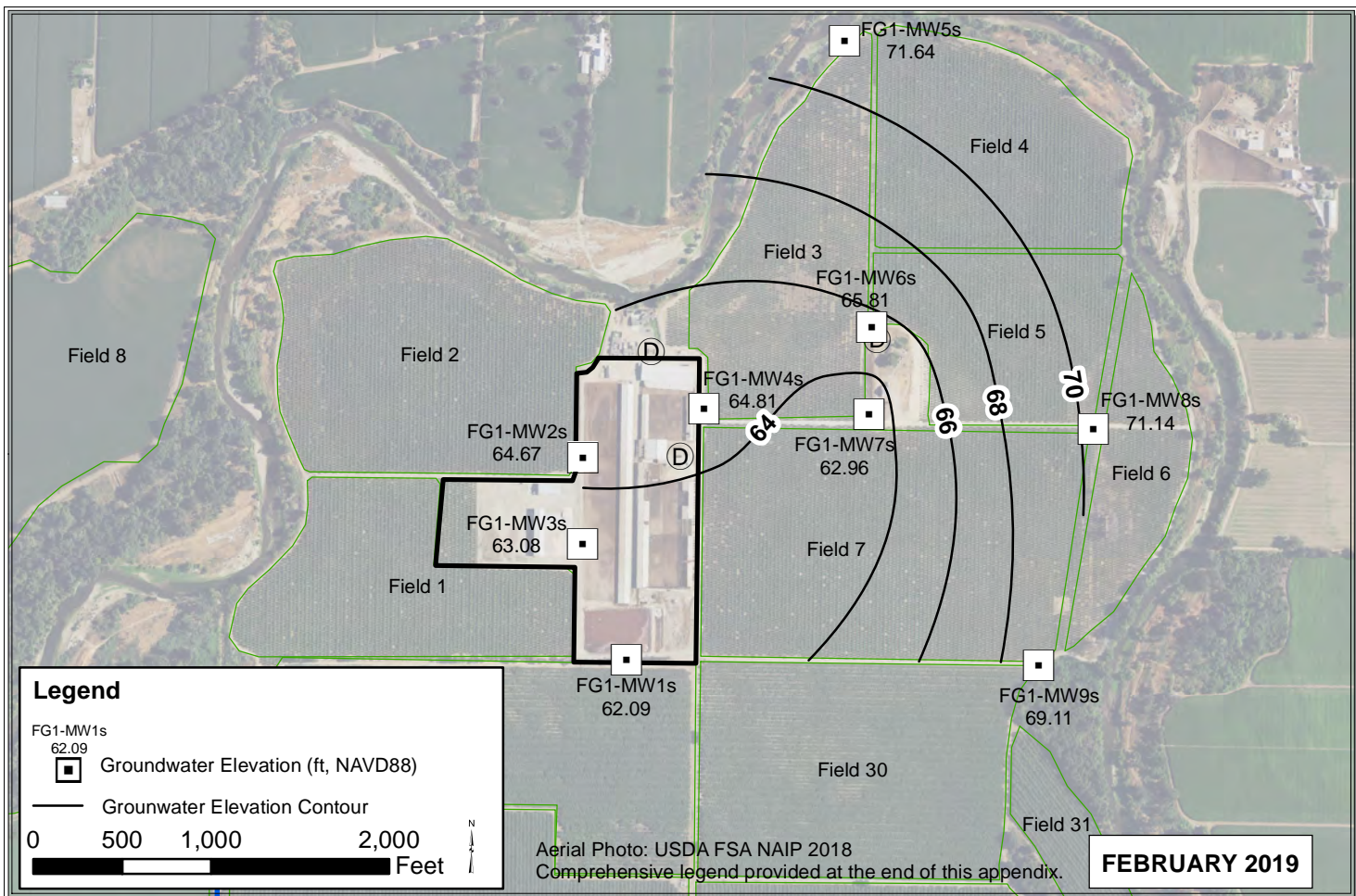
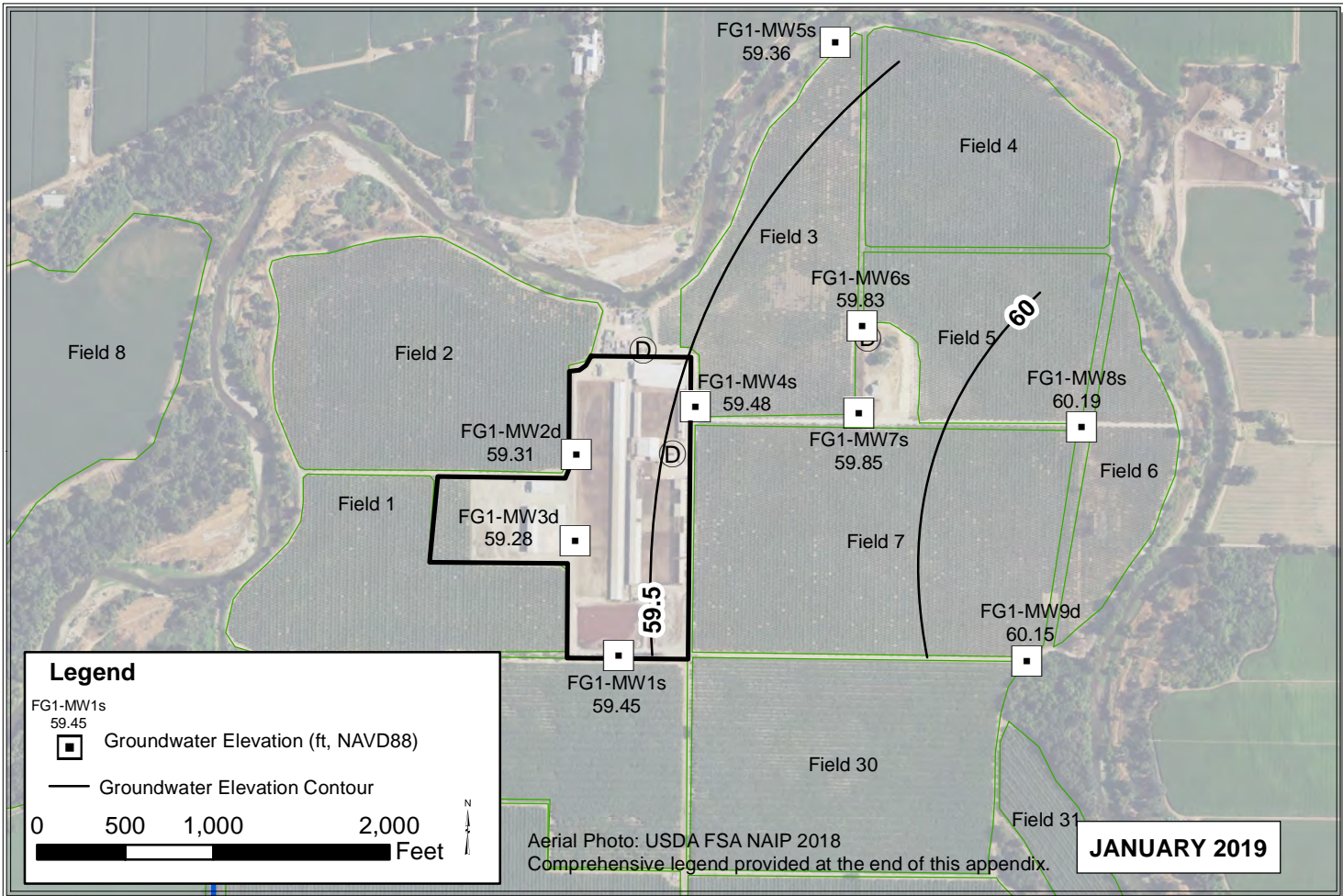

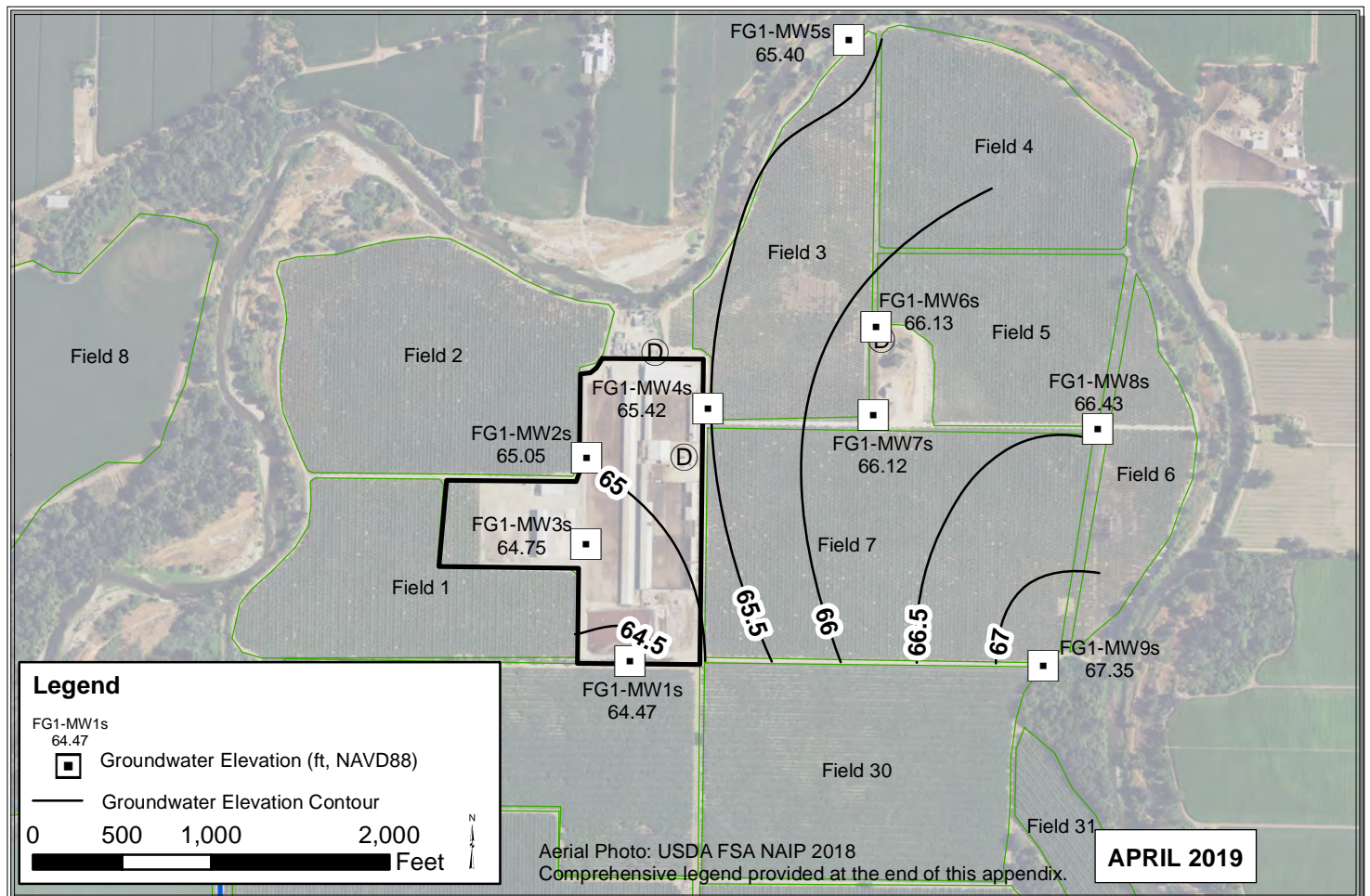
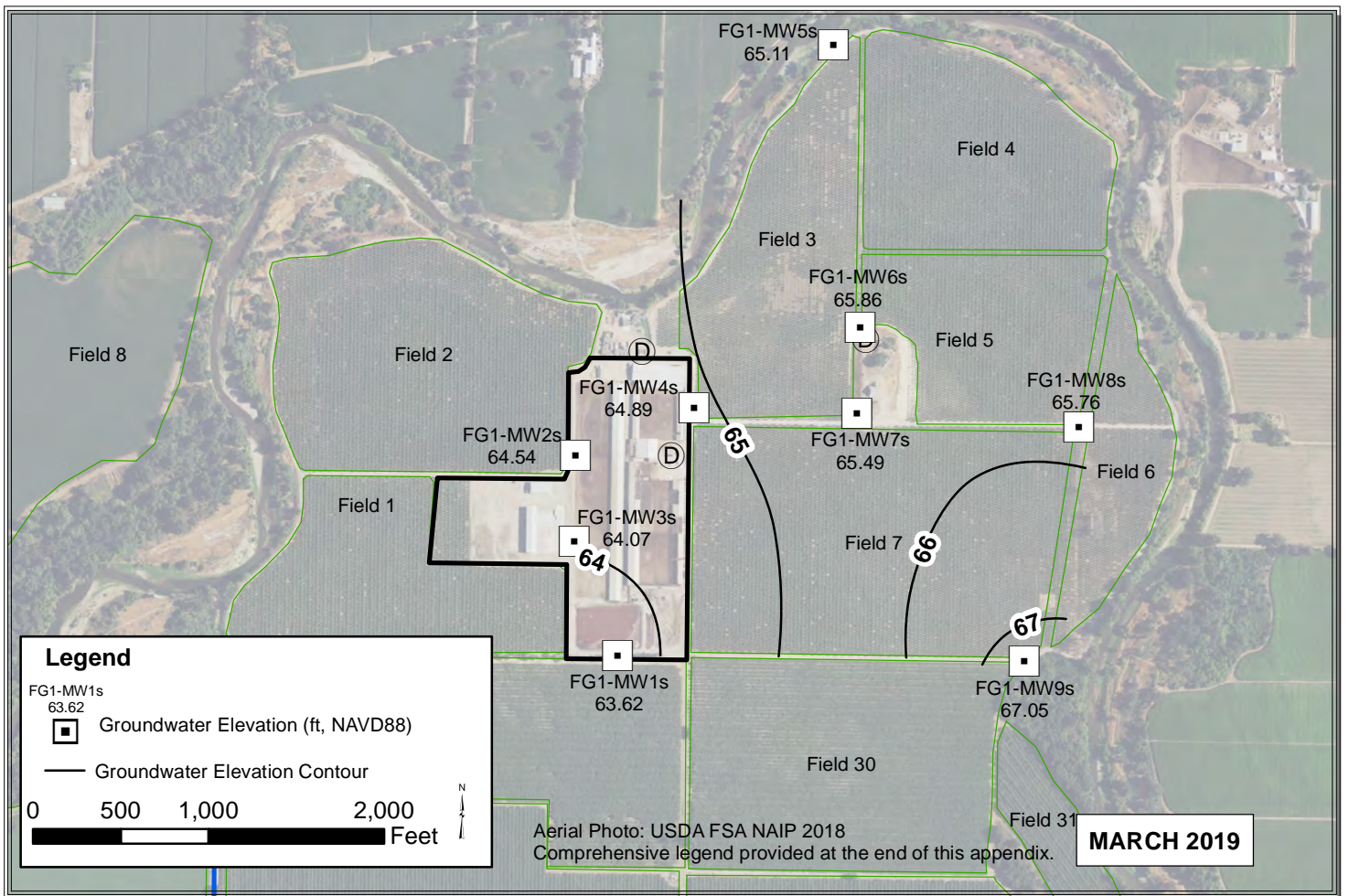

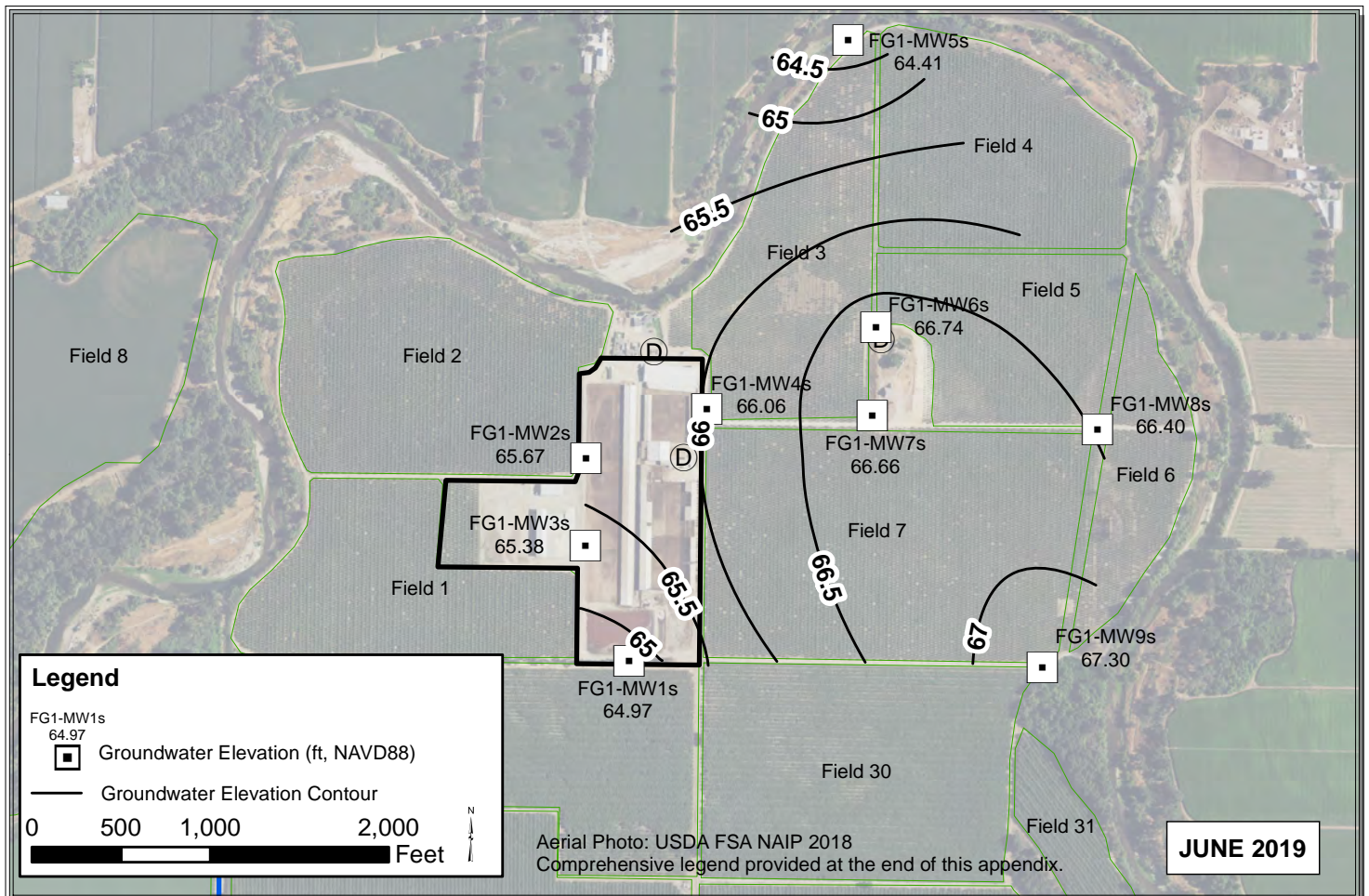
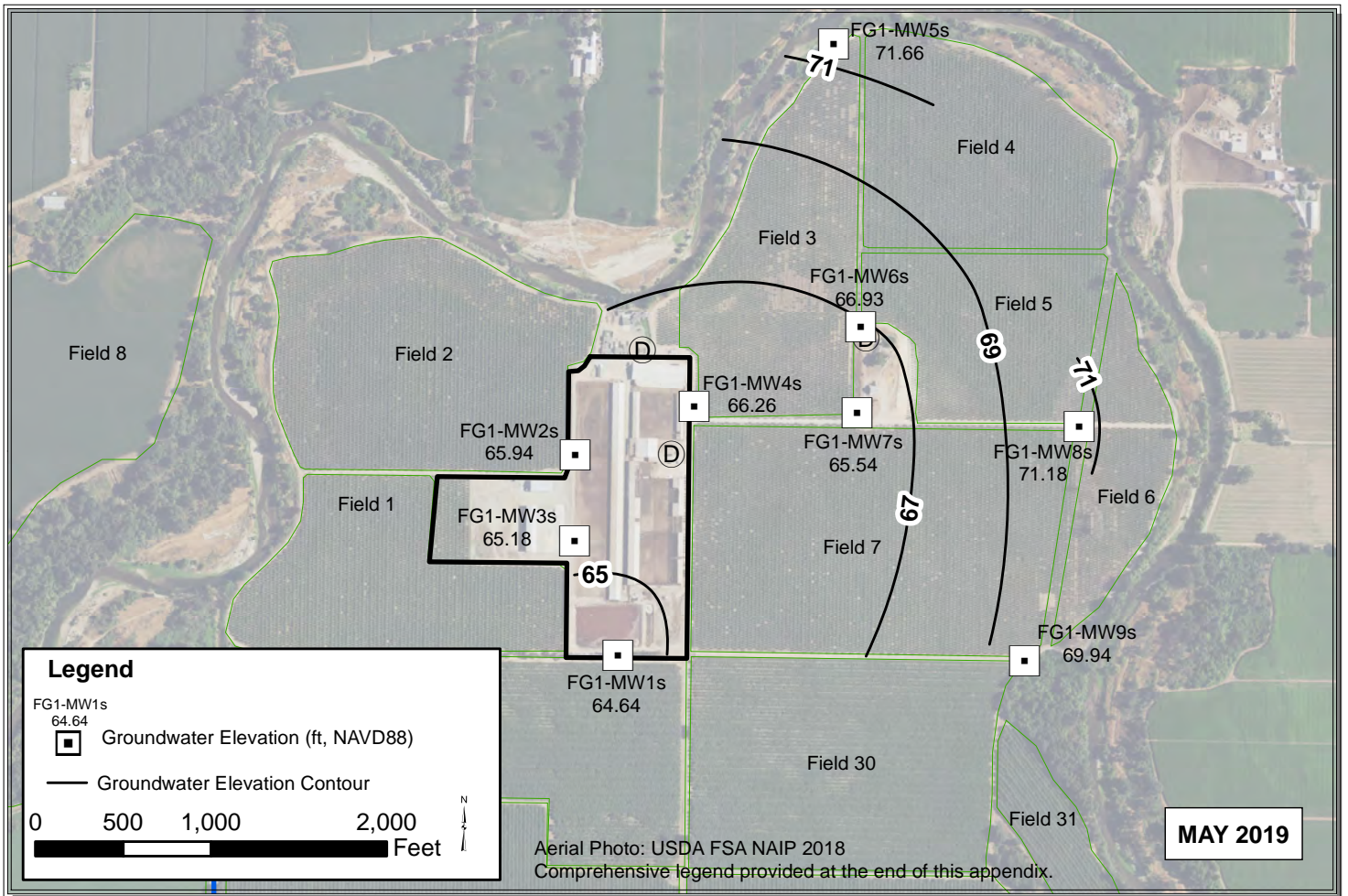

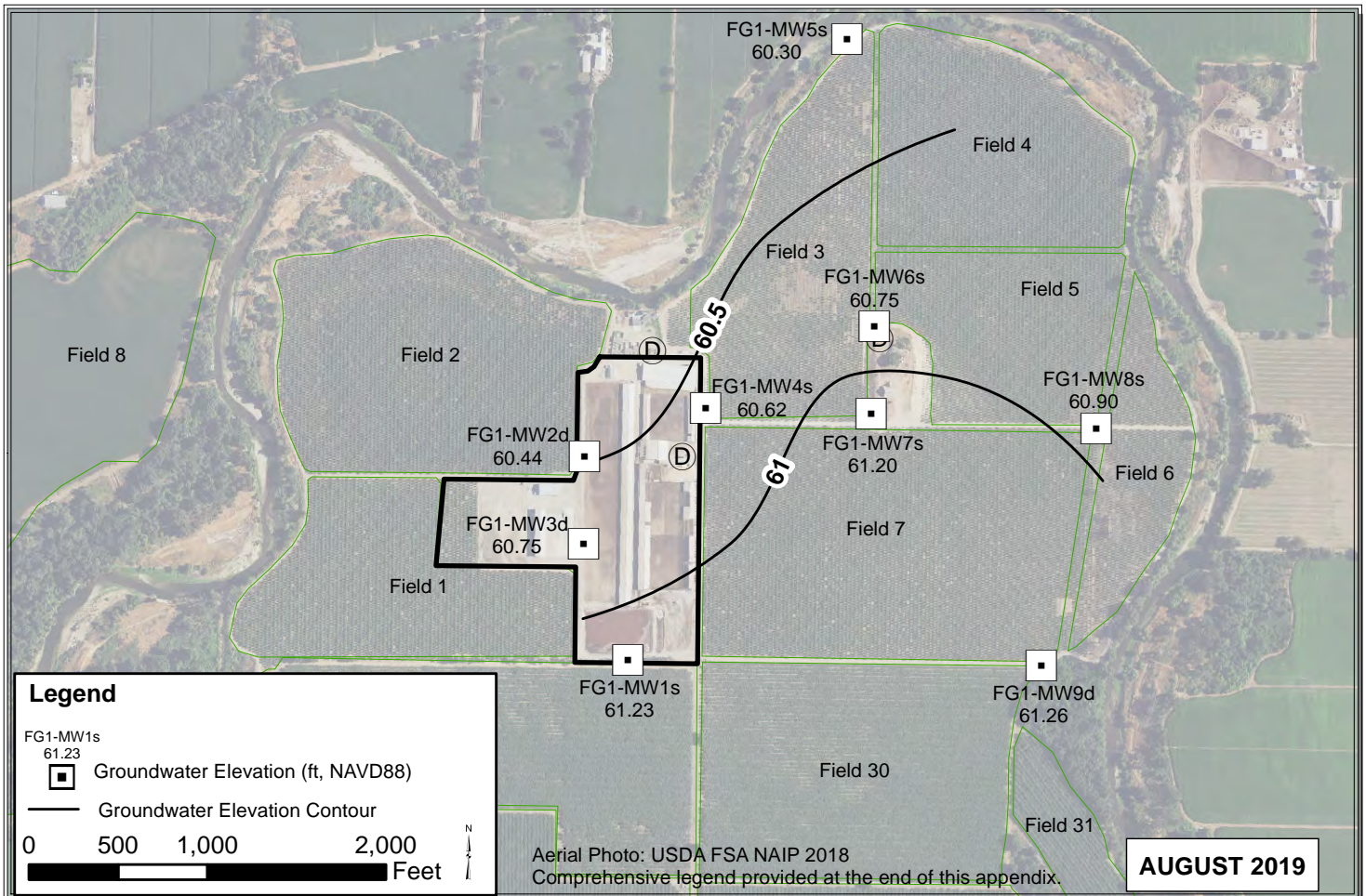
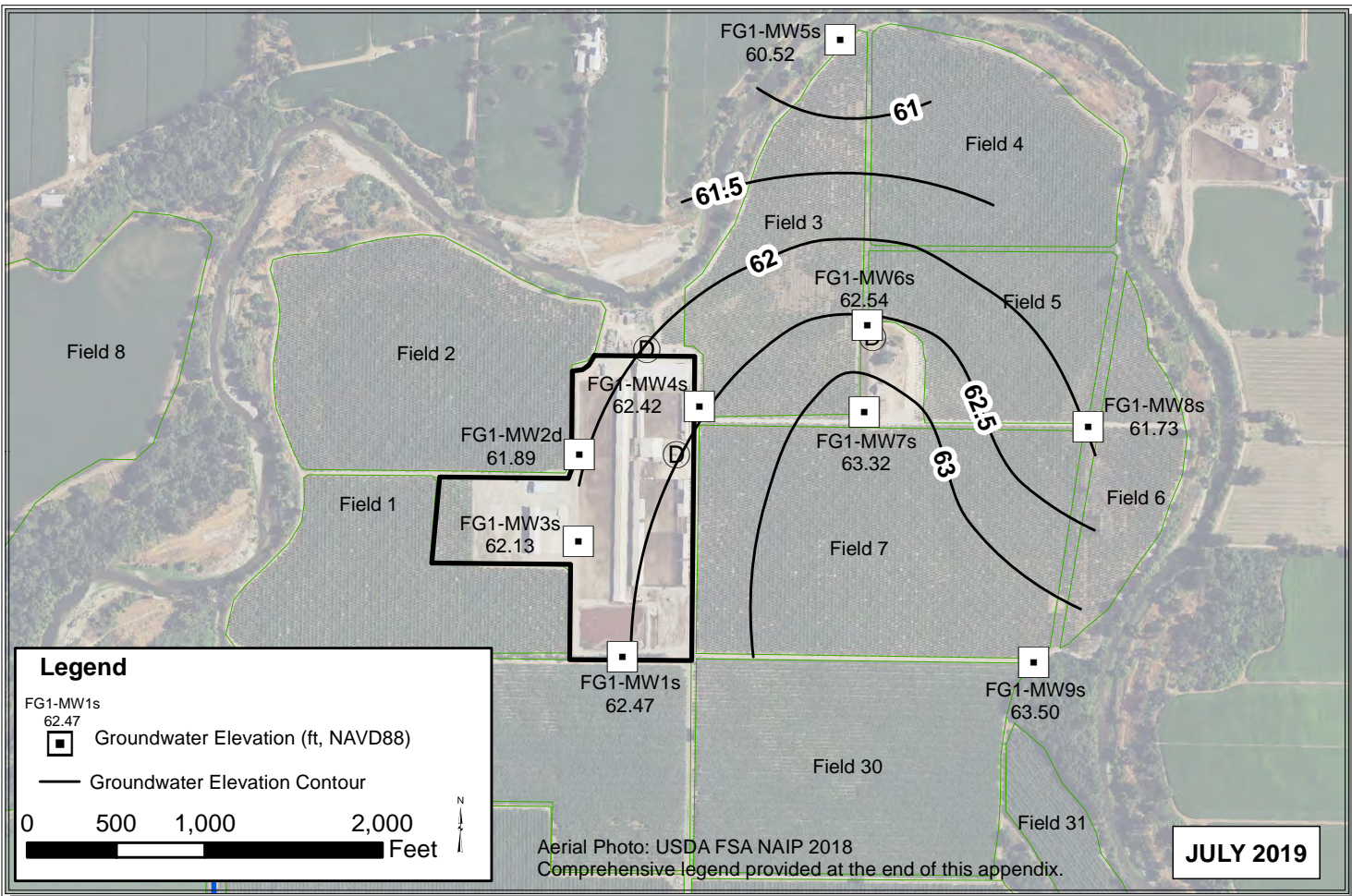

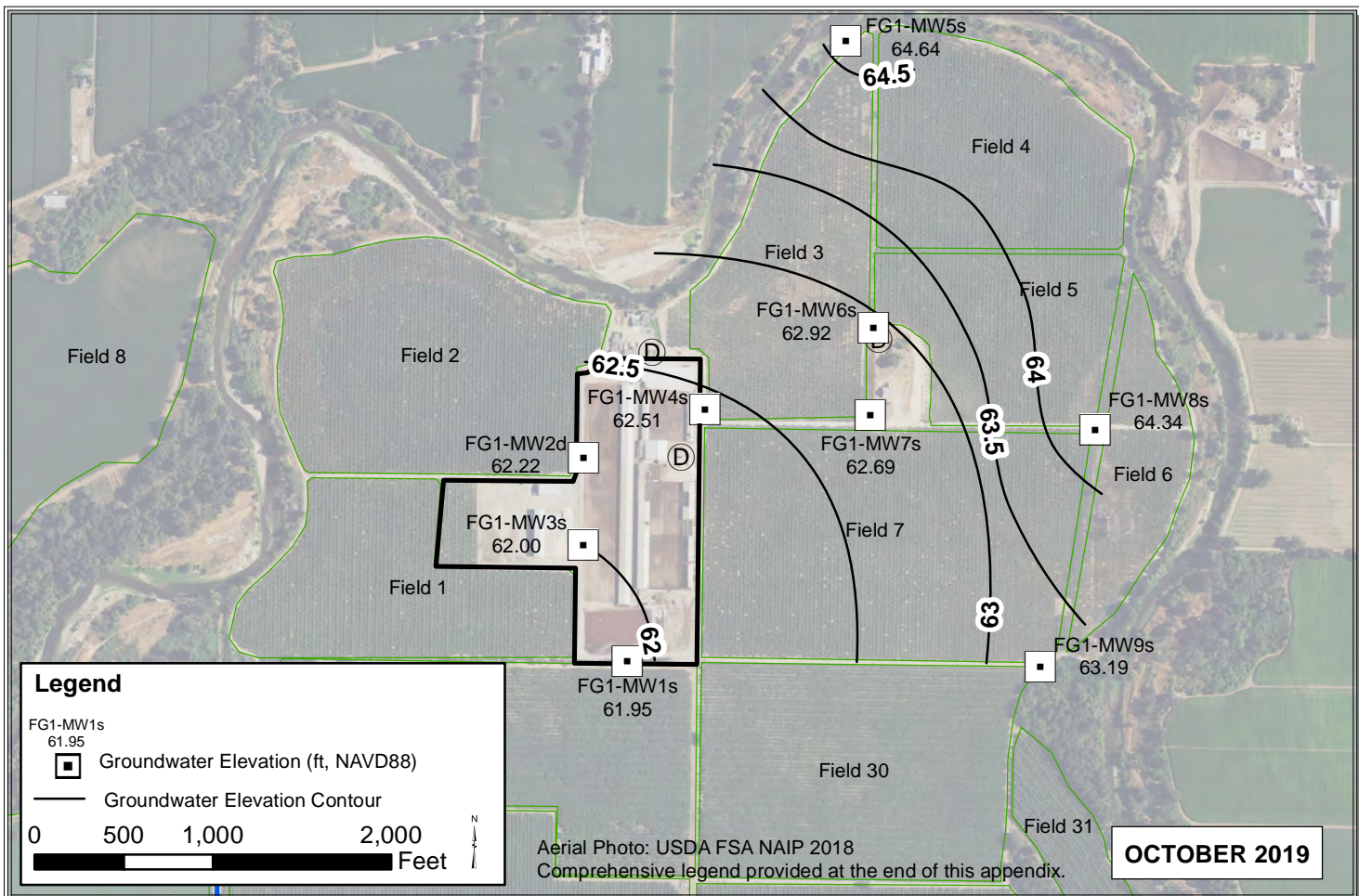
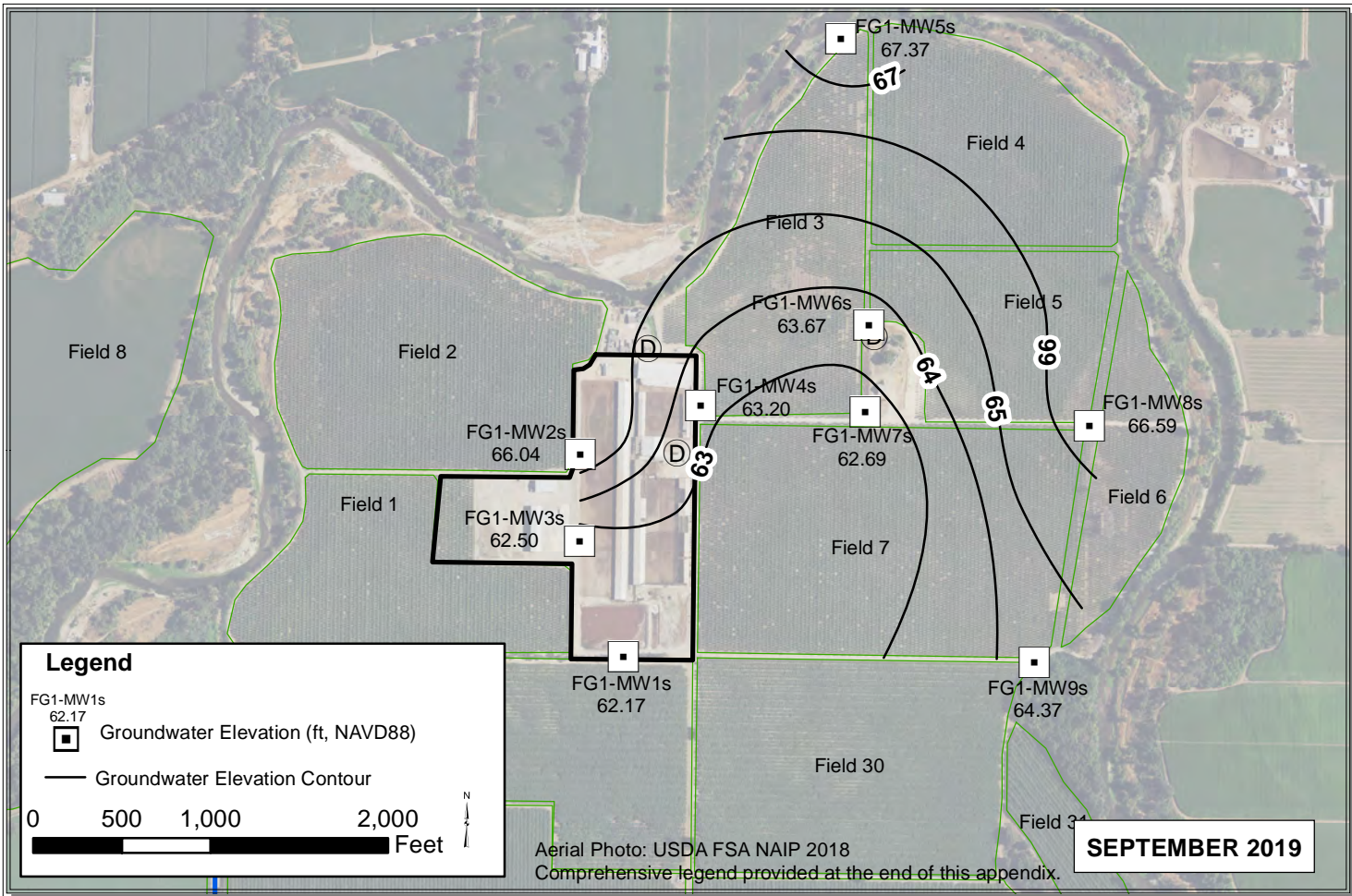

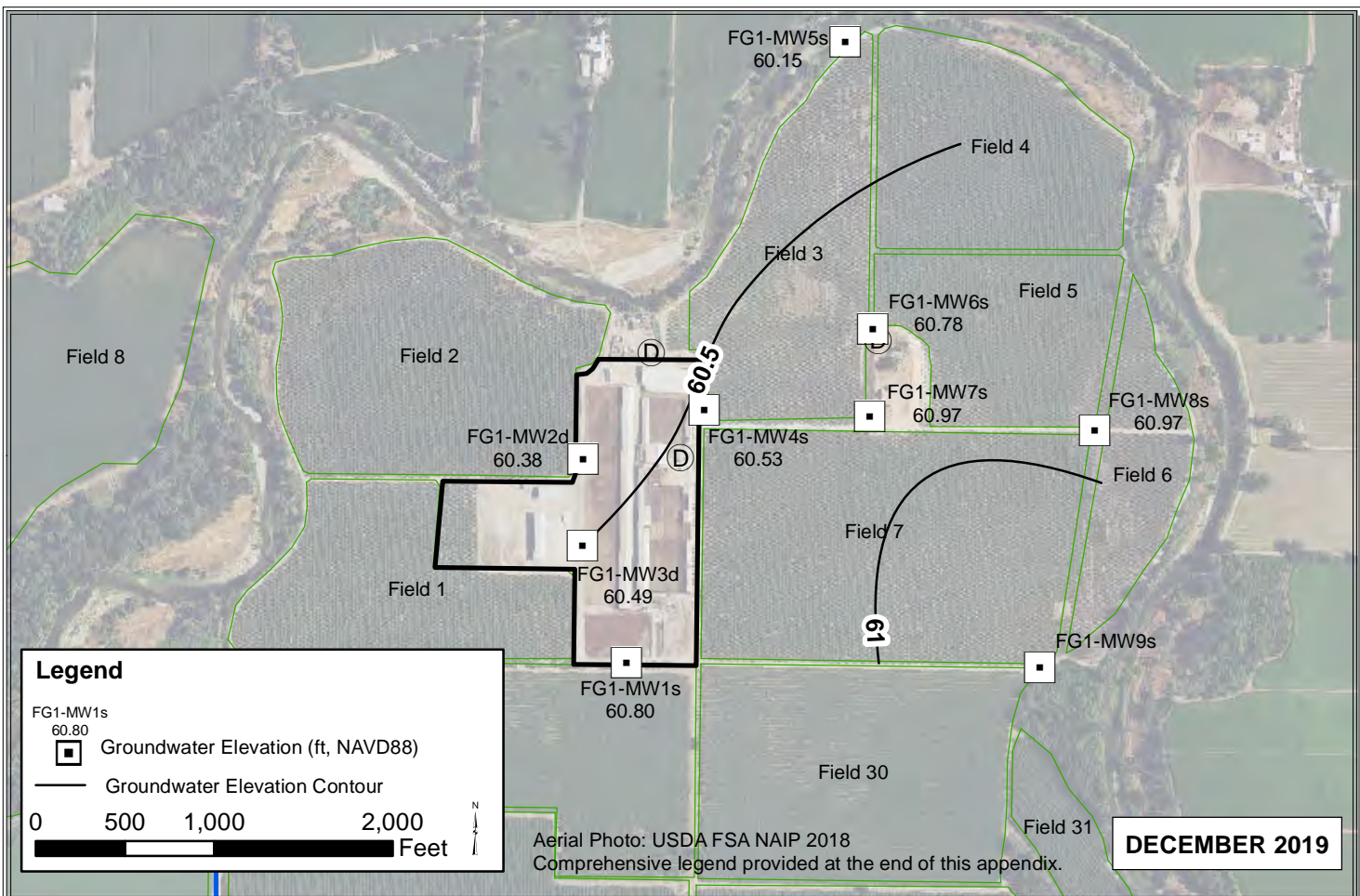
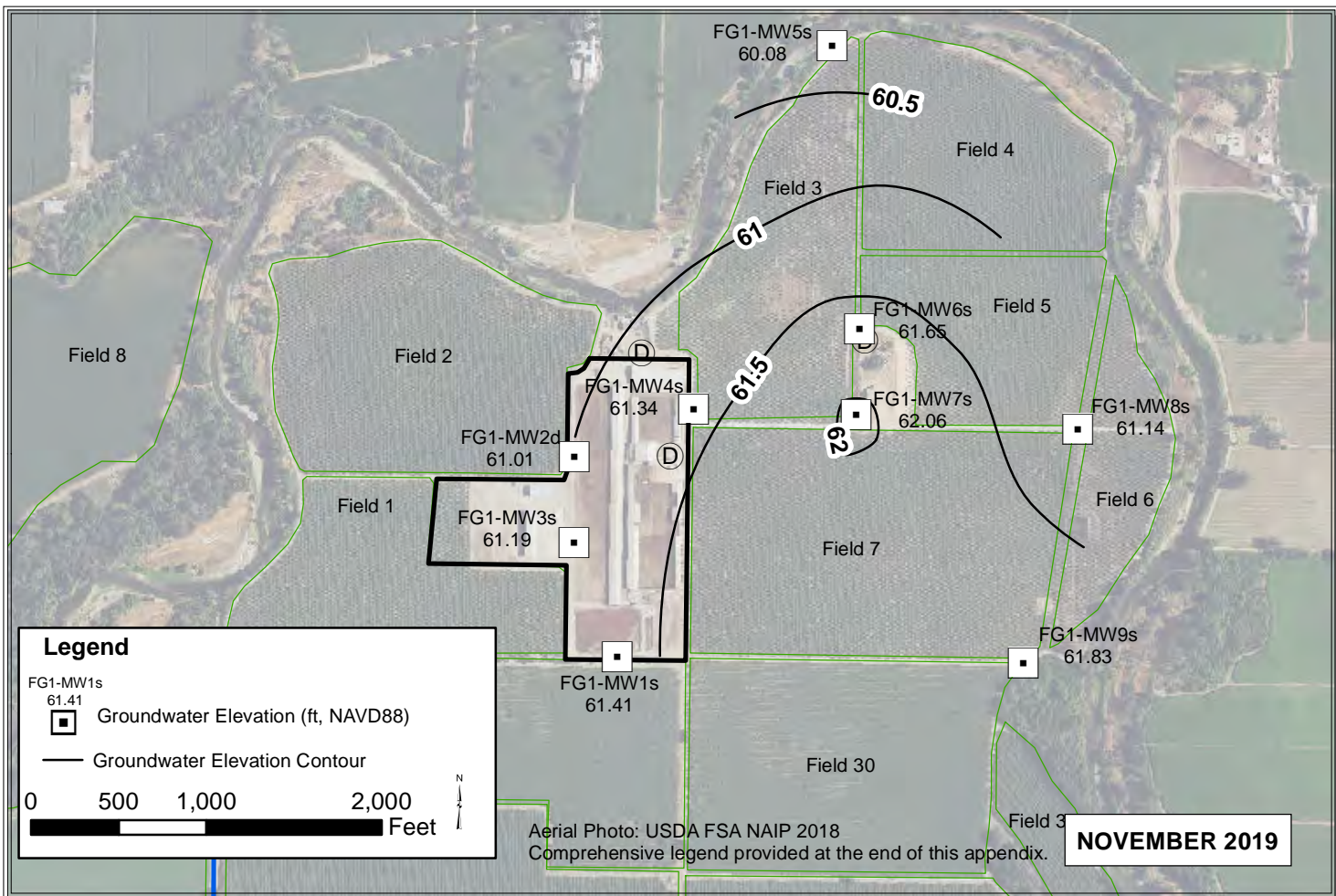

BEA

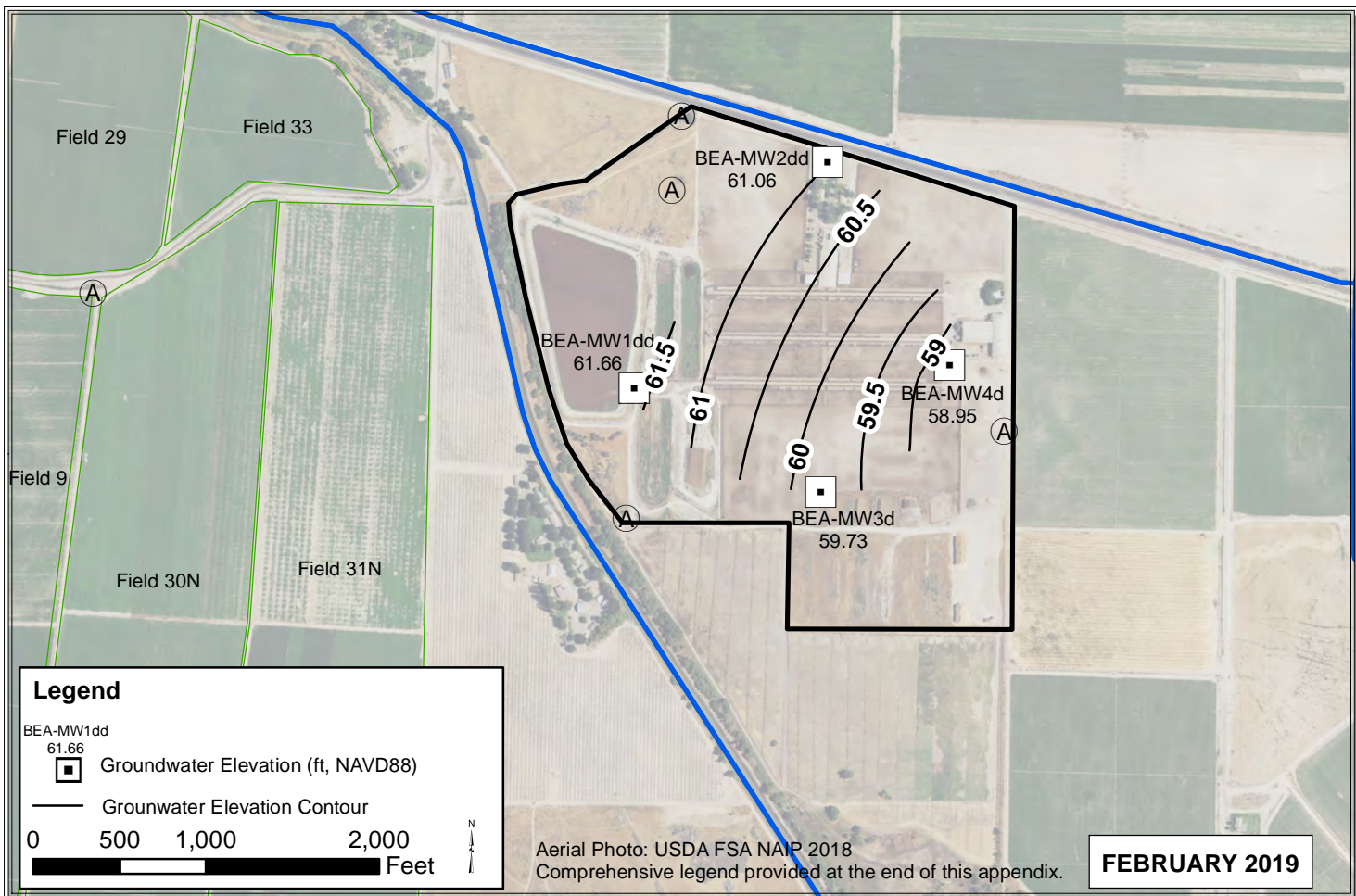
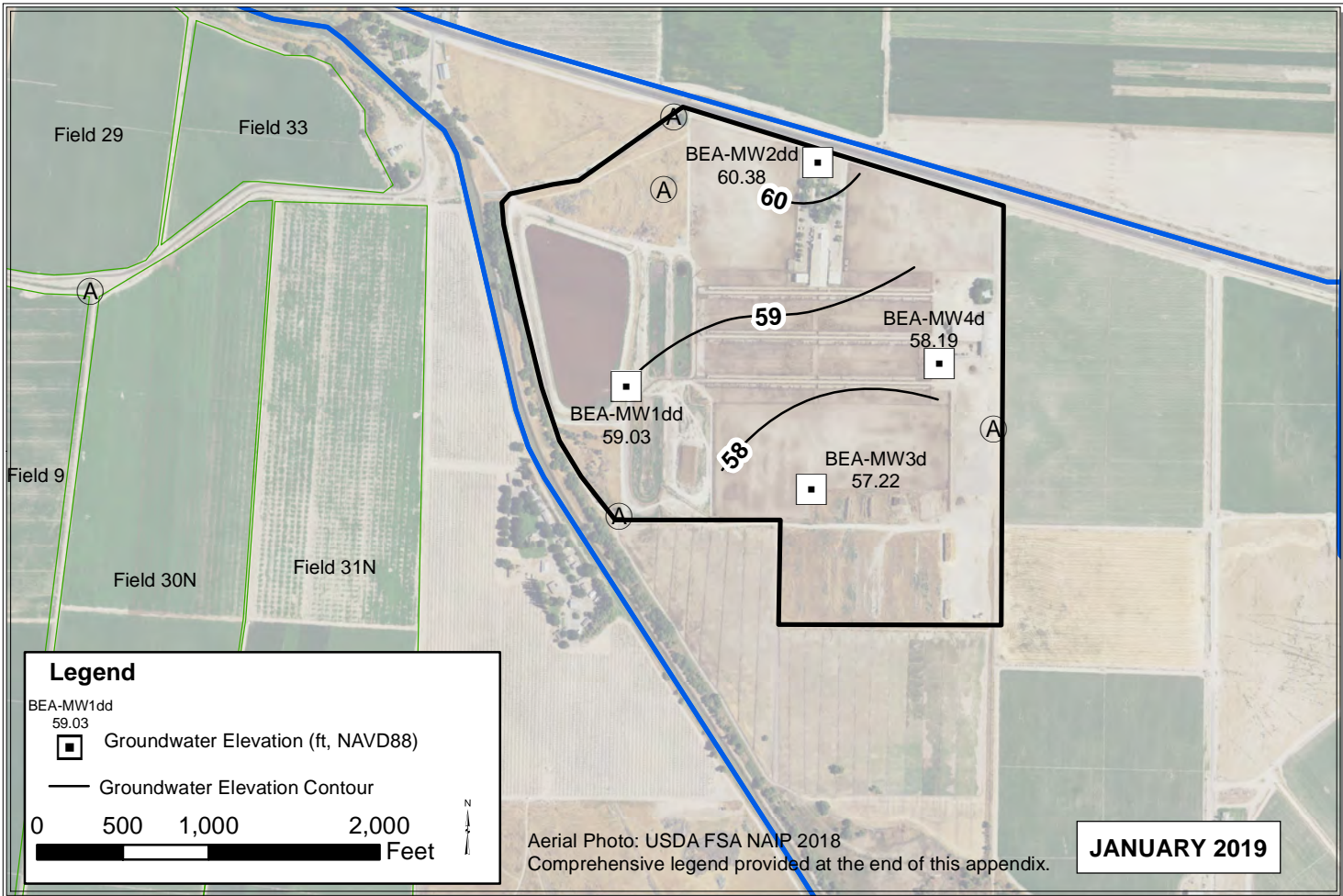

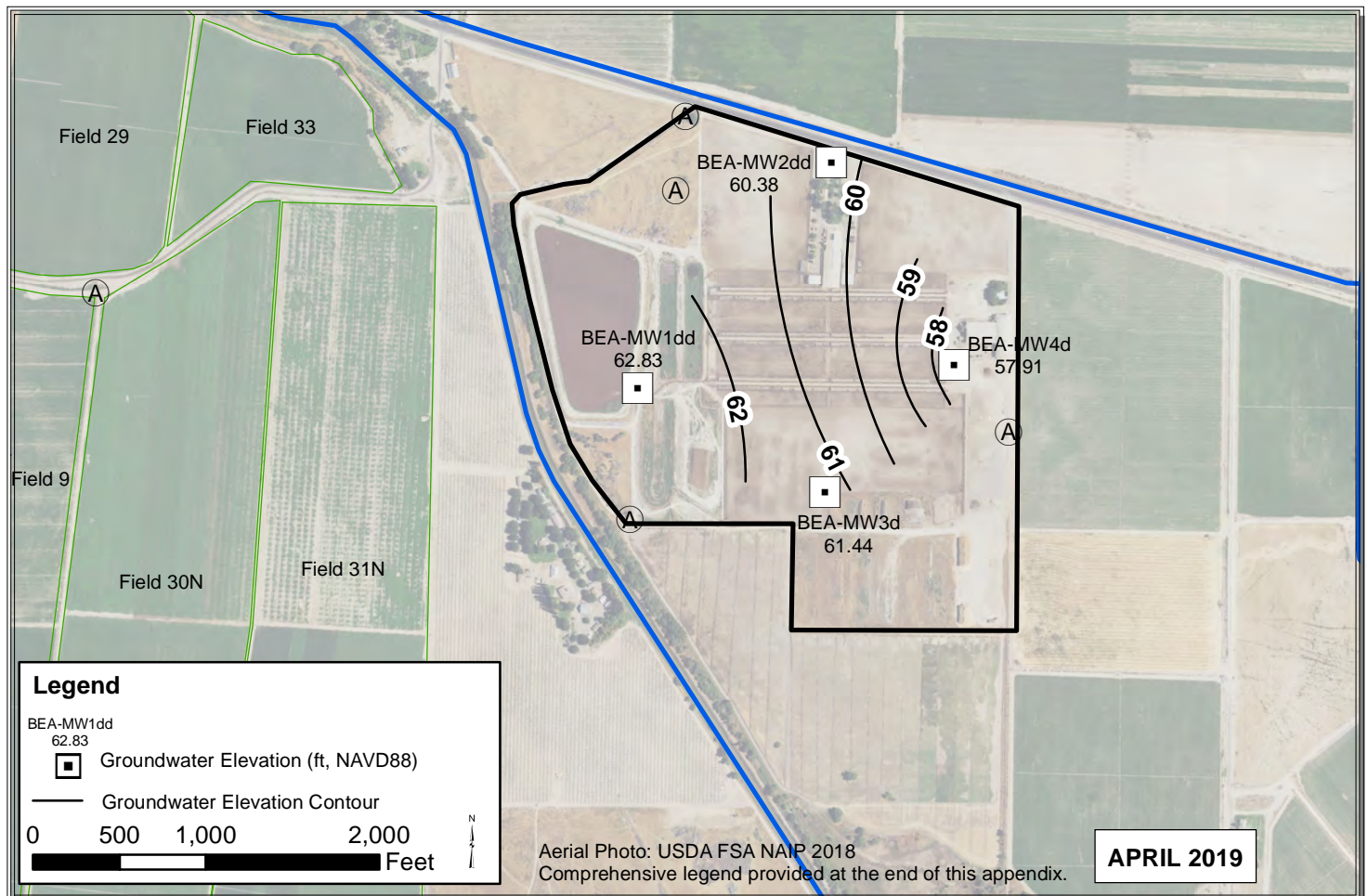
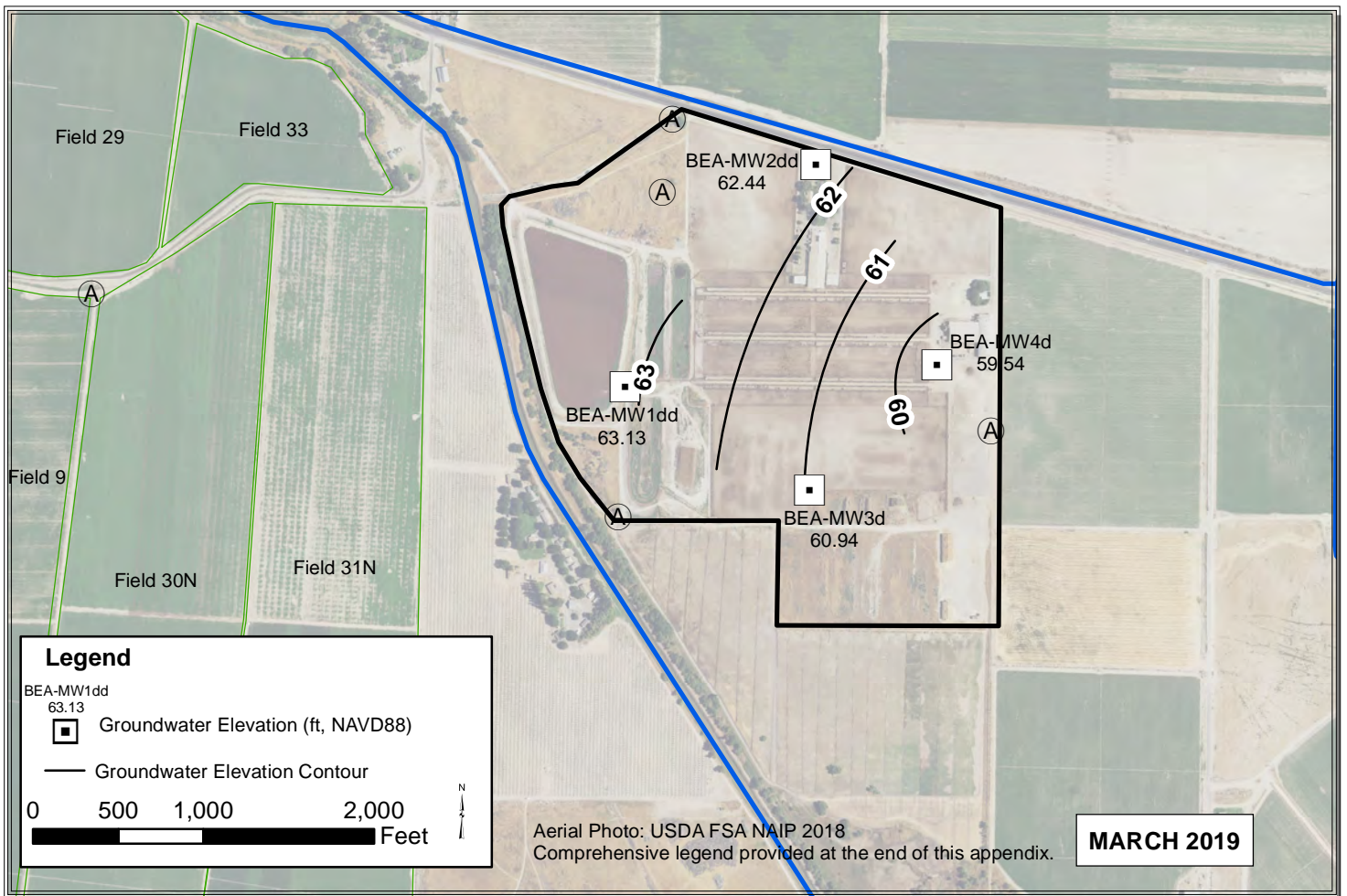

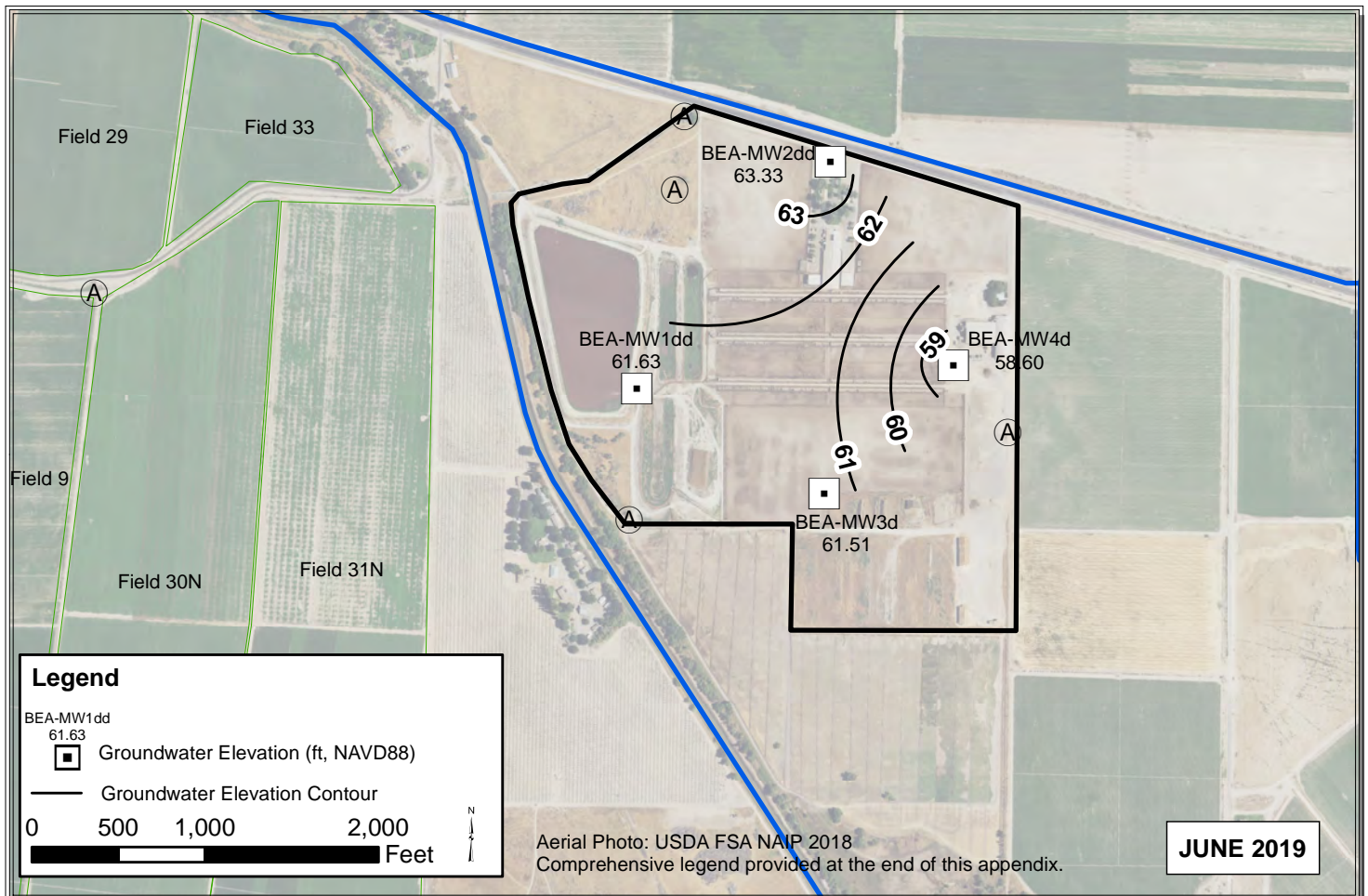
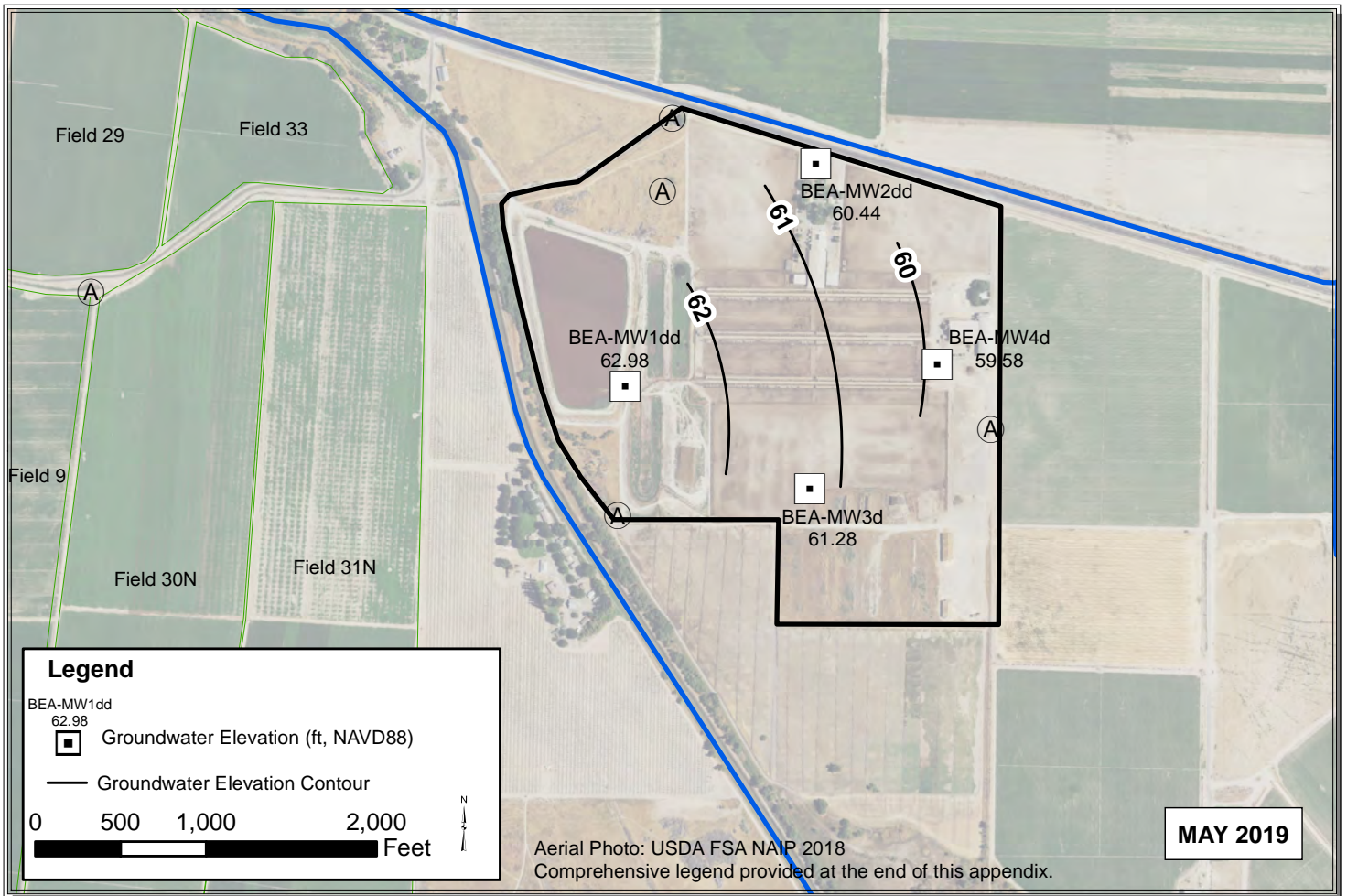

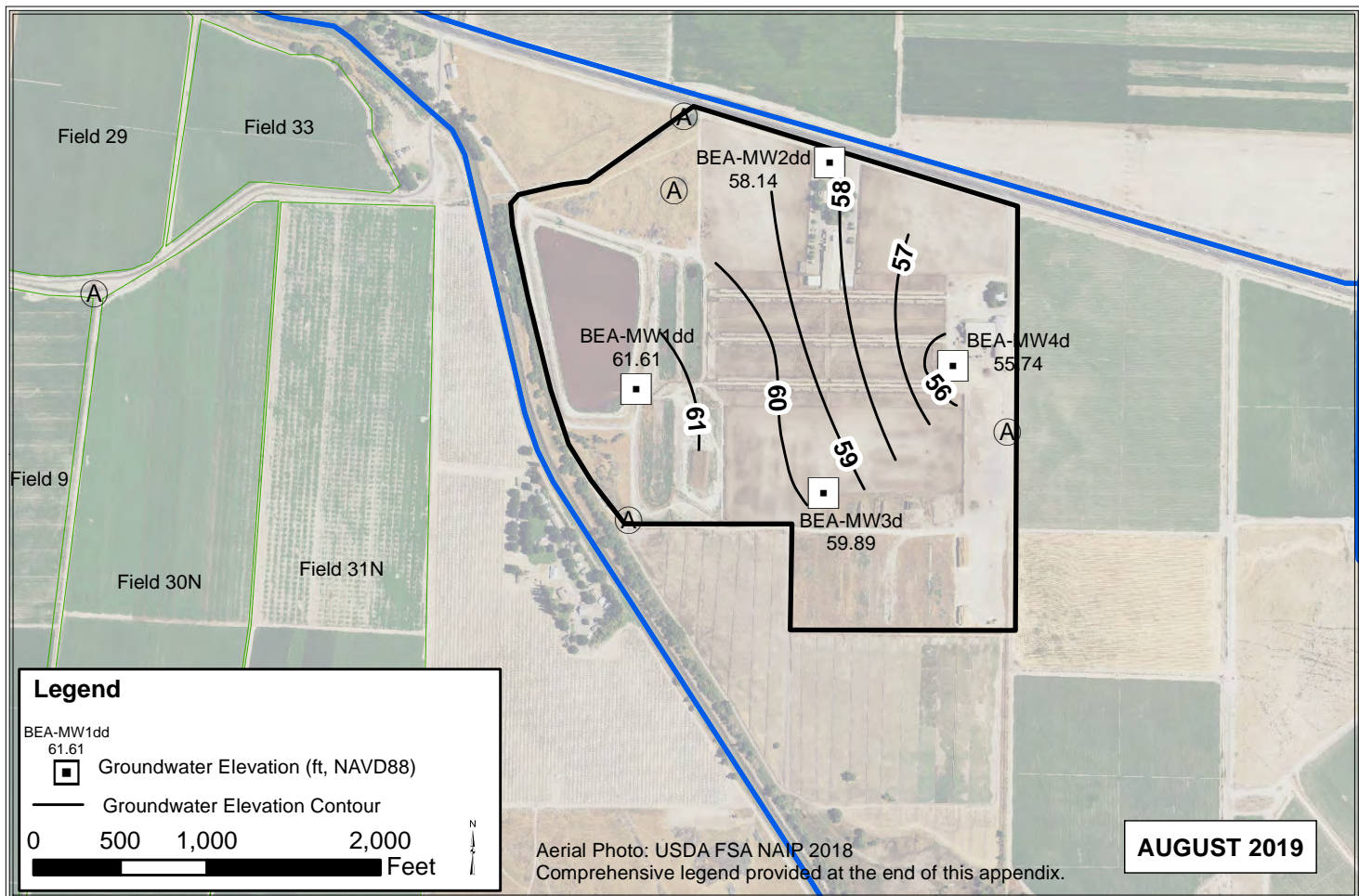
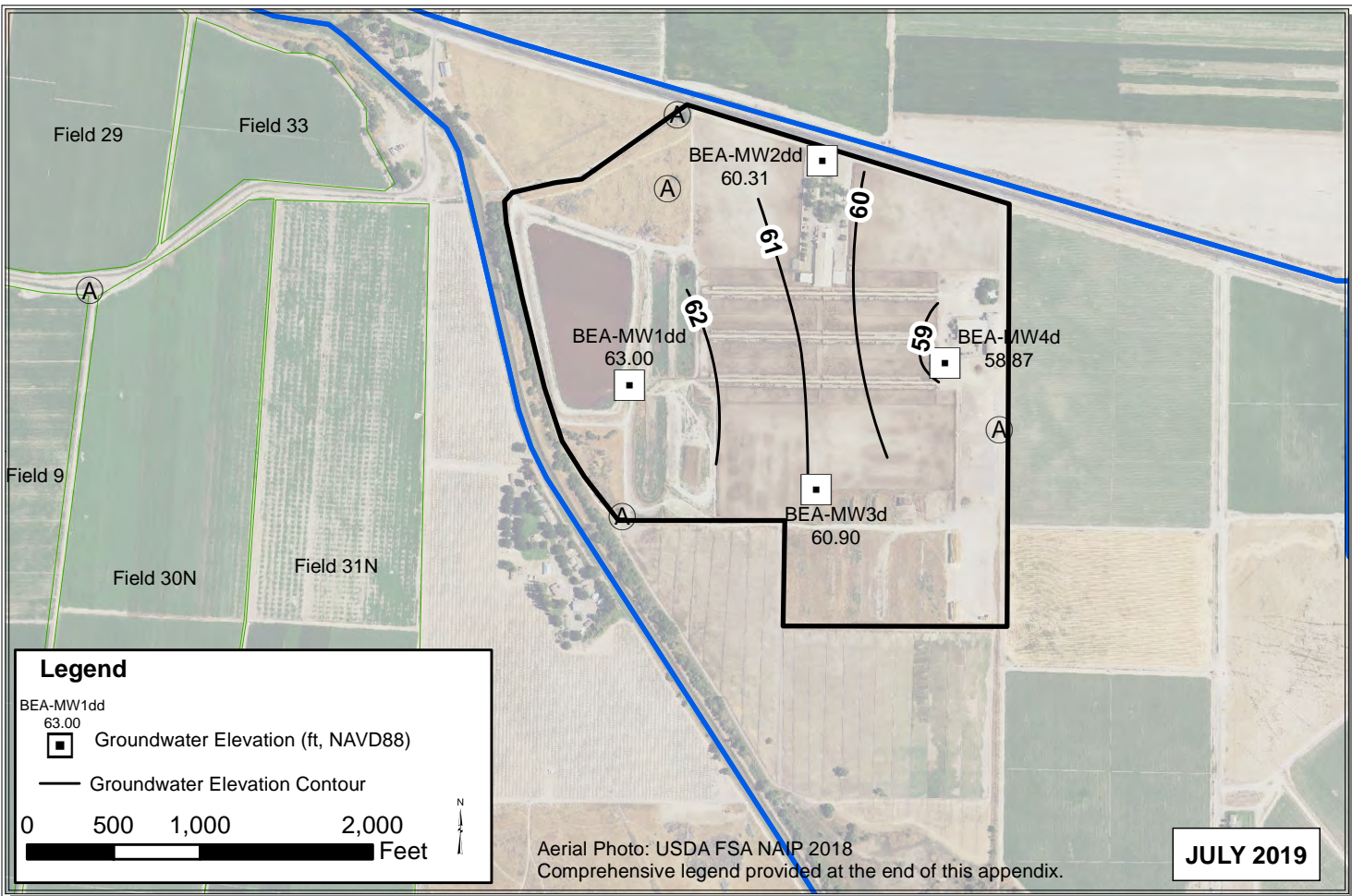

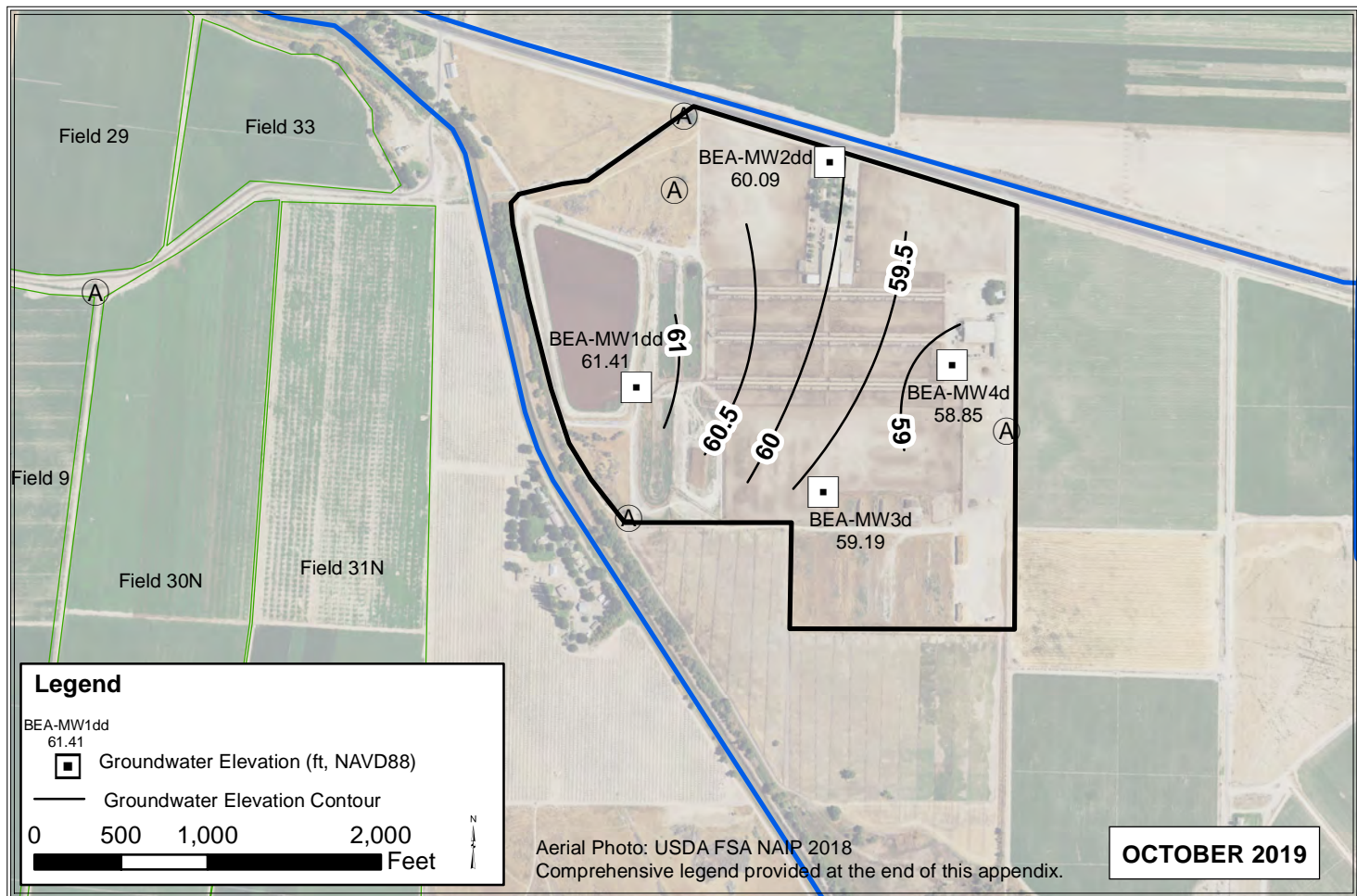
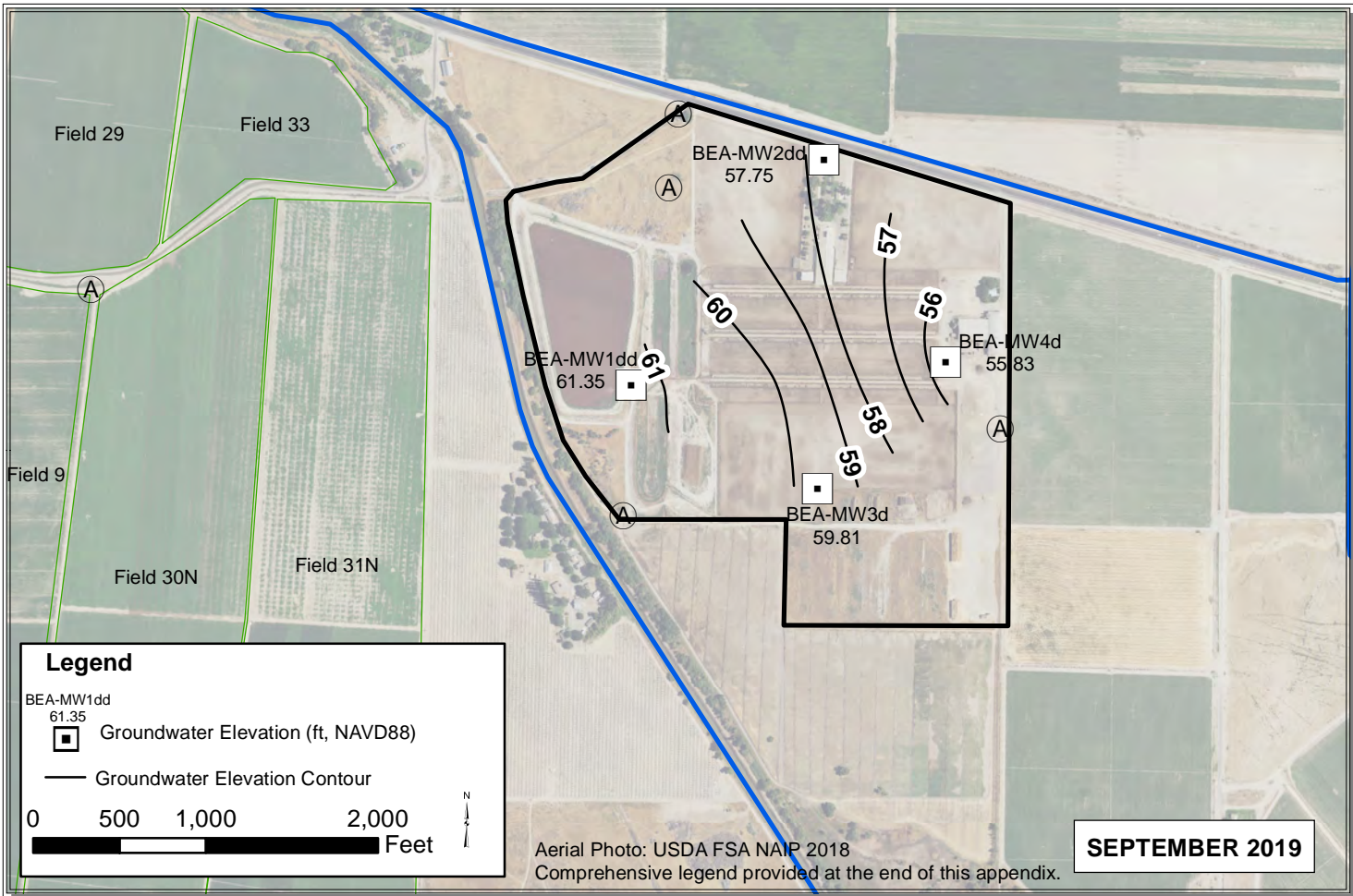

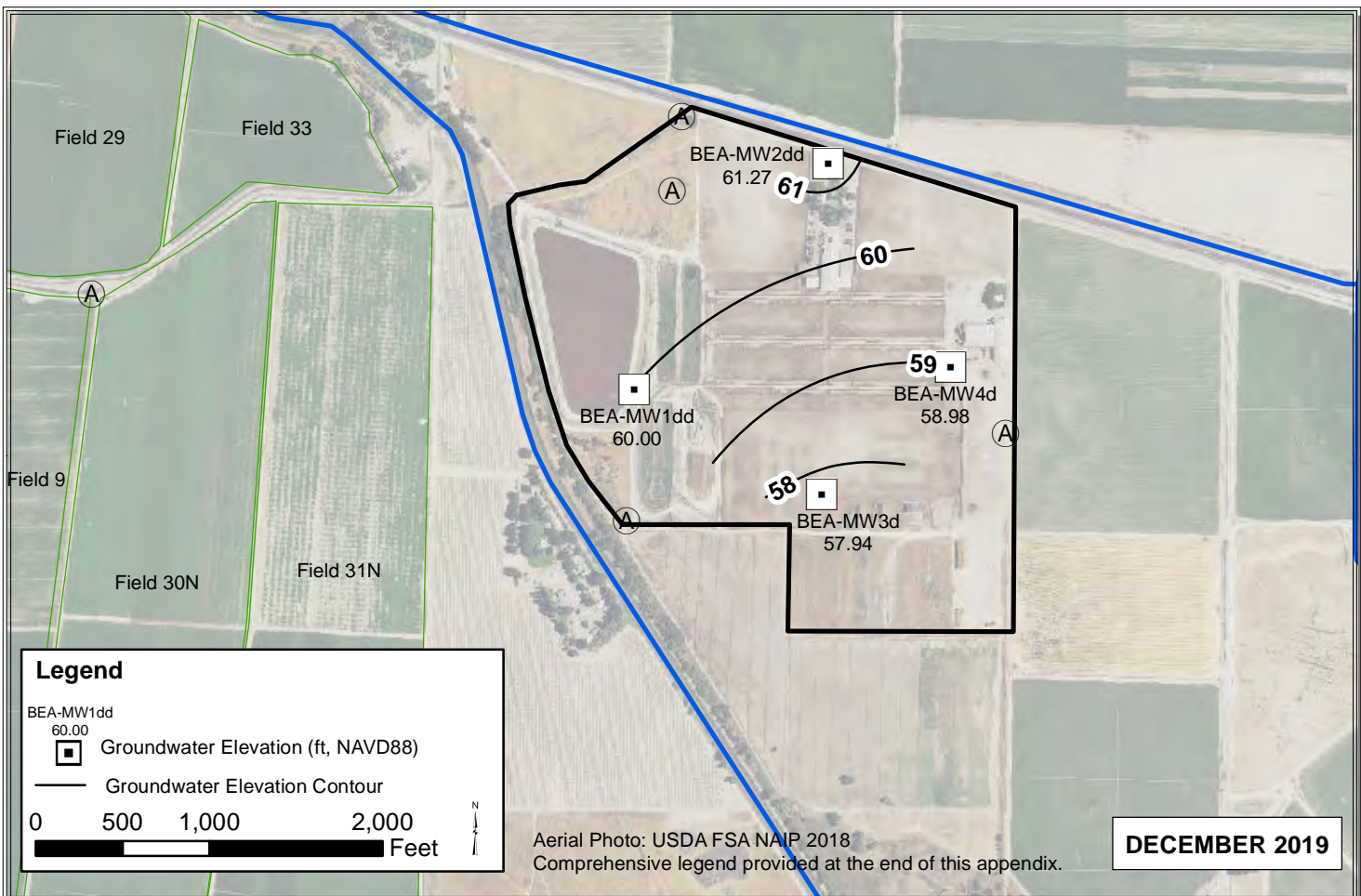
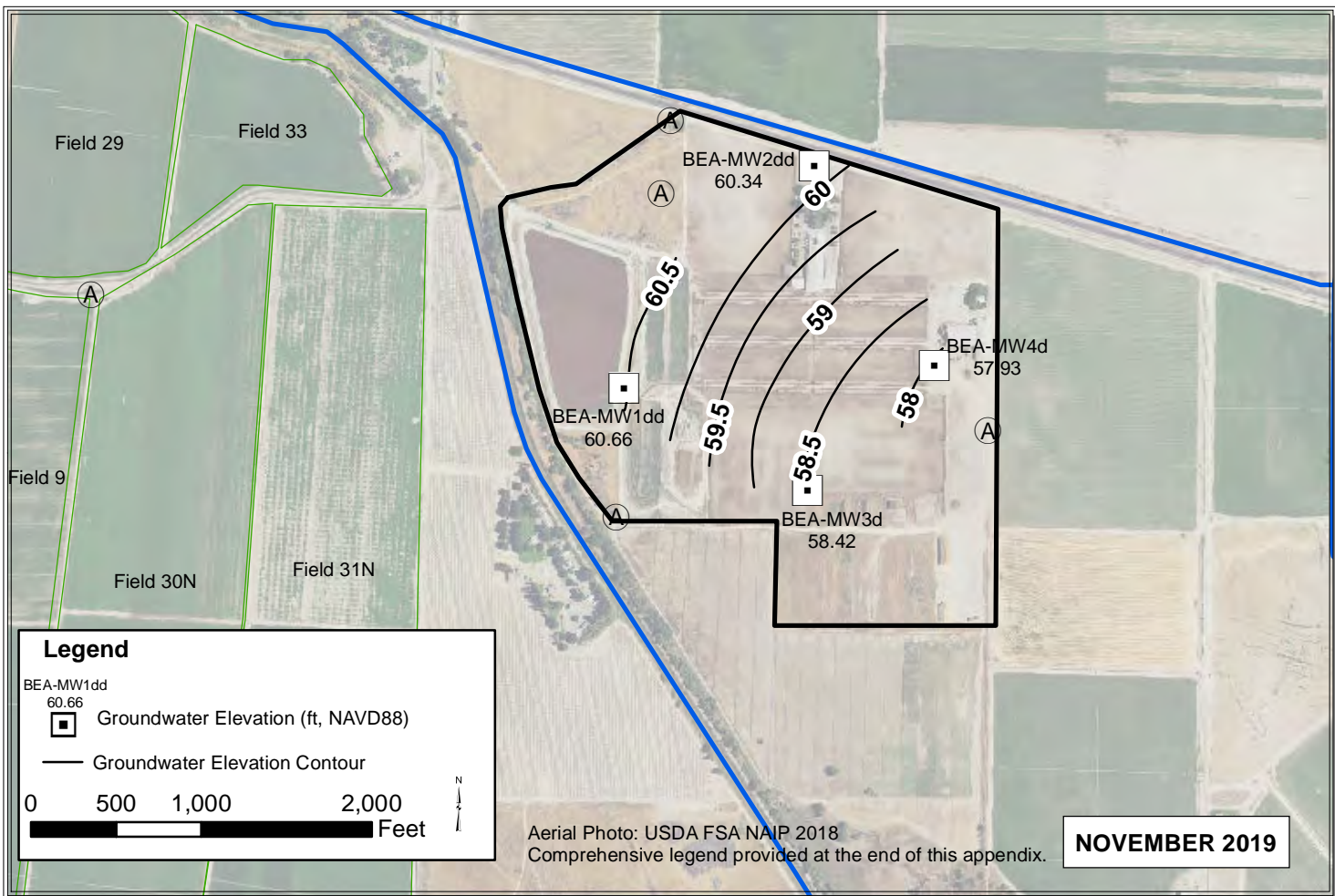

COT

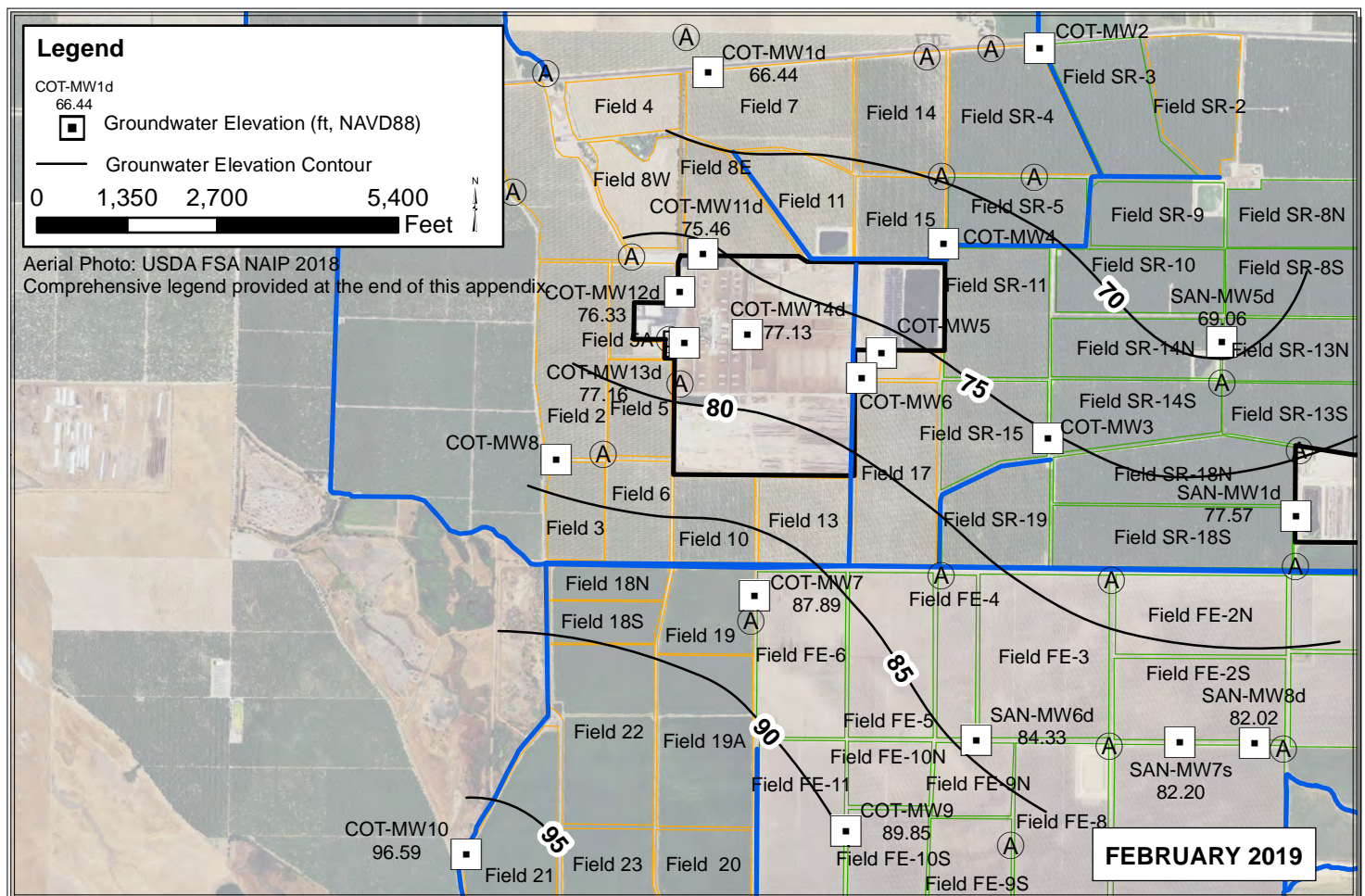
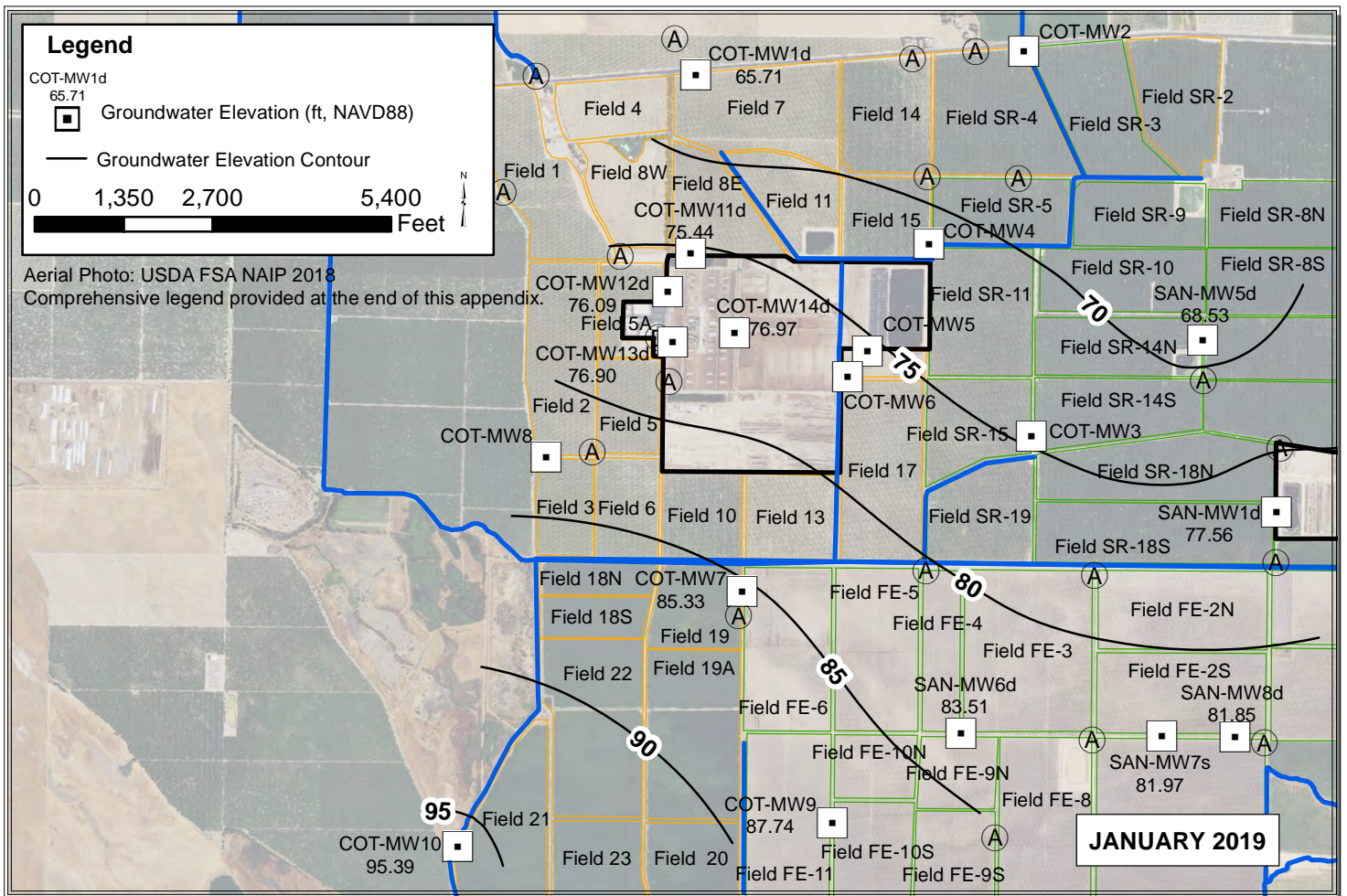

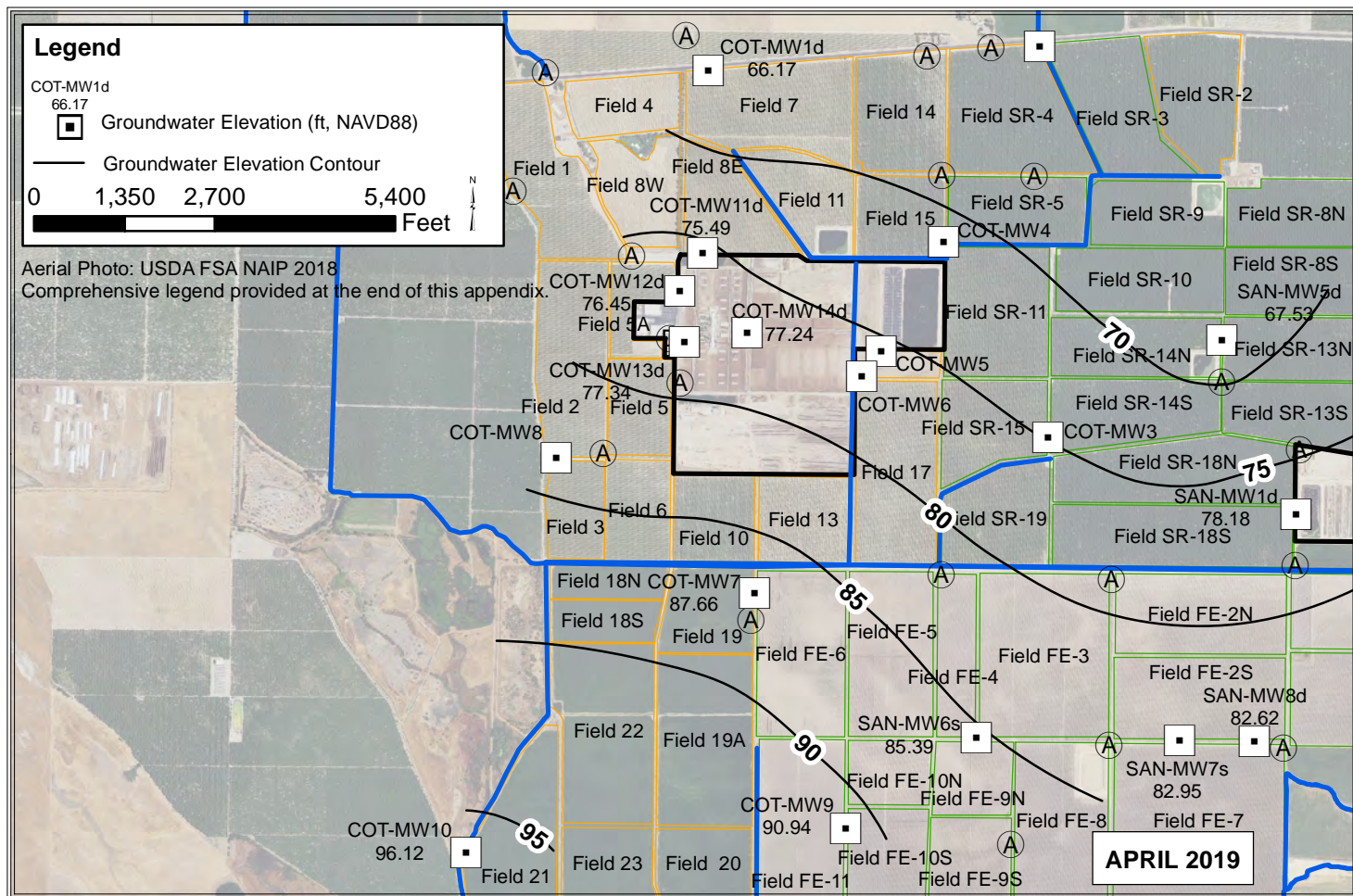
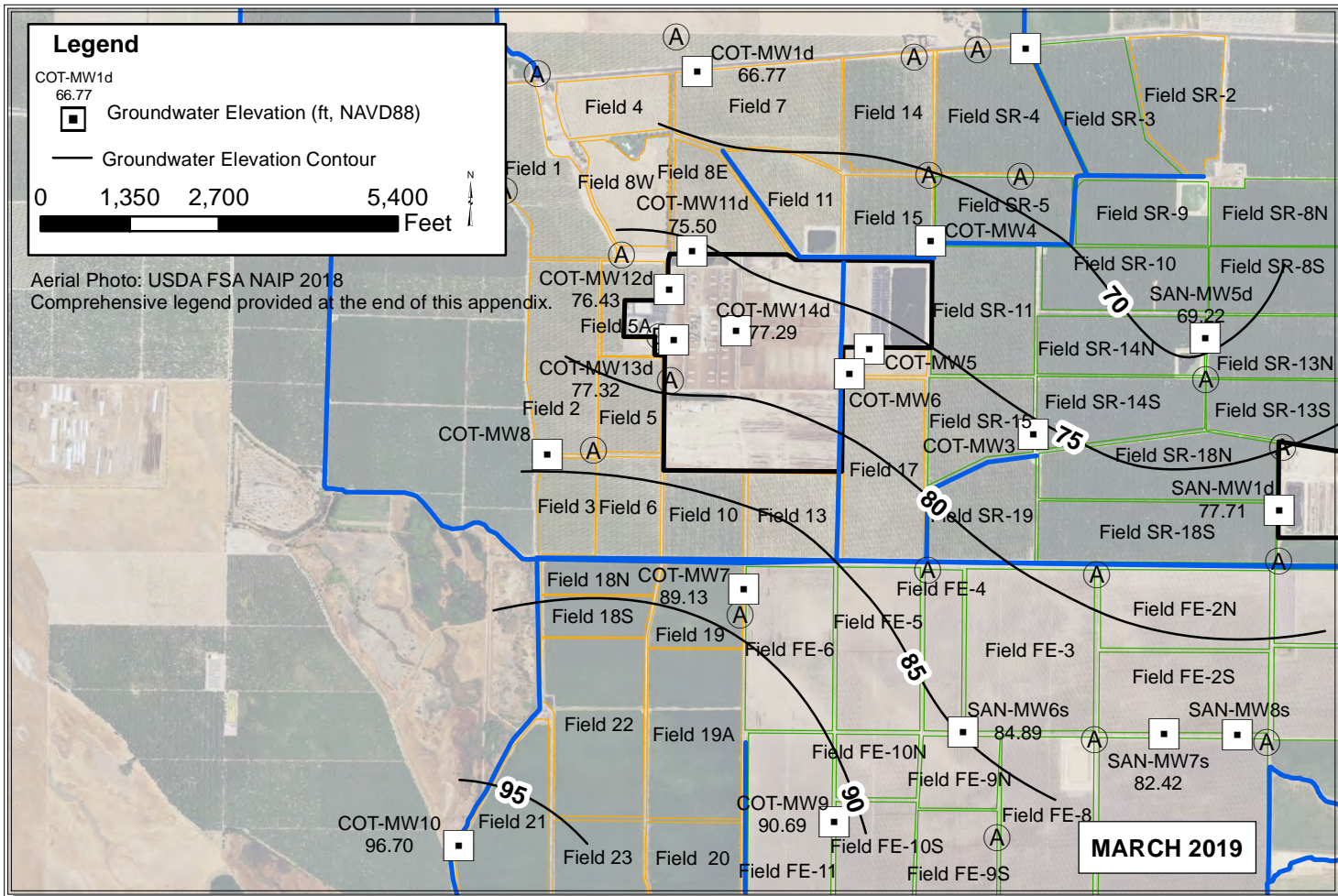

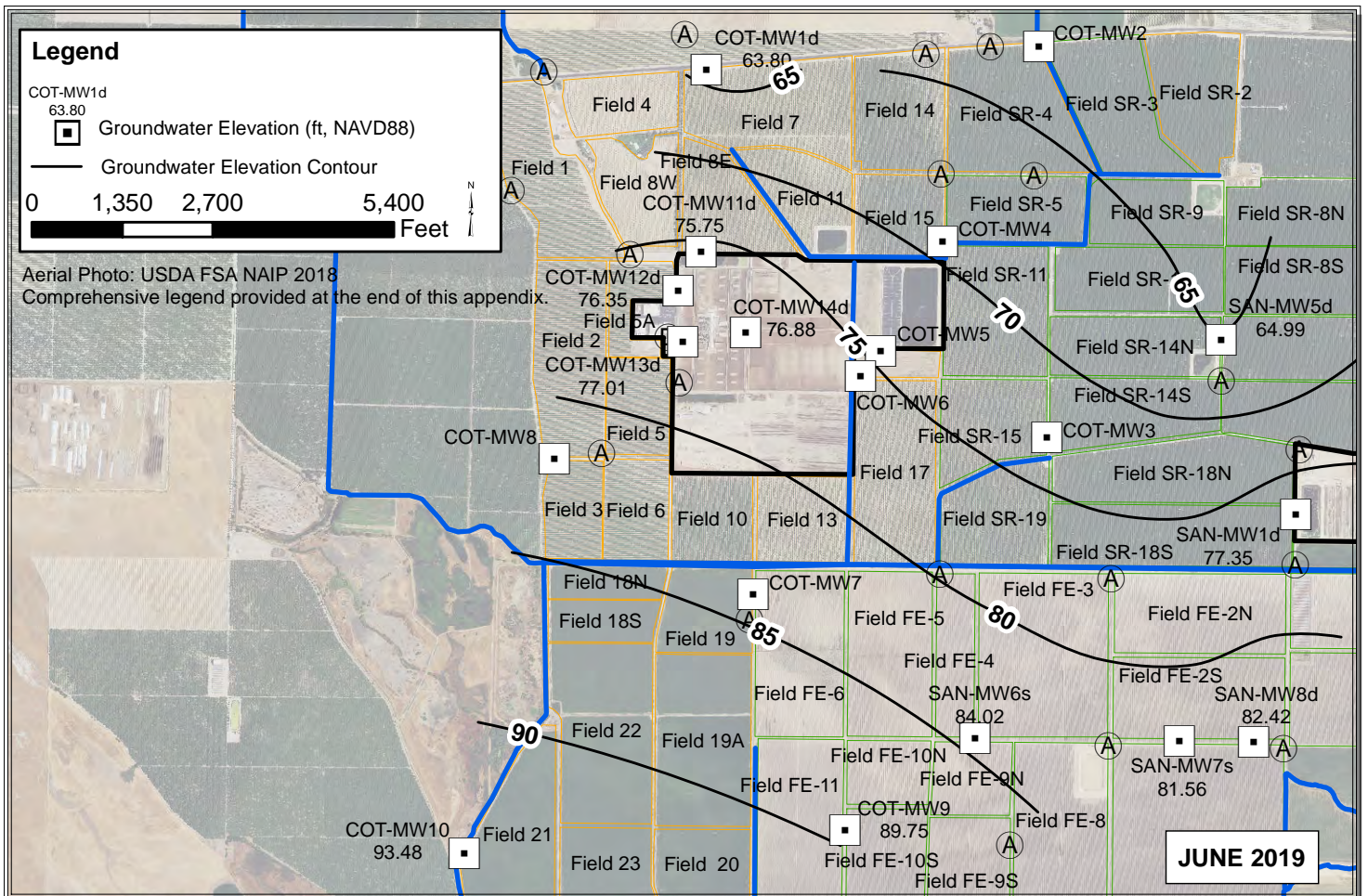
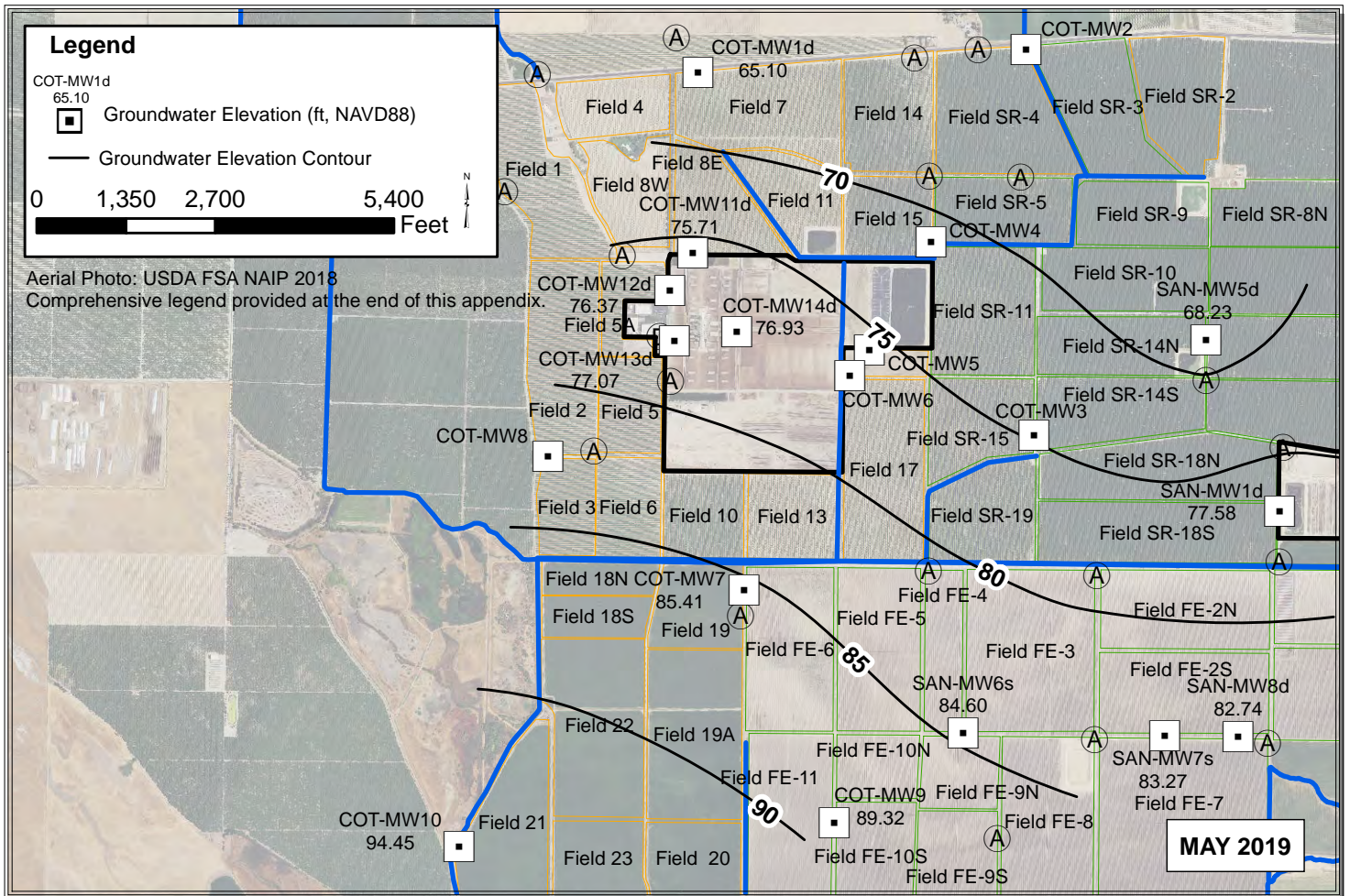

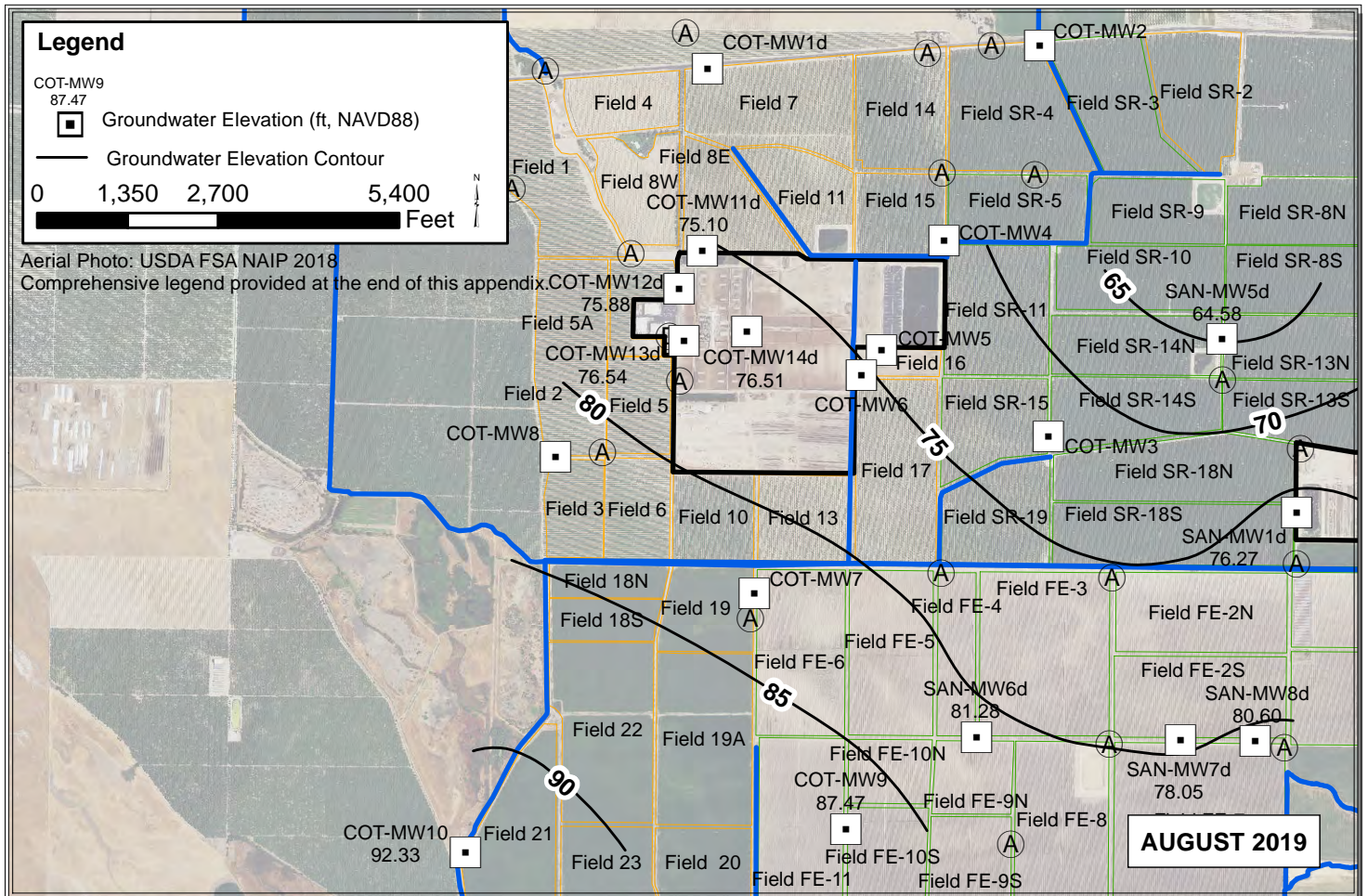
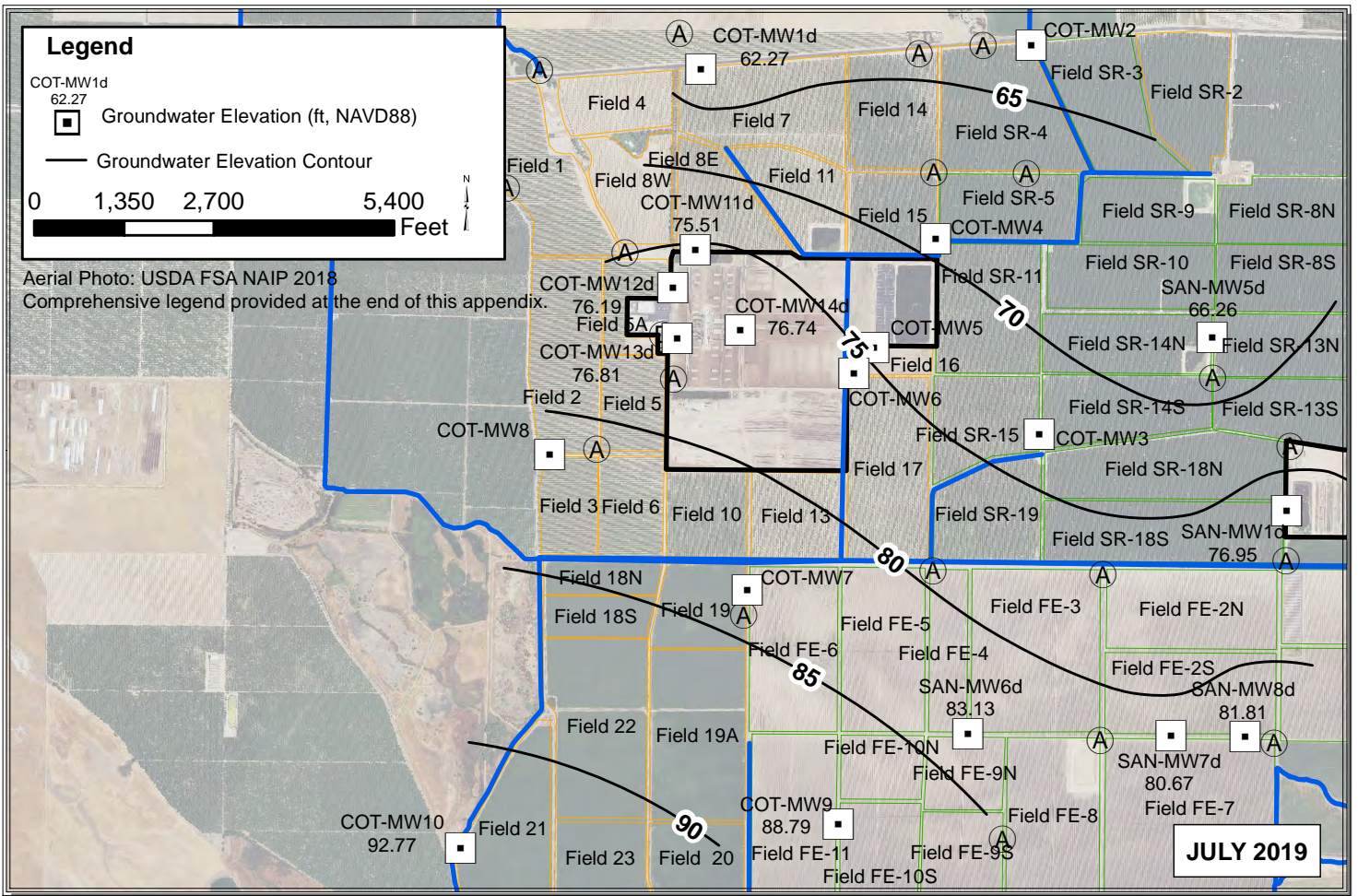

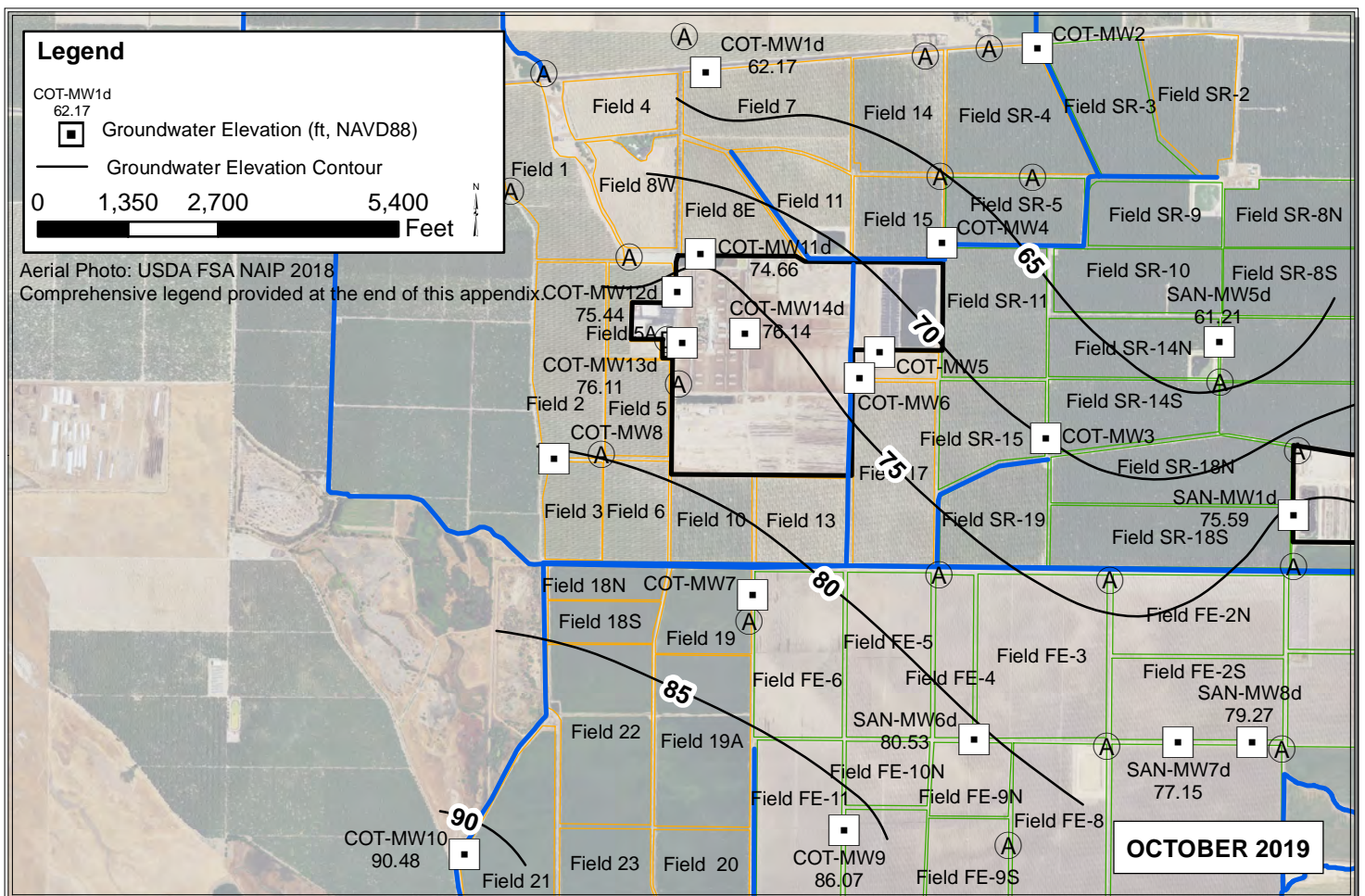
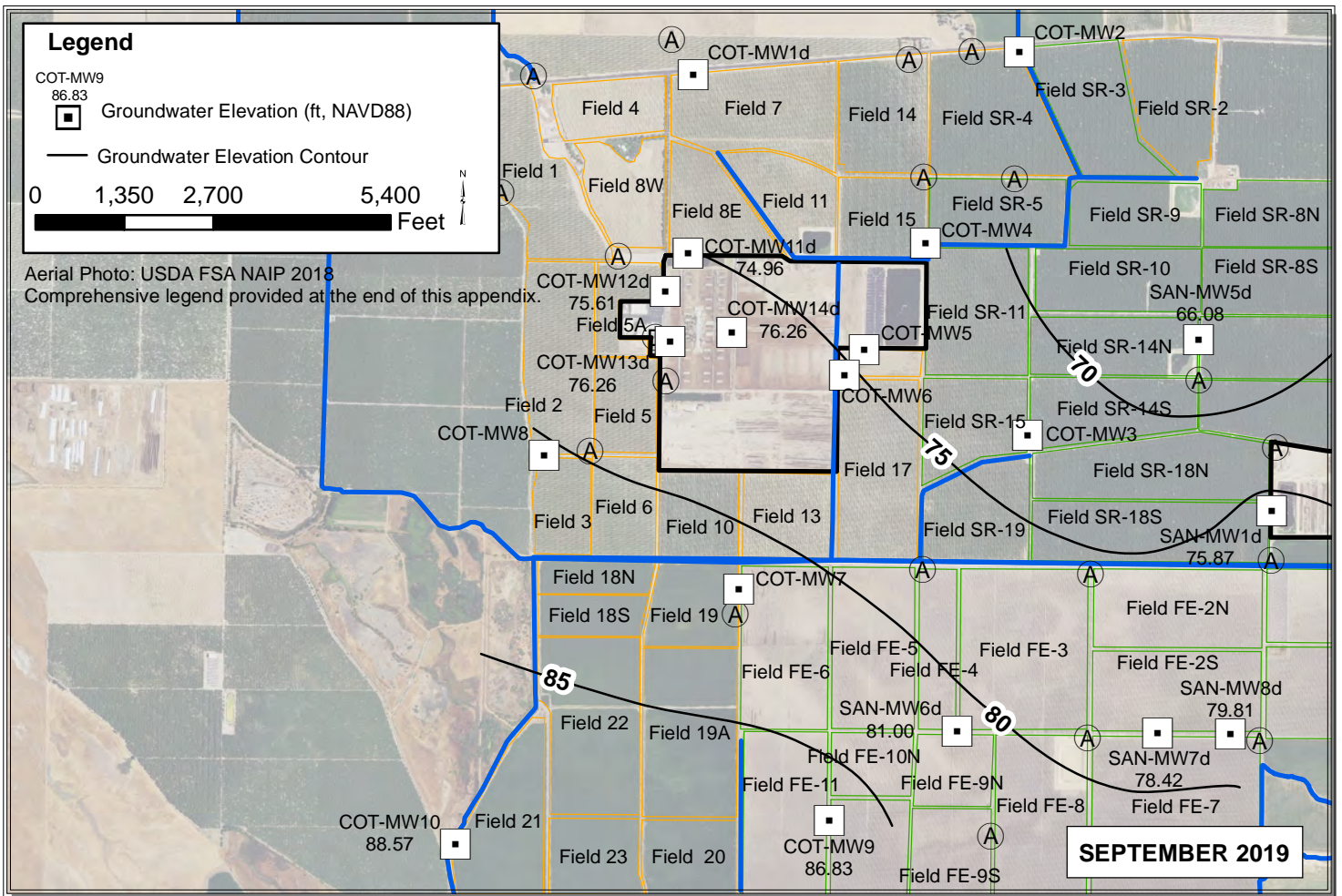

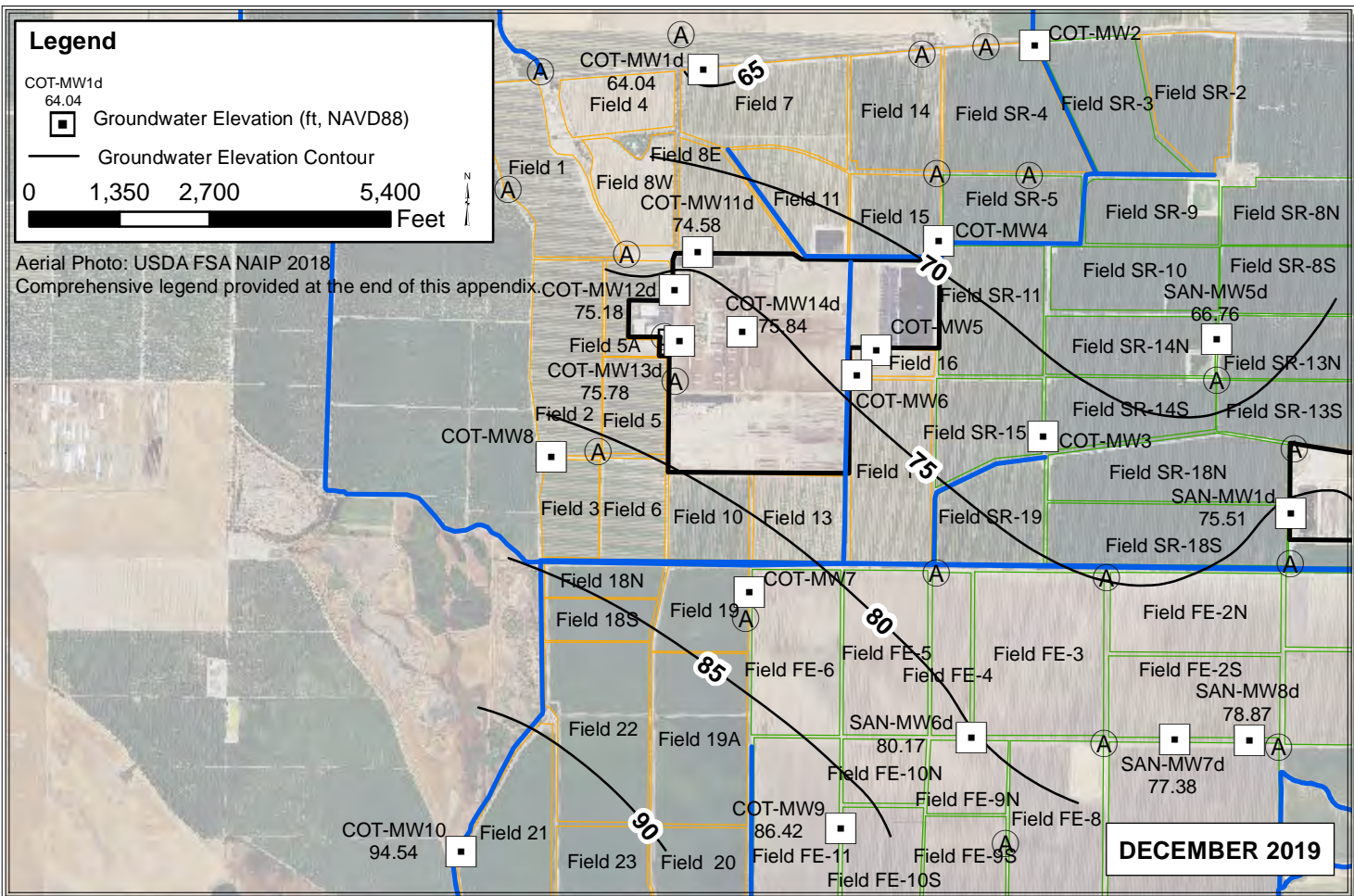
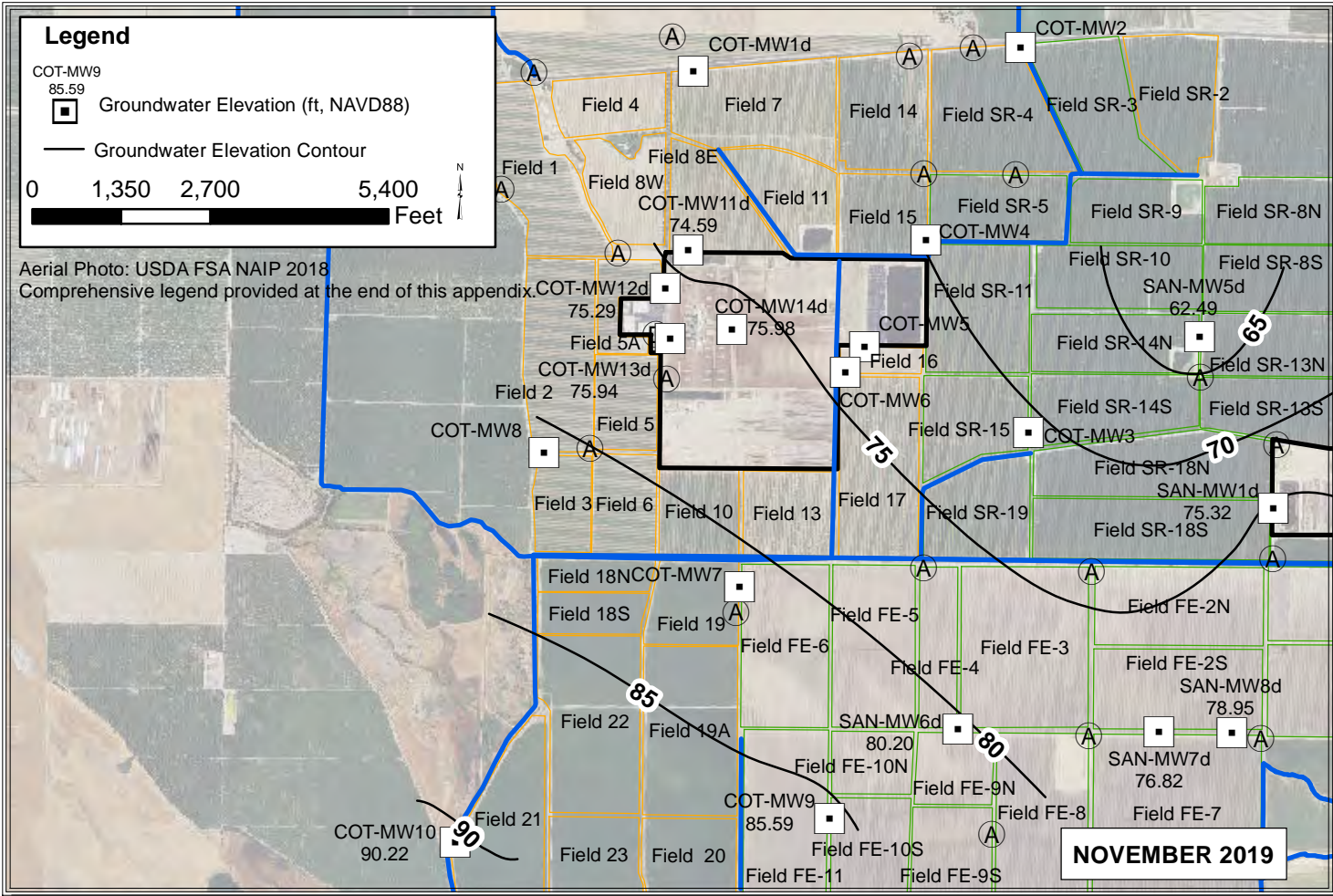

SAN

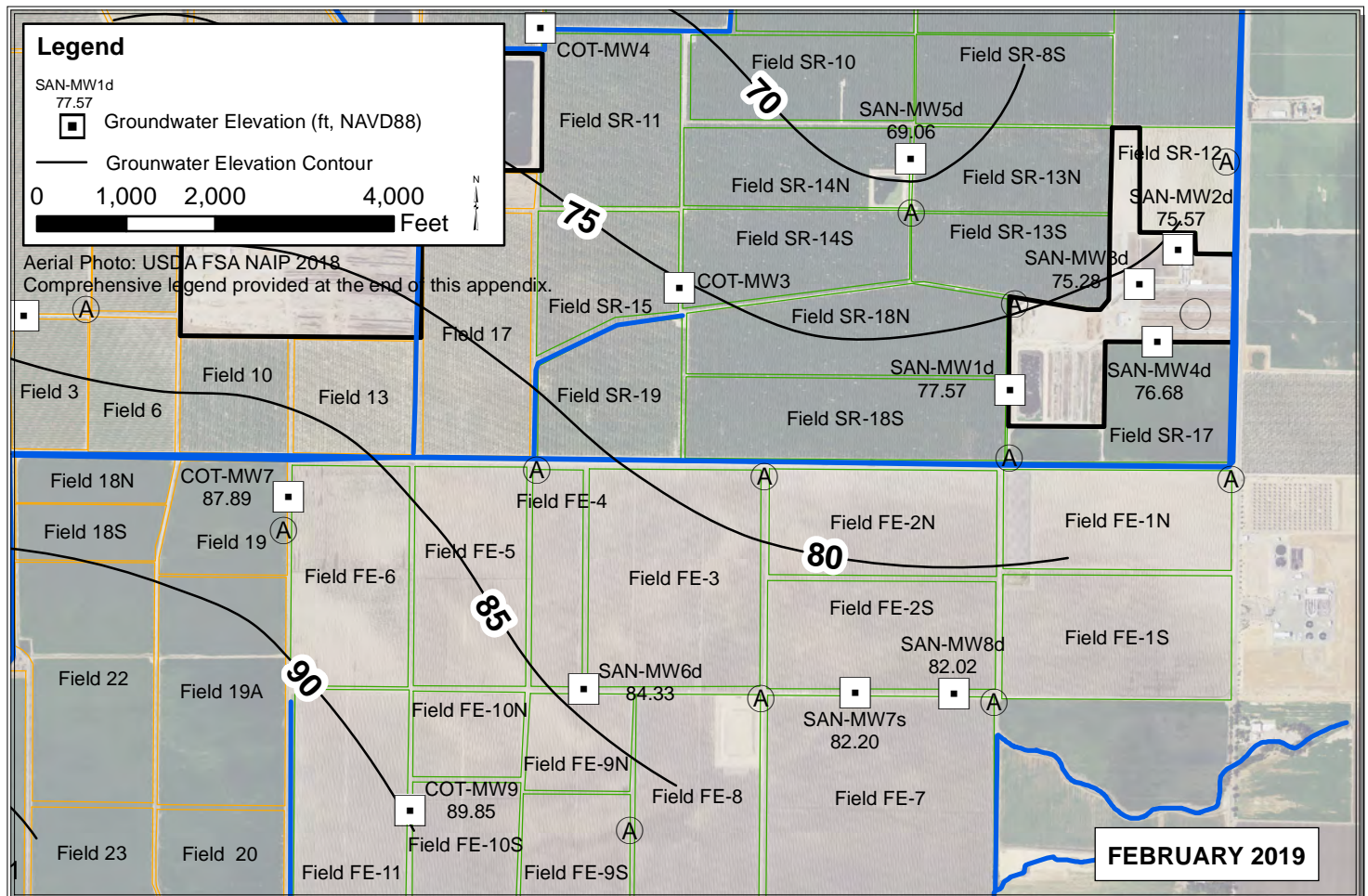
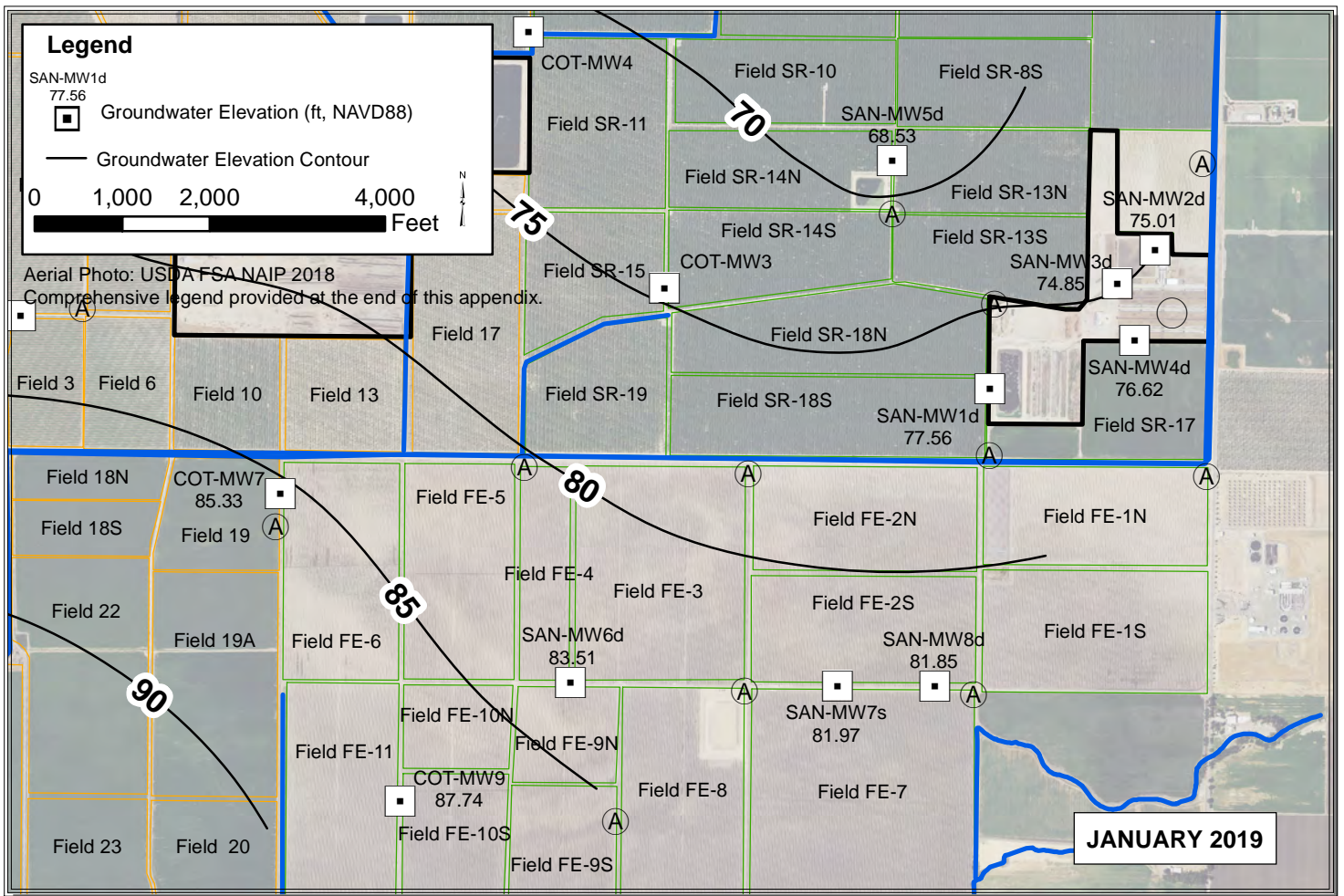

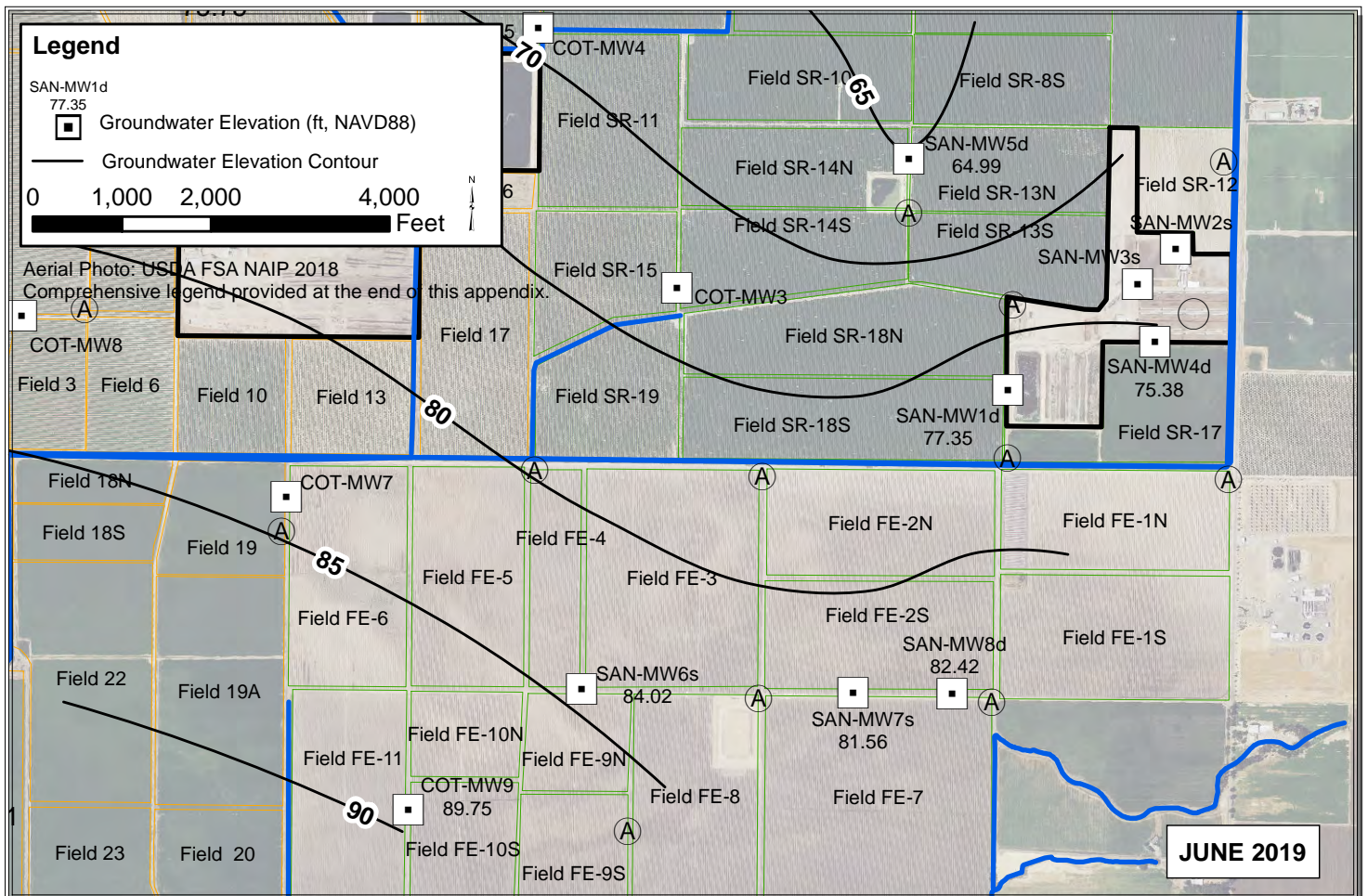
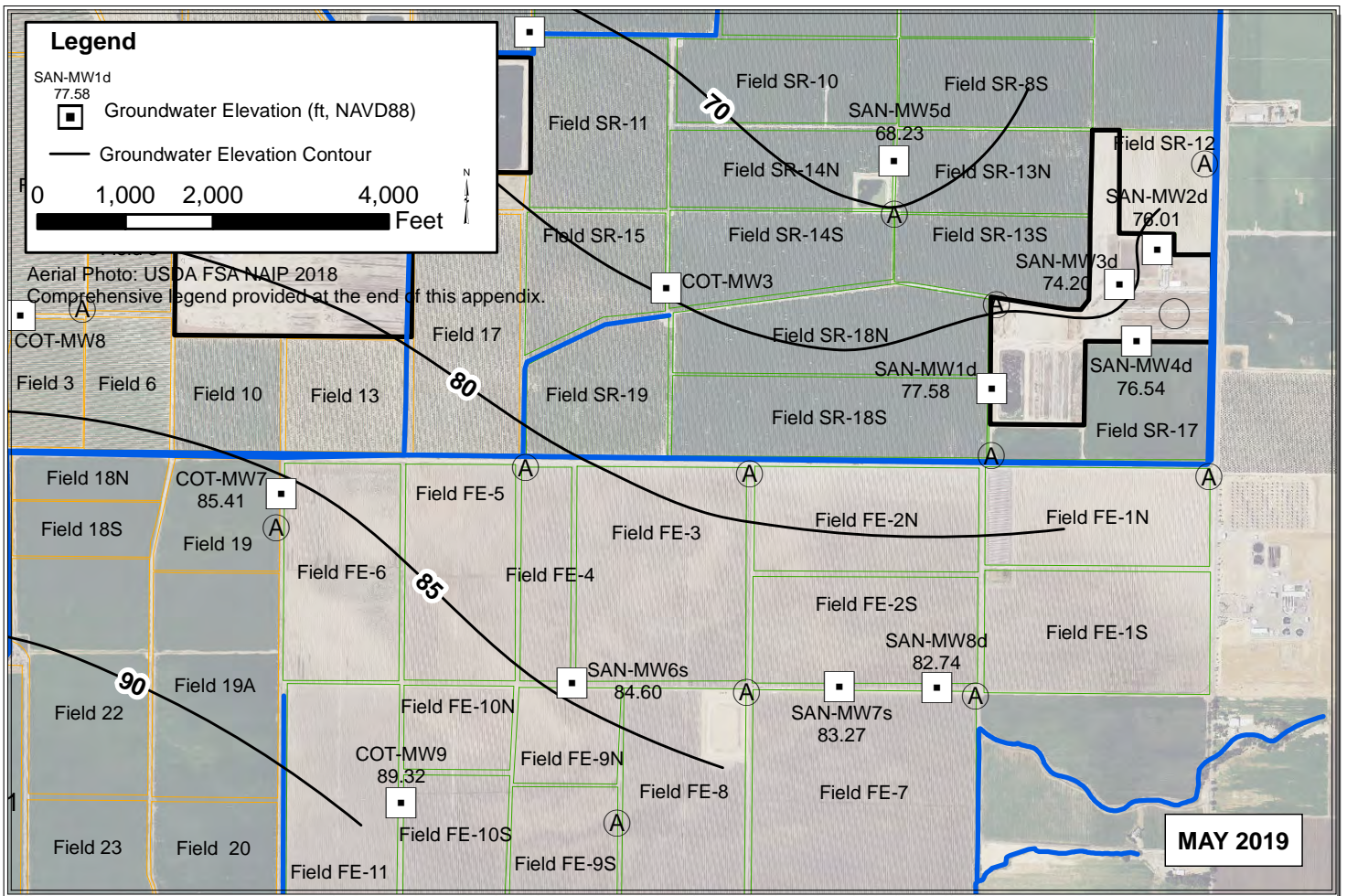

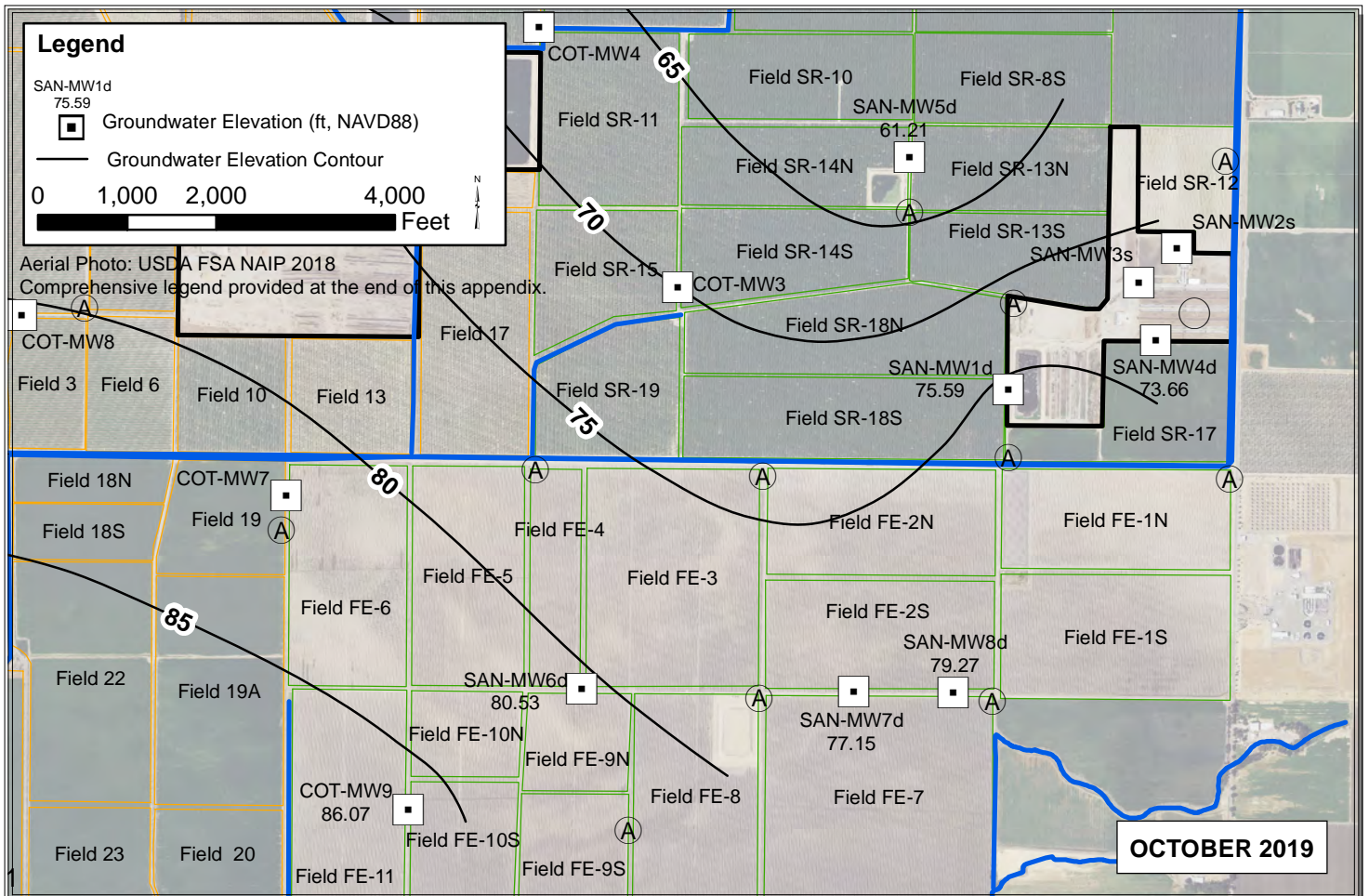
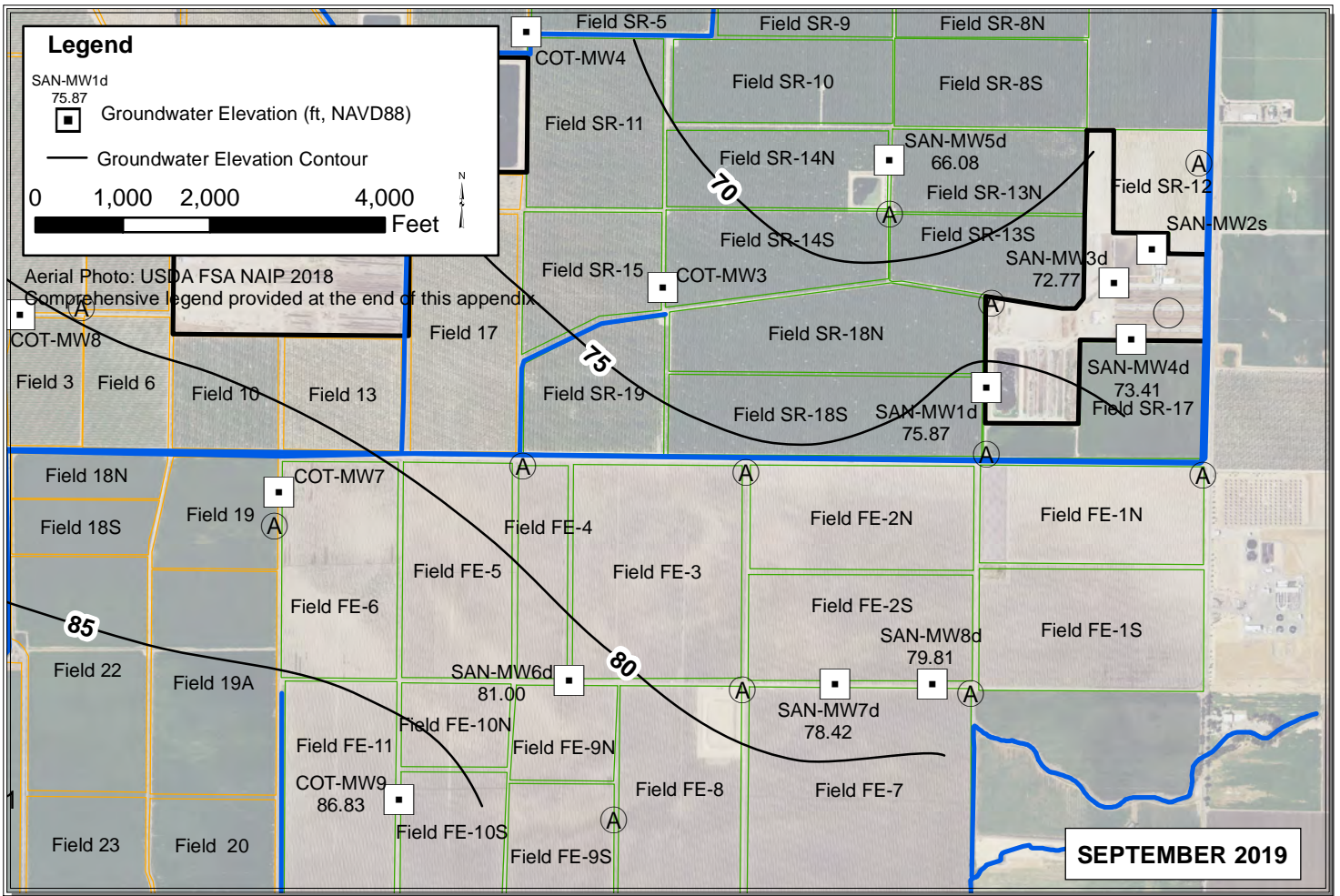

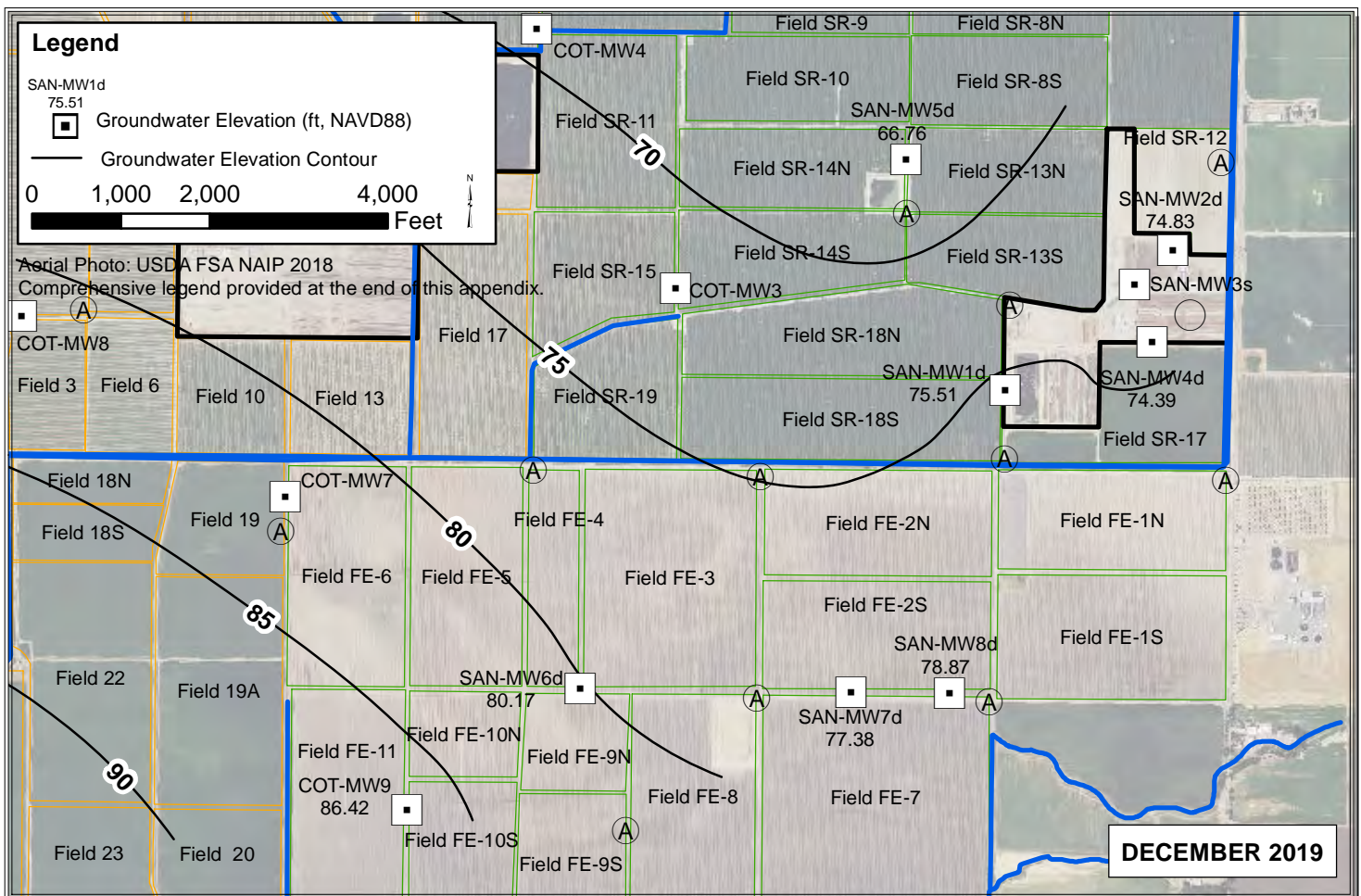
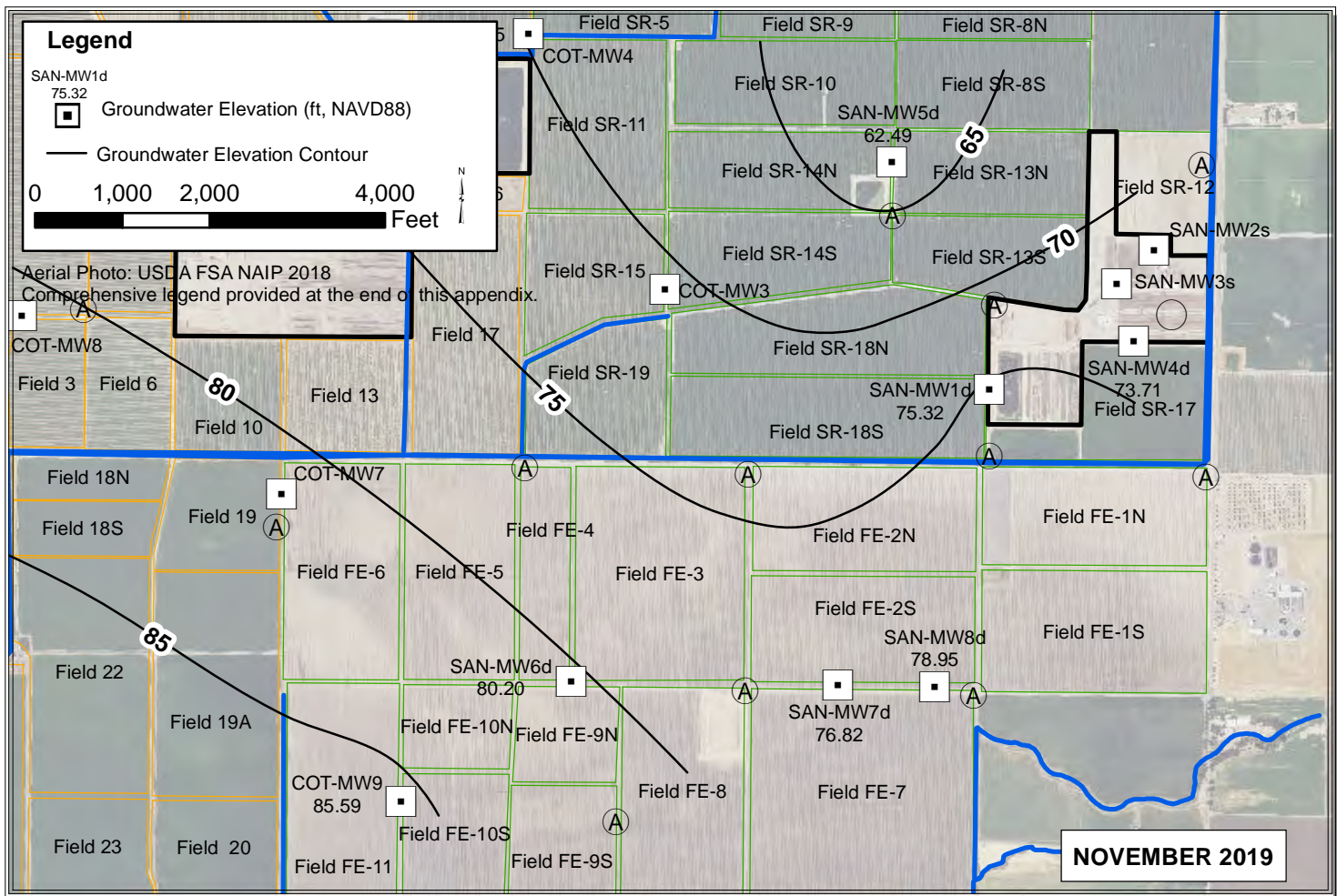

GEN

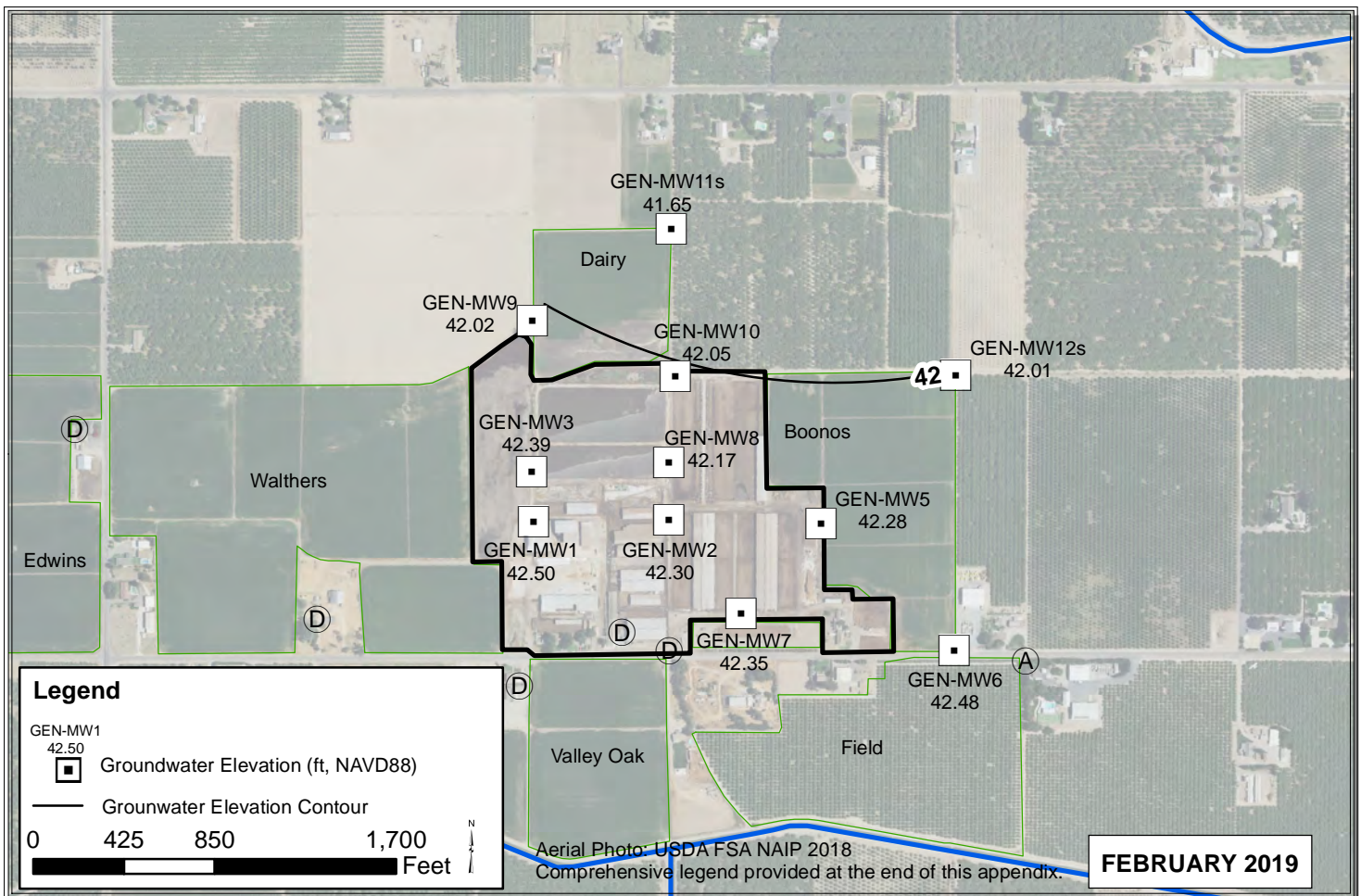
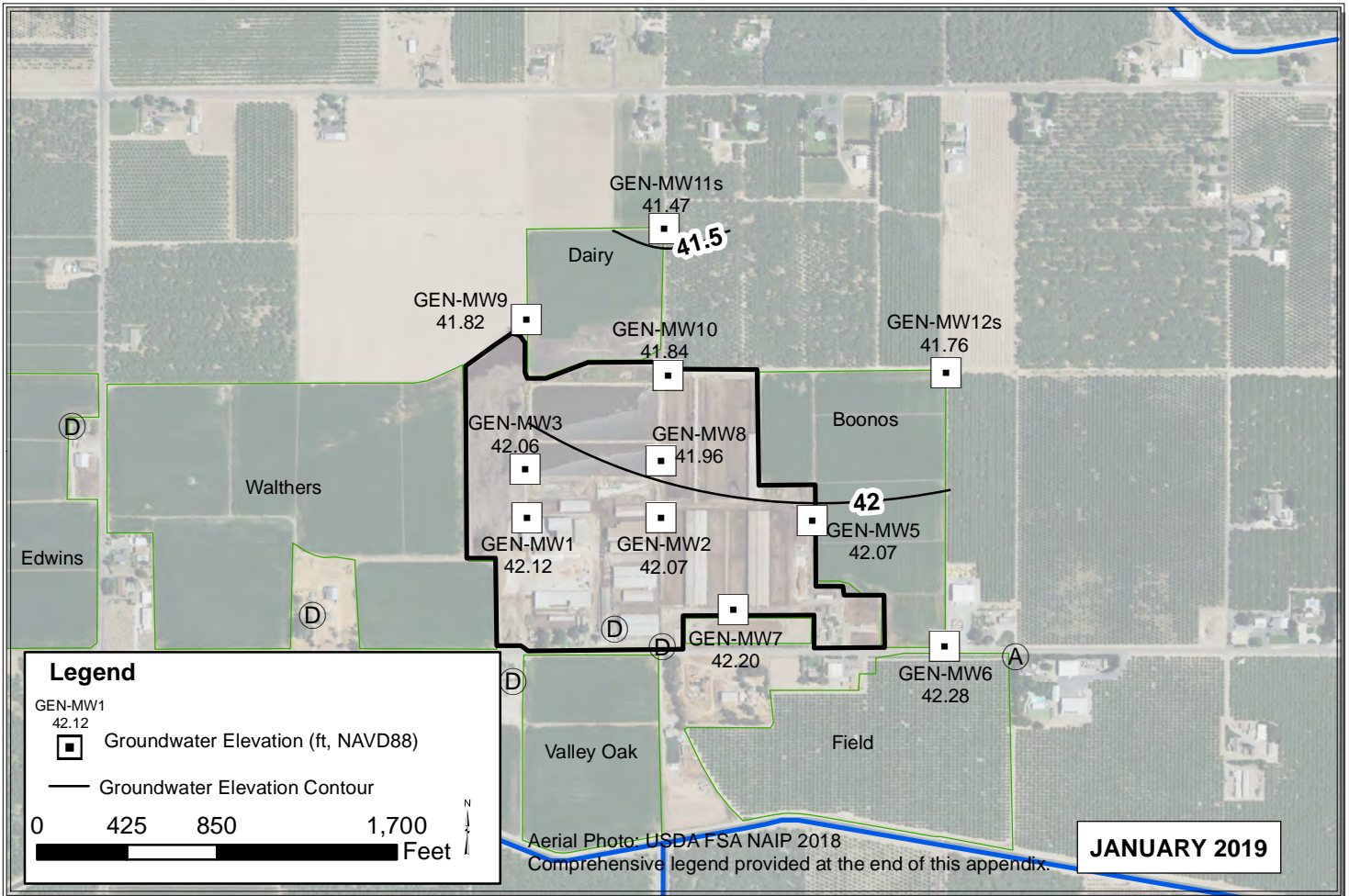

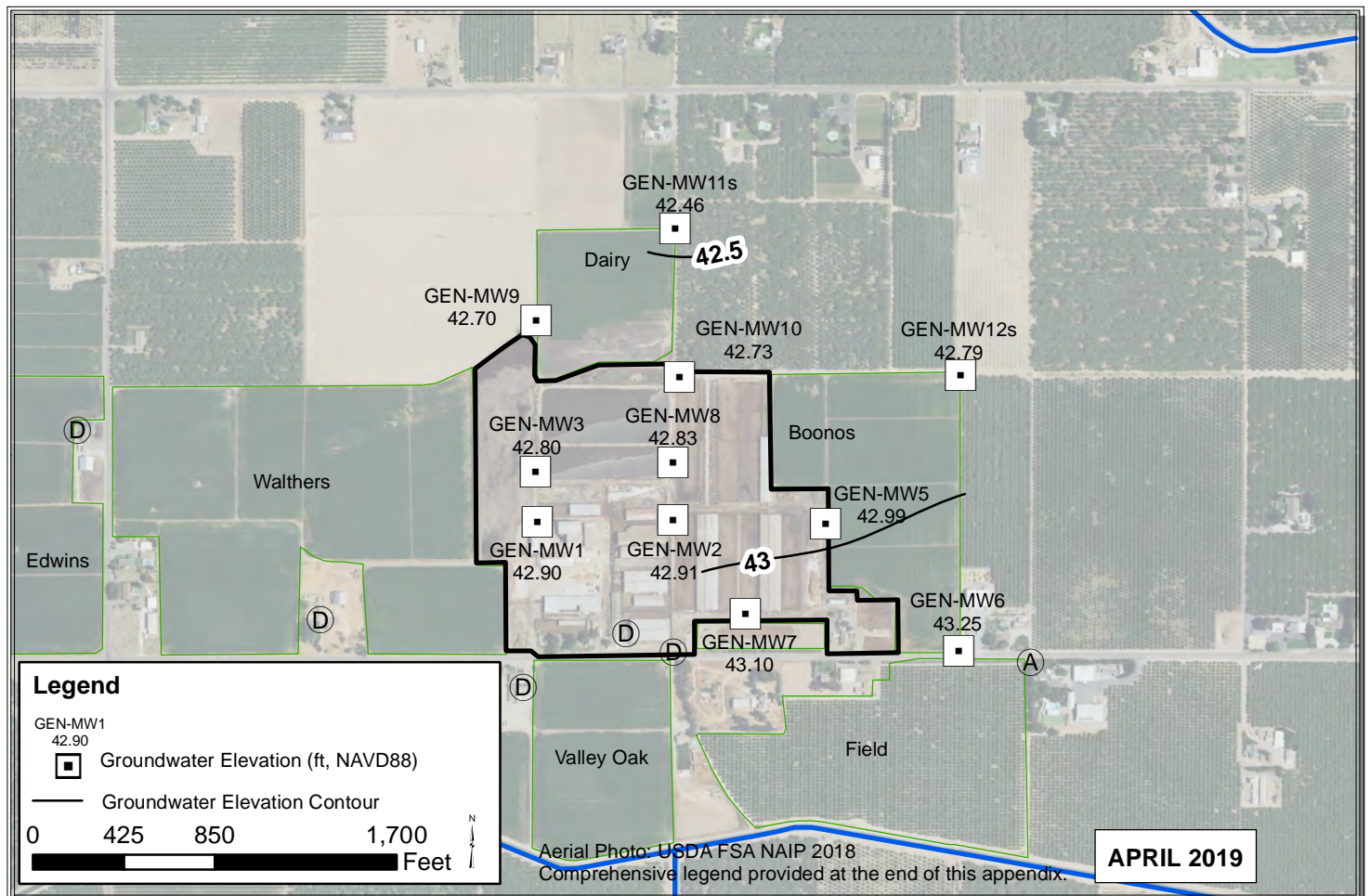
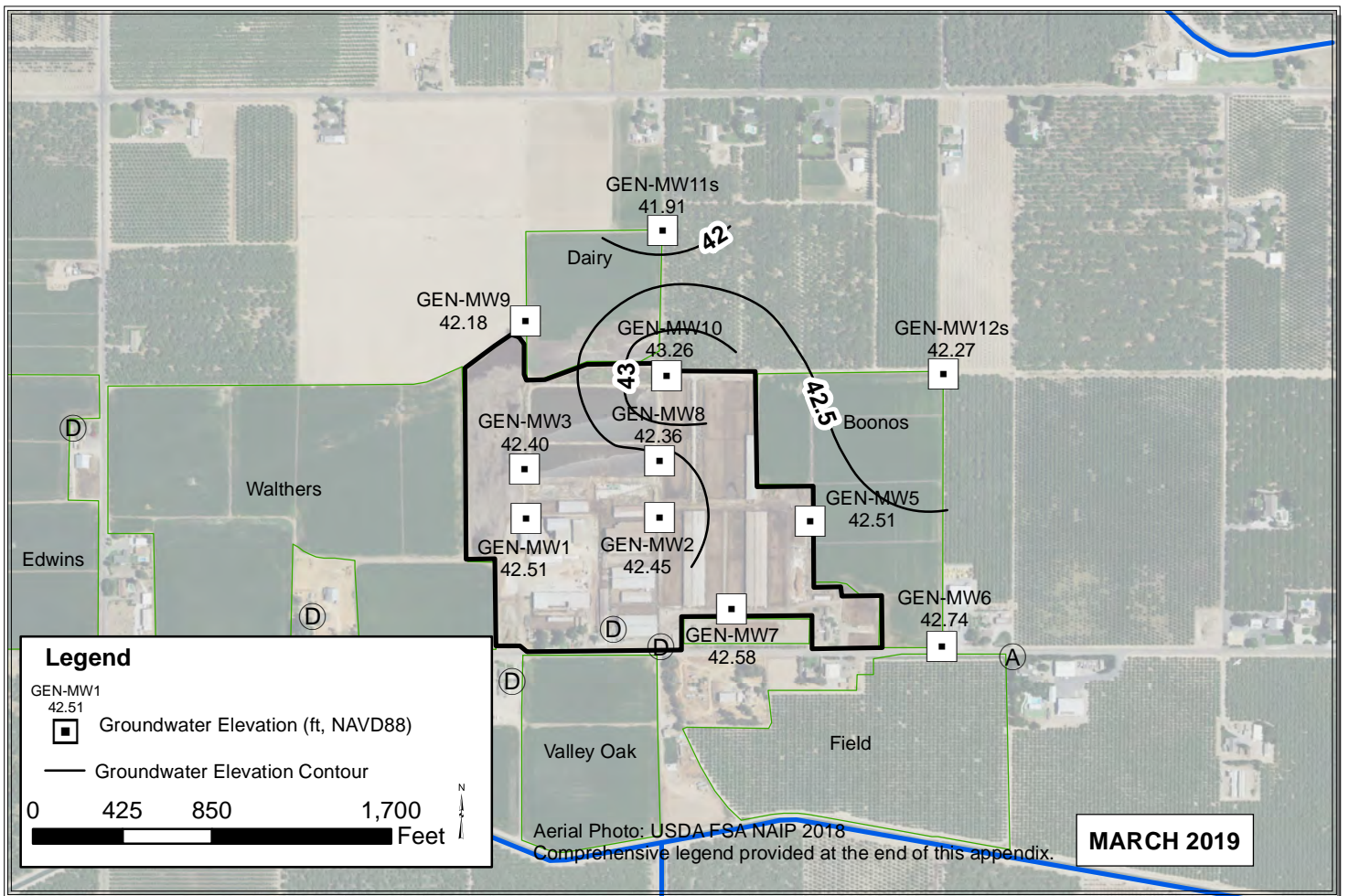

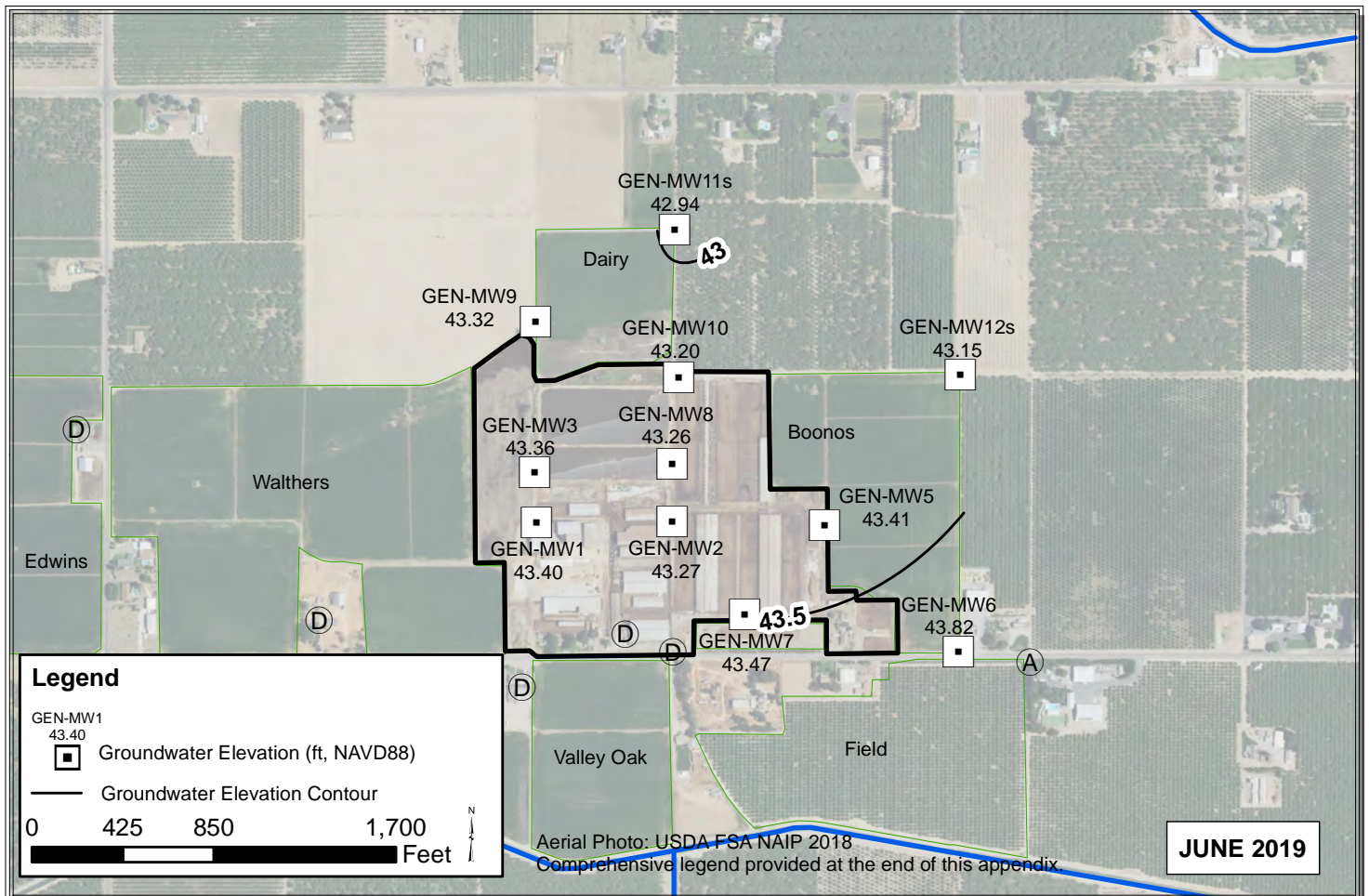
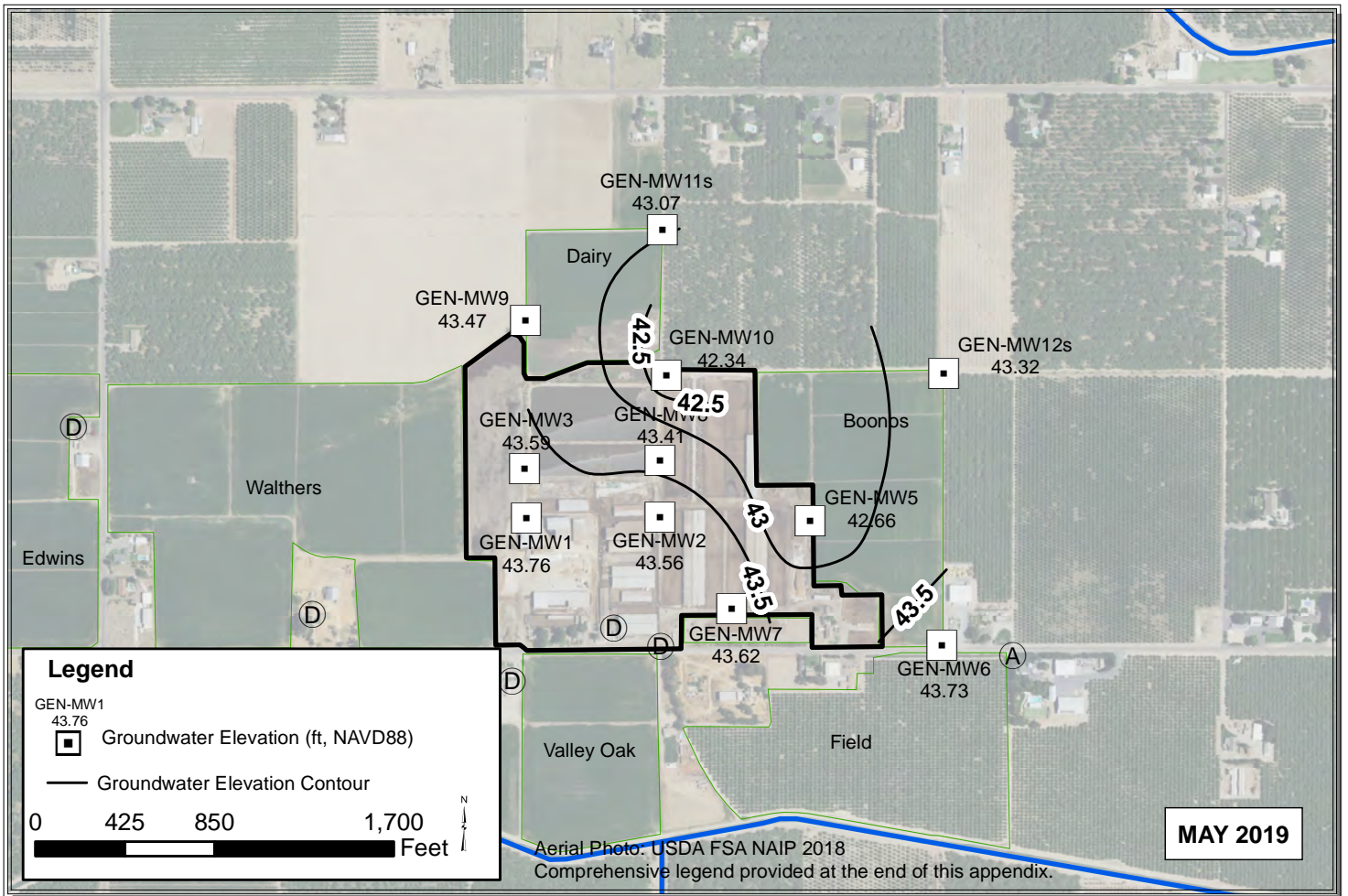

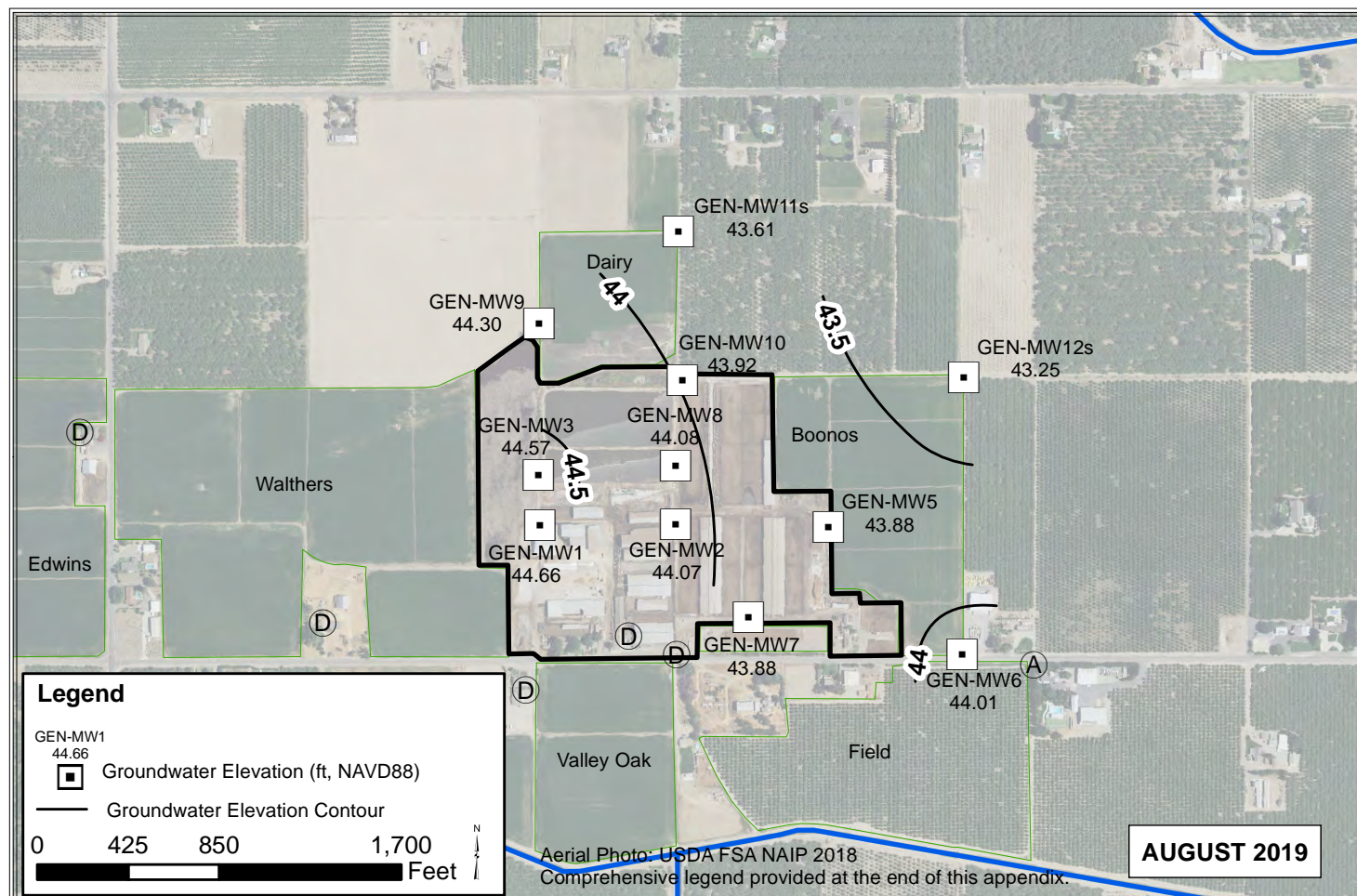
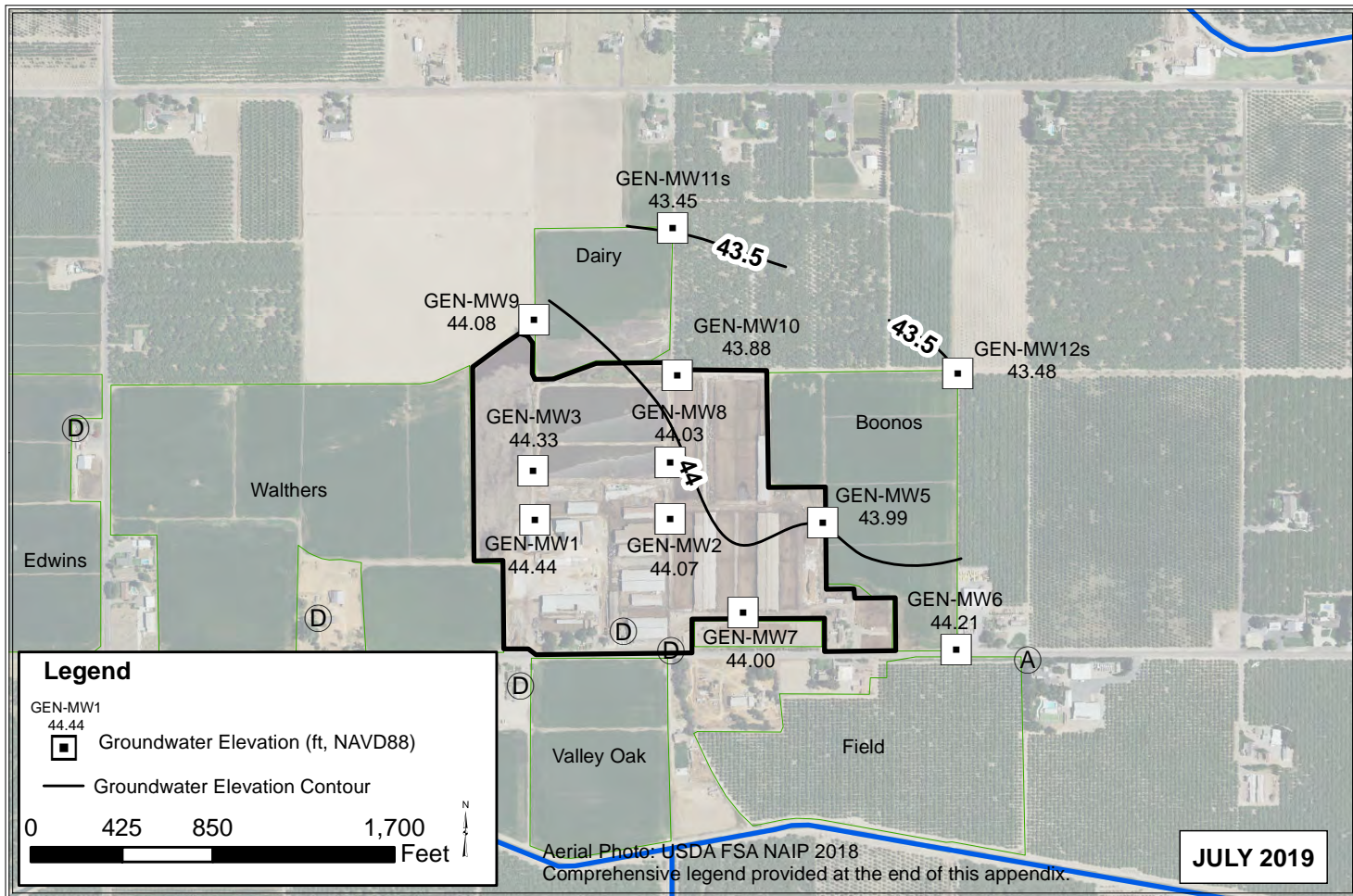

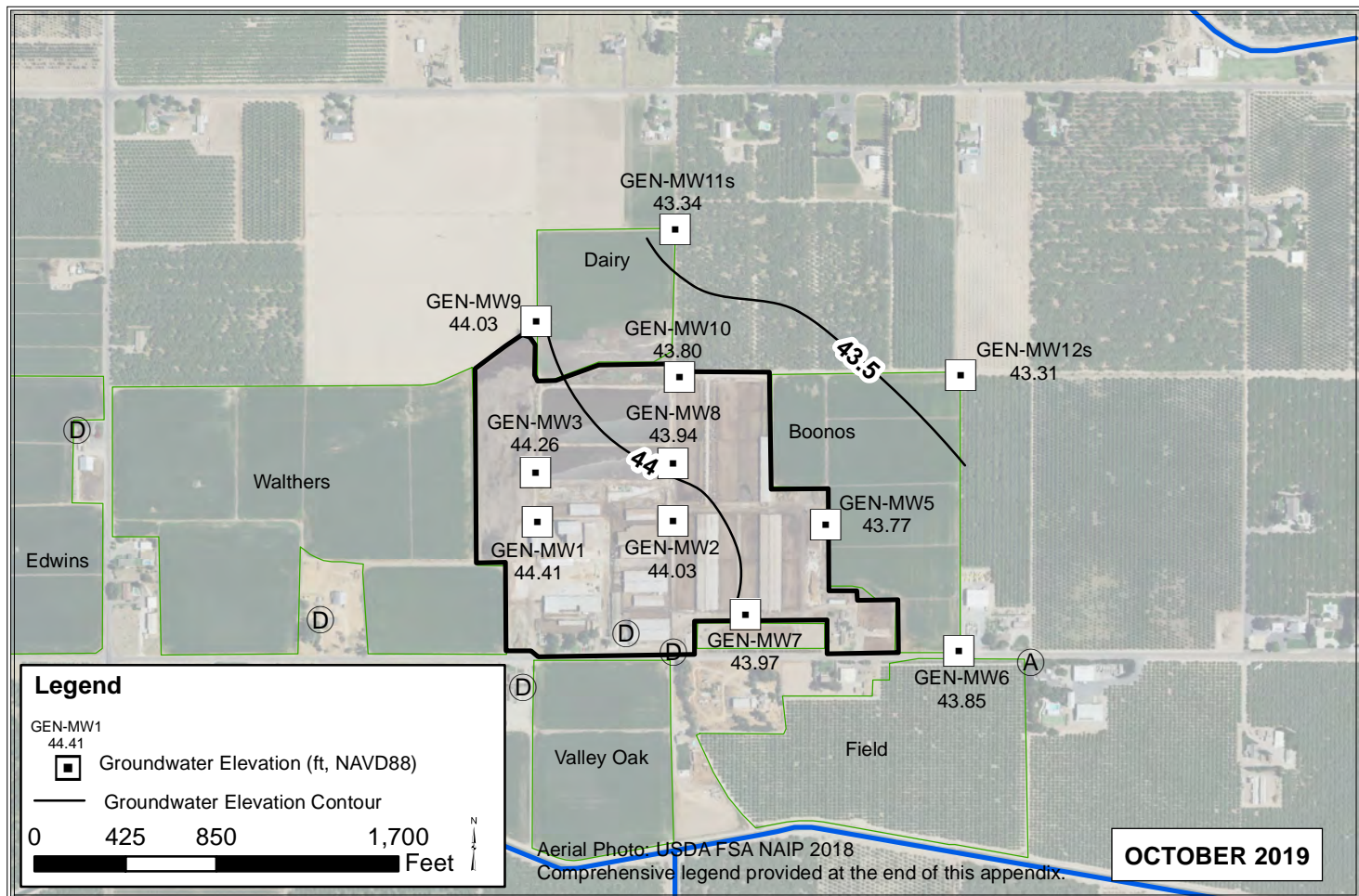
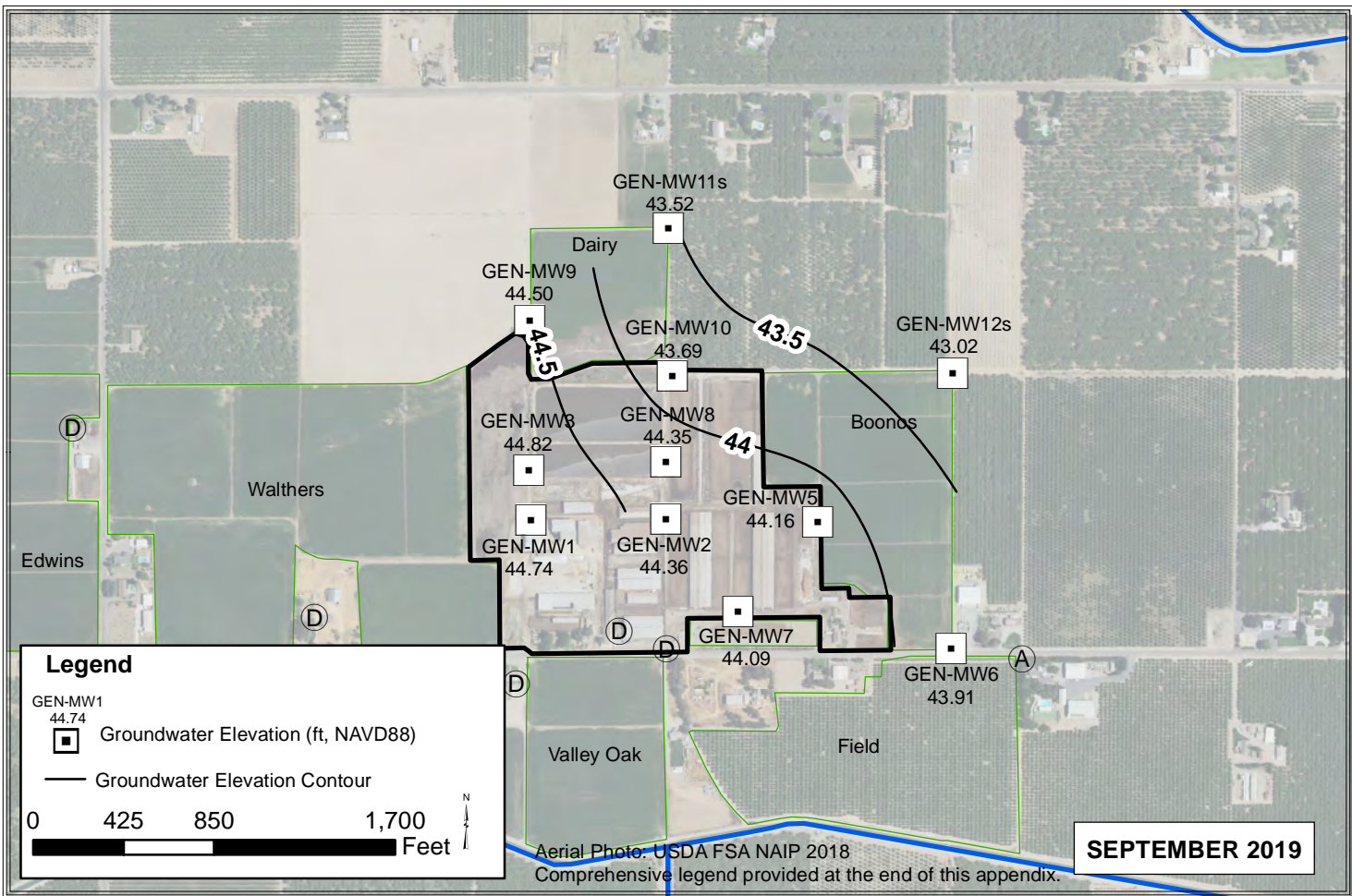

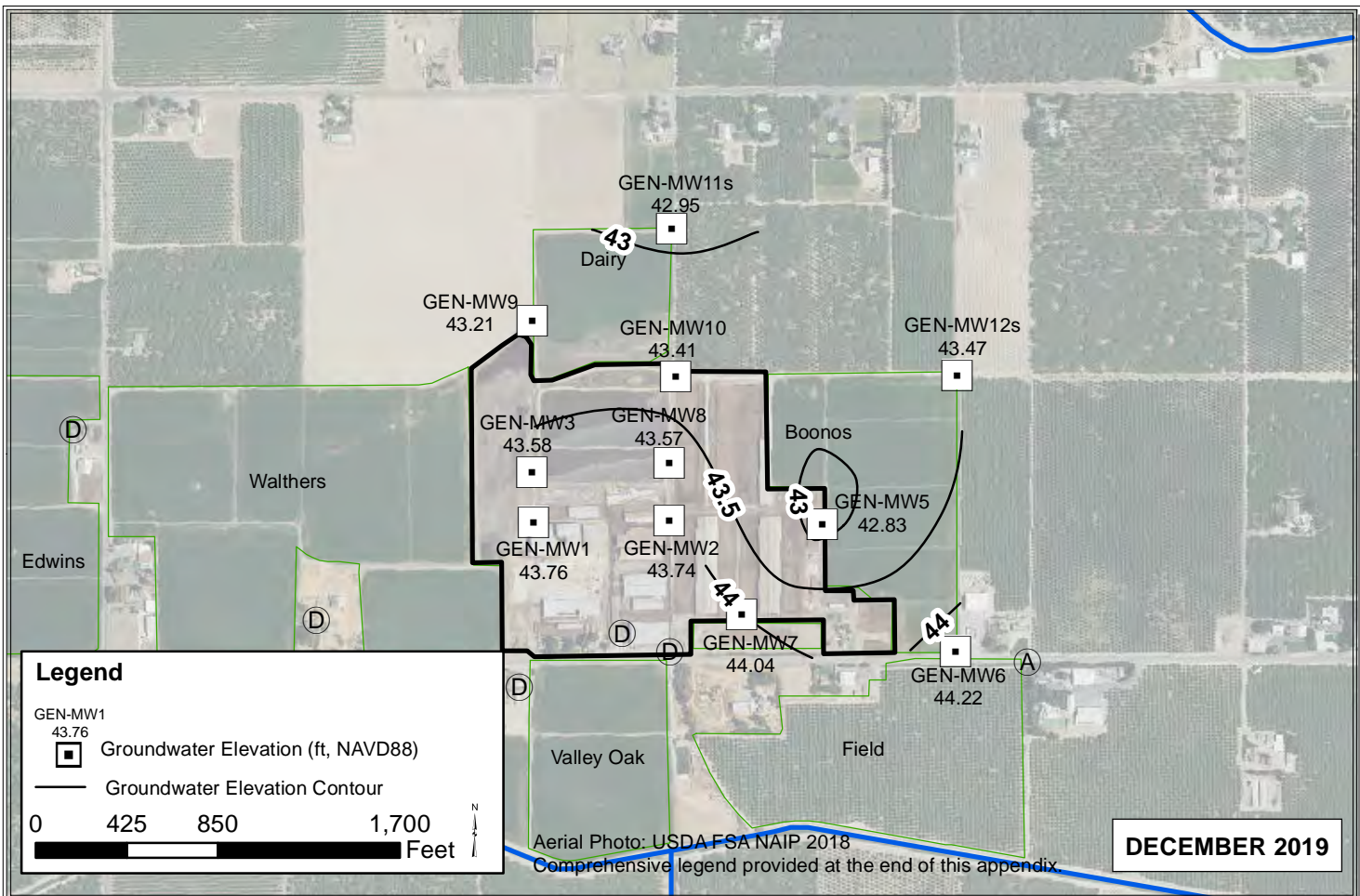
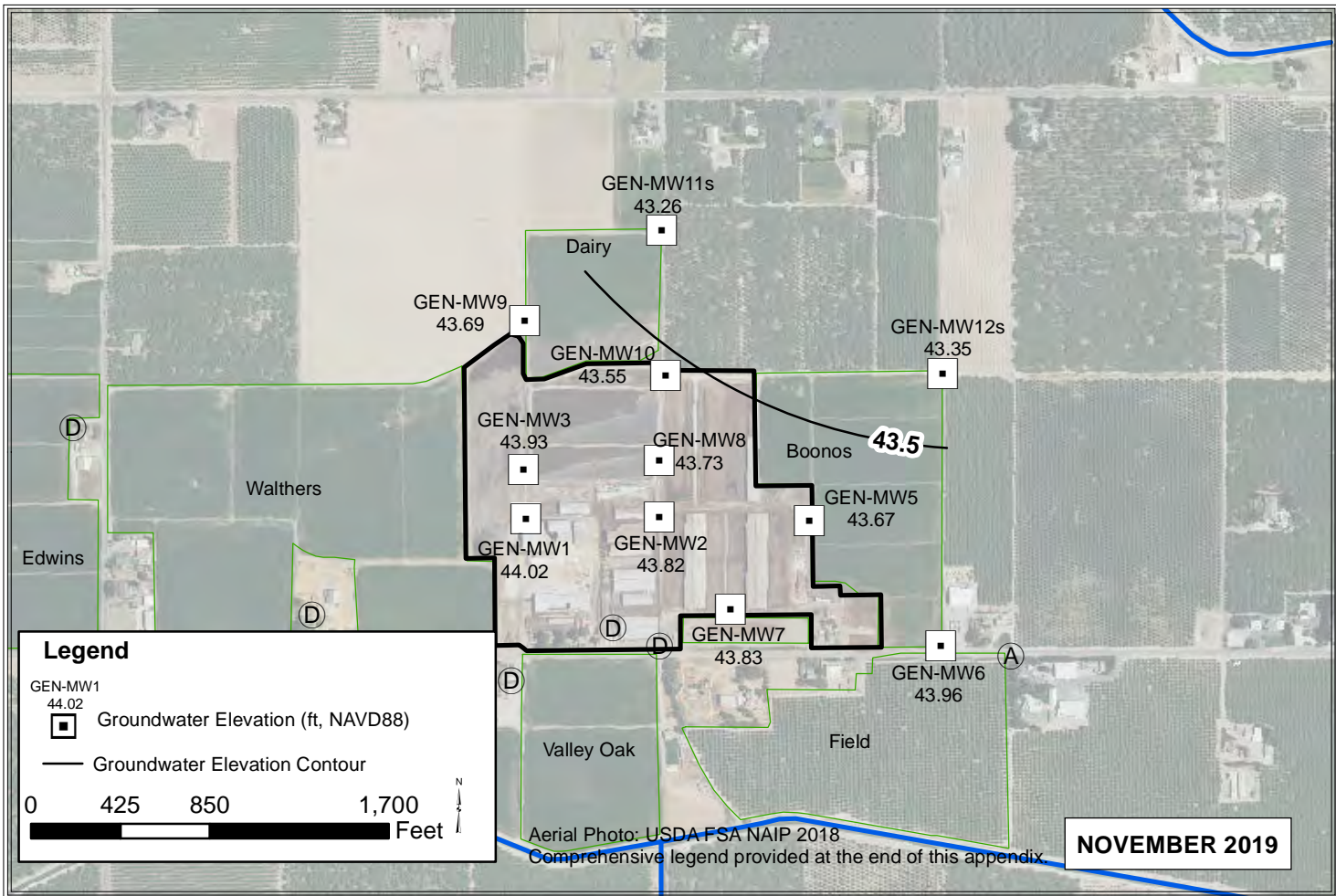

TRO

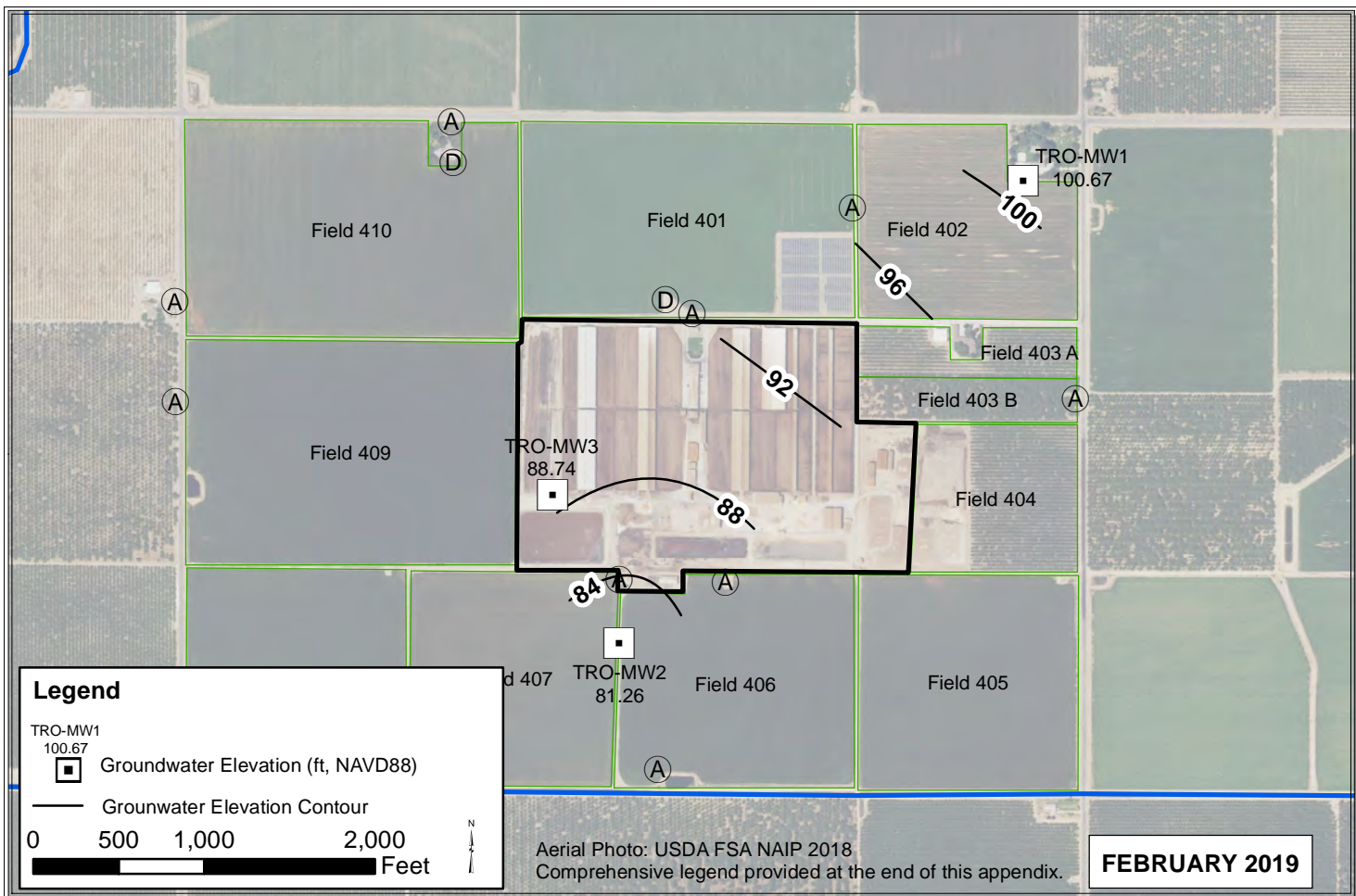
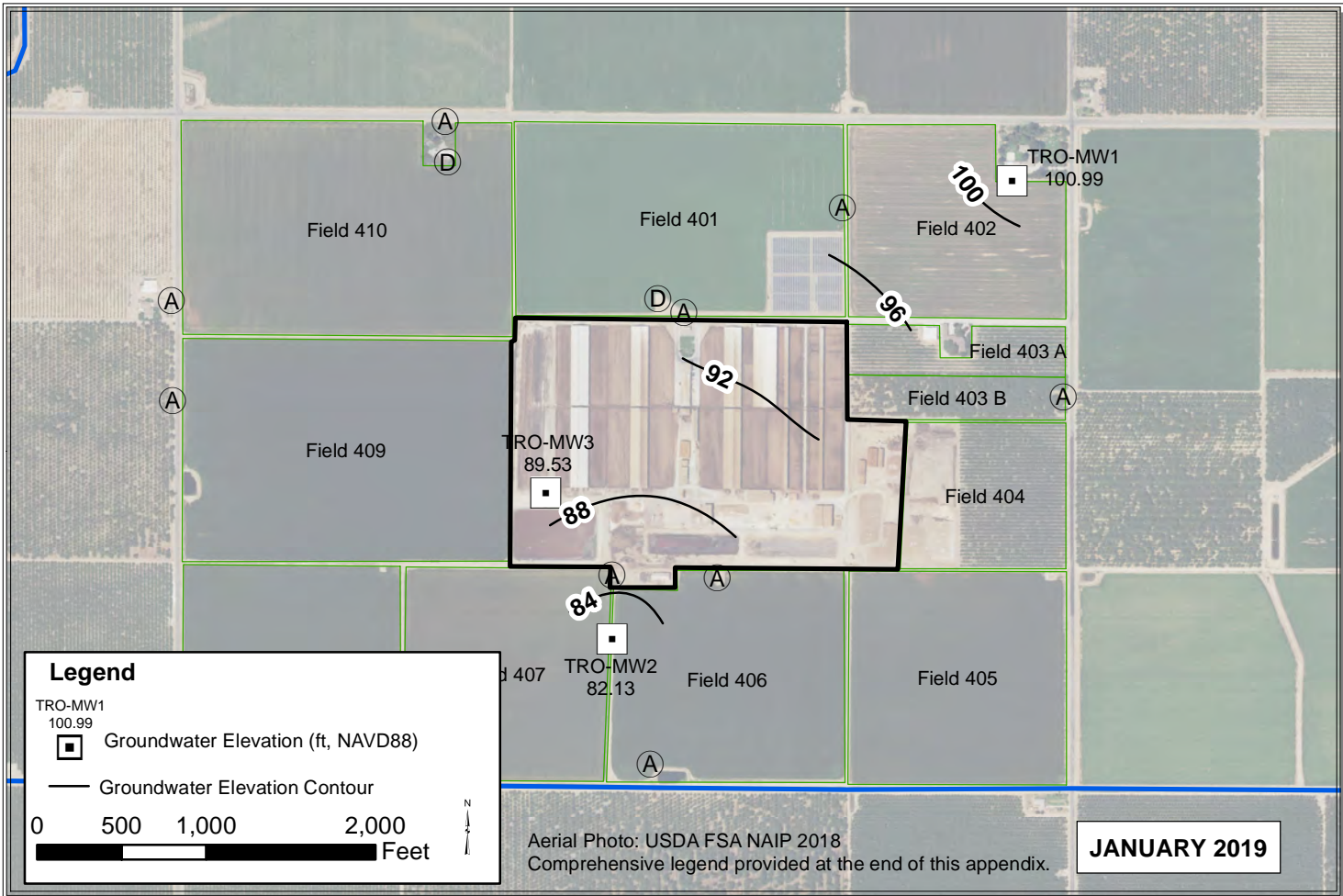

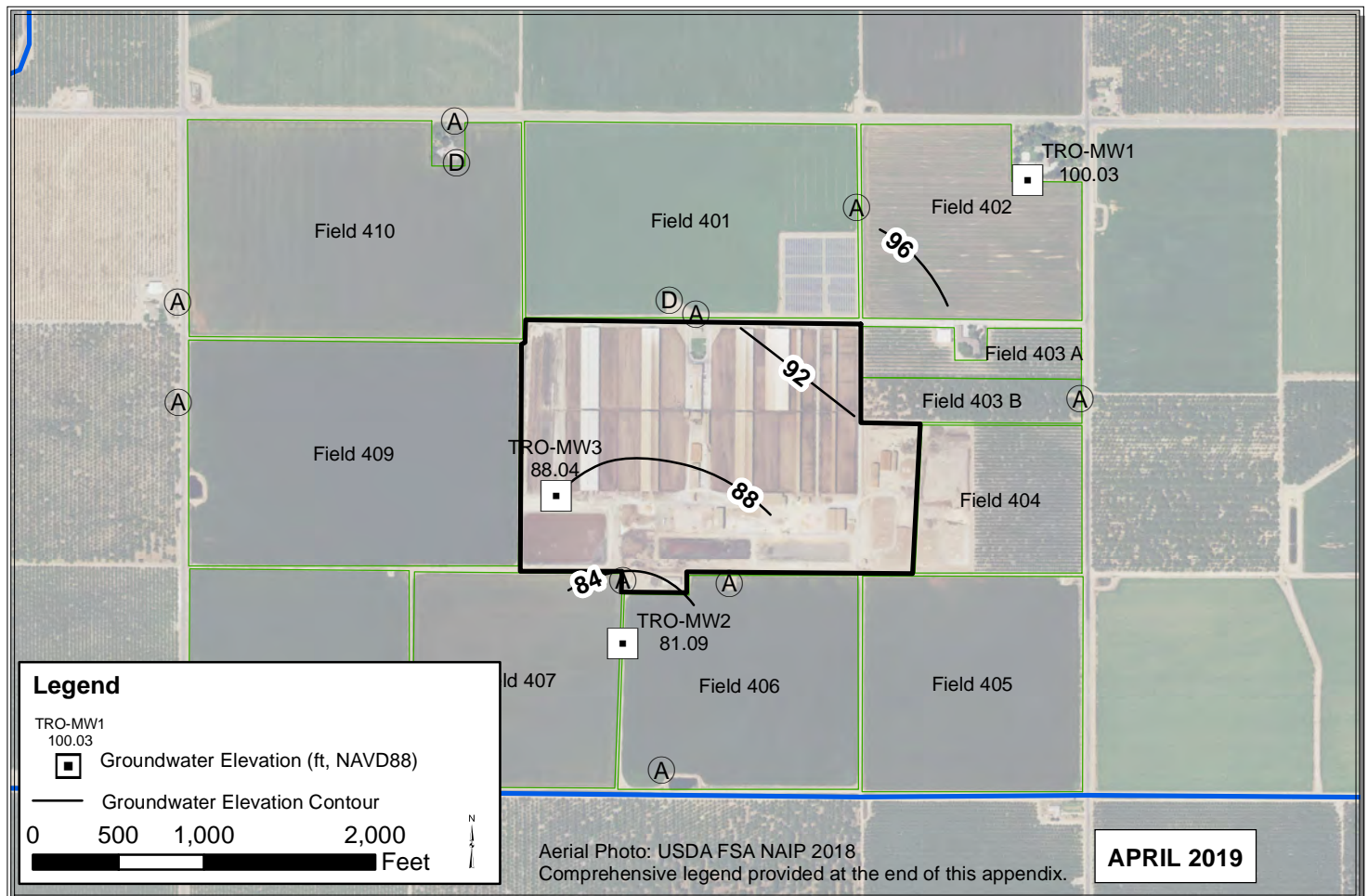
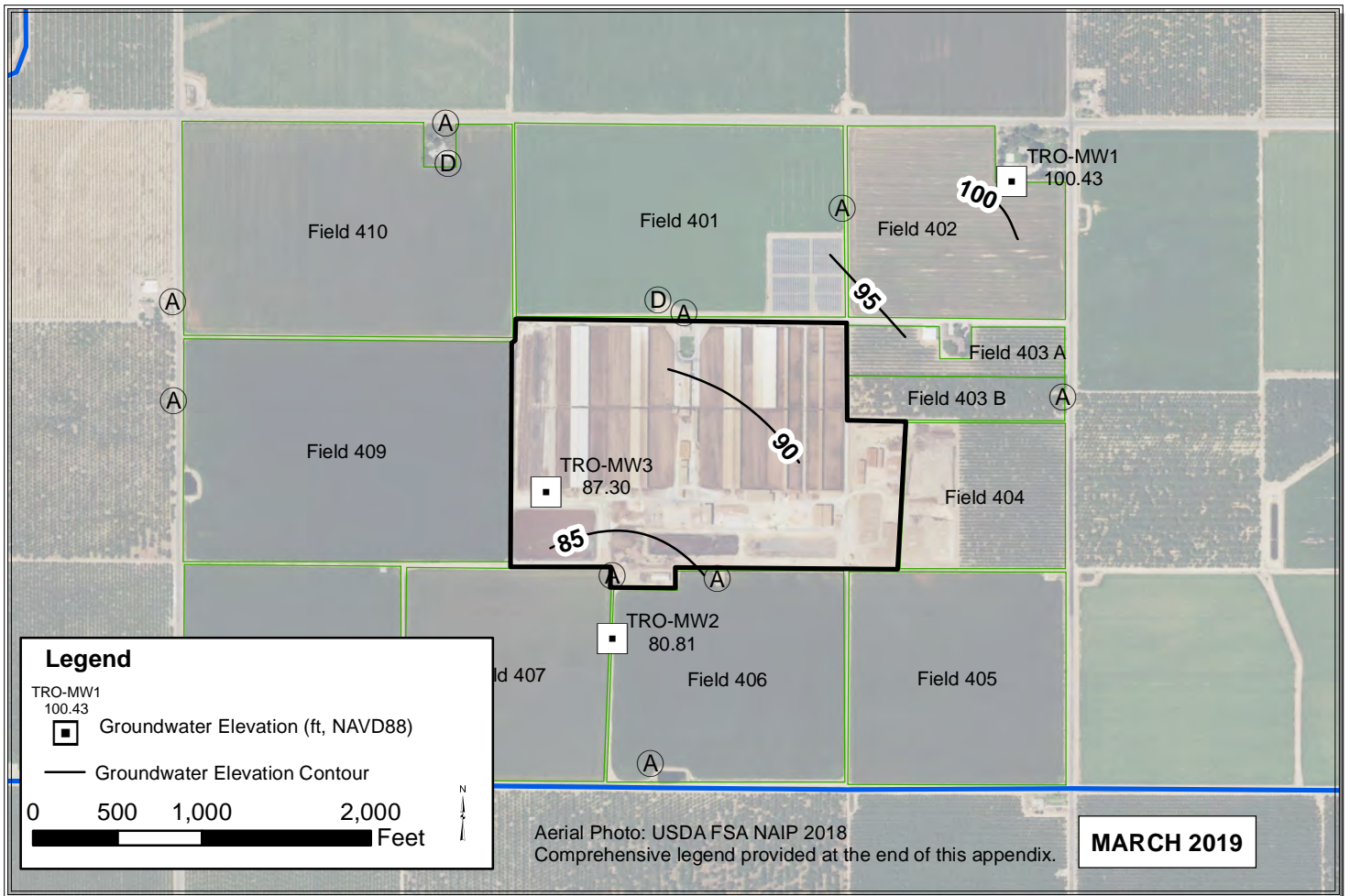

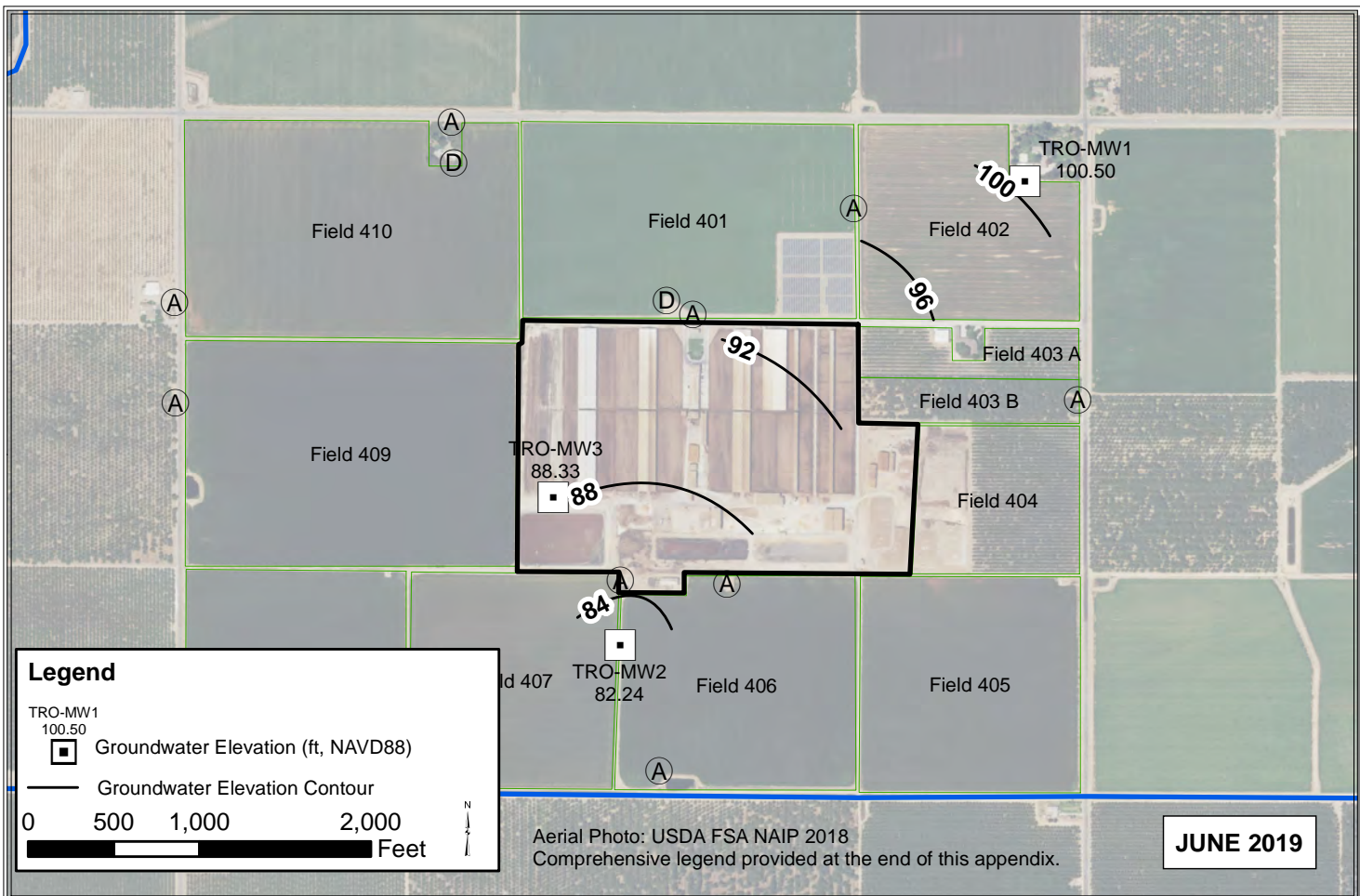
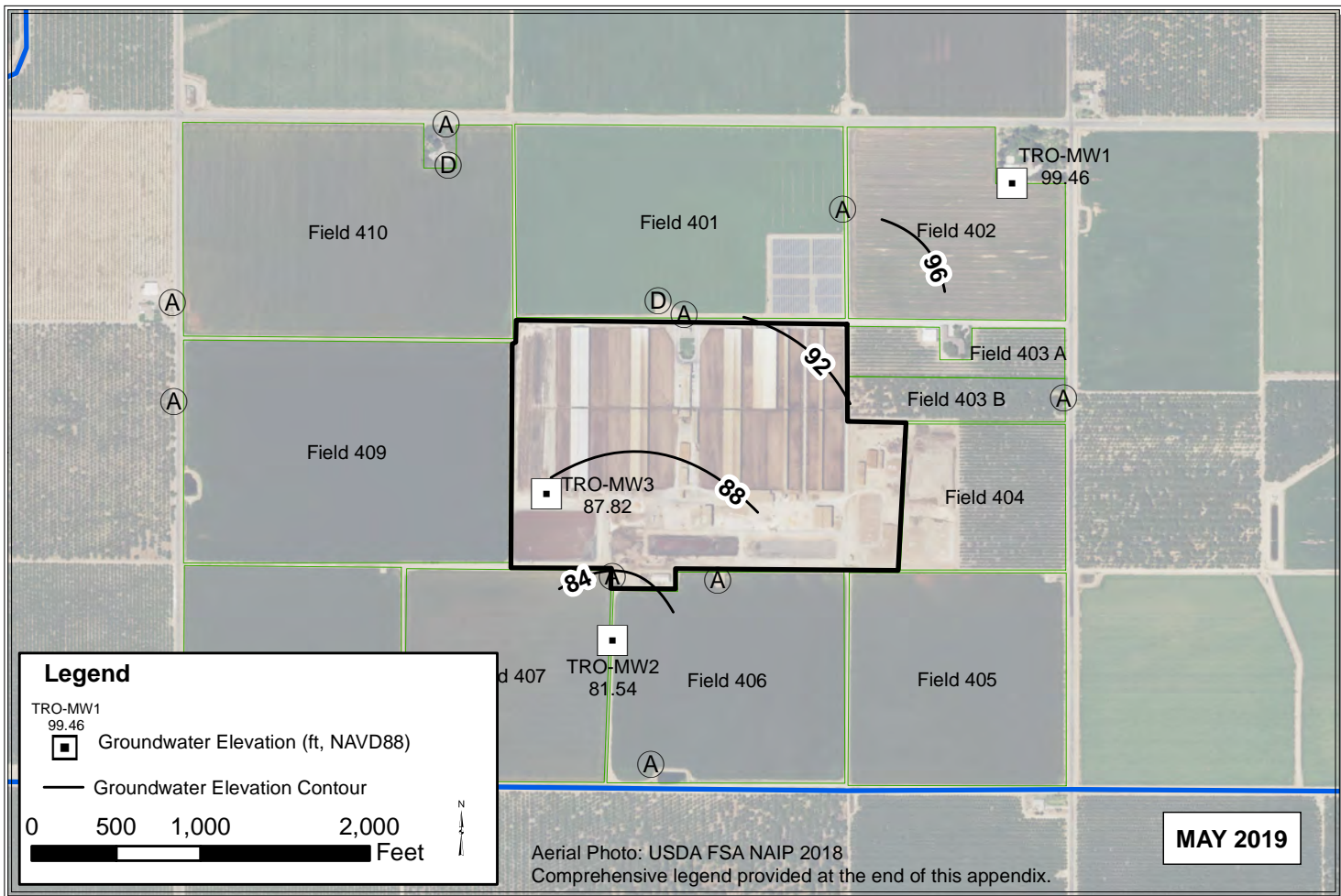

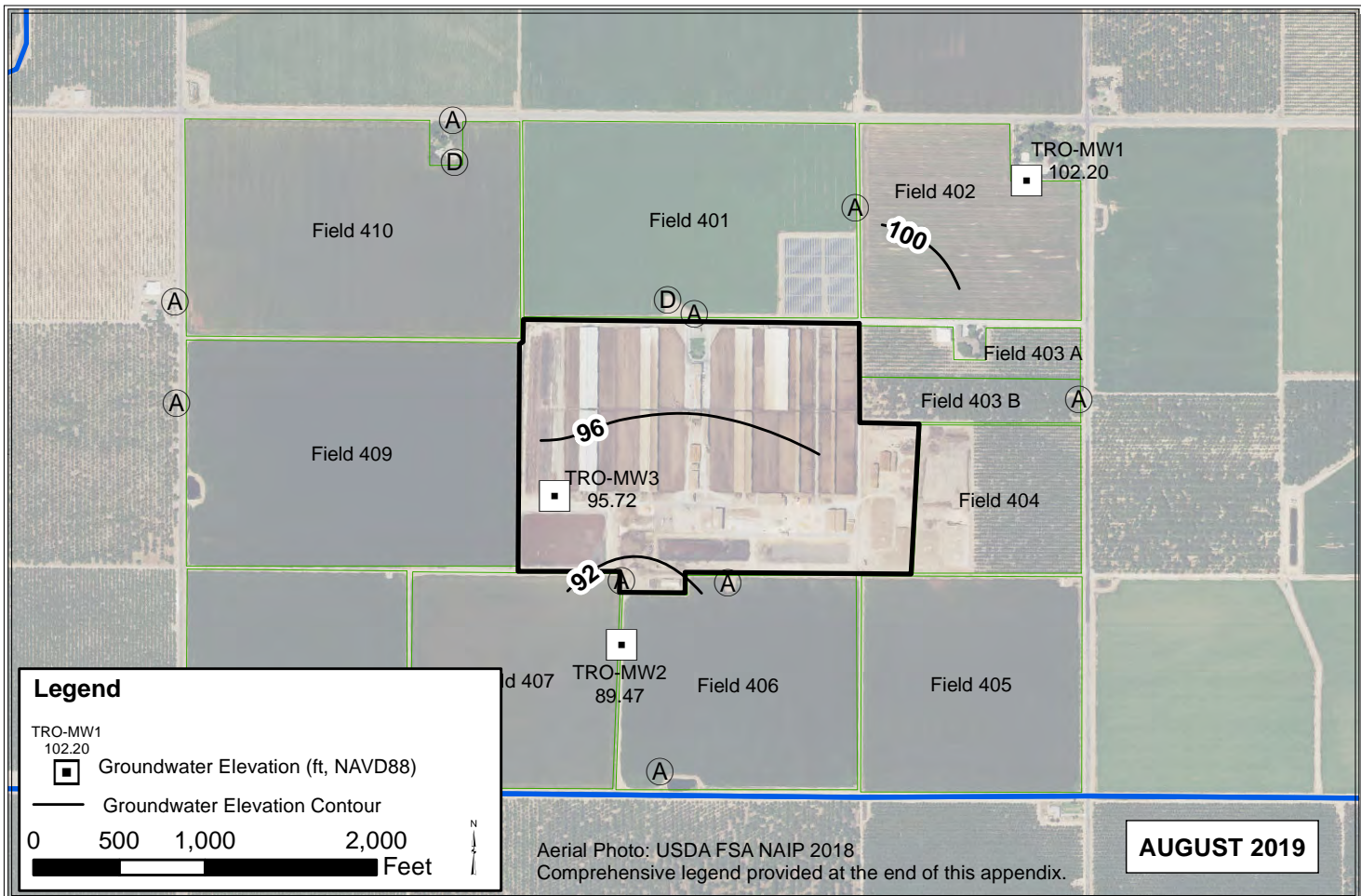
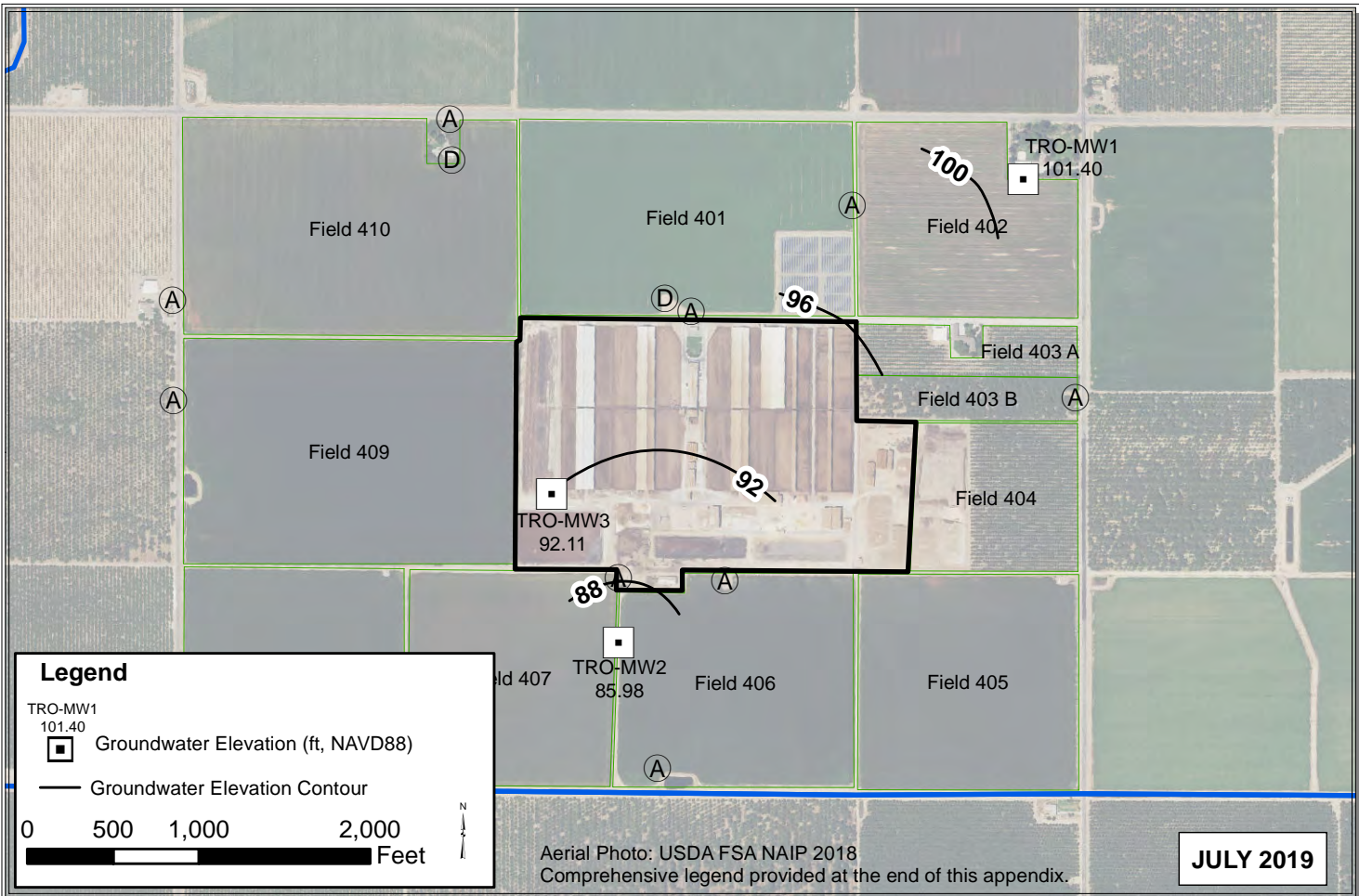

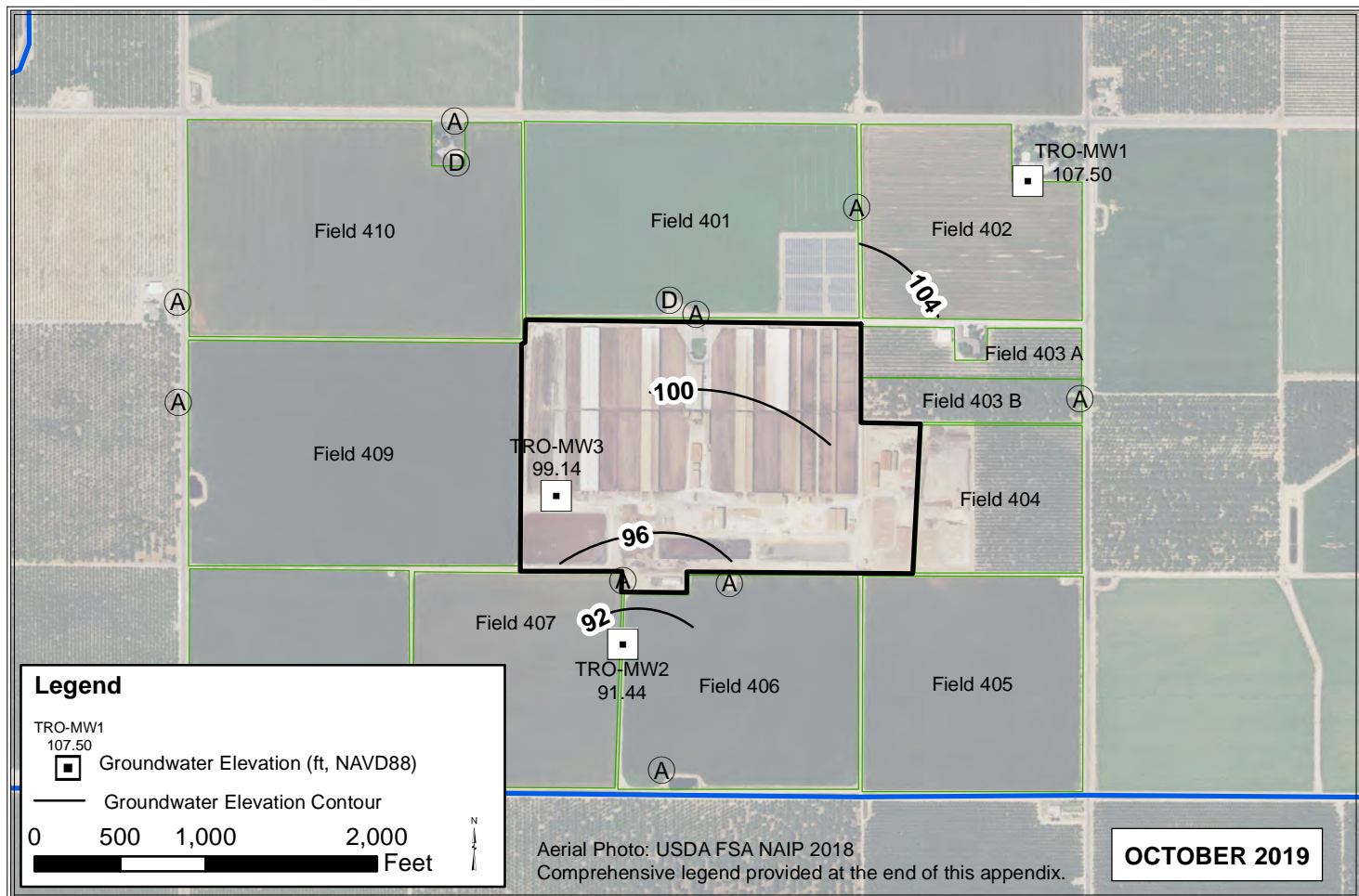
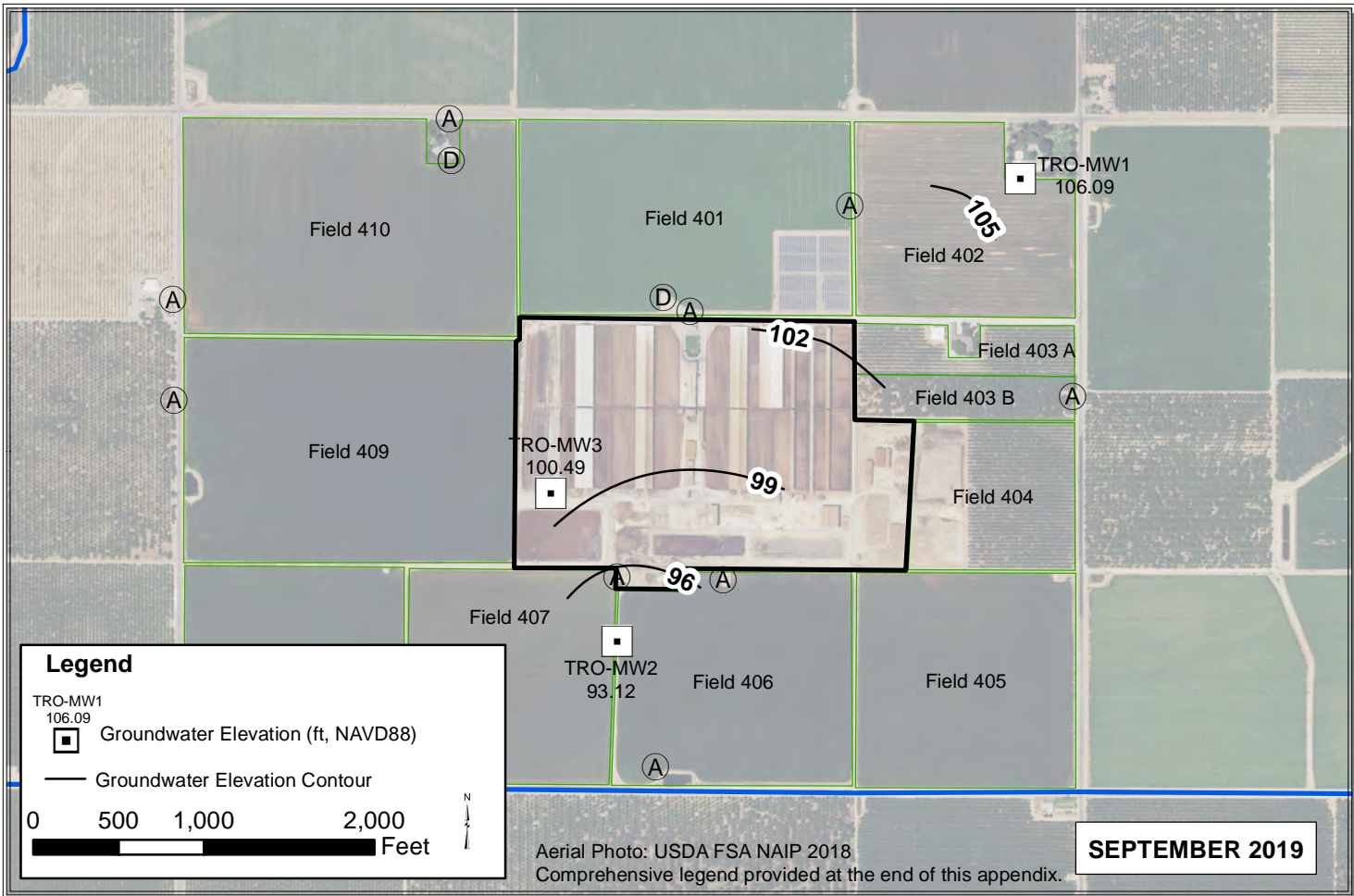

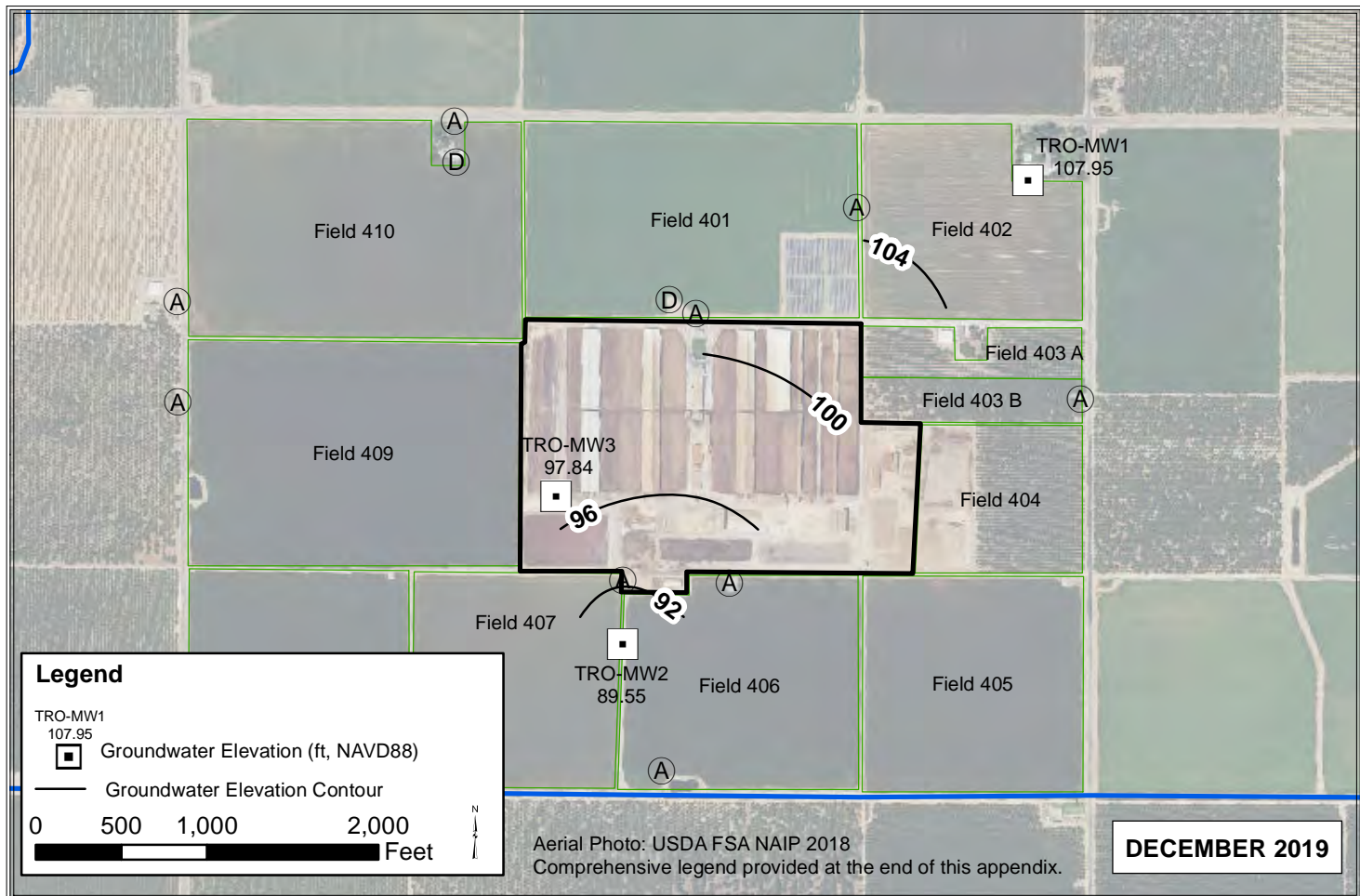
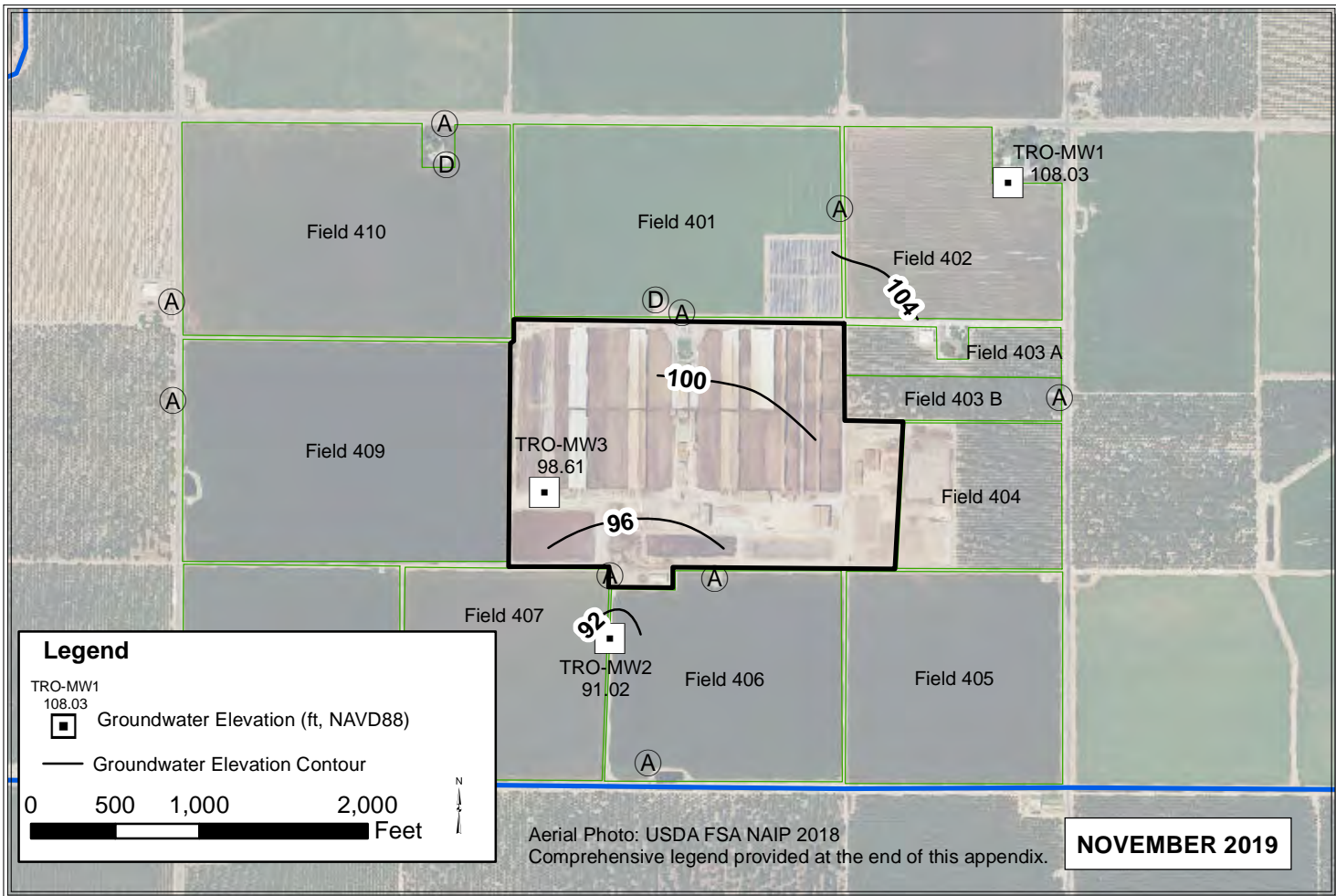

PLS

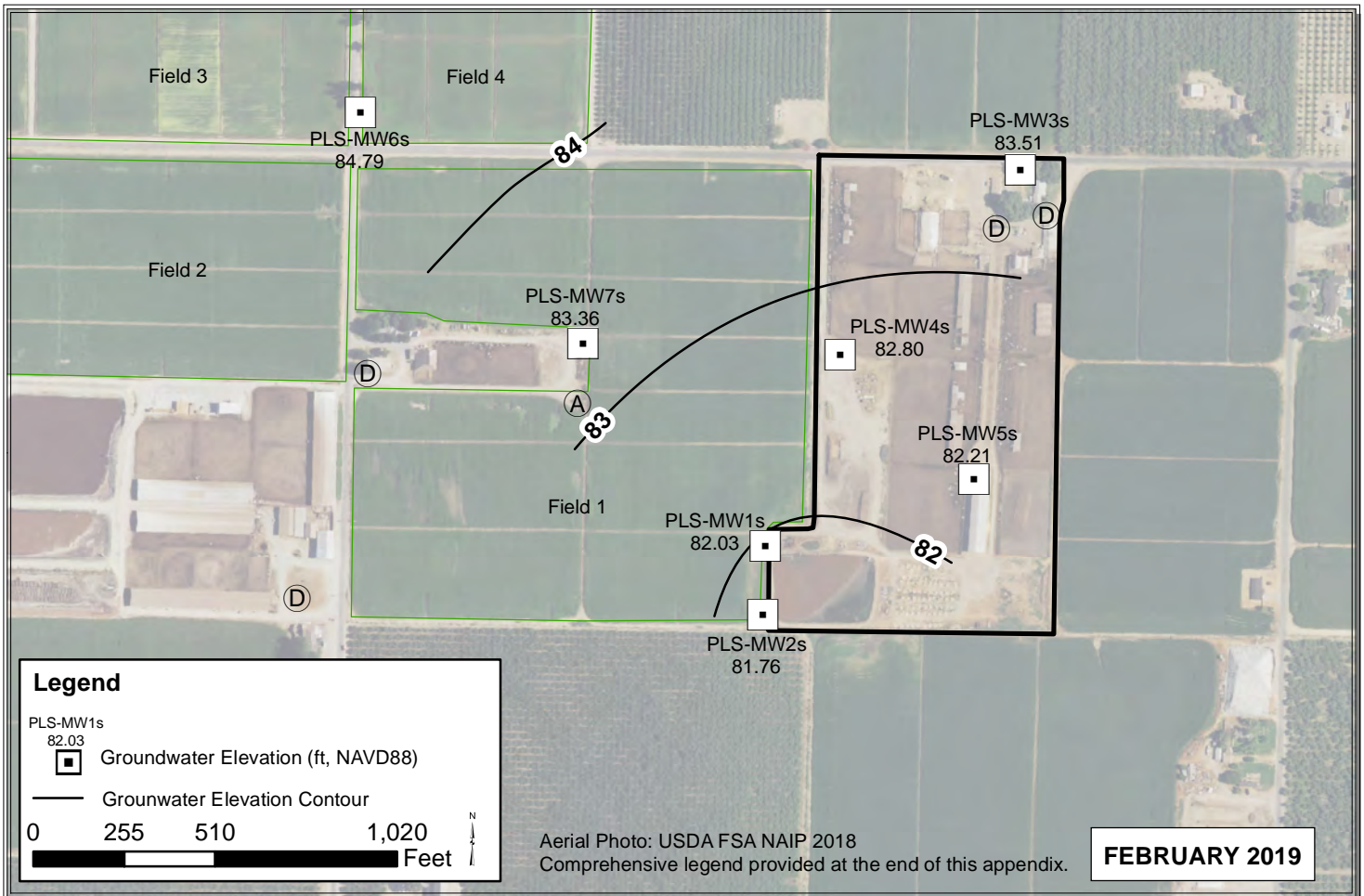
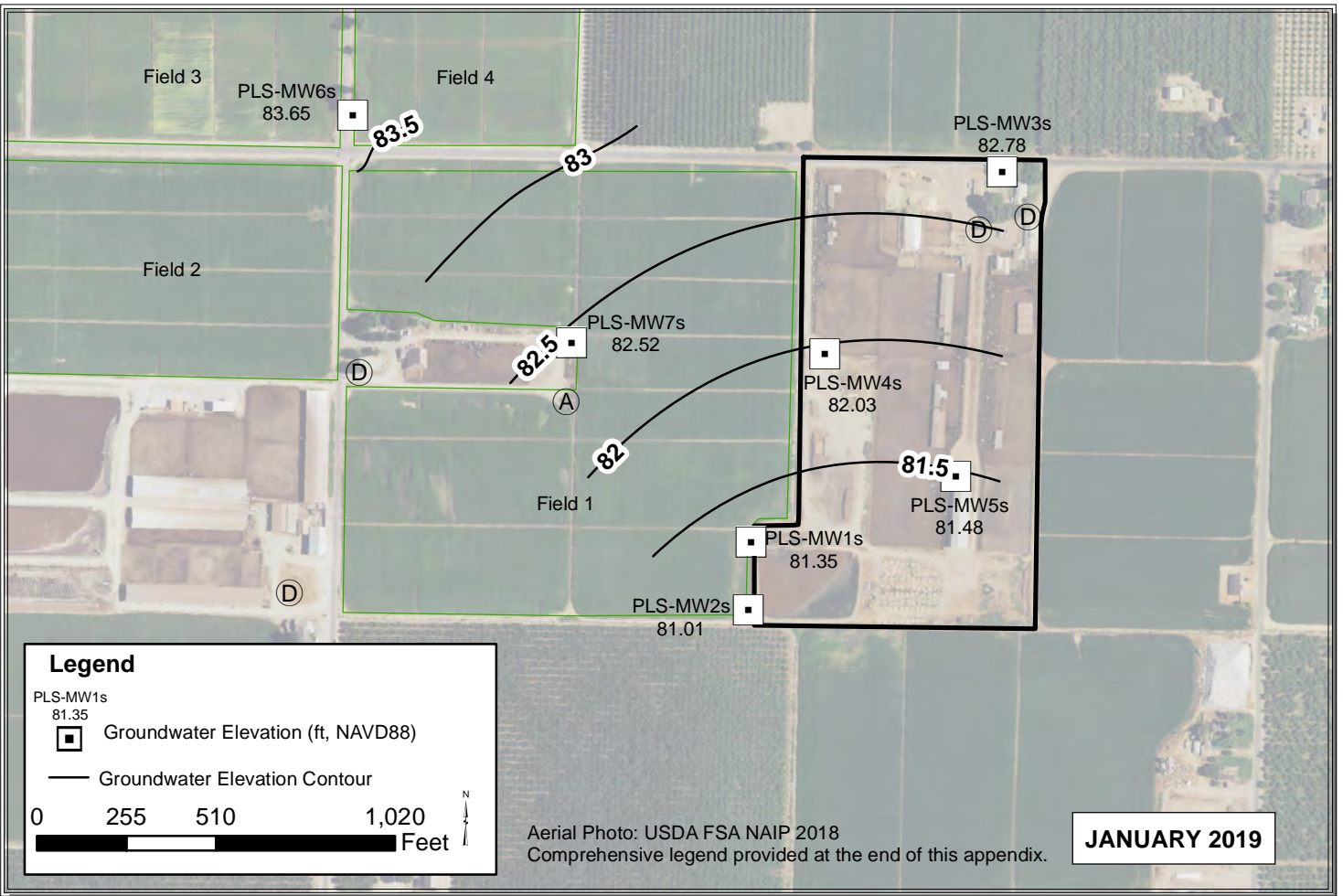

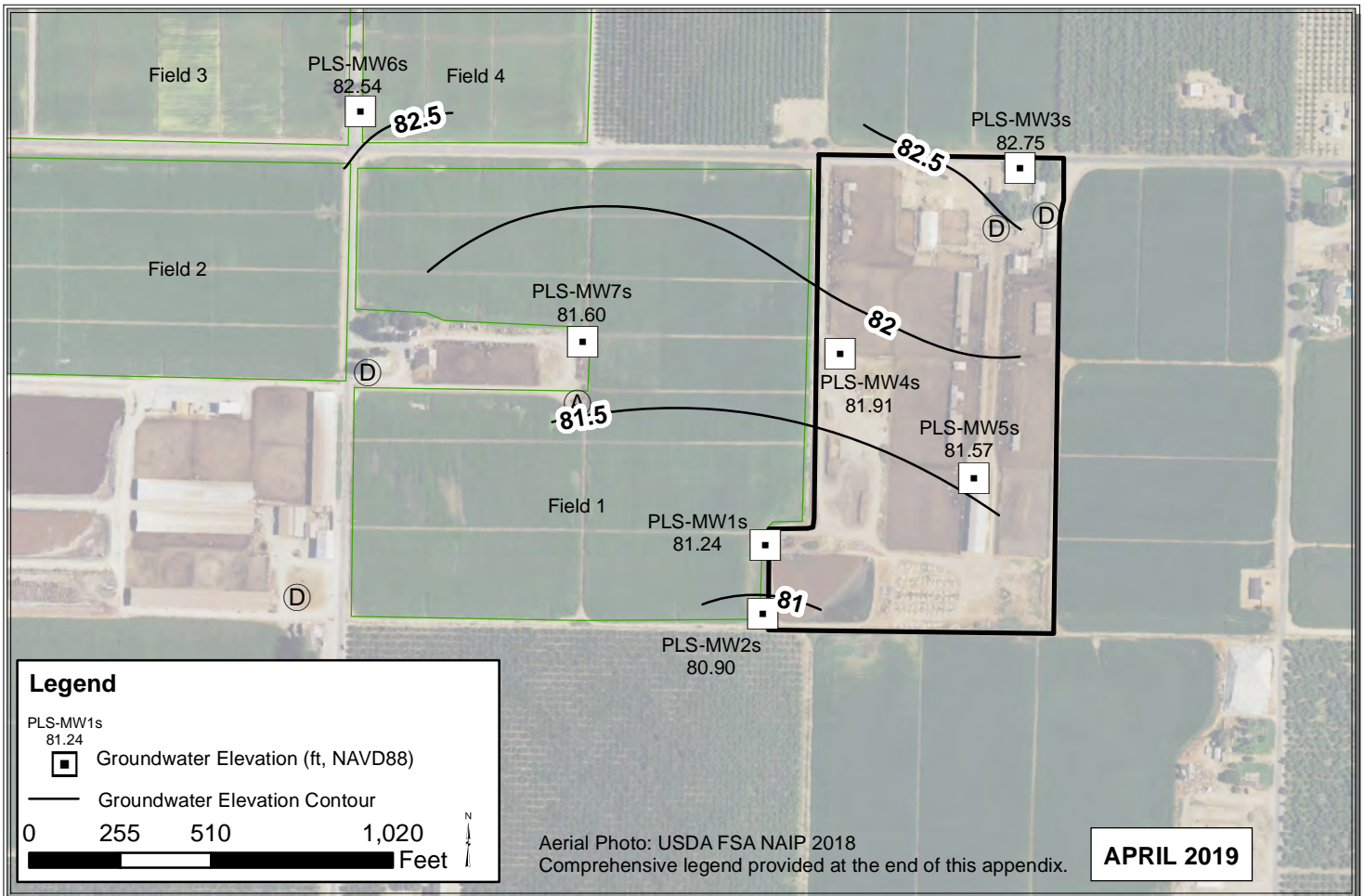
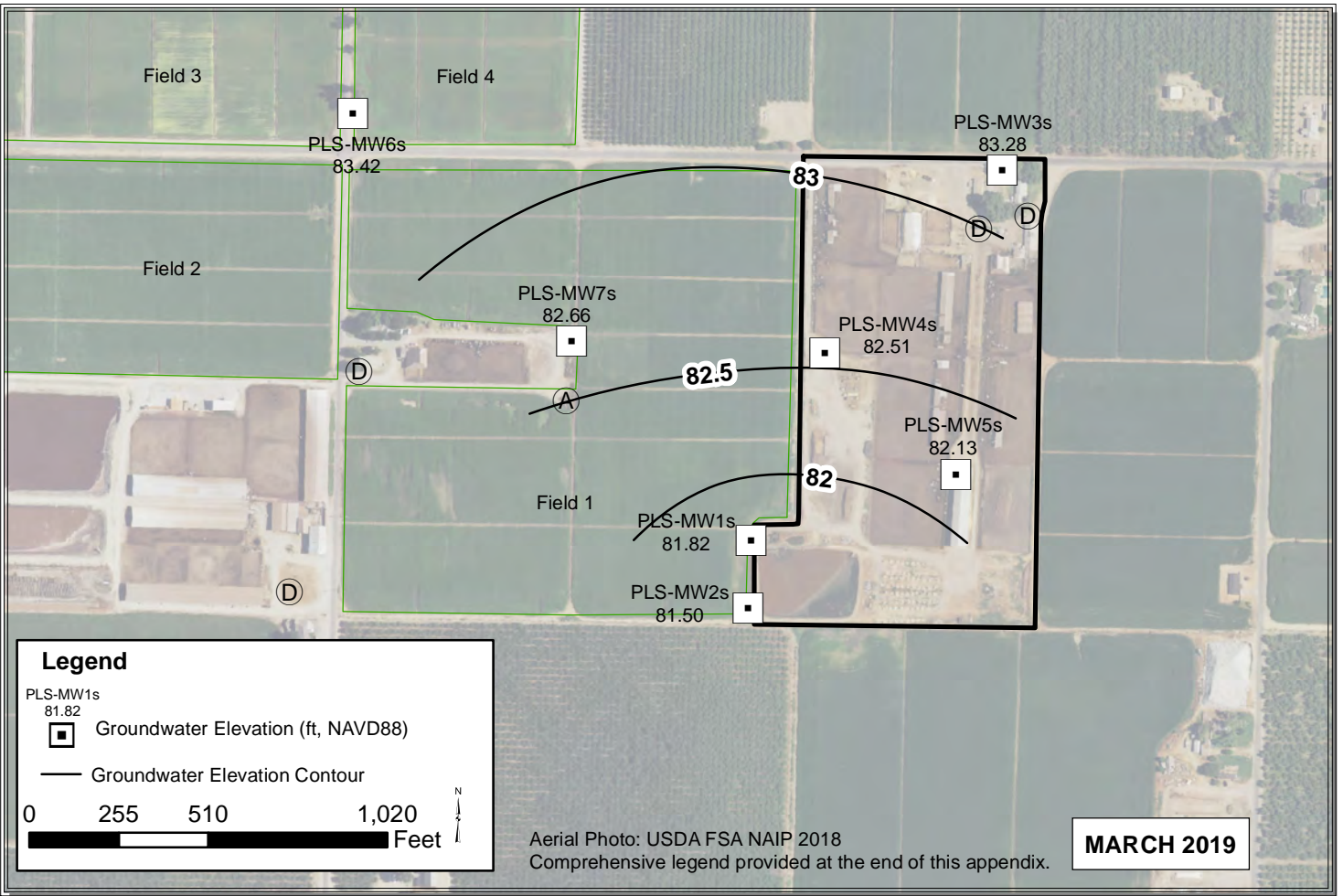

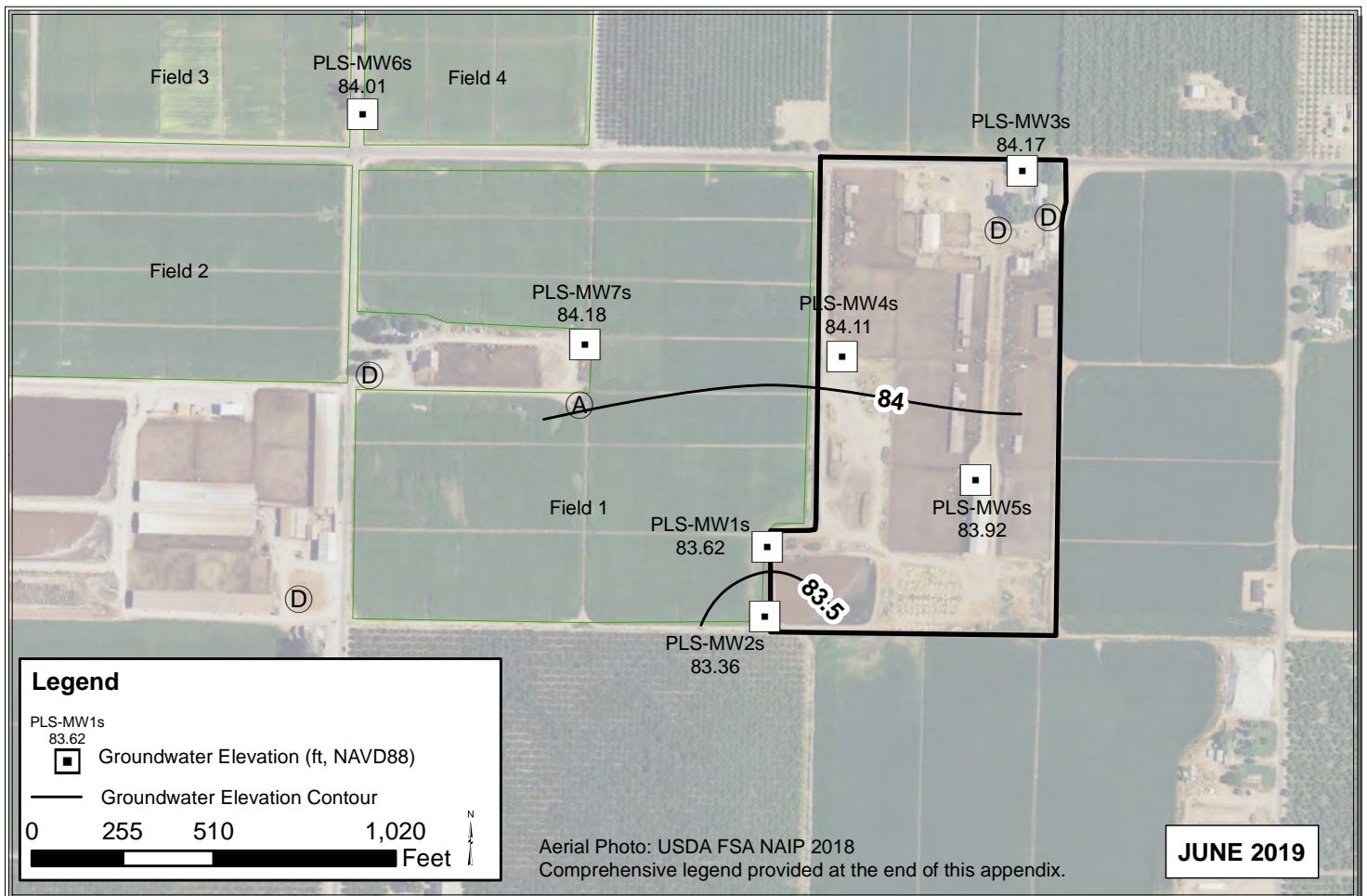
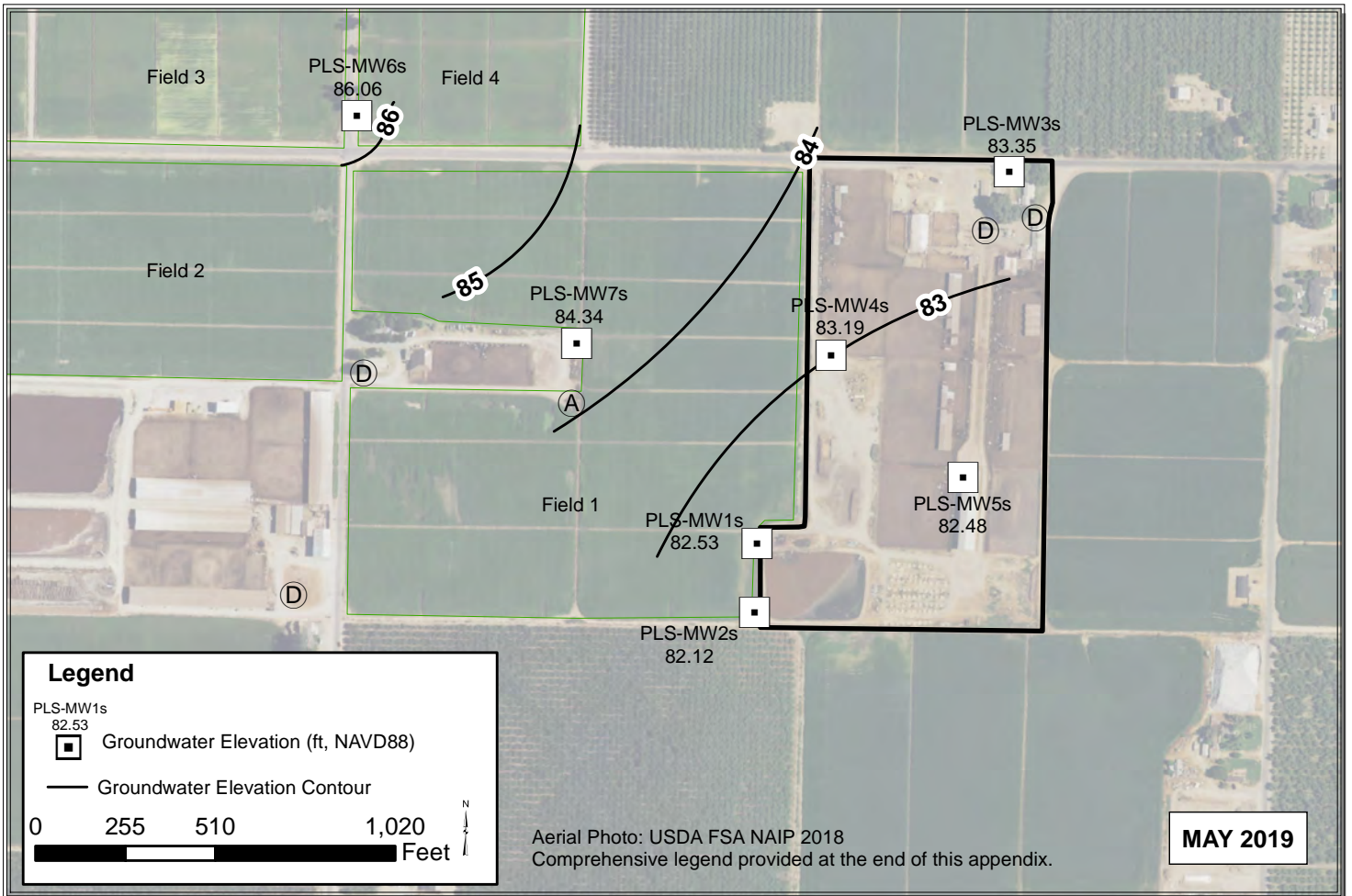

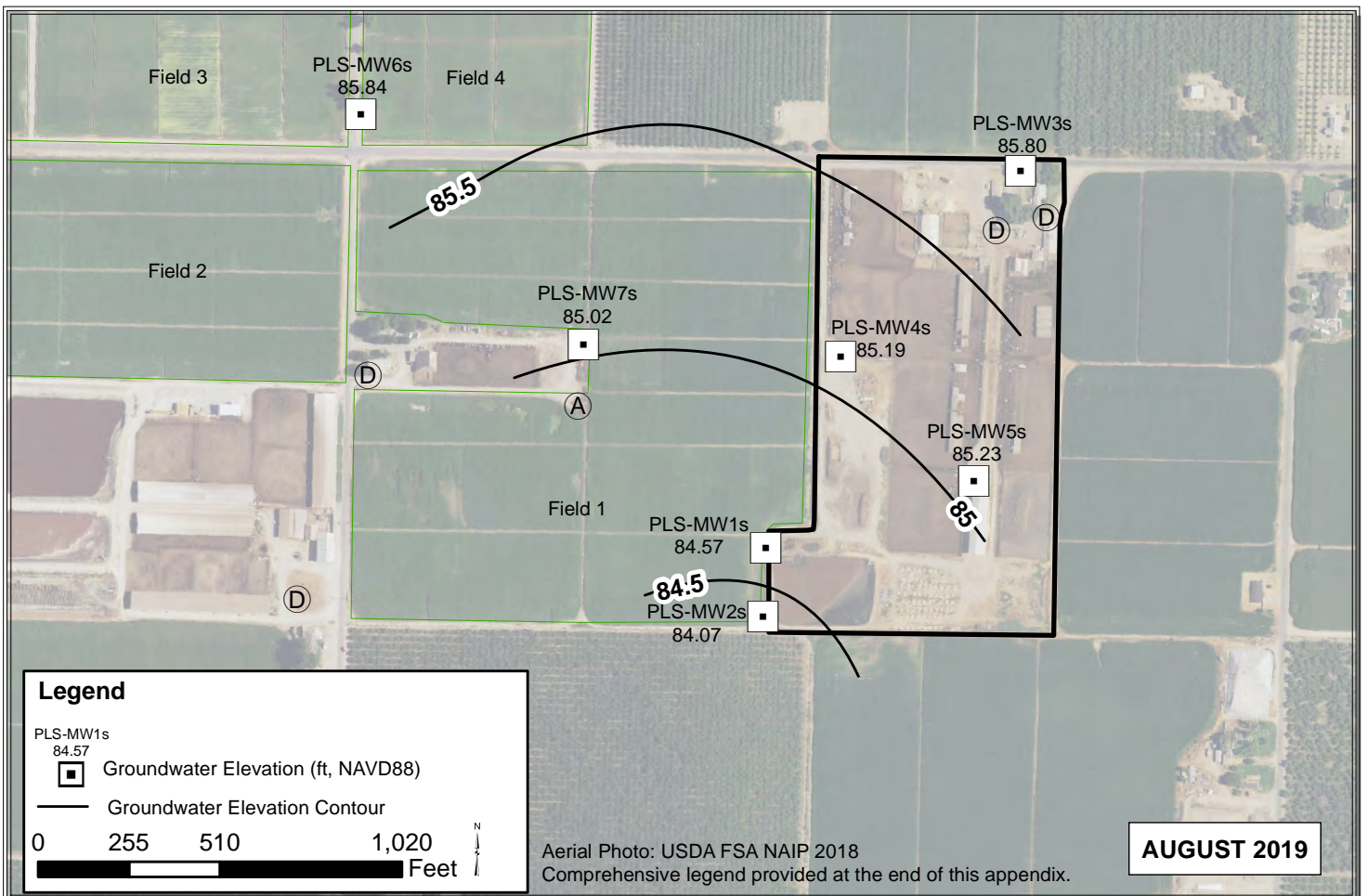
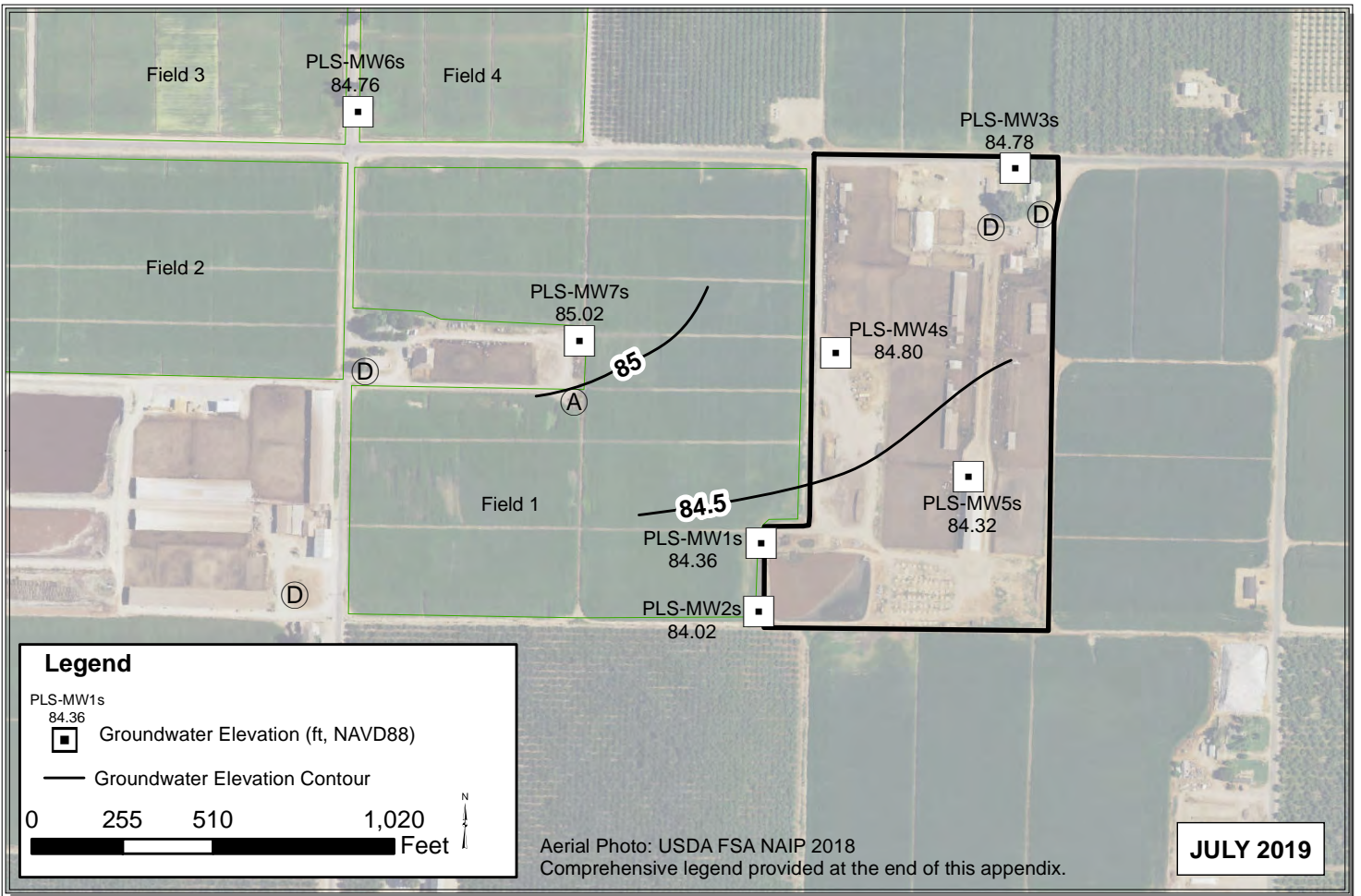

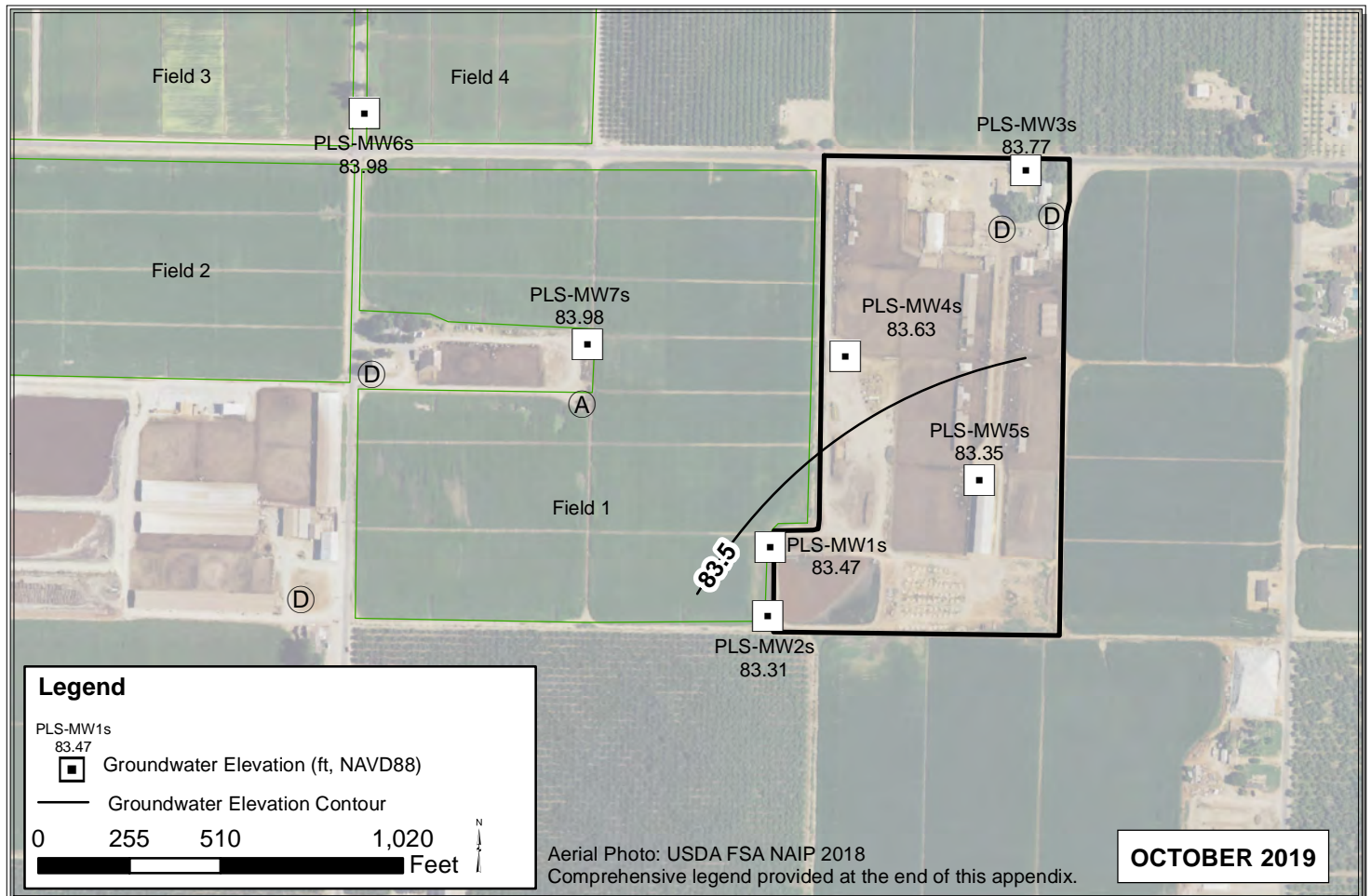
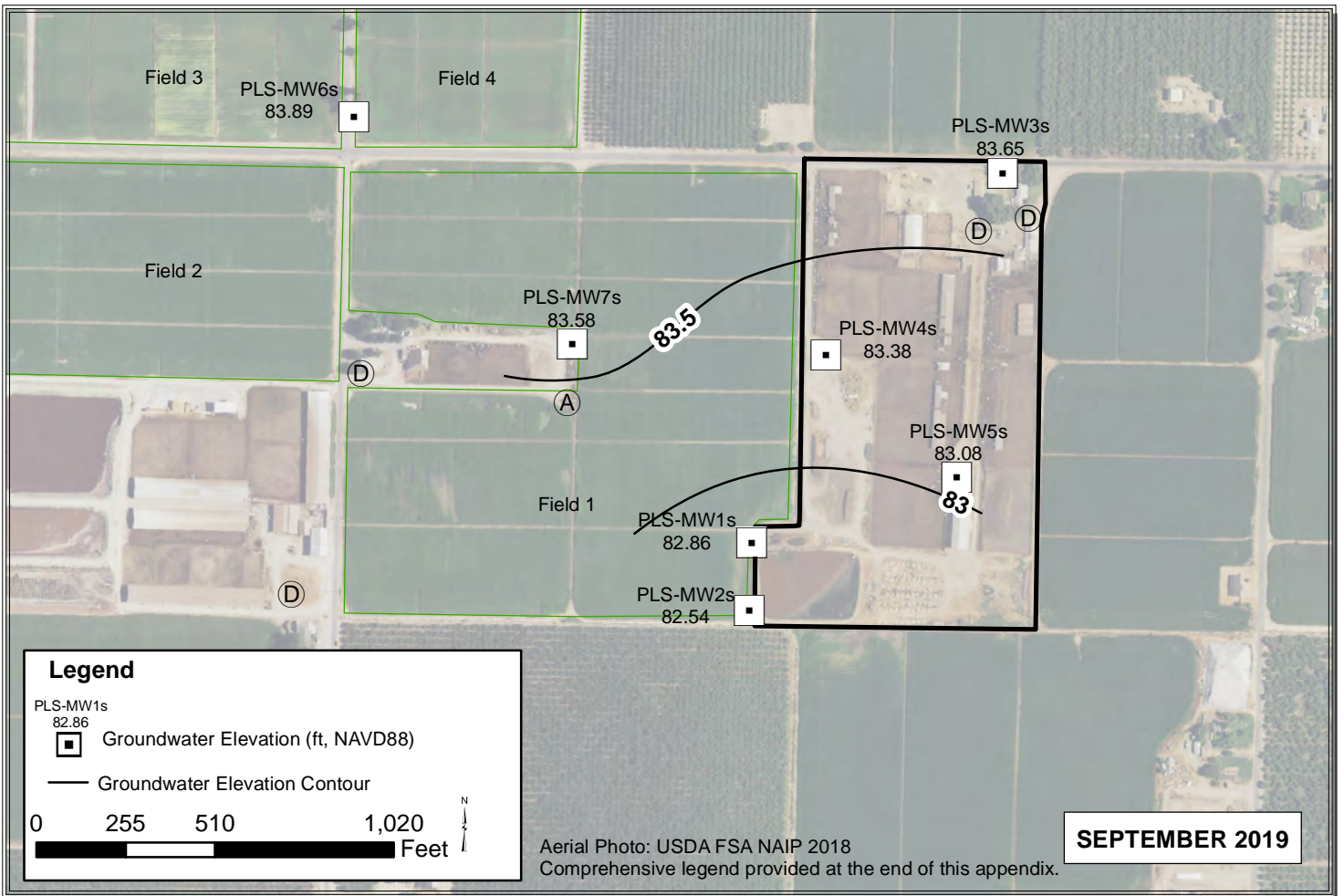

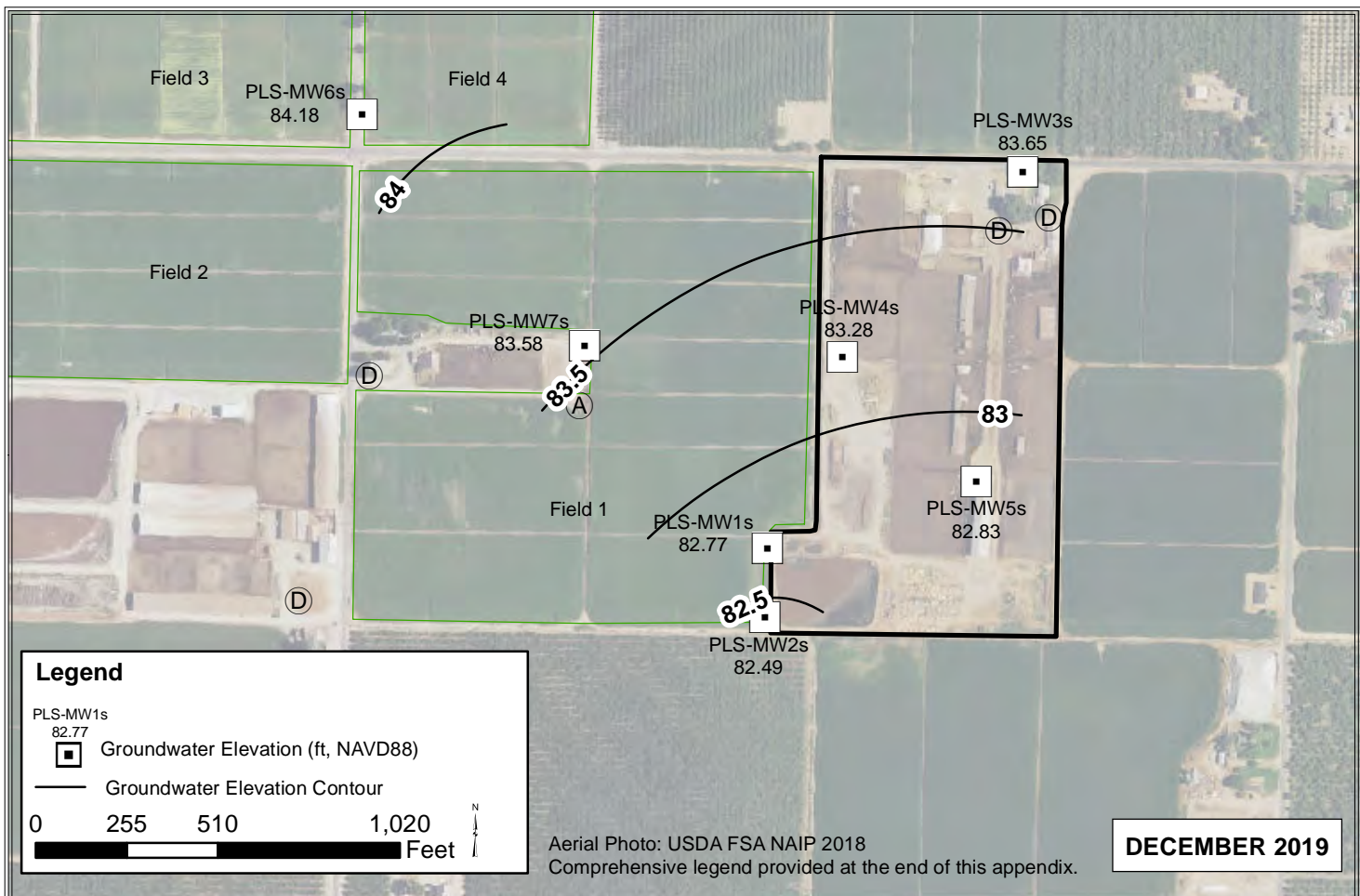
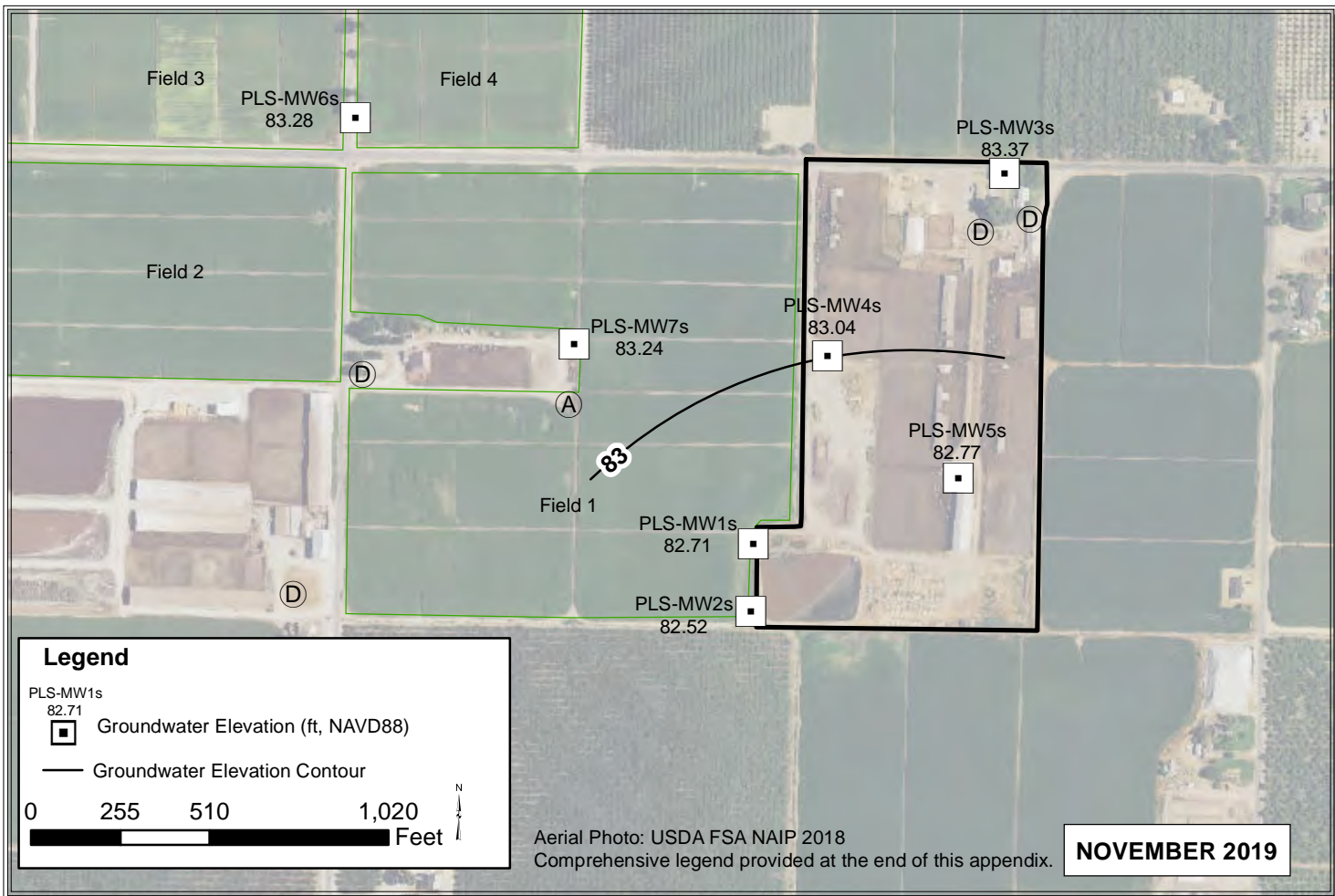

CAE

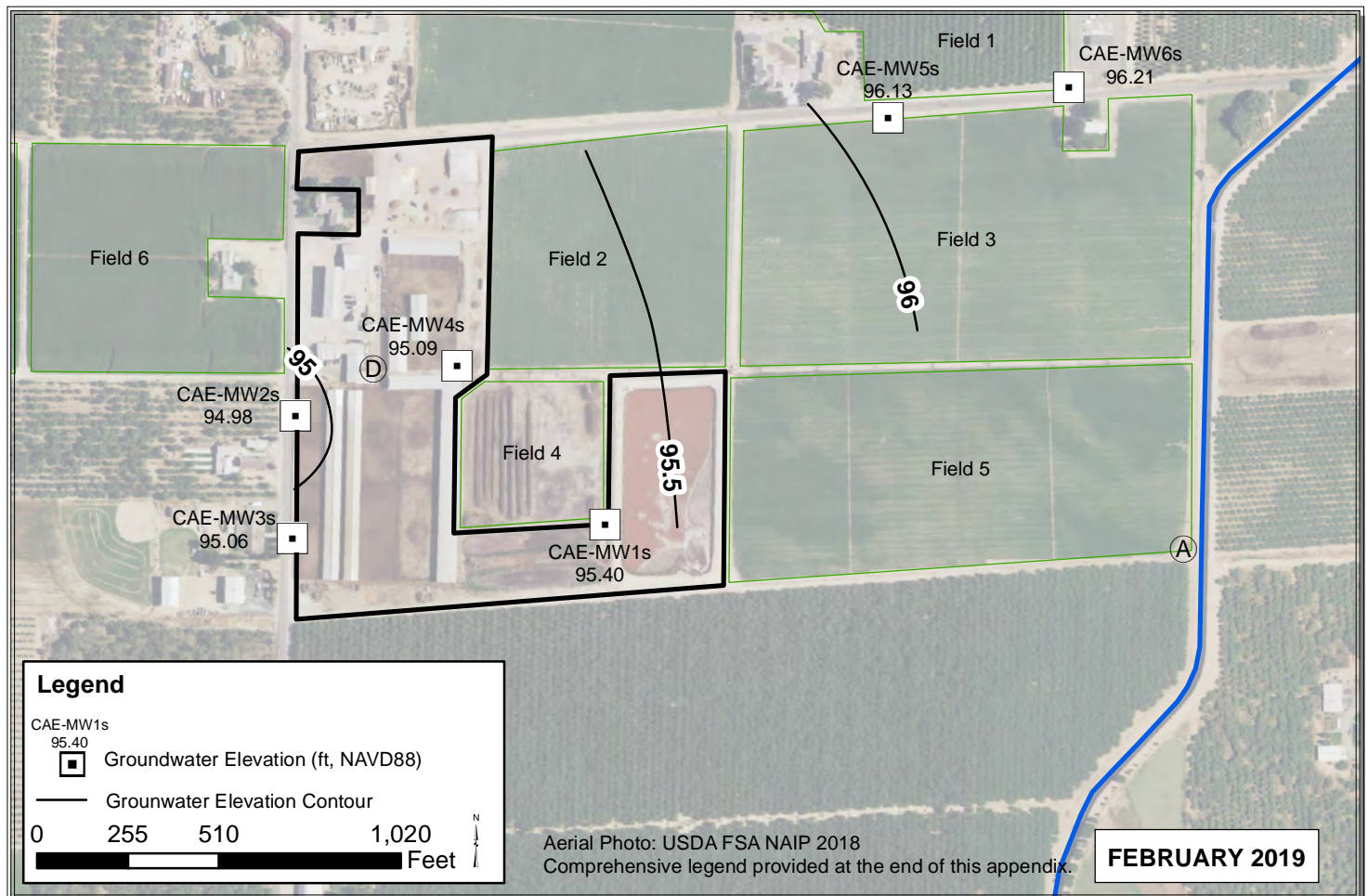
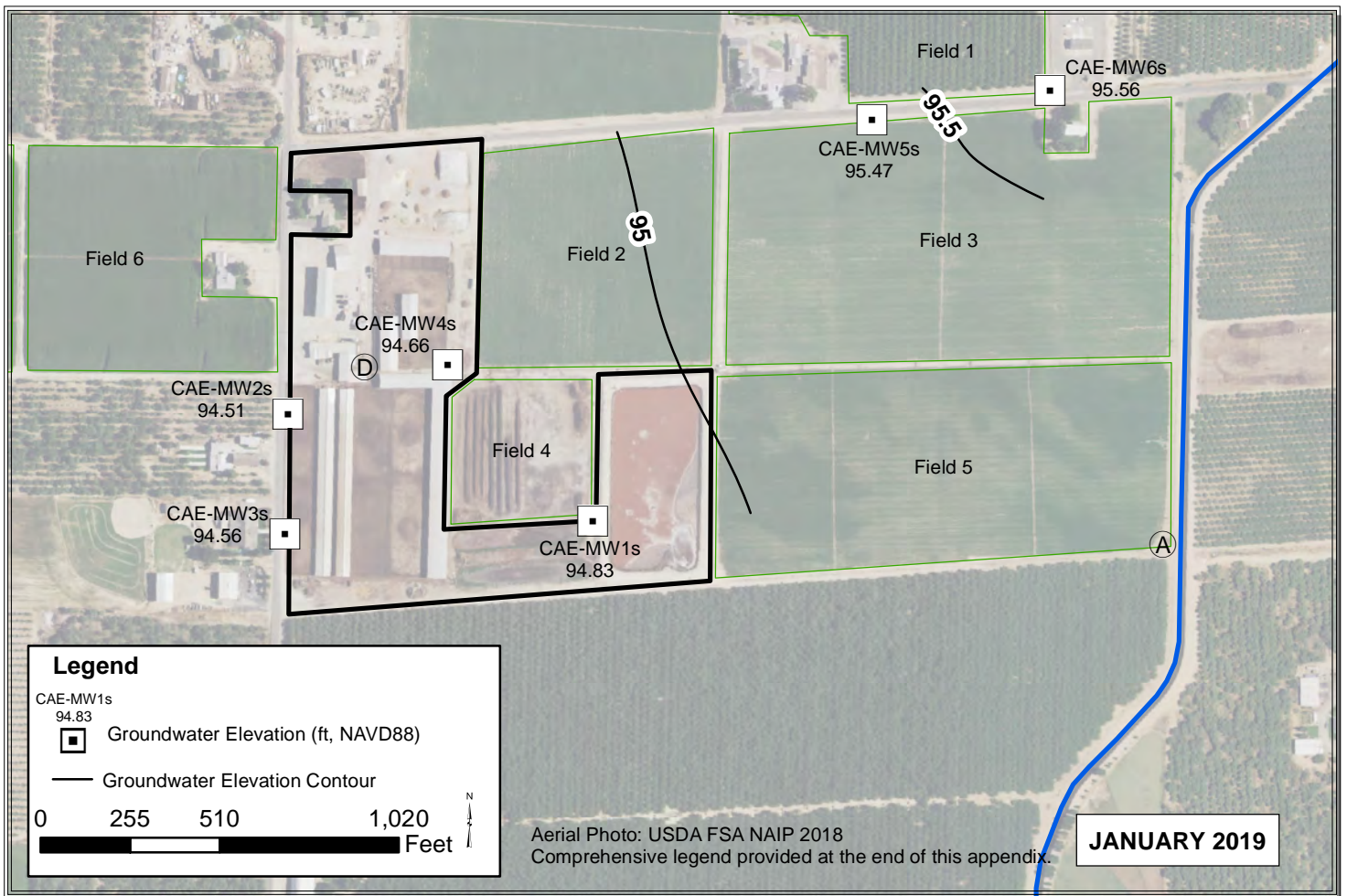

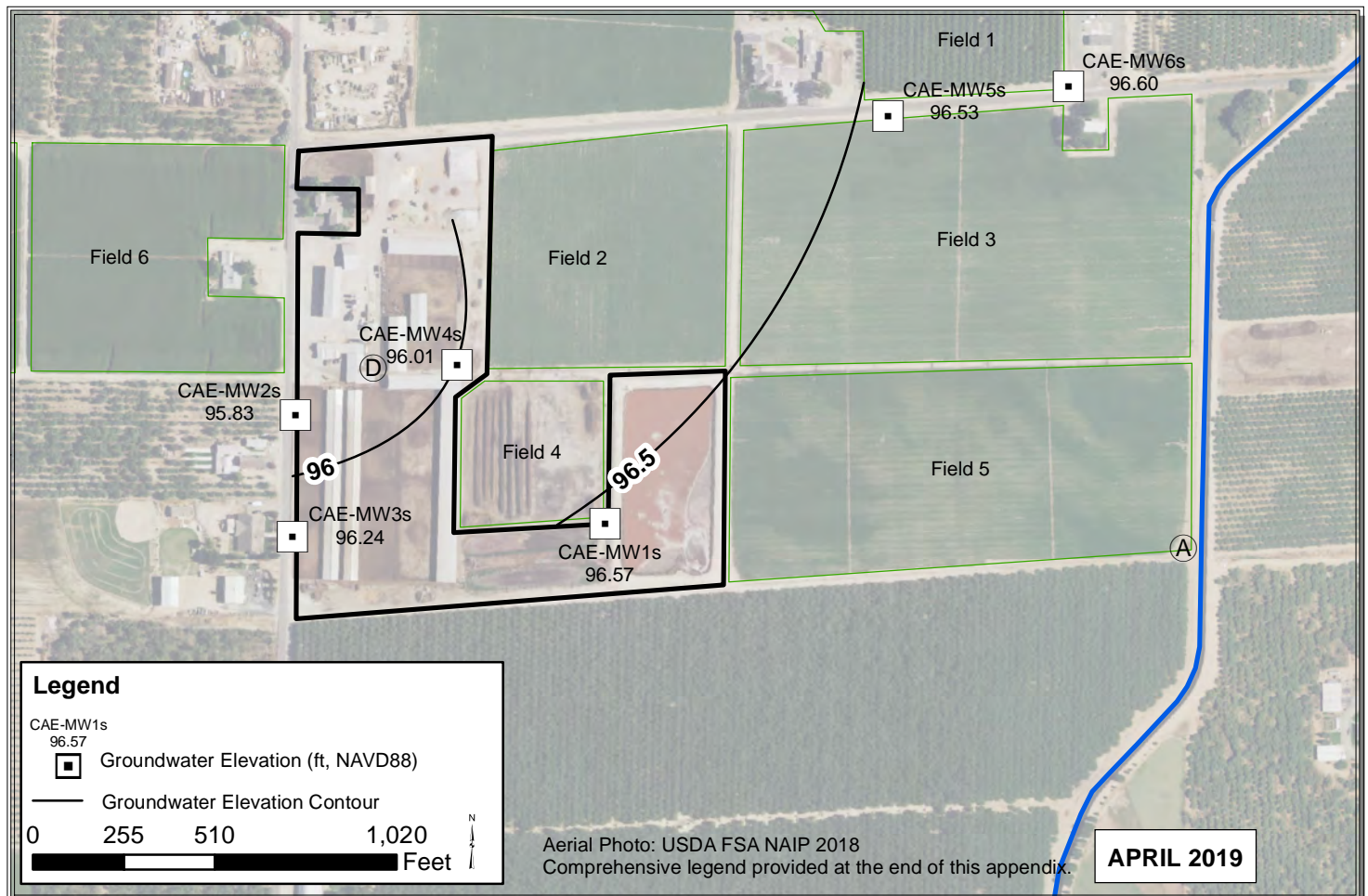
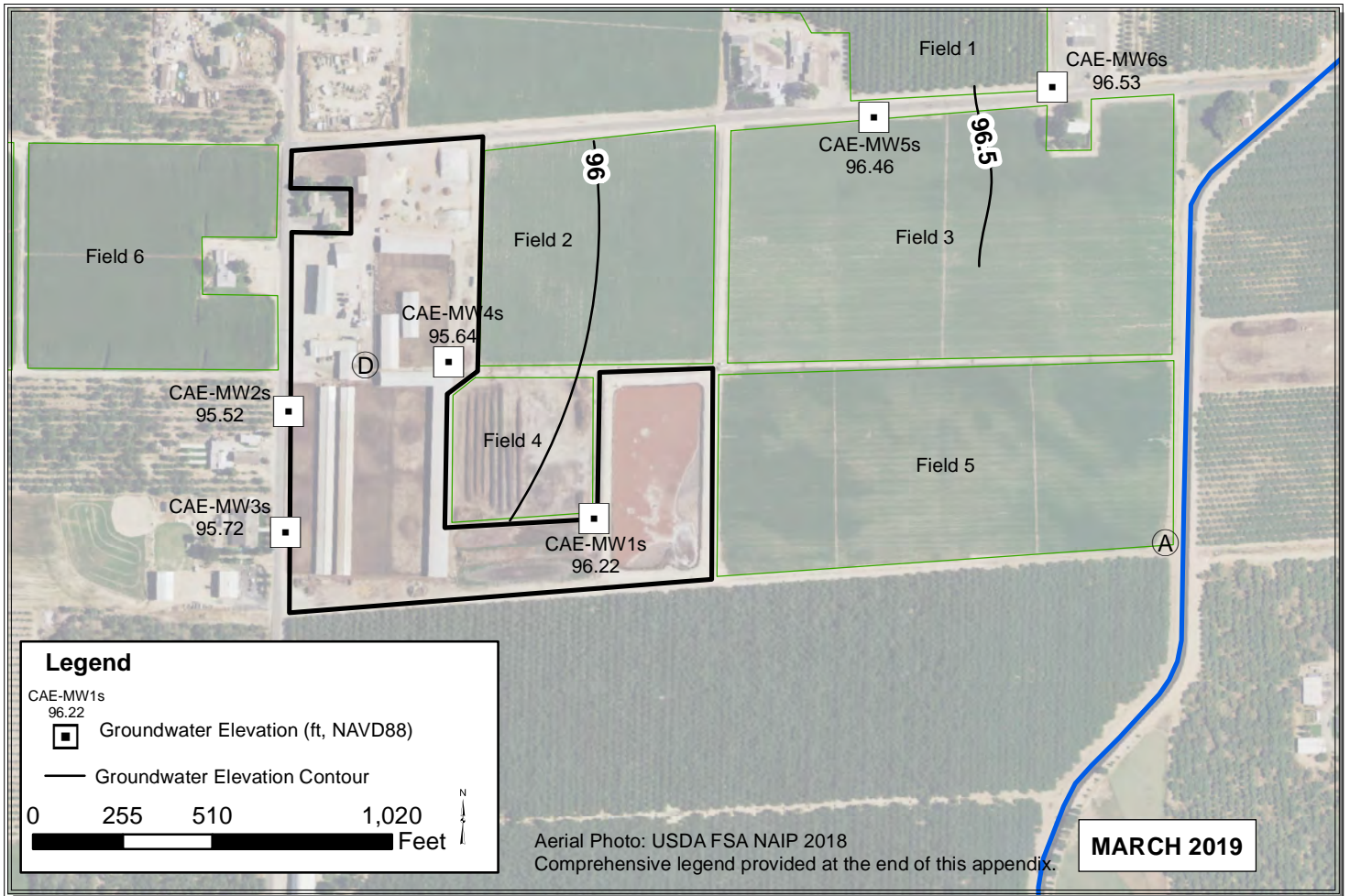

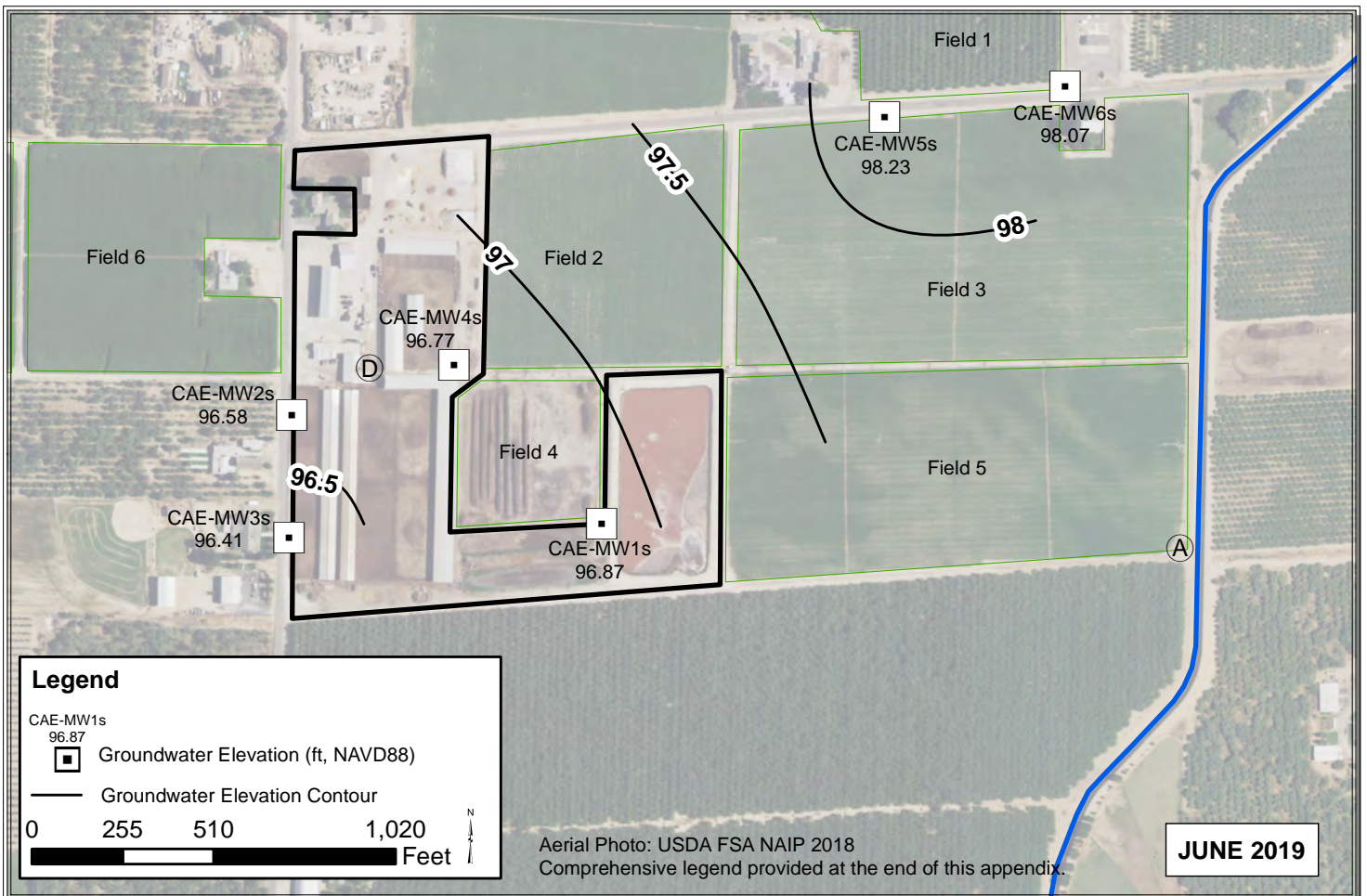
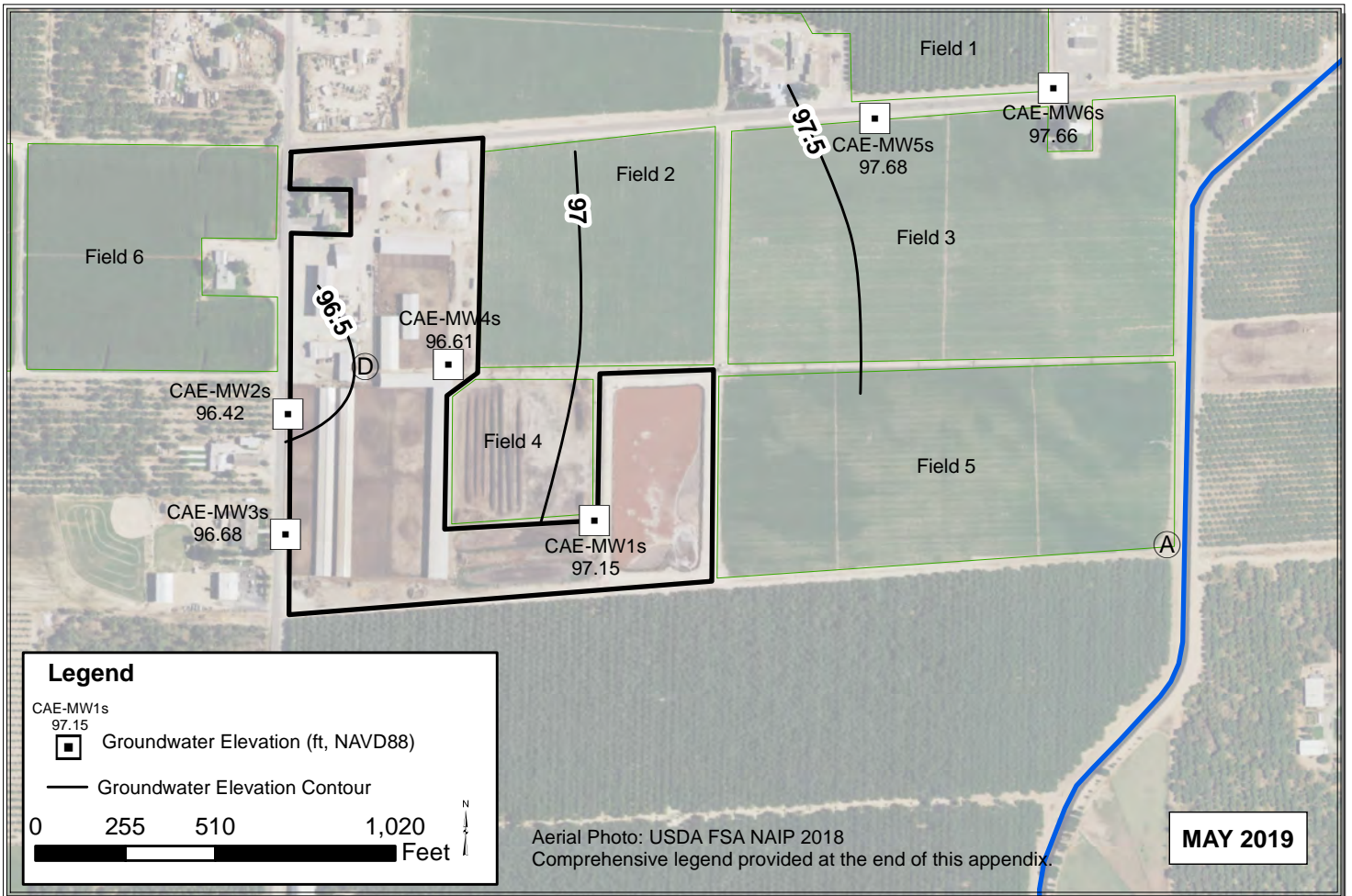

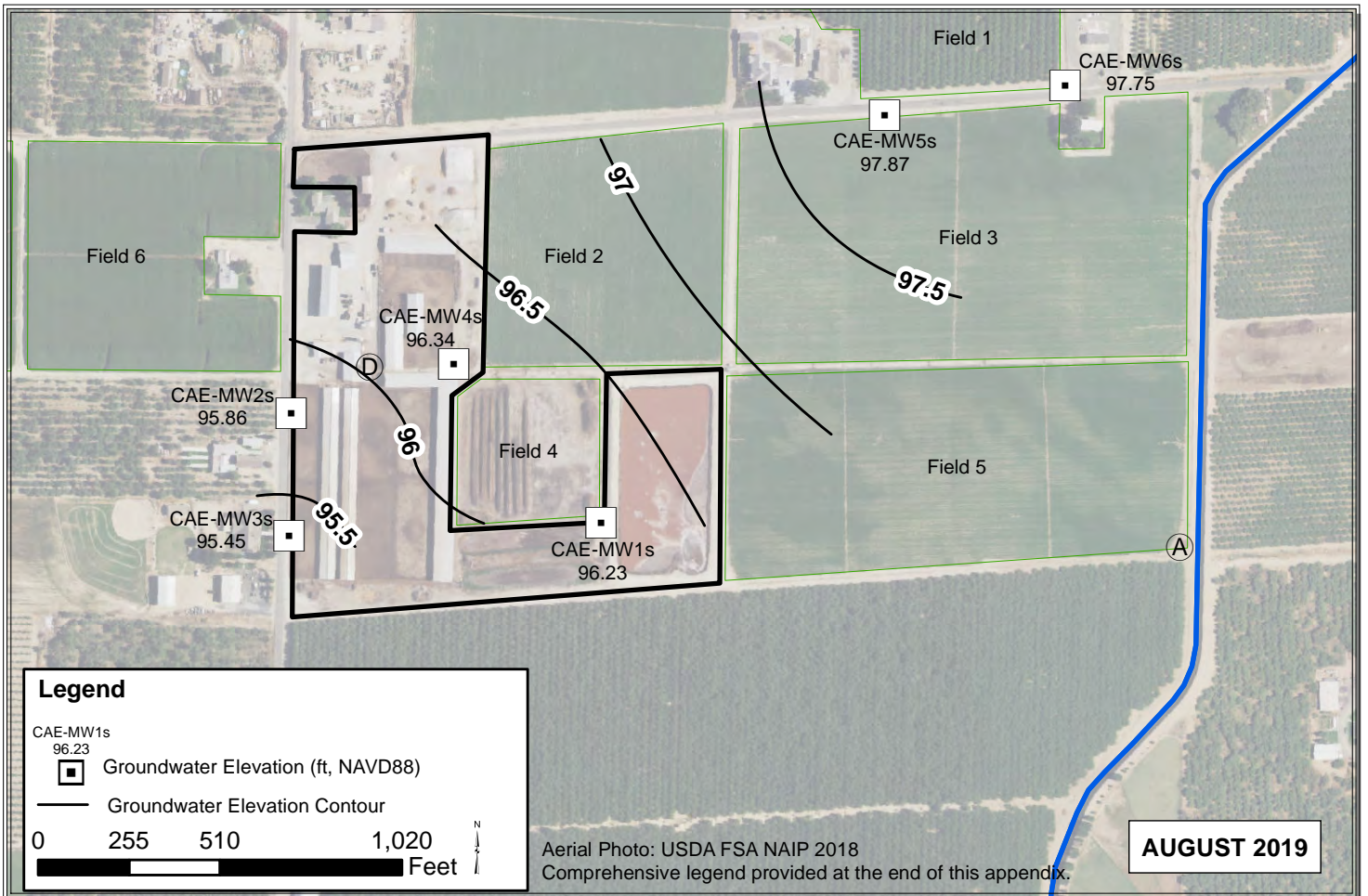
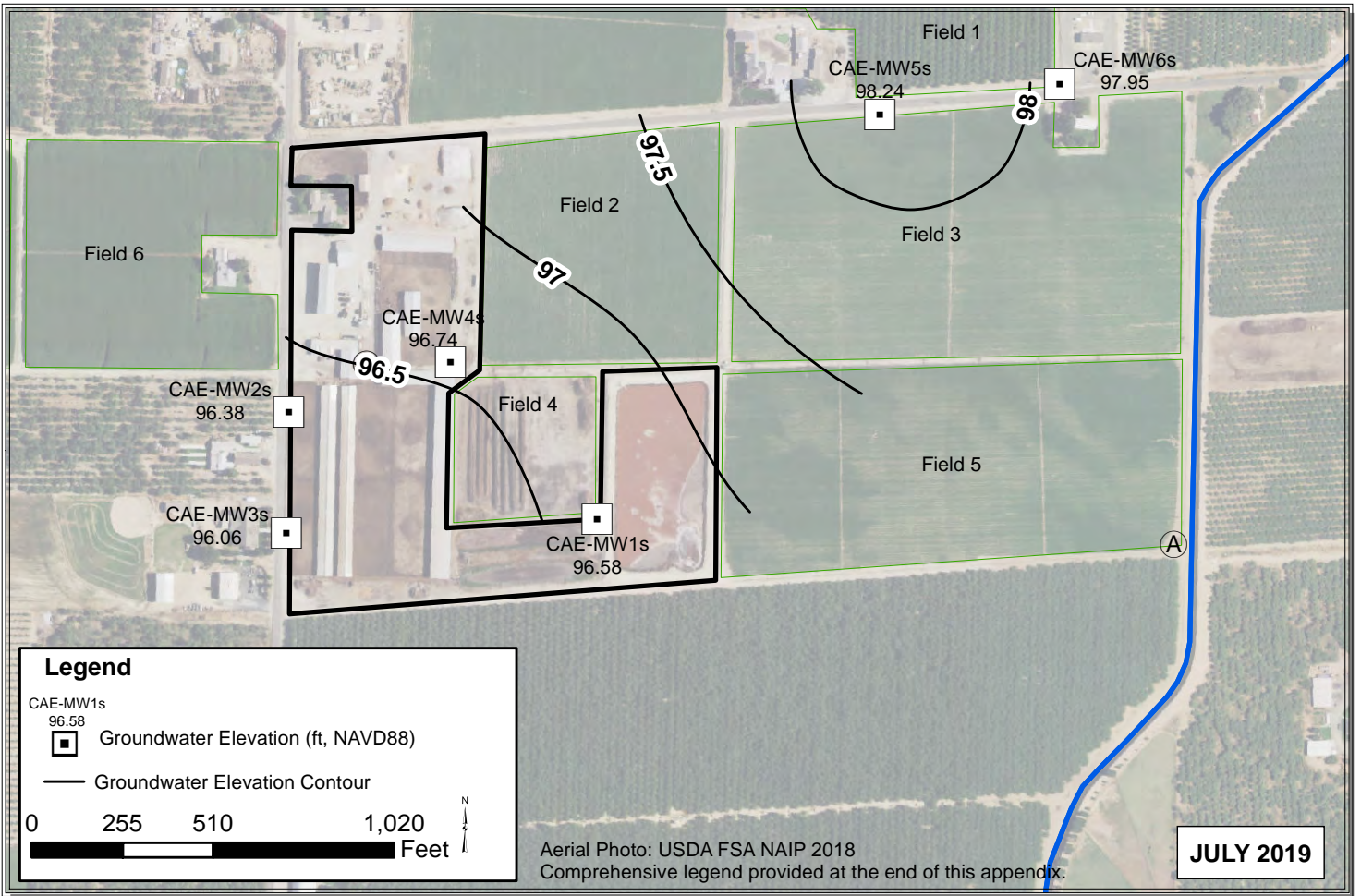

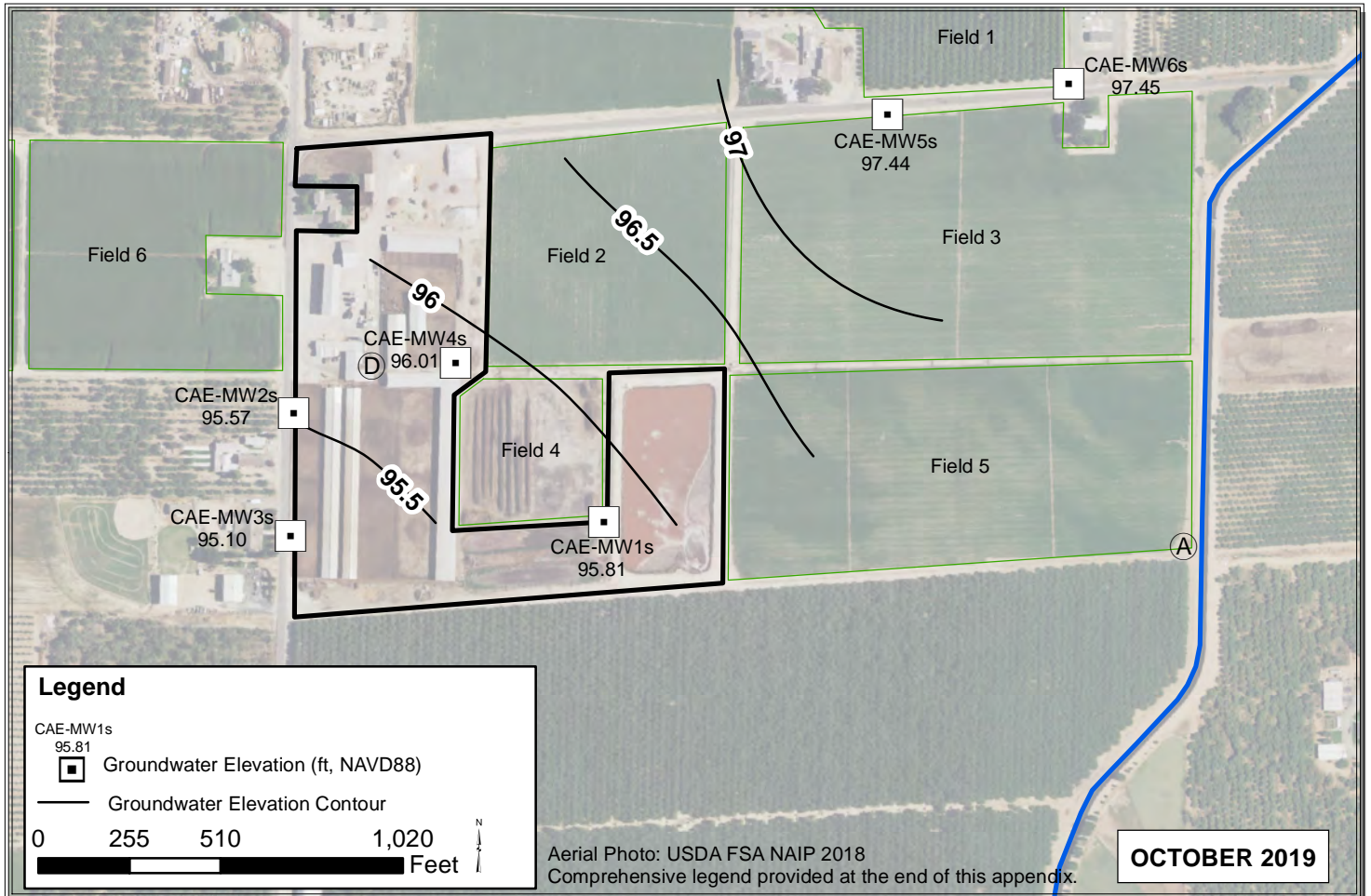
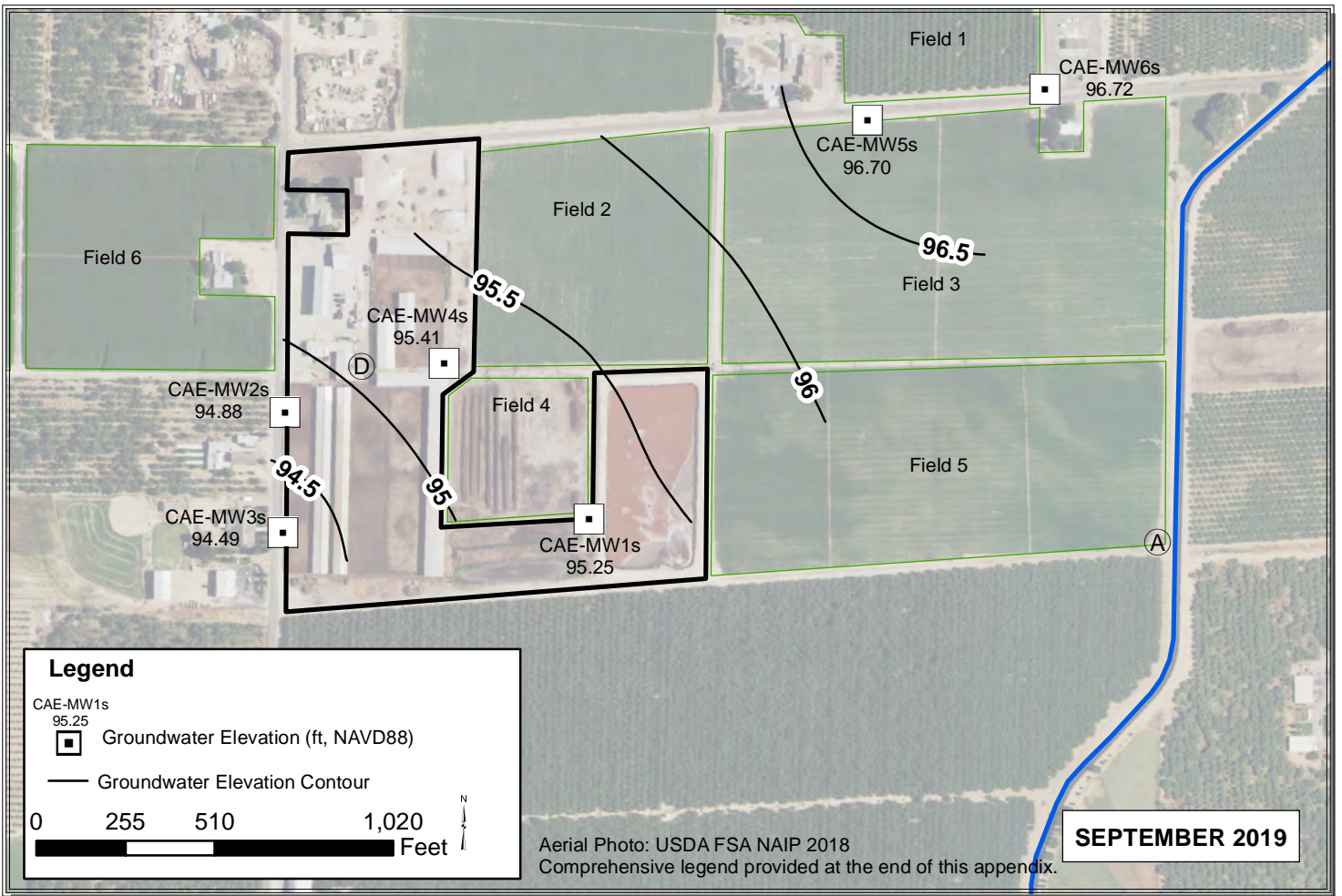

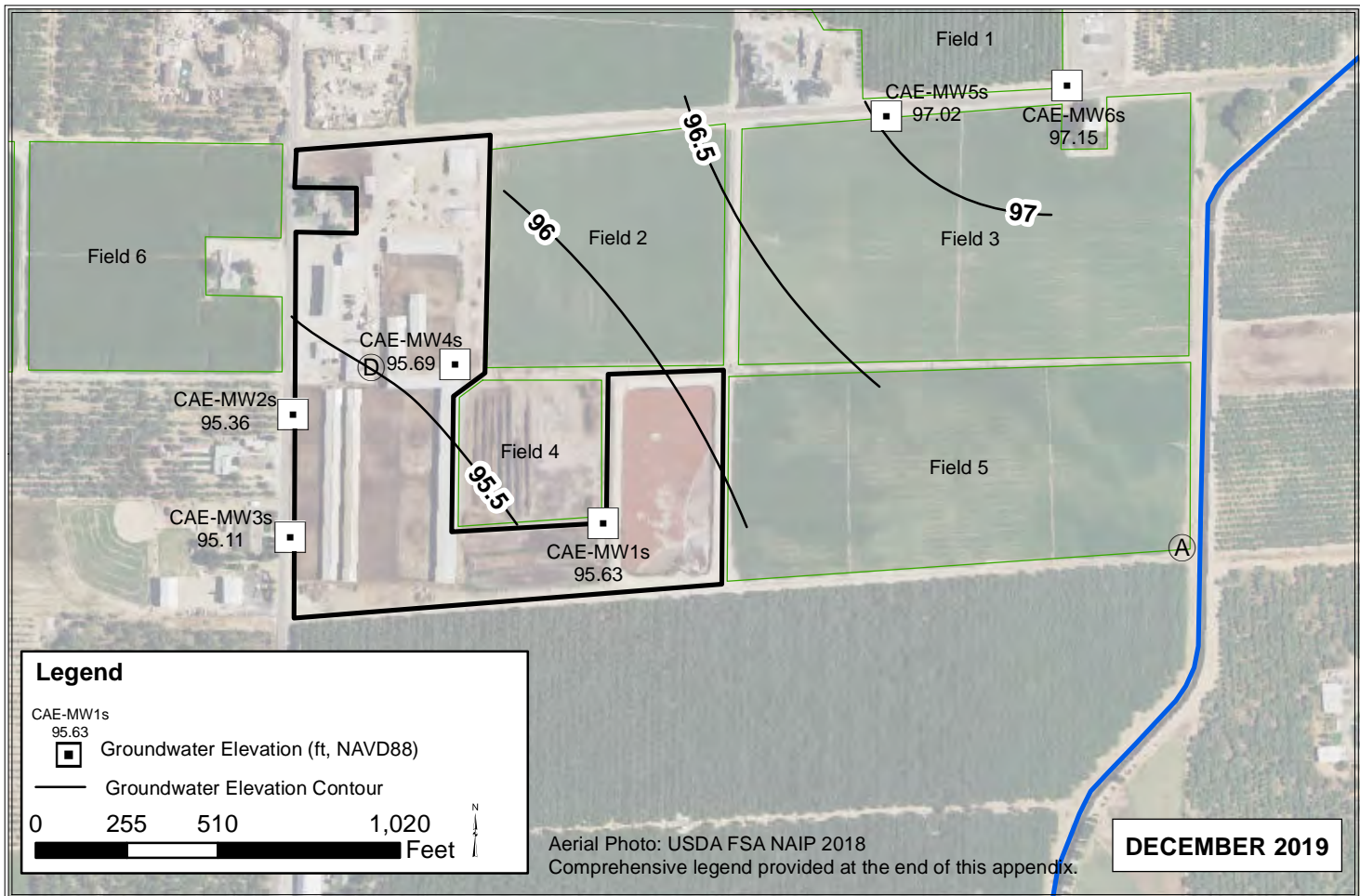
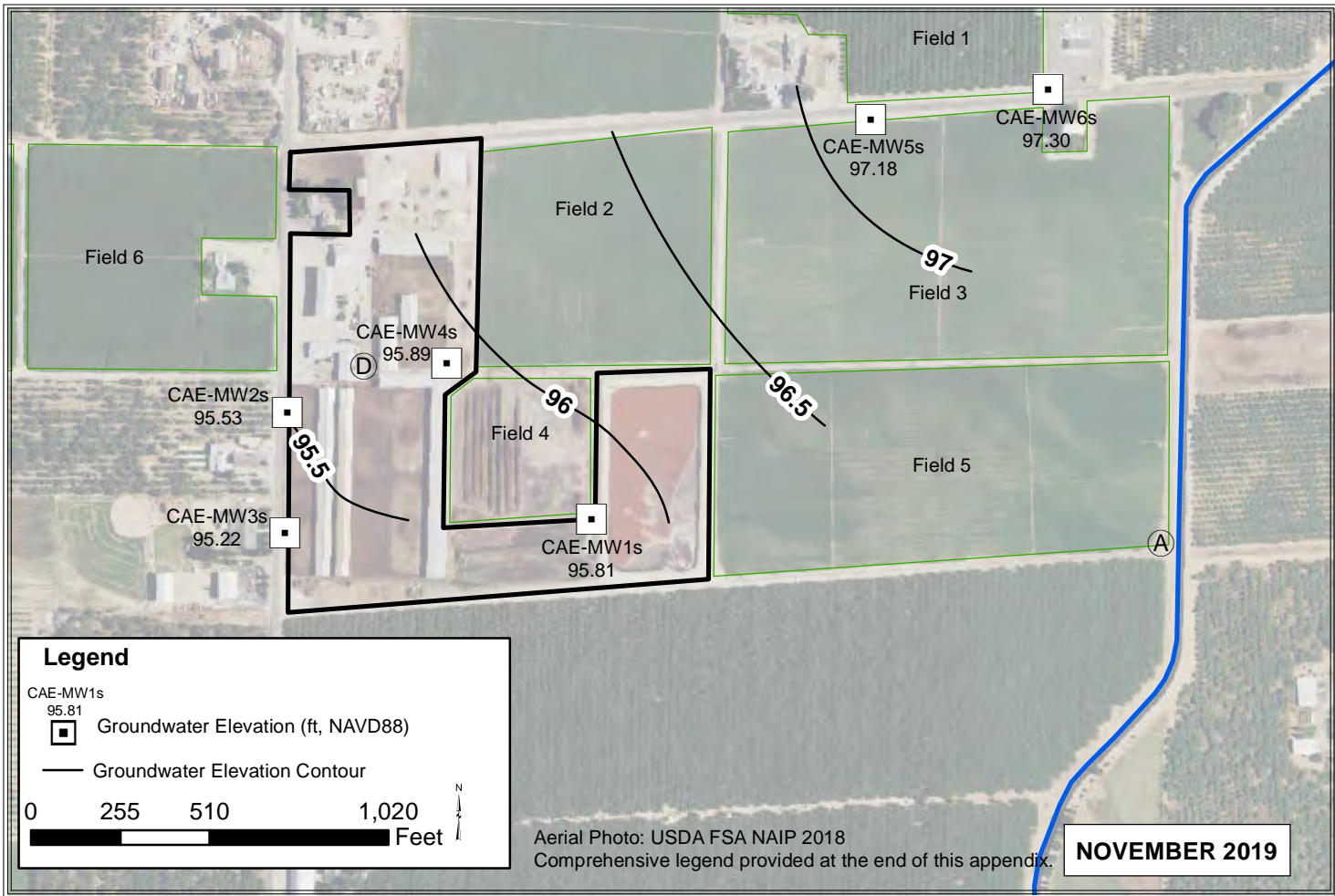

ROB

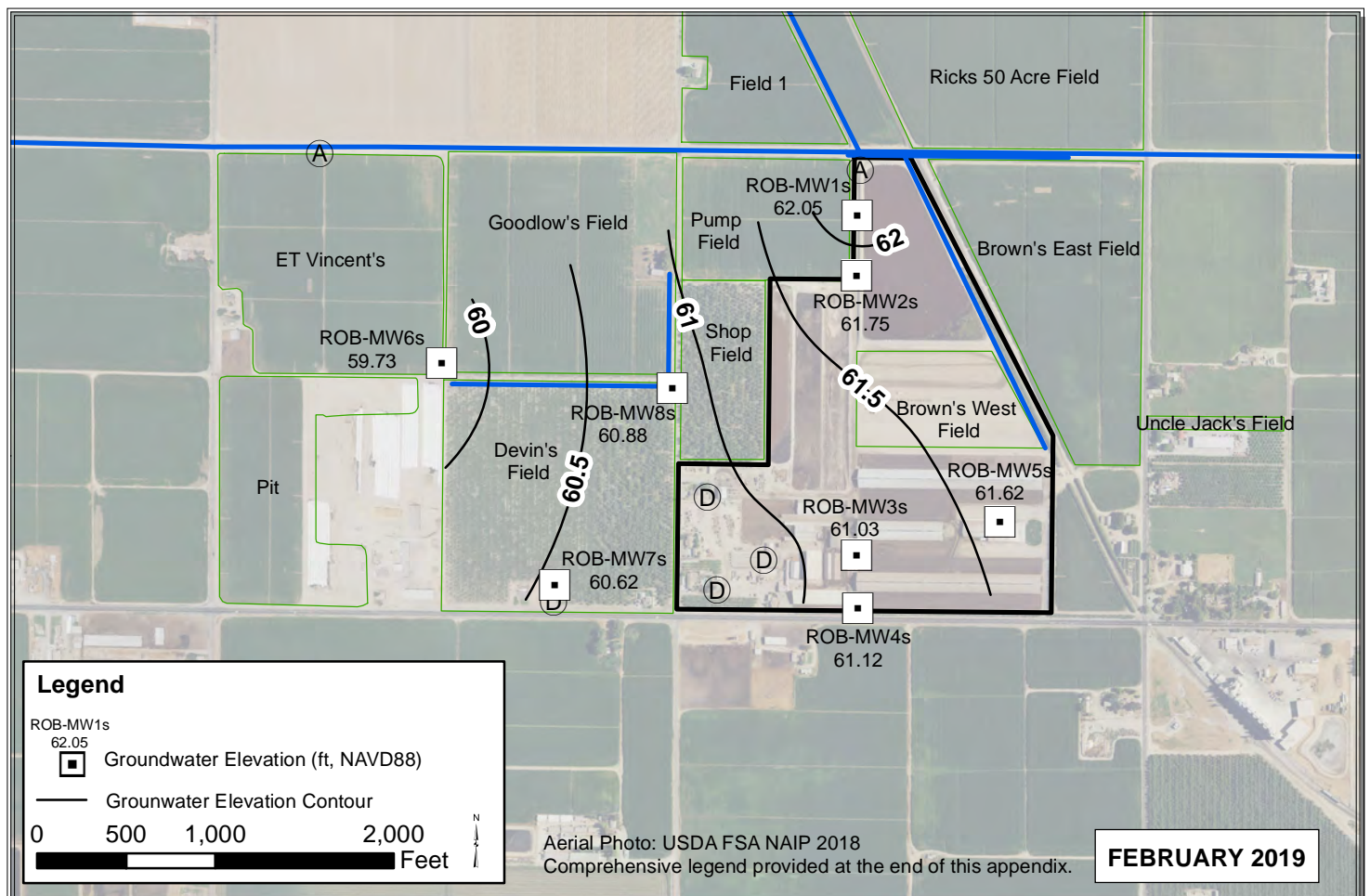
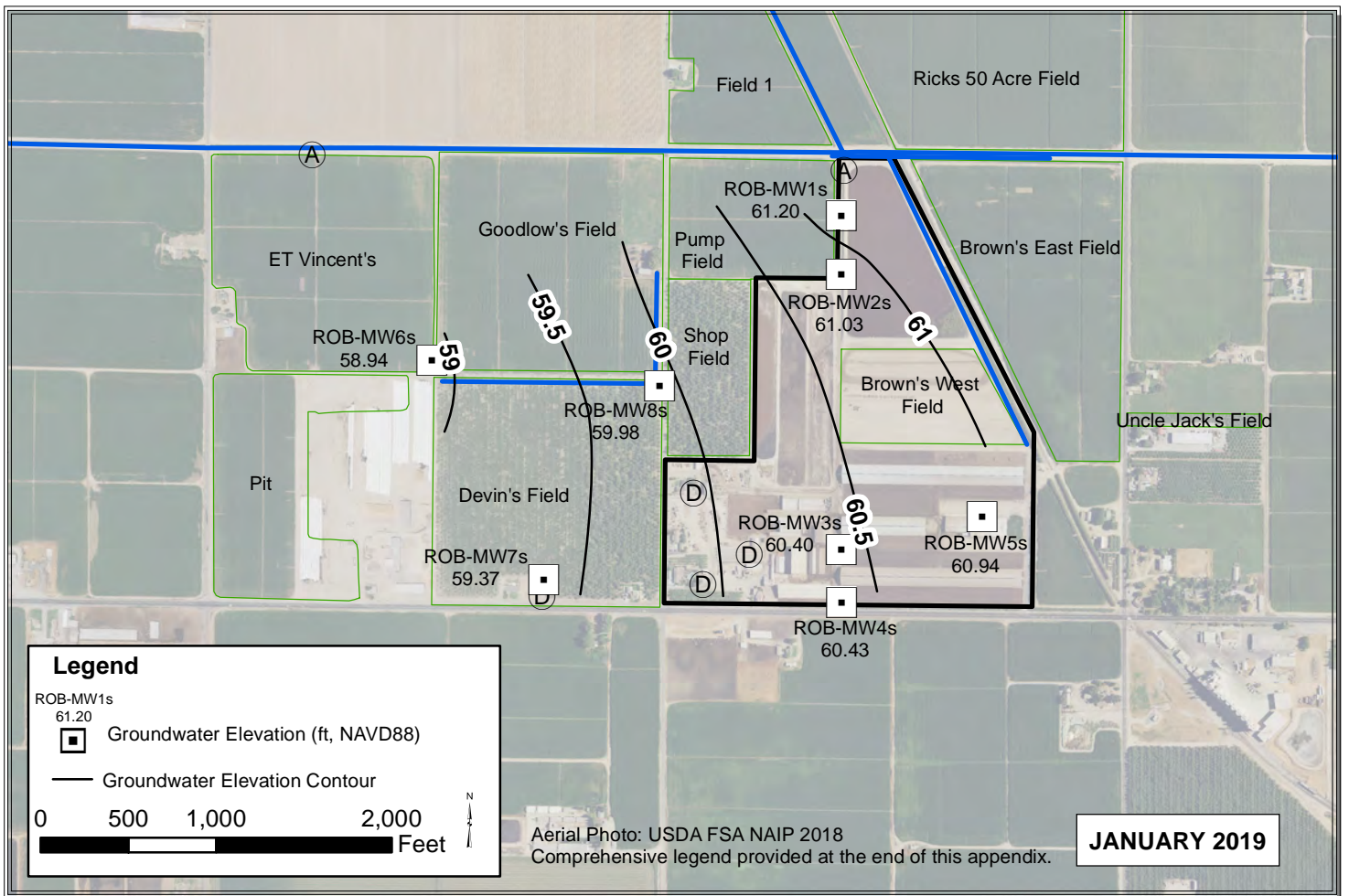

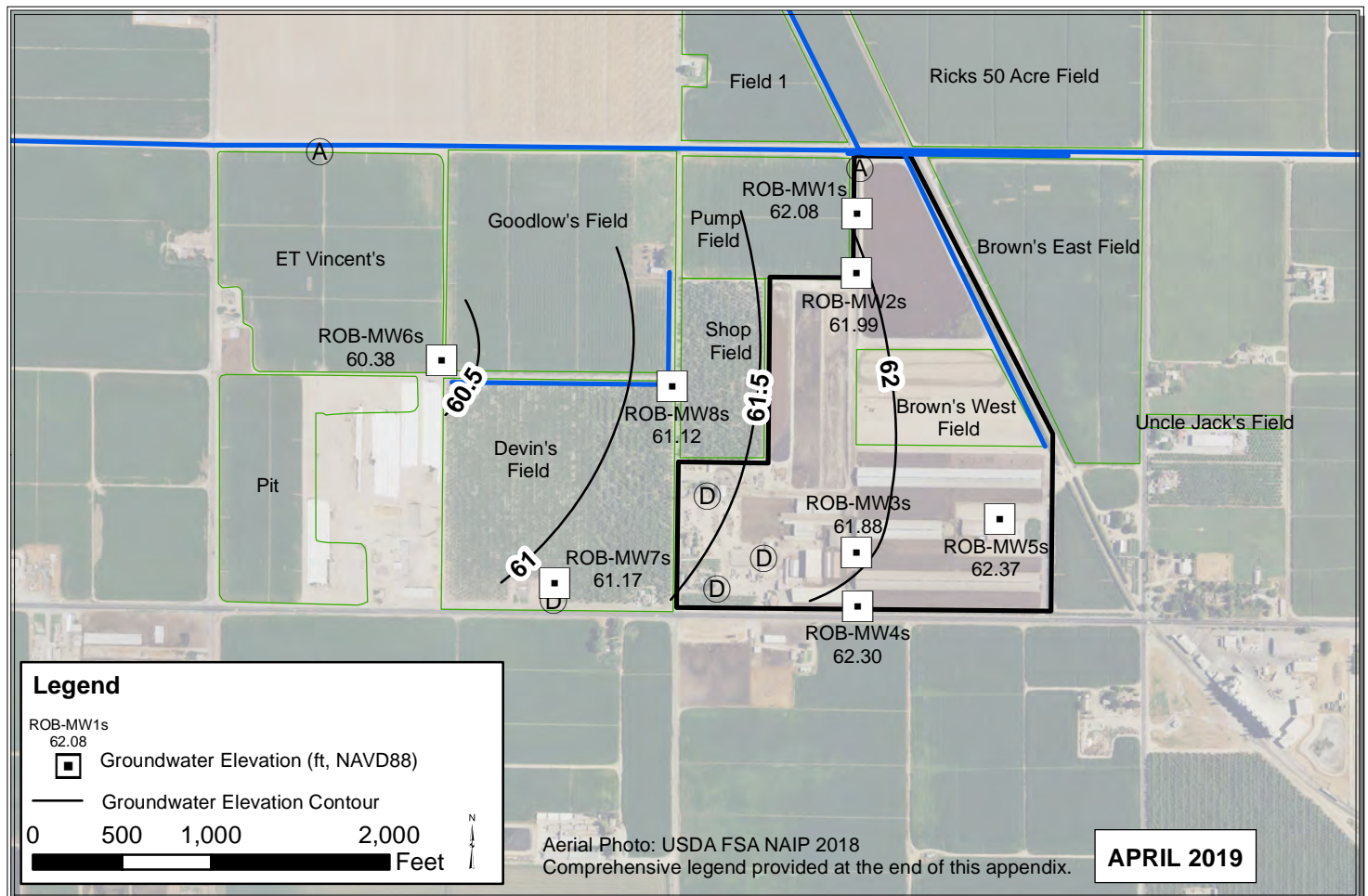
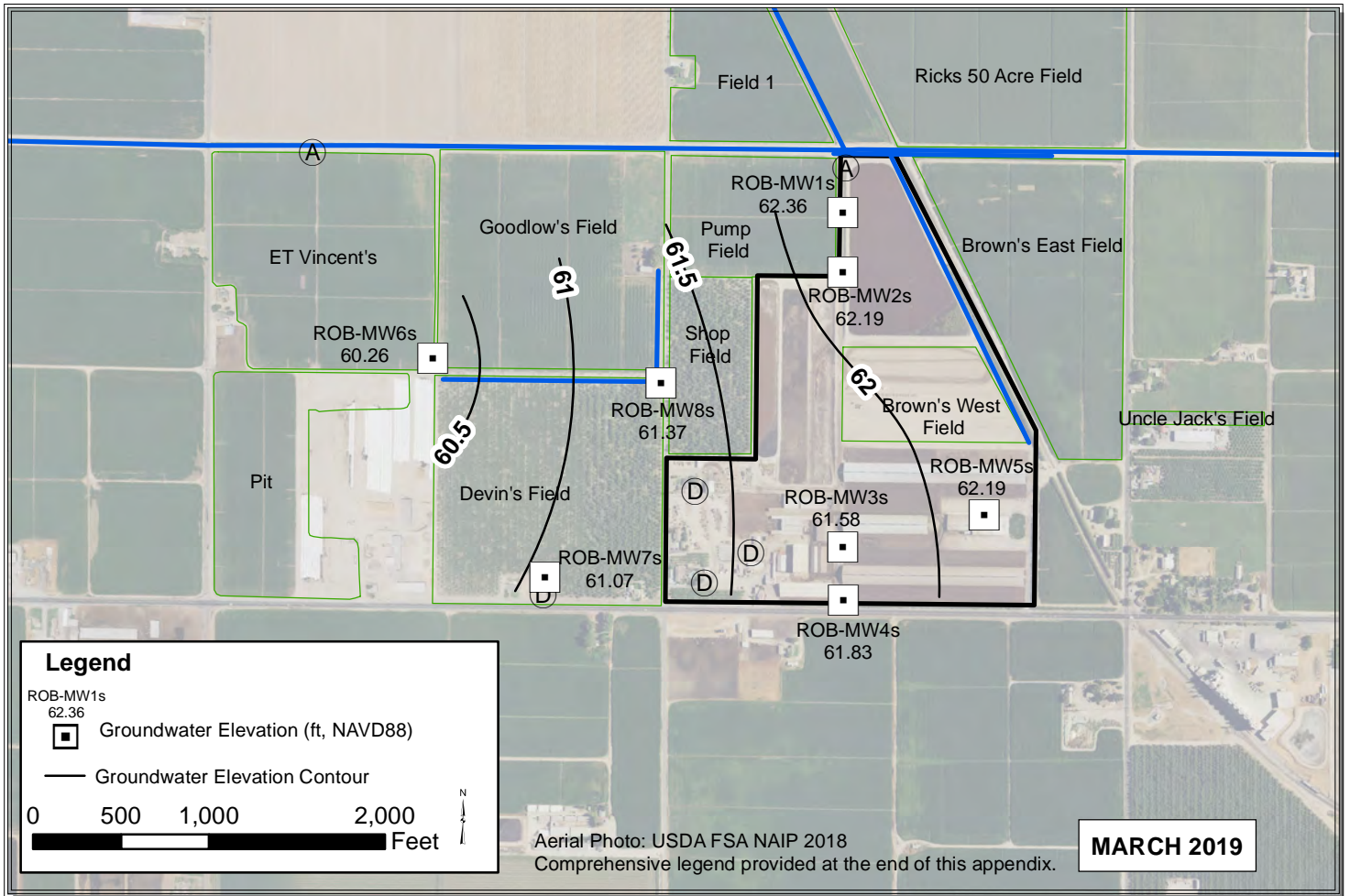

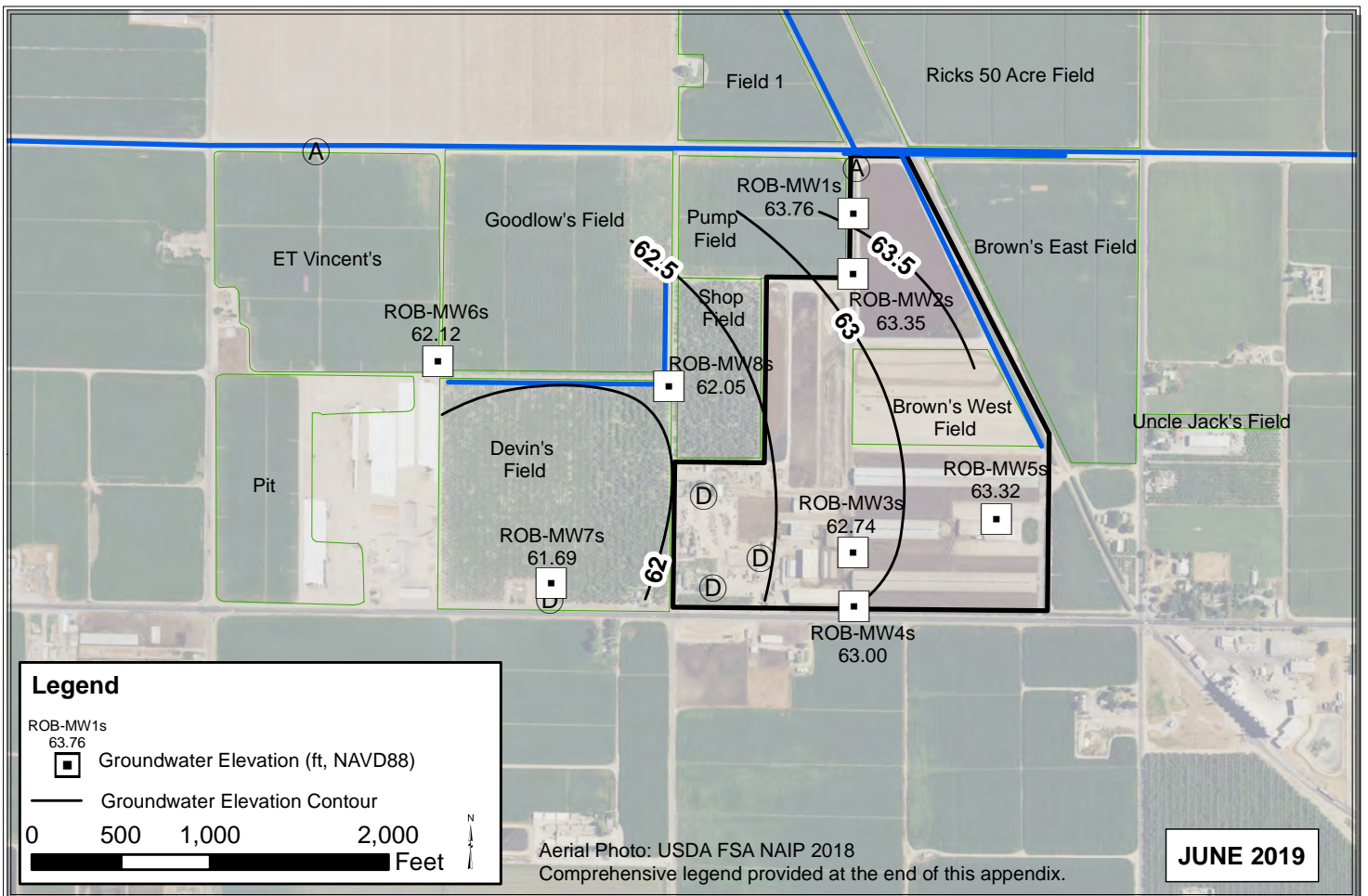
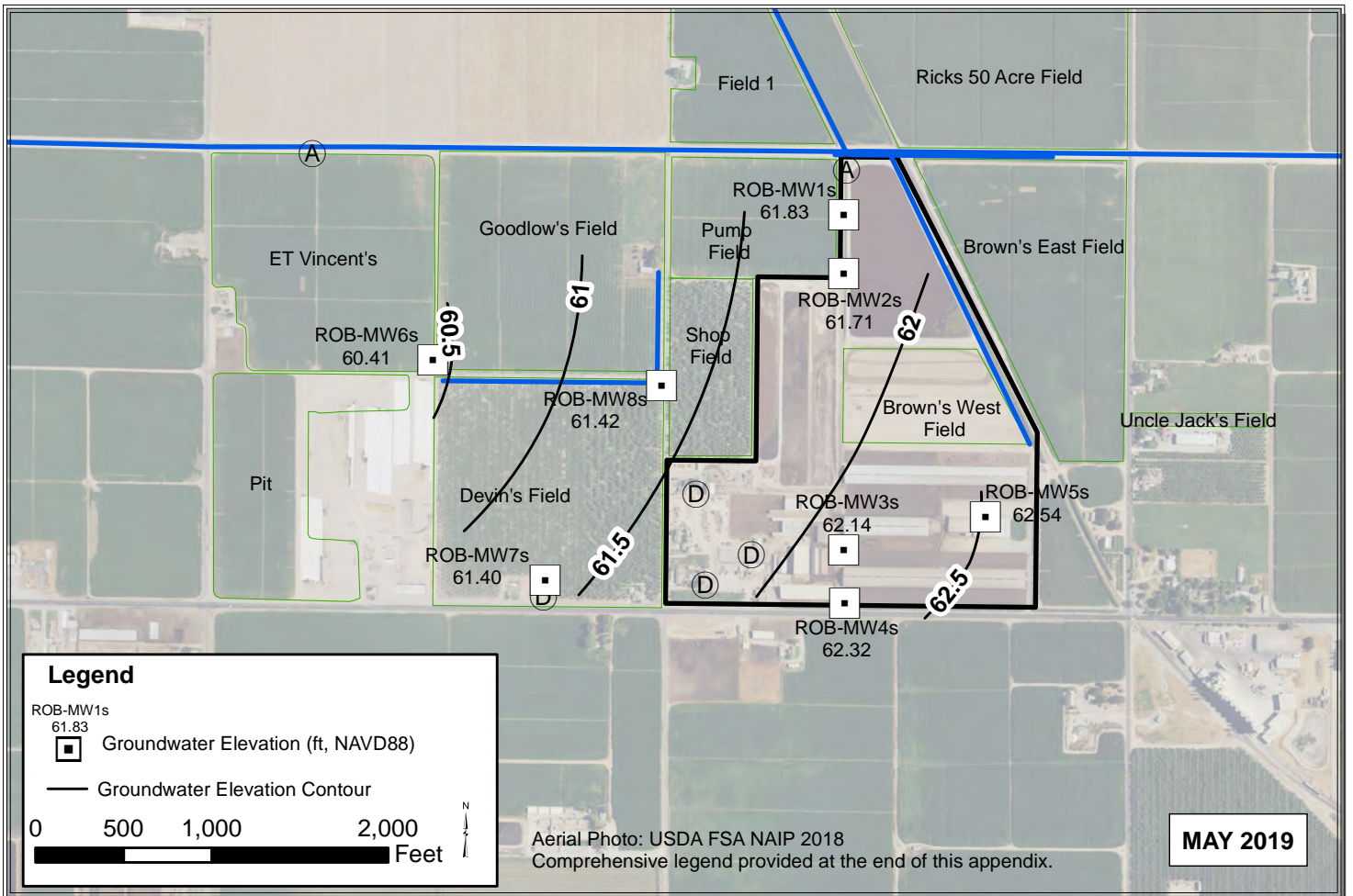

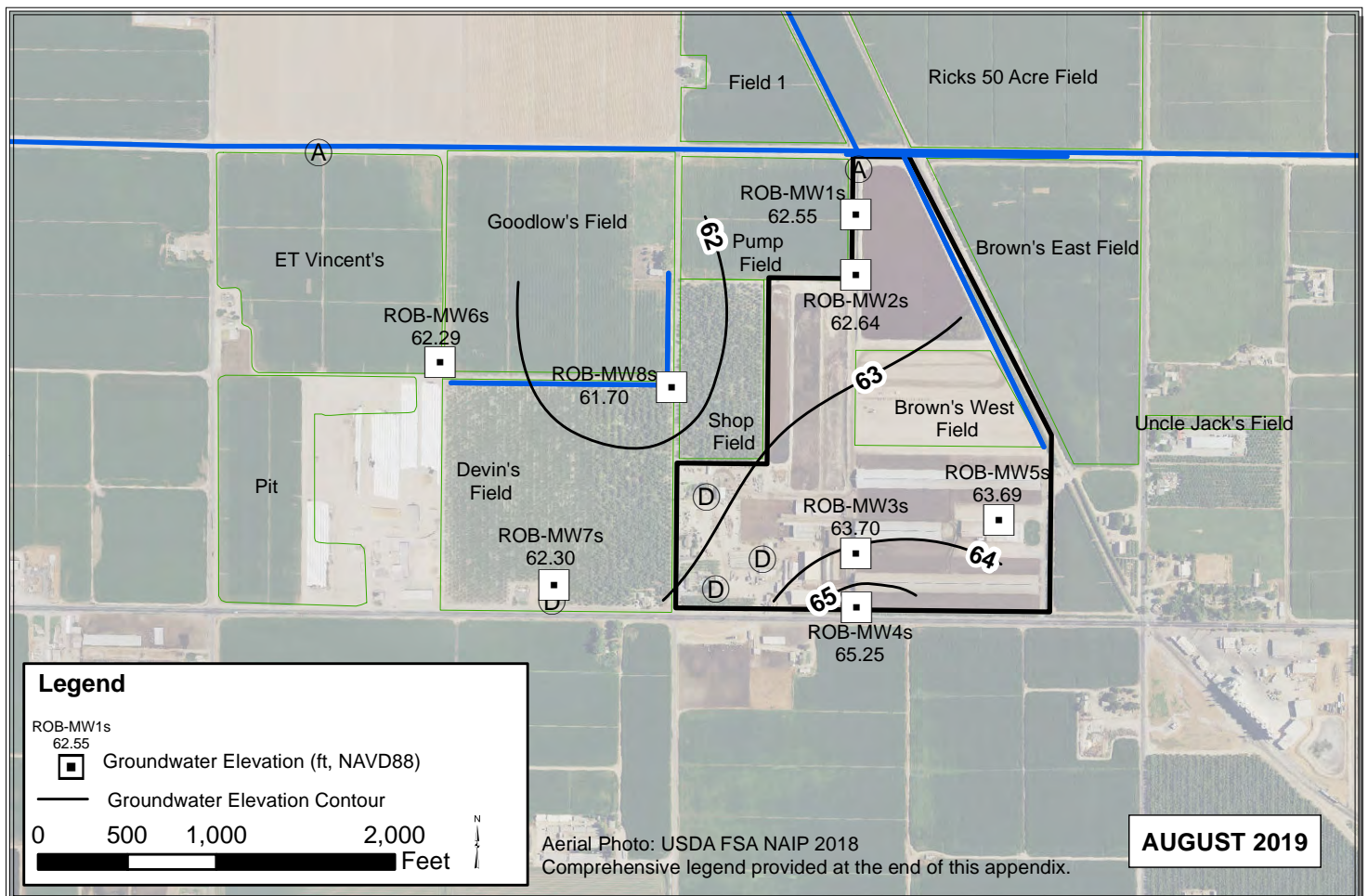
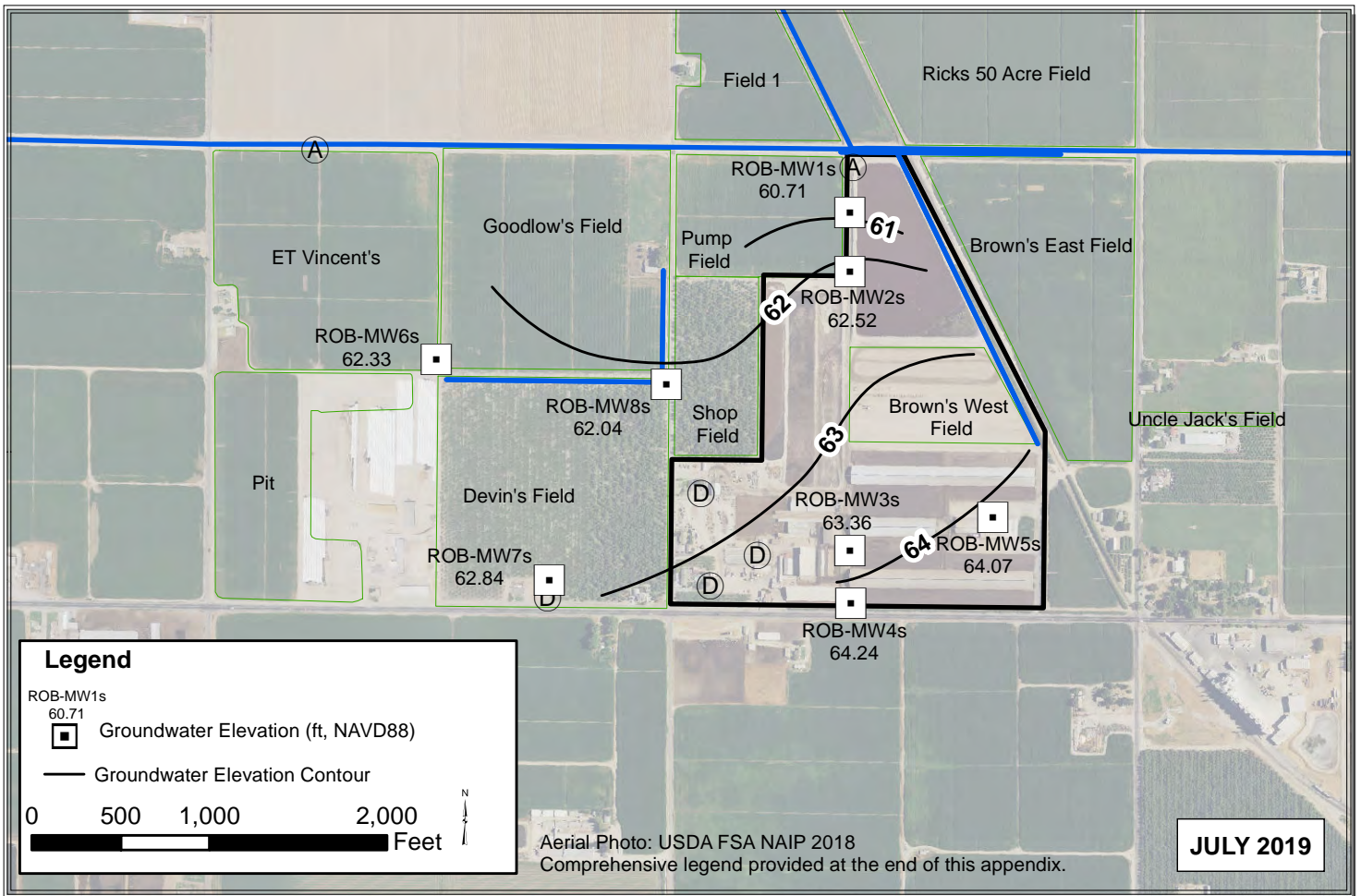

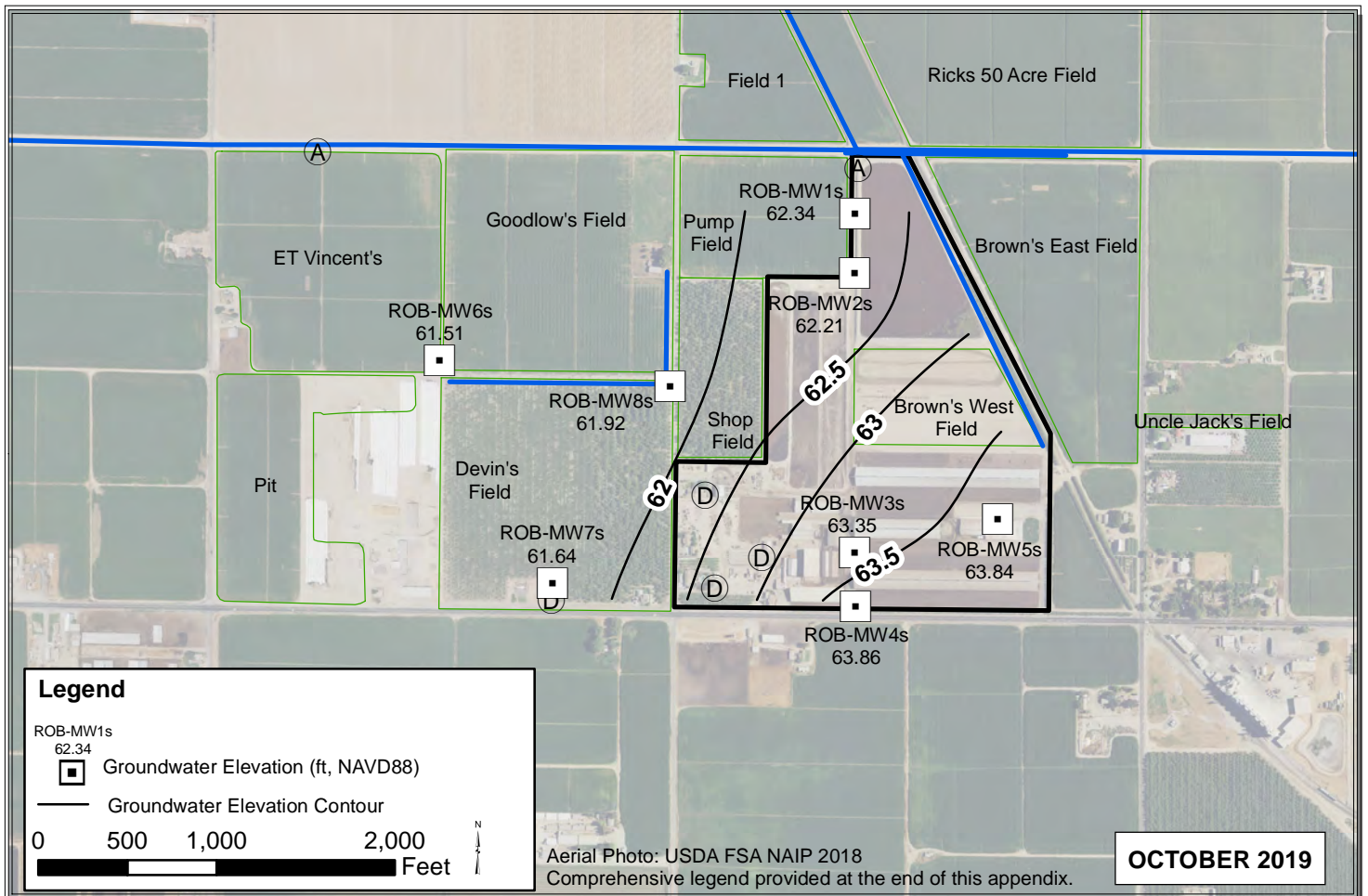
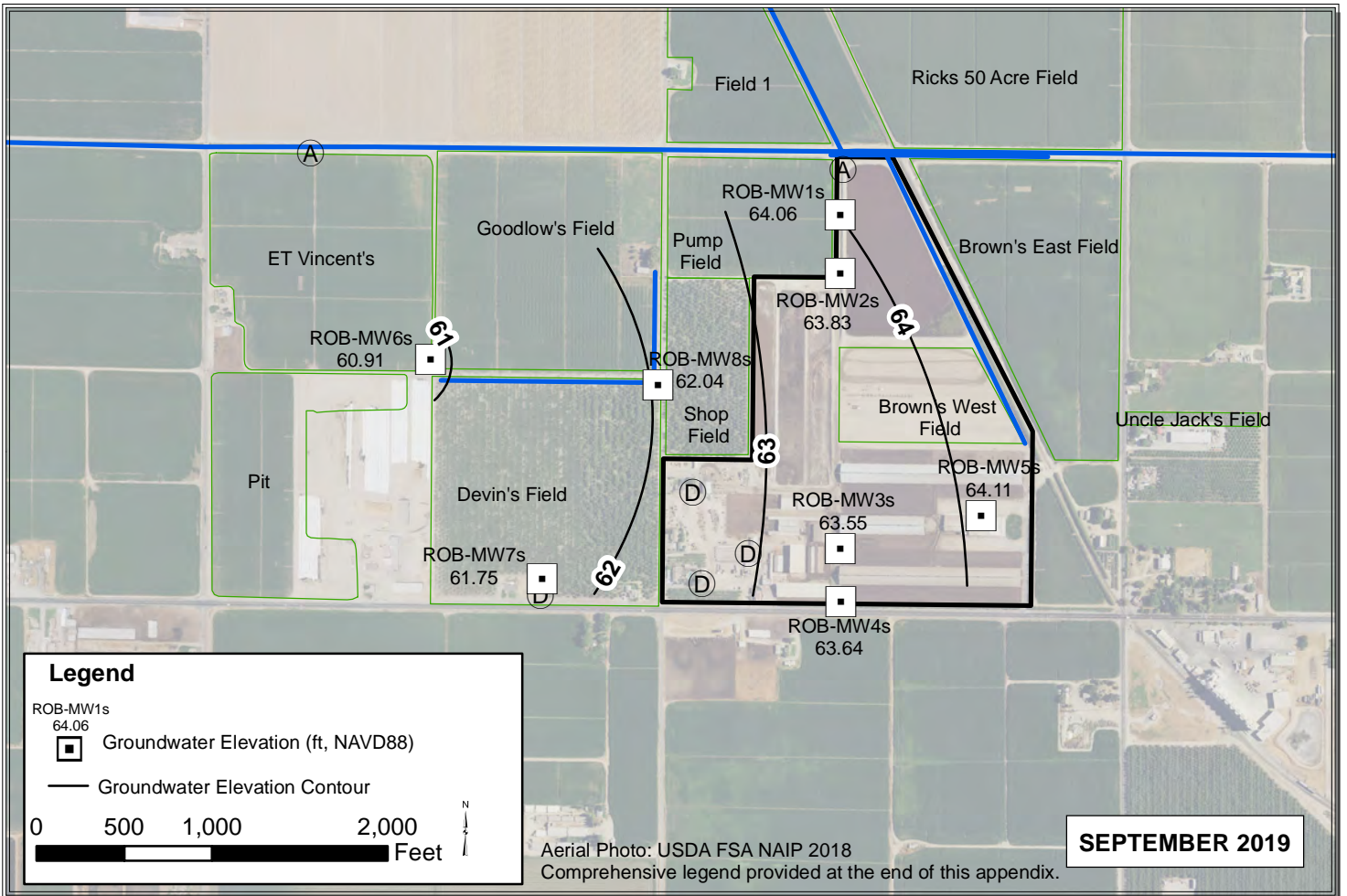

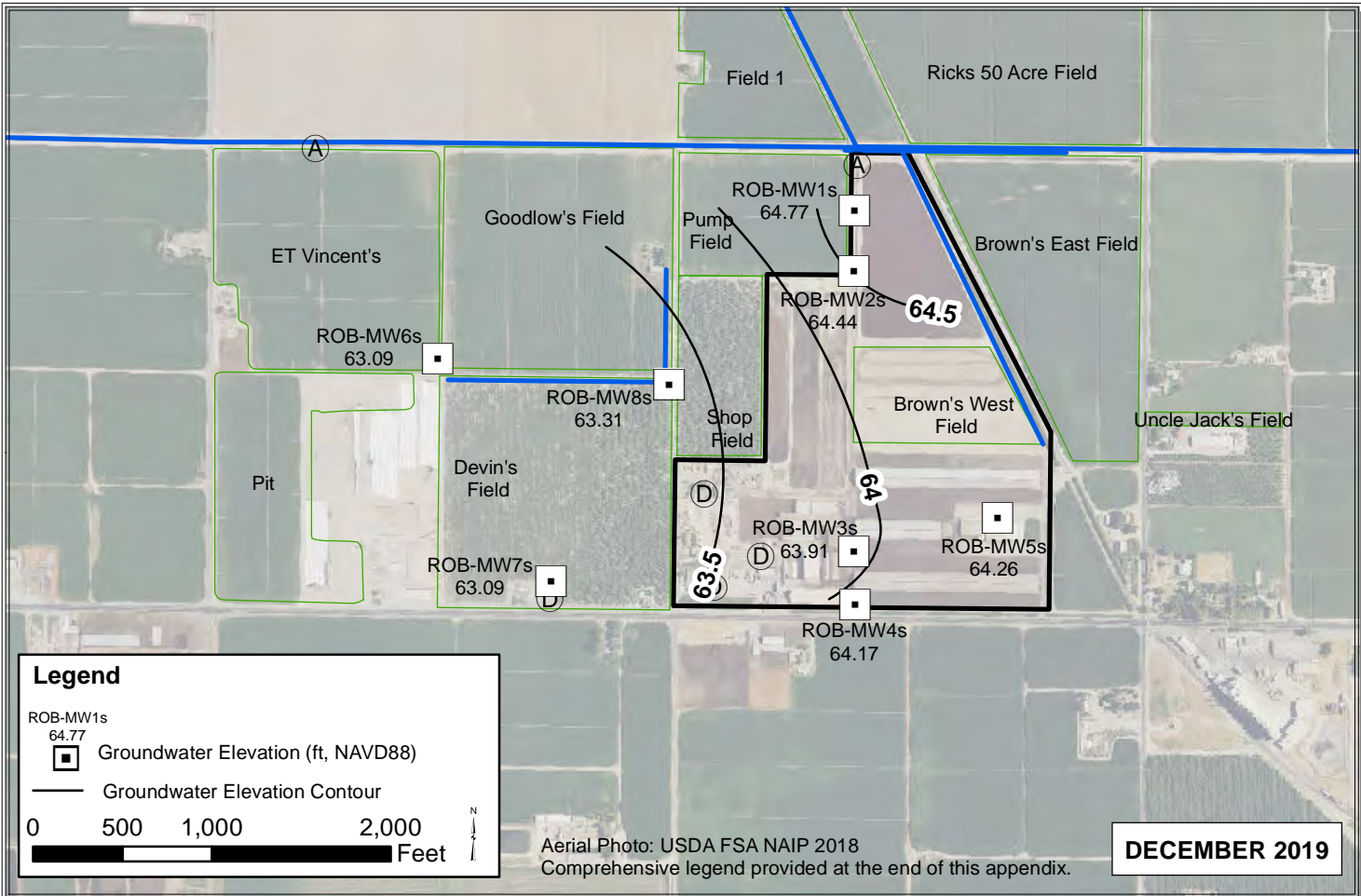
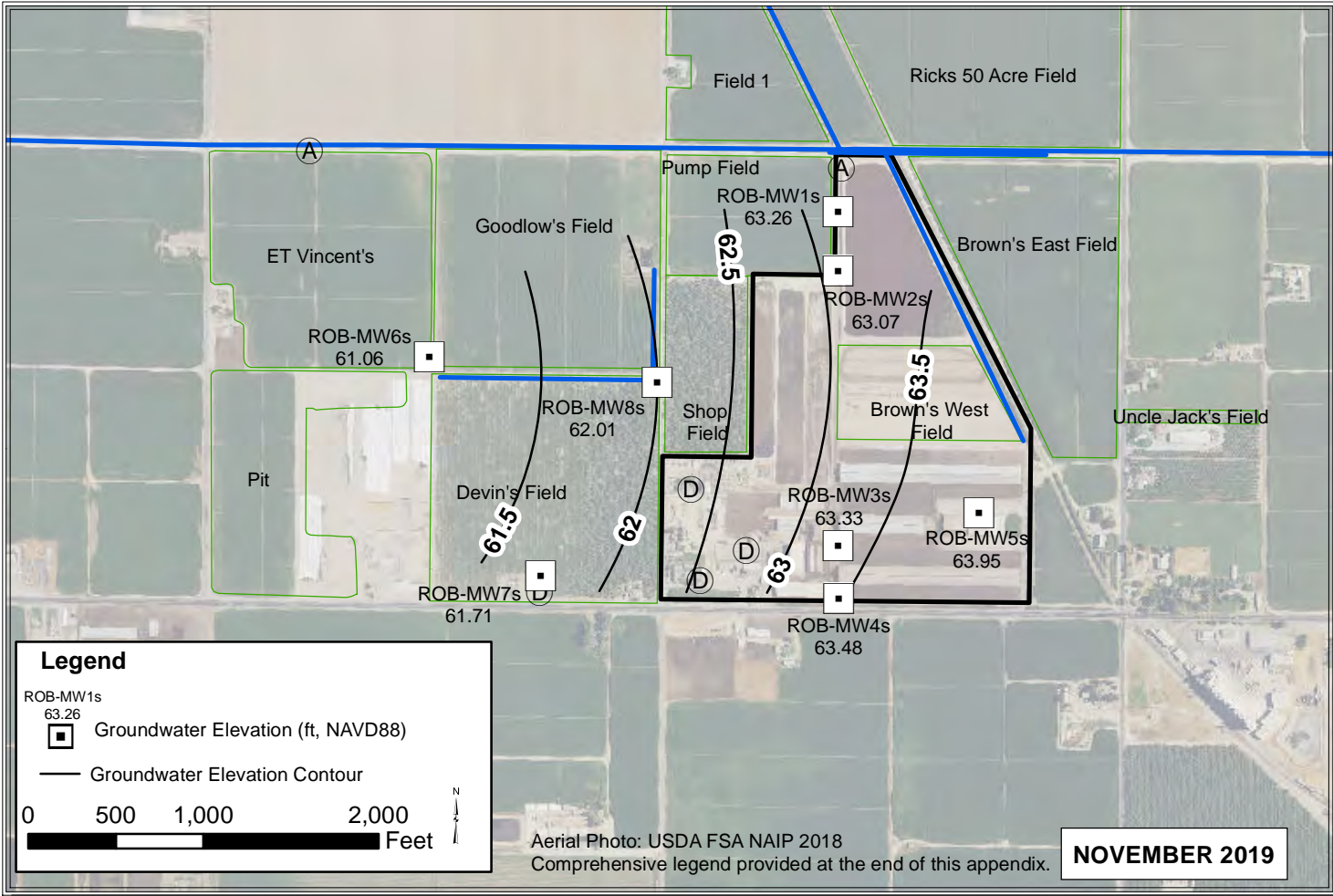

WOO

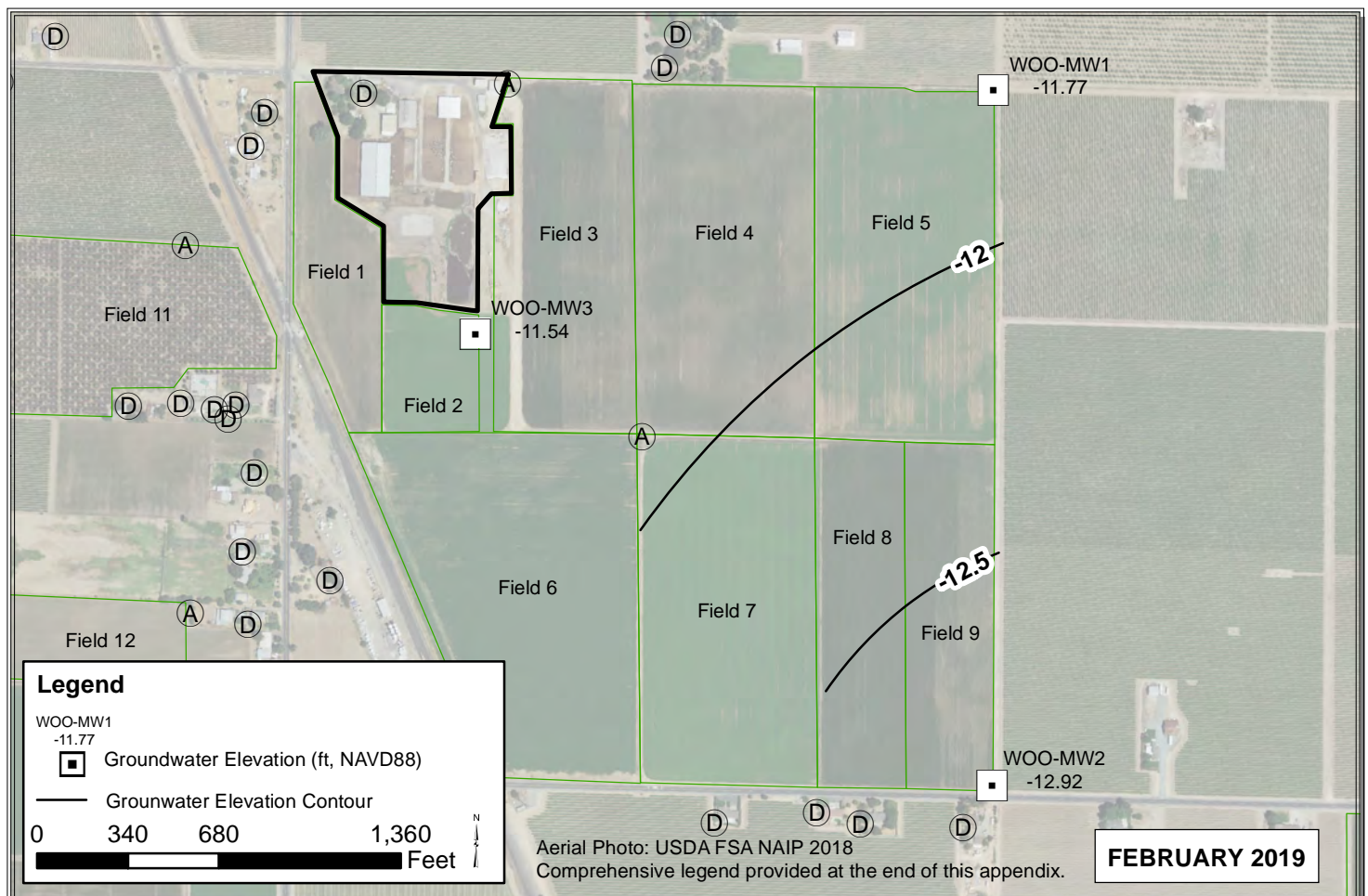
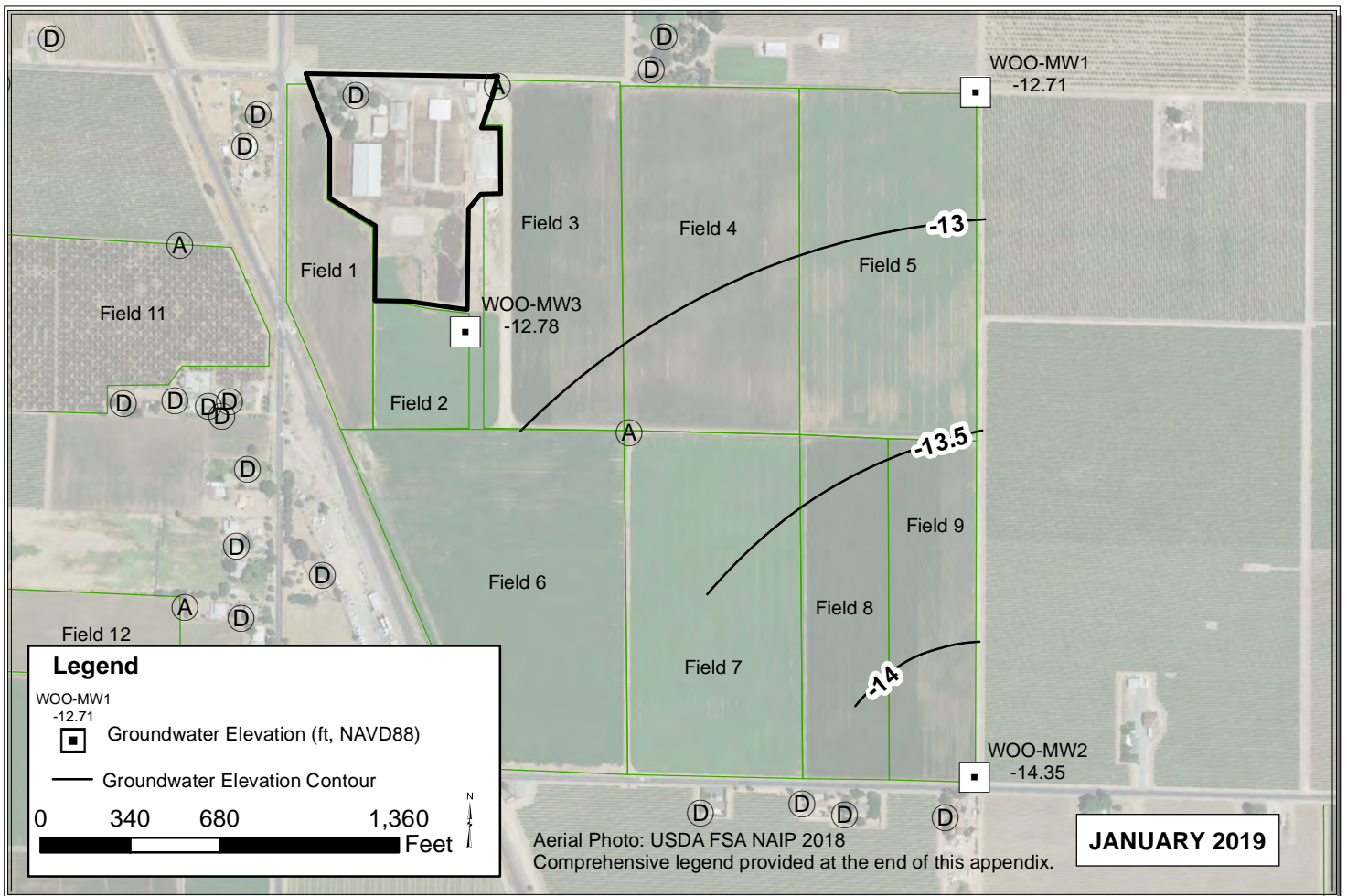

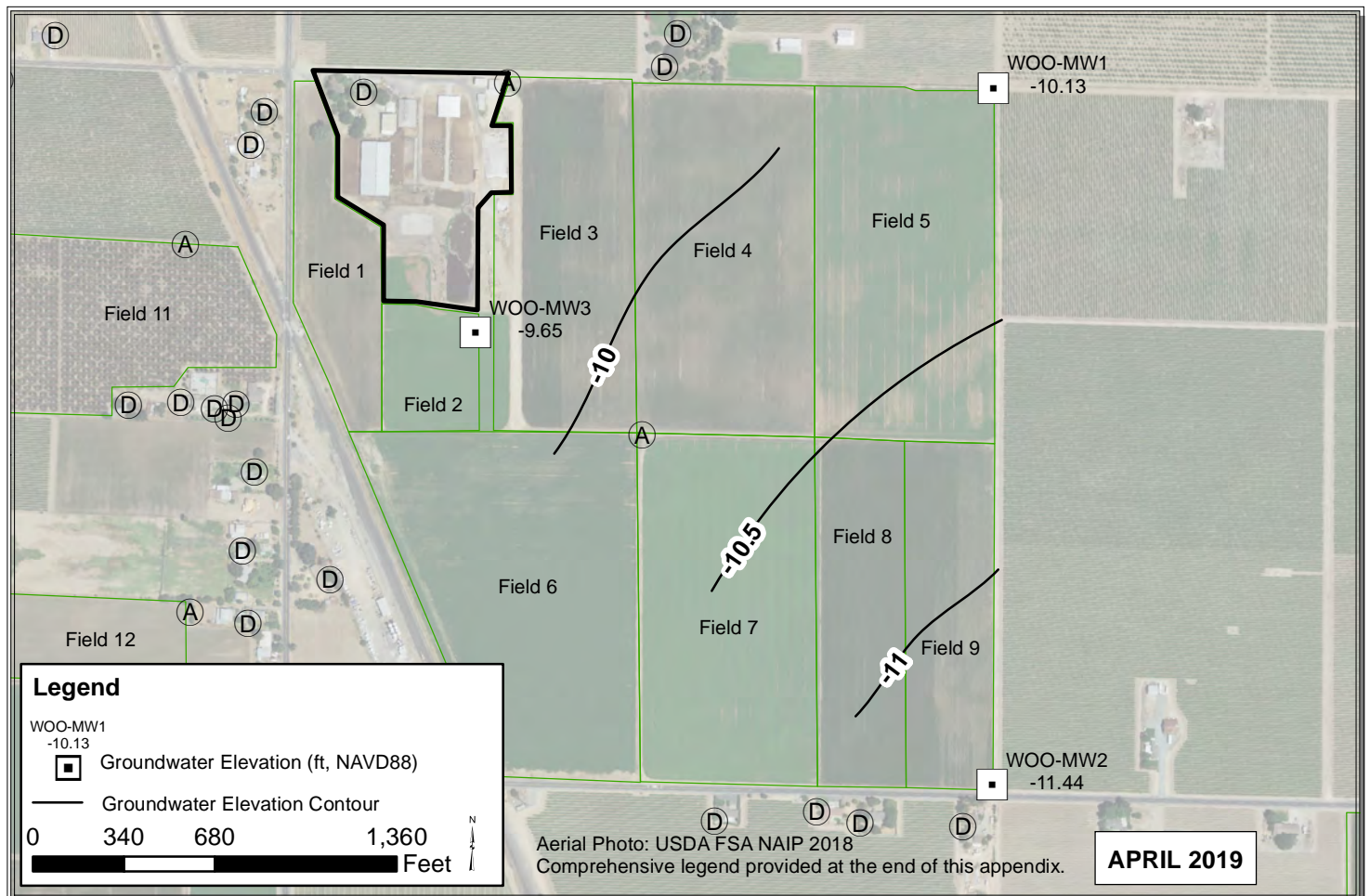
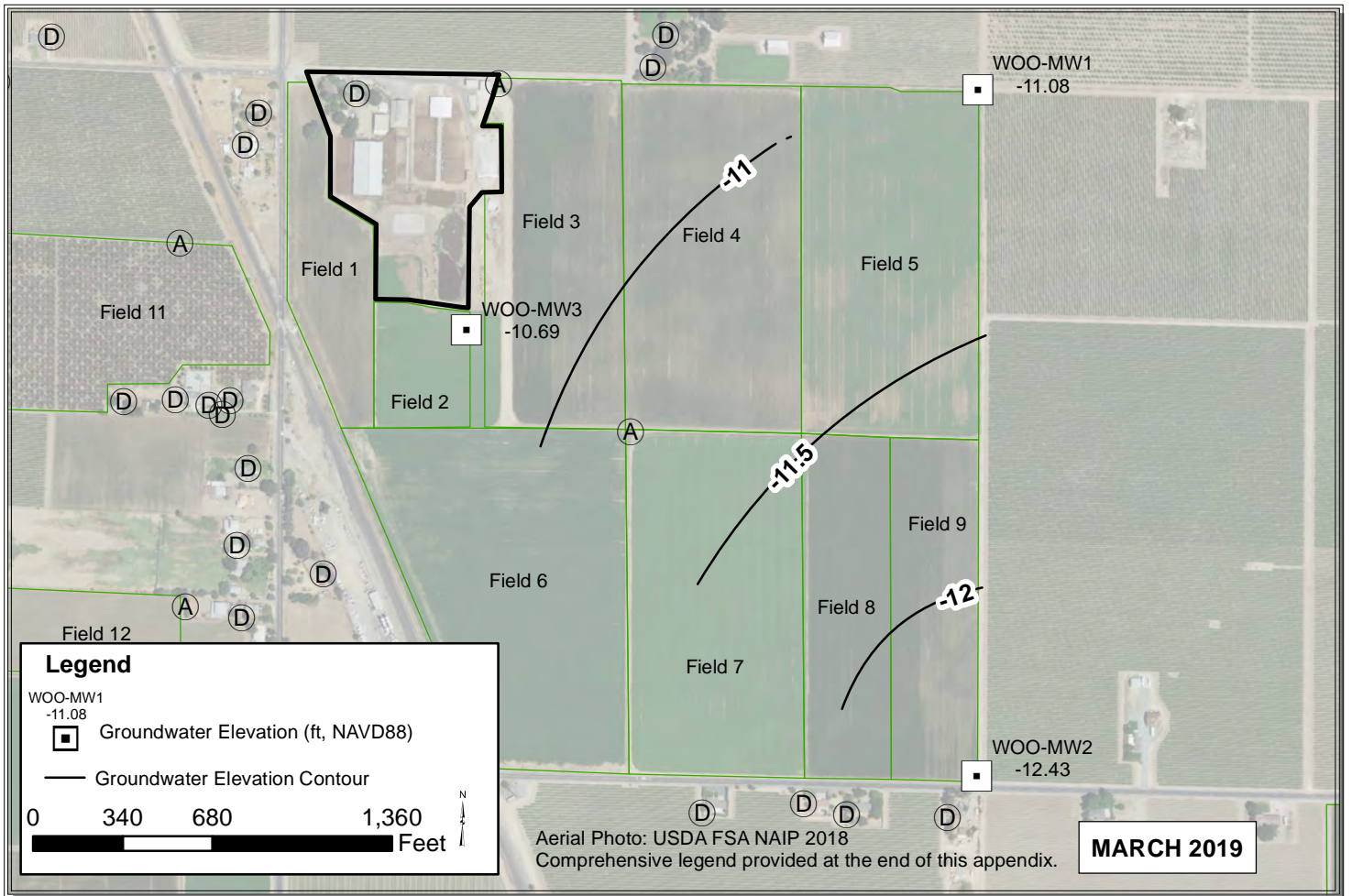

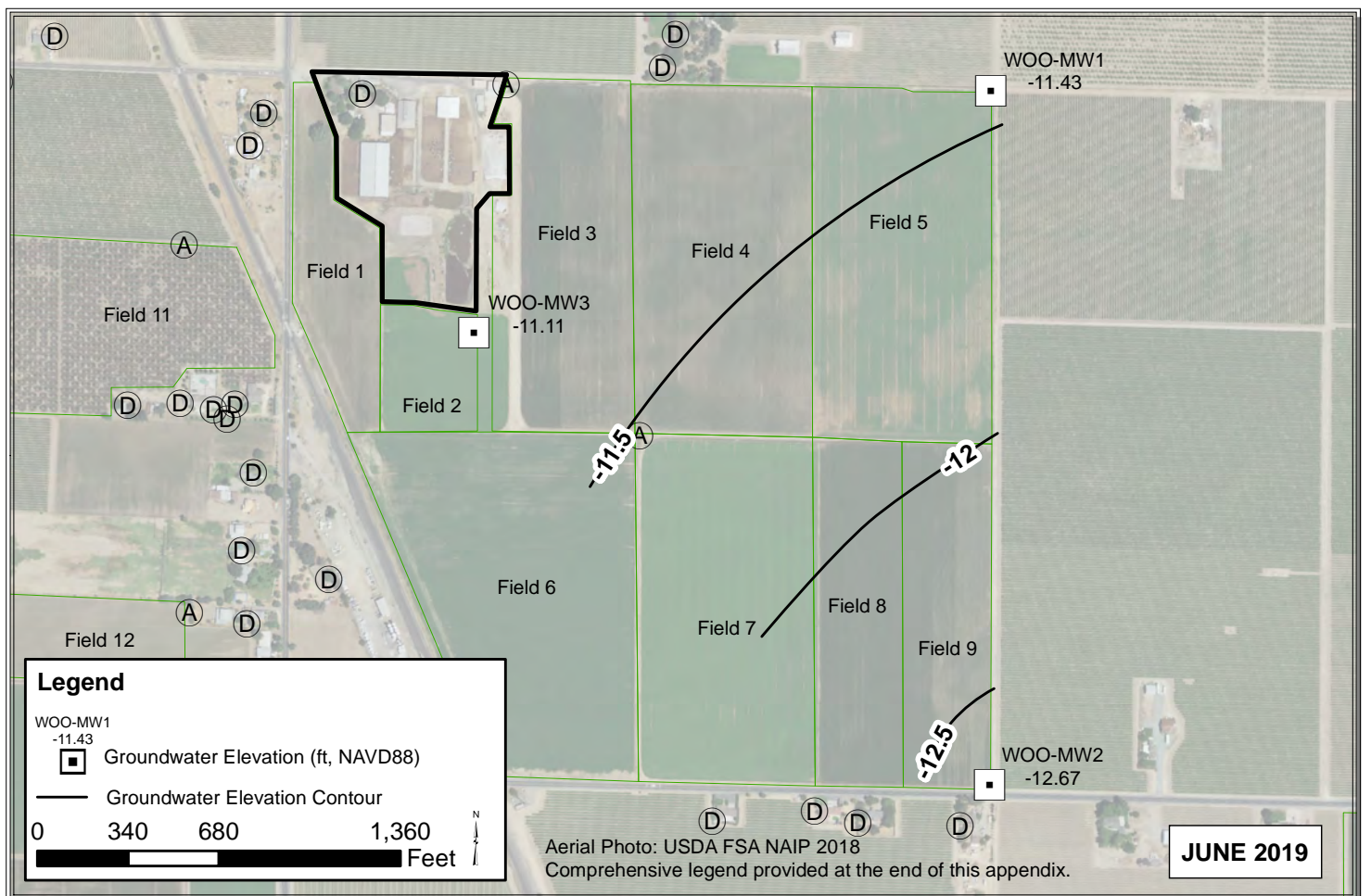
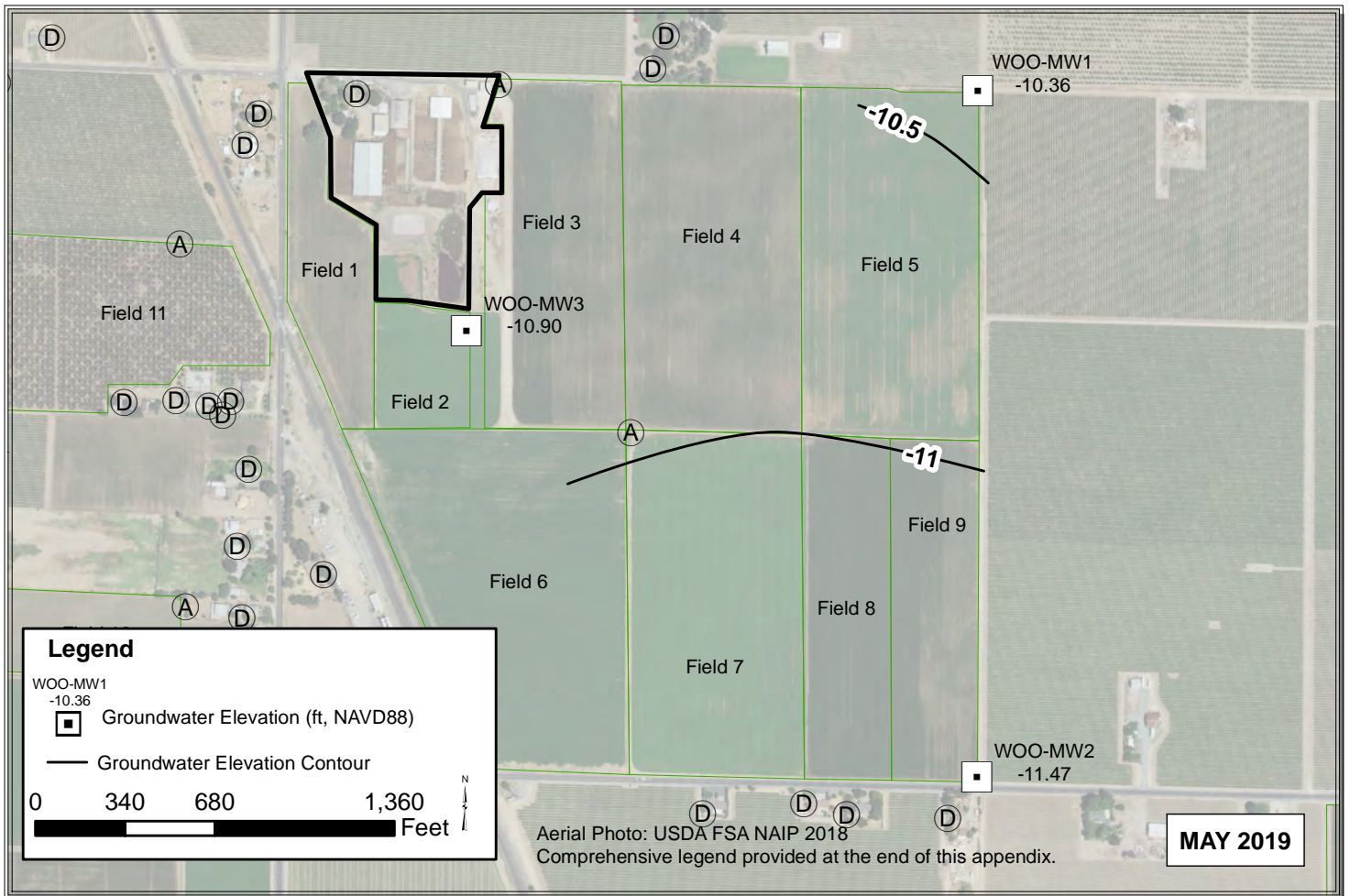

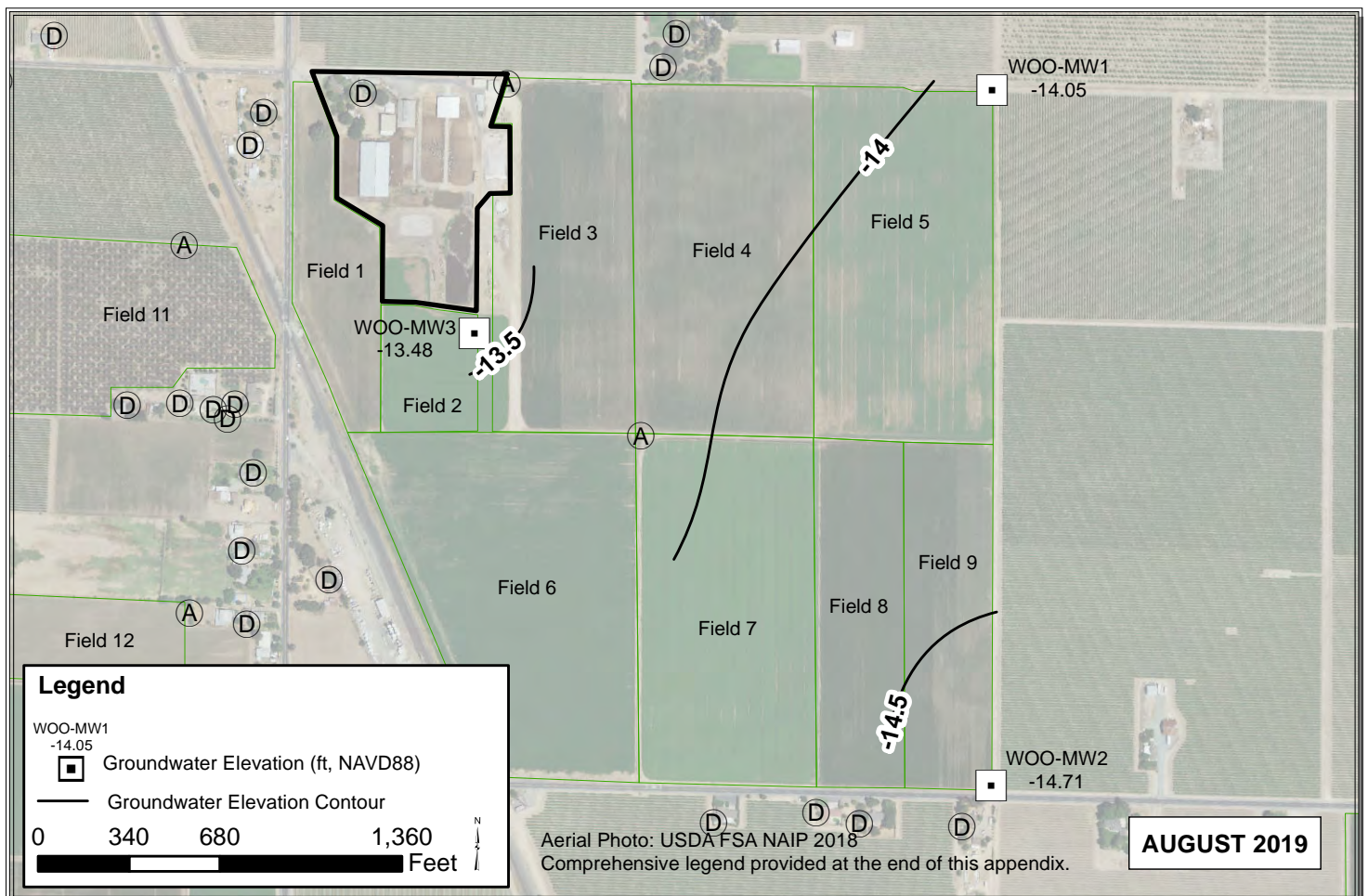
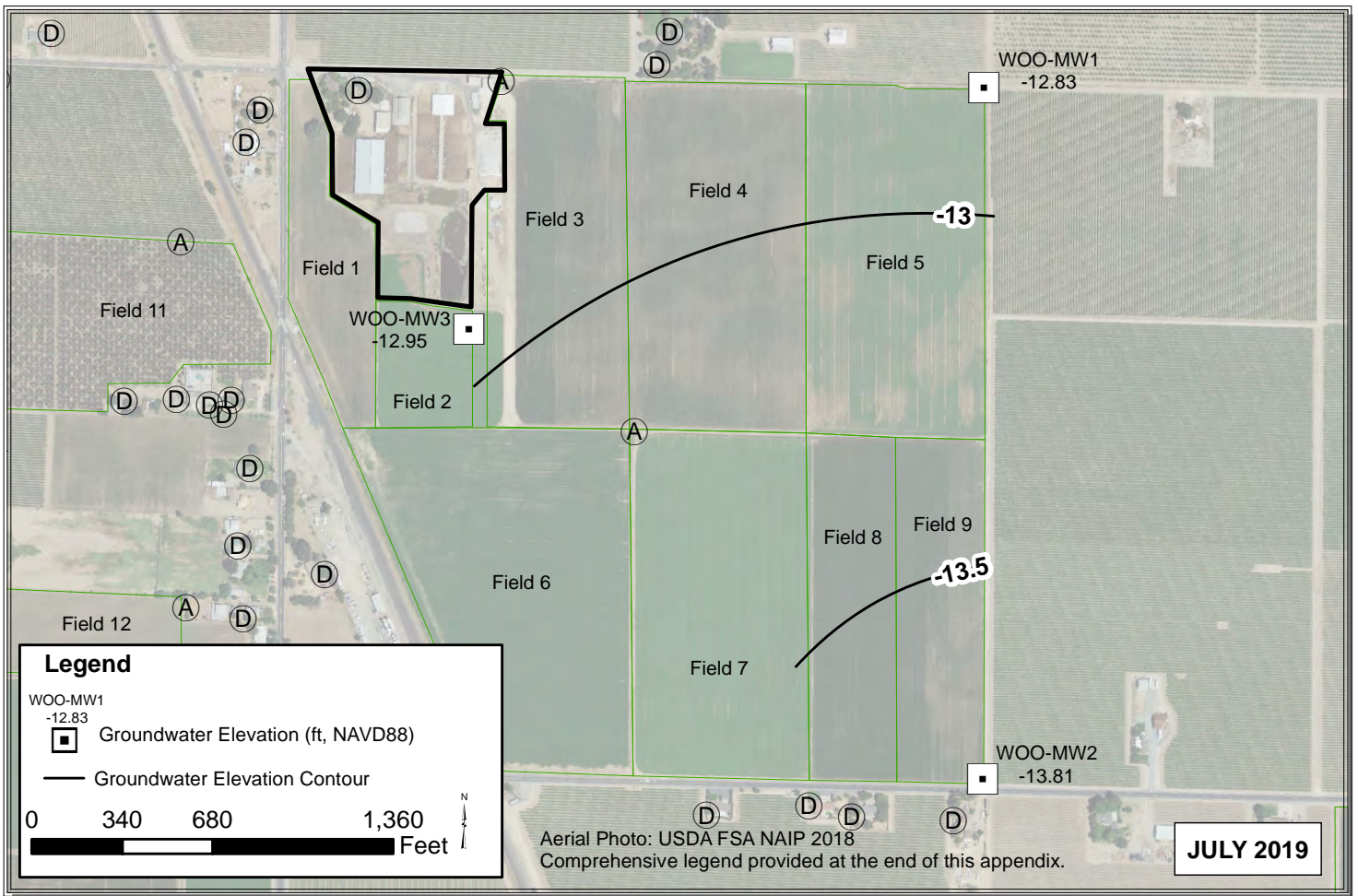

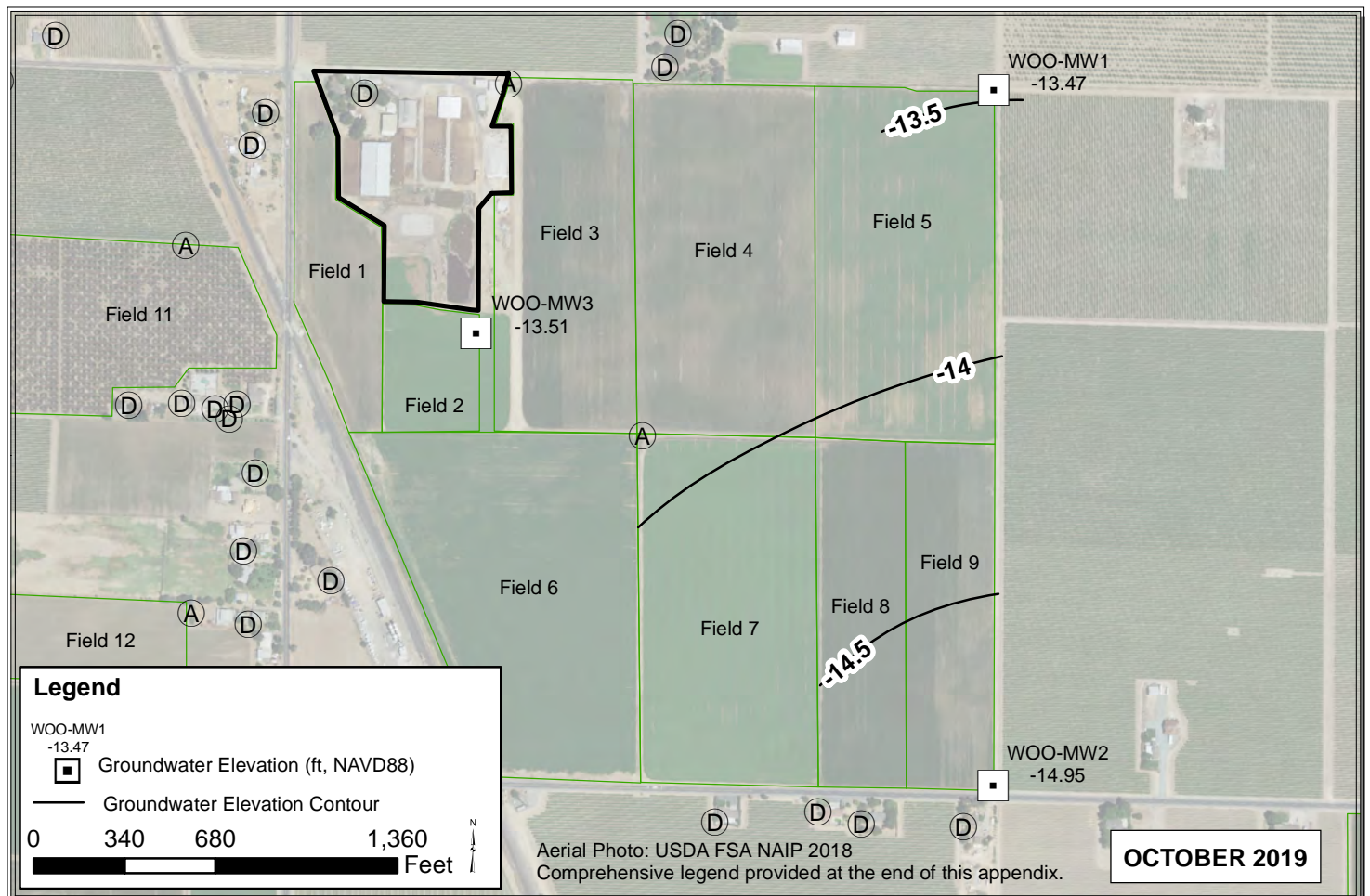
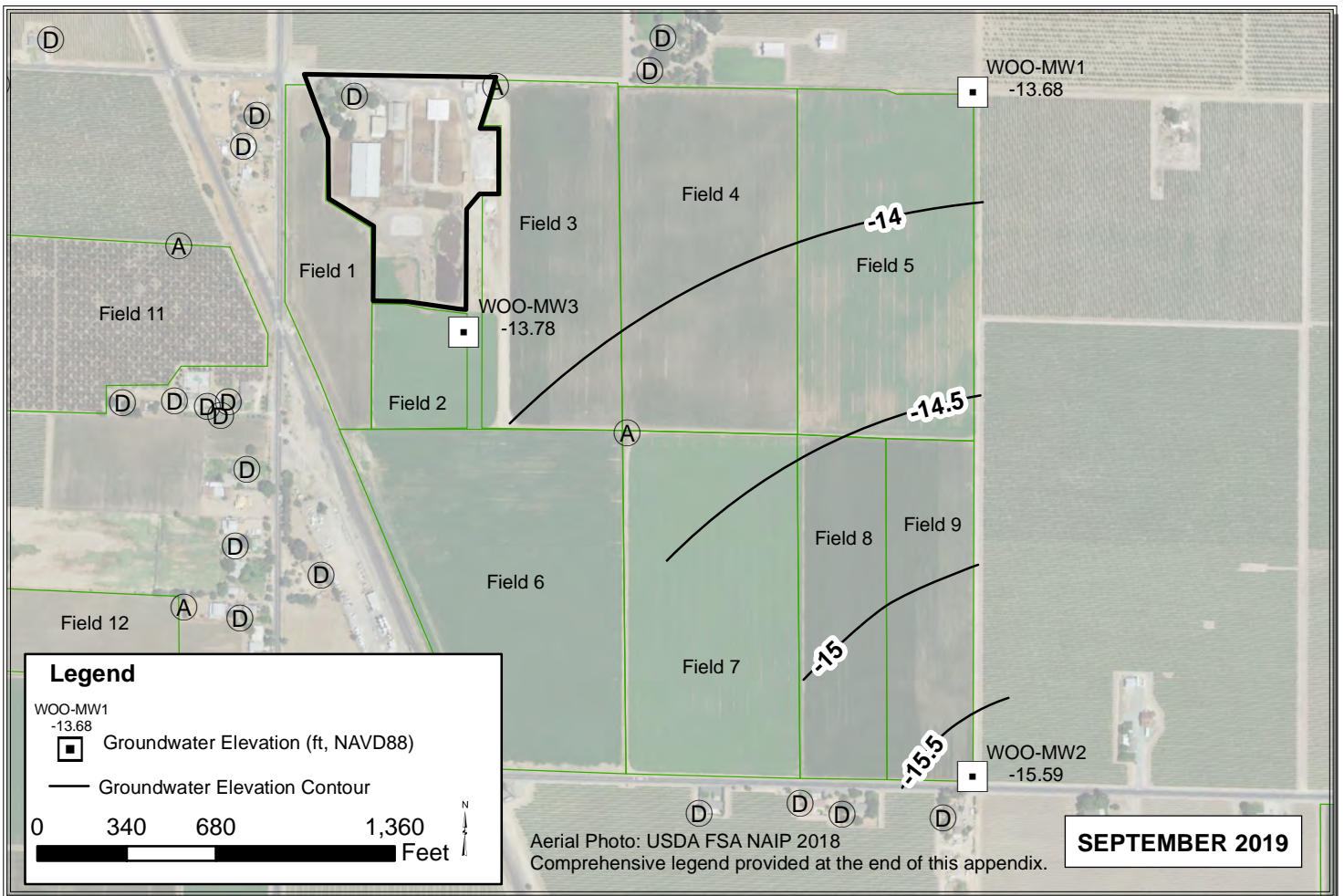

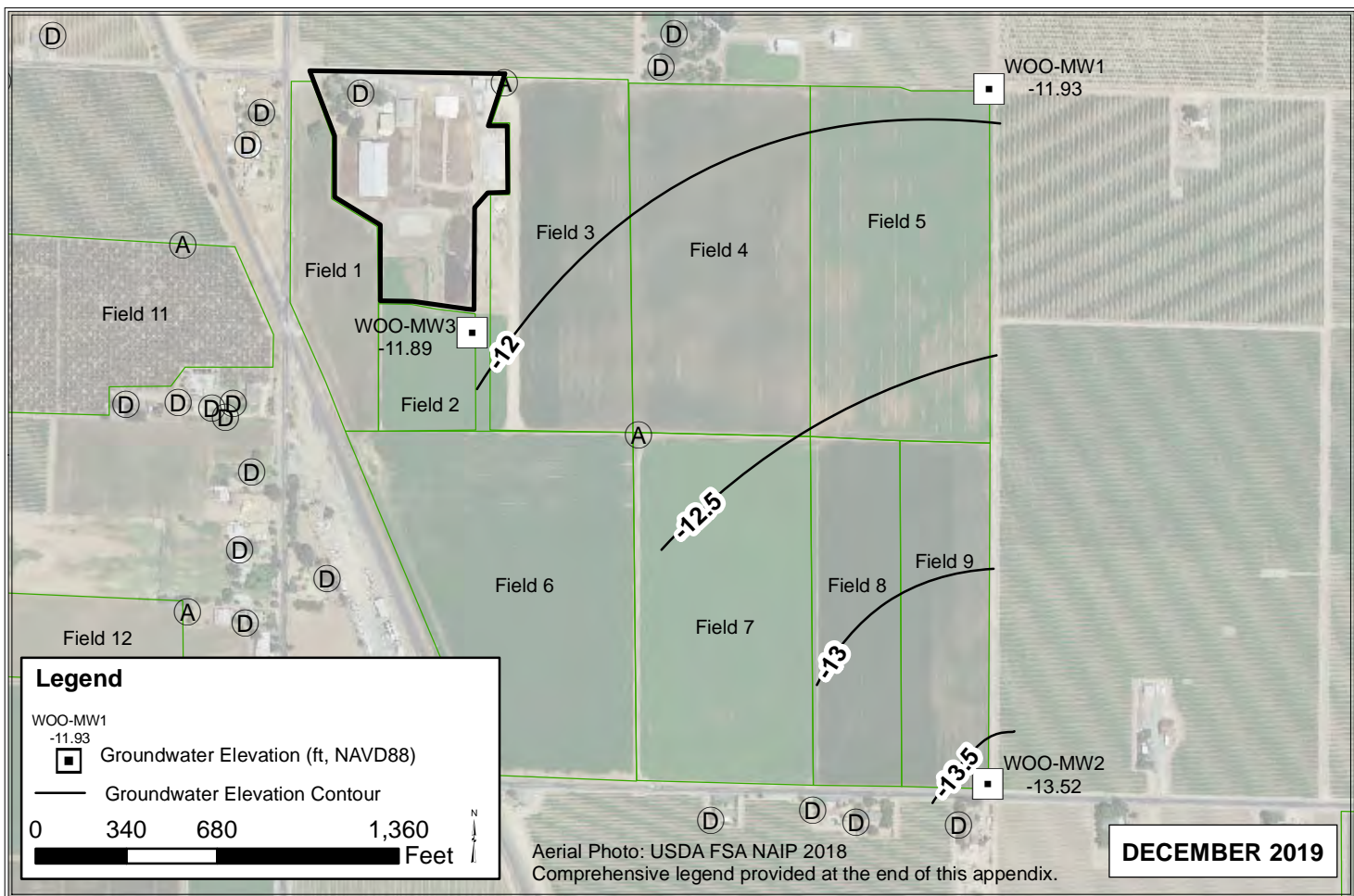
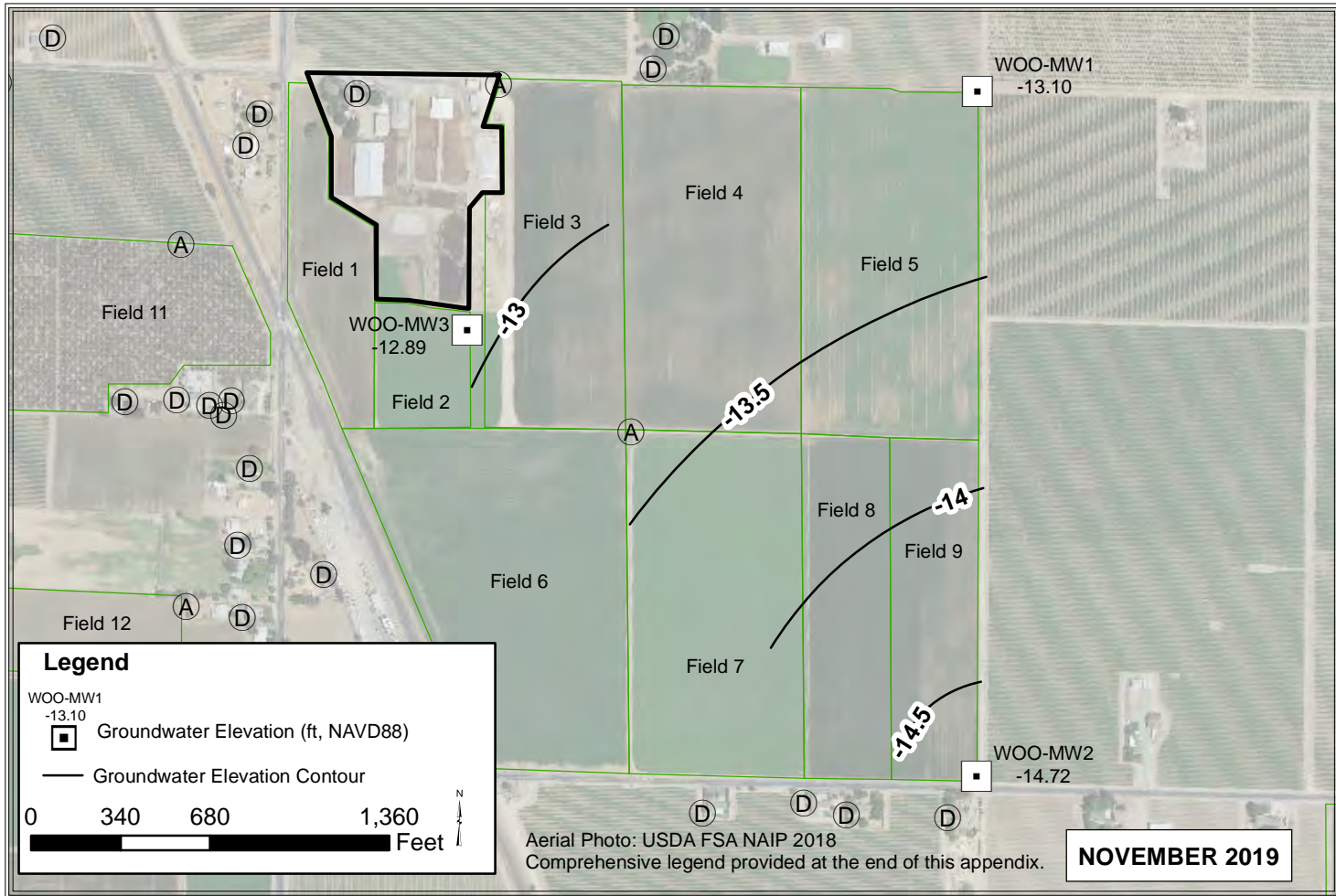

ANT

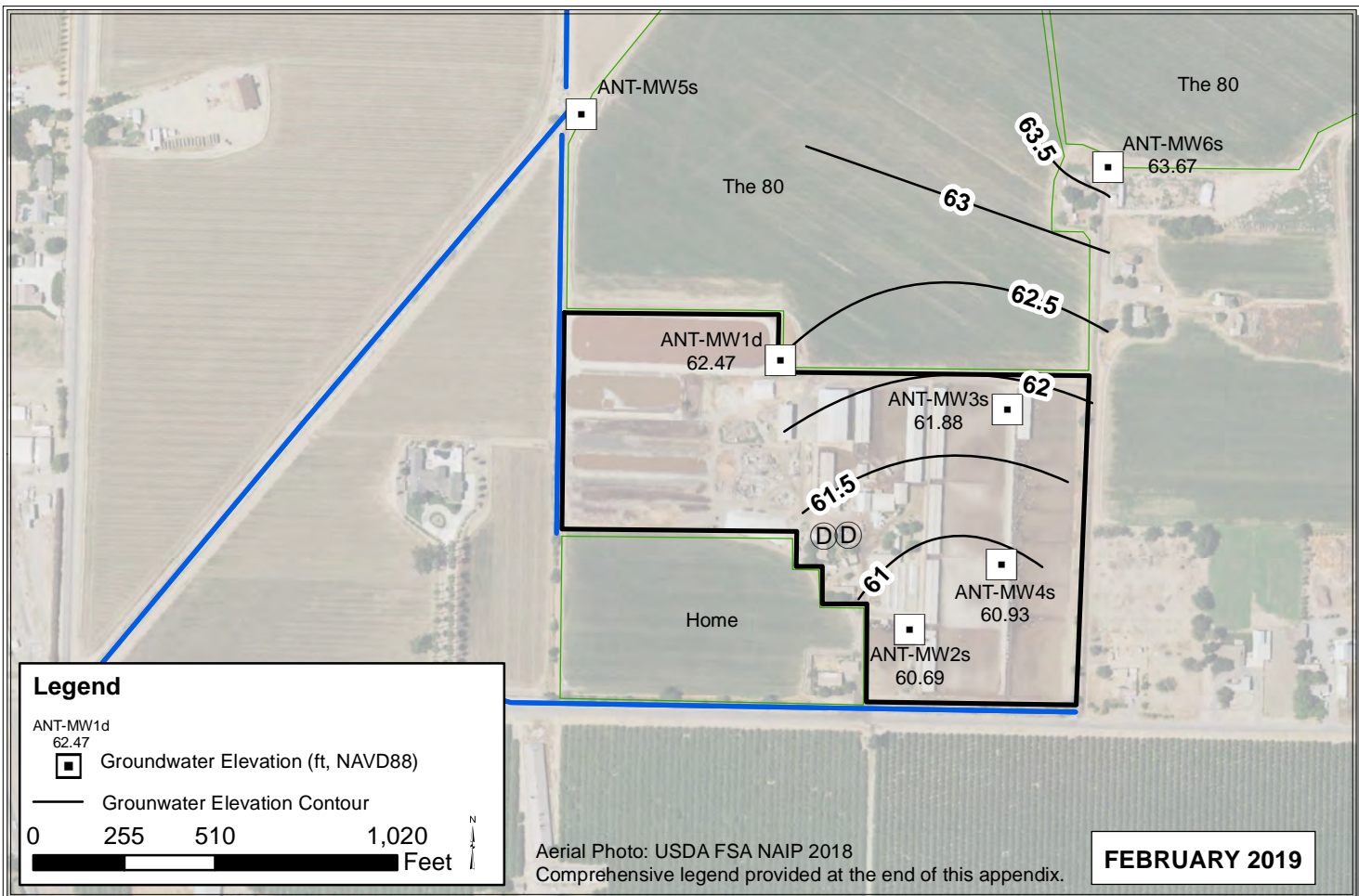
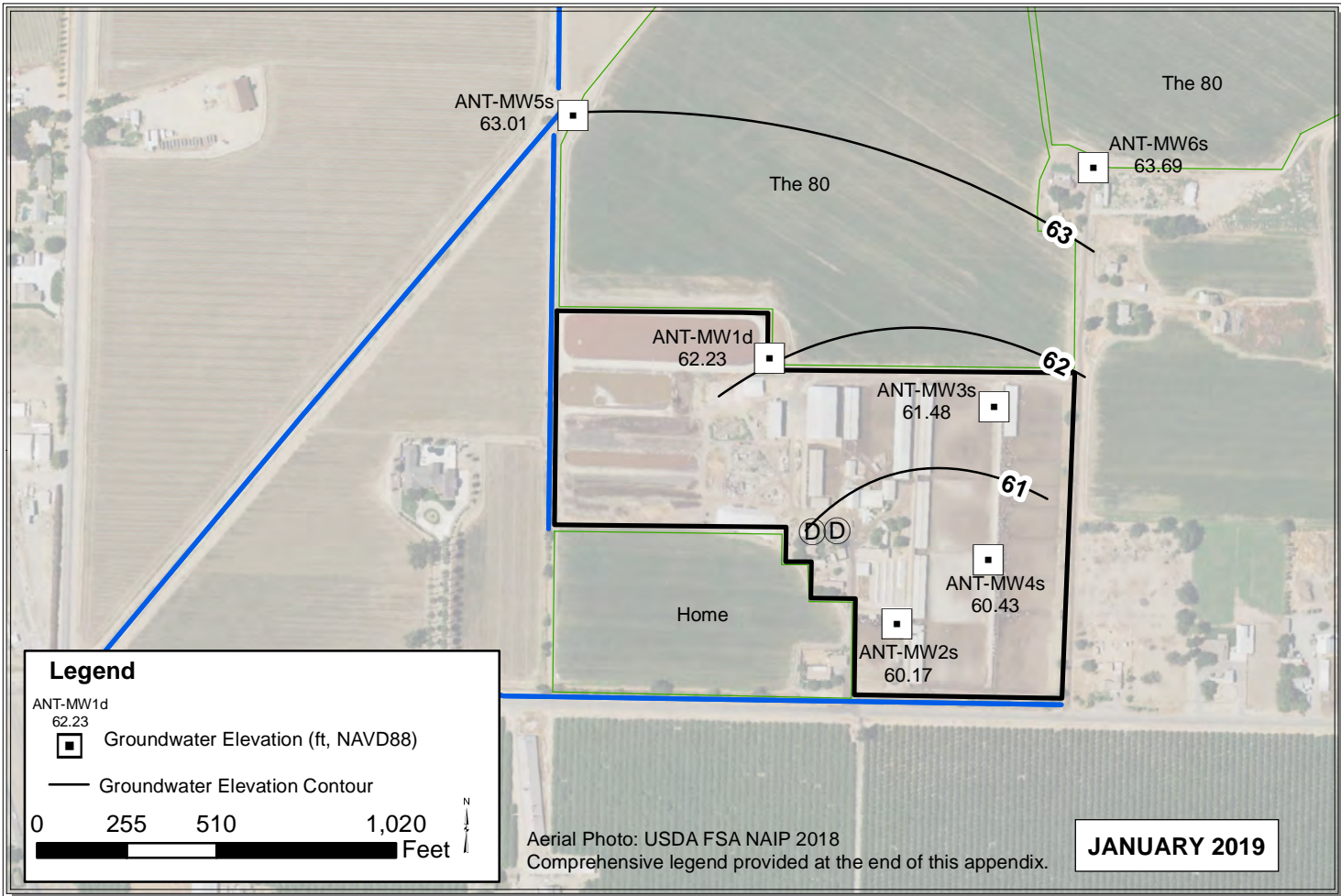

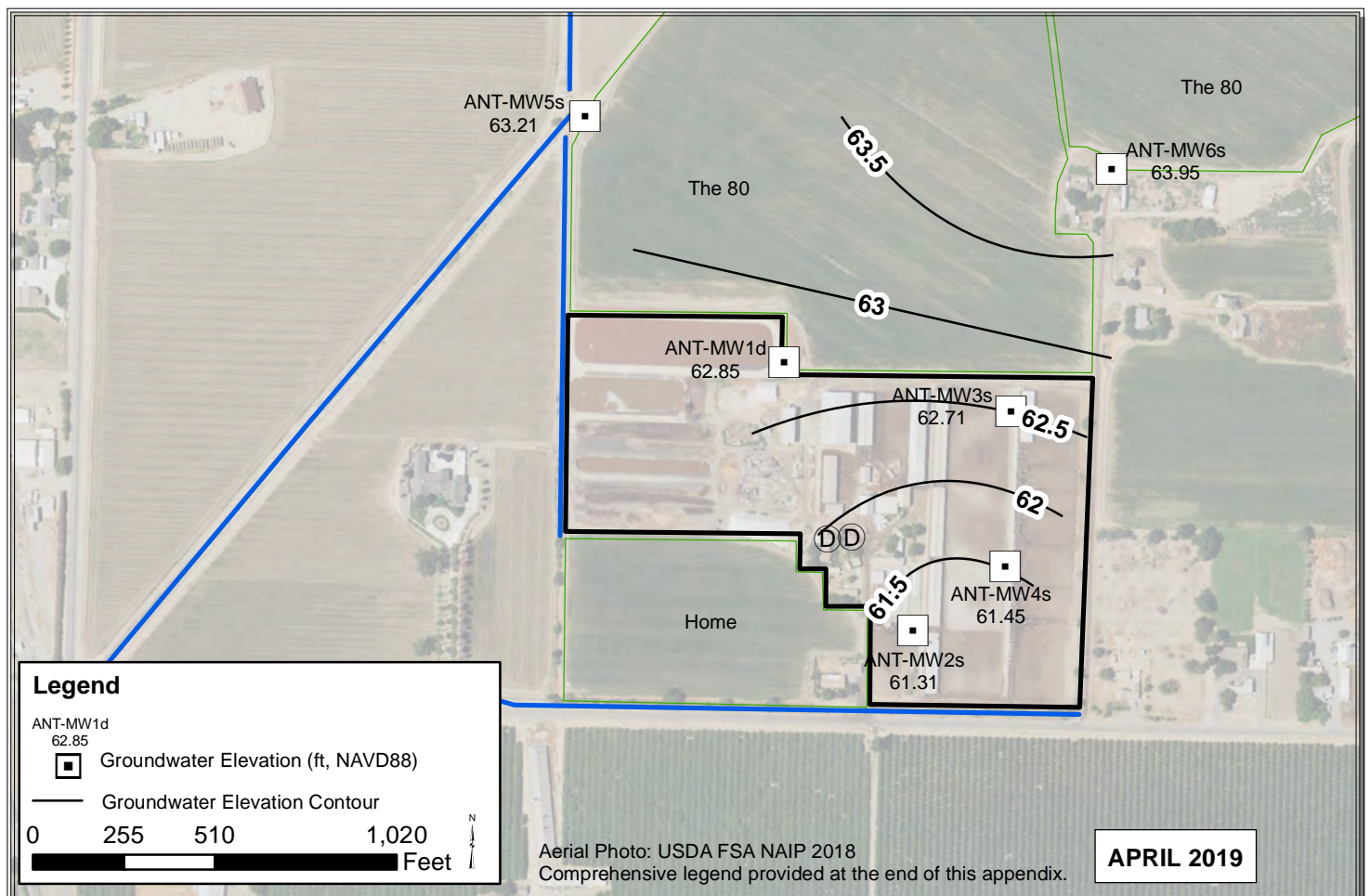
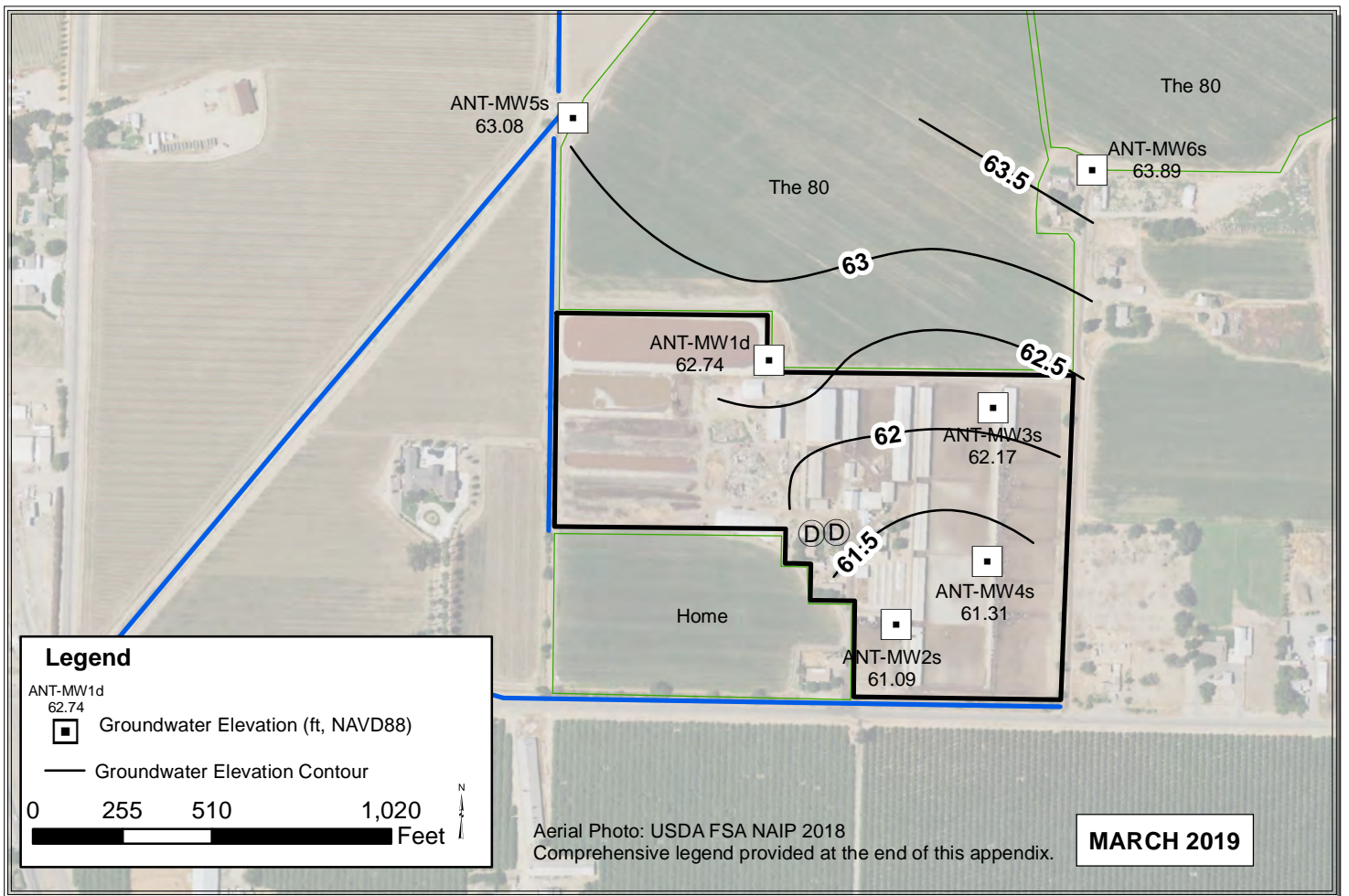

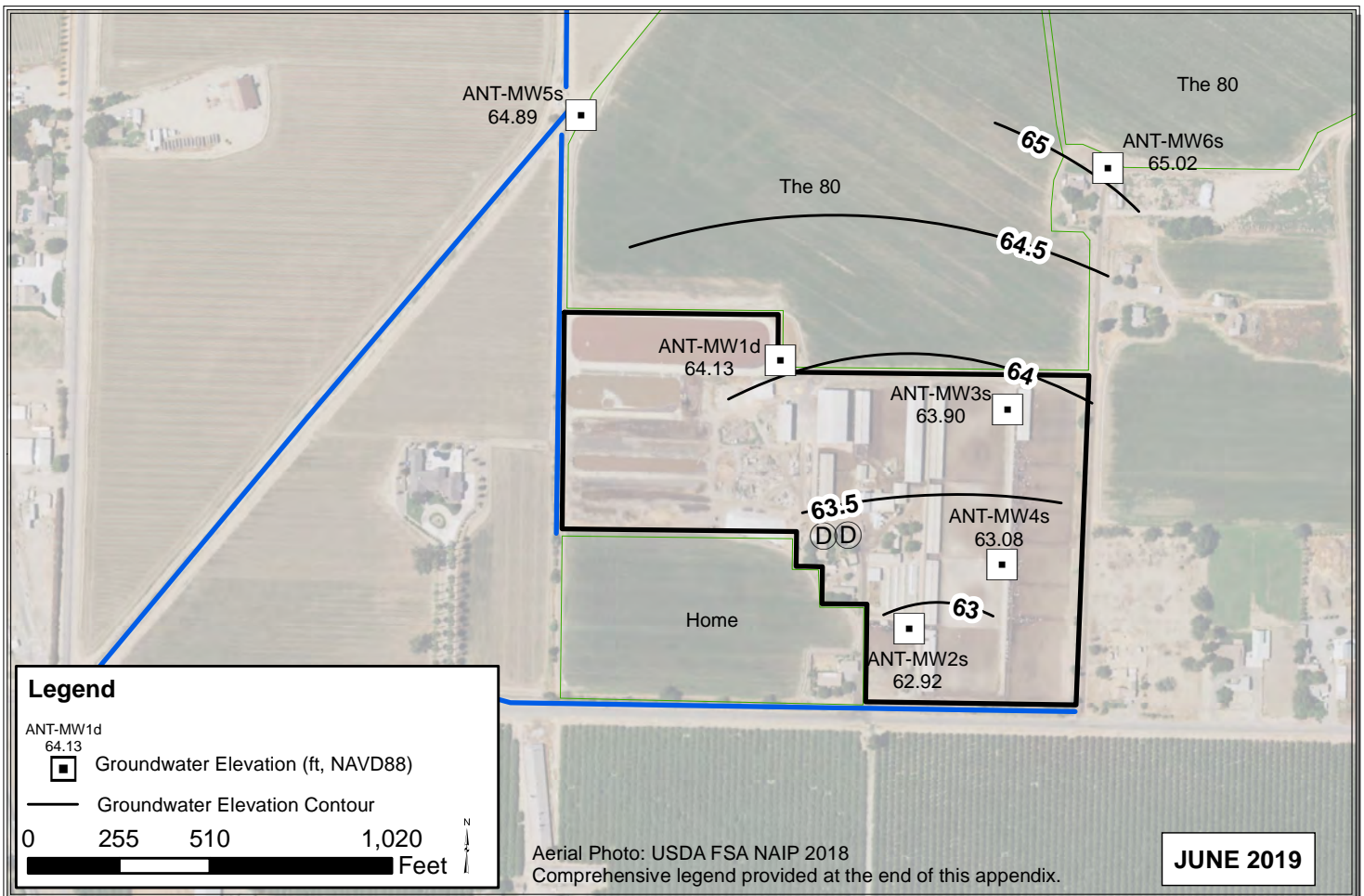
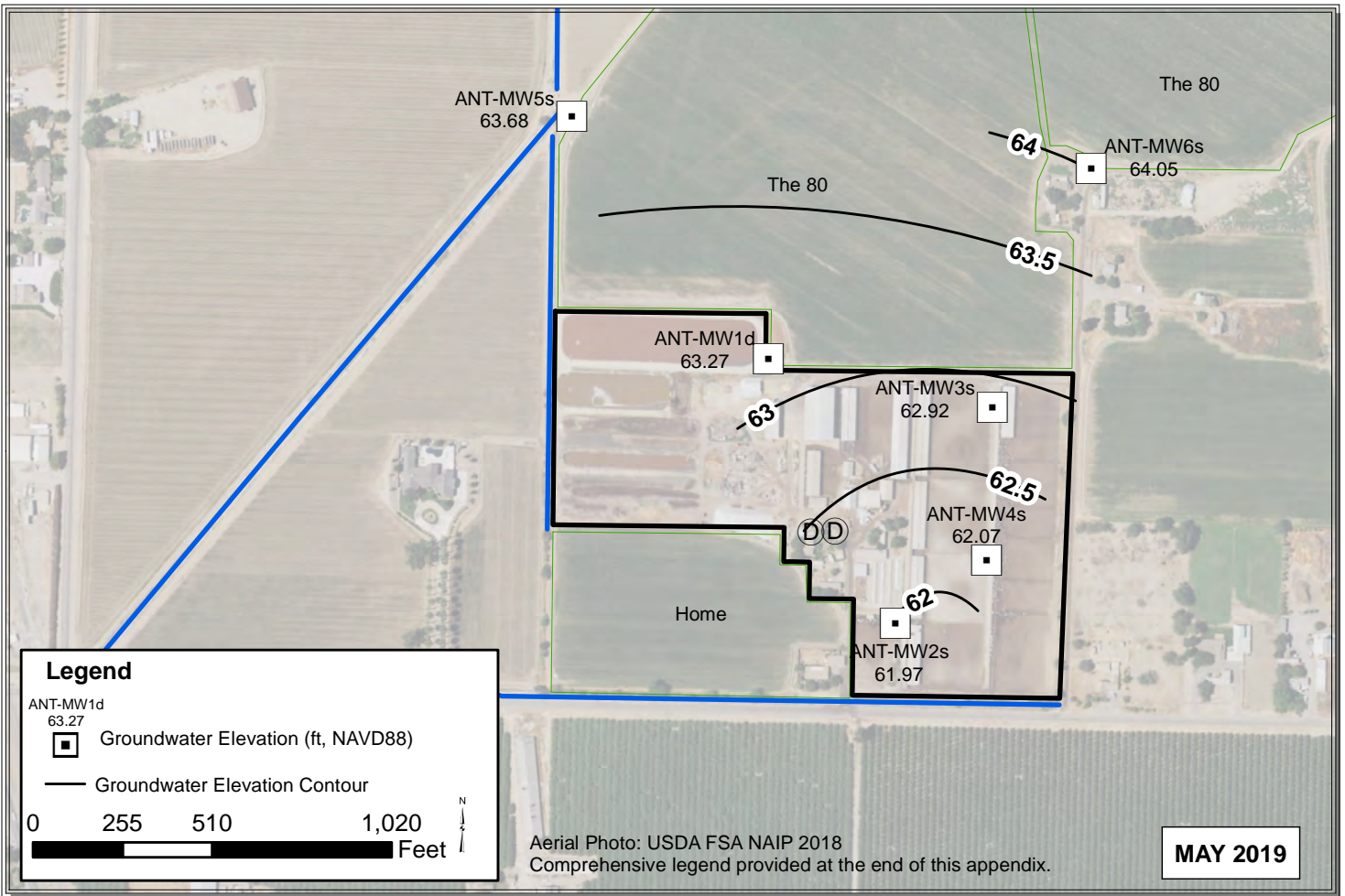

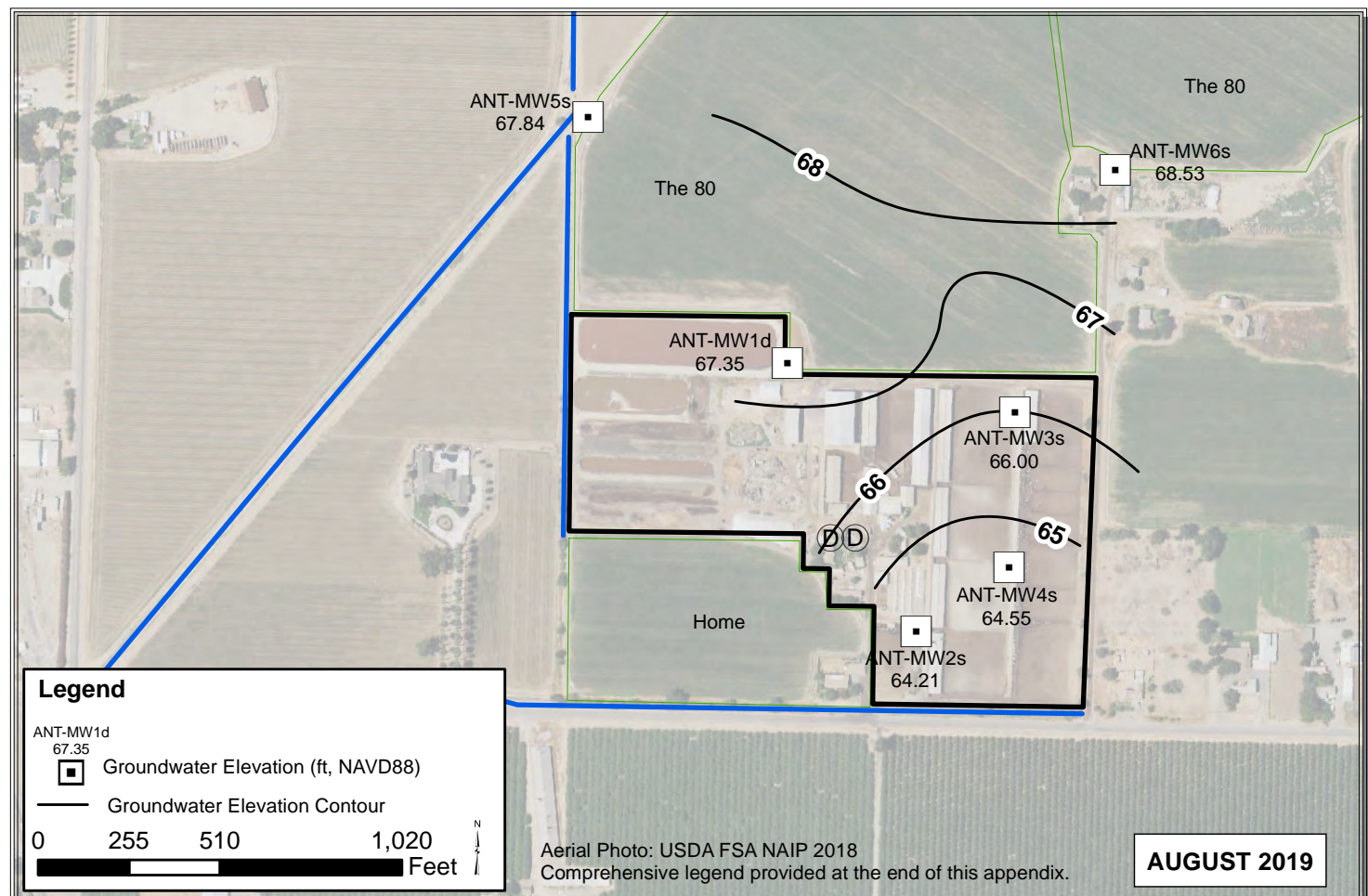
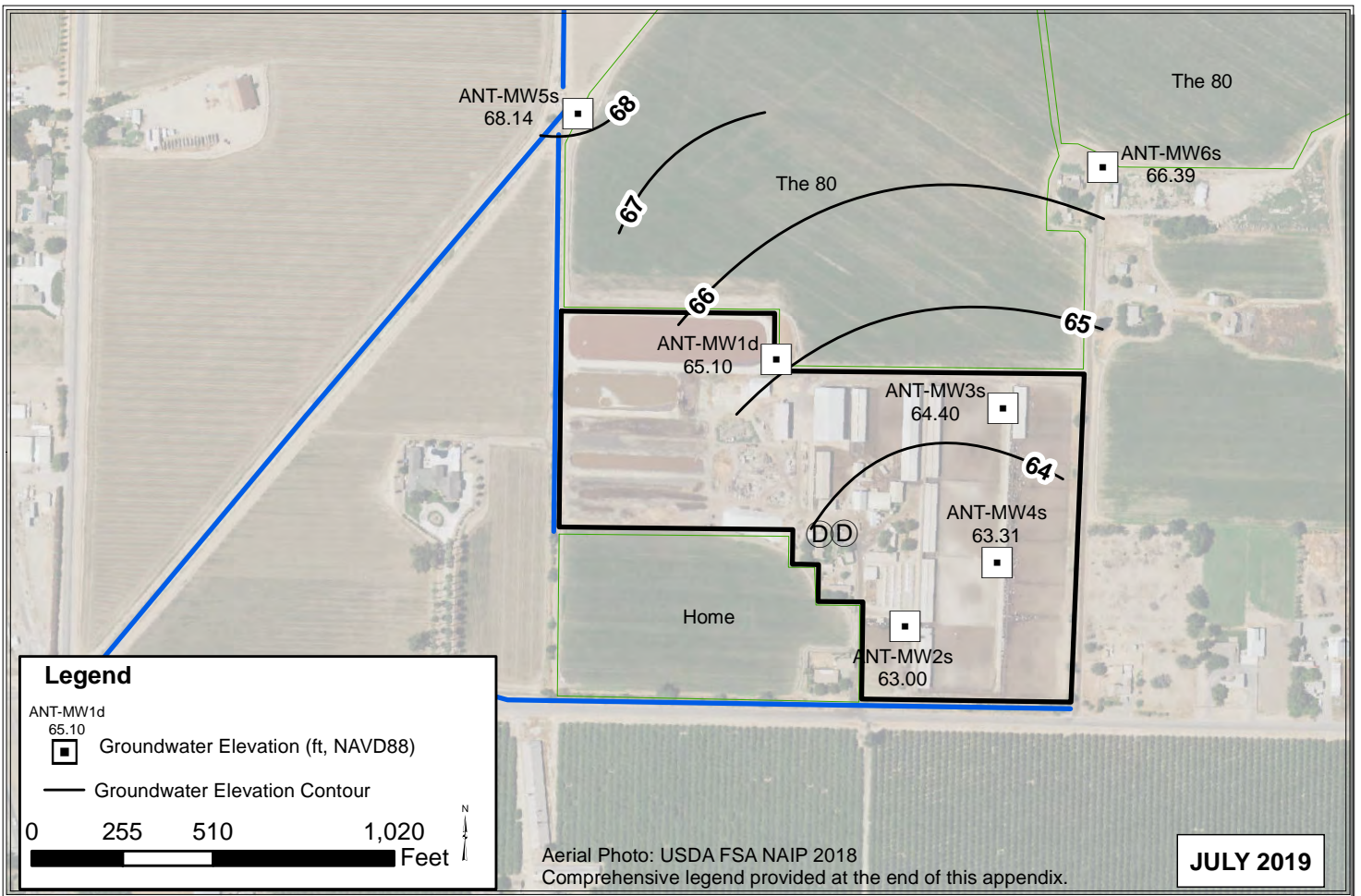

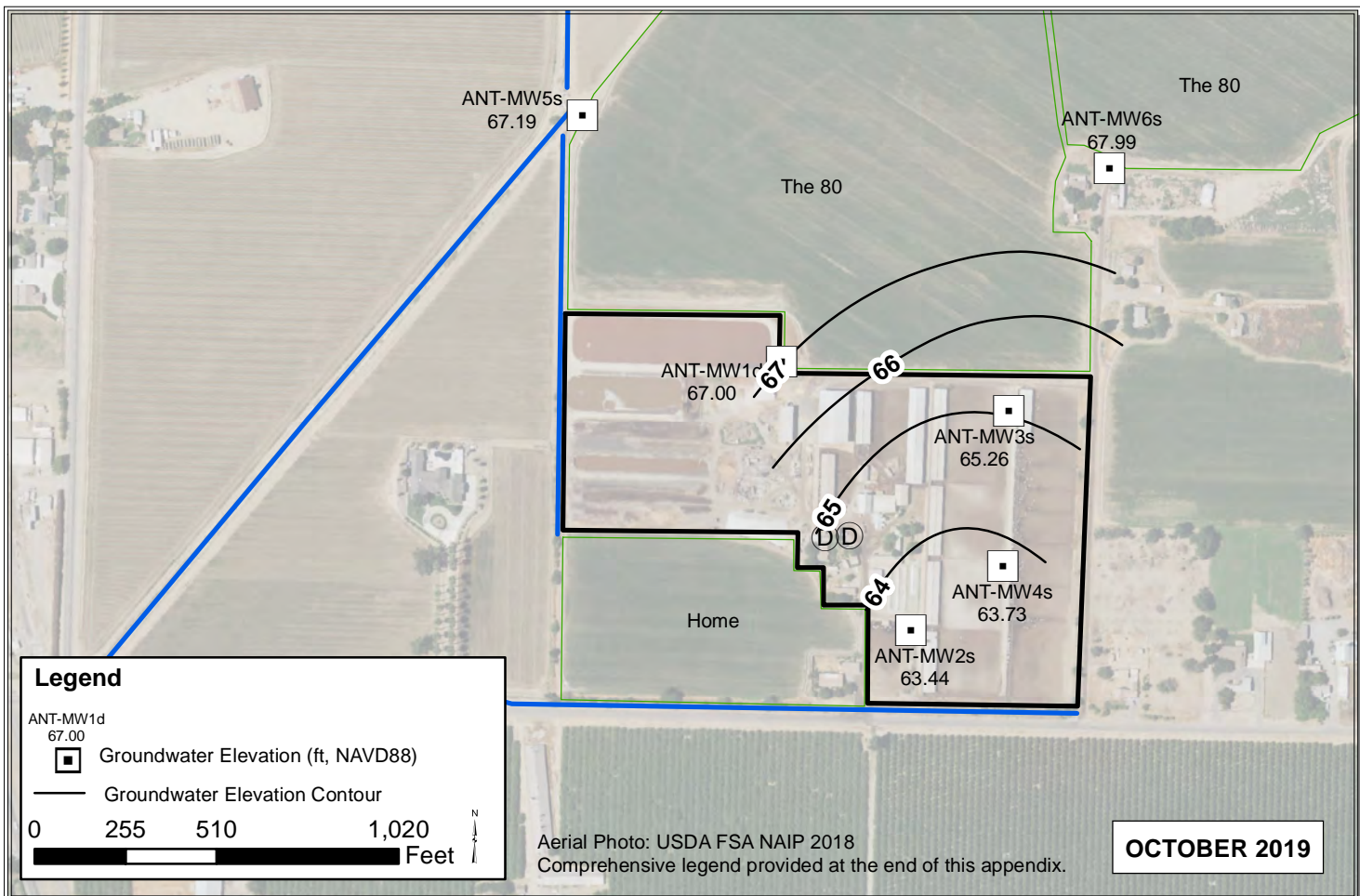
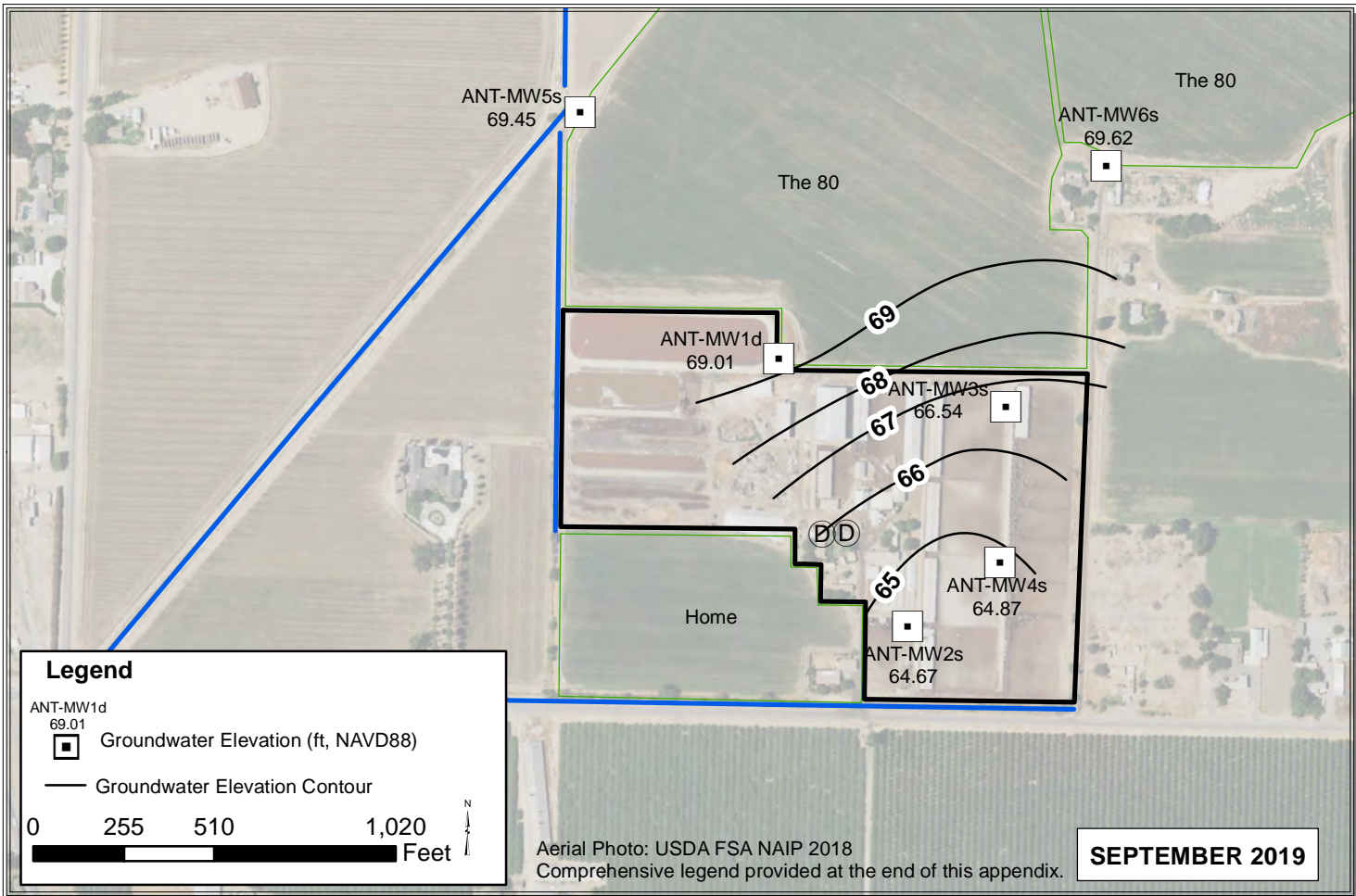

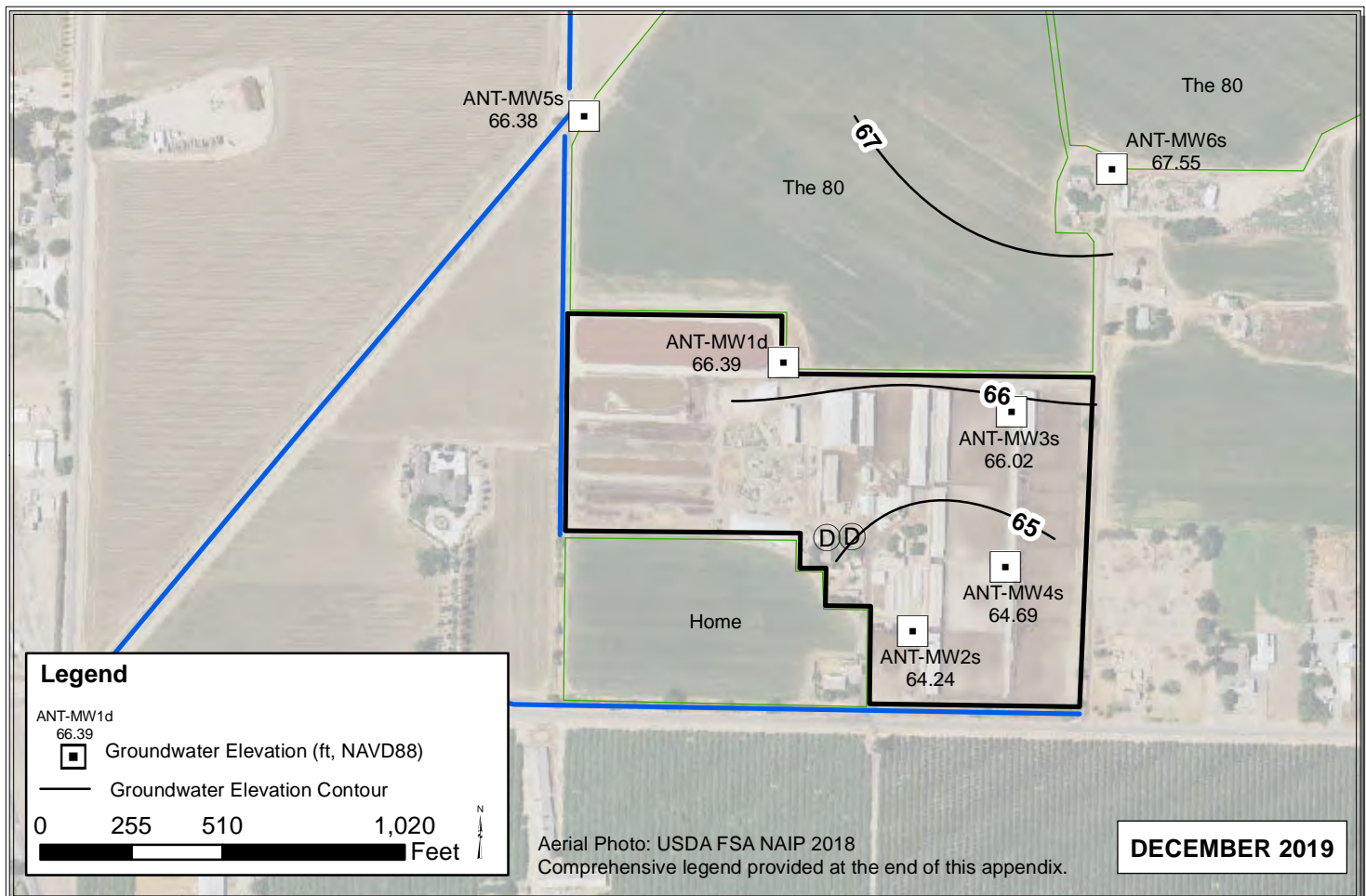
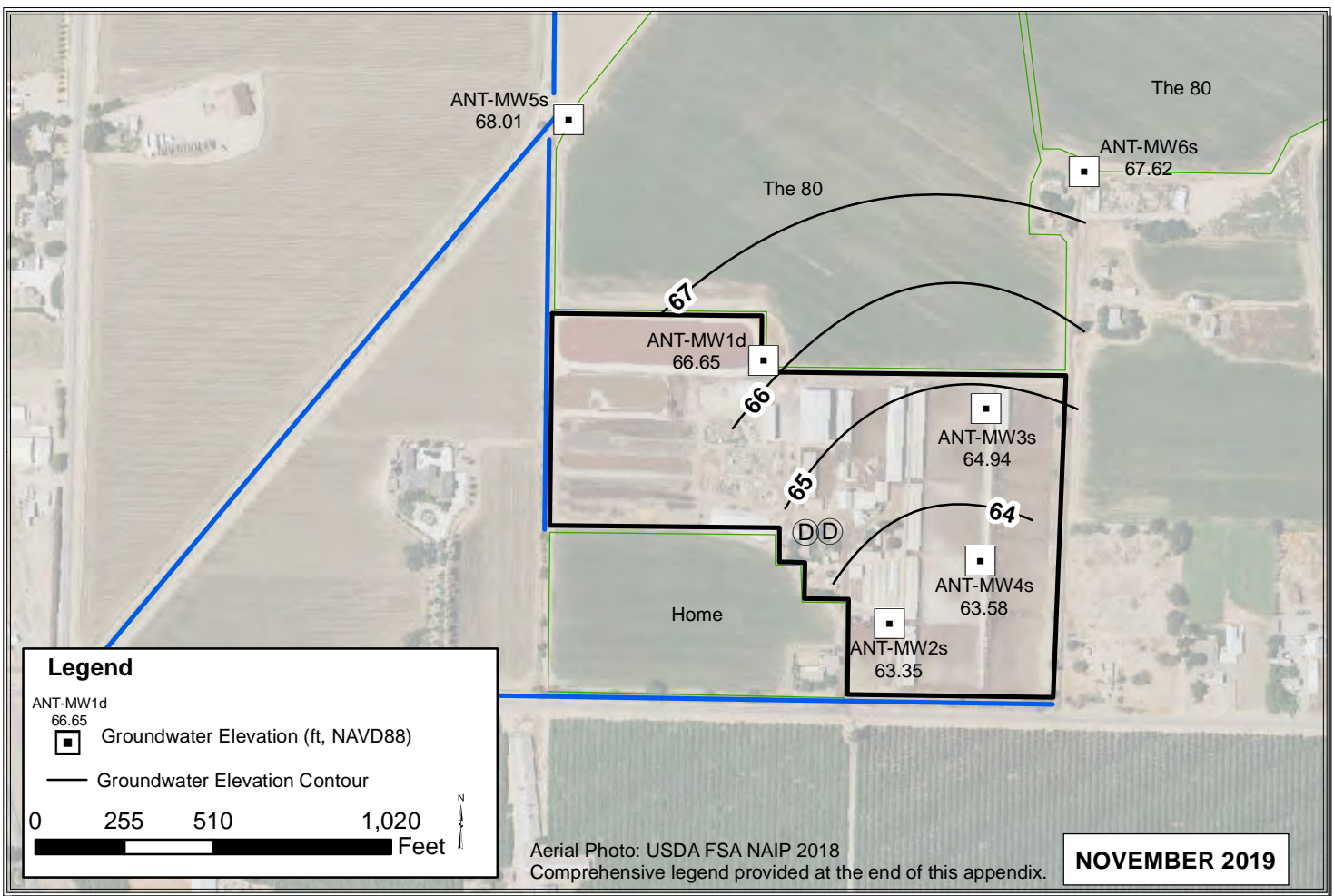

COR

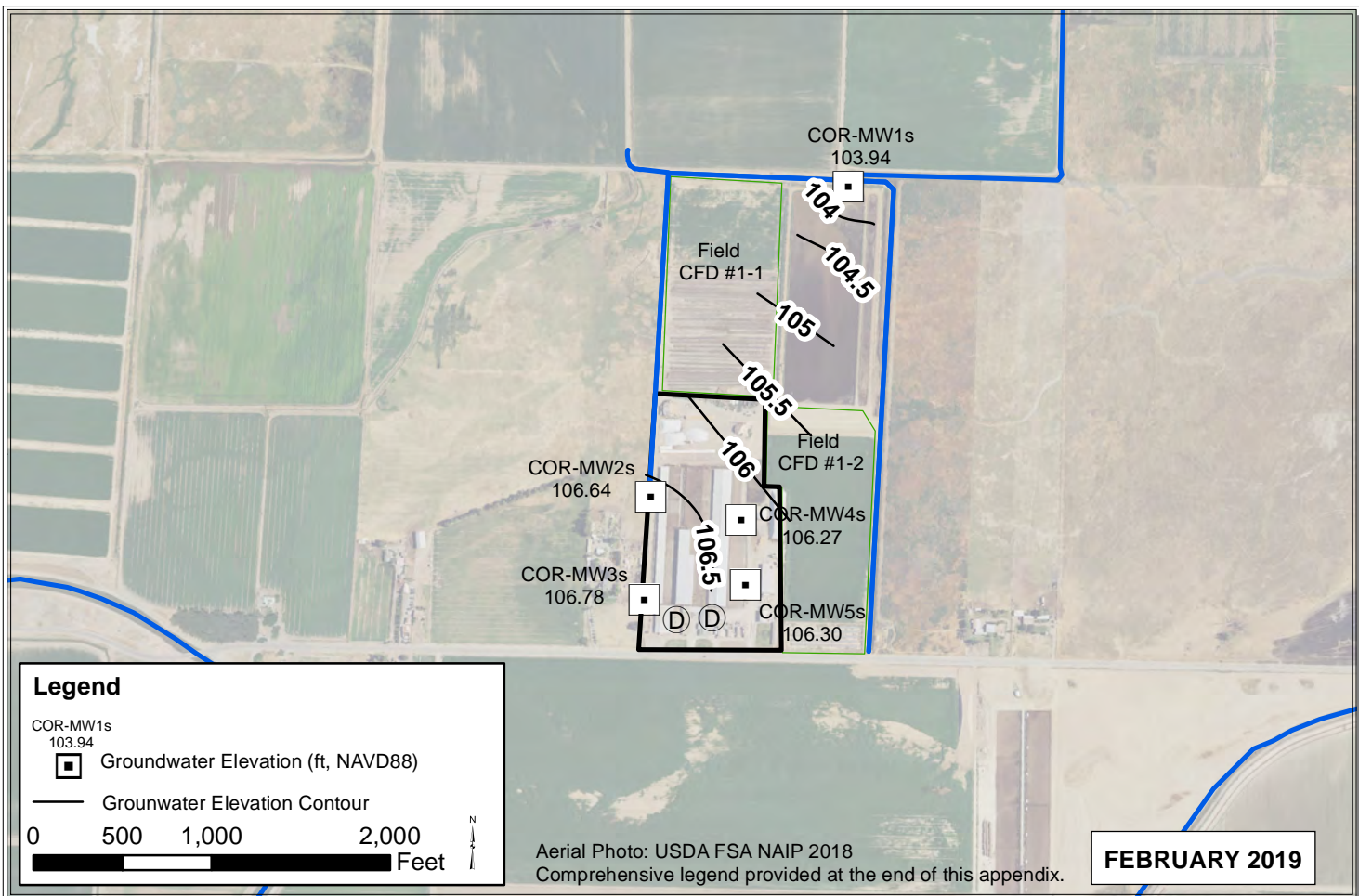
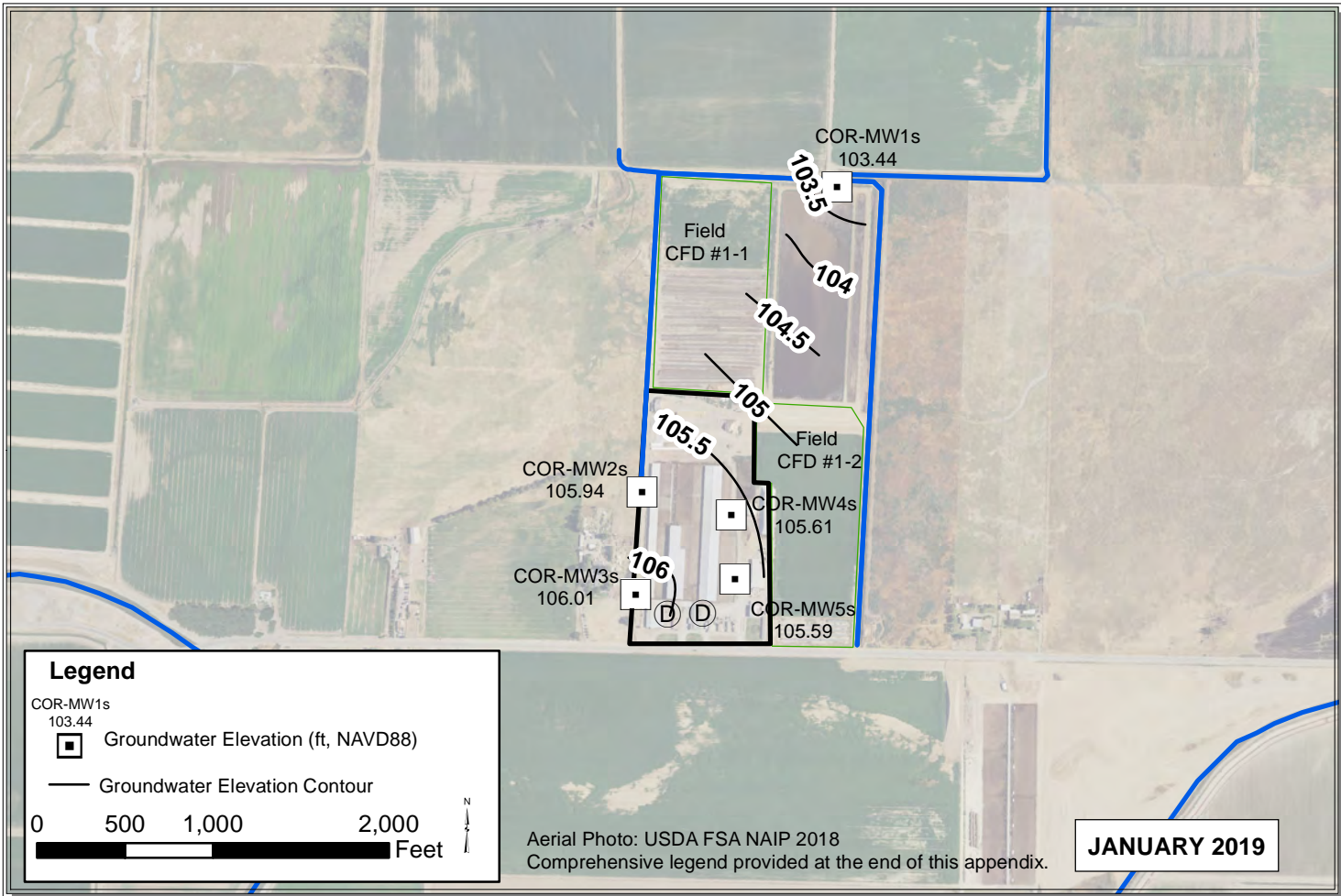

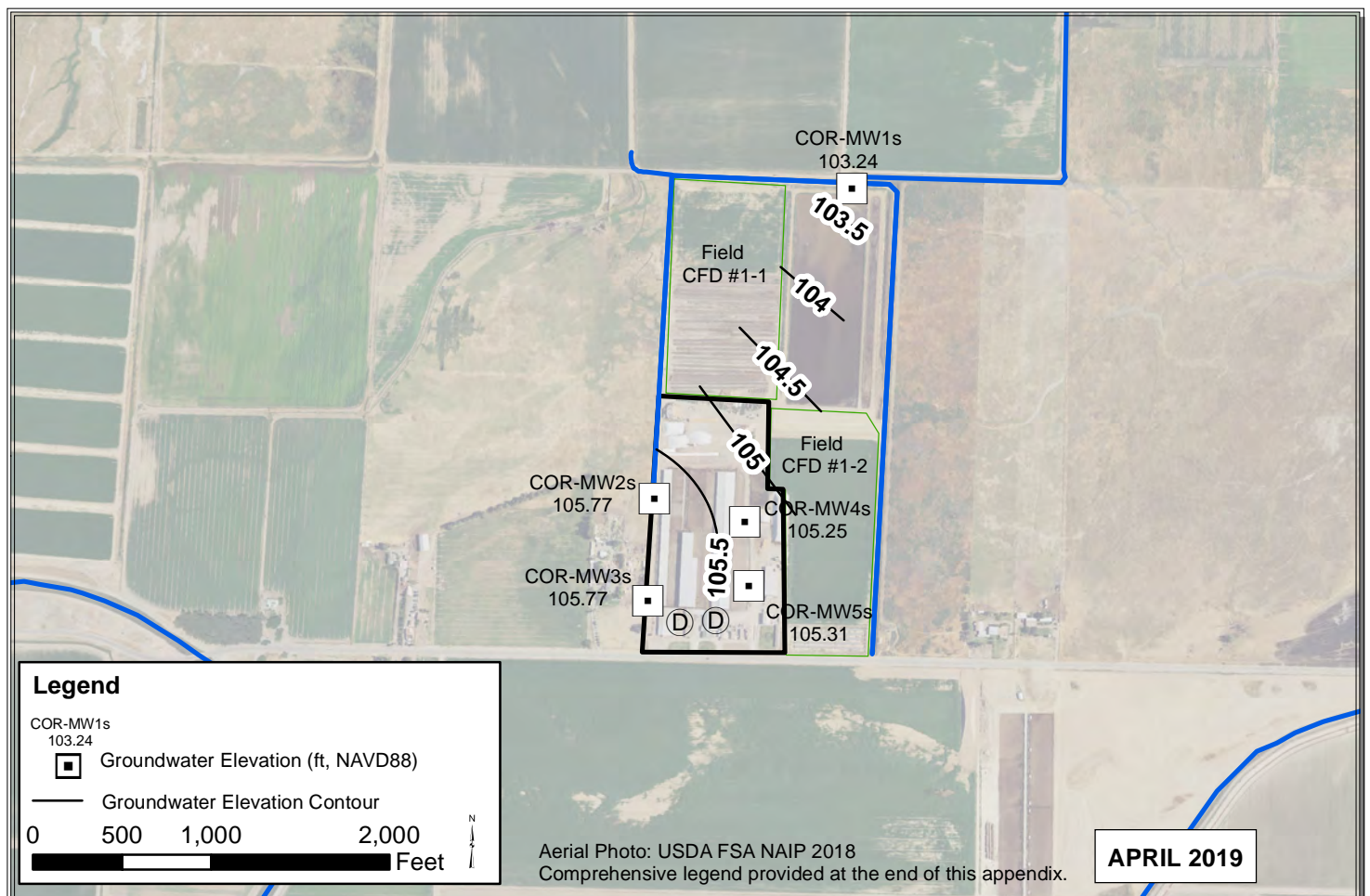
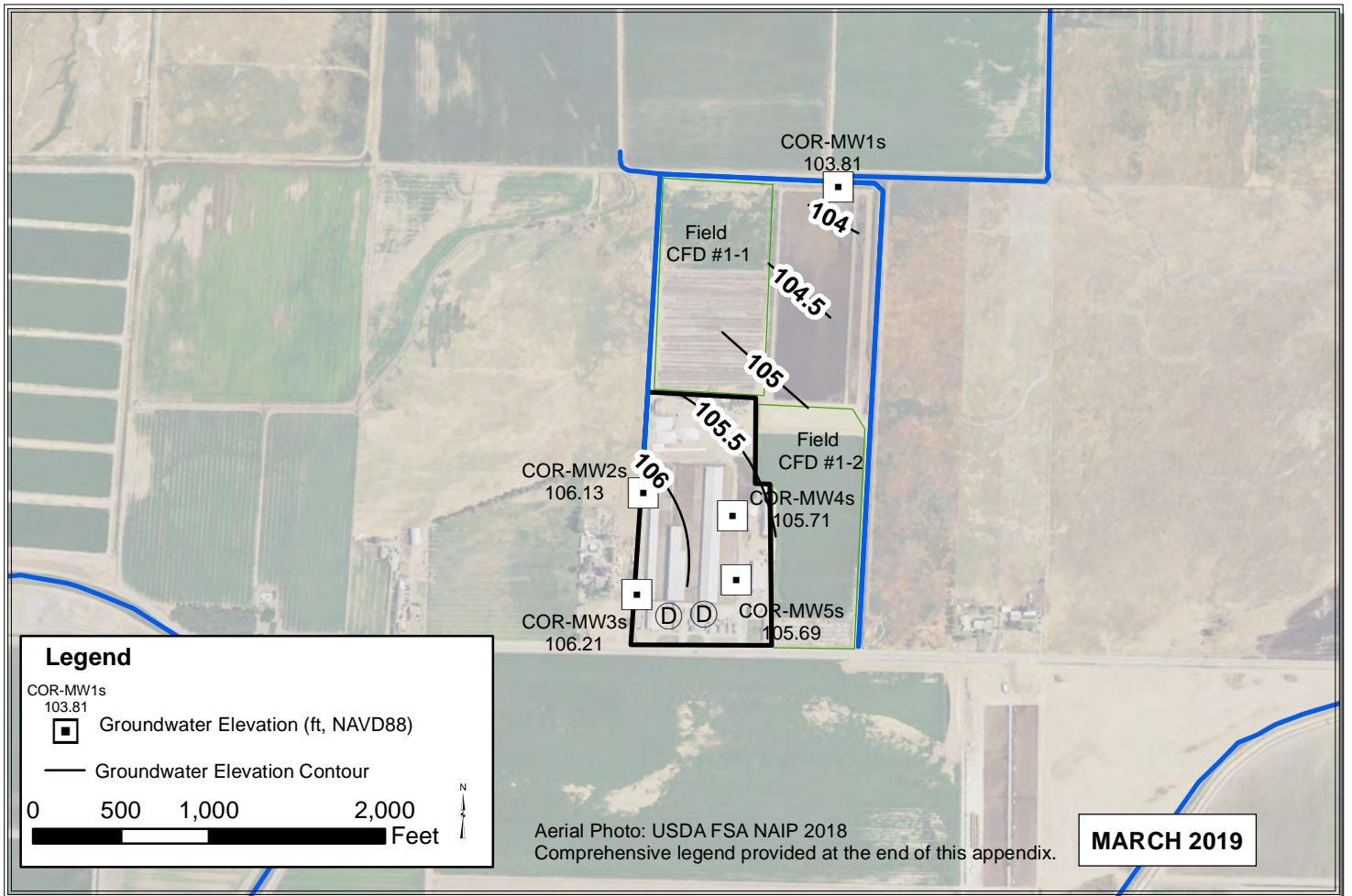

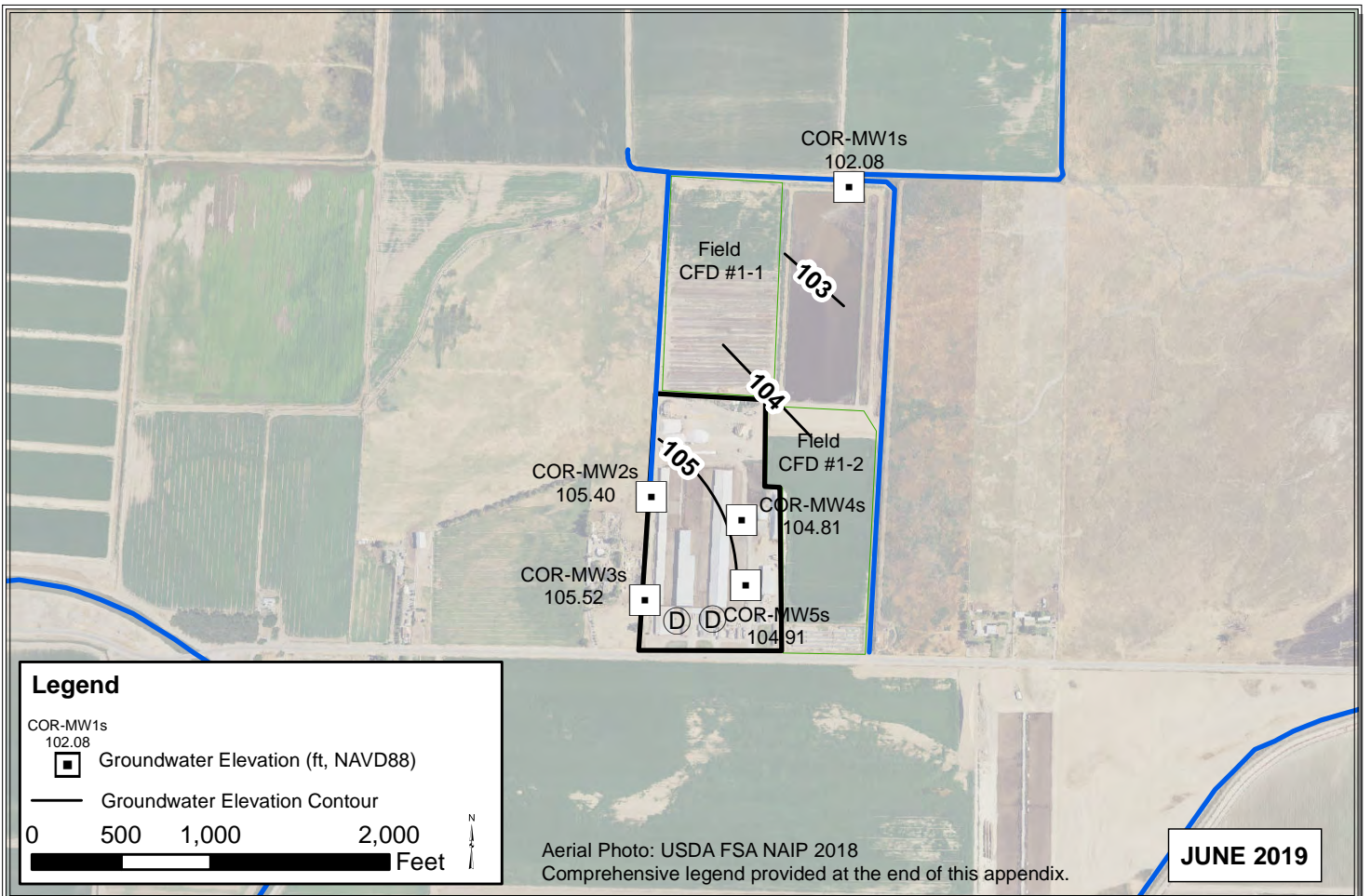
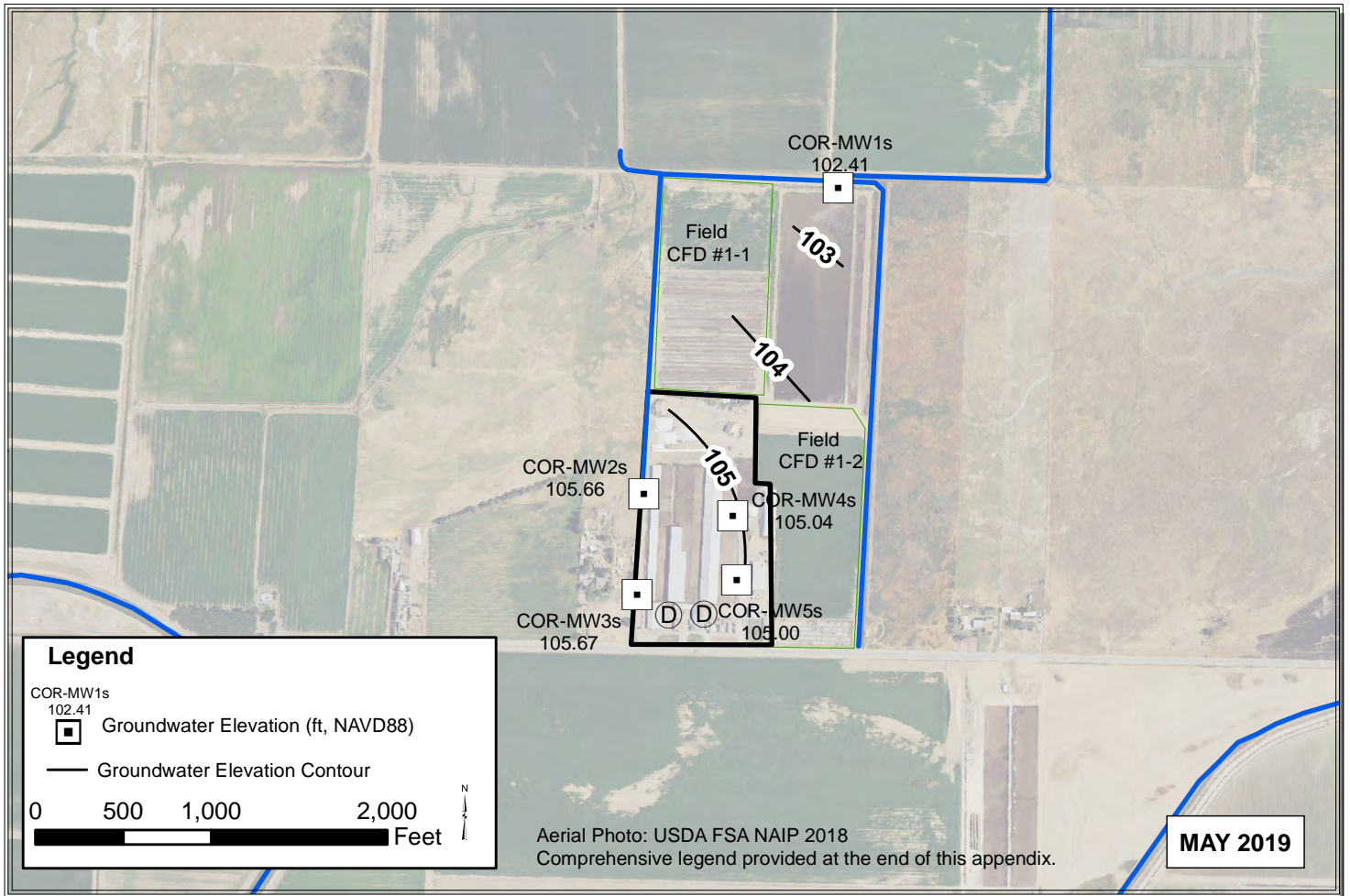

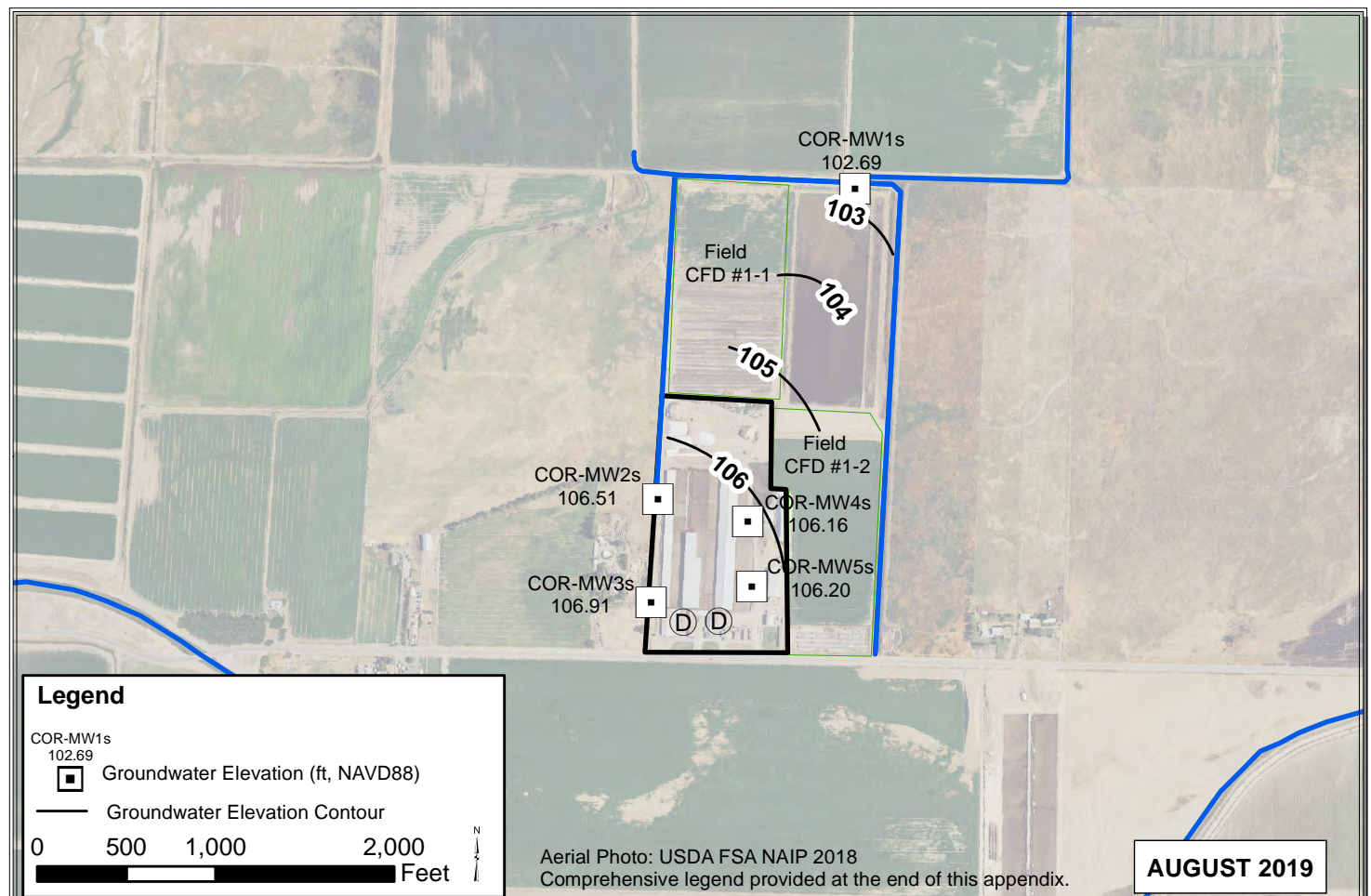
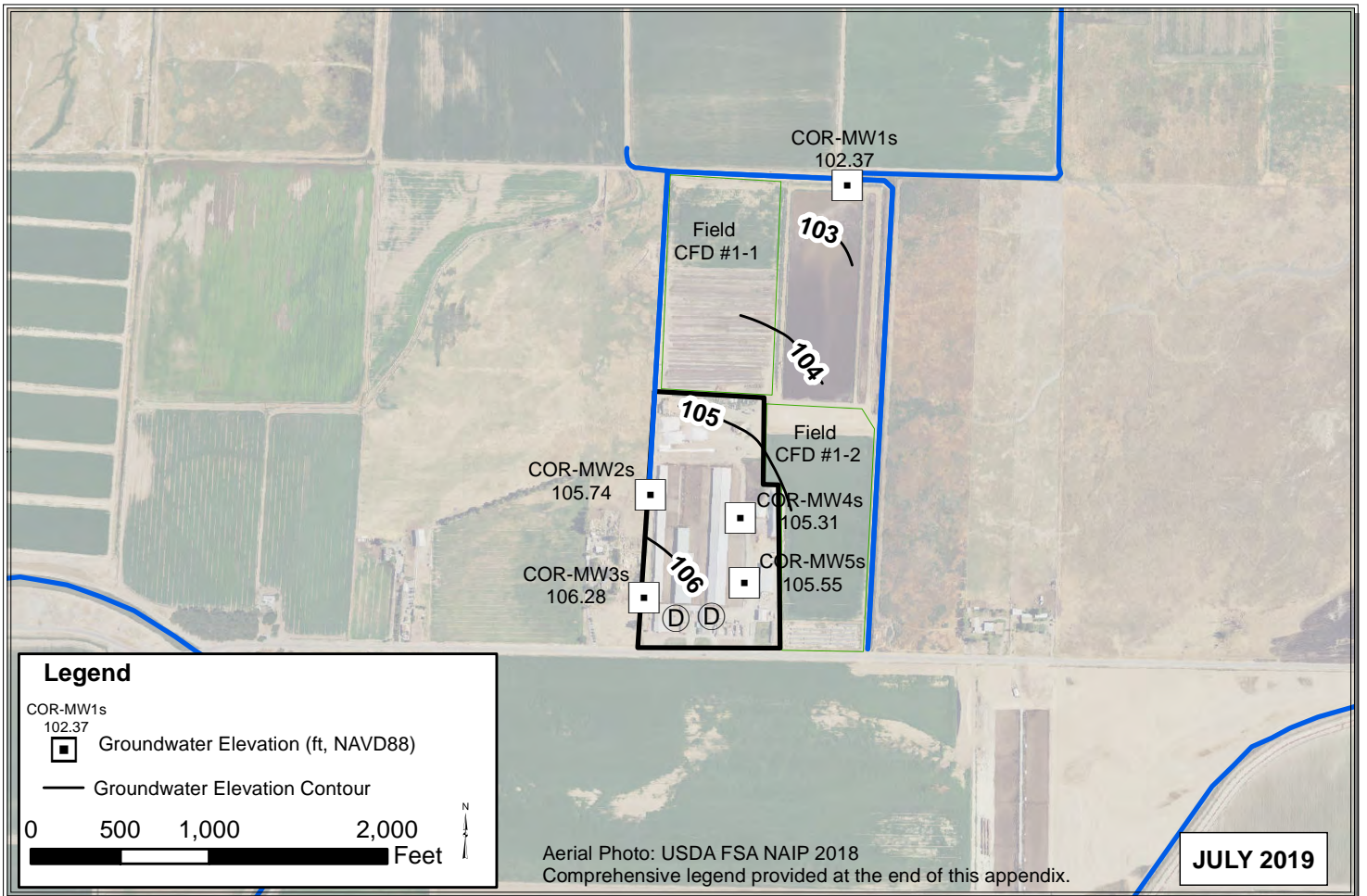

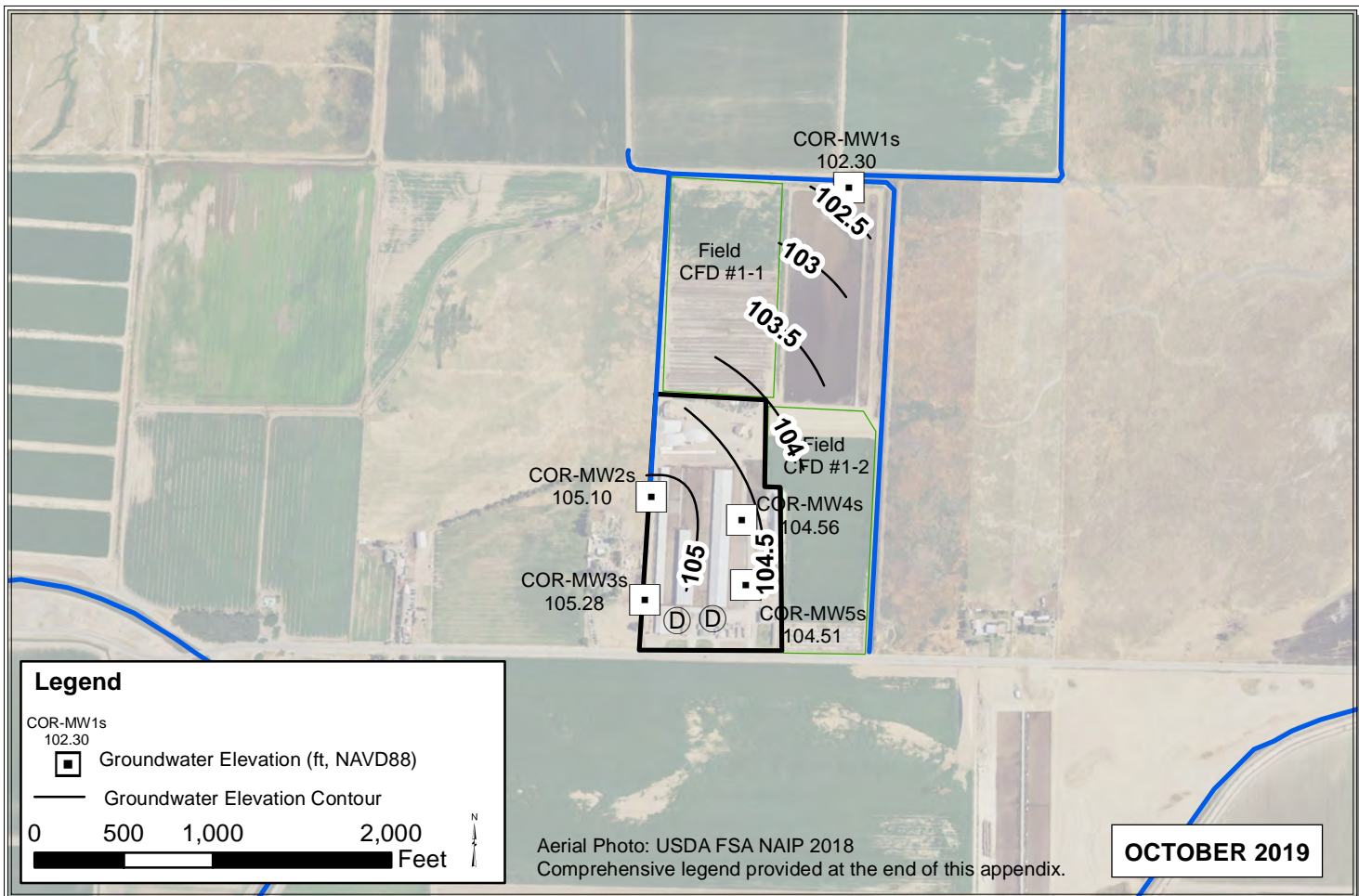
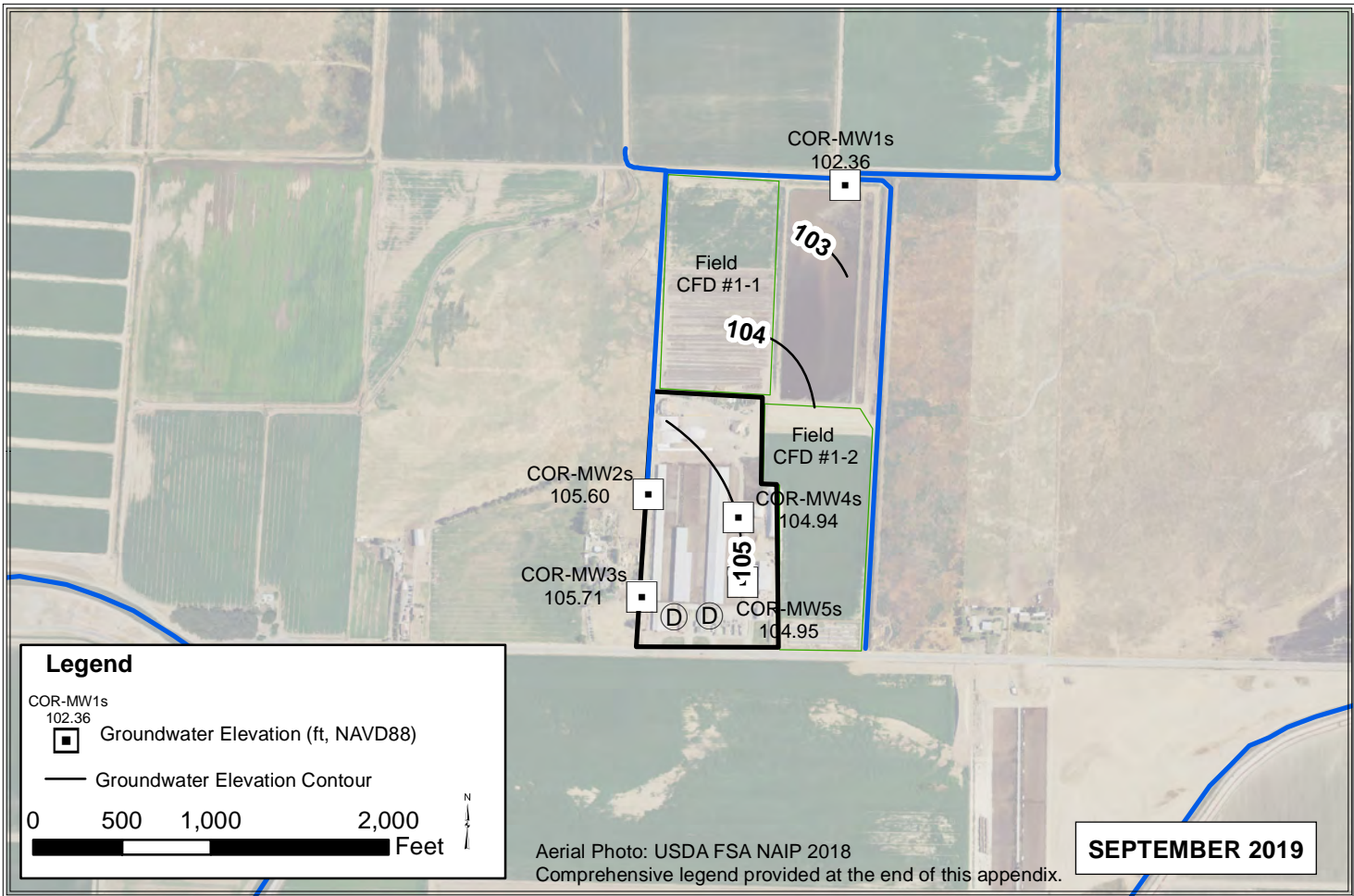

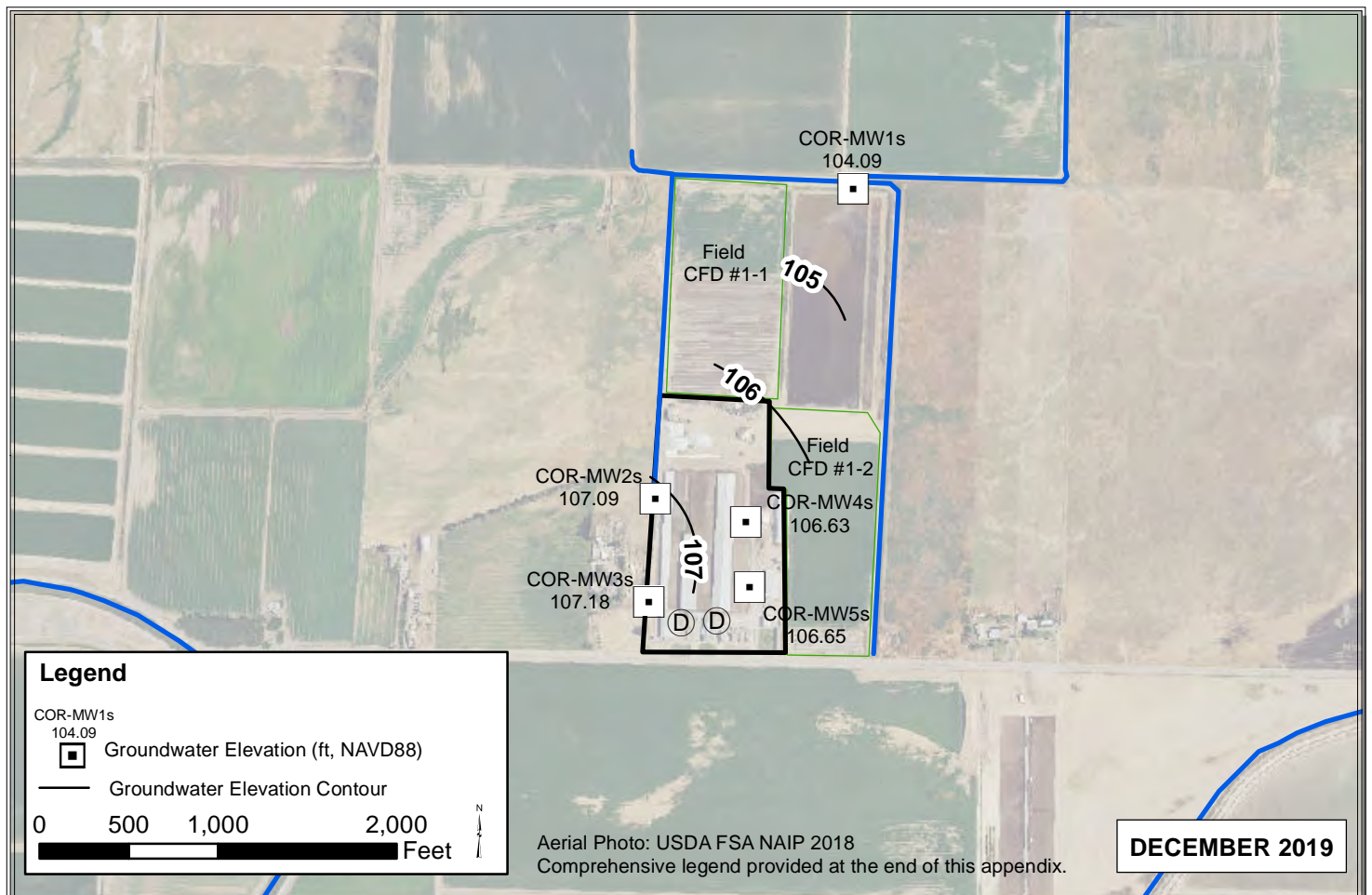
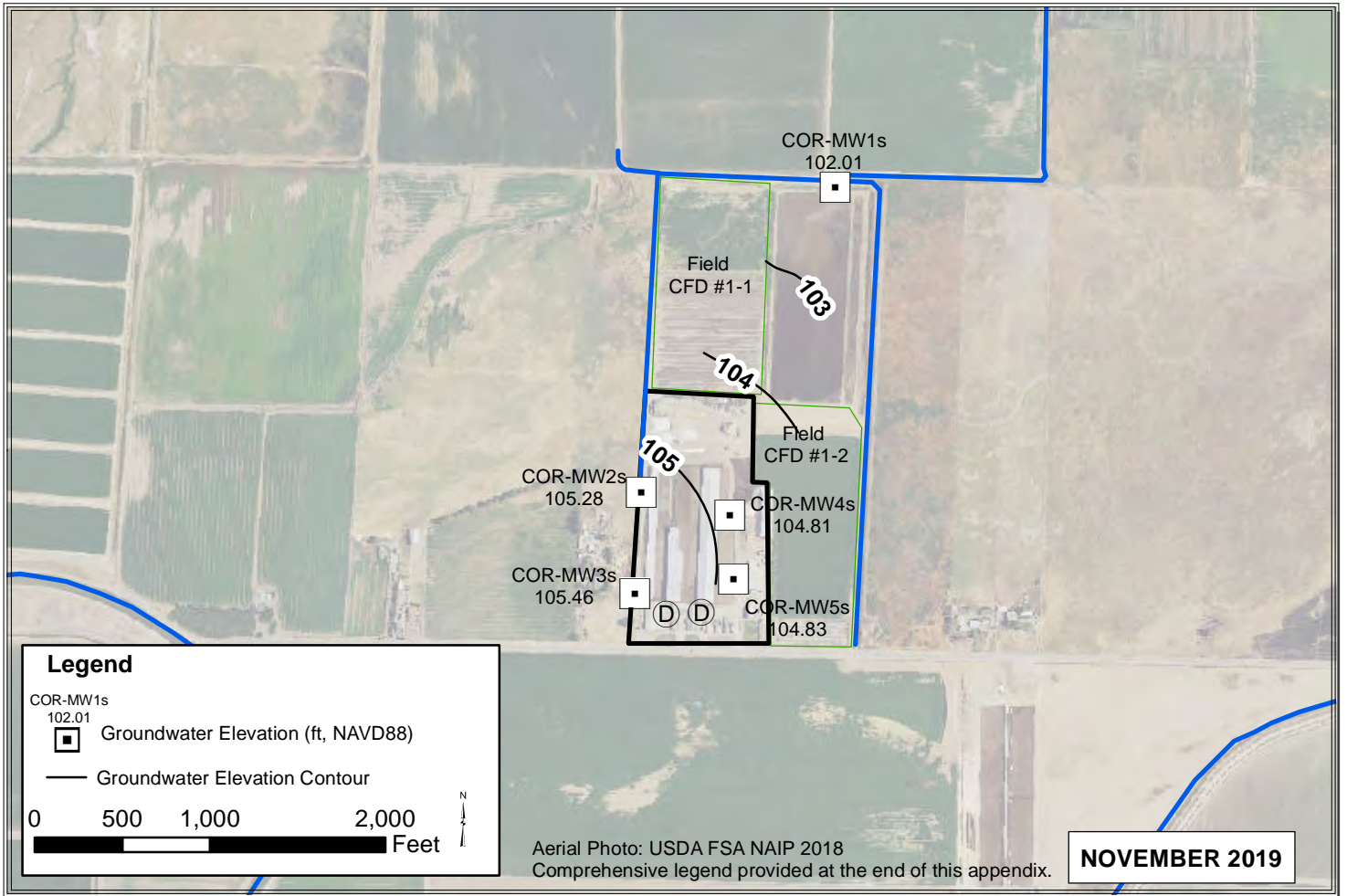

FG2

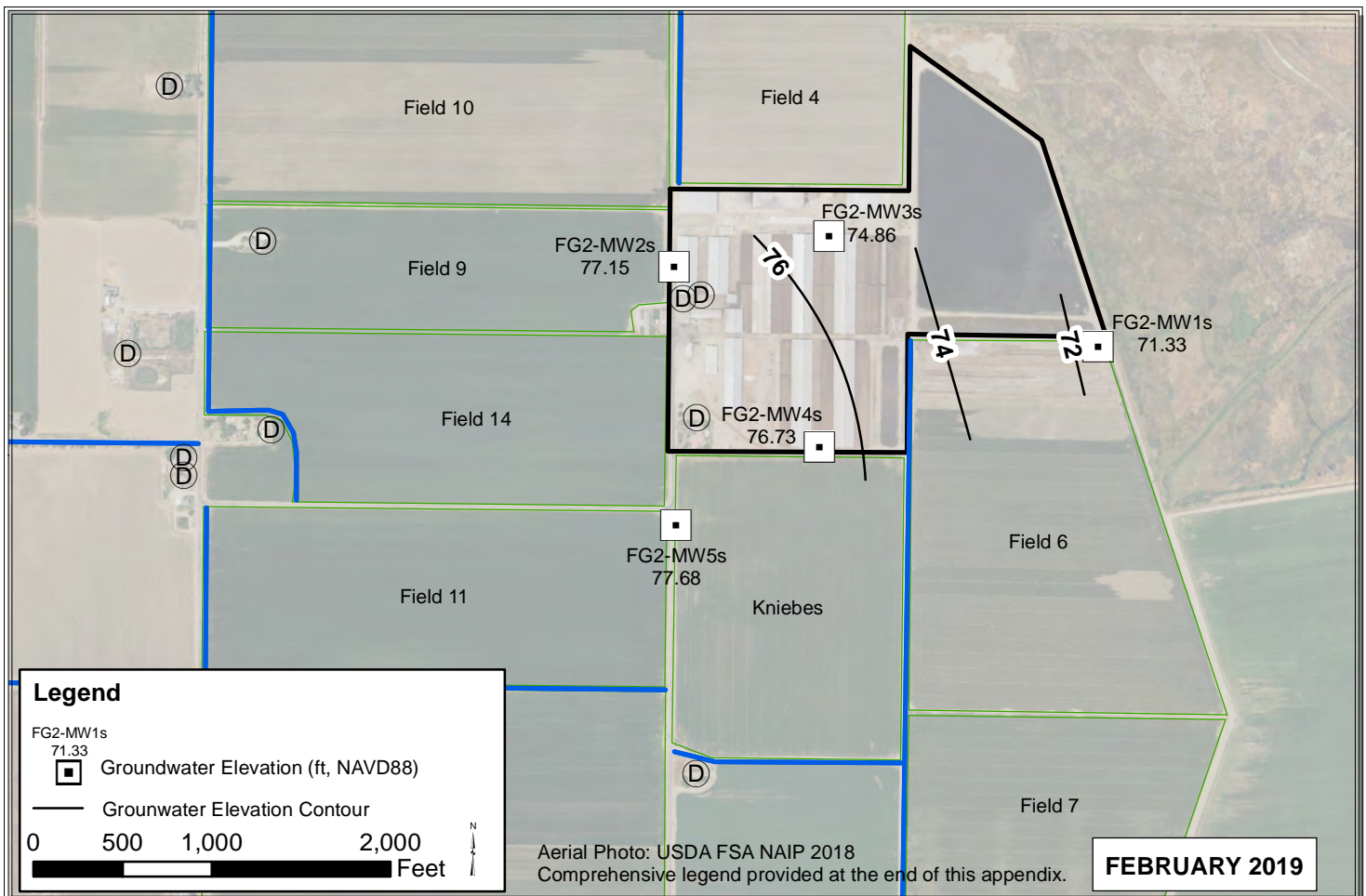
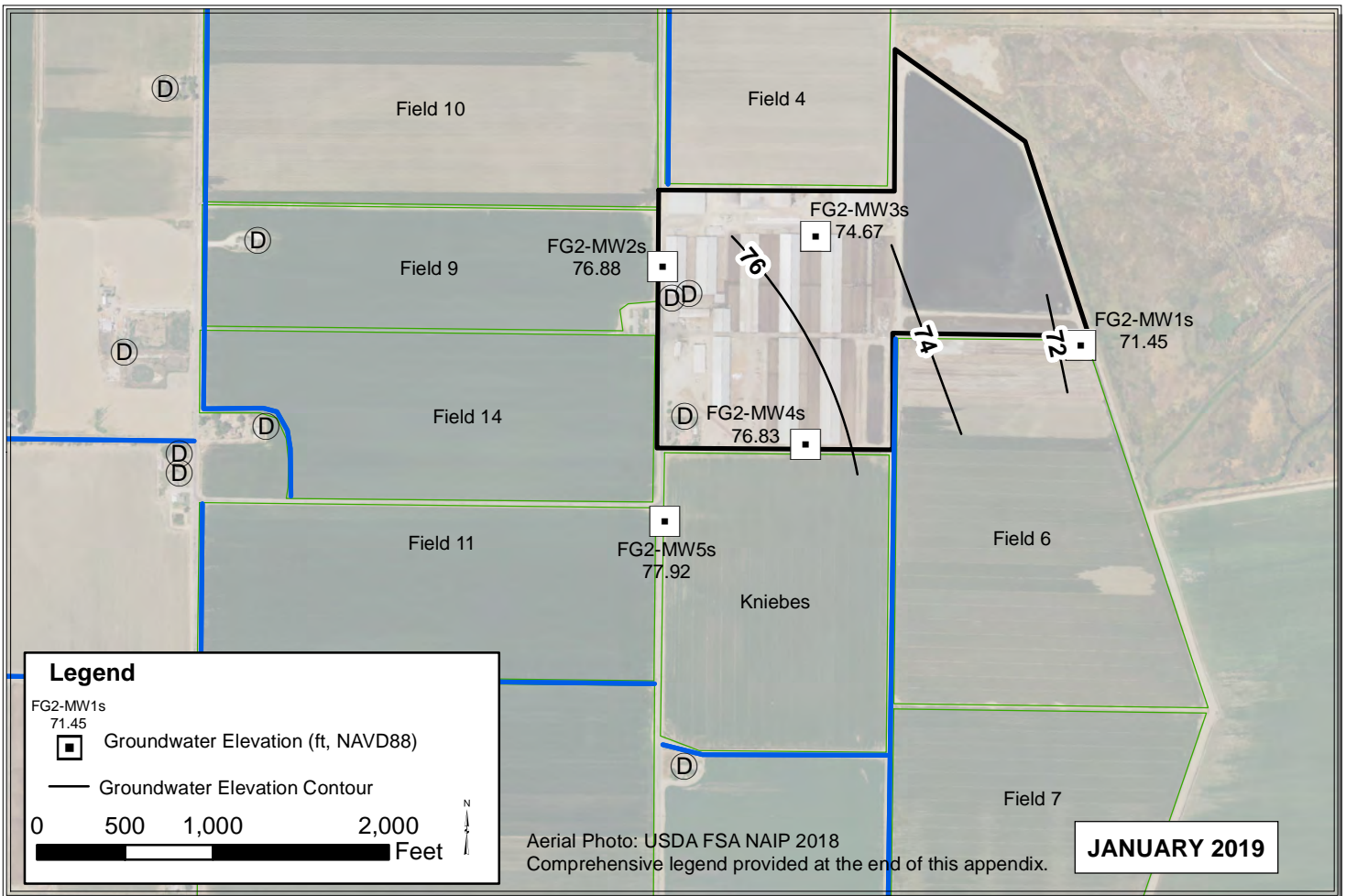

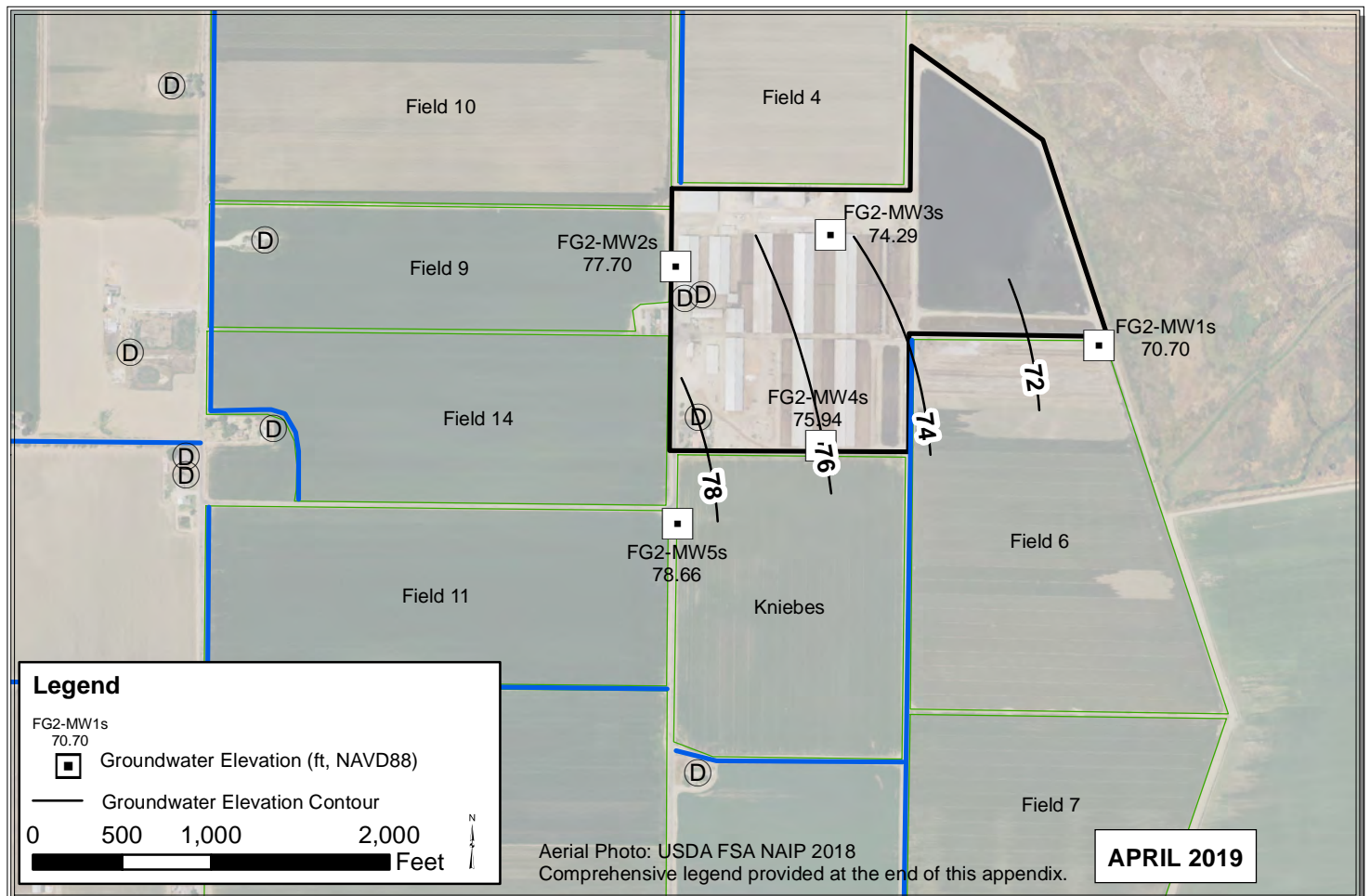
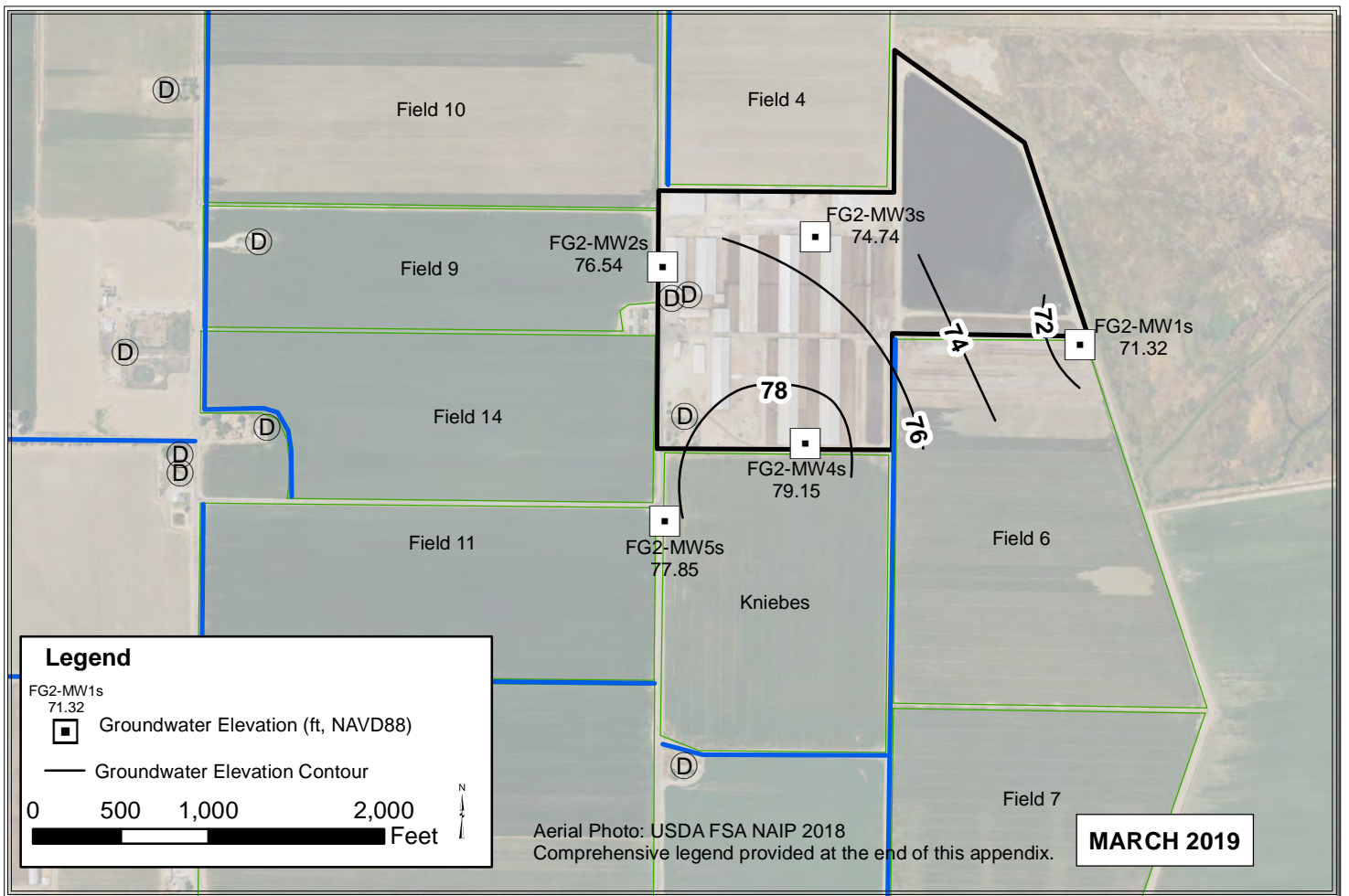

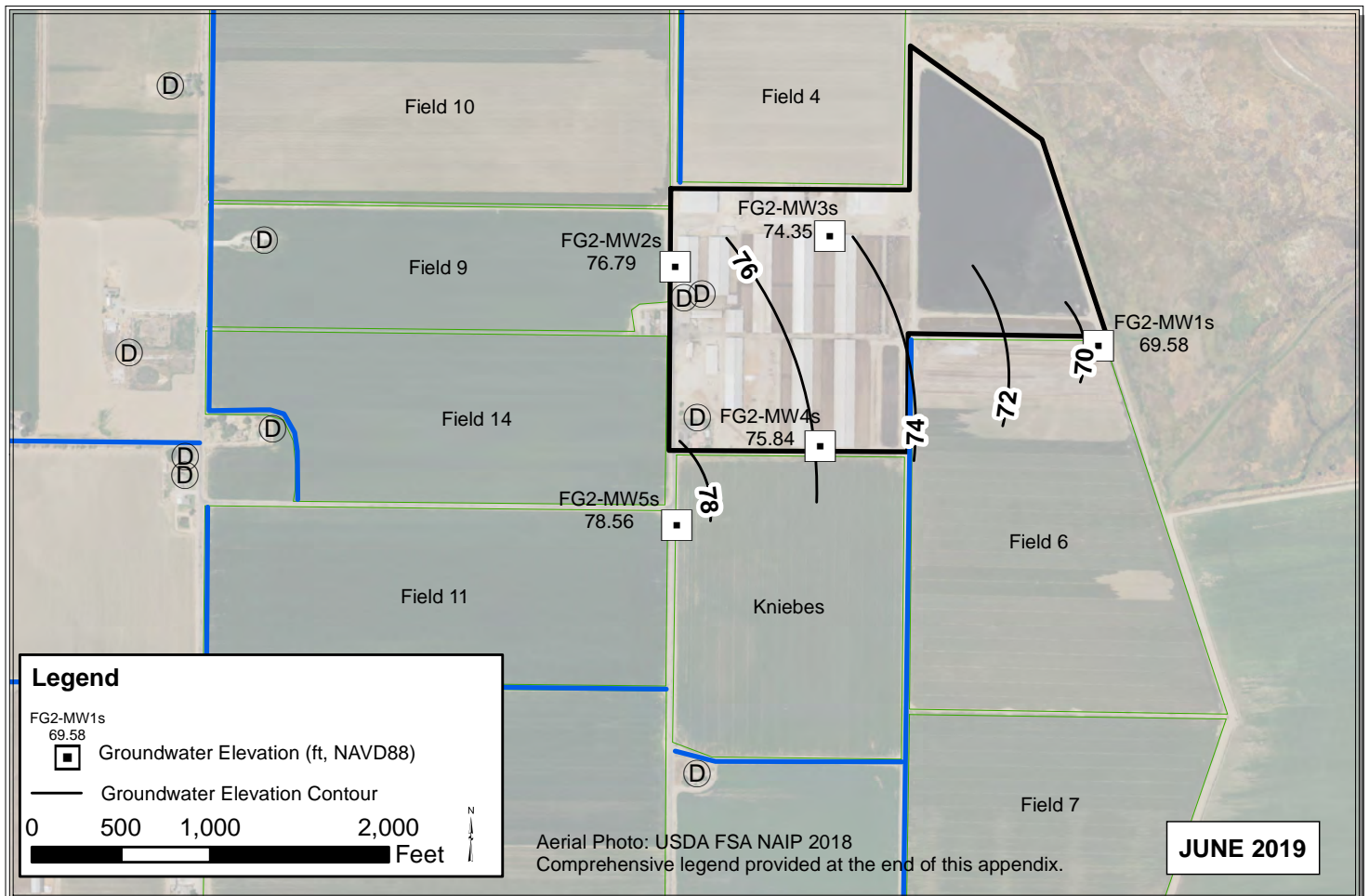
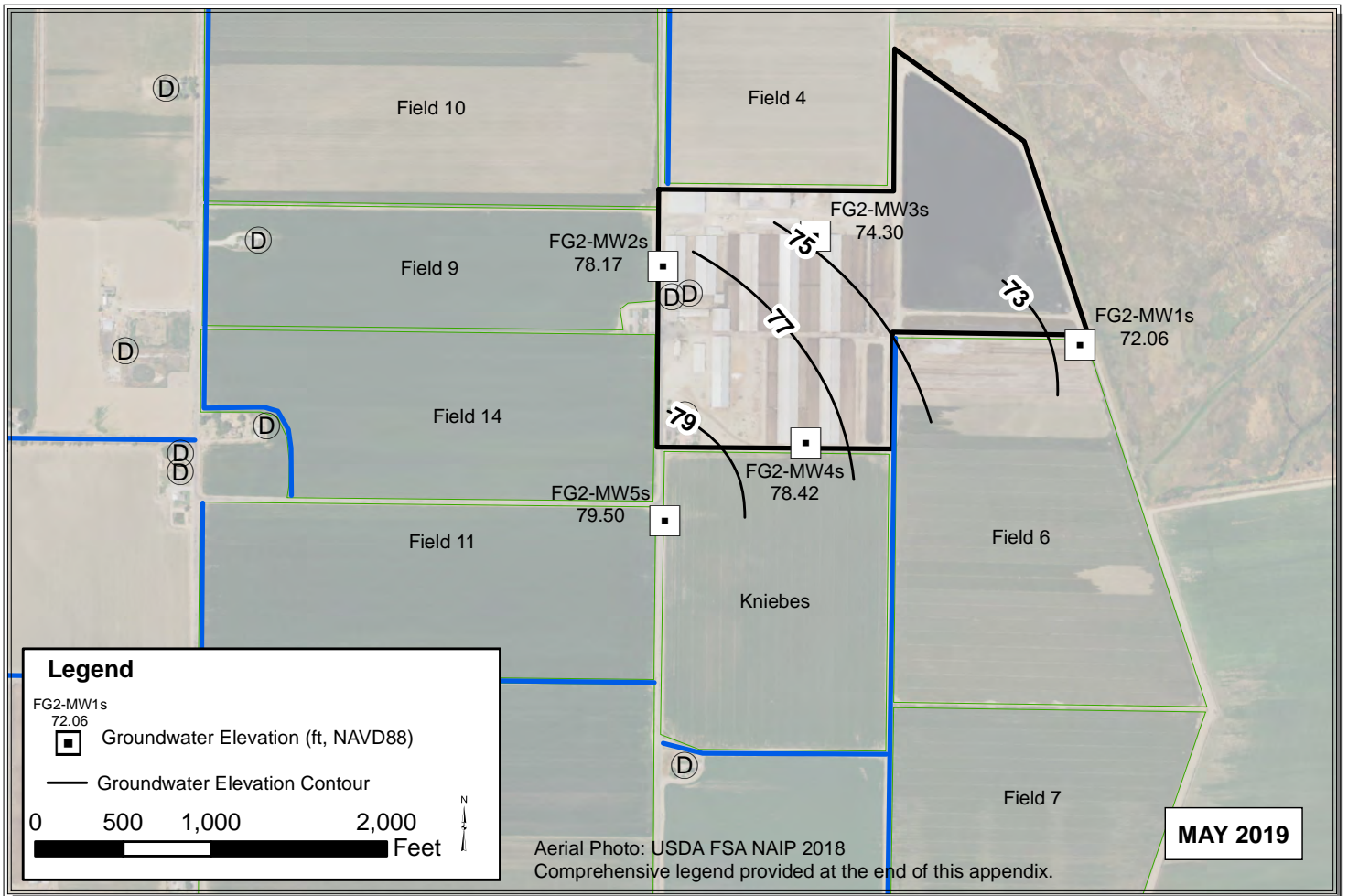

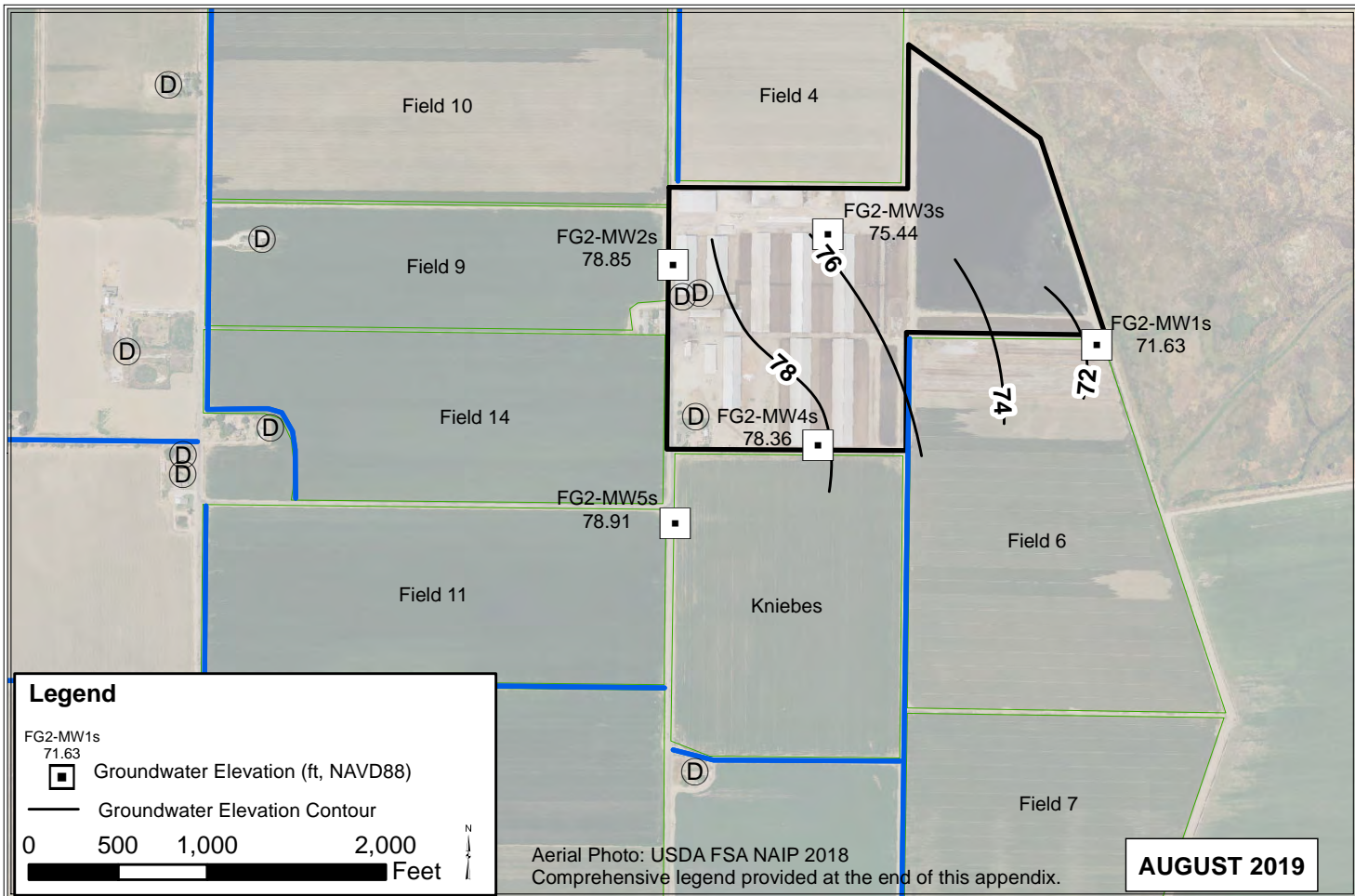
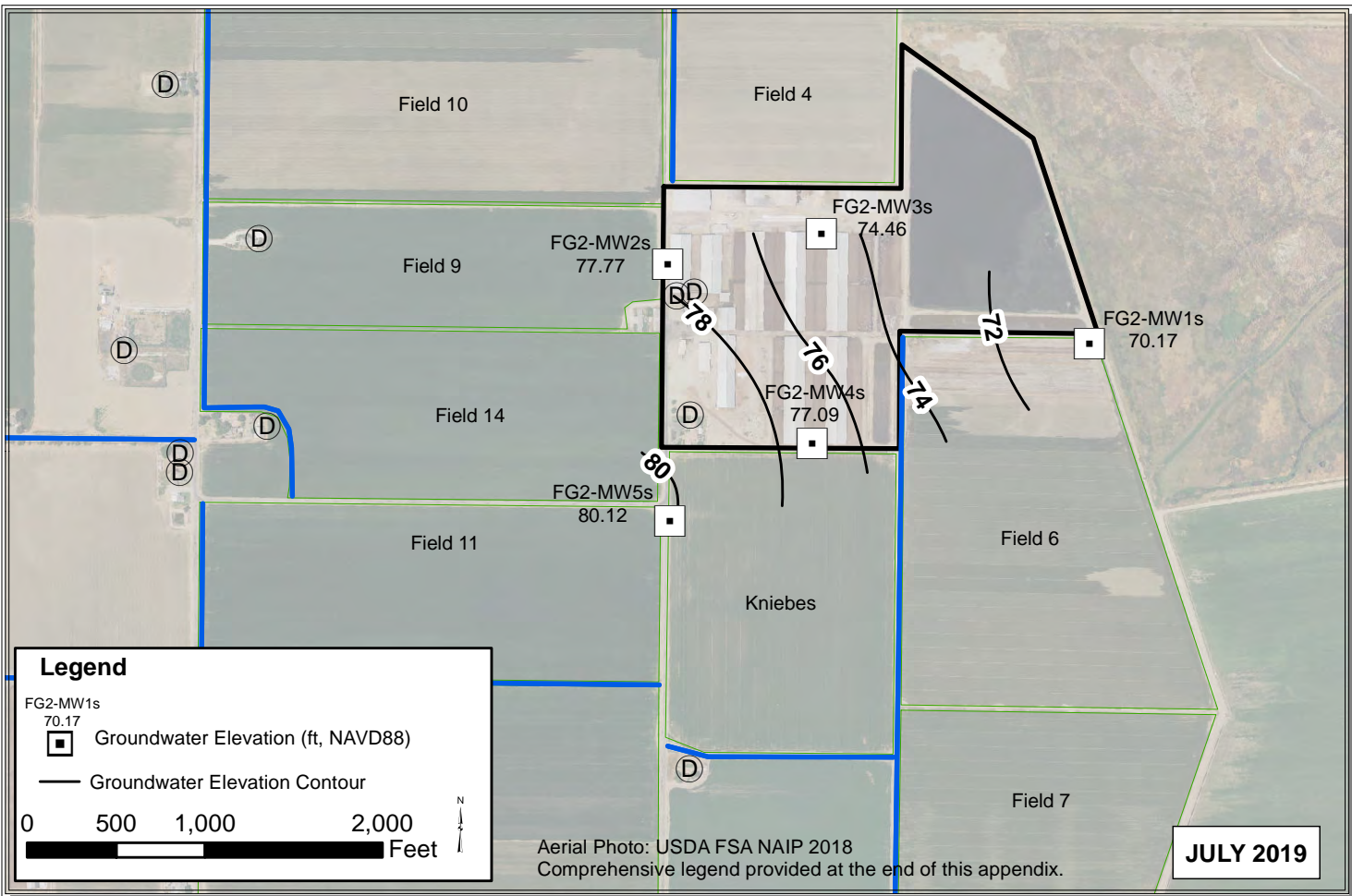

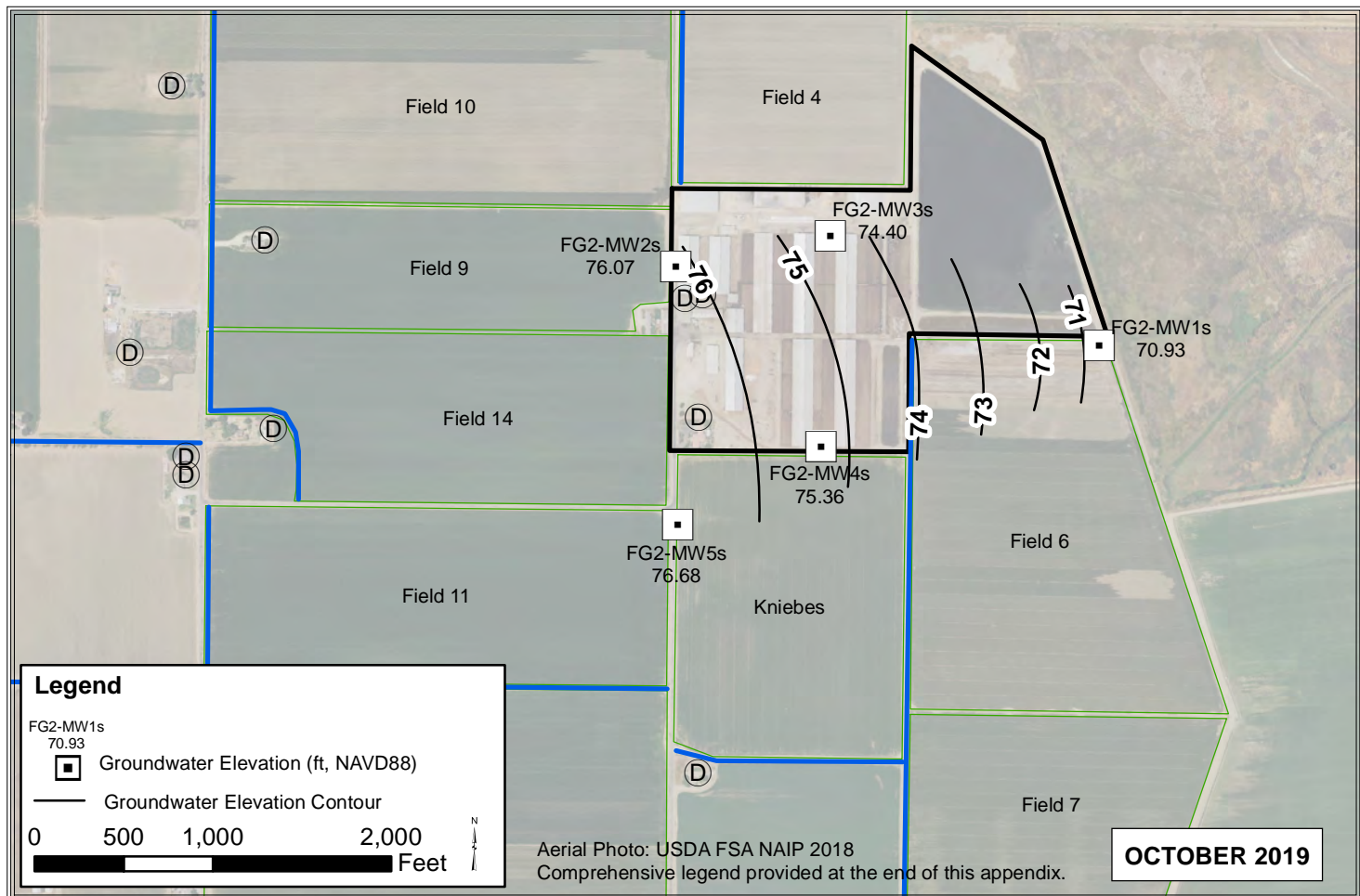
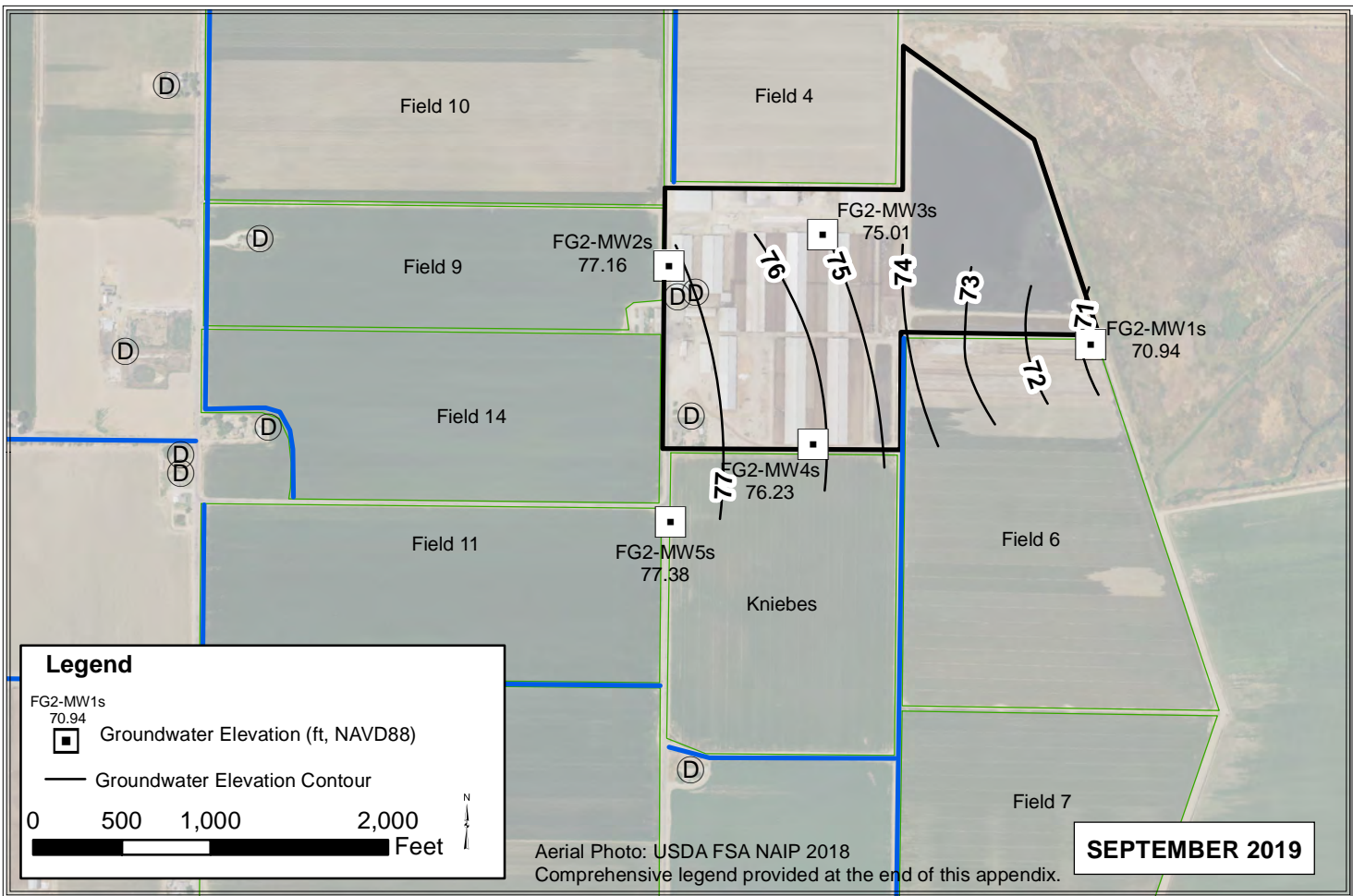

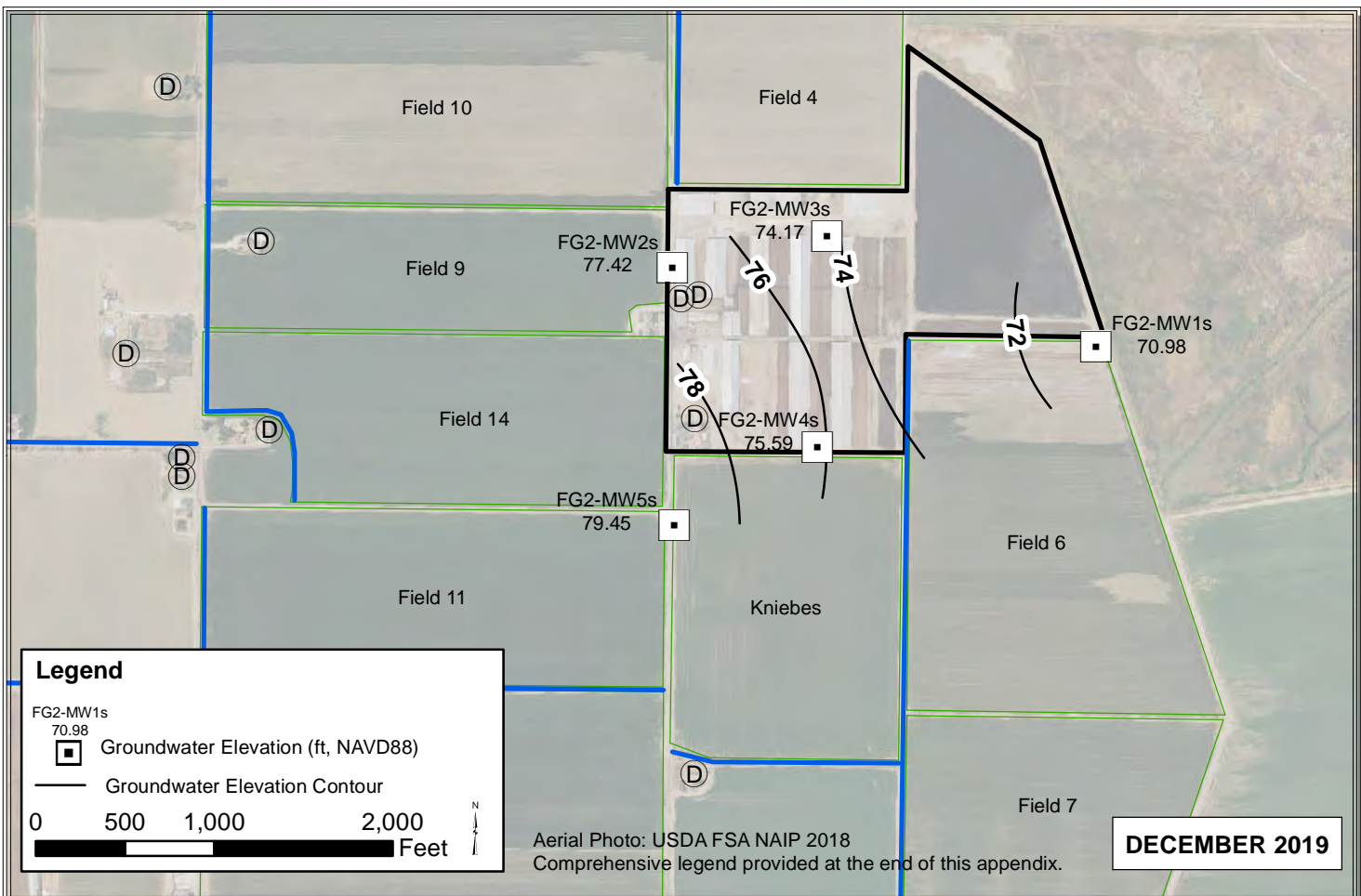
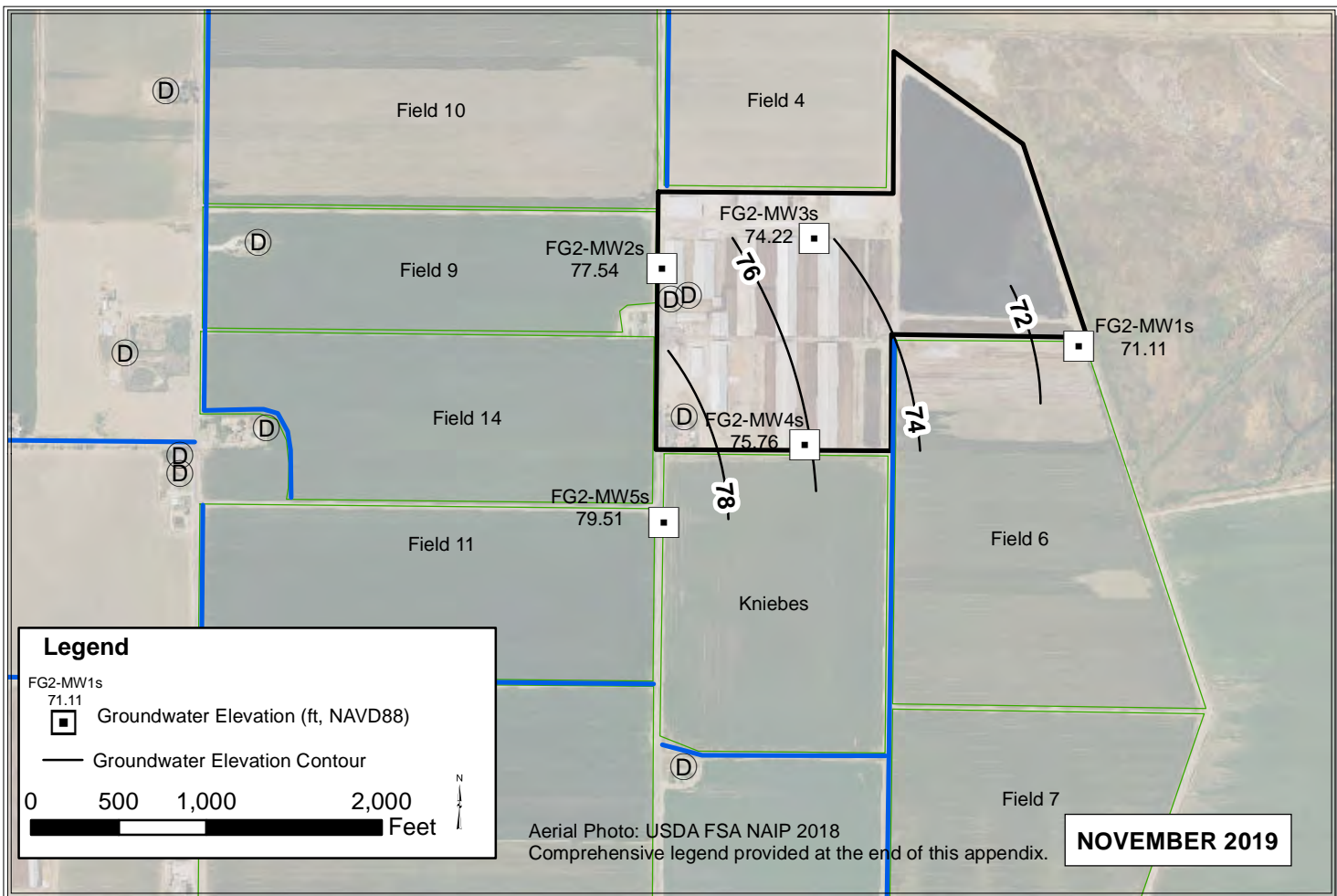

GOD

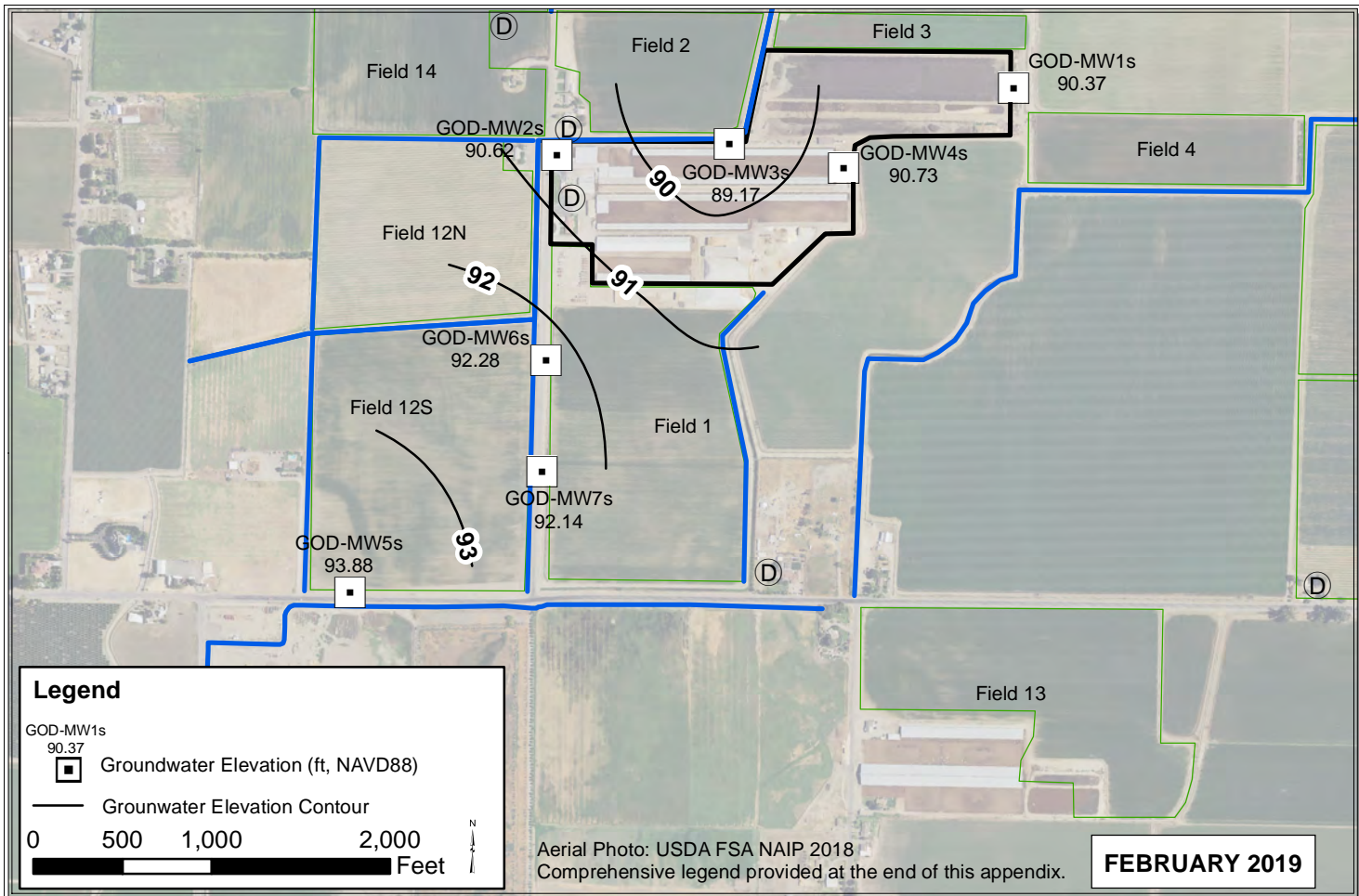
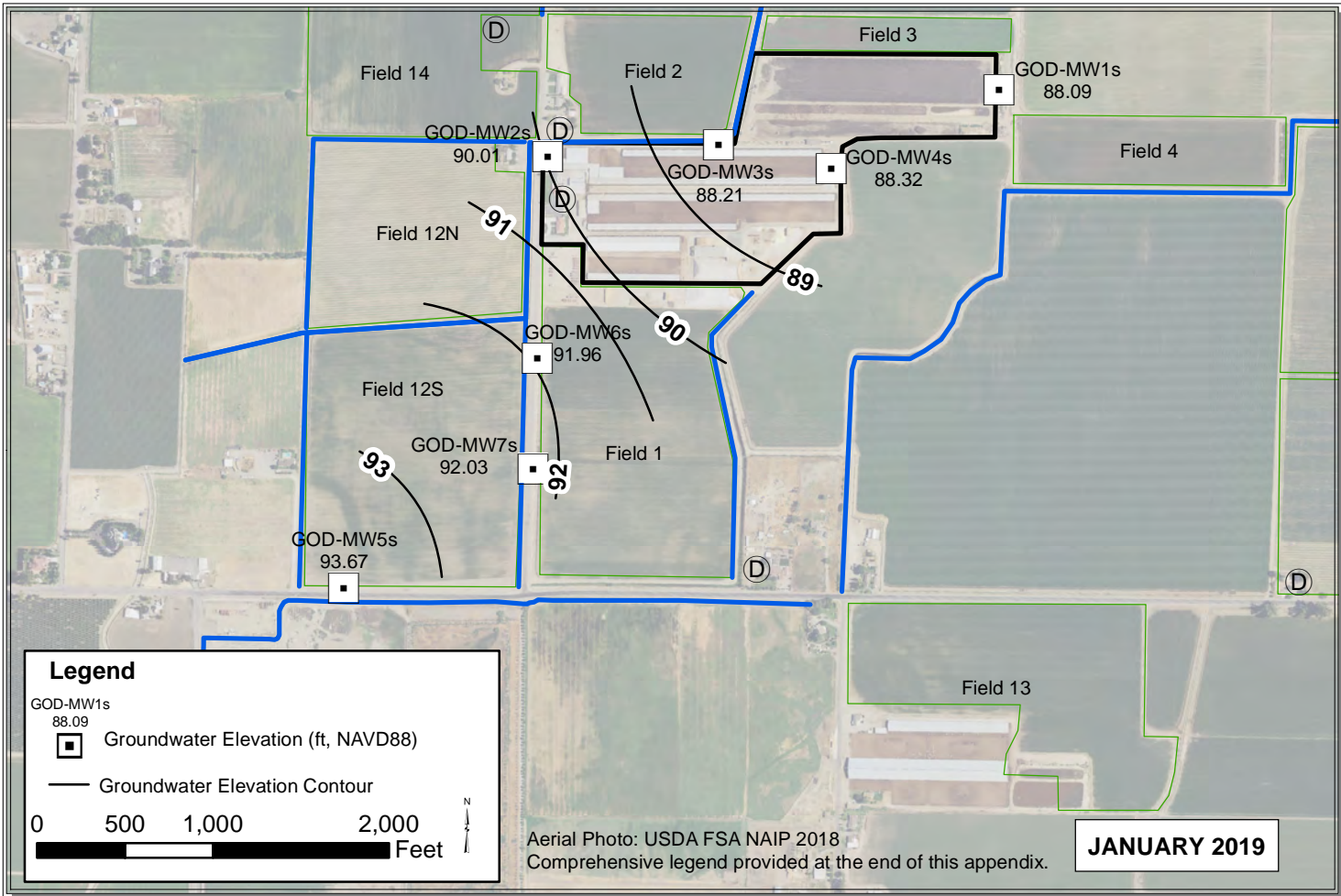

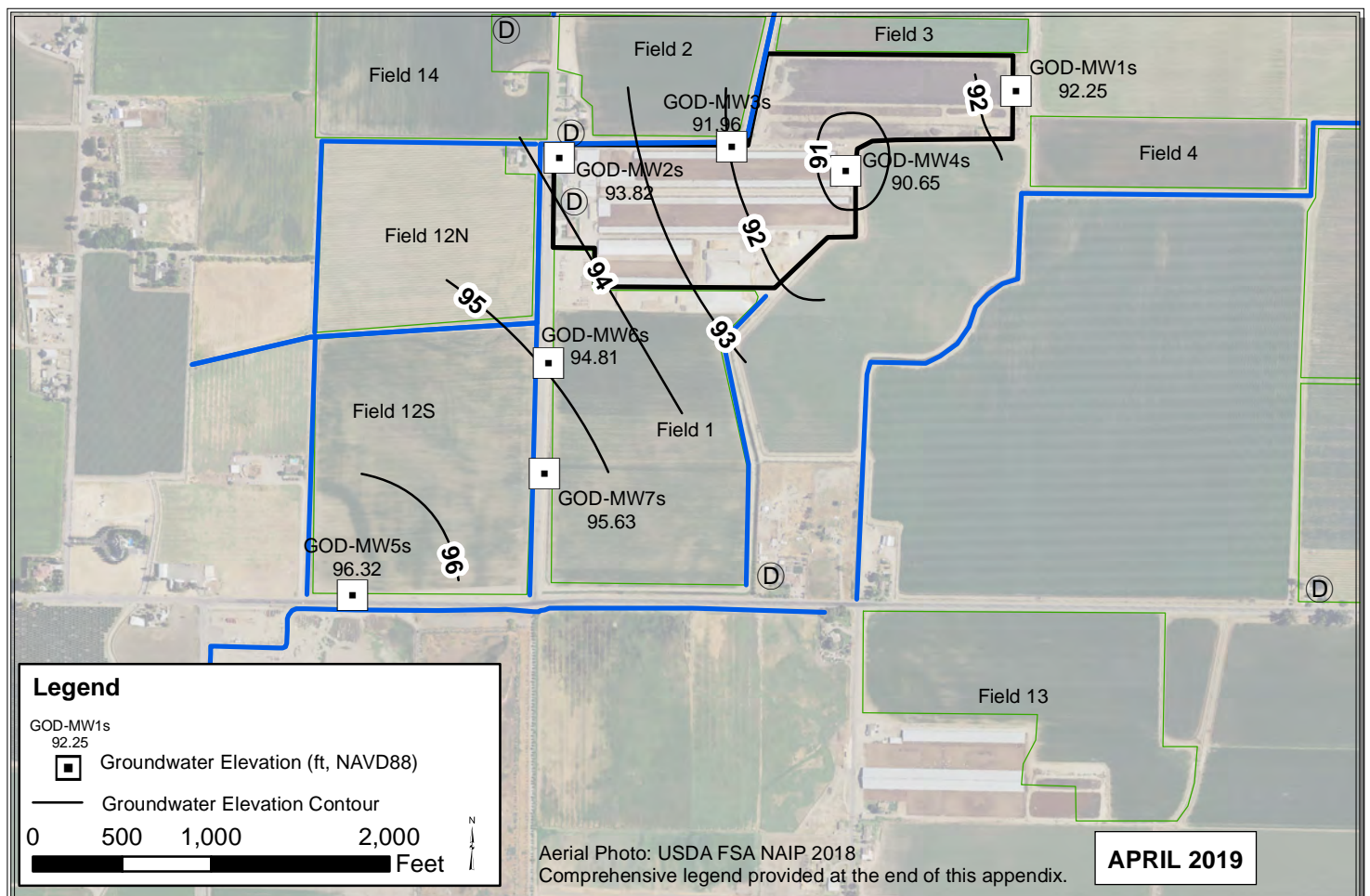
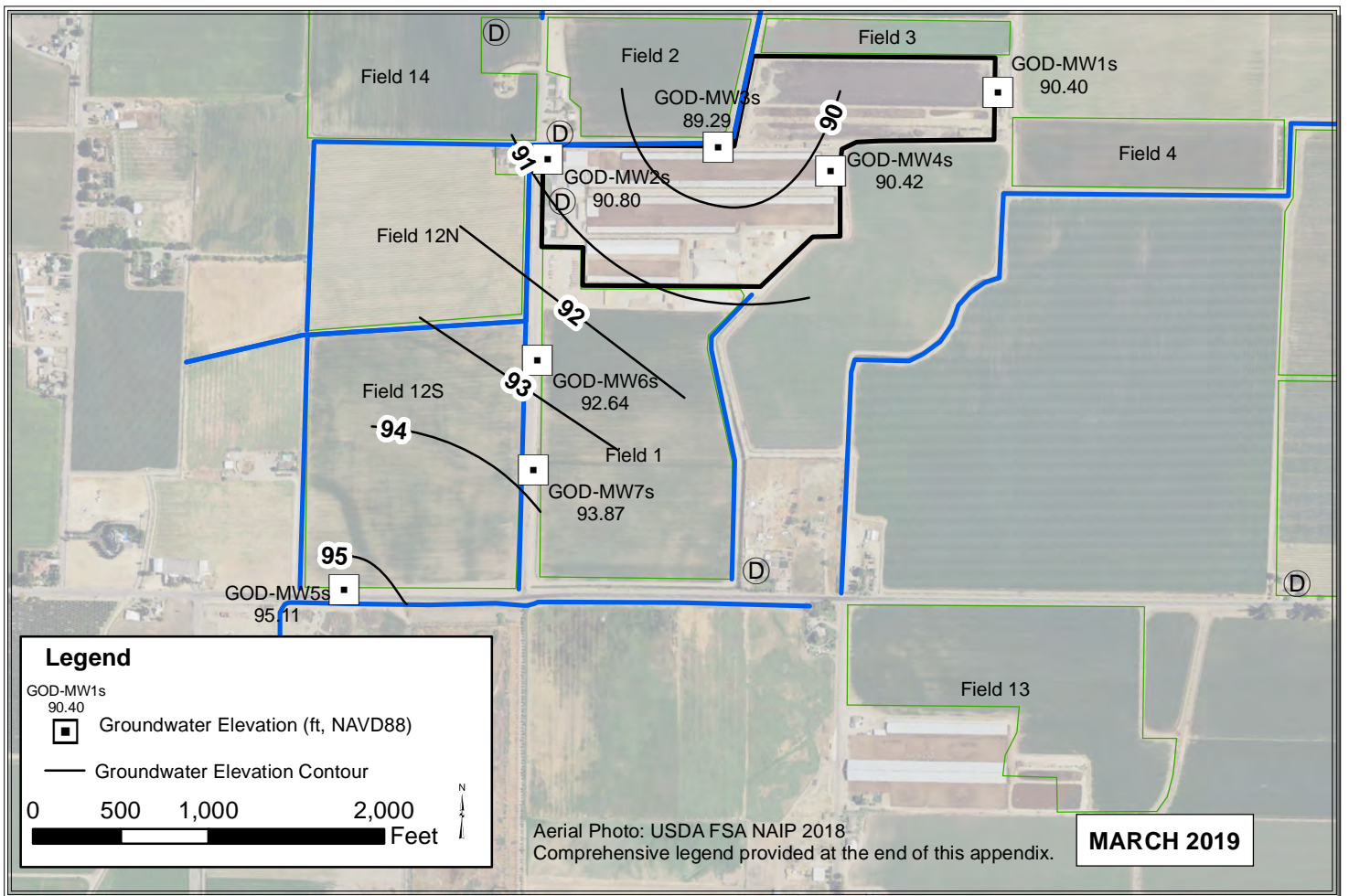

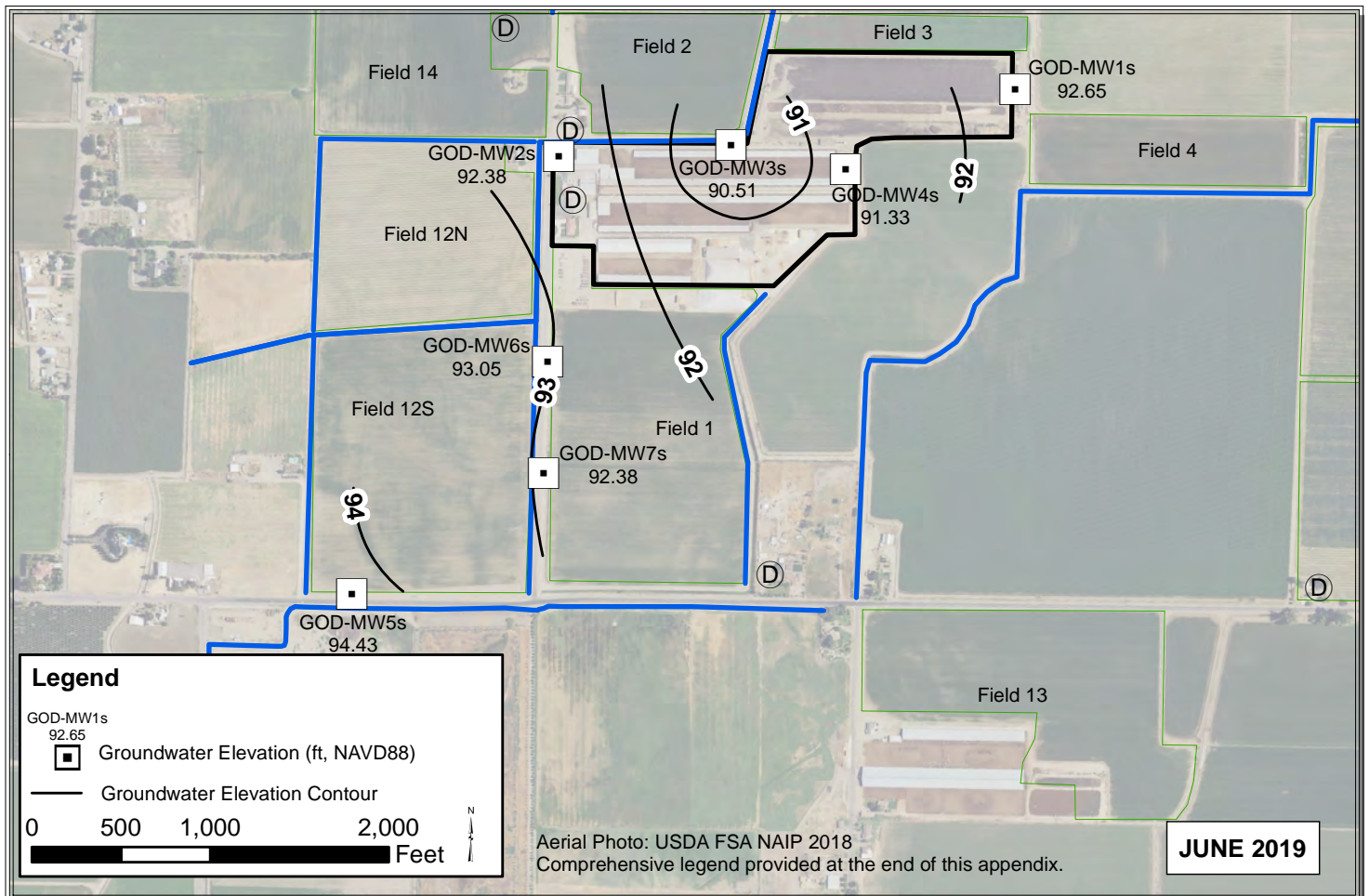
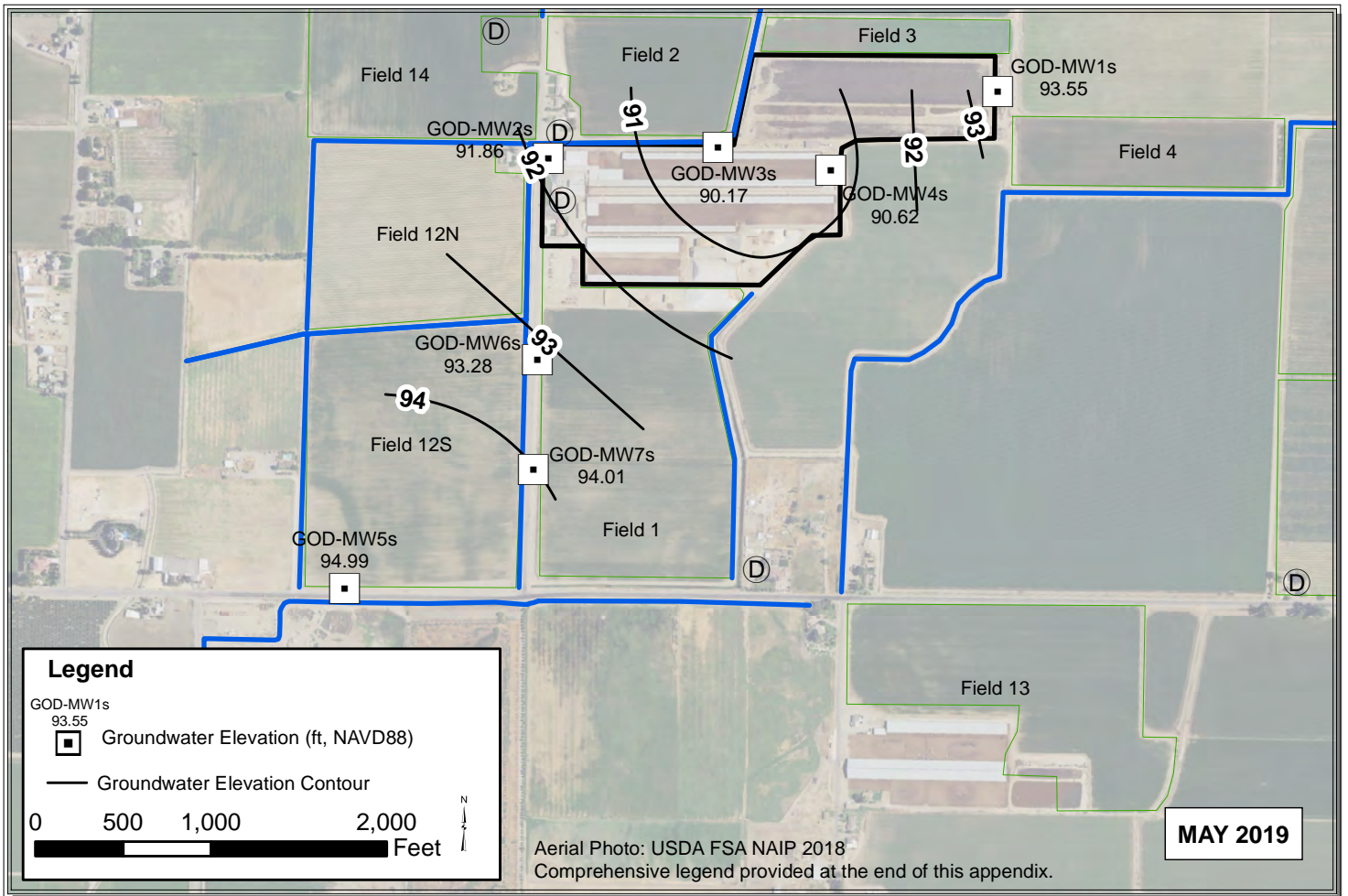

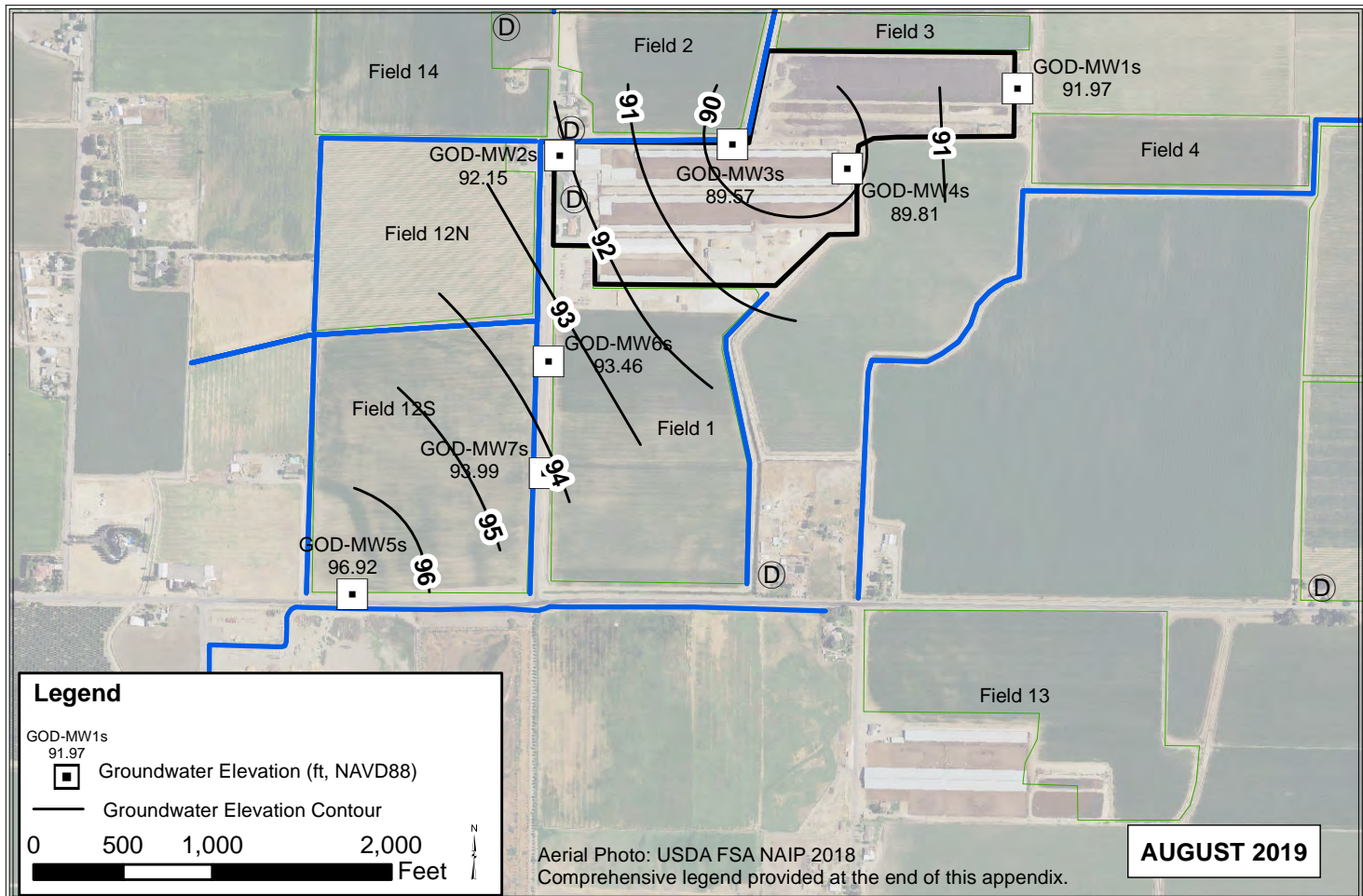
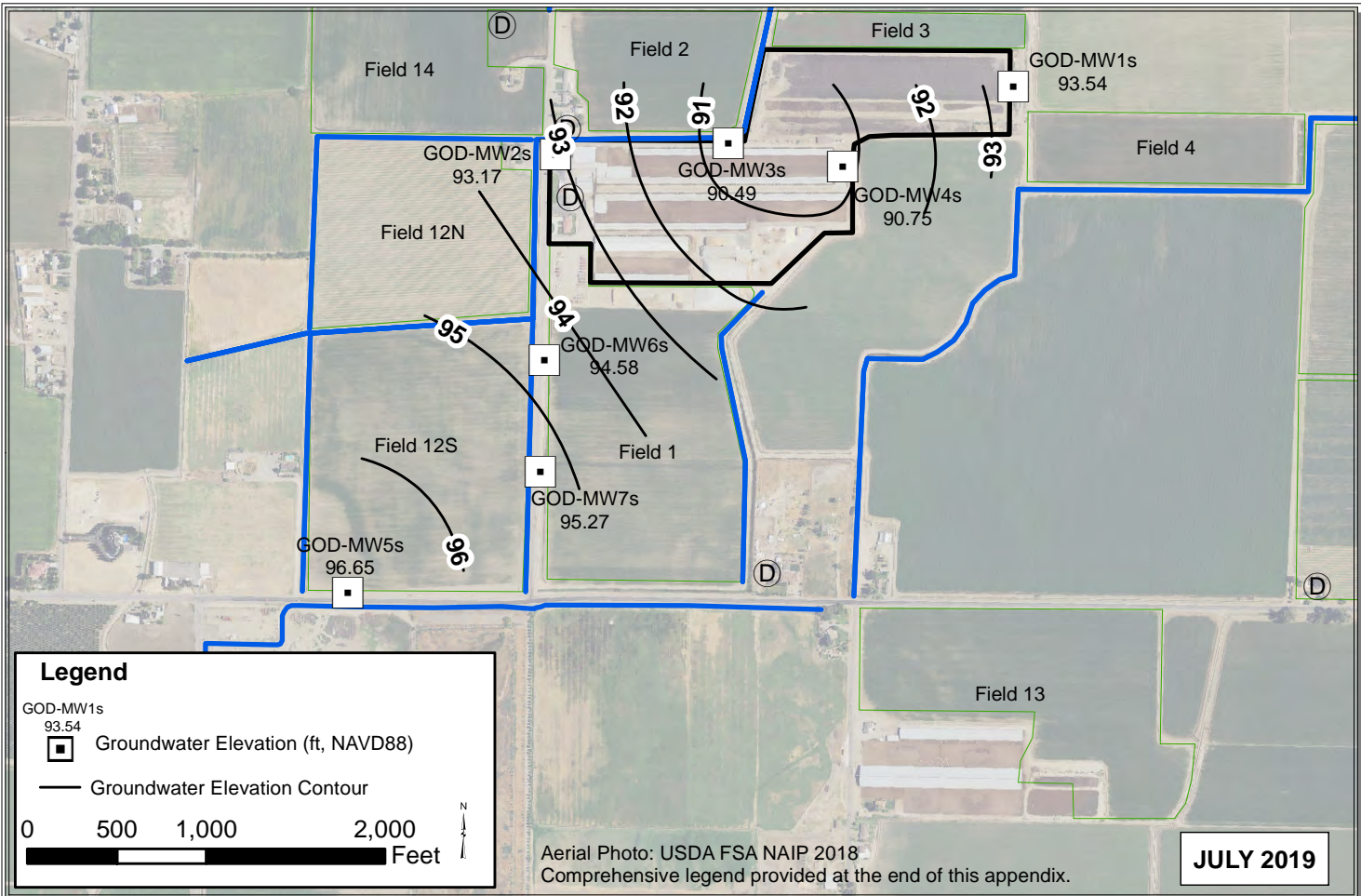

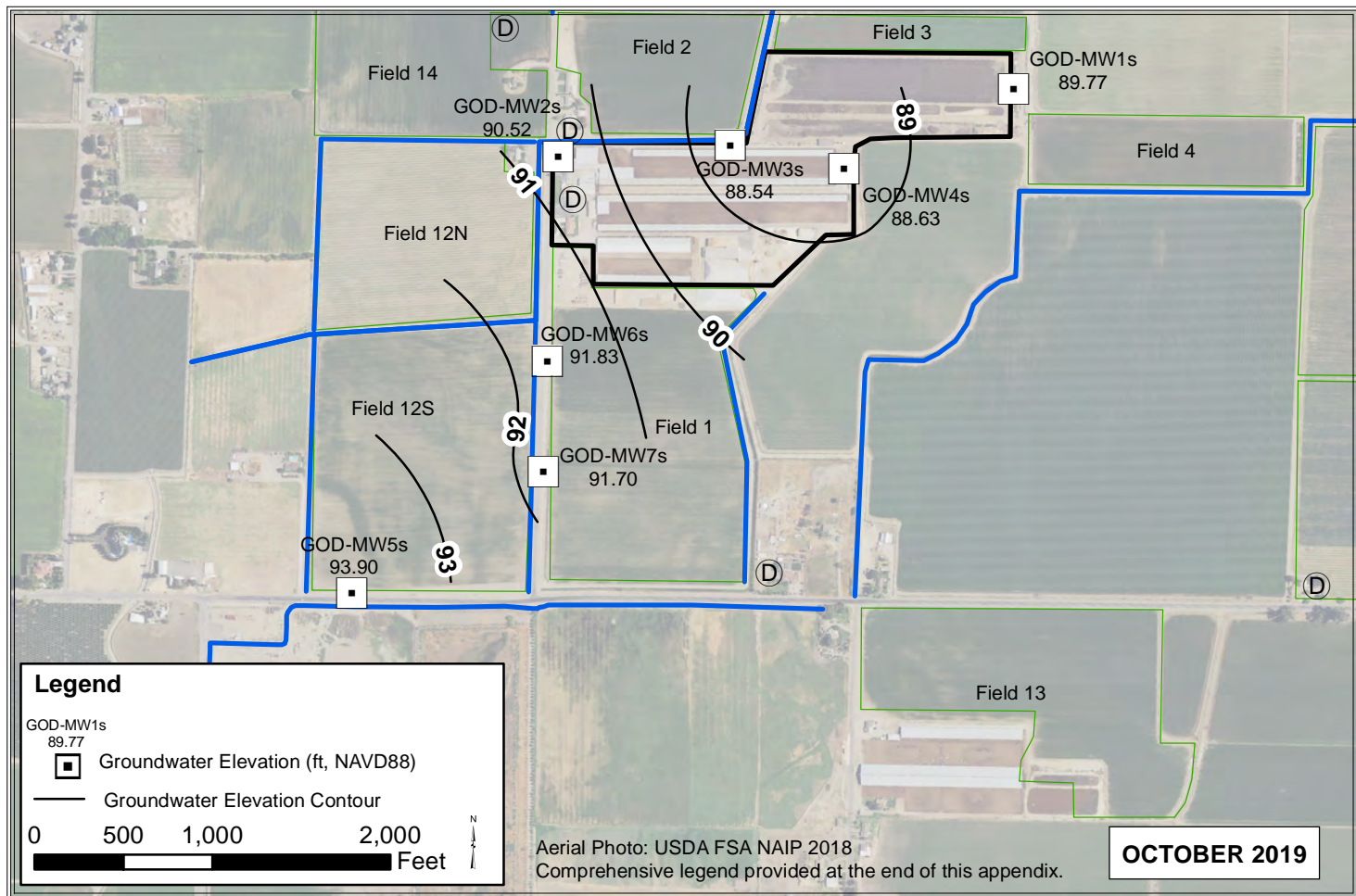
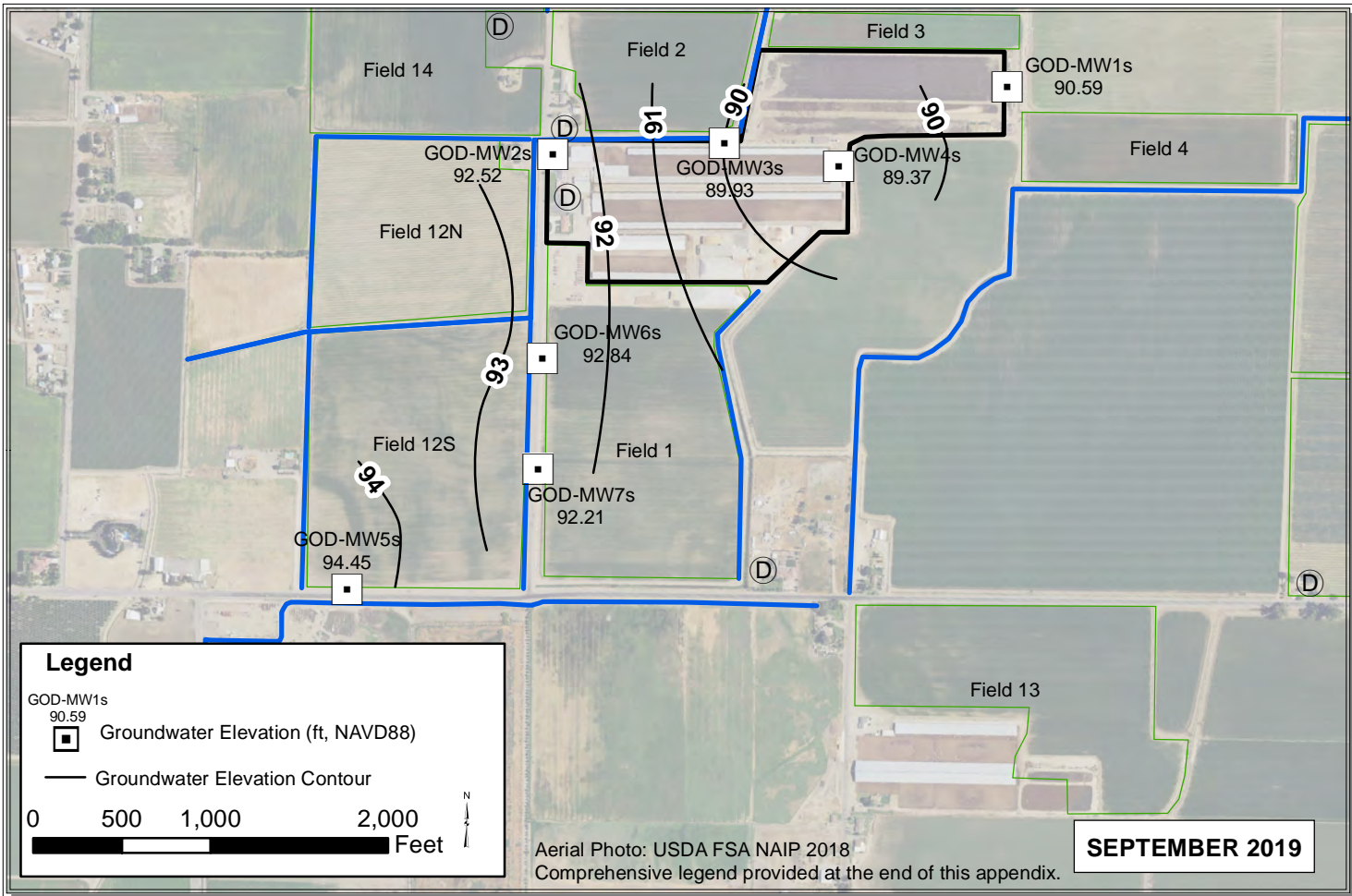

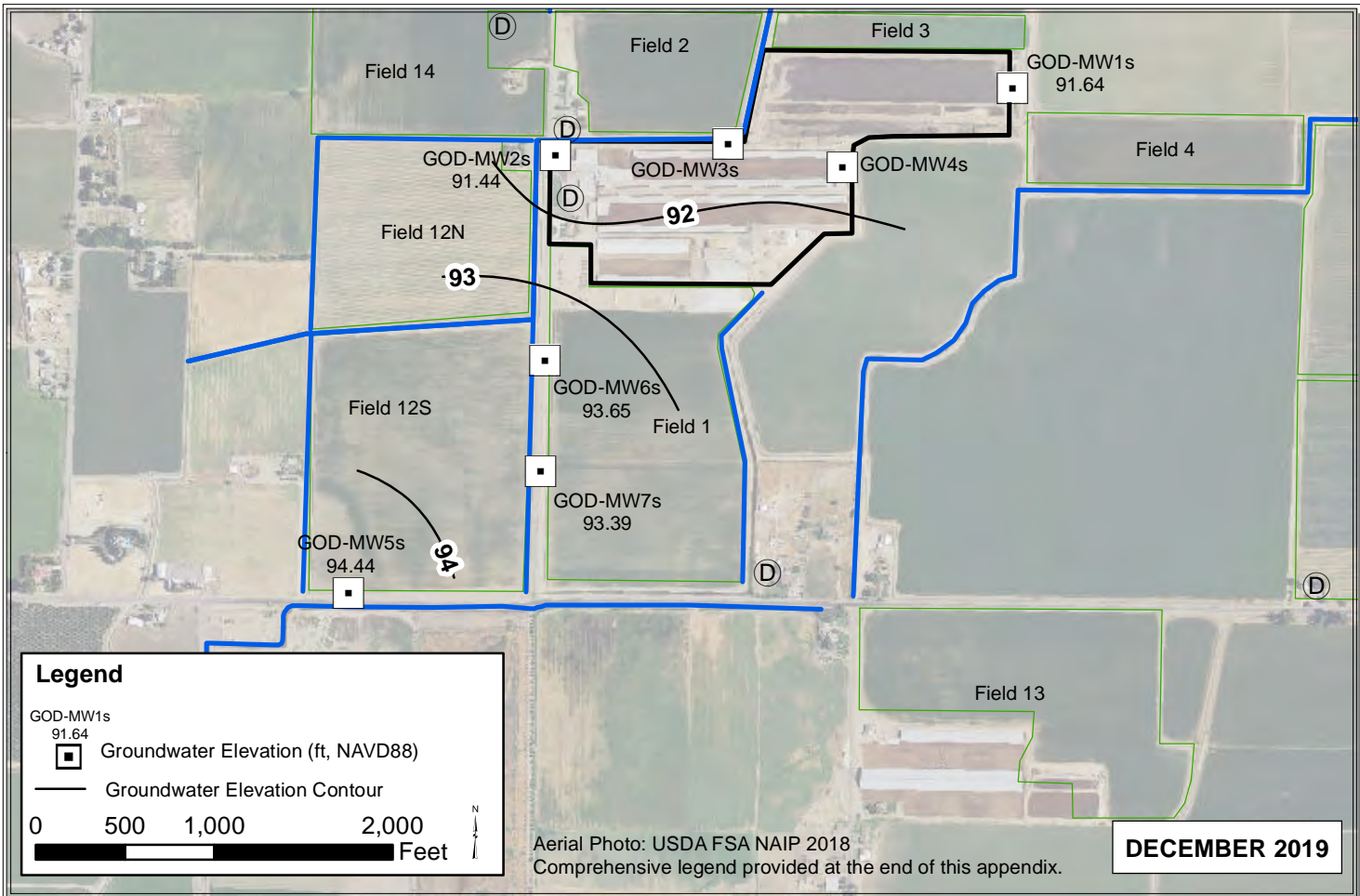
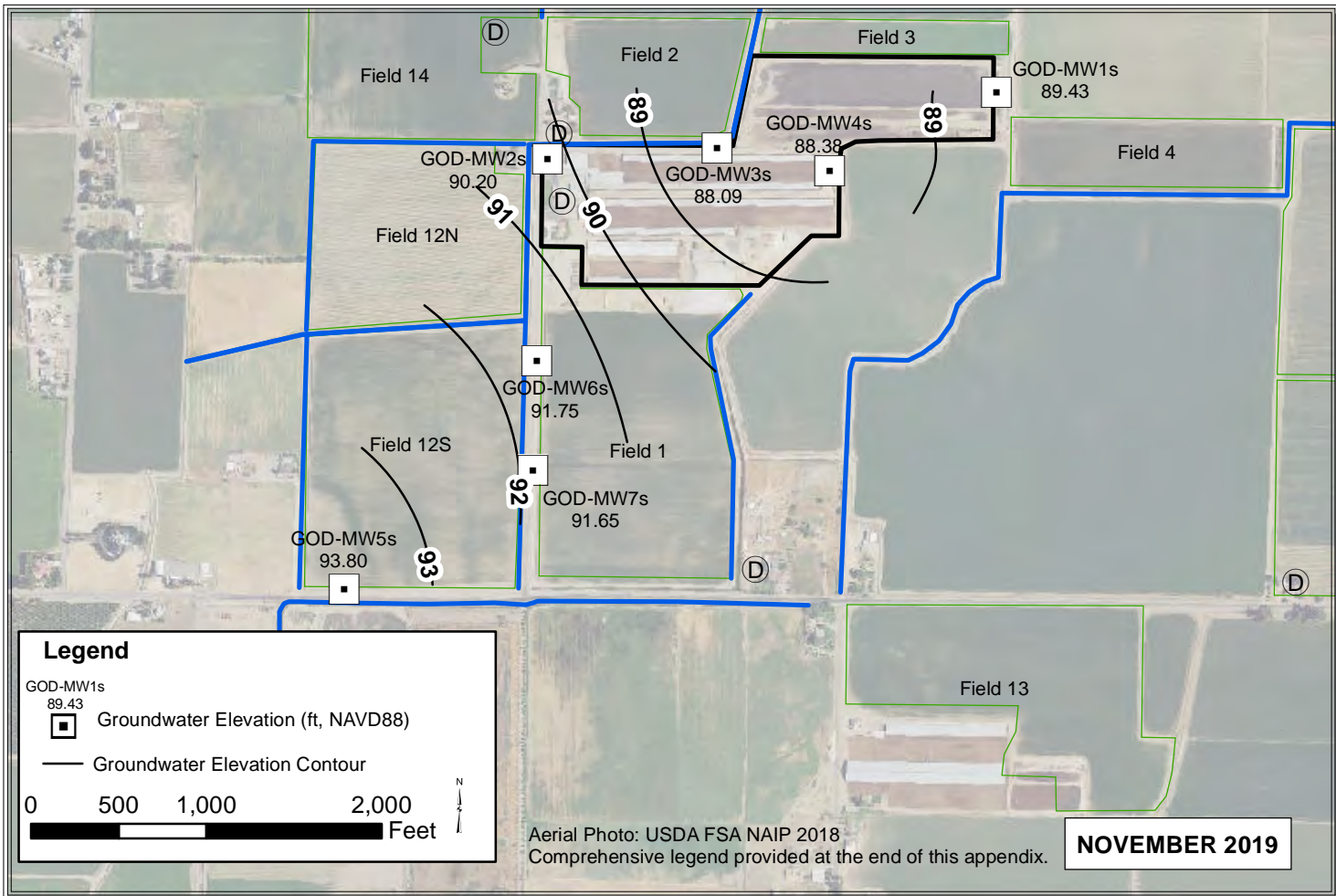

MAC and NUN

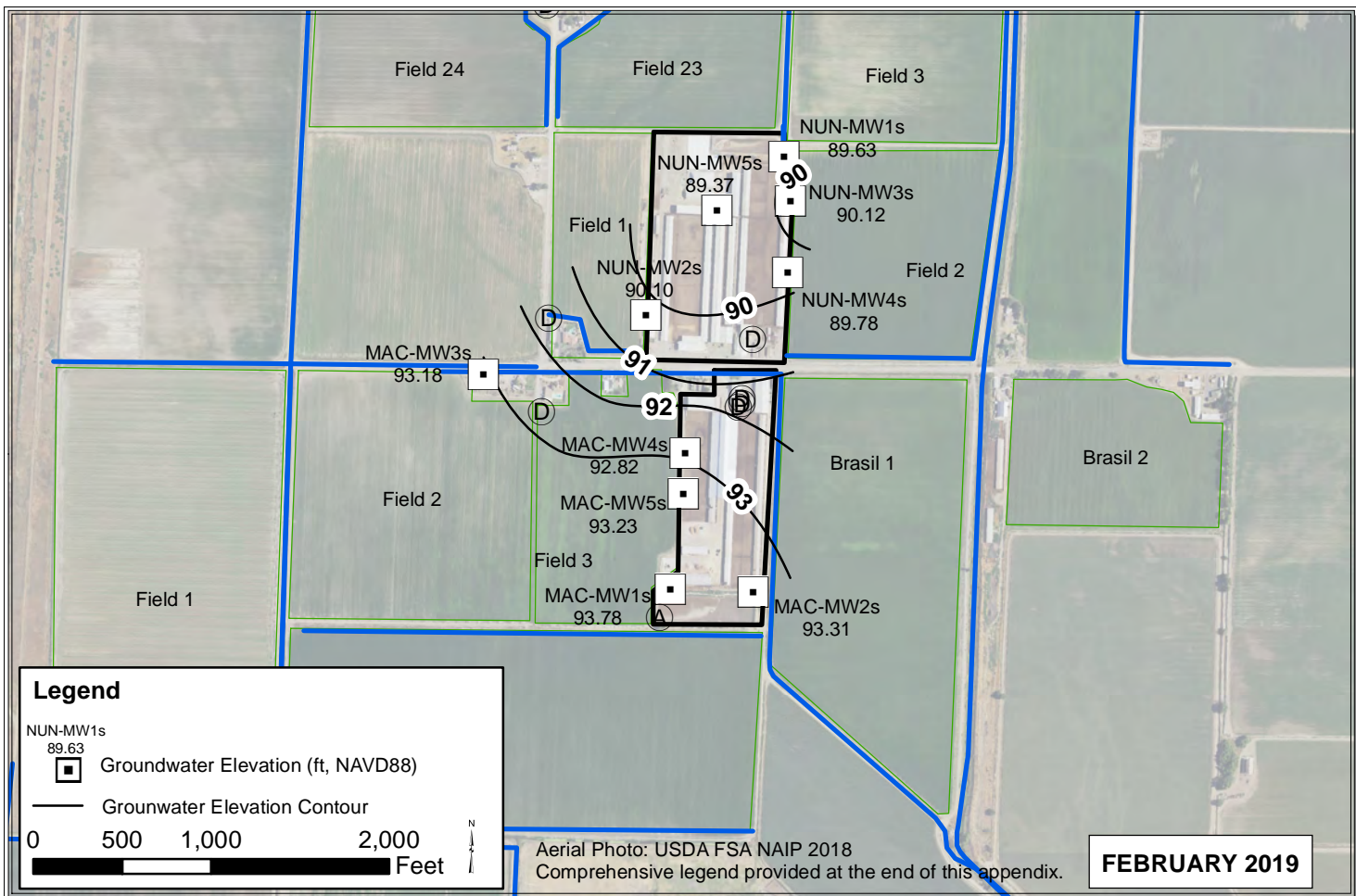
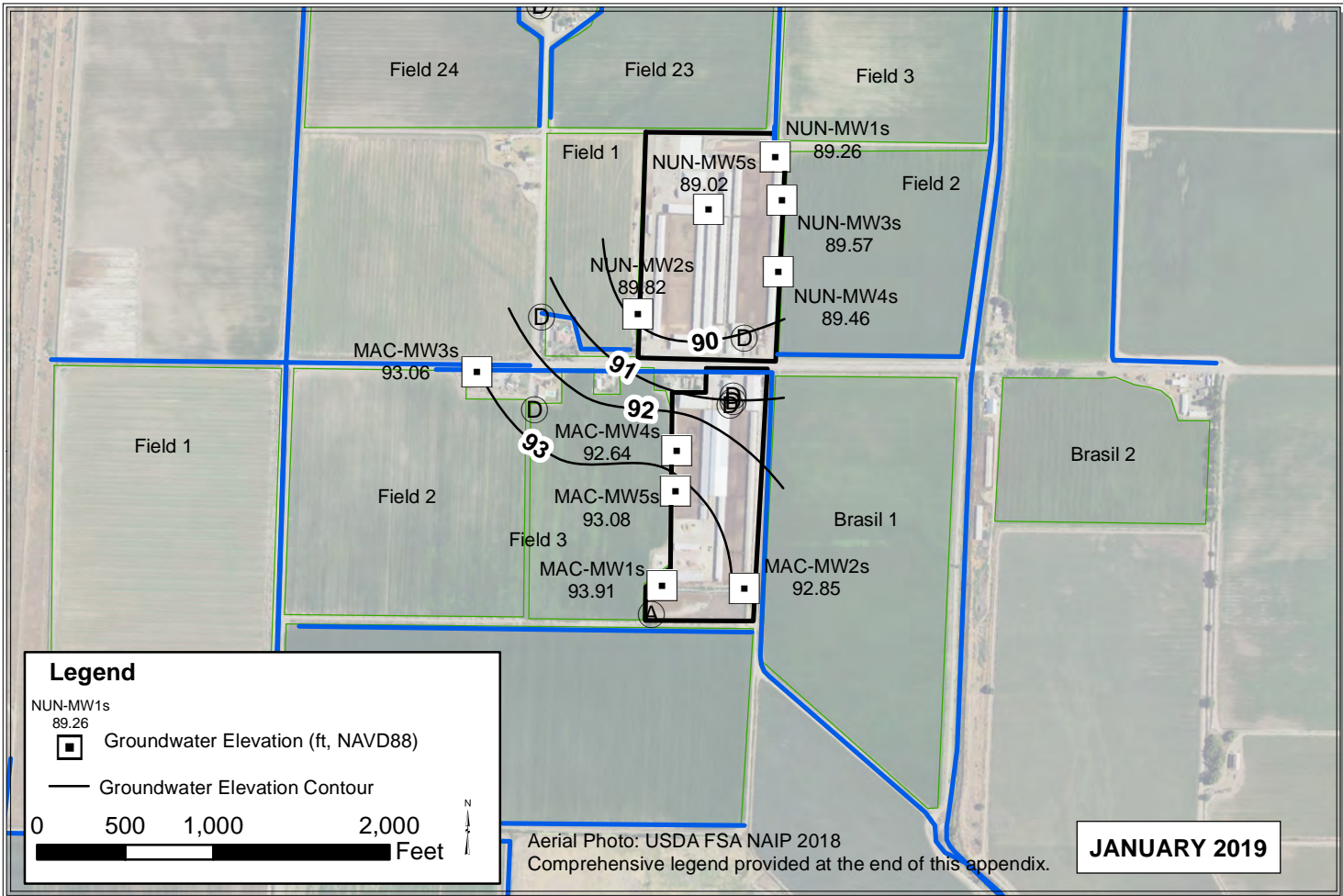

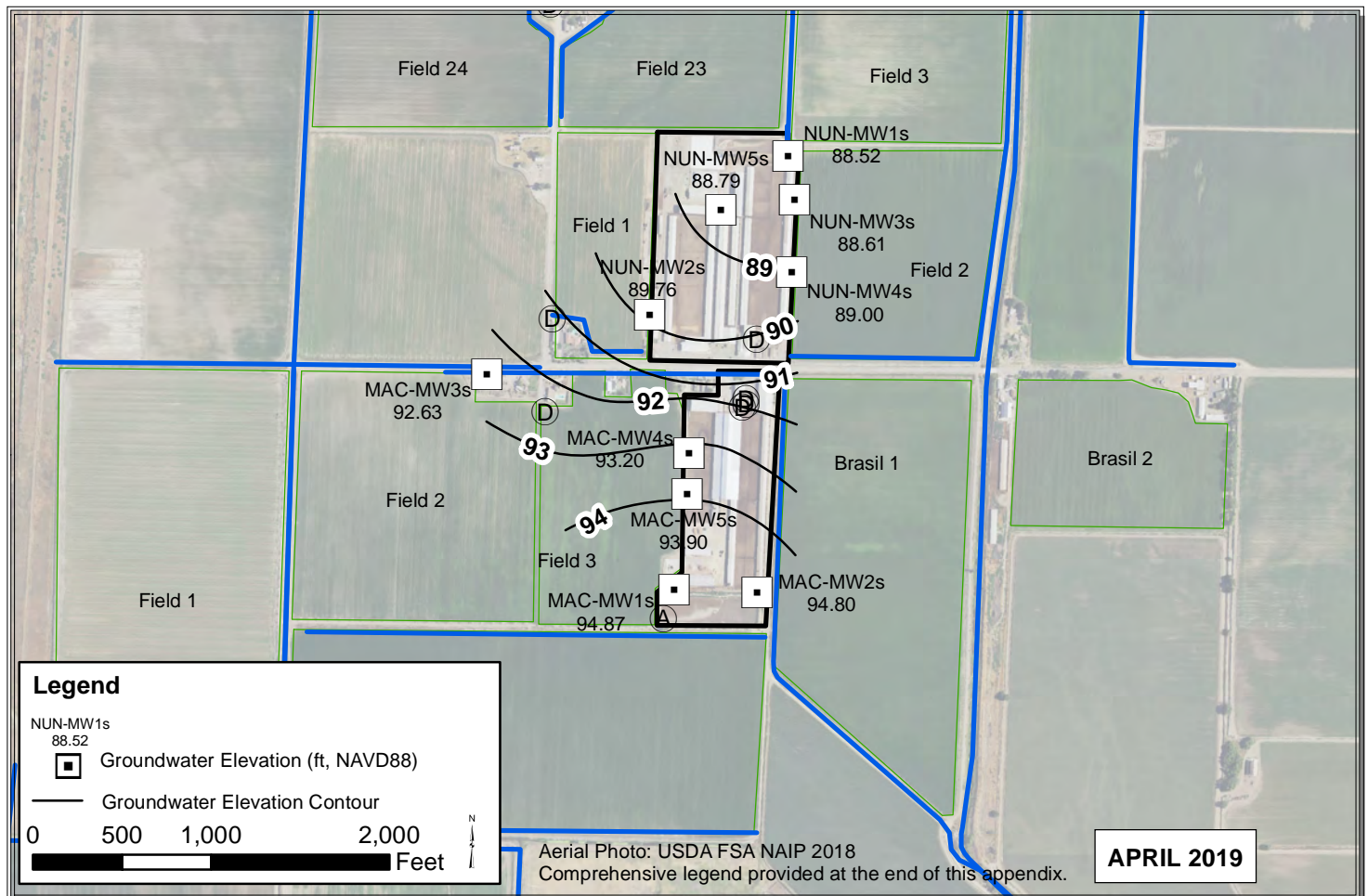
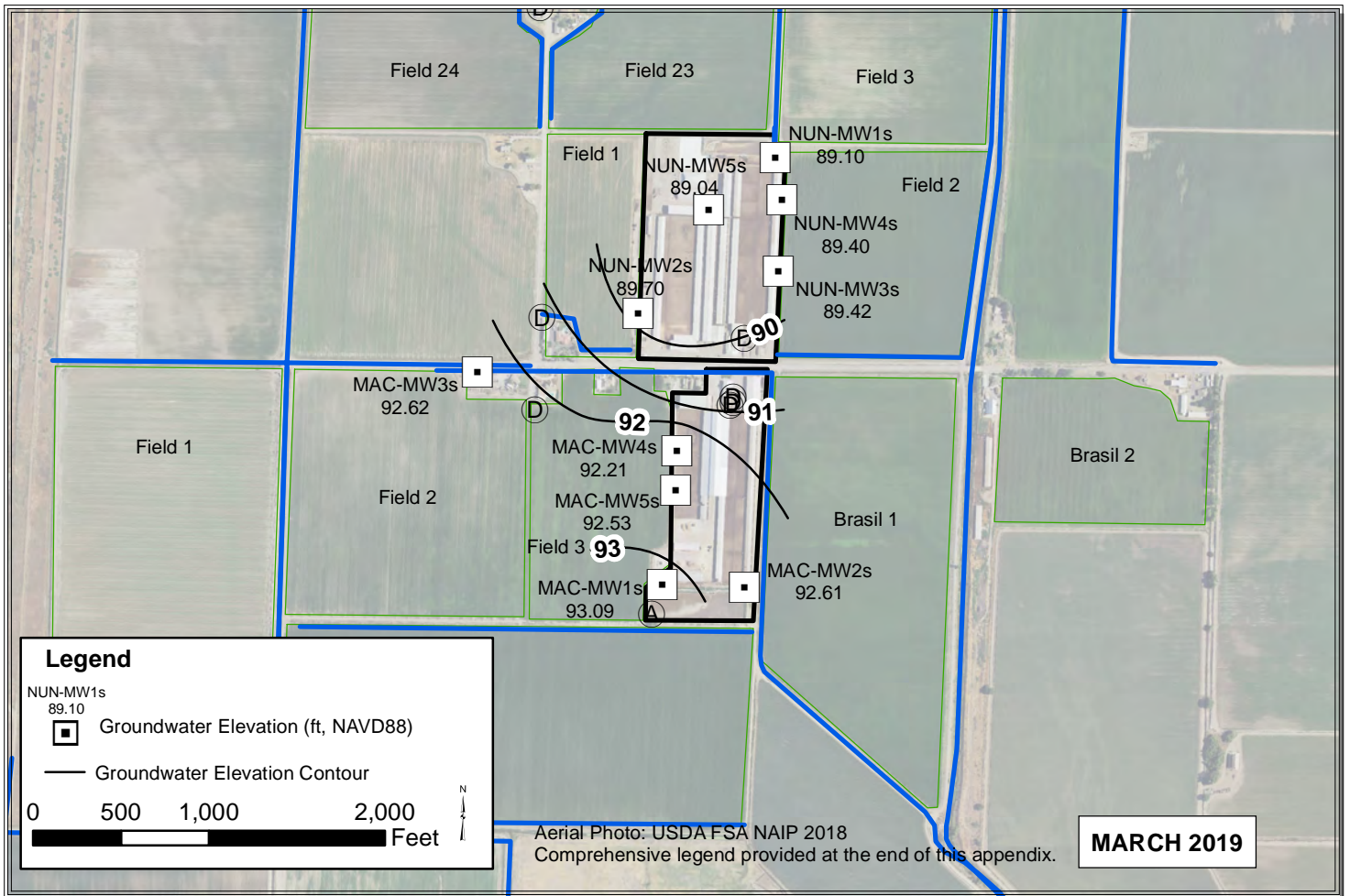

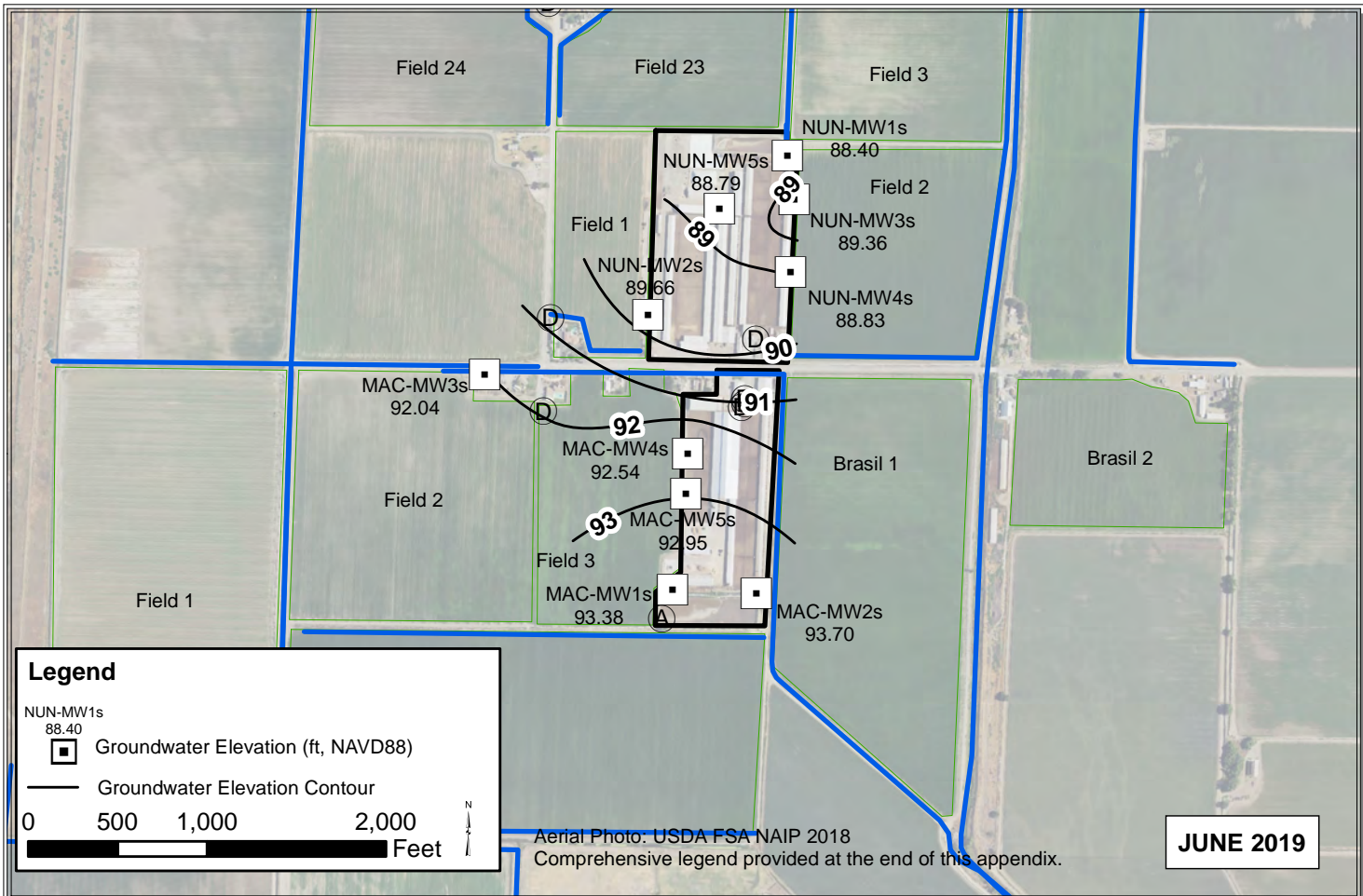
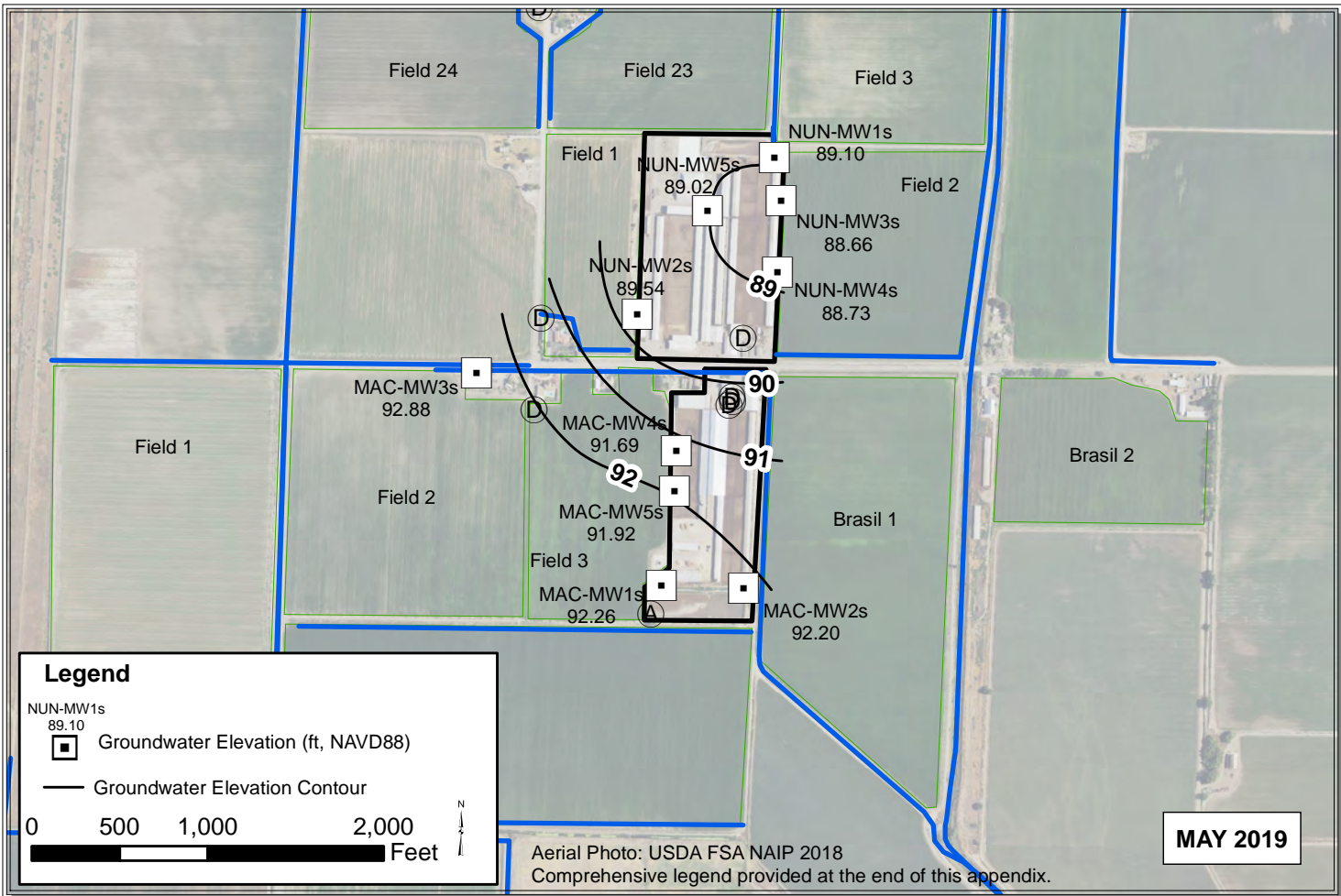

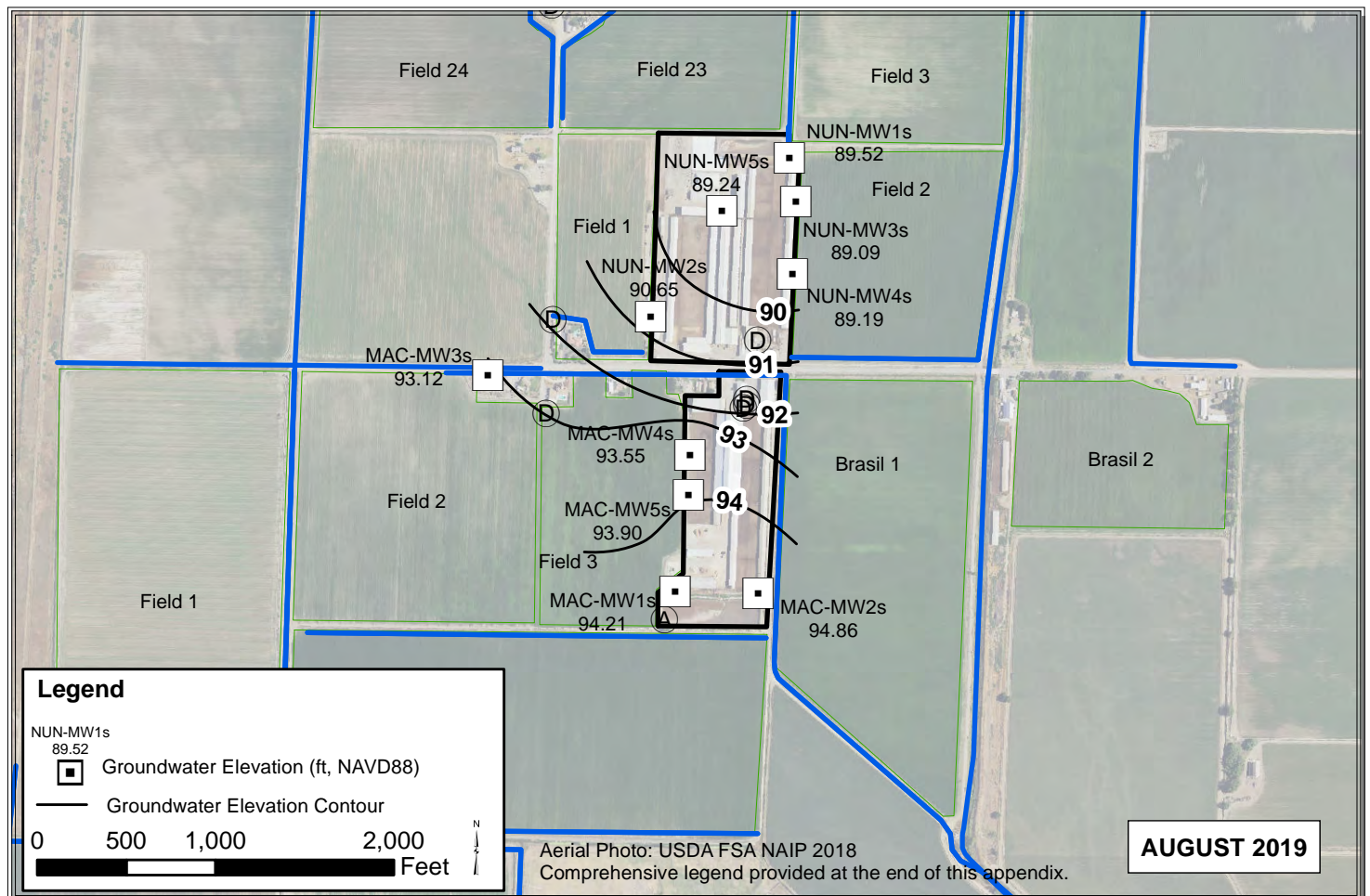
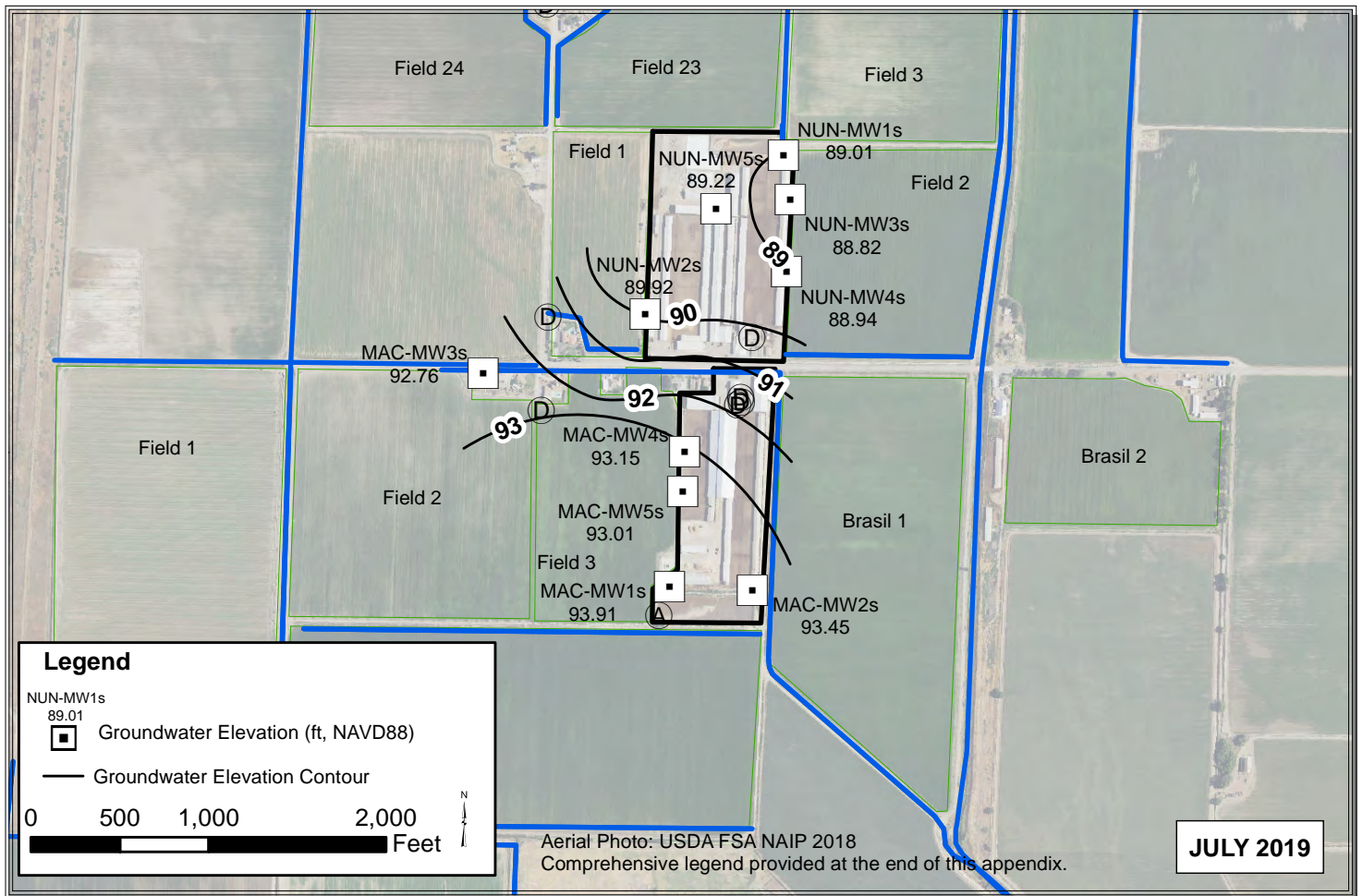

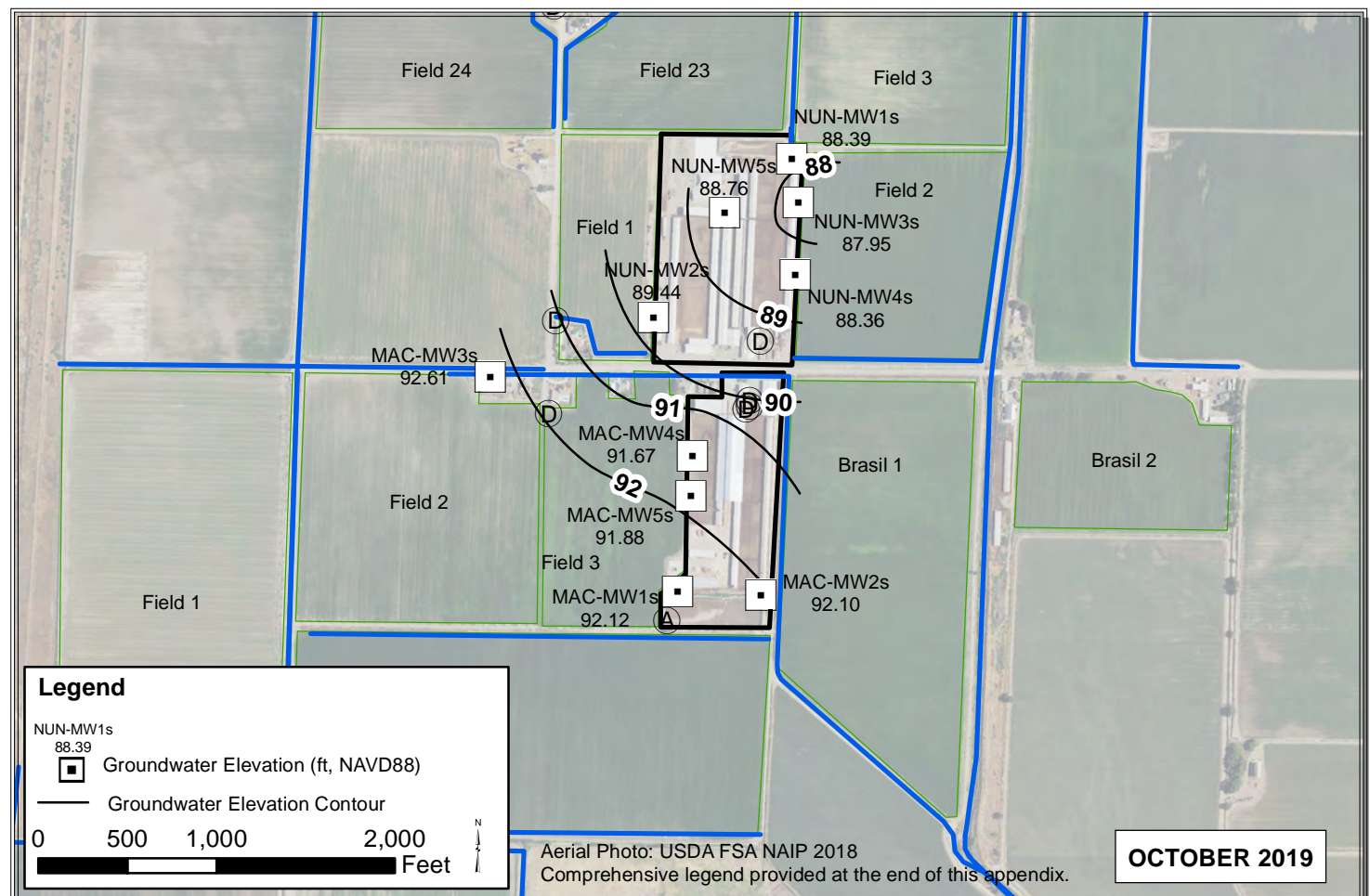
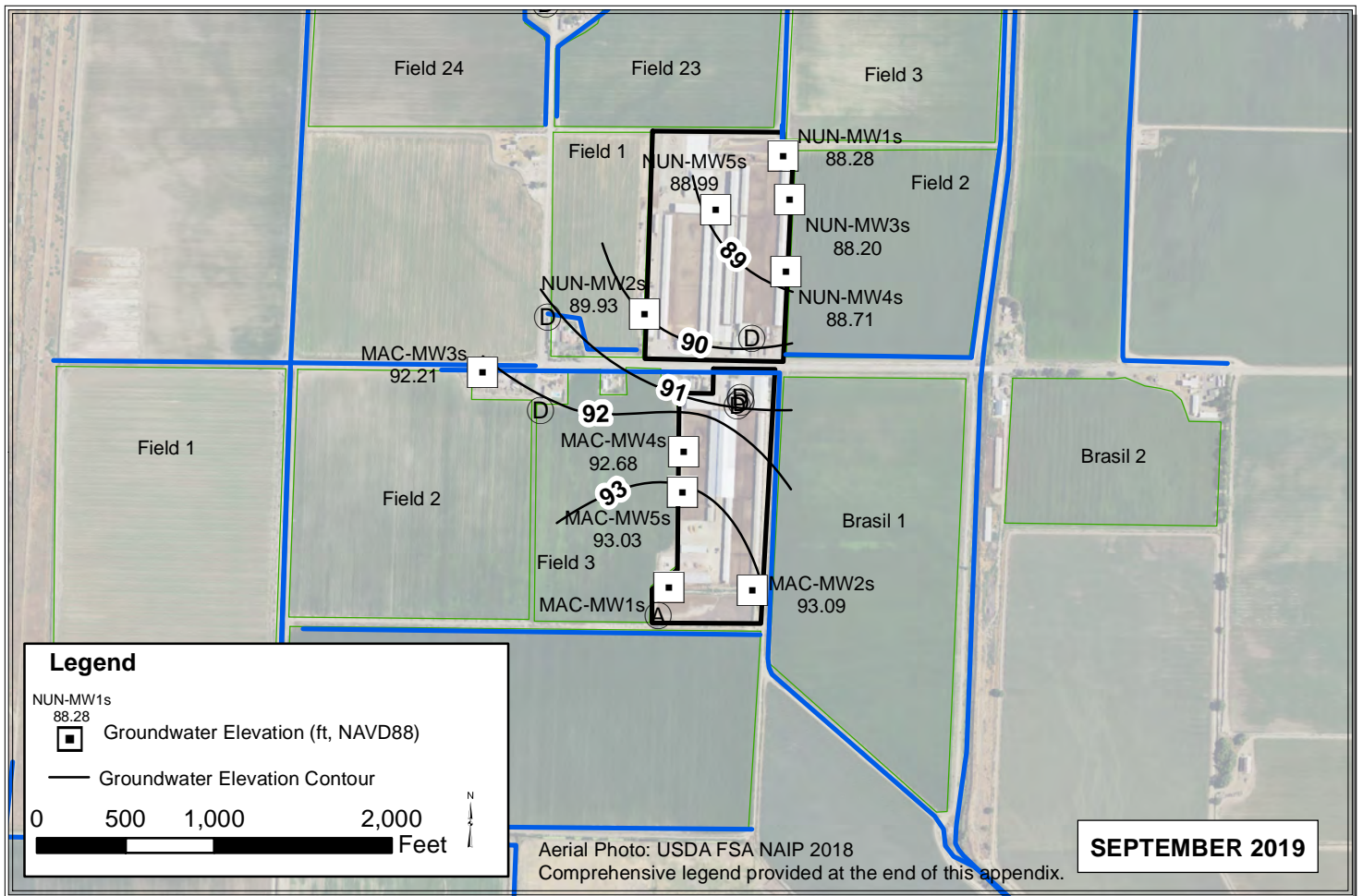

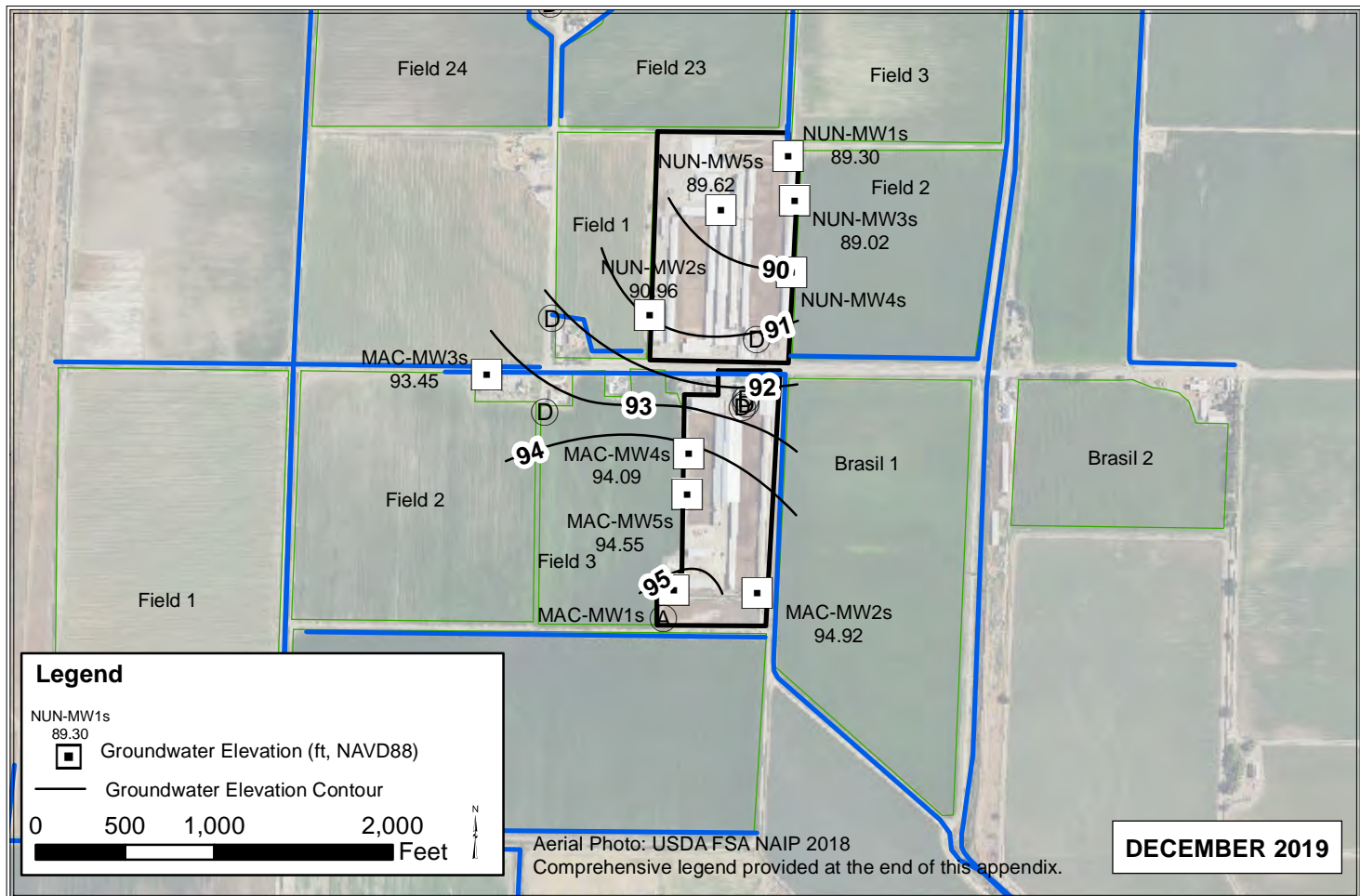
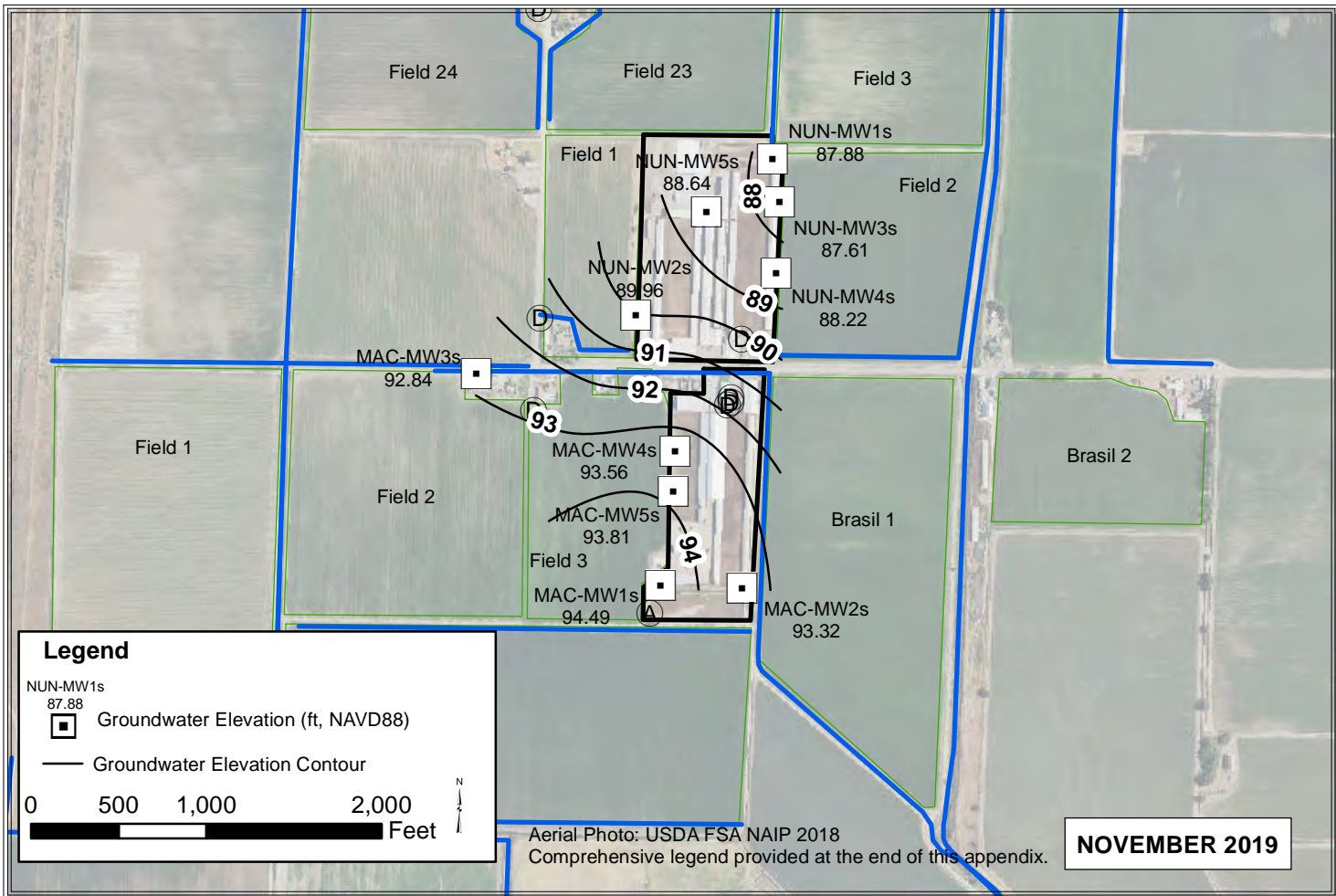

MOO

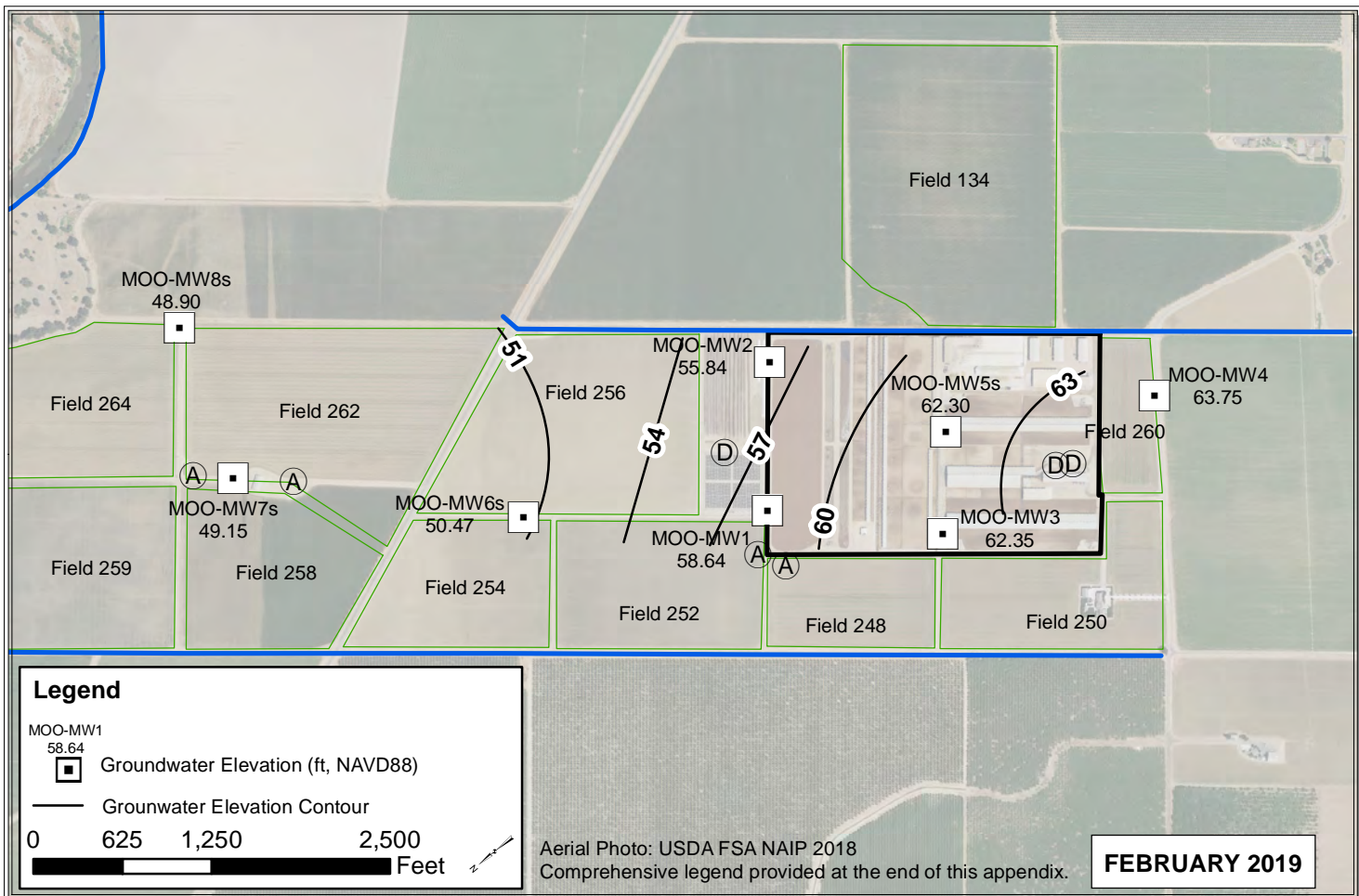
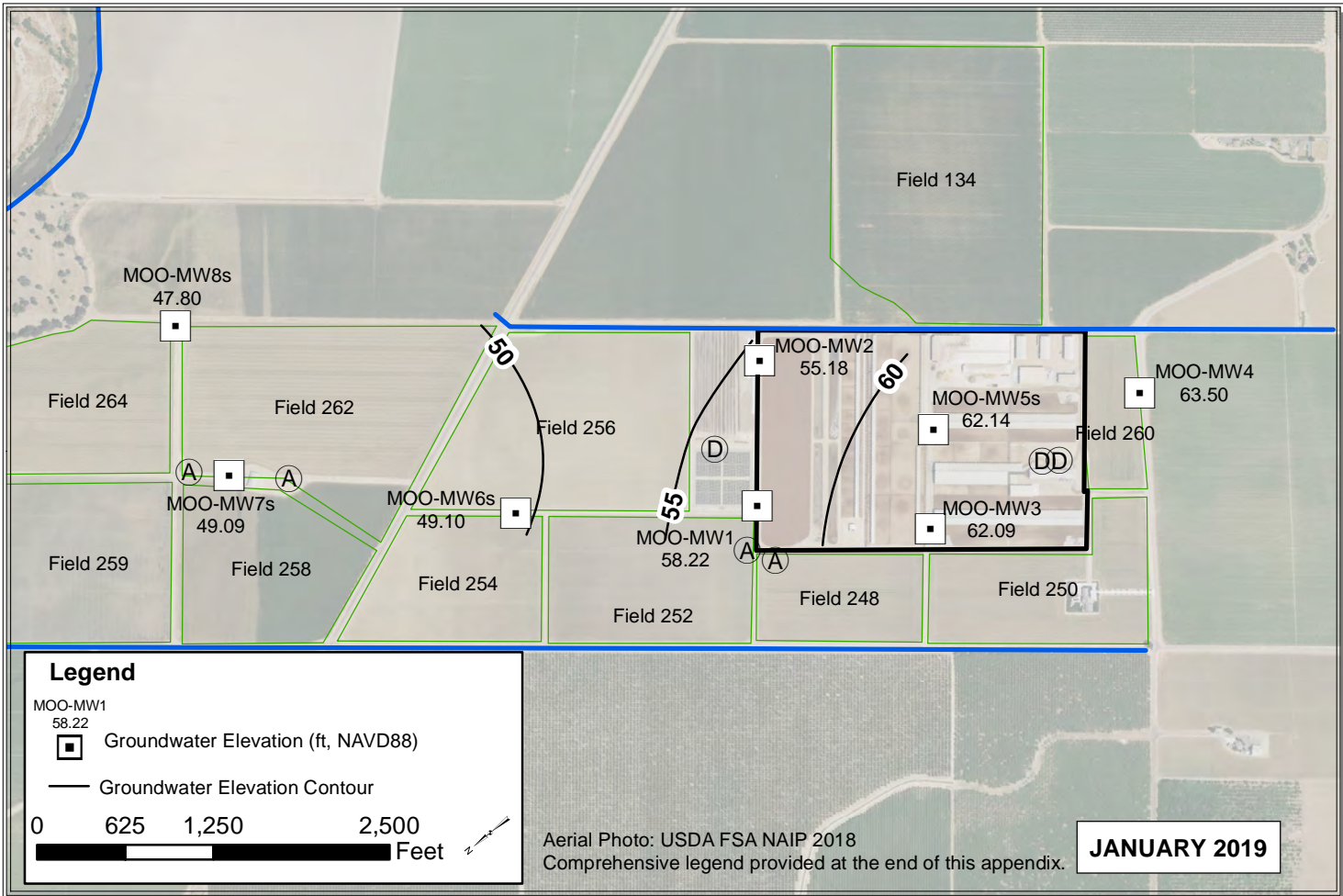

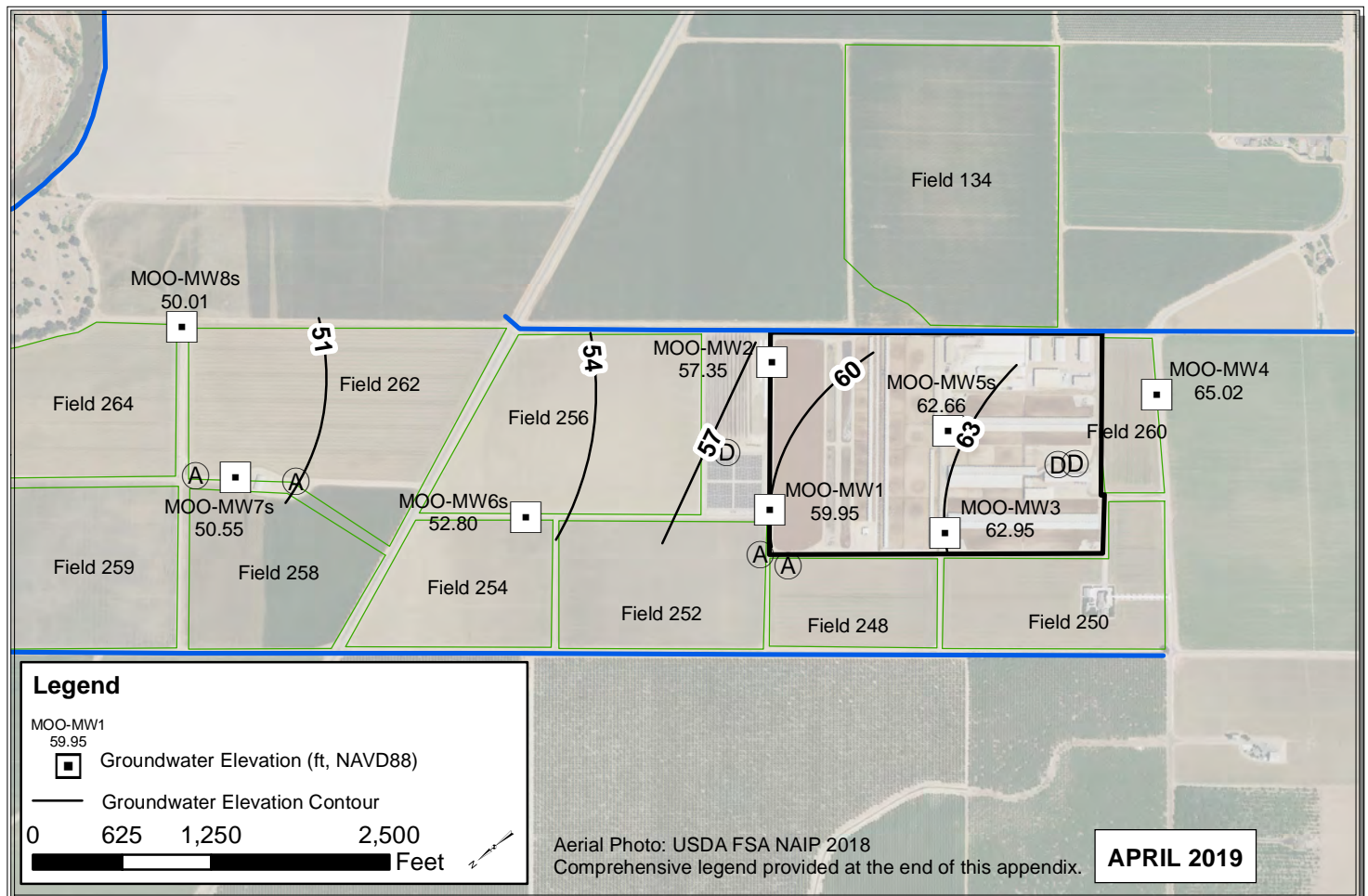
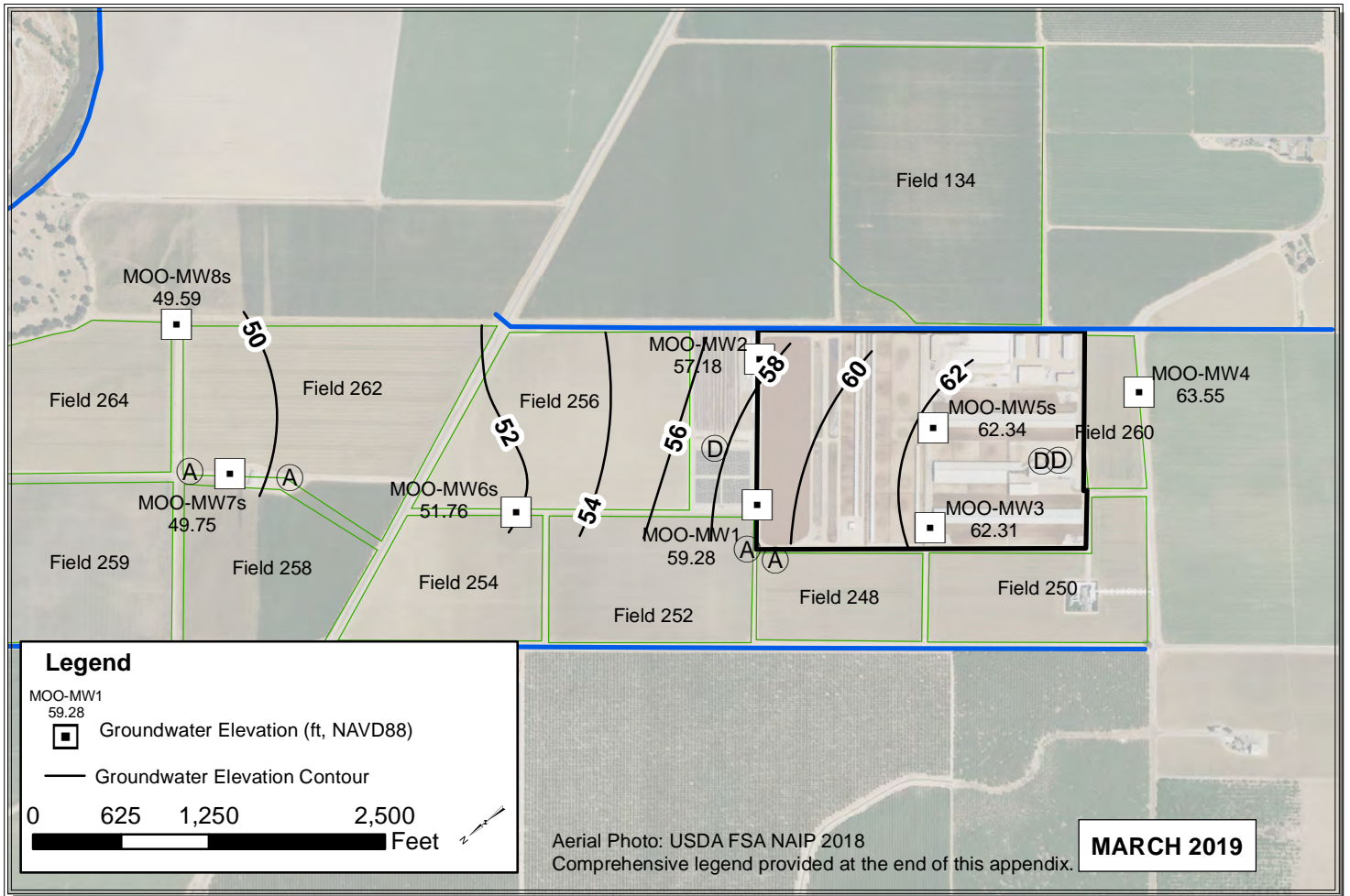

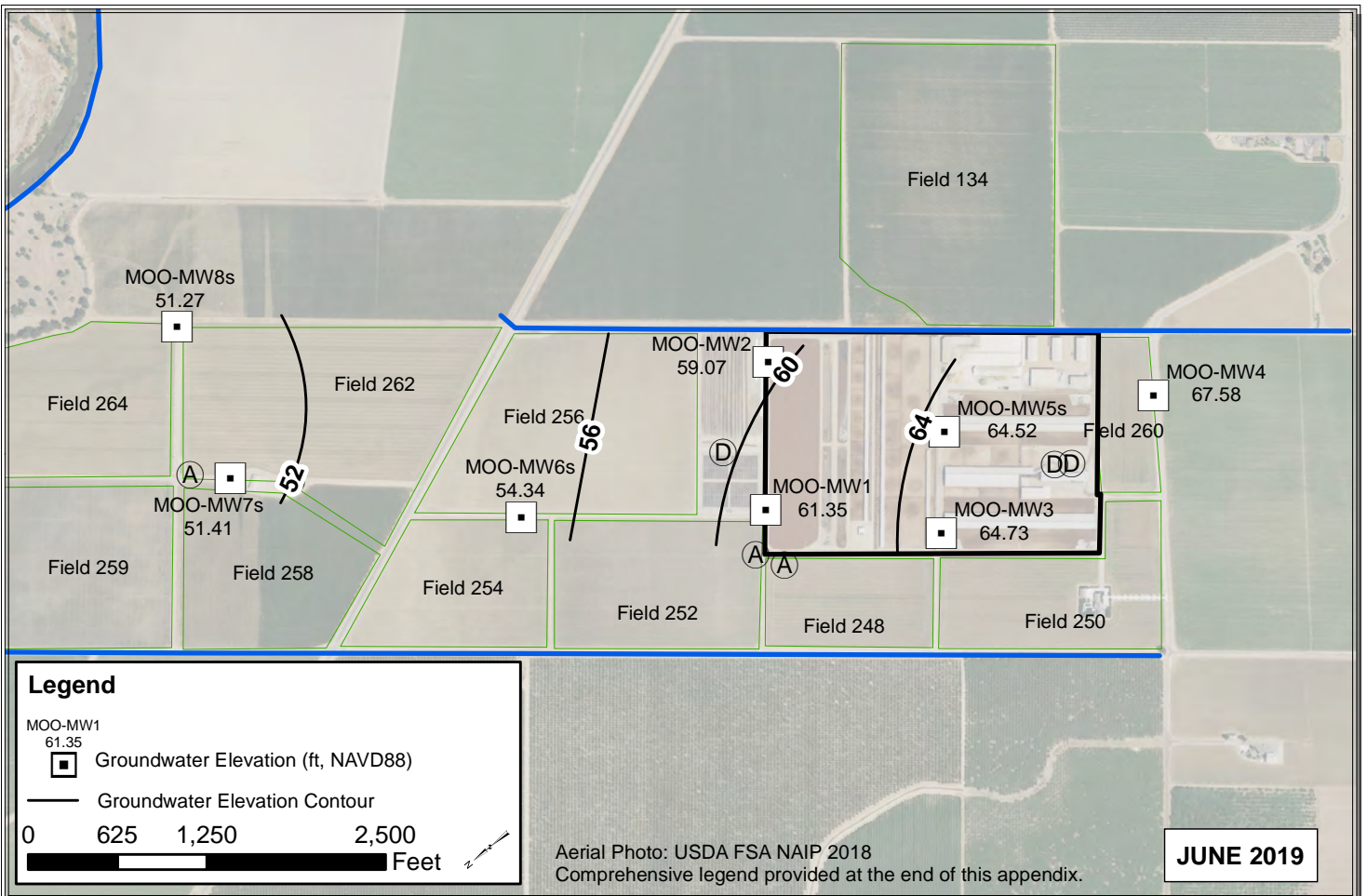
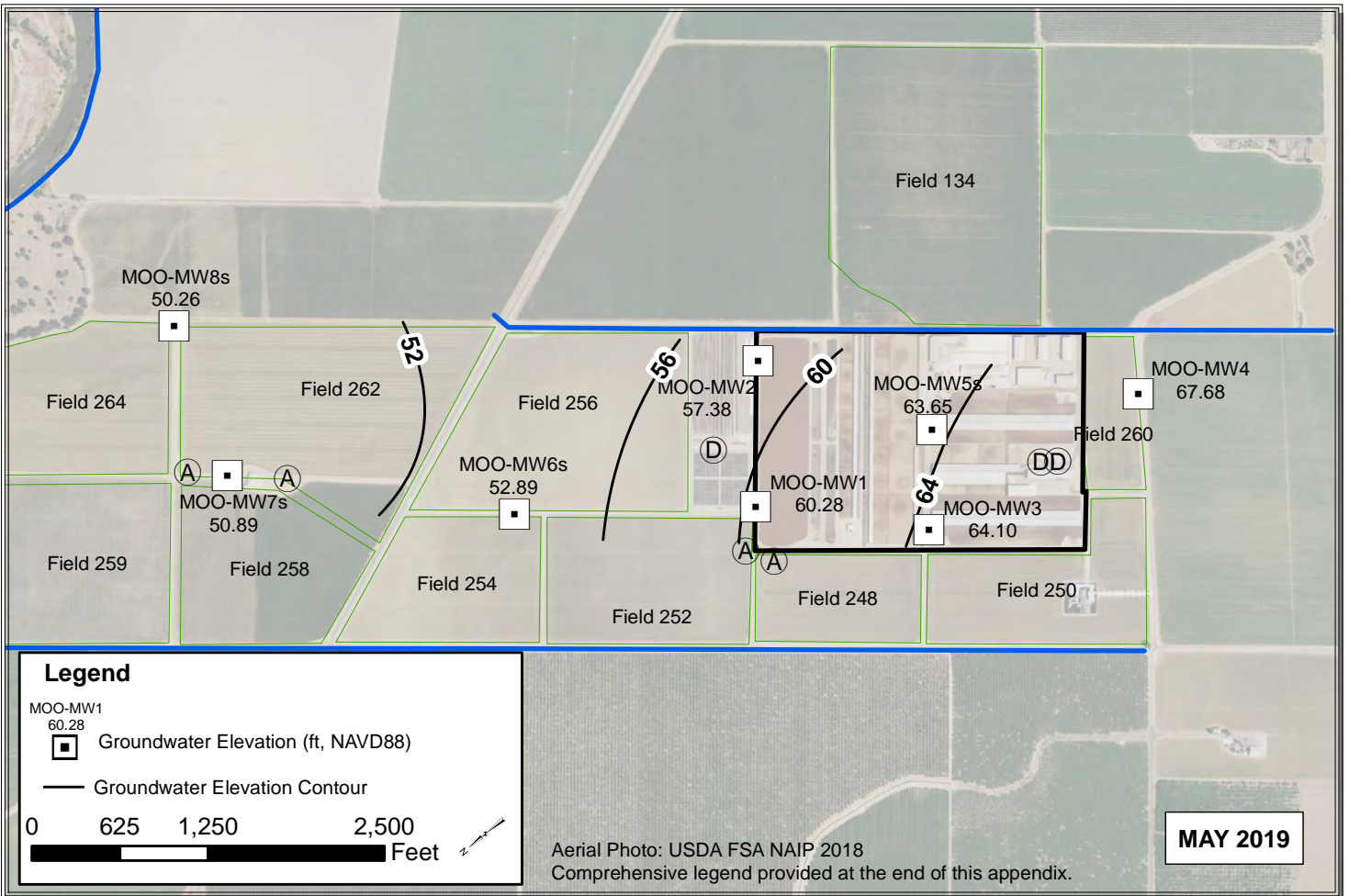

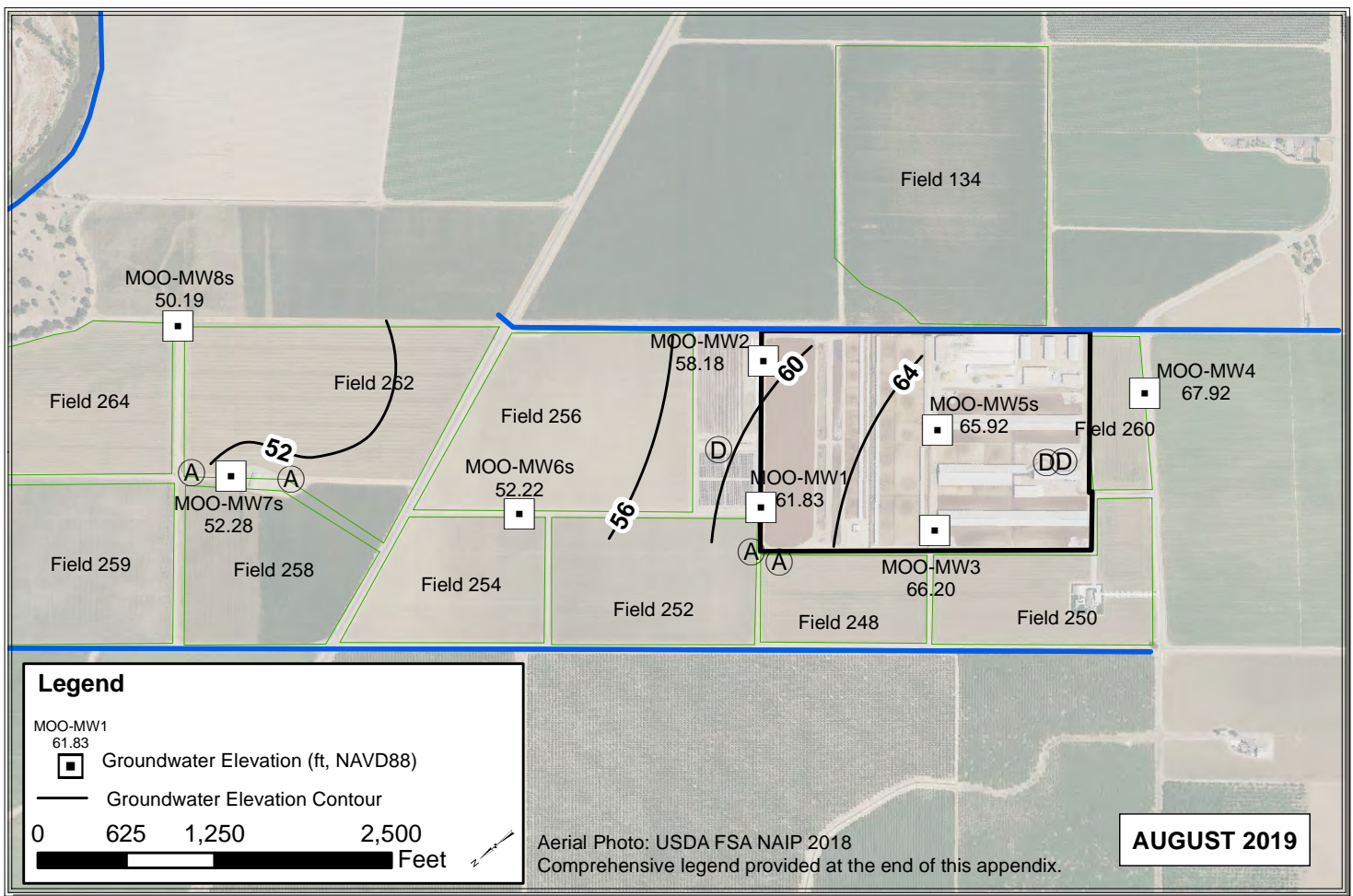
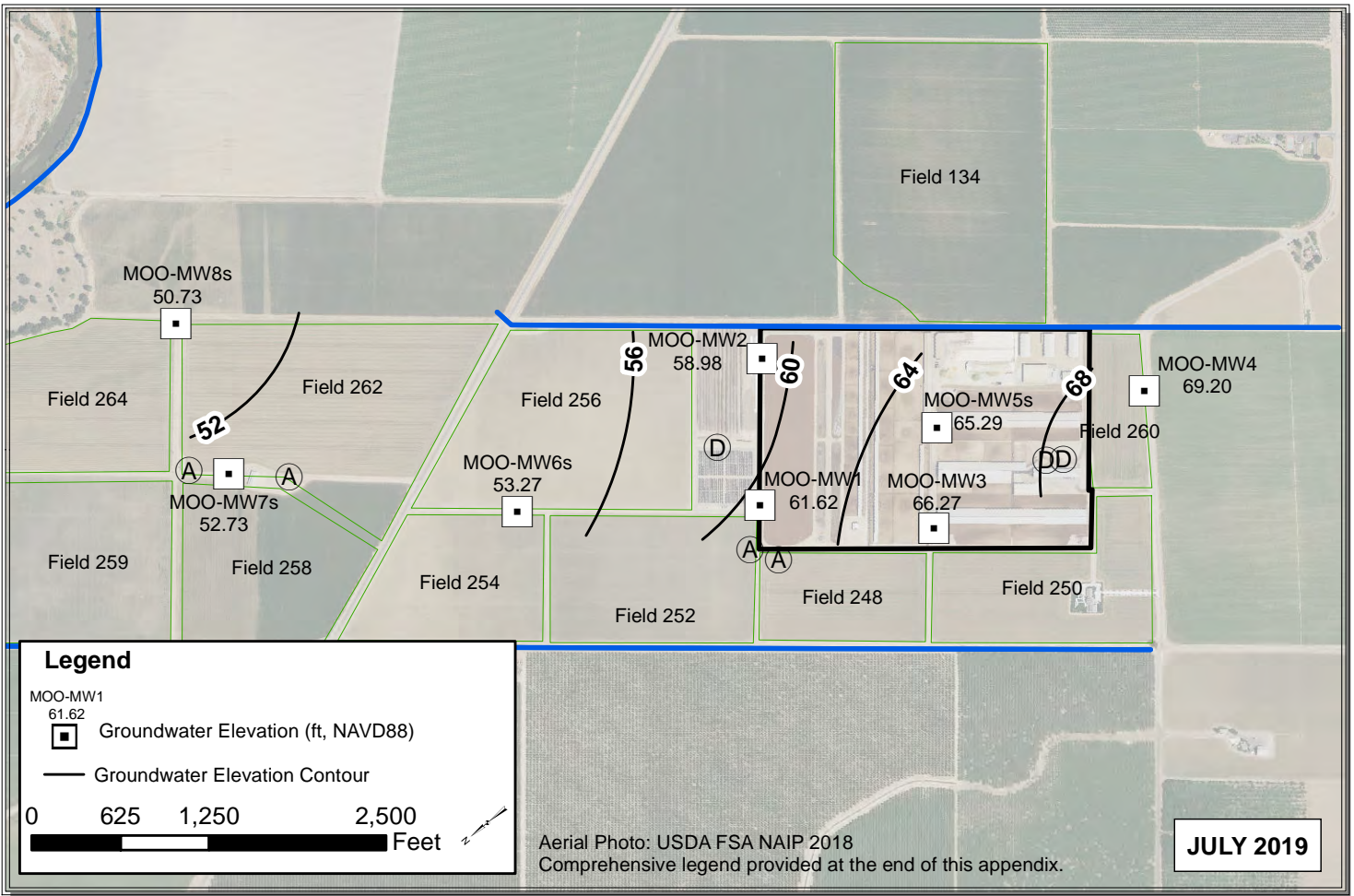

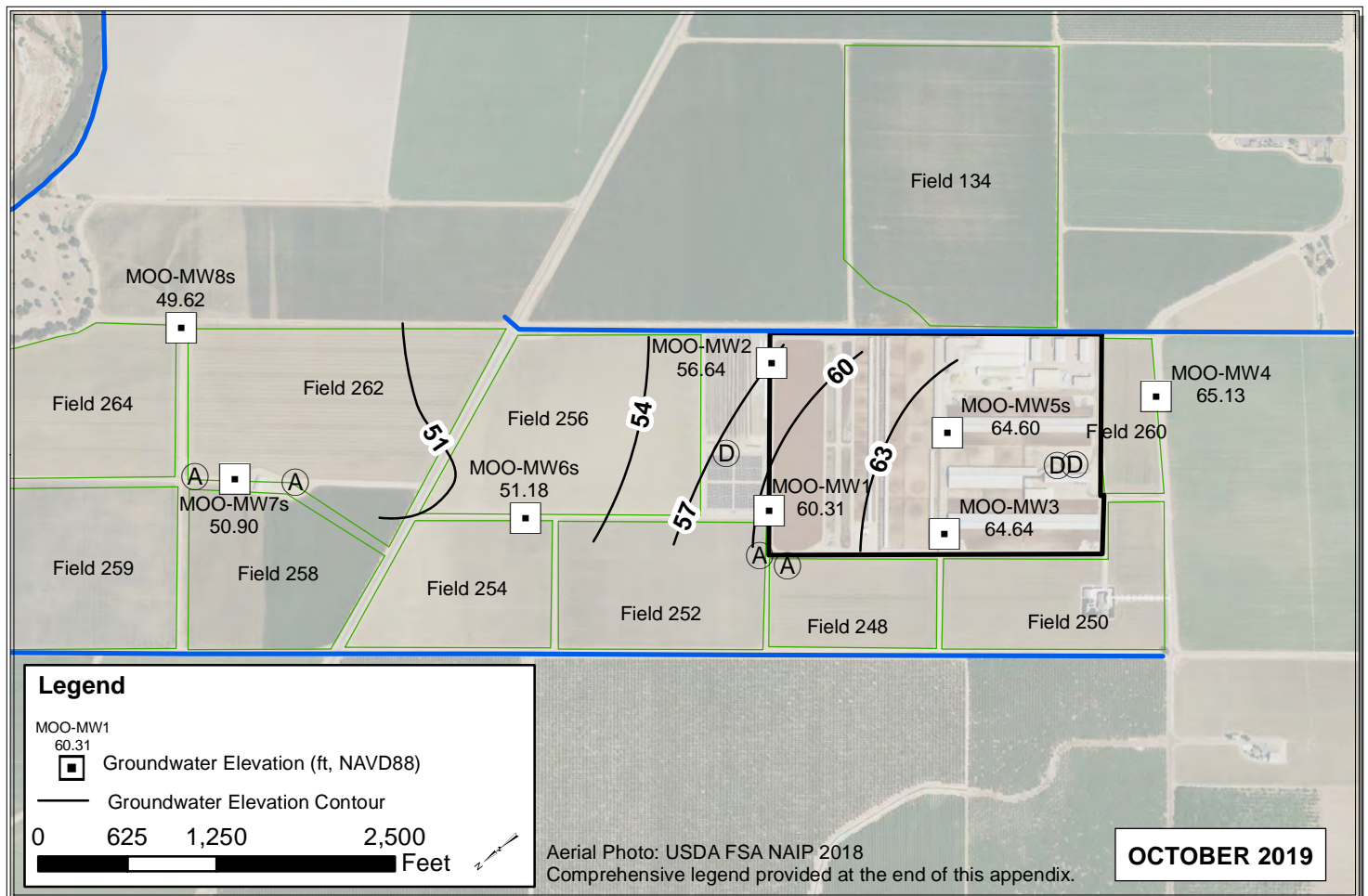
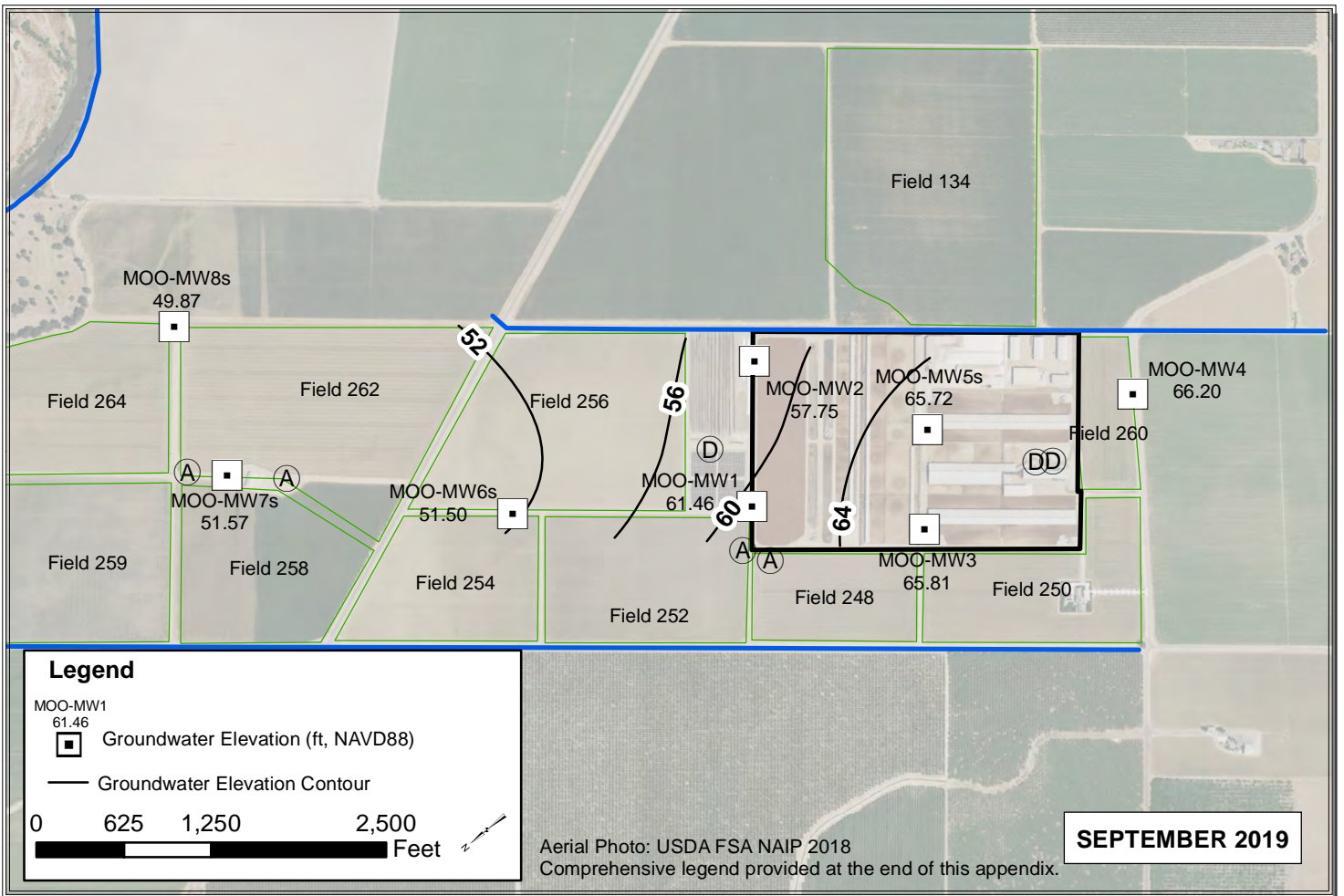

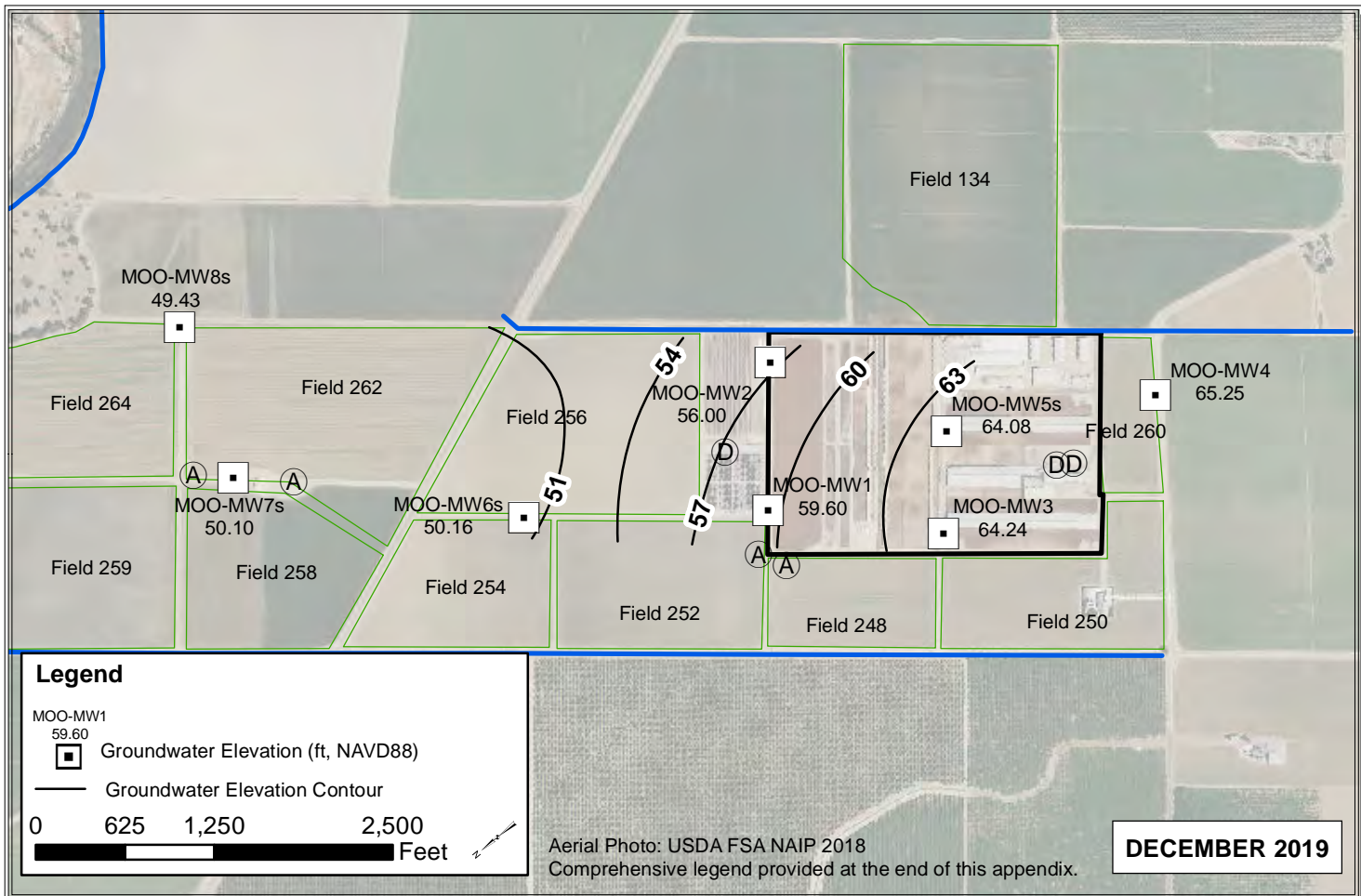
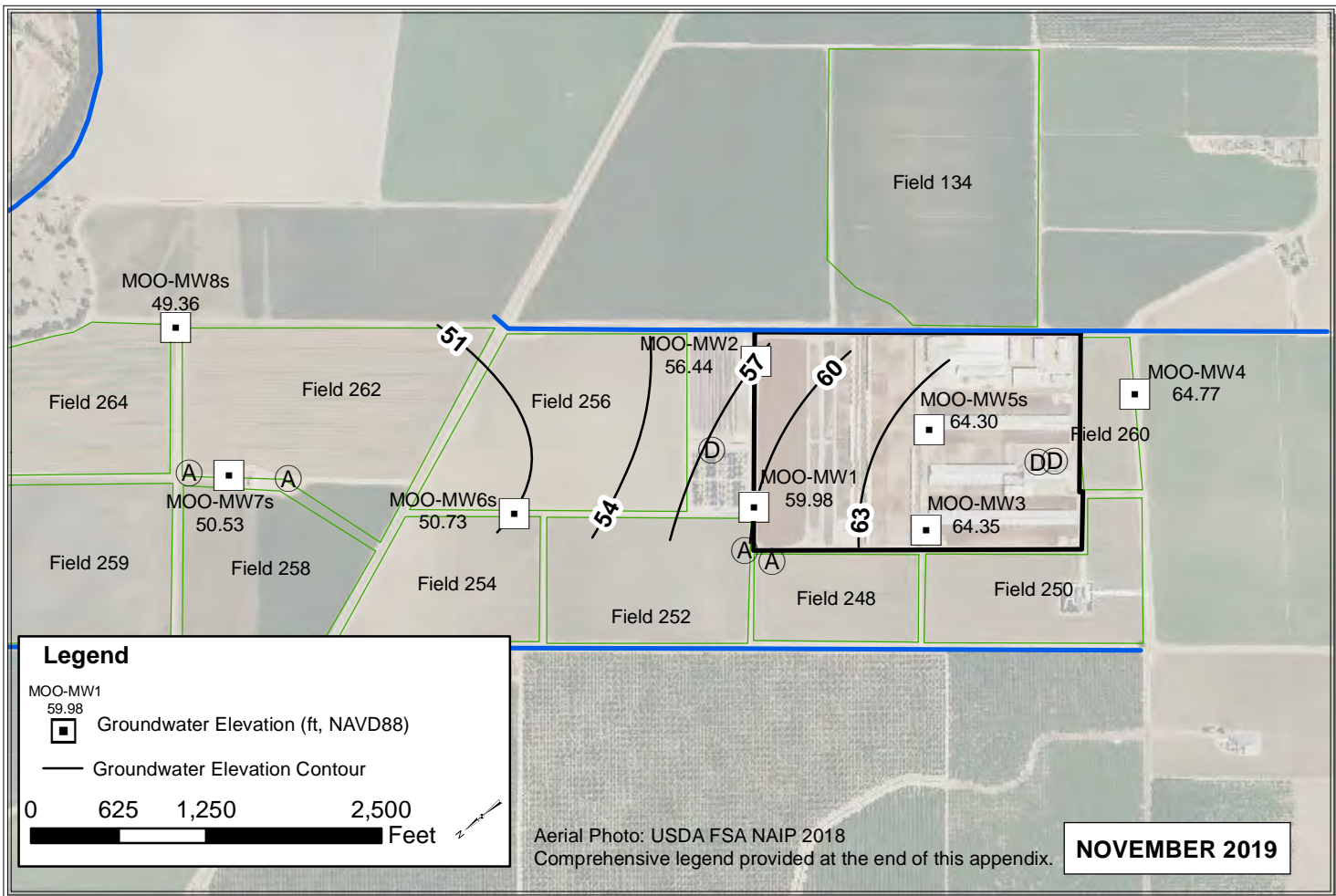

TON

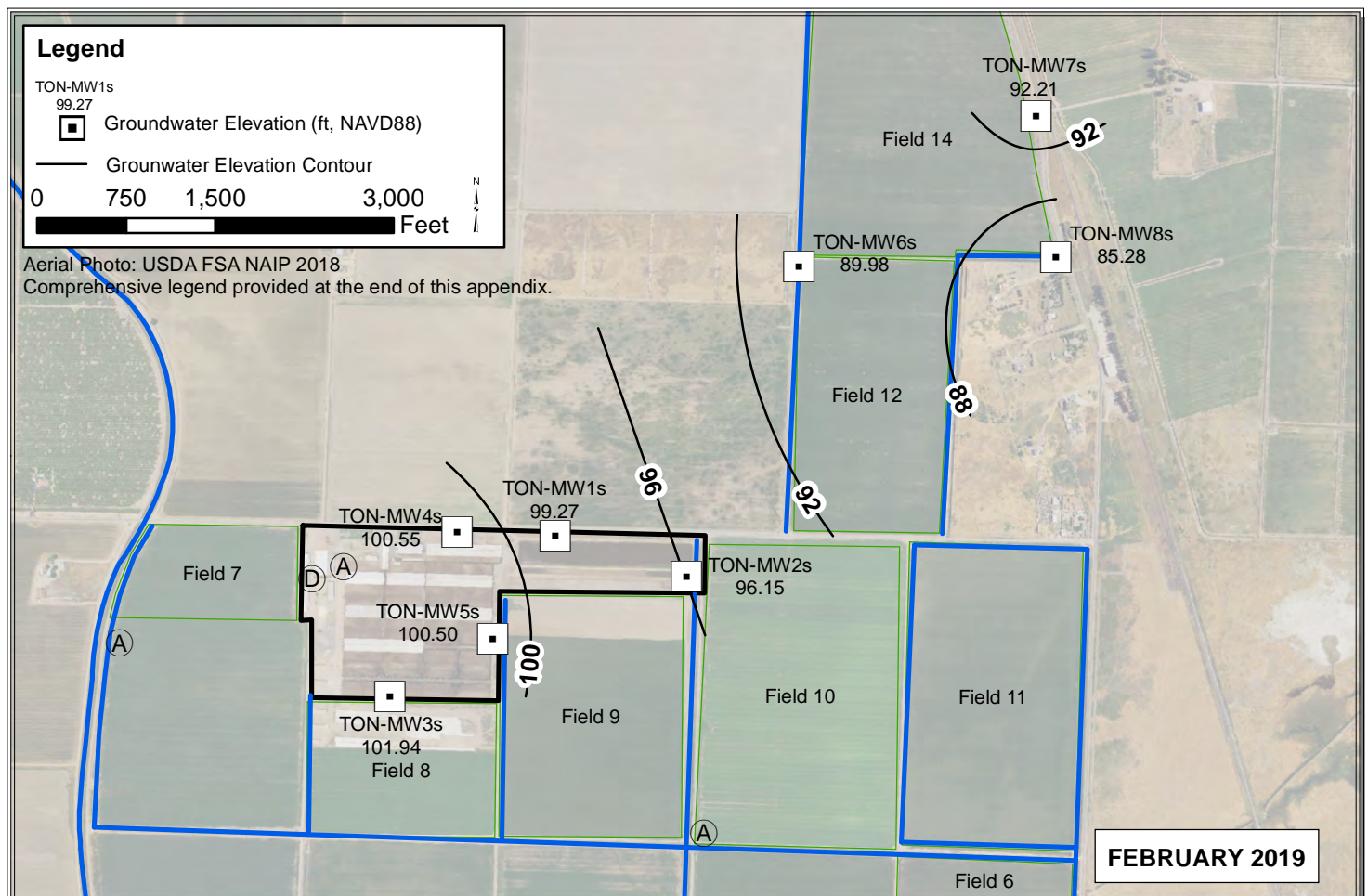
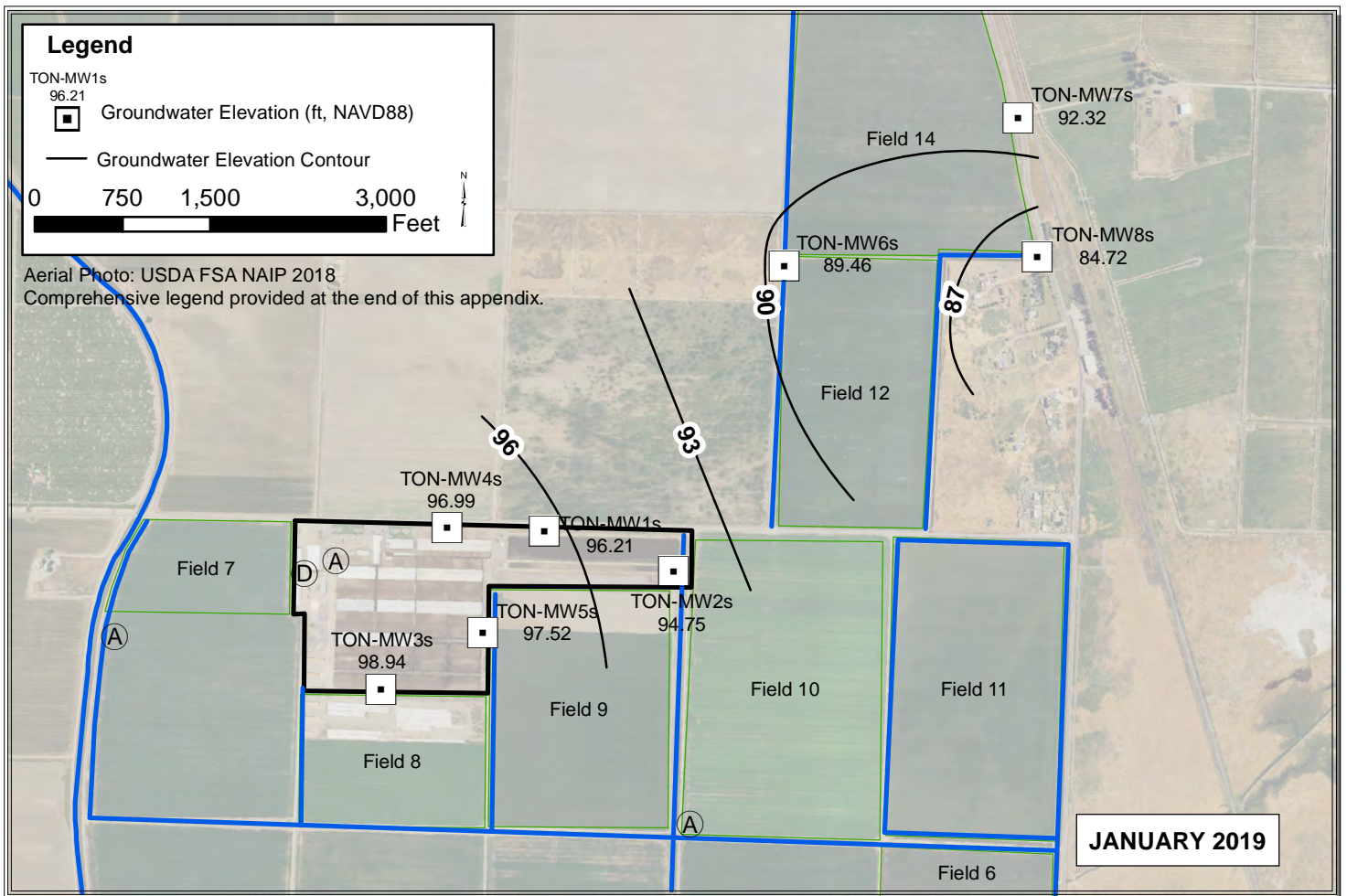

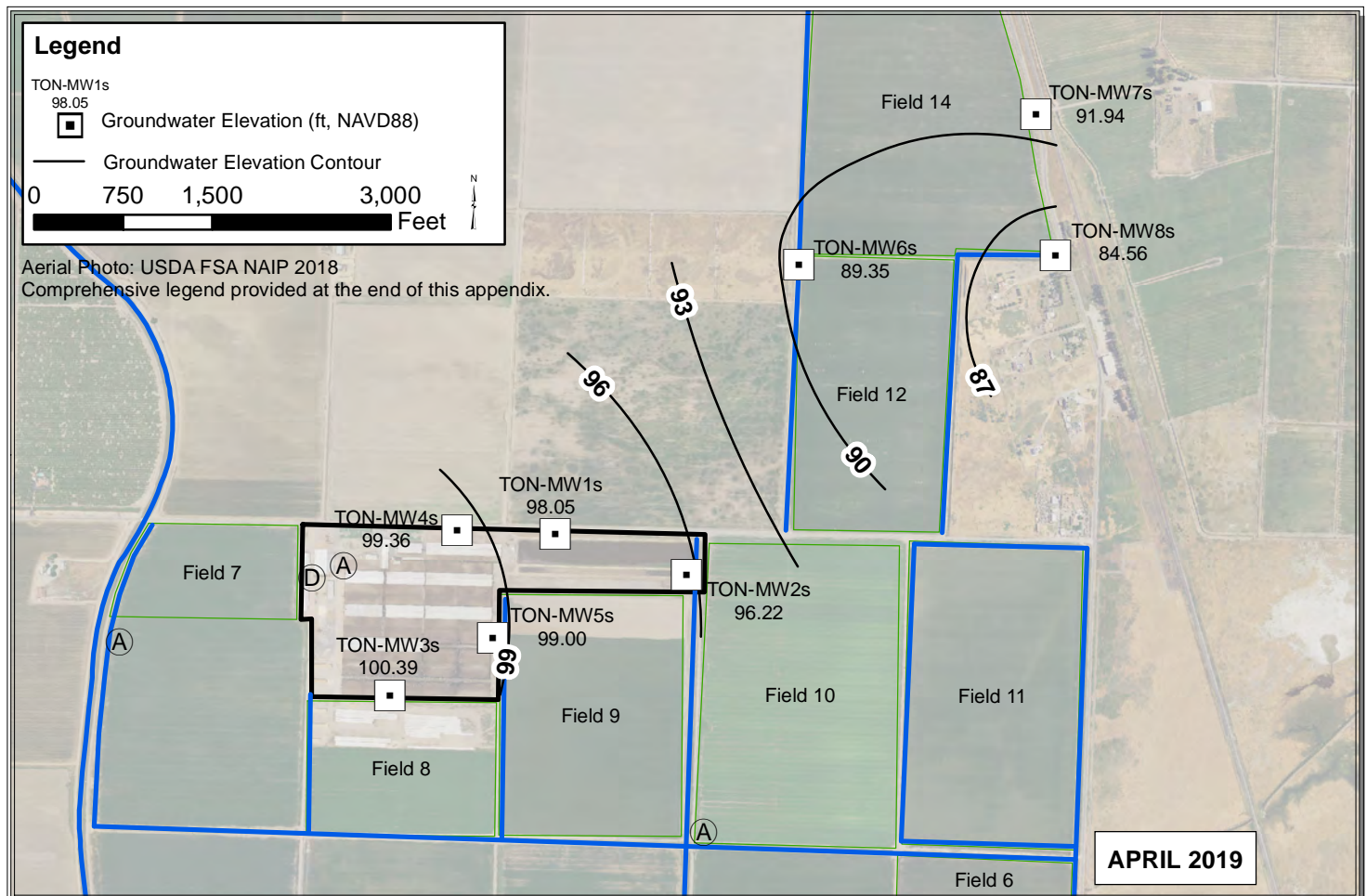
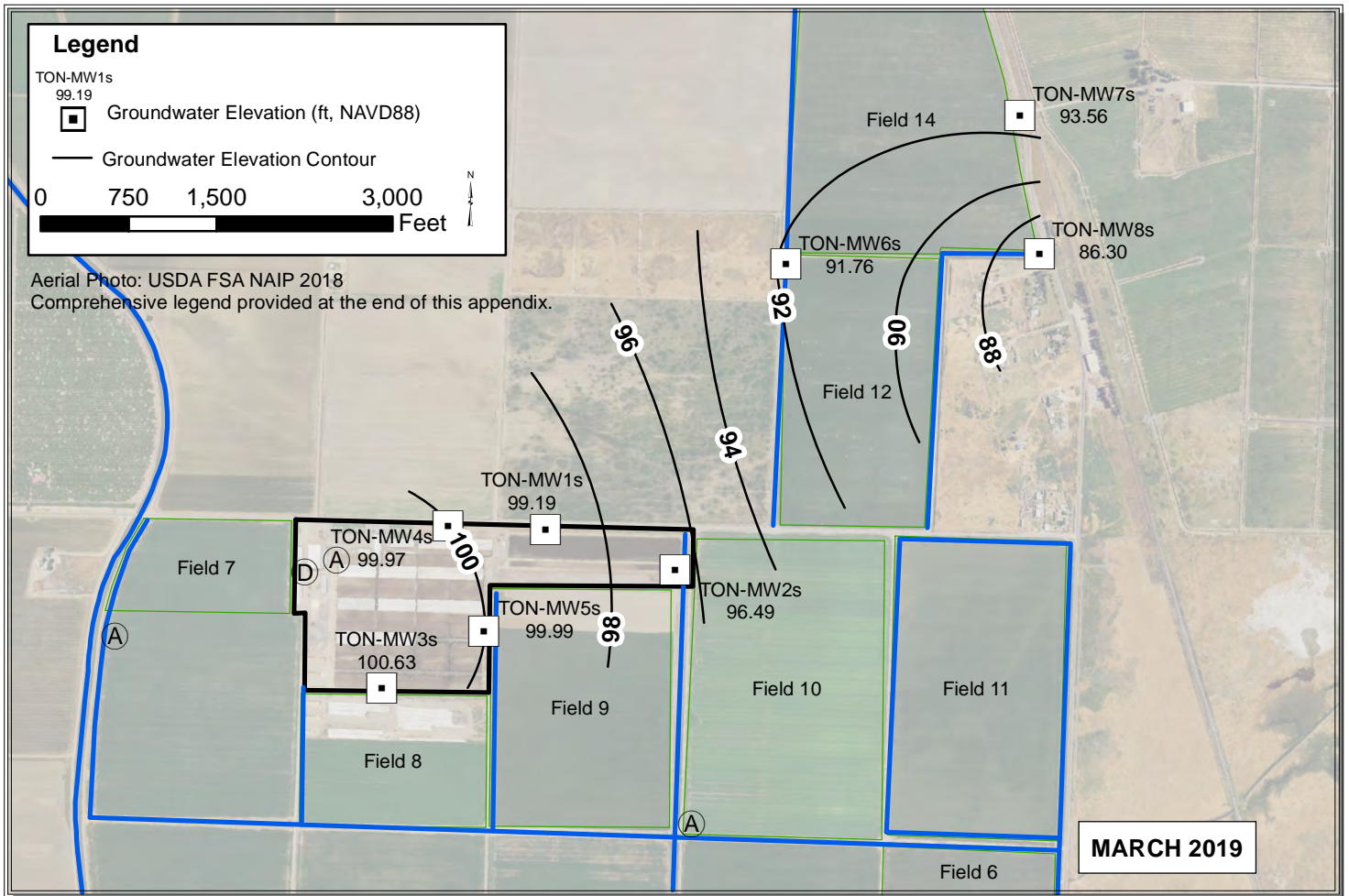

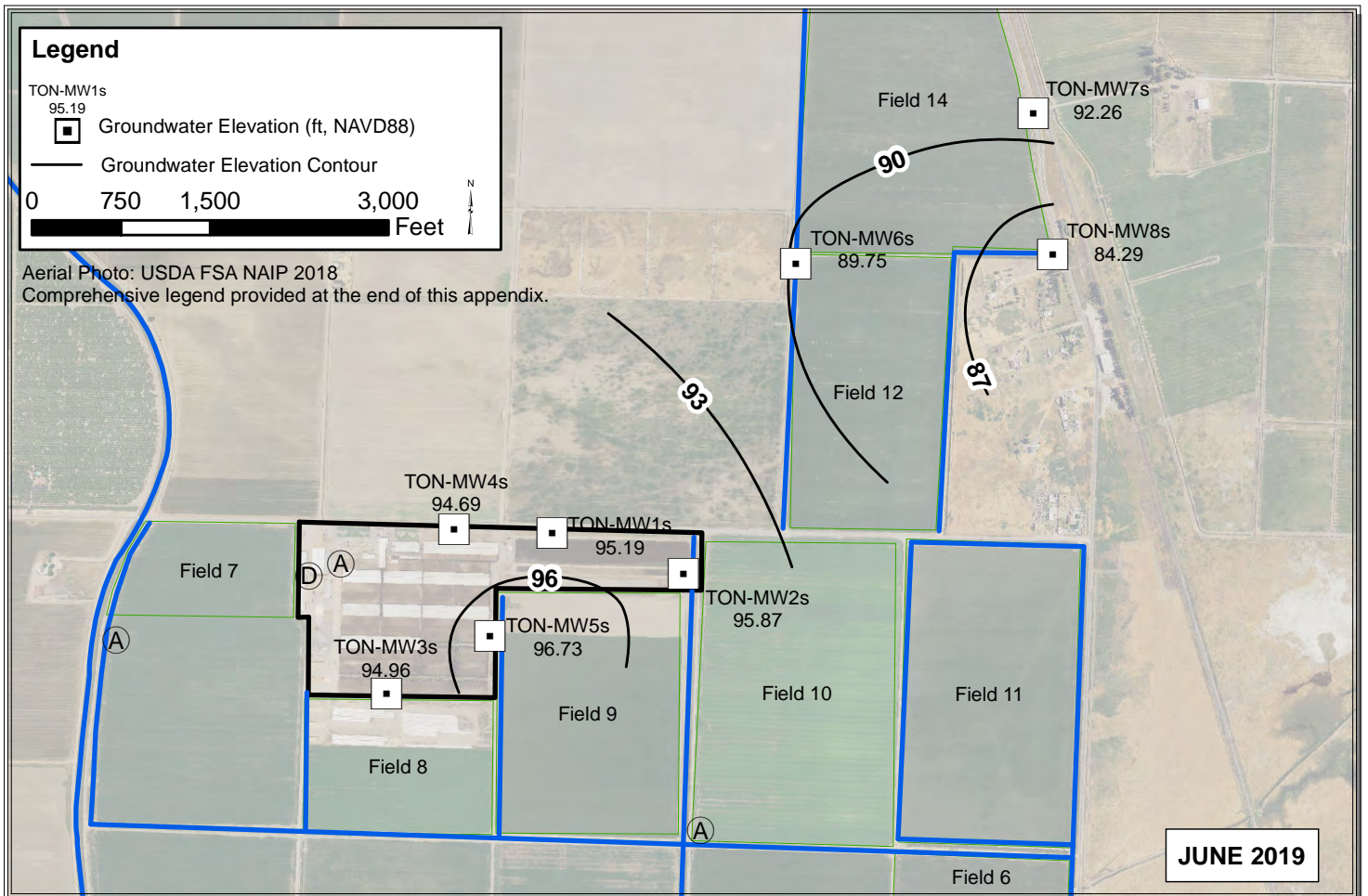
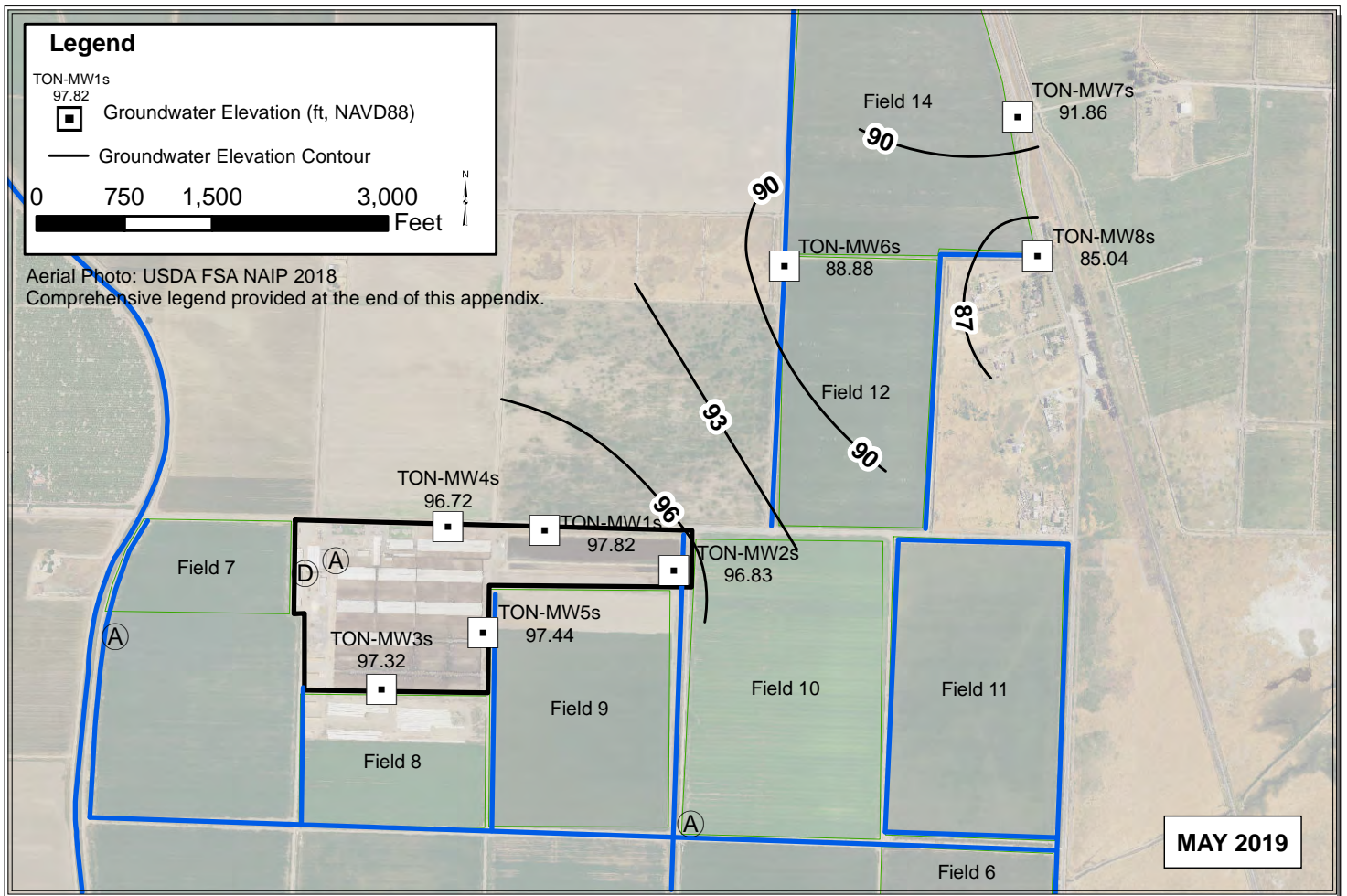

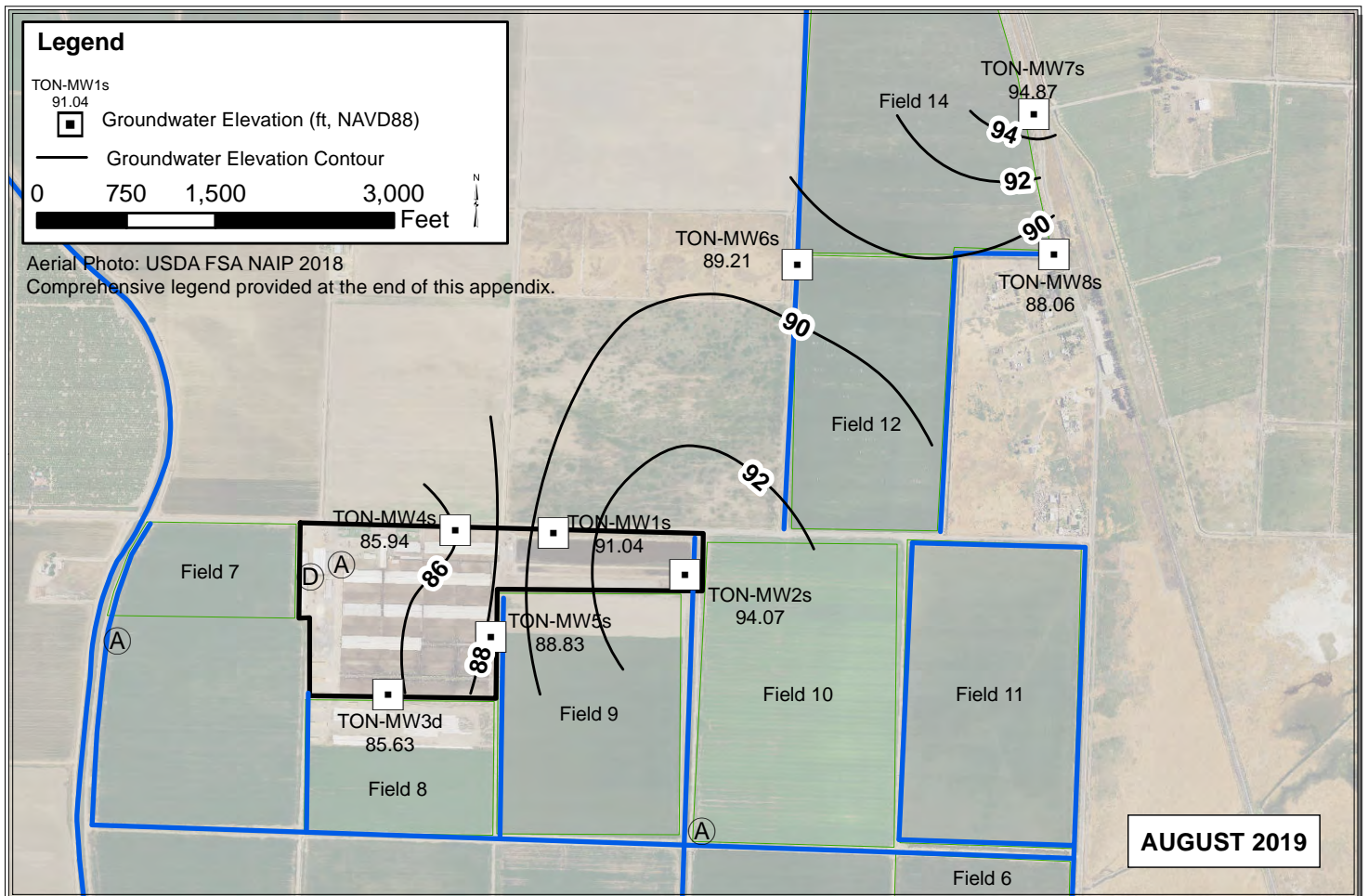
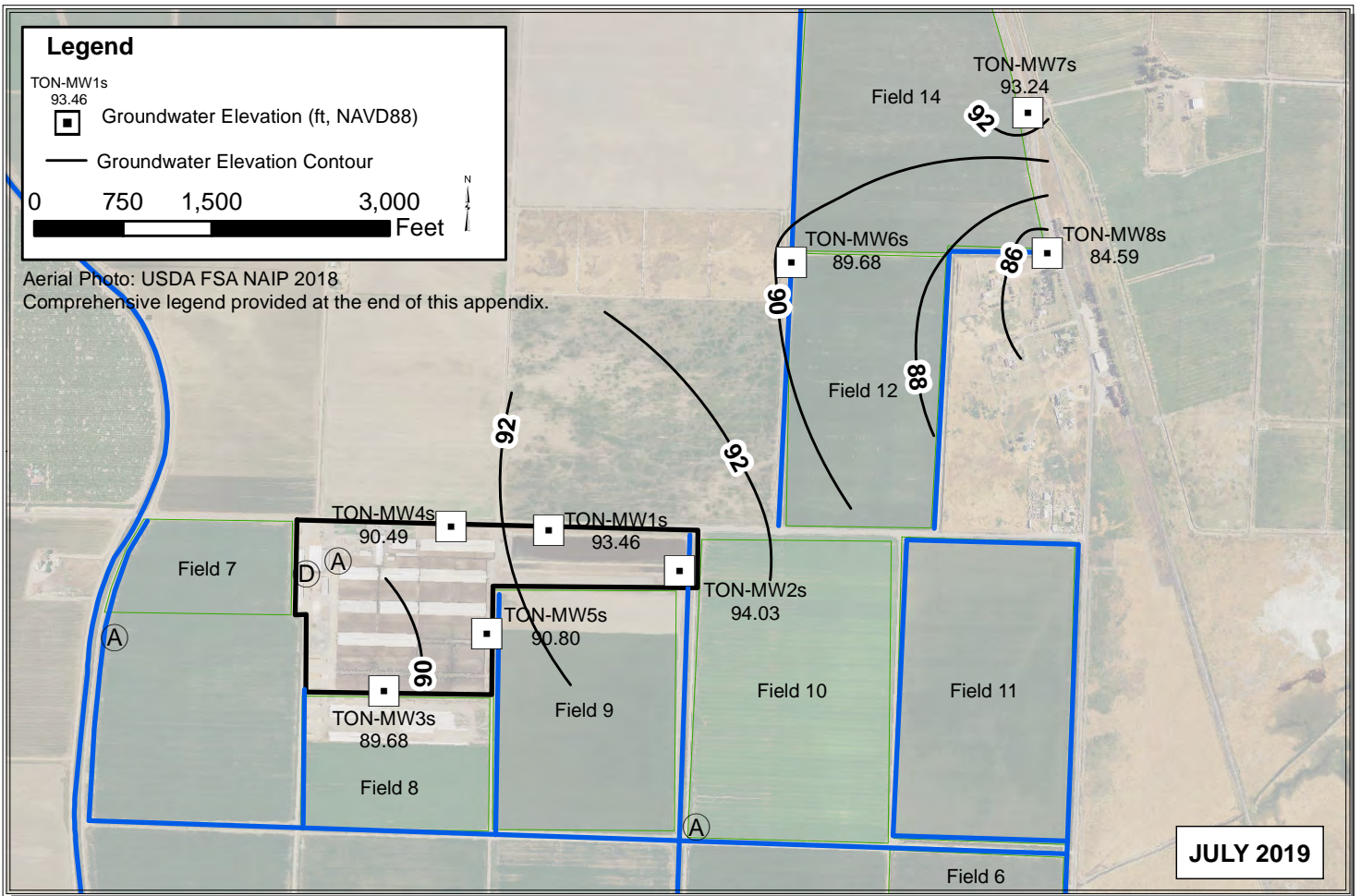

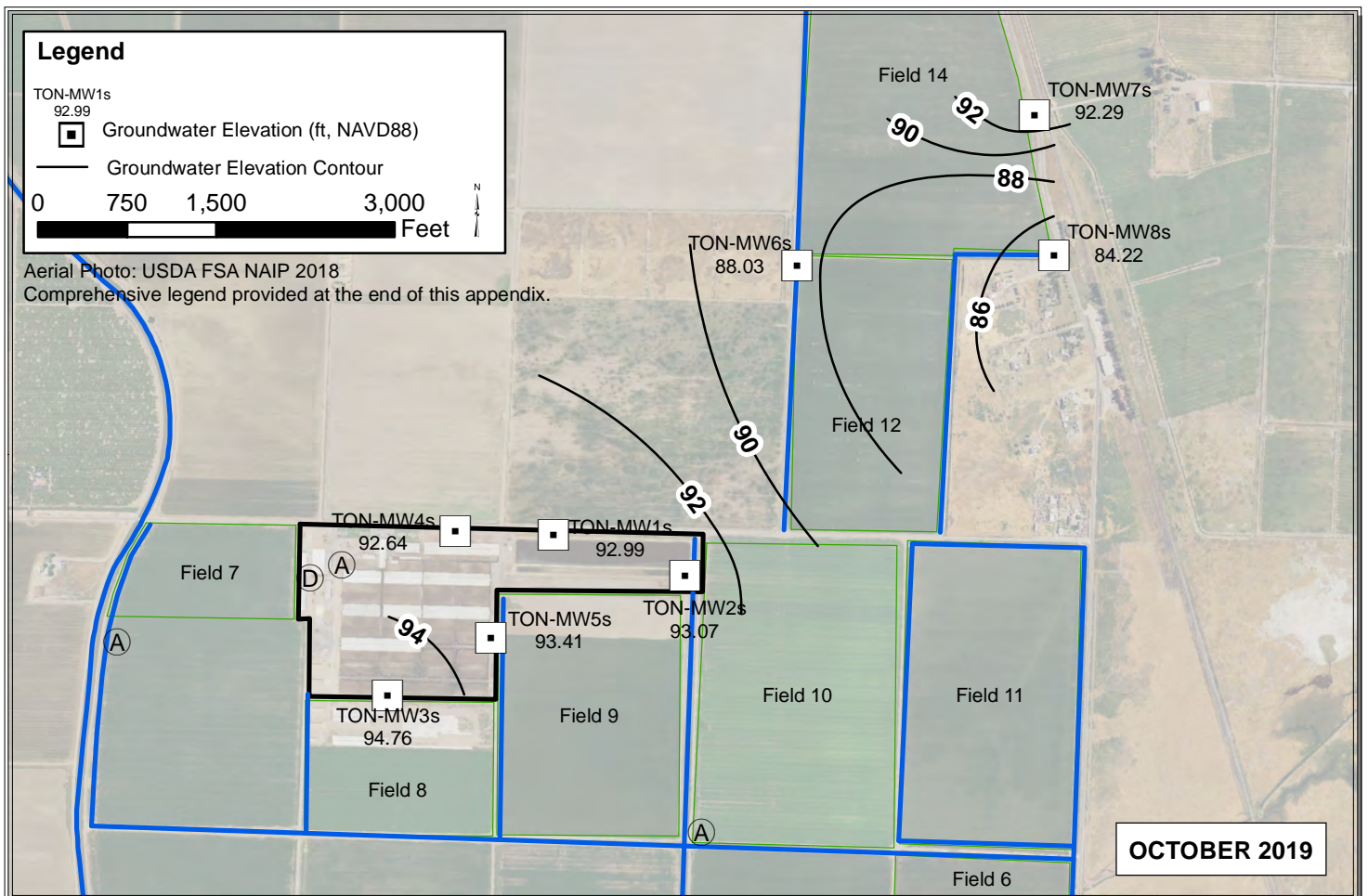
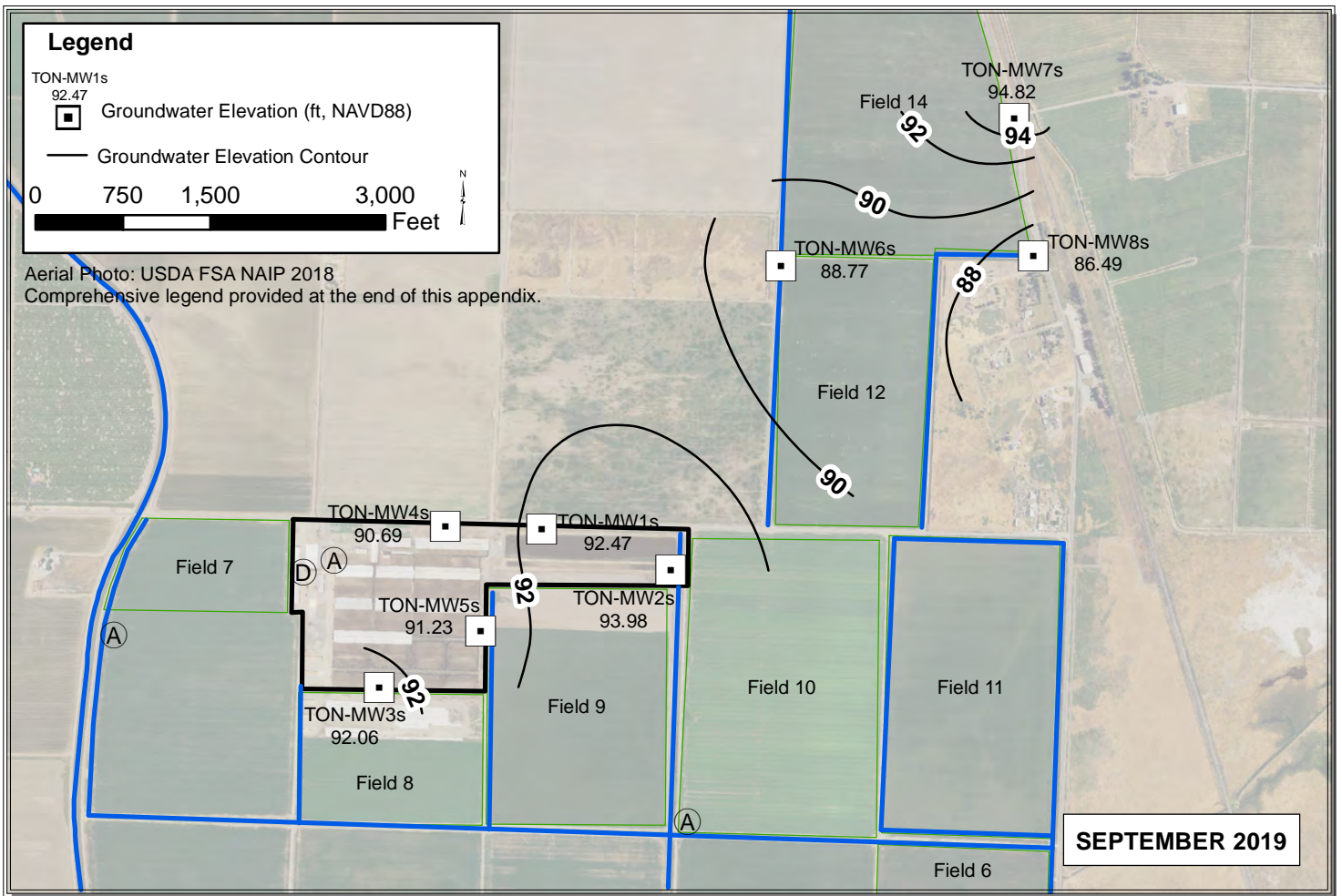

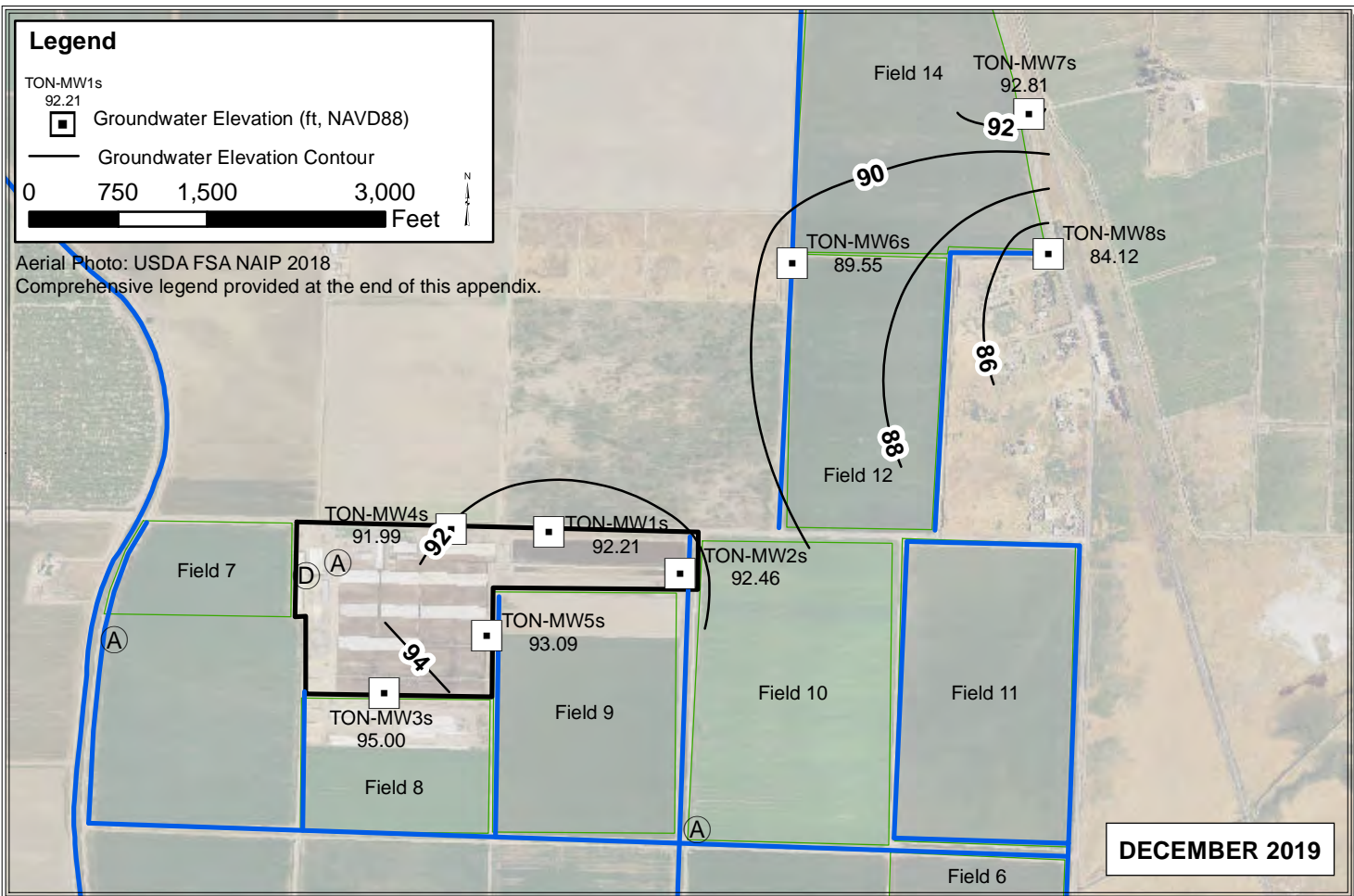
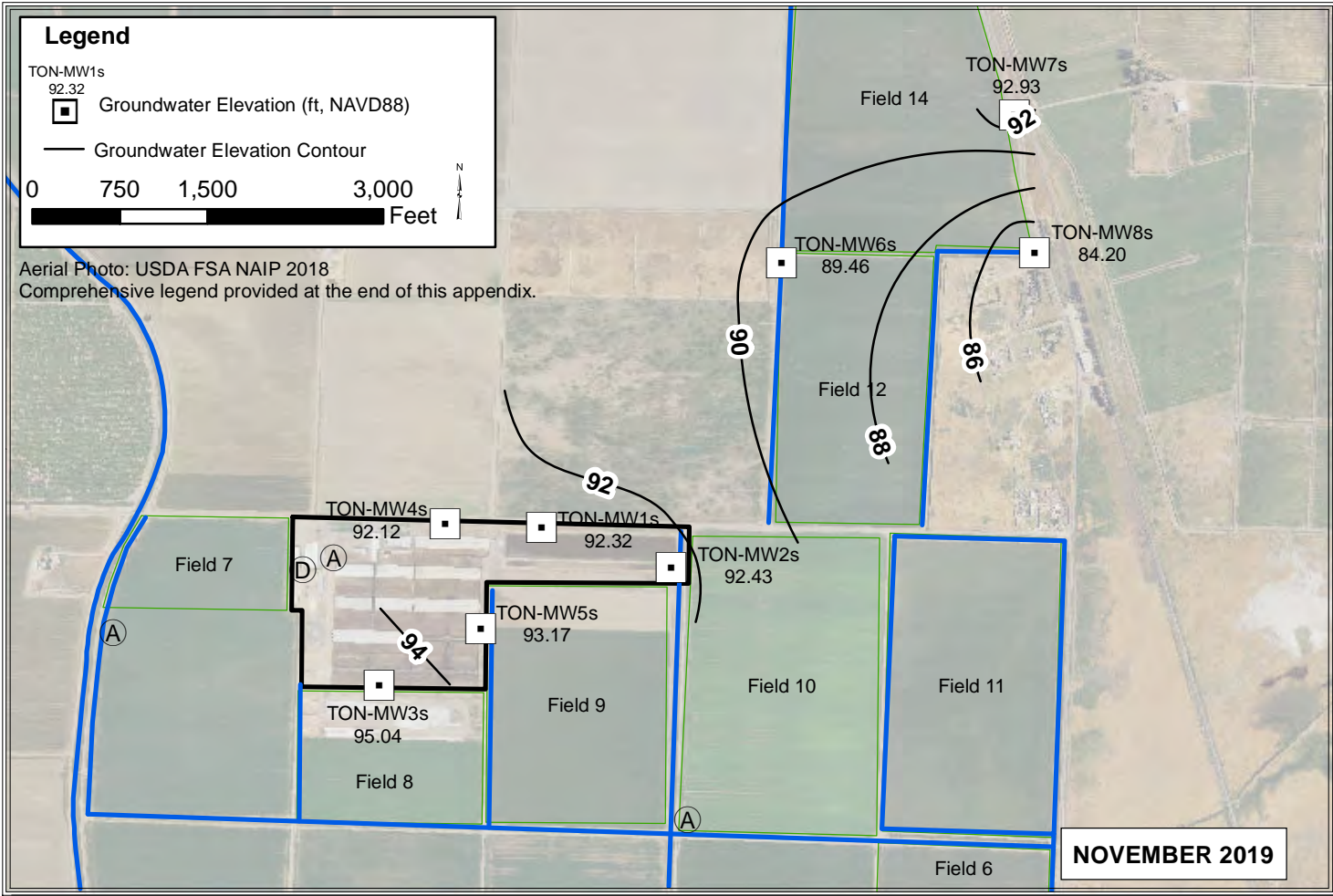

BRE

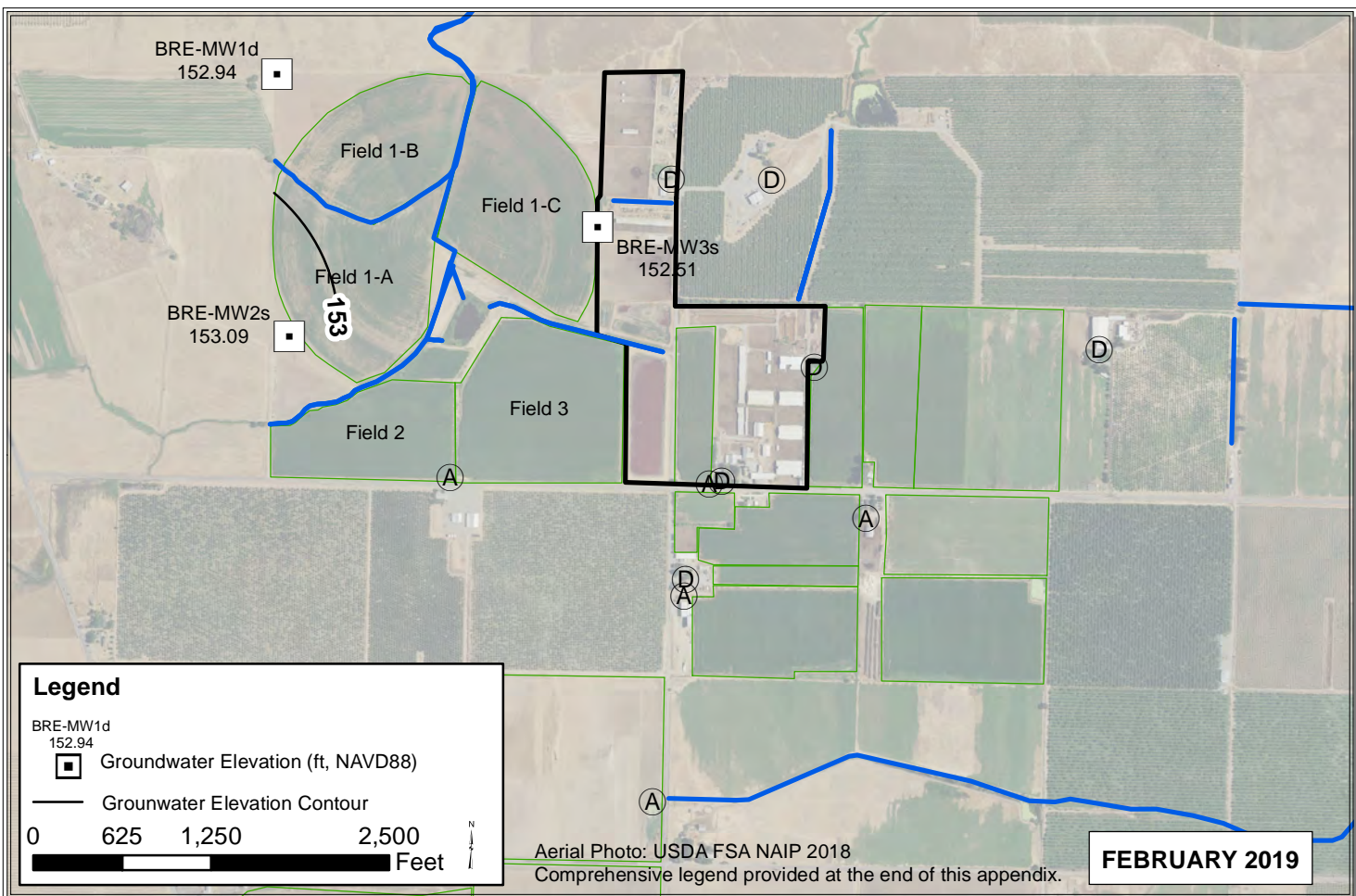
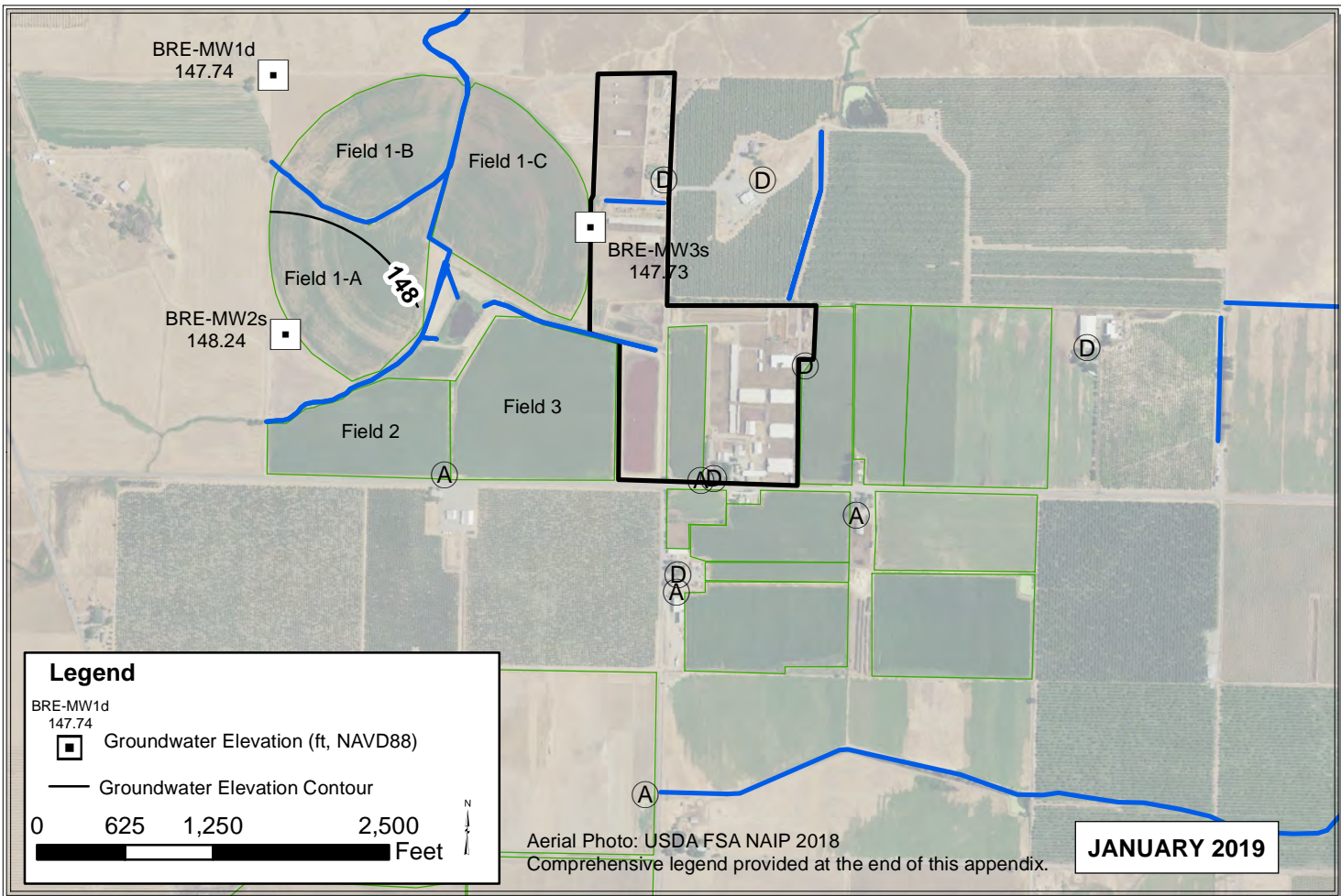

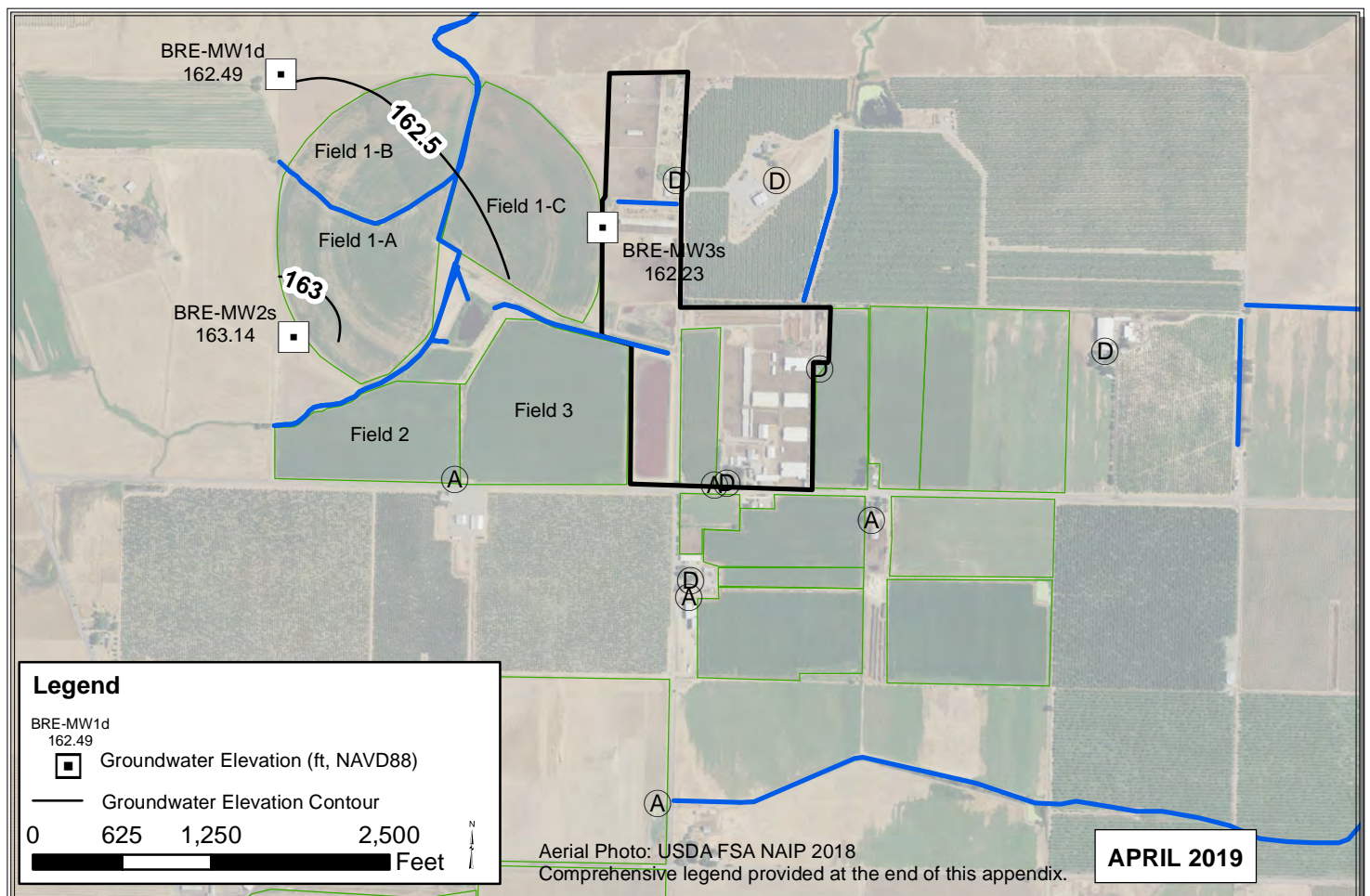
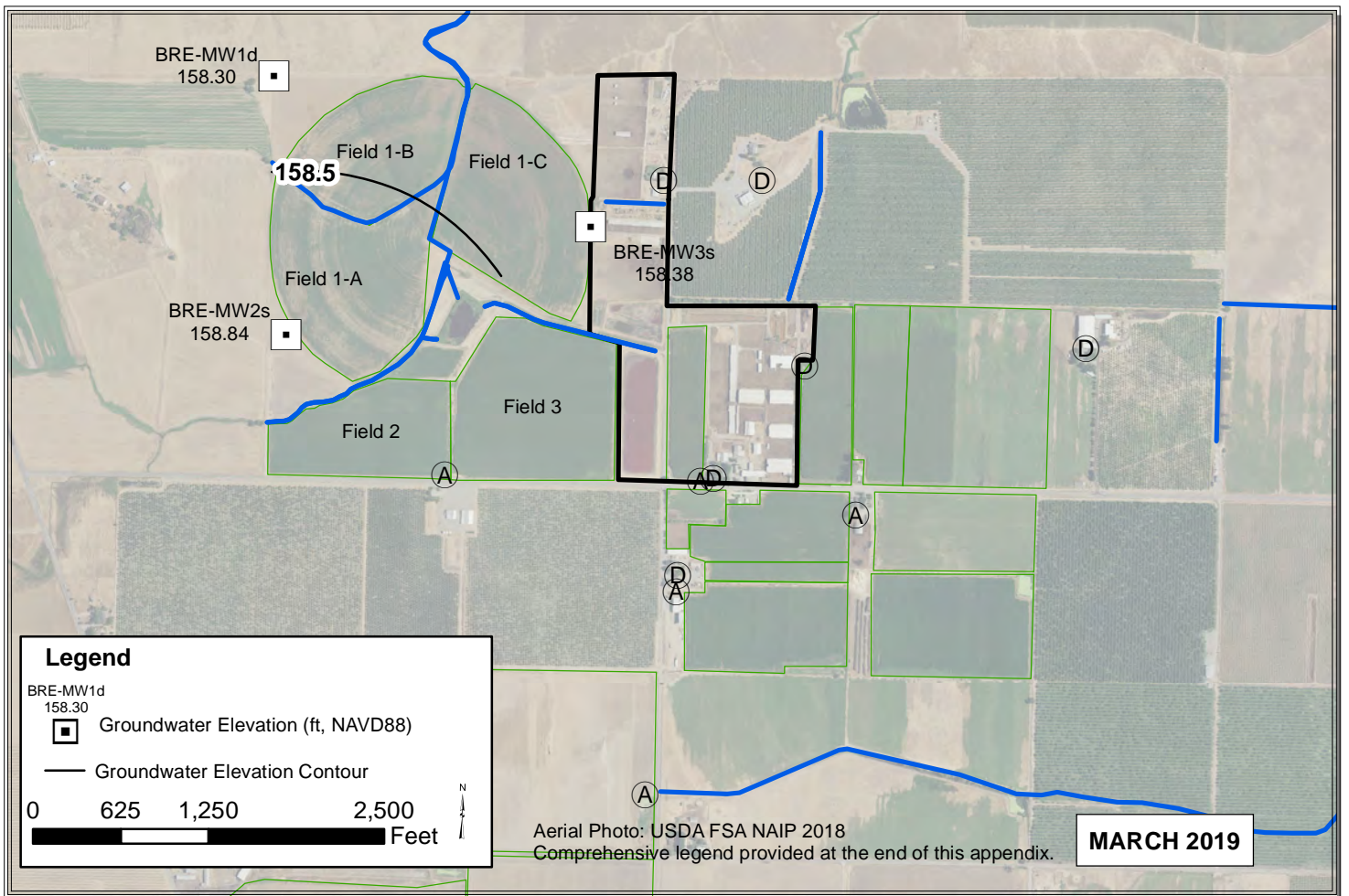

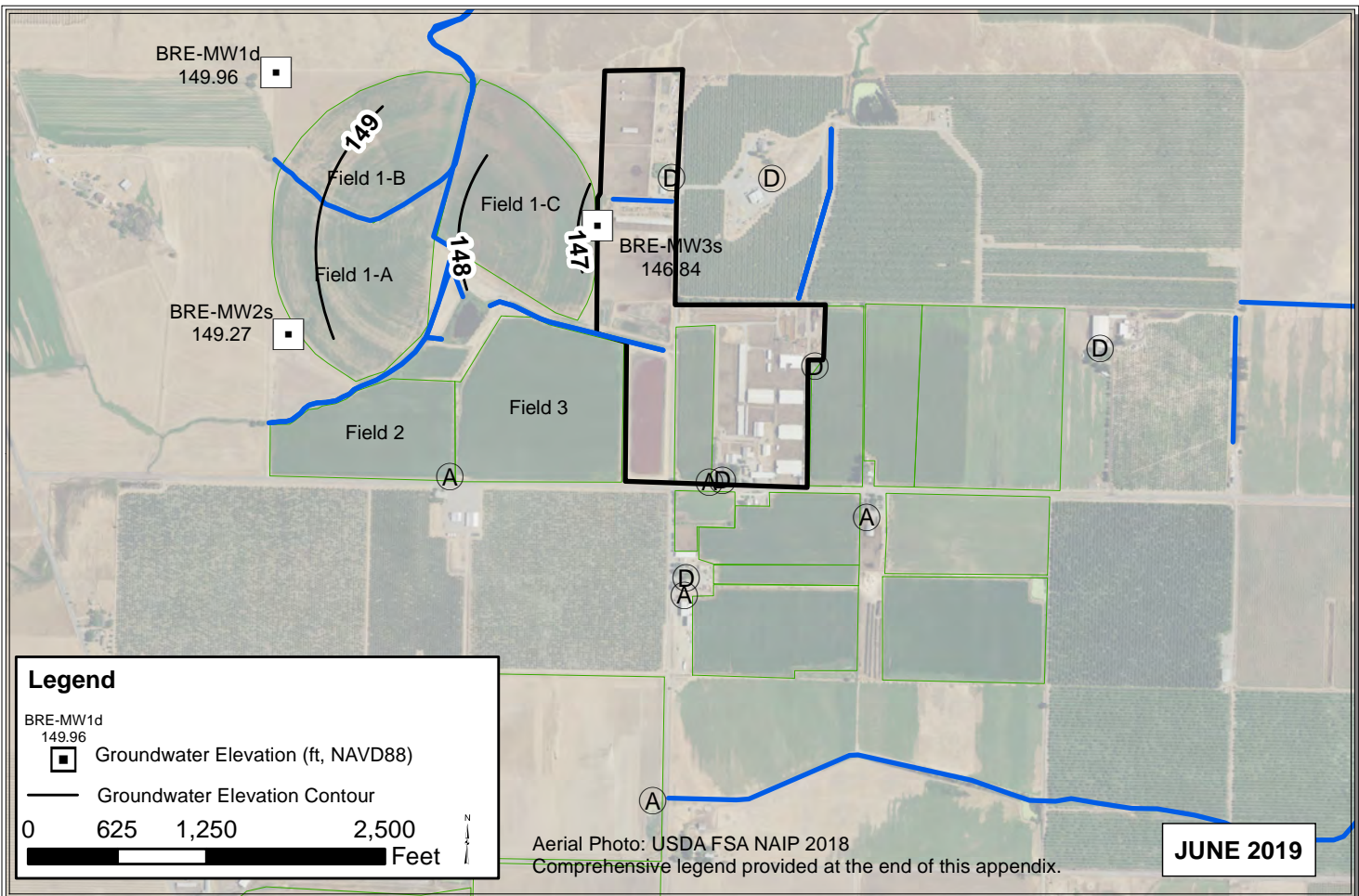
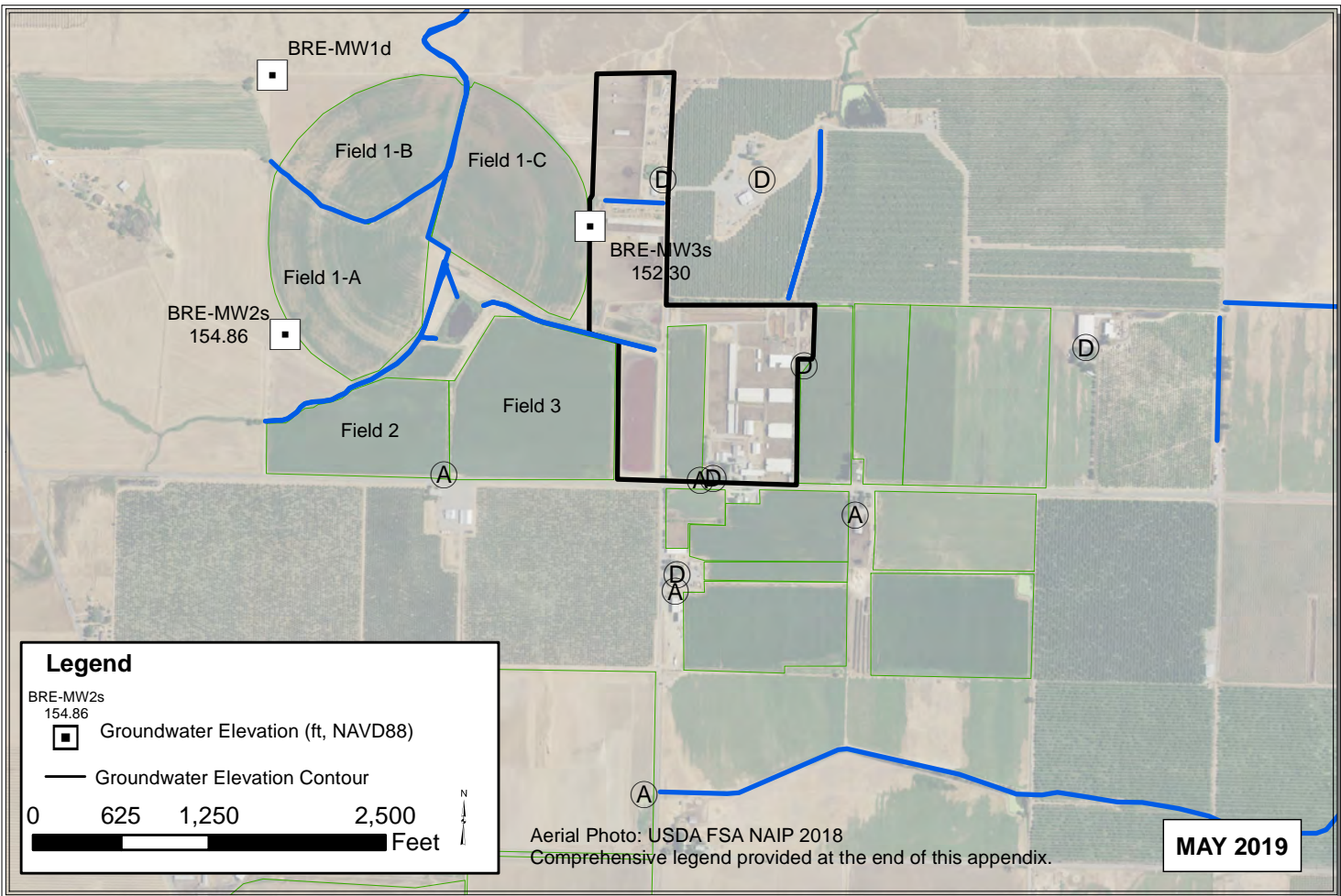

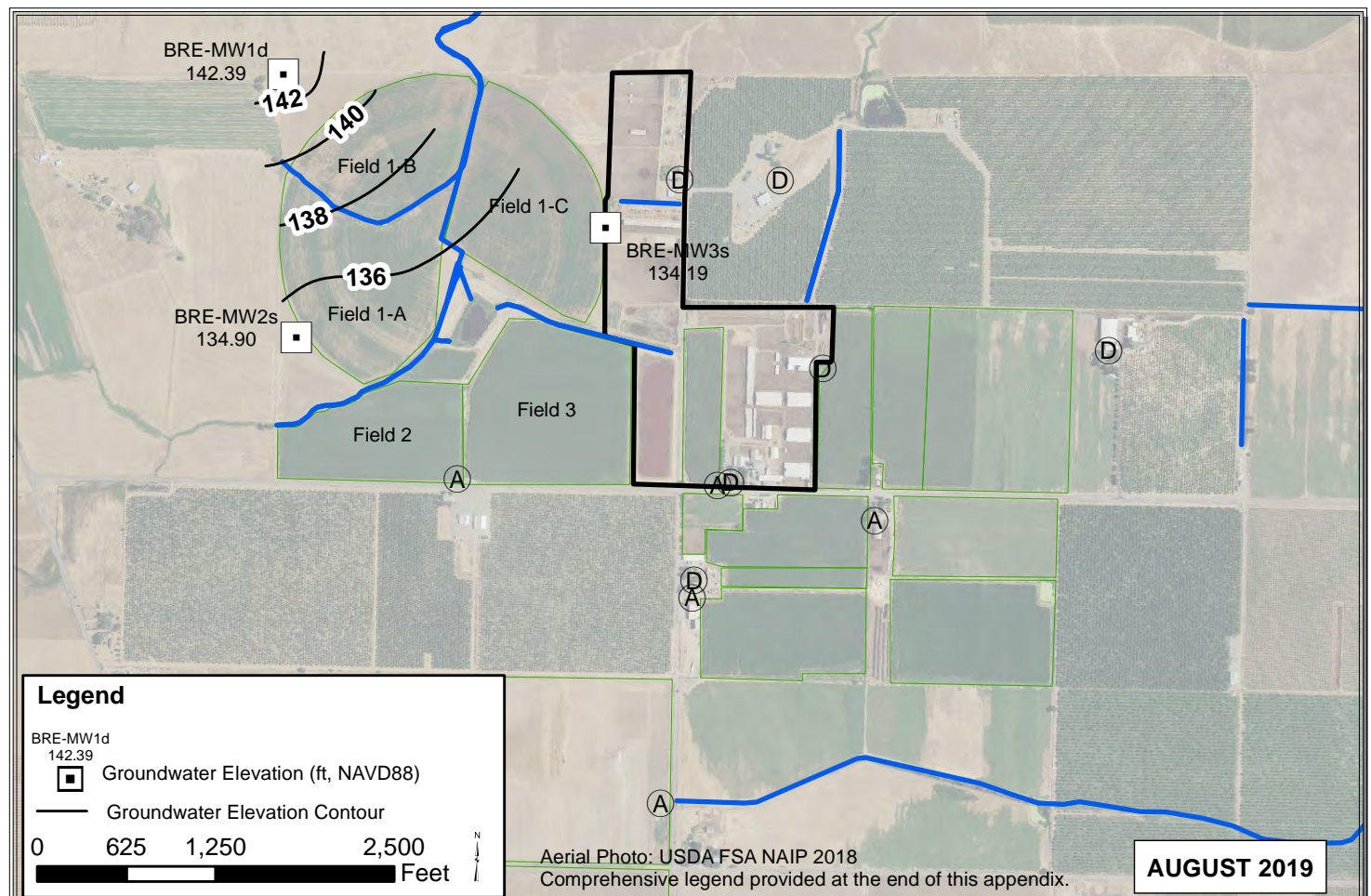
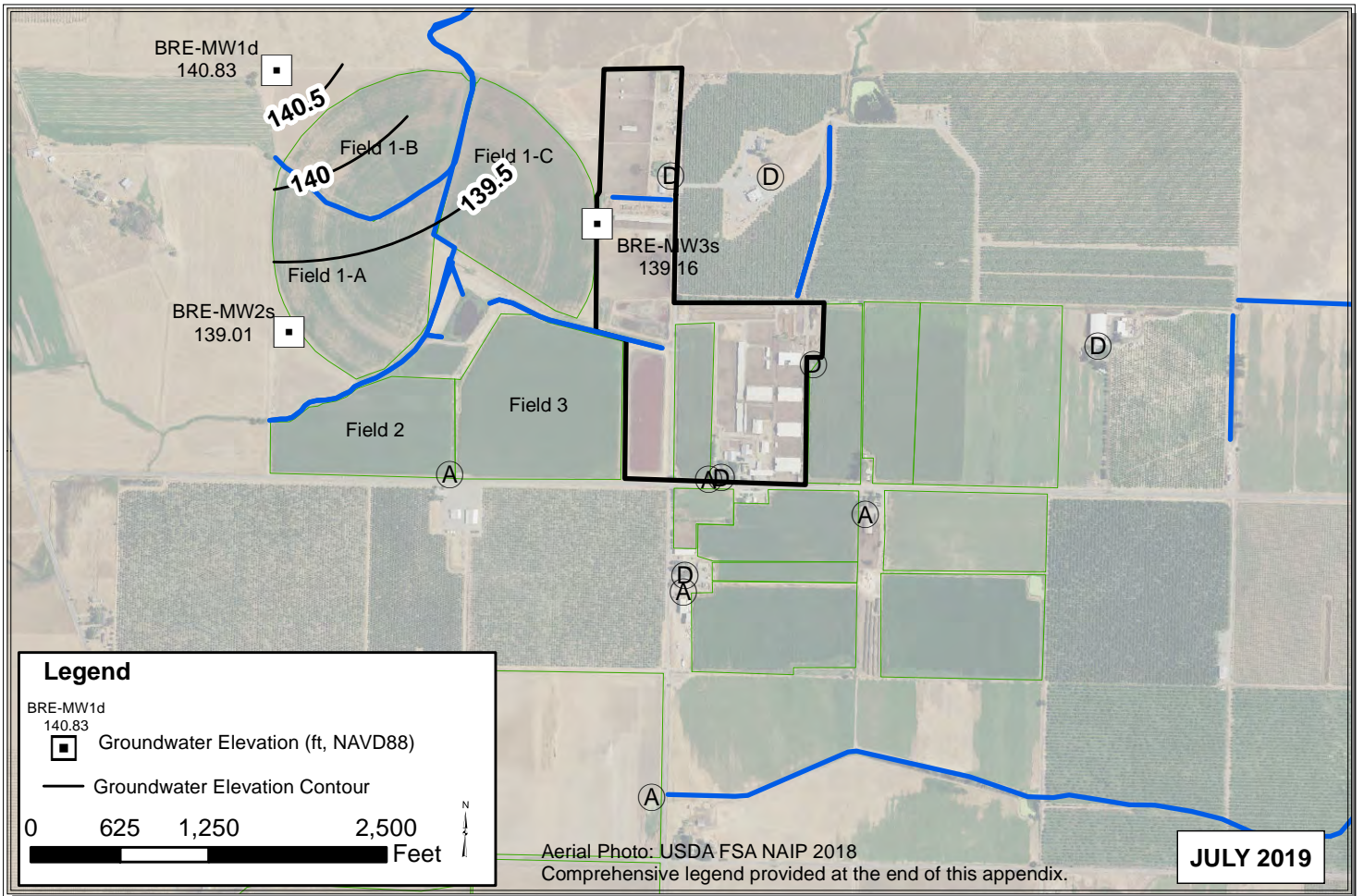

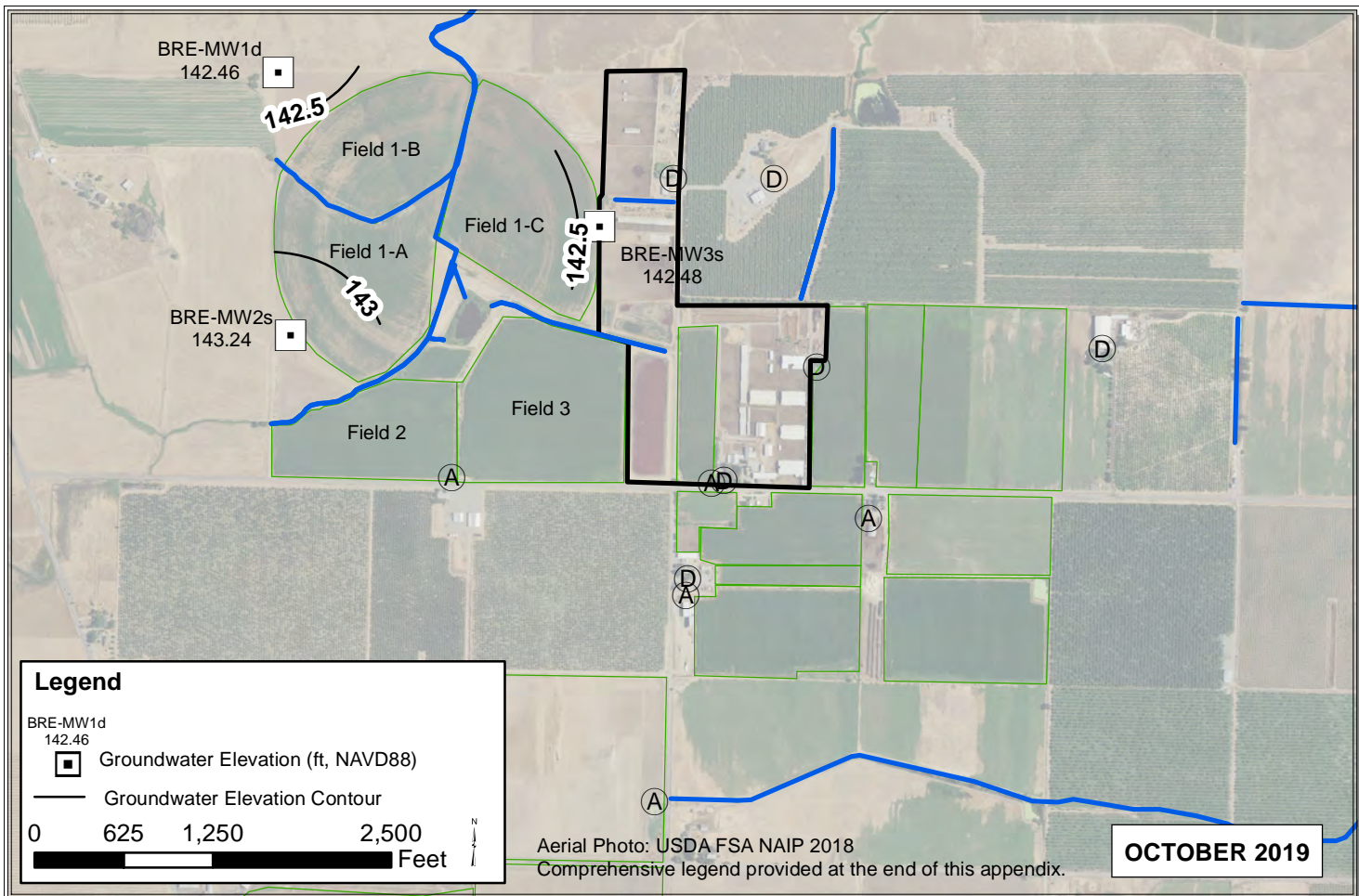
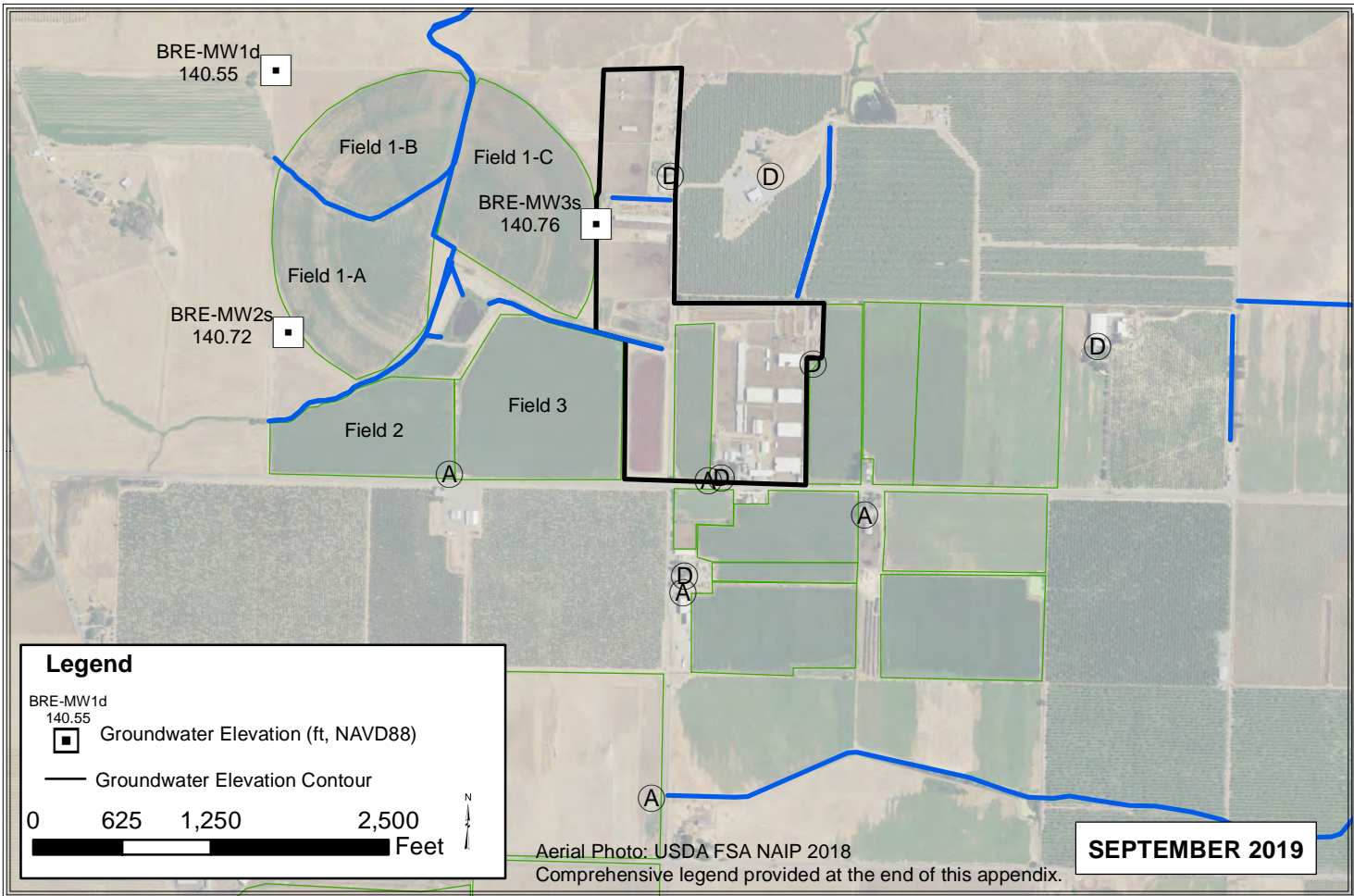

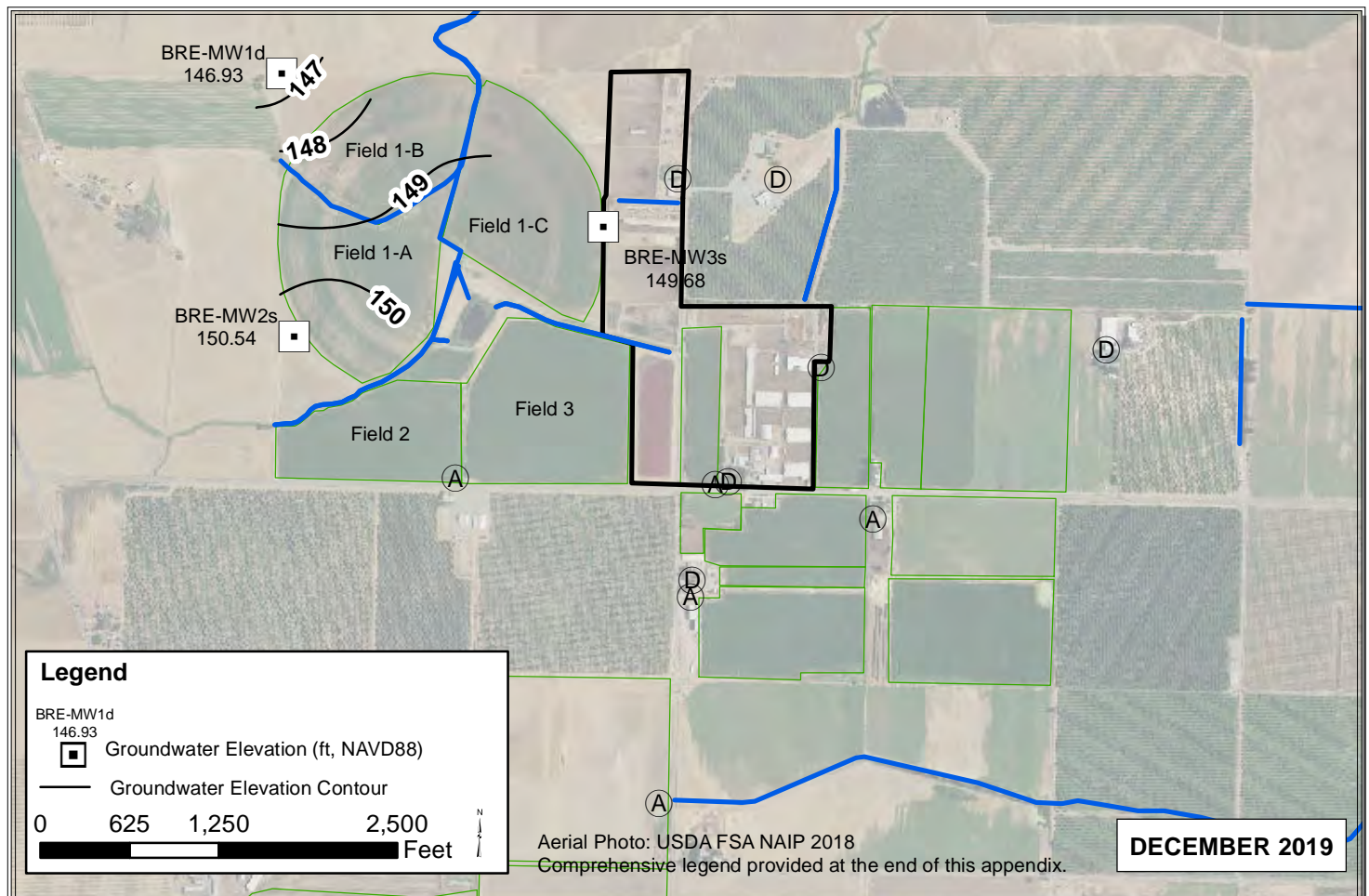
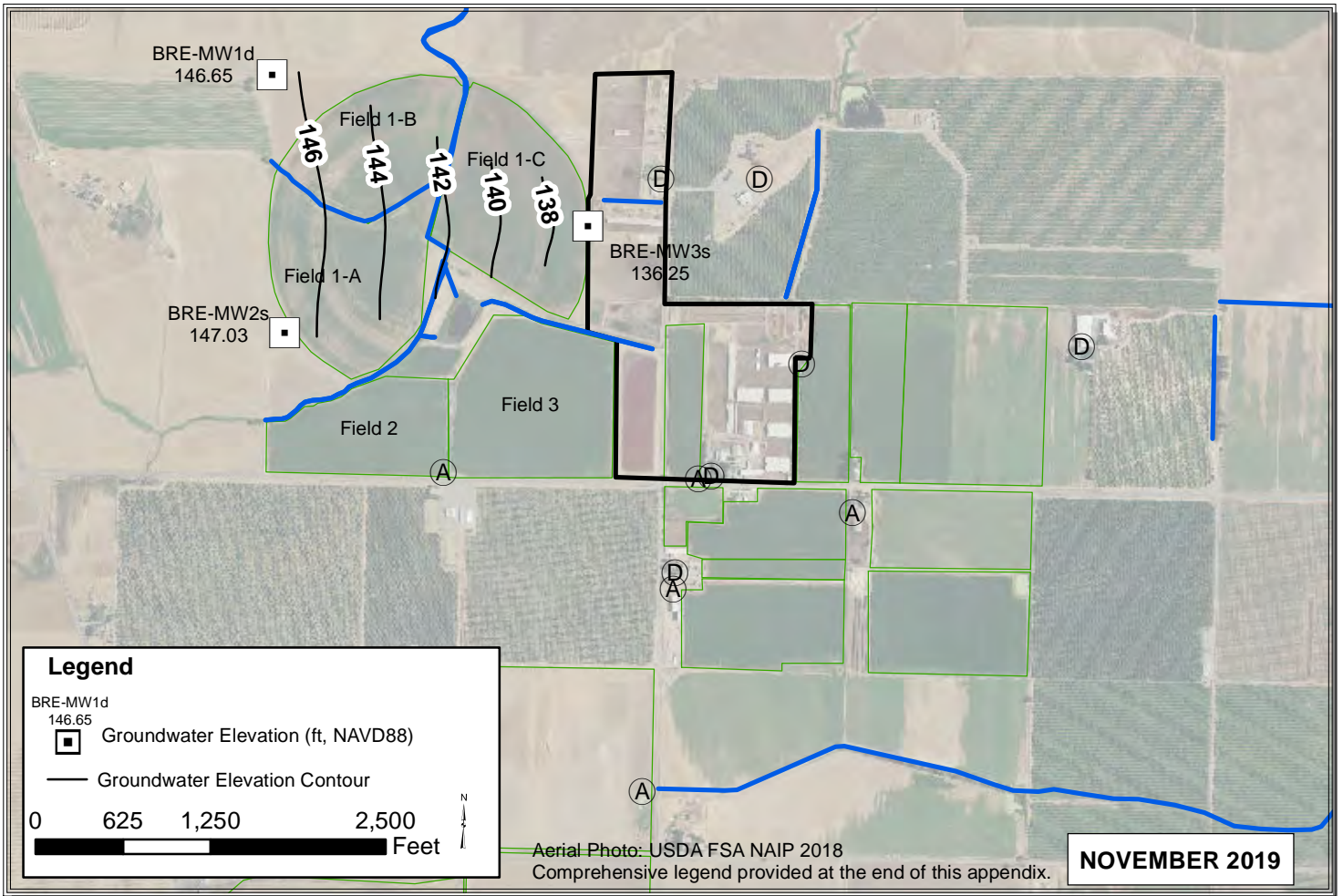

CRE

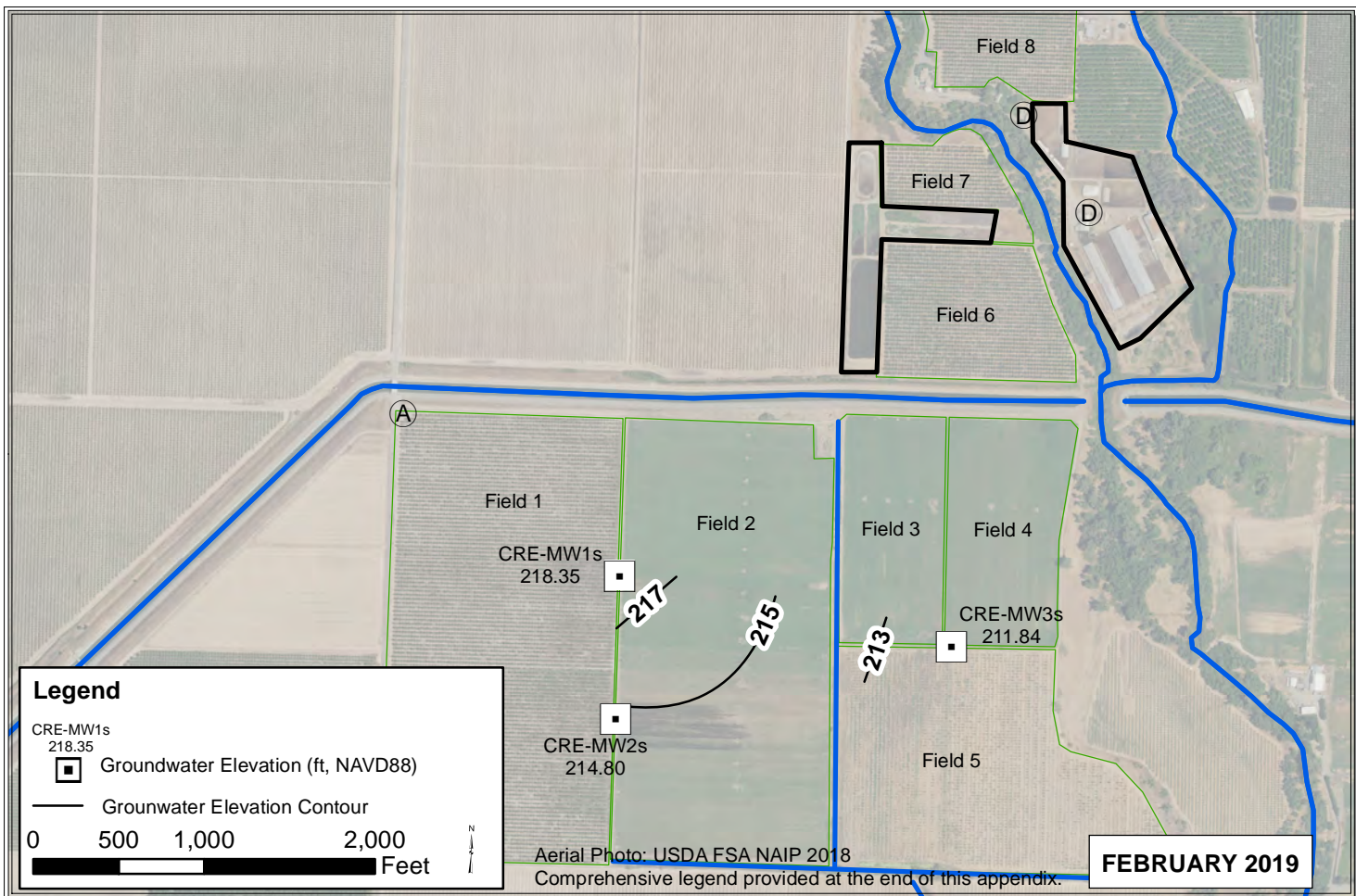
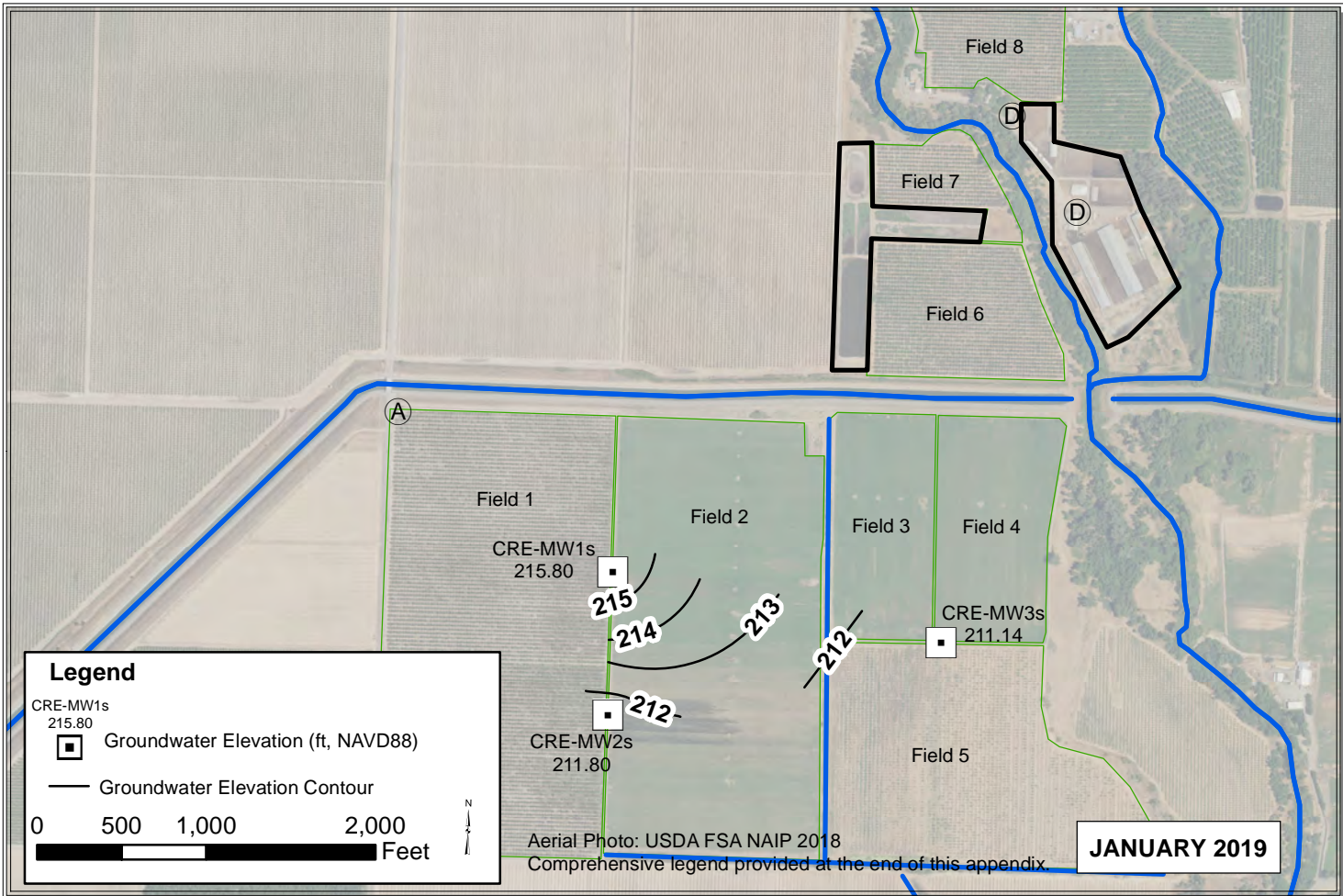

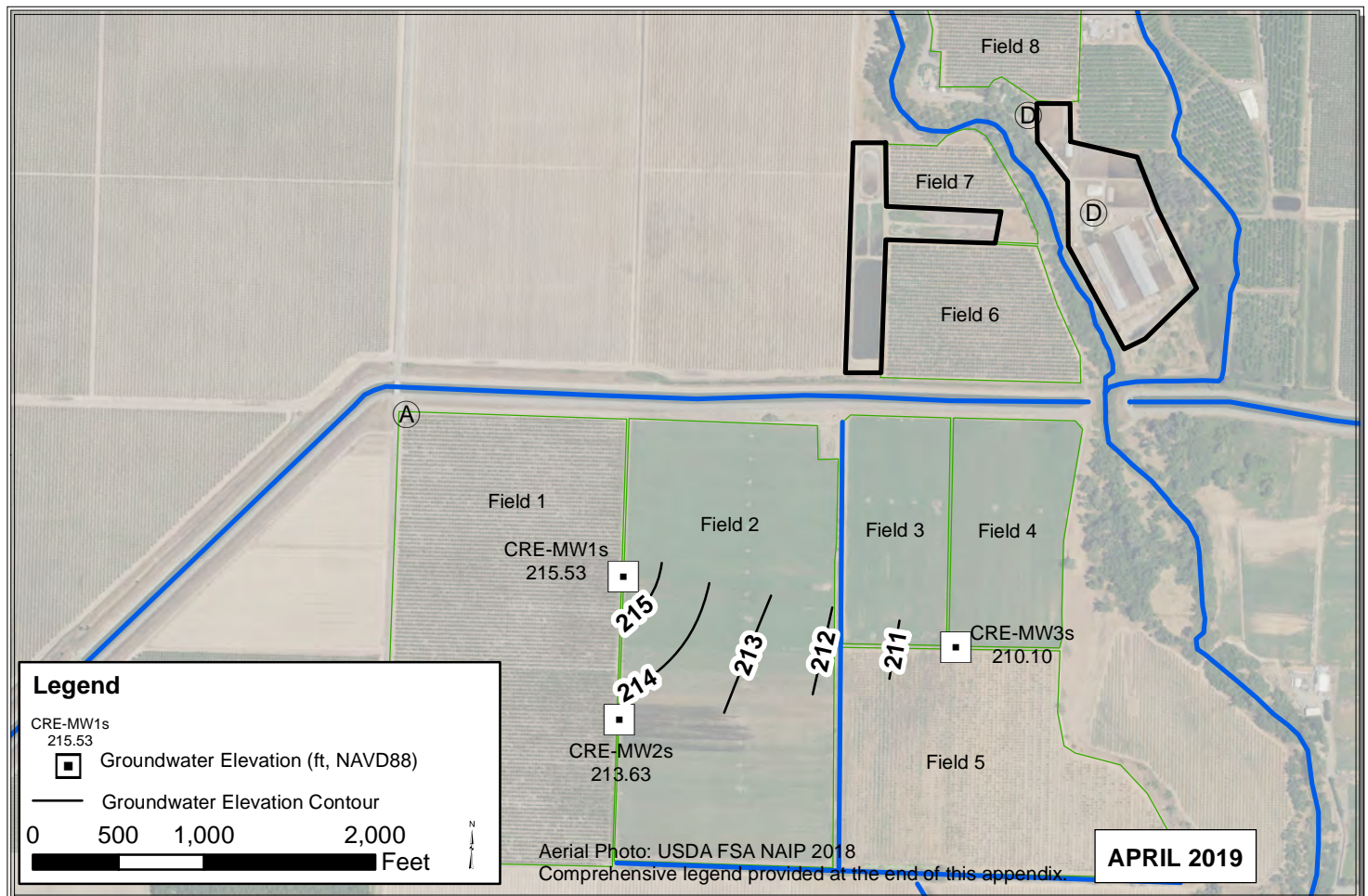
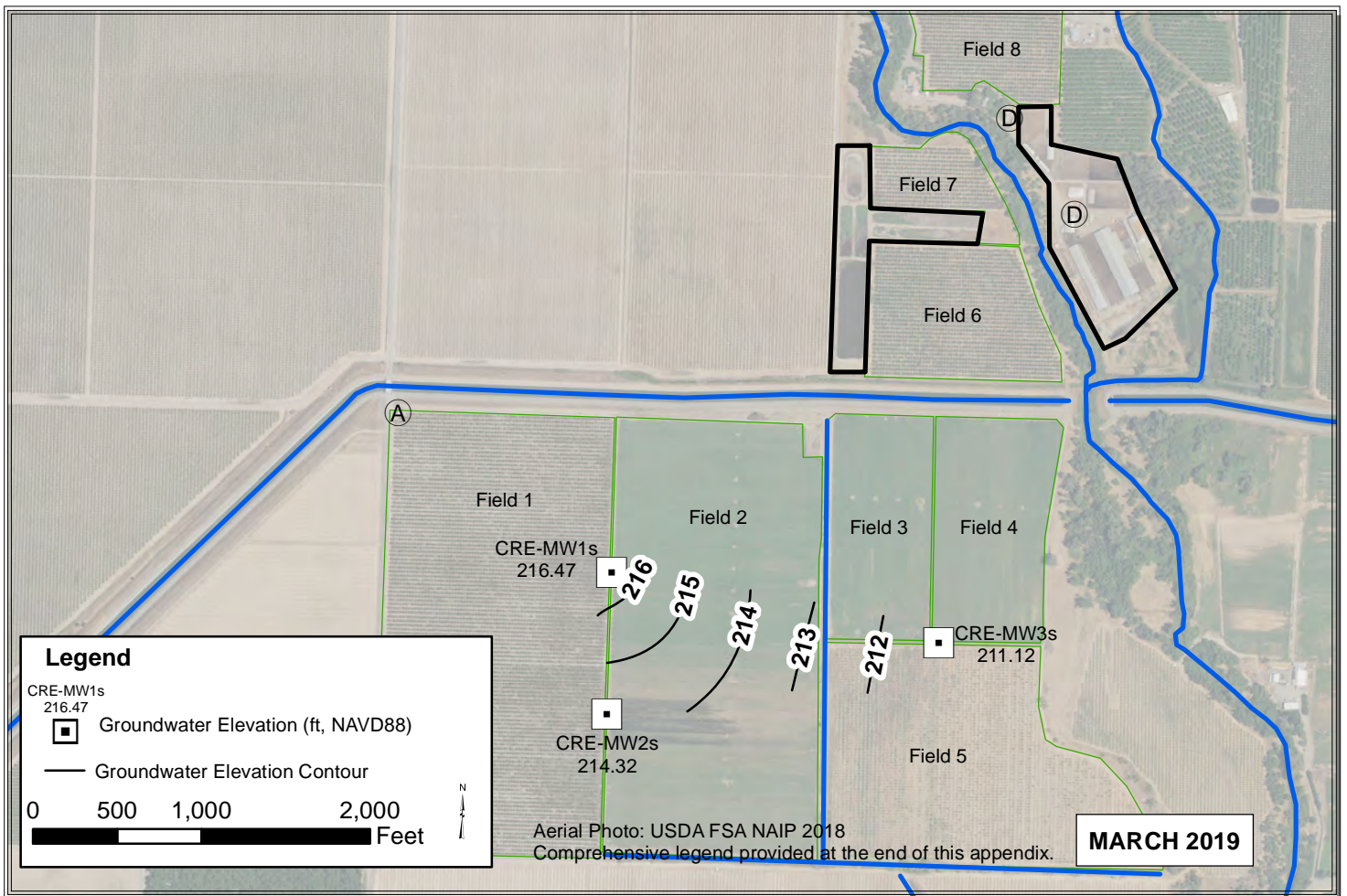

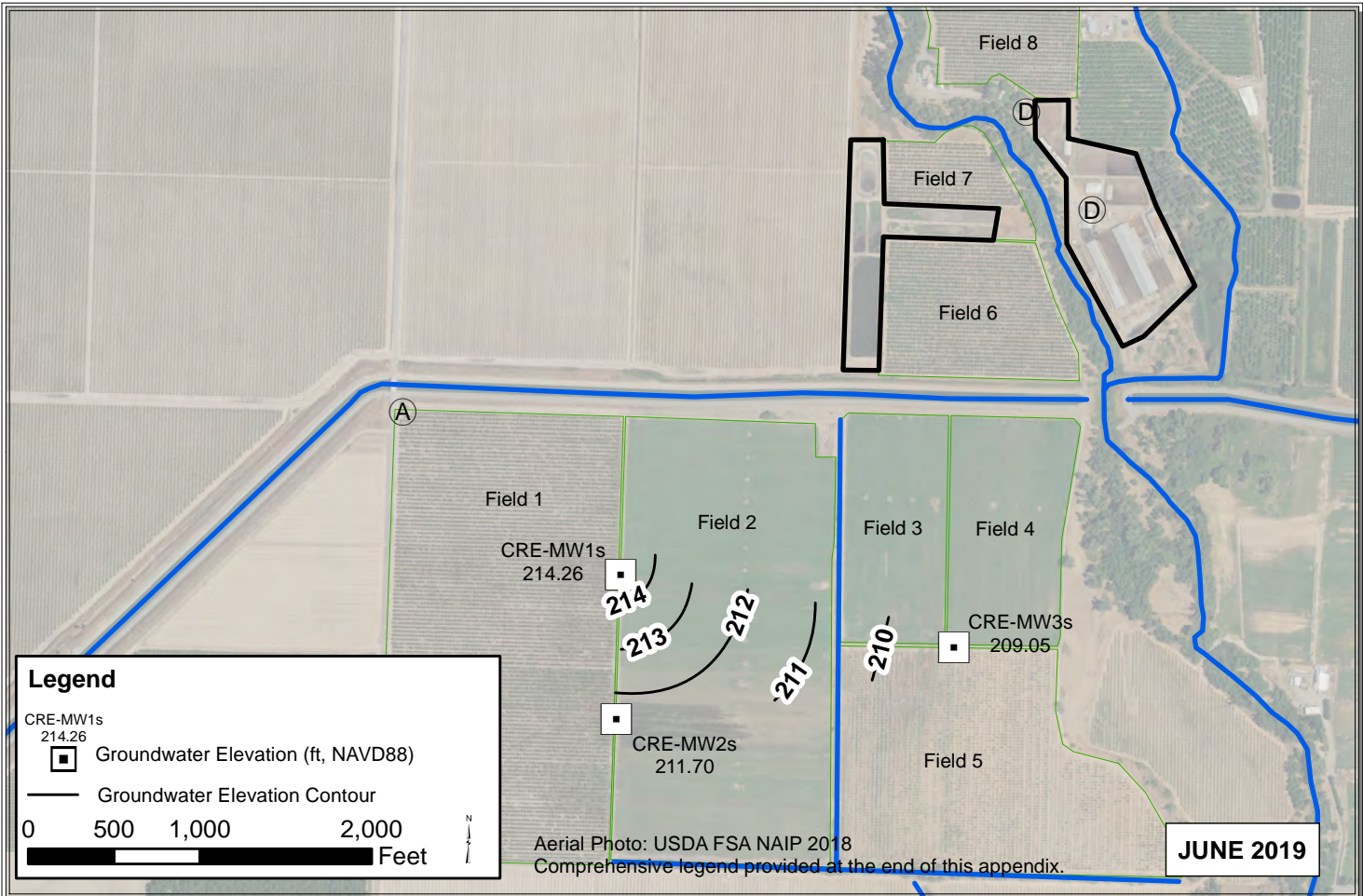
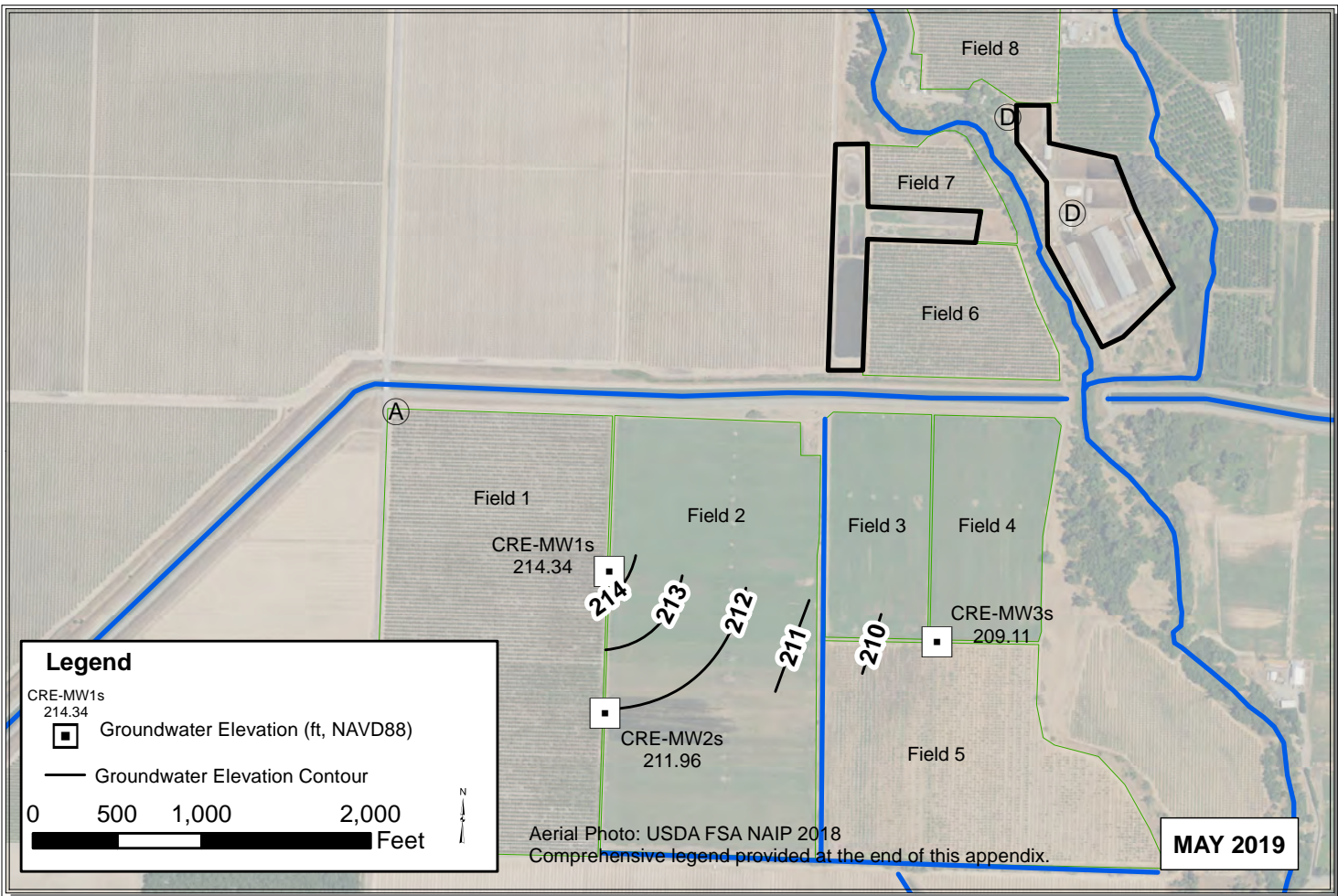

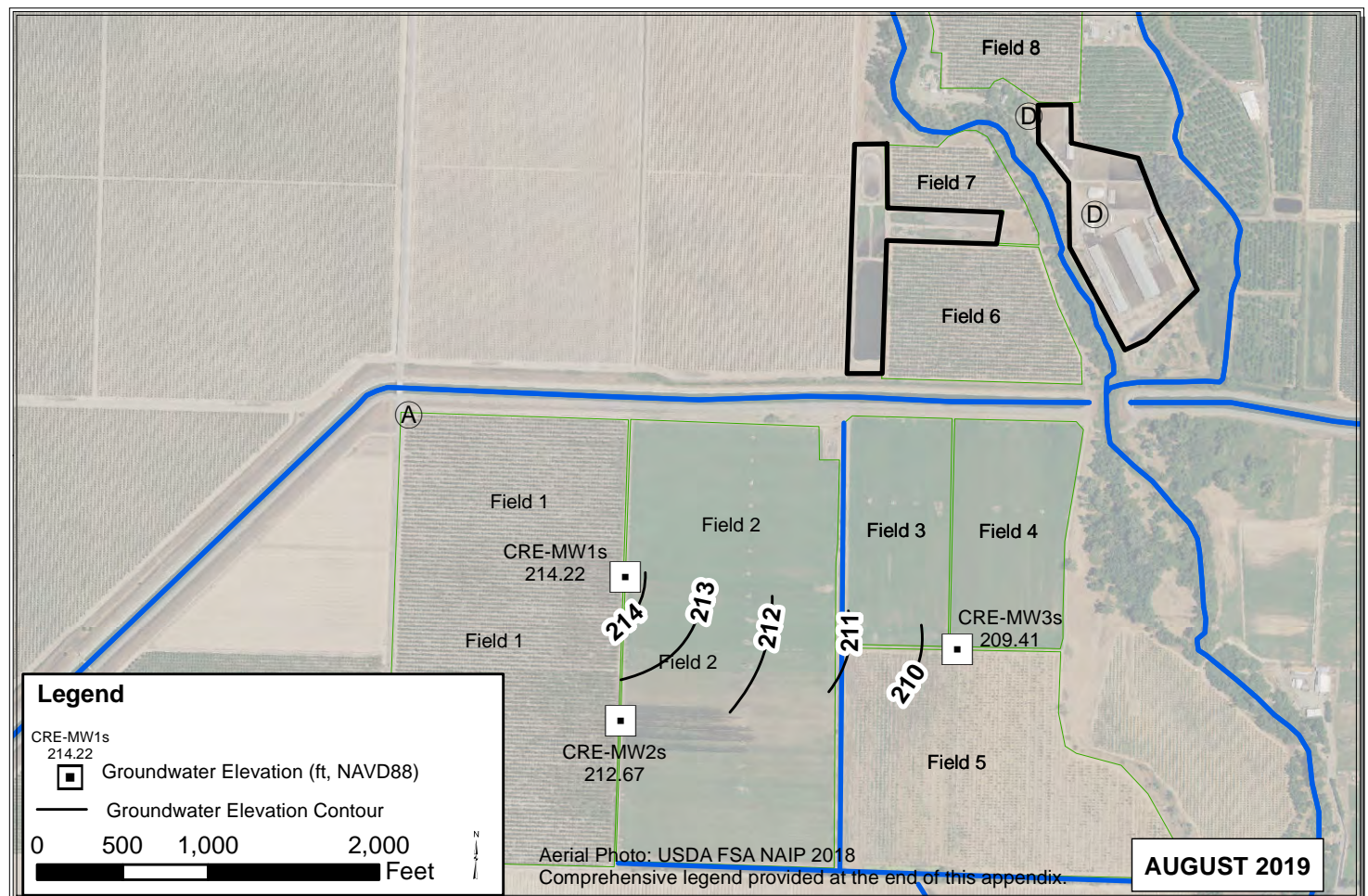
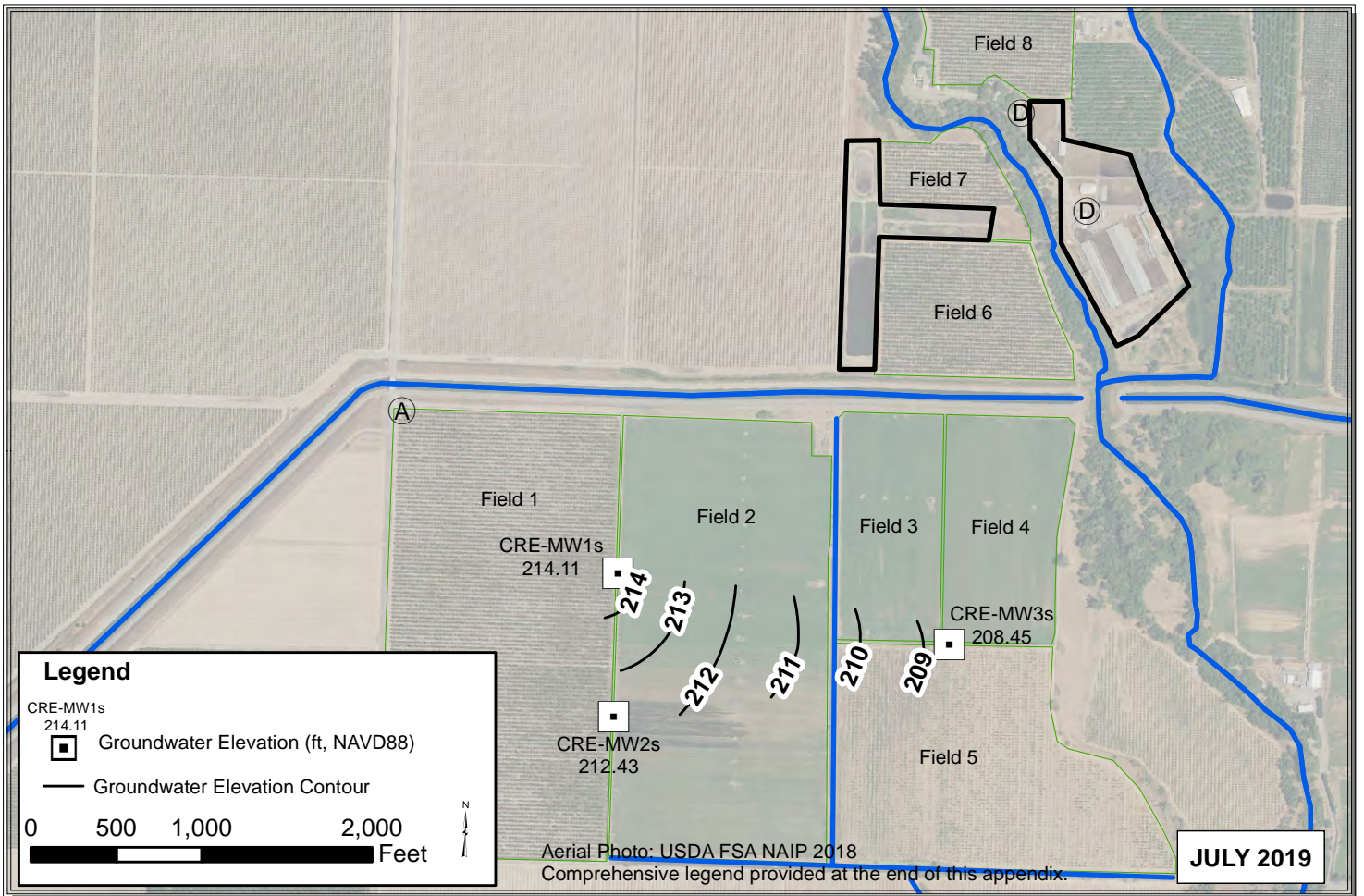

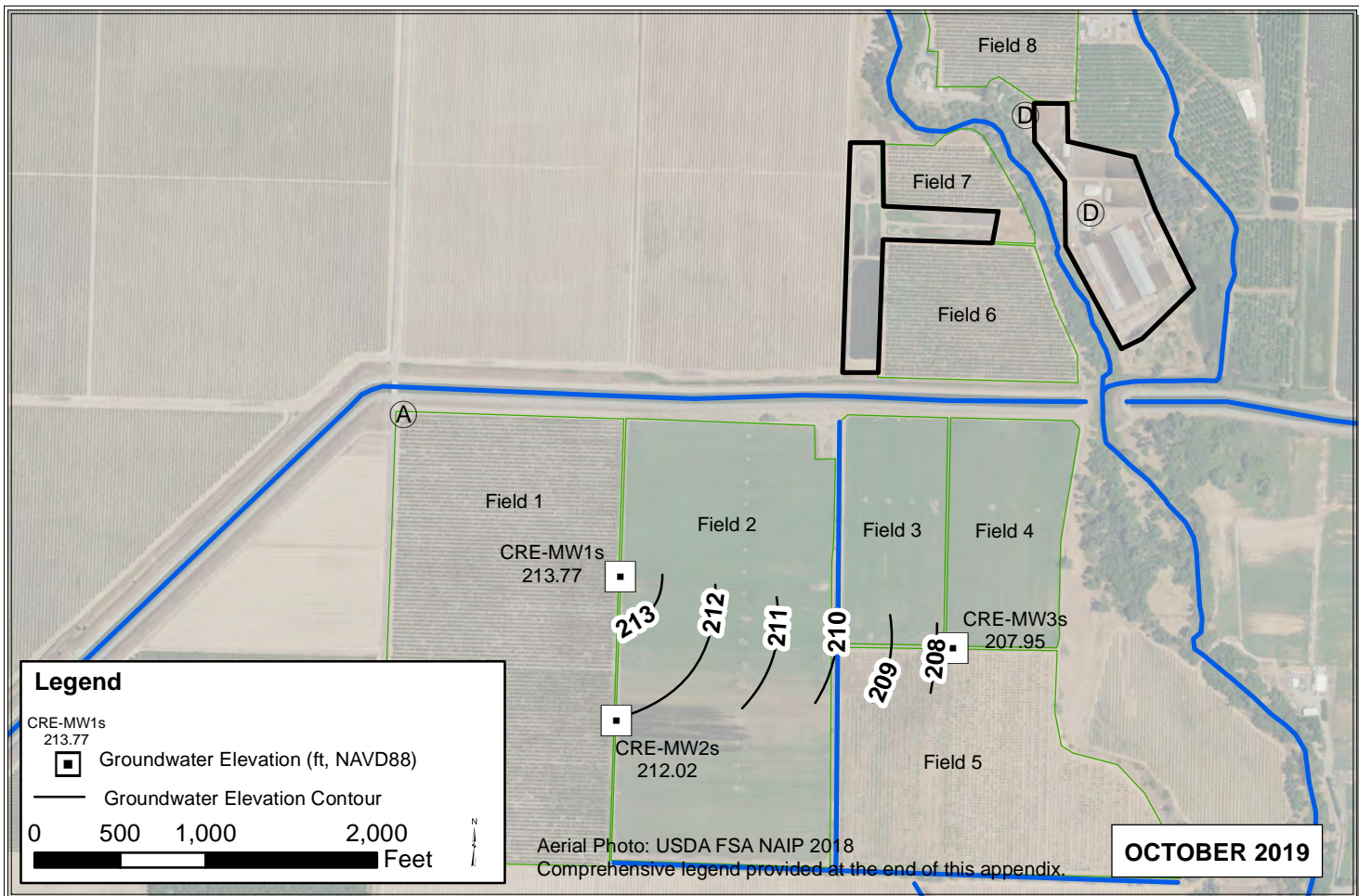
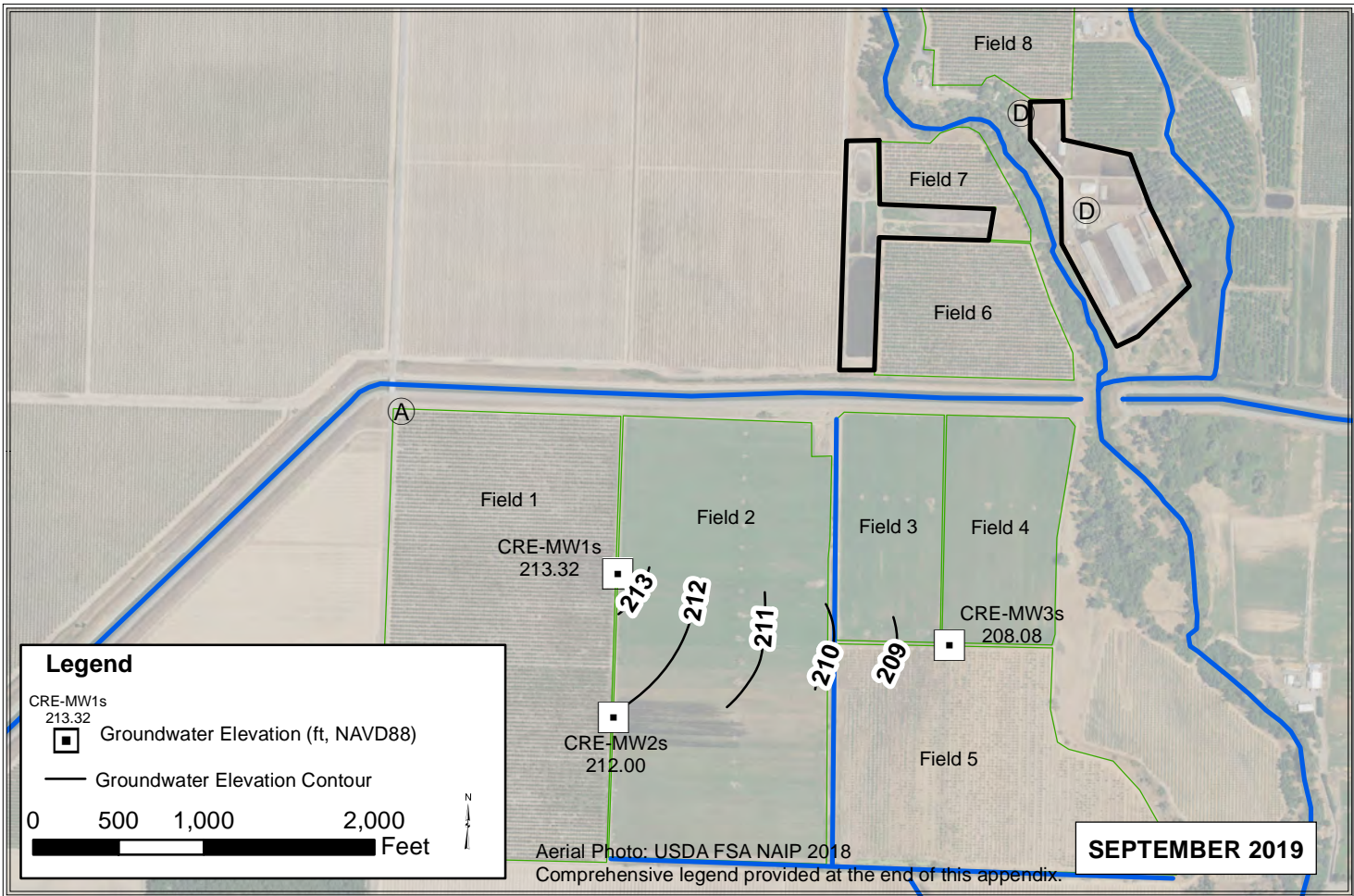

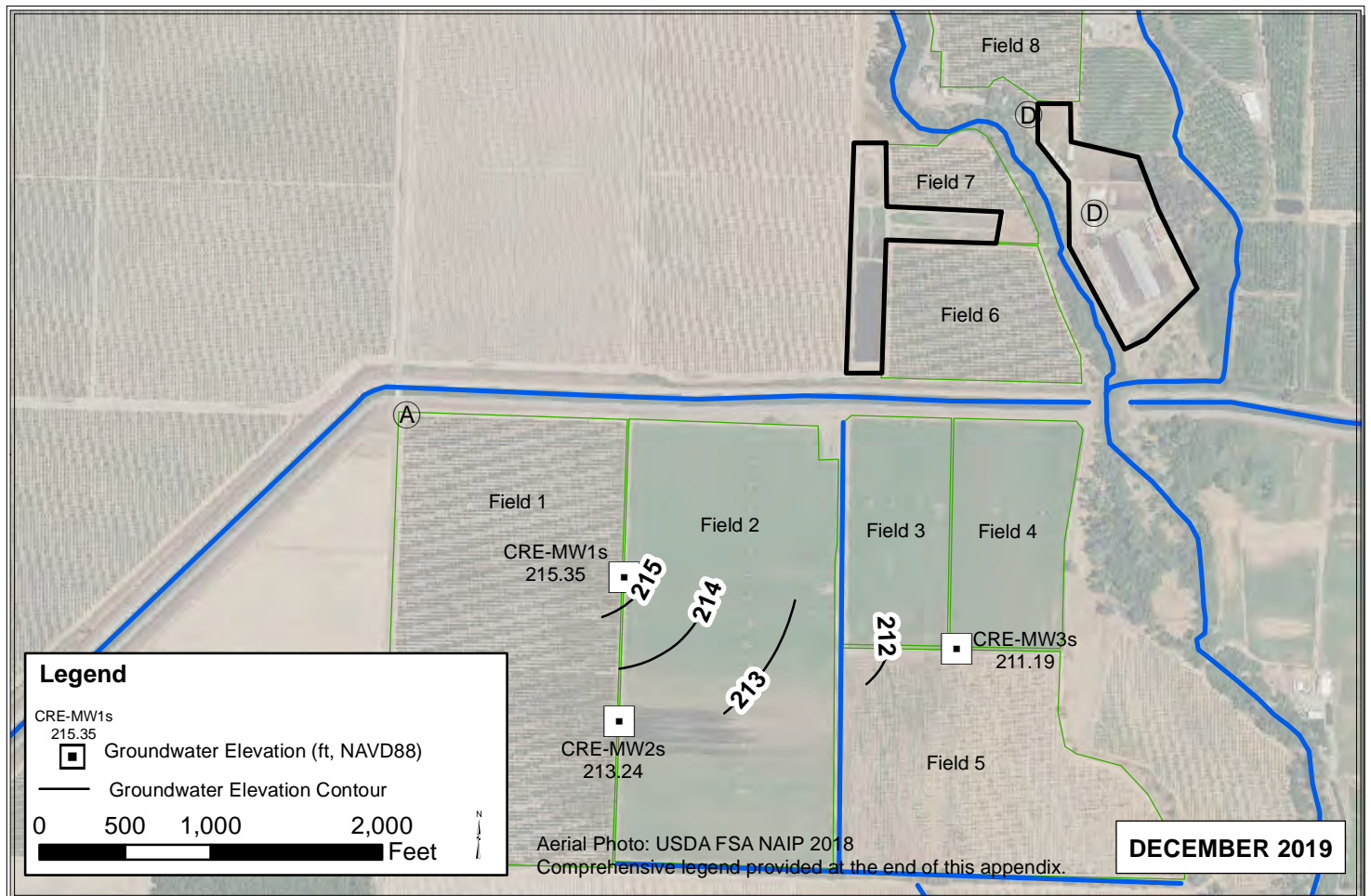
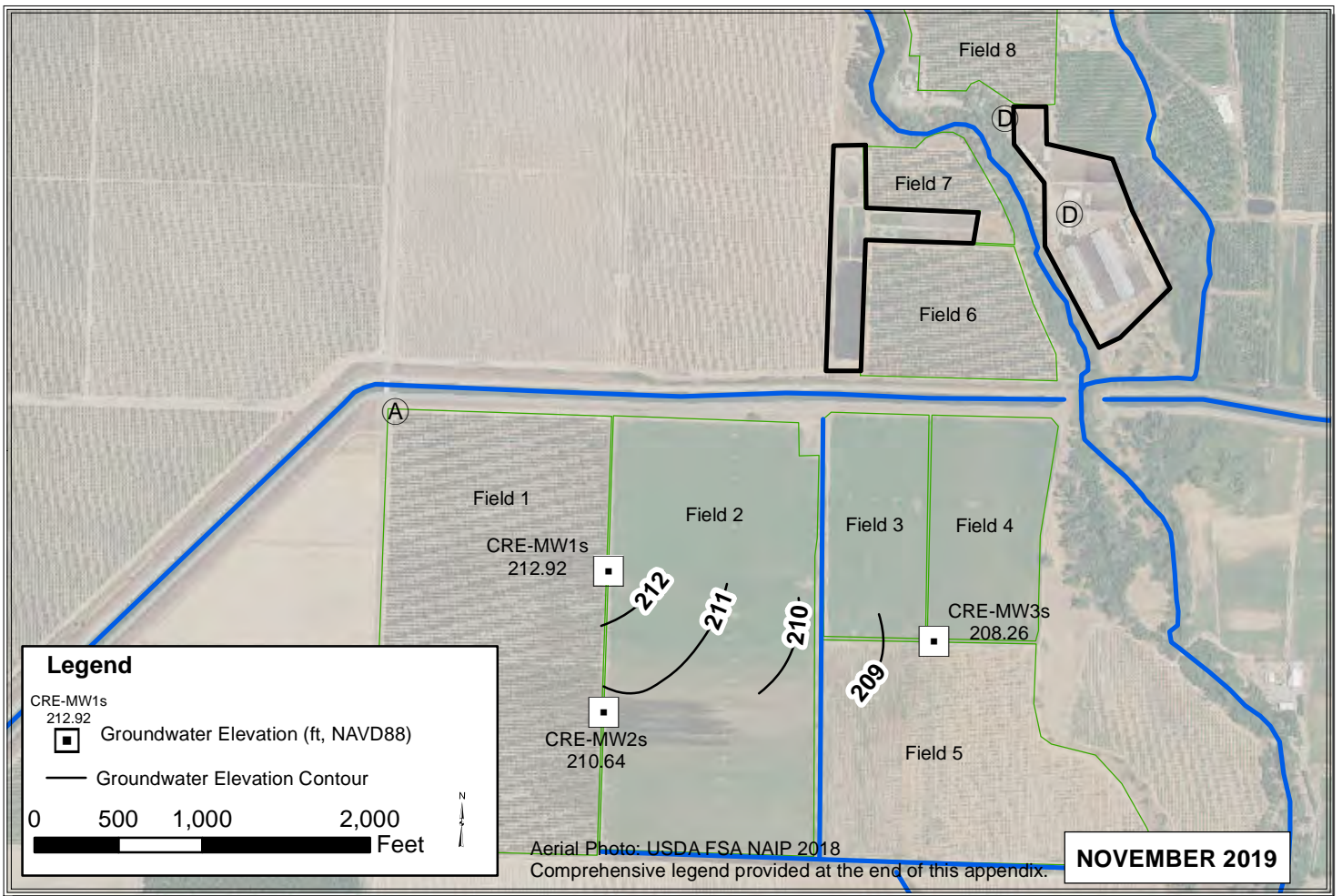

MTS

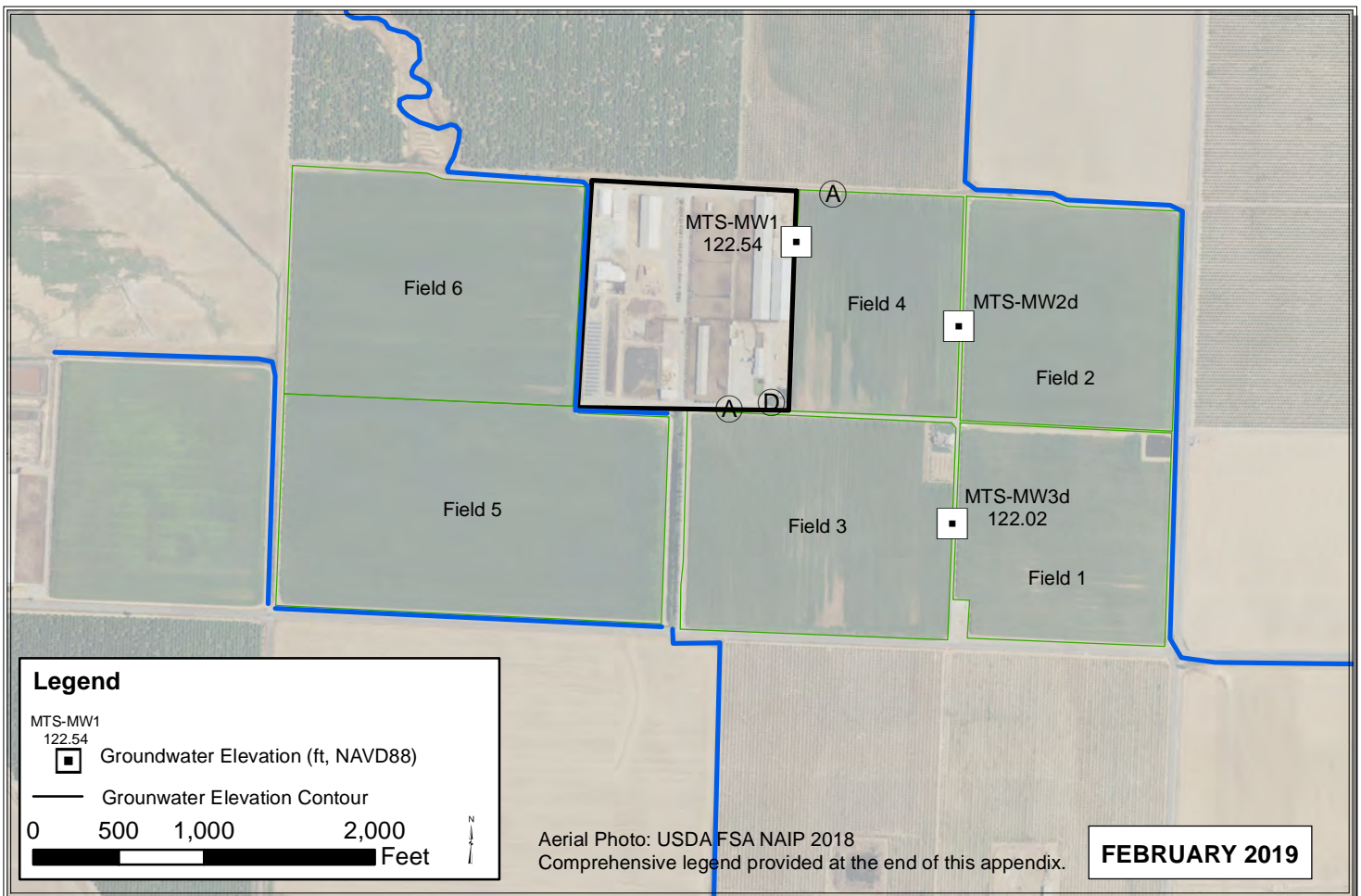
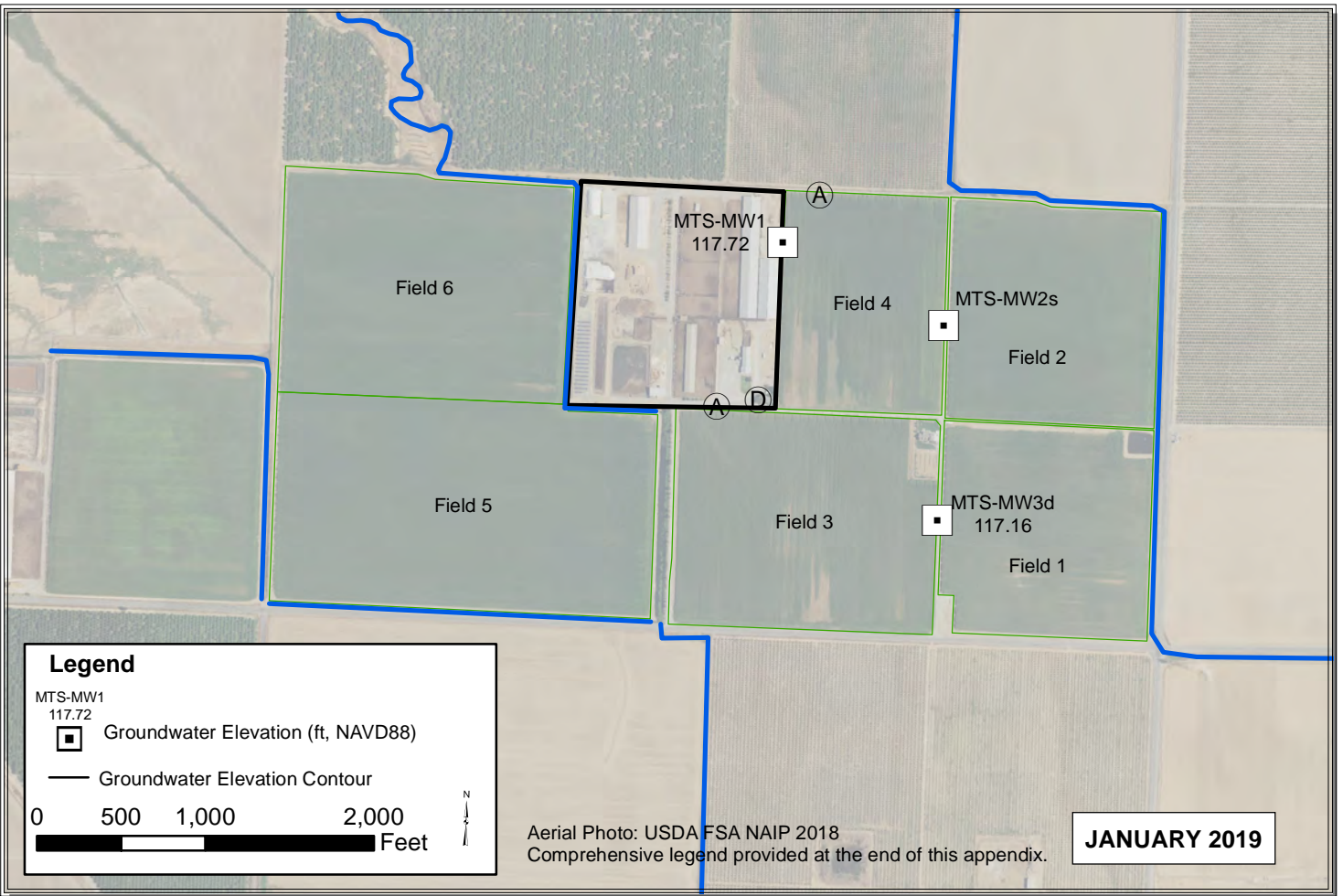

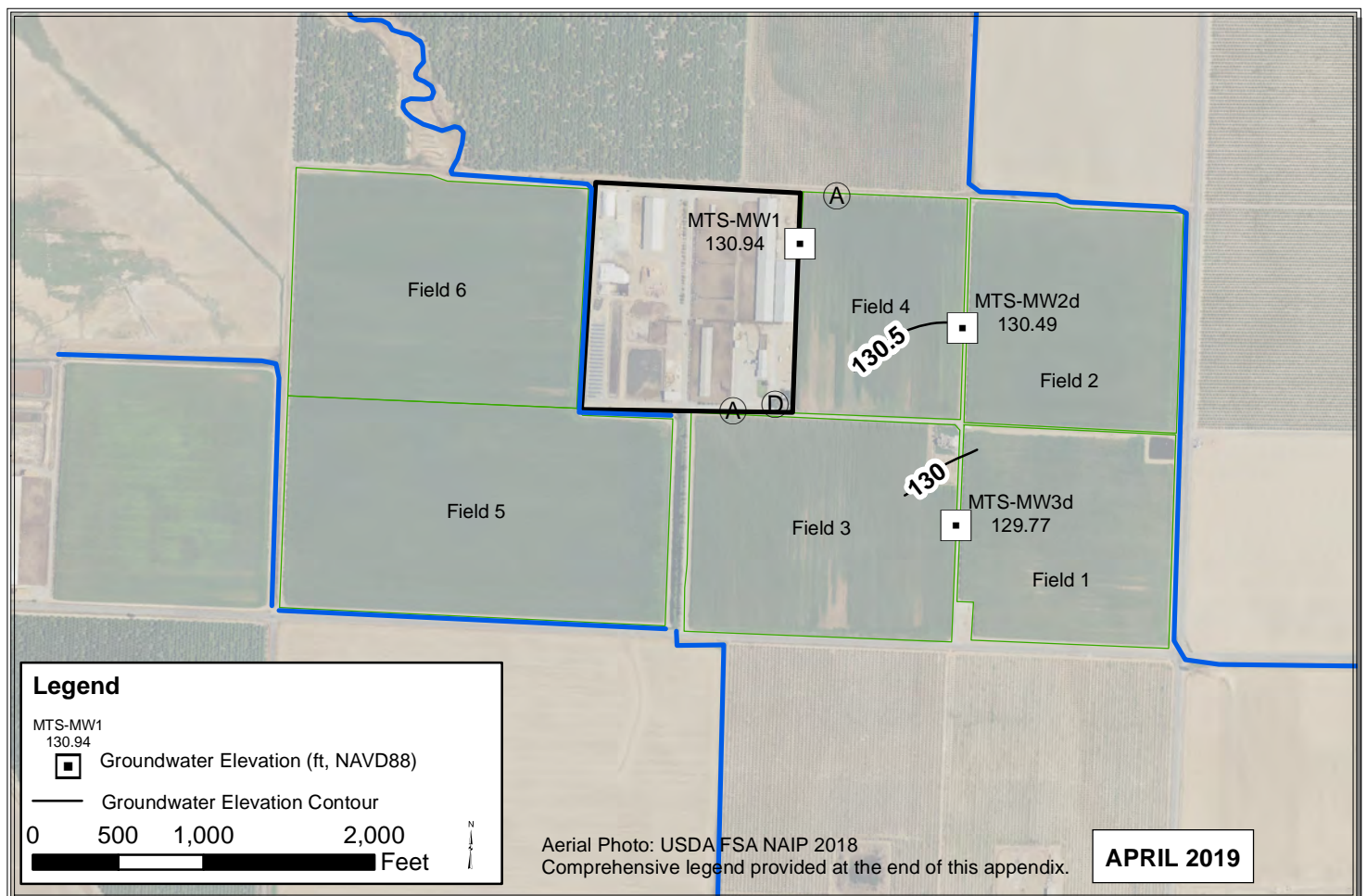
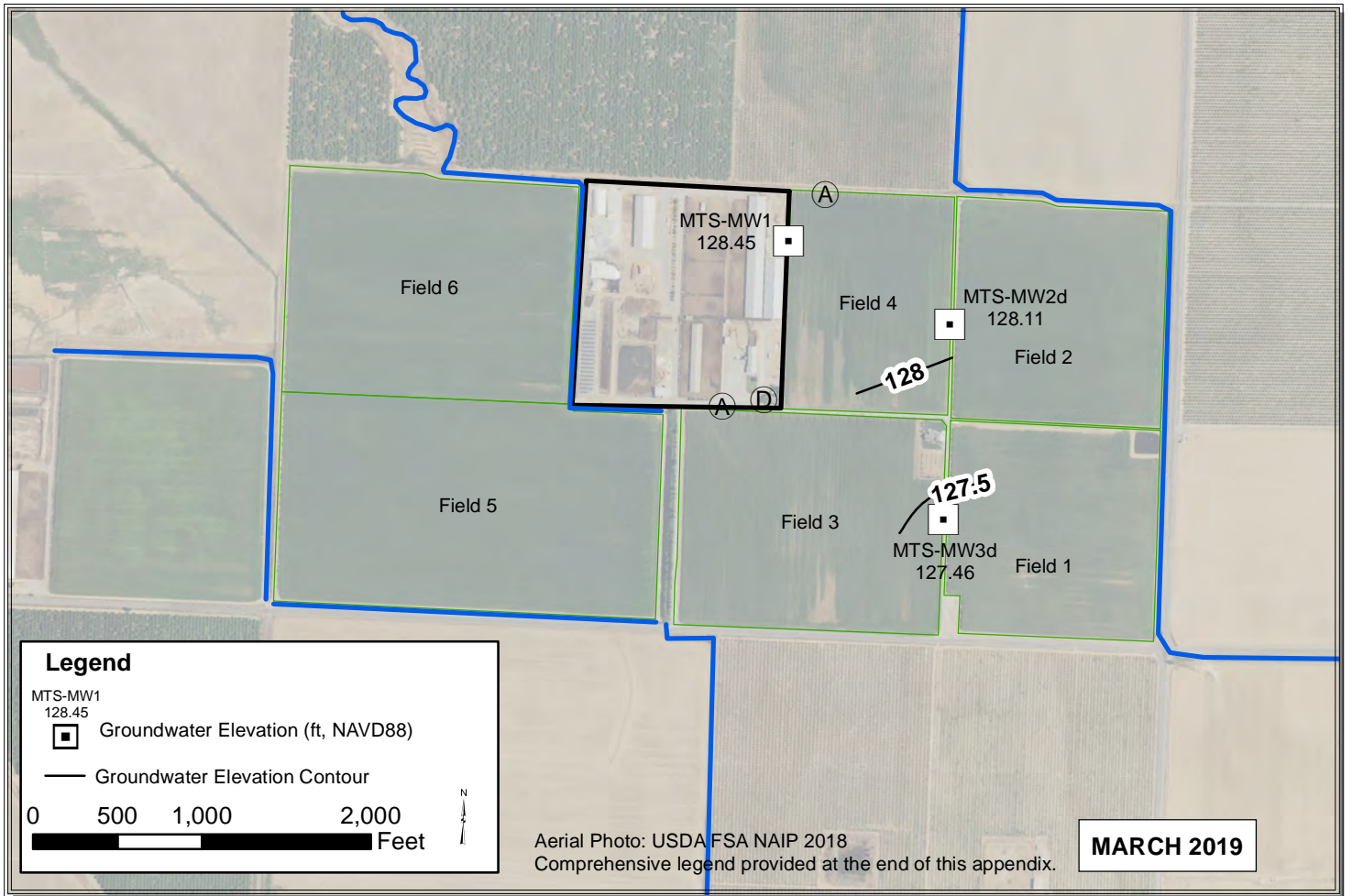

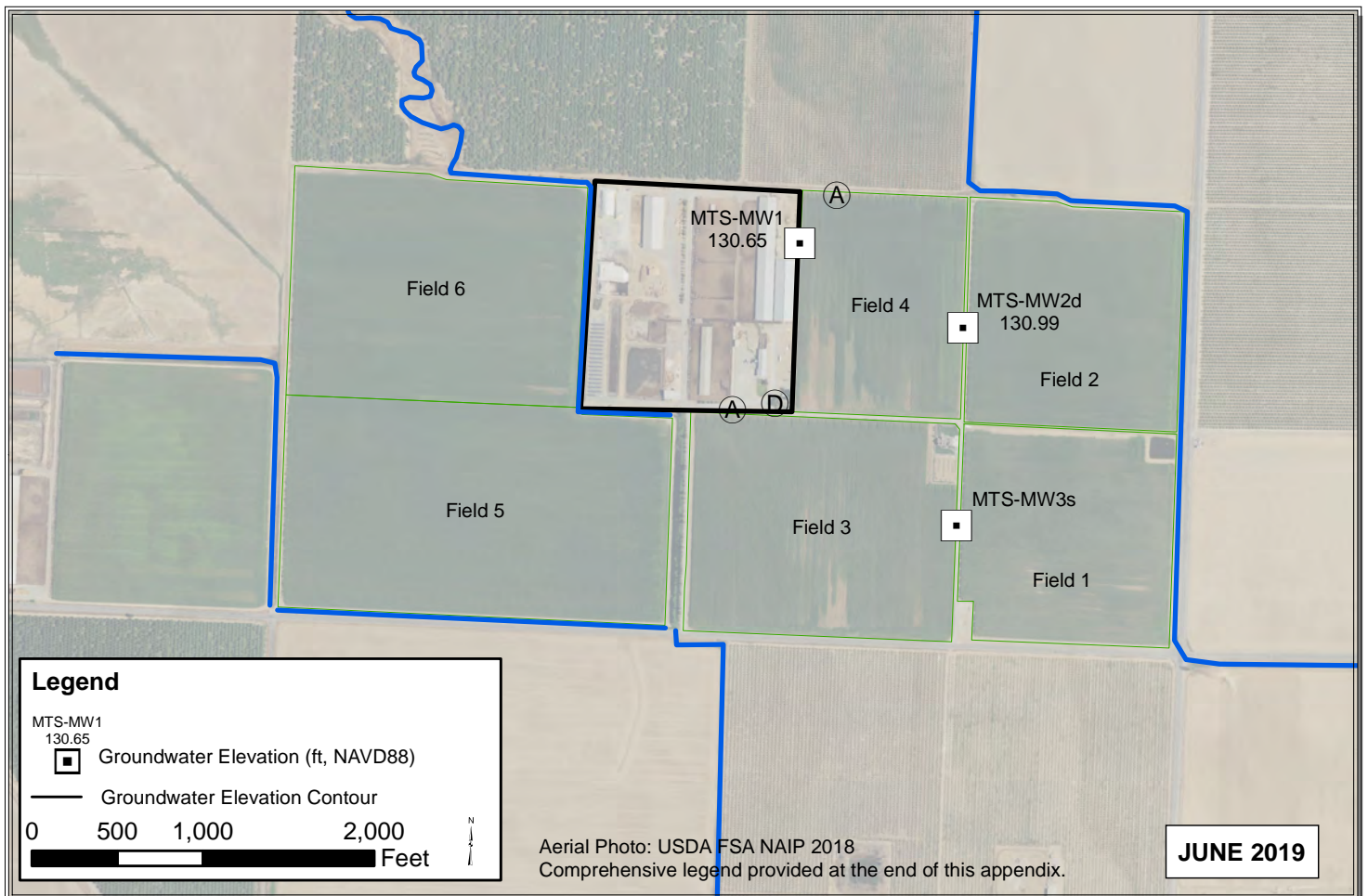
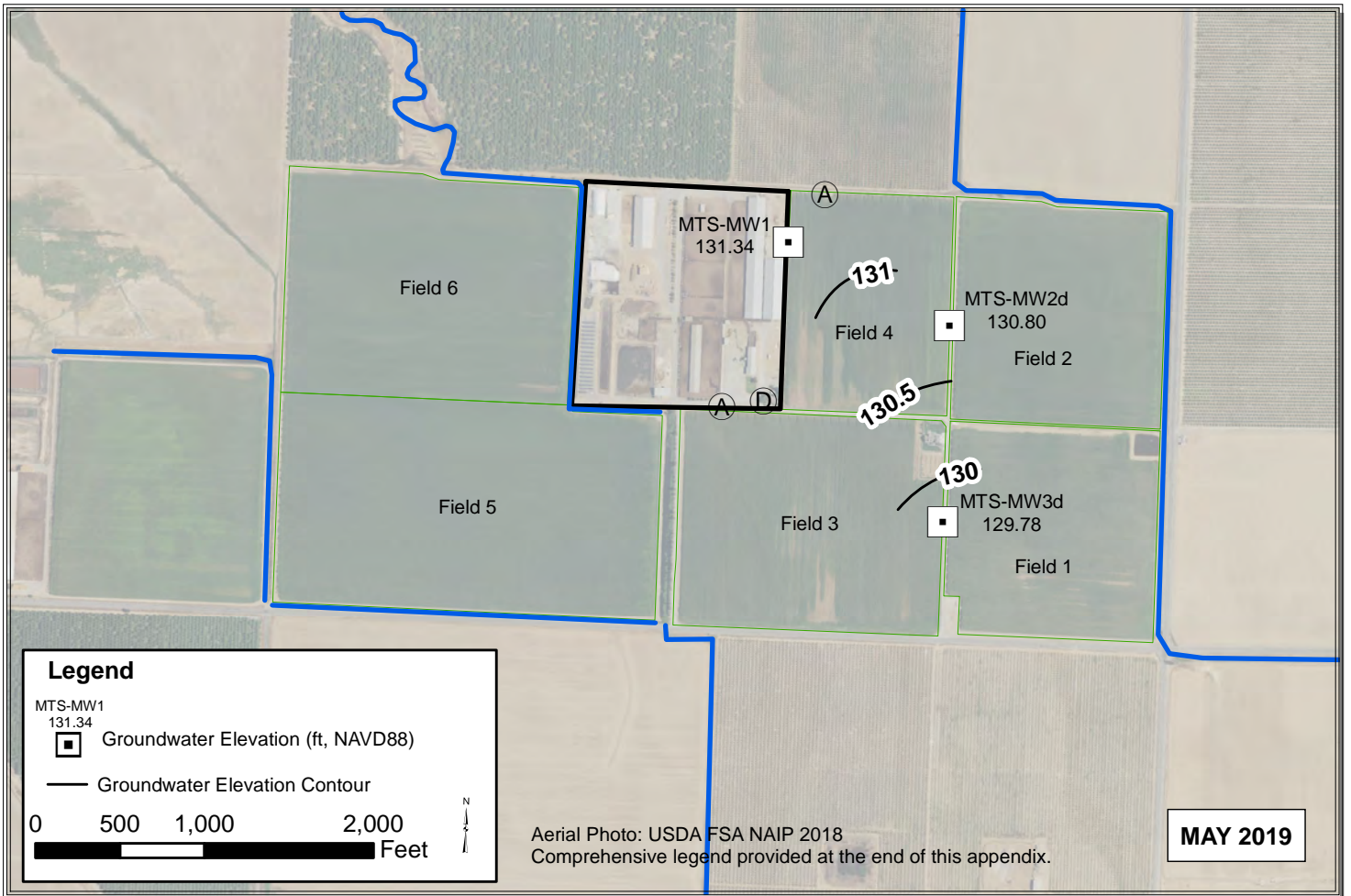

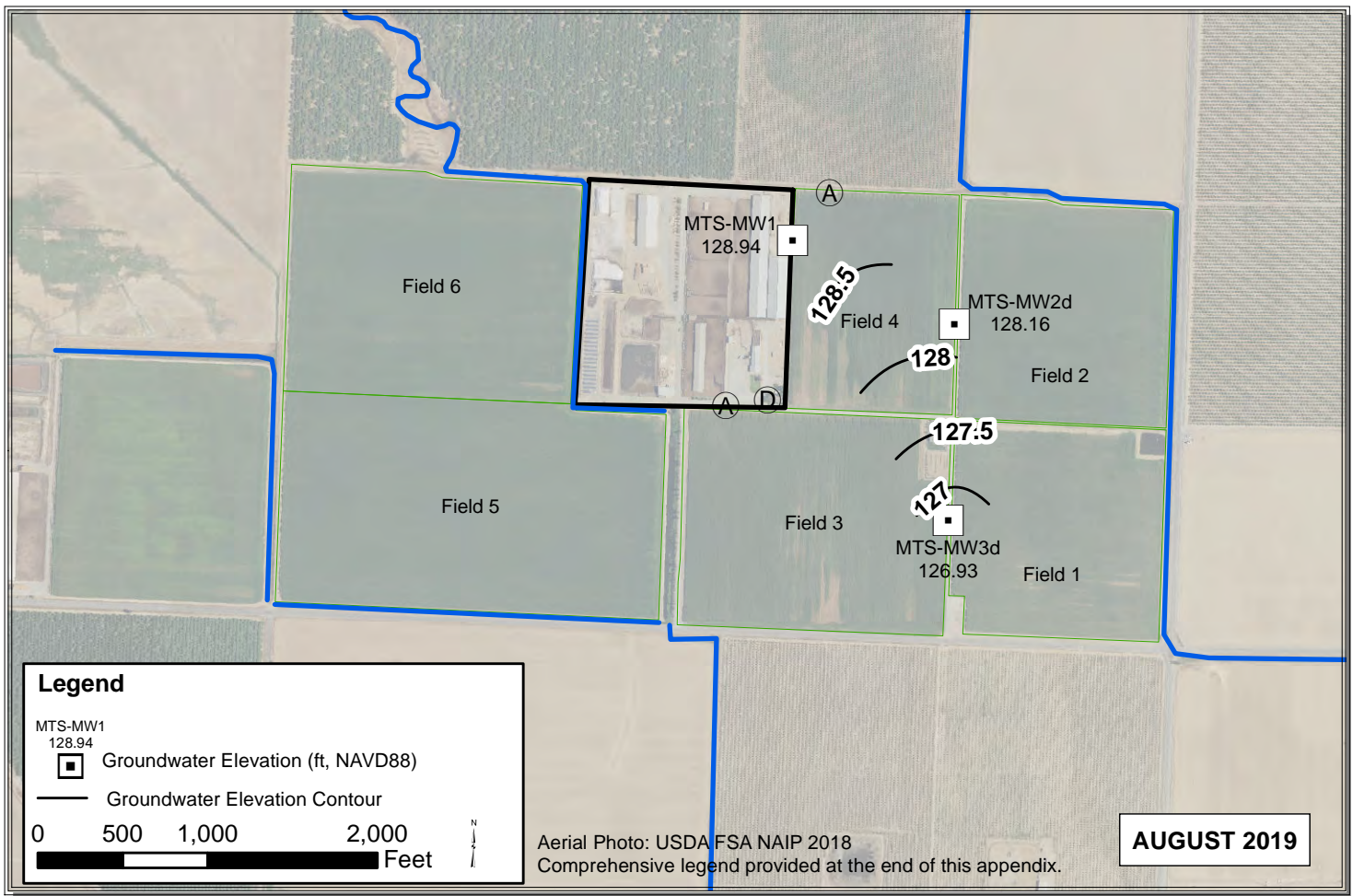
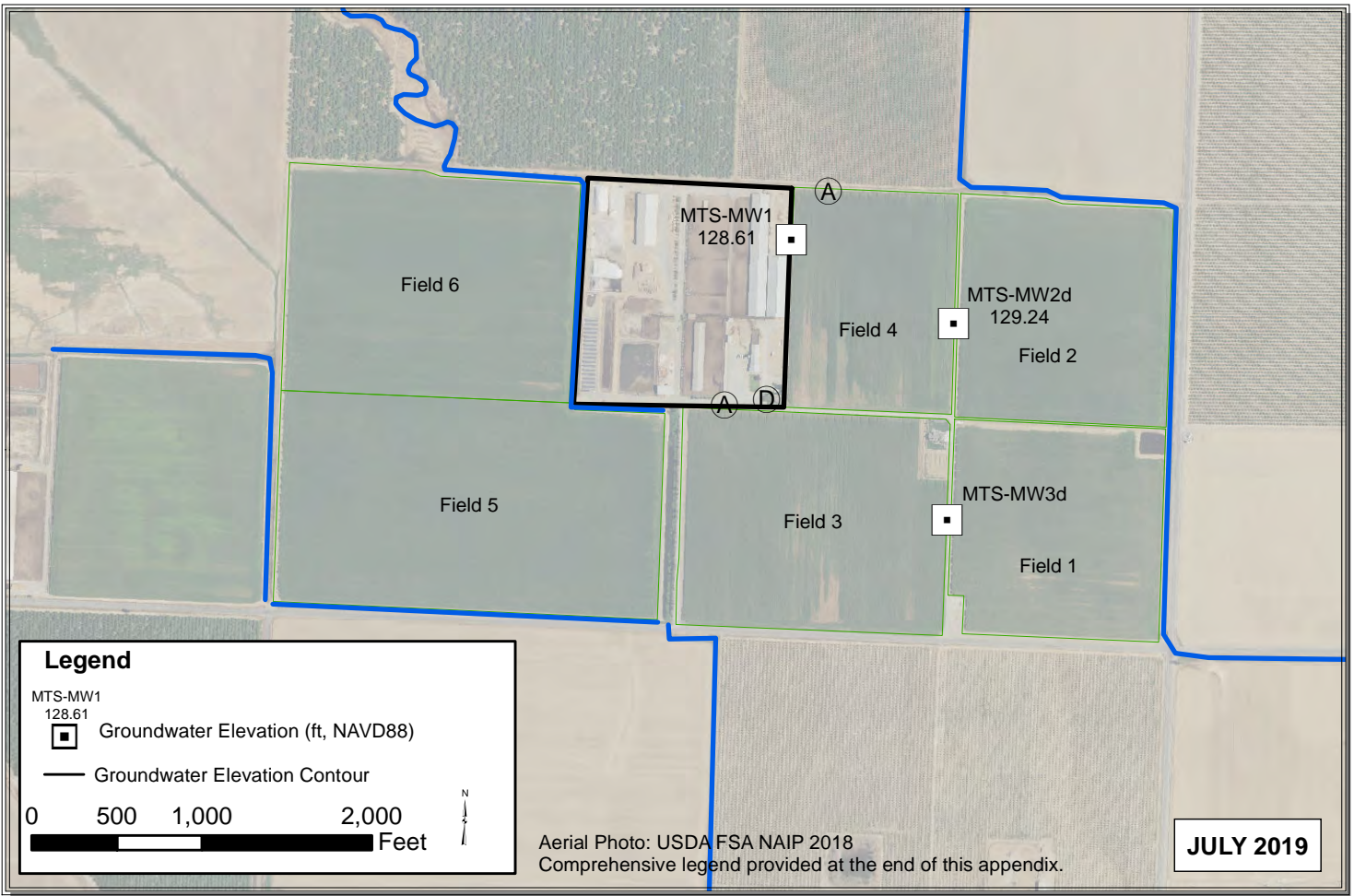

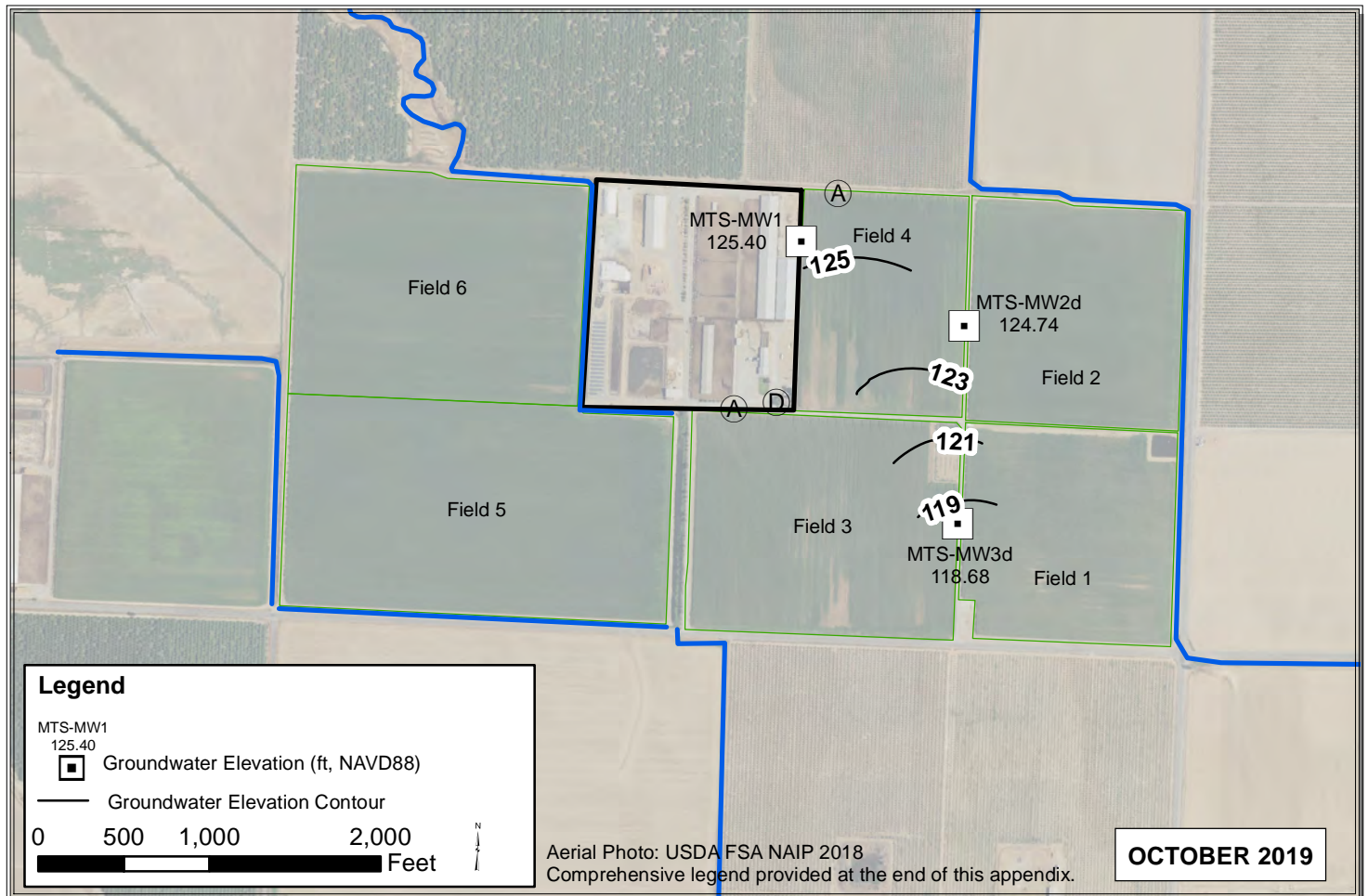
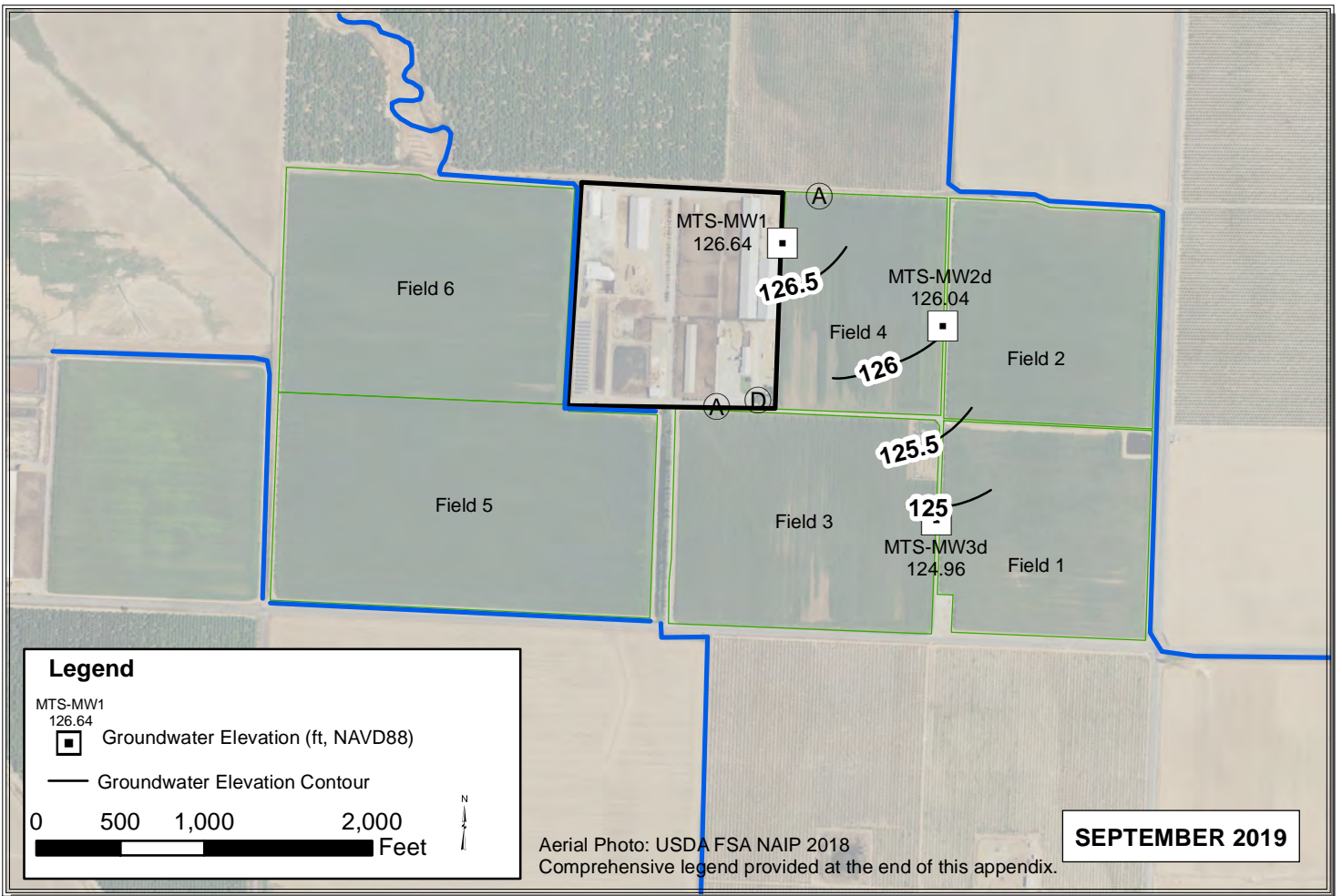

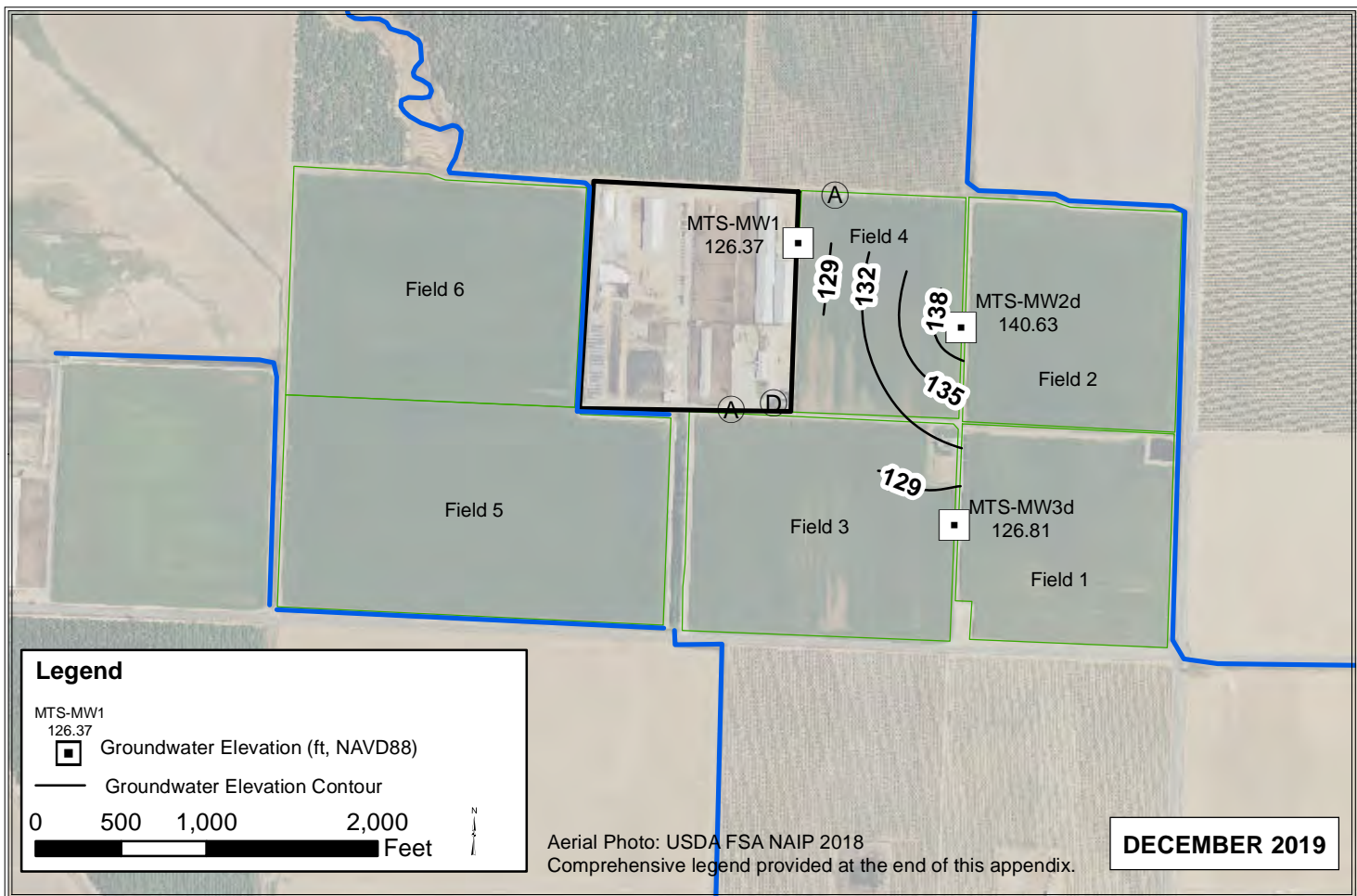
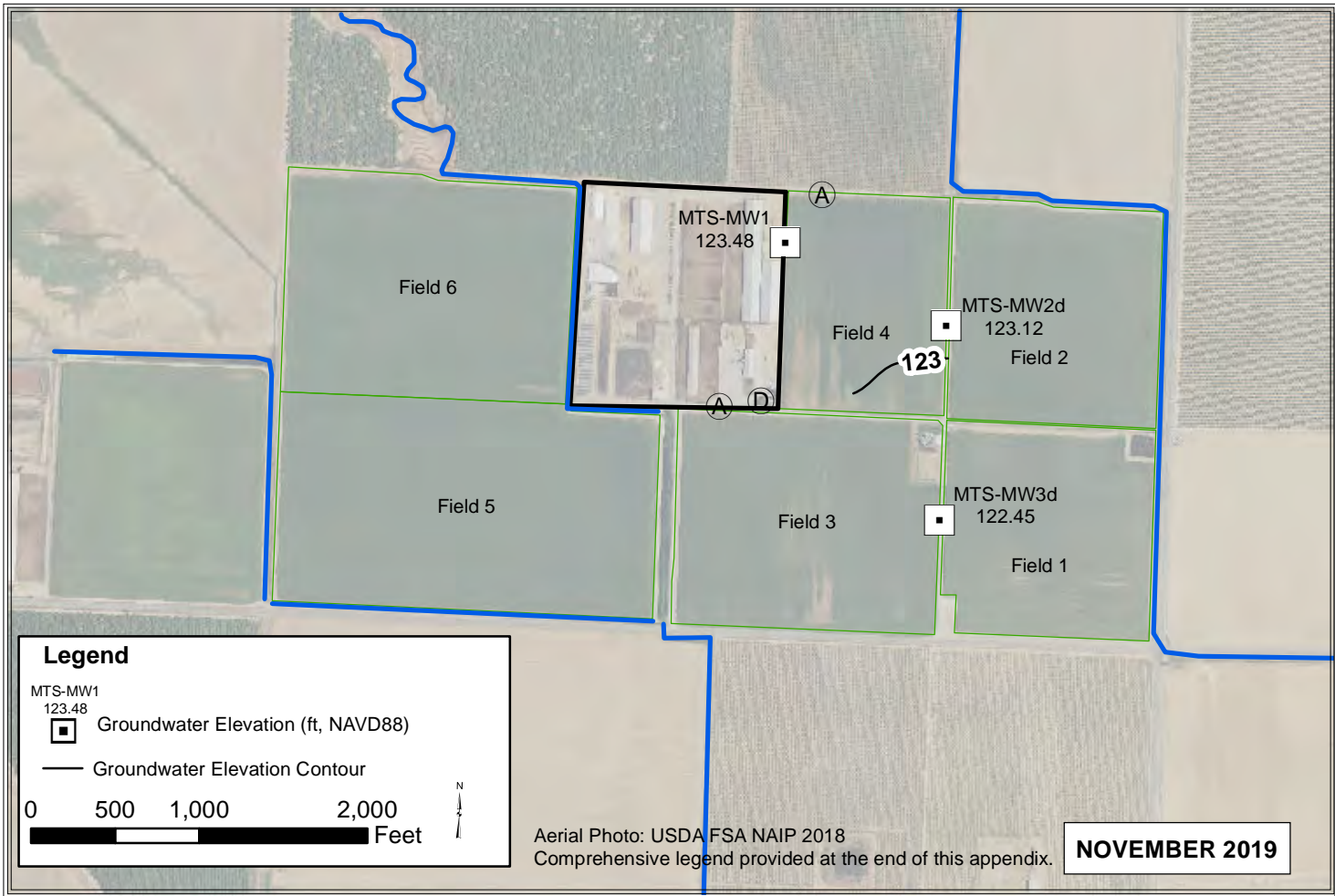

AUK

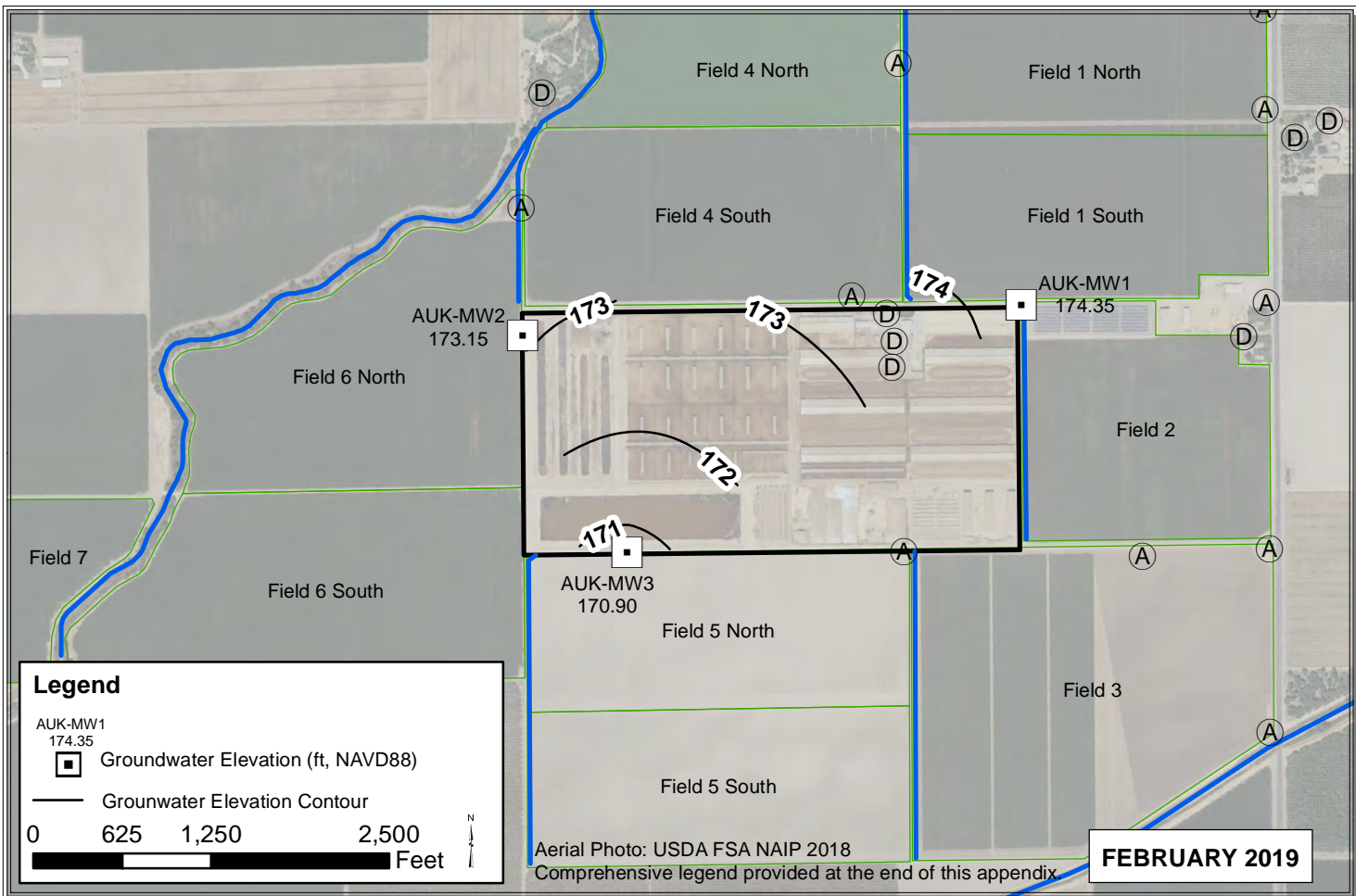
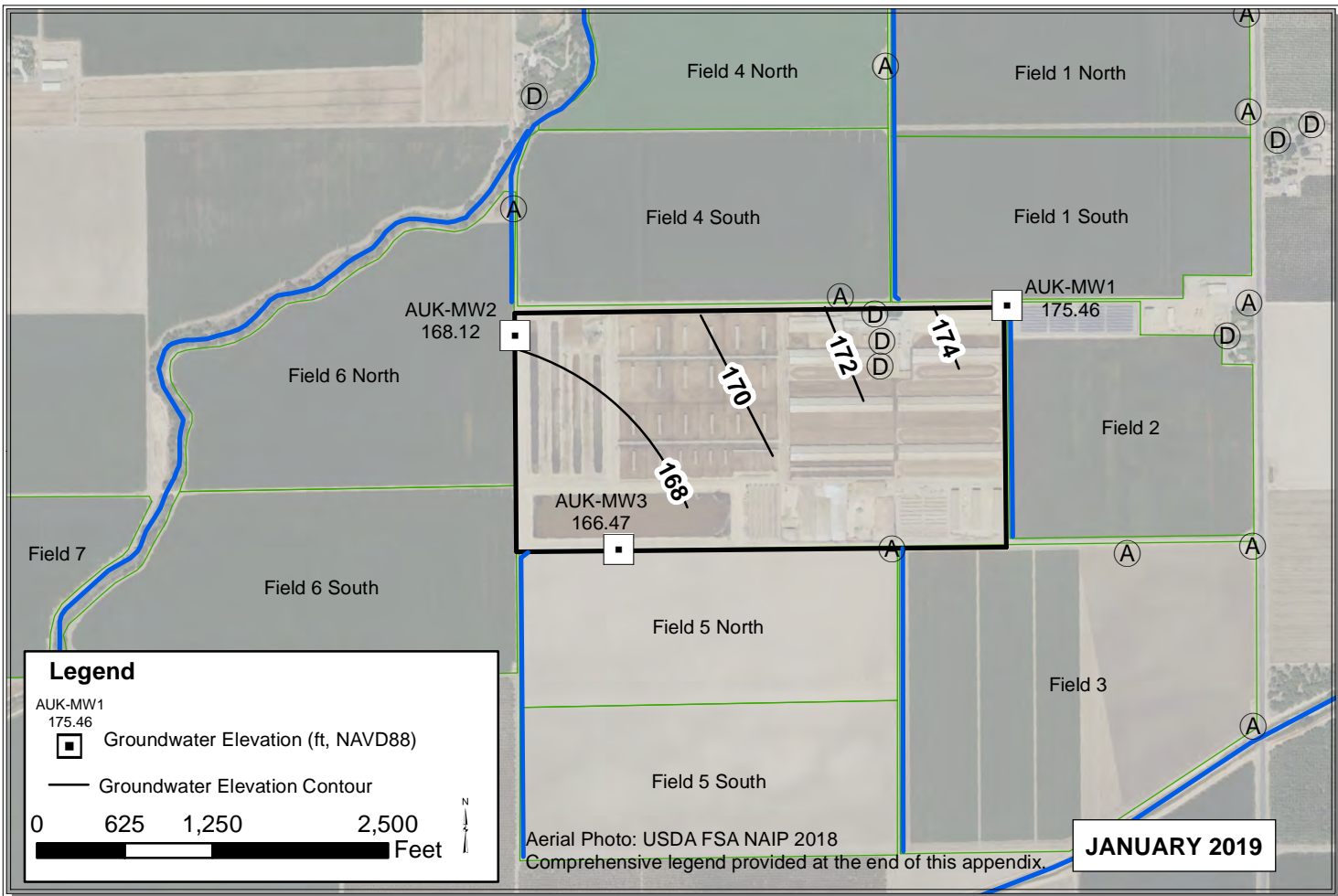

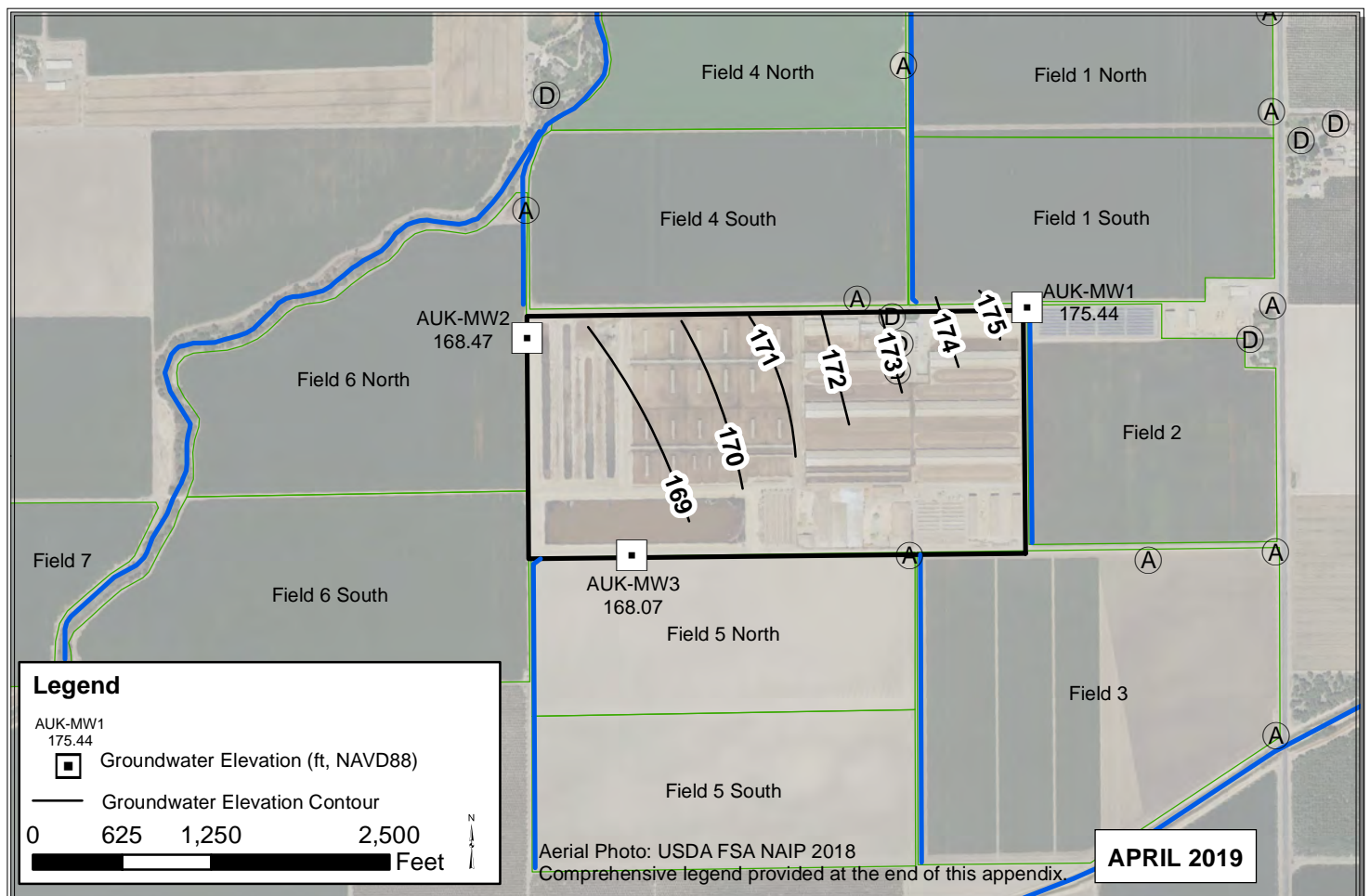
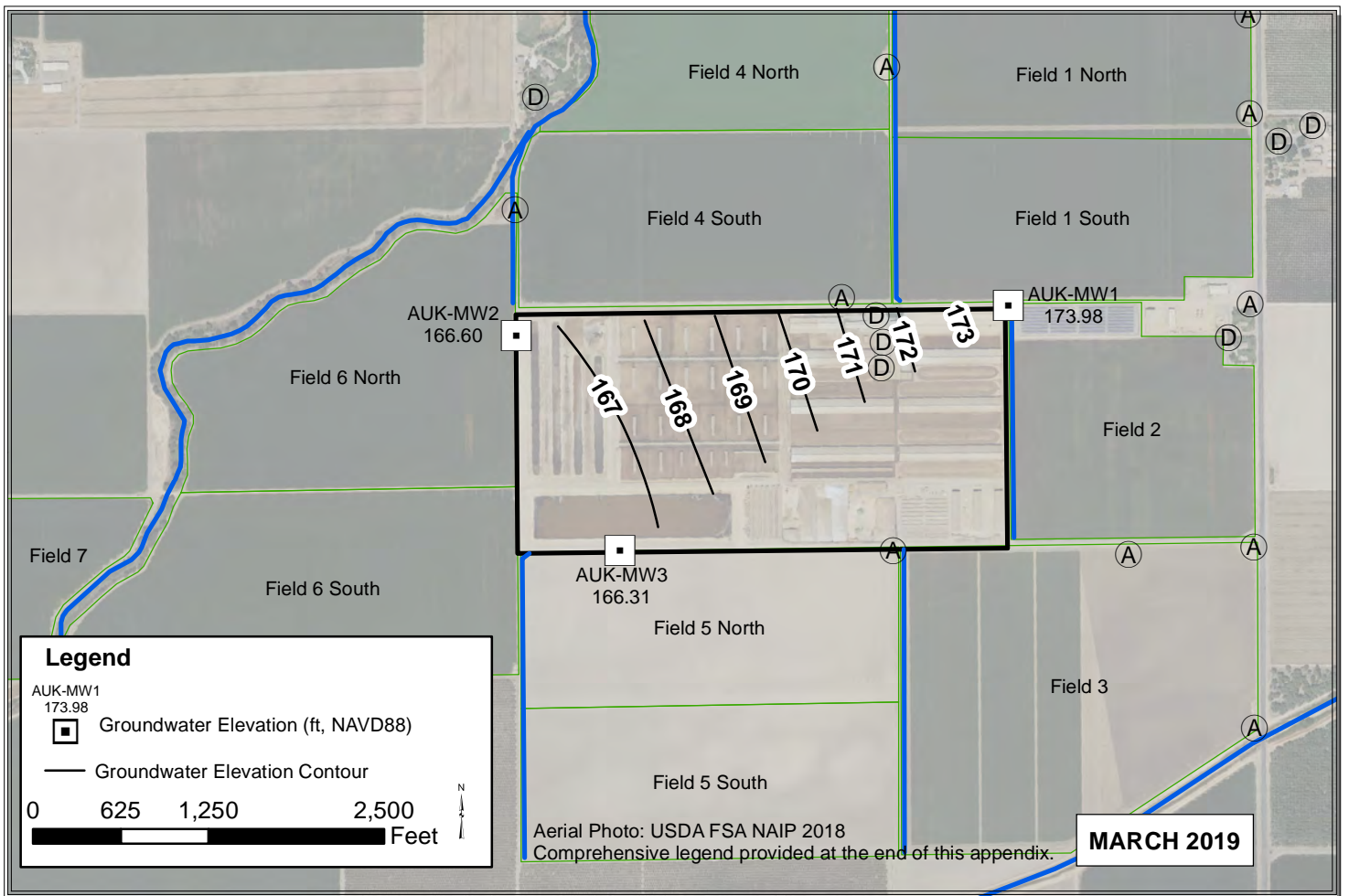

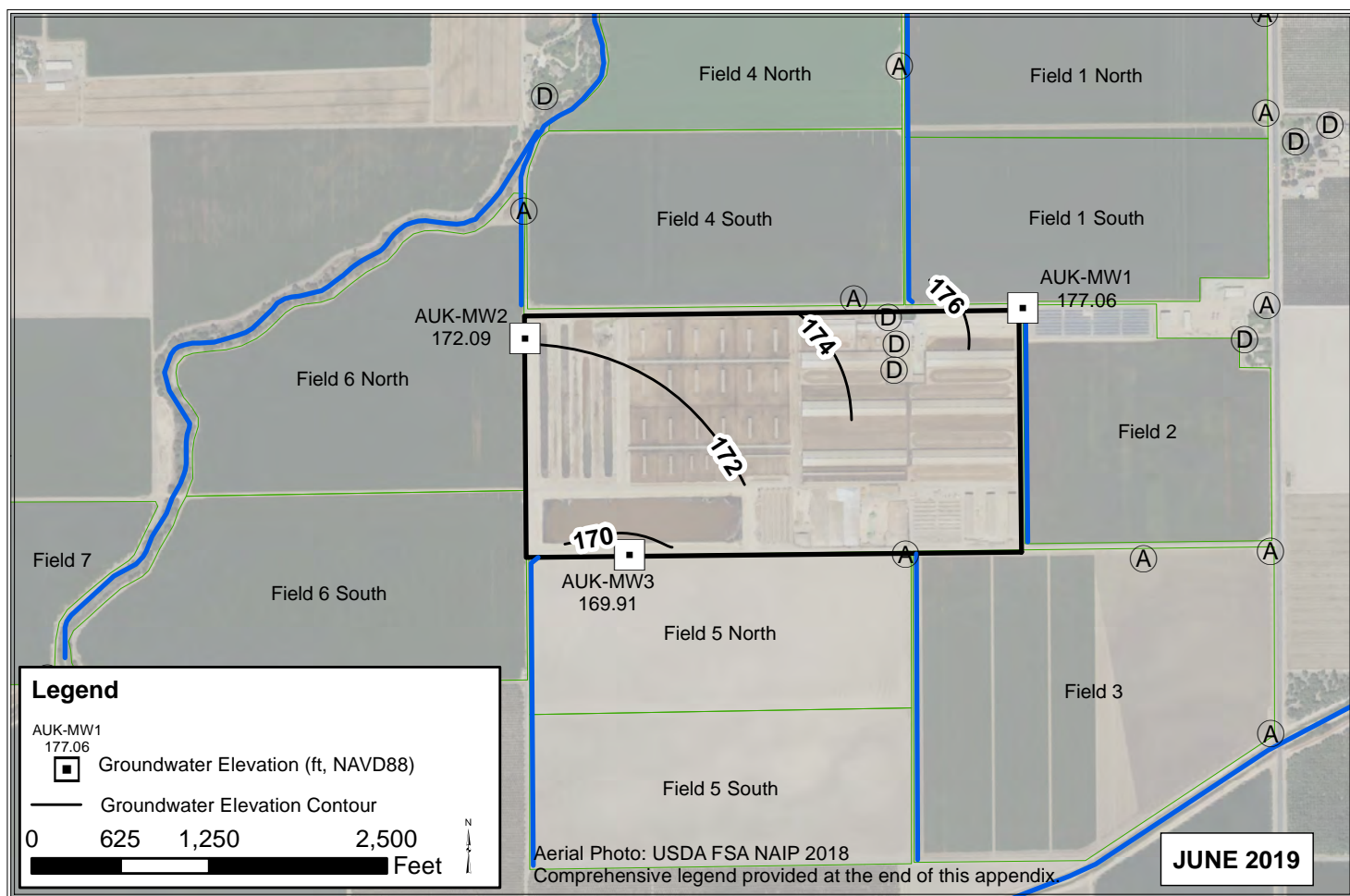
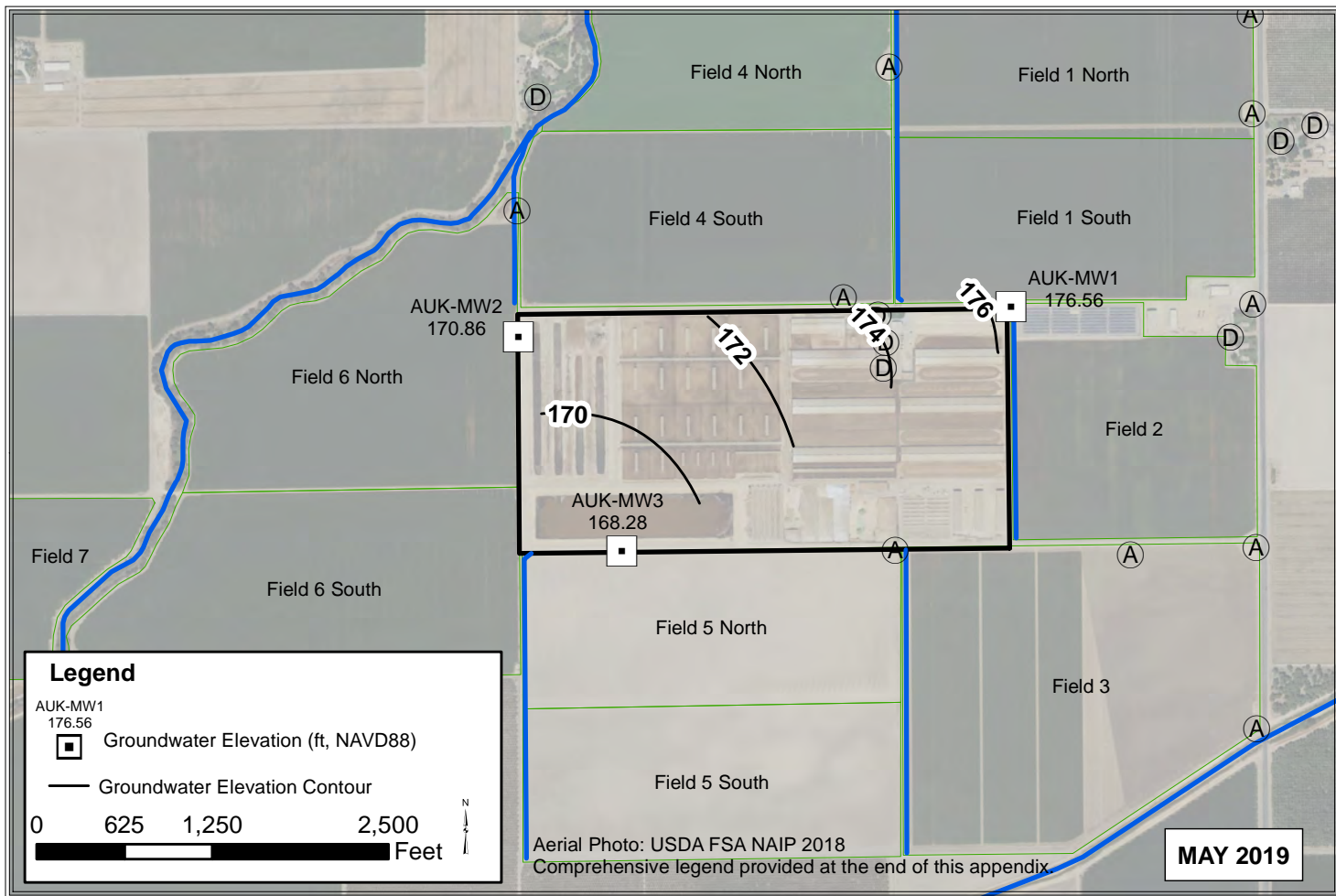

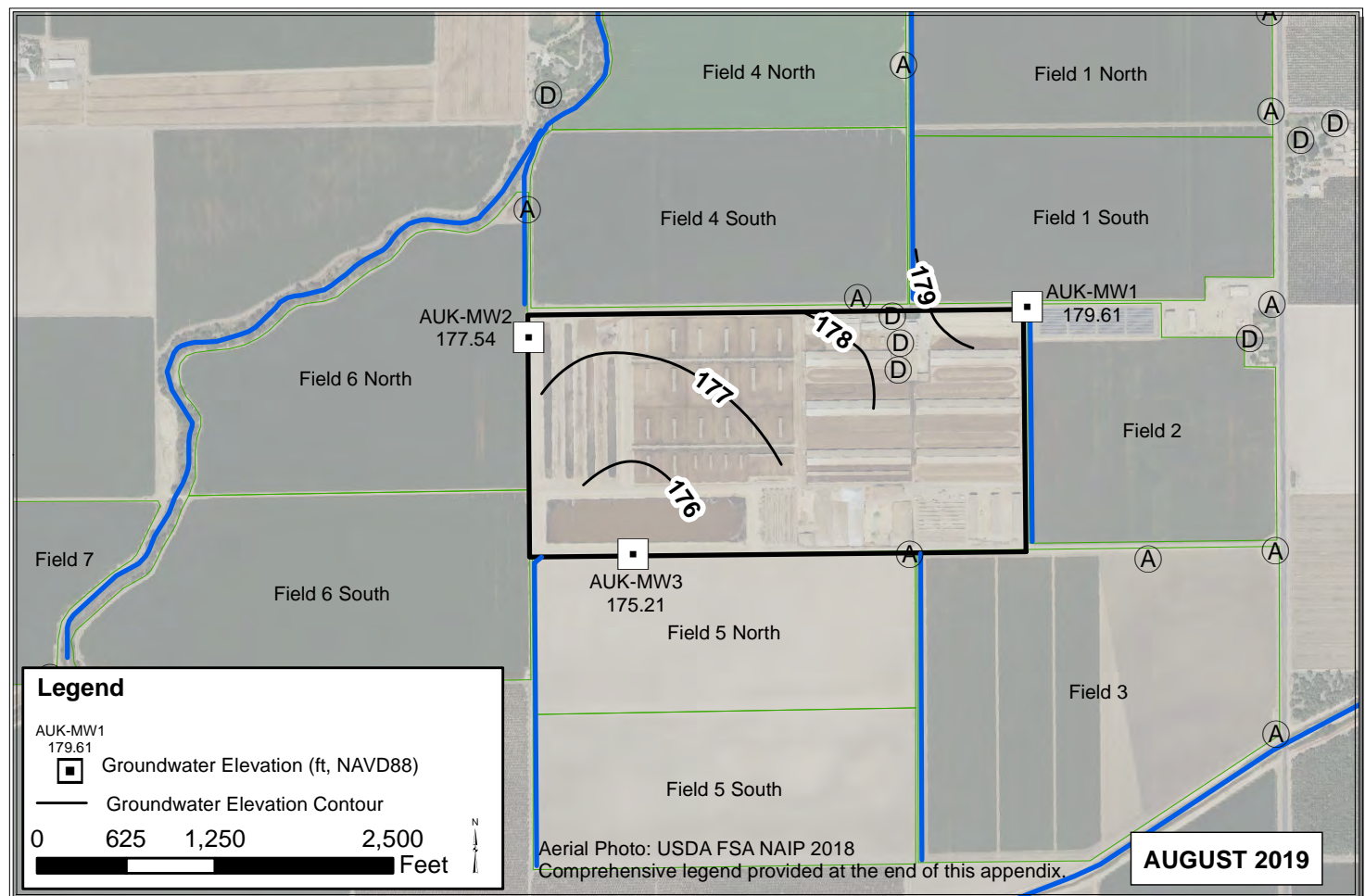
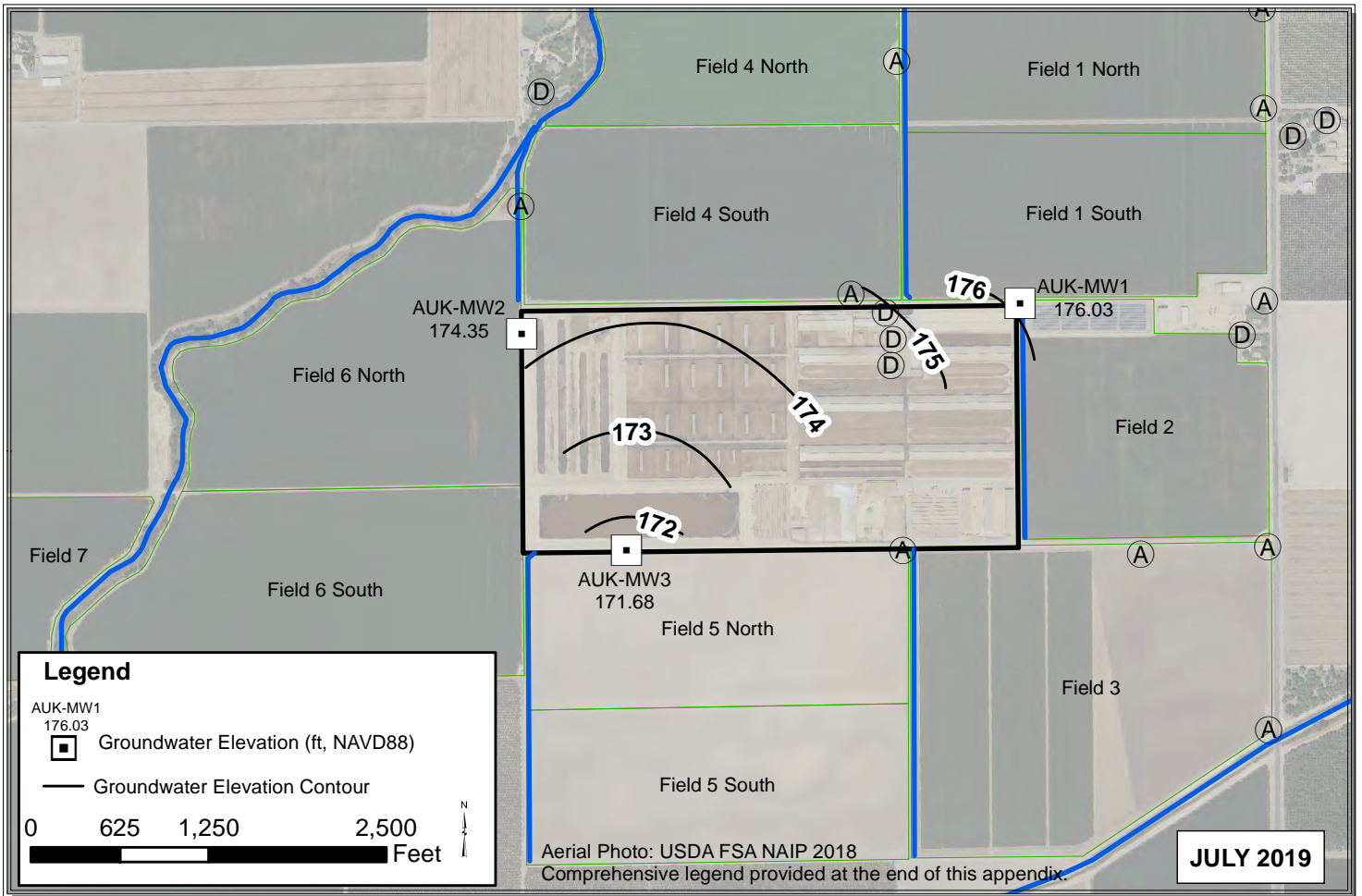

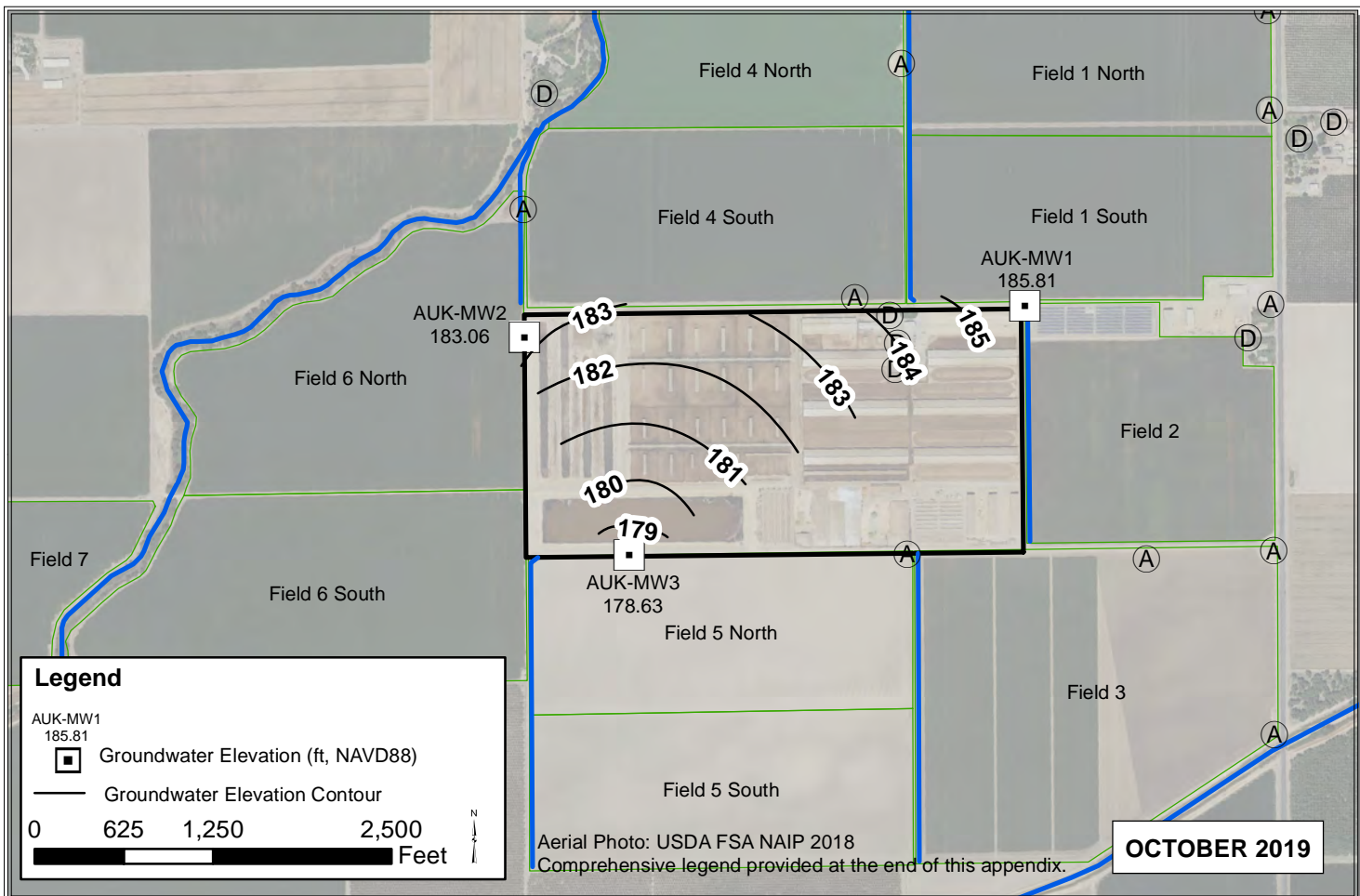
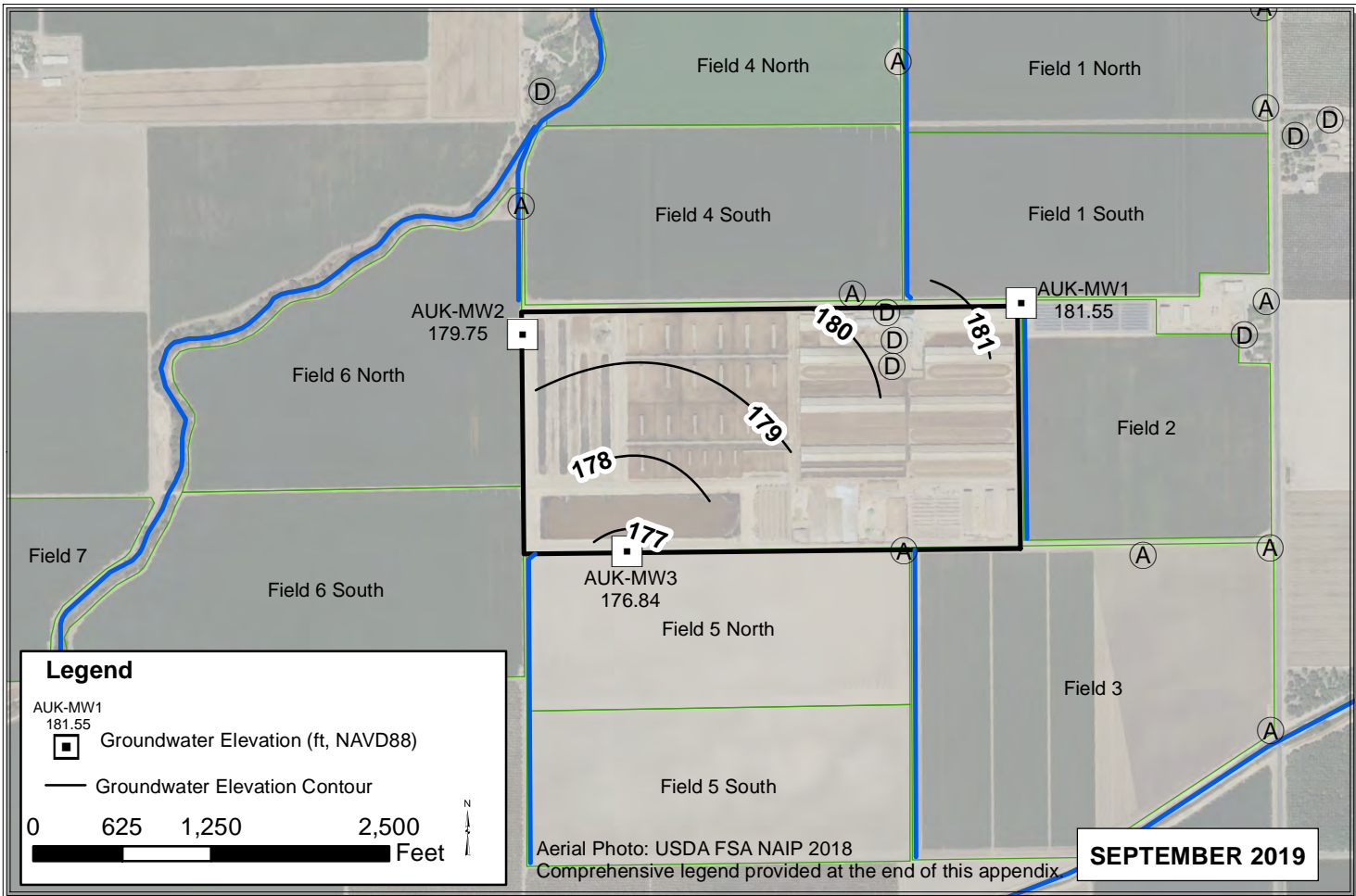

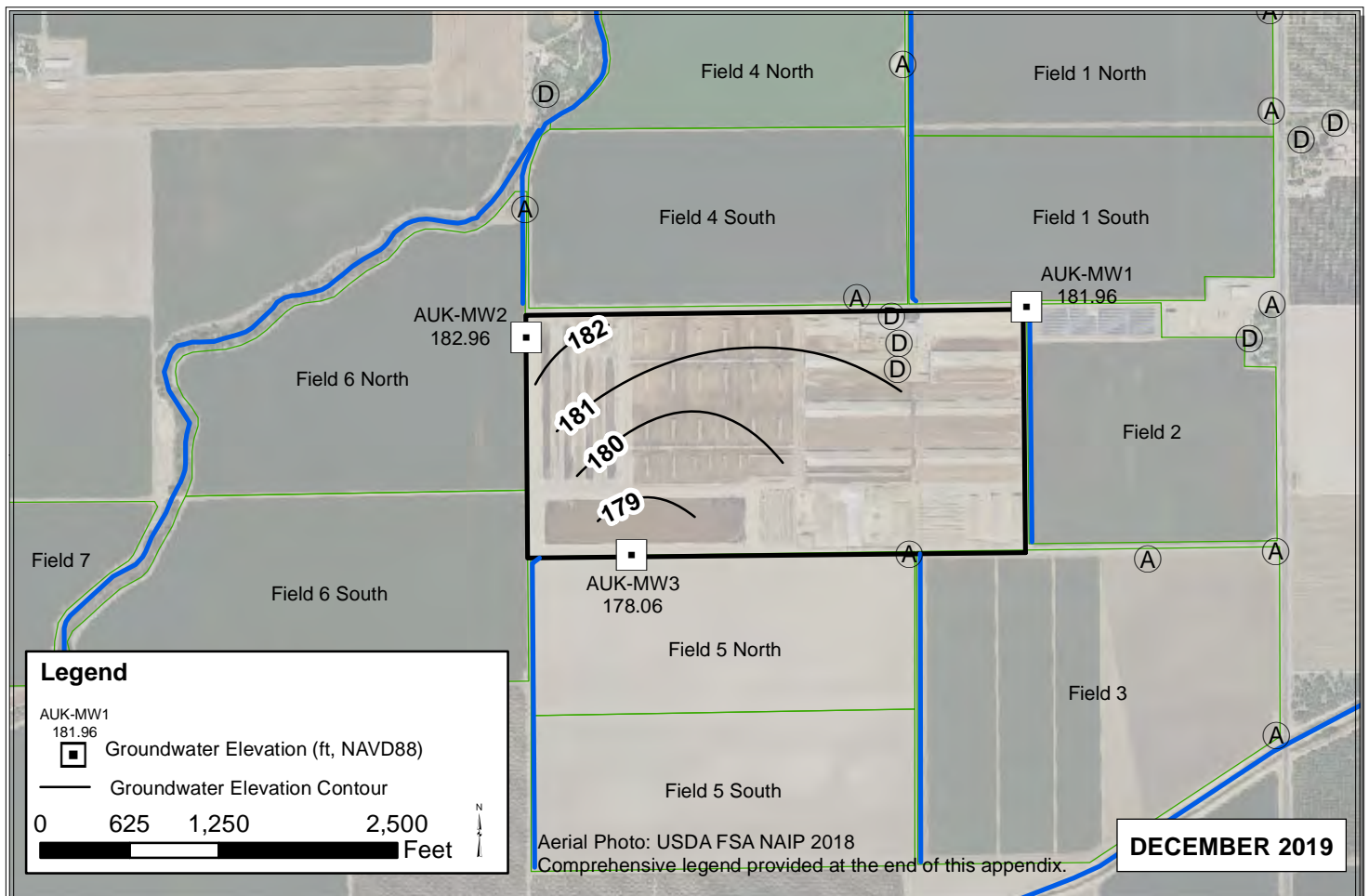
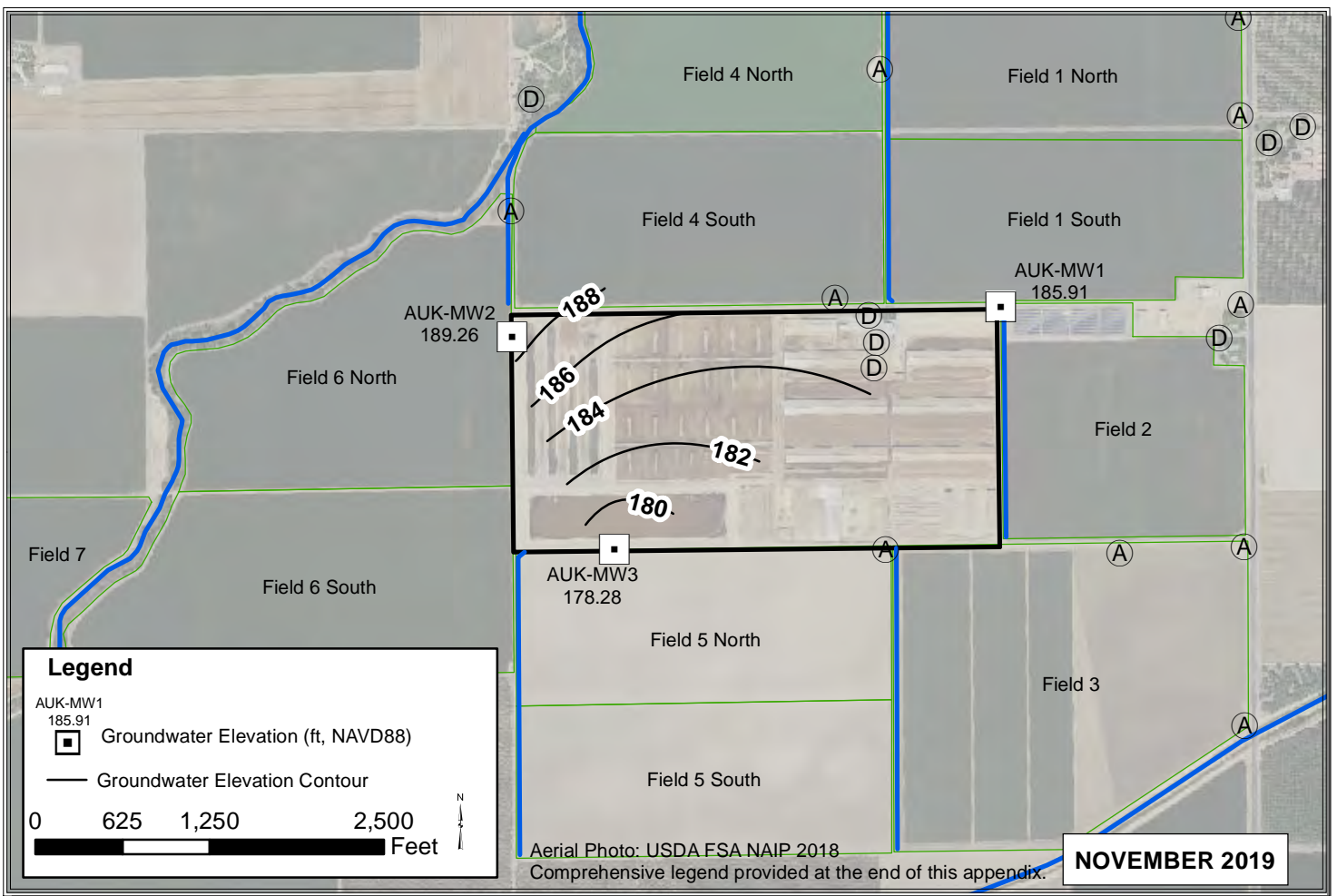

DLF

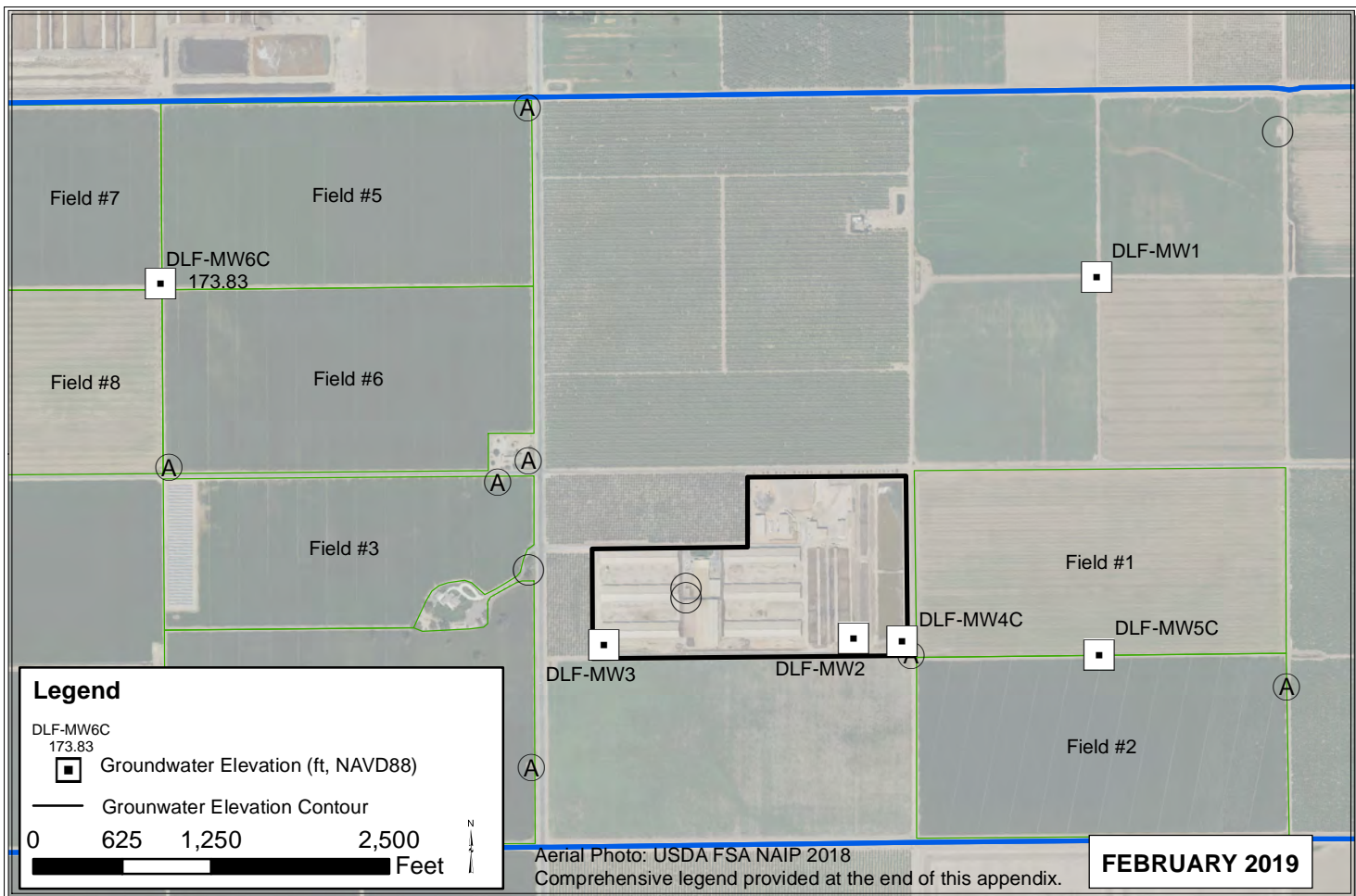
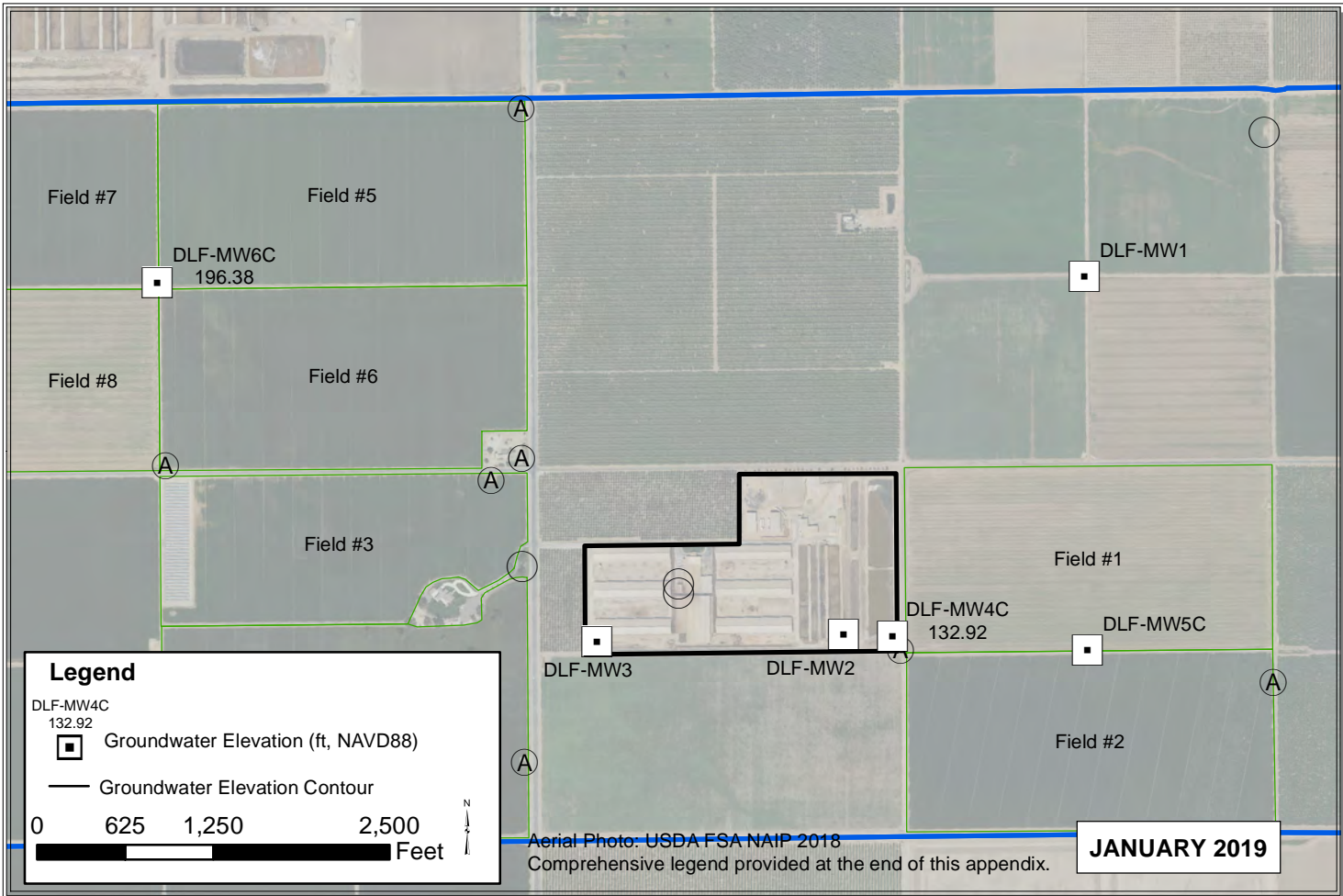

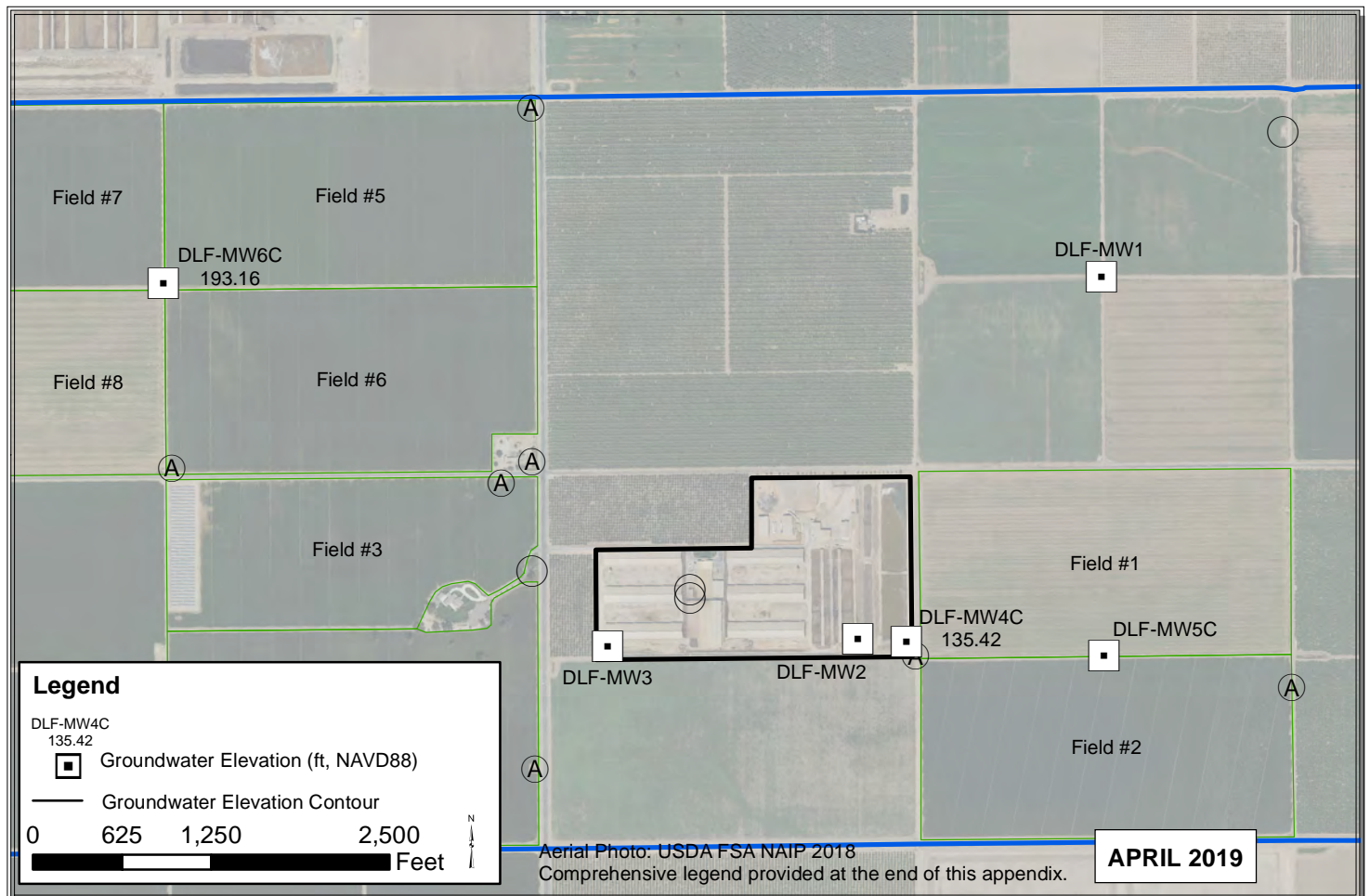
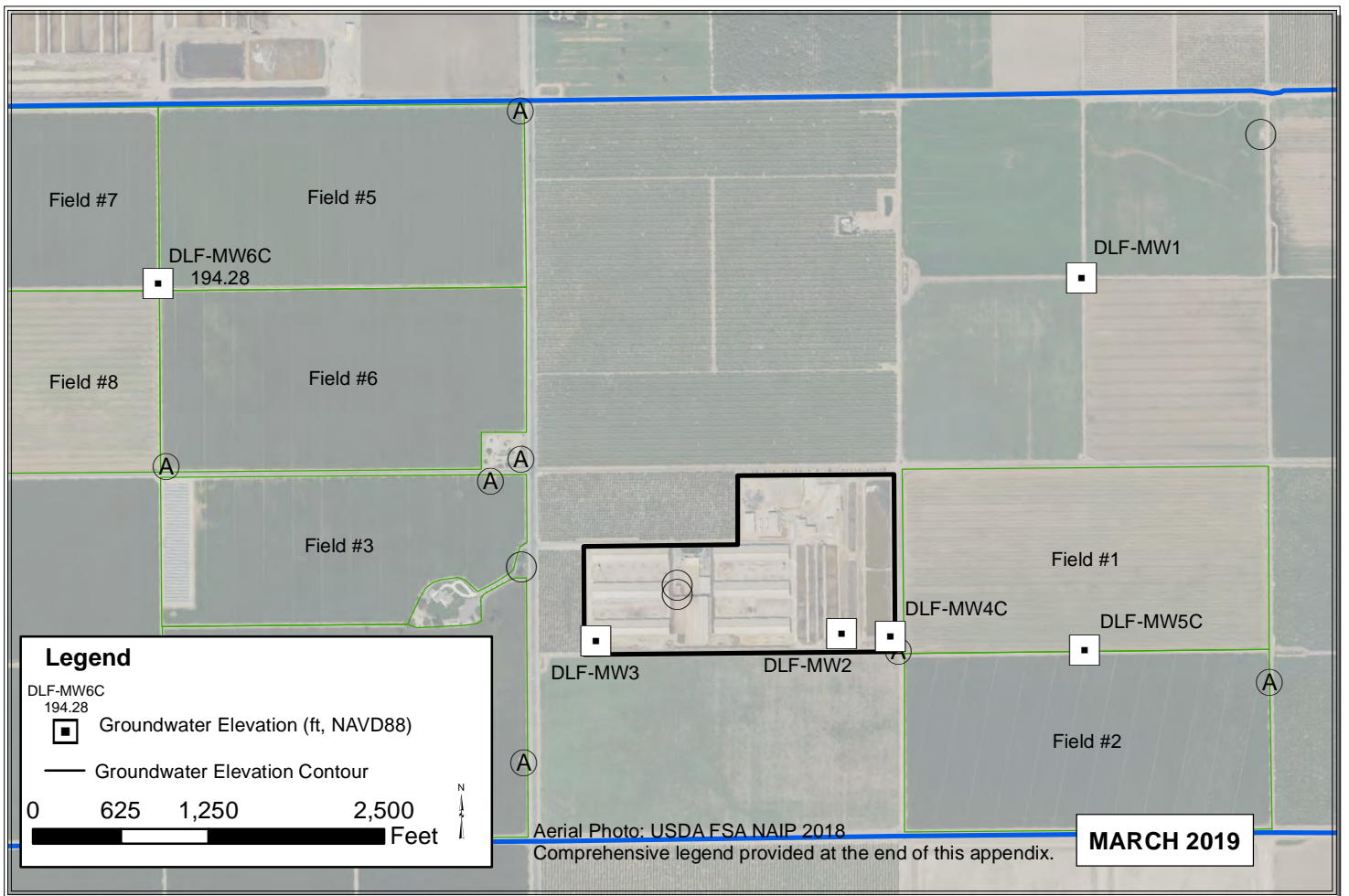

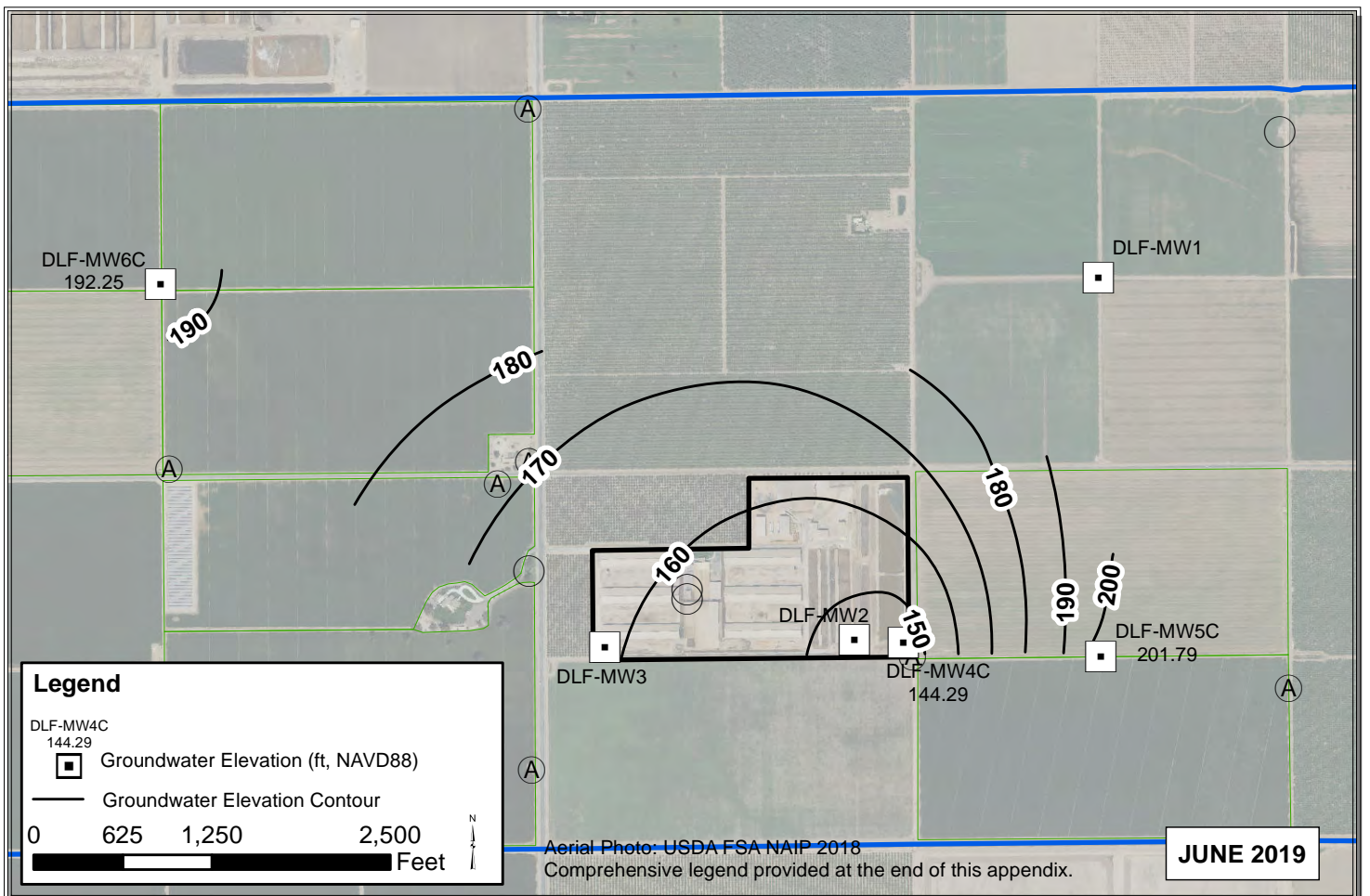
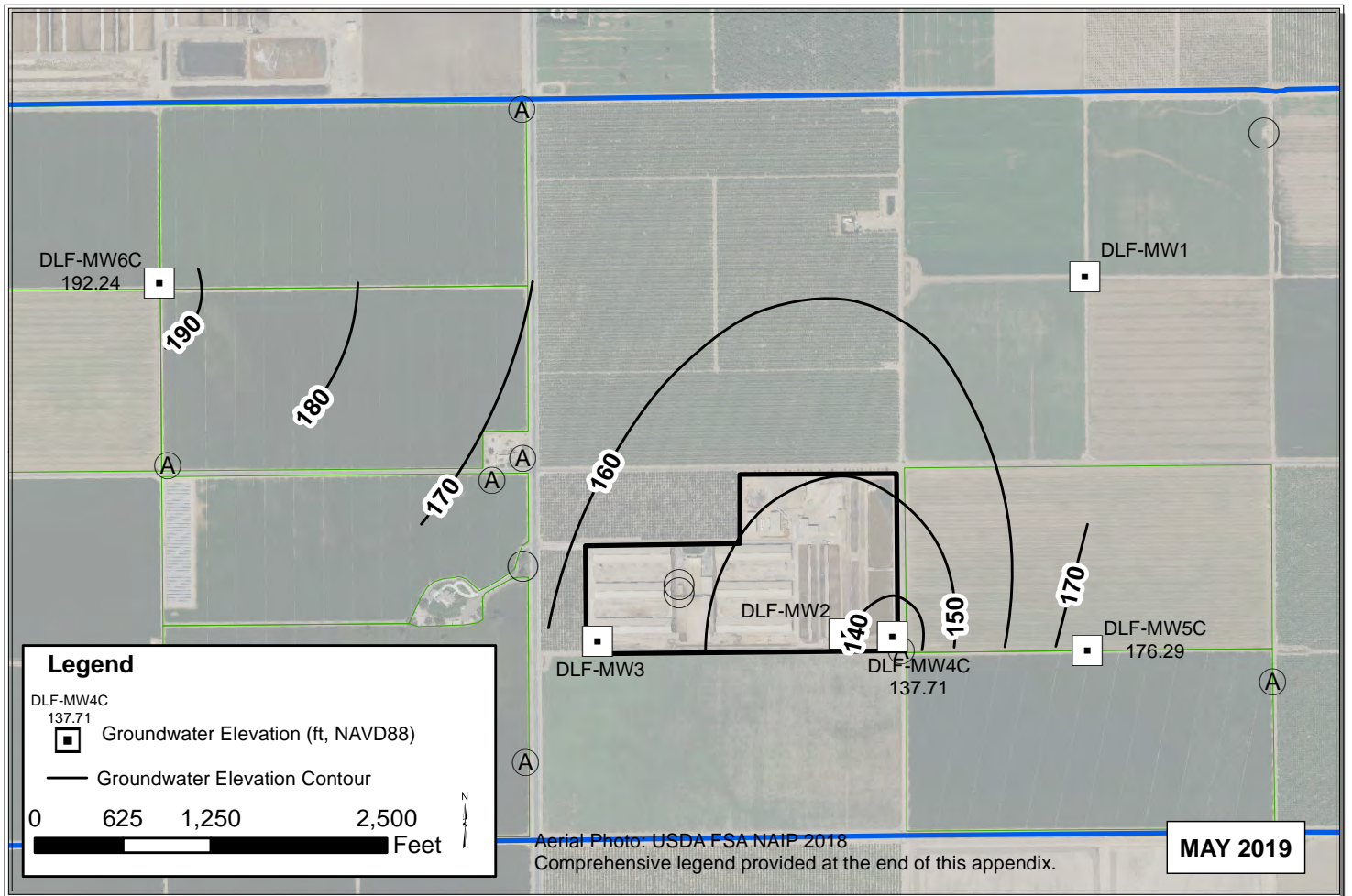

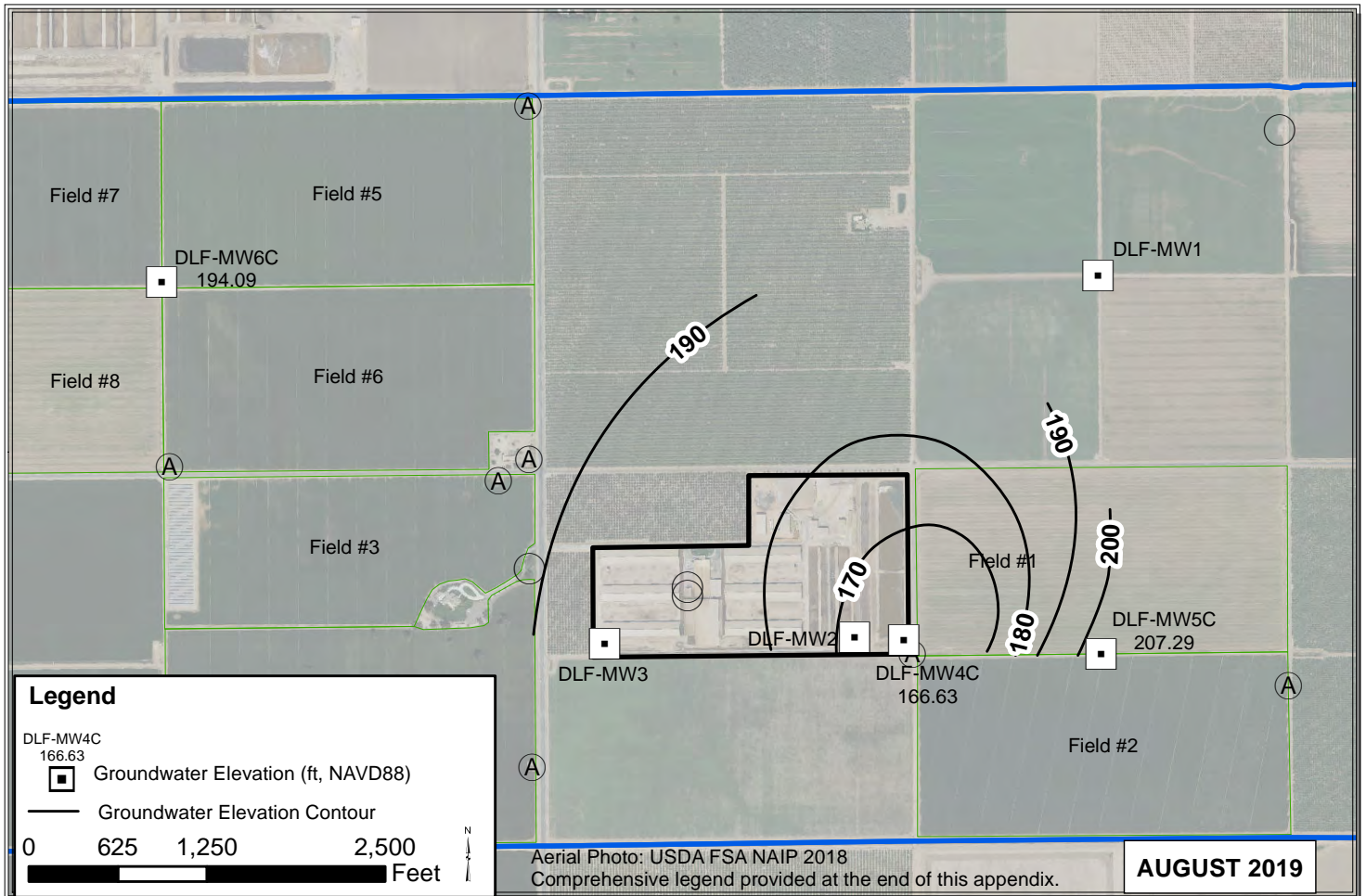
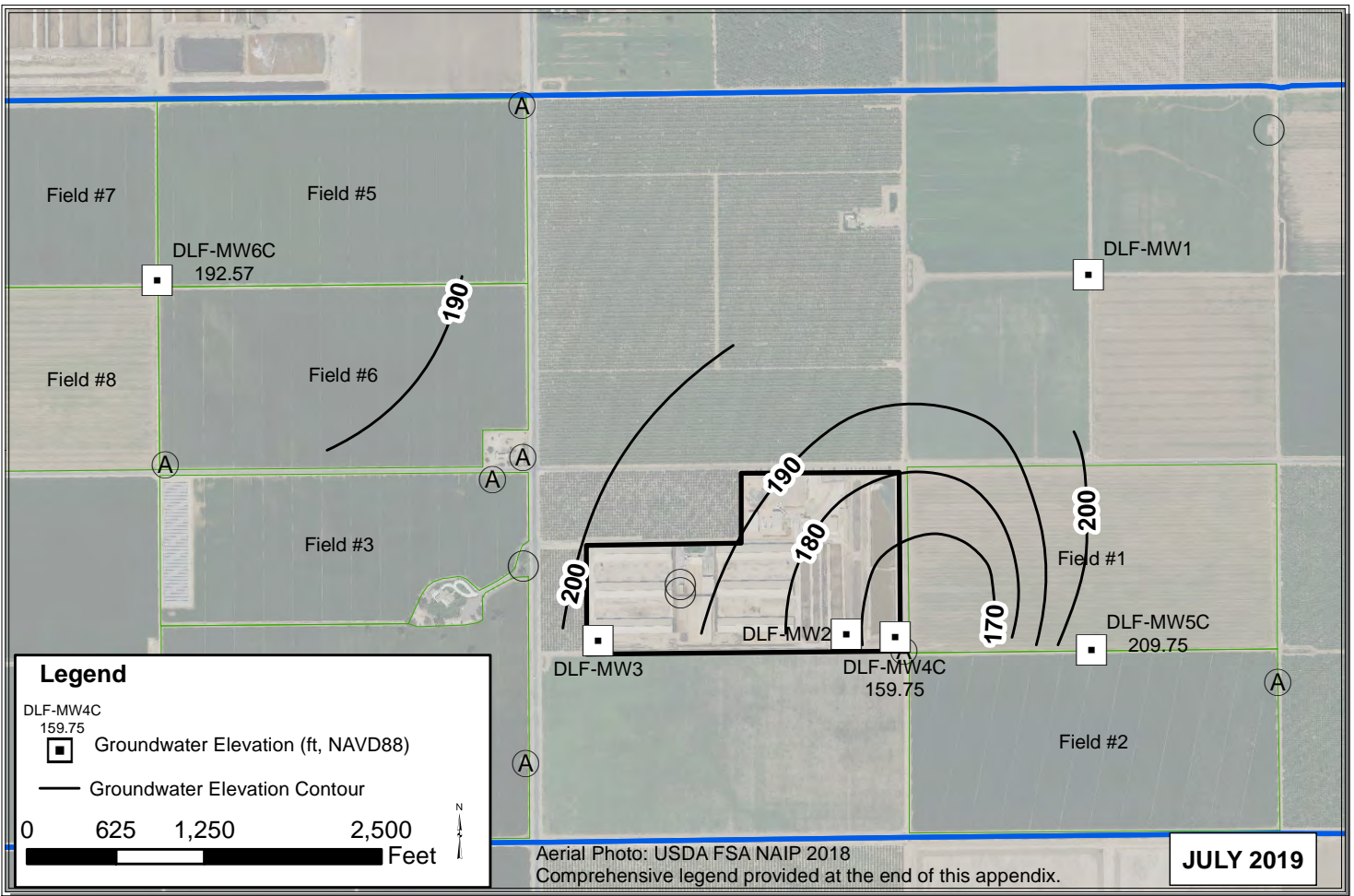

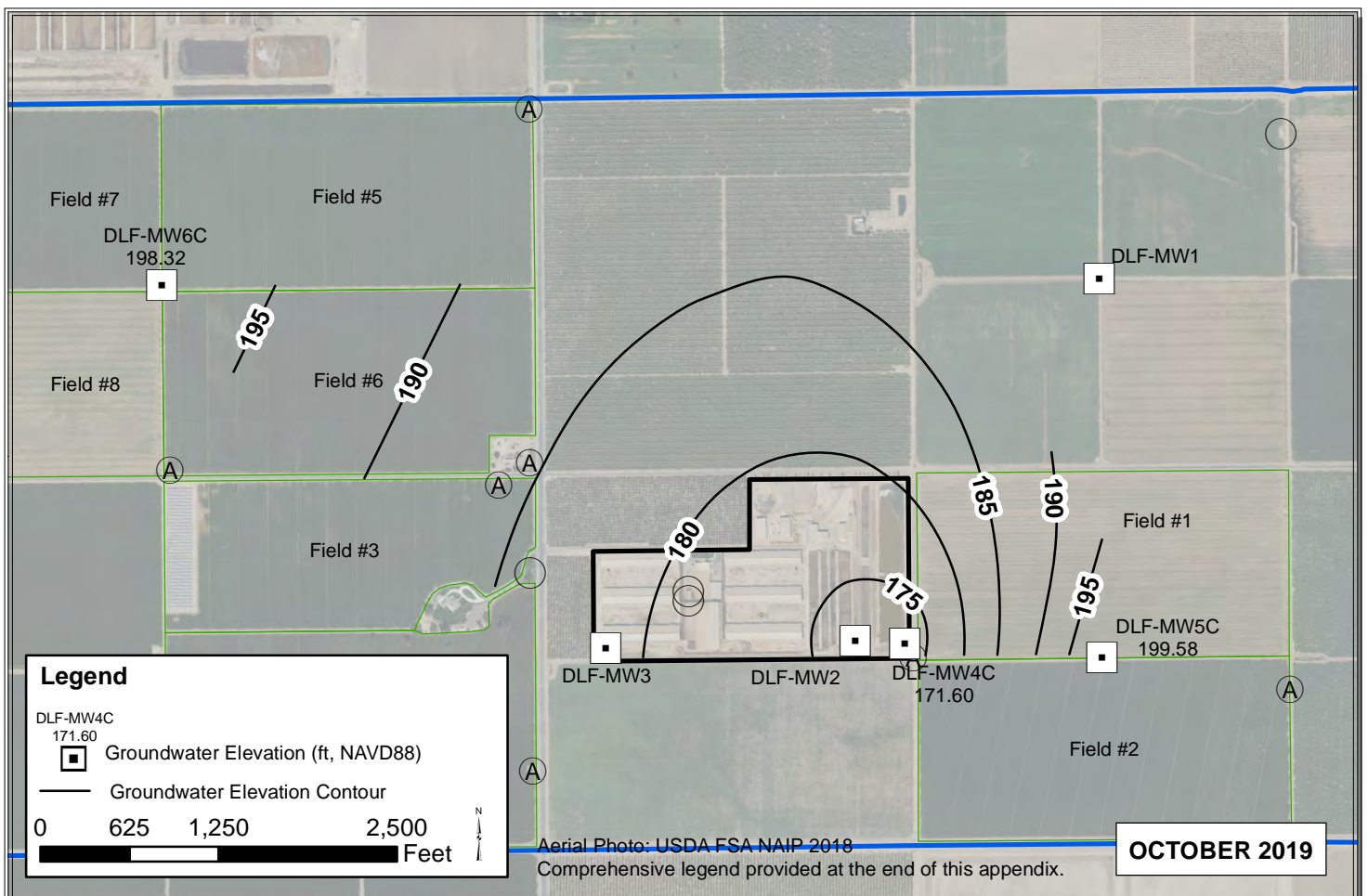
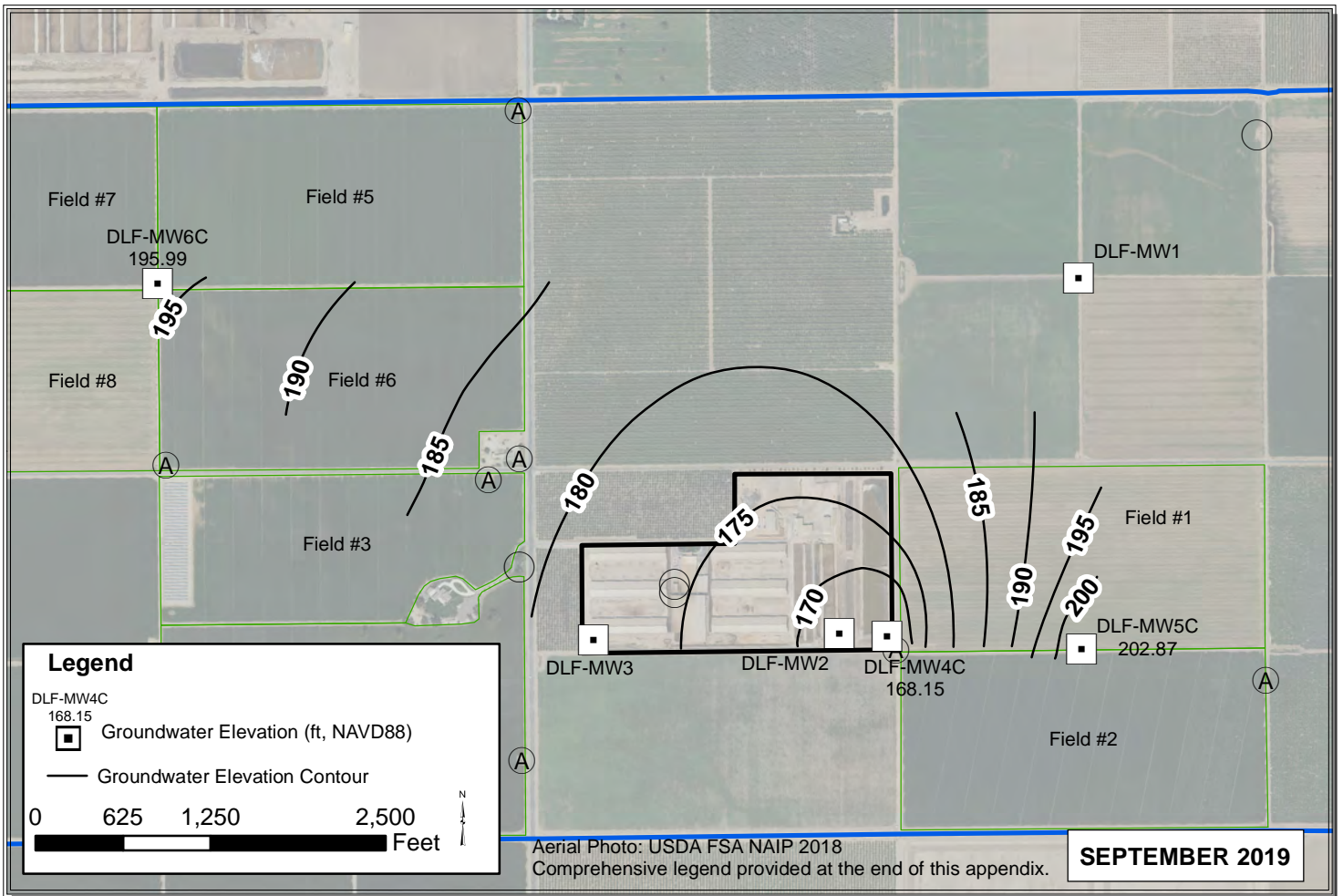

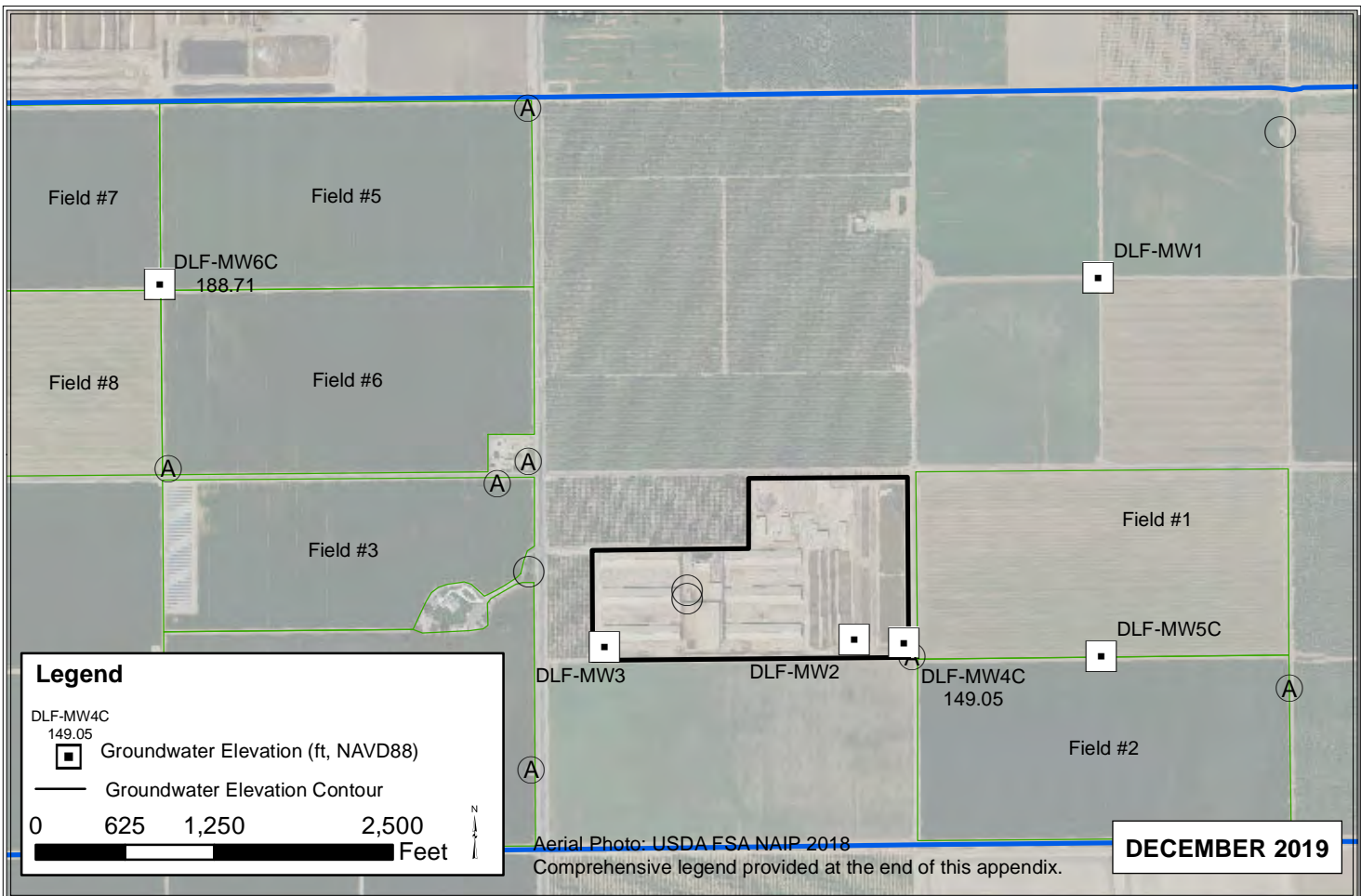
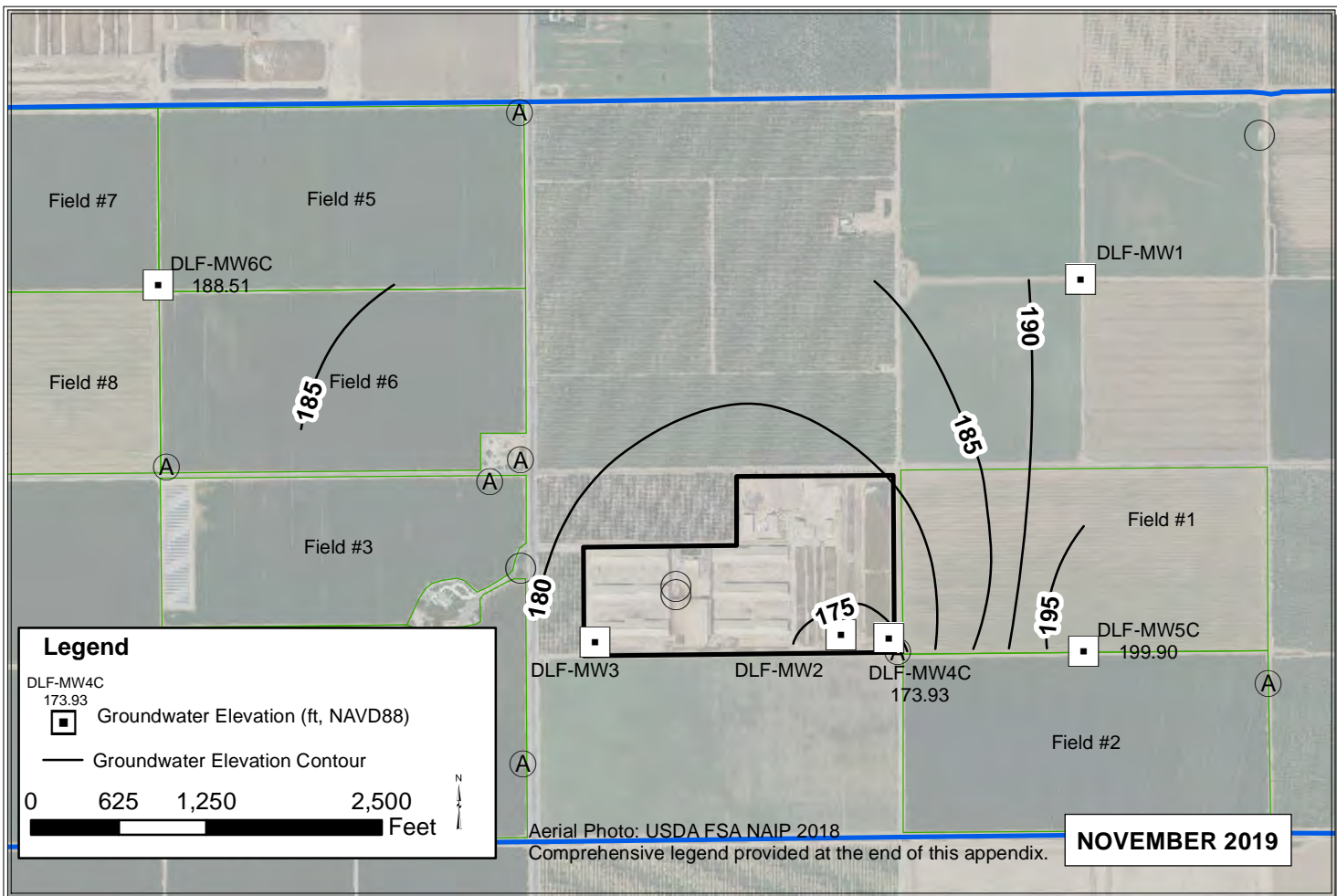

ELK

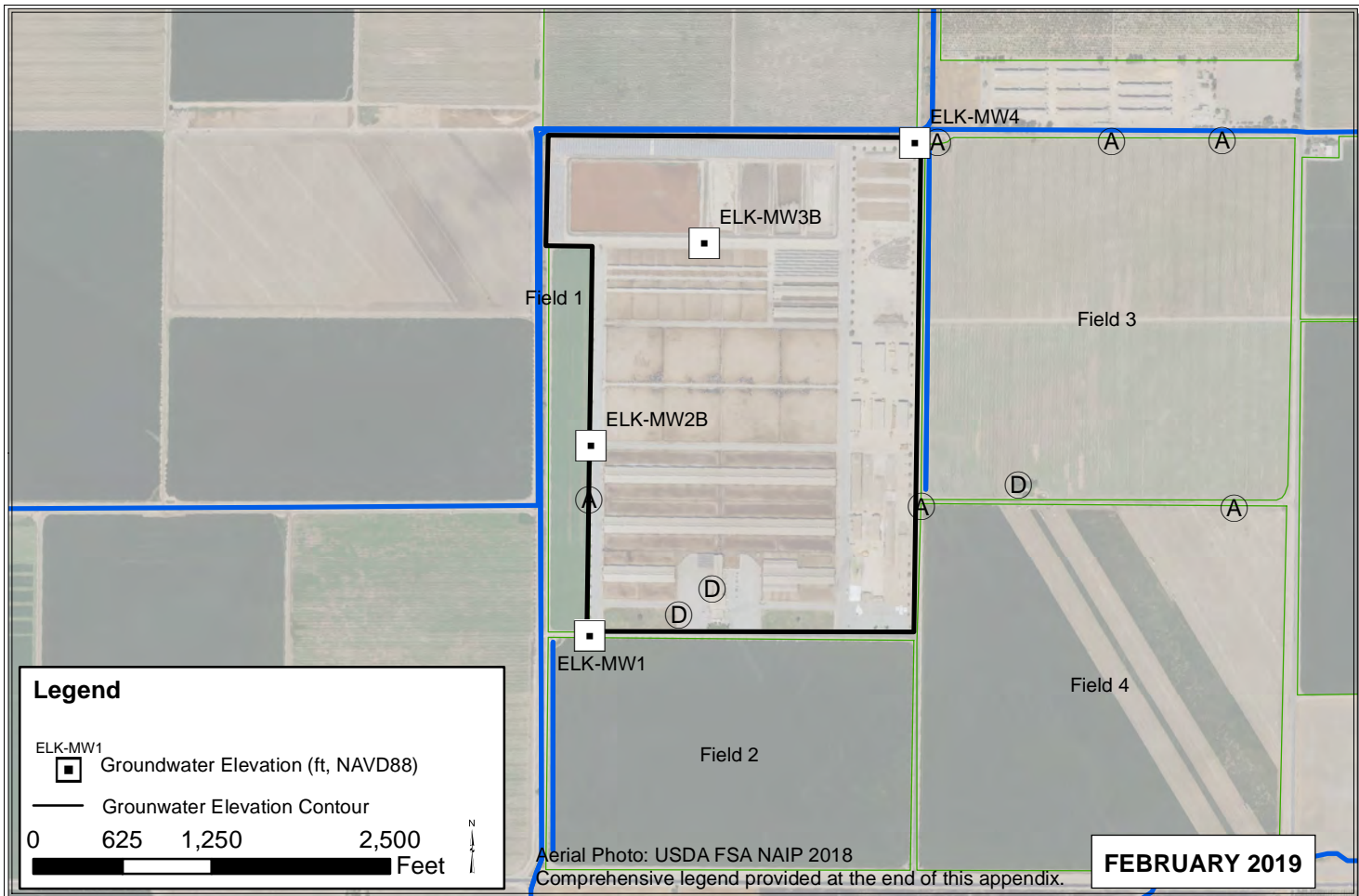
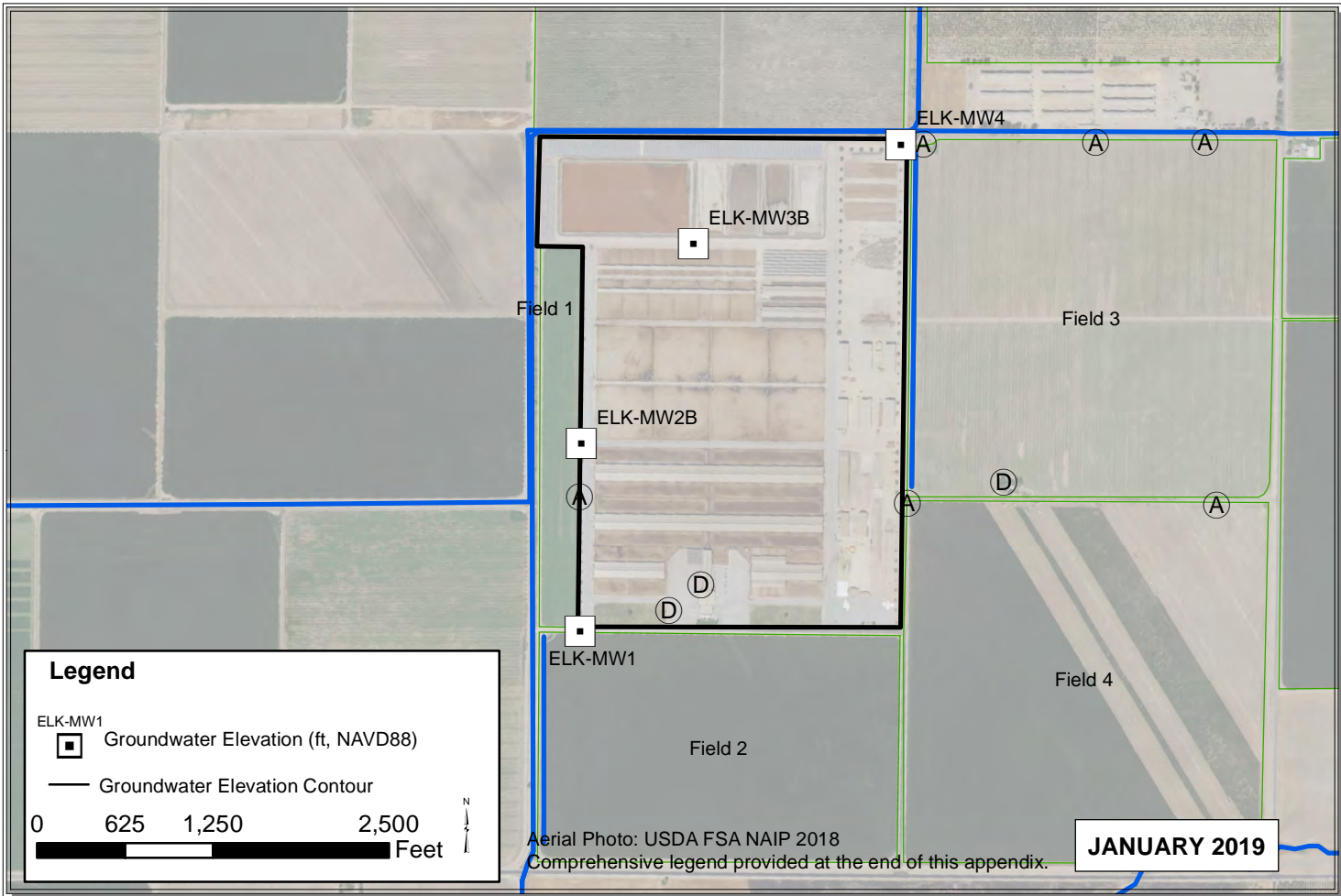

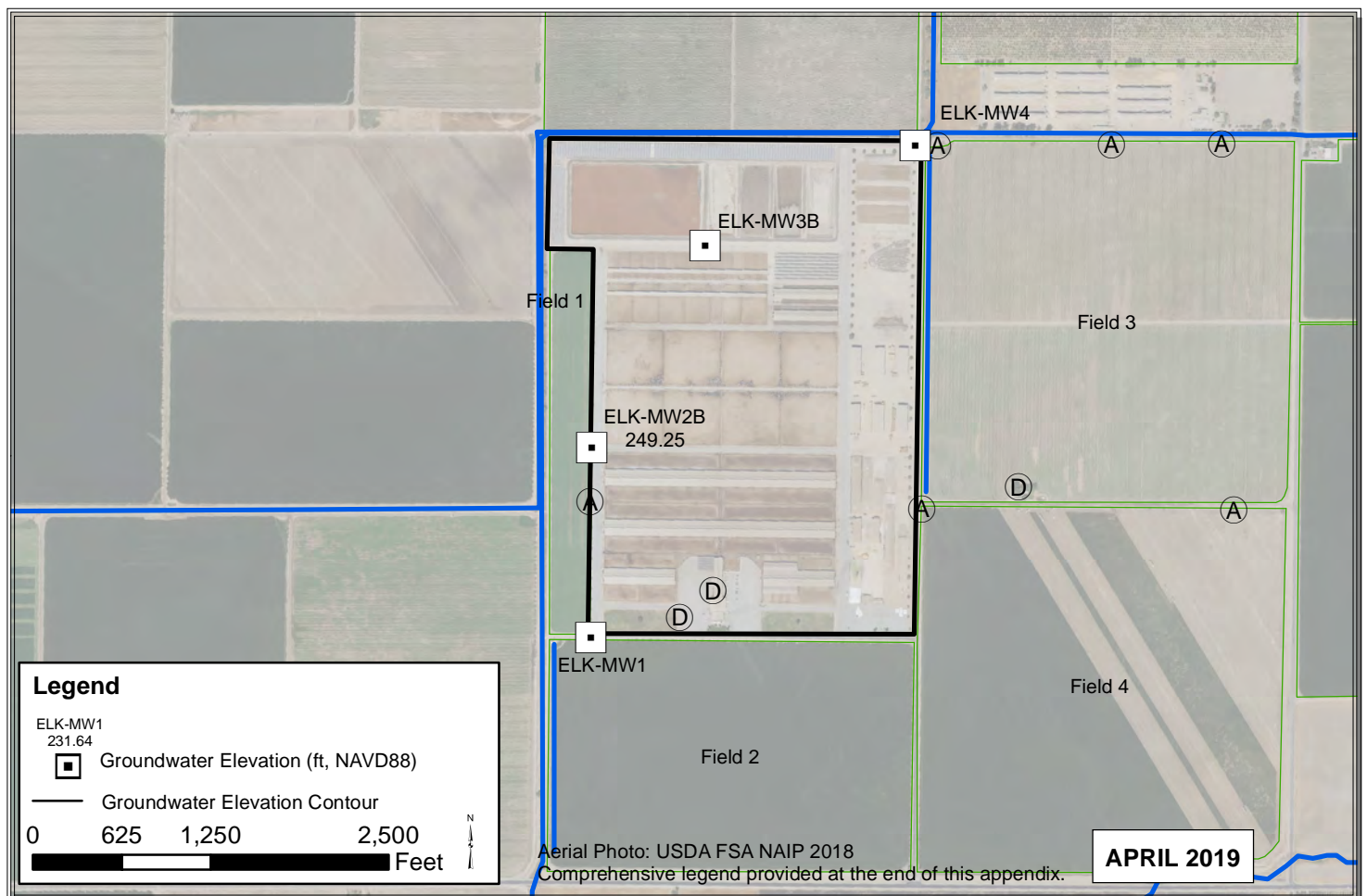
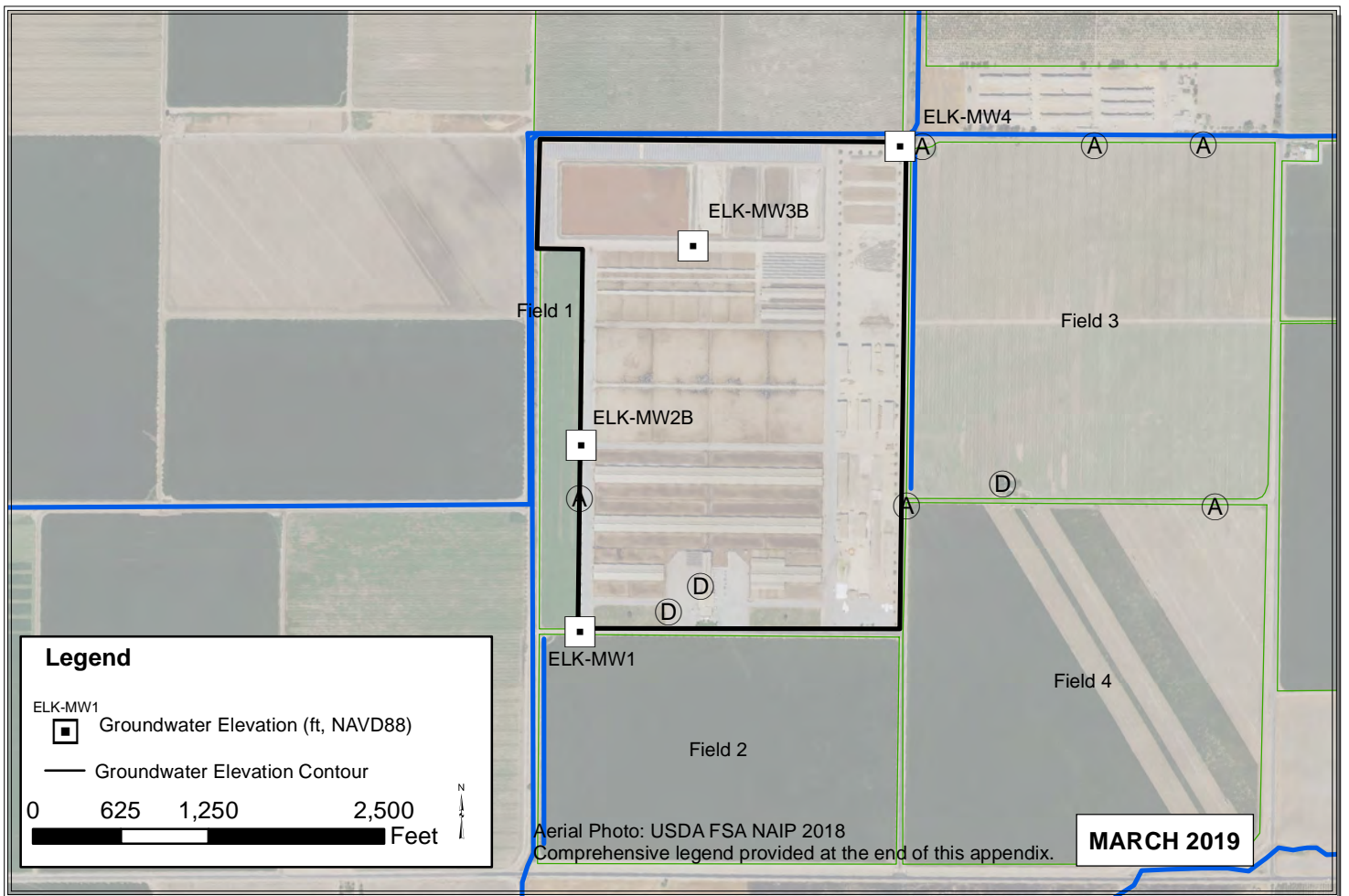

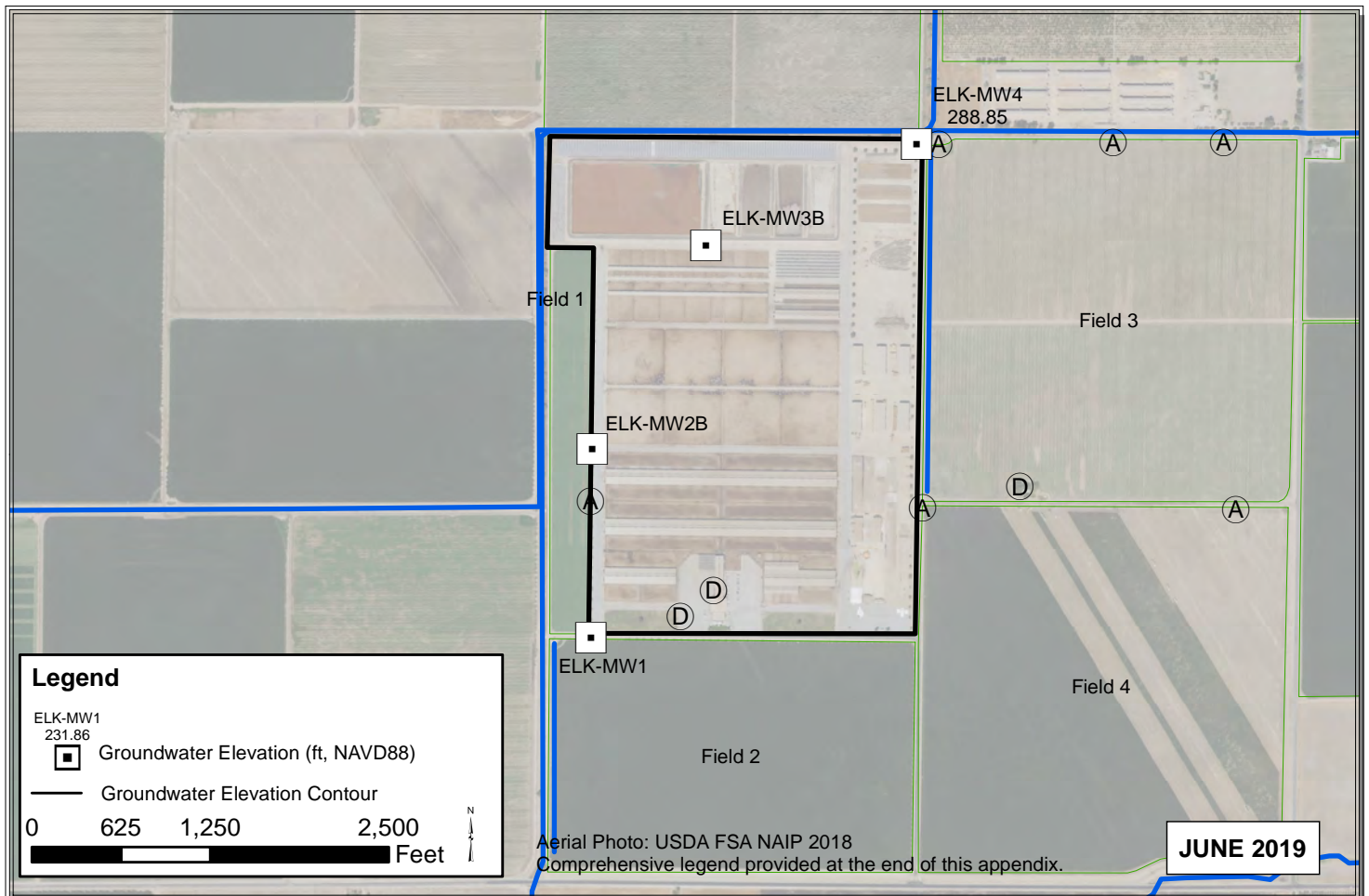
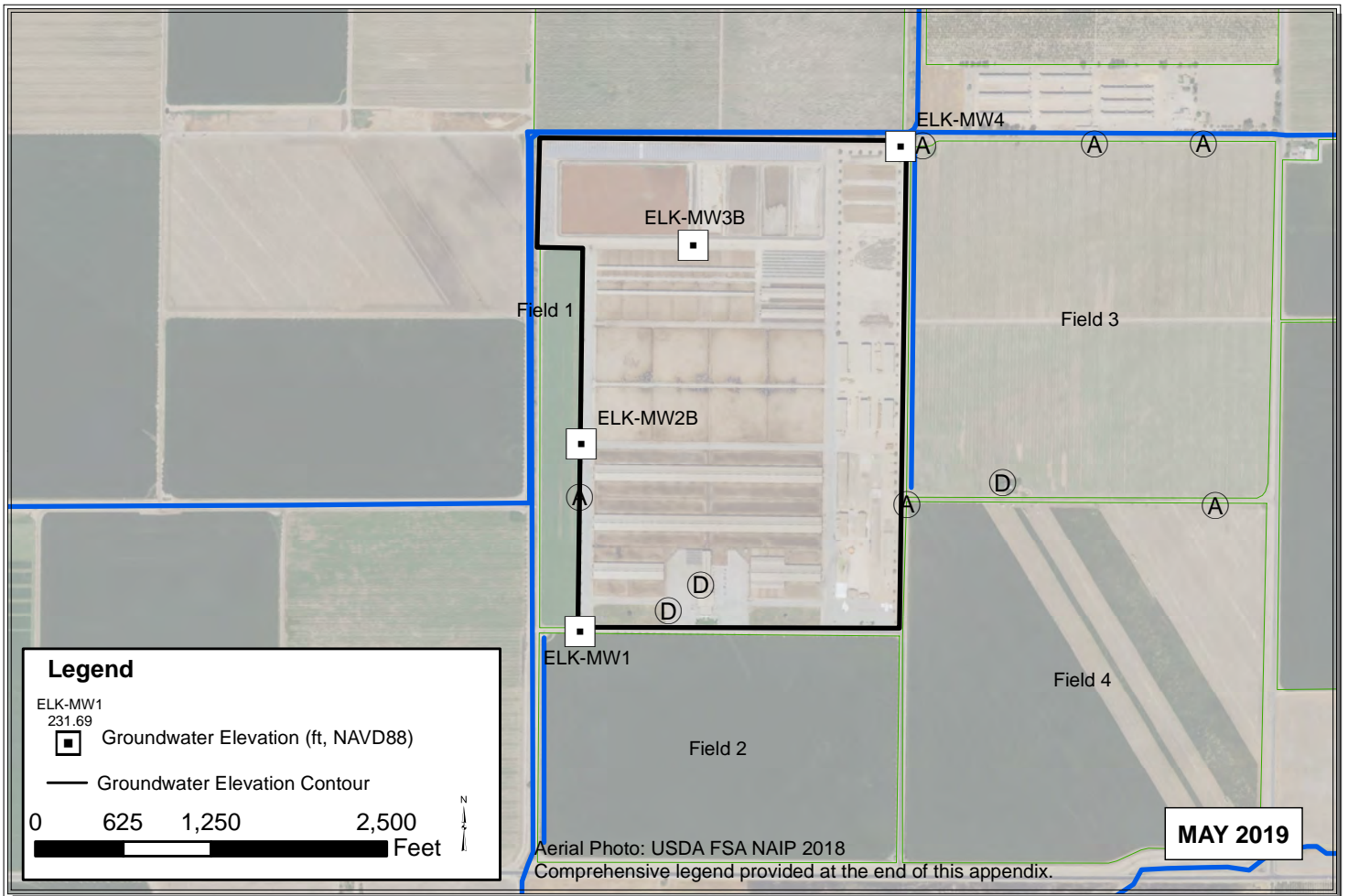

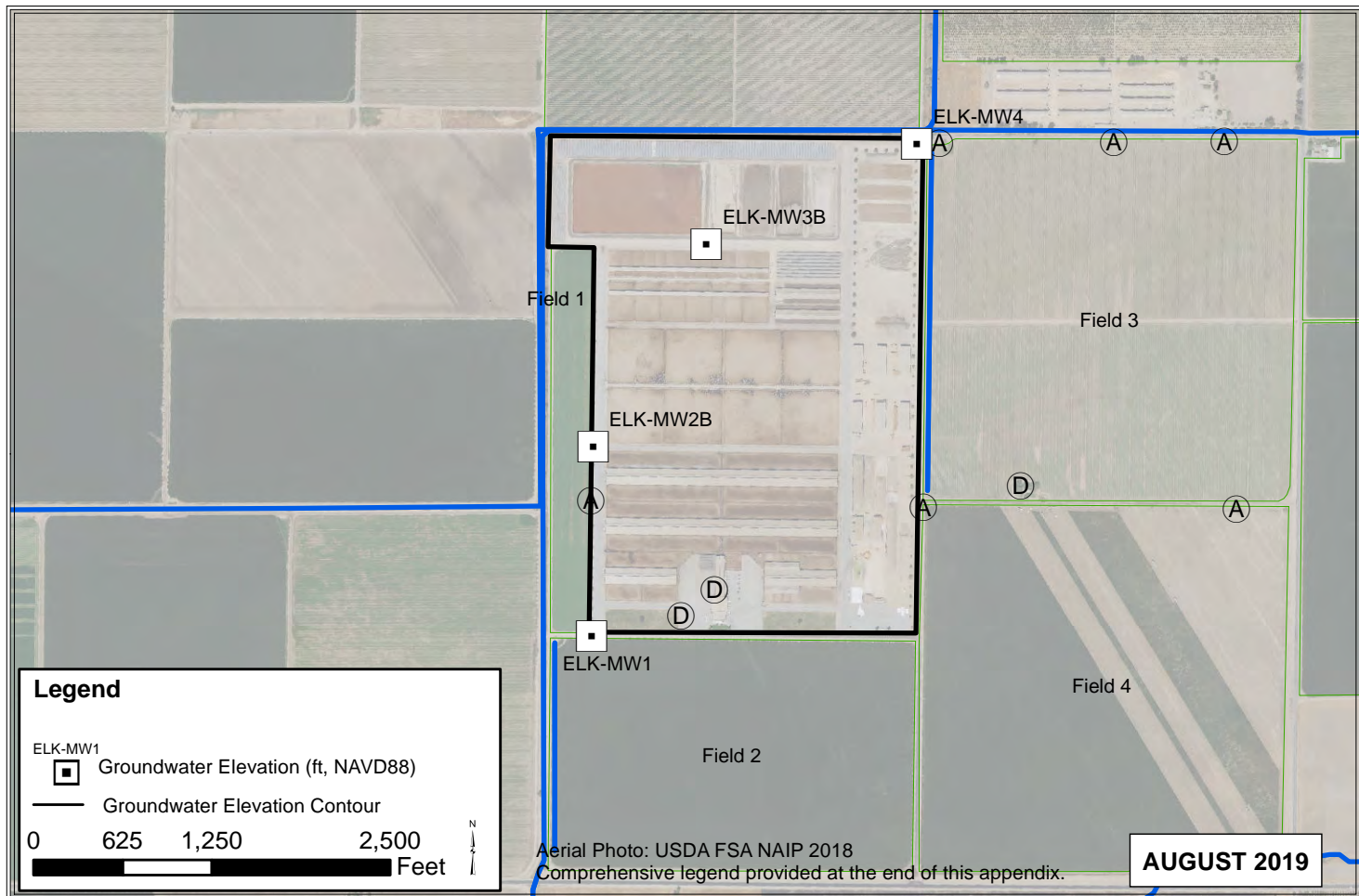
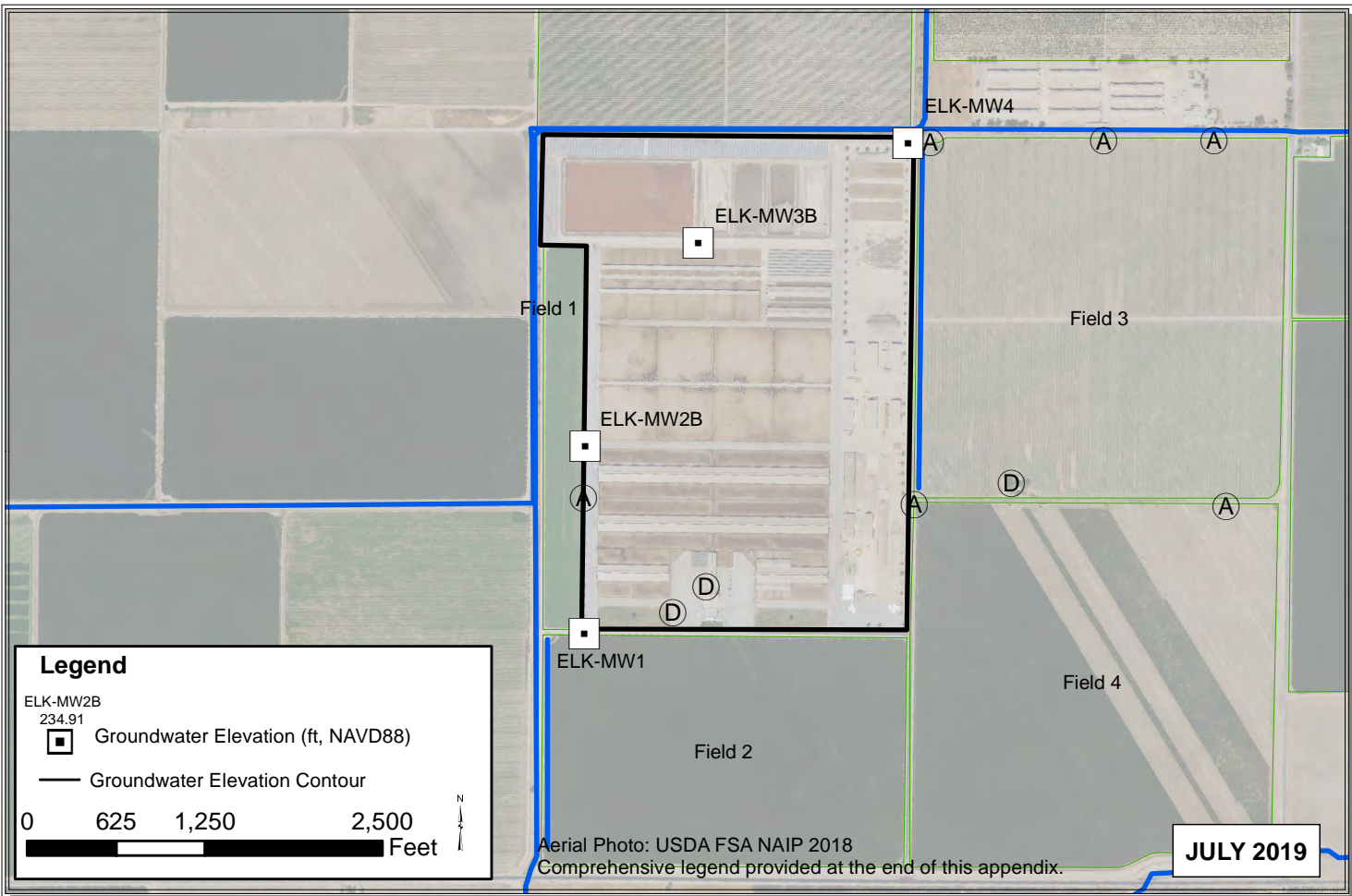

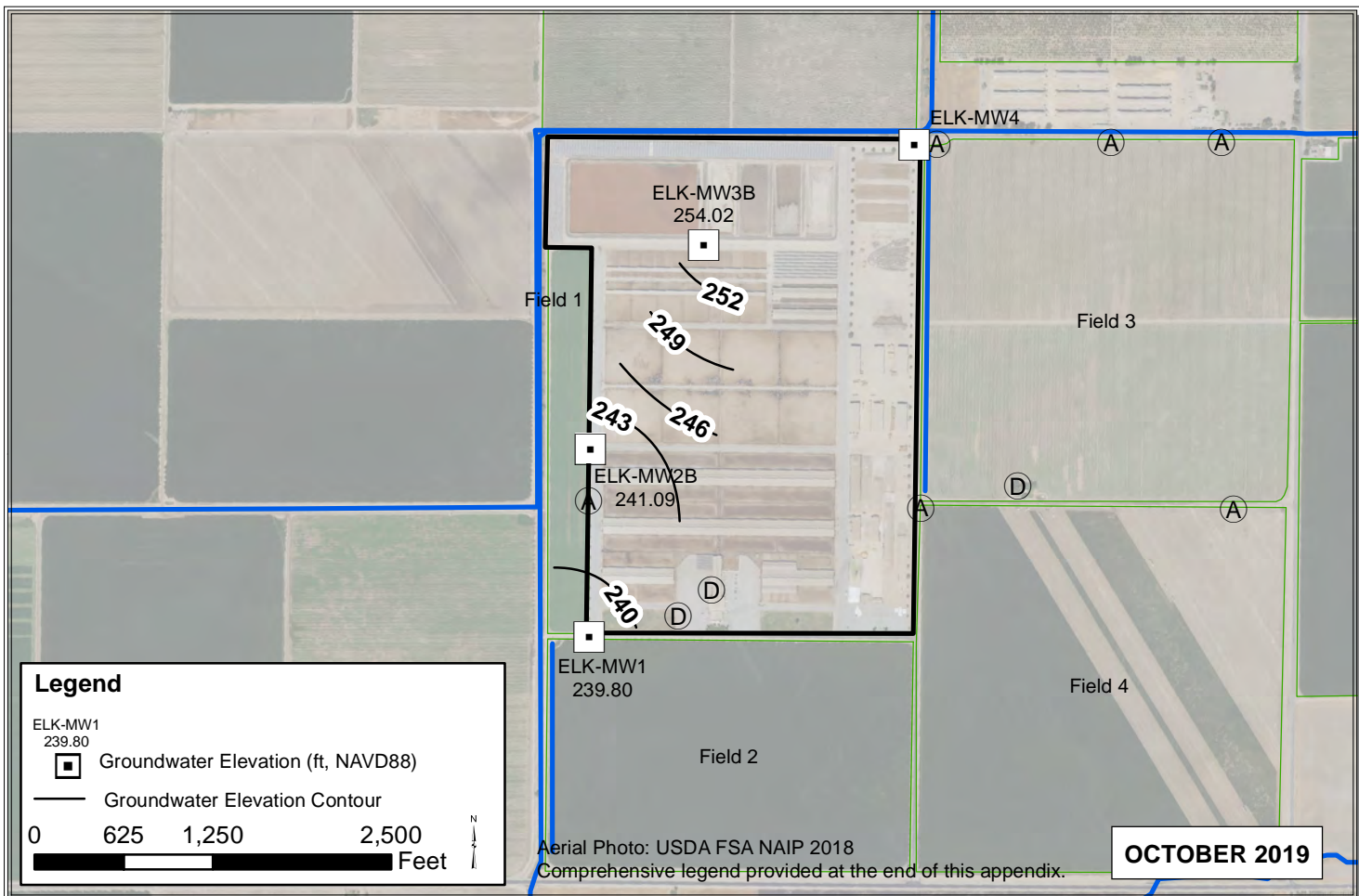
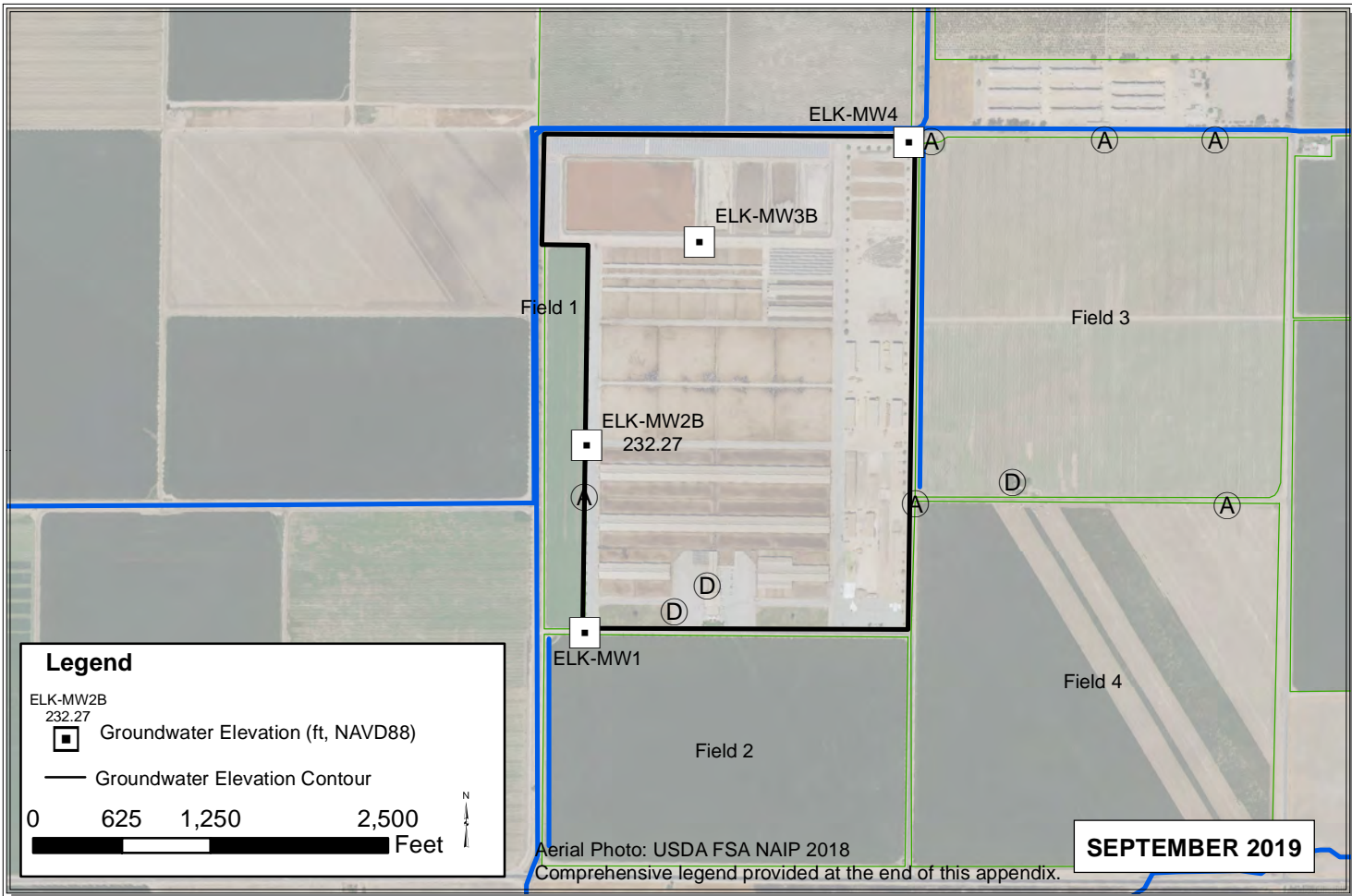

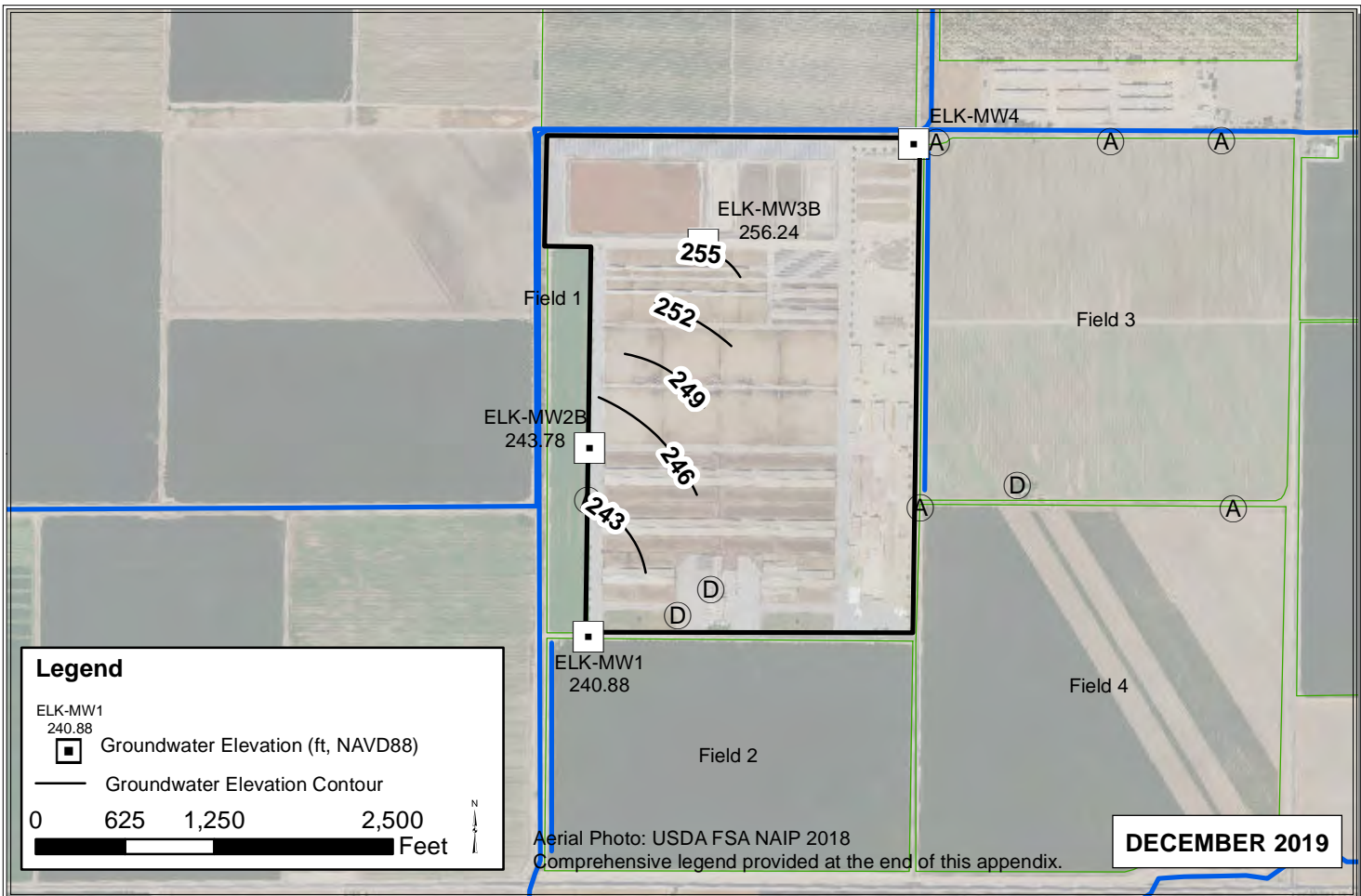
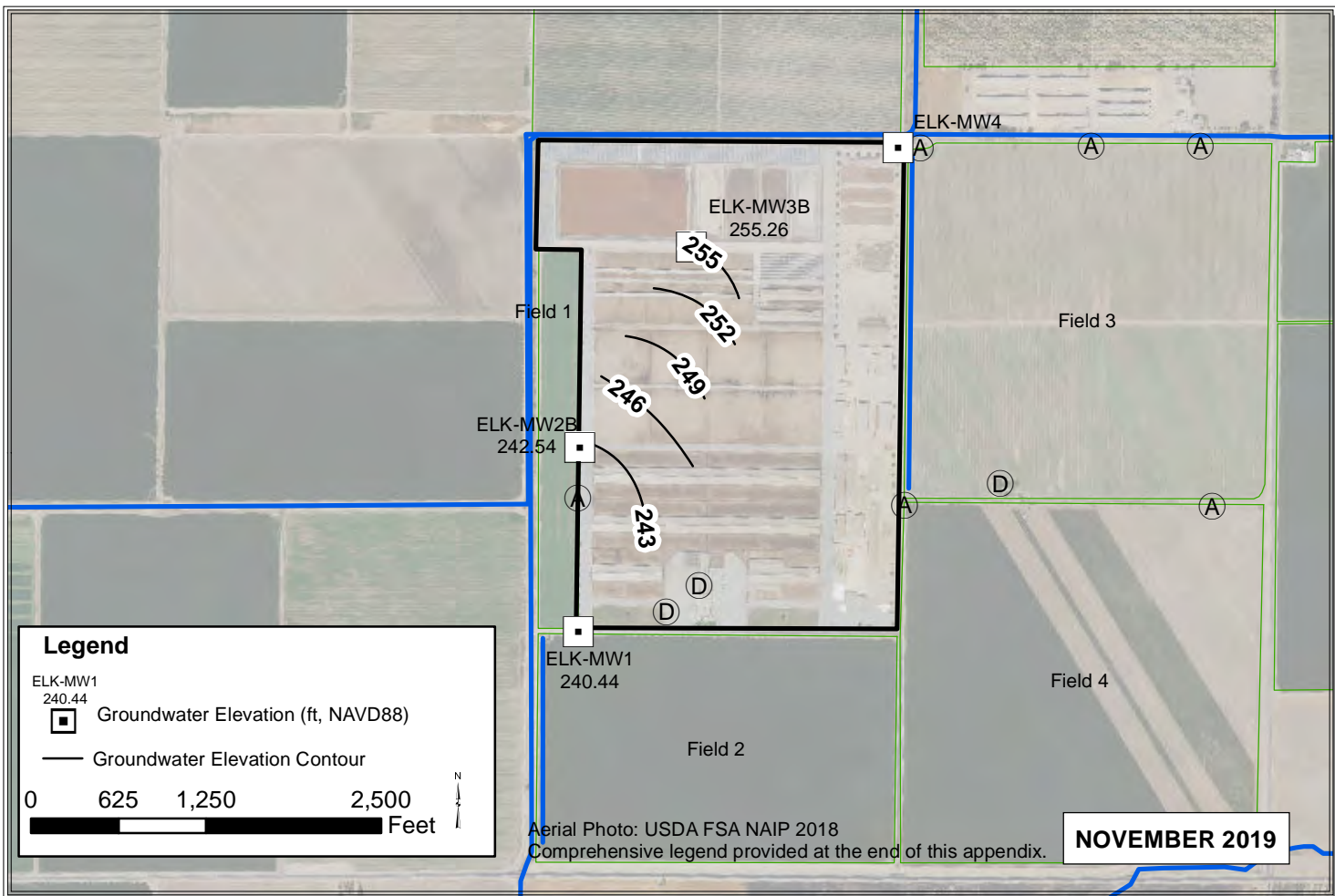

ZZI

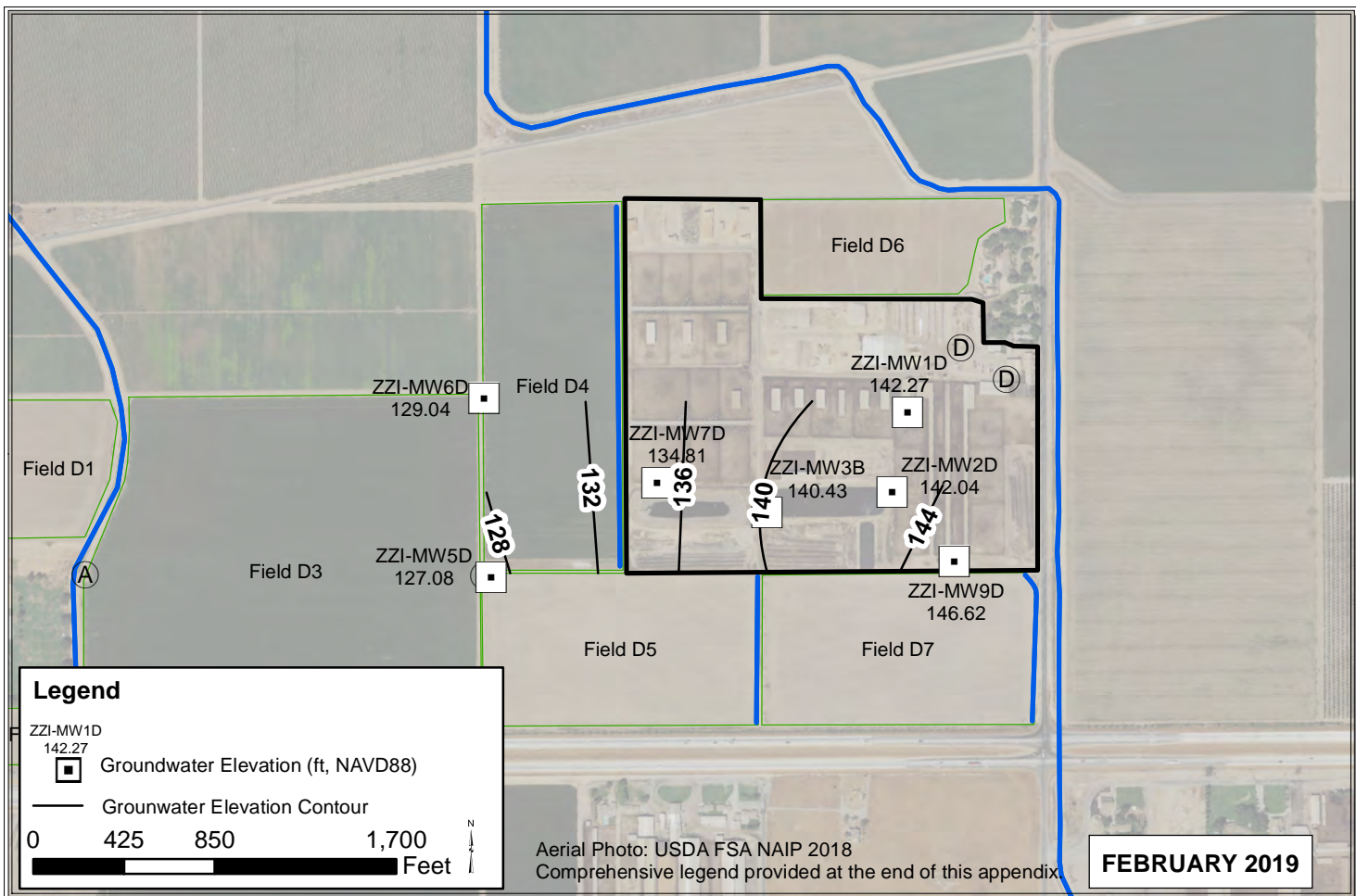
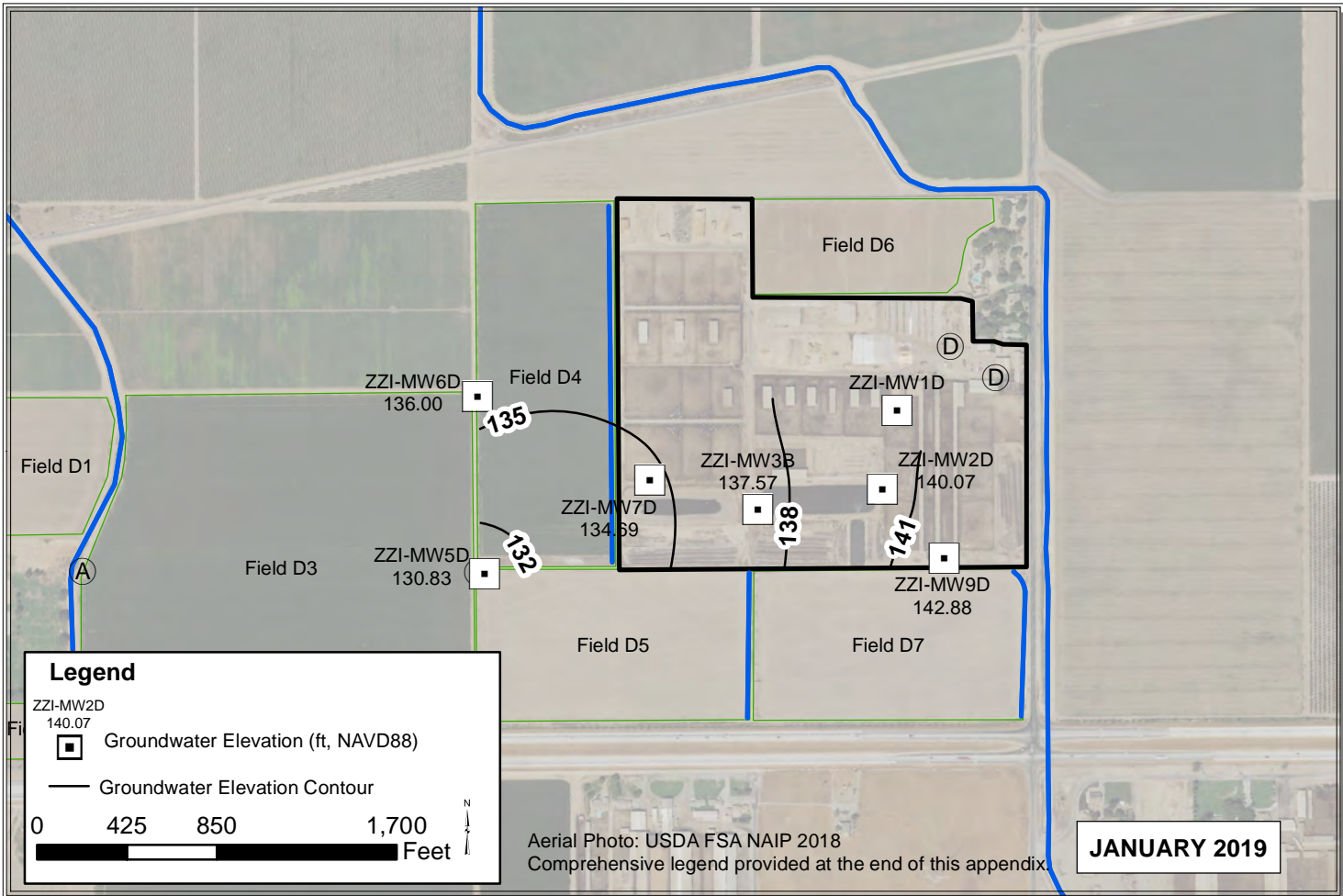

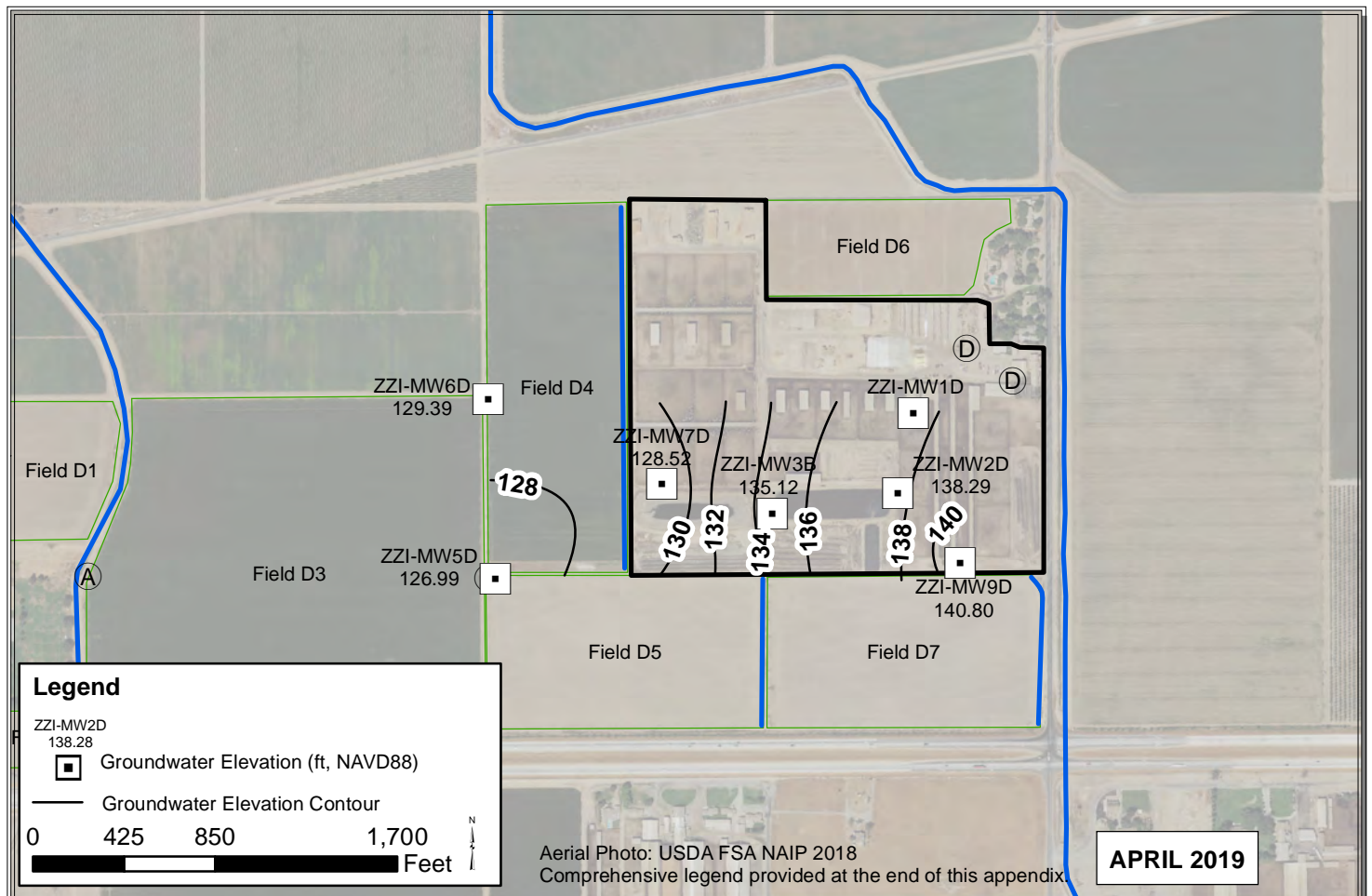
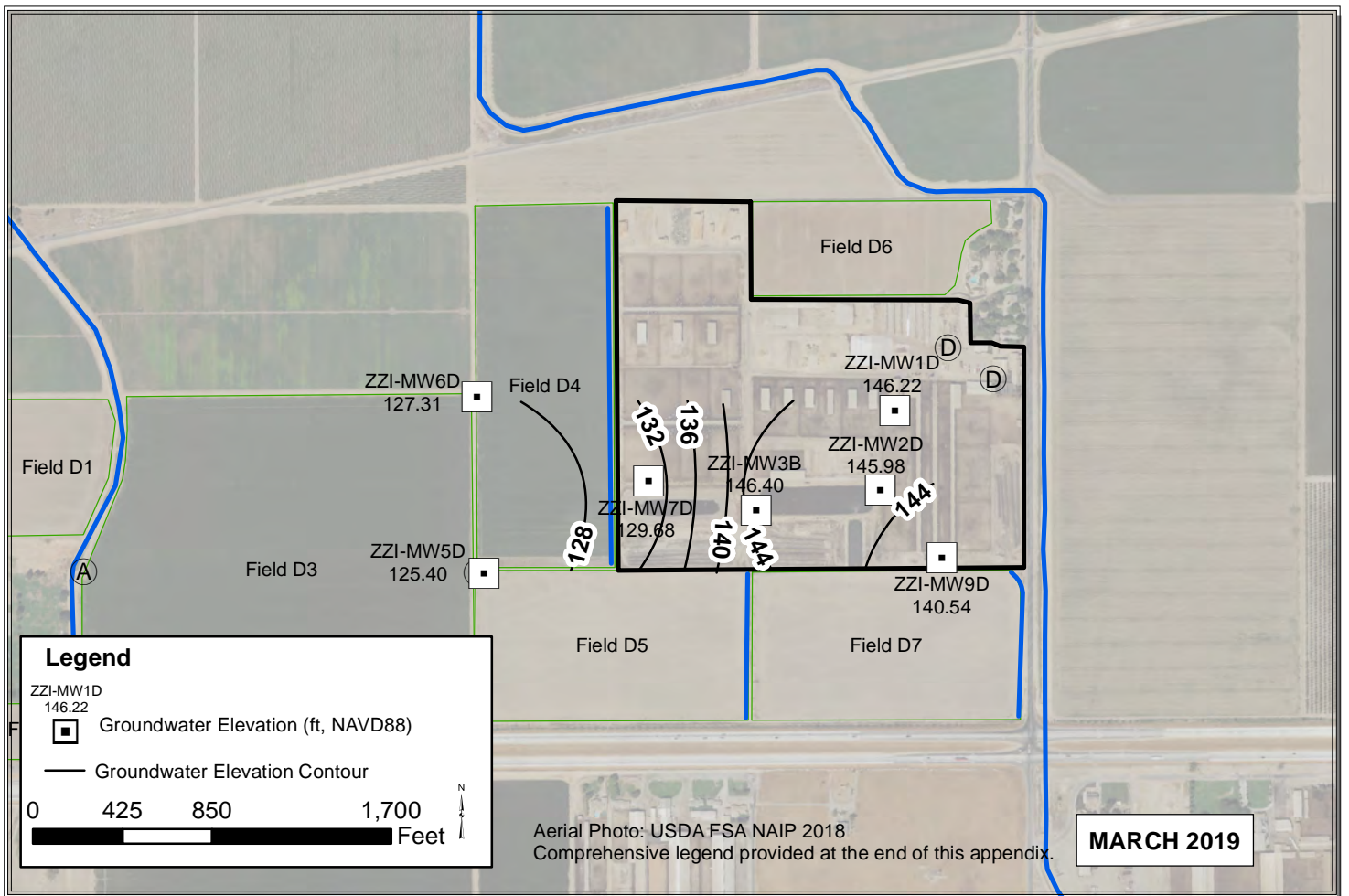

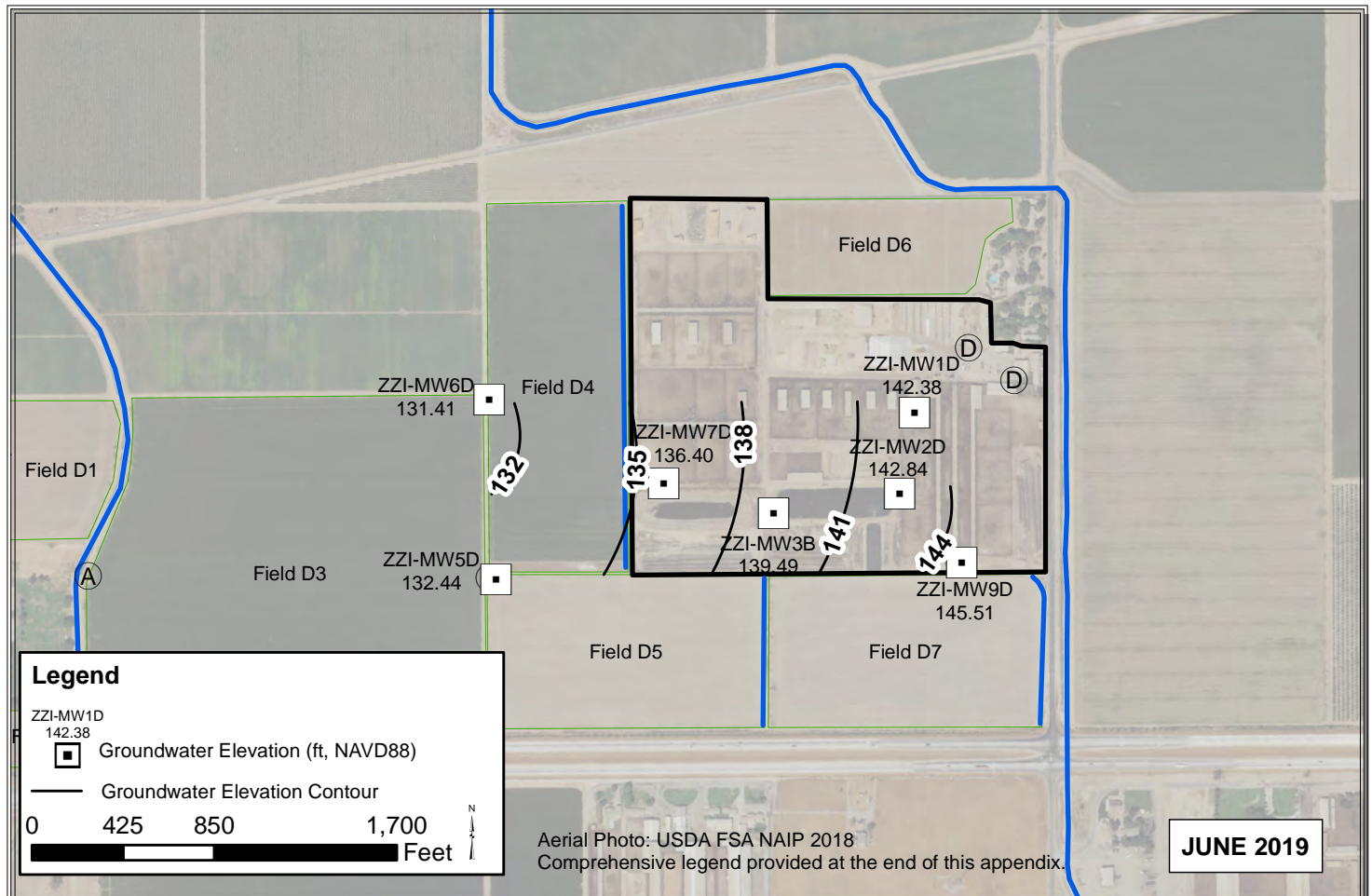
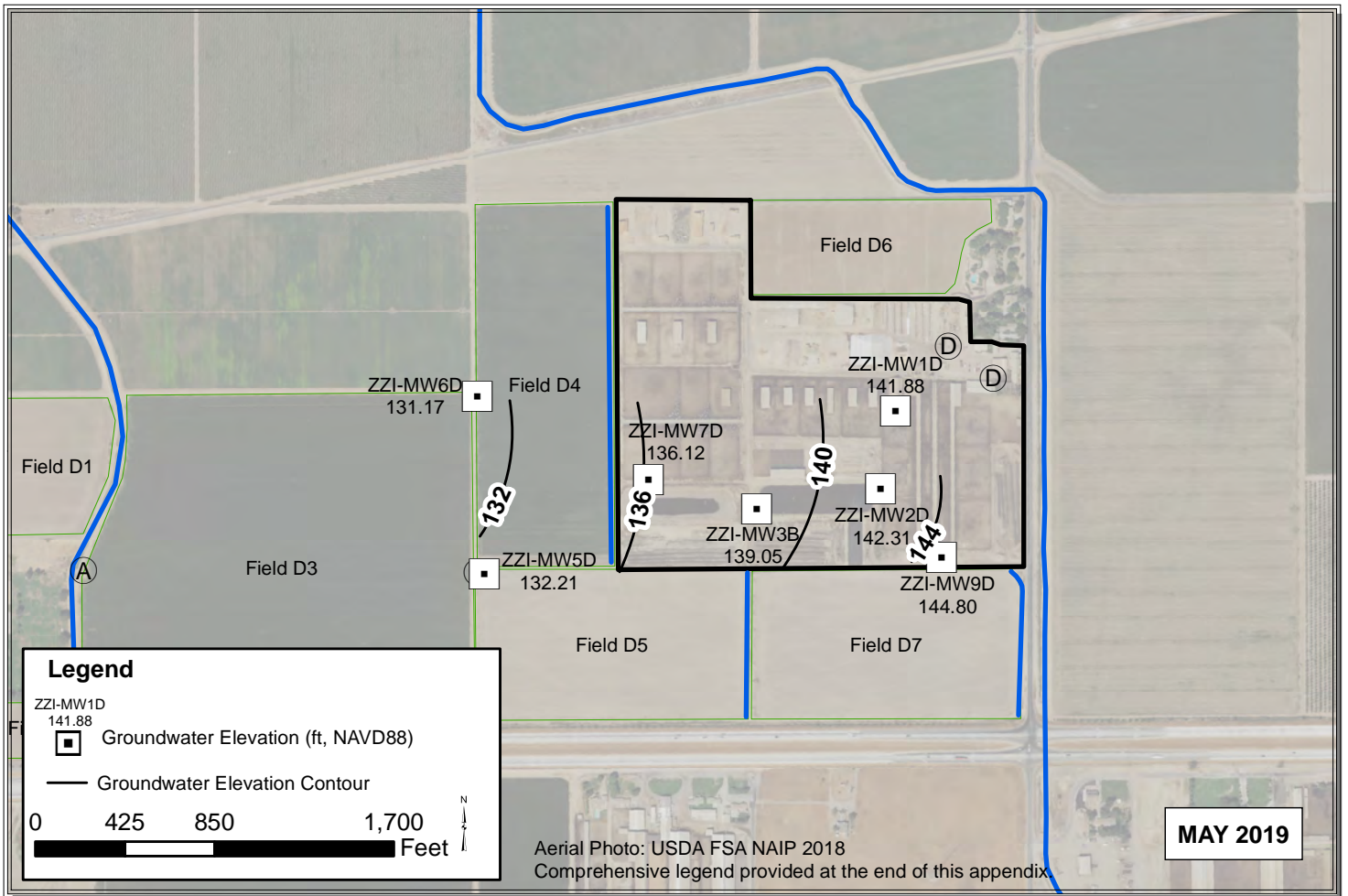

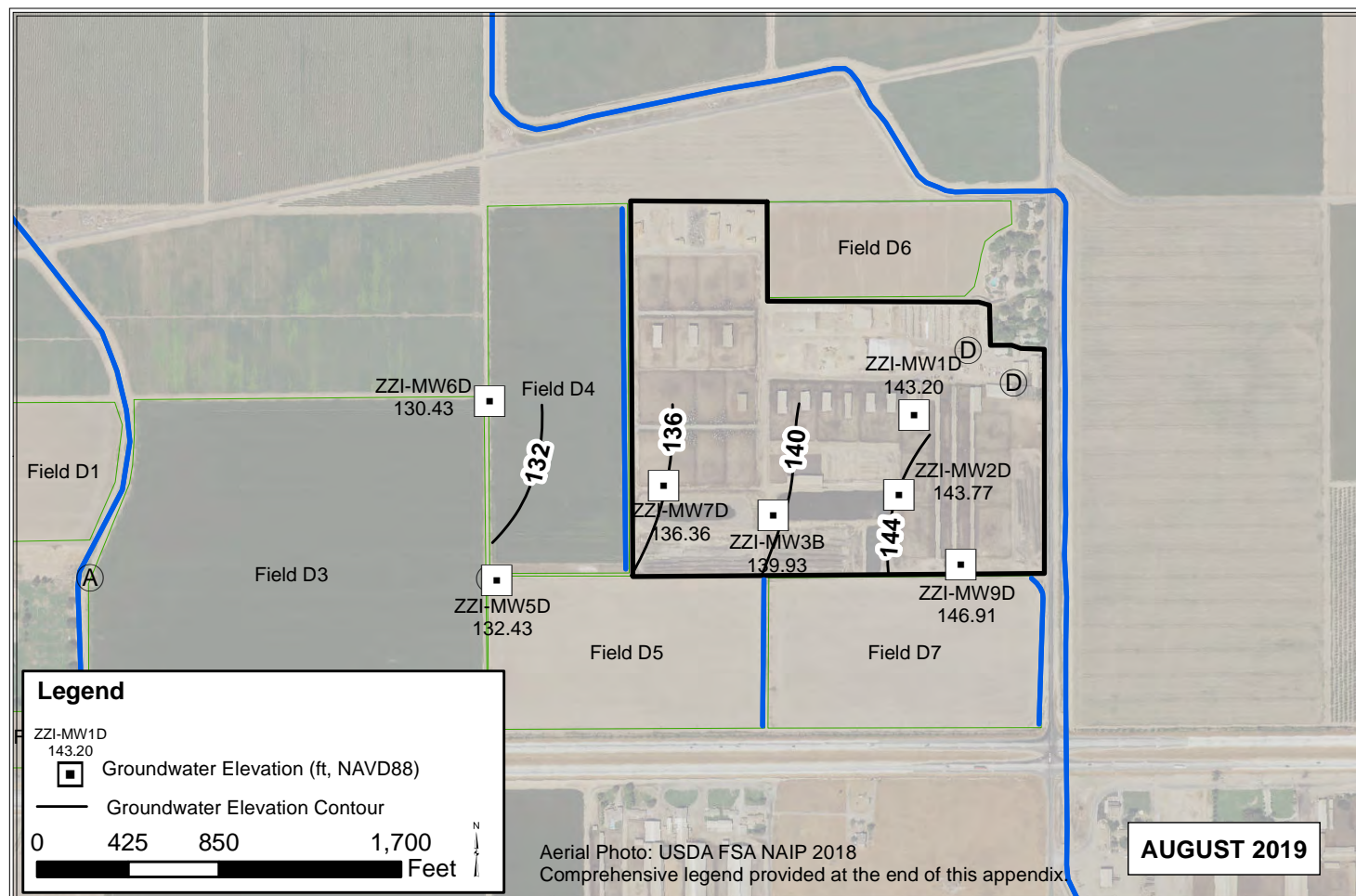
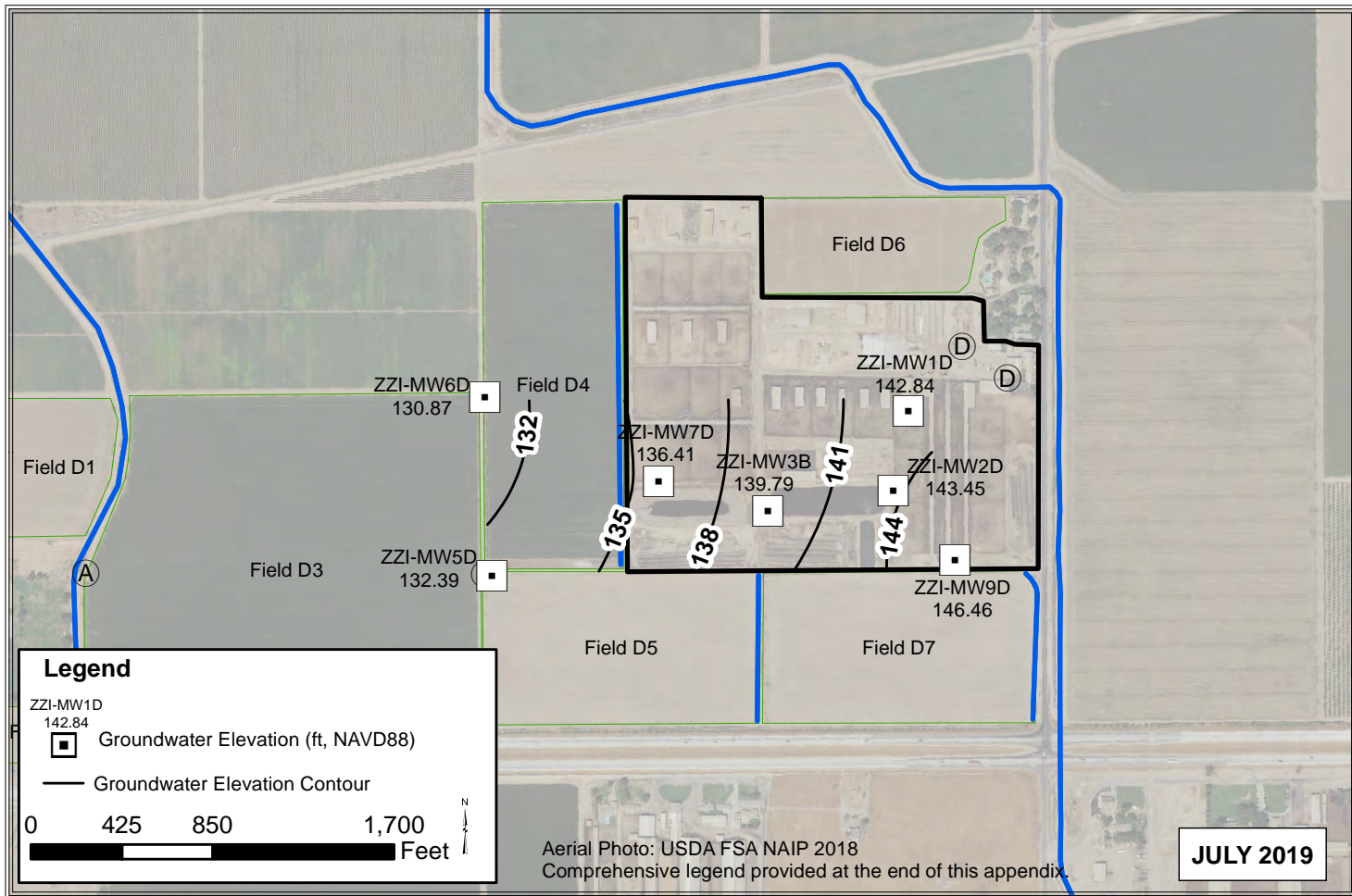

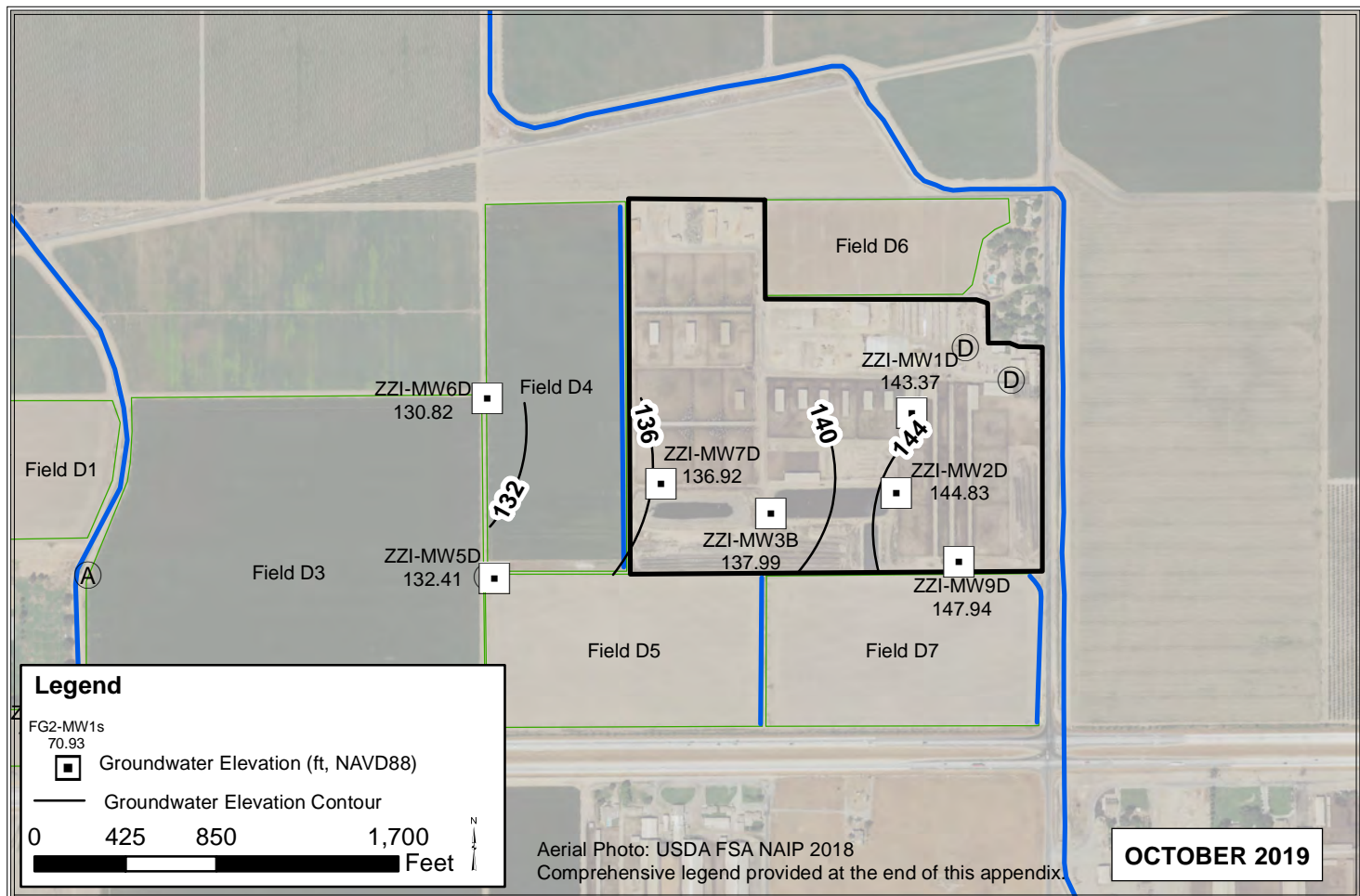
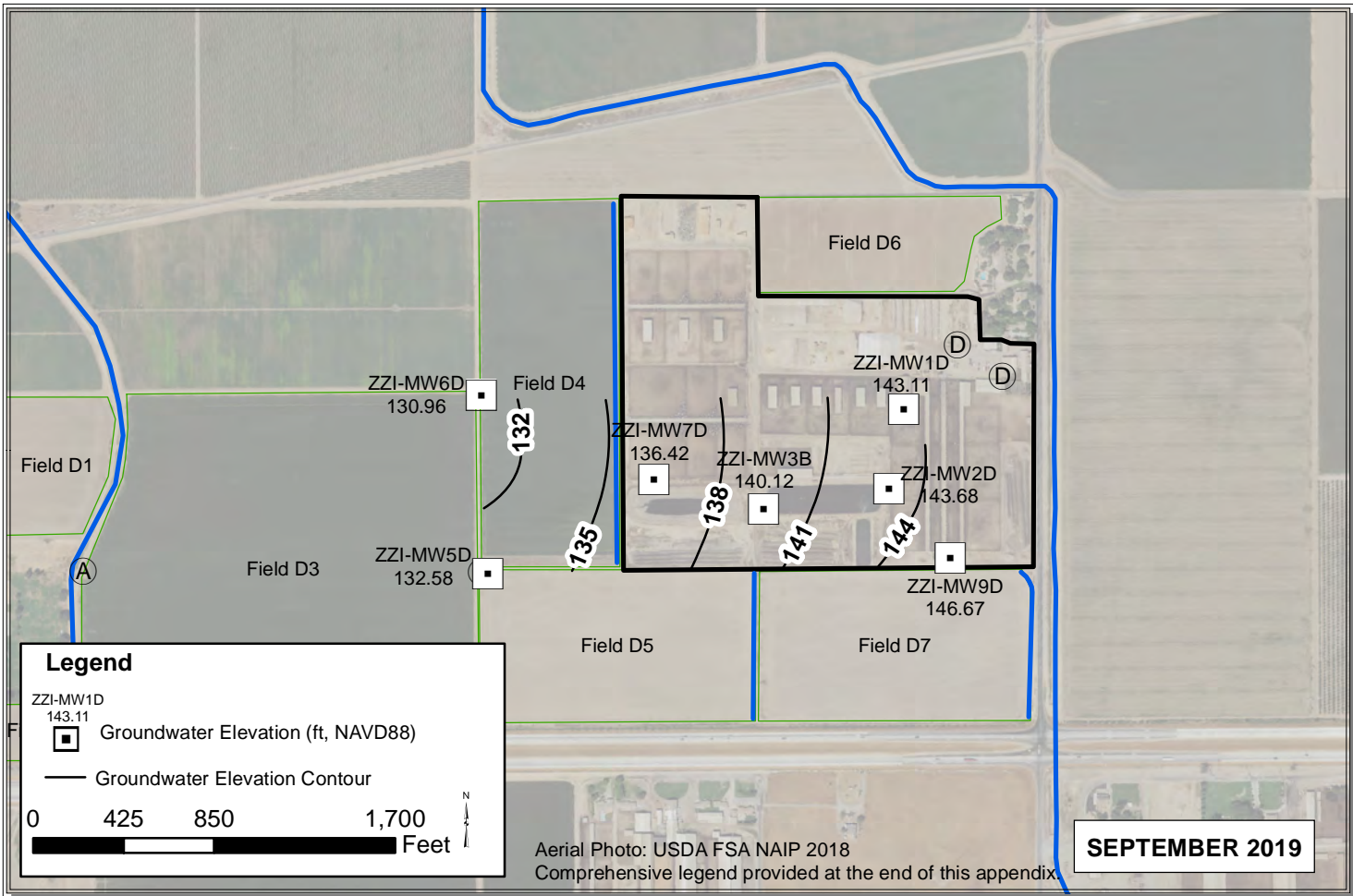

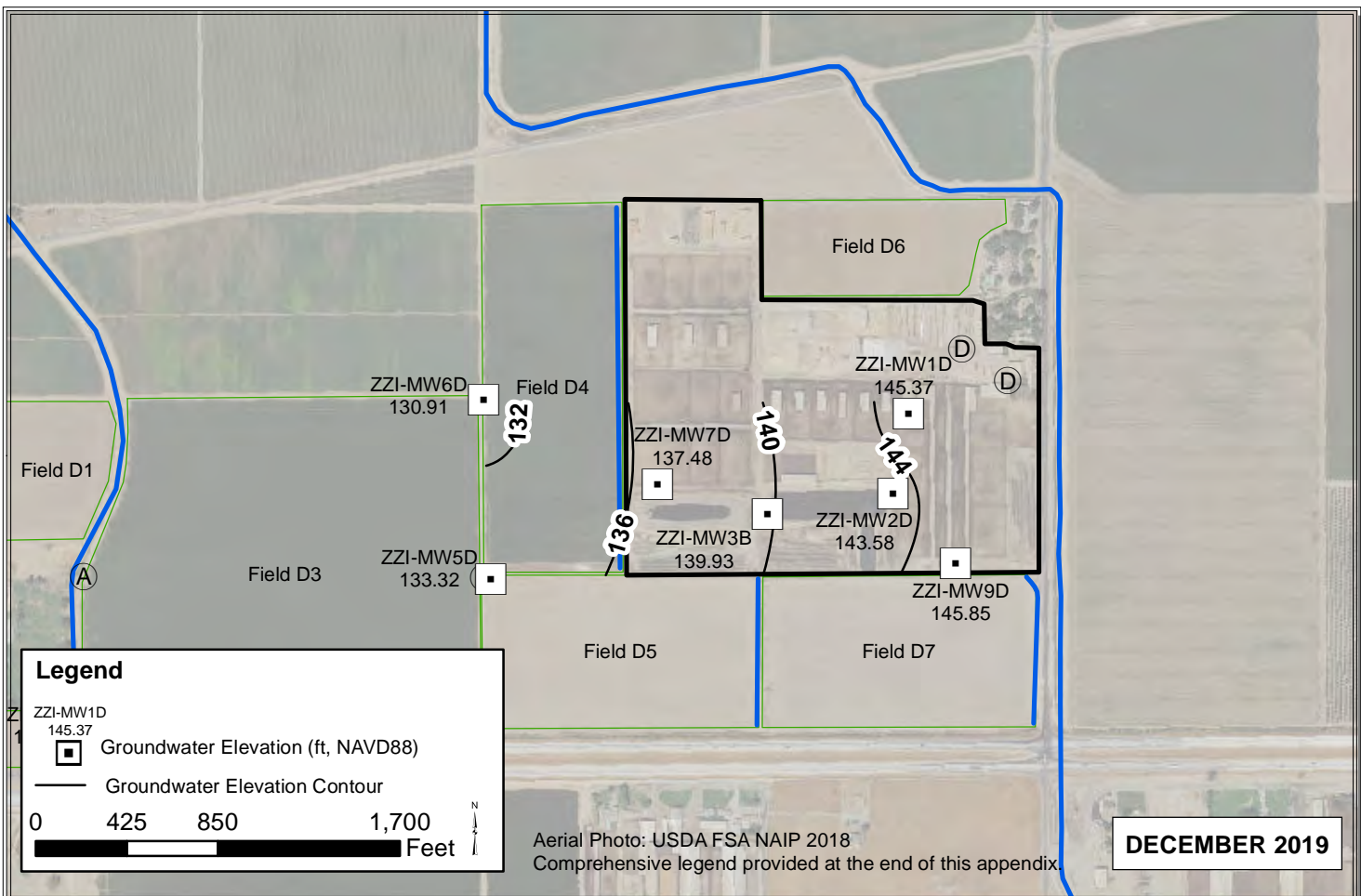
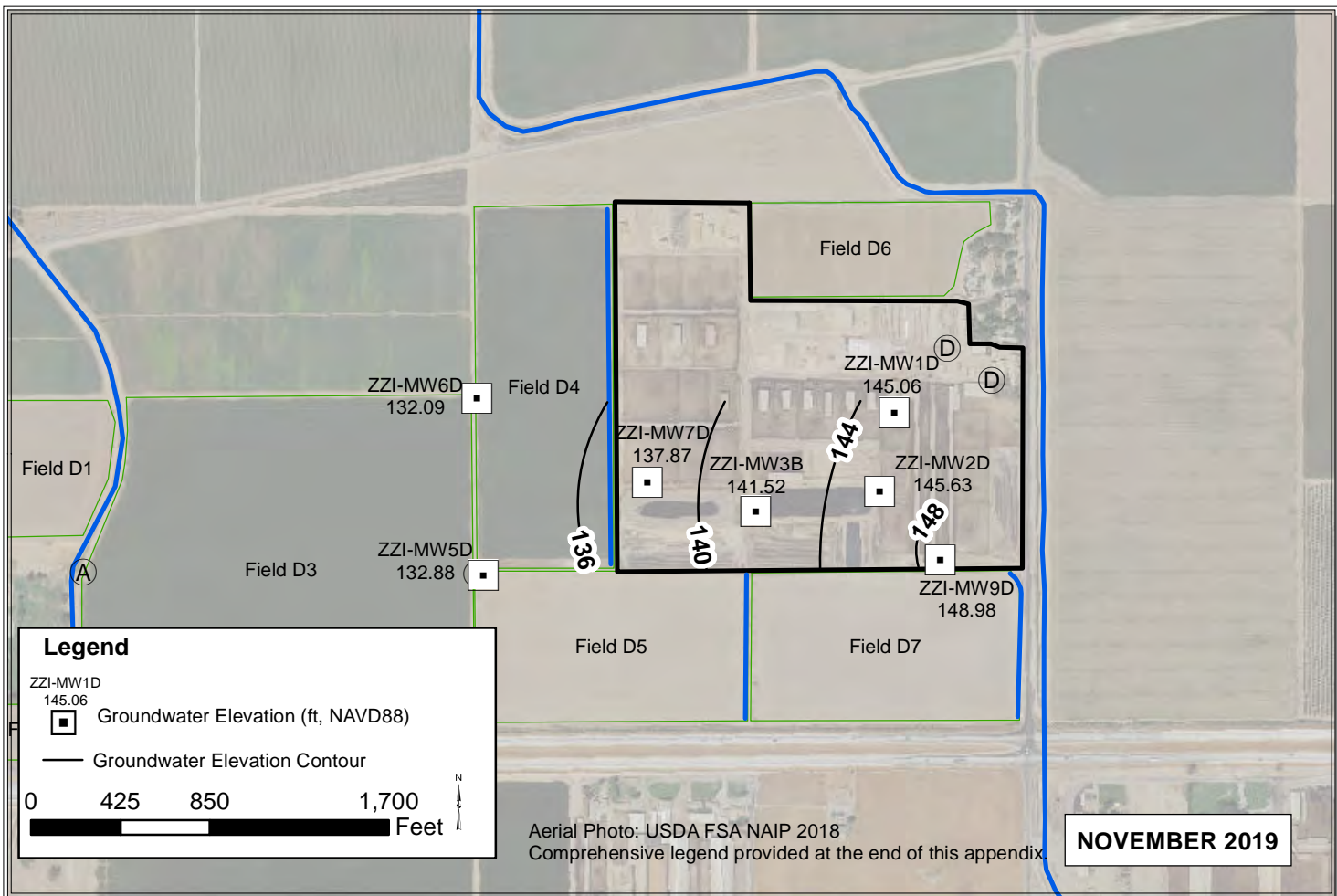

HOL

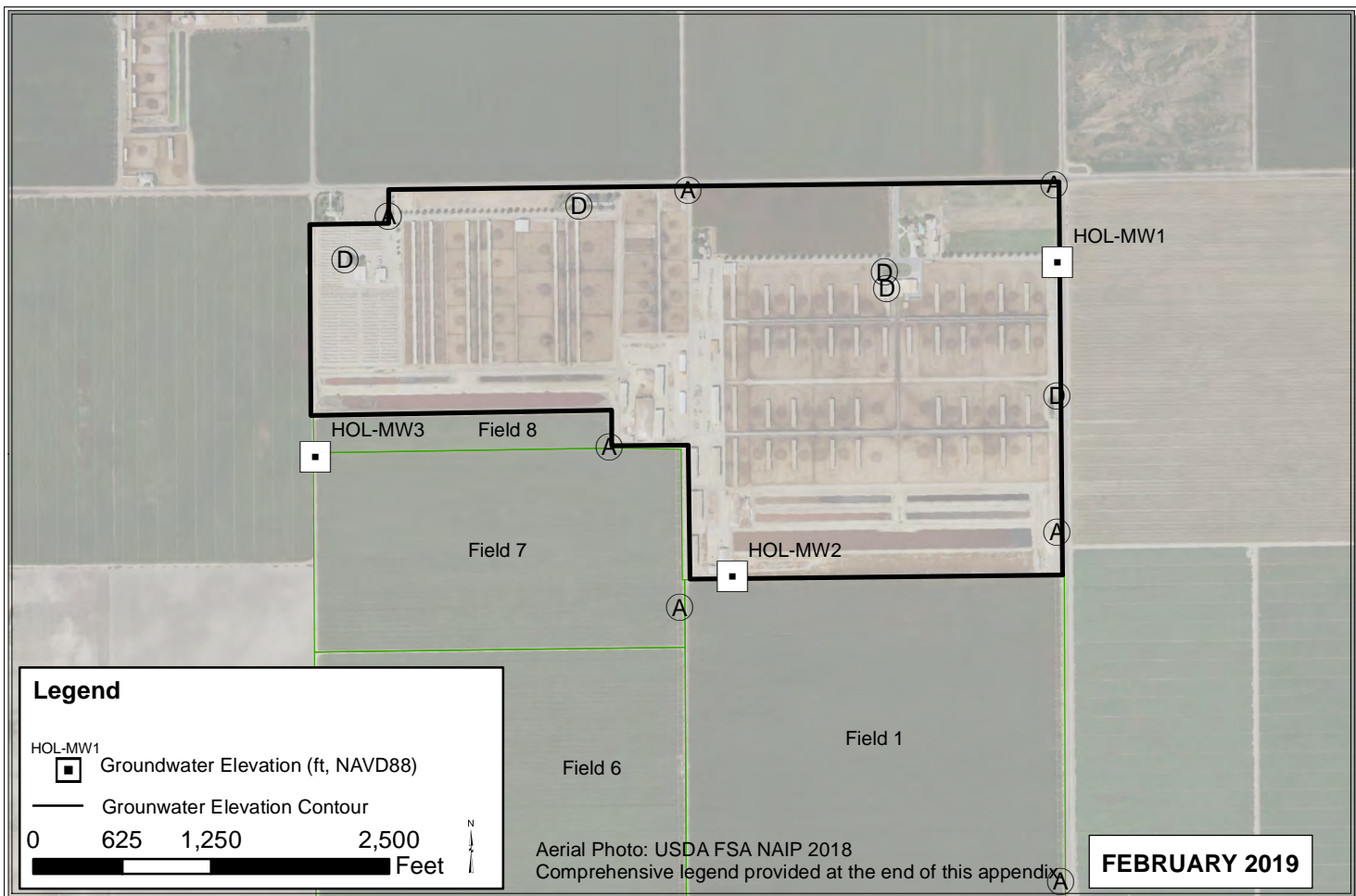
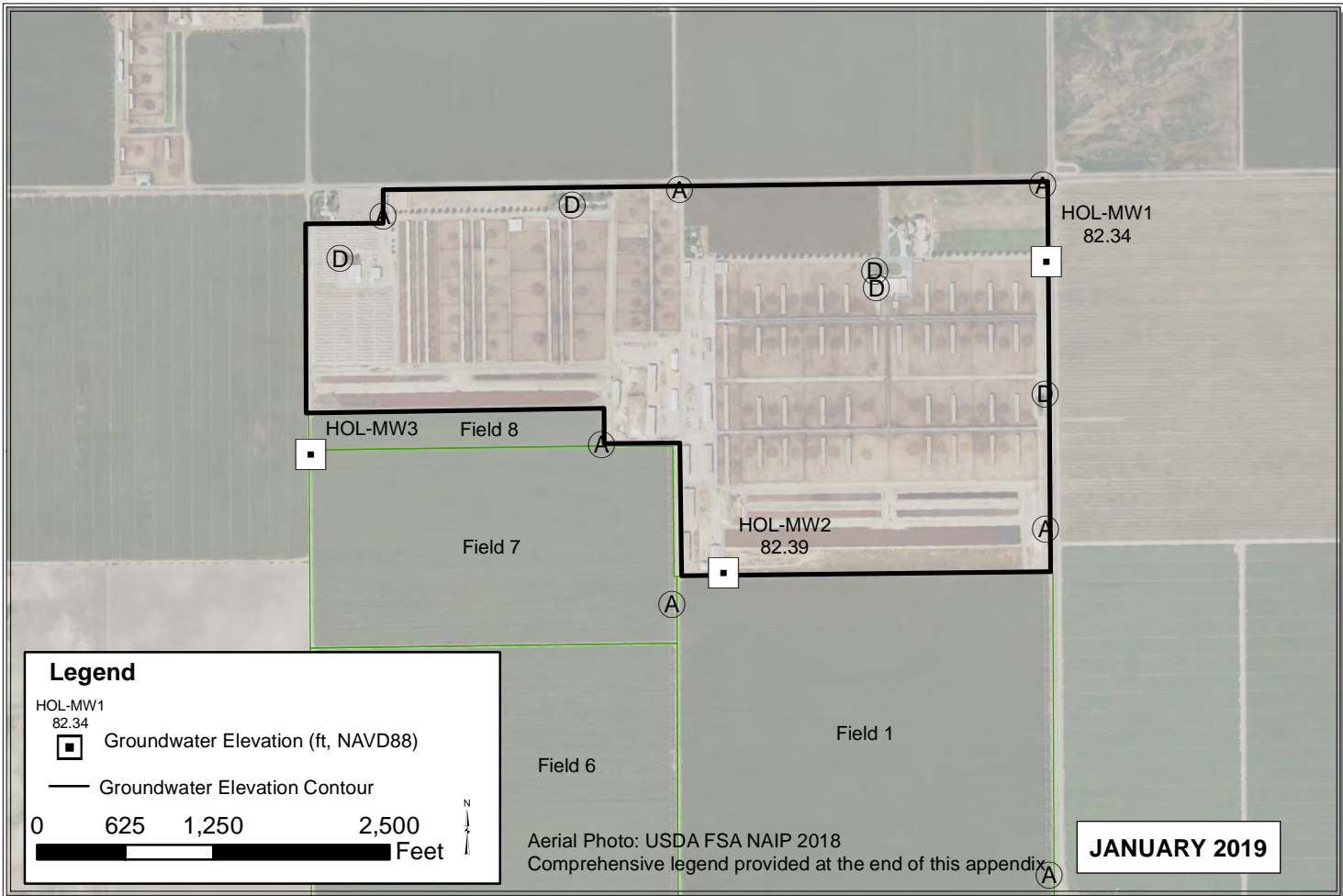

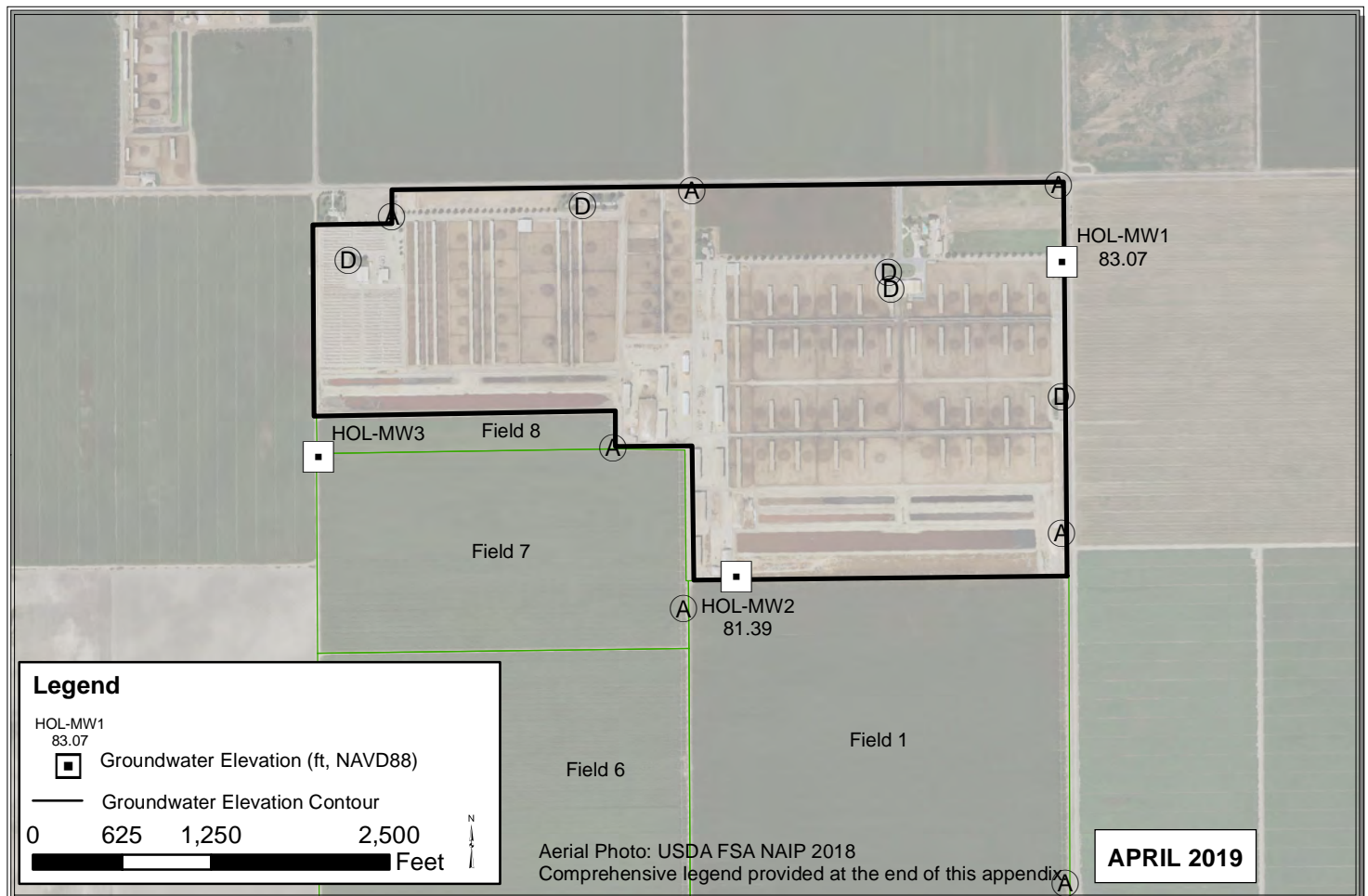
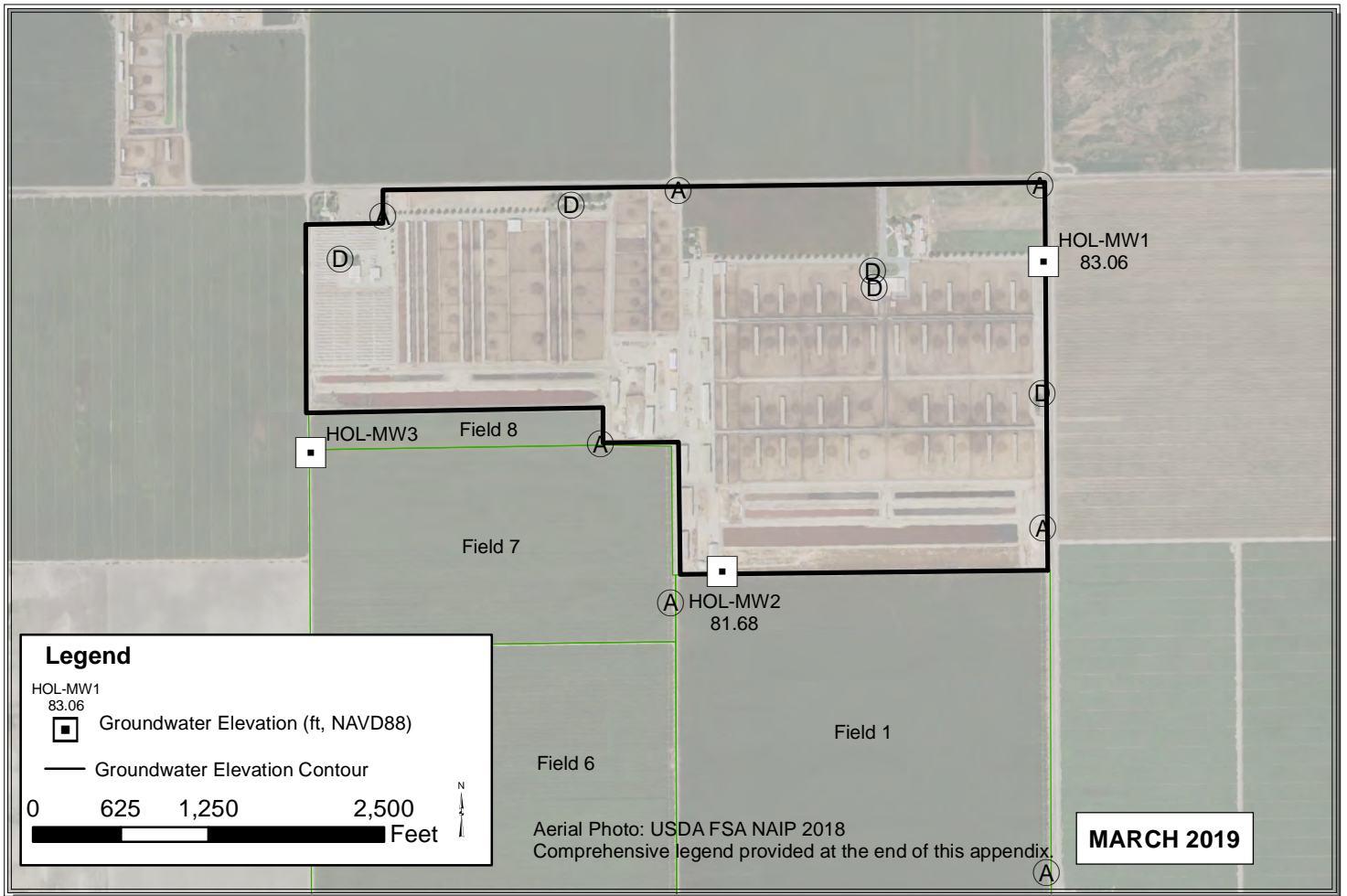

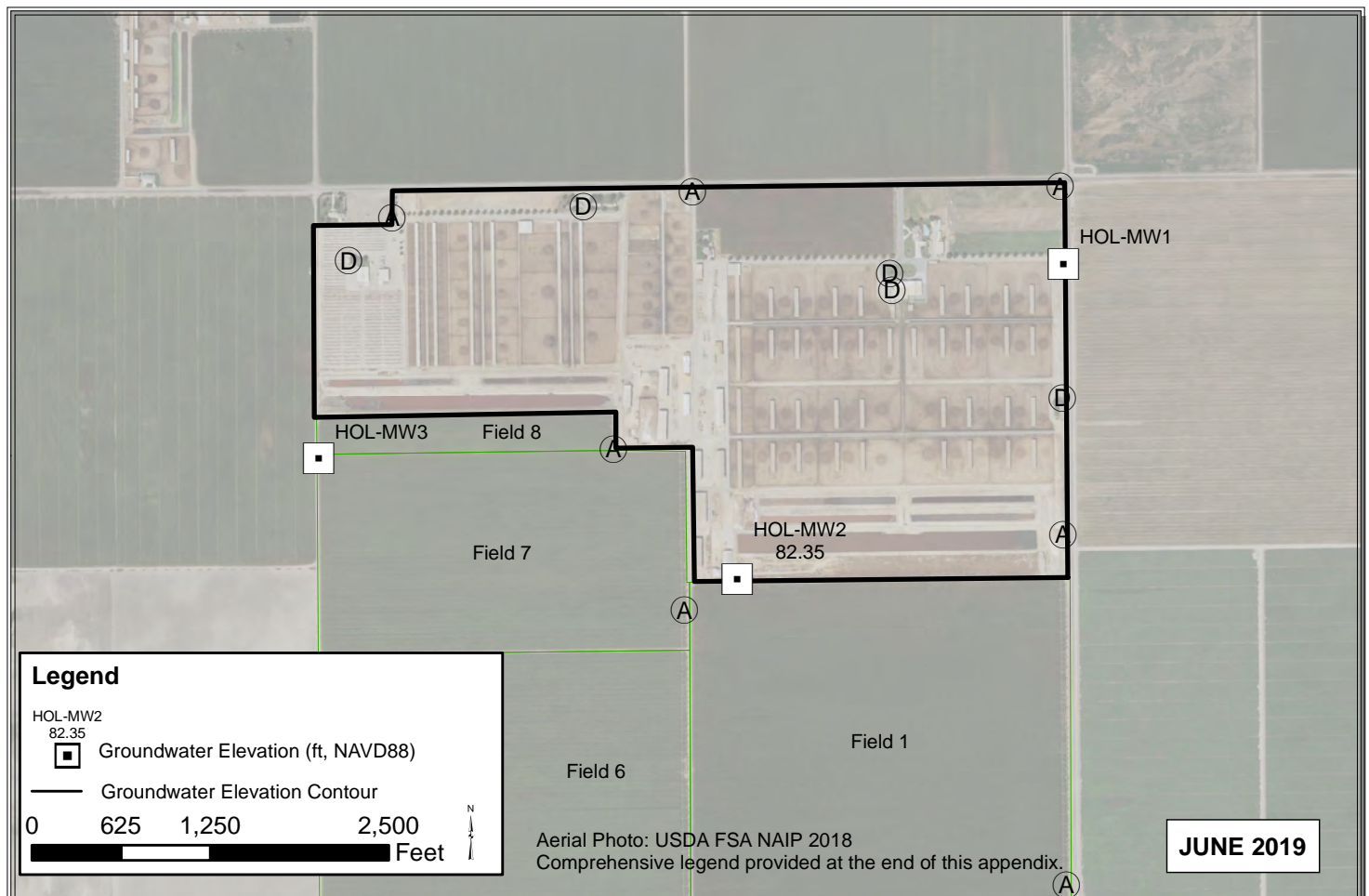
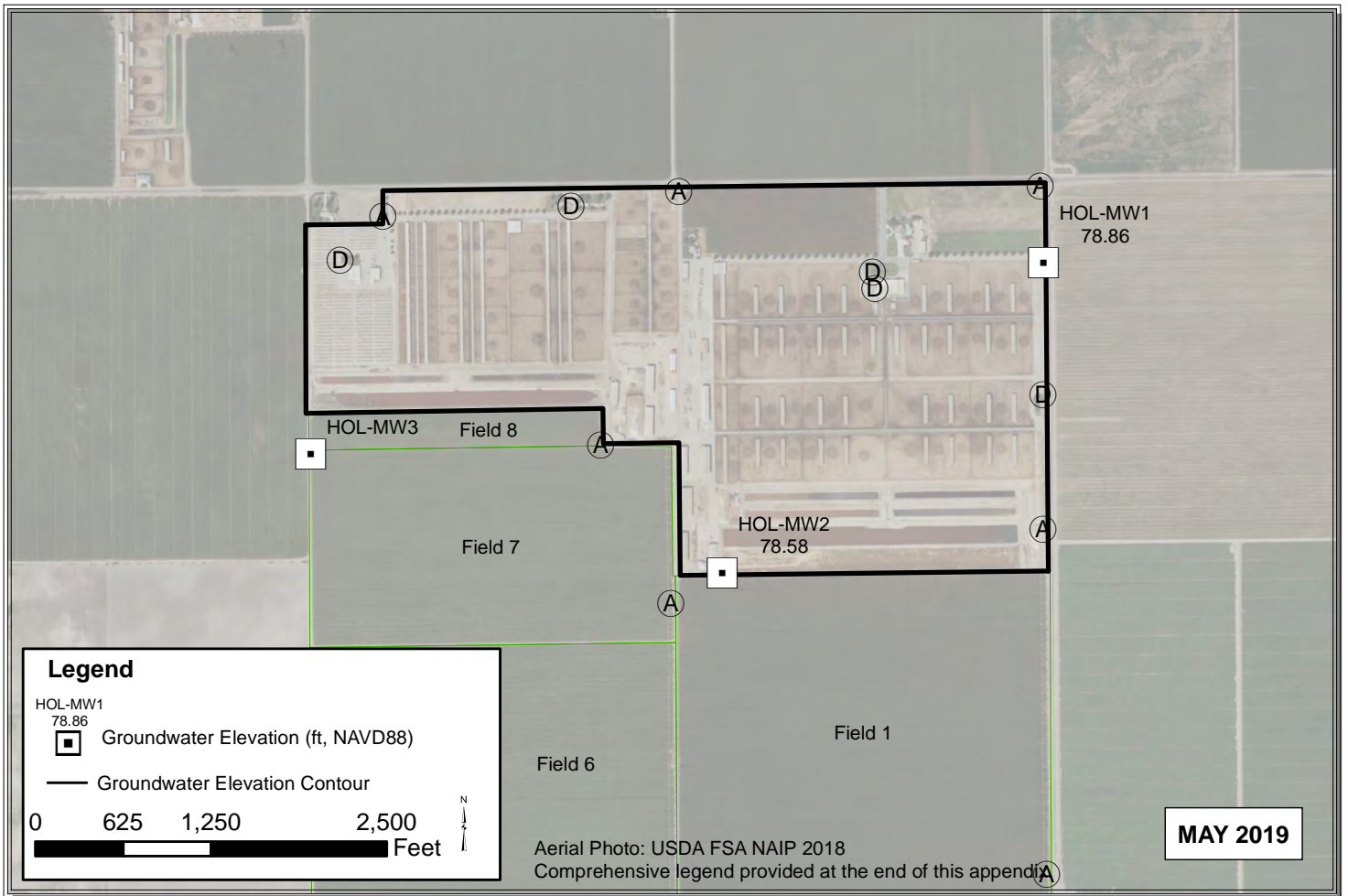

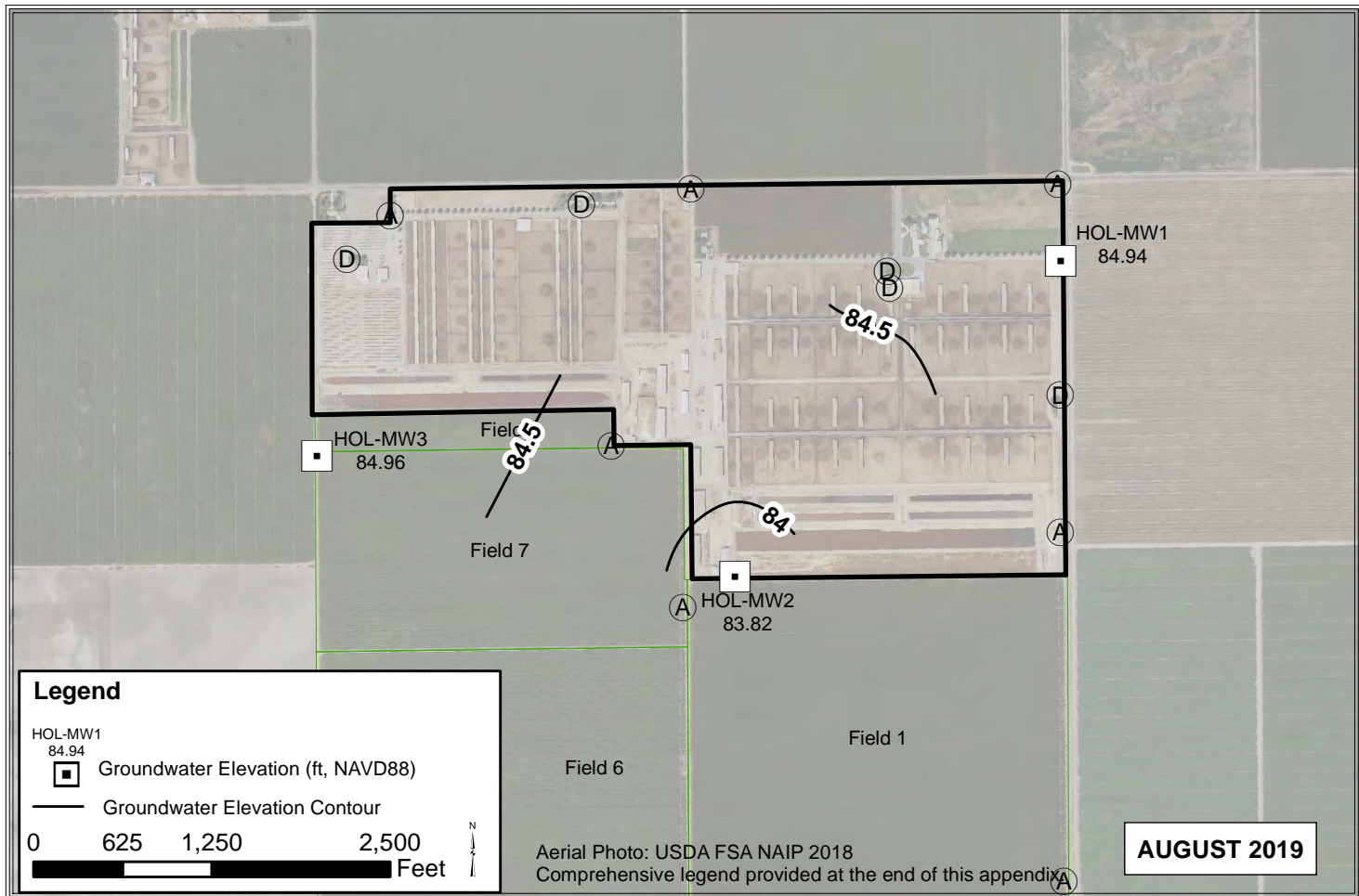
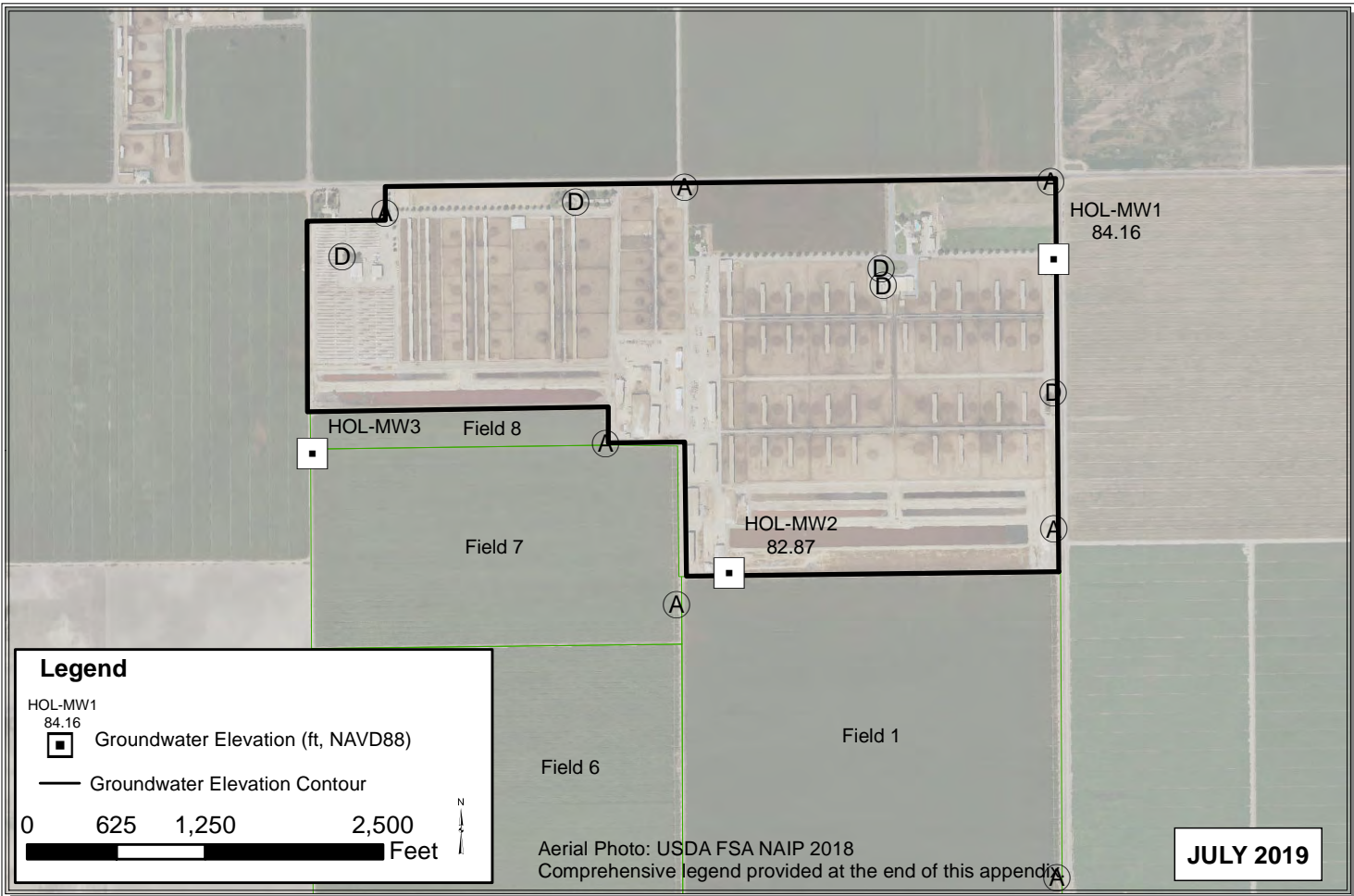

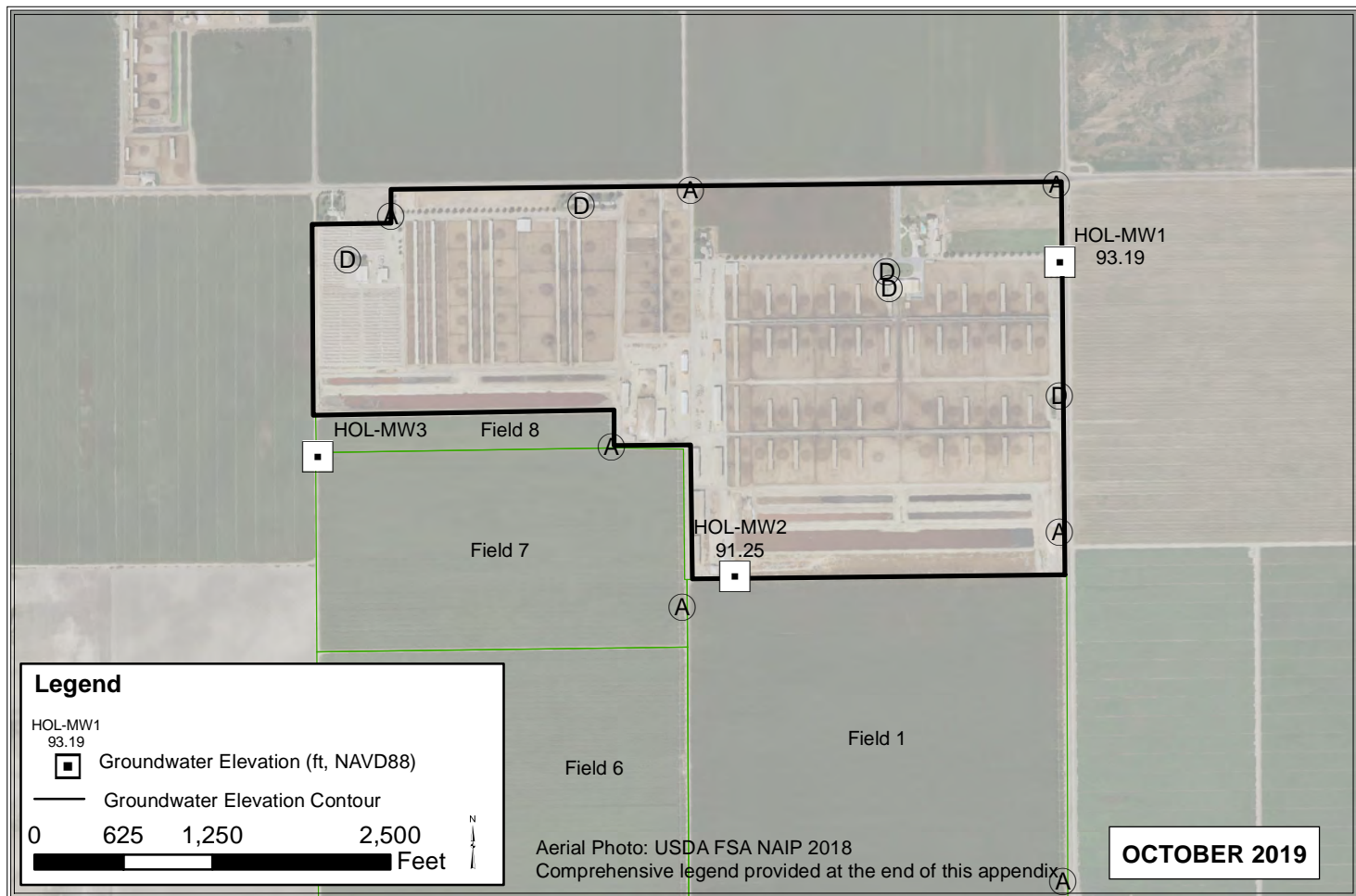
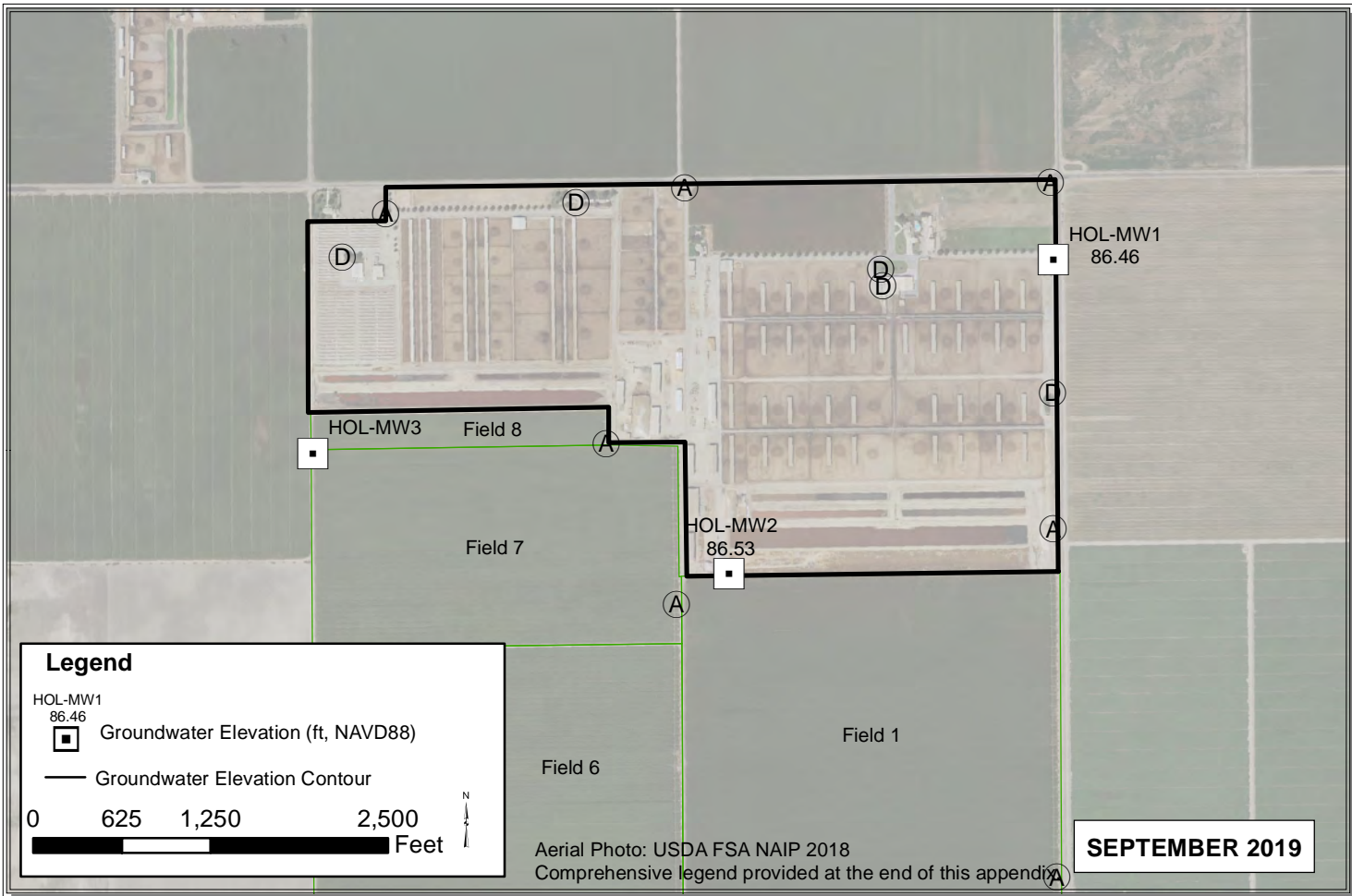

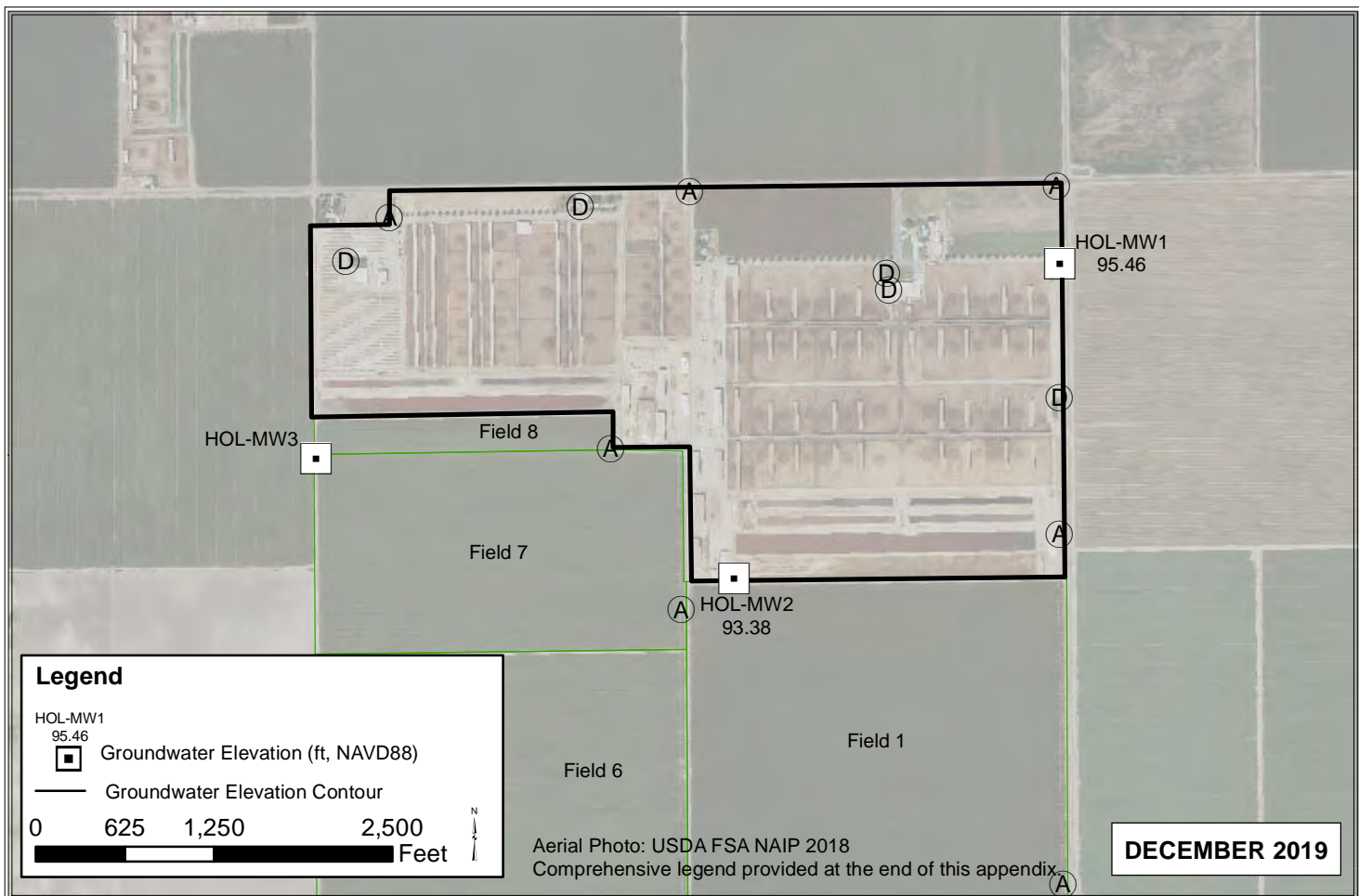
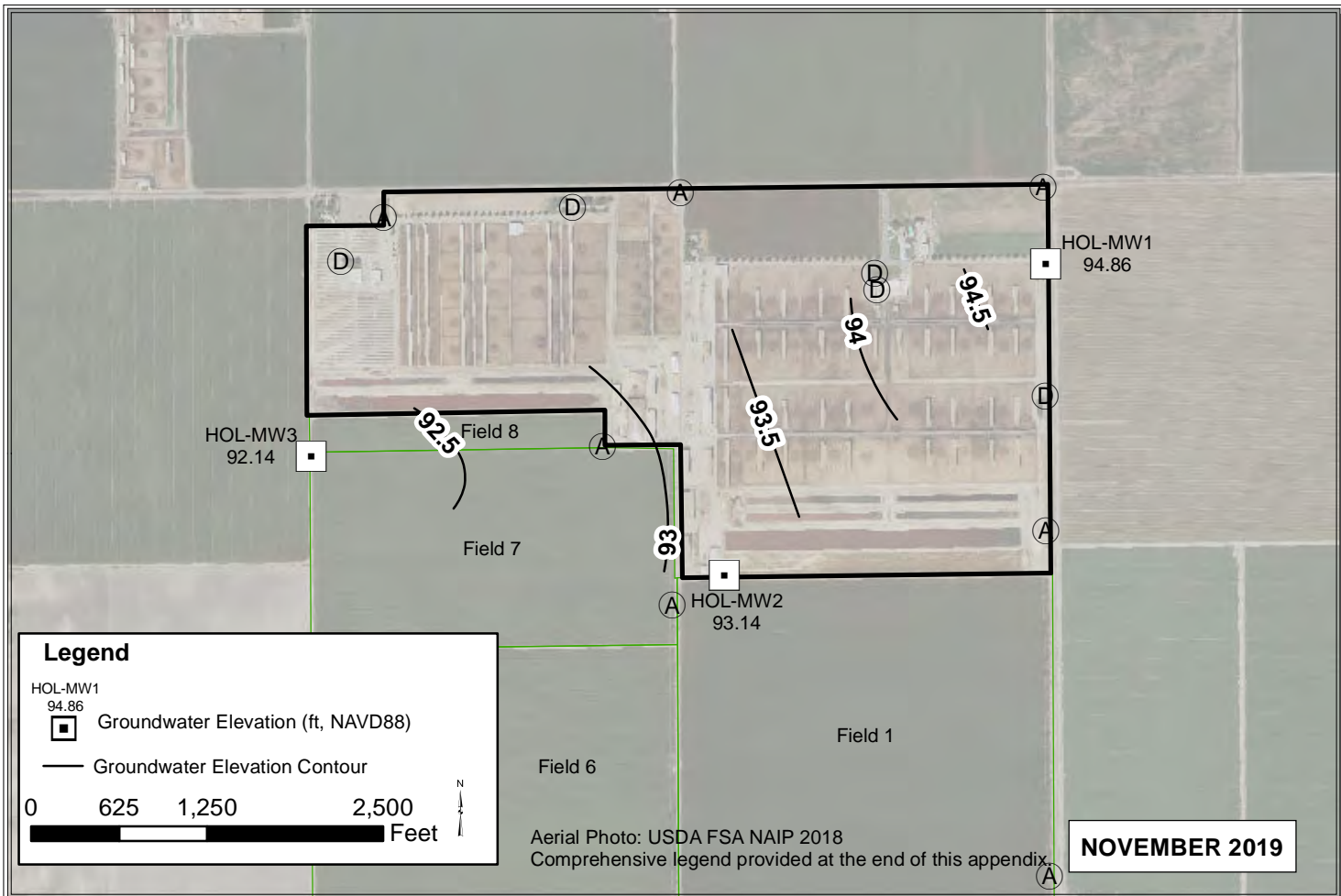

HYN

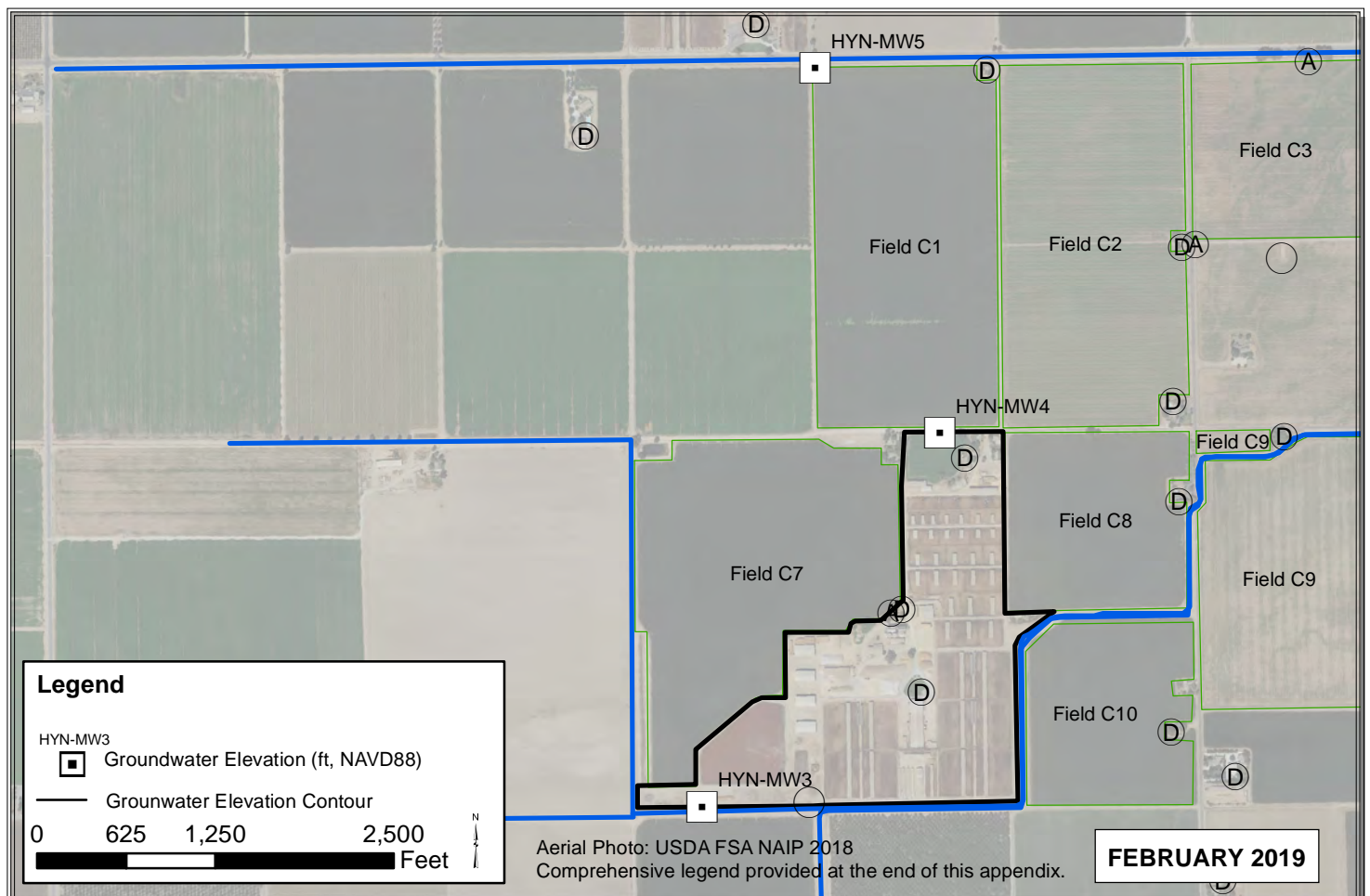
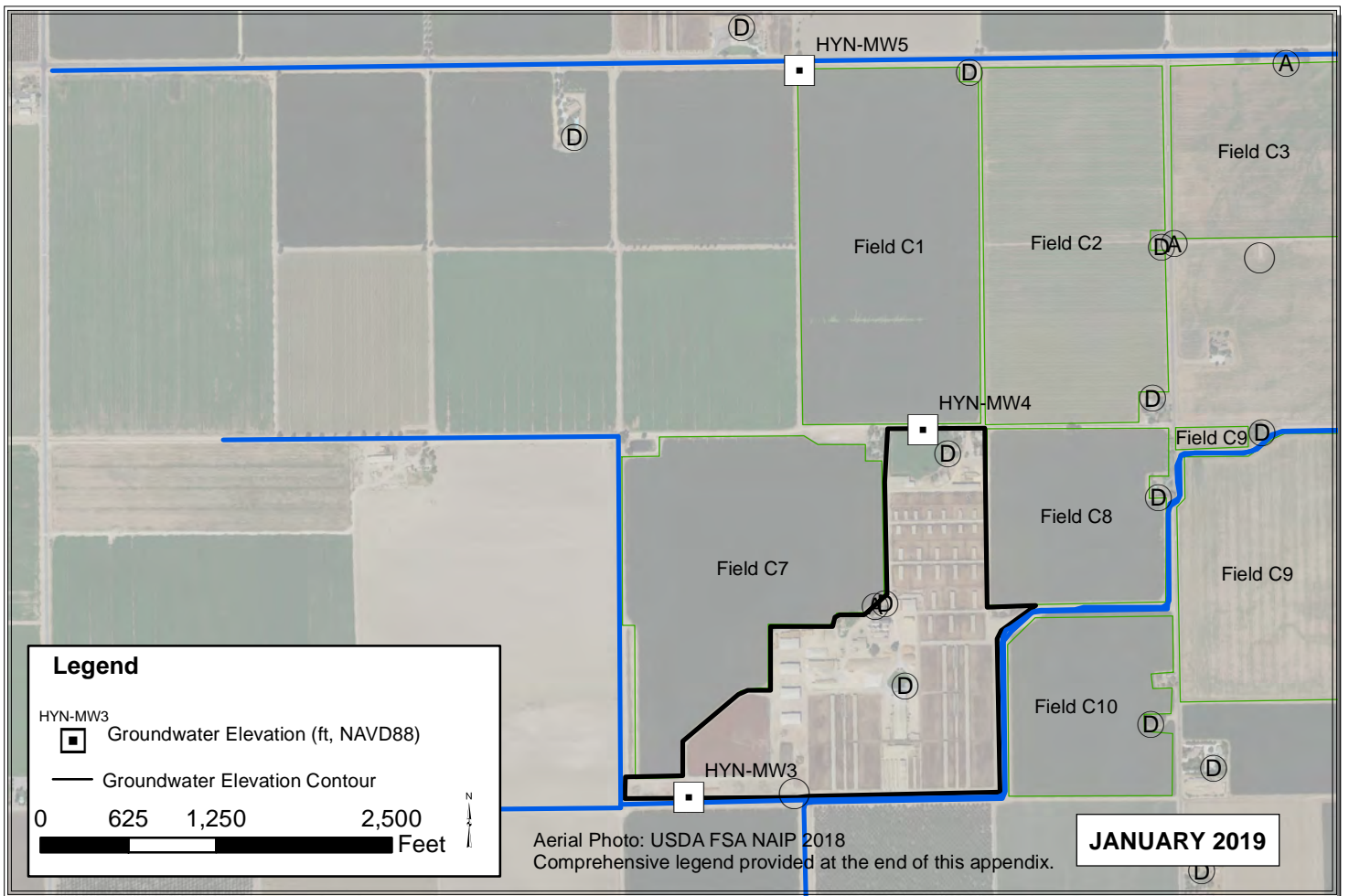

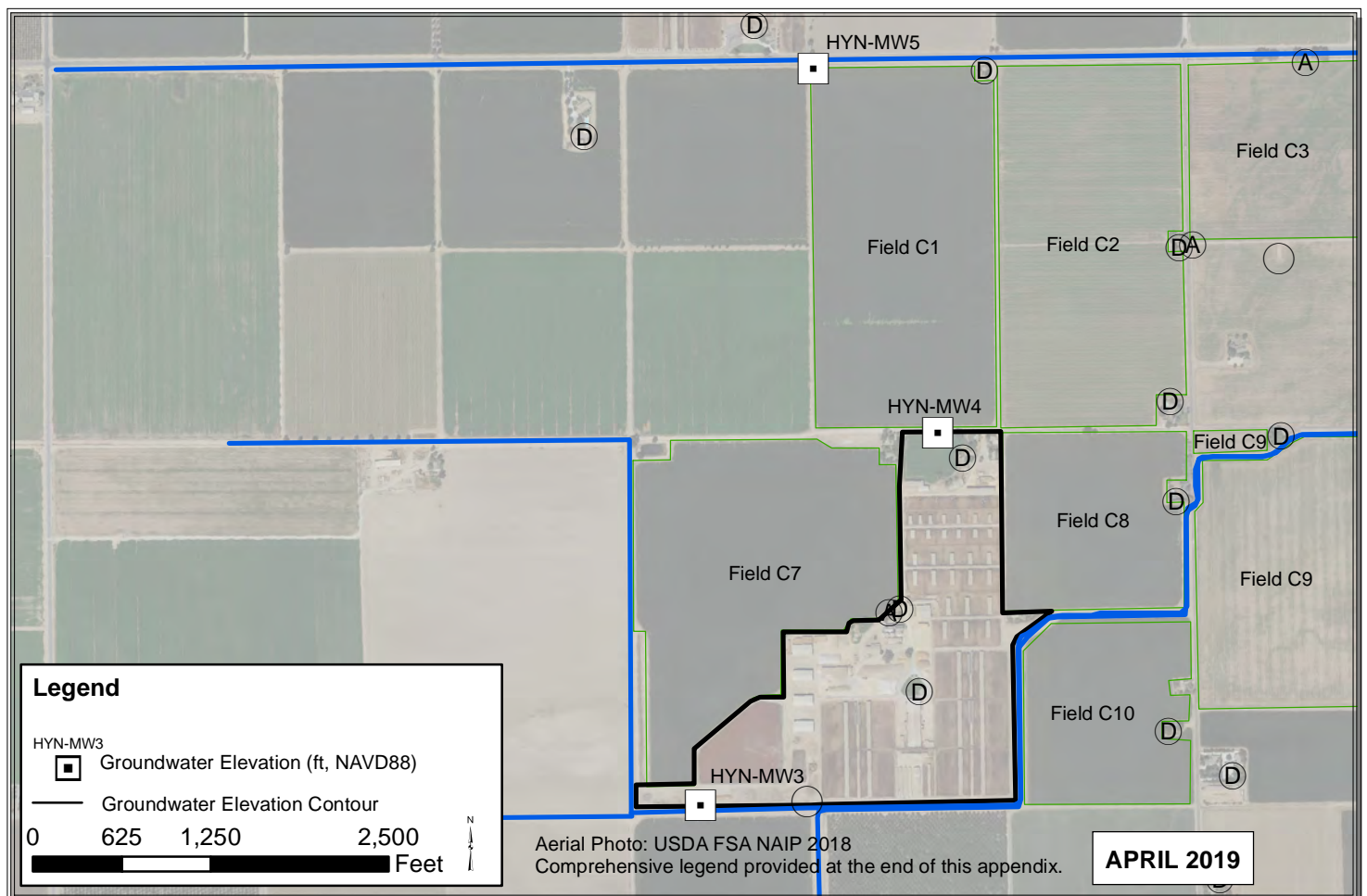
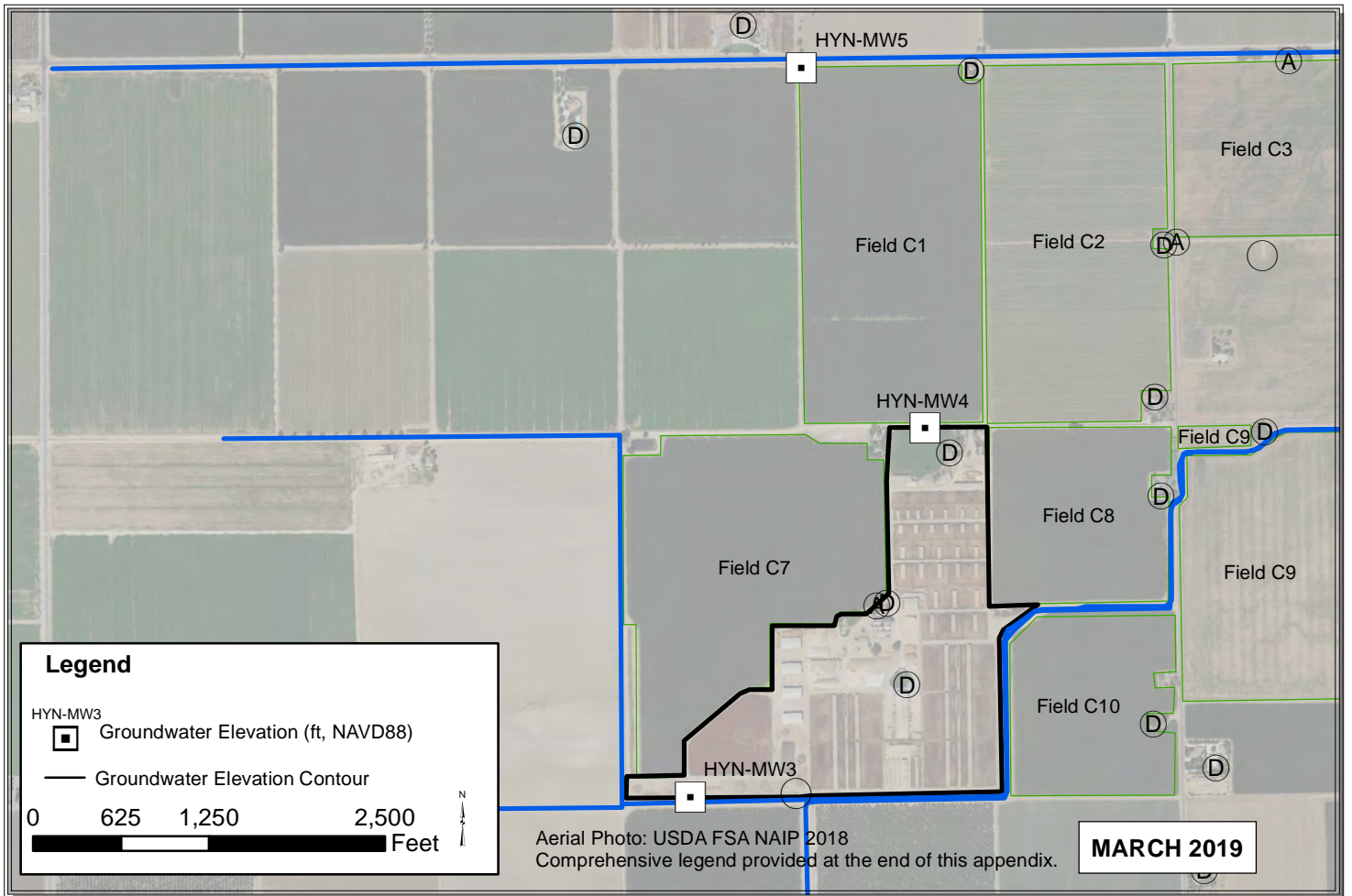

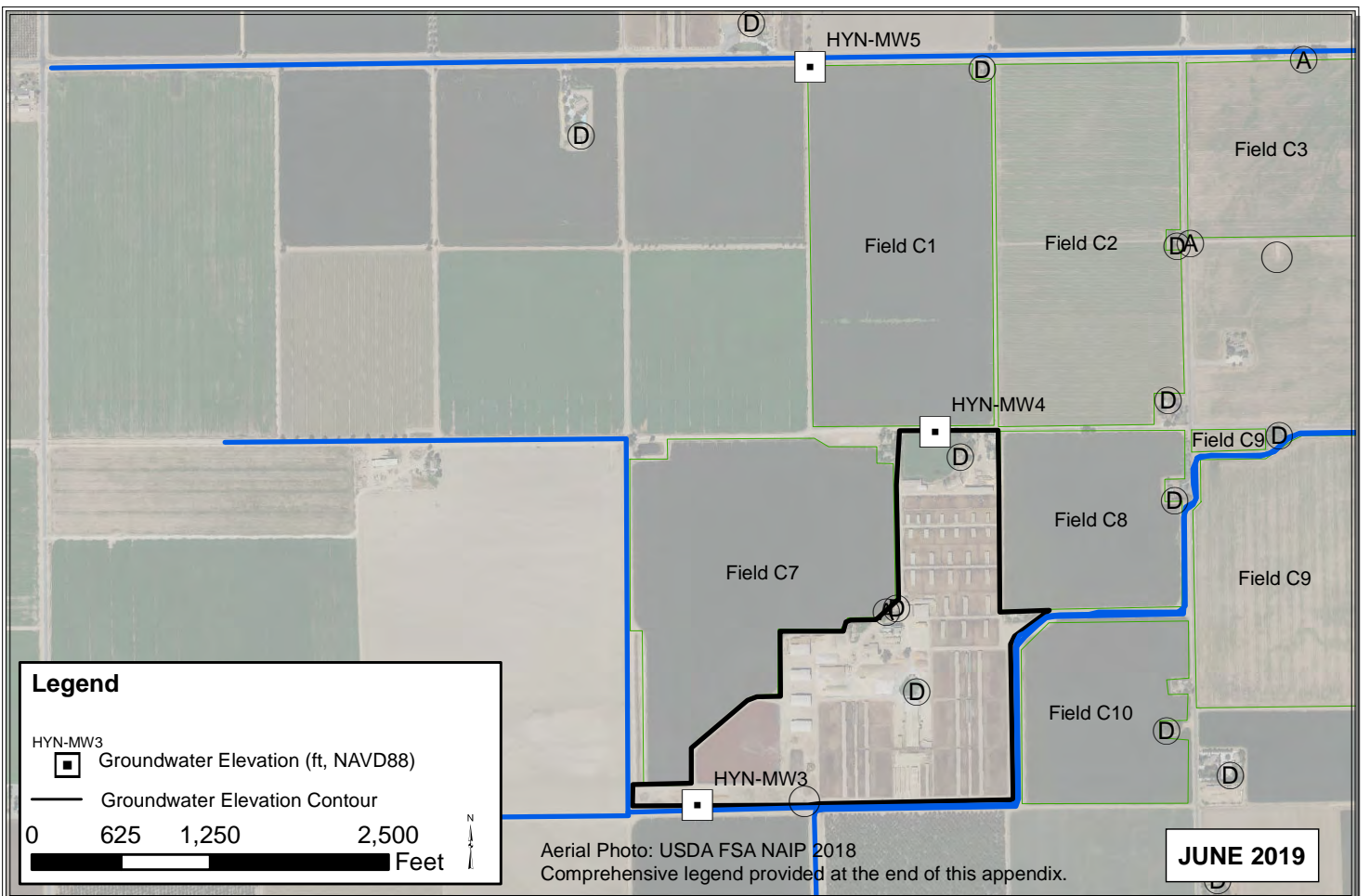
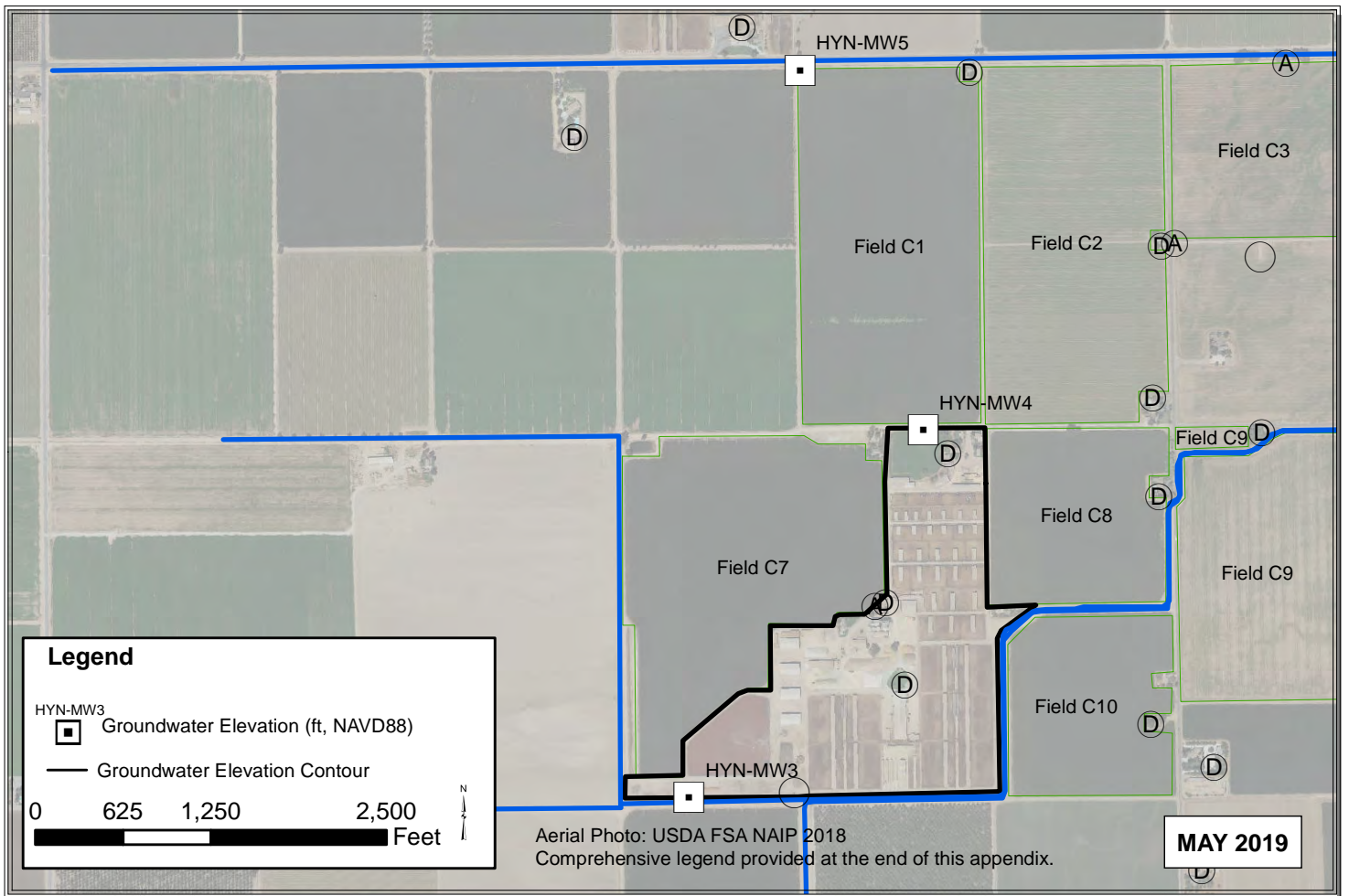

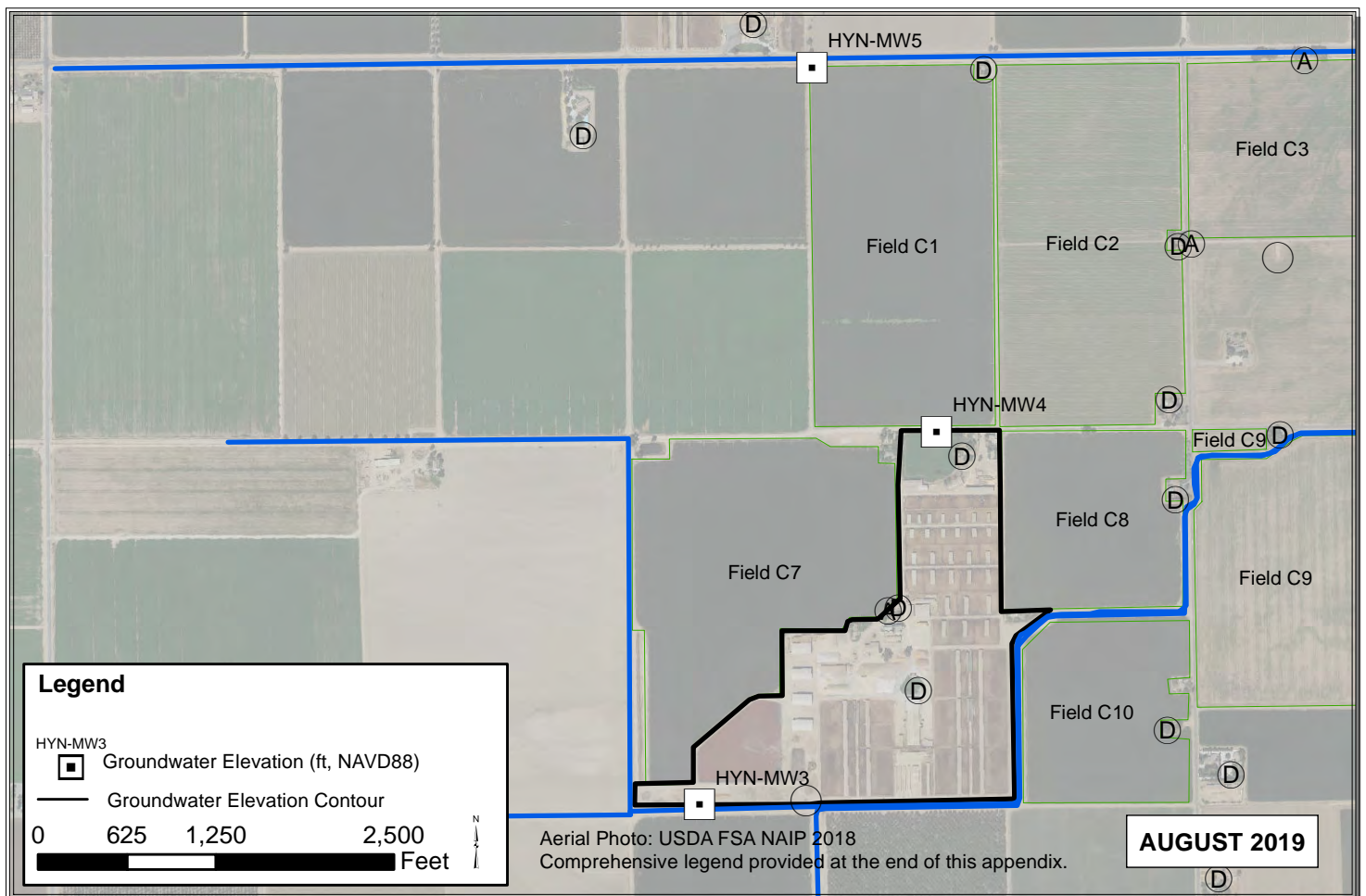
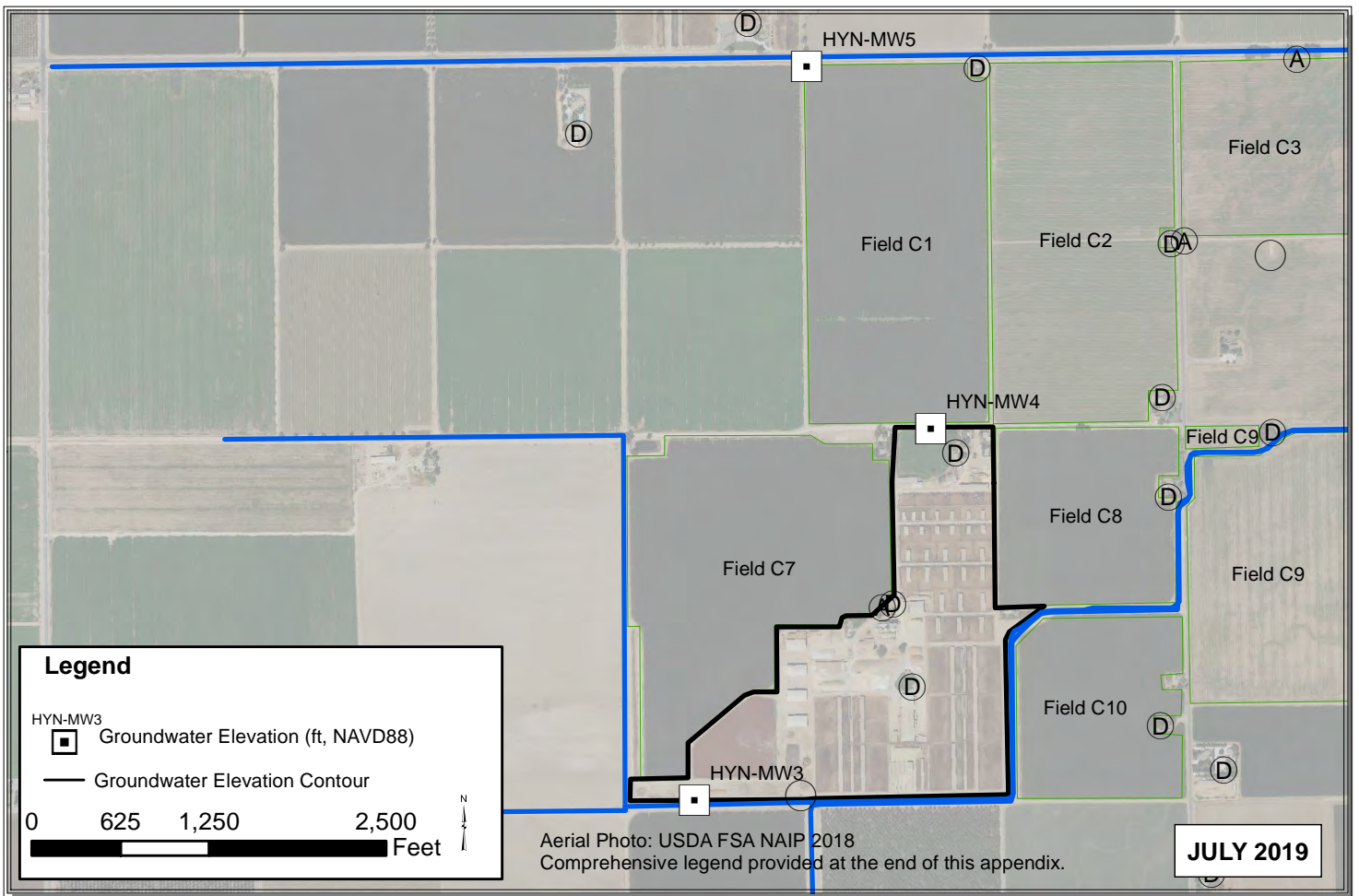

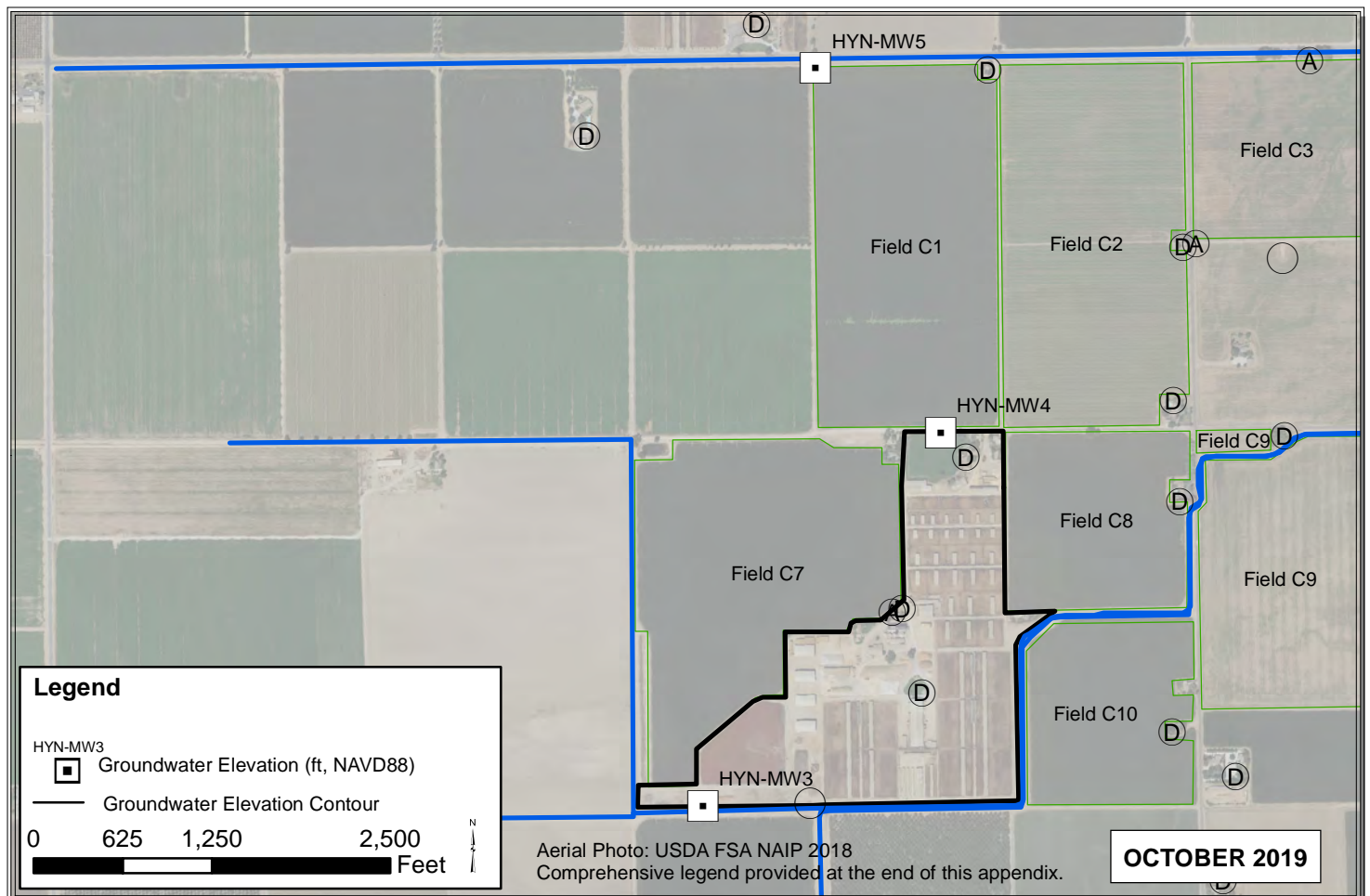
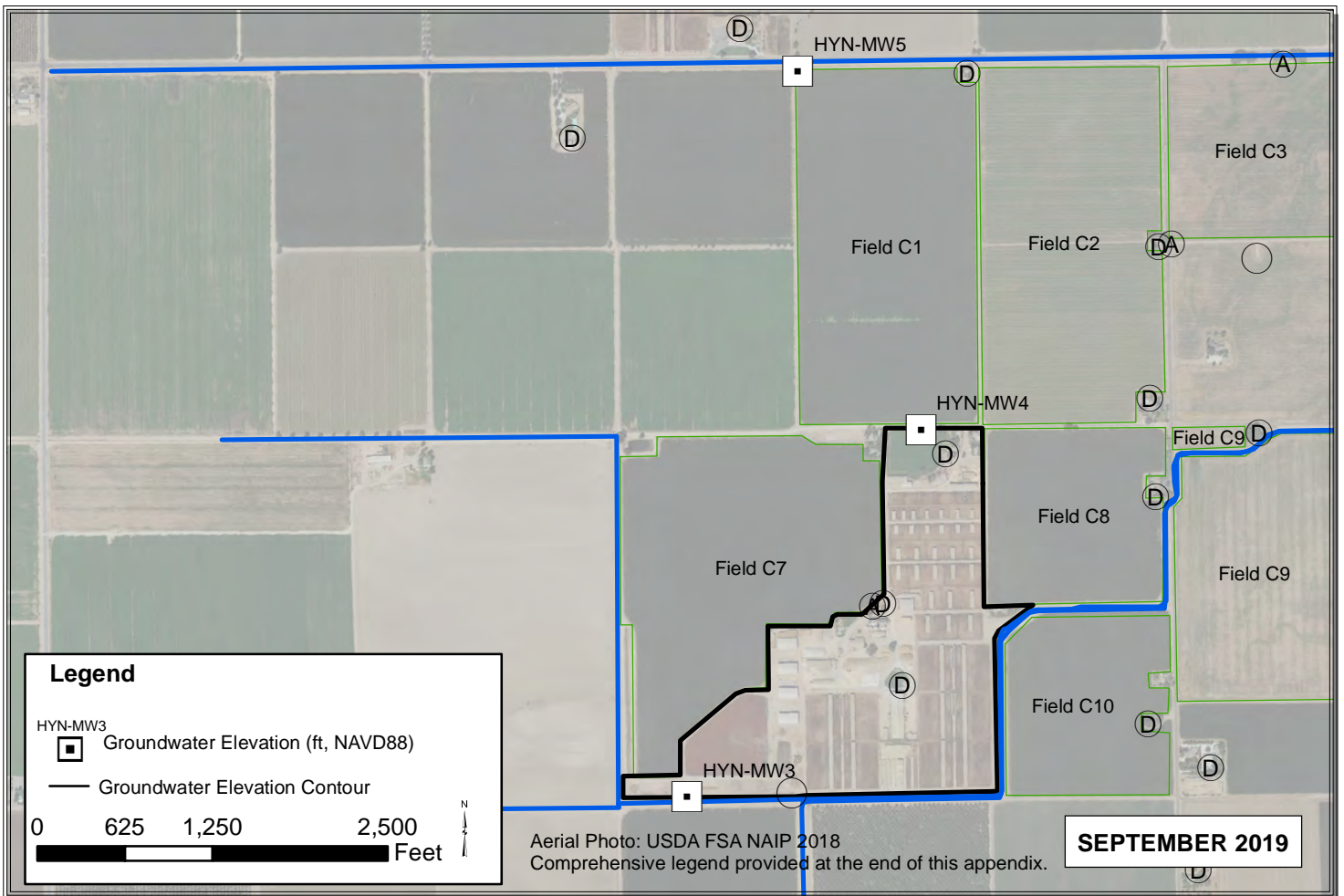

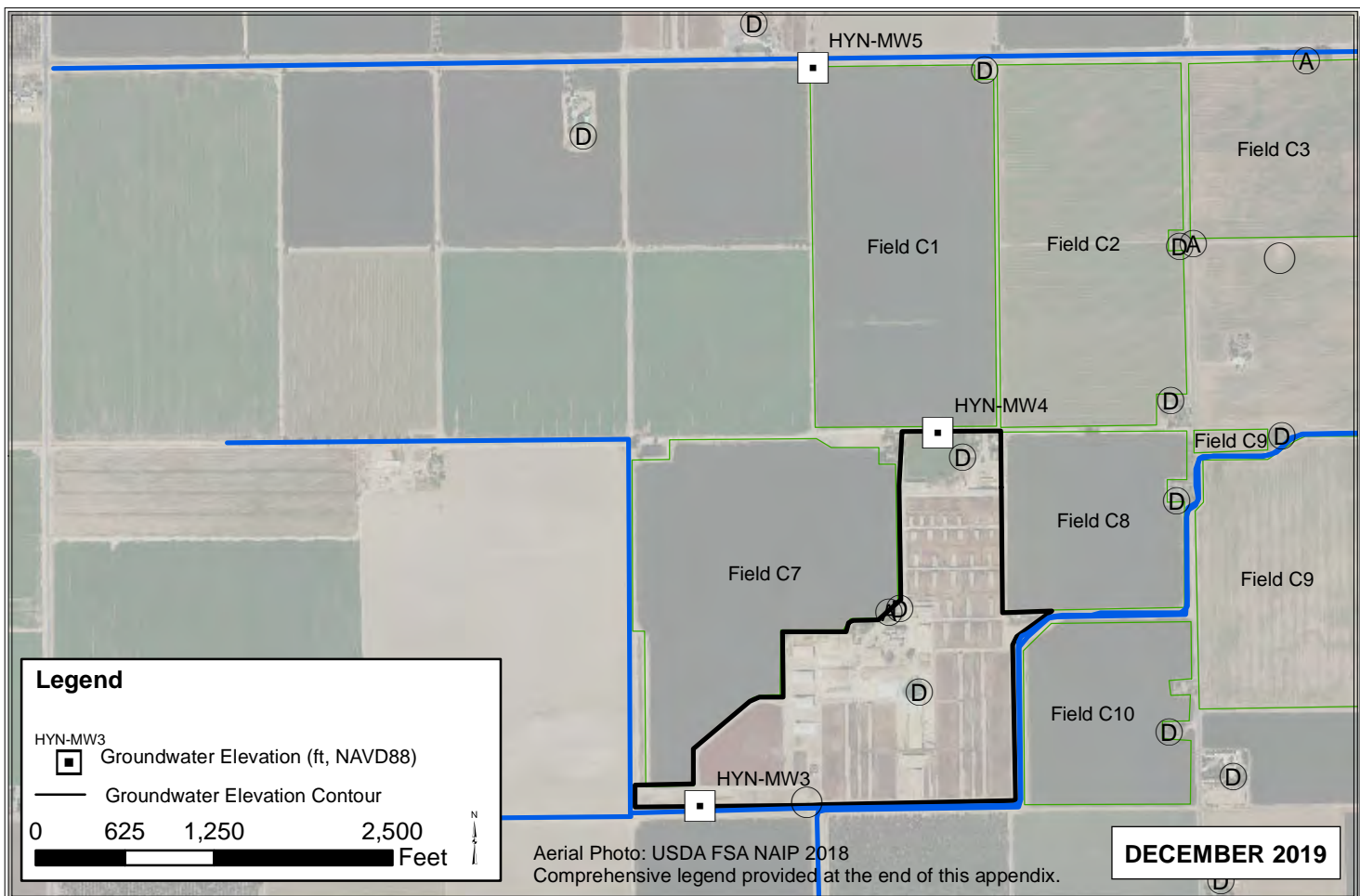
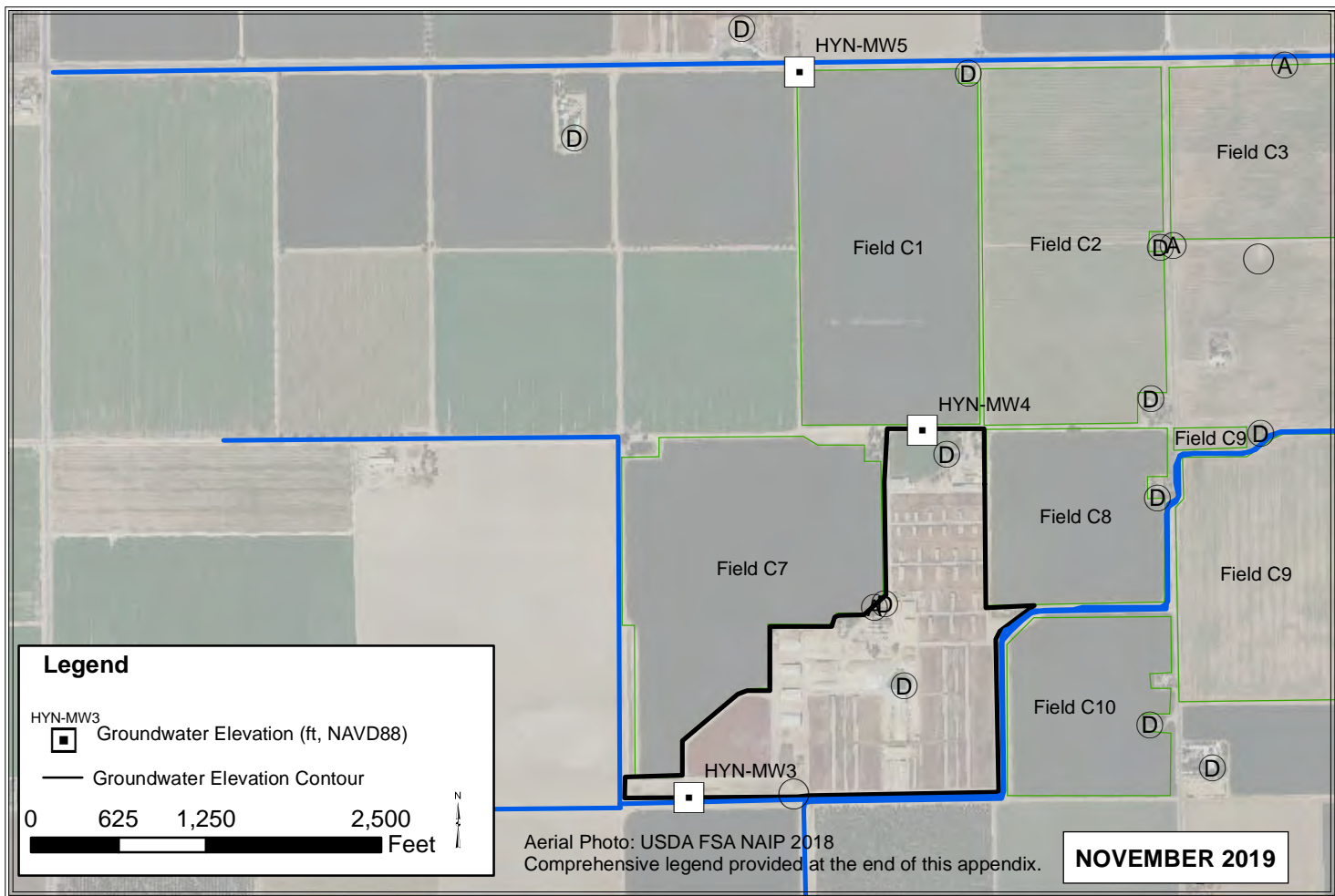

JAD

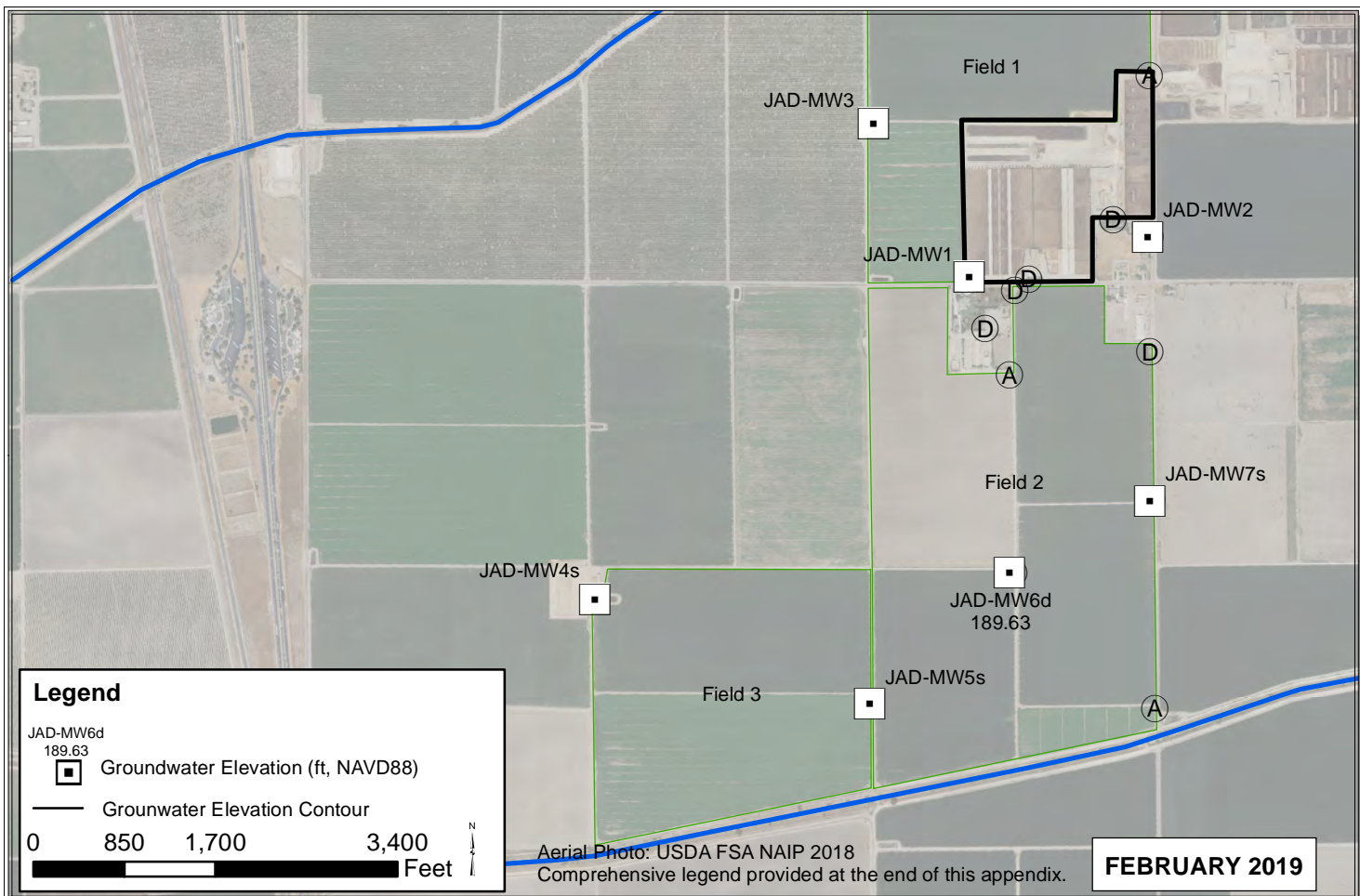
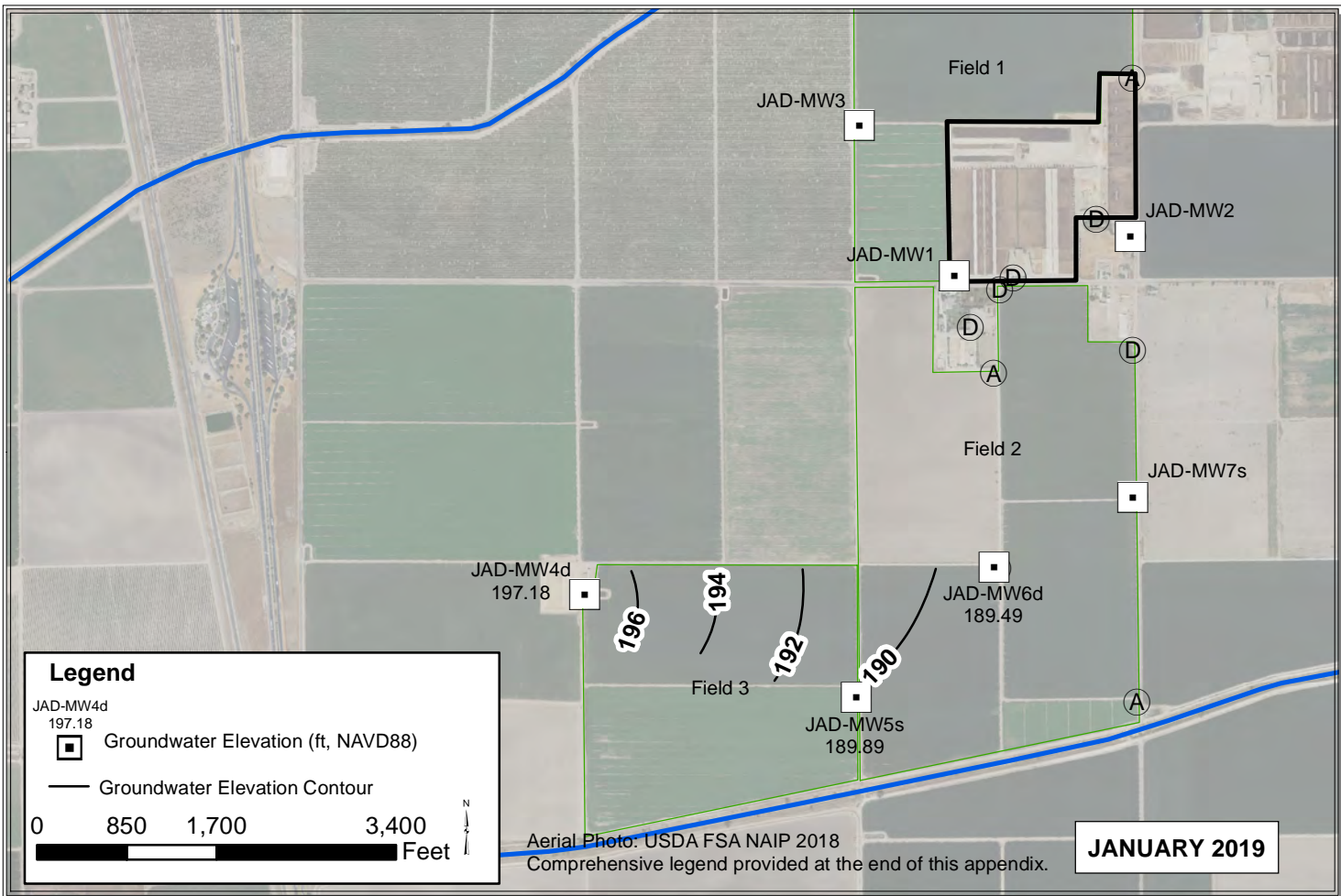

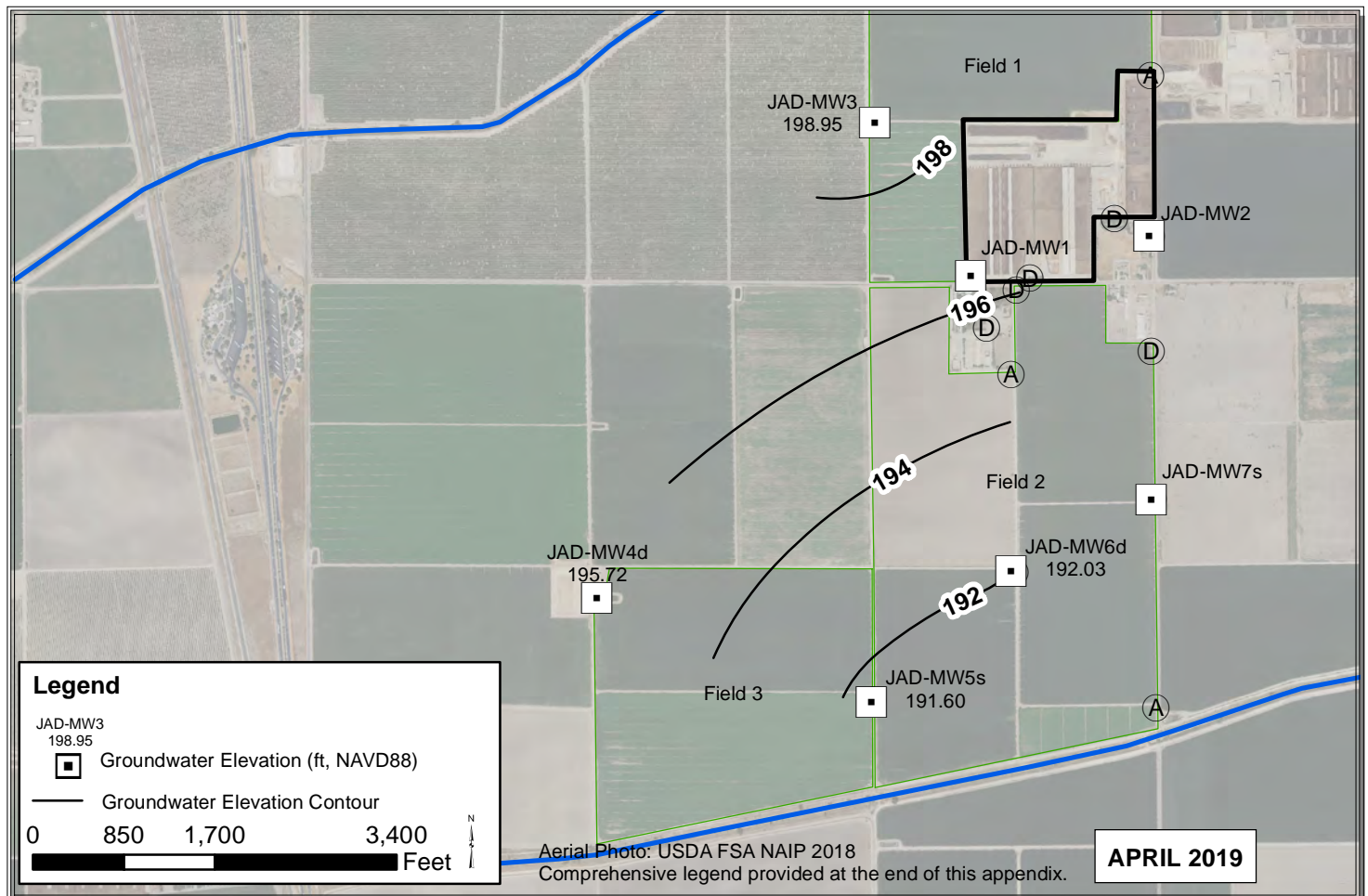
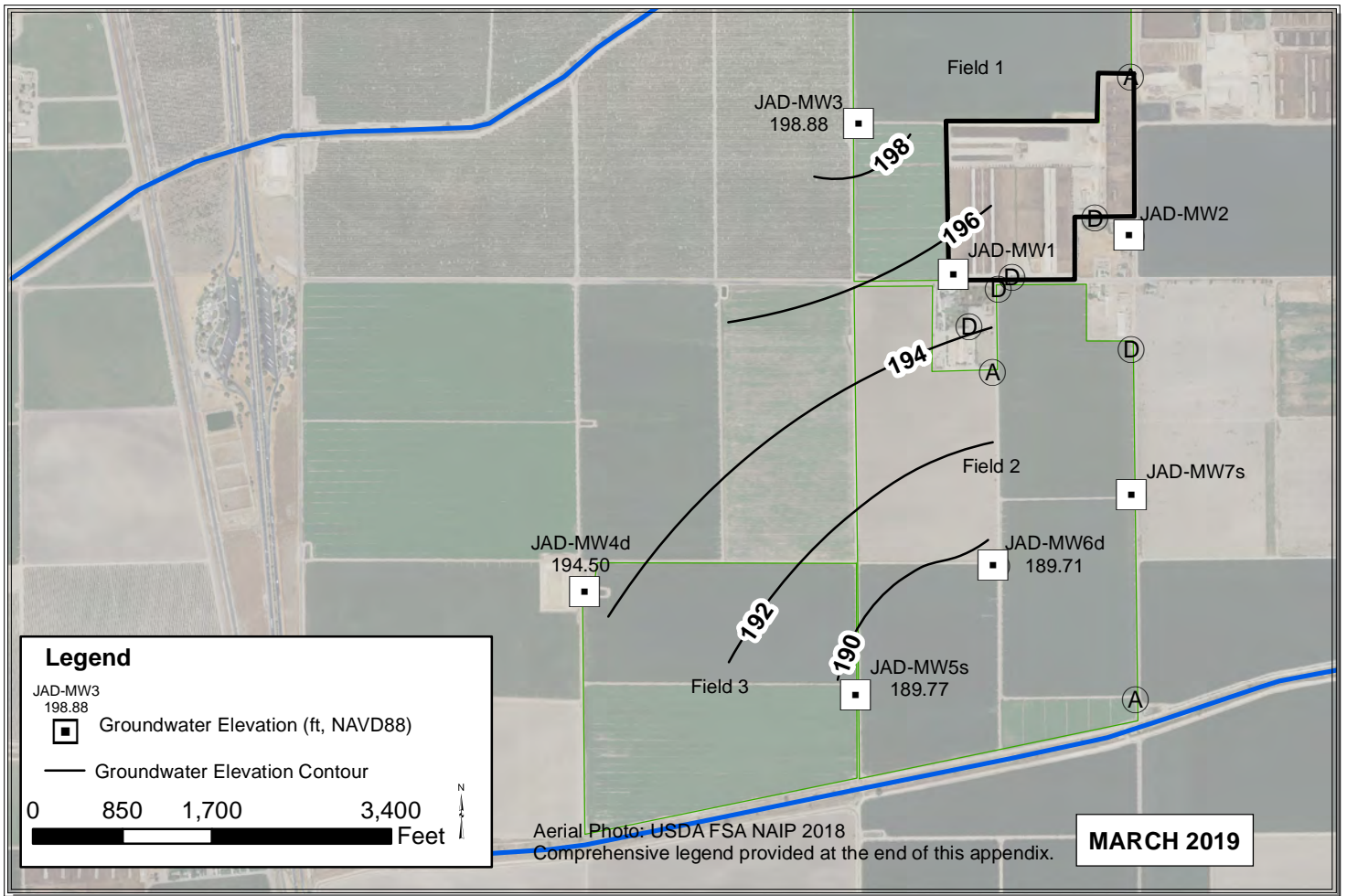

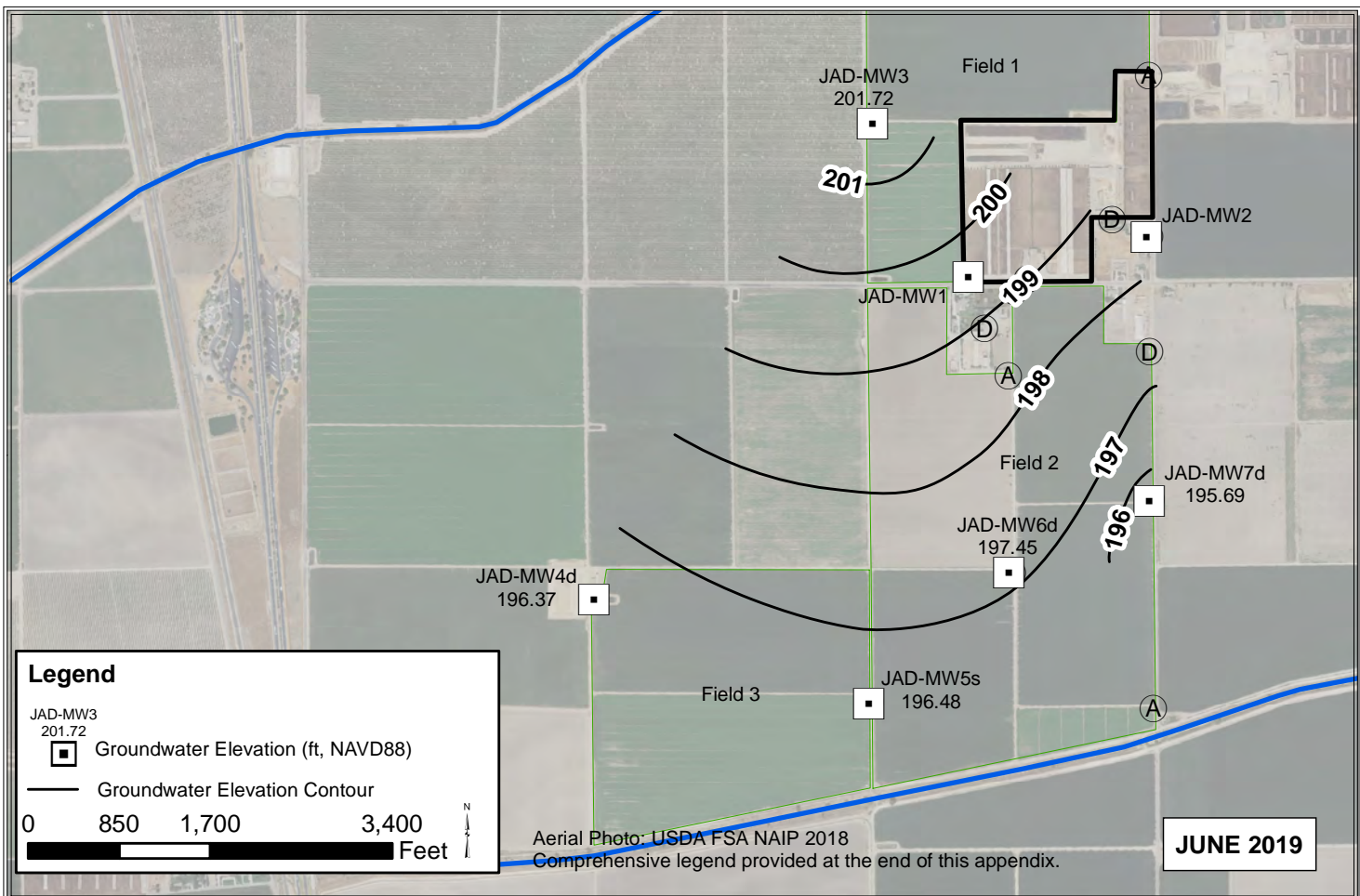
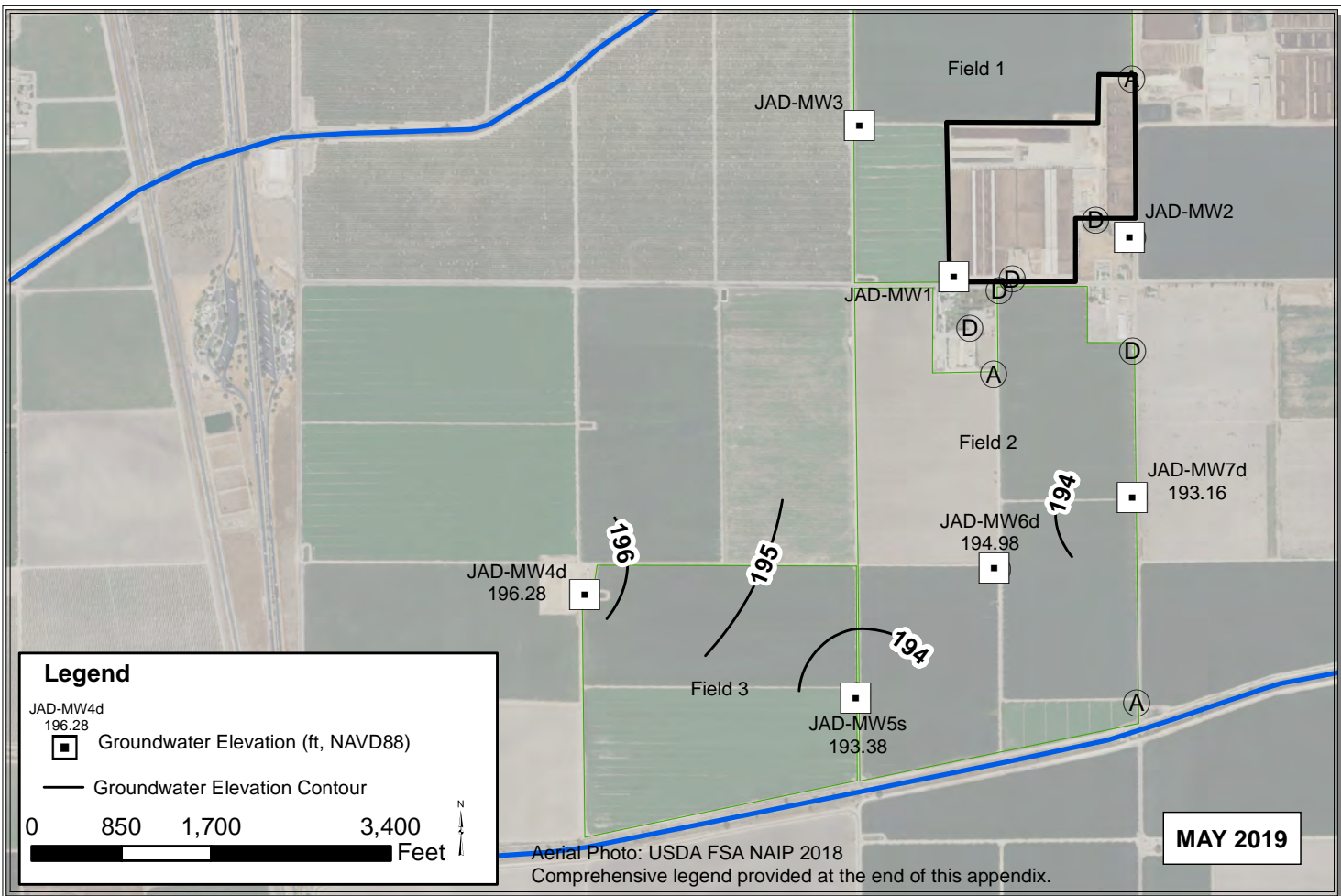

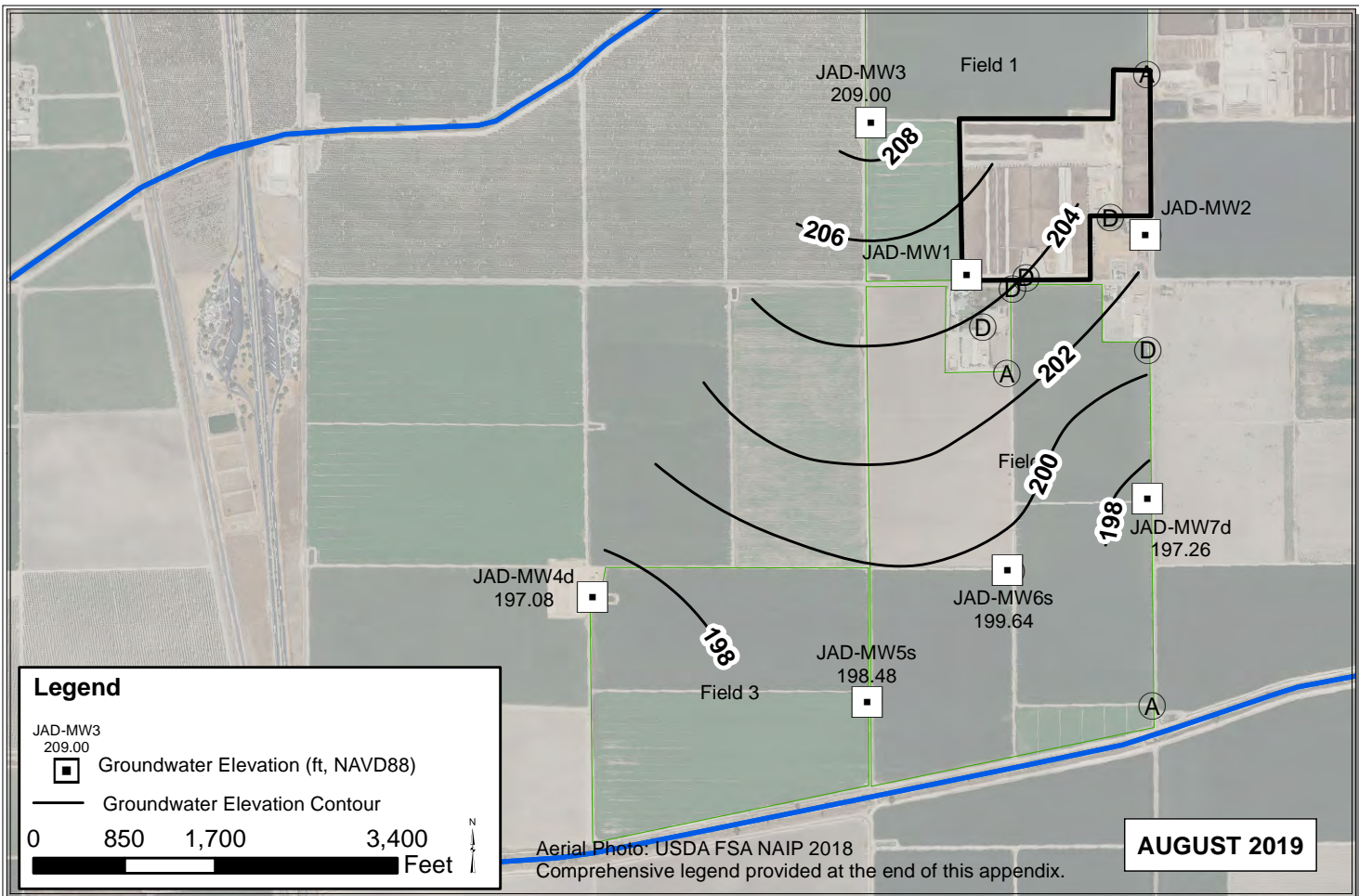
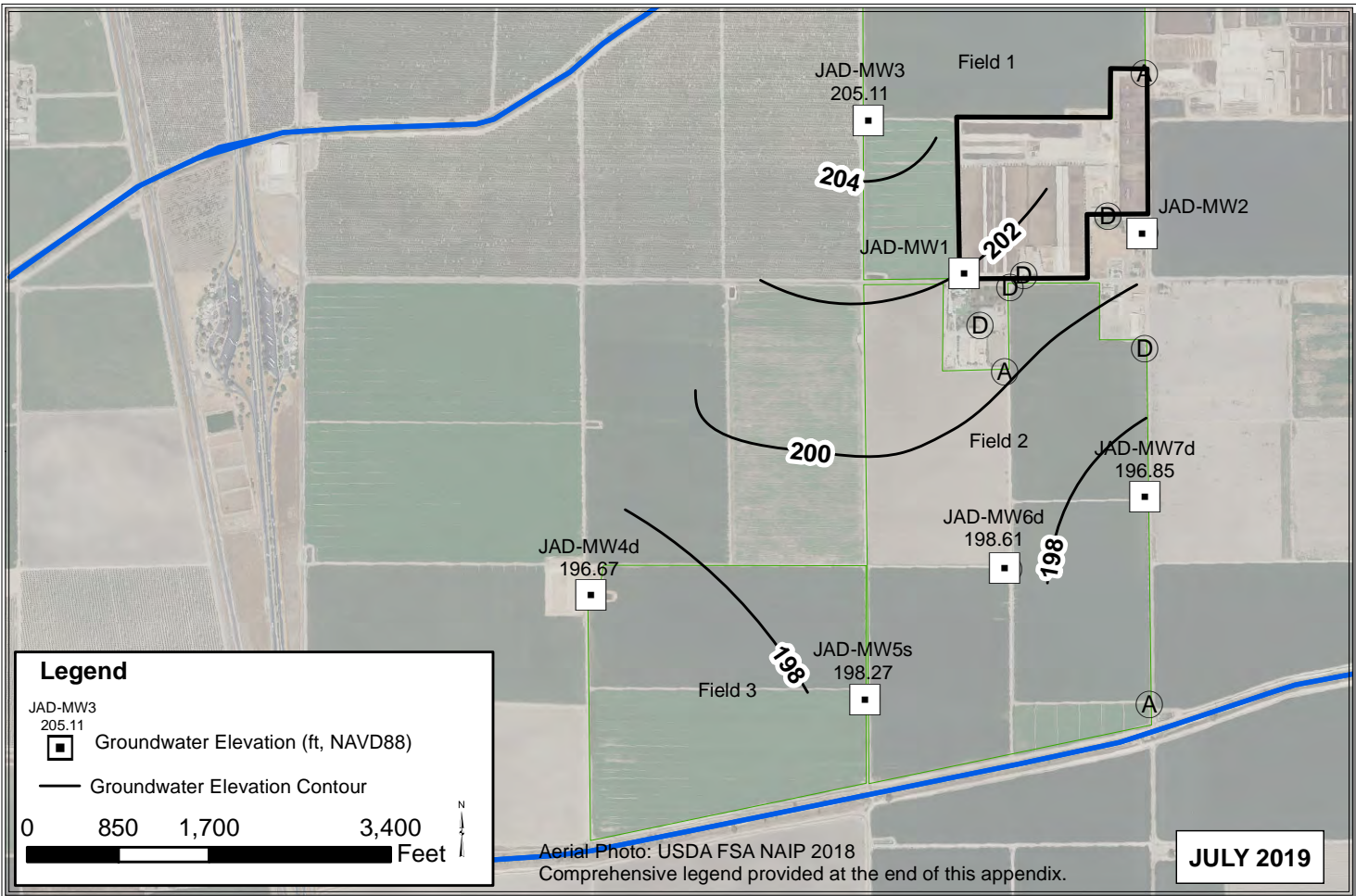

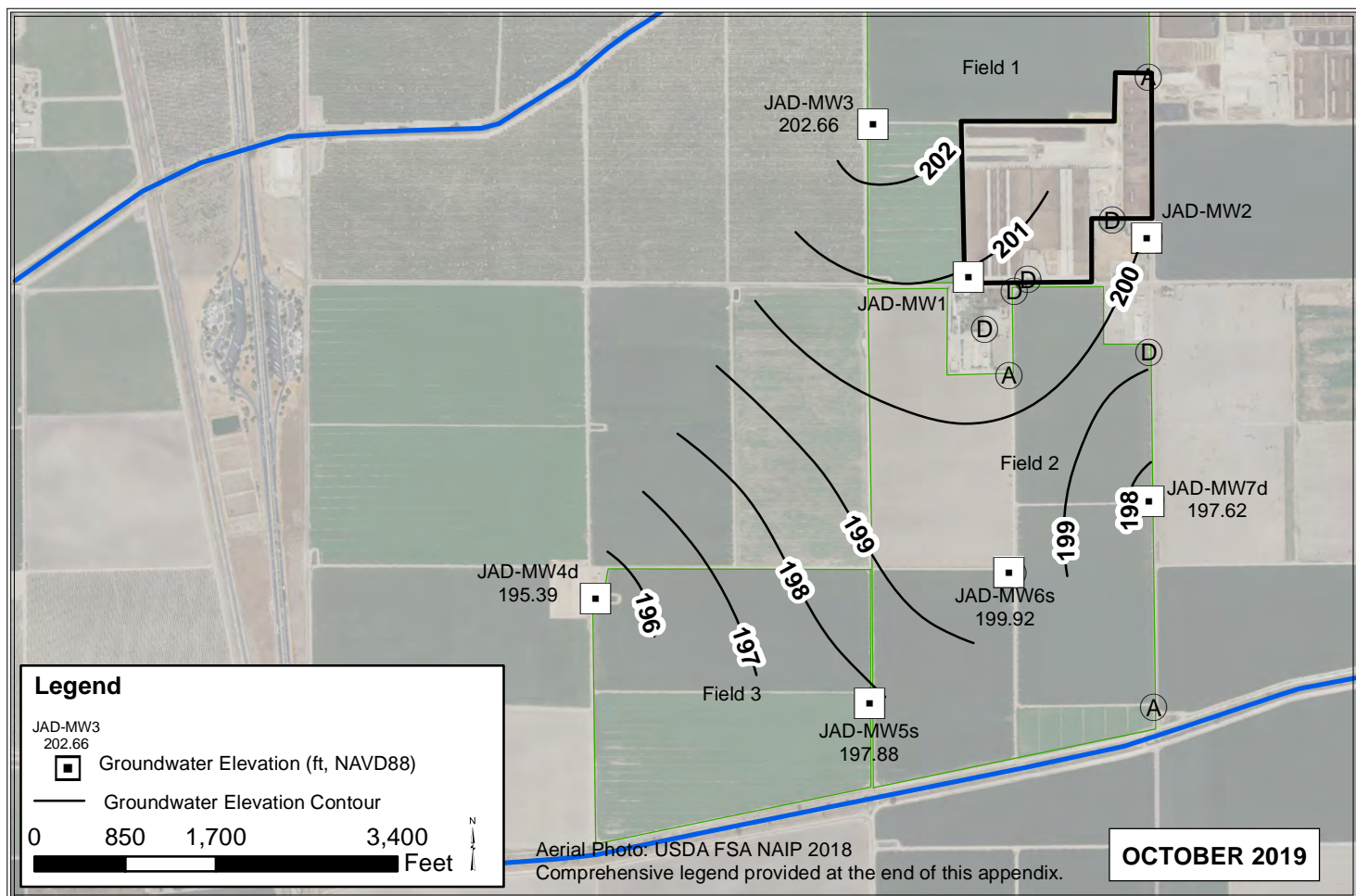
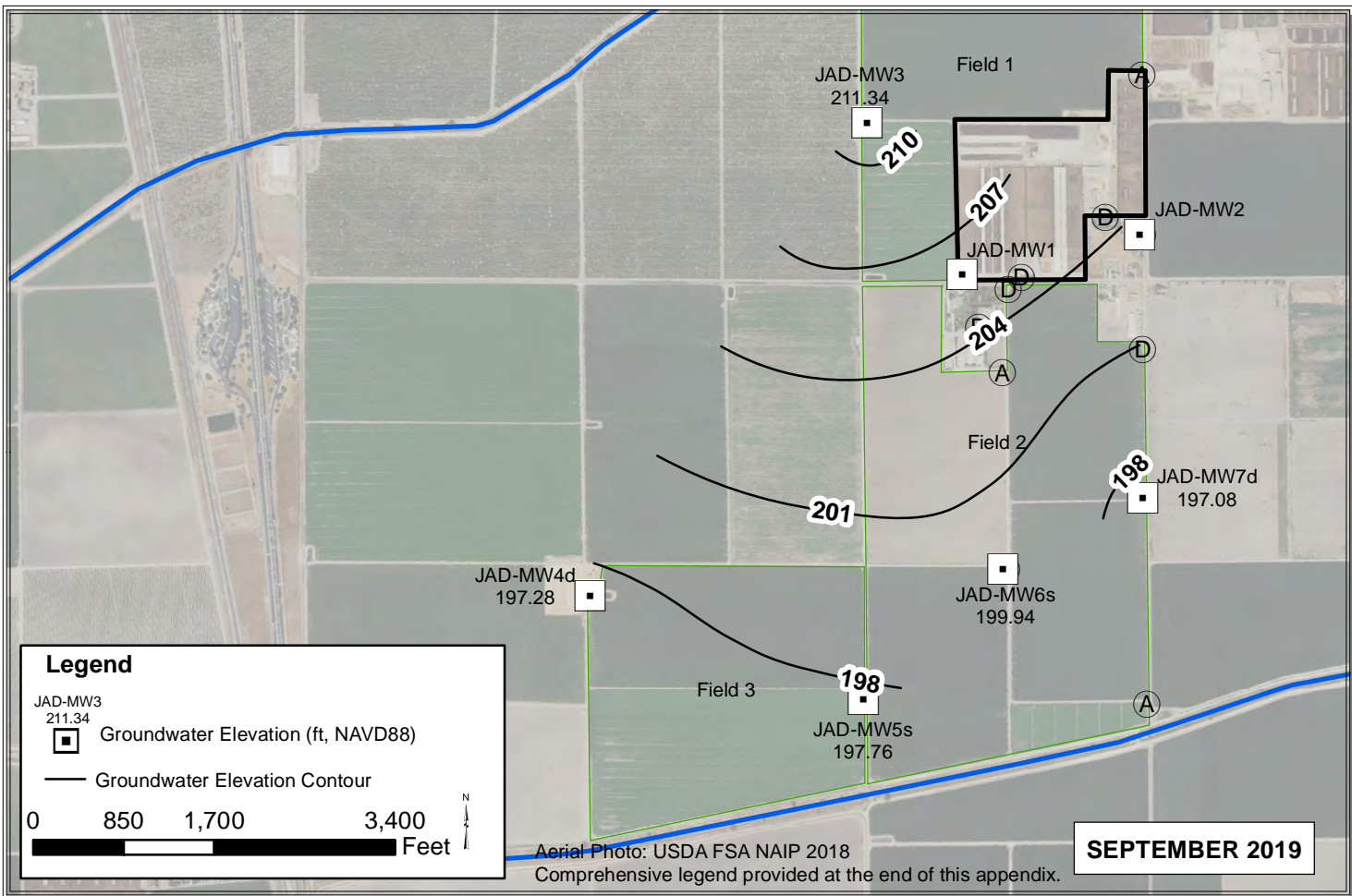

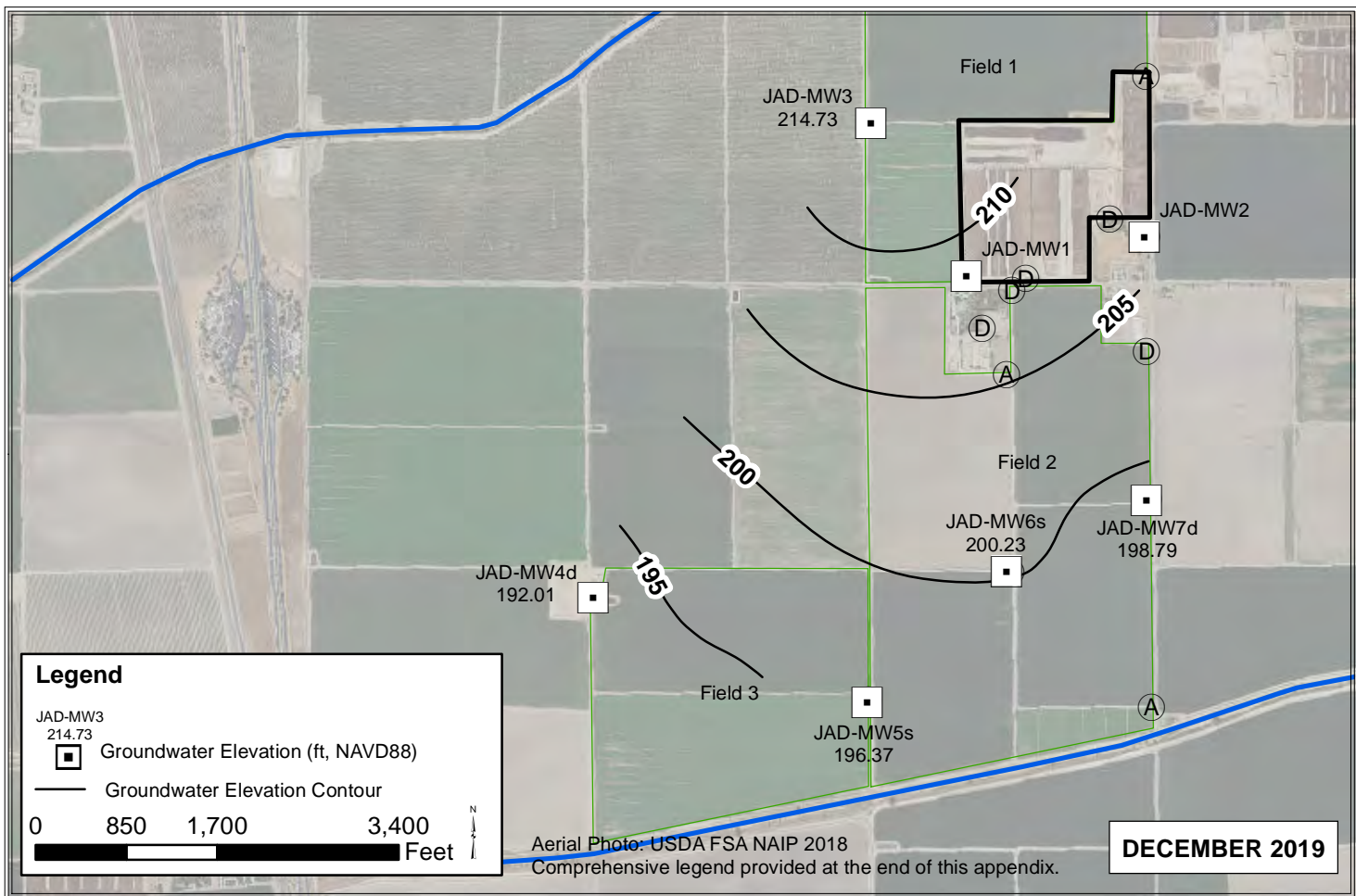
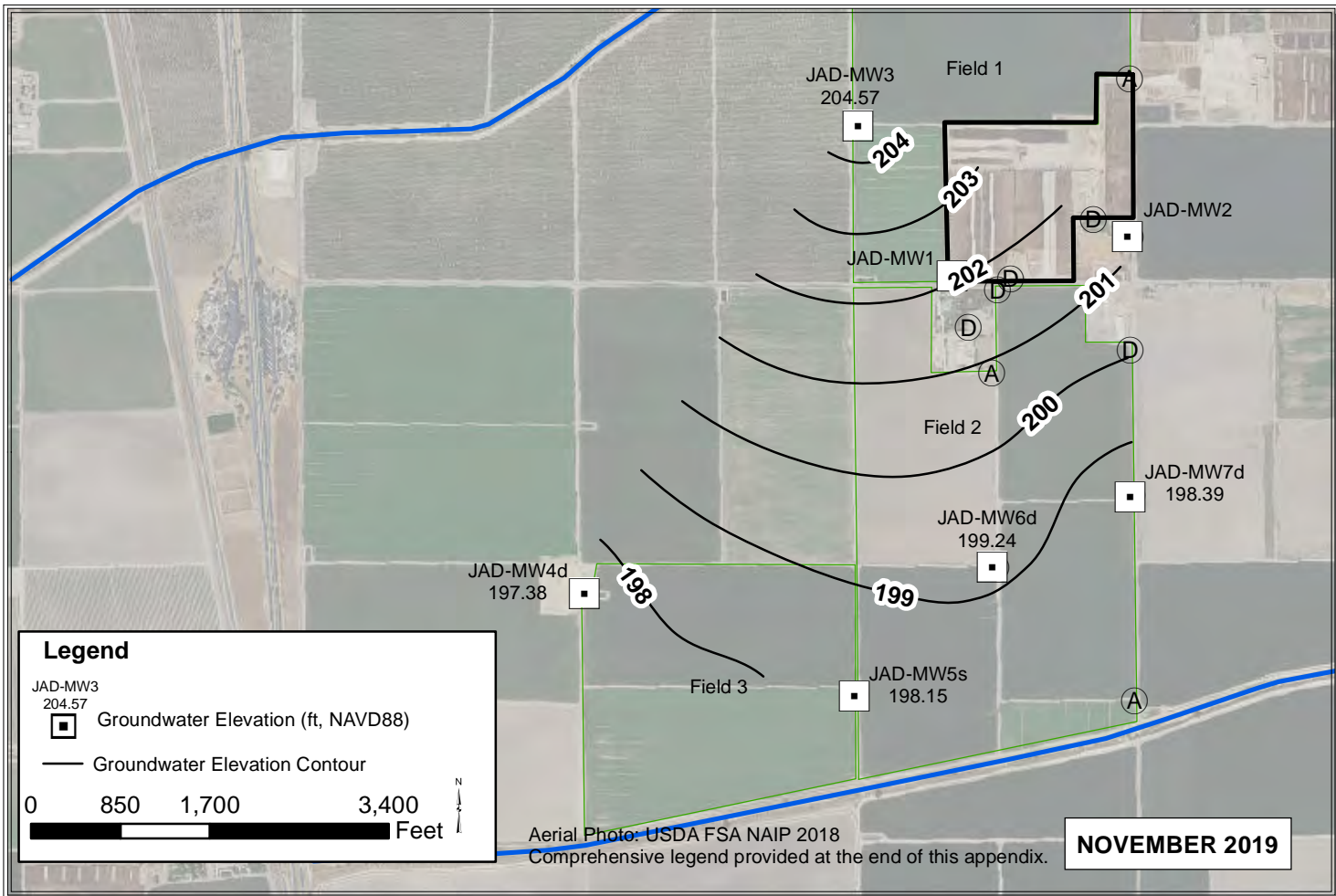

LON

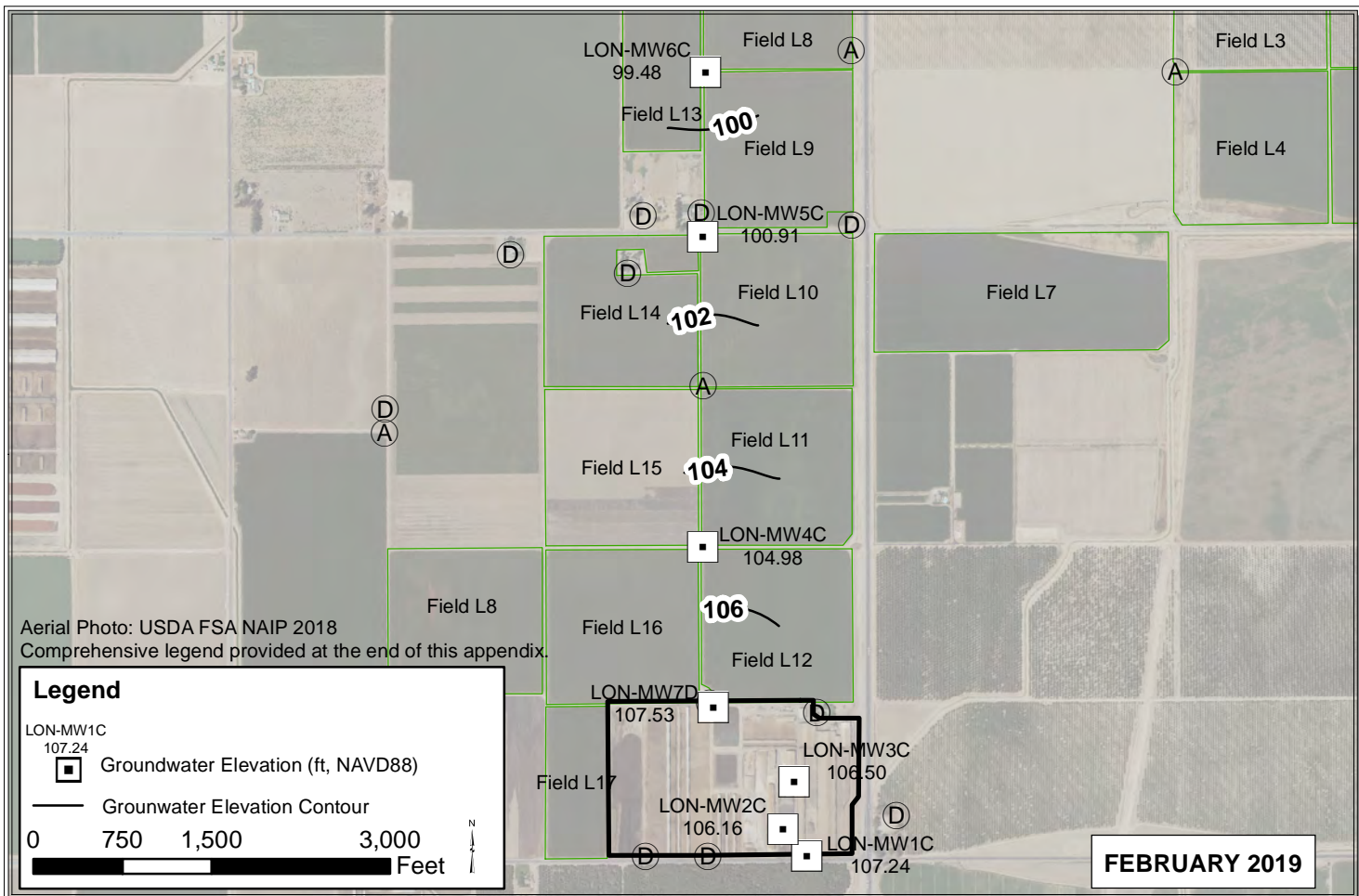
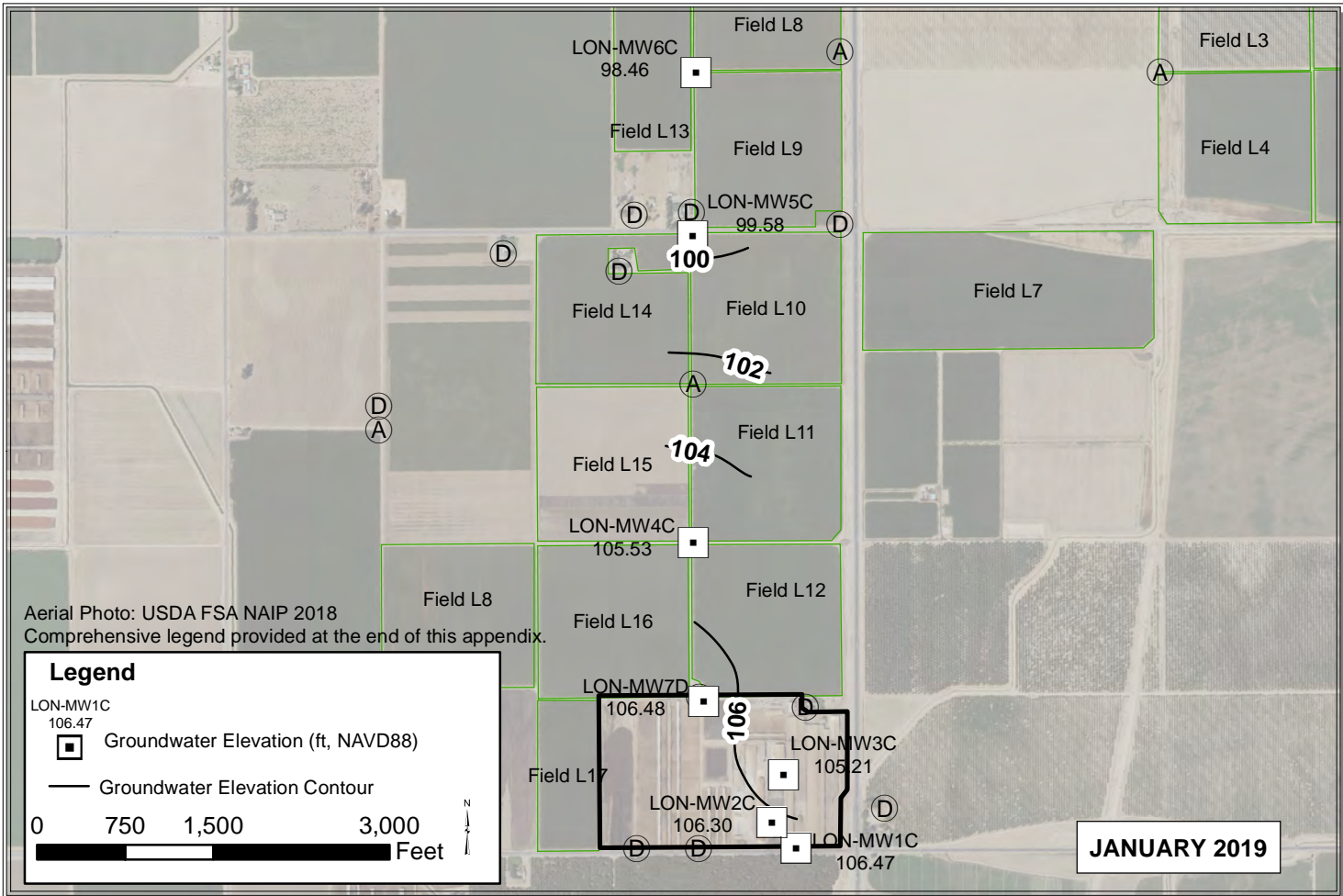

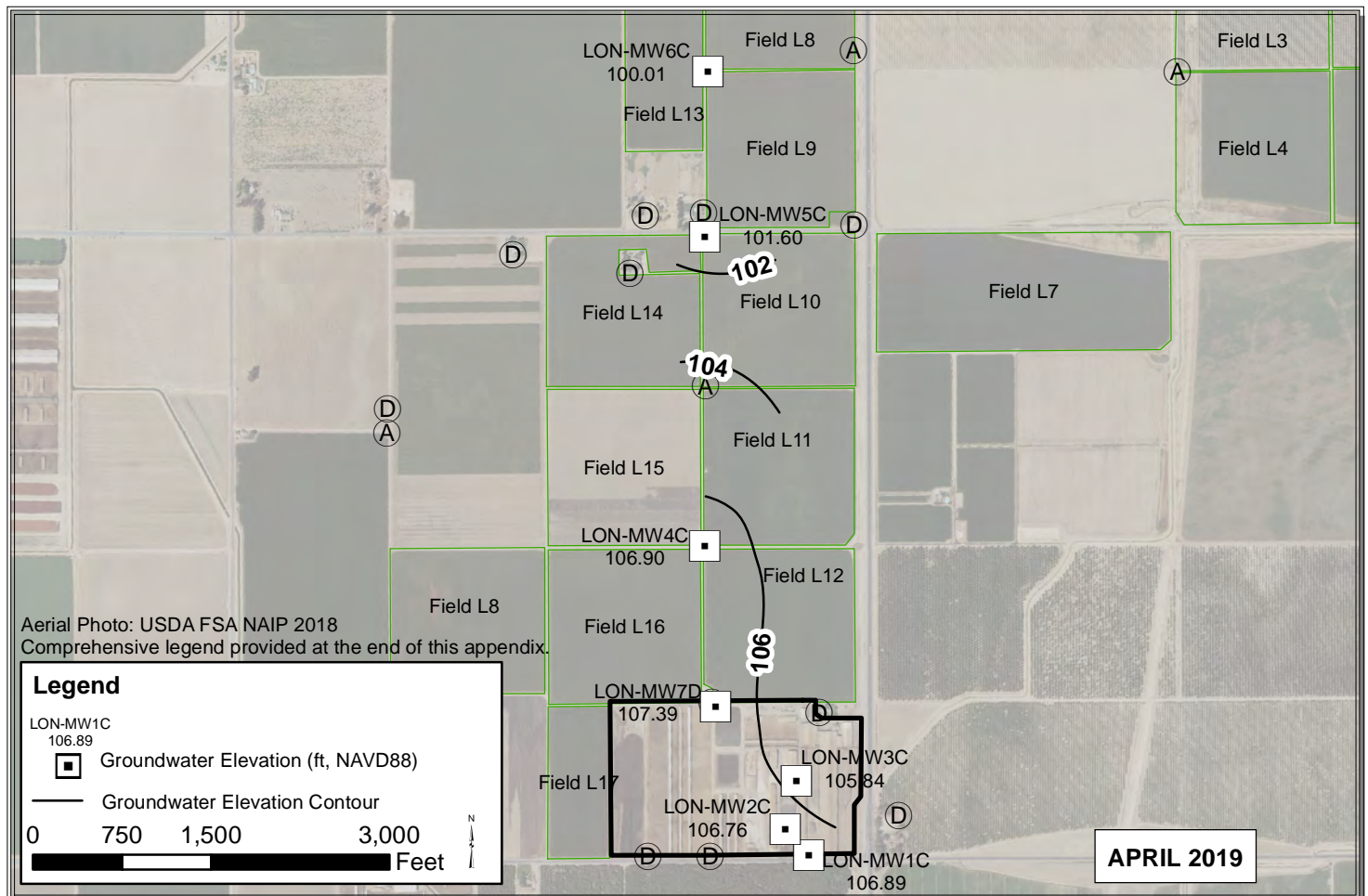
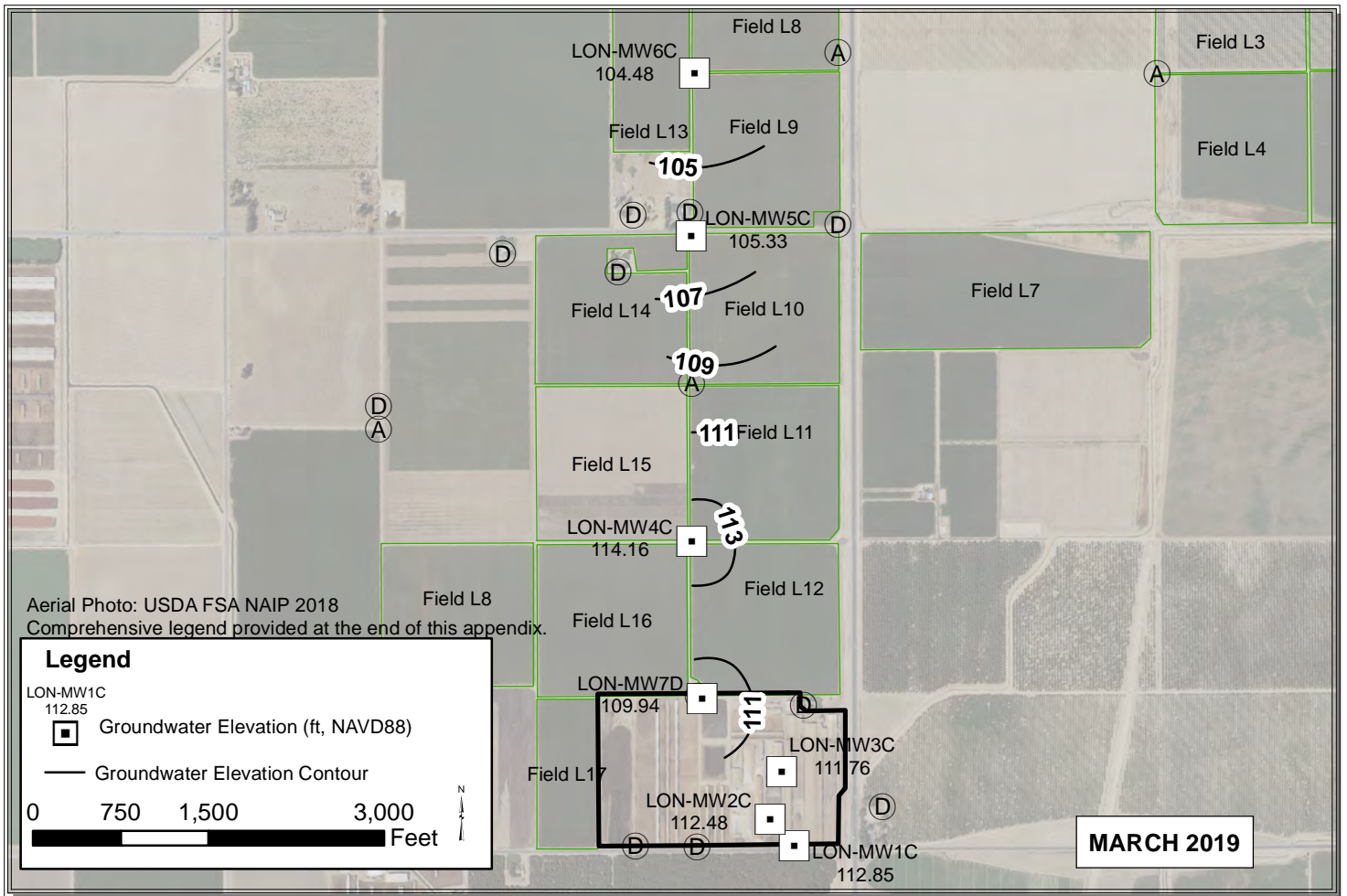

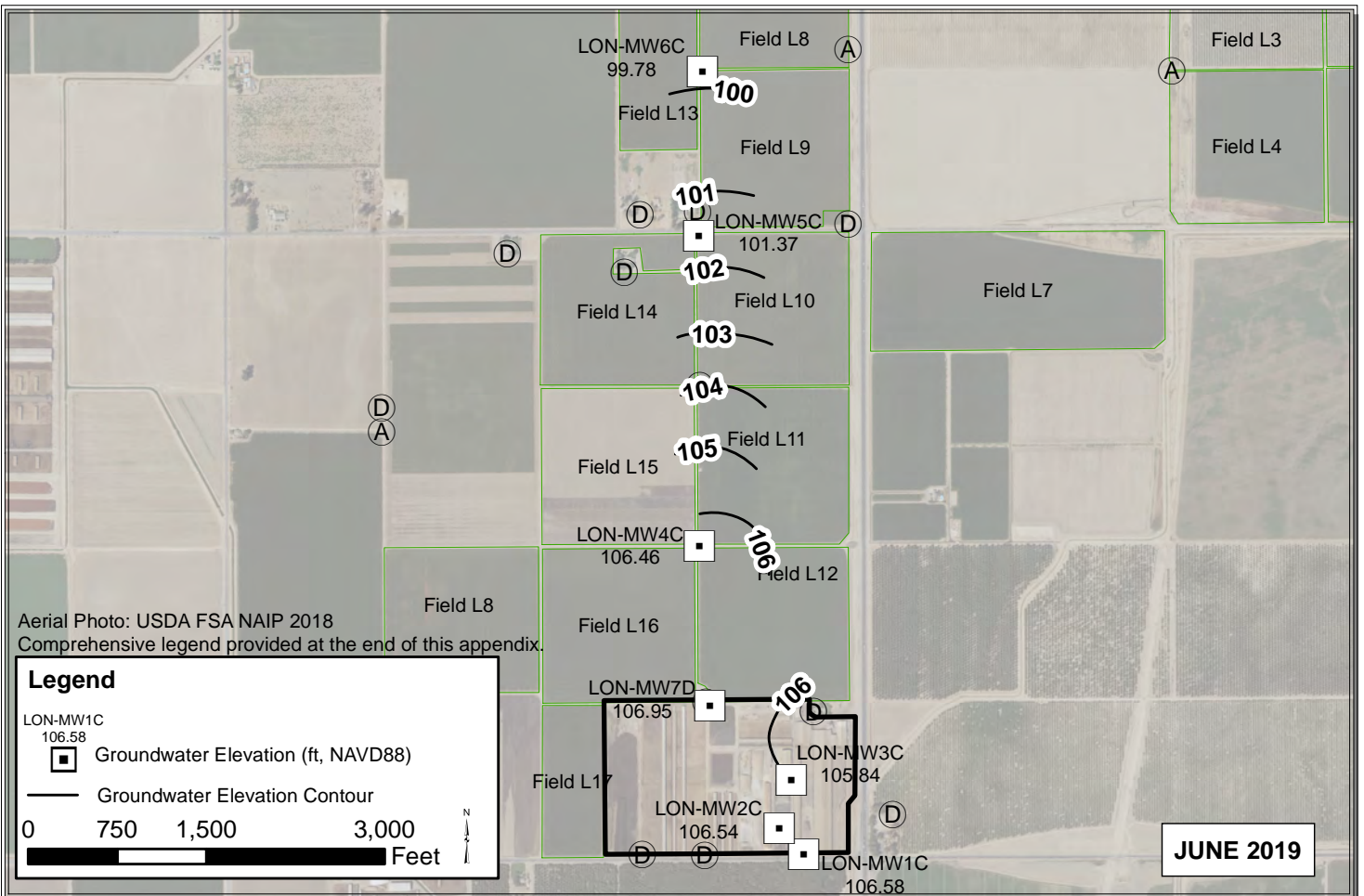
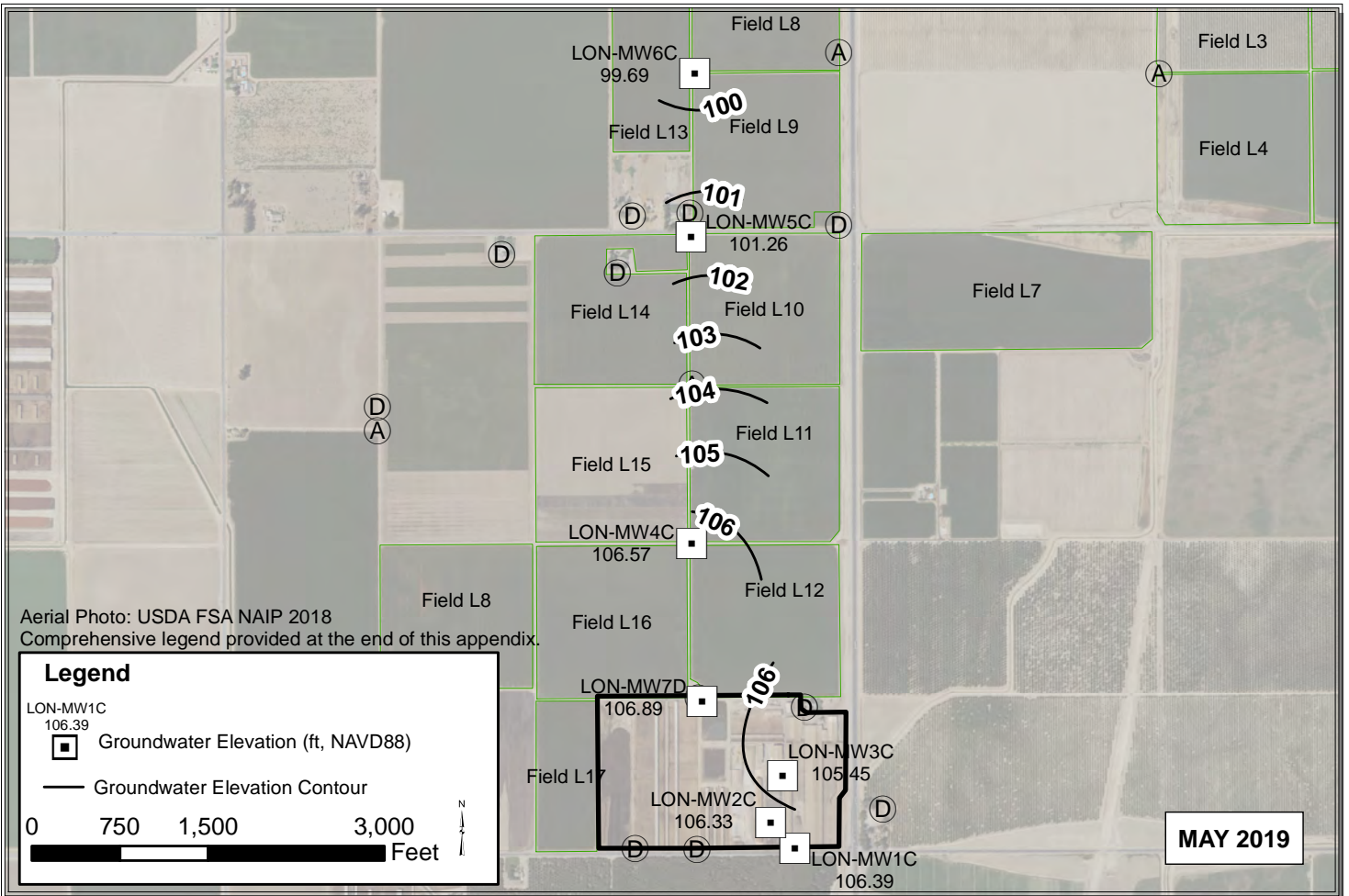

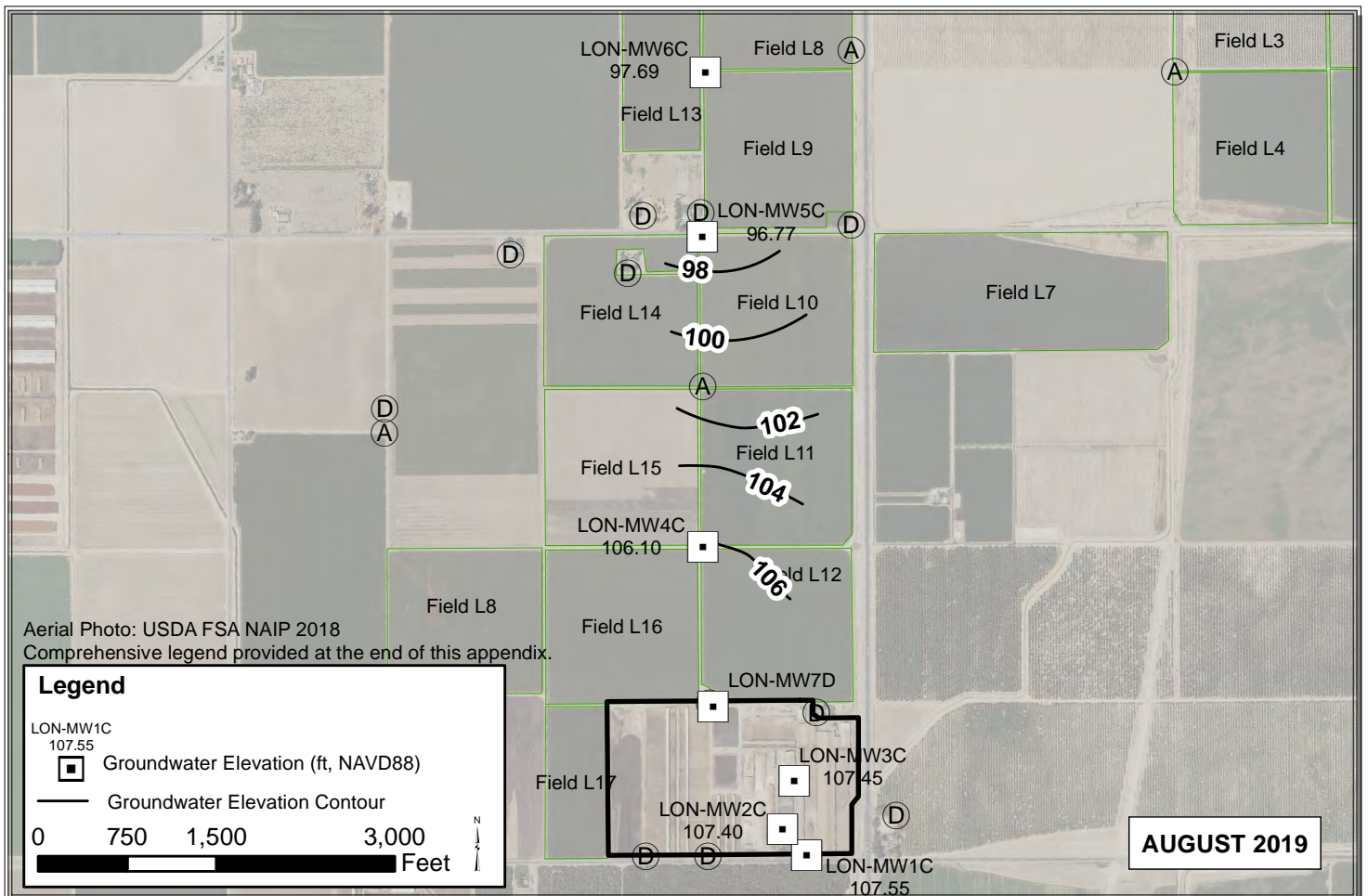
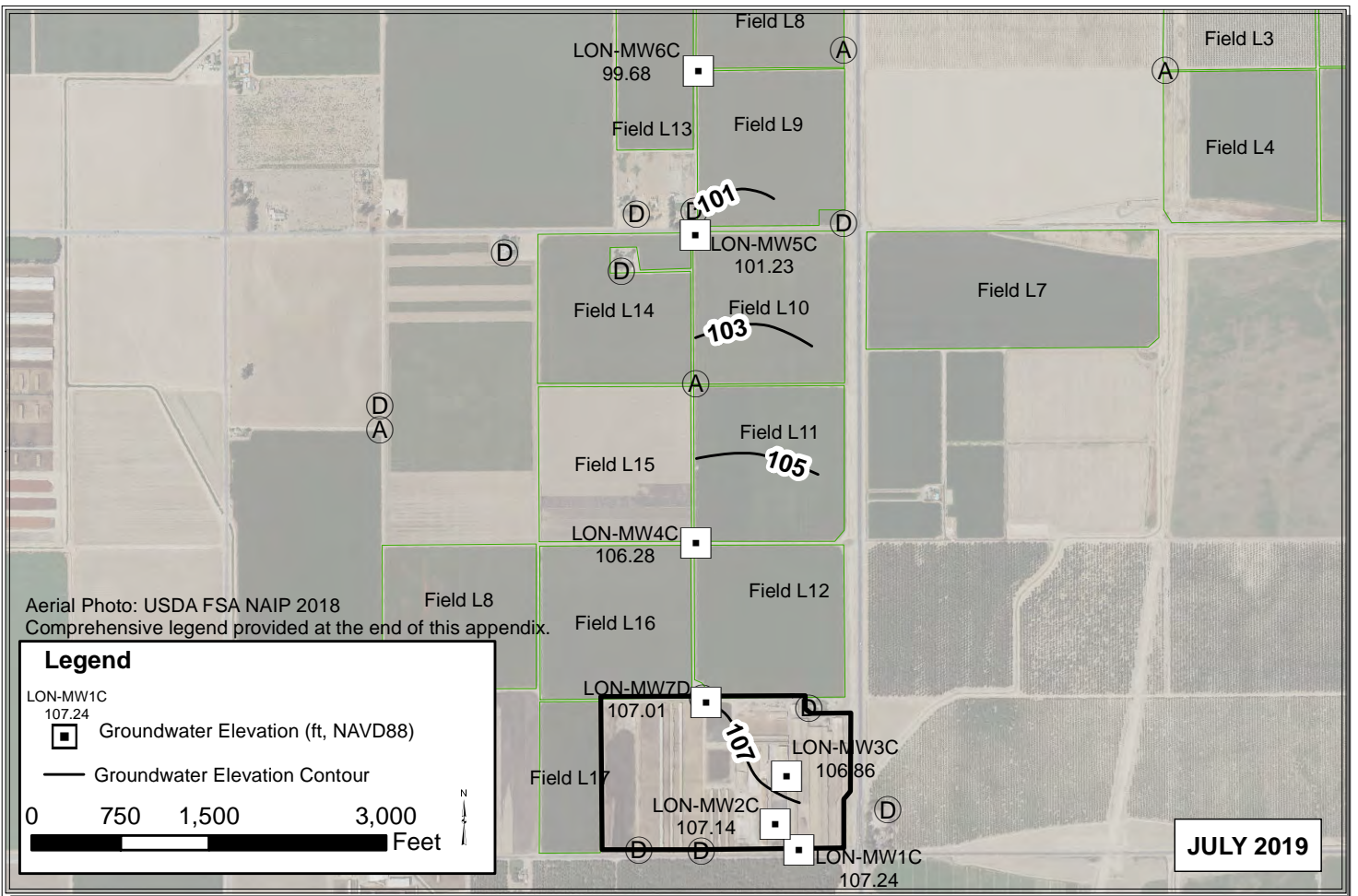

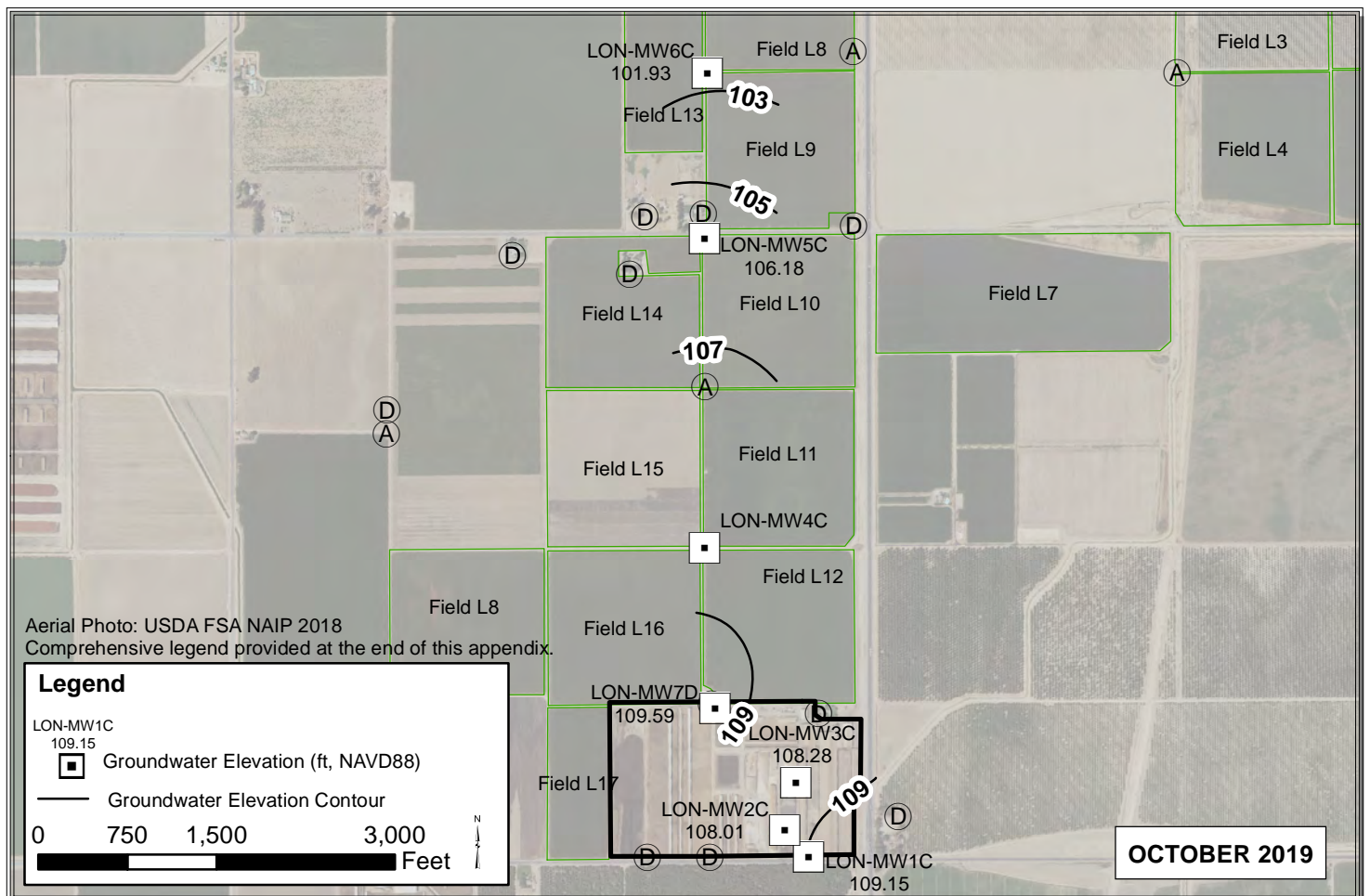
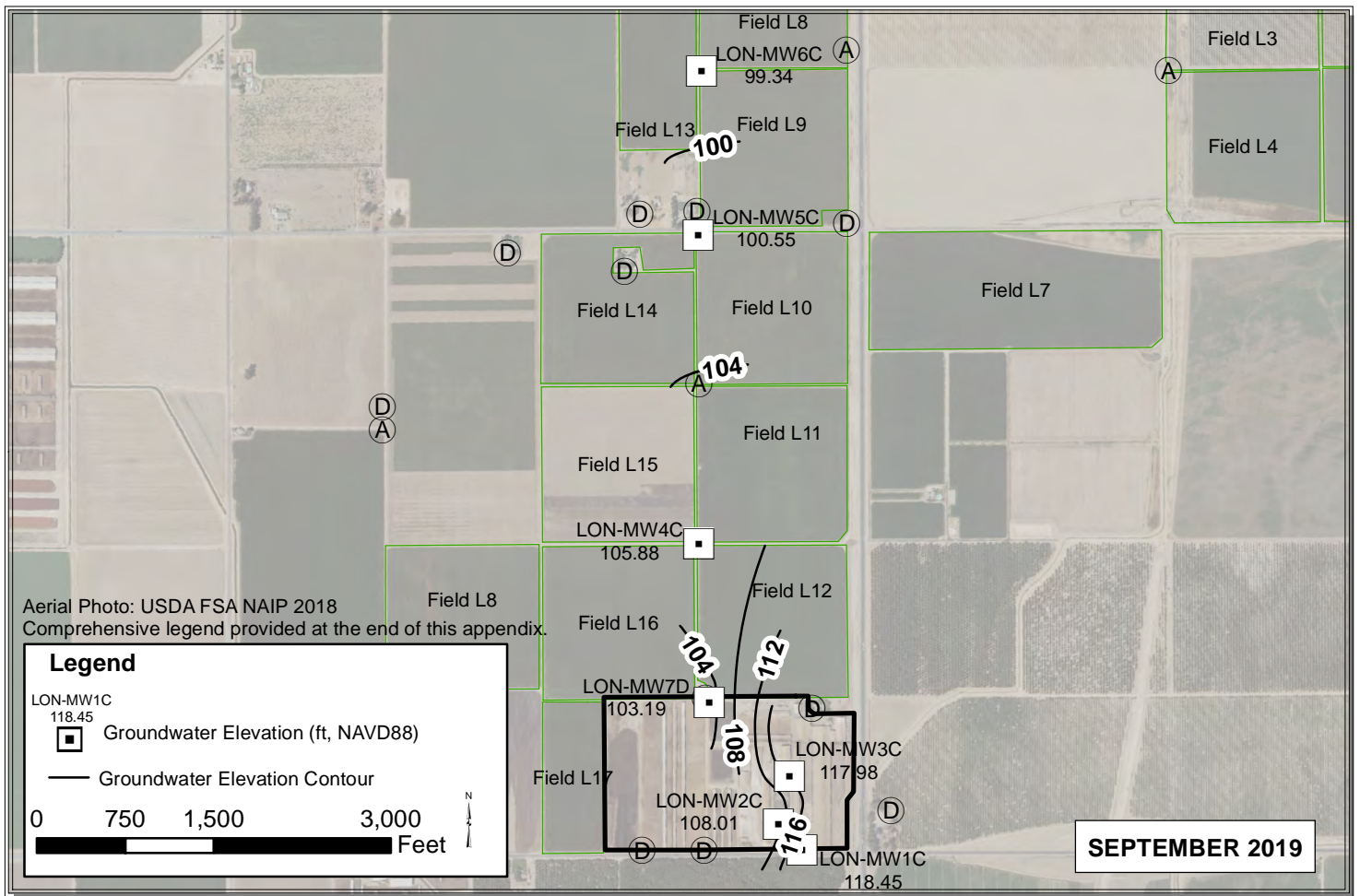

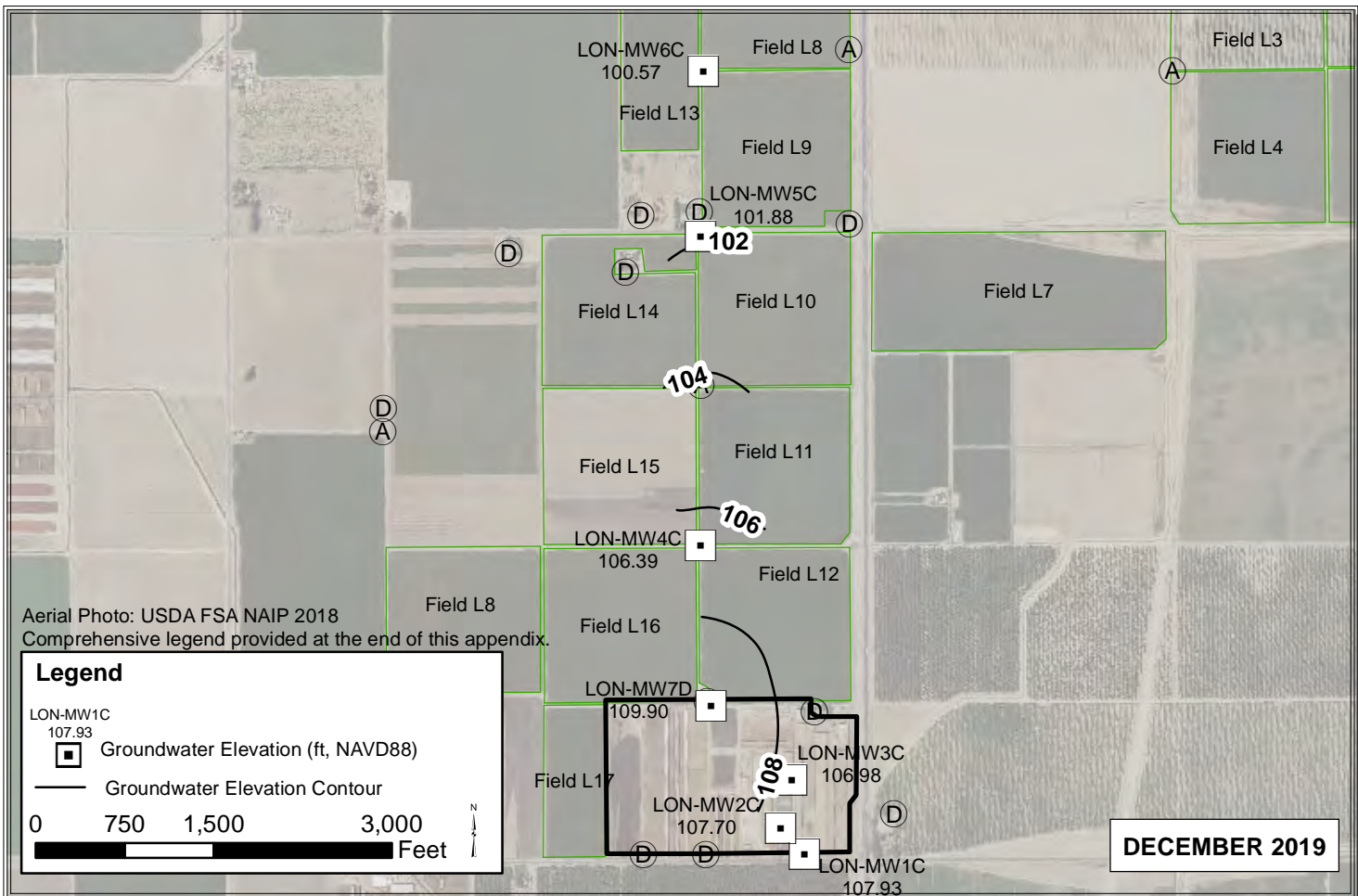
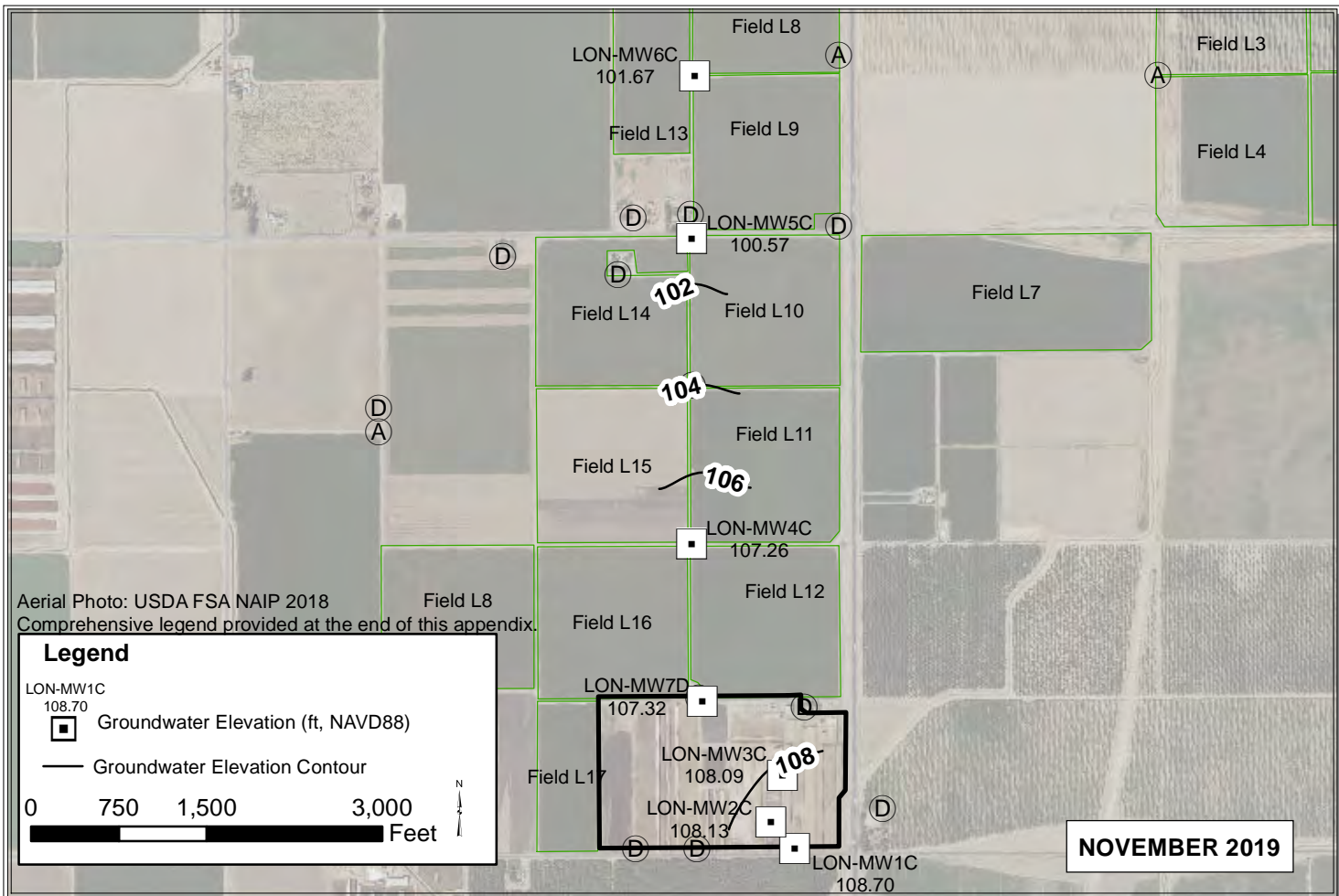

ADO

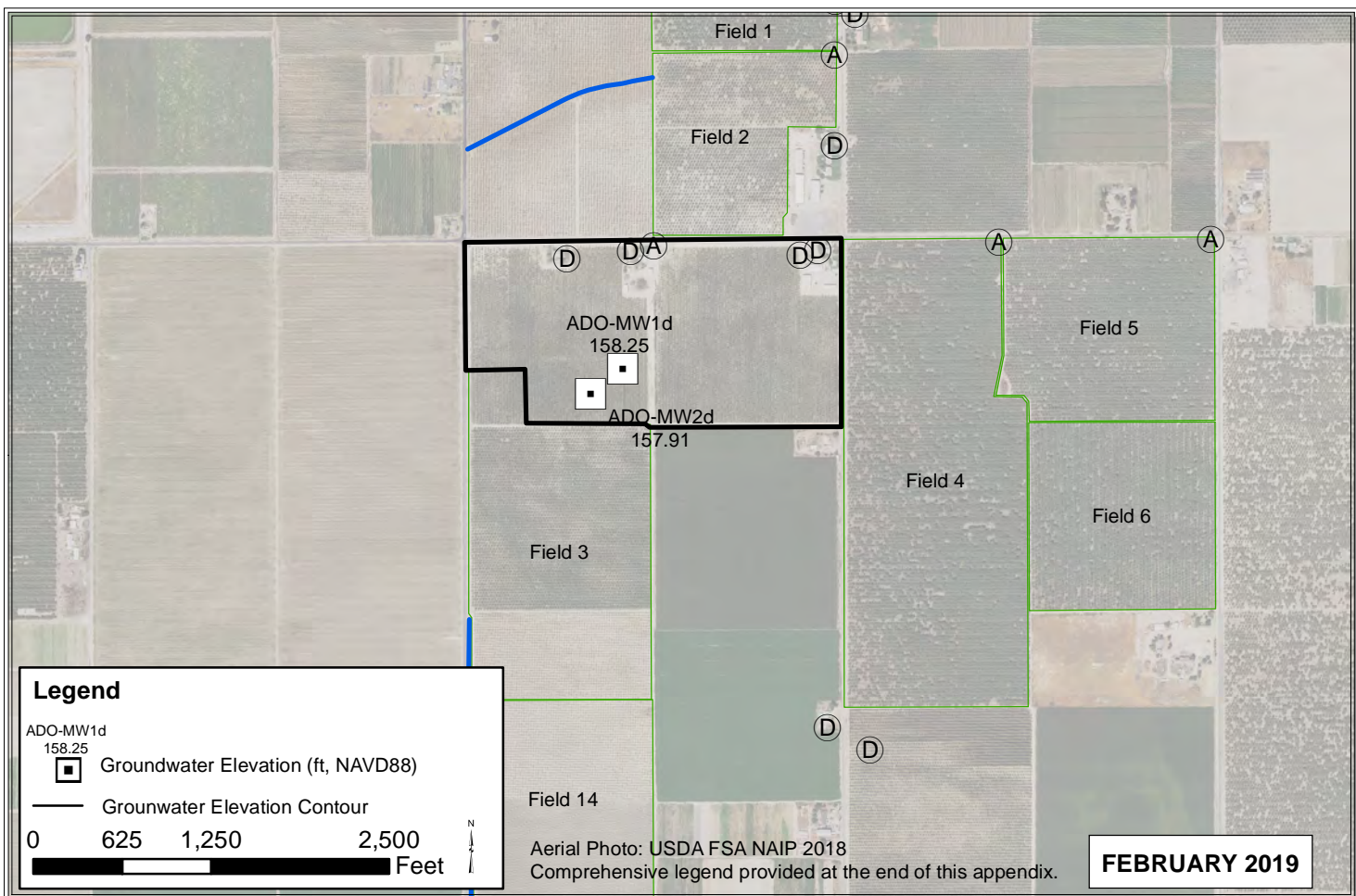
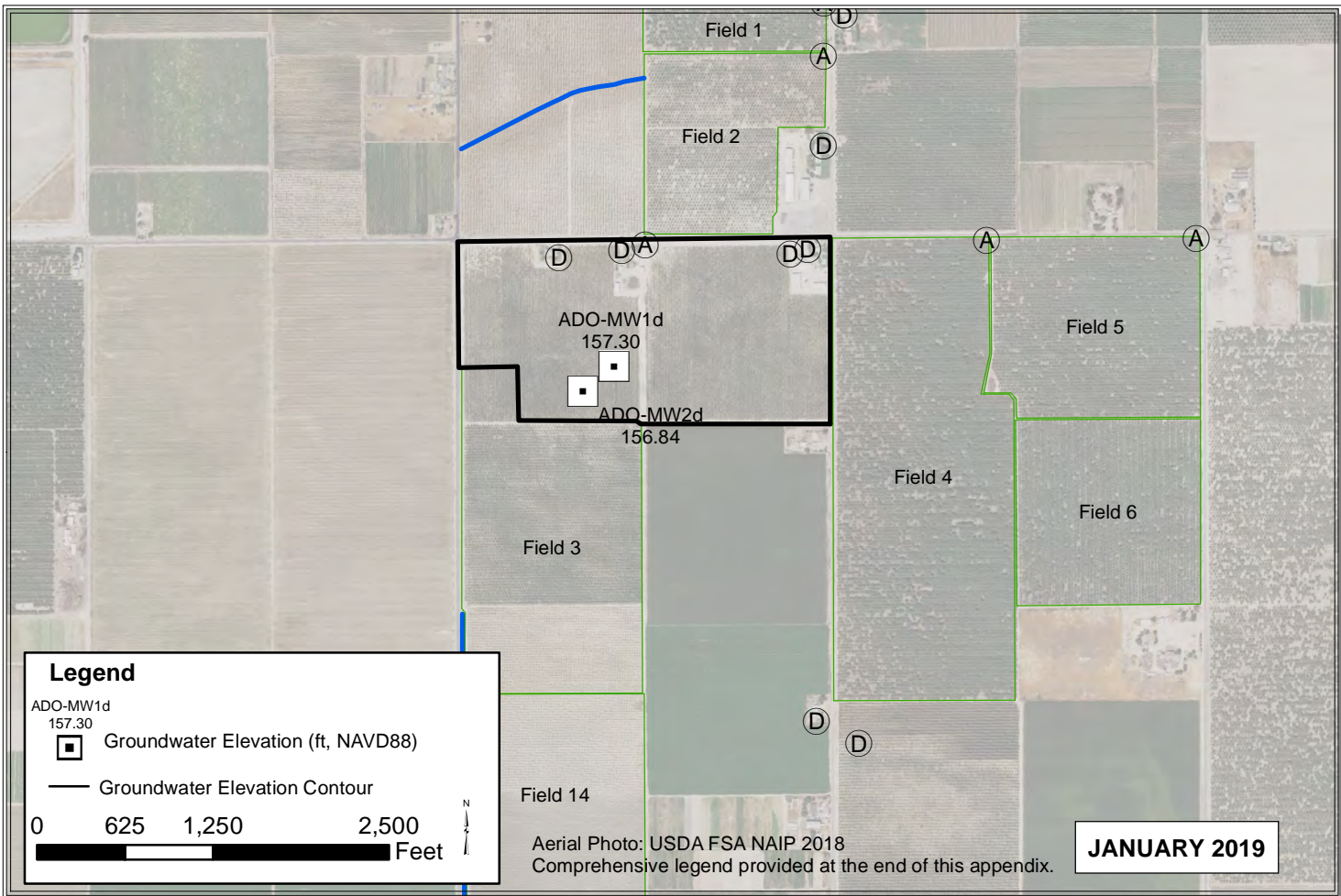

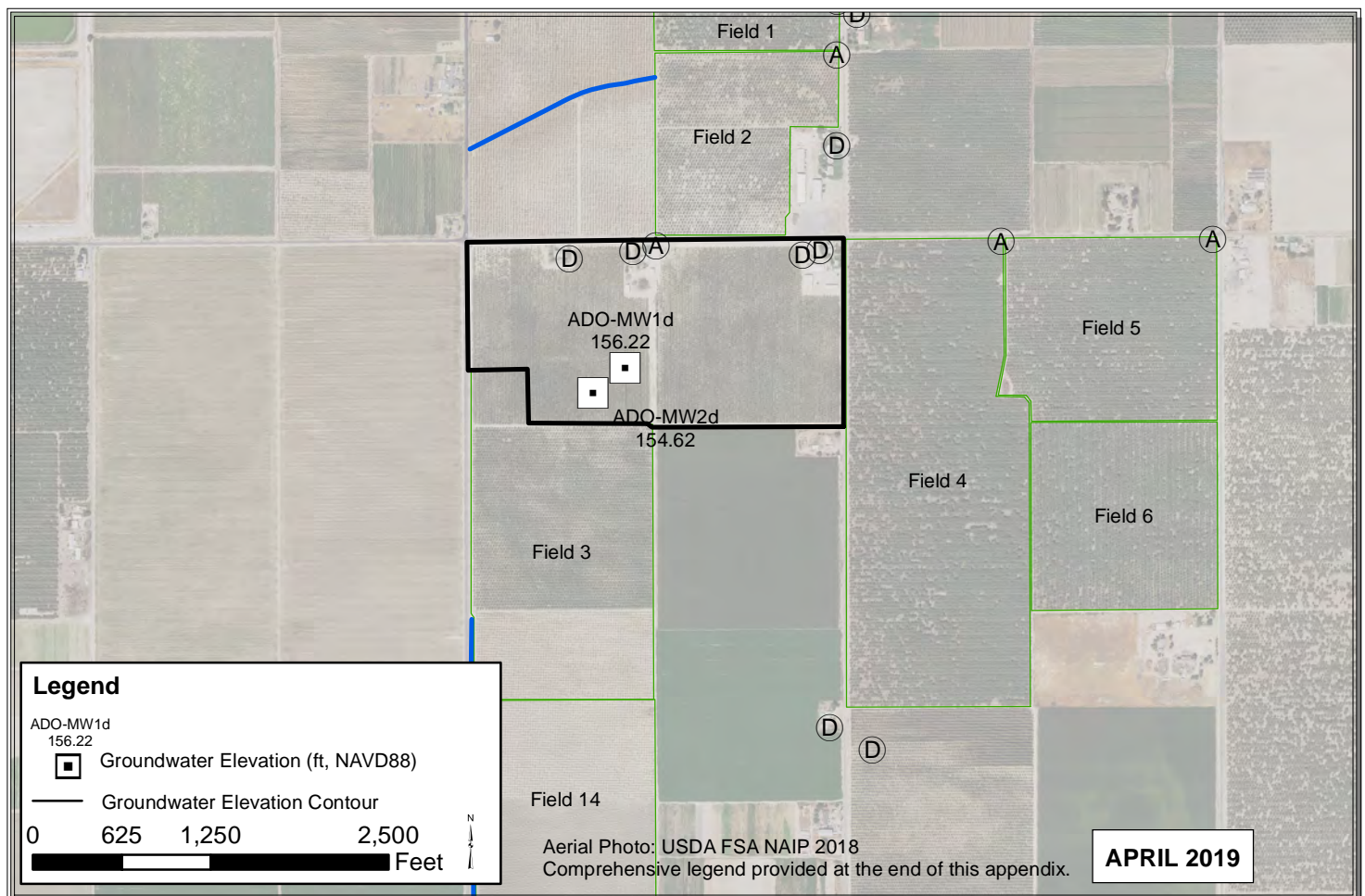
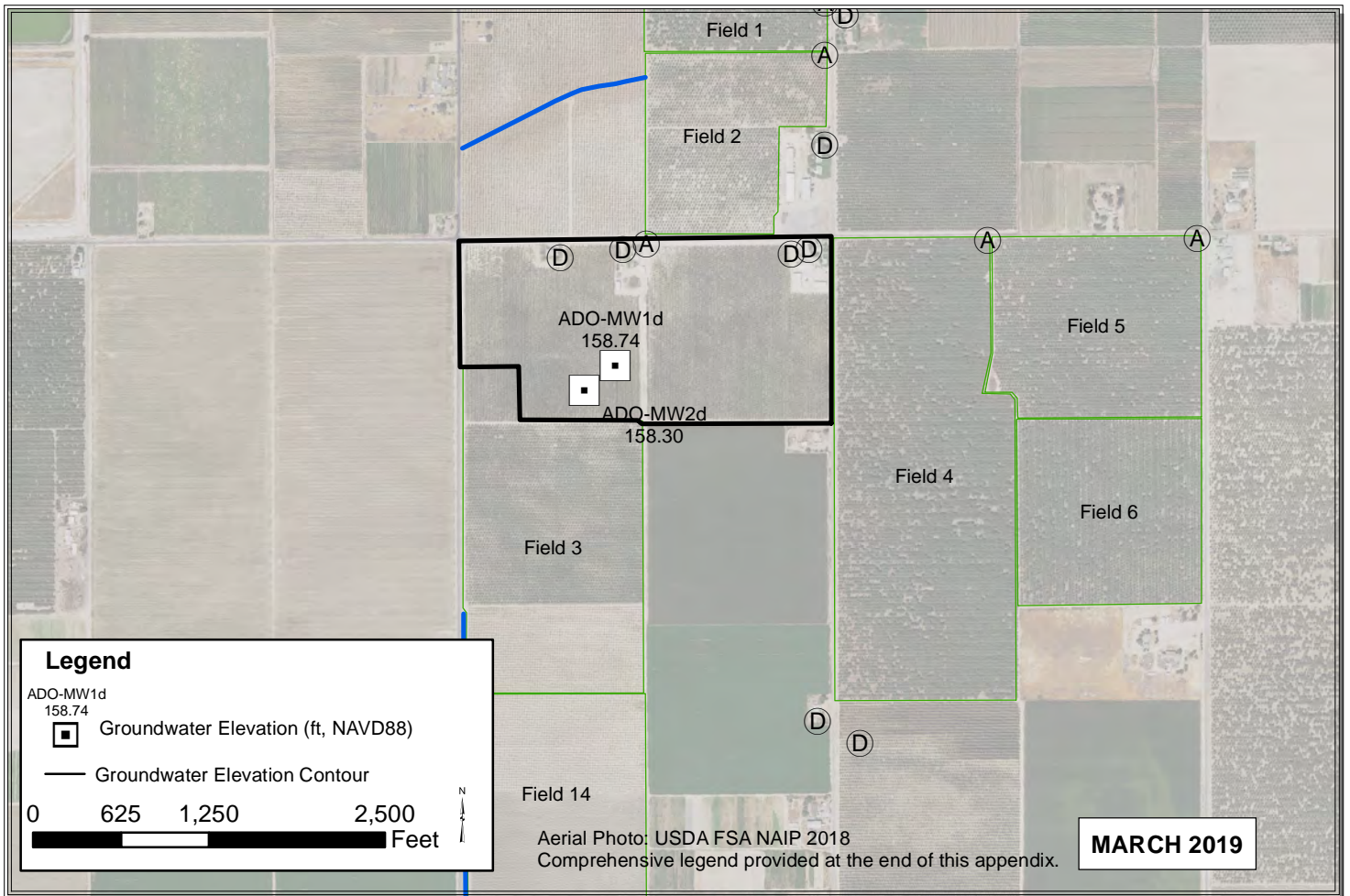

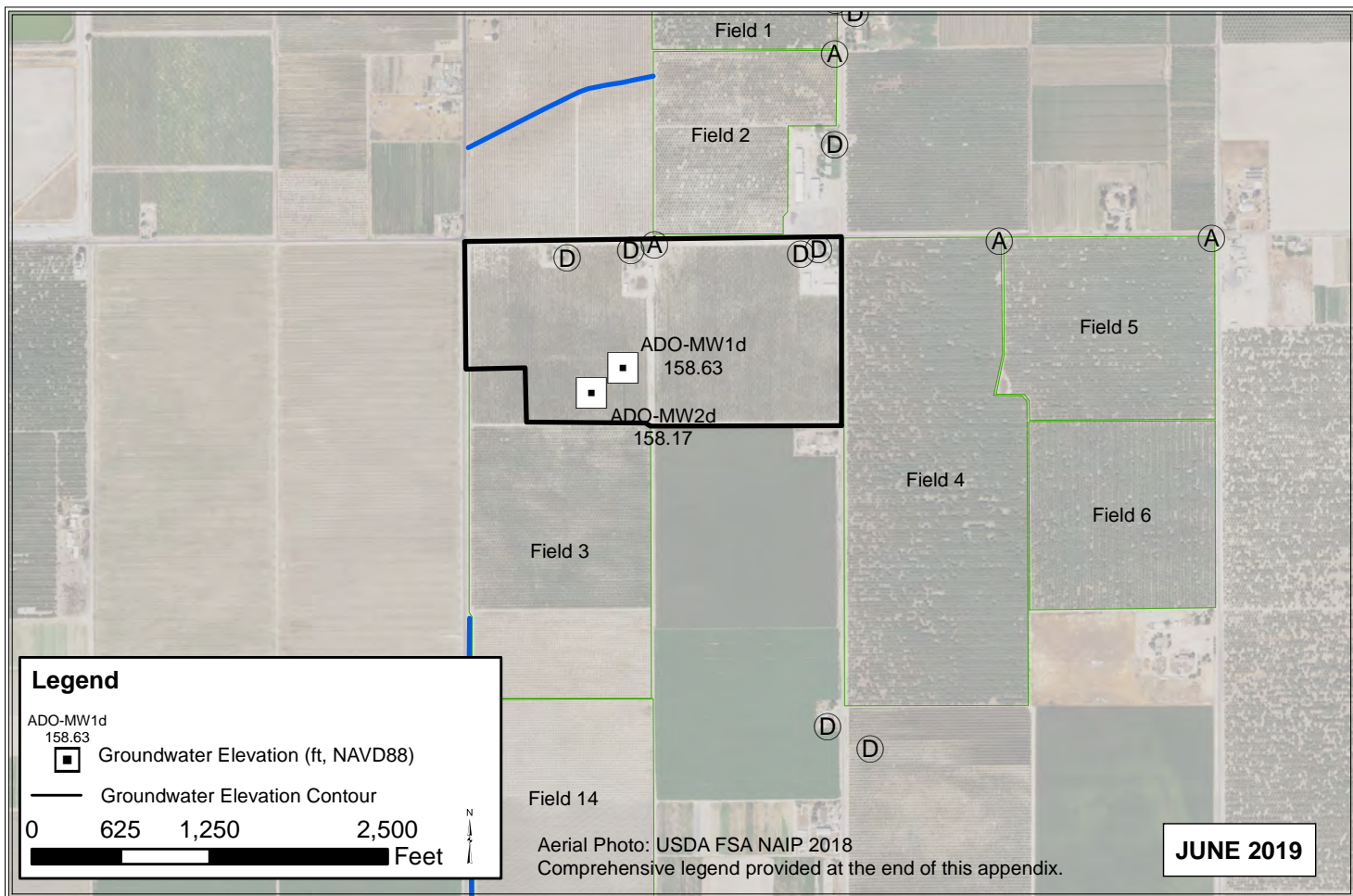
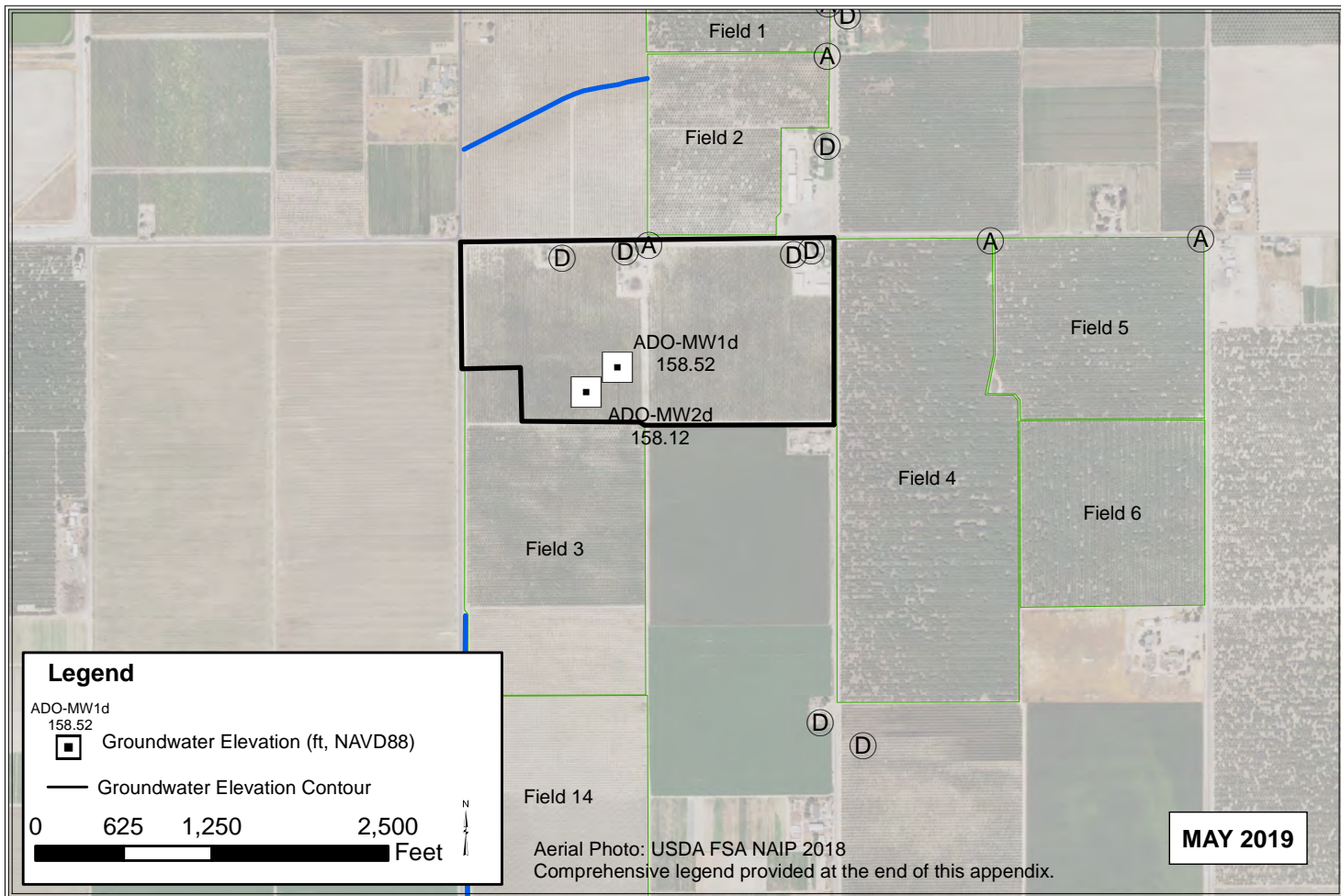

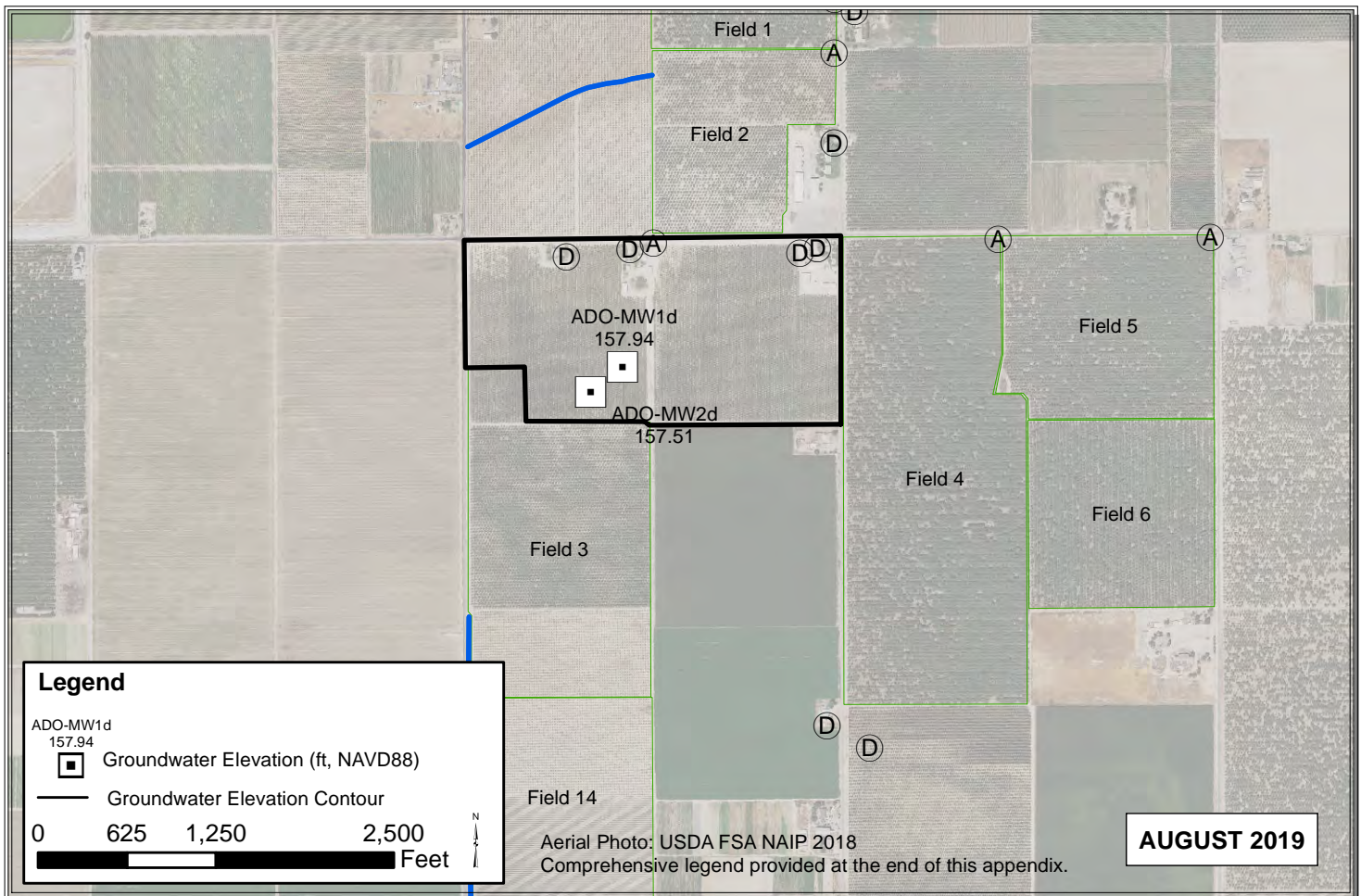
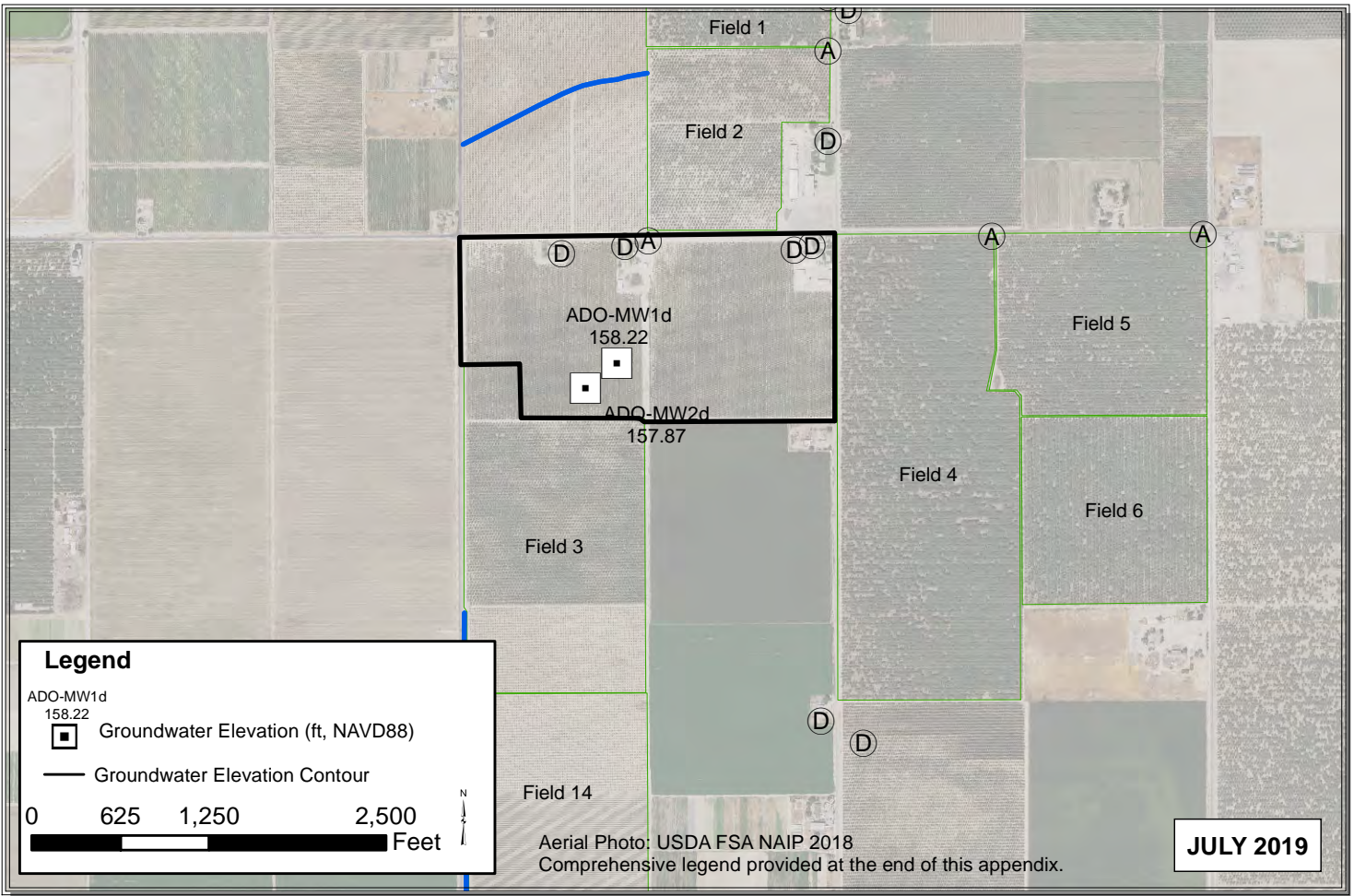

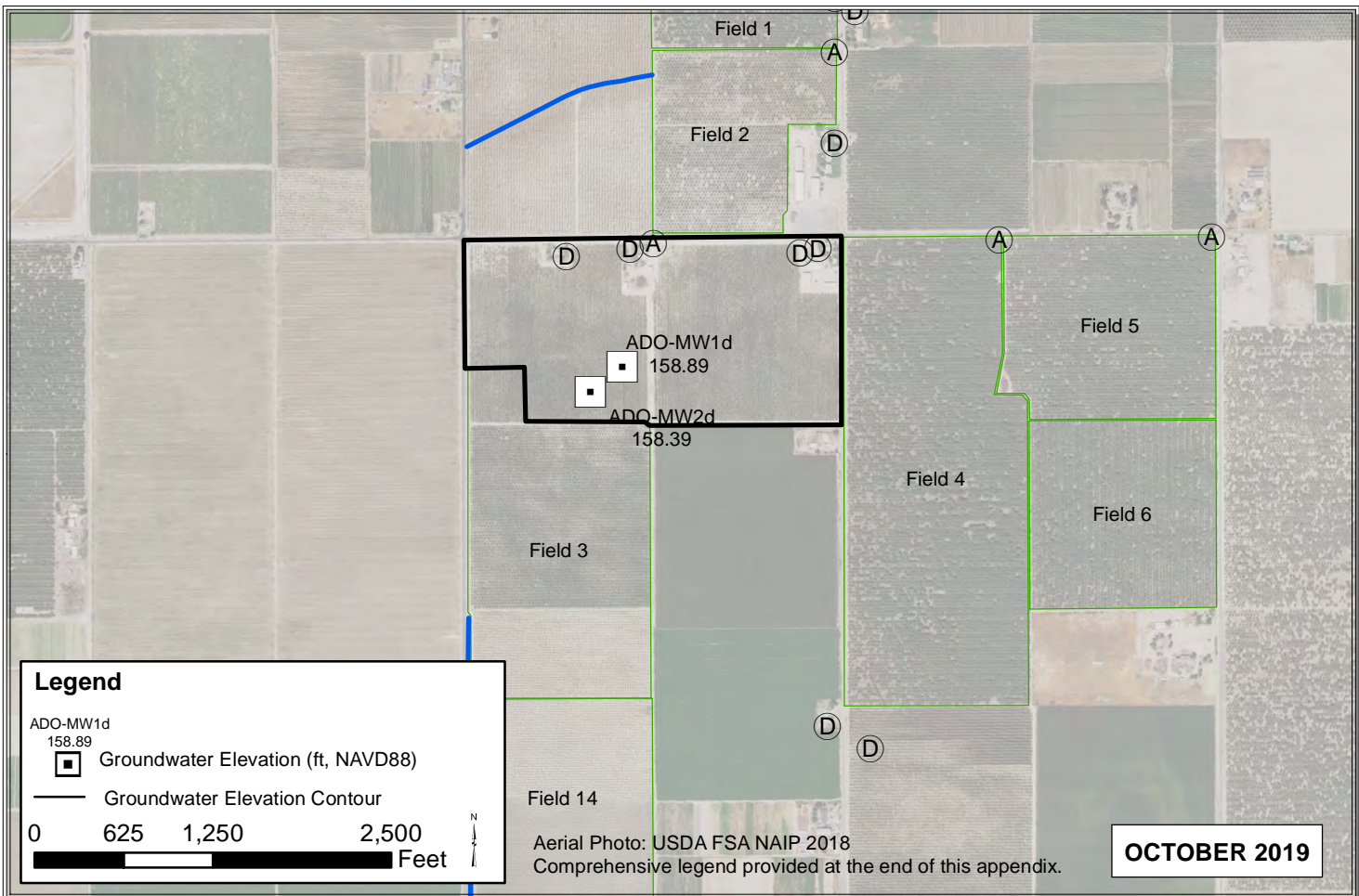
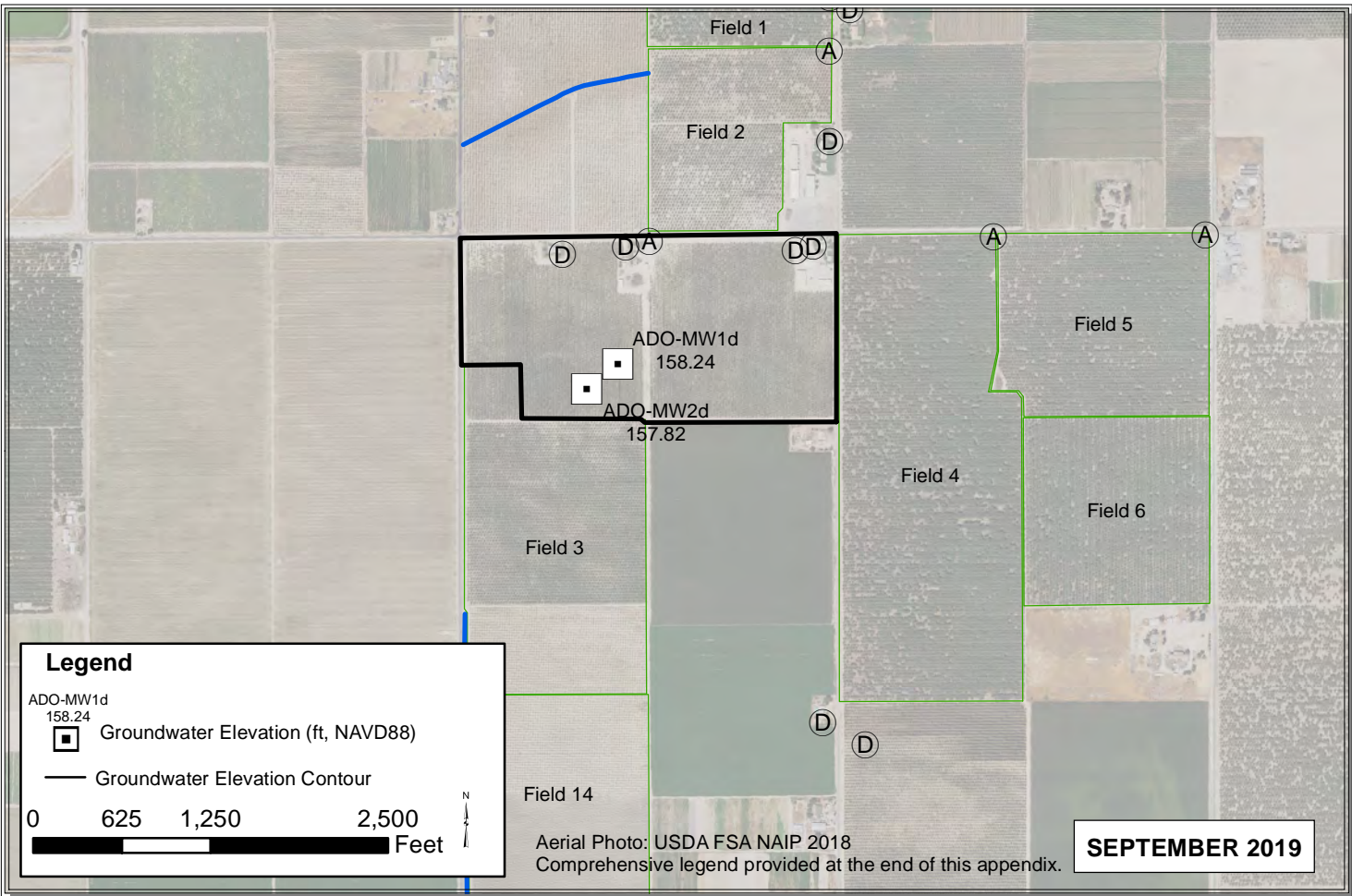

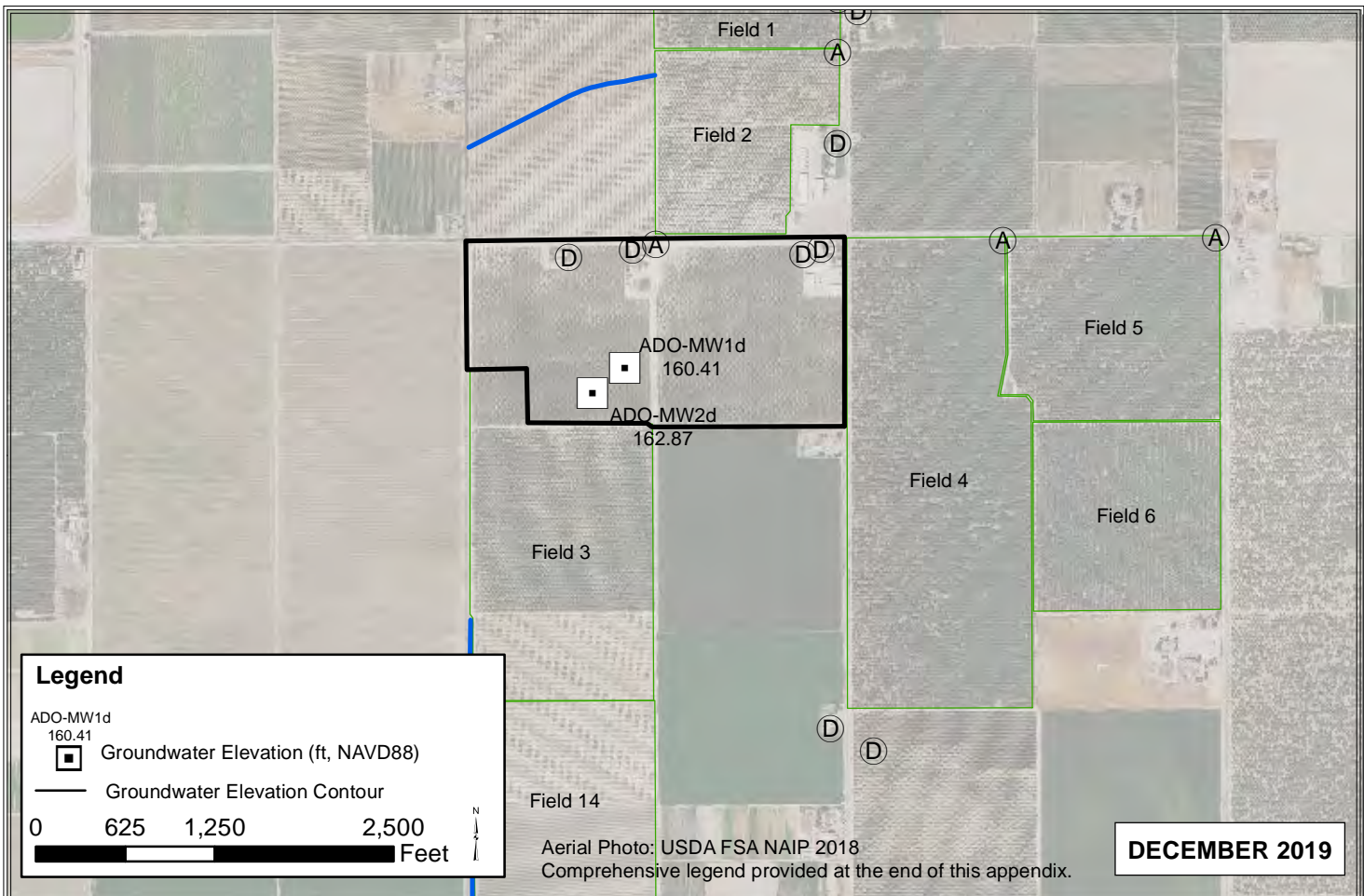
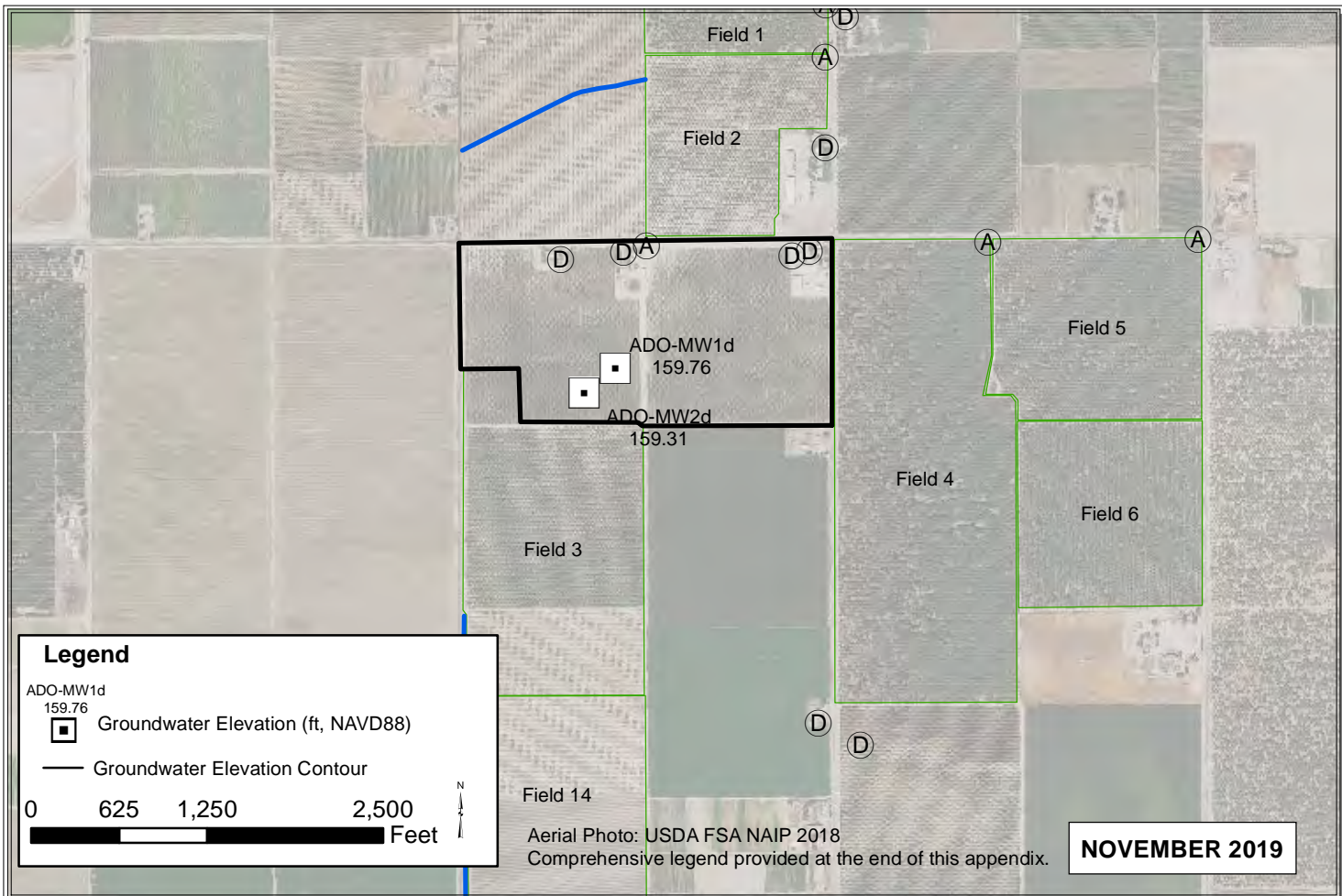

MAL

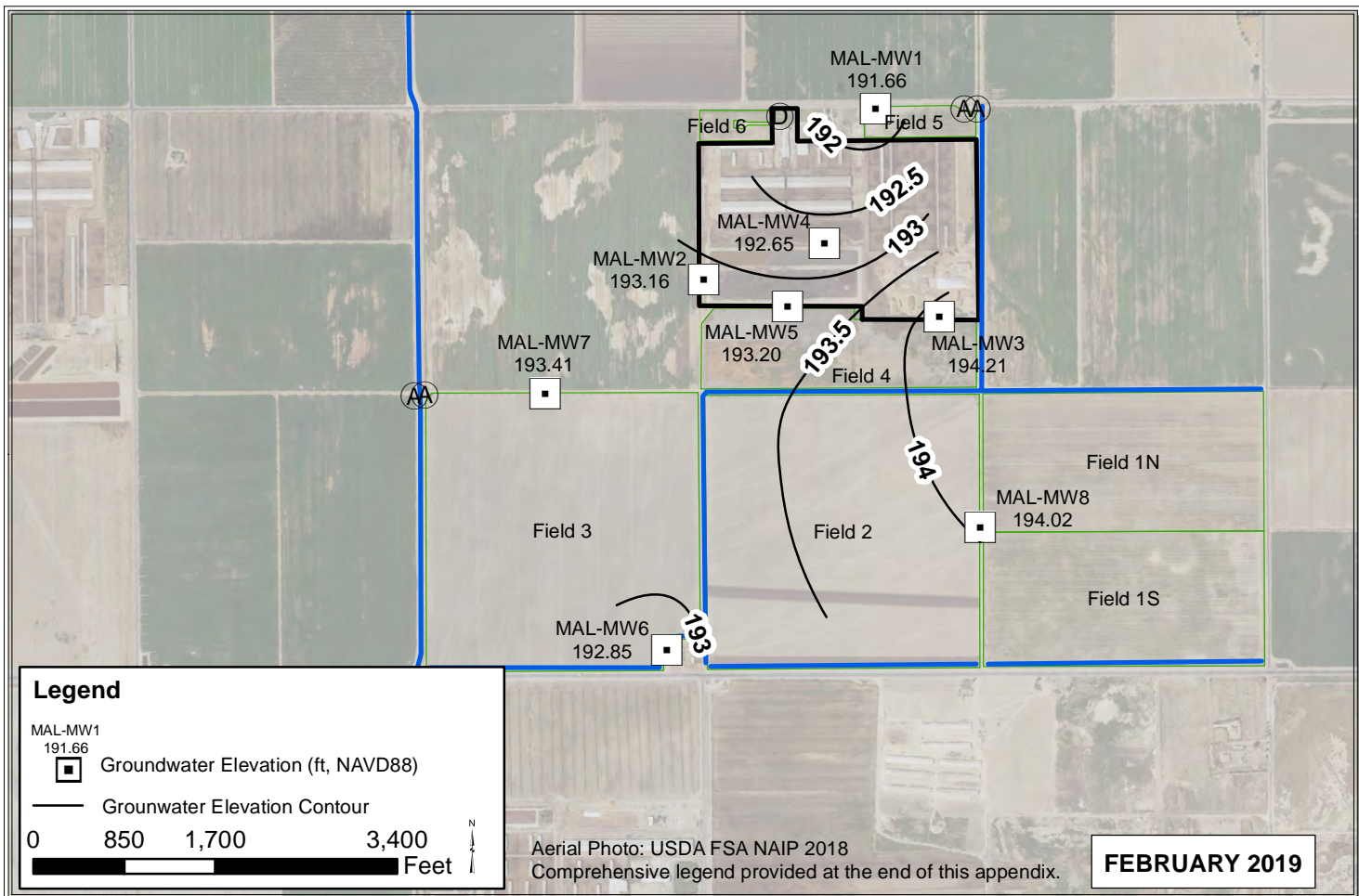
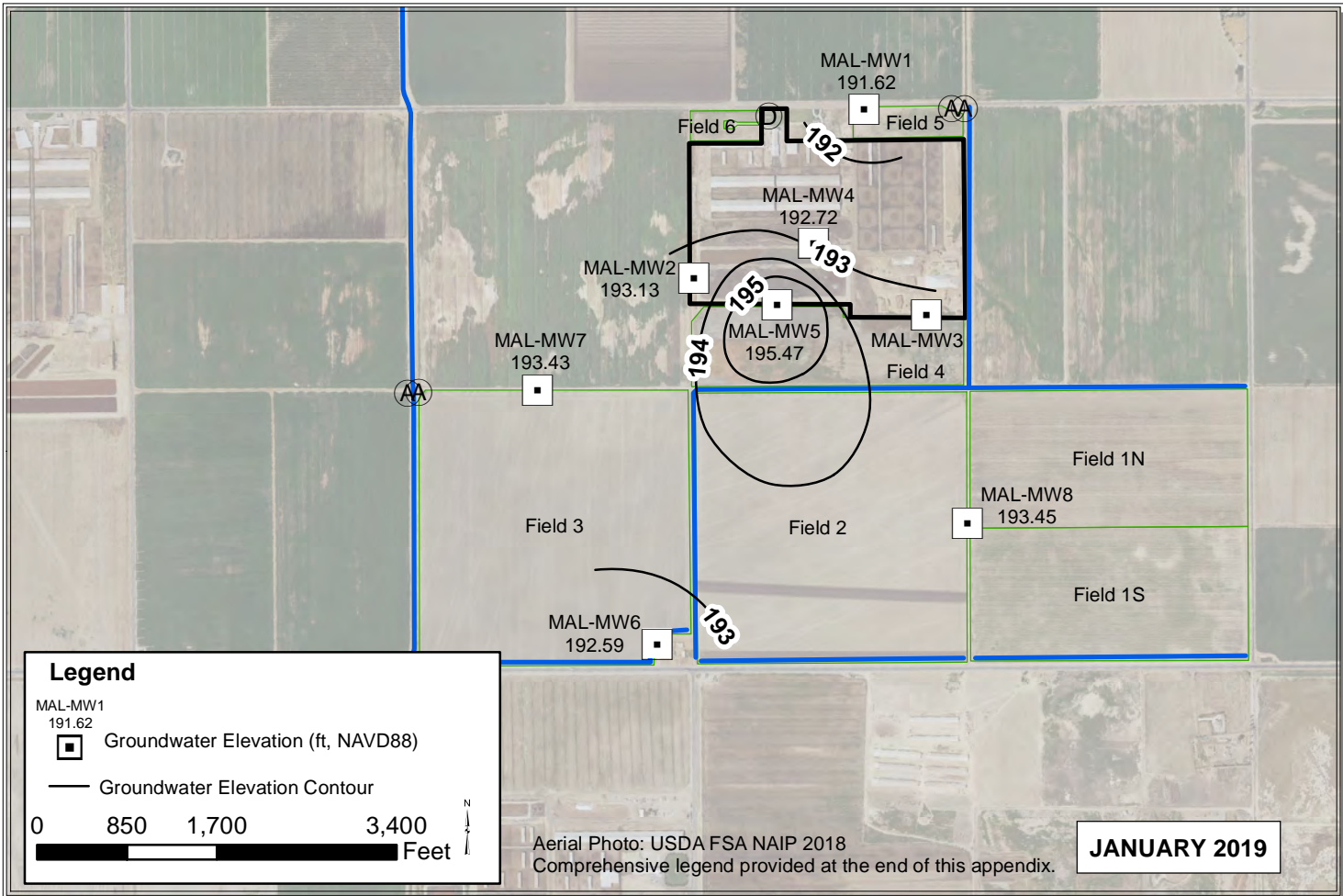

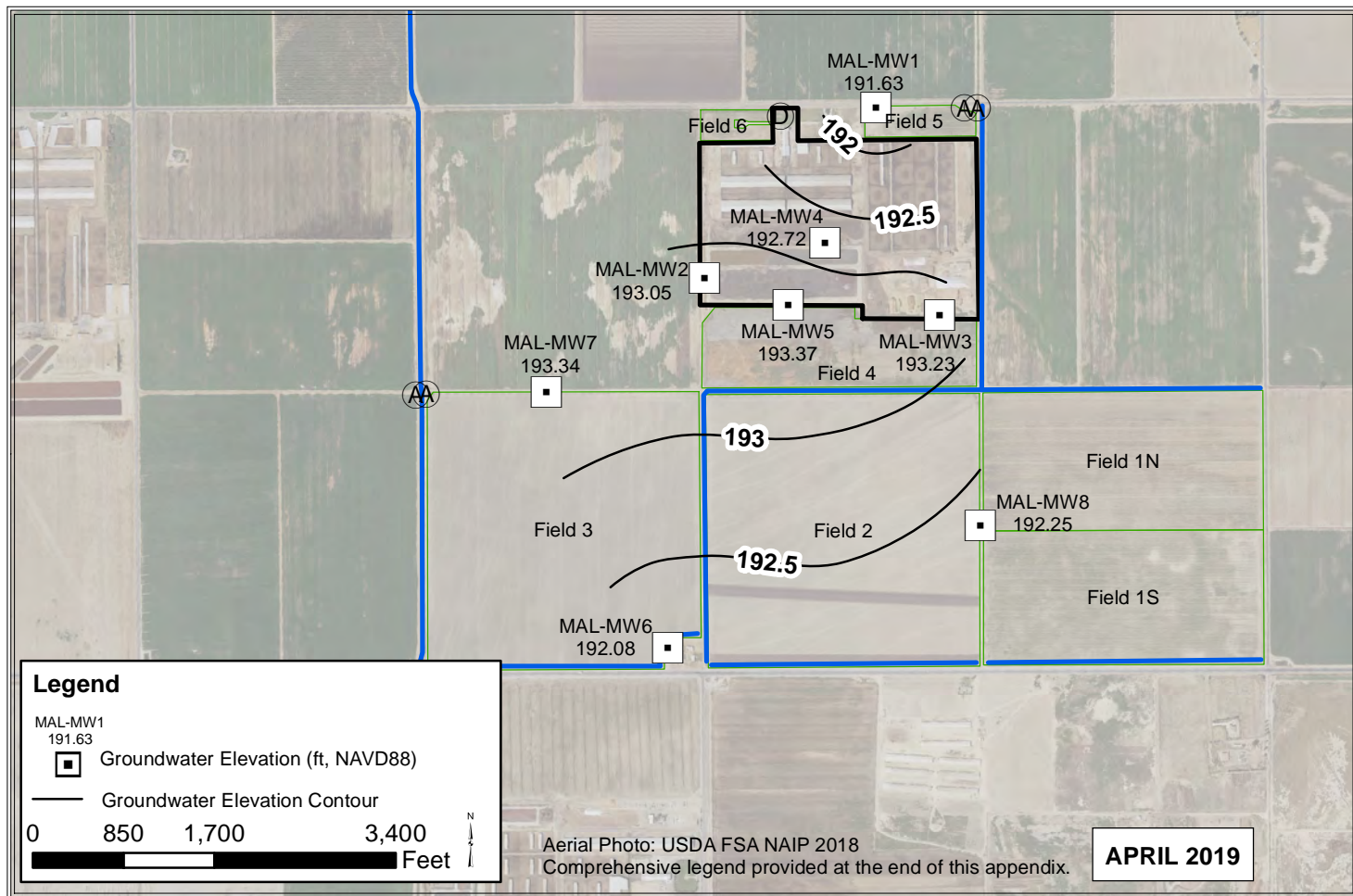
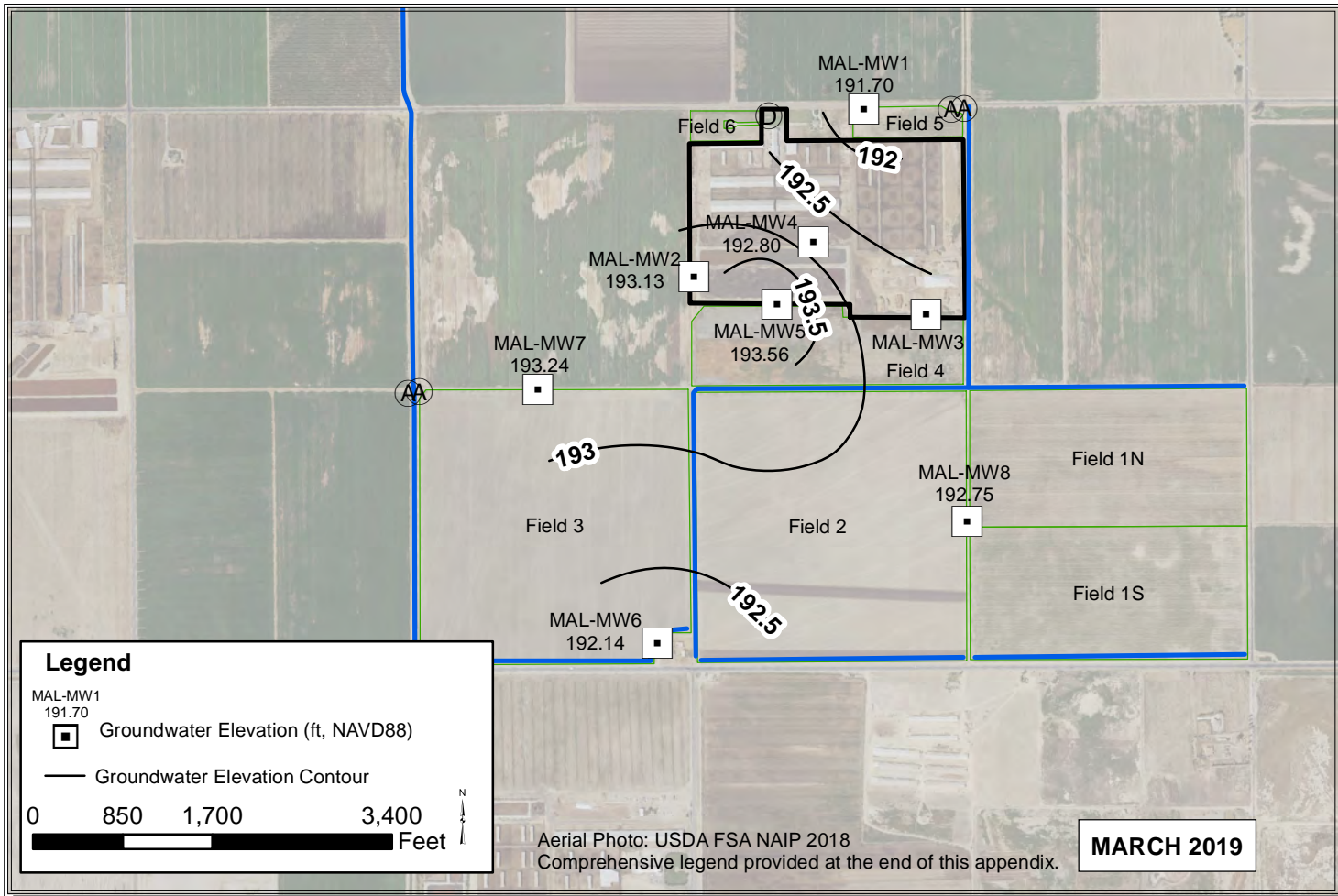

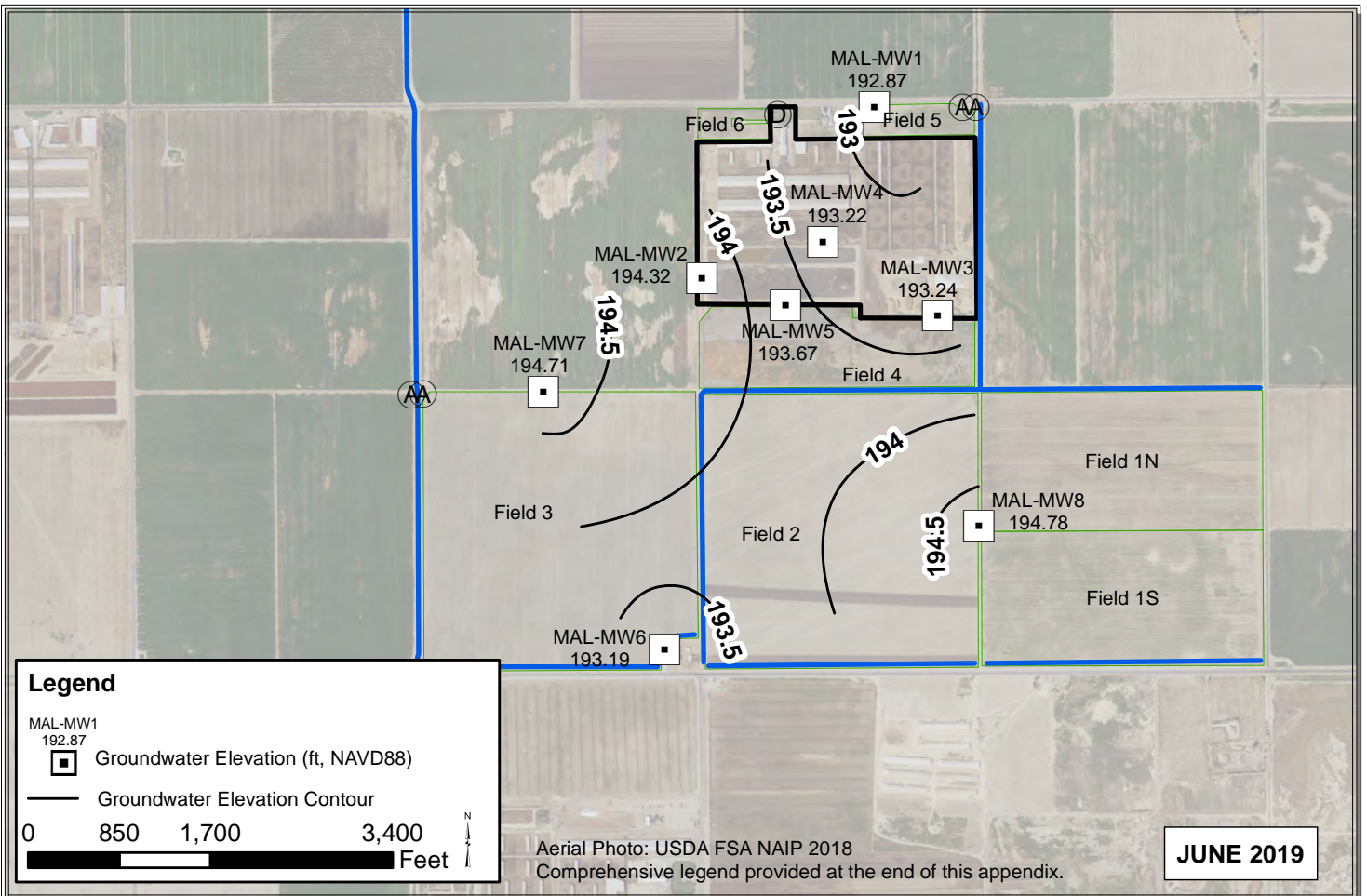
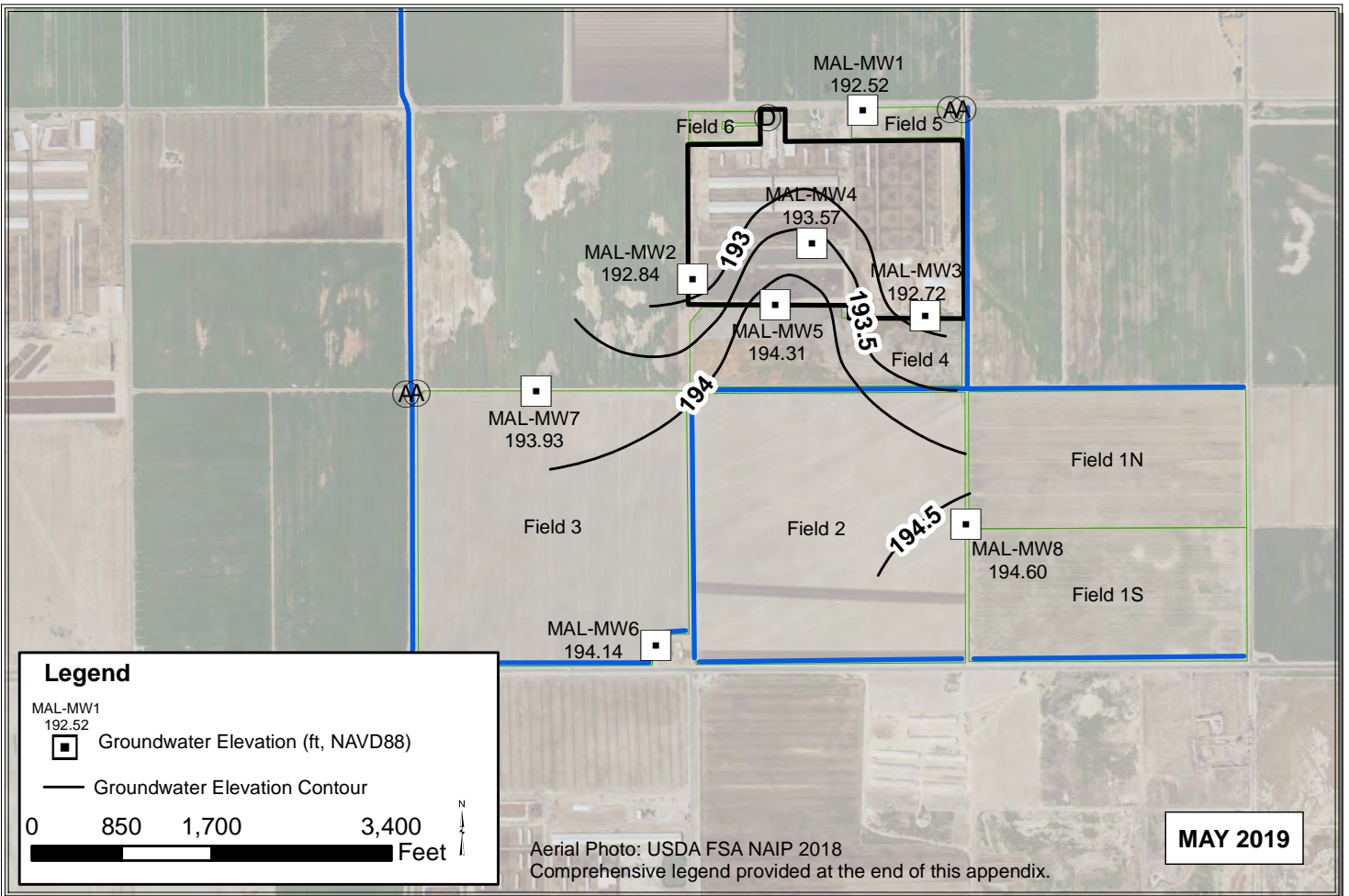

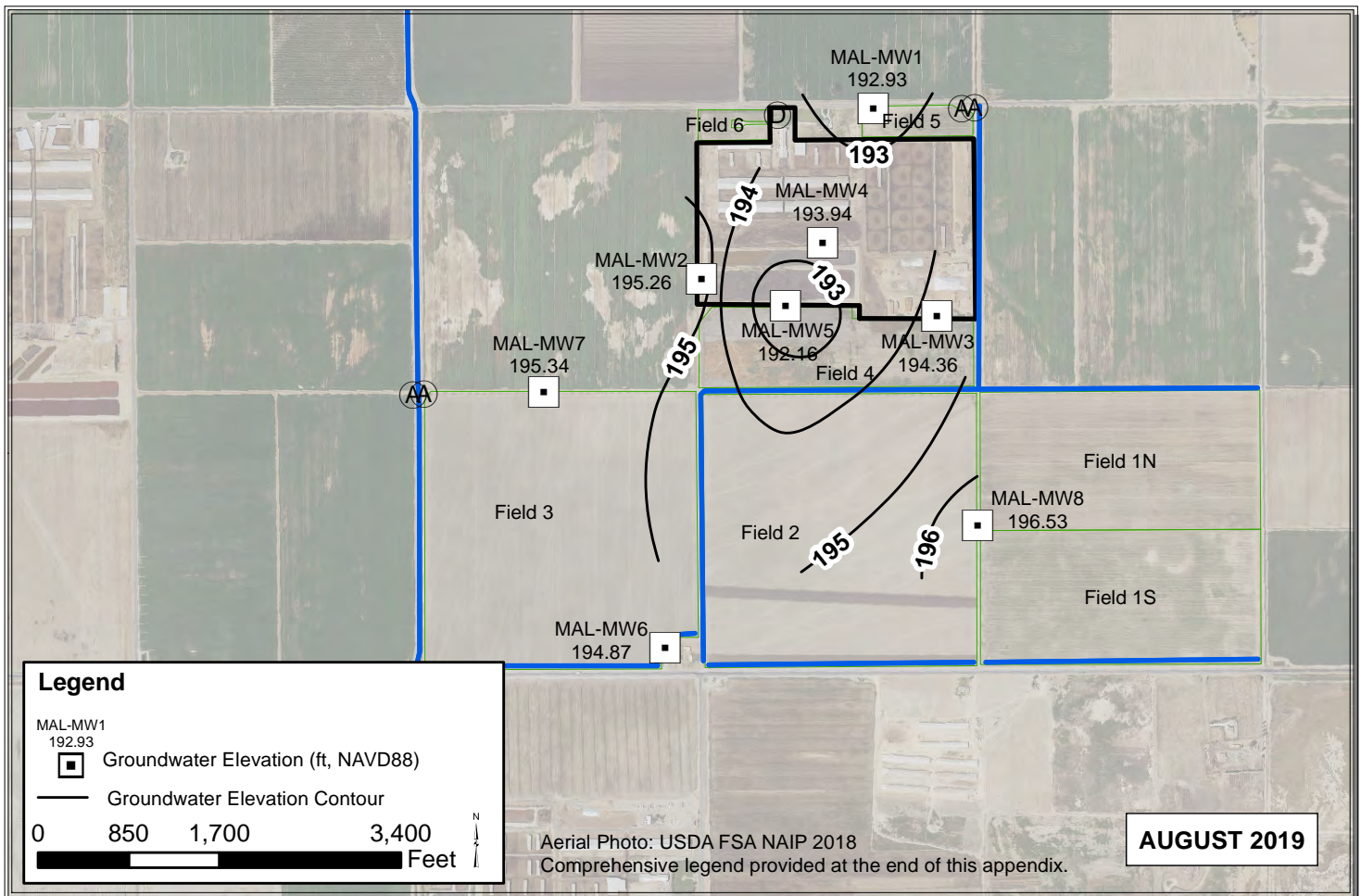
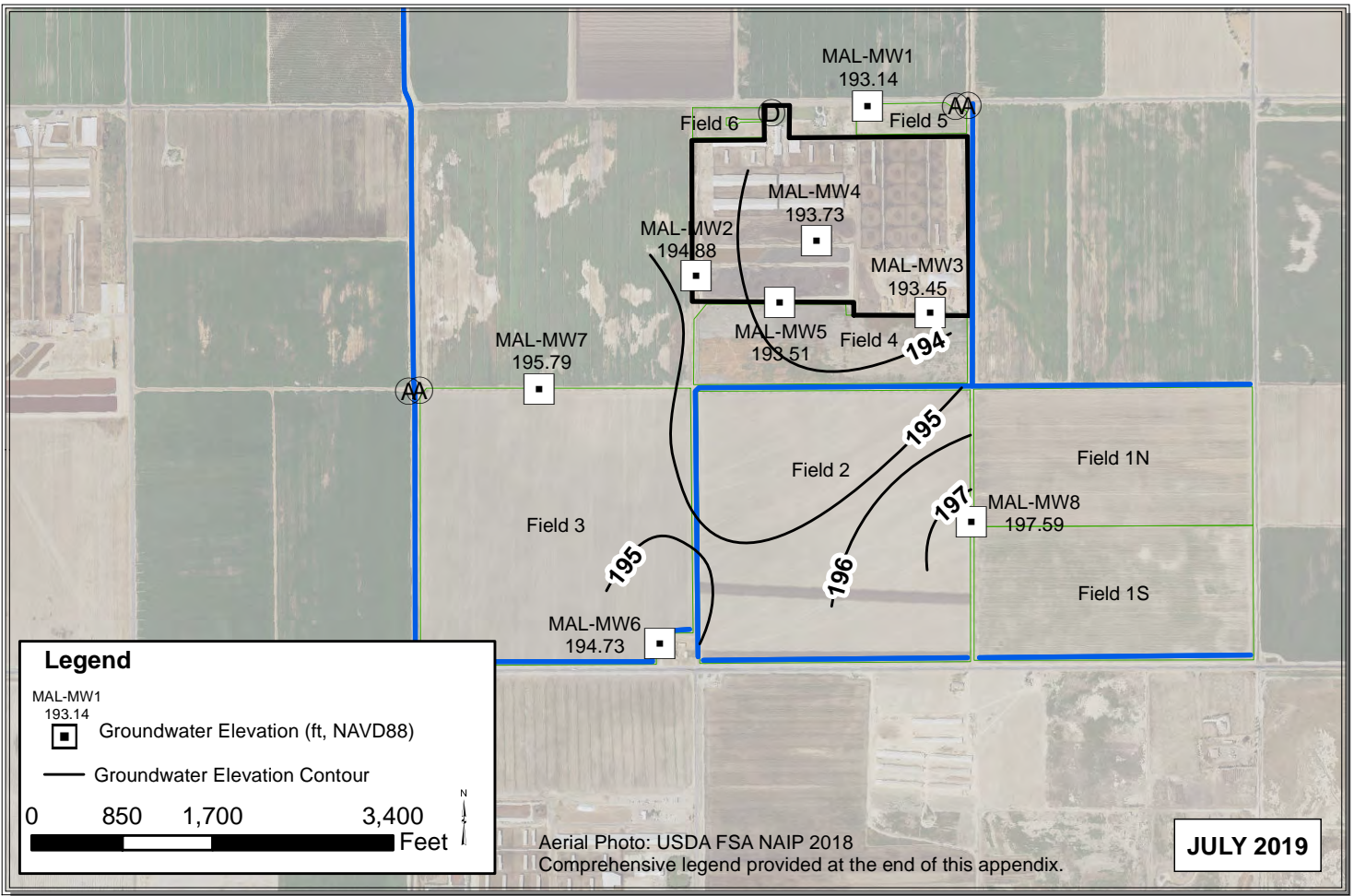

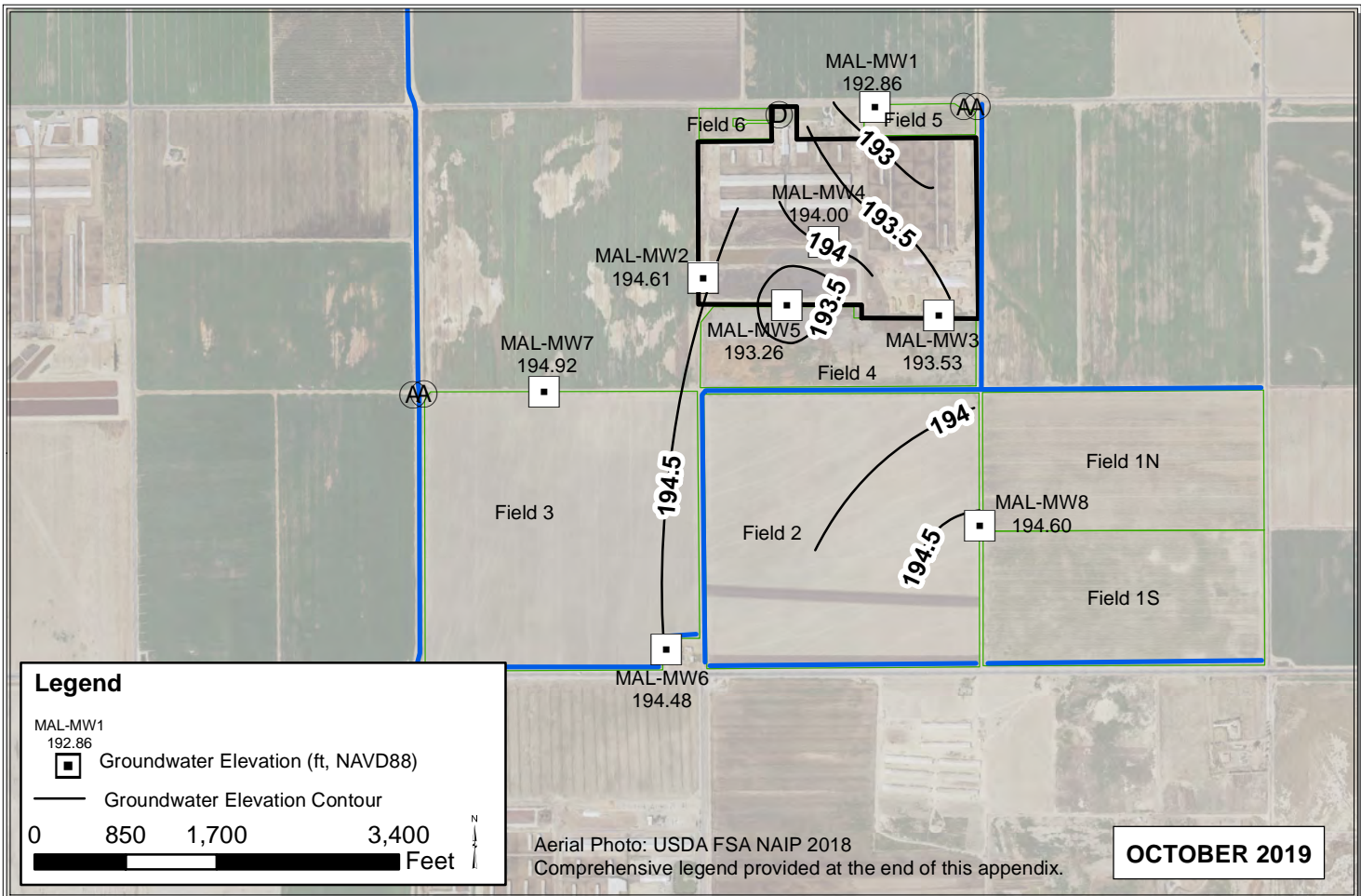
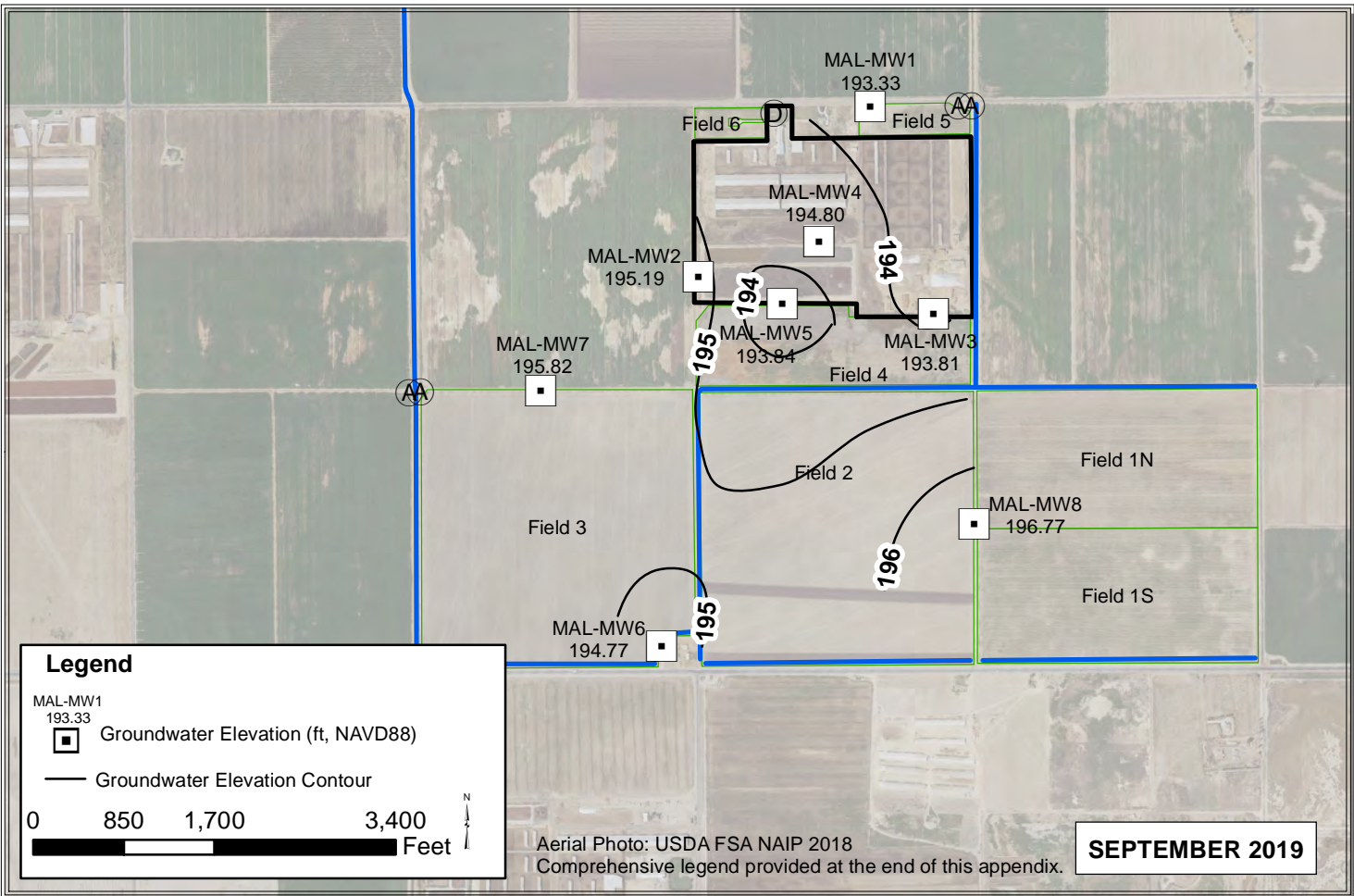

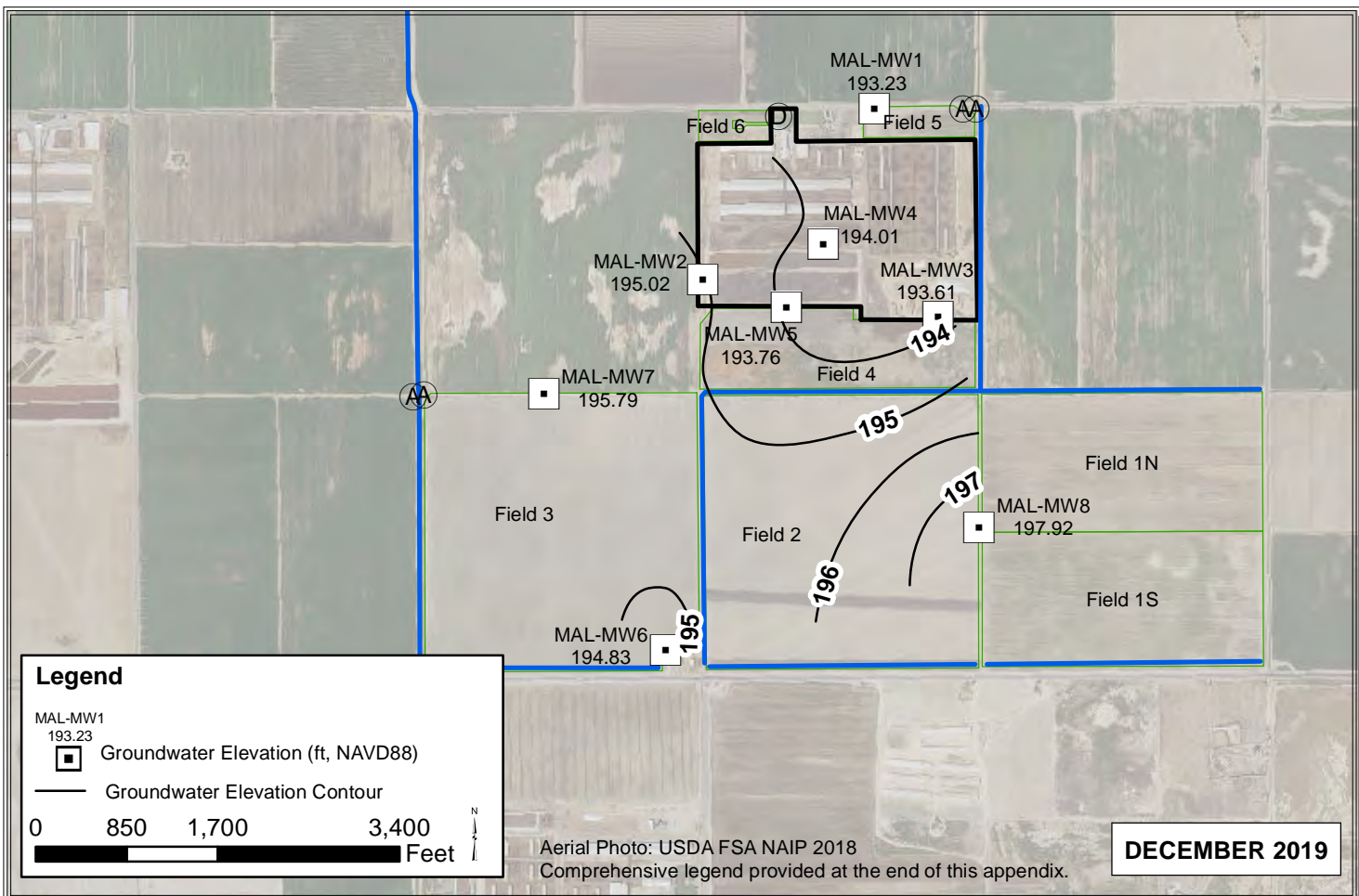
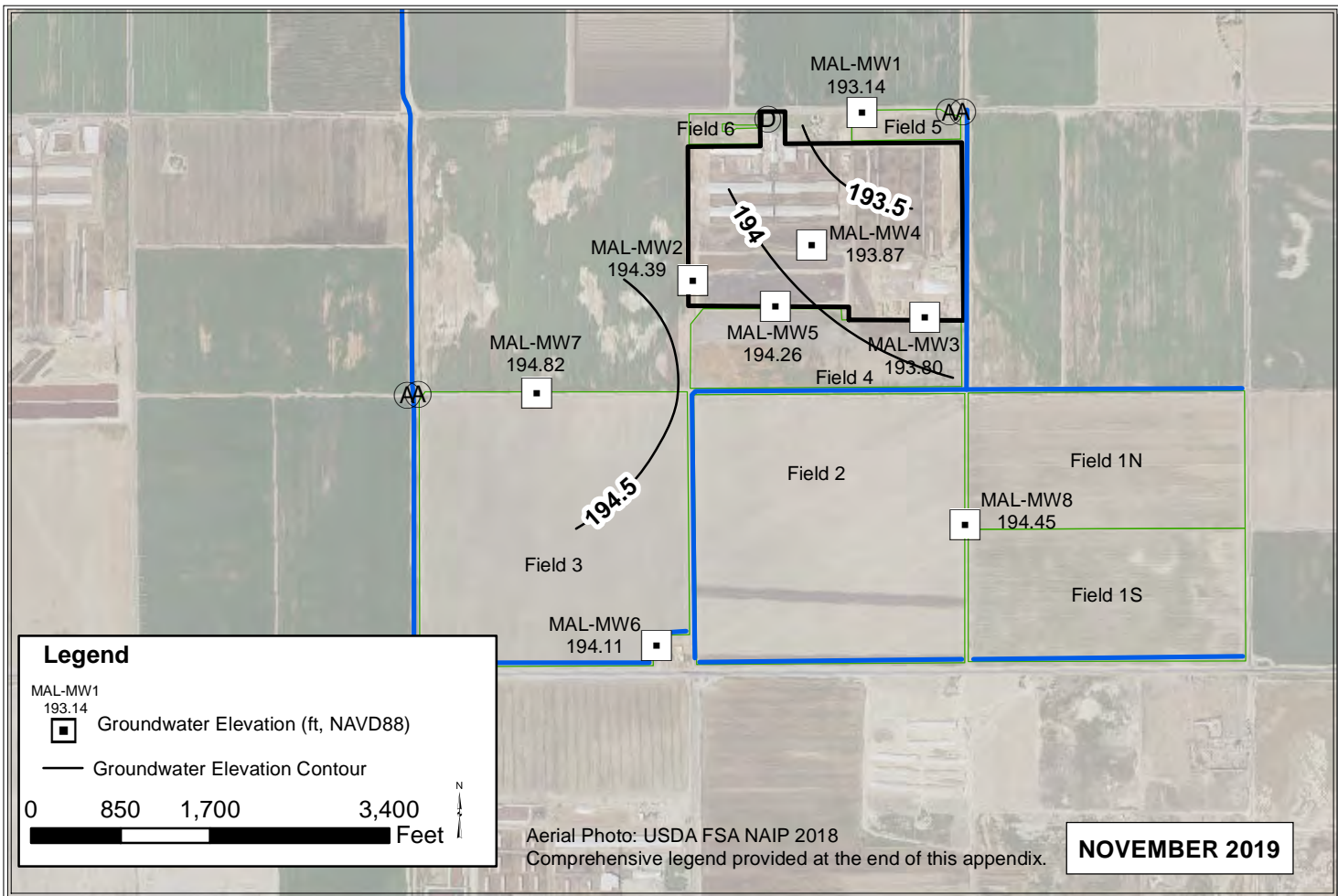

MAP and ZON

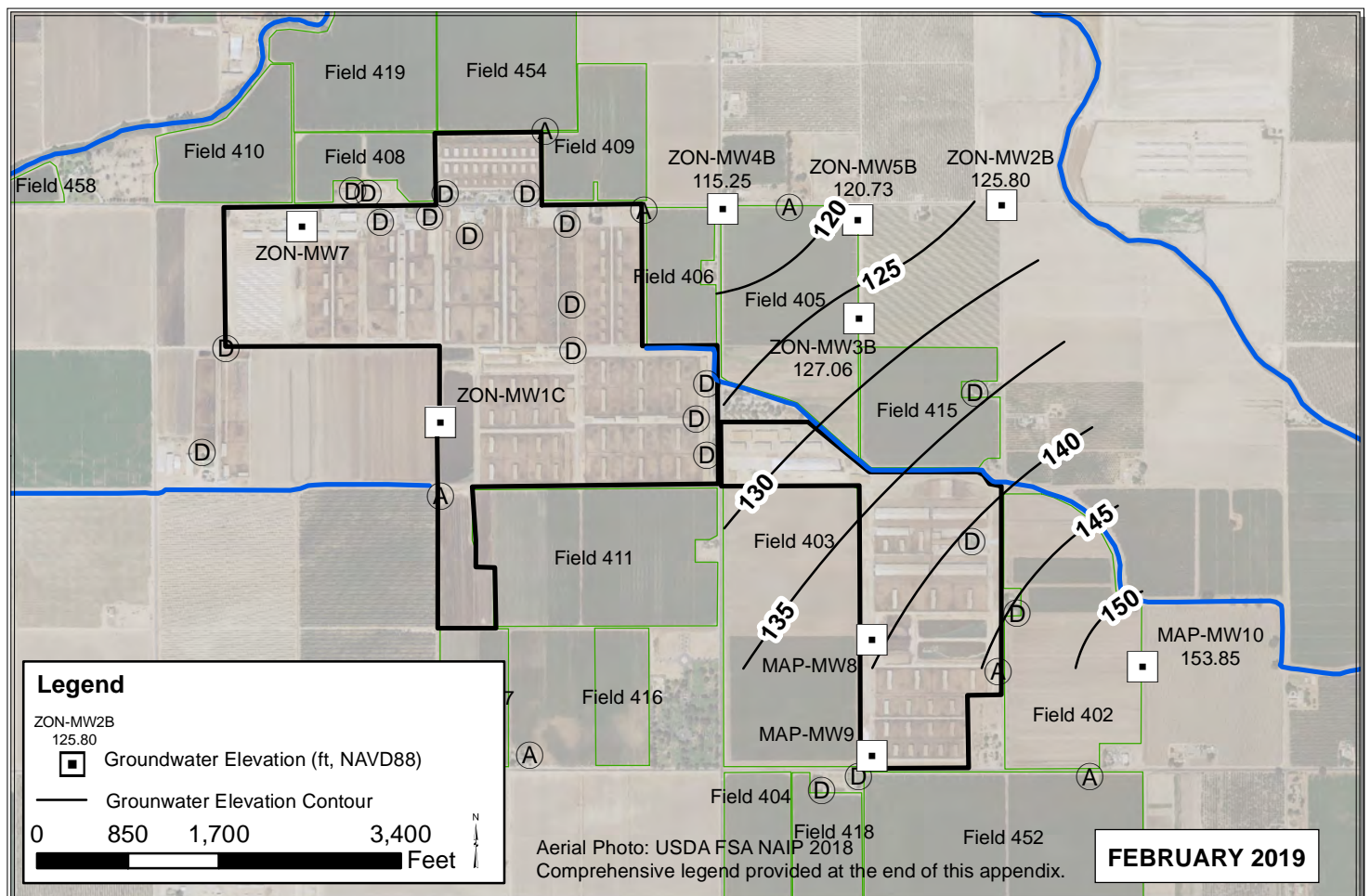
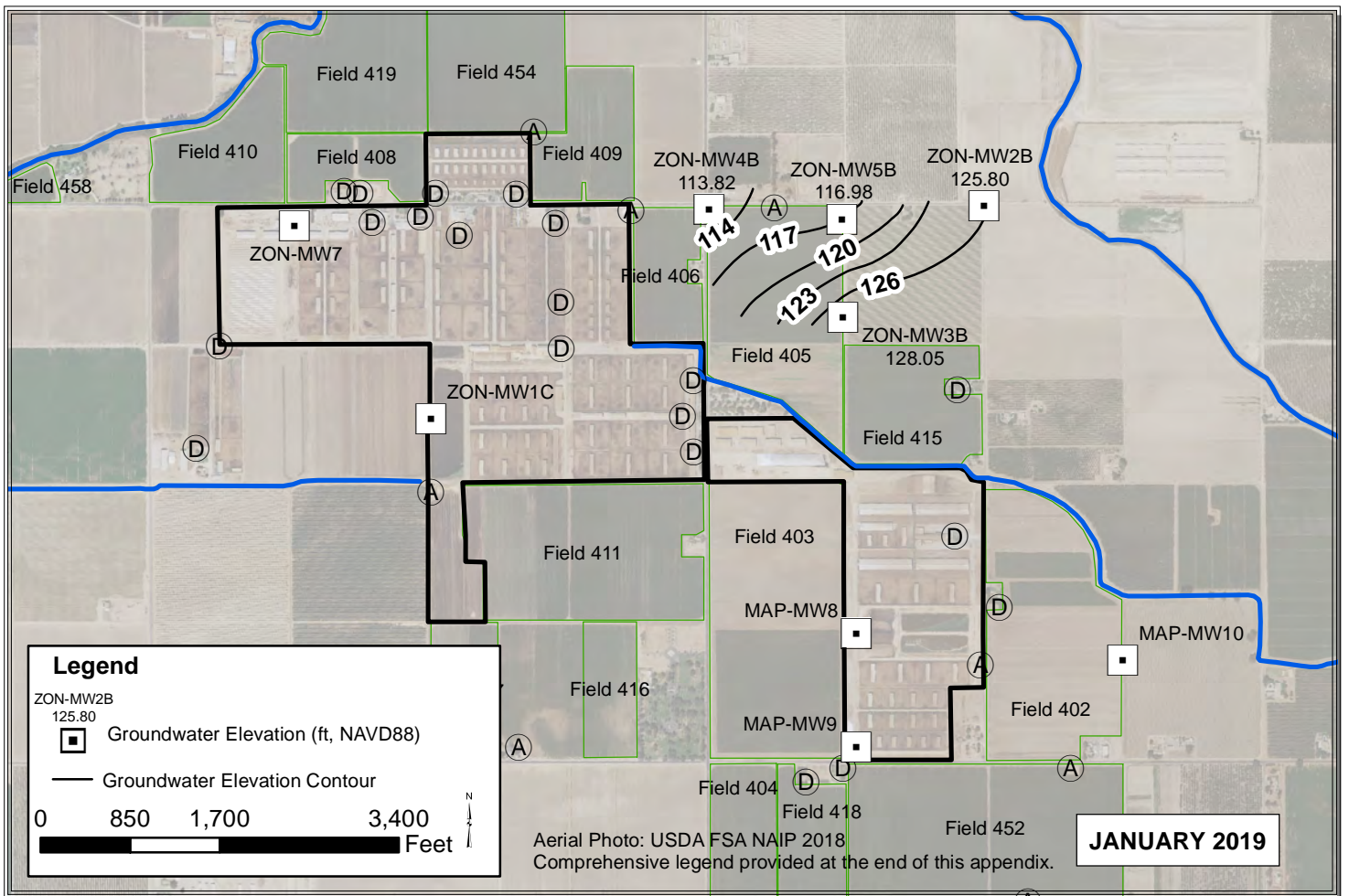

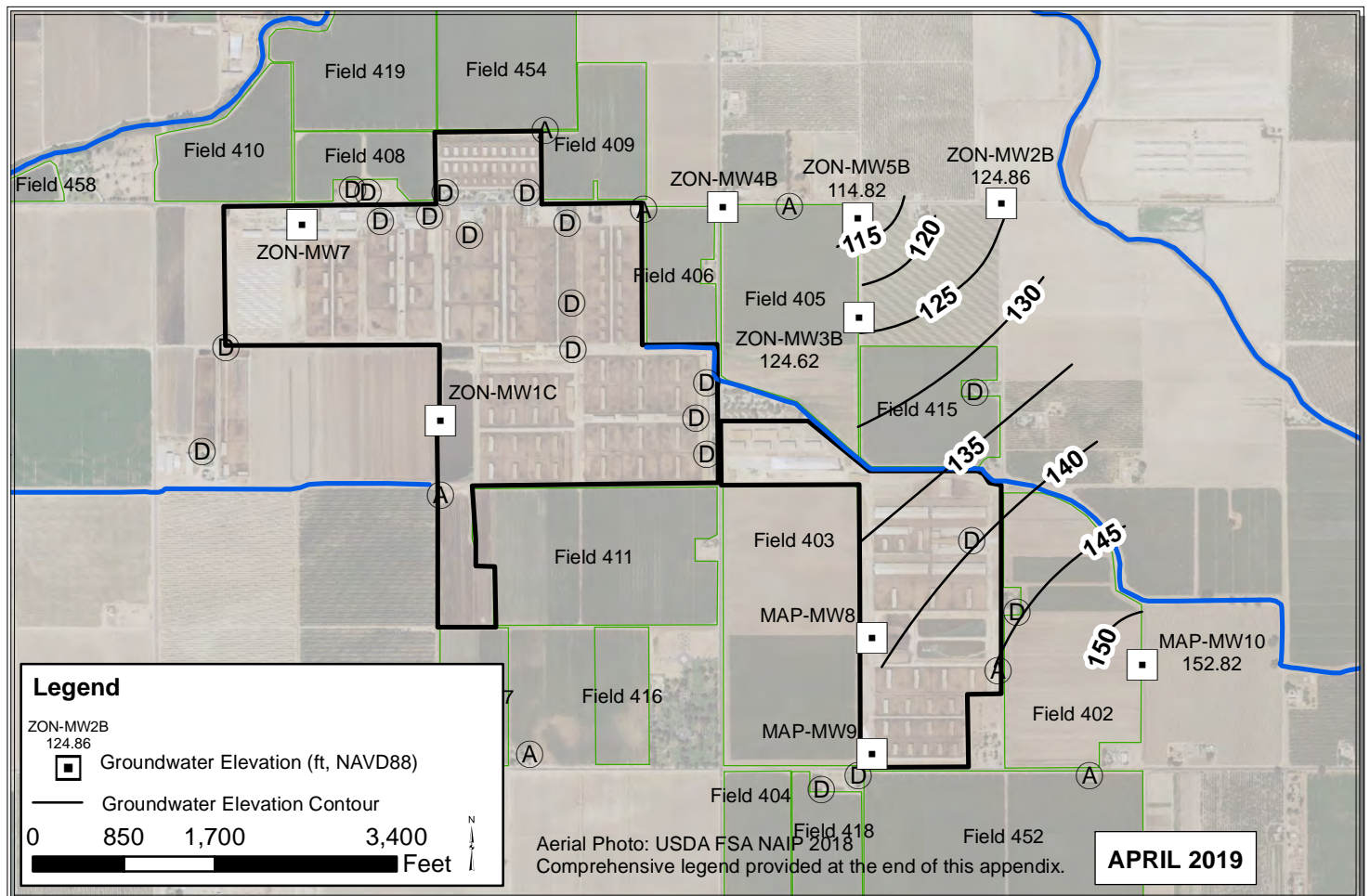
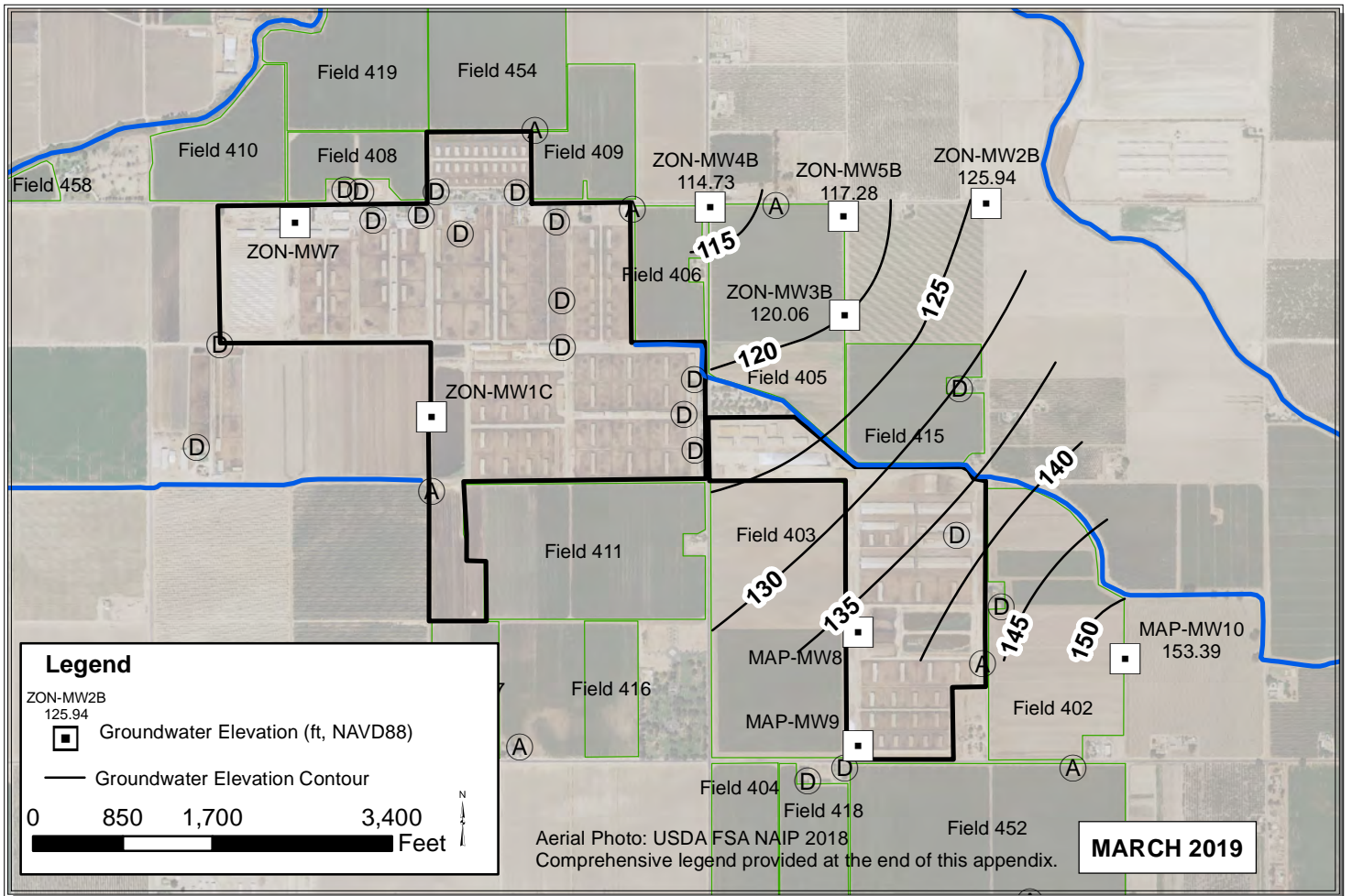

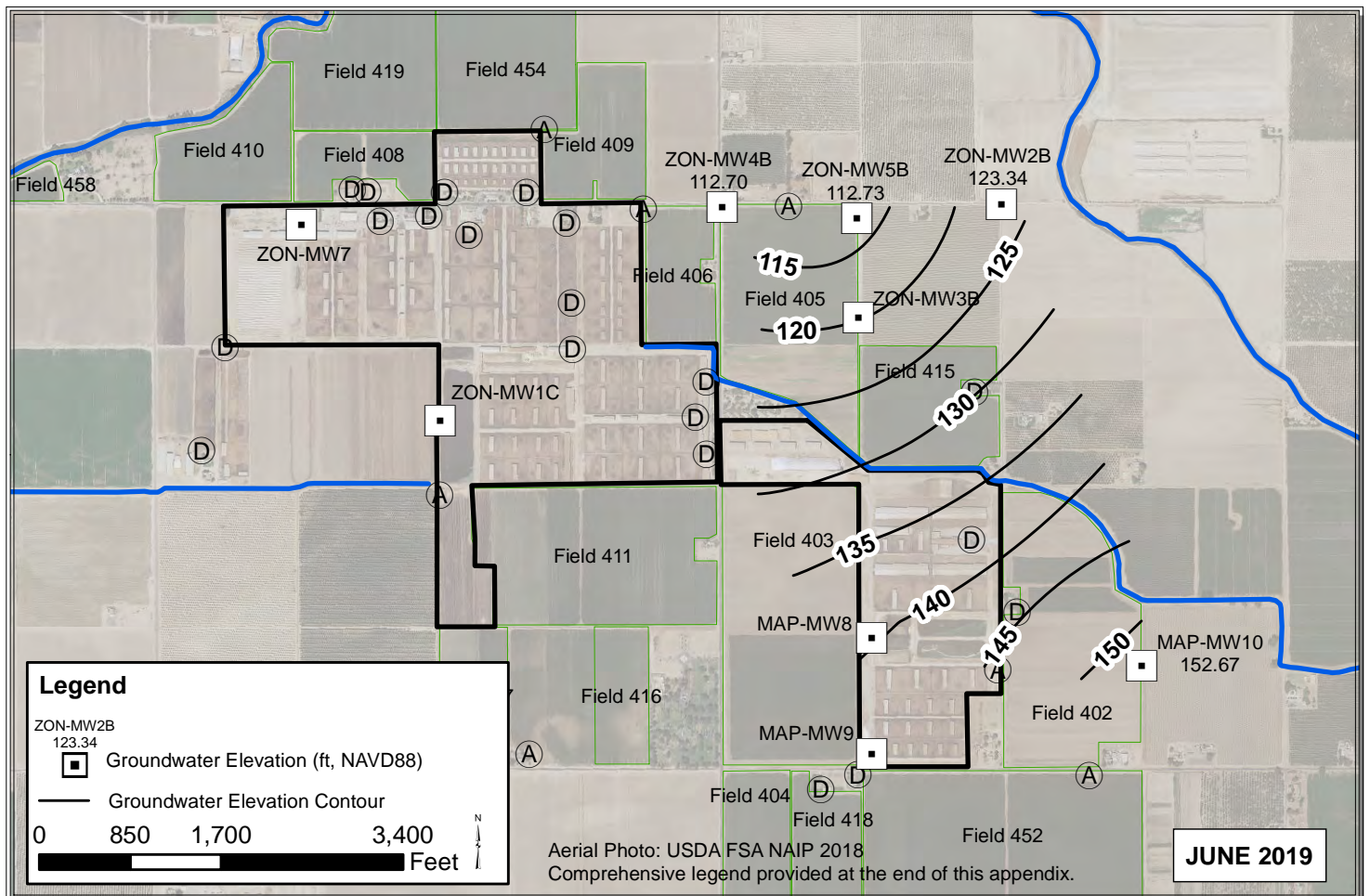
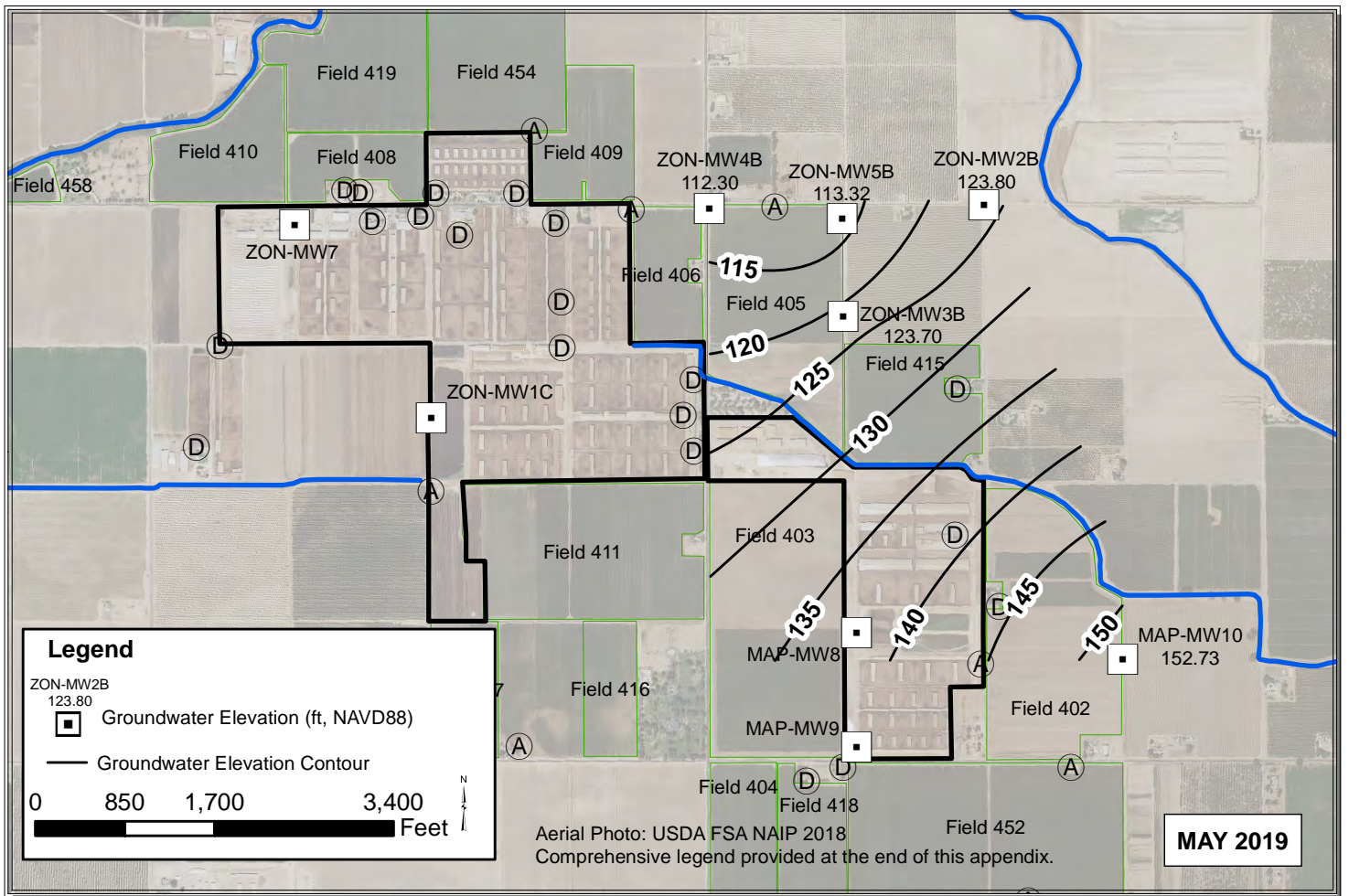

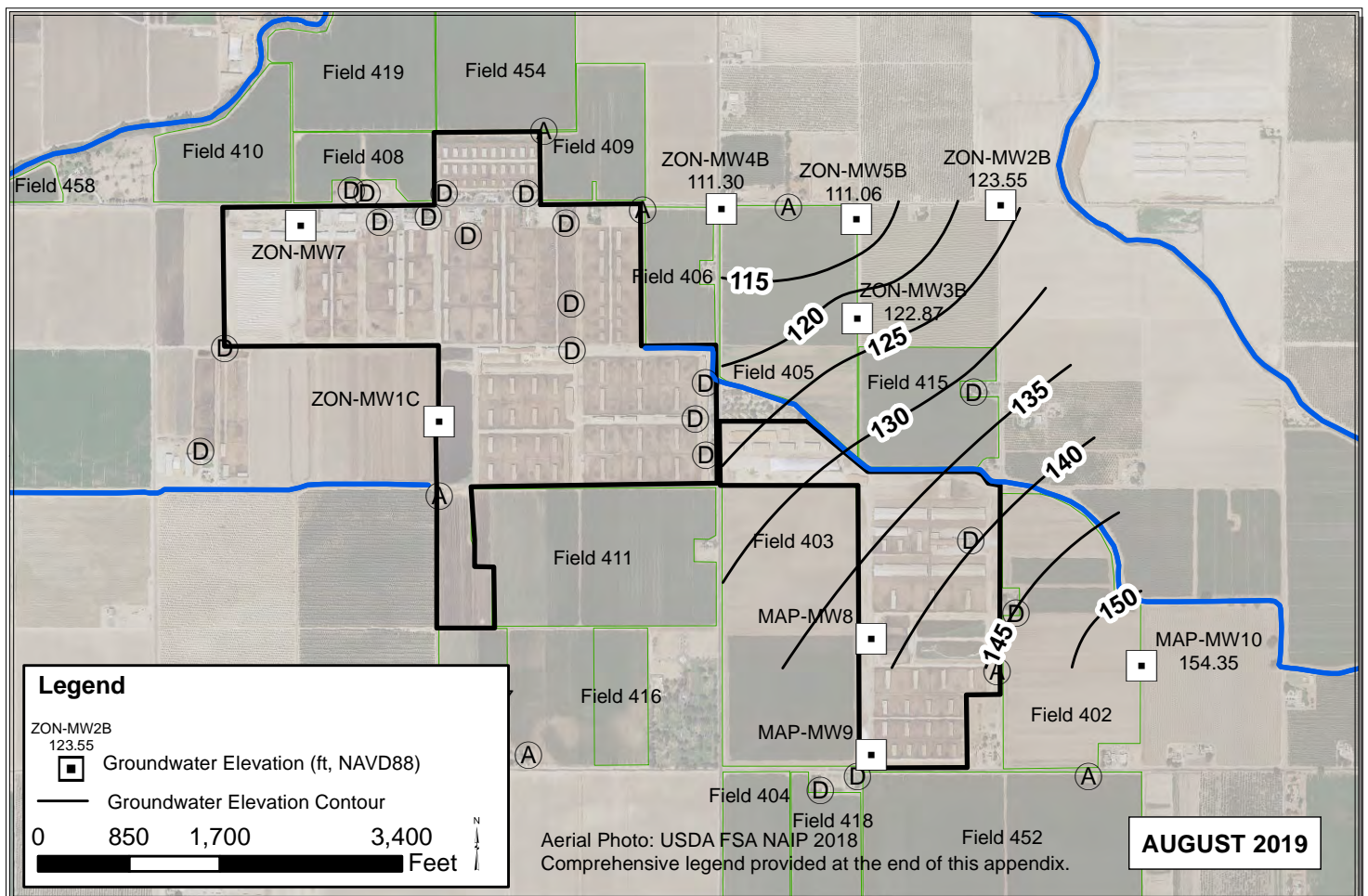
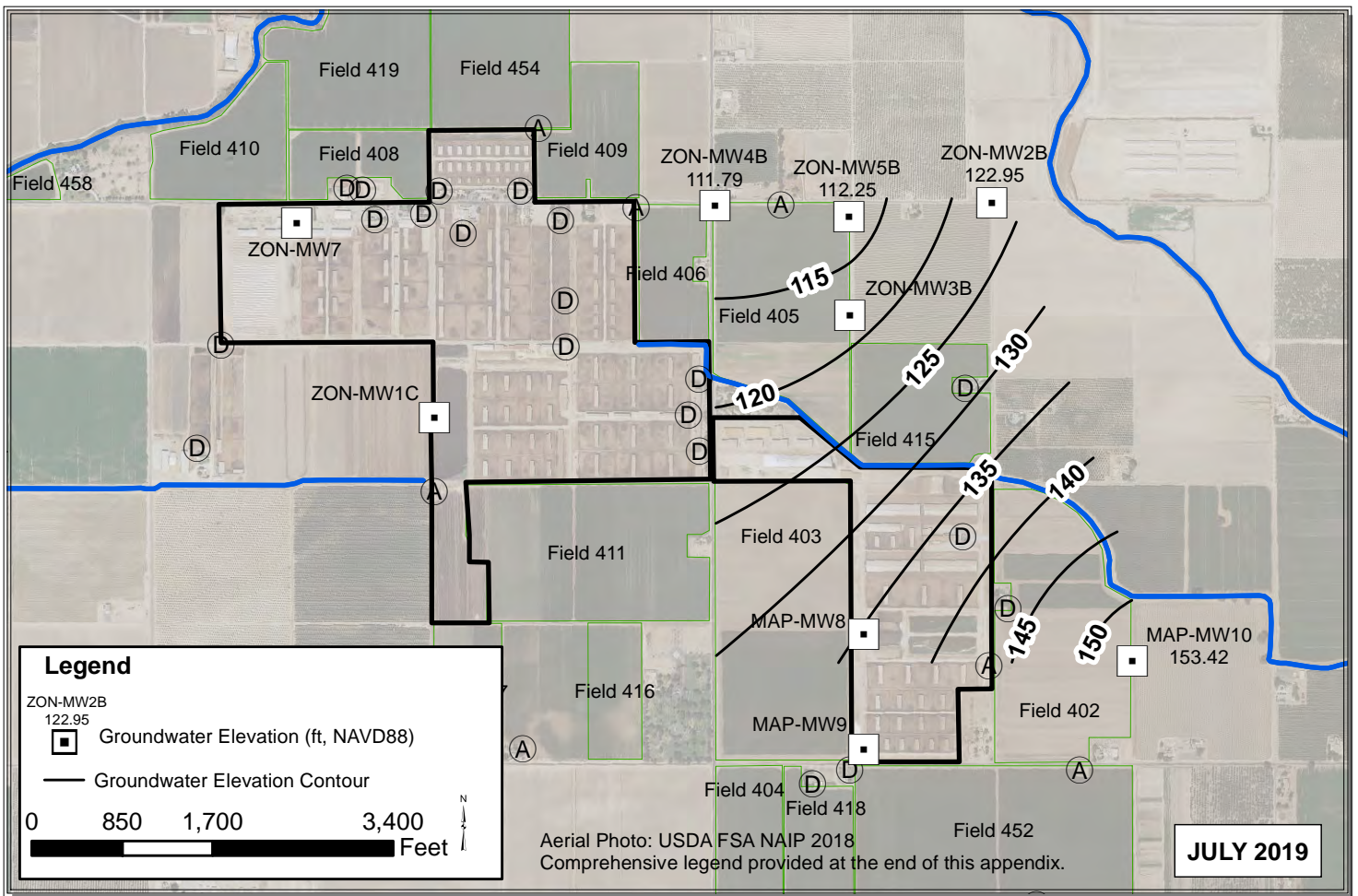

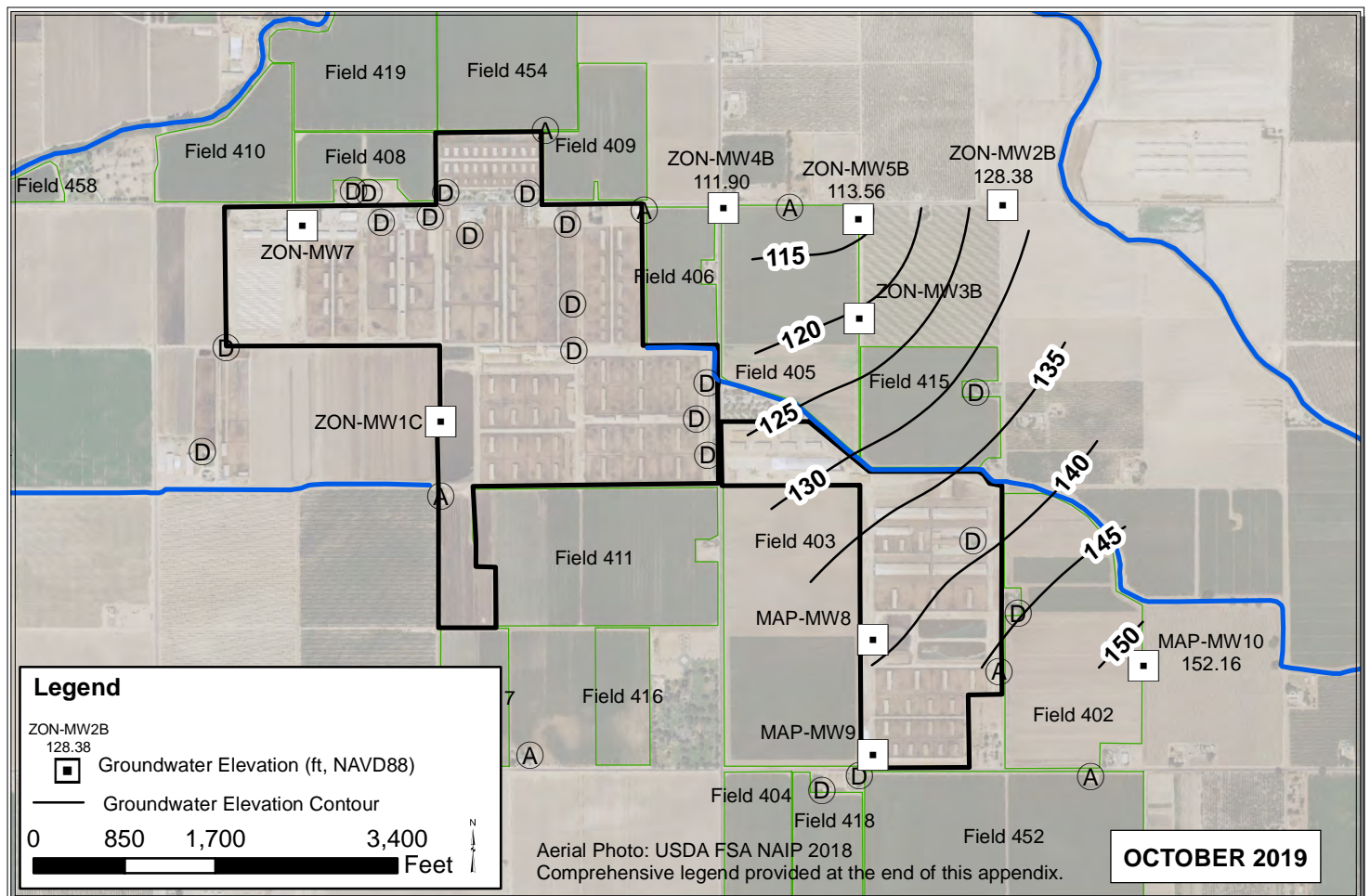
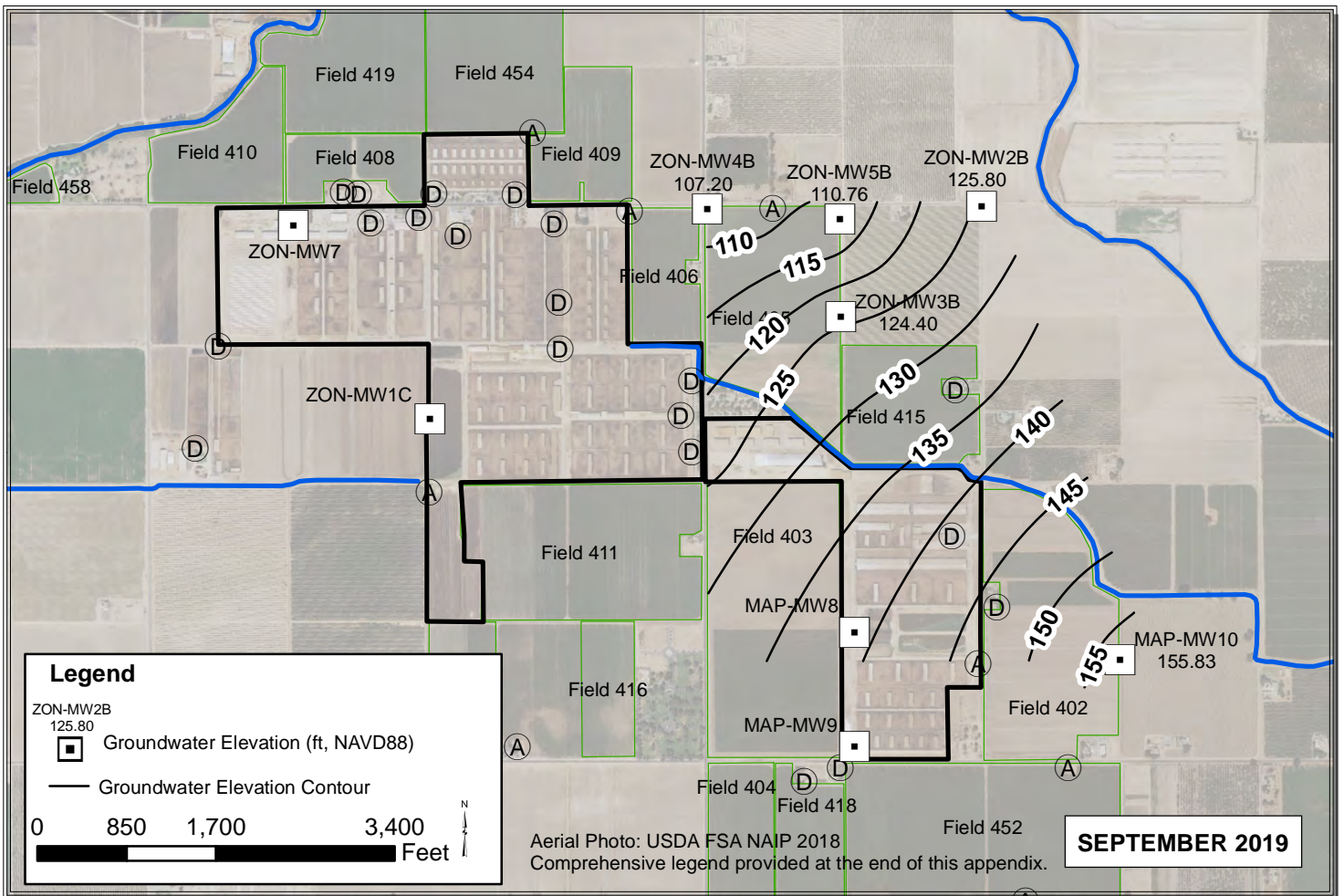

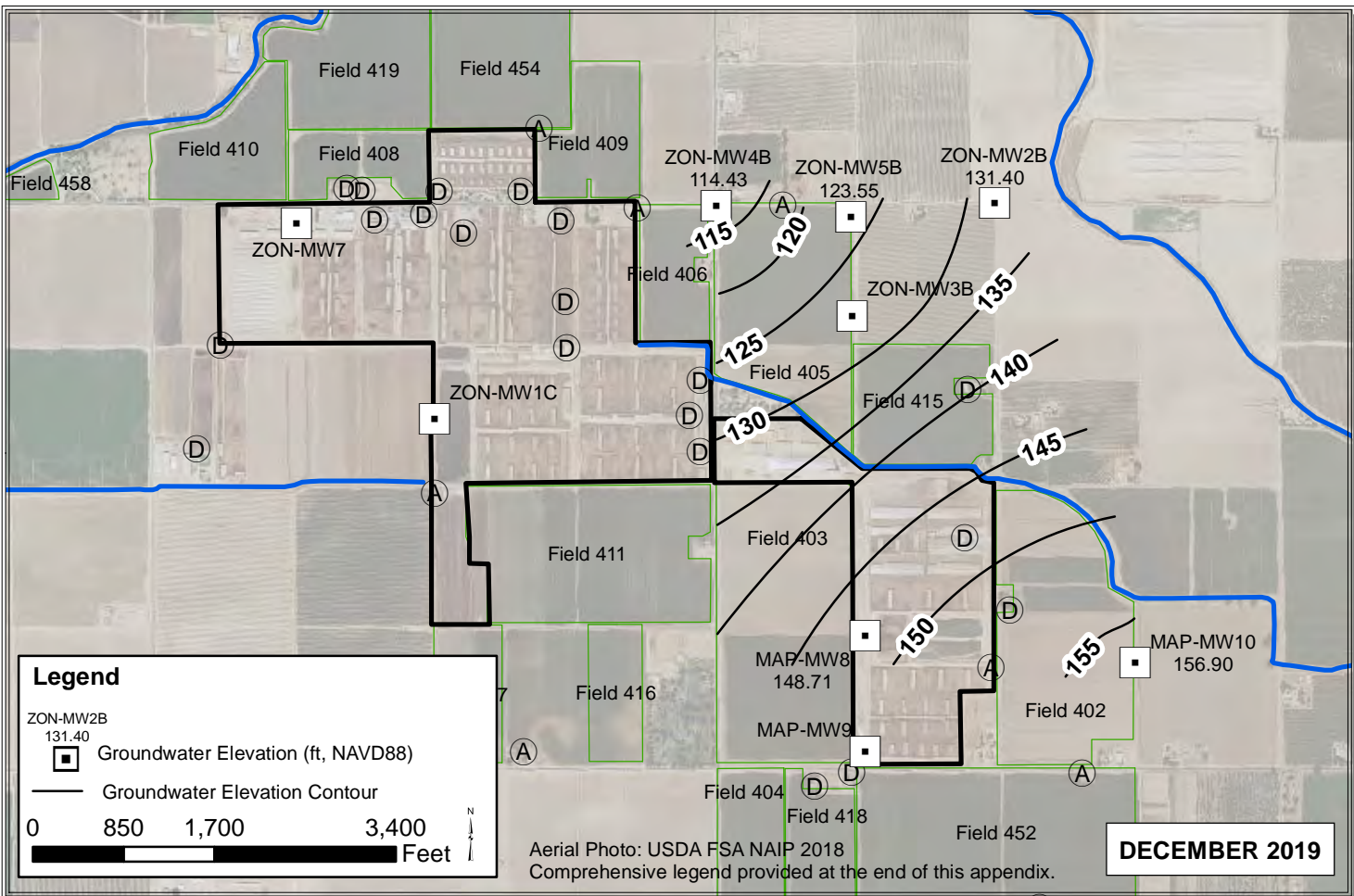
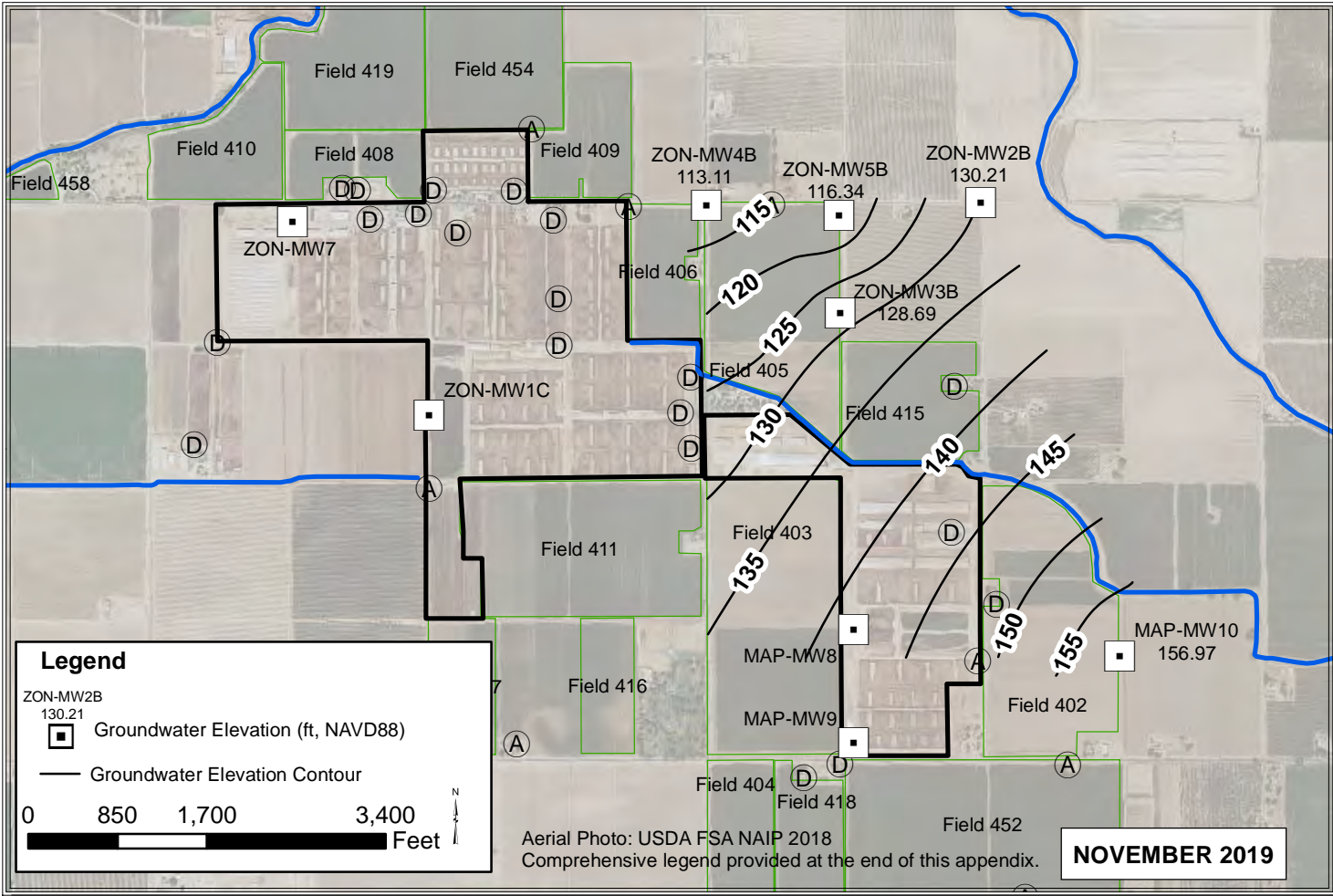

RIC

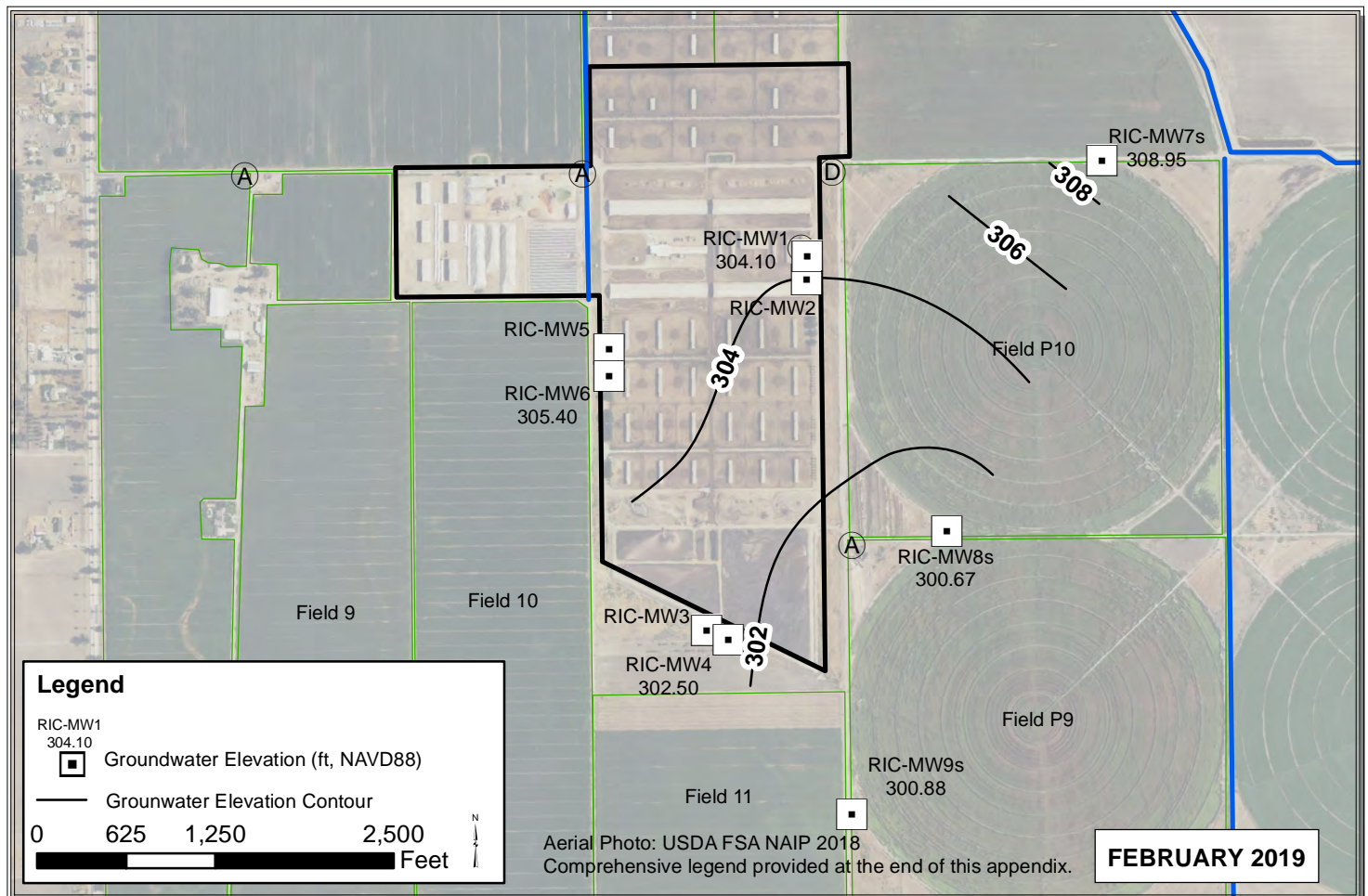
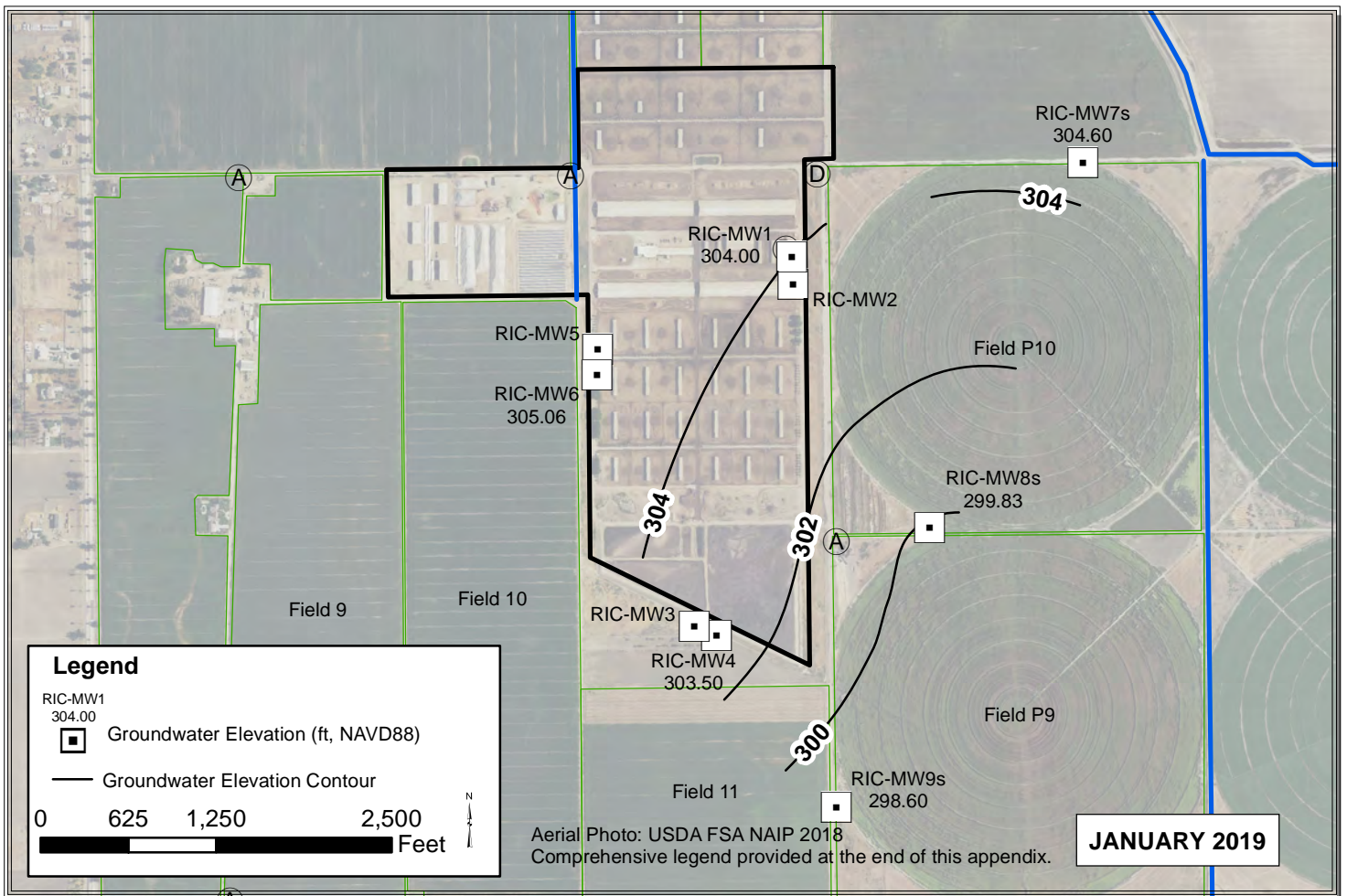

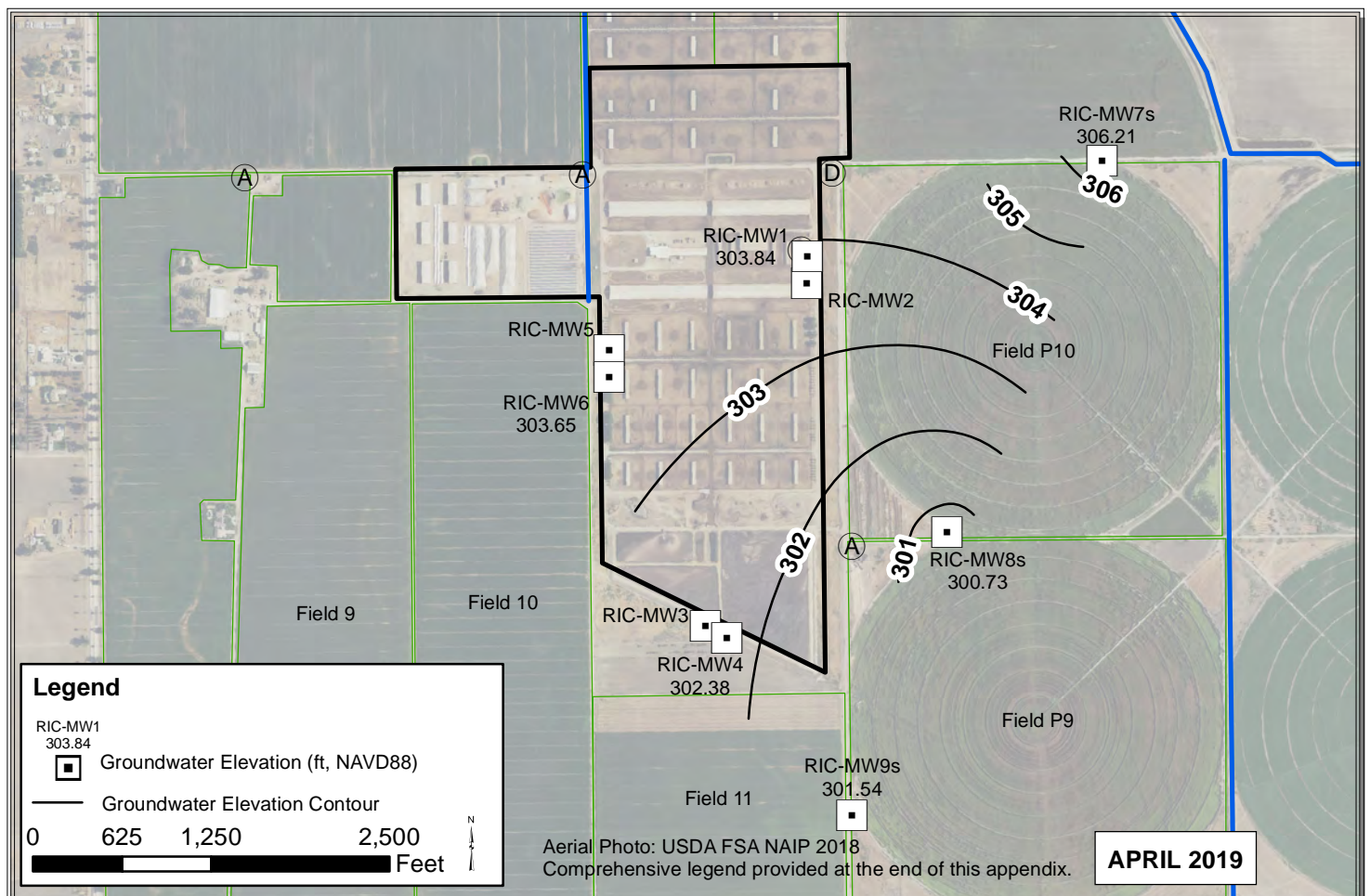
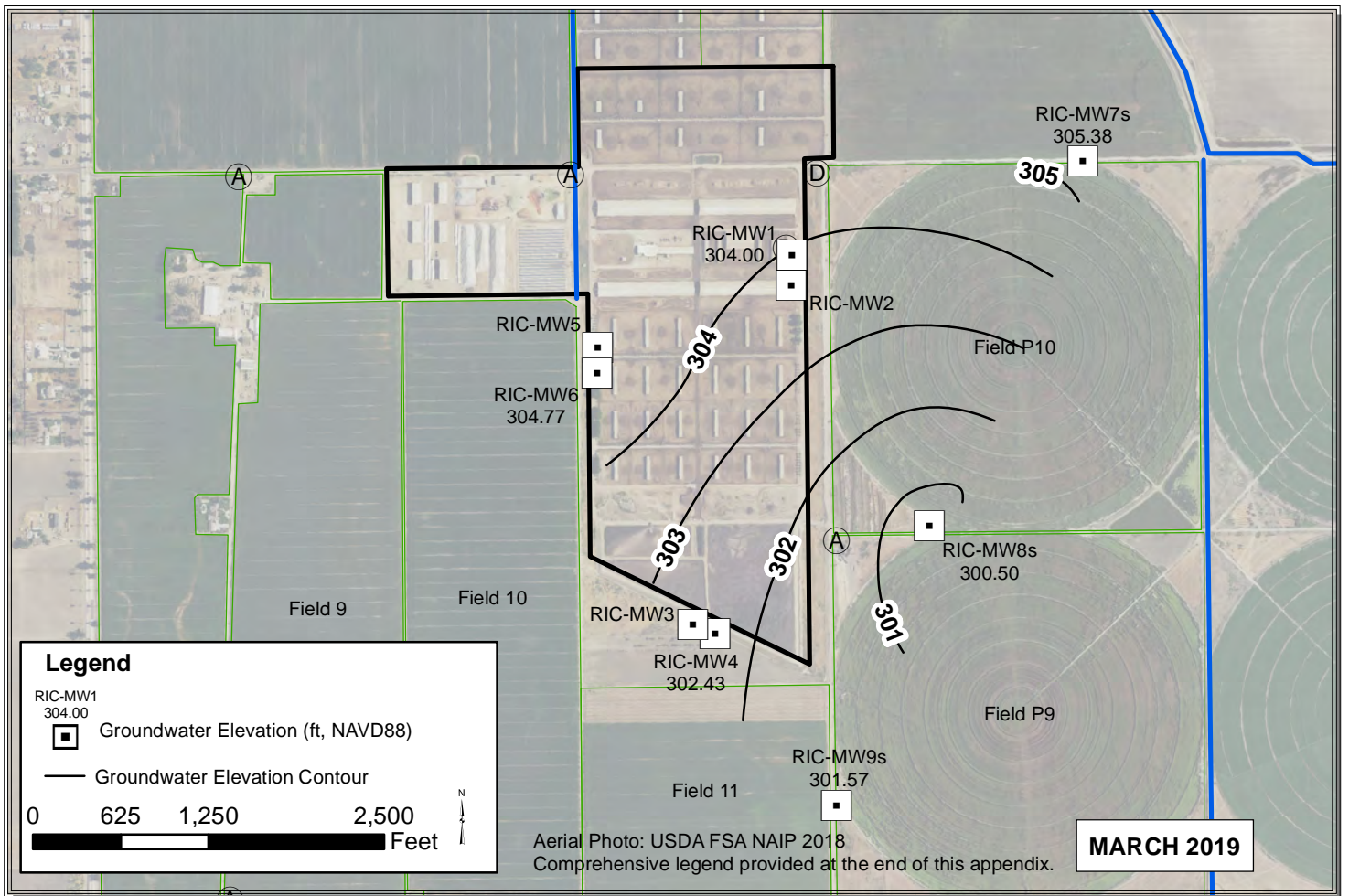

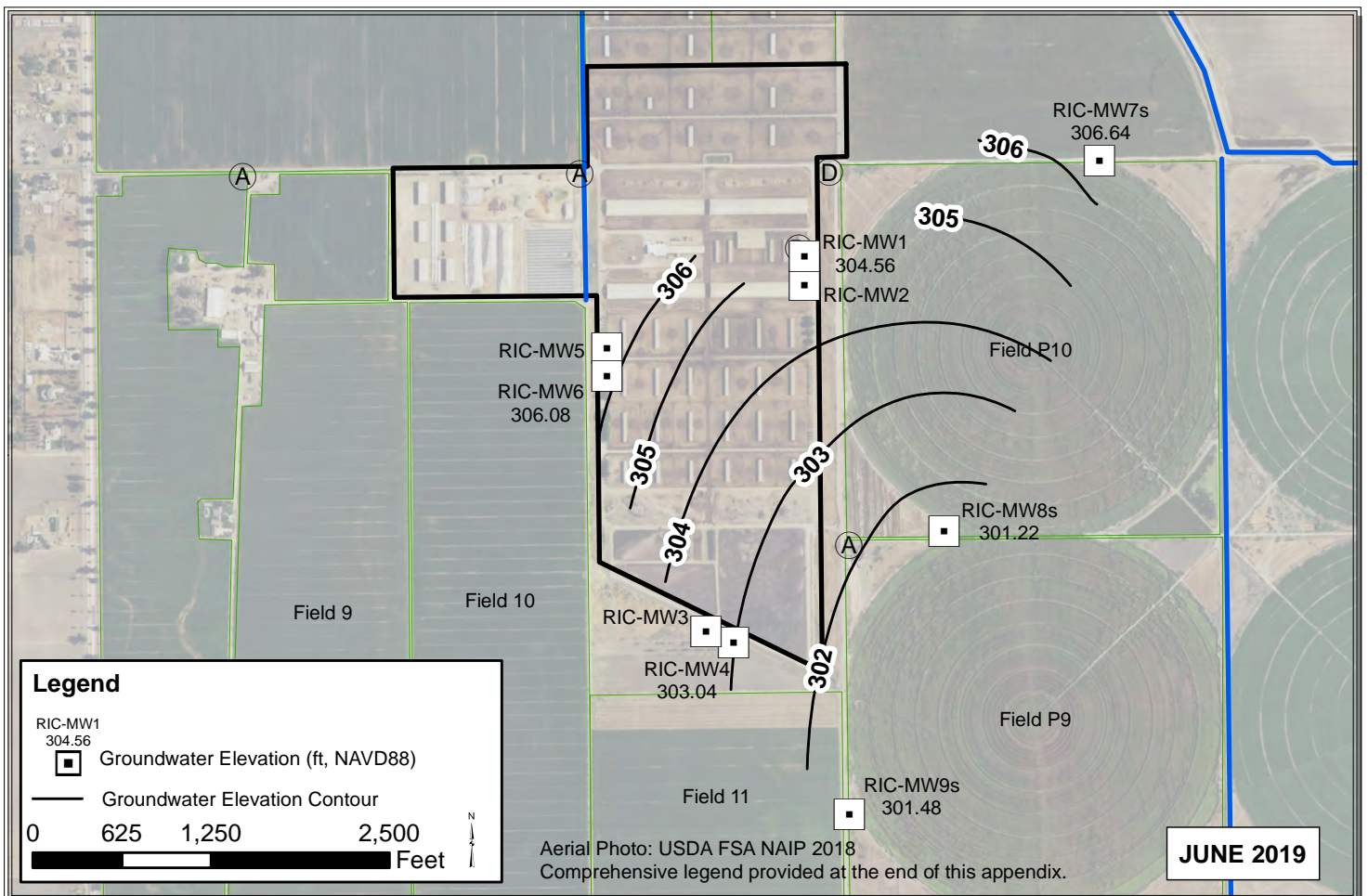
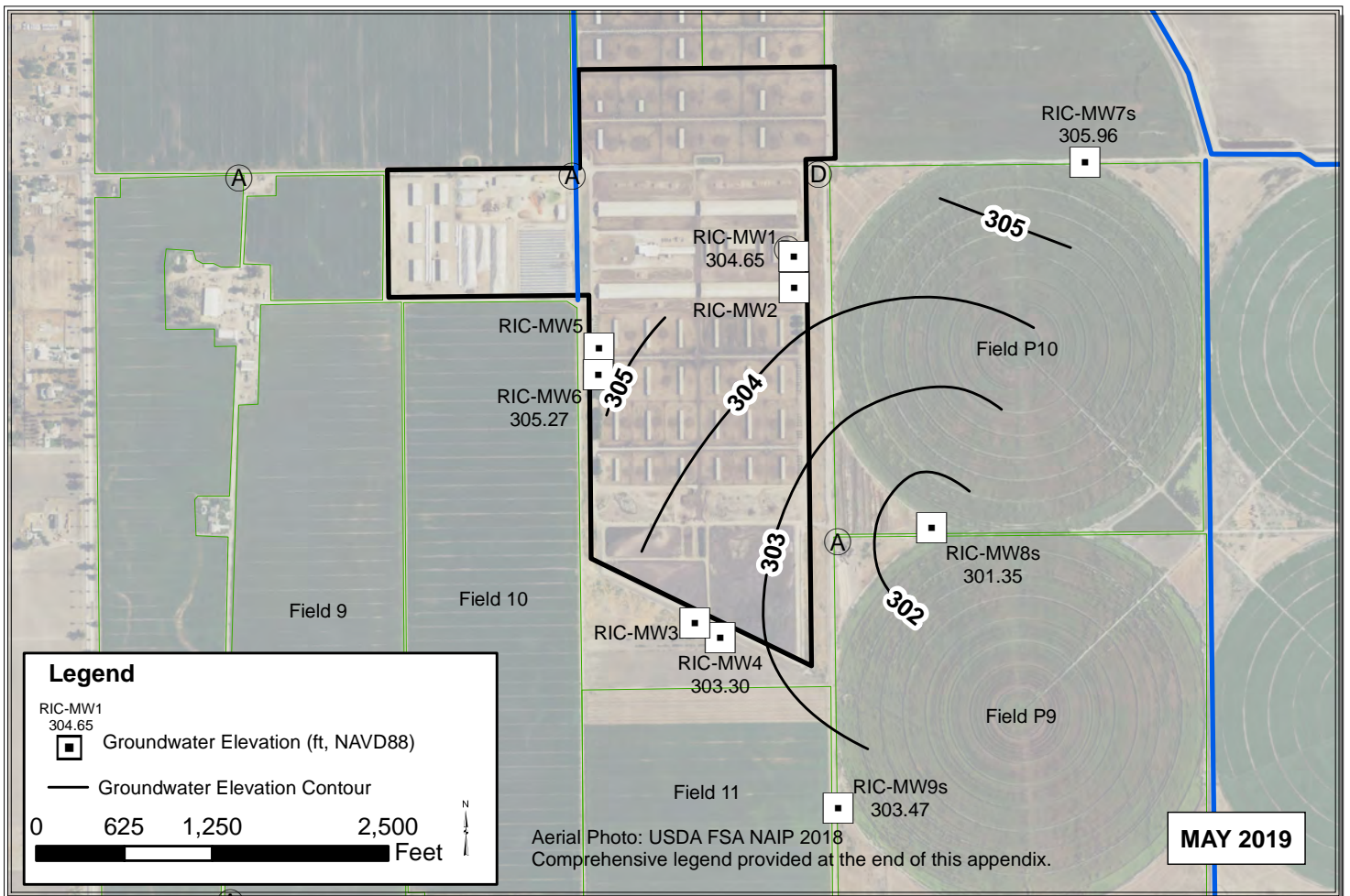

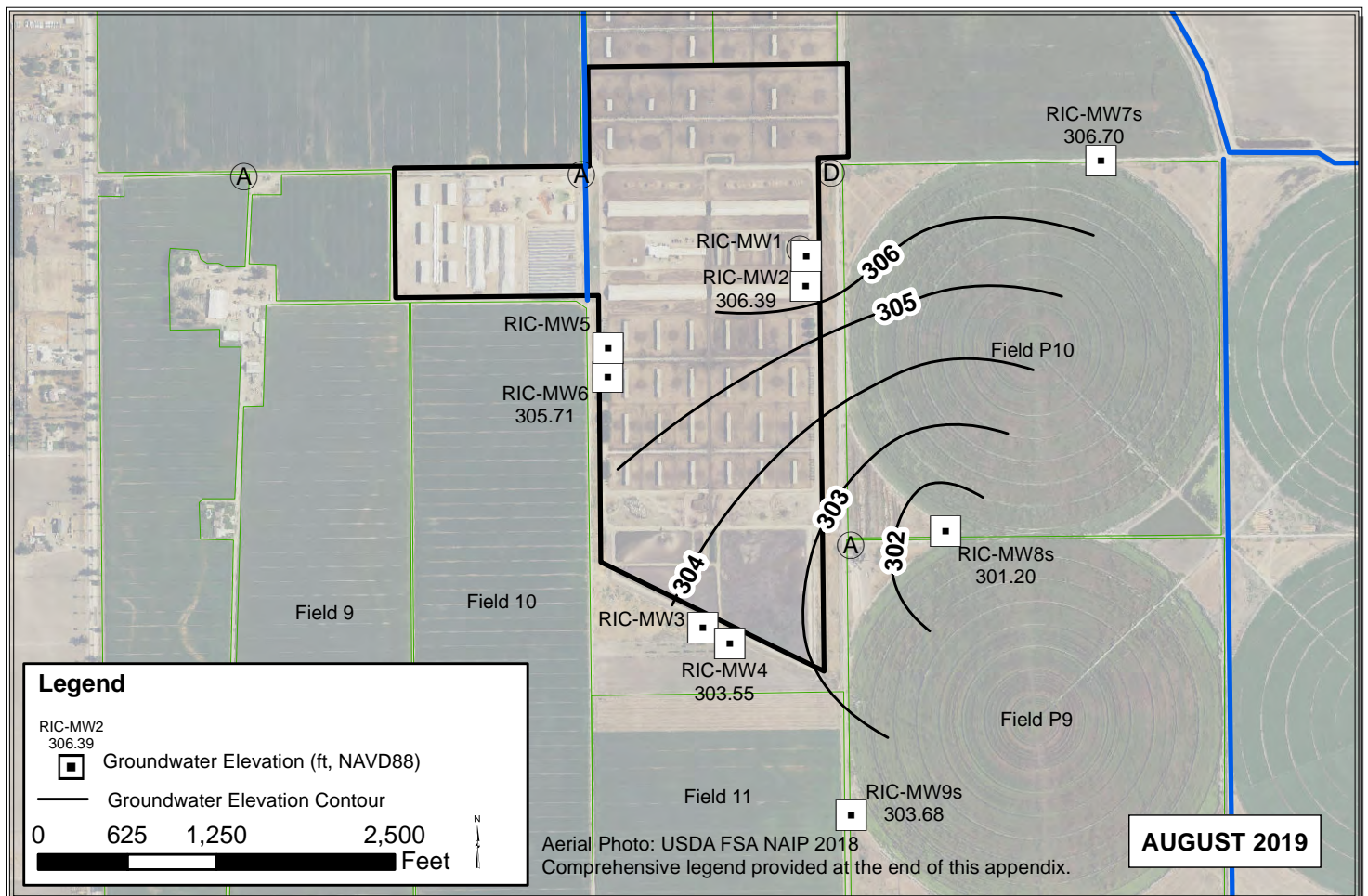
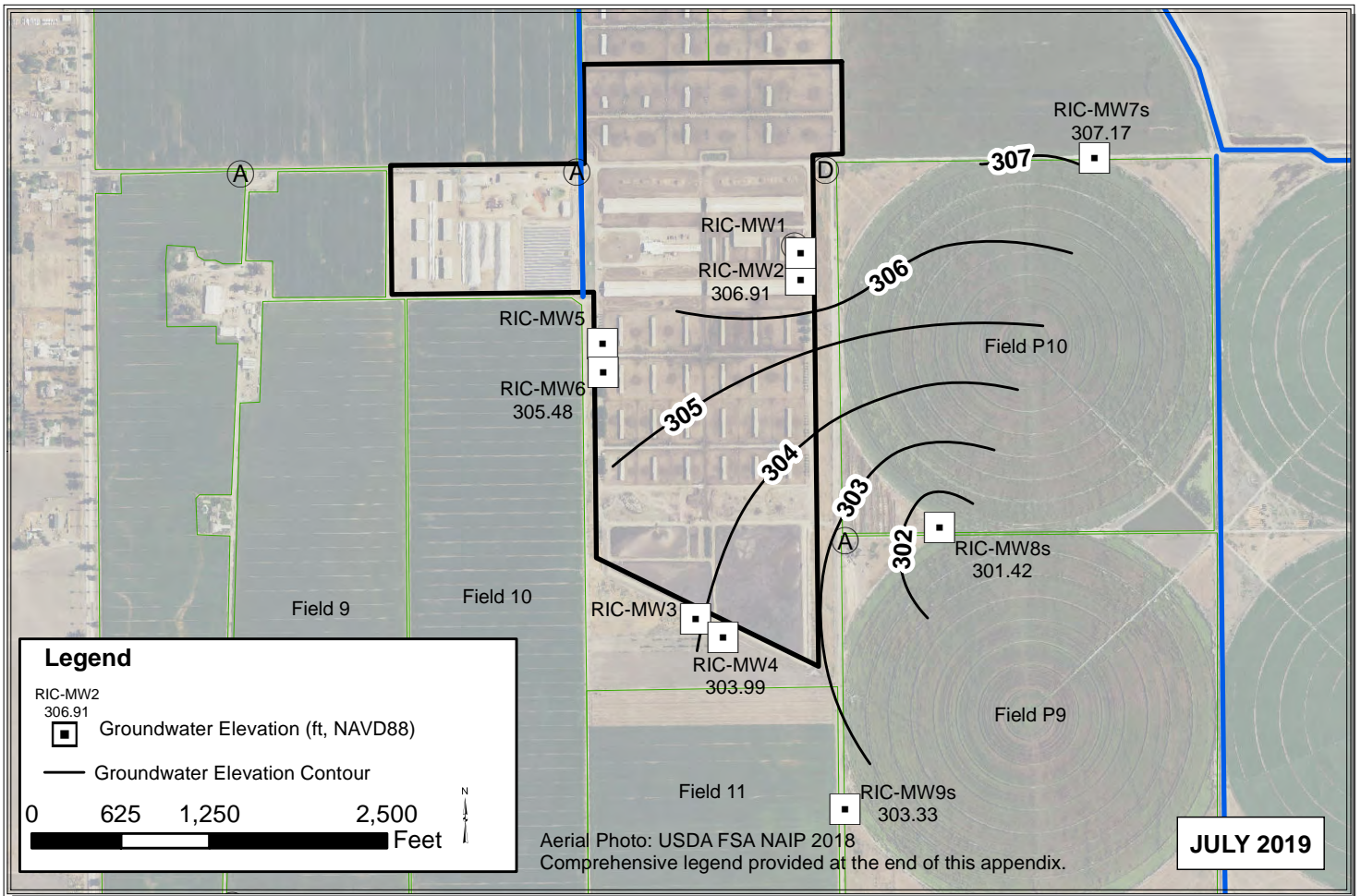

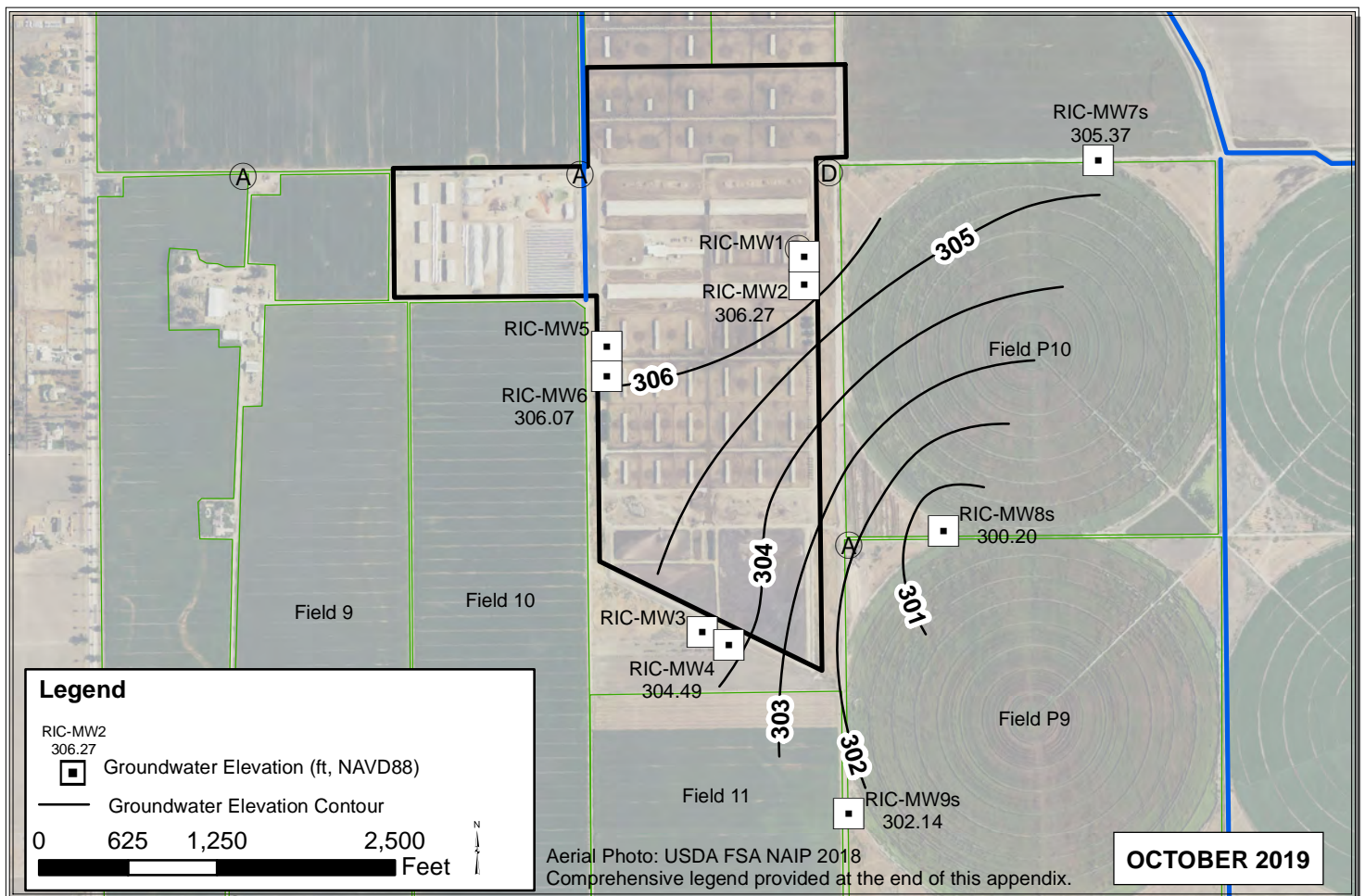
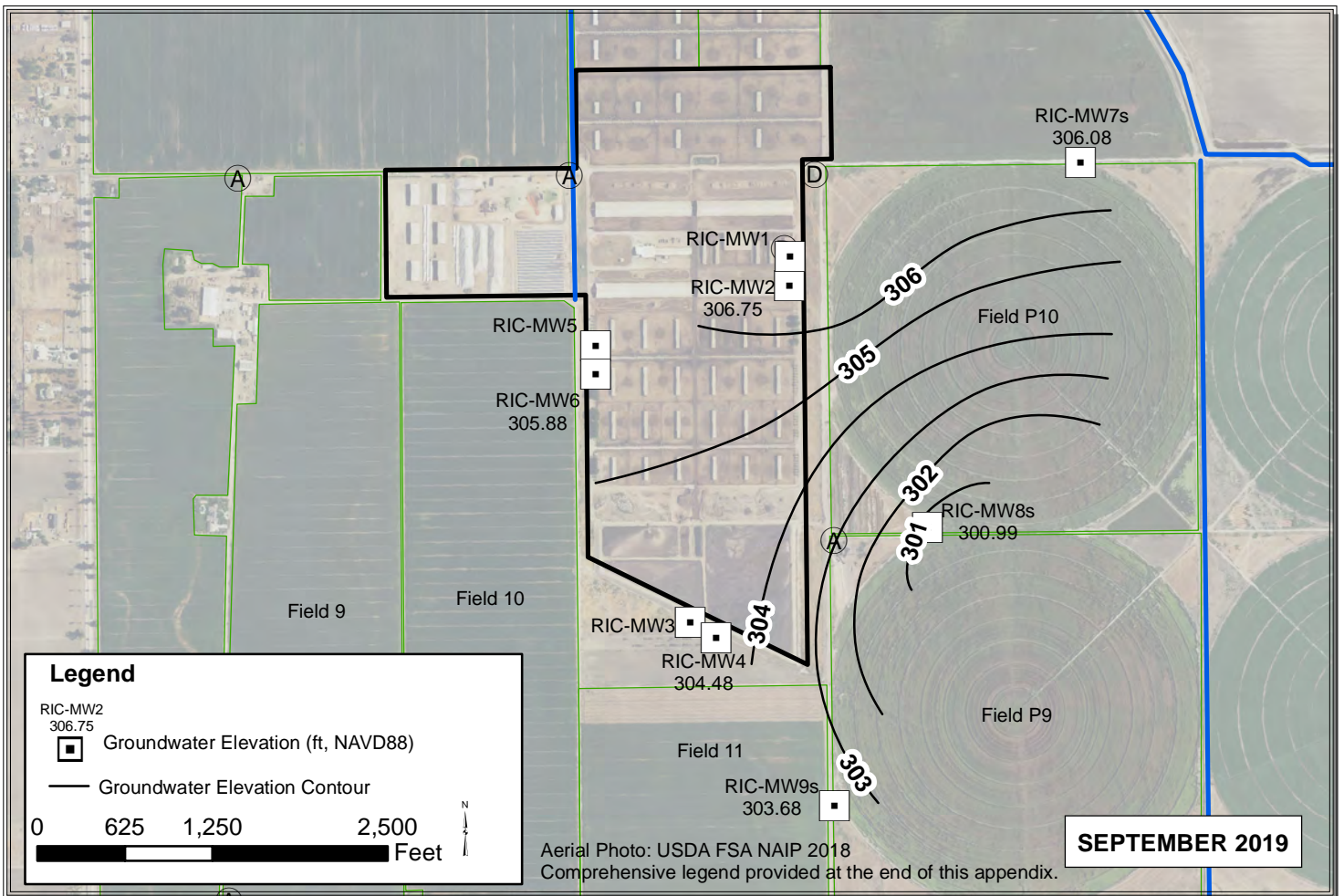

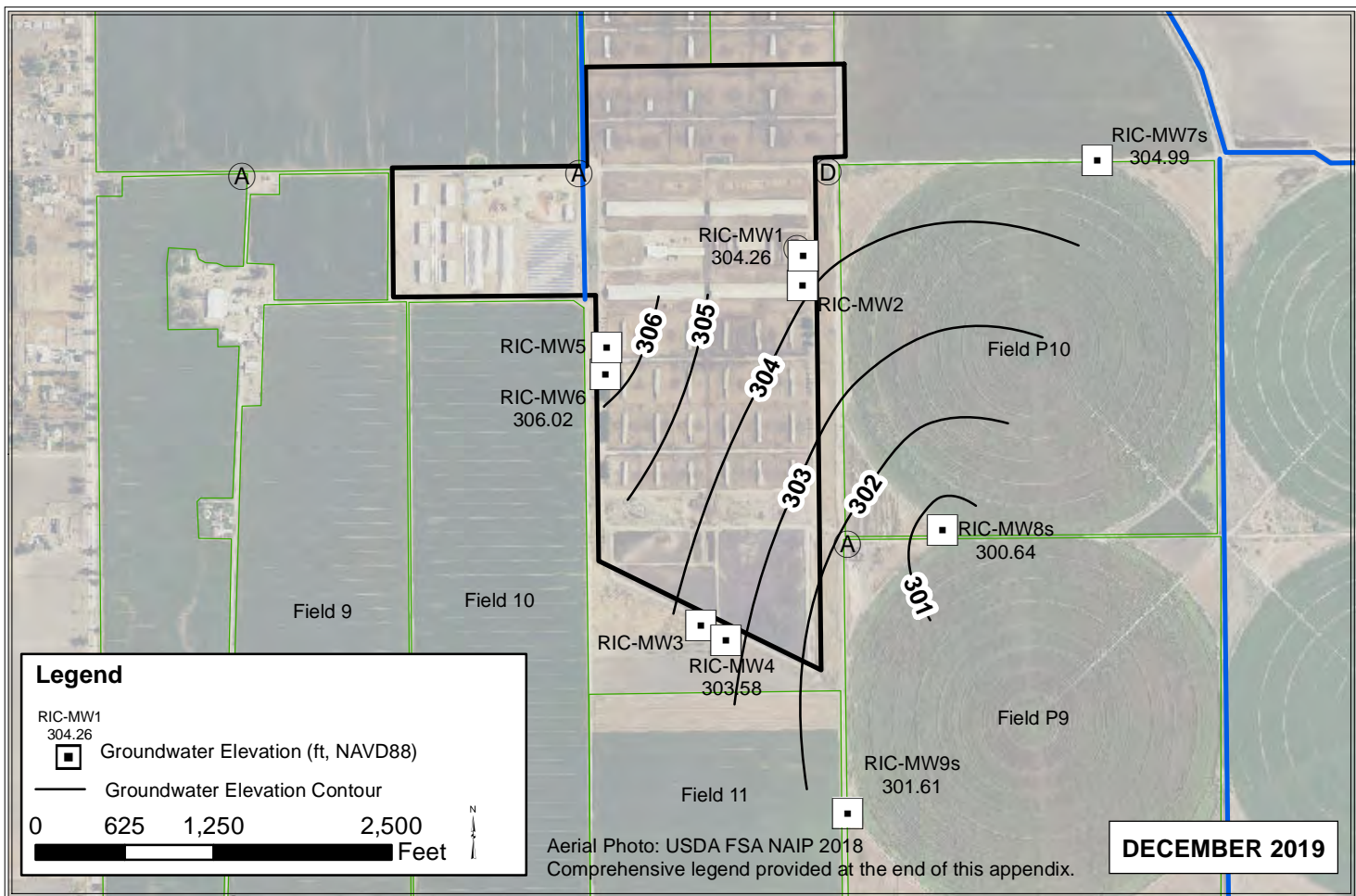
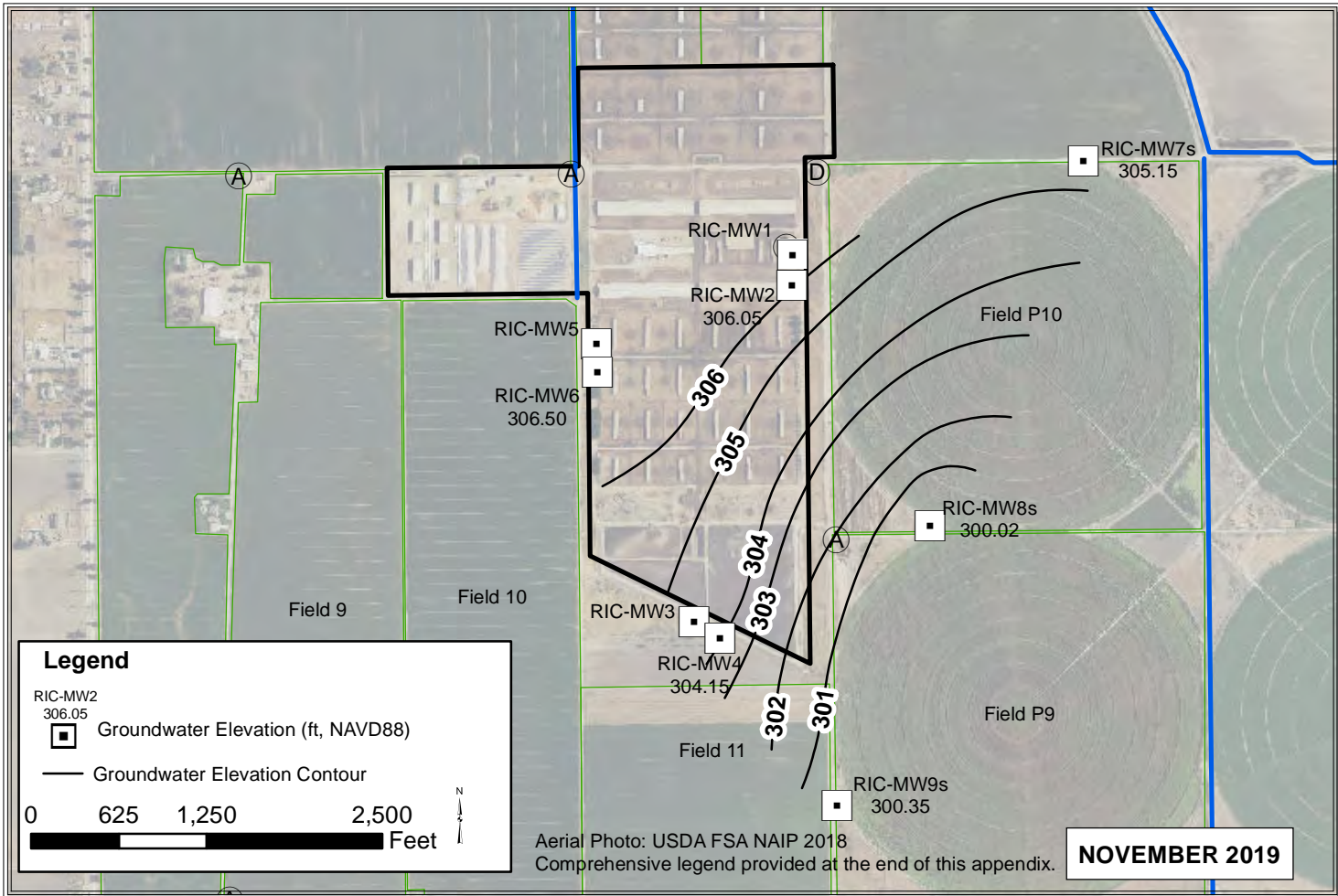

SIE

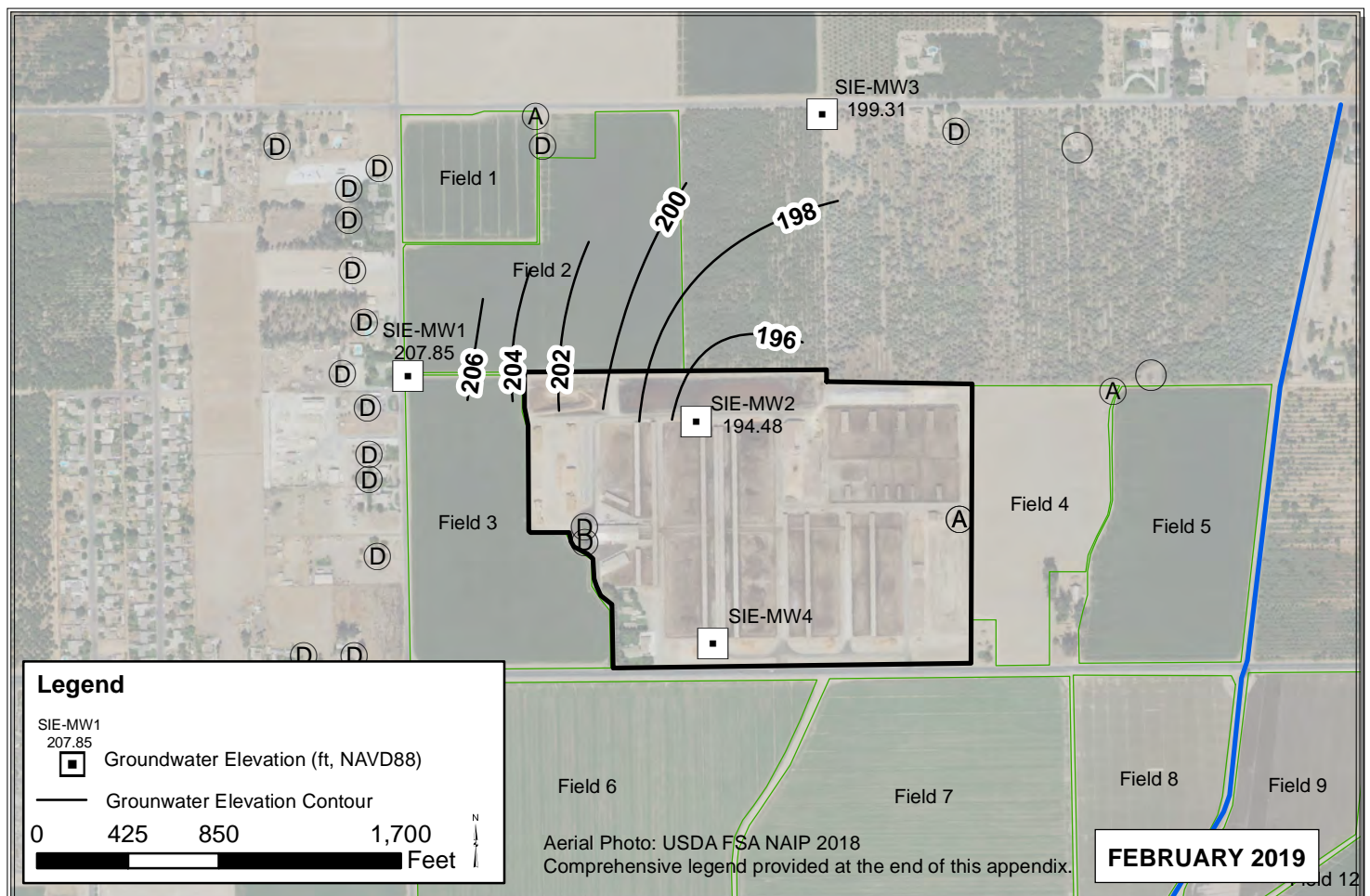
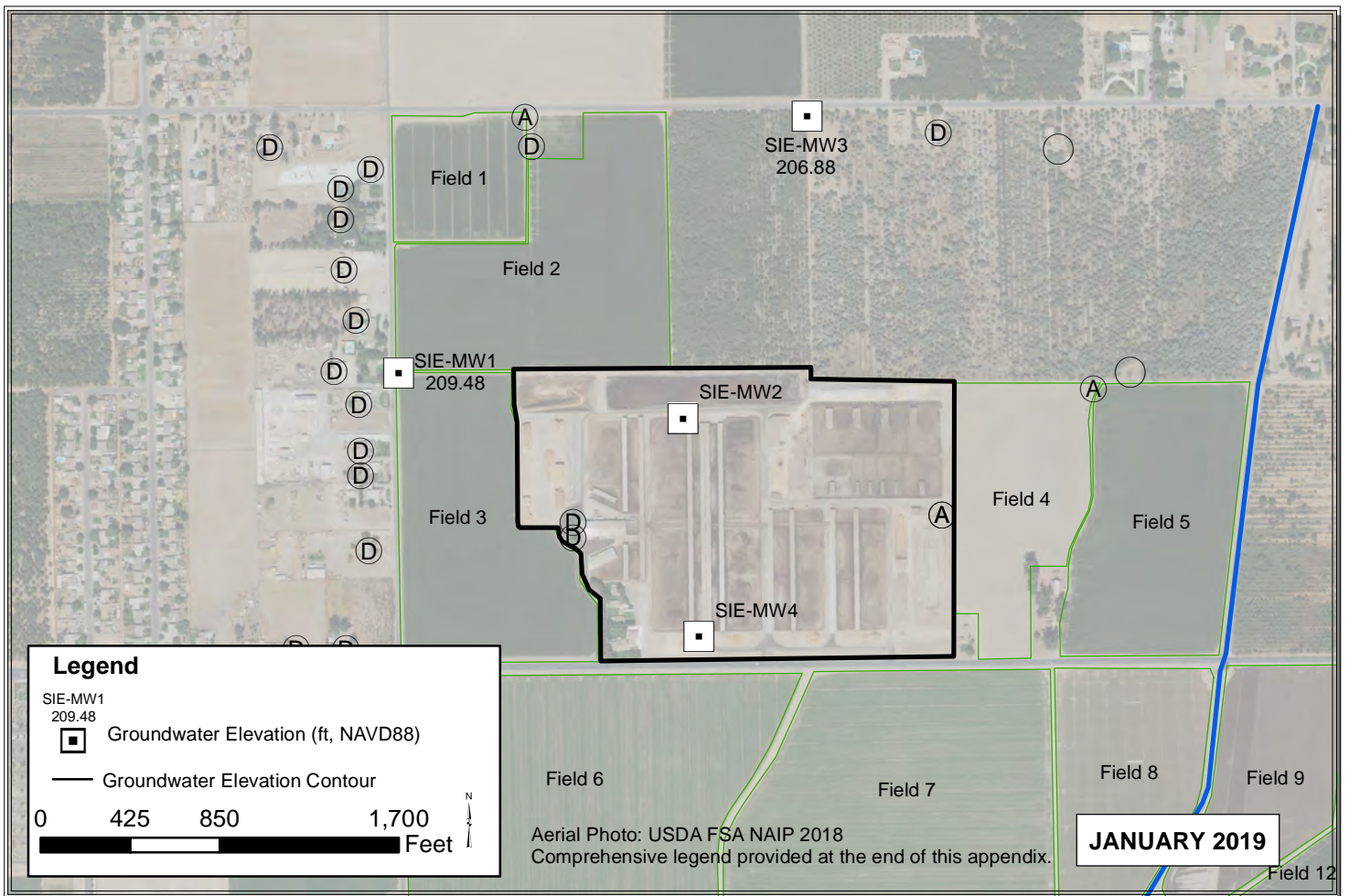

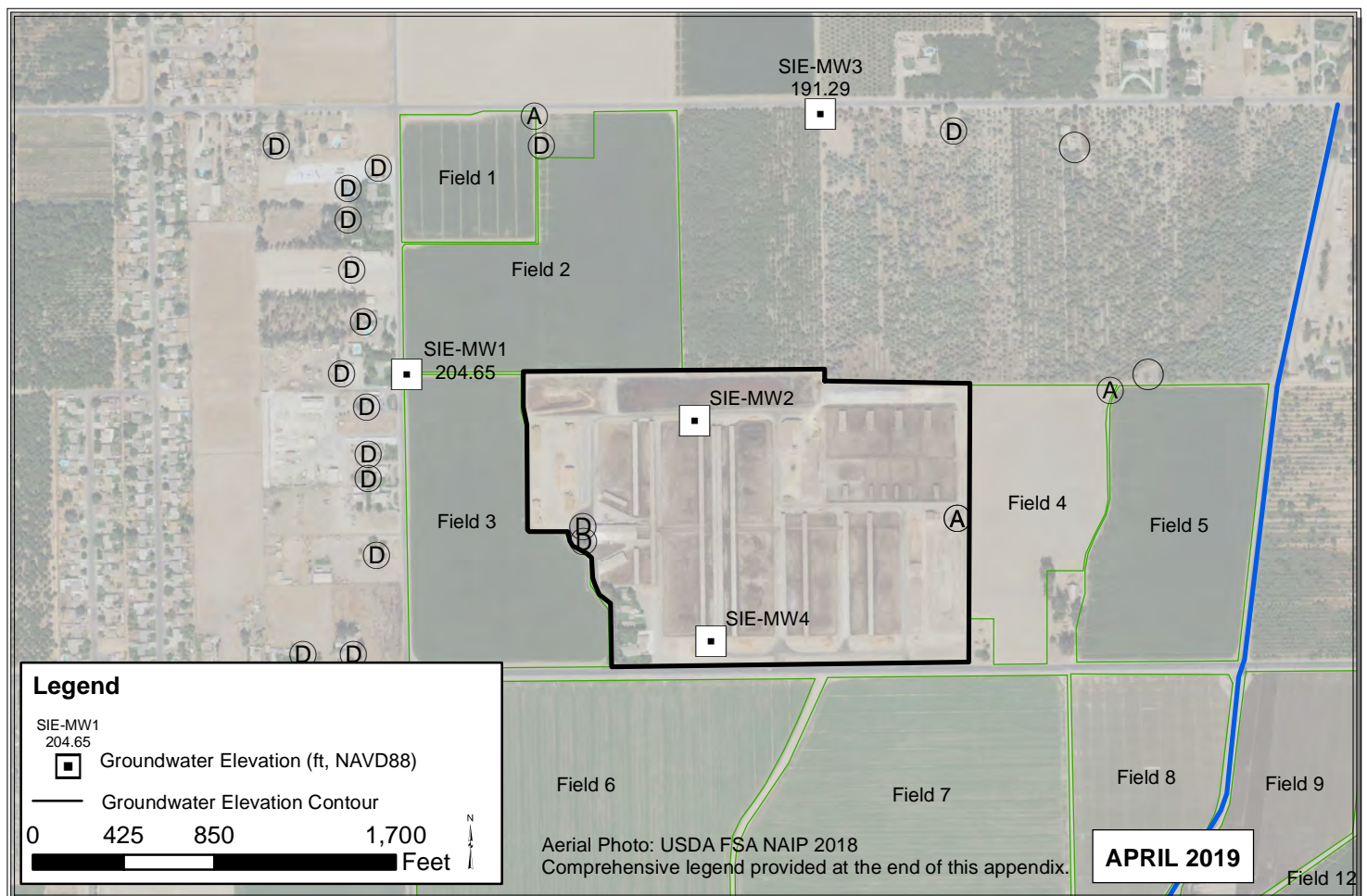
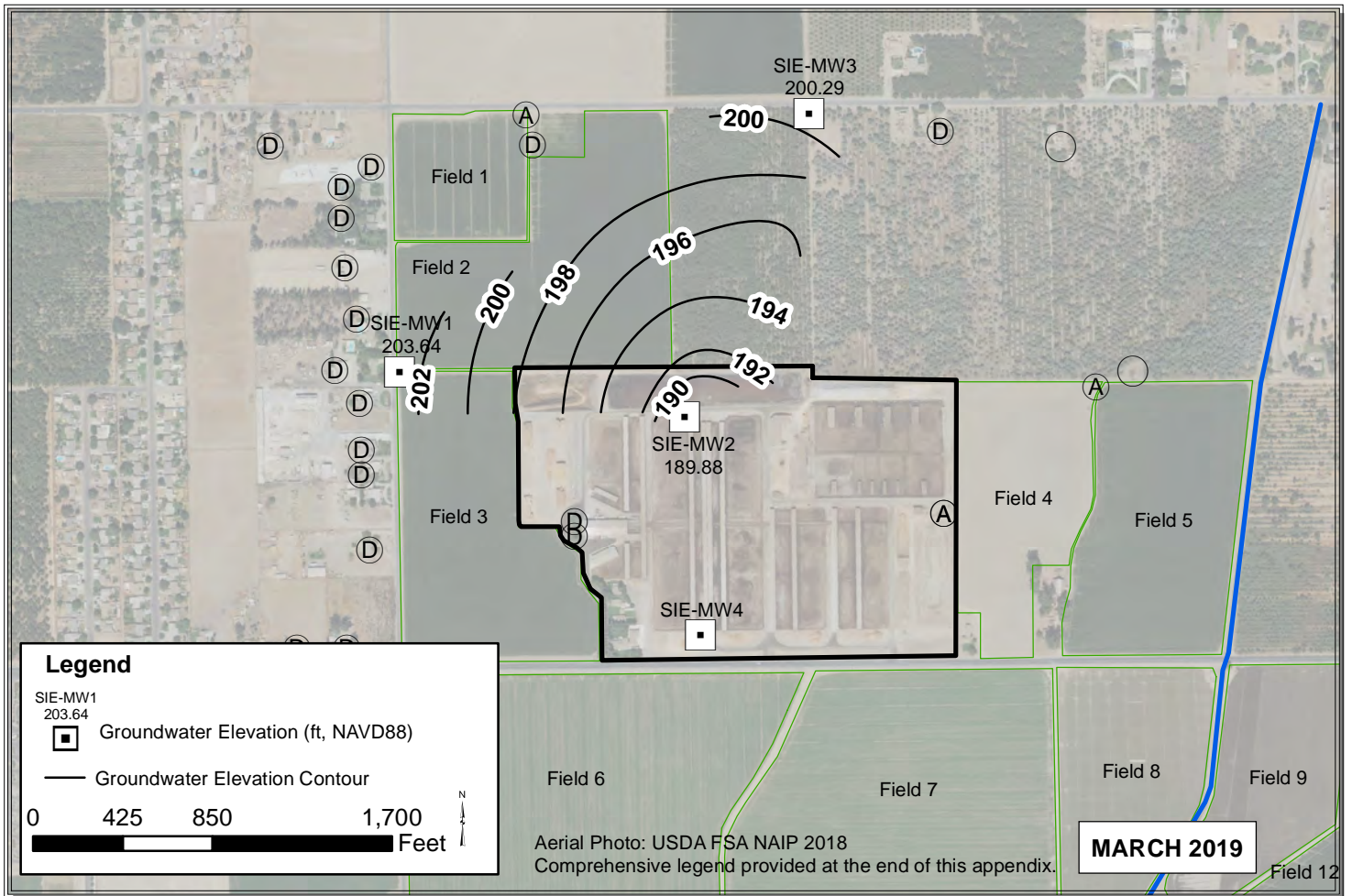

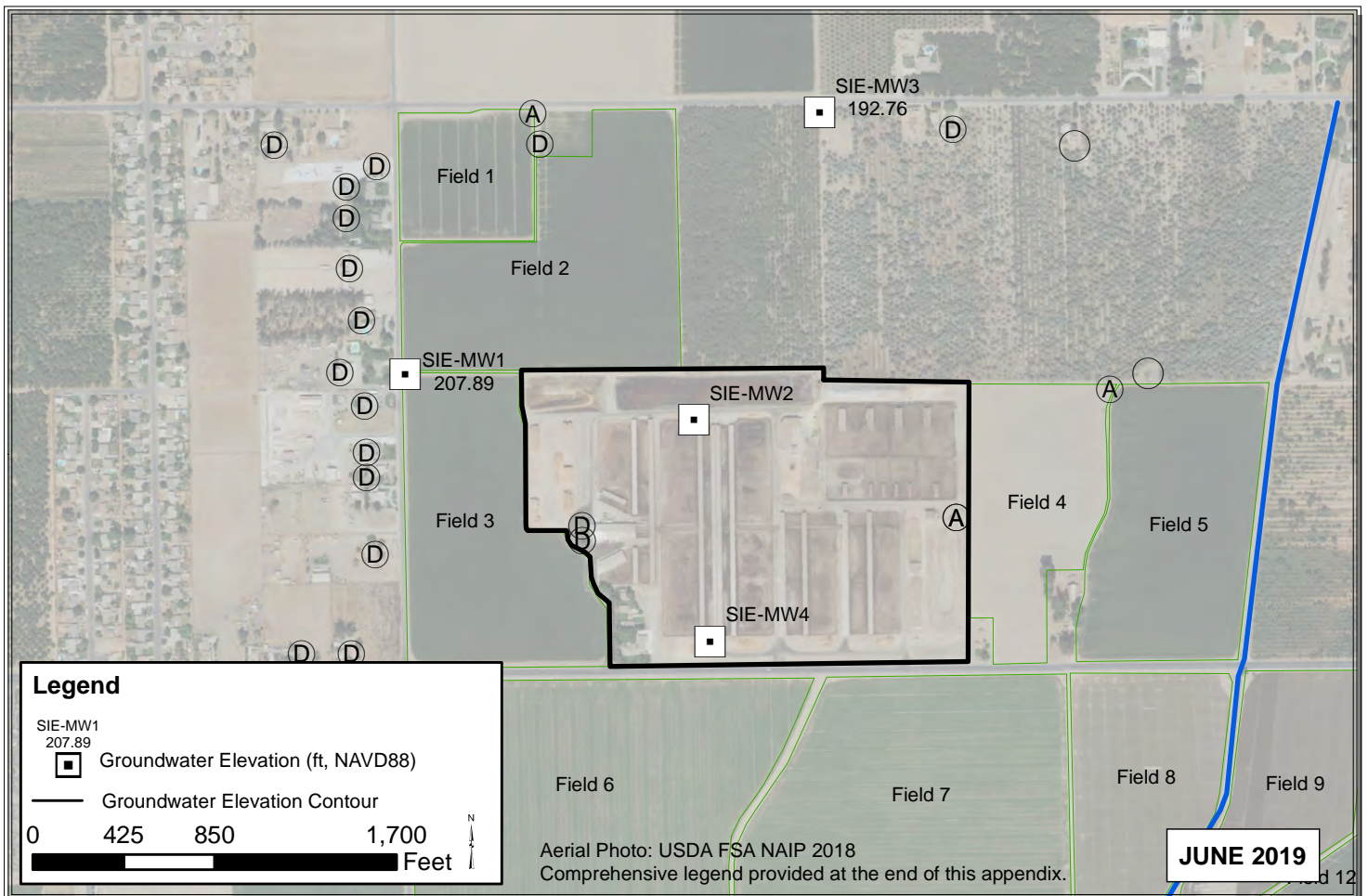
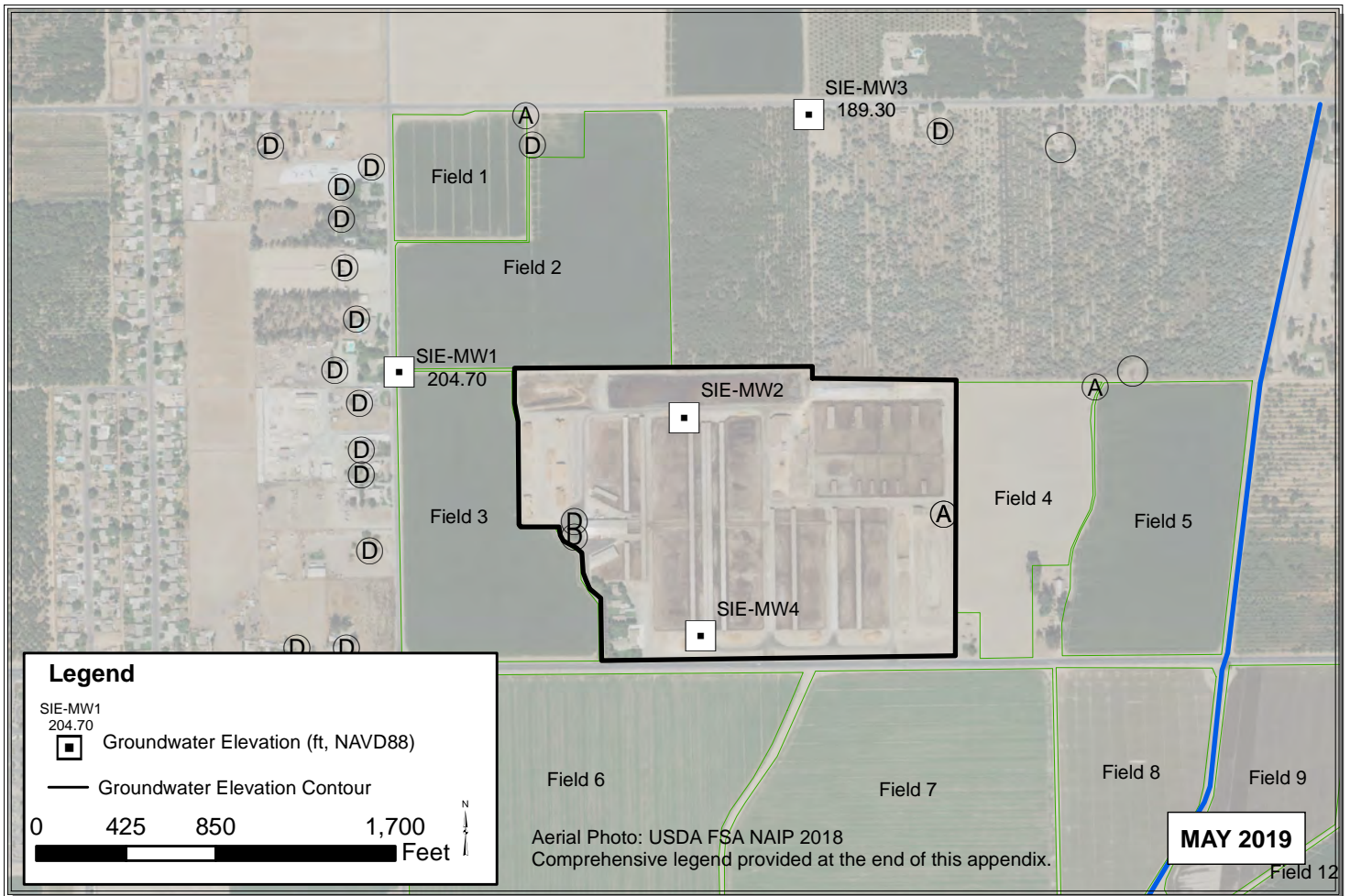

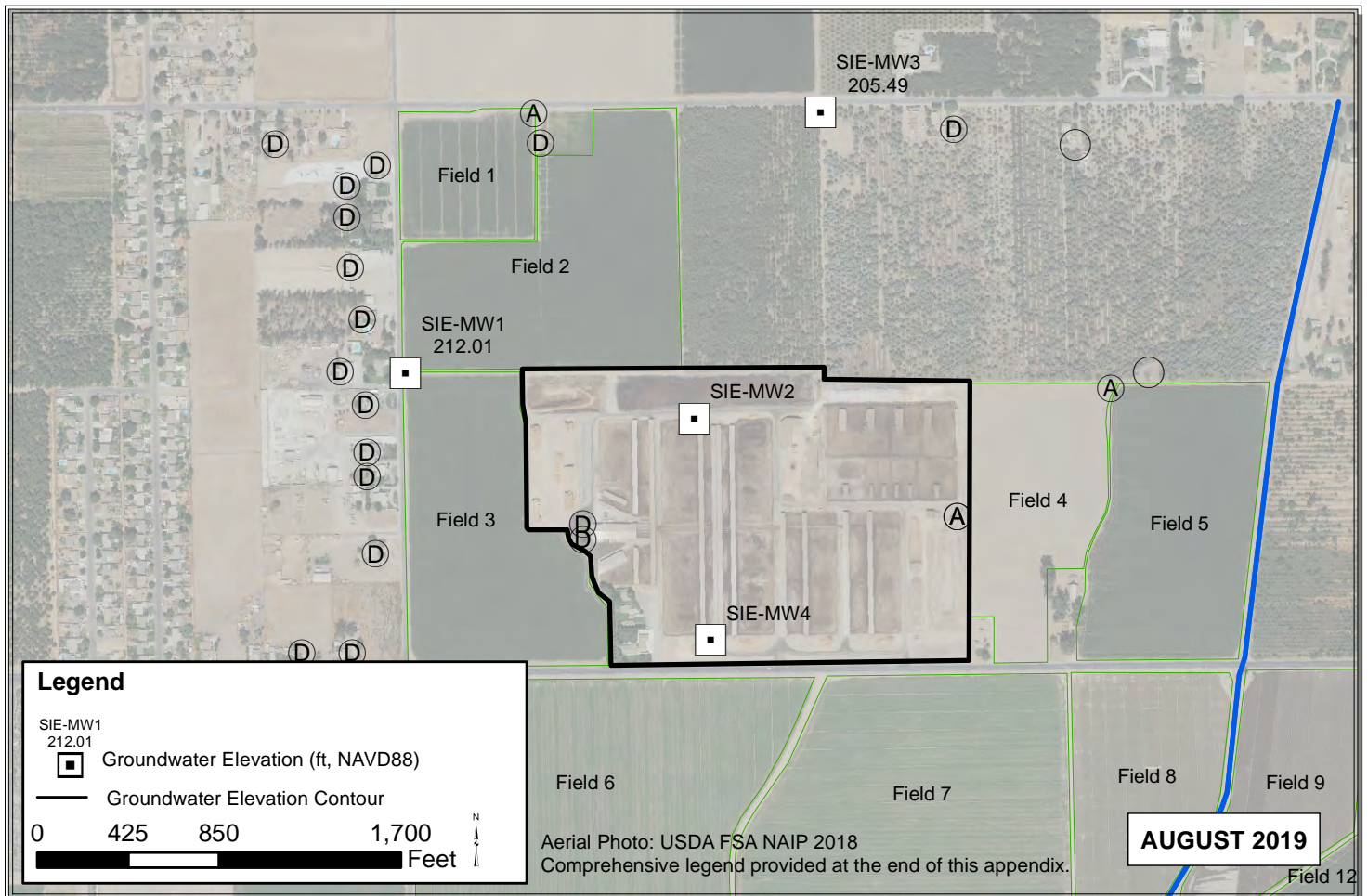
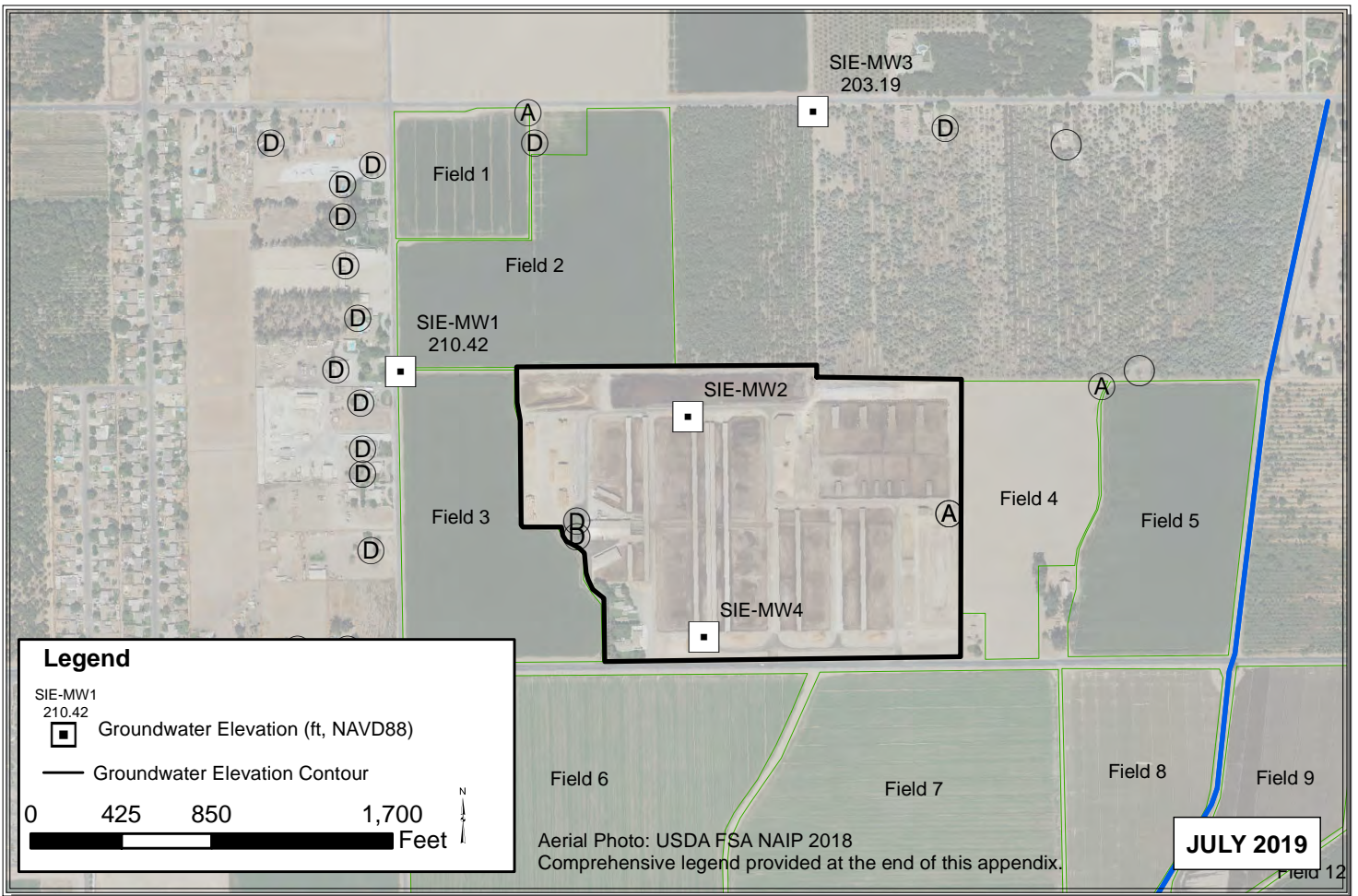

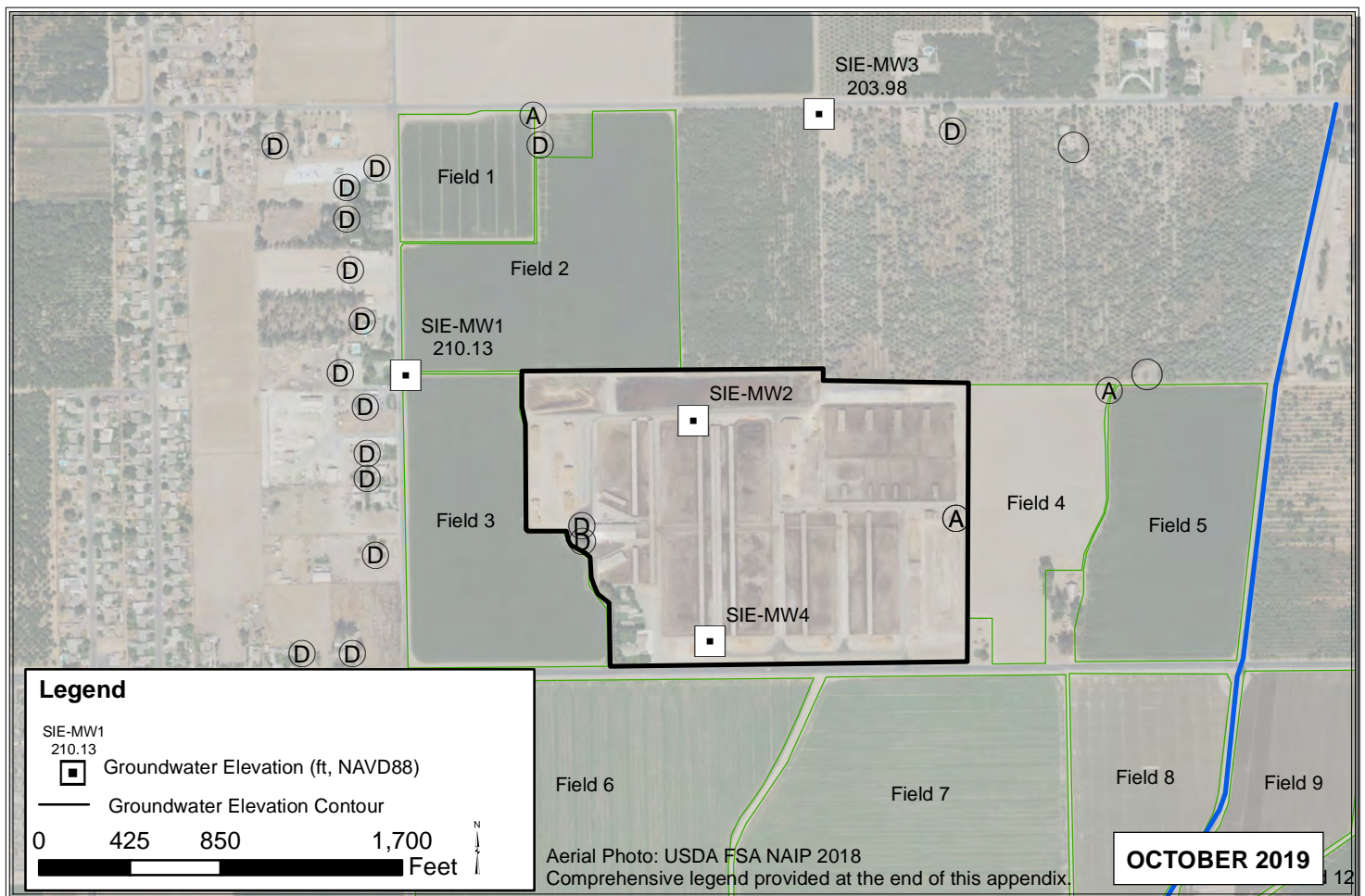
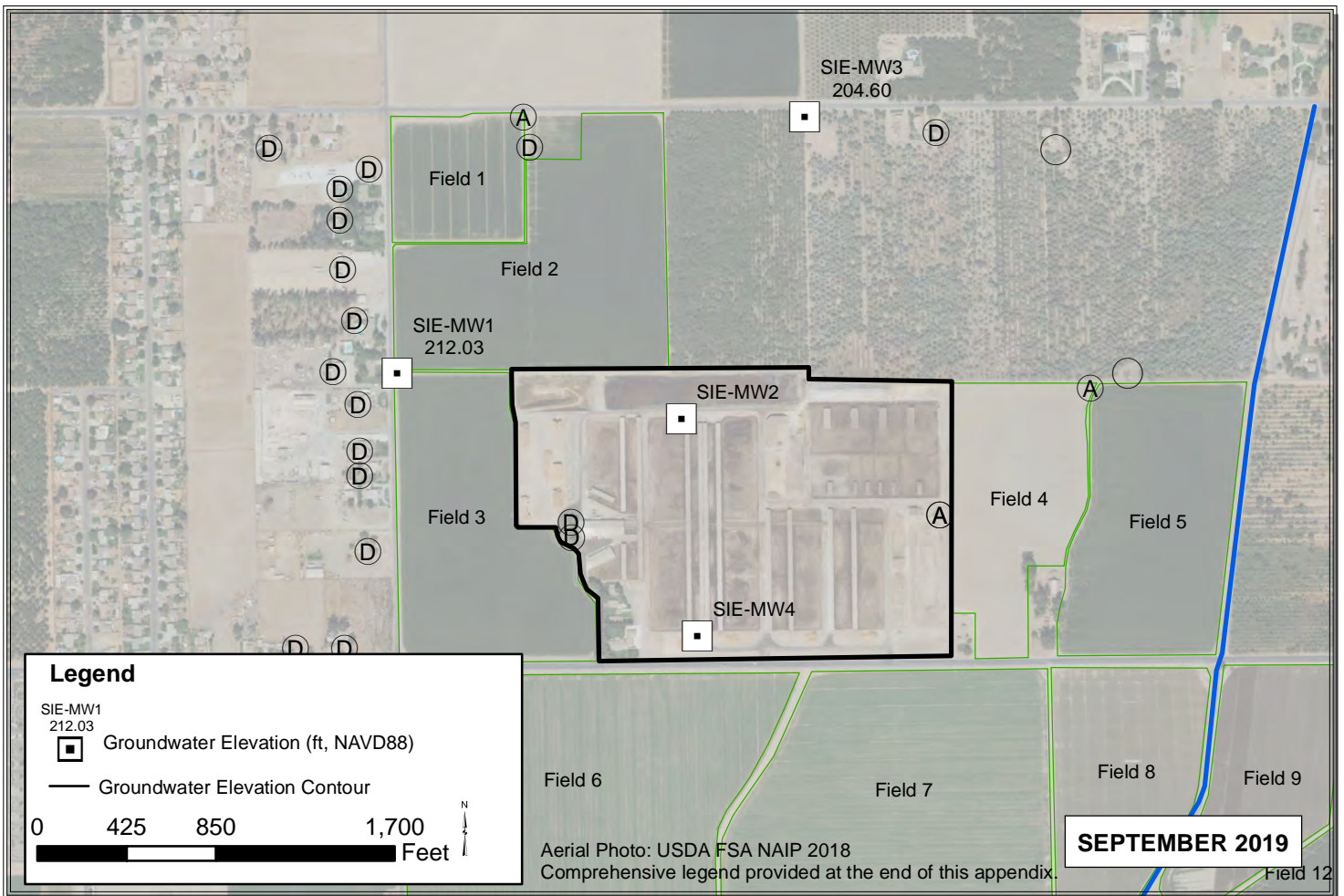

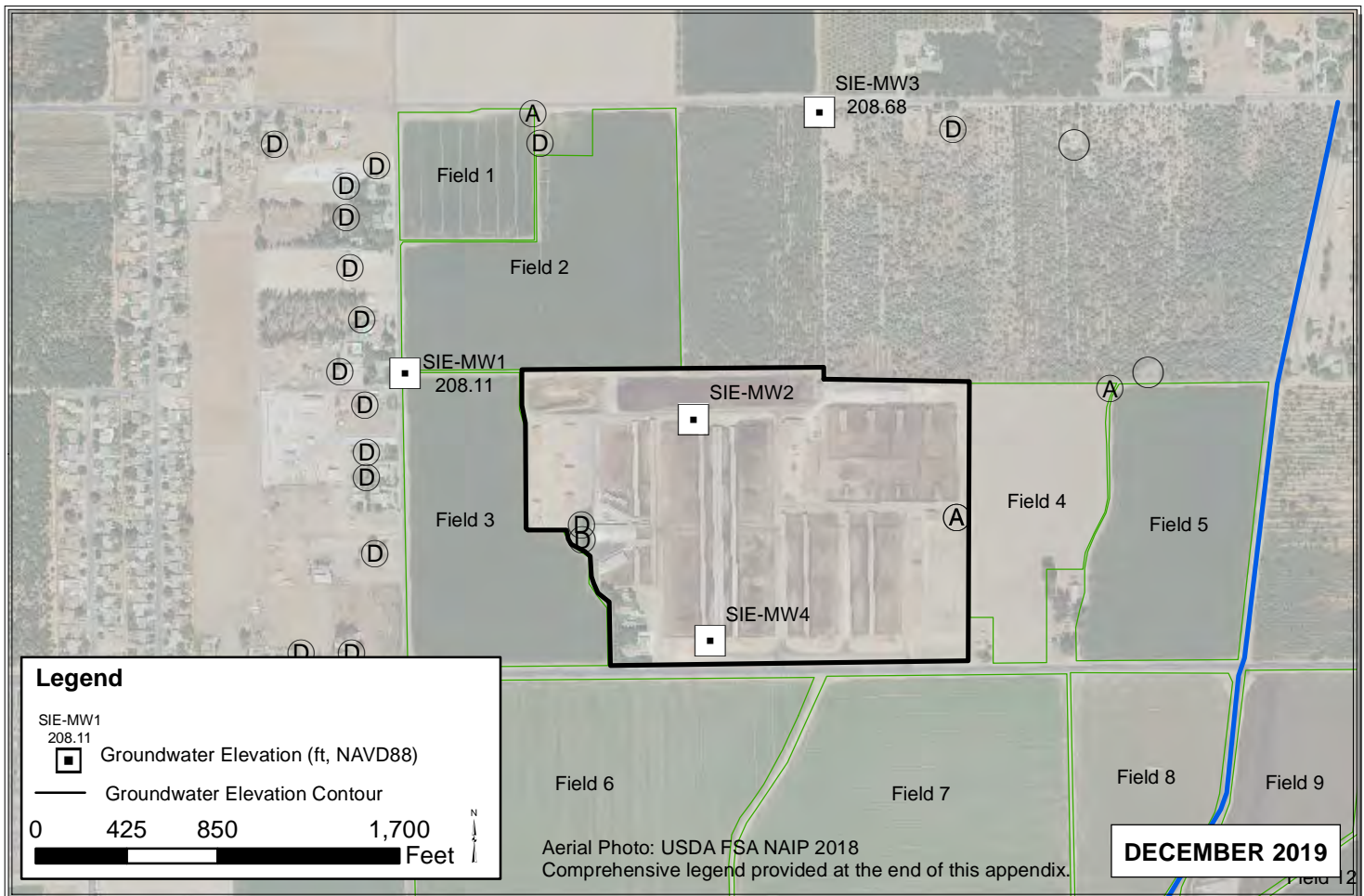
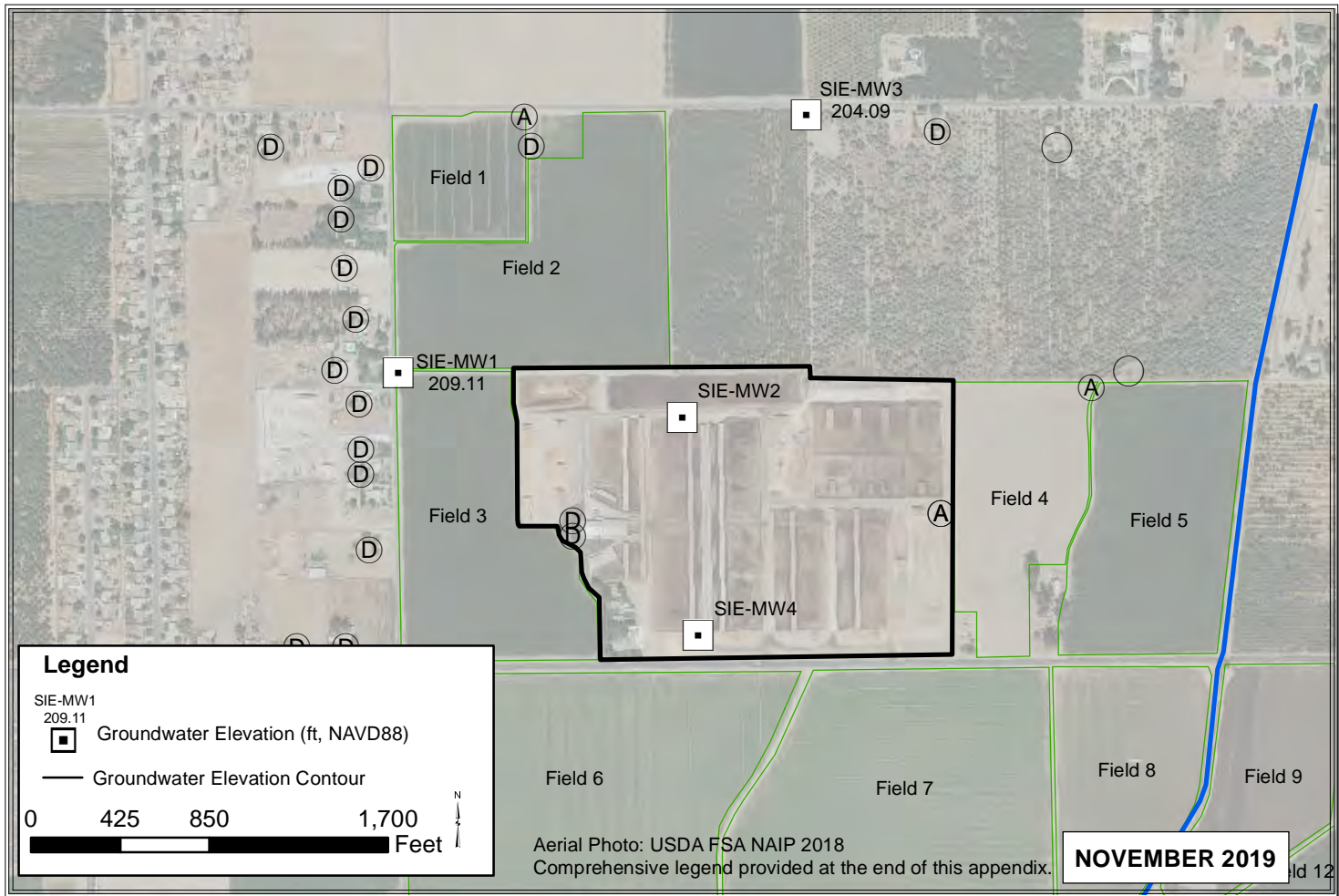

SO₂

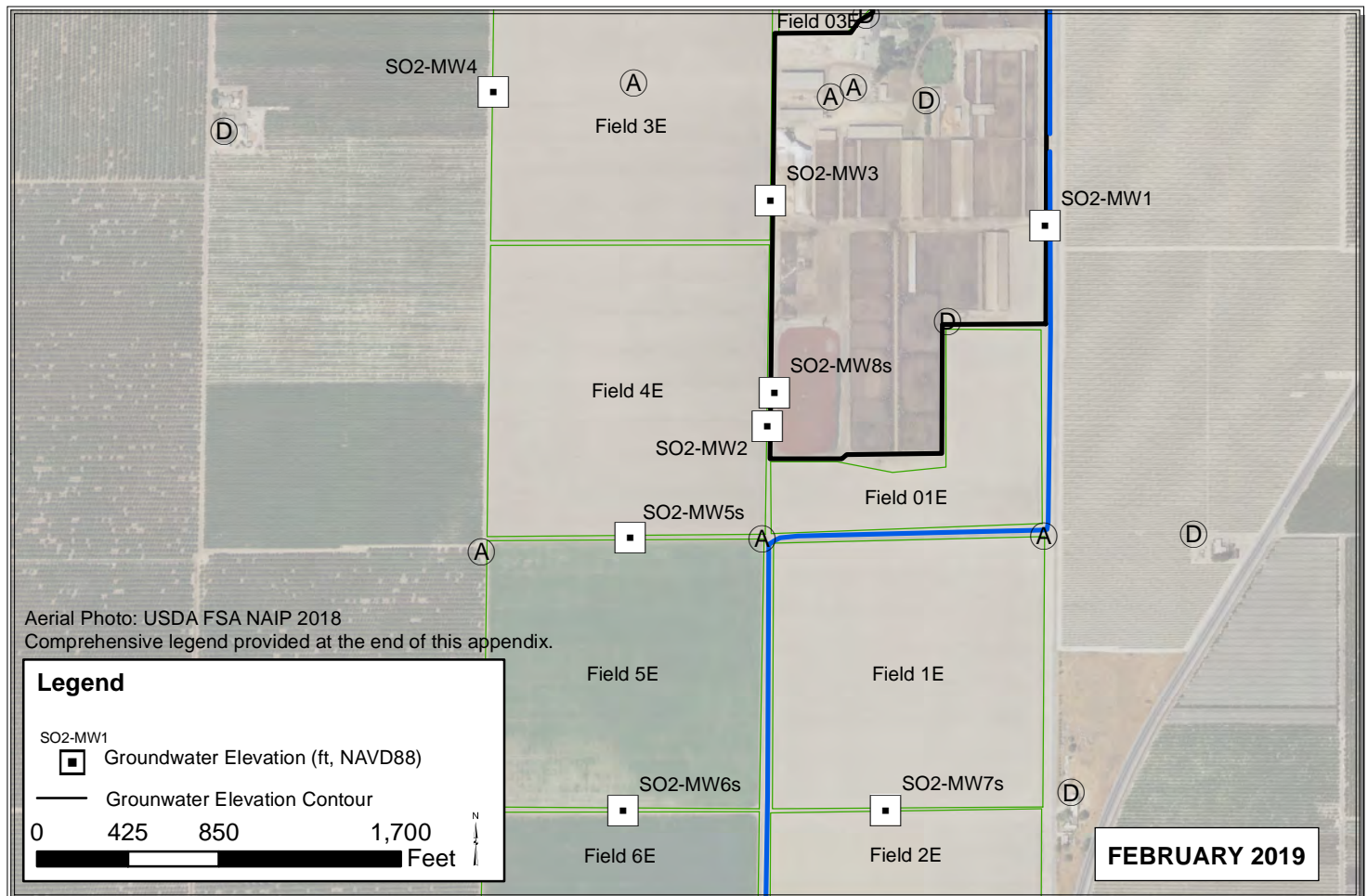
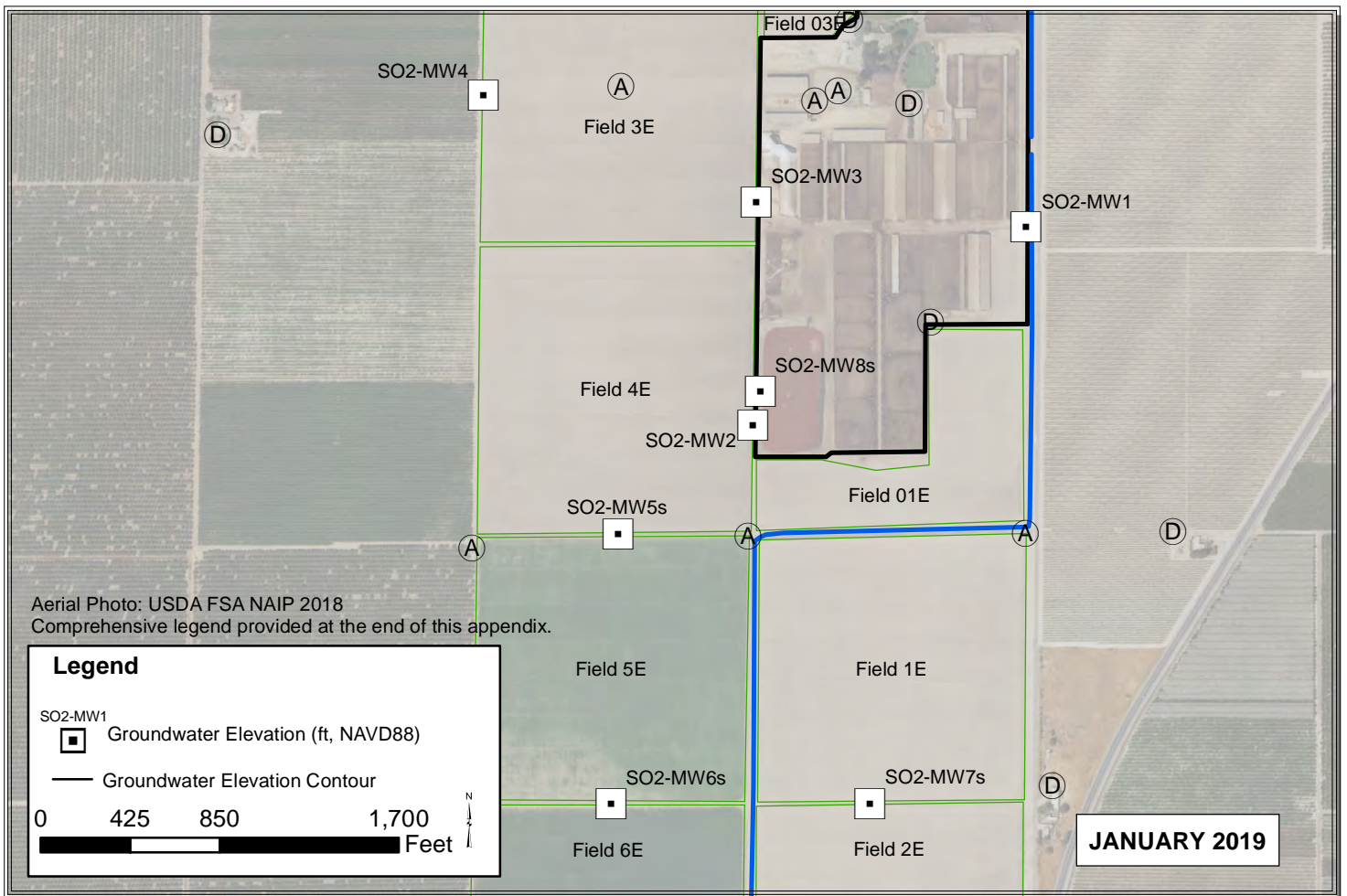

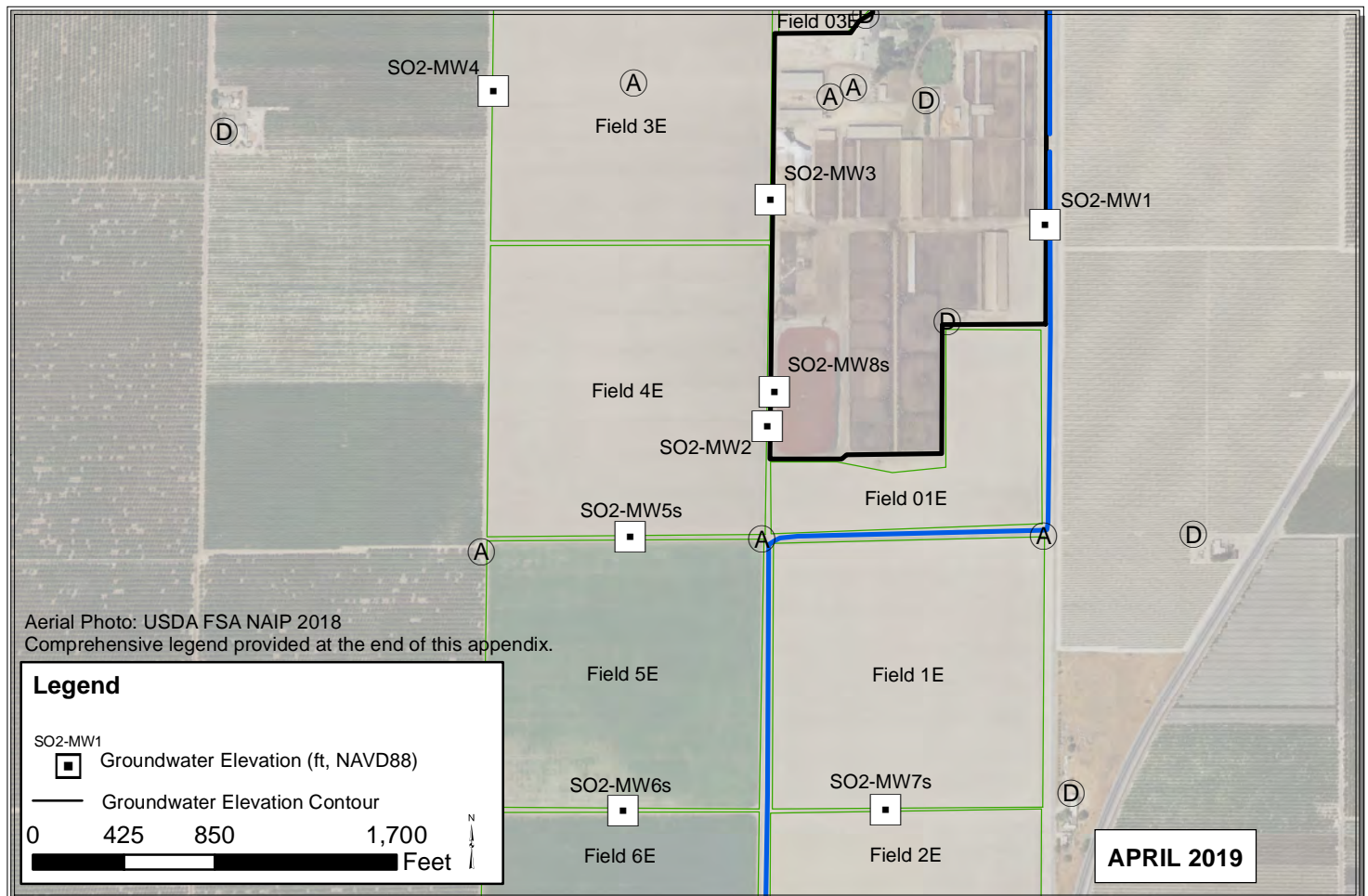
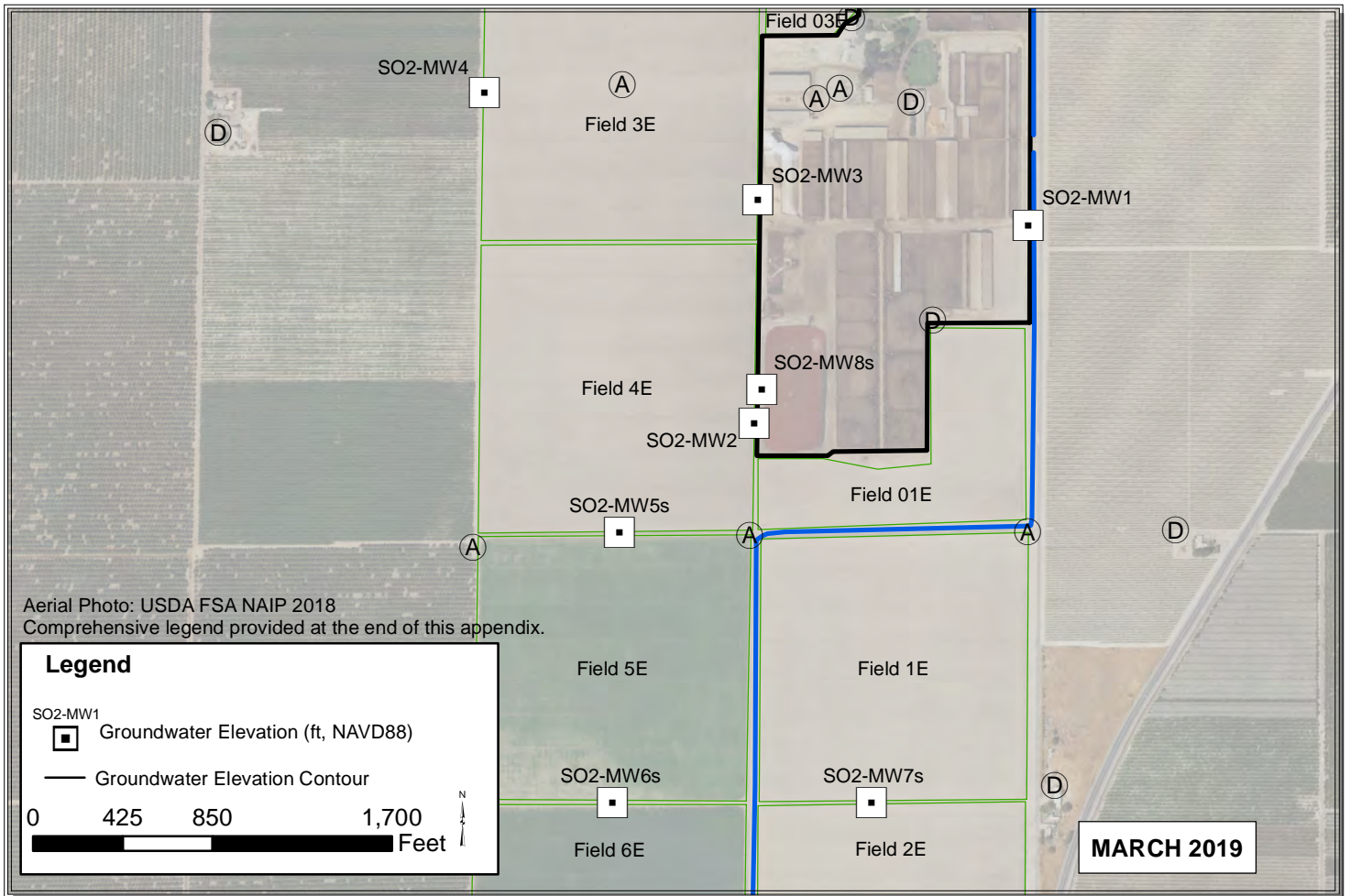

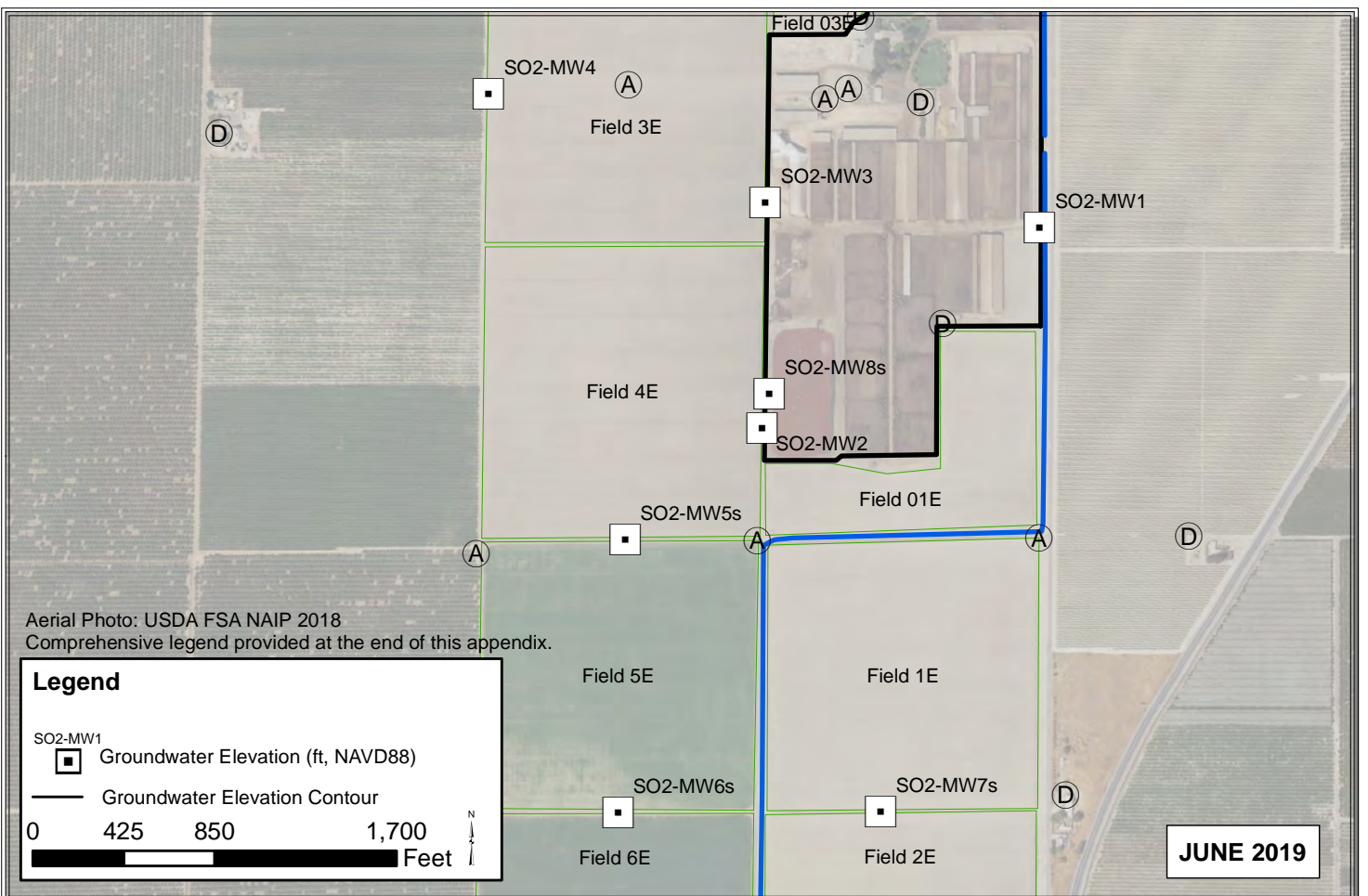
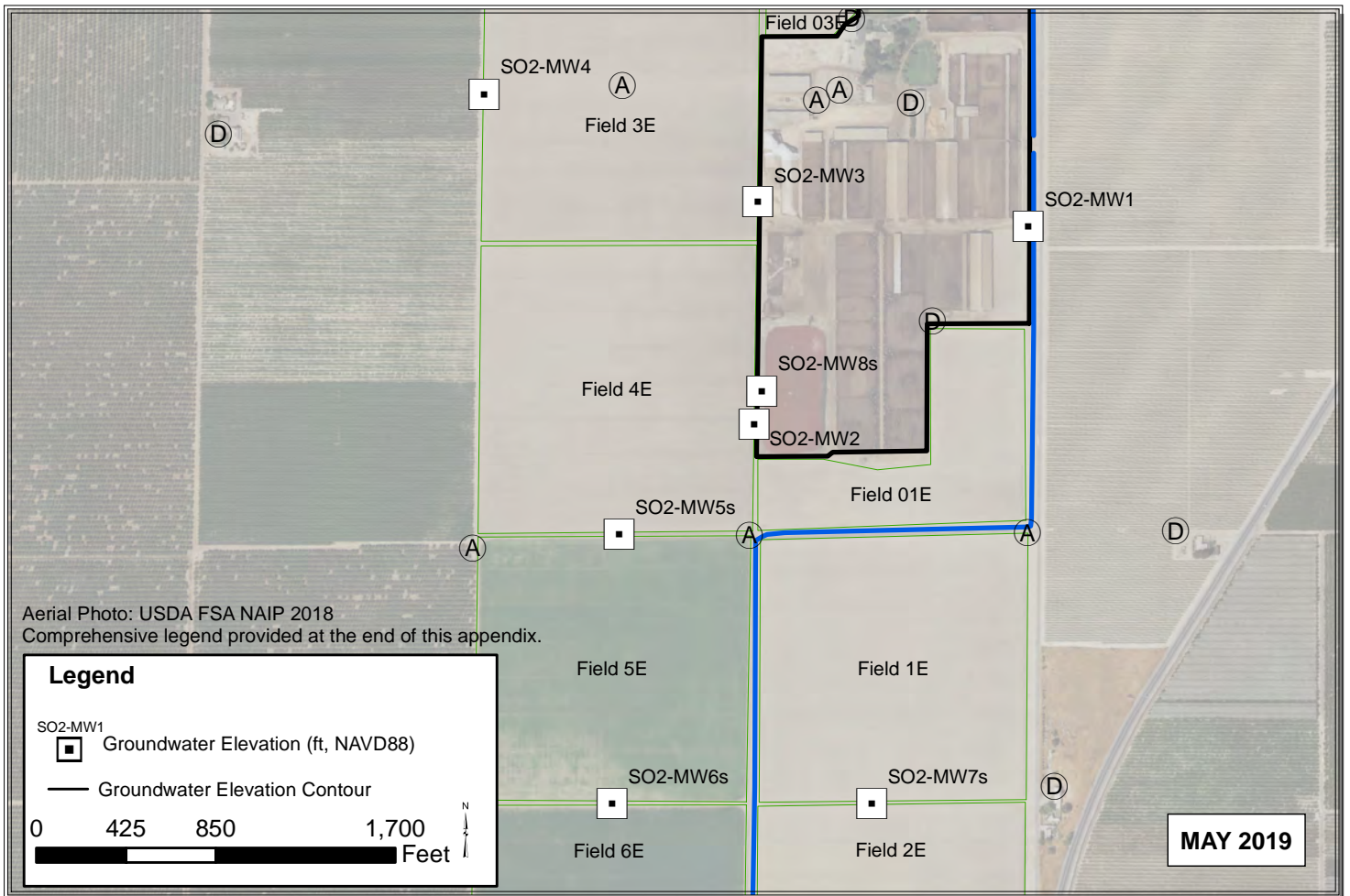

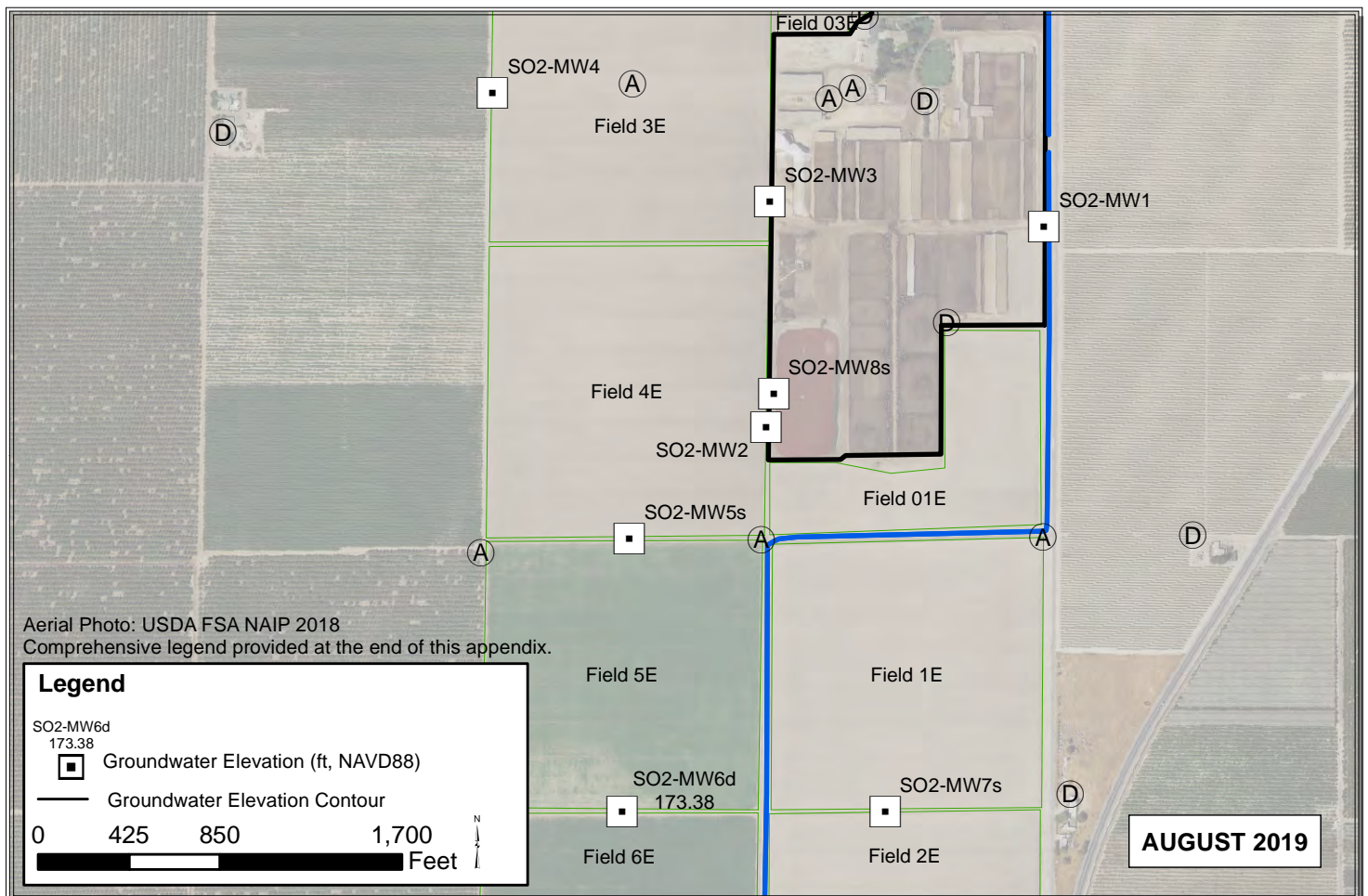
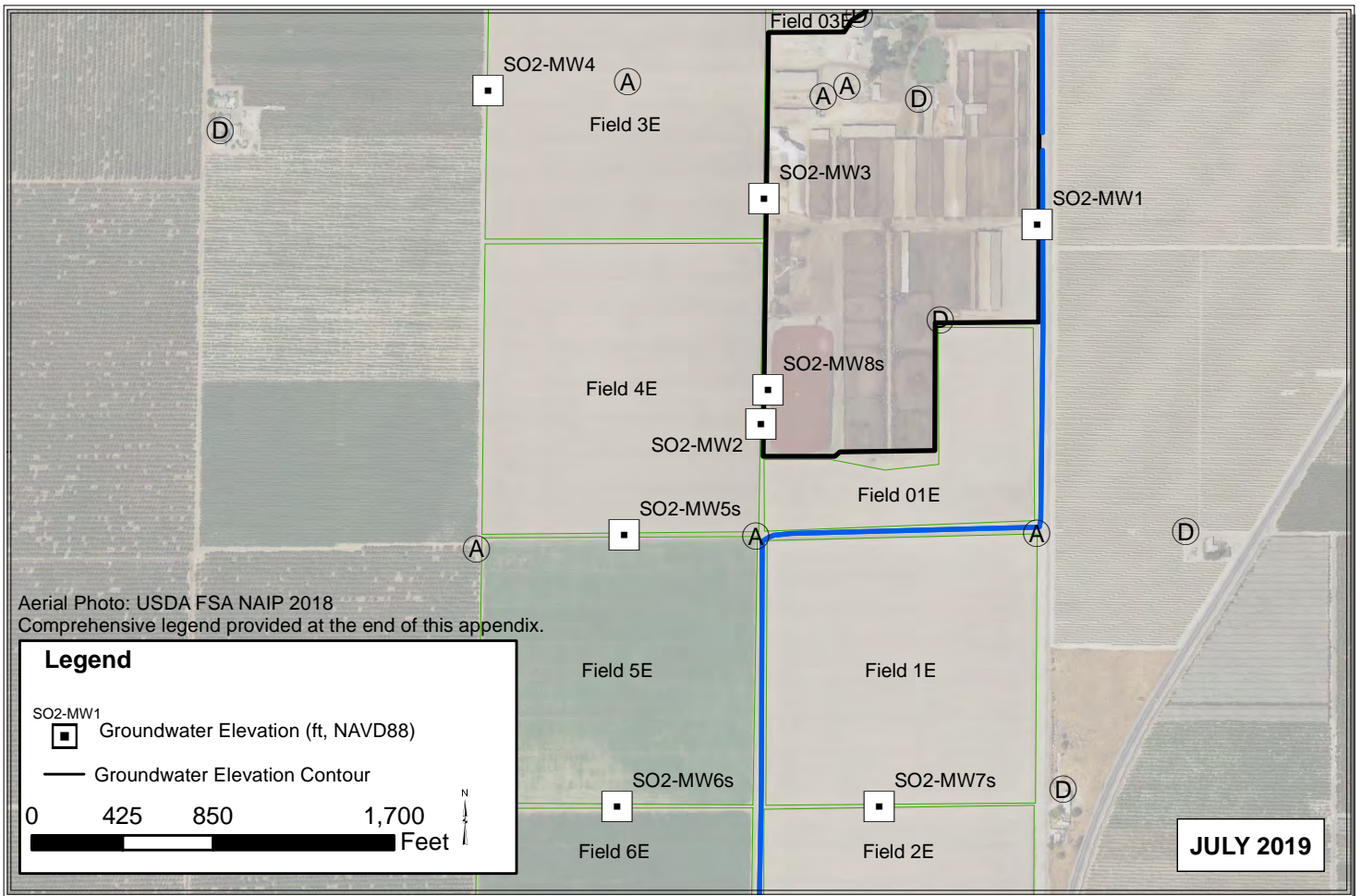

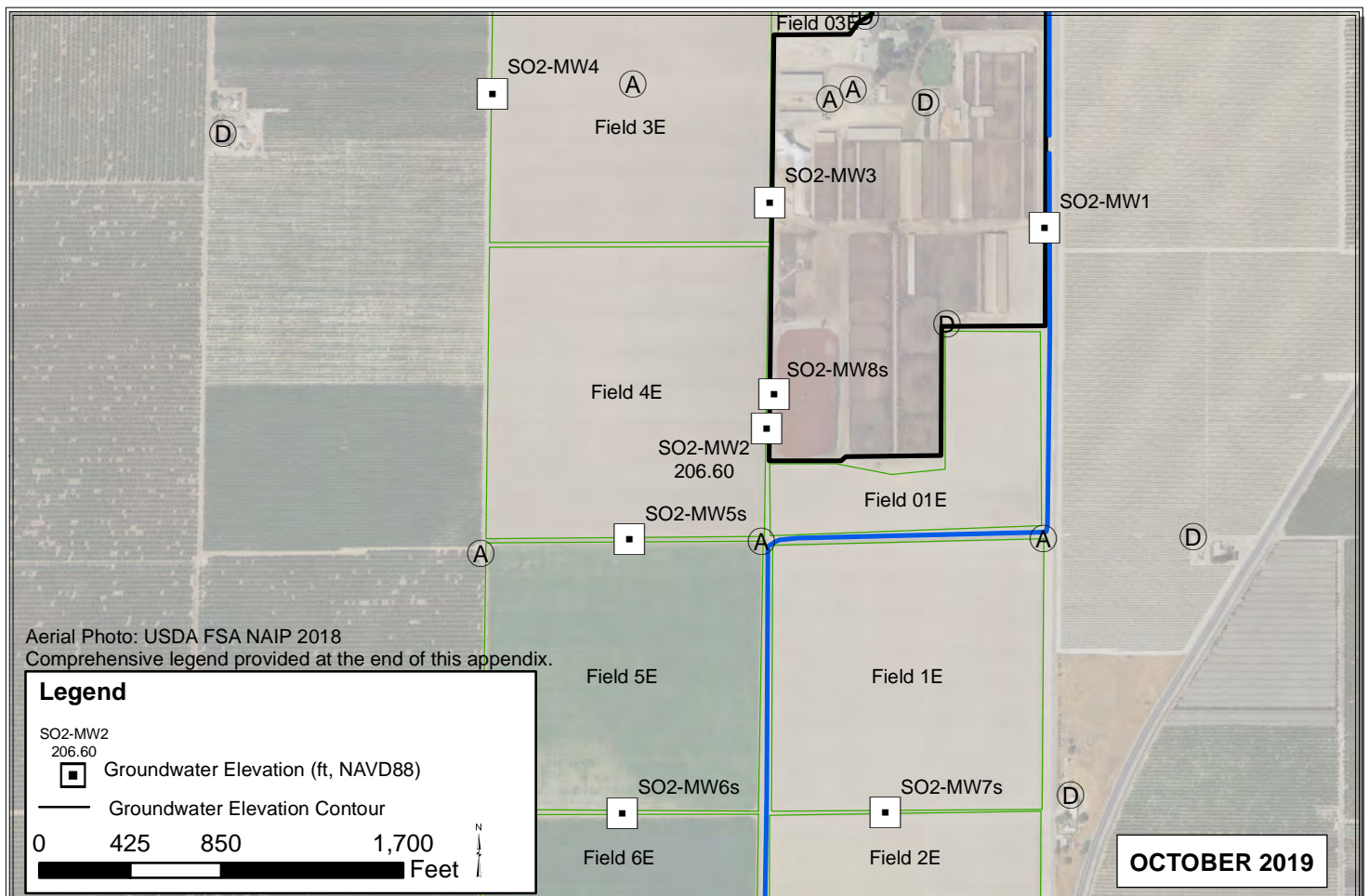
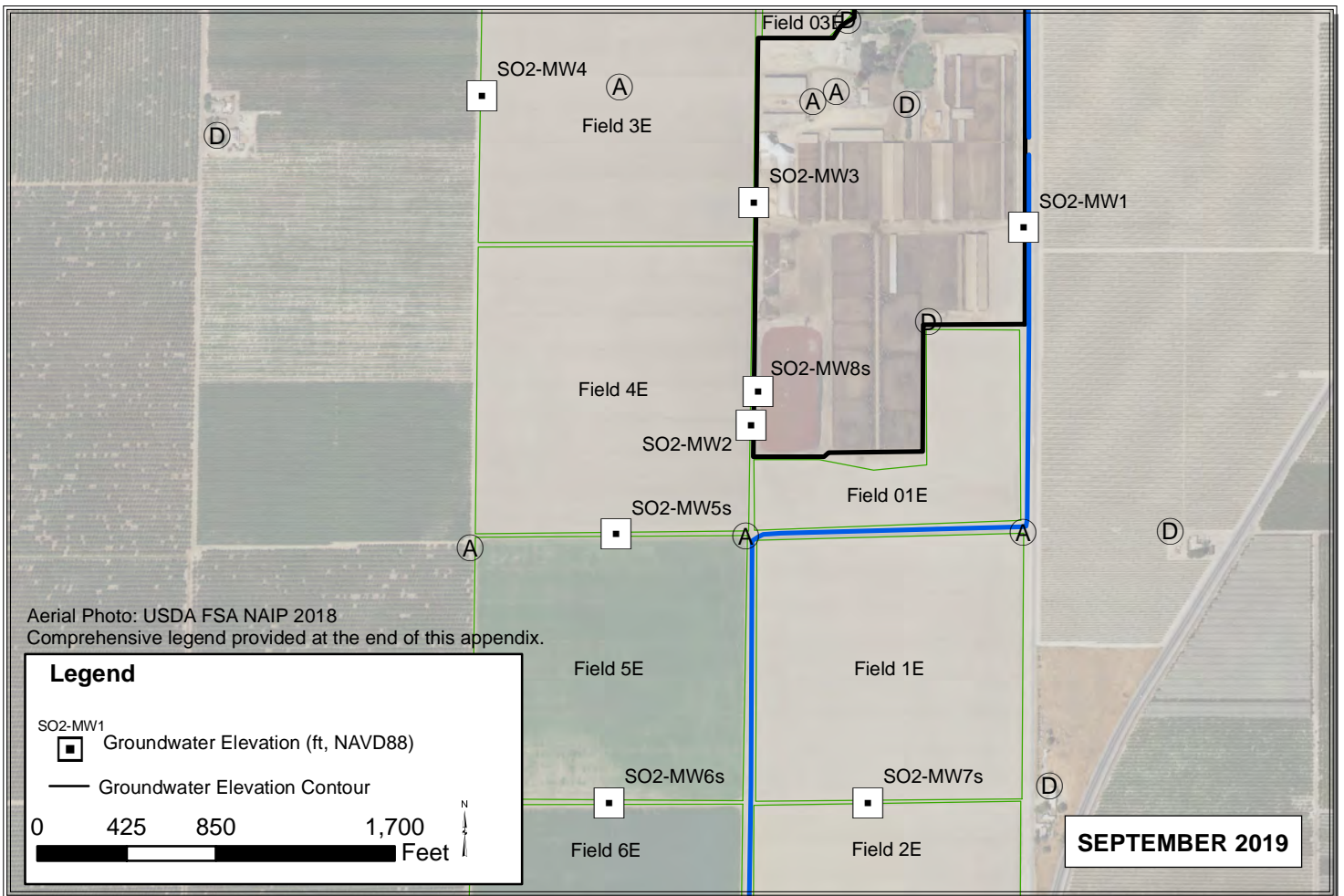

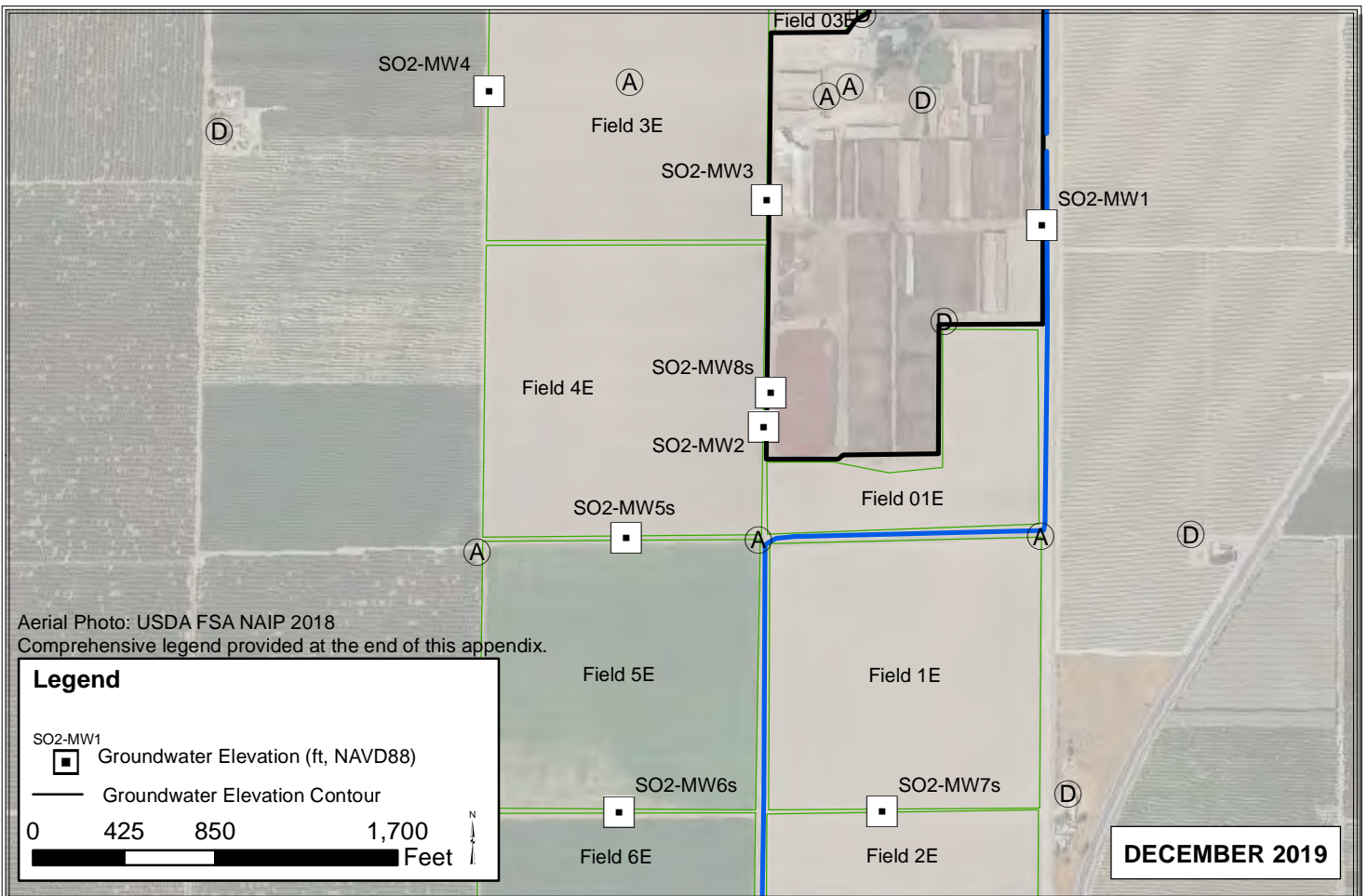
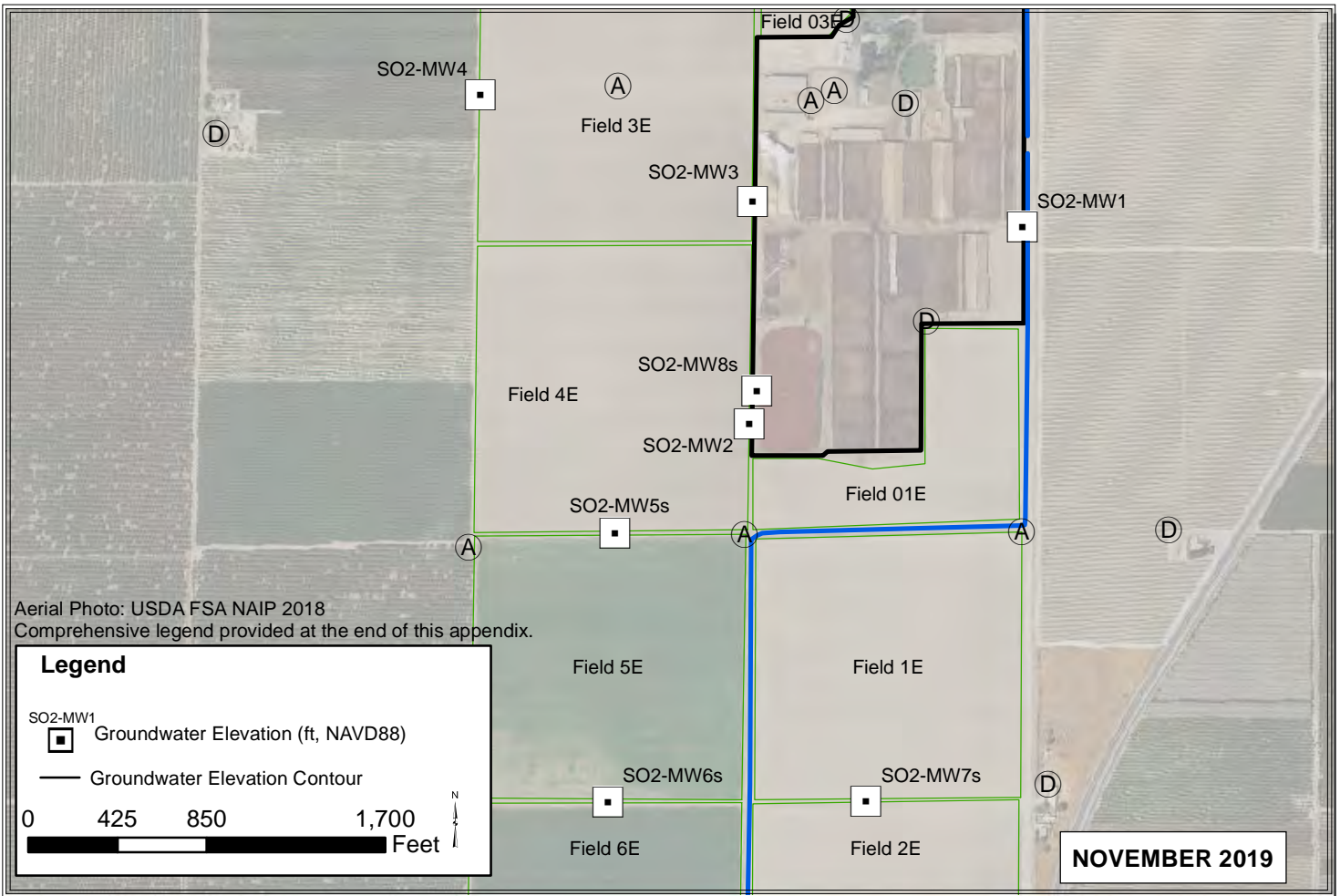

SOJ

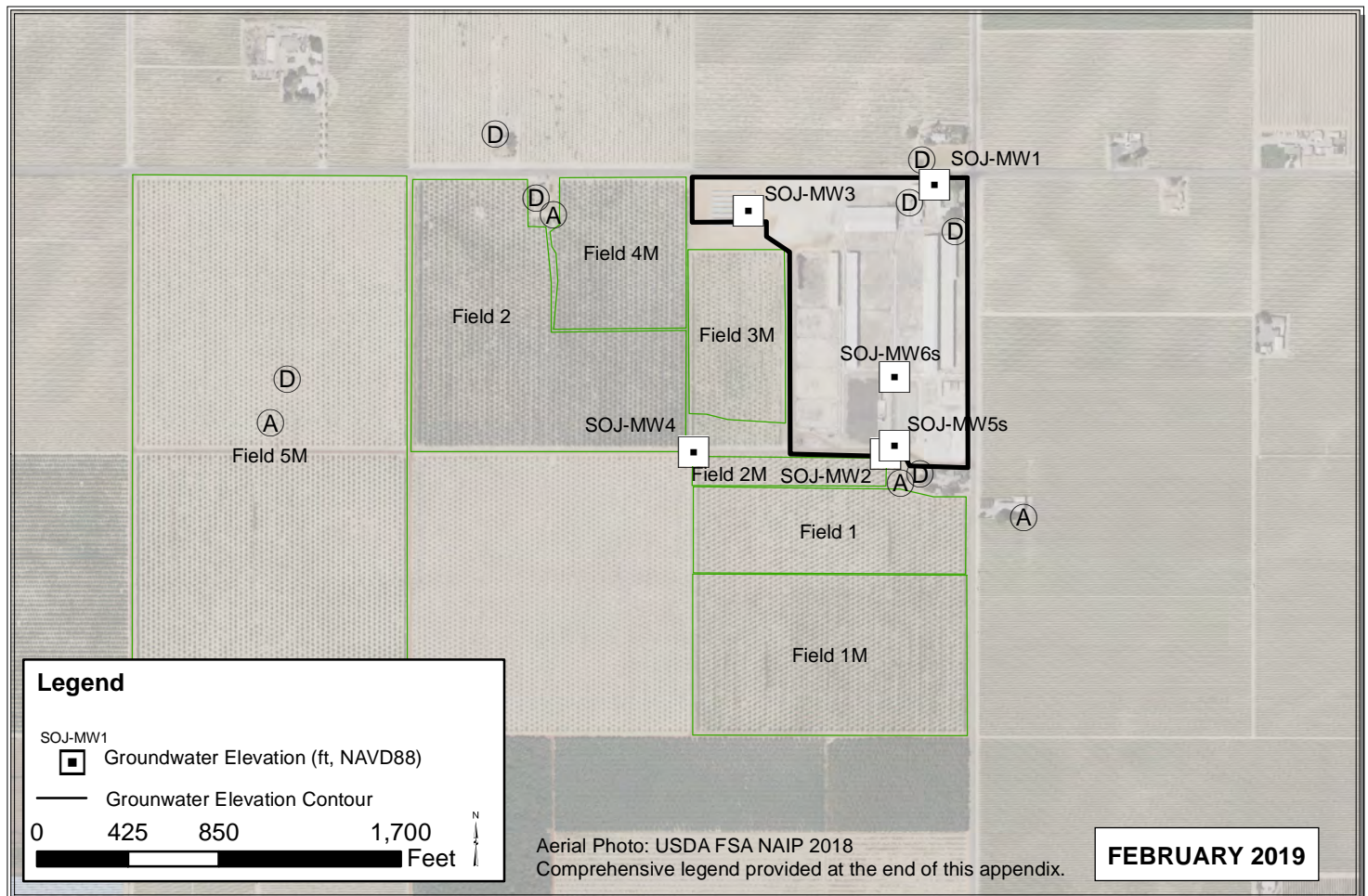
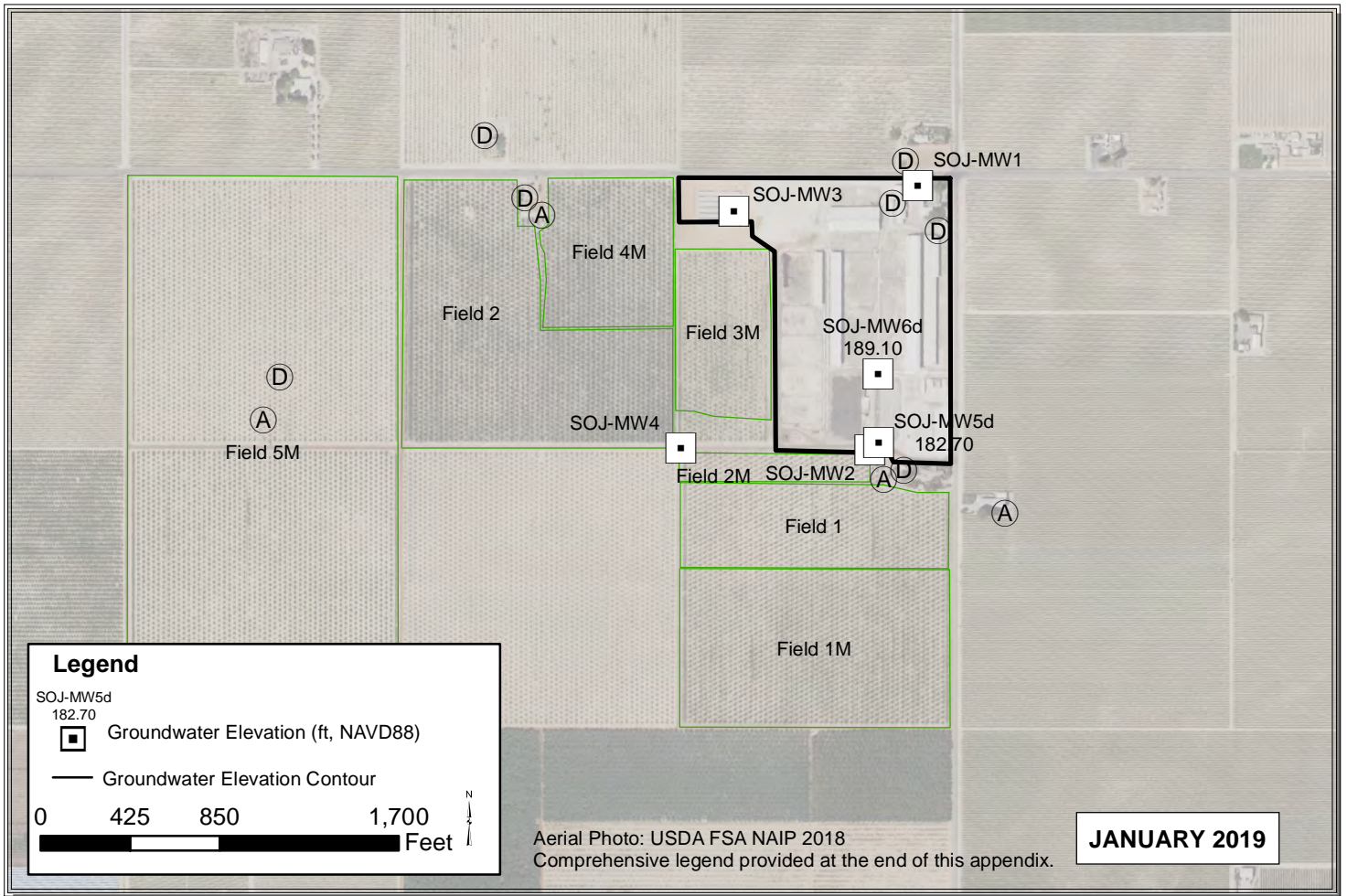

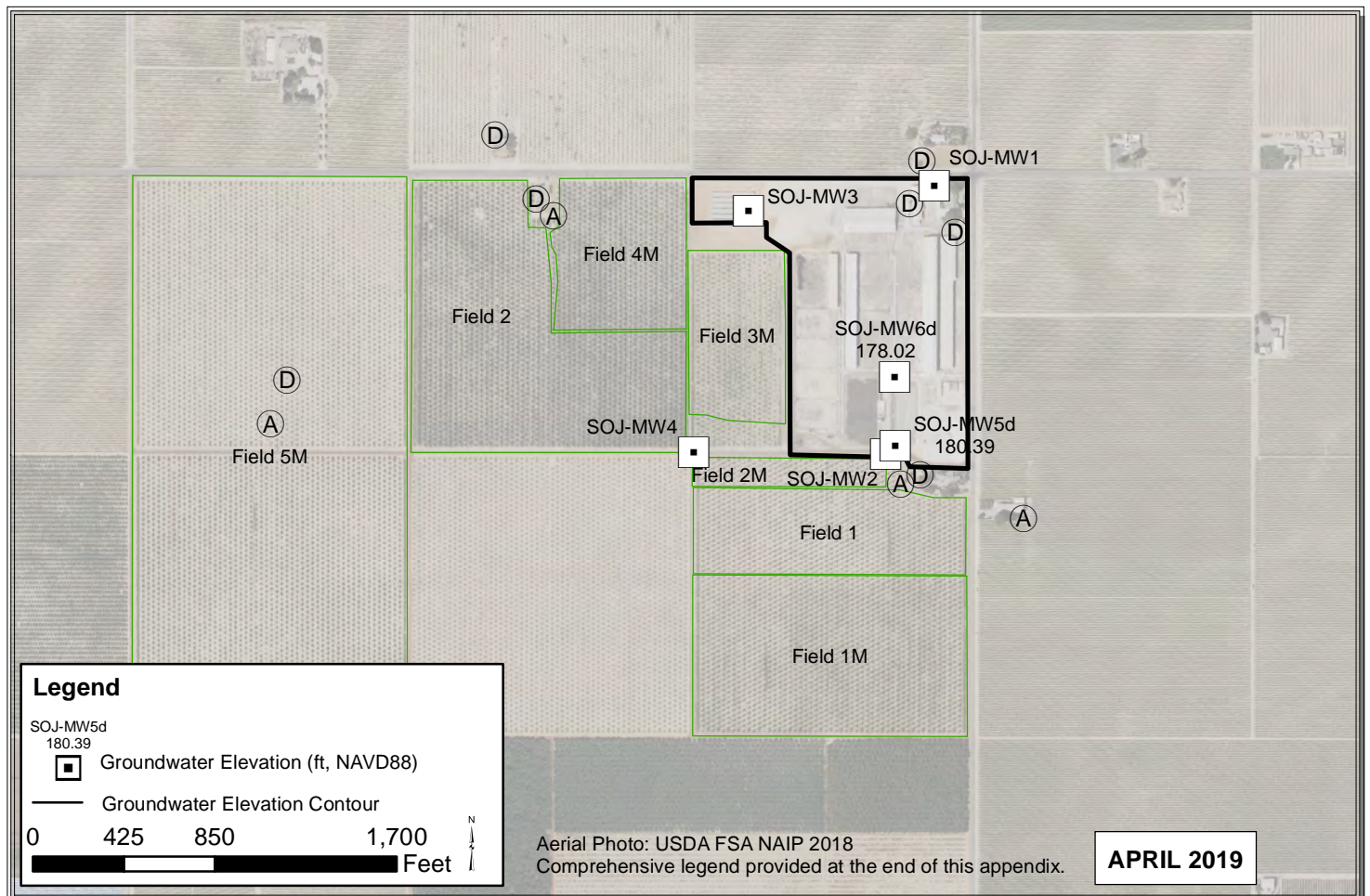
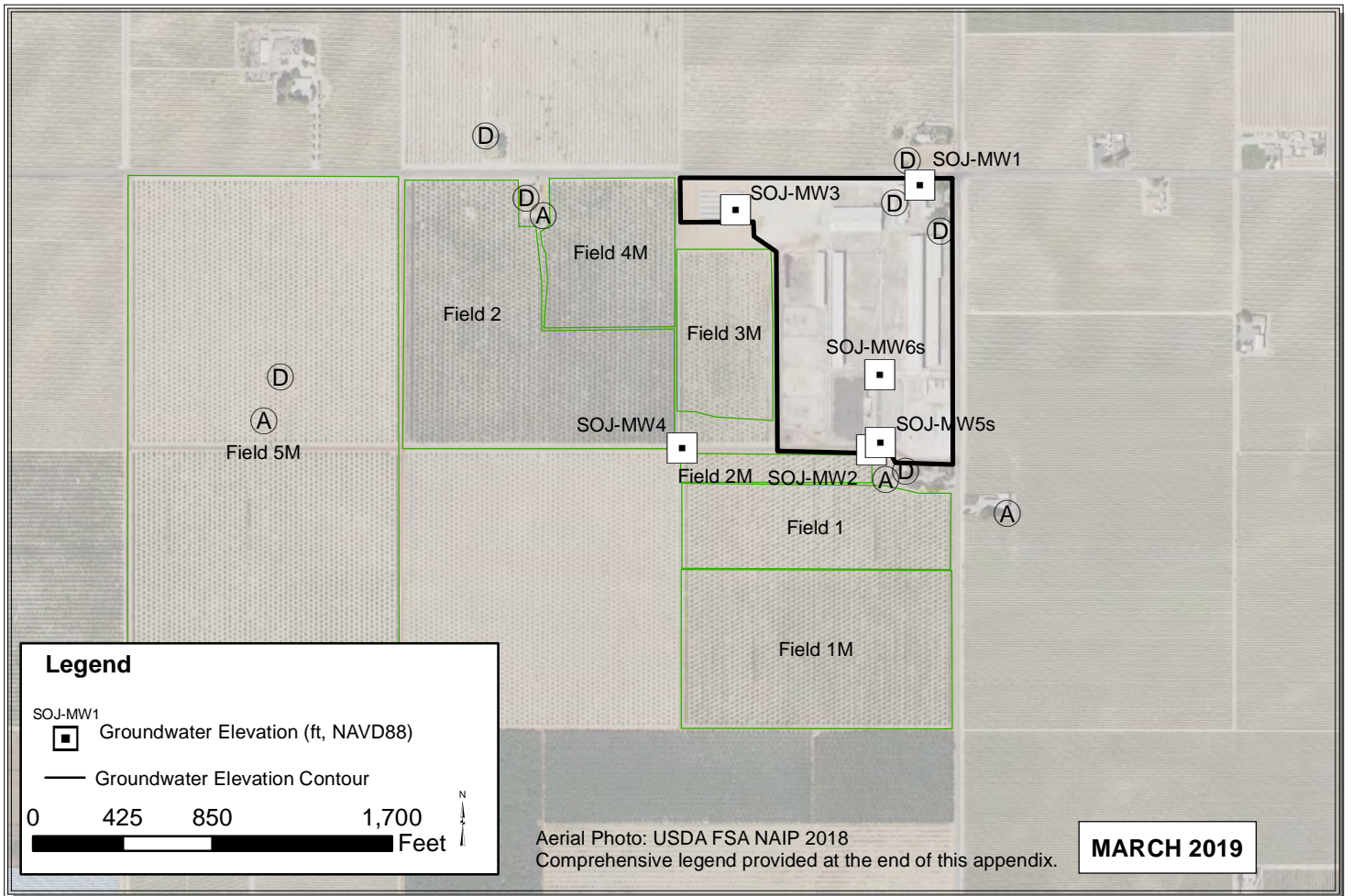

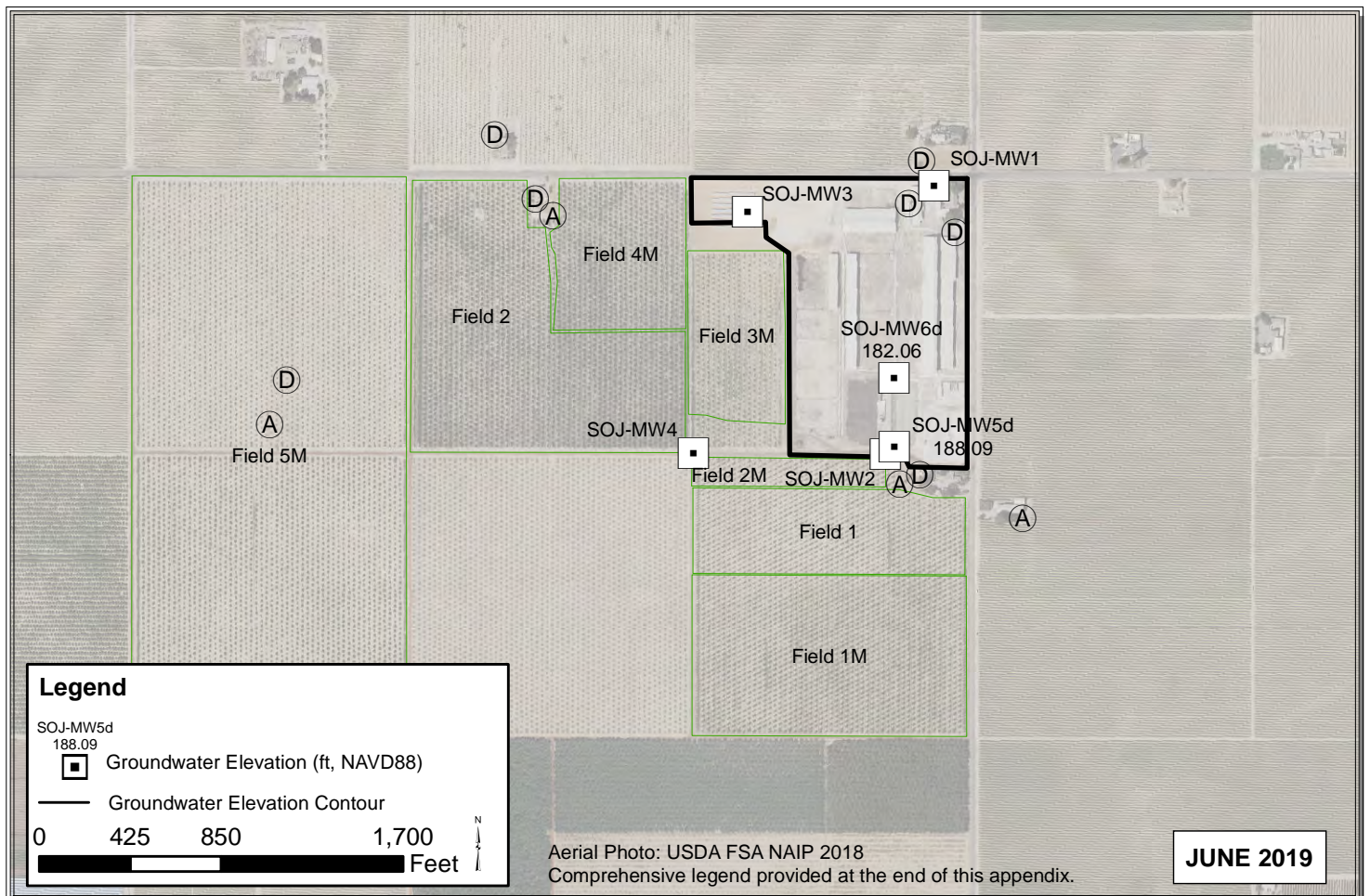
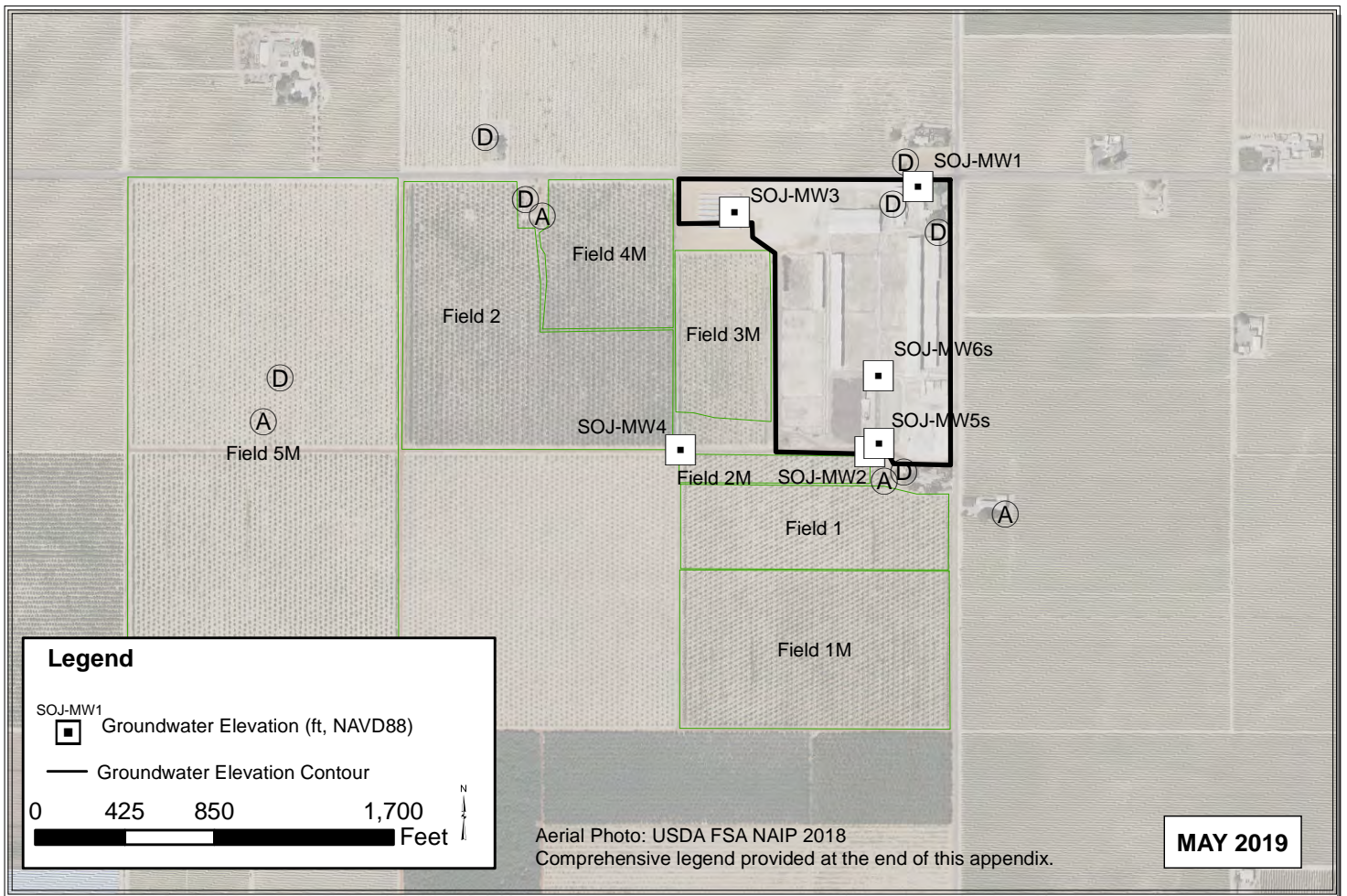

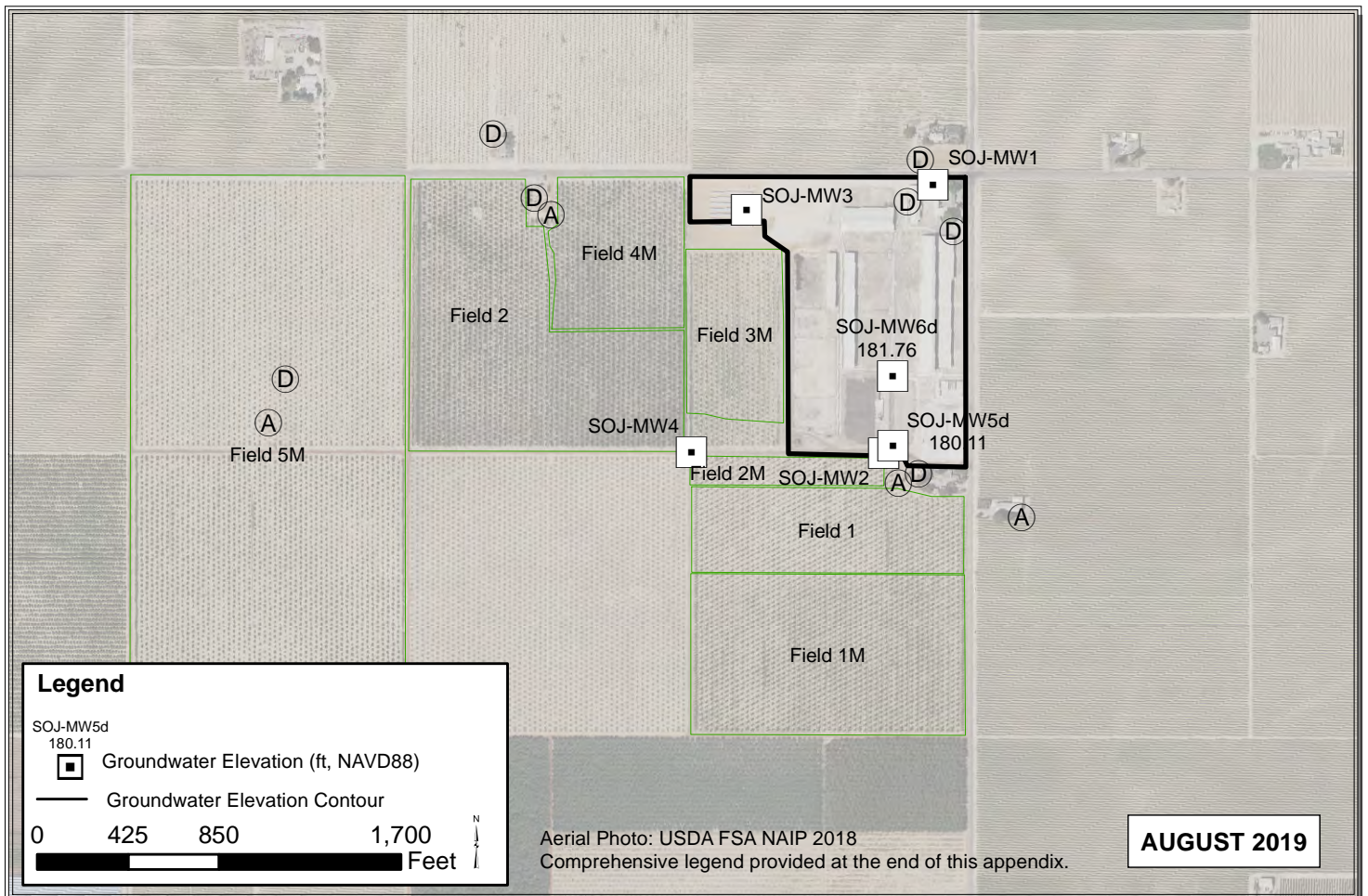
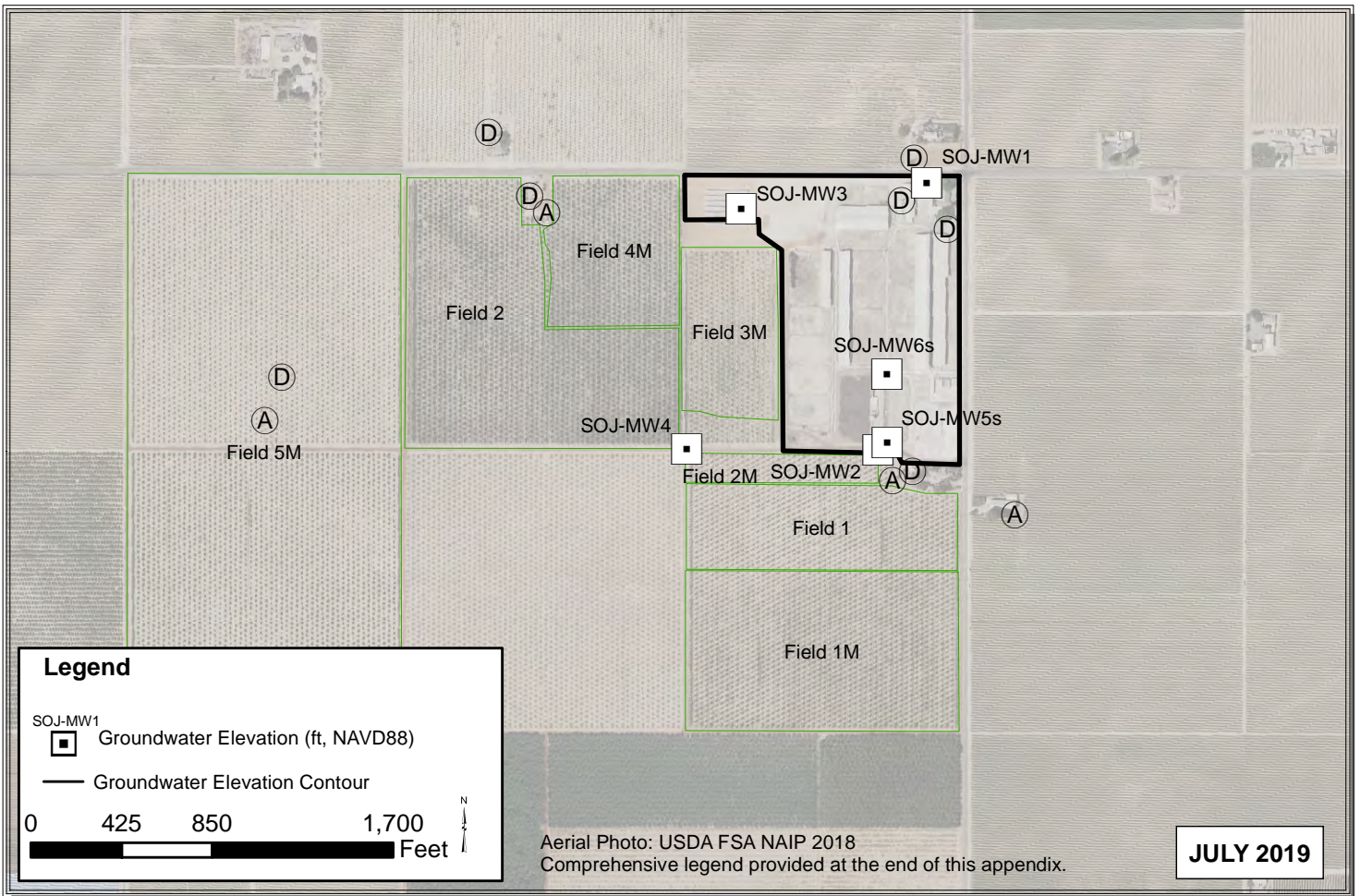

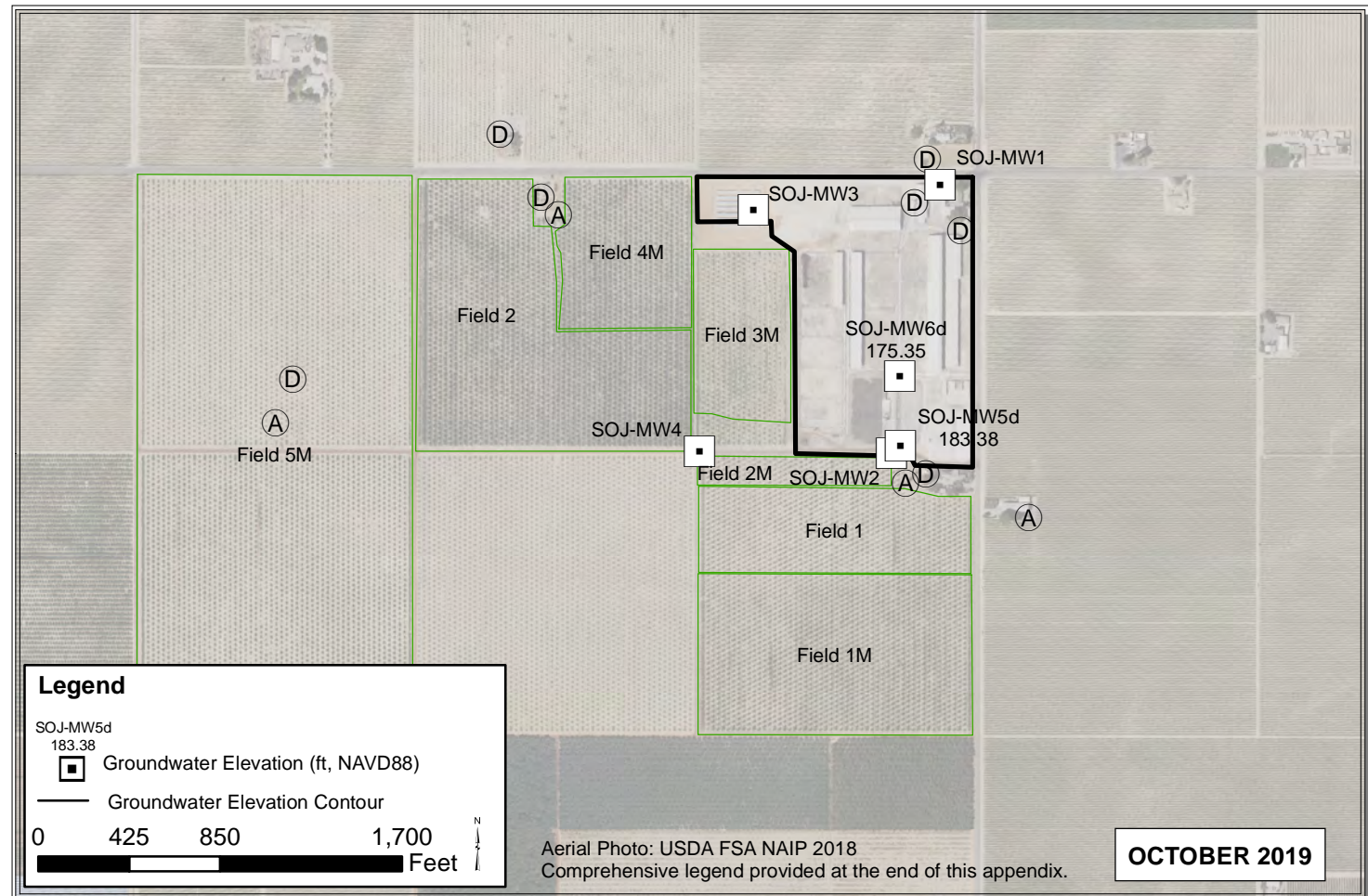
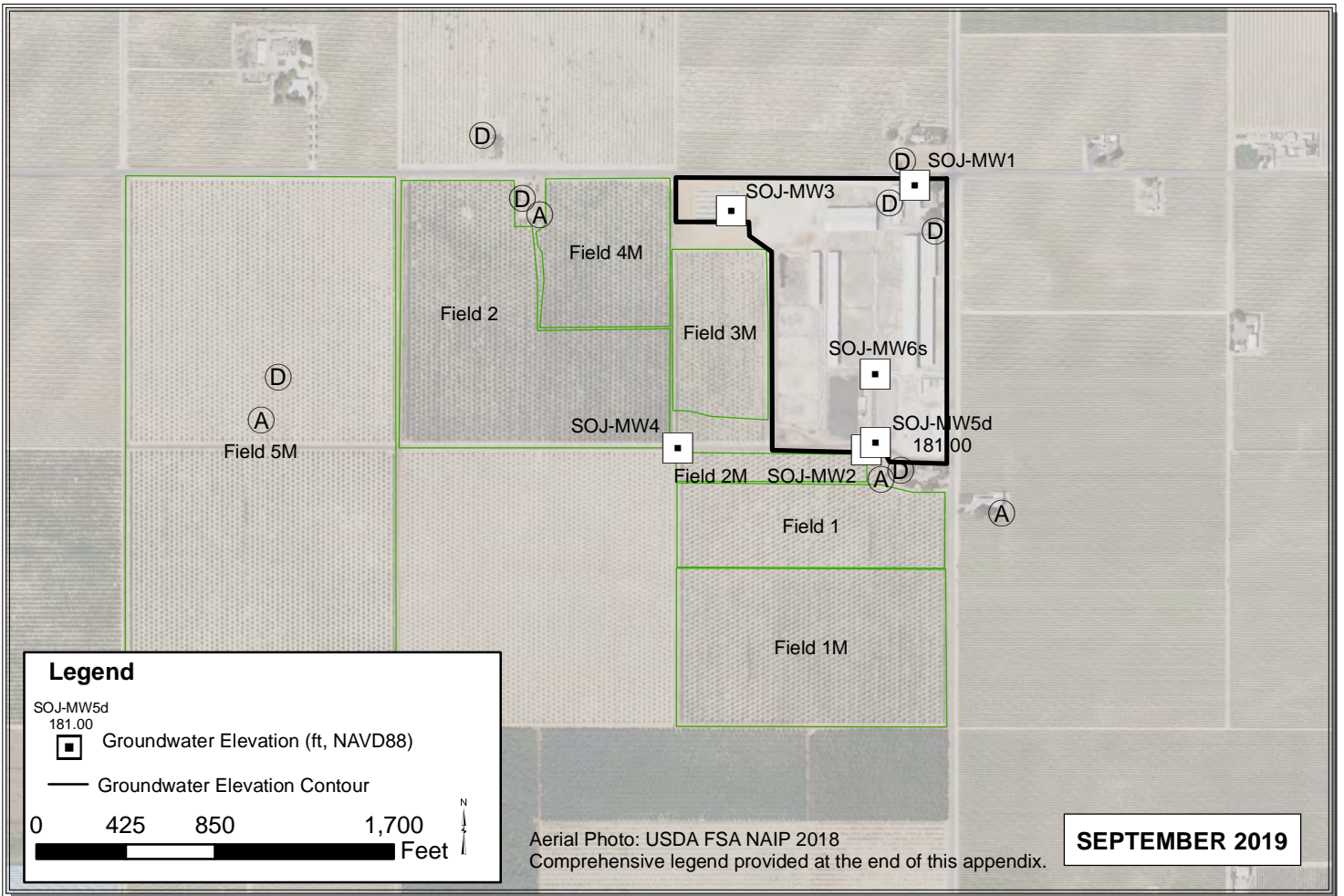

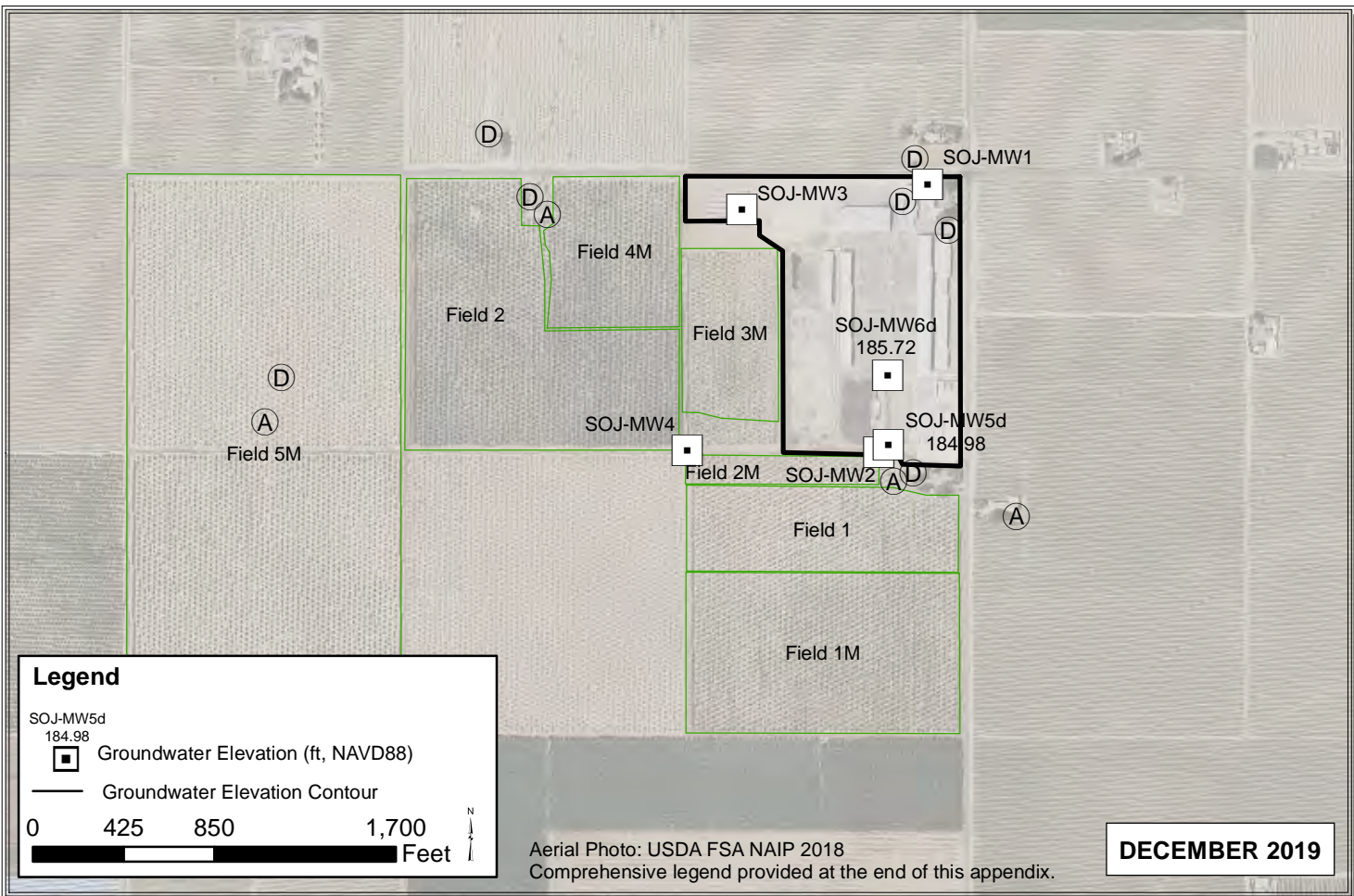
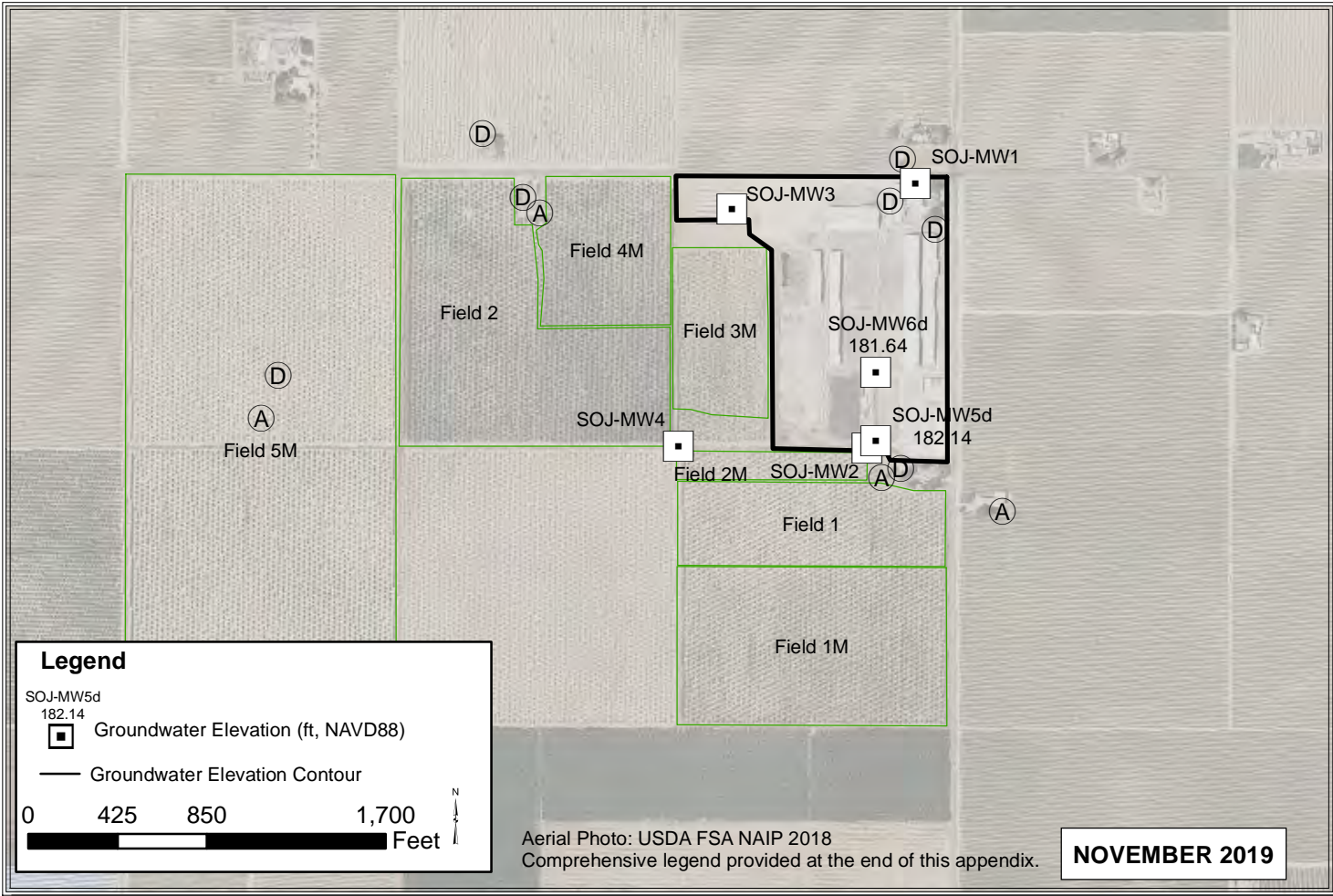

Attachment A6

Apparent Horizontal Gradients Between a Selection of Well Pairs

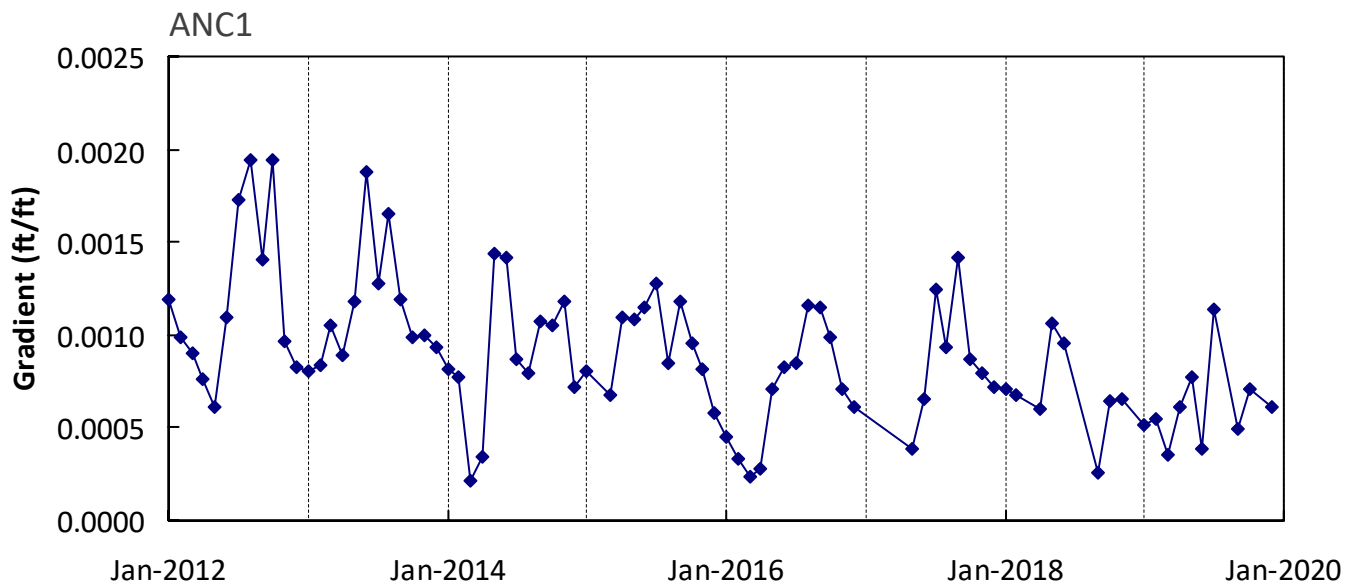
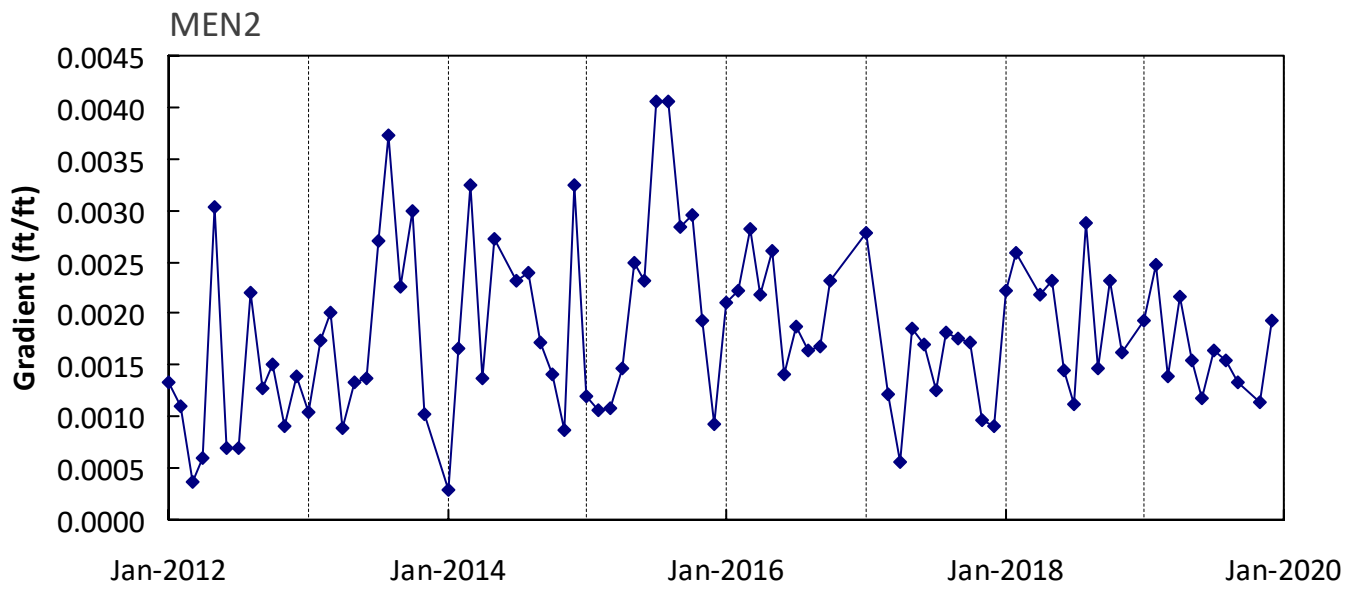
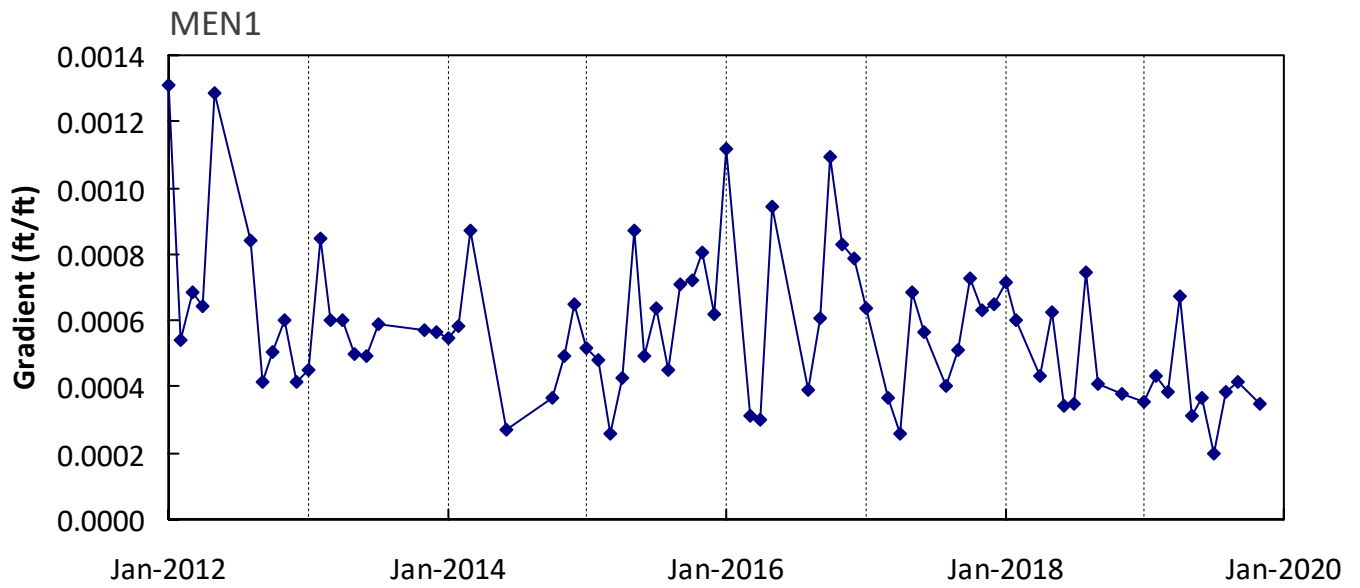

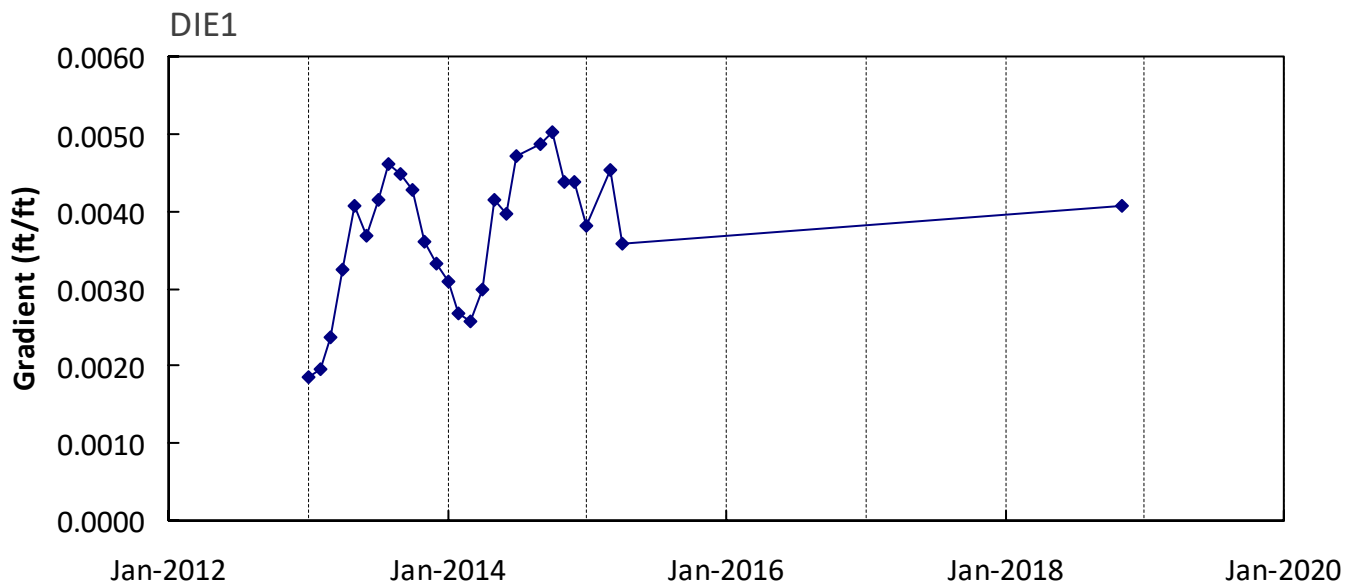
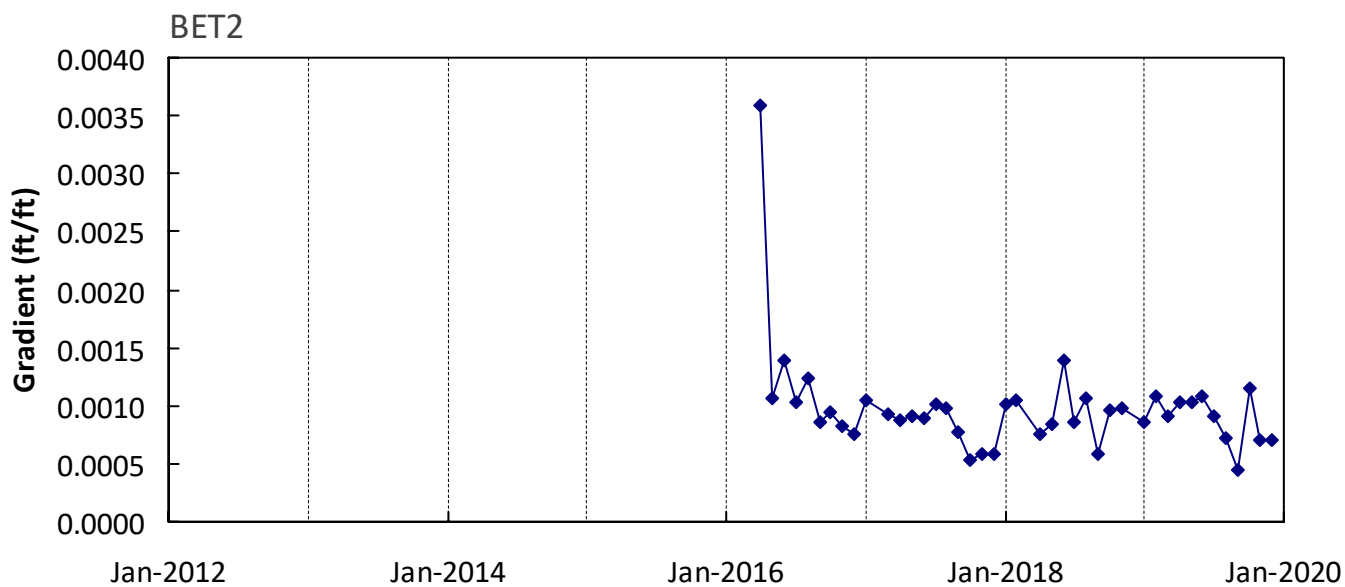
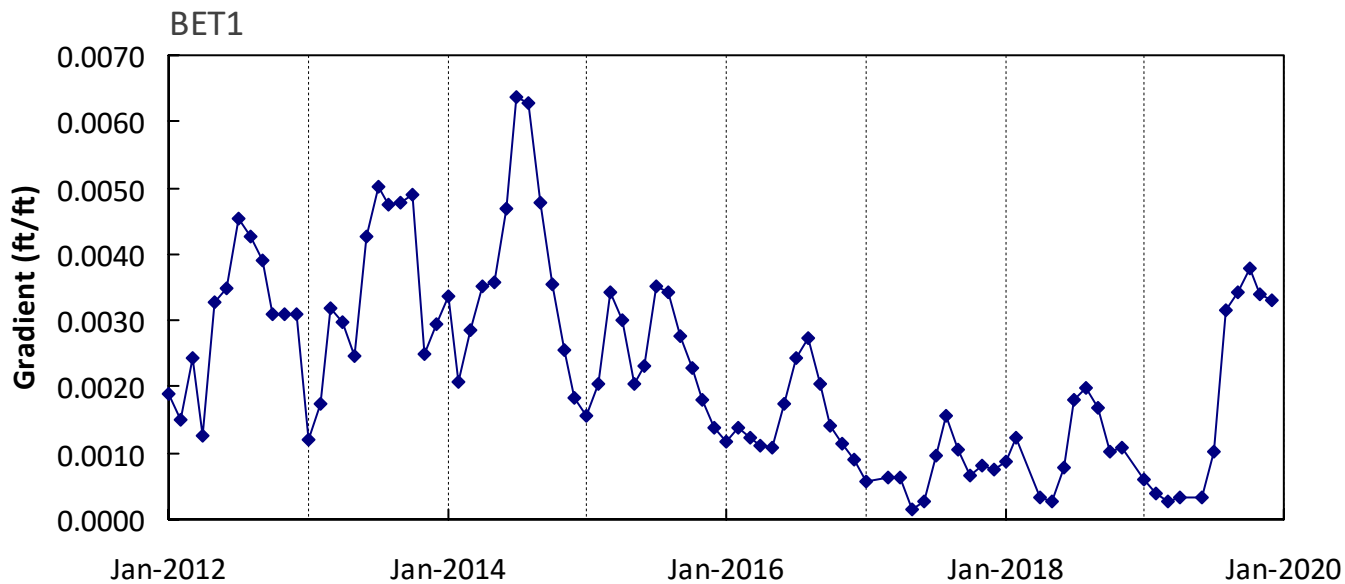

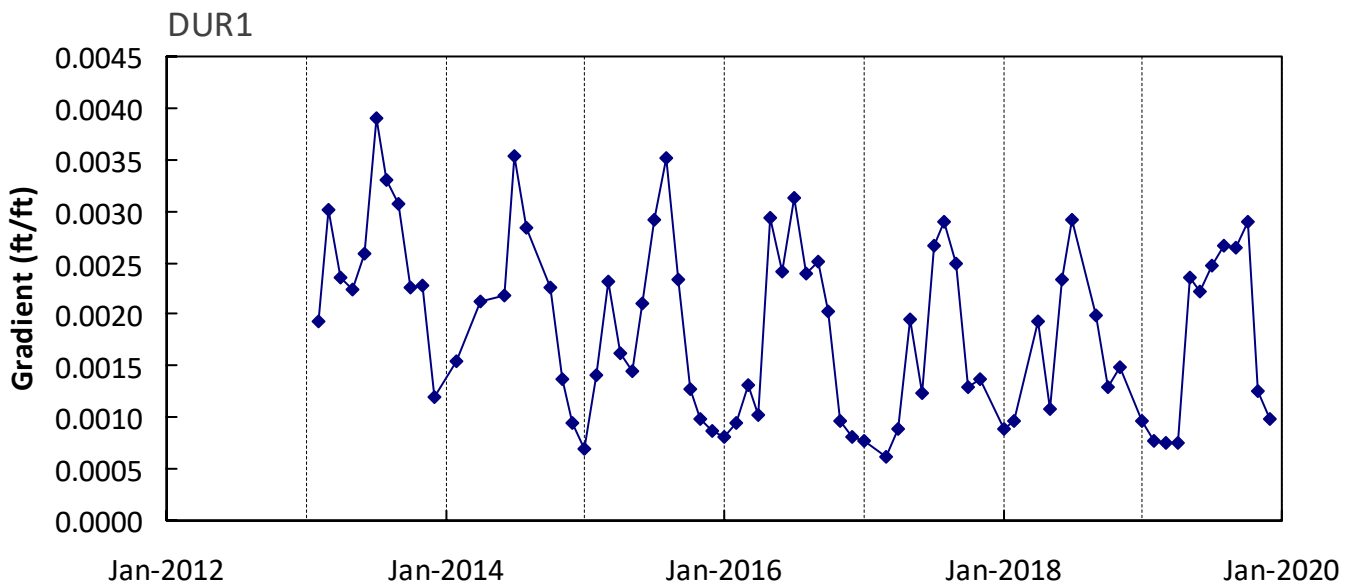
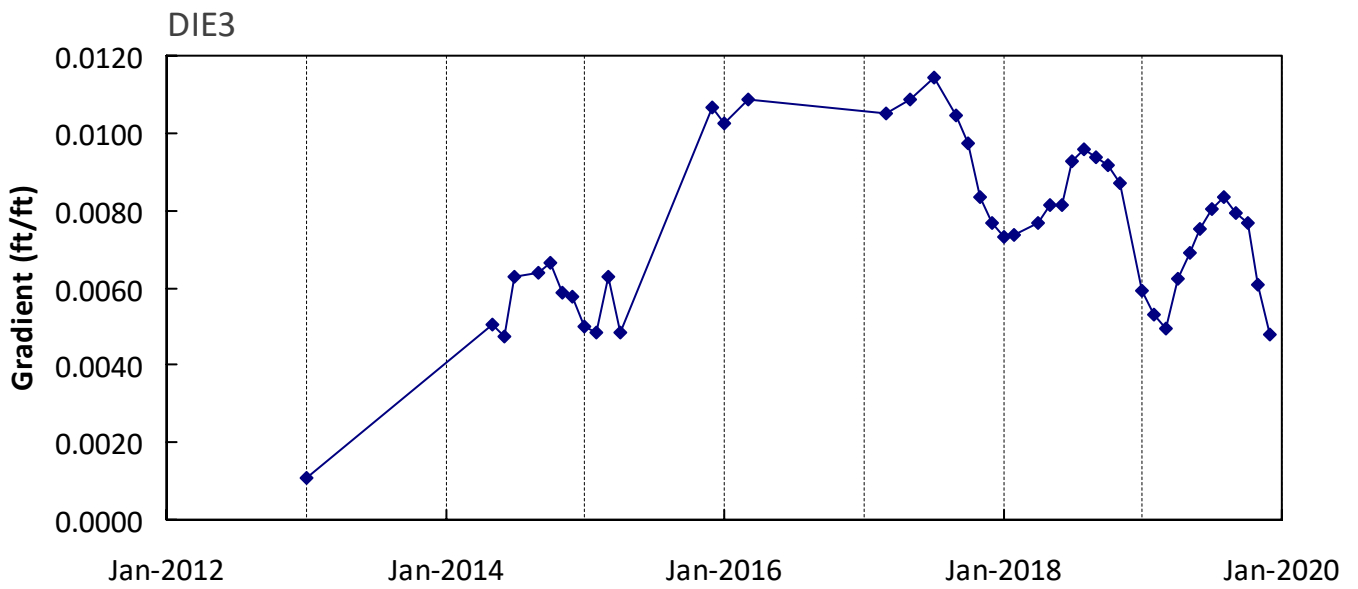
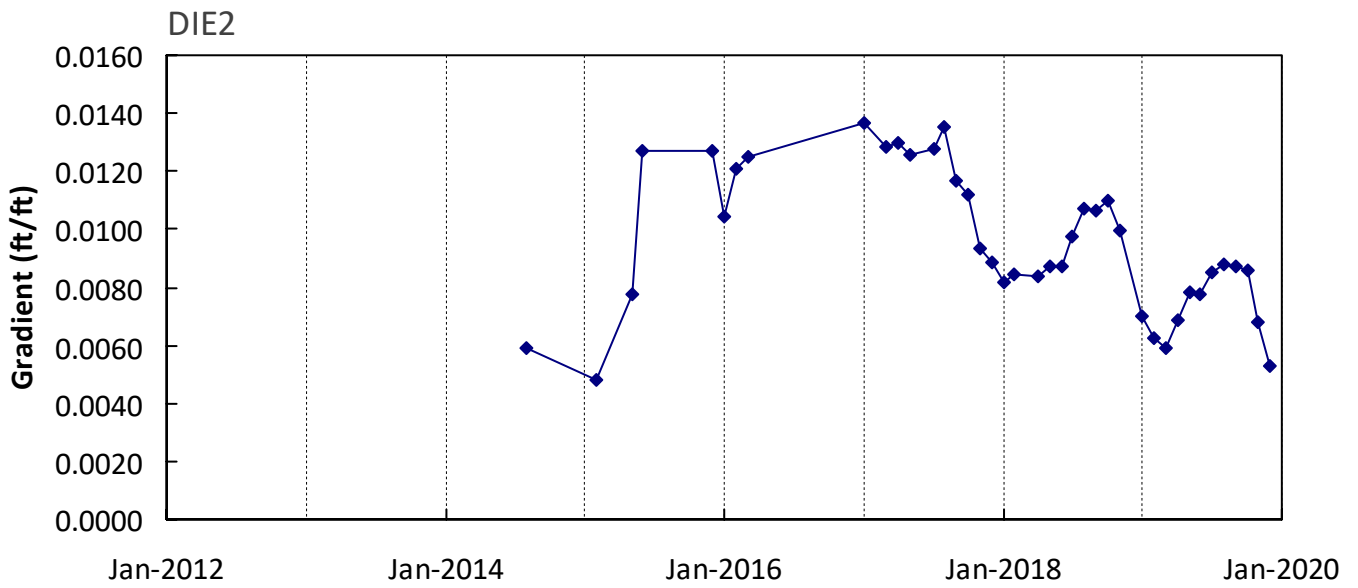

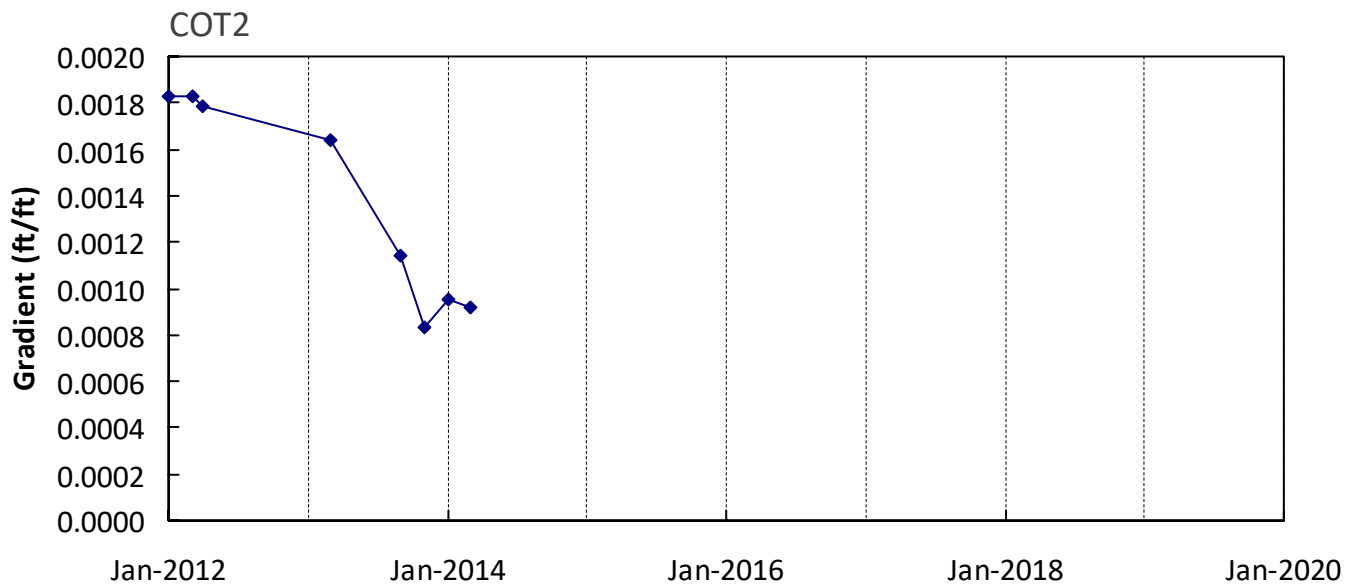
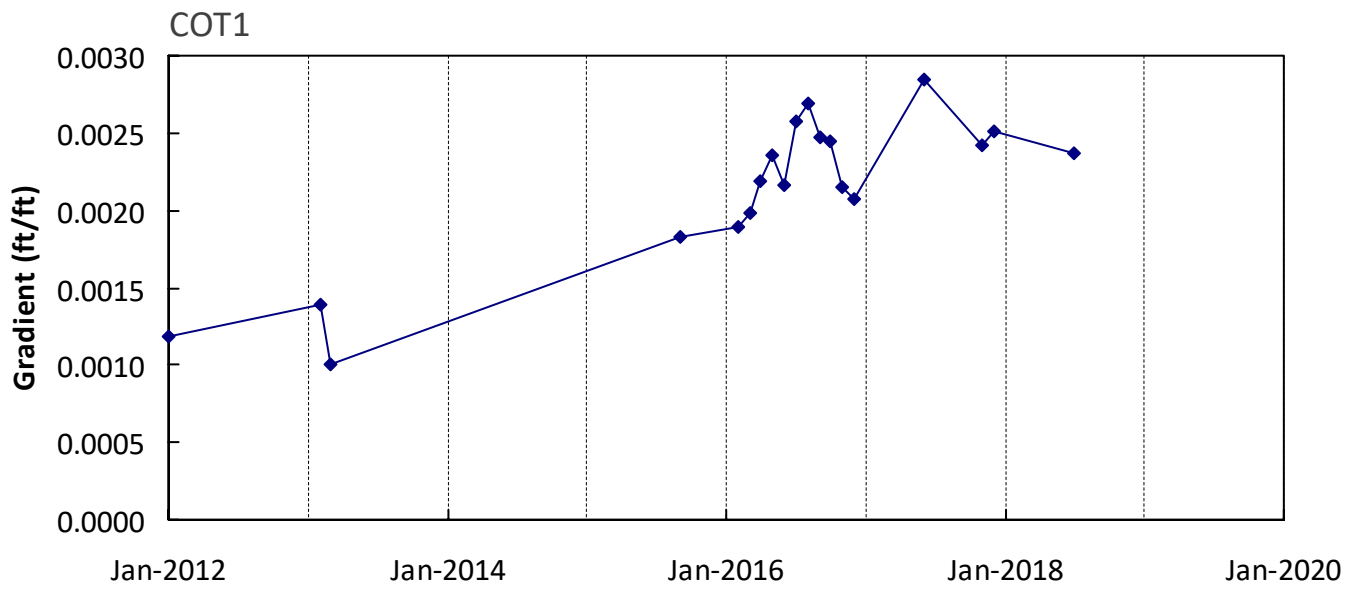
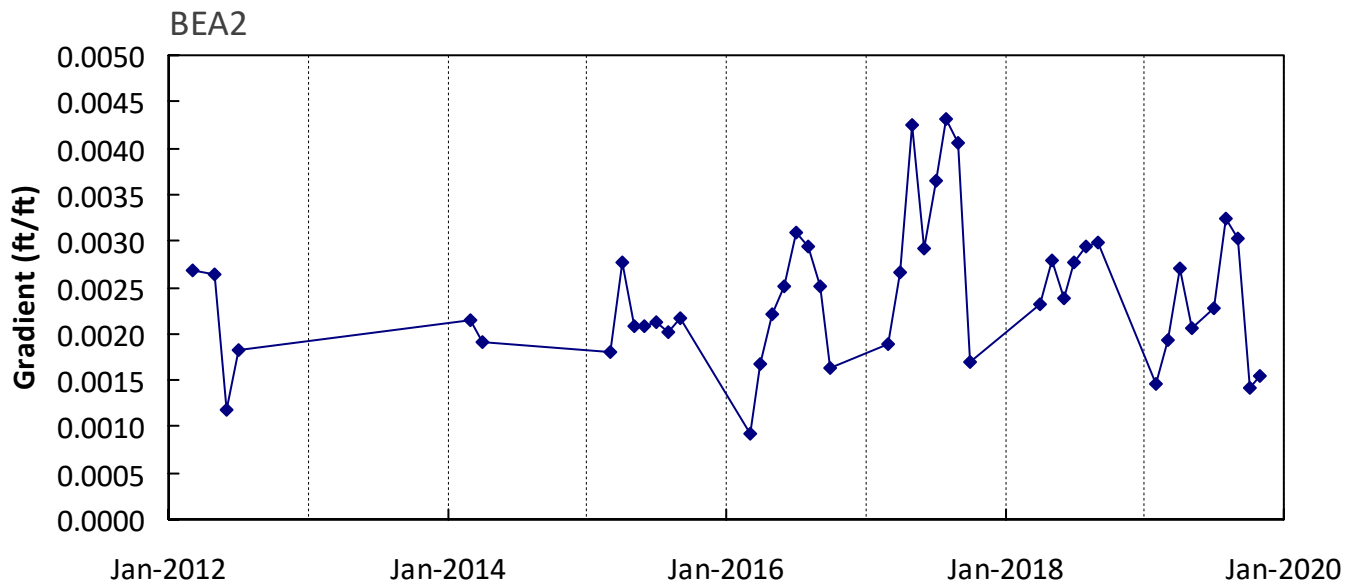

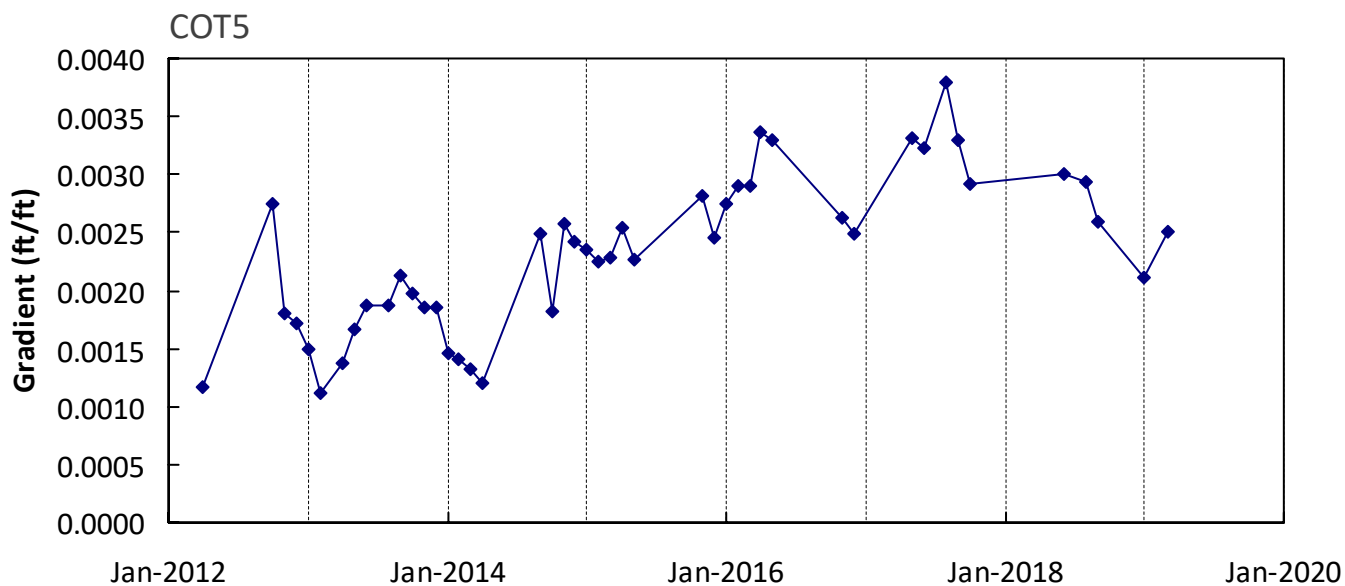
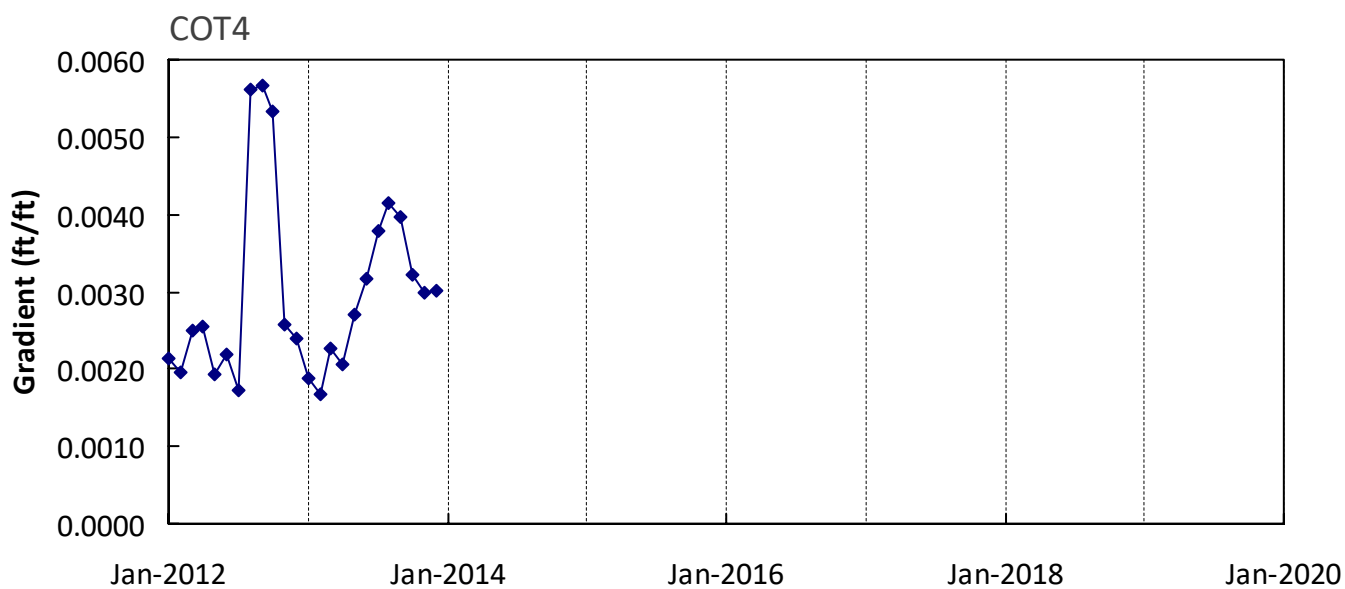
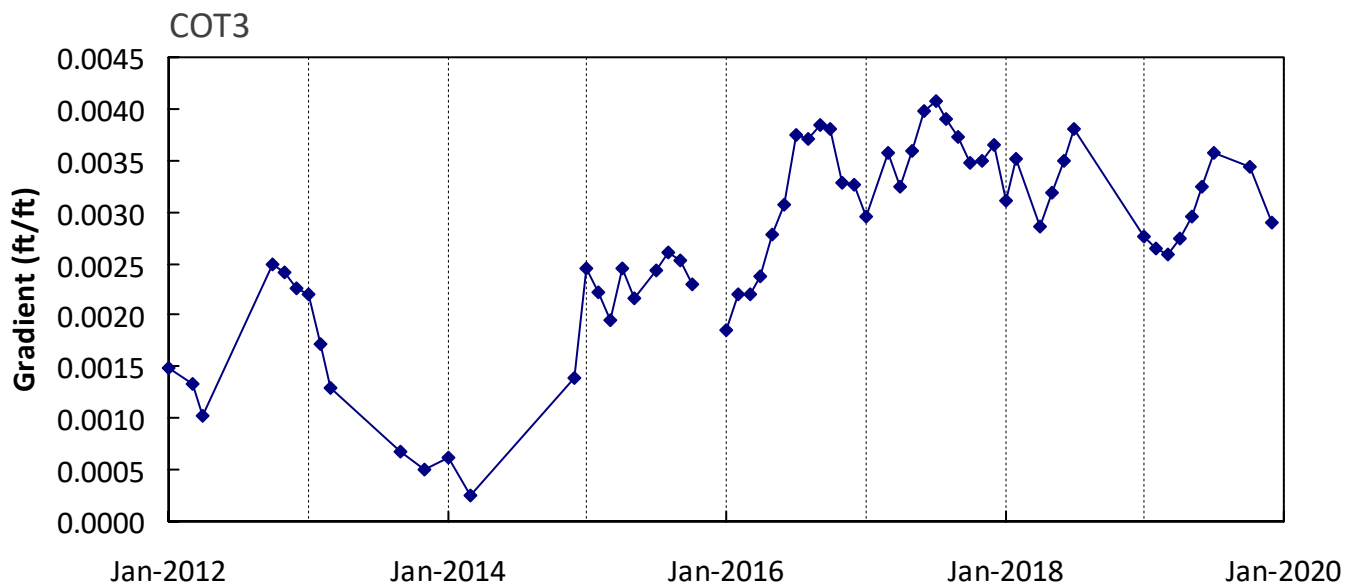

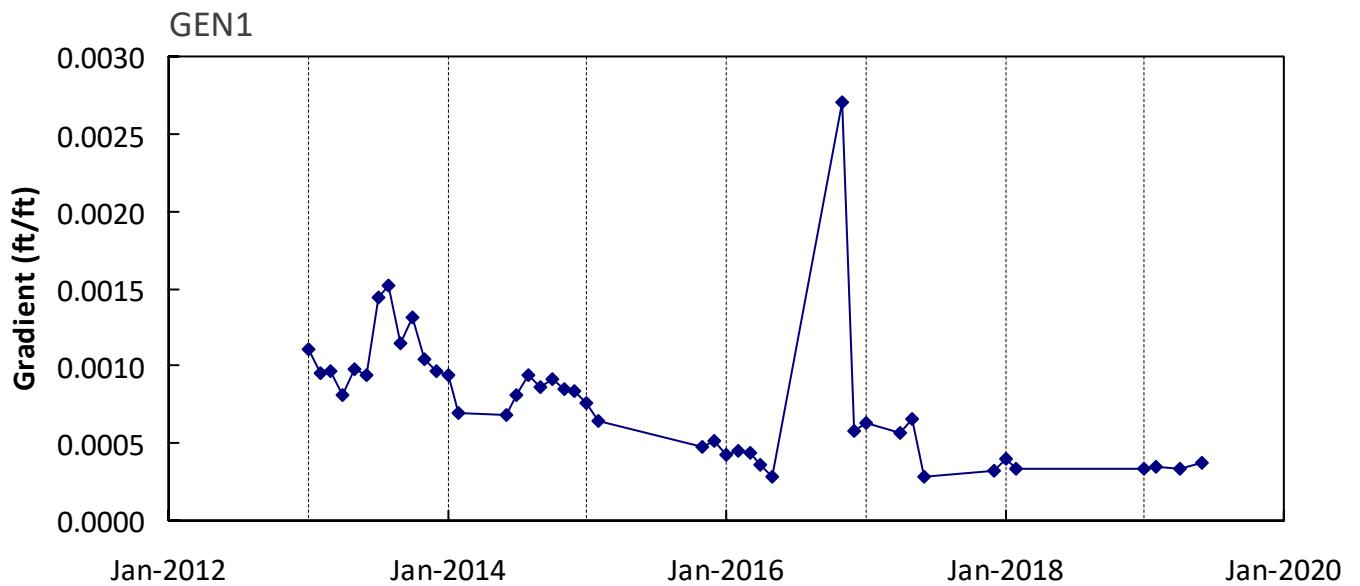
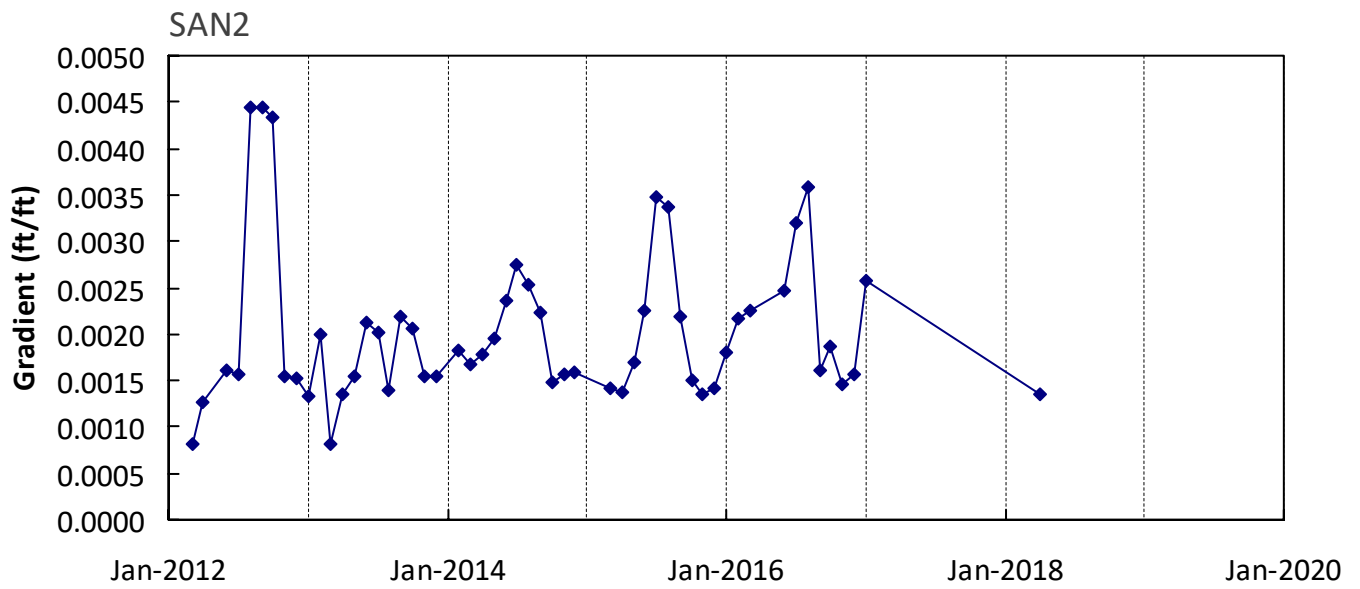
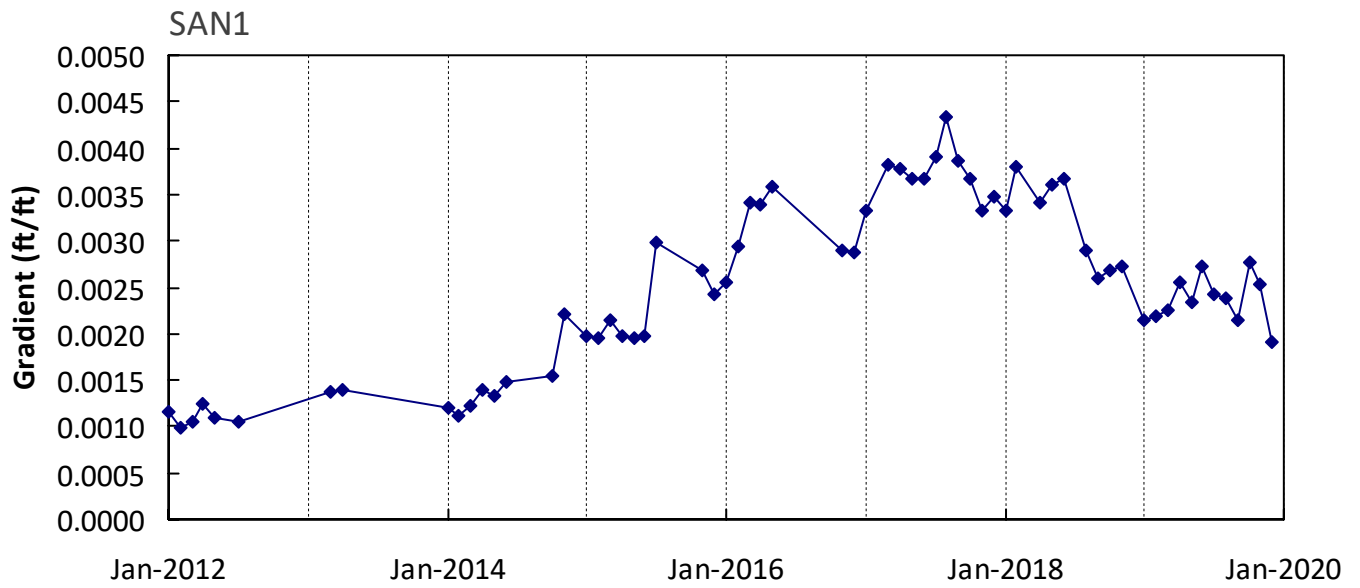

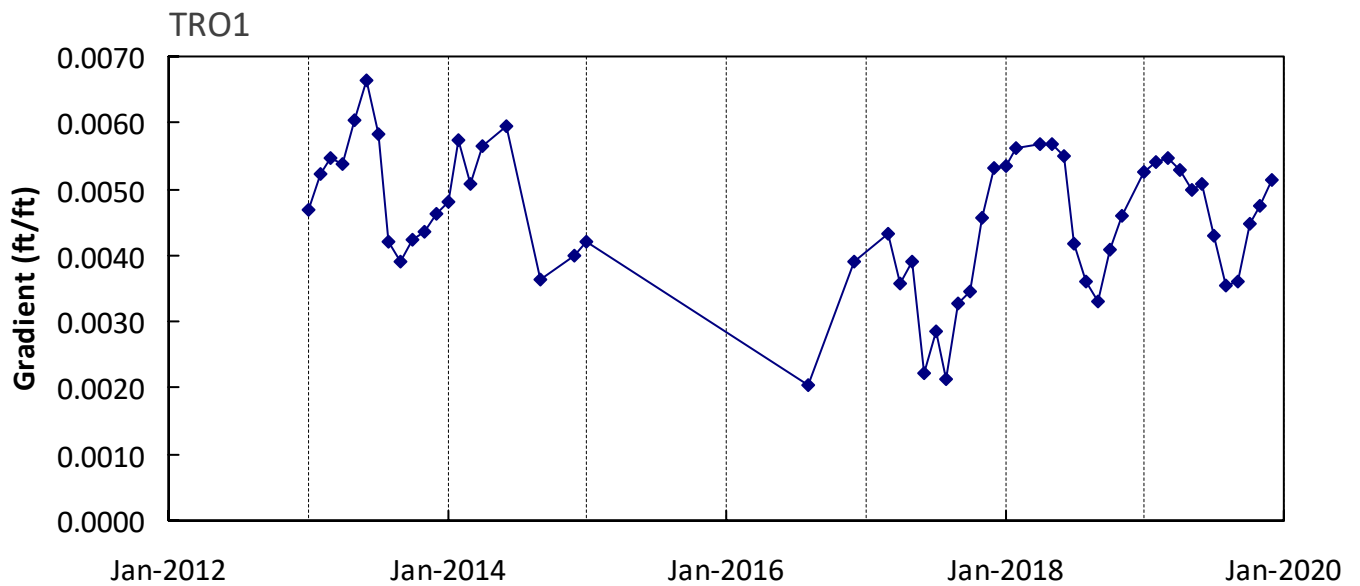
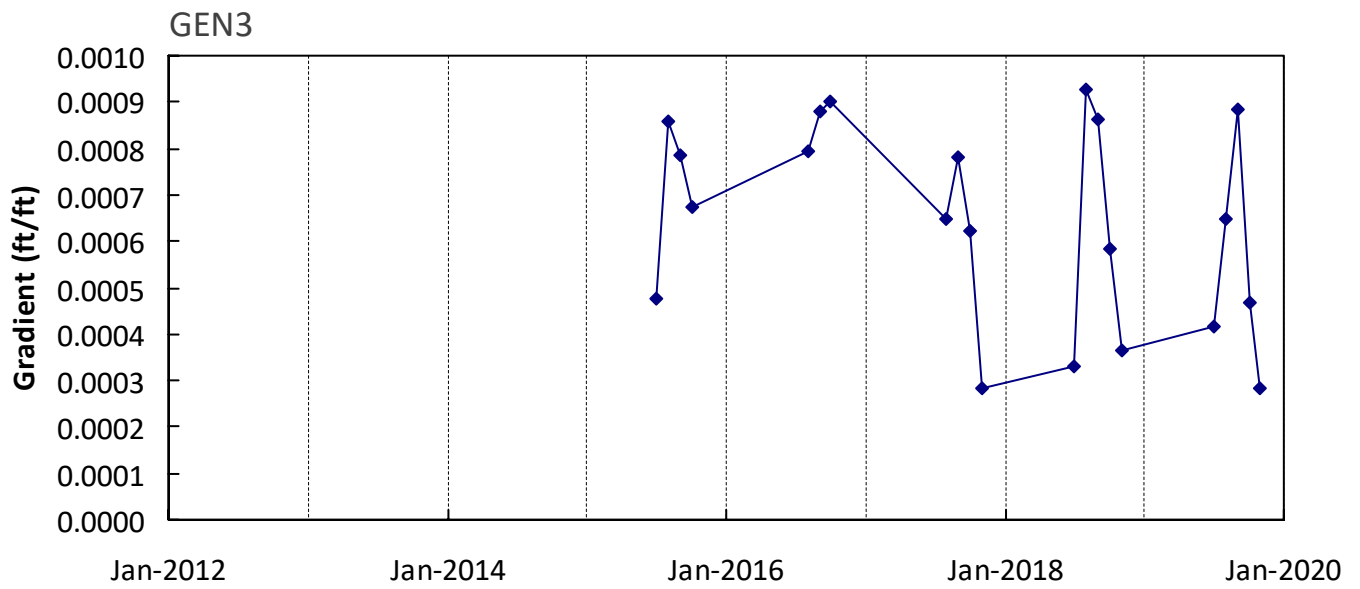
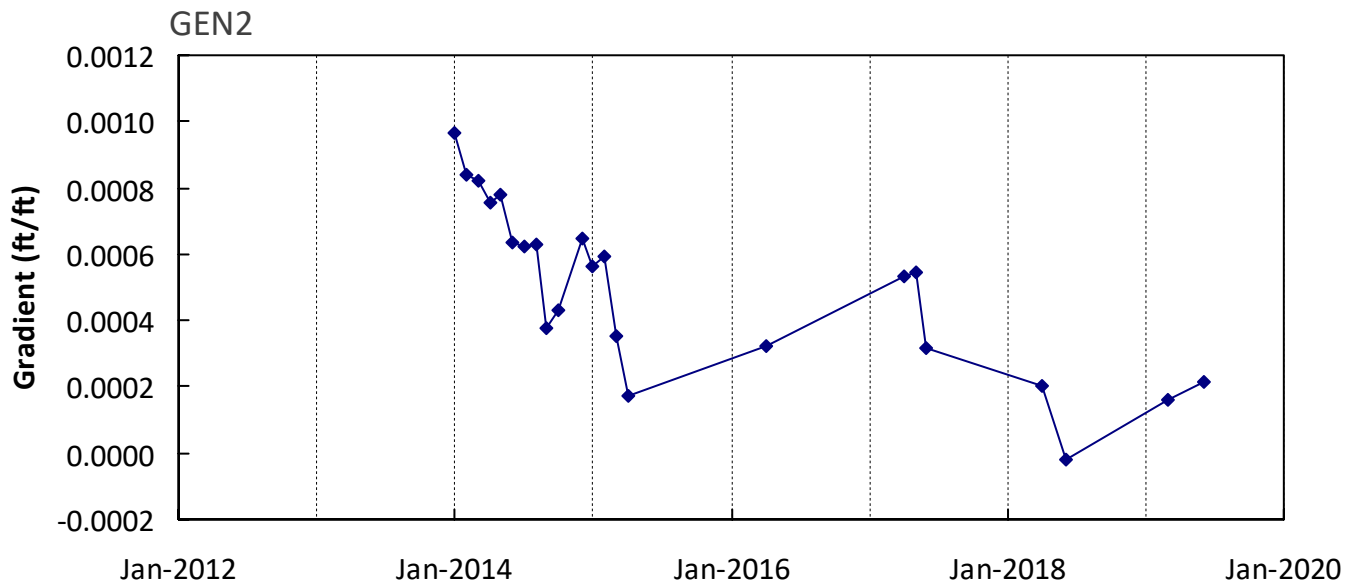

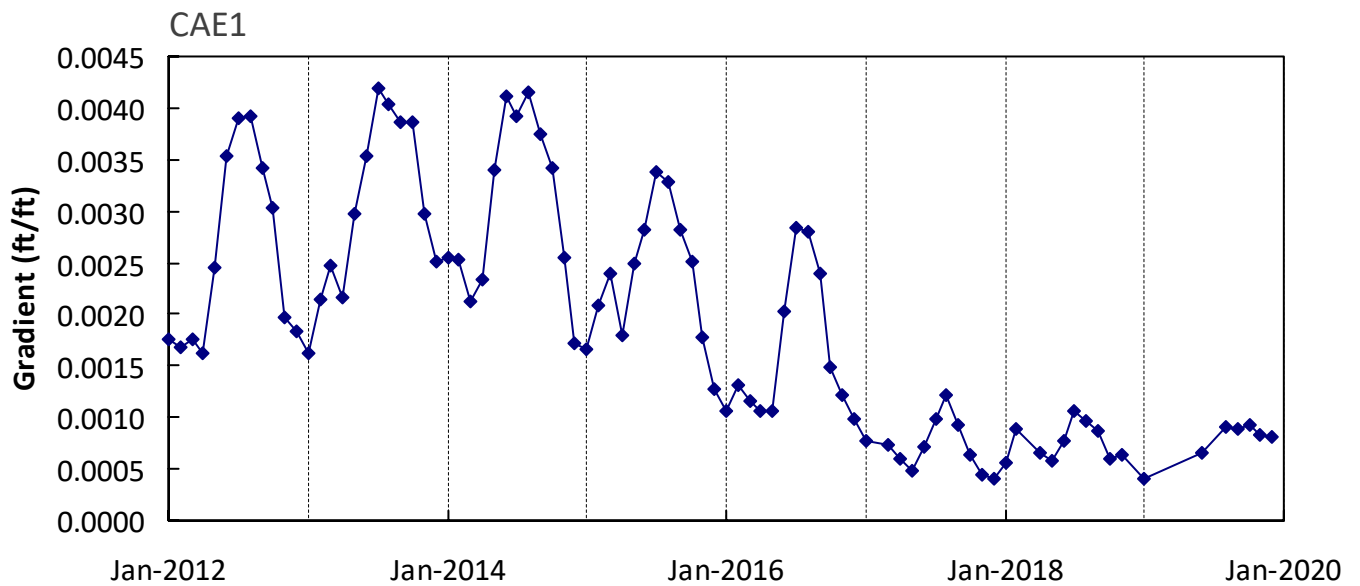
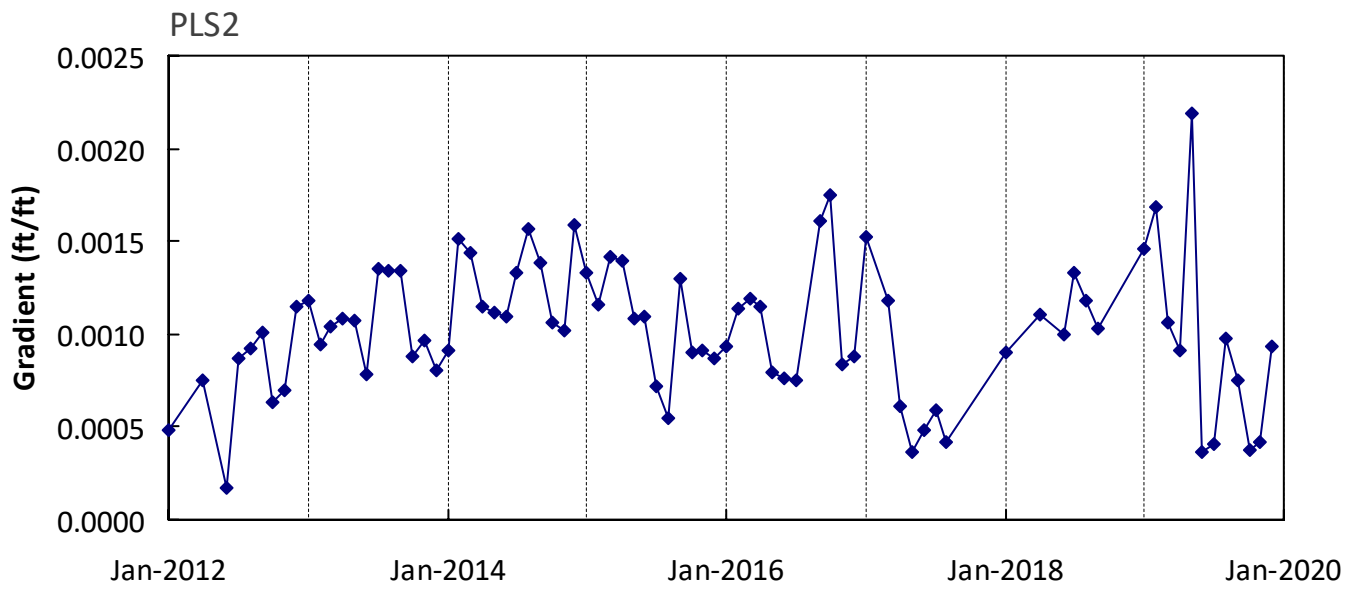
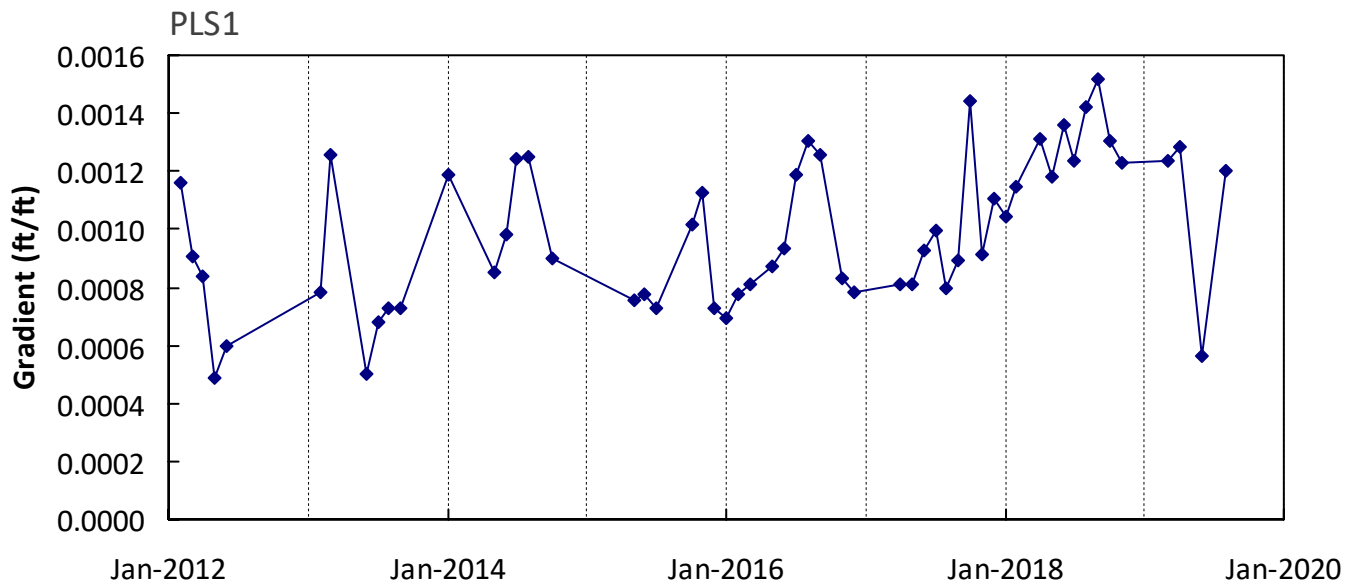

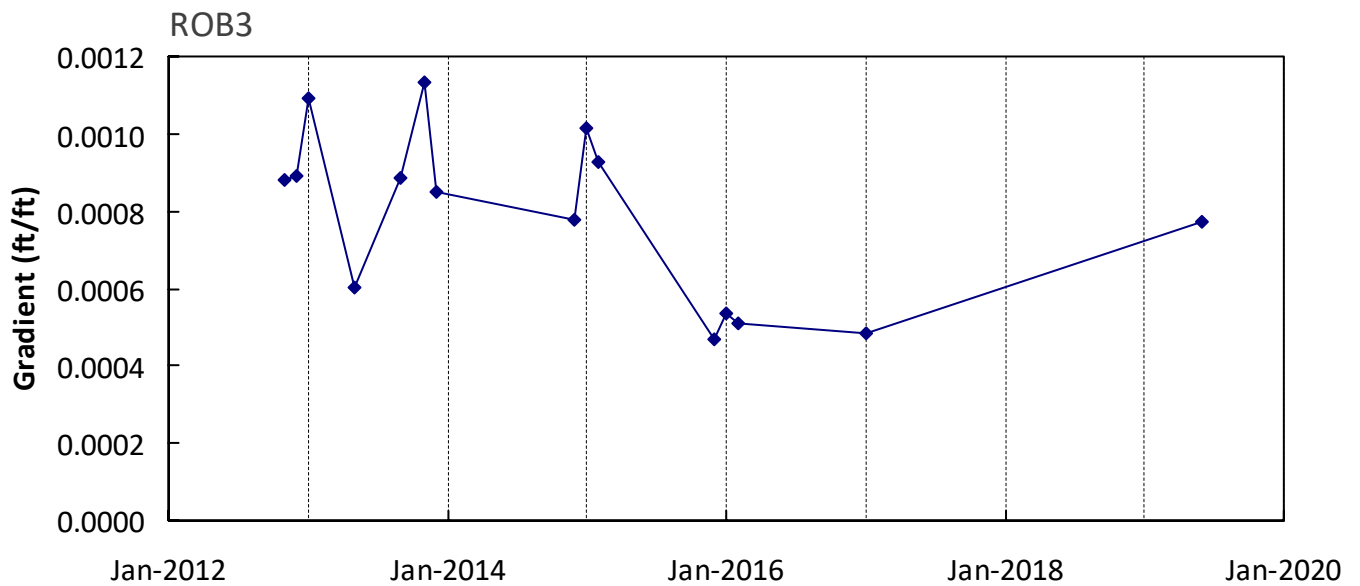
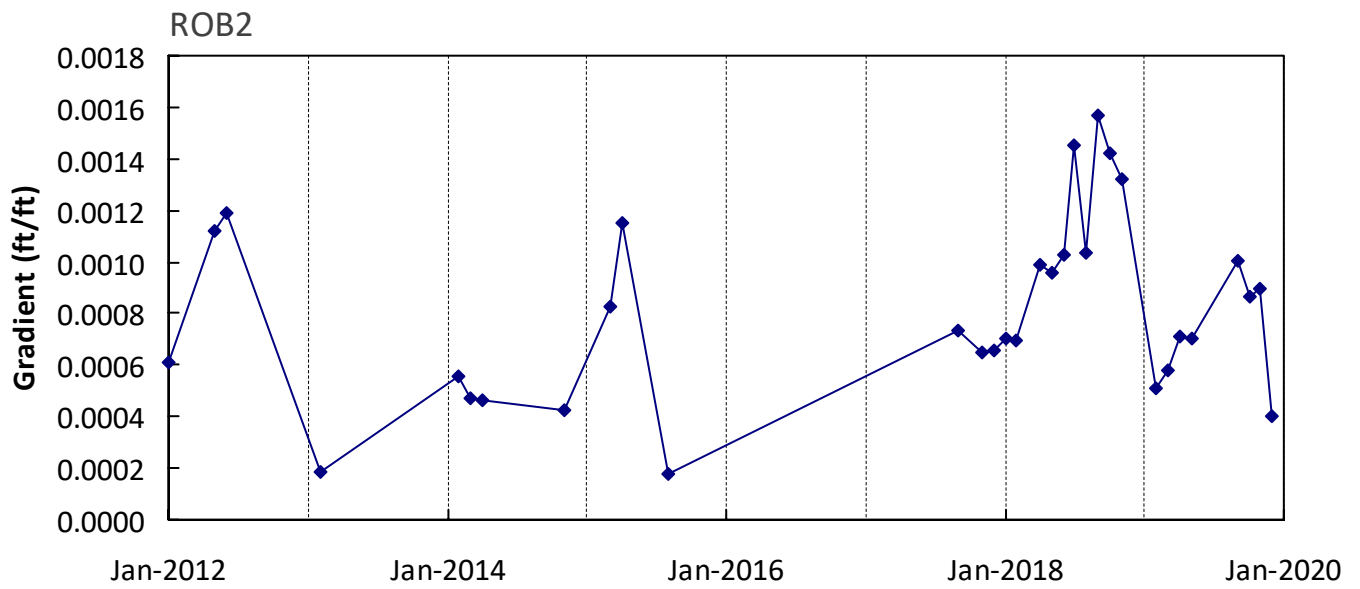
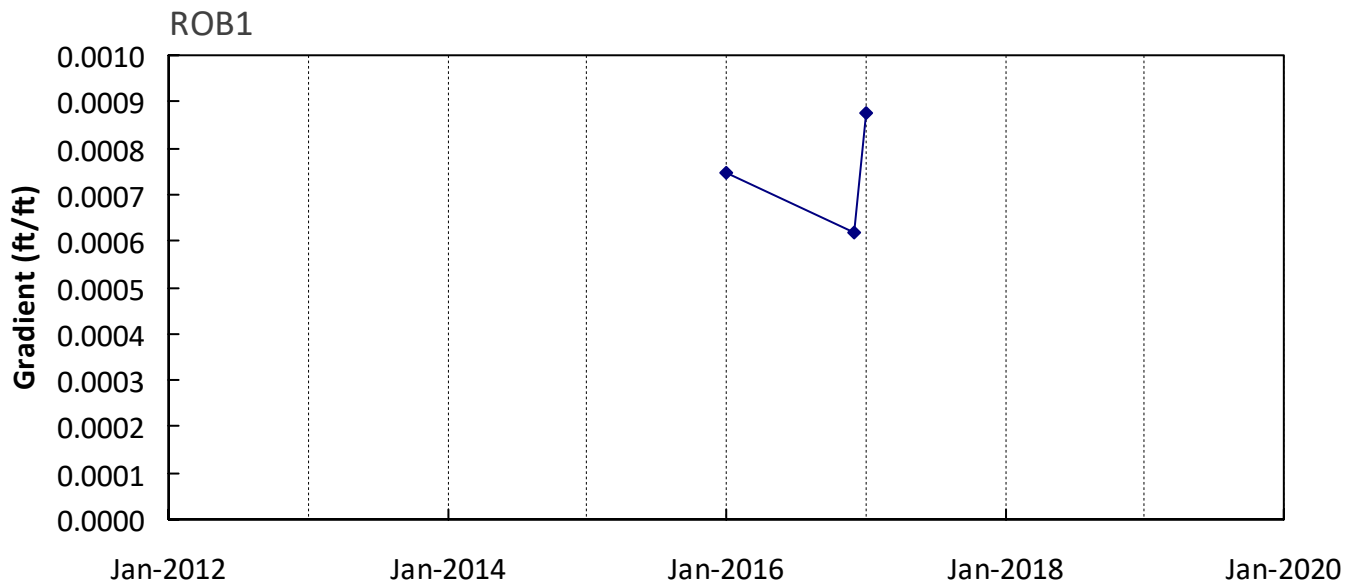

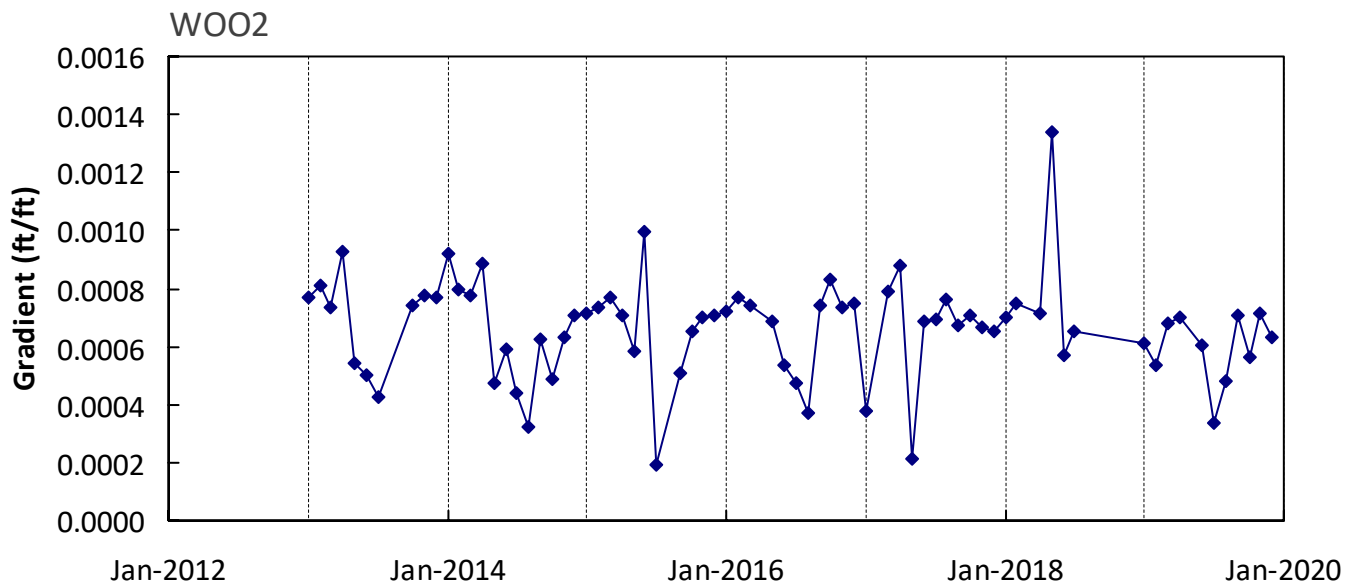
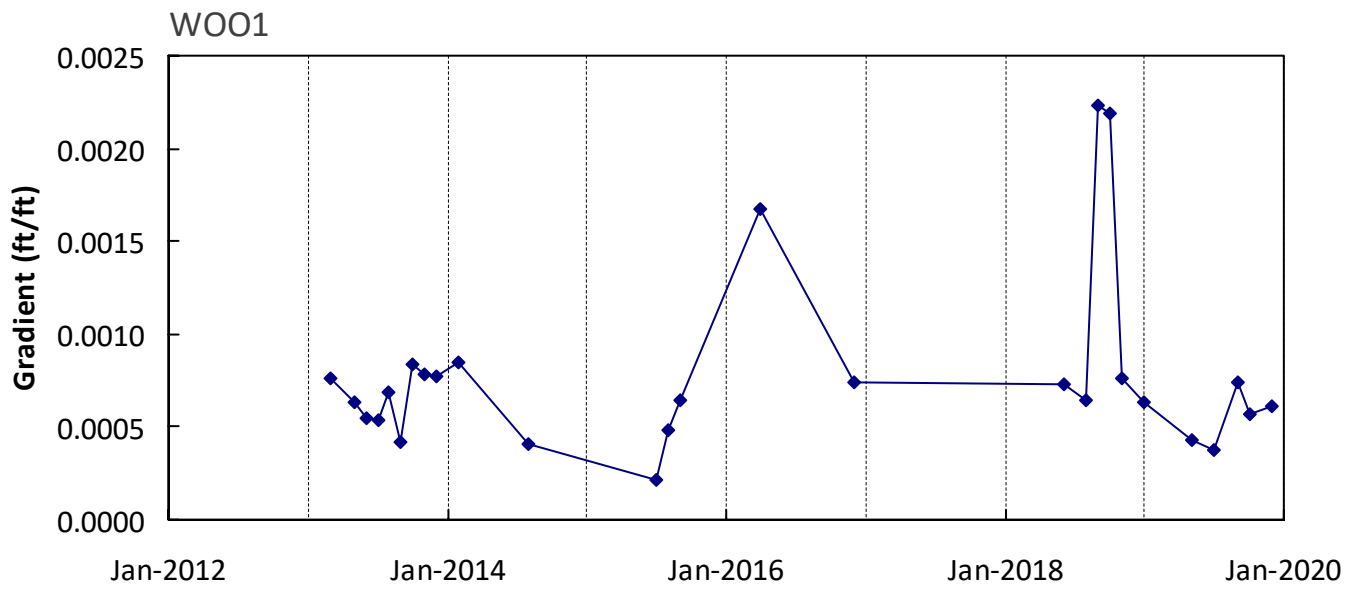
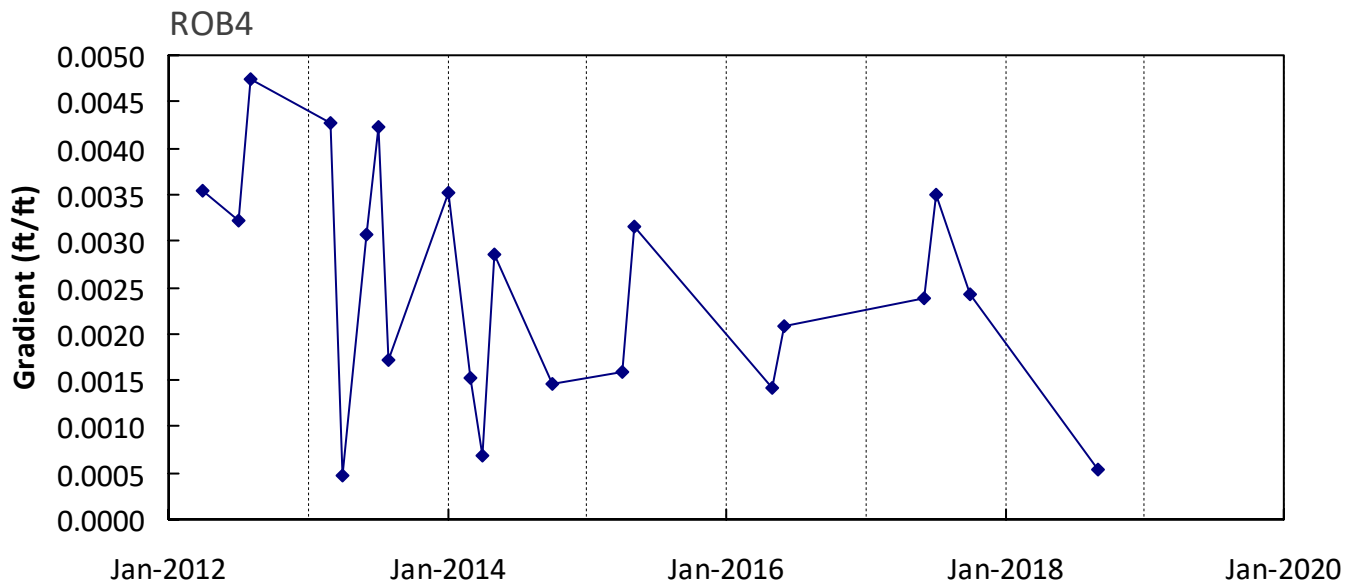

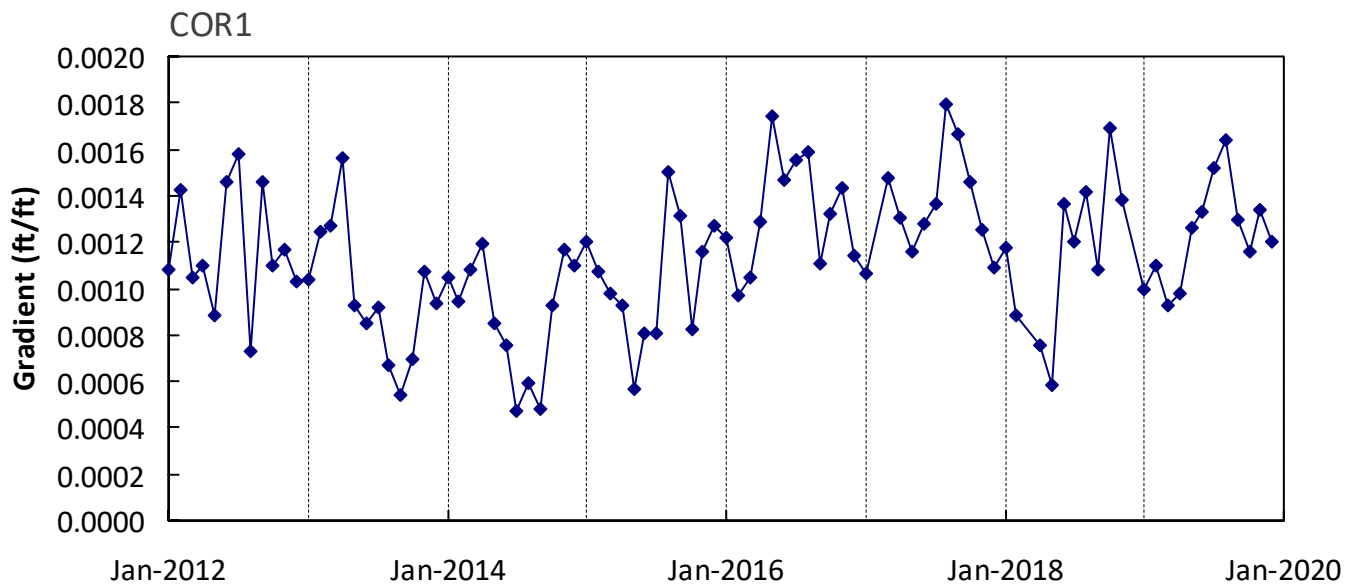
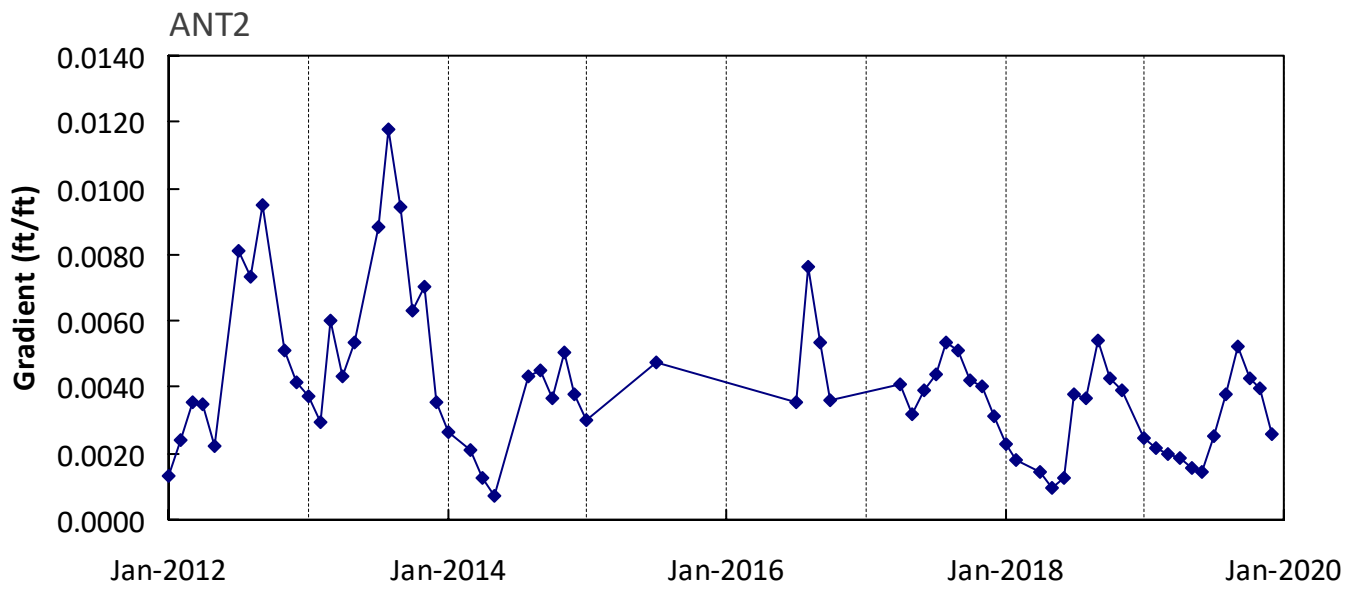
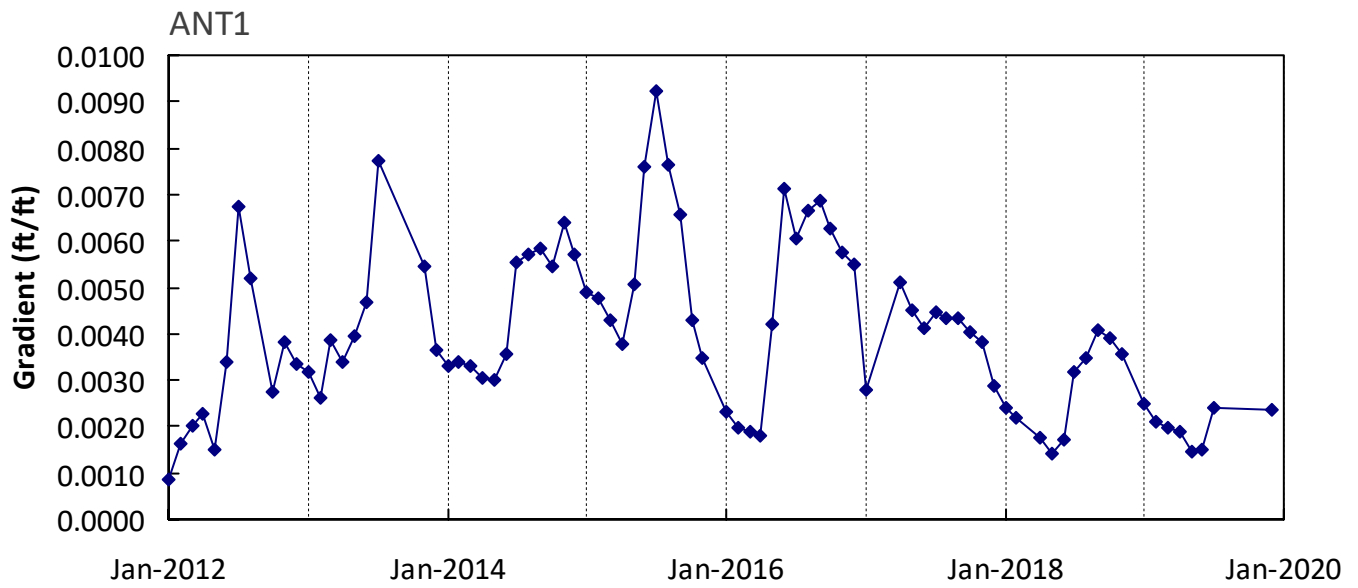

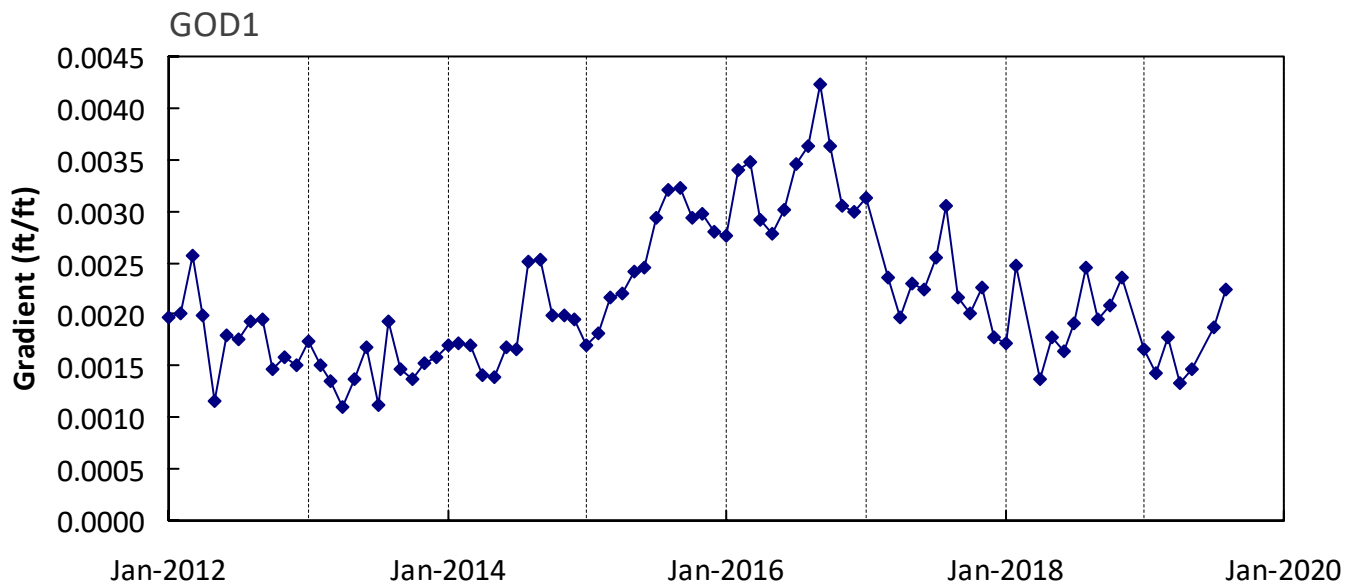
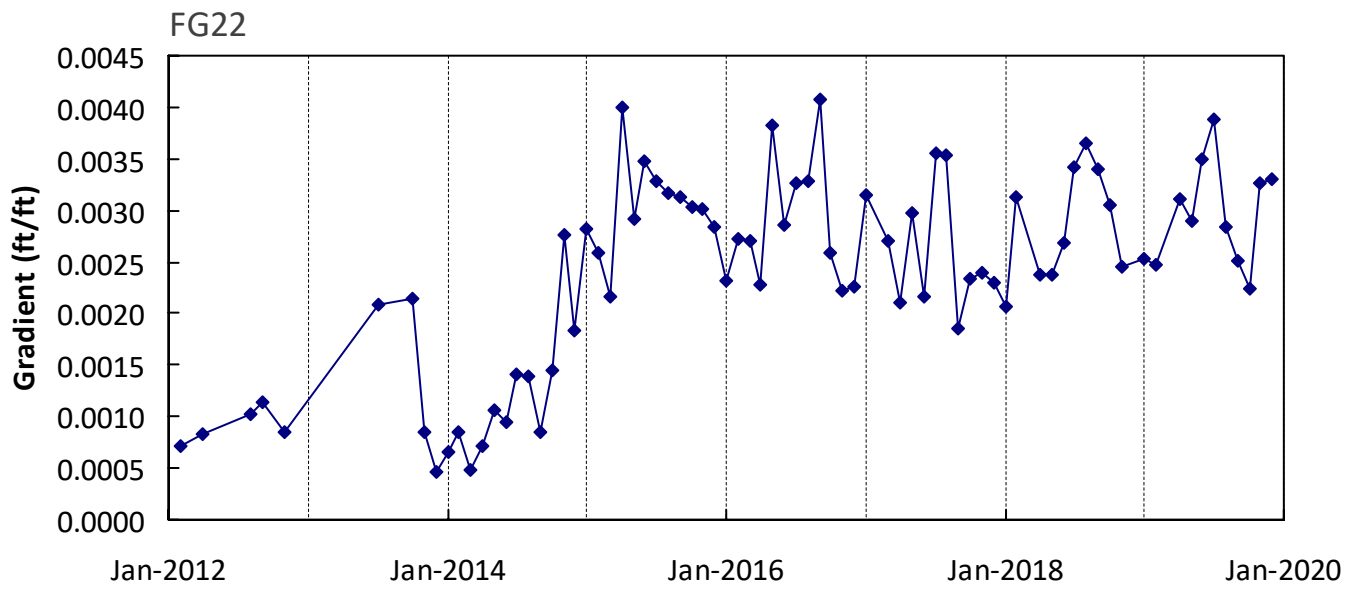
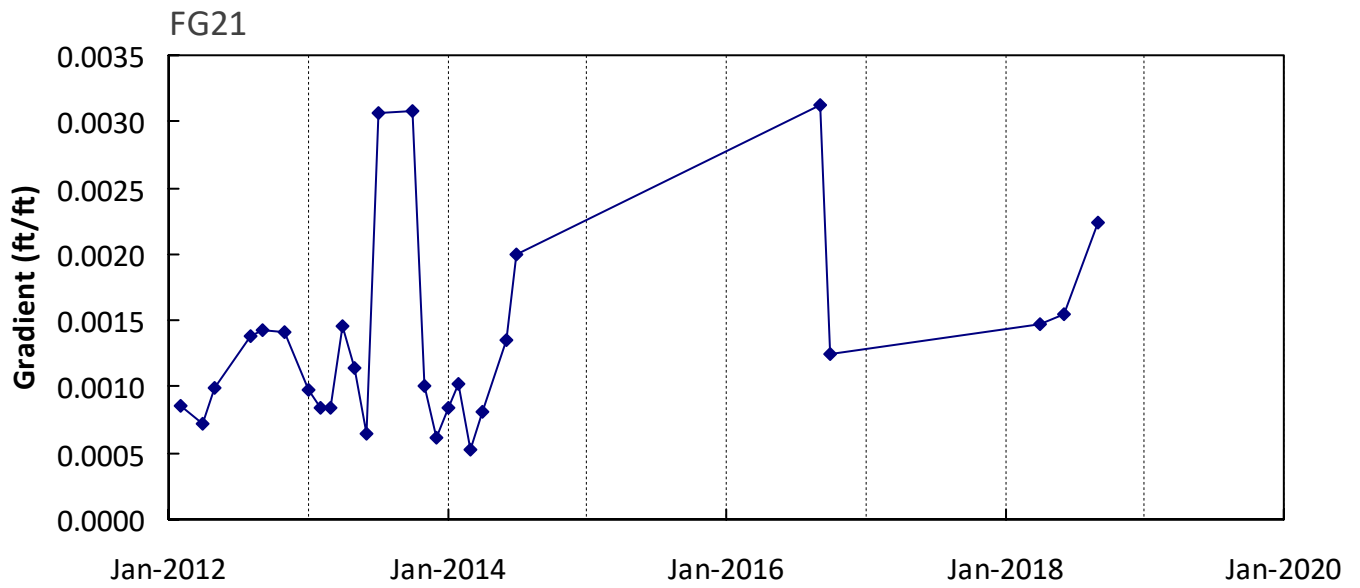

GOD2

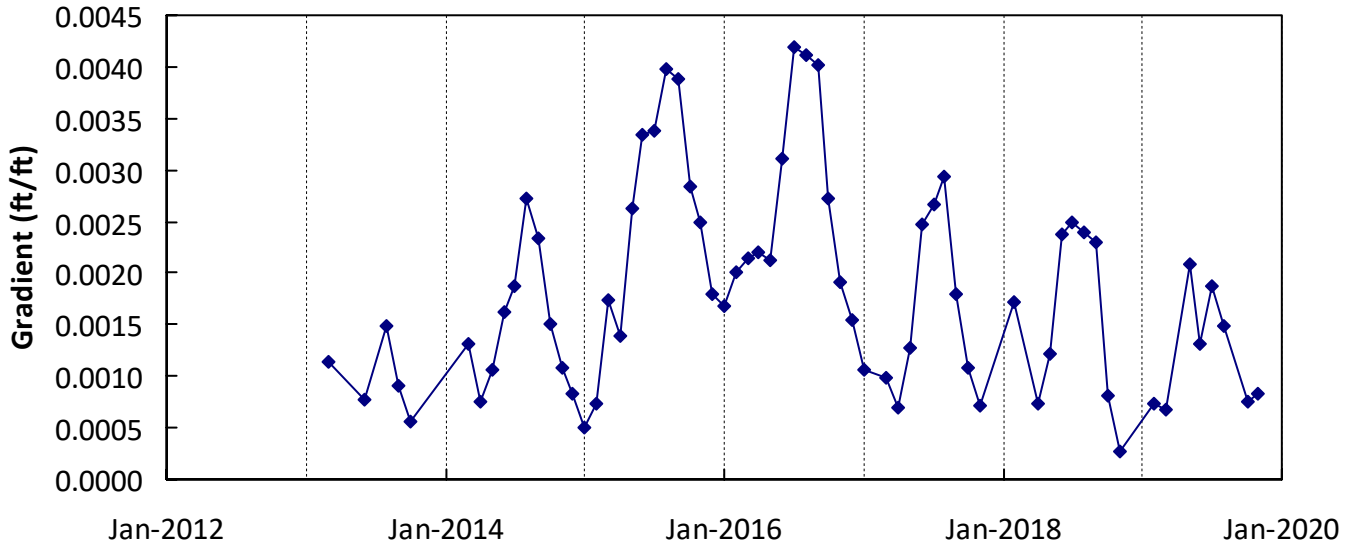

MAC1

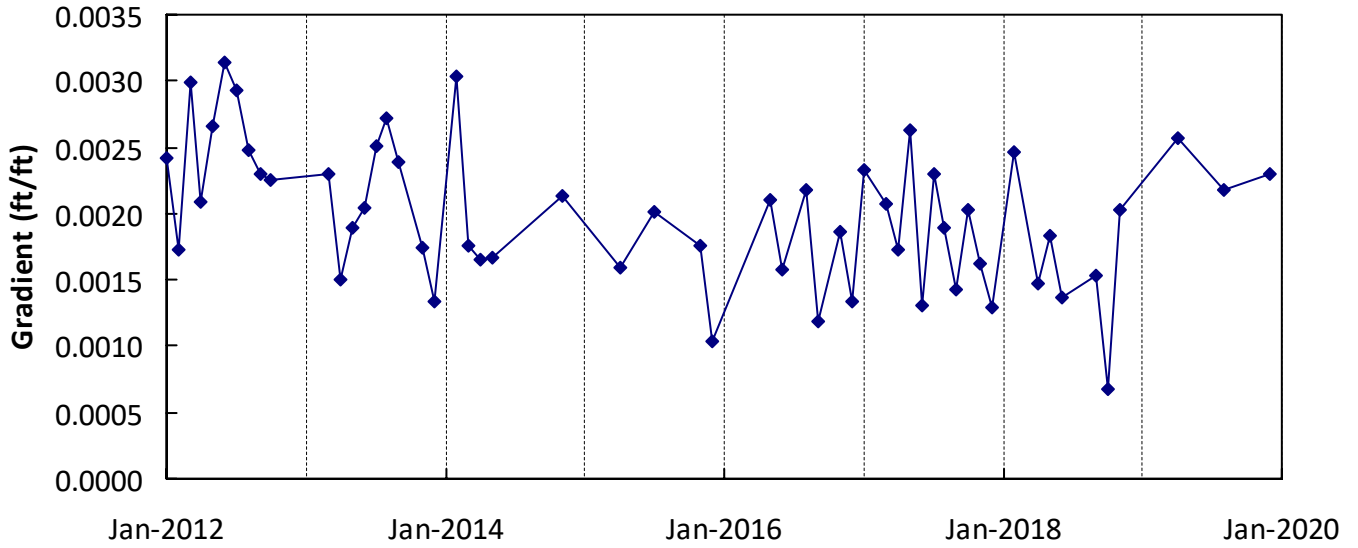

MAC2

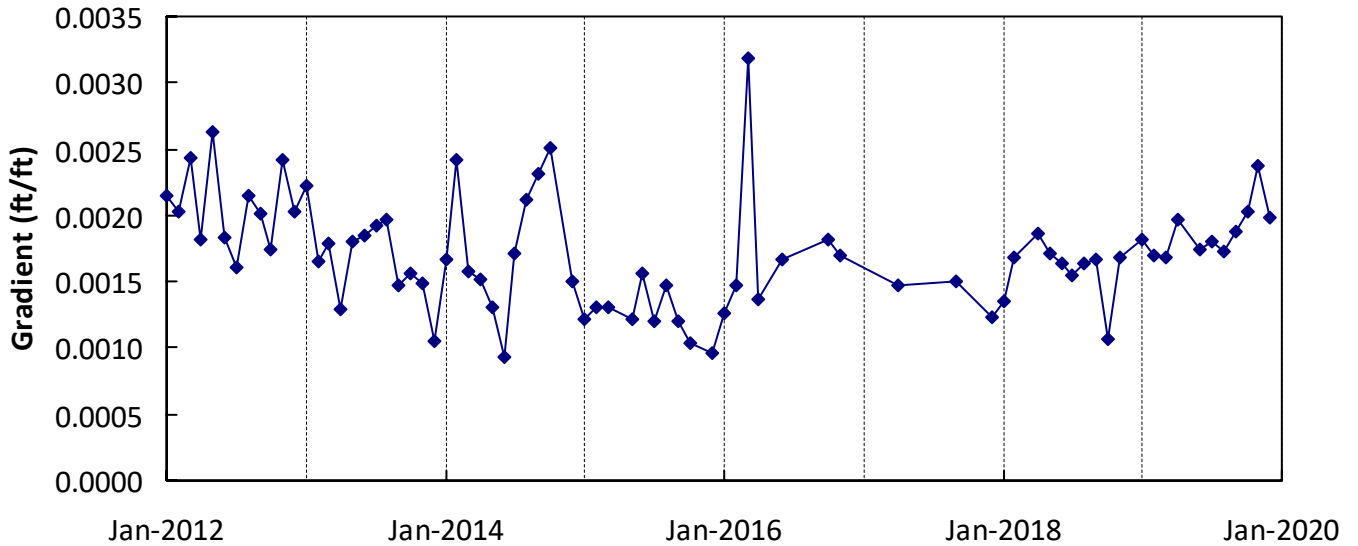

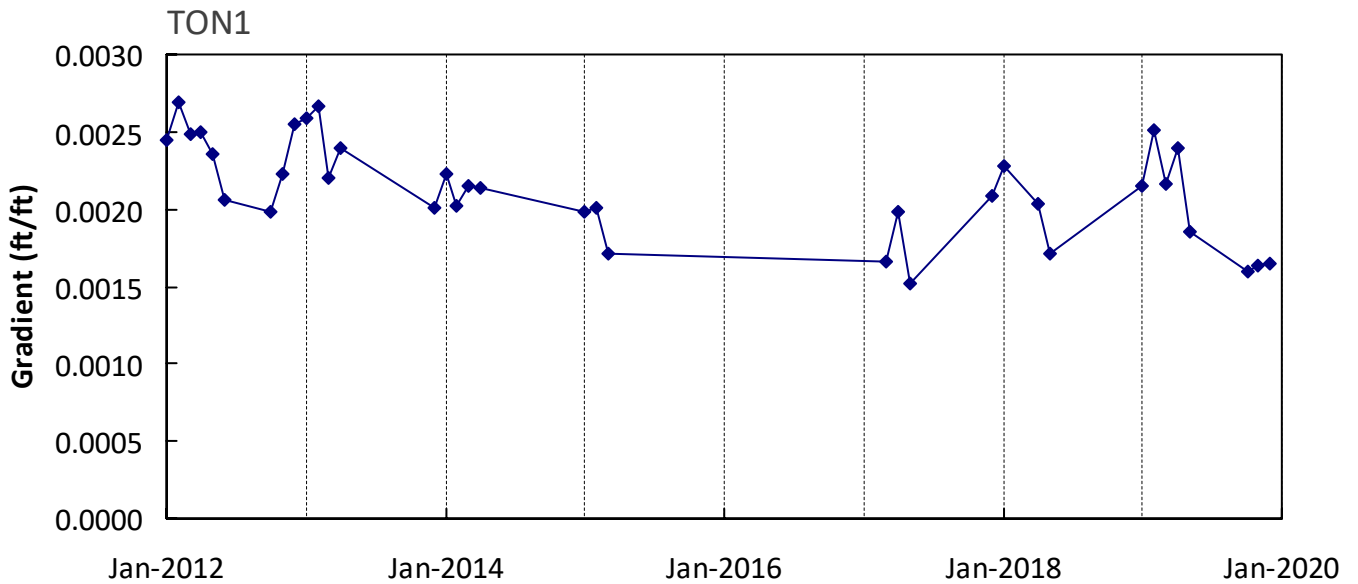
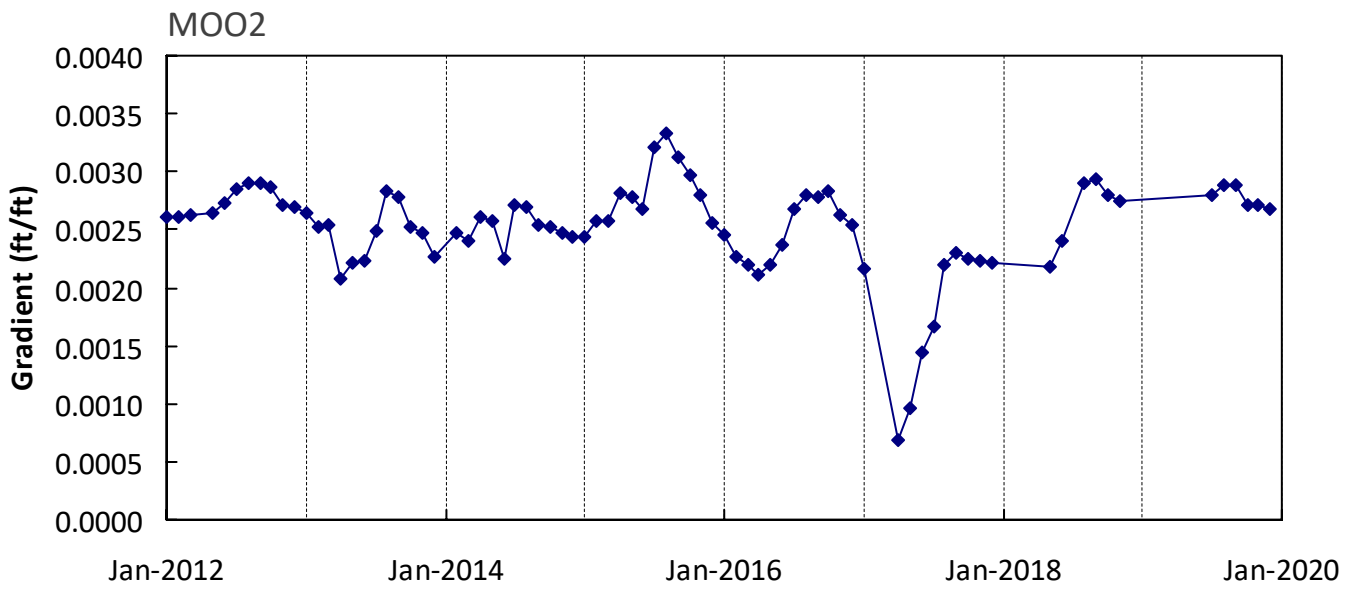
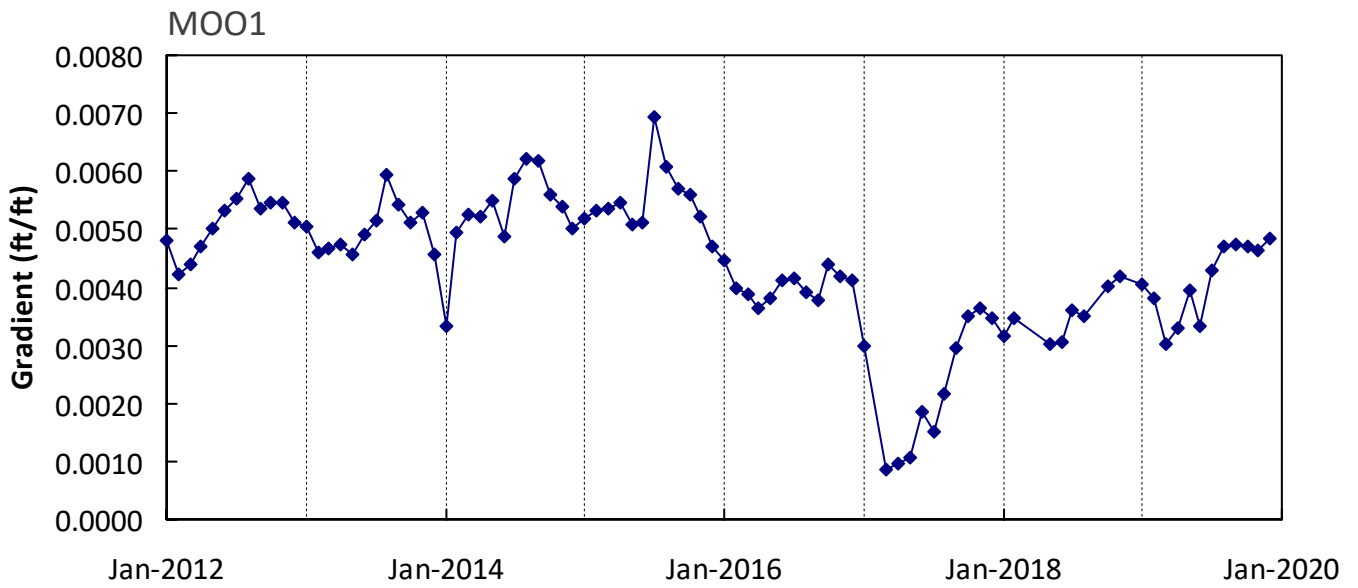

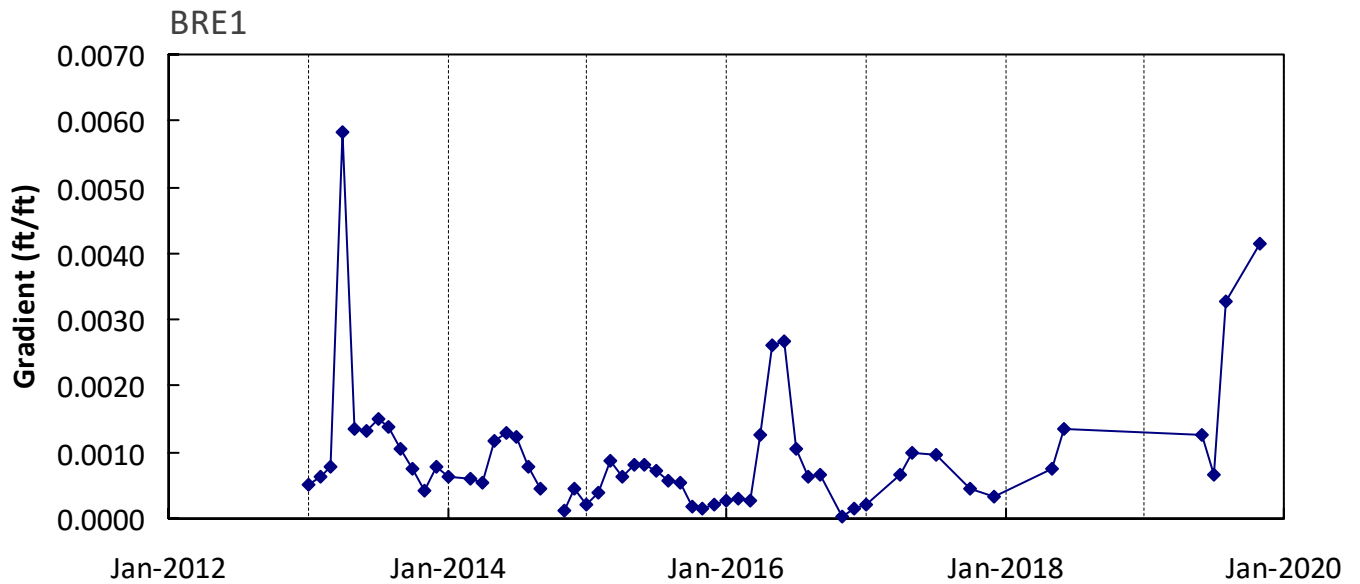
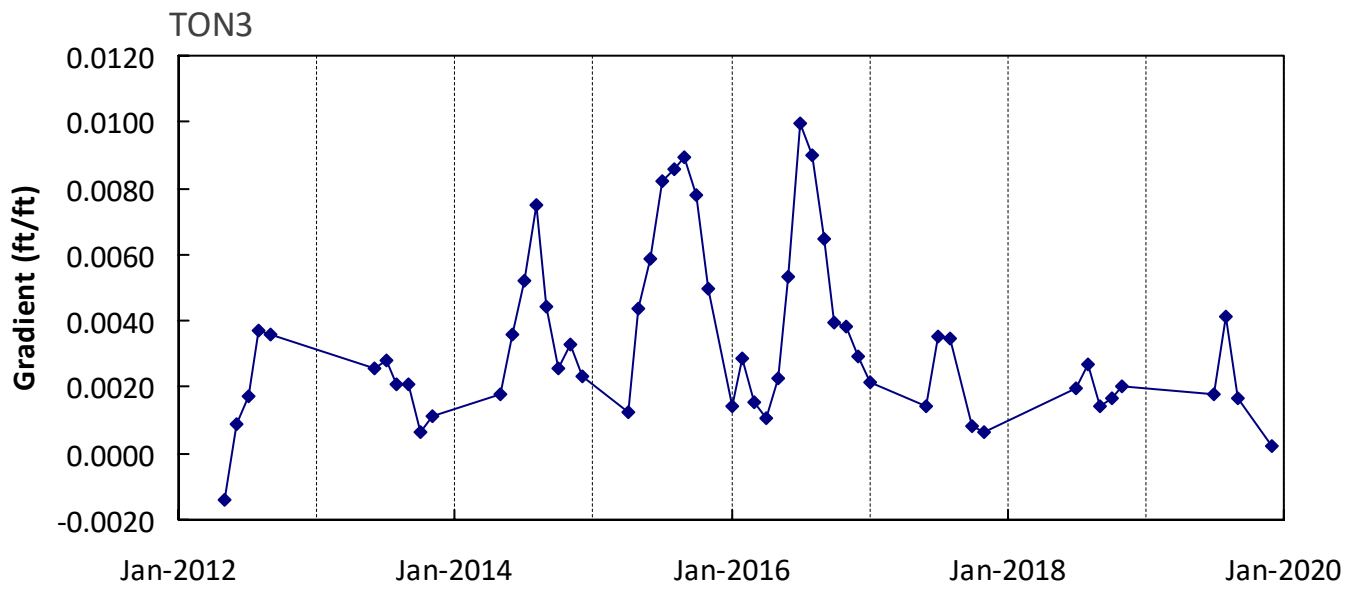
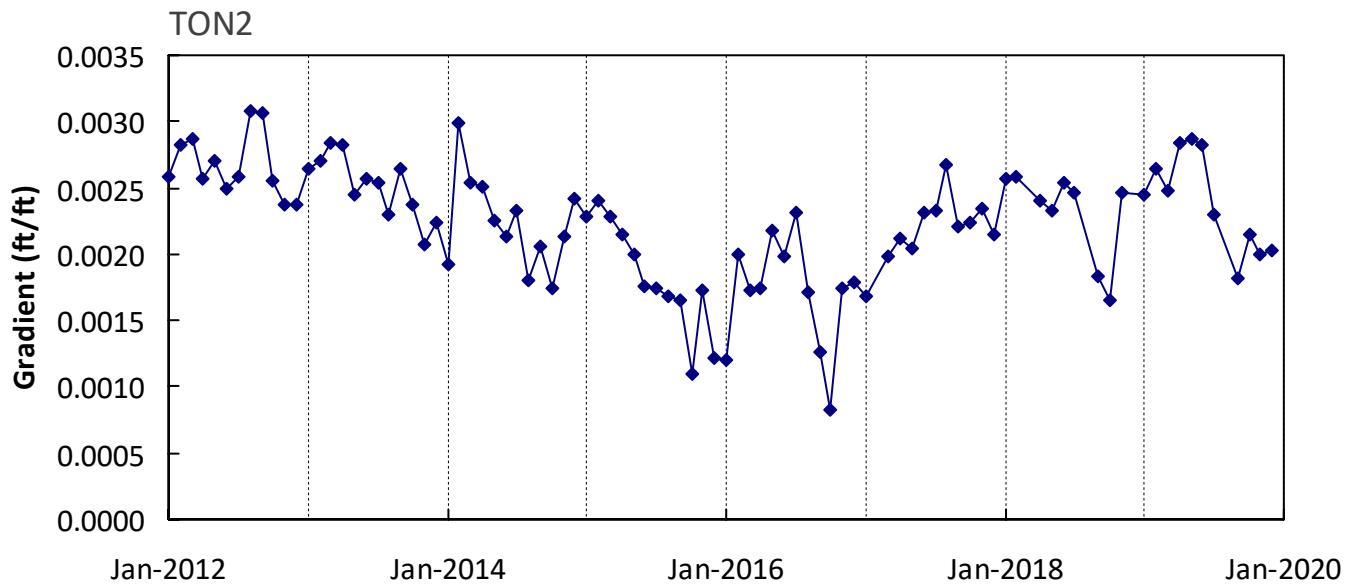

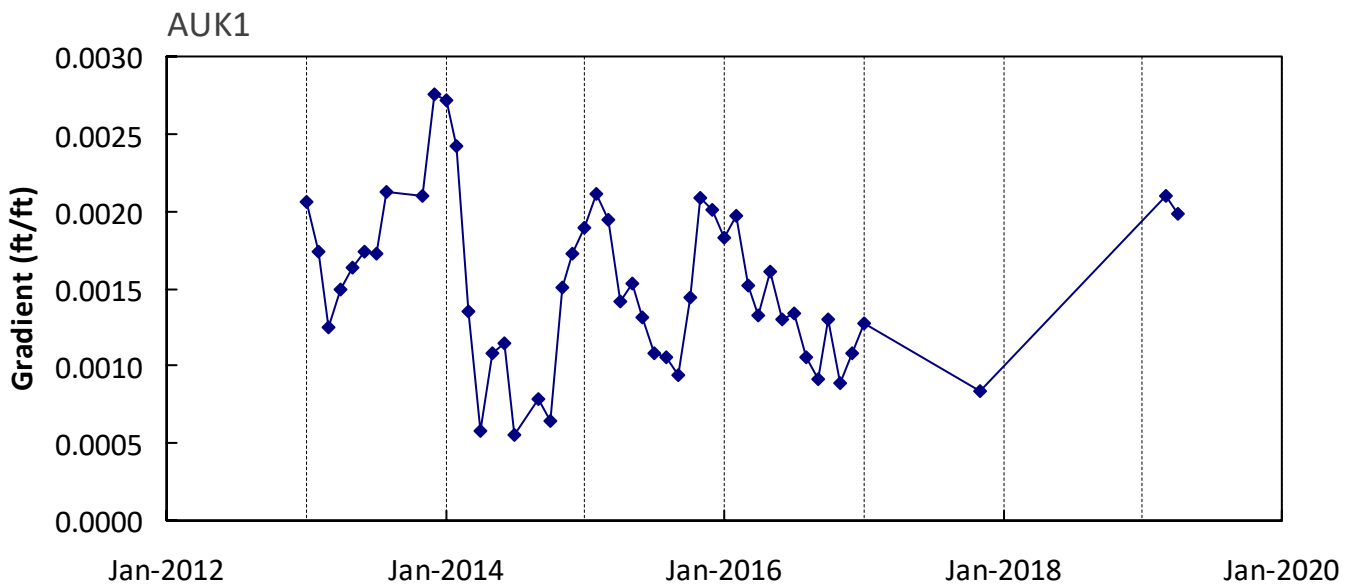
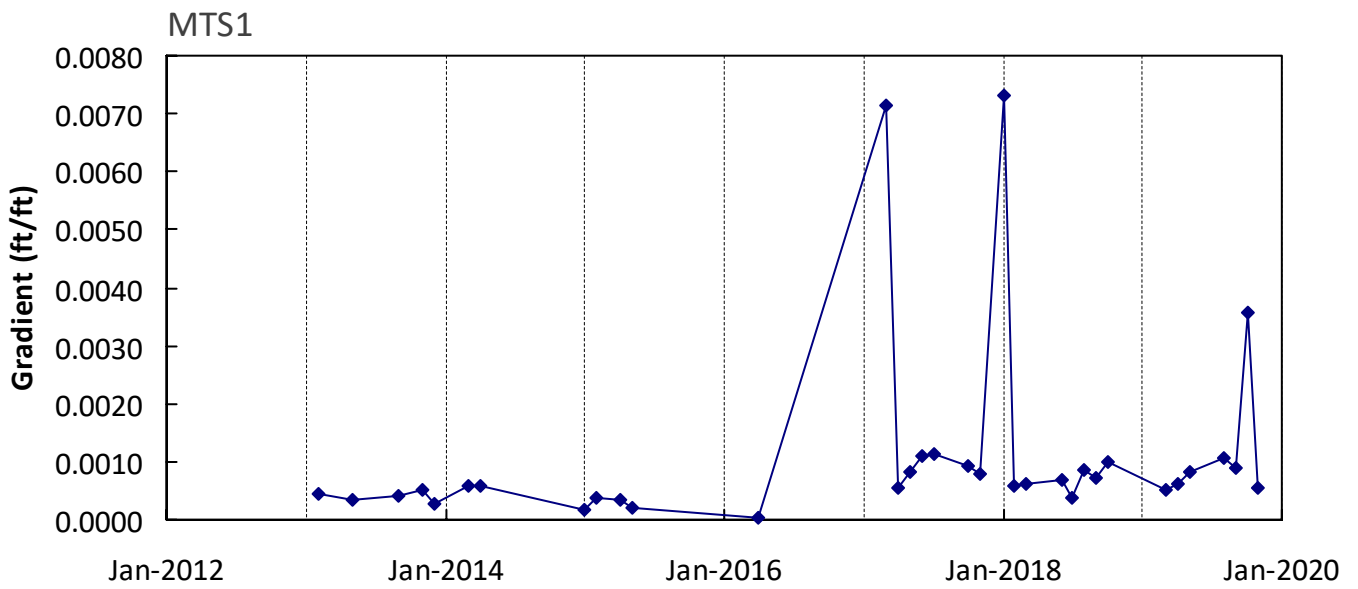
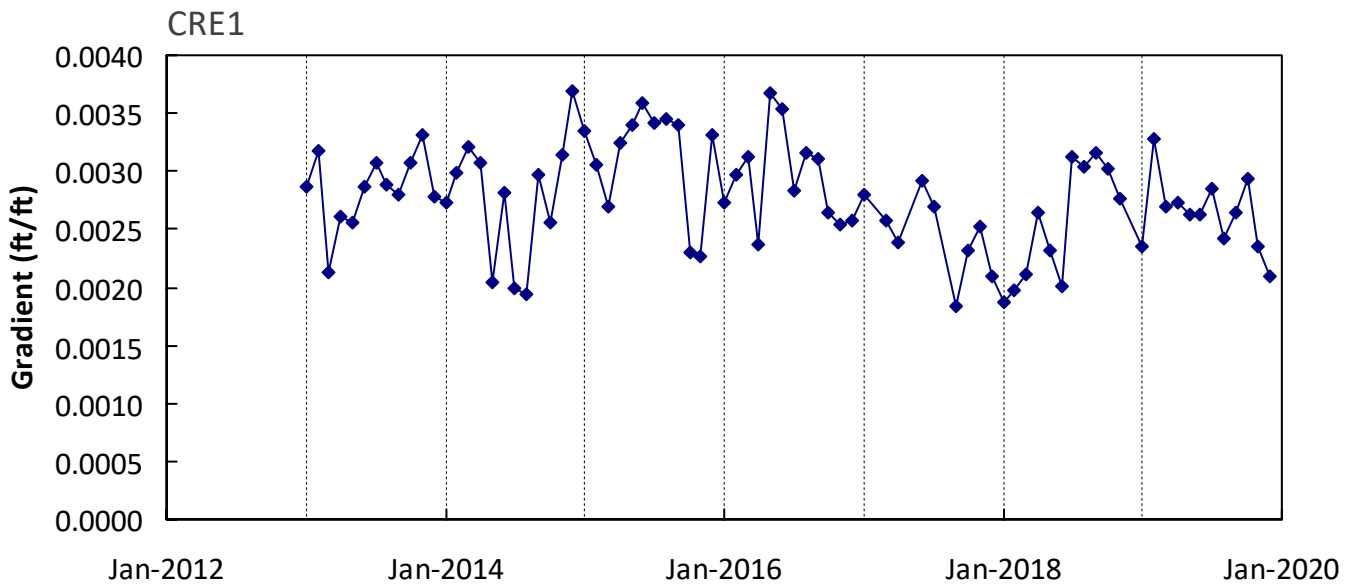

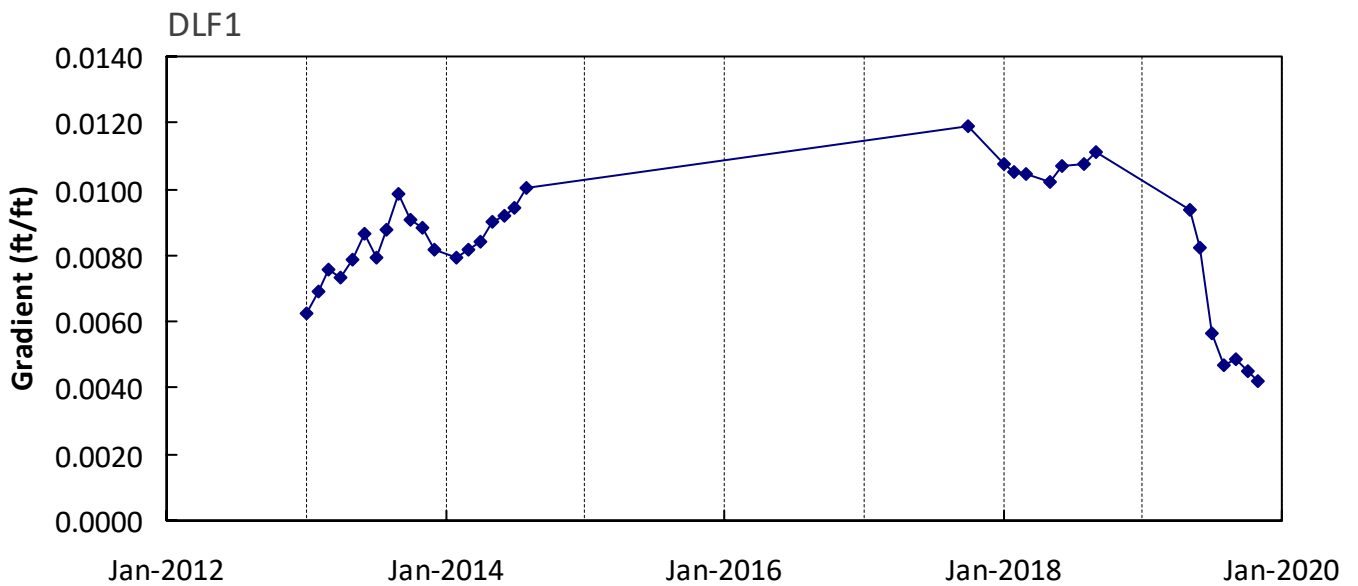
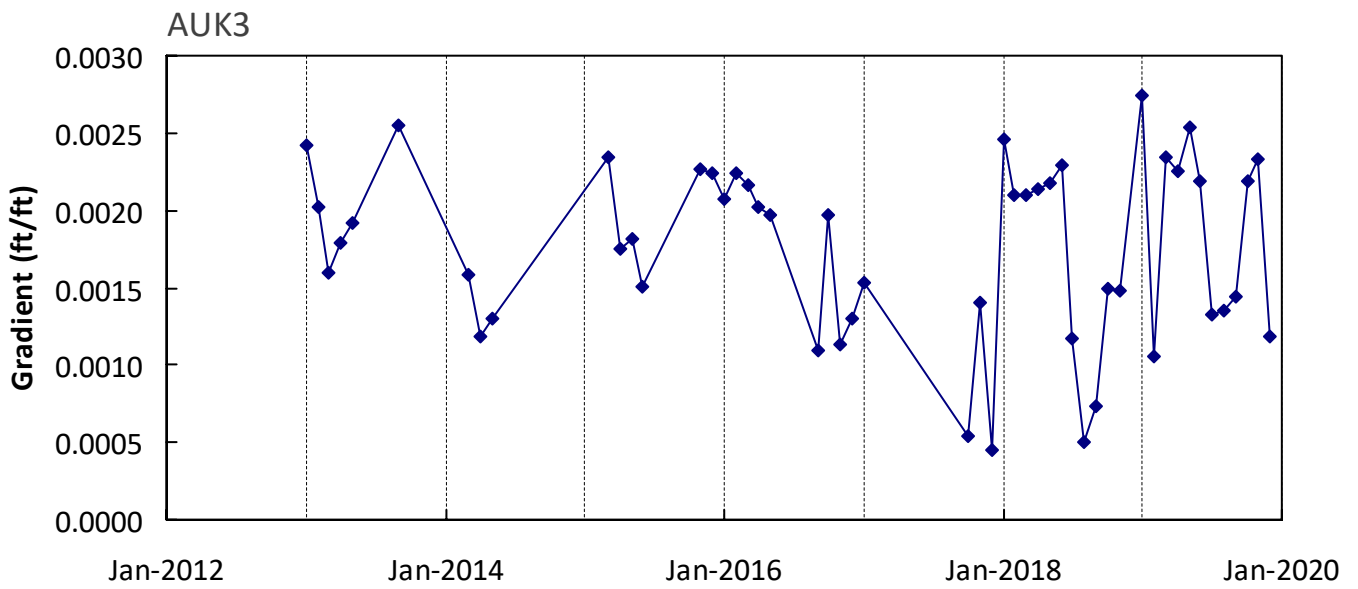
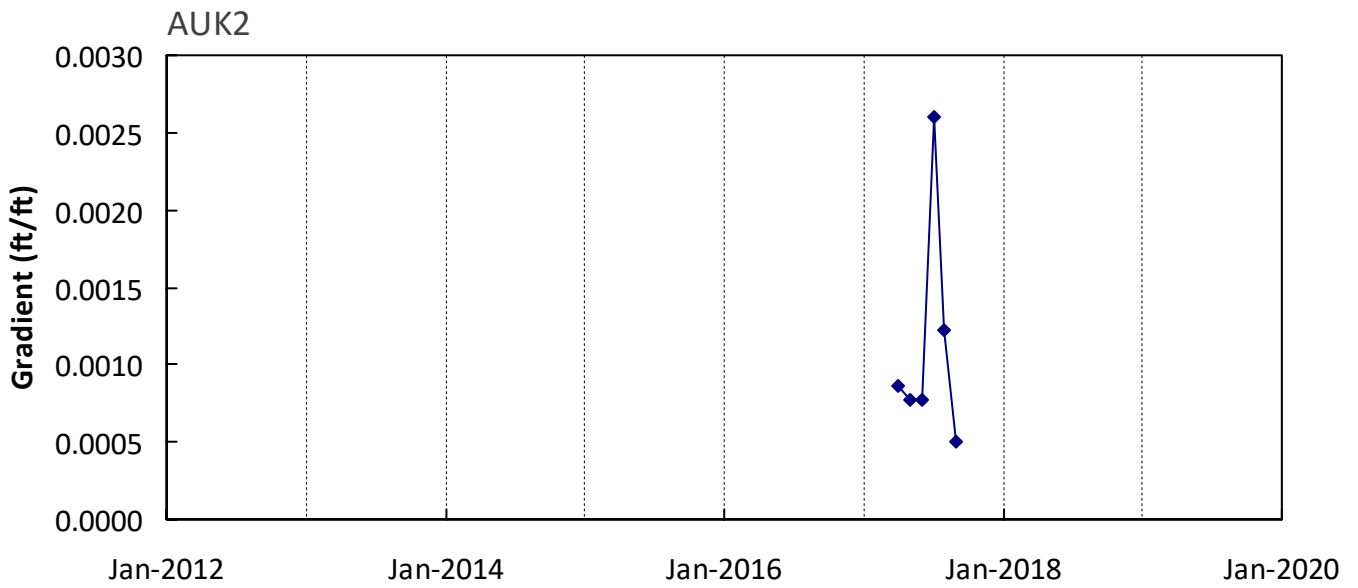

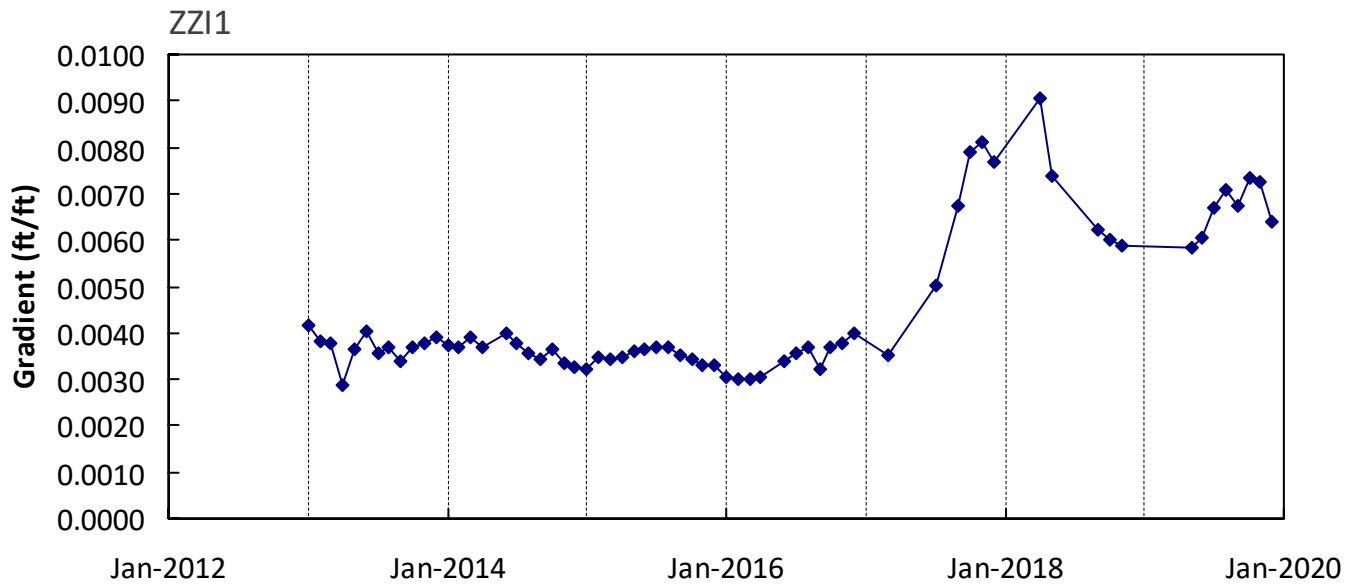
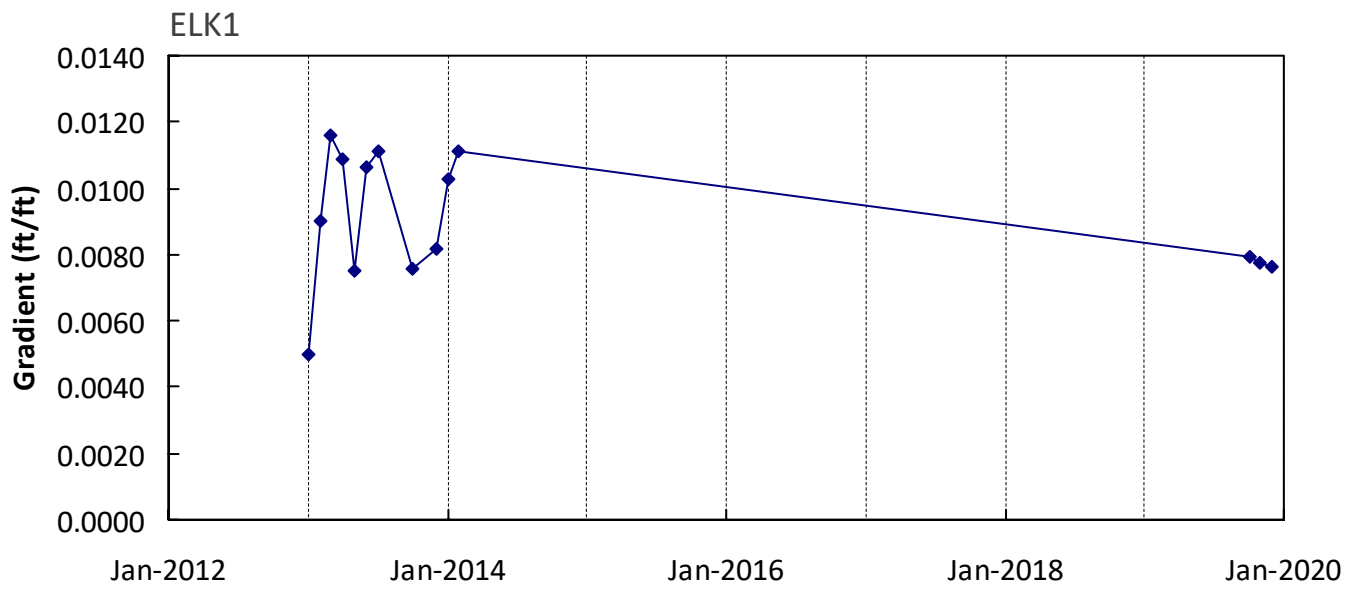
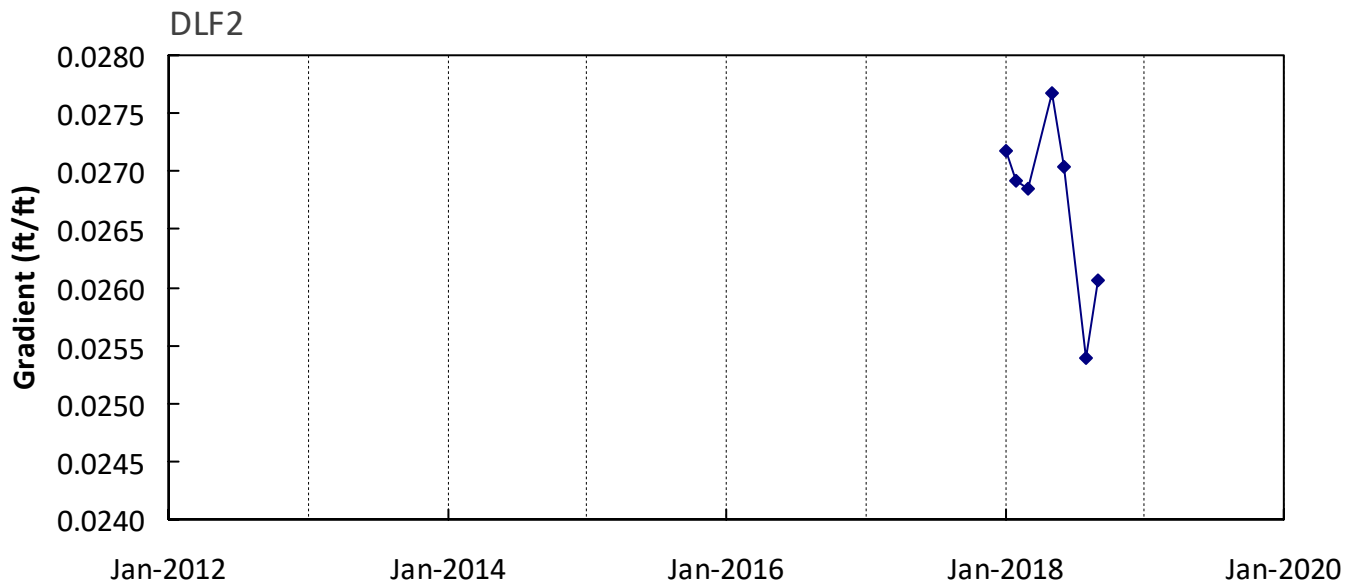

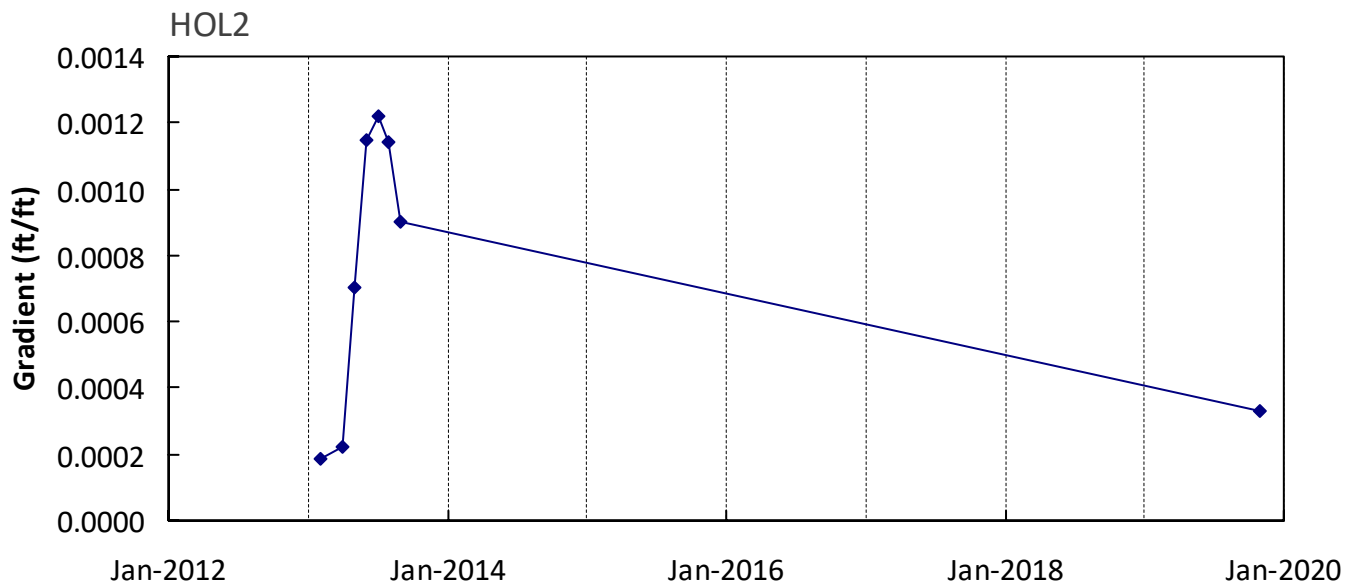
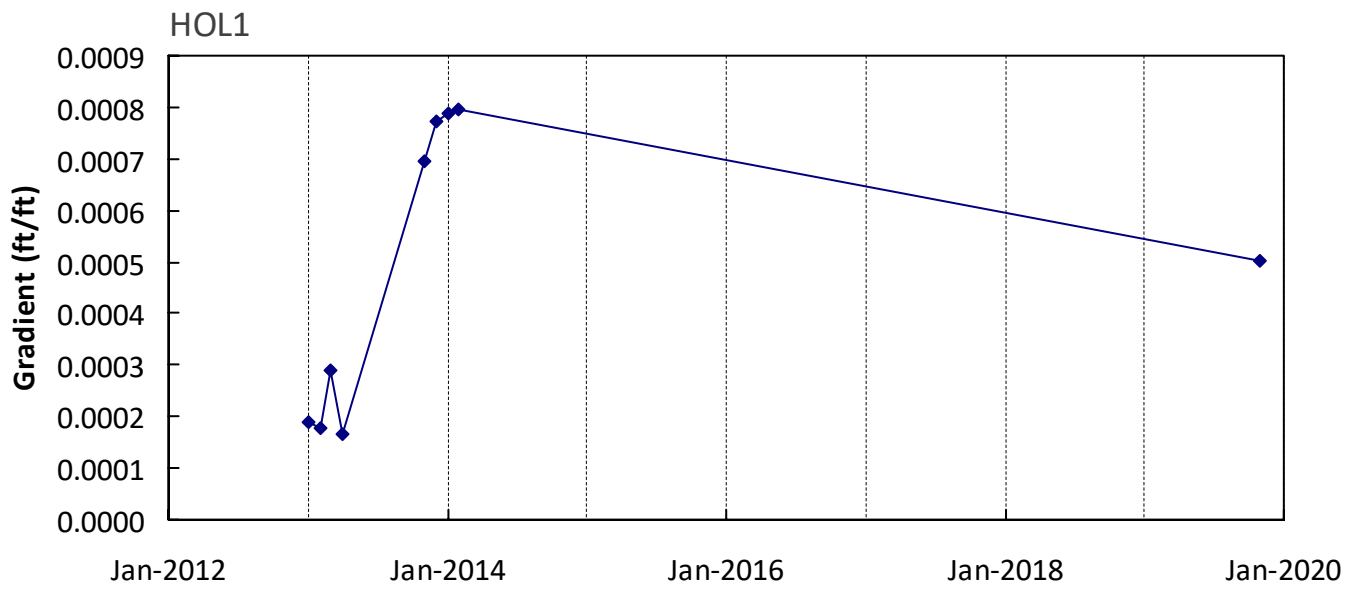
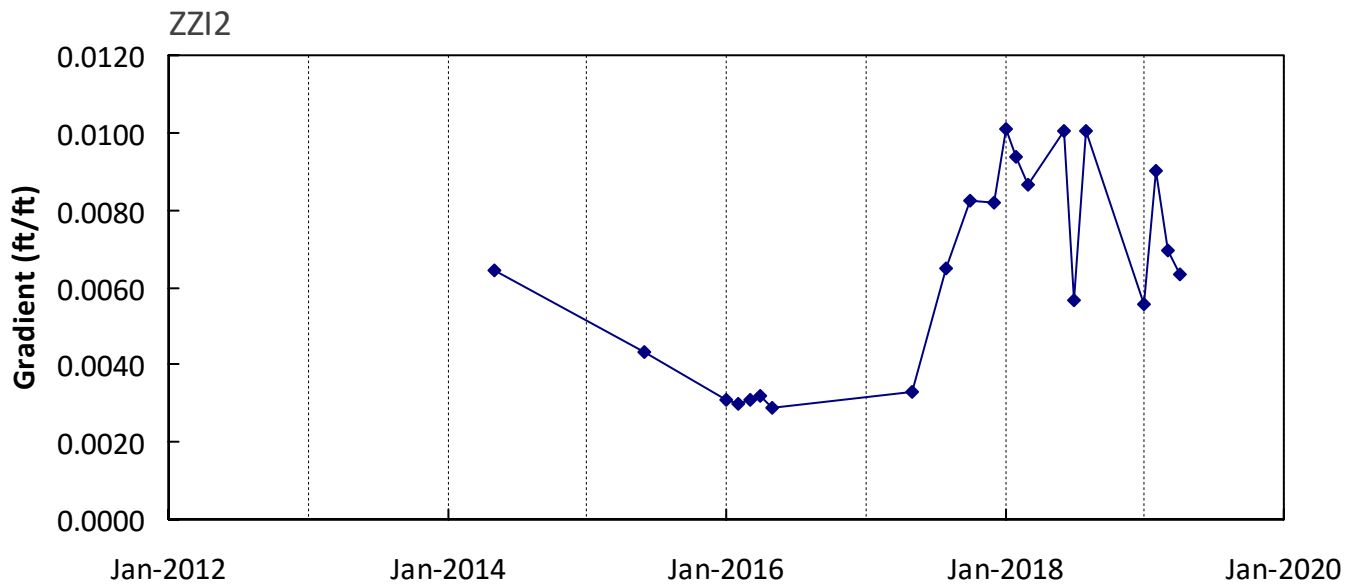

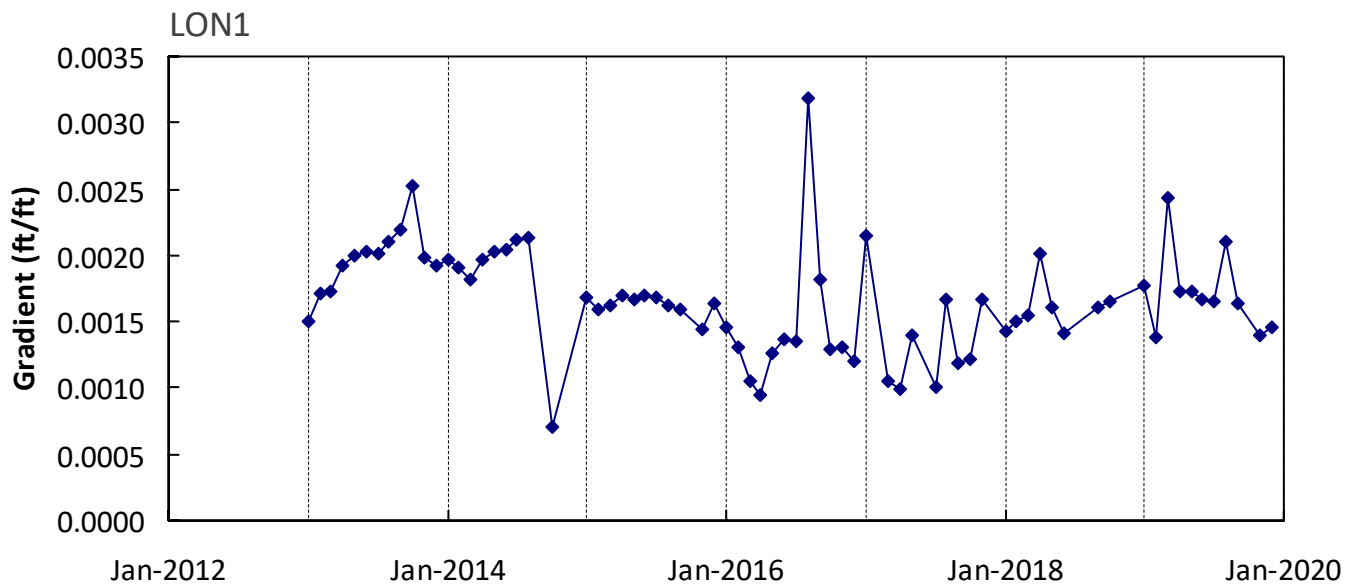
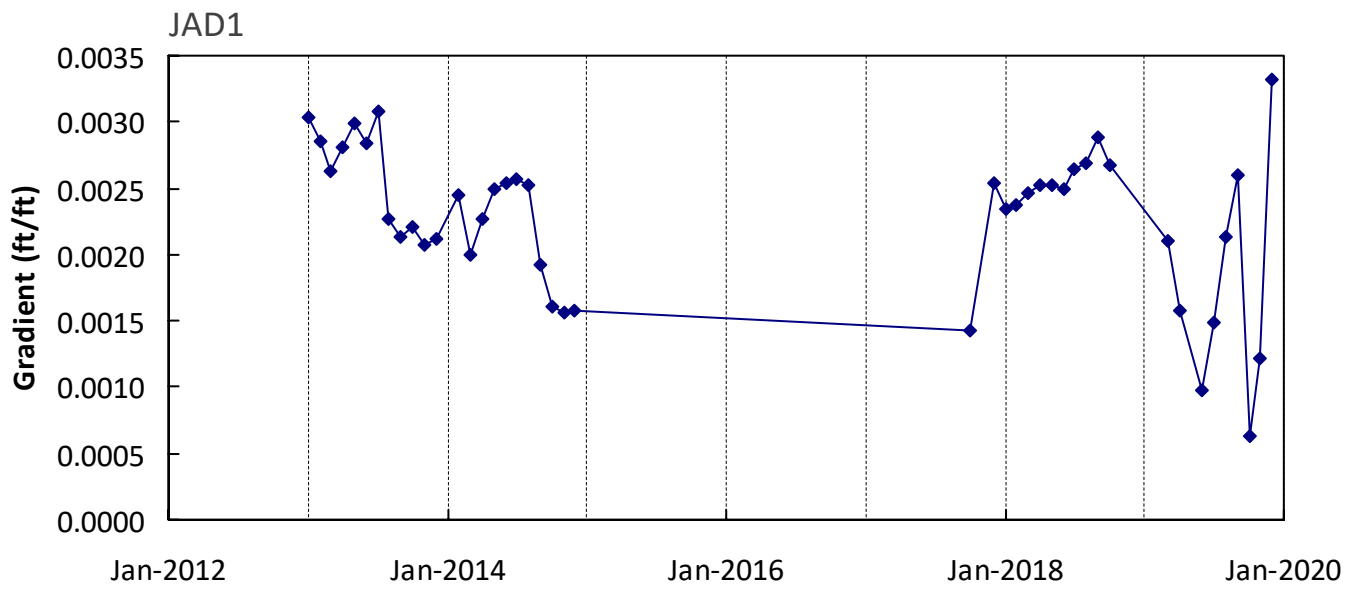
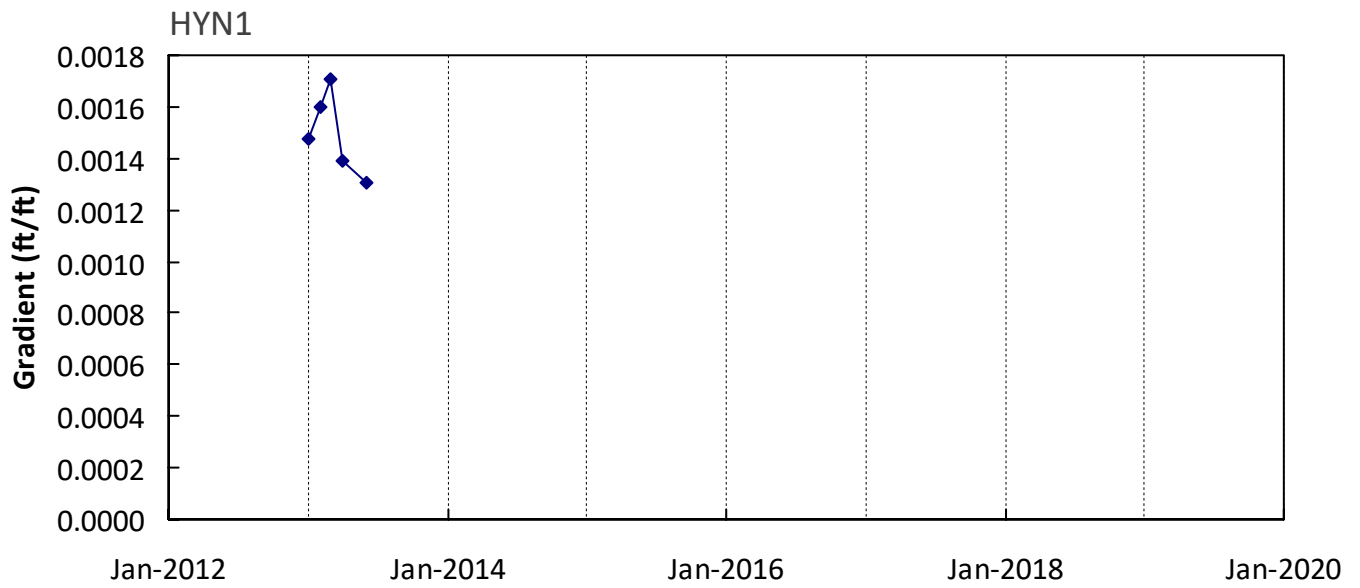

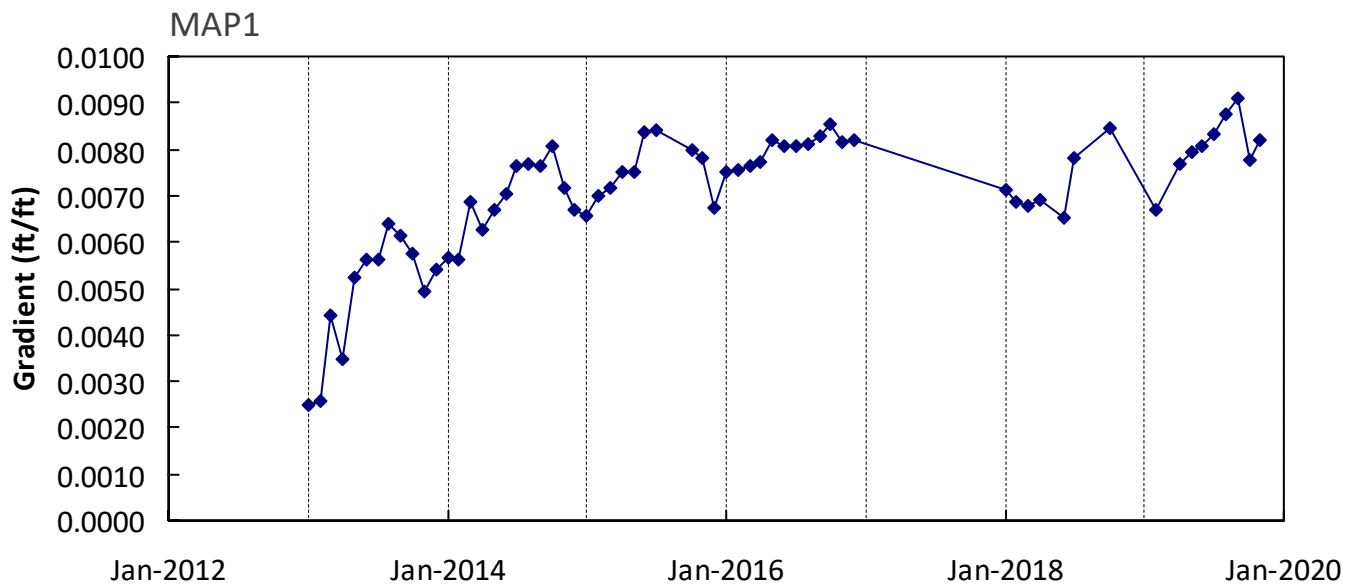
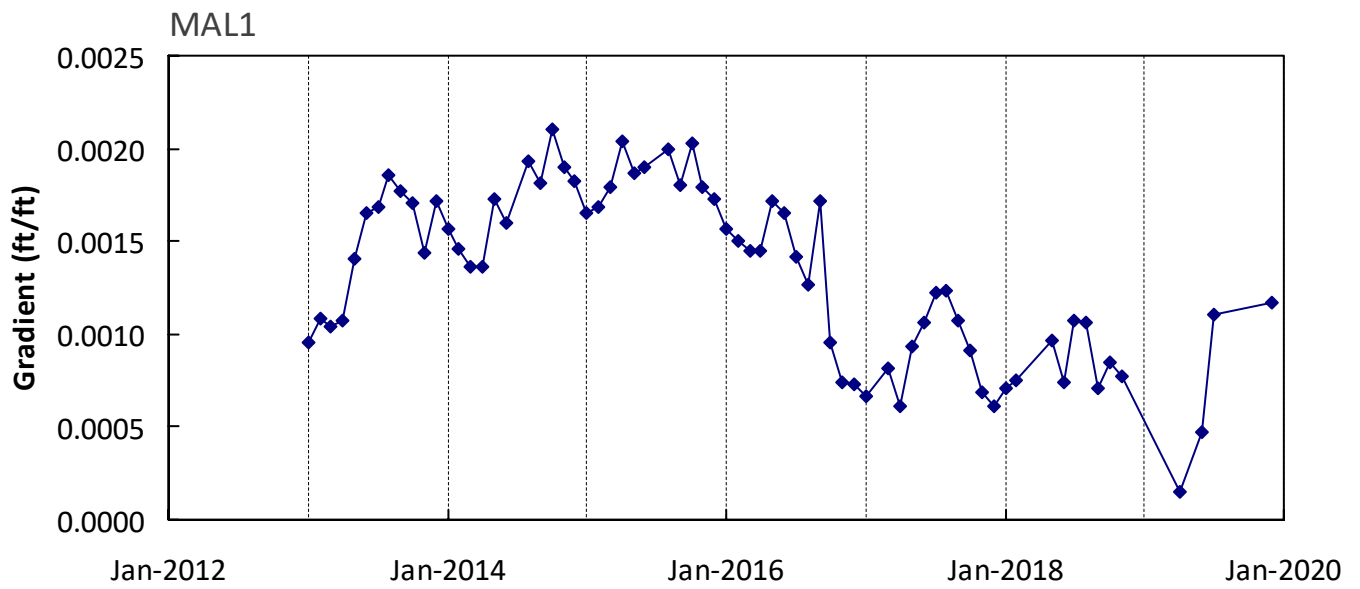
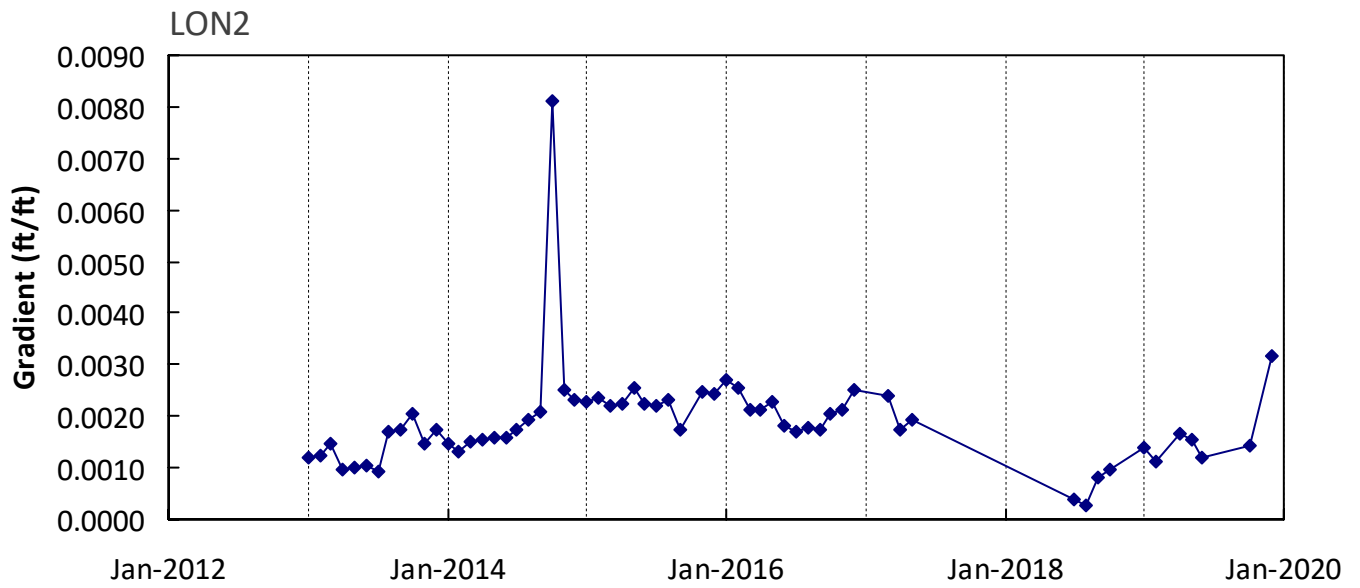

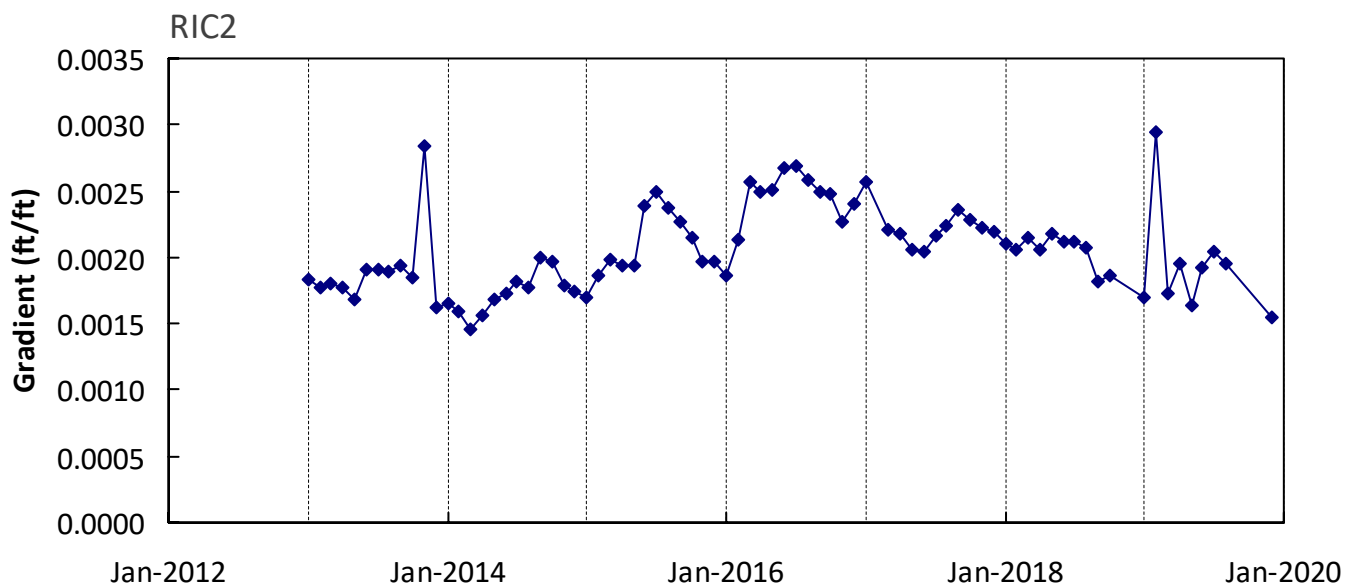
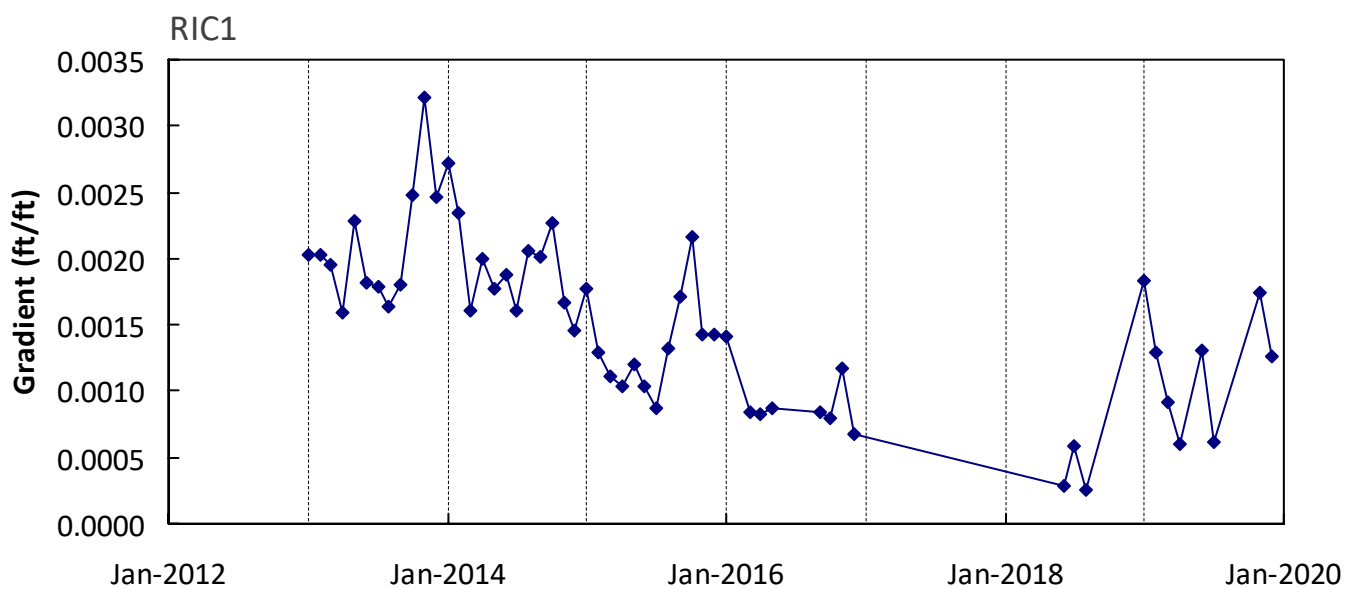
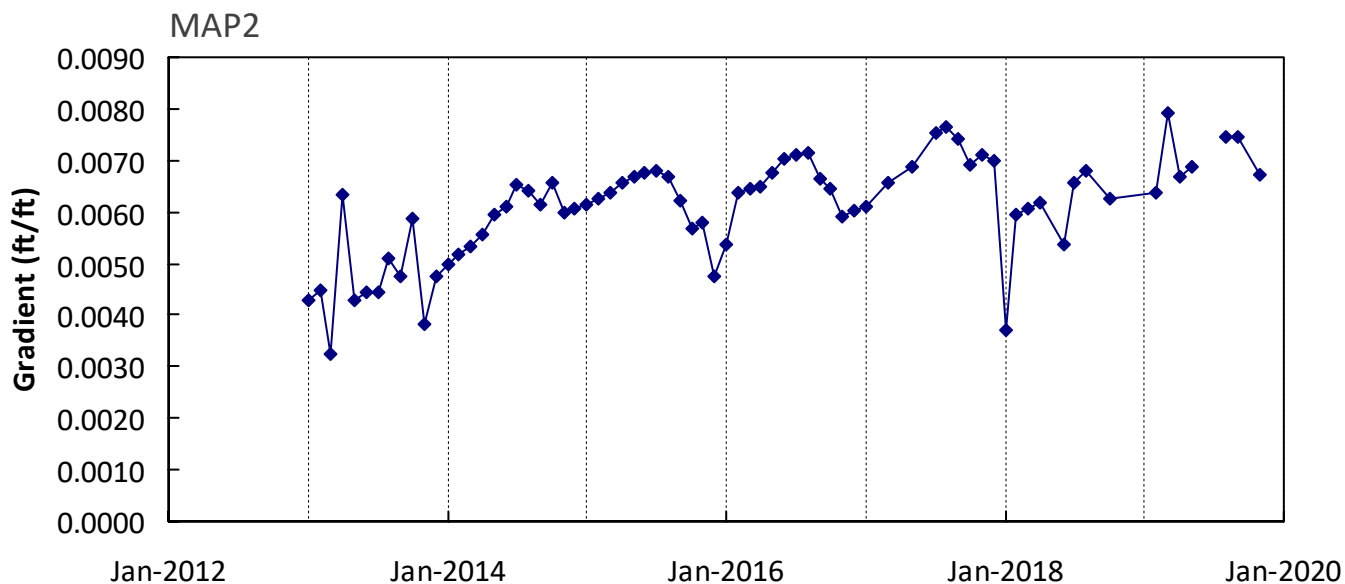

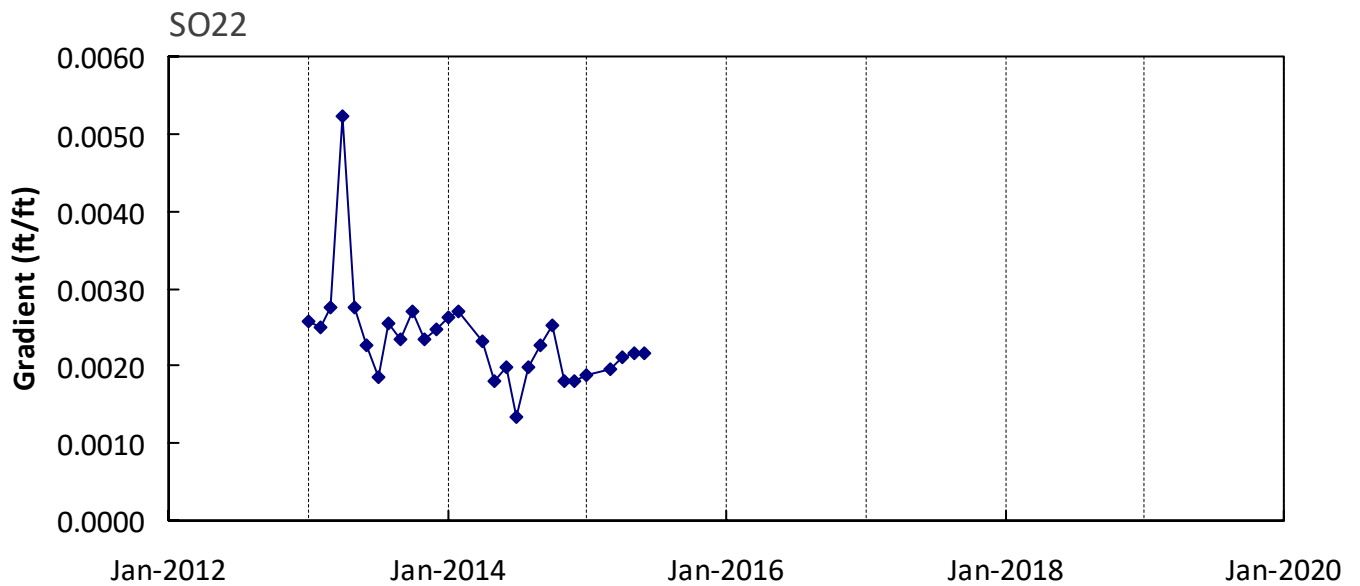
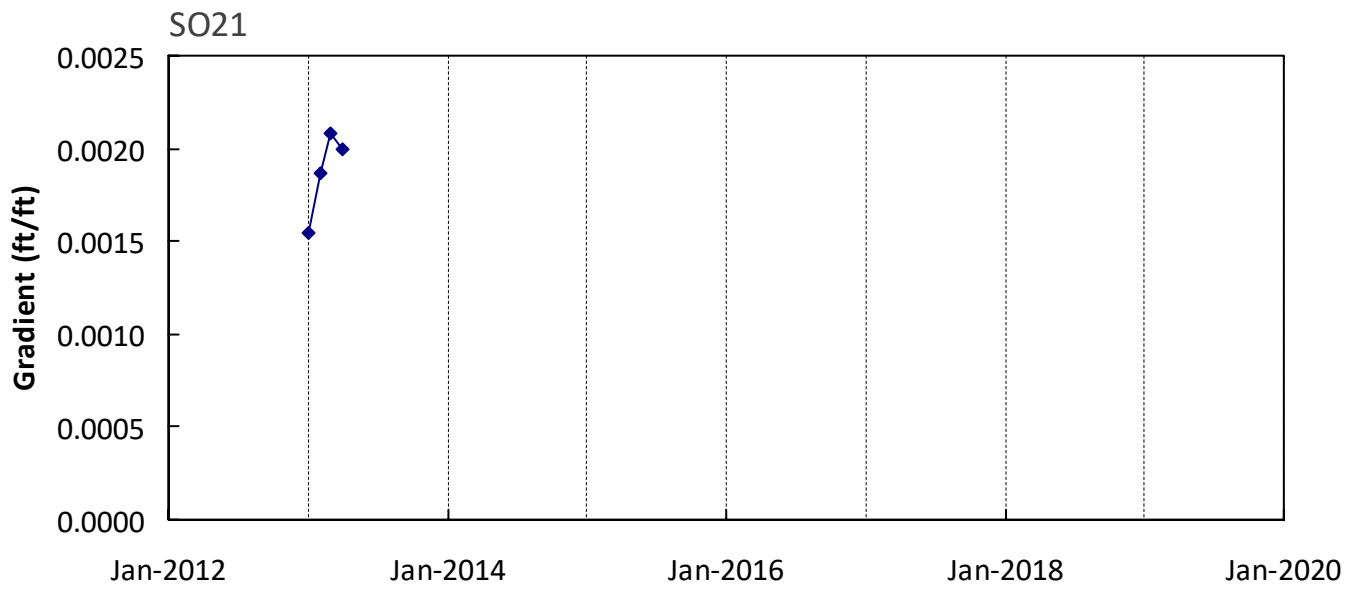
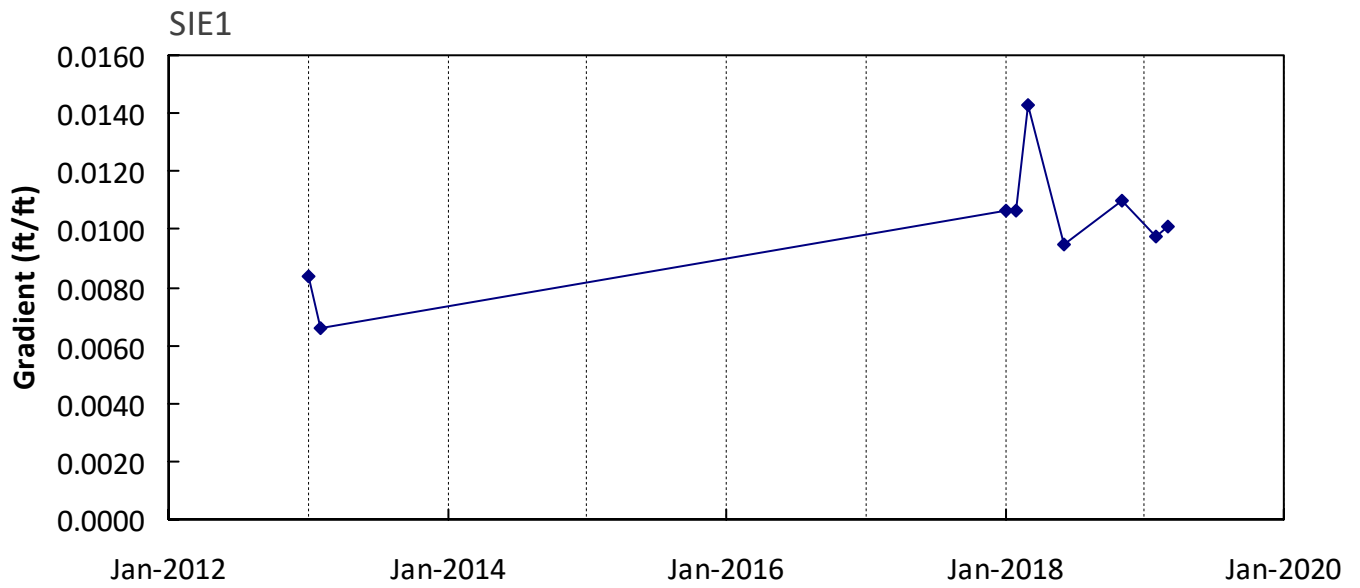

Attachment A7

Specific Conductance and Total Dissolved Solids Concentrations in Groundwater, Time Series Plots

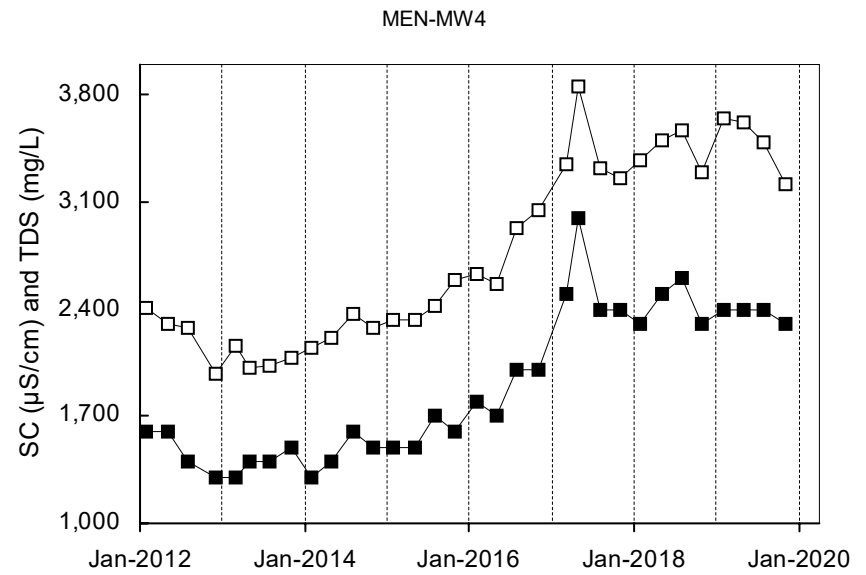
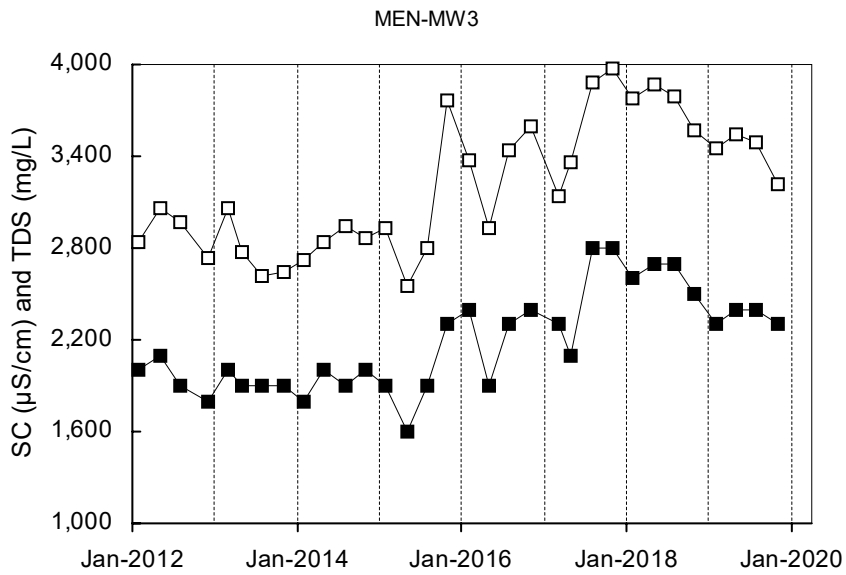
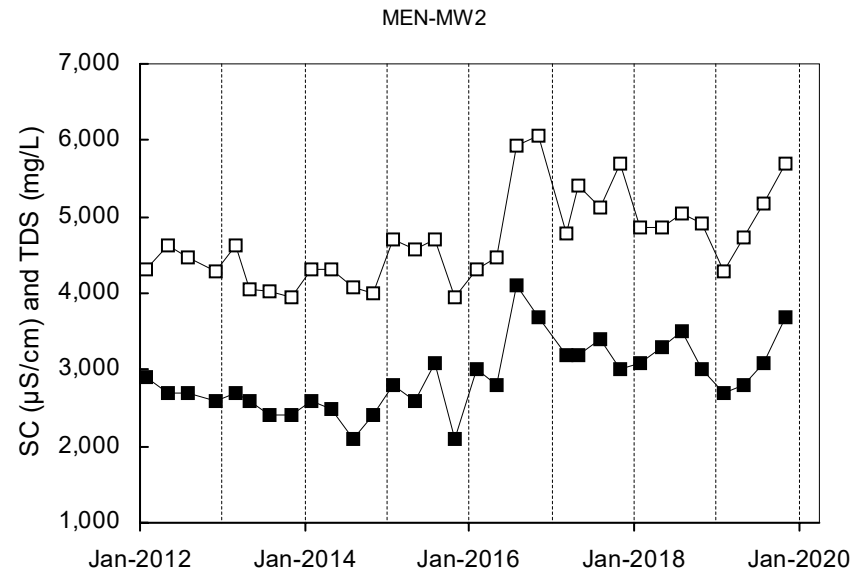
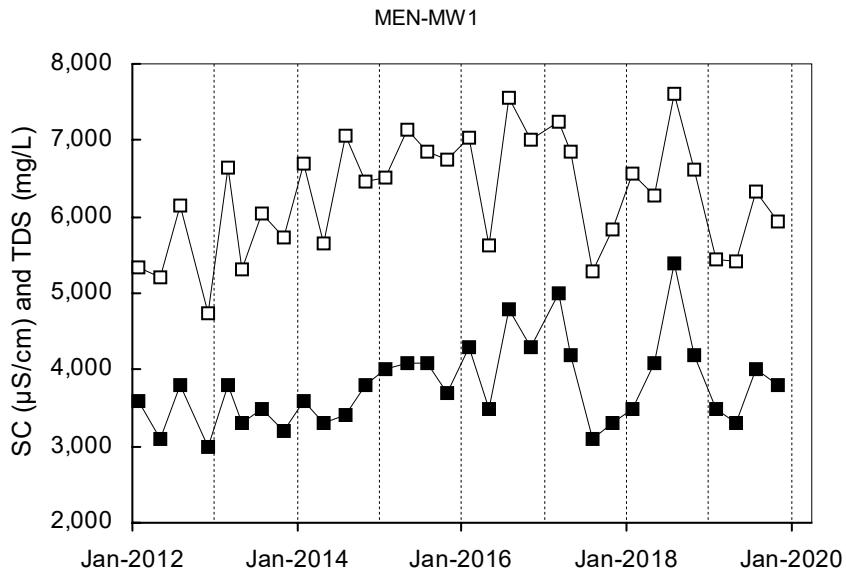

Total Dissolved Solids
 Specific Conductance
 Shallow Well shown with black symbols
 Deep Well shown with orange symbols
 "dd" Well shown with blue symbols

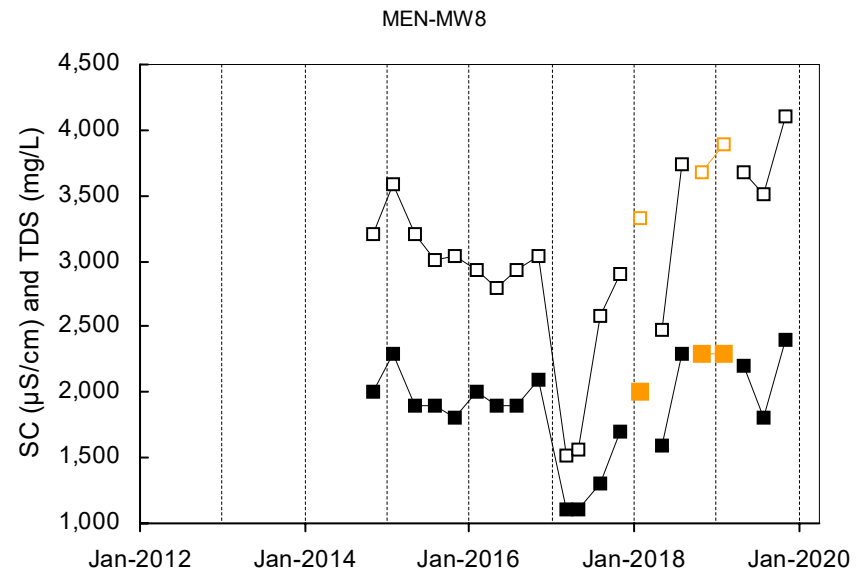
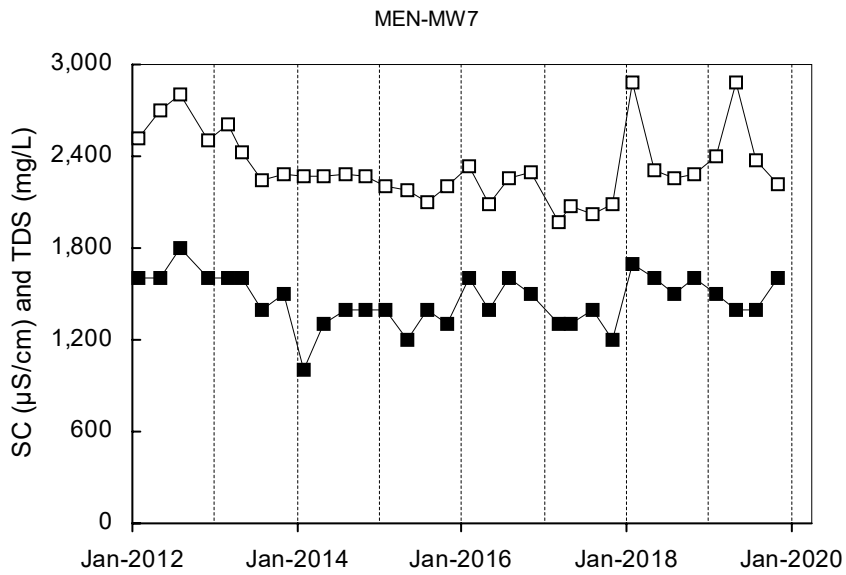
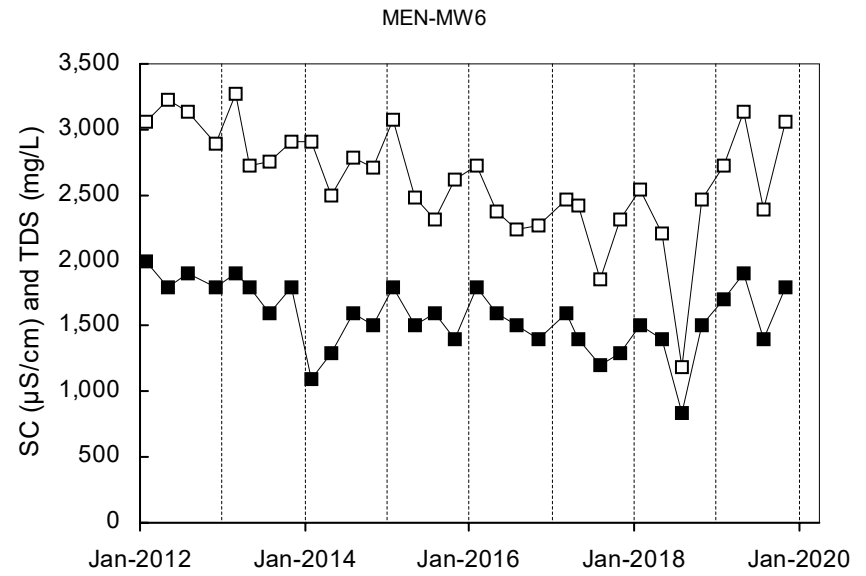
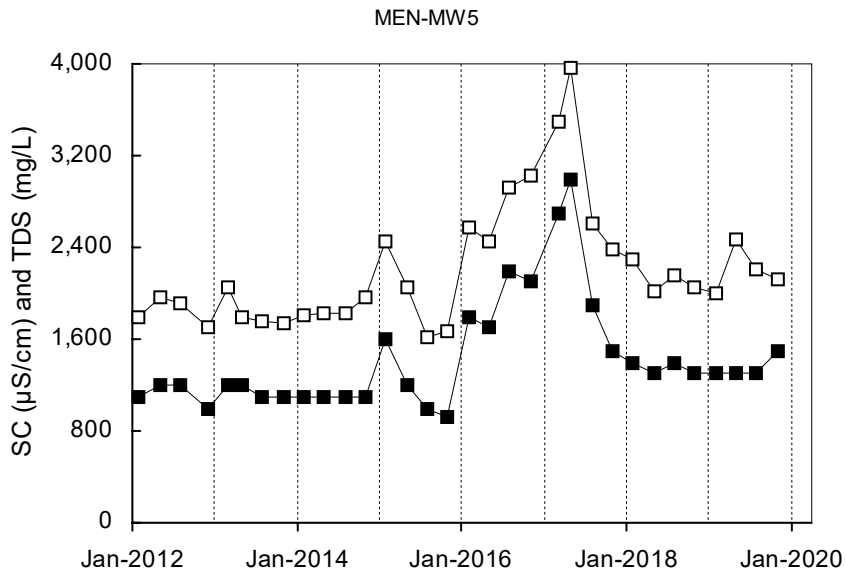

Total Dissolved Solids
 Specific Conductance
 Shallow Well shown with black symbols
 Deep Well shown with orange symbols
 "dd" Well shown with blue symbols

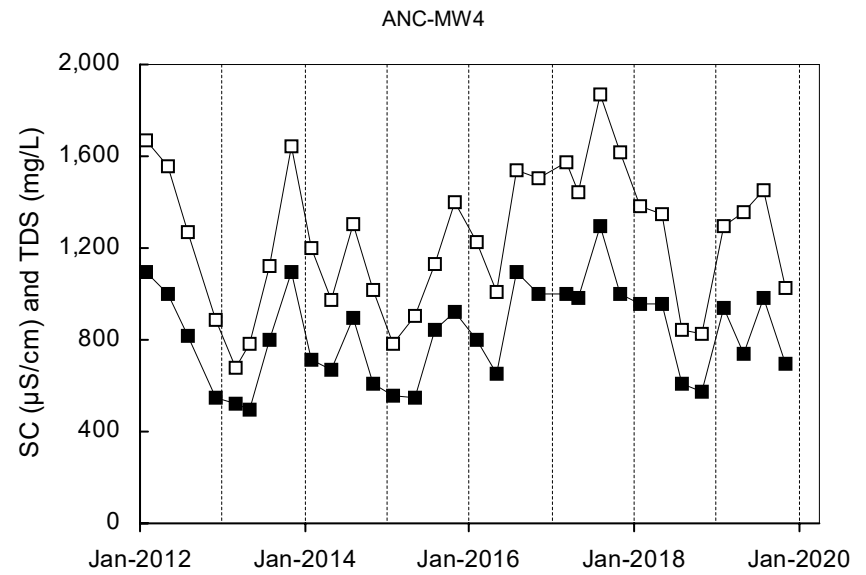
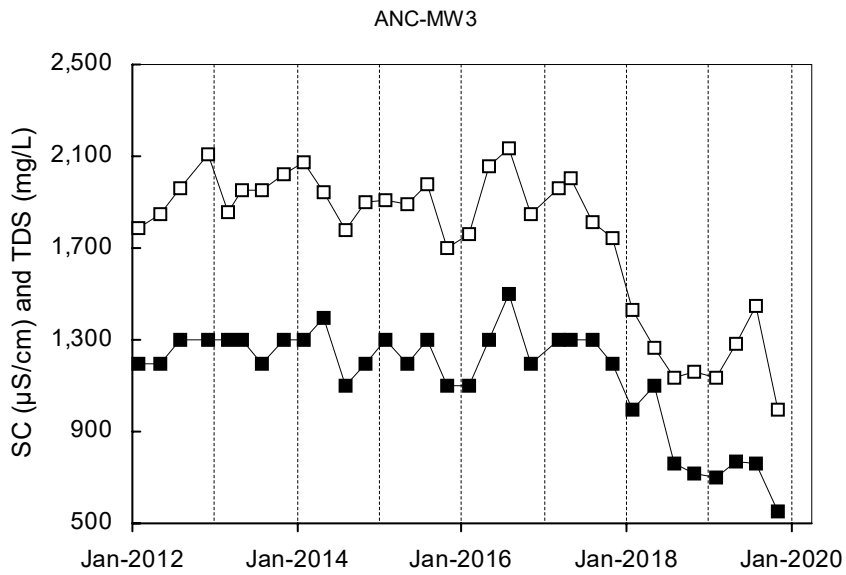
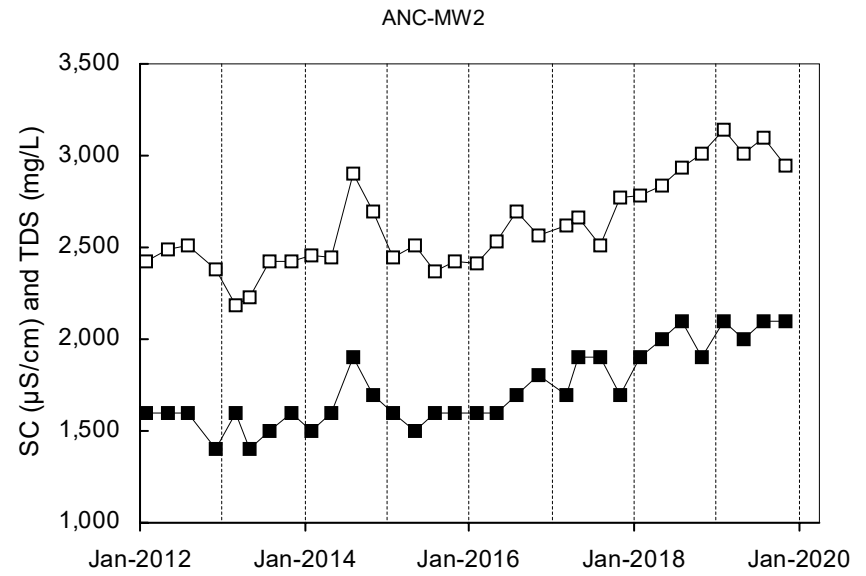
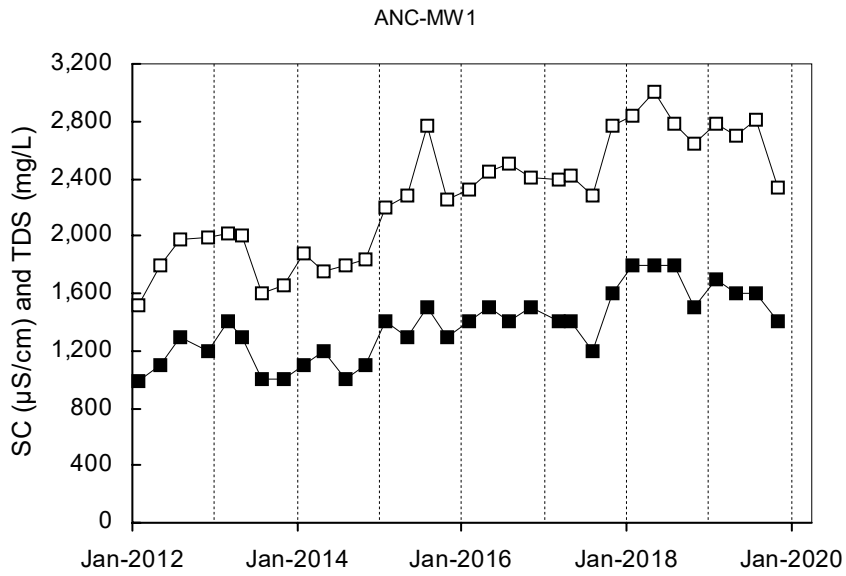

Total Dissolved Solids
 Specific Conductance
 Shallow Well shown with black symbols
 Deep Well shown with orange symbols
 "dd" Well shown with blue symbols

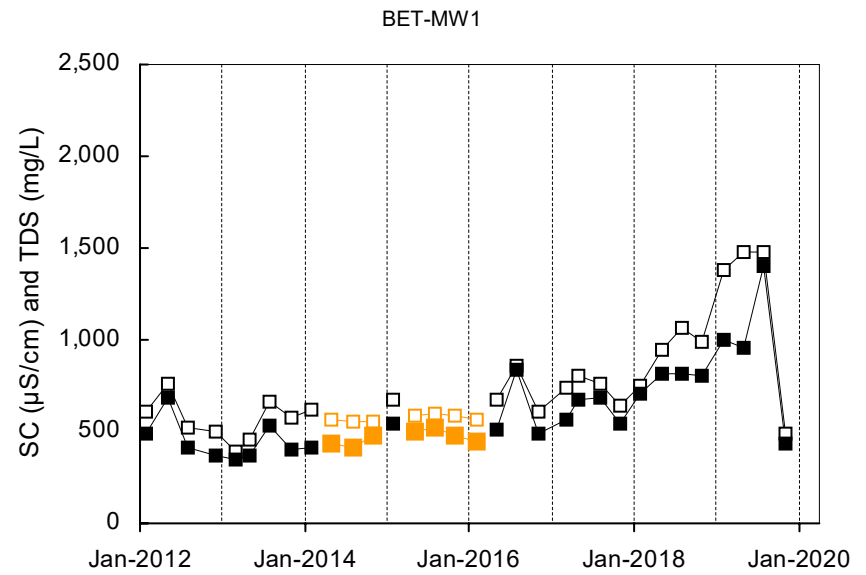
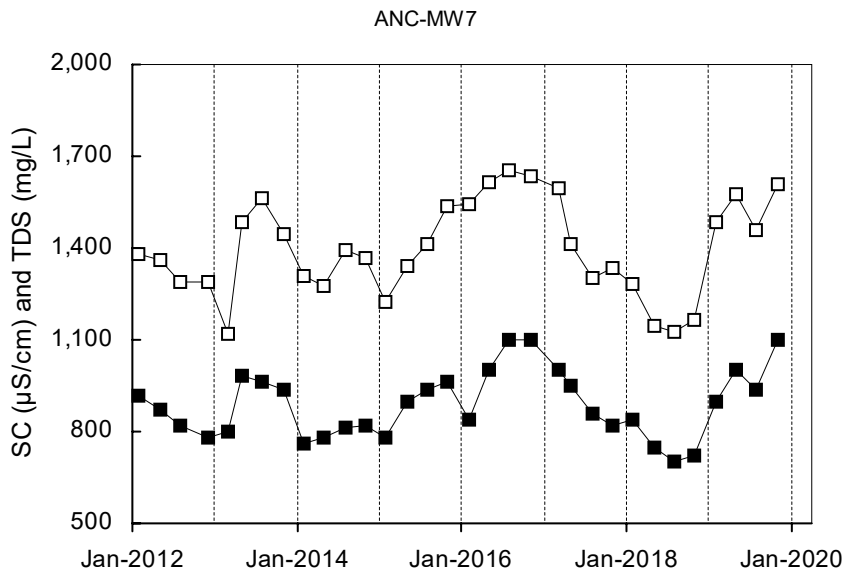
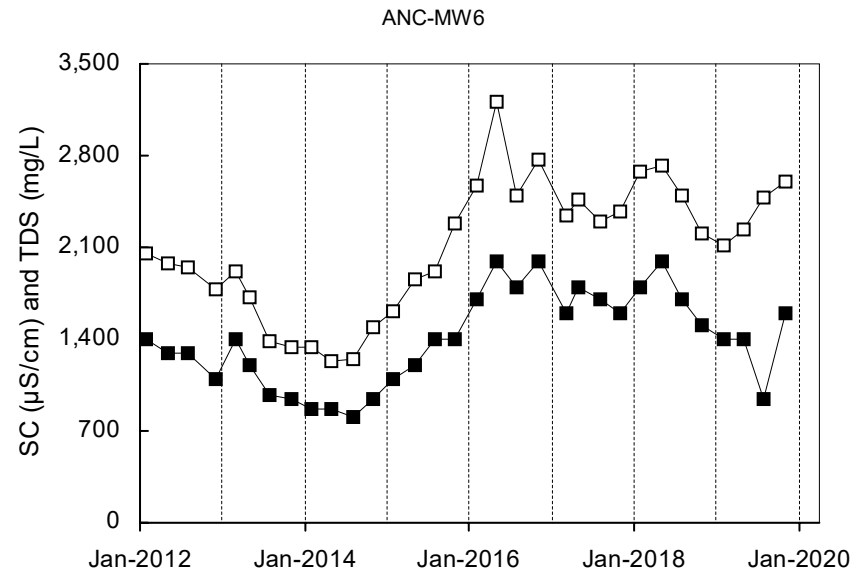
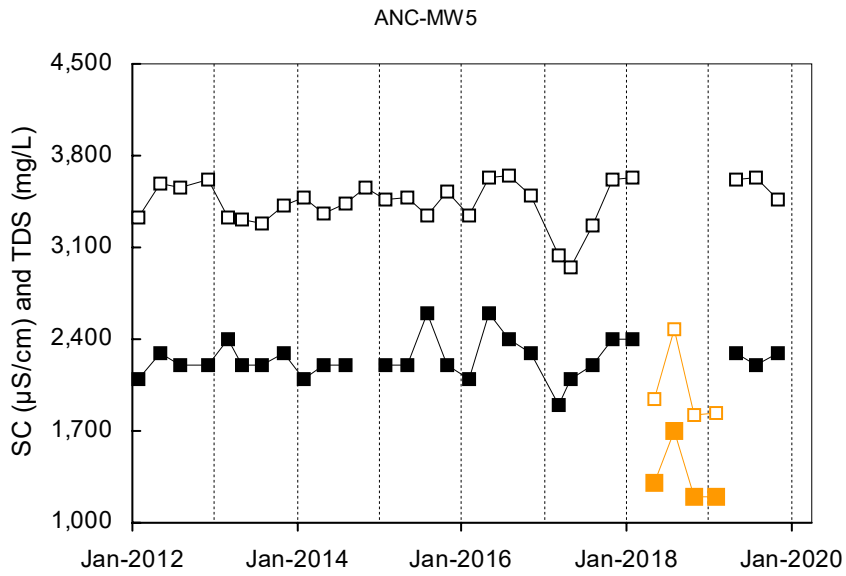

Total Dissolved Solids
 Specific Conductance
 Shallow Well shown with black symbols
 Deep Well shown with orange symbols
 "dd" Well shown with blue symbols

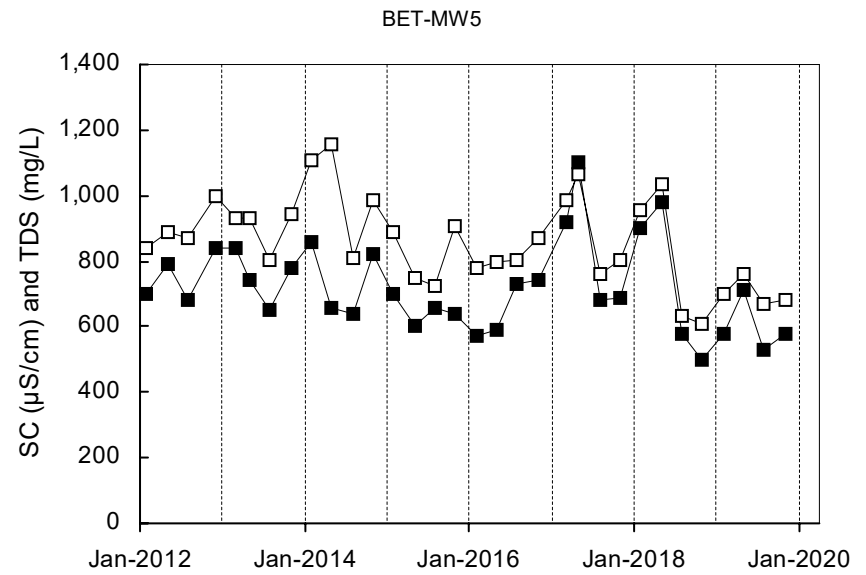
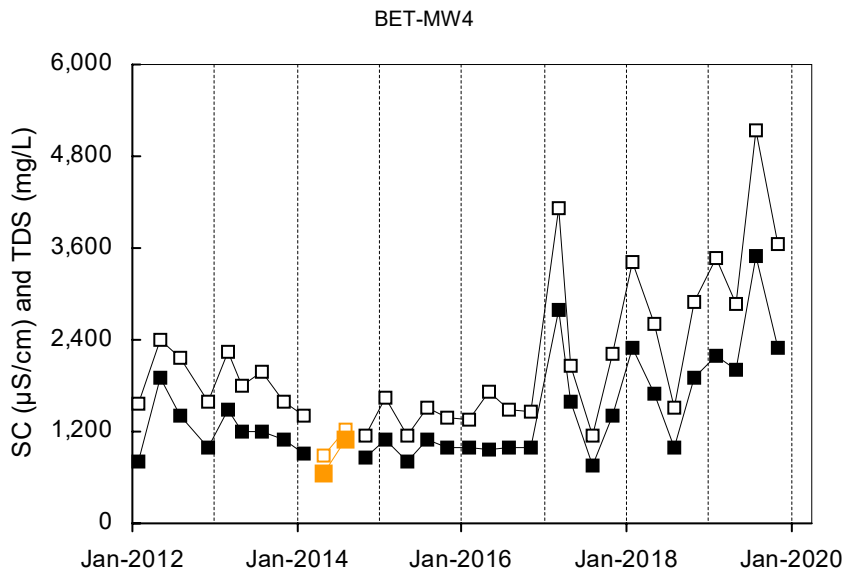
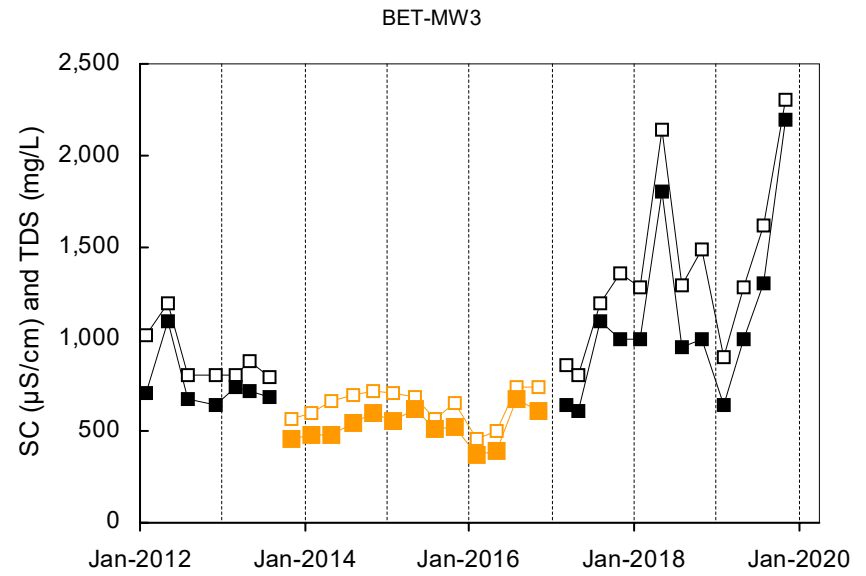
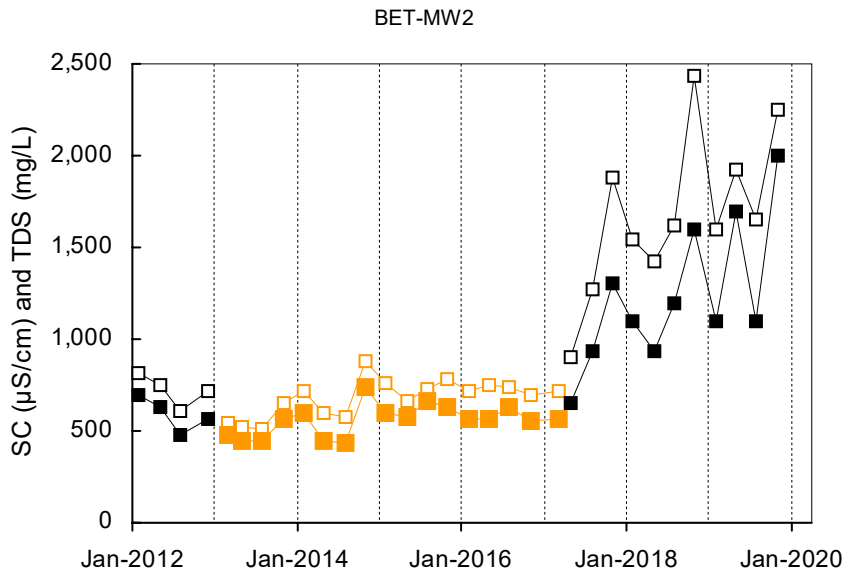

Total Dissolved Solids
 Specific Conductance
 Shallow Well shown with black symbols
 Deep Well shown with orange symbols
 "dd" Well shown with blue symbols

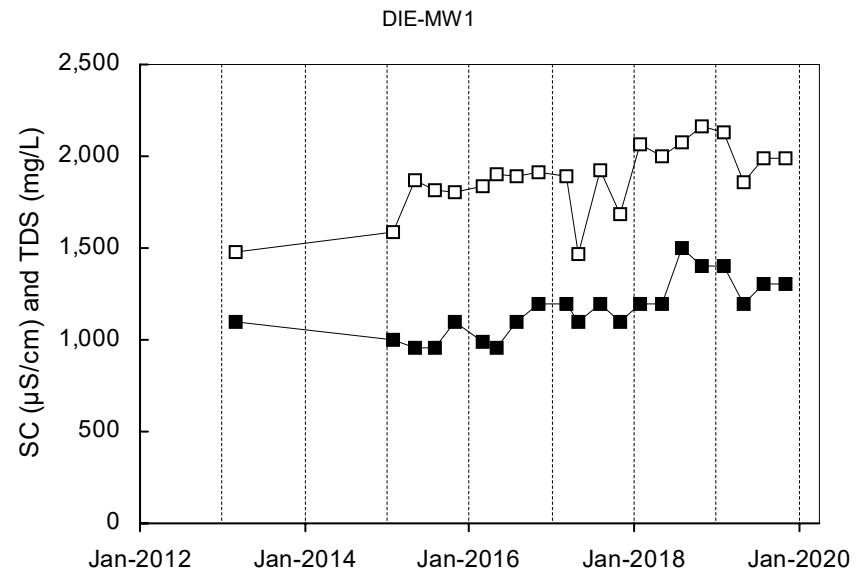
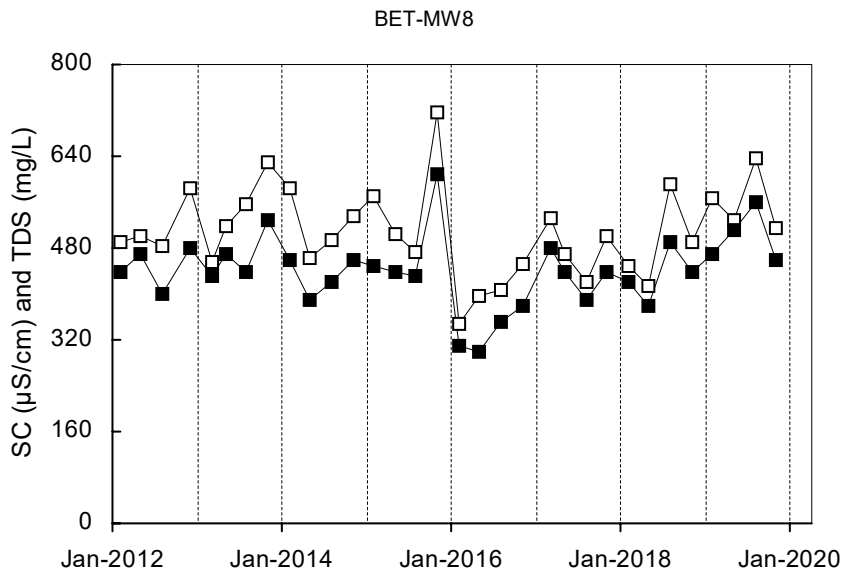
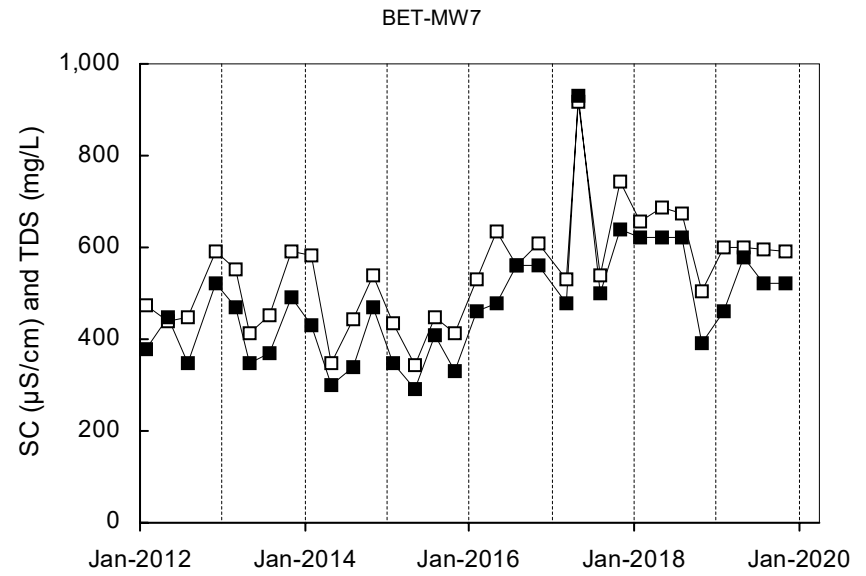
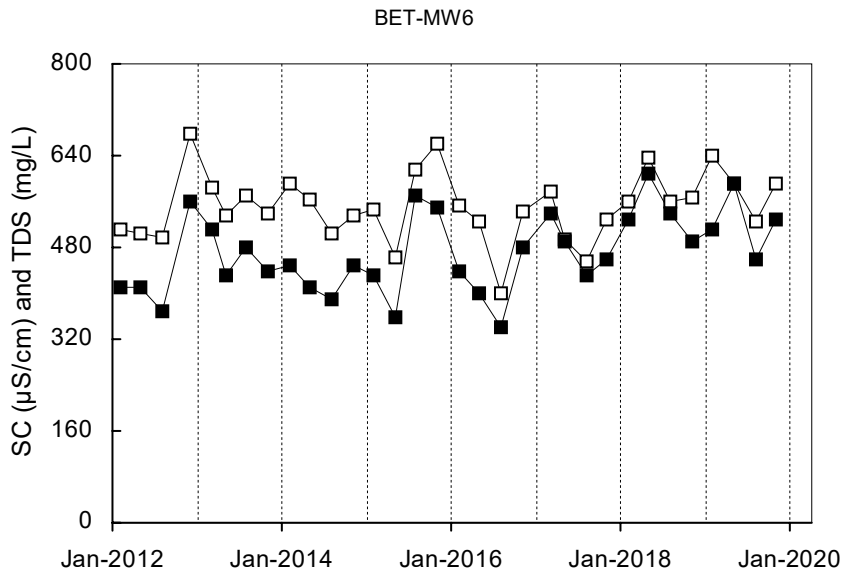

Total Dissolved Solids
 Specific Conductance
 Shallow Well shown with black symbols
 Deep Well shown with orange symbols
 "dd" Well shown with blue symbols

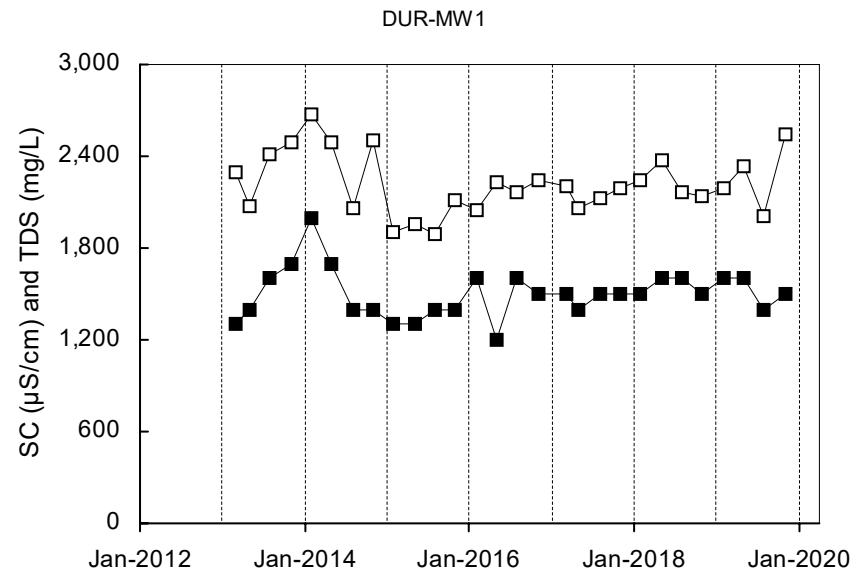
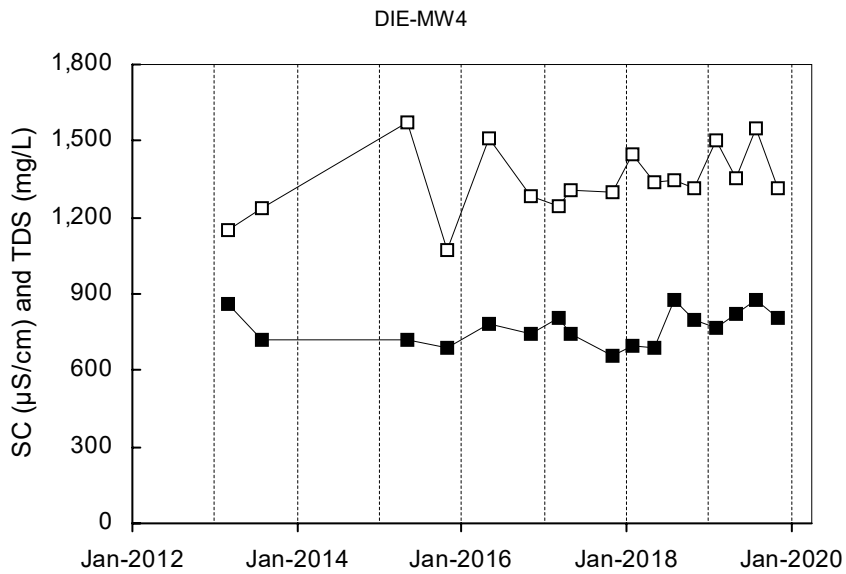
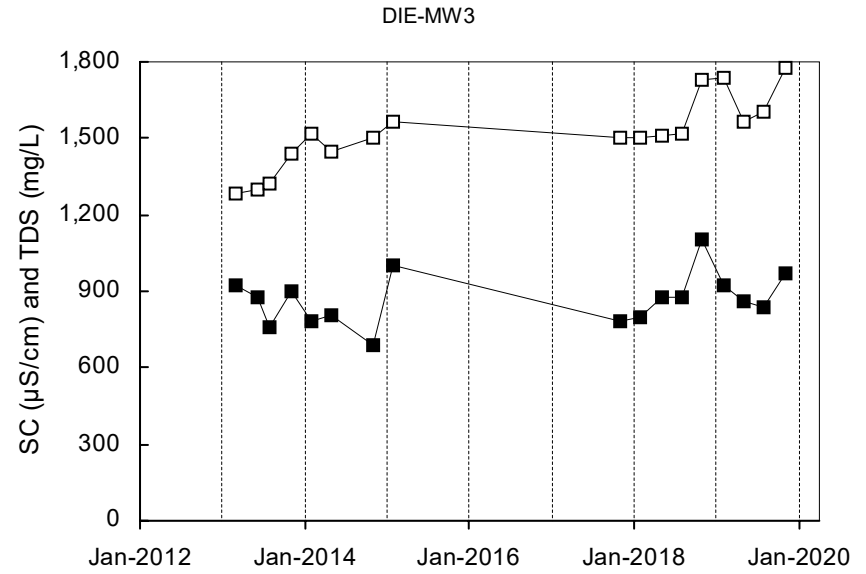
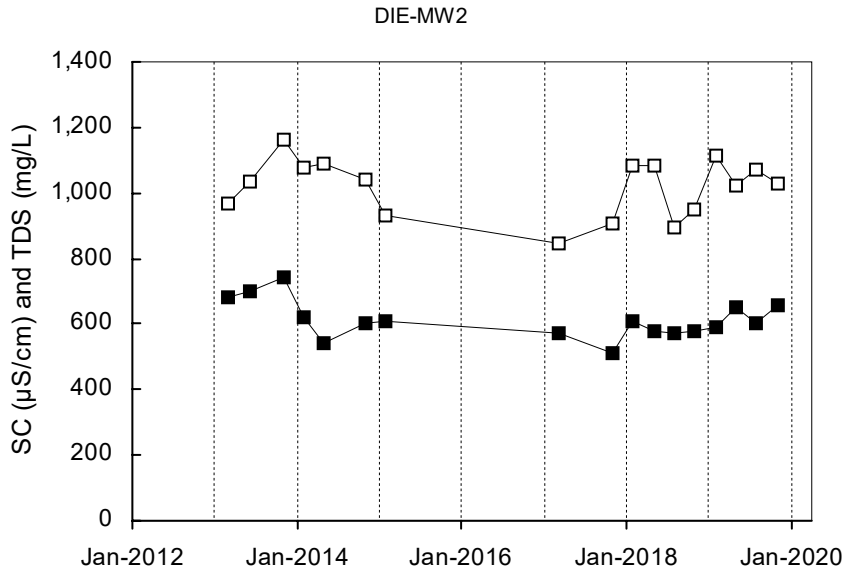

Total Dissolved Solids
 Specific Conductance
Shallow Well shown with black symbols
 Deep Well shown with orange symbols
 "dd" Well shown with blue symbols

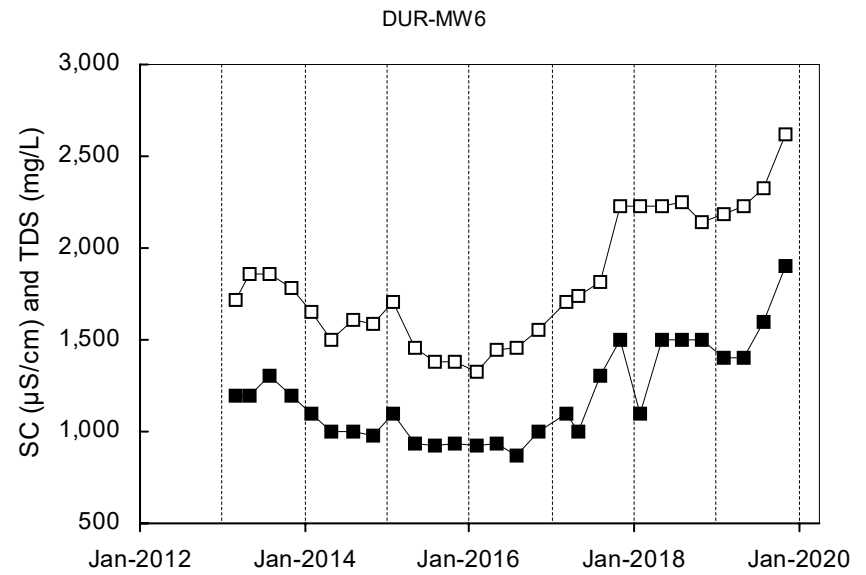
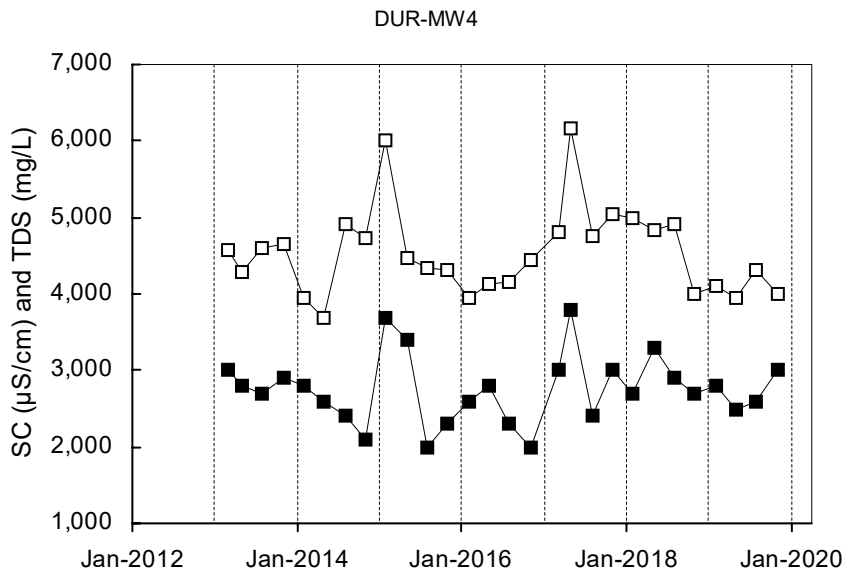
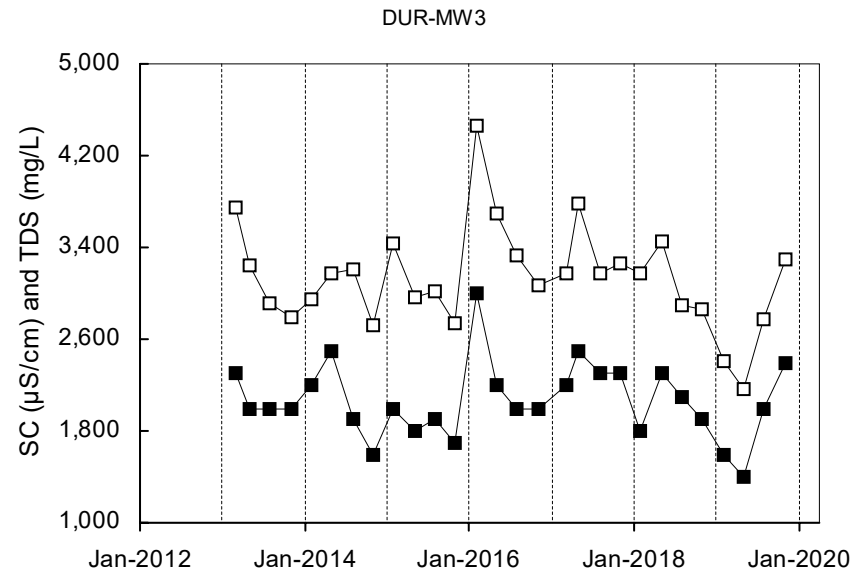
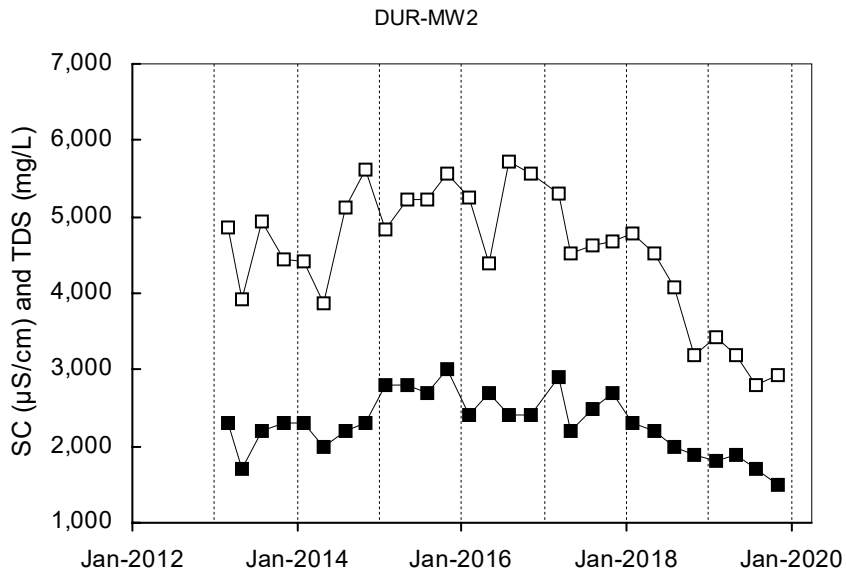

Total Dissolved Solids
 Specific Conductance
 Shallow Well shown with black symbols
 Deep Well shown with orange symbols
 "dd" Well shown with blue symbols

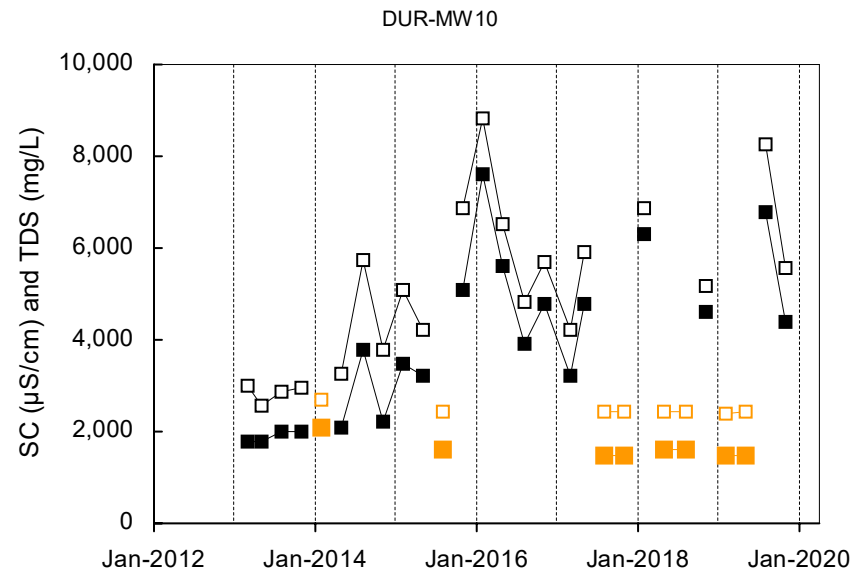
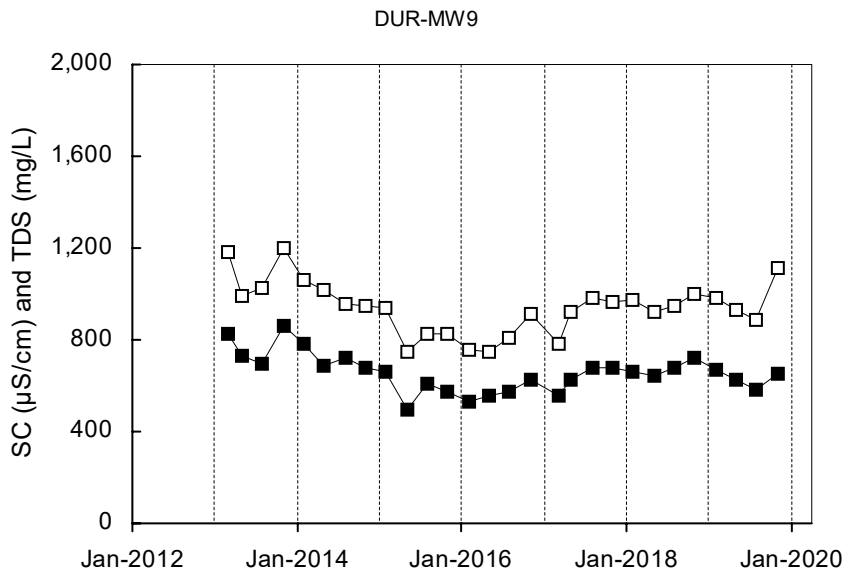
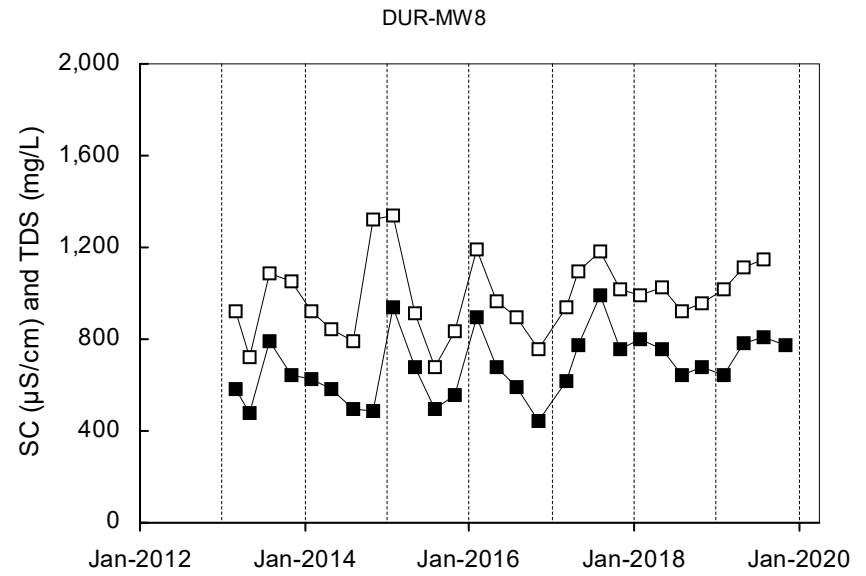
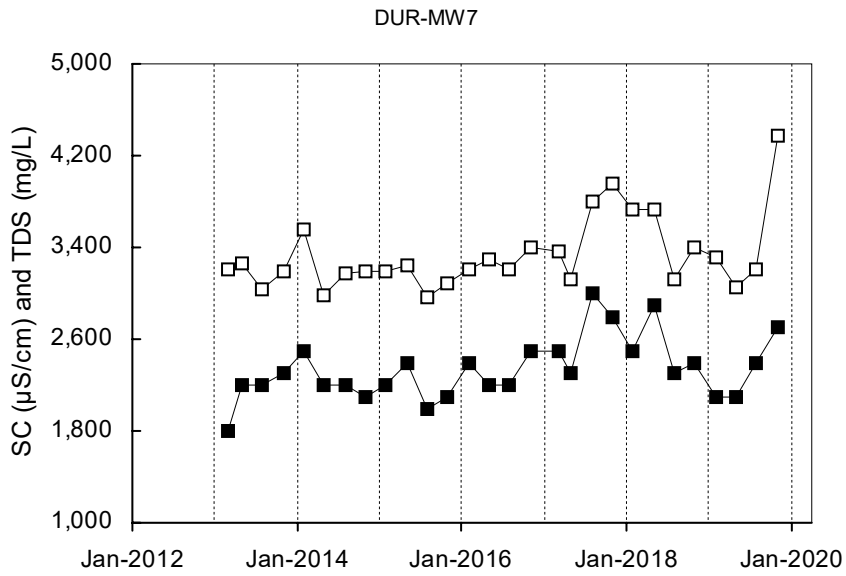

Total Dissolved Solids
 Specific Conductance
 Shallow Well shown with black symbols
 Deep Well shown with orange symbols
 "dd" Well shown with blue symbols

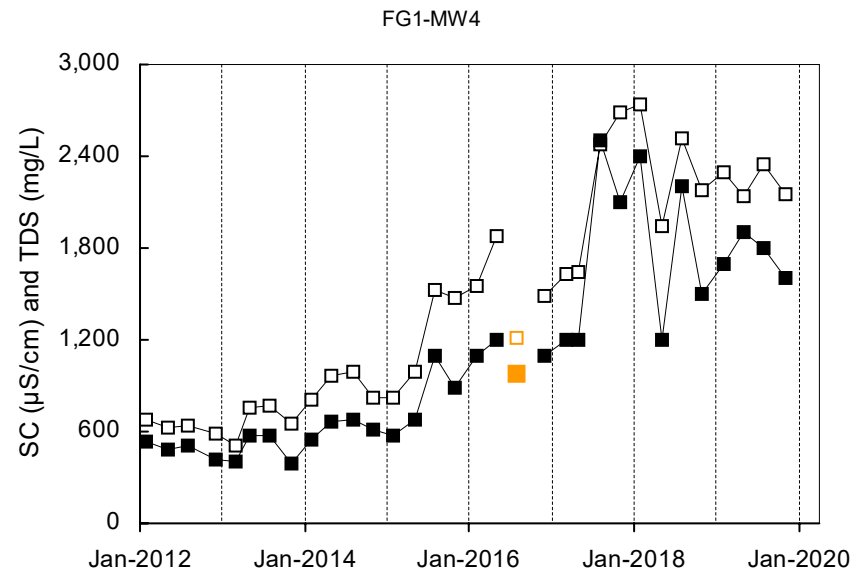
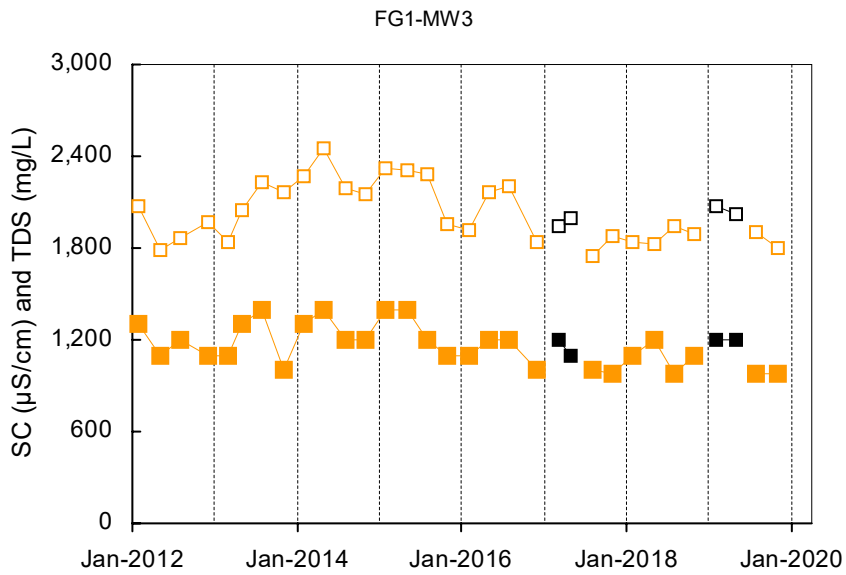
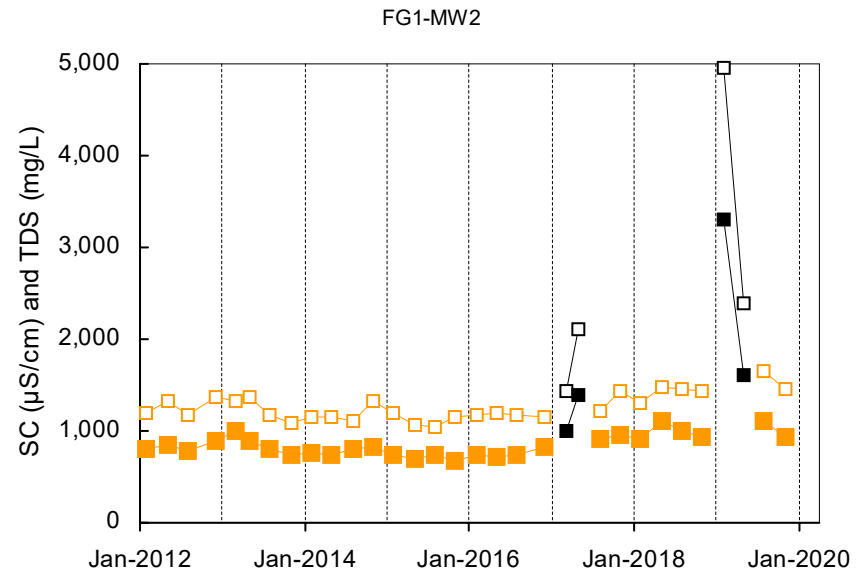
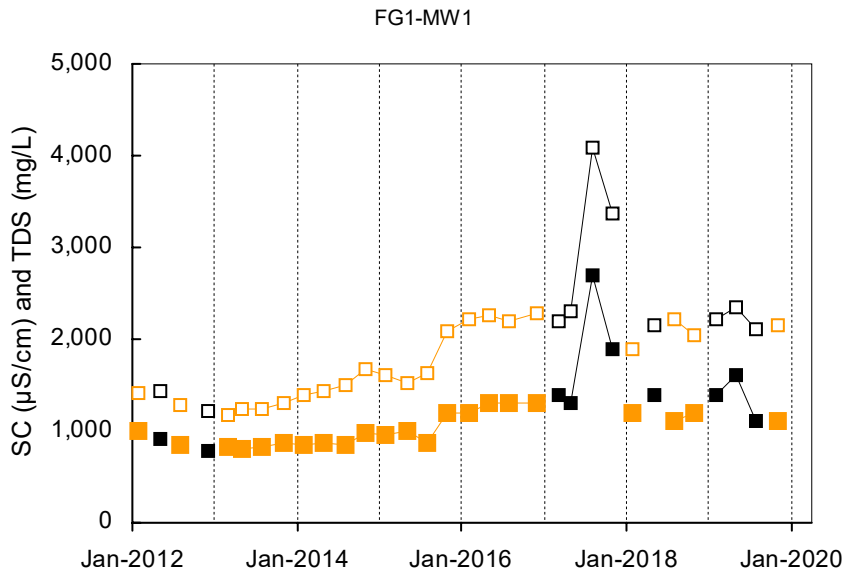

Total Dissolved Solids
 Specific Conductance
 Shallow Well shown with black symbols
 Deep Well shown with orange symbols
 "dd" Well shown with blue symbols

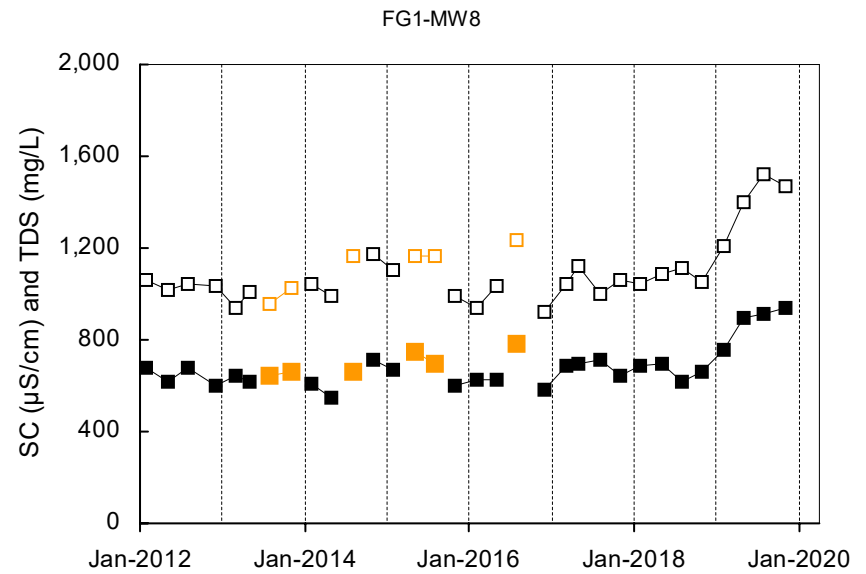
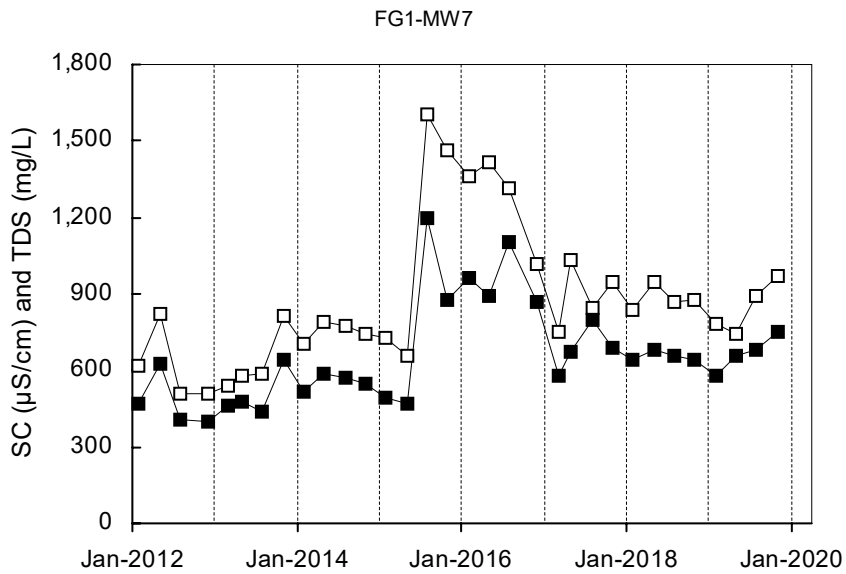
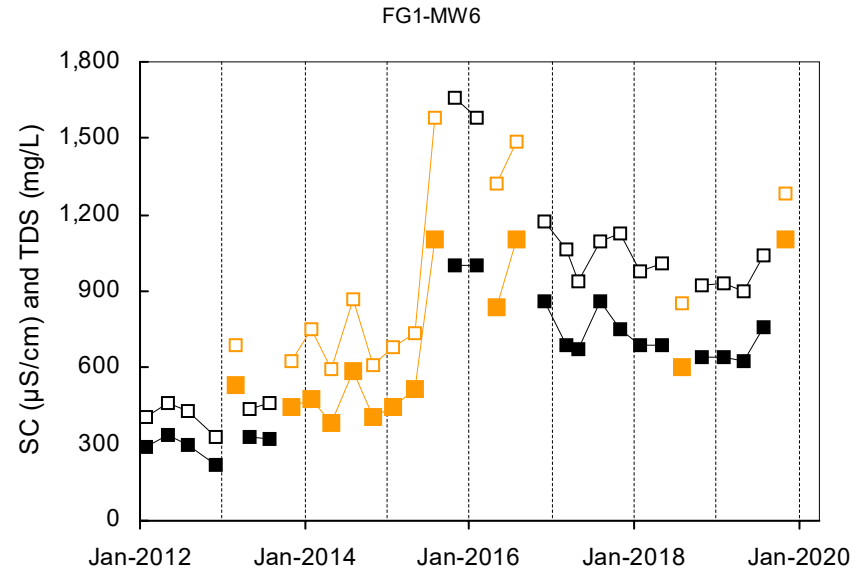
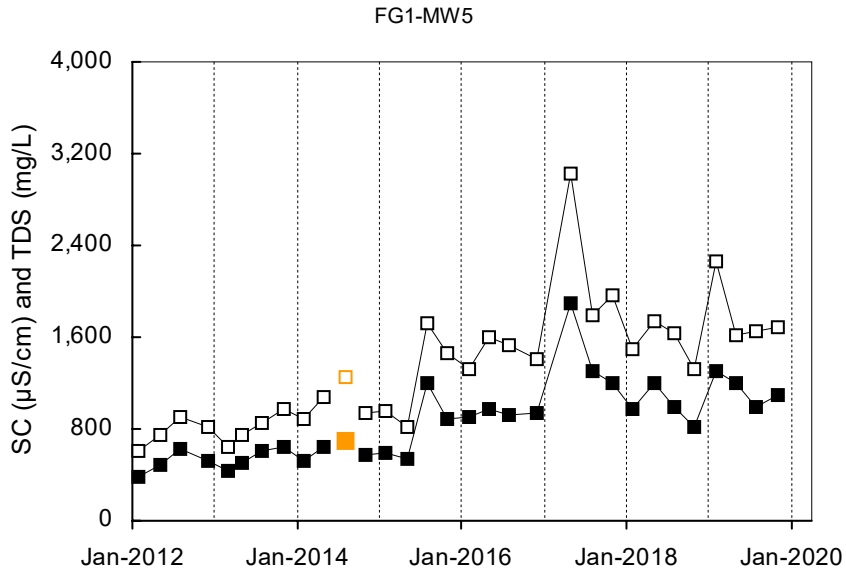

Total Dissolved Solids
 Specific Conductance
 Shallow Well shown with black symbols
 Deep Well shown with orange symbols
 "dd" Well shown with blue symbols

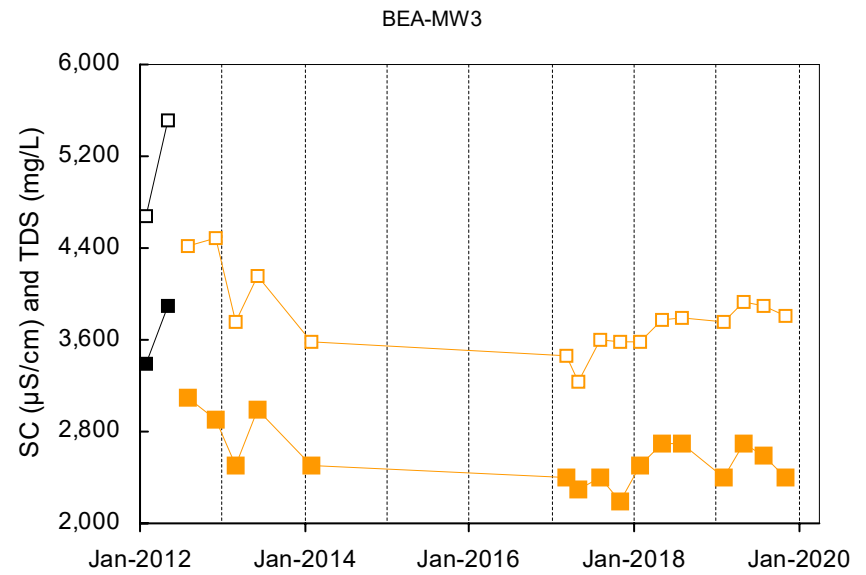
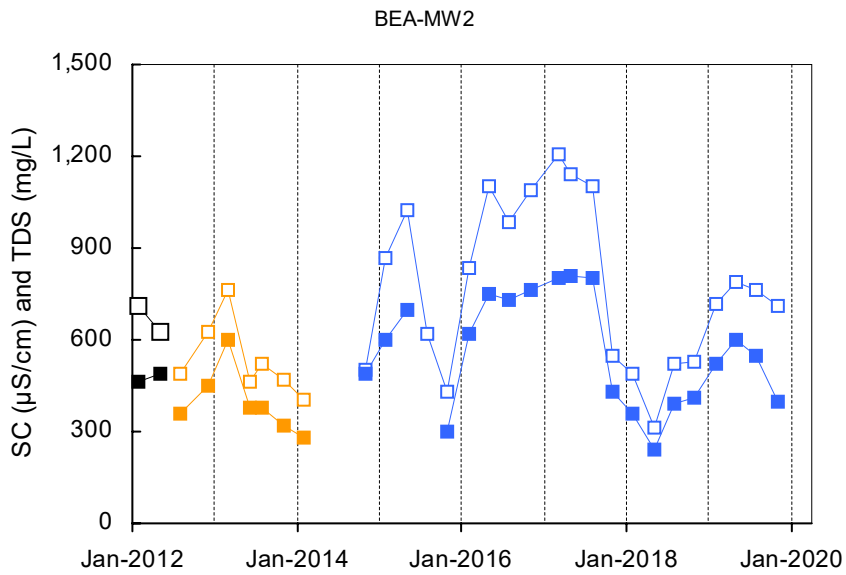
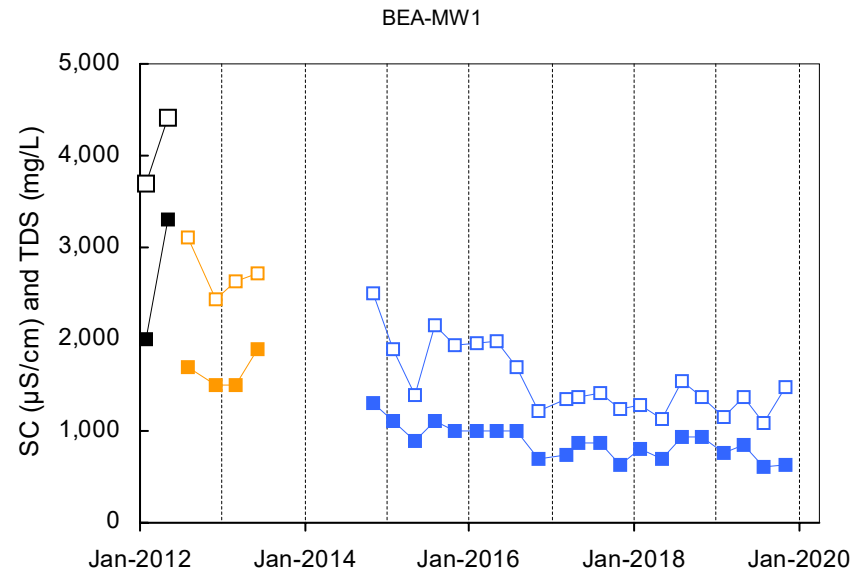
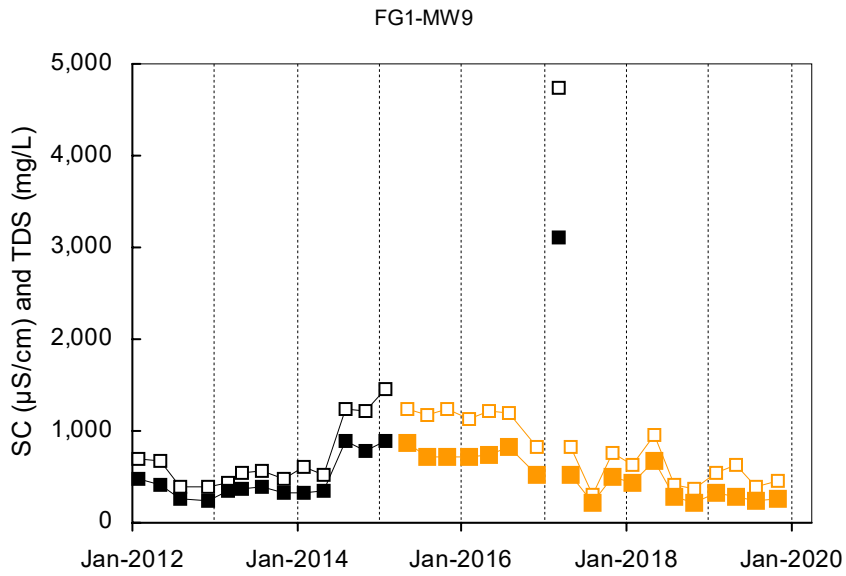

Total Dissolved Solids
 Specific Conductance
 Shallow Well shown with black symbols
 Deep Well shown with orange symbols
 "dd" Well shown with blue symbols

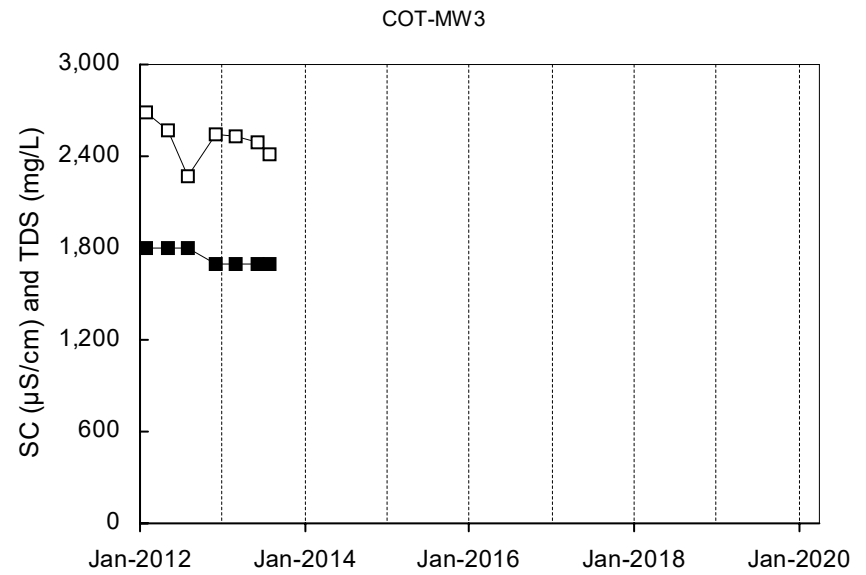
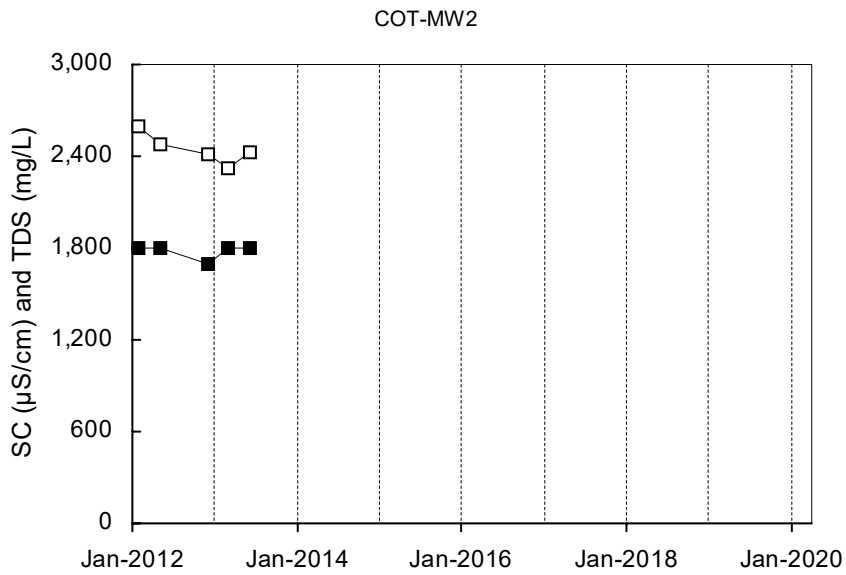
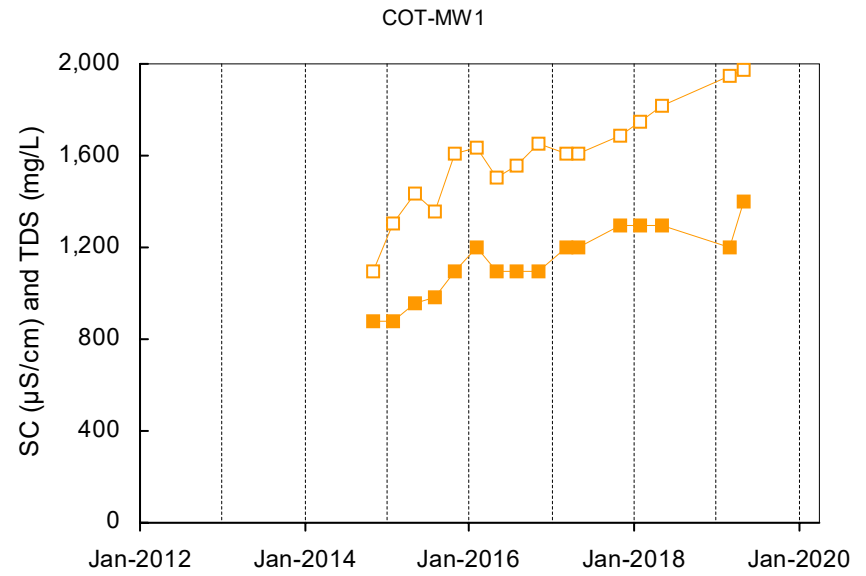
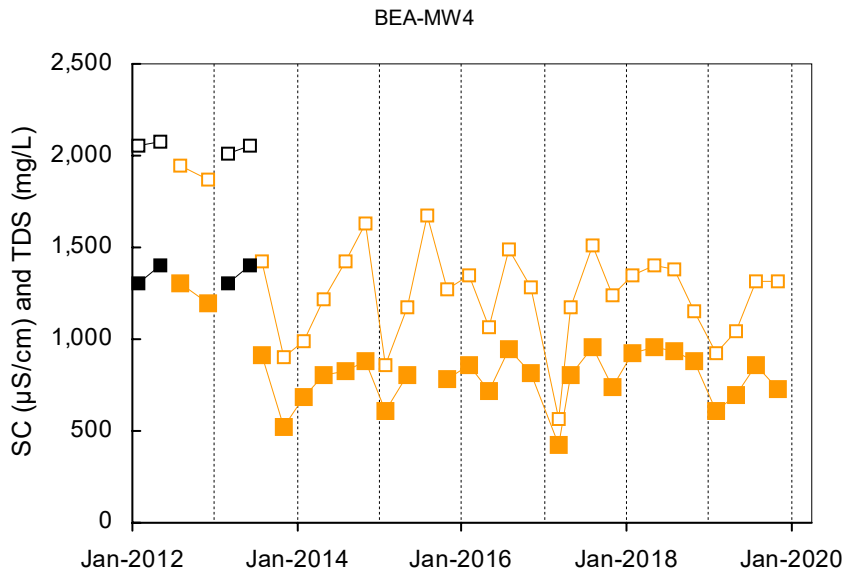

Total Dissolved Solids
 Specific Conductance
 Shallow Well shown with black symbols
 Deep Well shown with orange symbols
 "dd" Well shown with blue symbols

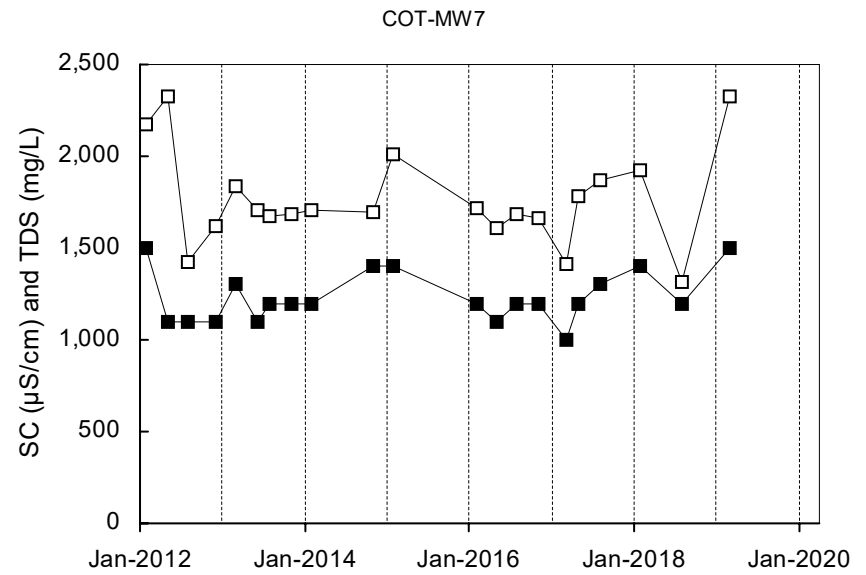
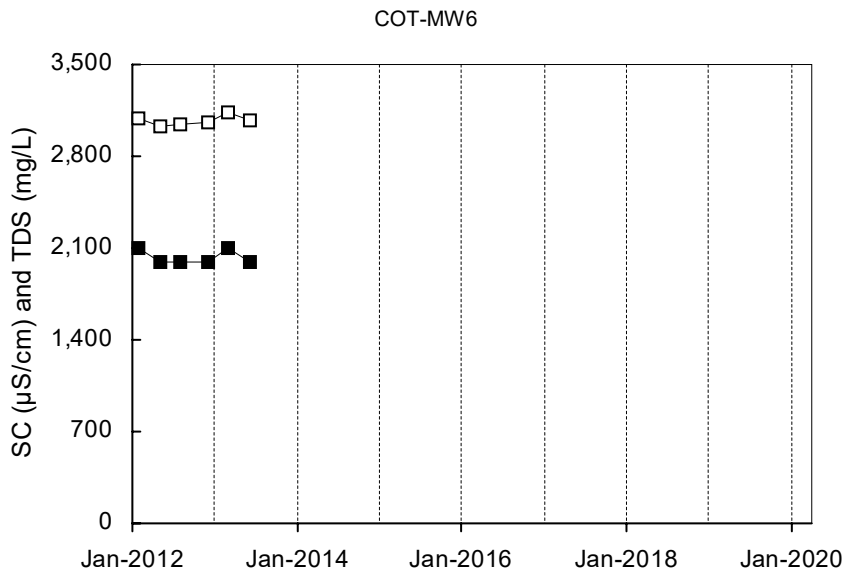
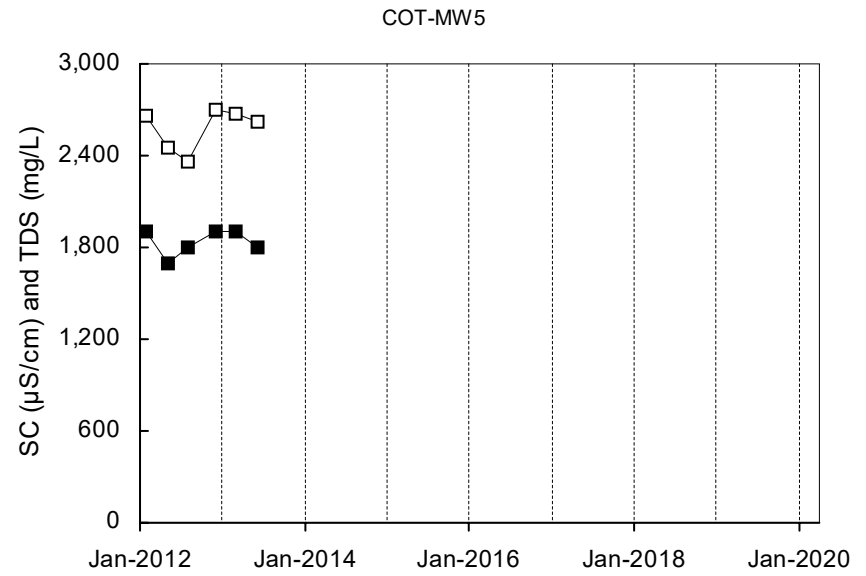
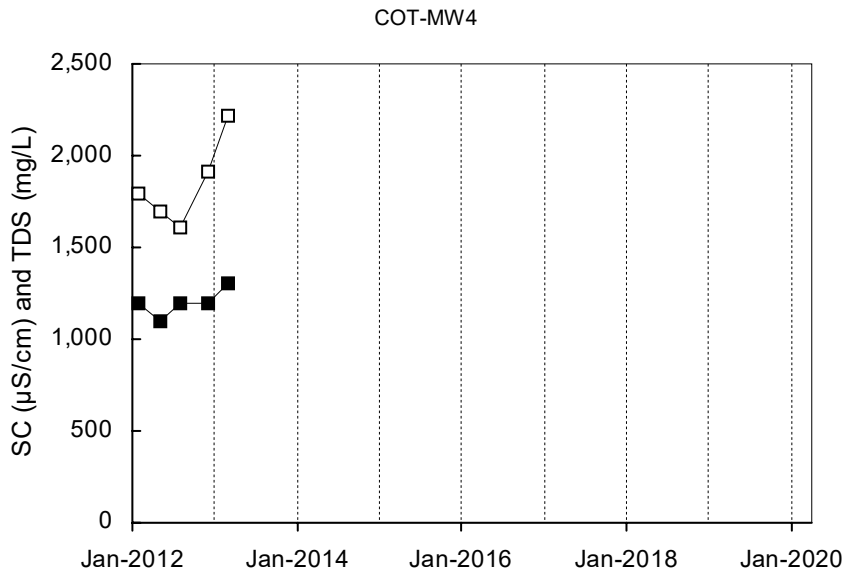

■ Total Dissolved Solids □ Specific Conductance
 Shallow Well shown with black symbols Deep Well shown with orange symbols "dd" Well shown with blue symbols

COT-MW8

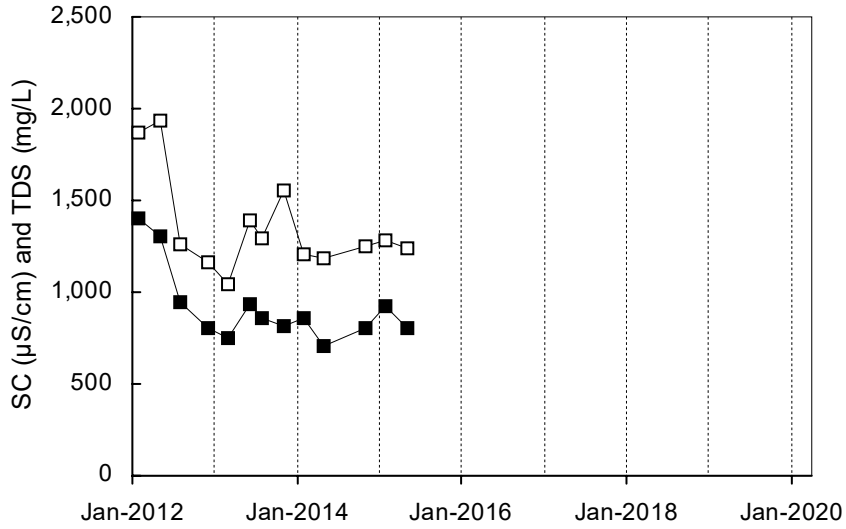

COT-MW9

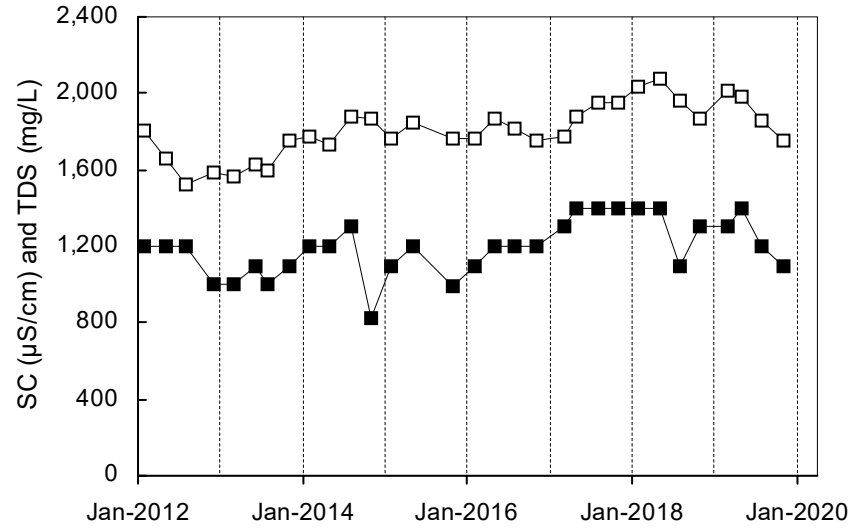

COT-MW10

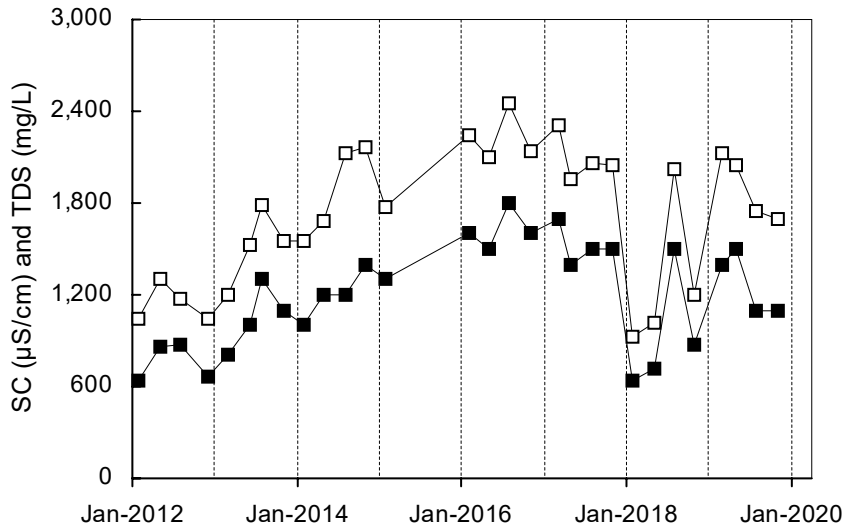

COT-MW11

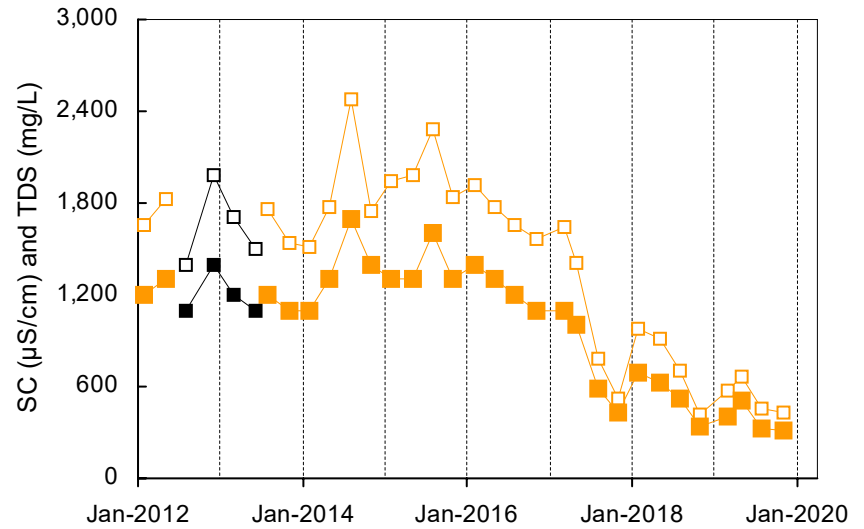

■ Total Dissolved Solids □ Specific Conductance

Shallow Well shown with black symbols

Deep Well shown with orange symbols

"dd" Well shown with blue symbols

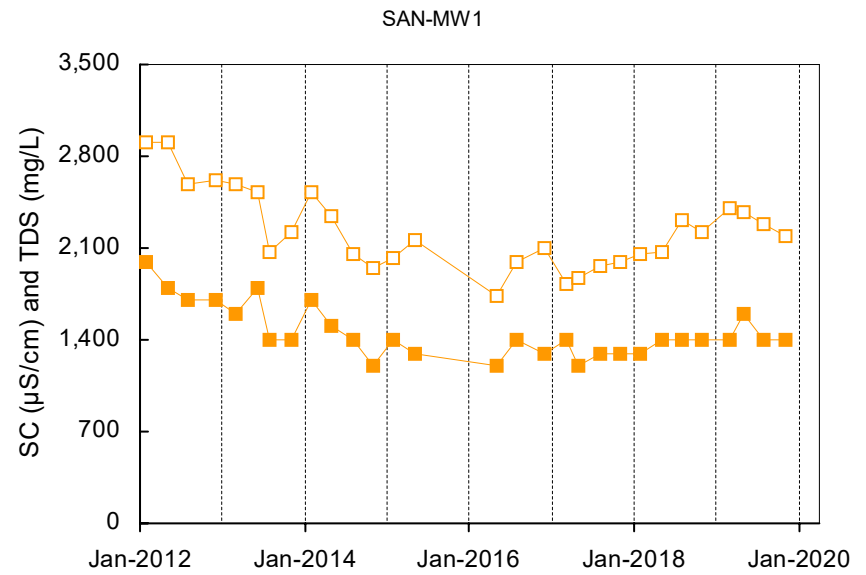
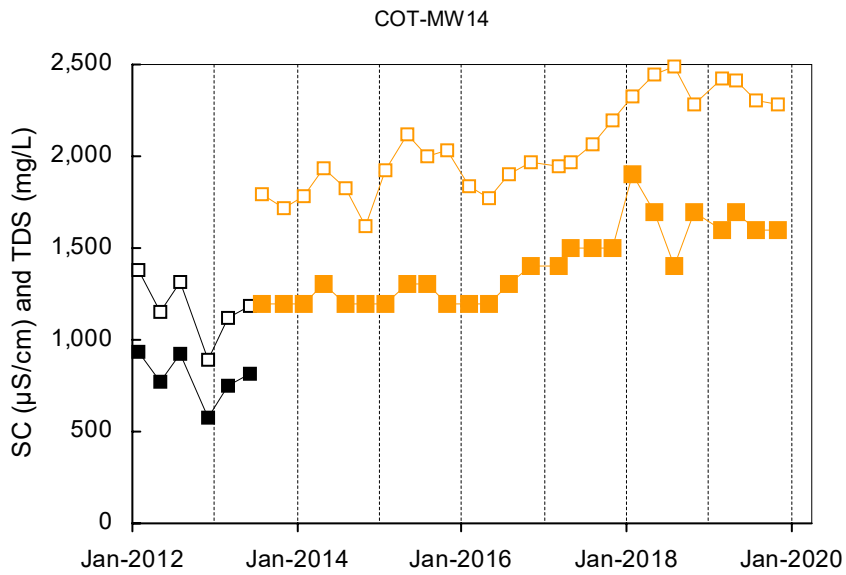
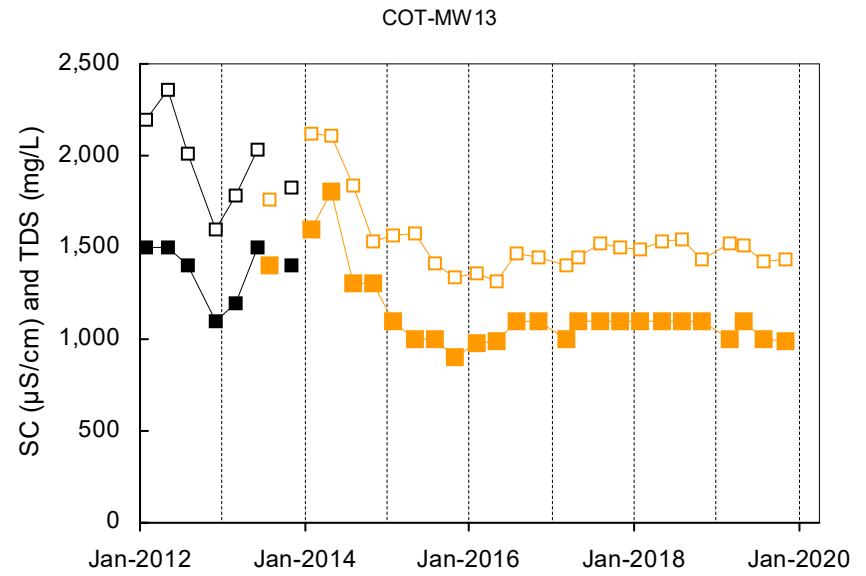
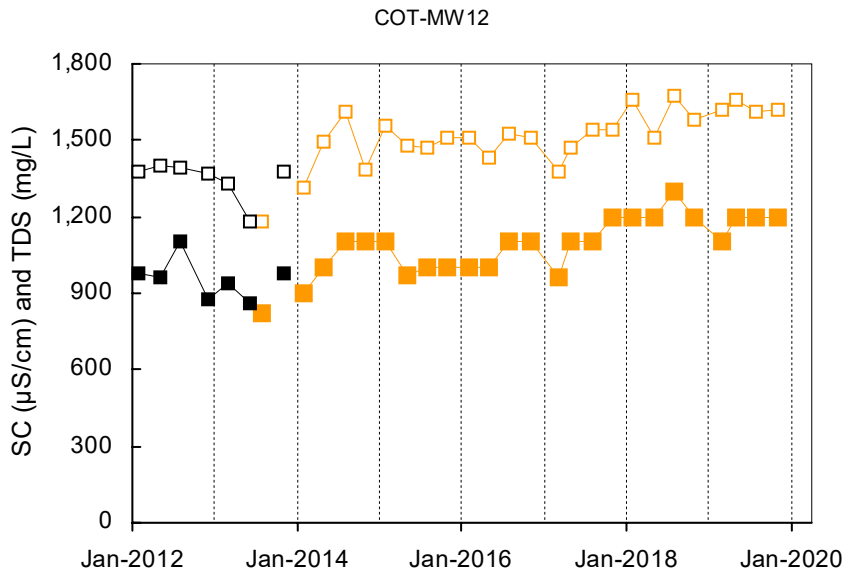

Total Dissolved Solids
 Specific Conductance
 Shallow Well shown with black symbols
 Deep Well shown with orange symbols
 "dd" Well shown with blue symbols

SAN-MW2

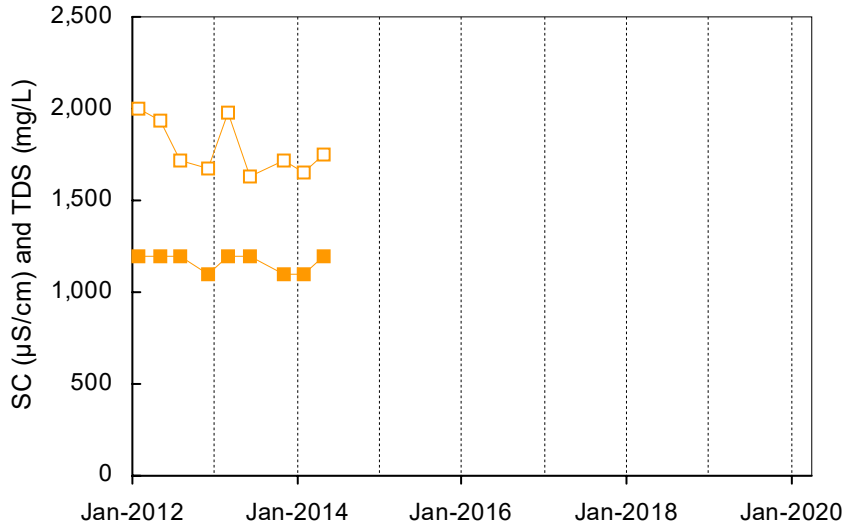

SAN-MW3

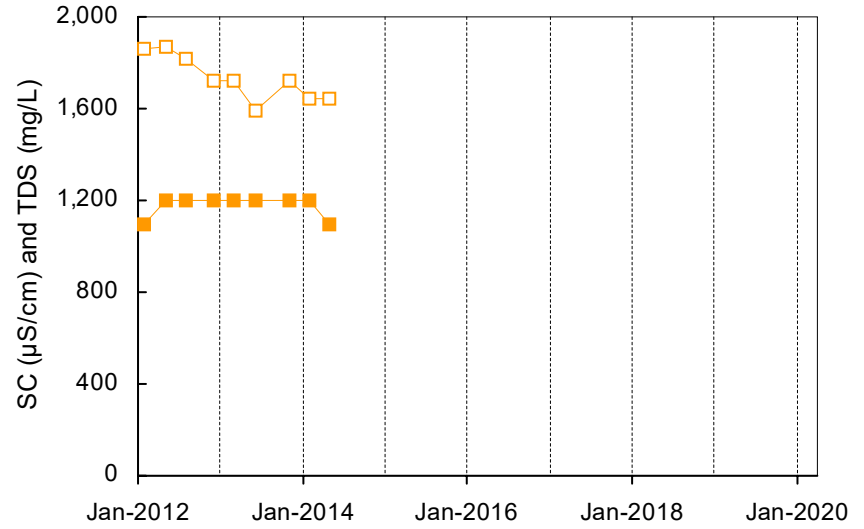

SAN-MW4

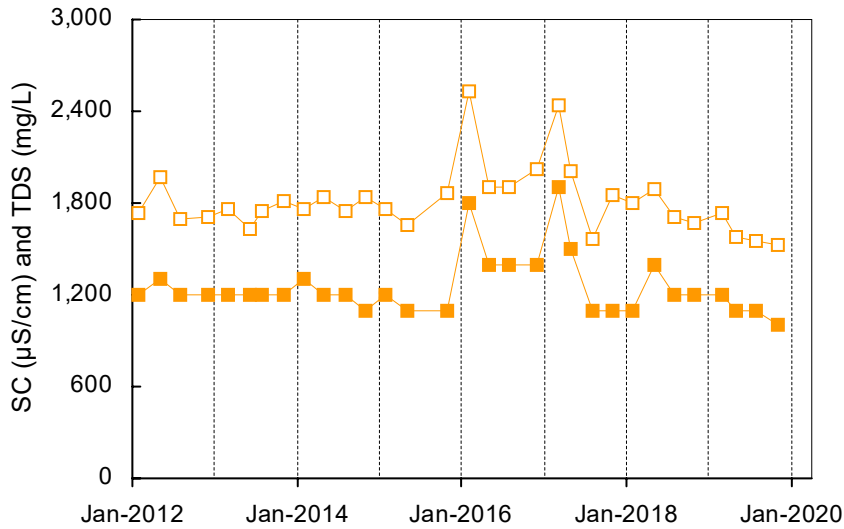

SAN-MW5

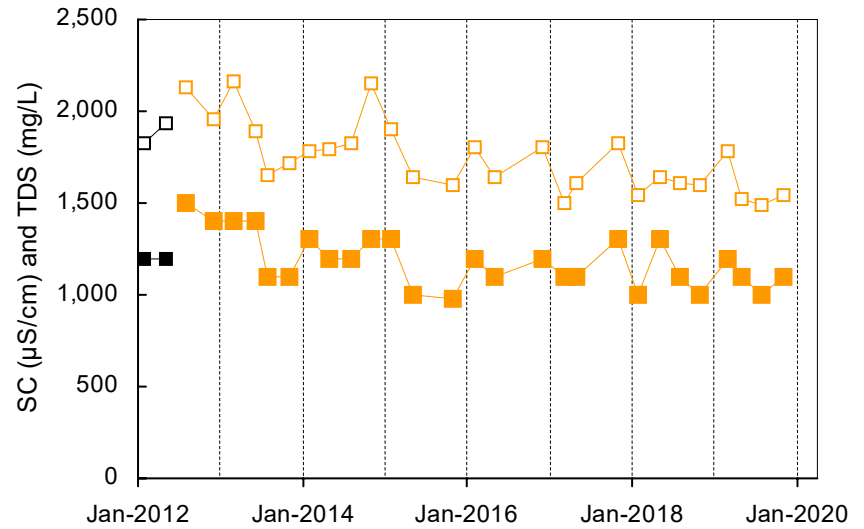

■ Total Dissolved Solids □ Specific Conductance

Shallow Well shown with black symbols

Deep Well shown with orange symbols

"dd" Well shown with blue symbols

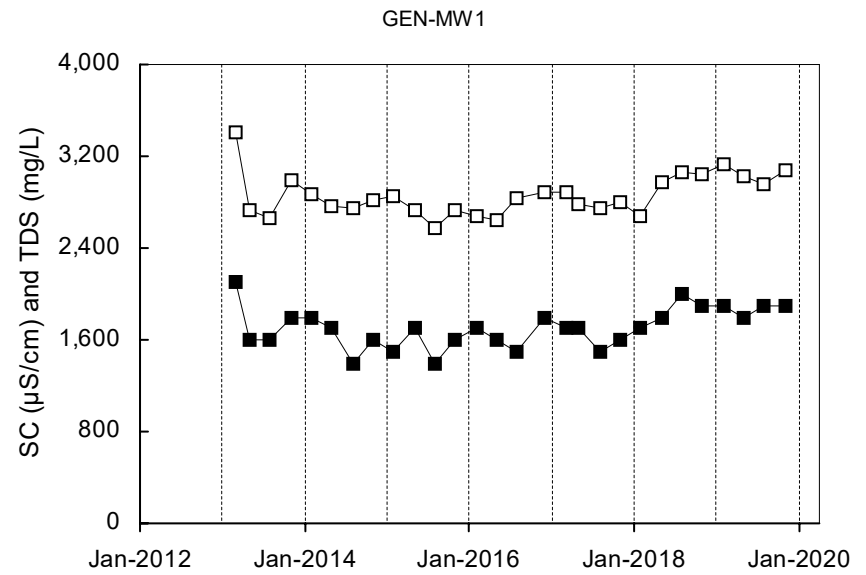
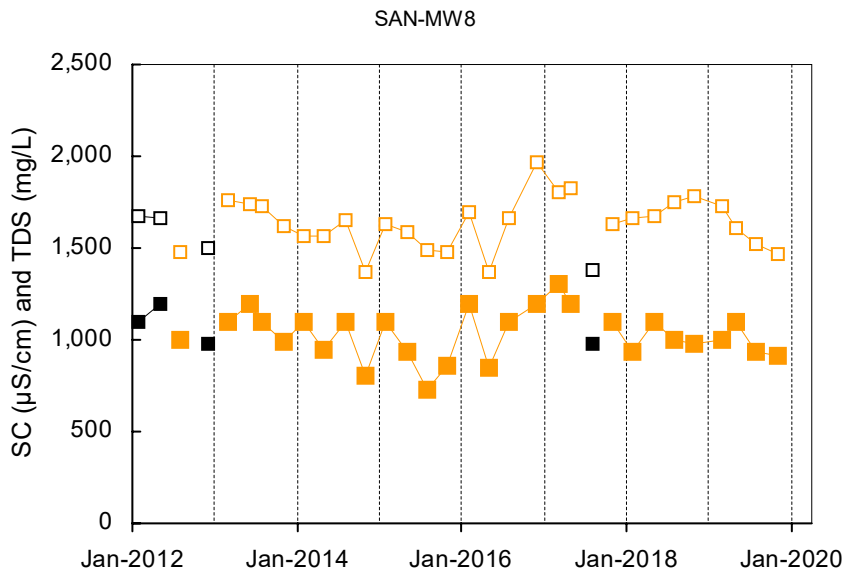
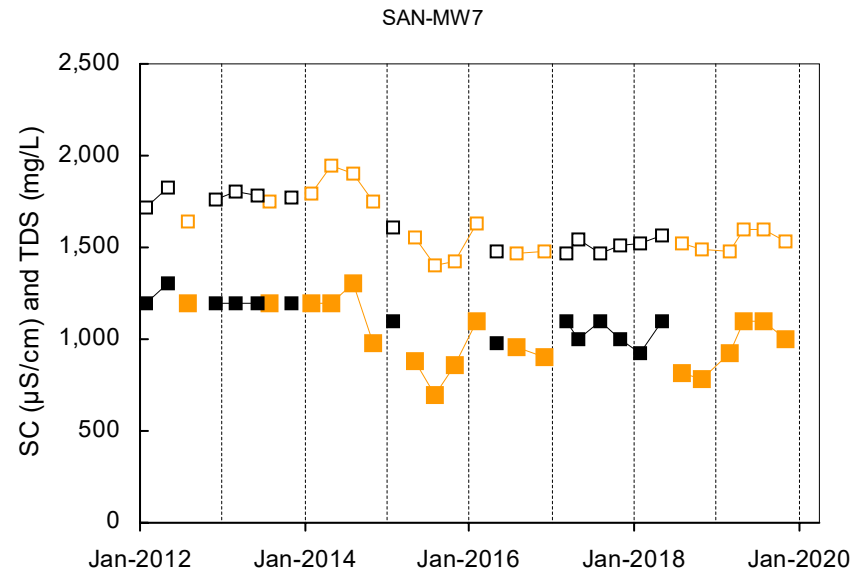
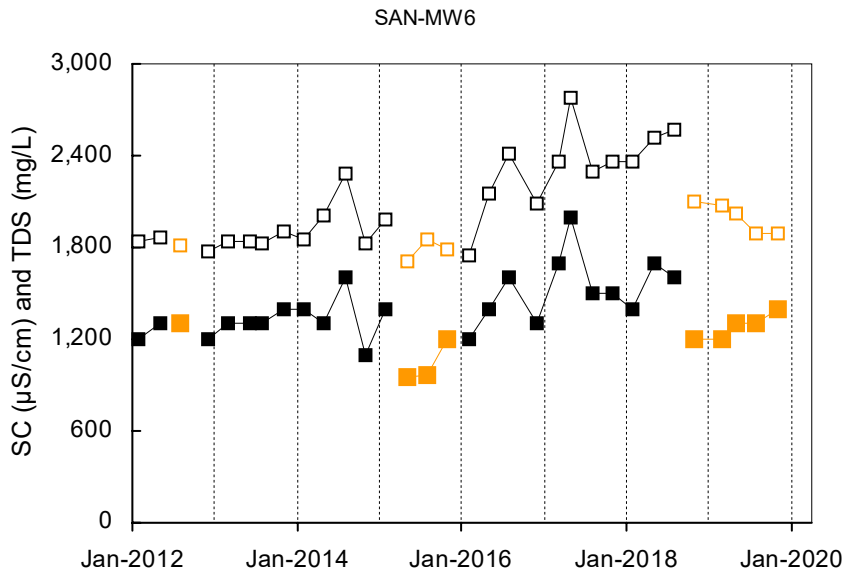

Total Dissolved Solids
 Specific Conductance
 Shallow Well shown with black symbols
 Deep Well shown with orange symbols
 "dd" Well shown with blue symbols

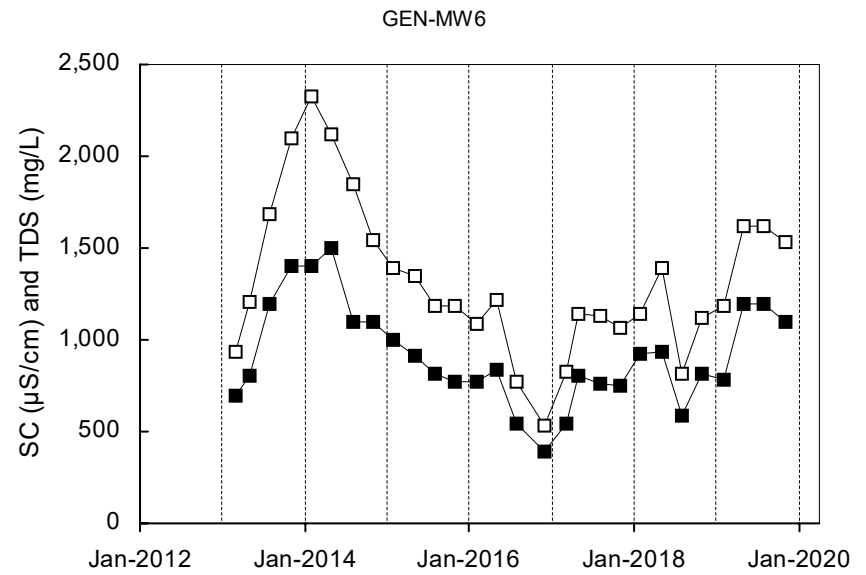
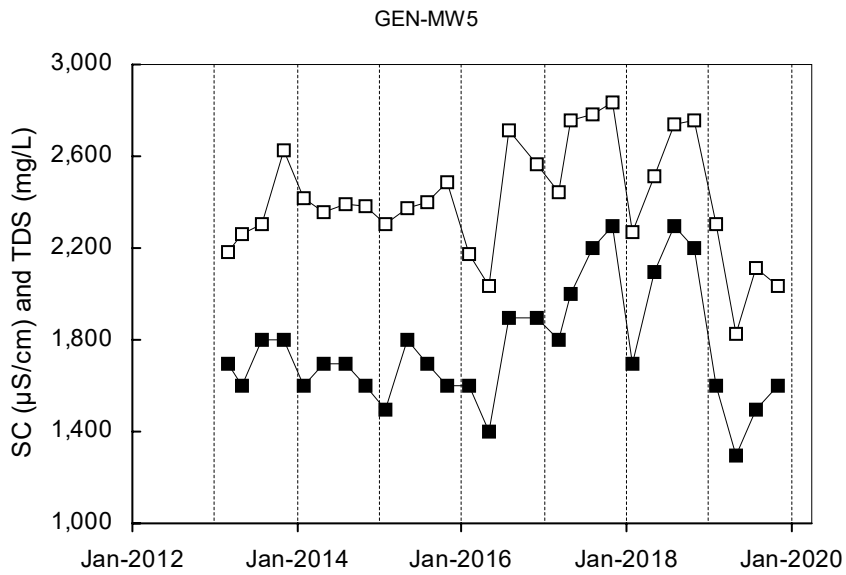
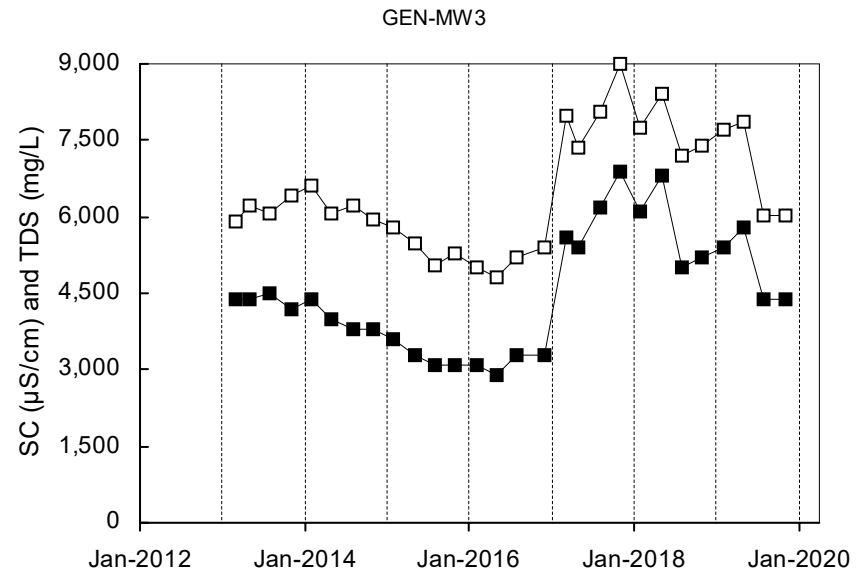
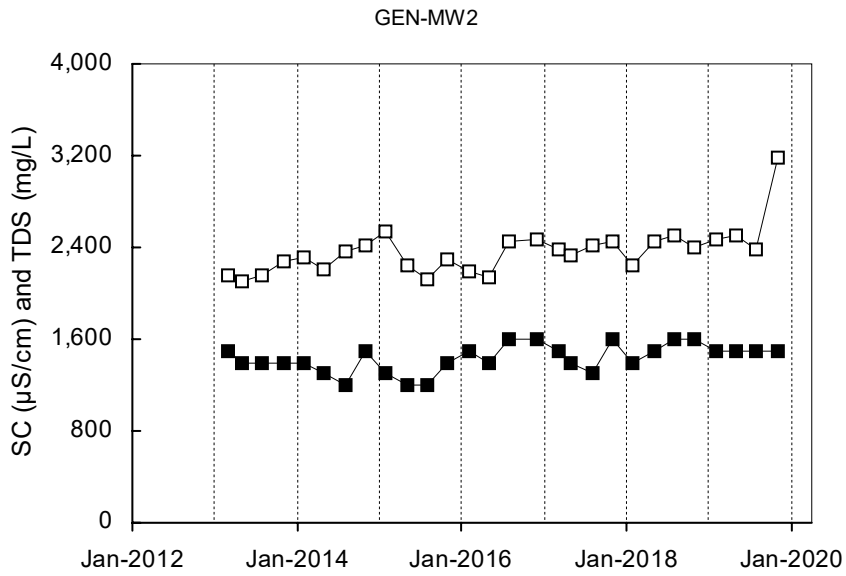

Total Dissolved Solids
 Specific Conductance
 Shallow Well shown with black symbols
 Deep Well shown with orange symbols
 "dd" Well shown with blue symbols

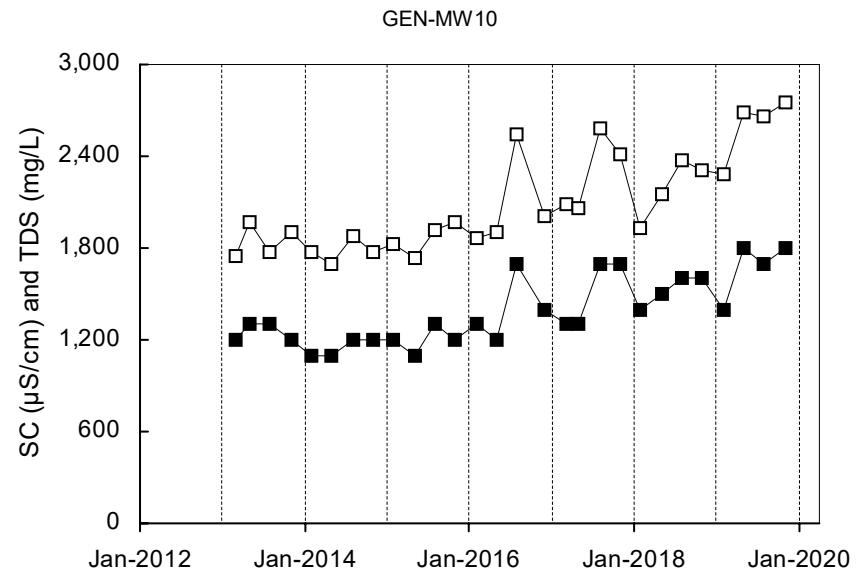
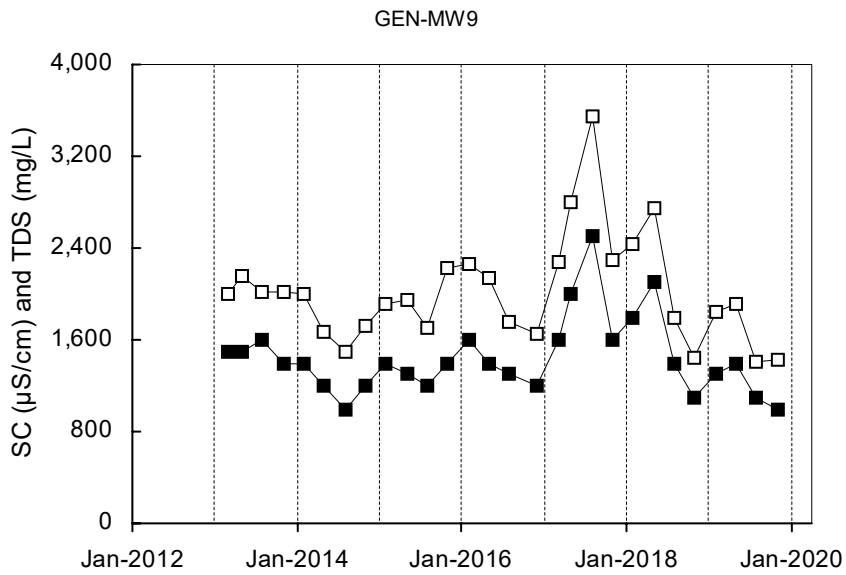
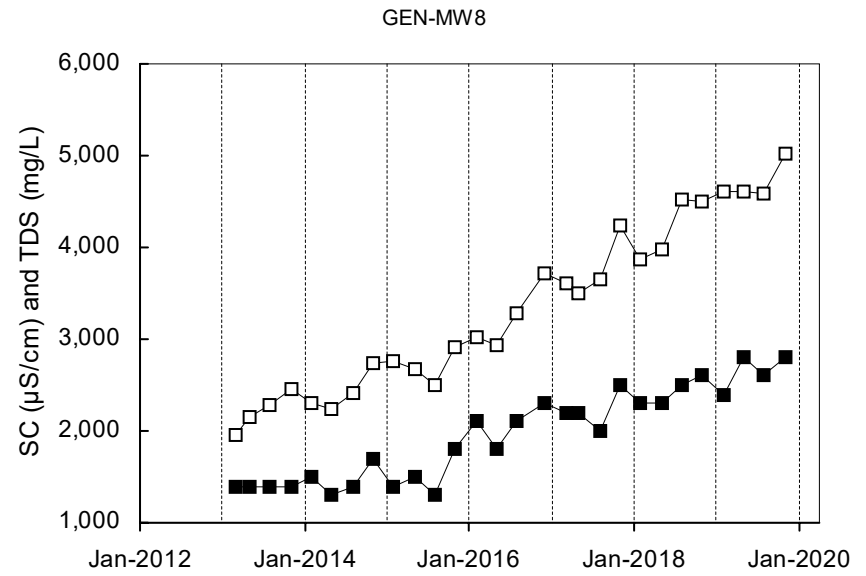
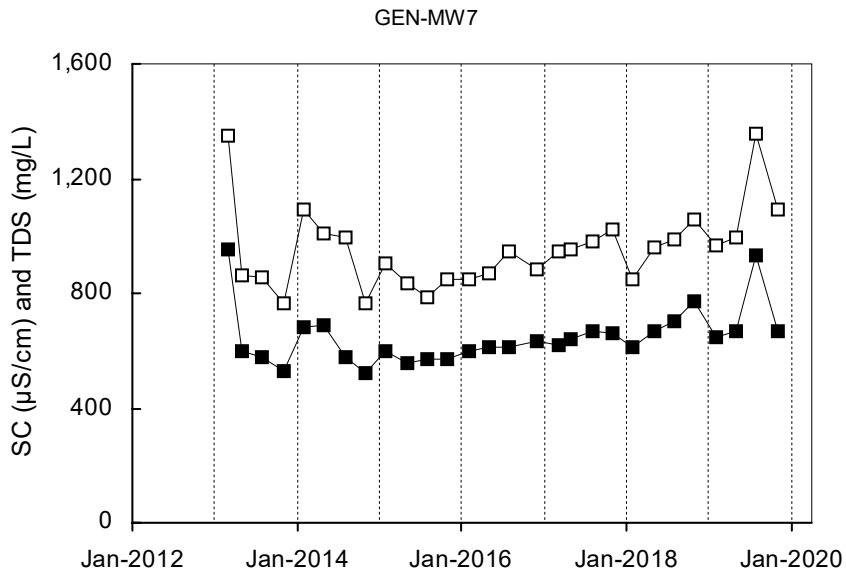

Total Dissolved Solids
 Specific Conductance
 Shallow Well shown with black symbols
 Deep Well shown with orange symbols
 "dd" Well shown with blue symbols

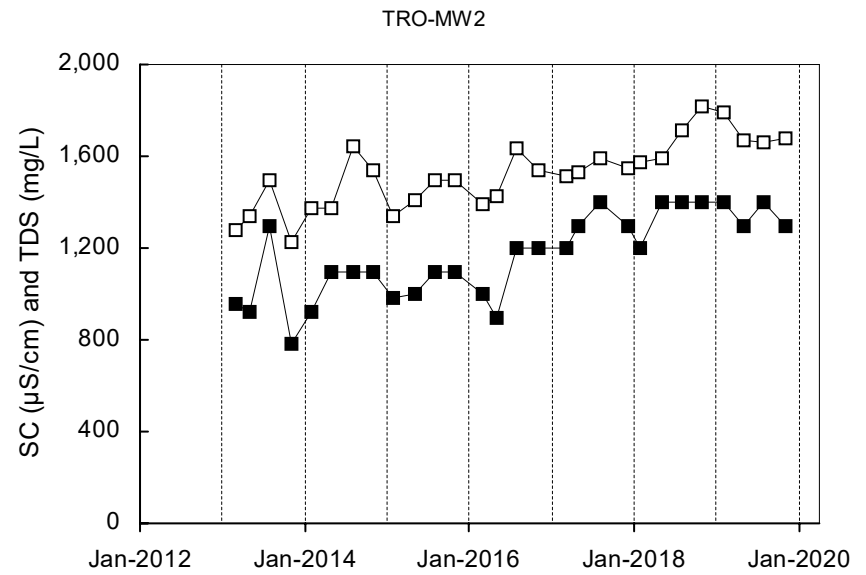
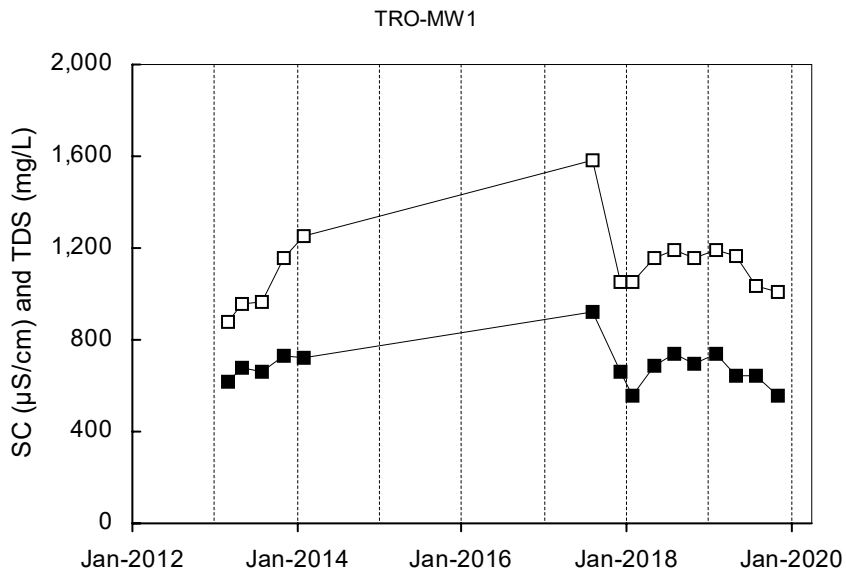
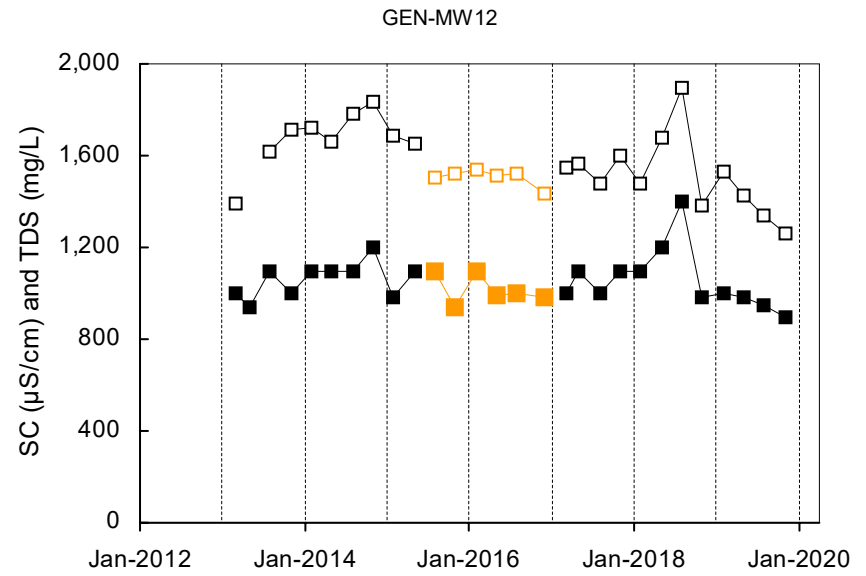
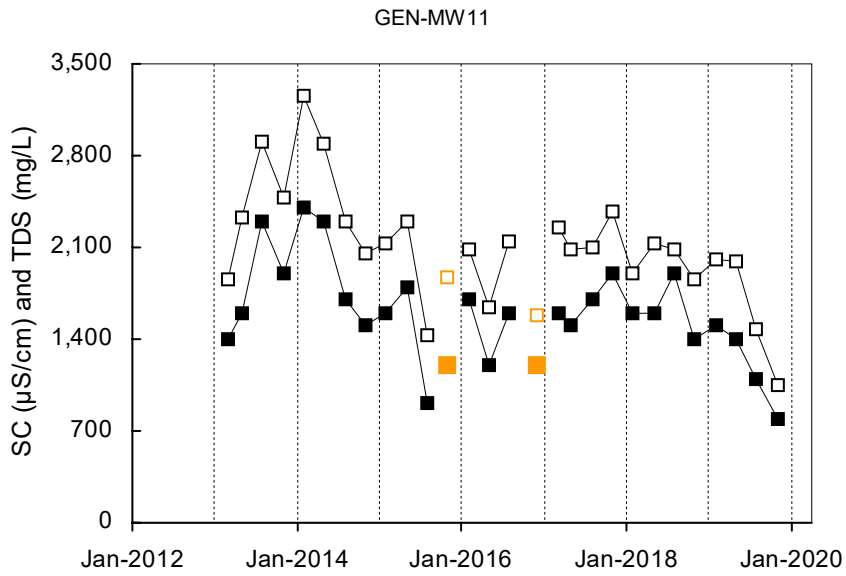

Total Dissolved Solids
 Specific Conductance
 Shallow Well shown with black symbols
 Deep Well shown with orange symbols
 "dd" Well shown with blue symbols

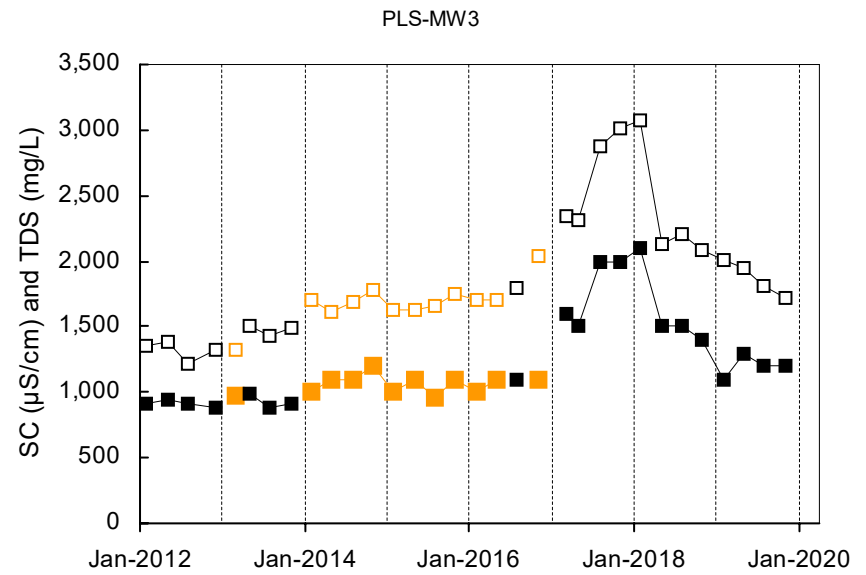
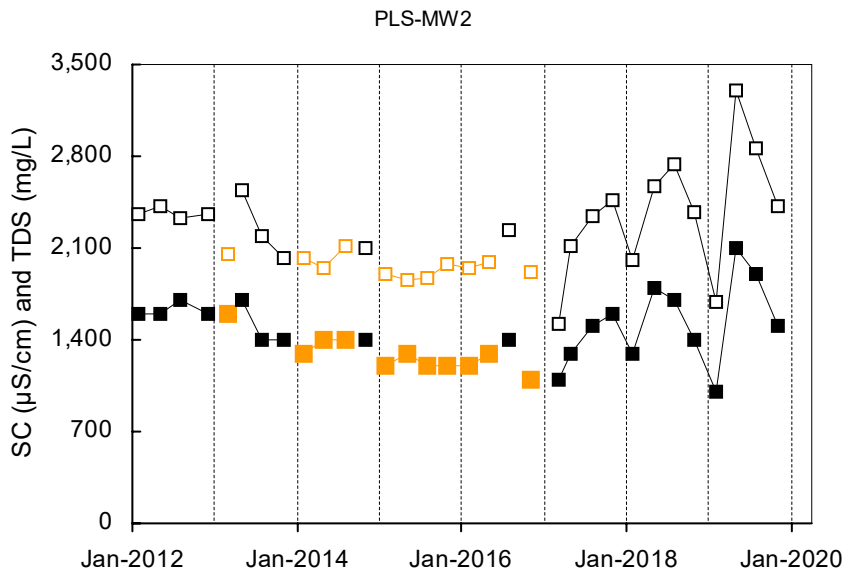
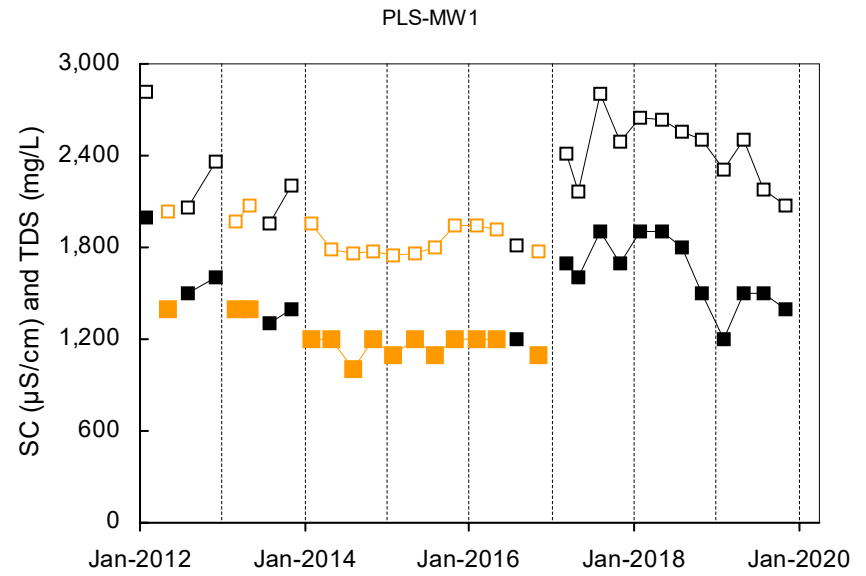
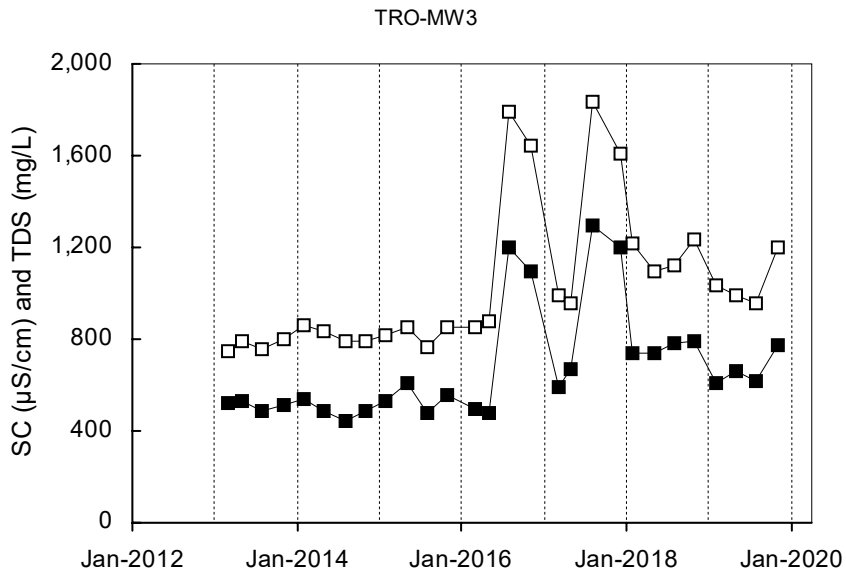

Total Dissolved Solids
 Specific Conductance
 Shallow Well shown with black symbols
 Deep Well shown with orange symbols
 "dd" Well shown with blue symbols

PLS-MW4

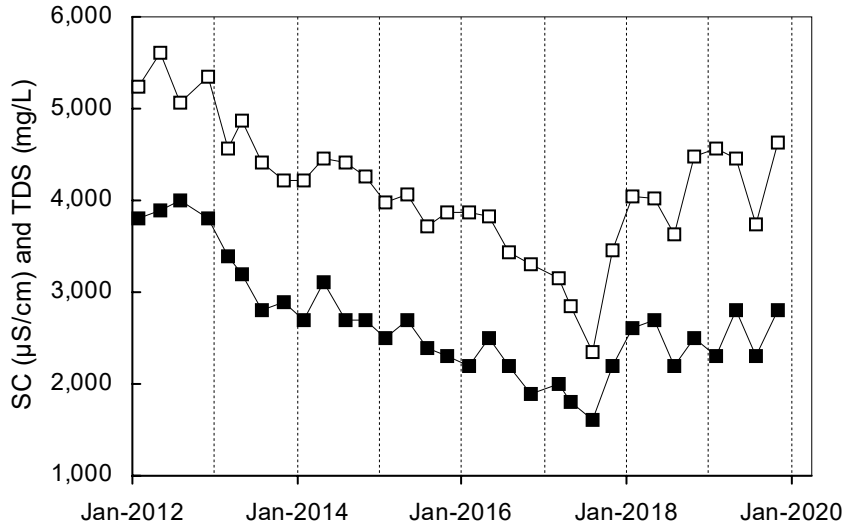

PLS-MW5

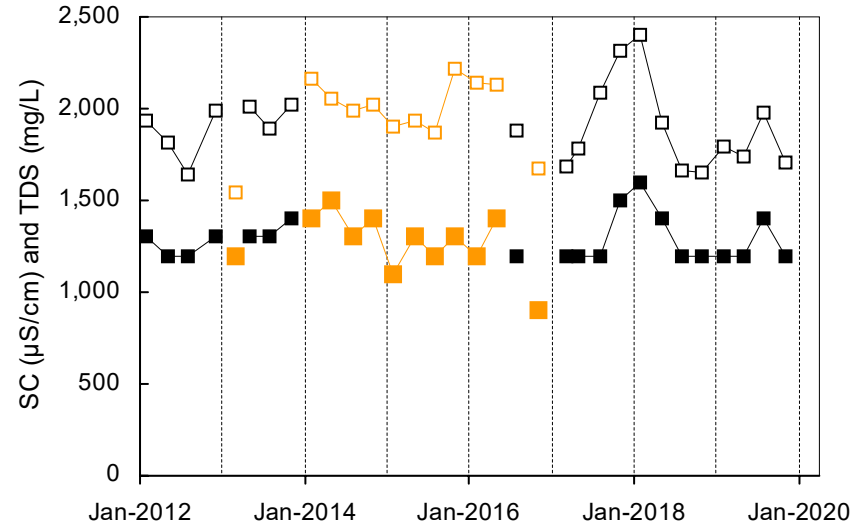

PLS-MW6

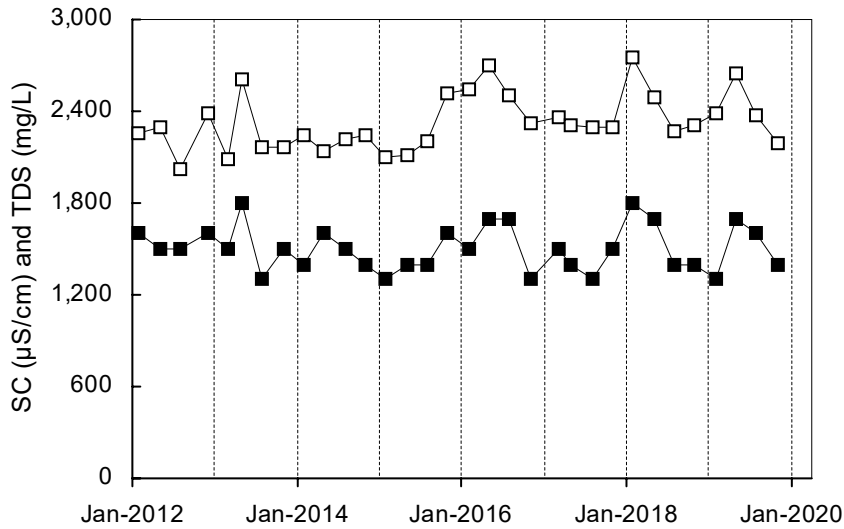

PLS-MW7

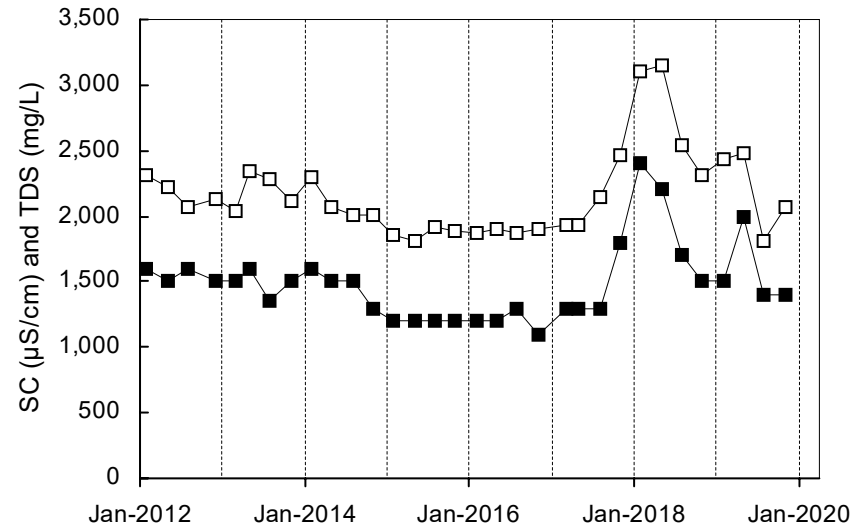

■ Total Dissolved Solids □ Specific Conductance

Shallow Well shown with black symbols

Deep Well shown with orange symbols

"dd" Well shown with blue symbols

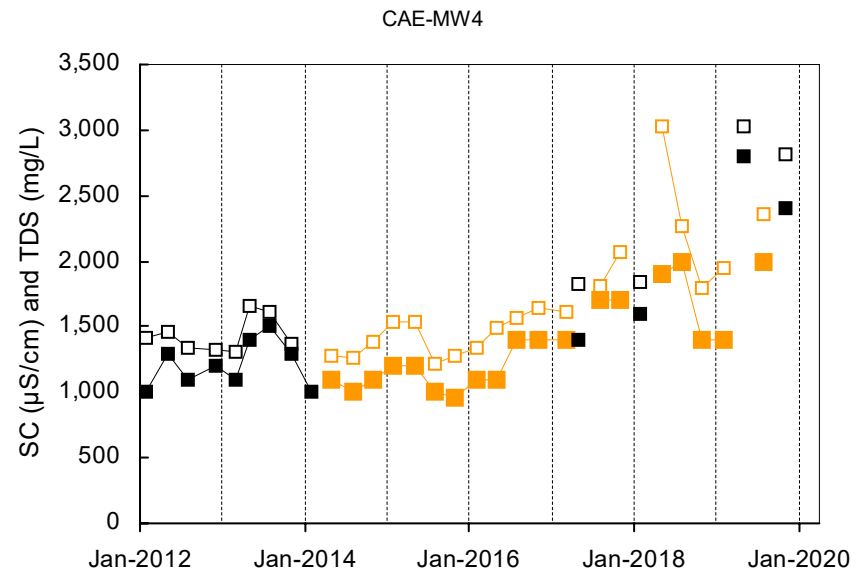
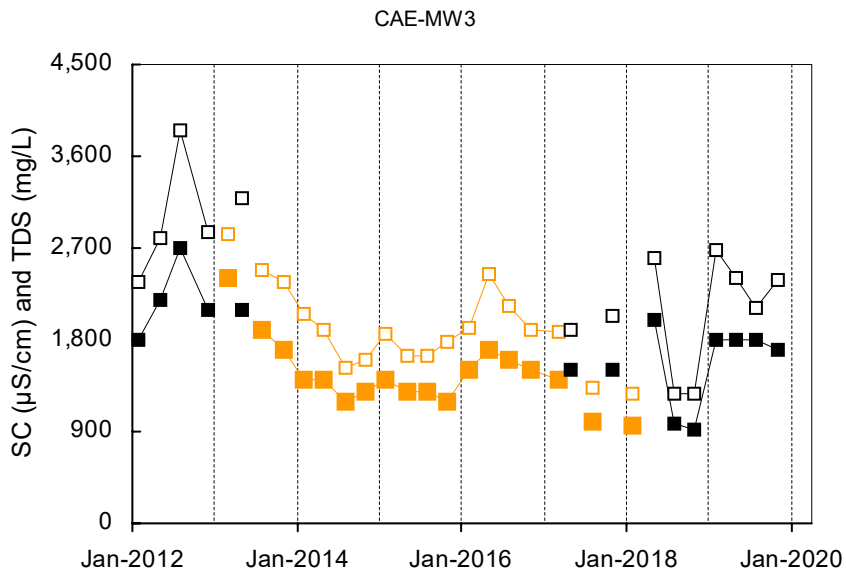
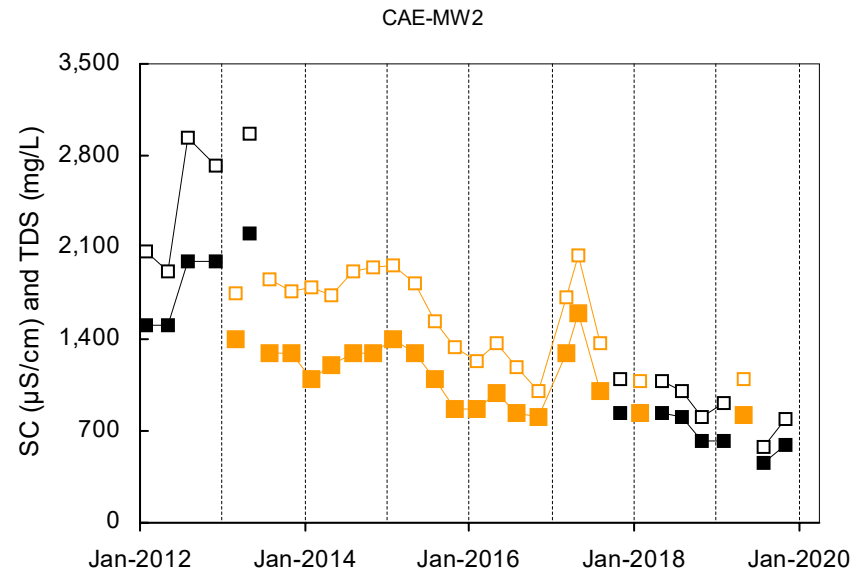
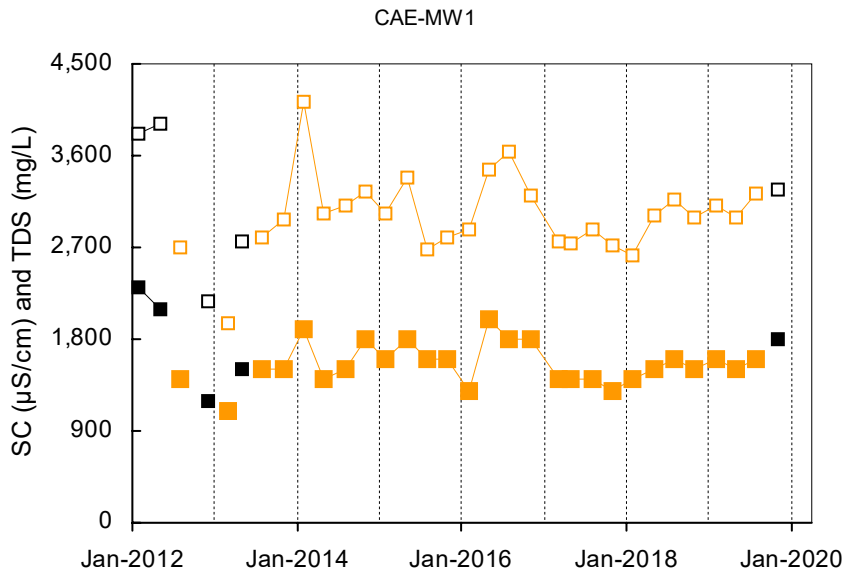

Total Dissolved Solids
 Specific Conductance
 Shallow Well shown with black symbols
 Deep Well shown with orange symbols
 "dd" Well shown with blue symbols

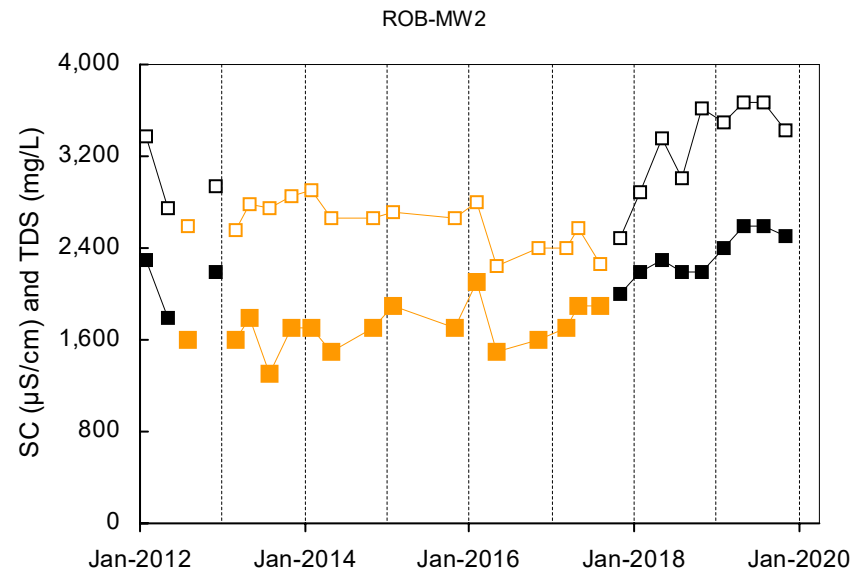
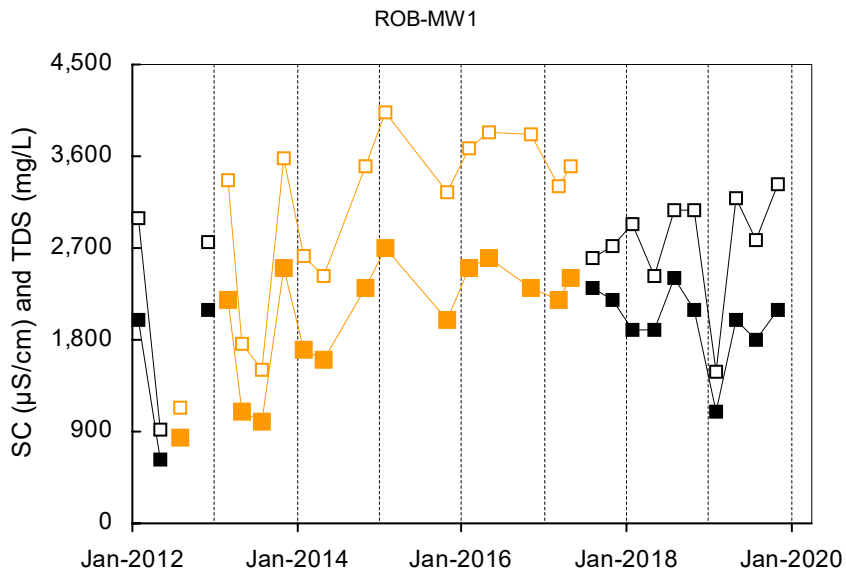
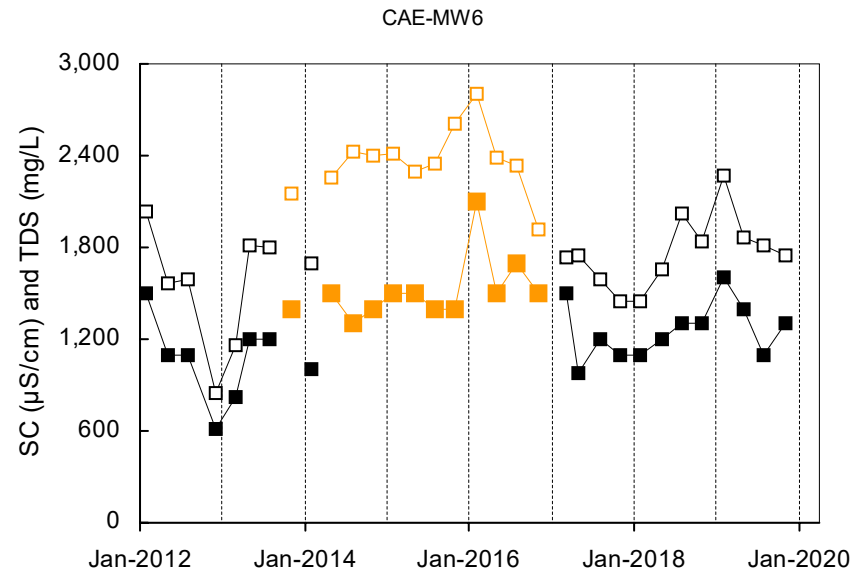
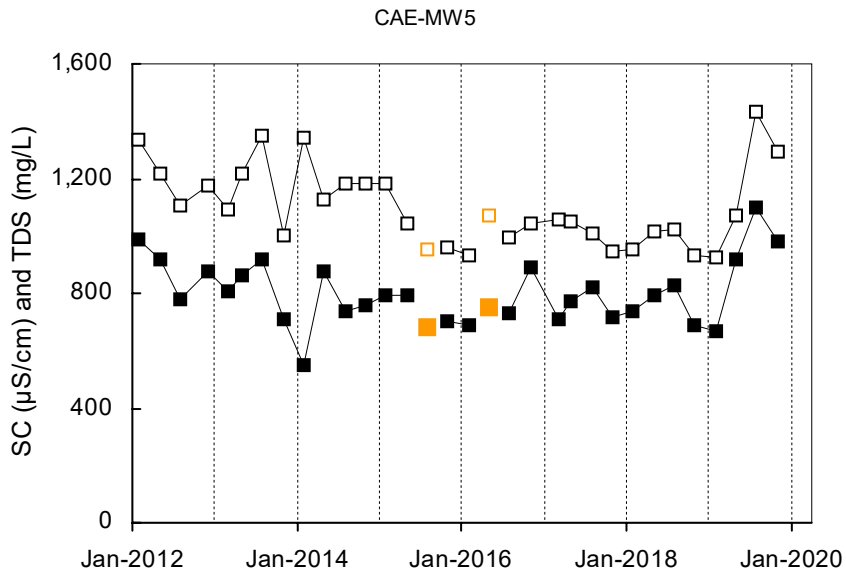

Total Dissolved Solids
 Specific Conductance
 Shallow Well shown with black symbols
 Deep Well shown with orange symbols
 "dd" Well shown with blue symbols

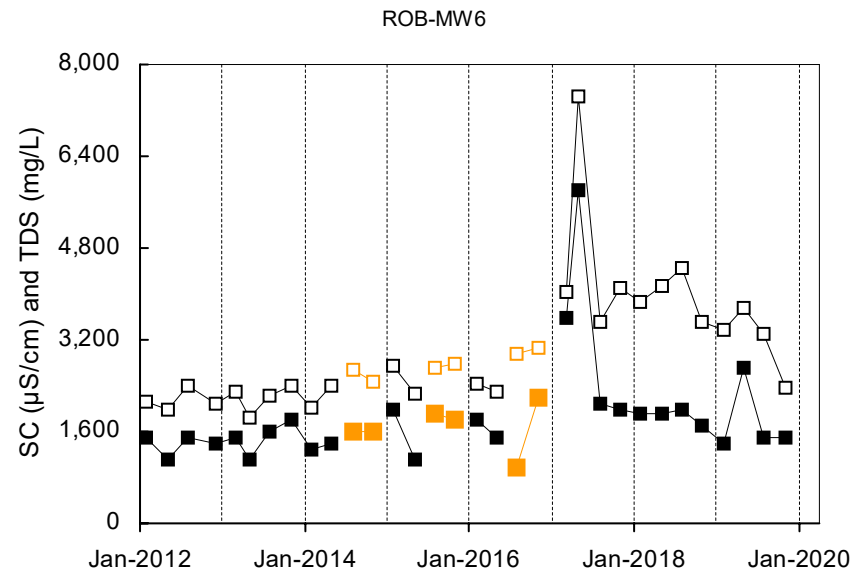
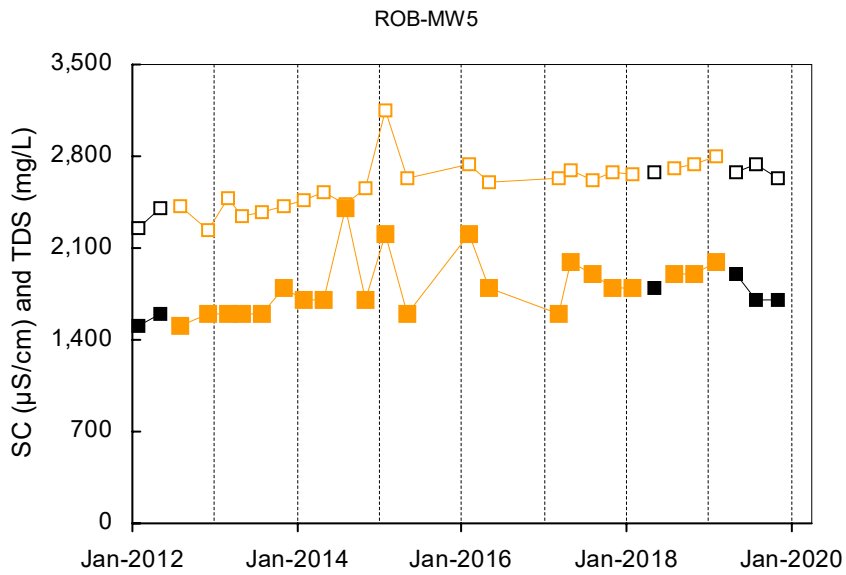
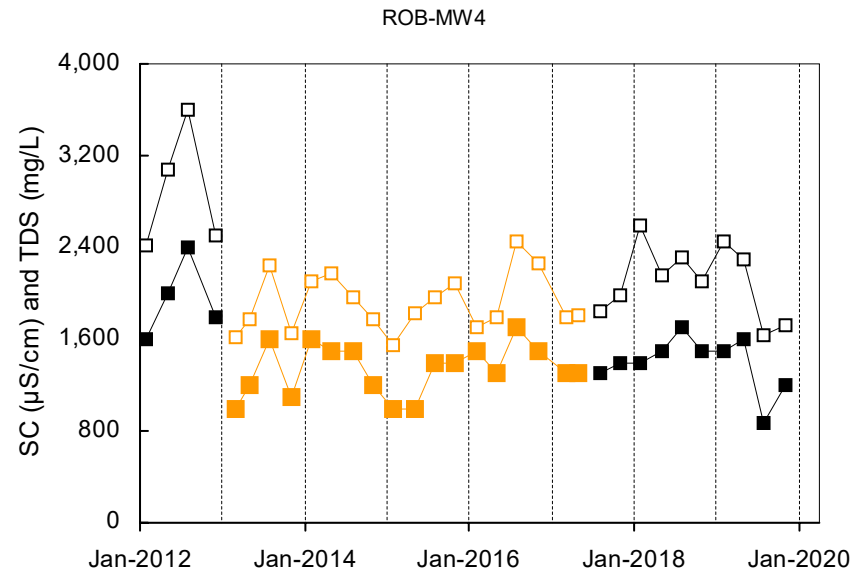
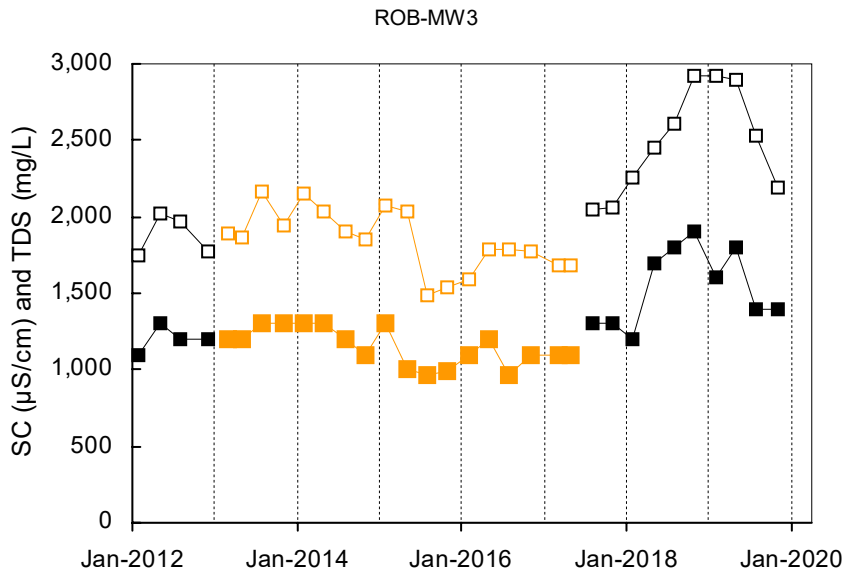

Total Dissolved Solids
 Specific Conductance
 Shallow Well shown with black symbols
 Deep Well shown with orange symbols
 "dd" Well shown with blue symbols

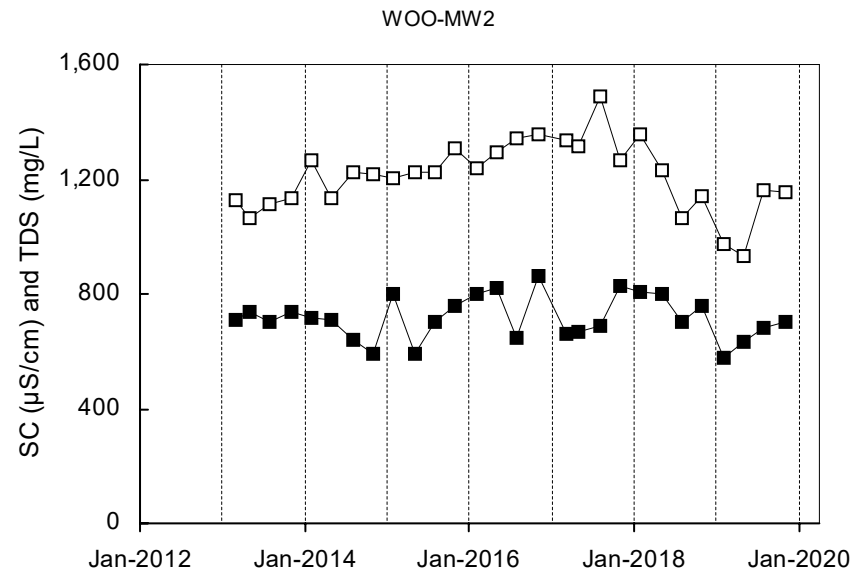
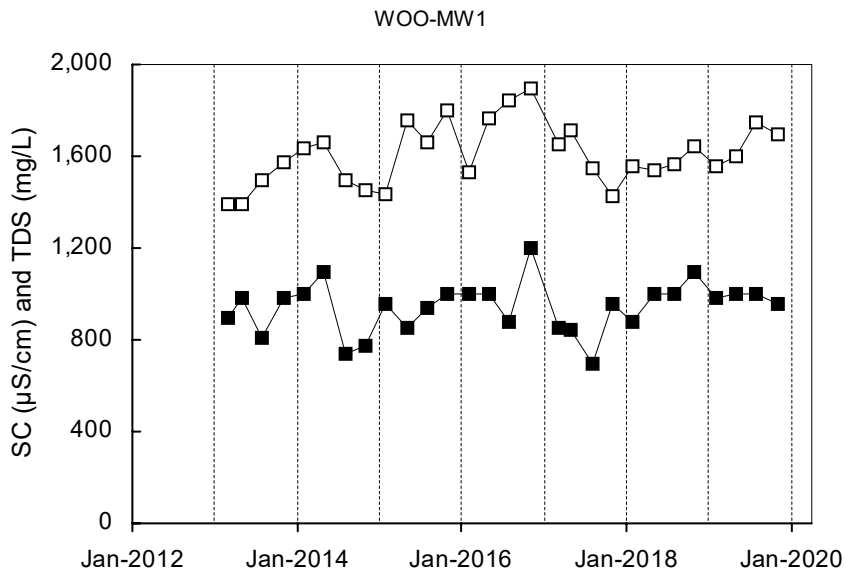
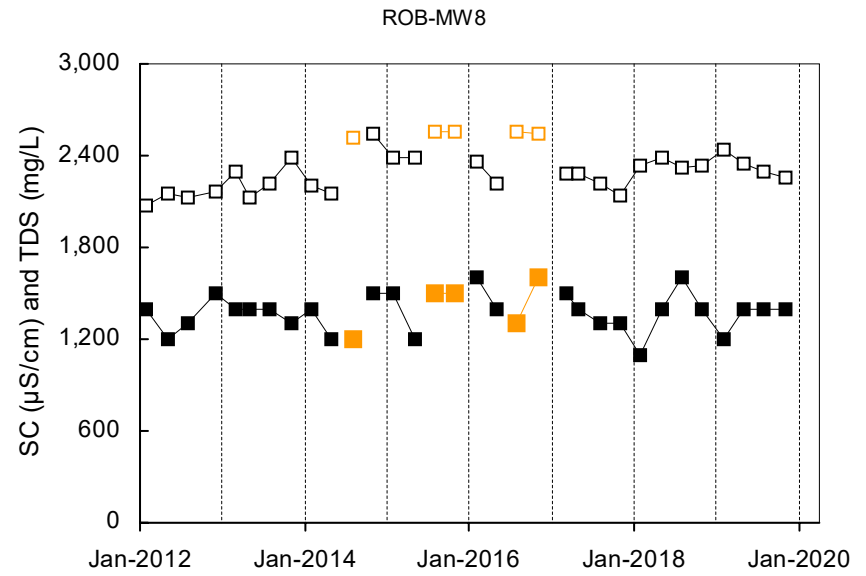
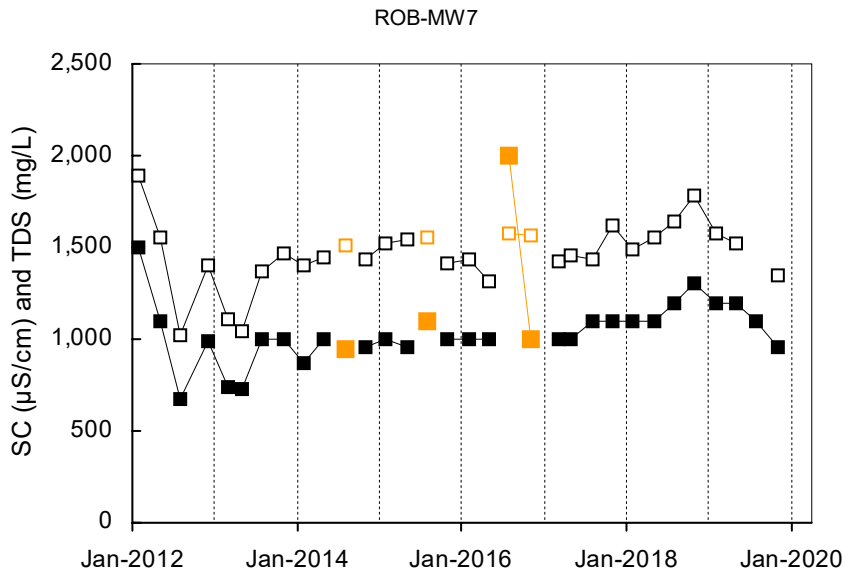

Total Dissolved Solids
 Specific Conductance
 Shallow Well shown with black symbols
 Deep Well shown with orange symbols
 "dd" Well shown with blue symbols

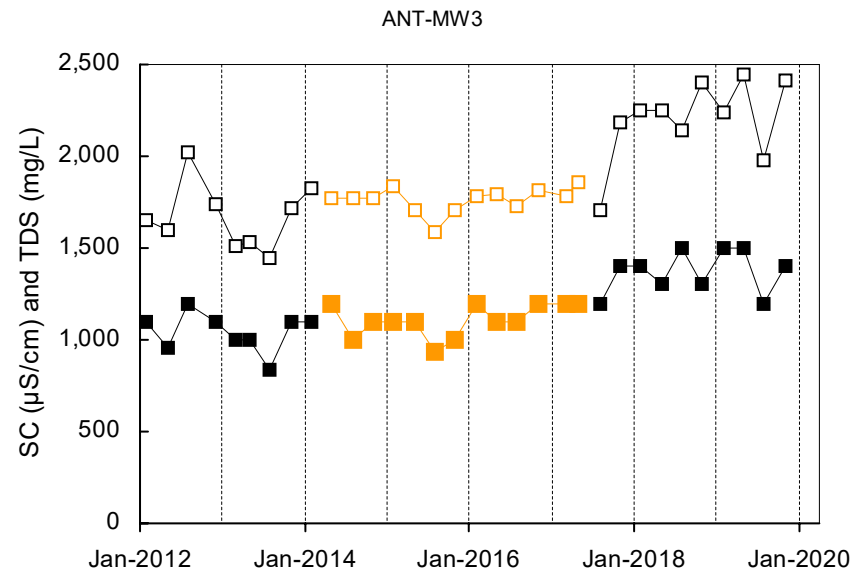
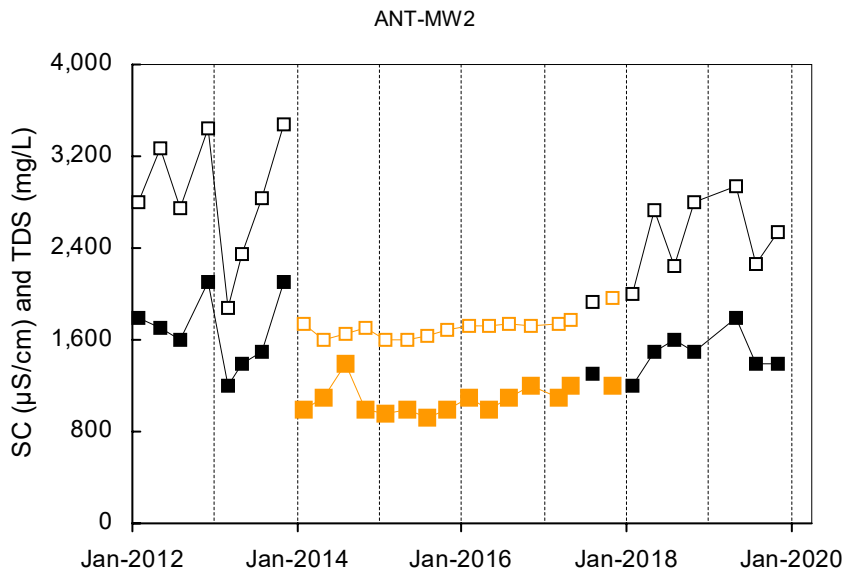
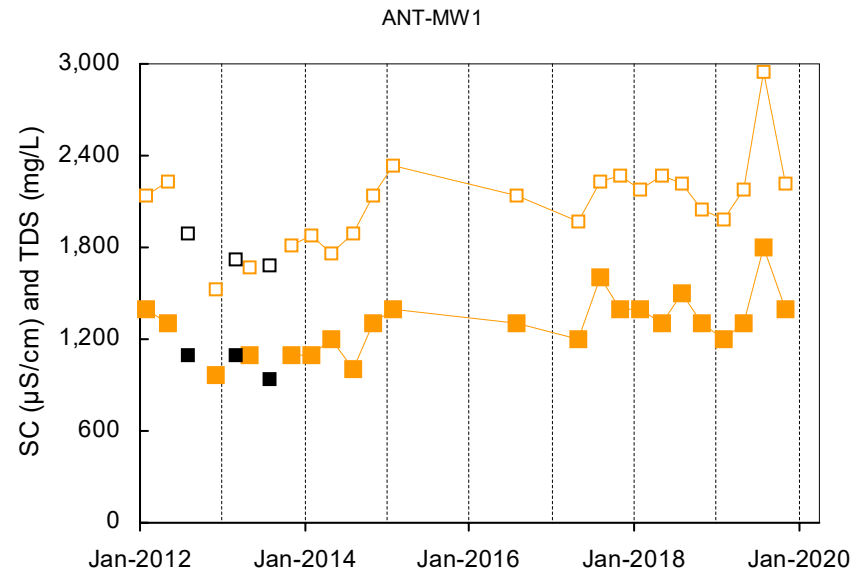
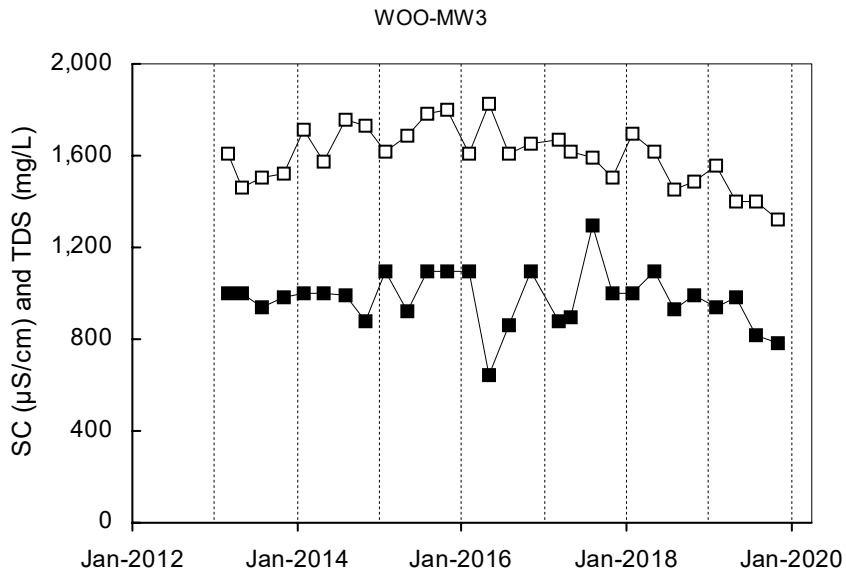

Total Dissolved Solids
 Specific Conductance
 Shallow Well shown with black symbols
 Deep Well shown with orange symbols
 "dd" Well shown with blue symbols

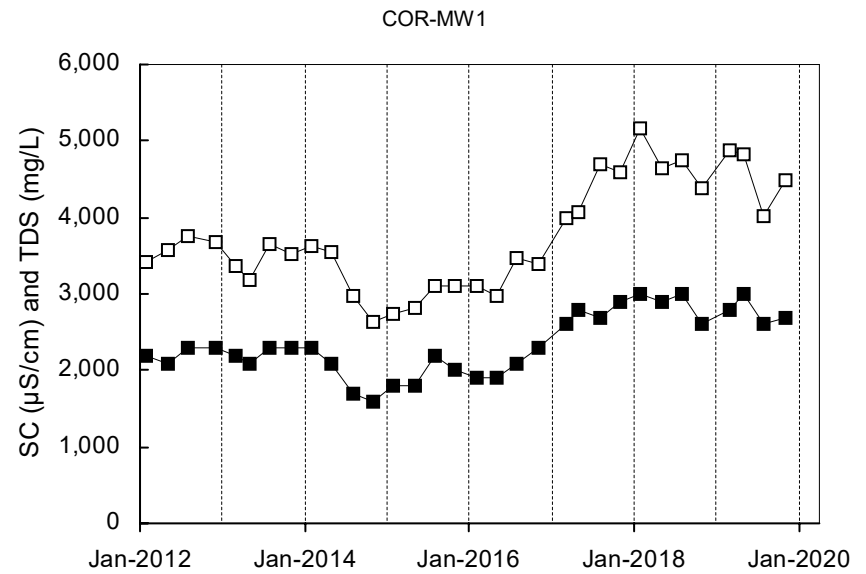
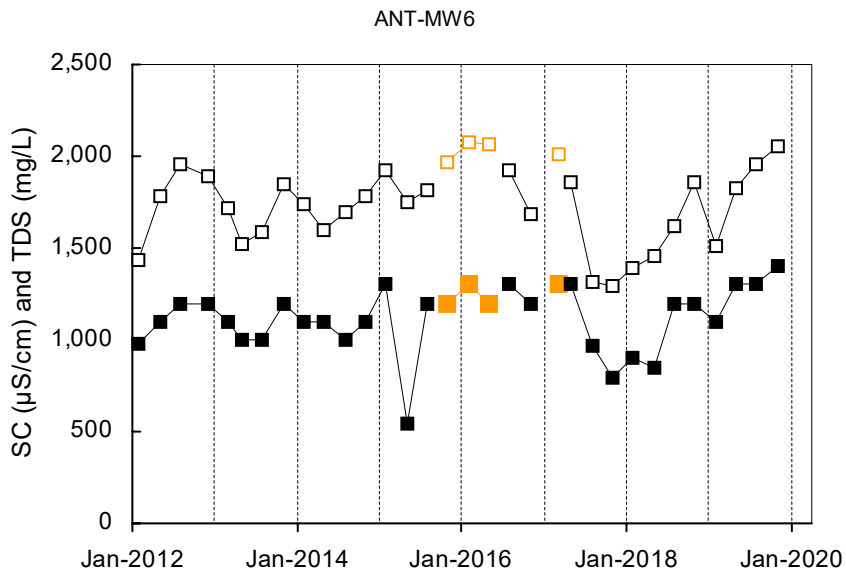
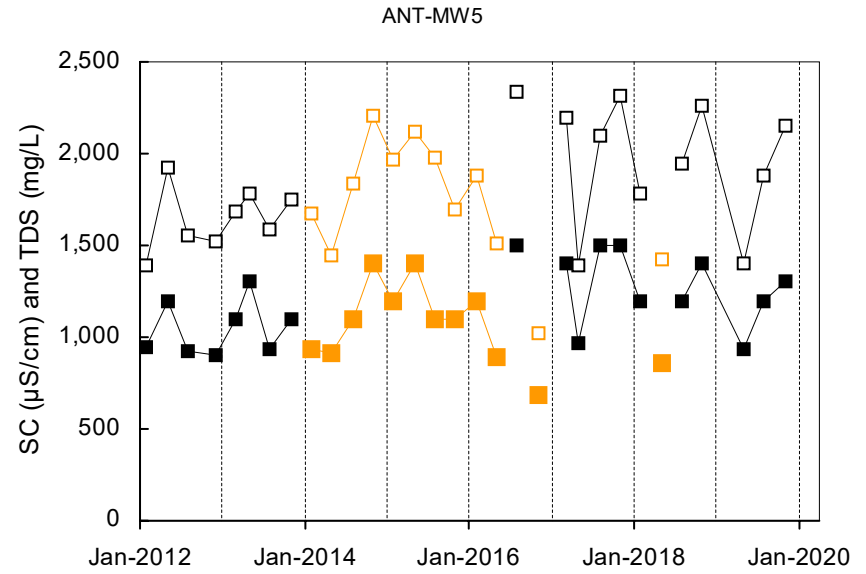
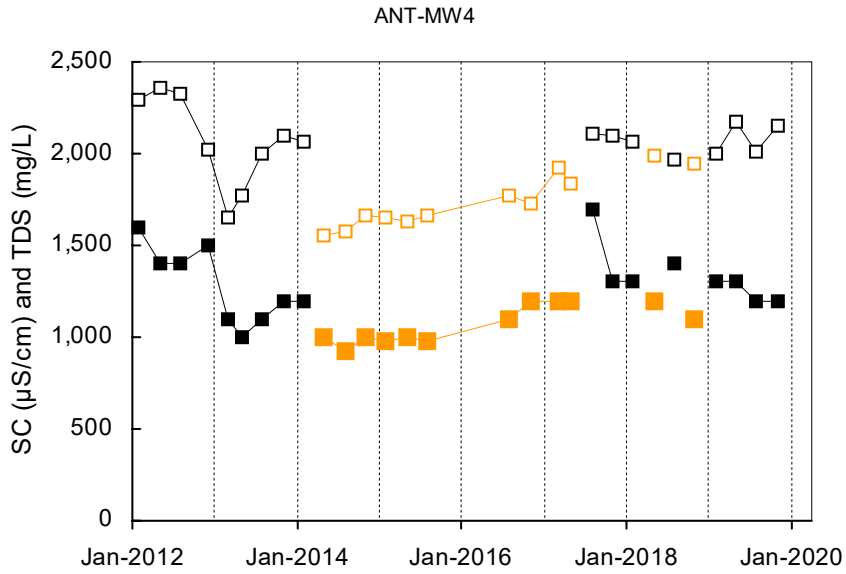

Total Dissolved Solids
 Specific Conductance
 Shallow Well shown with black symbols
 Deep Well shown with orange symbols
 "dd" Well shown with blue symbols

COR-MW2

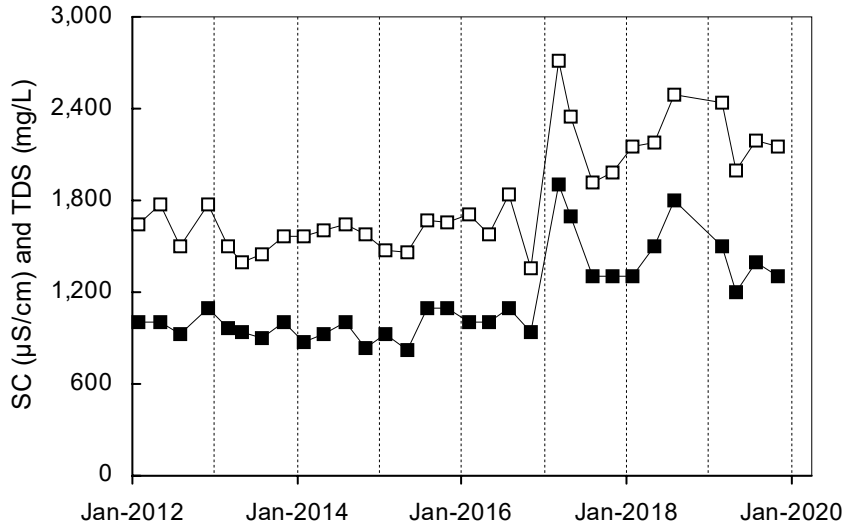

COR-MW3

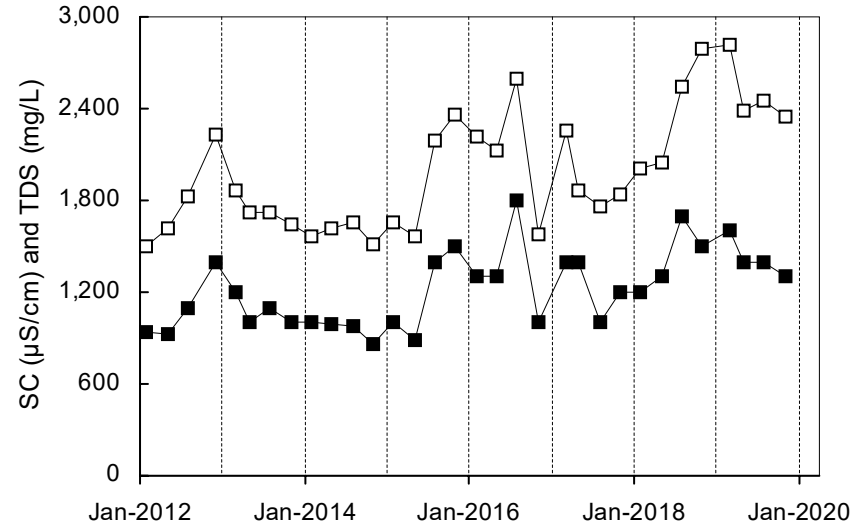

COR-MW4

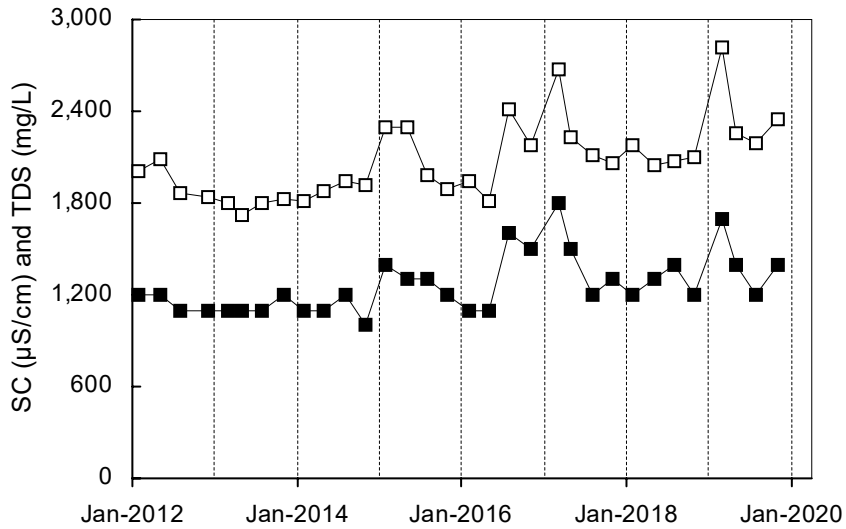

COR-MW5

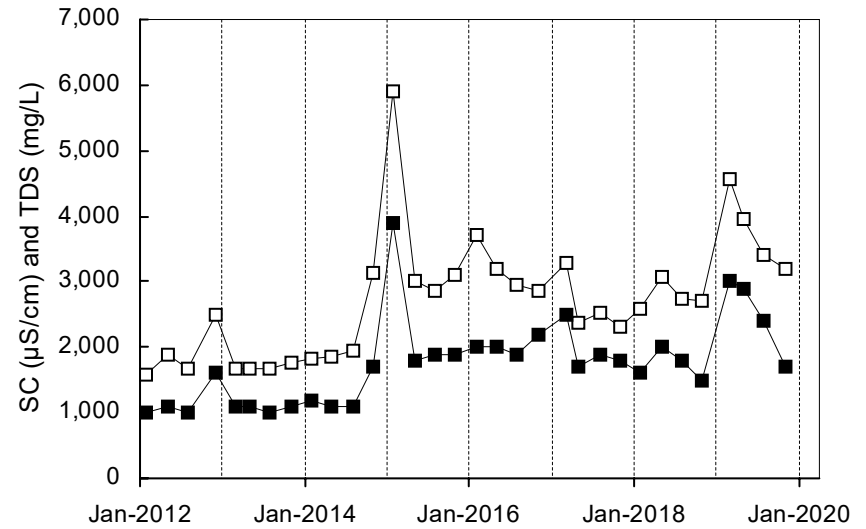

■ Total Dissolved Solids □ Specific Conductance

Shallow Well shown with black symbols

Deep Well shown with orange symbols

"dd" Well shown with blue symbols

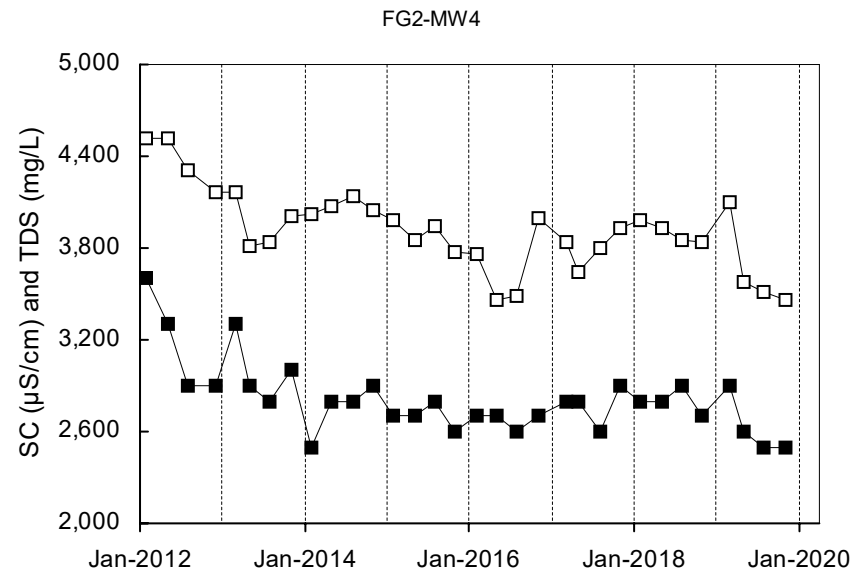
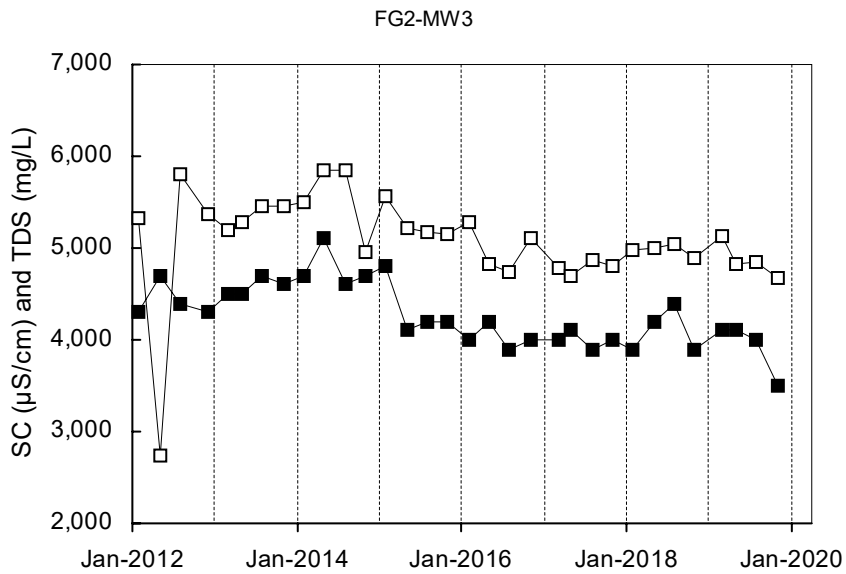
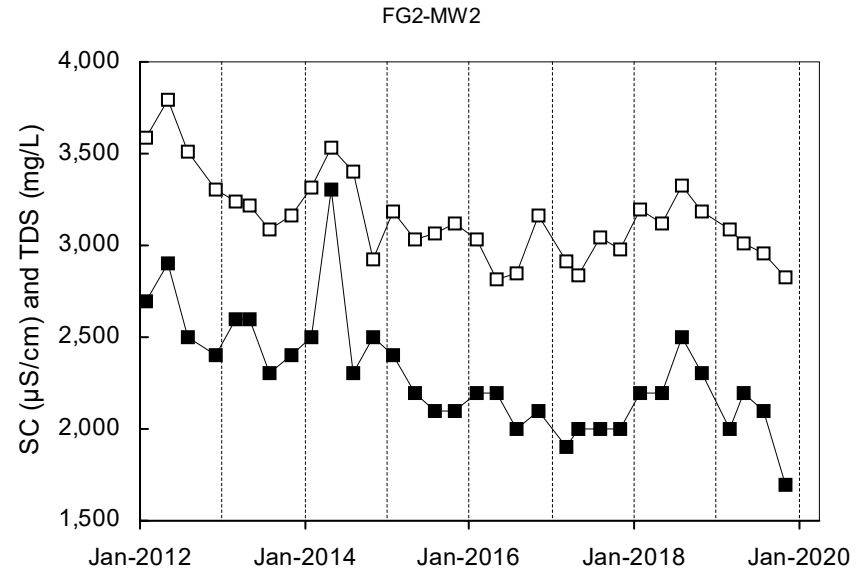
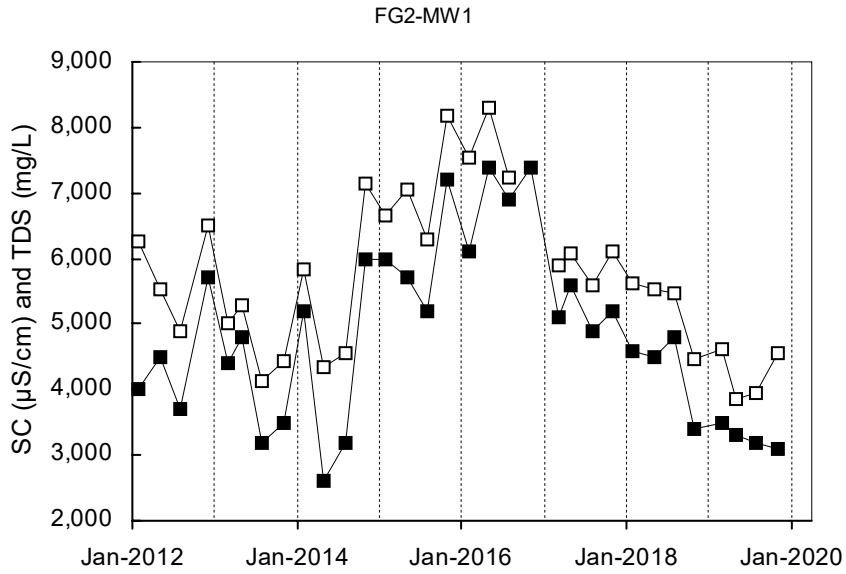

Total Dissolved Solids
 Specific Conductance
 Shallow Well shown with black symbols
 Deep Well shown with orange symbols
 "dd" Well shown with blue symbols

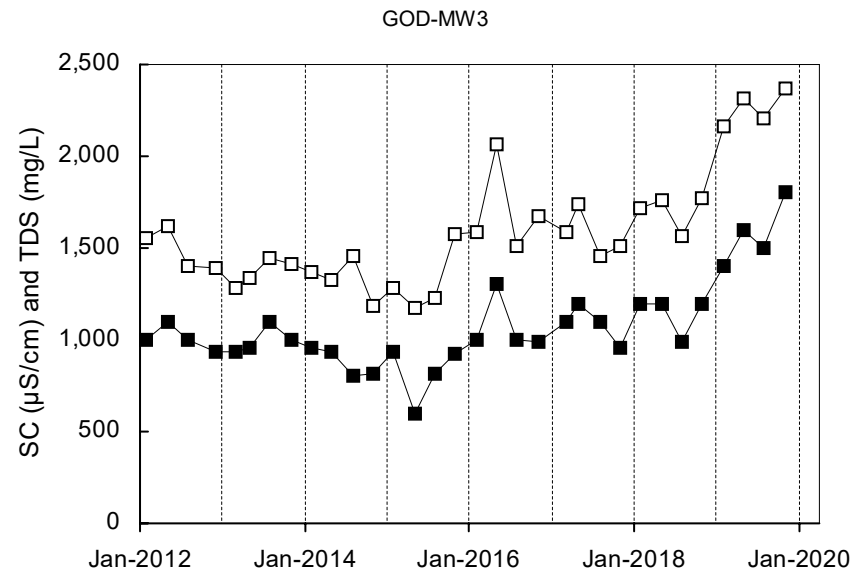
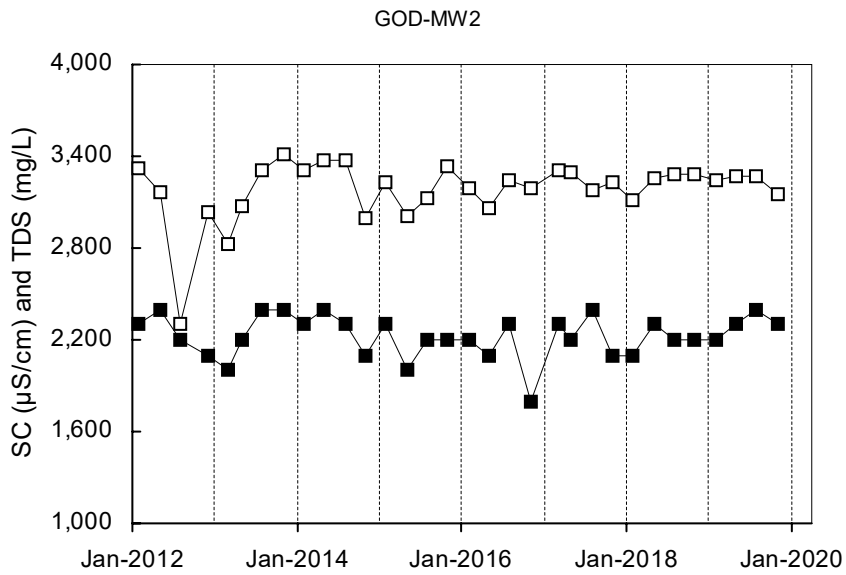
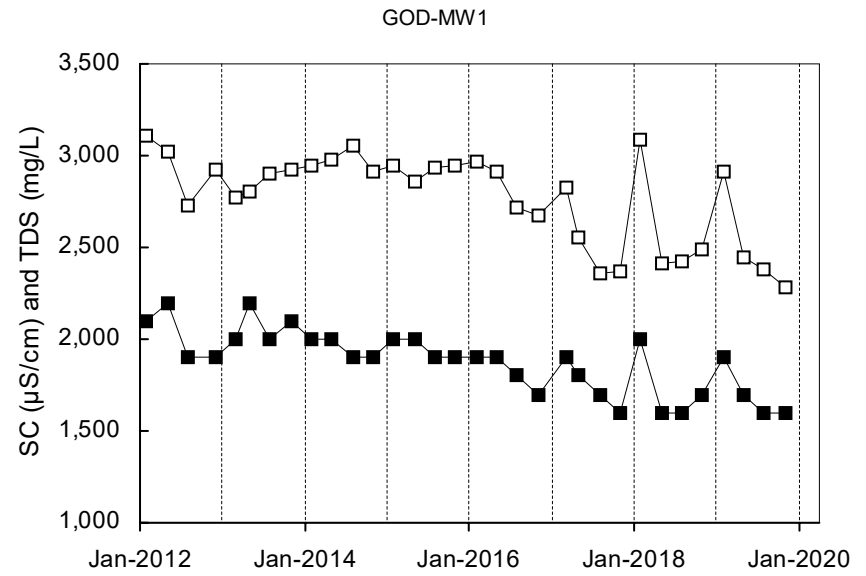
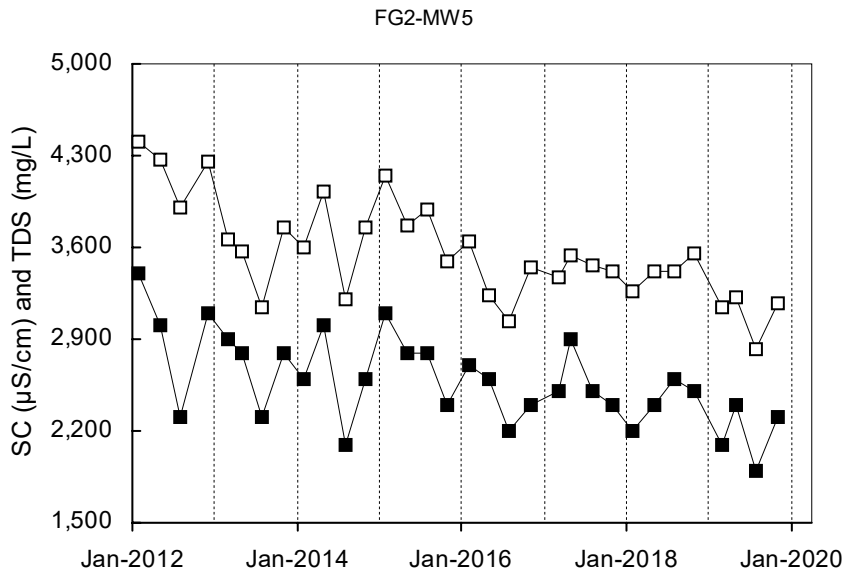

Total Dissolved Solids
 Specific Conductance
 Shallow Well shown with black symbols
 Deep Well shown with orange symbols
 "dd" Well shown with blue symbols

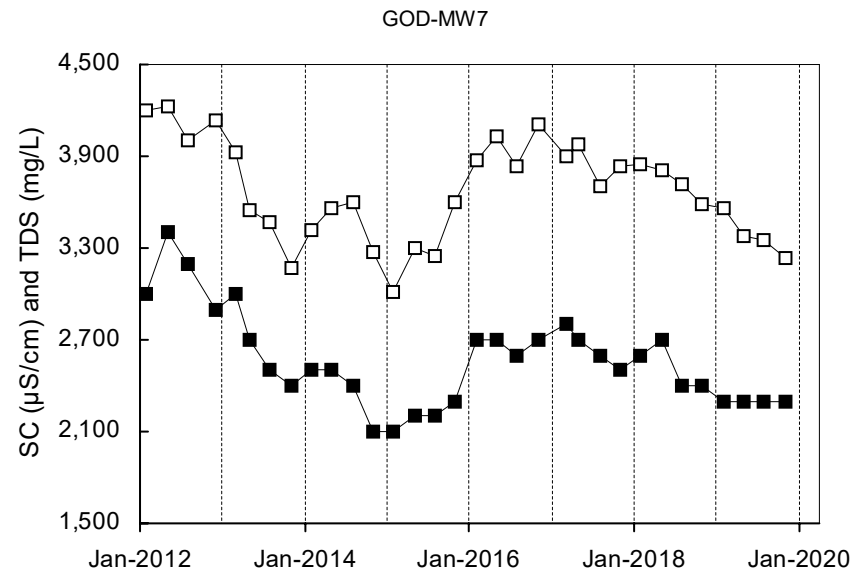
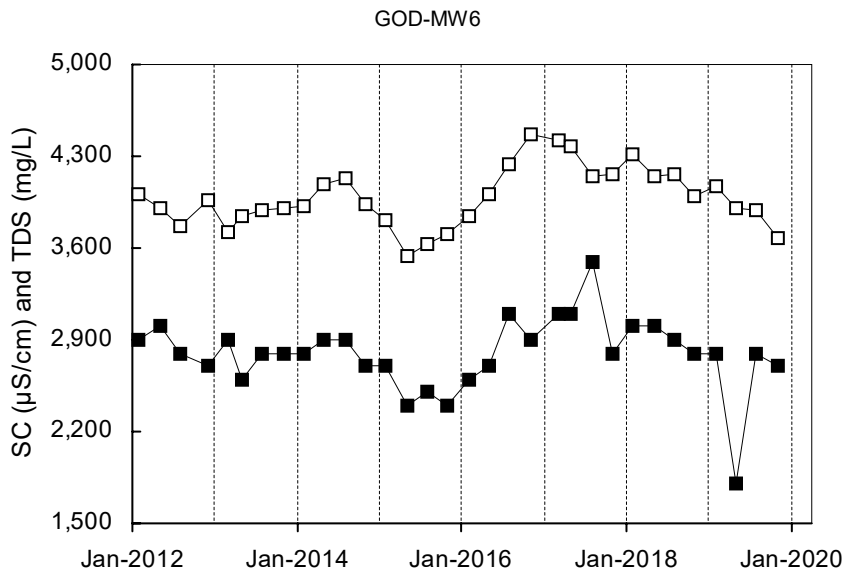
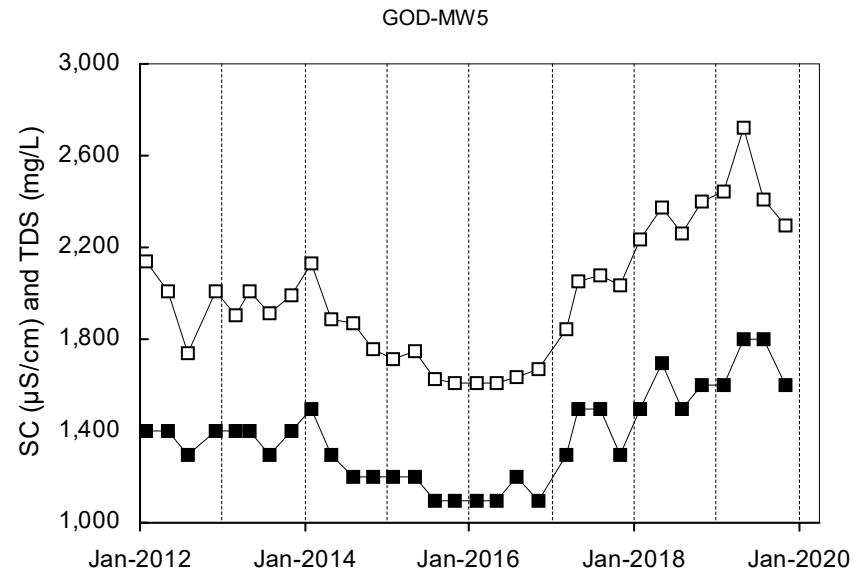
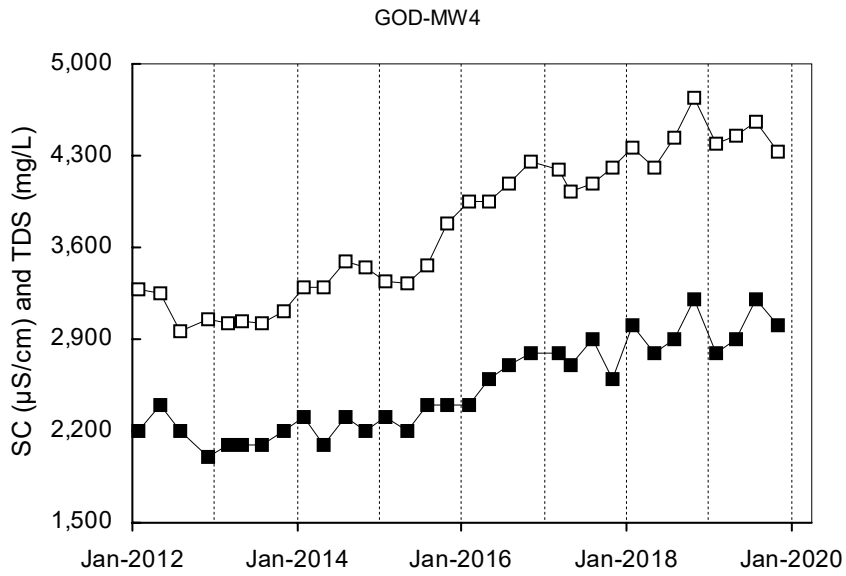

Total Dissolved Solids
 Specific Conductance
 Shallow Well shown with black symbols
 Deep Well shown with orange symbols
 "dd" Well shown with blue symbols

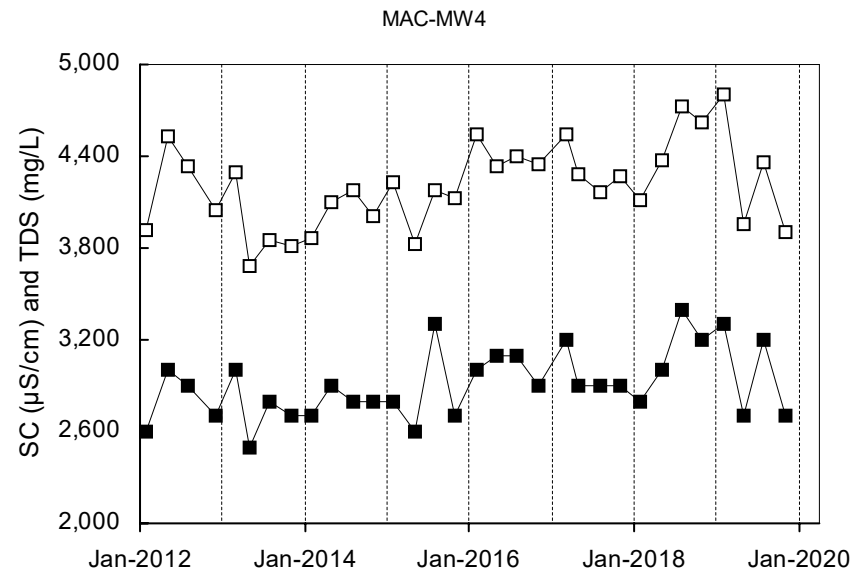
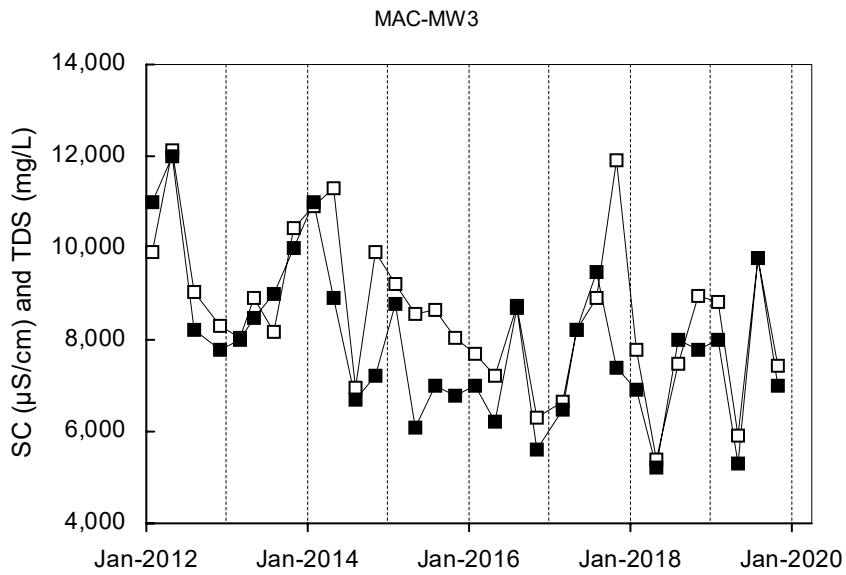
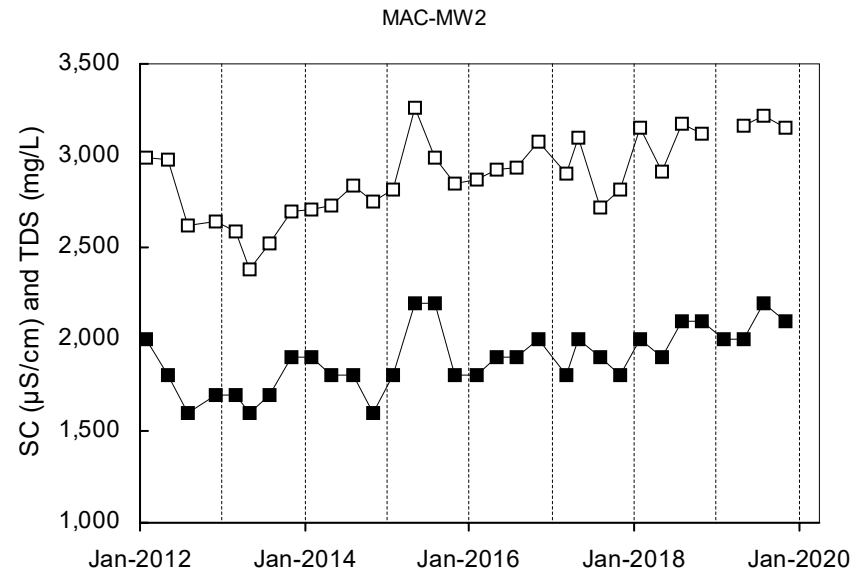
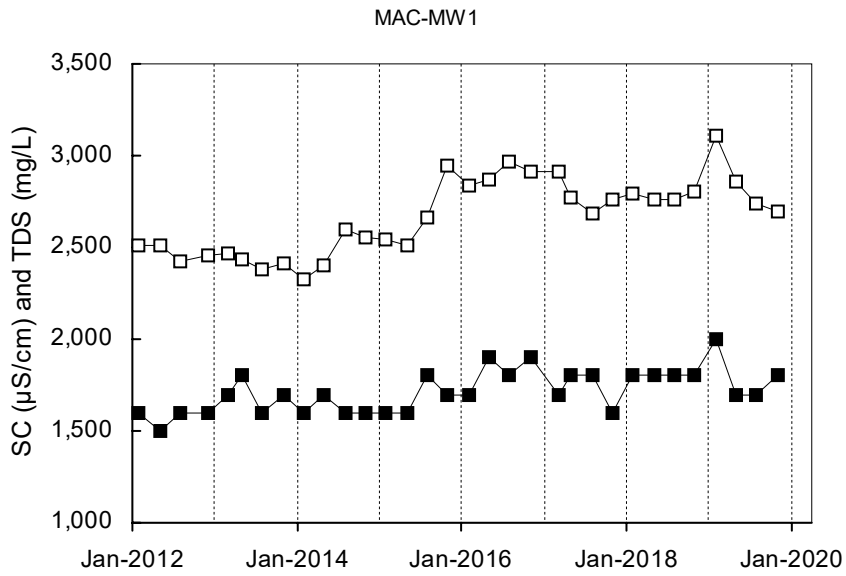

Total Dissolved Solids
 Specific Conductance
 Shallow Well shown with black symbols
 Deep Well shown with orange symbols
 "dd" Well shown with blue symbols

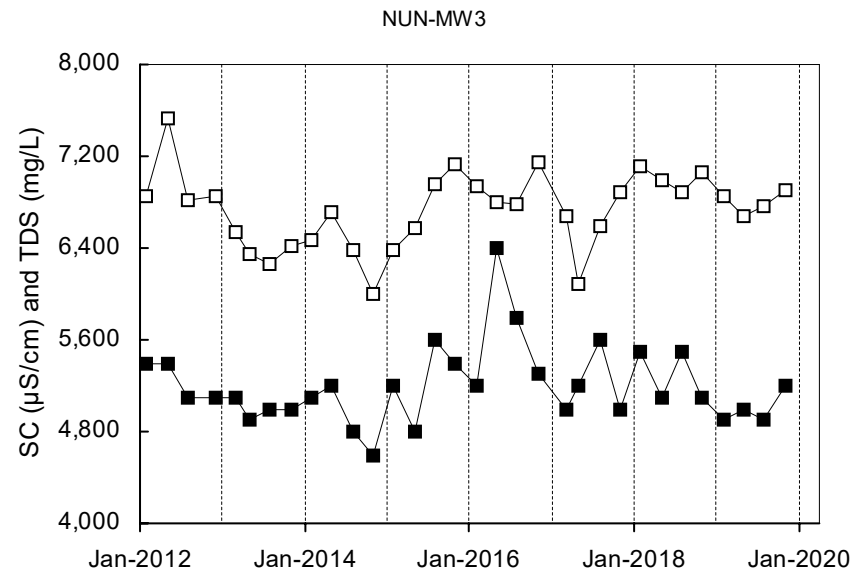
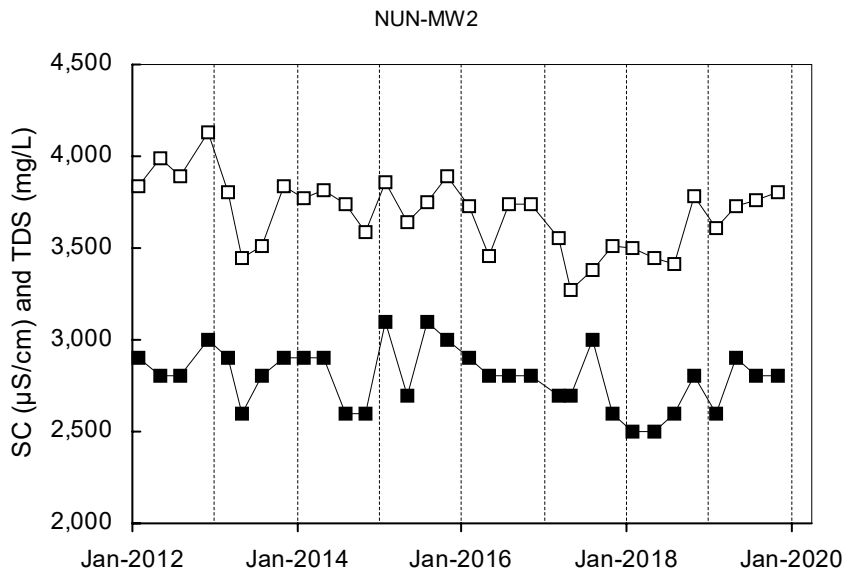
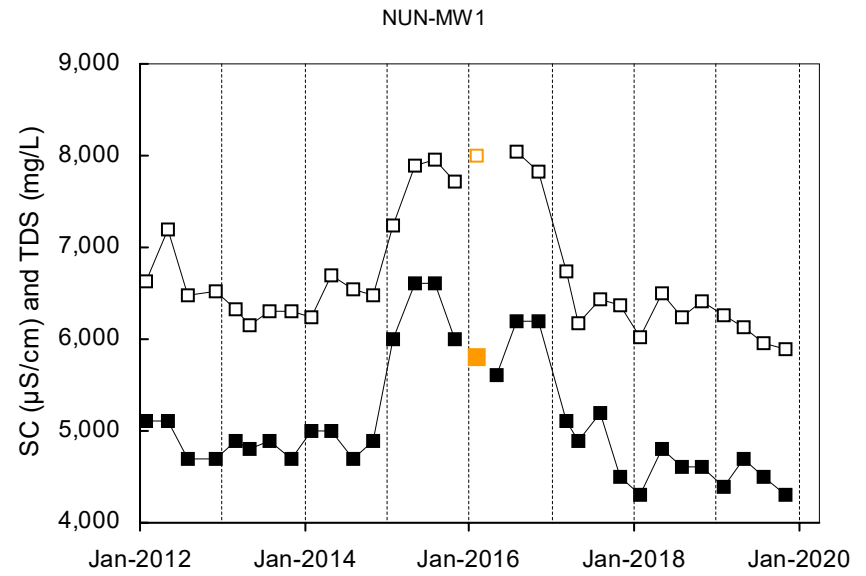
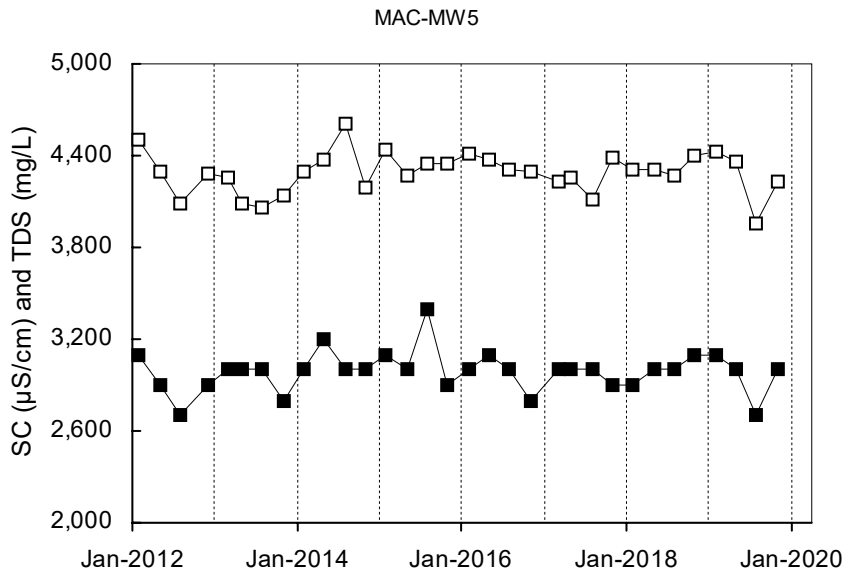

Total Dissolved Solids
 Specific Conductance
 Shallow Well shown with black symbols
 Deep Well shown with orange symbols
 "dd" Well shown with blue symbols

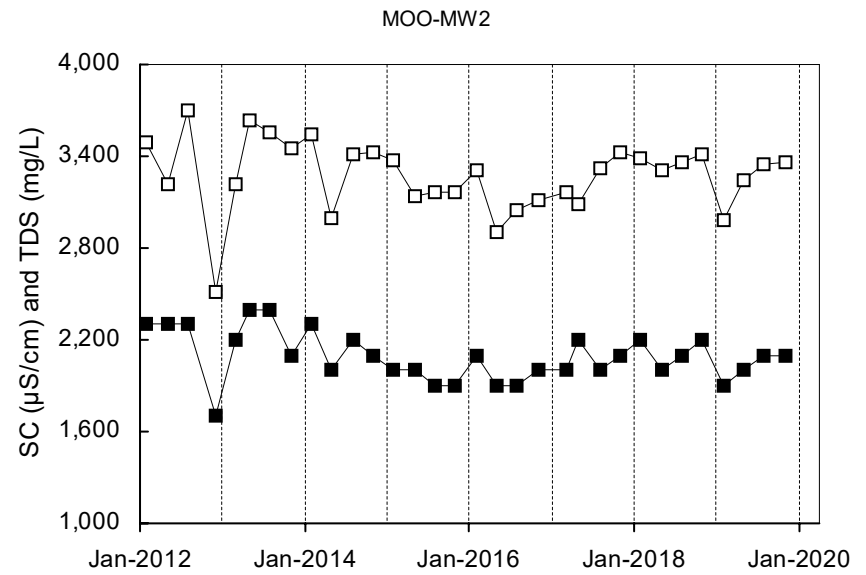
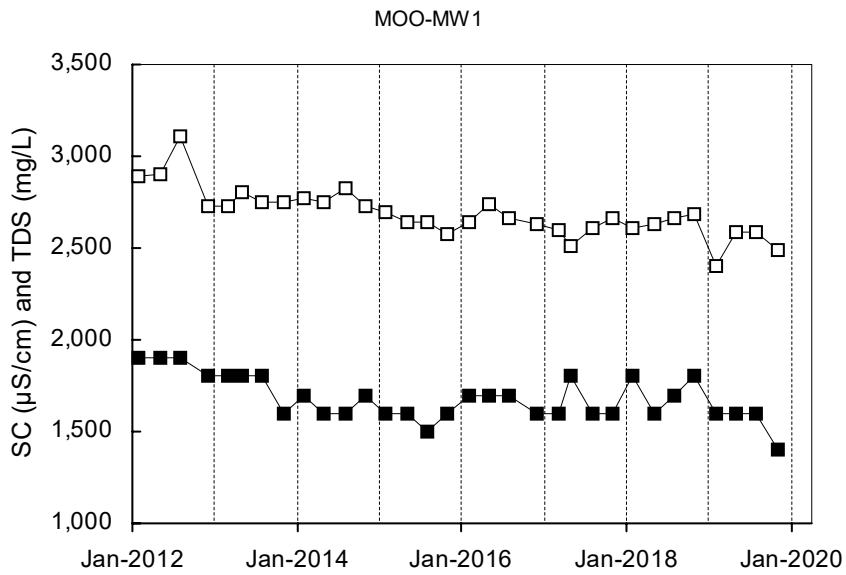
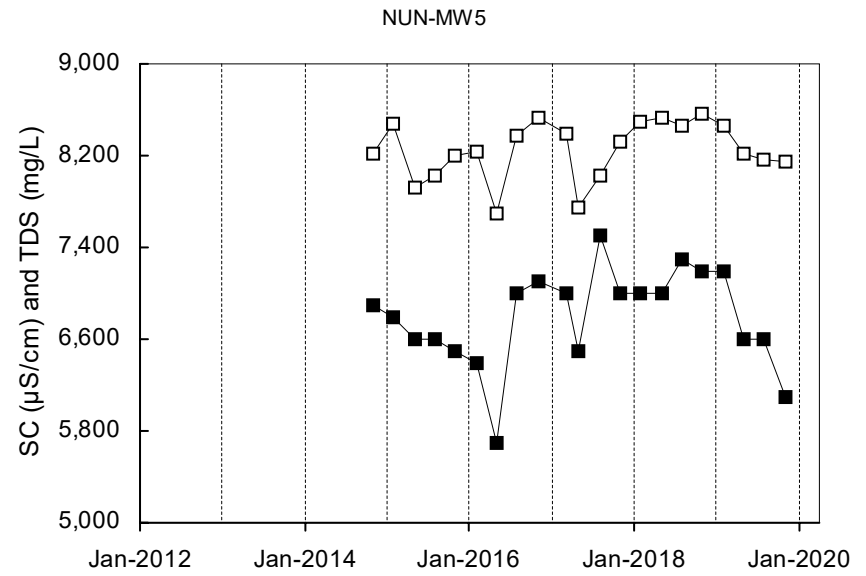
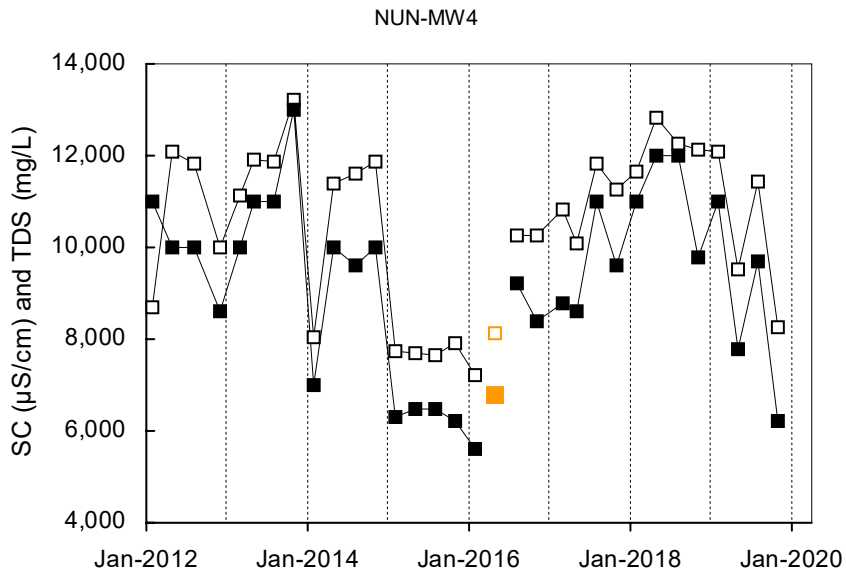

Total Dissolved Solids
 Specific Conductance
 Shallow Well shown with black symbols
 Deep Well shown with orange symbols
 "dd" Well shown with blue symbols

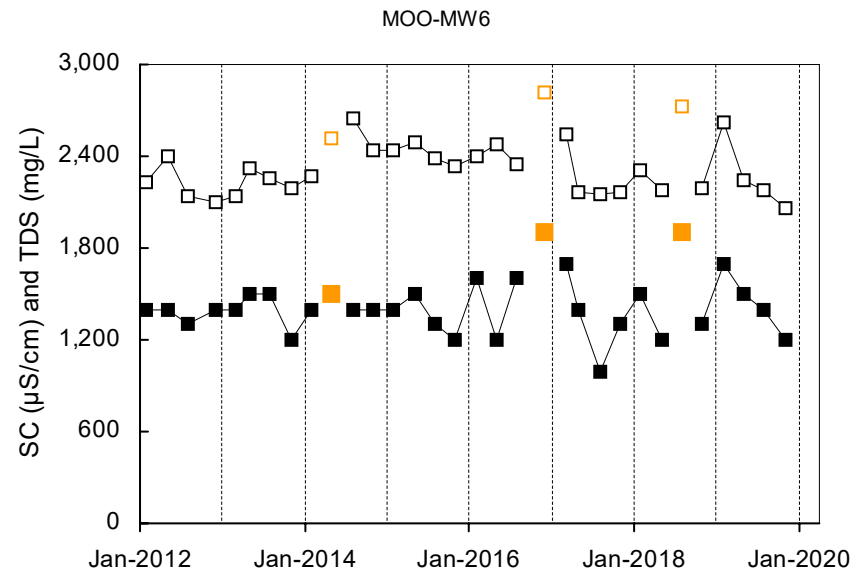
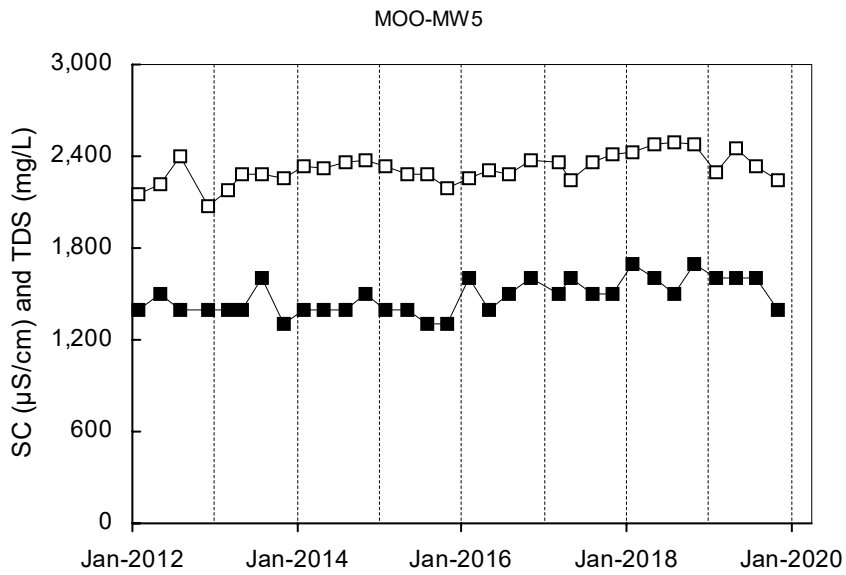
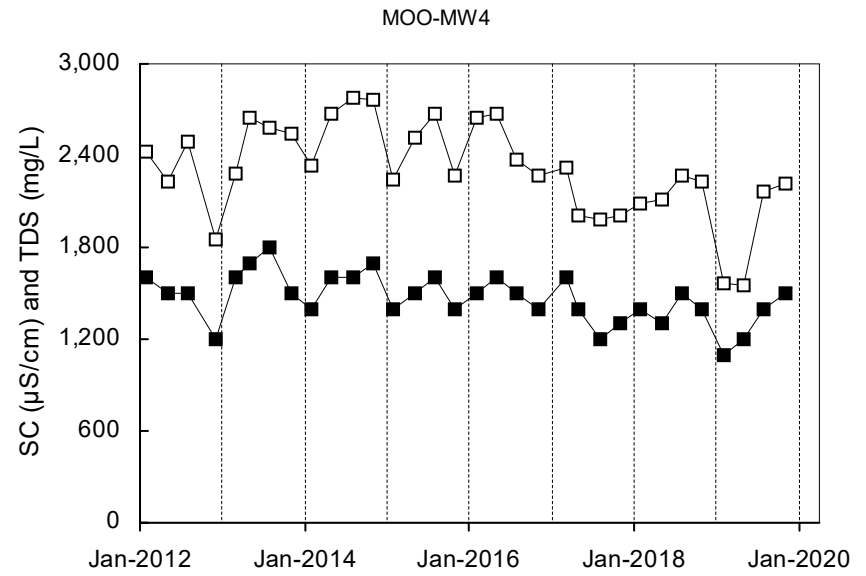
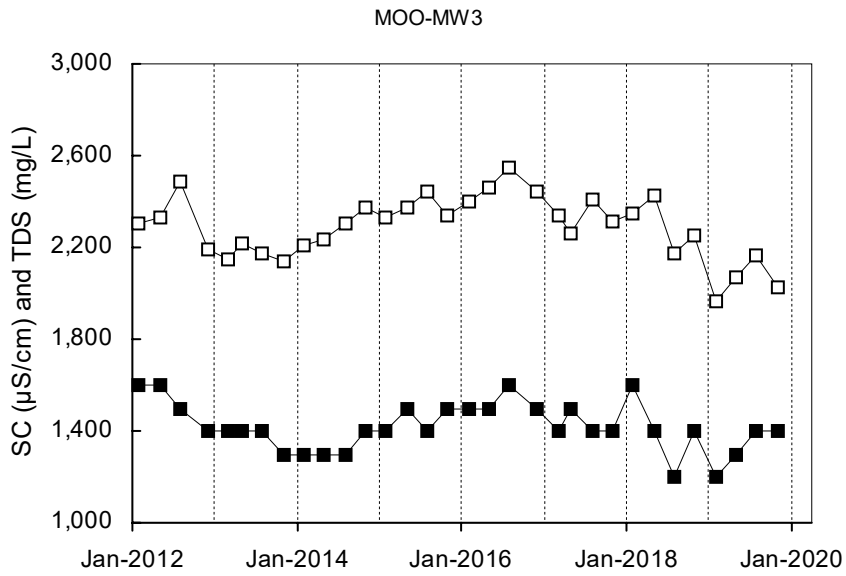

Total Dissolved Solids
 Specific Conductance
 Shallow Well shown with black symbols
 Deep Well shown with orange symbols
 "dd" Well shown with blue symbols

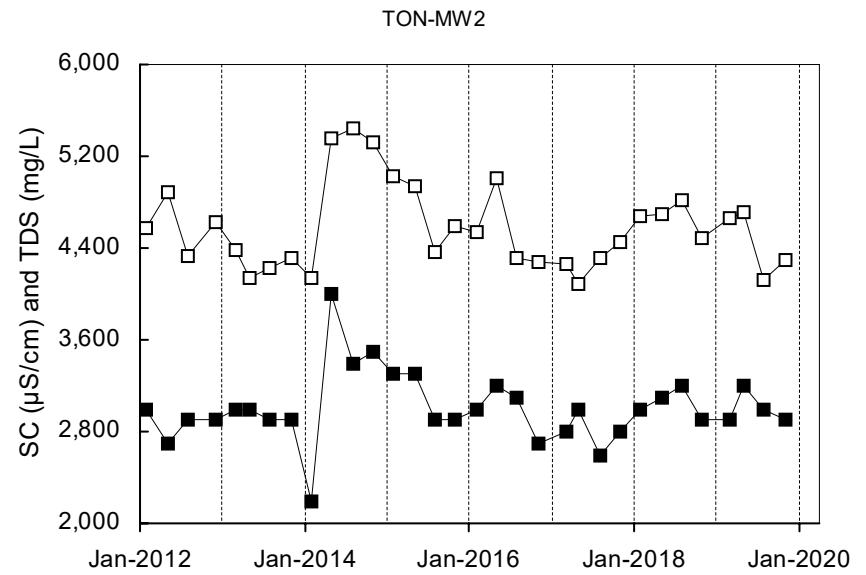
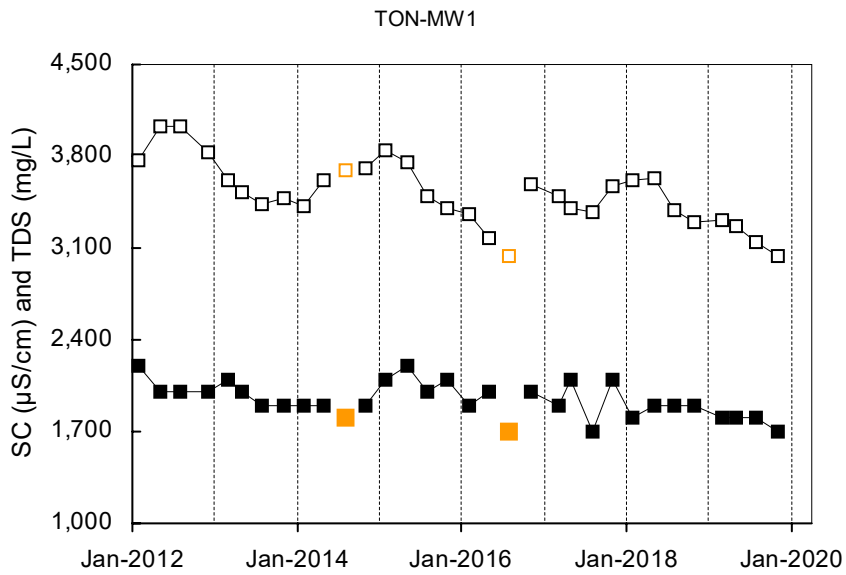
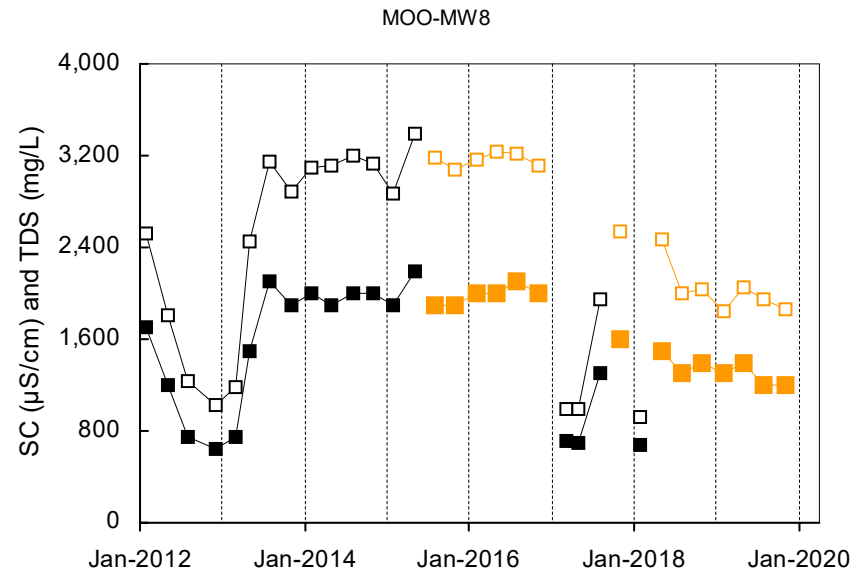
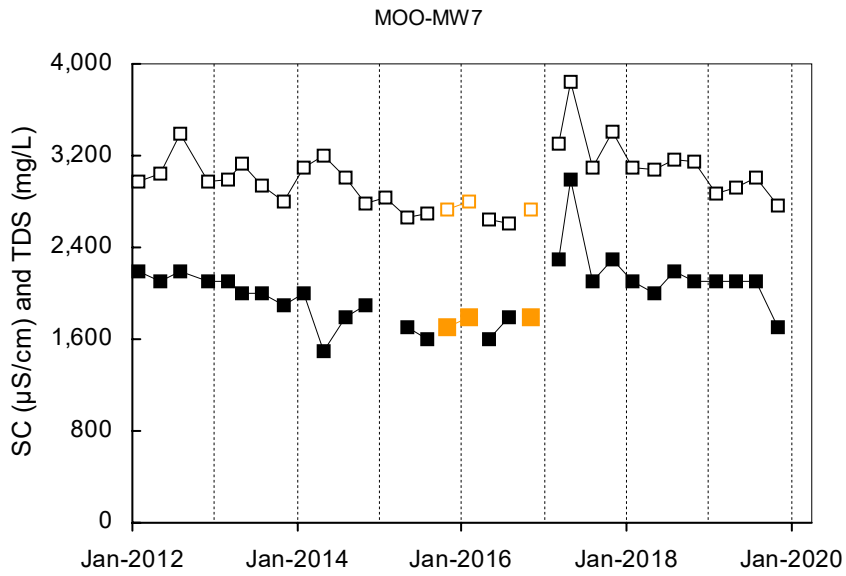

Total Dissolved Solids
 Specific Conductance
 Shallow Well shown with black symbols
 Deep Well shown with orange symbols
 "dd" Well shown with blue symbols

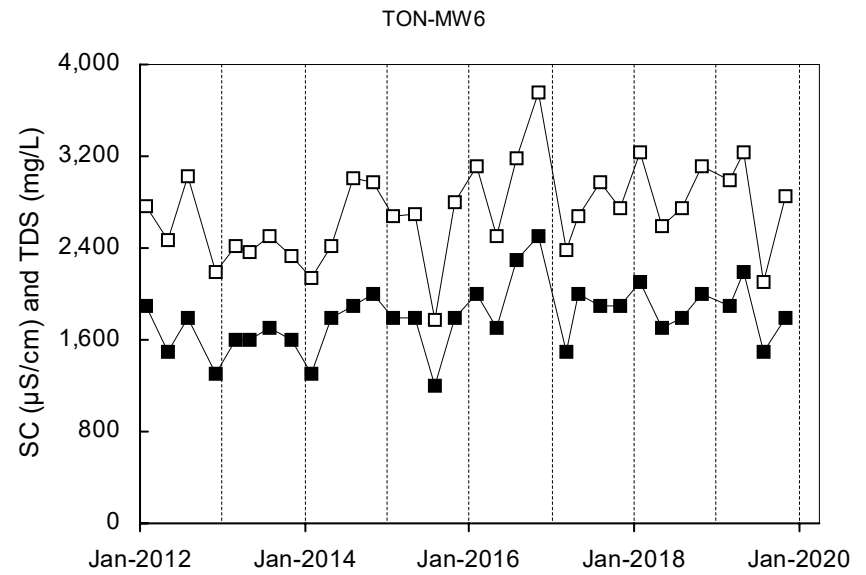
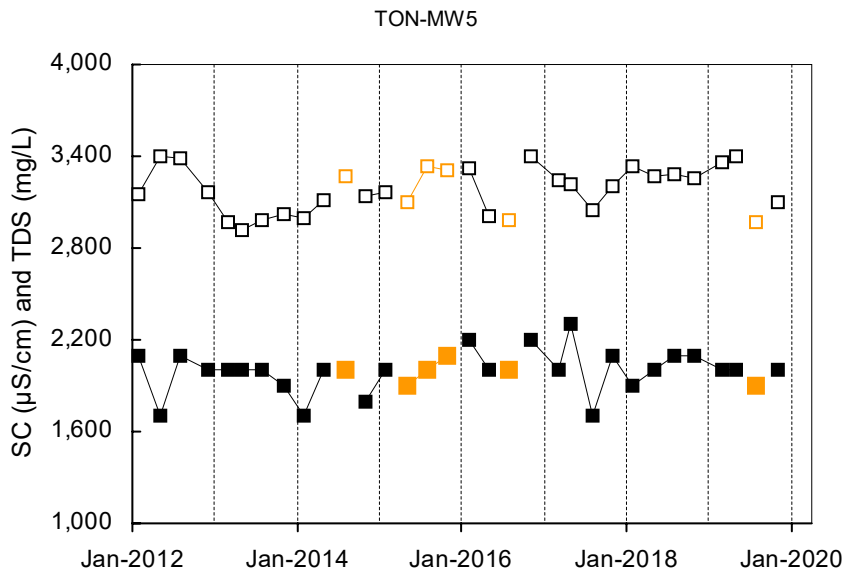
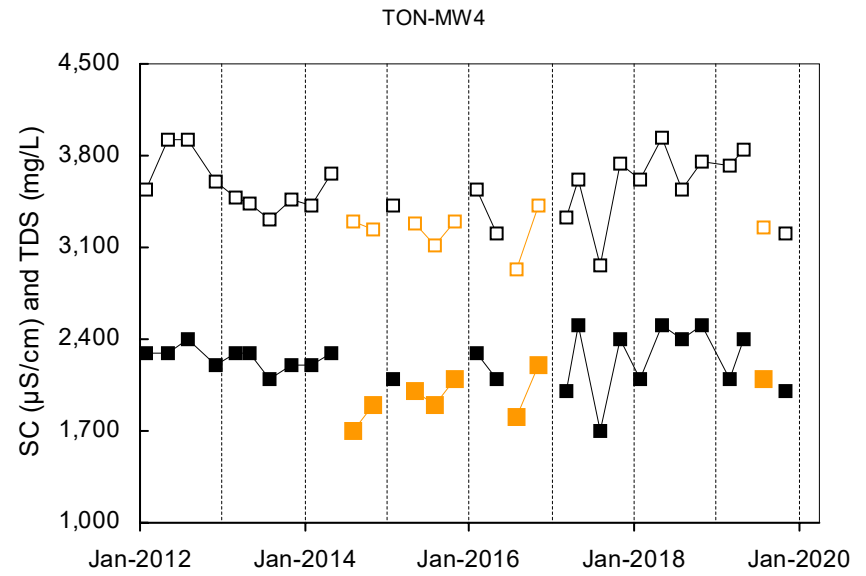
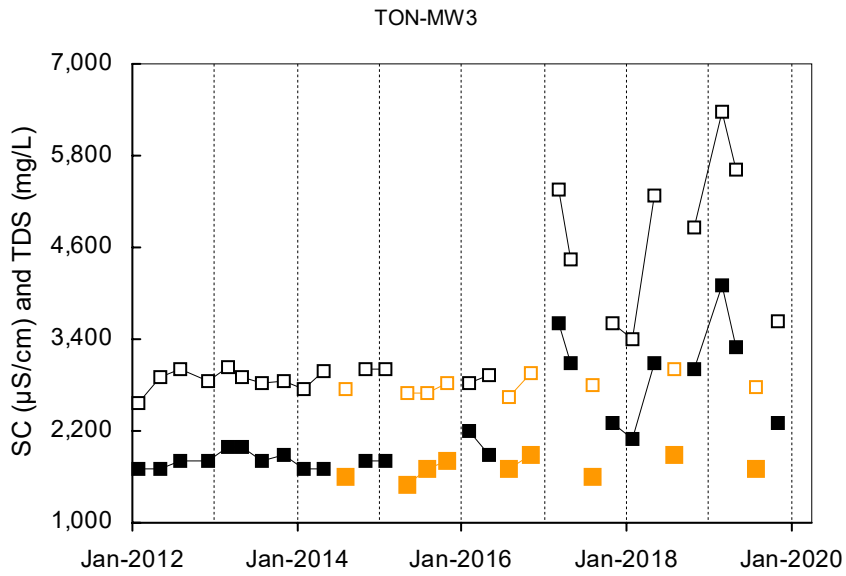

Total Dissolved Solids
 Specific Conductance
 Shallow Well shown with black symbols
 Deep Well shown with orange symbols
 "dd" Well shown with blue symbols

TON-MW7

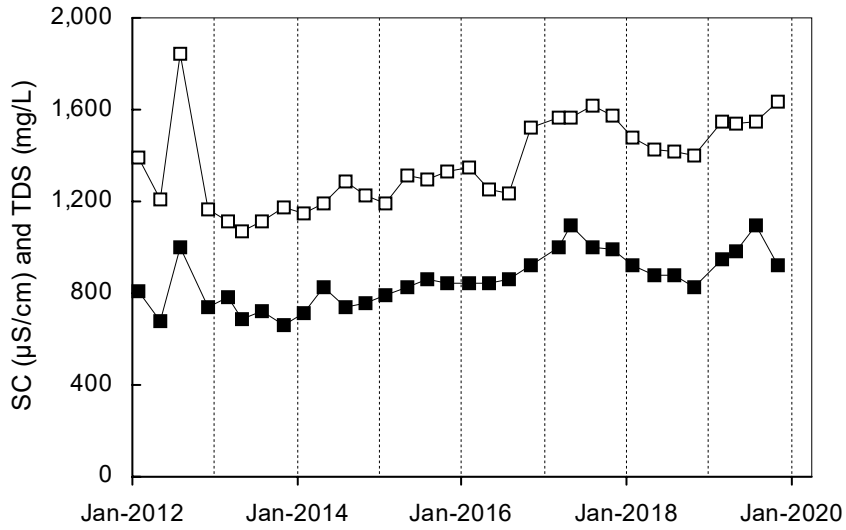

TON-MW8

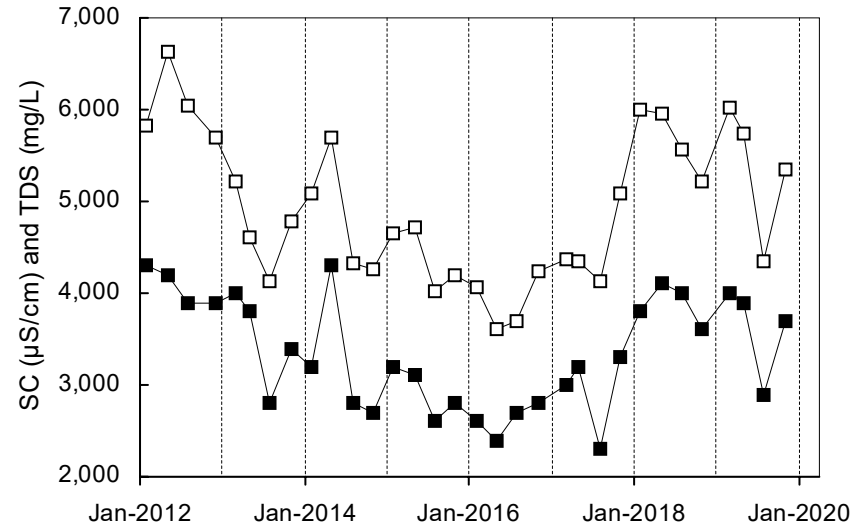

BRE-MW1

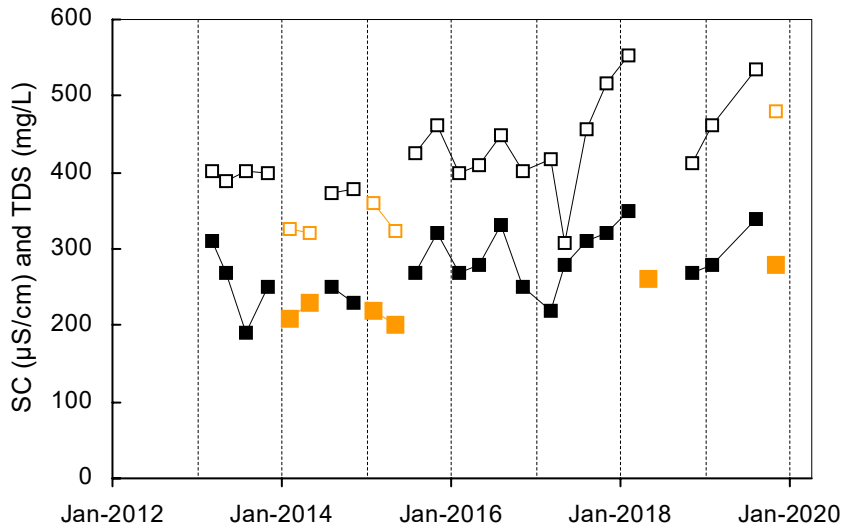

BRE-MW2

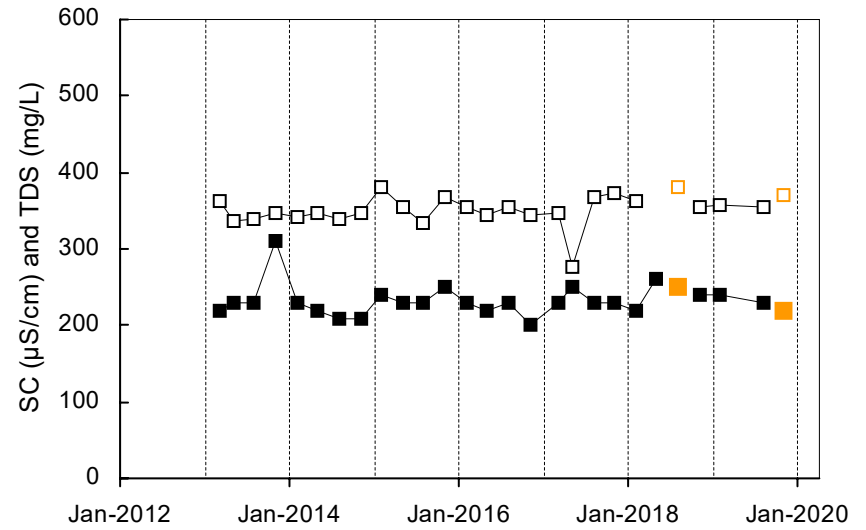

■ Total Dissolved Solids □ Specific Conductance

Shallow Well shown with black symbols

Deep Well shown with orange symbols

"dd" Well shown with blue symbols

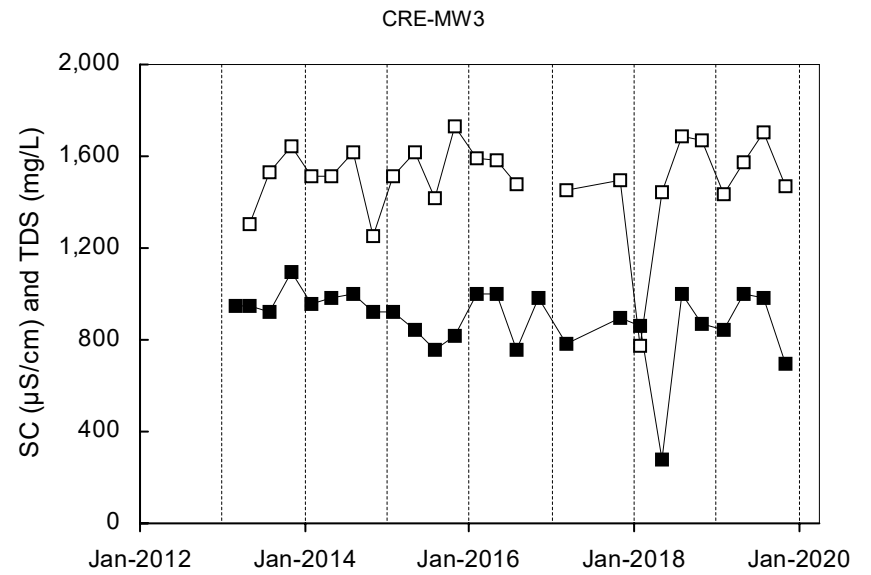
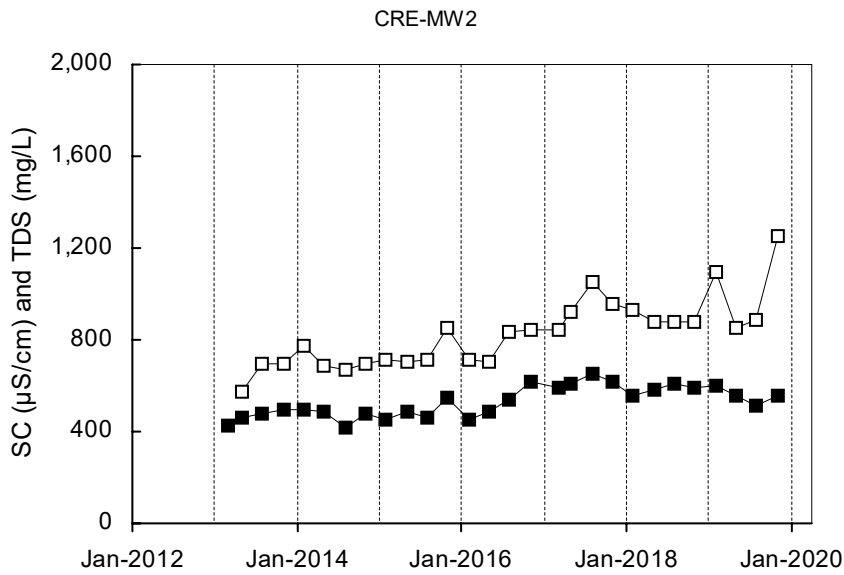
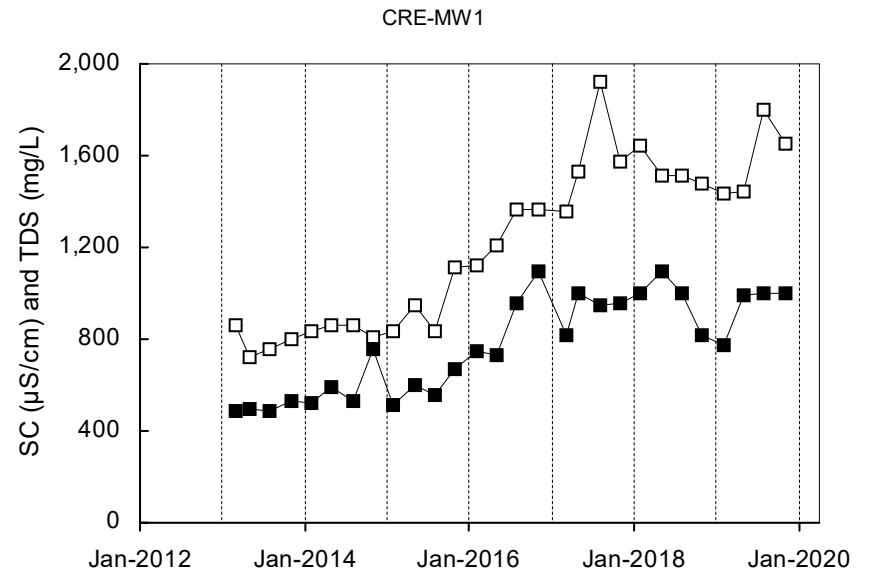
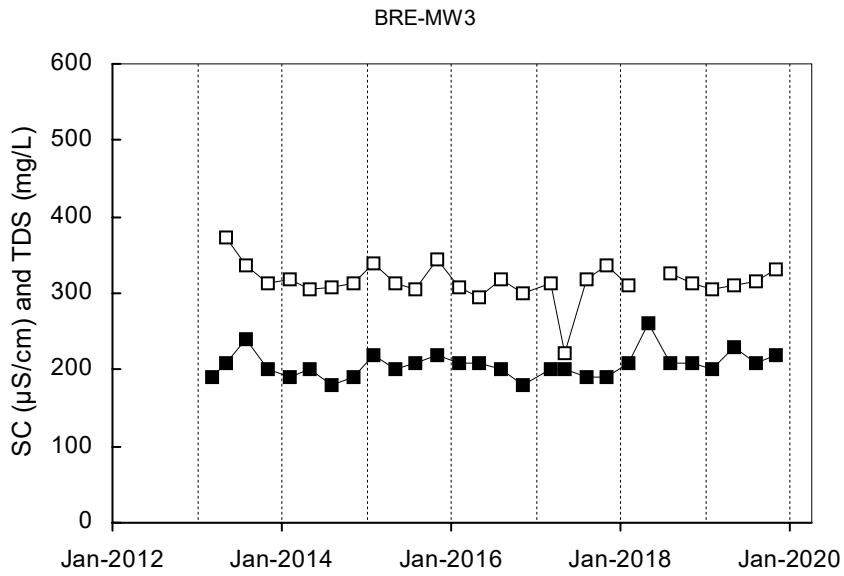

Total Dissolved Solids
 Specific Conductance
 Shallow Well shown with black symbols
 Deep Well shown with orange symbols
 "dd" Well shown with blue symbols

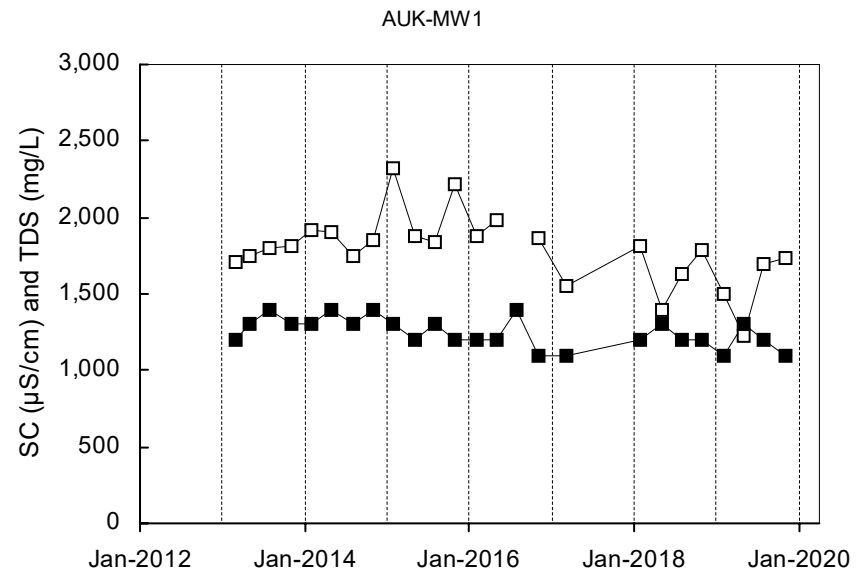
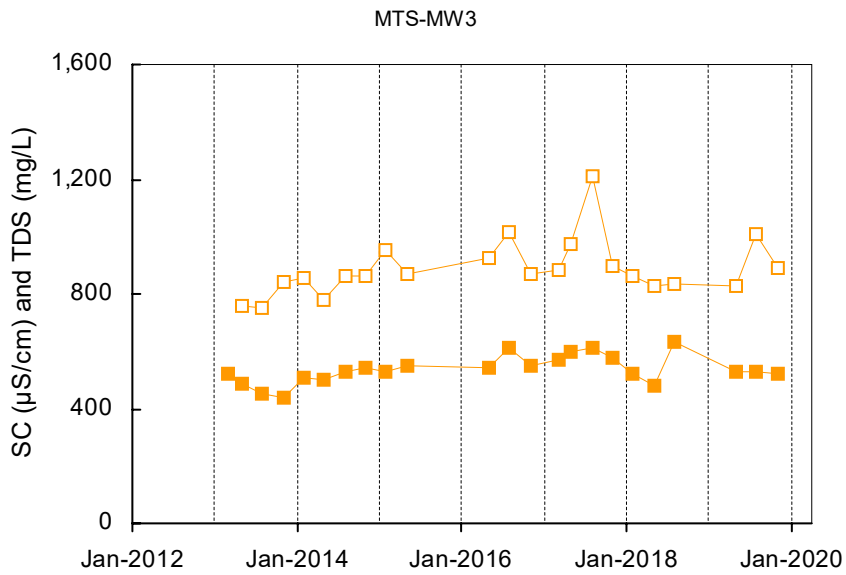
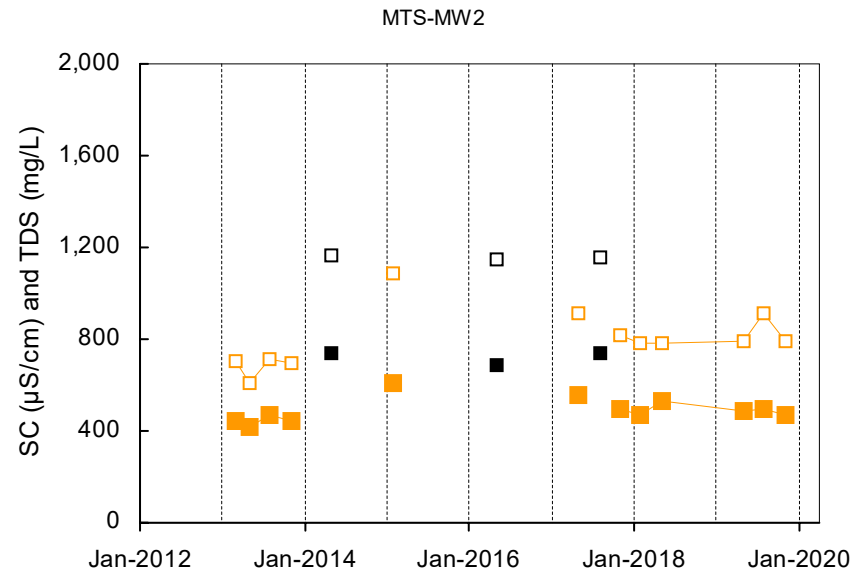
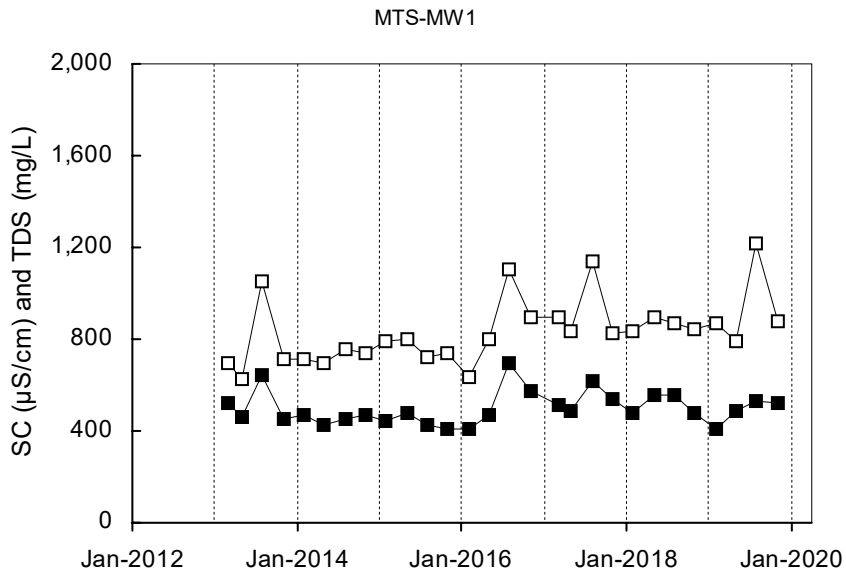

Total Dissolved Solids
 Specific Conductance
 Shallow Well shown with black symbols
 Deep Well shown with orange symbols
 "dd" Well shown with blue symbols

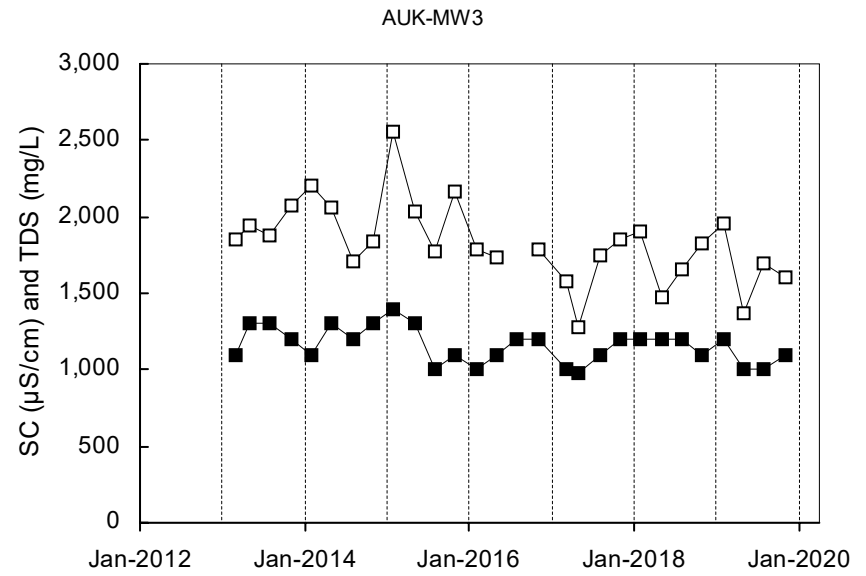
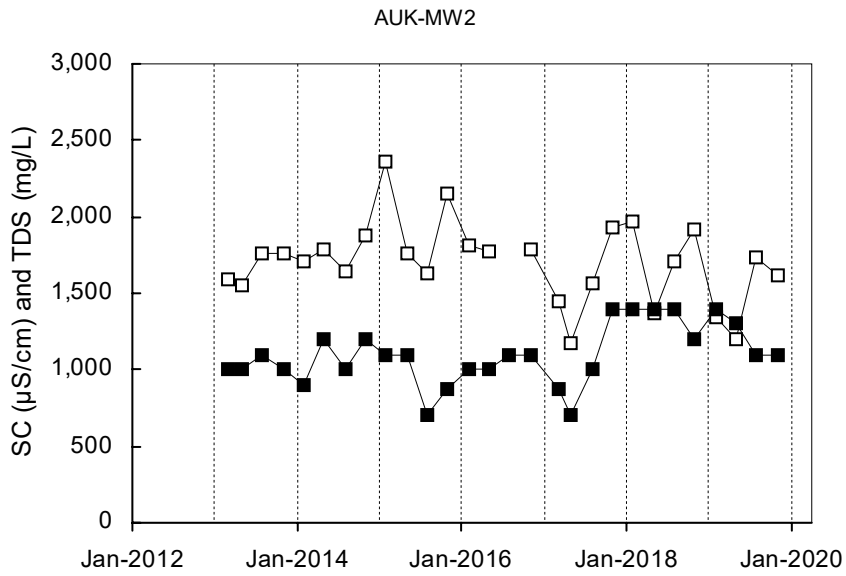

DLF-MW1

Not Sampled

DLF-MW2

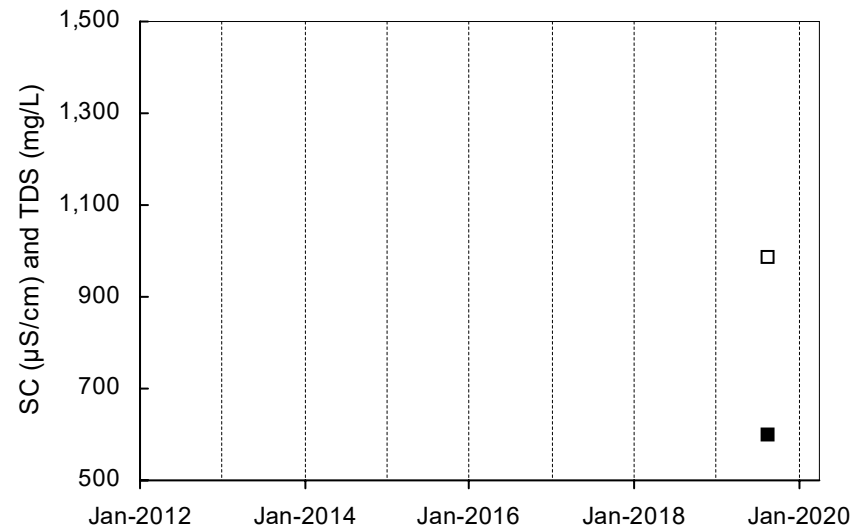

■ Total Dissolved Solids □ Specific Conductance

Shallow Well shown with black symbols

Deep Well shown with orange symbols

"dd" Well shown with blue symbols

DLF-MW3

Not Sampled

DLF-MW4A

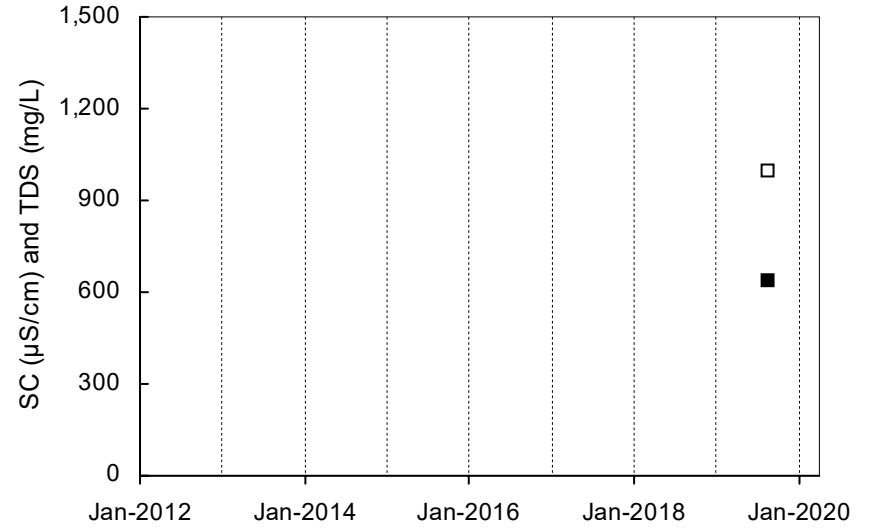

DLF-MW4B

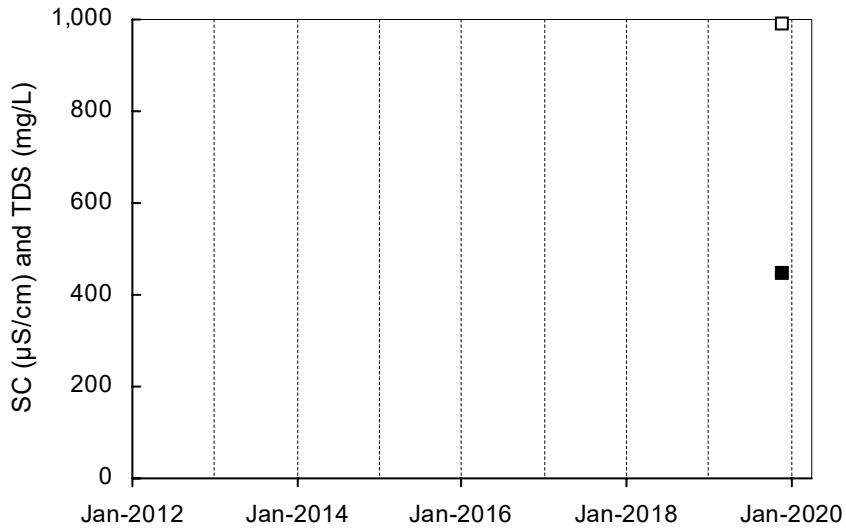

DLF-MW4C

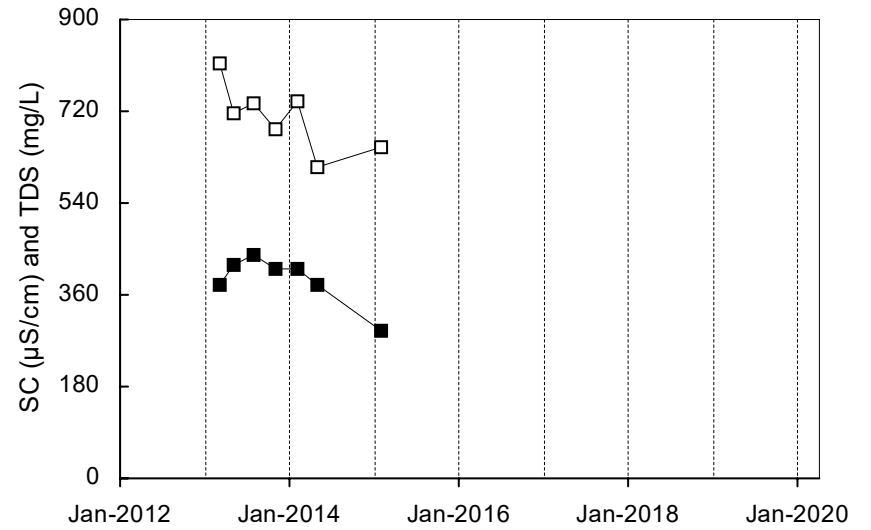

■ Total Dissolved Solids □ Specific Conductance

Shallow Well shown with black symbols

Deep Well shown with orange symbols

"dd" Well shown with blue symbols

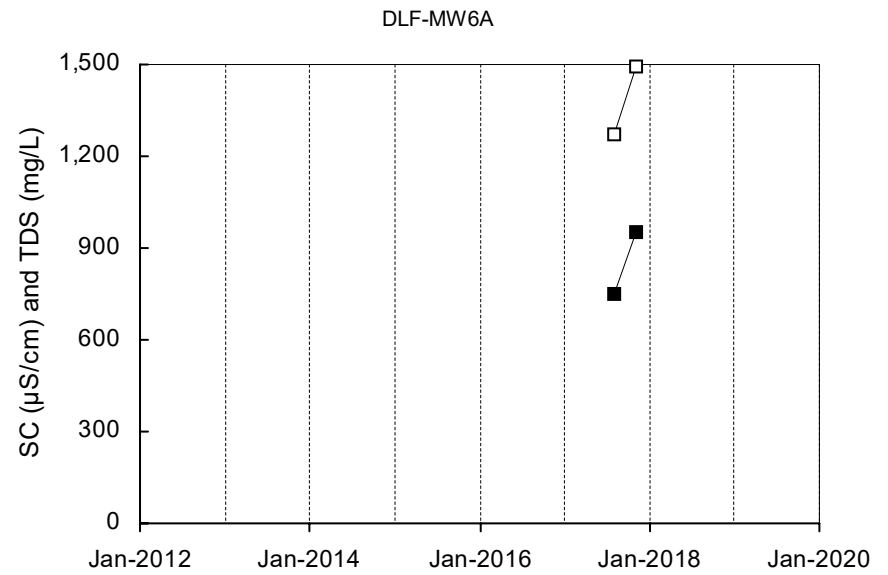
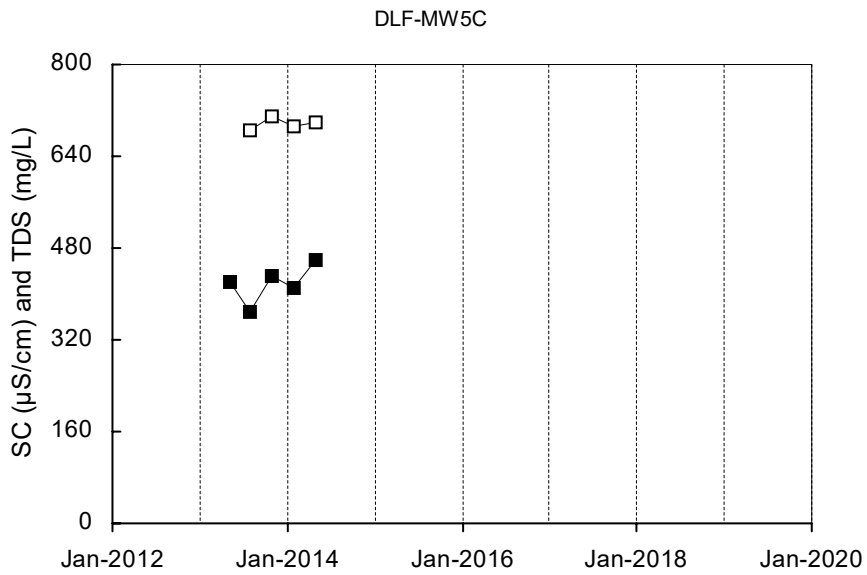
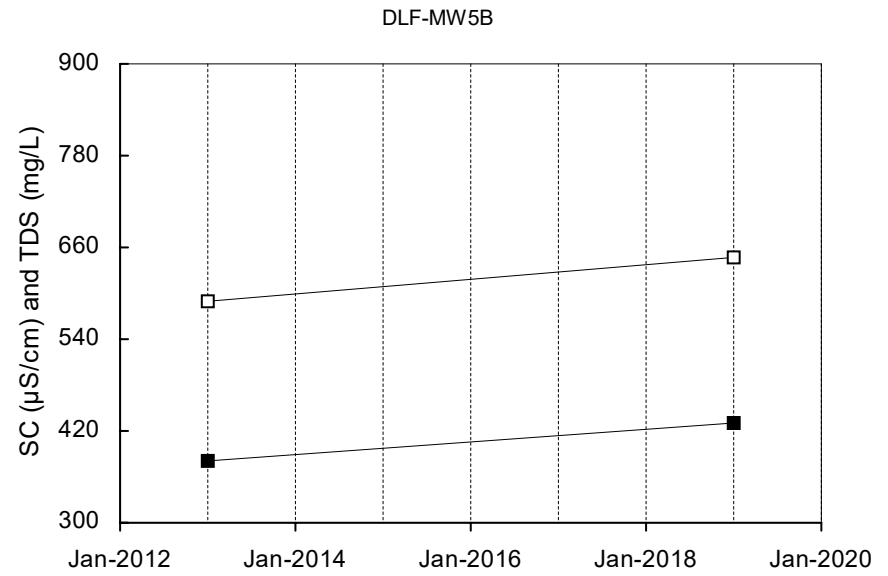
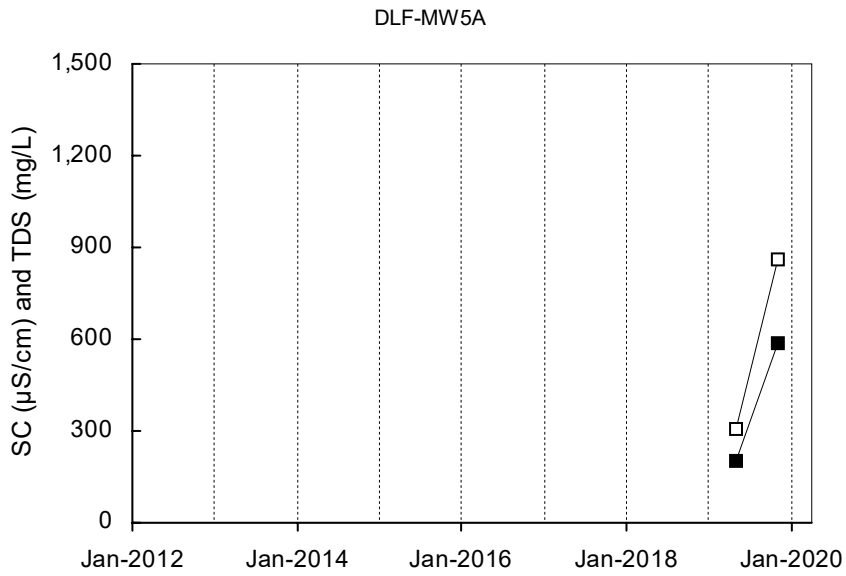

Total Dissolved Solids
 Specific Conductance
Shallow Well shown with black symbols
 Deep Well shown with orange symbols
 "dd" Well shown with blue symbols

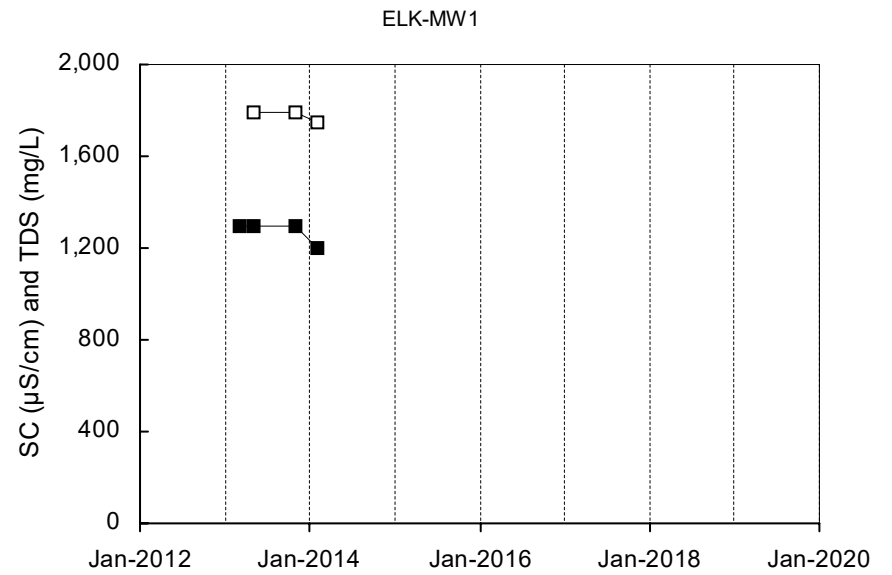
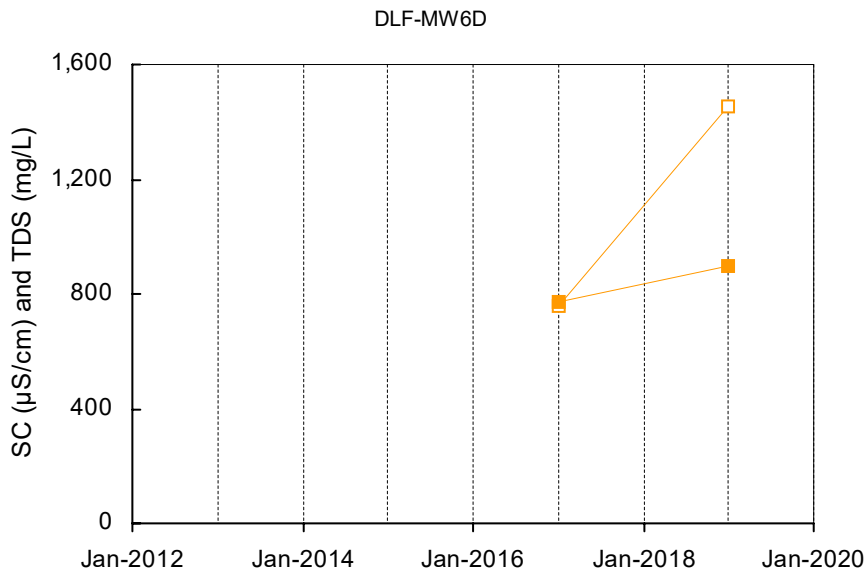
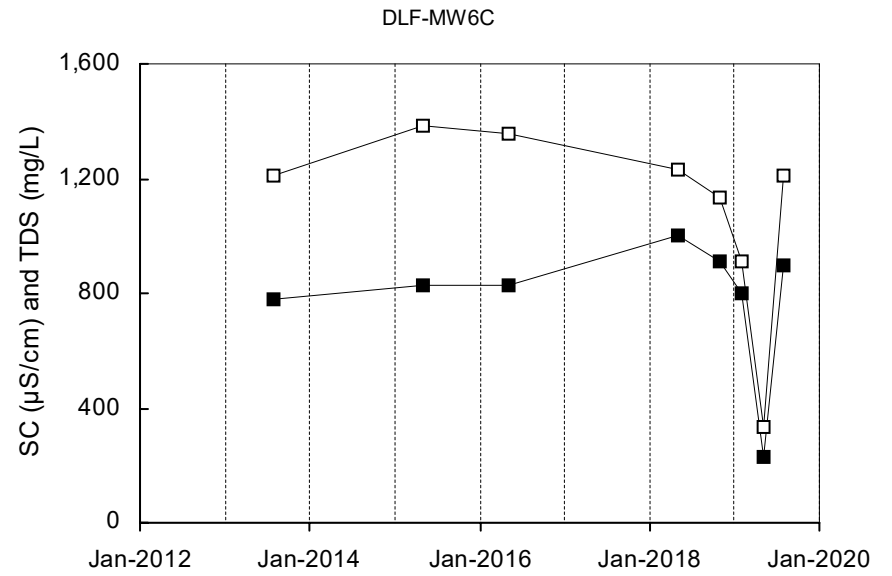
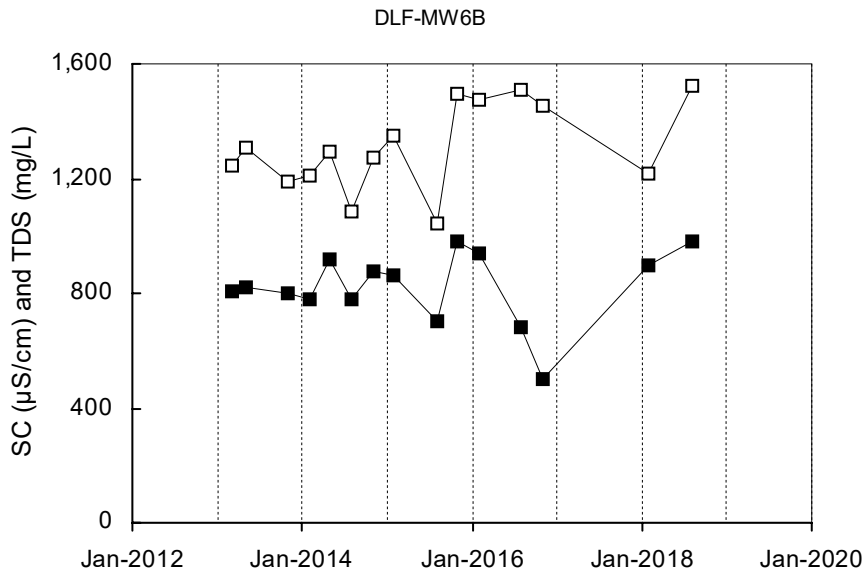

■ Total Dissolved Solids □ Specific Conductance
 Shallow Well shown with black symbols Deep Well shown with orange symbols "dd" Well shown with blue symbols

ELK-MW2A

Not Sampled

ELK-MW2B

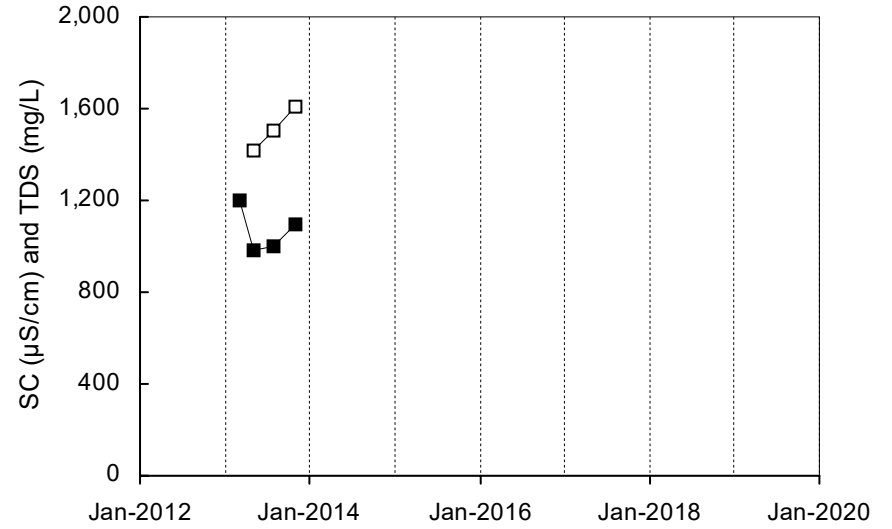

ELK-MW3A

Not Sampled

ELK-MW3B

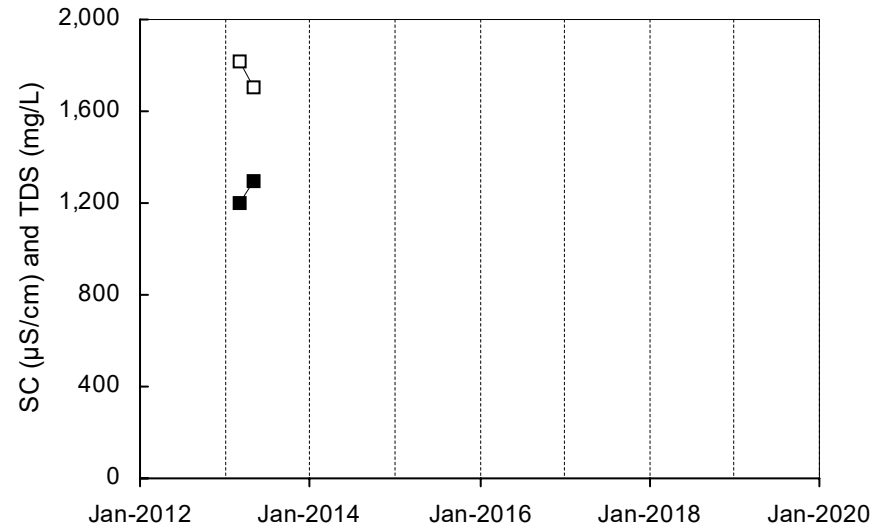

■ Total Dissolved Solids □ Specific Conductance

Shallow Well shown with black symbols

Deep Well shown with orange symbols

"dd" Well shown with blue symbols

ELK-MW4

Not Sampled

ZZI-MW1A

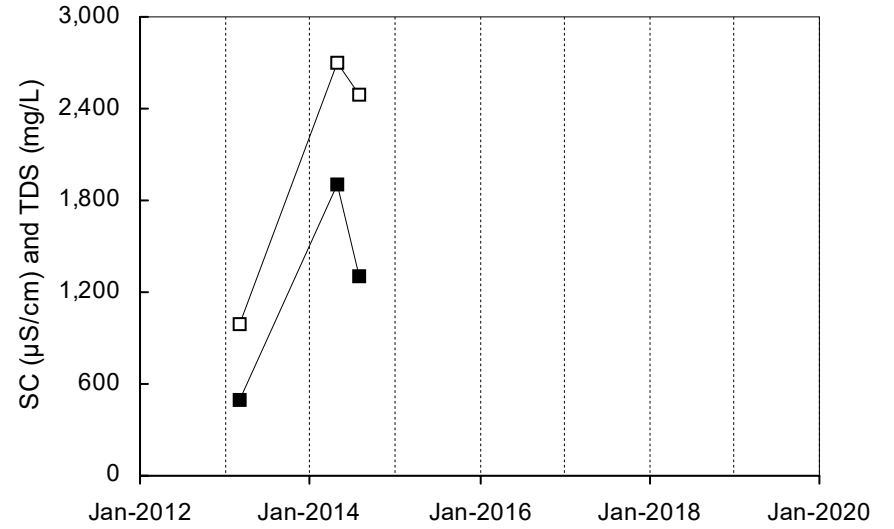

ZZI-MW1B

Not Sampled

ZZI-MW1C

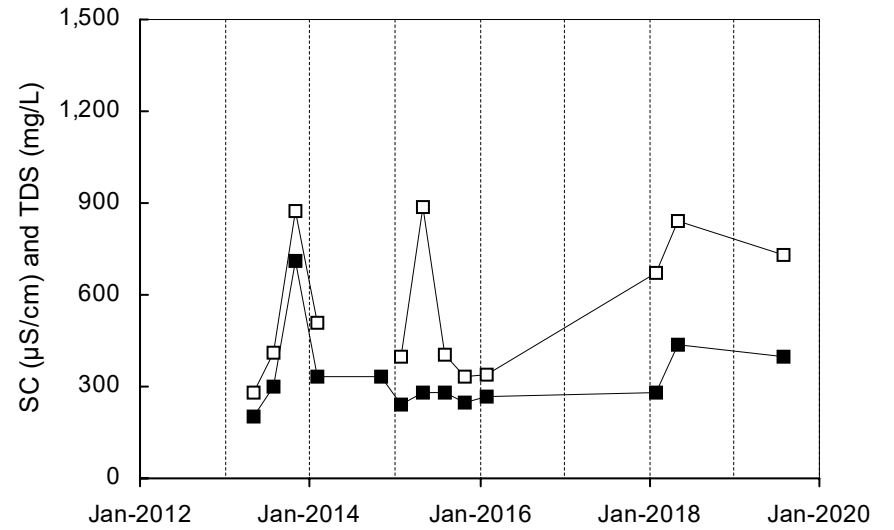

■ Total Dissolved Solids □ Specific Conductance

Shallow Well shown with black symbols

Deep Well shown with orange symbols

"dd" Well shown with blue symbols

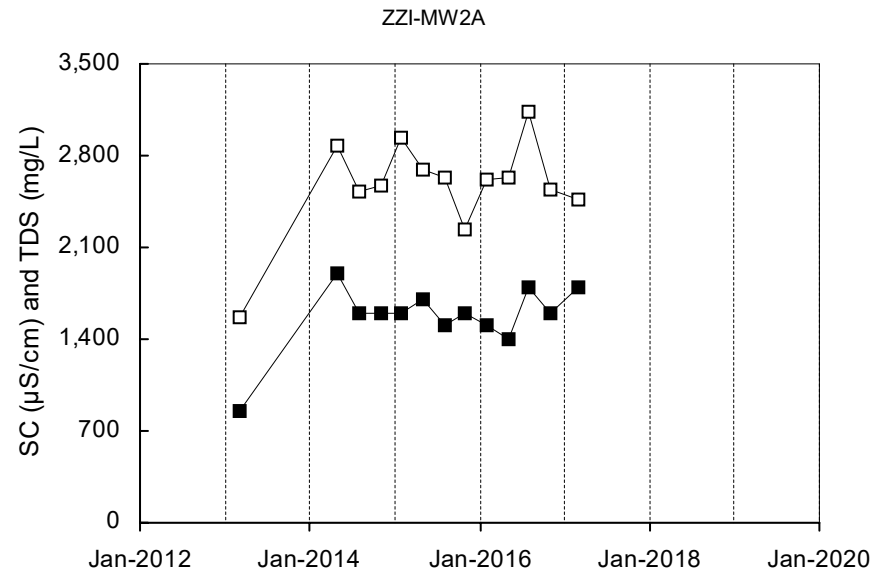
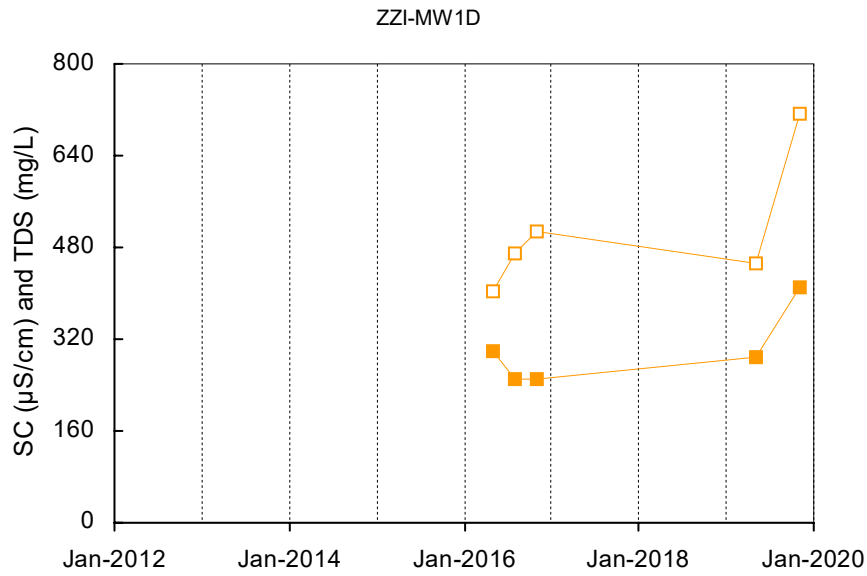

ZZI-MW2B
Not Sampled

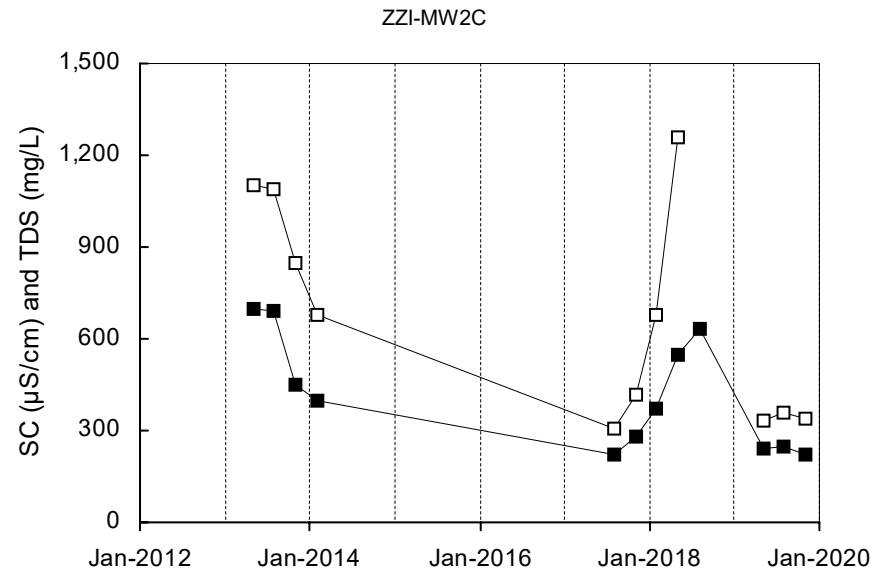

■ Total Dissolved Solids □ Specific Conductance
 Shallow Well shown with black symbols Deep Well shown with orange symbols "dd" Well shown with blue symbols

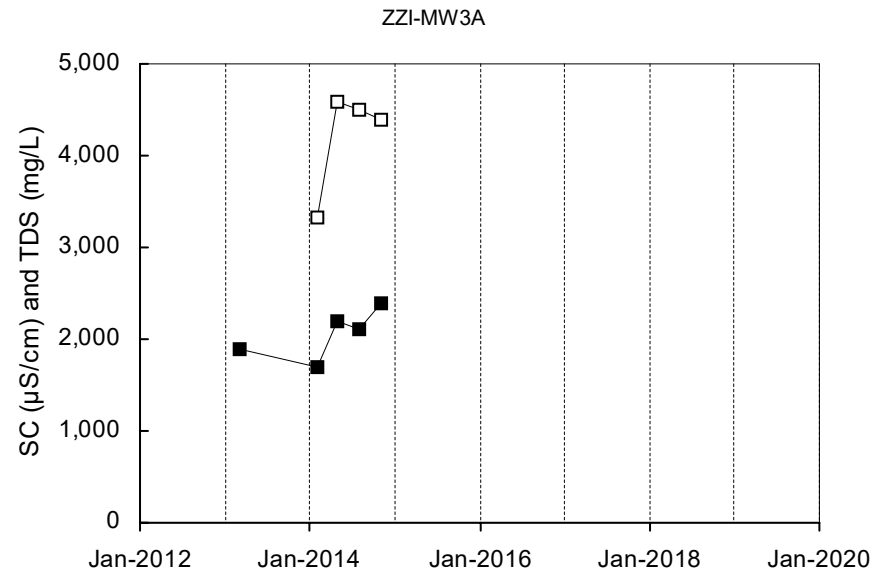
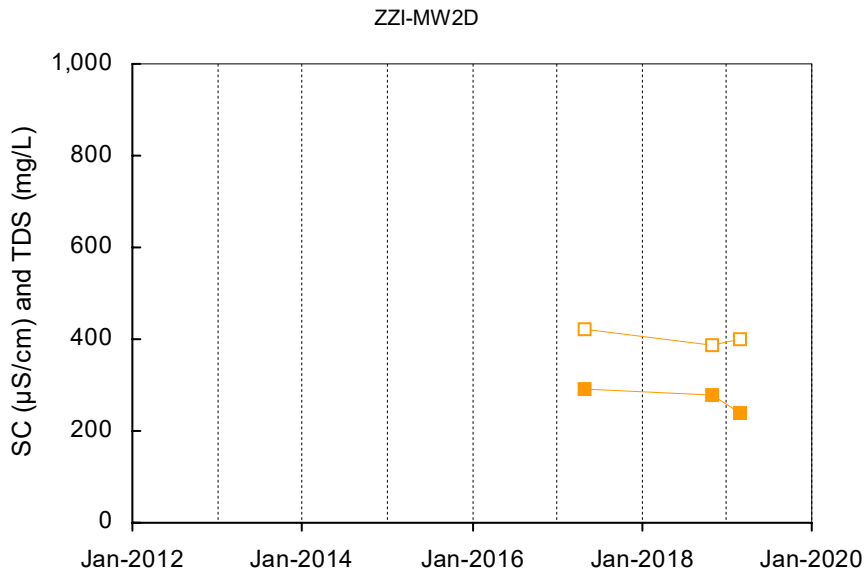

ZZI-MW3AA

Not Sampled

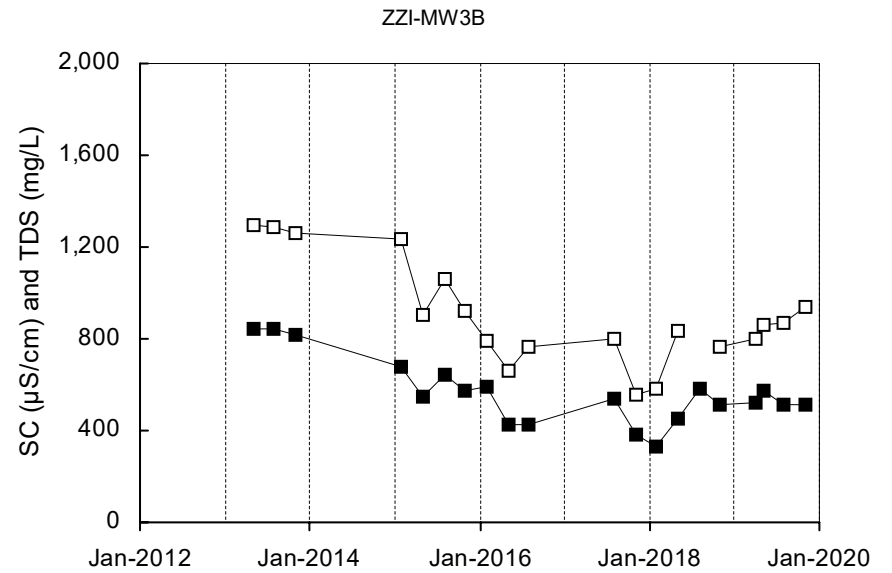

■ Total Dissolved Solids □ Specific Conductance

Shallow Well shown with black symbols

Deep Well shown with orange symbols

"dd" Well shown with blue symbols

ZZI-MW5A

Not Sampled

ZZI-MW5B

Not Sampled

ZZI-MW5C

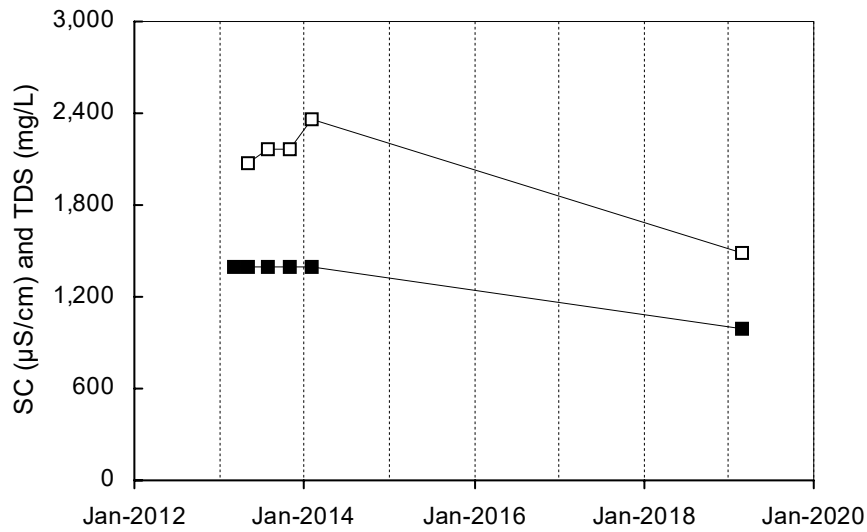

ZZI-MW5D

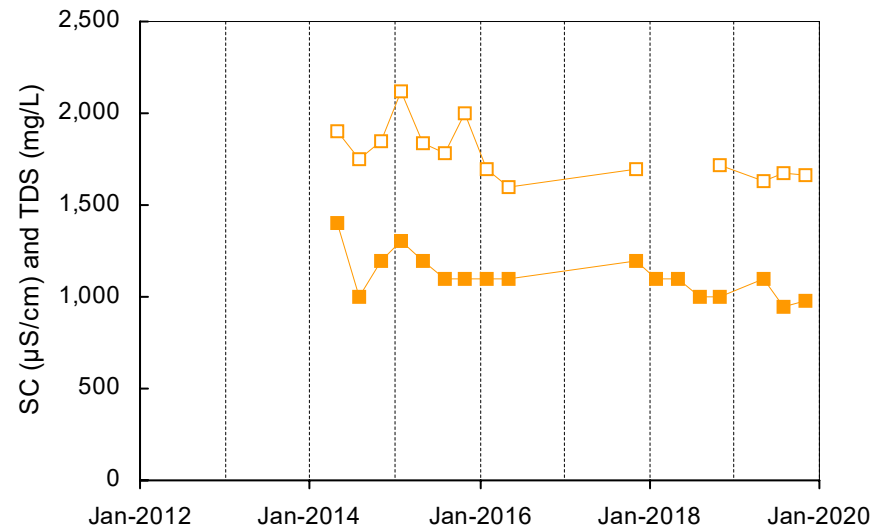

■ Total Dissolved Solids □ Specific Conductance

Shallow Well shown with black symbols

Deep Well shown with orange symbols

"dd" Well shown with blue symbols

ZZI-MW6A

Not Sampled

ZZI-MW6B

Not Sampled

ZZI-MW6C

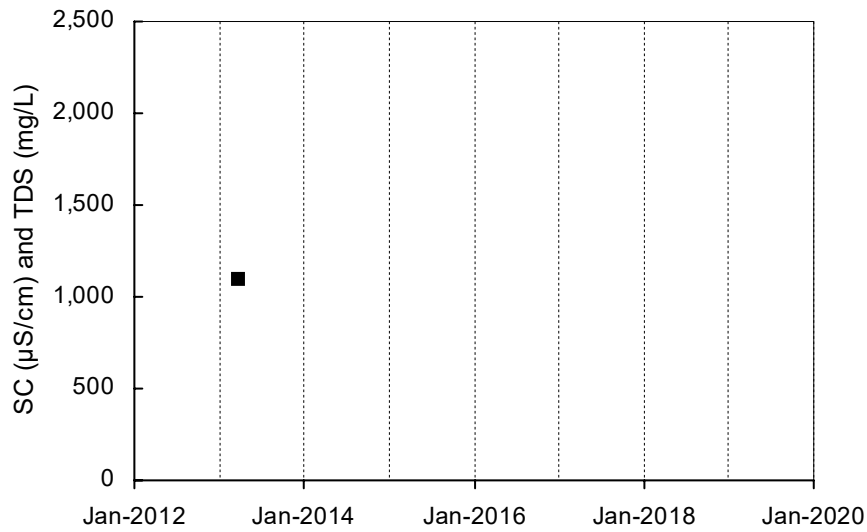

ZZI-MW6D

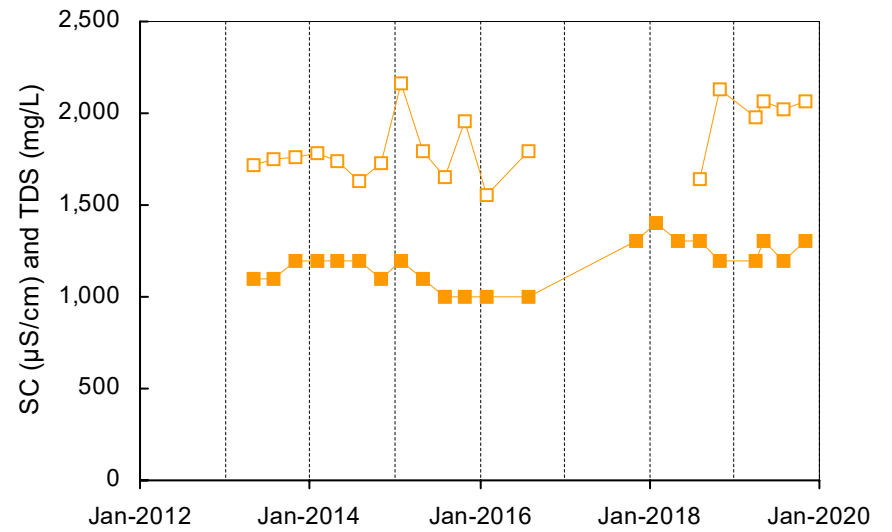

■ Total Dissolved Solids □ Specific Conductance

Shallow Well shown with black symbols

Deep Well shown with orange symbols

"dd" Well shown with blue symbols

ZZI-MW7A

Not Sampled

ZZI-MW7B

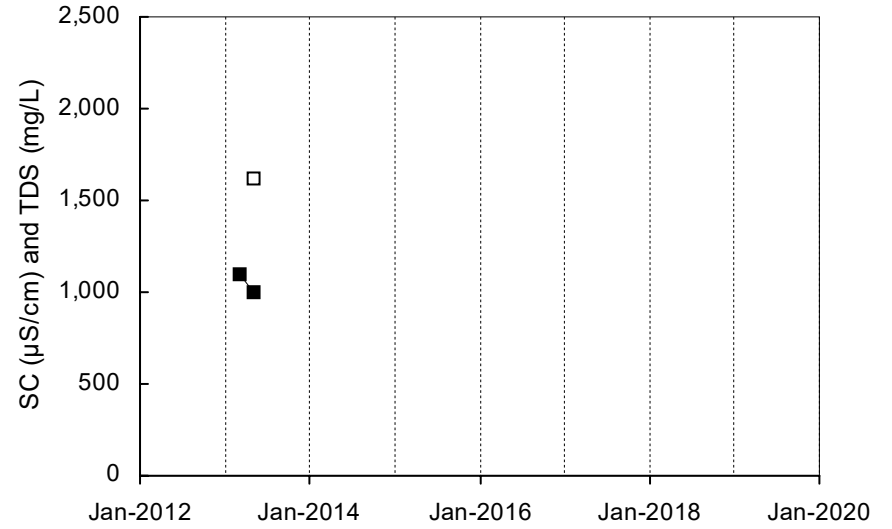

ZZI-MW7C

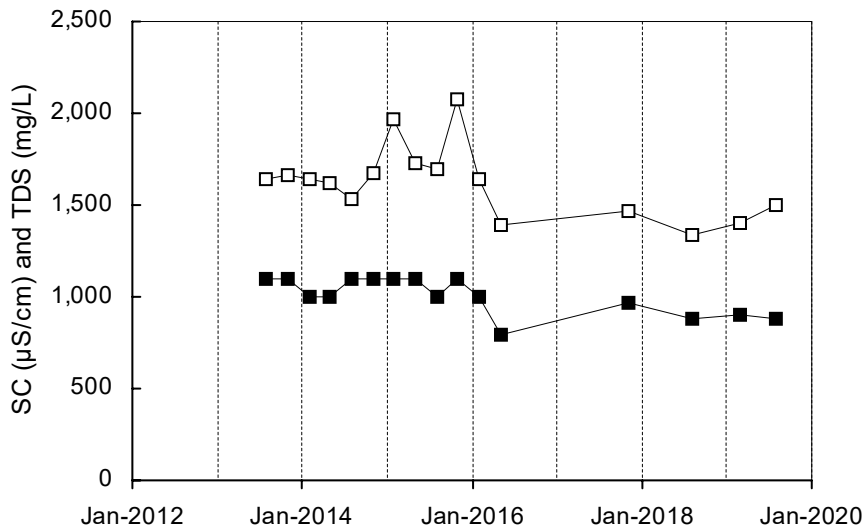

ZZI-MW7D

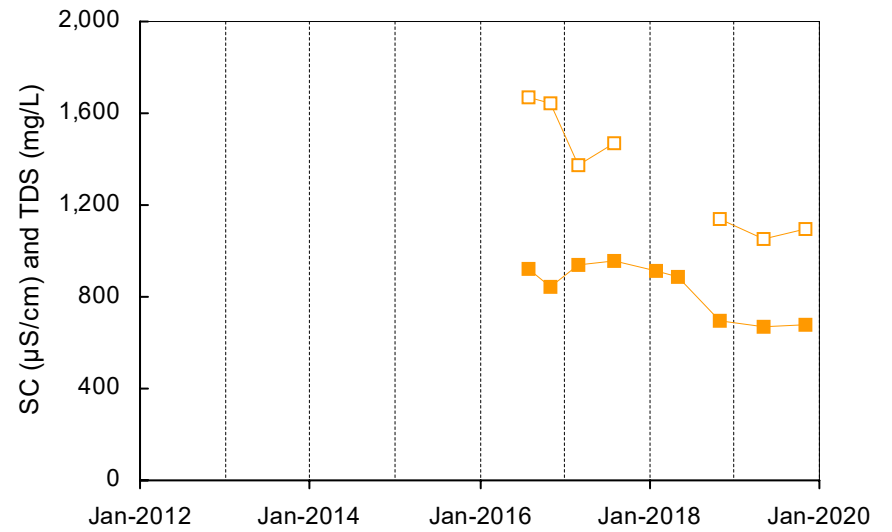

■ Total Dissolved Solids □ Specific Conductance

Shallow Well shown with black symbols

Deep Well shown with orange symbols

"dd" Well shown with blue symbols

ZZI-MW9A

Not Sampled

ZZI-MW9B

Not Sampled

ZZI-MW9C

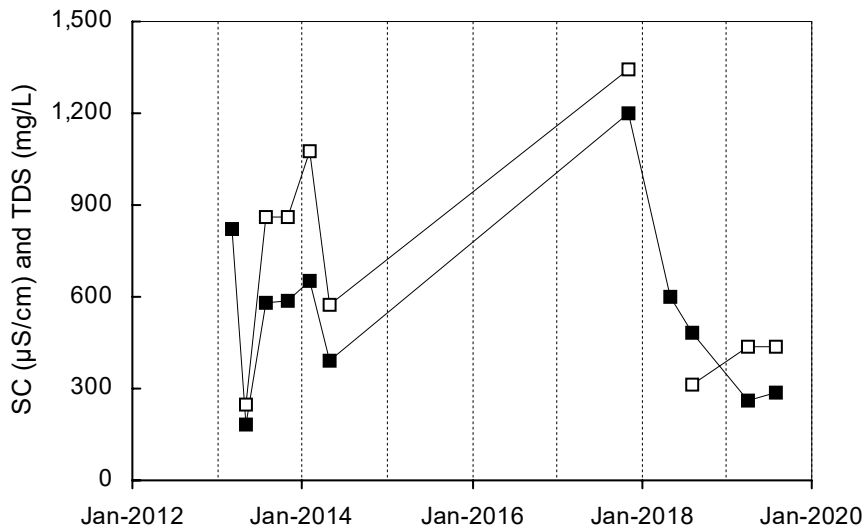

ZZI-MW9D

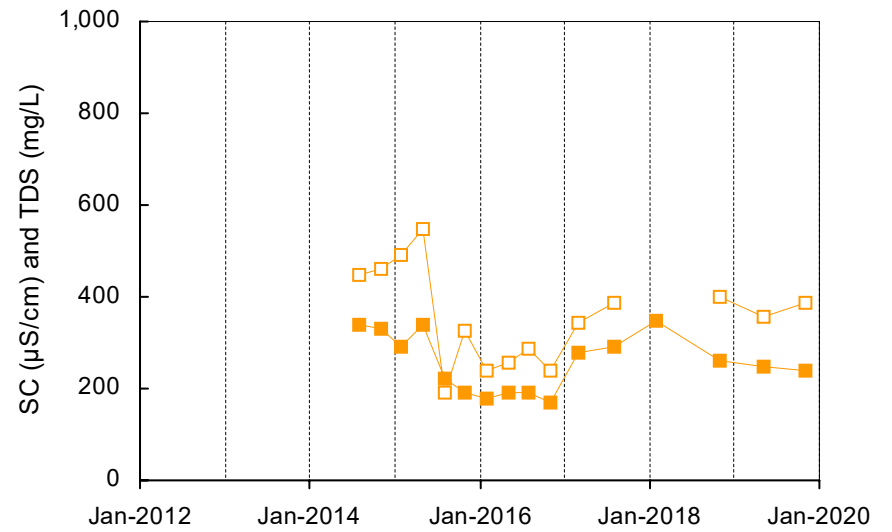

■ Total Dissolved Solids □ Specific Conductance

Shallow Well shown with black symbols

Deep Well shown with orange symbols

"dd" Well shown with blue symbols

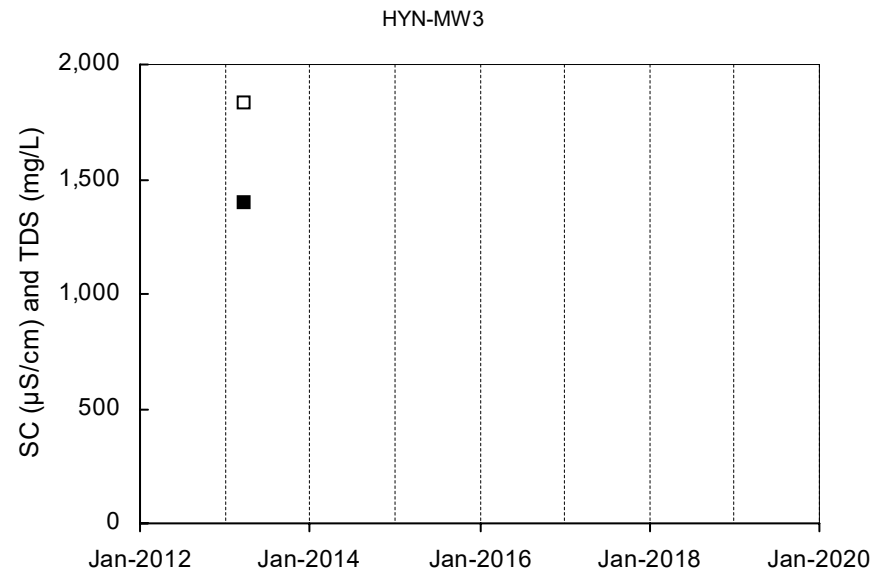
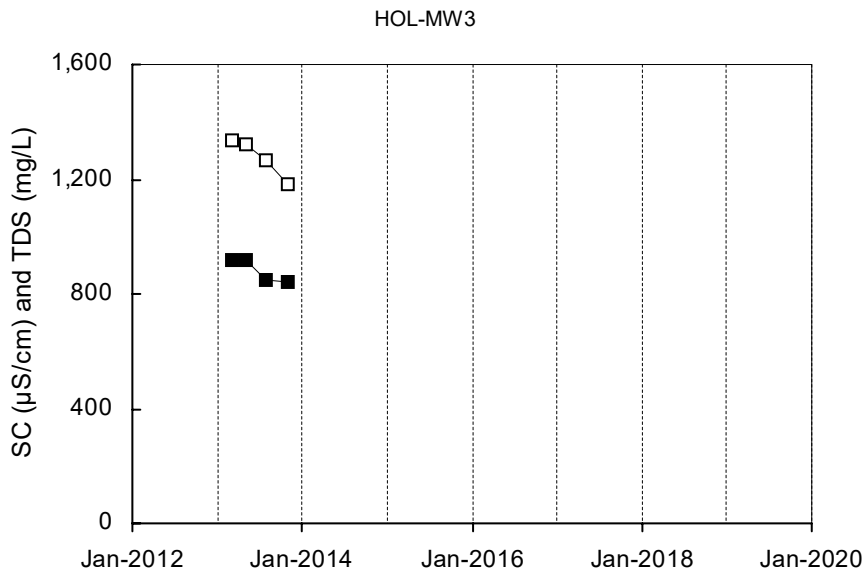
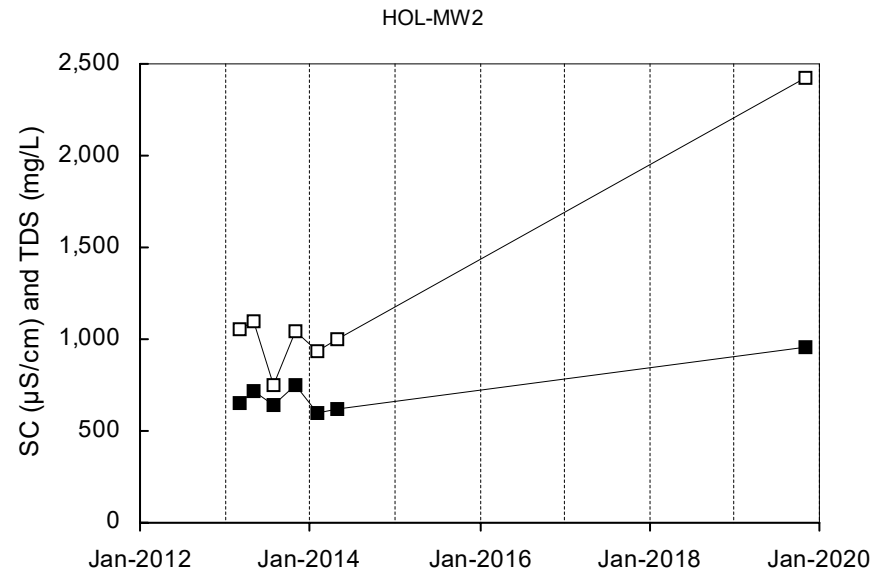
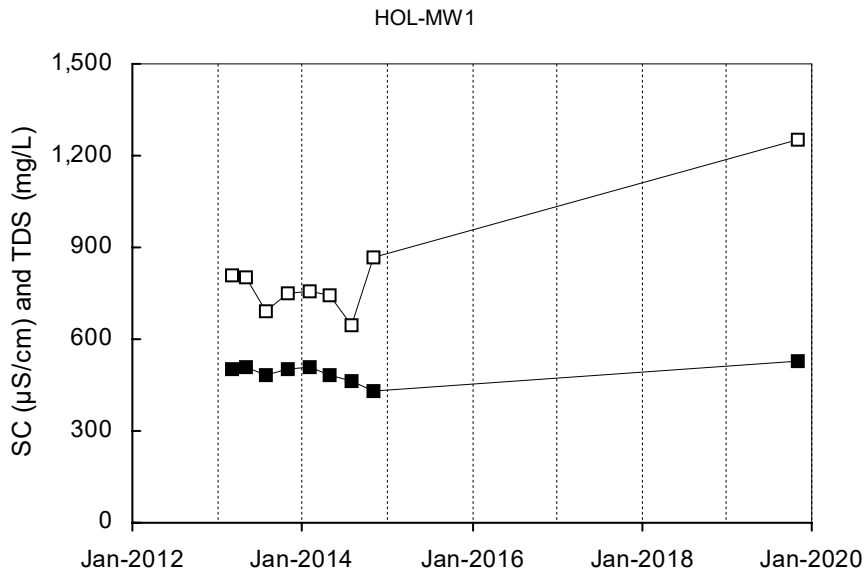

■ Total Dissolved Solids □ Specific Conductance
 Shallow Well shown with black symbols Deep Well shown with orange symbols "dd" Well shown with blue symbols

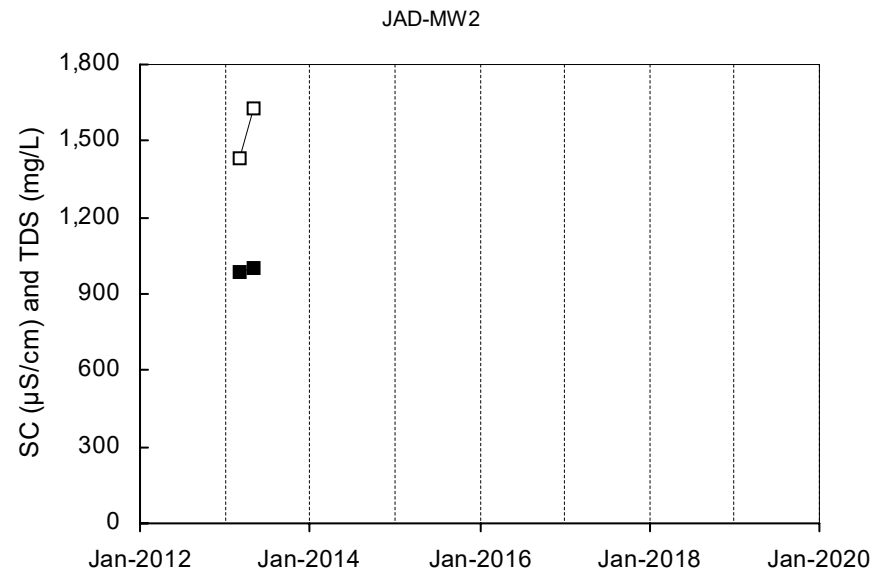
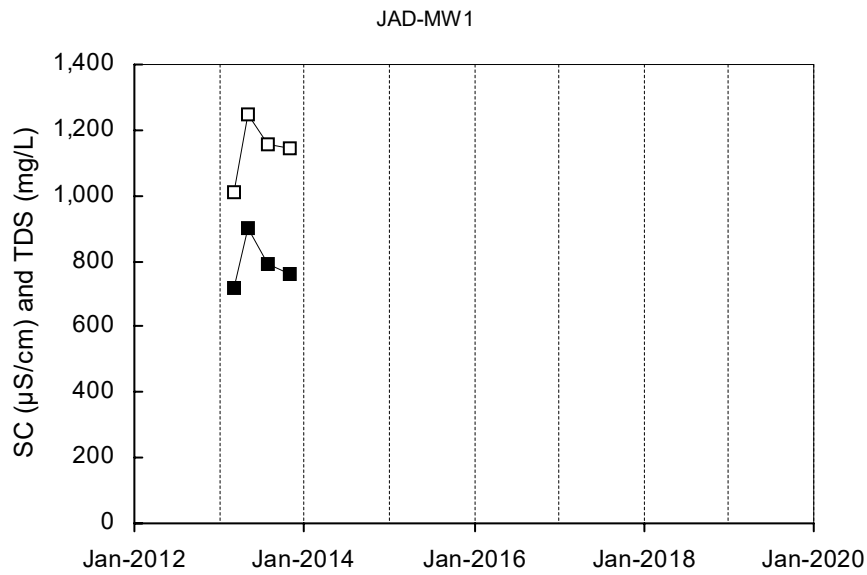
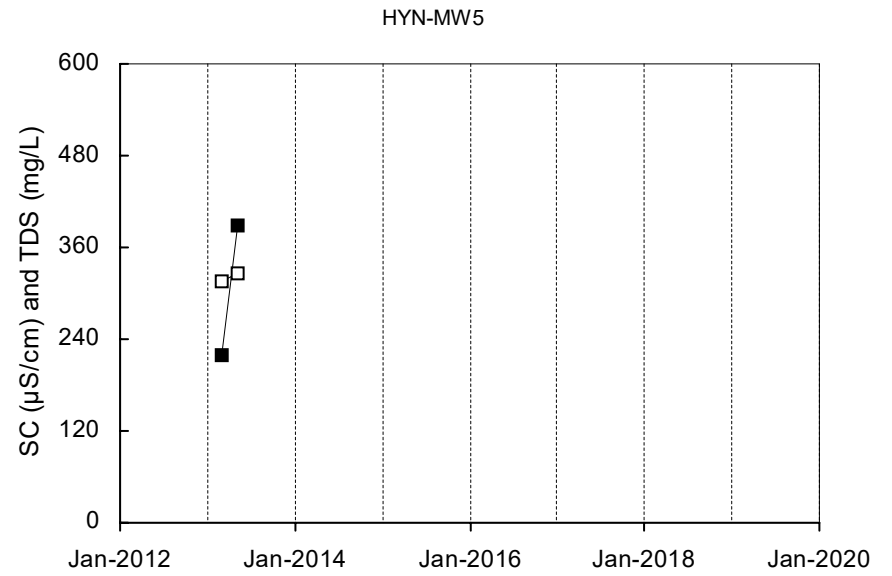
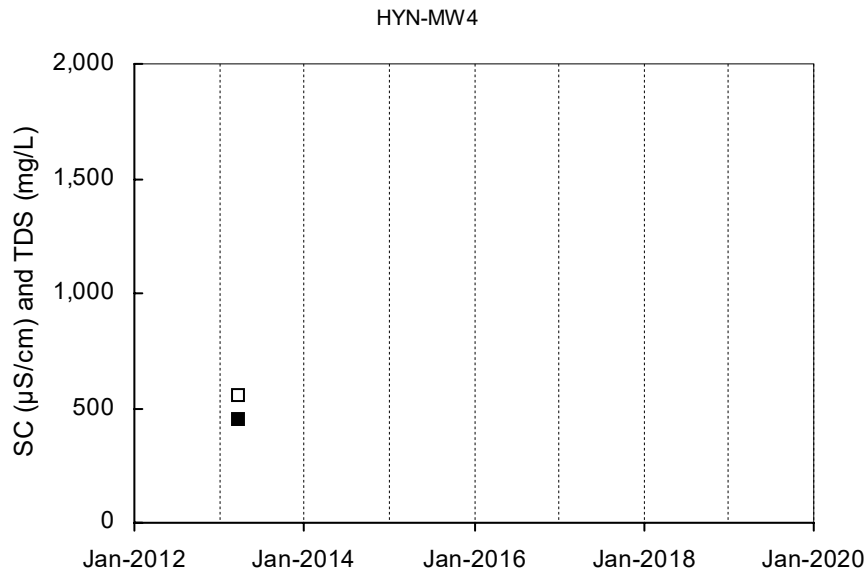

■ Total Dissolved Solids □ Specific Conductance
 Shallow Well shown with black symbols Deep Well shown with orange symbols "dd" Well shown with blue symbols

JAD-MW3

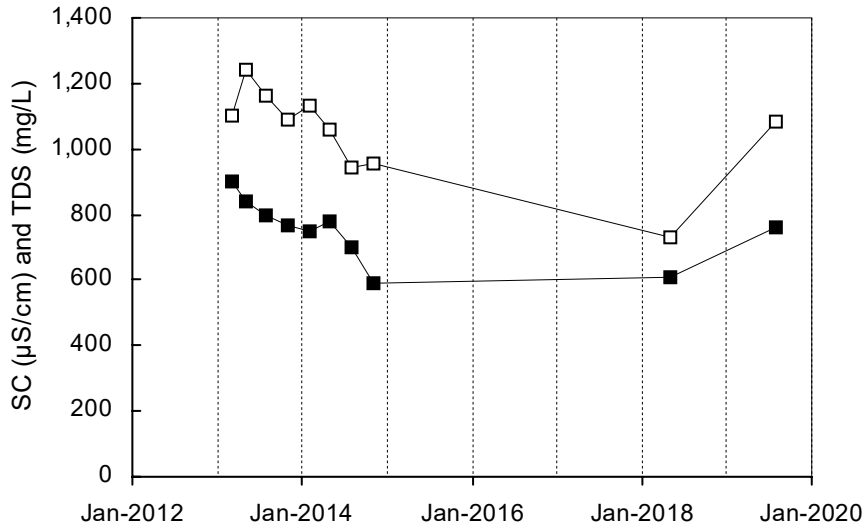

JAD-MW4

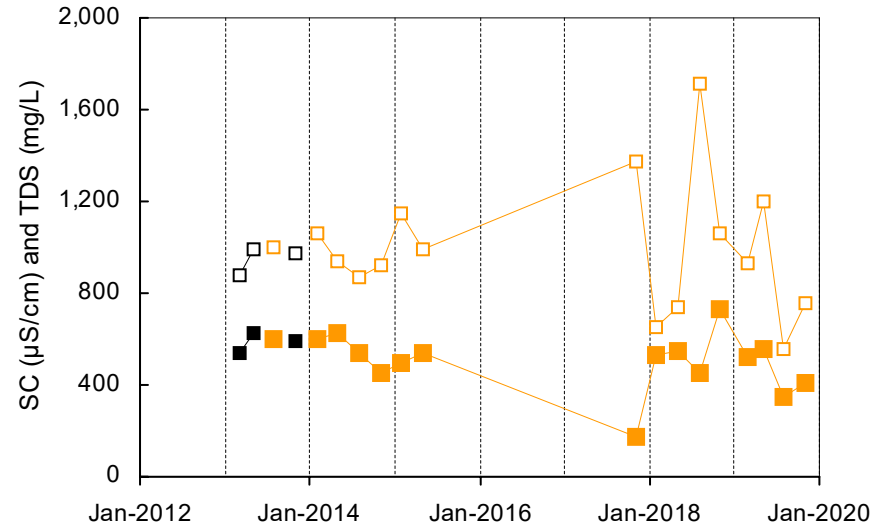

JAD-MW5

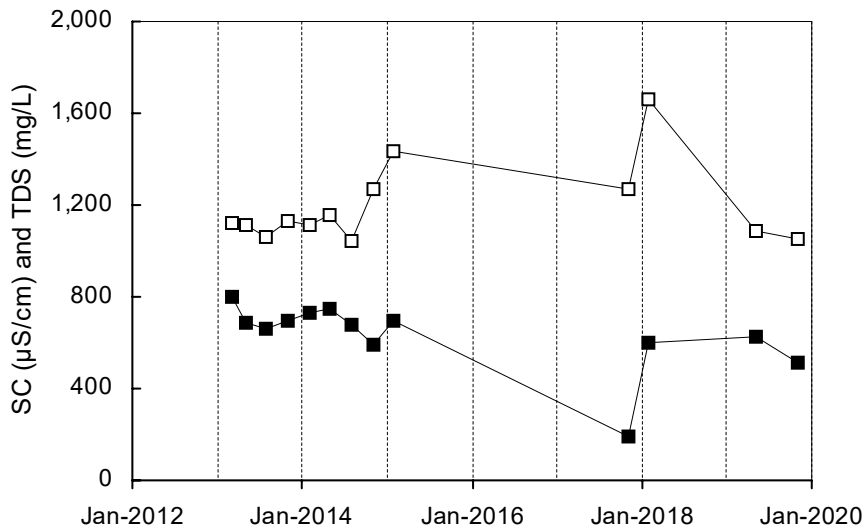

JAD-MW6

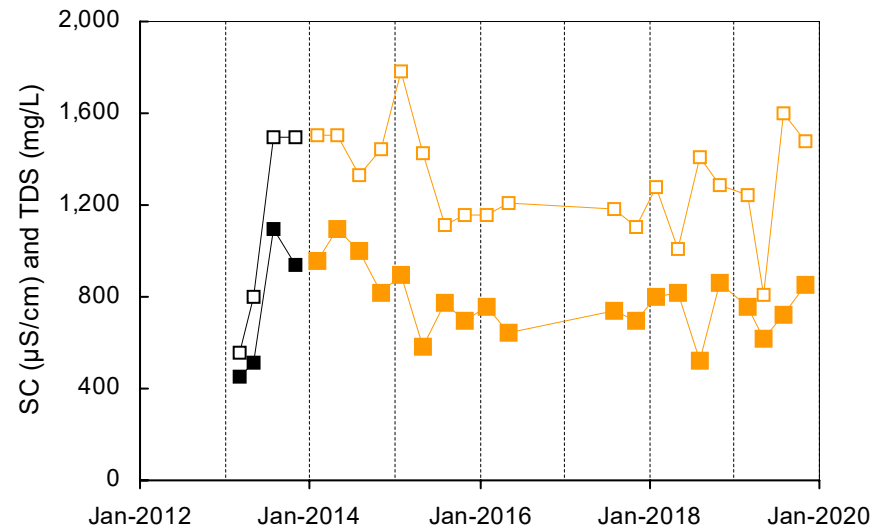

■ Total Dissolved Solids □ Specific Conductance

Shallow Well shown with black symbols

Deep Well shown with orange symbols

"dd" Well shown with blue symbols

JAD-MW7

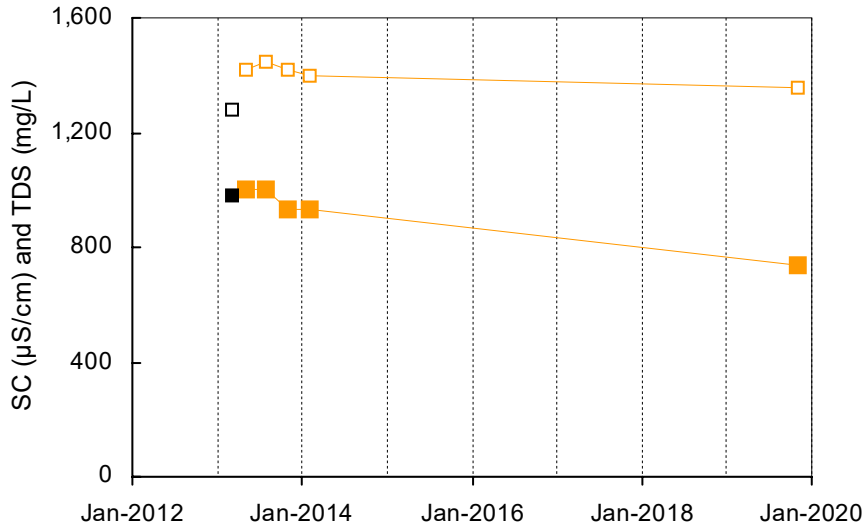

LON-MW1A

Not Sampled

LON-MW1B

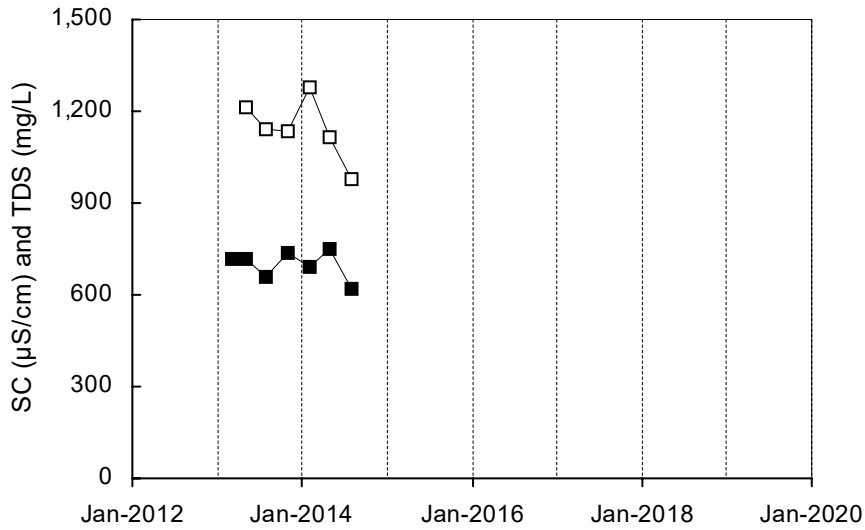

LON-MW1C

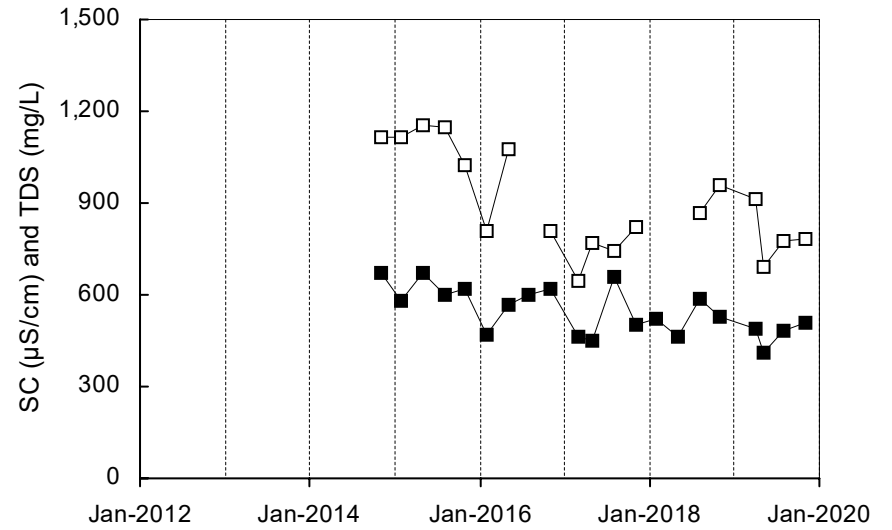

■ Total Dissolved Solids □ Specific Conductance

Shallow Well shown with black symbols

Deep Well shown with orange symbols

"dd" Well shown with blue symbols

LON-MW2A

Not Sampled

LON-MW2B

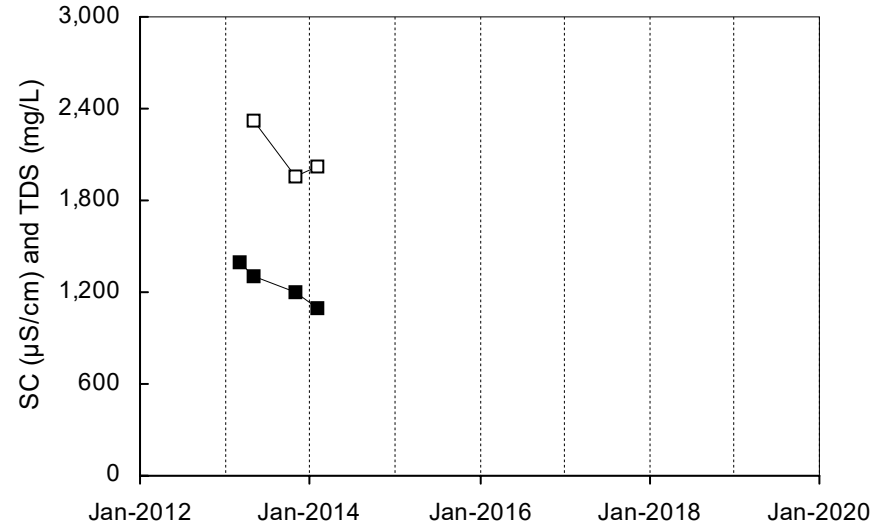

LON-MW2C

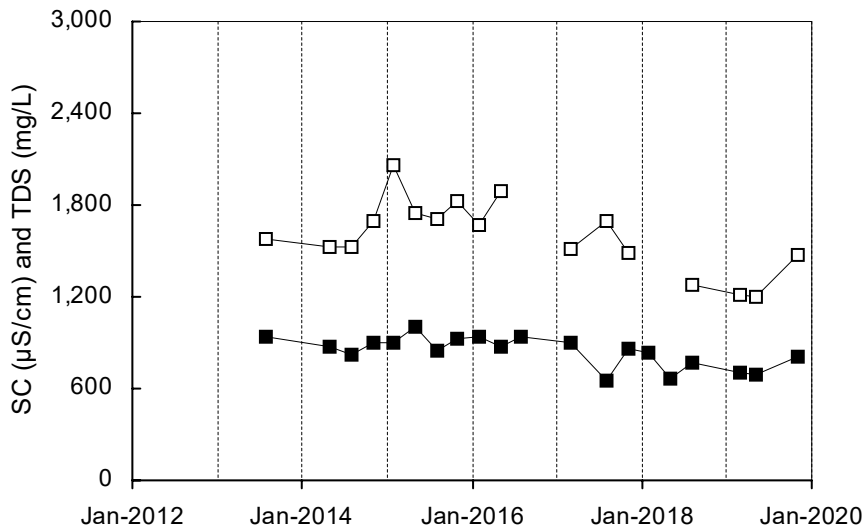

LON-MW3A

Not Sampled

■ Total Dissolved Solids □ Specific Conductance

Shallow Well shown with black symbols

Deep Well shown with orange symbols

"dd" Well shown with blue symbols

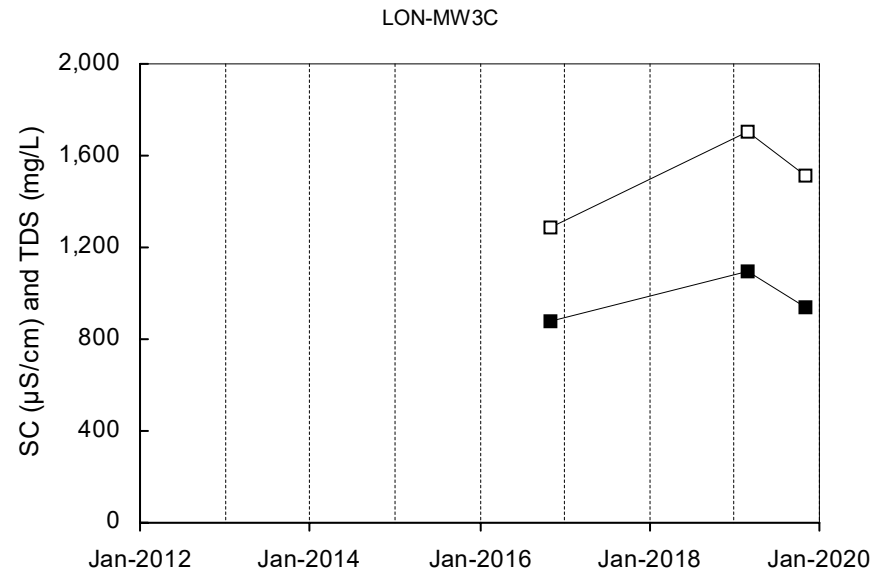
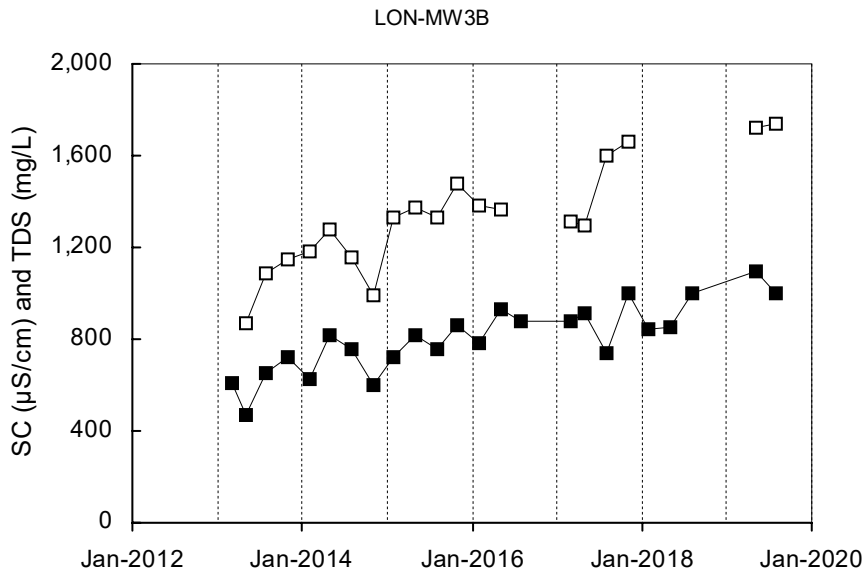

LON-MW4A

Not Sampled

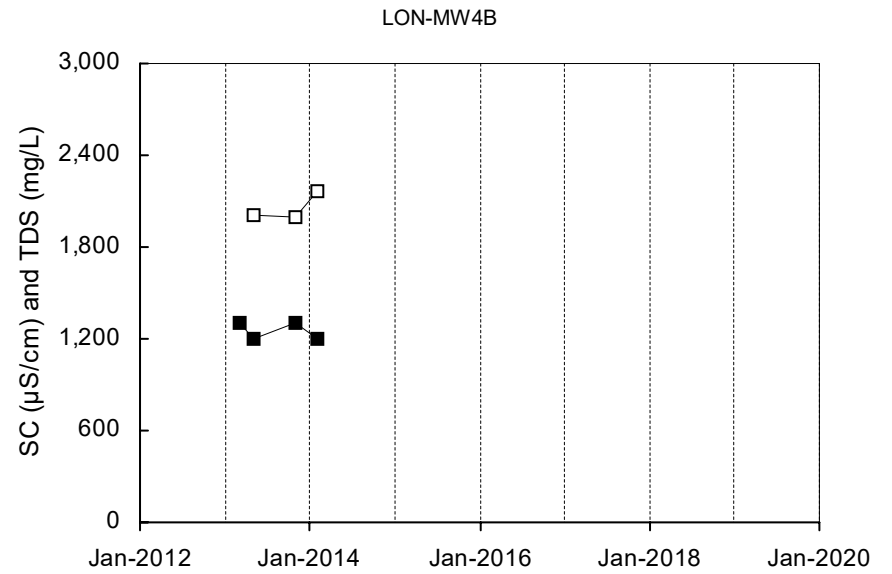

■ Total Dissolved Solids □ Specific Conductance

Shallow Well shown with black symbols

Deep Well shown with orange symbols

"dd" Well shown with blue symbols

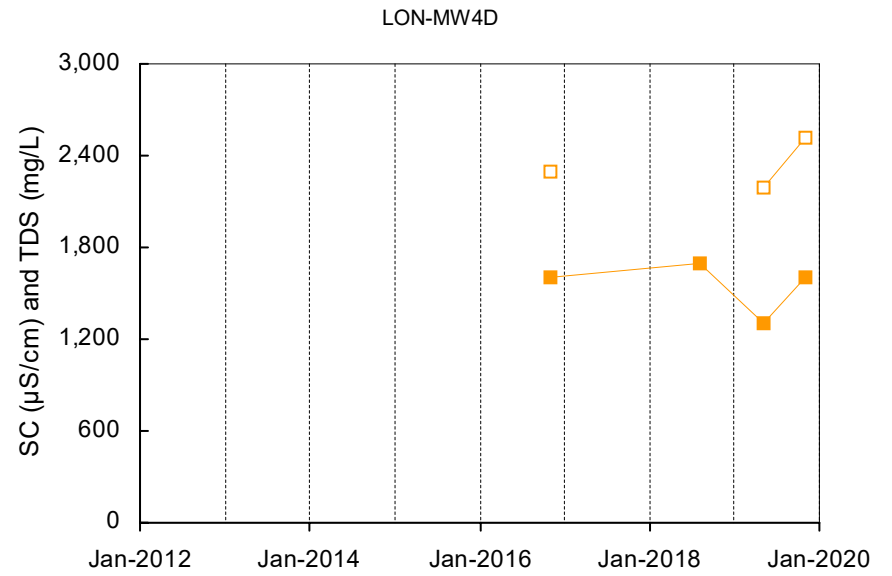
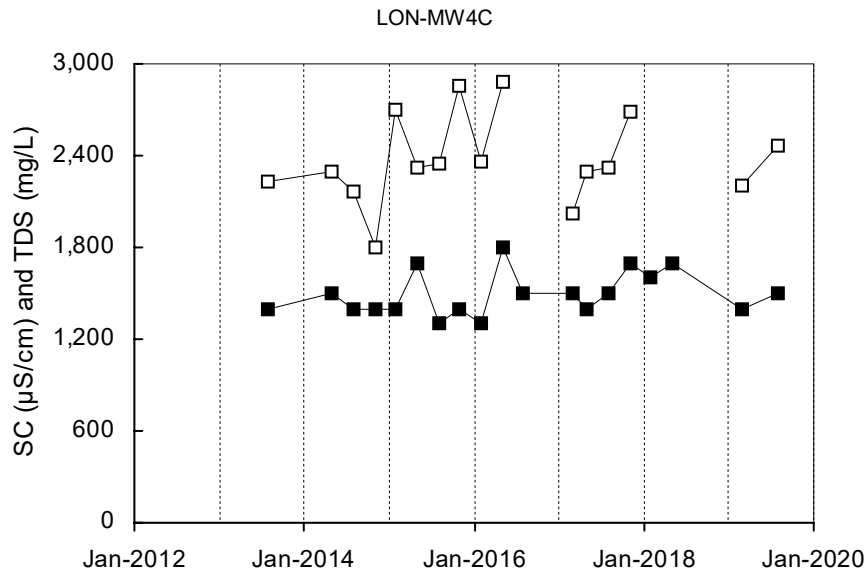

LON-MW5A

Not Sampled

LON-MW5B

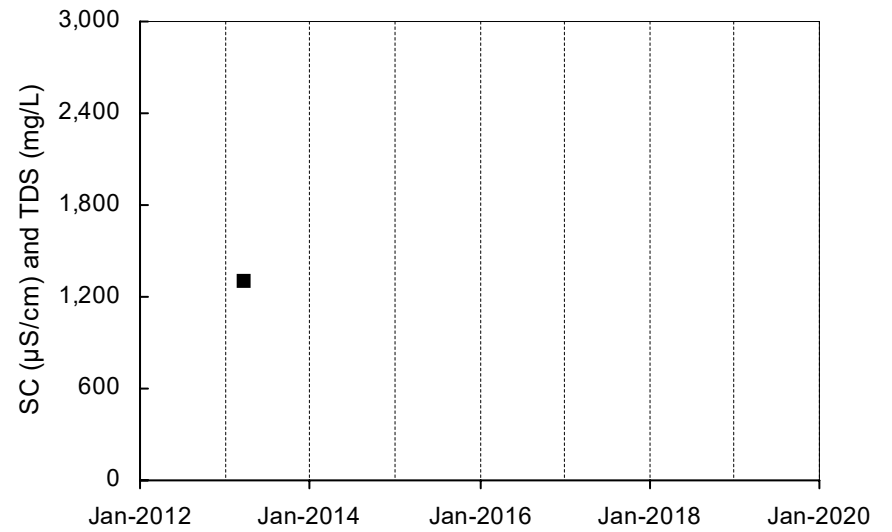

■ Total Dissolved Solids □ Specific Conductance

Shallow Well shown with black symbols

Deep Well shown with orange symbols

"dd" Well shown with blue symbols

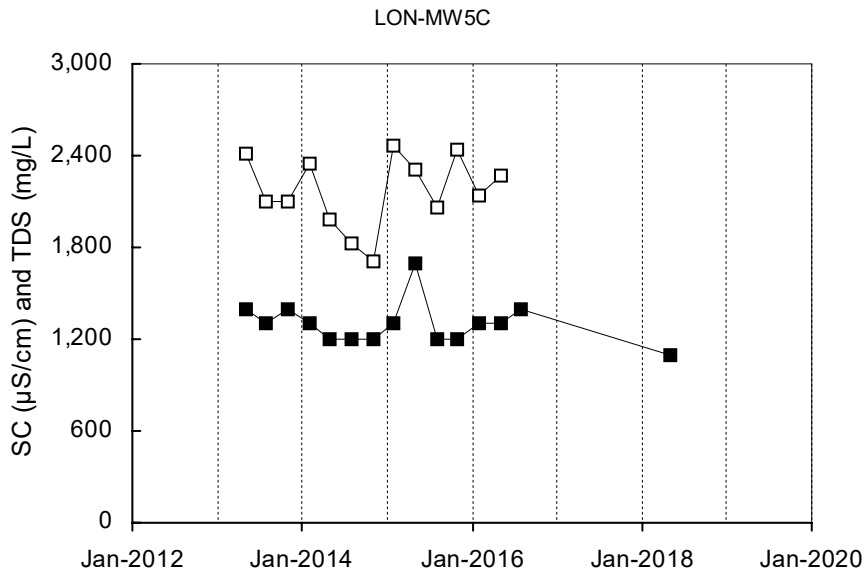

LON-MW6A

Not Sampled

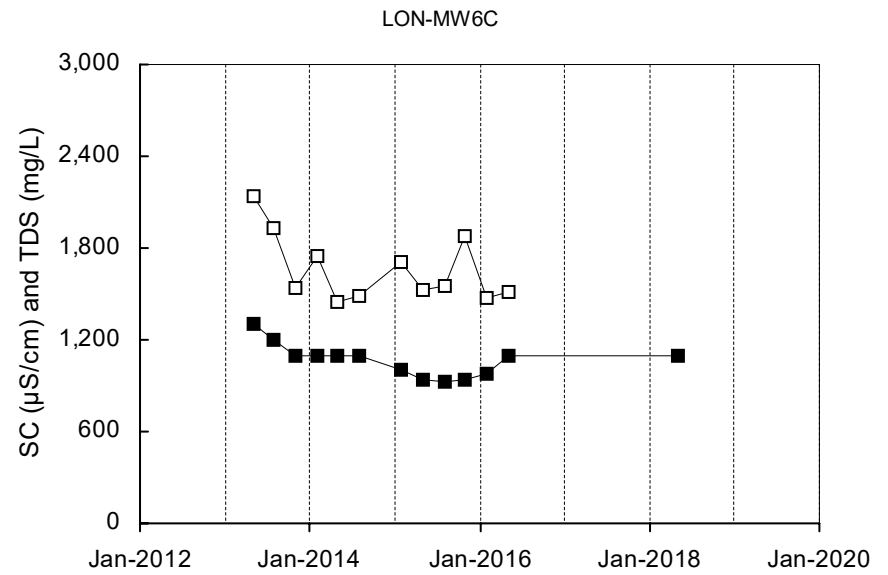
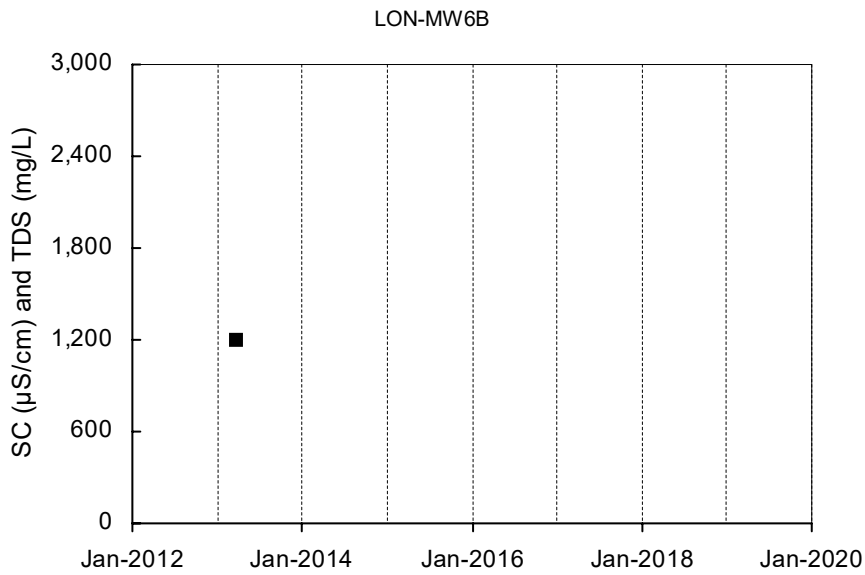

■ Total Dissolved Solids □ Specific Conductance
 Shallow Well shown with black symbols Deep Well shown with orange symbols "dd" Well shown with blue symbols

LON-MW7A

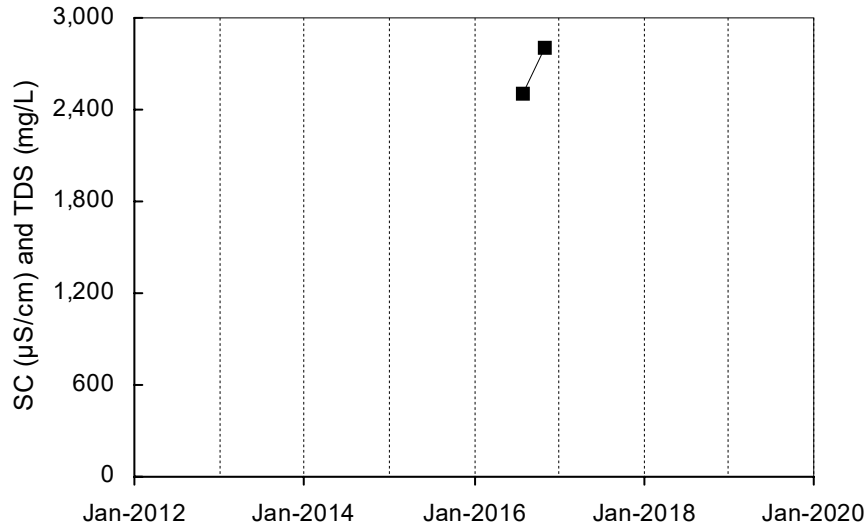

LON-MW7B

Not Sampled

LON-MW7C

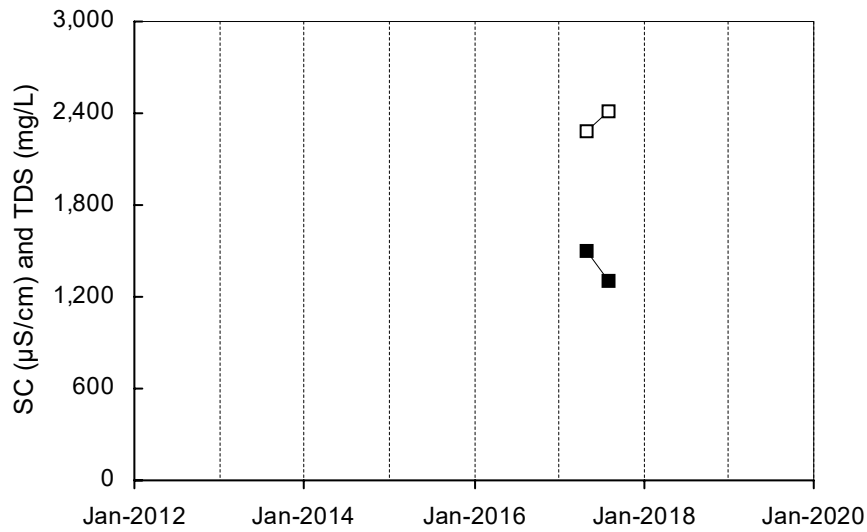

LON-MW7D

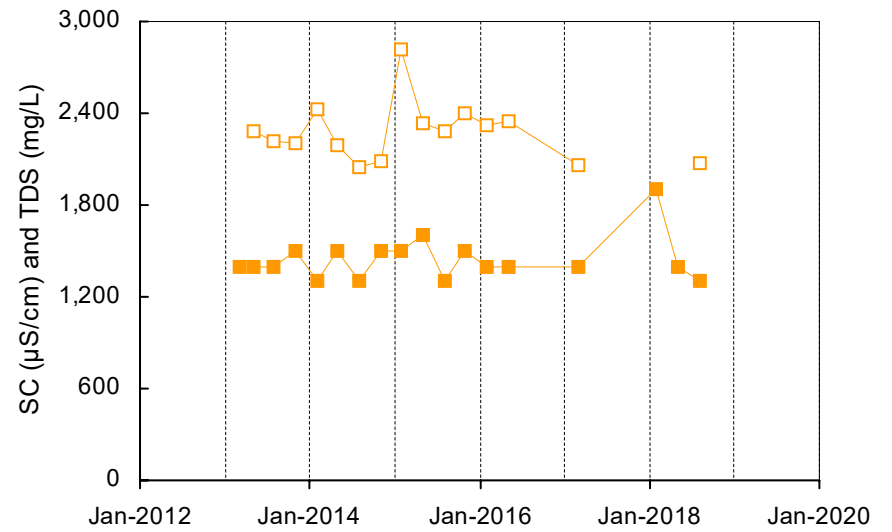

■ Total Dissolved Solids □ Specific Conductance

Shallow Well shown with black symbols

Deep Well shown with orange symbols

"dd" Well shown with blue symbols

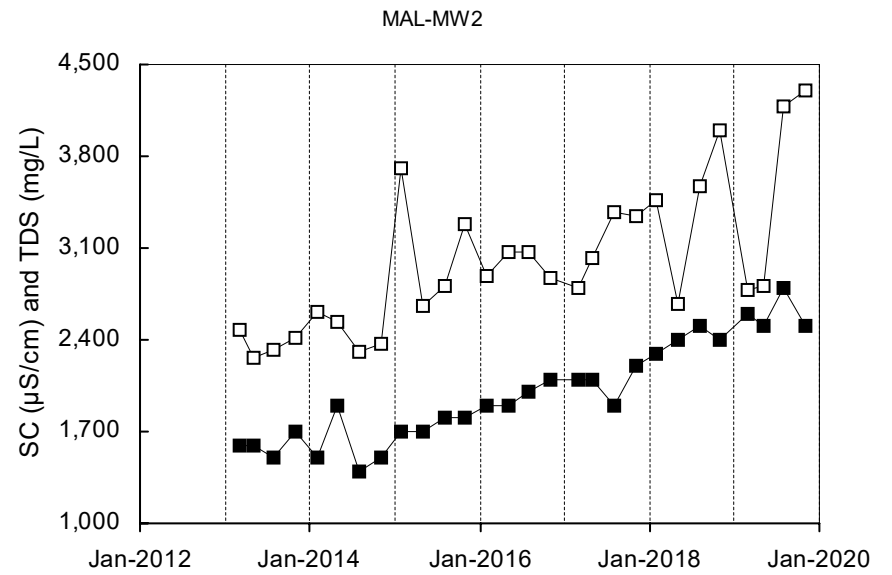
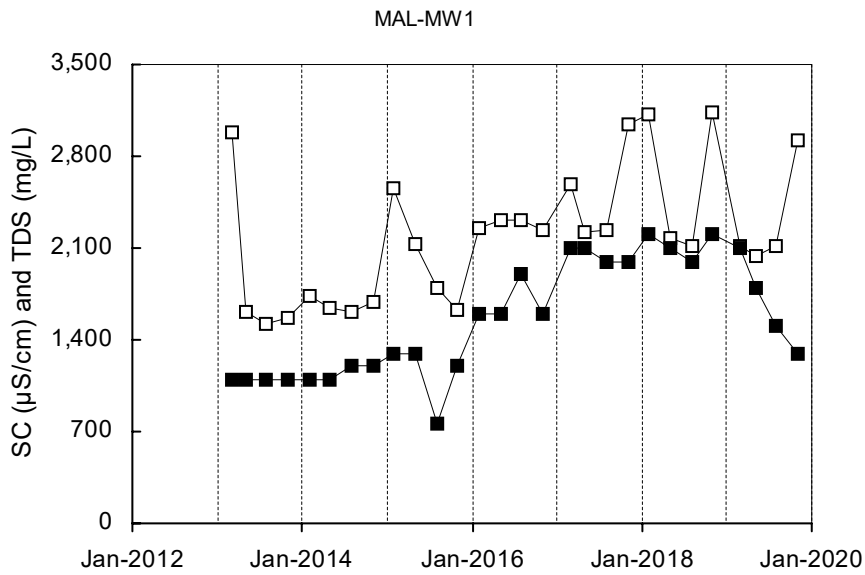
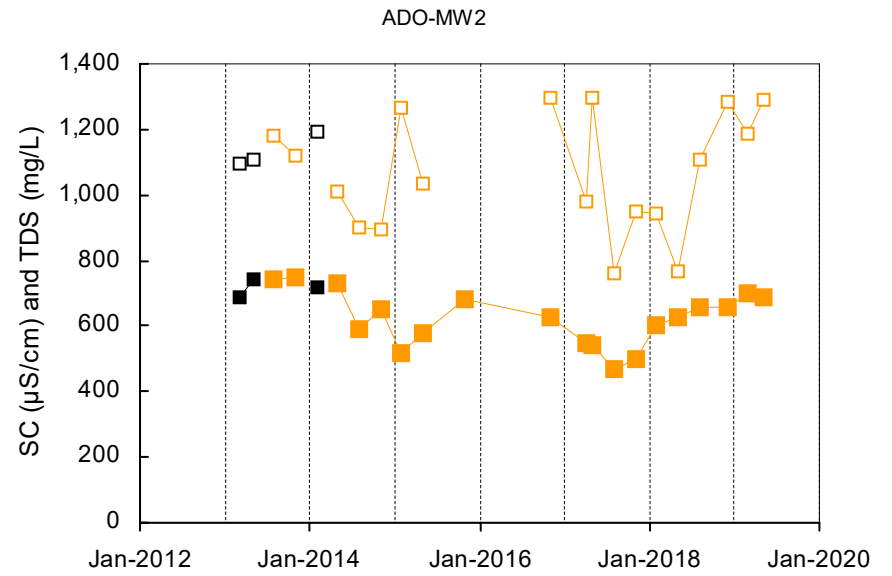
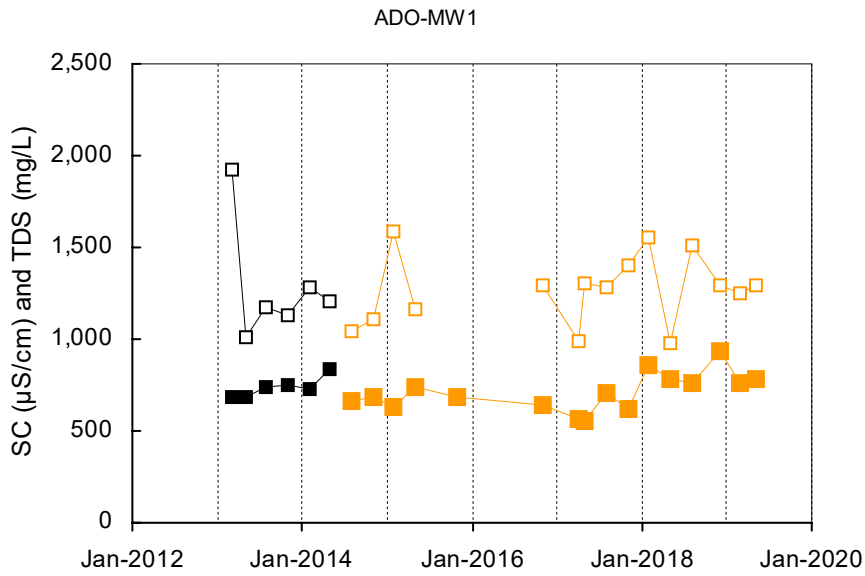

■ Total Dissolved Solids □ Specific Conductance

Shallow Well shown with black symbols

Deep Well shown with orange symbols

"dd" Well shown with blue symbols

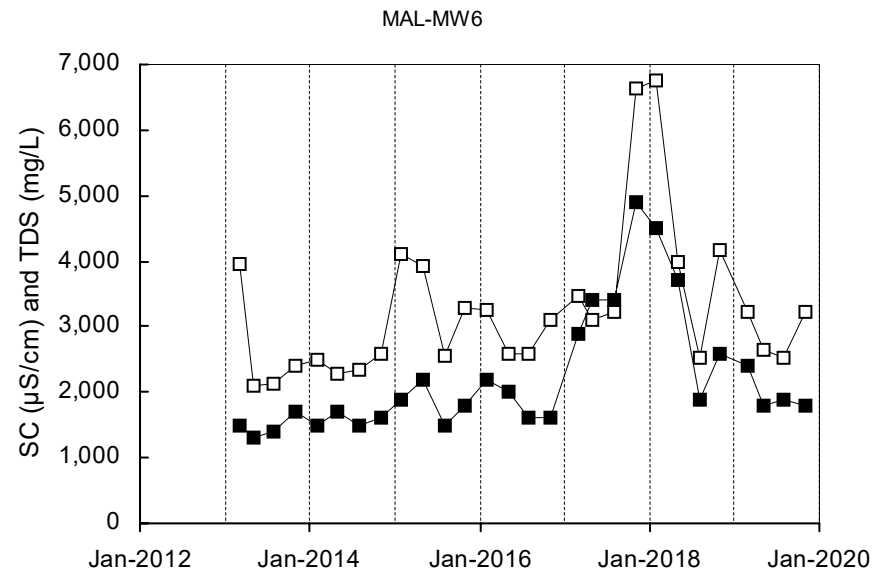
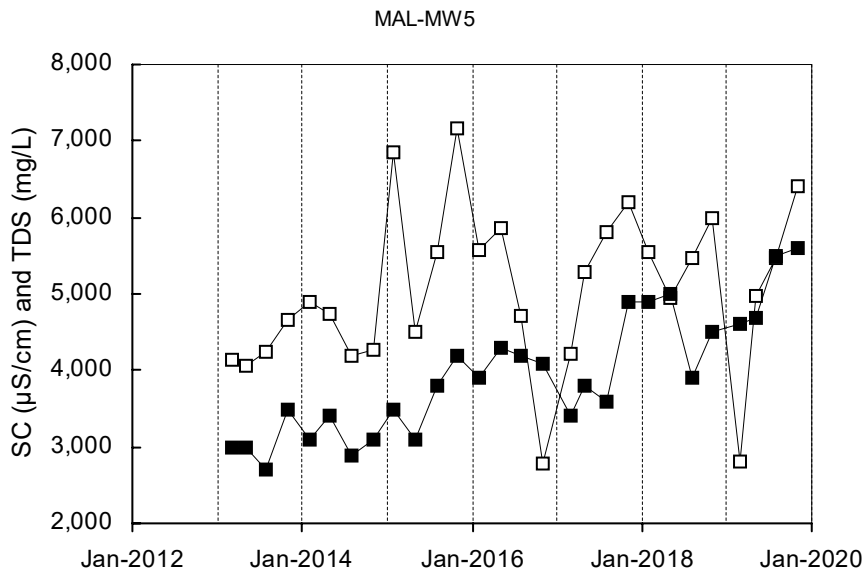
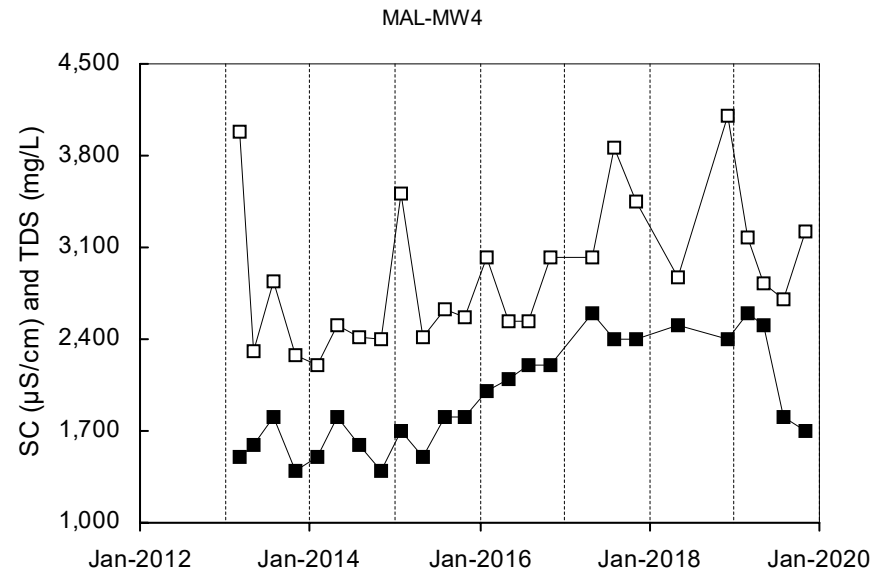
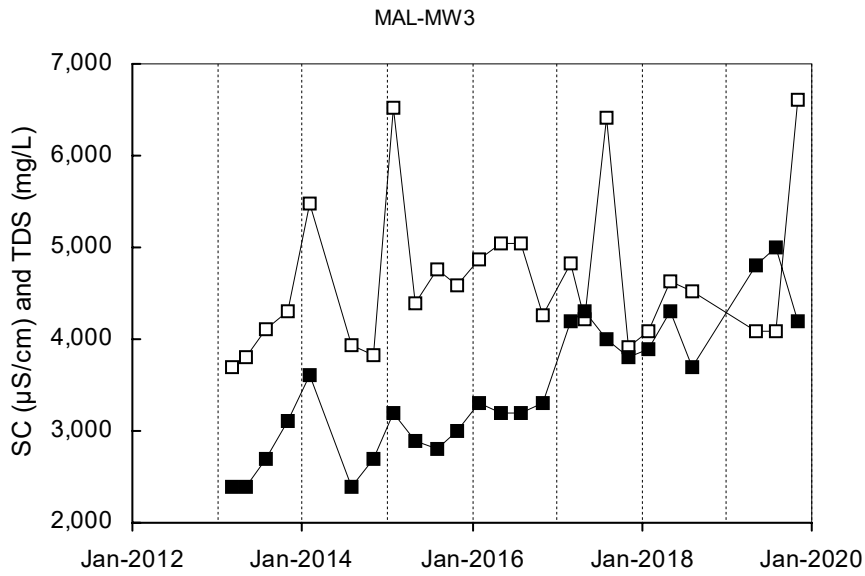

Total Dissolved Solids
 Specific Conductance
Shallow Well shown with black symbols
 Deep Well shown with orange symbols
 "dd" Well shown with blue symbols

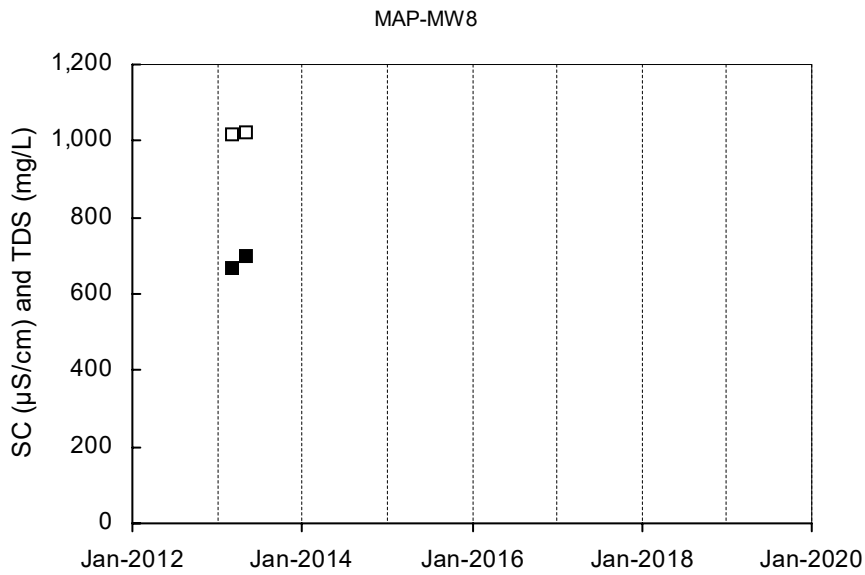
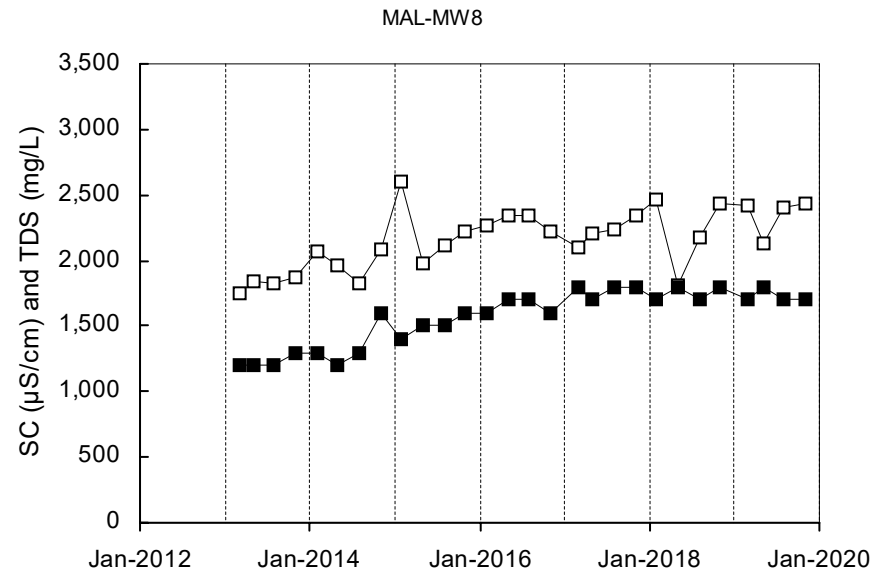
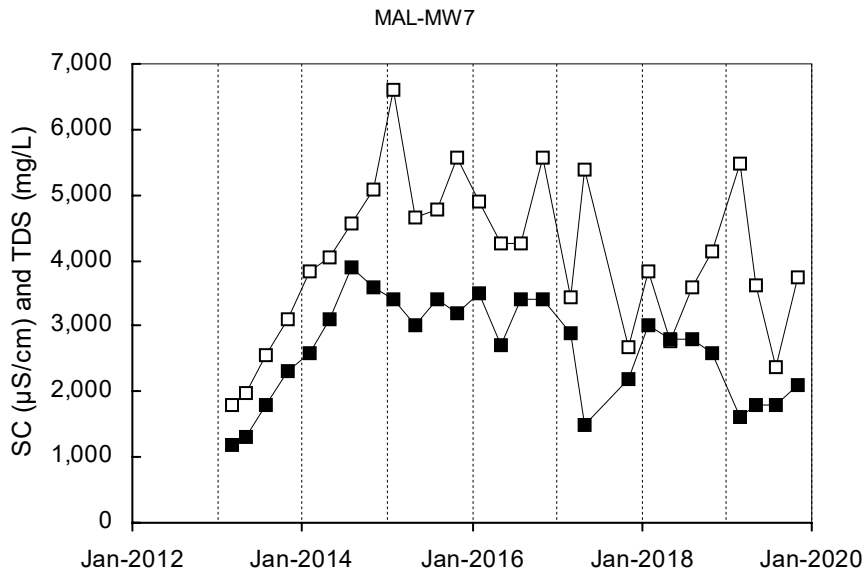

MAP-MW9

Not Sampled

■ Total Dissolved Solids □ Specific Conductance
 Shallow Well shown with black symbols Deep Well shown with orange symbols "dd" Well shown with blue symbols

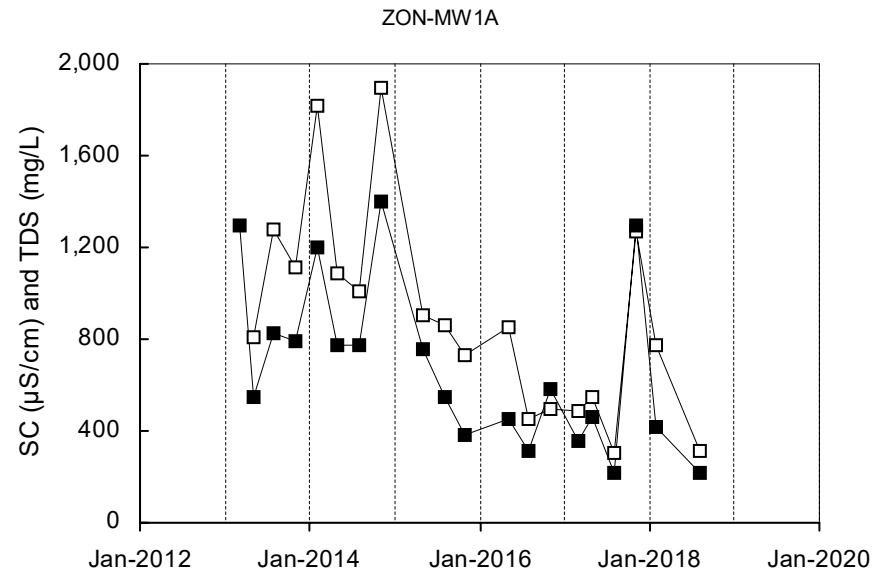
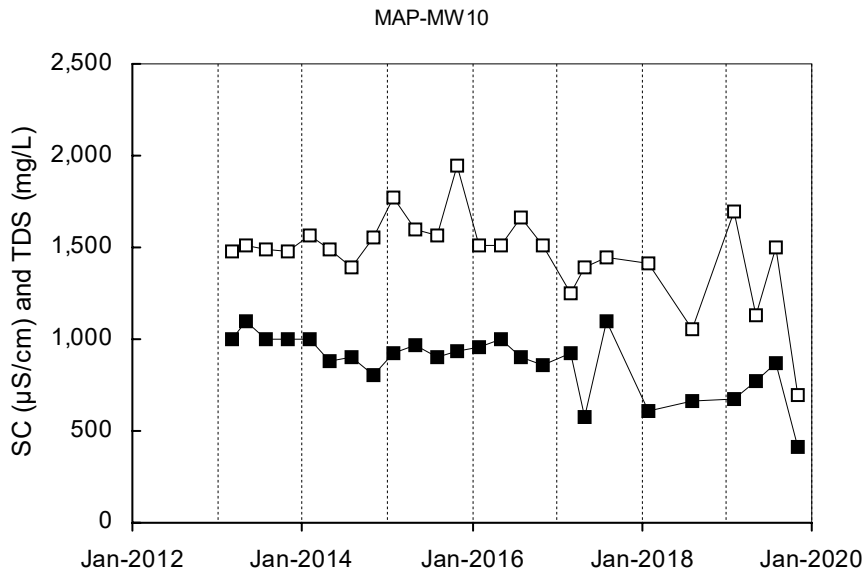

ZON-MW1B

Not Sampled

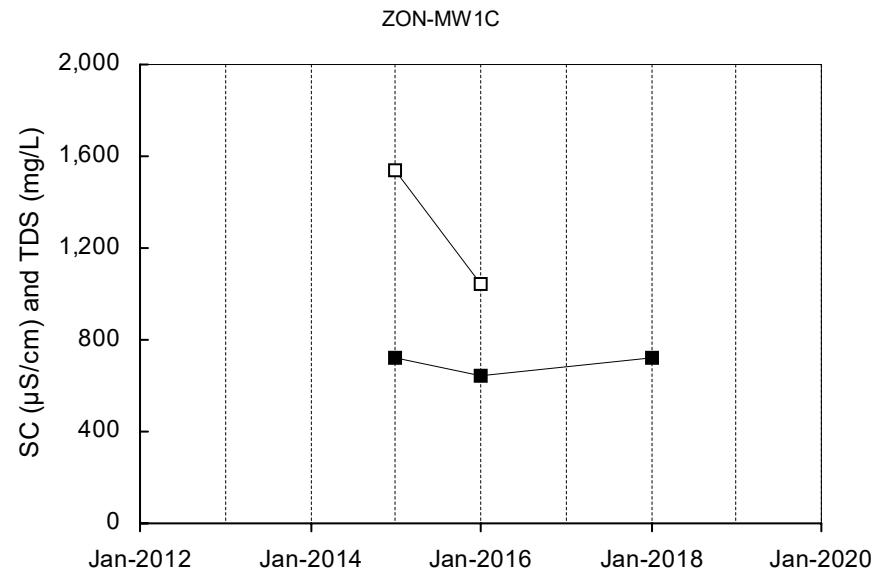

■ Total Dissolved Solids □ Specific Conductance
 Shallow Well shown with black symbols Deep Well shown with orange symbols "dd" Well shown with blue symbols

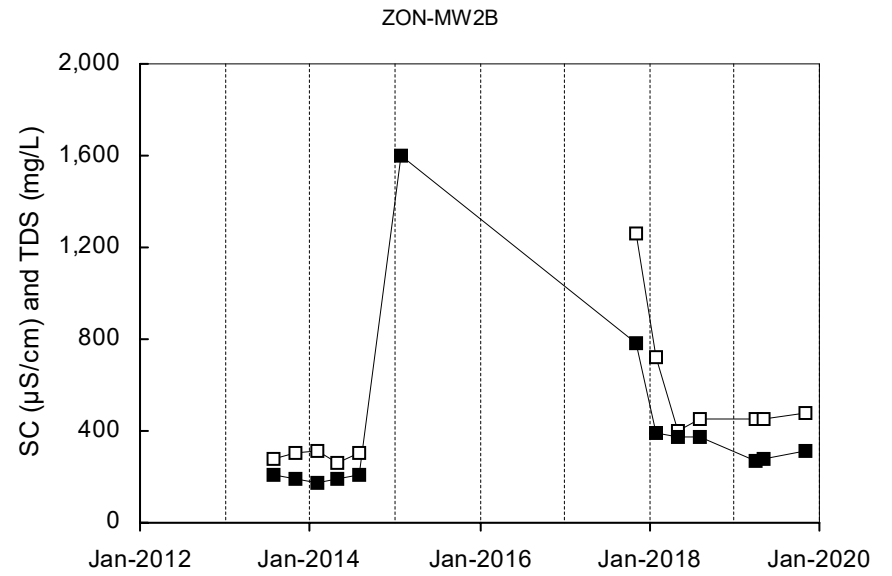
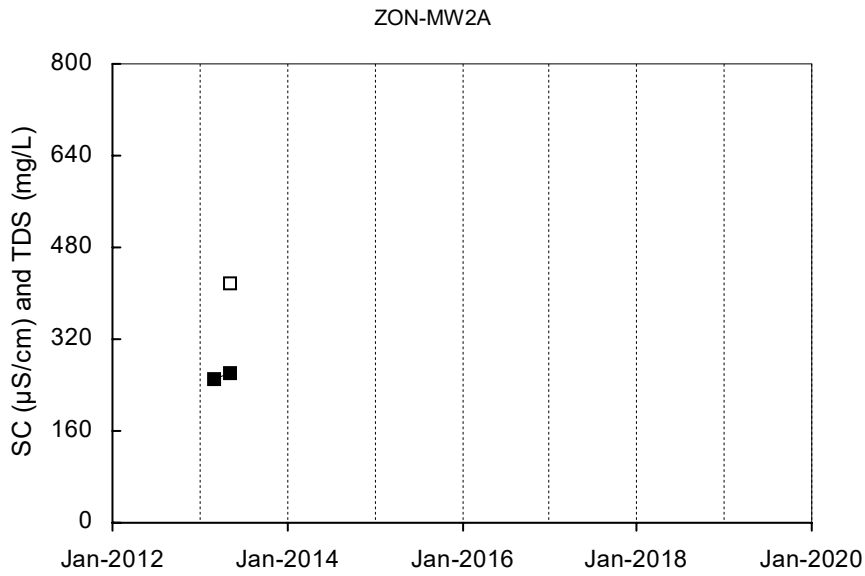

ZON-MW3A

Not Sampled

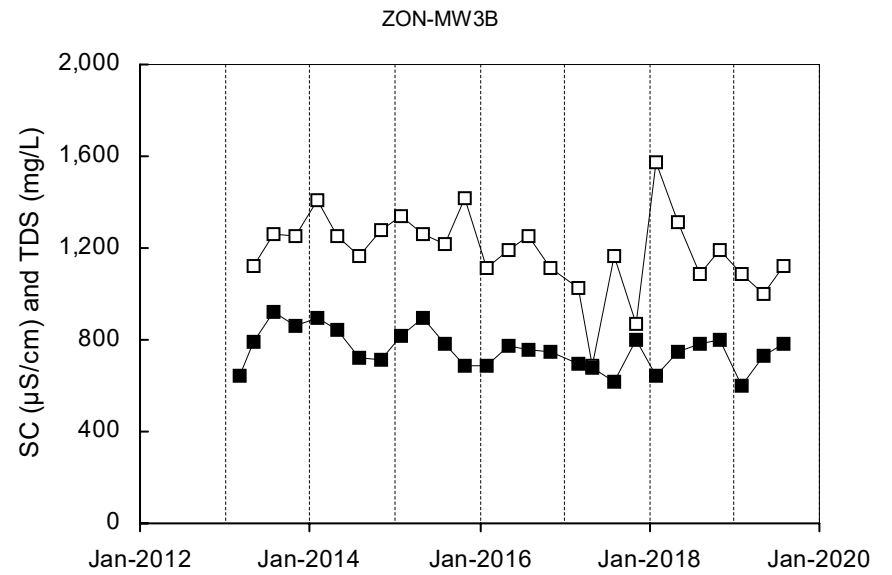

■ Total Dissolved Solids □ Specific Conductance

Shallow Well shown with black symbols

Deep Well shown with orange symbols

"dd" Well shown with blue symbols

ZON-MW4A

Not Sampled

ZON-MW4B

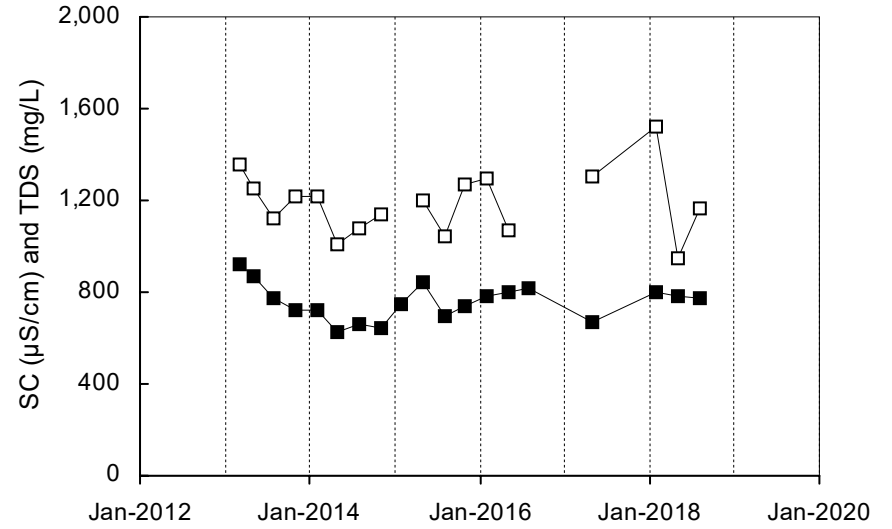

ZON-MW5A

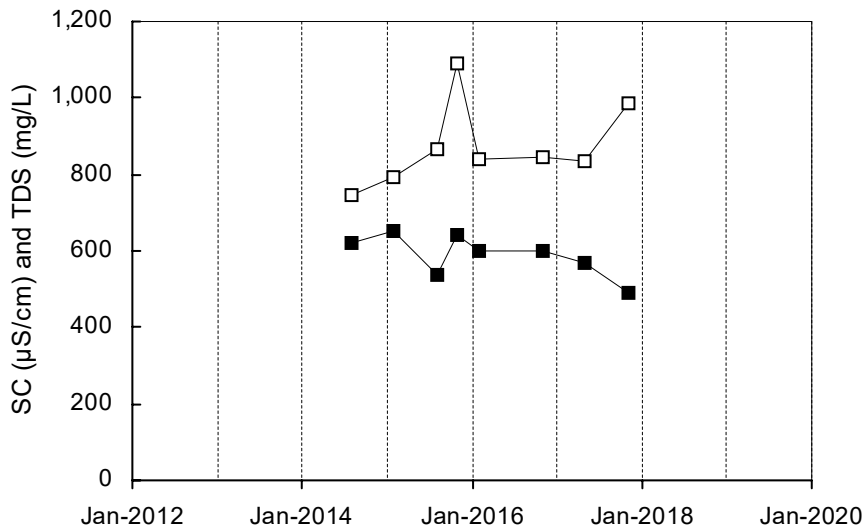

ZON-MW5B

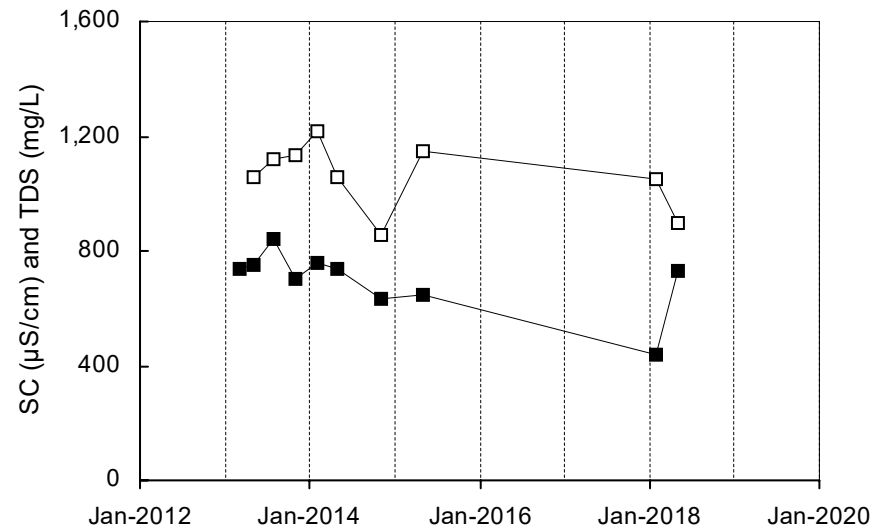

■ Total Dissolved Solids □ Specific Conductance

Shallow Well shown with black symbols

Deep Well shown with orange symbols

"dd" Well shown with blue symbols

ZON-MW7

Not Sampled

RIC-MW1

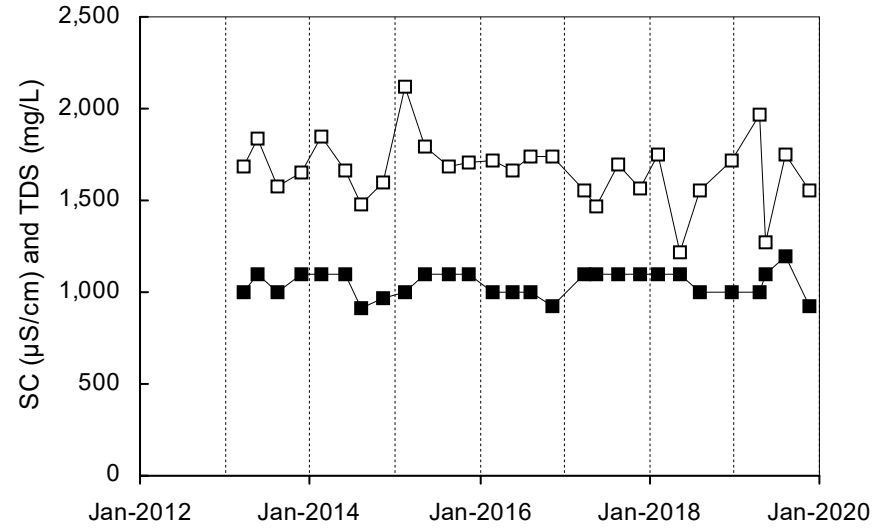

RIC-MW2

Not Sampled

RIC-MW3

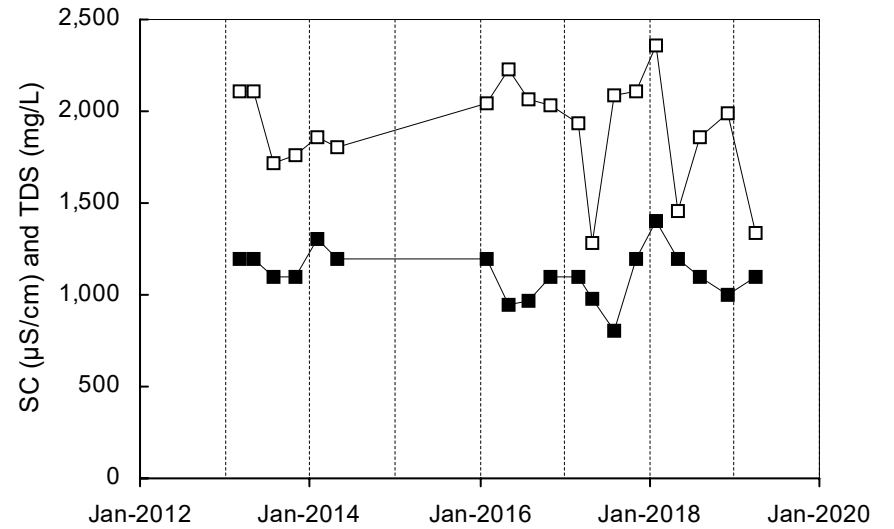

■ Total Dissolved Solids □ Specific Conductance

Shallow Well shown with black symbols

Deep Well shown with orange symbols

"dd" Well shown with blue symbols

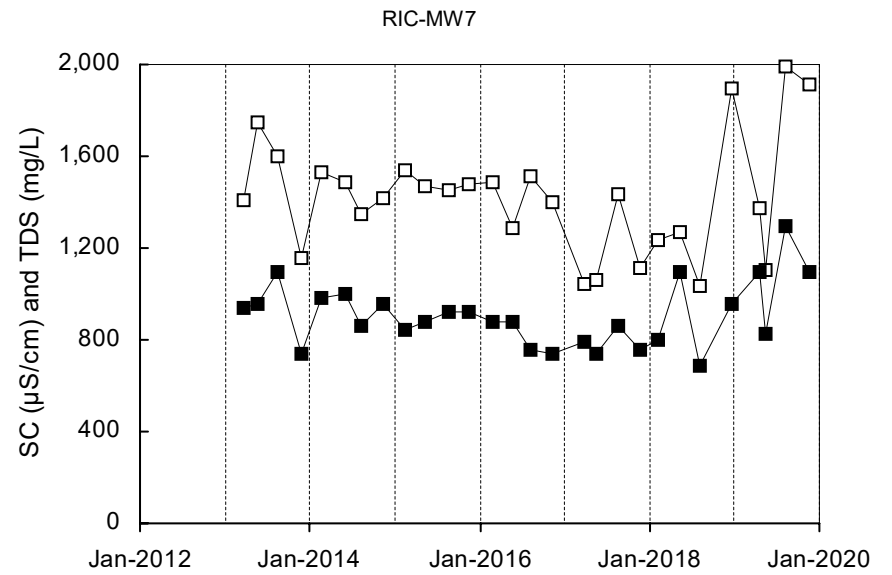
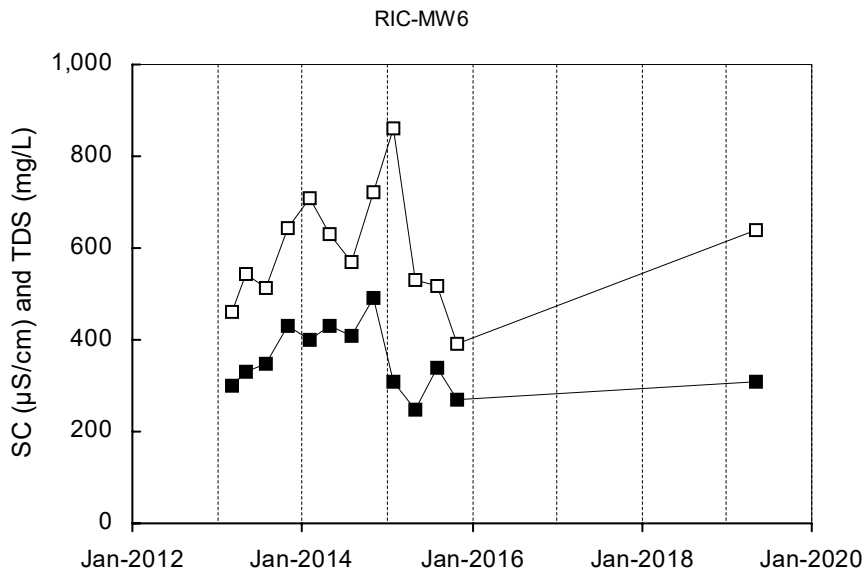
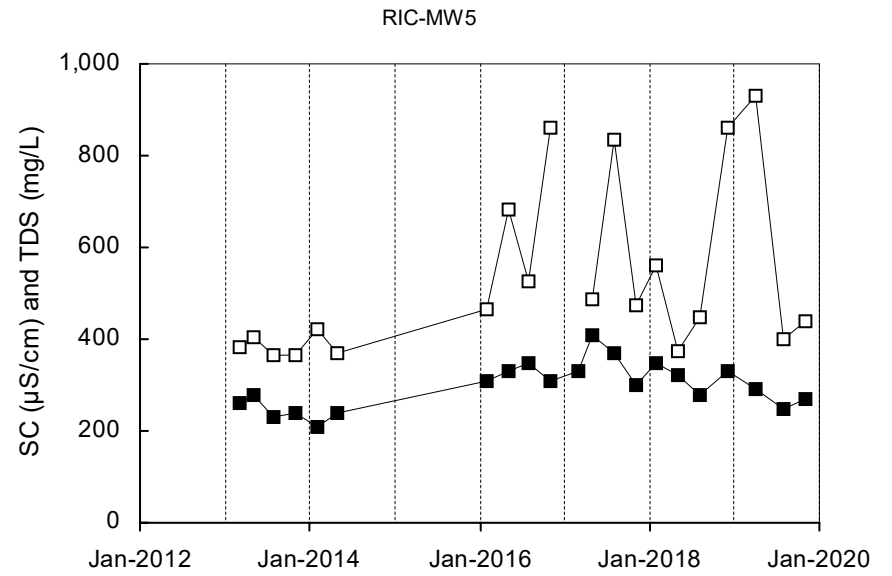
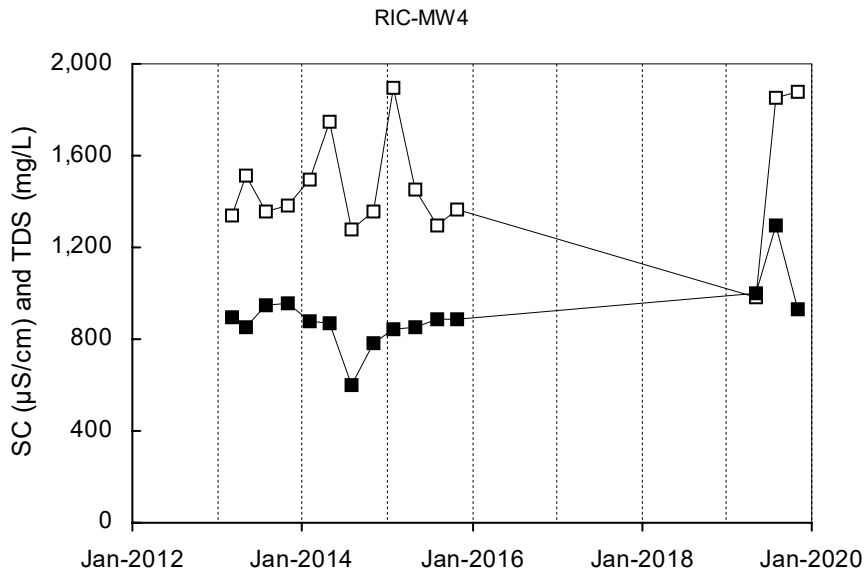

Total Dissolved Solids
 Specific Conductance
 Shallow Well shown with black symbols
 Deep Well shown with orange symbols
 "dd" Well shown with blue symbols

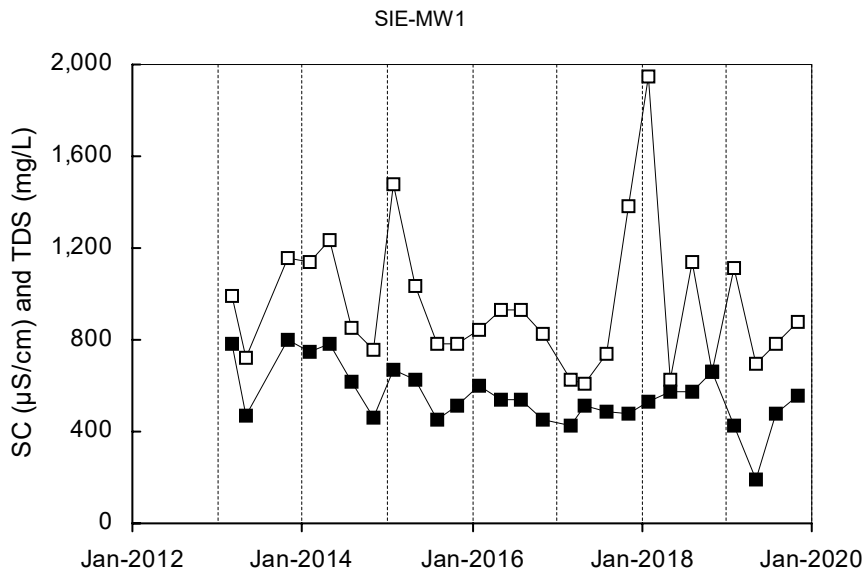
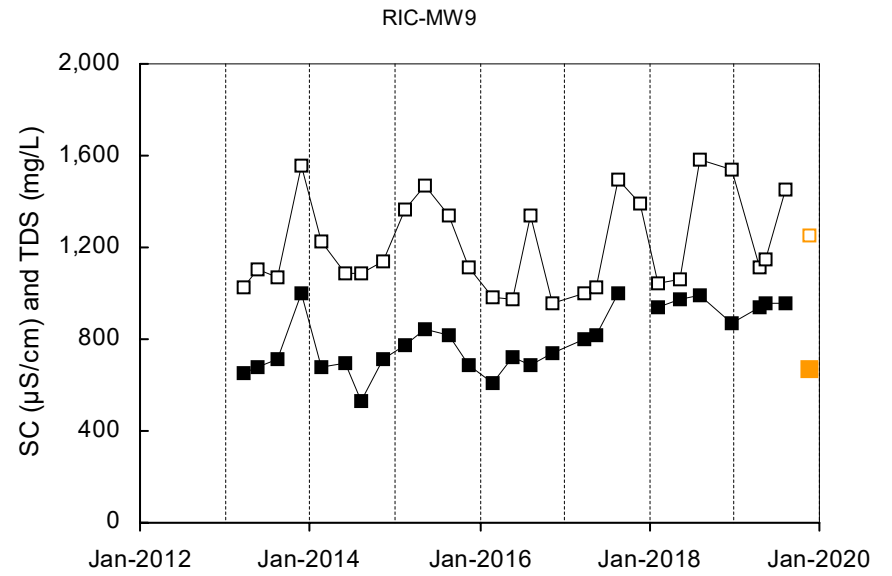
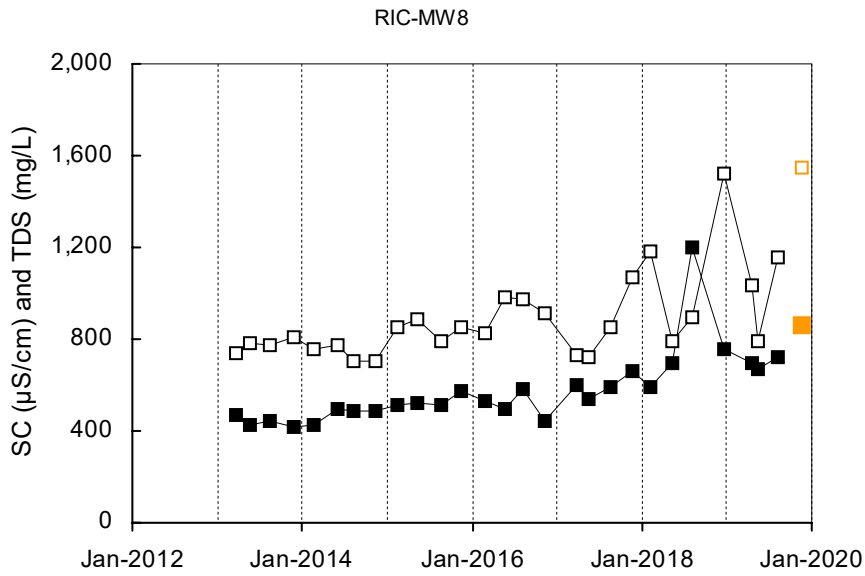

SIE-MW2

Not Sampled

■ Total Dissolved Solids □ Specific Conductance

Shallow Well shown with black symbols

Deep Well shown with orange symbols

"dd" Well shown with blue symbols

SIE-MW3

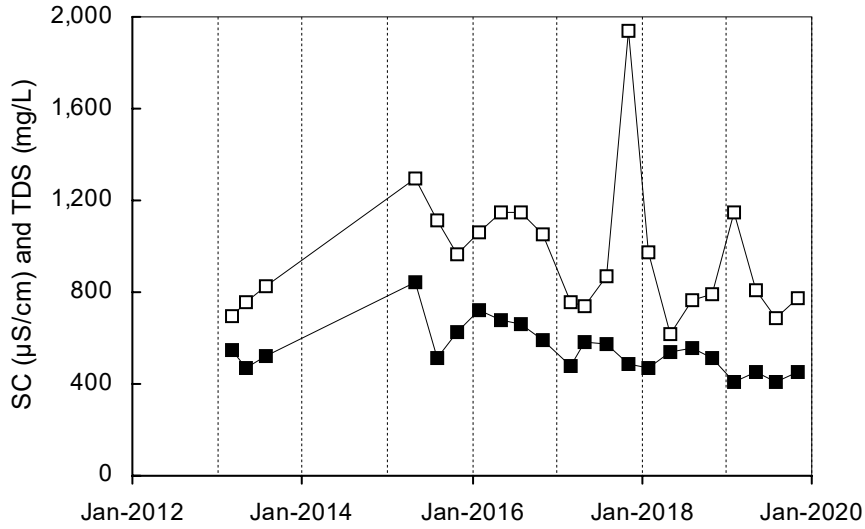

SIE-MW4

Not Sampled

SO2-MW1

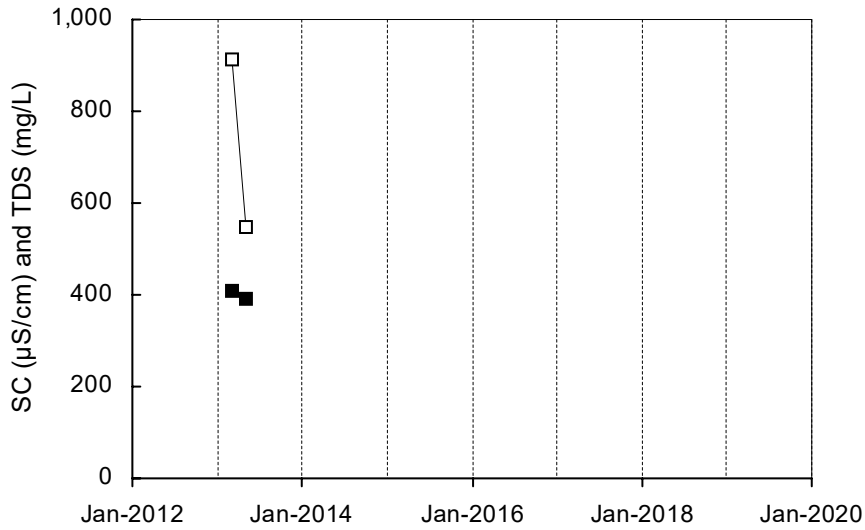

SO2-MW2

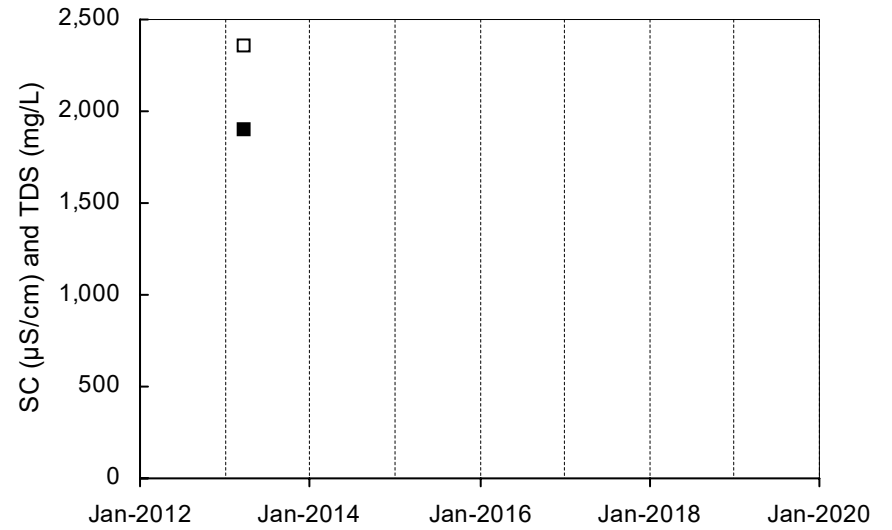

■ Total Dissolved Solids □ Specific Conductance

Shallow Well shown with black symbols

Deep Well shown with orange symbols

"dd" Well shown with blue symbols

SO2-MW3

Not Sampled

SO2-MW4

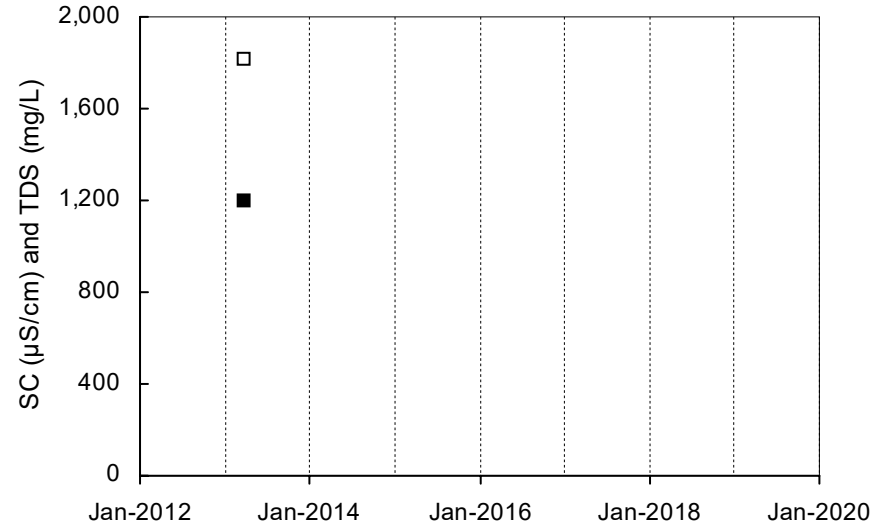

SO2-MW5

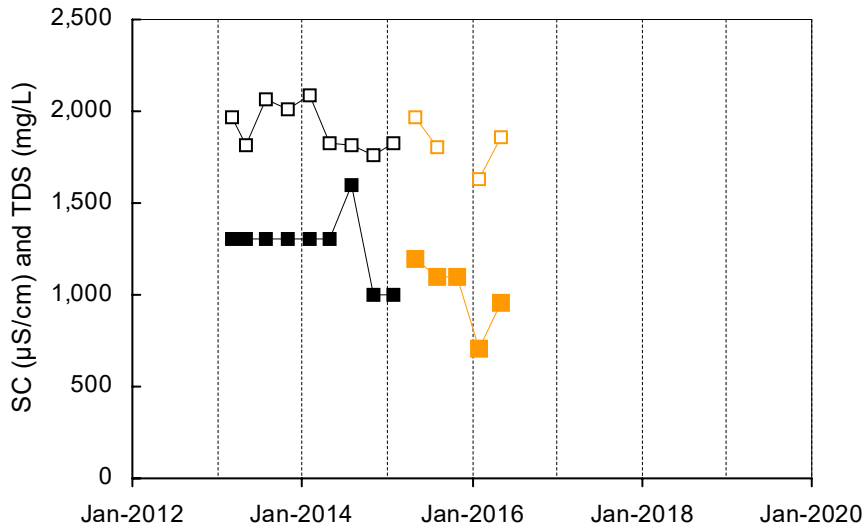

SO2-MW6

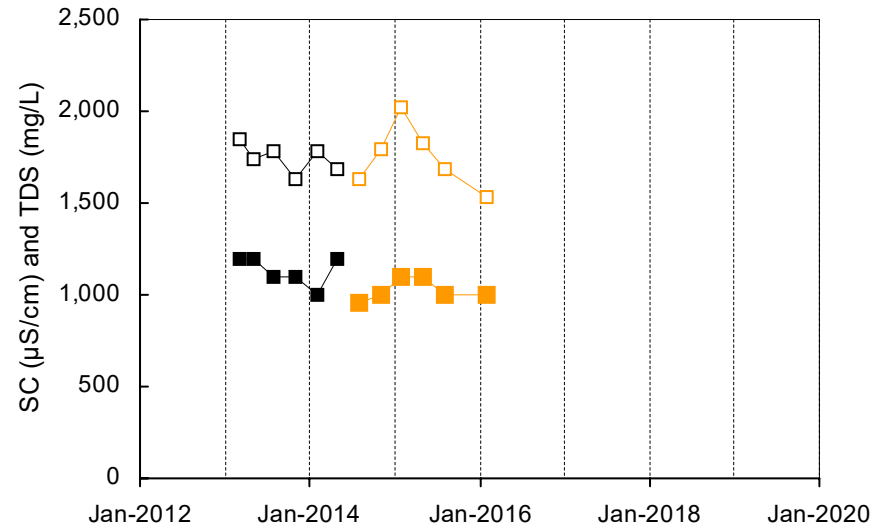

Total Dissolved Solids
 Specific Conductance
 Shallow Well shown with black symbols
 Deep Well shown with orange symbols
 "dd" Well shown with blue symbols

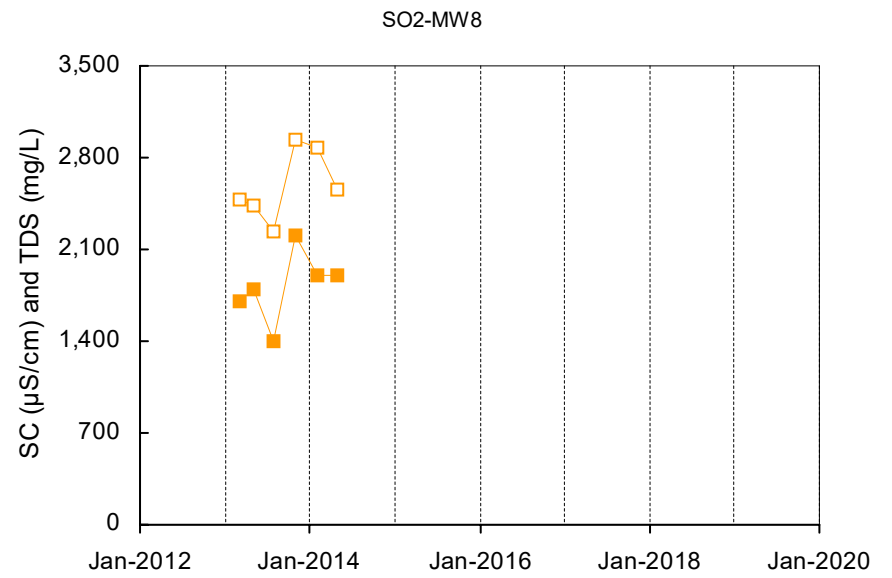
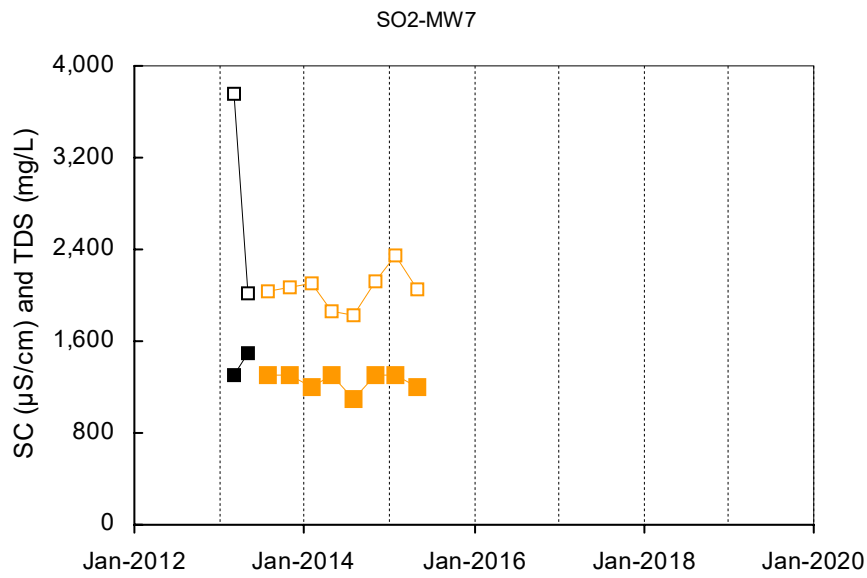

SOJ-MW1

Not Sampled

SOJ-MW2

Not Sampled

■ Total Dissolved Solids □ Specific Conductance

Shallow Well shown with black symbols

Deep Well shown with orange symbols

"dd" Well shown with blue symbols

SOJ-MW3

Not Sampled

SOJ-MW4

Not Sampled

SOJ-MW5

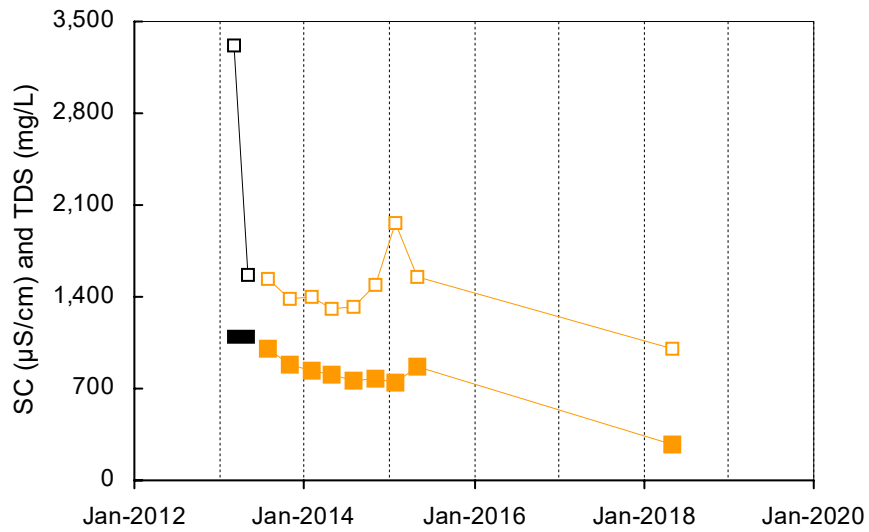

SOJ-MW6

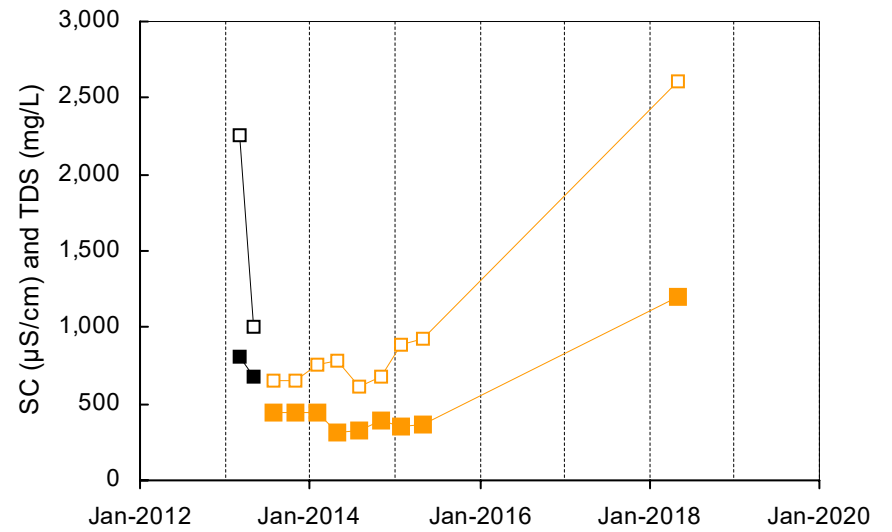

■ Total Dissolved Solids □ Specific Conductance

Shallow Well shown with black symbols

Deep Well shown with orange symbols

"dd" Well shown with blue symbols

Attachment A8

Nitrogen Components Concentrations in Groundwater, Time Series Plots

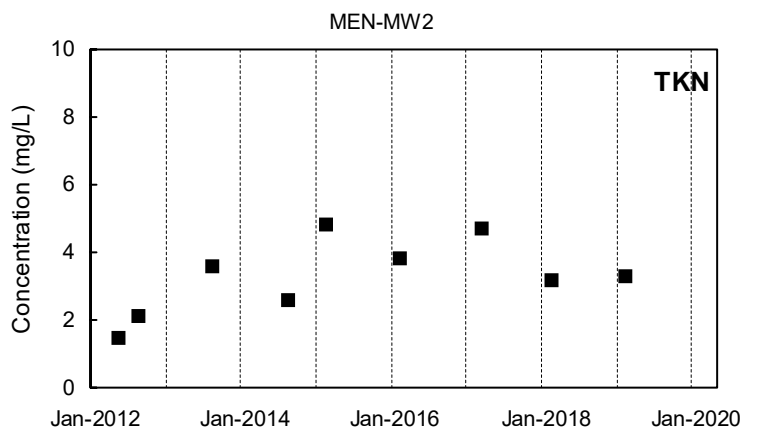
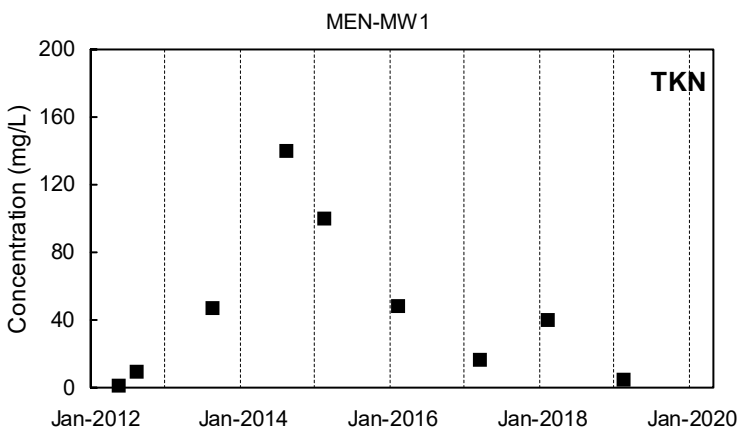
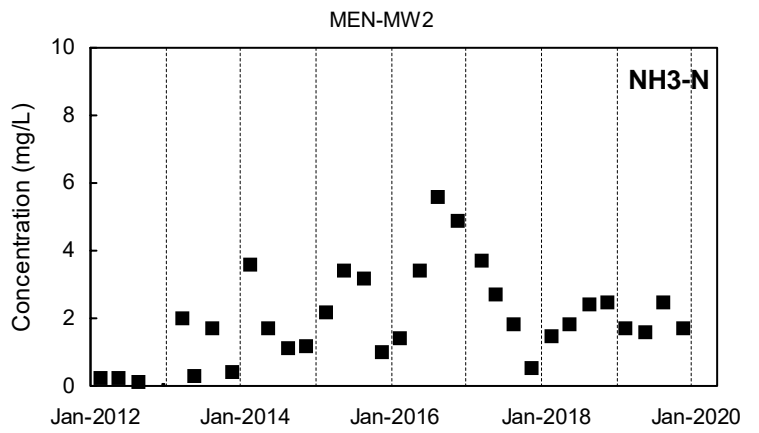
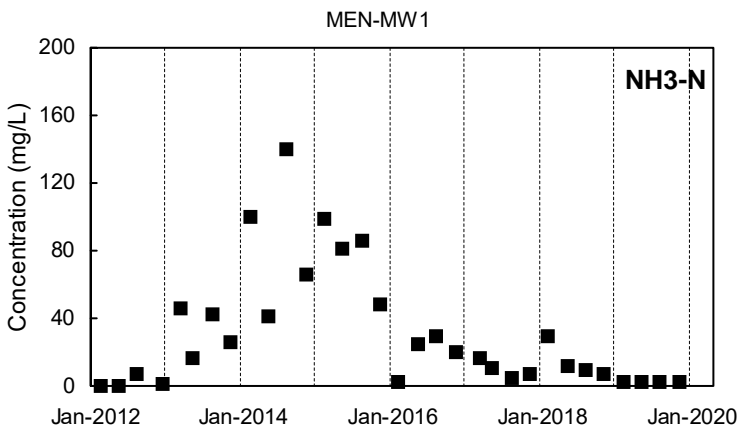
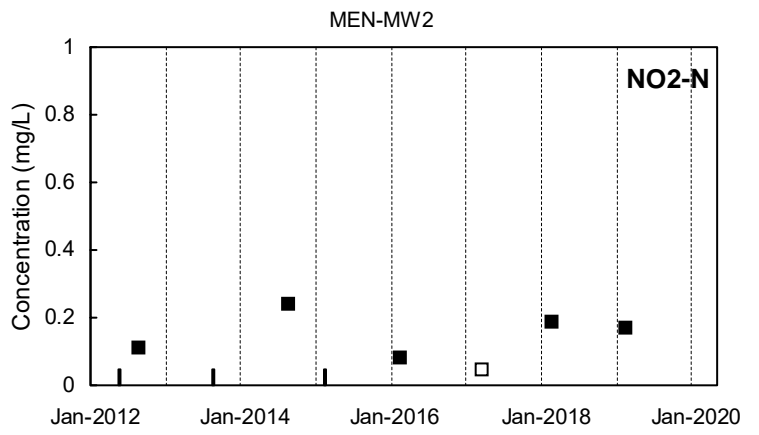
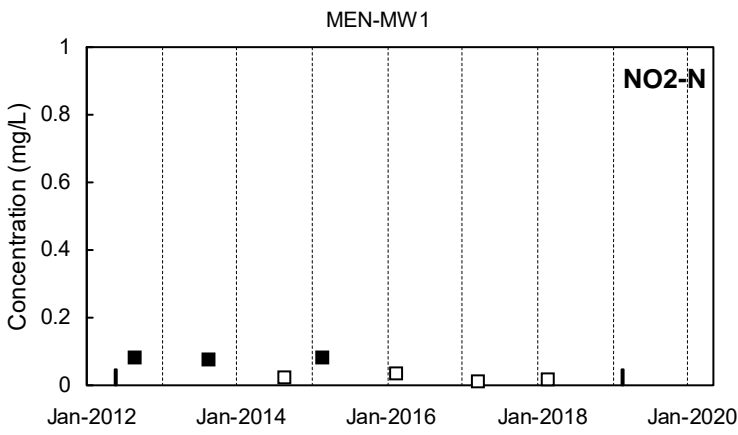
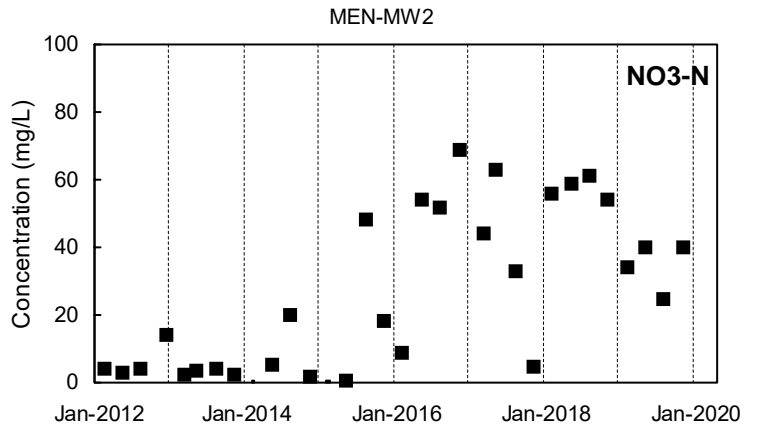
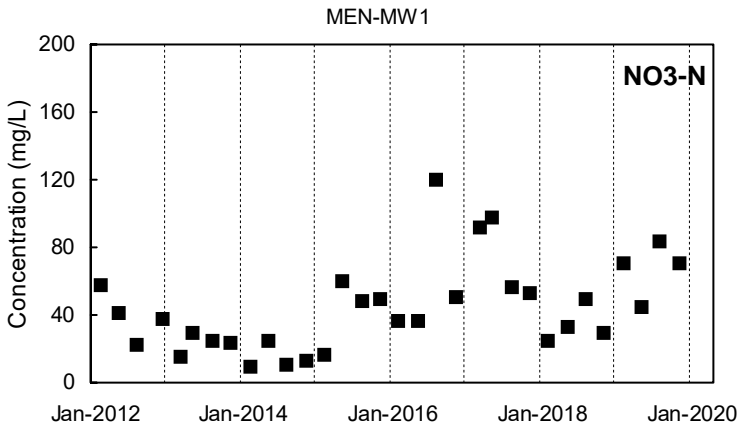

Detected Value
 'J'-Flag (value between reporting limit and detection limit)
 Non-Detect Range
 Shallow Well shown with black symbols
 Deep Well shown with orange symbols
 "dd" Well shown with blue symbols

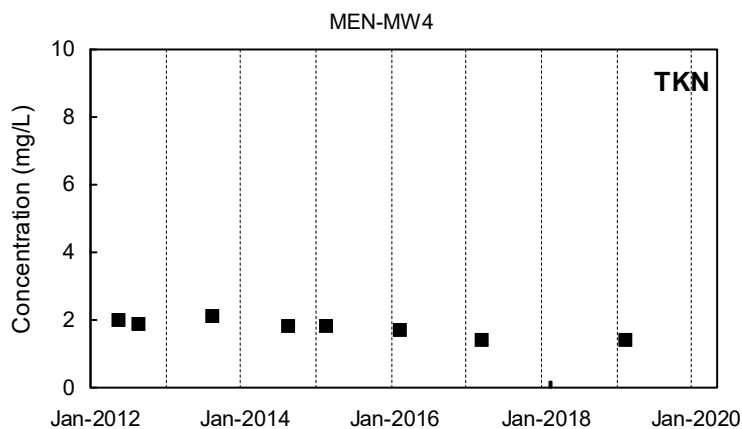
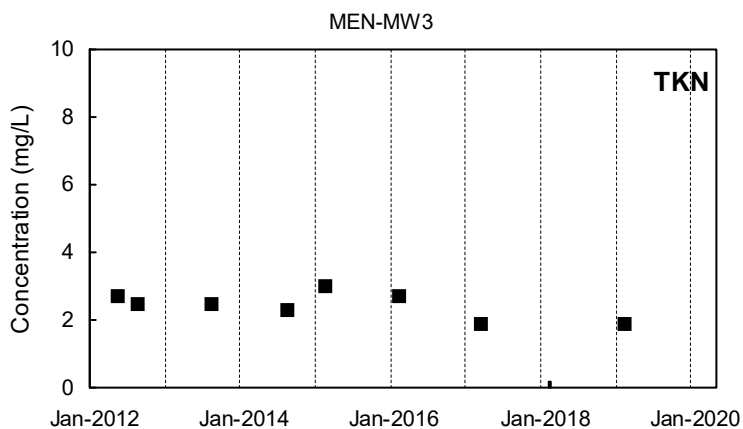
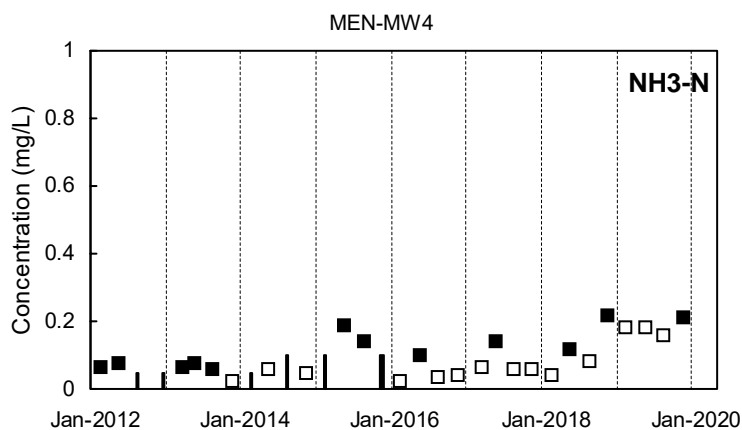
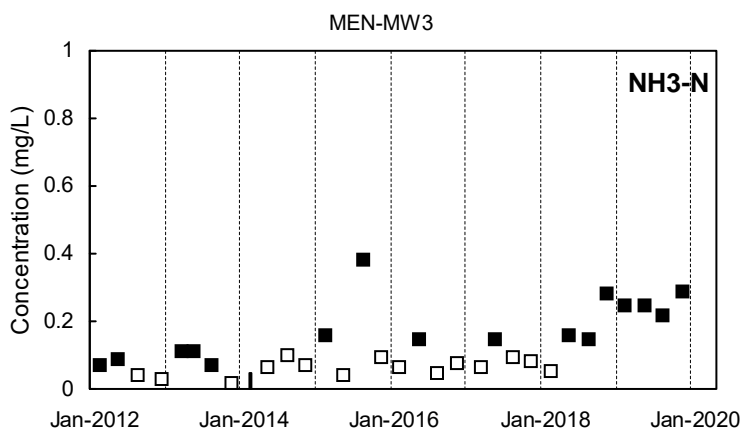
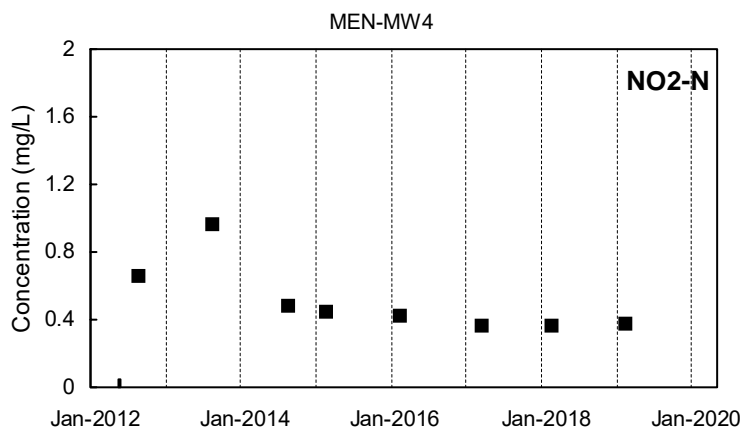
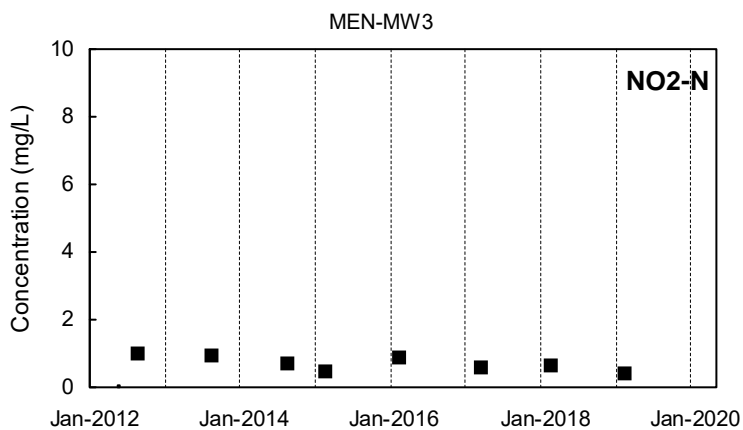
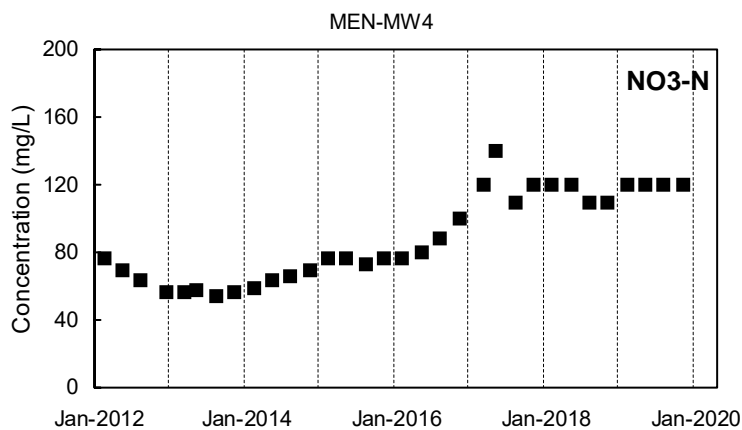
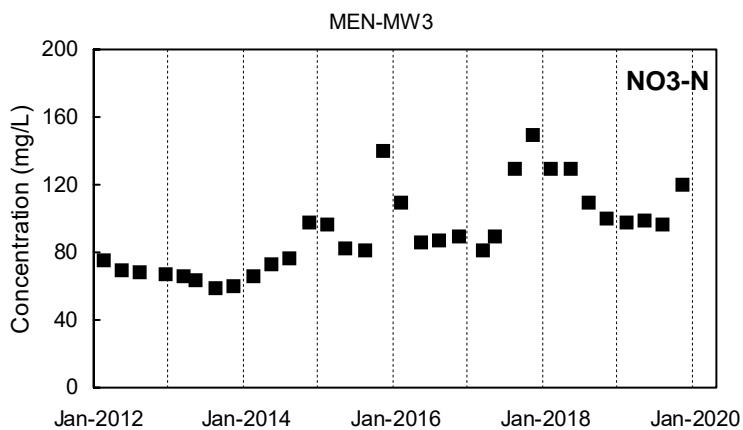

Detected Value
 'J'-Flag (value between reporting limit and detection limit)
 Non-Detect Range
 Shallow Well shown with black symbols
 Deep Well shown with orange symbols
 "dd" Well shown with blue symbols

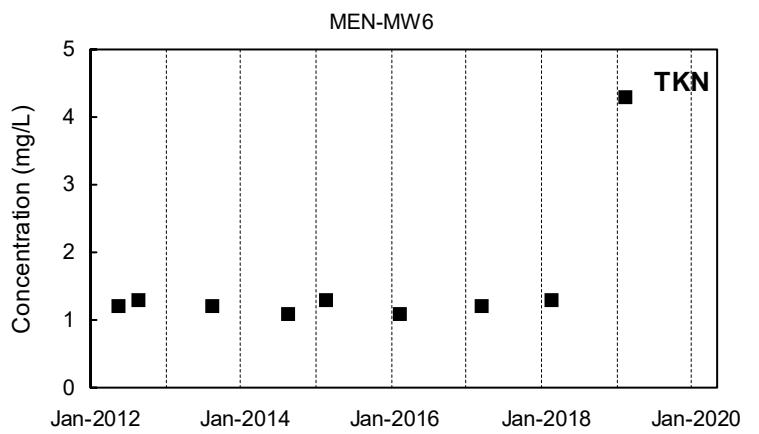
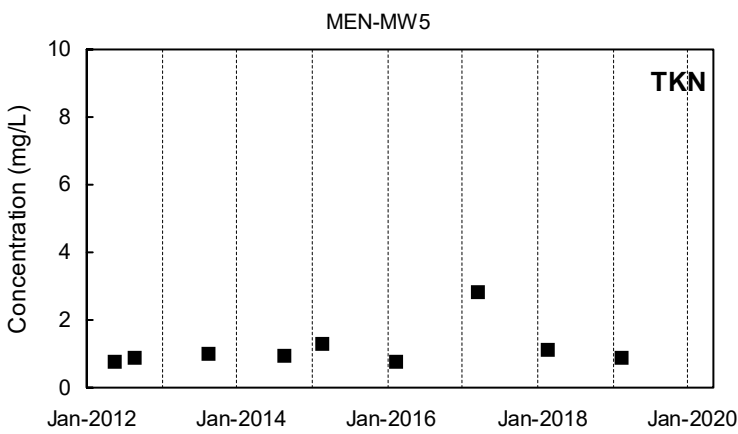
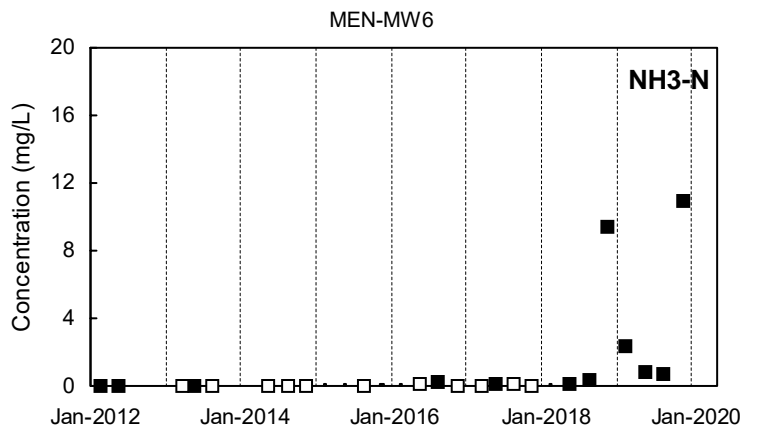
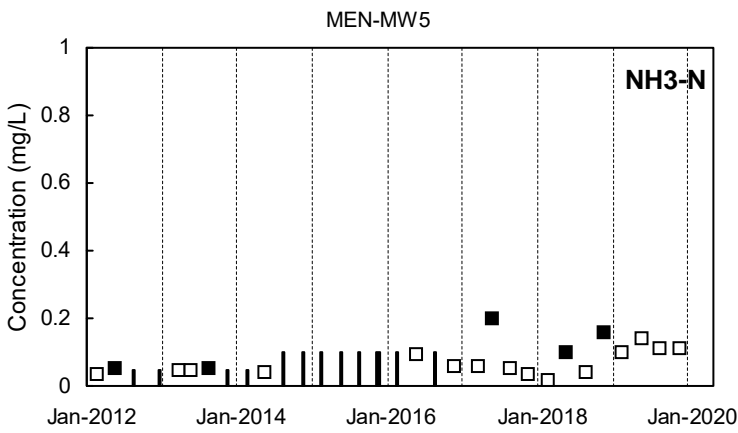
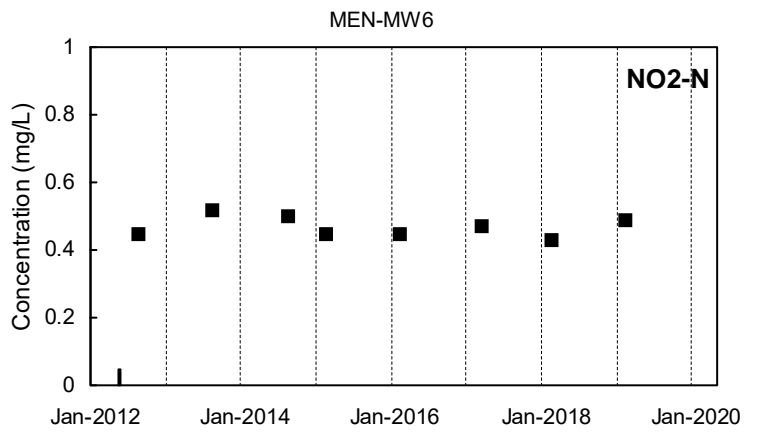
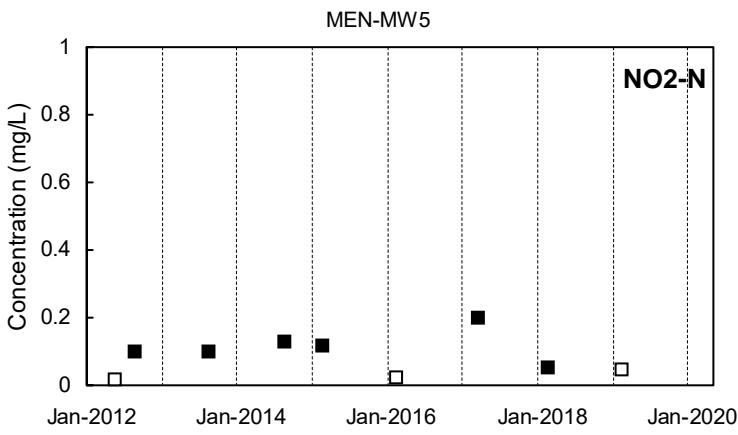
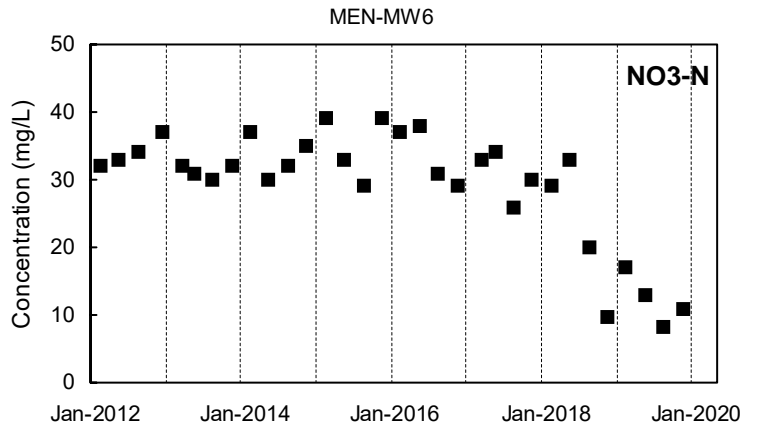
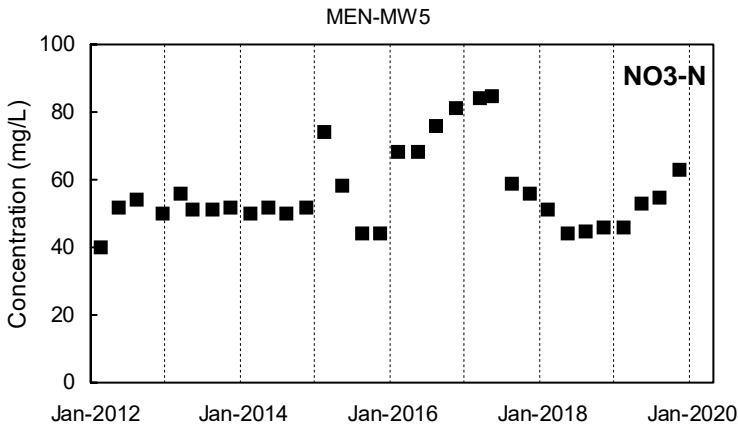

Detected Value
 'J'-Flag (value between reporting limit and detection limit)
 Non-Detect Range
 Shallow Well shown with black symbols
 Deep Well shown with orange symbols
 "dd" Well shown with blue symbols

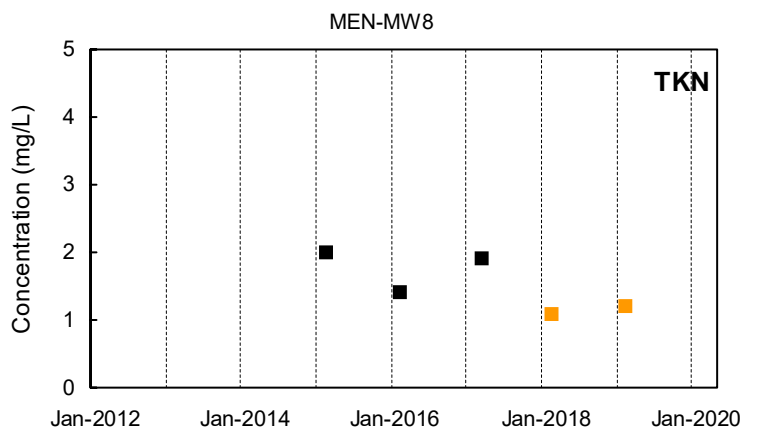
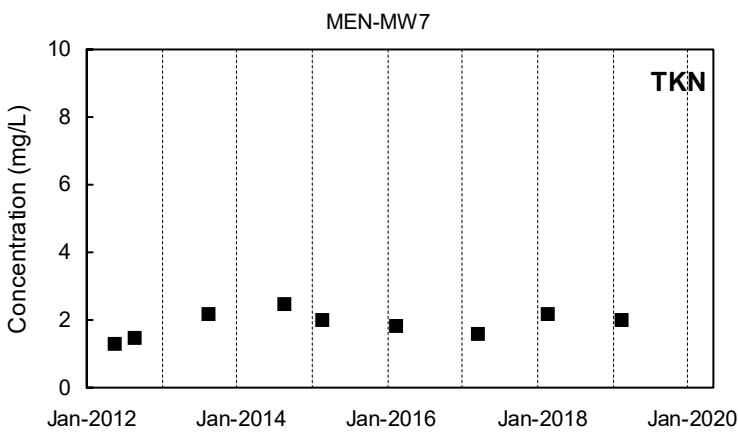
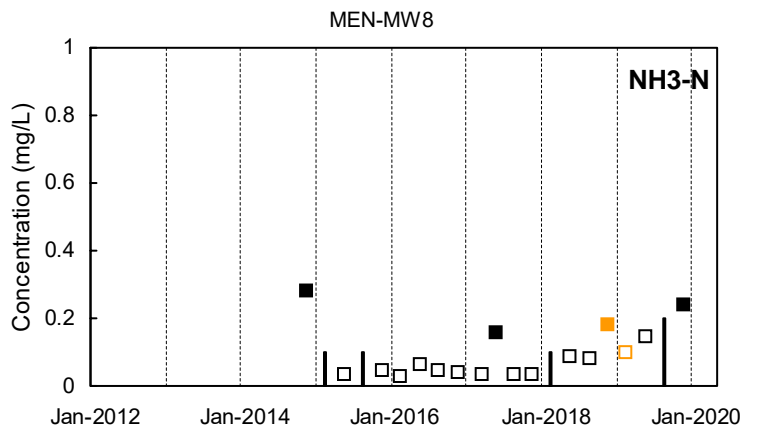
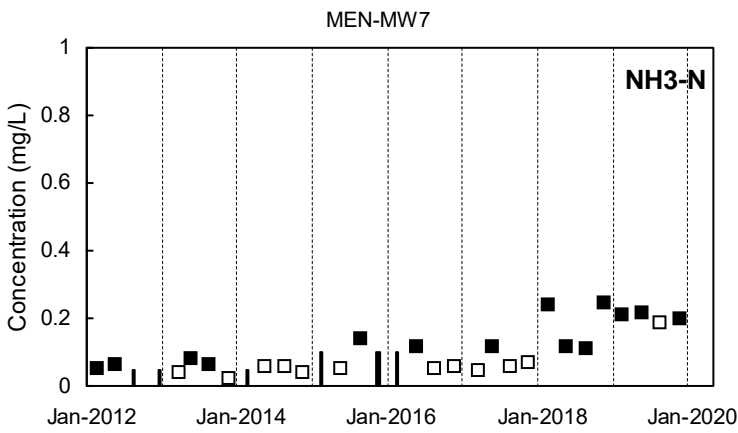
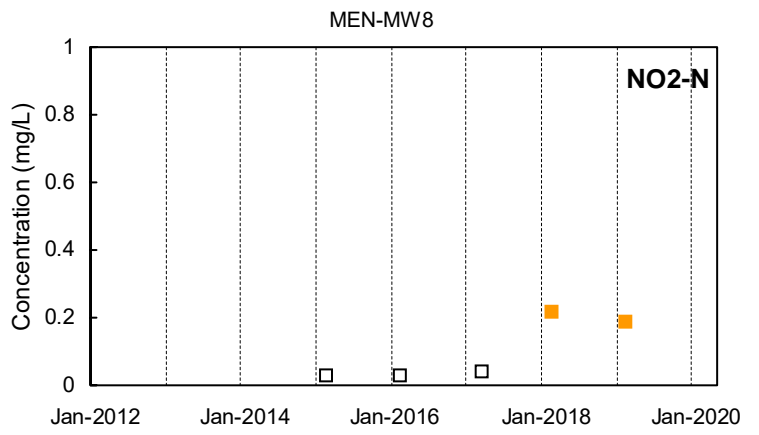
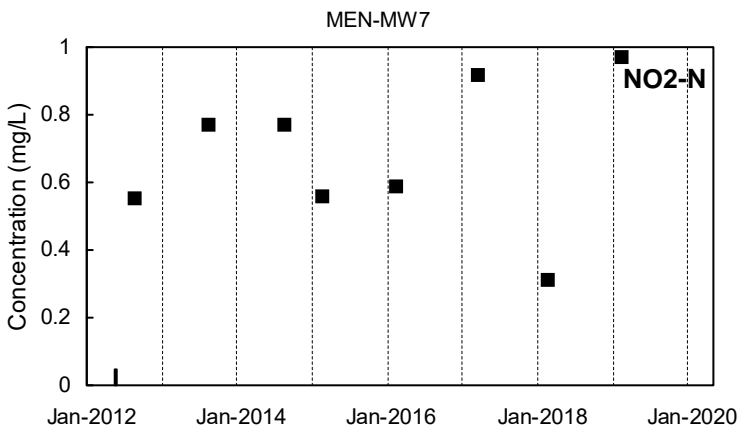
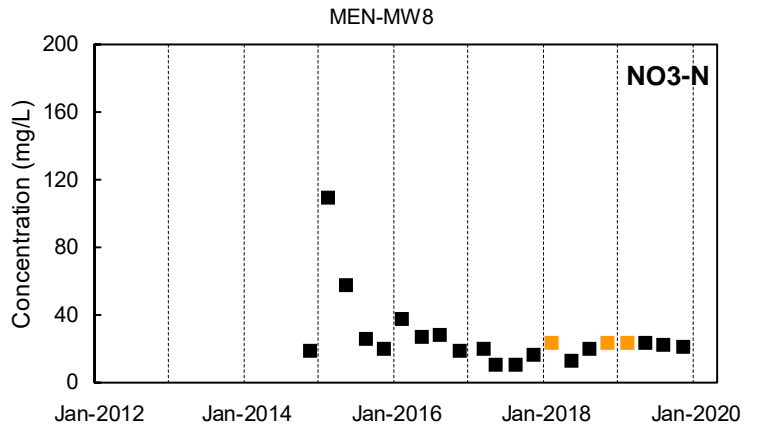
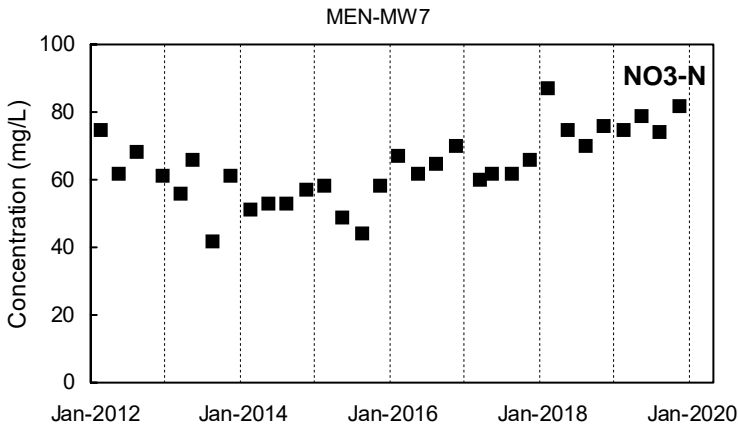

Detected Value
 'J'-Flag (value between reporting limit and detection limit)
 Non-Detect Range
 Shallow Well shown with black symbols
 Deep Well shown with orange symbols
 "dd" Well shown with blue symbols

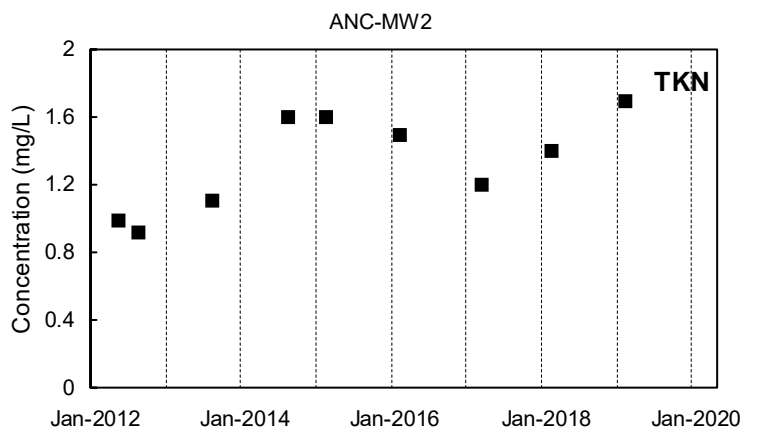
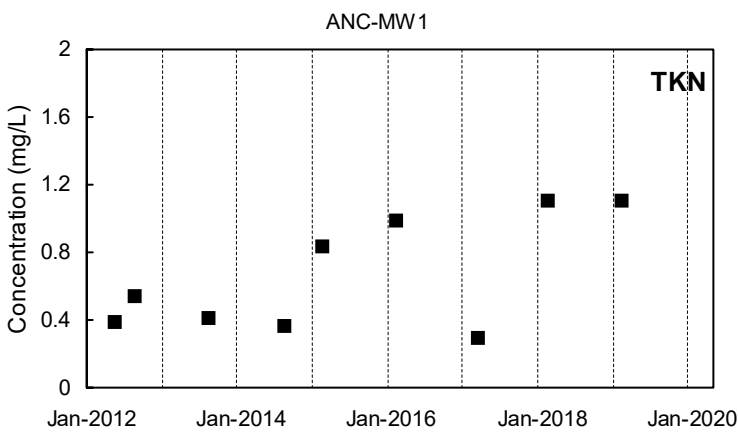
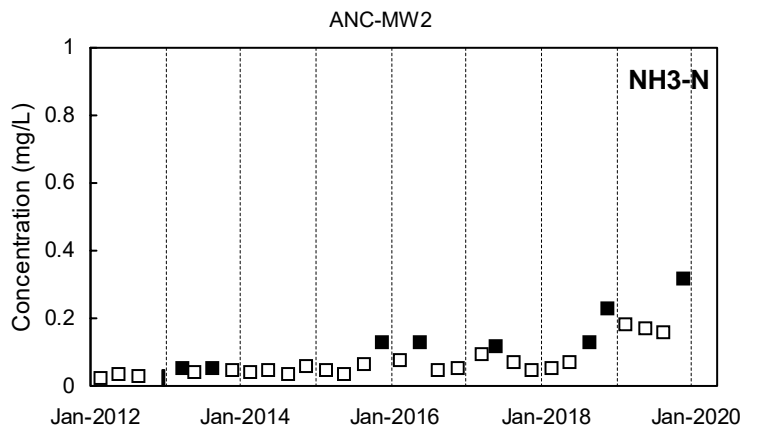
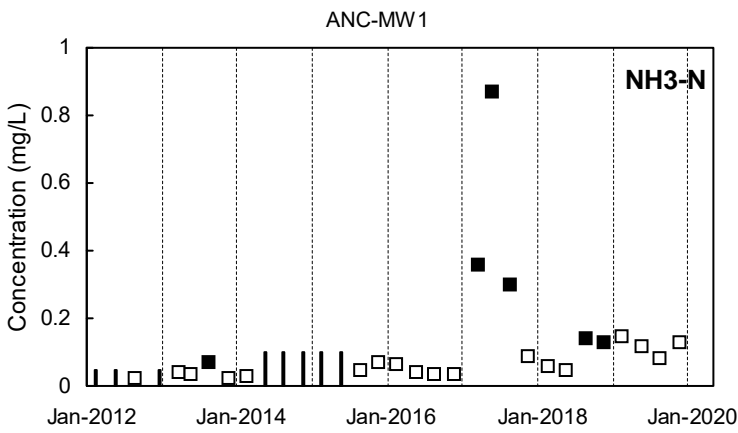
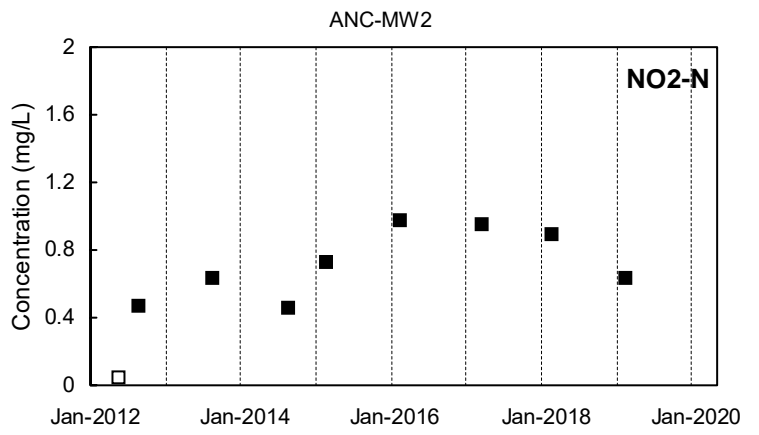
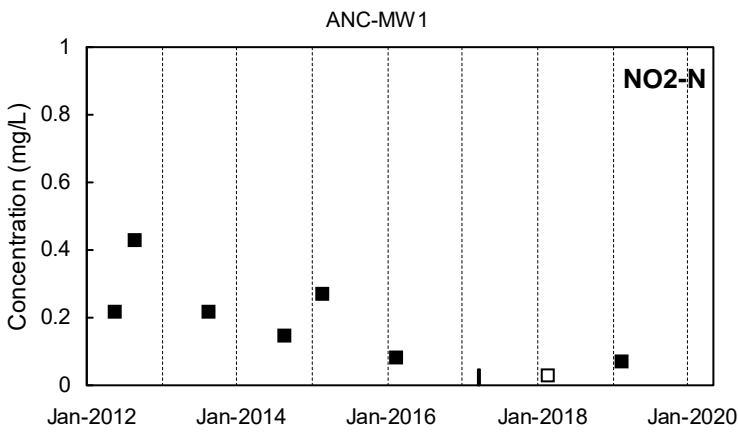
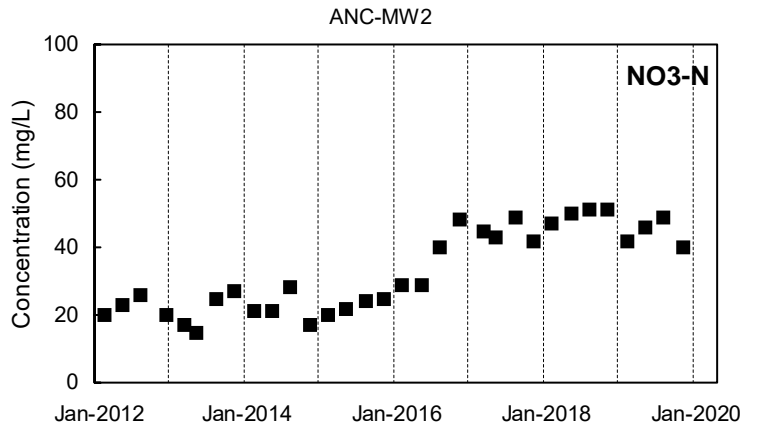
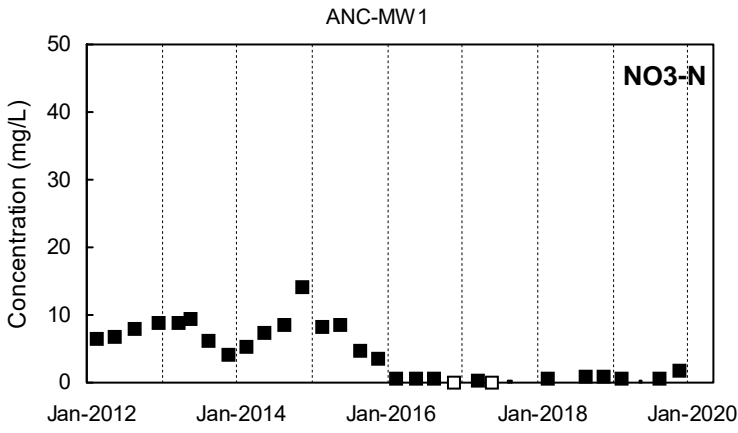

Detected Value
 'J'-Flag (value between reporting limit and detection limit)
 Non-Detect Range
 Shallow Well shown with black symbols
 Deep Well shown with orange symbols
 "dd" Well shown with blue symbols

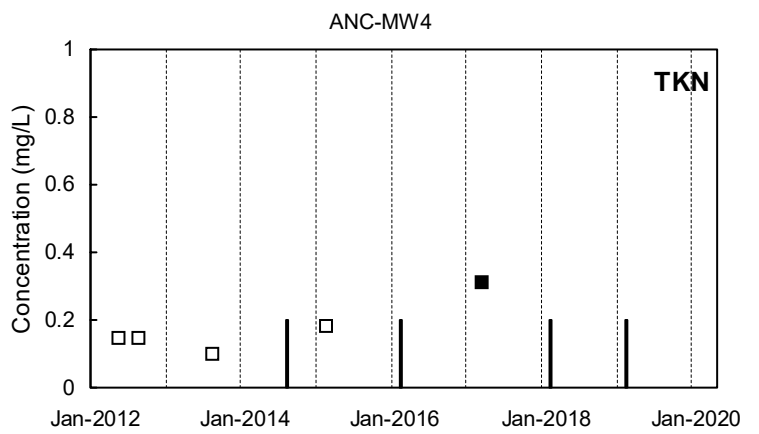
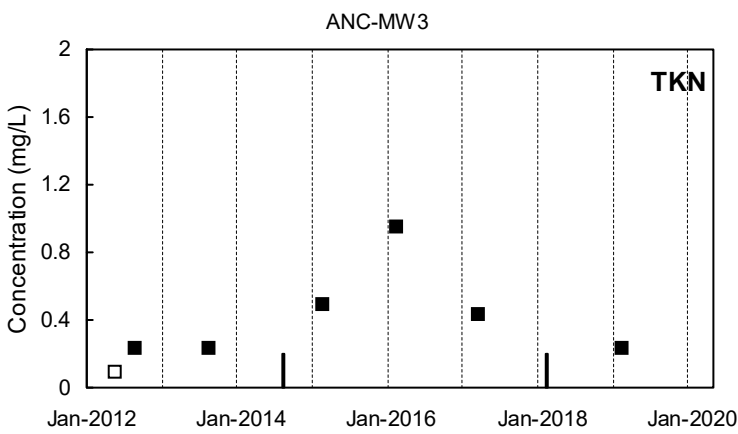
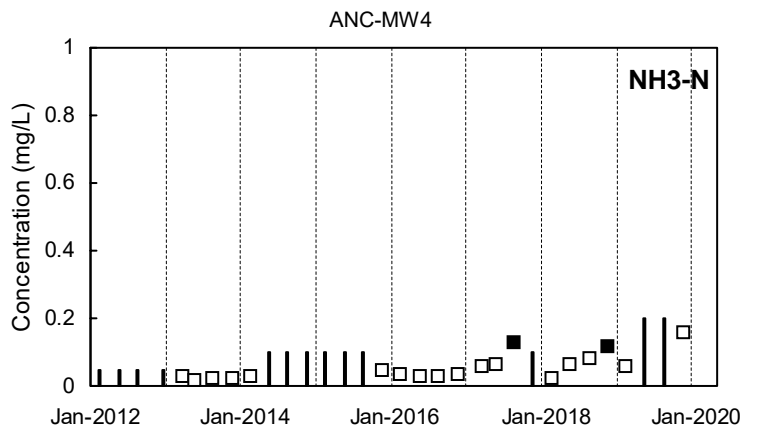
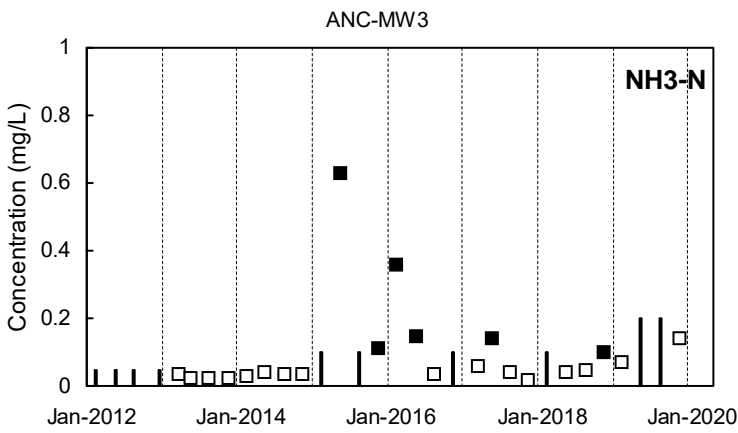
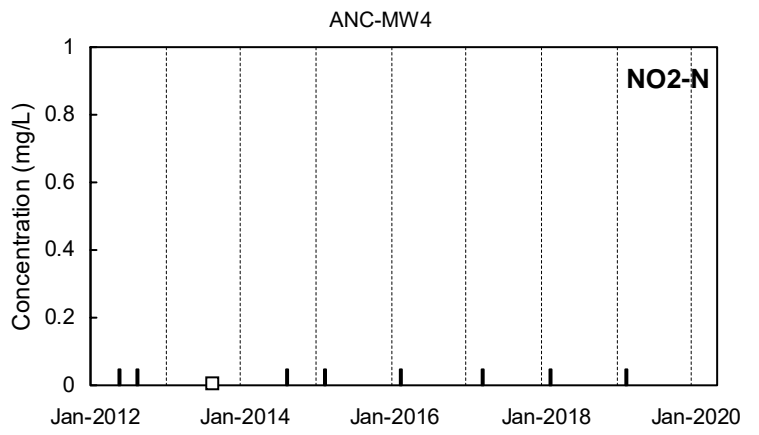
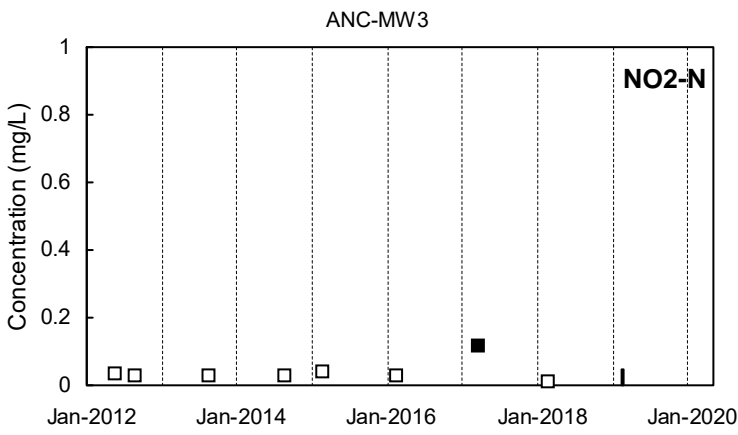
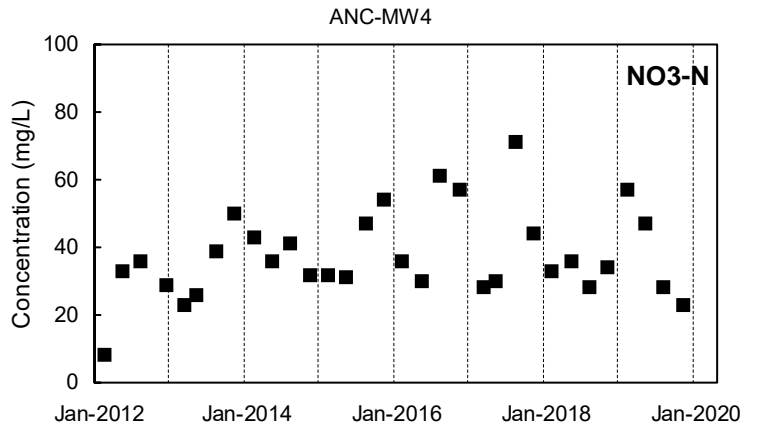
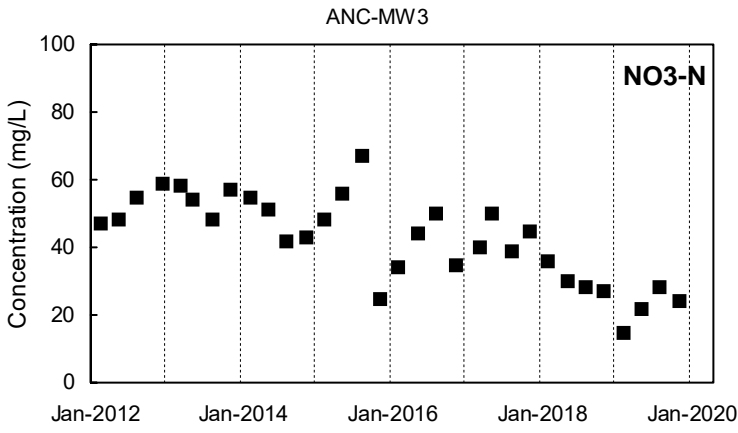

Detected Value
 'J'-Flag (value between reporting limit and detection limit)
 Non-Detect Range
 Shallow Well shown with black symbols
 Deep Well shown with orange symbols
 "dd" Well shown with blue symbols

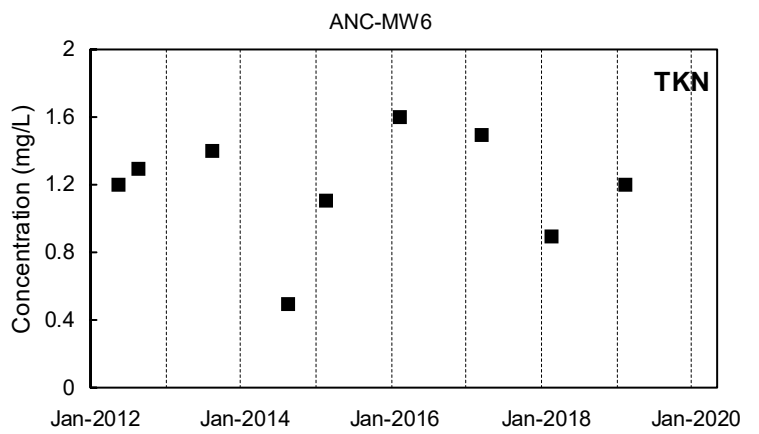
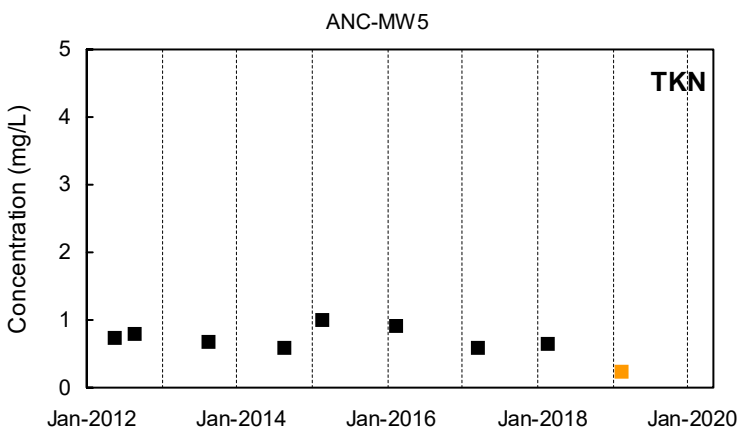
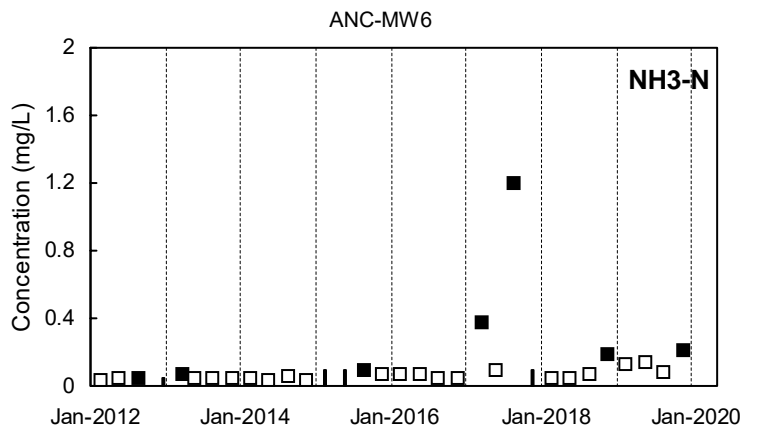
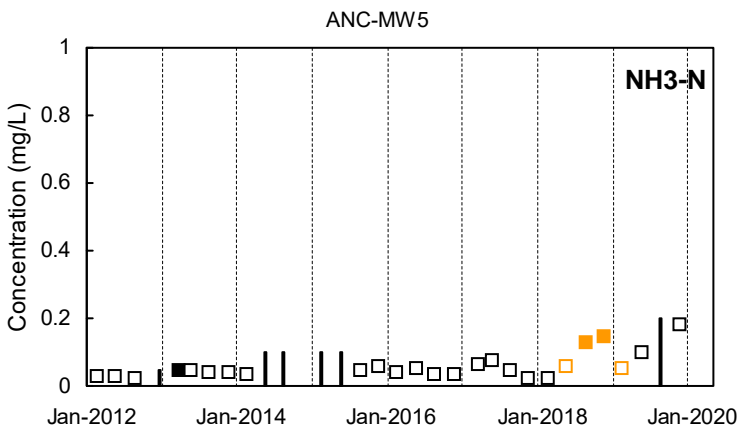
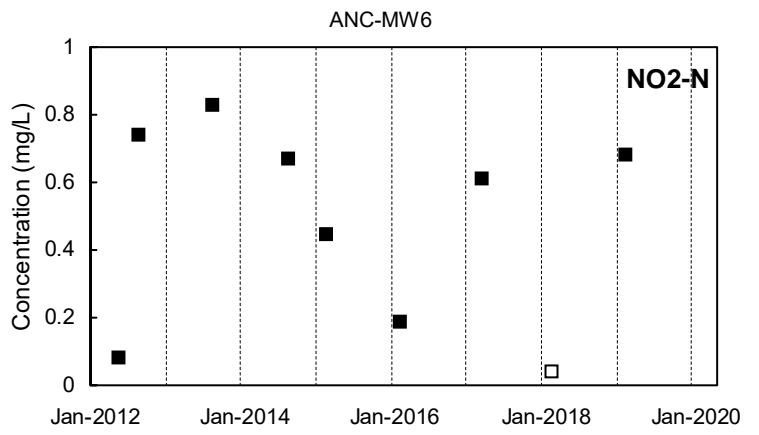
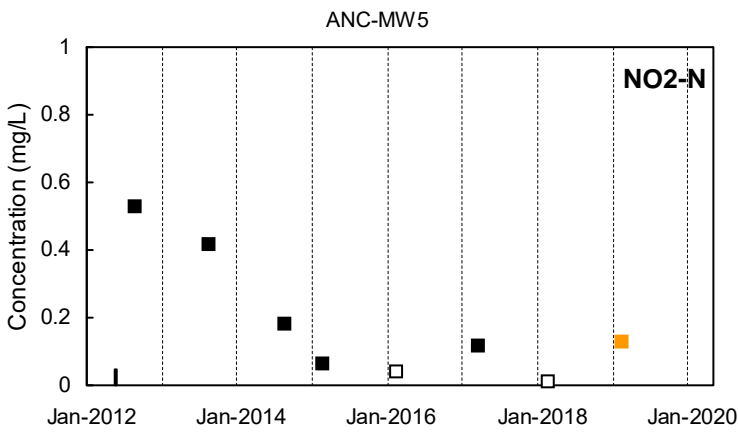
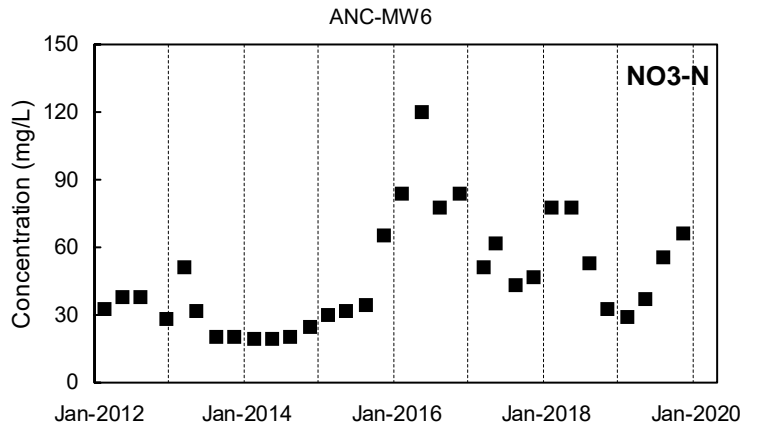
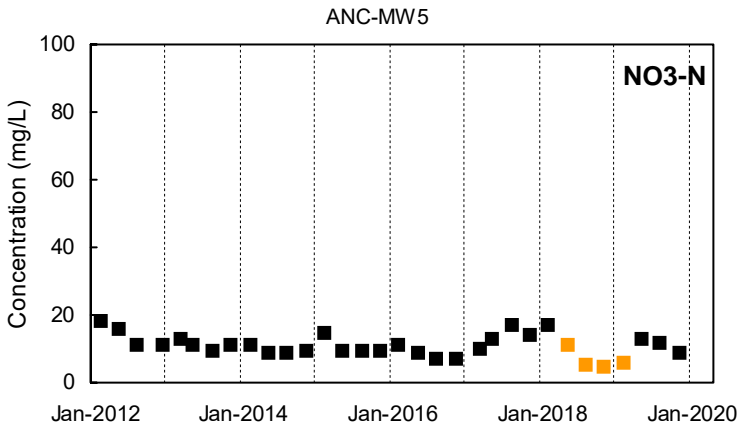

Detected Value
 'J'-Flag (value between reporting limit and detection limit)
 Non-Detect Range
 Shallow Well shown with black symbols
 Deep Well shown with orange symbols
 "dd" Well shown with blue symbols

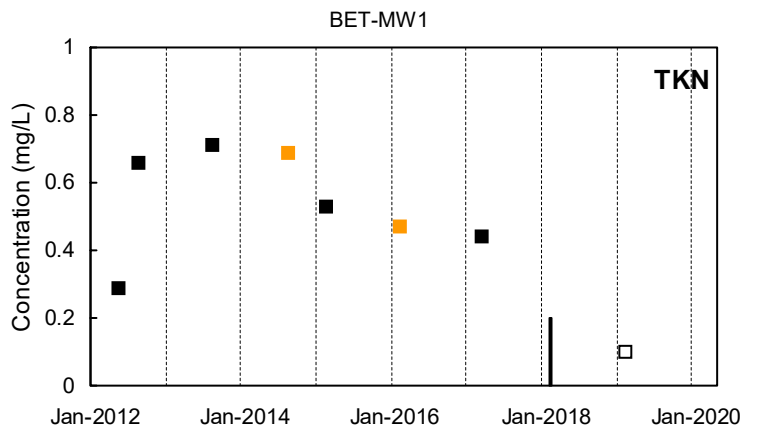
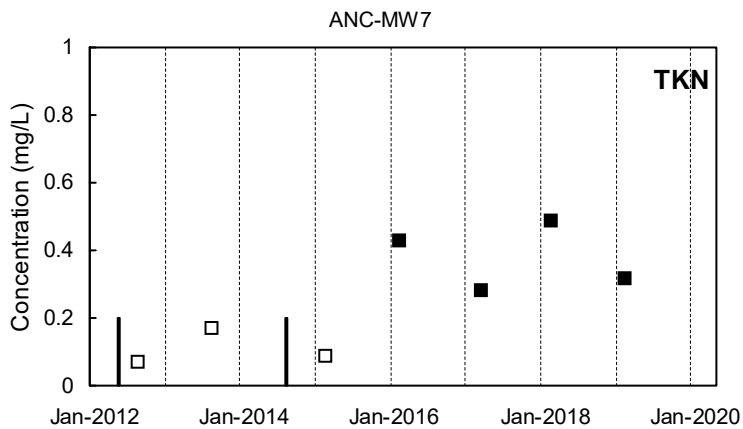
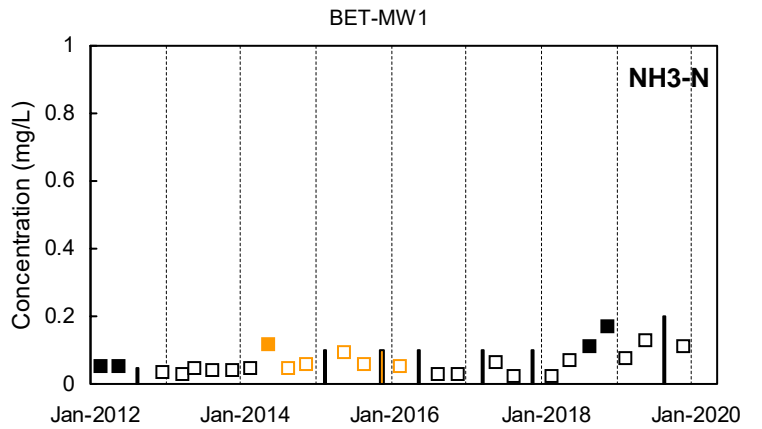
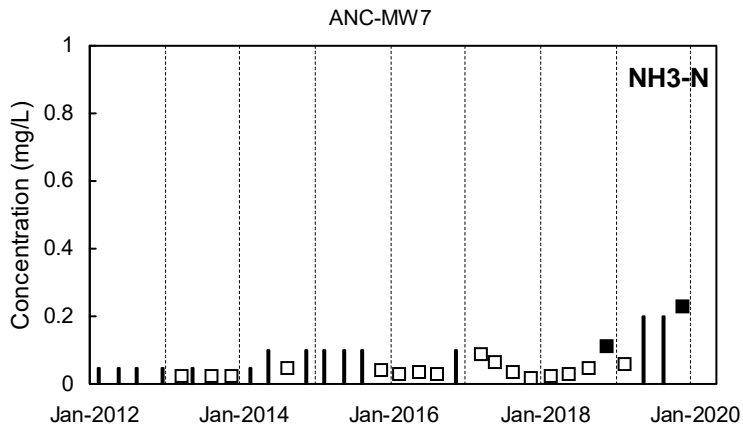
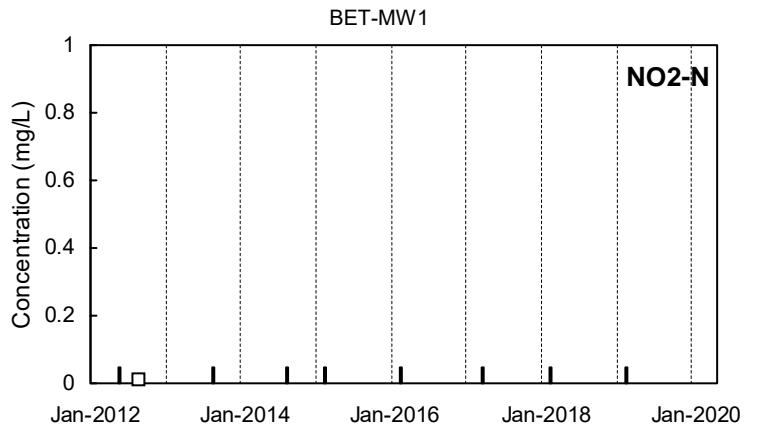
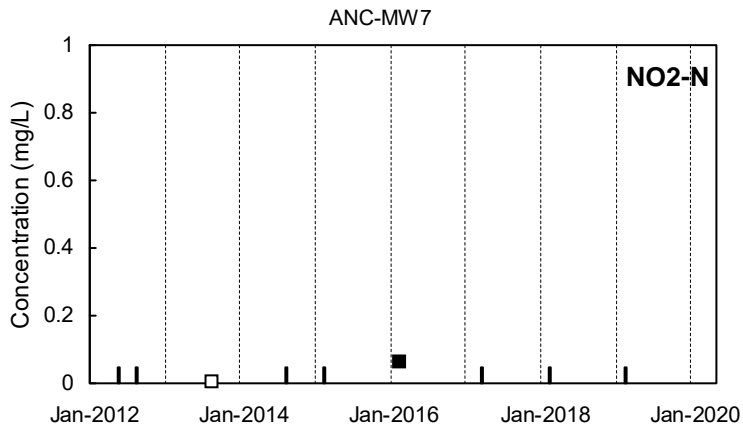
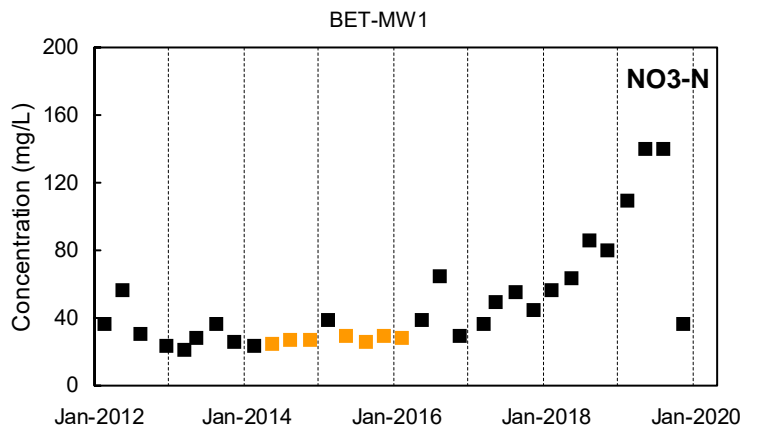
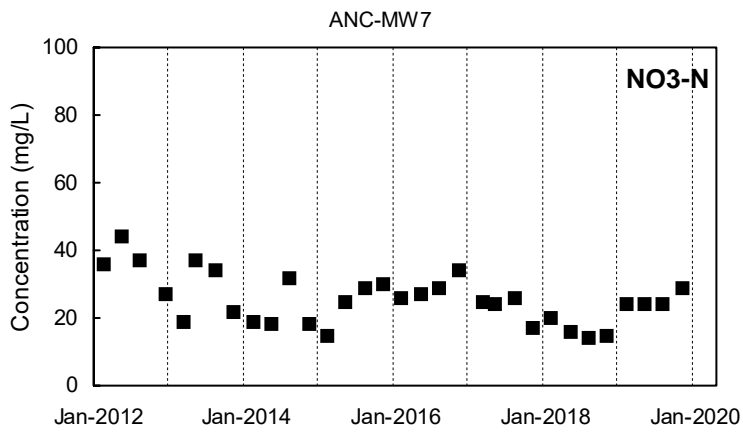

Detected Value
 'J'-Flag (value between reporting limit and detection limit)
 Non-Detect Range
 Shallow Well shown with black symbols
 Deep Well shown with orange symbols
 "dd" Well shown with blue symbols

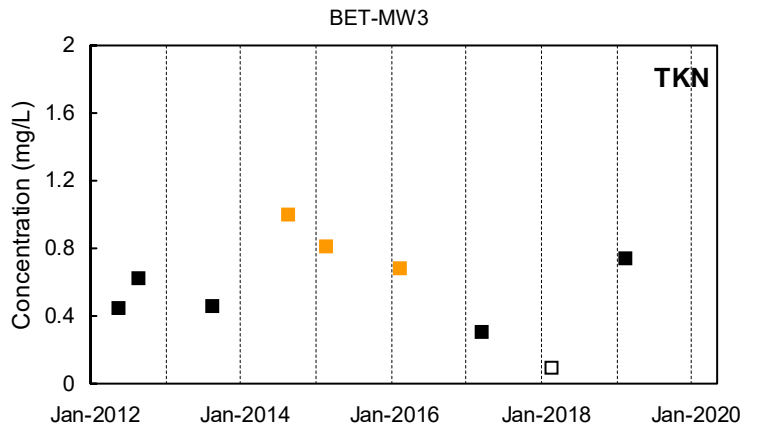
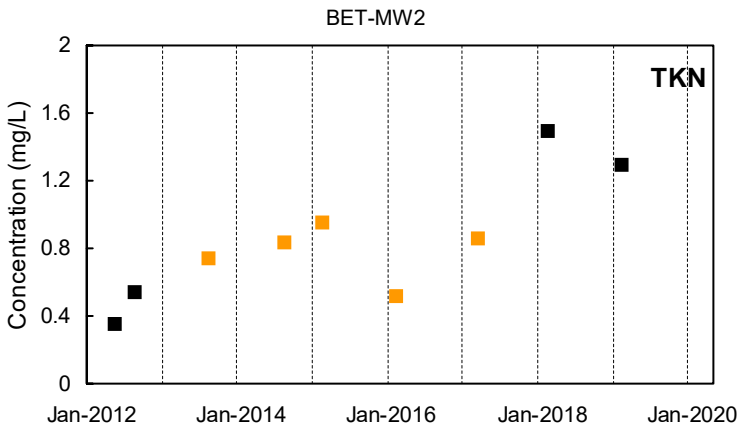
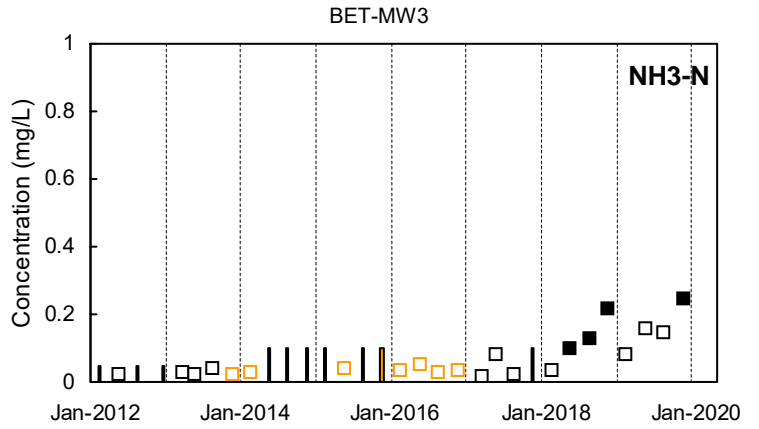
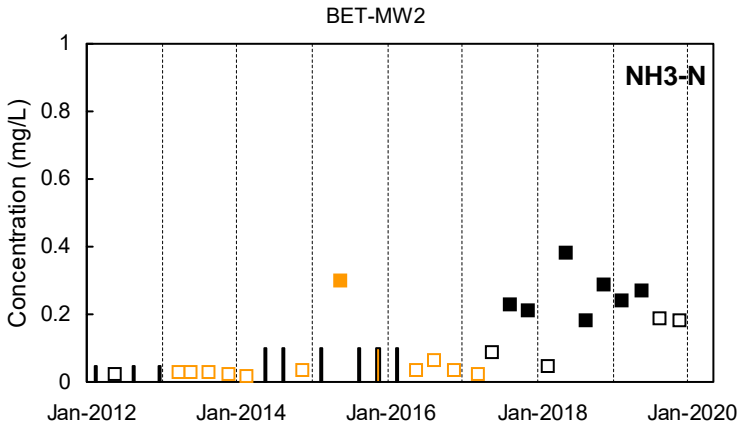
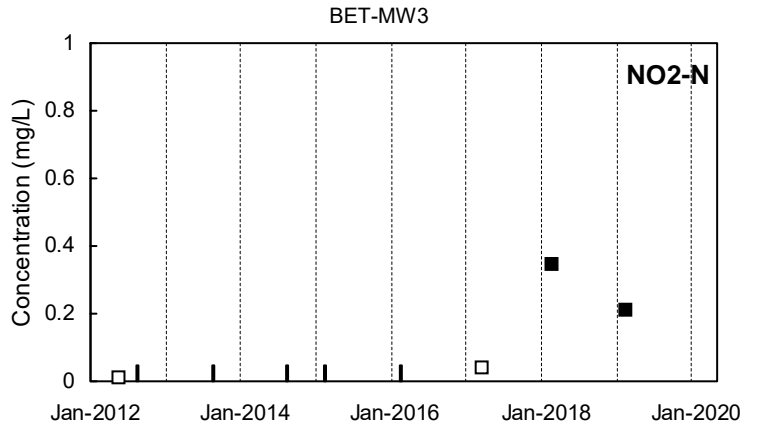
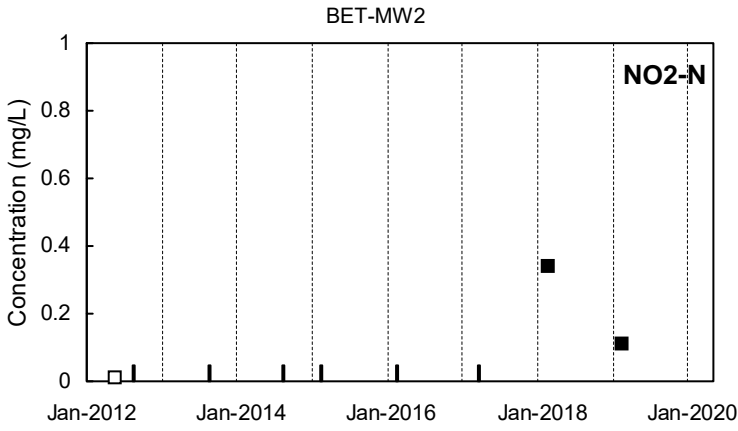
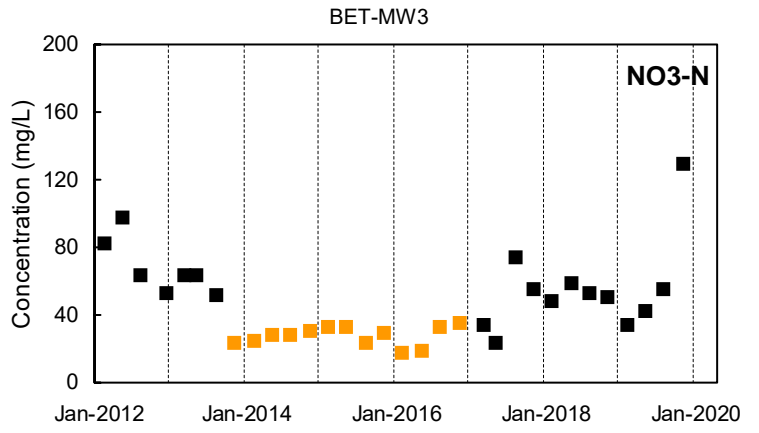
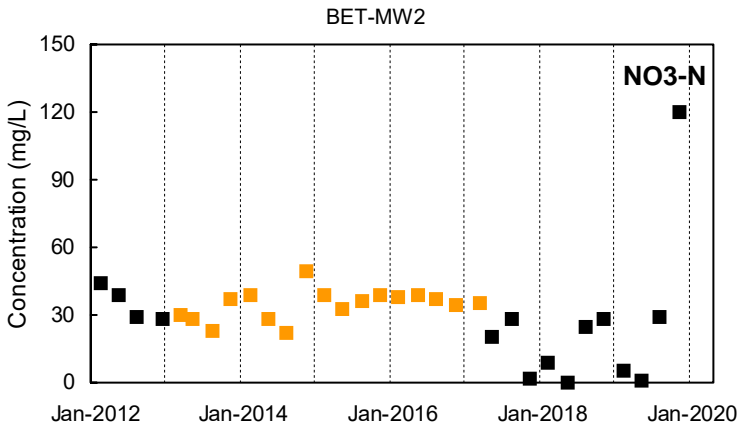

Detected Value
 'J'-Flag (value between reporting limit and detection limit)
 Non-Detect Range
 Shallow Well shown with black symbols
 Deep Well shown with orange symbols
 "dd" Well shown with blue symbols

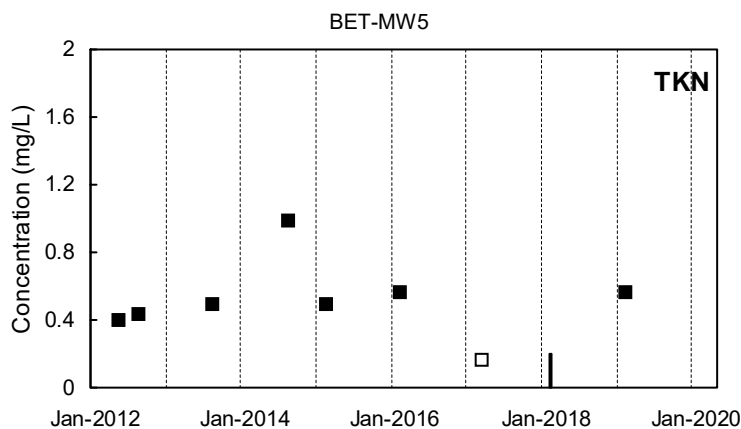
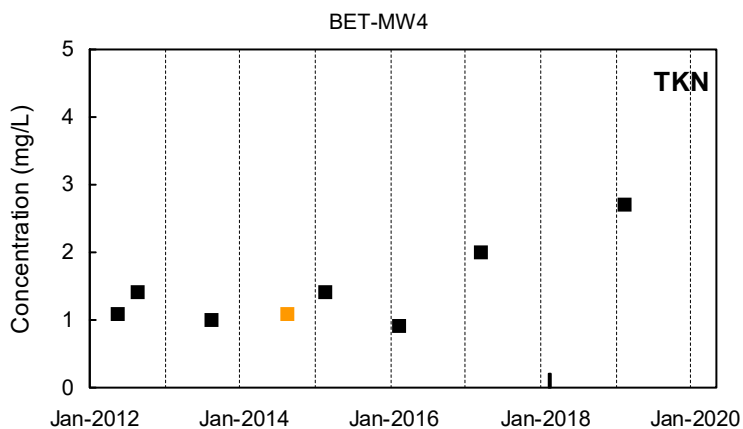
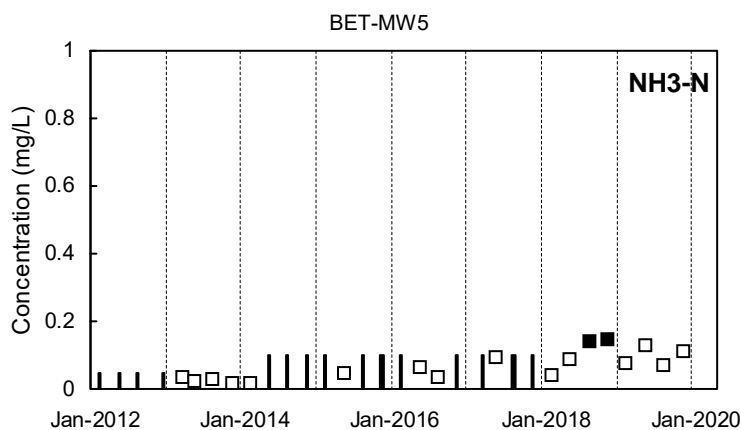
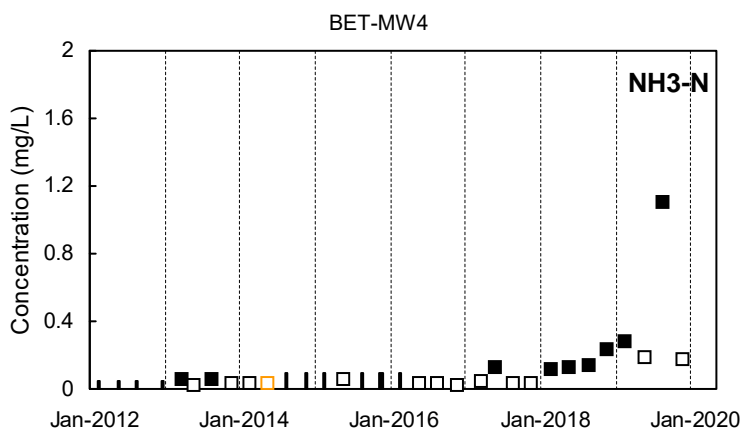
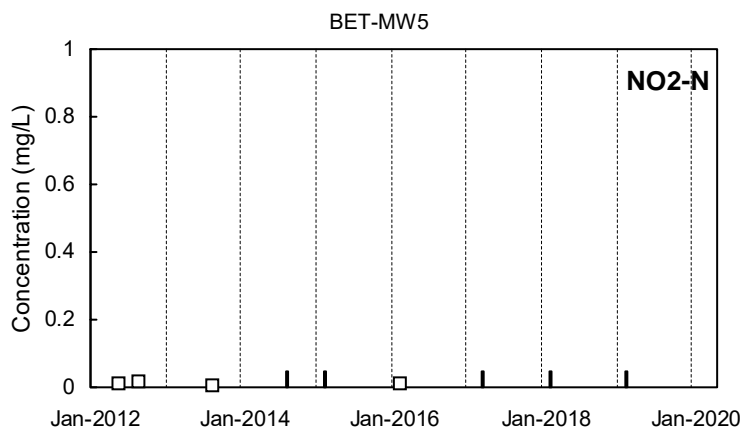
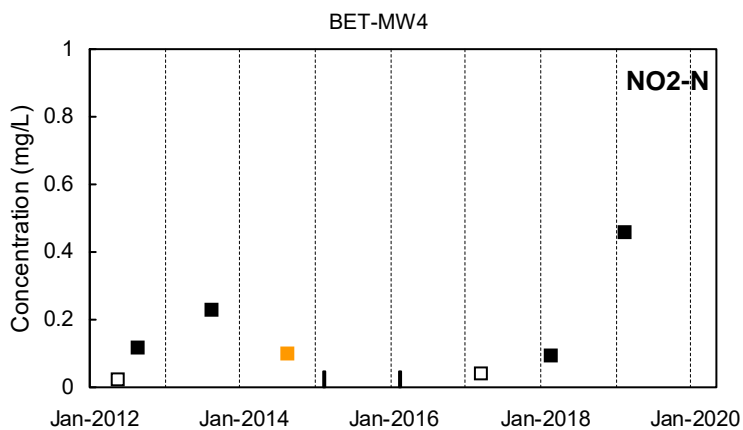
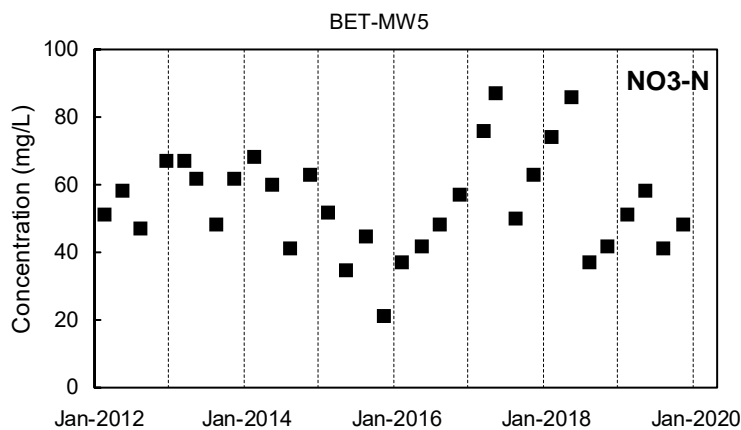
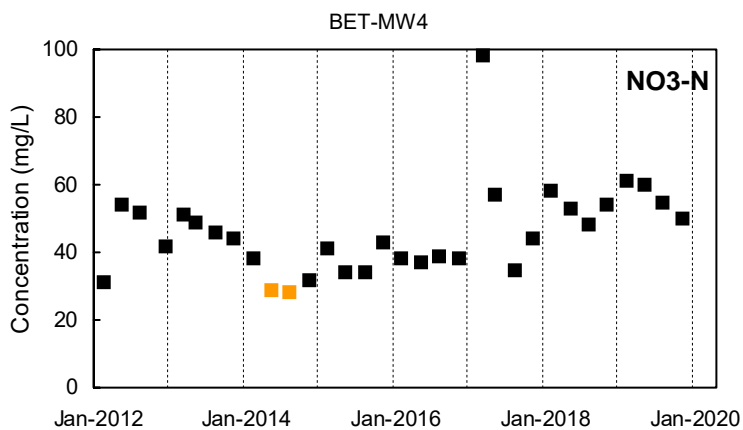

Detected Value
 'J'-Flag (value between reporting limit and detection limit)
 Non-Detect Range
 Shallow Well shown with black symbols
 Deep Well shown with orange symbols
 "dd" Well shown with blue symbols

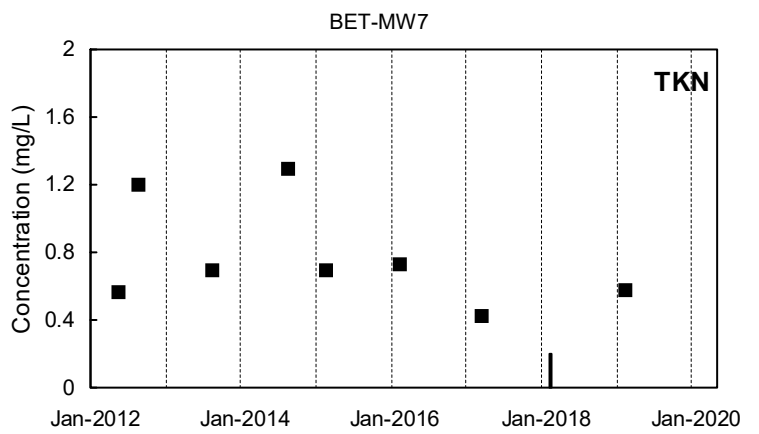
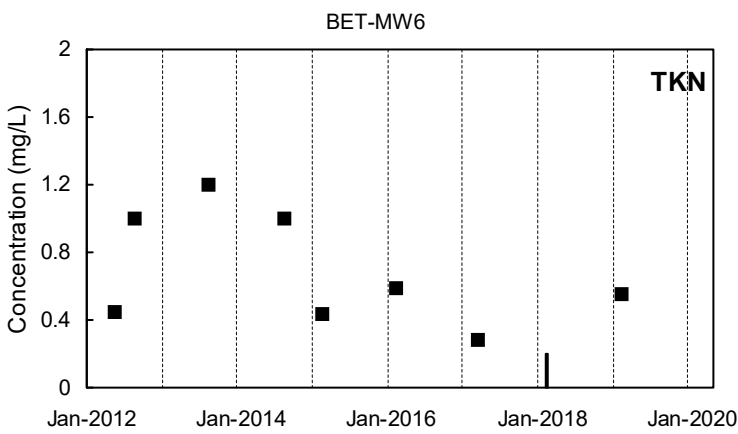
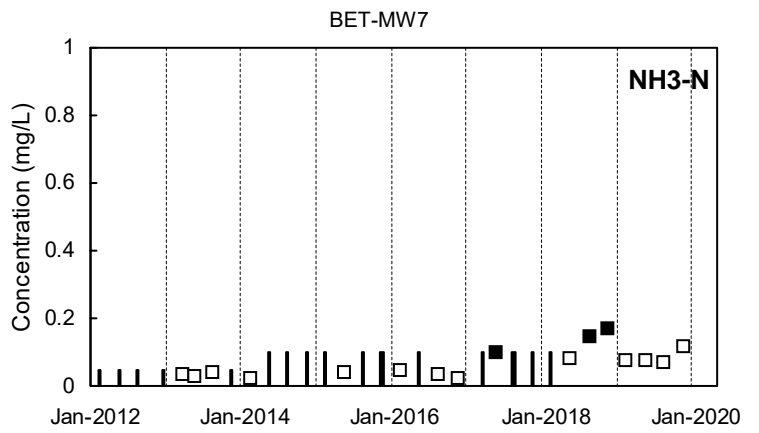
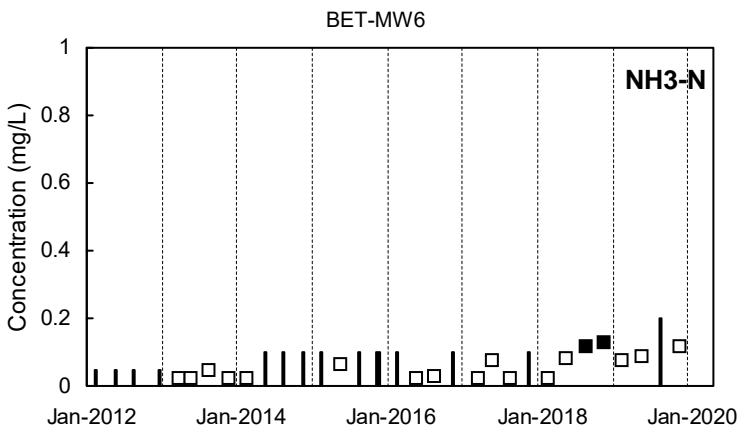
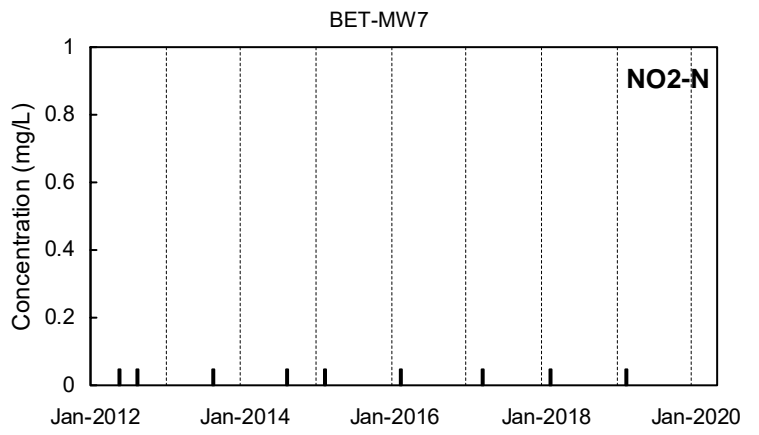
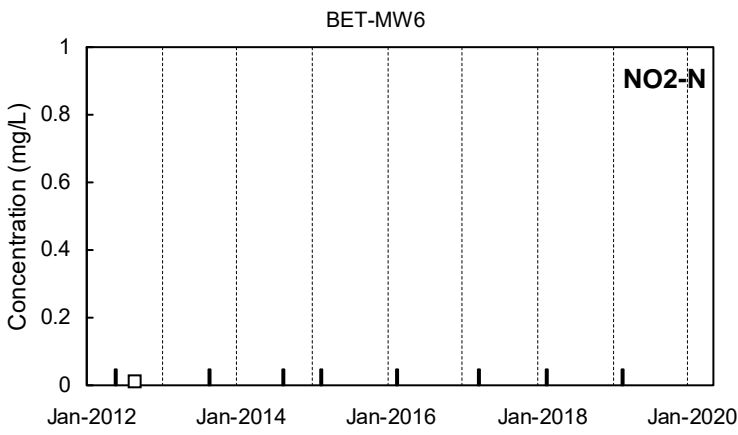
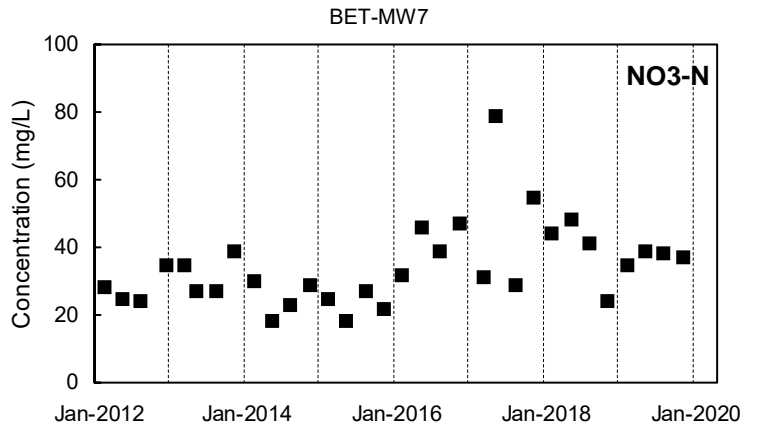
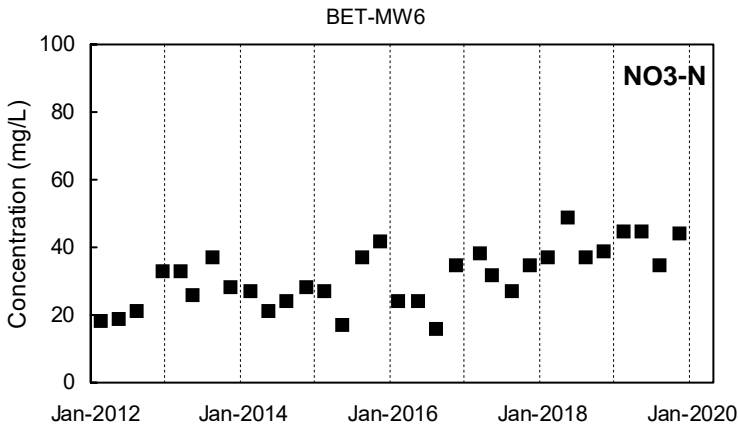

Detected Value
 'J'-Flag (value between reporting limit and detection limit)
 Non-Detect Range
 Shallow Well shown with black symbols Deep Well shown with orange symbols "dd" Well shown with blue symbols

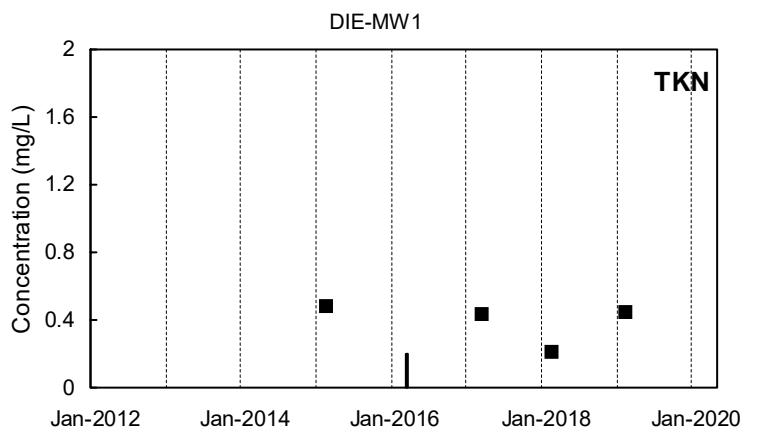
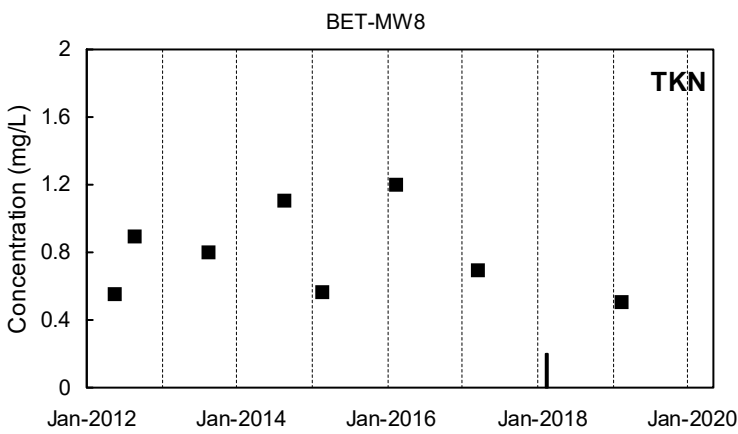
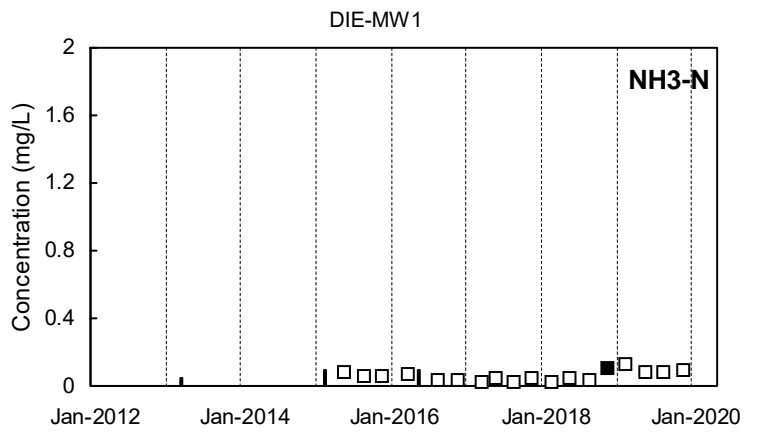
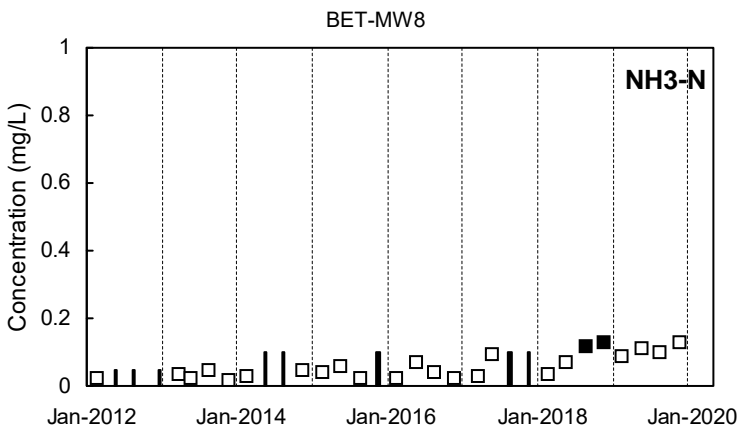
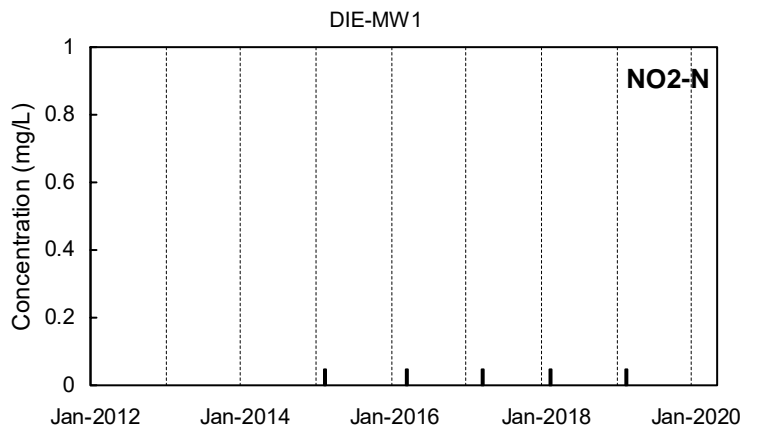
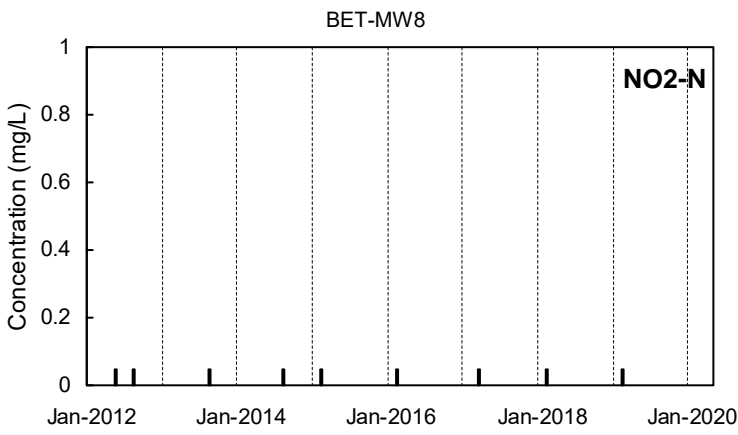
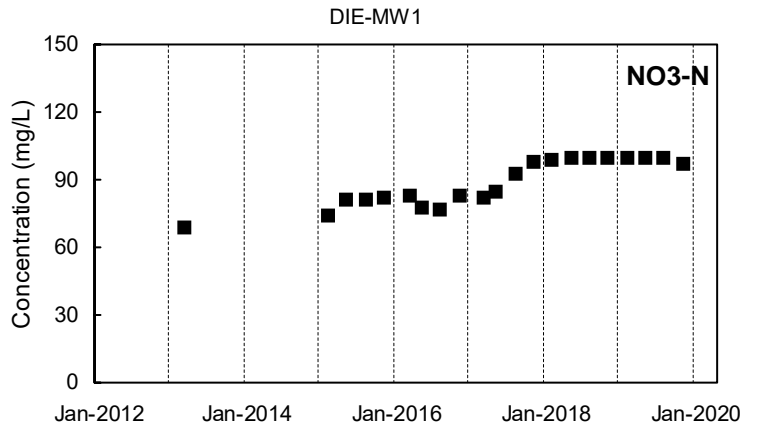
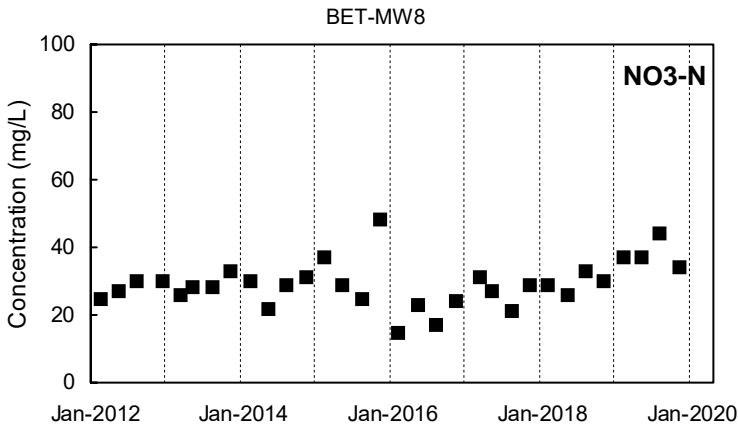

Detected Value
 'J'-Flag (value between reporting limit and detection limit)
 Non-Detect Range
 Shallow Well shown with black symbols
 Deep Well shown with orange symbols
 "dd" Well shown with blue symbols

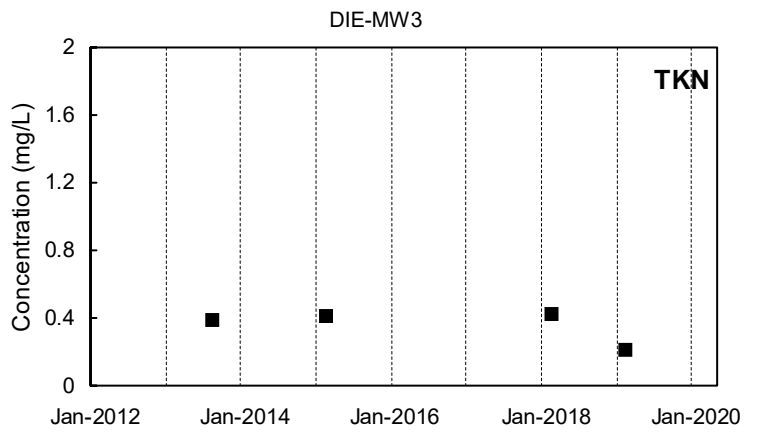
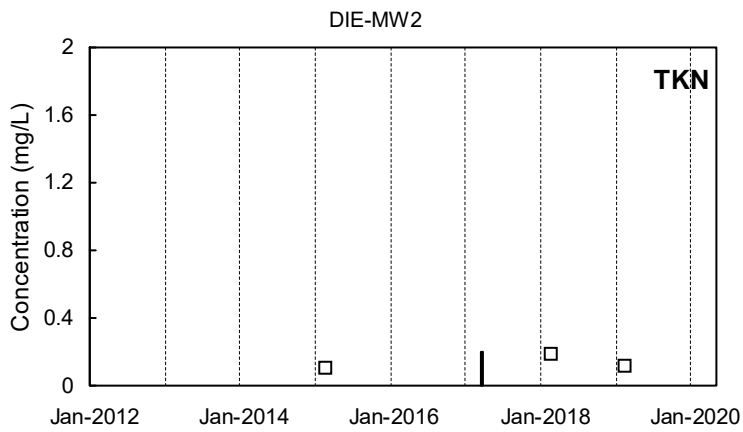
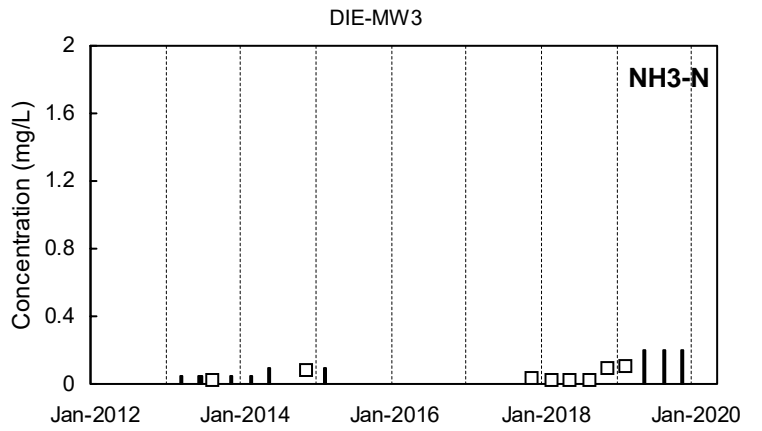
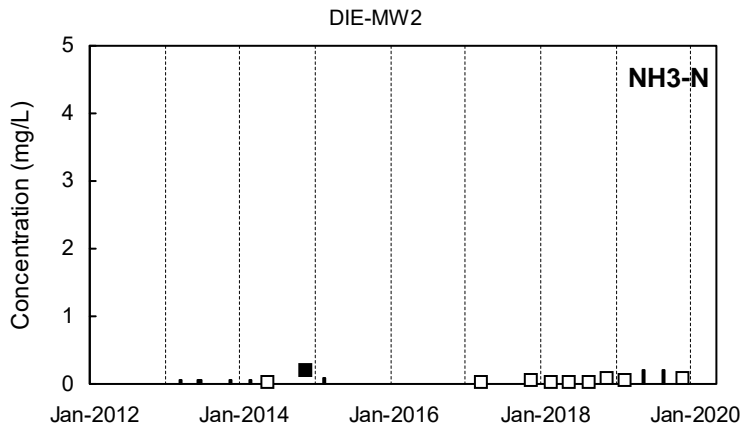
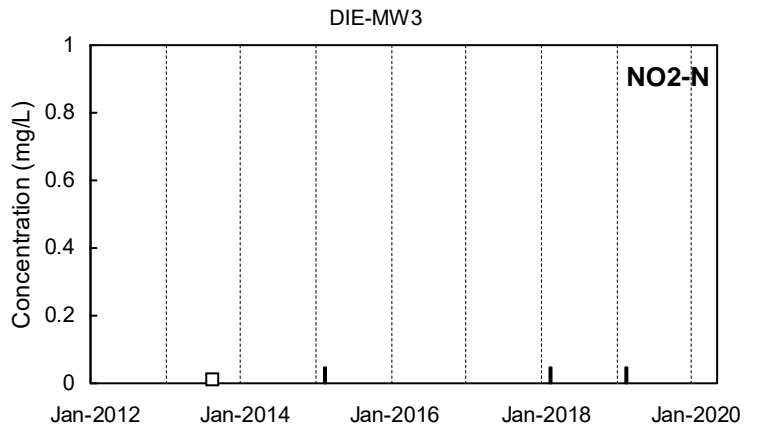
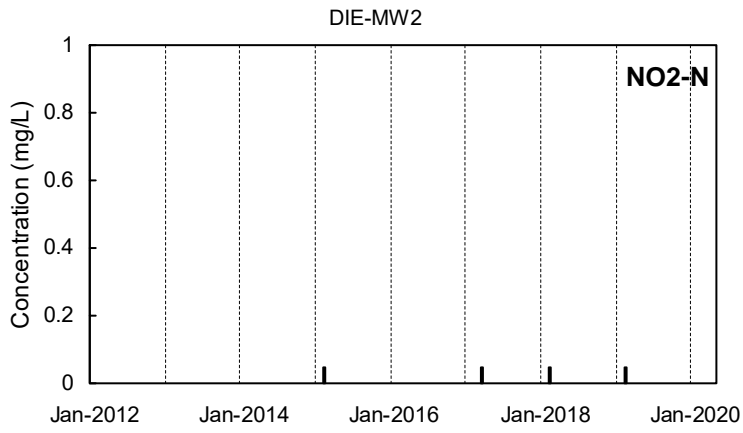
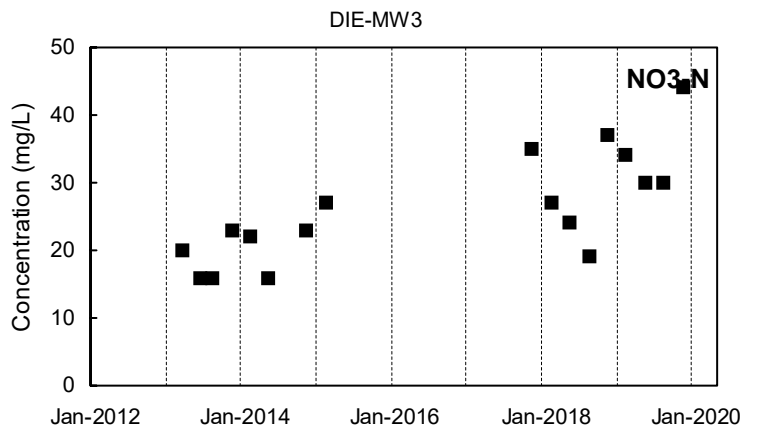
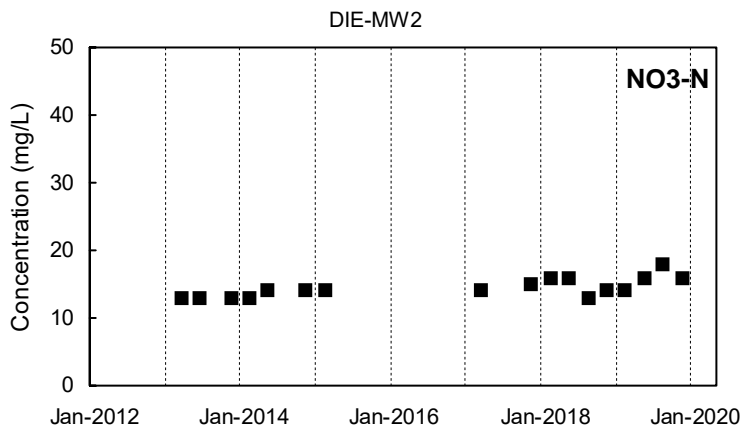

Detected Value
 'J'-Flag (value between reporting limit and detection limit)
 Non-Detect Range
 Shallow Well shown with black symbols Deep Well shown with orange symbols "dd" Well shown with blue symbols

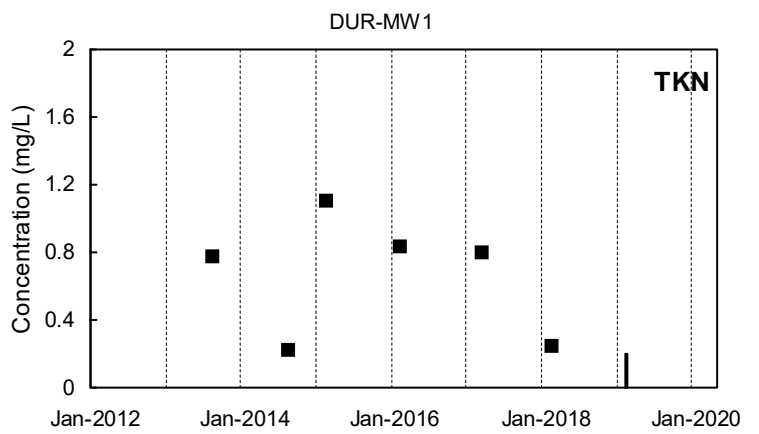
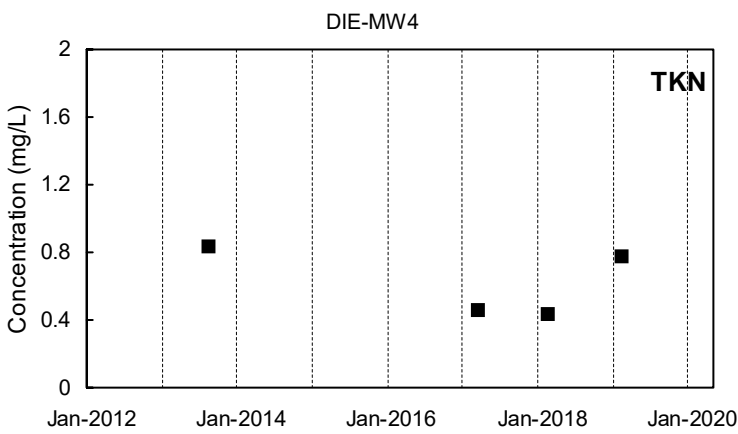
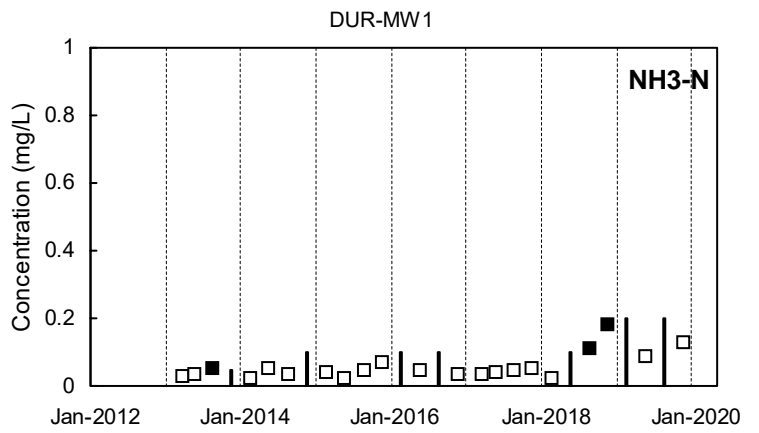
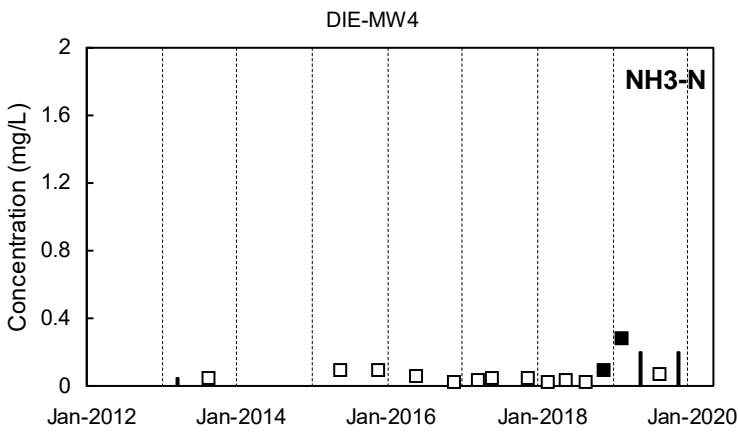
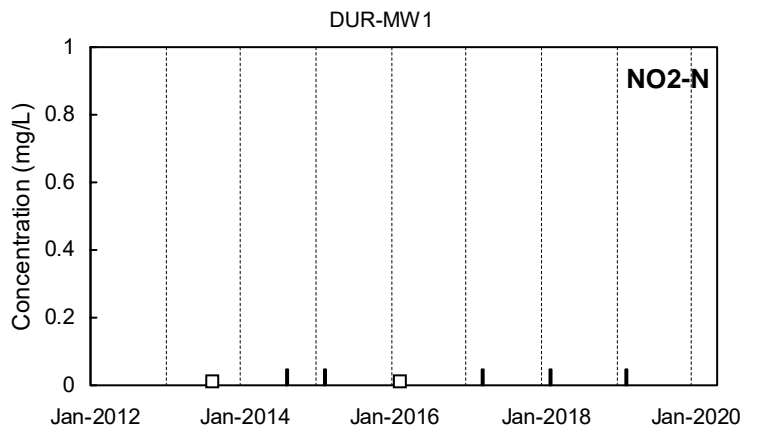
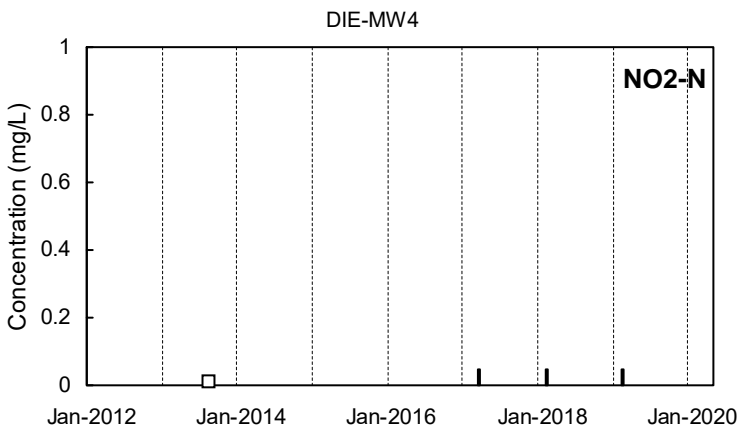
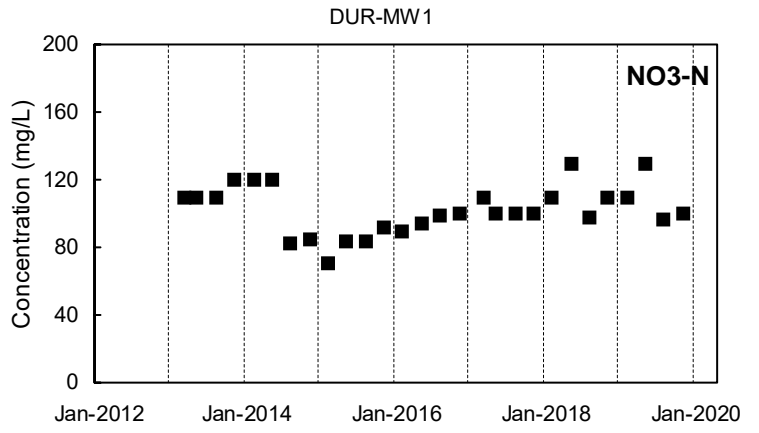
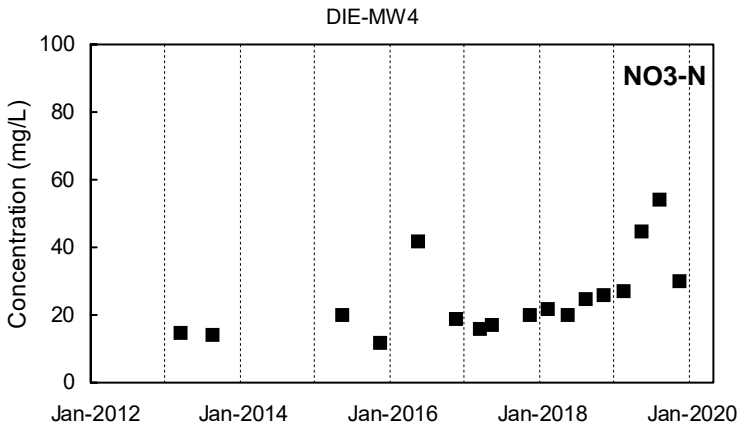

Detected Value
 'J'-Flag (value between reporting limit and detection limit)
 Non-Detect Range
Shallow Well shown with black symbols
Deep Well shown with orange symbols
"dd" Well shown with blue symbols

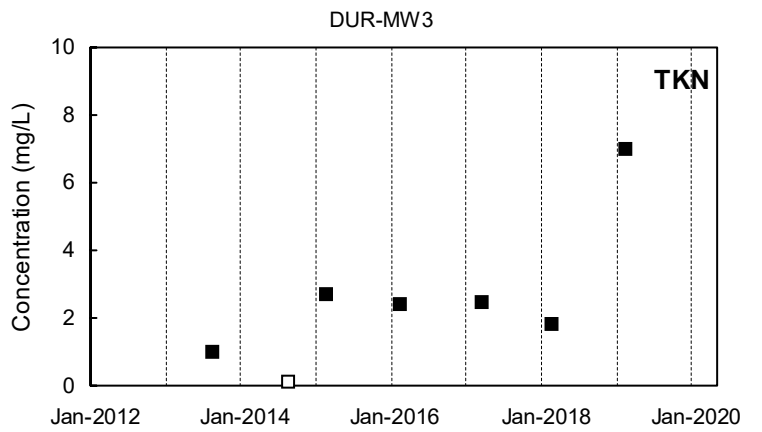
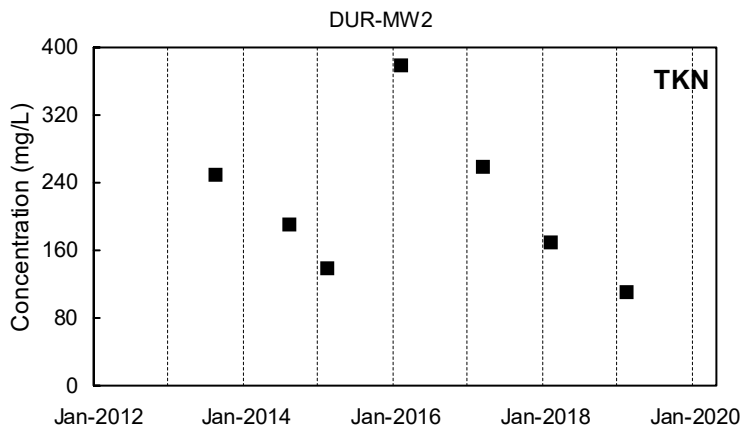
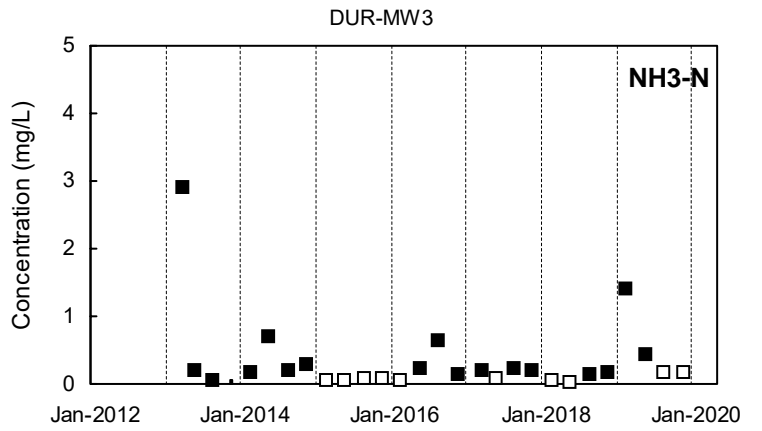
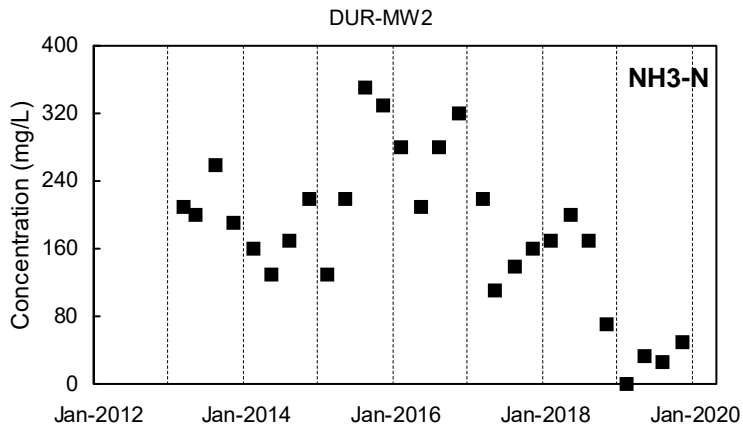
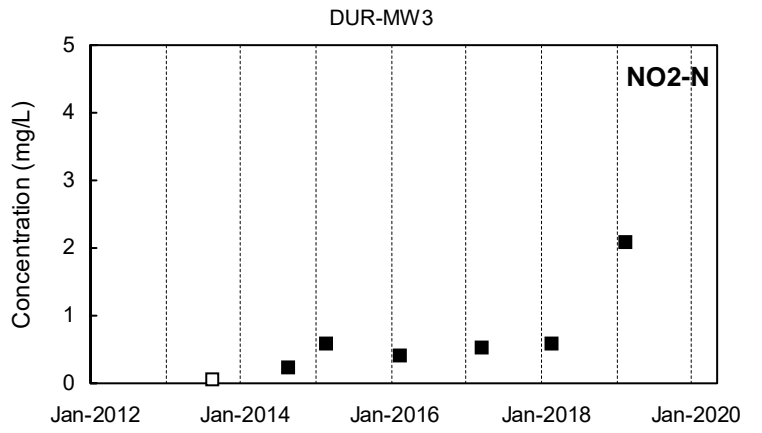
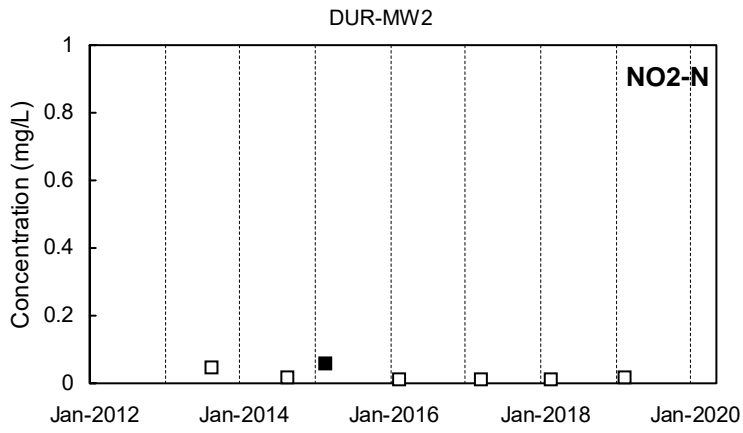
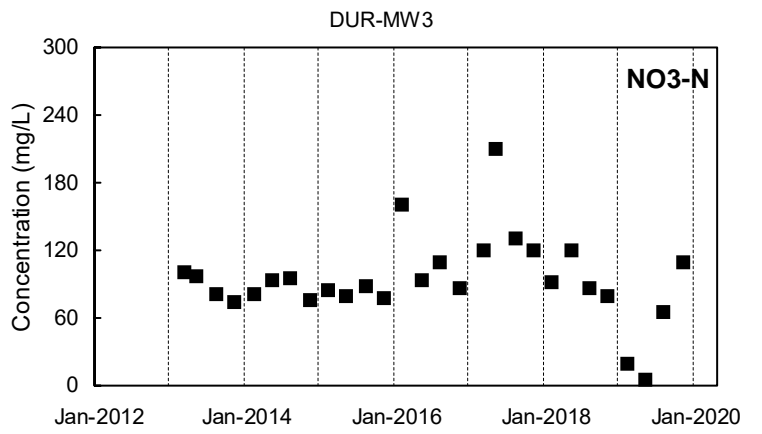
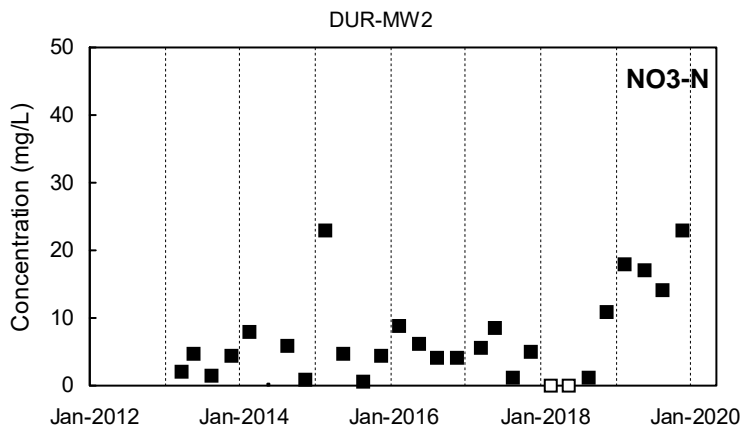

Detected Value
 'J'-Flag (value between reporting limit and detection limit)
 Non-Detect Range
 Shallow Well shown with black symbols
 Deep Well shown with orange symbols
 "dd" Well shown with blue symbols

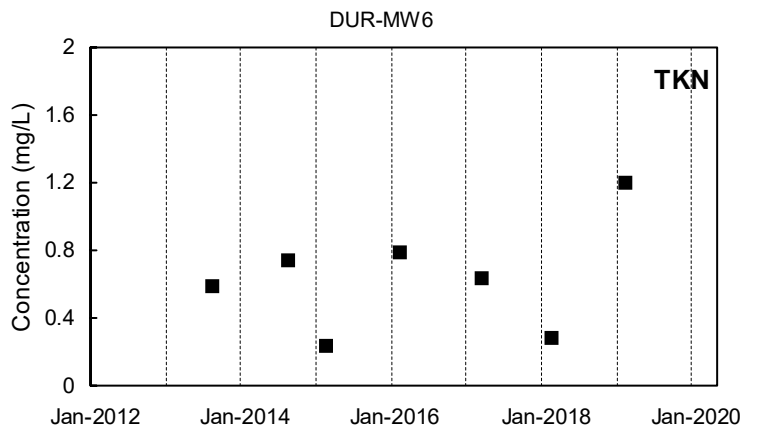
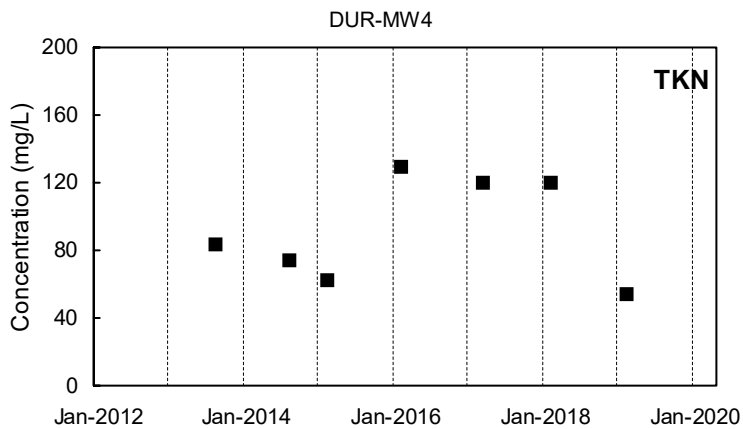
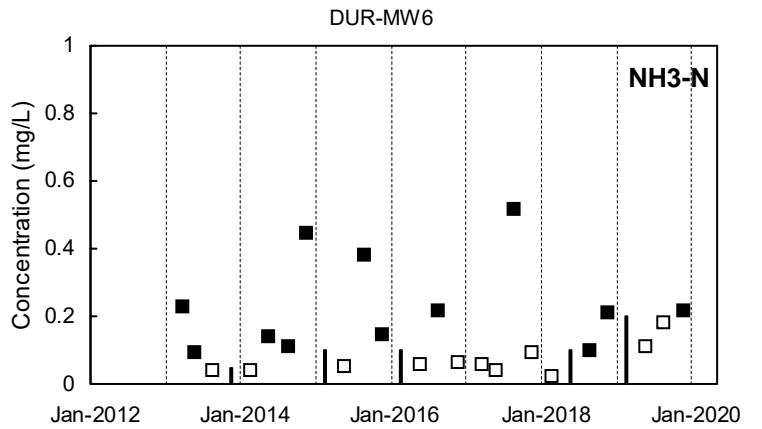
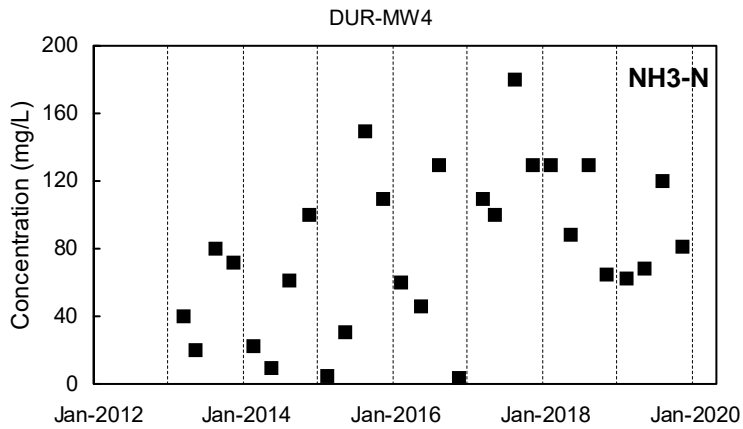
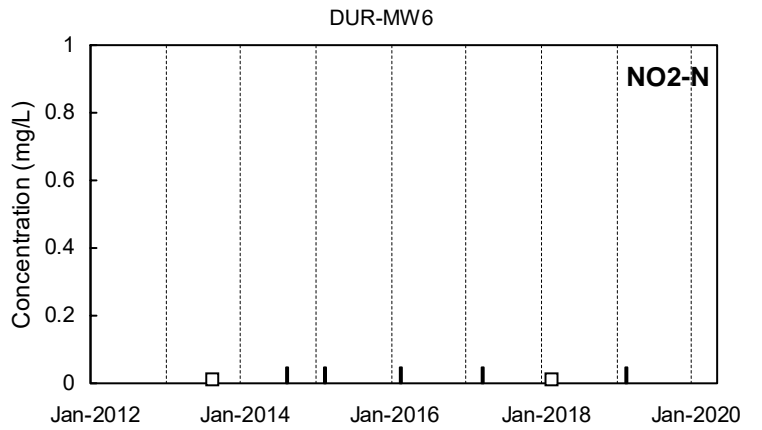
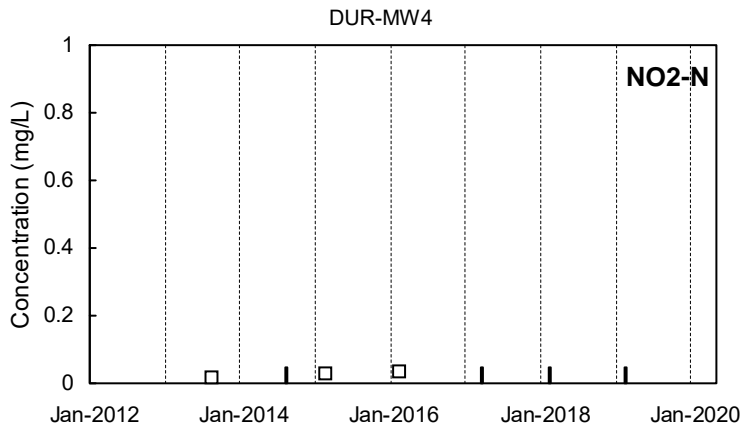
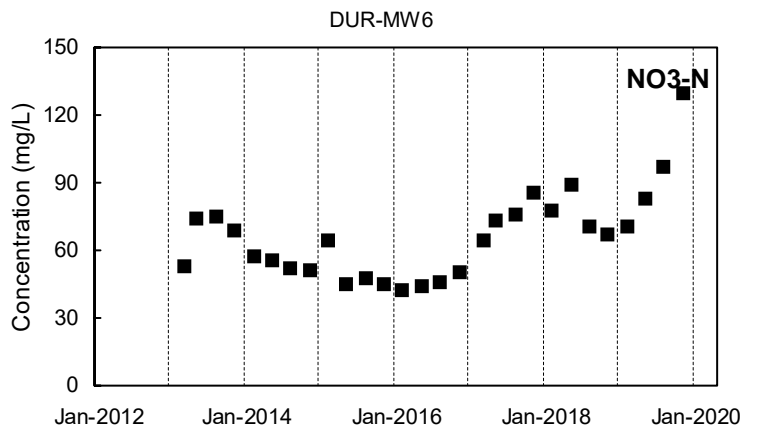
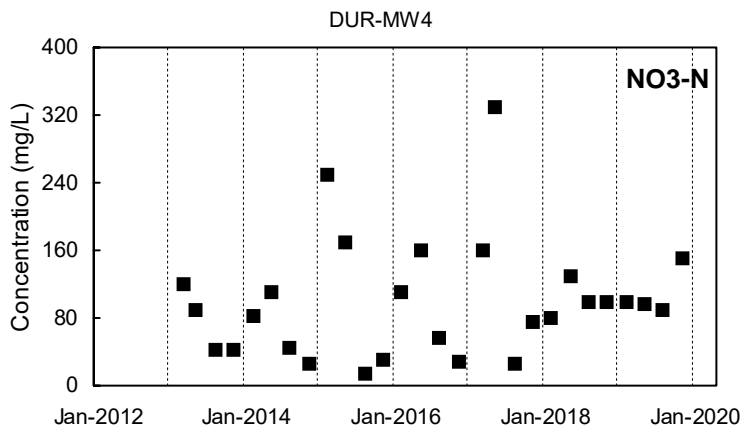

Detected Value
 'J'-Flag (value between reporting limit and detection limit)
 Non-Detect Range
 Shallow Well shown with black symbols
 Deep Well shown with orange symbols
 "dd" Well shown with blue symbols

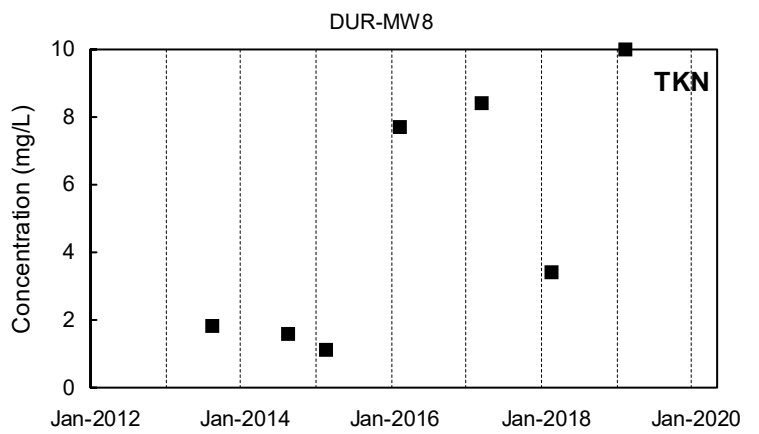
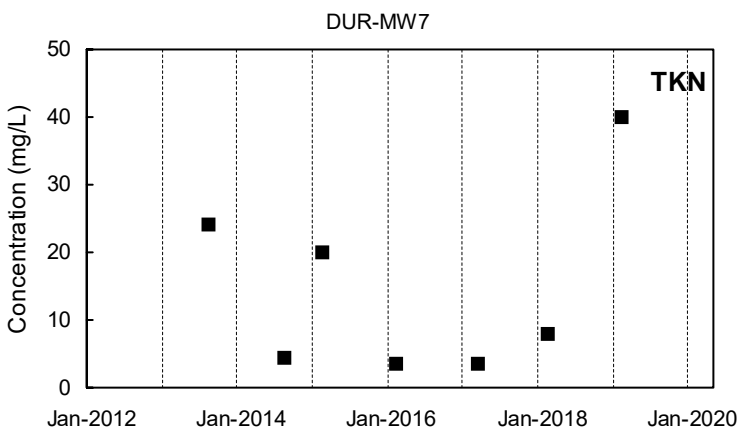
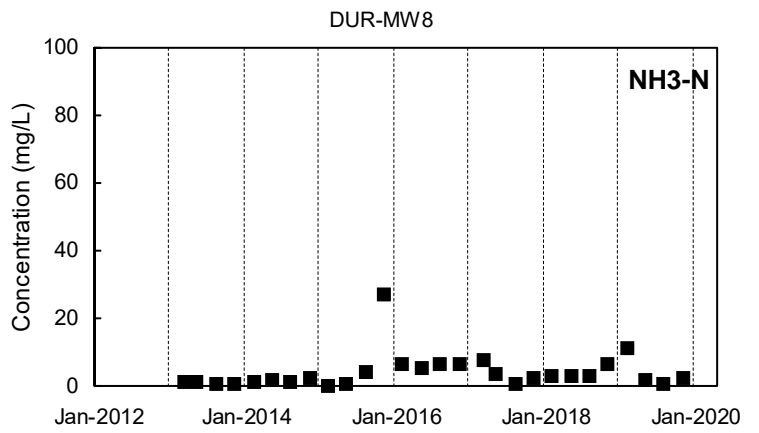
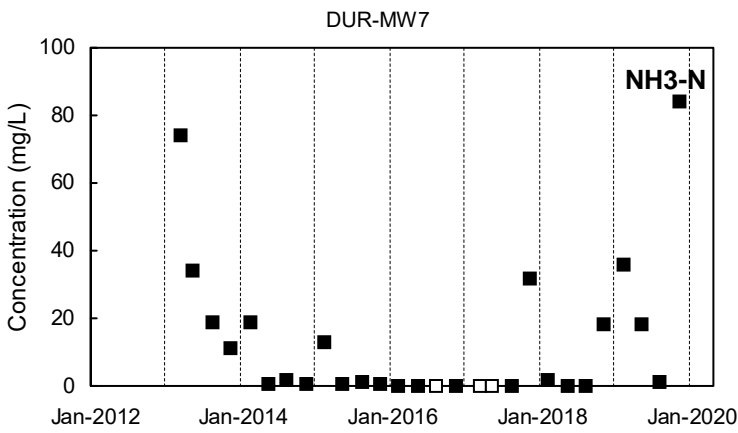
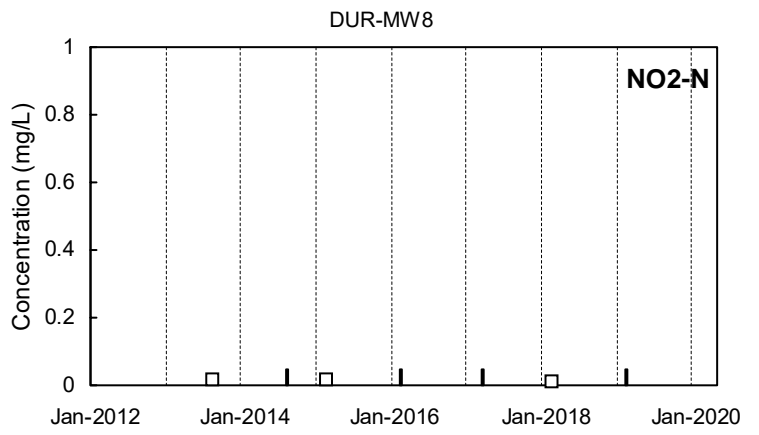
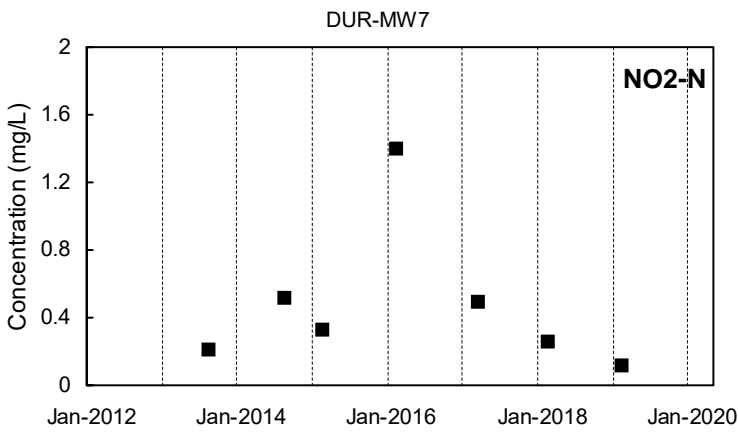
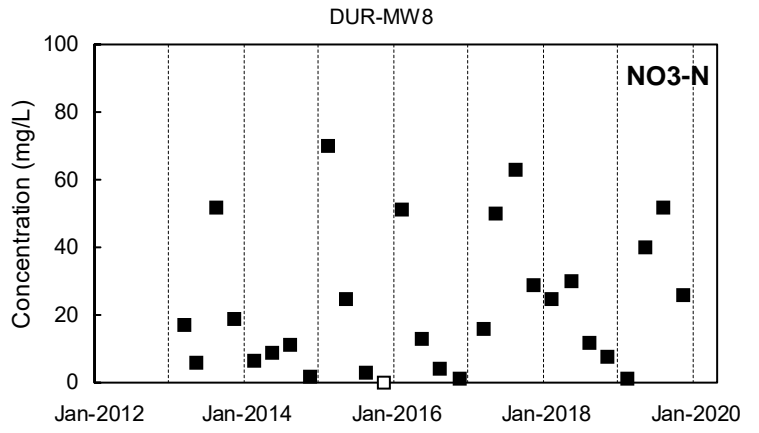
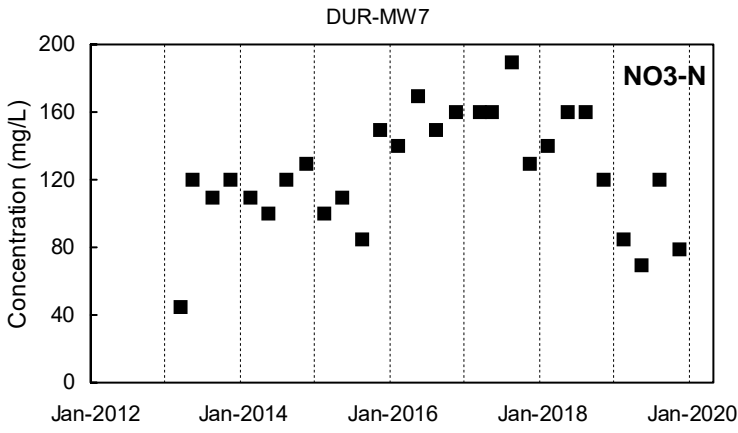

Detected Value
 'J'-Flag (value between reporting limit and detection limit)
 Non-Detect Range
 Shallow Well shown with black symbols
 Deep Well shown with orange symbols
 "dd" Well shown with blue symbols

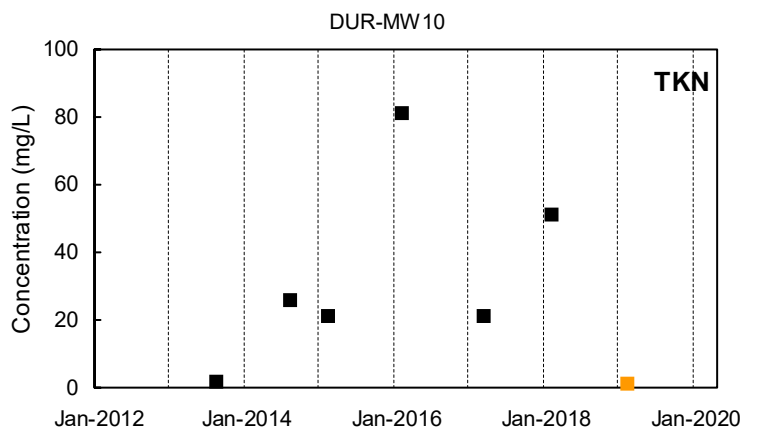
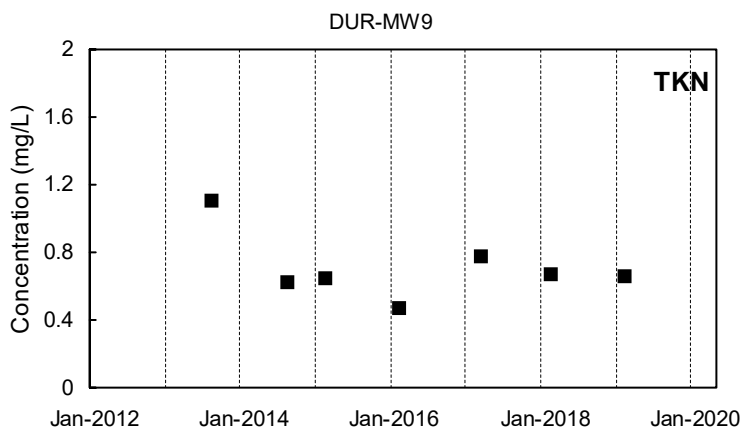
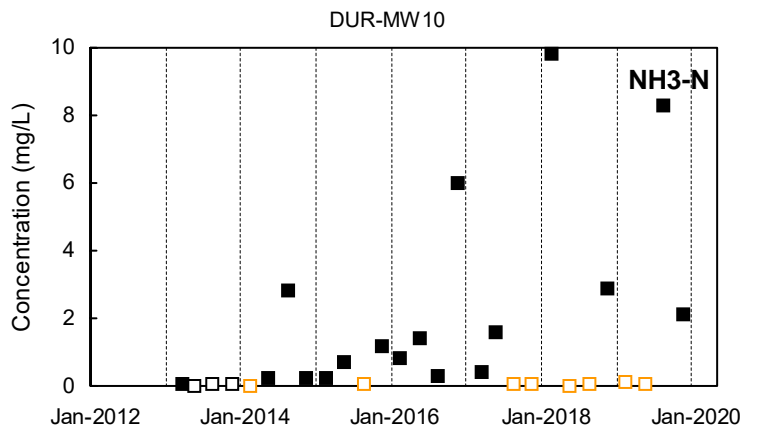
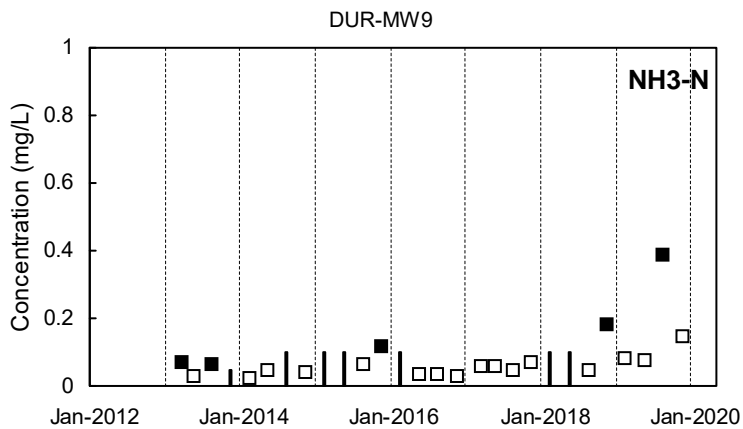
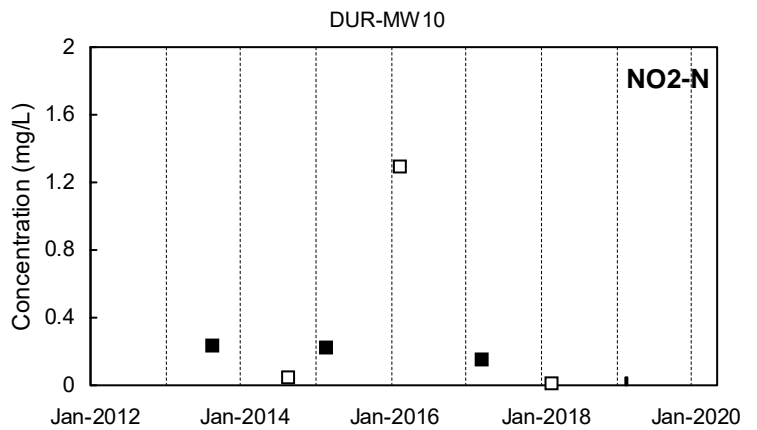
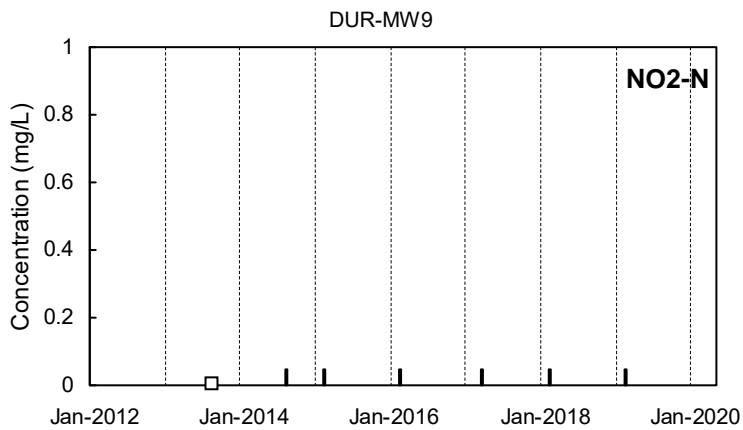
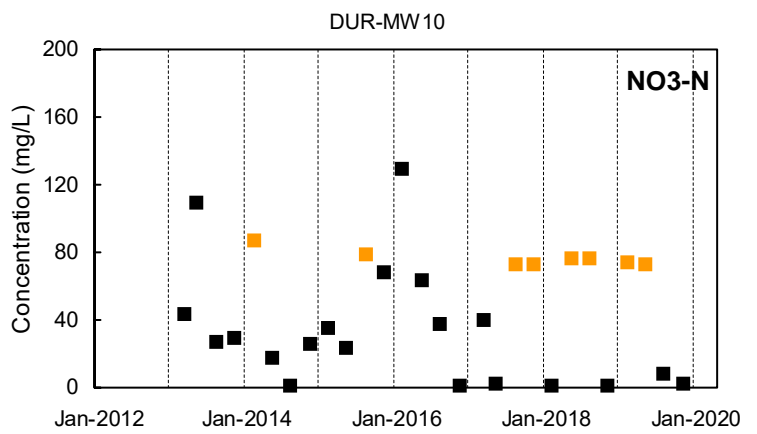
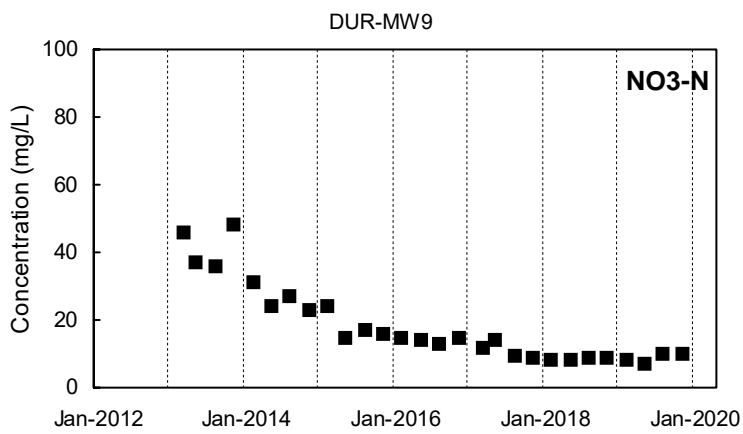

Detected Value
 'J'-Flag (value between reporting limit and detection limit)
 Non-Detect Range
 Shallow Well shown with black symbols
 Deep Well shown with orange symbols
 "dd" Well shown with blue symbols

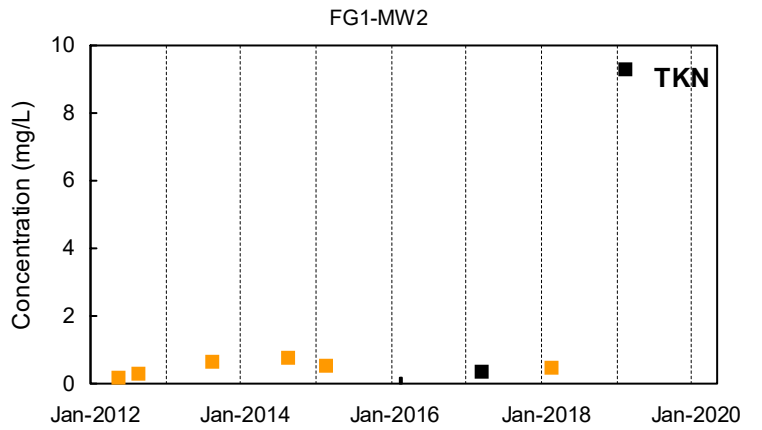
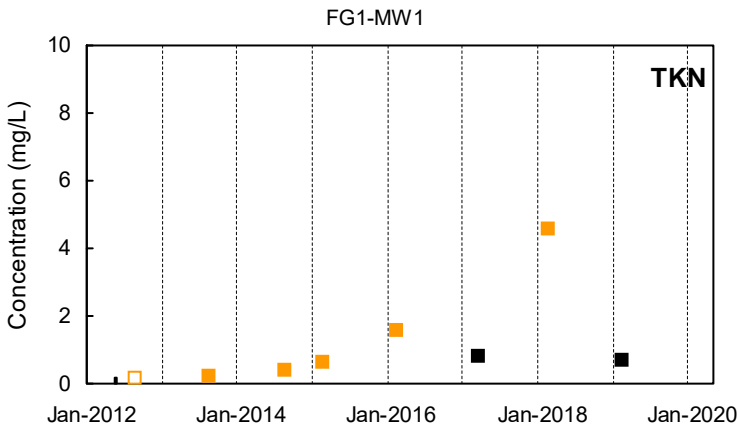
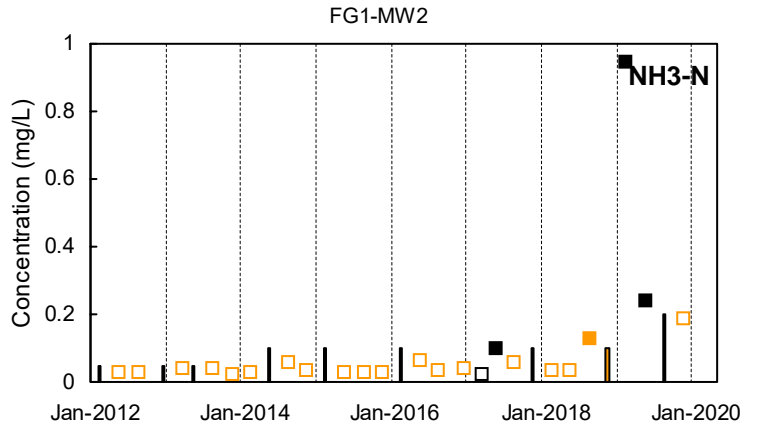
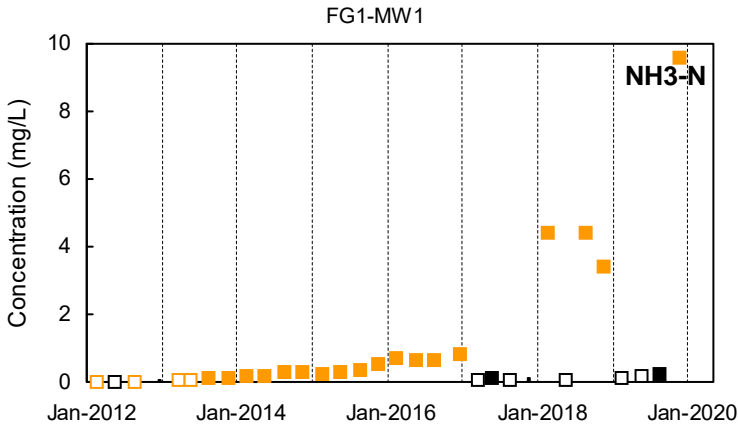
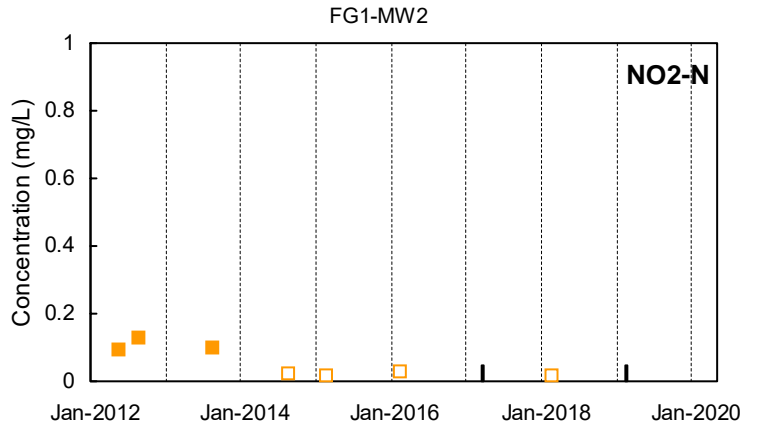
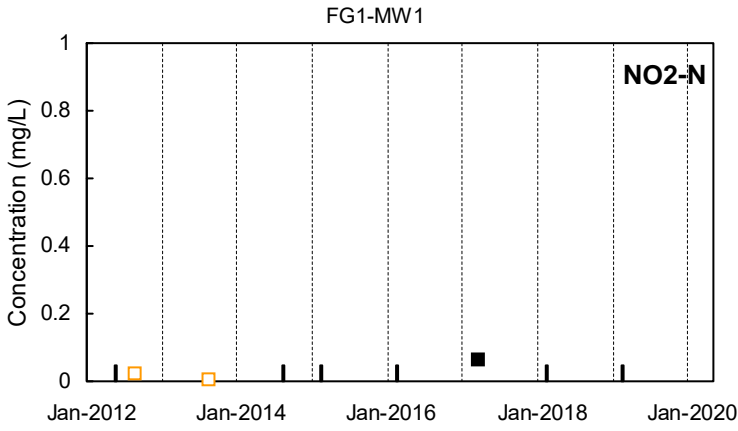
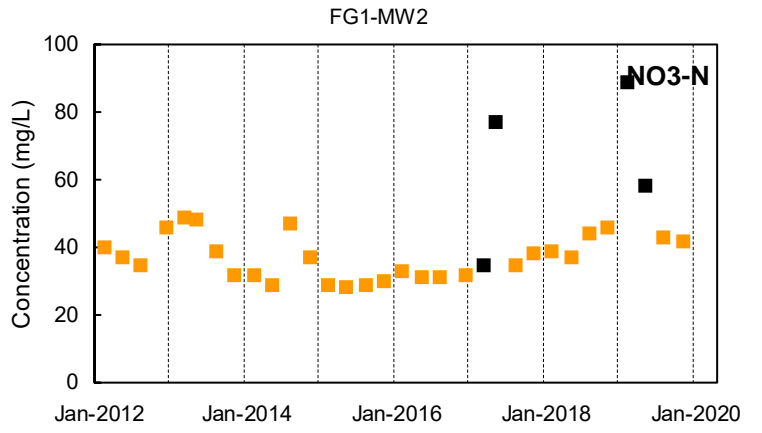
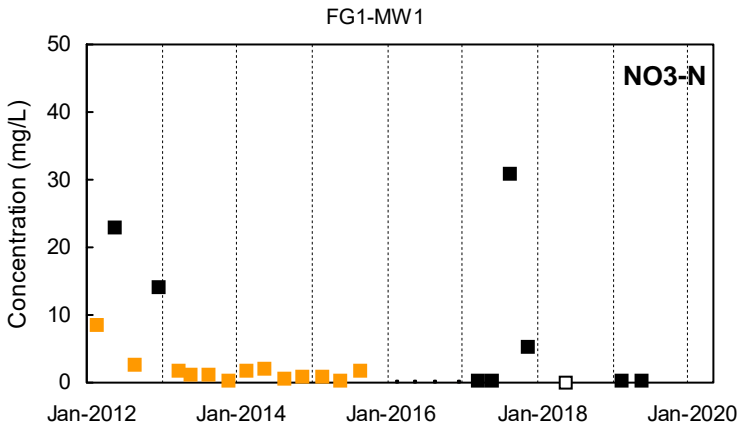

■ Detected Value □ 'J'-Flag (value between reporting limit and detection limit) ■ Non-Detect Range
 Shallow Well shown with black symbols Deep Well shown with orange symbols "dd" Well shown with blue symbols

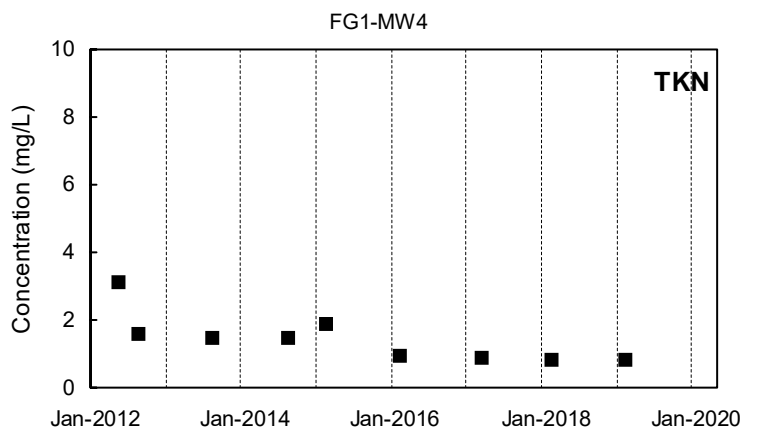
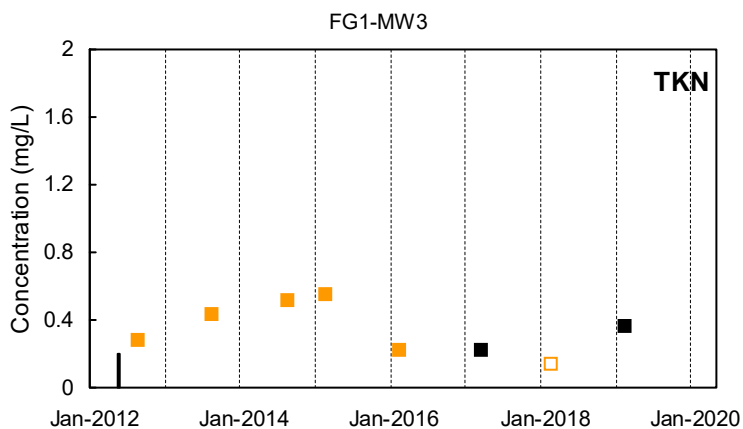
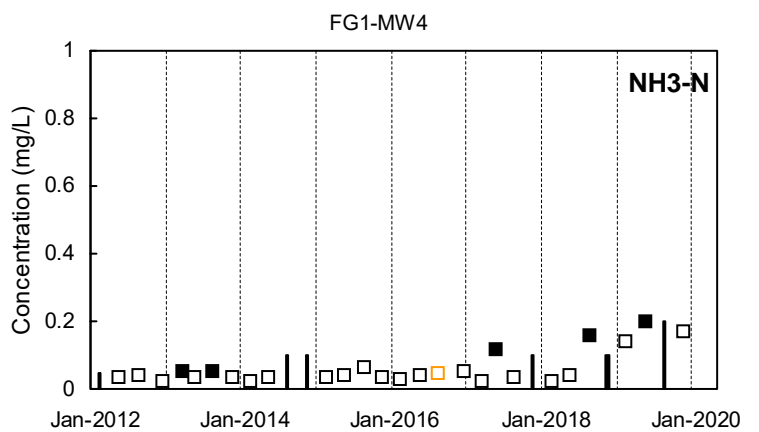
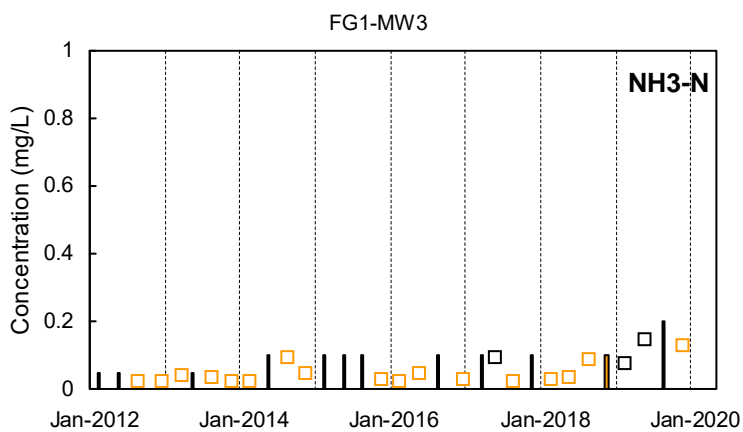
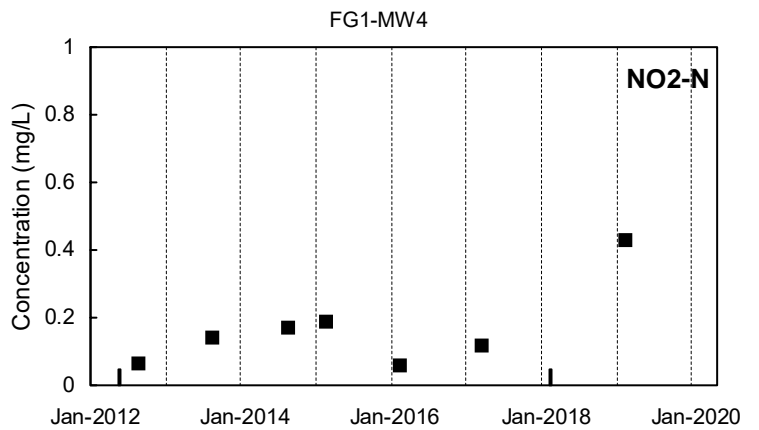
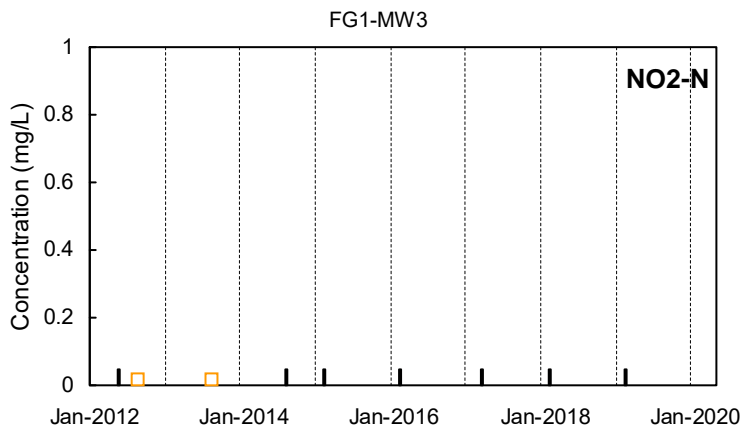
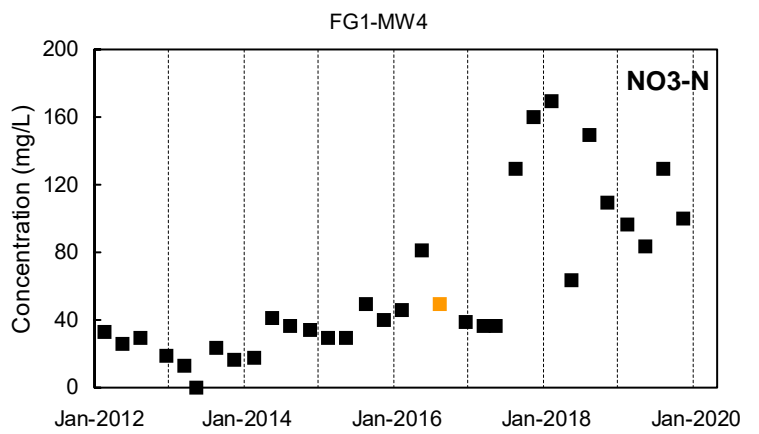
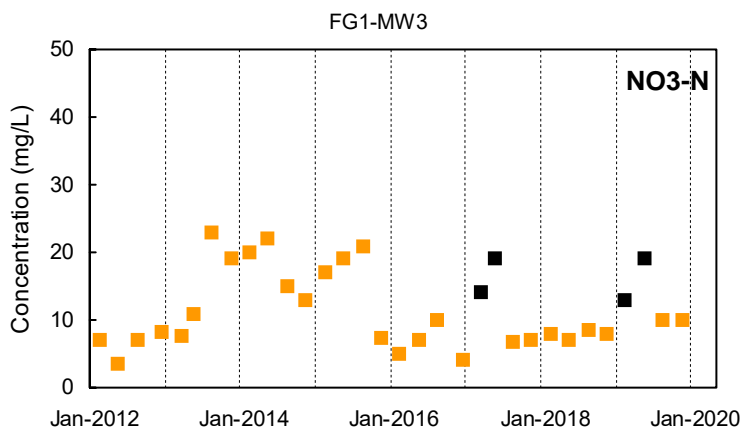

Detected Value
 'J'-Flag (value between reporting limit and detection limit)
 Non-Detect Range
 Shallow Well shown with black symbols Deep Well shown with orange symbols "dd" Well shown with blue symbols

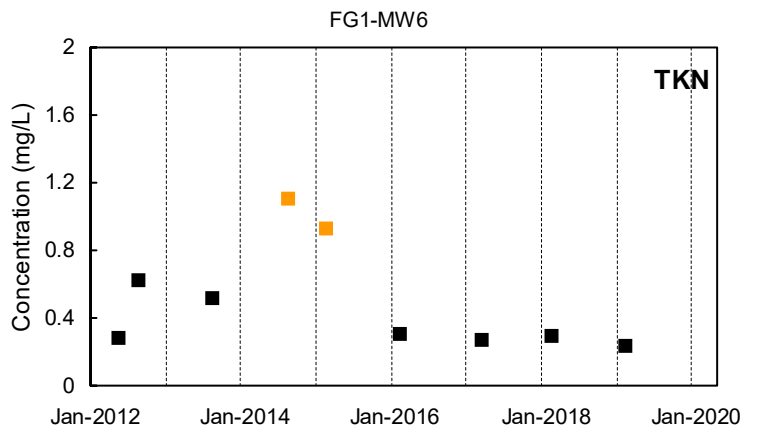
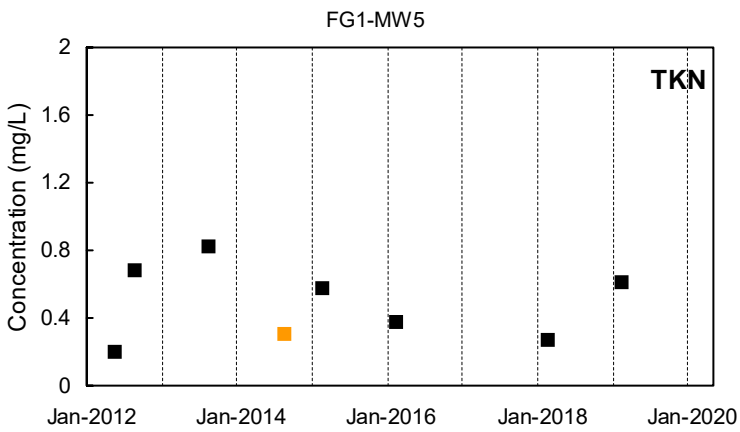
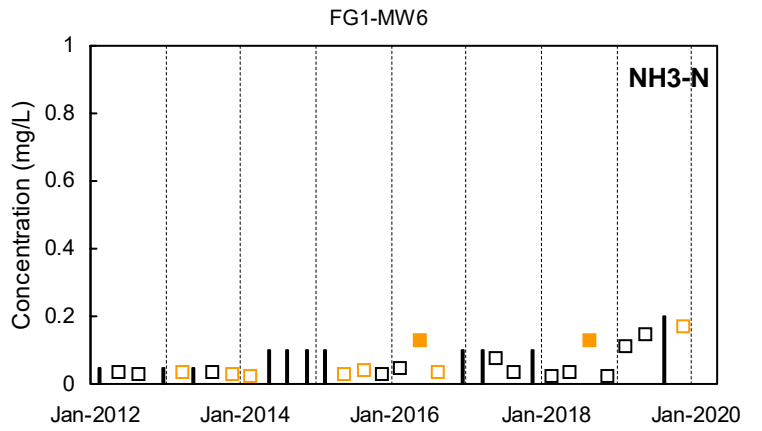
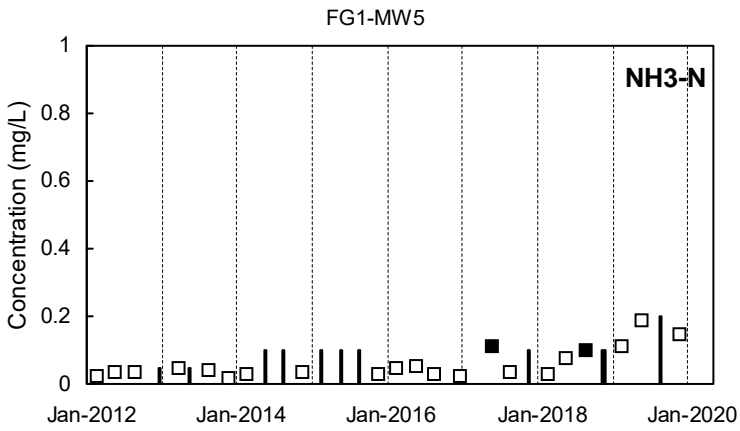
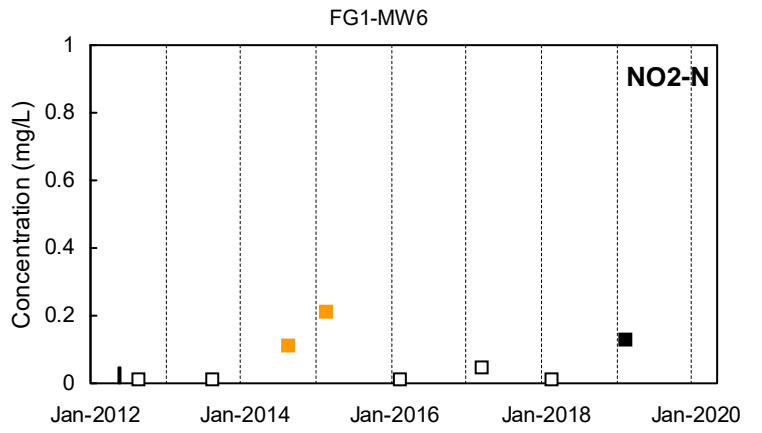
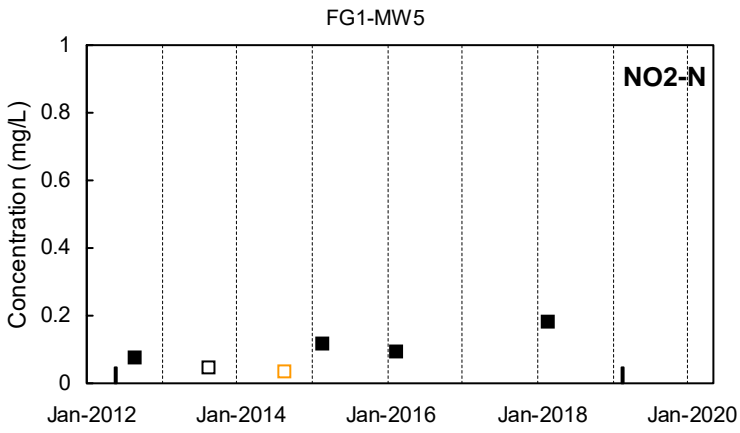
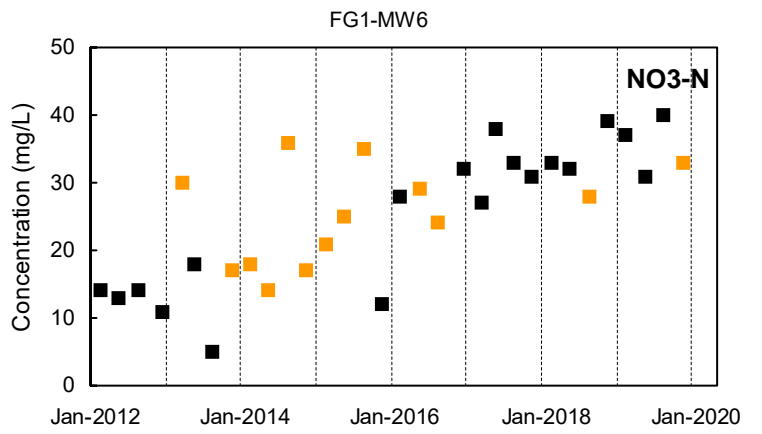
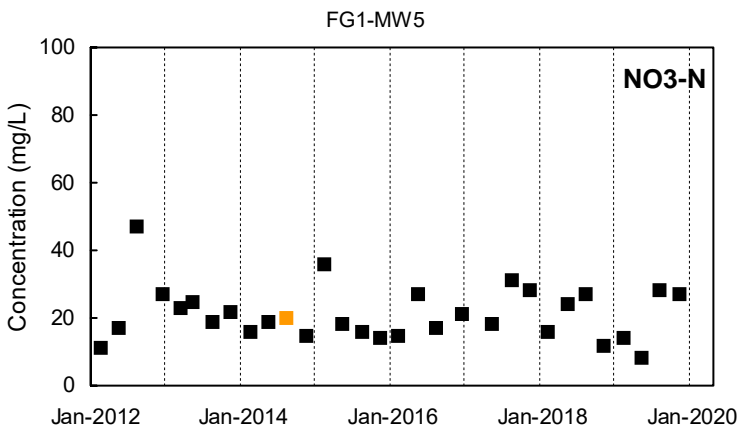

Detected Value
 'J'-Flag (value between reporting limit and detection limit)
 Non-Detect Range
Shallow Well shown with black symbols
Deep Well shown with orange symbols
"dd" Well shown with blue symbols

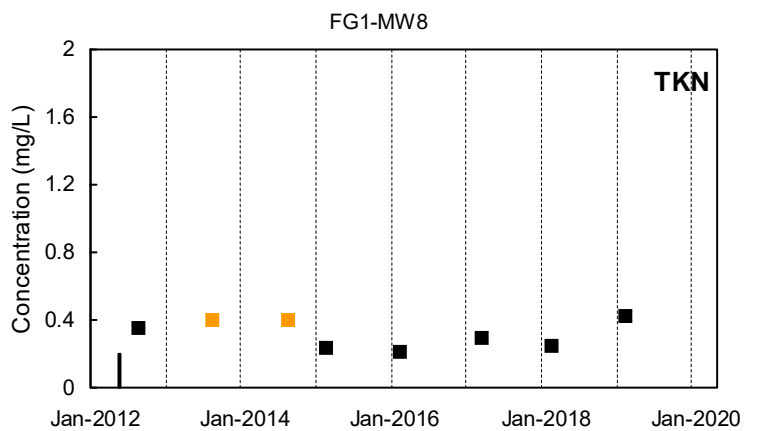
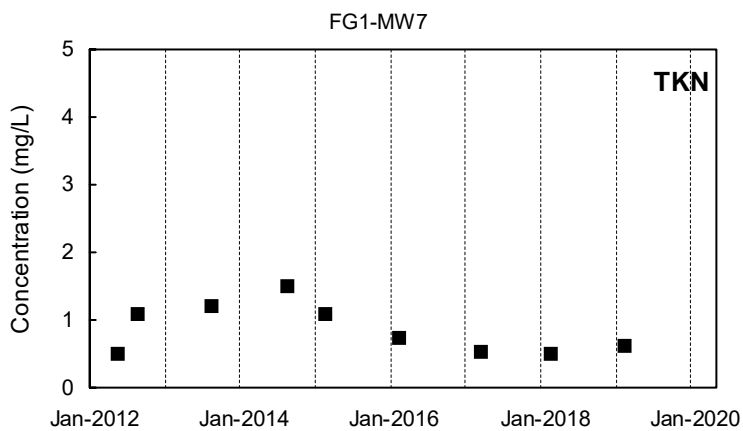
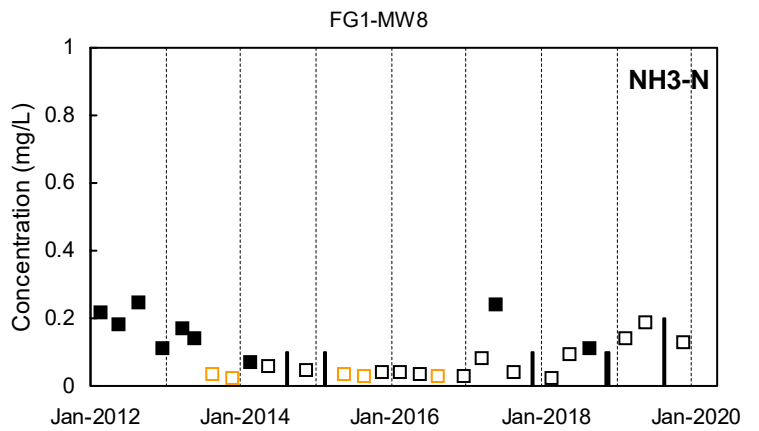
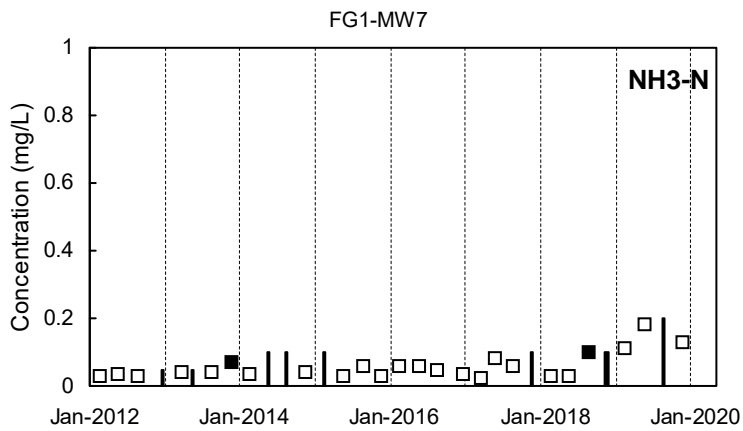
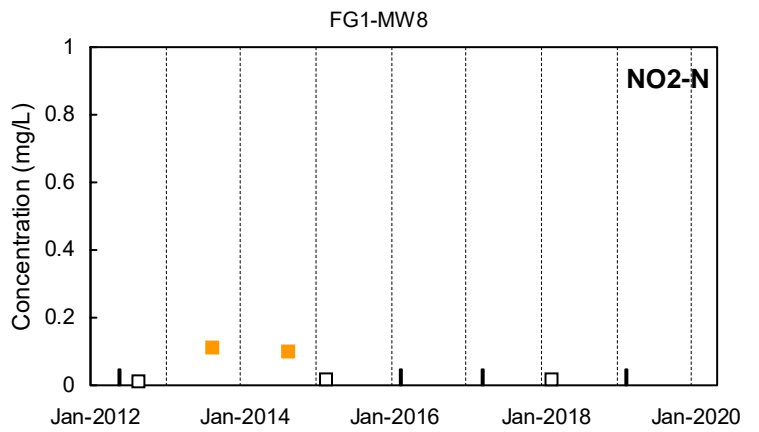
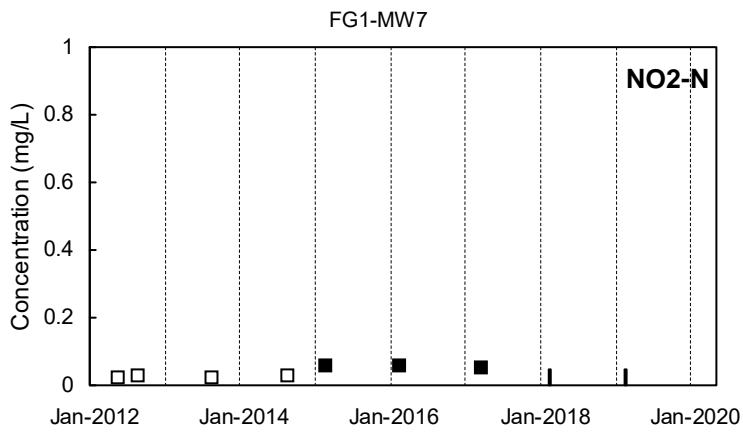
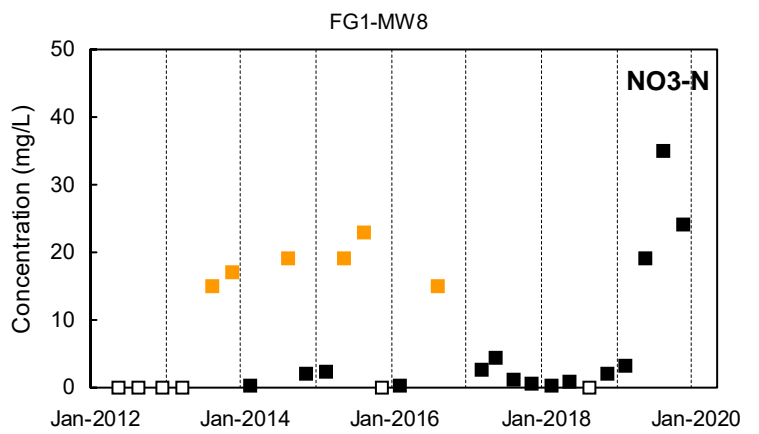
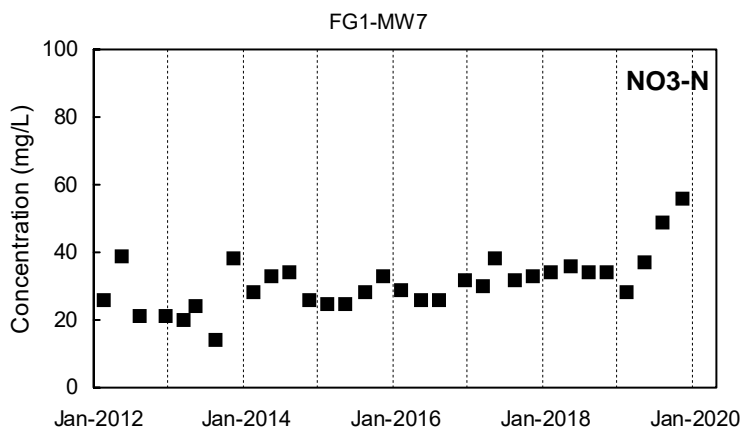

Detected Value
 'J'-Flag (value between reporting limit and detection limit)
 Non-Detect Range
 Shallow Well shown with black symbols
 Deep Well shown with orange symbols
 "dd" Well shown with blue symbols

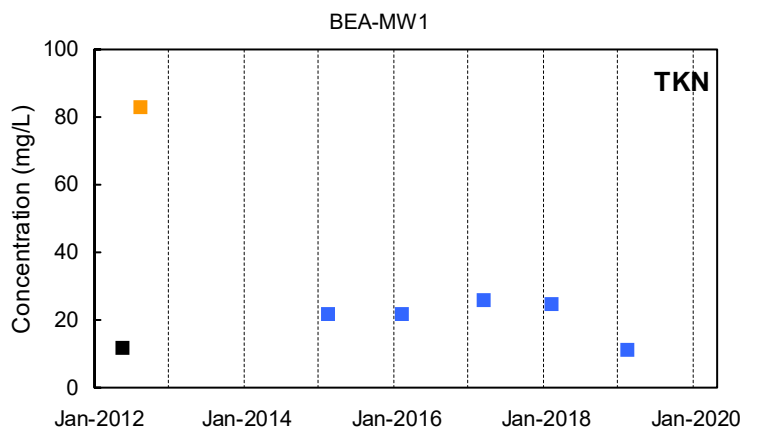
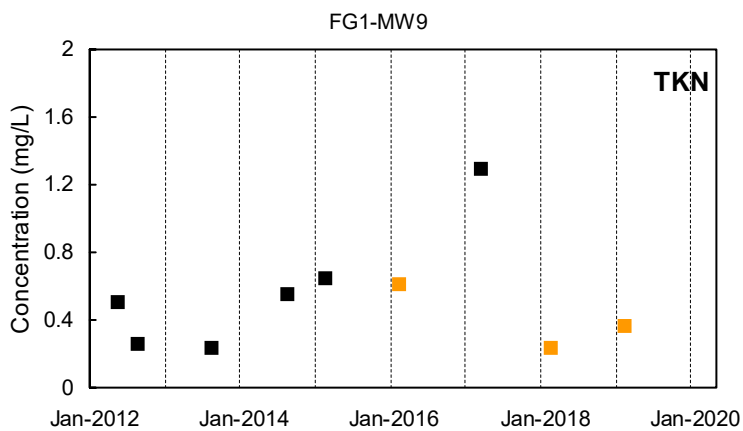
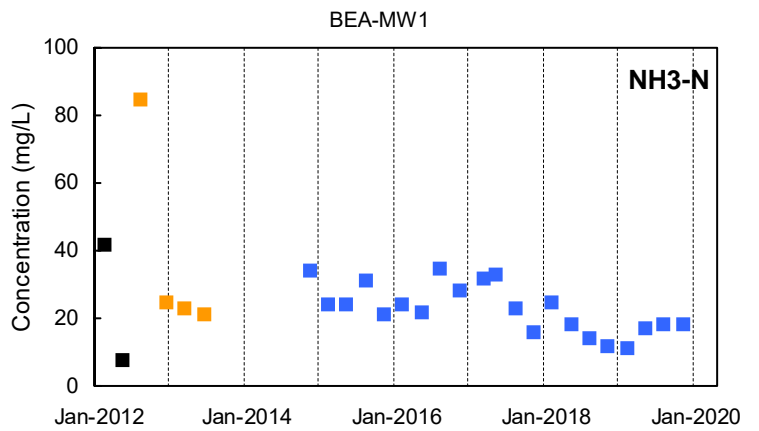
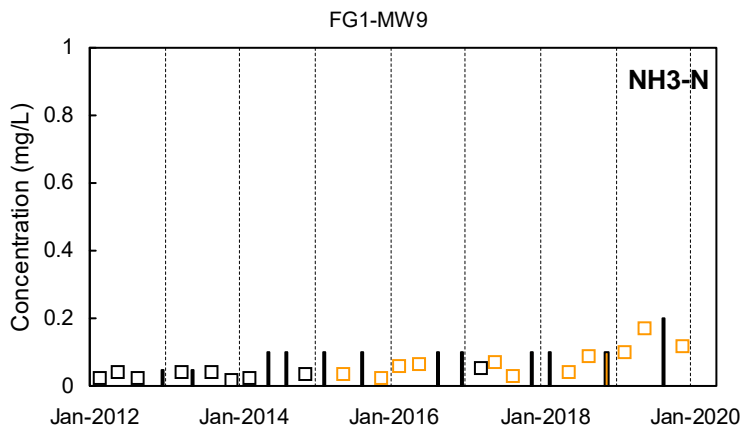
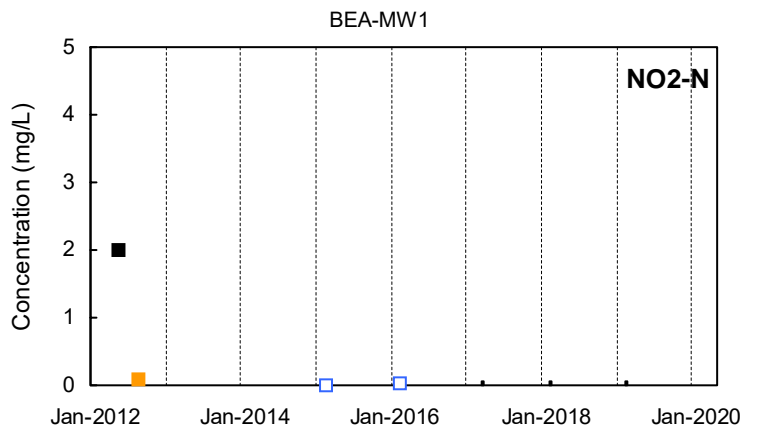
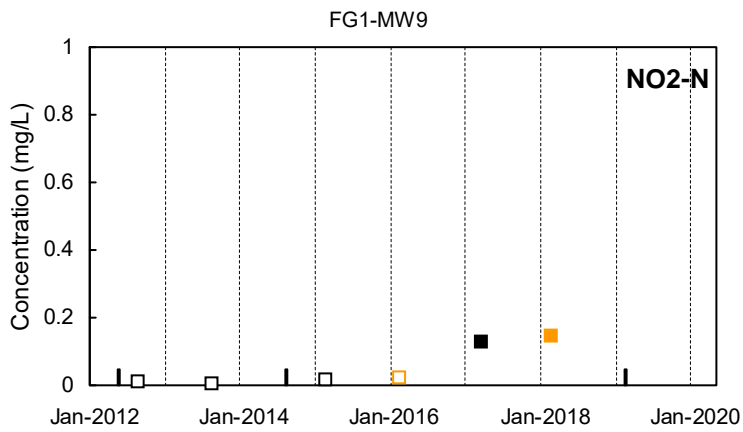
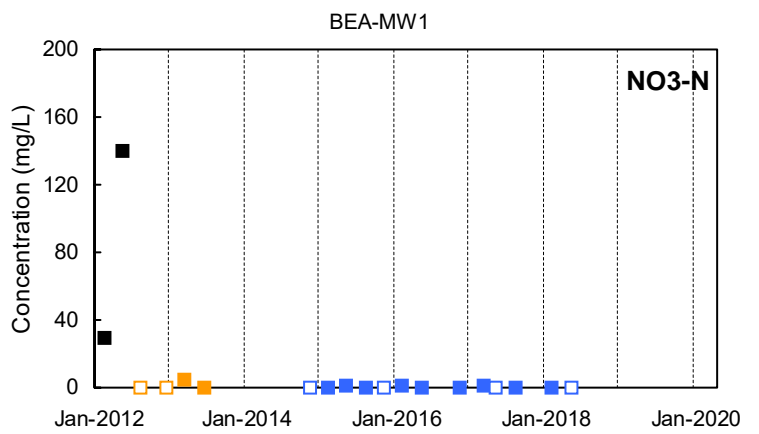
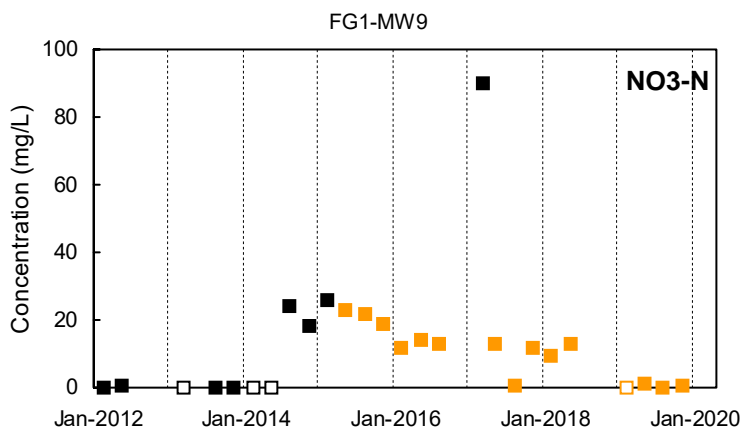

Detected Value
 'J'-Flag (value between reporting limit and detection limit)
 Non-Detect Range
 Shallow Well shown with black symbols Deep Well shown with orange symbols "dd" Well shown with blue symbols

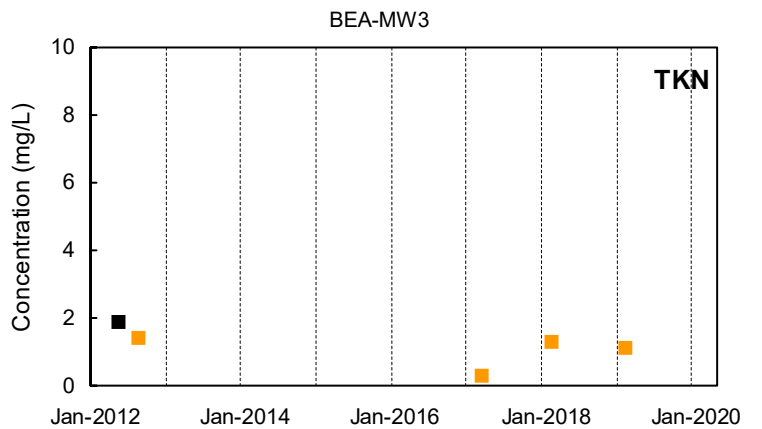
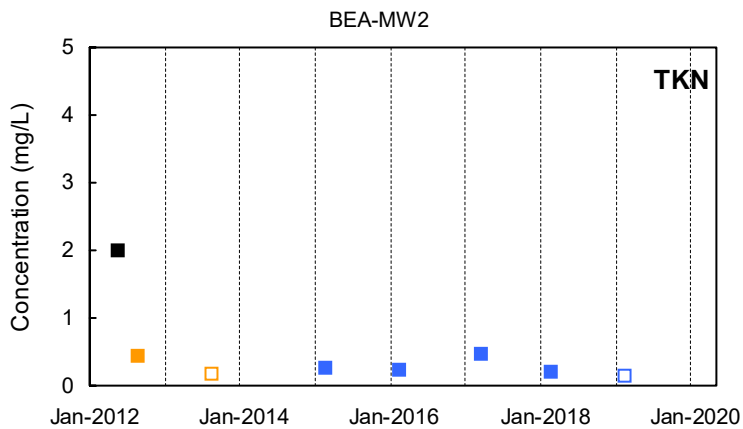
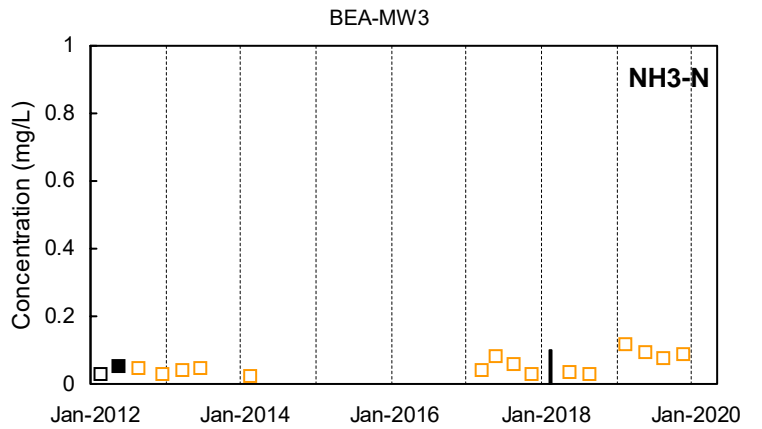
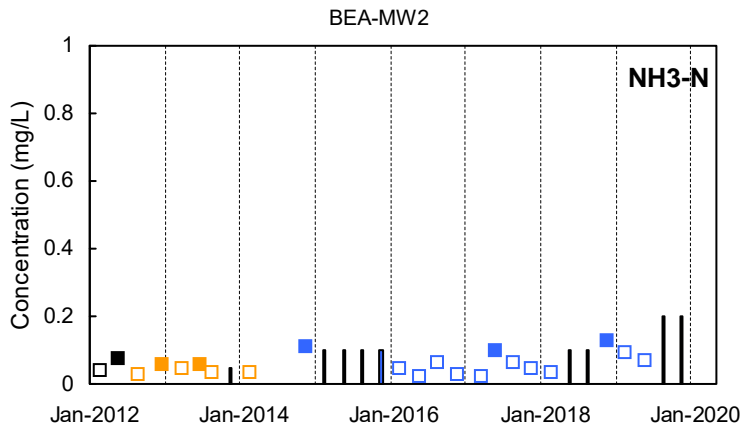
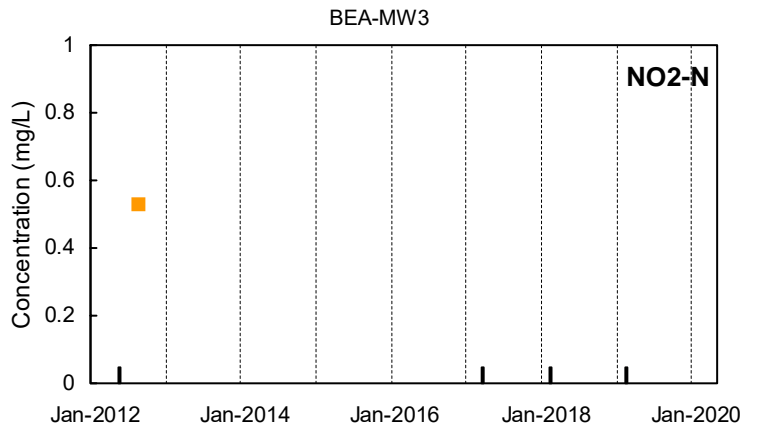
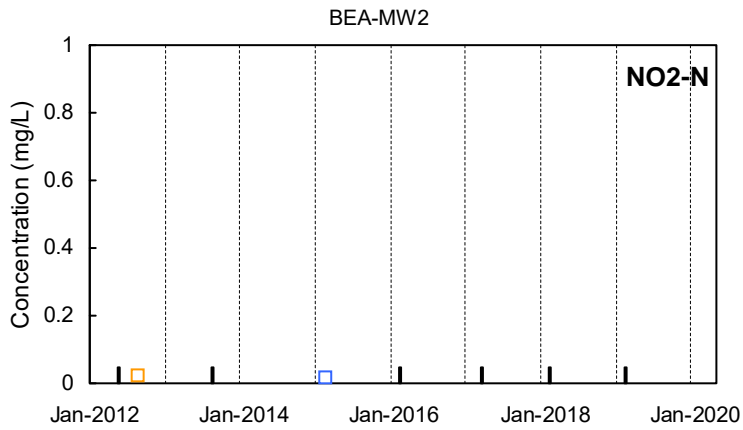
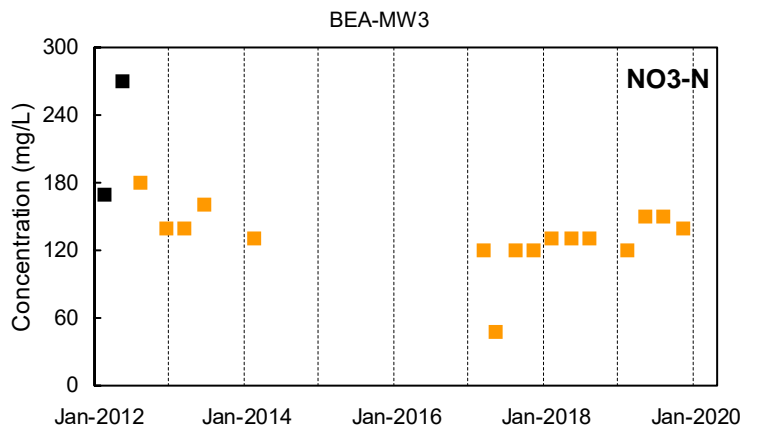
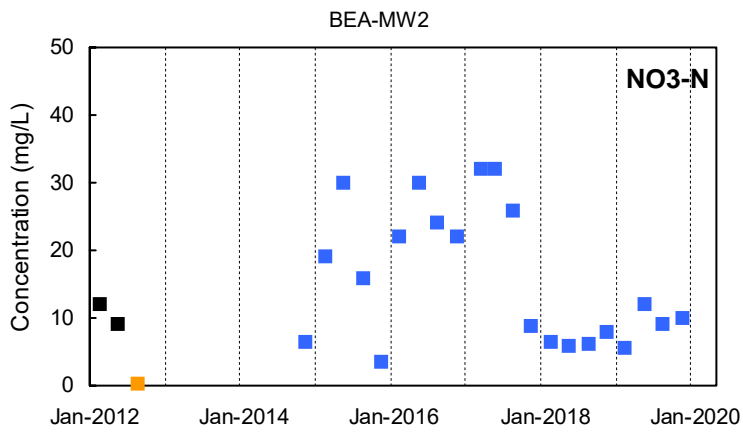

Detected Value
 'J'-Flag (value between reporting limit and detection limit)
 Non-Detect Range
 Shallow Well shown with black symbols
 Deep Well shown with orange symbols
 "dd" Well shown with blue symbols

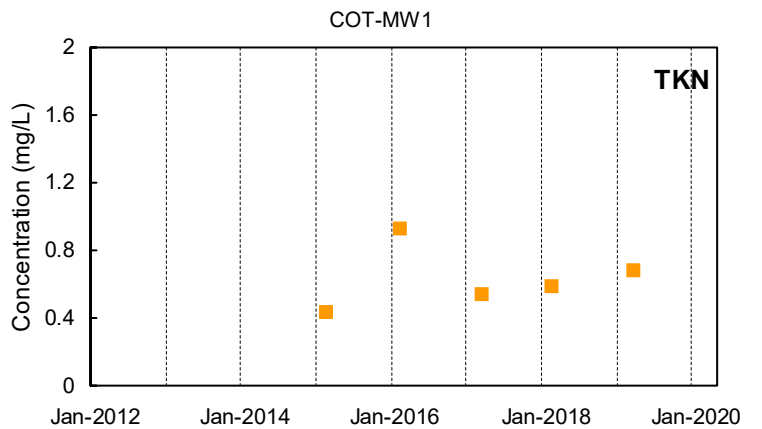
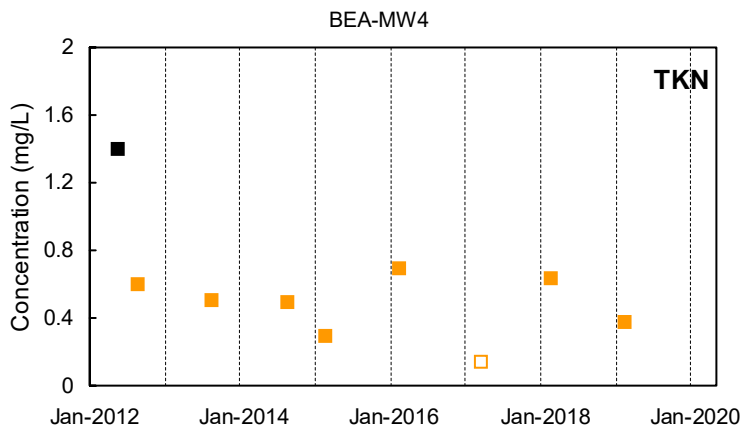
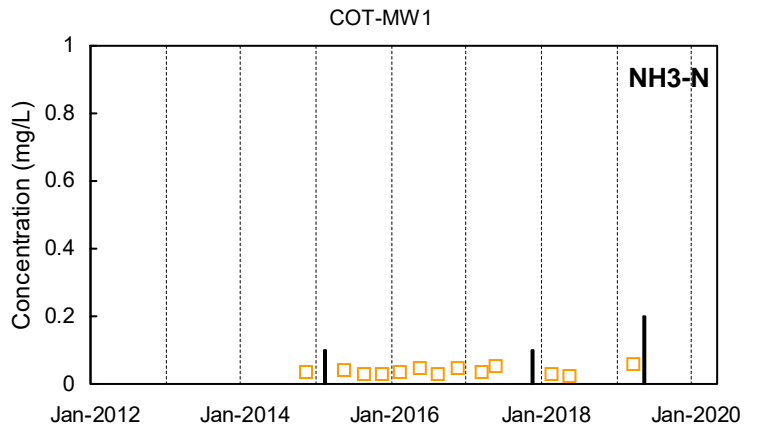
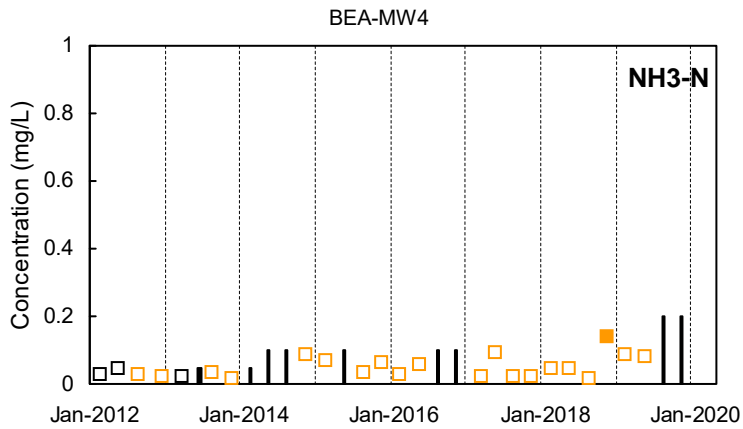
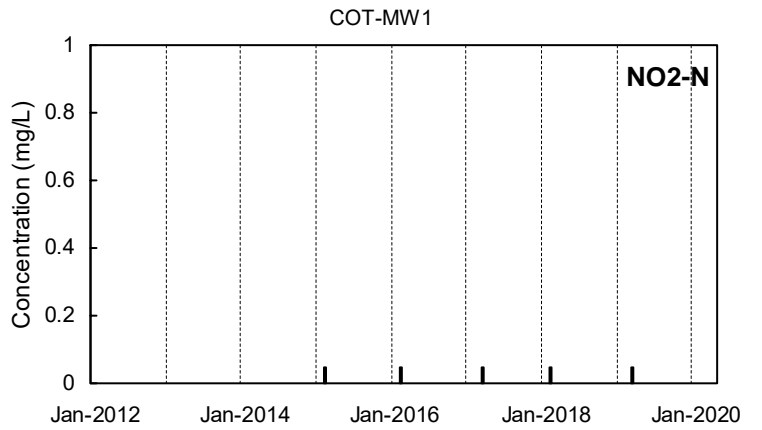
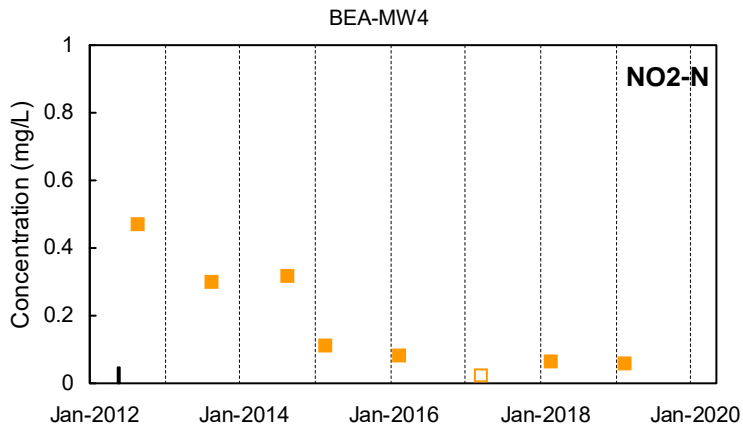
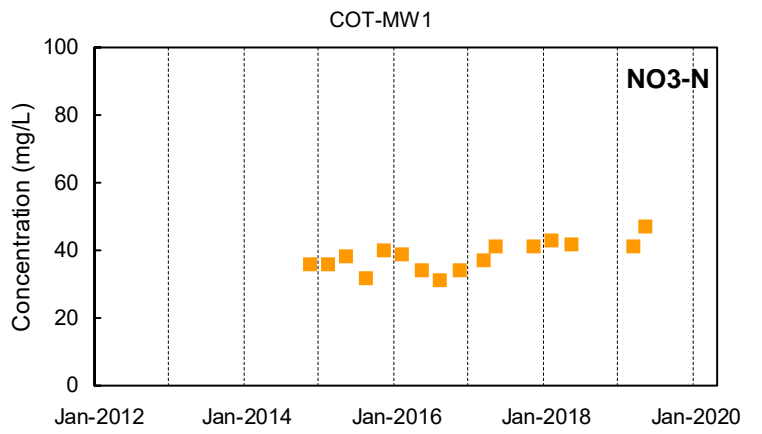
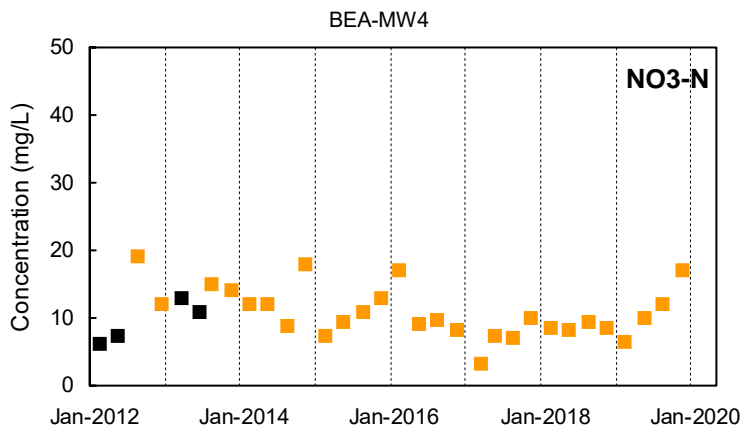

■ Detected Value □ 'J'-Flag (value between reporting limit and detection limit) ■ Non-Detect Range
 ■ Shallow Well shown with black symbols ■ Deep Well shown with orange symbols ■ "dd" Well shown with blue symbols

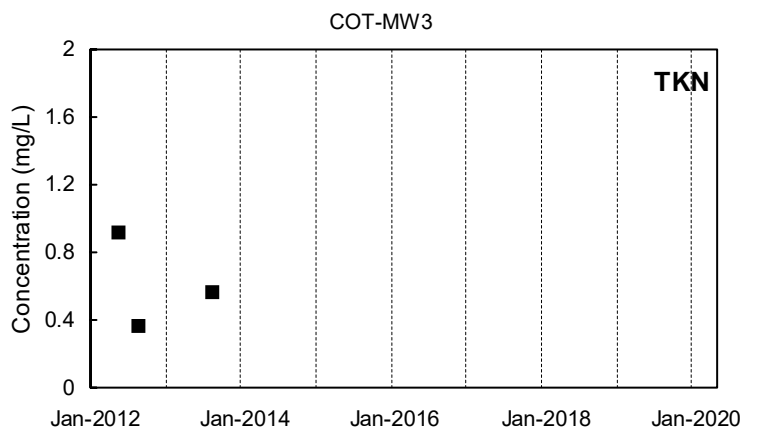
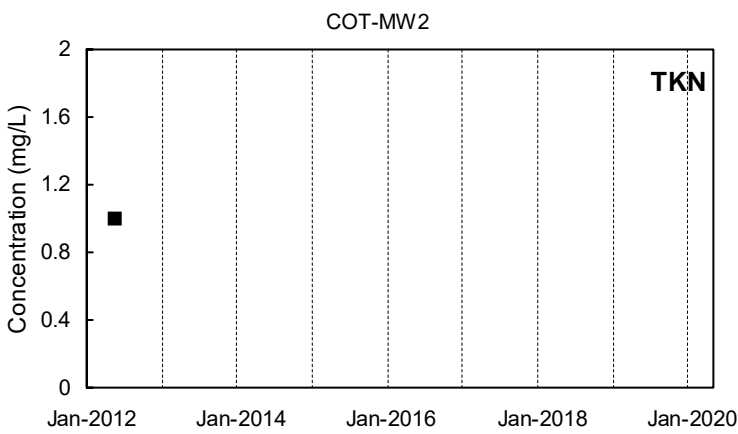
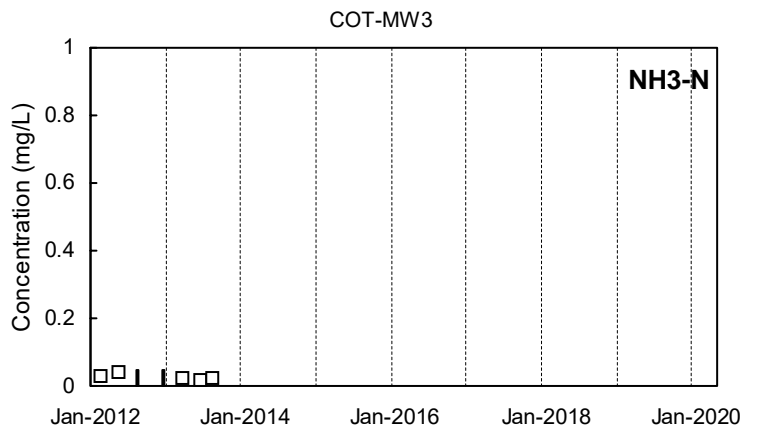
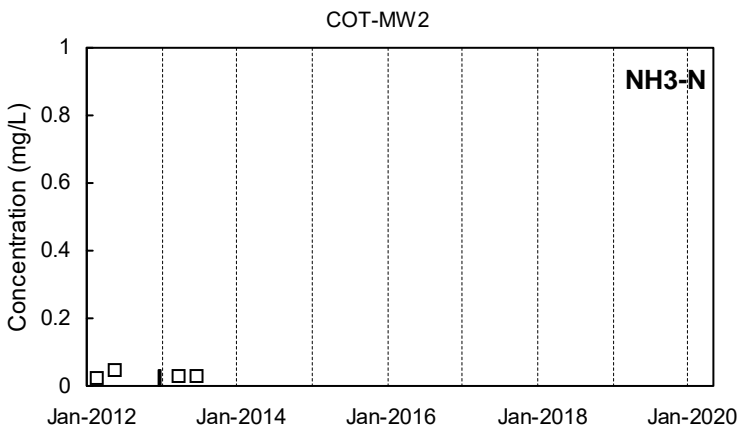
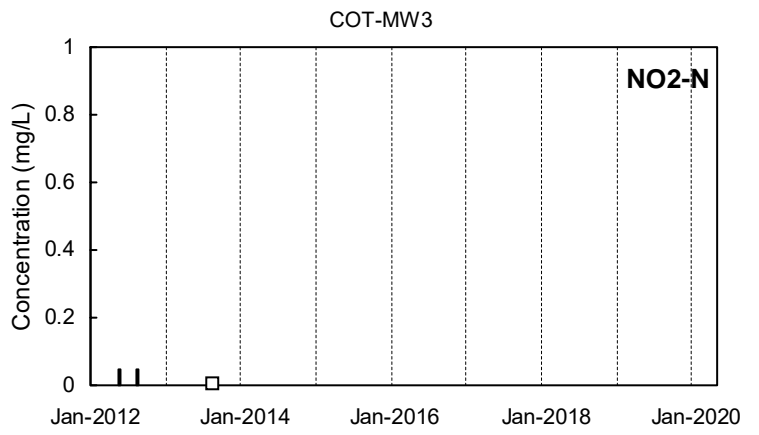
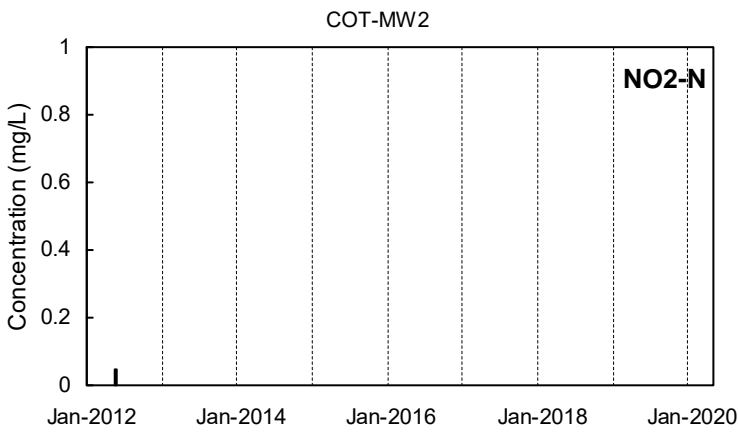
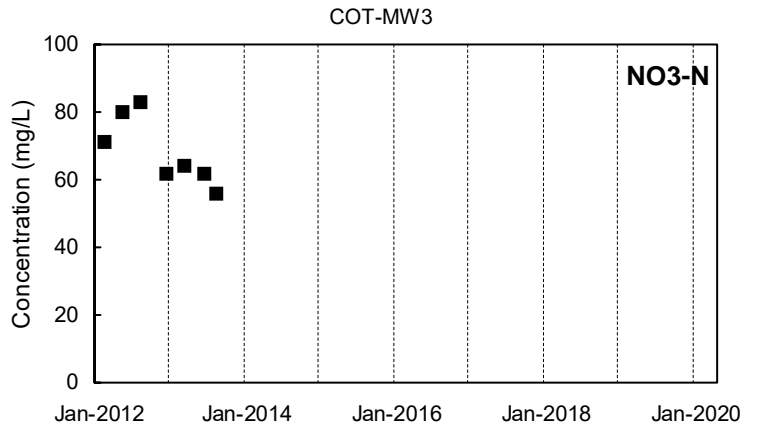
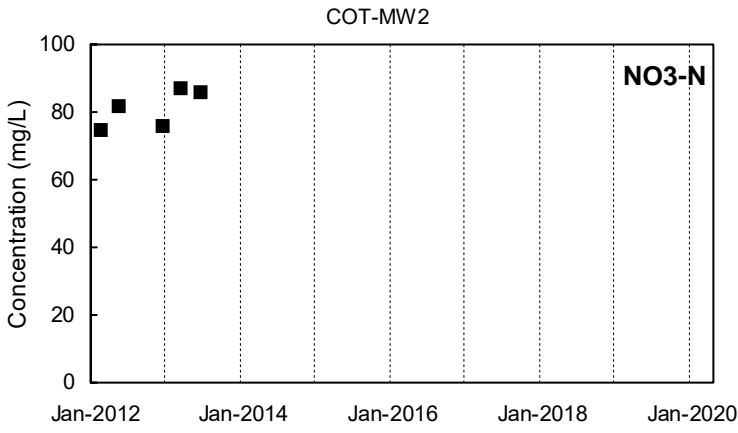

Detected Value
 'J'-Flag (value between reporting limit and detection limit)
 Non-Detect Range
 Shallow Well shown with black symbols
 Deep Well shown with orange symbols
 "dd" Well shown with blue symbols

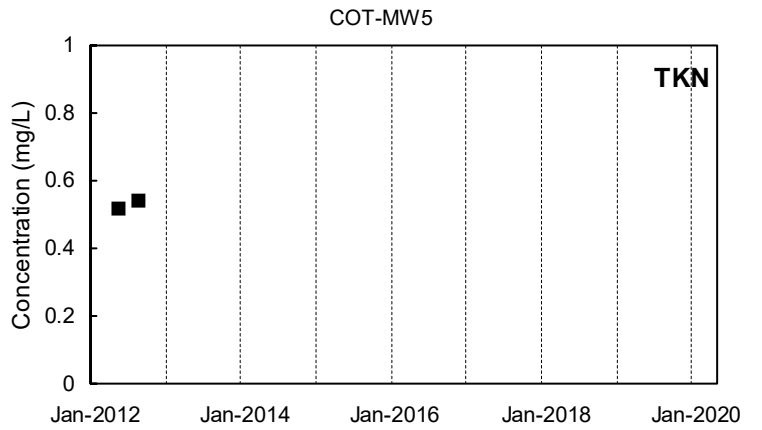
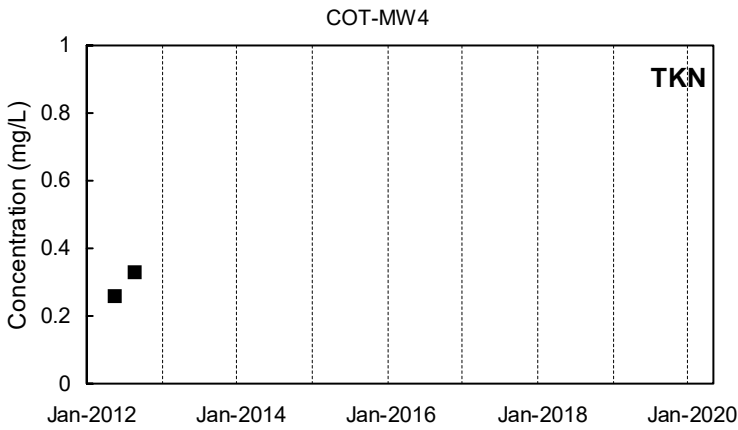
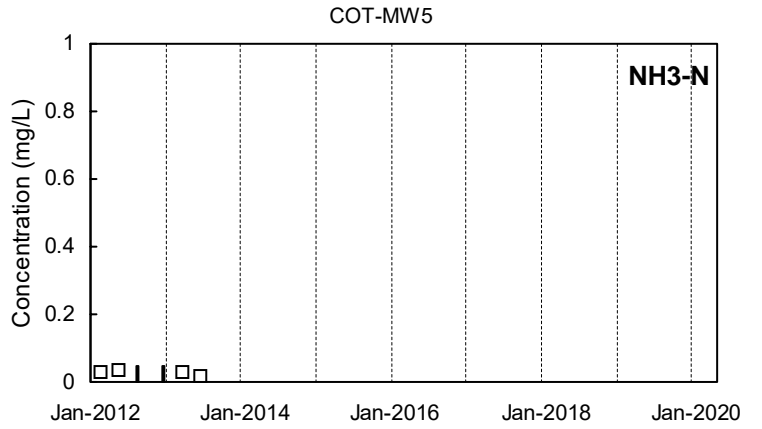
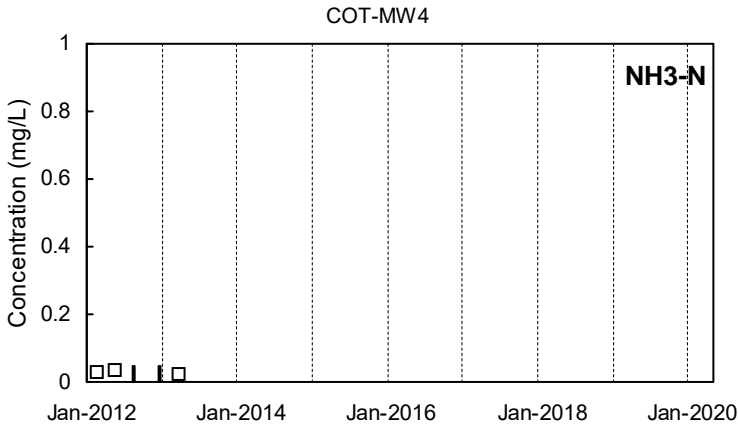
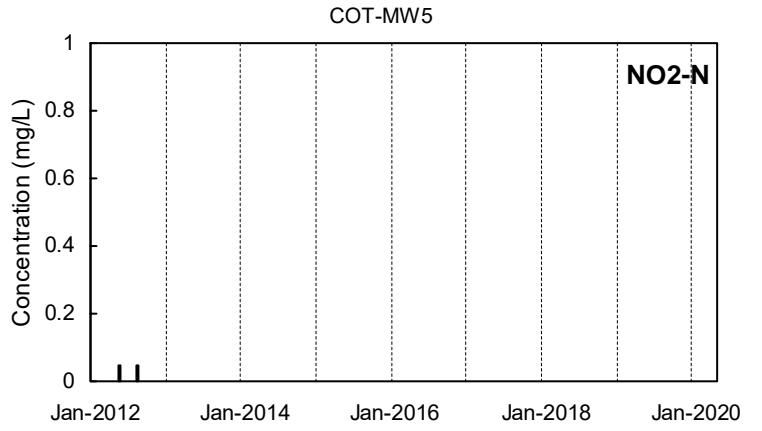
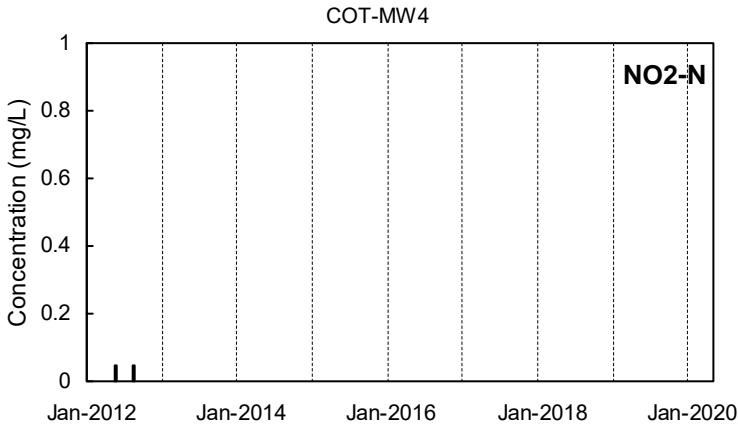
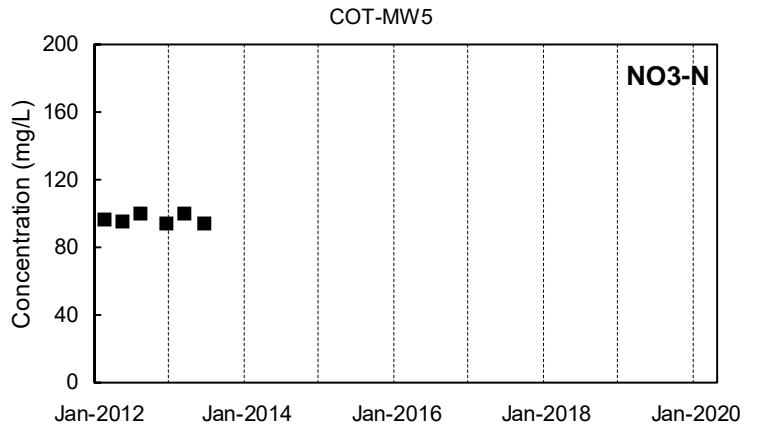
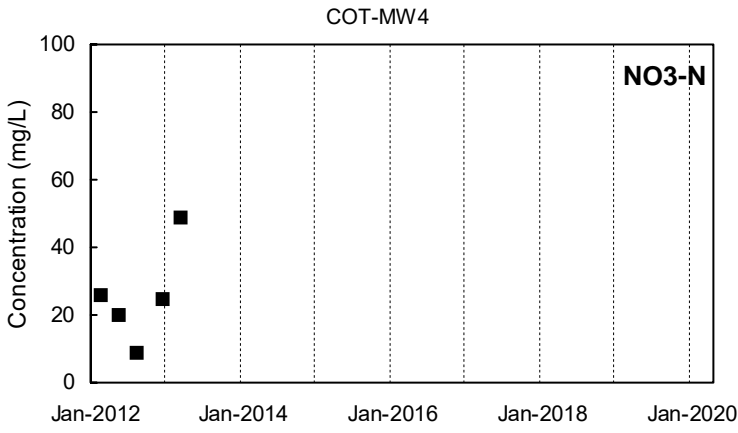

Detected Value
 'J'-Flag (value between reporting limit and detection limit)
 Non-Detect Range
Shallow Well shown with black symbols
Deep Well shown with orange symbols
"dd" Well shown with blue symbols

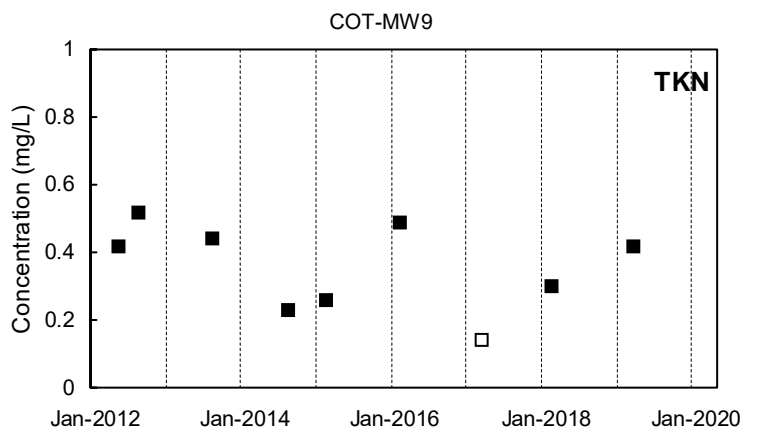
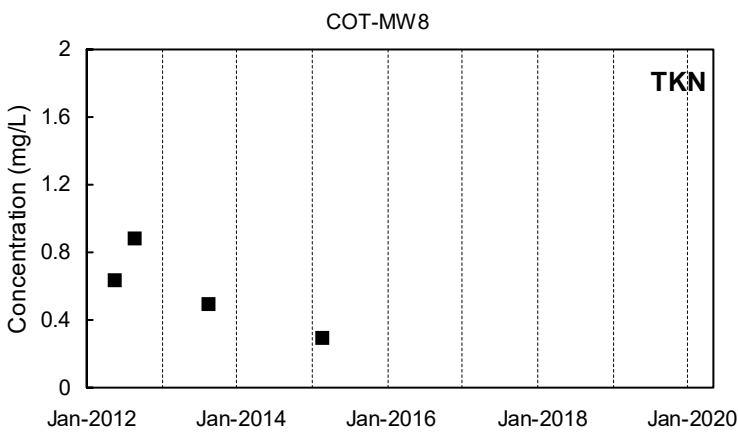
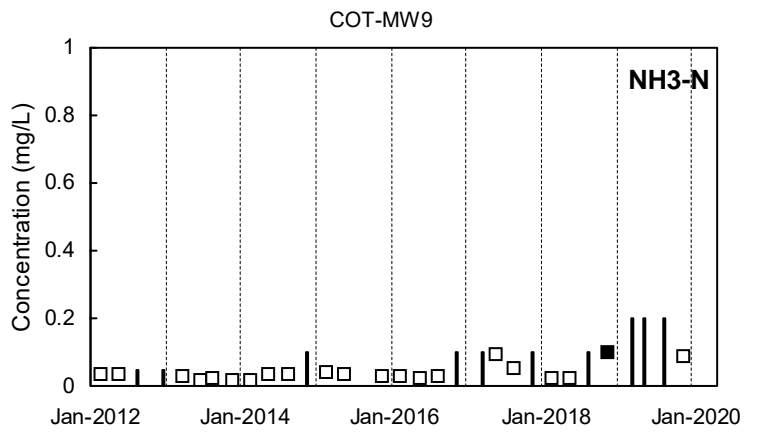
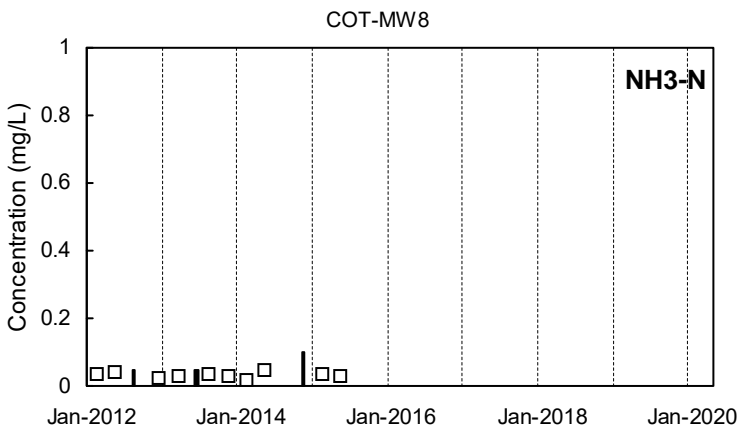
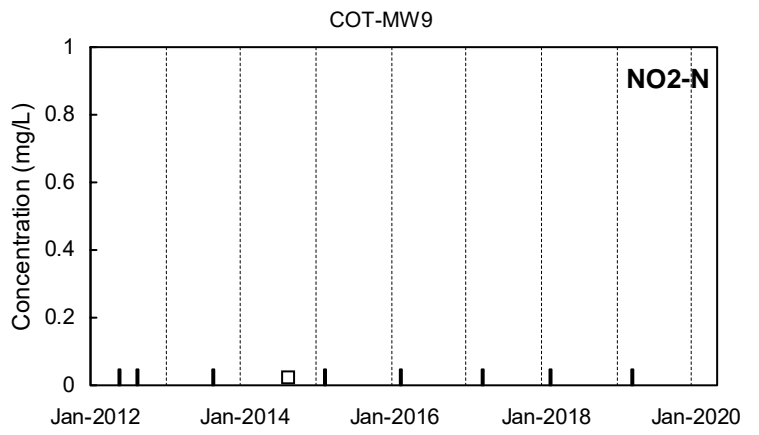
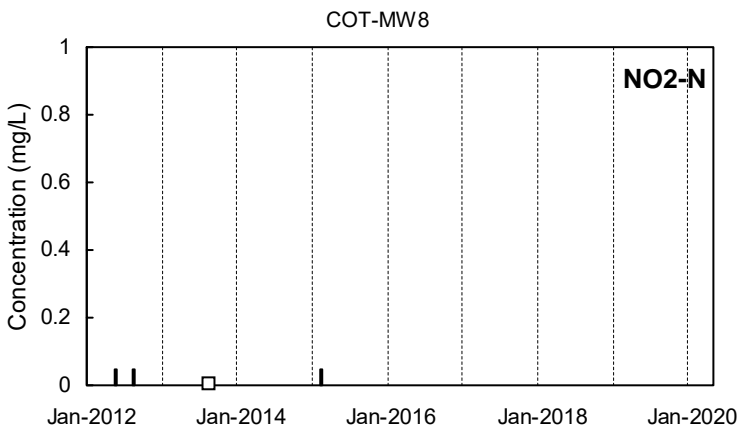
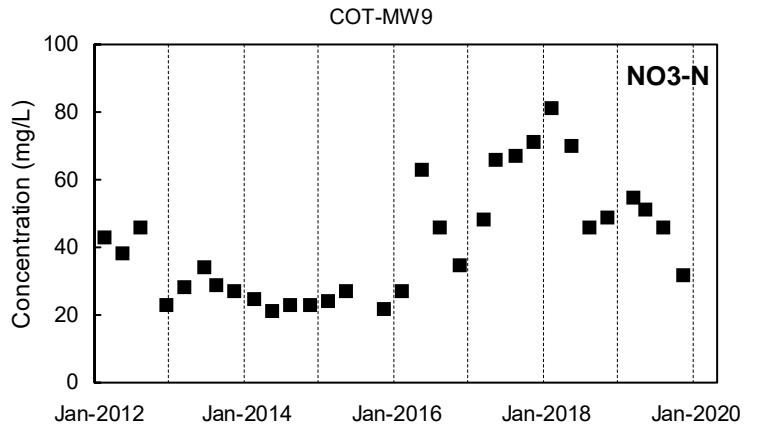
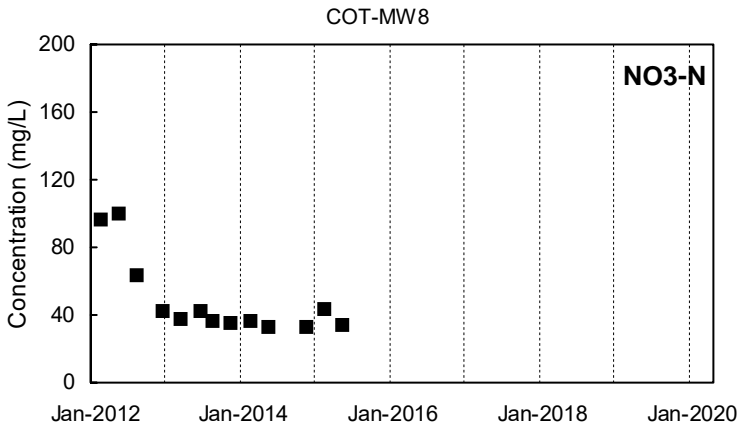

Detected Value
 'J'-Flag (value between reporting limit and detection limit)
 Non-Detect Range
 Shallow Well shown with black symbols
 Deep Well shown with orange symbols
 "dd" Well shown with blue symbols

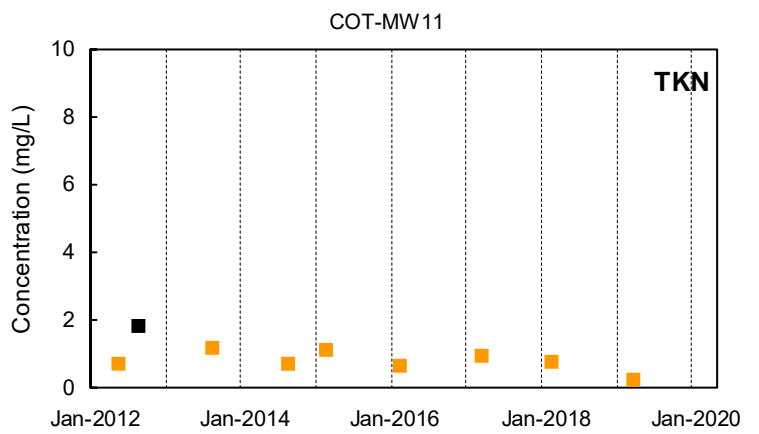
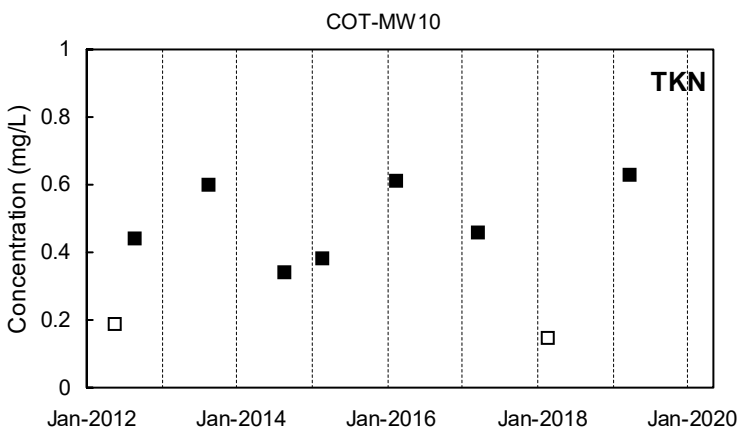
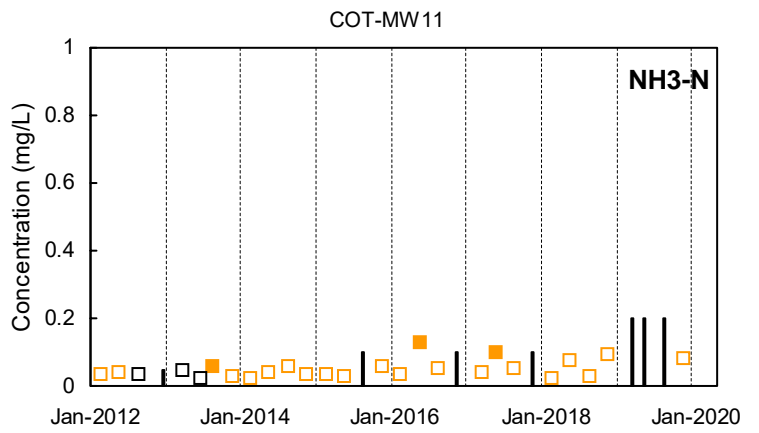
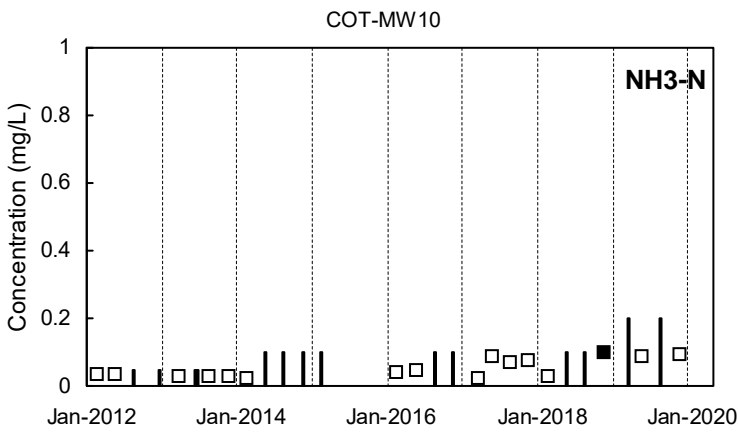
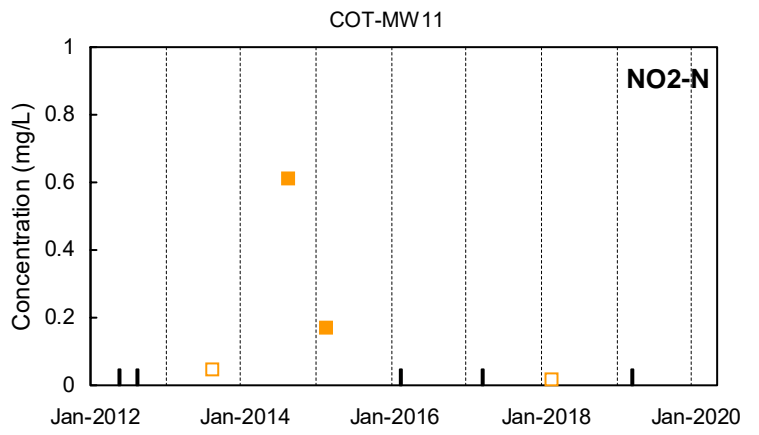
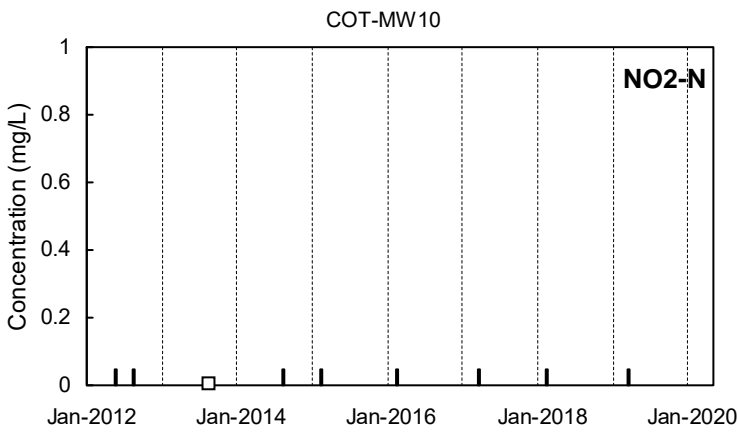
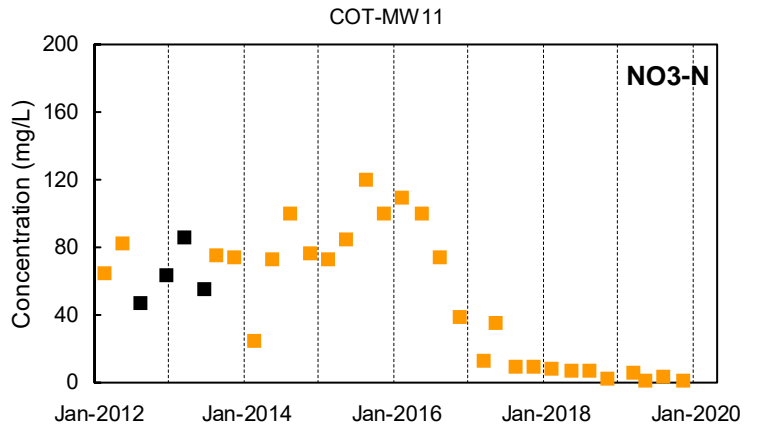
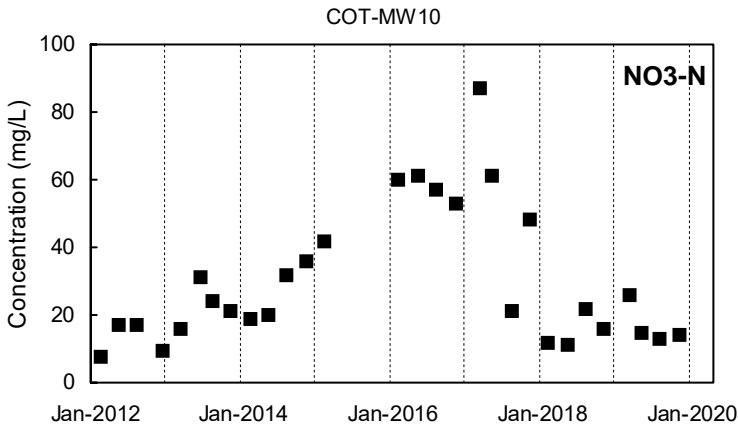

Detected Value
 'J'-Flag (value between reporting limit and detection limit)
 Non-Detect Range
 Shallow Well shown with black symbols
 Deep Well shown with orange symbols
 "dd" Well shown with blue symbols

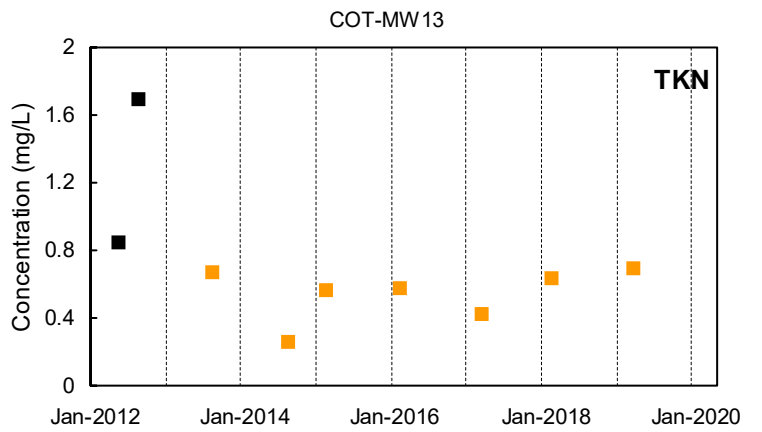
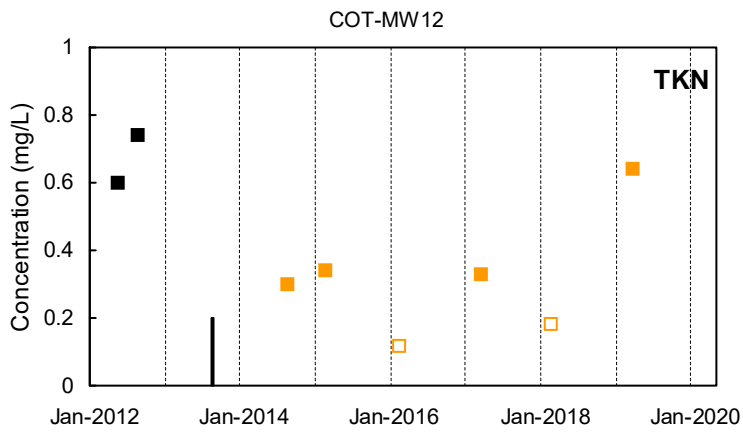
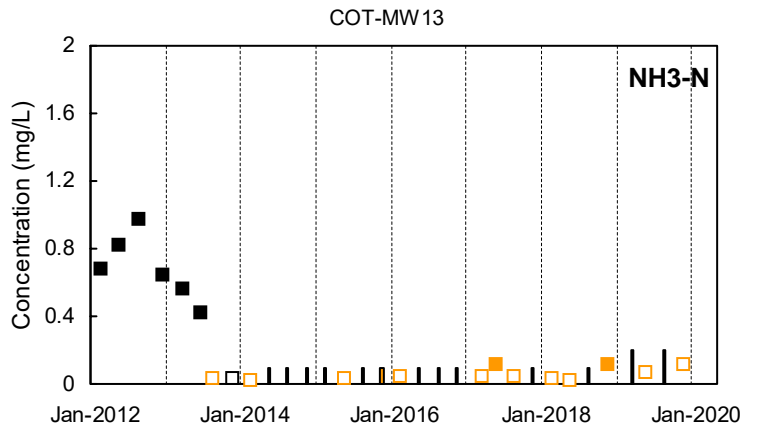
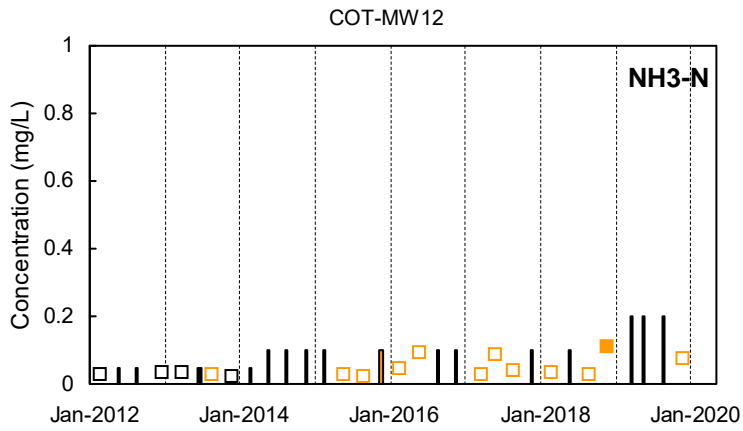
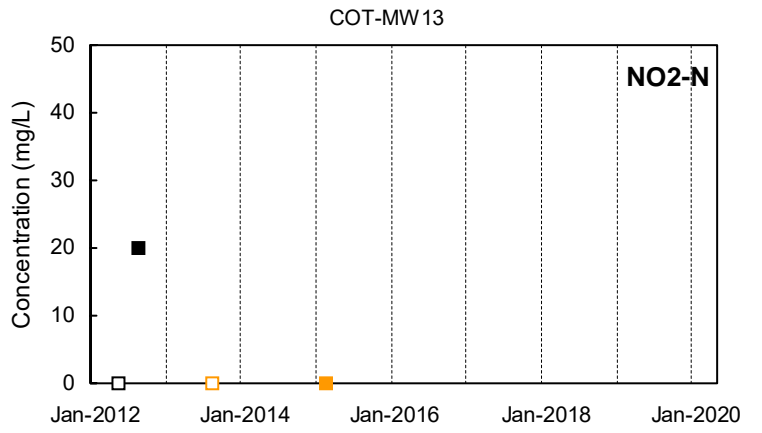
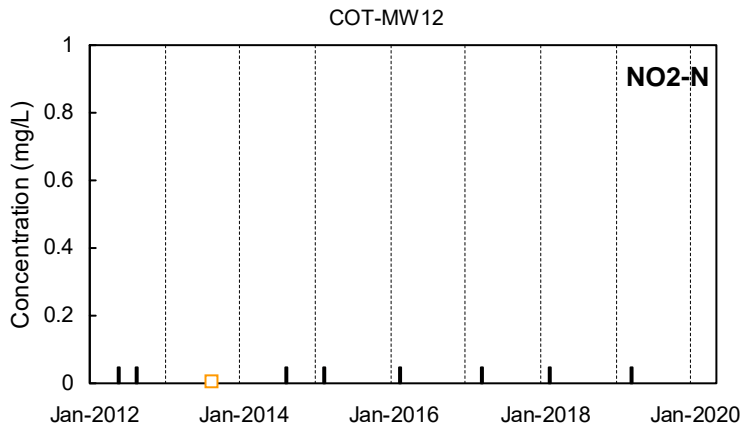
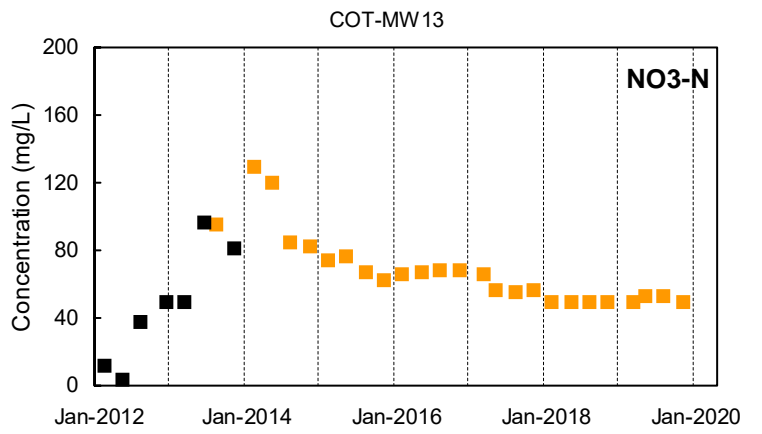
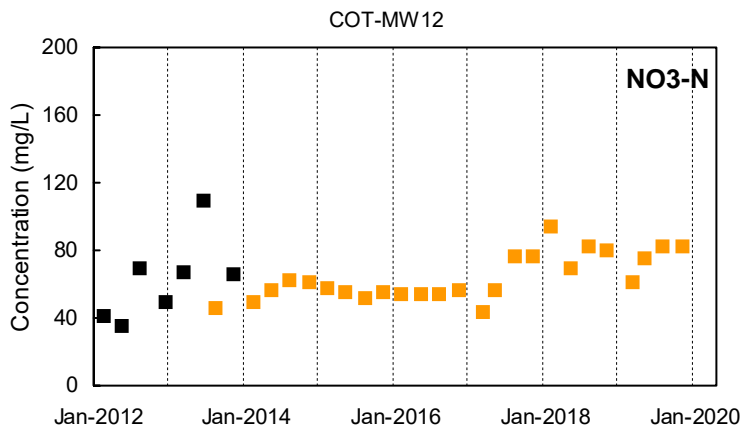

■ Detected Value □ 'J'-Flag (value between reporting limit and detection limit) ■ Non-Detect Range
 ■ Shallow Well shown with black symbols ■ Deep Well shown with orange symbols ■ "dd" Well shown with blue symbols

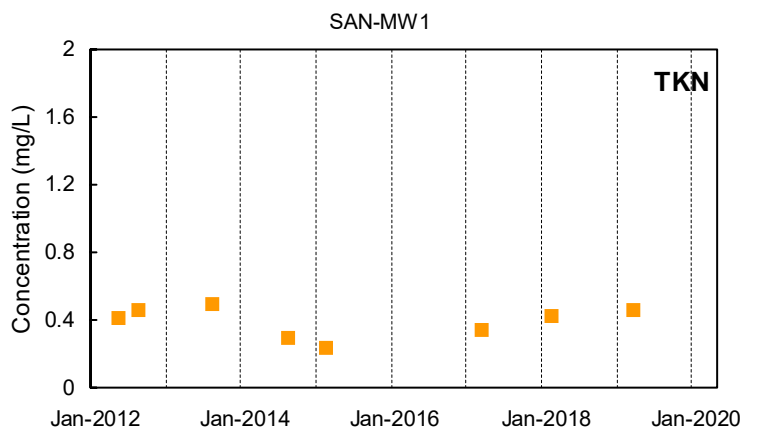
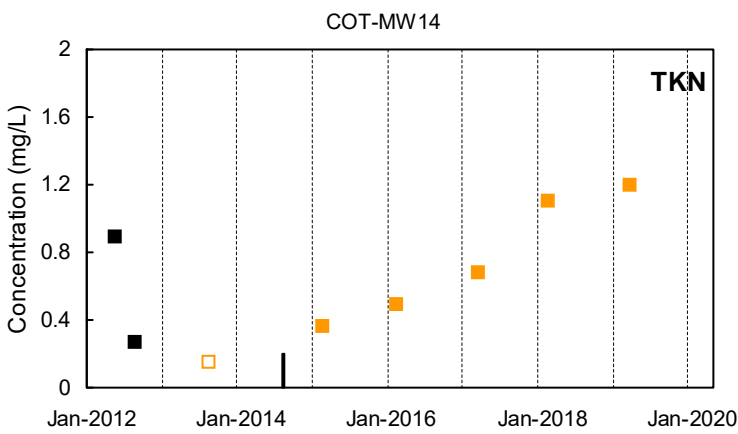
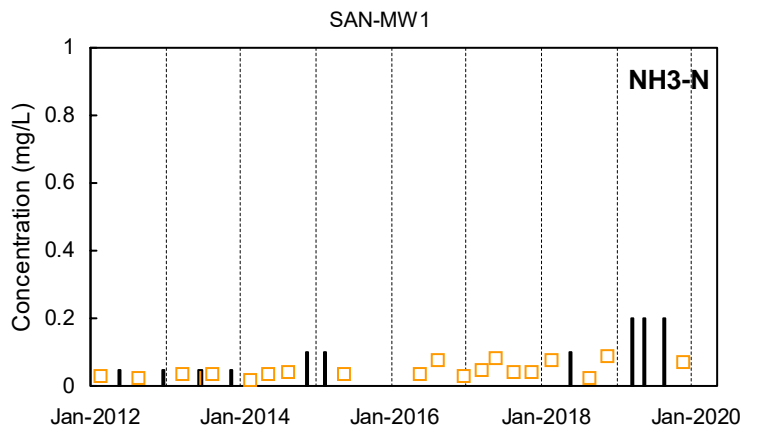
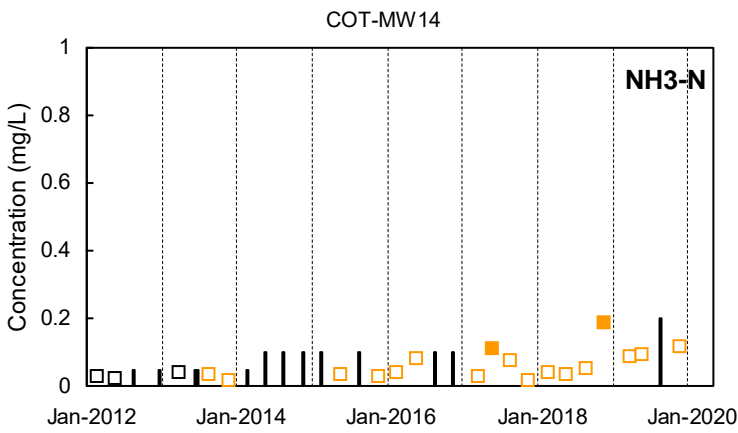
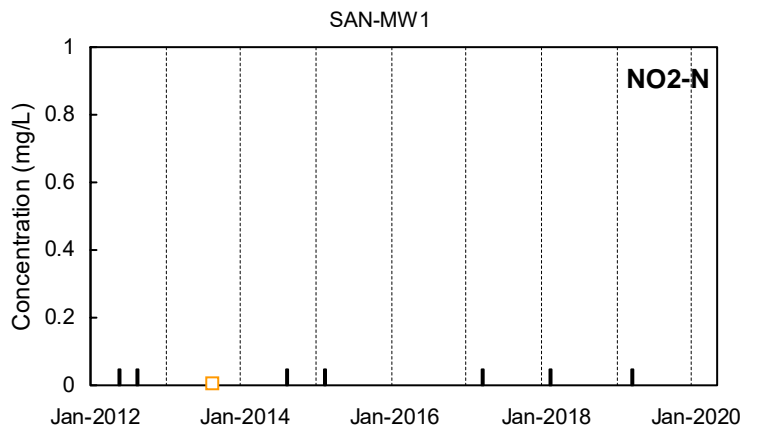
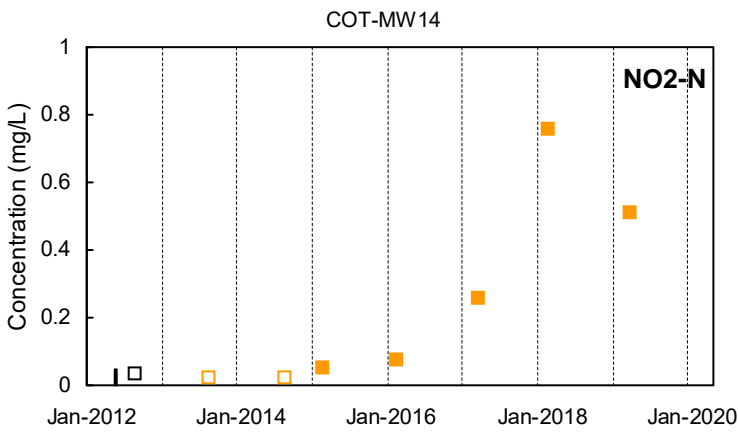
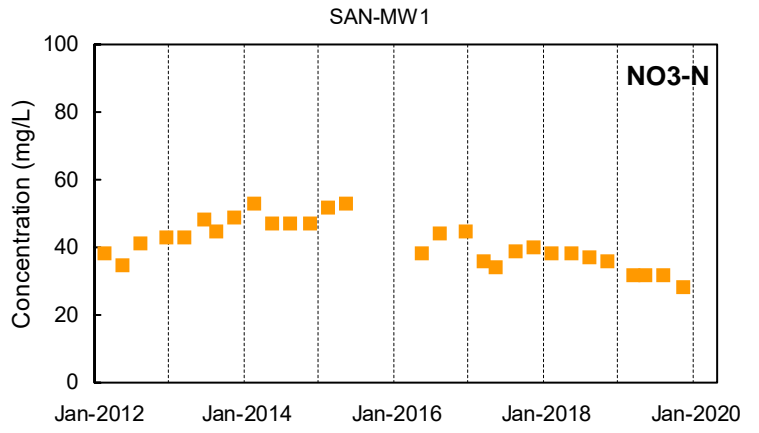
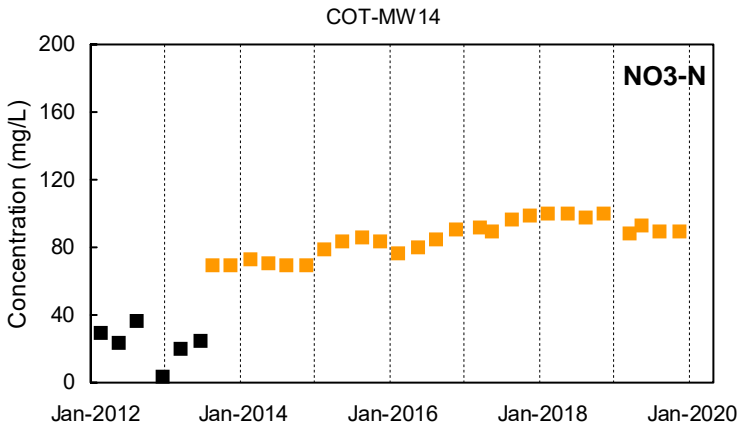

Detected Value
 'J'-Flag (value between reporting limit and detection limit)
 Non-Detect Range
 Shallow Well shown with black symbols
 Deep Well shown with orange symbols
 "dd" Well shown with blue symbols

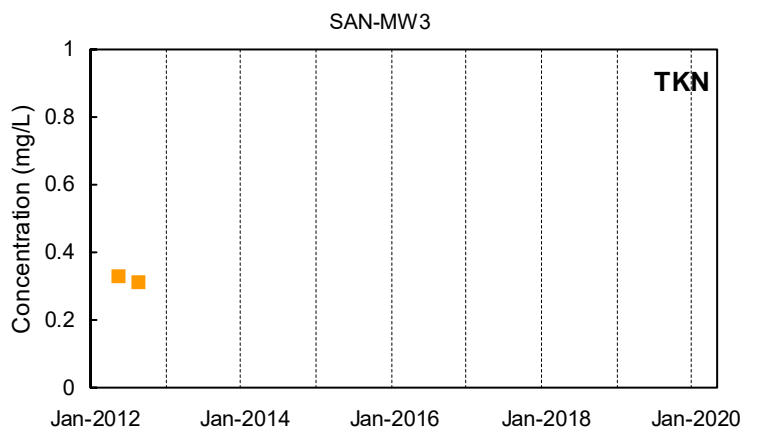
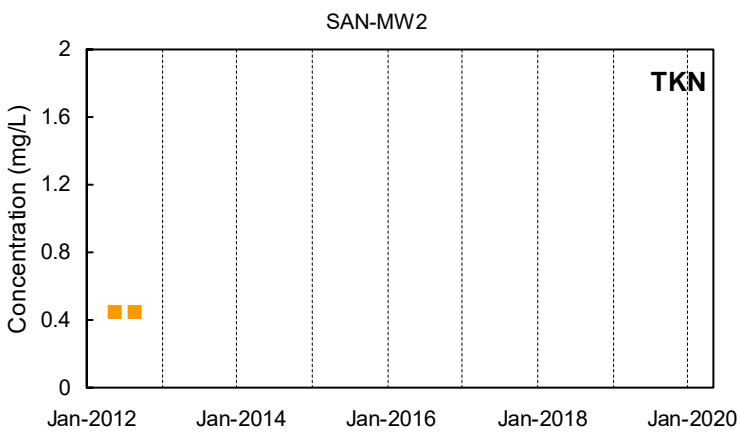
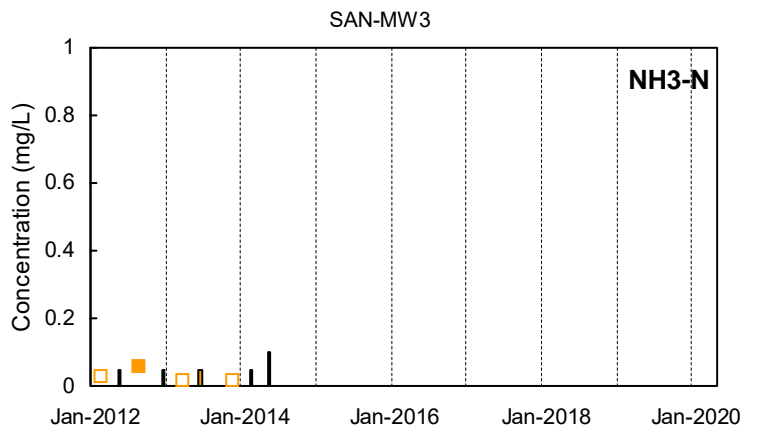
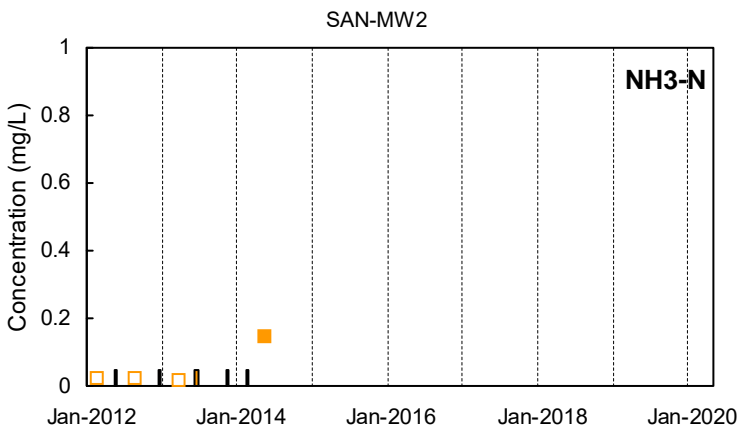
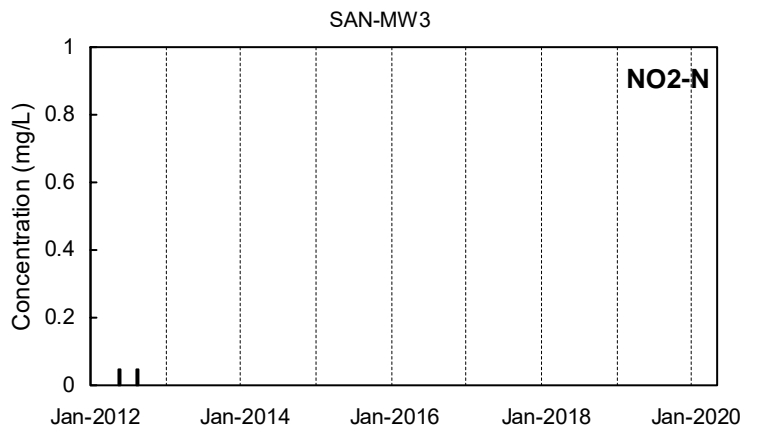
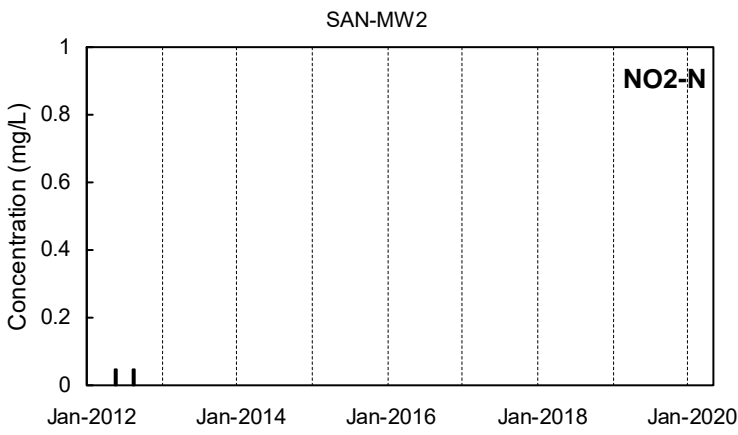
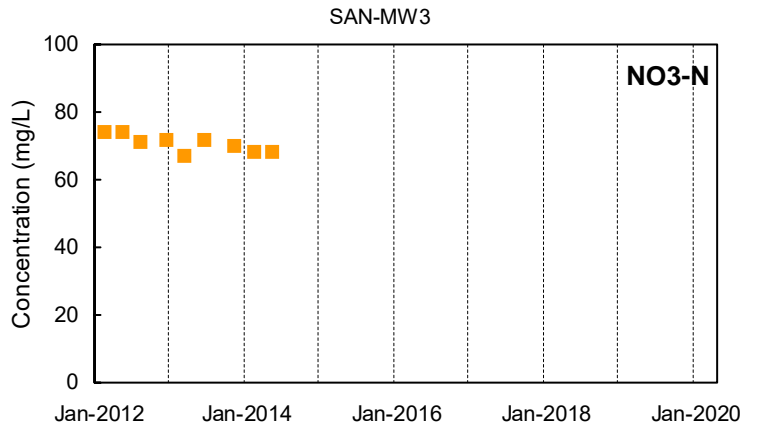
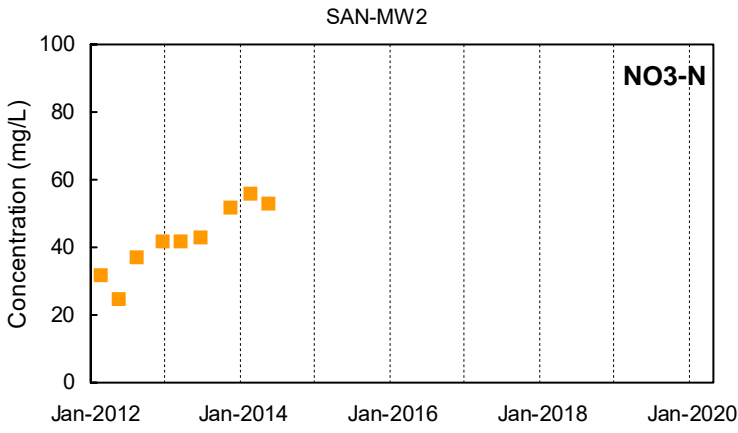

■ Detected Value □ 'J'-Flag (value between reporting limit and detection limit) ■ Non-Detect Range
 Shallow Well shown with black symbols Deep Well shown with orange symbols "dd" Well shown with blue symbols

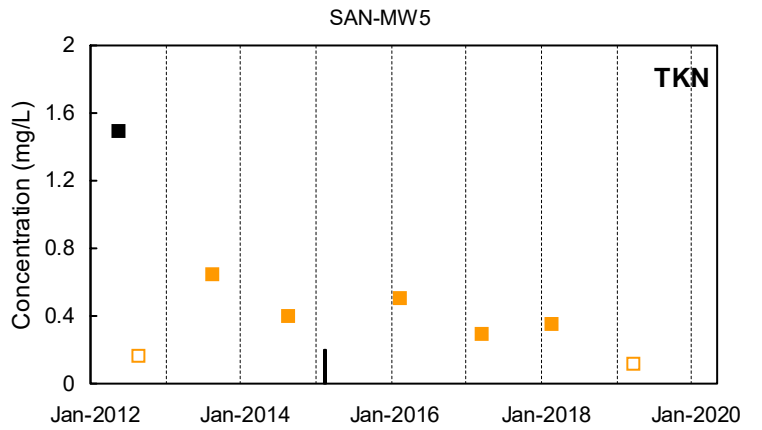
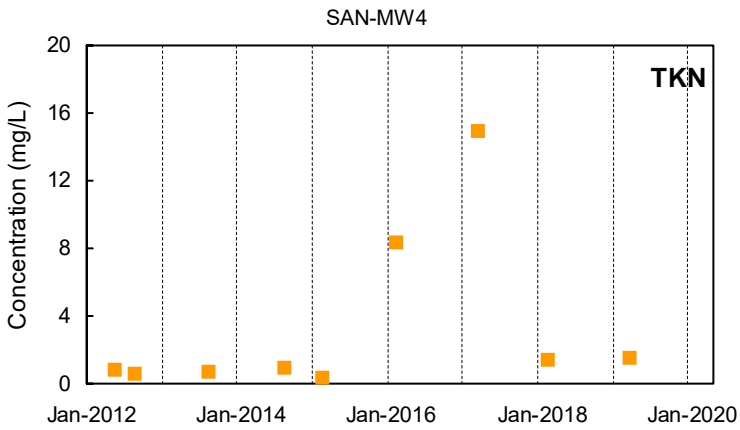
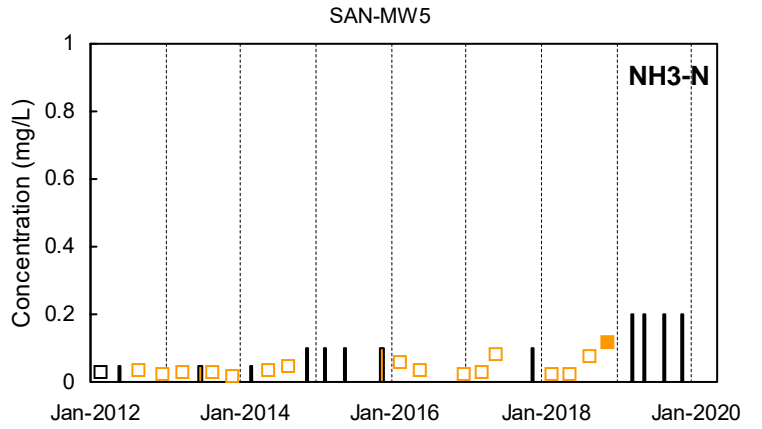
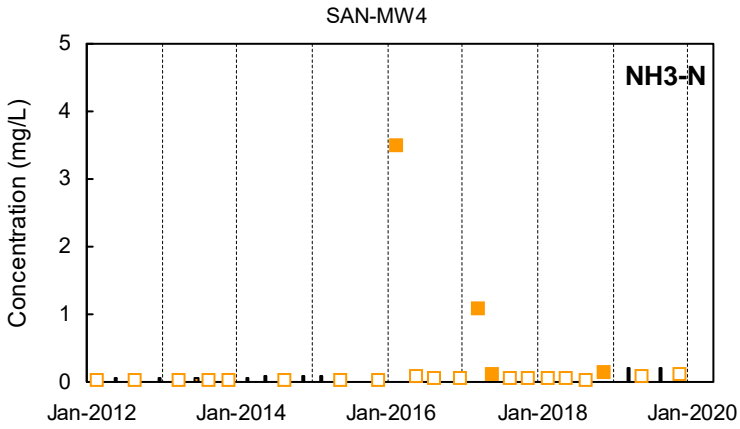
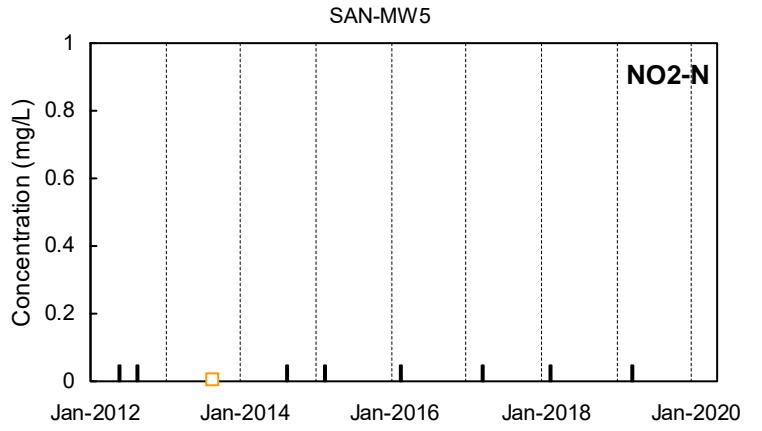
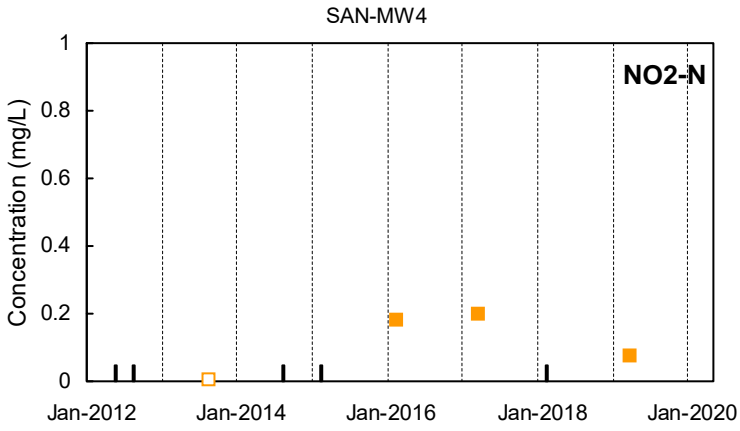
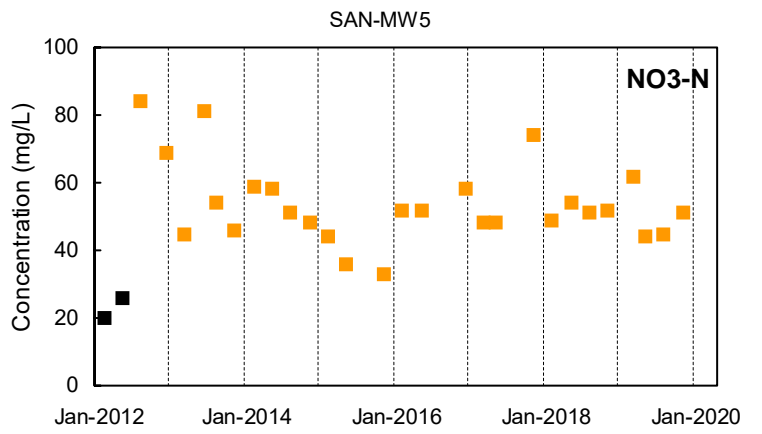
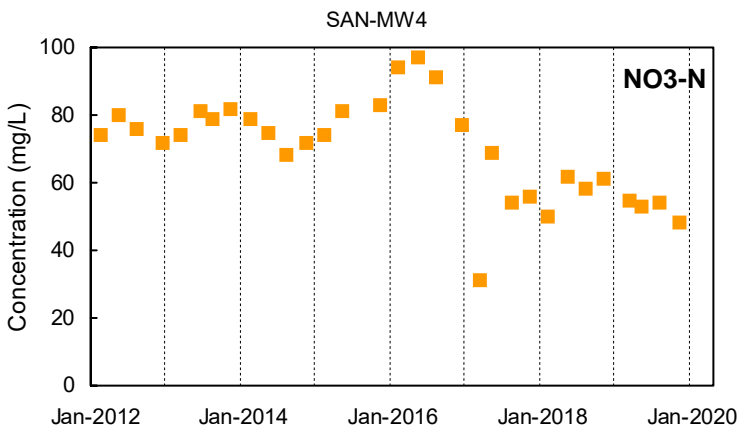

Detected Value
 'J'-Flag (value between reporting limit and detection limit)
 Non-Detect Range
 Shallow Well shown with black symbols
 Deep Well shown with orange symbols
 "dd" Well shown with blue symbols

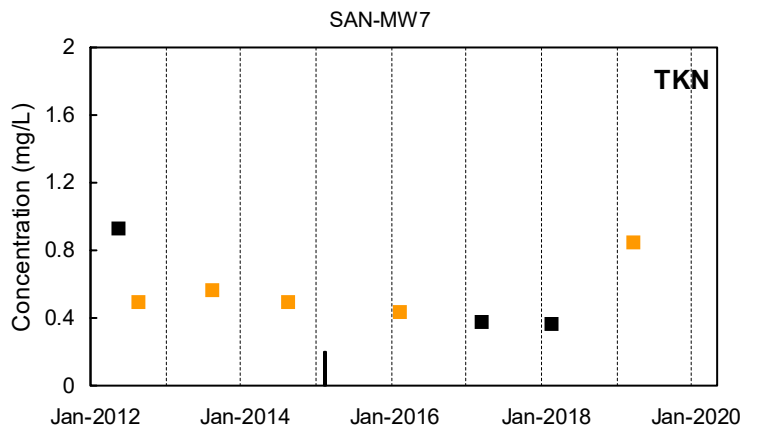
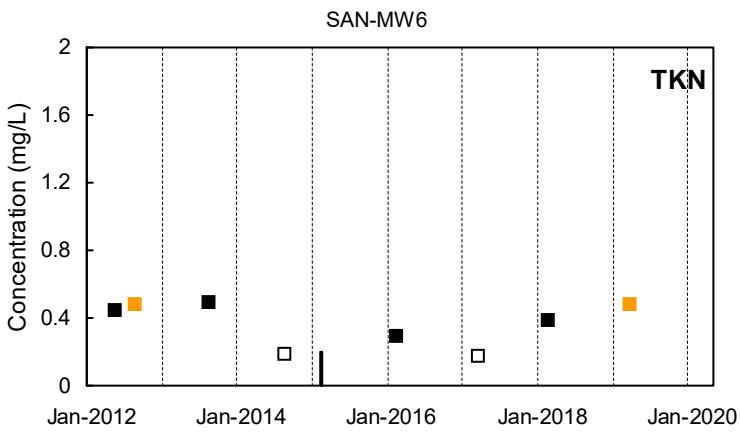
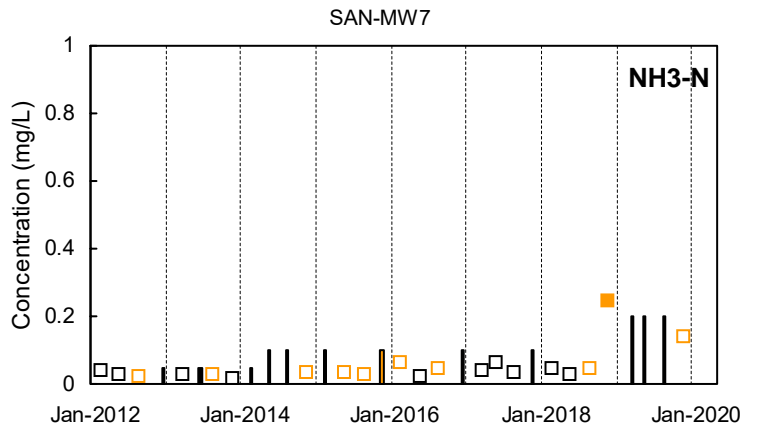
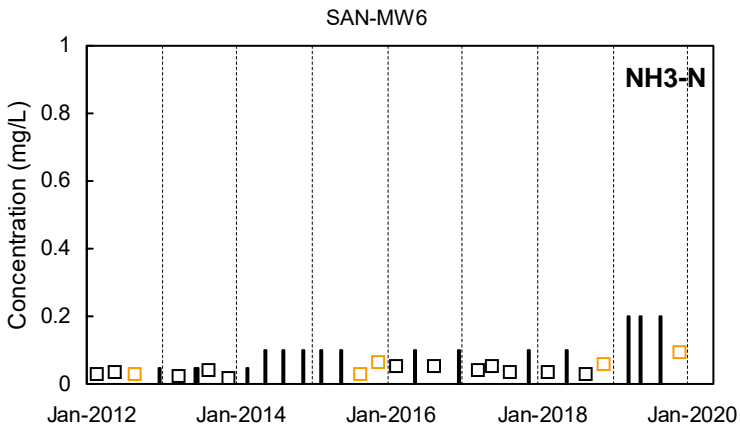
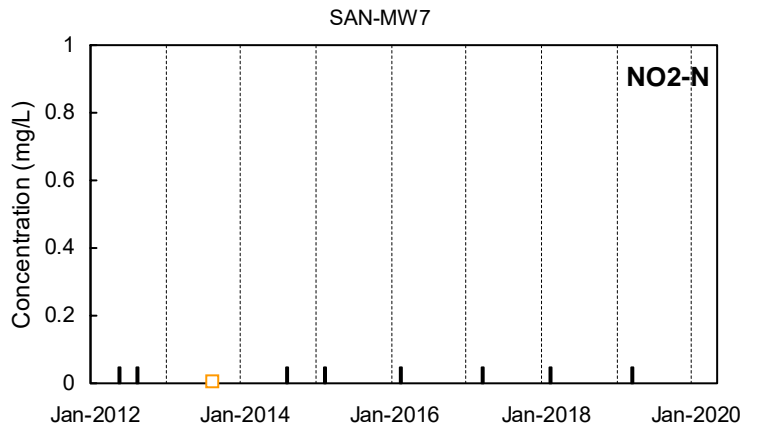
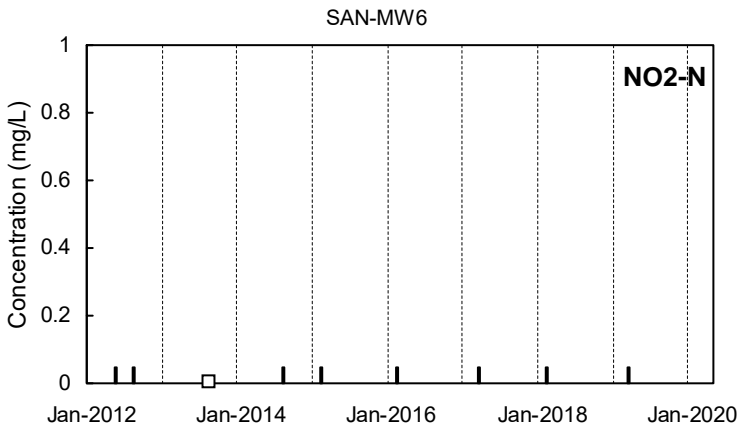
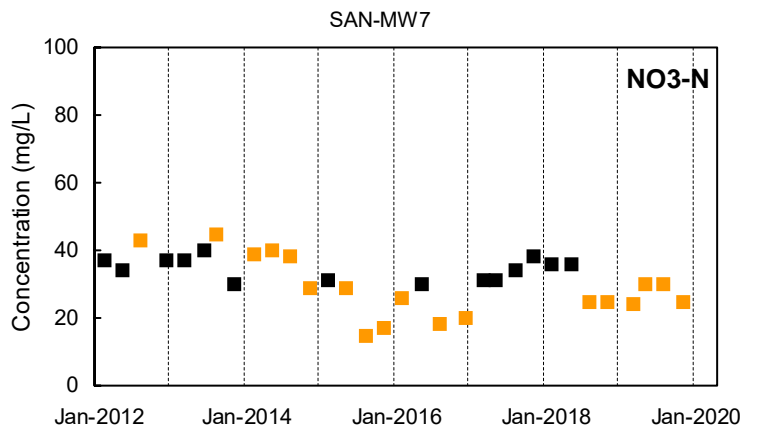
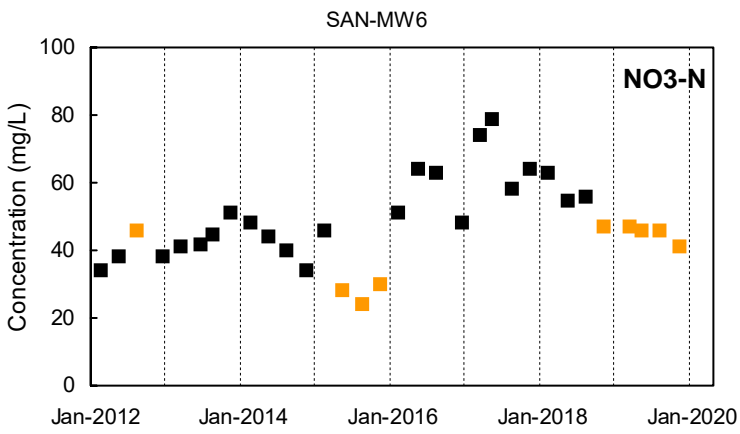

Detected Value
 'J'-Flag (value between reporting limit and detection limit)
 Non-Detect Range
 Shallow Well shown with black symbols
 Deep Well shown with orange symbols
 "dd" Well shown with blue symbols

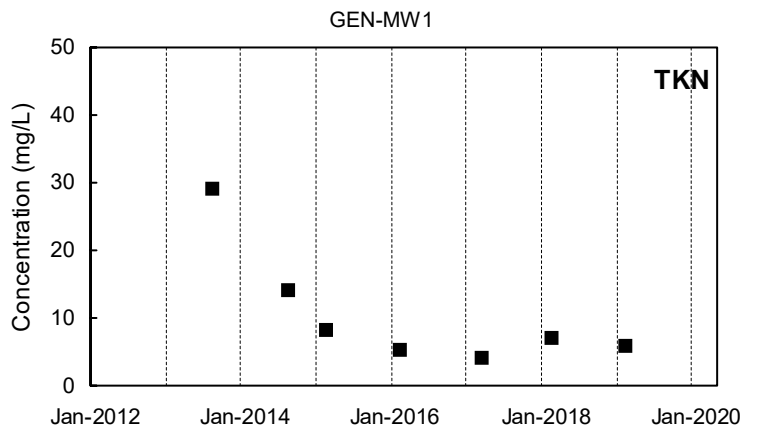
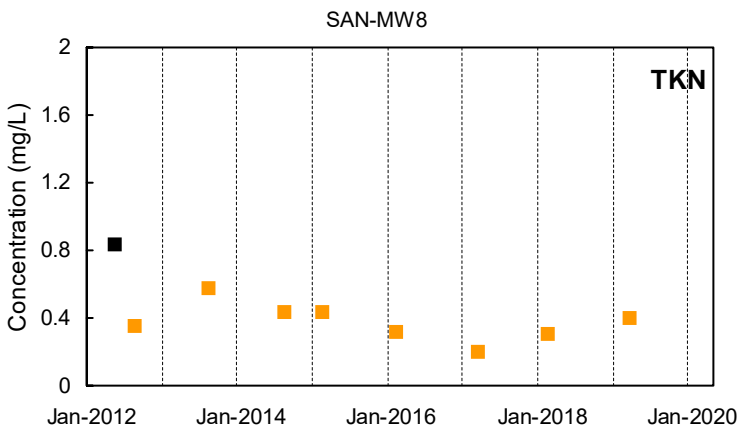
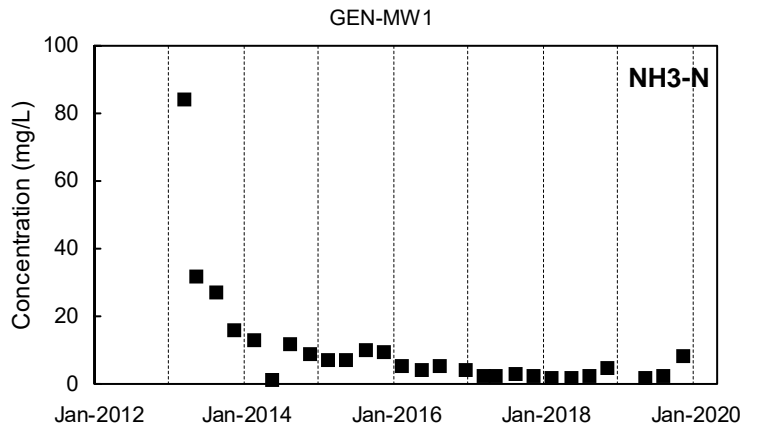
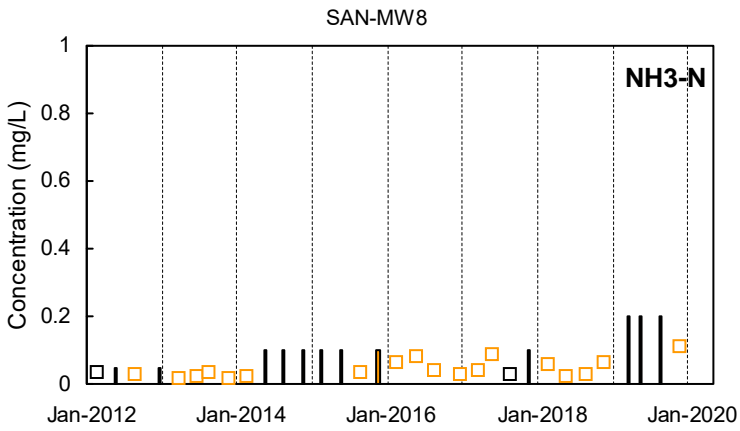
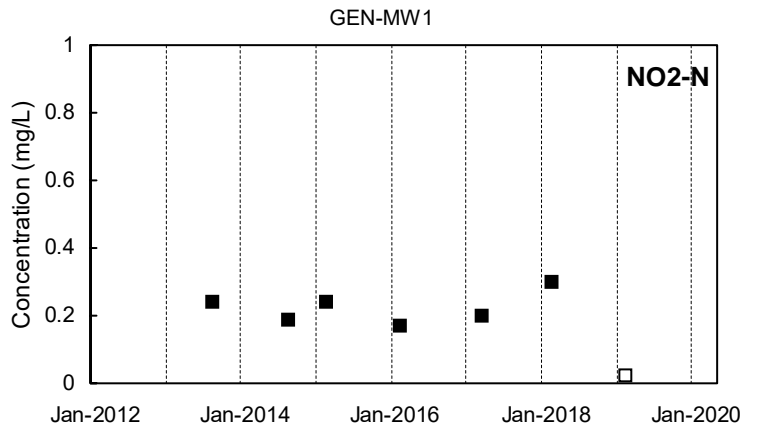
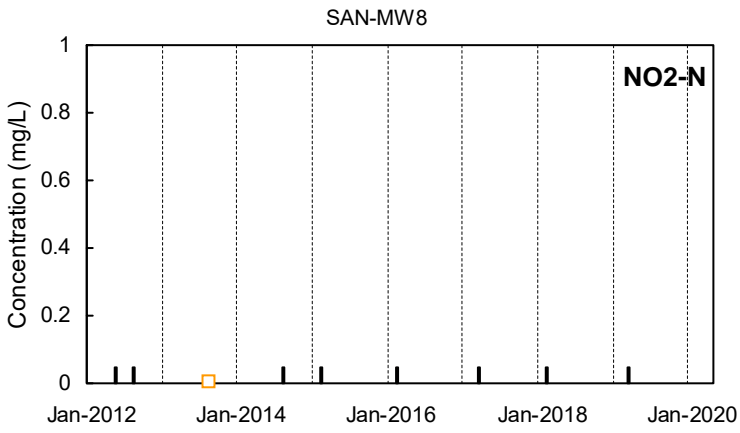
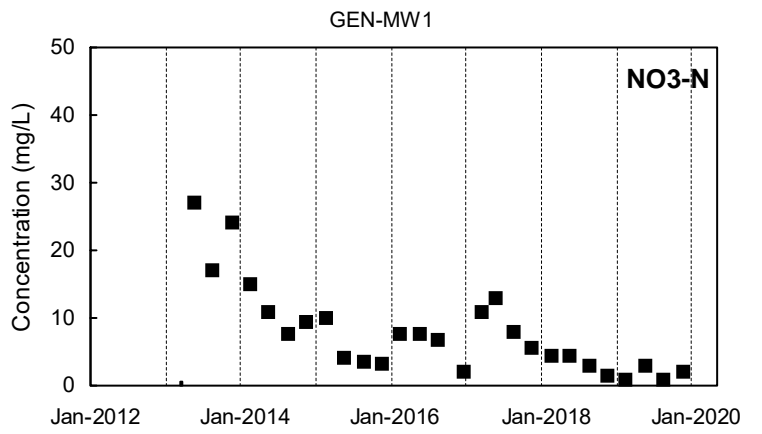
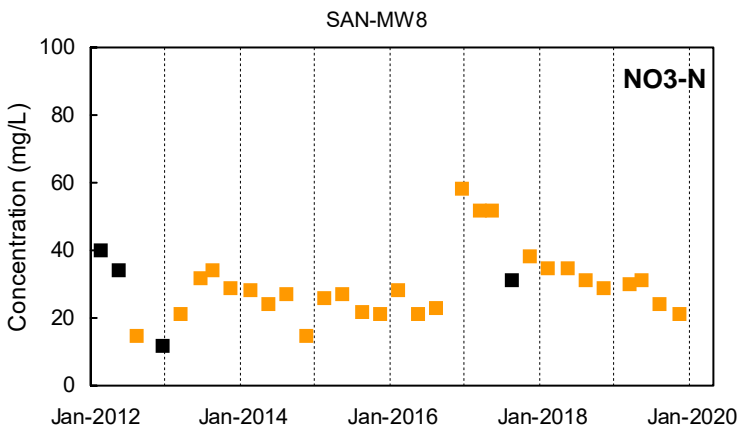

Detected Value
 'J'-Flag (value between reporting limit and detection limit)
 Non-Detect Range
 Shallow Well shown with black symbols
 Deep Well shown with orange symbols
 "dd" Well shown with blue symbols

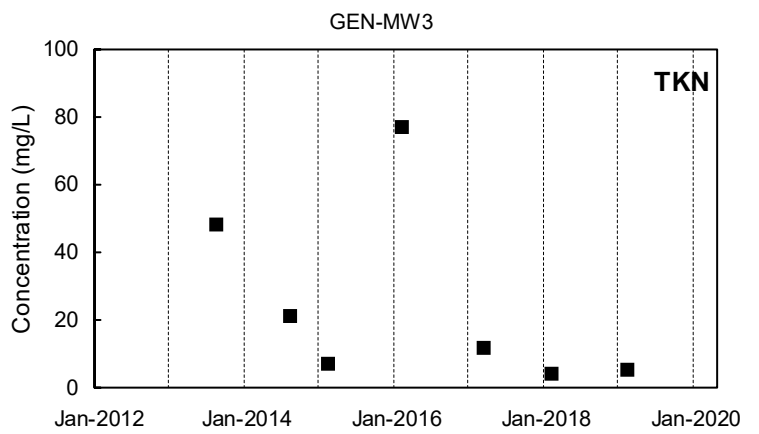
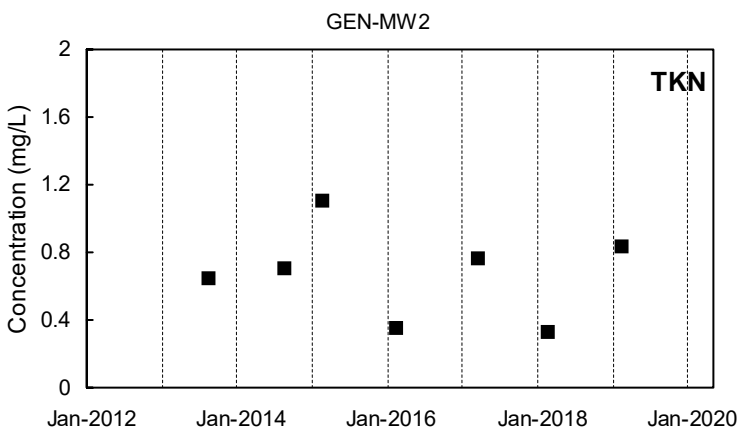
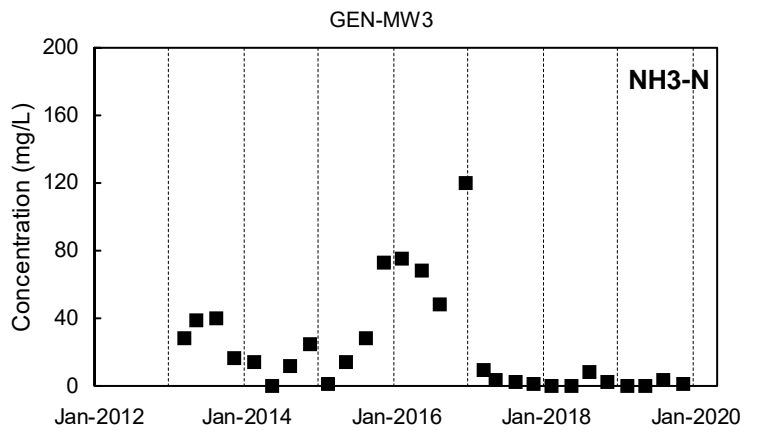
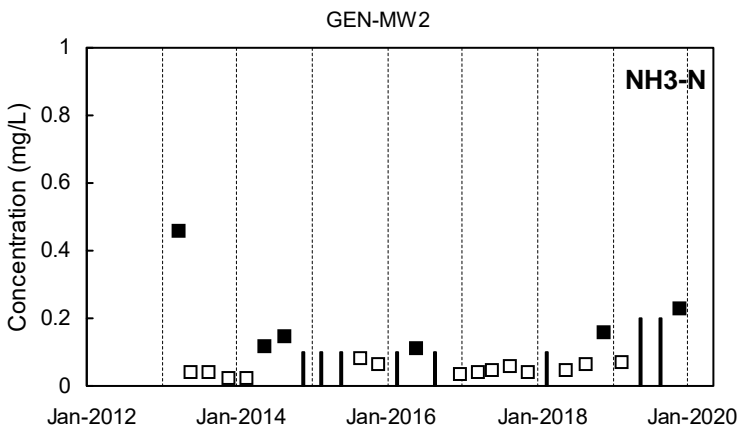
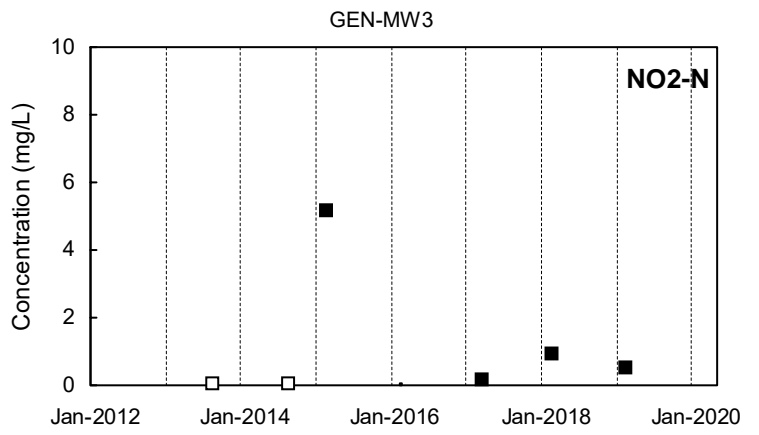
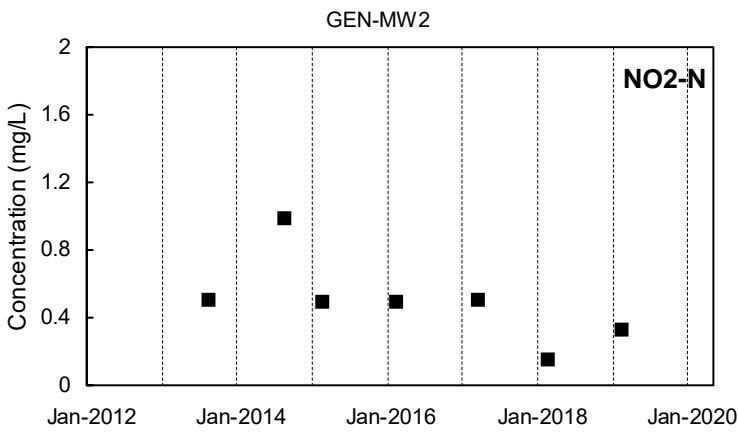
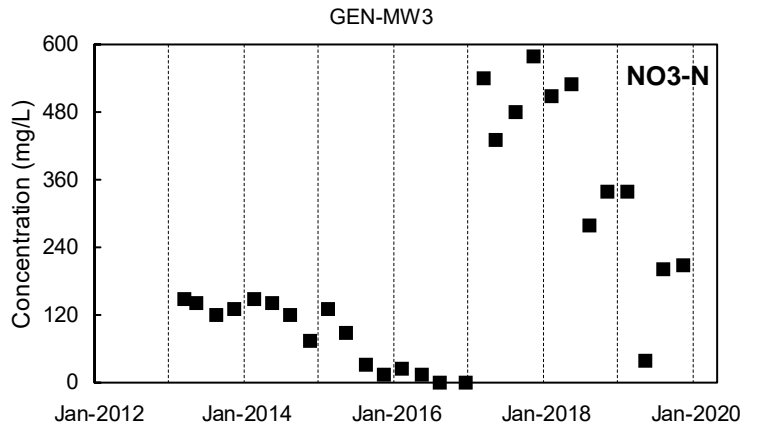
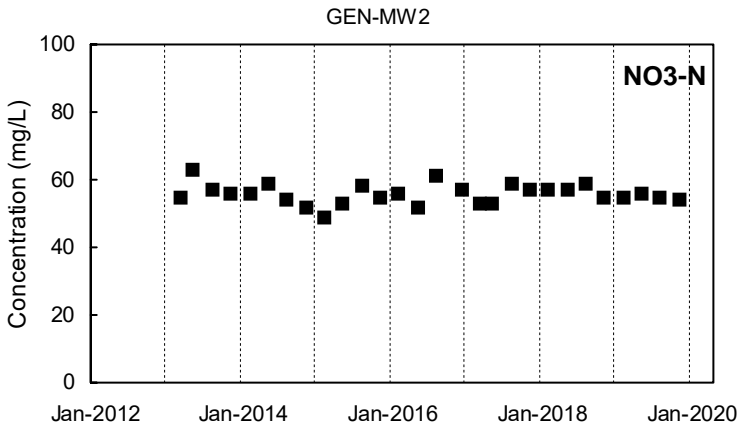

Detected Value
 'J'-Flag (value between reporting limit and detection limit)
 Non-Detect Range
 Shallow Well shown with black symbols
 Deep Well shown with orange symbols
 "dd" Well shown with blue symbols

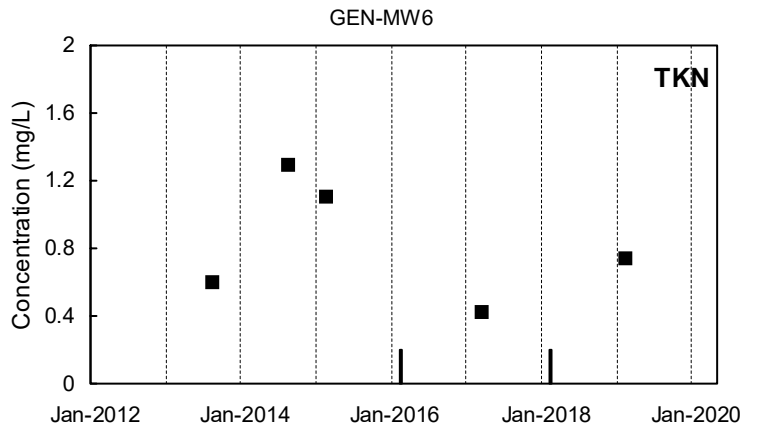
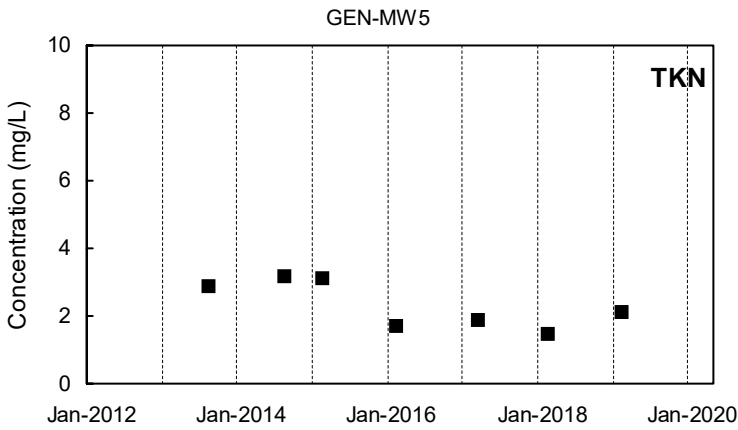
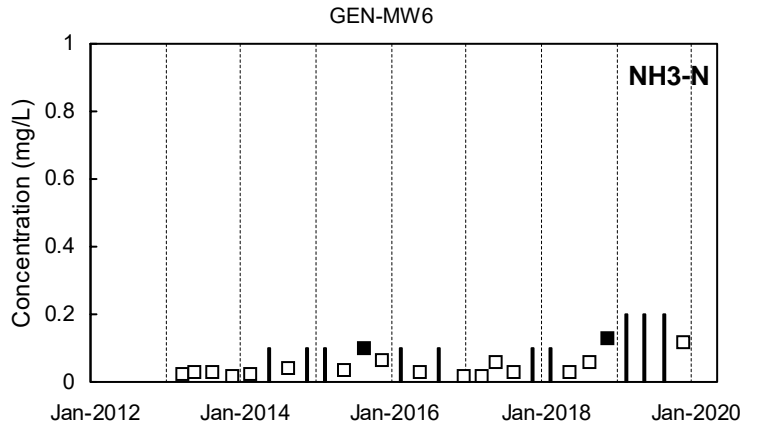
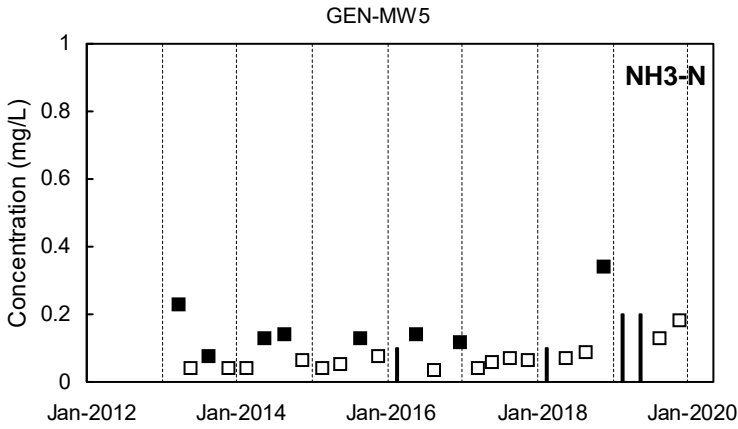
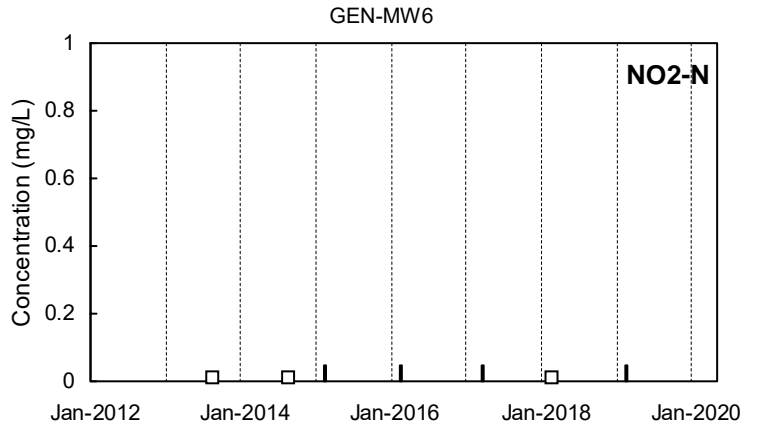
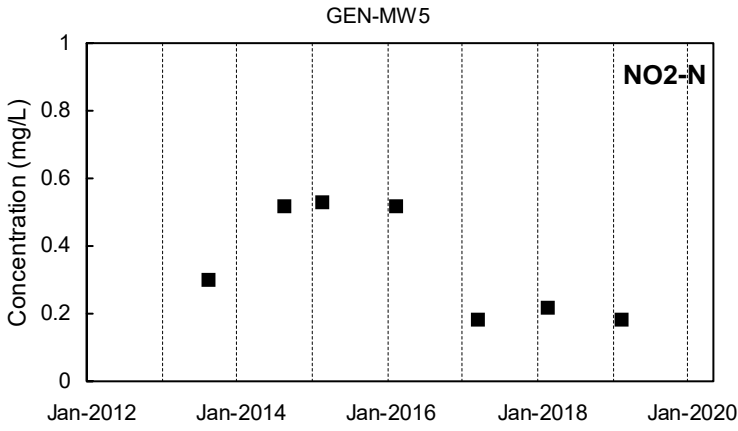
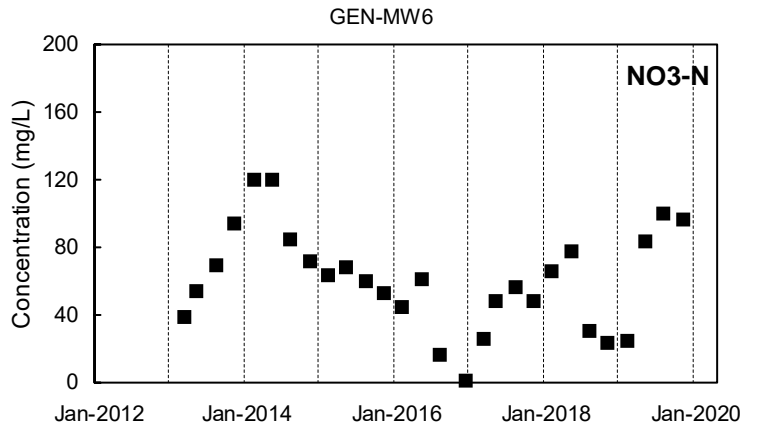
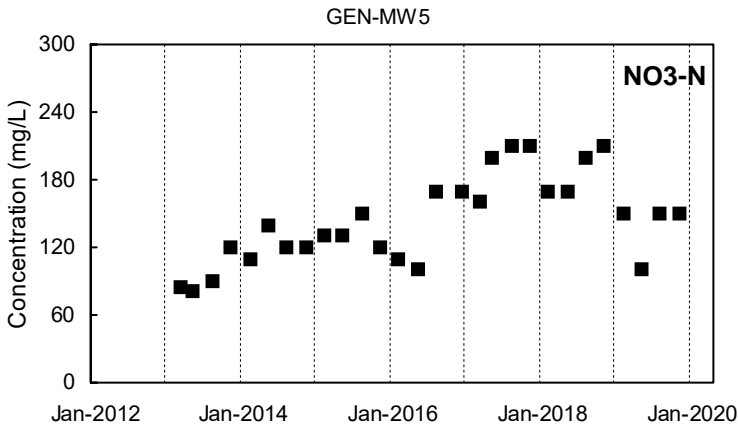

Detected Value
 'J'-Flag (value between reporting limit and detection limit)
 Non-Detect Range
 Shallow Well shown with black symbols
 Deep Well shown with orange symbols
 "dd" Well shown with blue symbols

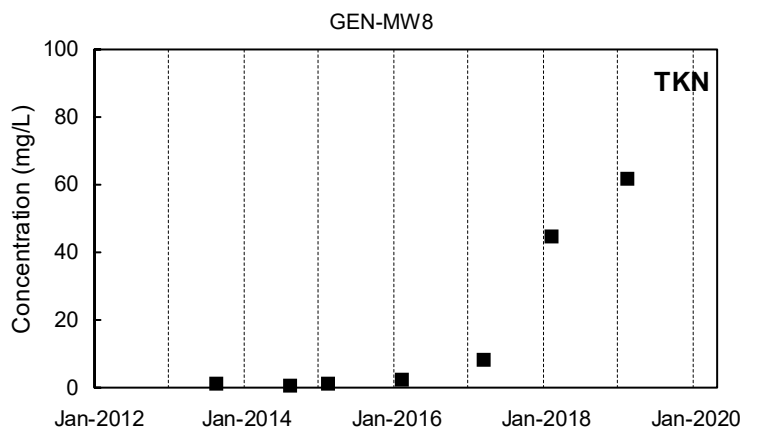
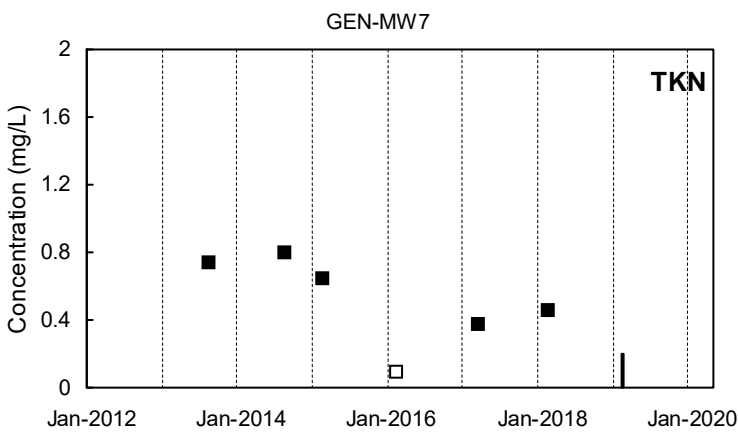
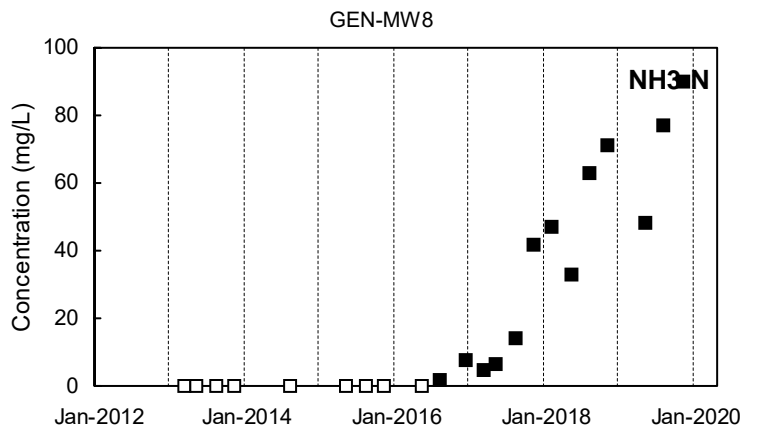
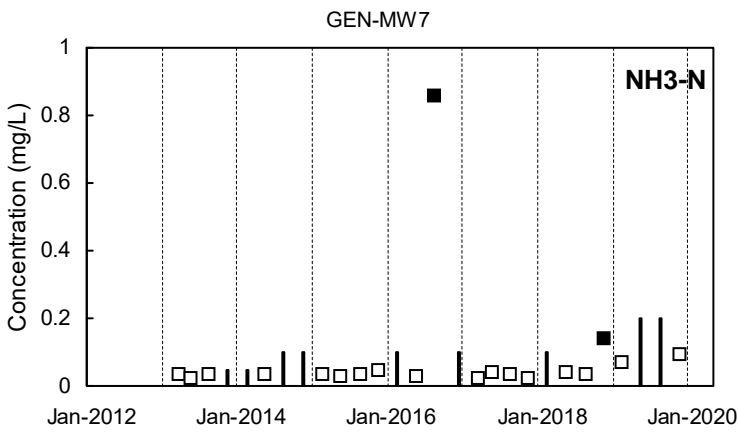
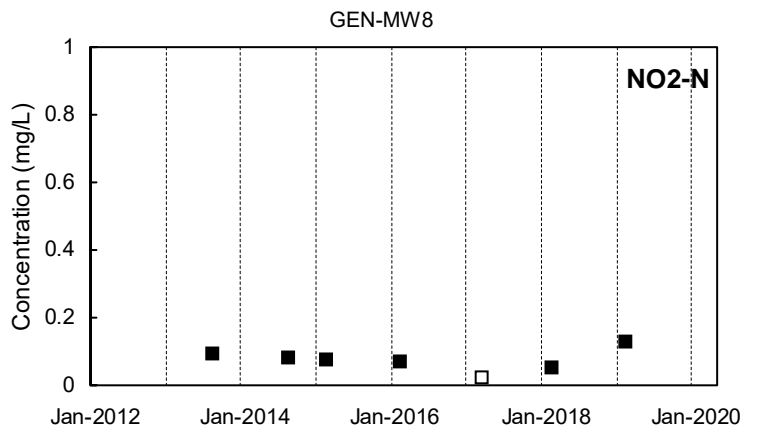
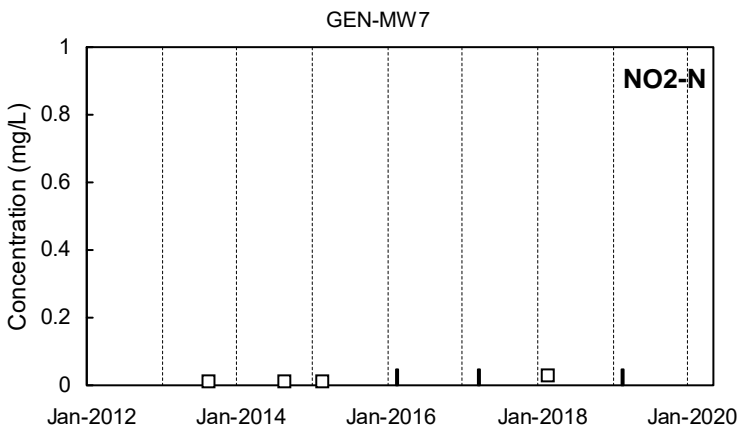
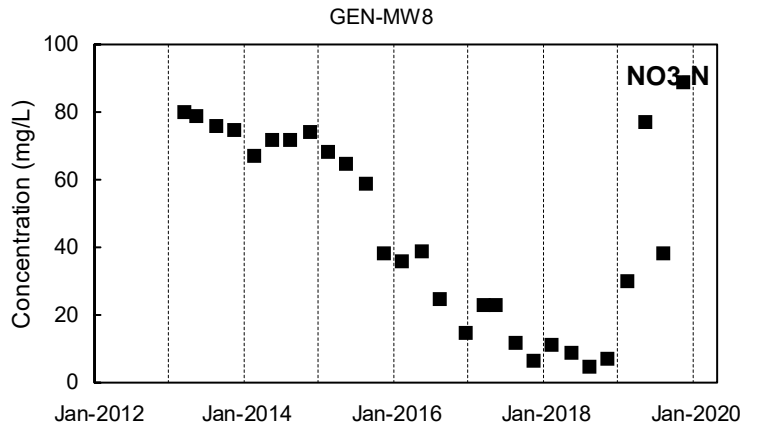
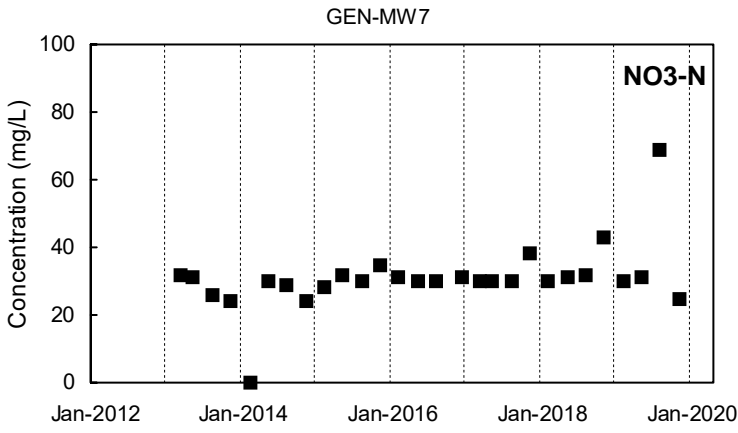

Detected Value
 'J'-Flag (value between reporting limit and detection limit)
 Non-Detect Range
 Shallow Well shown with black symbols
 Deep Well shown with orange symbols
 "dd" Well shown with blue symbols

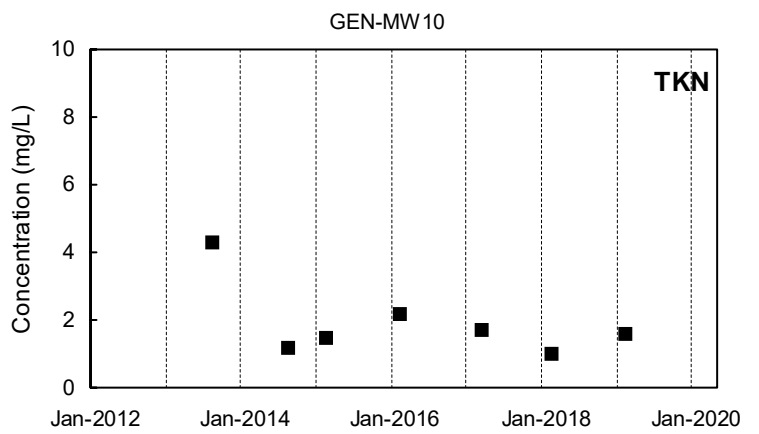
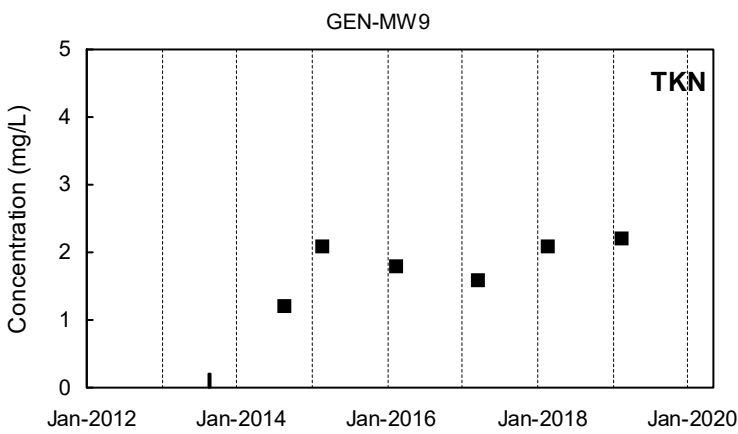
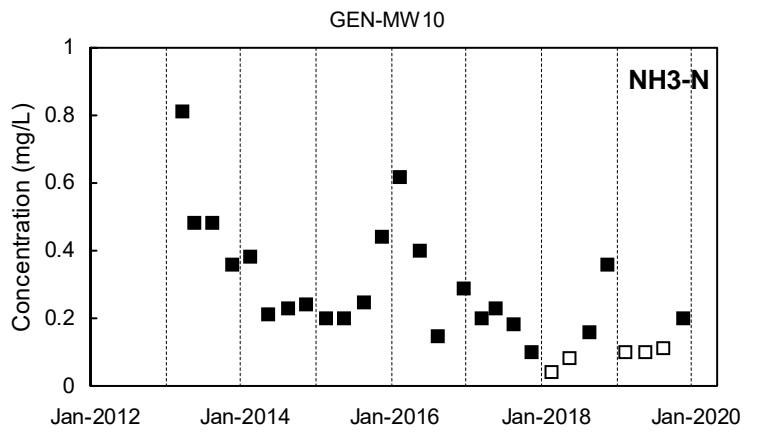
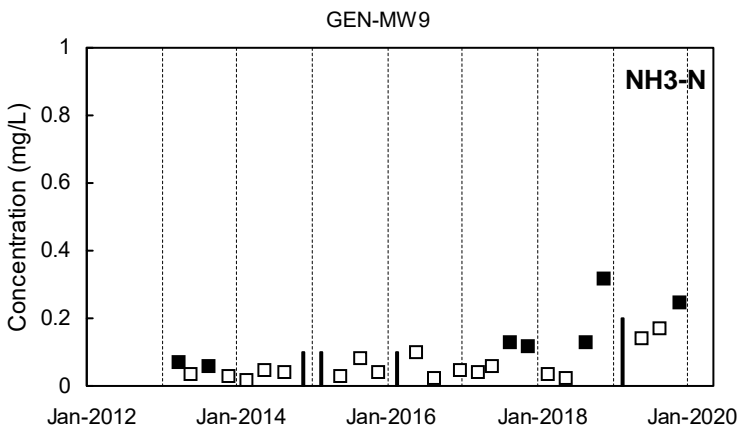
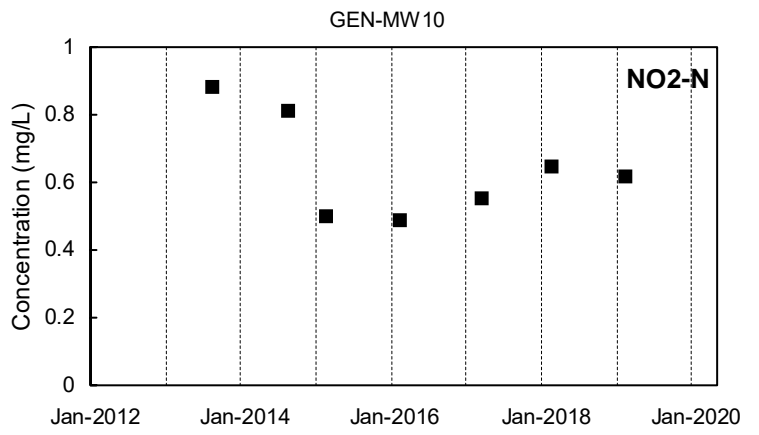
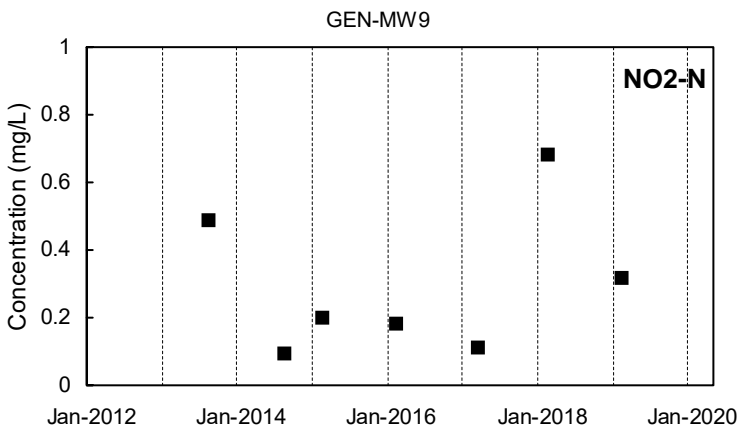
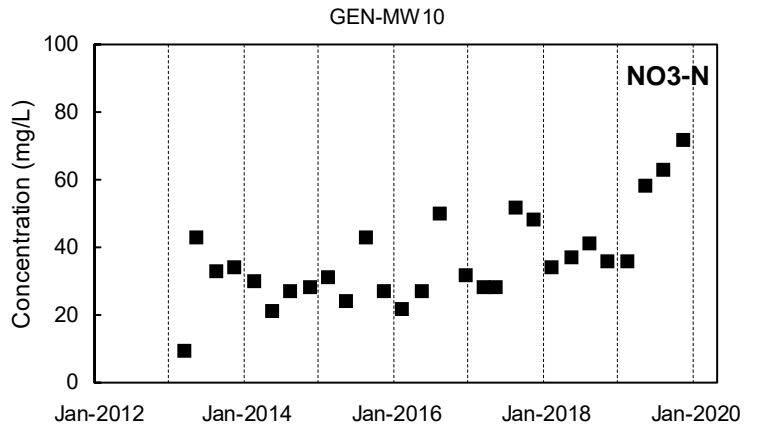
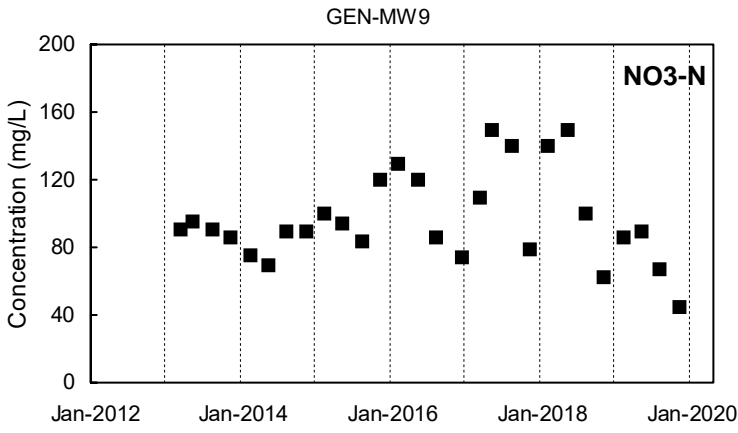

Detected Value
 'J'-Flag (value between reporting limit and detection limit)
 Non-Detect Range
 Shallow Well shown with black symbols Deep Well shown with orange symbols "dd" Well shown with blue symbols

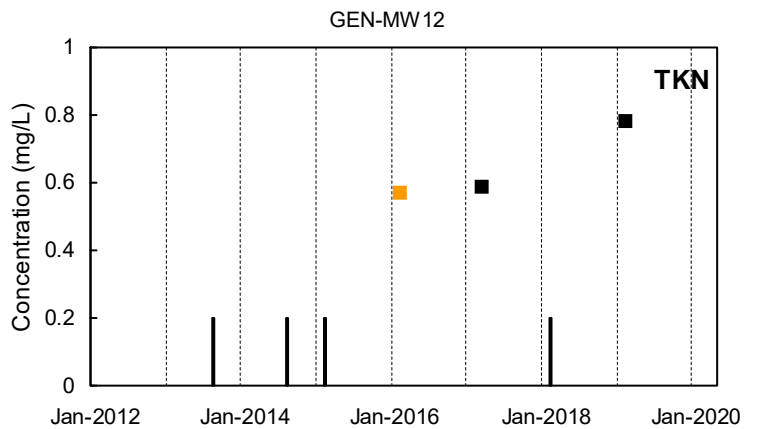
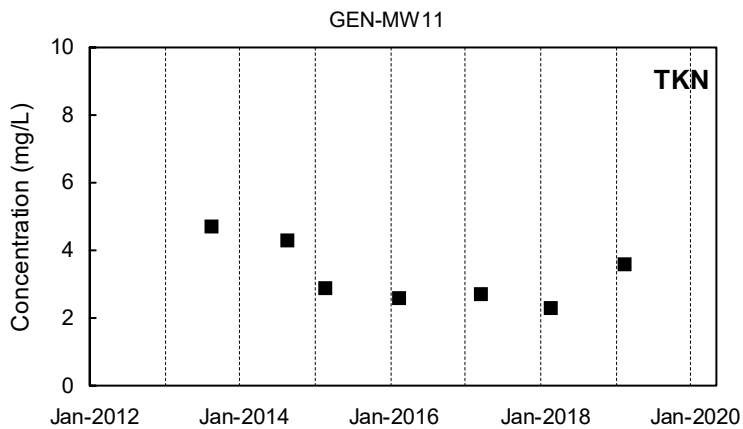
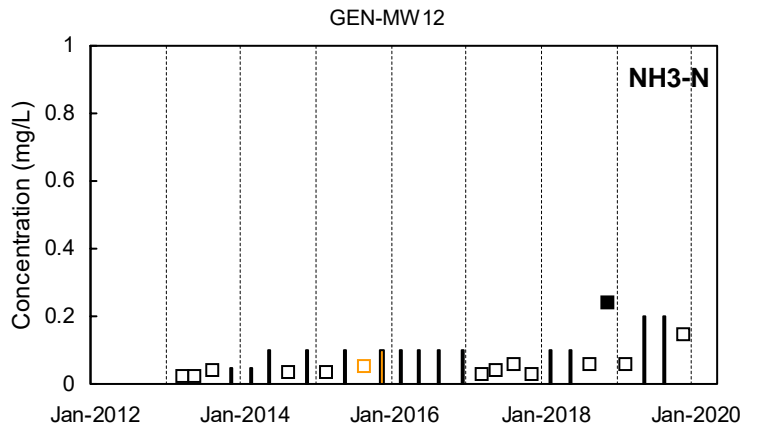
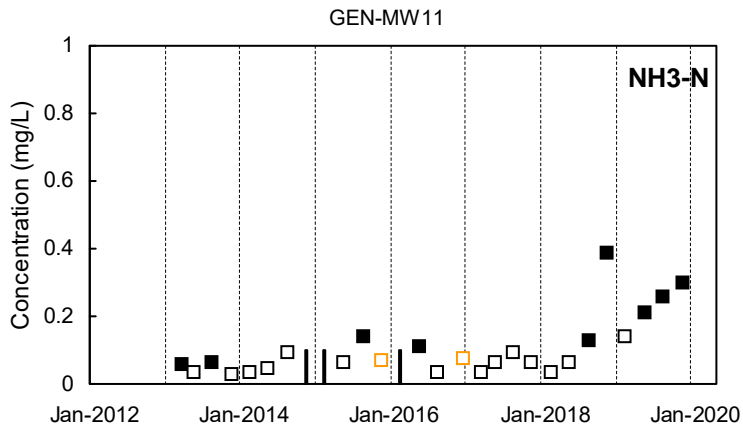
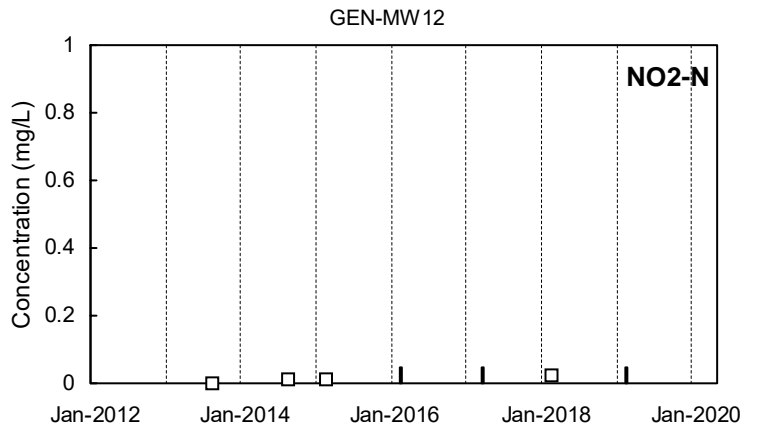
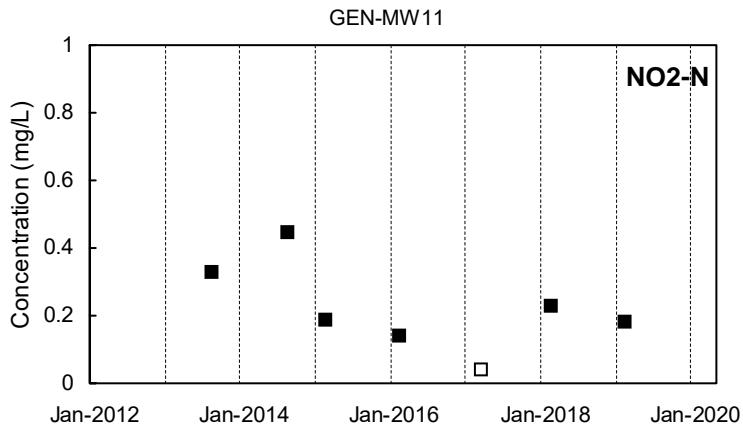
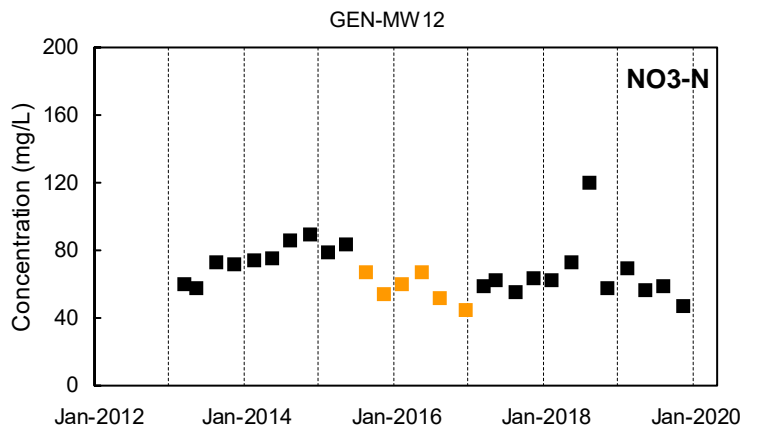
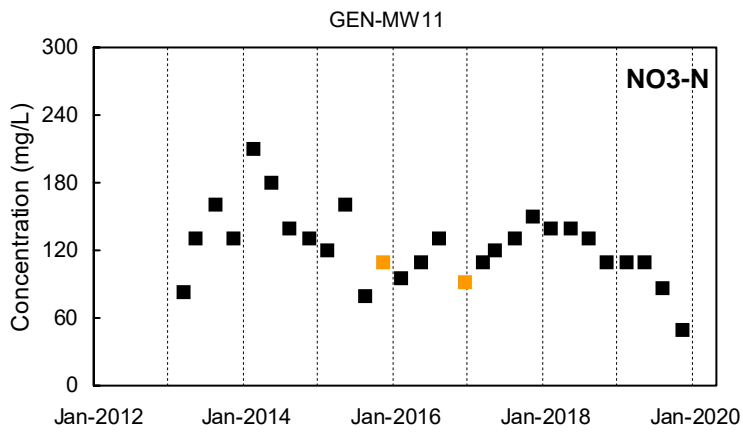

Detected Value
 'J'-Flag (value between reporting limit and detection limit)
 Non-Detect Range
 Shallow Well shown with black symbols
 Deep Well shown with orange symbols
 "dd" Well shown with blue symbols

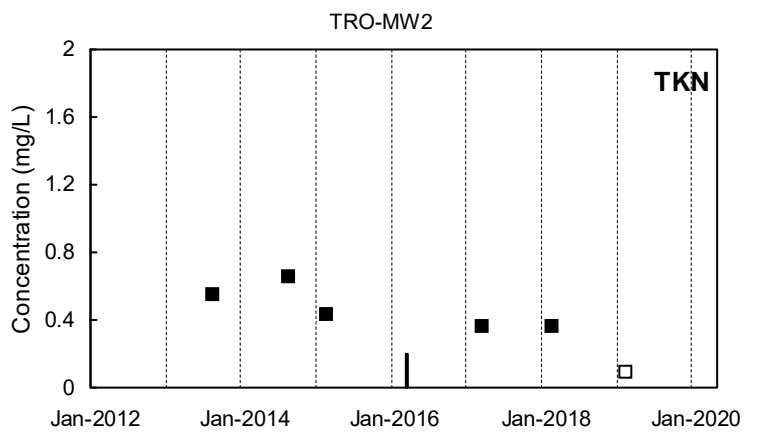
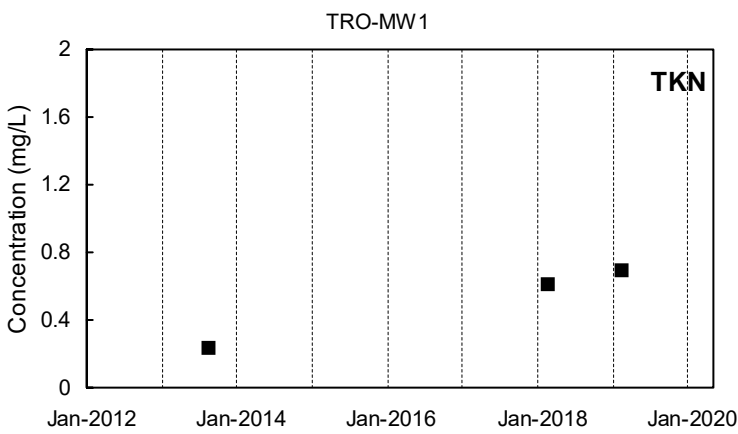
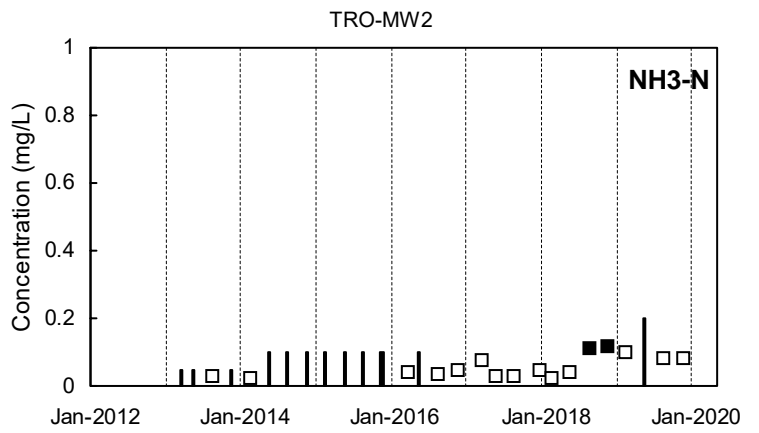
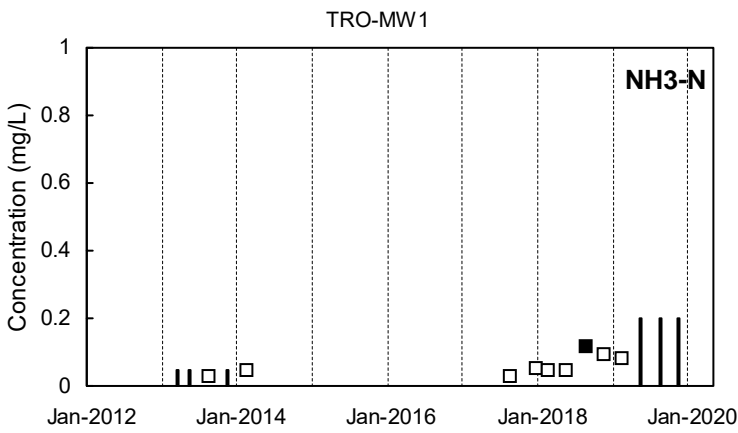
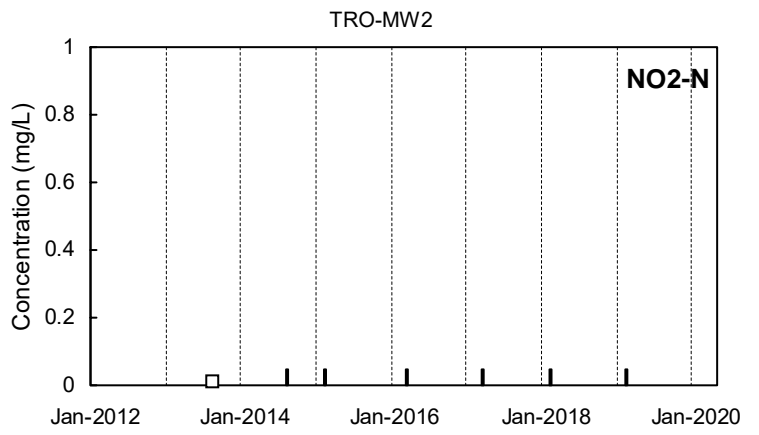
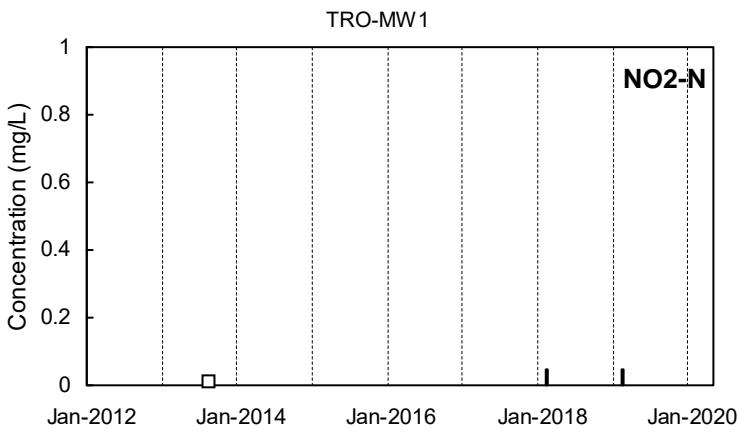
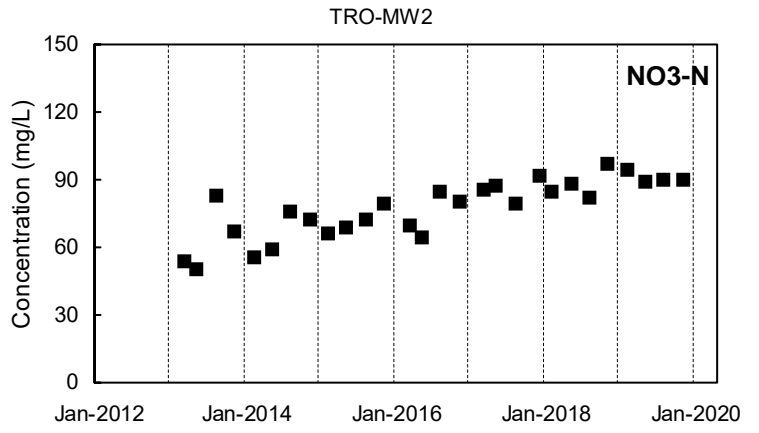
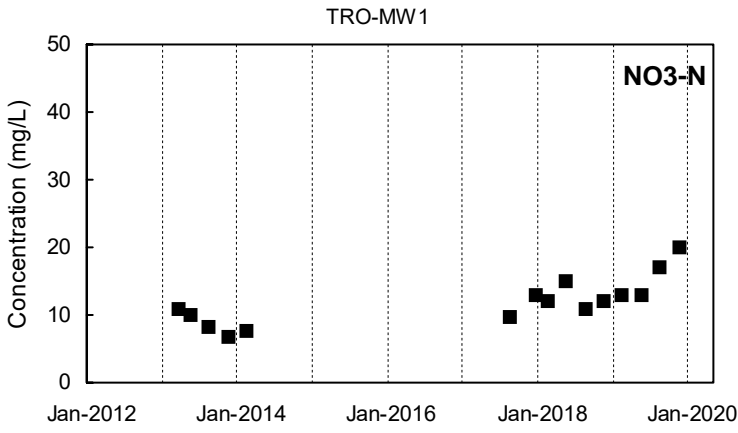

Detected Value
 'J'-Flag (value between reporting limit and detection limit)
 Non-Detect Range
Shallow Well shown with black symbols
Deep Well shown with orange symbols
"dd" Well shown with blue symbols

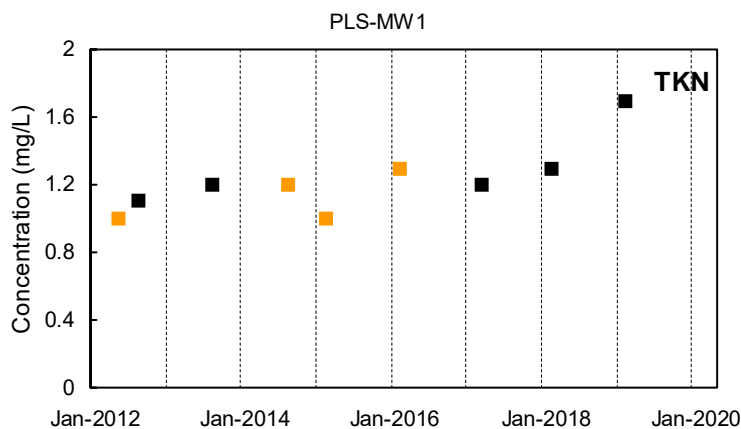
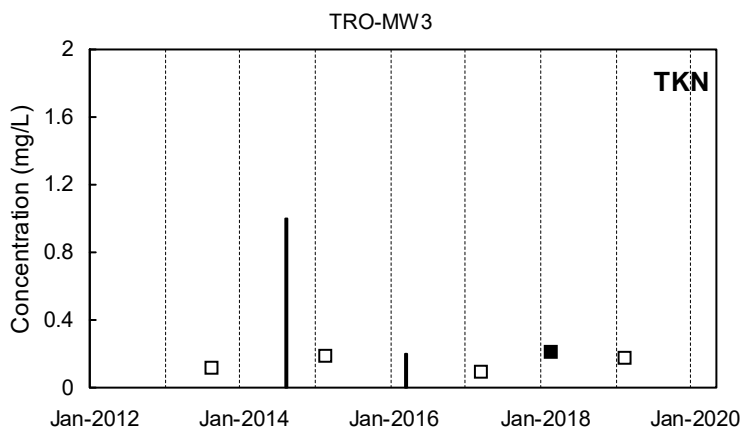
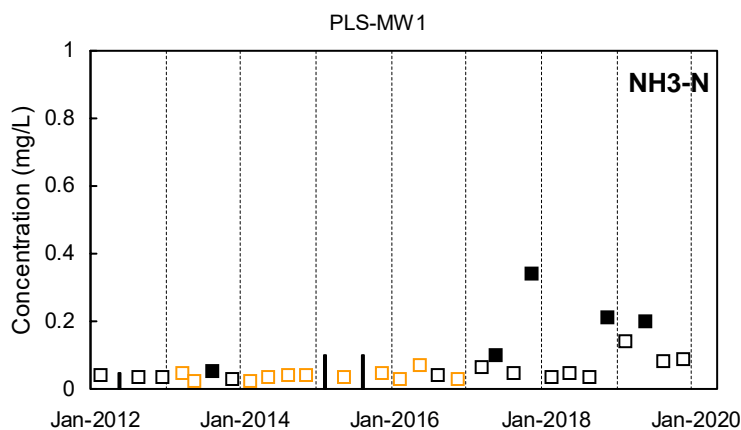
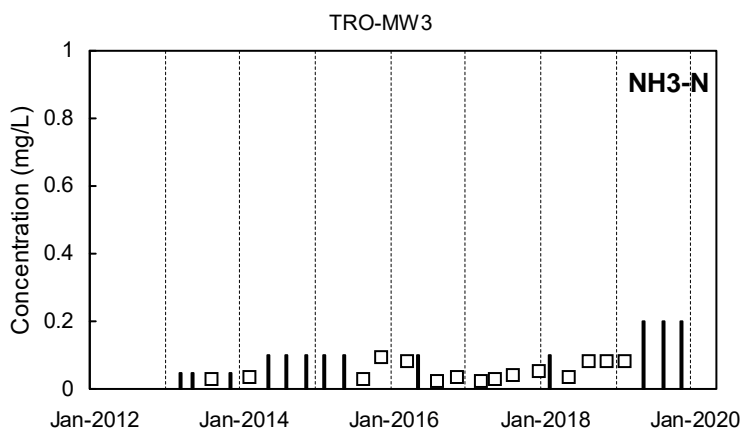
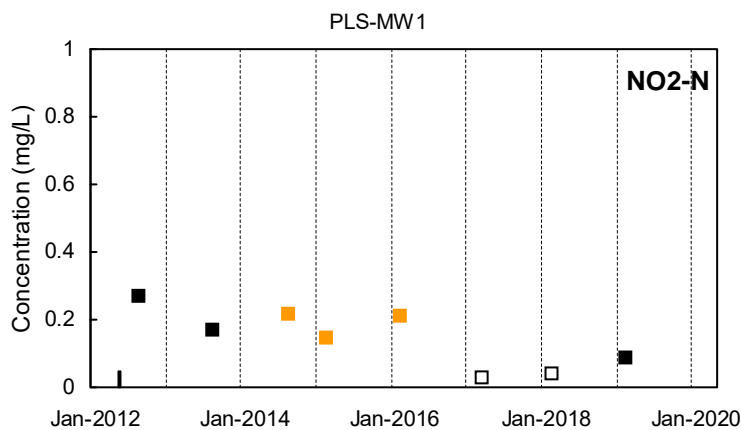
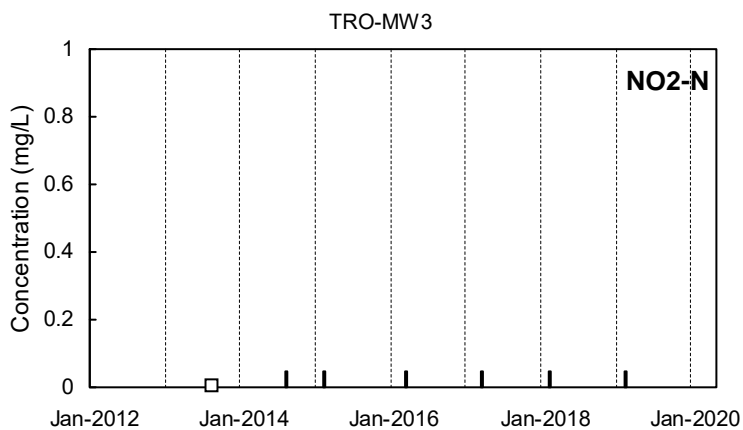
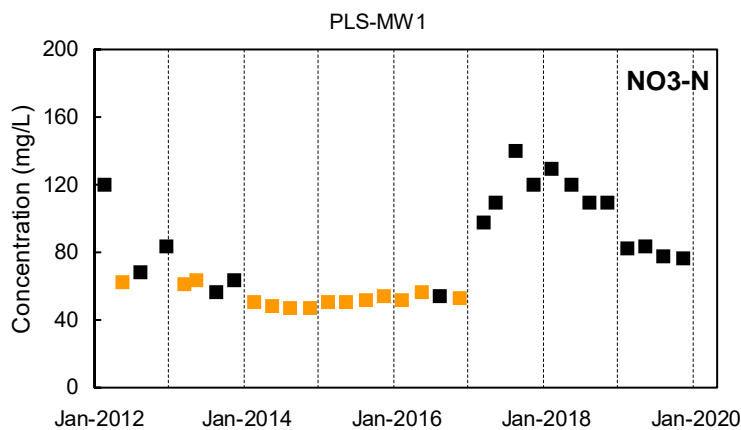
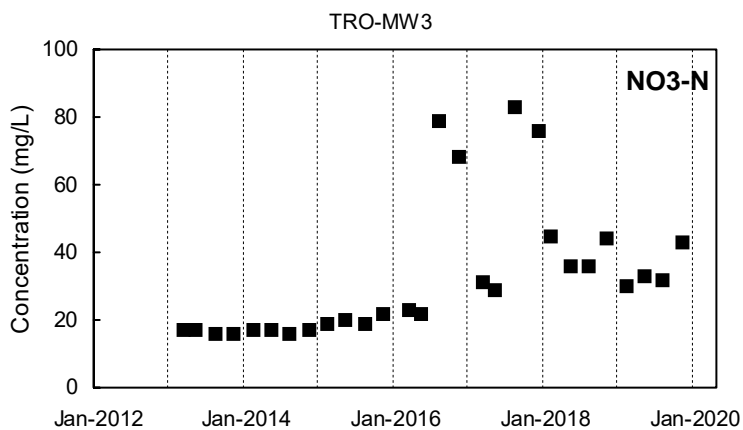

Detected Value
 'J'-Flag (value between reporting limit and detection limit)
 Non-Detect Range
 Shallow Well shown with black symbols Deep Well shown with orange symbols "dd" Well shown with blue symbols

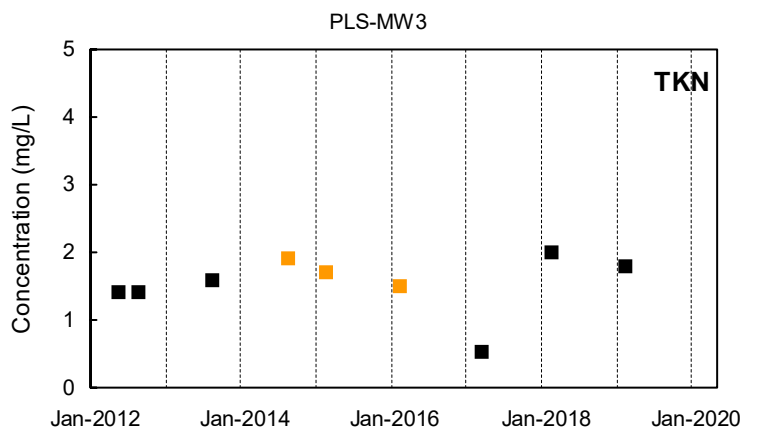
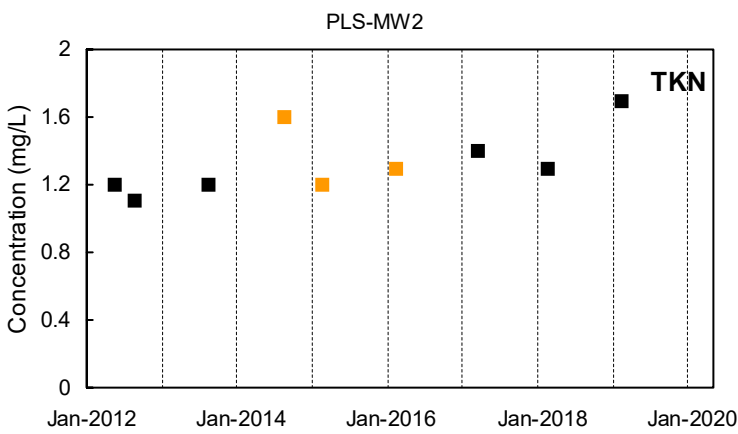
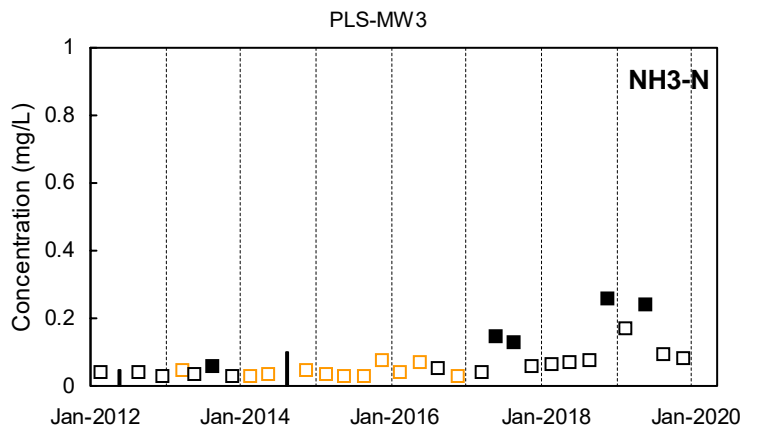
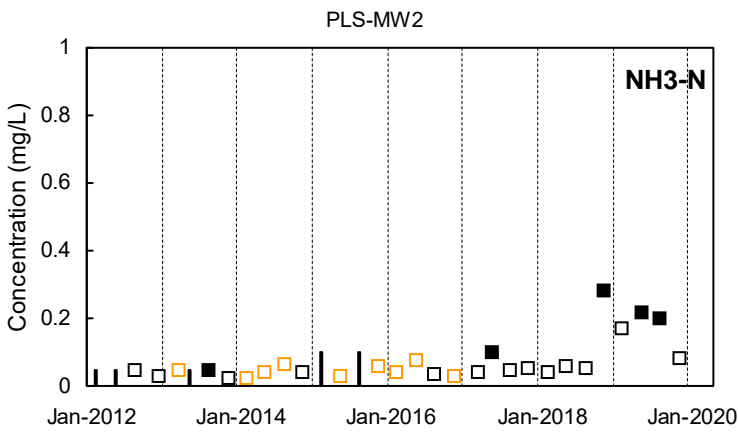
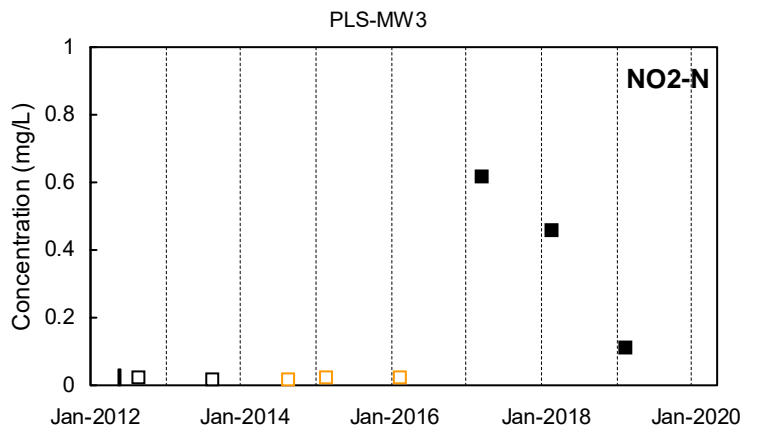
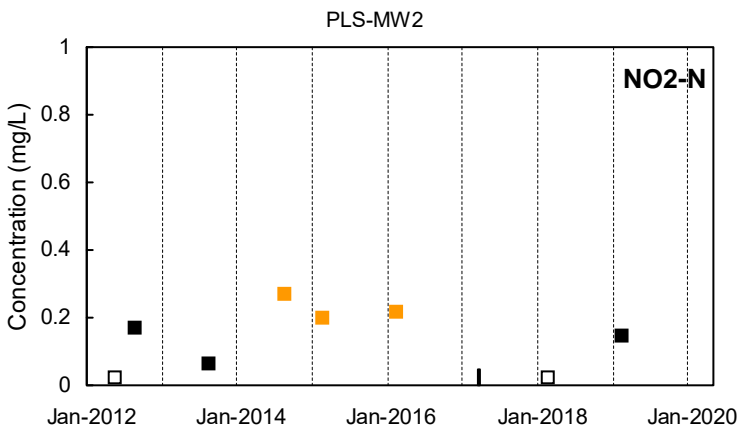
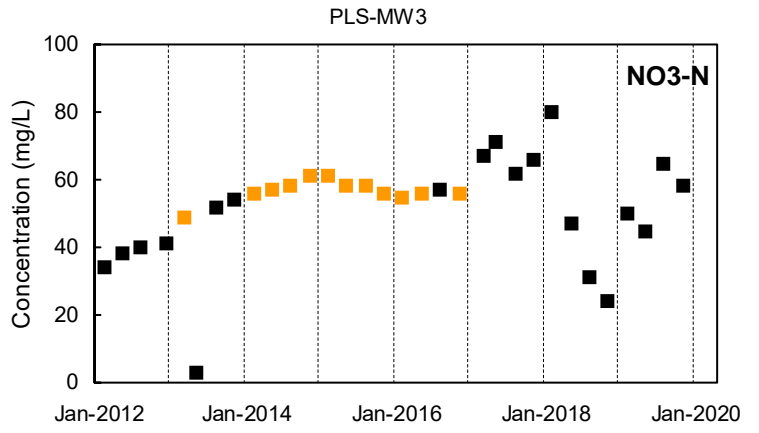
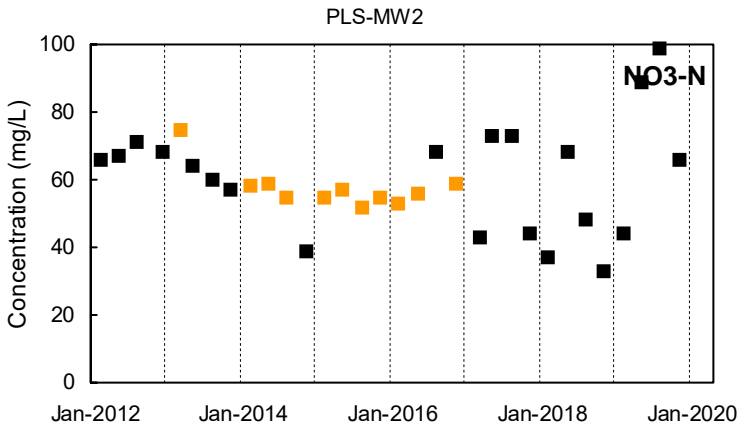

Detected Value
 'J'-Flag (value between reporting limit and detection limit)
 Non-Detect Range
 Shallow Well shown with black symbols
 Deep Well shown with orange symbols
 "dd" Well shown with blue symbols

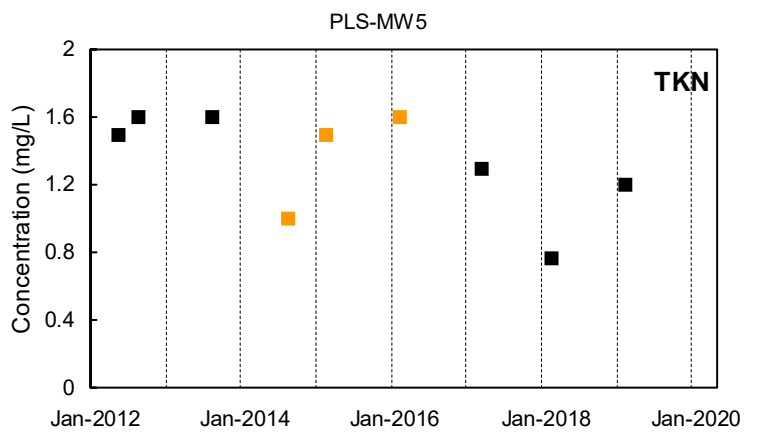
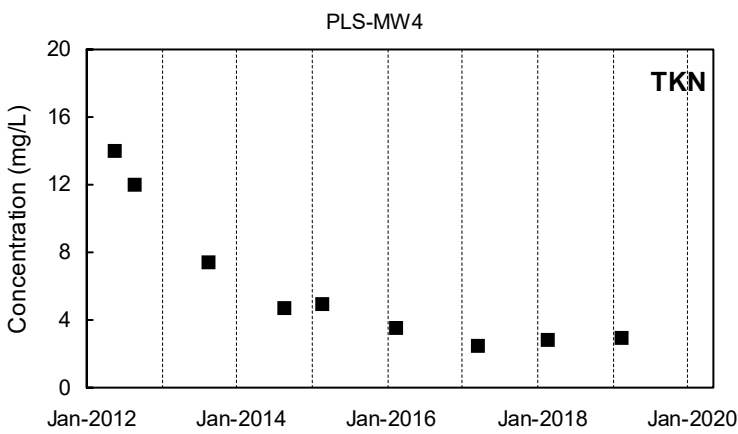
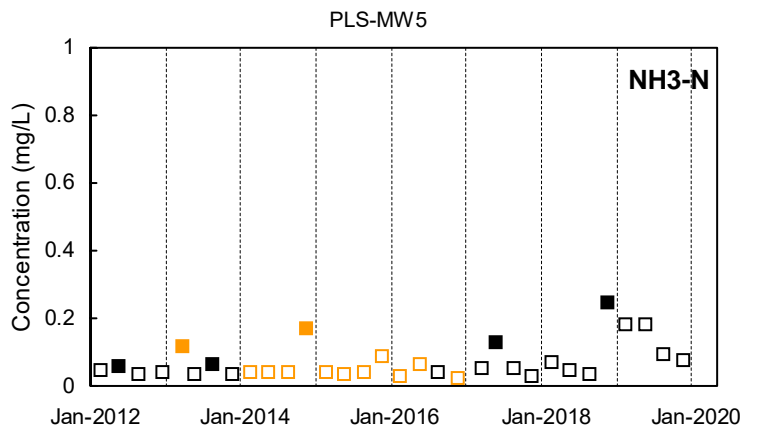
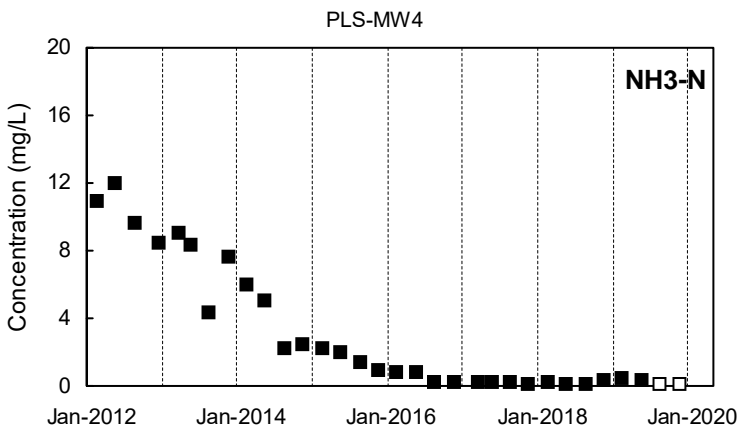
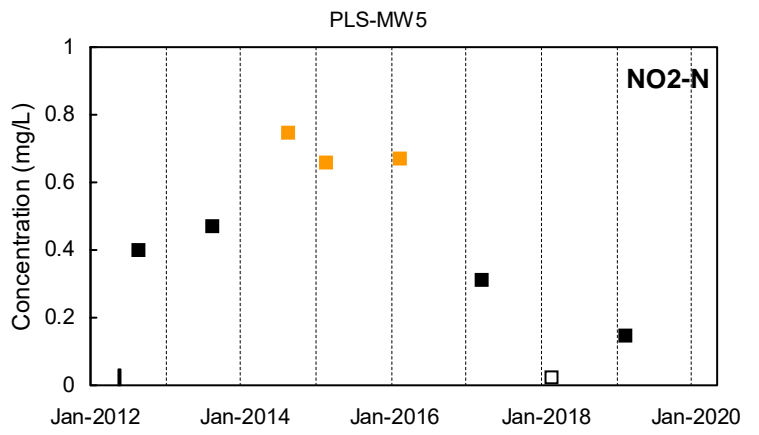
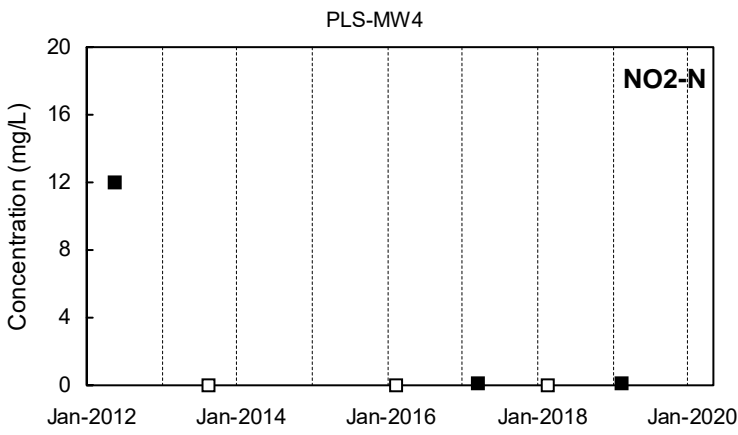
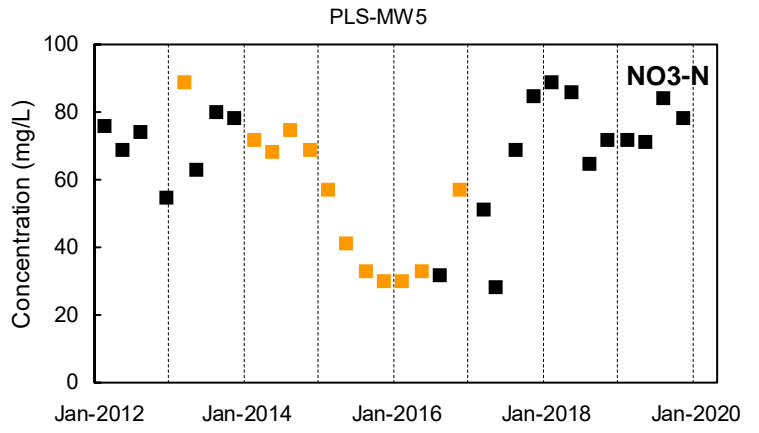
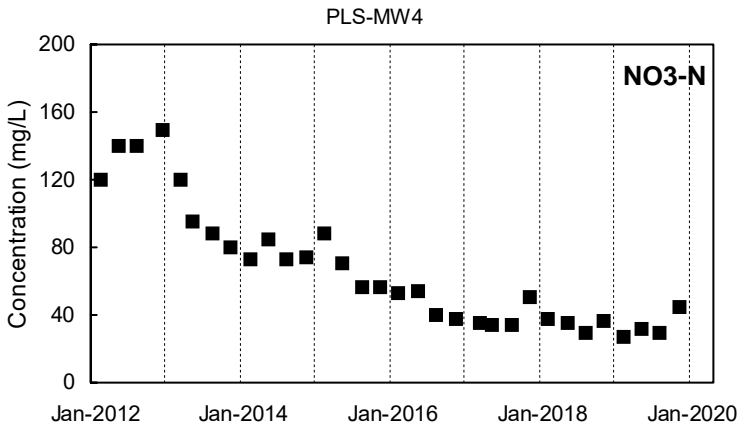

Detected Value
 'J'-Flag (value between reporting limit and detection limit)
 Non-Detect Range
 Shallow Well shown with black symbols
 Deep Well shown with orange symbols
 "dd" Well shown with blue symbols

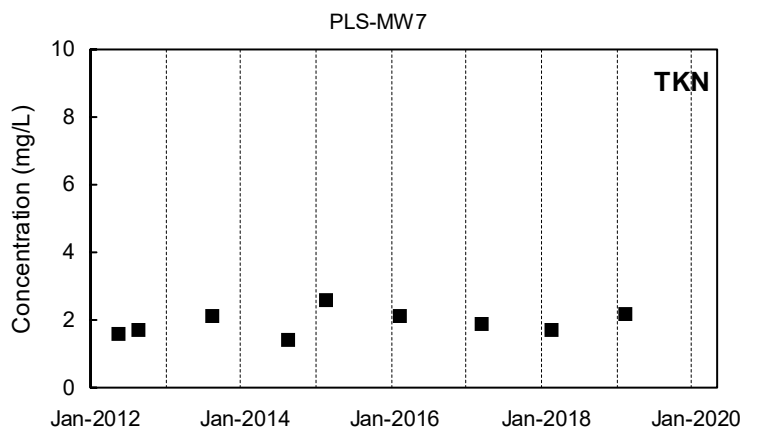
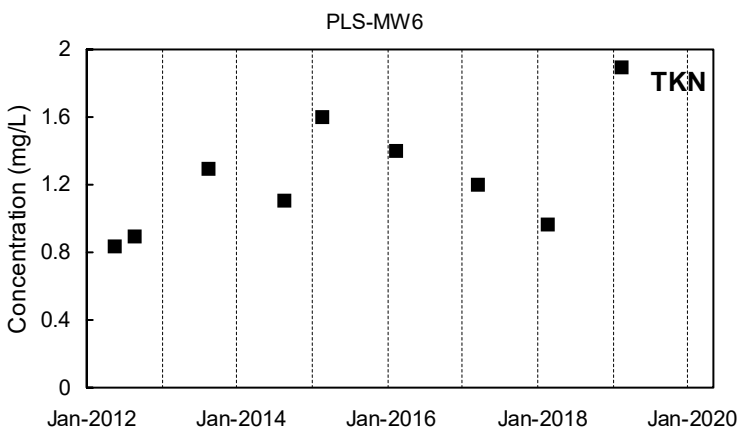
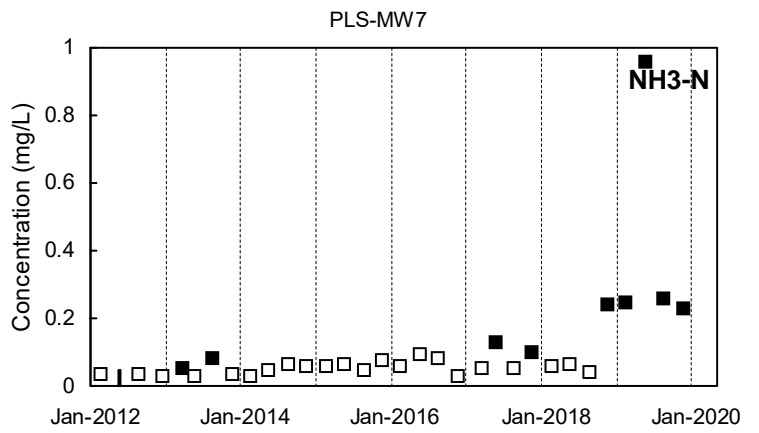
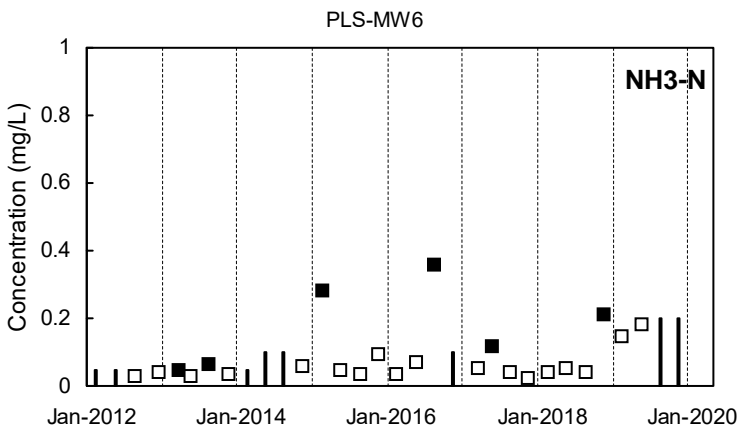
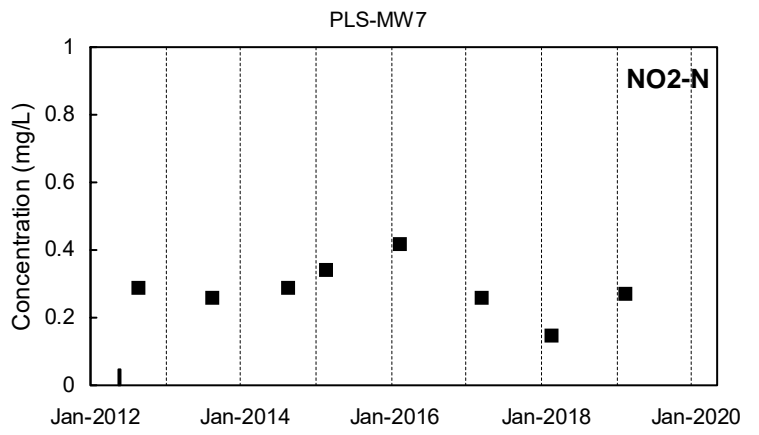
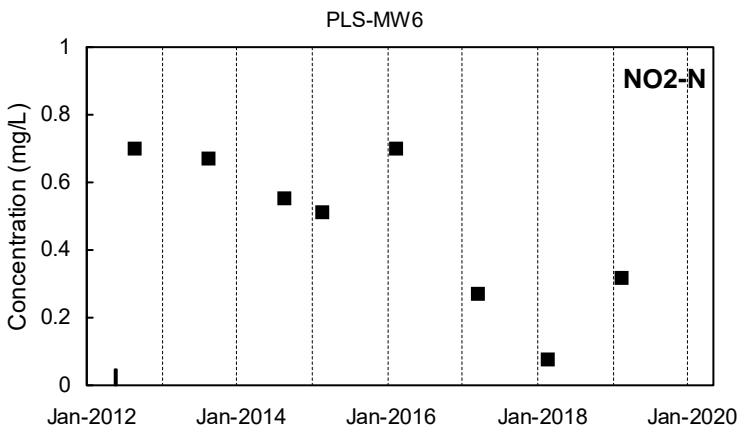
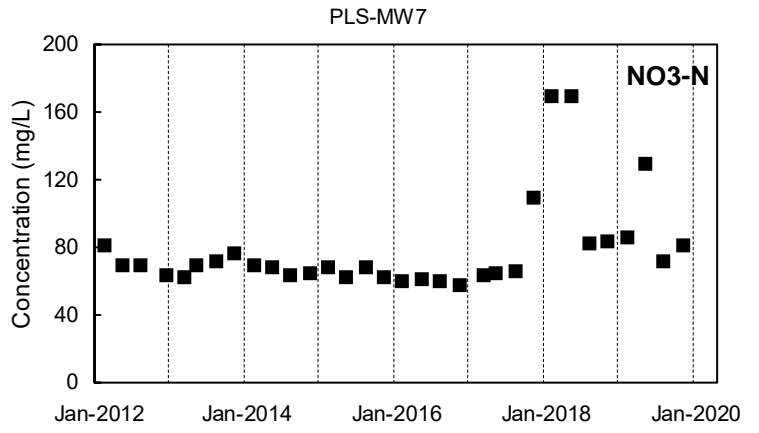
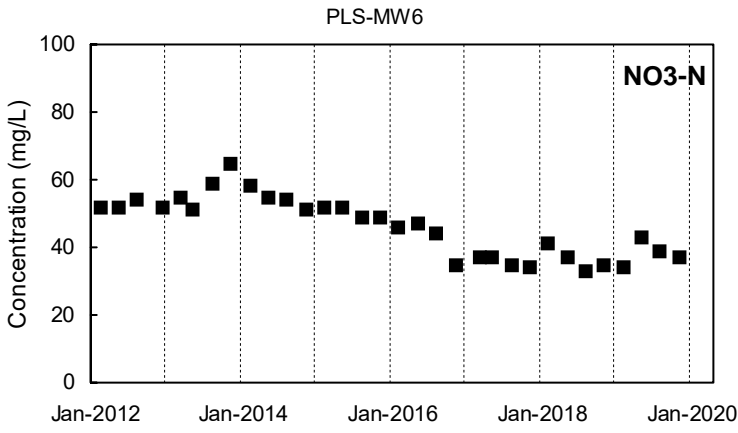

Detected Value
 'J'-Flag (value between reporting limit and detection limit)
 Non-Detect Range
 Shallow Well shown with black symbols
 Deep Well shown with orange symbols
 "dd" Well shown with blue symbols

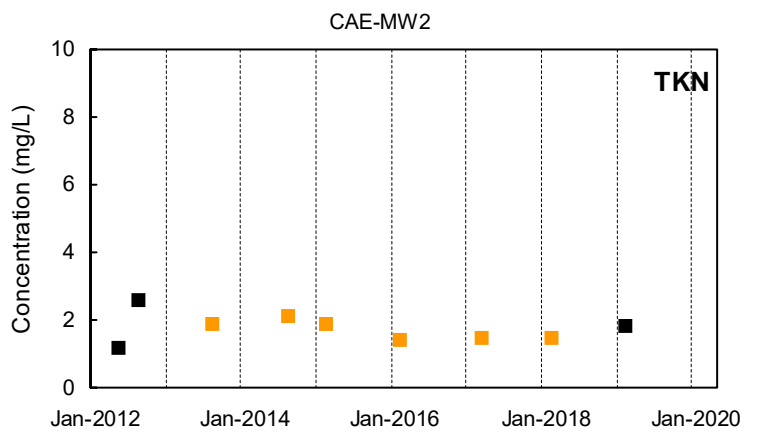
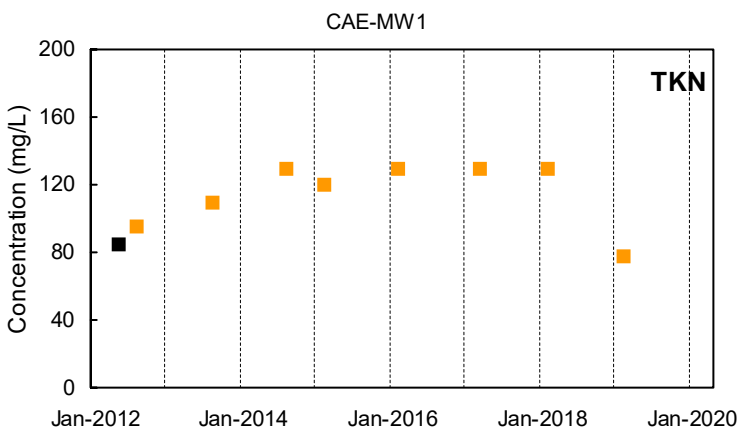
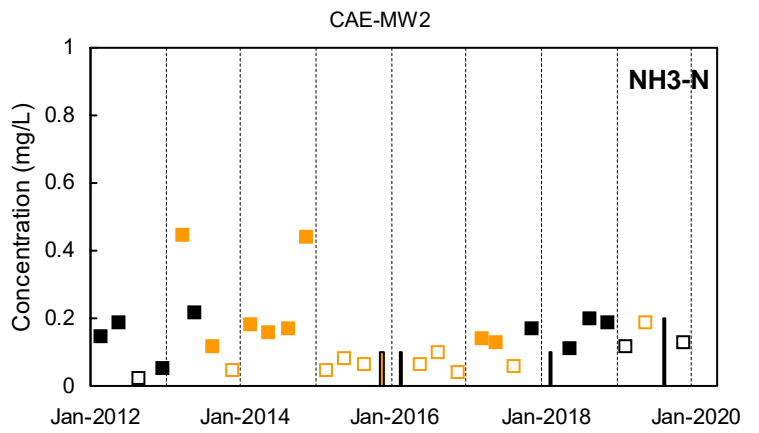
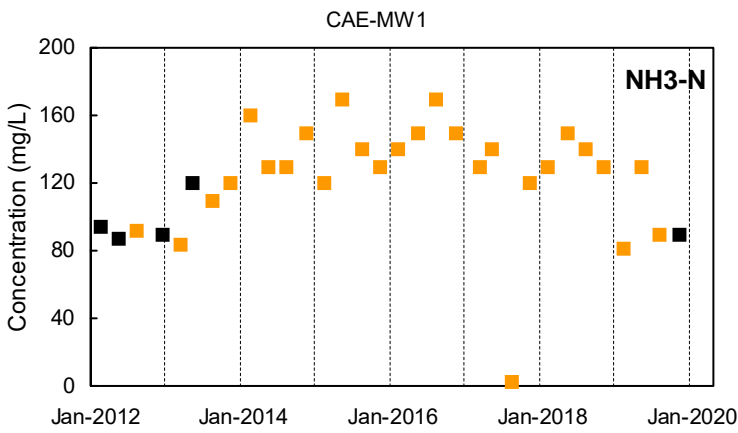
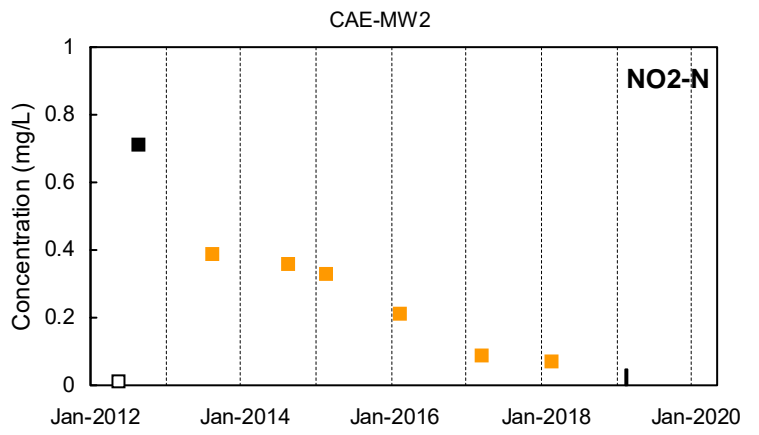
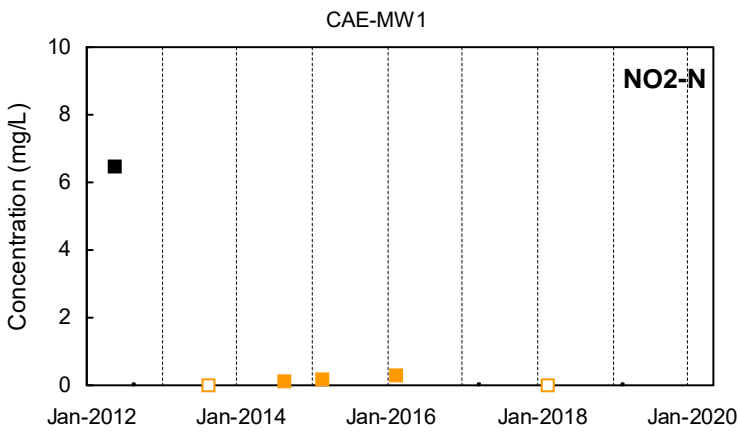
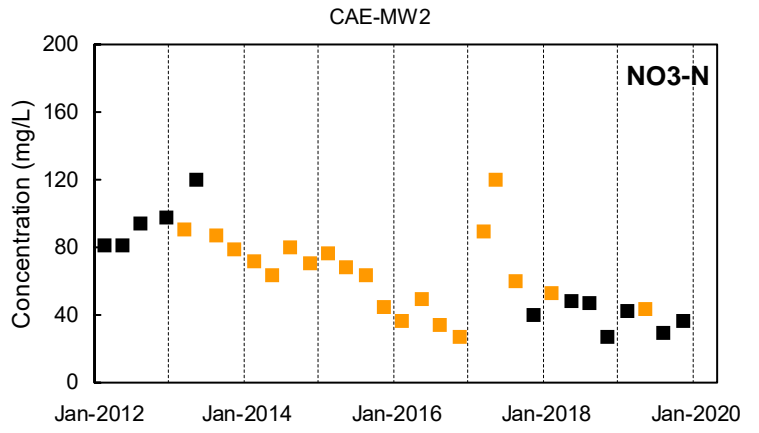
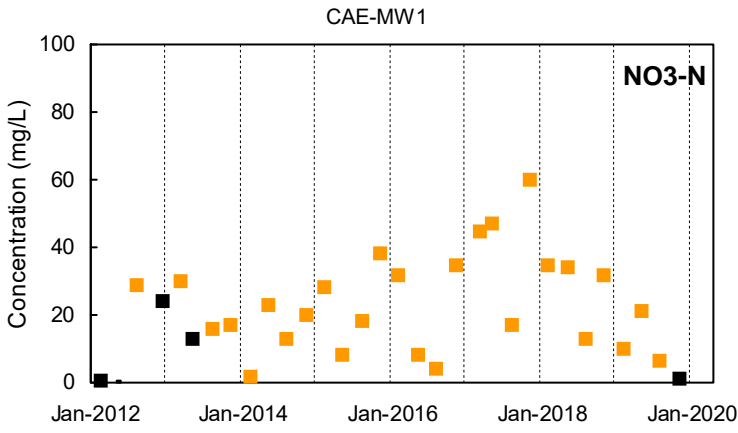

Detected Value
 'J'-Flag (value between reporting limit and detection limit)
 Non-Detect Range
 Shallow Well shown with black symbols
 Deep Well shown with orange symbols
 "dd" Well shown with blue symbols

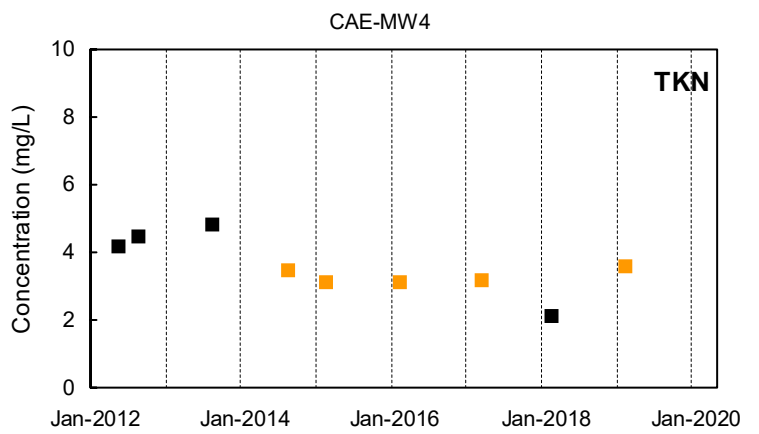
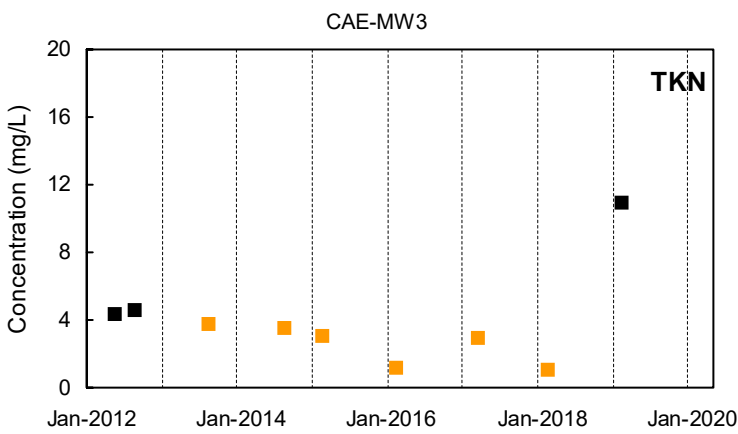
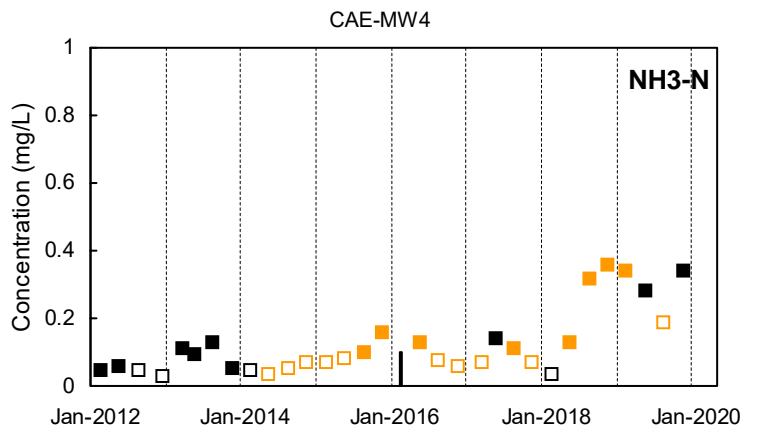
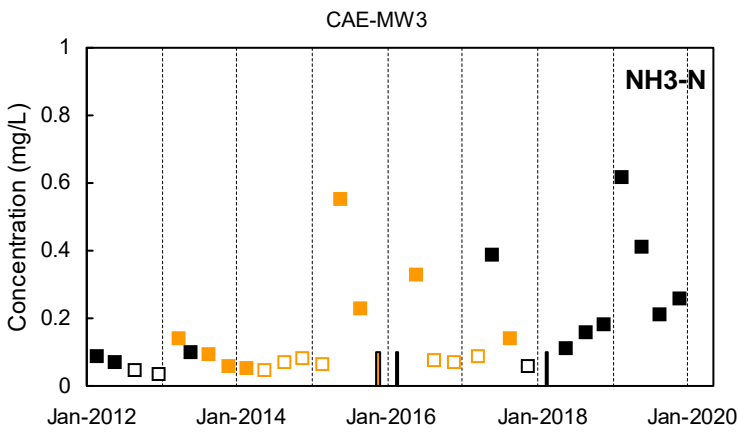
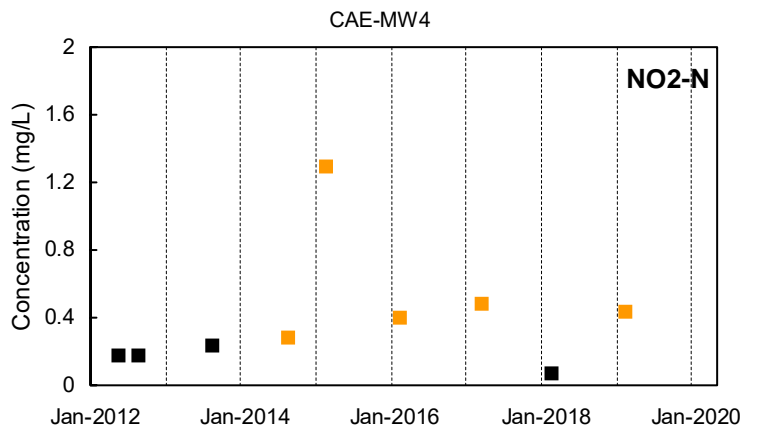
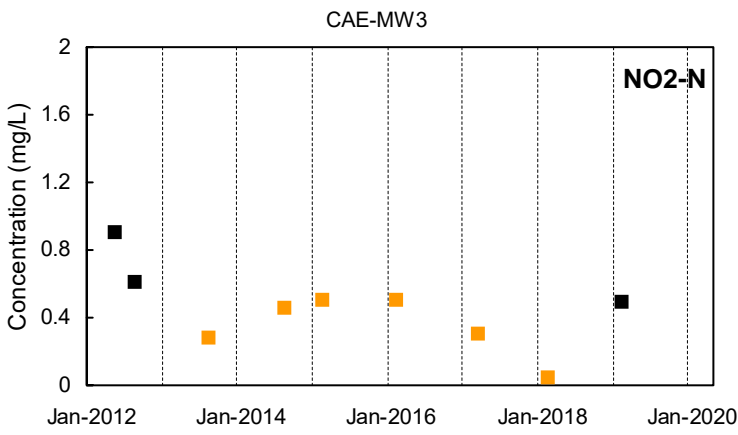
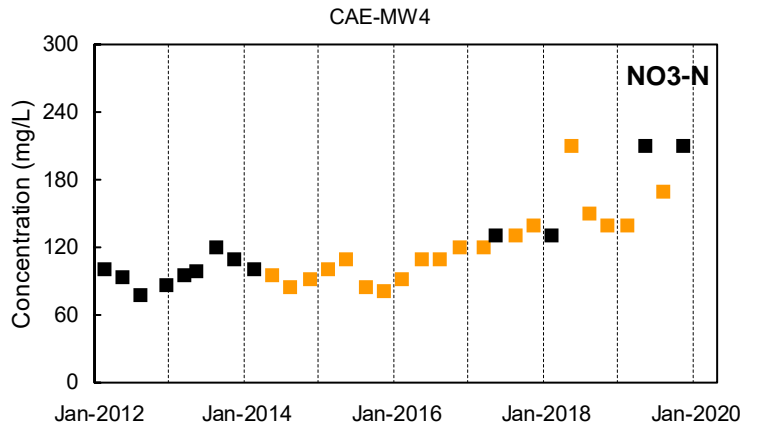
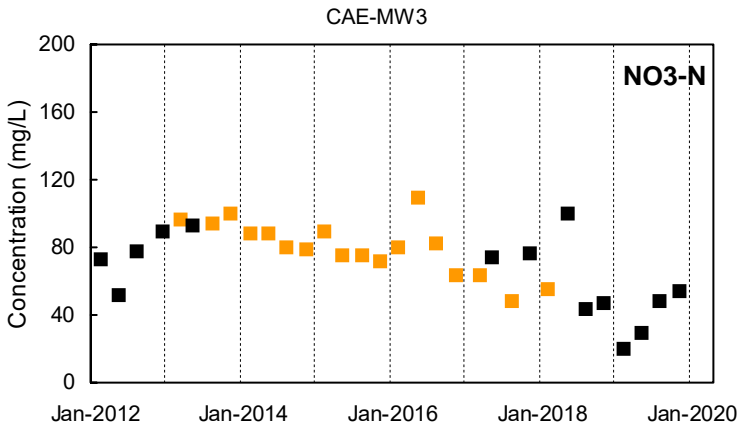

Detected Value
 'J'-Flag (value between reporting limit and detection limit)
 Non-Detect Range
 Shallow Well shown with black symbols
 Deep Well shown with orange symbols
 "dd" Well shown with blue symbols

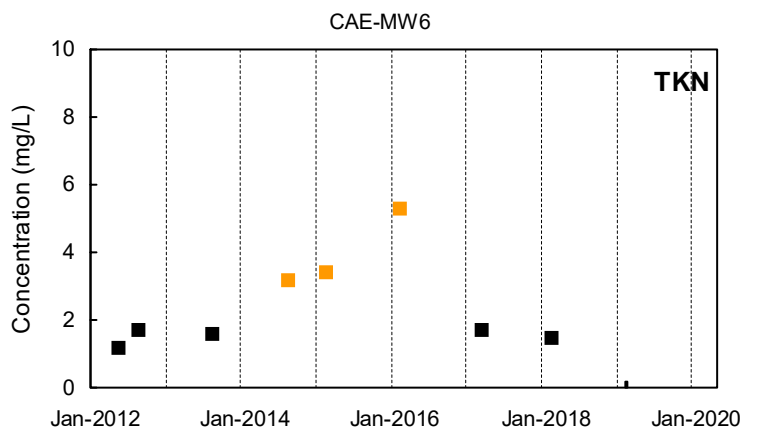
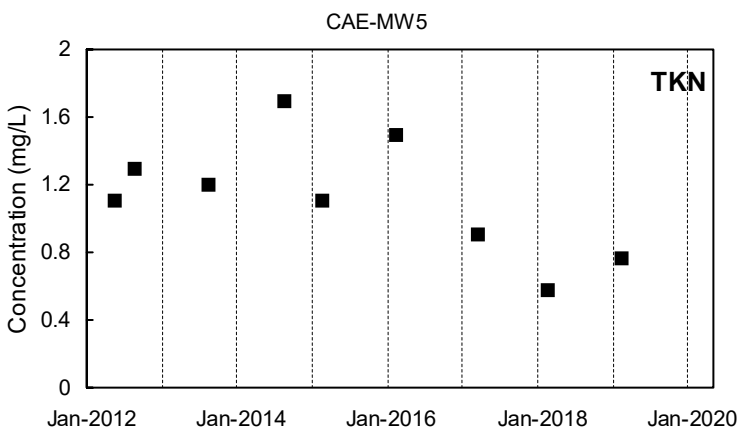
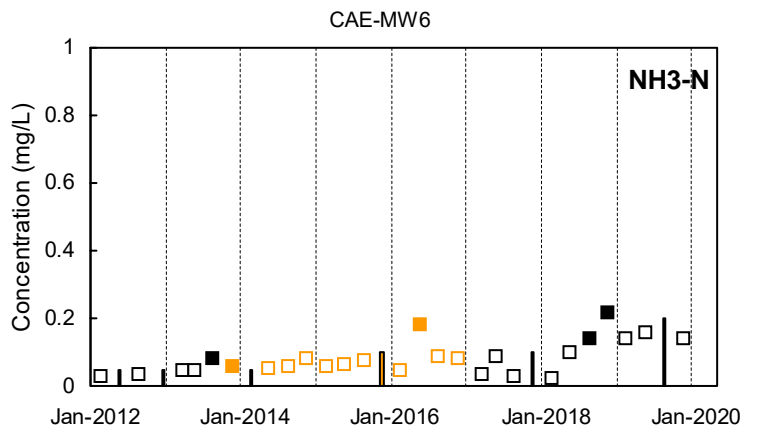
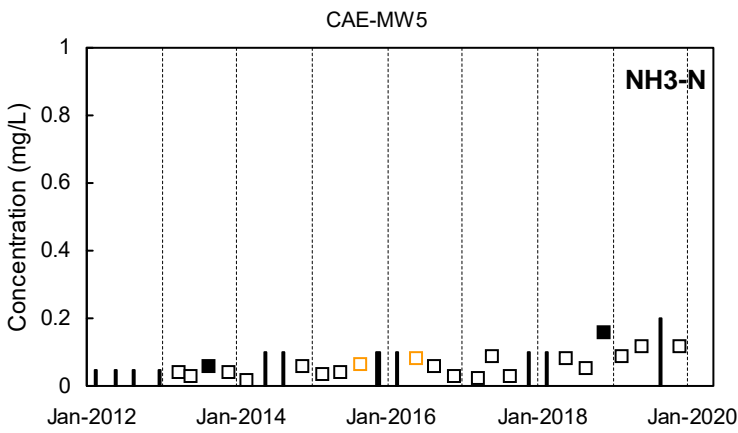
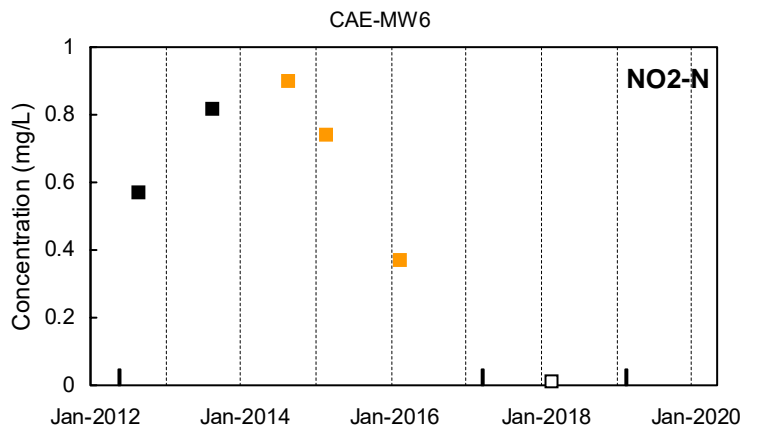
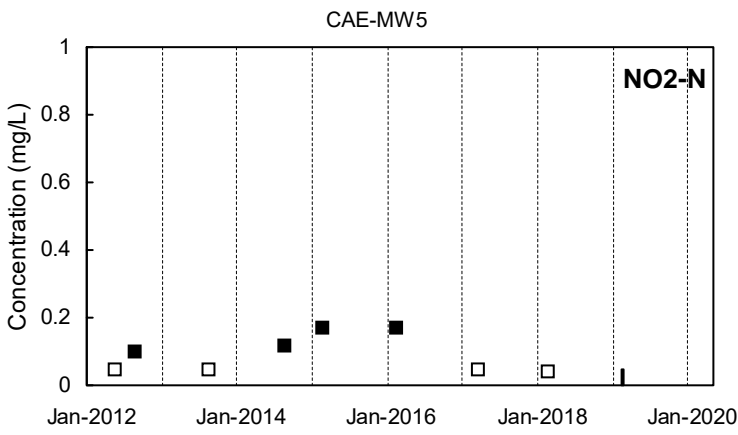
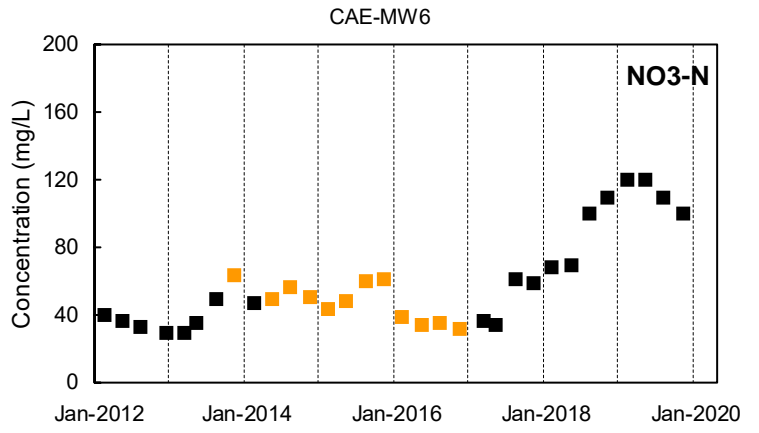
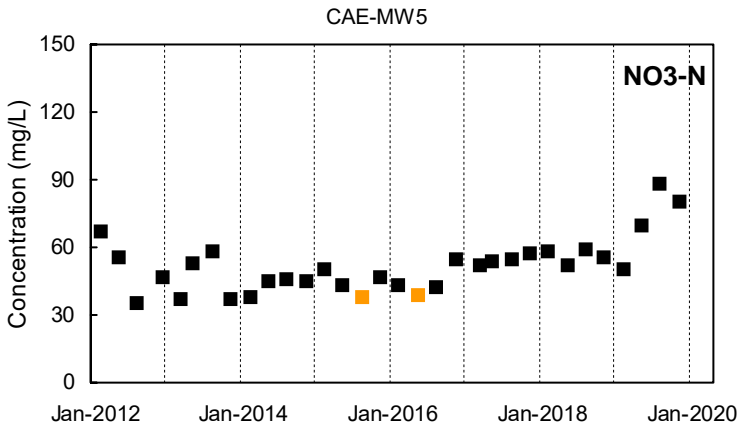

Detected Value
 'J'-Flag (value between reporting limit and detection limit)
 Non-Detect Range
 Shallow Well shown with black symbols
 Deep Well shown with orange symbols
 "dd" Well shown with blue symbols

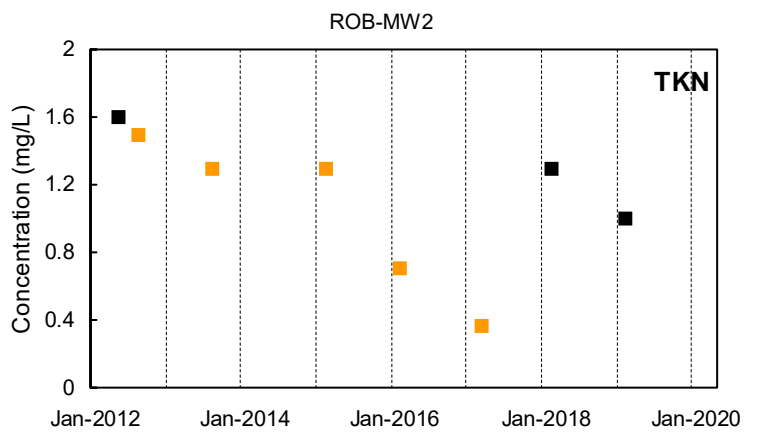
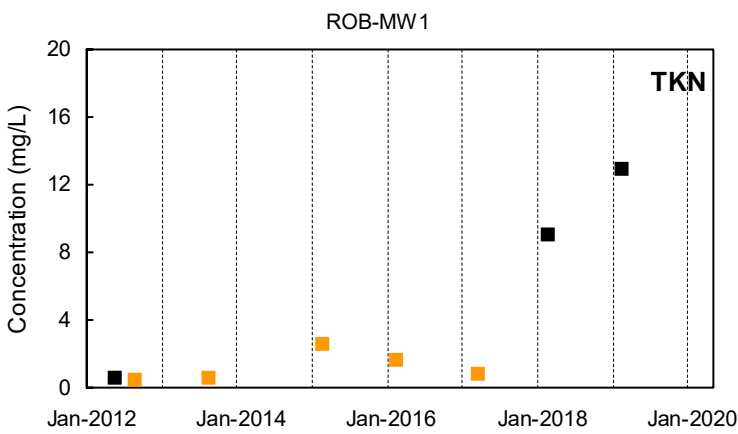
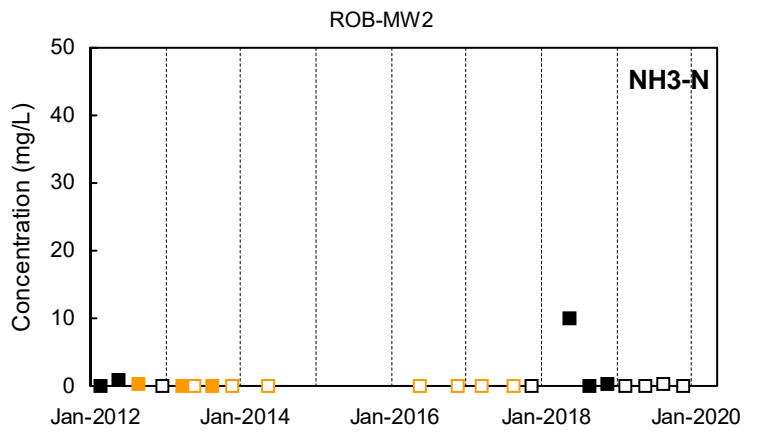
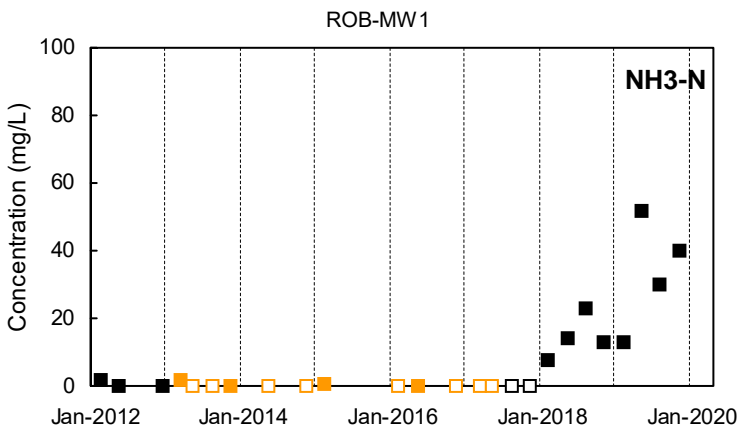
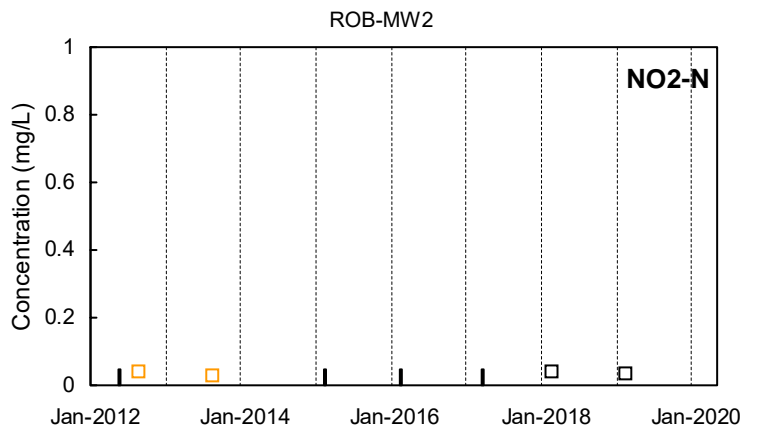
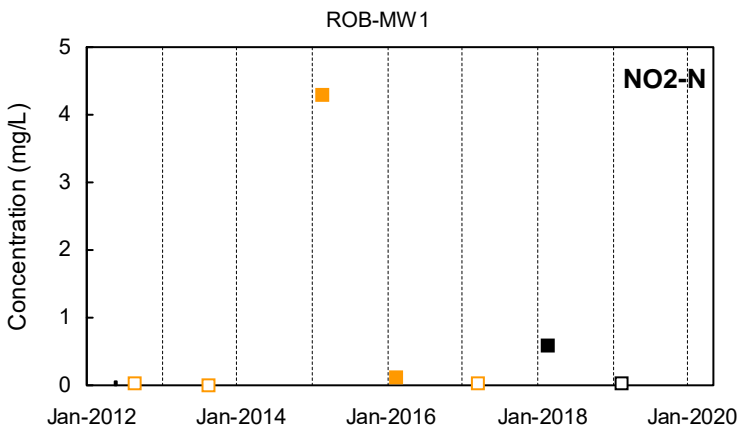
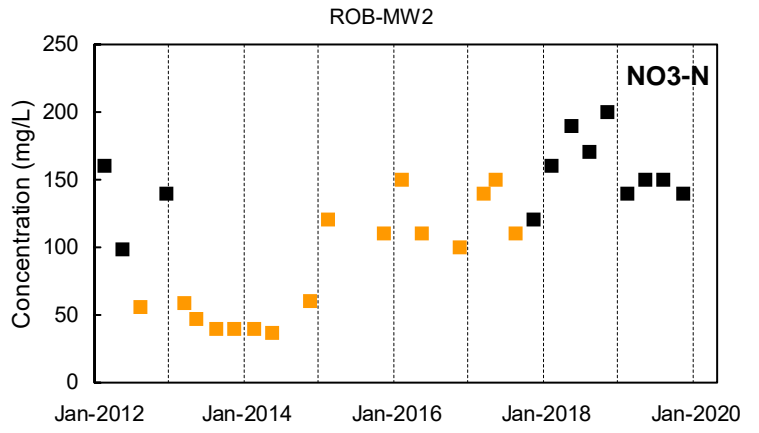
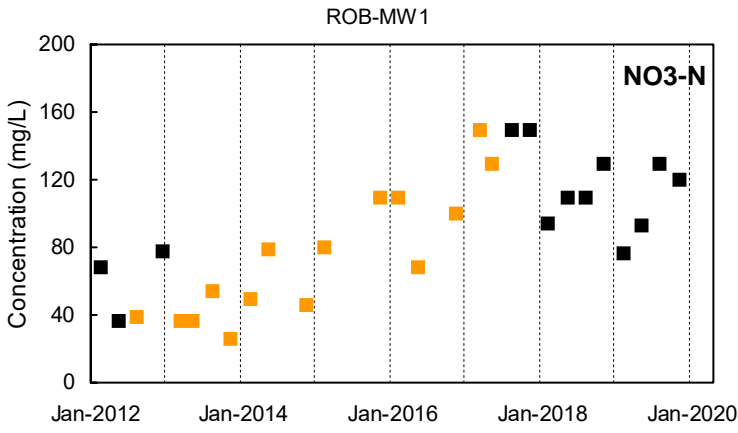

Detected Value
 'J'-Flag (value between reporting limit and detection limit)
 Non-Detect Range
 Shallow Well shown with black symbols
 Deep Well shown with orange symbols
 "dd" Well shown with blue symbols

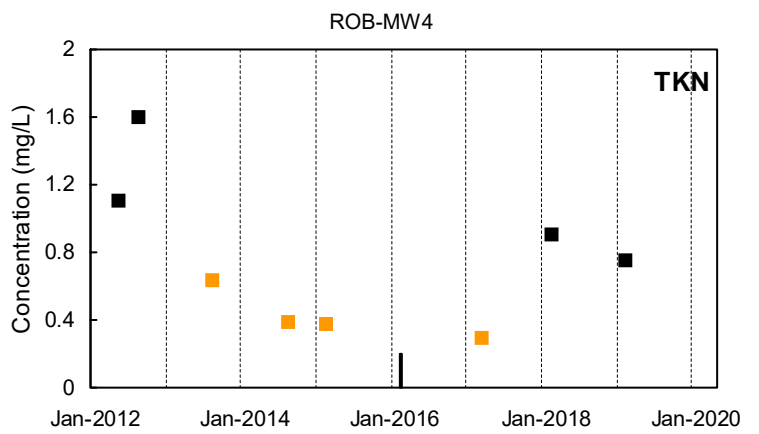
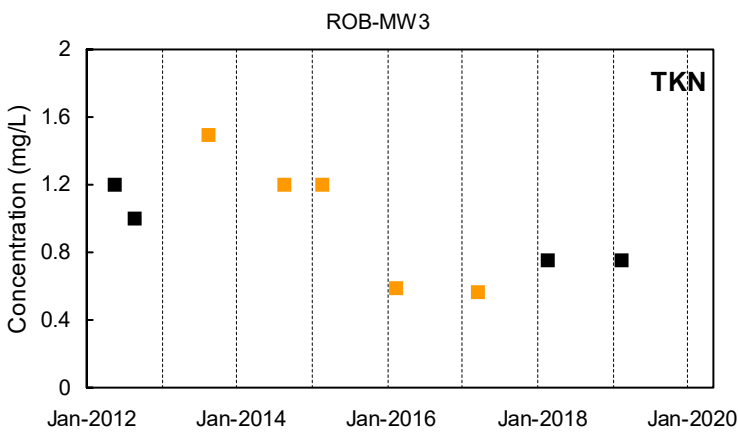
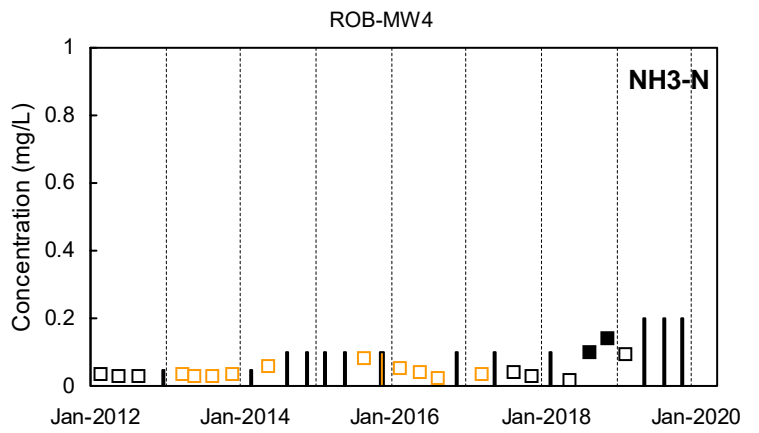
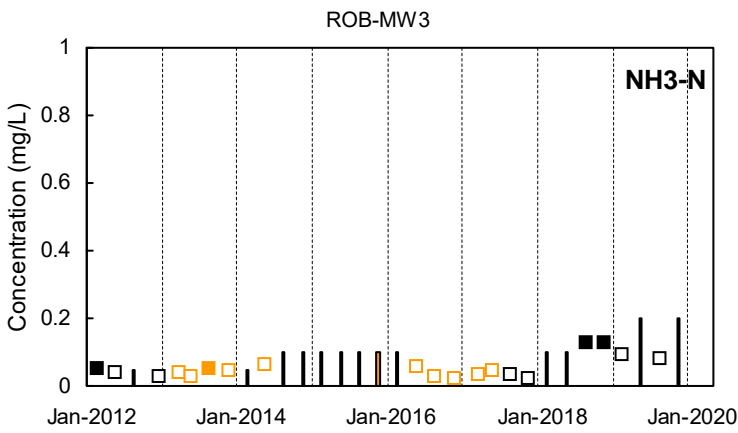
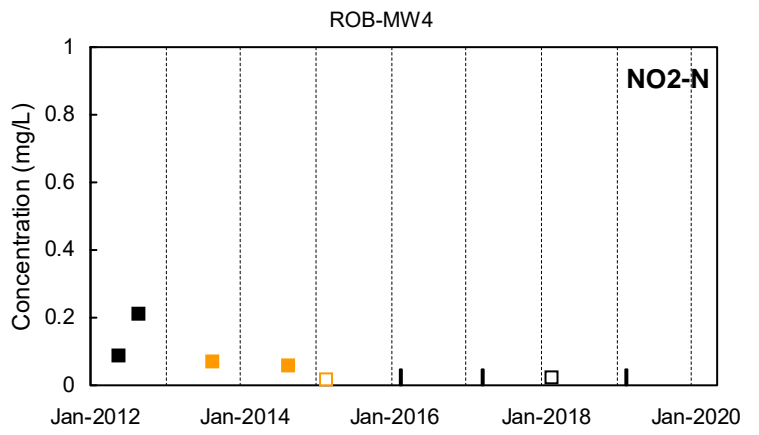
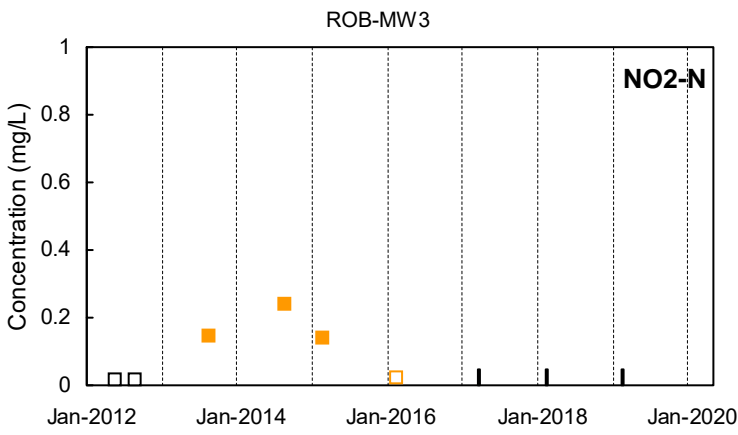
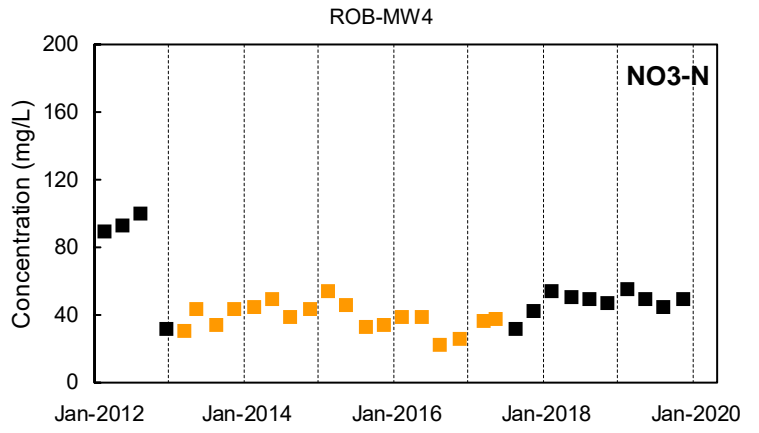
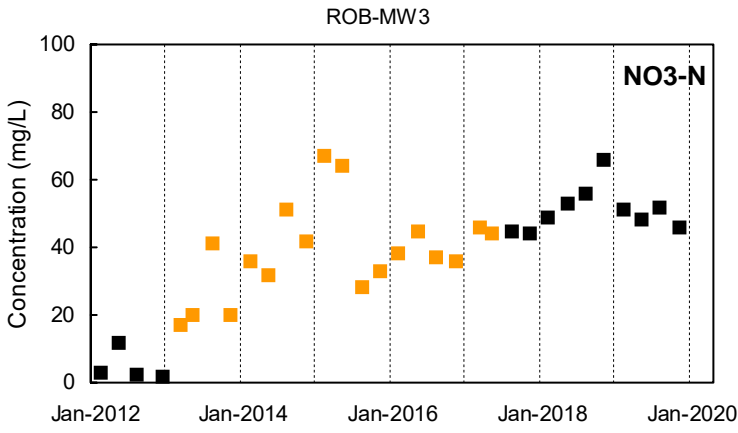

Detected Value
 'J'-Flag (value between reporting limit and detection limit)
 Non-Detect Range
 Shallow Well shown with black symbols
 Deep Well shown with orange symbols
 "dd" Well shown with blue symbols

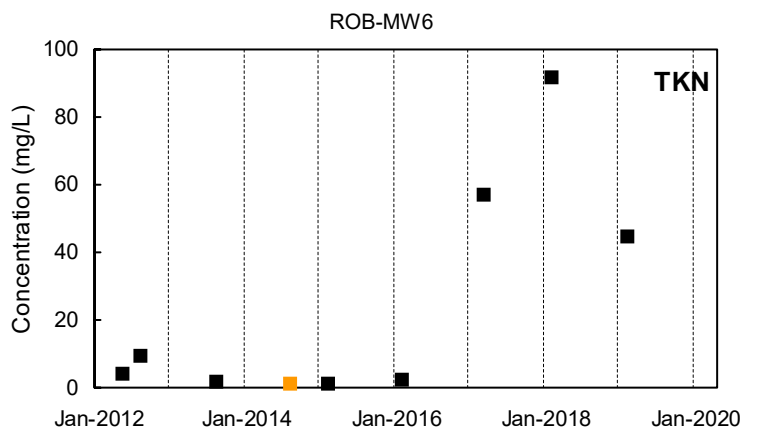
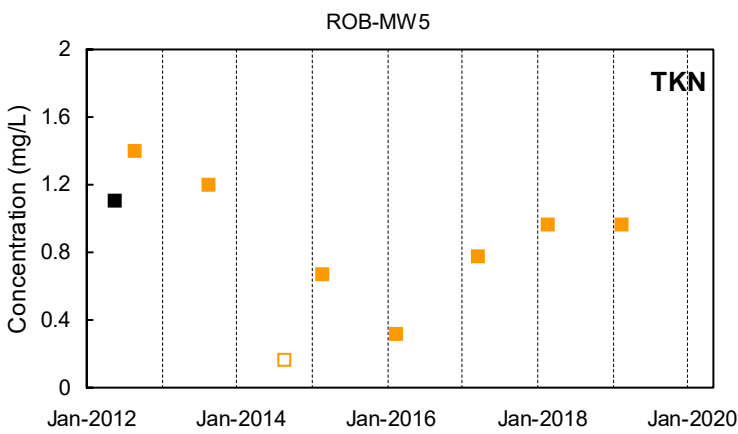
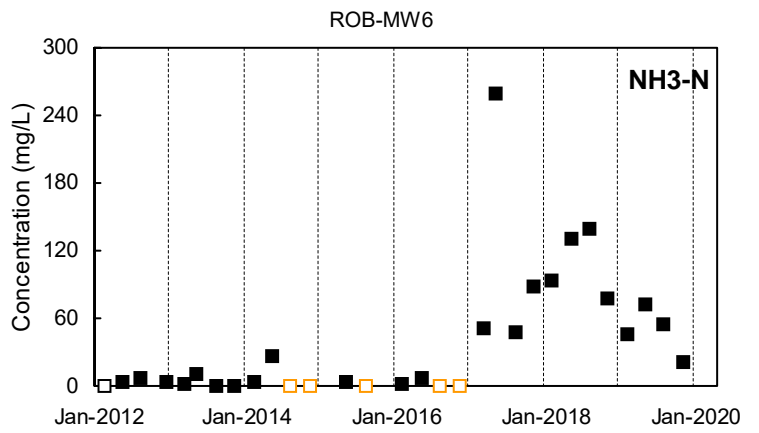
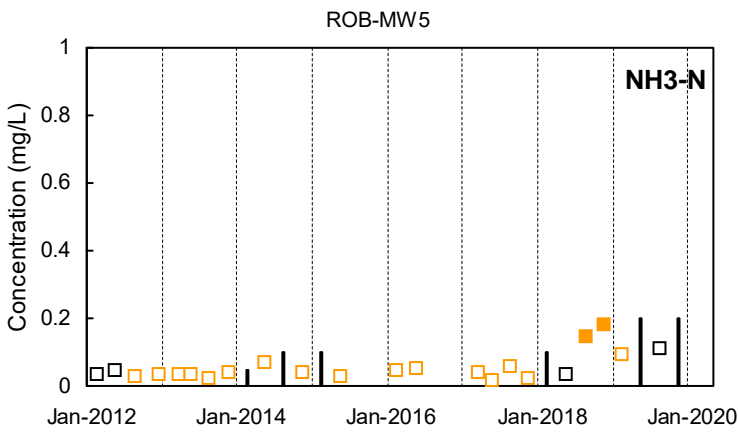
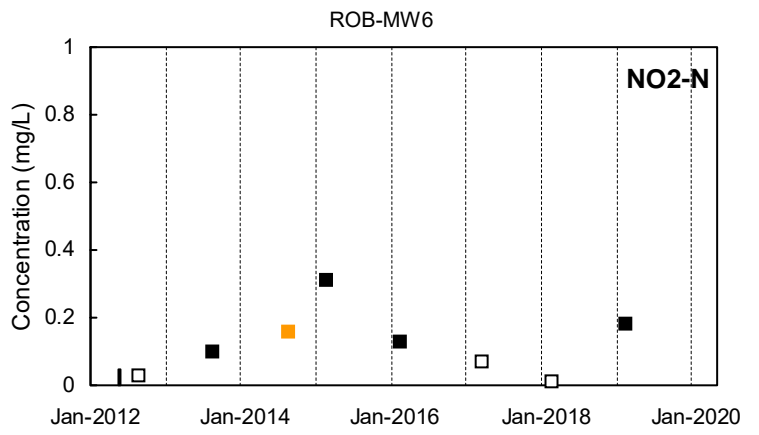
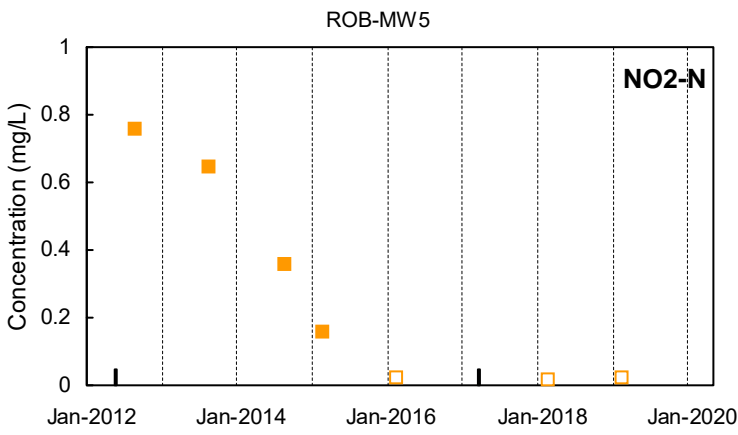
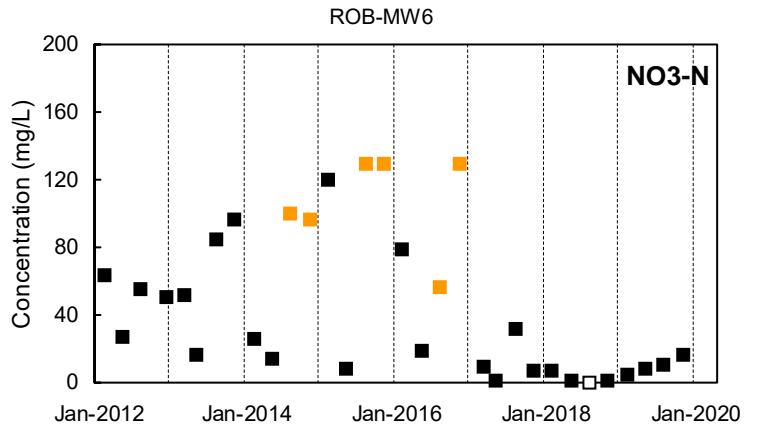
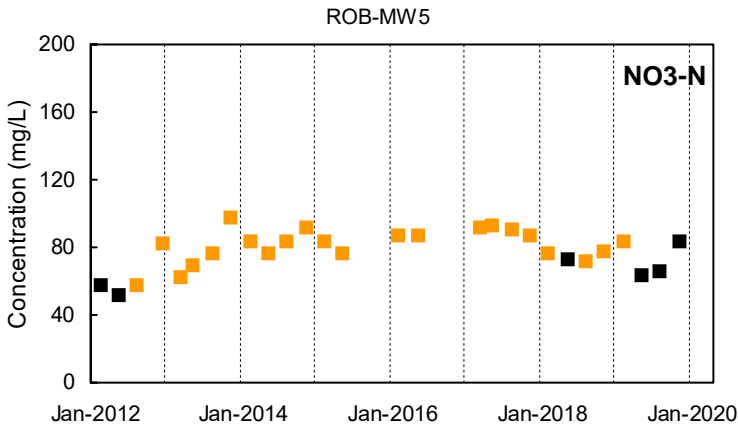

Detected Value
 'J'-Flag (value between reporting limit and detection limit)
 Non-Detect Range
 Shallow Well shown with black symbols
 Deep Well shown with orange symbols
 "dd" Well shown with blue symbols

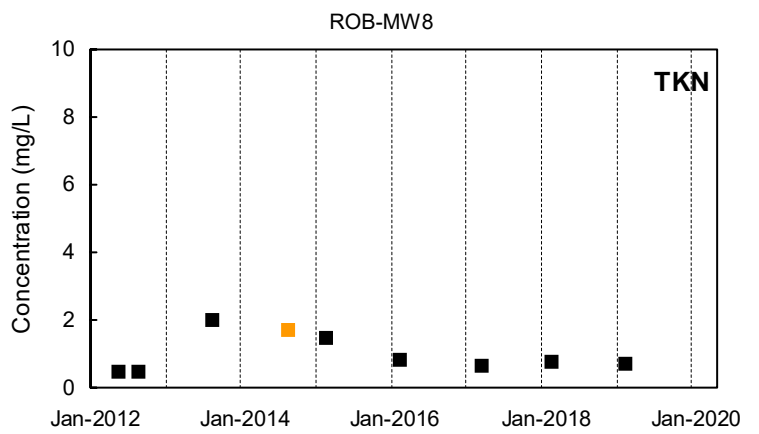
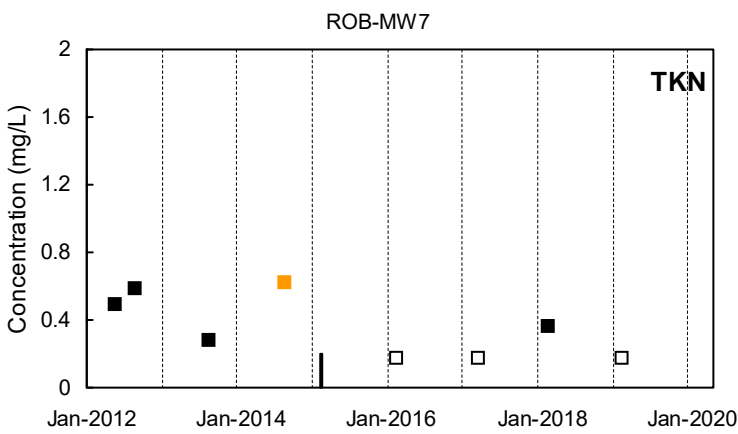
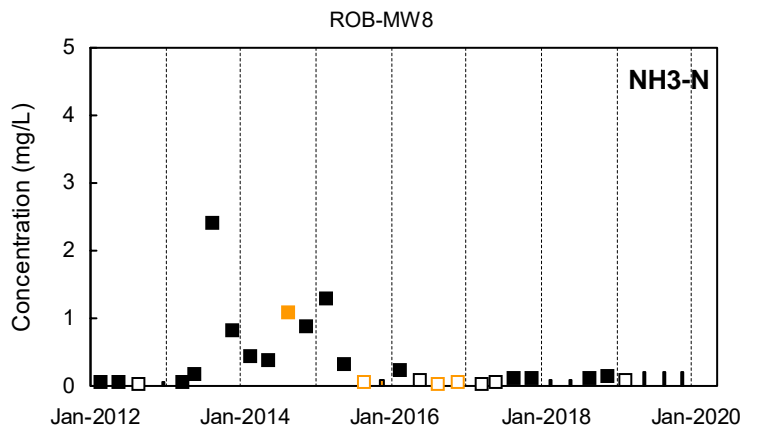
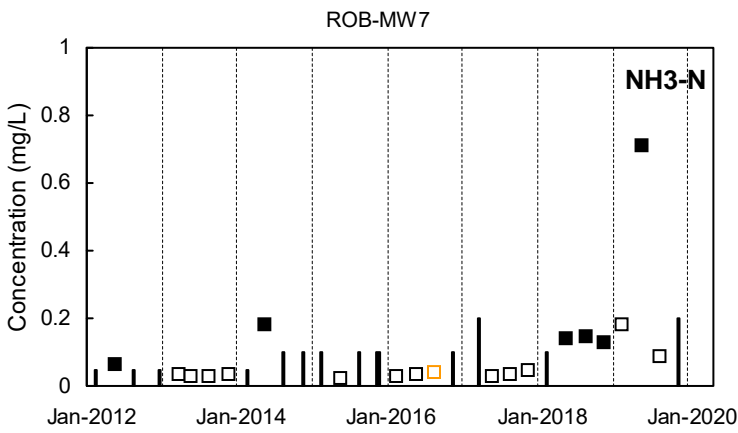
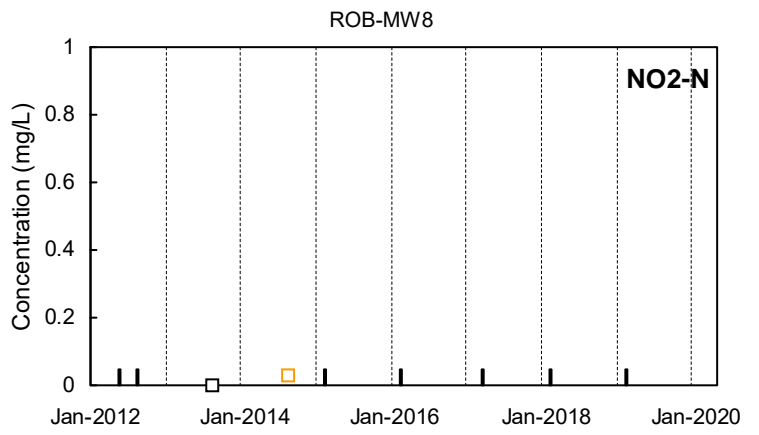
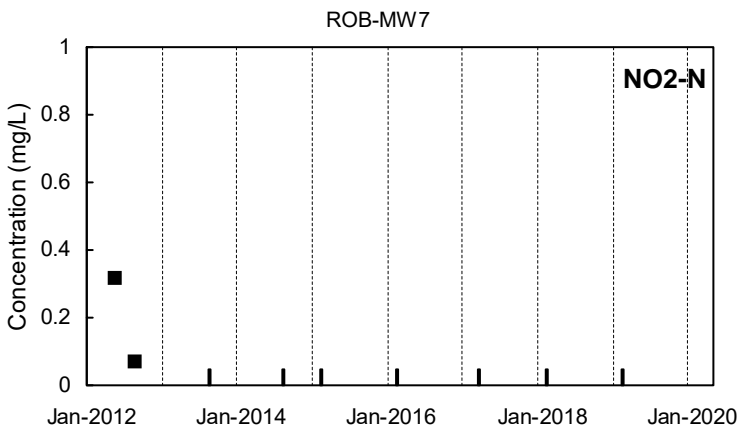
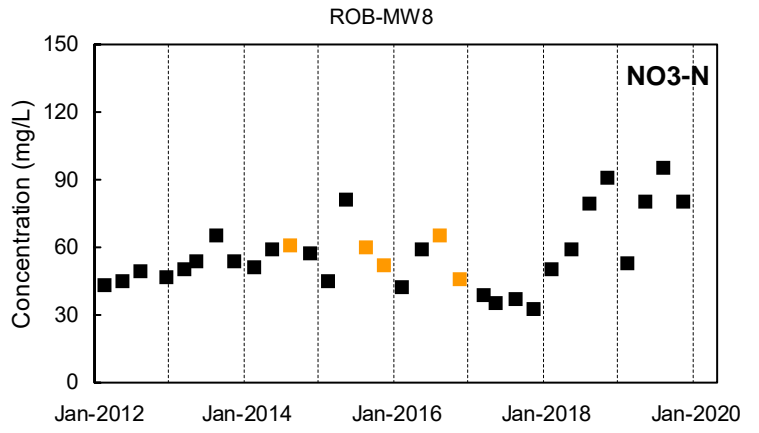
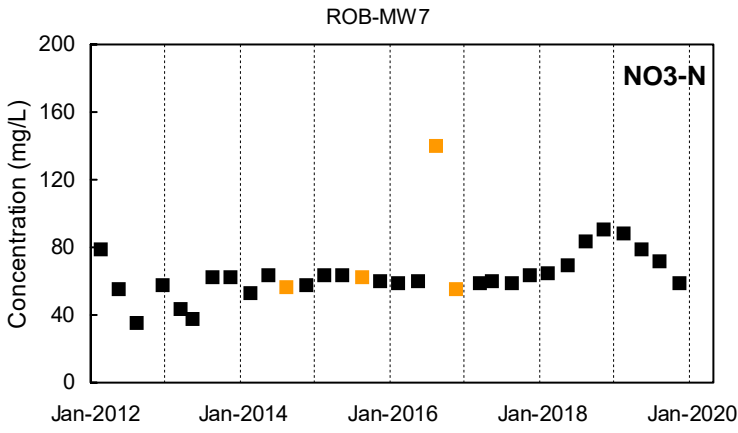

Detected Value
 'J'-Flag (value between reporting limit and detection limit)
 Non-Detect Range
 Shallow Well shown with black symbols Deep Well shown with orange symbols "dd" Well shown with blue symbols

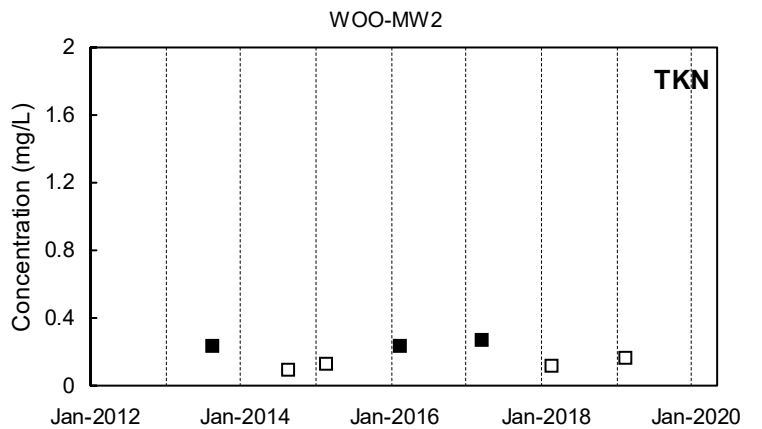
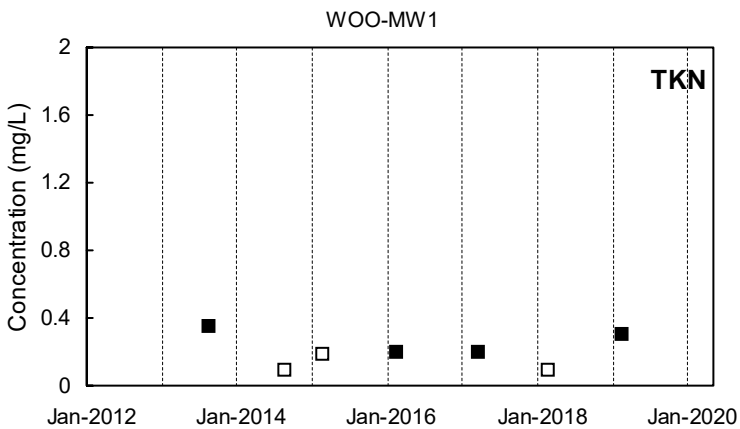
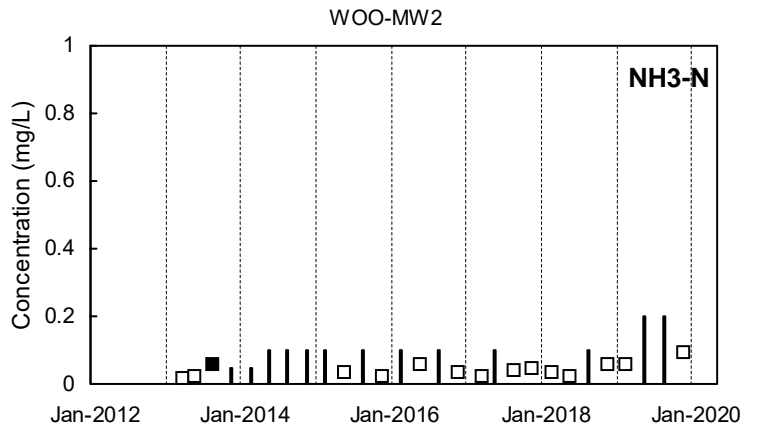
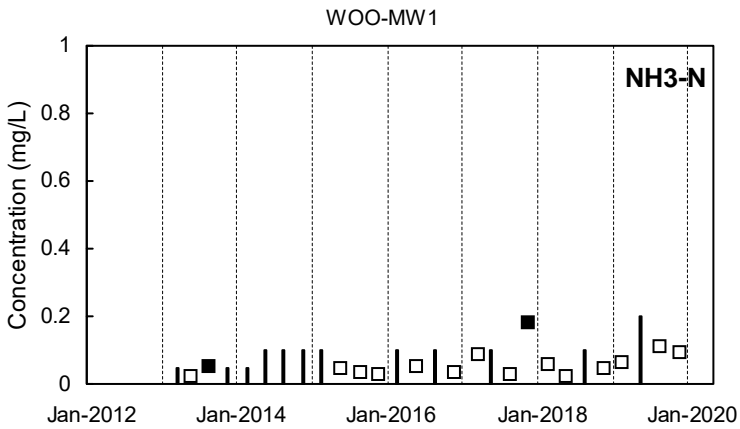
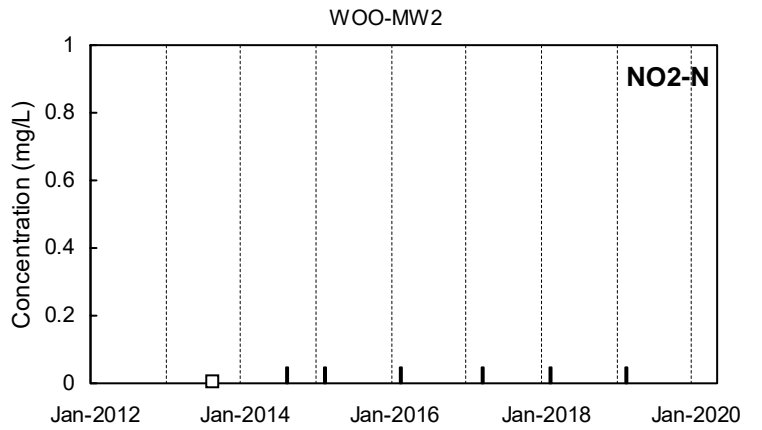
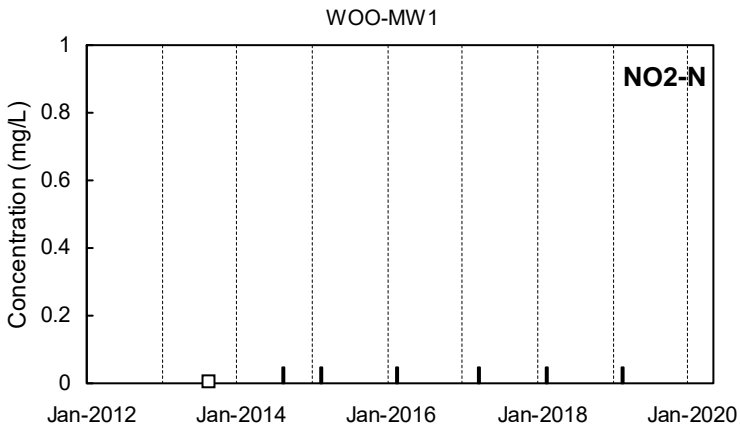
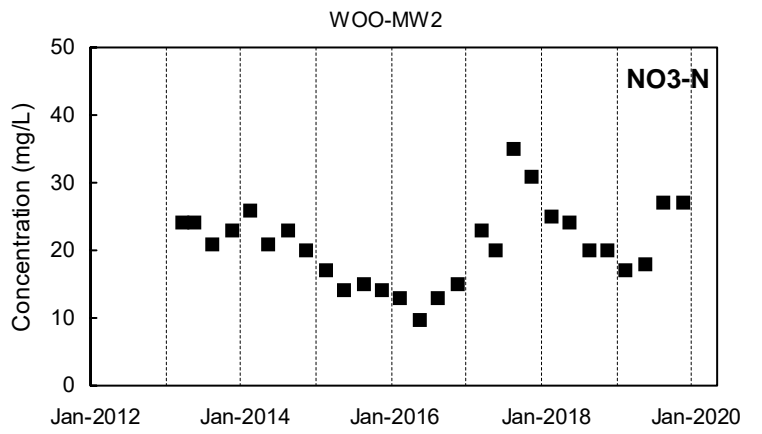
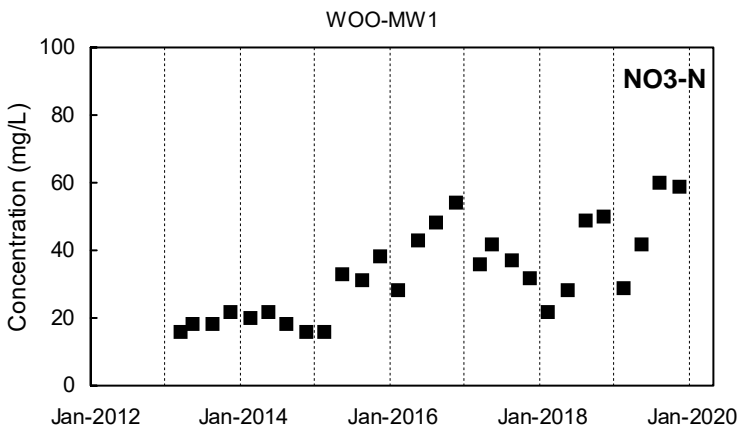

Detected Value
 'J'-Flag (value between reporting limit and detection limit)
 Non-Detect Range
 Shallow Well shown with black symbols
 Deep Well shown with orange symbols
 "dd" Well shown with blue symbols

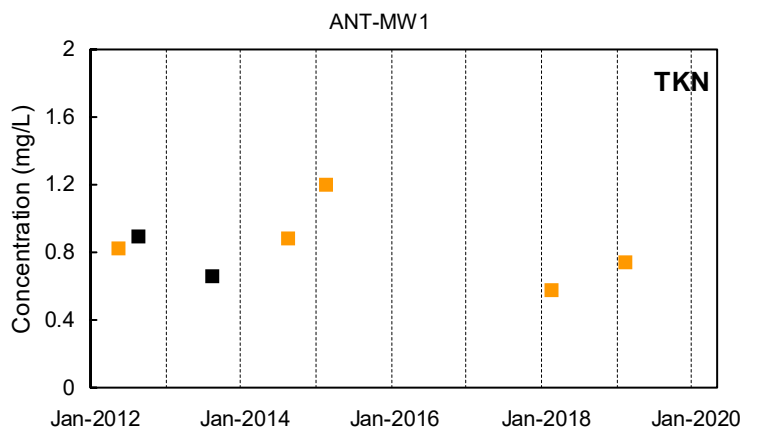
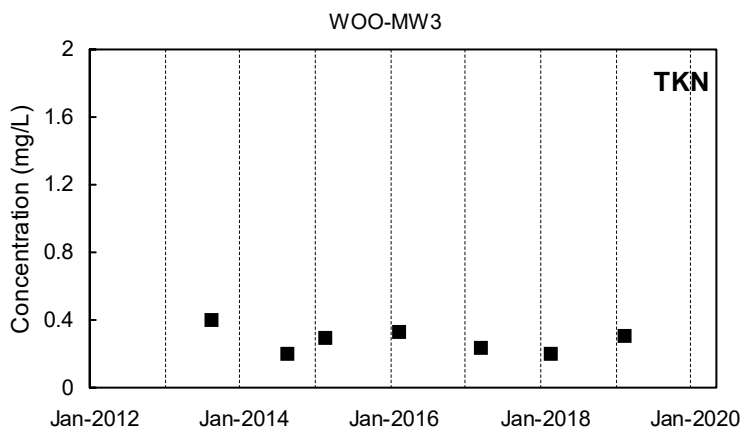
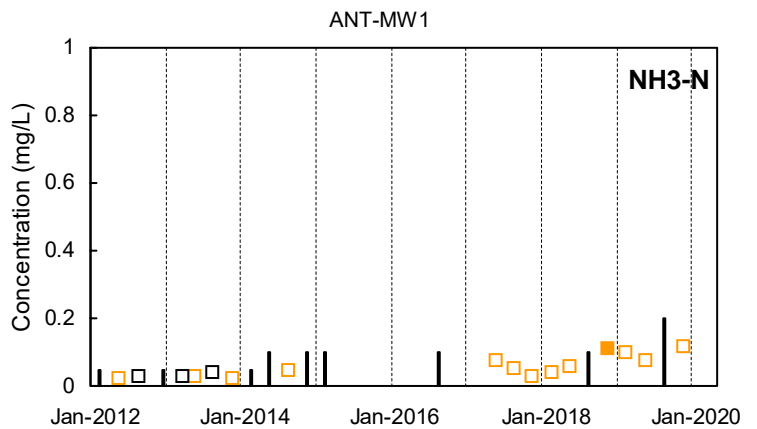
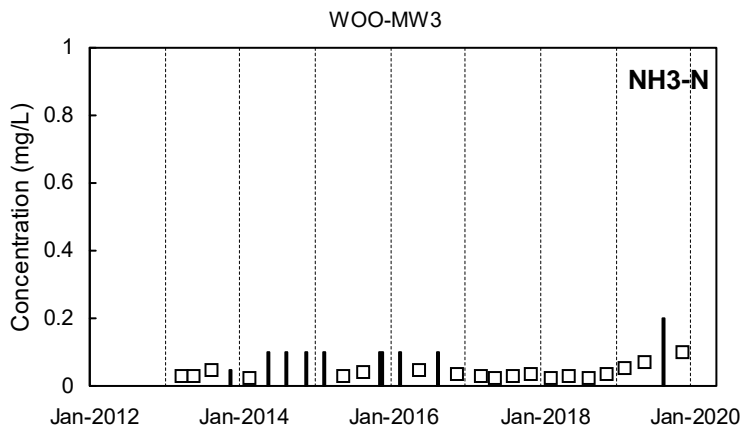
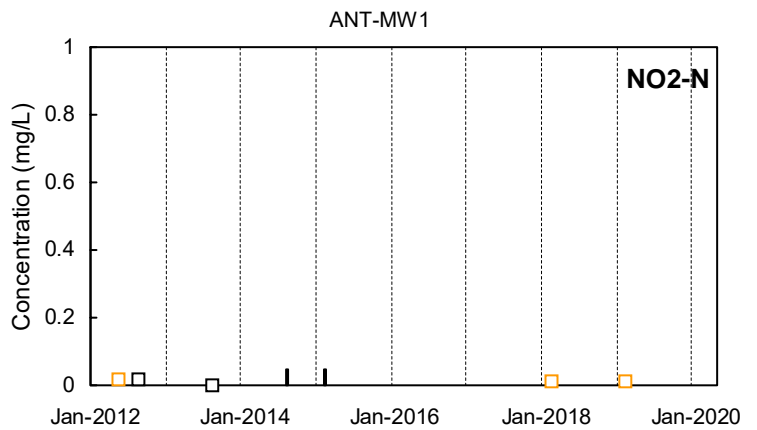
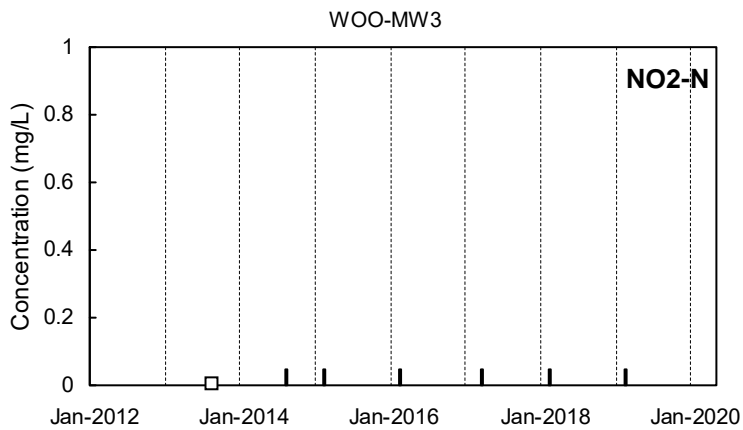
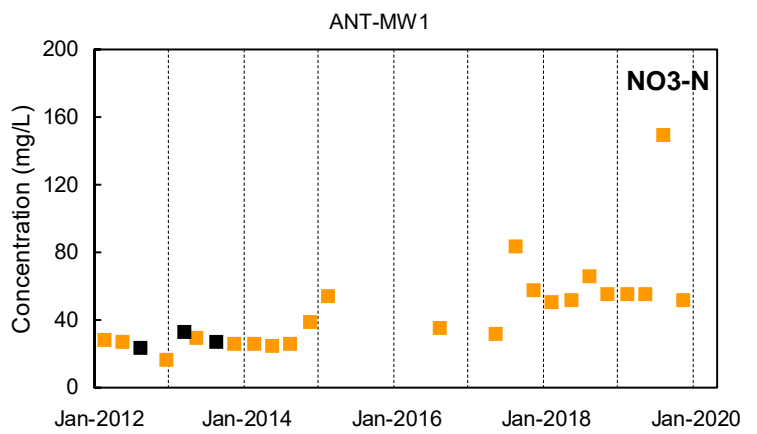
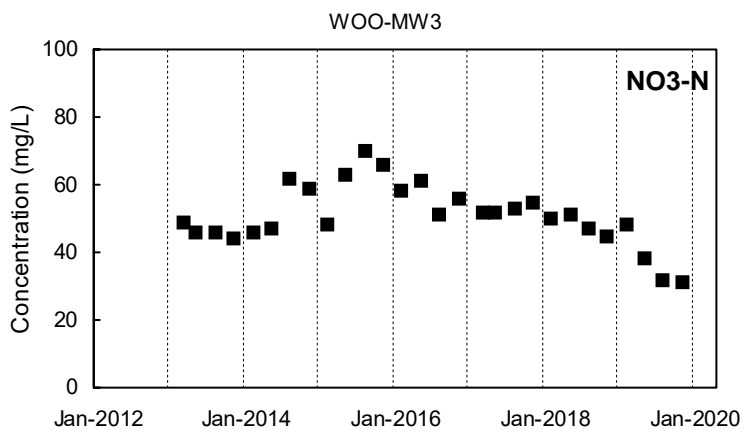

Detected Value
 'J'-Flag (value between reporting limit and detection limit)
 Non-Detect Range
 Shallow Well shown with black symbols
 Deep Well shown with orange symbols
 "dd" Well shown with blue symbols

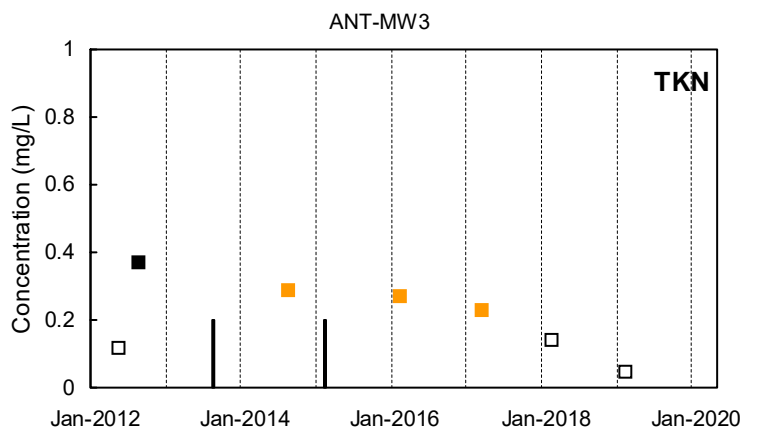
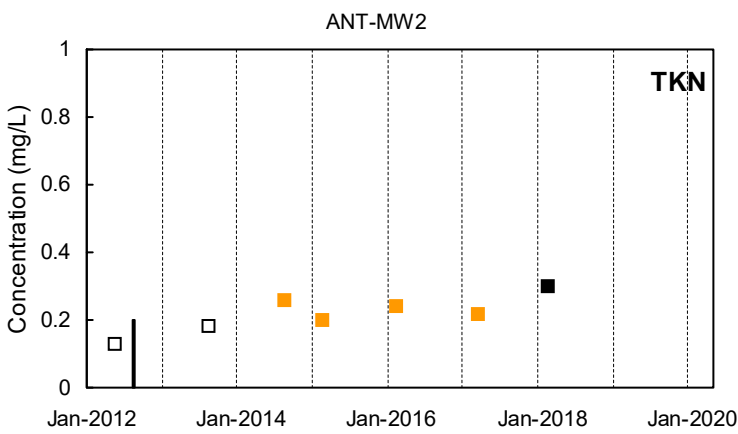
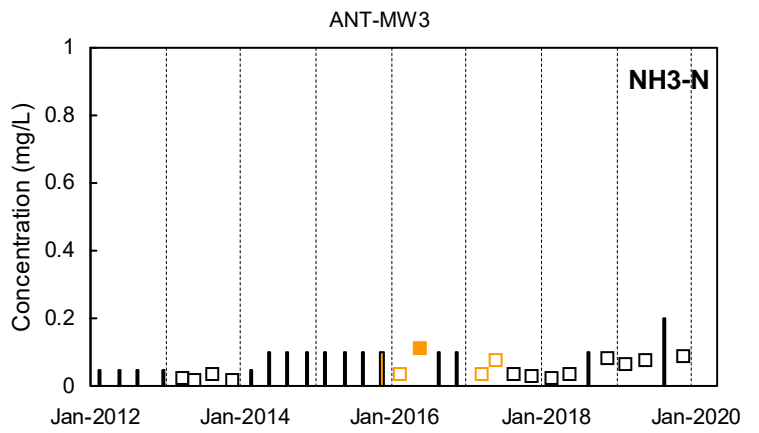
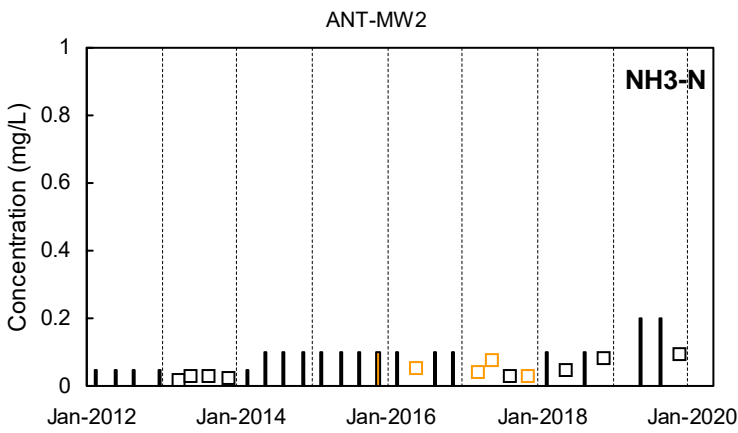
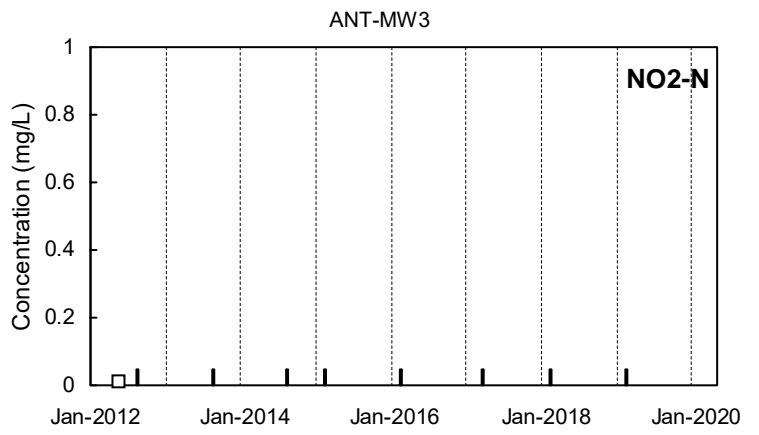
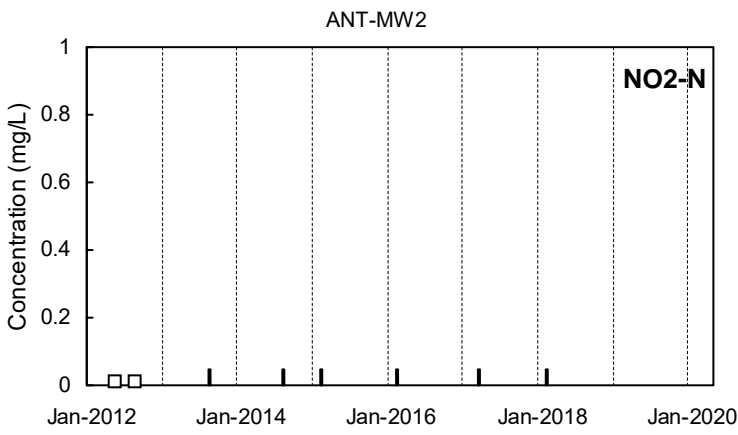
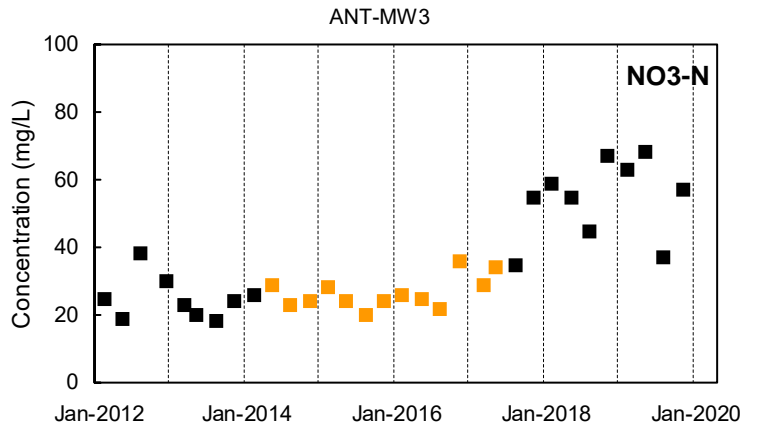
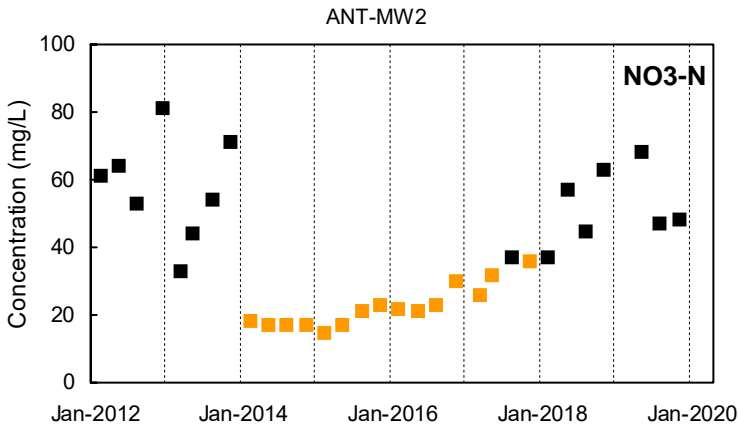

Detected Value
 'J'-Flag (value between reporting limit and detection limit)
 Non-Detect Range
 Shallow Well shown with black symbols
 Deep Well shown with orange symbols
 "dd" Well shown with blue symbols

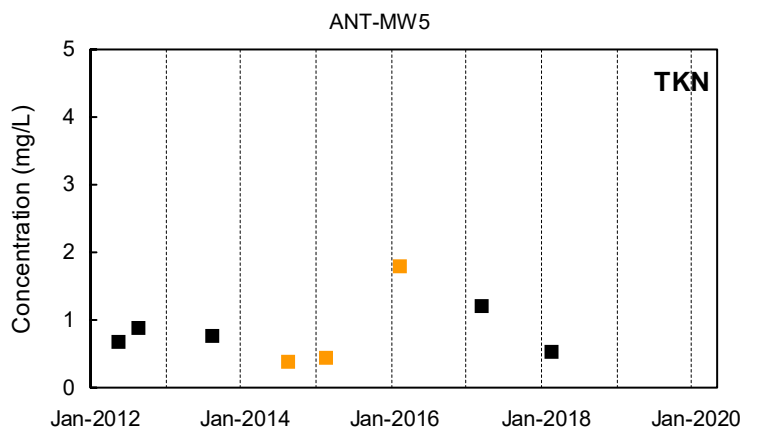
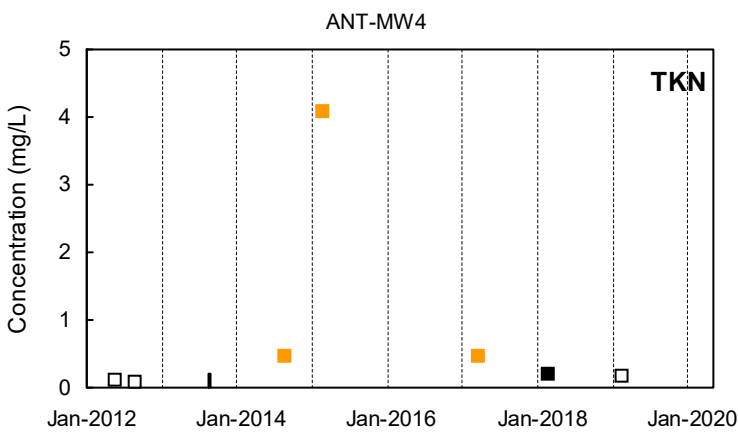
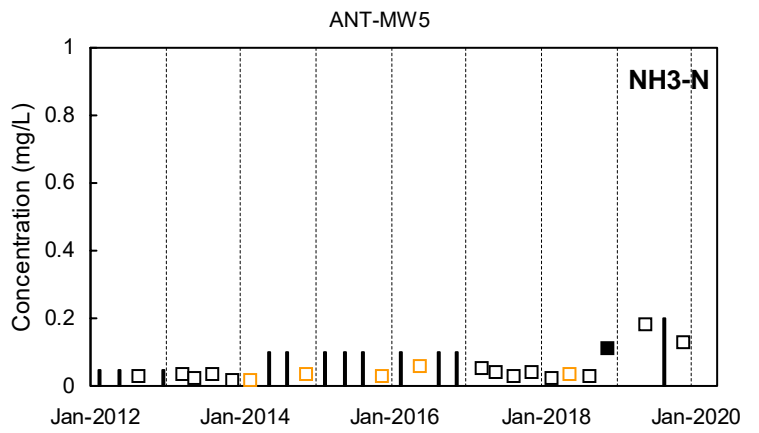
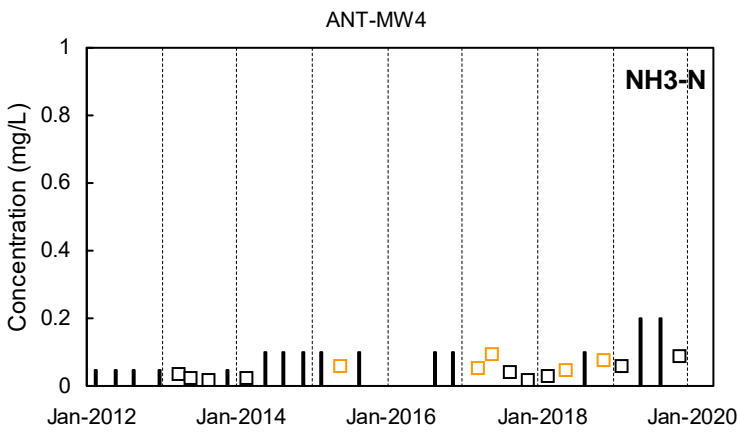
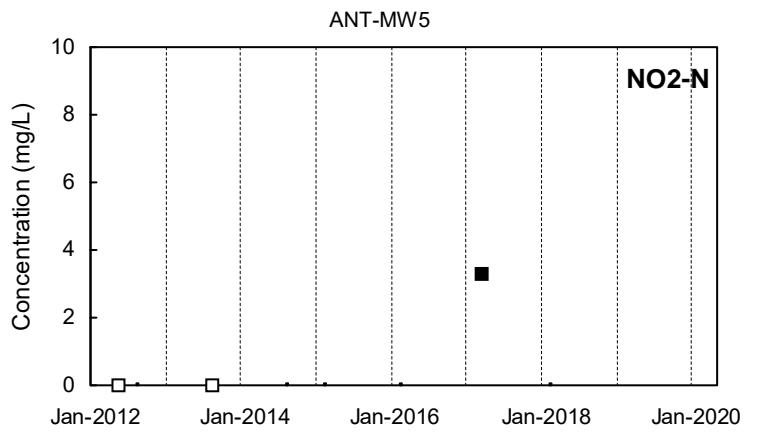
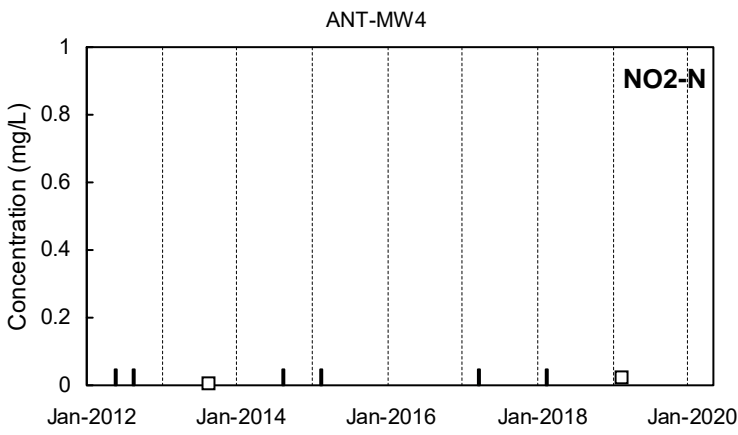
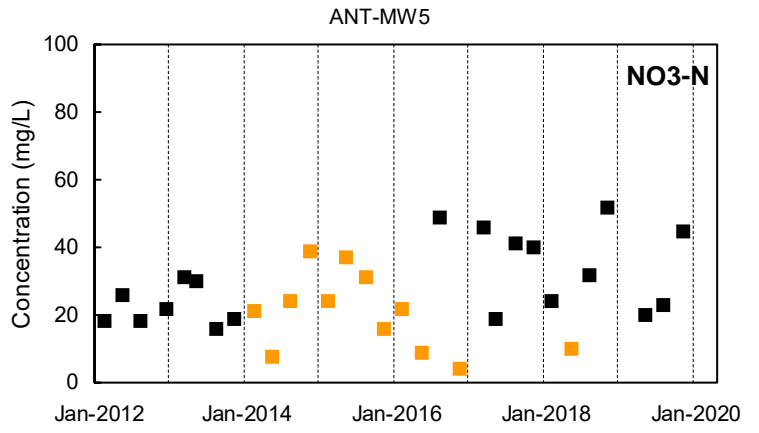
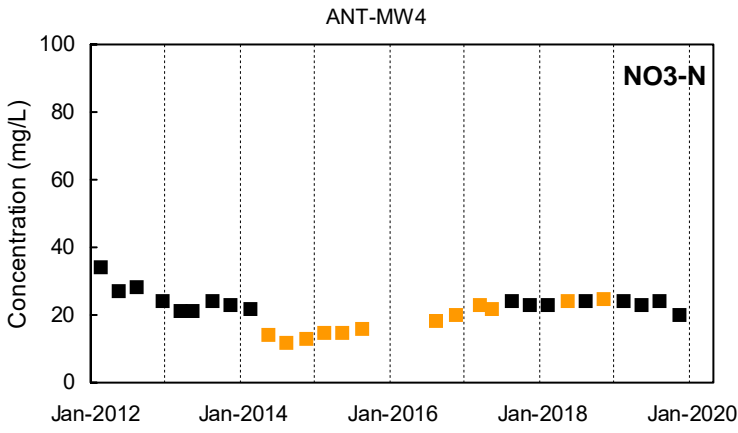

Detected Value
 'J'-Flag (value between reporting limit and detection limit)
 Non-Detect Range
 Shallow Well shown with black symbols
 Deep Well shown with orange symbols
 "dd" Well shown with blue symbols

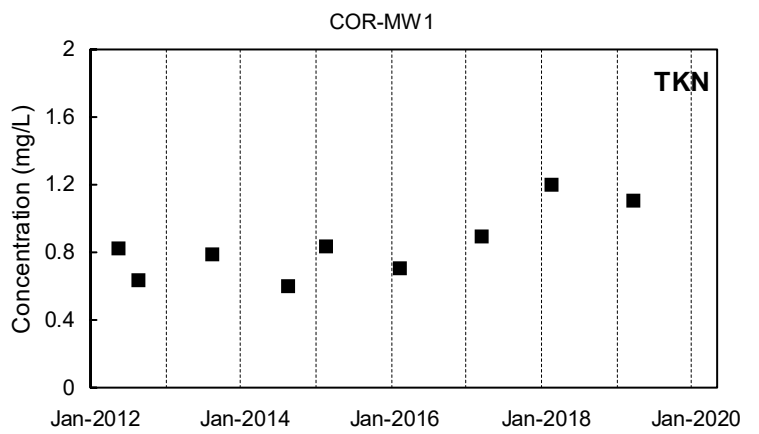
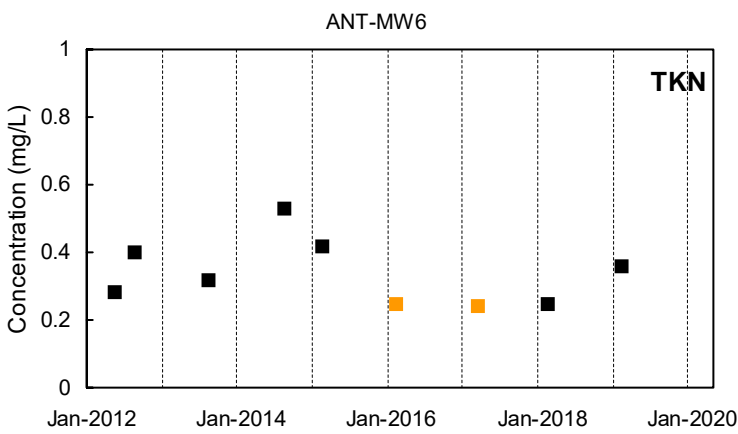
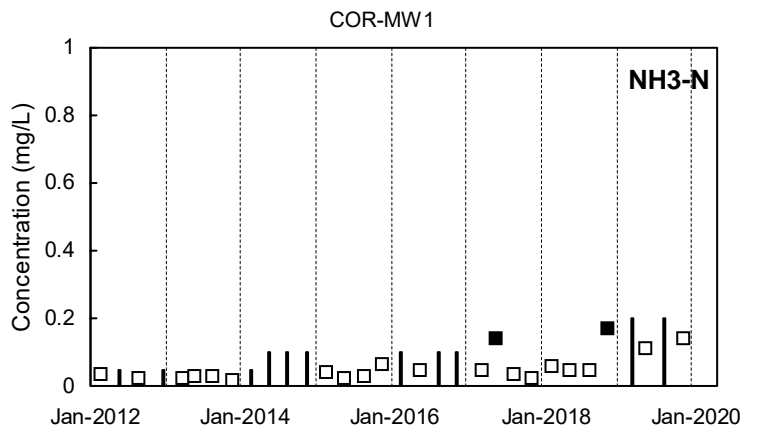
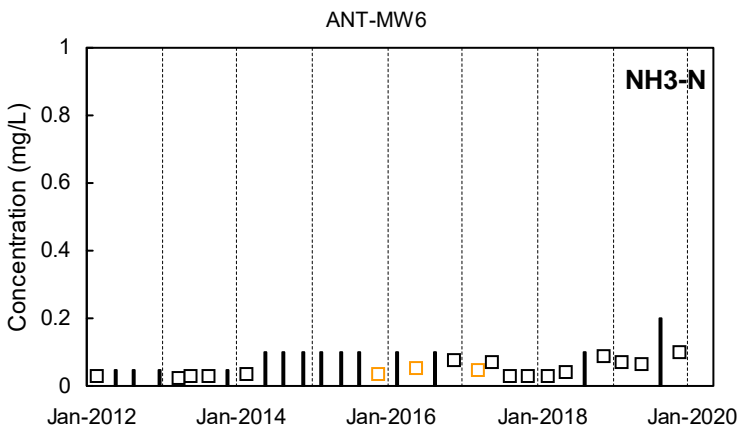
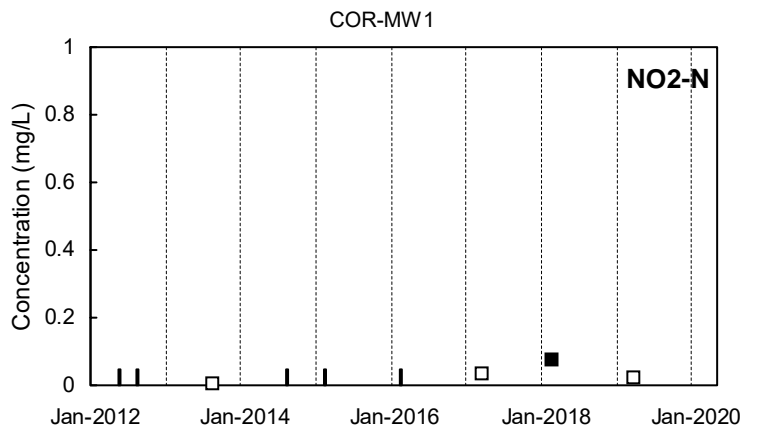
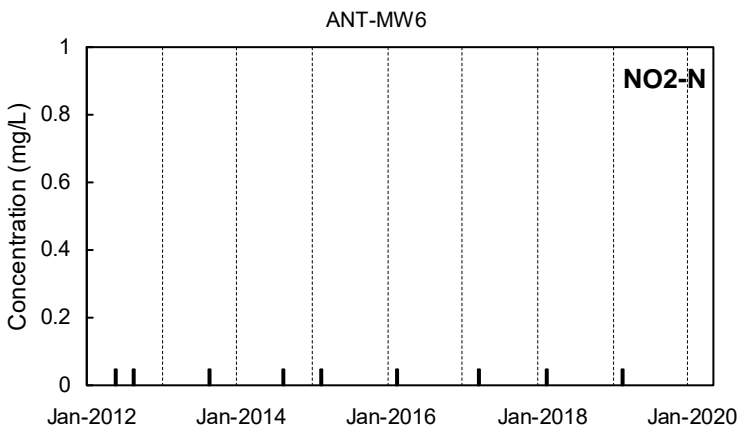
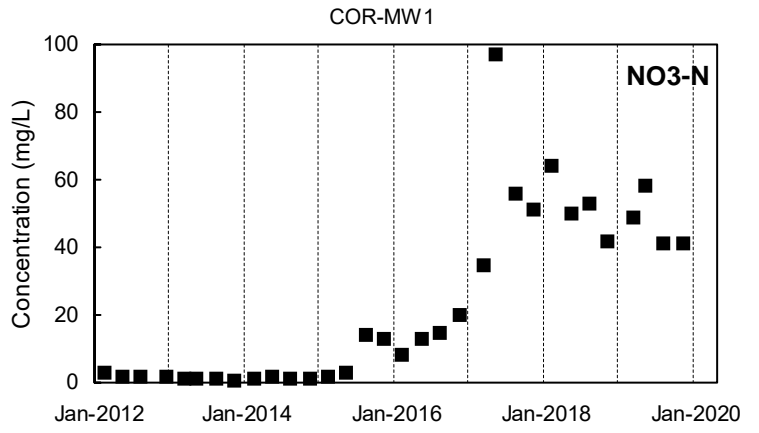
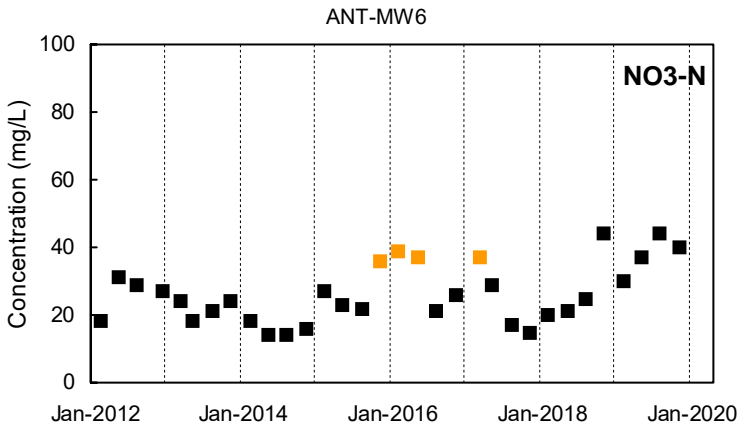

Detected Value
 'J'-Flag (value between reporting limit and detection limit)
 Non-Detect Range
 Shallow Well shown with black symbols
 Deep Well shown with orange symbols
 "dd" Well shown with blue symbols

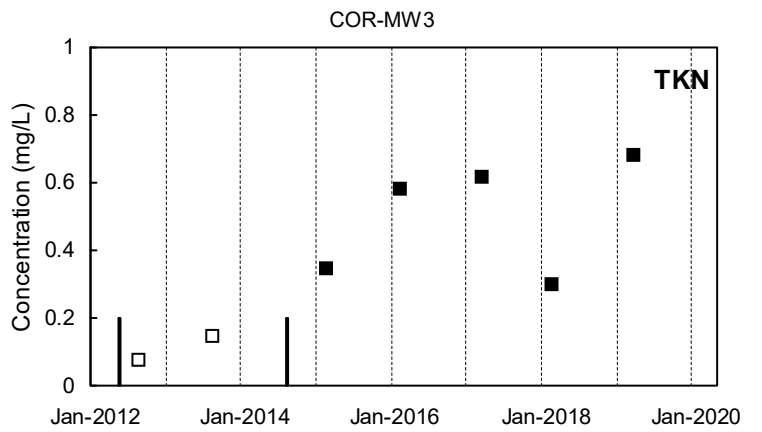
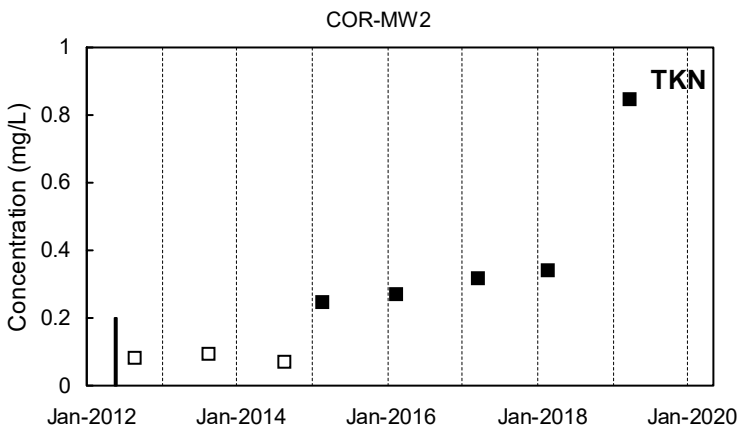
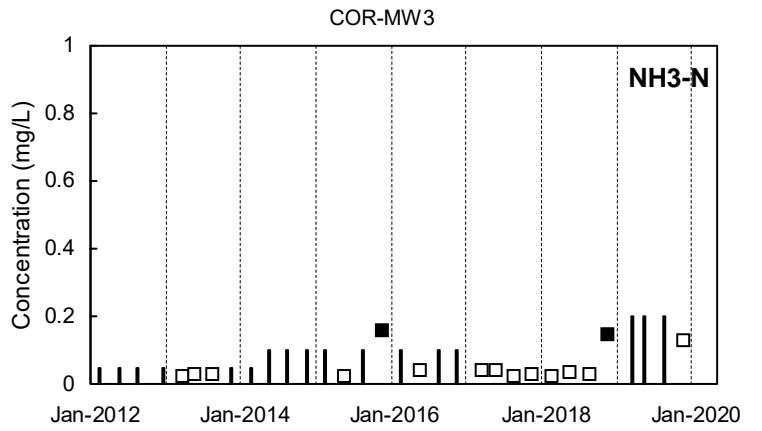
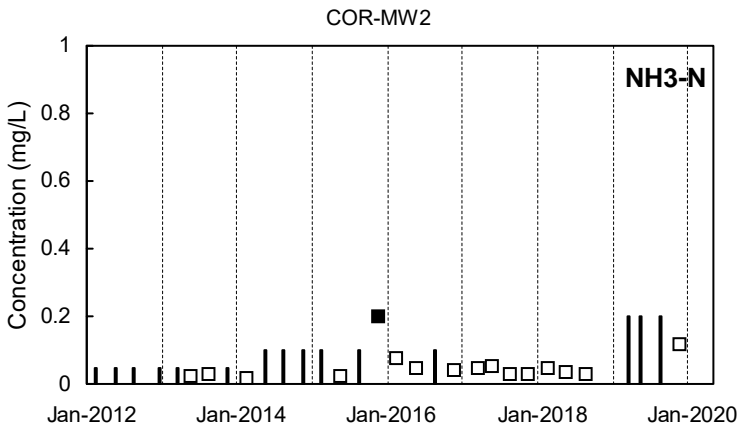
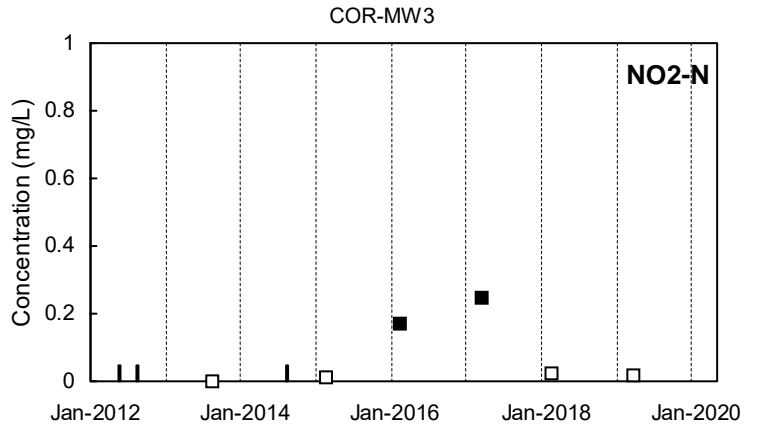
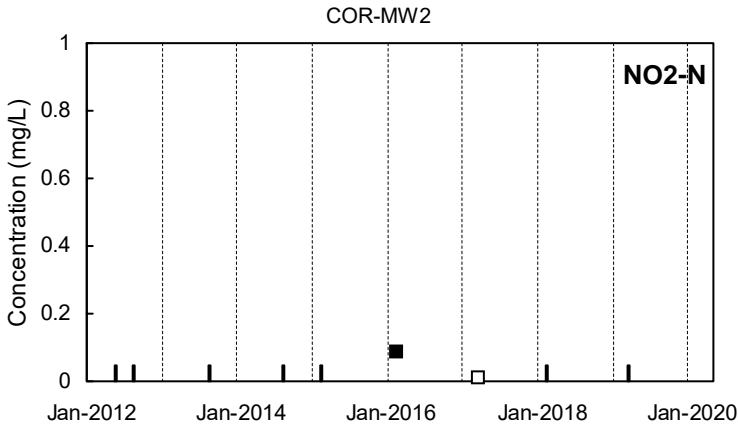
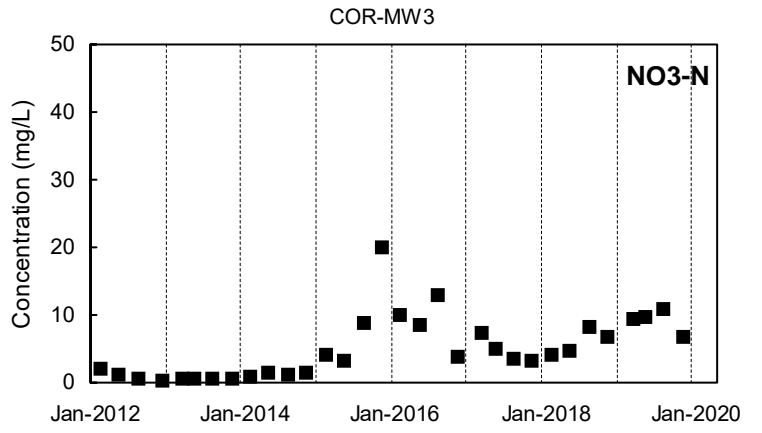
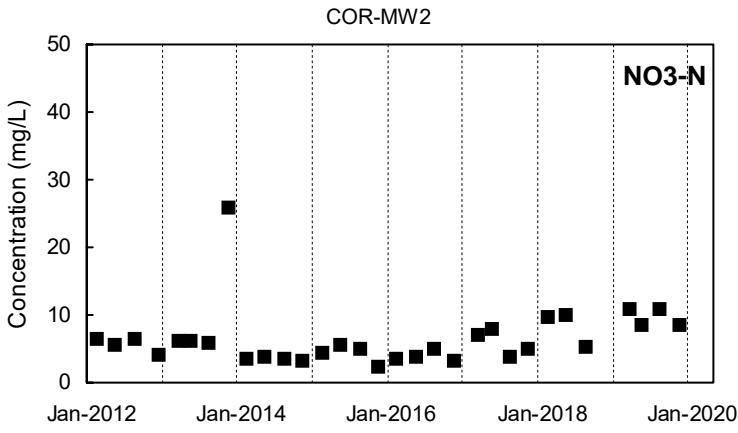

Detected Value
 'J'-Flag (value between reporting limit and detection limit)
 Non-Detect Range
 Shallow Well shown with black symbols
 Deep Well shown with orange symbols
 "dd" Well shown with blue symbols

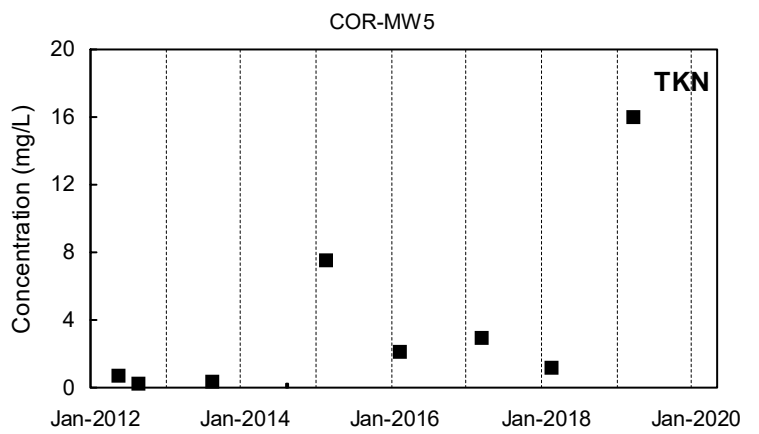
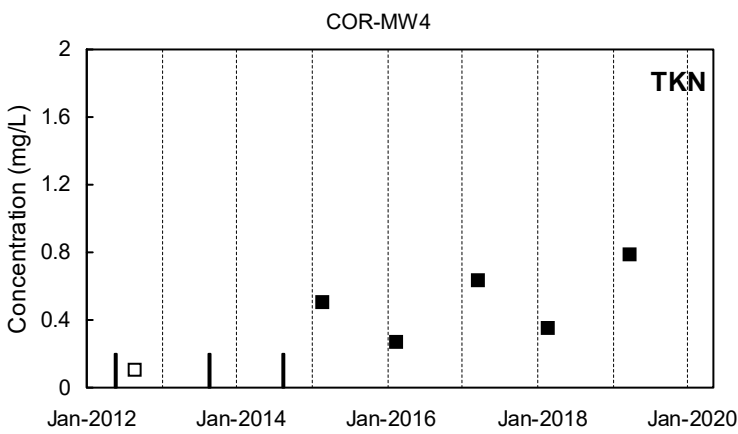
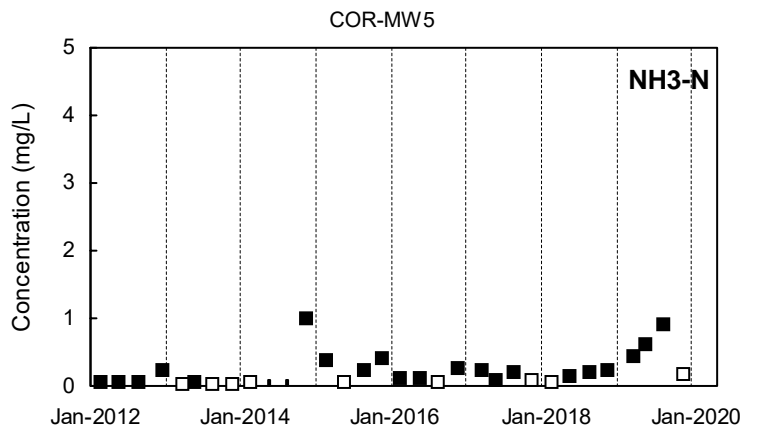
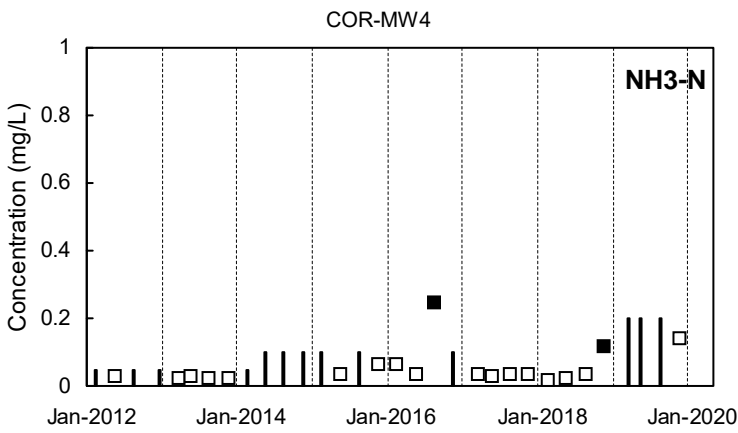
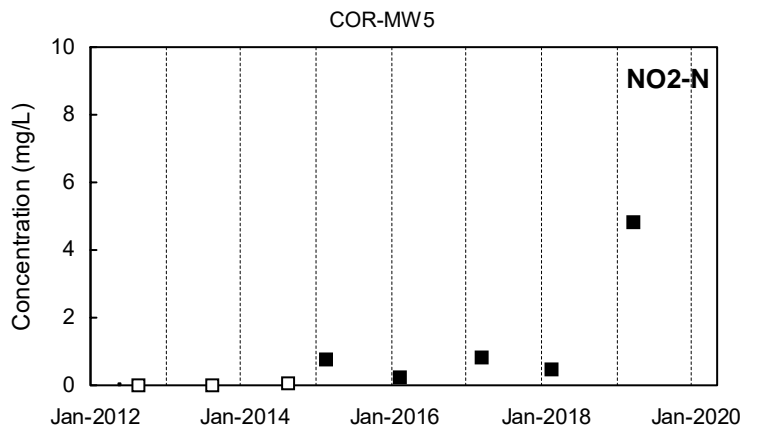
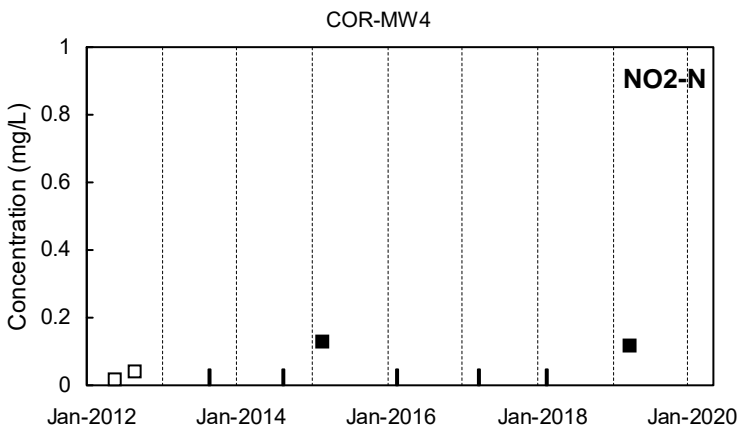
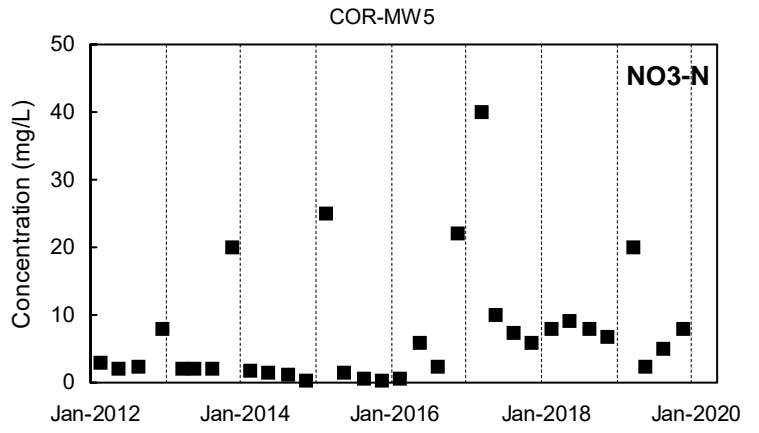
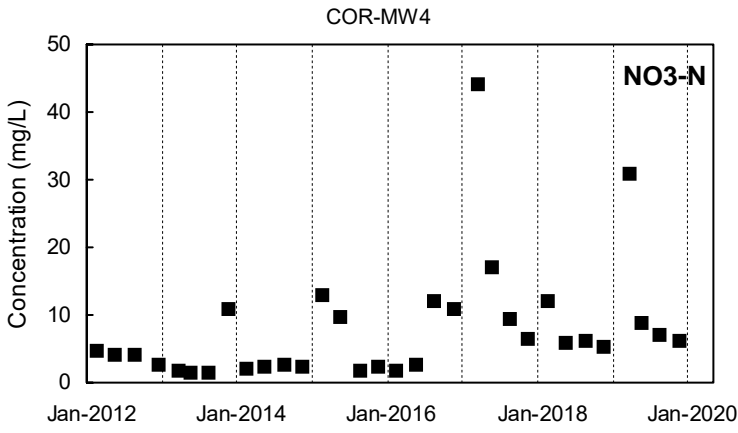

Detected Value
 'J'-Flag (value between reporting limit and detection limit)
 Non-Detect Range
 Shallow Well shown with black symbols
 Deep Well shown with orange symbols
 "dd" Well shown with blue symbols

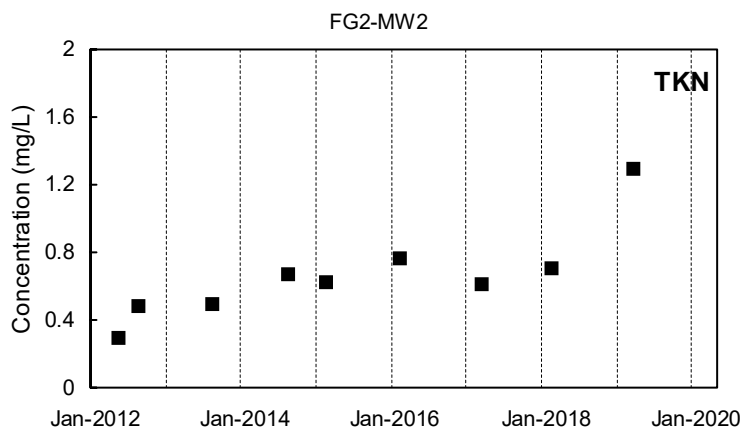
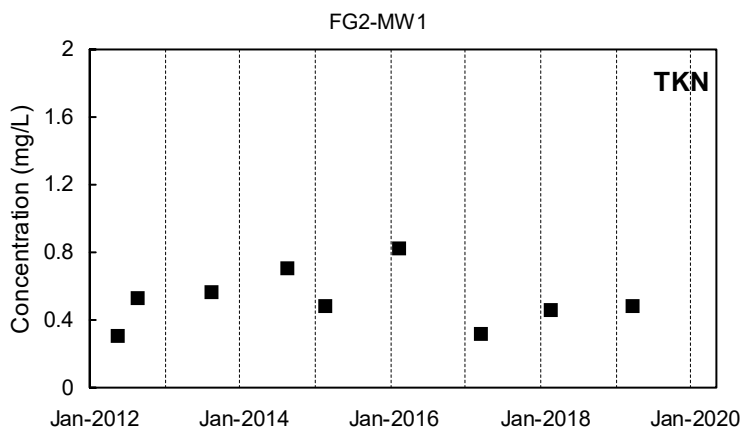
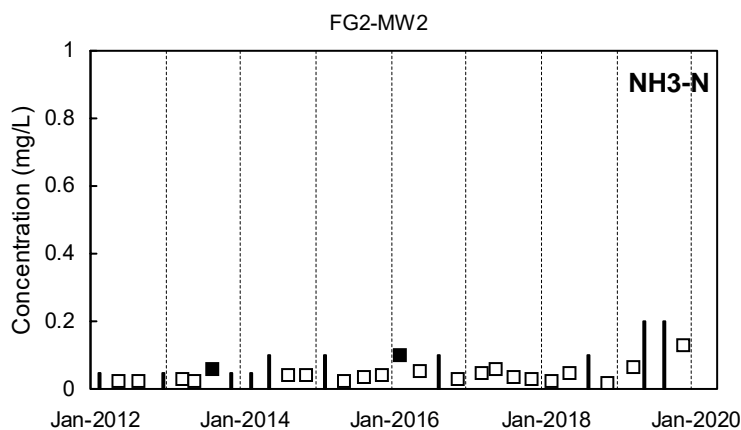
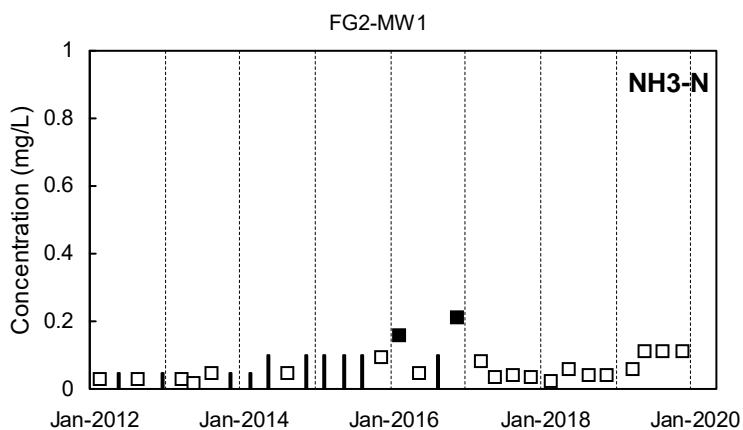
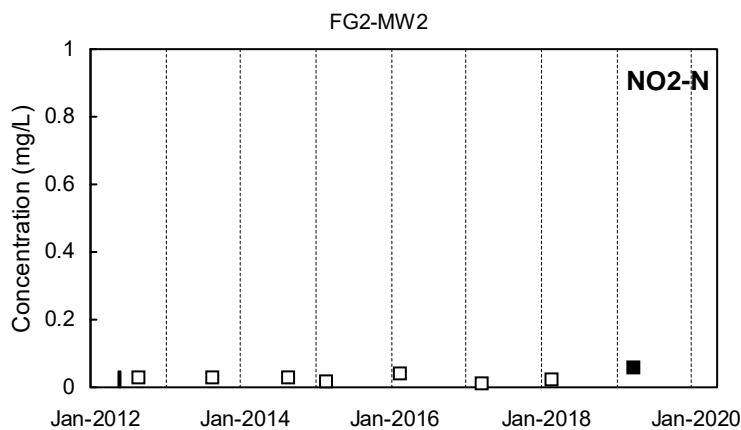
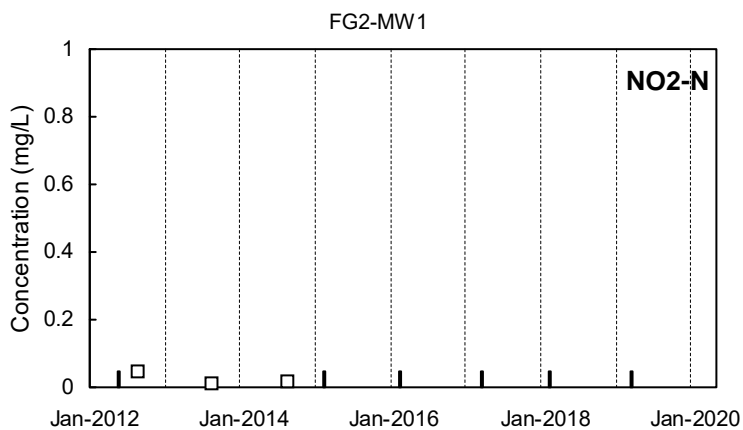
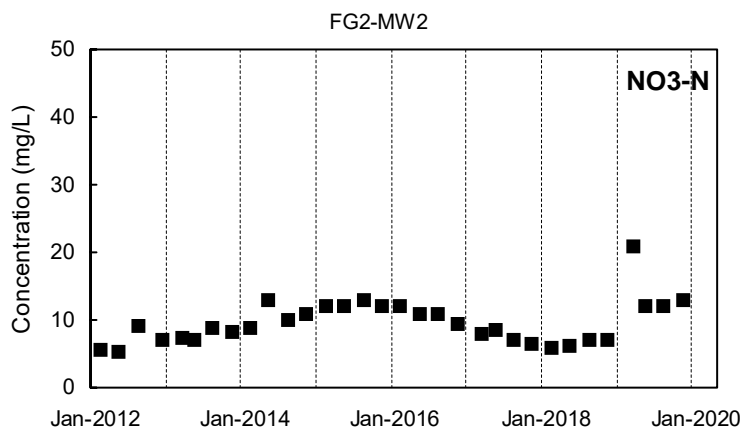
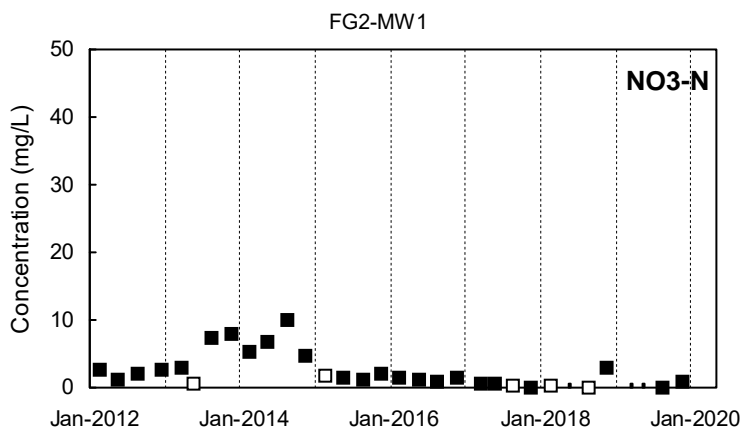

Detected Value
 'J'-Flag (value between reporting limit and detection limit)
 Non-Detect Range
 Shallow Well shown with black symbols
 Deep Well shown with orange symbols
 "dd" Well shown with blue symbols

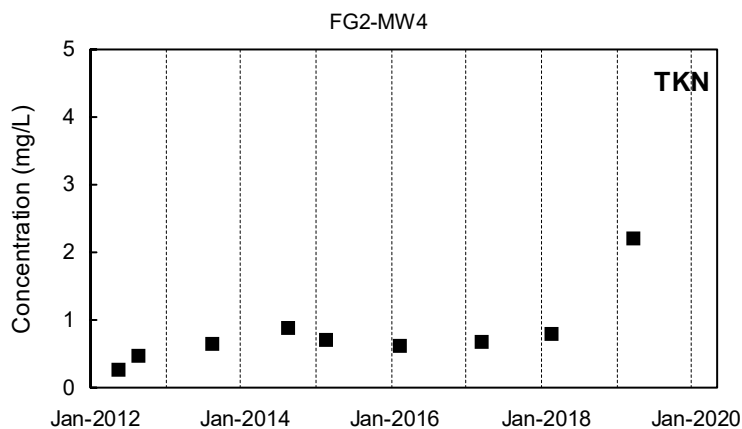
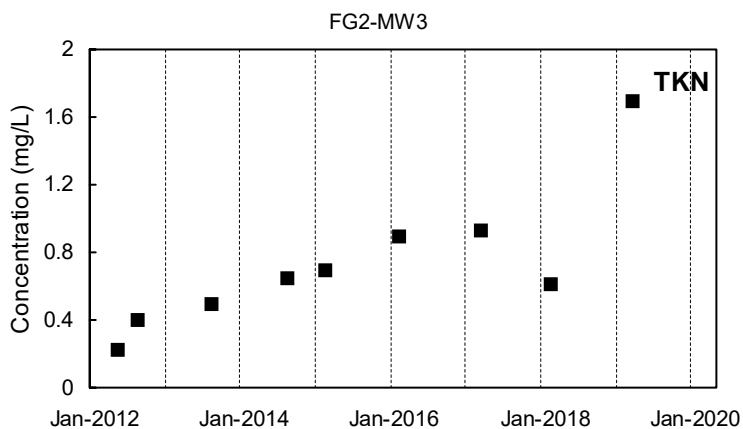
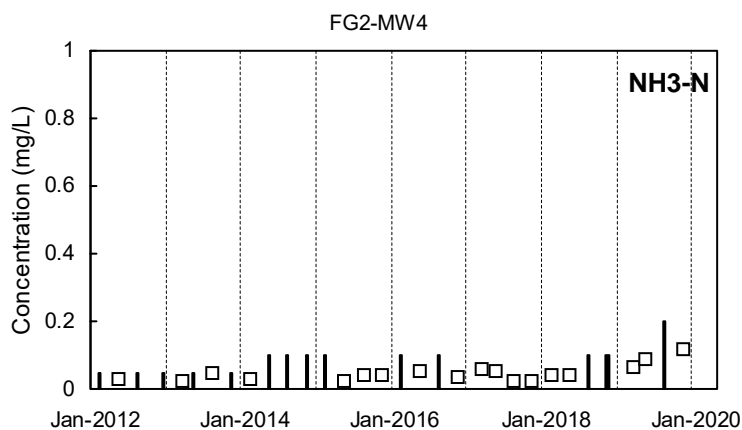
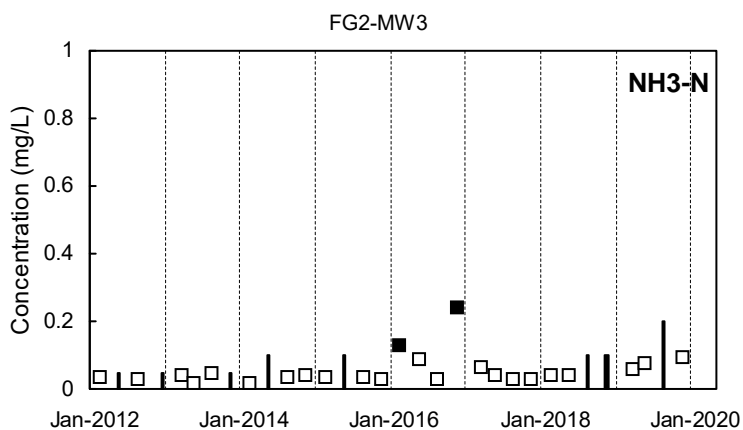
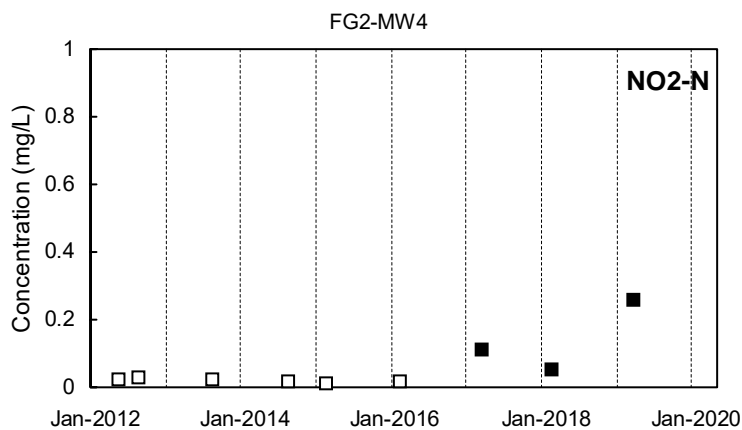
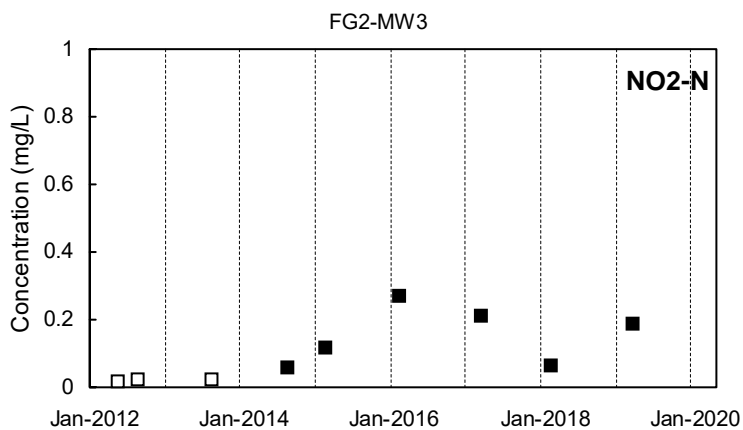
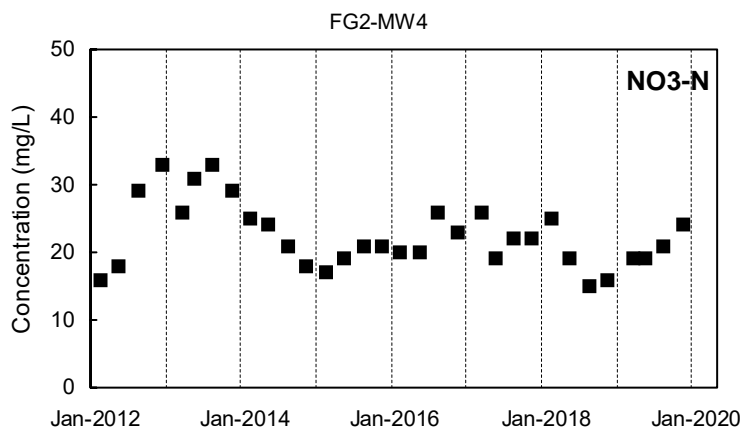
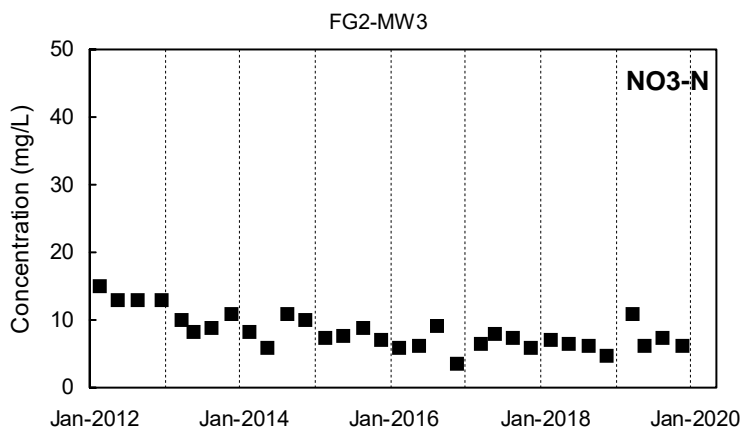

Detected Value
 'J'-Flag (value between reporting limit and detection limit)
 Non-Detect Range
Shallow Well shown with black symbols
Deep Well shown with orange symbols
"dd" Well shown with blue symbols

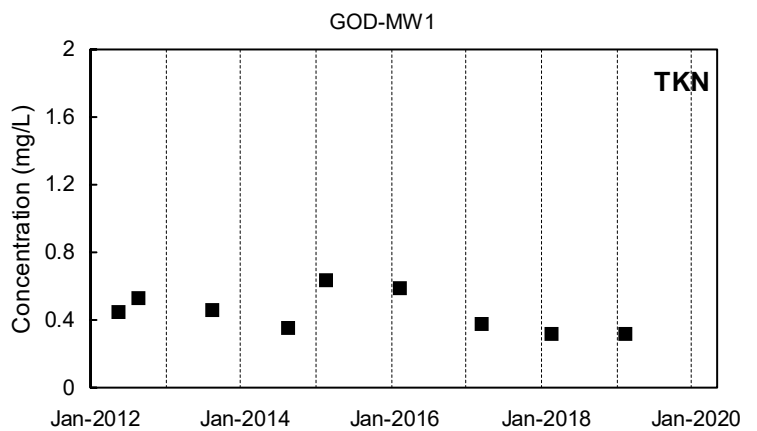
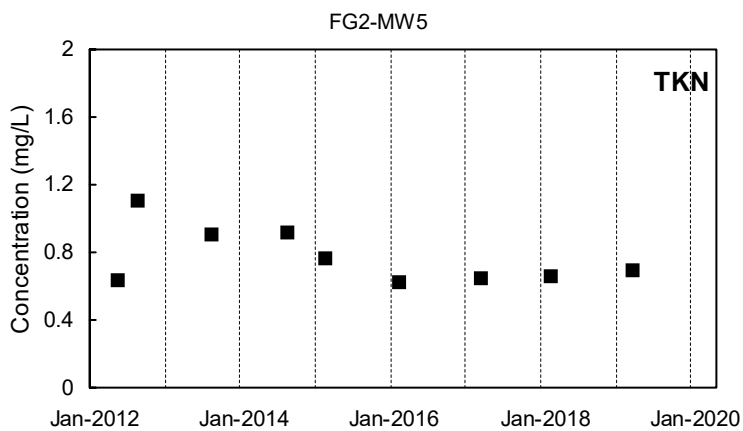
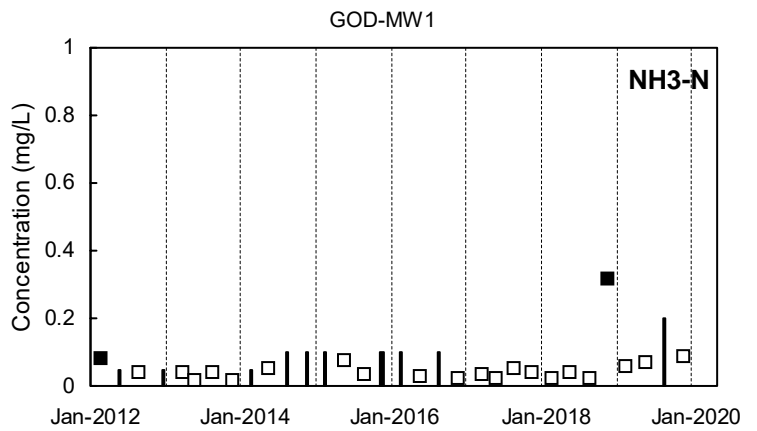
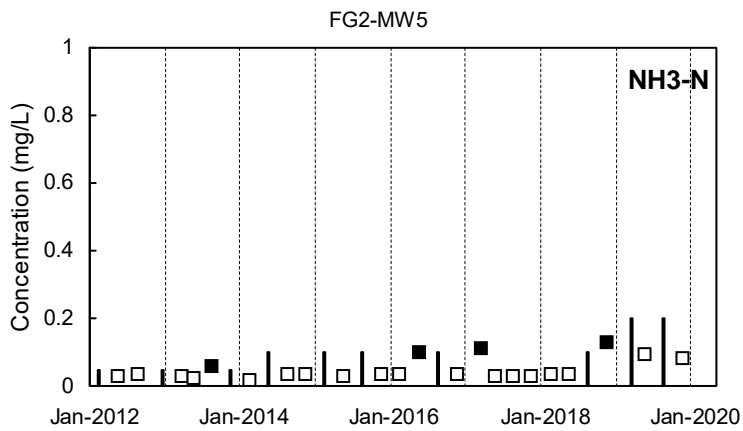
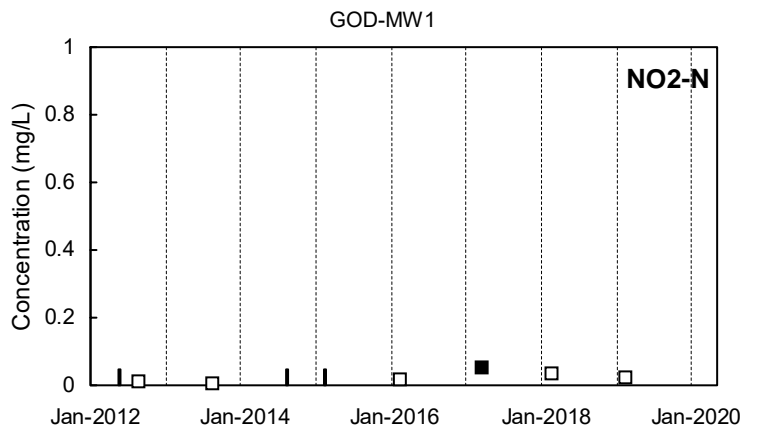
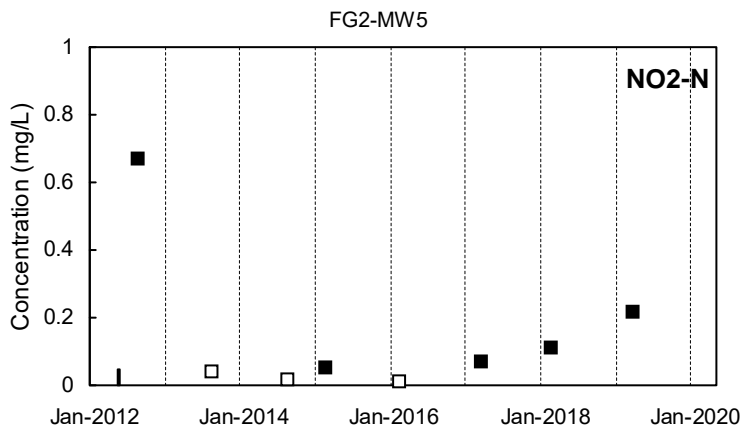
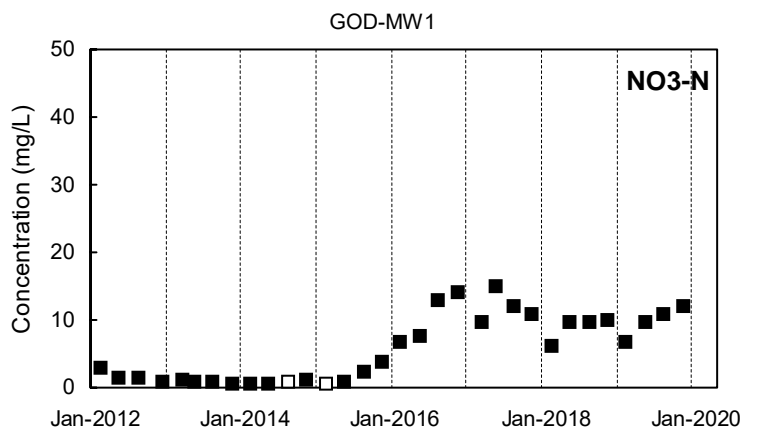
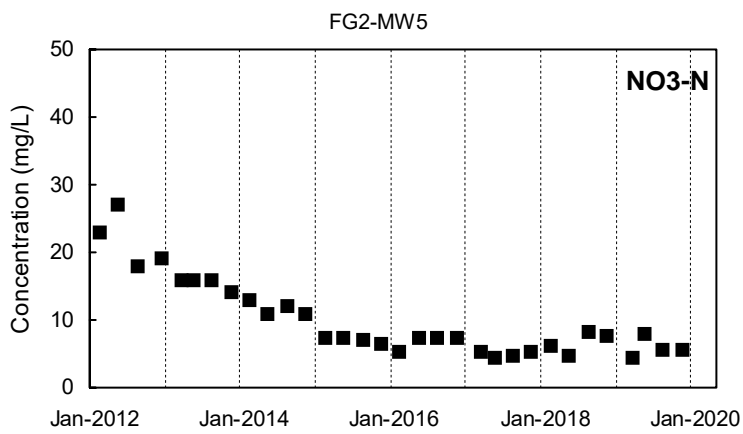

Detected Value
 'J'-Flag (value between reporting limit and detection limit)
 Non-Detect Range
 Shallow Well shown with black symbols
 Deep Well shown with orange symbols
 "dd" Well shown with blue symbols

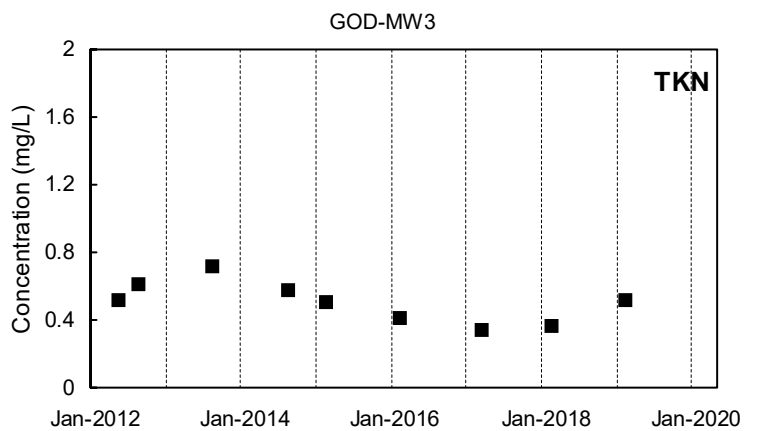
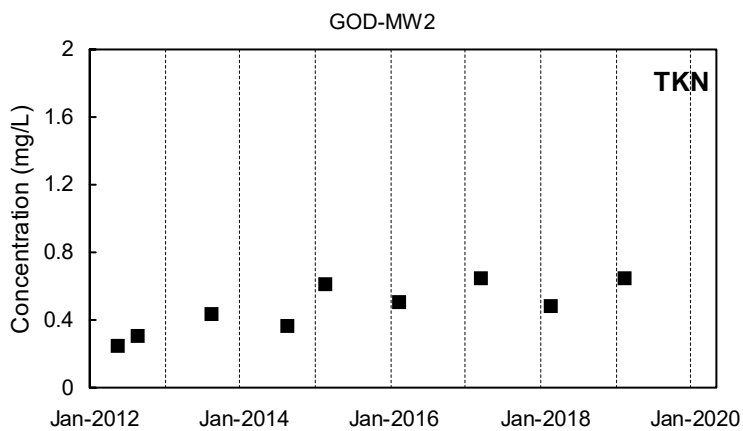
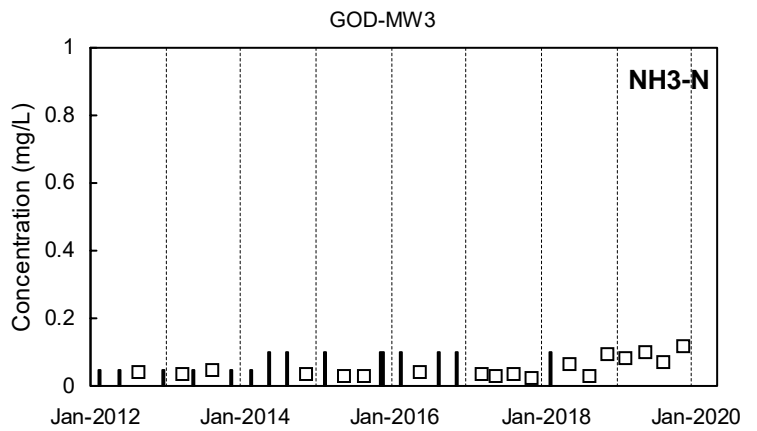
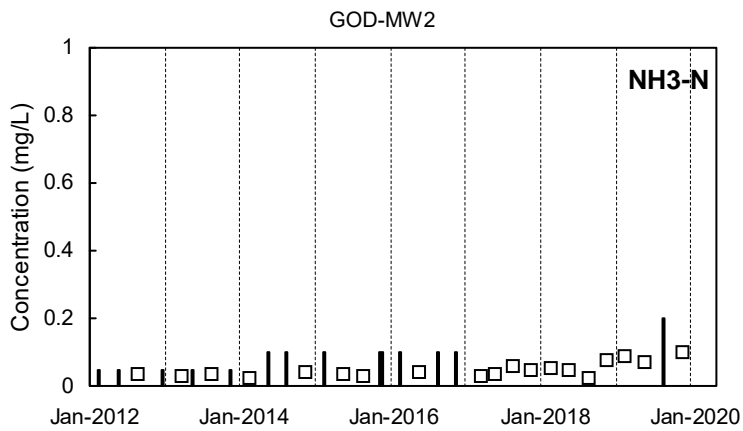
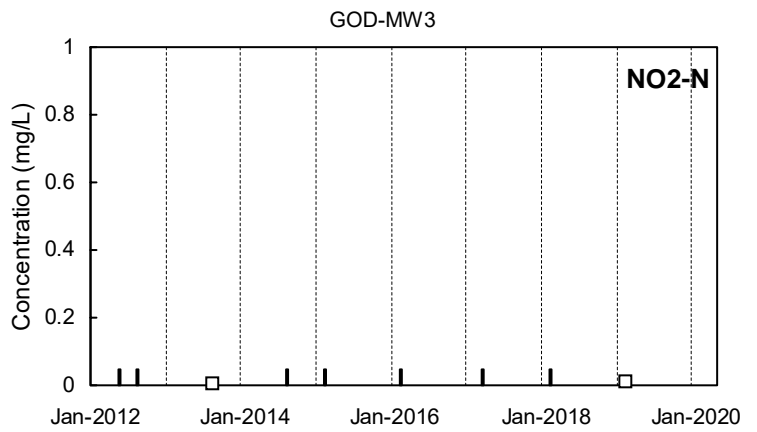
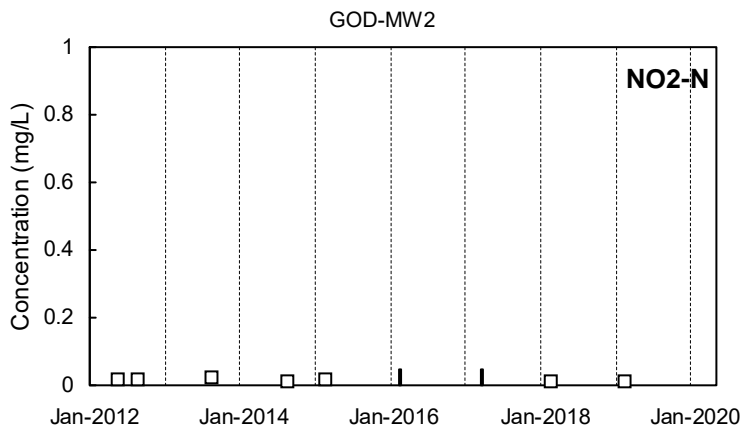
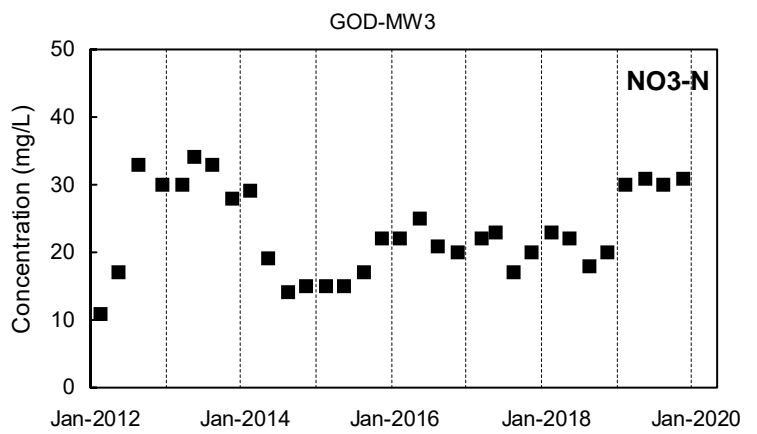
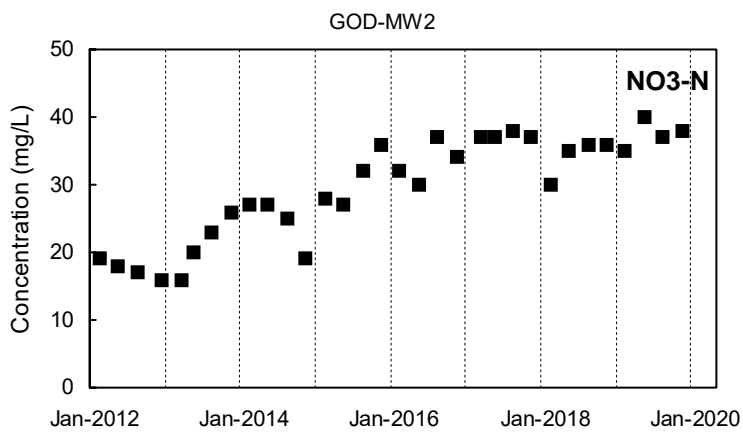

Detected Value
 'J'-Flag (value between reporting limit and detection limit)
 Non-Detect Range
Shallow Well shown with black symbols
Deep Well shown with orange symbols
"dd" Well shown with blue symbols

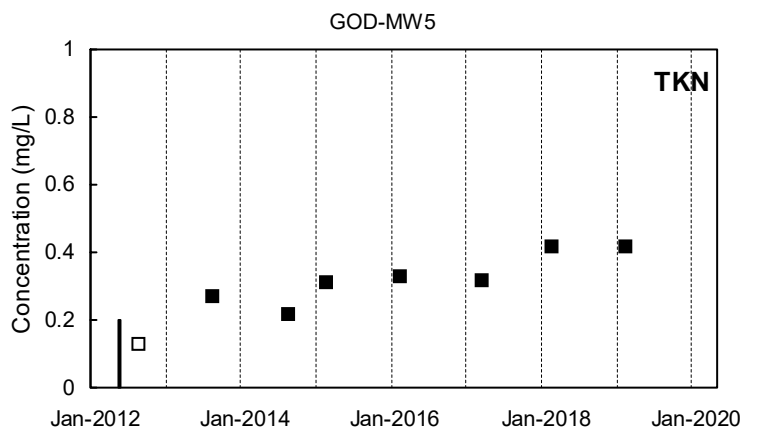
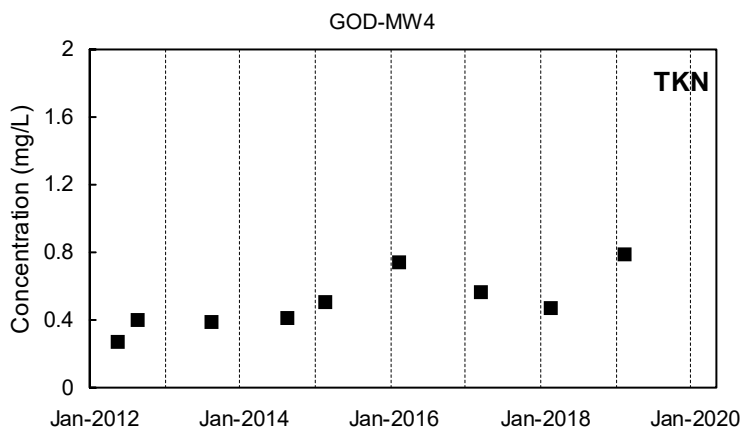
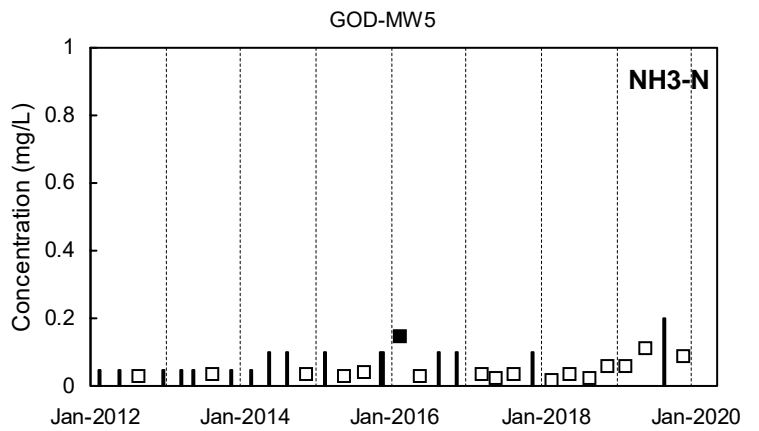
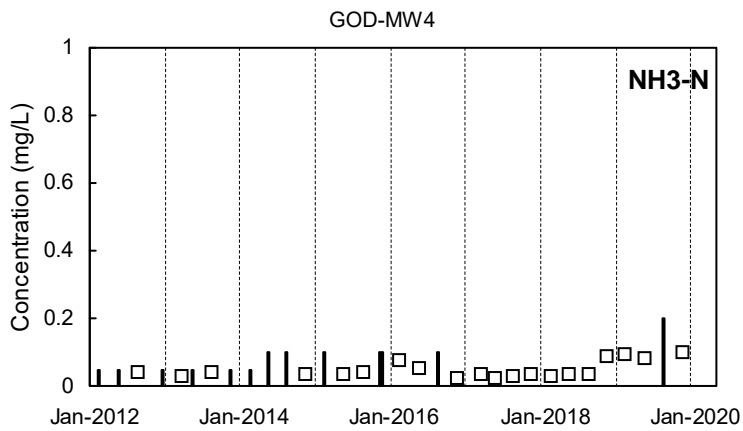
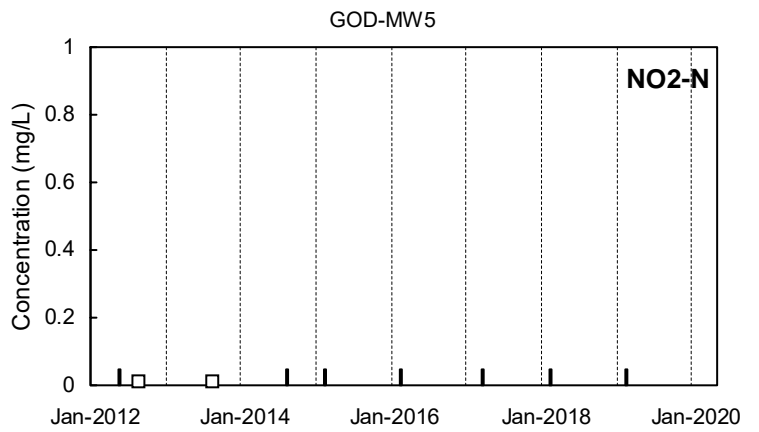
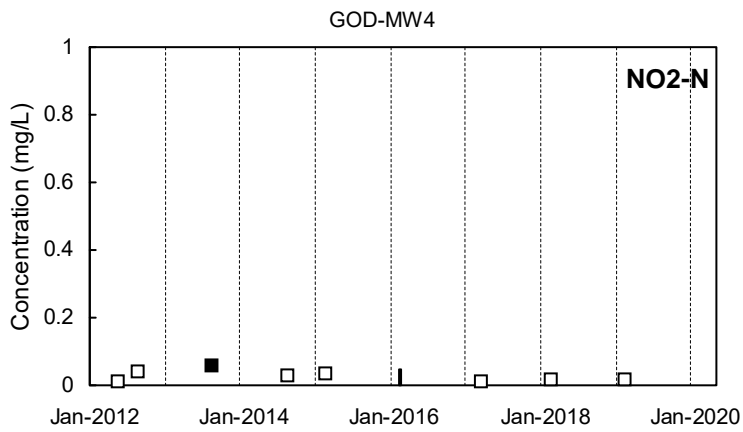
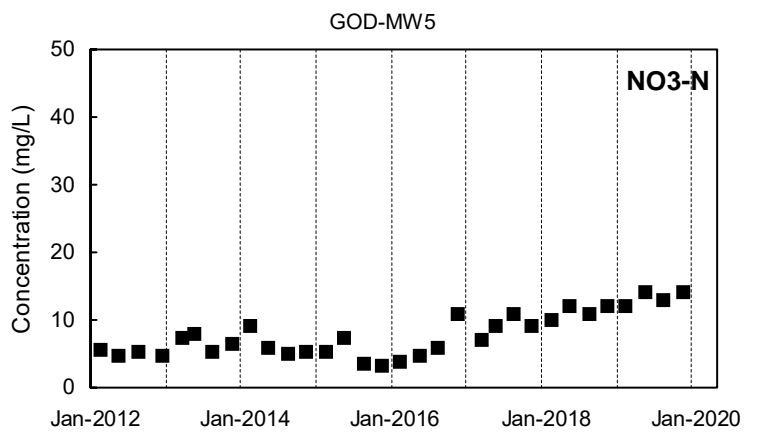
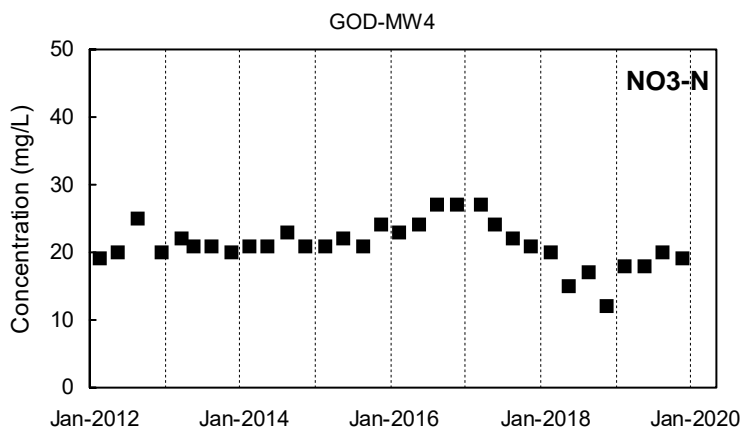

Detected Value
 'J'-Flag (value between reporting limit and detection limit)
 Non-Detect Range
 Shallow Well shown with black symbols
 Deep Well shown with orange symbols
 "dd" Well shown with blue symbols

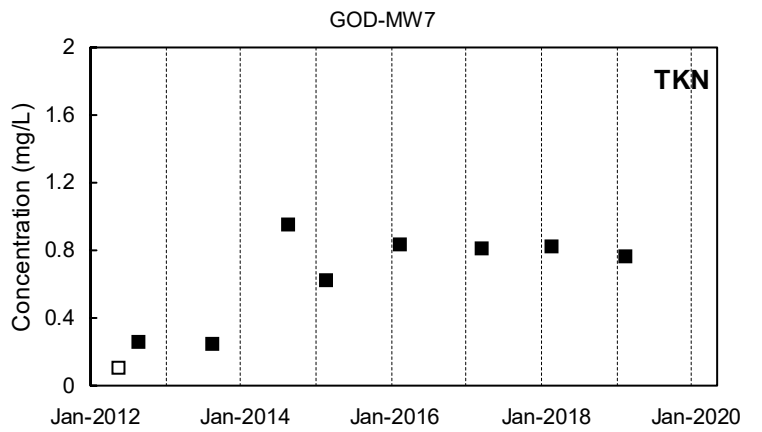
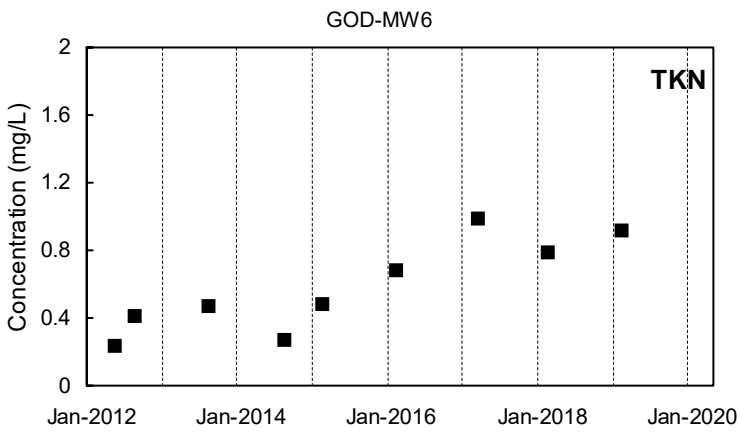
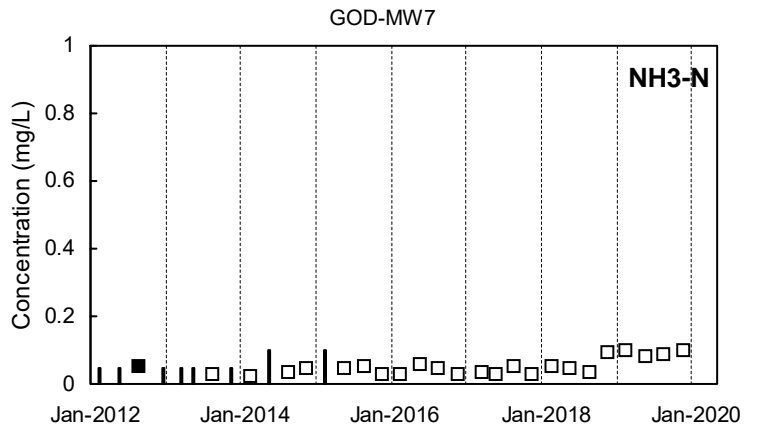
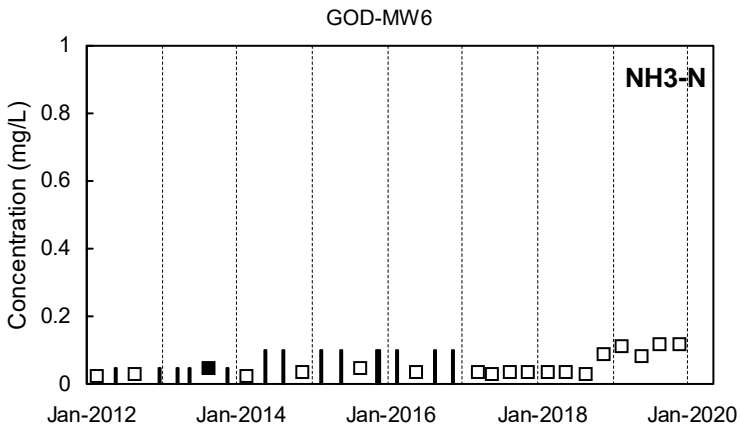
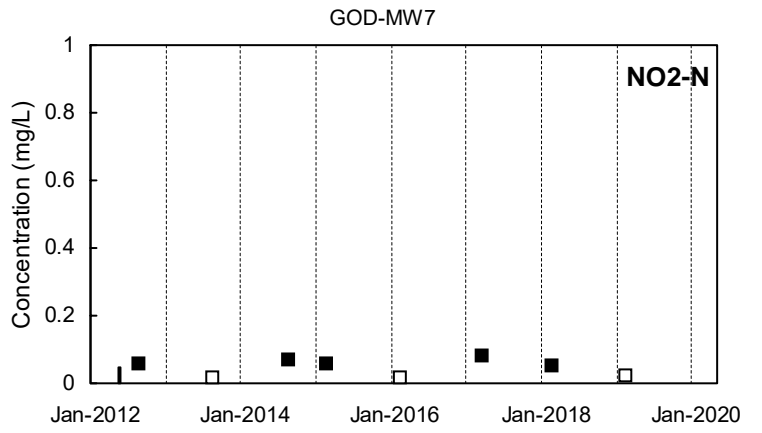
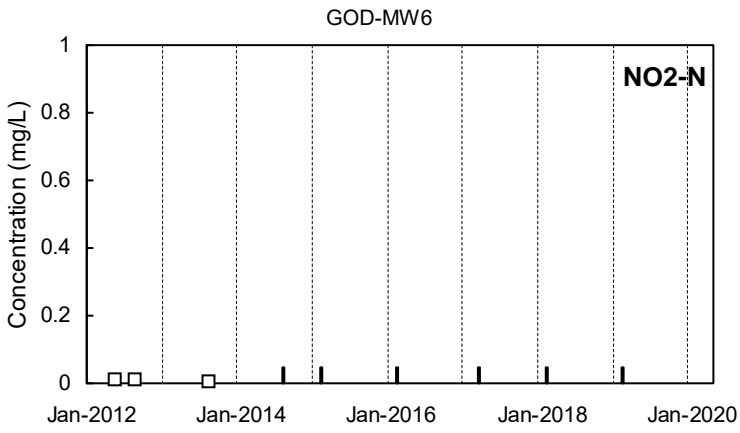
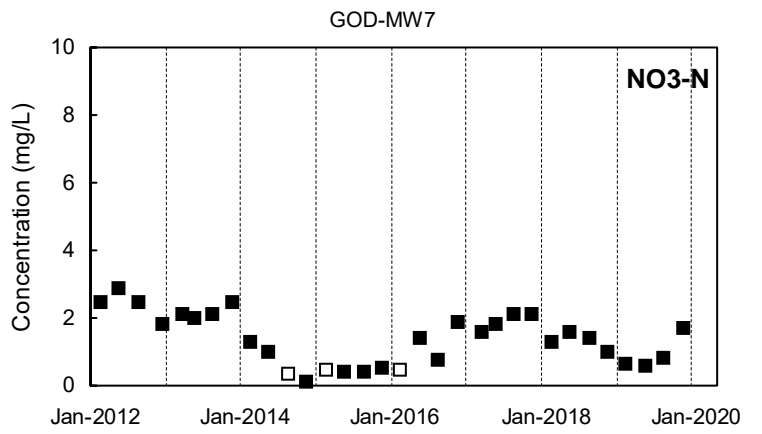
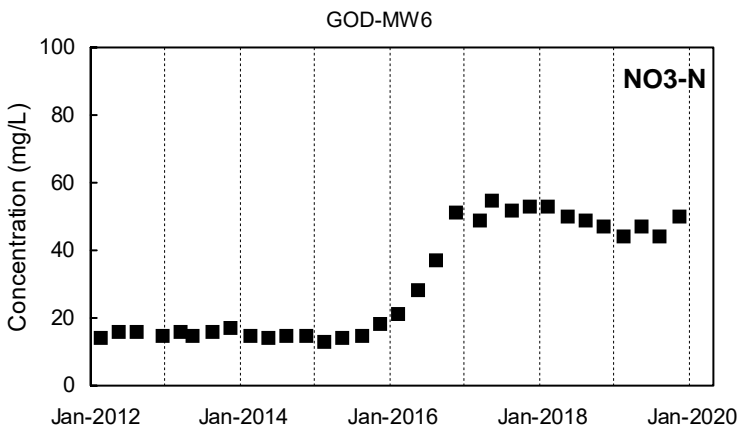

Detected Value
 'J'-Flag (value between reporting limit and detection limit)
 Non-Detect Range
 Shallow Well shown with black symbols
 Deep Well shown with orange symbols
 "dd" Well shown with blue symbols

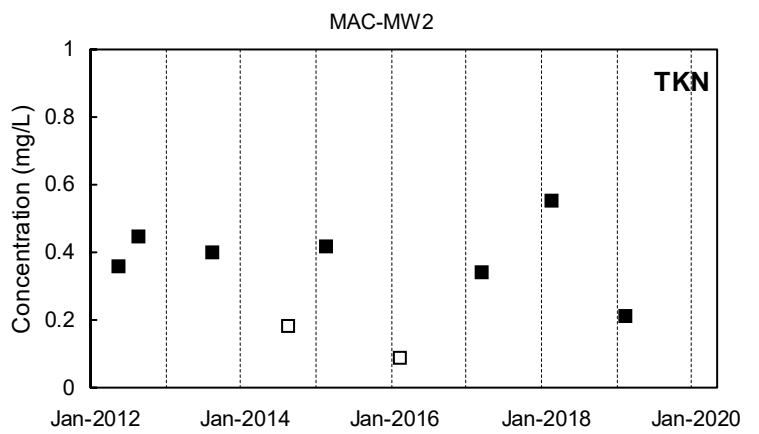
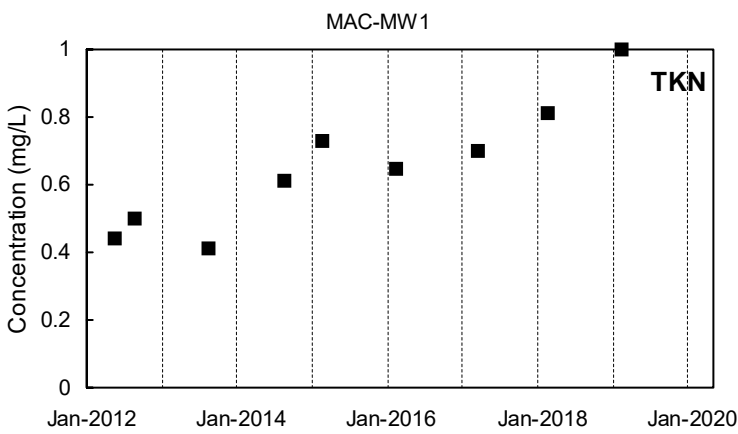
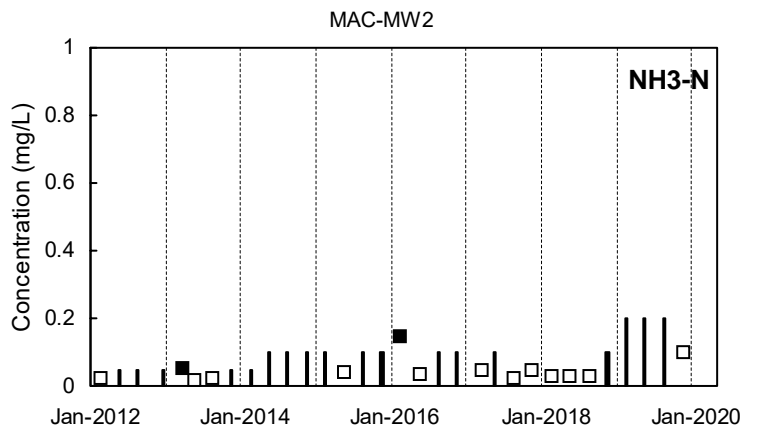
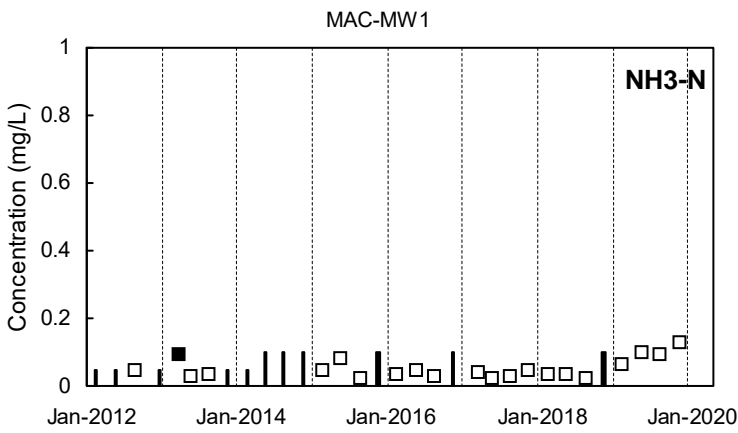
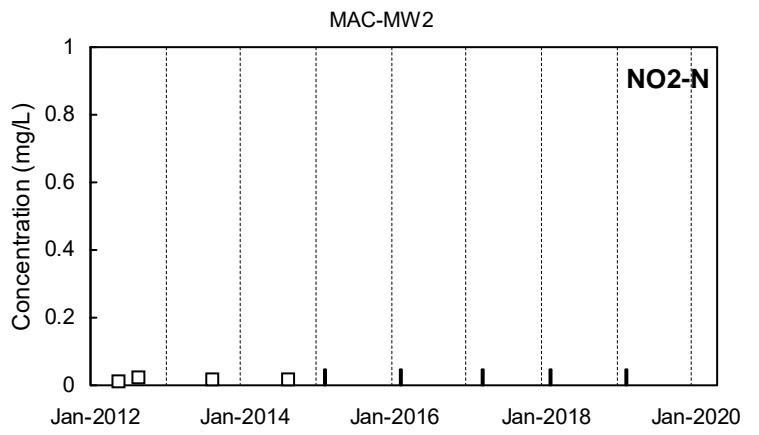
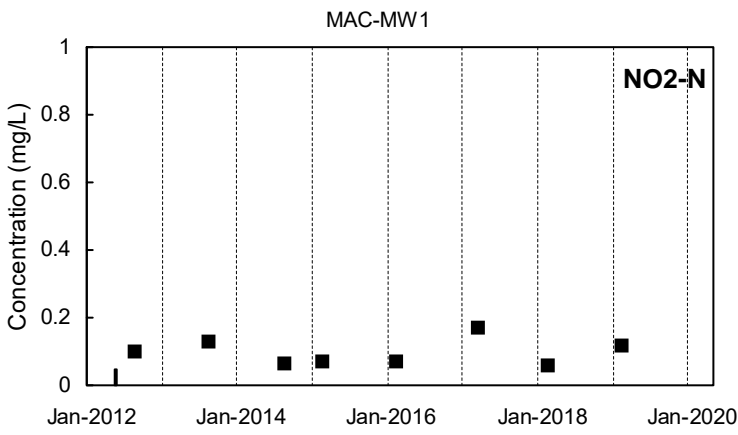
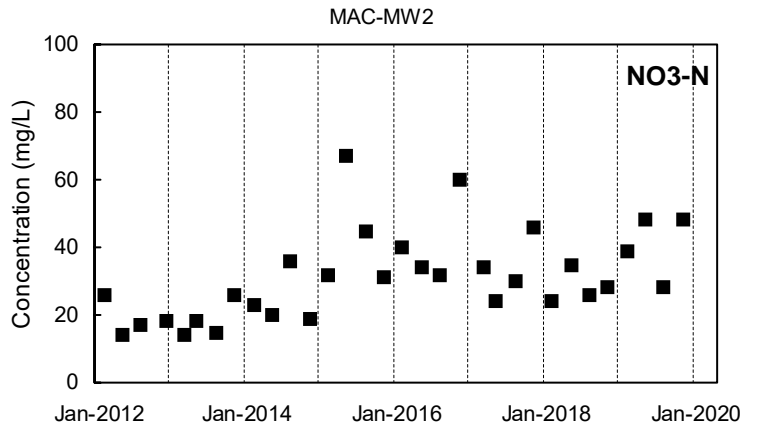
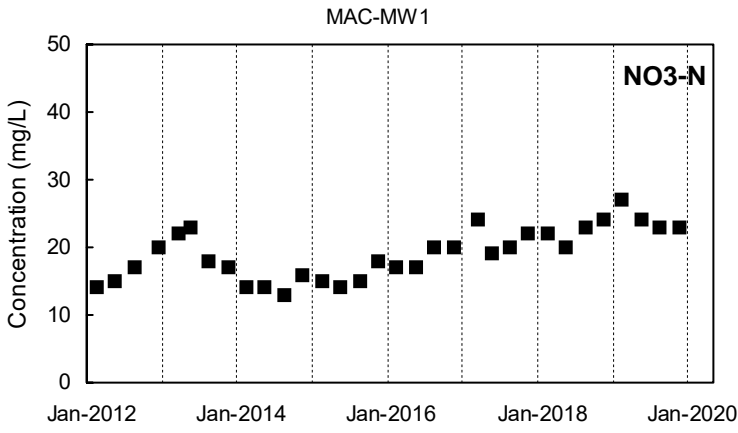

Detected Value
 'J'-Flag (value between reporting limit and detection limit)
 Non-Detect Range
 Shallow Well shown with black symbols
 Deep Well shown with orange symbols
 "dd" Well shown with blue symbols

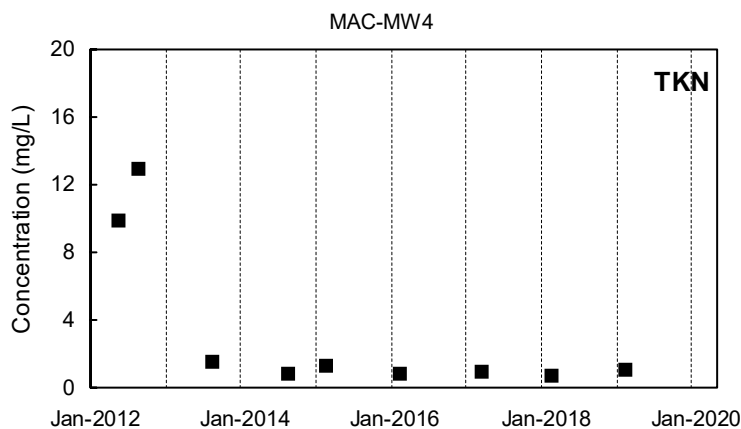
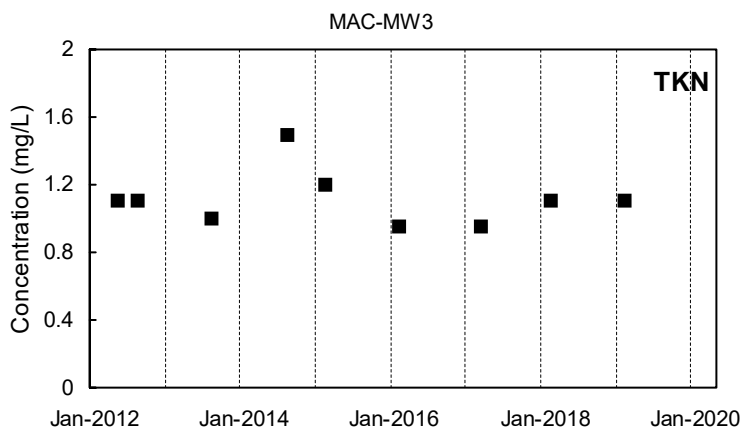
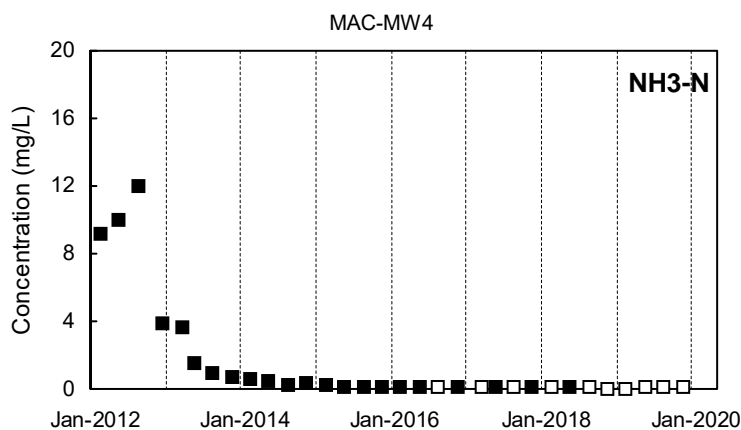
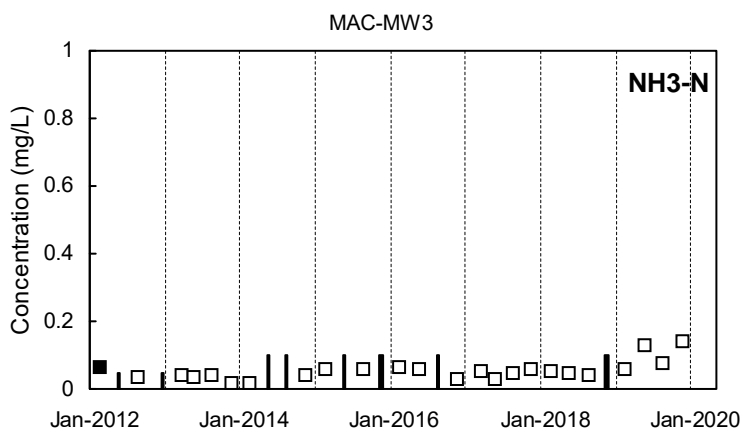
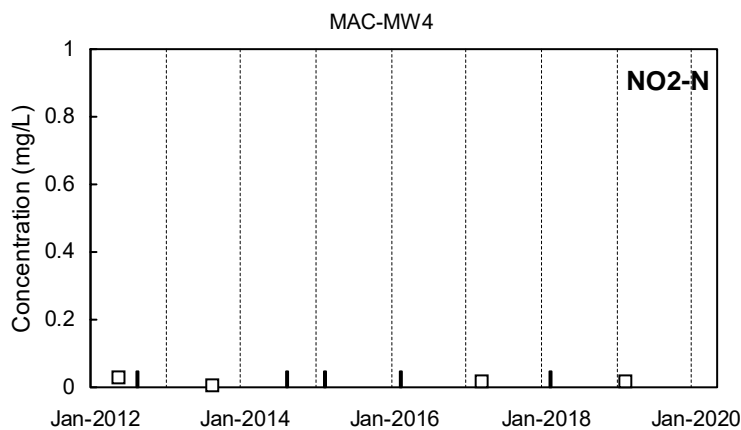
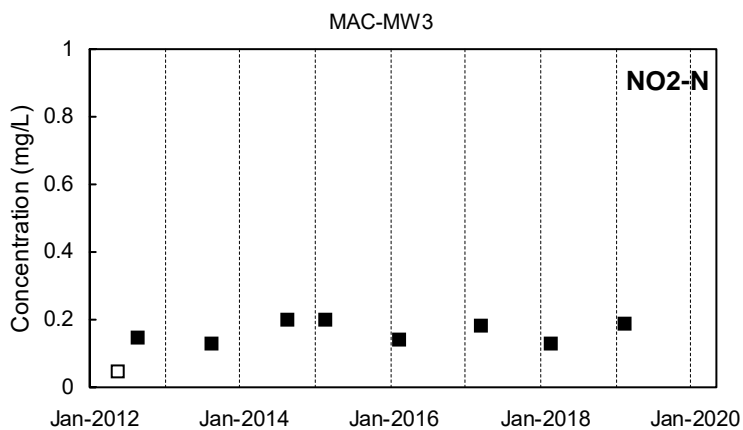
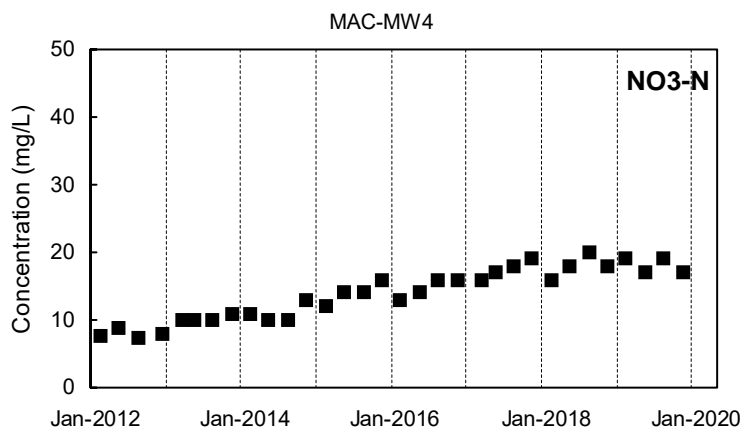
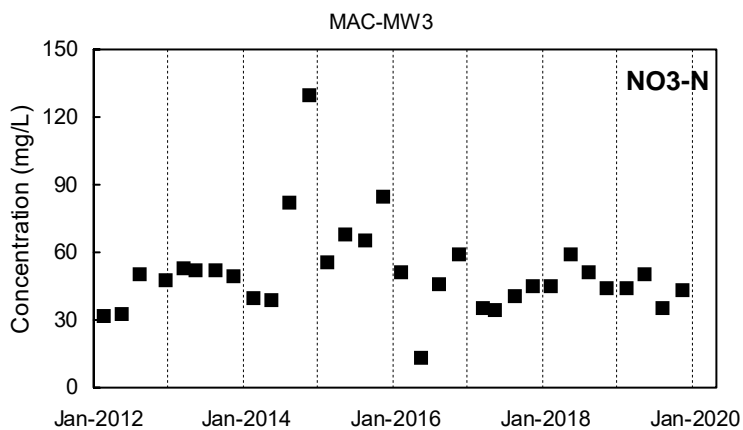

Detected Value
 'J'-Flag (value between reporting limit and detection limit)
 Non-Detect Range
Shallow Well shown with black symbols
Deep Well shown with orange symbols
"dd" Well shown with blue symbols

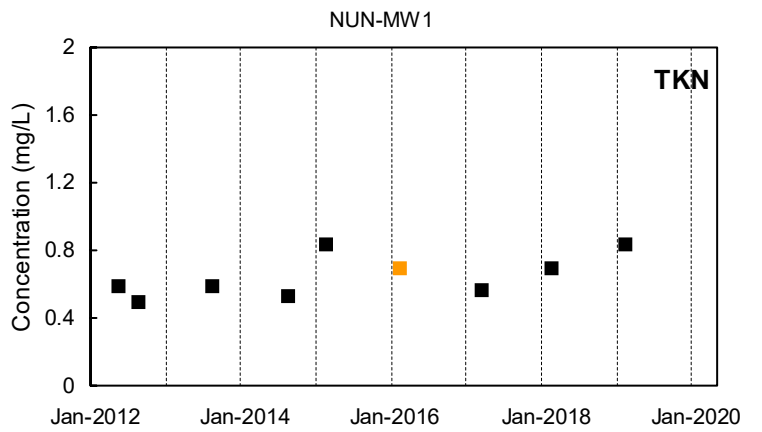
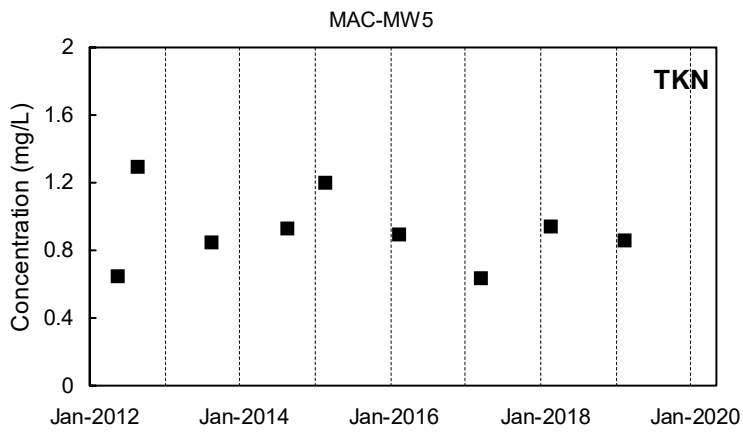
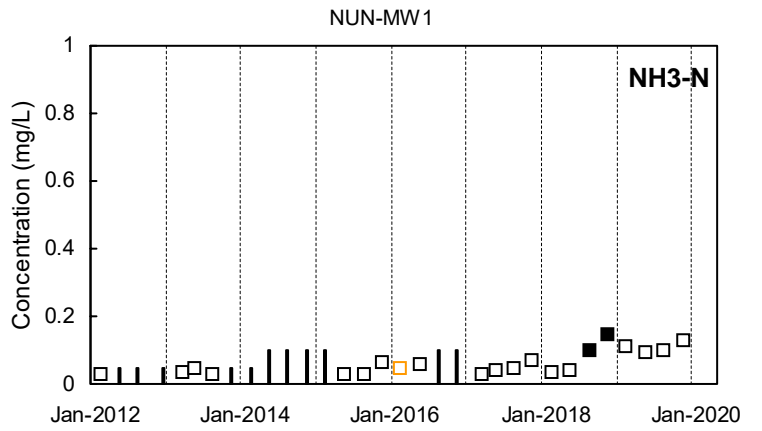
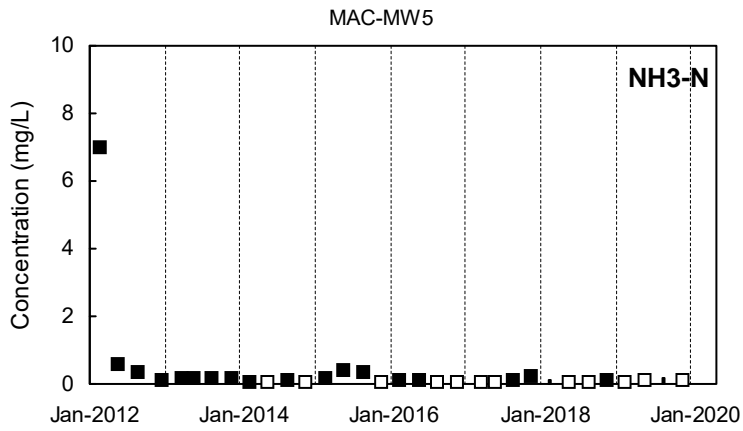
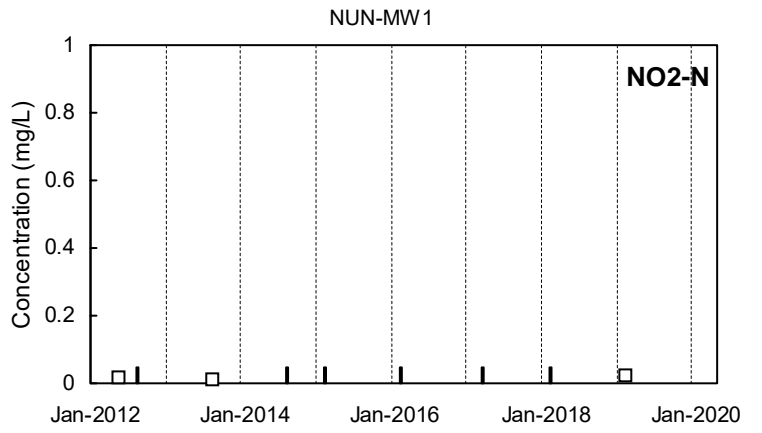
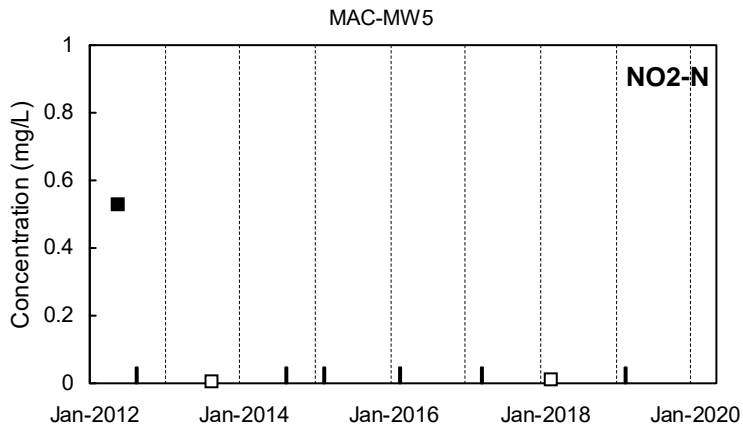
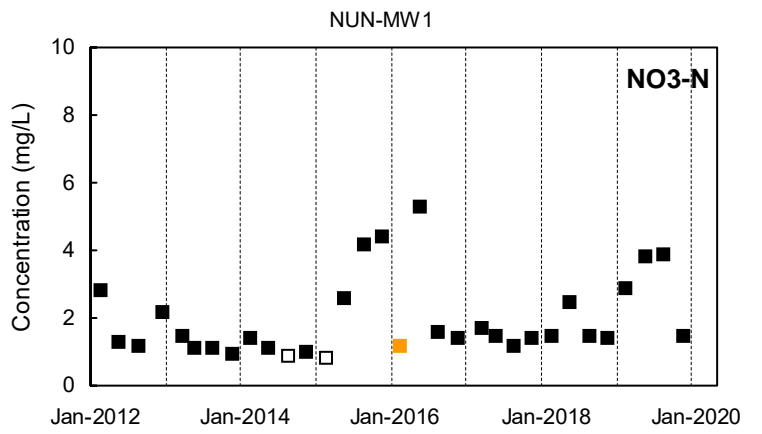
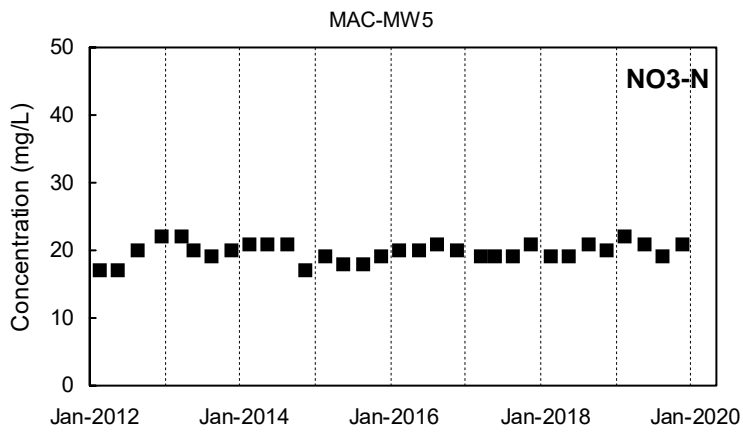

Detected Value
 'J'-Flag (value between reporting limit and detection limit)
 Non-Detect Range
 Shallow Well shown with black symbols
 Deep Well shown with orange symbols
 "dd" Well shown with blue symbols

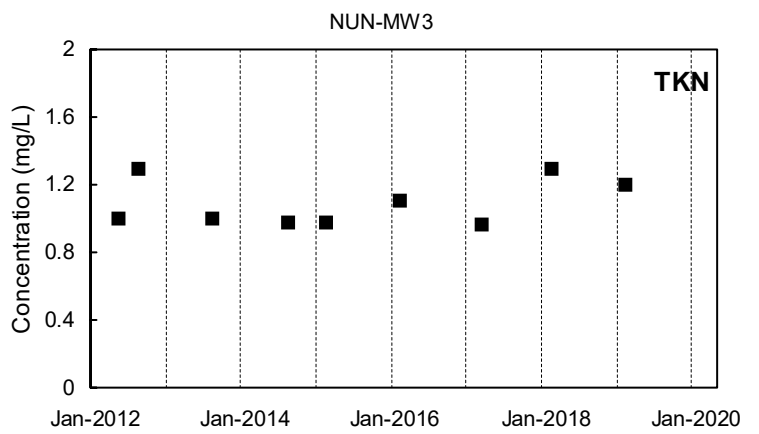
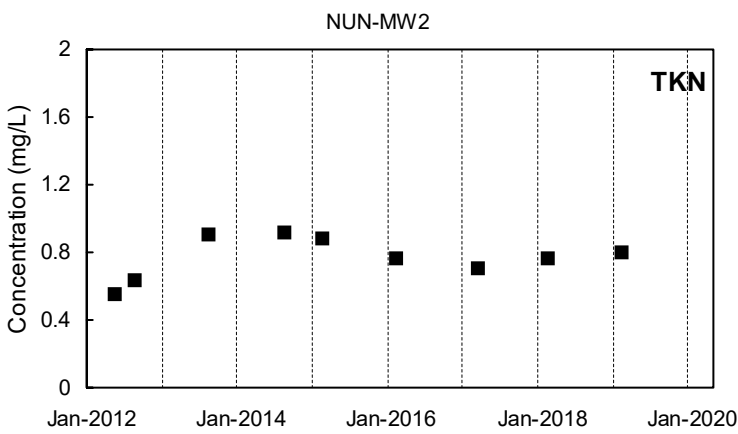
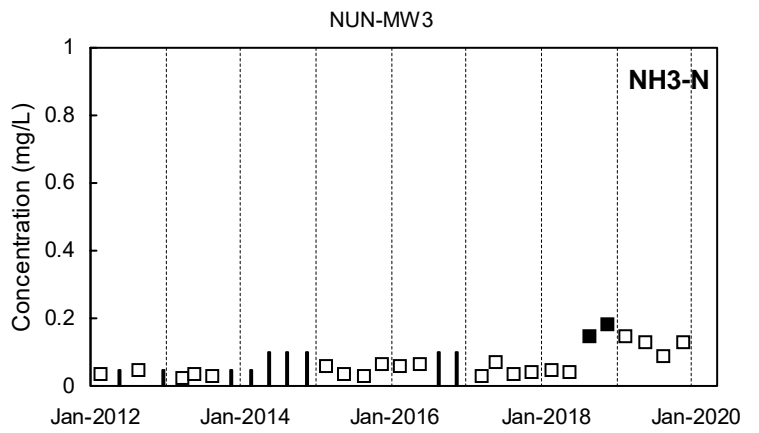
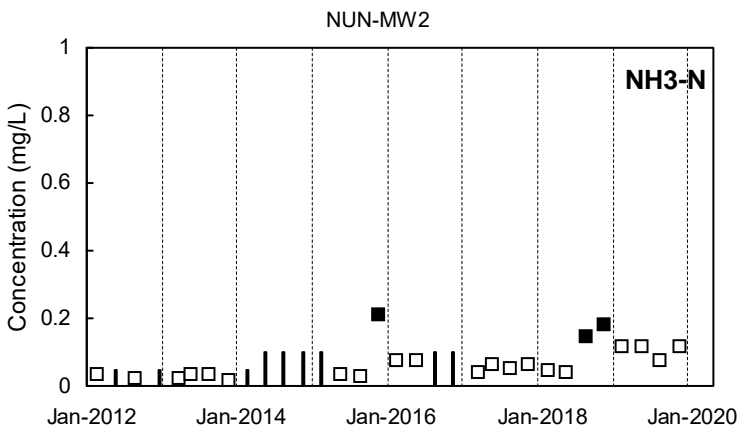
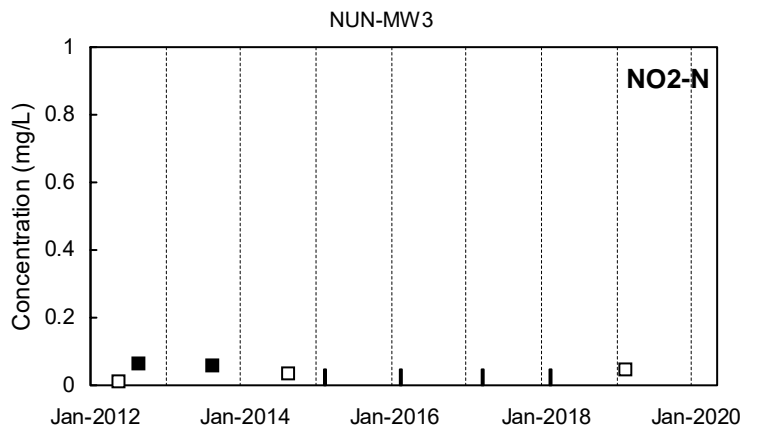
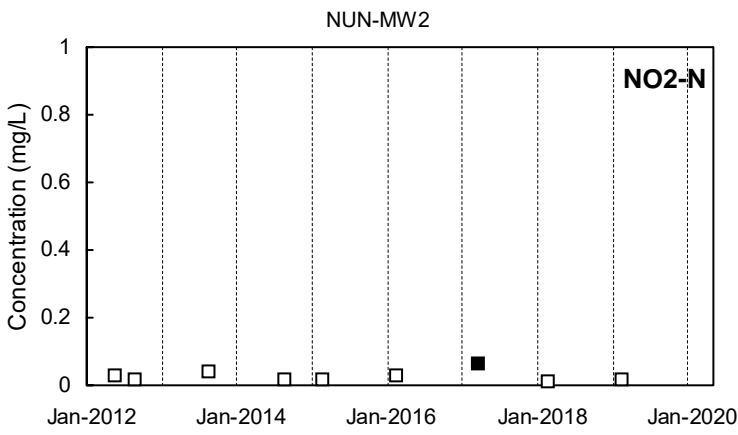
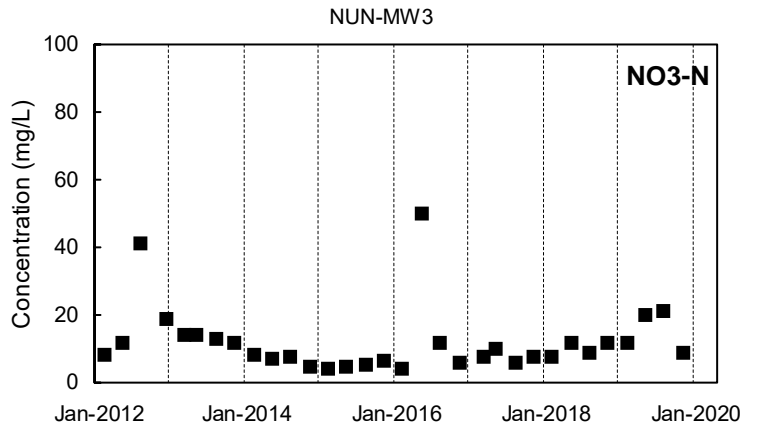
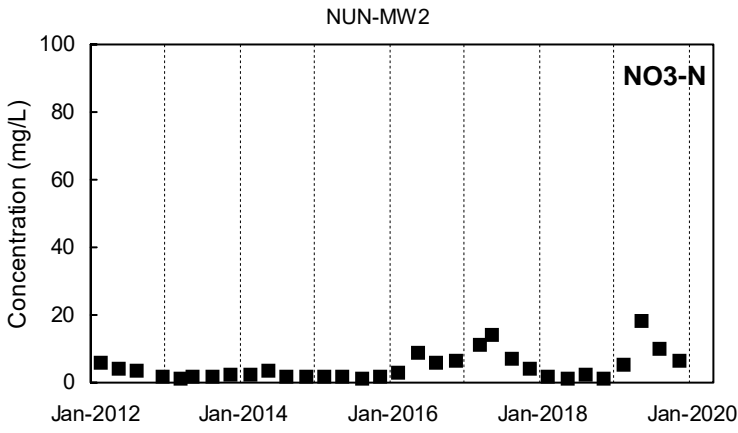

Detected Value
 'J'-Flag (value between reporting limit and detection limit)
 Non-Detect Range
Shallow Well shown with black symbols
Deep Well shown with orange symbols
"dd" Well shown with blue symbols

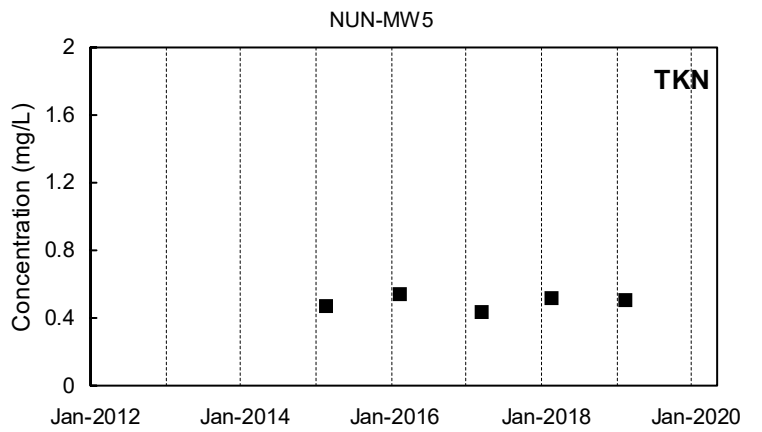
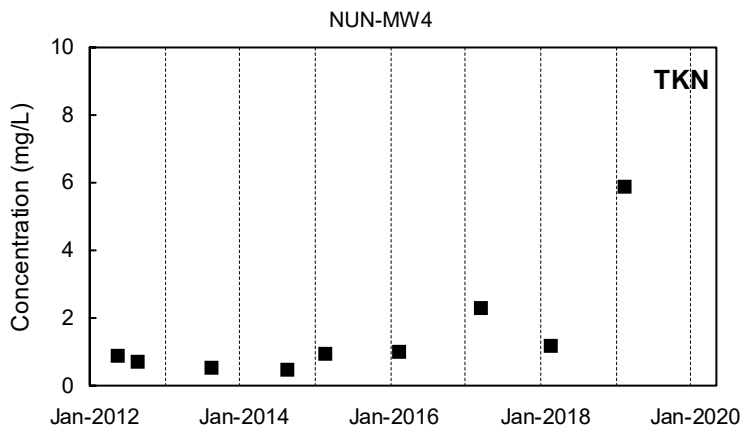
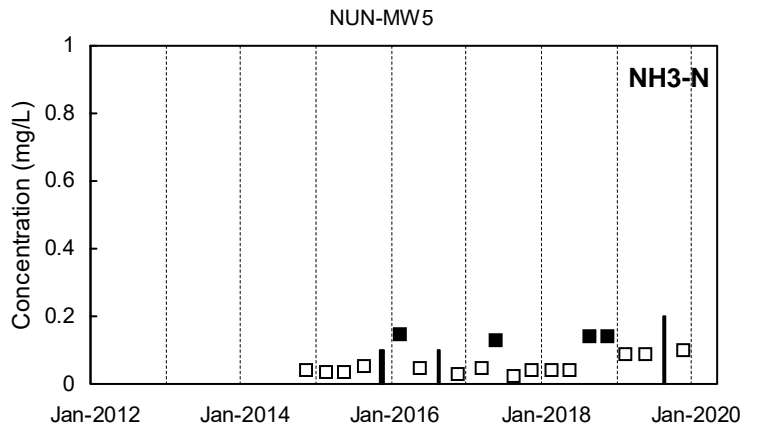
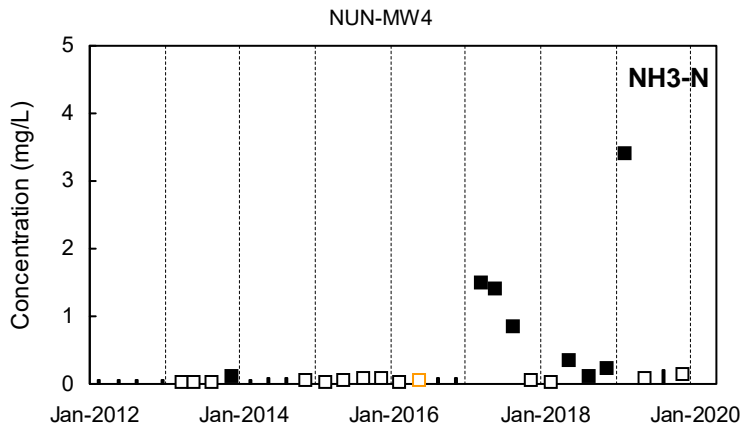
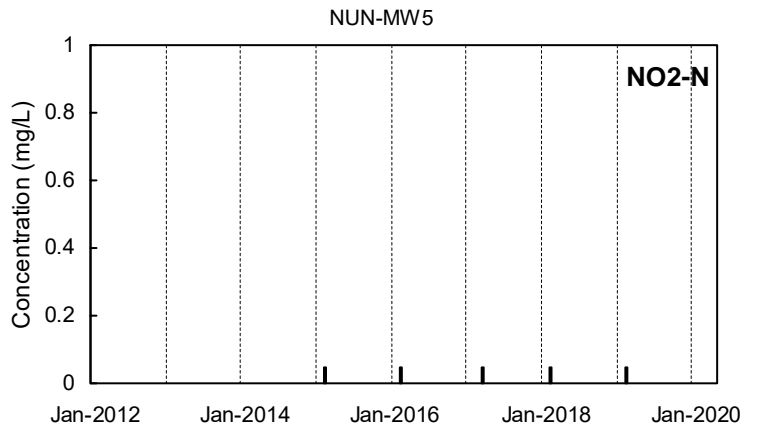
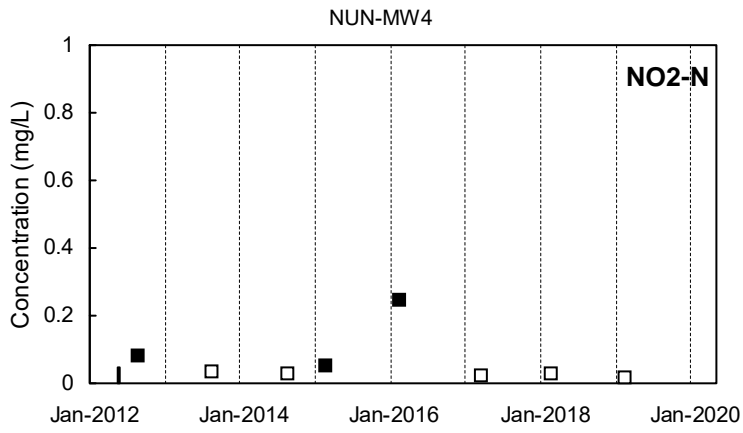
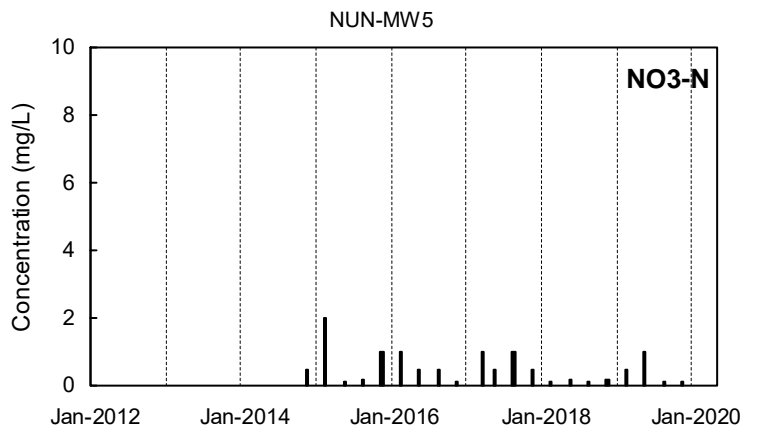
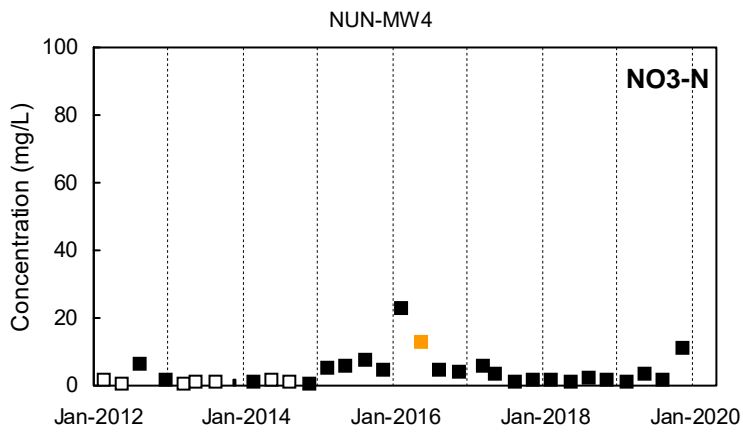

Detected Value
 'J'-Flag (value between reporting limit and detection limit)
 Non-Detect Range
 Shallow Well shown with black symbols
 Deep Well shown with orange symbols
 "dd" Well shown with blue symbols

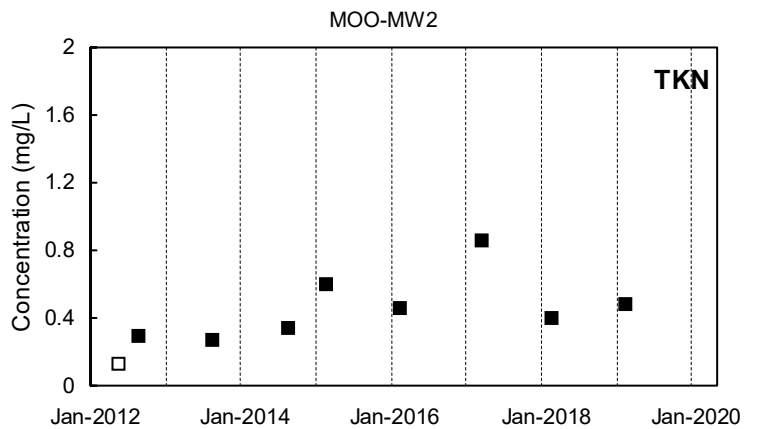
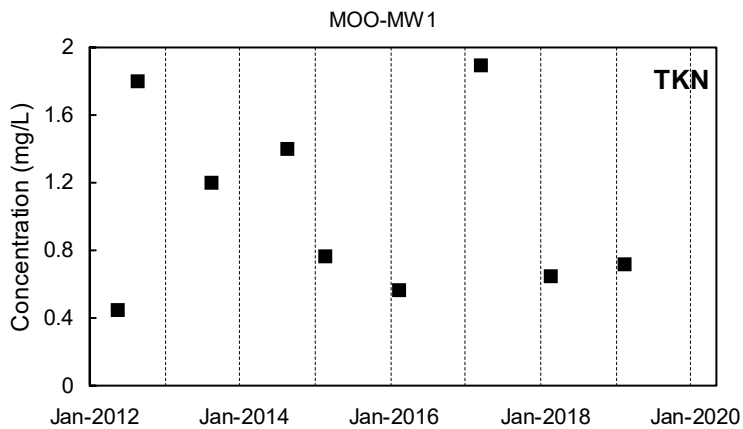
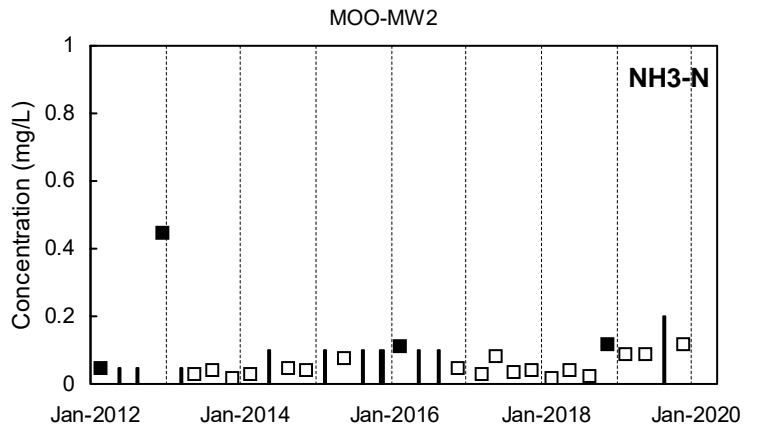
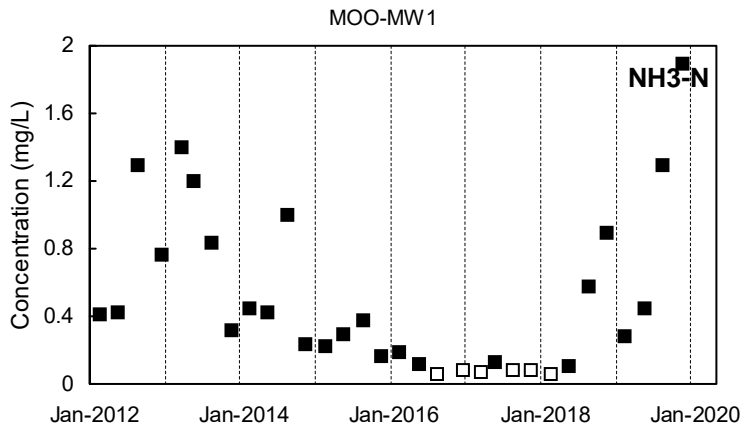
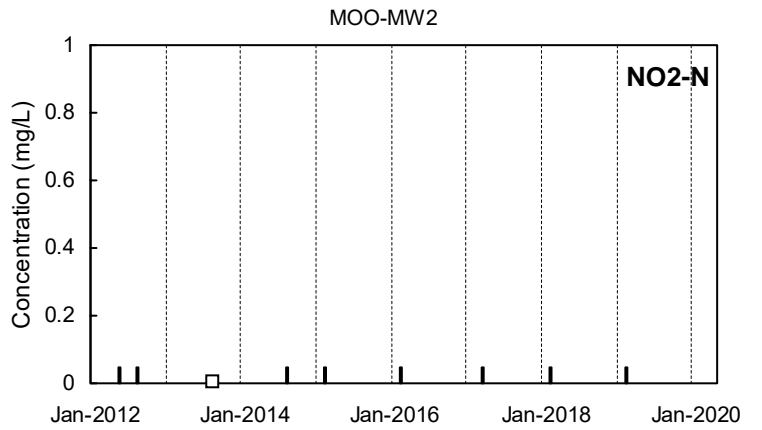
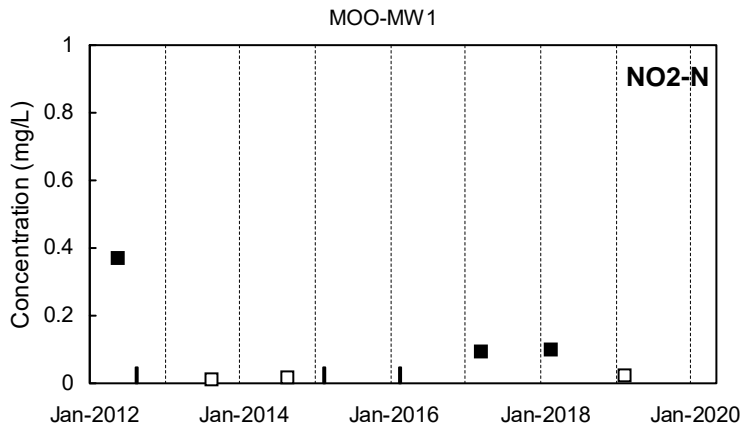
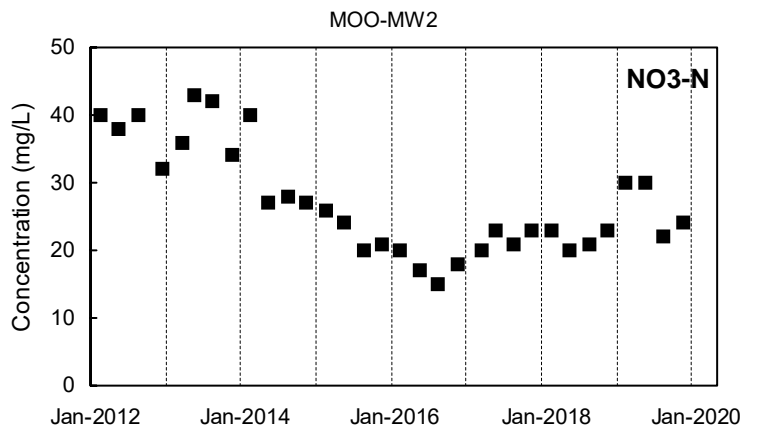
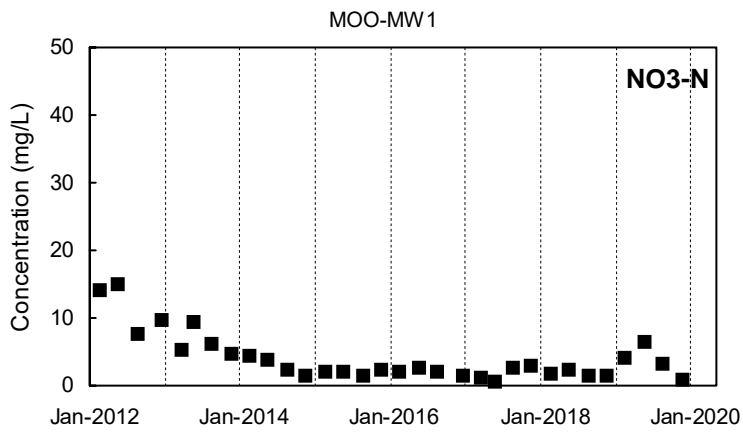

Detected Value
 'J'-Flag (value between reporting limit and detection limit)
 Non-Detect Range
 Shallow Well shown with black symbols
 Deep Well shown with orange symbols
 "dd" Well shown with blue symbols

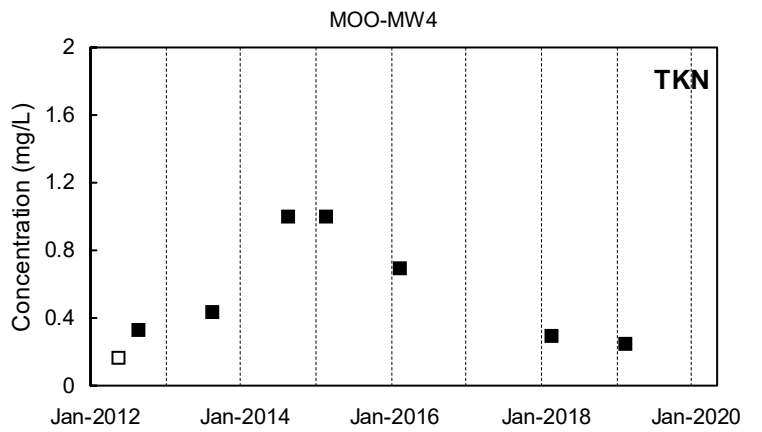
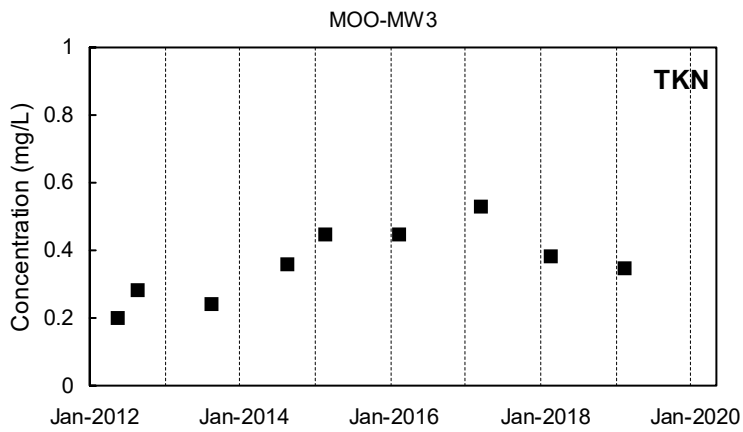
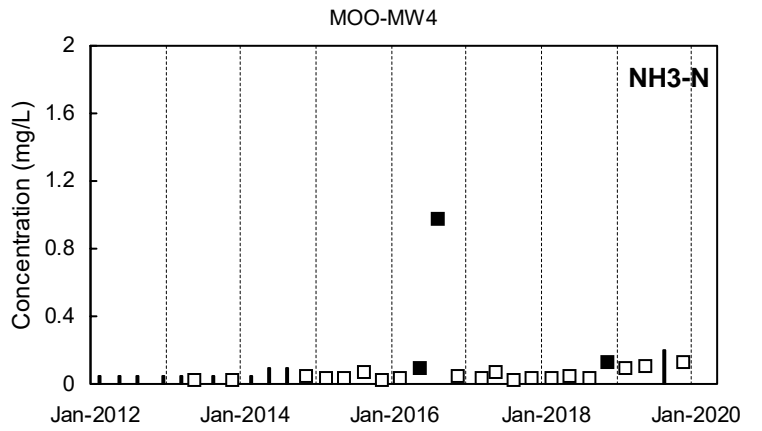
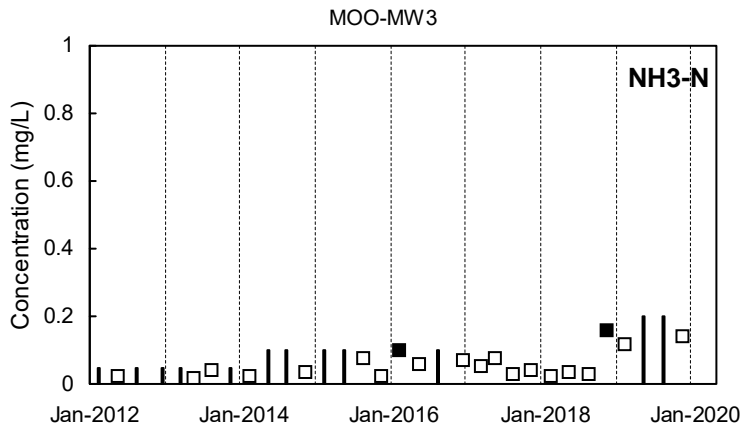
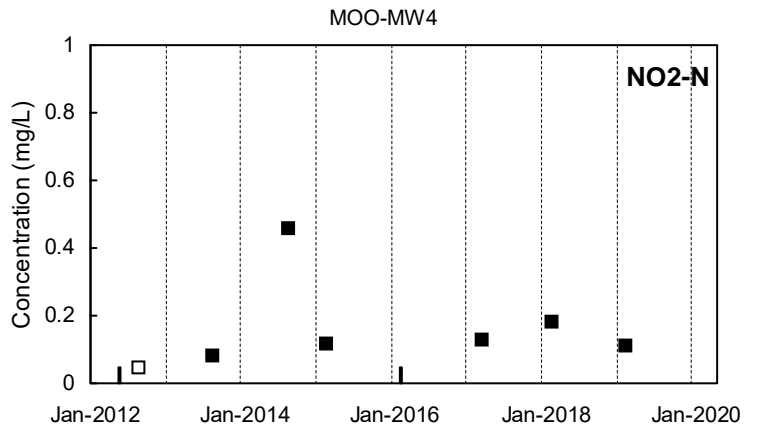
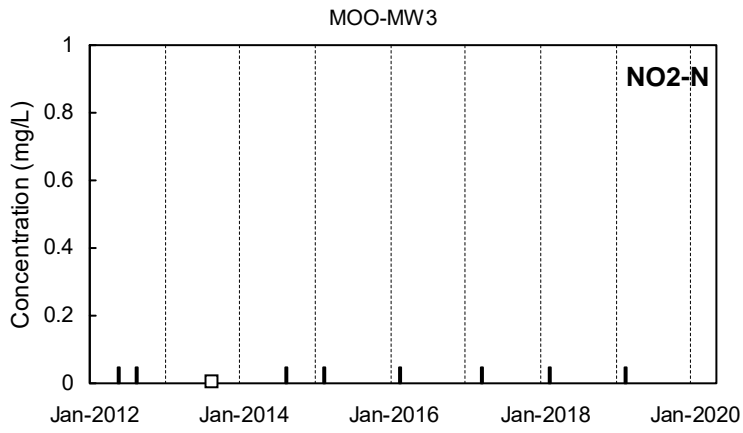
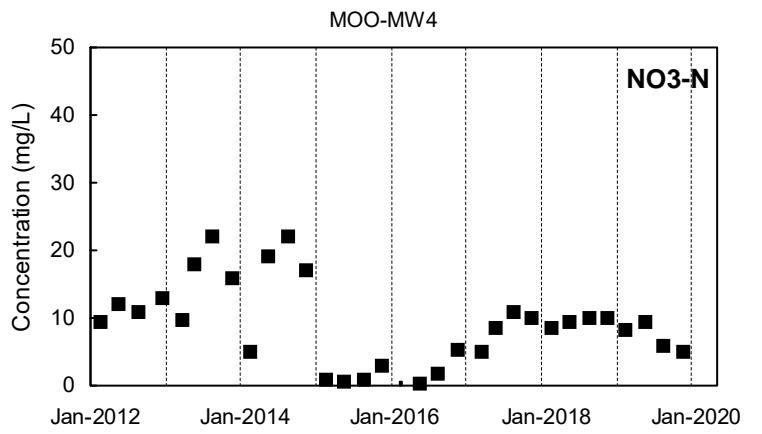
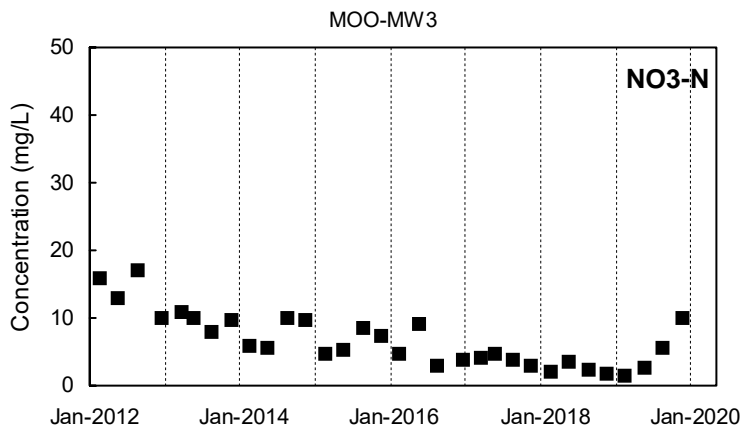

Detected Value
 'J'-Flag (value between reporting limit and detection limit)
 Non-Detect Range
Shallow Well shown with black symbols
Deep Well shown with orange symbols
"dd" Well shown with blue symbols

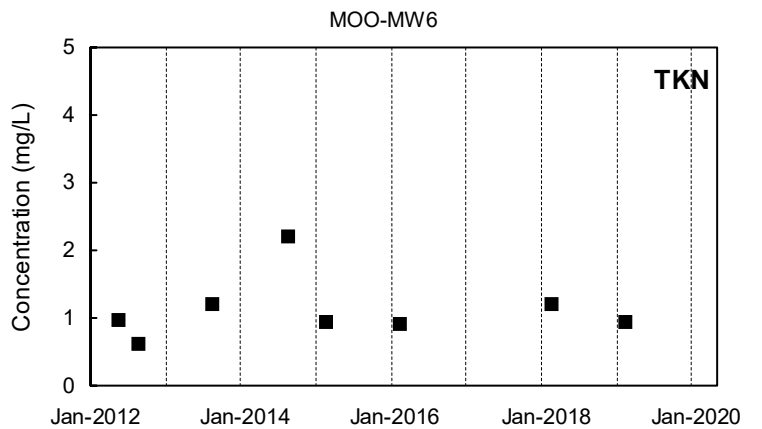
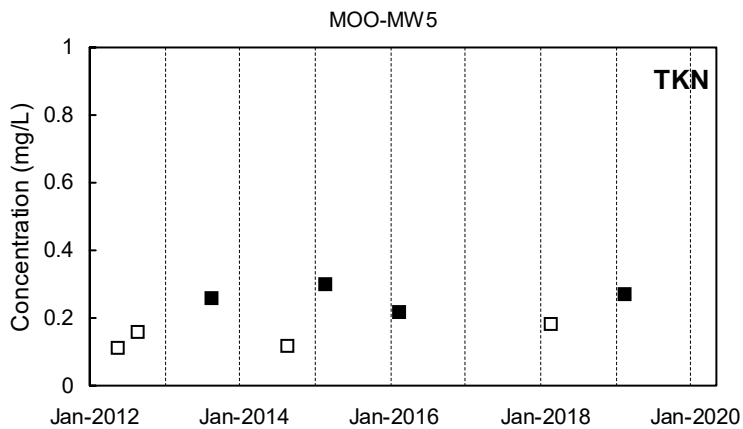
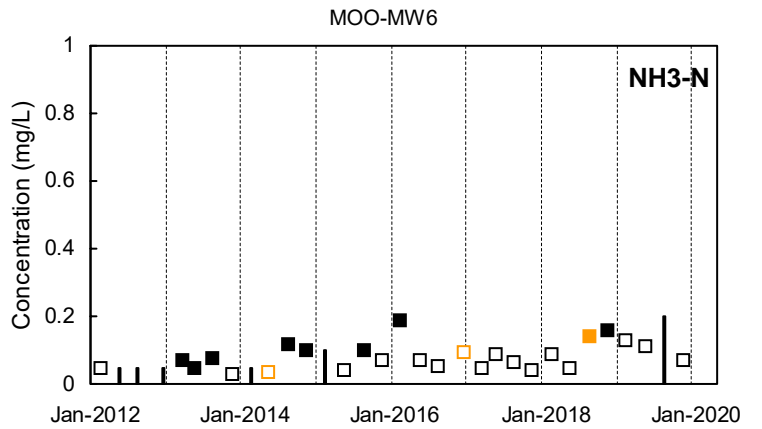
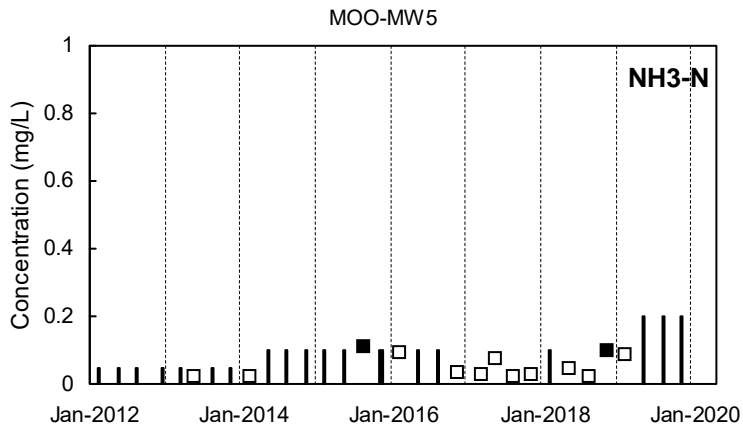
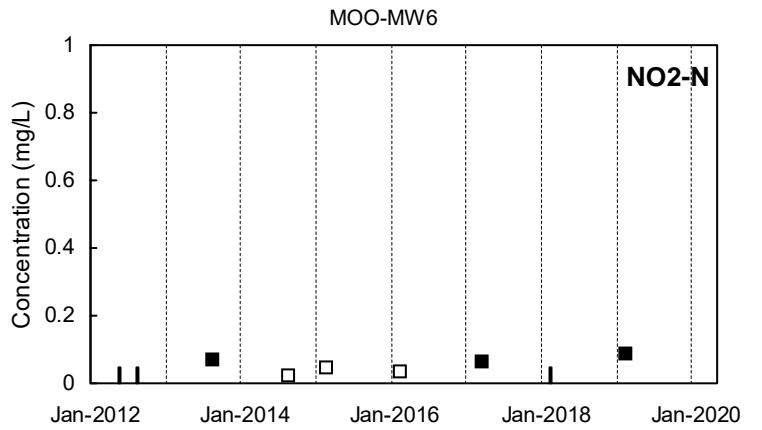
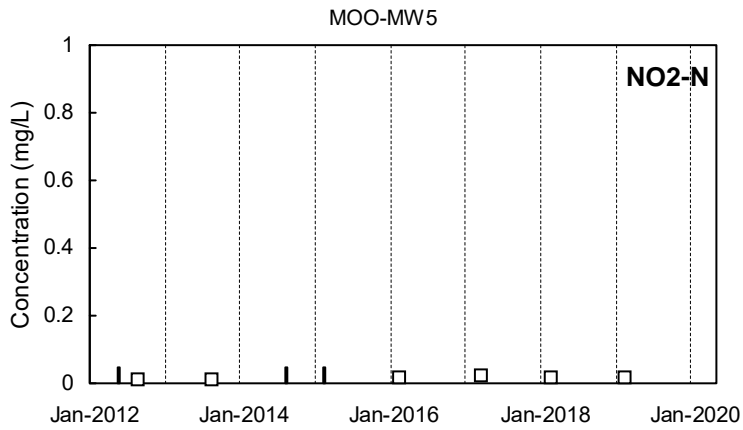
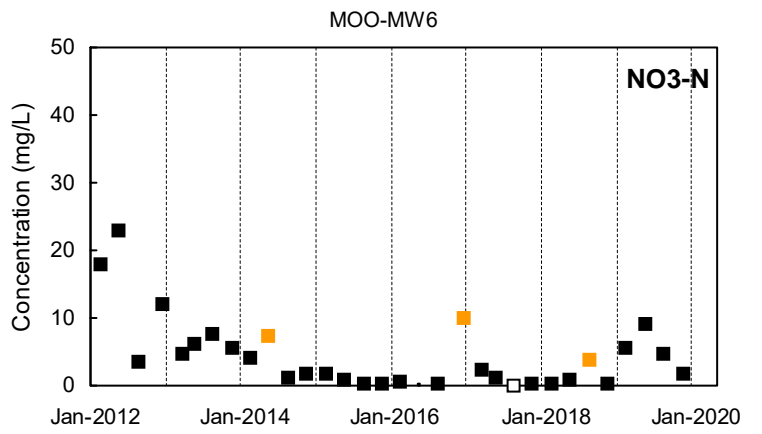
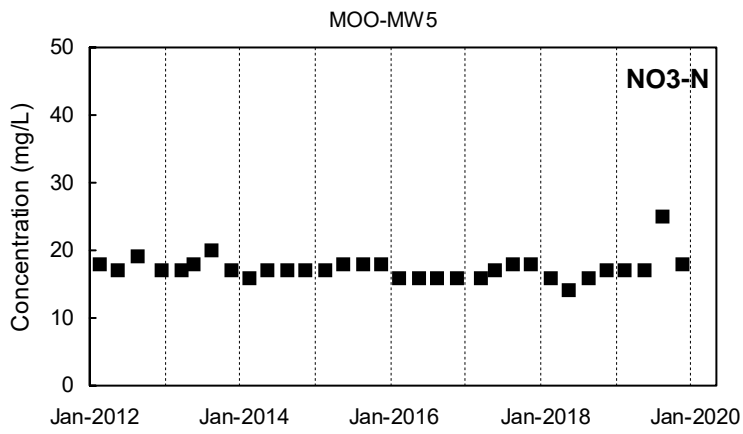

Detected Value
 'J'-Flag (value between reporting limit and detection limit)
 Non-Detect Range
Shallow Well shown with black symbols
Deep Well shown with orange symbols
"dd" Well shown with blue symbols

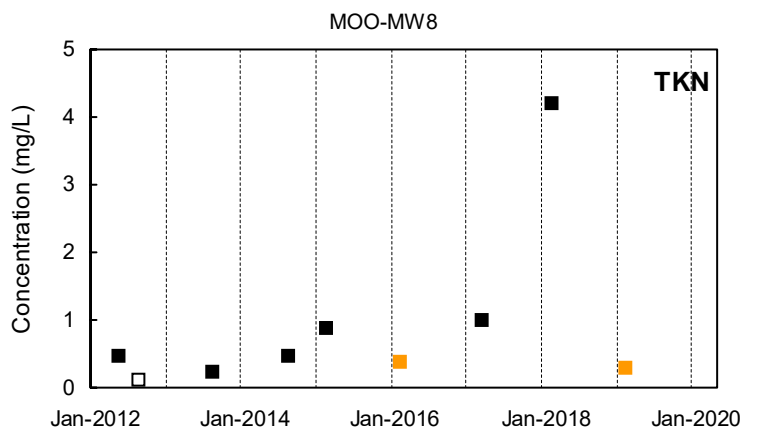
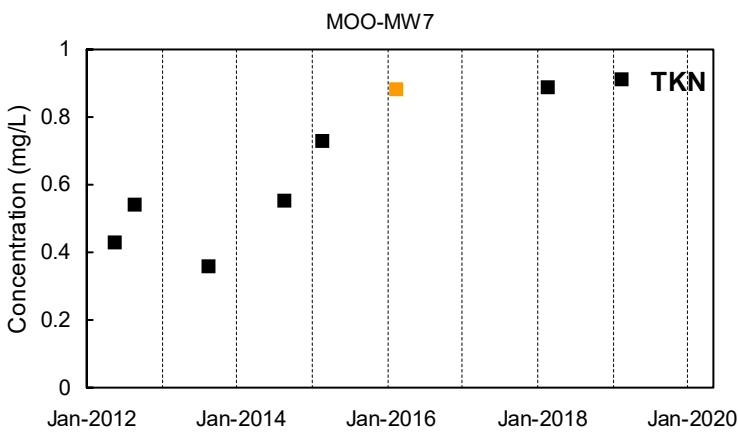
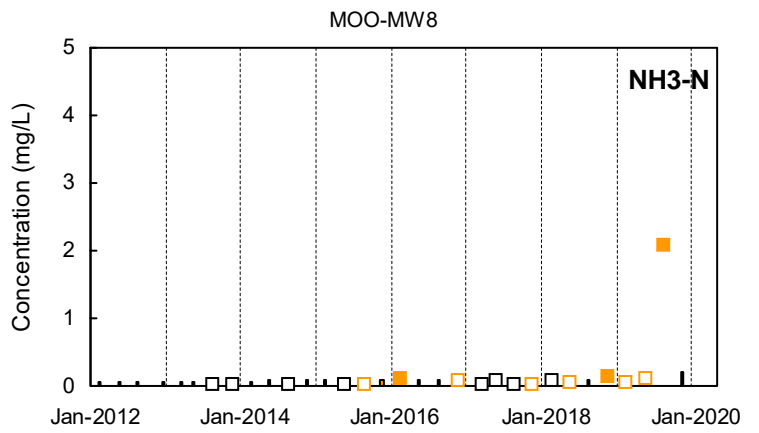
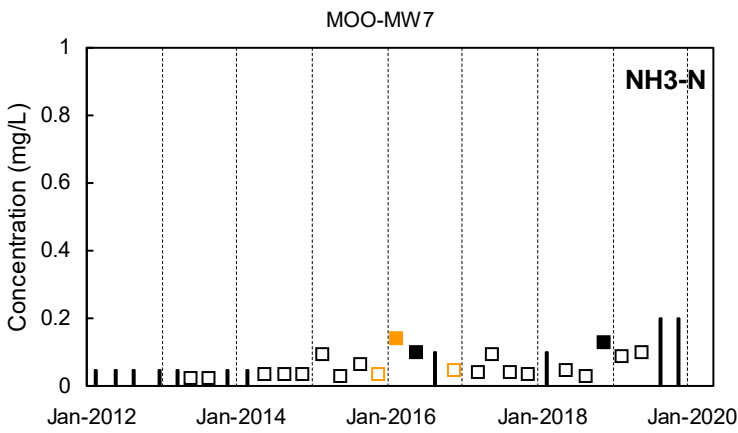
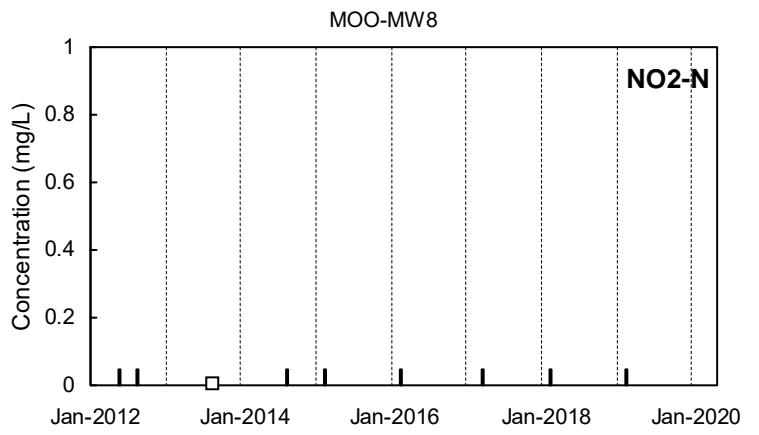
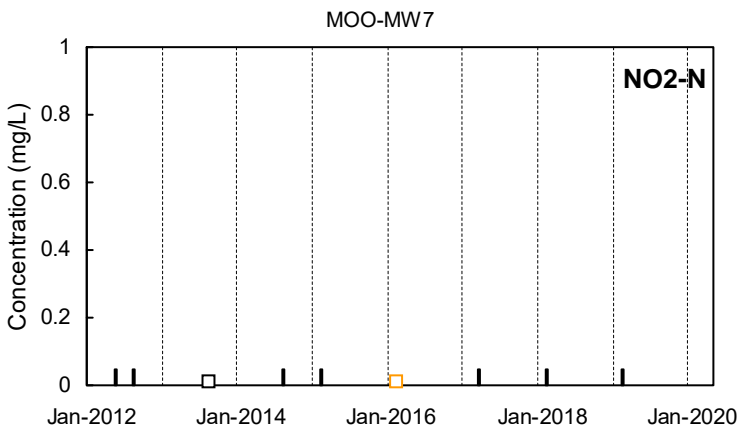
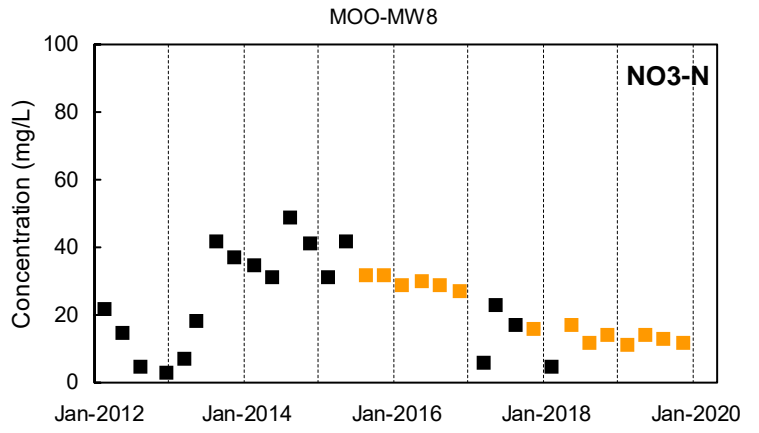
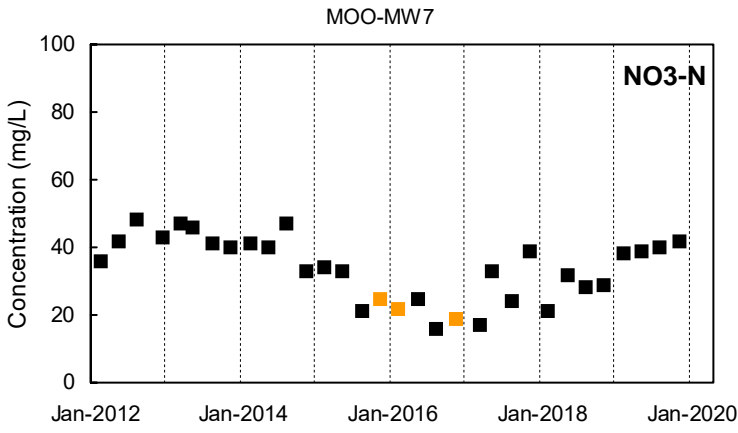

Detected Value
 'J'-Flag (value between reporting limit and detection limit)
 Non-Detect Range
 Shallow Well shown with black symbols Deep Well shown with orange symbols "dd" Well shown with blue symbols

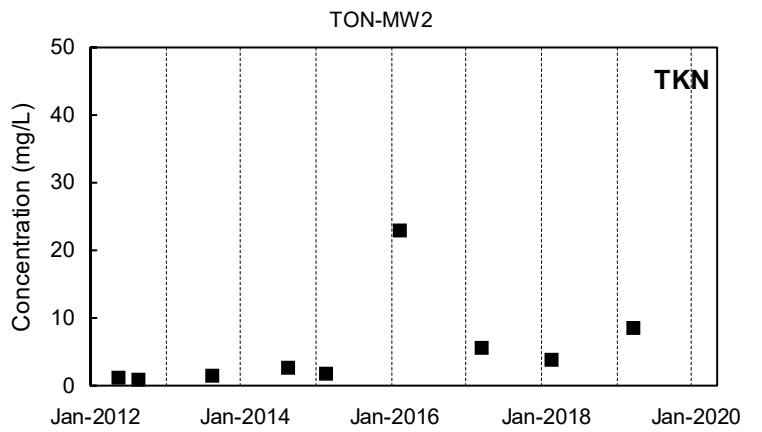
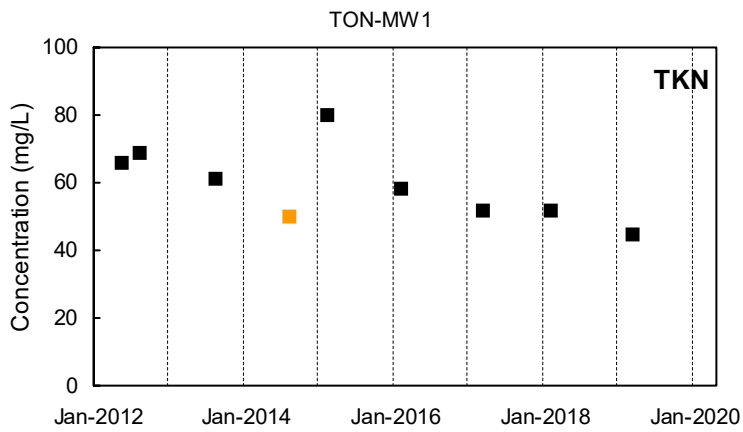
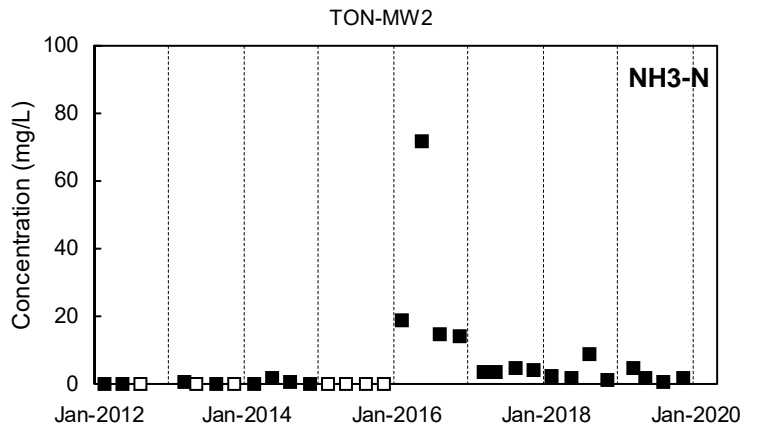
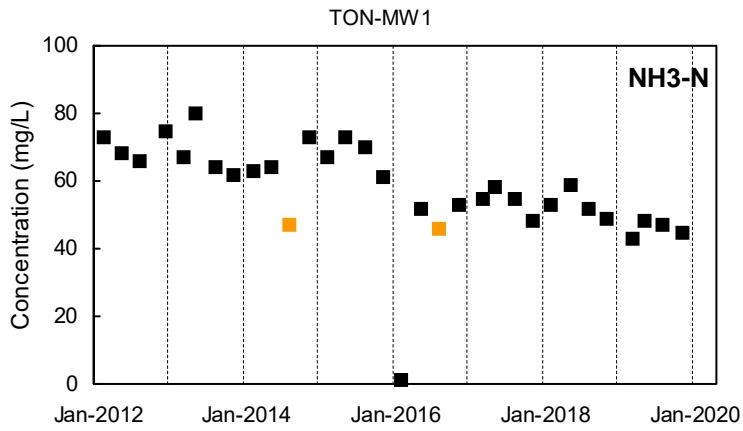
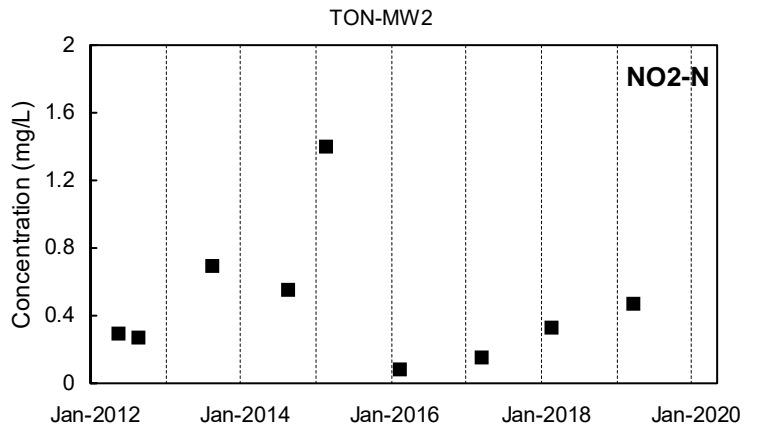
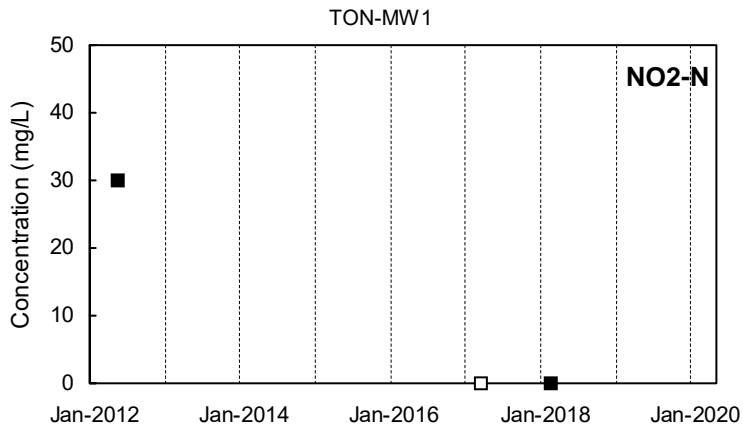
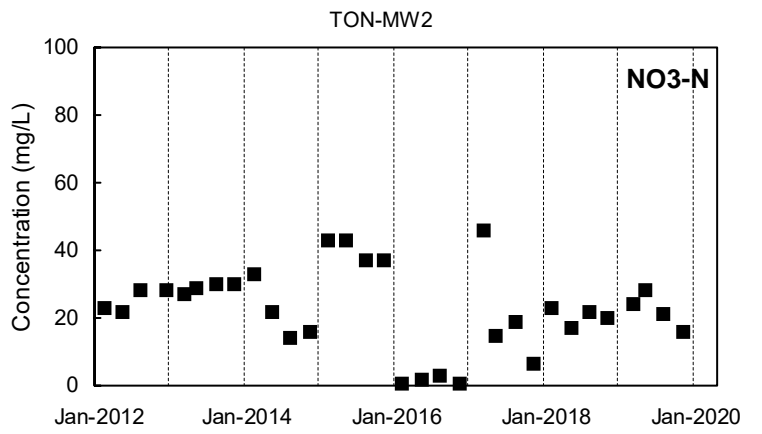
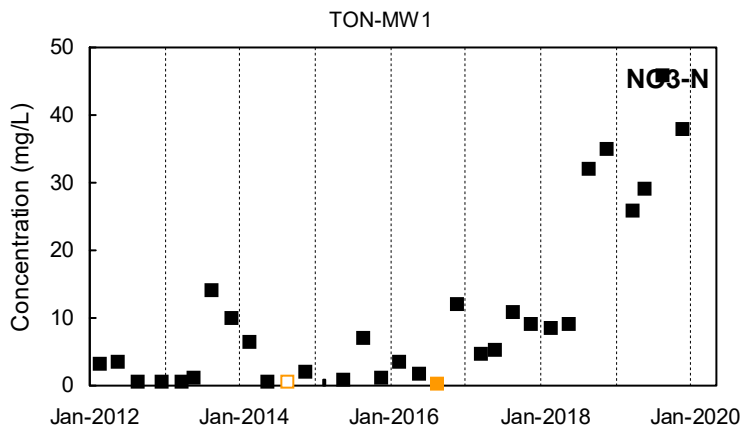

Detected Value
 'J'-Flag (value between reporting limit and detection limit)
 Non-Detect Range
 Shallow Well shown with black symbols
 Deep Well shown with orange symbols
 "dd" Well shown with blue symbols

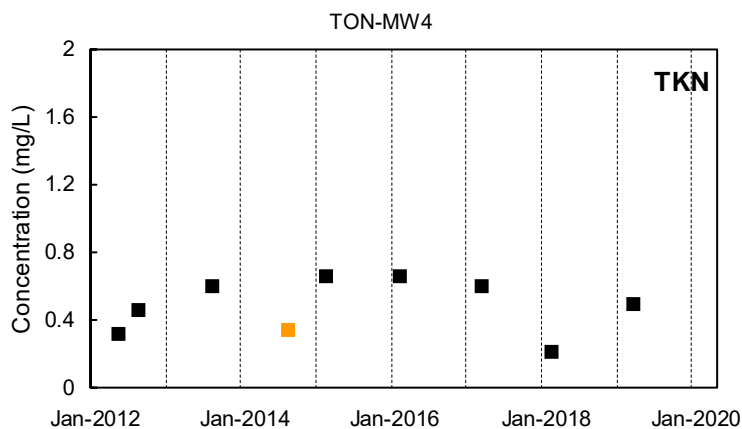
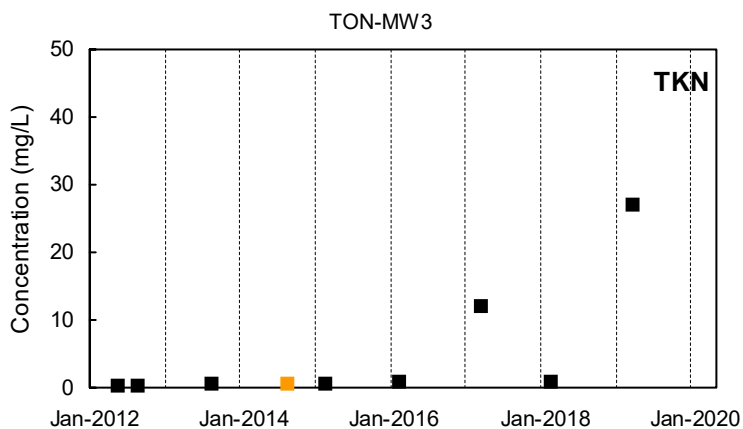
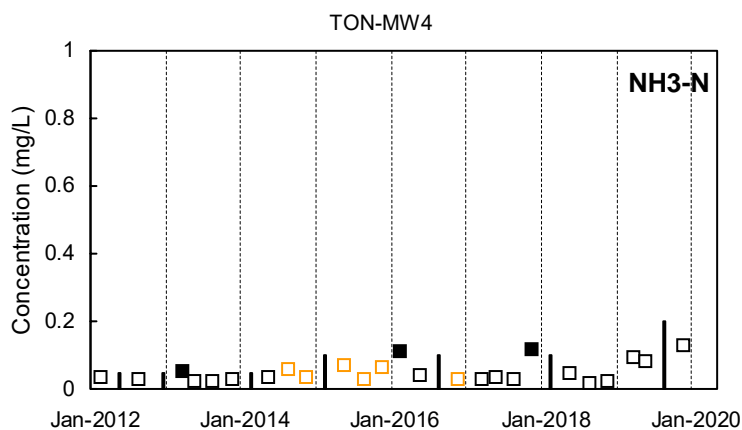
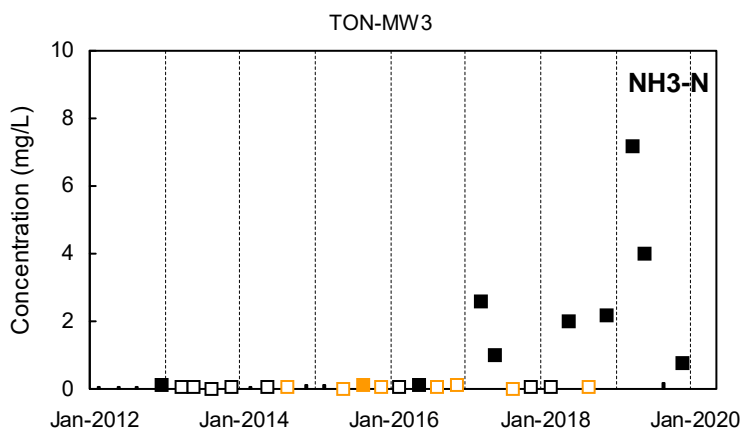
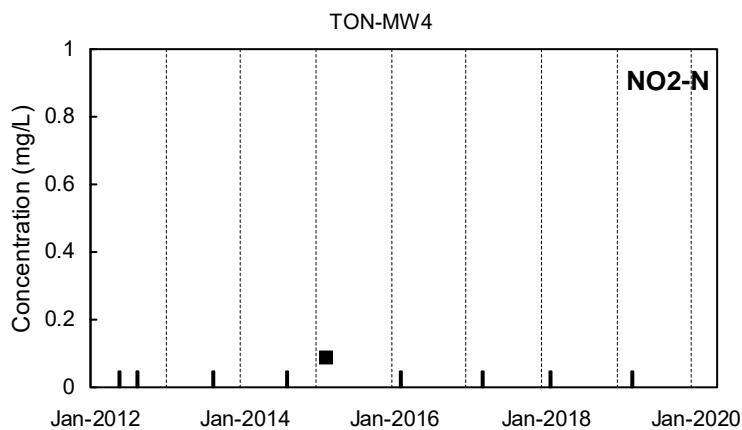
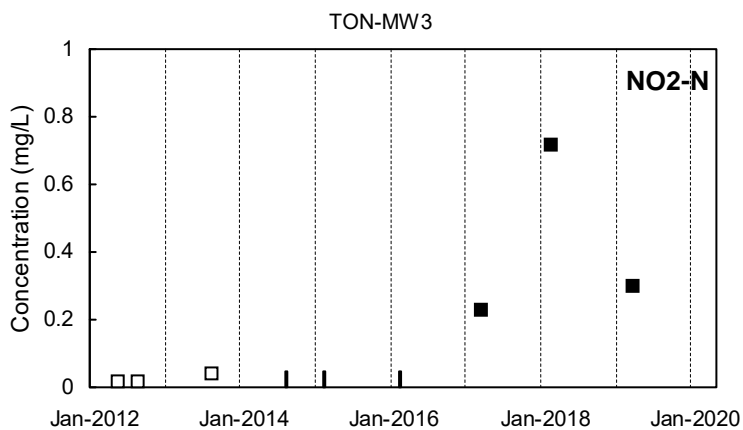
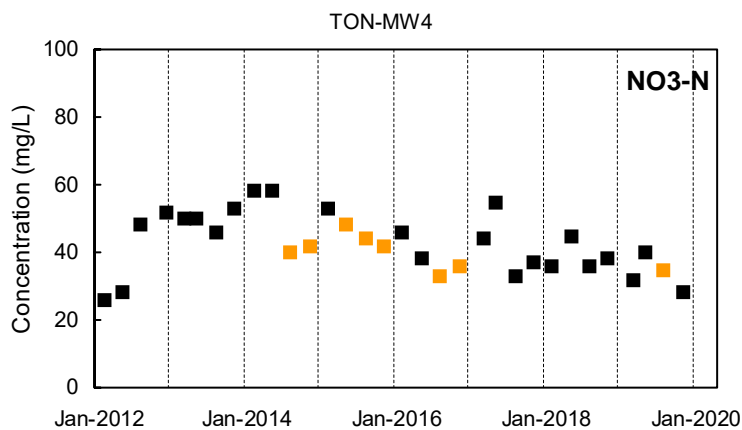
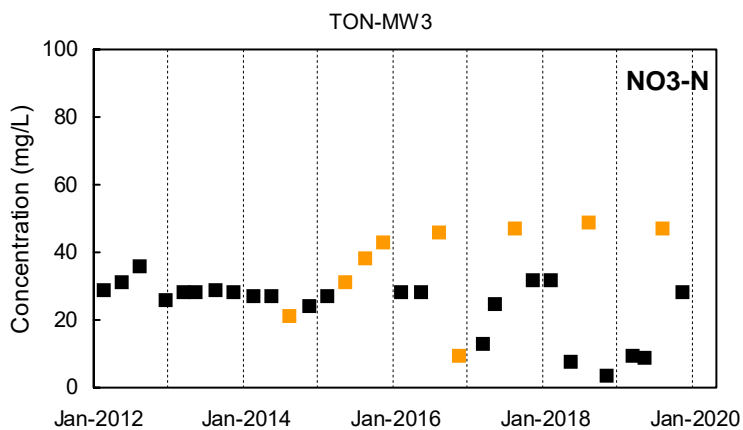

Detected Value
 'J'-Flag (value between reporting limit and detection limit)
 Non-Detect Range
 Shallow Well shown with black symbols
 Deep Well shown with orange symbols
 "dd" Well shown with blue symbols

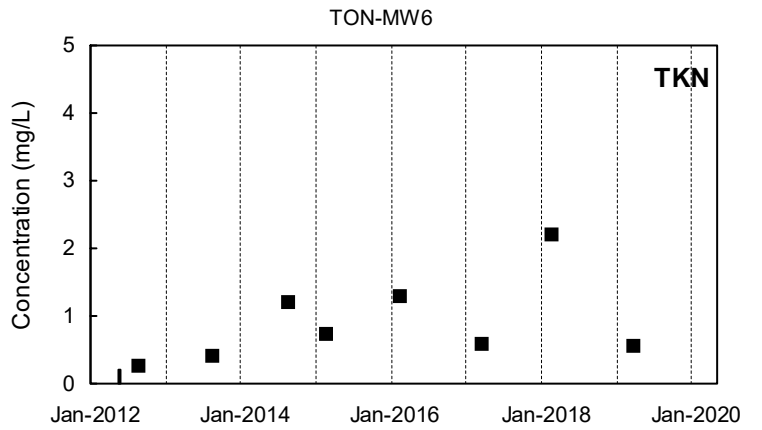
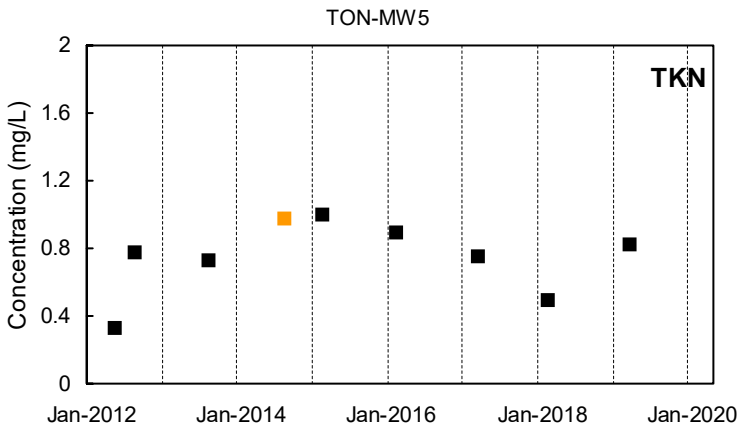
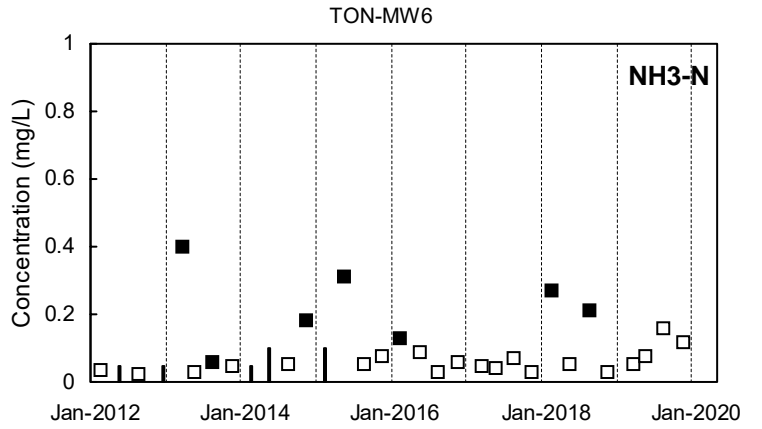
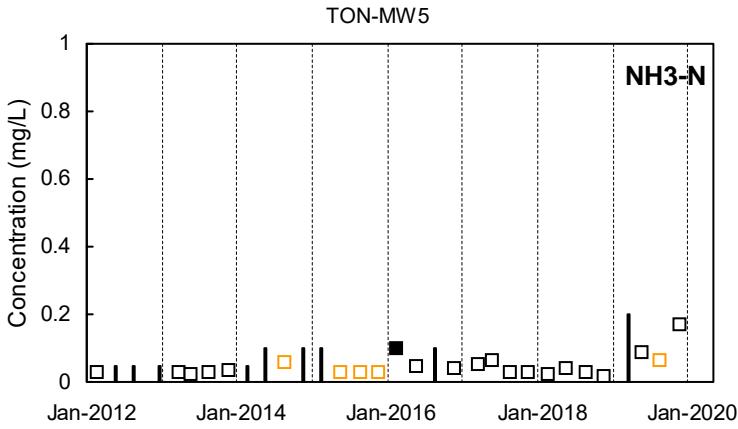
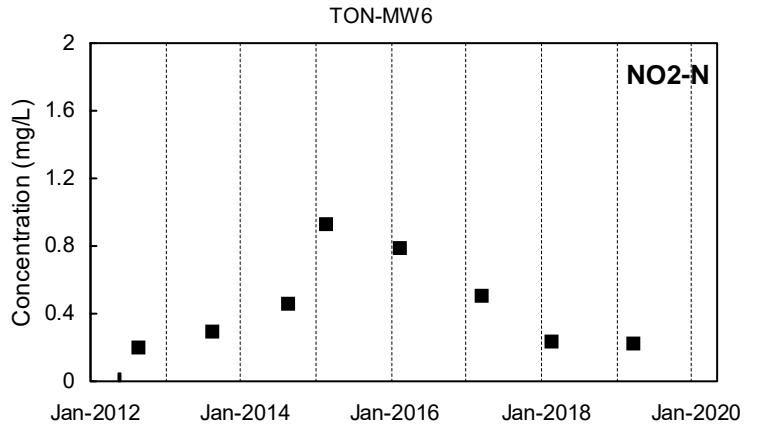
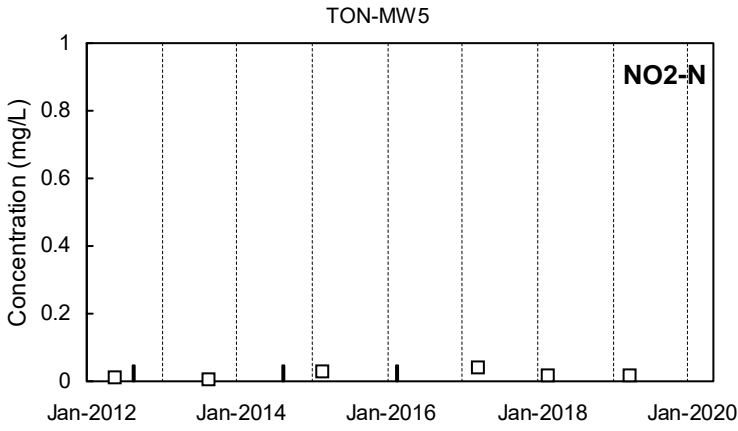
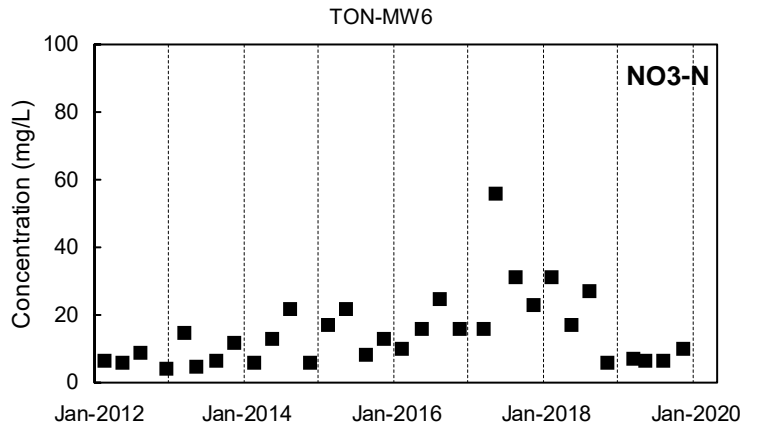
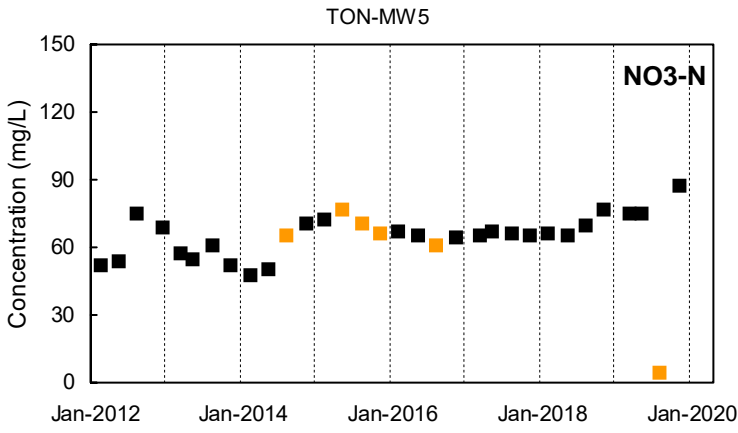

Detected Value
 'J'-Flag (value between reporting limit and detection limit)
 Non-Detect Range
 Shallow Well shown with black symbols
 Deep Well shown with orange symbols
 "dd" Well shown with blue symbols

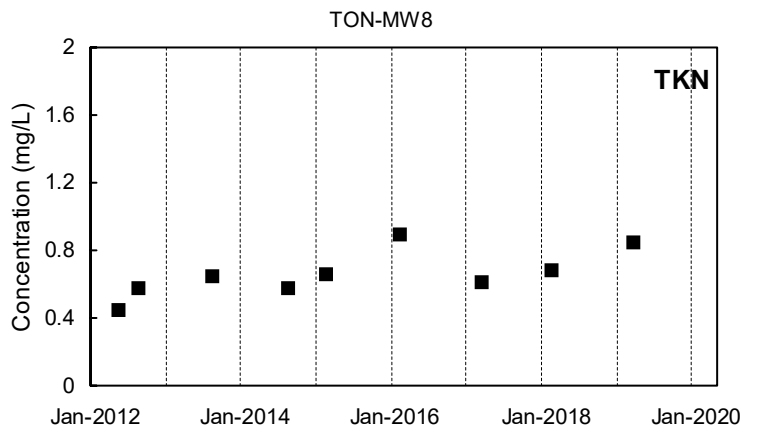
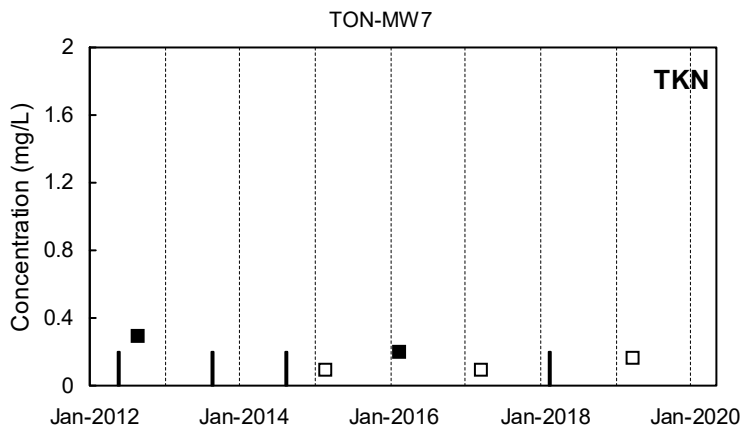
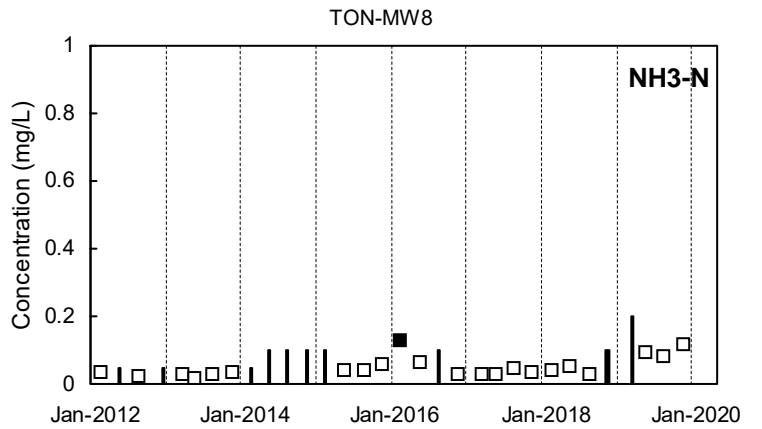
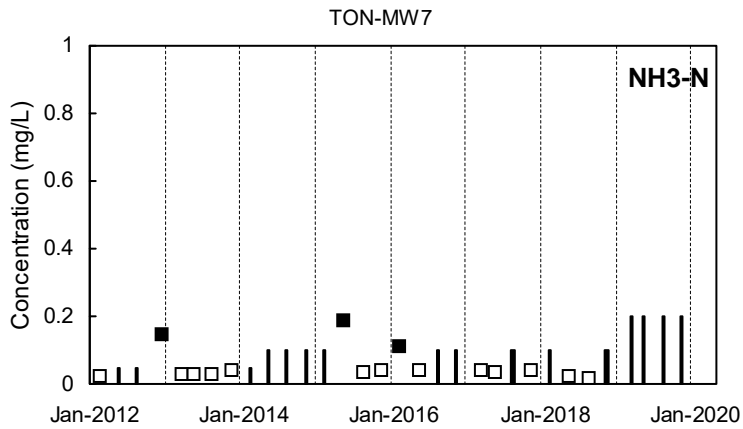
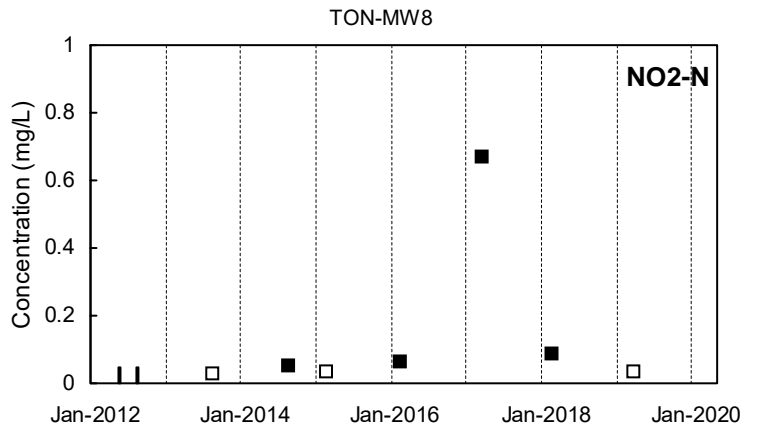
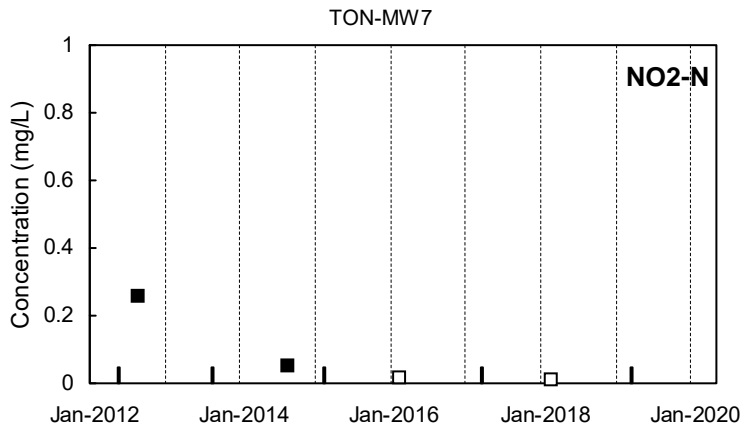
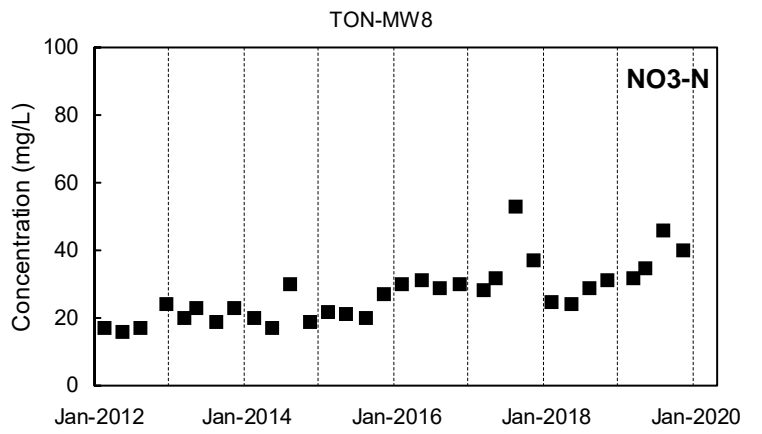
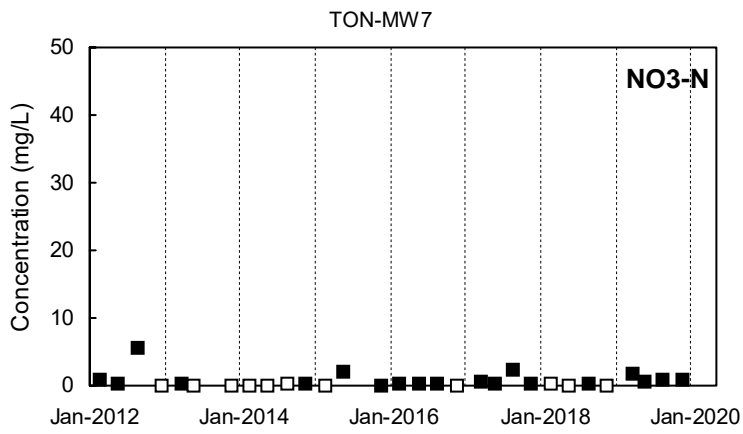

Detected Value
 'J'-Flag (value between reporting limit and detection limit)
 Non-Detect Range
 Shallow Well shown with black symbols
 Deep Well shown with orange symbols
 "dd" Well shown with blue symbols

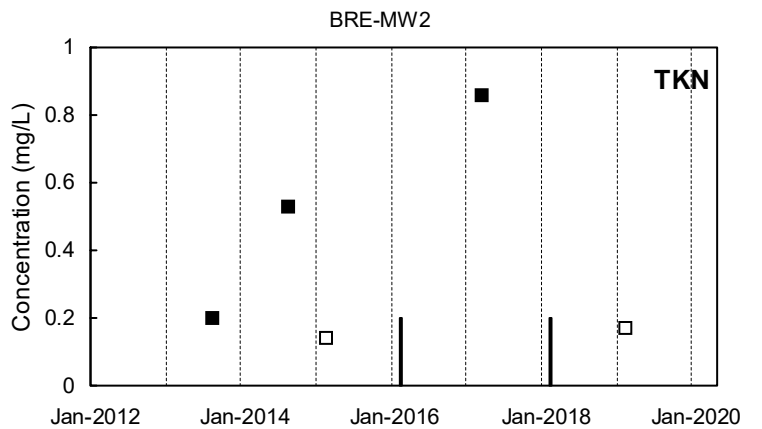
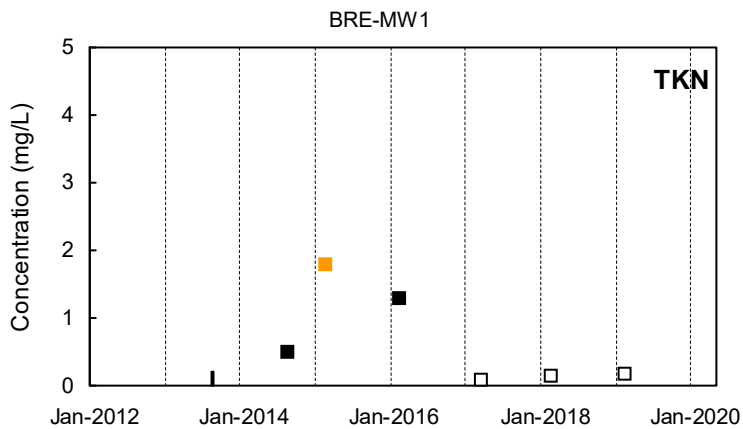
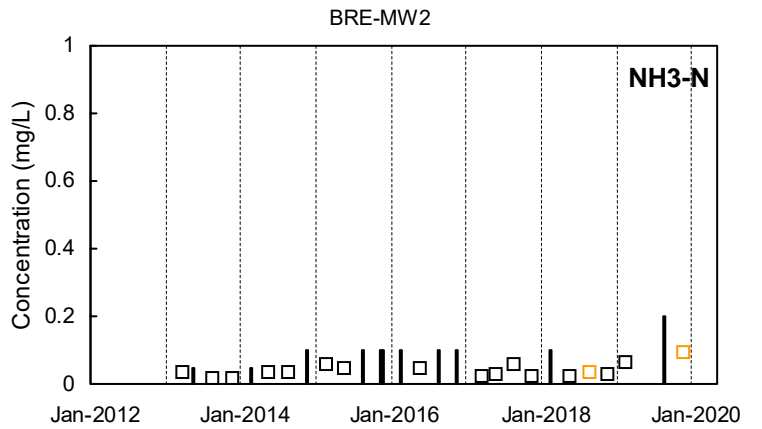
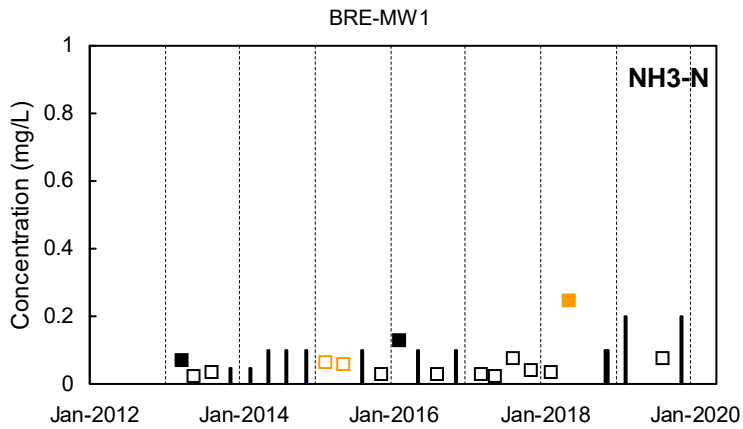
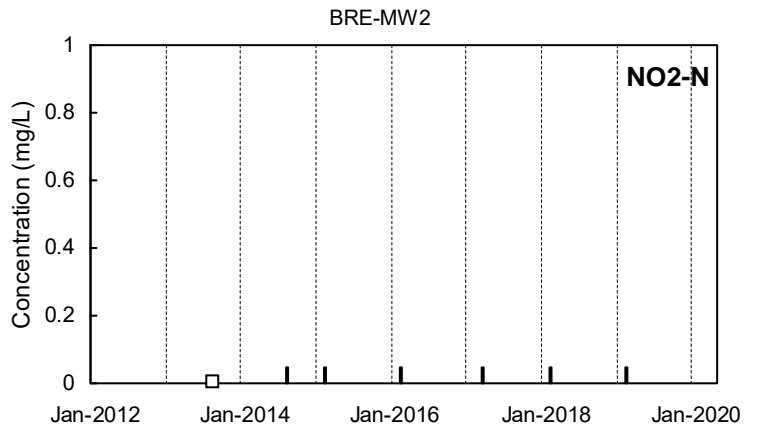
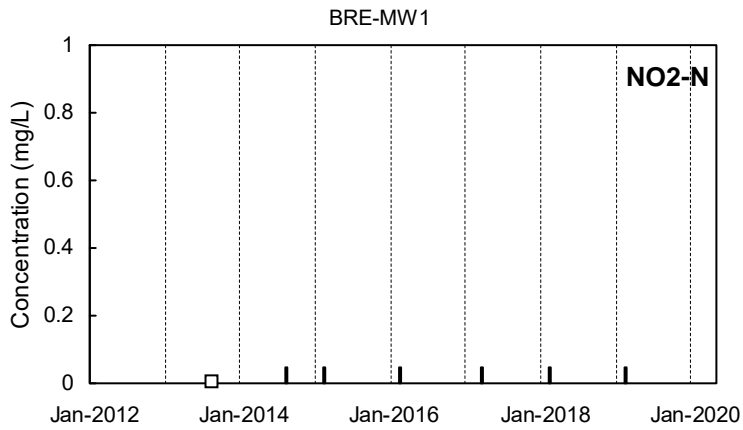
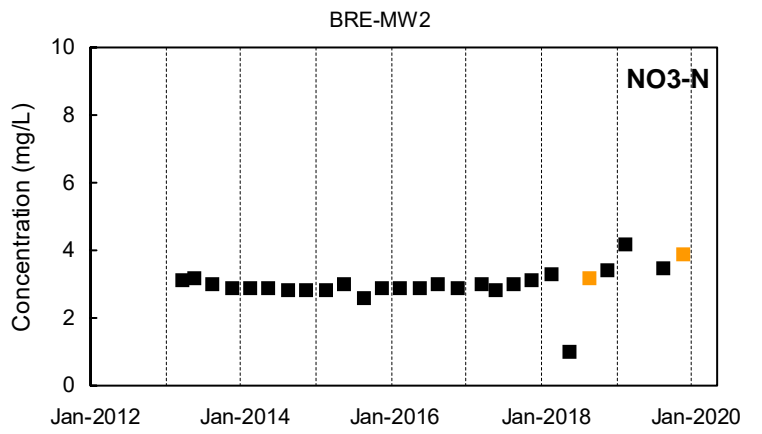
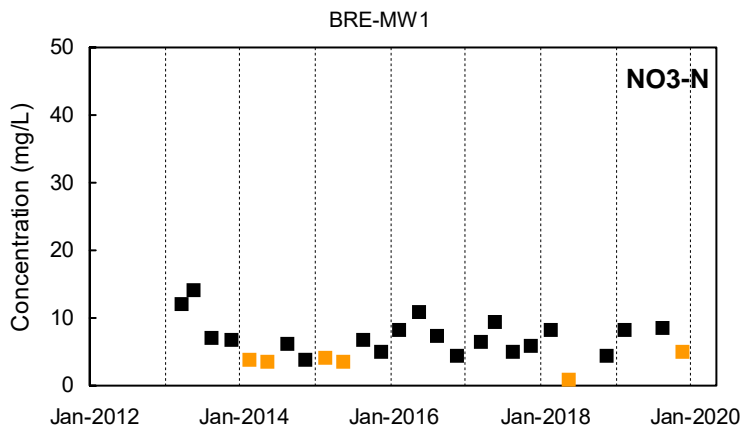

■ Detected Value □ 'J'-Flag (value between reporting limit and detection limit) ■ Non-Detect Range
 ■ Shallow Well shown with black symbols ■ Deep Well shown with orange symbols ■ "dd" Well shown with blue symbols

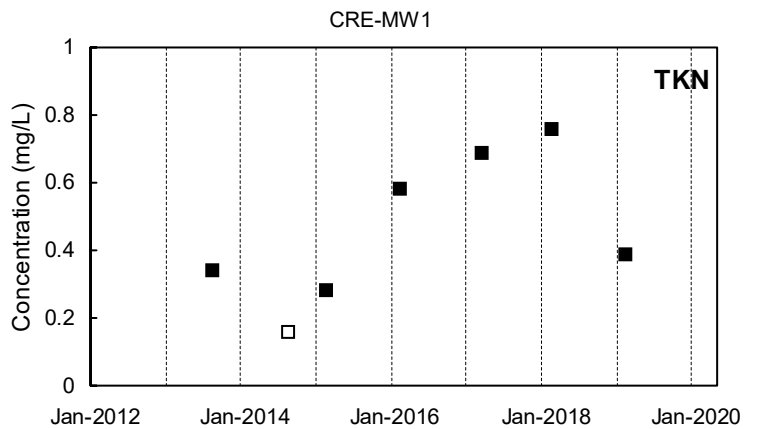
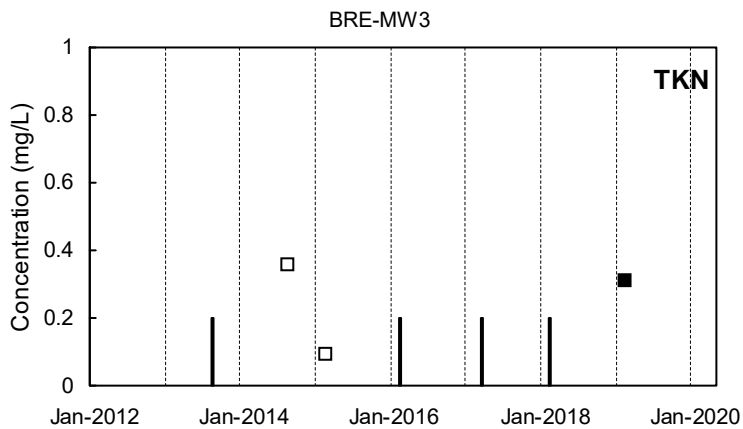
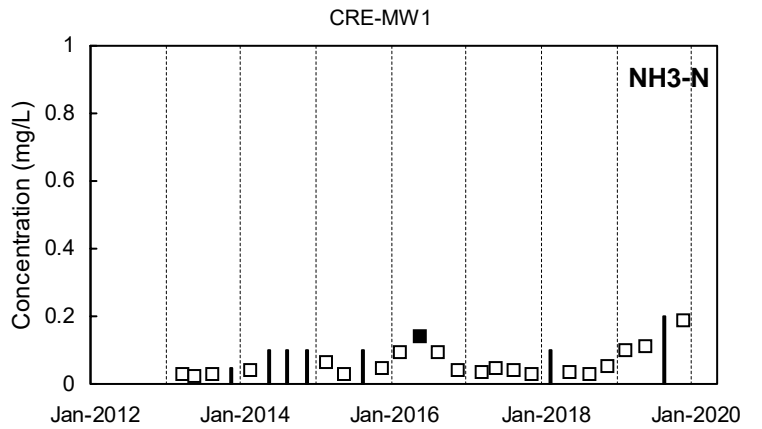
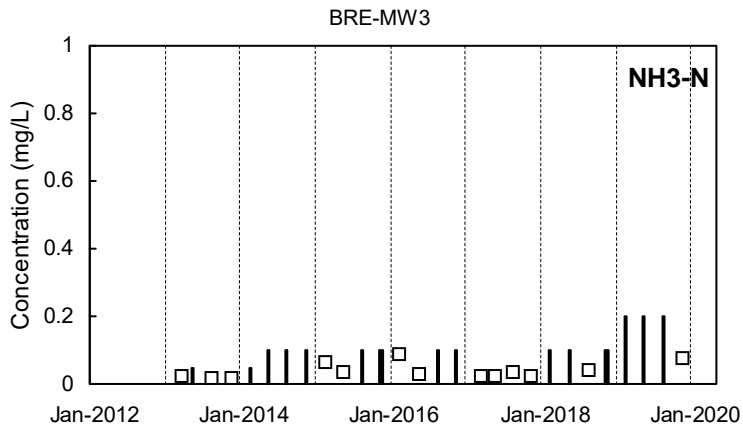
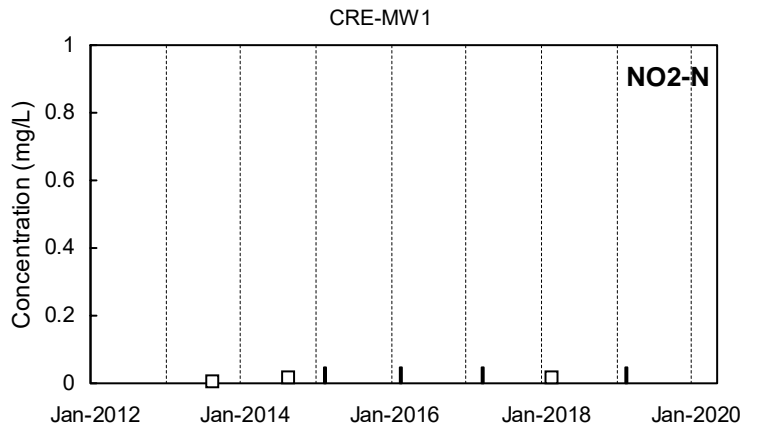
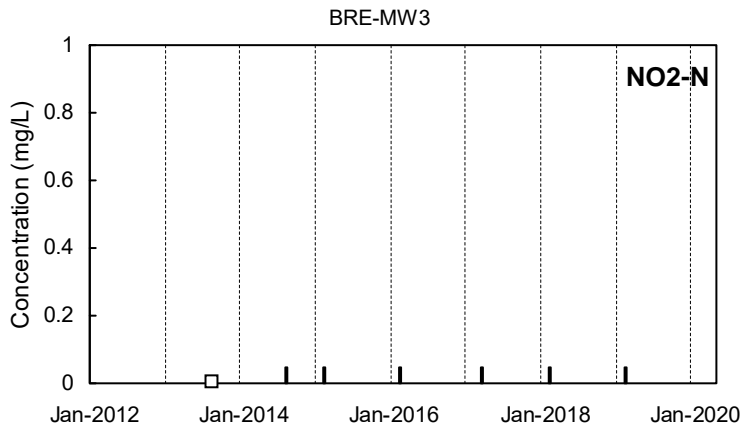
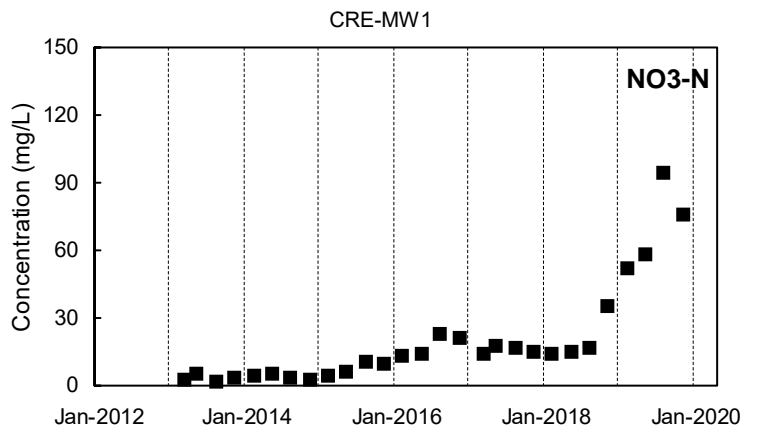
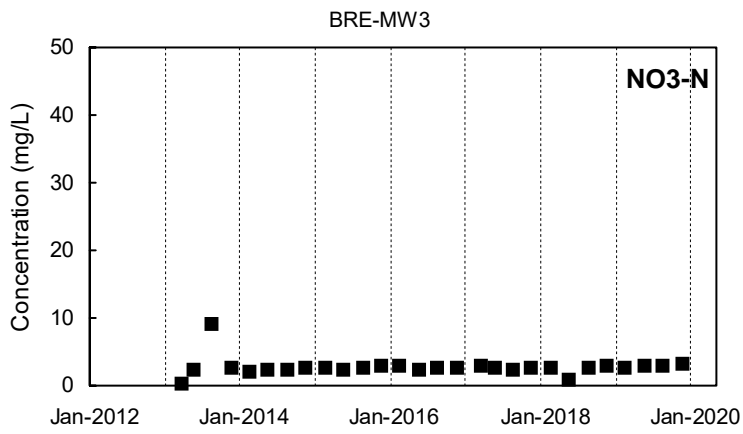

Detected Value
 'J'-Flag (value between reporting limit and detection limit)
 Non-Detect Range
 Shallow Well shown with black symbols
 Deep Well shown with orange symbols
 "dd" Well shown with blue symbols

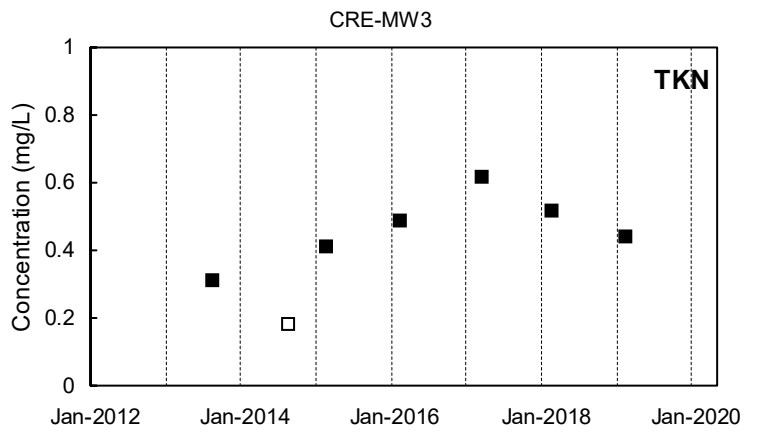
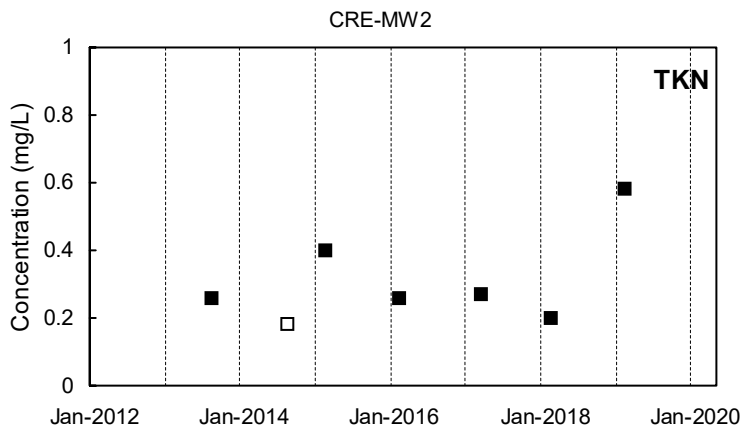
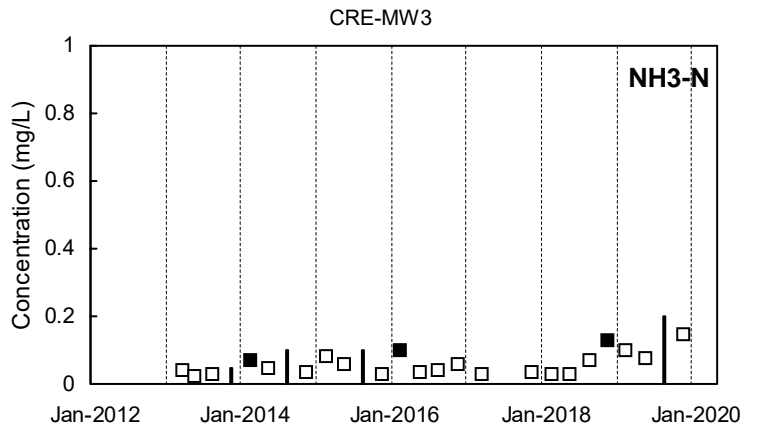
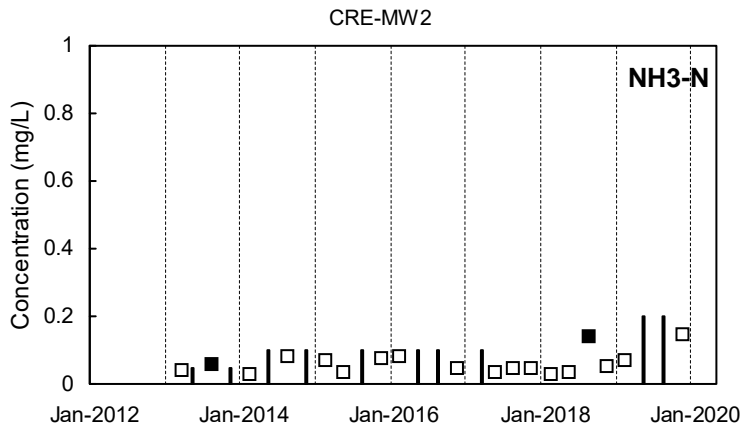
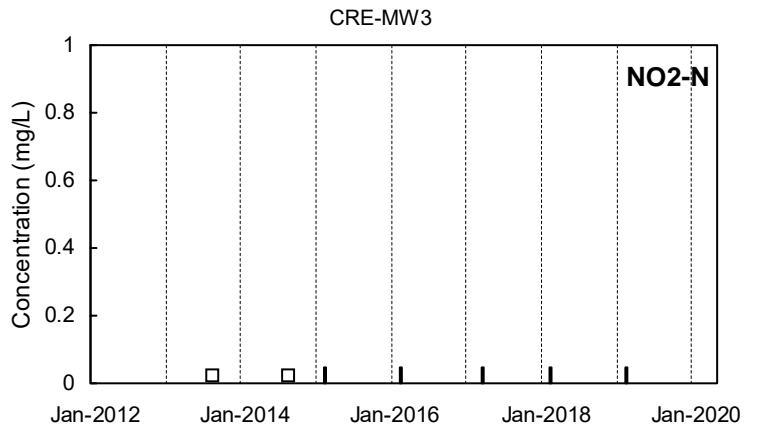
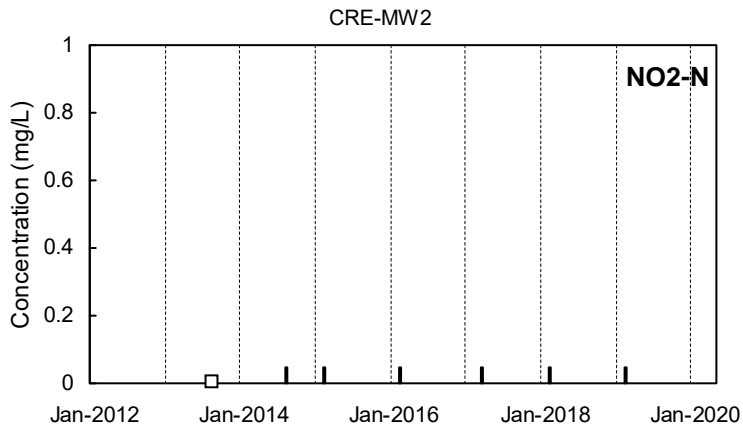
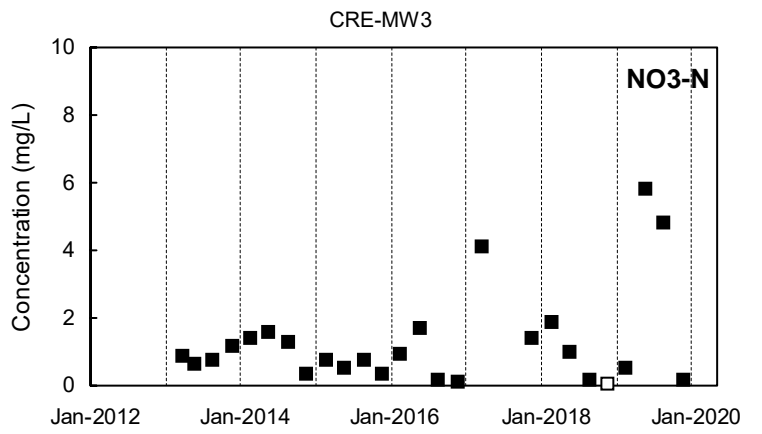
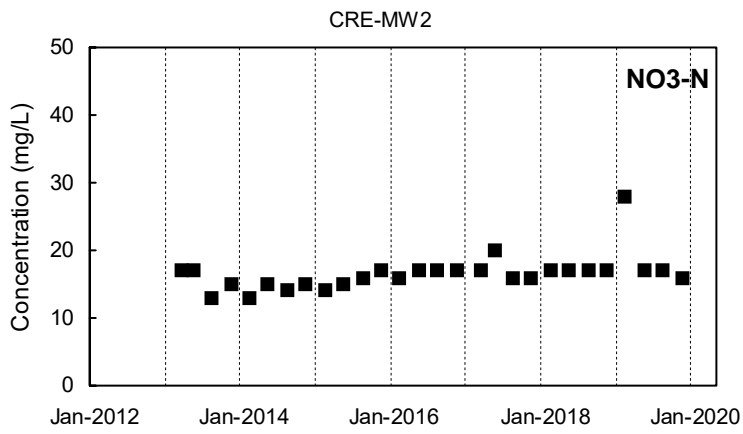

Detected Value
 'J'-Flag (value between reporting limit and detection limit)
 Non-Detect Range
 Shallow Well shown with black symbols
 Deep Well shown with orange symbols
 "dd" Well shown with blue symbols

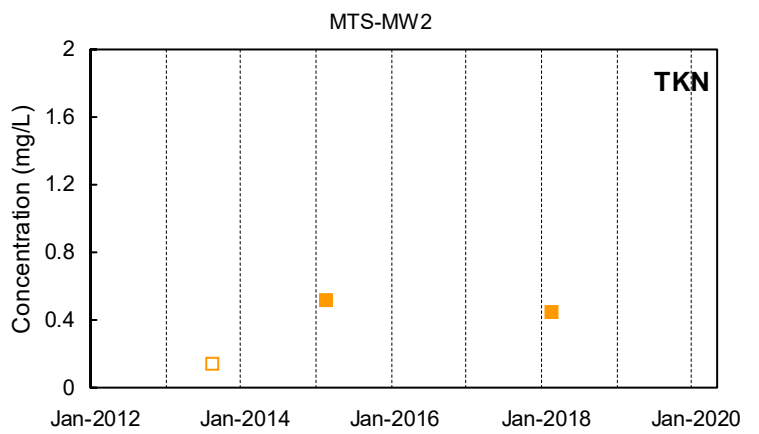
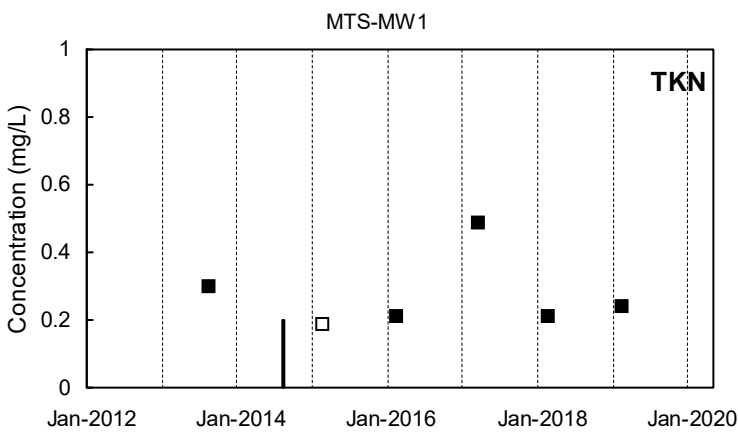
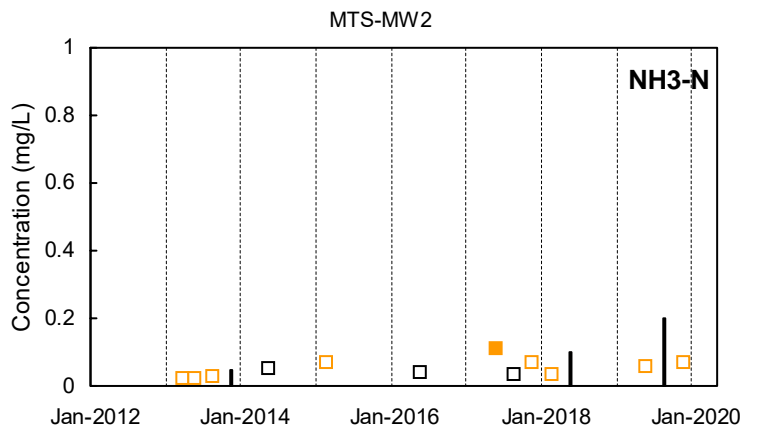
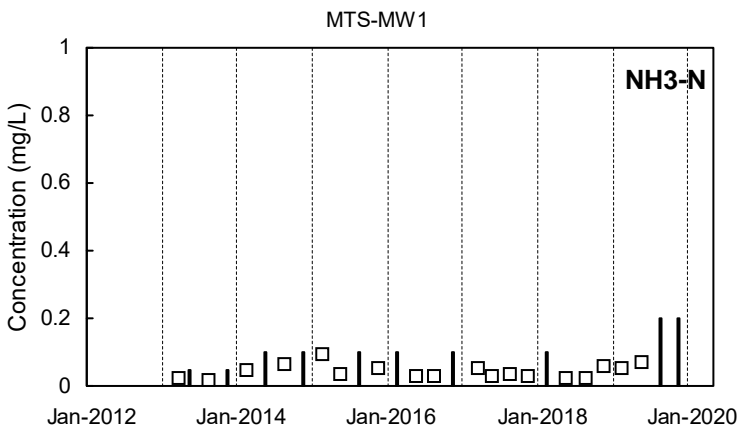
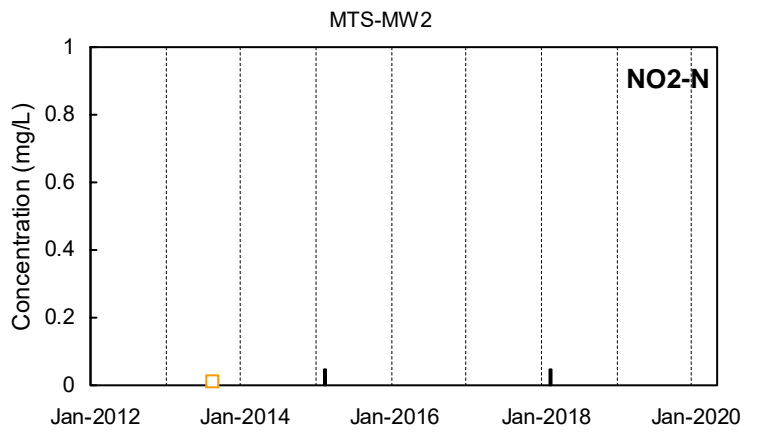
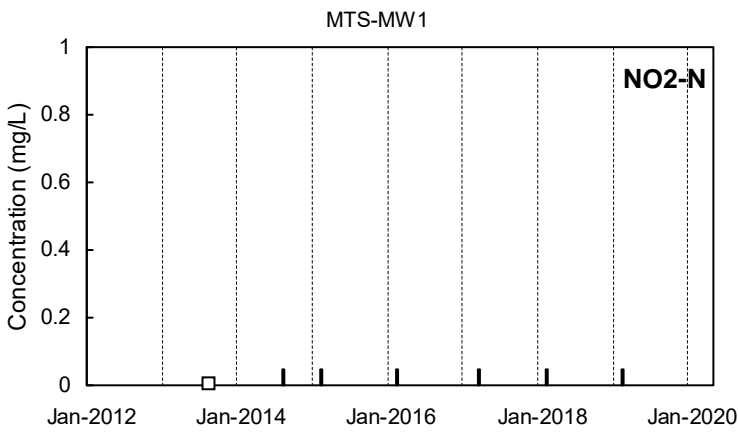
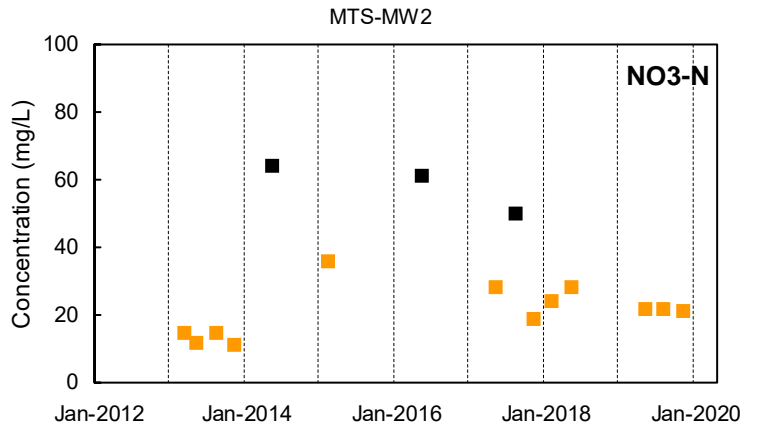
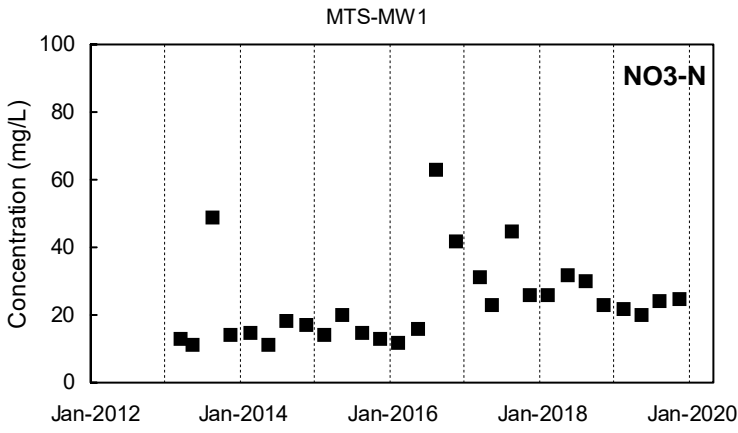

Detected Value
 'J'-Flag (value between reporting limit and detection limit)
 Non-Detect Range
 Shallow Well shown with black symbols
 Deep Well shown with orange symbols
 "dd" Well shown with blue symbols

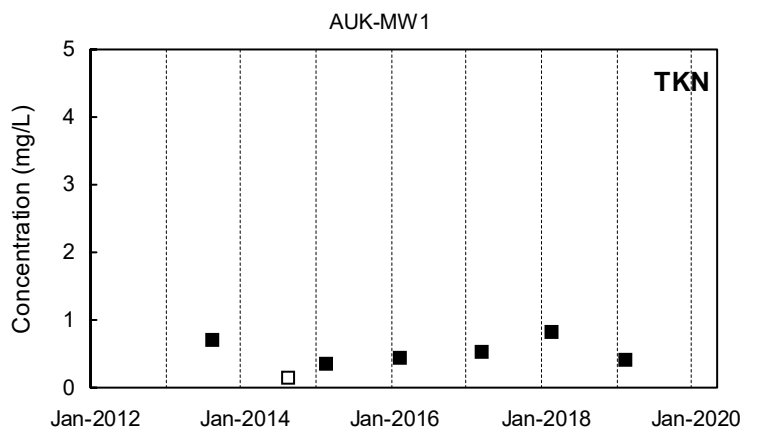
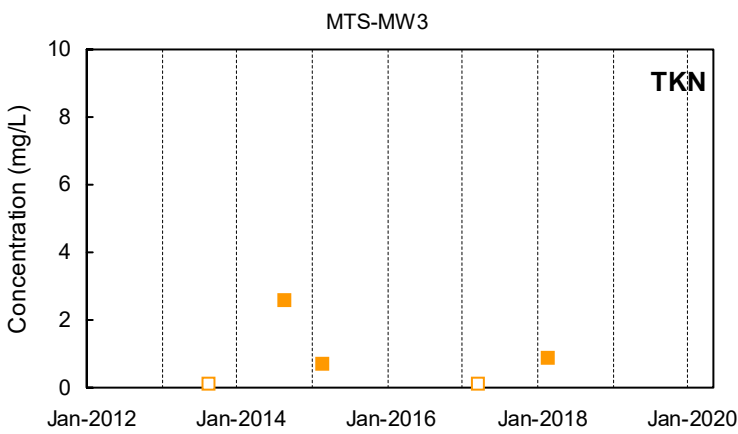
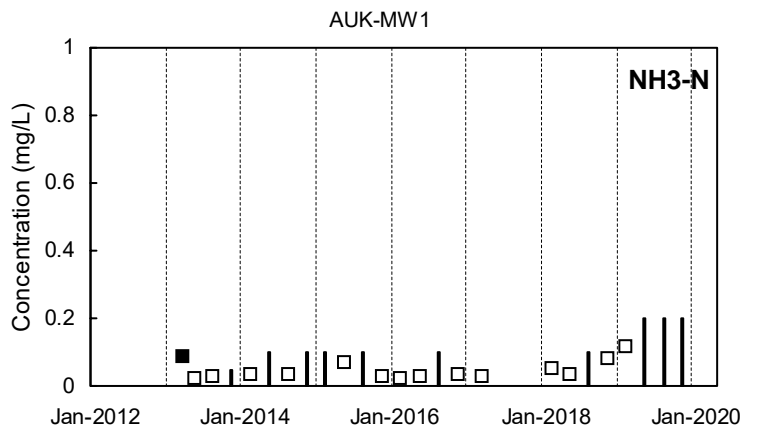
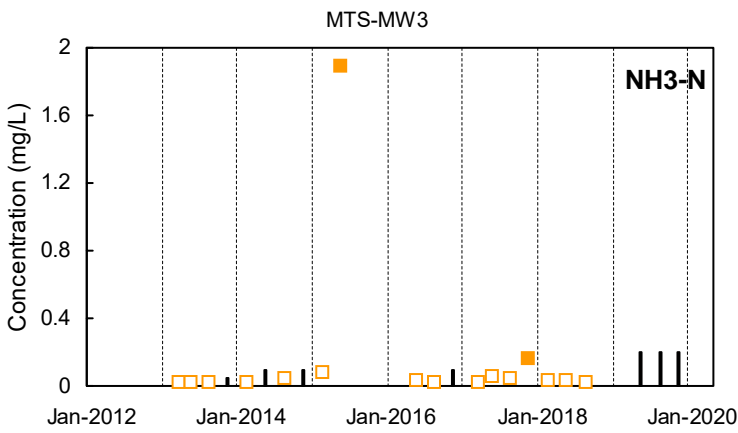
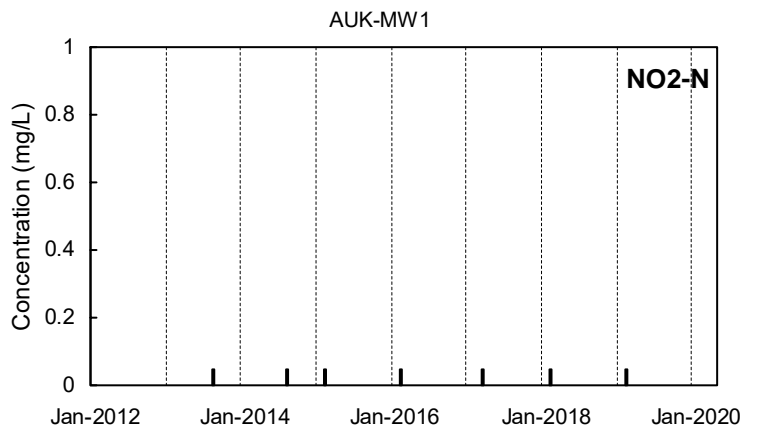
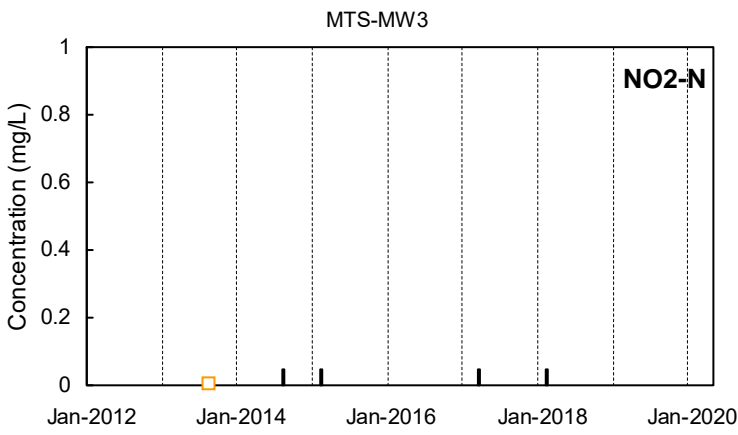
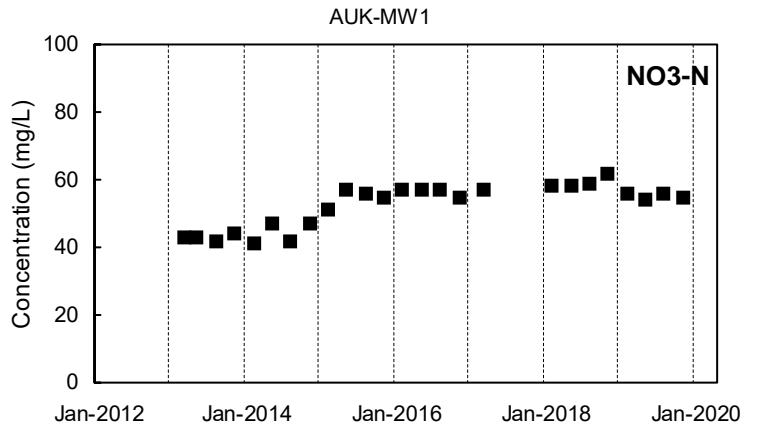
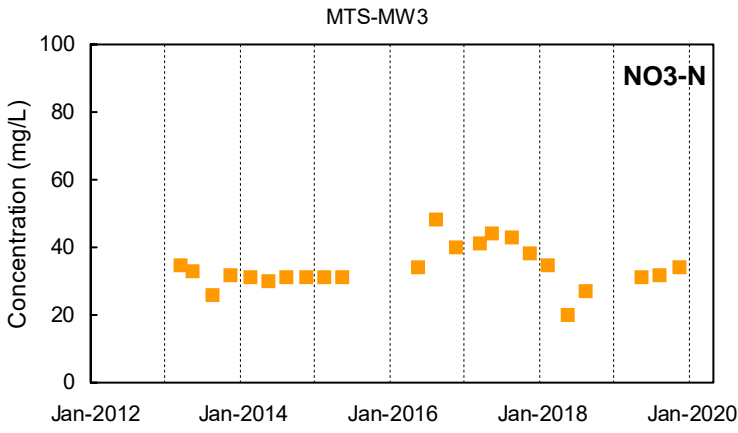

■ Detected Value
 □ 'J'-Flag (value between reporting limit and detection limit)
 Non-Detect Range
■ Shallow Well shown with black symbols
■ Deep Well shown with orange symbols
■ "dd" Well shown with blue symbols

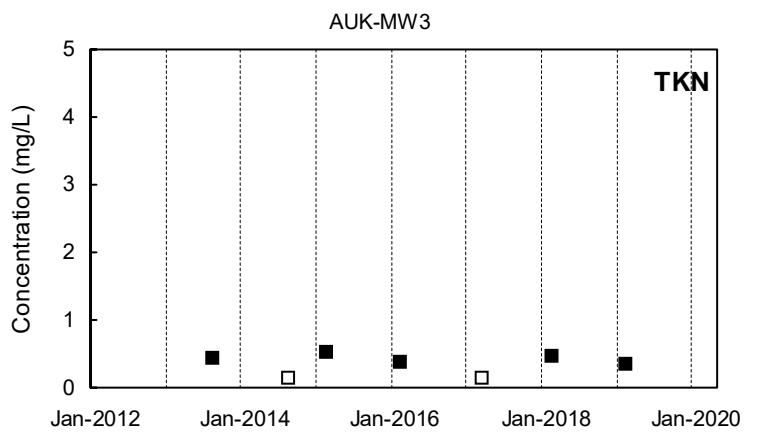
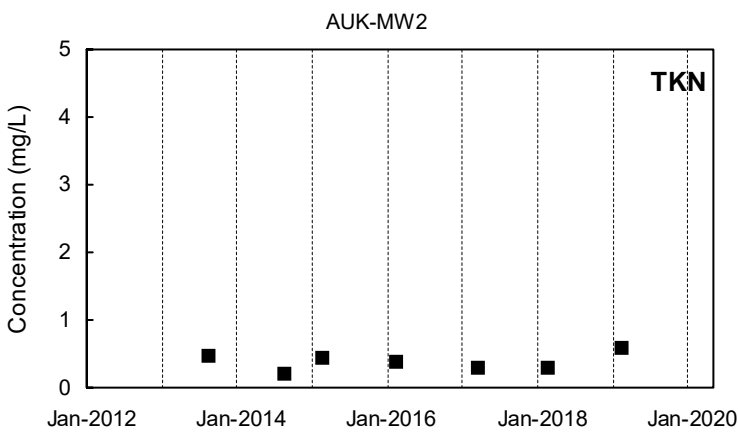
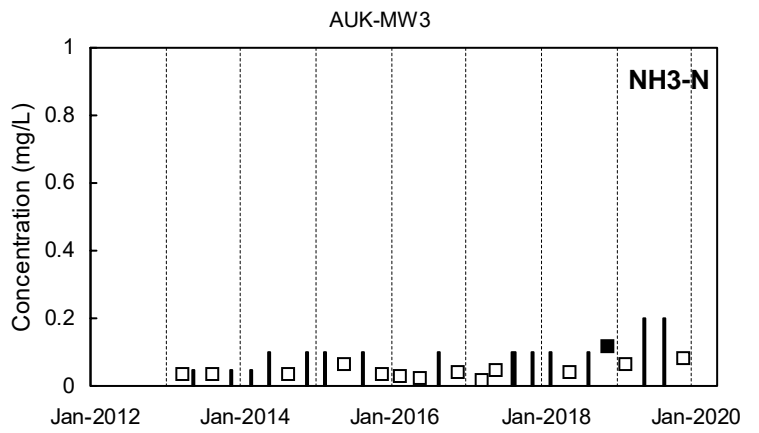
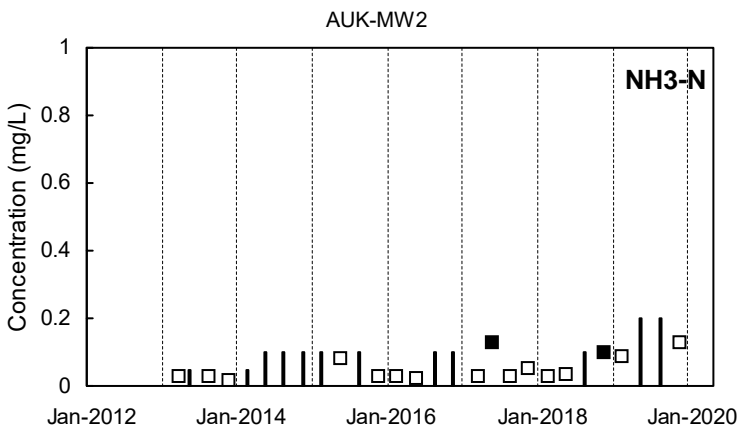
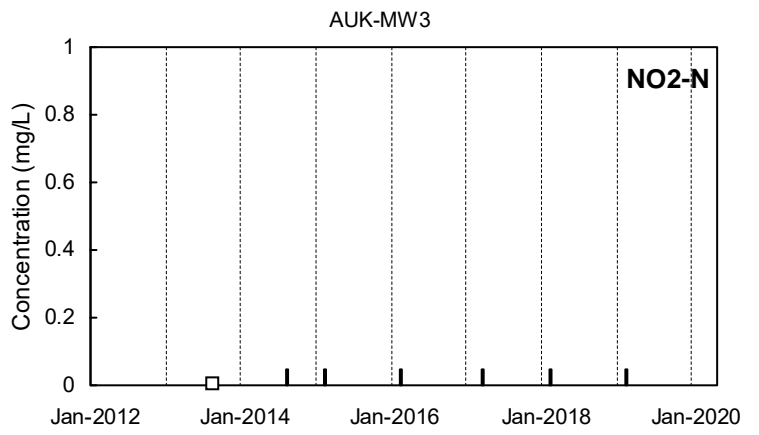
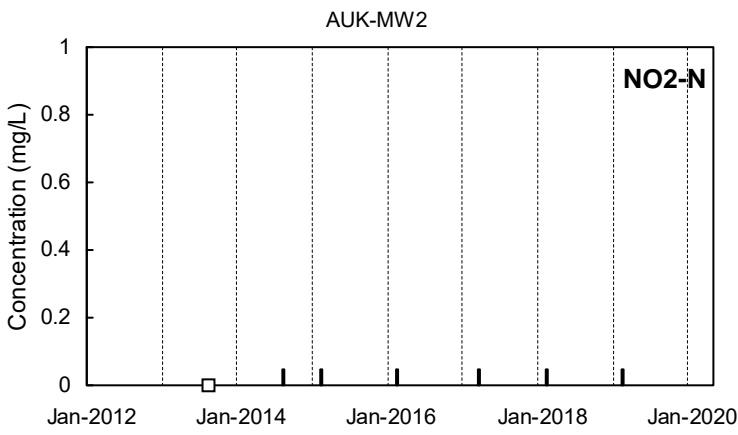
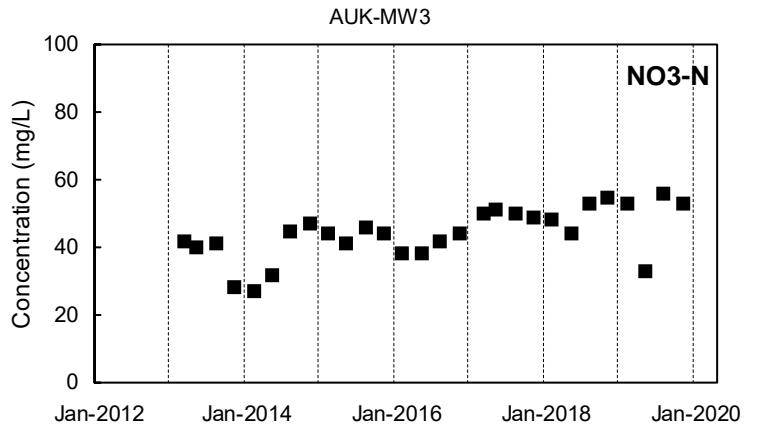
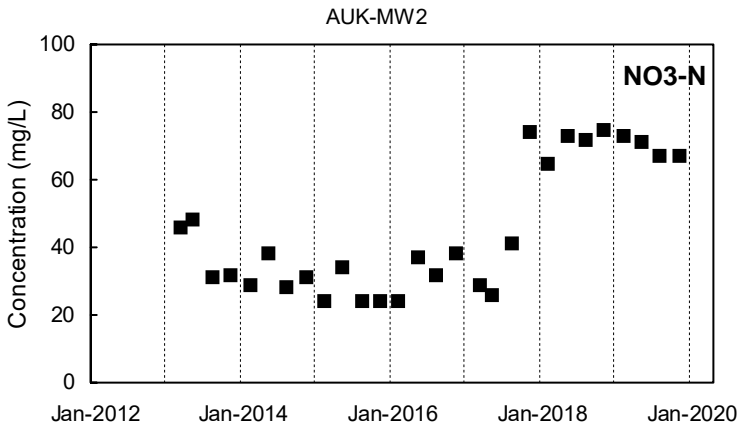

Detected Value
 'J'-Flag (value between reporting limit and detection limit)
 Non-Detect Range
 Shallow Well shown with black symbols
 Deep Well shown with orange symbols
 "dd" Well shown with blue symbols

DLF-MW1

DLF-MW2

NO3-N
Not Sampled

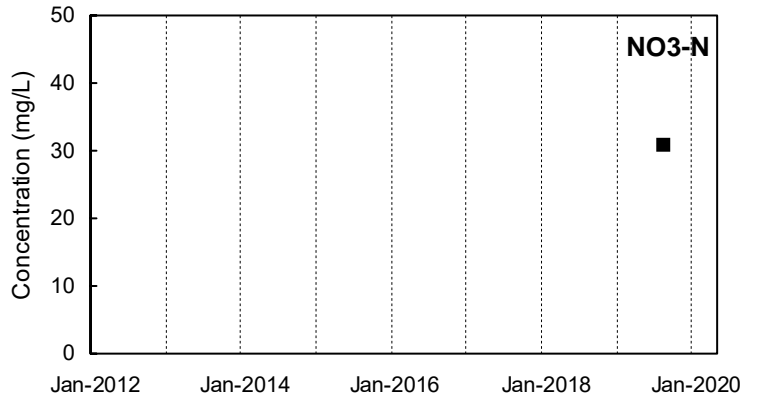

DLF-MW1

DLF-MW2

NO2-N
Not Sampled

NO2-N
Not Sampled

DLF-MW1

DLF-MW2

NH3-N
Not Sampled

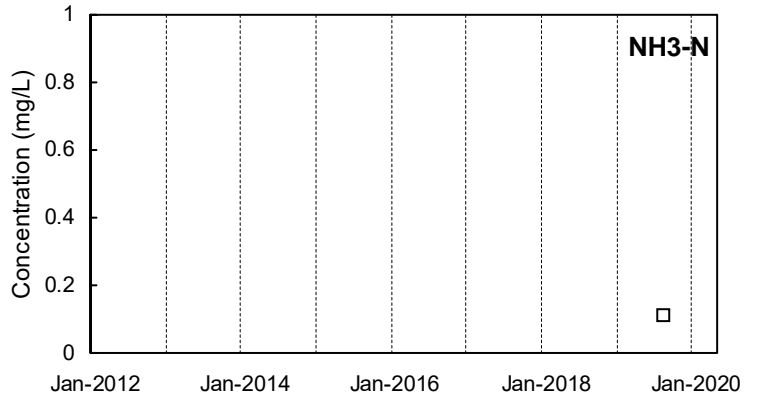

DLF-MW1

DLF-MW2

TKN
Not Sampled

TKN
Not Sampled

■ Detected Value

□ 'J'-Flag (value between reporting limit and detection limit)

█ Non-Detect Range

Shallow Well shown with black symbols

Deep Well shown with orange symbols

"dd" Well shown with blue symbols

DLF-MW3

DLF-MW4A

NO3-N
Not Sampled

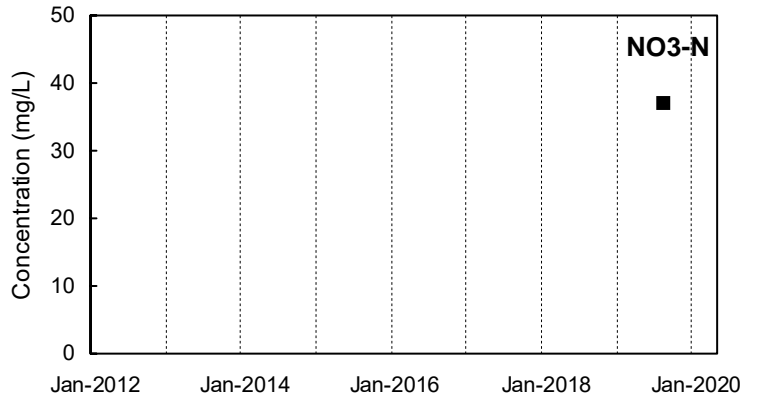

DLF-MW3

DLF-MW4A

NO2-N
Not Sampled

NO2-N
Not Sampled

DLF-MW3

DLF-MW4A

NH3-N
Not Sampled

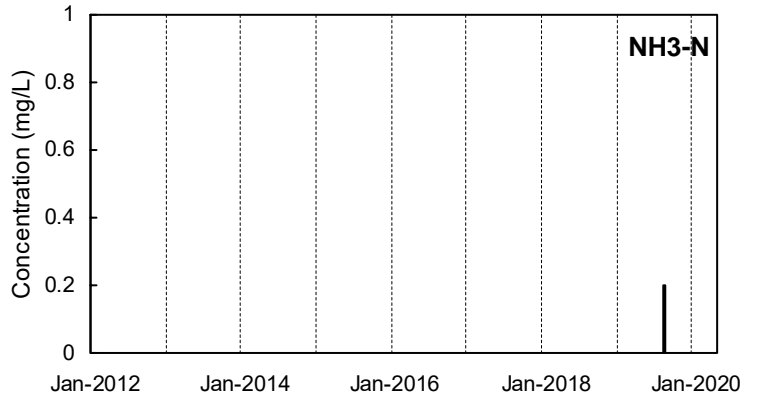

DLF-MW3

DLF-MW4A

TKN
Not Sampled

TKN
Not Sampled

■ Detected Value

□ 'J'-Flag (value between reporting limit and detection limit)

■ Non-Detect Range

Shallow Well shown with black symbols

Deep Well shown with orange symbols

"dd" Well shown with blue symbols

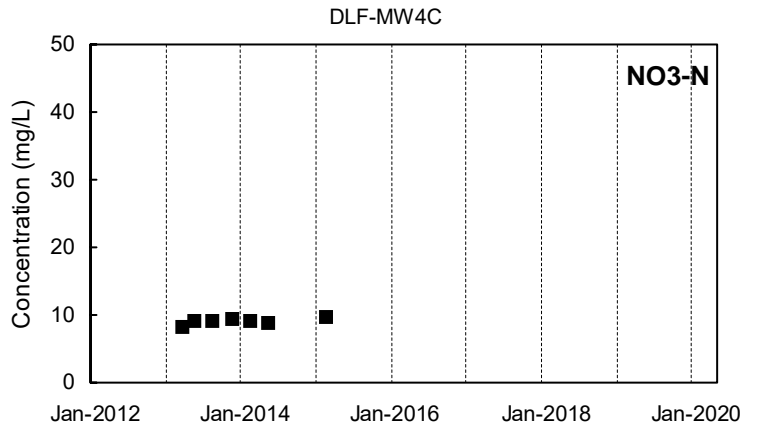
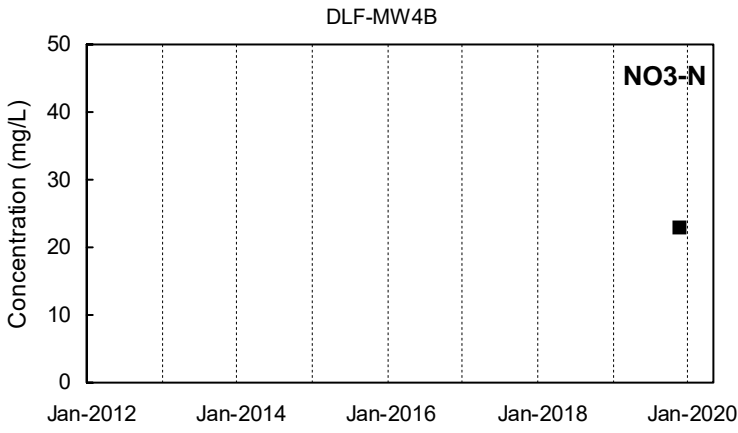

DLF-MW4B
NO2-N
Not Sampled

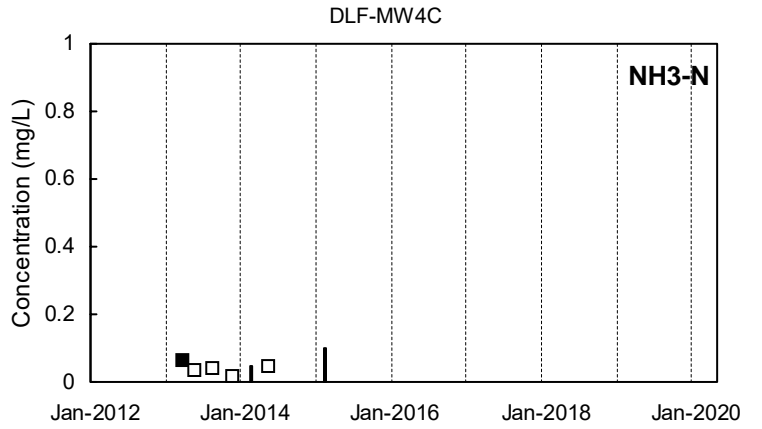
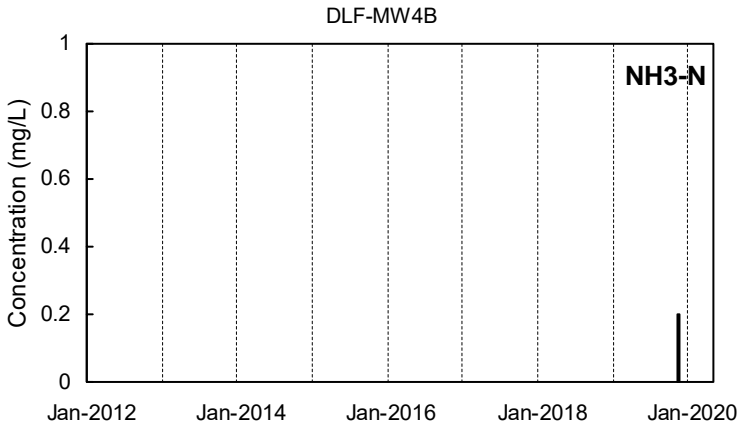
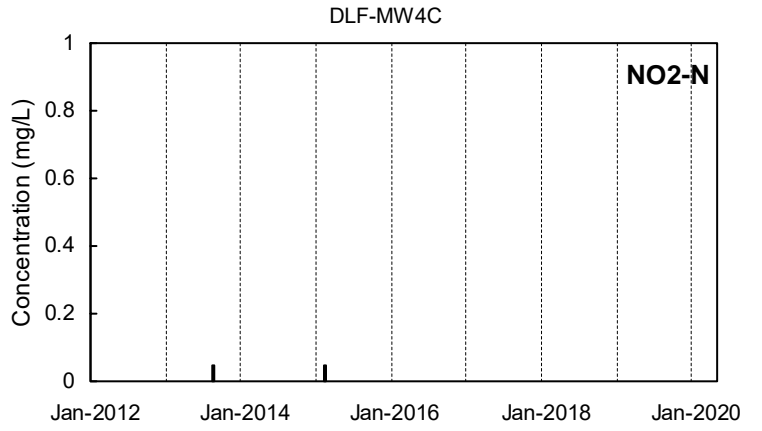

DLF-MW4B
TKN
Not Sampled

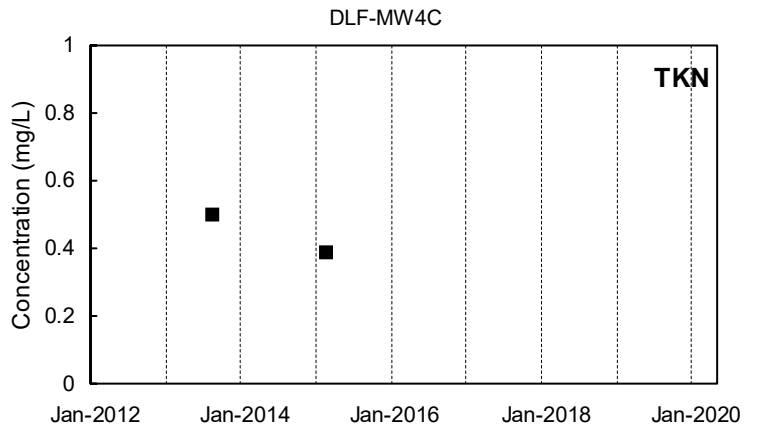

Detected Value
 'J'-Flag (value between reporting limit and detection limit)
 Non-Detect Range
 Shallow Well shown with black symbols Deep Well shown with orange symbols "dd" Well shown with blue symbols

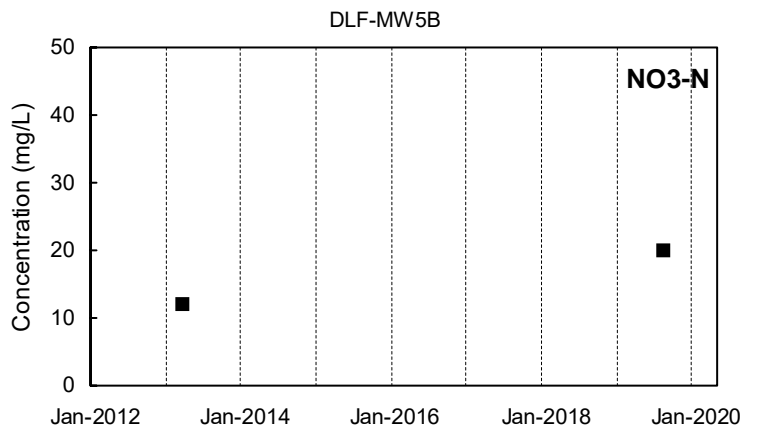
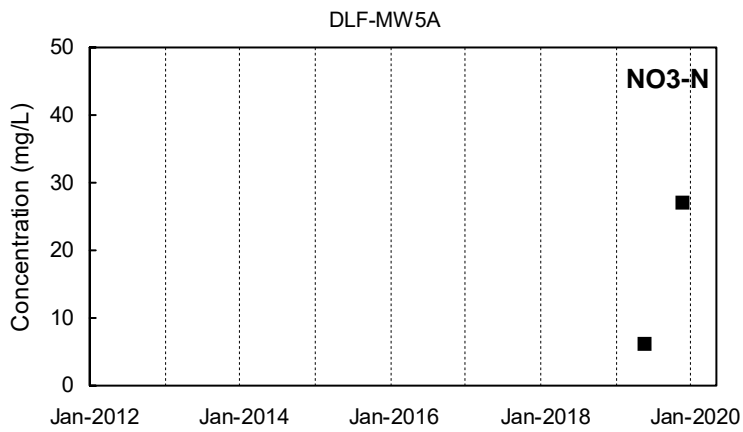

DLF-MW5A

DLF-MW5B

NO2-N
Not Sampled

NO2-N
Not Sampled

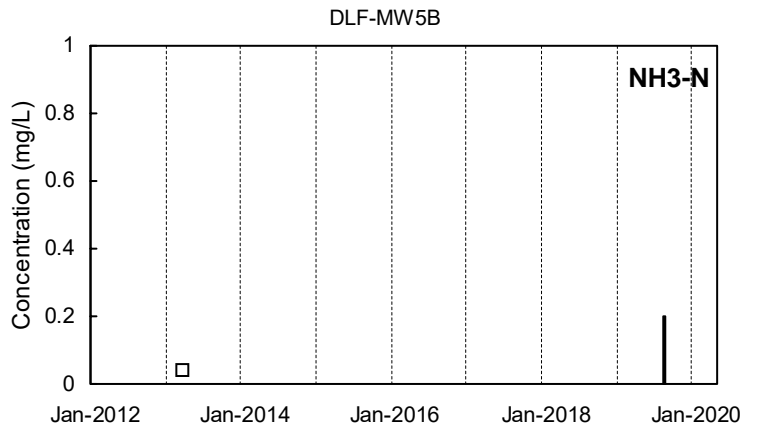
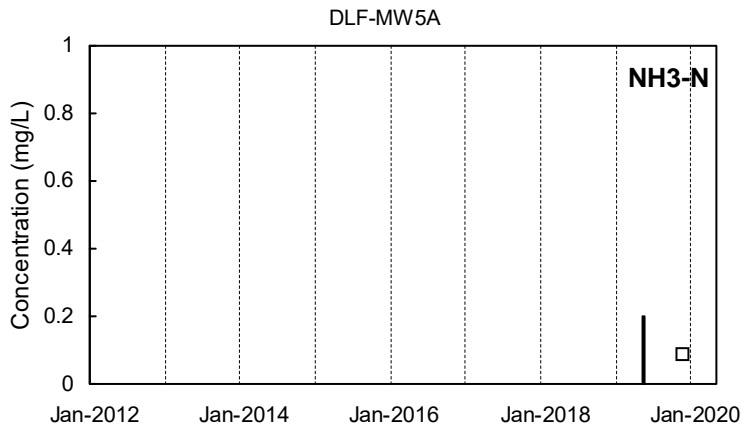

DLF-MW5A

DLF-MW5B

TKN
Not Sampled

TKN
Not Sampled

Detected Value
 'J'-Flag (value between reporting limit and detection limit)
 Non-Detect Range
 Shallow Well shown with black symbols Deep Well shown with orange symbols "dd" Well shown with blue symbols

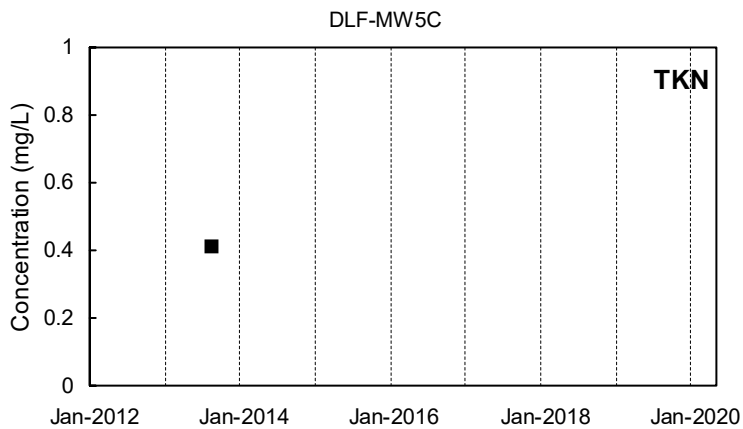
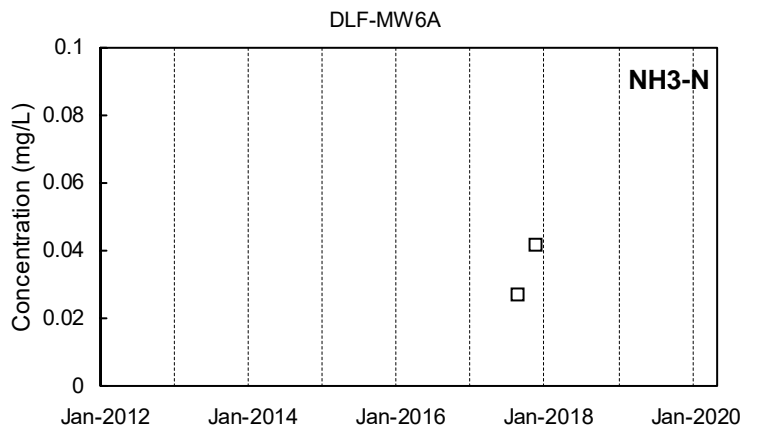
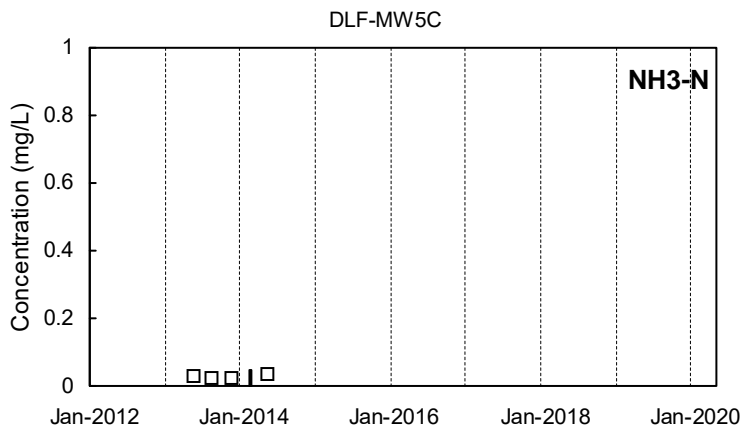
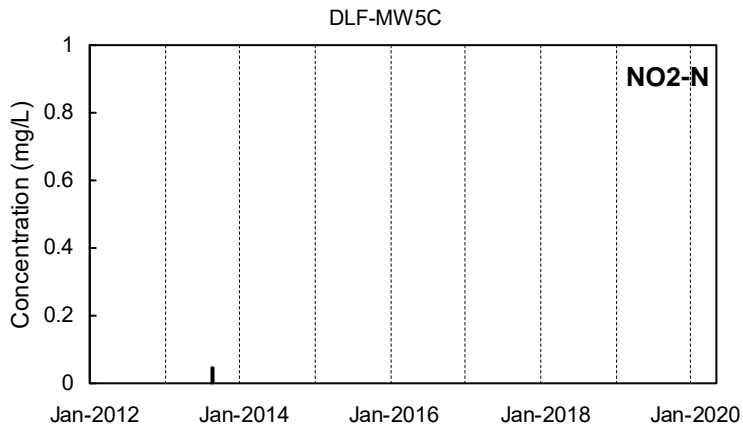
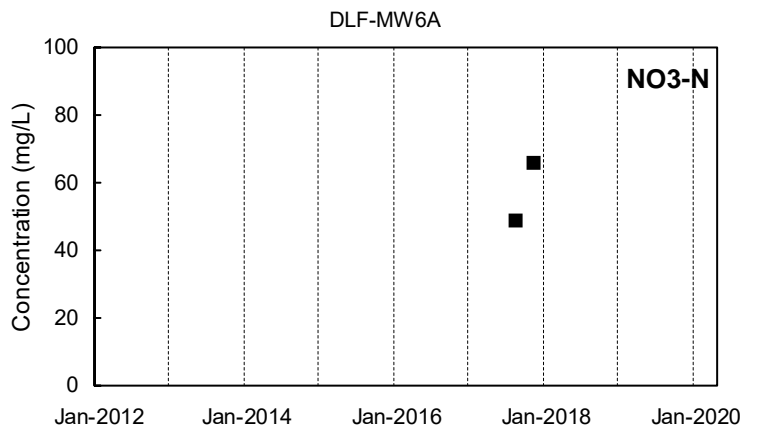
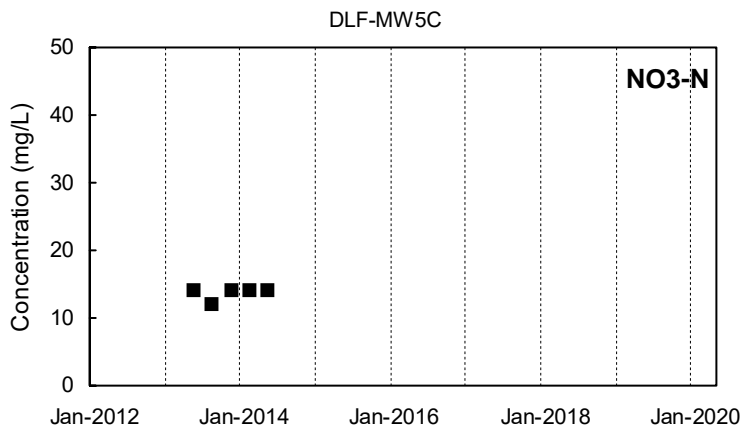

Detected Value
 'J'-Flag (value between reporting limit and detection limit)
 Non-Detect Range
 Shallow Well shown with black symbols Deep Well shown with orange symbols "dd" Well shown with blue symbols

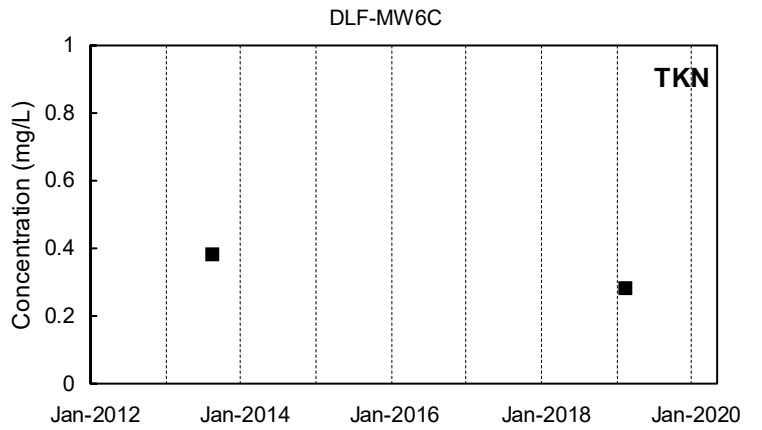
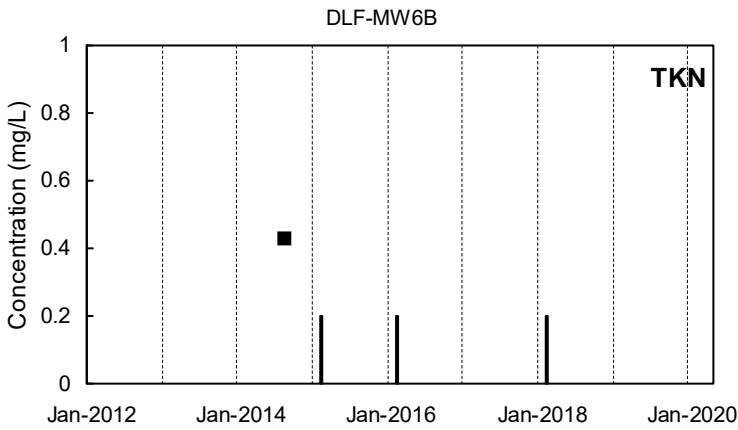
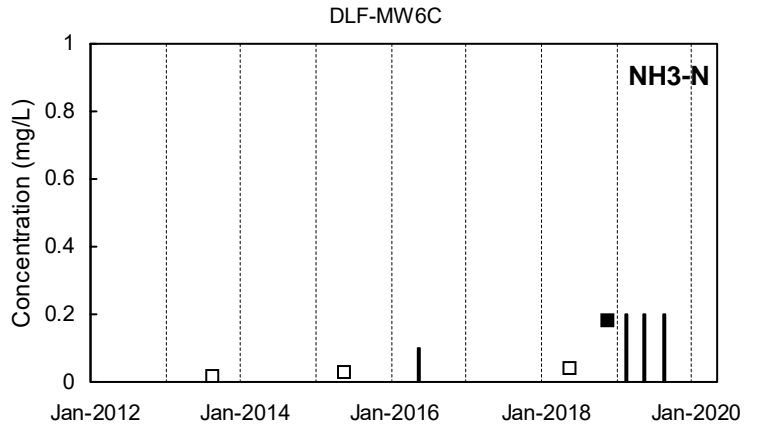
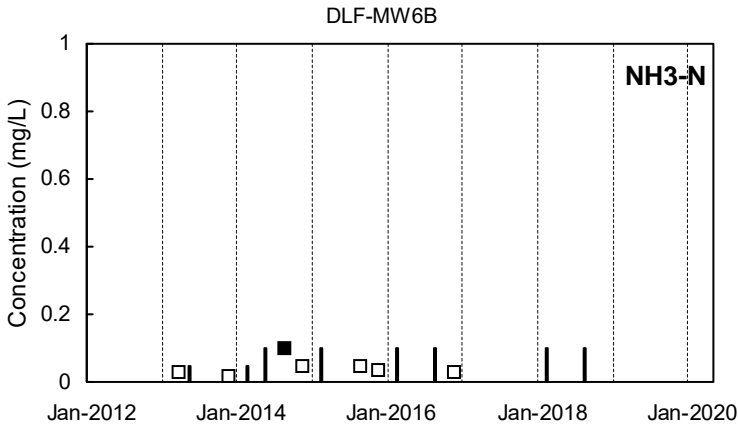
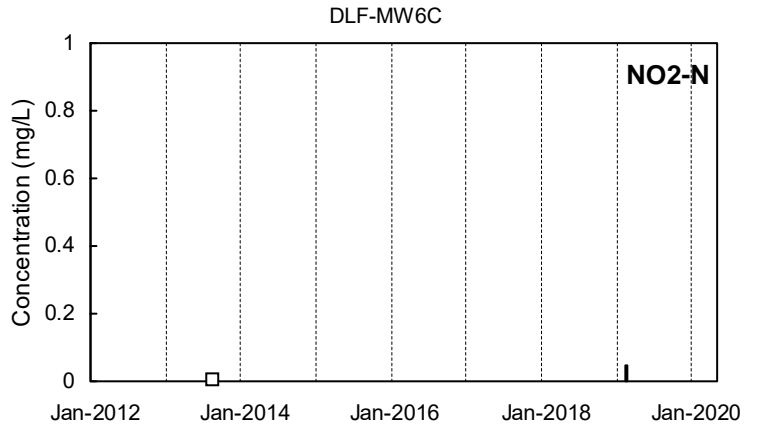
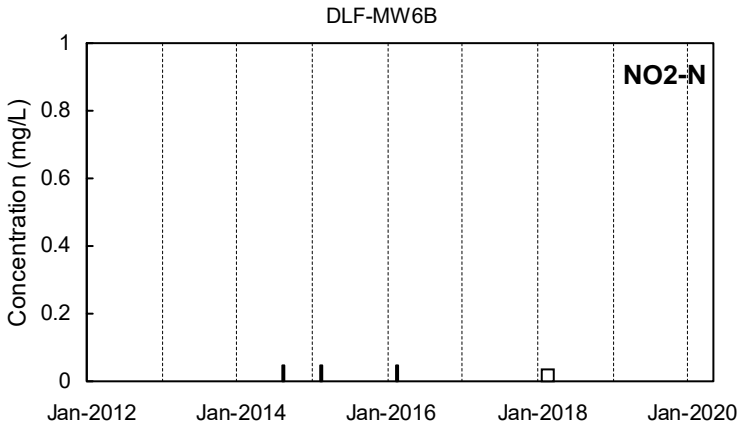
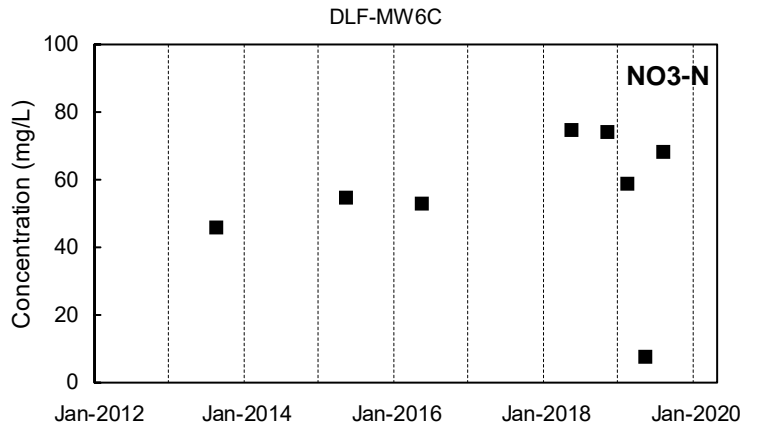
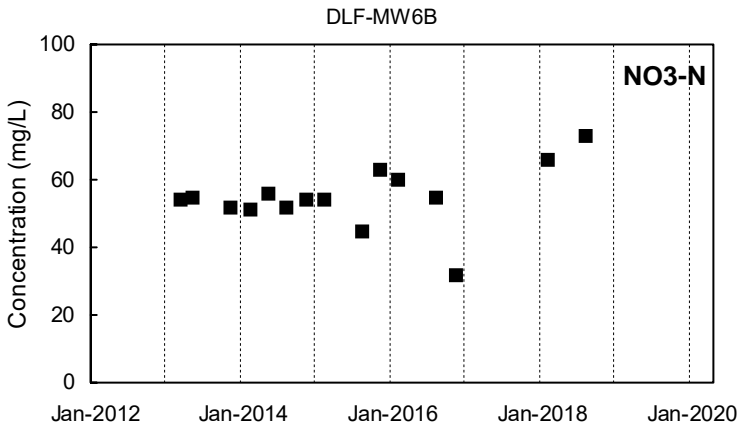

■ Detected Value □ 'J'-Flag (value between reporting limit and detection limit) ■ Non-Detect Range
 Shallow Well shown with black symbols Deep Well shown with orange symbols "dd" Well shown with blue symbols

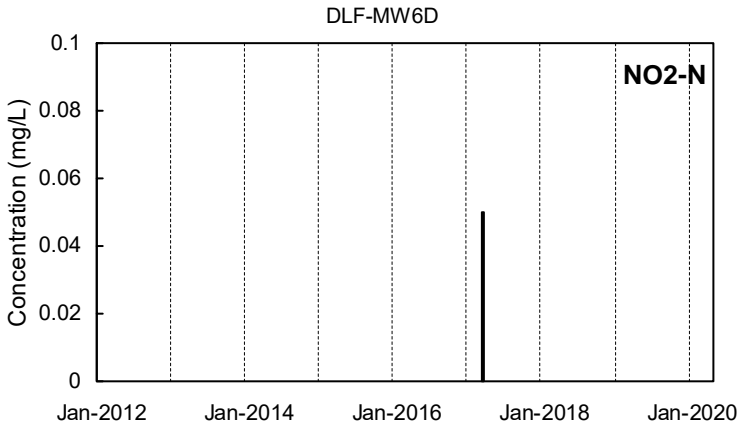
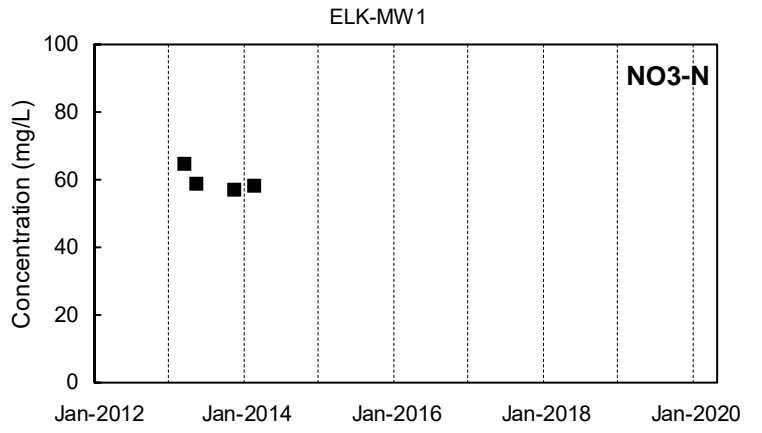
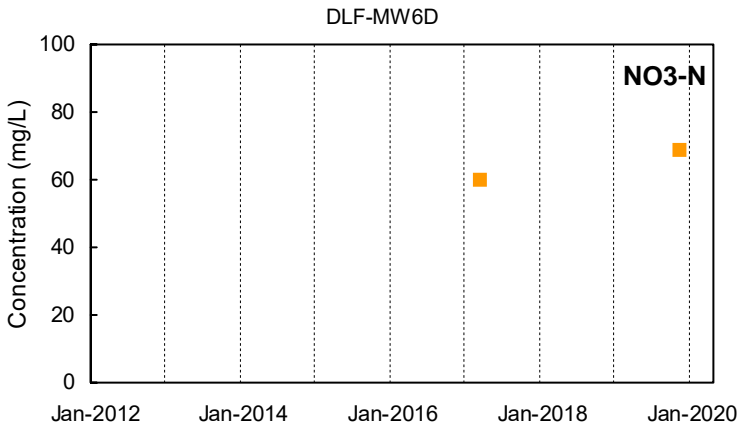

ELK-MW1
NO2-N
Not Sampled

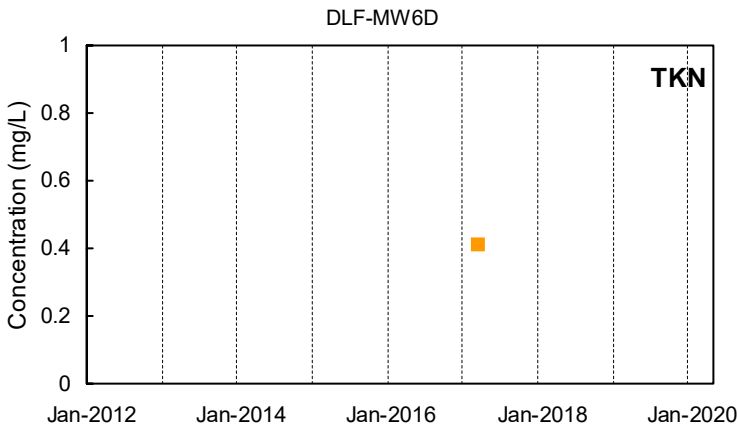
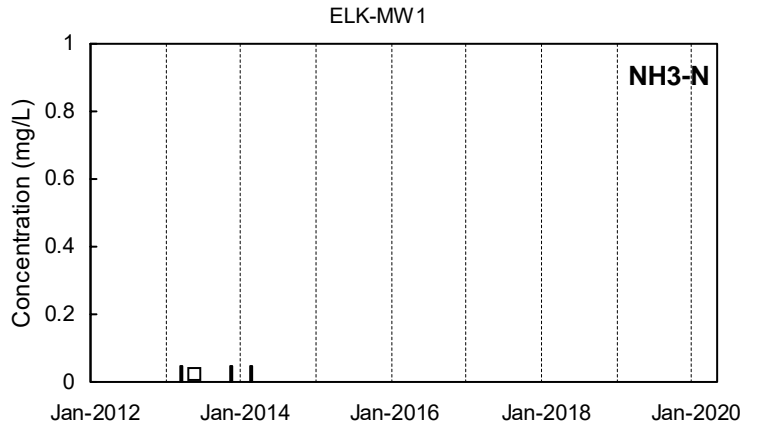
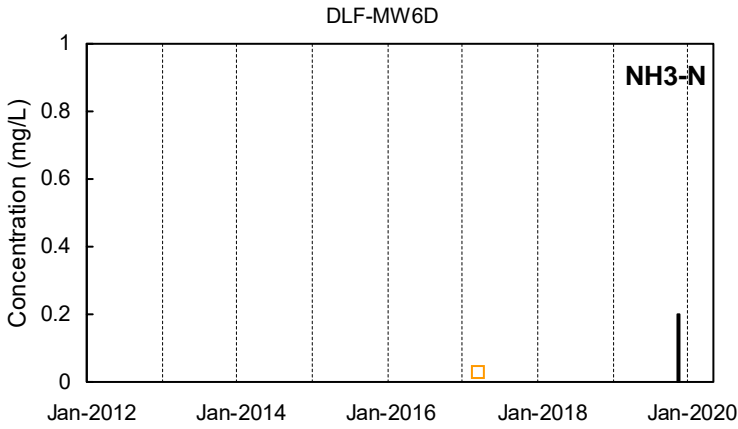

ELK-MW1
TKN
Not Sampled

Detected Value
 'J'-Flag (value between reporting limit and detection limit)
 Non-Detect Range
 Shallow Well shown with black symbols
 Deep Well shown with orange symbols
 "dd" Well shown with blue symbols

ELK-MW2A

NO3-N
Not Sampled

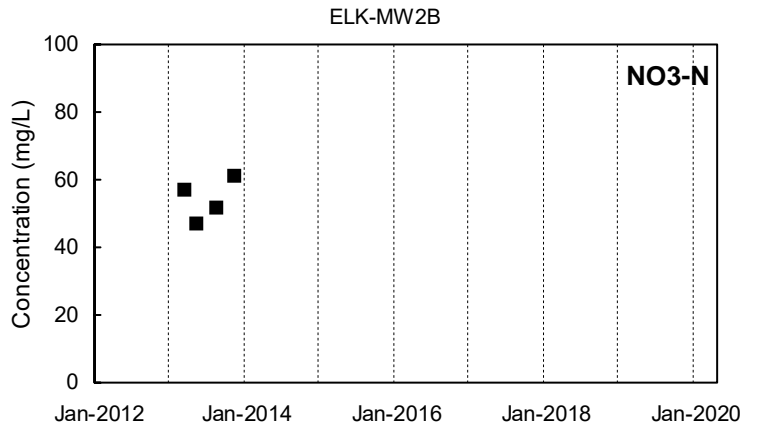

ELK-MW2A

NO2-N
Not Sampled

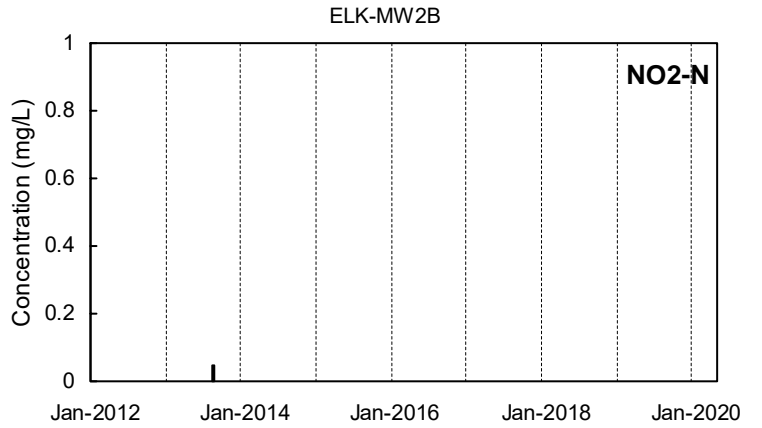

ELK-MW2A

NH3-N
Not Sampled

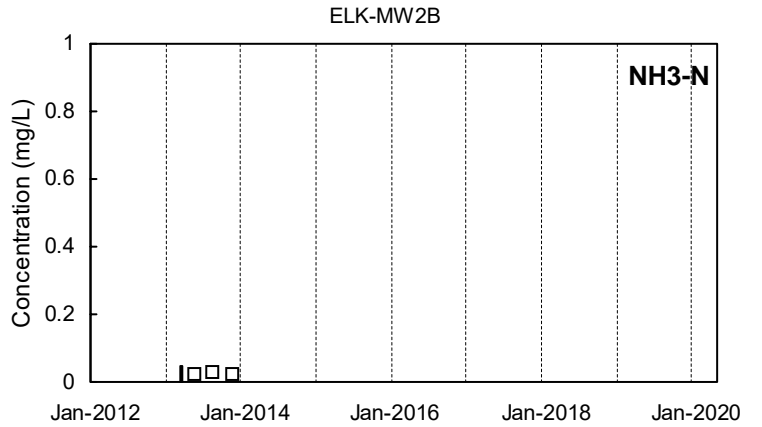

ELK-MW2A

TKN
Not Sampled

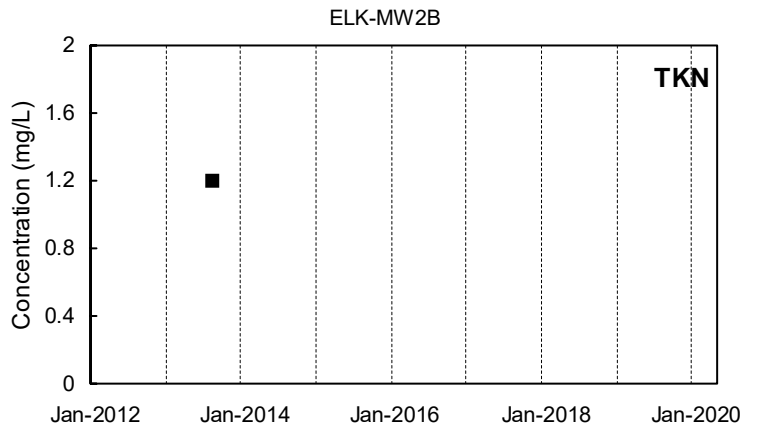

■ Detected Value □ 'J'-Flag (value between reporting limit and detection limit) ■ Non-Detect Range
 Shallow Well shown with black symbols Deep Well shown with orange symbols "dd" Well shown with blue symbols

ELK-MW3A

NO3-N

Not Sampled

ELK-MW3B

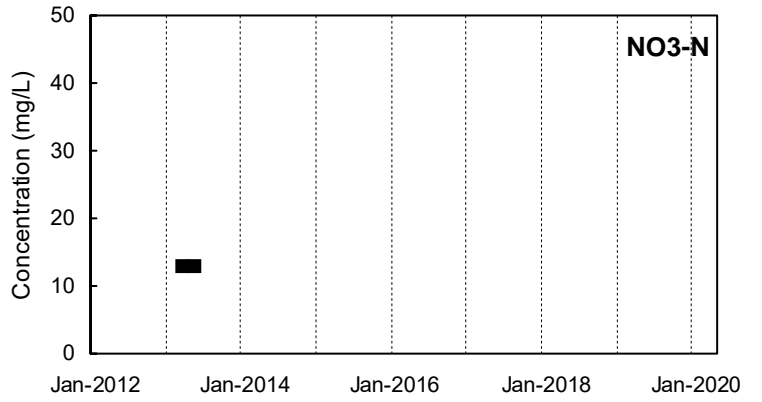

ELK-MW3A

NO2-N

Not Sampled

ELK-MW3B

NO2-N

Not Sampled

ELK-MW3A

NH3-N

Not Sampled

ELK-MW3B

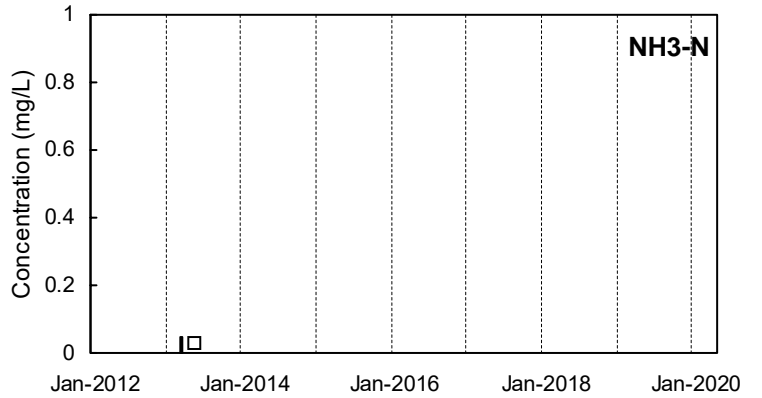

ELK-MW3A

TKN

Not Sampled

ELK-MW3B

TKN

Not Sampled

■ Detected Value

□ 'J'-Flag (value between reporting limit and detection limit)

■ Non-Detect Range

Shallow Well shown with black symbols

Deep Well shown with orange symbols

"dd" Well shown with blue symbols

ELK-MW4

NO3-N

Not Sampled

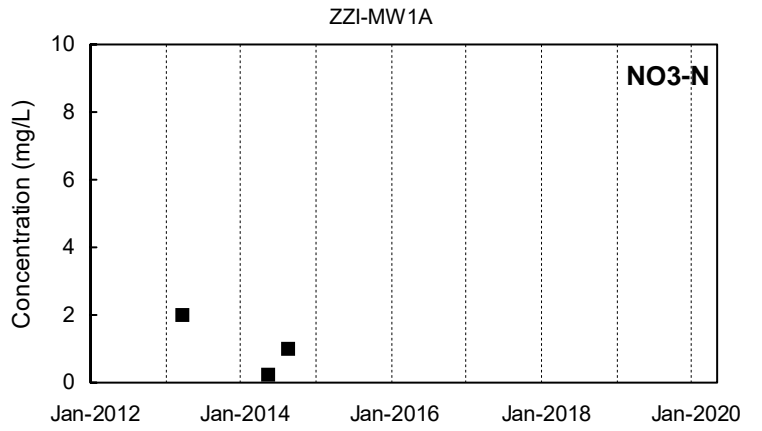

ELK-MW4

NO2-N

Not Sampled

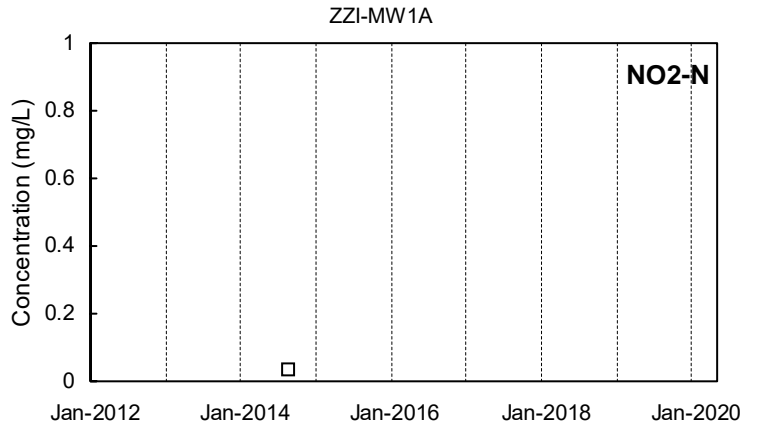

ELK-MW4

NH3-N

Not Sampled

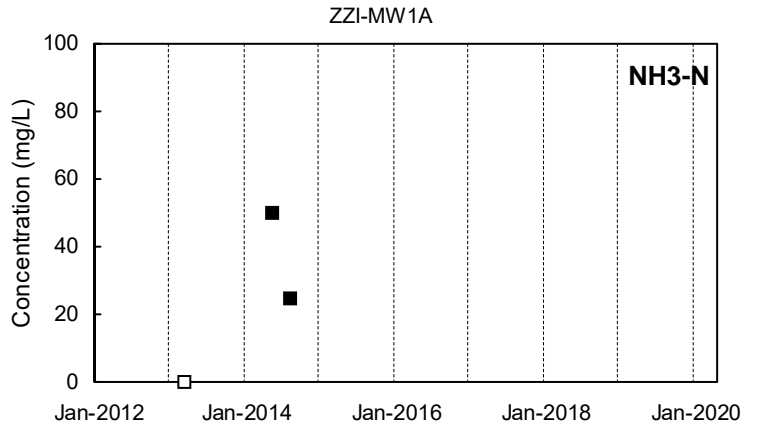

ELK-MW4

TKN

Not Sampled

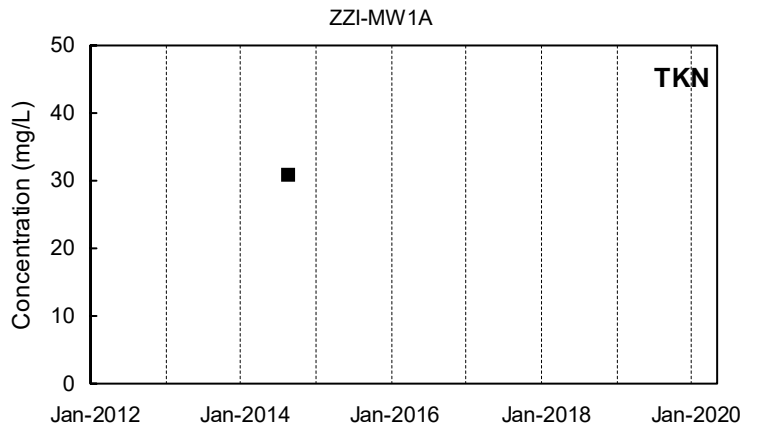

■ Detected Value

□ 'J'-Flag (value between reporting limit and detection limit)

■ Non-Detect Range

Shallow Well shown with black symbols

Deep Well shown with orange symbols

"dd" Well shown with blue symbols

ZZI-MW1B

NO3-N

Not Sampled

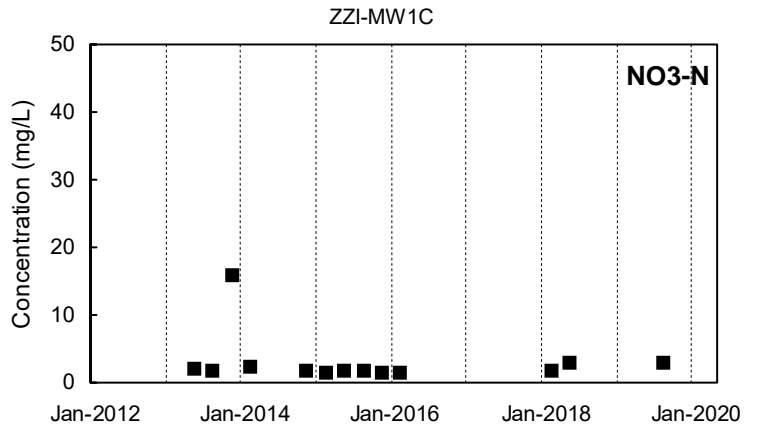

ZZI-MW1B

NO2-N

Not Sampled

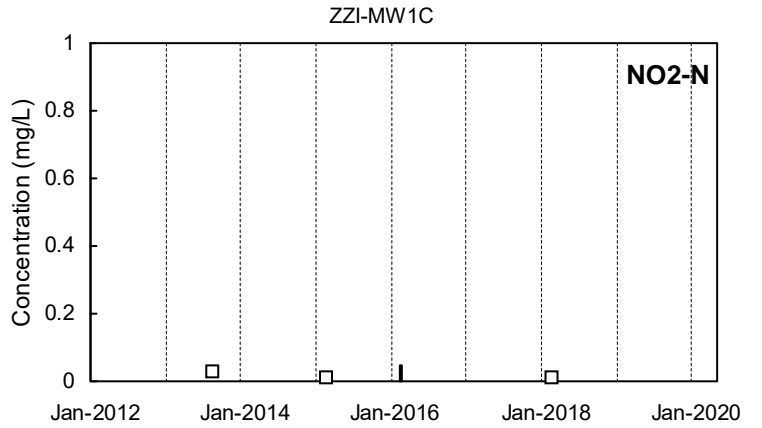

ZZI-MW1B

NH3-N

Not Sampled

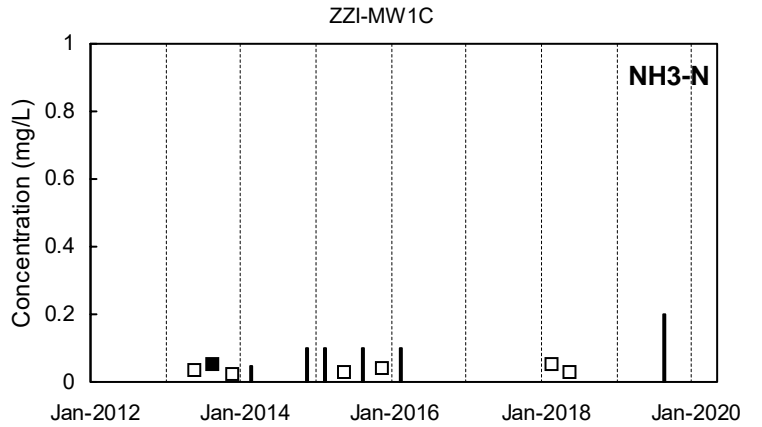

ZZI-MW1B

TKN

Not Sampled

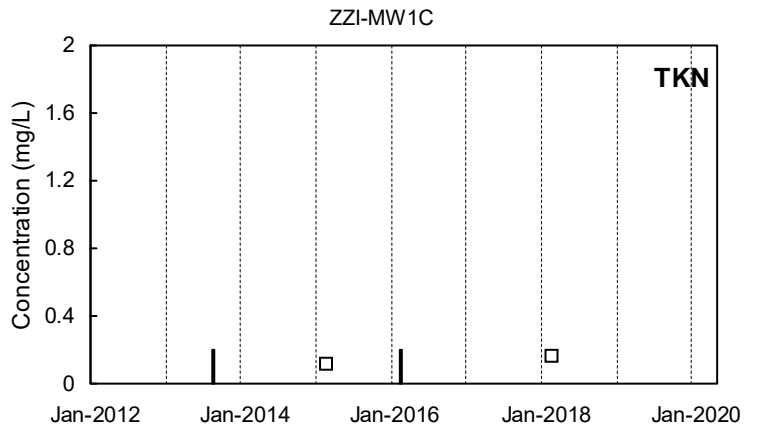

■ Detected Value □ 'J'-Flag (value between reporting limit and detection limit) ■ Non-Detect Range
 ■ Shallow Well shown with black symbols ■ Deep Well shown with orange symbols ■ "dd" Well shown with blue symbols

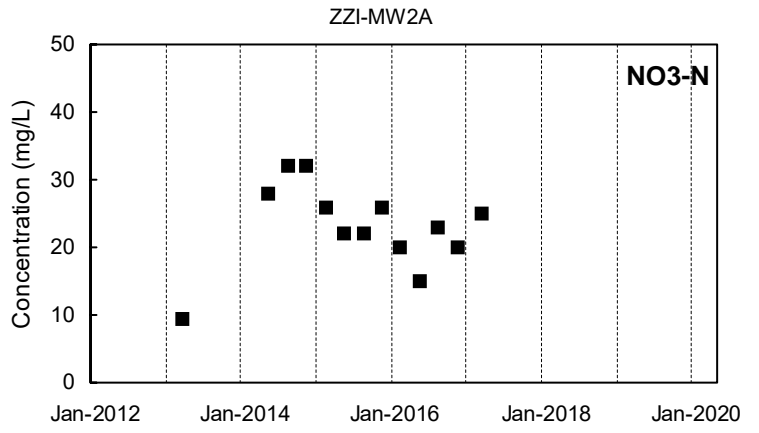
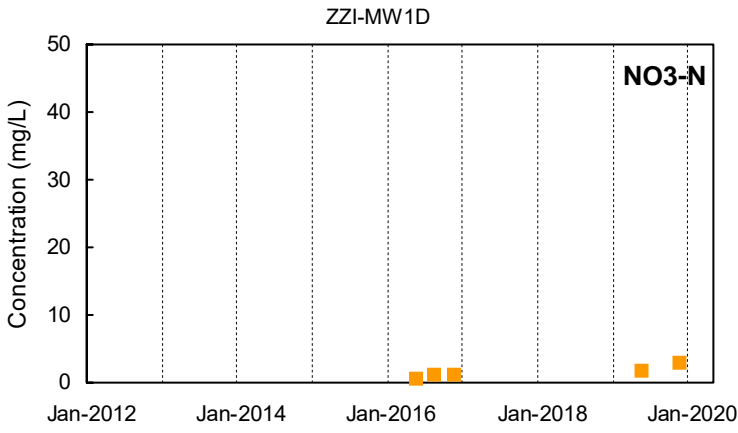

ZZI-MW1D NO2-N
Not Sampled

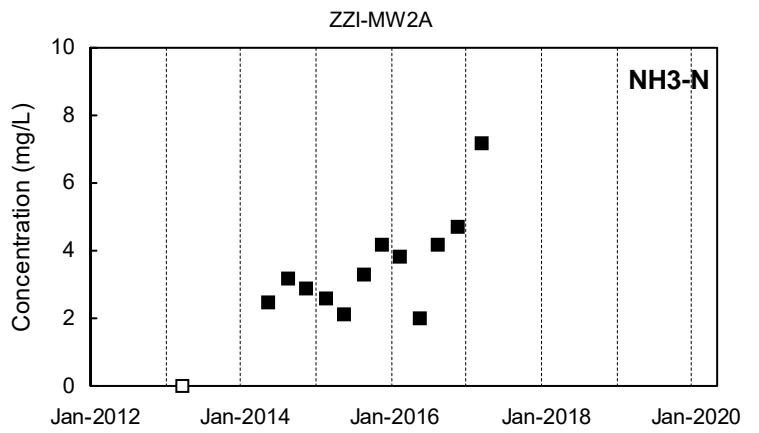
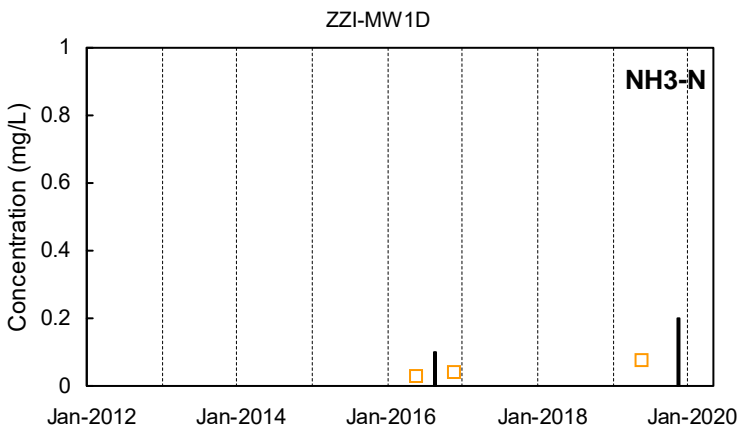
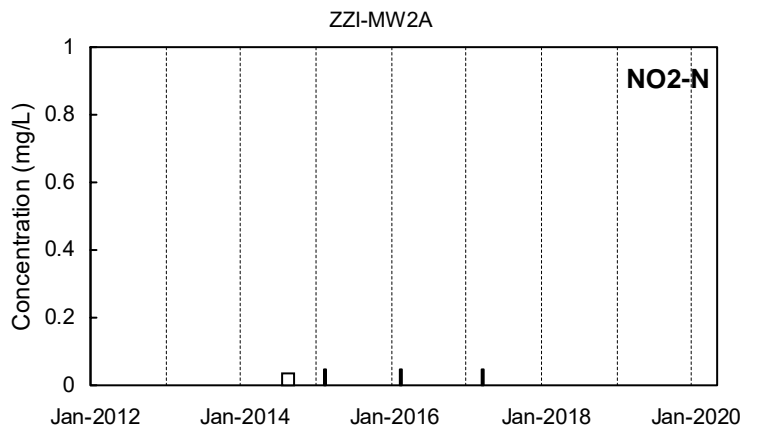

ZZI-MW1D TKN
Not Sampled

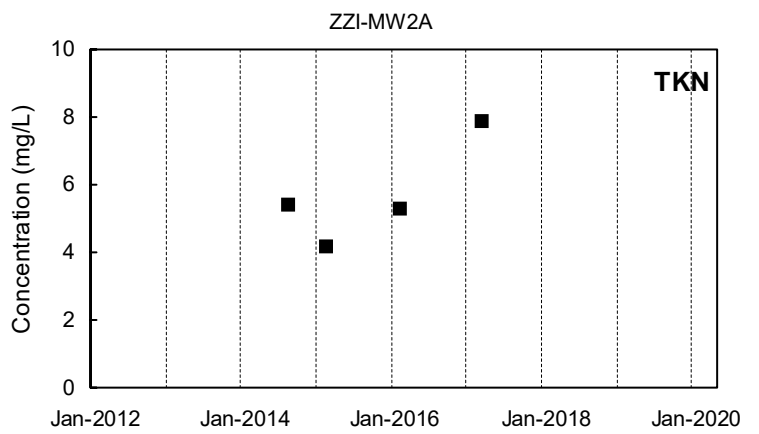

Detected Value
 'J'-Flag (value between reporting limit and detection limit)
 Non-Detect Range
Shallow Well shown with black symbols
Deep Well shown with orange symbols
"dd" Well shown with blue symbols

ZZI-MW2B

NO3-N

Not Sampled

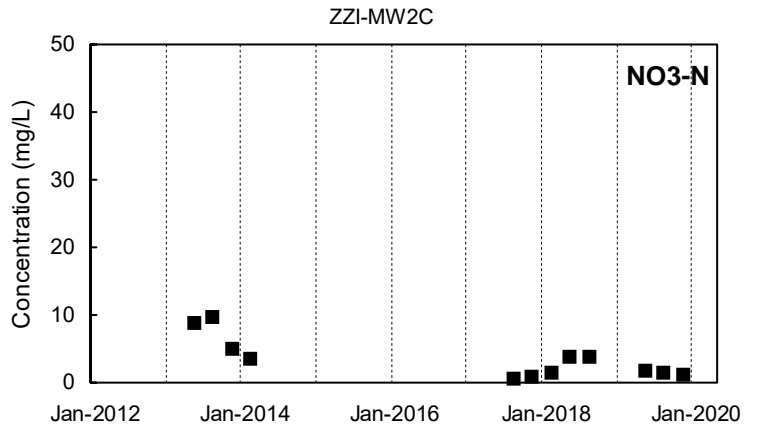

ZZI-MW2B

NO2-N

Not Sampled

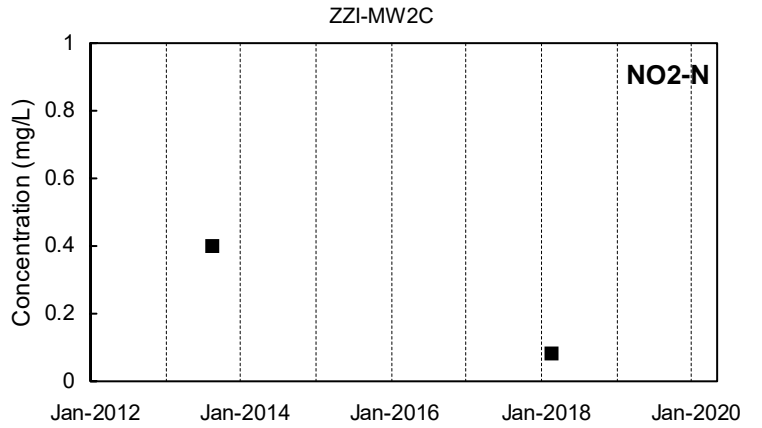

ZZI-MW2B

NH3-N

Not Sampled

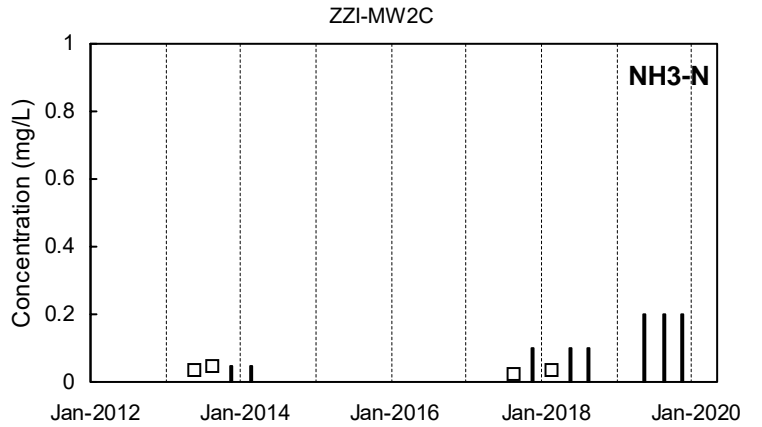

ZZI-MW2B

TKN

Not Sampled

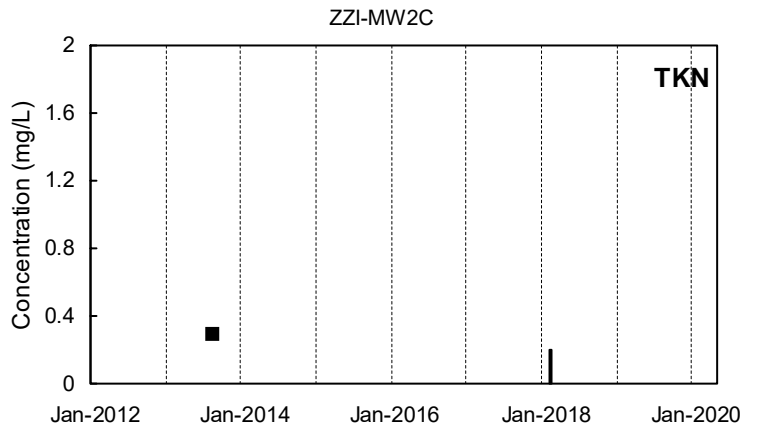

■ Detected Value

□ 'J'-Flag (value between reporting limit and detection limit)

■ Non-Detect Range

Shallow Well shown with black symbols

Deep Well shown with orange symbols

"dd" Well shown with blue symbols

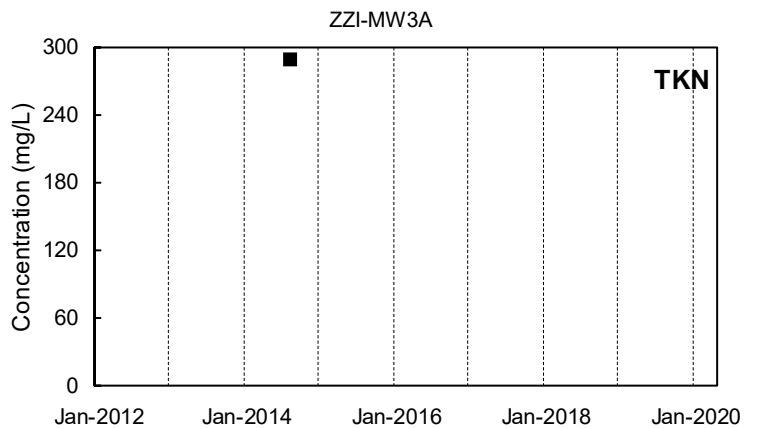
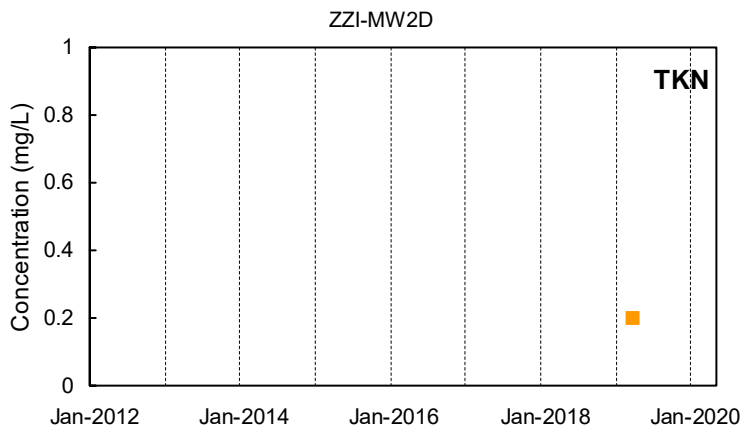
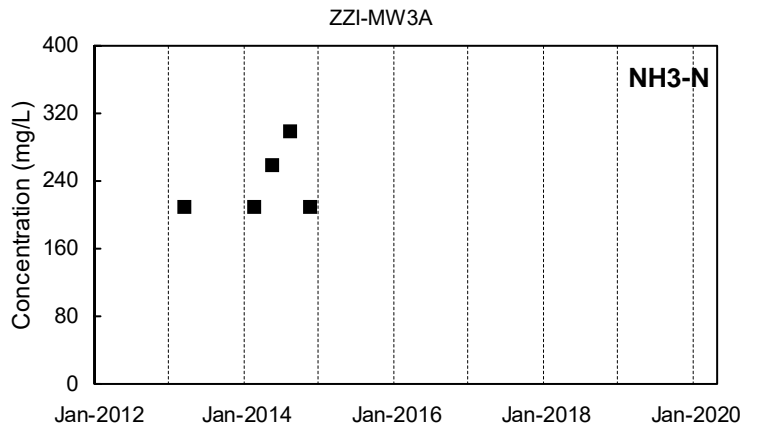
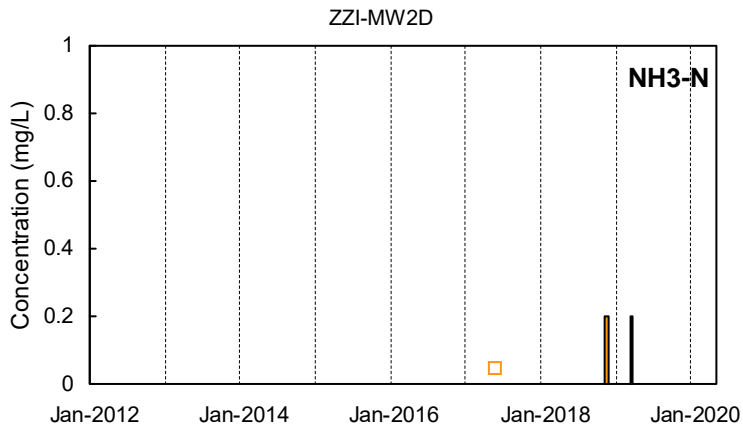
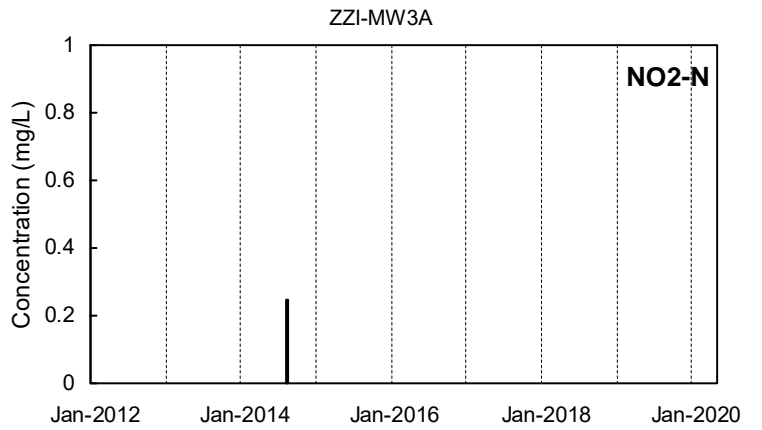
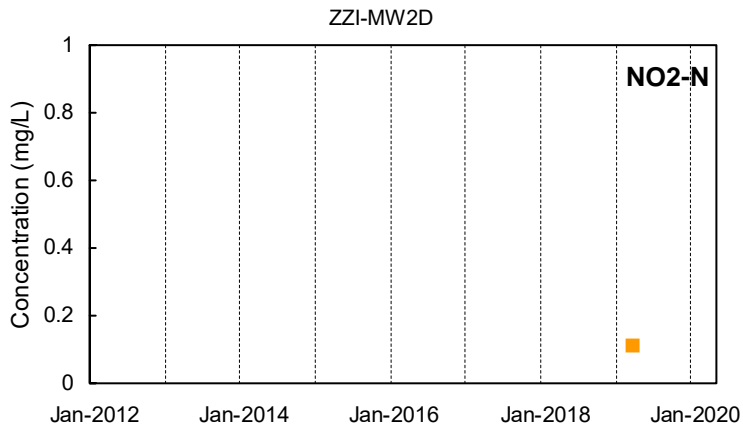
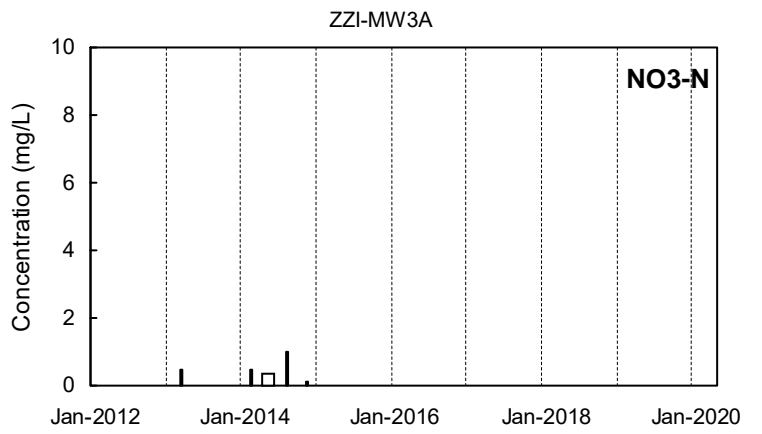
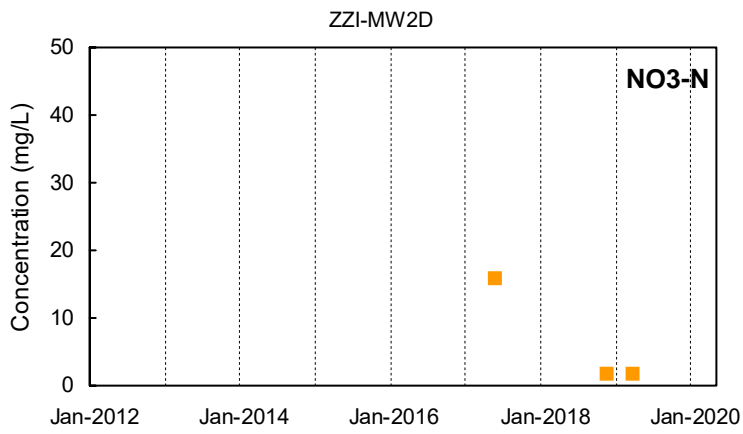

■ Detected Value □ 'J'-Flag (value between reporting limit and detection limit) ■ Non-Detect Range
 ■ Shallow Well shown with black symbols ■ Deep Well shown with orange symbols ■ "dd" Well shown with blue symbols

ZZI-MW5A

ZZI-MW5B

NO3-N

NO3-N

Not Sampled

Not Sampled

ZZI-MW5A

ZZI-MW5B

NO2-N

NO2-N

Not Sampled

Not Sampled

ZZI-MW5A

ZZI-MW5B

NH3-N

NH3-N

Not Sampled

Not Sampled

ZZI-MW5A

ZZI-MW5B

TKN

TKN

Not Sampled

Not Sampled

Detected Value
 'J'-Flag (value between reporting limit and detection limit)
 Non-Detect Range

Shallow Well shown with black symbols
 Deep Well shown with orange symbols
 "dd" Well shown with blue symbols

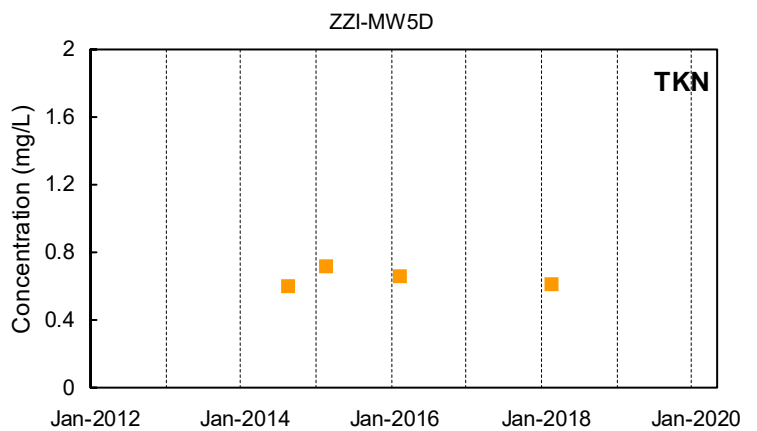
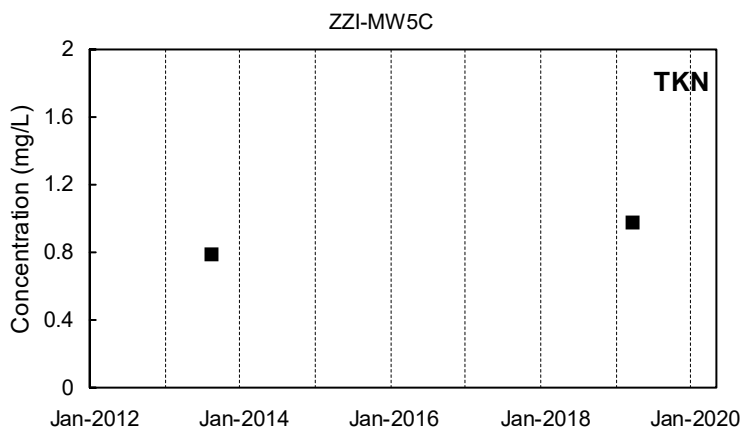
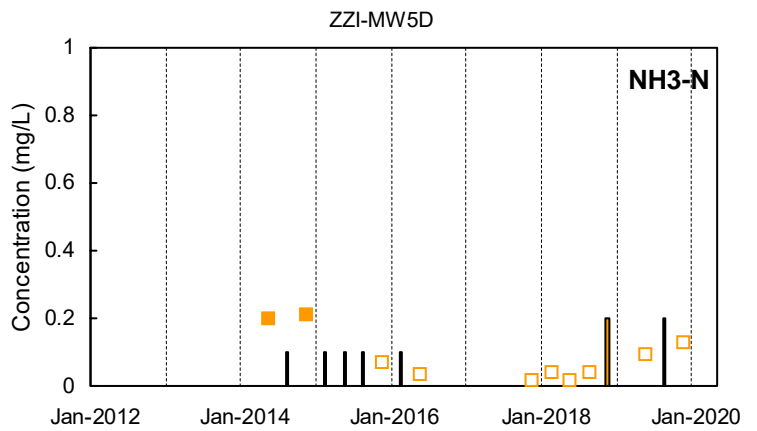
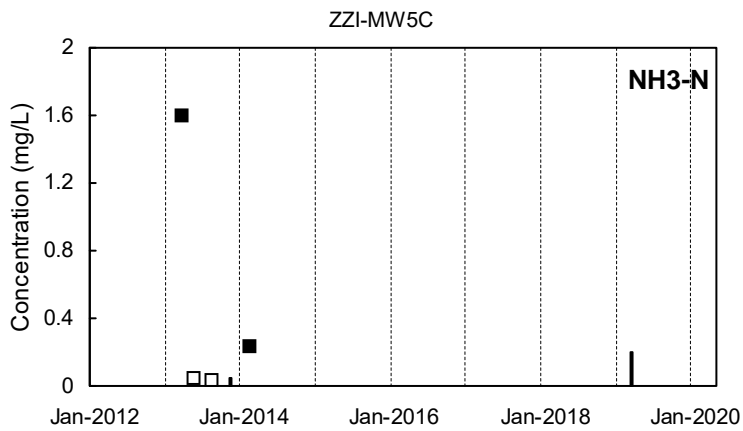
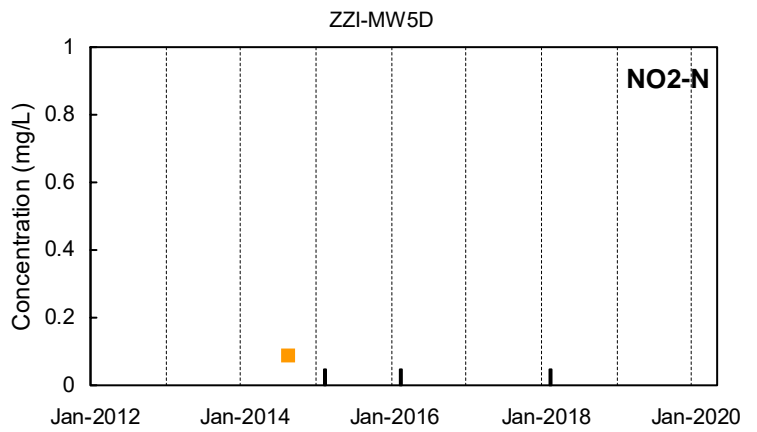
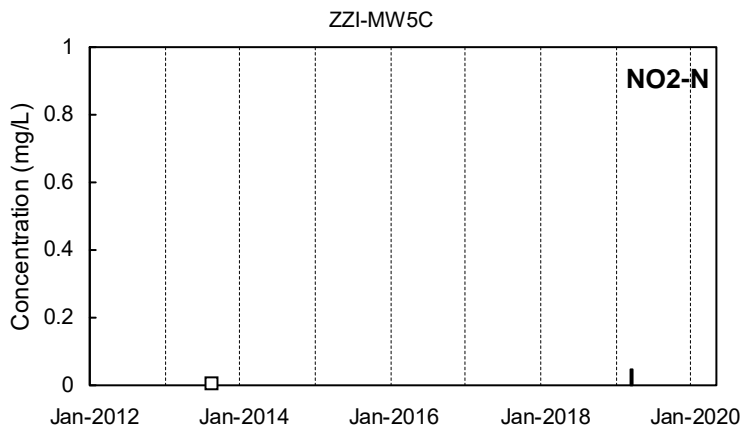
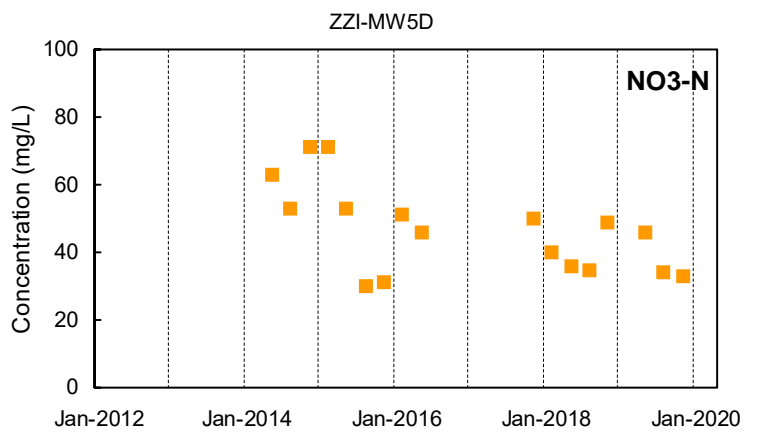
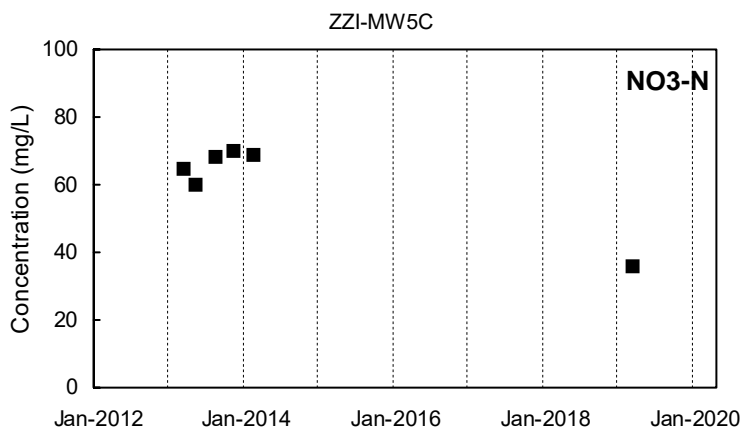

Detected Value
 'J'-Flag (value between reporting limit and detection limit)
 Non-Detect Range
 Shallow Well shown with black symbols
 Deep Well shown with orange symbols
 "dd" Well shown with blue symbols

ZZI-MW6A

ZZI-MW6B

NO3-N

NO3-N

Not Sampled

Not Sampled

ZZI-MW6A

ZZI-MW6B

NO2-N

NO2-N

Not Sampled

Not Sampled

ZZI-MW6A

ZZI-MW6B

NH3-N

NH3-N

Not Sampled

Not Sampled

ZZI-MW6A

ZZI-MW6B

TKN

TKN

Not Sampled

Not Sampled

Detected Value
 'J'-Flag (value between reporting limit and detection limit)
 Non-Detect Range

Shallow Well shown with black symbols
 Deep Well shown with orange symbols
 "dd" Well shown with blue symbols

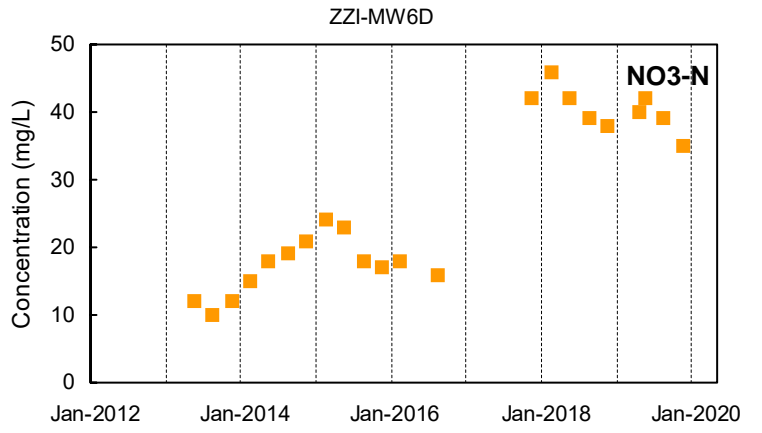
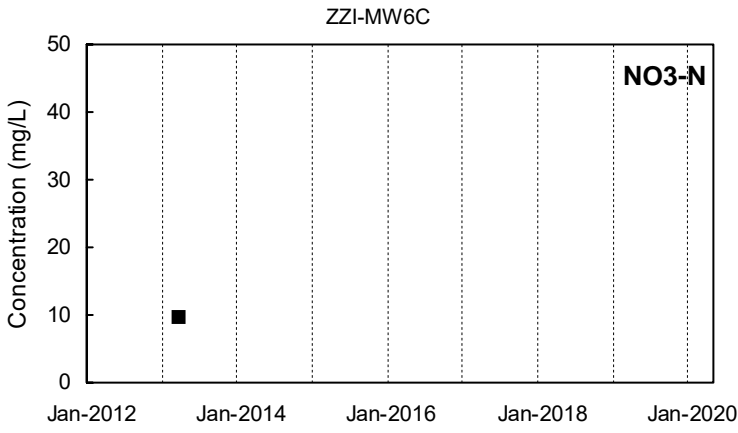

ZZI-MW6C
NO2-N
Not Sampled

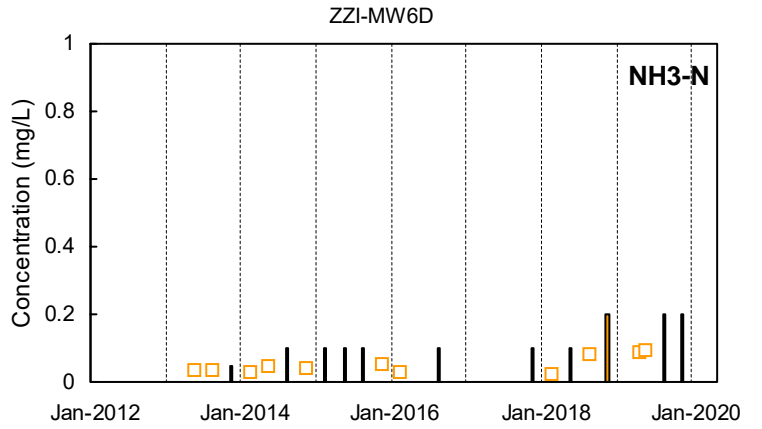
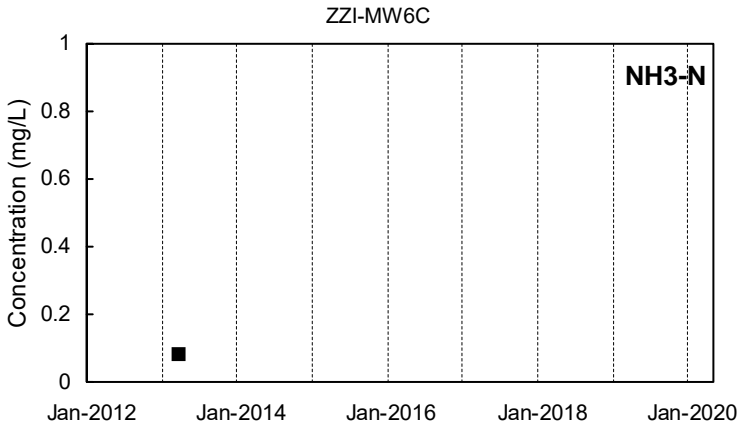
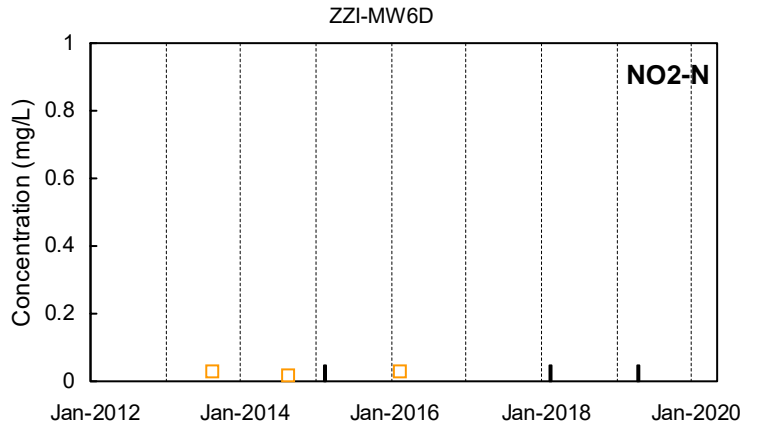

ZZI-MW6C
TKN
Not Sampled

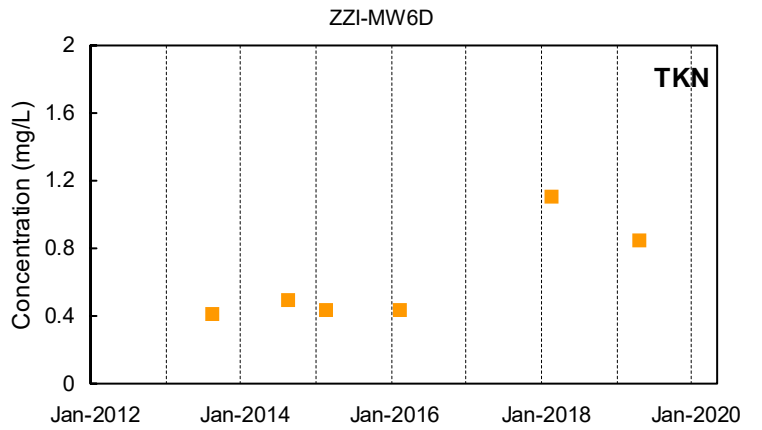

■ Detected Value □ 'J'-Flag (value between reporting limit and detection limit) ■ Non-Detect Range
 ■ Shallow Well shown with black symbols ■ Deep Well shown with orange symbols ■ "dd" Well shown with blue symbols

ZZI-MW7A

ZZI-MW7B

NO3-N
Not Sampled

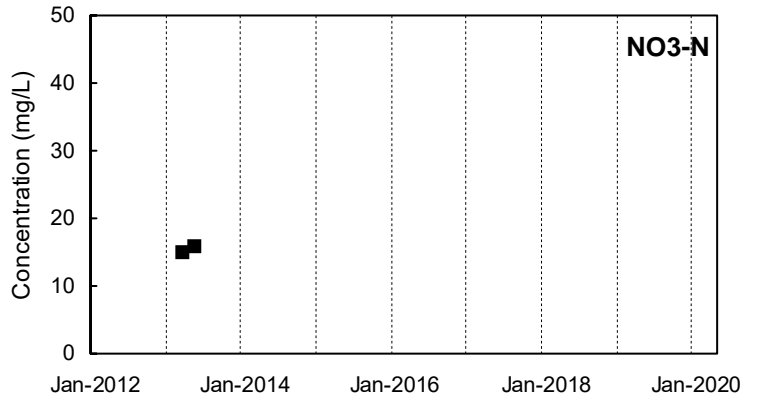

ZZI-MW7A

ZZI-MW7B

NO2-N
Not Sampled

NO2-N
Not Sampled

ZZI-MW7A

ZZI-MW7B

NH3-N
Not Sampled

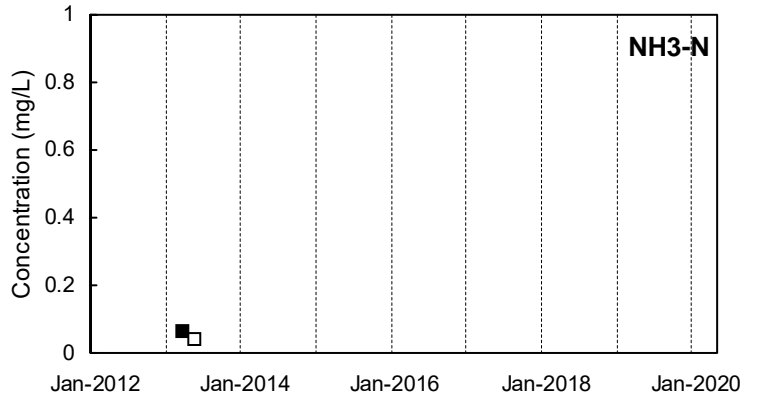

ZZI-MW7A

ZZI-MW7B

TKN
Not Sampled

TKN
Not Sampled

■ Detected Value

□ 'J'-Flag (value between reporting limit and detection limit)

■ Non-Detect Range

Shallow Well shown with black symbols

Deep Well shown with orange symbols

"dd" Well shown with blue symbols

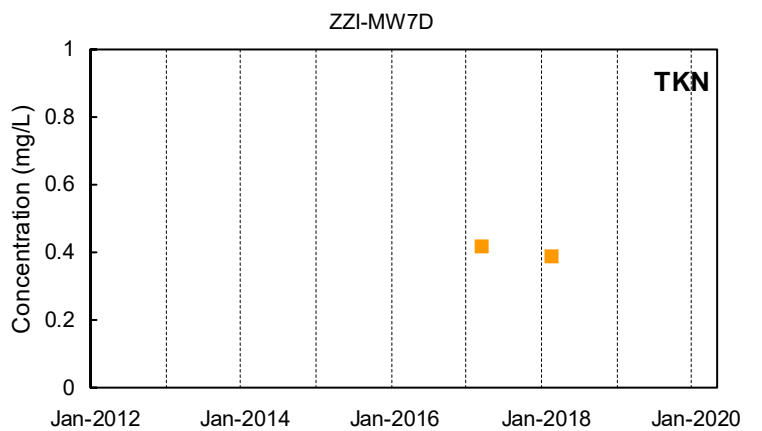
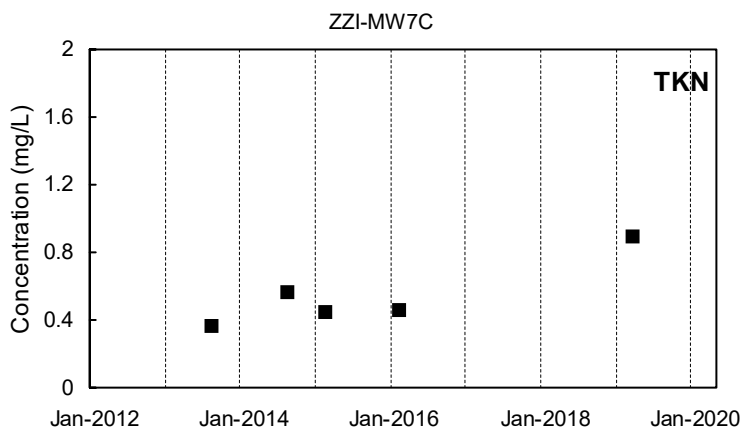
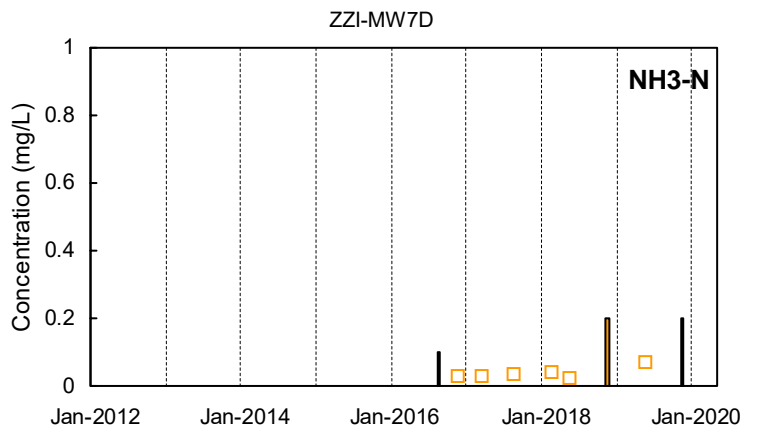
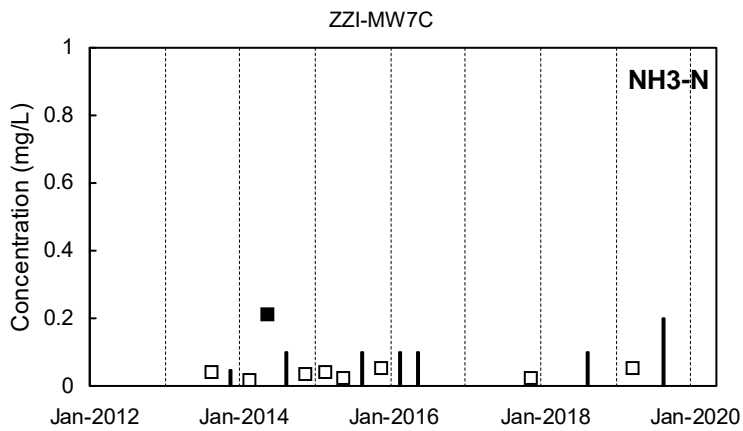
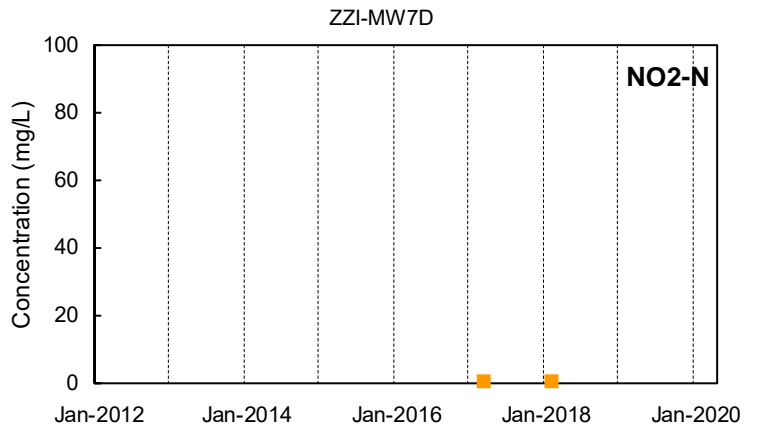
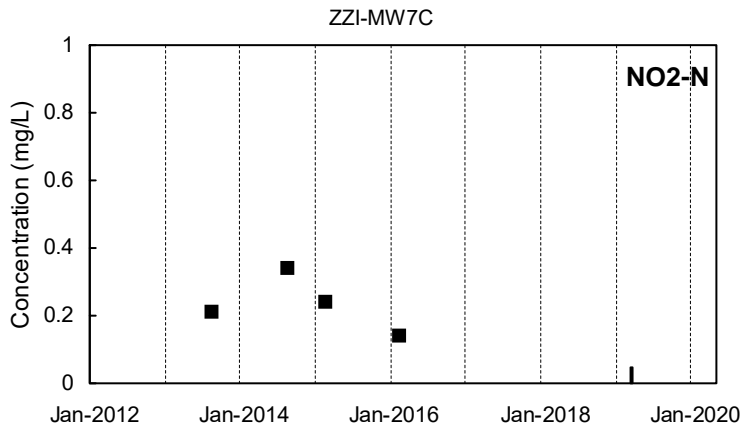
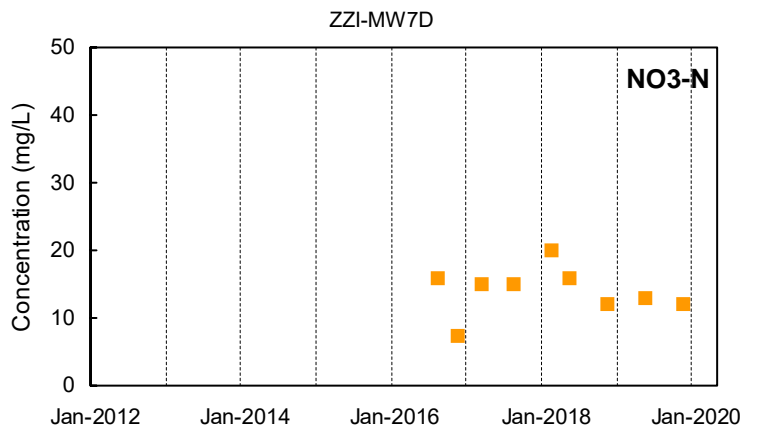
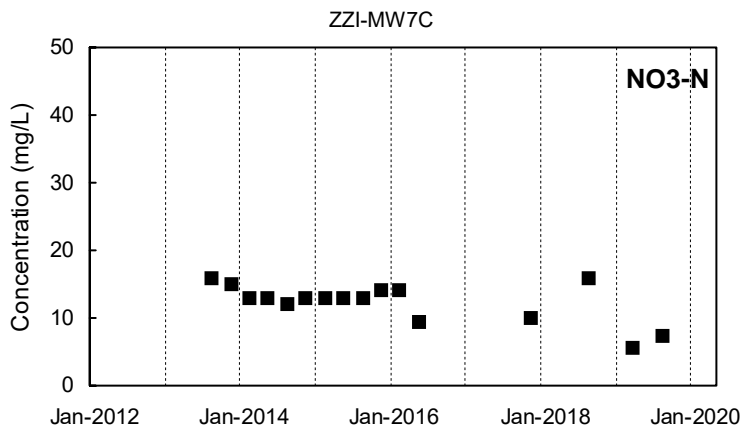

■ Detected Value □ 'J'-Flag (value between reporting limit and detection limit) ■ Non-Detect Range
 ■ Shallow Well shown with black symbols ■ Deep Well shown with orange symbols ■ "dd" Well shown with blue symbols

ZZI-MW9A

ZZI-MW9B

NO3-N

NO3-N

Not Sampled

Not Sampled

ZZI-MW9A

ZZI-MW9B

NO2-N

NO2-N

Not Sampled

Not Sampled

ZZI-MW9A

ZZI-MW9B

NH3-N

NH3-N

Not Sampled

Not Sampled

ZZI-MW9A

ZZI-MW9B

TKN

TKN

Not Sampled

Not Sampled

Detected Value
 'J'-Flag (value between reporting limit and detection limit)
 Non-Detect Range
 Shallow Well shown with black symbols
 Deep Well shown with orange symbols
 "dd" Well shown with blue symbols

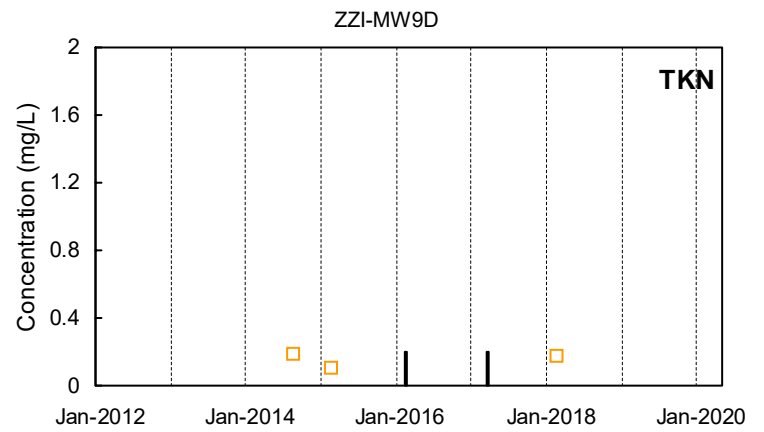
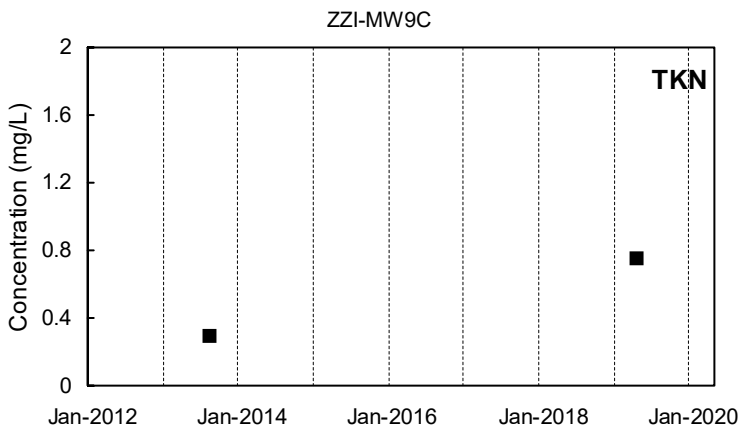
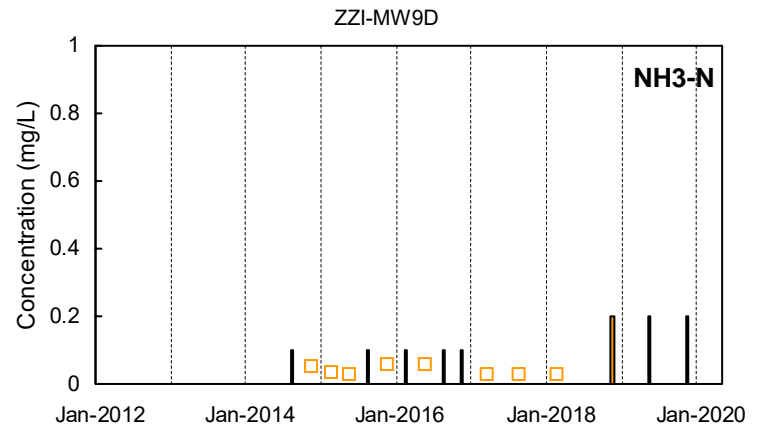
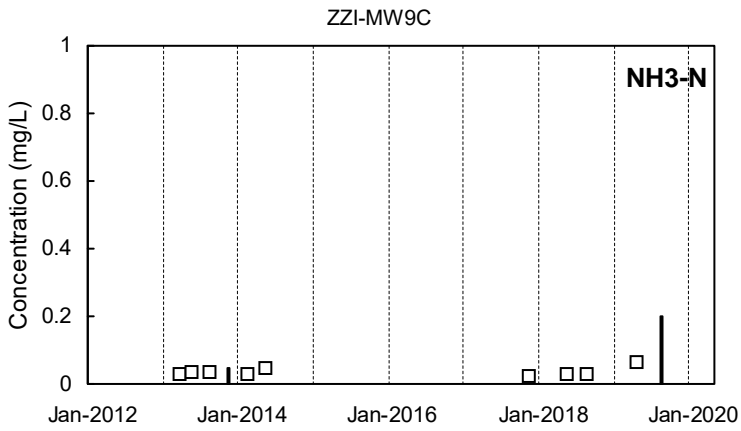
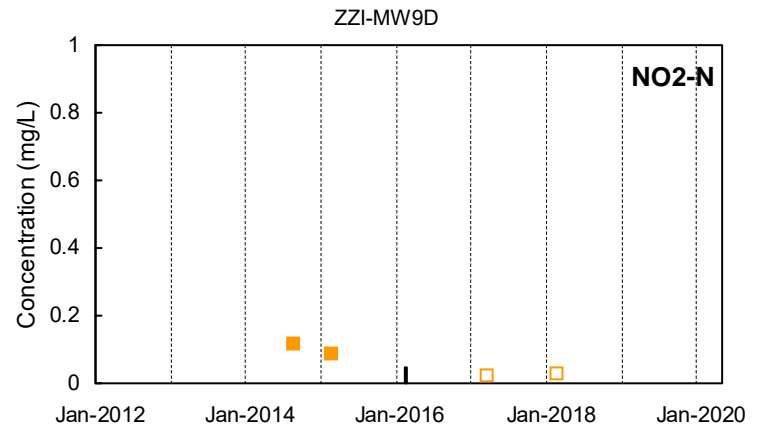
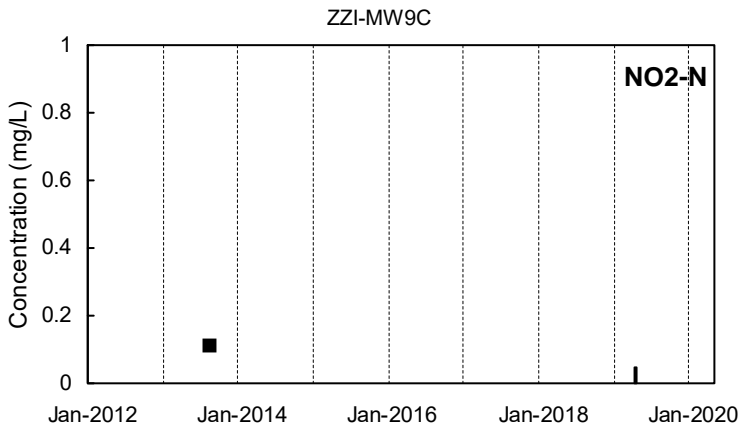
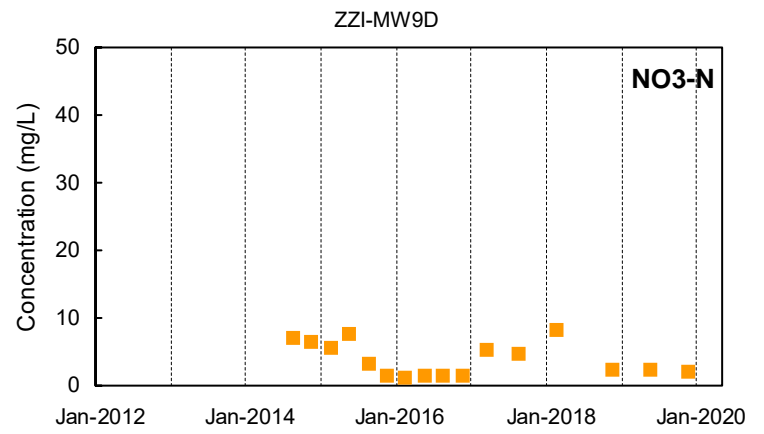
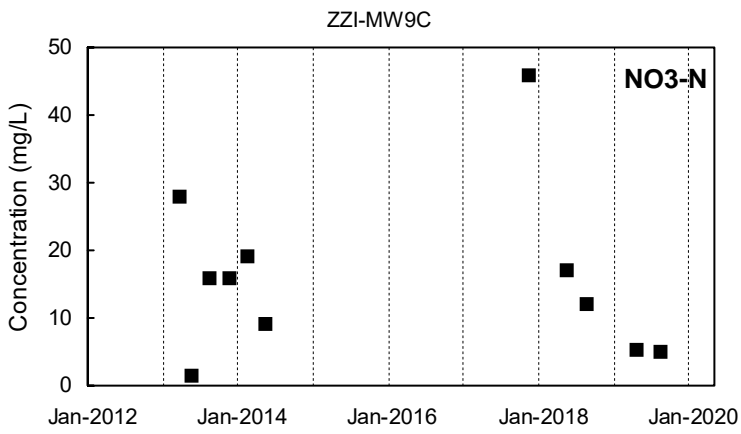

Detected Value
 'J'-Flag (value between reporting limit and detection limit)
 Non-Detect Range
 Shallow Well shown with black symbols
 Deep Well shown with orange symbols
 "dd" Well shown with blue symbols

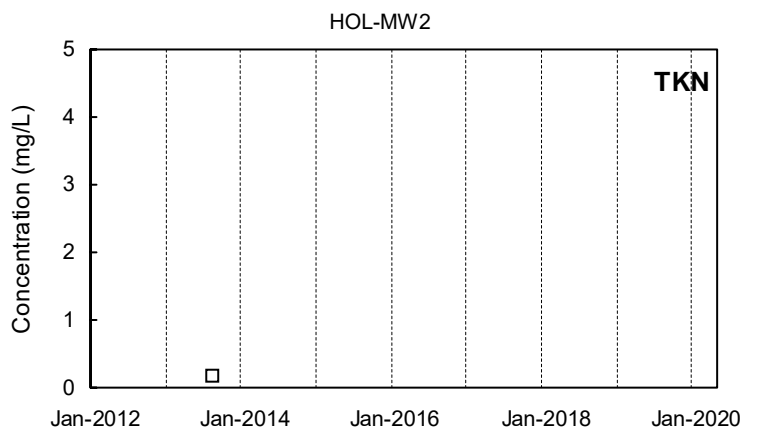
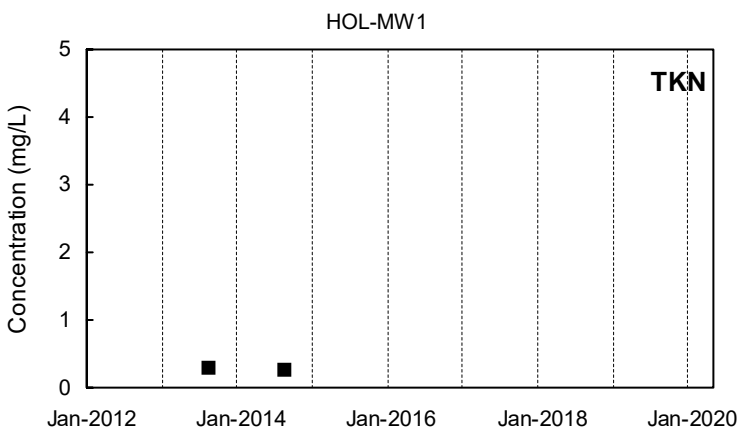
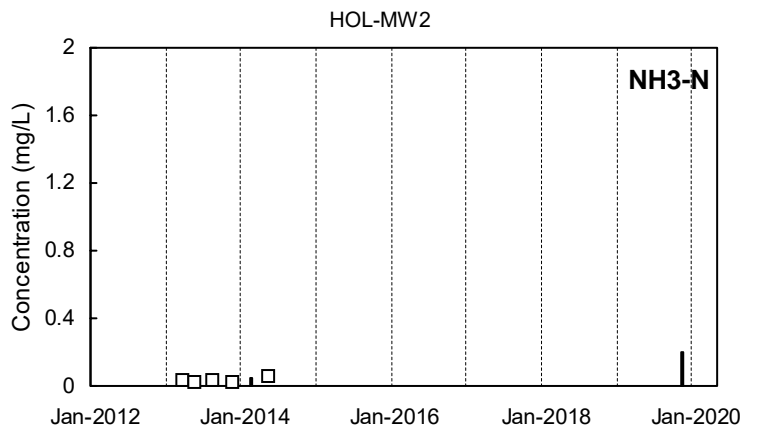
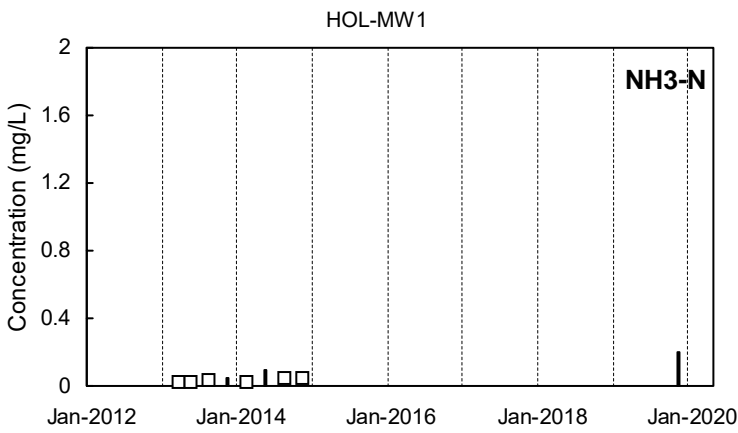
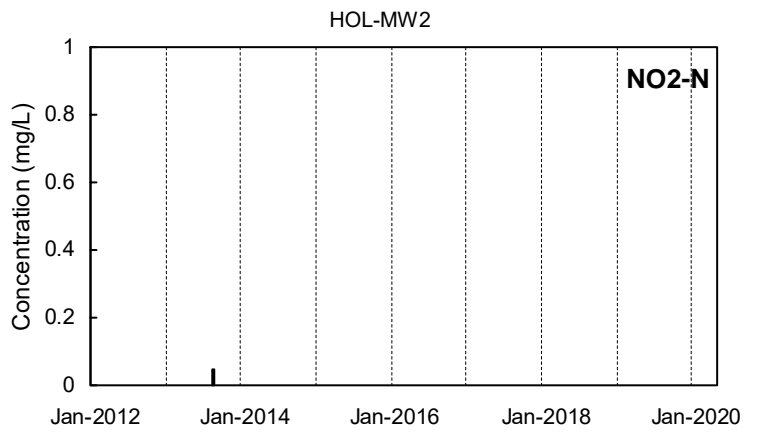
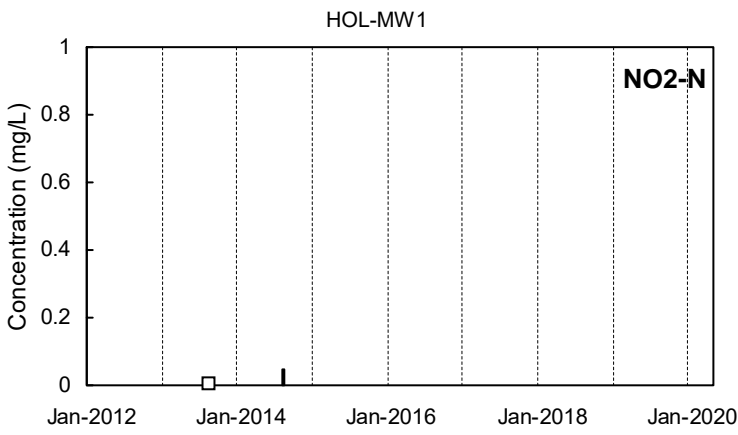
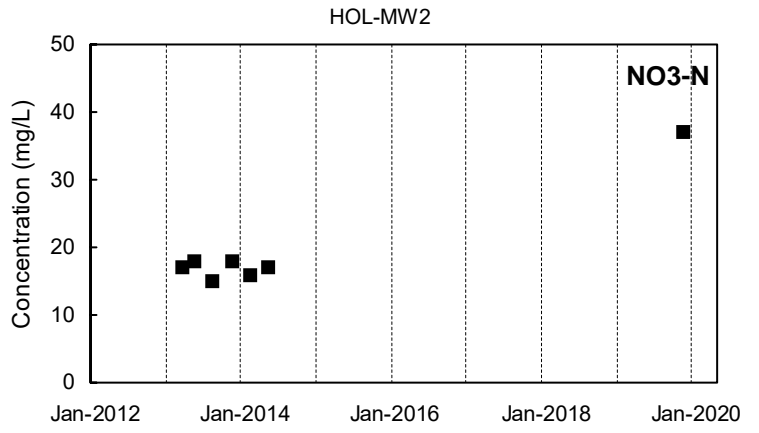
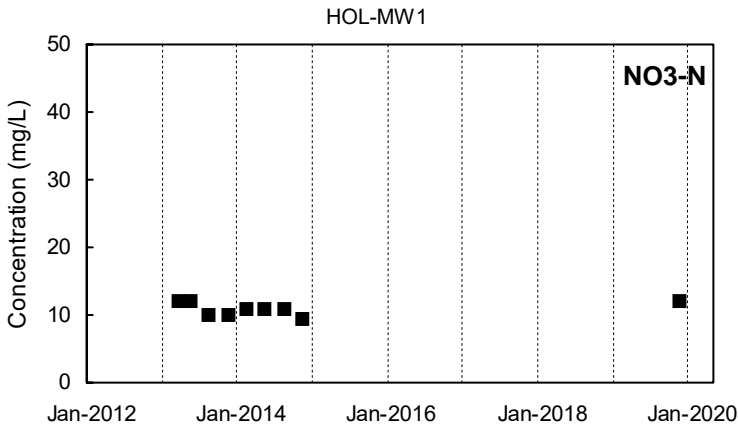

Detected Value
 'J'-Flag (value between reporting limit and detection limit)
 Non-Detect Range
 Shallow Well shown with black symbols Deep Well shown with orange symbols "dd" Well shown with blue symbols

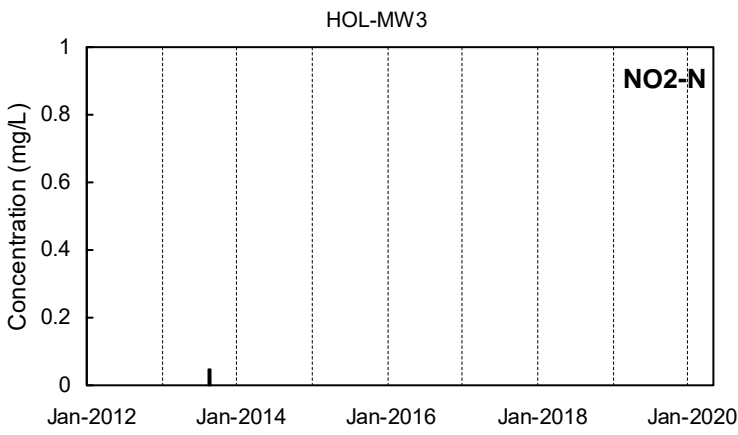
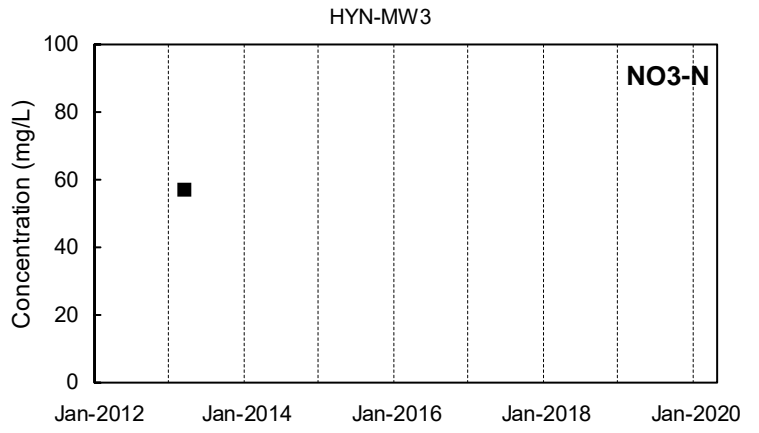
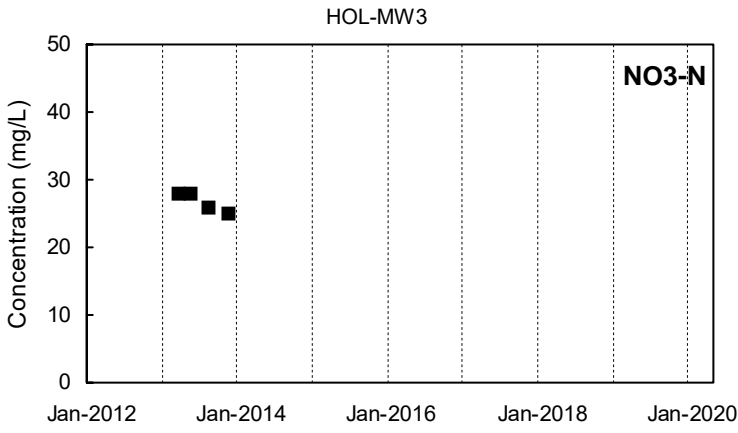

HYN-MW3
NO2-N
Not Sampled

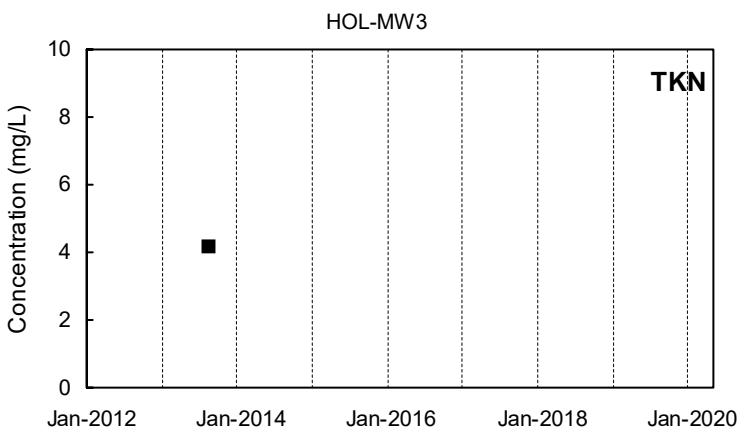
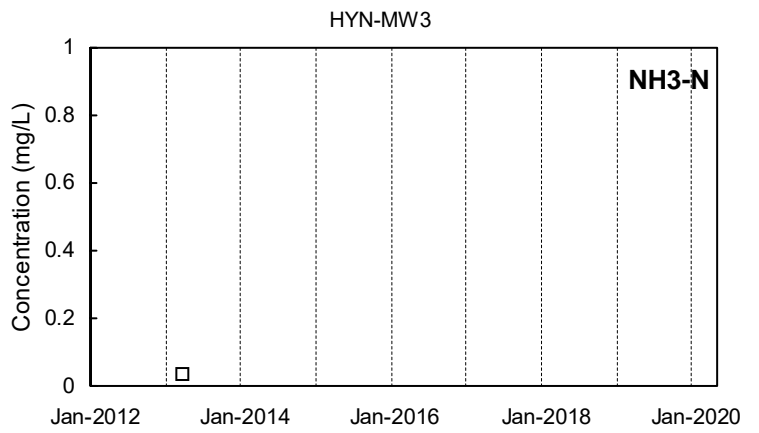
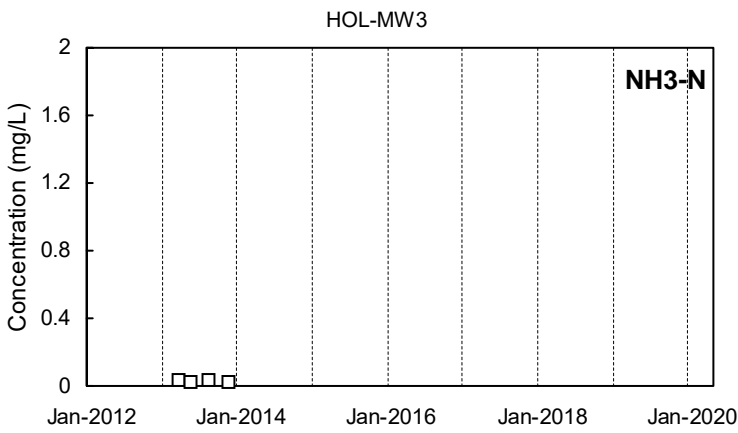

HYN-MW3
TKN
Not Sampled

Detected Value
 'J'-Flag (value between reporting limit and detection limit)
 Non-Detect Range
 Shallow Well shown with black symbols Deep Well shown with orange symbols "dd" Well shown with blue symbols

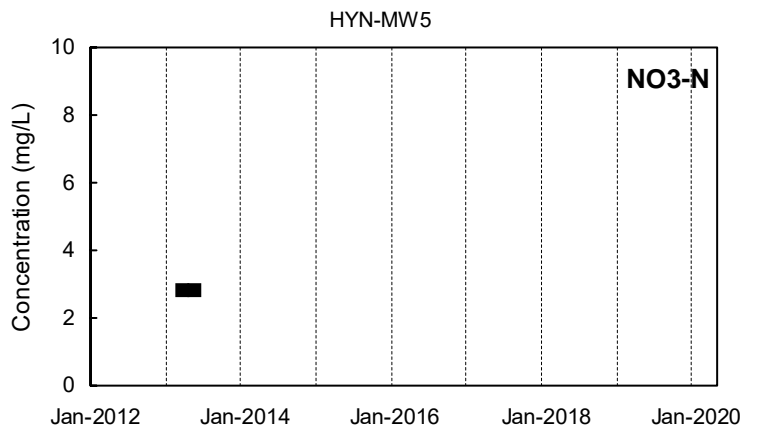
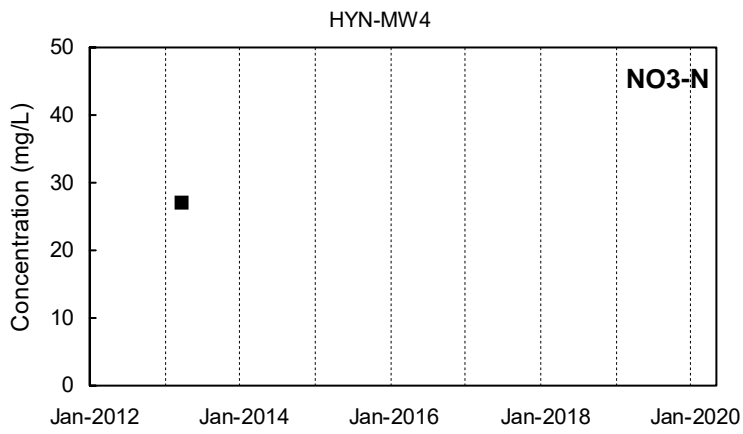

HYN-MW4

HYN-MW5

NO2-N

Not Sampled

NO2-N

Not Sampled

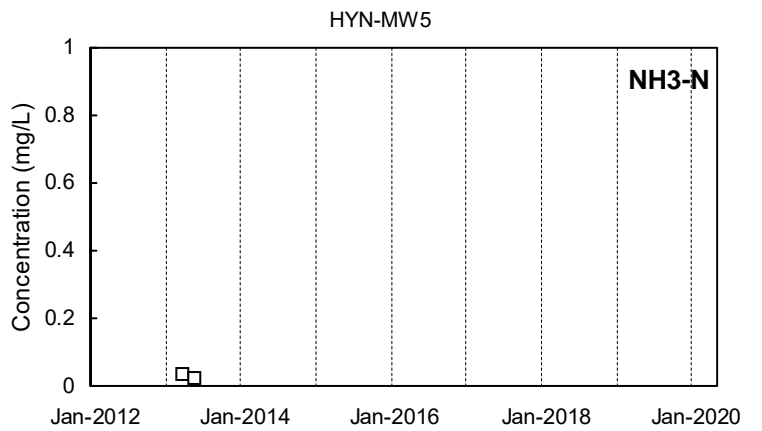
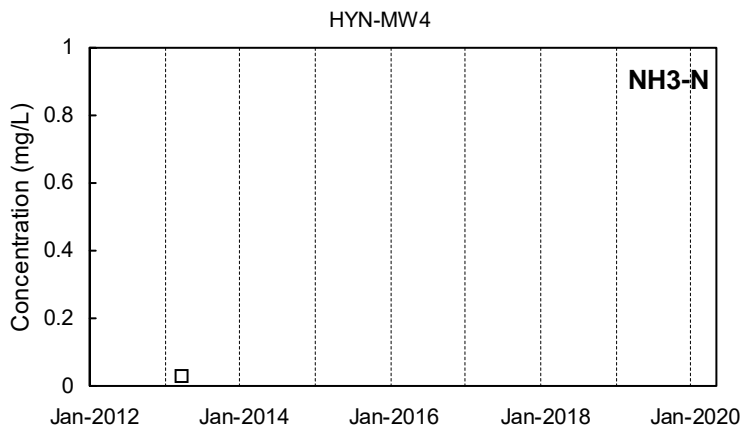

HYN-MW4

HYN-MW5

TKN

Not Sampled

TKN

Not Sampled

Detected Value
 'J'-Flag (value between reporting limit and detection limit)
 Non-Detect Range
Shallow Well shown with black symbols
 Deep Well shown with orange symbols
 "dd" Well shown with blue symbols

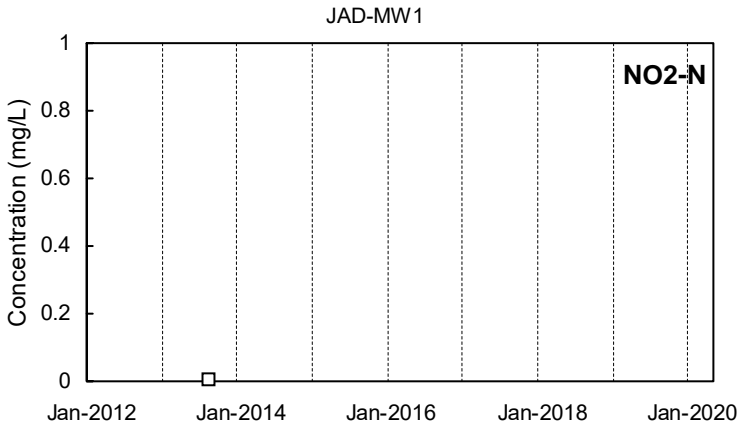
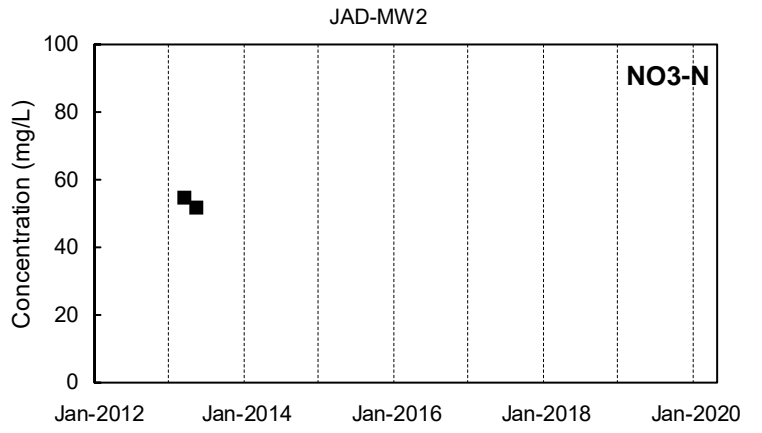
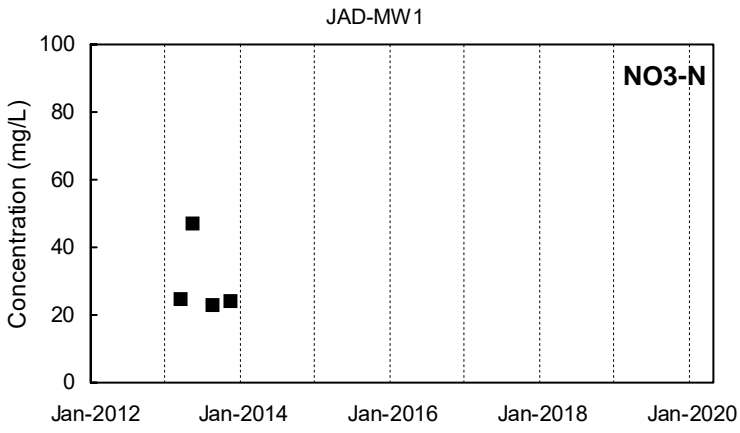

JAD-MW2

NO2-N
Not Sampled

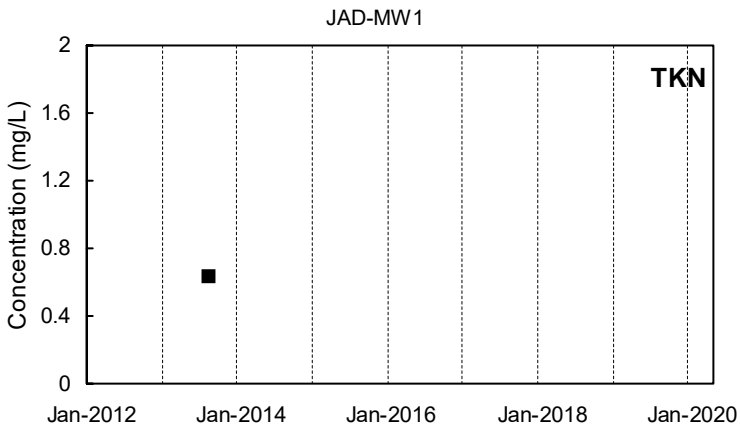
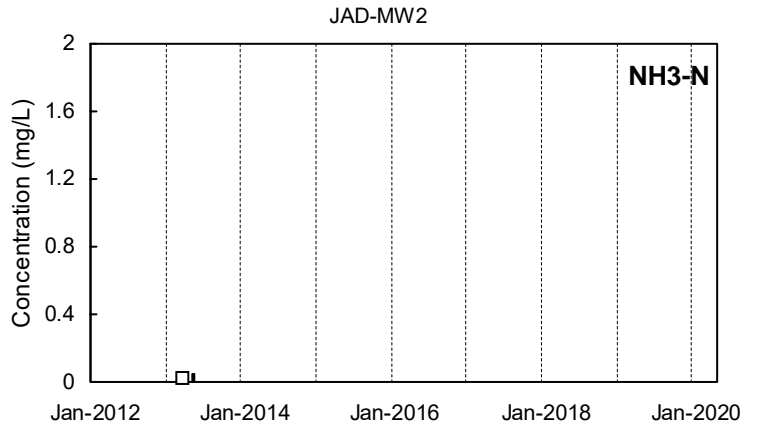
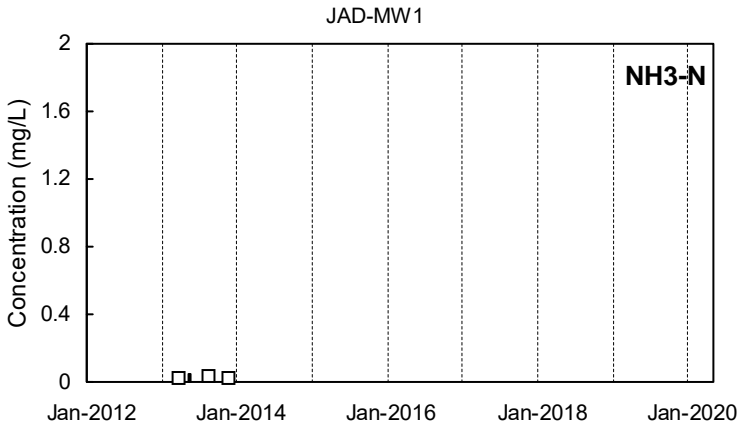

JAD-MW2

TKN
Not Sampled

Detected Value
 'J'-Flag (value between reporting limit and detection limit)
 Non-Detect Range

Shallow Well shown with black symbols
Deep Well shown with orange symbols
"dd" Well shown with blue symbols

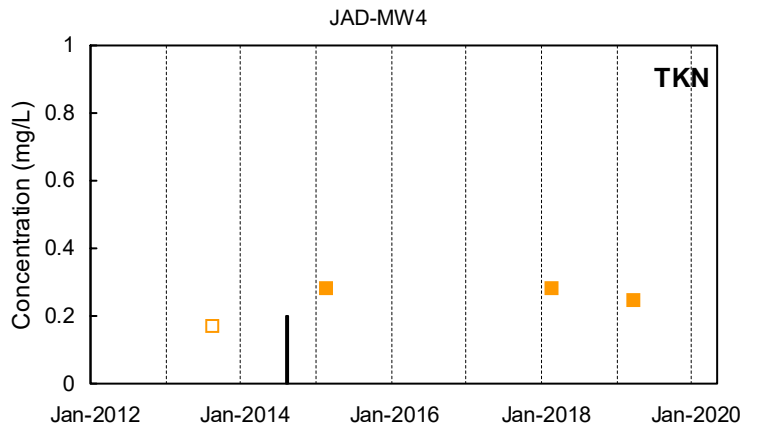
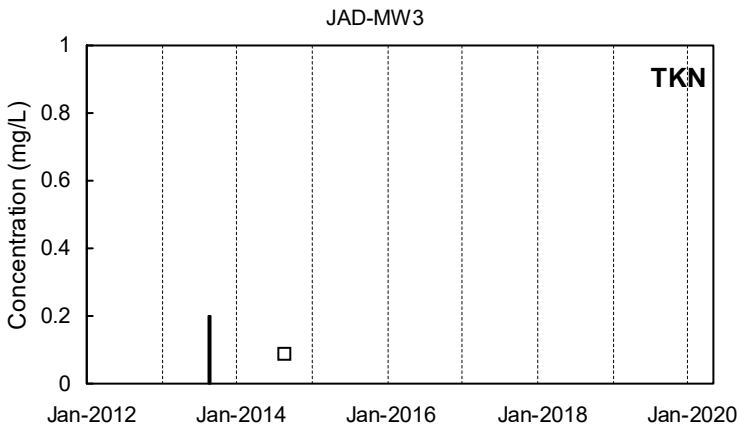
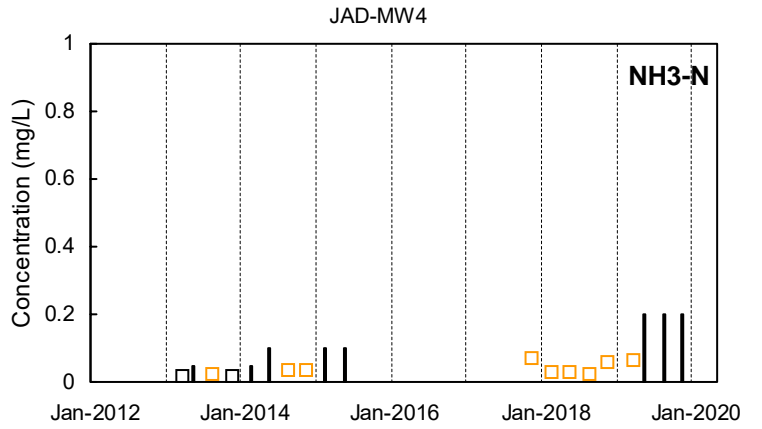
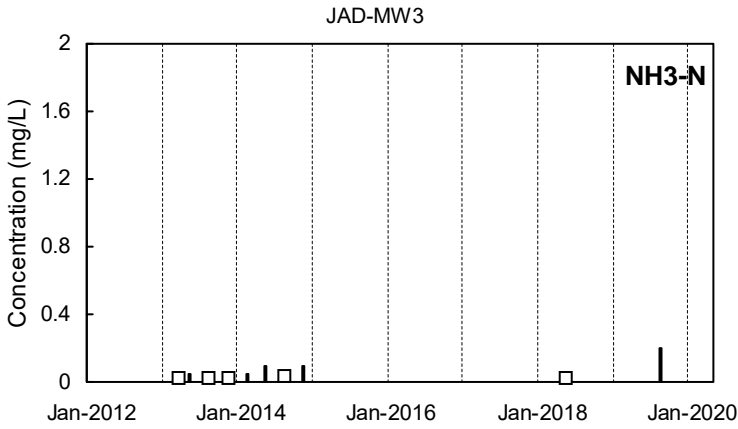
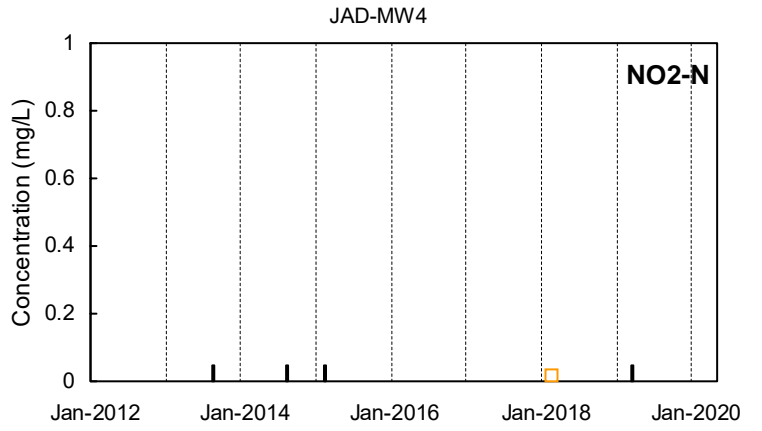
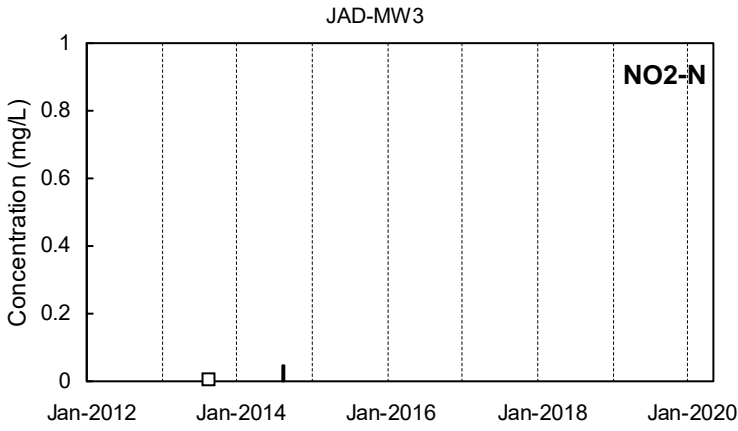
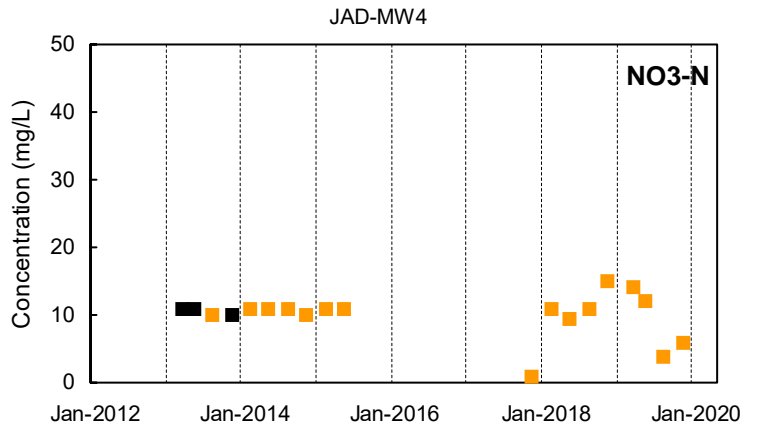
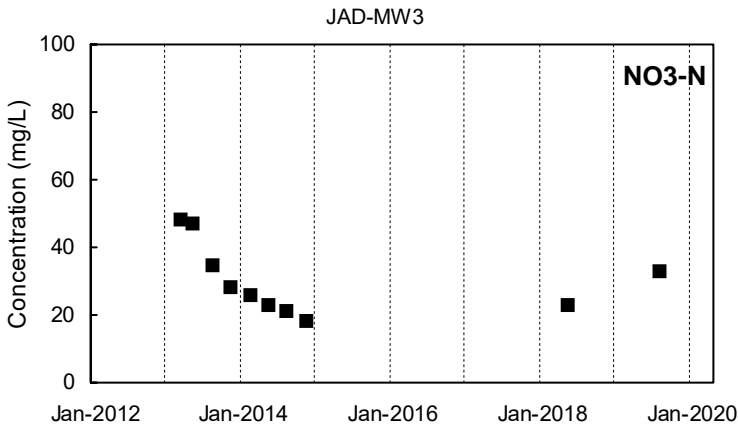

■ Detected Value □ 'J'-Flag (value between reporting limit and detection limit) ■ Non-Detect Range
 ■ Shallow Well shown with black symbols ■ Deep Well shown with orange symbols ■ "dd" Well shown with blue symbols

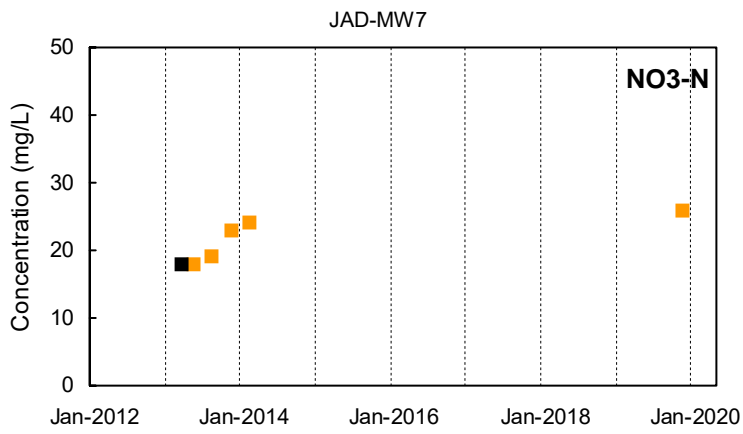

LON-MW1A

NO3-N
Not Sampled

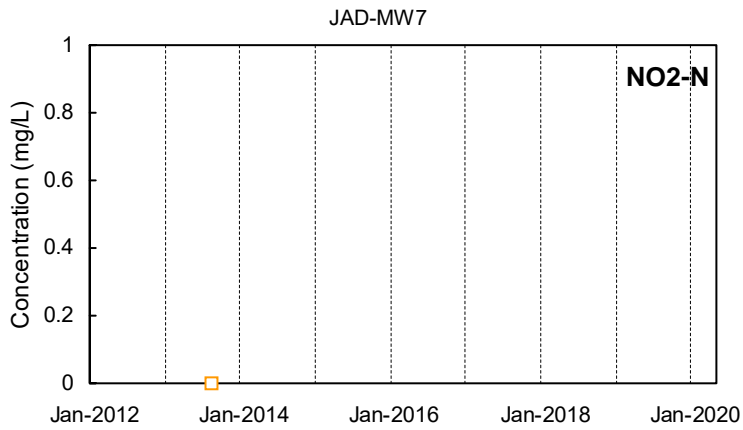

LON-MW1A

NO2-N
Not Sampled

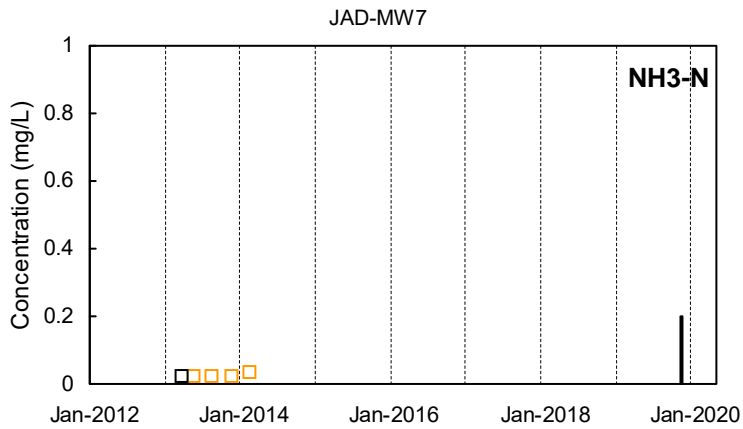

LON-MW1A

NH3-N
Not Sampled

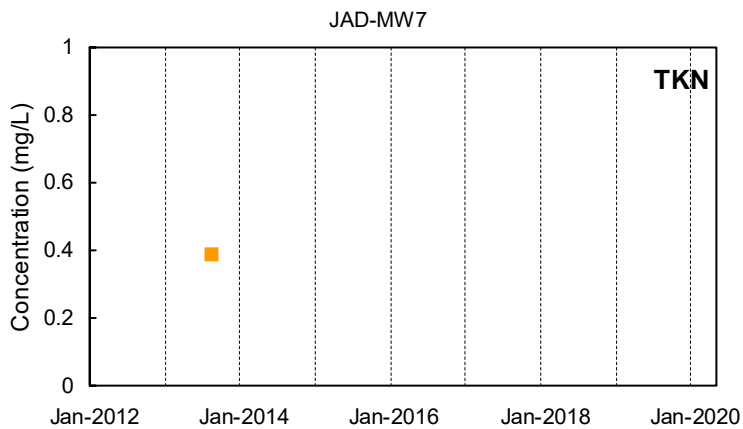

LON-MW1A

TKN
Not Sampled

Detected Value
 'J'-Flag (value between reporting limit and detection limit)
 Non-Detect Range

Shallow Well shown with black symbols
Deep Well shown with orange symbols
"dd" Well shown with blue symbols

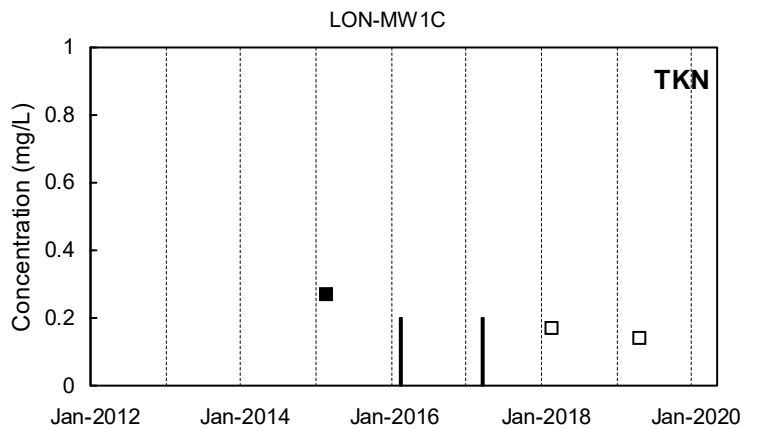
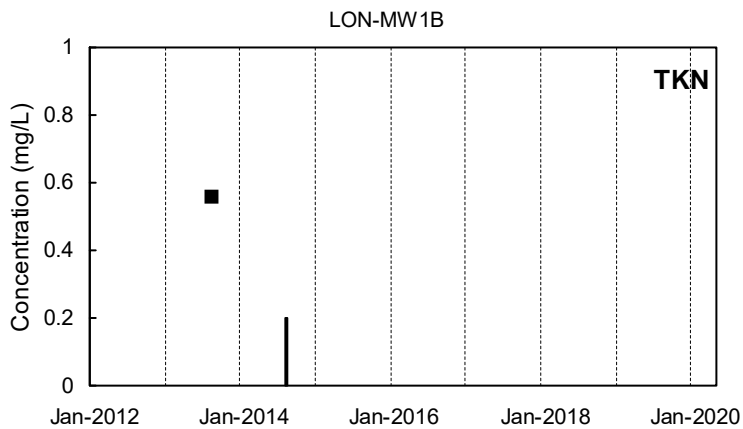
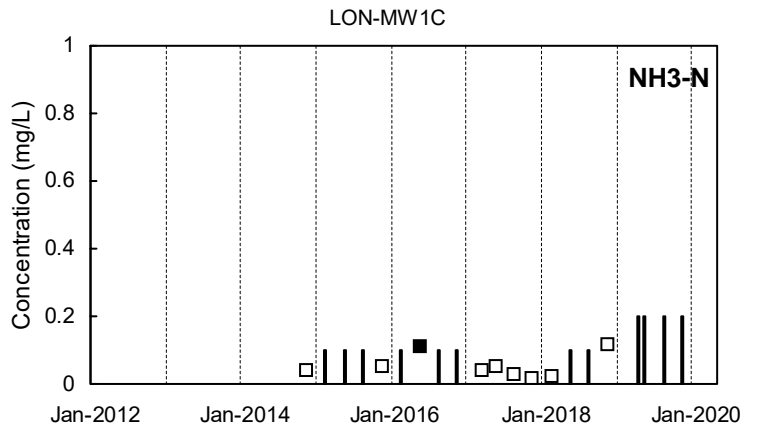
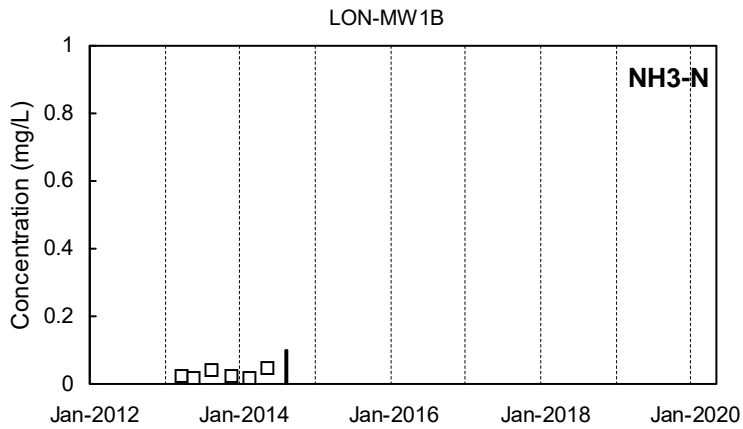
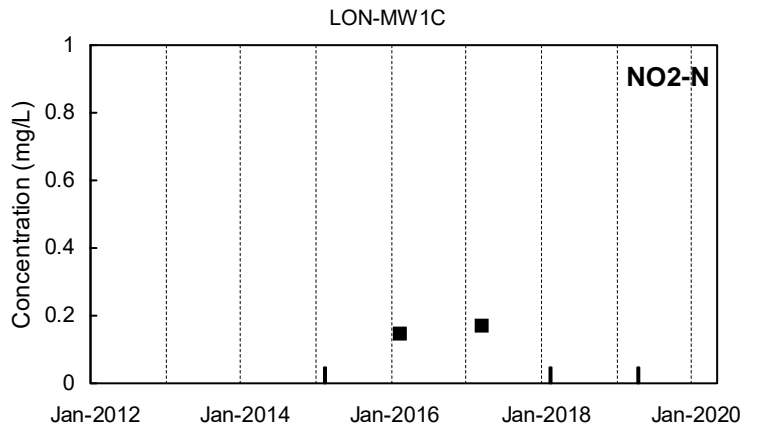
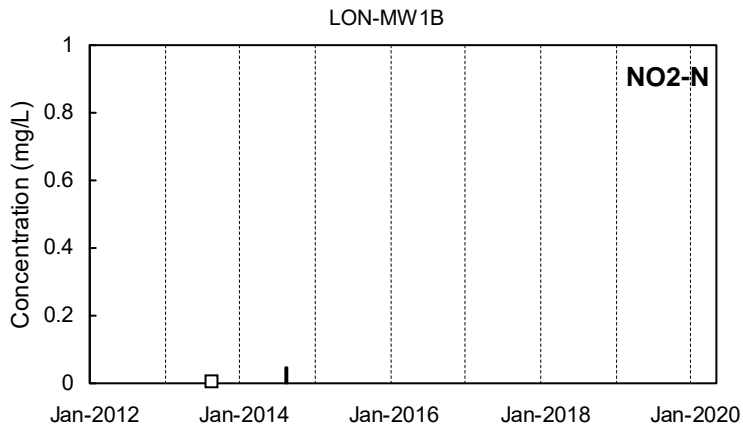
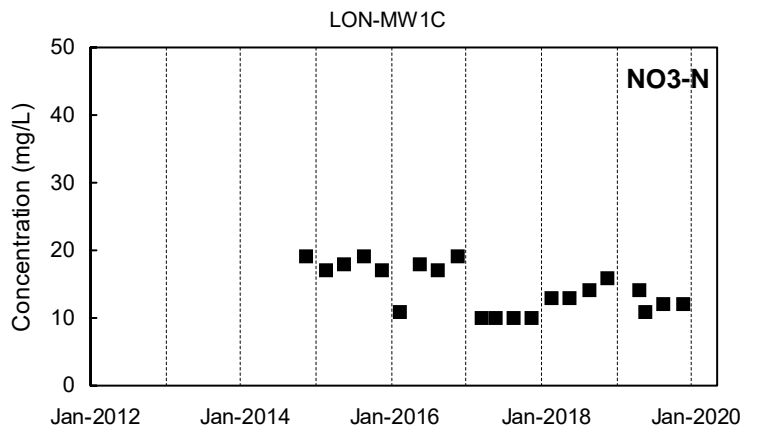
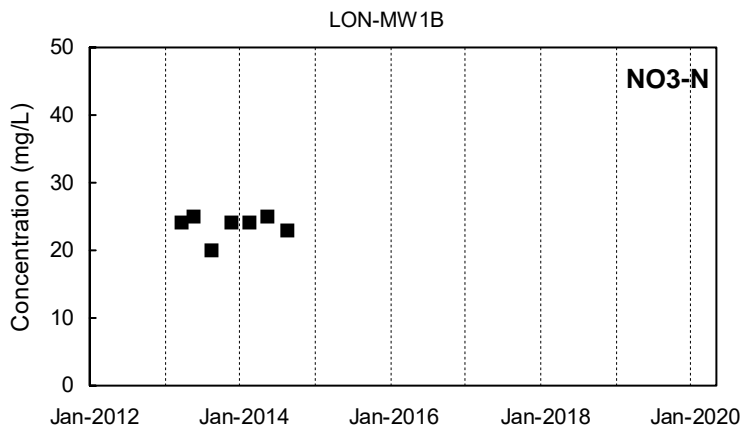

Detected Value
 'J'-Flag (value between reporting limit and detection limit)
 Non-Detect Range
Shallow Well shown with black symbols
Deep Well shown with orange symbols
"dd" Well shown with blue symbols

LON-MW2A

NO3-N
Not Sampled

LON-MW2B

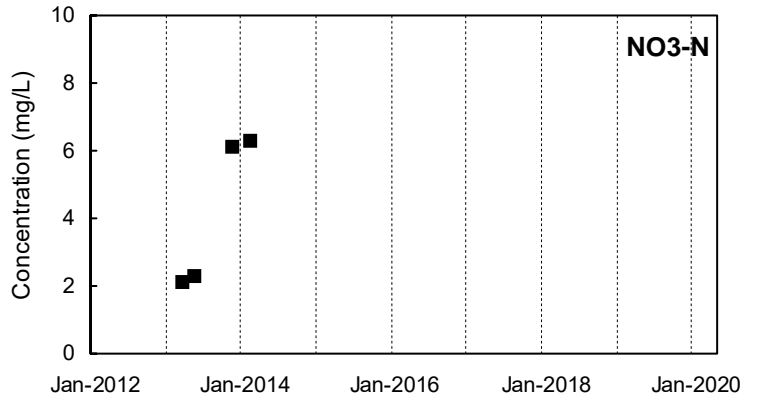

LON-MW2A

NO2-N
Not Sampled

LON-MW2B

NO2-N
Not Sampled

LON-MW2A

NH3-N
Not Sampled

LON-MW2B

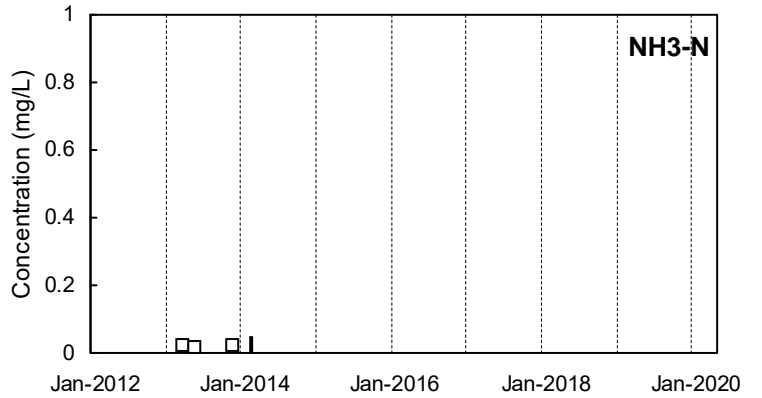

LON-MW2A

TKN
Not Sampled

LON-MW2B

TKN
Not Sampled

■ Detected Value

□ 'J'-Flag (value between reporting limit and detection limit)

■ Non-Detect Range

Shallow Well shown with black symbols

Deep Well shown with orange symbols

"dd" Well shown with blue symbols

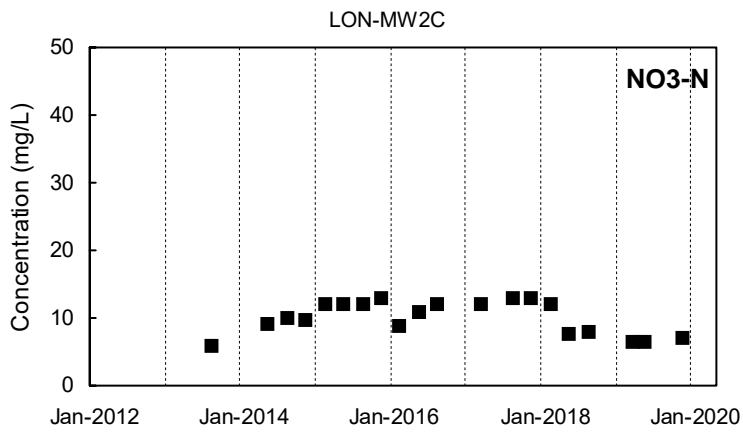

LON-MW3A

NO3-N
Not Sampled

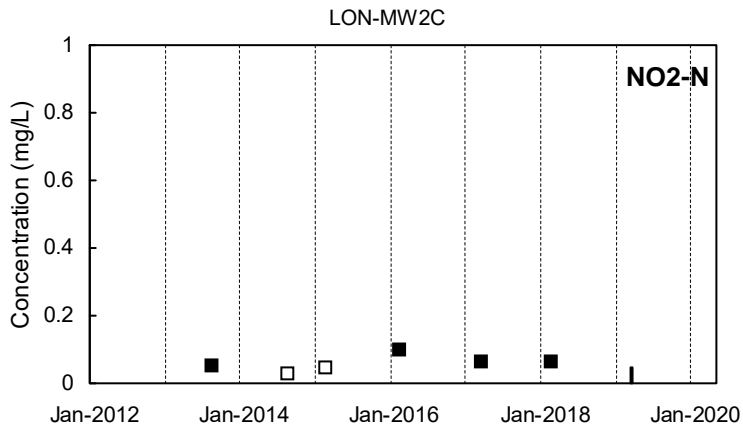

LON-MW3A

NO2-N
Not Sampled

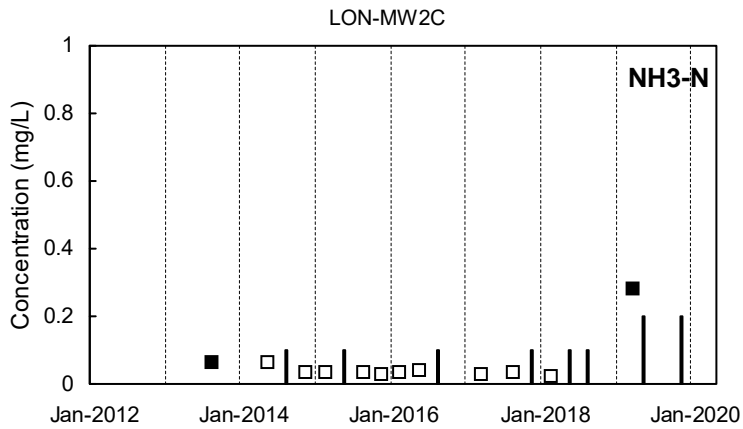

LON-MW3A

NH3-N
Not Sampled

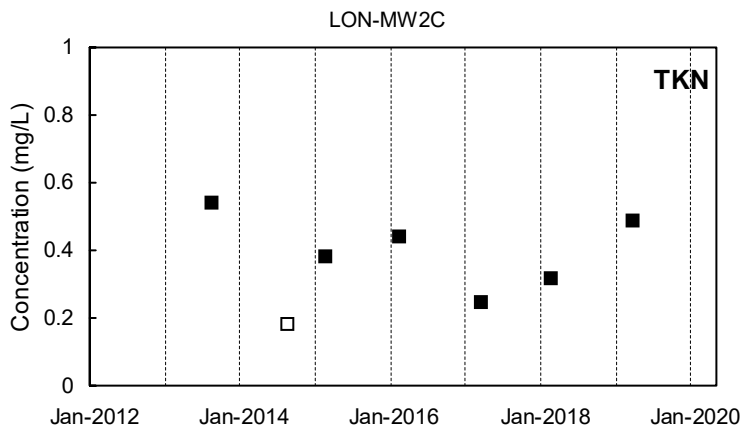

LON-MW3A

TKN
Not Sampled

Detected Value
 'J'-Flag (value between reporting limit and detection limit)
 Non-Detect Range
 Shallow Well shown with black symbols Deep Well shown with orange symbols "dd" Well shown with blue symbols

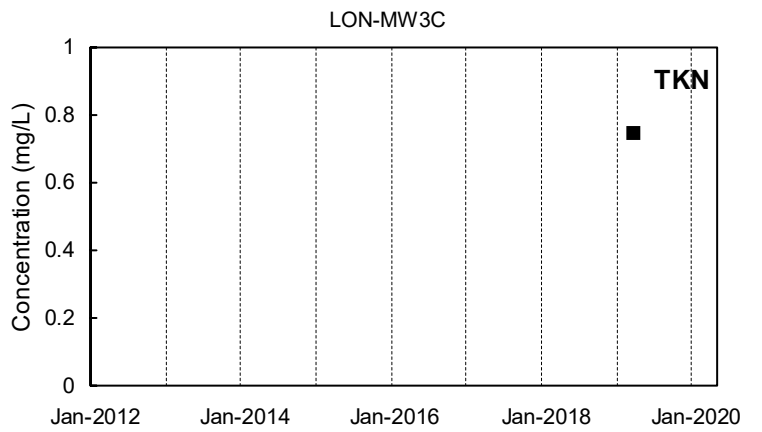
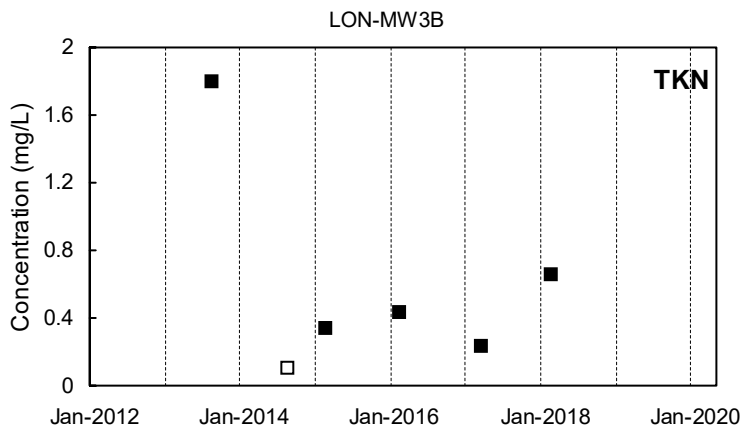
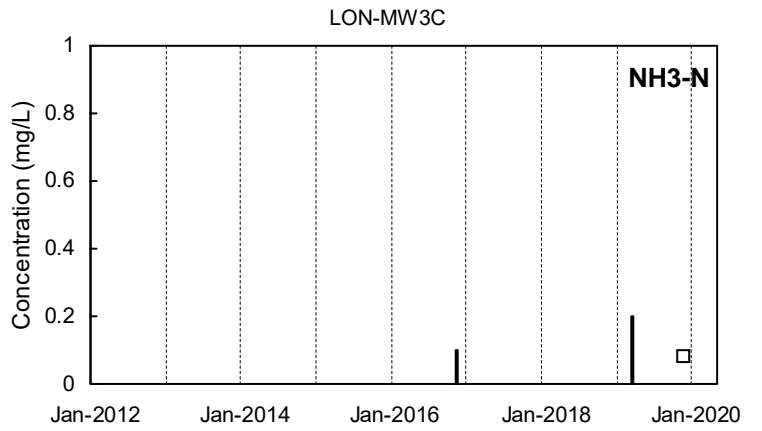
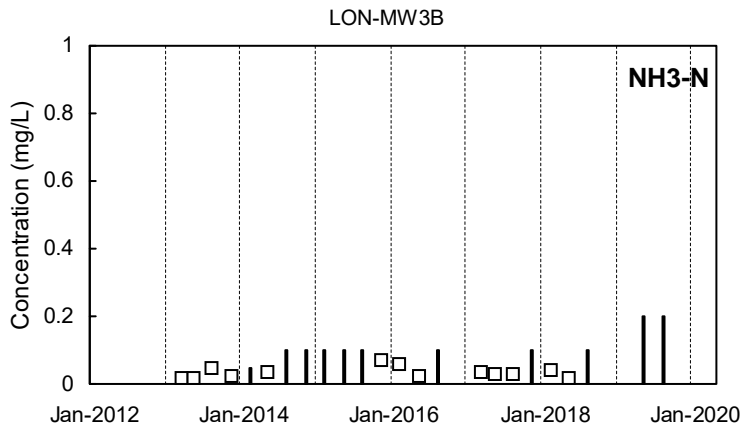
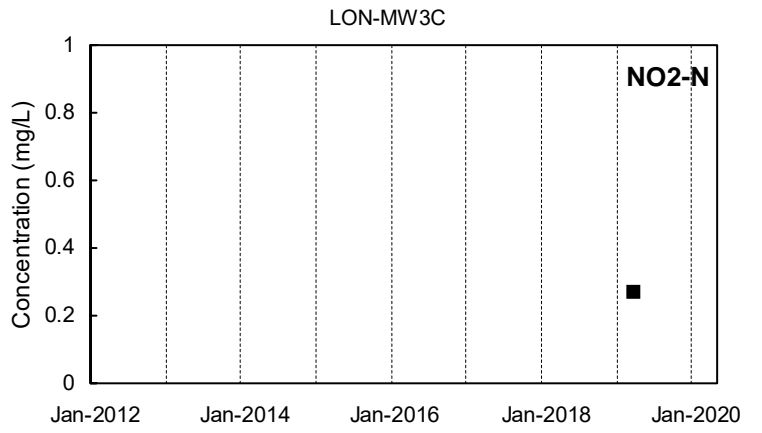
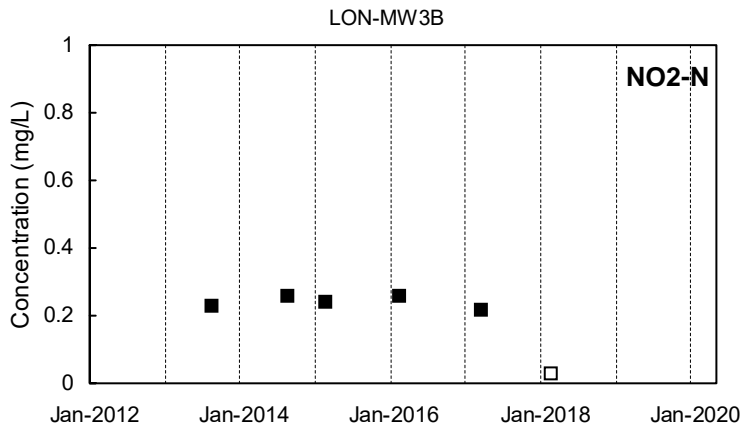
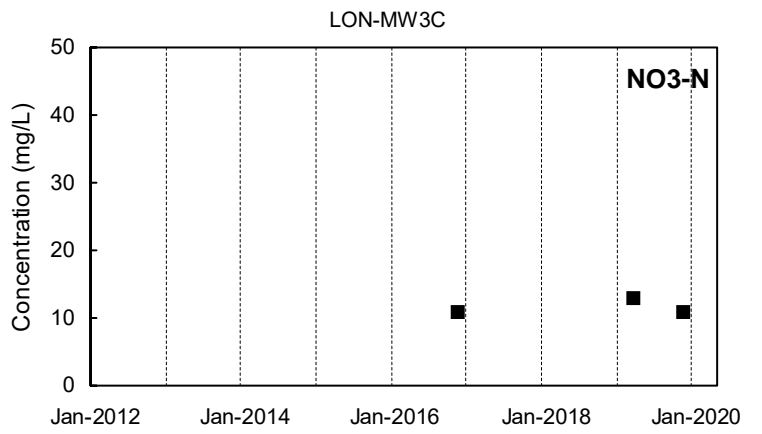
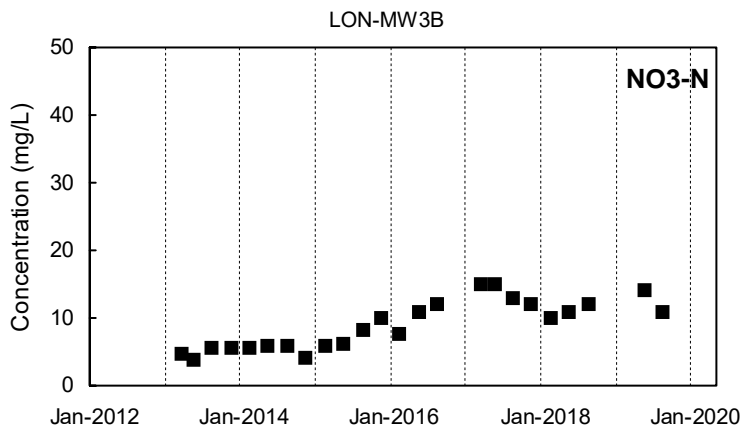

Detected Value
 'J'-Flag (value between reporting limit and detection limit)
 Non-Detect Range
Shallow Well shown with black symbols
Deep Well shown with orange symbols
"dd" Well shown with blue symbols

LON-MW4A

NO3-N

Not Sampled

LON-MW4B

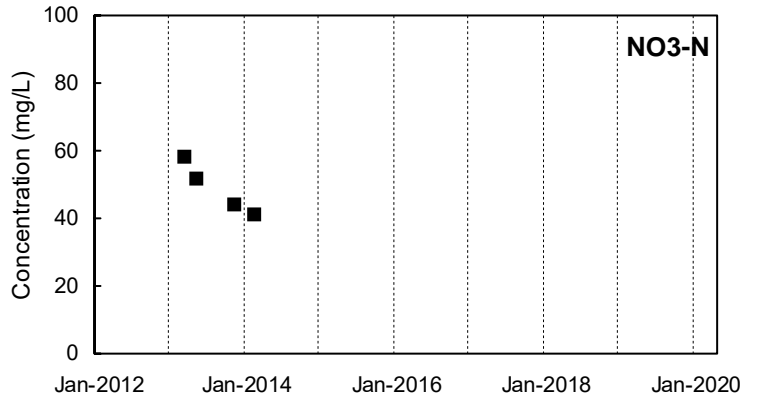

LON-MW4A

NO2-N

Not Sampled

LON-MW4B

NO2-N

Not Sampled

LON-MW4A

NH3-N

Not Sampled

LON-MW4B

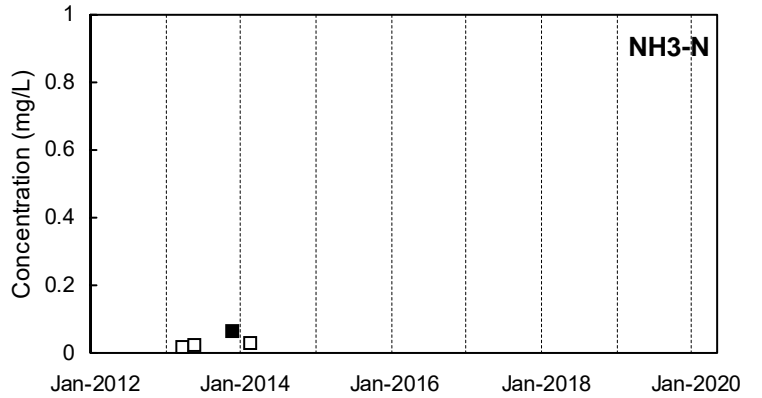

LON-MW4A

TKN

Not Sampled

LON-MW4B

TKN

Not Sampled

■ Detected Value

□ 'J'-Flag (value between reporting limit and detection limit)

■ Non-Detect Range

Shallow Well shown with black symbols

Deep Well shown with orange symbols

"dd" Well shown with blue symbols

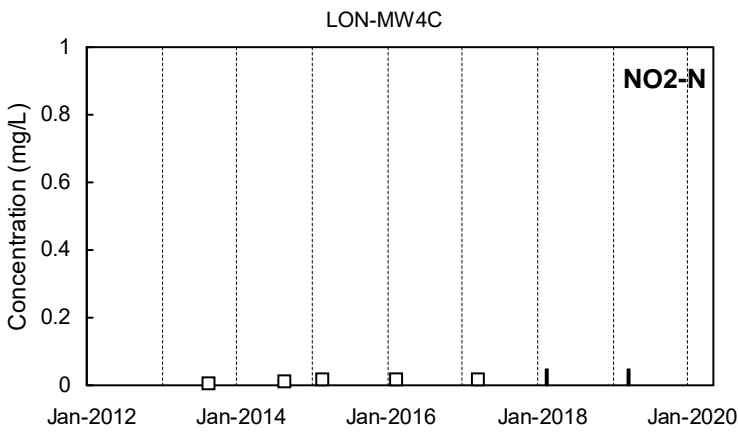
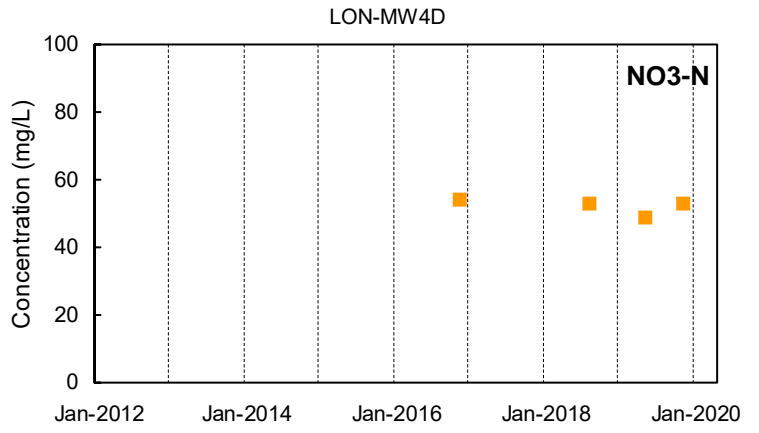
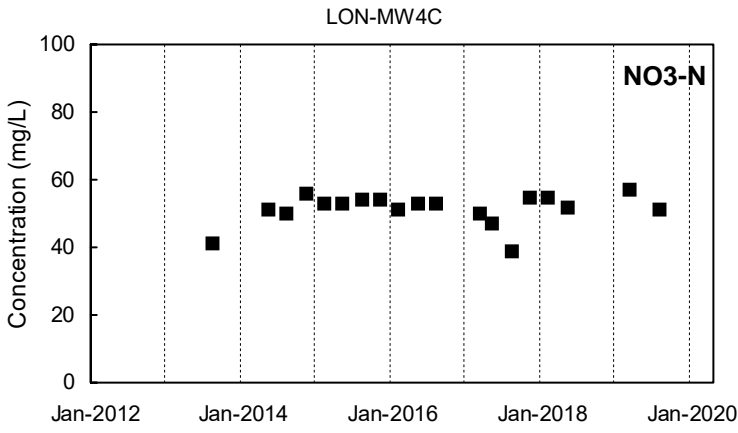

LON-MW4D
NO2-N
Not Sampled

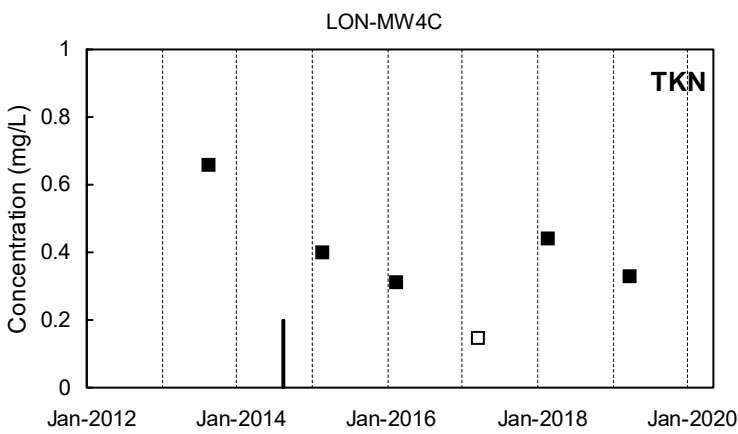
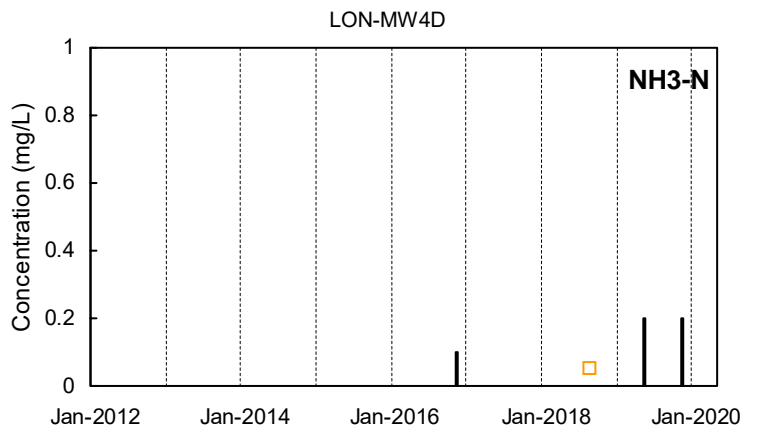
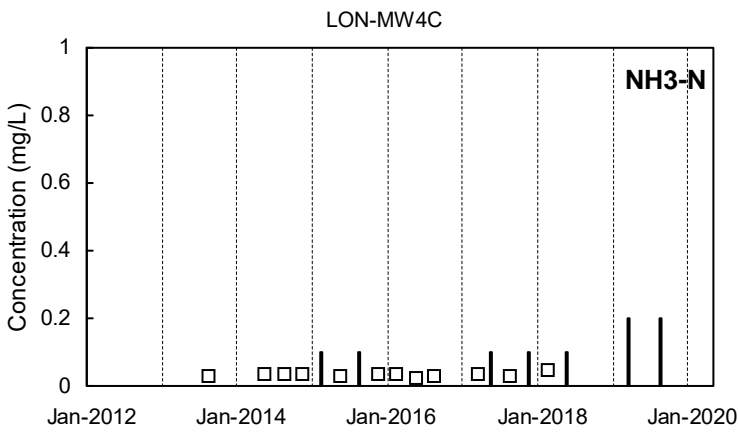

LON-MW4D
TKN
Not Sampled

Detected Value
 'J'-Flag (value between reporting limit and detection limit)
 Non-Detect Range
 Shallow Well shown with black symbols Deep Well shown with orange symbols "dd" Well shown with blue symbols

LON-MW5A

NO3-N

Not Sampled

LON-MW5B

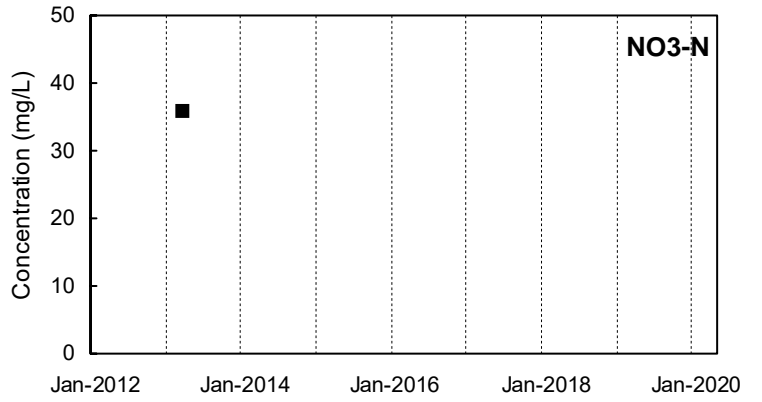

LON-MW5A

NO2-N

Not Sampled

LON-MW5B

NO2-N

Not Sampled

LON-MW5A

NH3-N

Not Sampled

LON-MW5B

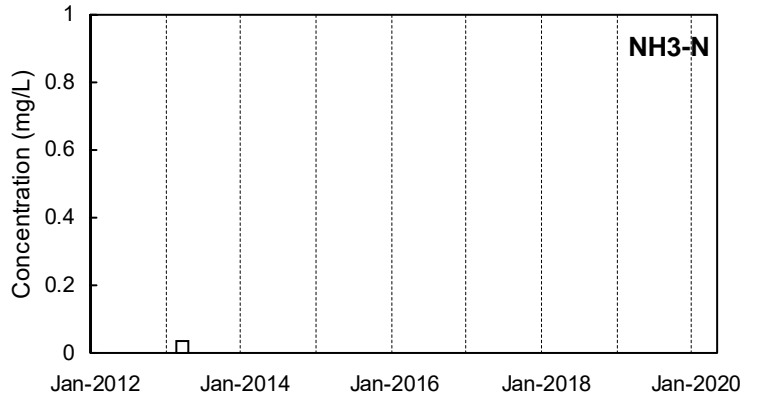

LON-MW5A

TKN

Not Sampled

LON-MW5B

TKN

Not Sampled

■ Detected Value

□ 'J'-Flag (value between reporting limit and detection limit)

■ Non-Detect Range

Shallow Well shown with black symbols

Deep Well shown with orange symbols

"dd" Well shown with blue symbols

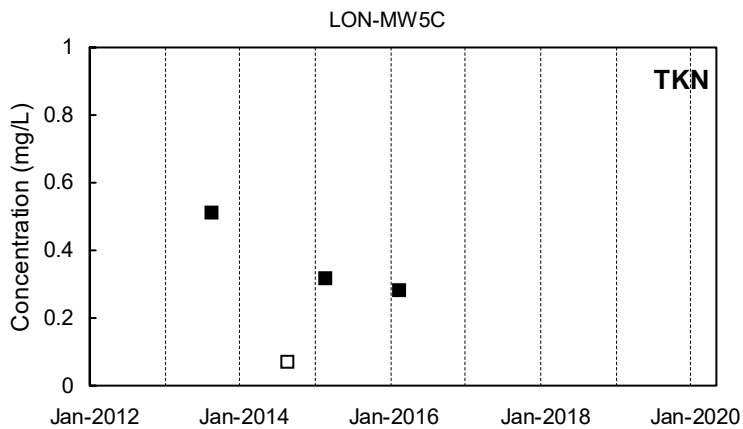
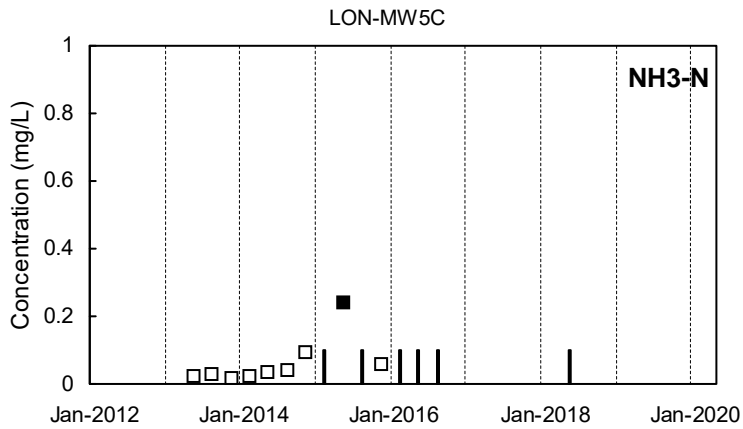
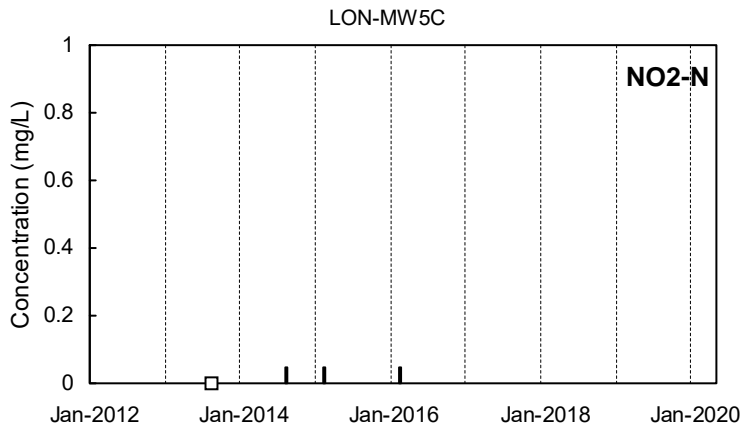
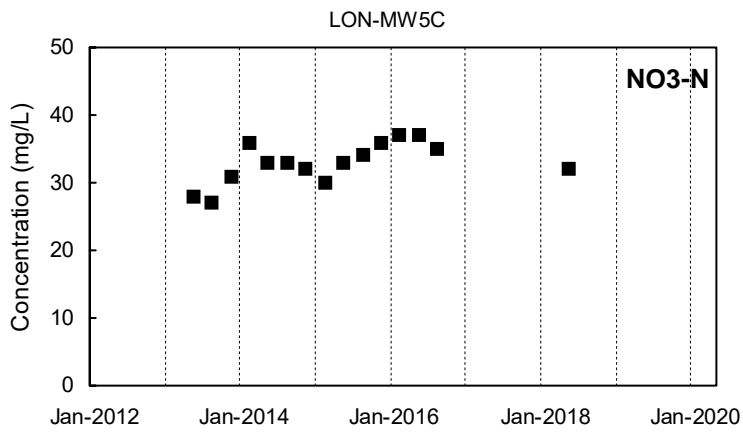

Detected Value
 'J'-Flag (value between reporting limit and detection limit)
 Non-Detect Range
 Shallow Well shown with black symbols
 Deep Well shown with orange symbols
 "dd" Well shown with blue symbols

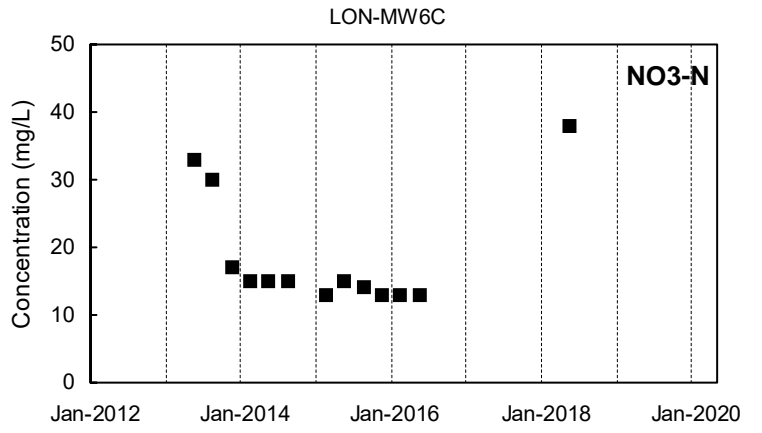
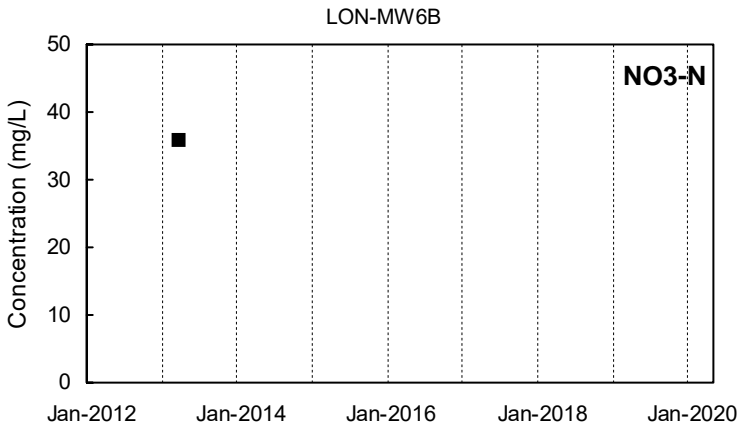

LON-MW6B
NO2-N
Not Sampled

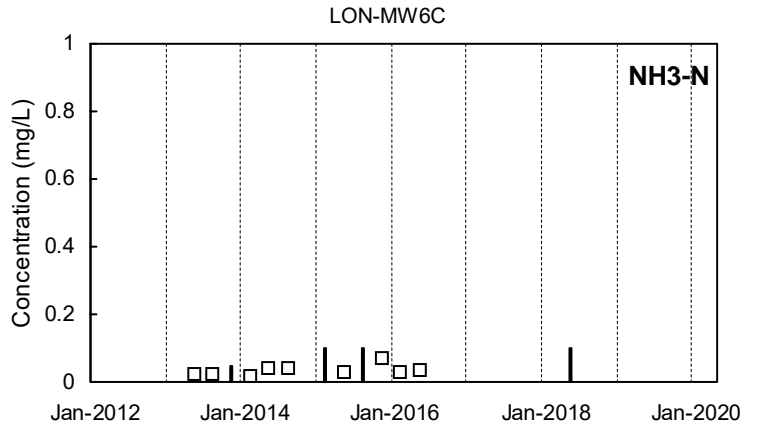
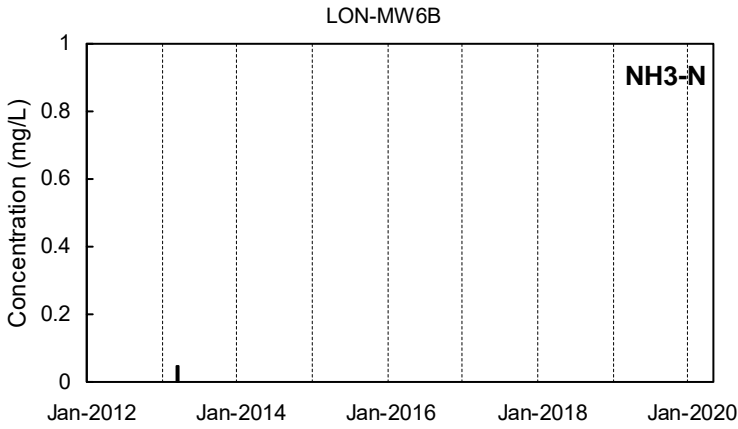
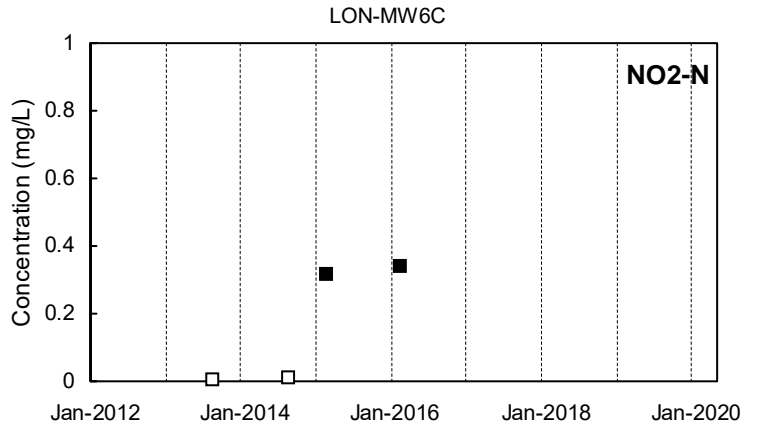

LON-MW6B
TKN
Not Sampled

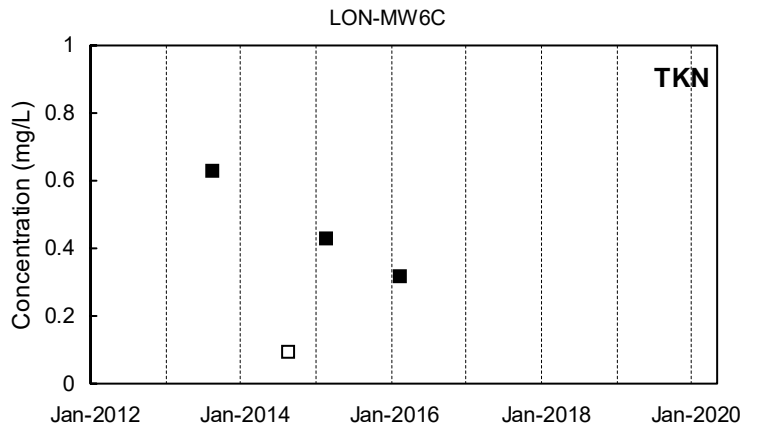

Detected Value
 'J'-Flag (value between reporting limit and detection limit)
 Non-Detect Range
Shallow Well shown with black symbols
Deep Well shown with orange symbols
"dd" Well shown with blue symbols

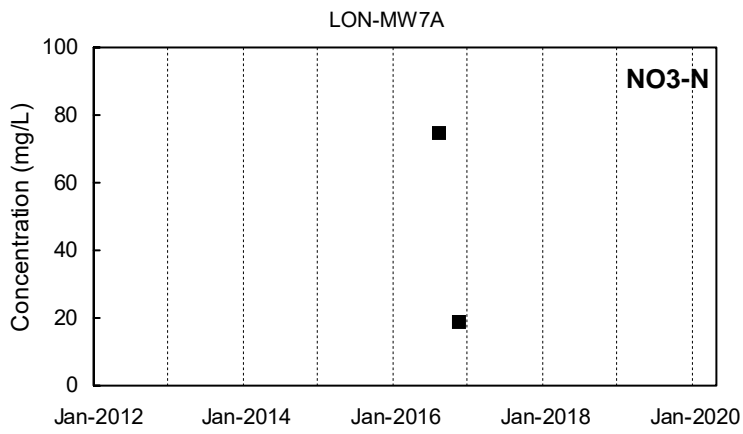

LON-MW7B

NO3-N
Not Sampled

LON-MW7A

NO2-N
Not Sampled

LON-MW7B

NO2-N
Not Sampled

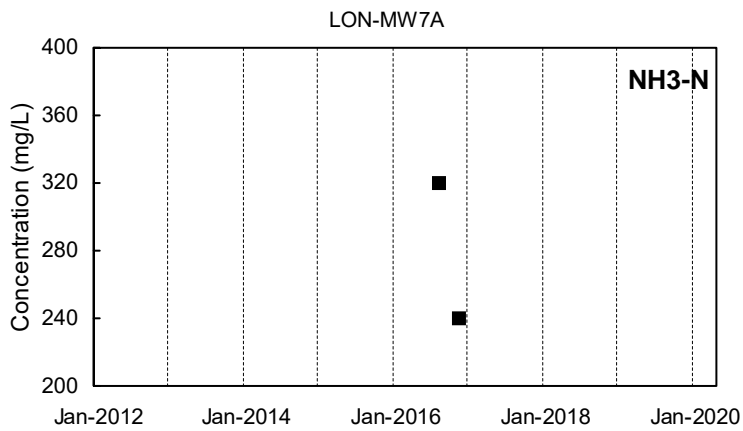

LON-MW7B

NH3-N
Not Sampled

LON-MW7A

TKN
Not Sampled

LON-MW7B

TKN
Not Sampled

■ Detected Value □ 'J'-Flag (value between reporting limit and detection limit) ■ Non-Detect Range
 Shallow Well shown with black symbols Deep Well shown with orange symbols "dd" Well shown with blue symbols

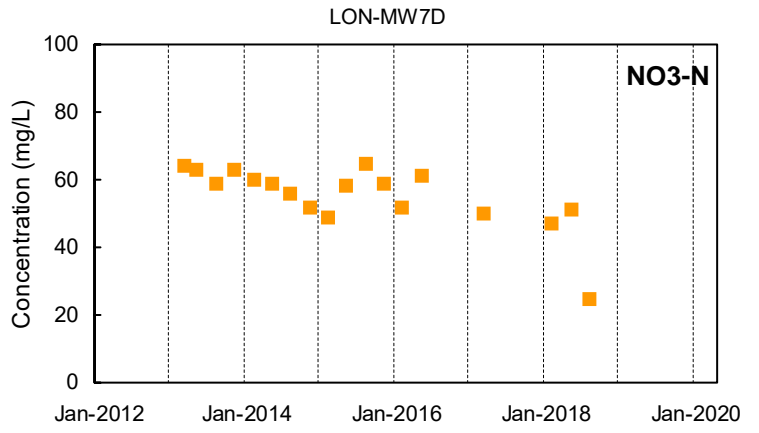
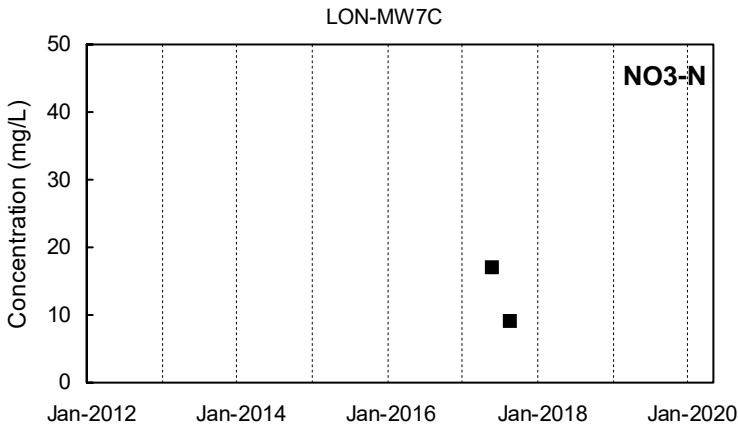

LON-MW7C

NO2-N
Not Sampled

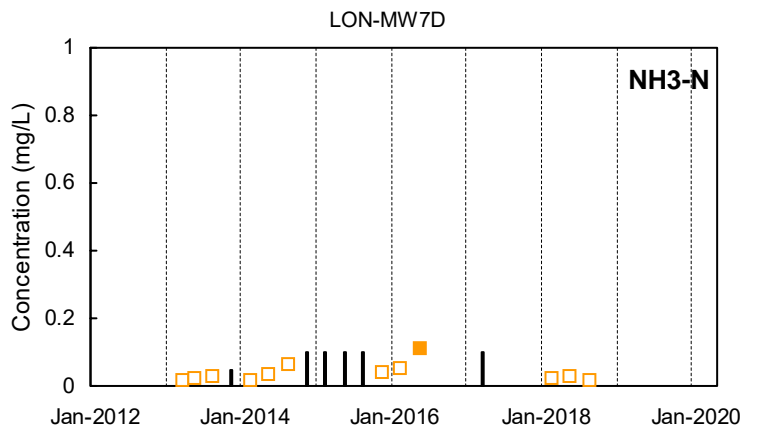
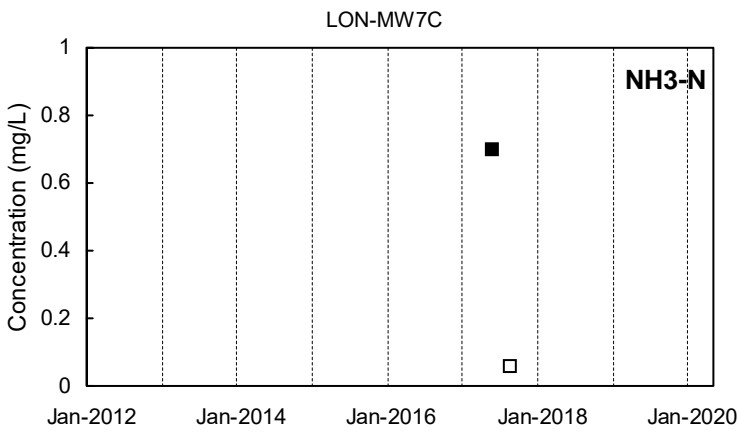
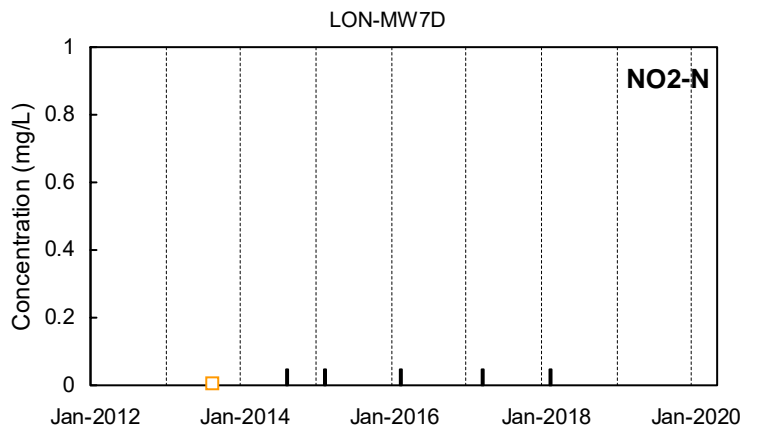

LON-MW7C

TKN
Not Sampled

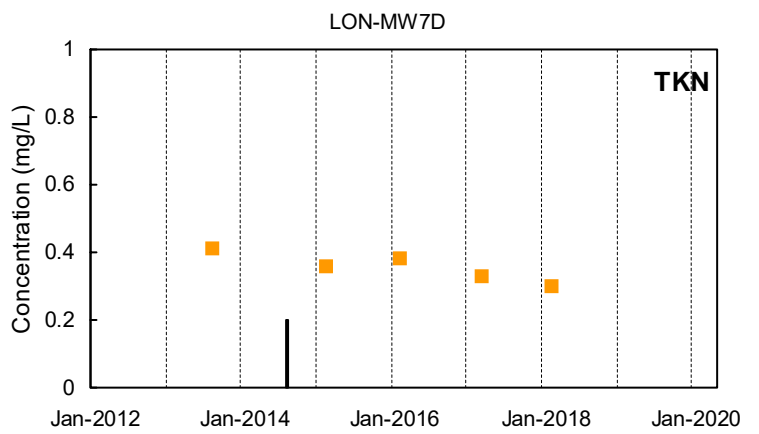

Detected Value
 'J'-Flag (value between reporting limit and detection limit)
 Non-Detect Range
 Shallow Well shown with black symbols
 Deep Well shown with orange symbols
 "dd" Well shown with blue symbols

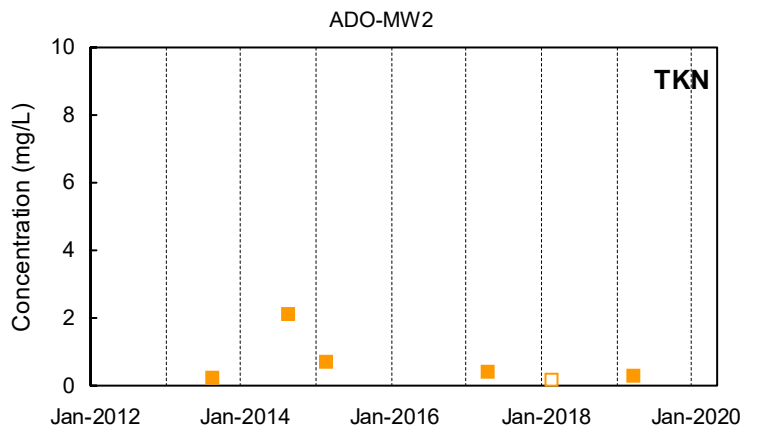
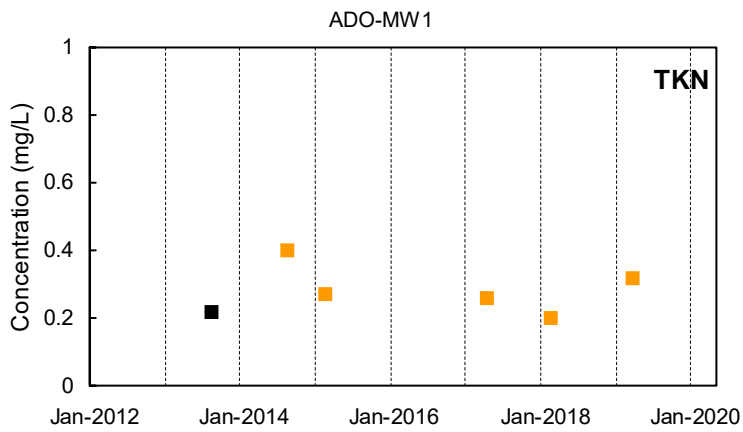
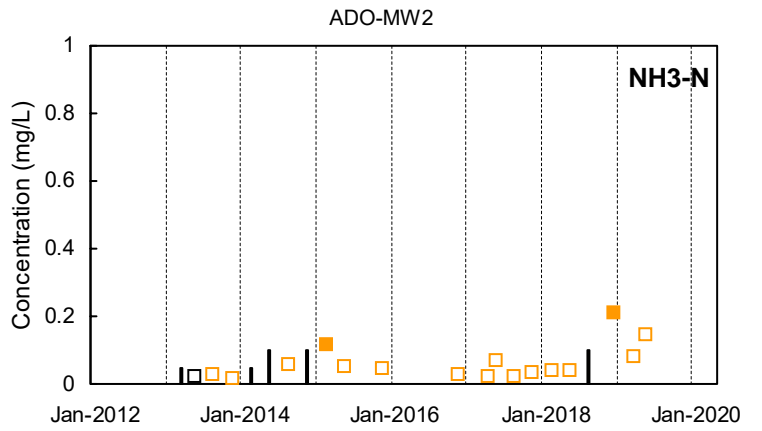
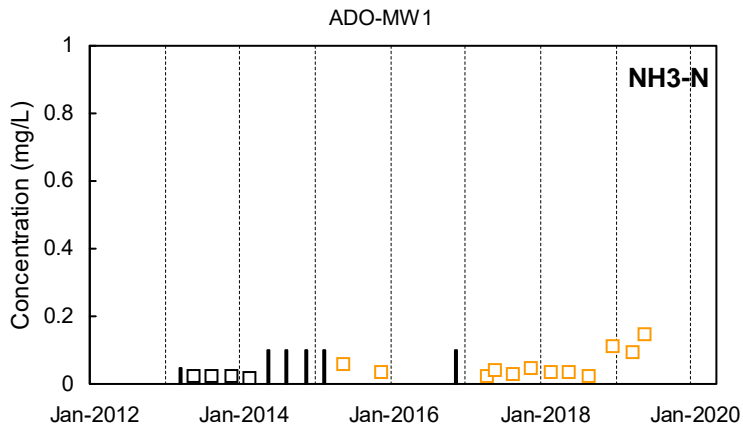
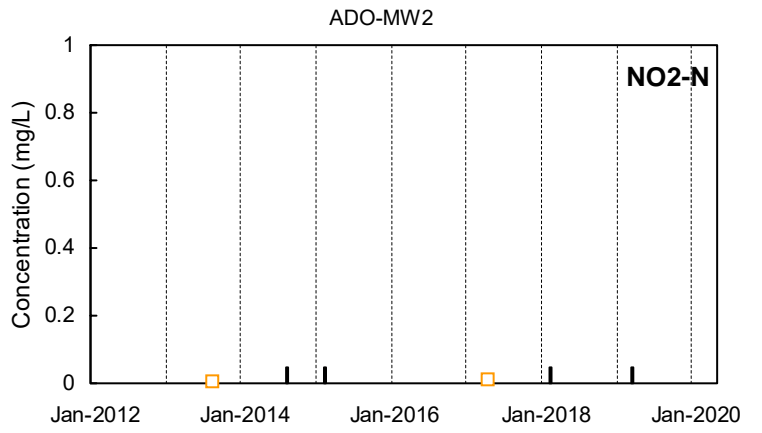
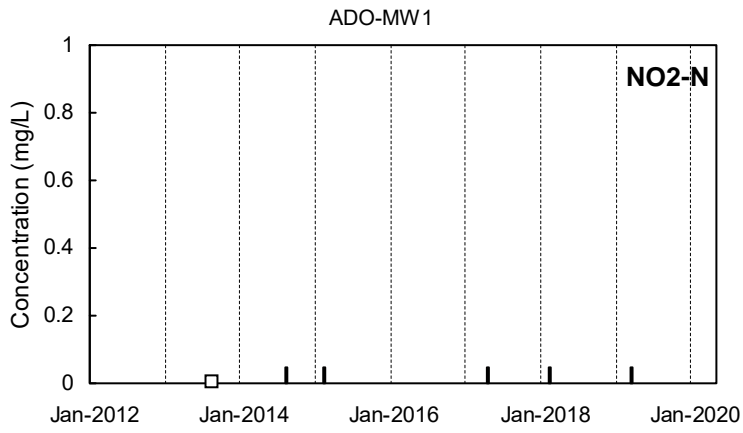
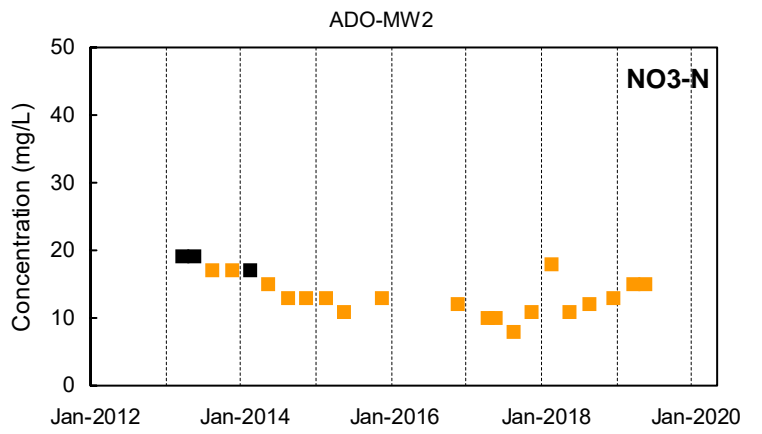
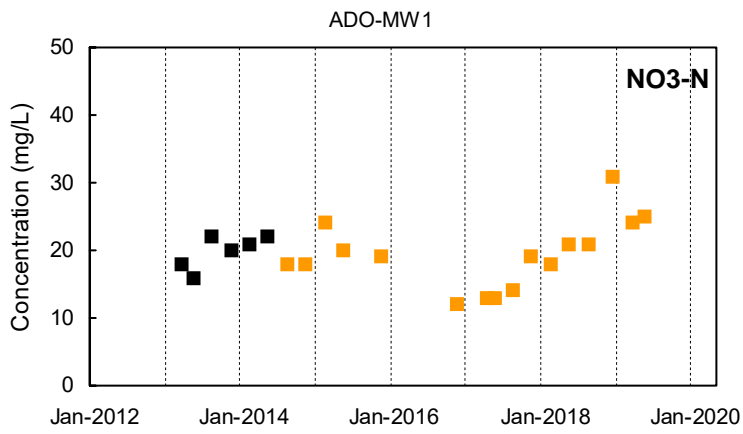

■ Detected Value □ 'J'-Flag (value between reporting limit and detection limit) ■ Non-Detect Range
 ■ Shallow Well shown with black symbols ■ Deep Well shown with orange symbols ■ "dd" Well shown with blue symbols

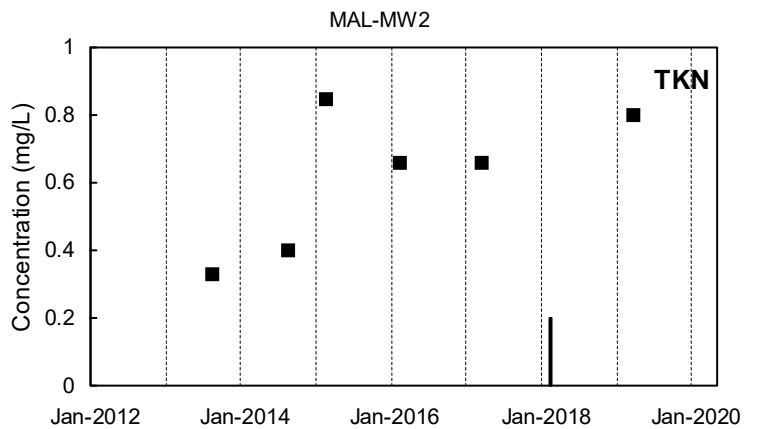
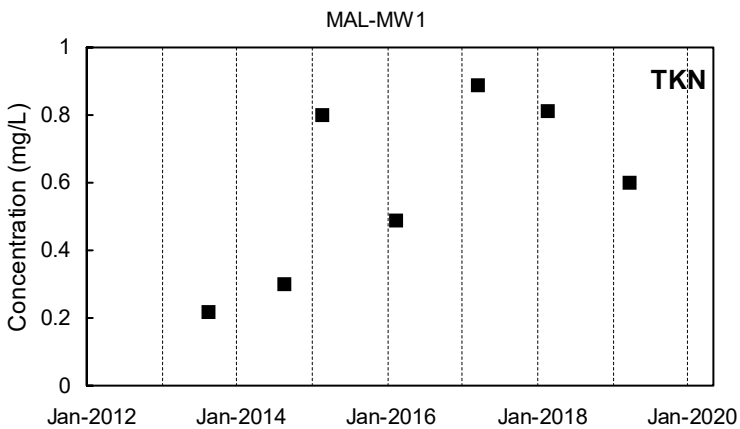
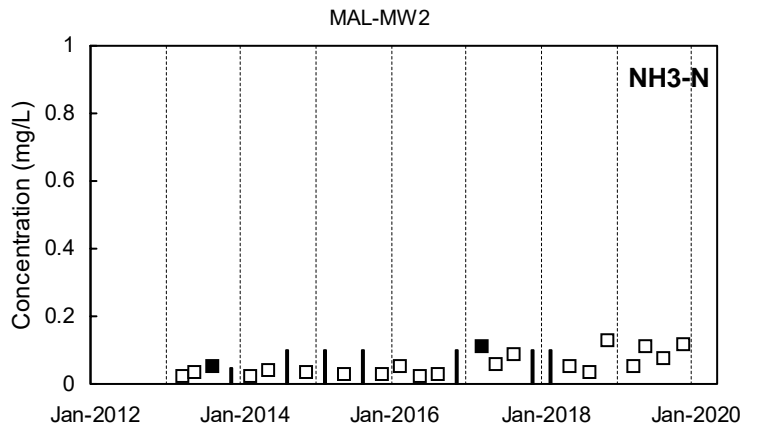
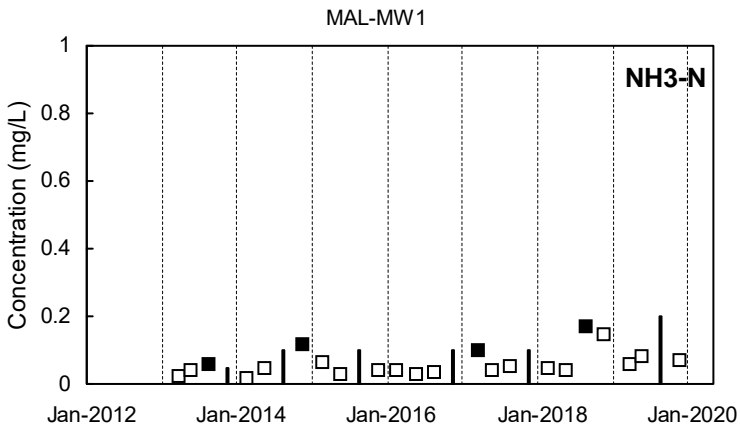
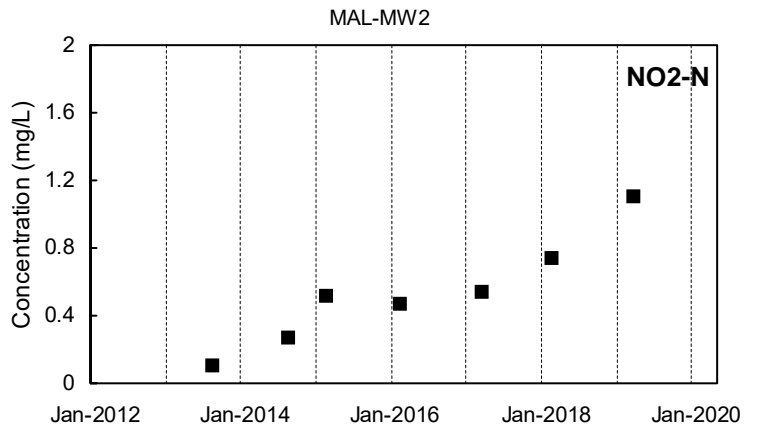
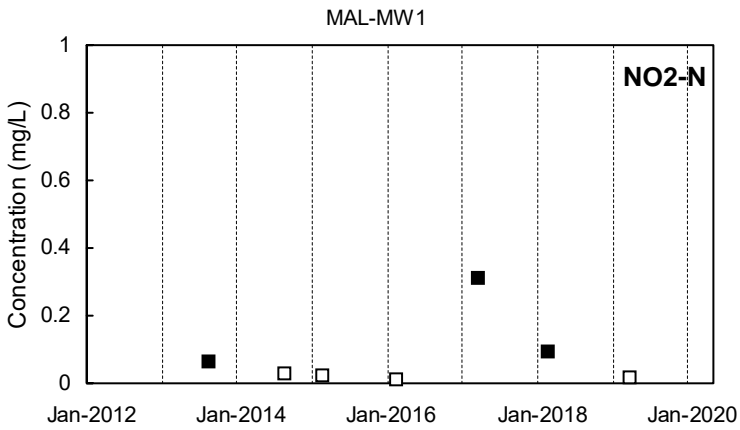
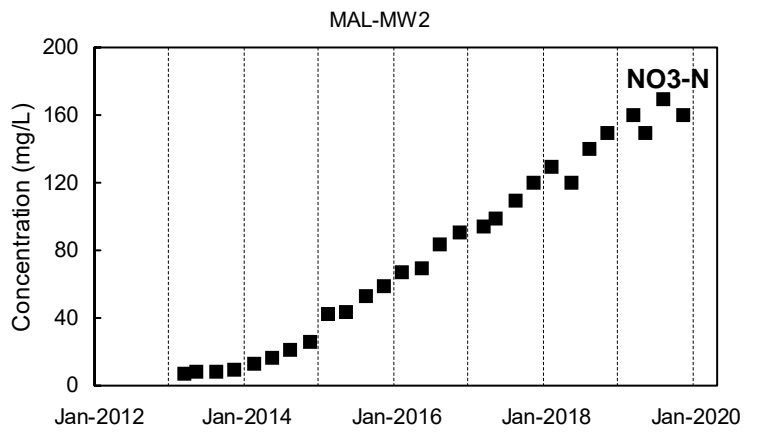
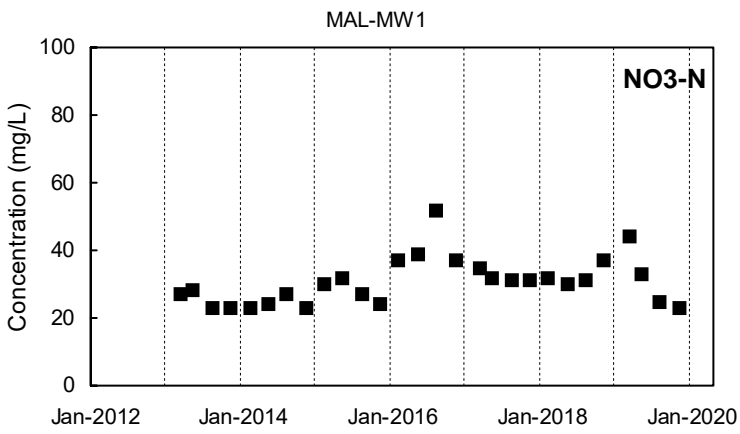

■ Detected Value □ 'J'-Flag (value between reporting limit and detection limit) ■ Non-Detect Range
 Shallow Well shown with black symbols Deep Well shown with orange symbols "dd" Well shown with blue symbols

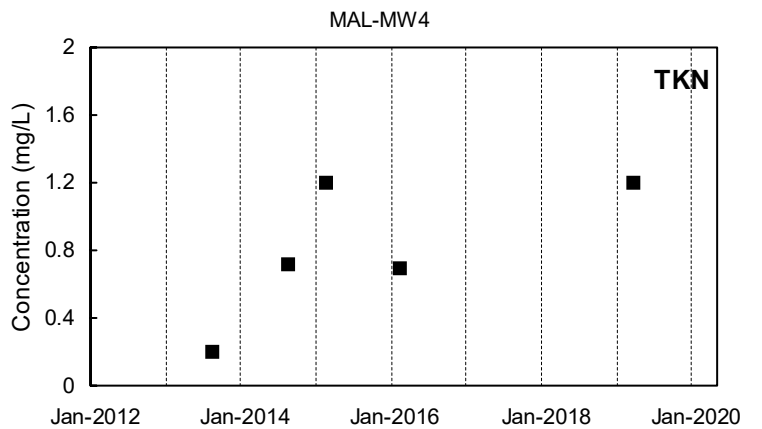
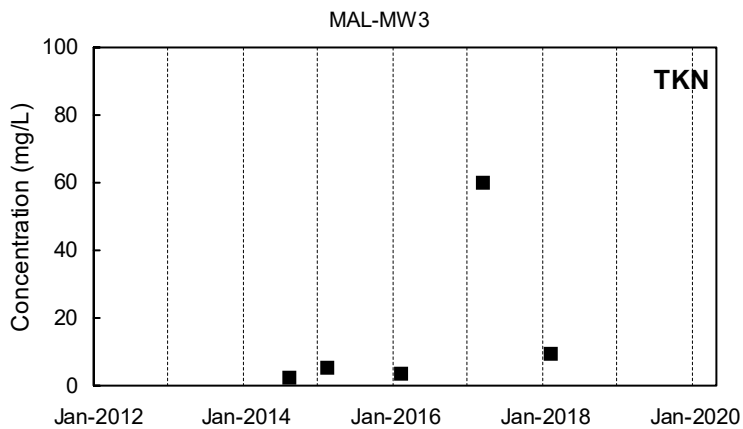
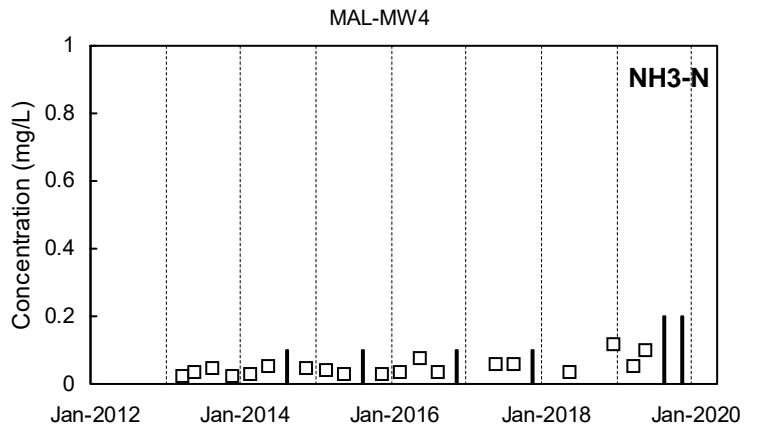
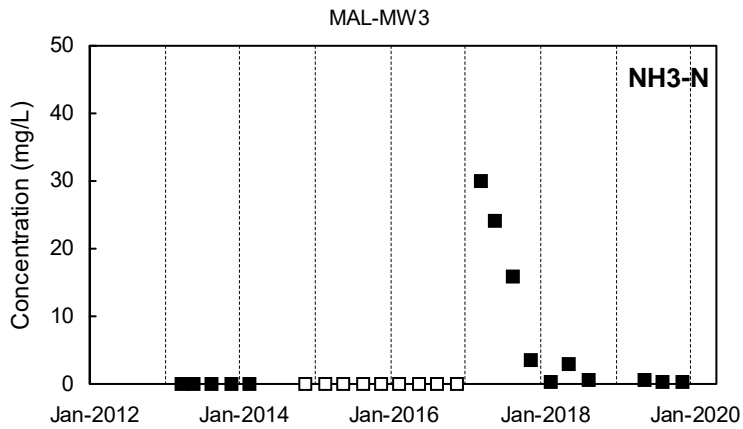
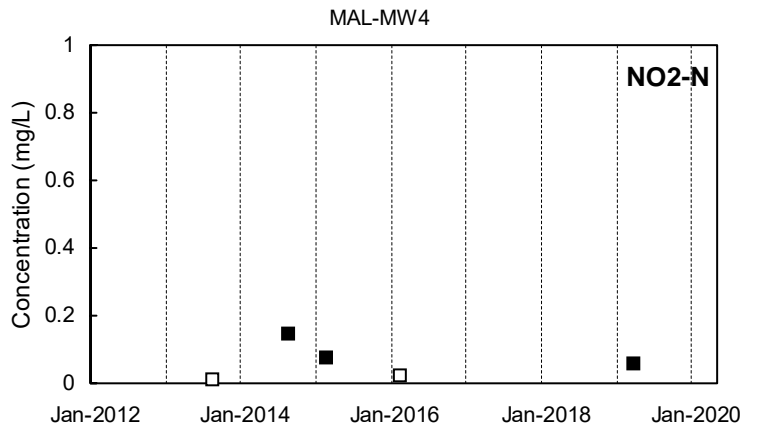
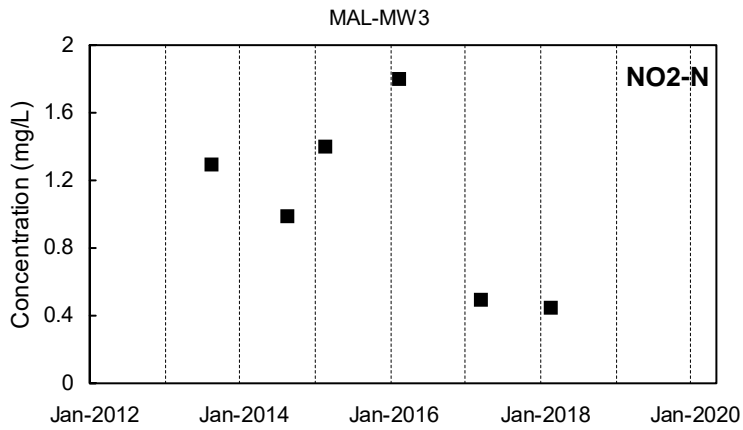
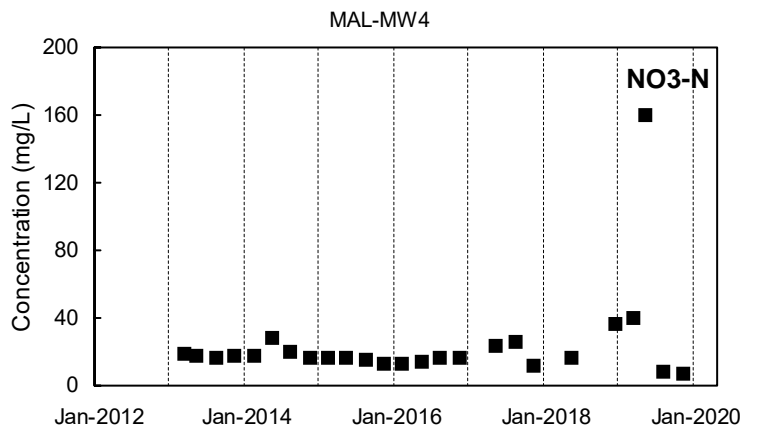
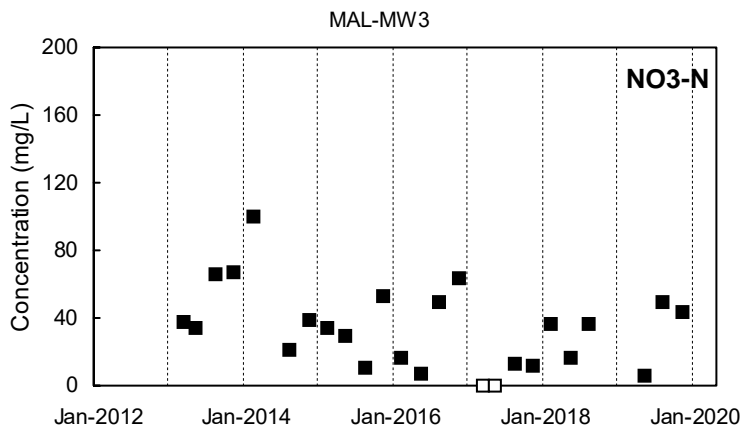

Detected Value
 'J'-Flag (value between reporting limit and detection limit)
 Non-Detect Range
 Shallow Well shown with black symbols
 Deep Well shown with orange symbols
 "dd" Well shown with blue symbols

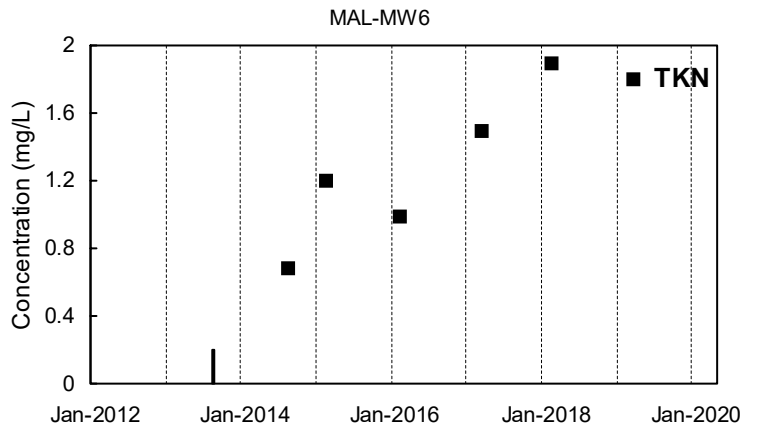
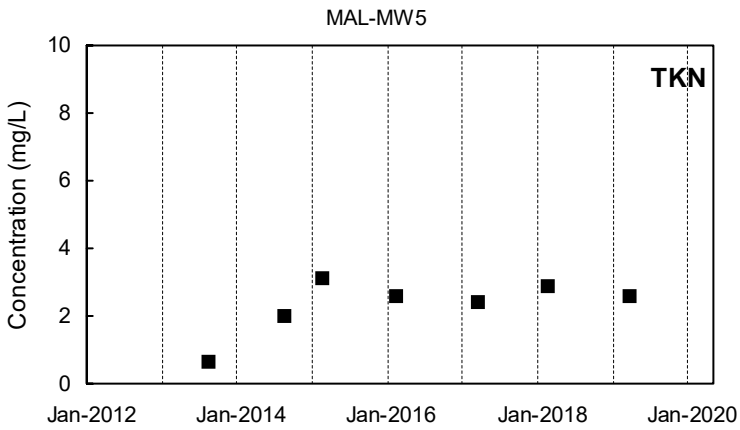
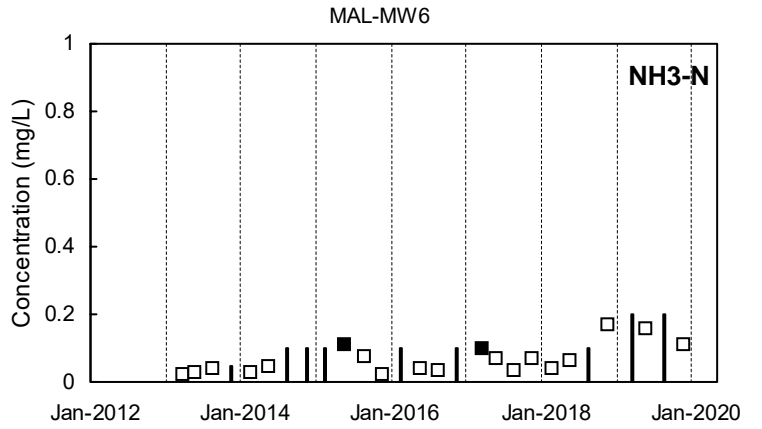
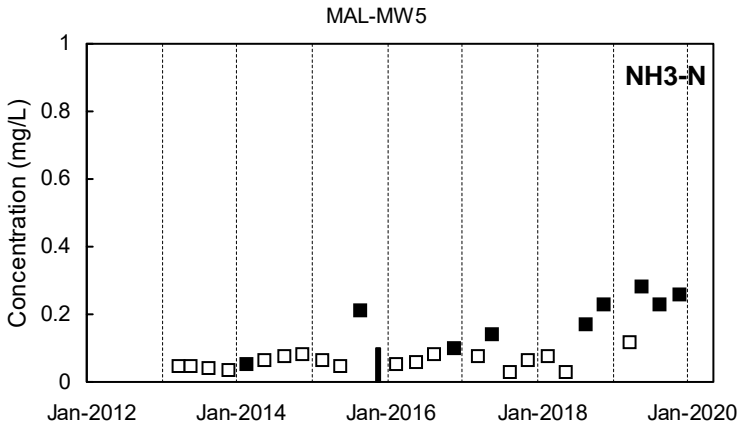
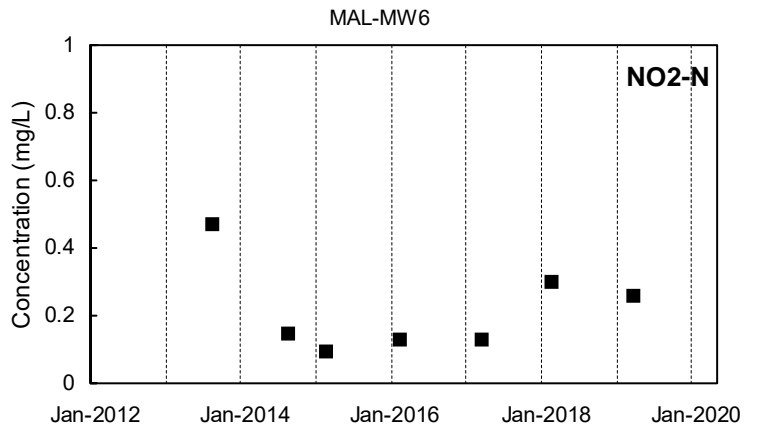
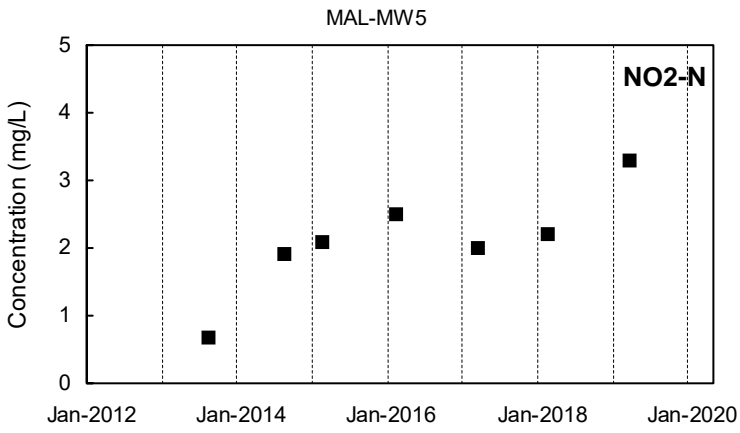
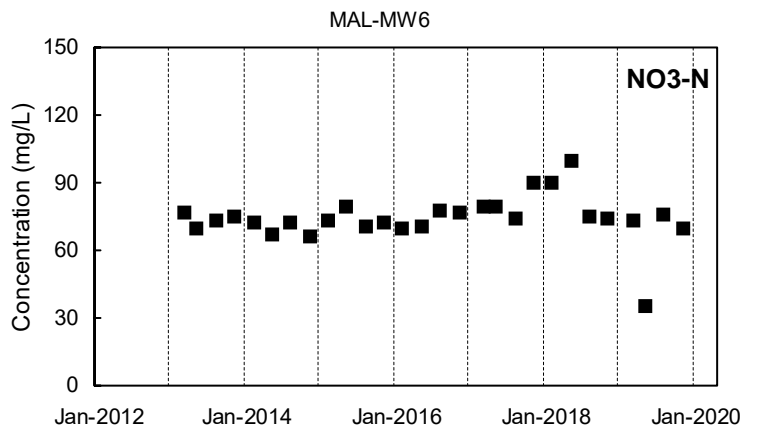
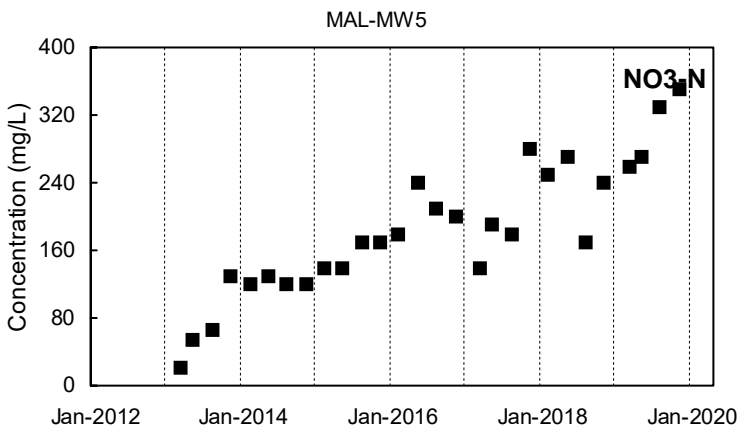

Detected Value
 'J'-Flag (value between reporting limit and detection limit)
 Non-Detect Range
 Shallow Well shown with black symbols
 Deep Well shown with orange symbols
 "dd" Well shown with blue symbols

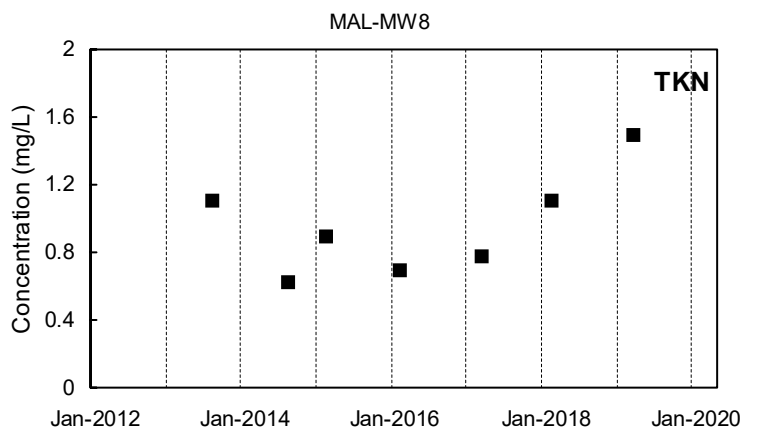
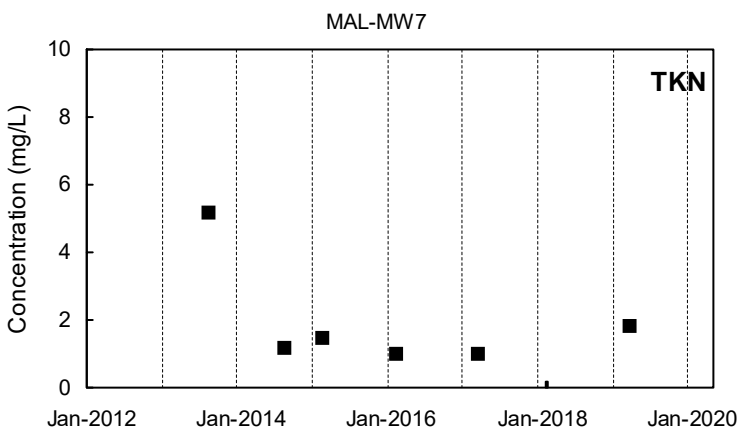
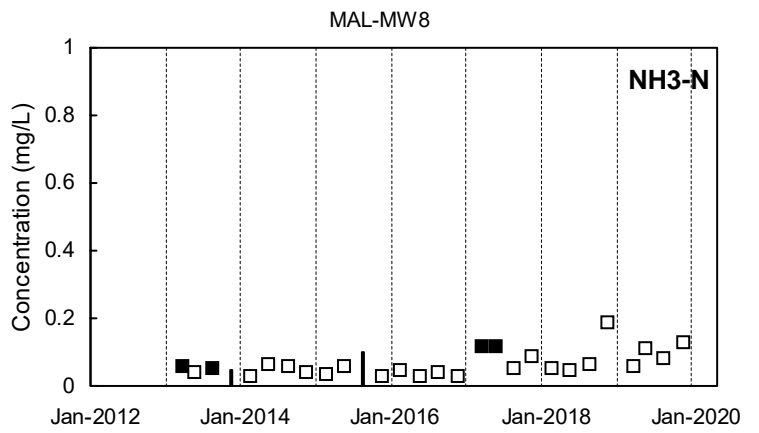
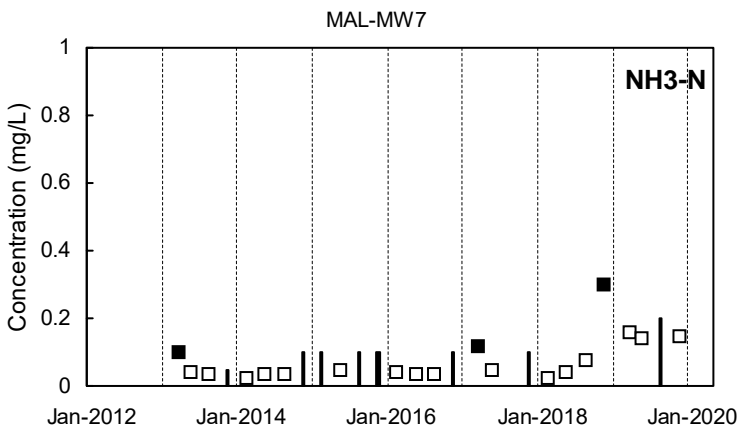
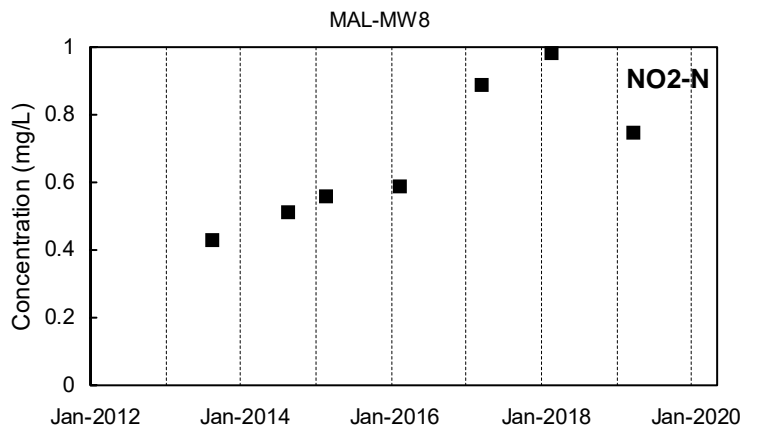
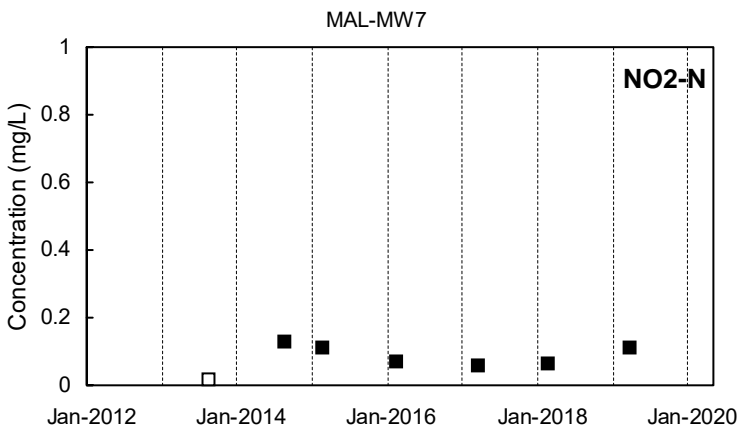
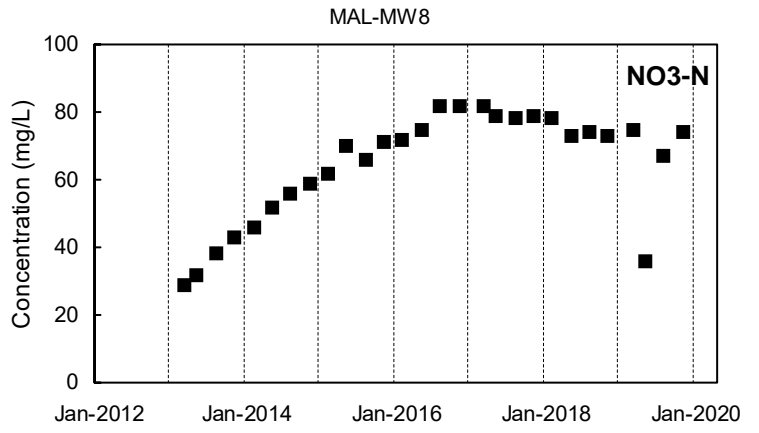
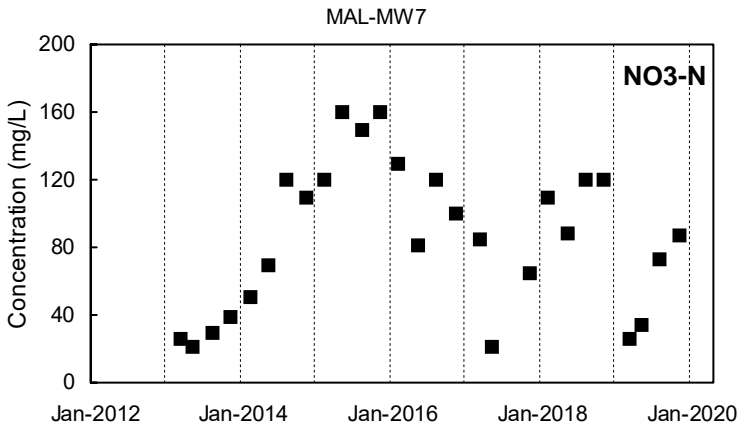

Detected Value
 'J'-Flag (value between reporting limit and detection limit)
 Non-Detect Range
Shallow Well shown with black symbols
Deep Well shown with orange symbols
"dd" Well shown with blue symbols

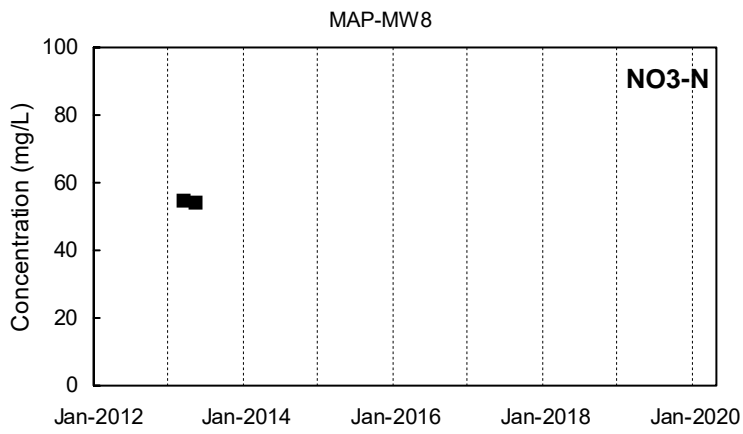

MAP-MW9

NO3-N
Not Sampled

MAP-MW8

NO2-N
Not Sampled

MAP-MW9

NO2-N
Not Sampled

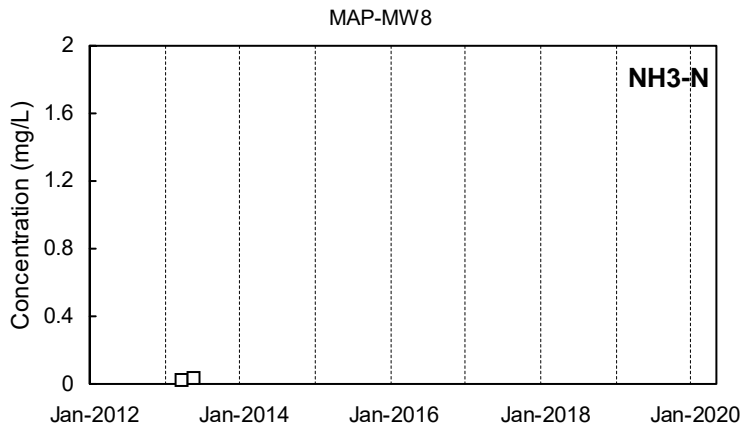

MAP-MW9

NH3-N
Not Sampled

MAP-MW8

TKN
Not Sampled

MAP-MW9

TKN
Not Sampled

Detected Value
 'J'-Flag (value between reporting limit and detection limit)
 Non-Detect Range

Shallow Well shown with black symbols
Deep Well shown with orange symbols
"dd" Well shown with blue symbols

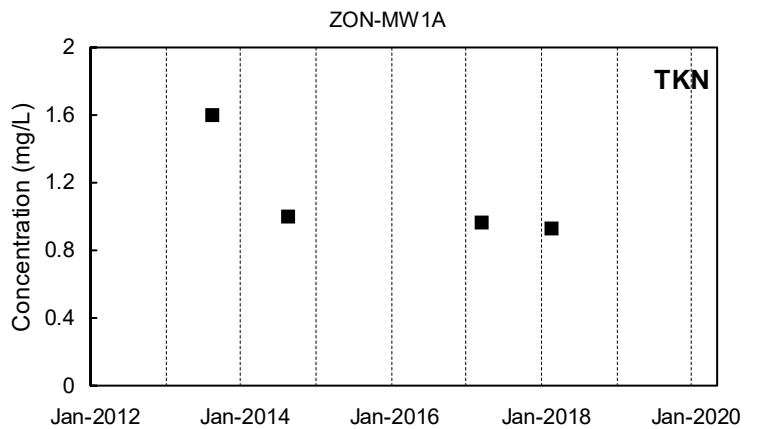
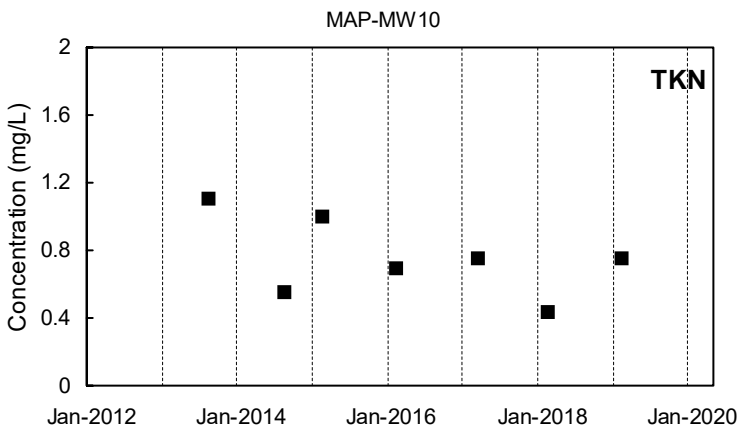
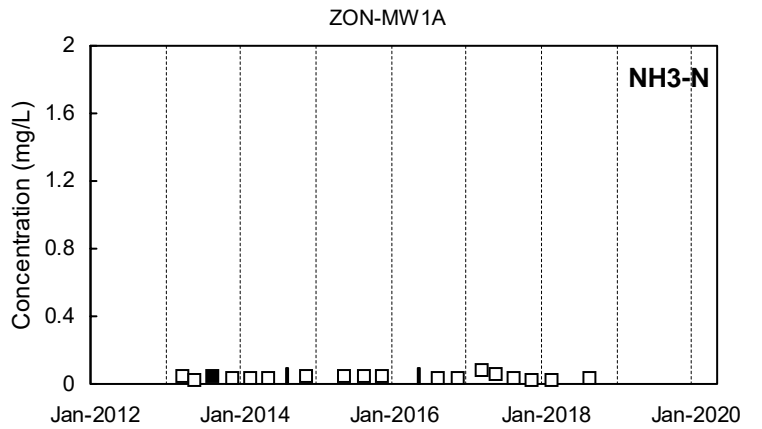
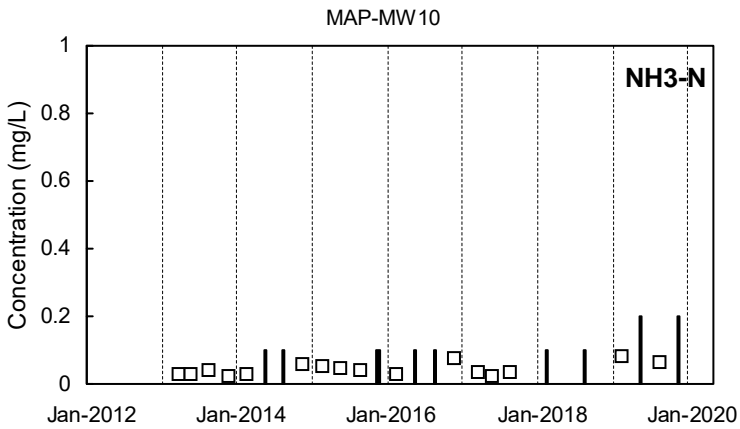
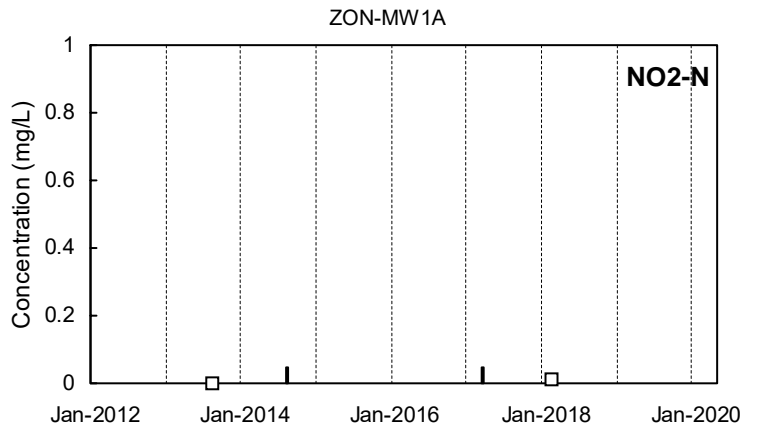
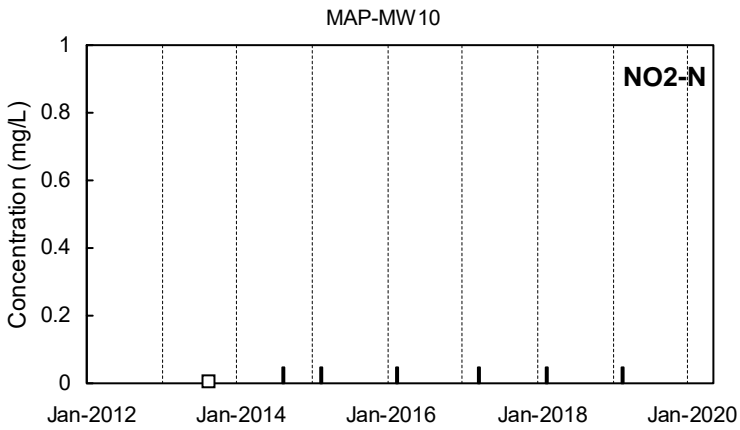
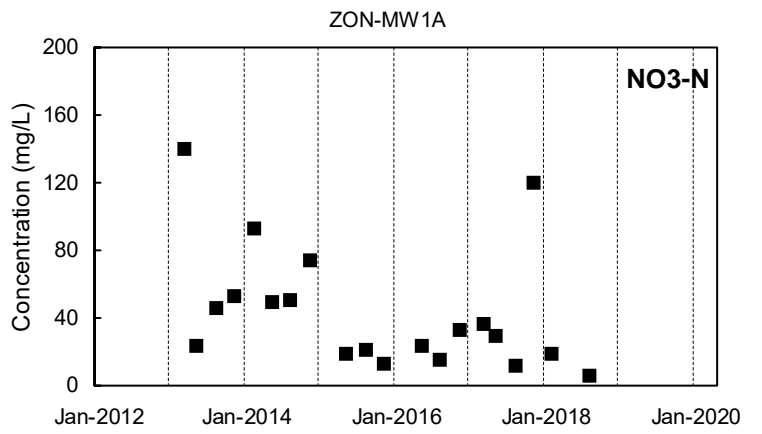
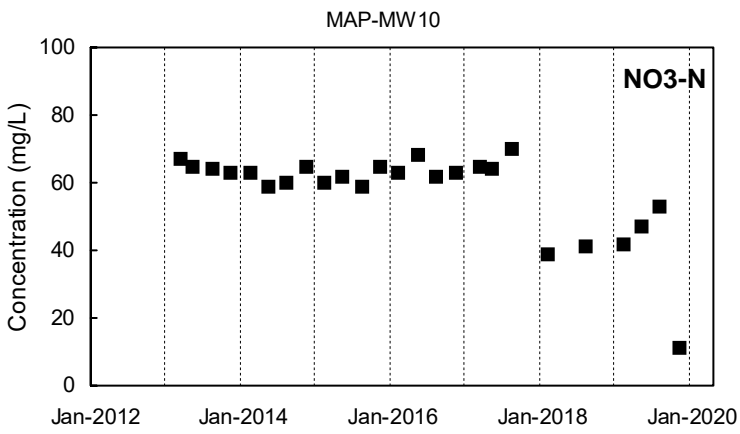

Detected Value
 'J'-Flag (value between reporting limit and detection limit)
 Non-Detect Range
 Shallow Well shown with black symbols
 Deep Well shown with orange symbols
 "dd" Well shown with blue symbols

ZON-MW1B

NO3-N
Not Sampled

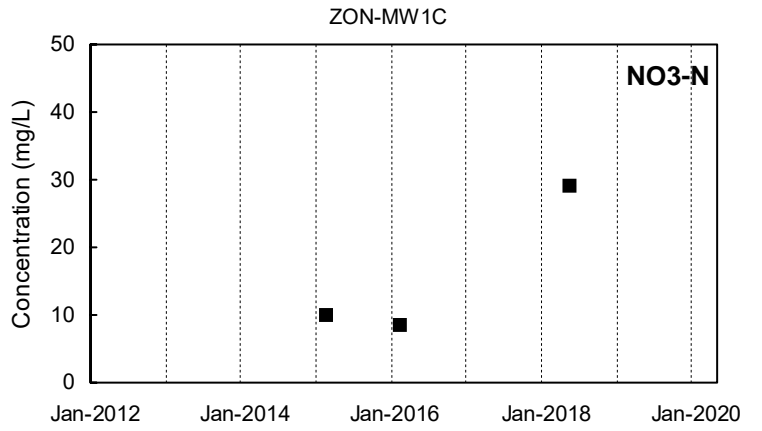

ZON-MW1B

NO2-N
Not Sampled

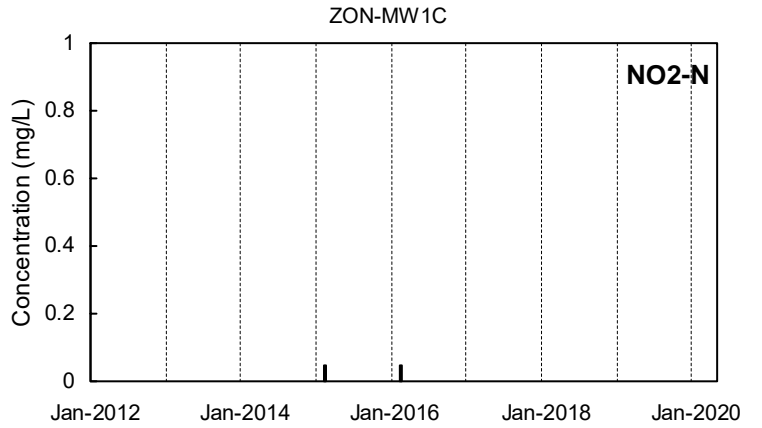

ZON-MW1B

NH3-N
Not Sampled

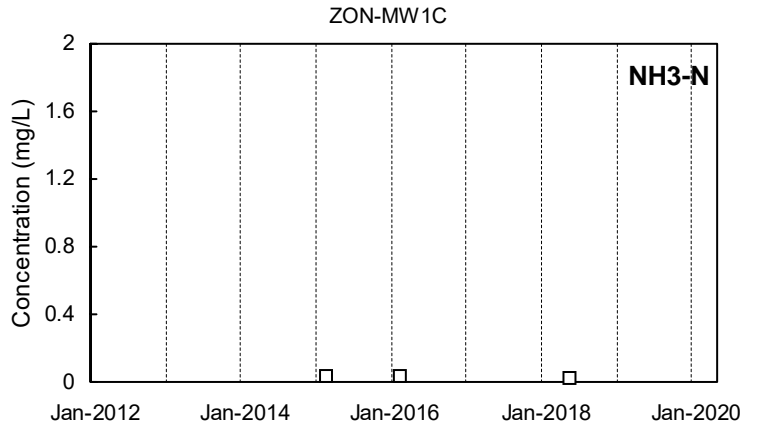

ZON-MW1B

TKN
Not Sampled

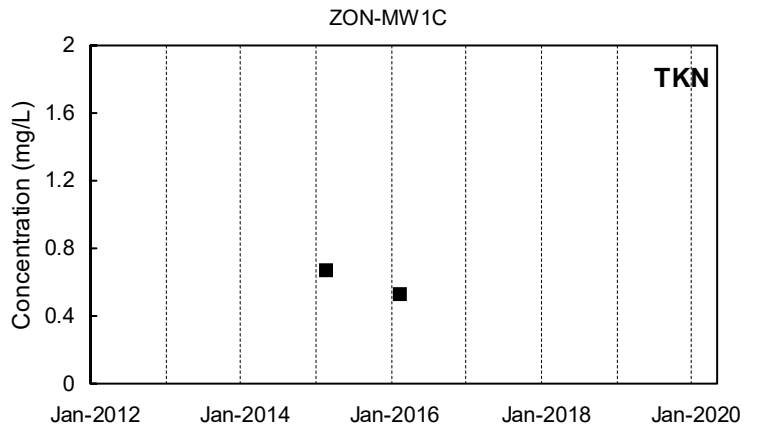

■ Detected Value

□ 'J'-Flag (value between reporting limit and detection limit)

■ Non-Detect Range

Shallow Well shown with black symbols

Deep Well shown with orange symbols

"dd" Well shown with blue symbols

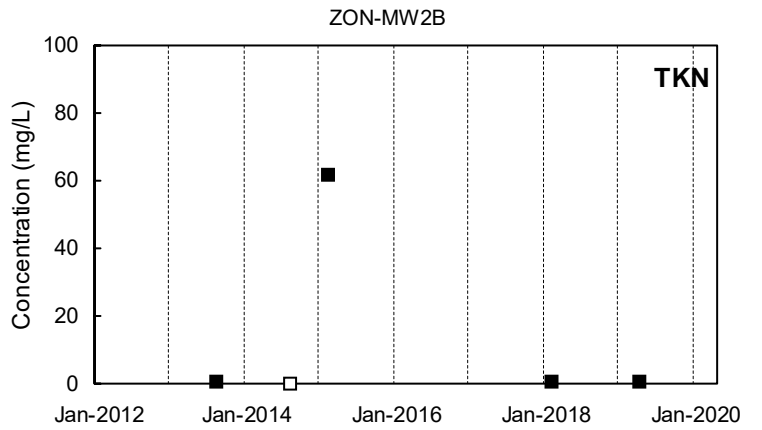
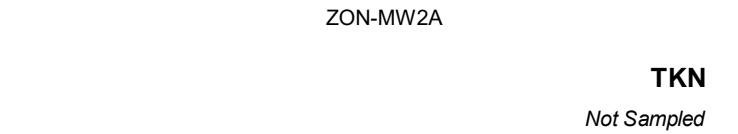
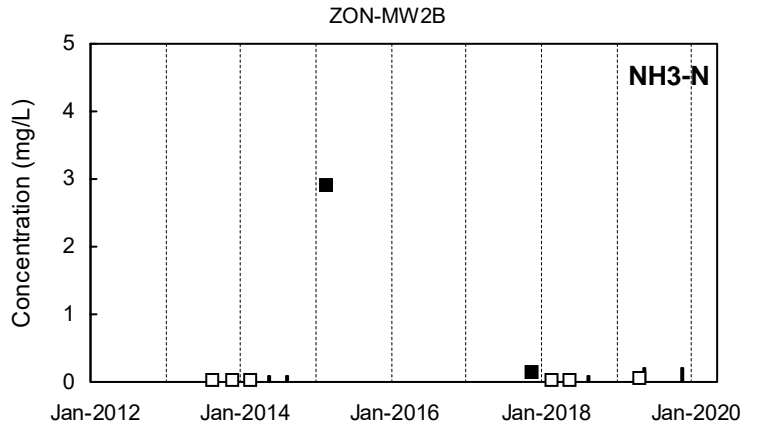
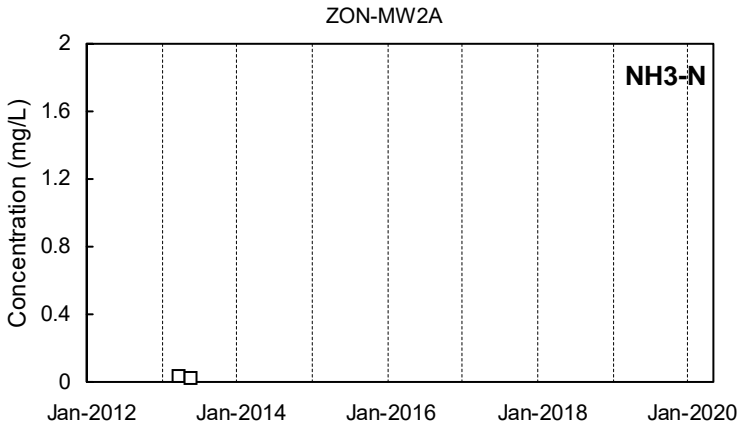
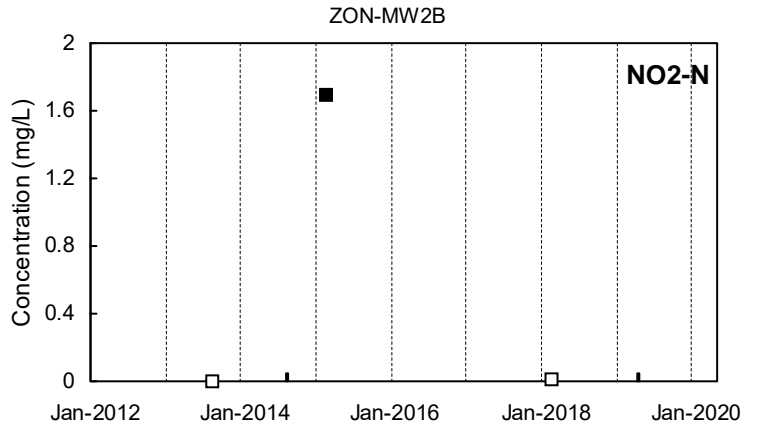
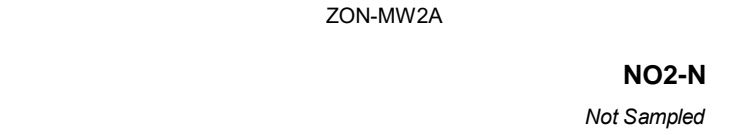
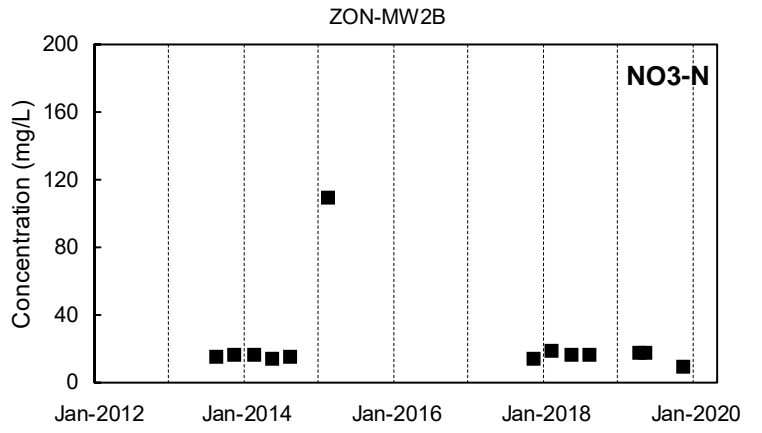
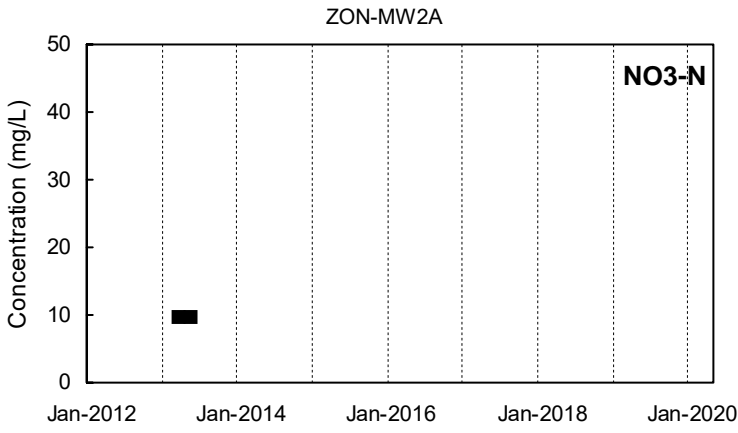

Detected Value
 'J'-Flag (value between reporting limit and detection limit)
 Non-Detect Range
 Shallow Well shown with black symbols Deep Well shown with orange symbols "dd" Well shown with blue symbols

ZON-MW3A

NO3-N

Not Sampled

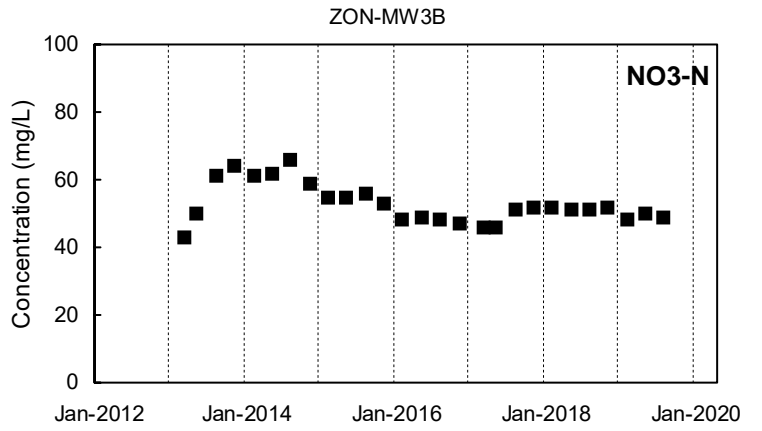

ZON-MW3A

NO2-N

Not Sampled

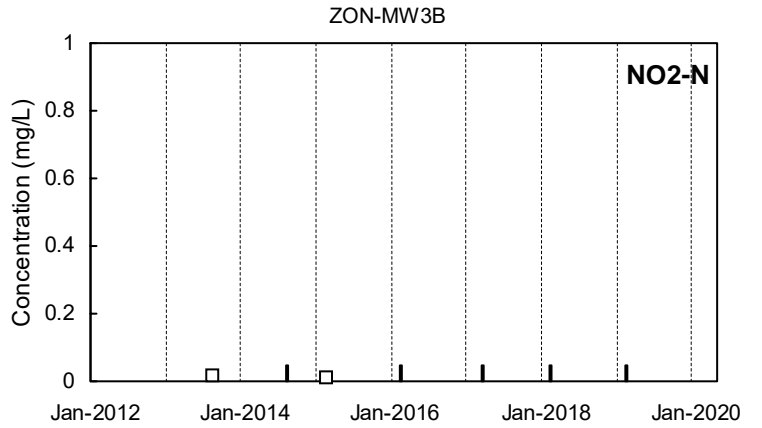

ZON-MW3A

NH3-N

Not Sampled

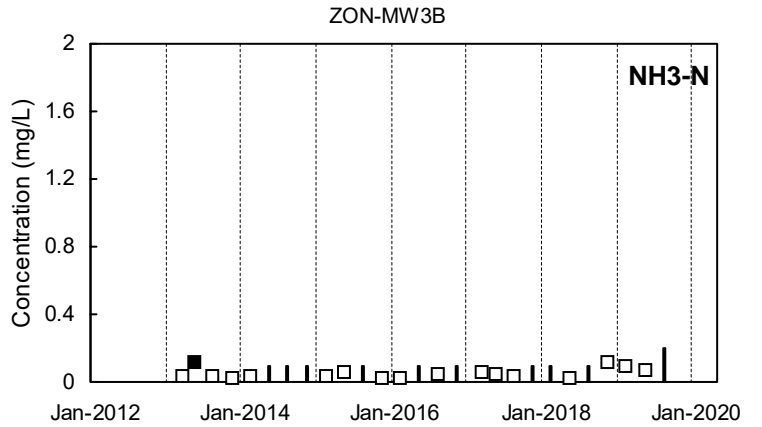

ZON-MW3A

TKN

Not Sampled

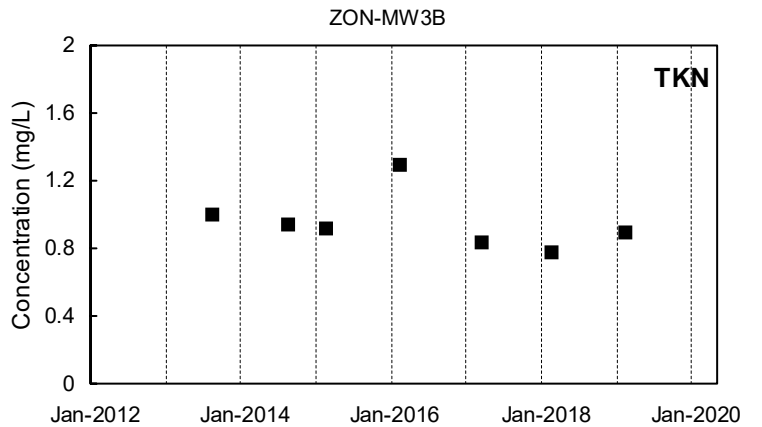

■ Detected Value □ 'J'-Flag (value between reporting limit and detection limit) ■ Non-Detect Range
 ■ Shallow Well shown with black symbols ■ Deep Well shown with orange symbols ■ "dd" Well shown with blue symbols

ZON-MW4A

NO3-N

Not Sampled

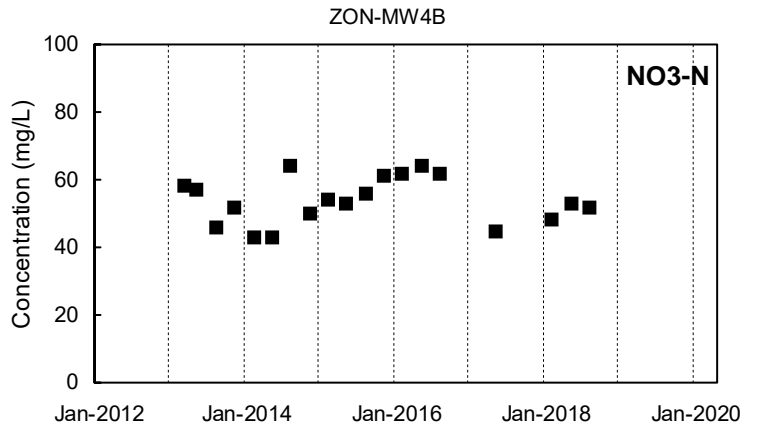

ZON-MW4A

NO2-N

Not Sampled

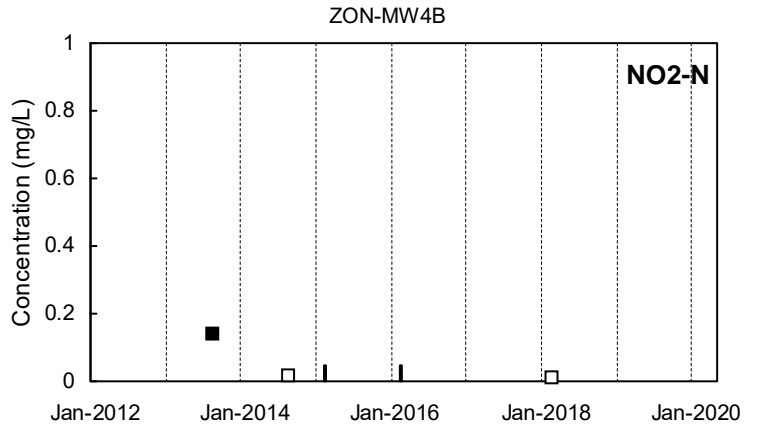

ZON-MW4A

NH3-N

Not Sampled

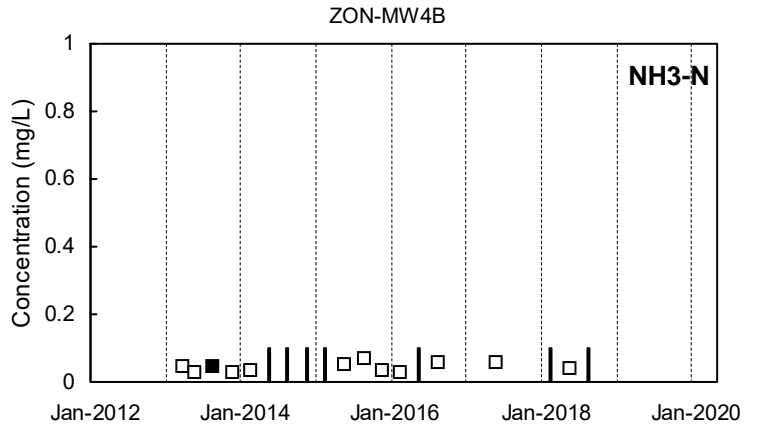

ZON-MW4A

TKN

Not Sampled

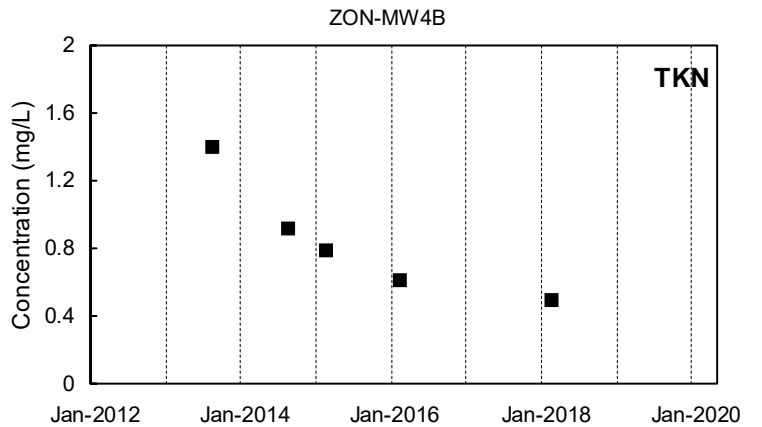

■ Detected Value

□ 'J'-Flag (value between reporting limit and detection limit)

■ Non-Detect Range

Shallow Well shown with black symbols

Deep Well shown with orange symbols

"dd" Well shown with blue symbols

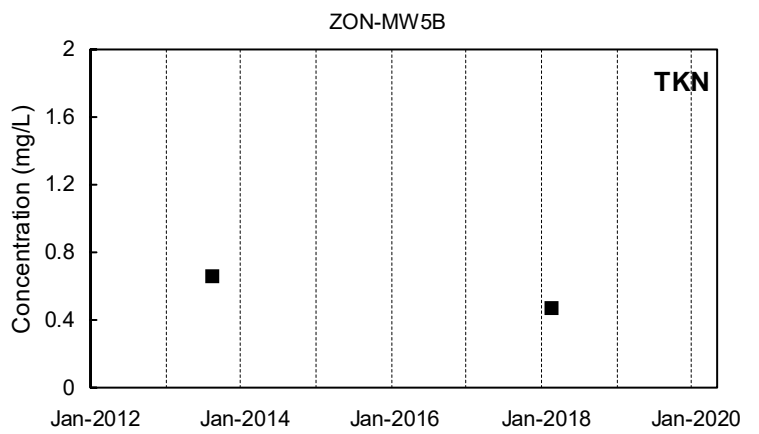
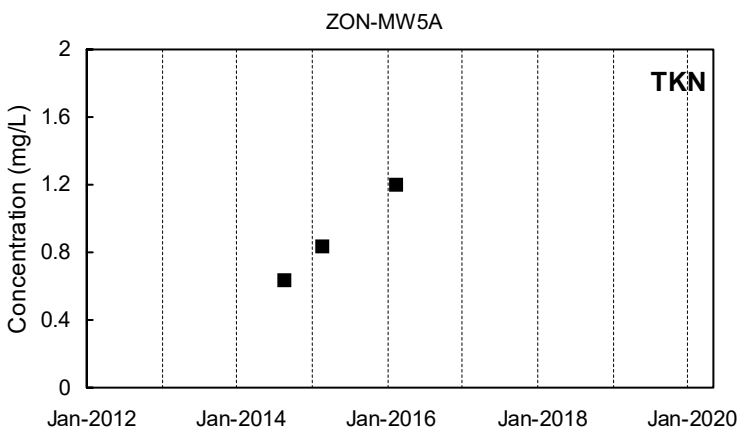
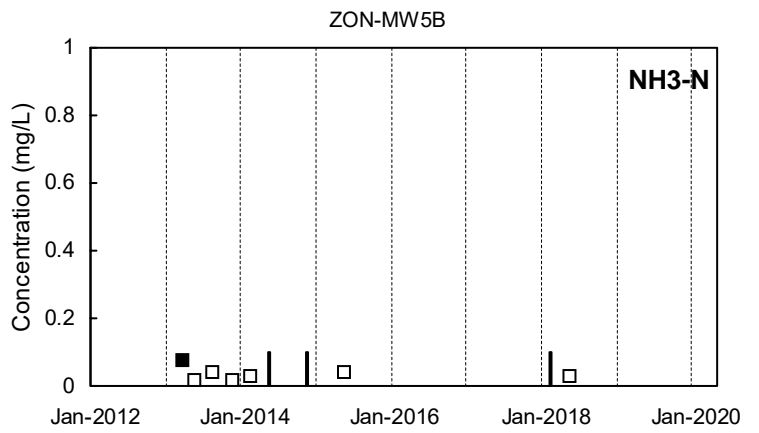
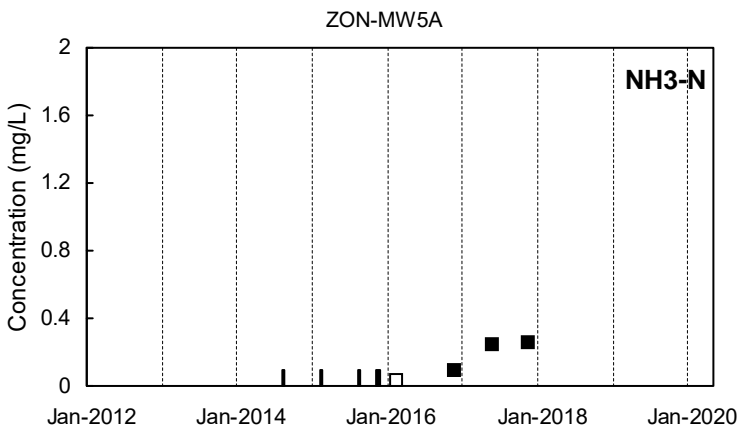
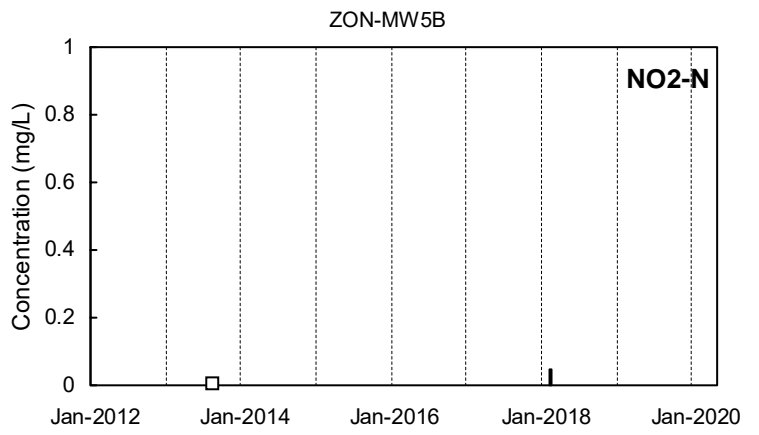
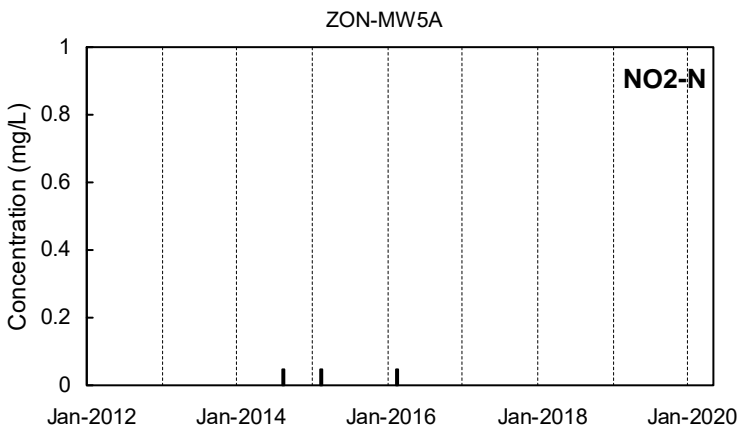
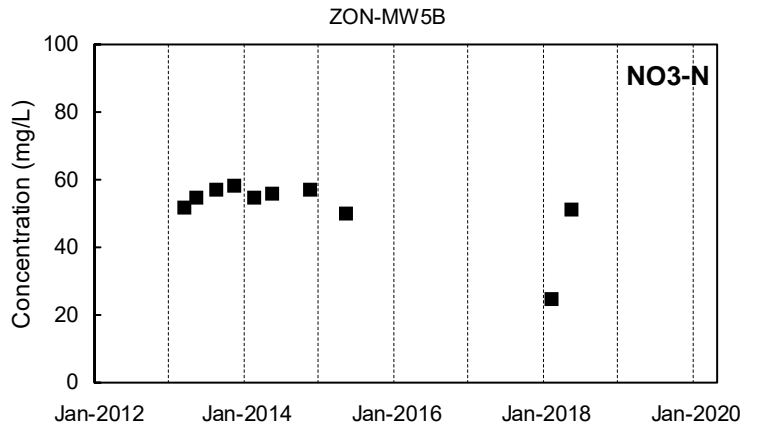
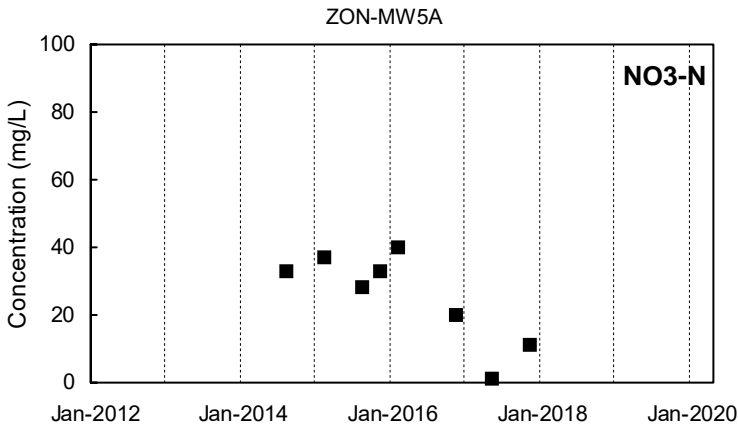

Detected Value
 'J'-Flag (value between reporting limit and detection limit)
 Non-Detect Range
Shallow Well shown with black symbols
 Deep Well shown with orange symbols
 "dd" Well shown with blue symbols

ZON-MW7

NO3-N
Not Sampled

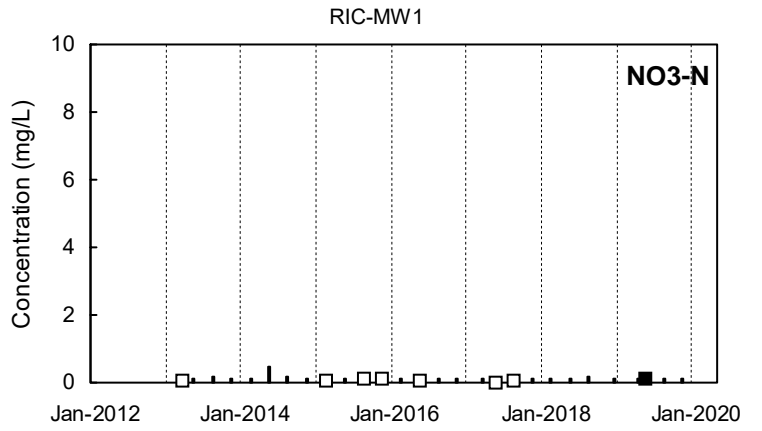

ZON-MW7

NO2-N
Not Sampled

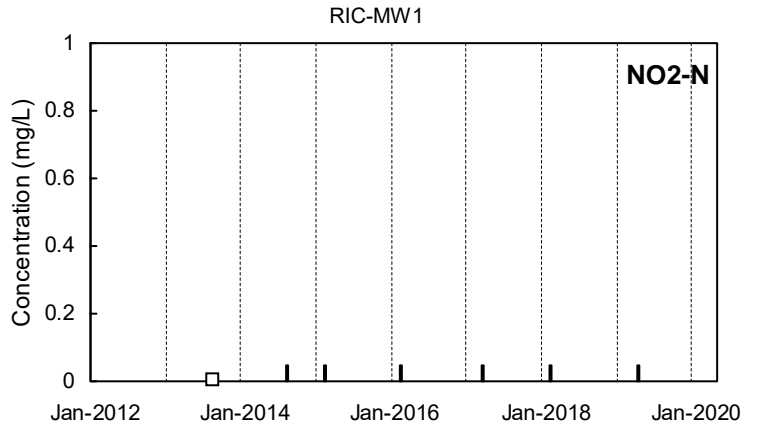

ZON-MW7

NH3-N
Not Sampled

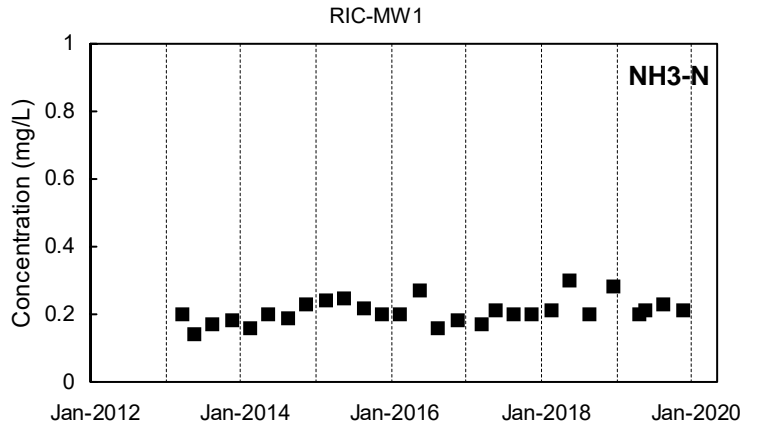

ZON-MW7

TKN
Not Sampled

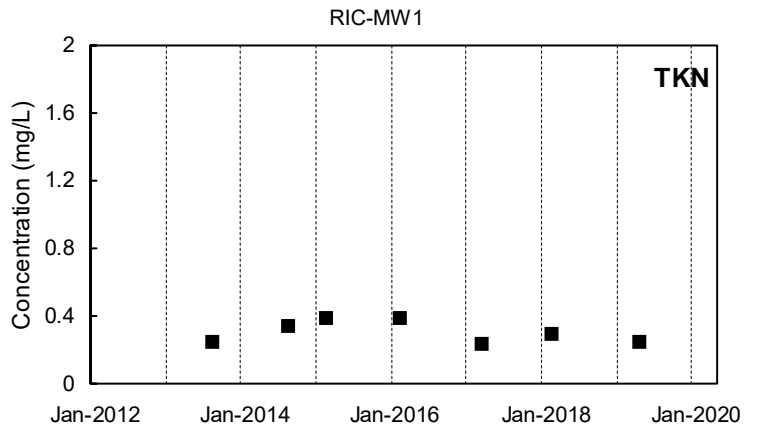

■ Detected Value □ 'J'-Flag (value between reporting limit and detection limit) ■ Non-Detect Range
 ■ Shallow Well shown with black symbols ■ Deep Well shown with orange symbols ■ "dd" Well shown with blue symbols

RIC-MW2

NO3-N

Not Sampled

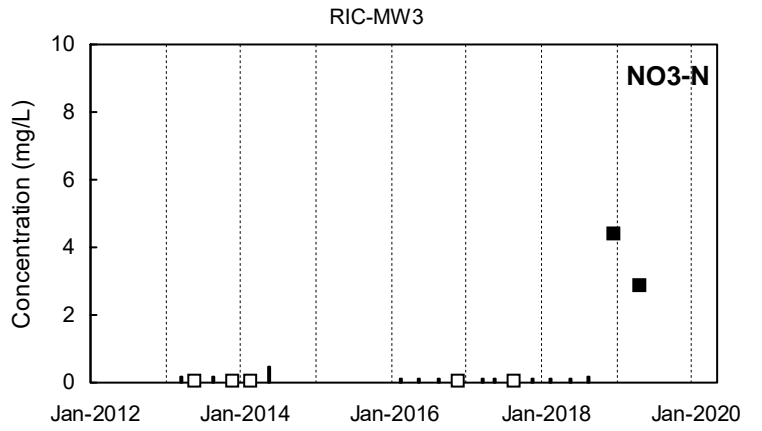

RIC-MW2

NO2-N

Not Sampled

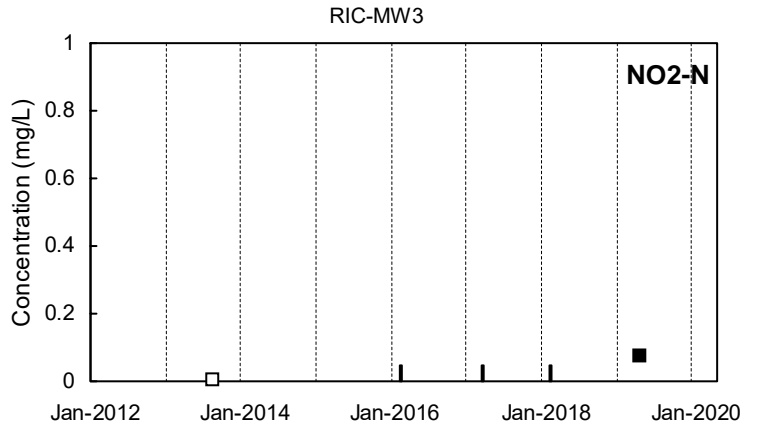

RIC-MW2

NH3-N

Not Sampled

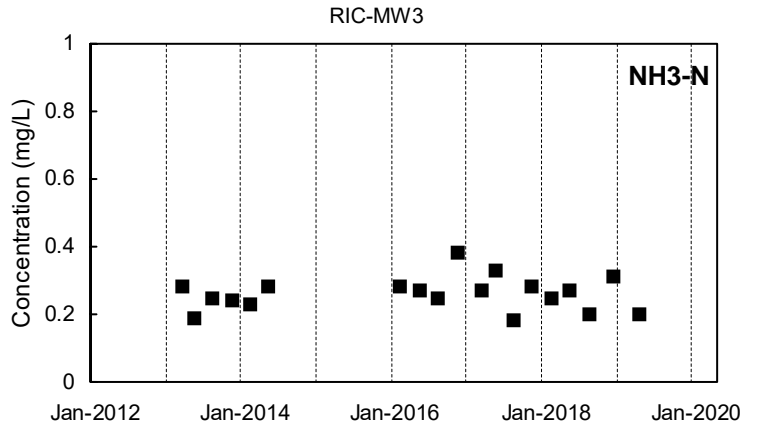

RIC-MW2

TKN

Not Sampled

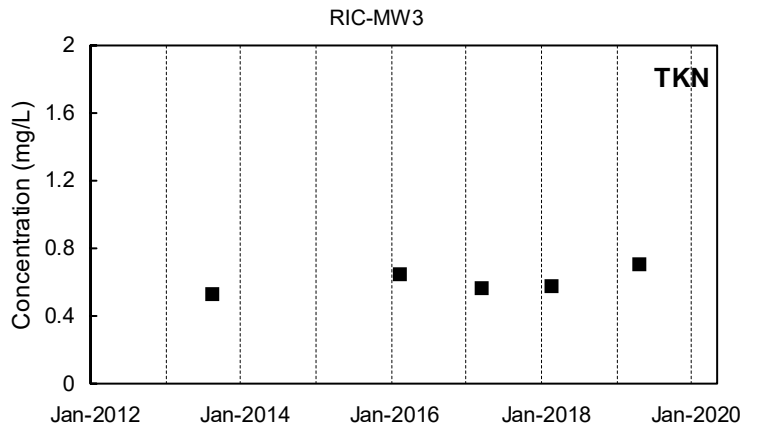

■ Detected Value □ 'J'-Flag (value between reporting limit and detection limit) ■ Non-Detect Range
 Shallow Well shown with black symbols Deep Well shown with orange symbols "dd" Well shown with blue symbols

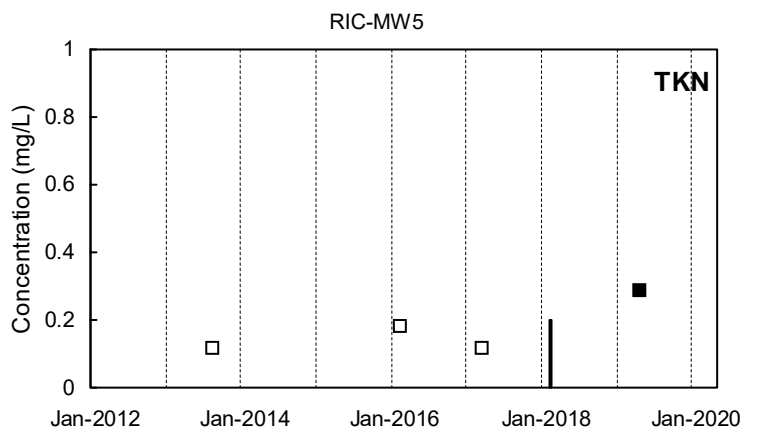
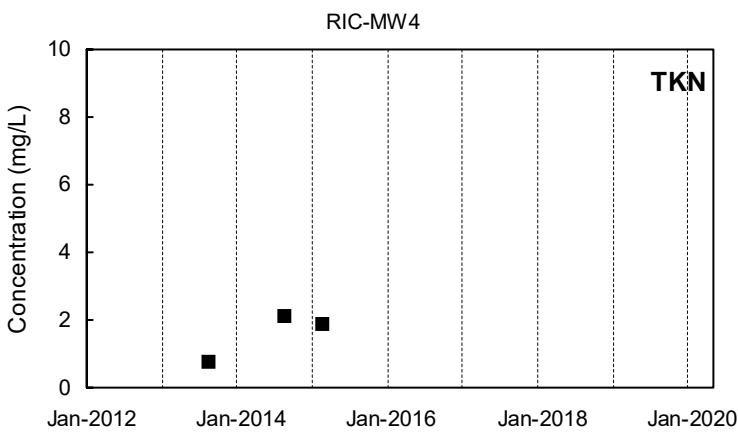
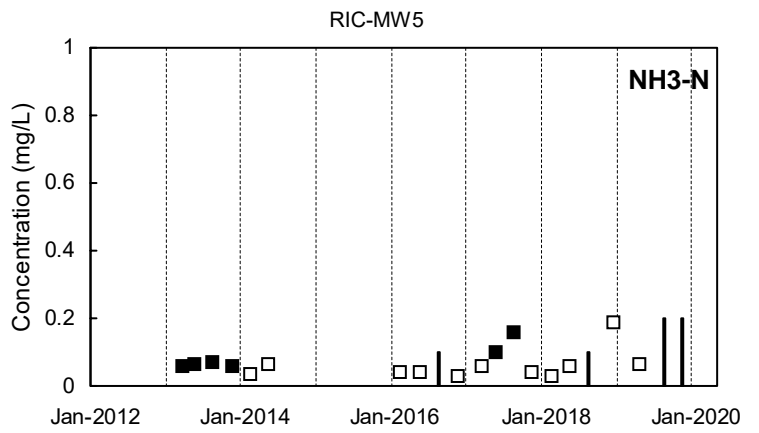
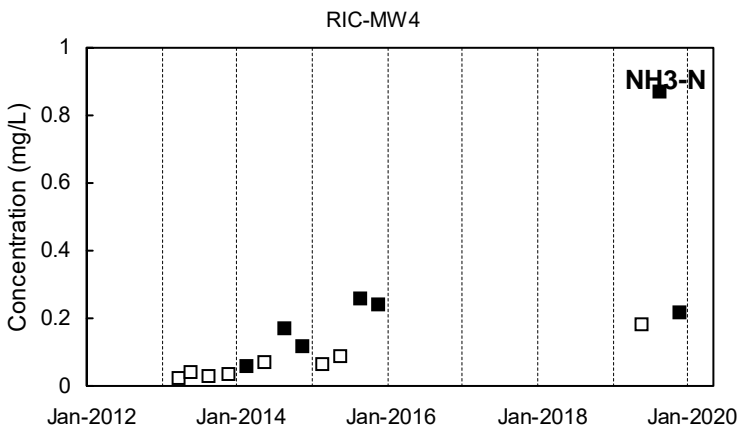
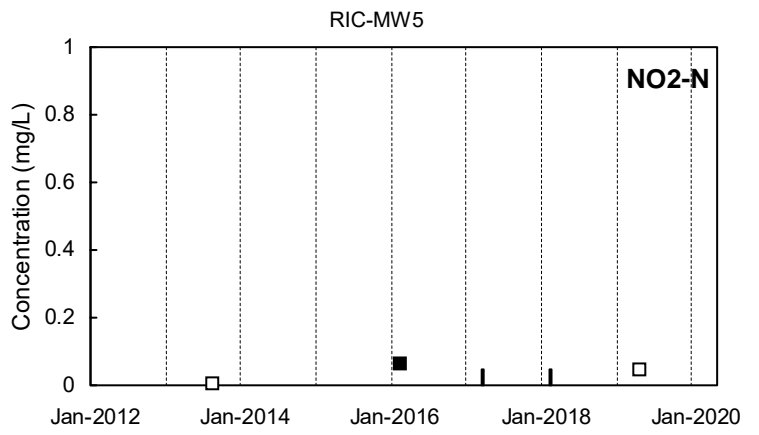
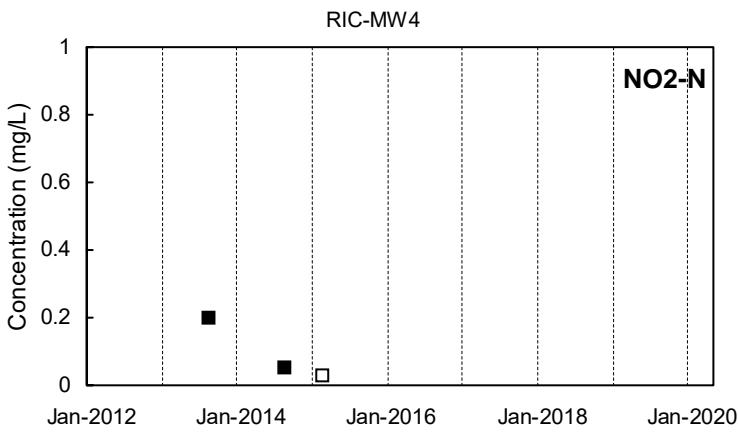
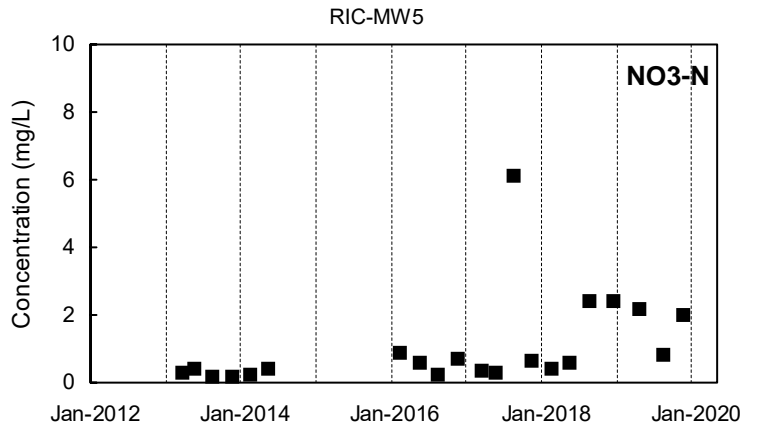
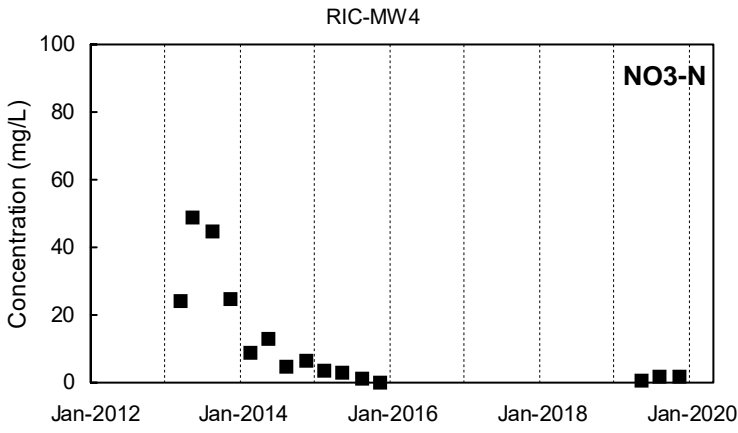

■ Detected Value □ 'J'-Flag (value between reporting limit and detection limit) ■ Non-Detect Range
 Shallow Well shown with black symbols Deep Well shown with orange symbols "dd" Well shown with blue symbols

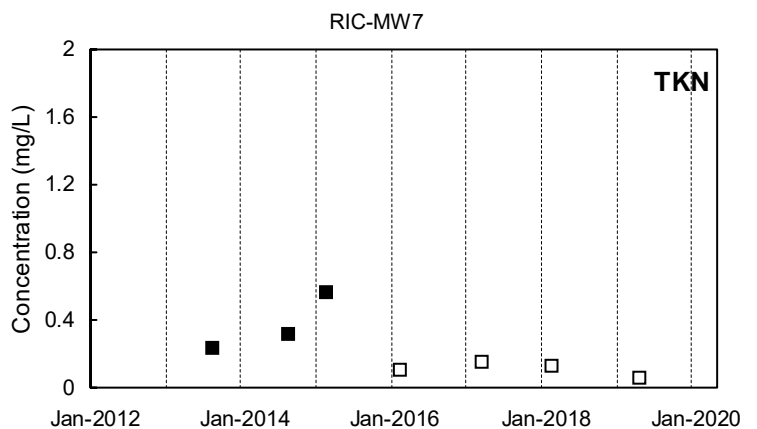
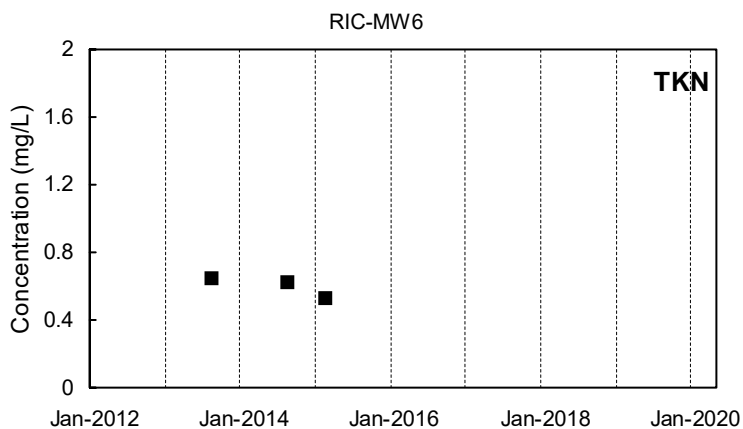
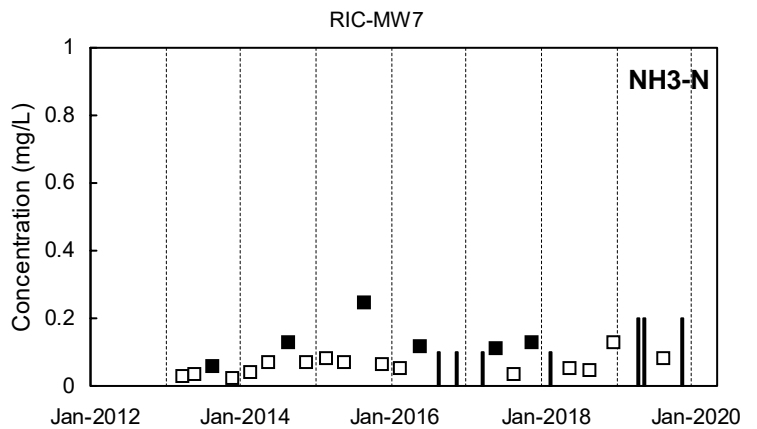
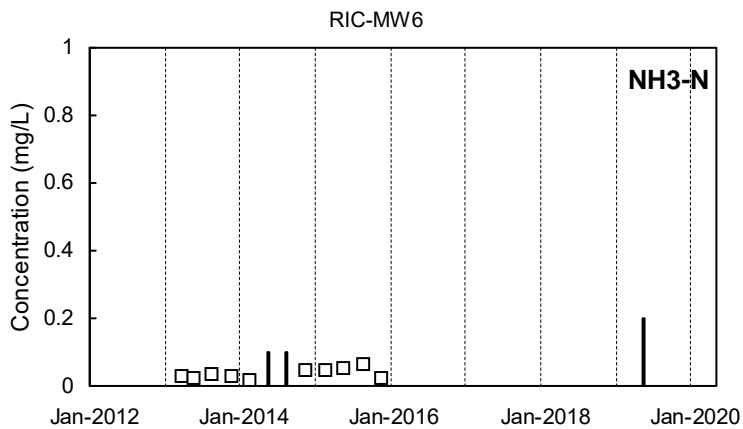
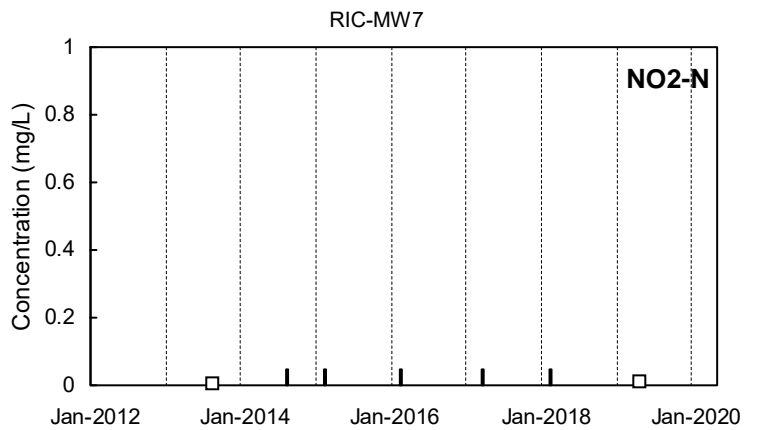
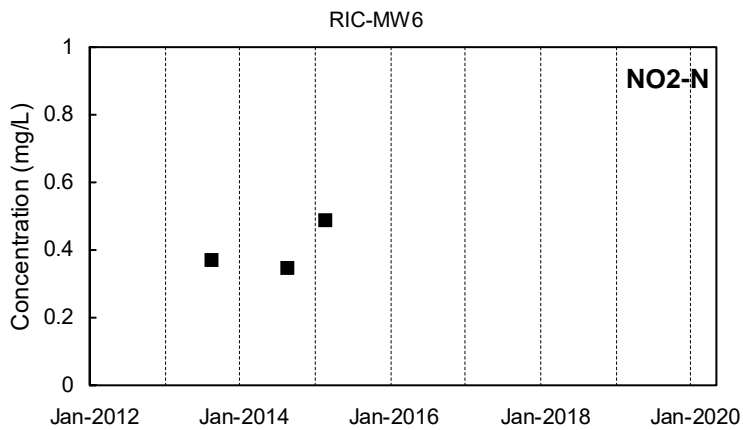
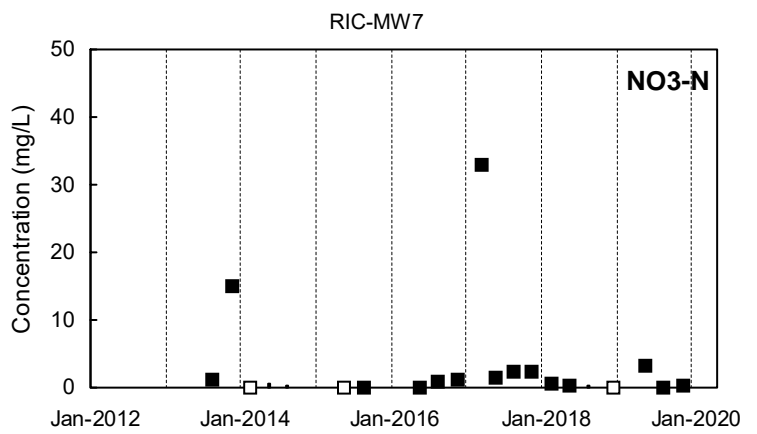
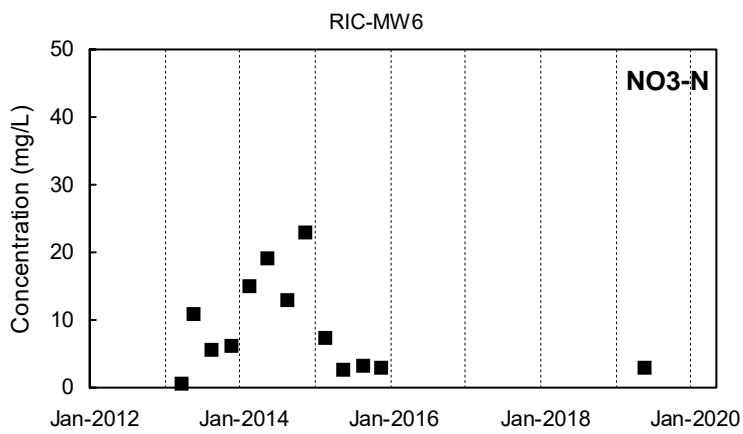

■ Detected Value □ 'J'-Flag (value between reporting limit and detection limit) ■ Non-Detect Range
 ■ Shallow Well shown with black symbols ■ Deep Well shown with orange symbols ■ "dd" Well shown with blue symbols

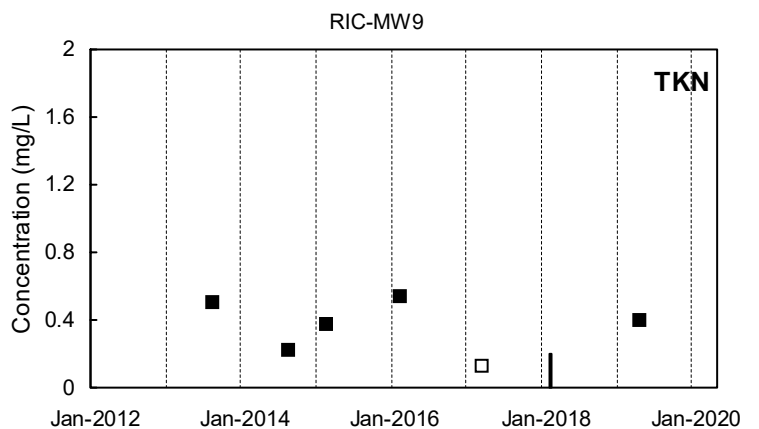
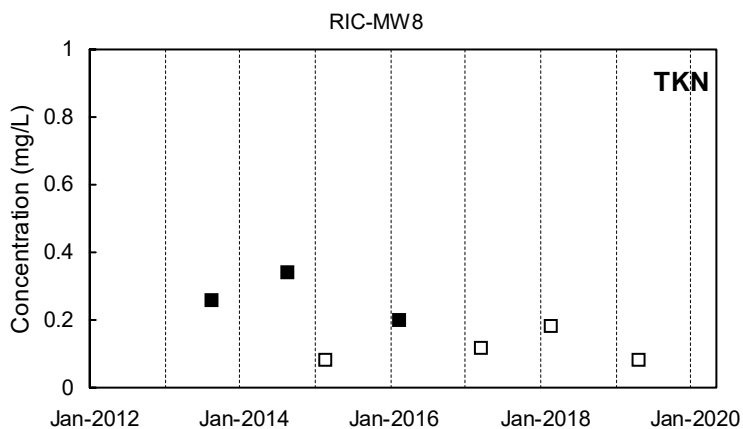
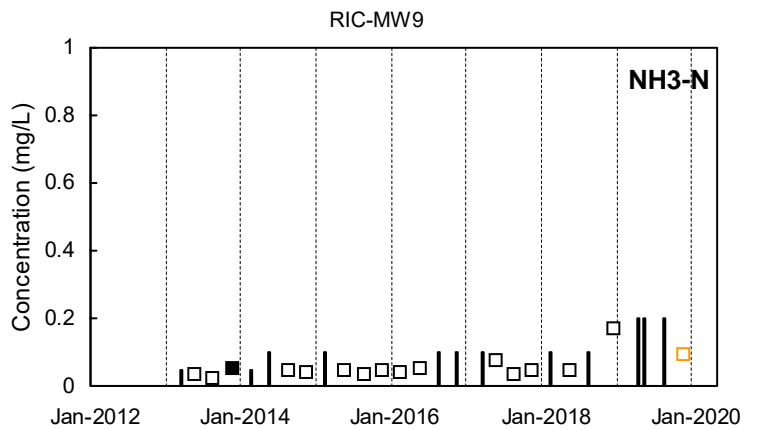
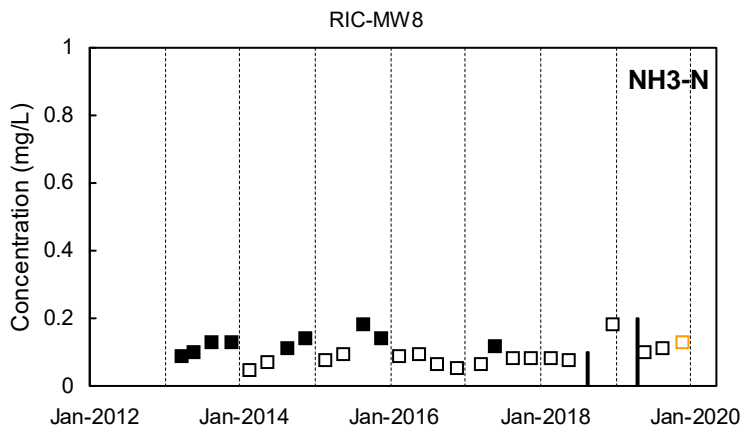
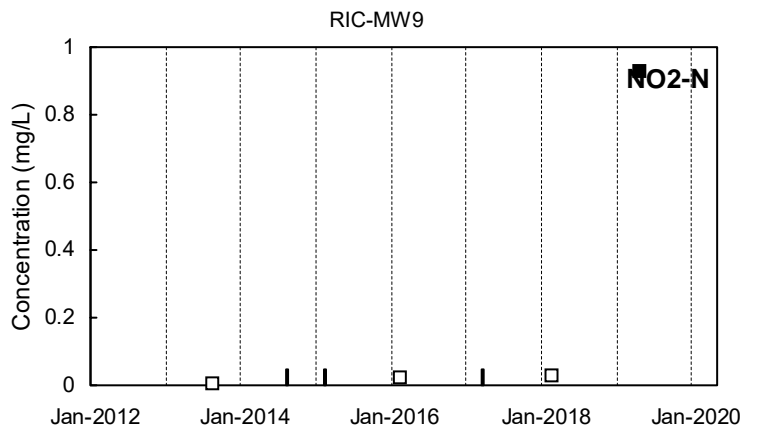
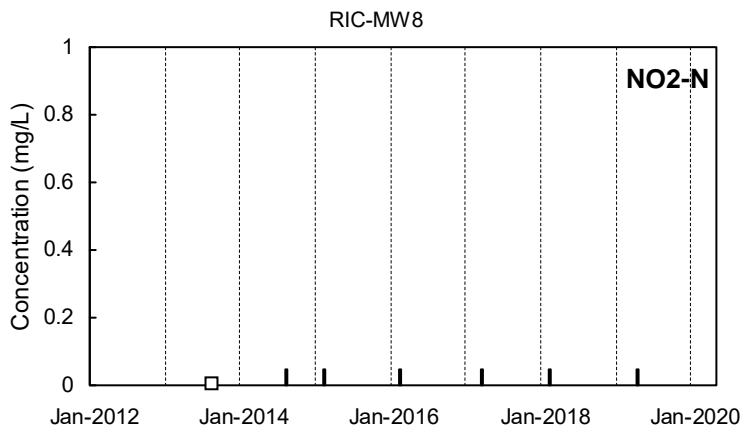
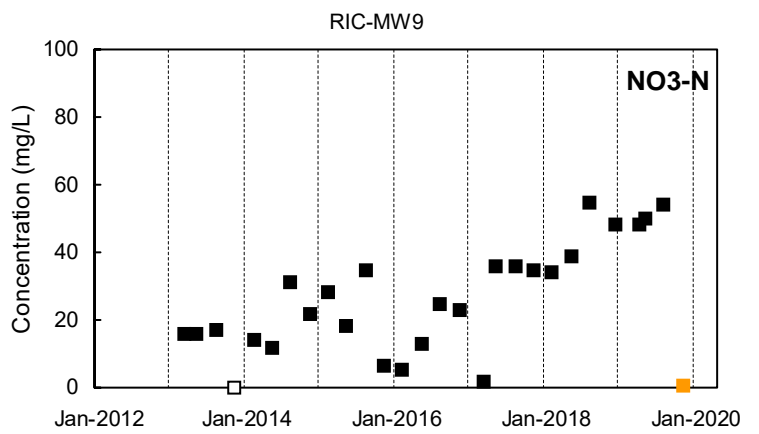
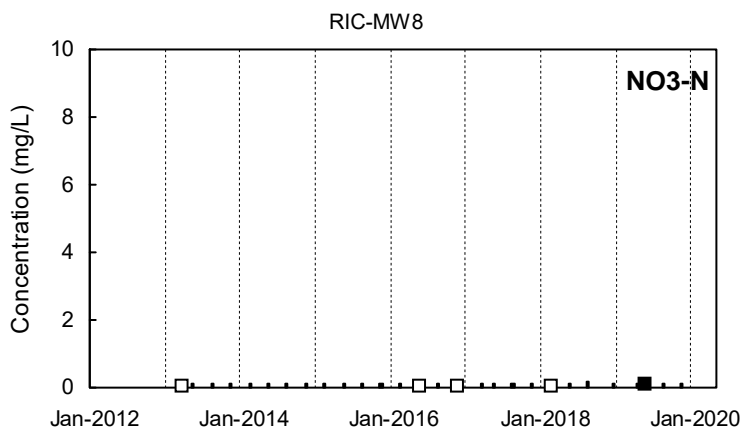

Detected Value
 'J'-Flag (value between reporting limit and detection limit)
 Non-Detect Range
 Shallow Well shown with black symbols
 Deep Well shown with orange symbols
 "dd" Well shown with blue symbols

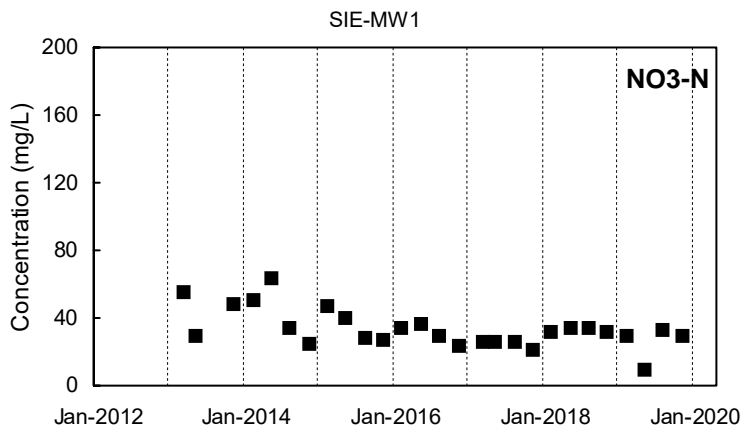

SIE-MW2

NO3-N
Not Sampled

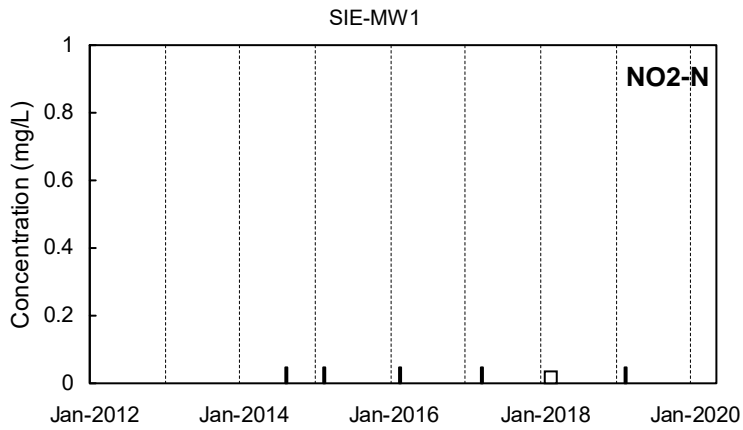

SIE-MW2

NO2-N
Not Sampled

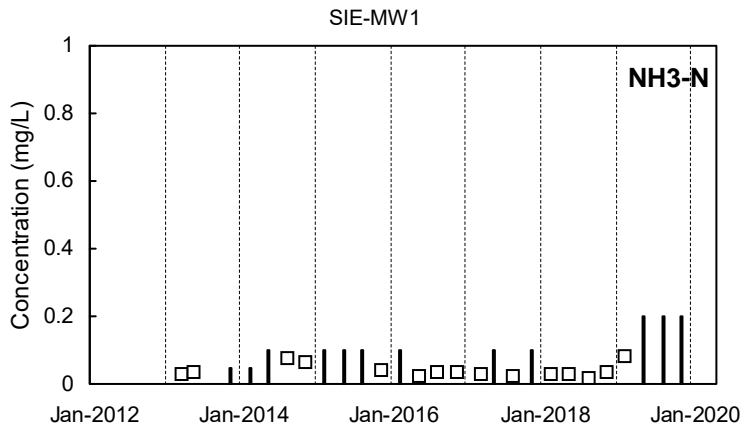

SIE-MW2

NH3-N
Not Sampled

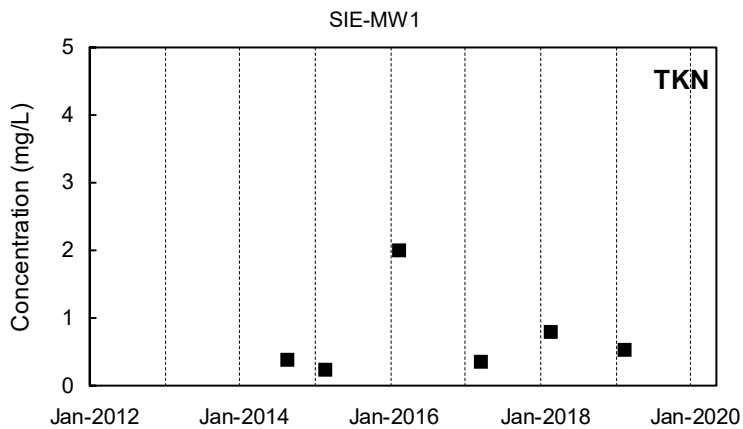

SIE-MW2

TKN
Not Sampled

Detected Value
 'J'-Flag (value between reporting limit and detection limit)
 Non-Detect Range

Shallow Well shown with black symbols
Deep Well shown with orange symbols
"dd" Well shown with blue symbols

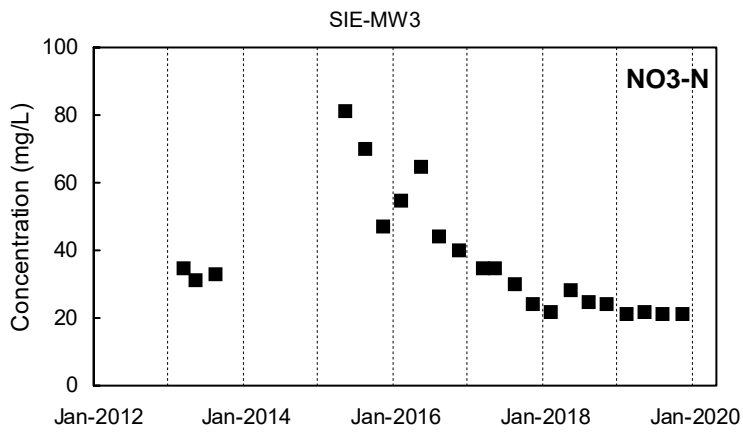

SIE-MW4

NO3-N
Not Sampled

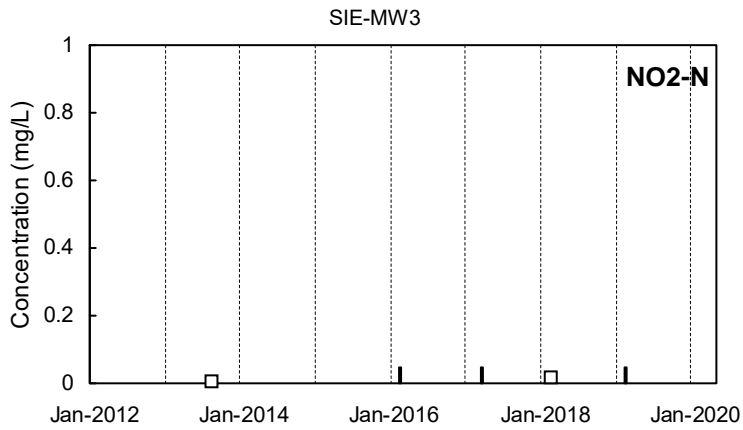

SIE-MW4

NO2-N
Not Sampled

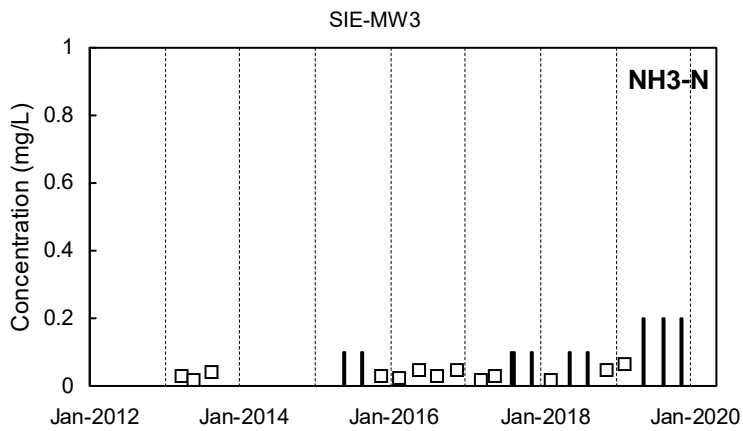

SIE-MW4

NH3-N
Not Sampled

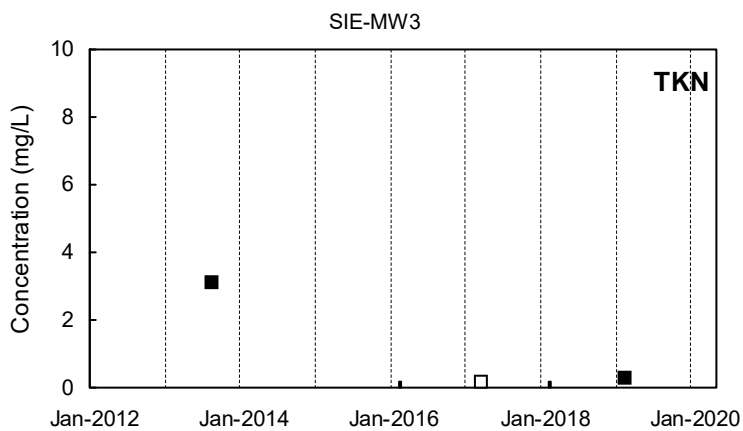

SIE-MW4

TKN
Not Sampled

Detected Value
 'J'-Flag (value between reporting limit and detection limit)
 Non-Detect Range
 Shallow Well shown with black symbols
 Deep Well shown with orange symbols
 "dd" Well shown with blue symbols

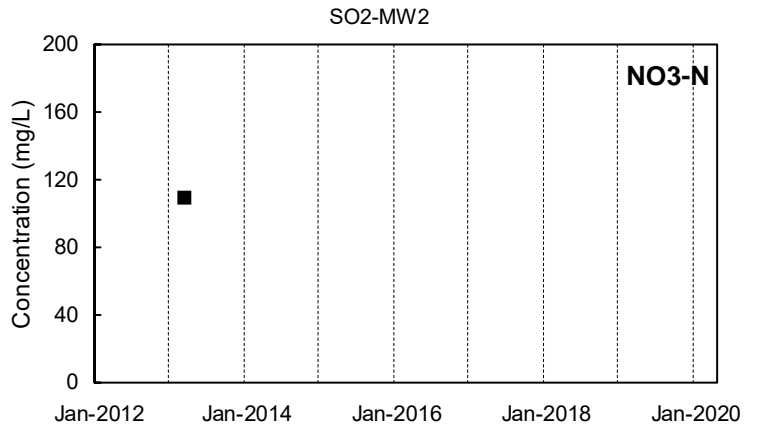
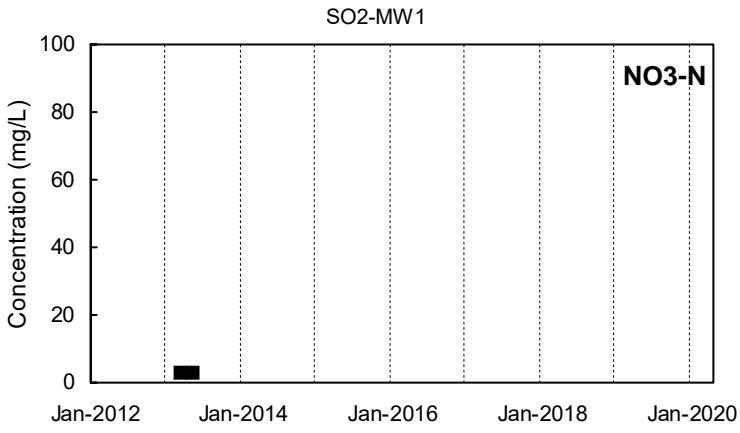

SO2-MW1

SO2-MW2

NO2-N
Not Sampled

NO2-N
Not Sampled

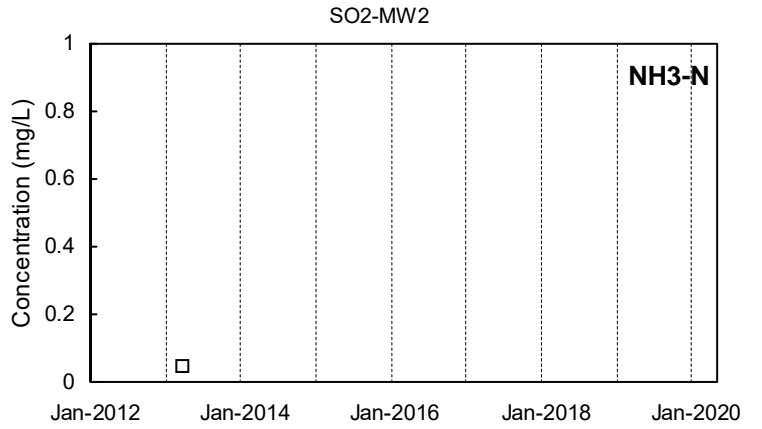
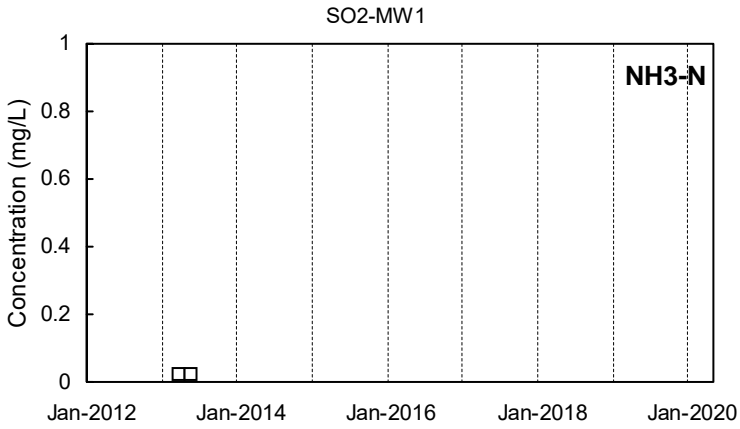

SO2-MW1

SO2-MW2

TKN
Not Sampled

TKN
Not Sampled

Detected Value
 'J'-Flag (value between reporting limit and detection limit)
 Non-Detect Range
 Shallow Well shown with black symbols Deep Well shown with orange symbols "dd" Well shown with blue symbols

SO2-MW3

NO3-N

Not Sampled

SO2-MW4

NO3-N

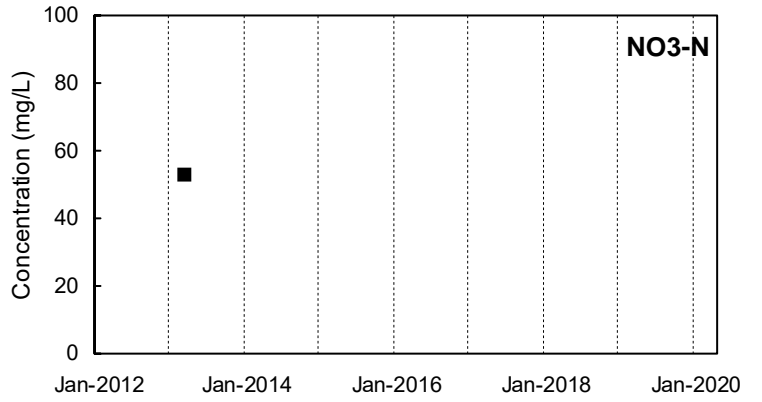

SO2-MW3

NO2-N

Not Sampled

SO2-MW4

NO2-N

Not Sampled

SO2-MW3

NH3-N

Not Sampled

SO2-MW4

NH3-N

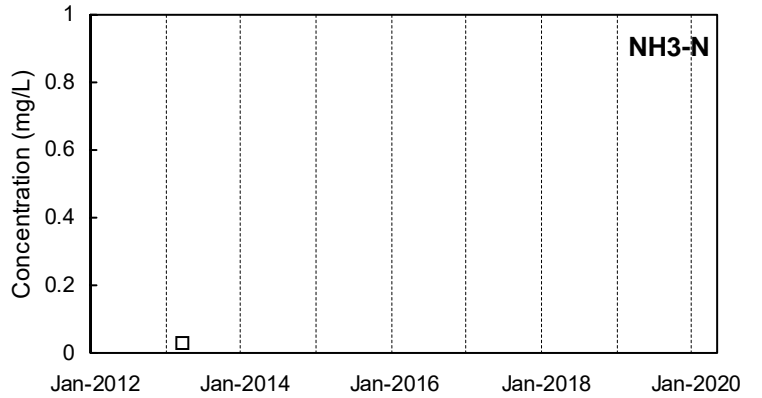

SO2-MW3

TKN

Not Sampled

SO2-MW4

TKN

Not Sampled

■ Detected Value

□ 'J'-Flag (value between reporting limit and detection limit)

■ Non-Detect Range

Shallow Well shown with black symbols

Deep Well shown with orange symbols

"dd" Well shown with blue symbols

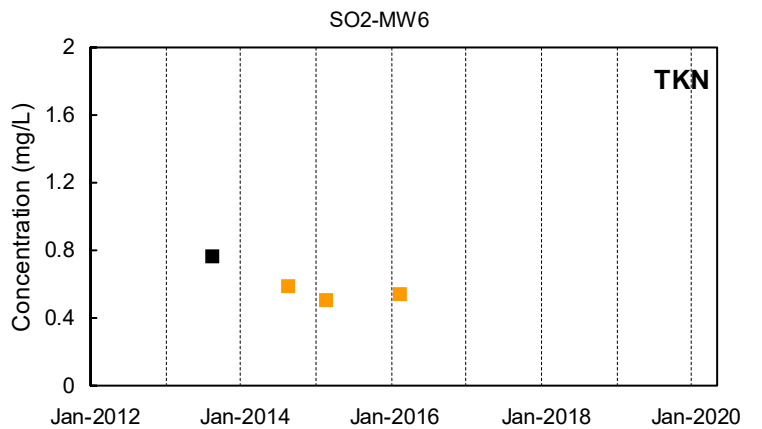
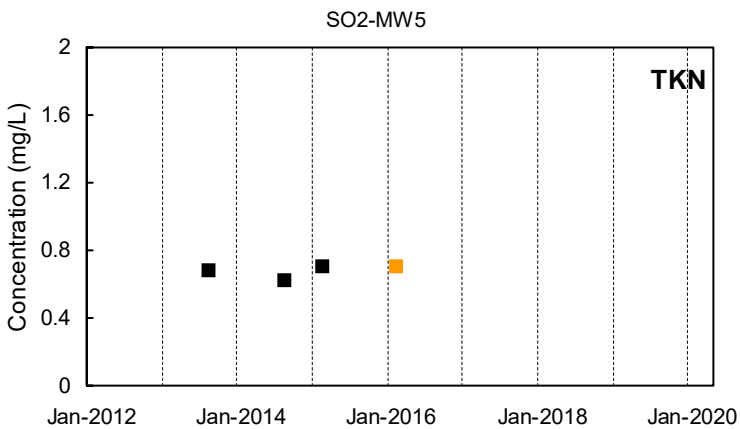
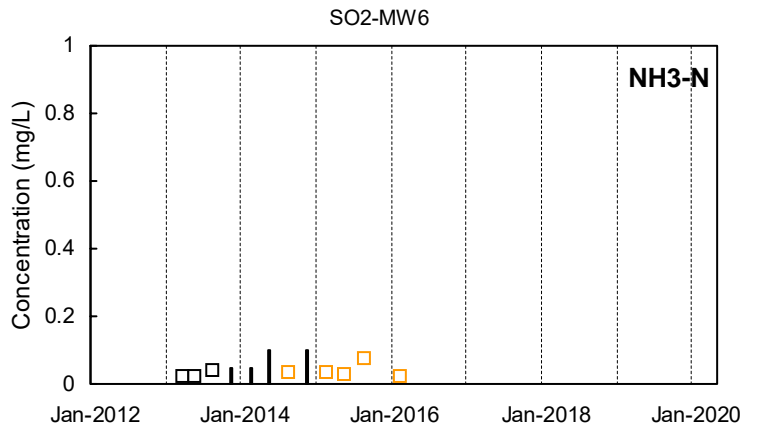
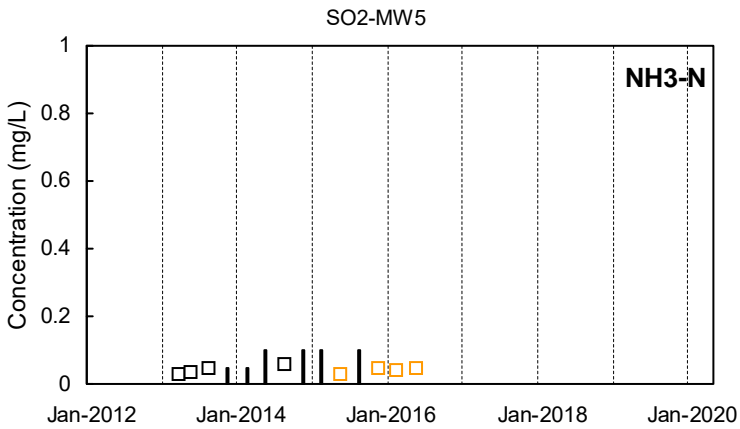
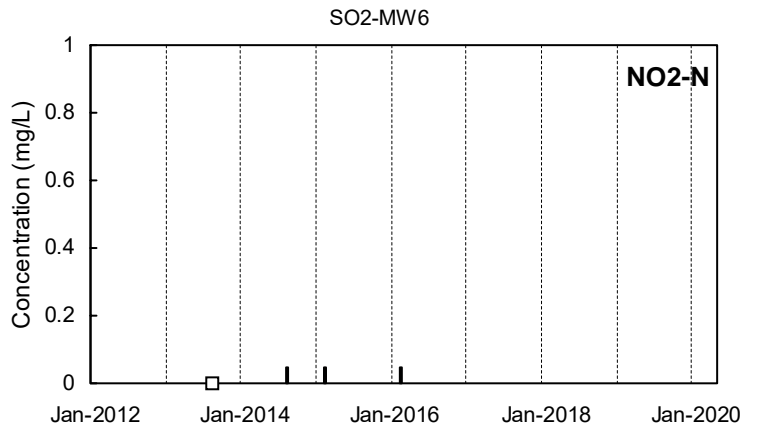
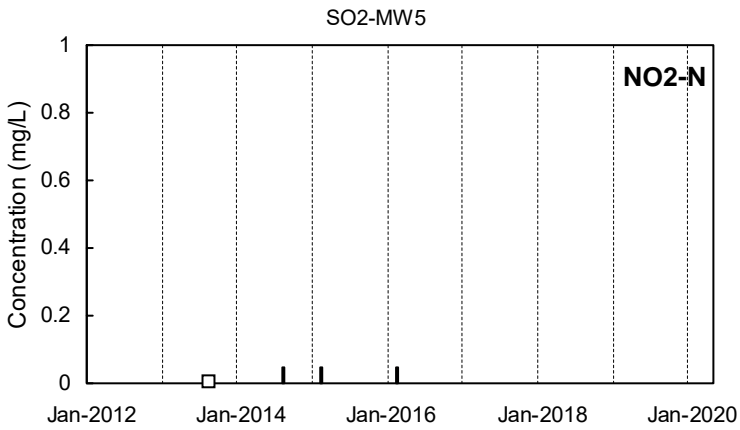
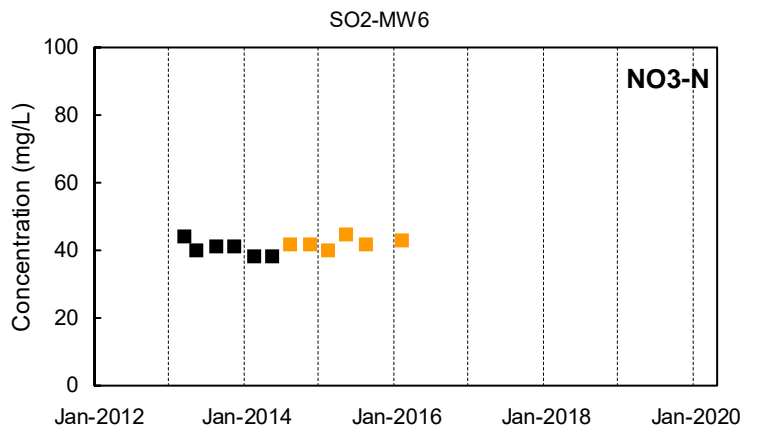
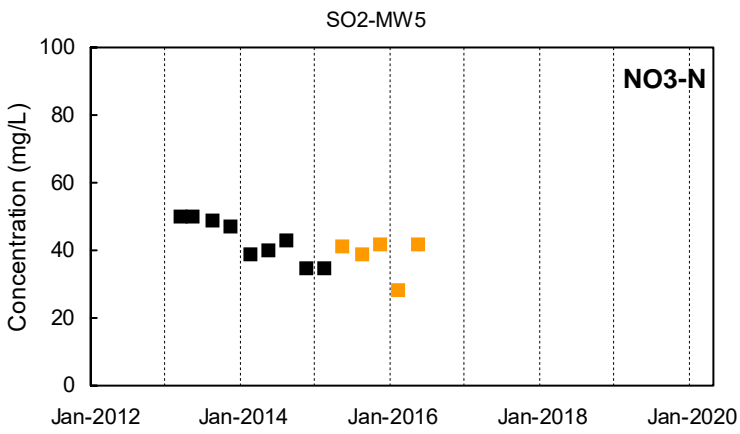

■ Detected Value □ 'J'-Flag (value between reporting limit and detection limit) ■ Non-Detect Range
 ■ Shallow Well shown with black symbols ■ Deep Well shown with orange symbols ■ "dd" Well shown with blue symbols

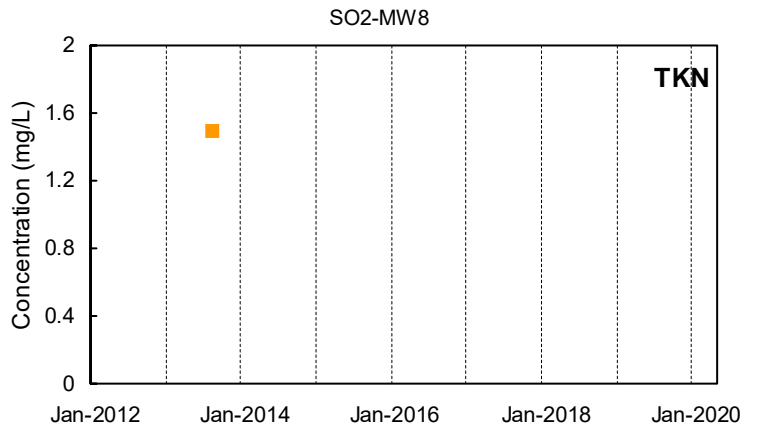
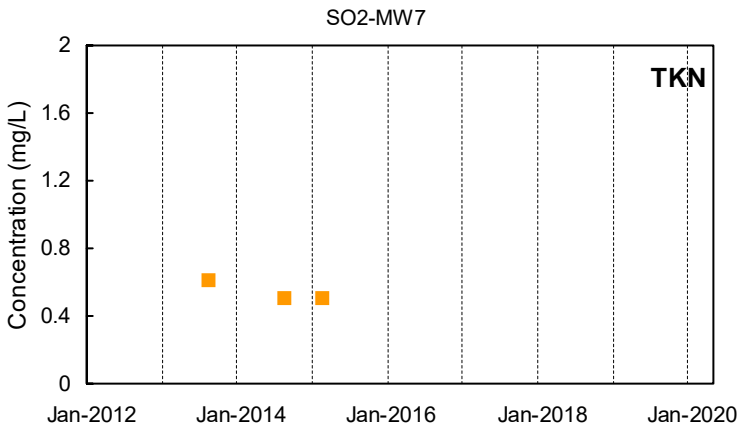
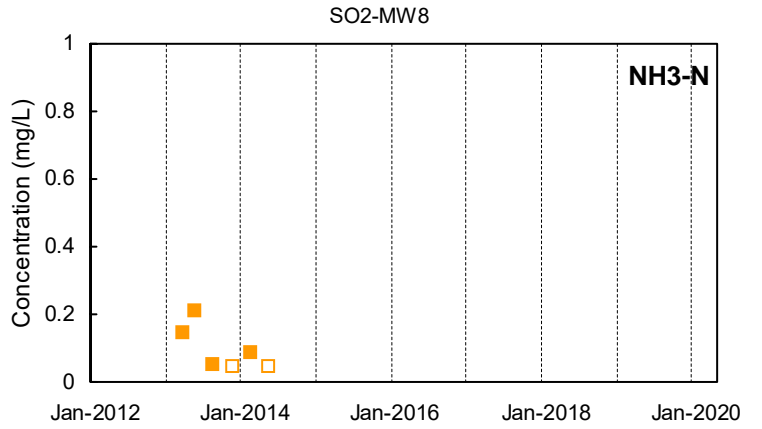
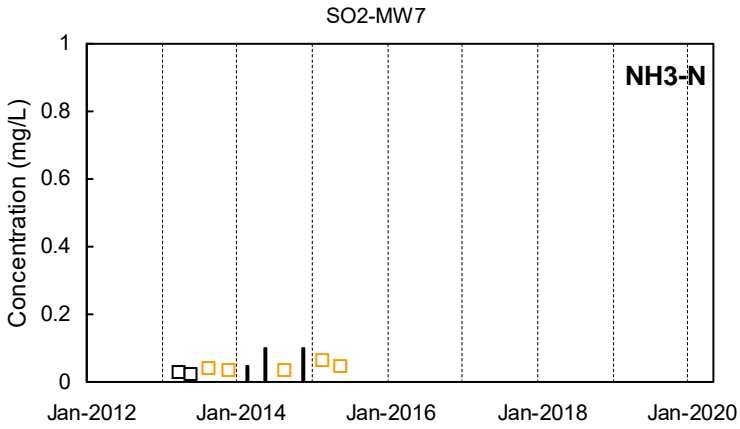
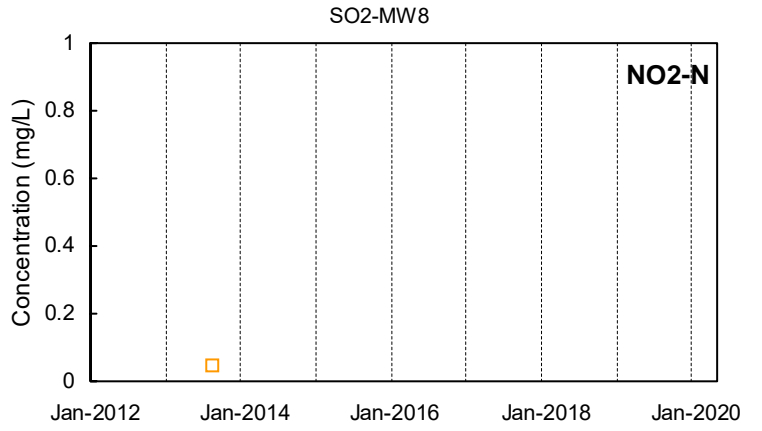
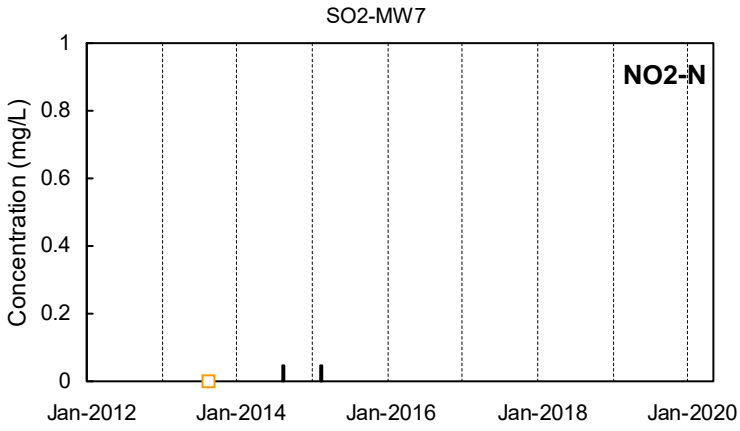
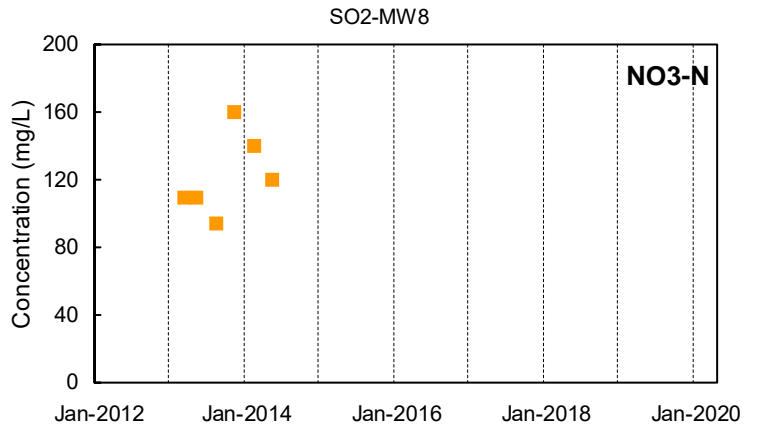
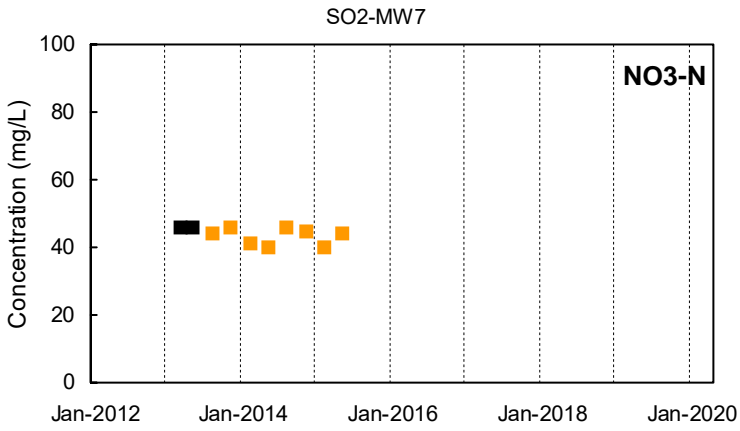

Detected Value
 'J'-Flag (value between reporting limit and detection limit)
 Non-Detect Range

Shallow Well shown with black symbols
 Deep Well shown with orange symbols
 "dd" Well shown with blue symbols

SOJ-MW1

SOJ-MW2

NO3-N

NO3-N

Not Sampled

Not Sampled

SOJ-MW1

SOJ-MW2

NO2-N

NO2-N

Not Sampled

Not Sampled

SOJ-MW1

SOJ-MW2

NH3-N

NH3-N

Not Sampled

Not Sampled

SOJ-MW1

SOJ-MW2

TKN

TKN

Not Sampled

Not Sampled

■ Detected Value □ 'J'-Flag (value between reporting limit and detection limit) ■ Non-Detect Range
 Shallow Well shown with black symbols Deep Well shown with orange symbols "dd" Well shown with blue symbols

SOJ-MW3

SOJ-MW4

NO3-N

NO3-N

Not Sampled

Not Sampled

SOJ-MW3

SOJ-MW4

NO2-N

NO2-N

Not Sampled

Not Sampled

SOJ-MW3

SOJ-MW4

NH3-N

NH3-N

Not Sampled

Not Sampled

SOJ-MW3

SOJ-MW4

TKN

TKN

Not Sampled

Not Sampled

■ Detected Value

□ 'J'-Flag (value between reporting limit and detection limit)

■ Non-Detect Range

Shallow Well shown with black symbols

Deep Well shown with orange symbols

"dd" Well shown with blue symbols

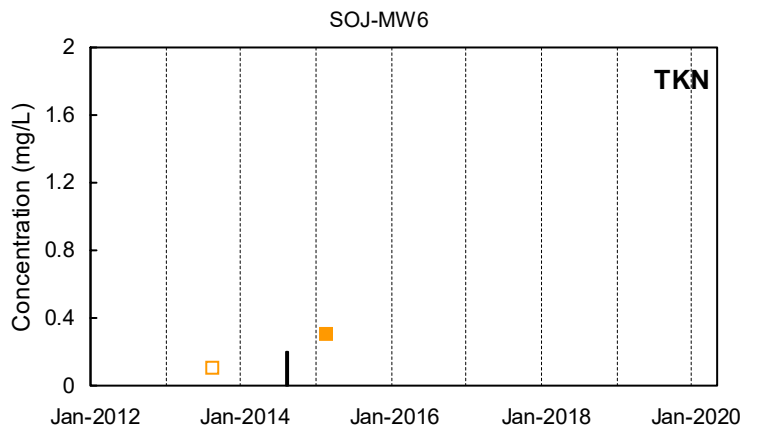
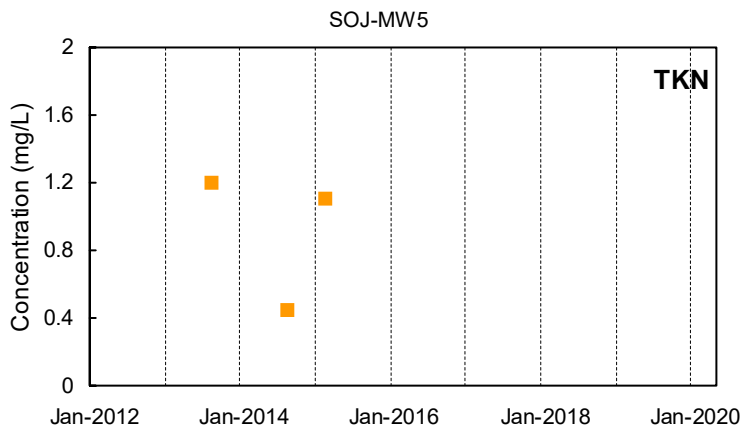
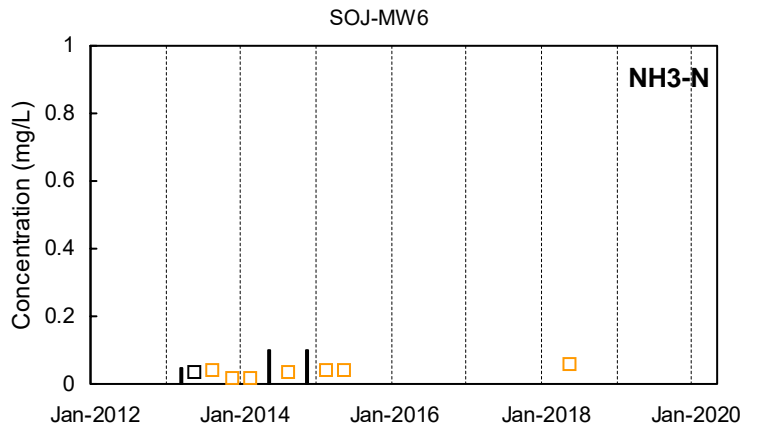
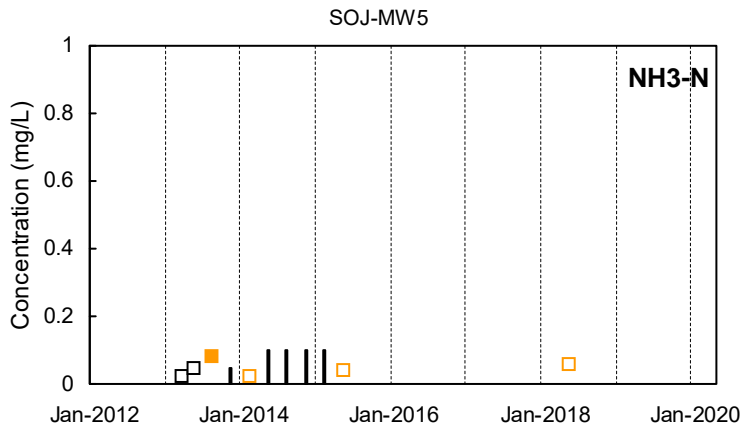
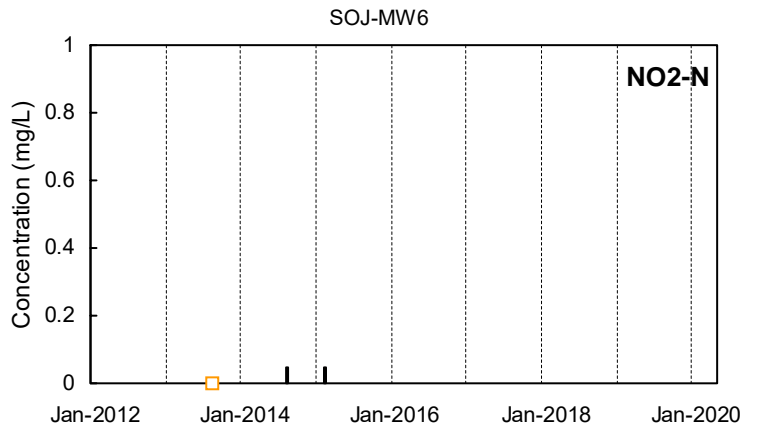
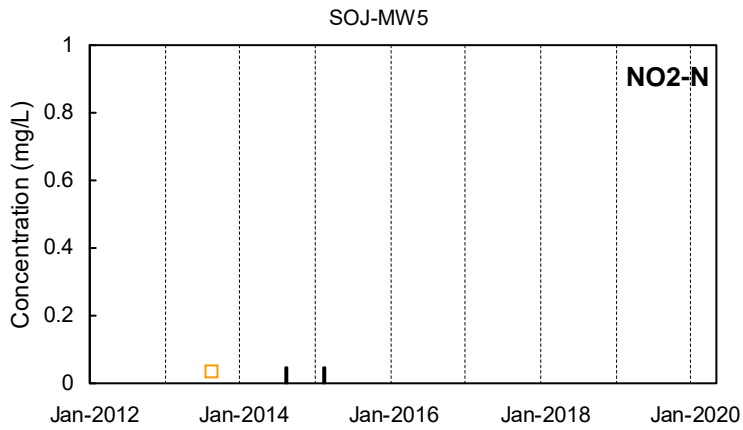
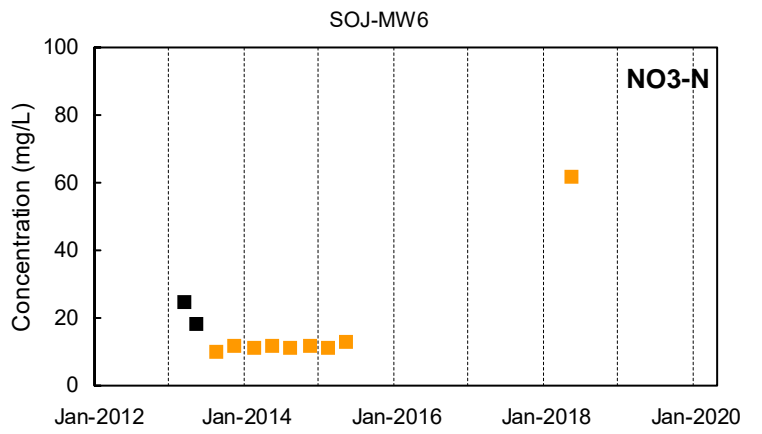
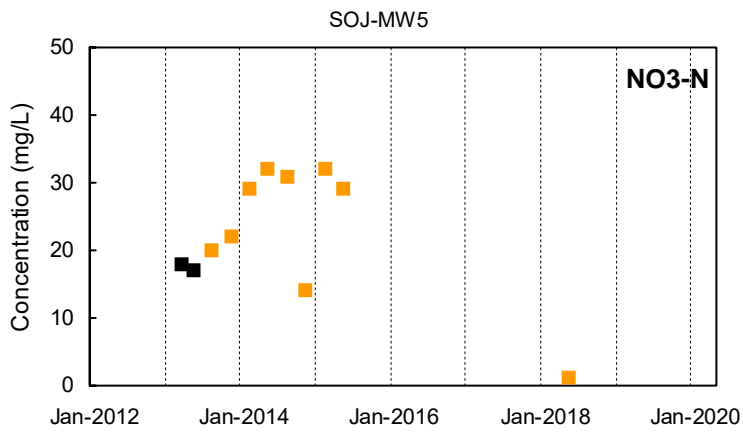

■ Detected Value □ 'J'-Flag (value between reporting limit and detection limit) ■ Non-Detect Range
 ■ Shallow Well shown with black symbols ■ Deep Well shown with orange symbols ■ "dd" Well shown with blue symbols

Attachment A9

General Mineral Concentrations in Groundwater, Time Series Plots

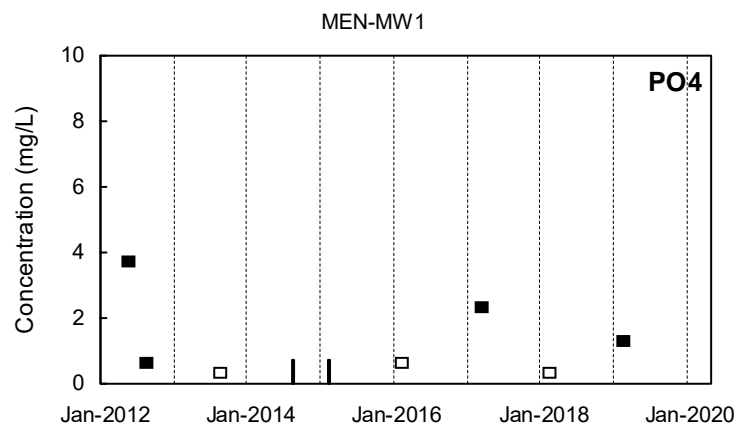
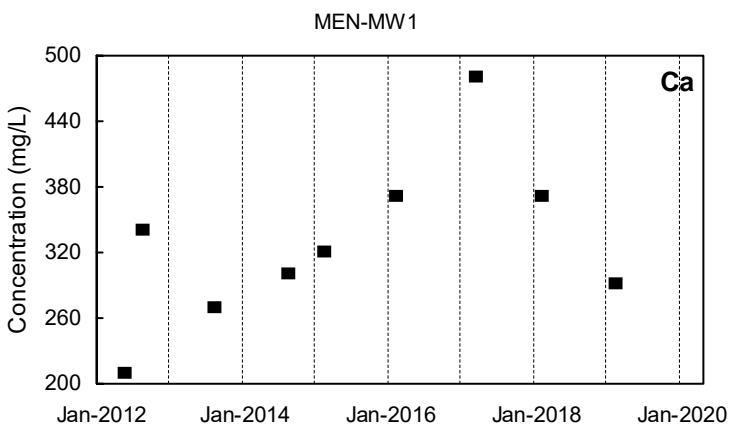
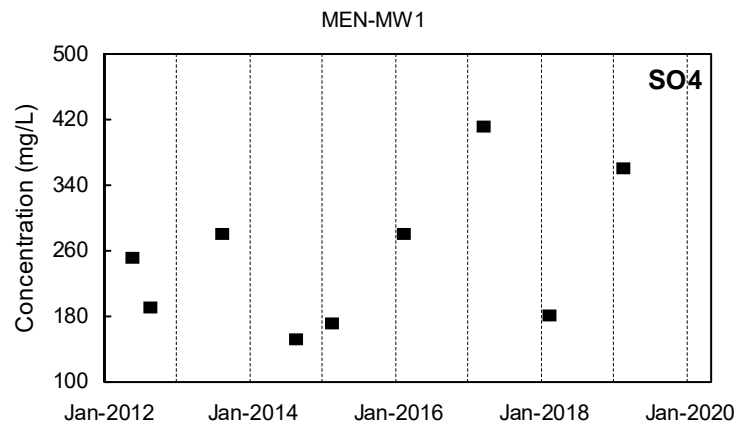
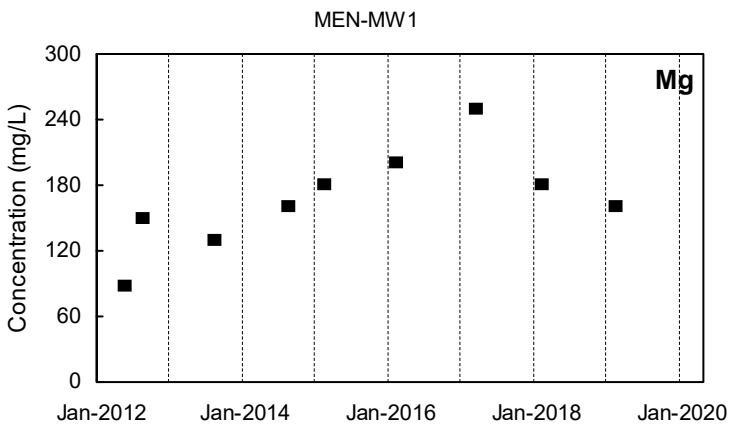
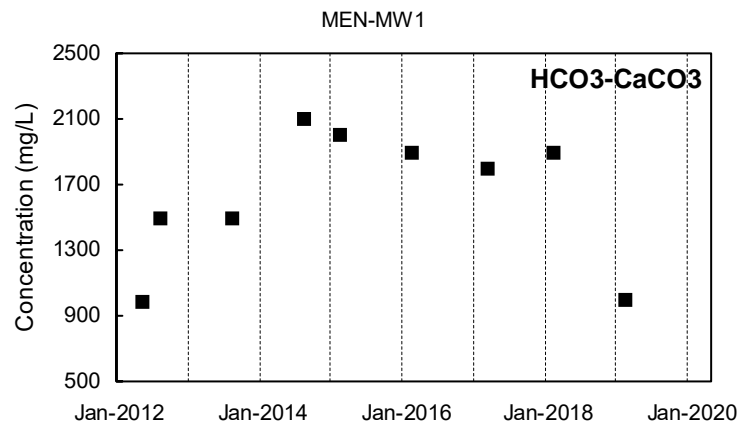
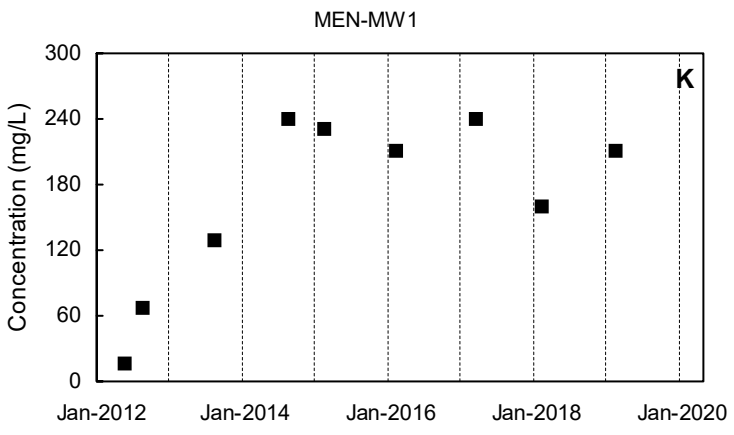
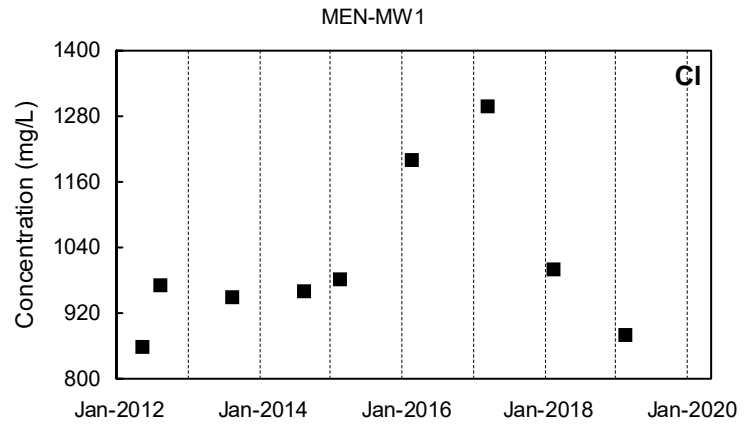
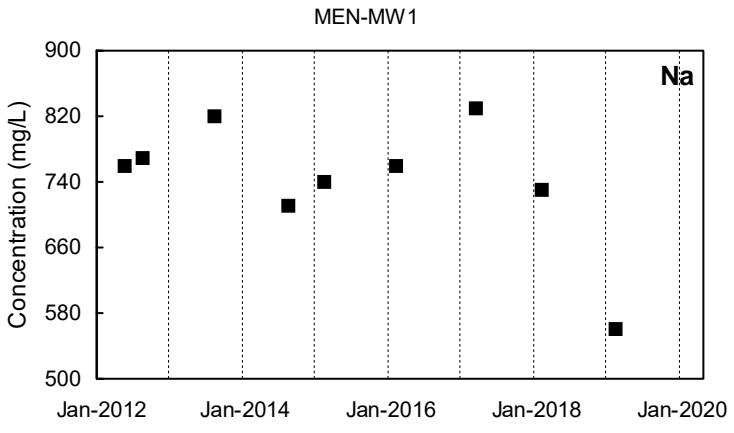

■ Detected Value □ 'J'-Flag (value between reporting limit and detection limit) ■ Non-Detect Range
 Shallow Well shown with black symbols Deep Well shown with orange symbols "dd" Well shown with blue symbols

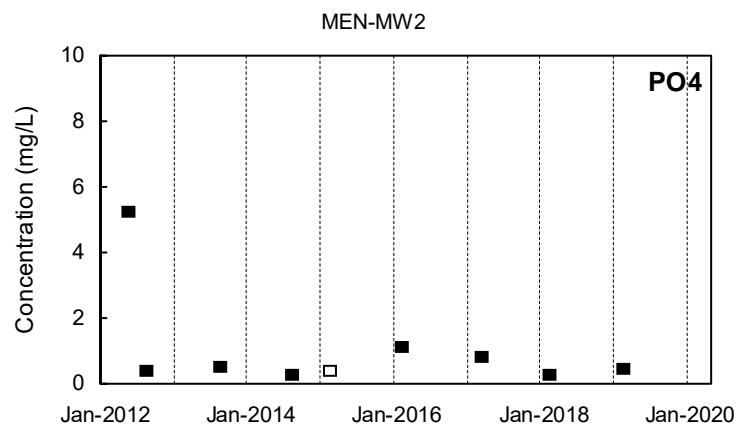
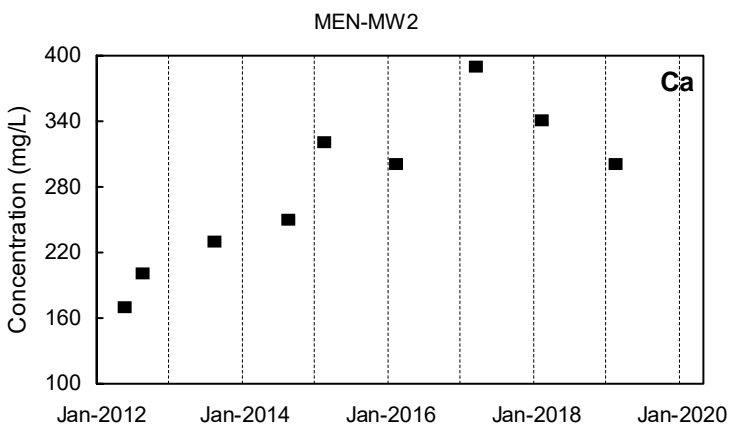
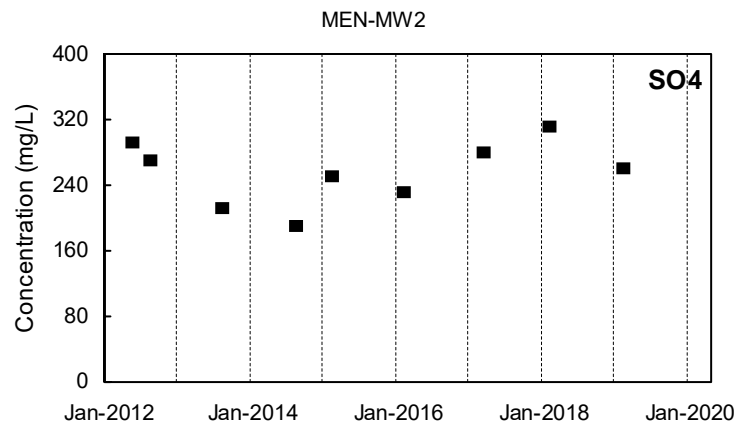
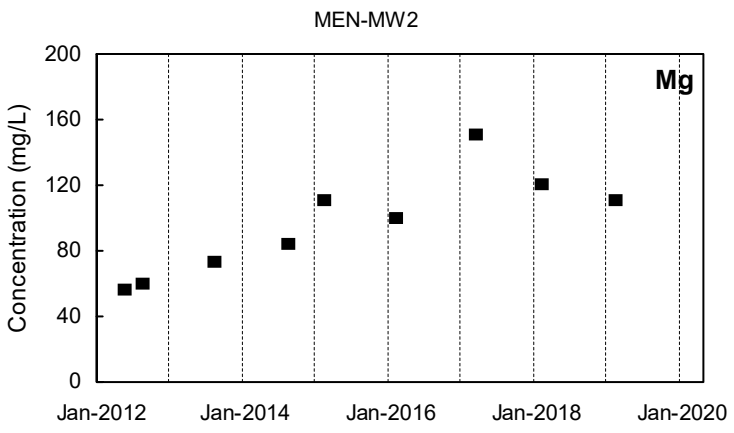
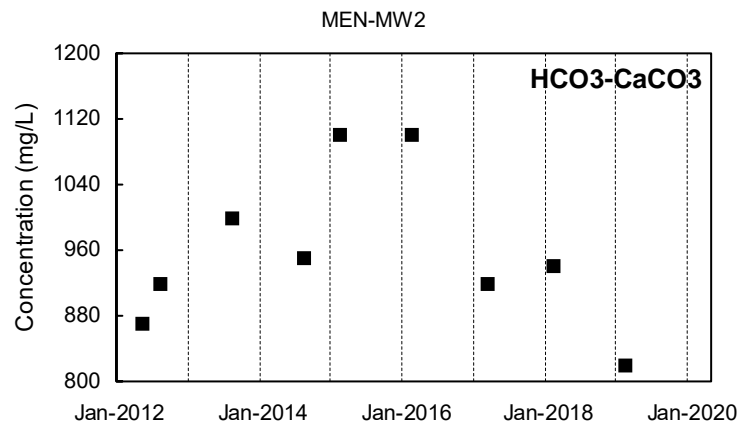
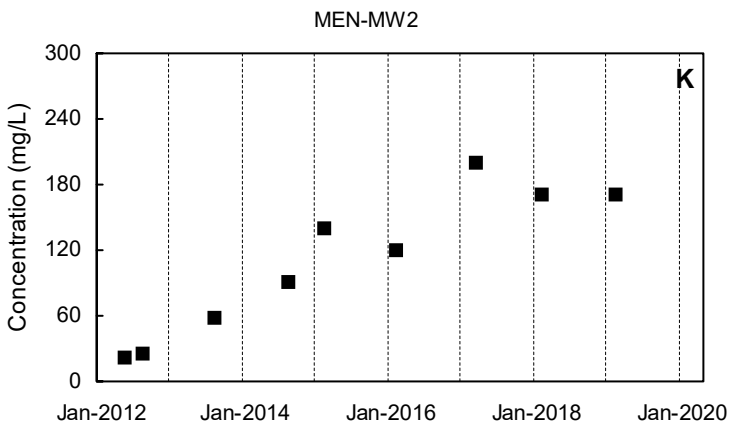
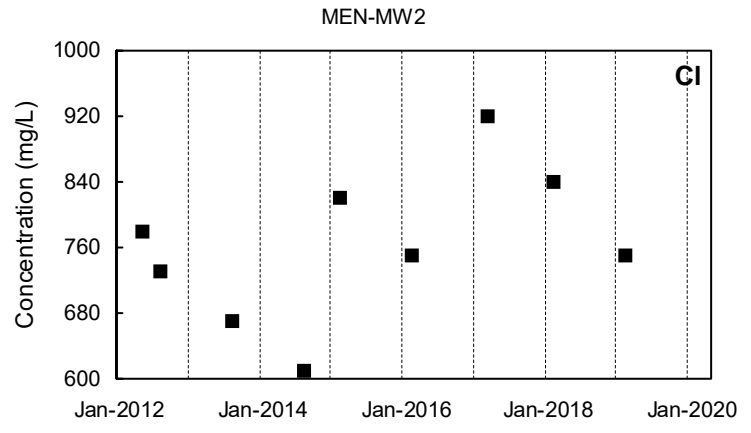
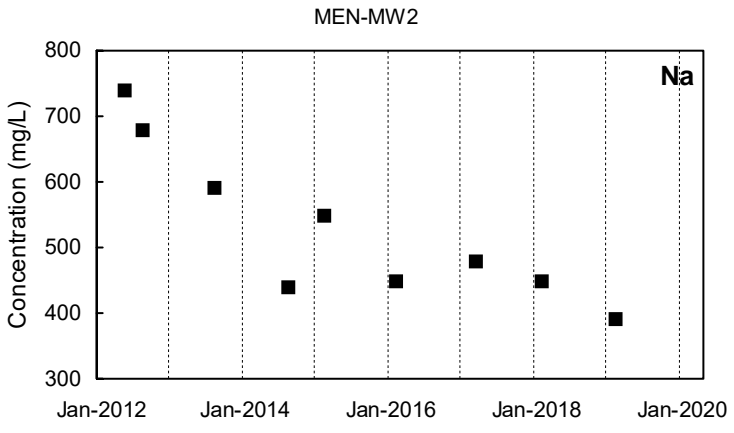

Detected Value
 'J'-Flag (value between reporting limit and detection limit)
 Non-Detect Range
 Shallow Well shown with black symbols
 Deep Well shown with orange symbols
 "dd" Well shown with blue symbols

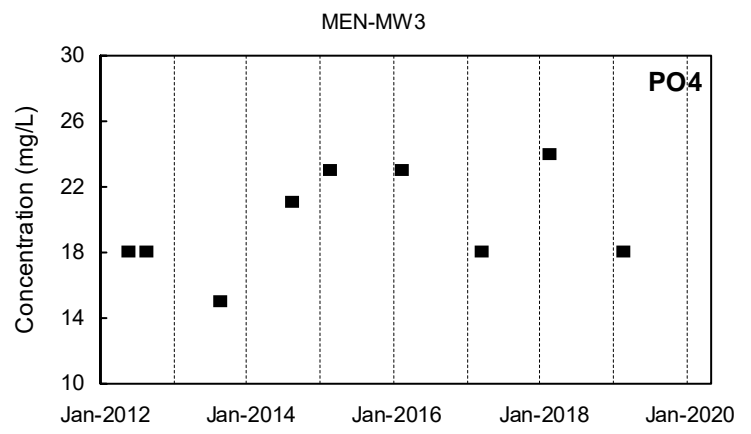
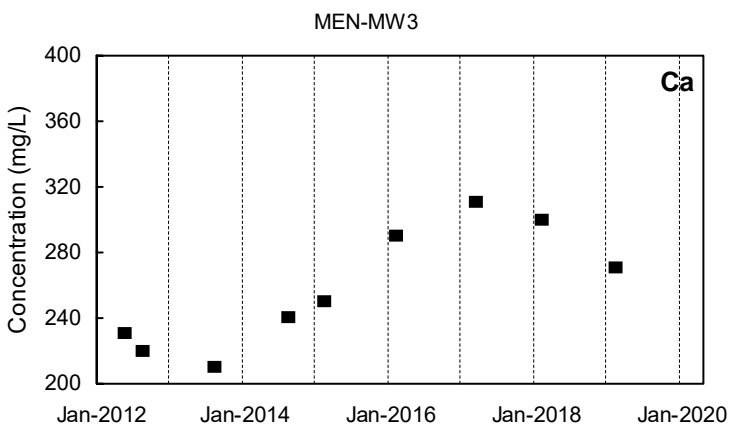
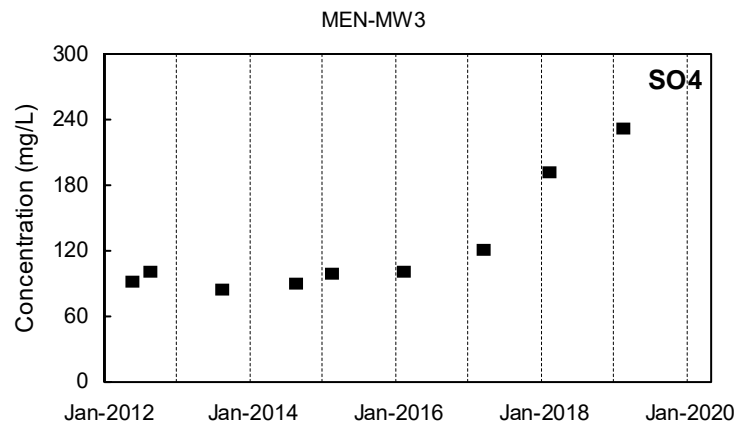
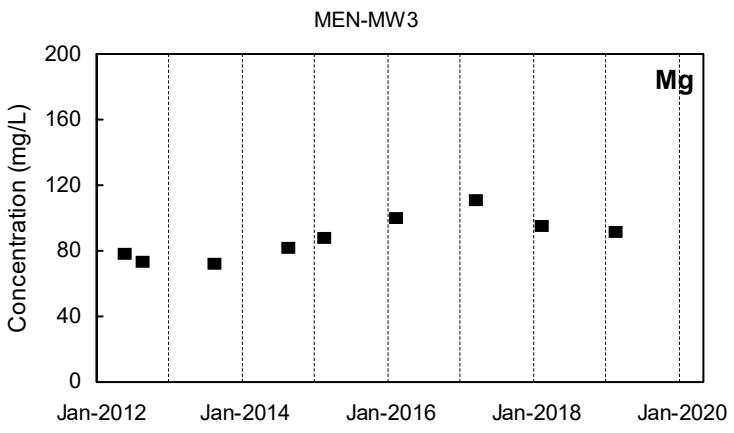
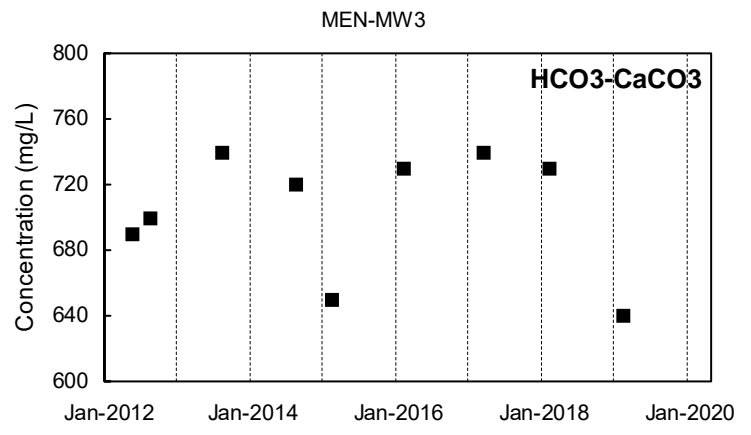
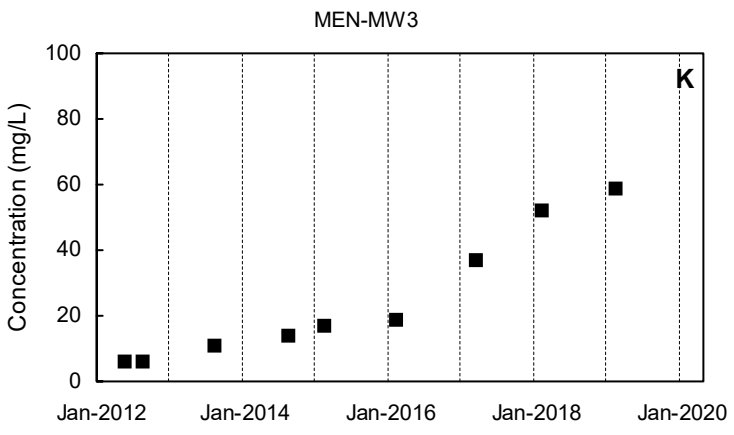
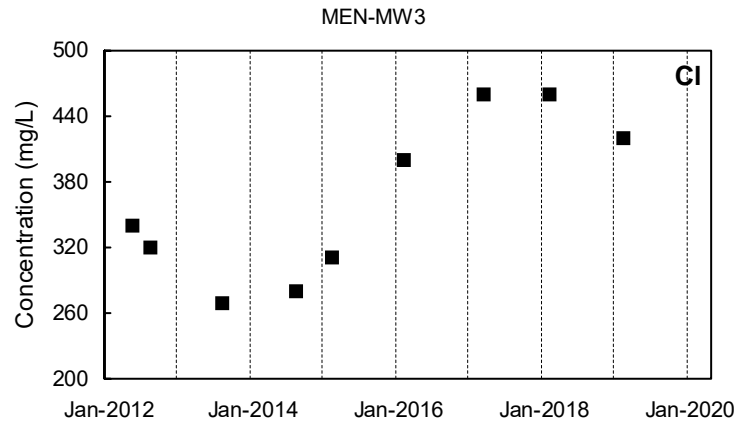
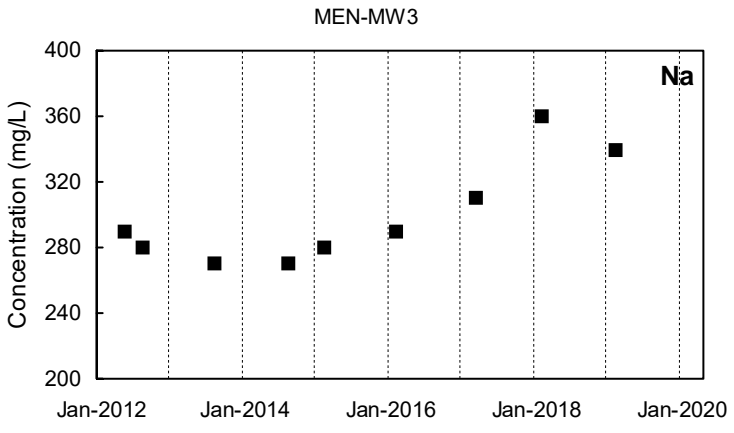

Detected Value
 'J'-Flag (value between reporting limit and detection limit)
 Non-Detect Range
 Shallow Well shown with black symbols Deep Well shown with orange symbols "dd" Well shown with blue symbols

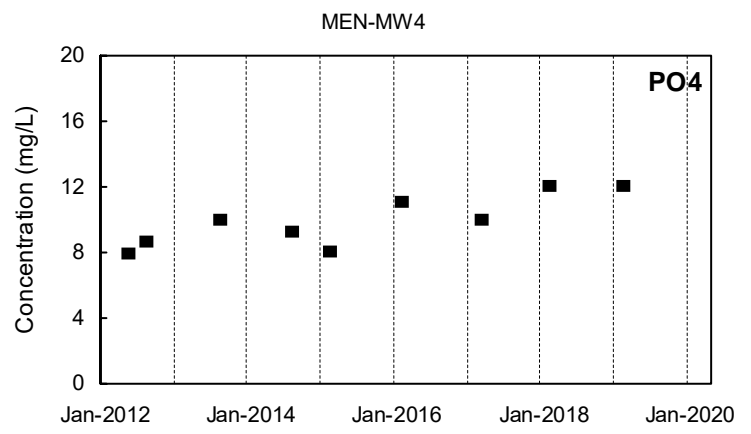
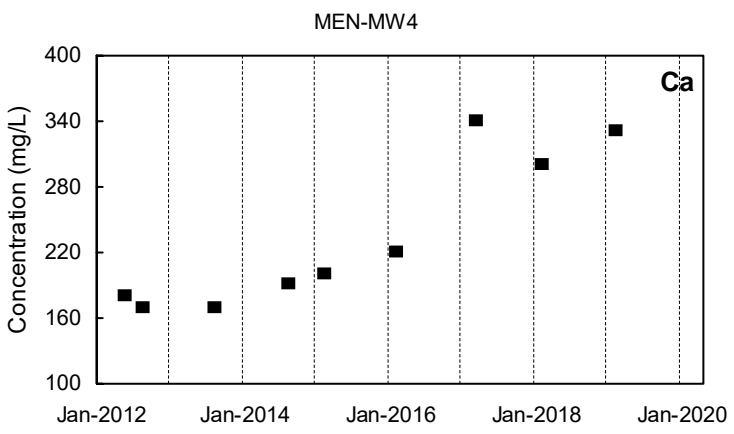
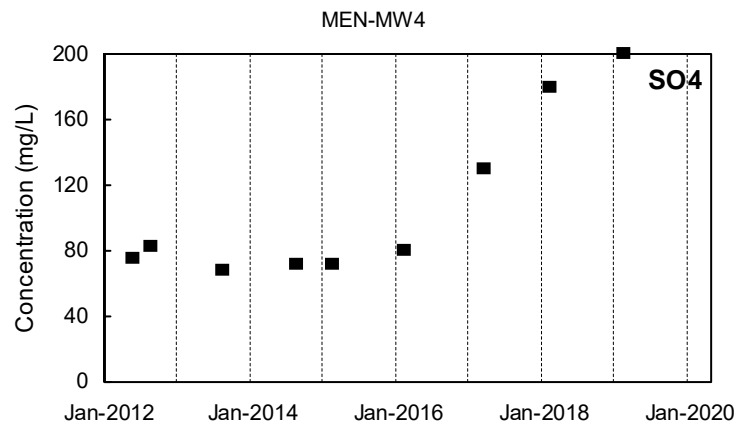
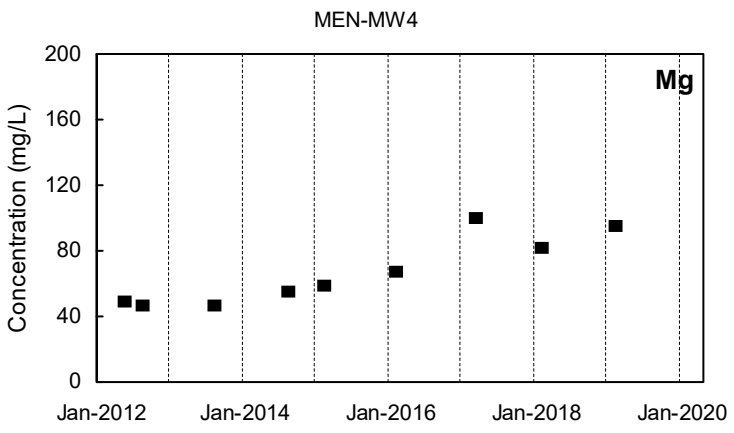
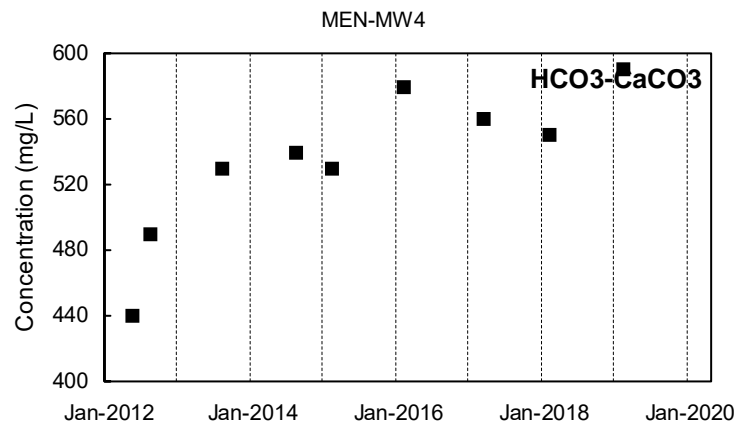
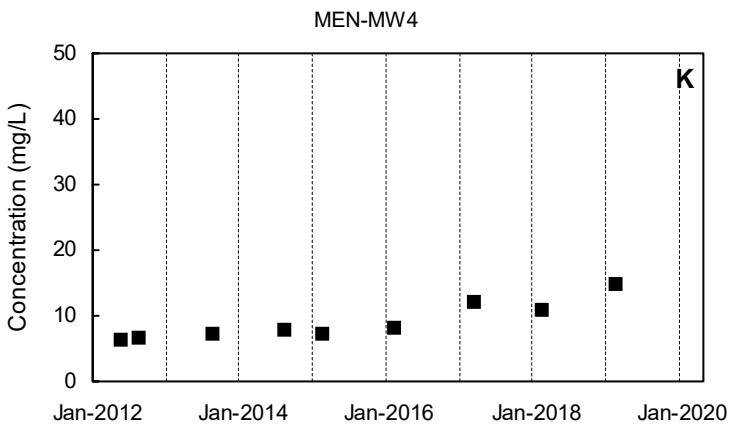
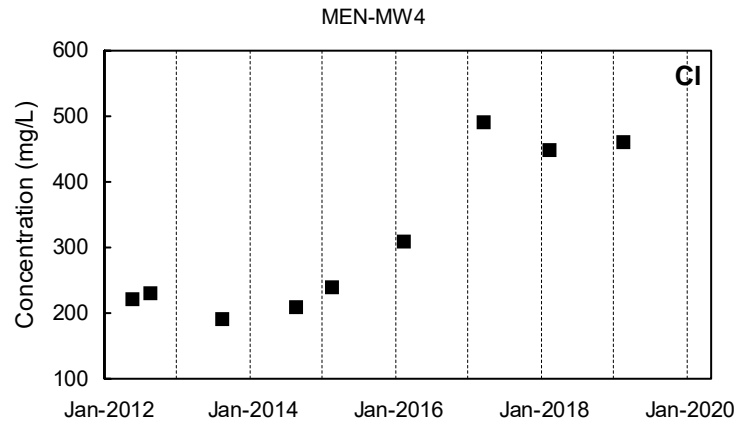
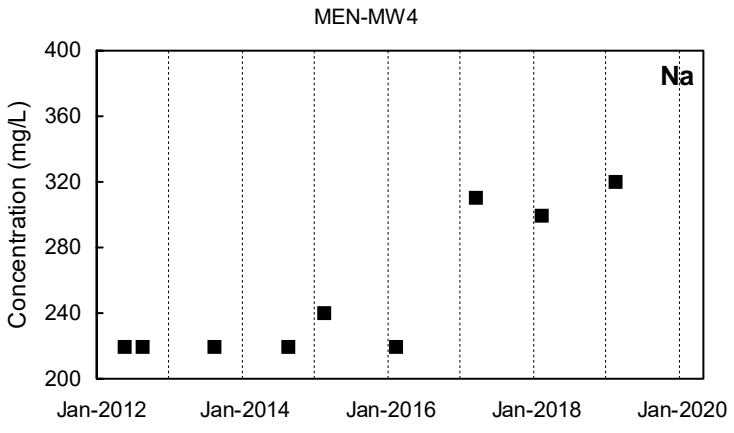

Detected Value
 'J'-Flag (value between reporting limit and detection limit)
 Non-Detect Range
 Shallow Well shown with black symbols
 Deep Well shown with orange symbols
 "dd" Well shown with blue symbols

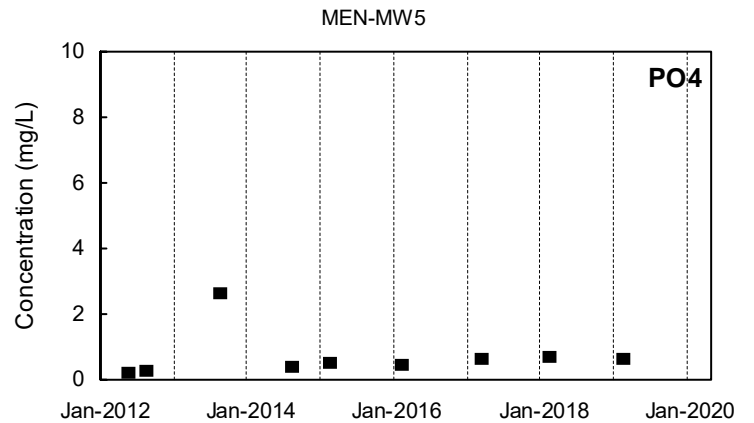
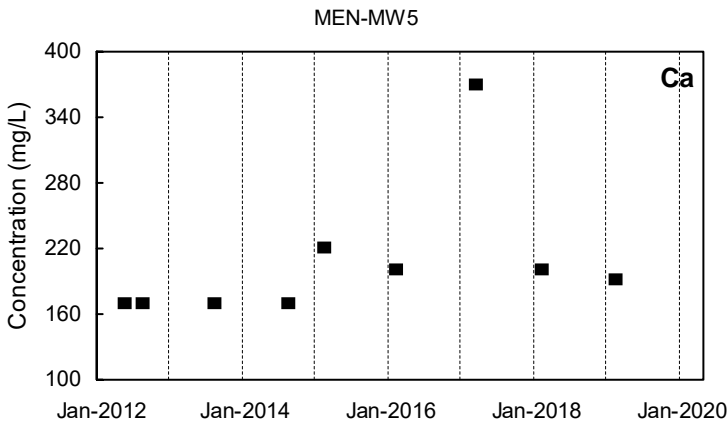
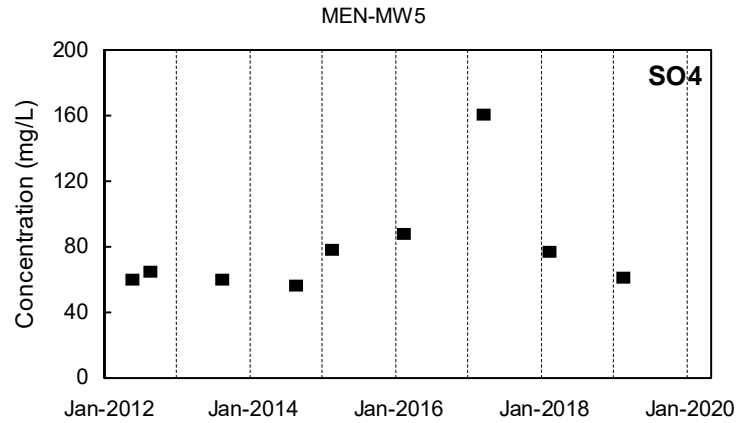
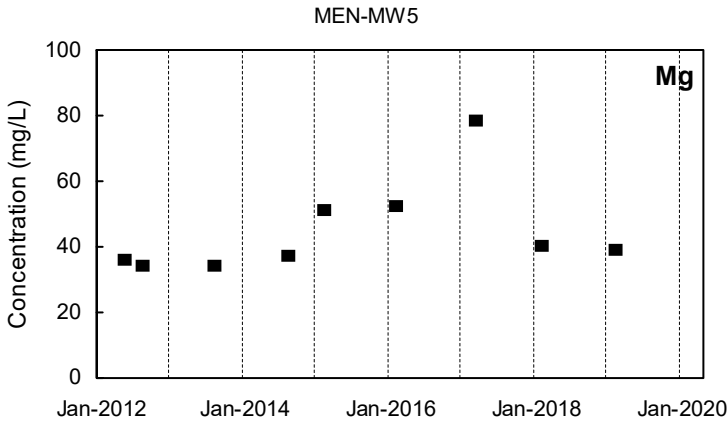
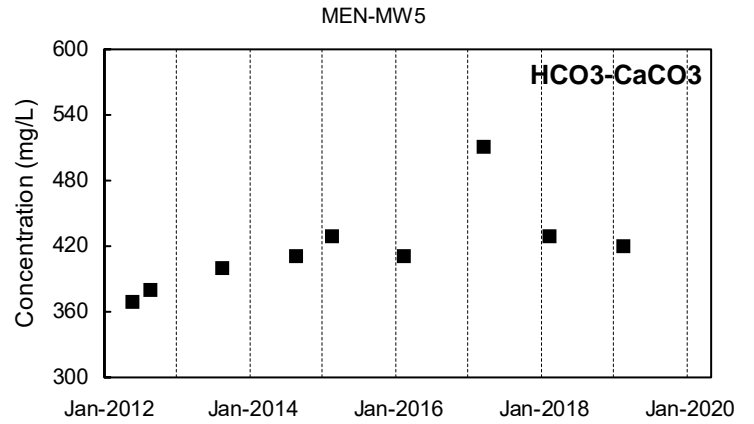
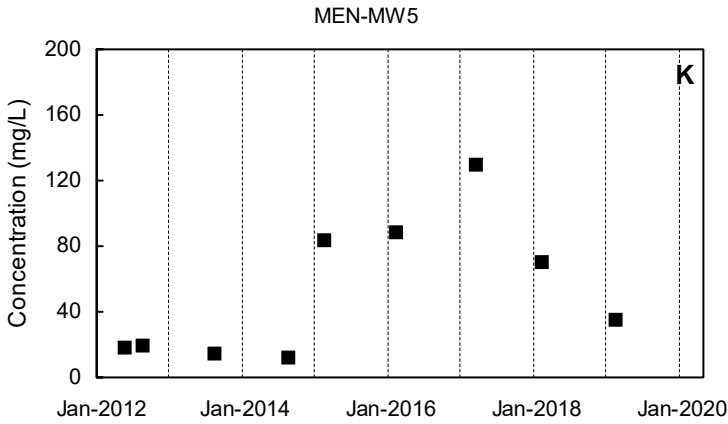
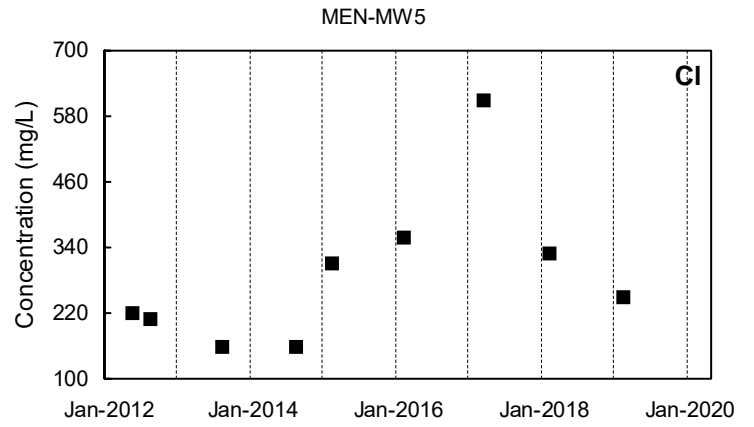
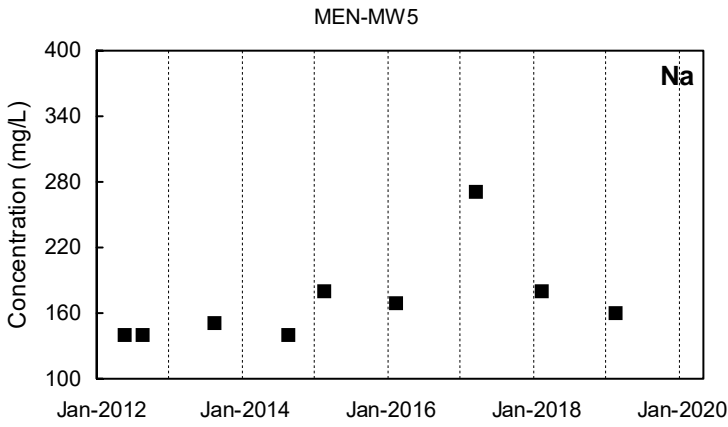

■ Detected Value □ 'J'-Flag (value between reporting limit and detection limit) ■ Non-Detect Range
 Shallow Well shown with black symbols Deep Well shown with orange symbols "dd" Well shown with blue symbols

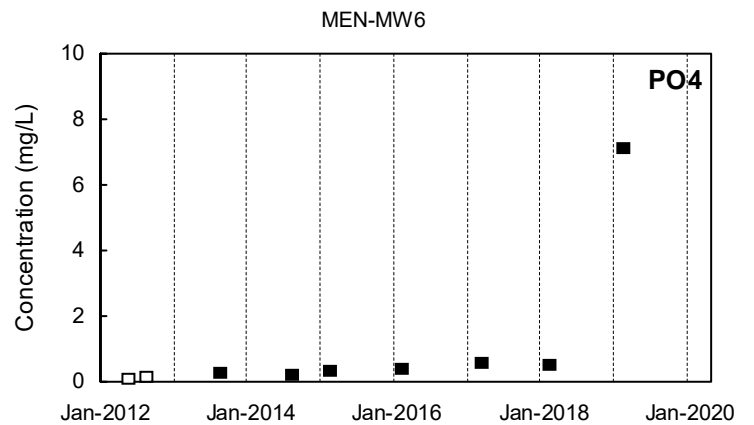
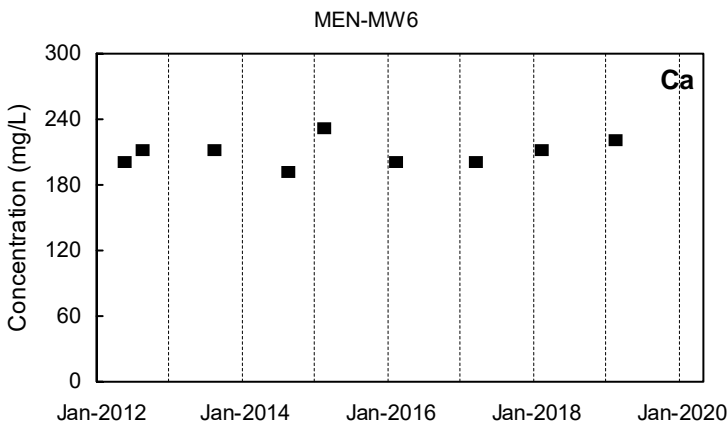
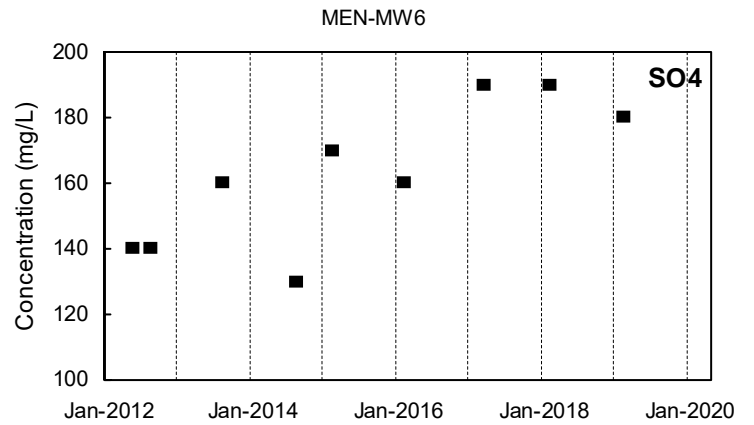
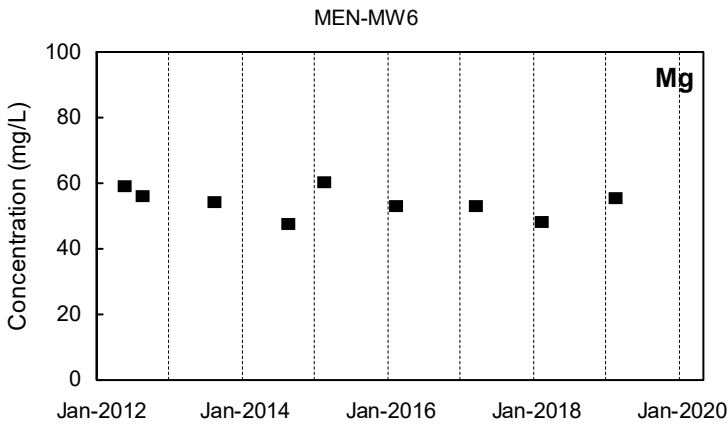
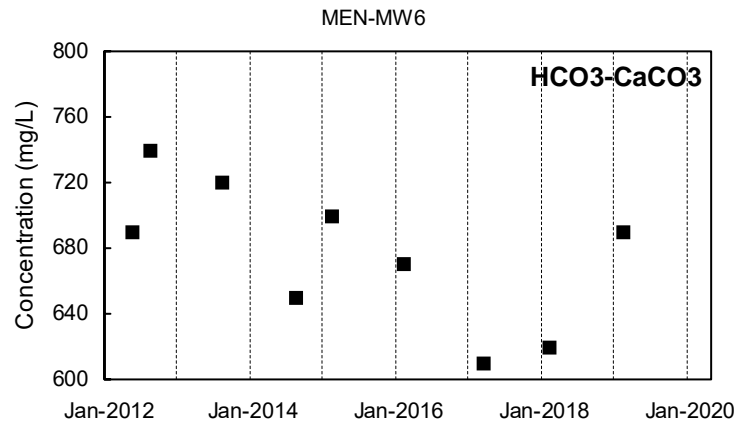
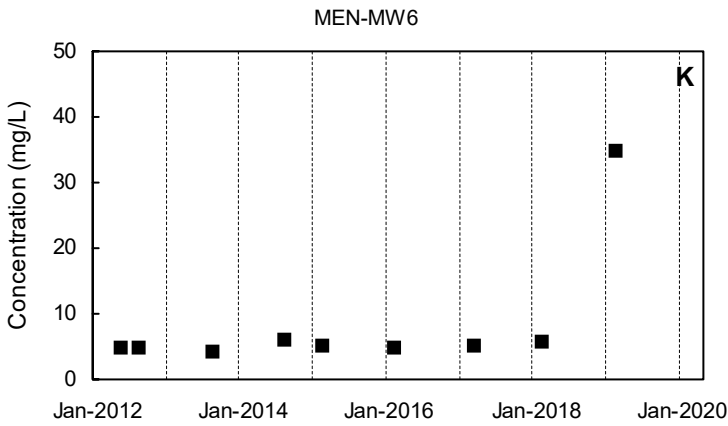
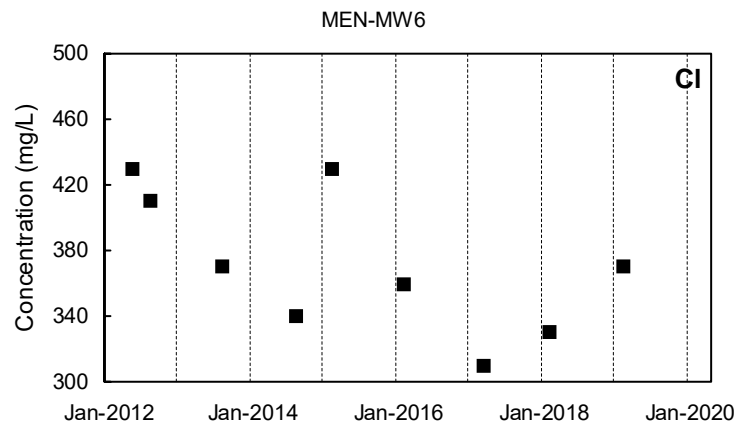
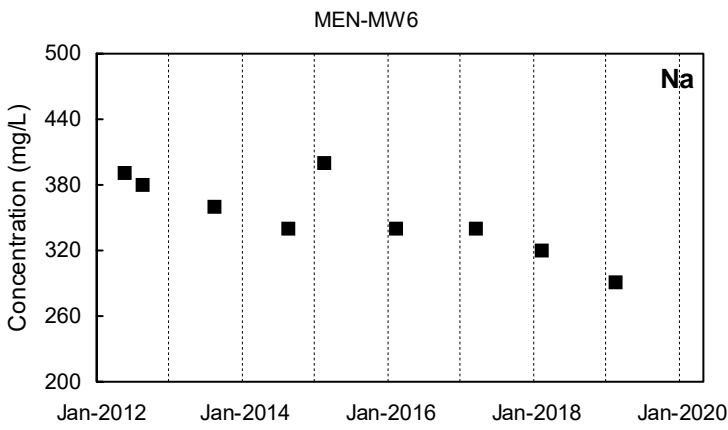

■ Detected Value □ 'J'-Flag (value between reporting limit and detection limit) ■ Non-Detect Range
 Shallow Well shown with black symbols Deep Well shown with orange symbols "dd" Well shown with blue symbols

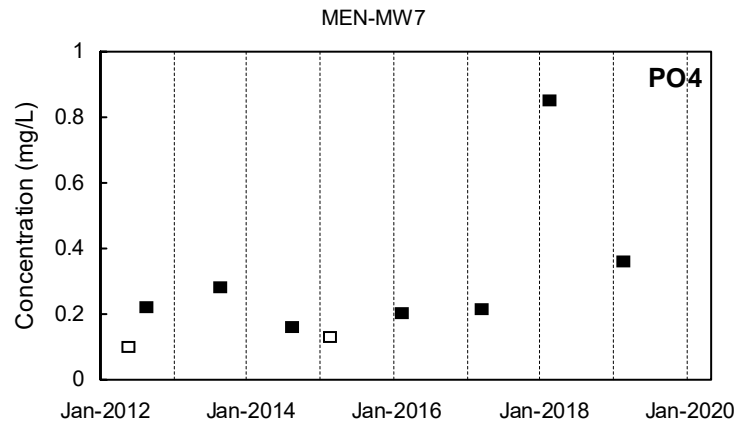
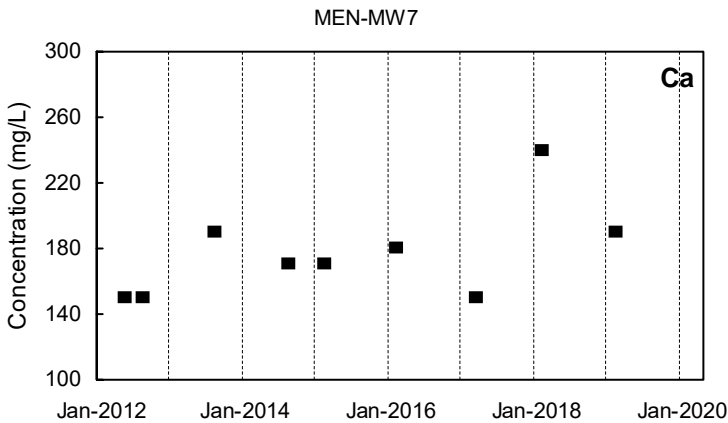
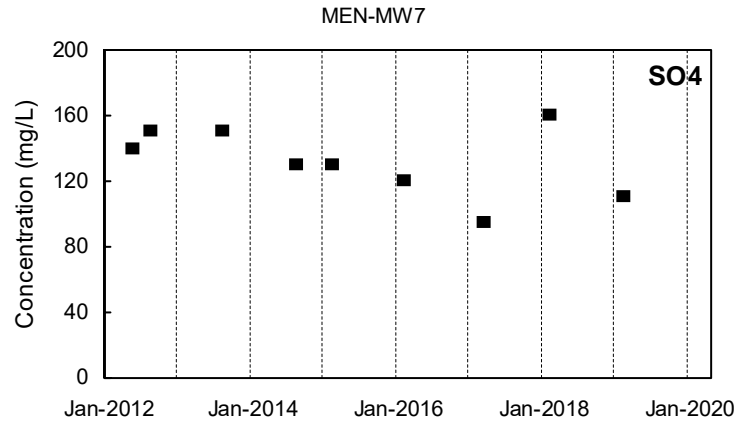
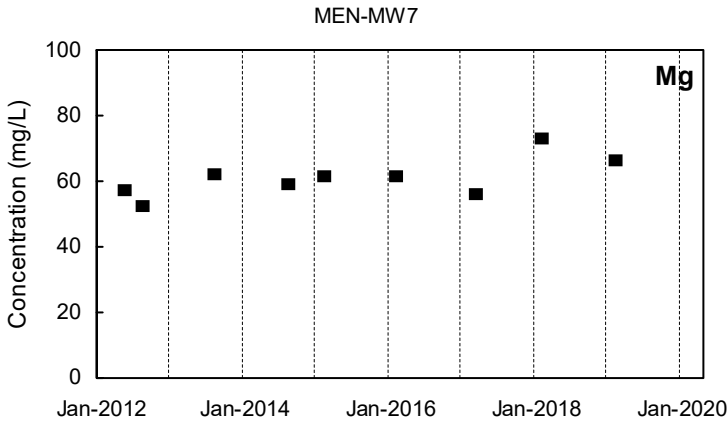
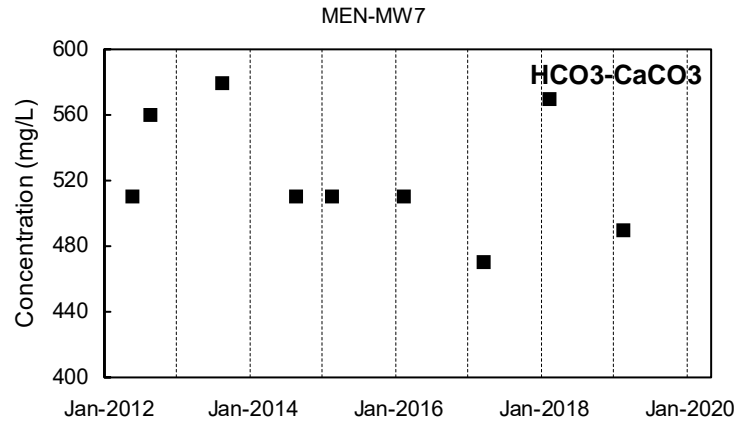
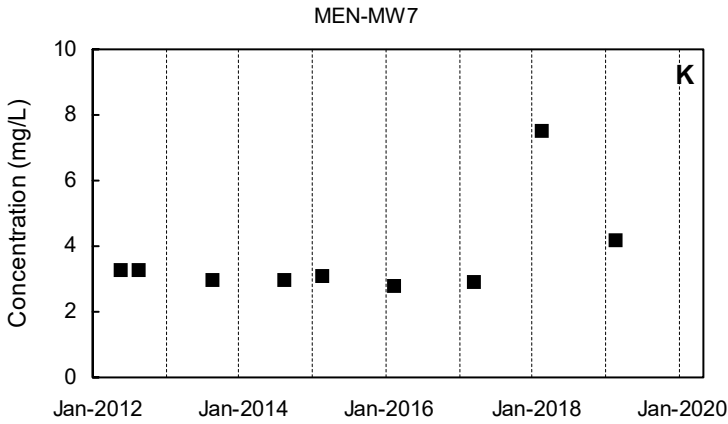
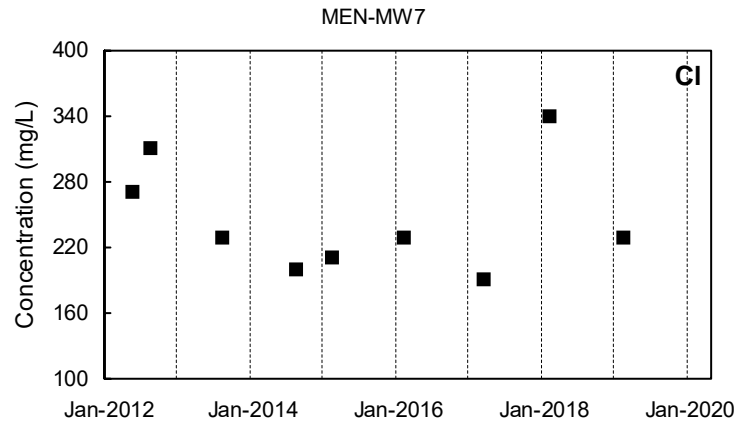
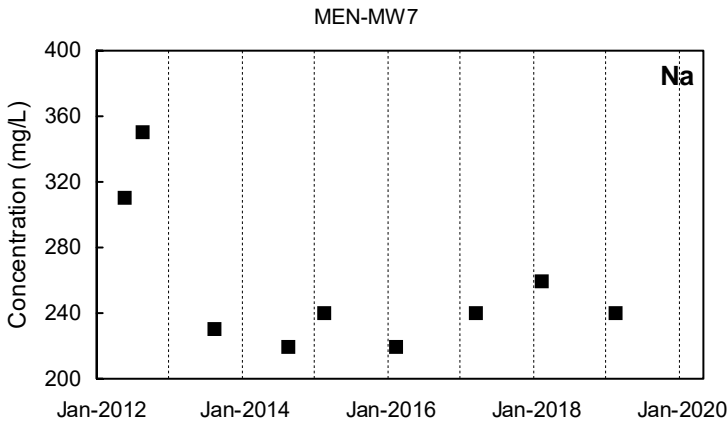

■ Detected Value □ 'J'-Flag (value between reporting limit and detection limit) [] Non-Detect Range
 Shallow Well shown with black symbols Deep Well shown with orange symbols "dd" Well shown with blue symbols

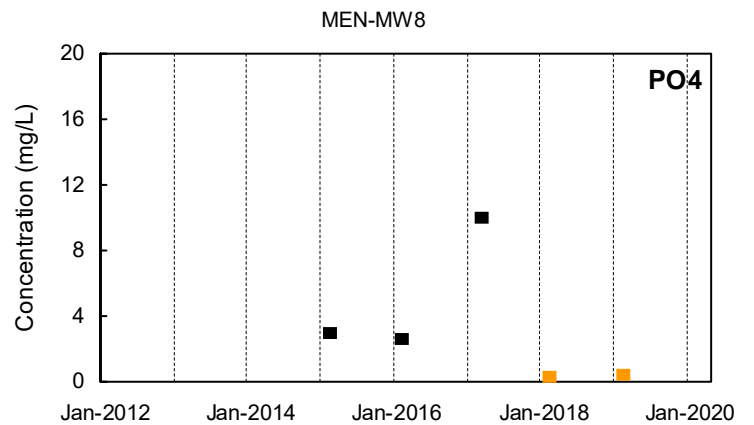
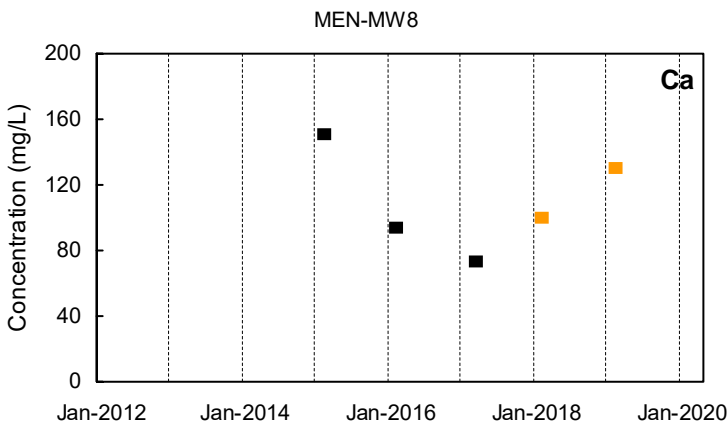
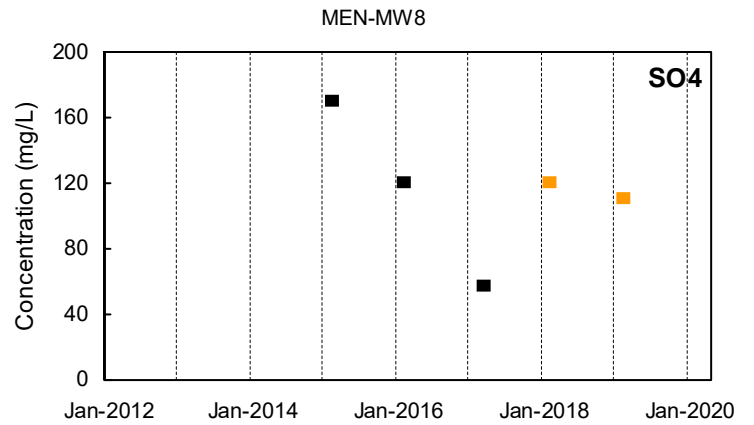
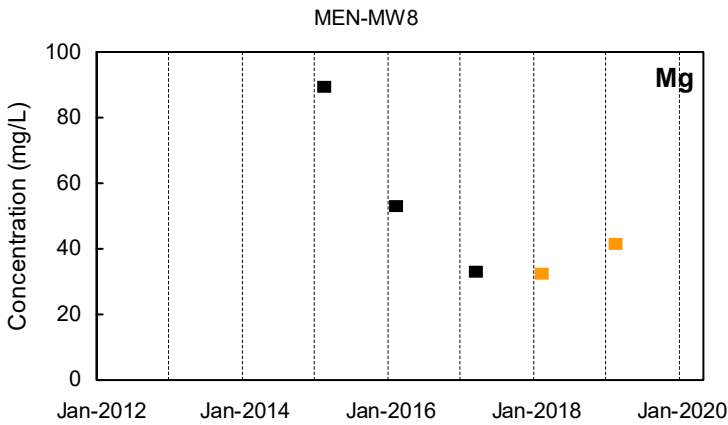
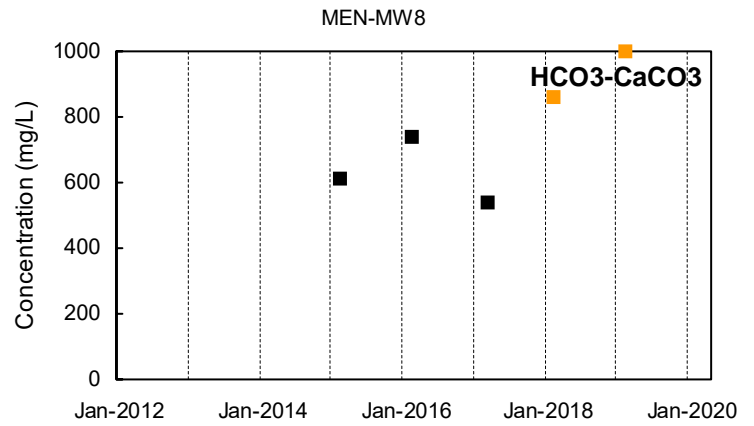
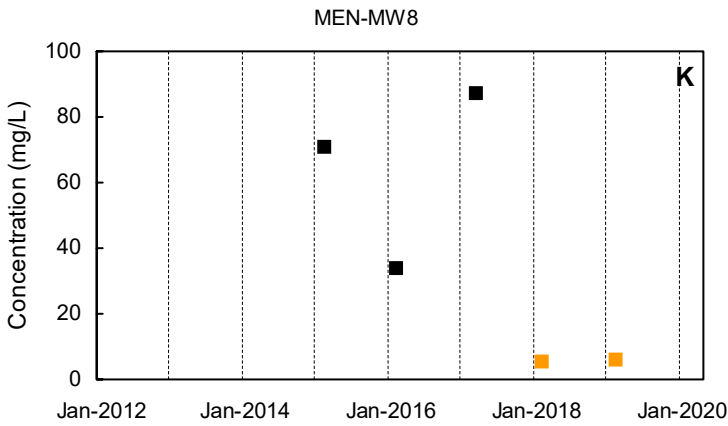
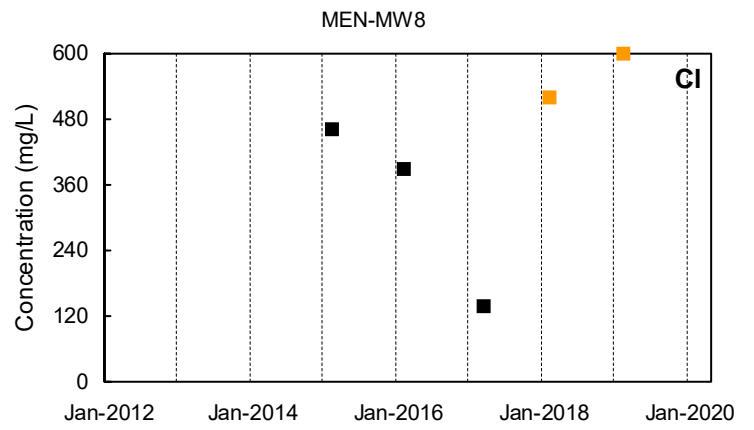
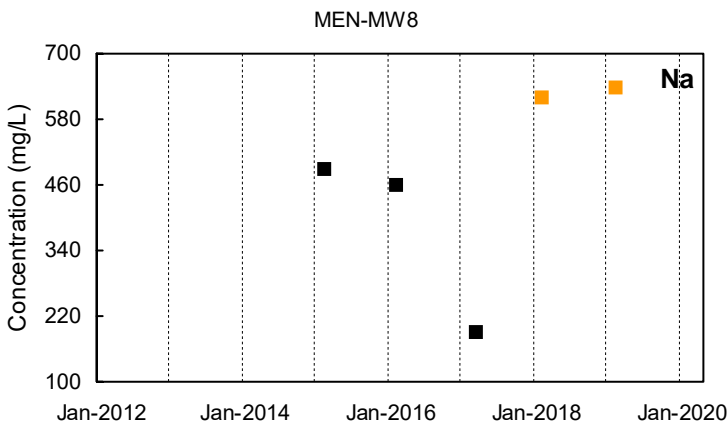

■ Detected Value □ 'J'-Flag (value between reporting limit and detection limit) ■ Non-Detect Range
 ■ Shallow Well shown with black symbols ■ Deep Well shown with orange symbols ■ "dd" Well shown with blue symbols

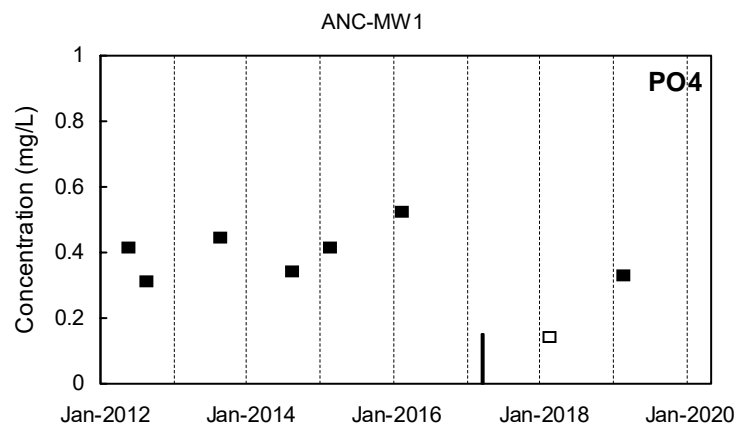
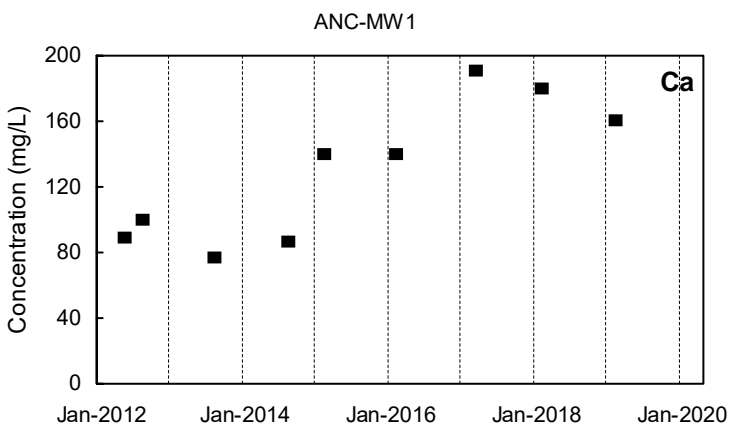
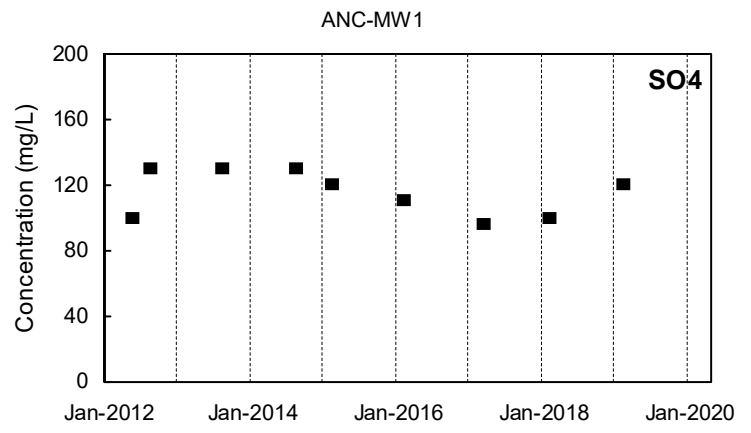
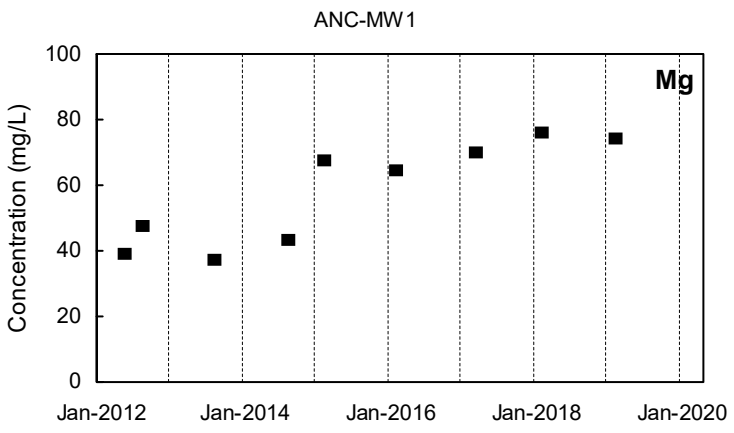
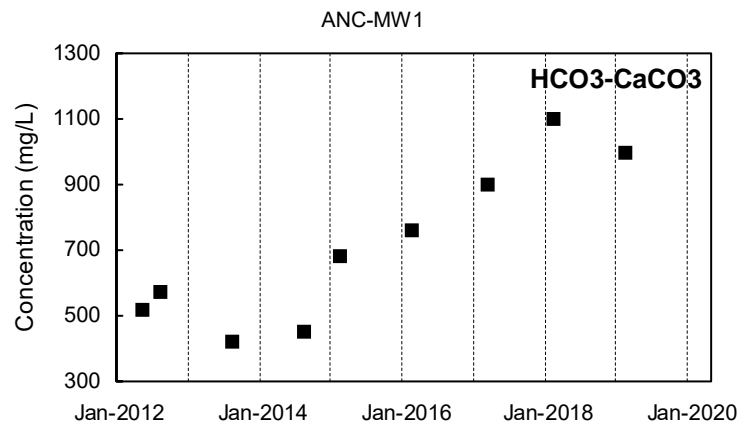
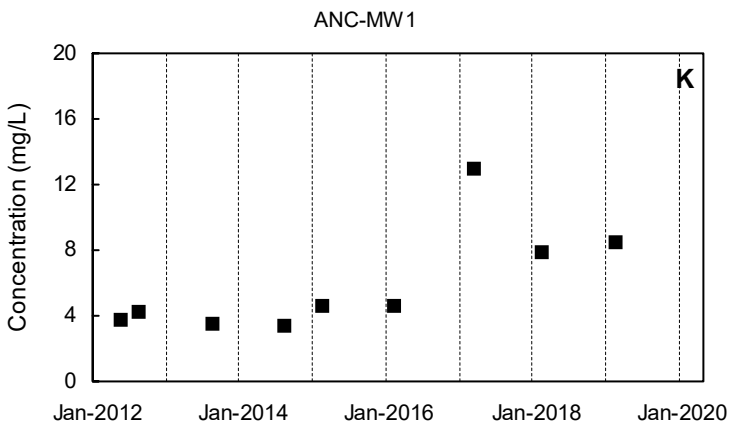
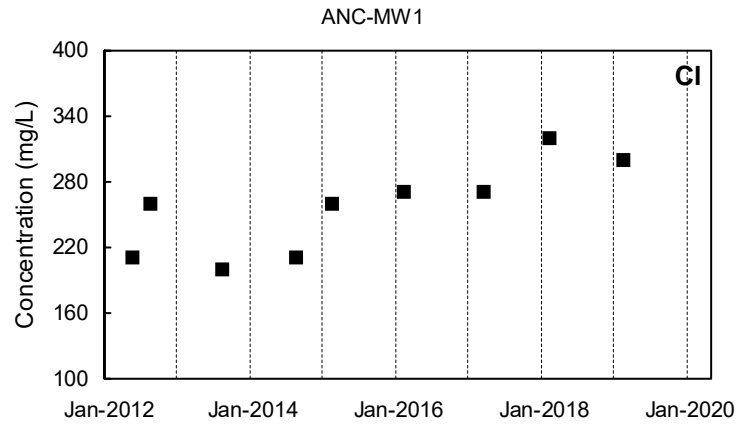
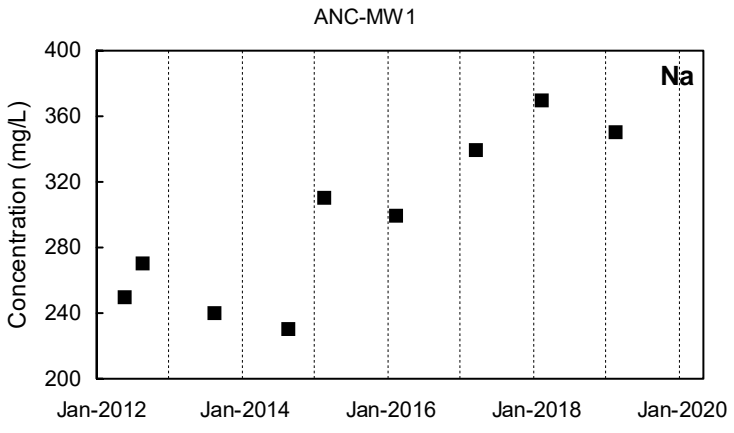

Detected Value
 'J'-Flag (value between reporting limit and detection limit)
 Non-Detect Range
 Shallow Well shown with black symbols
 Deep Well shown with orange symbols
 "dd" Well shown with blue symbols

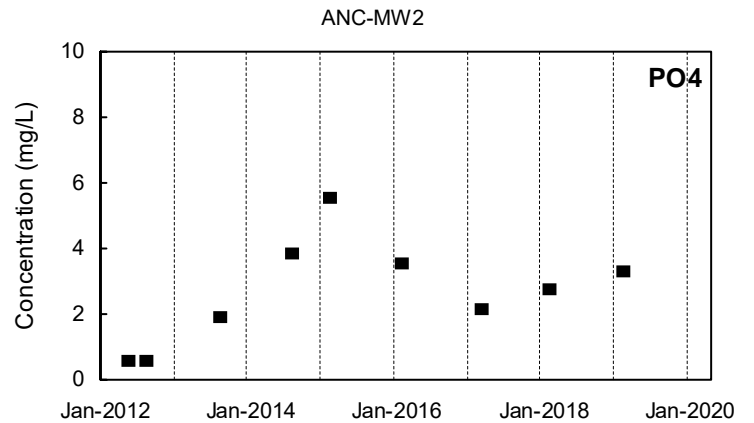
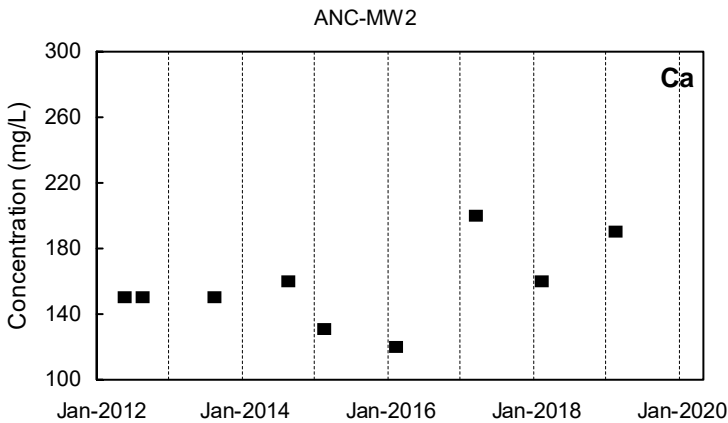
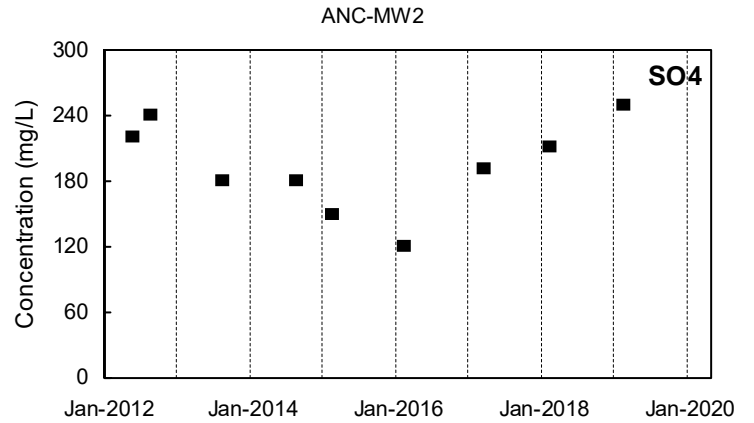
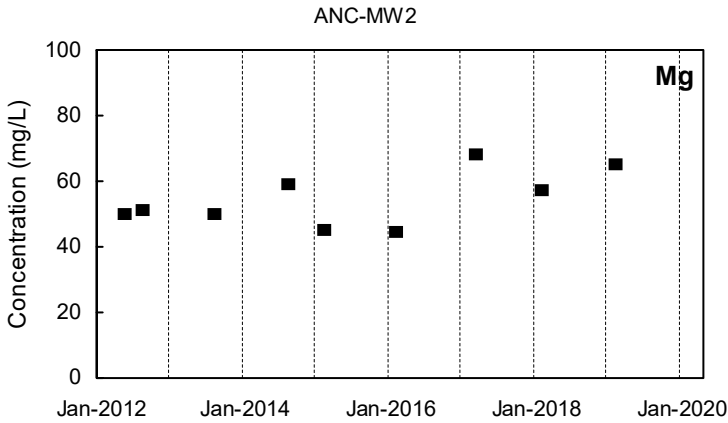
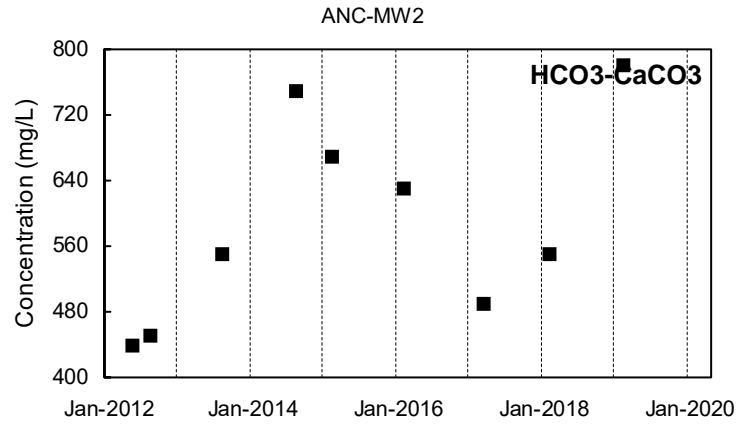
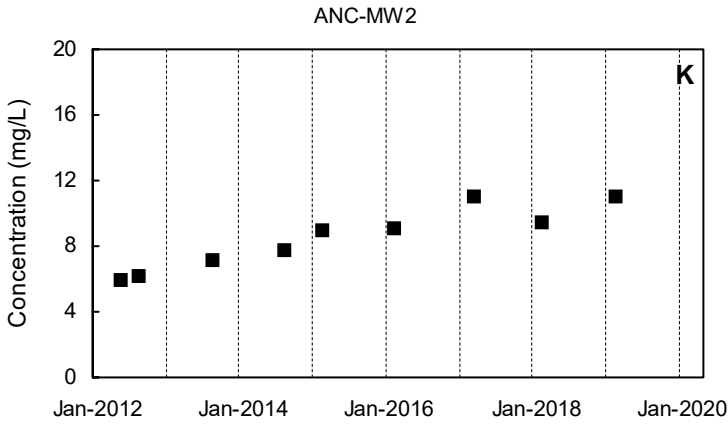
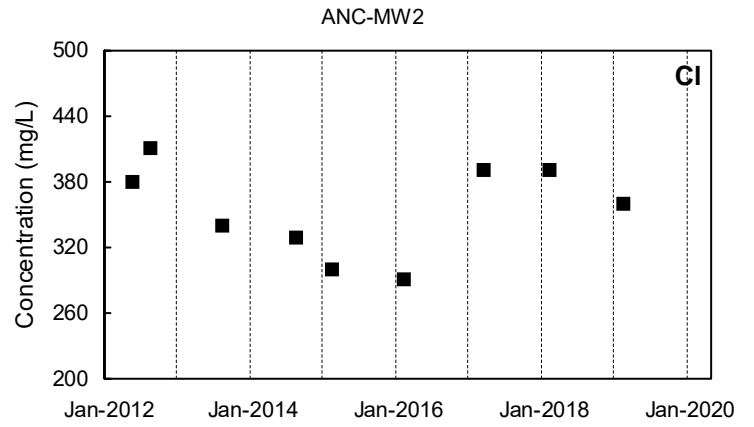
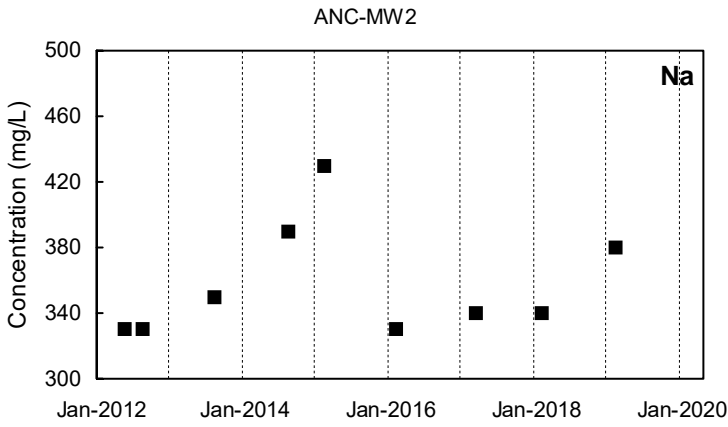

Detected Value
 'J'-Flag (value between reporting limit and detection limit)
 Non-Detect Range
 Shallow Well shown with black symbols
 Deep Well shown with orange symbols
 "dd" Well shown with blue symbols

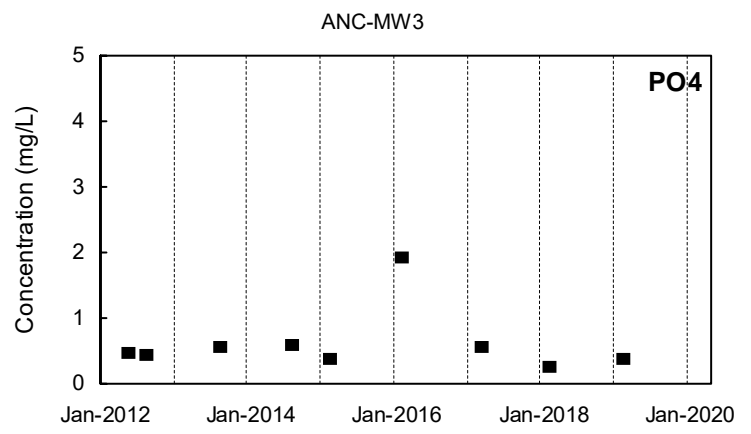
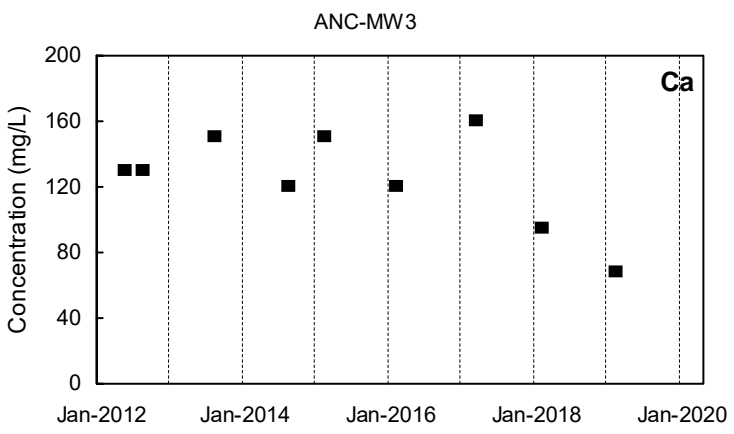
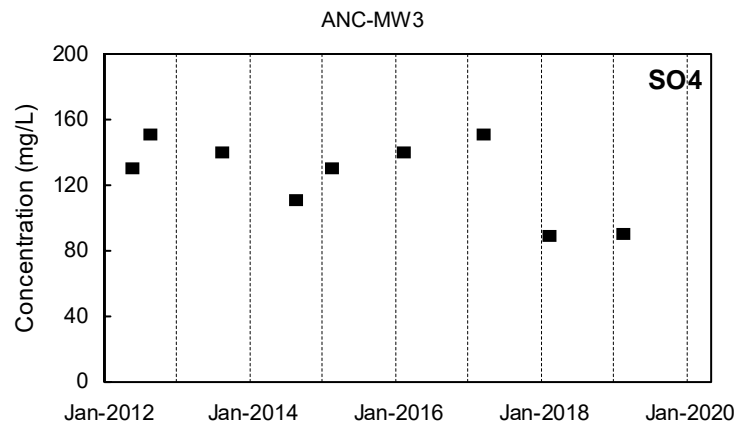
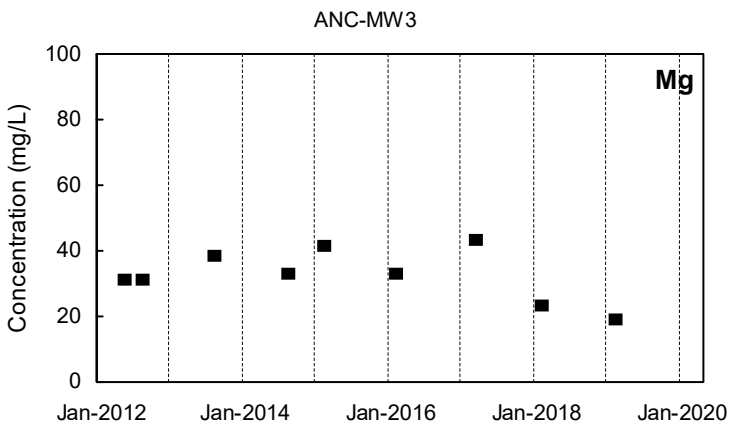
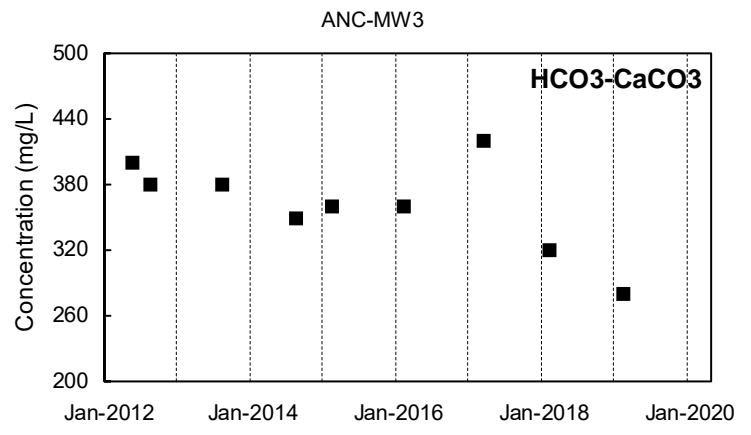
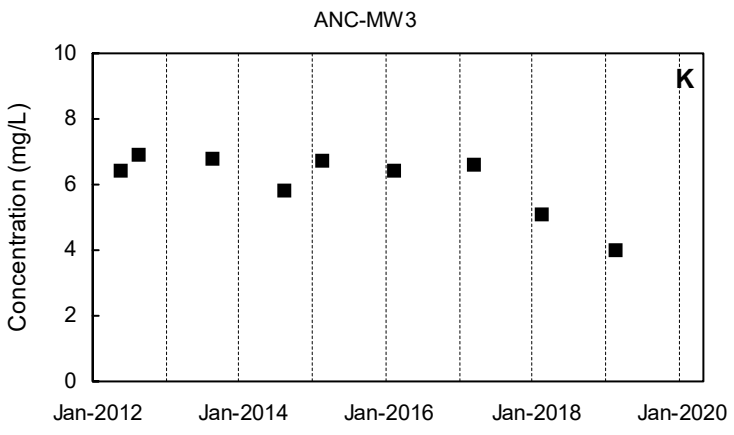
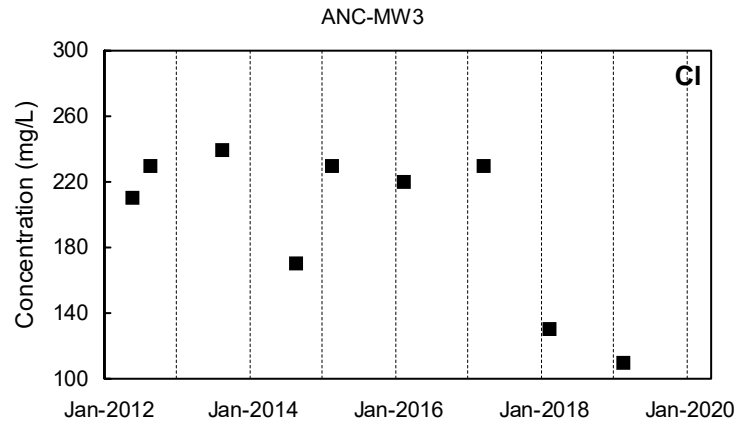
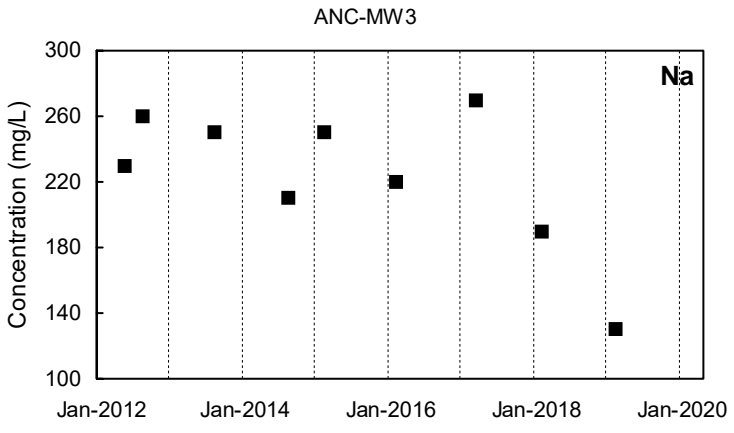

Detected Value
 'J'-Flag (value between reporting limit and detection limit)
 Non-Detect Range
 Shallow Well shown with black symbols
 Deep Well shown with orange symbols
 "dd" Well shown with blue symbols

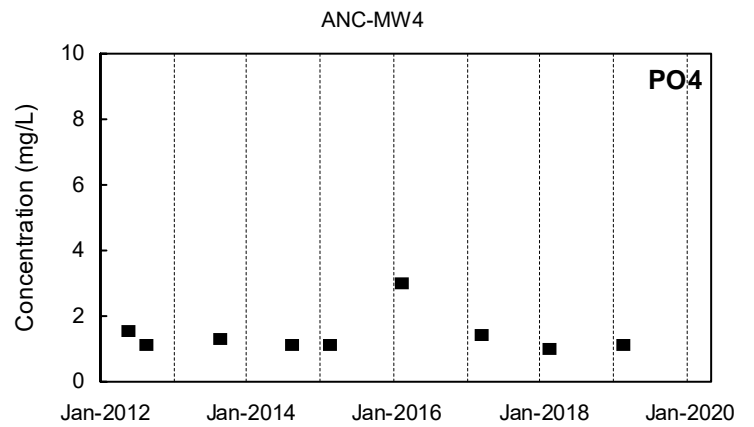
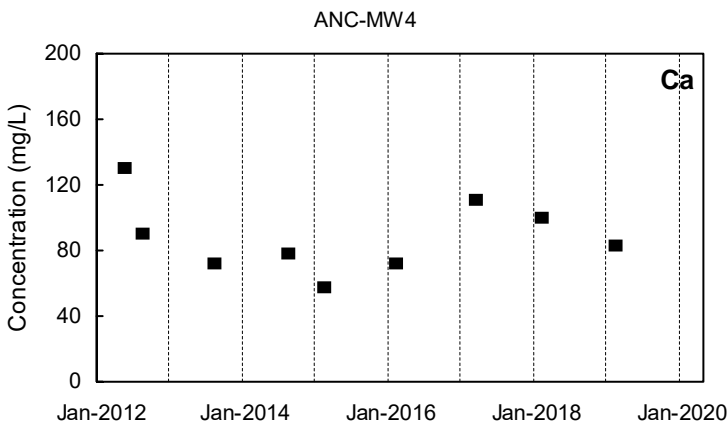
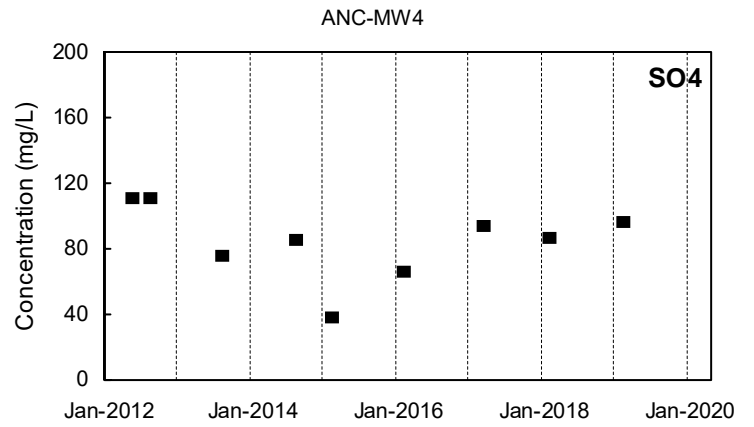
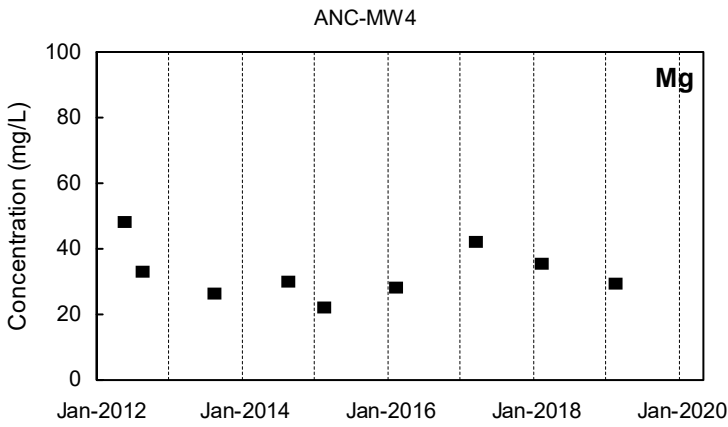
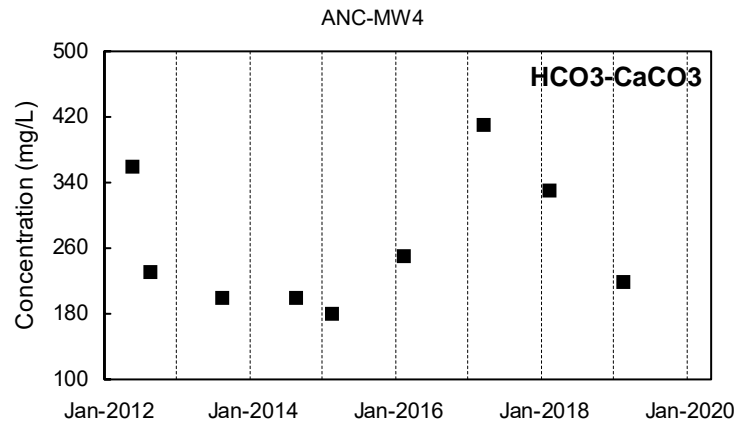
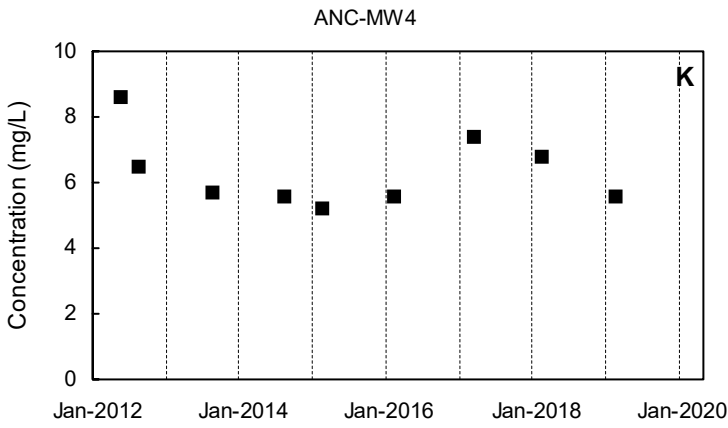
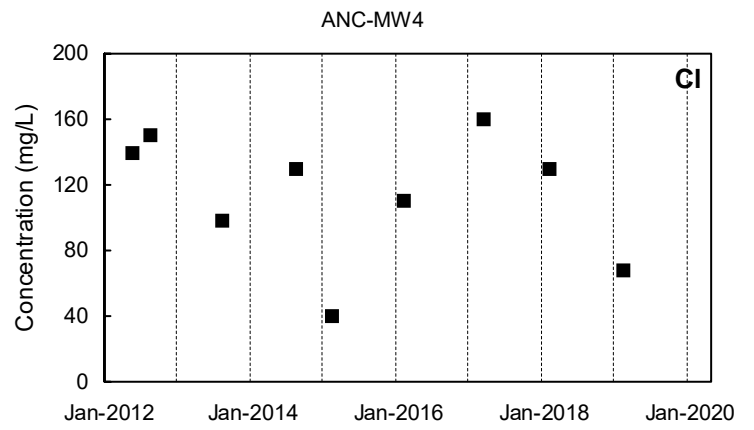
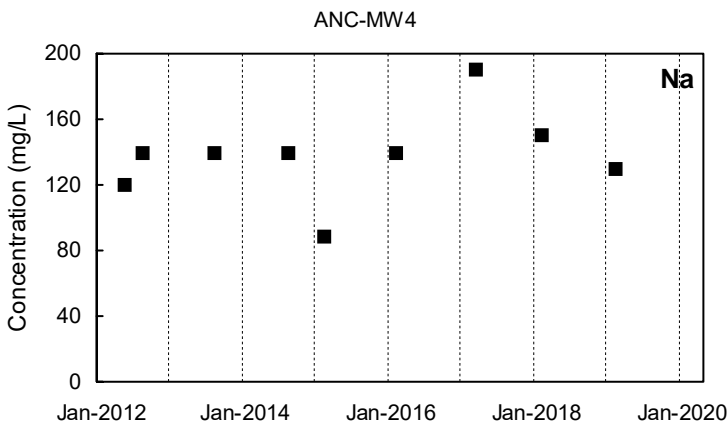

Detected Value
 'J'-Flag (value between reporting limit and detection limit)
 Non-Detect Range
 Shallow Well shown with black symbols
 Deep Well shown with orange symbols
 "dd" Well shown with blue symbols

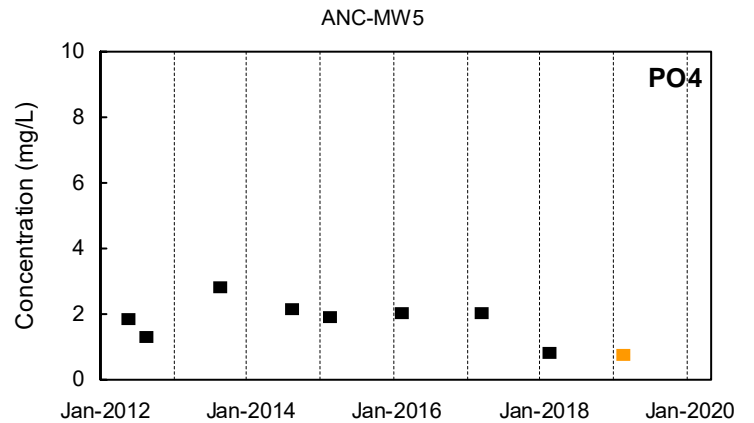
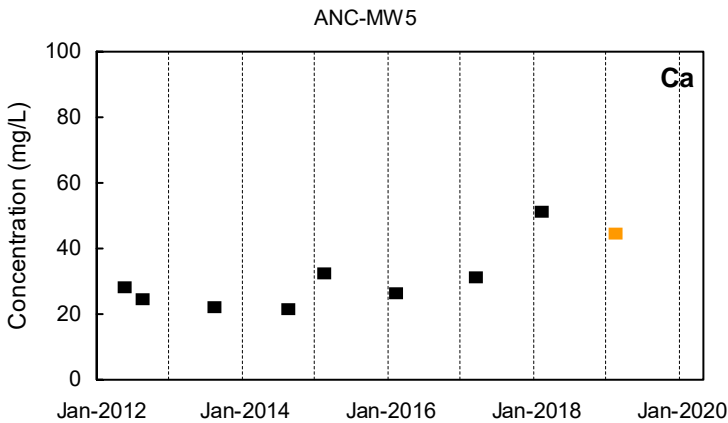
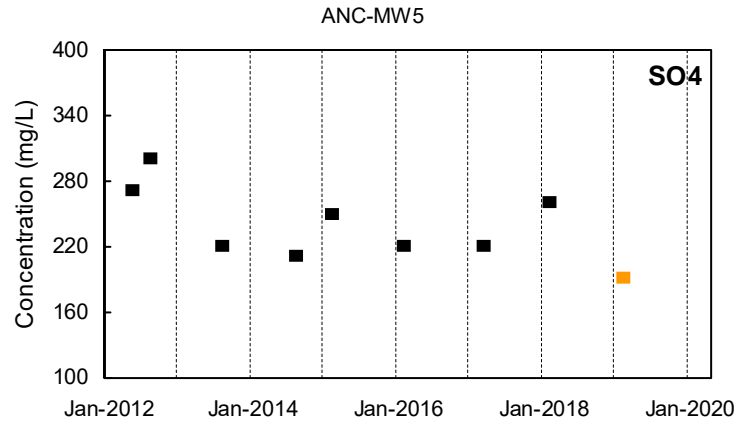
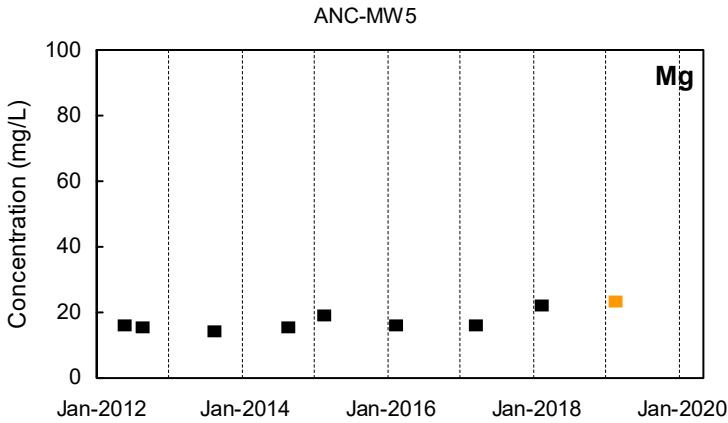
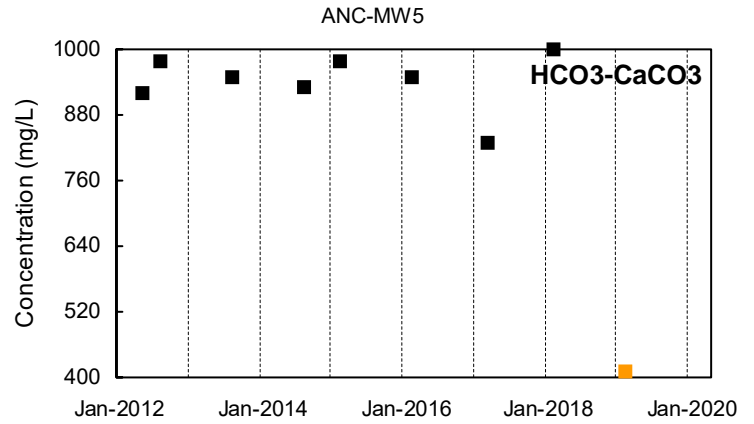
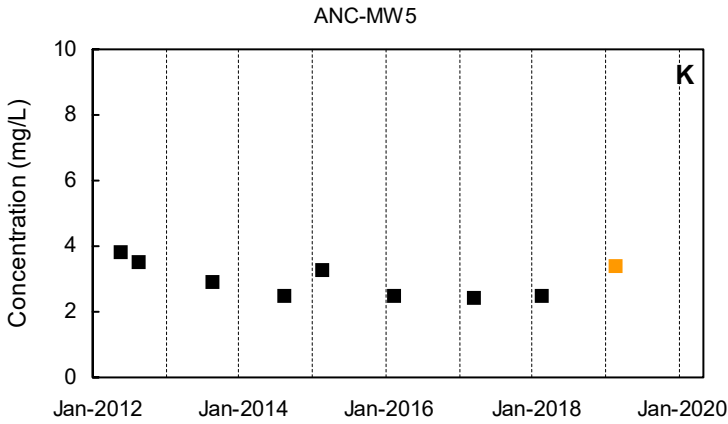
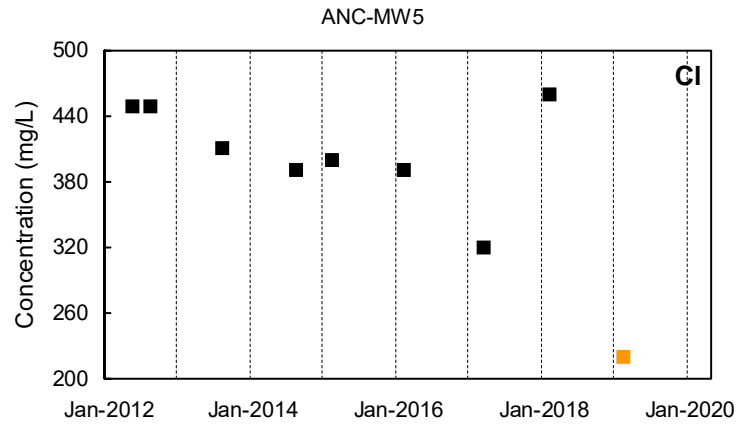
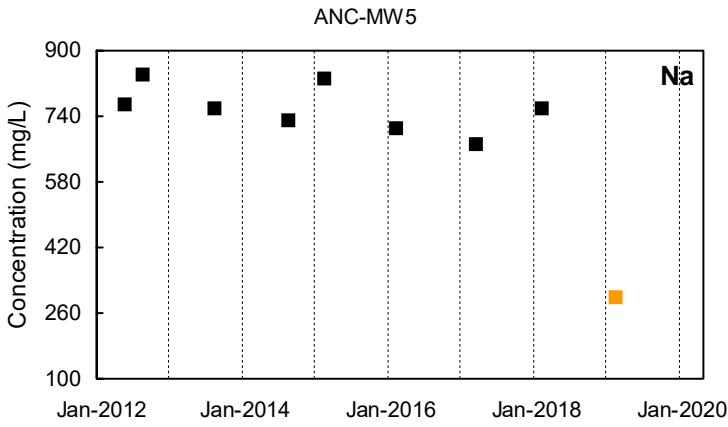

Detected Value
 'J'-Flag (value between reporting limit and detection limit)
 Non-Detect Range
 Shallow Well shown with black symbols
 Deep Well shown with orange symbols
 "dd" Well shown with blue symbols

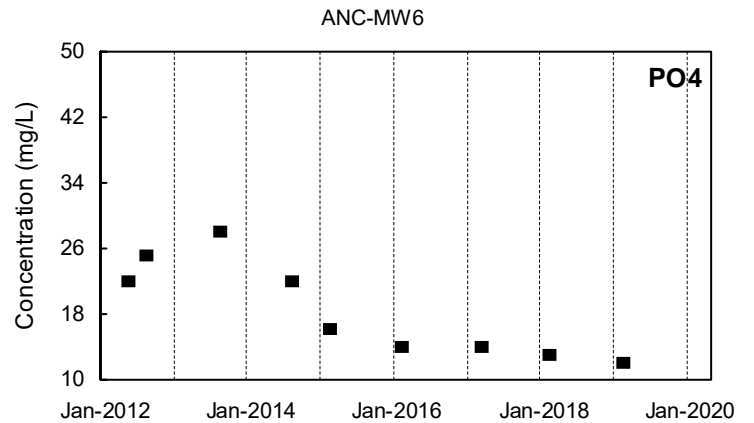
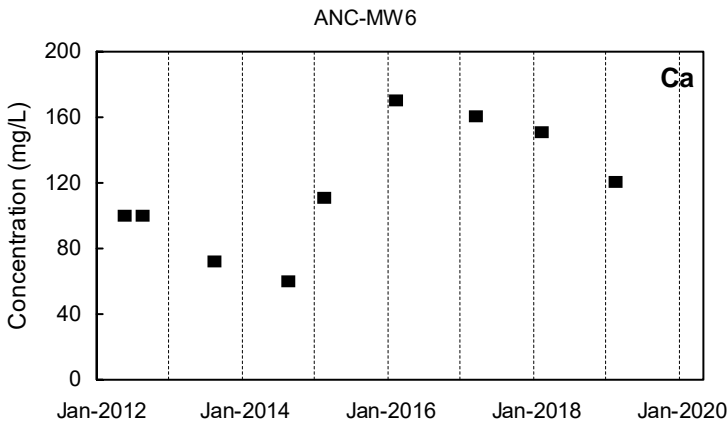
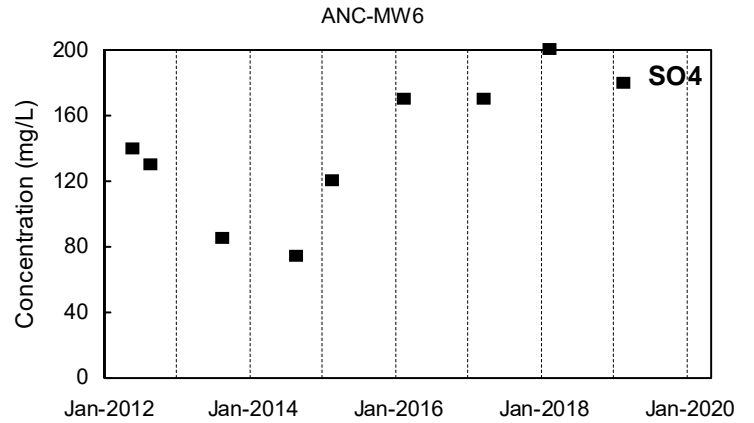
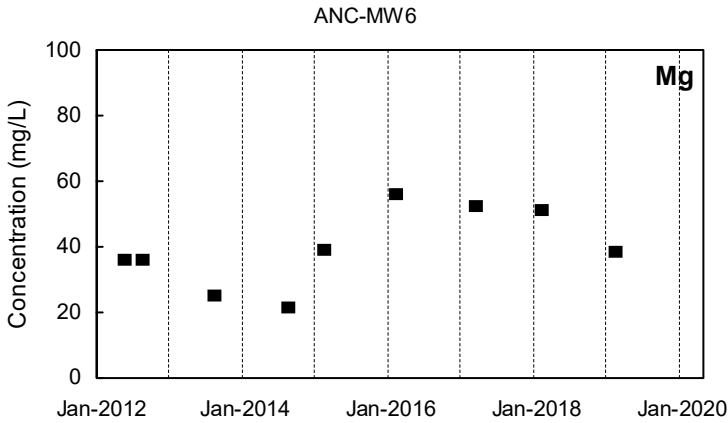
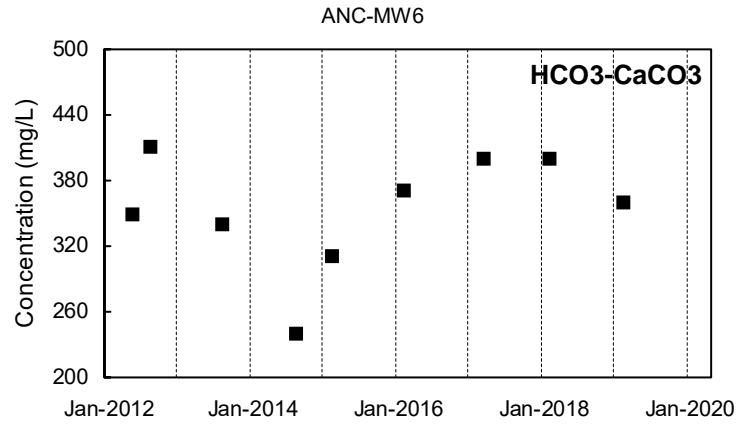
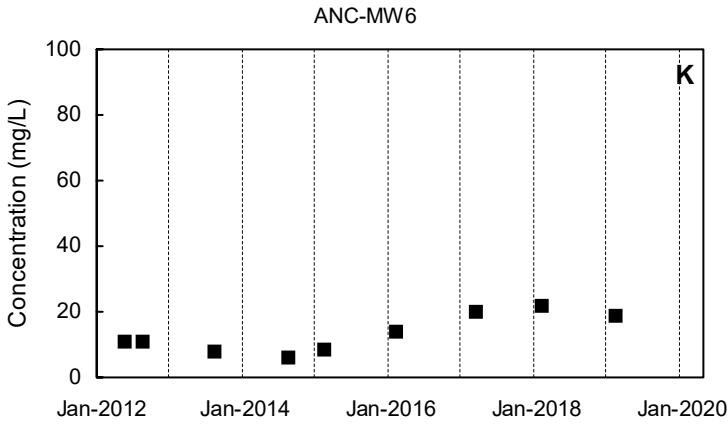
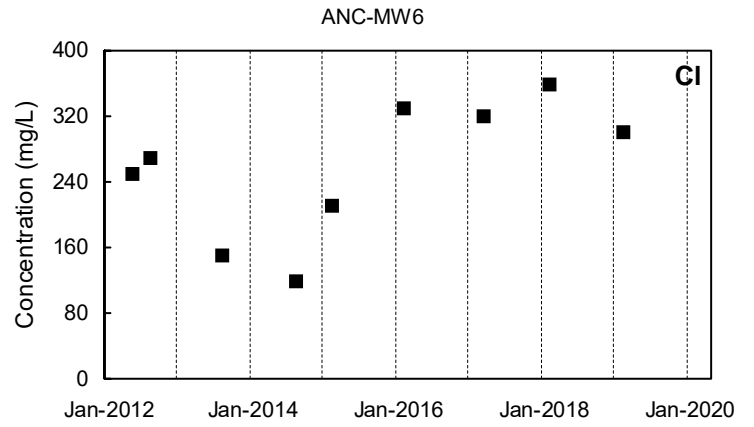
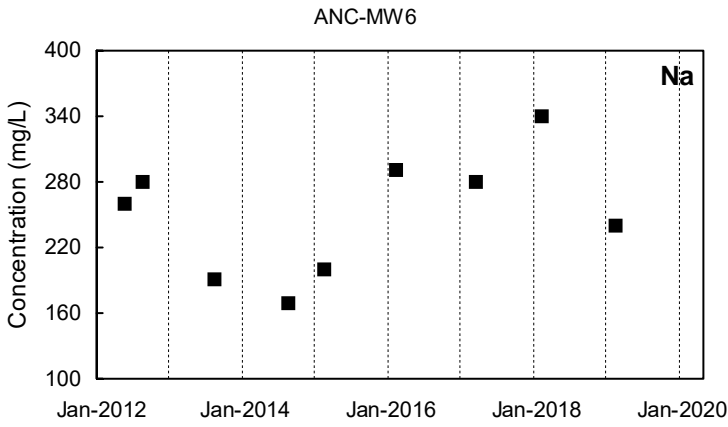

Detected Value
 'J'-Flag (value between reporting limit and detection limit)
 Non-Detect Range
 Shallow Well shown with black symbols
 Deep Well shown with orange symbols
 "dd" Well shown with blue symbols

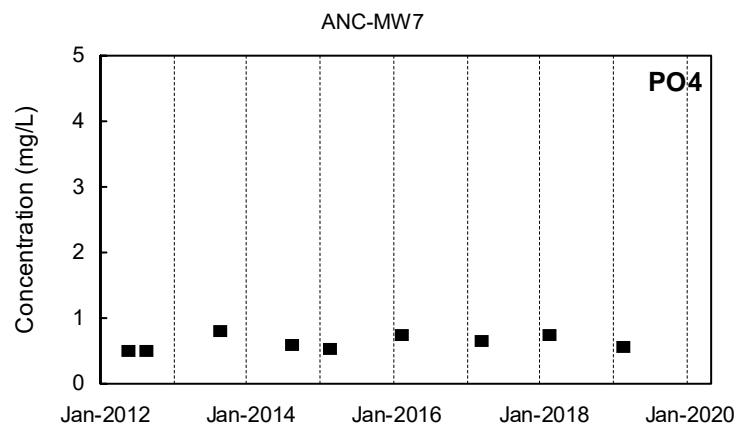
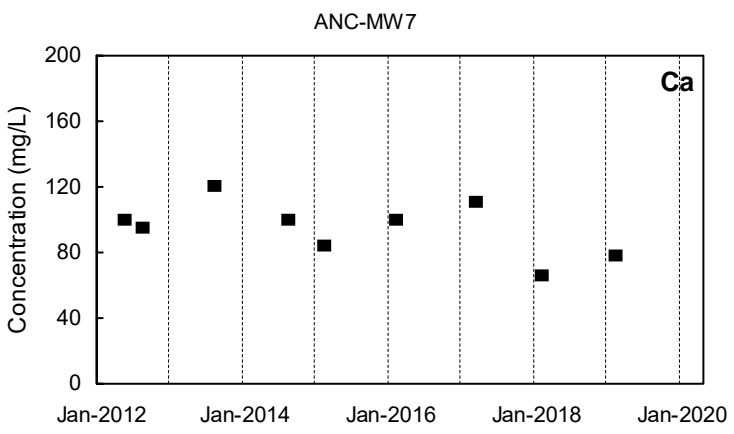
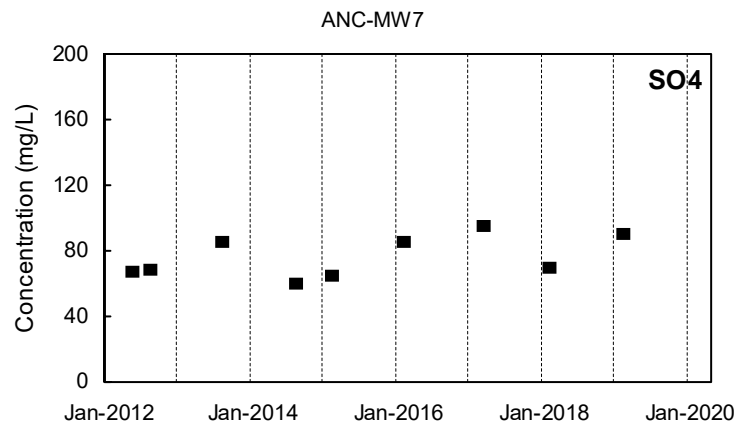
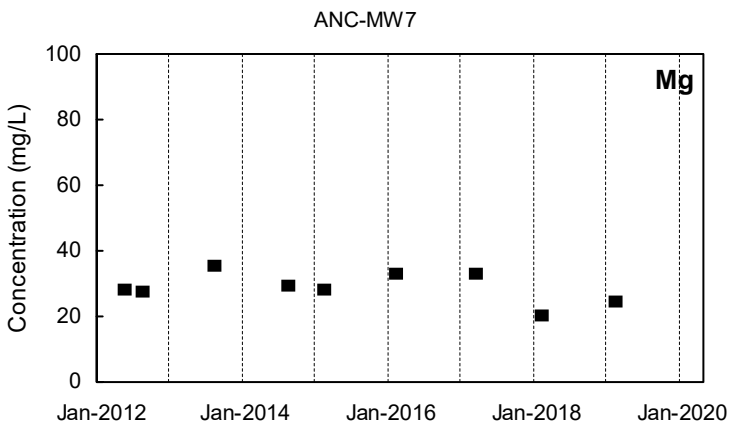
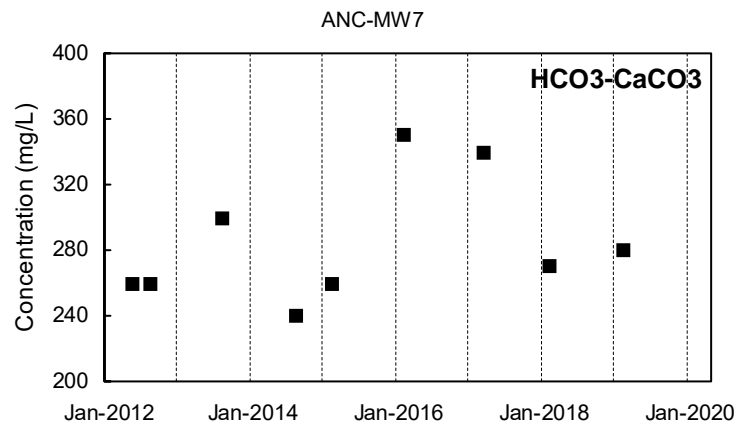
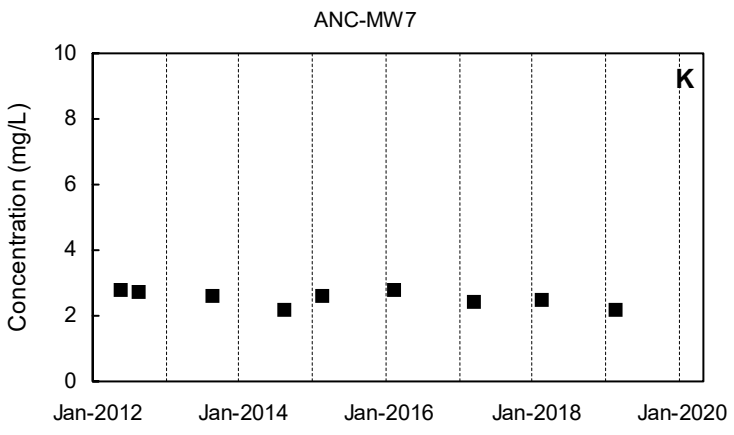
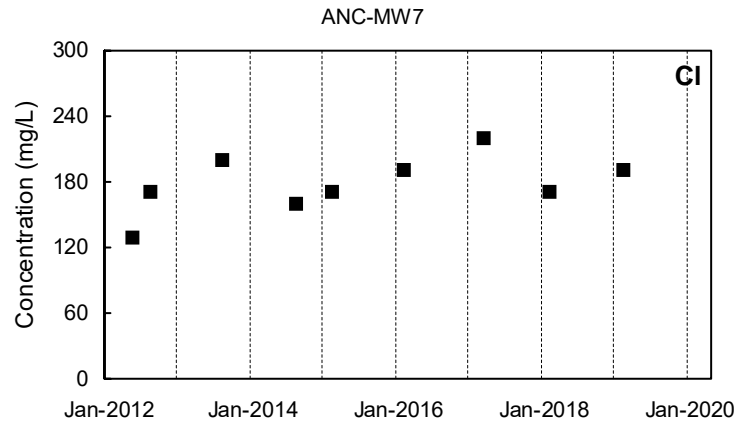
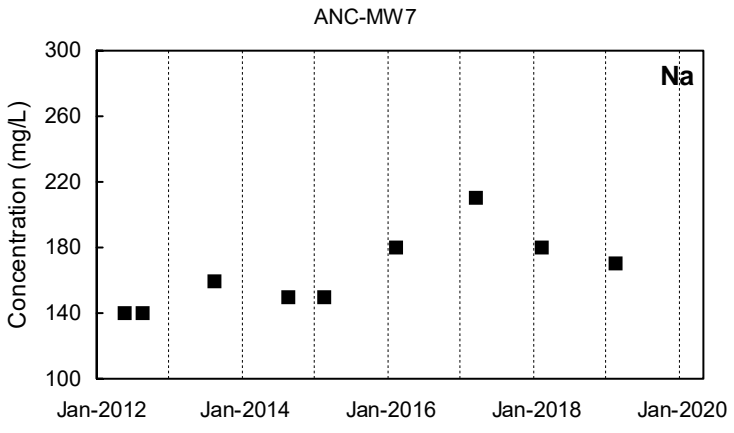

Detected Value
 'J'-Flag (value between reporting limit and detection limit)
 Non-Detect Range
 Shallow Well shown with black symbols
 Deep Well shown with orange symbols
 "dd" Well shown with blue symbols

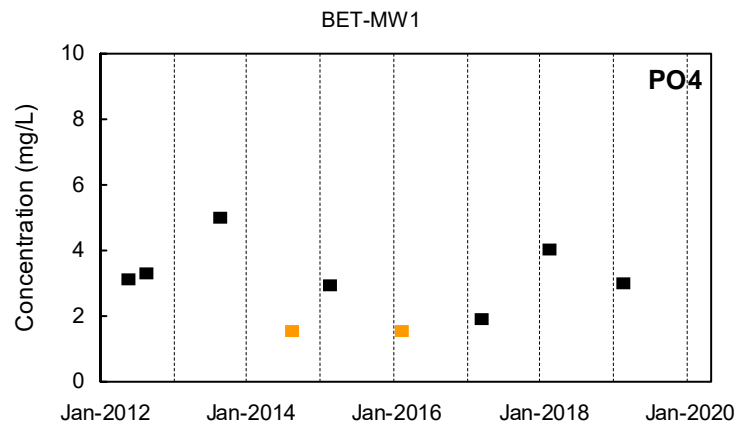
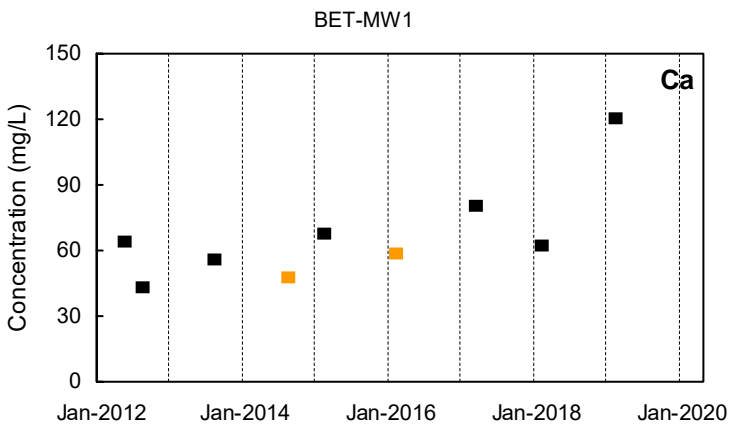
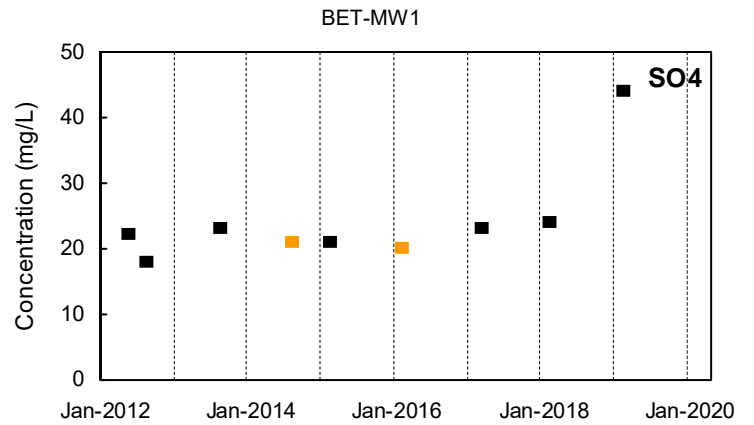
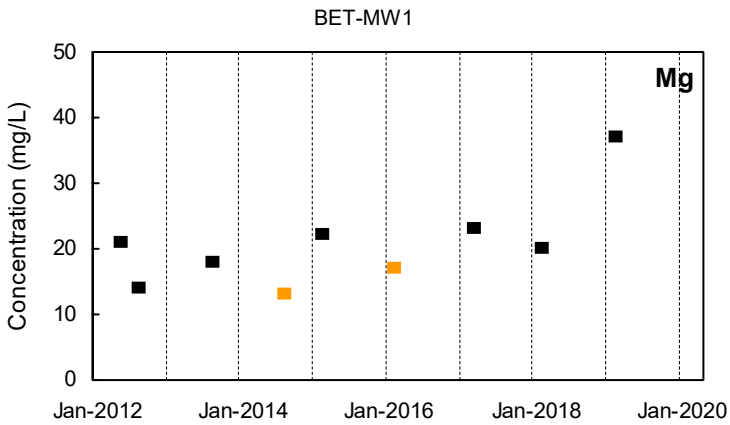
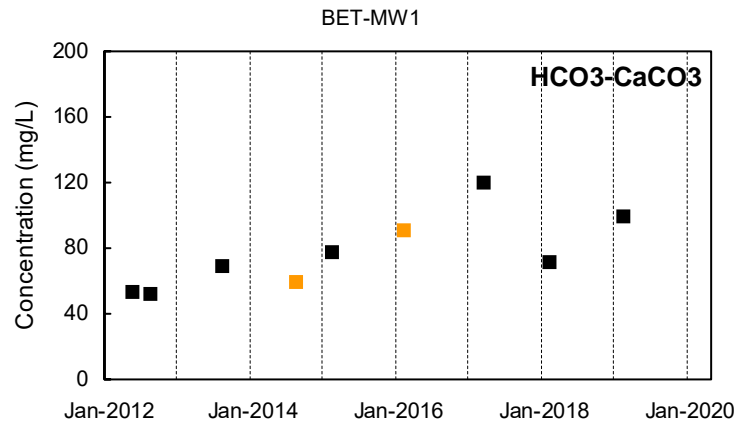
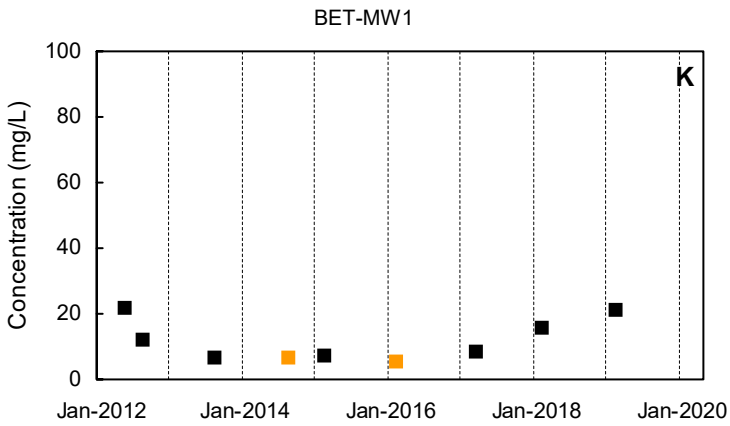
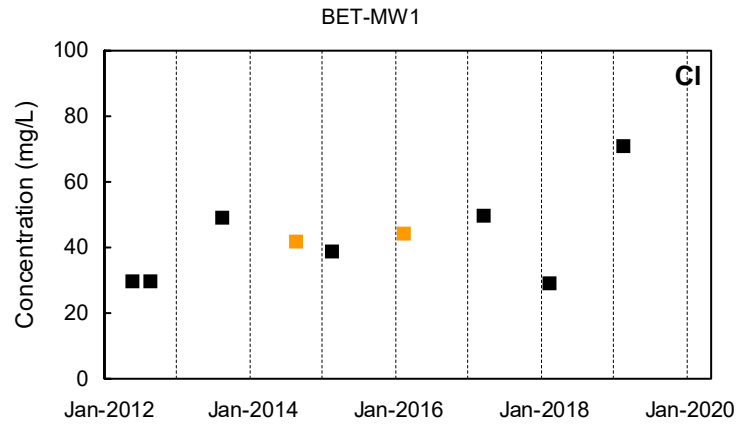
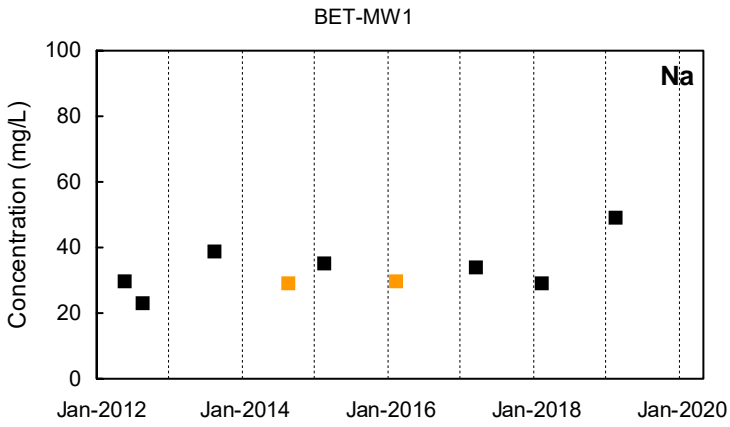

Detected Value
 'J'-Flag (value between reporting limit and detection limit)
 Non-Detect Range
 Shallow Well shown with black symbols Deep Well shown with orange symbols "dd" Well shown with blue symbols

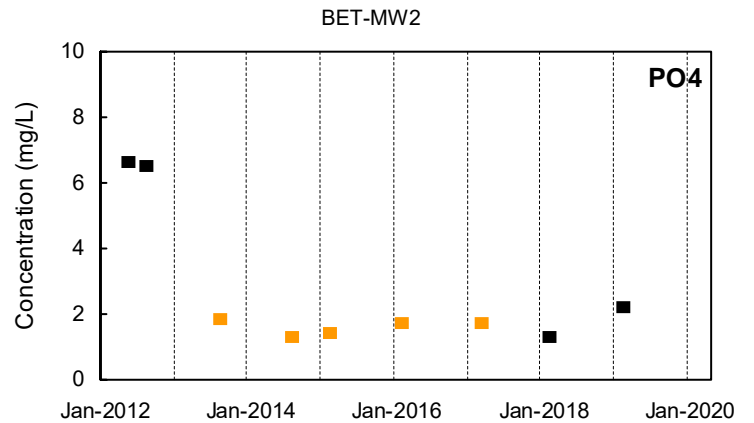
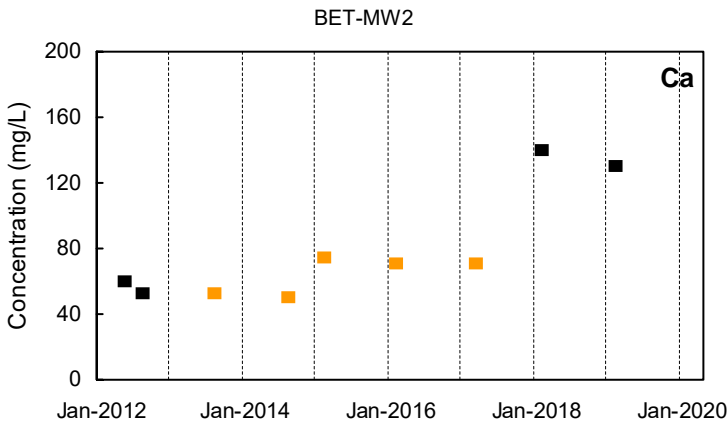
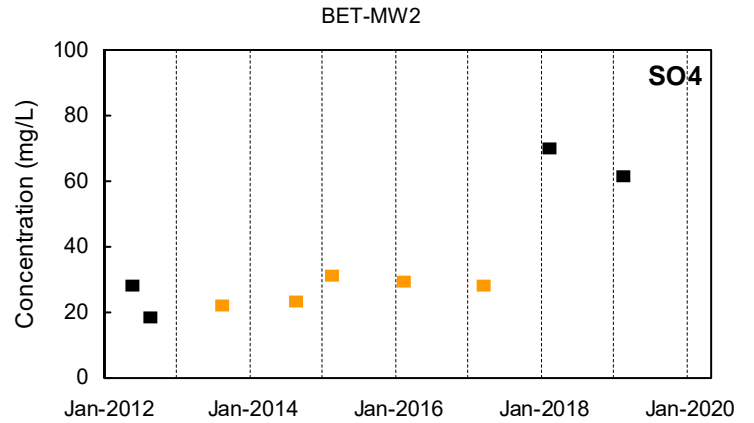
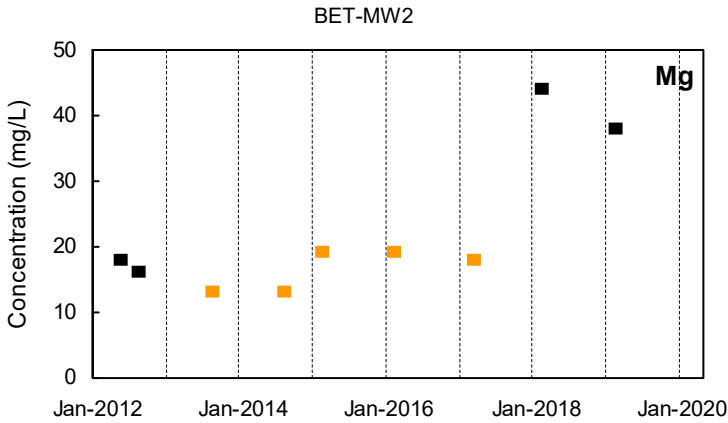
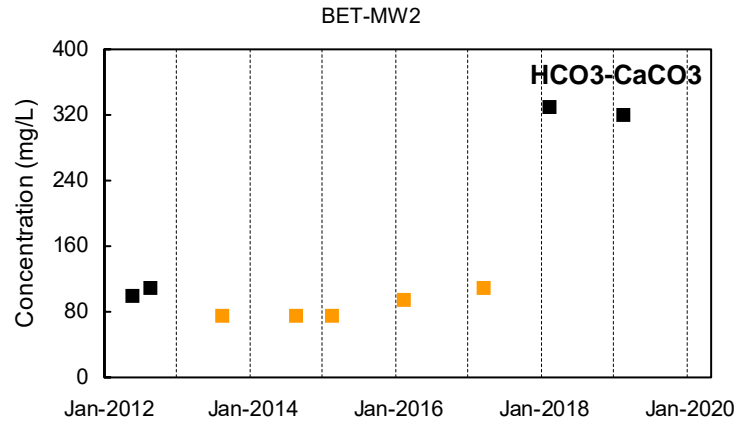
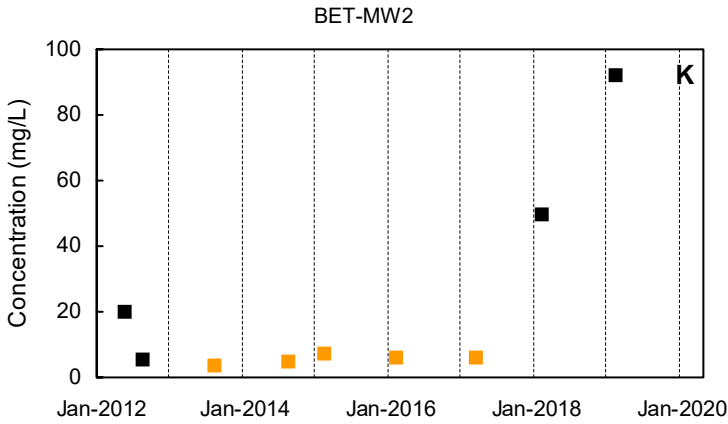
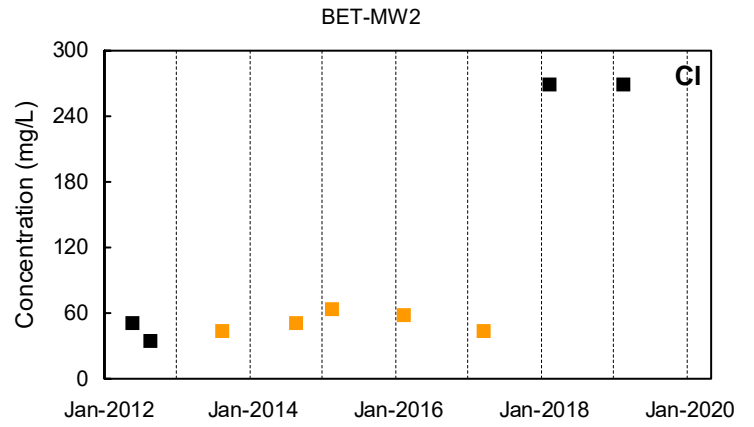
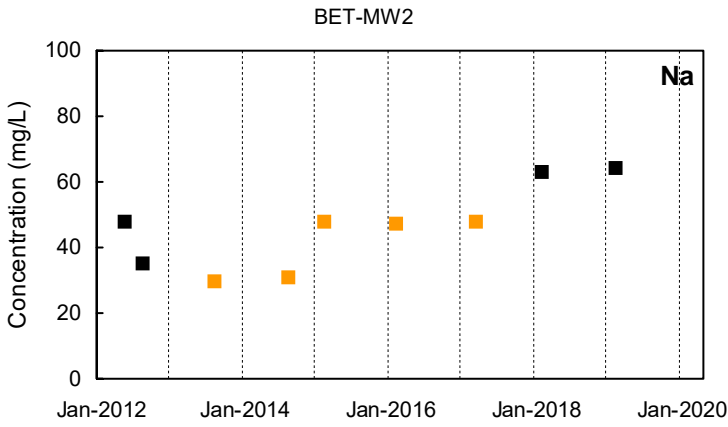

Detected Value
 'J'-Flag (value between reporting limit and detection limit)
 Non-Detect Range
 Shallow Well shown with black symbols Deep Well shown with orange symbols "dd" Well shown with blue symbols

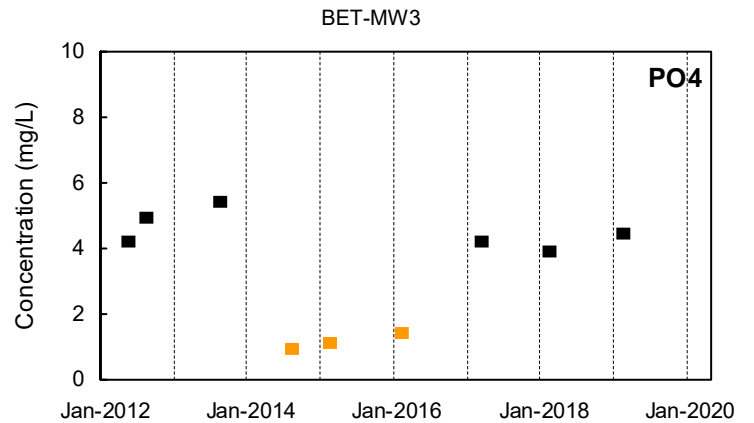
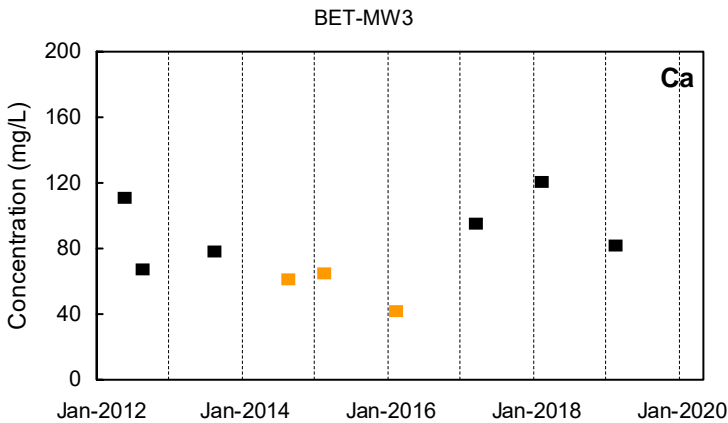
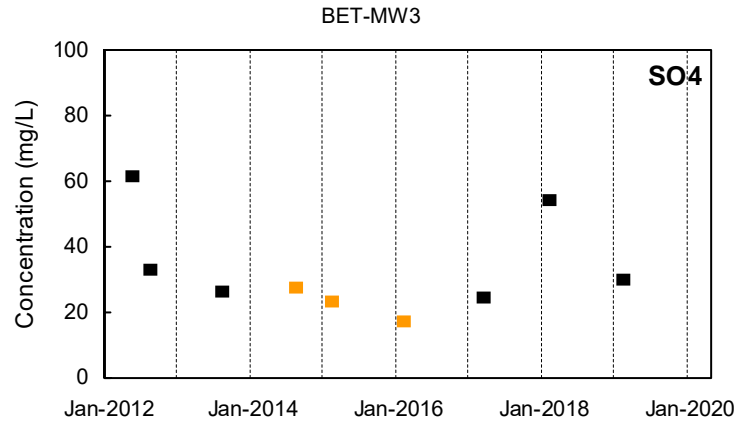
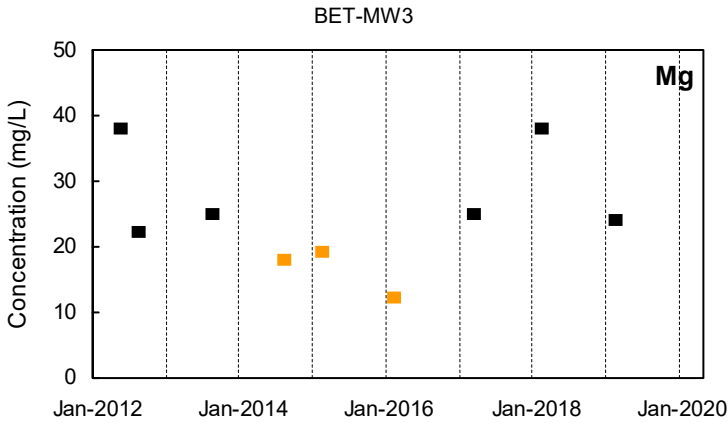
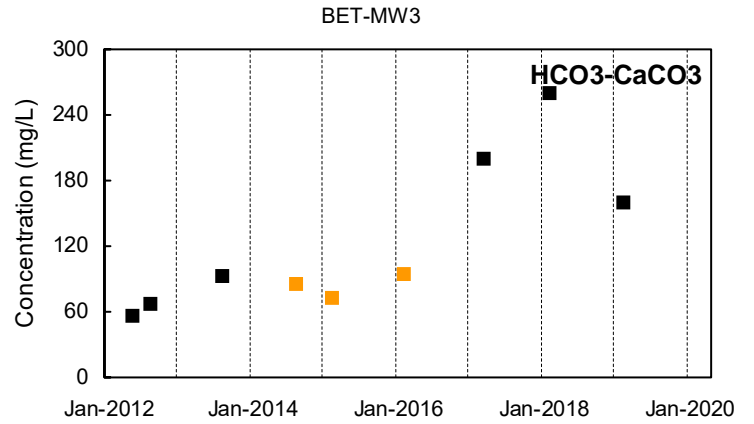
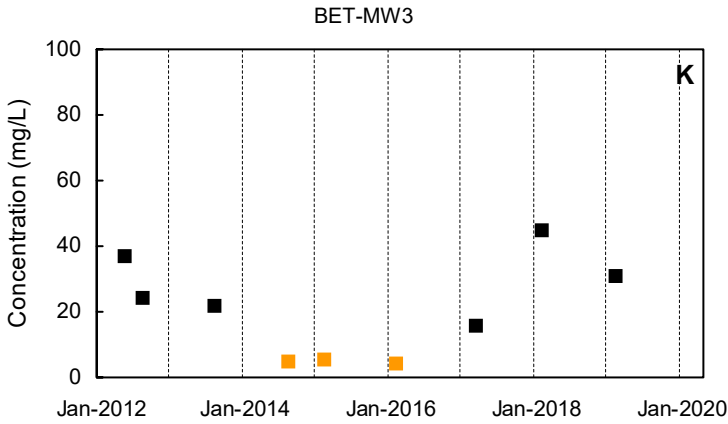
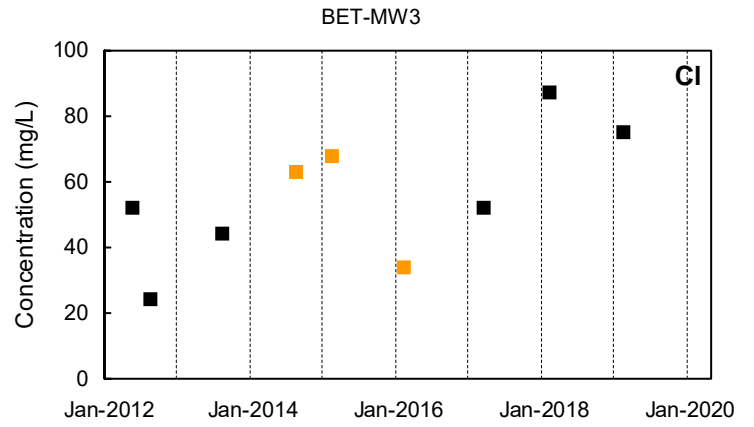
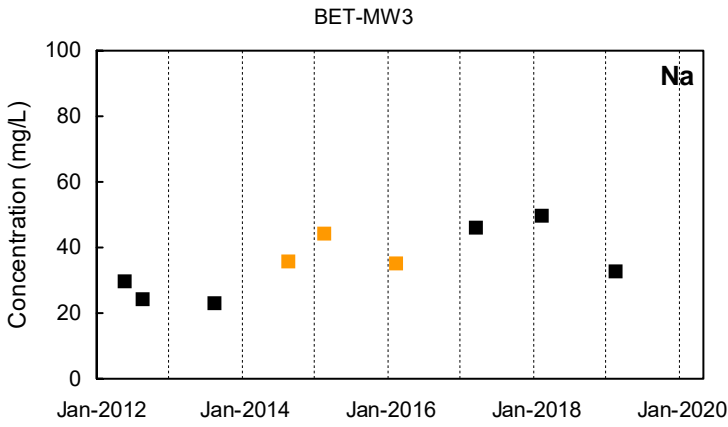

Detected Value
 'J'-Flag (value between reporting limit and detection limit)
 Non-Detect Range
 Shallow Well shown with black symbols Deep Well shown with orange symbols "dd" Well shown with blue symbols

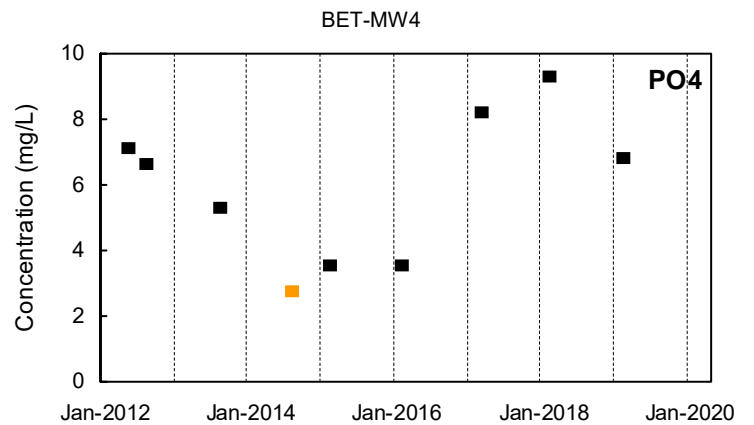
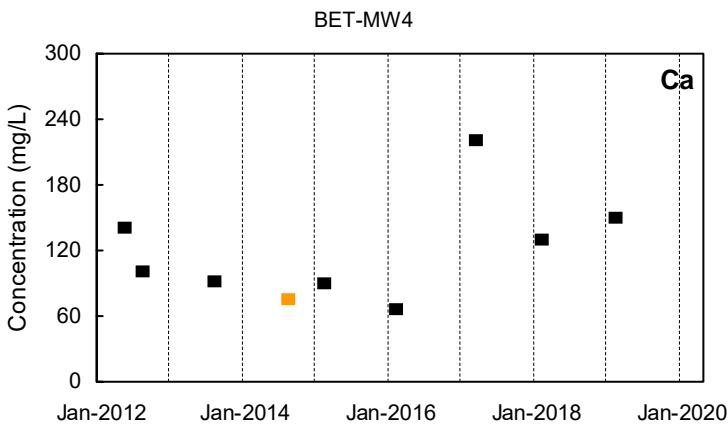
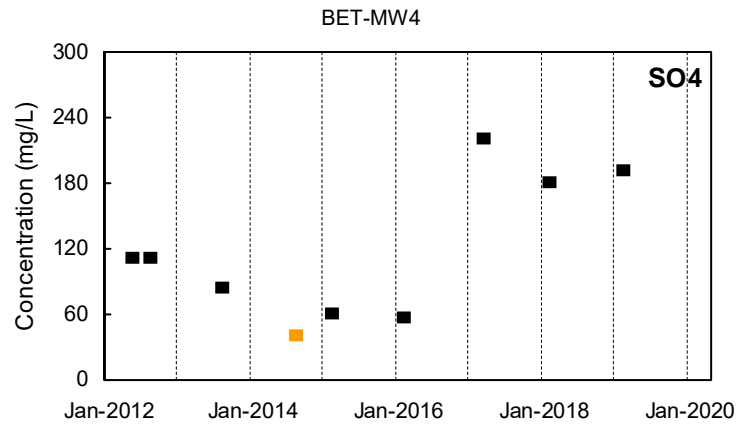
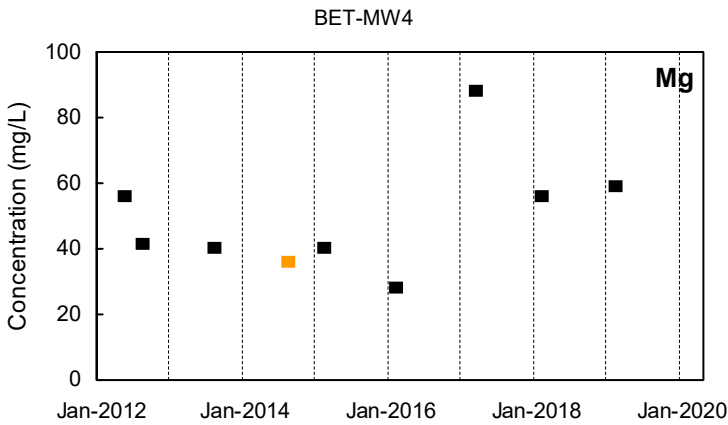
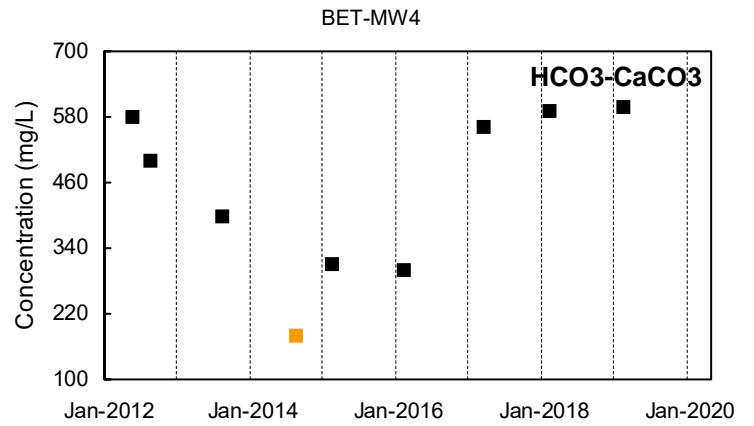
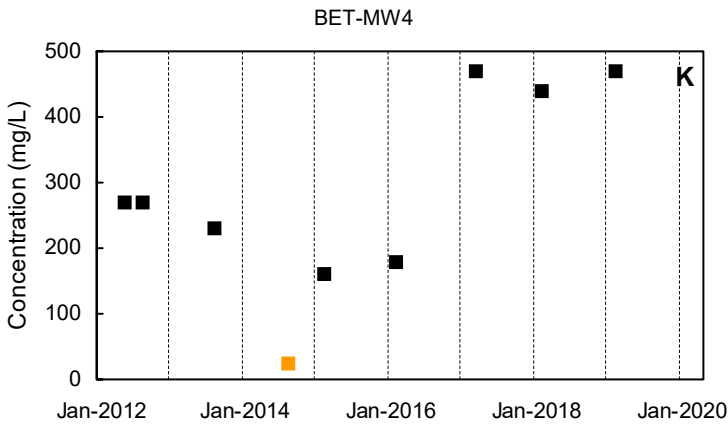
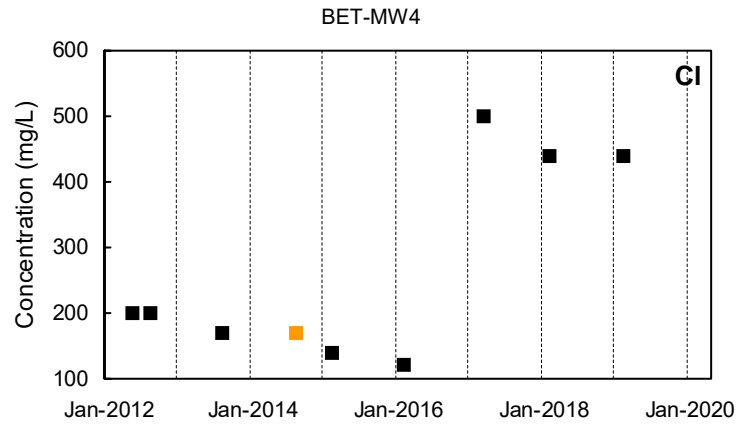
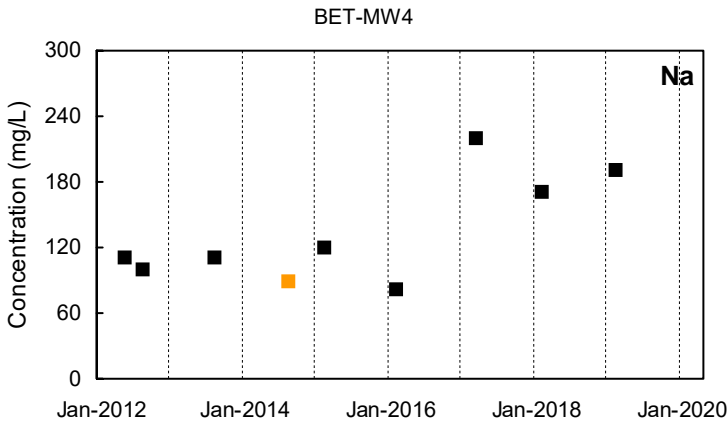

Detected Value
 'J'-Flag (value between reporting limit and detection limit)
 Non-Detect Range
 Shallow Well shown with black symbols
 Deep Well shown with orange symbols
 "dd" Well shown with blue symbols

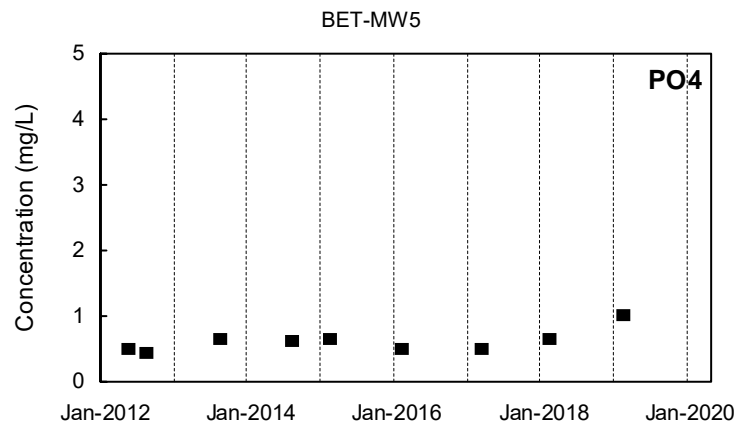
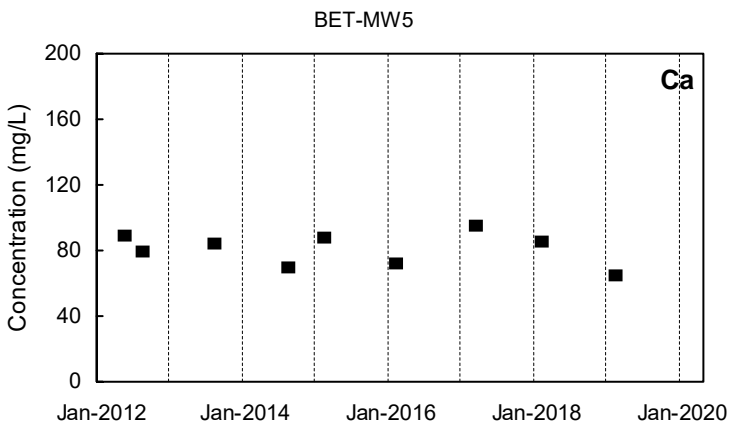
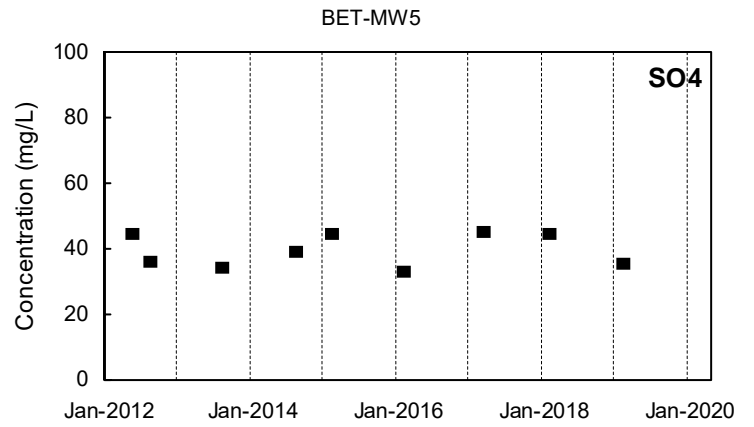
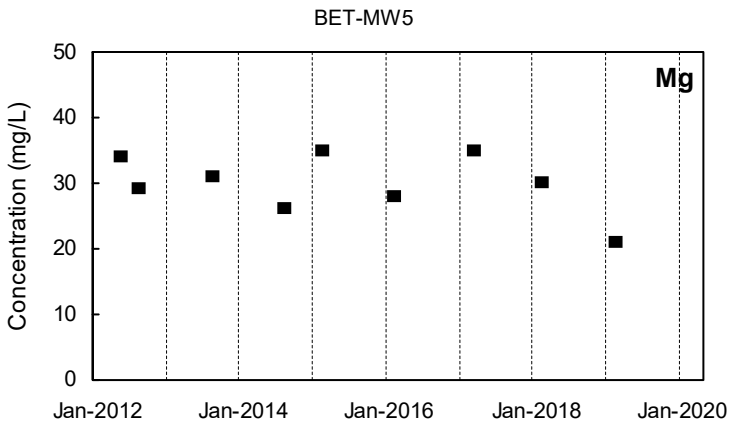
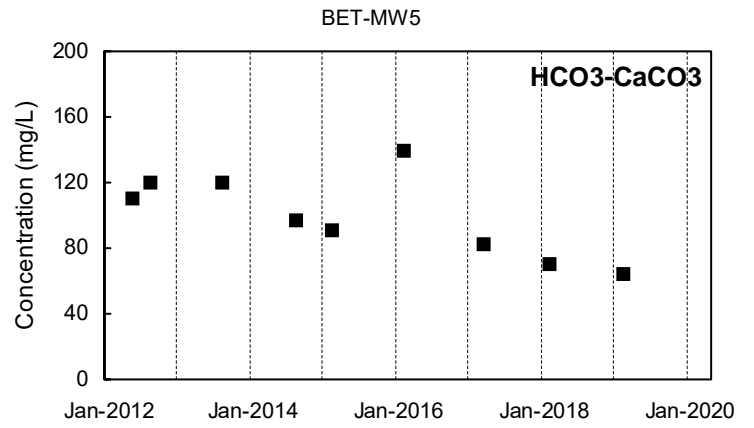
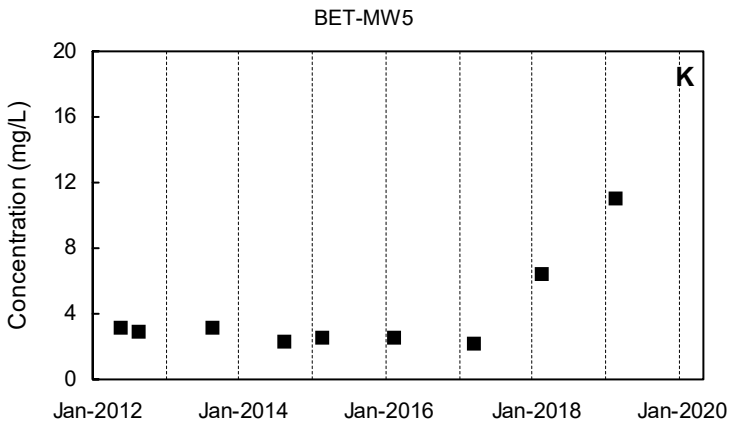
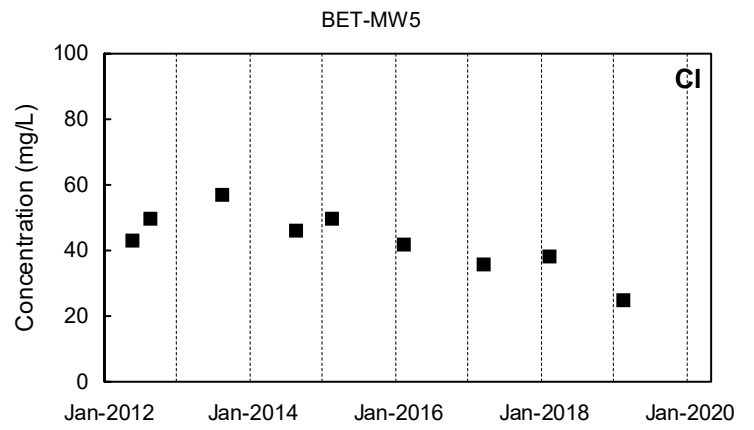
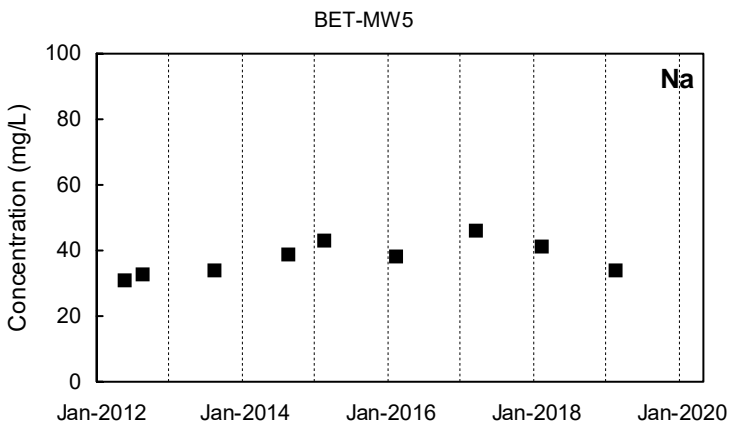

Detected Value
 'J'-Flag (value between reporting limit and detection limit)
 Non-Detect Range
 Shallow Well shown with black symbols Deep Well shown with orange symbols "dd" Well shown with blue symbols

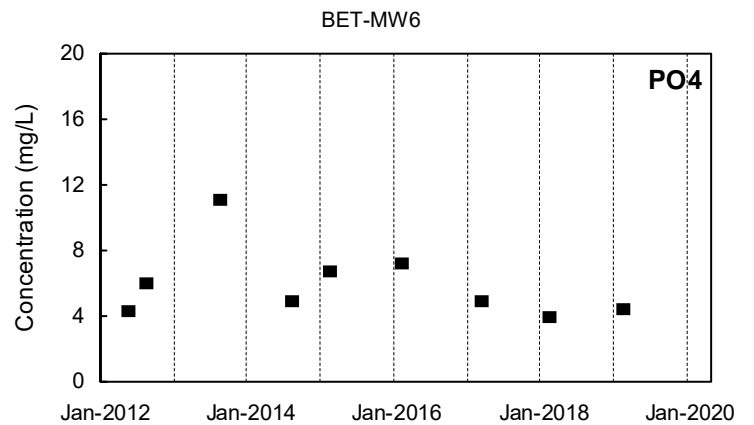
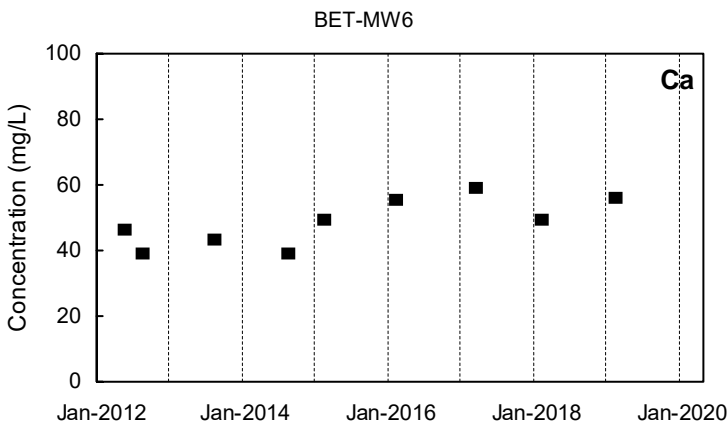
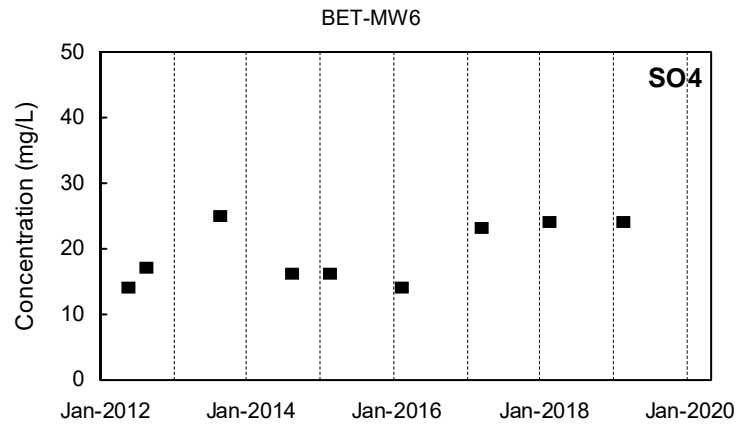
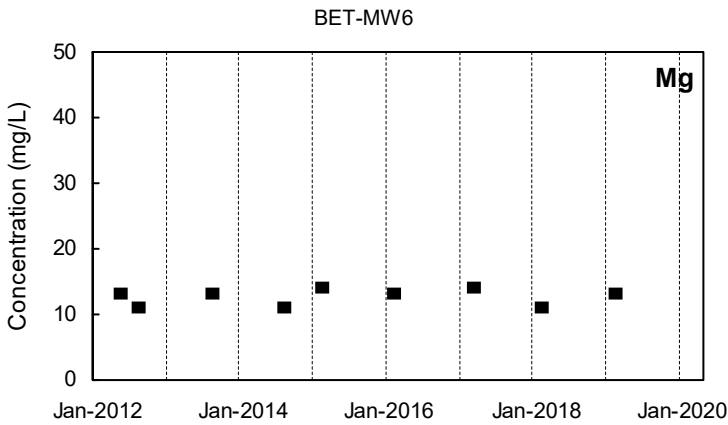
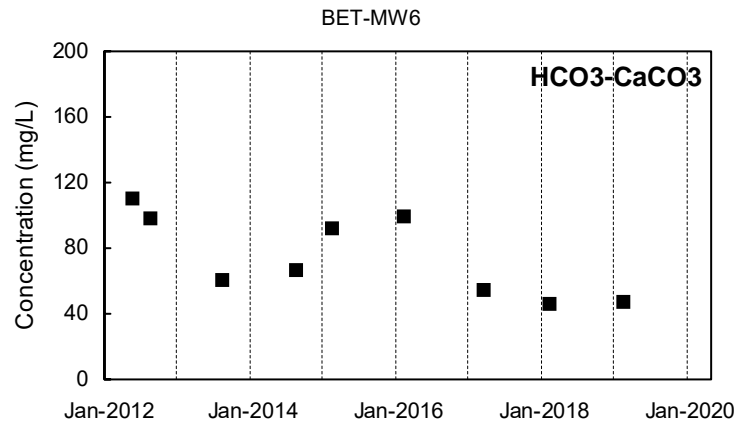
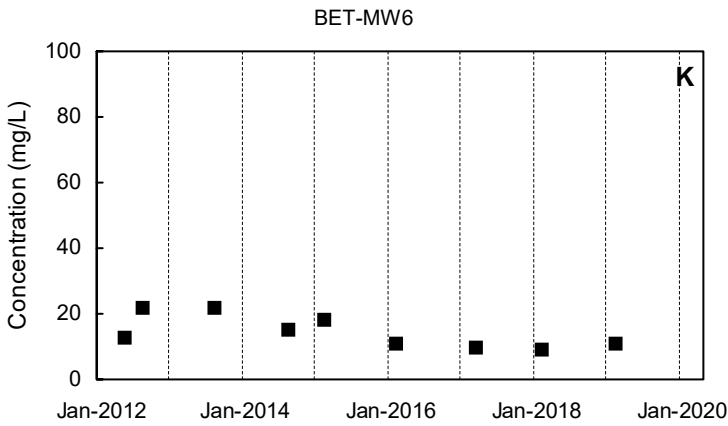
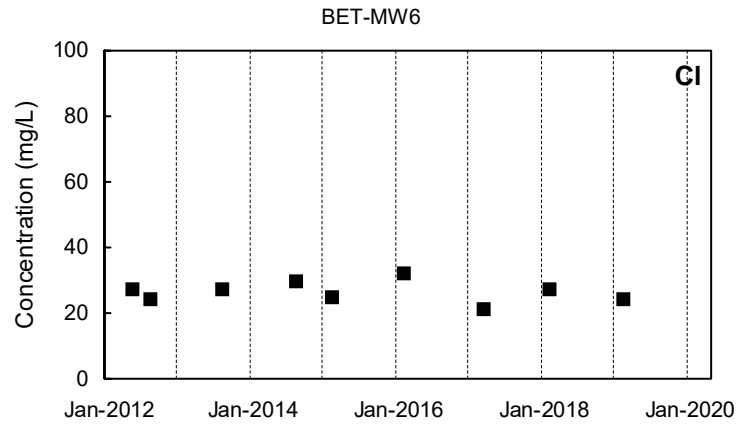
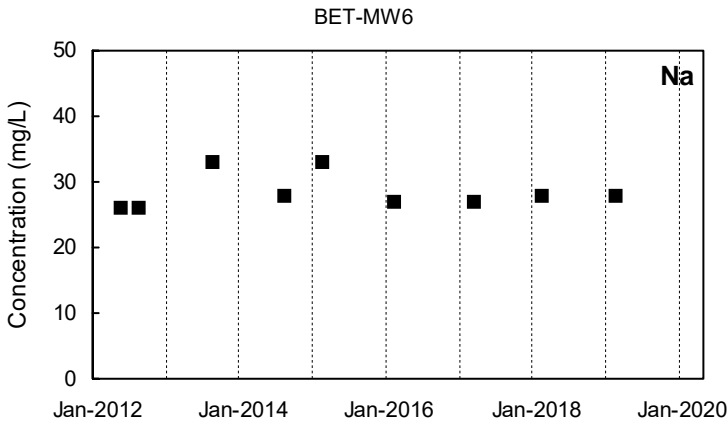

Detected Value
 'J'-Flag (value between reporting limit and detection limit)
 Non-Detect Range
 Shallow Well shown with black symbols
 Deep Well shown with orange symbols
 "dd" Well shown with blue symbols

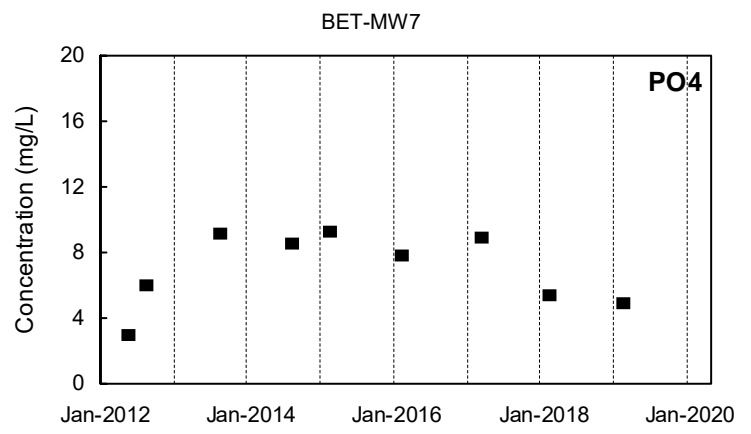
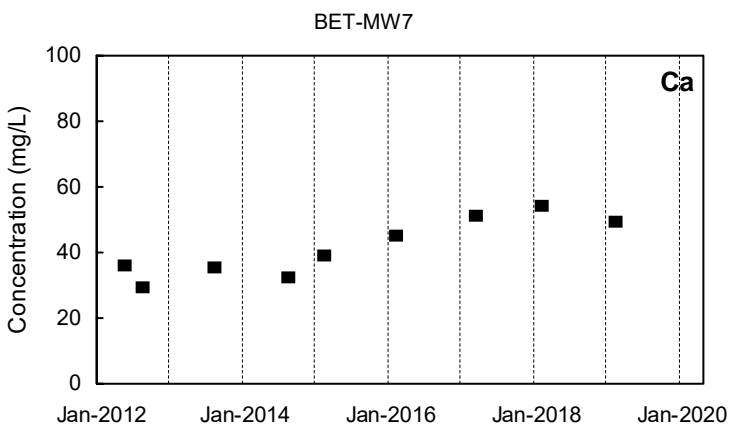
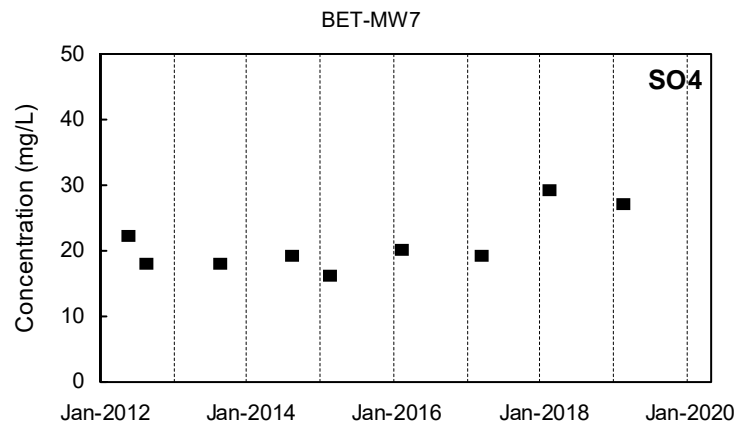
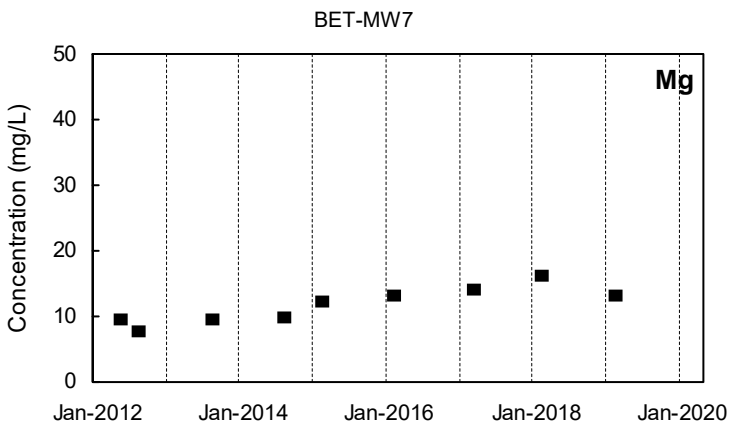
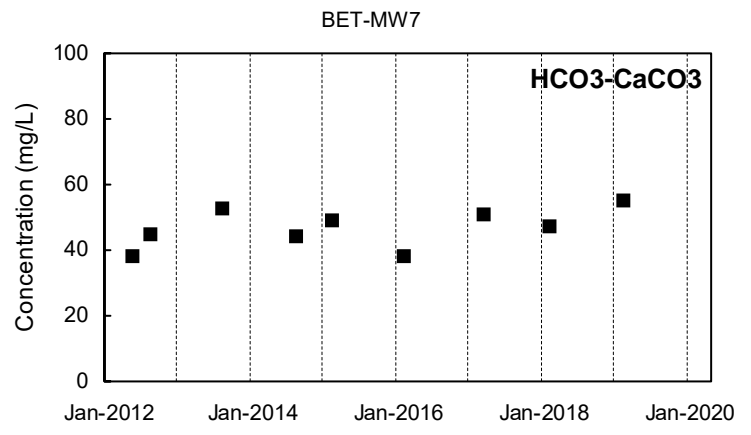
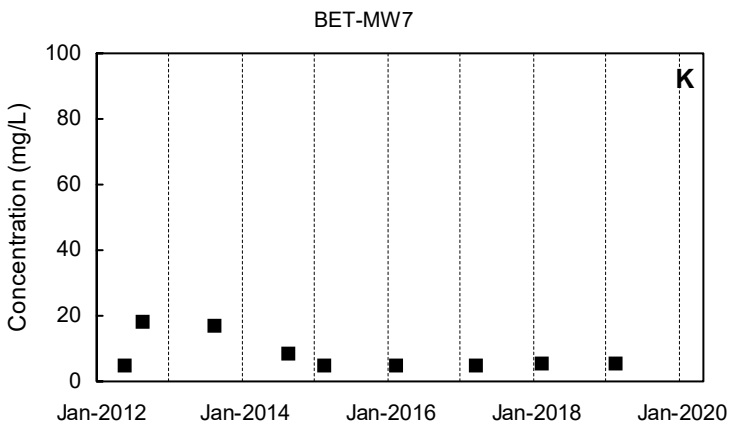
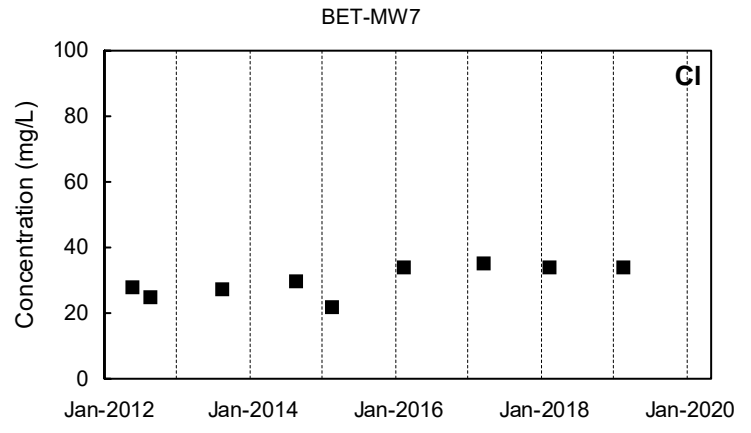
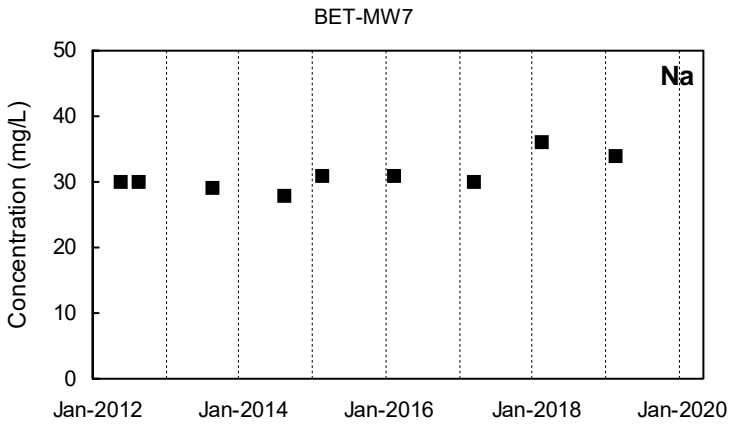

■ Detected Value □ 'J'-Flag (value between reporting limit and detection limit) ■ Non-Detect Range
 Shallow Well shown with black symbols Deep Well shown with orange symbols "dd" Well shown with blue symbols

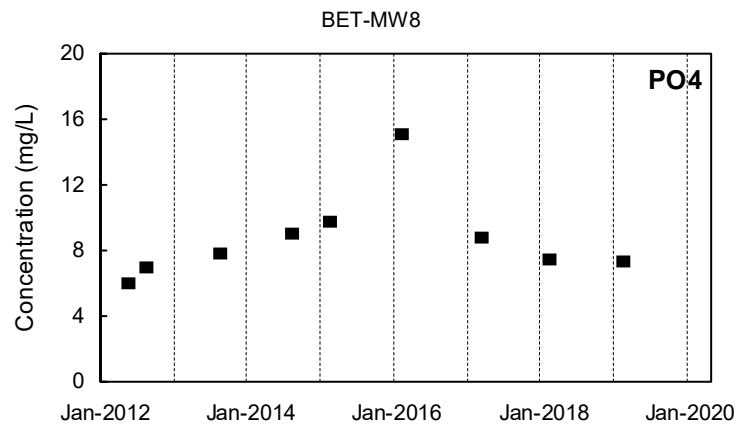
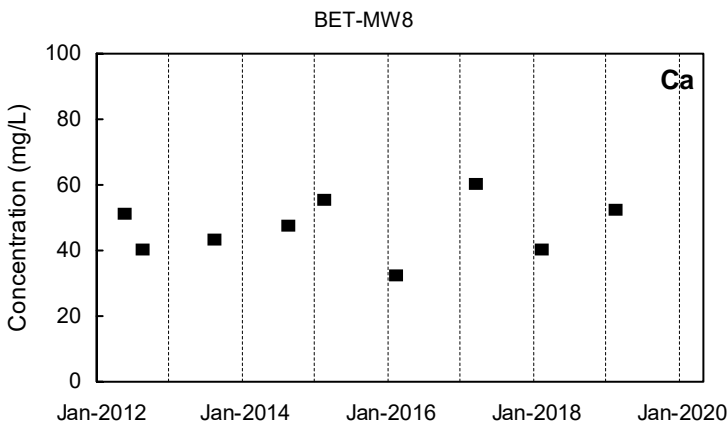
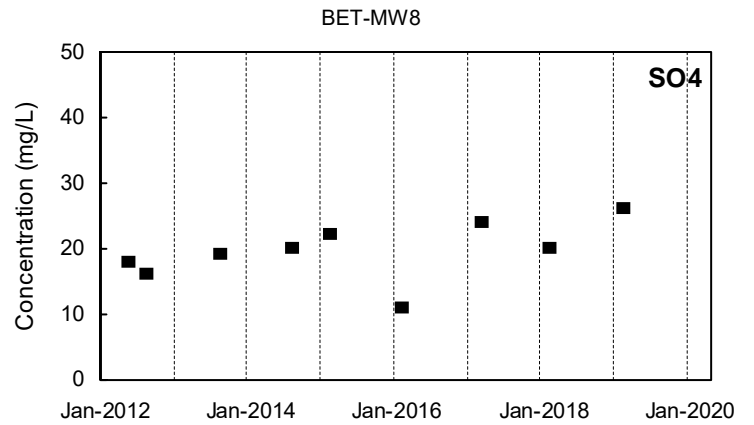
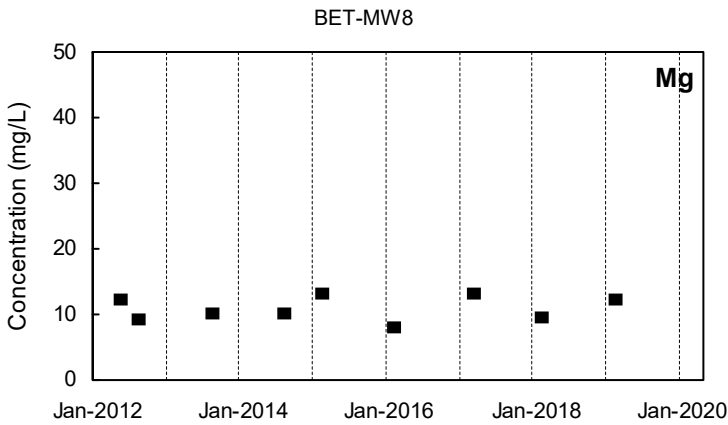
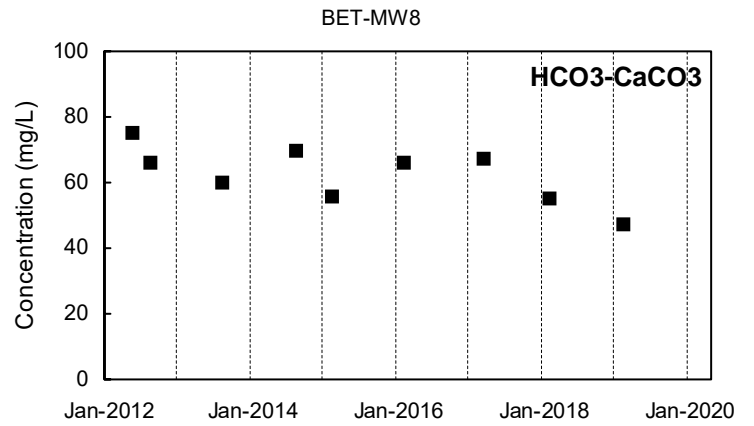
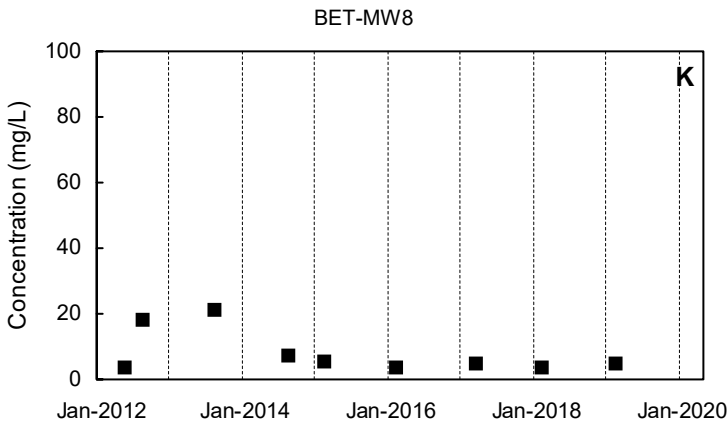
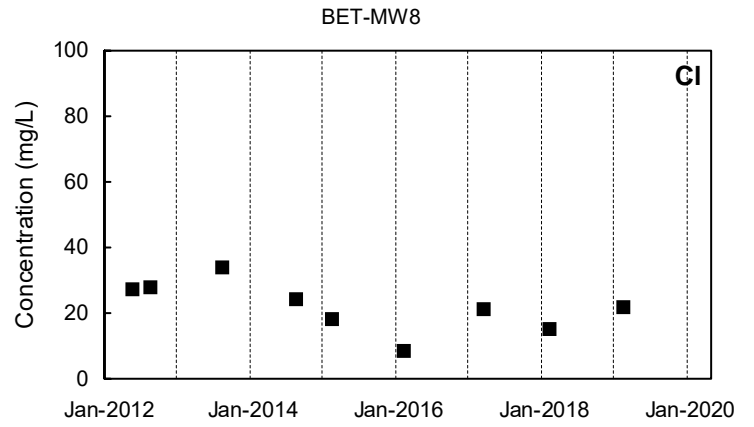
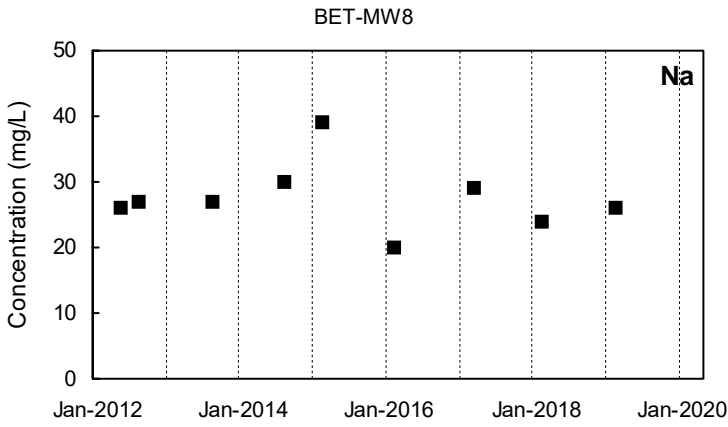

Detected Value
 'J'-Flag (value between reporting limit and detection limit)
 Non-Detect Range
 Shallow Well shown with black symbols
 Deep Well shown with orange symbols
 "dd" Well shown with blue symbols

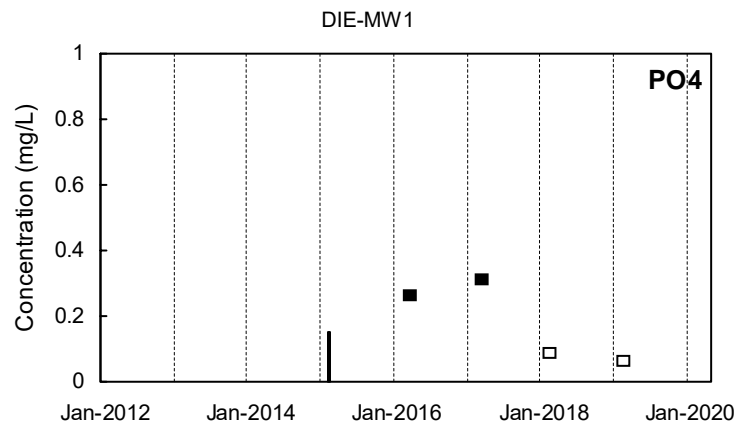
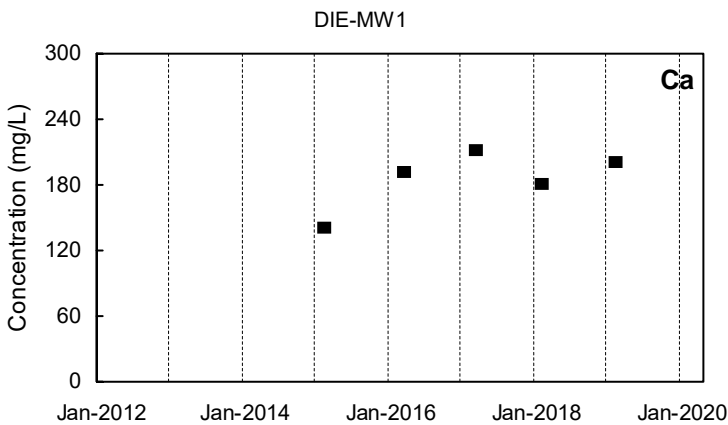
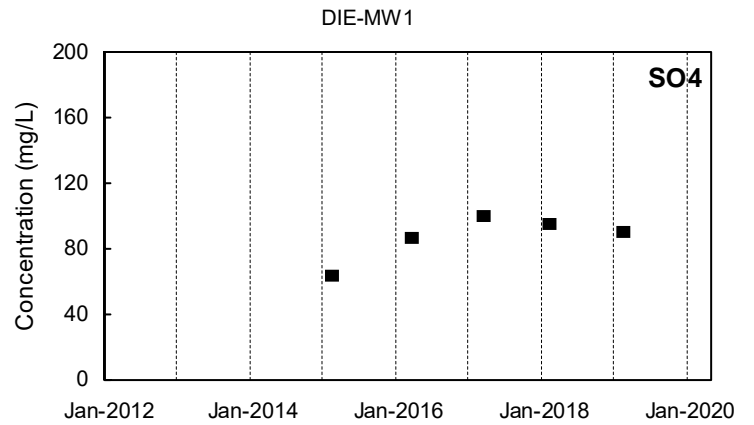
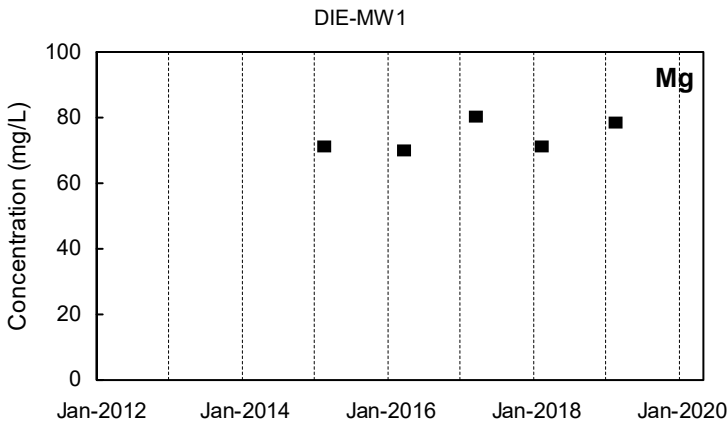
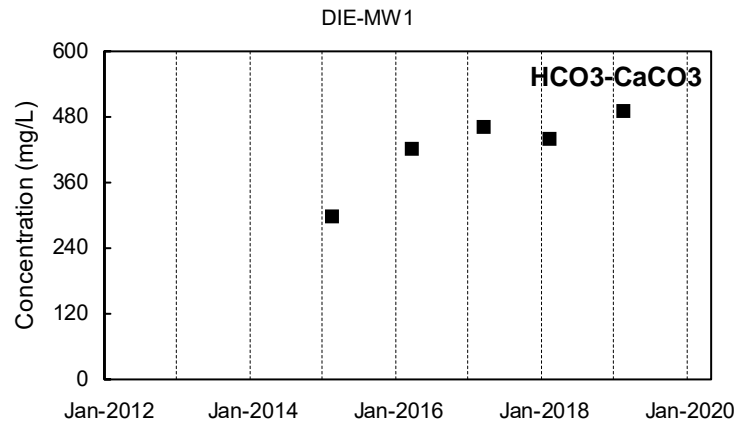
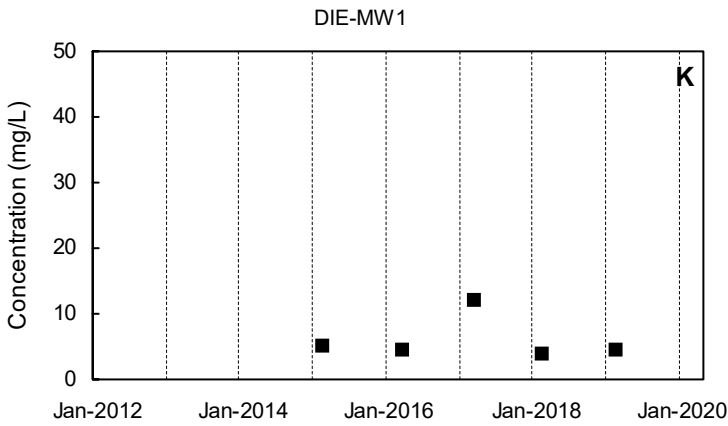
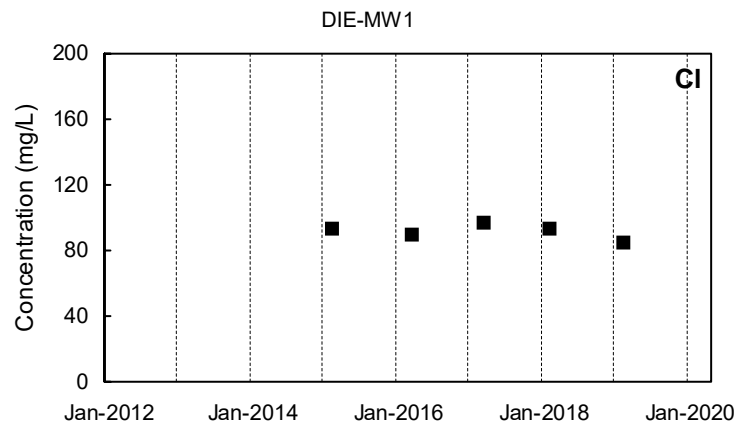
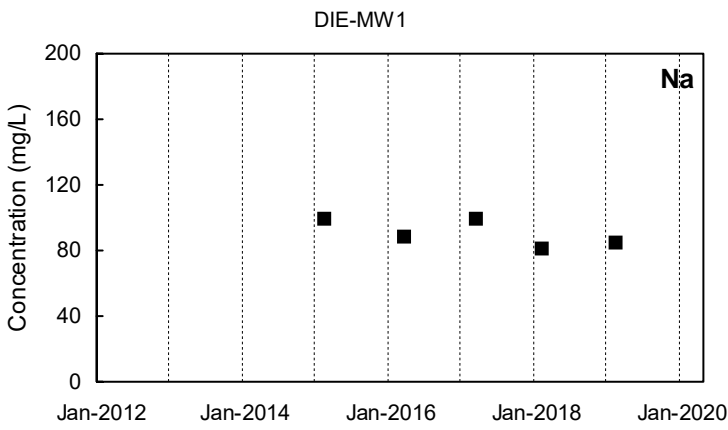

■ Detected Value □ 'J'-Flag (value between reporting limit and detection limit) ■ Non-Detect Range
 Shallow Well shown with black symbols Deep Well shown with orange symbols "dd" Well shown with blue symbols

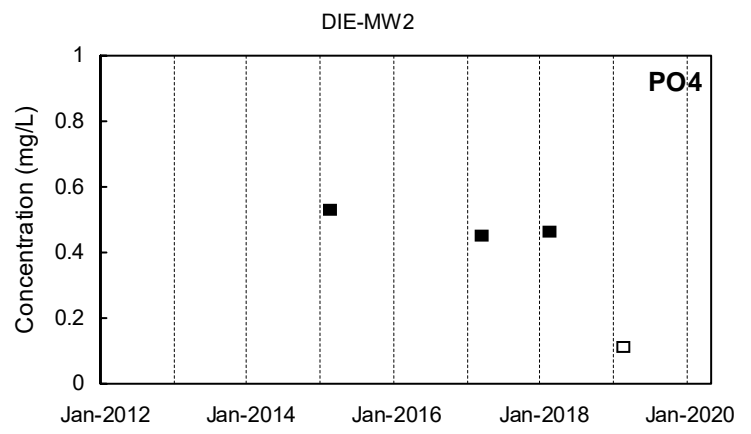
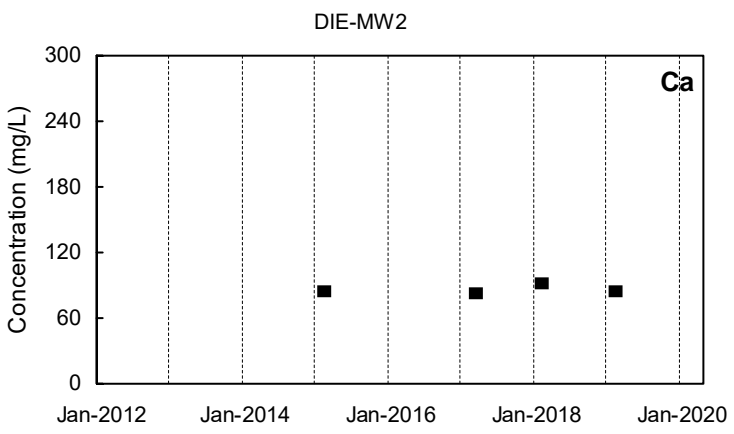
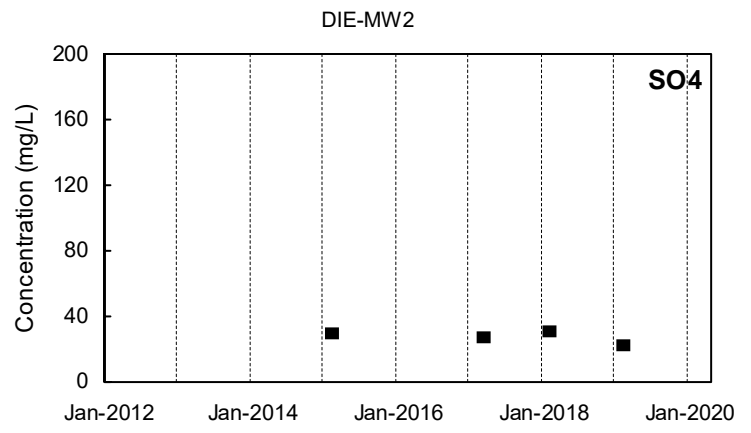
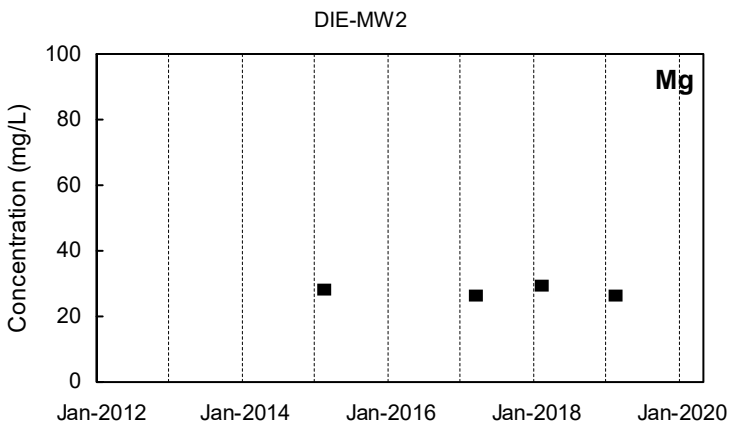
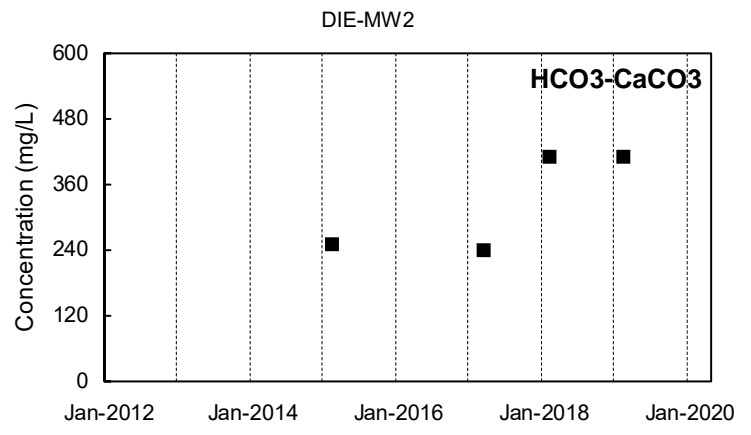
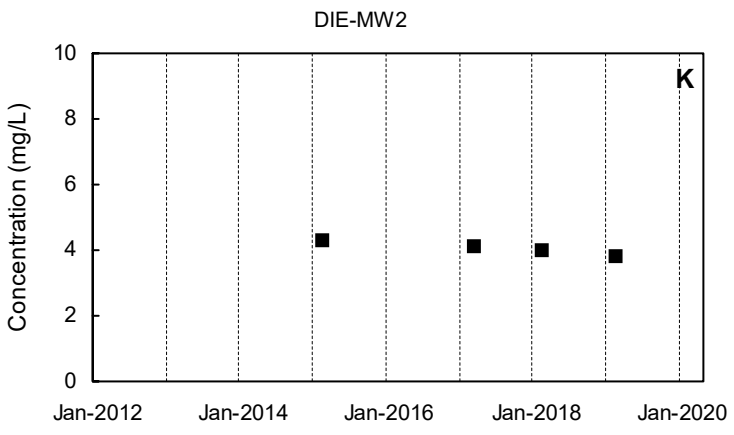
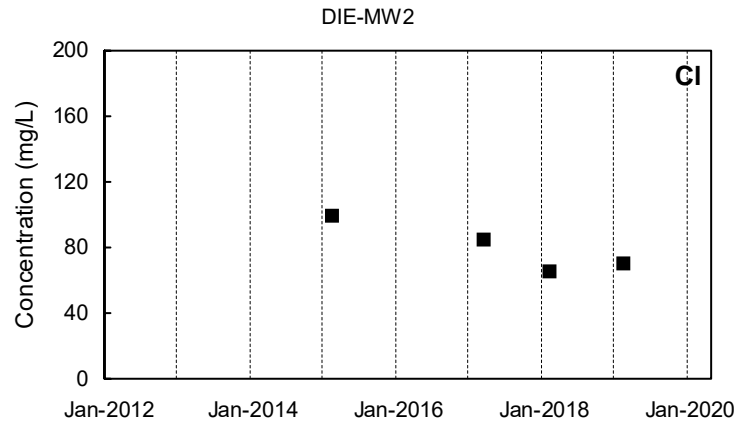
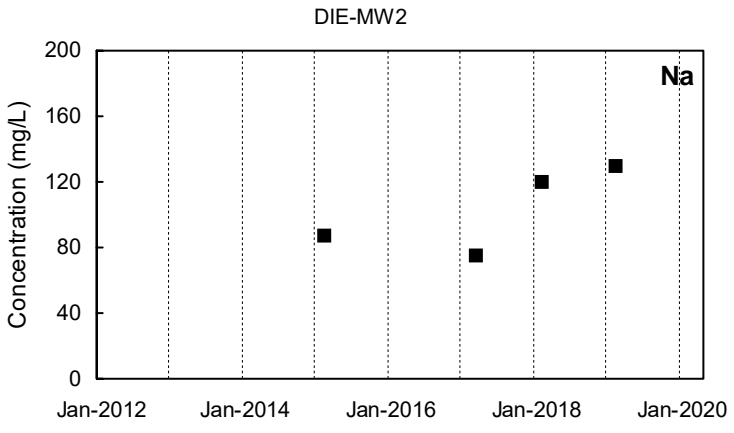

Detected Value
 'J'-Flag (value between reporting limit and detection limit)
 Non-Detect Range
 Shallow Well shown with black symbols
 Deep Well shown with orange symbols
 "dd" Well shown with blue symbols

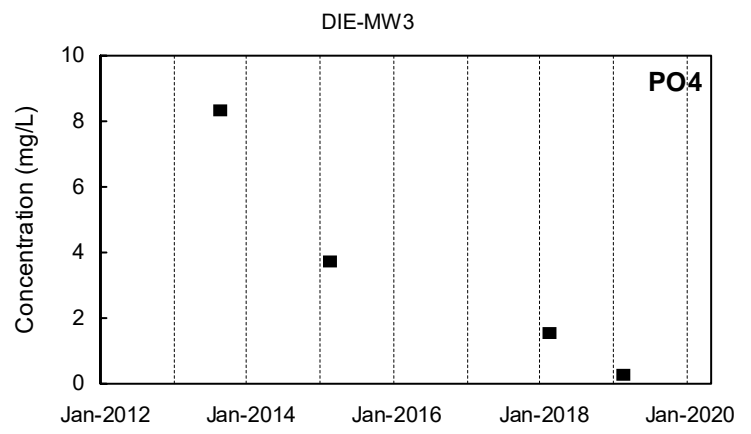
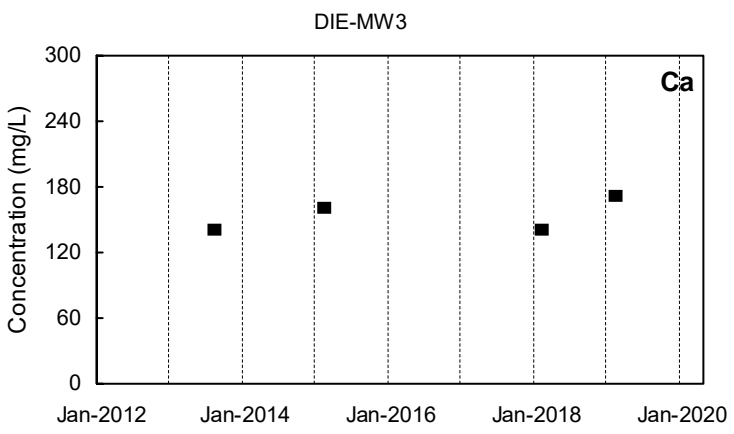
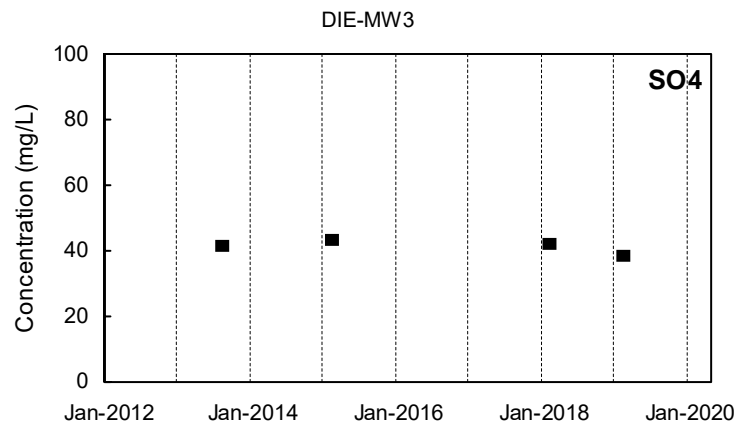
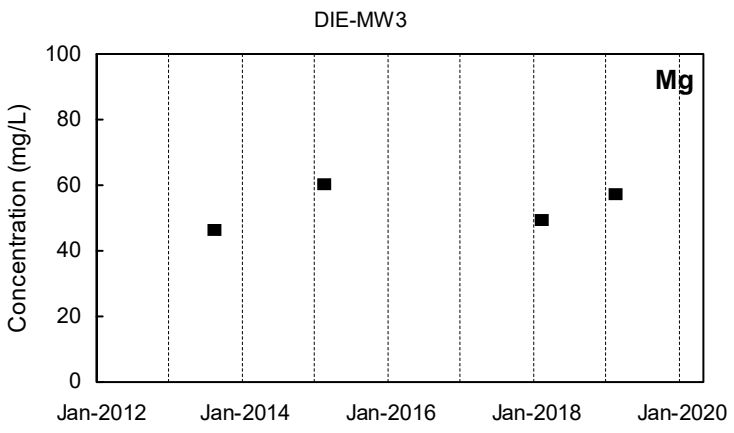
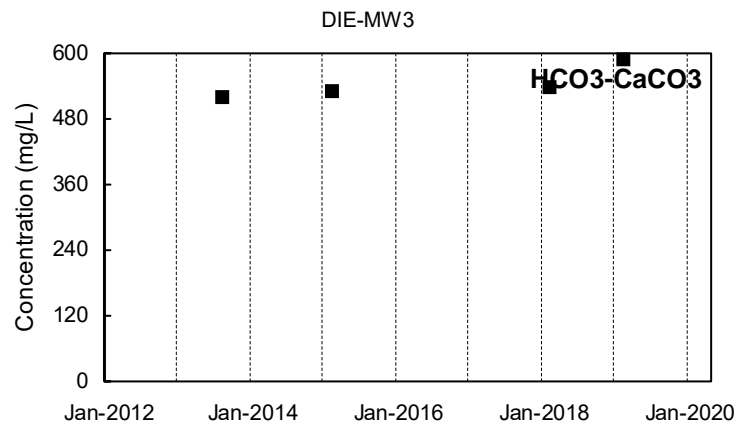
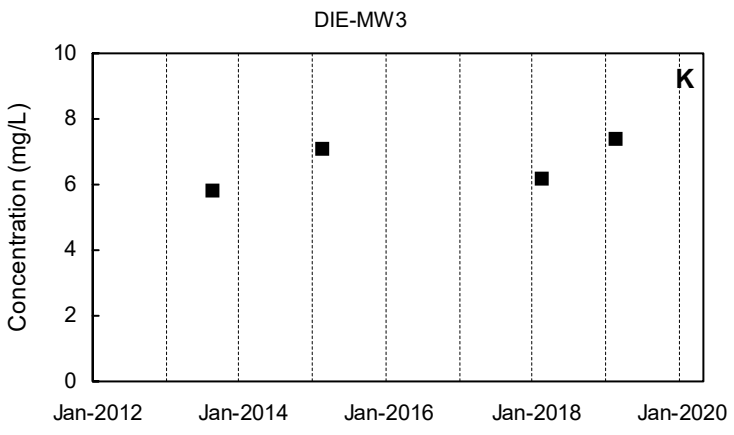
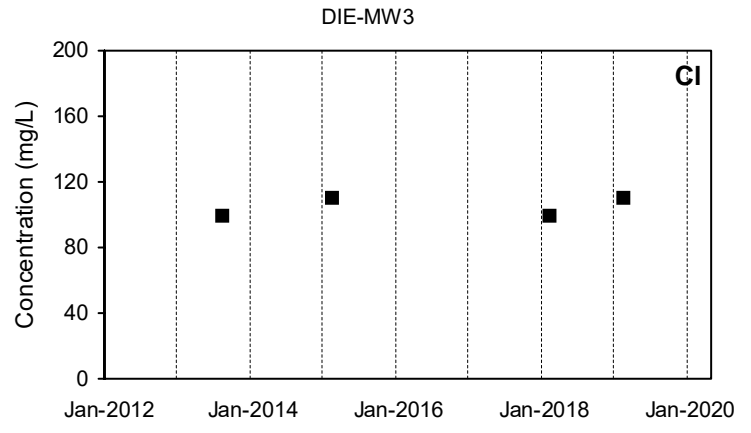
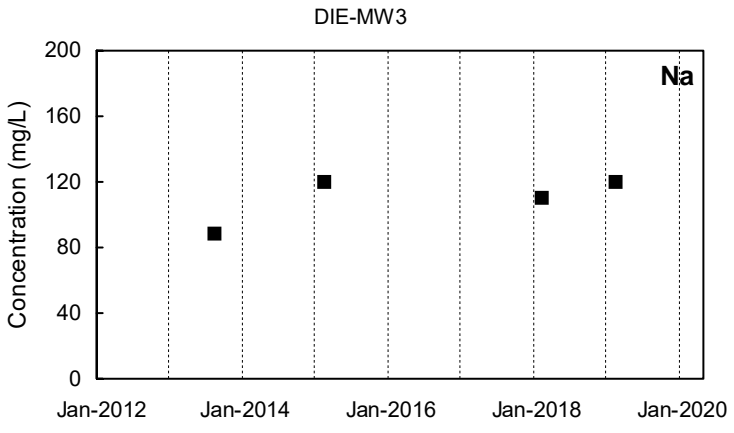

Detected Value
 'J'-Flag (value between reporting limit and detection limit)
 Non-Detect Range
 Shallow Well shown with black symbols
 Deep Well shown with orange symbols
 "dd" Well shown with blue symbols

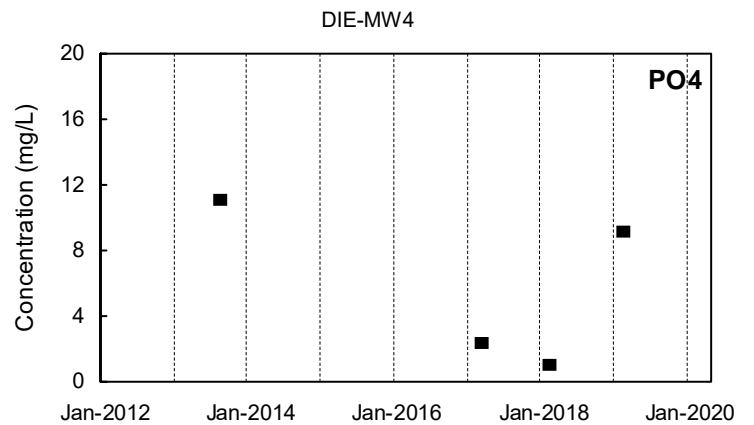
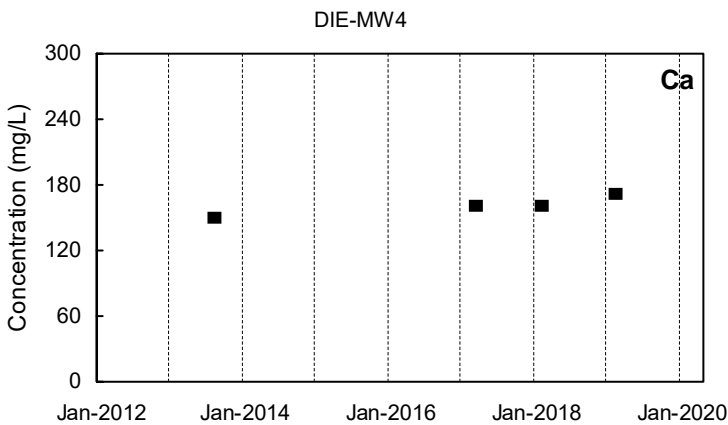
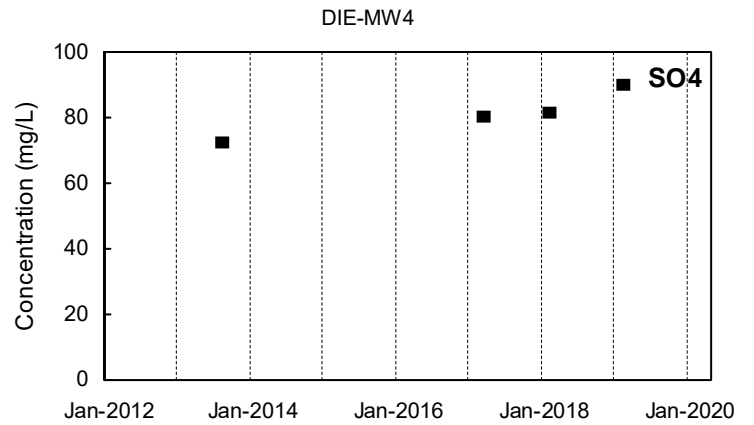
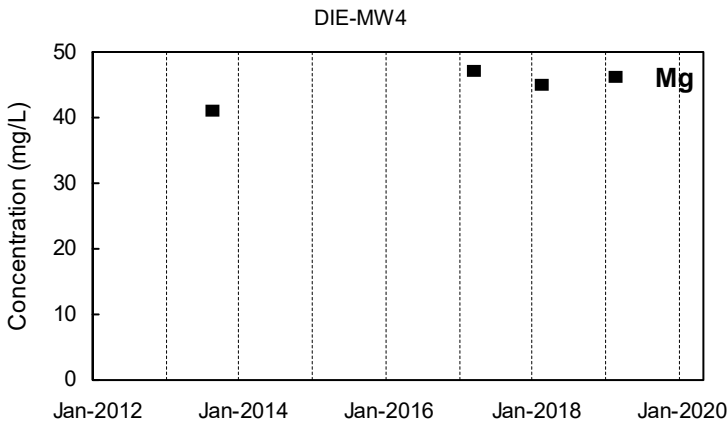
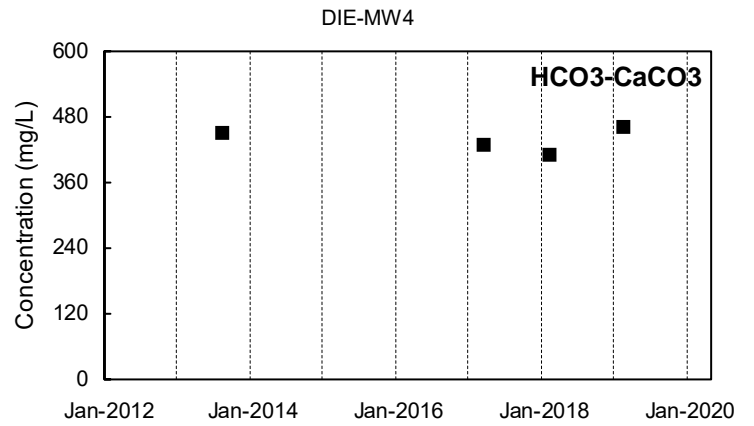
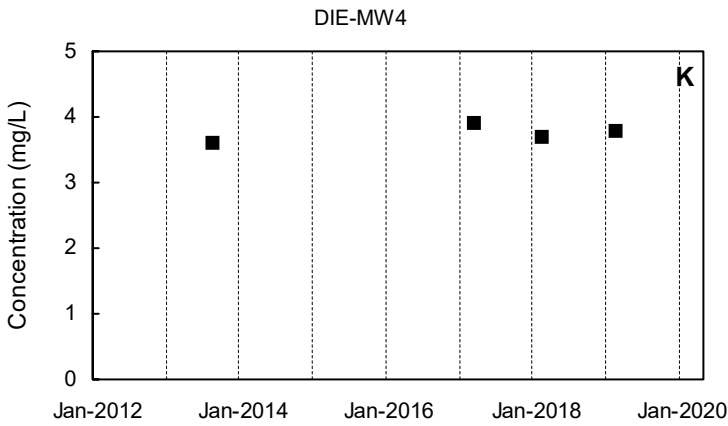
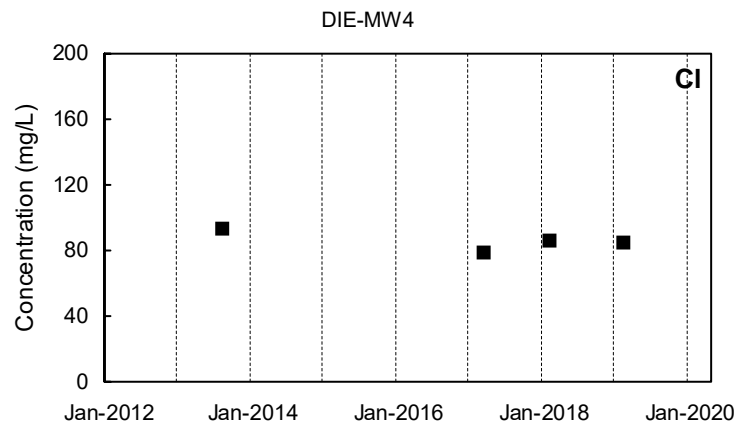
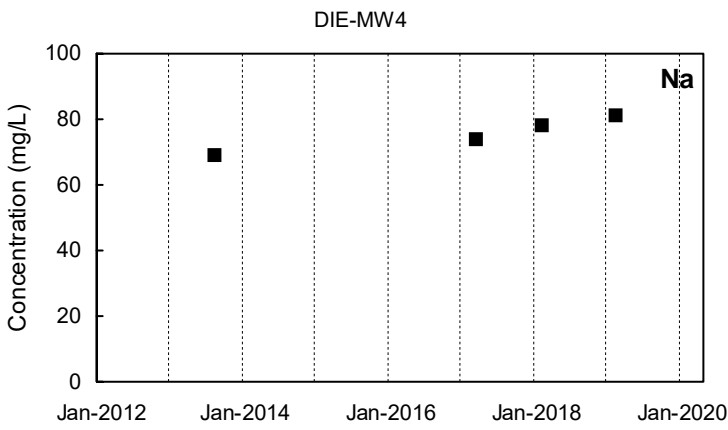

Detected Value
 'J'-Flag (value between reporting limit and detection limit)
 Non-Detect Range
 Shallow Well shown with black symbols
 Deep Well shown with orange symbols
 "dd" Well shown with blue symbols

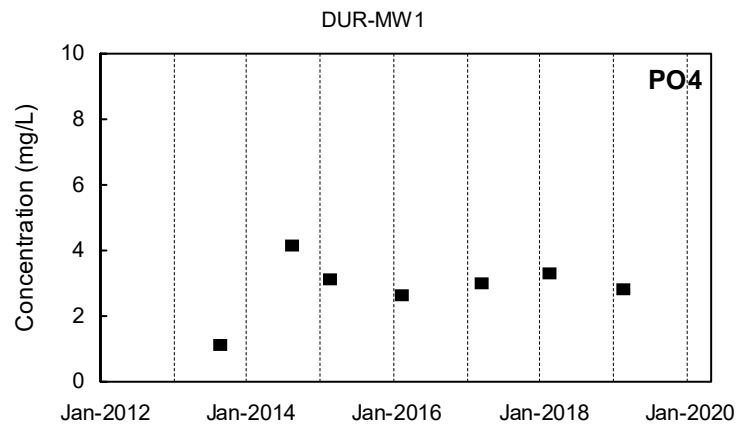
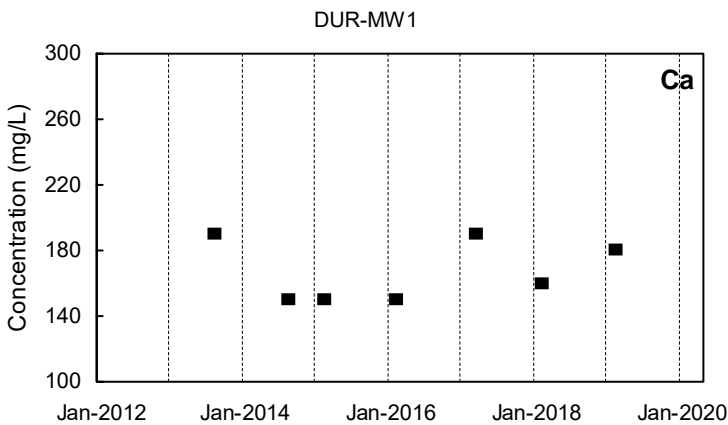
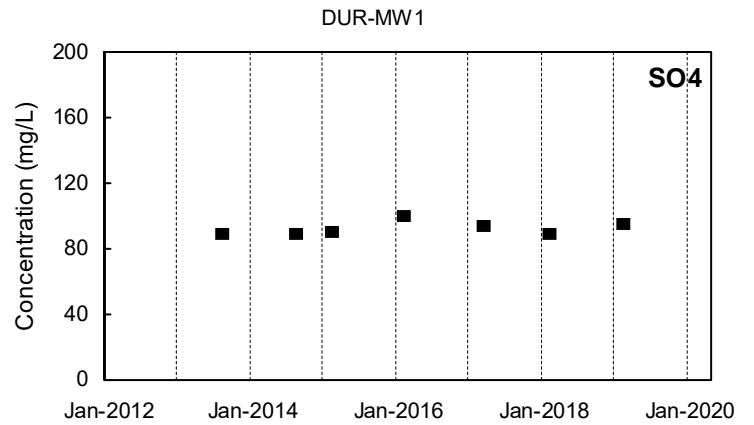
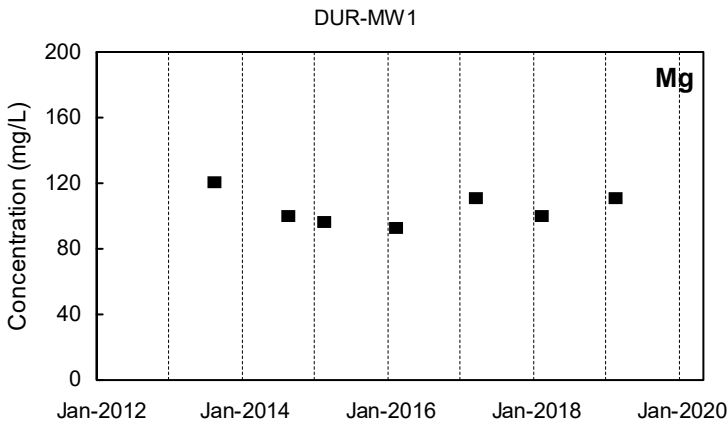
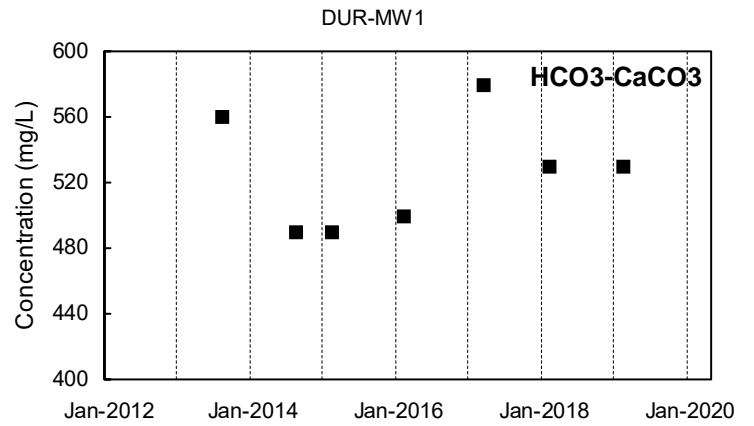
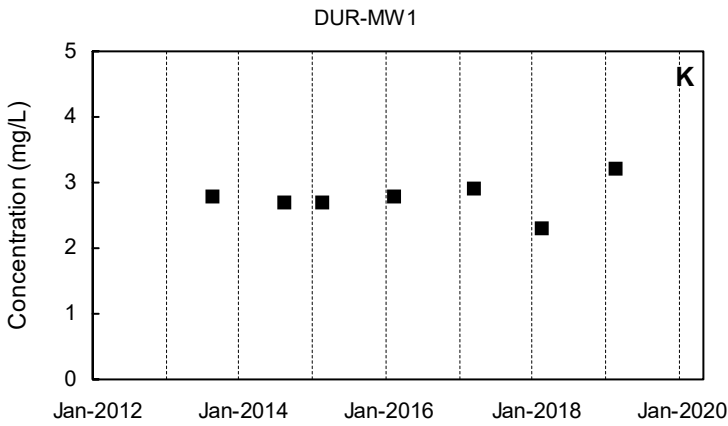
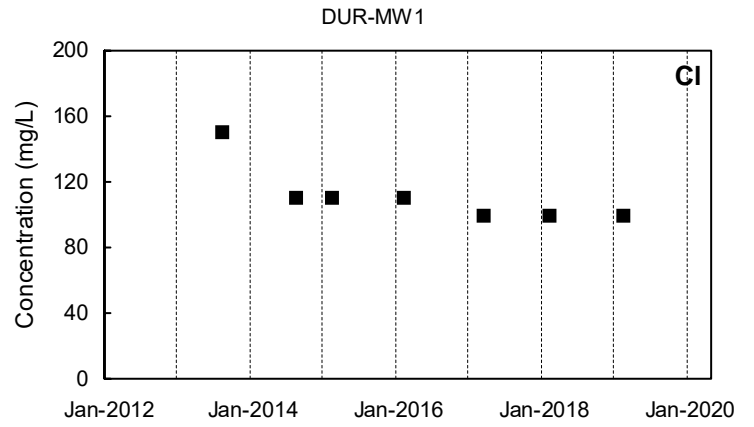
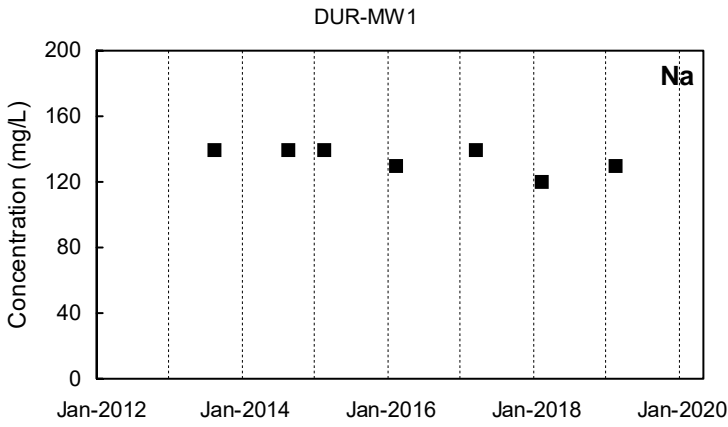

Detected Value
 'J'-Flag (value between reporting limit and detection limit)
 Non-Detect Range
 Shallow Well shown with black symbols
 Deep Well shown with orange symbols
 "dd" Well shown with blue symbols

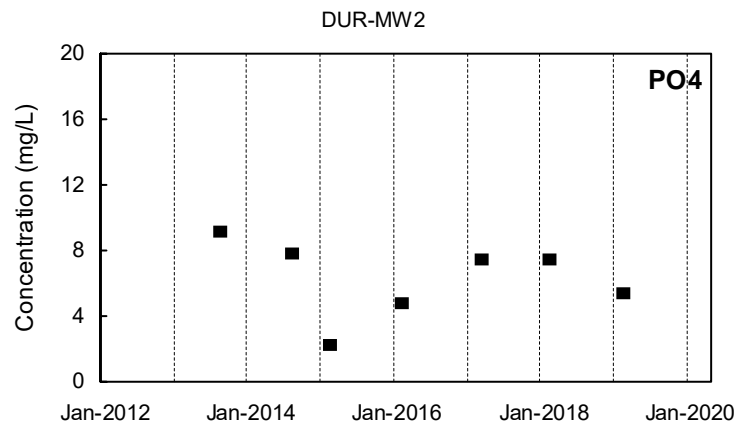
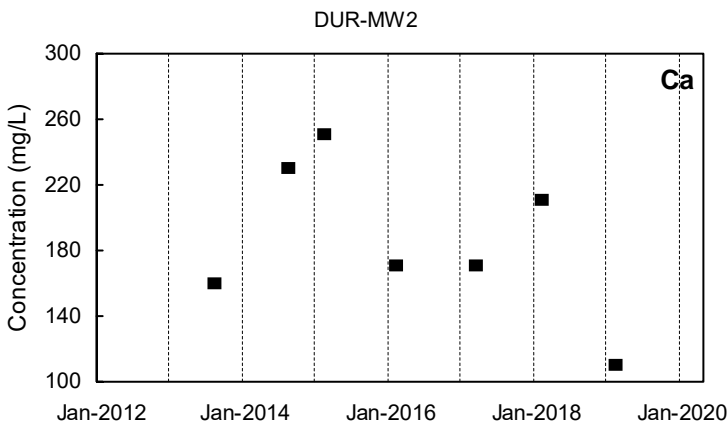
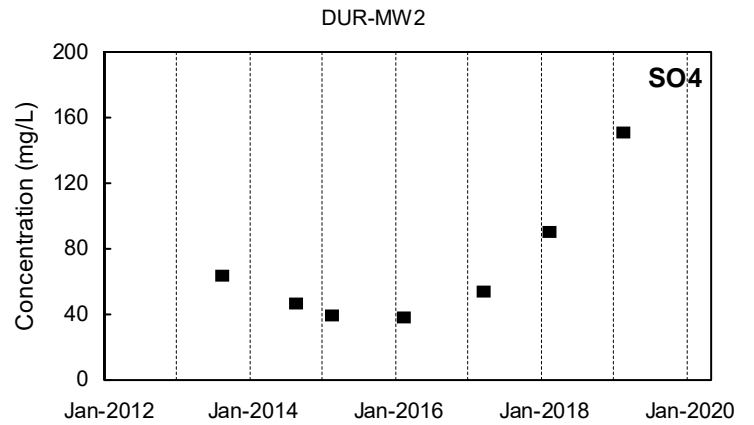
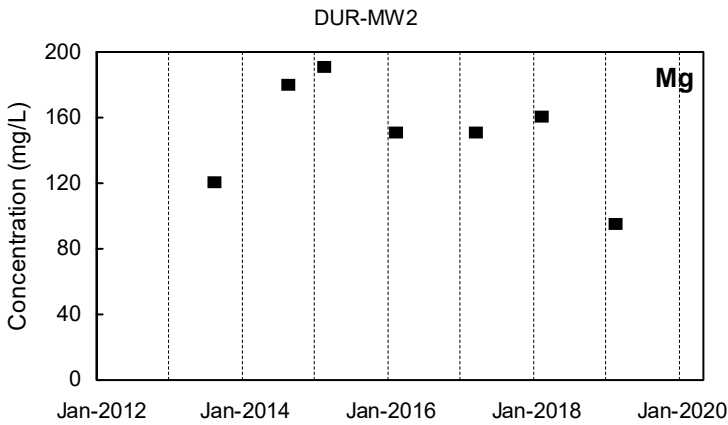
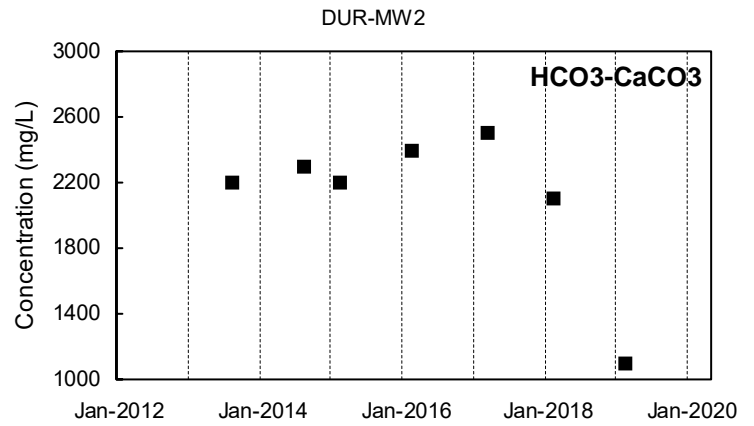
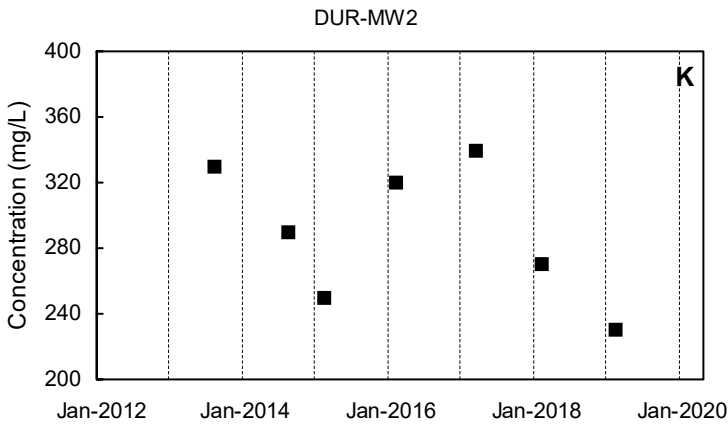
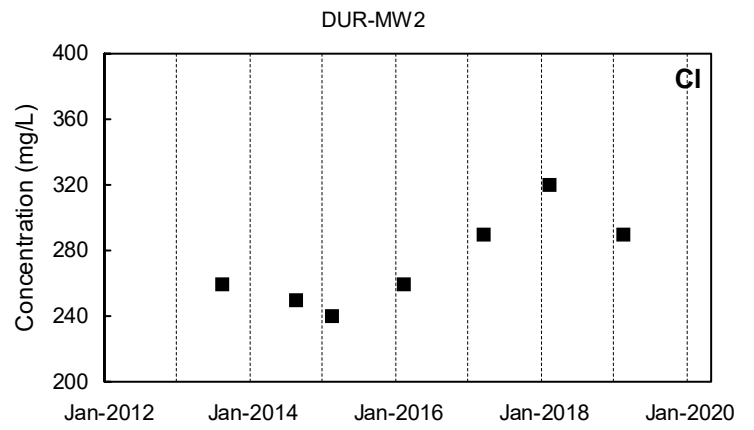
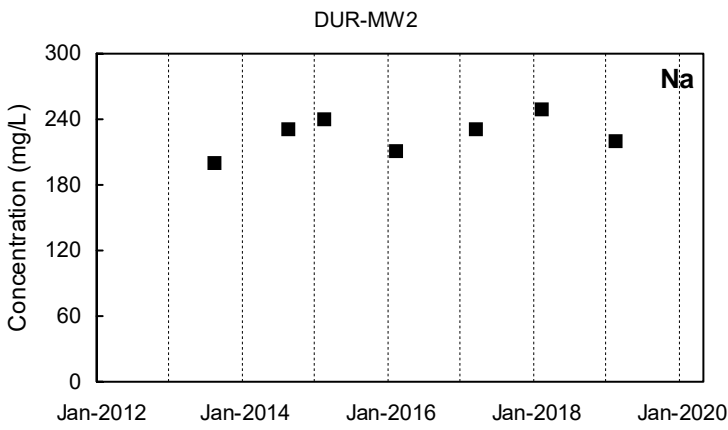

Detected Value
 'J'-Flag (value between reporting limit and detection limit)
 Non-Detect Range
 Shallow Well shown with black symbols
 Deep Well shown with orange symbols
 "dd" Well shown with blue symbols

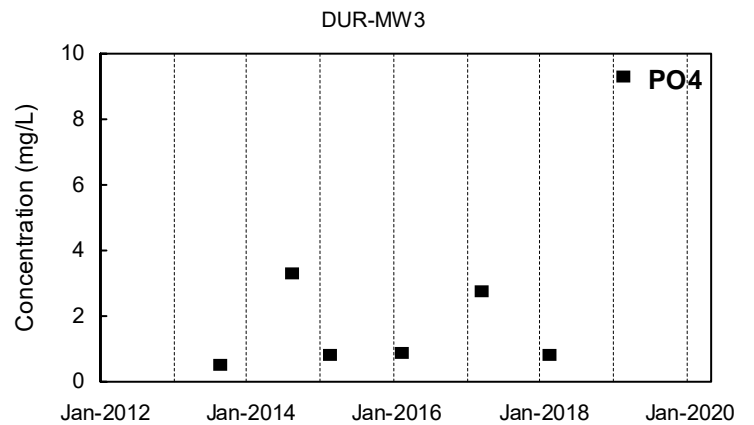
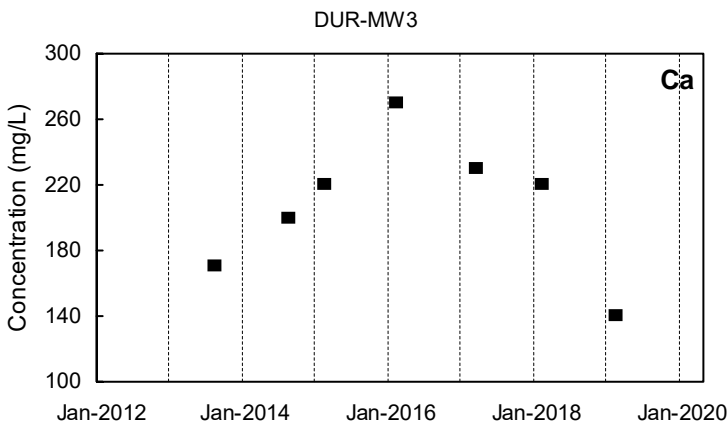
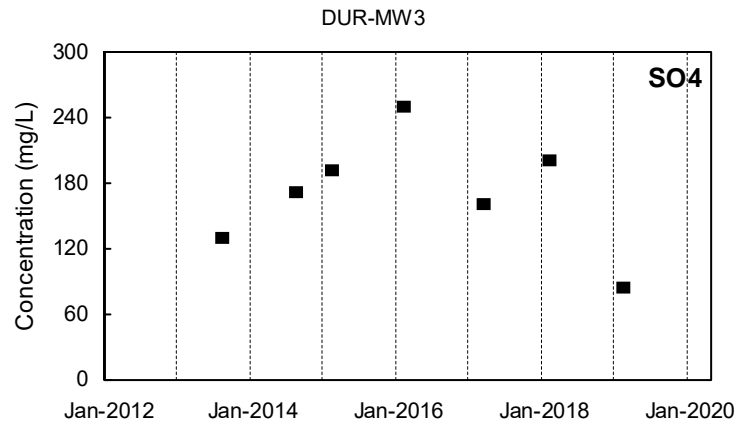
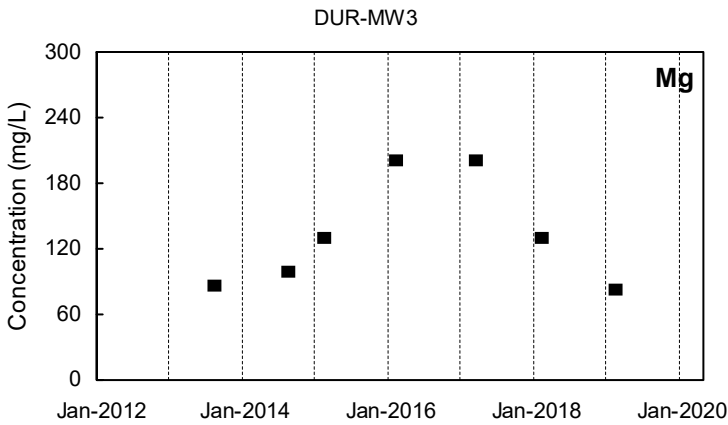
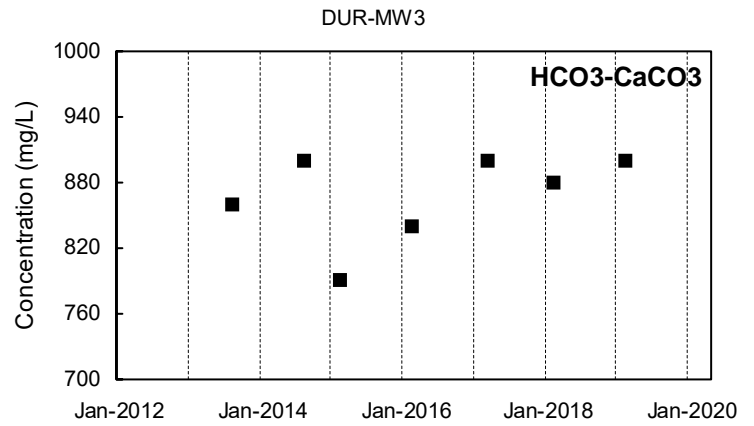
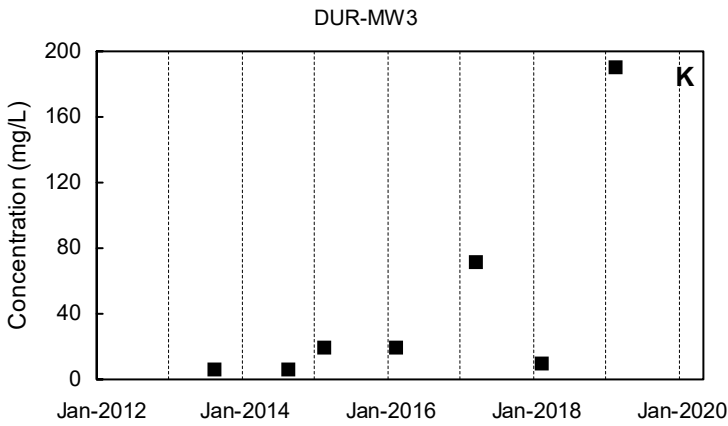
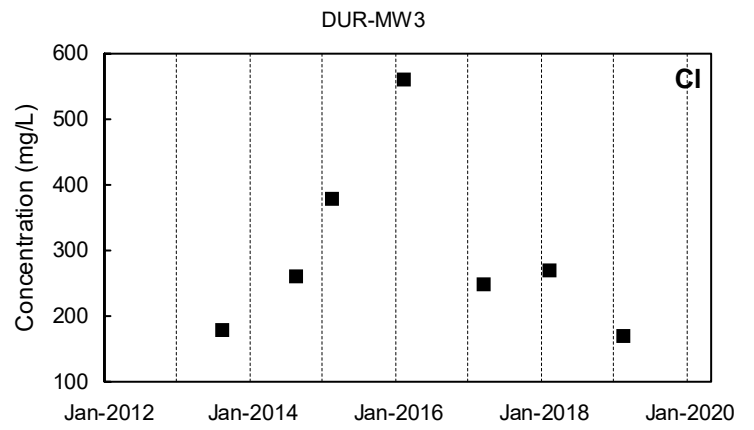
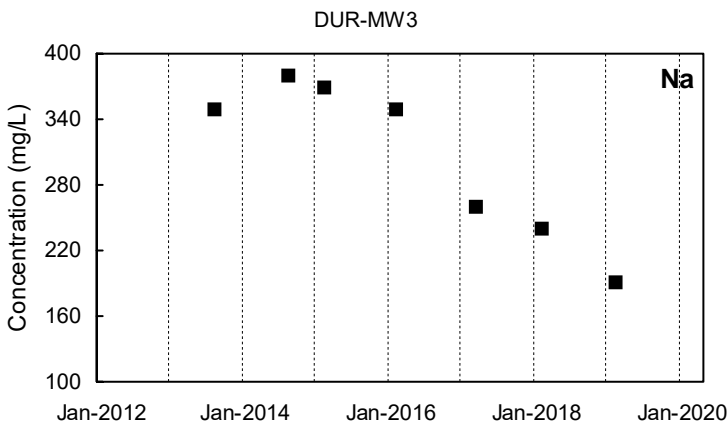

■ Detected Value □ 'J'-Flag (value between reporting limit and detection limit) ■ Non-Detect Range
 Shallow Well shown with black symbols Deep Well shown with orange symbols "dd" Well shown with blue symbols

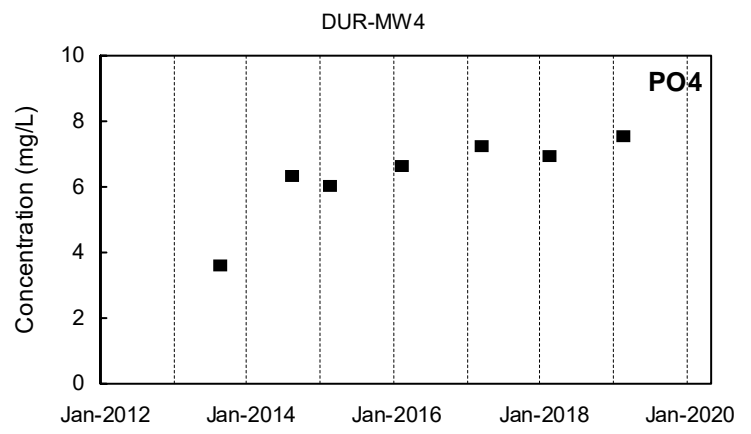
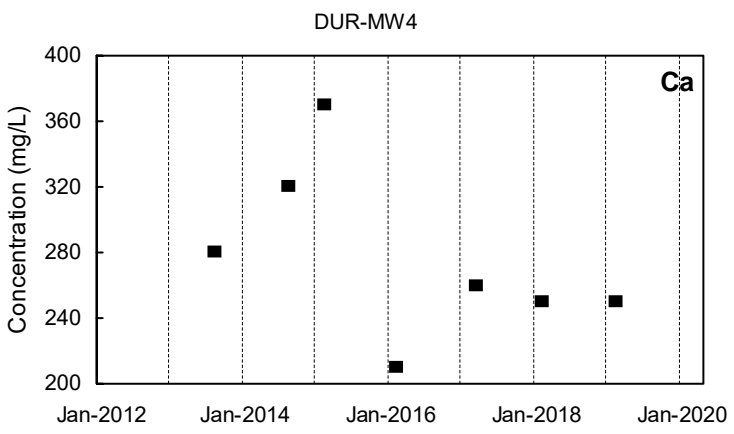
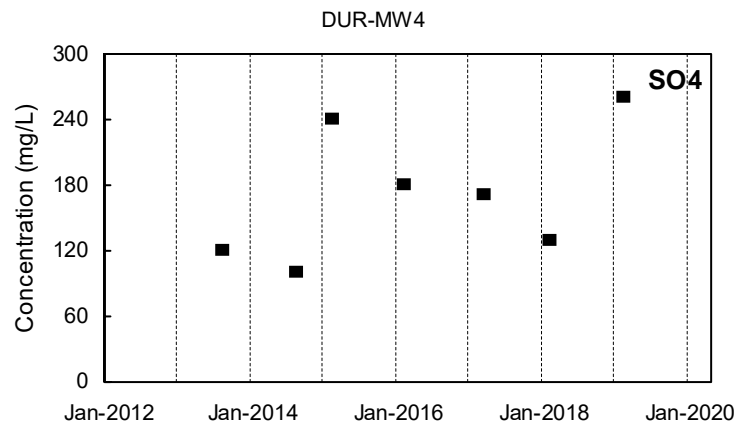
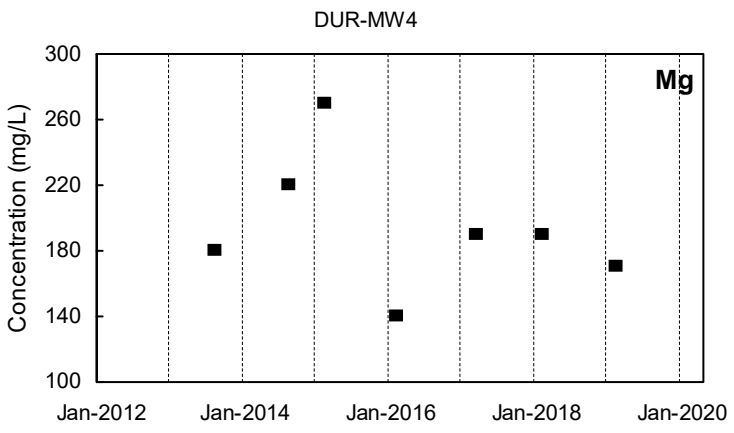
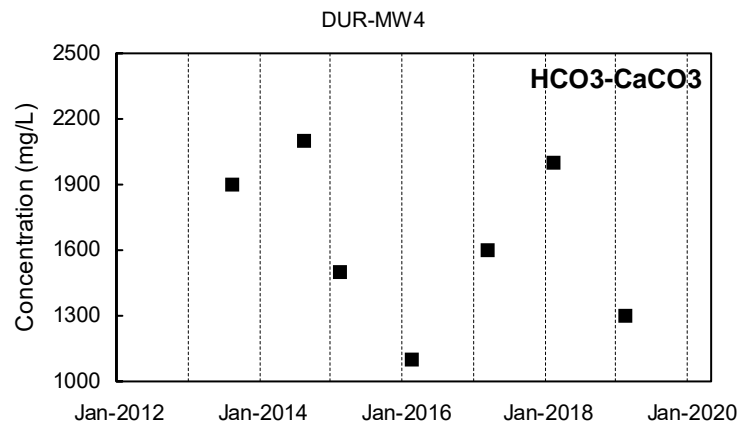
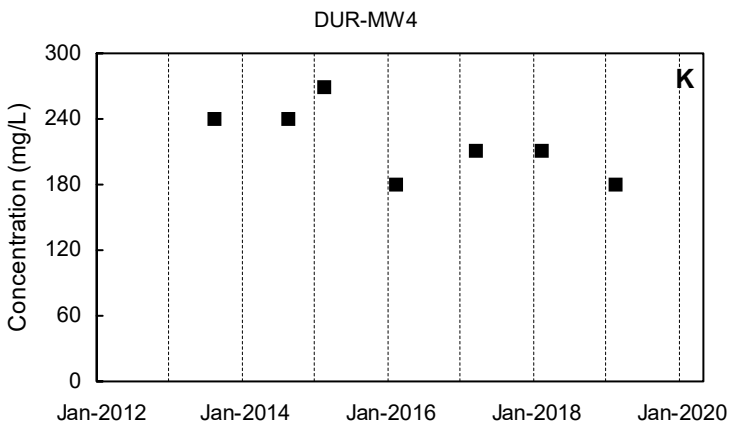
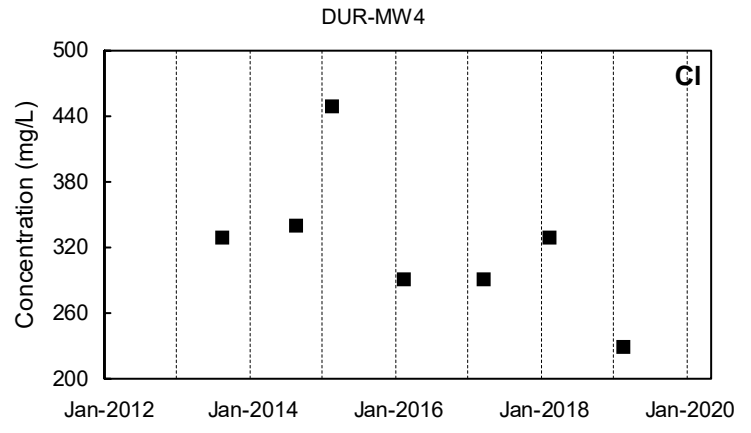
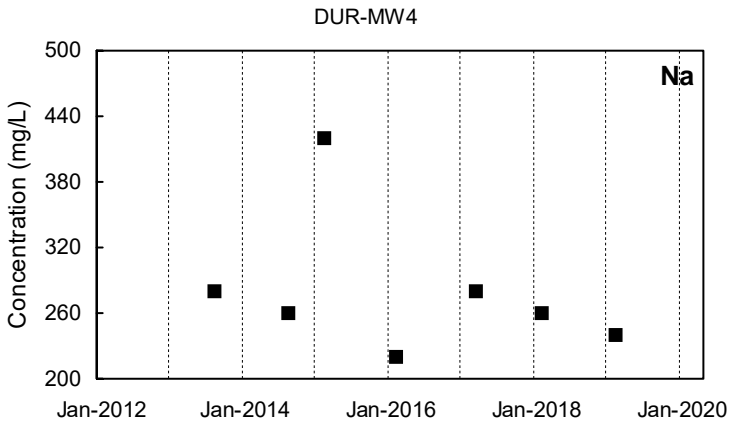

Detected Value
 'J'-Flag (value between reporting limit and detection limit)
 Non-Detect Range
 Shallow Well shown with black symbols
 Deep Well shown with orange symbols
 "dd" Well shown with blue symbols

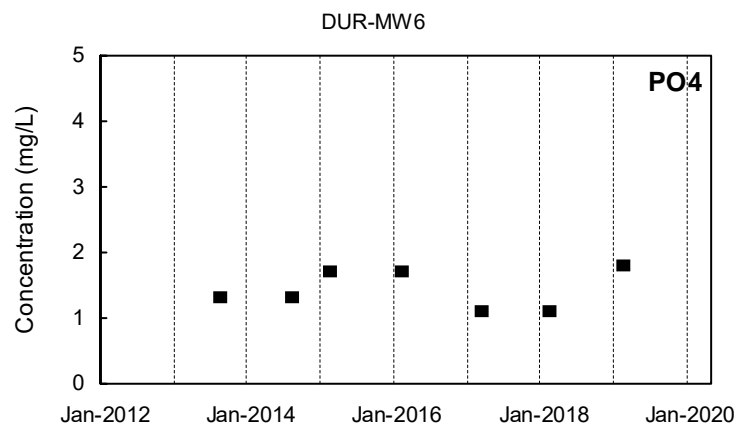
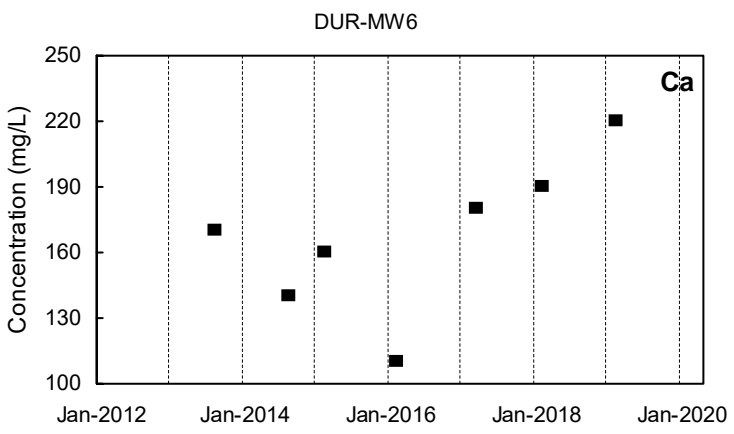
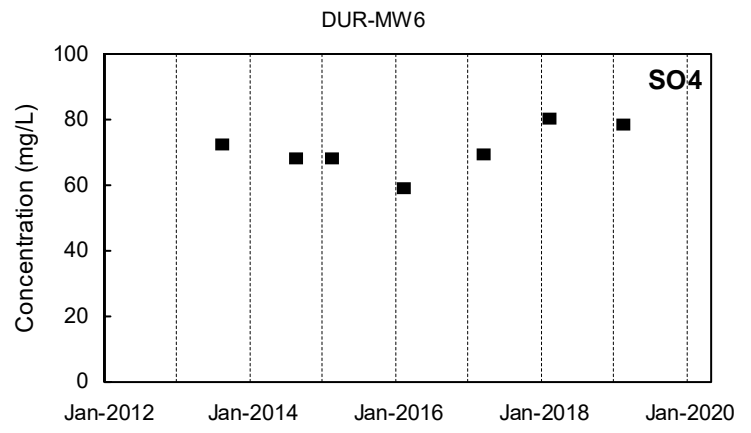
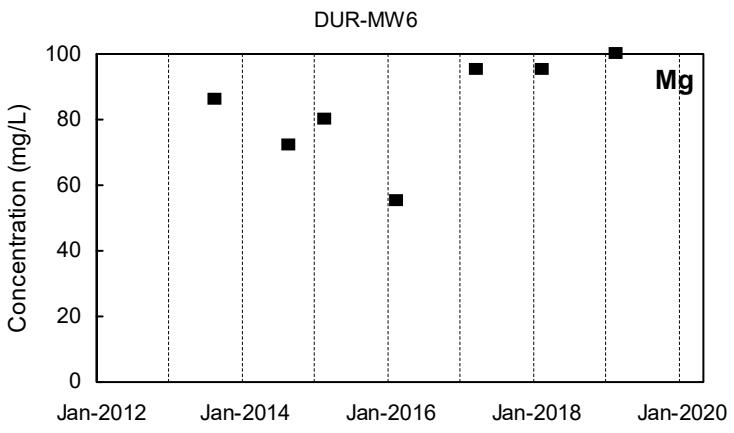
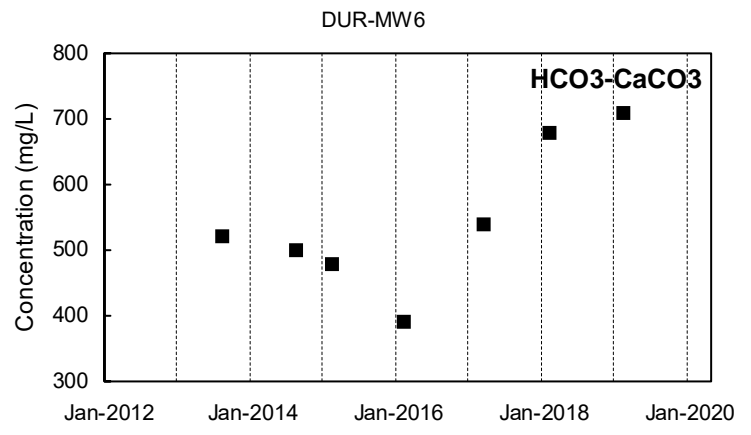
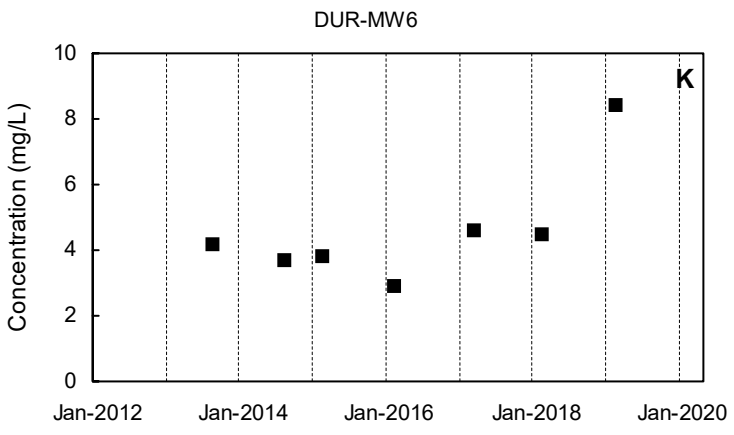
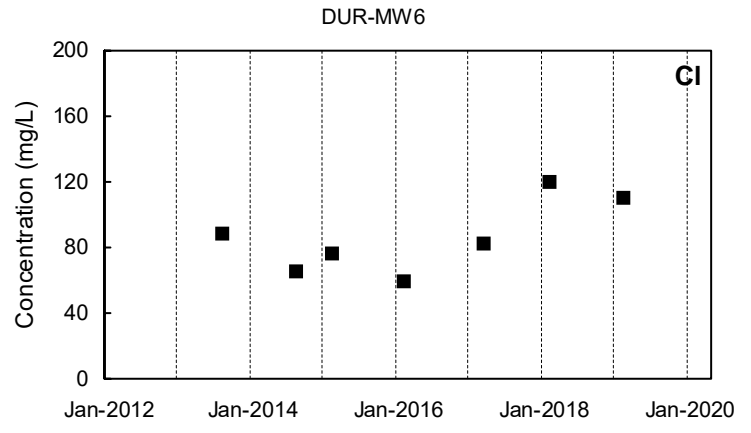
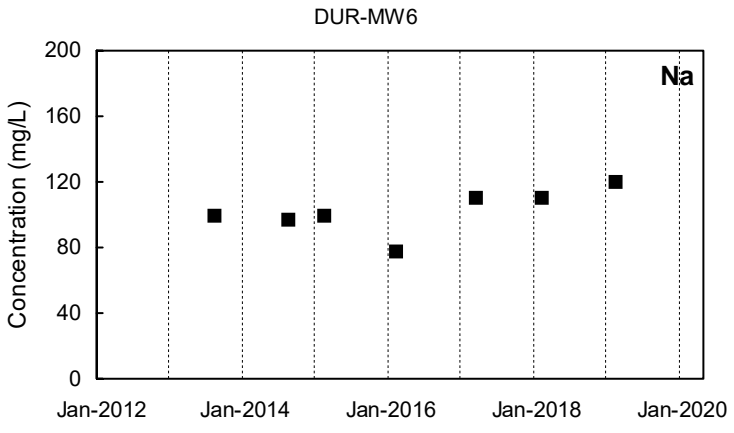

■ Detected Value □ 'J'-Flag (value between reporting limit and detection limit) ■ Non-Detect Range
 Shallow Well shown with black symbols Deep Well shown with orange symbols "dd" Well shown with blue symbols

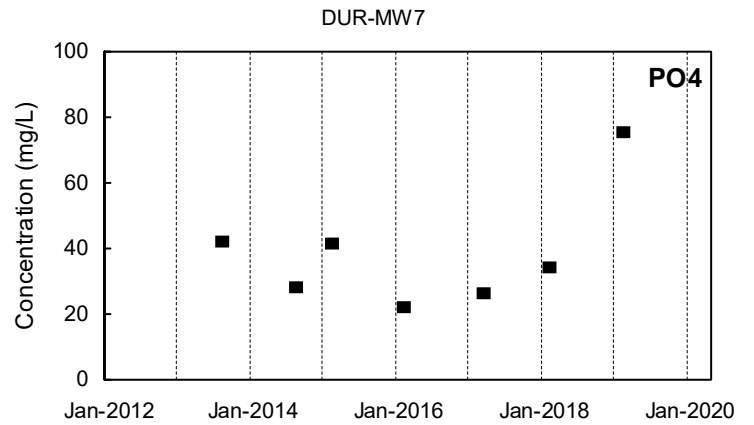
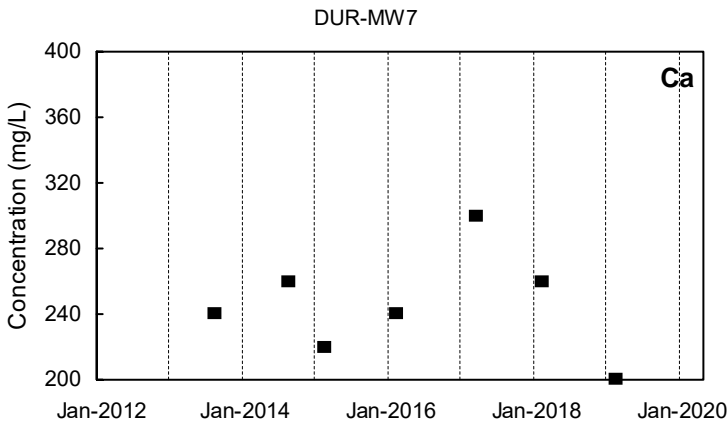
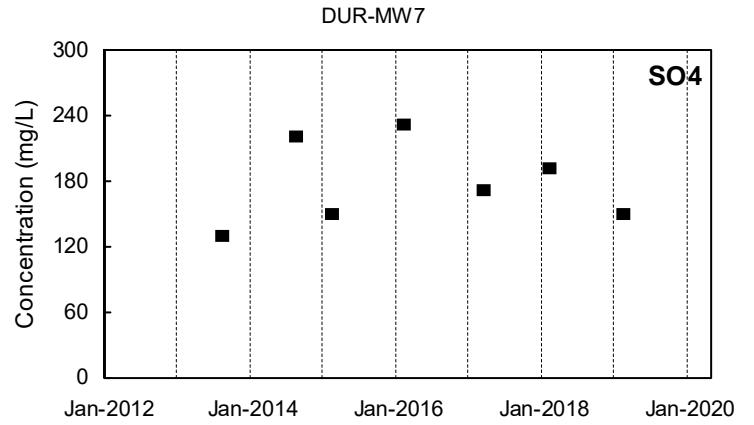
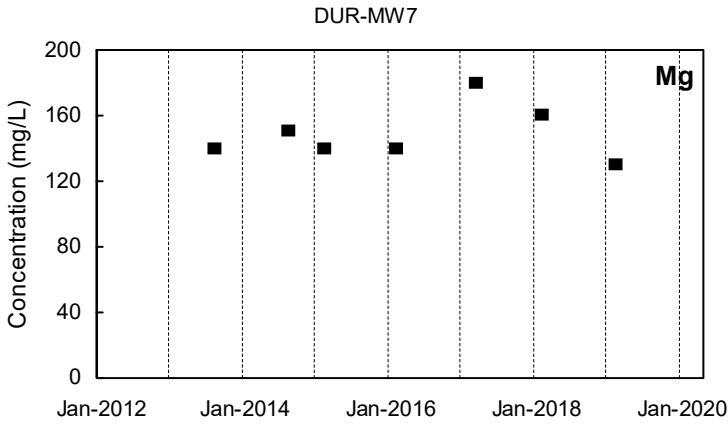
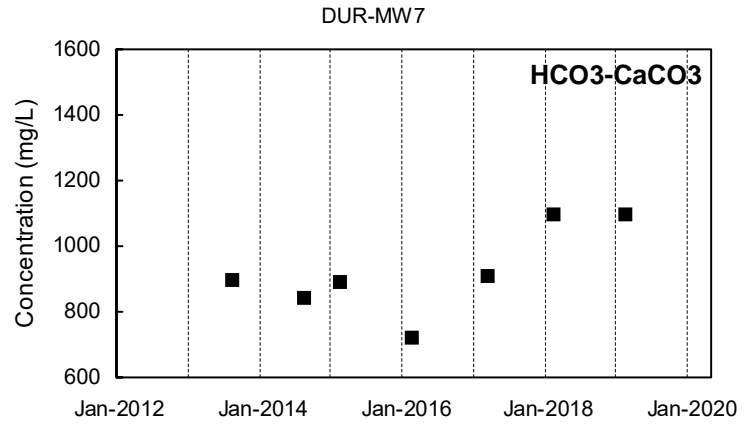
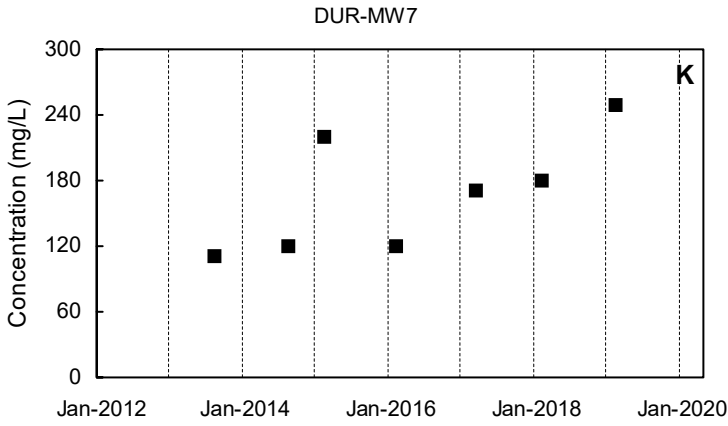
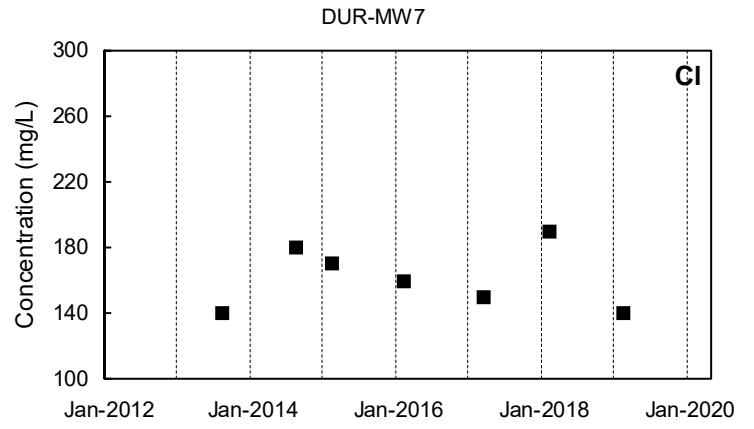
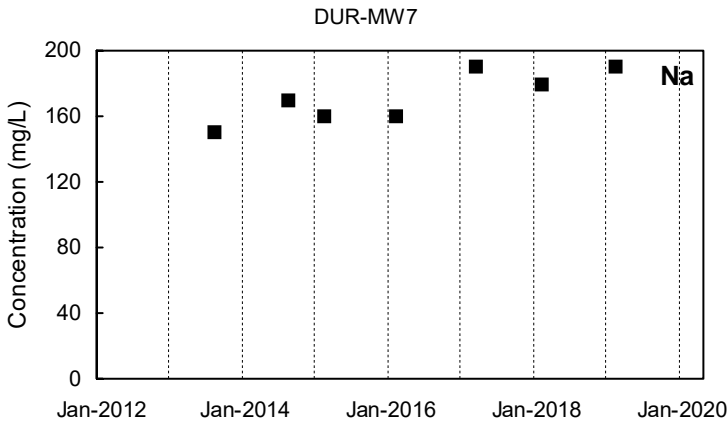

■ Detected Value □ 'J'-Flag (value between reporting limit and detection limit) ■ Non-Detect Range
 Shallow Well shown with black symbols Deep Well shown with orange symbols "dd" Well shown with blue symbols

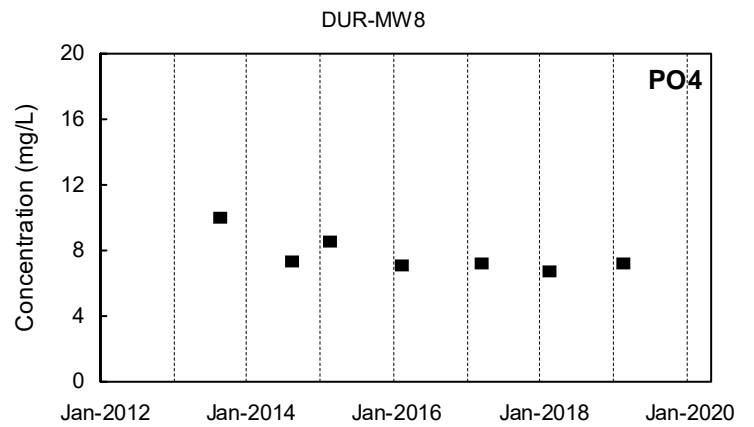
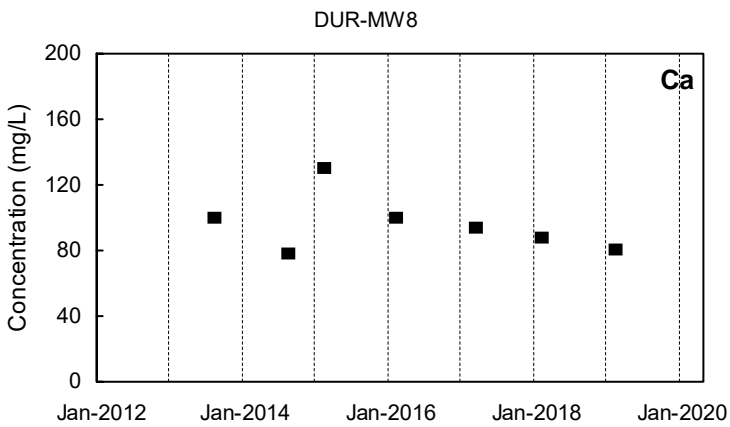
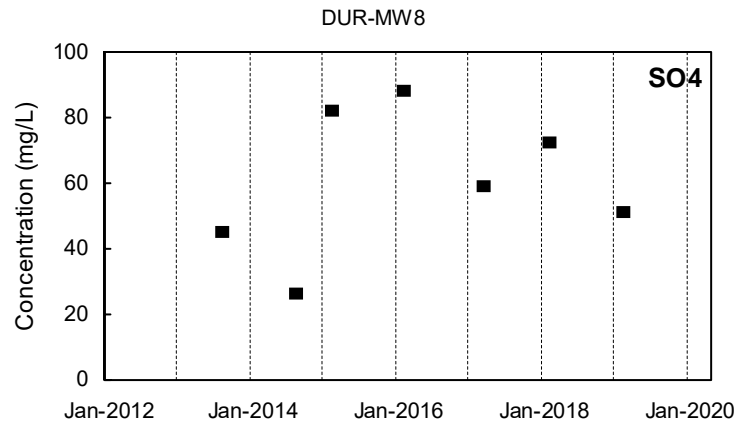
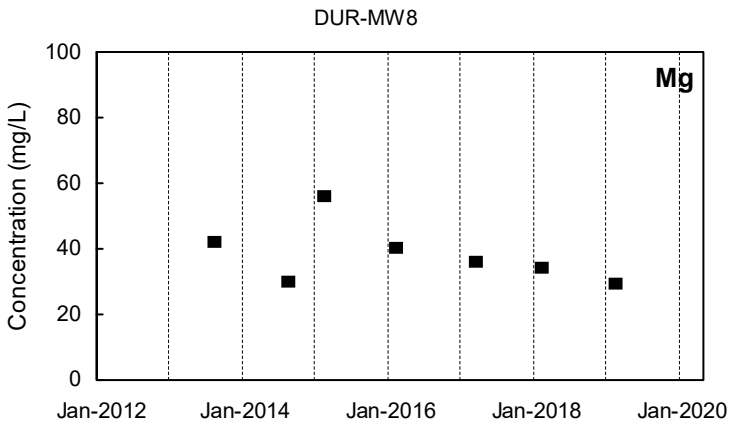
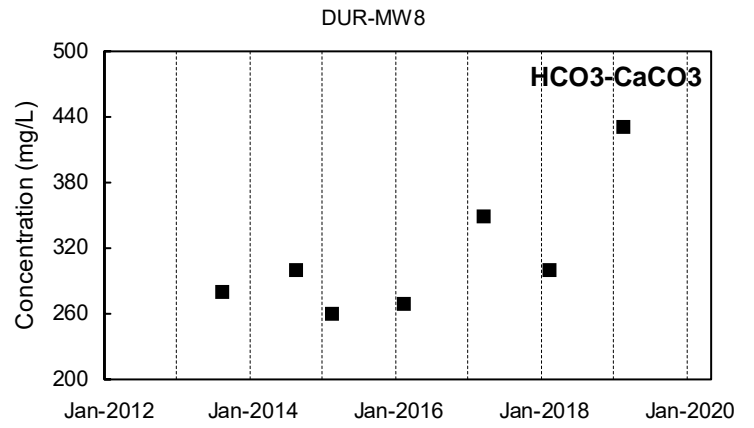
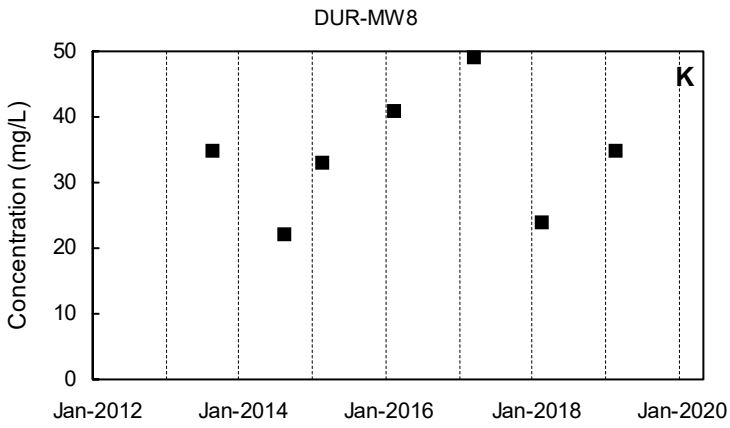
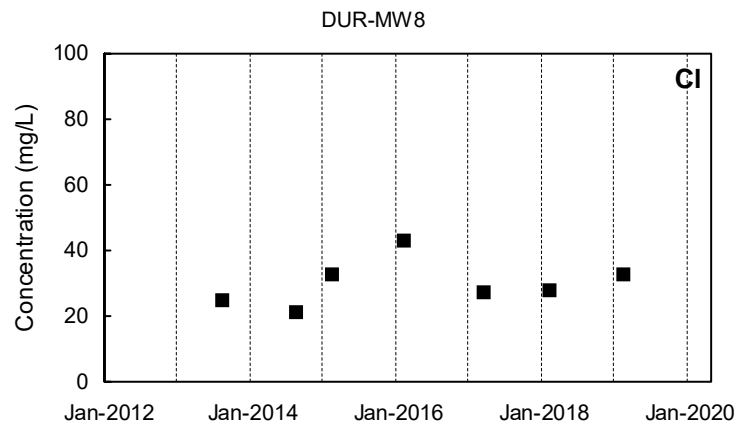
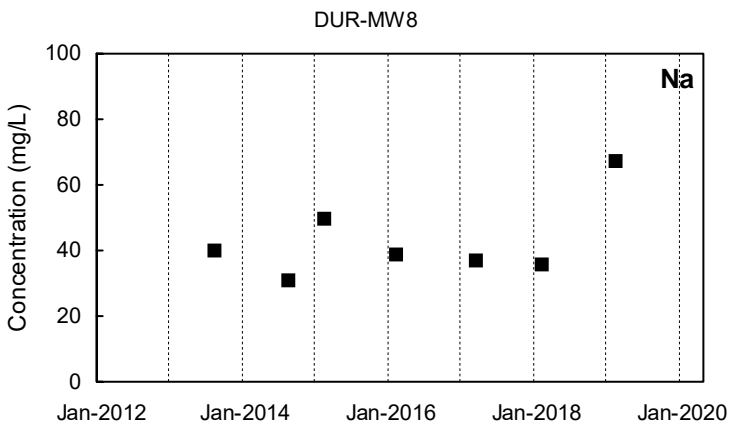

Detected Value
 'J'-Flag (value between reporting limit and detection limit)
 Non-Detect Range
 Shallow Well shown with black symbols
 Deep Well shown with orange symbols
 "dd" Well shown with blue symbols

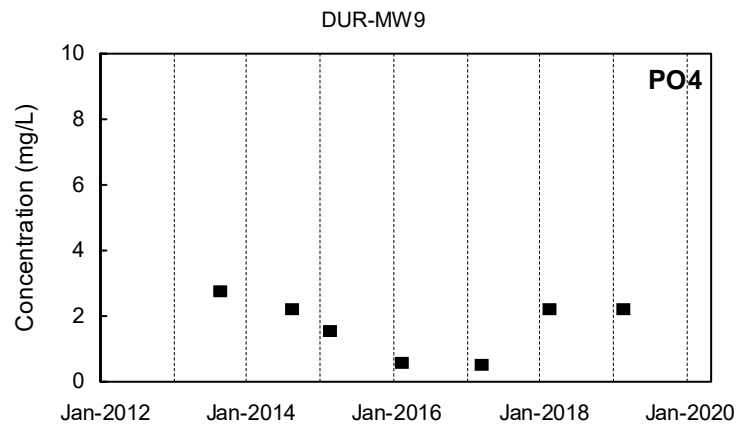
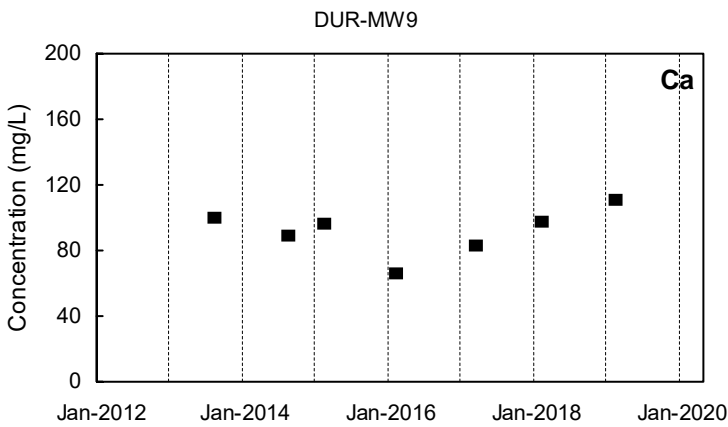
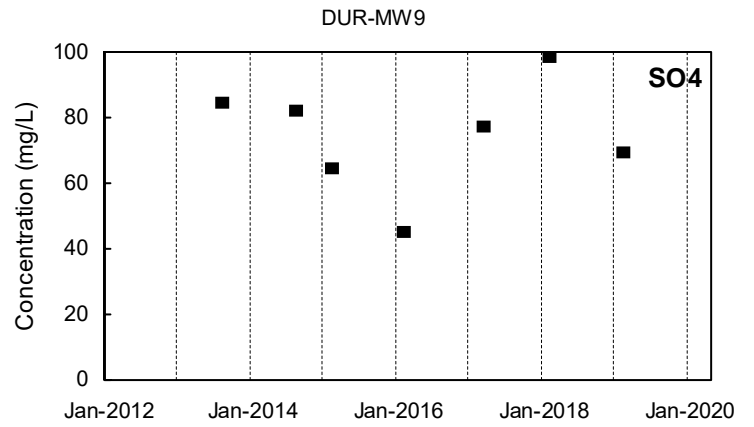
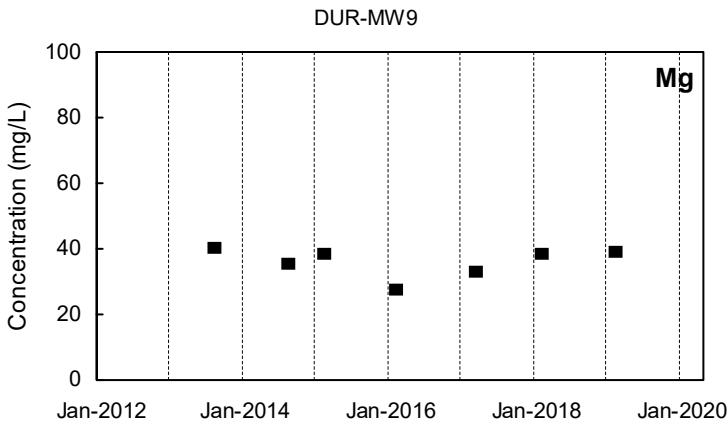
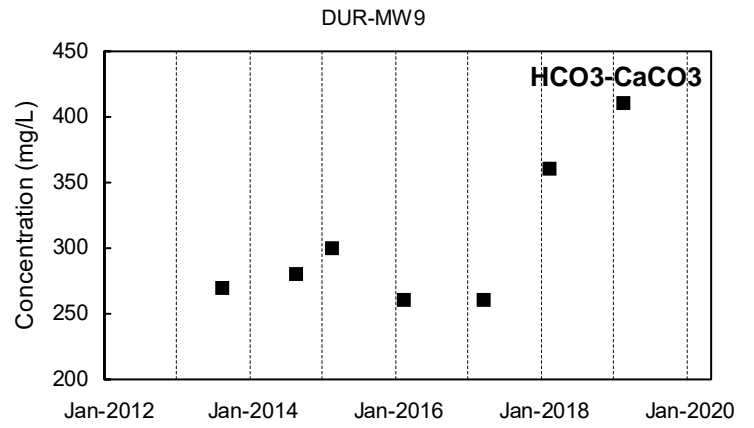
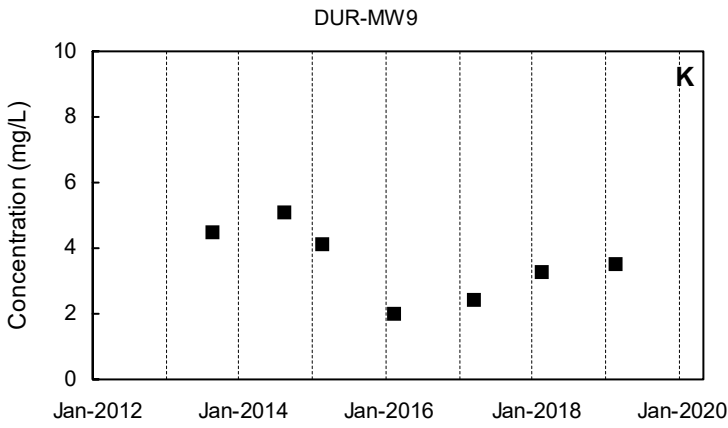
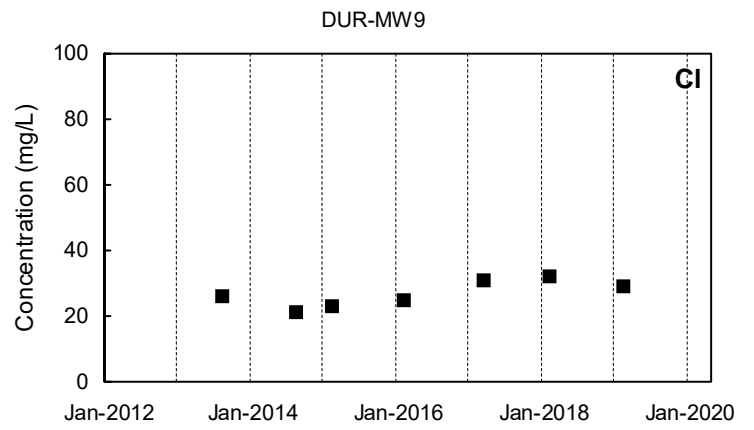
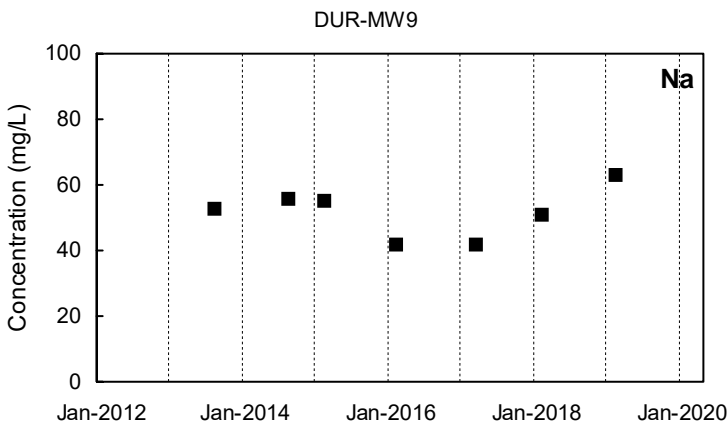

■ Detected Value □ 'J'-Flag (value between reporting limit and detection limit) ■ Non-Detect Range
 Shallow Well shown with black symbols Deep Well shown with orange symbols "dd" Well shown with blue symbols

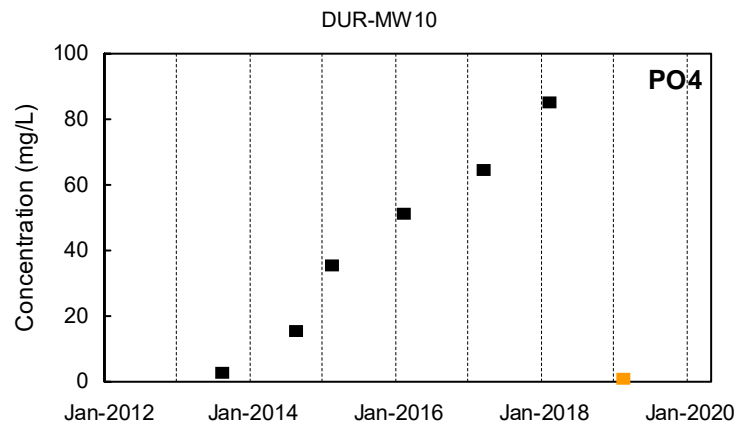
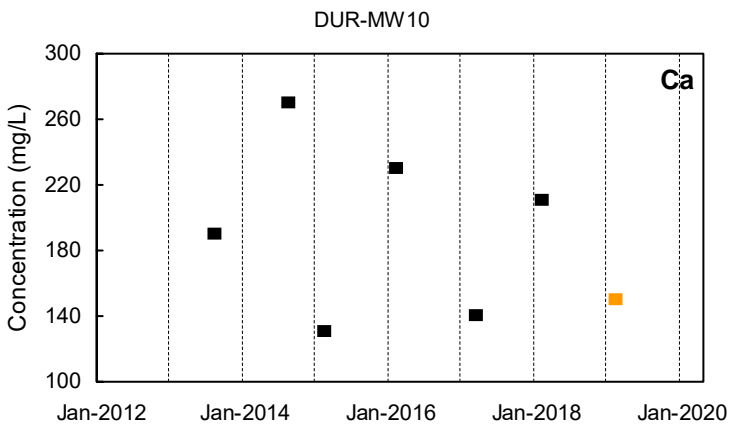
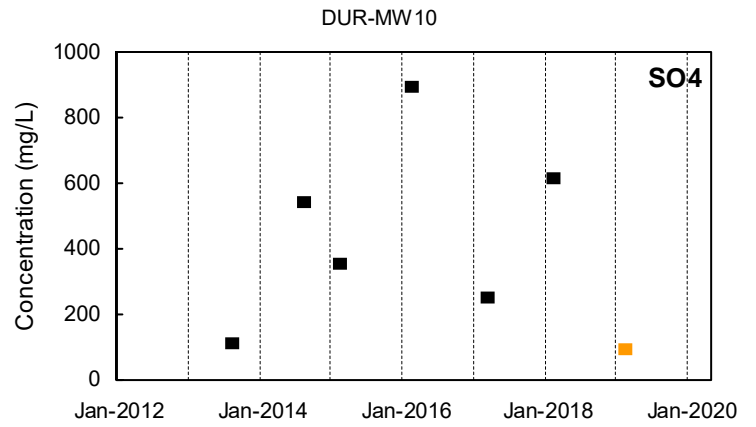
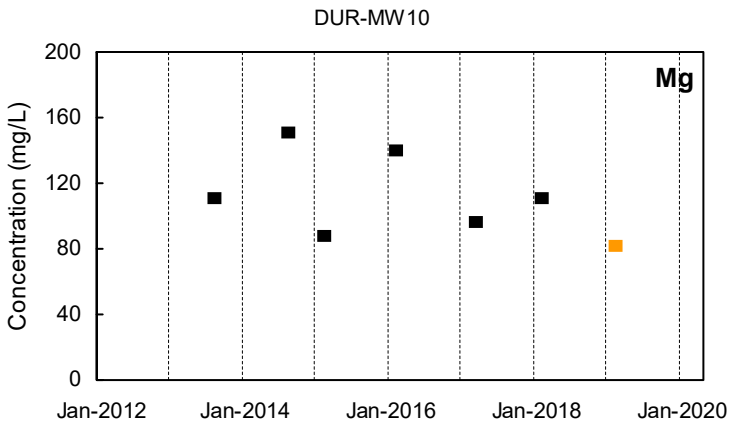
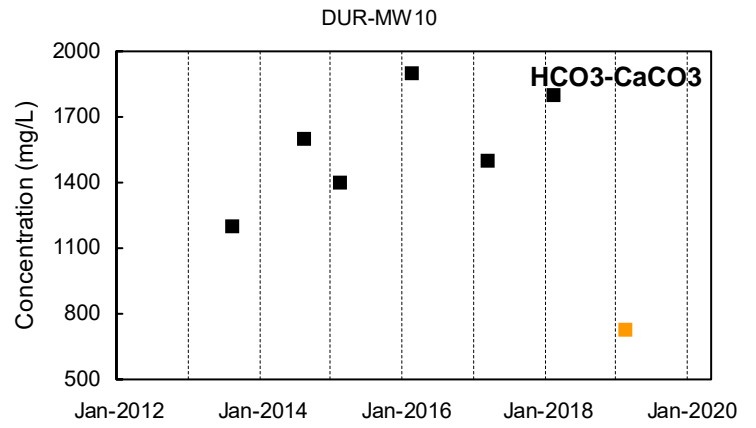
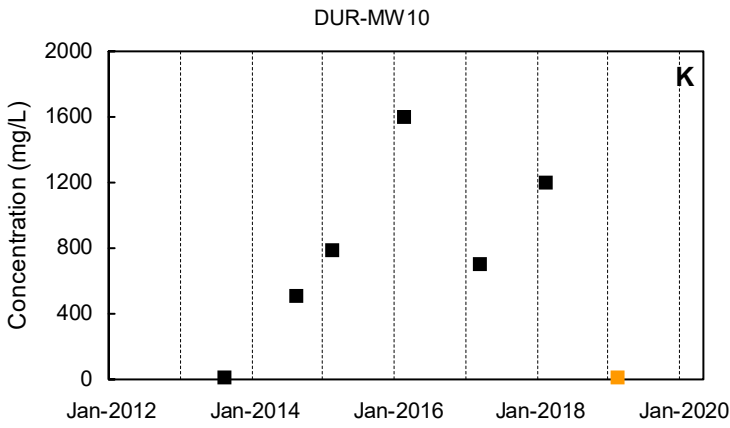
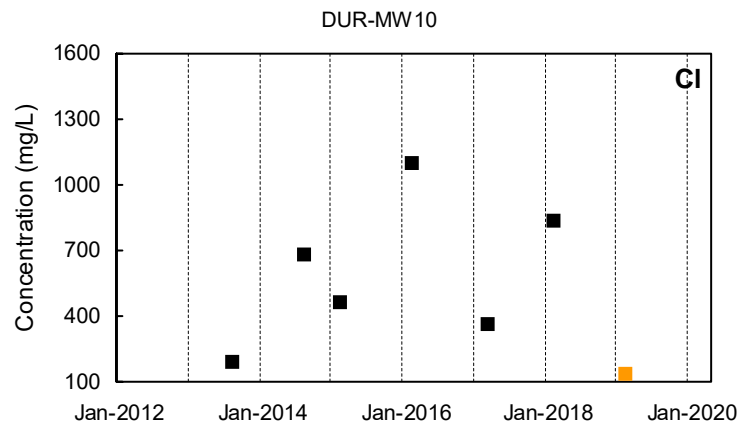
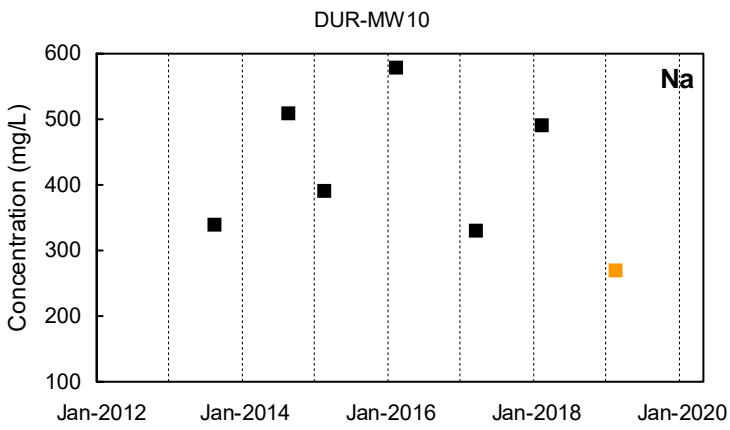

■ Detected Value □ 'J'-Flag (value between reporting limit and detection limit) ■ Non-Detect Range
 Shallow Well shown with black symbols Deep Well shown with orange symbols "dd" Well shown with blue symbols

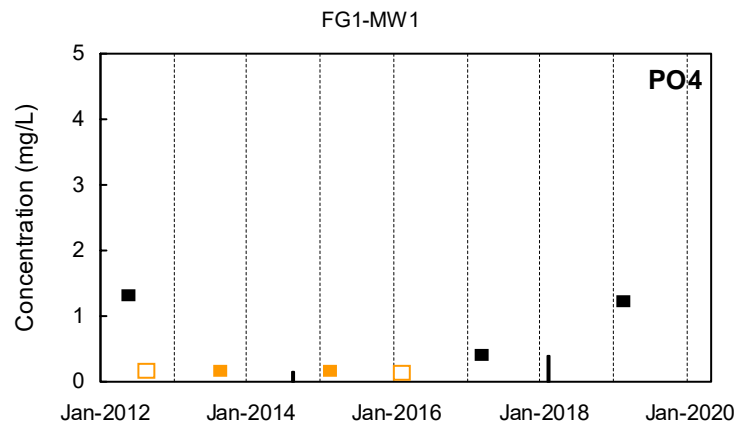
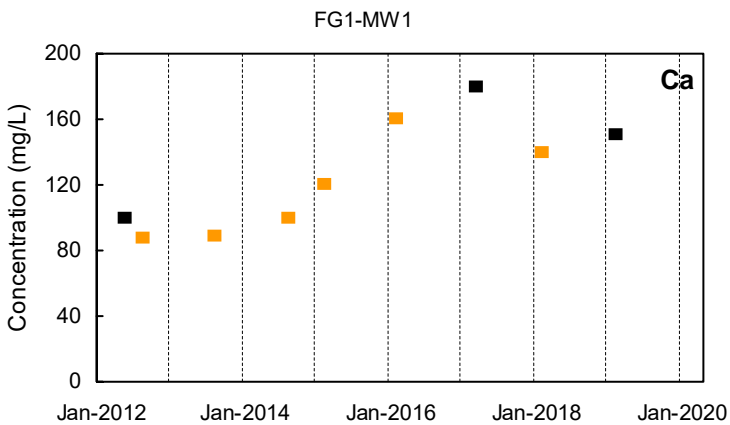
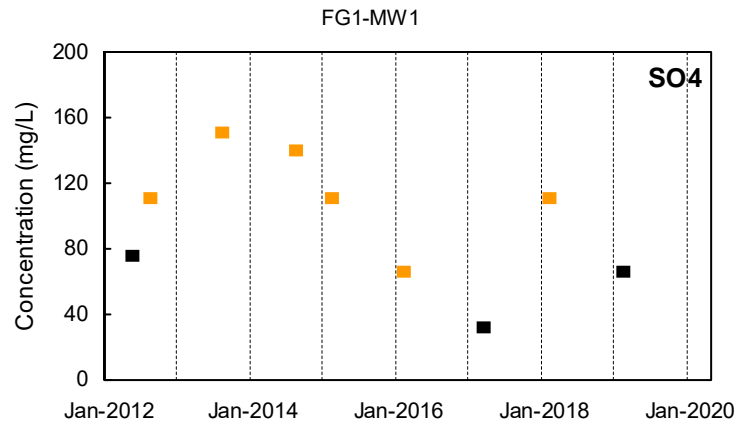
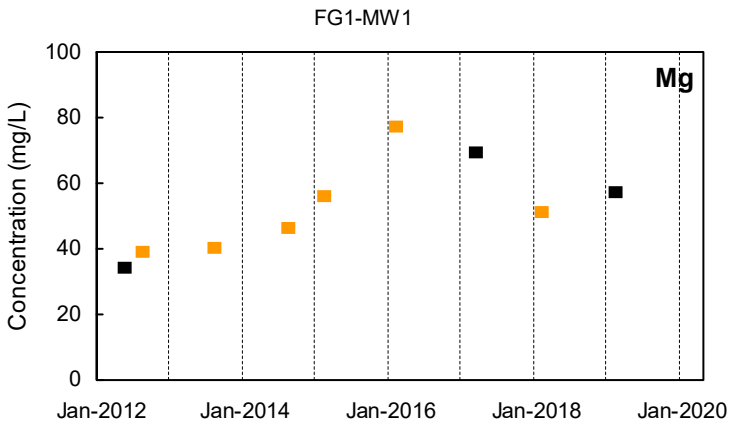
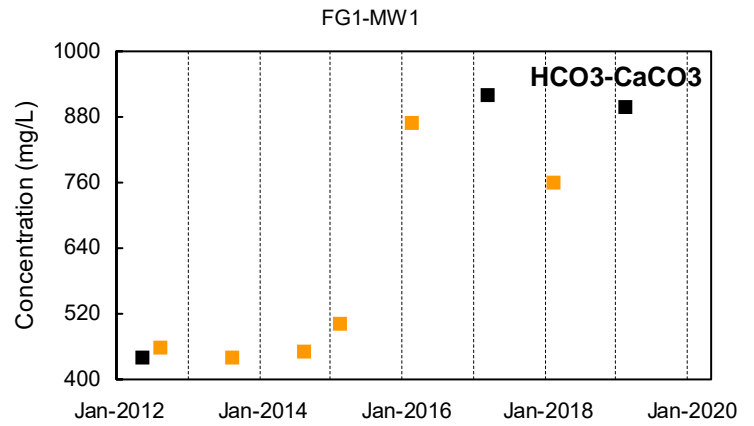
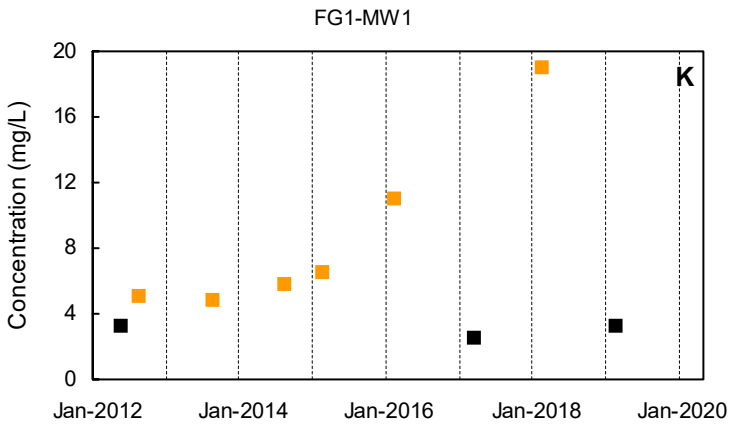
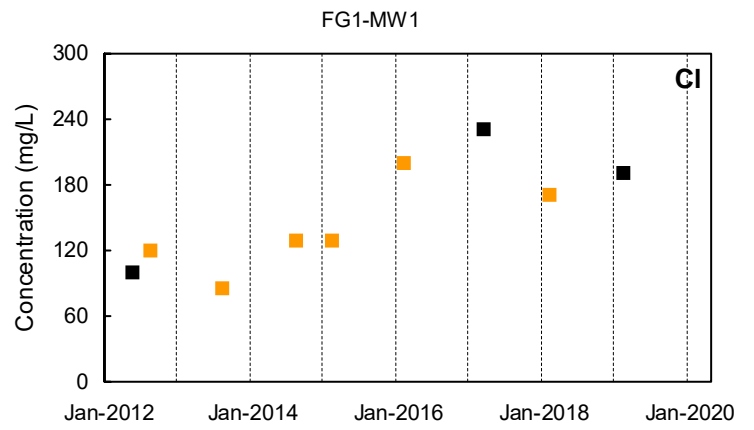
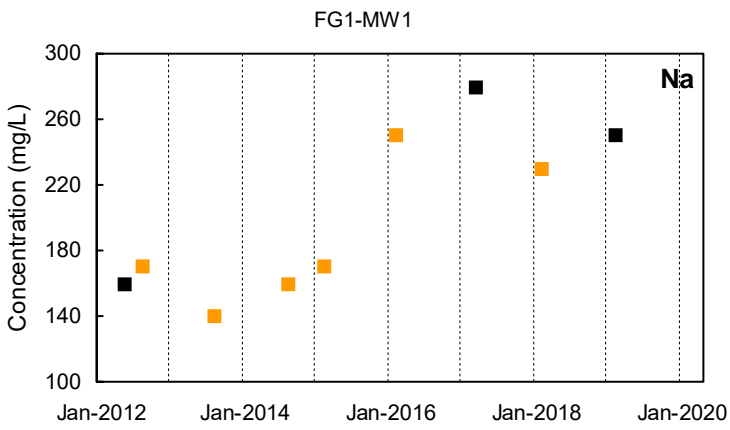

■ Detected Value □ 'J'-Flag (value between reporting limit and detection limit) ■ Non-Detect Range
 Shallow Well shown with black symbols Deep Well shown with orange symbols "dd" Well shown with blue symbols

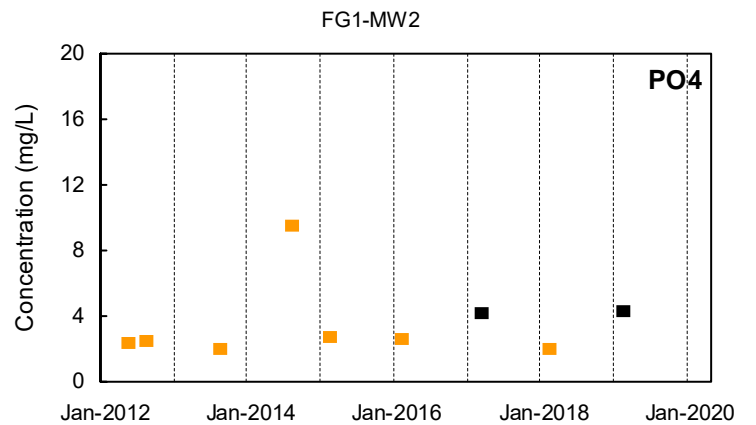
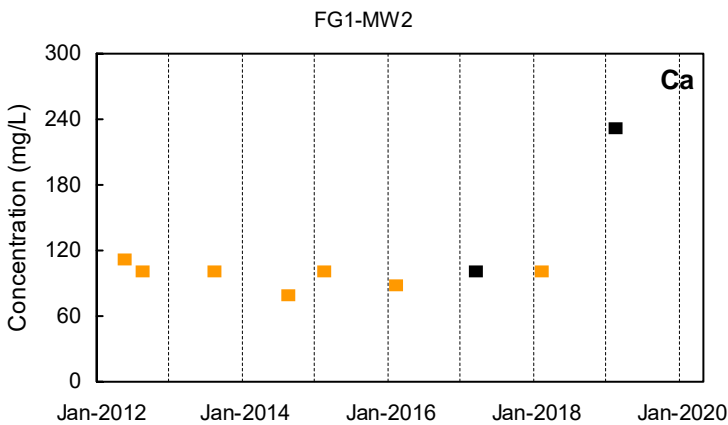
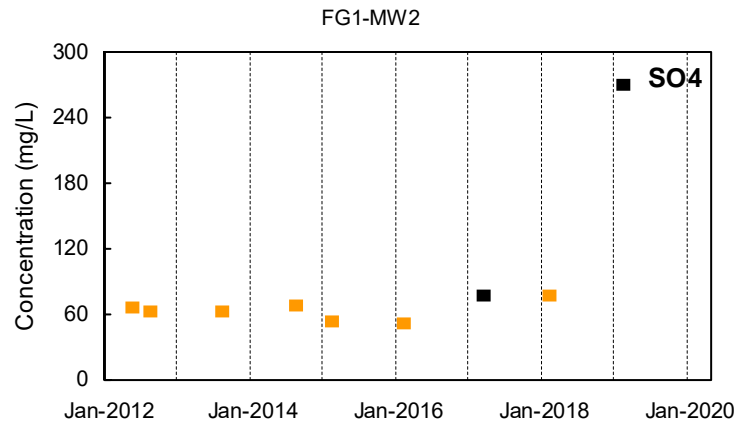
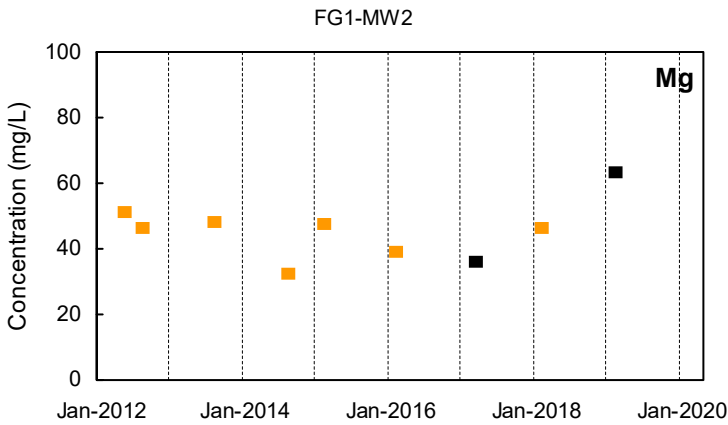
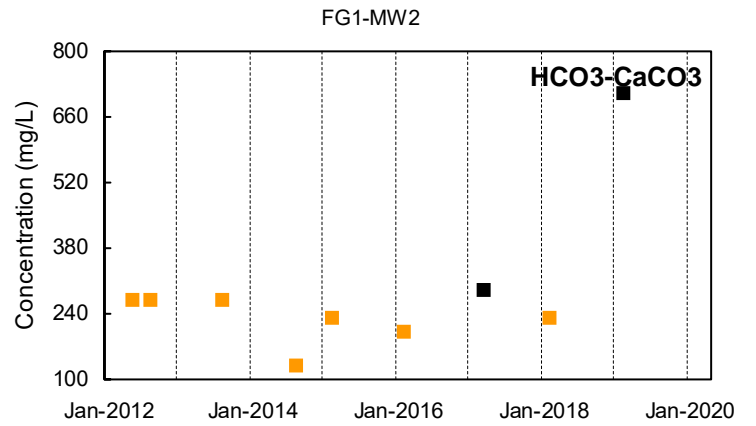
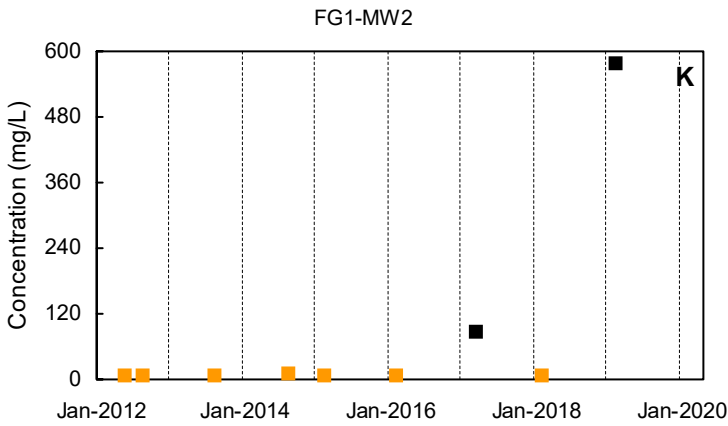
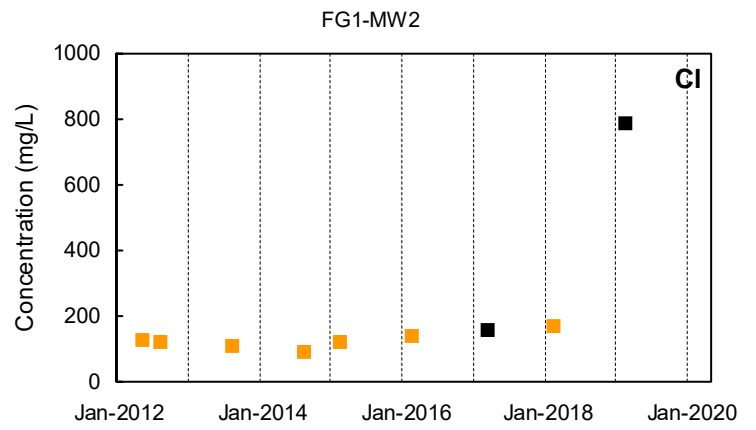
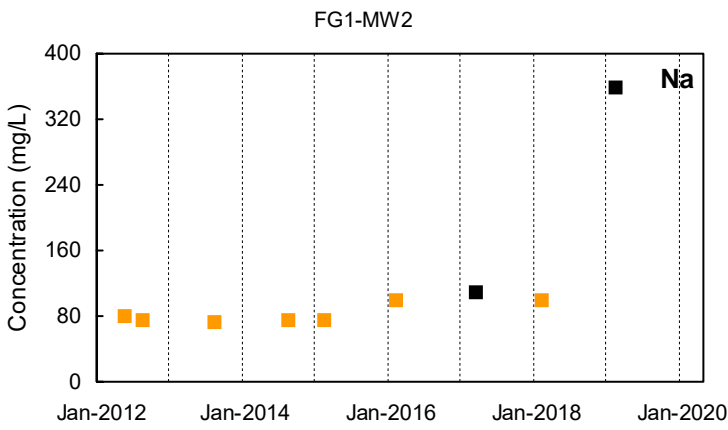

Detected Value
 'J'-Flag (value between reporting limit and detection limit)
 Non-Detect Range
 Shallow Well shown with black symbols
 Deep Well shown with orange symbols
 "dd" Well shown with blue symbols

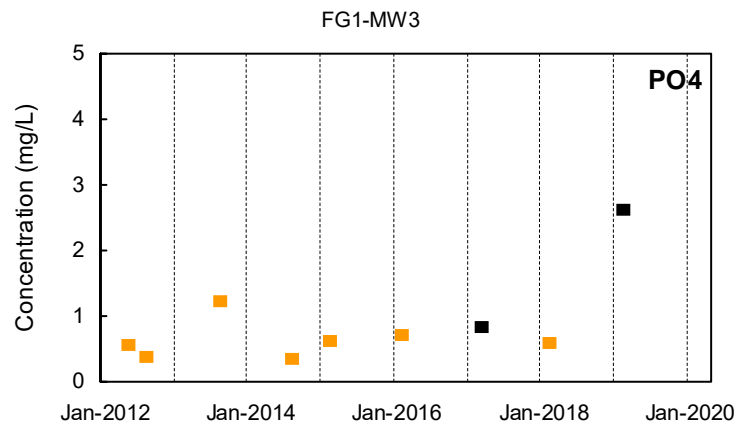
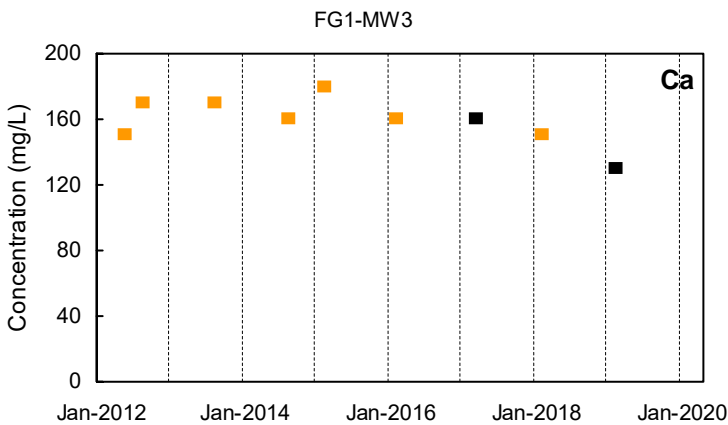
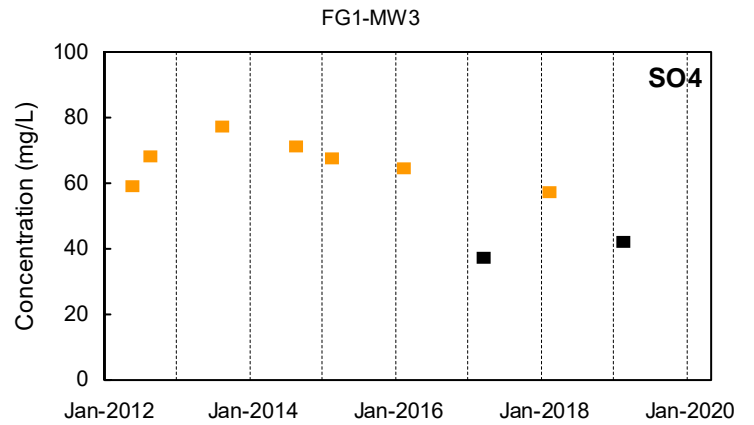
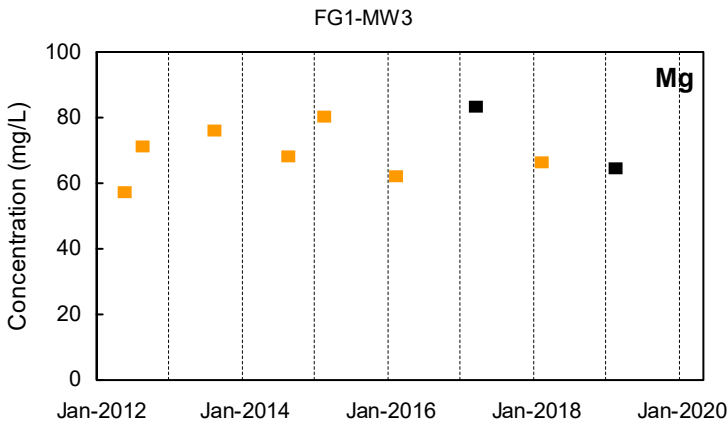
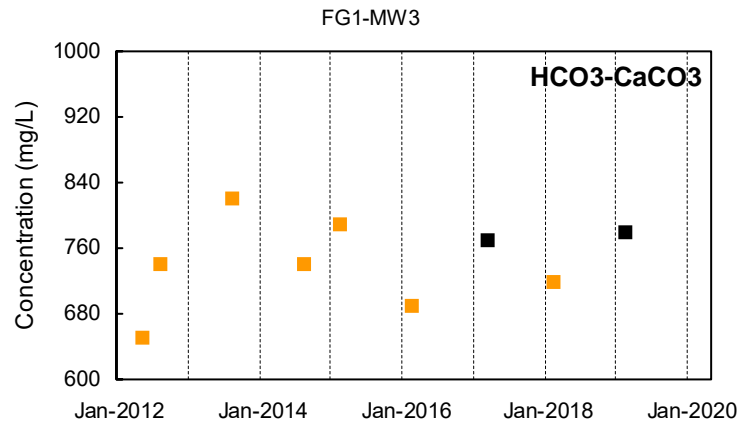
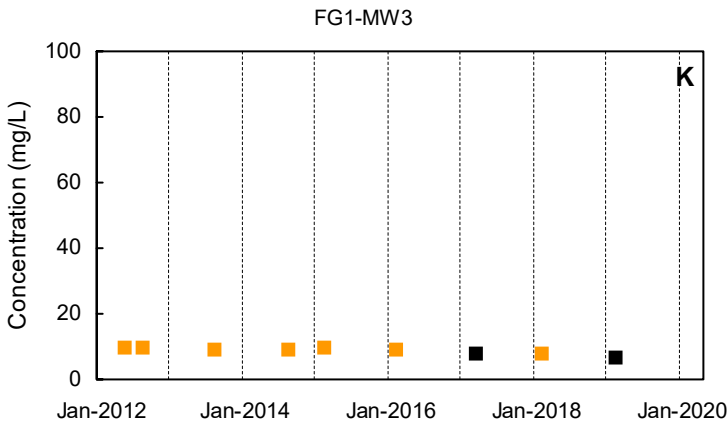
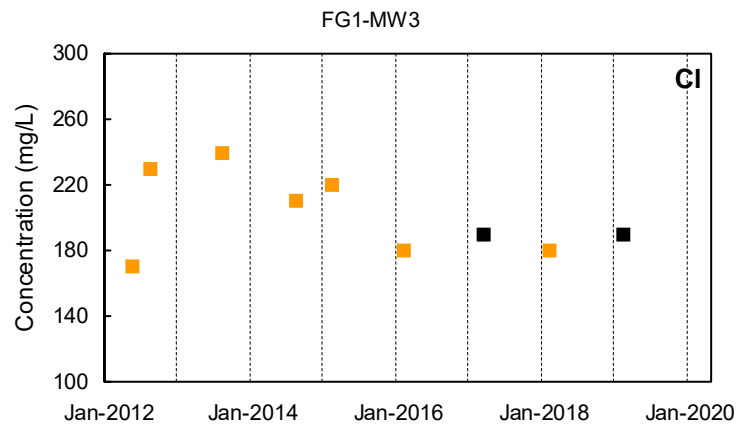
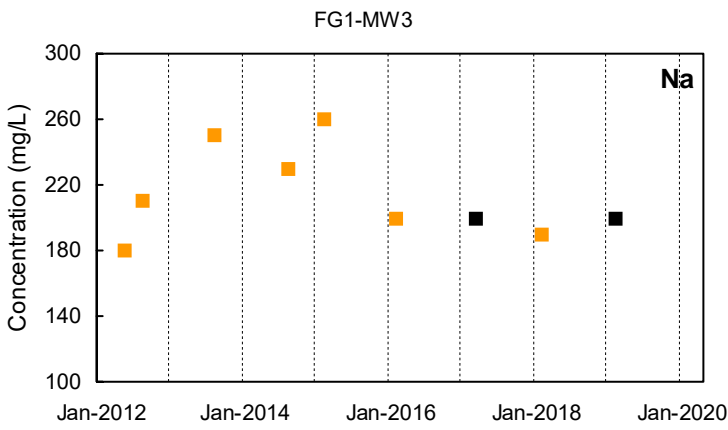

Detected Value
 'J'-Flag (value between reporting limit and detection limit)
 Non-Detect Range

Shallow Well shown with black symbols
Deep Well shown with orange symbols
"dd" Well shown with blue symbols

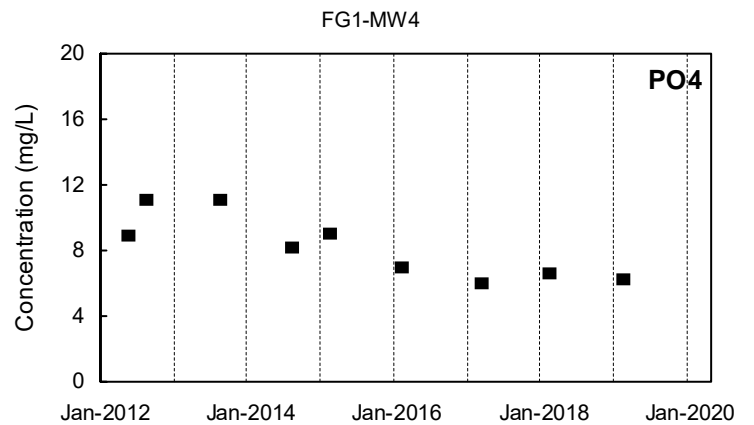
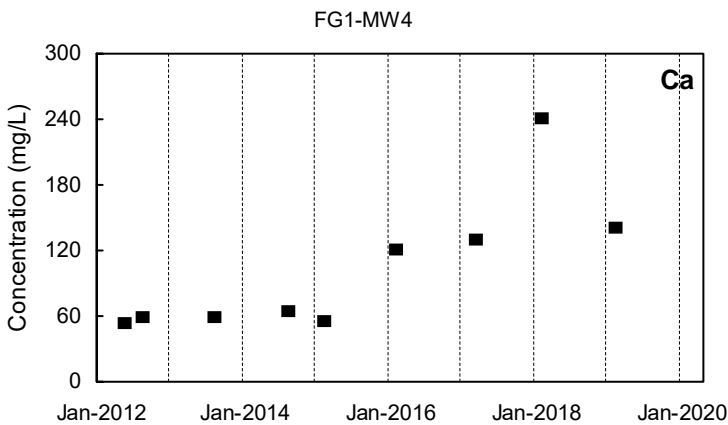
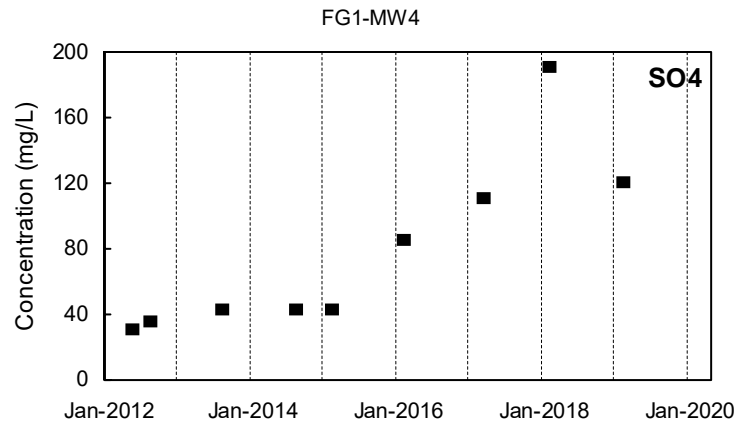
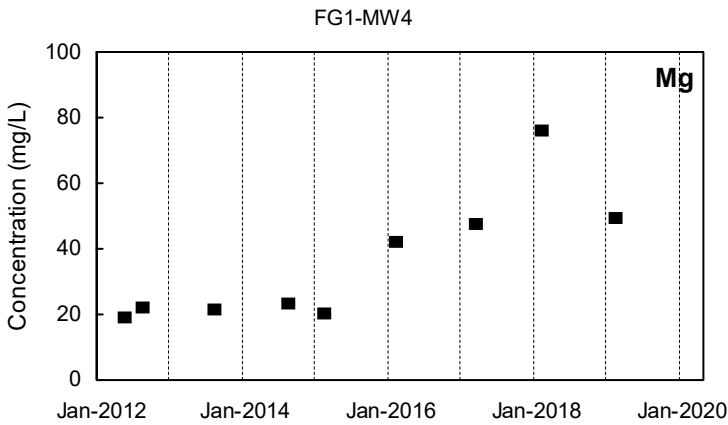
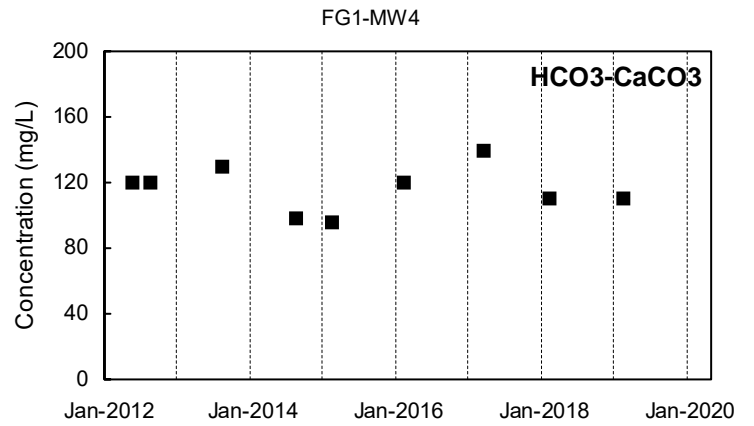
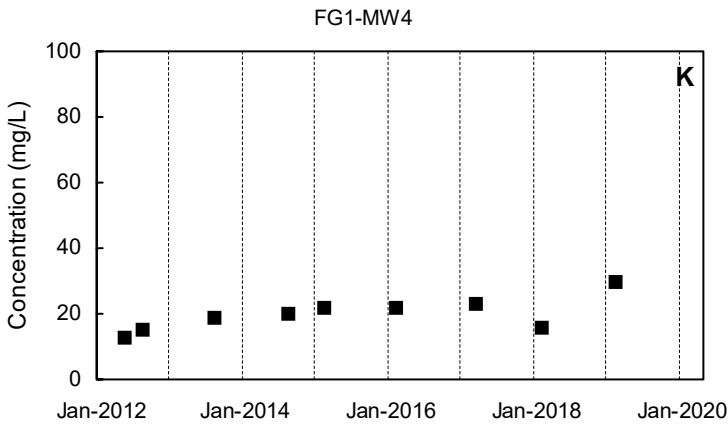
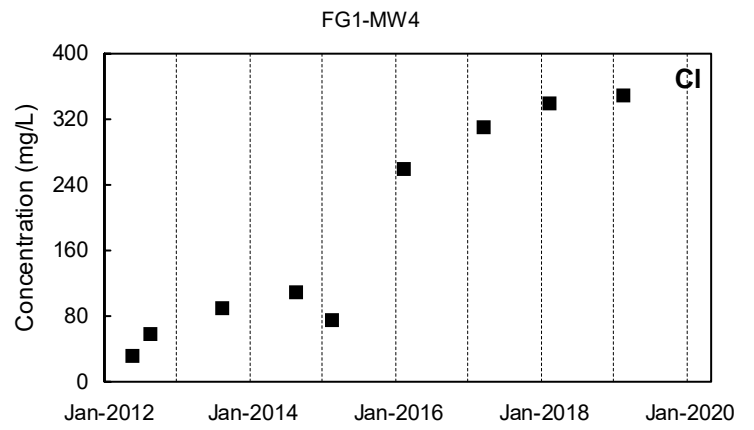
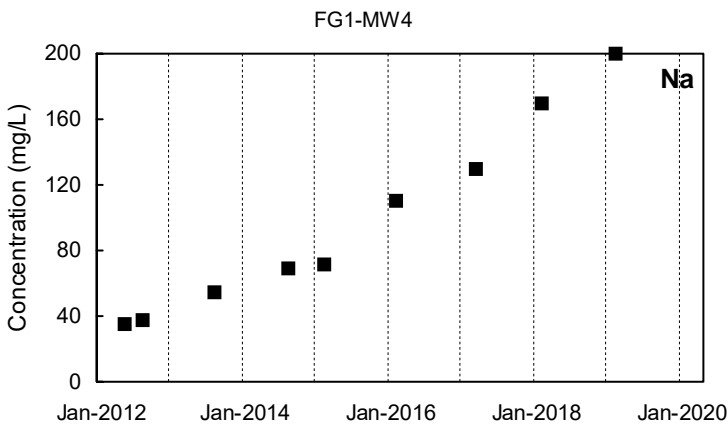

Detected Value
 'J'-Flag (value between reporting limit and detection limit)
 Non-Detect Range
 Shallow Well shown with black symbols
 Deep Well shown with orange symbols
 "dd" Well shown with blue symbols

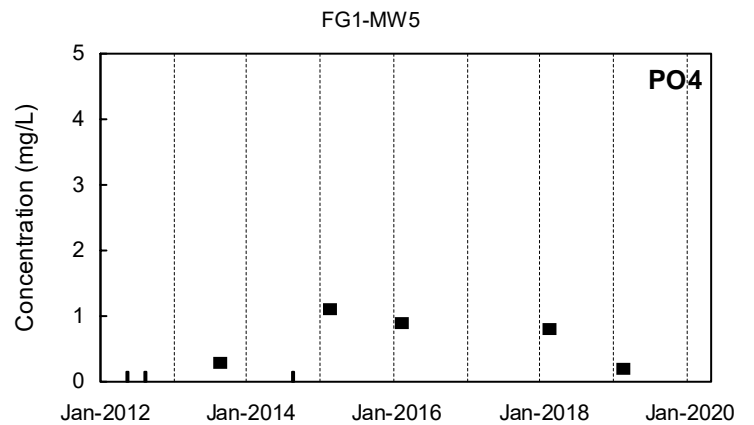
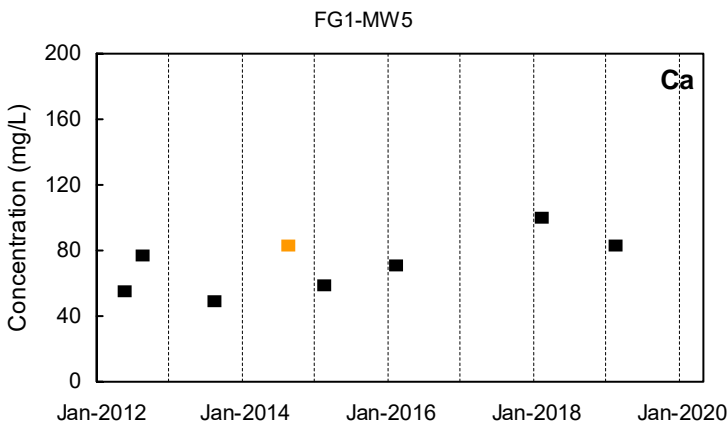
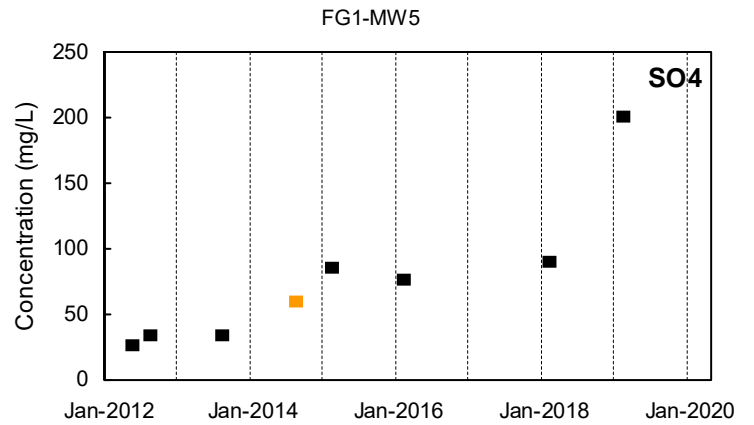
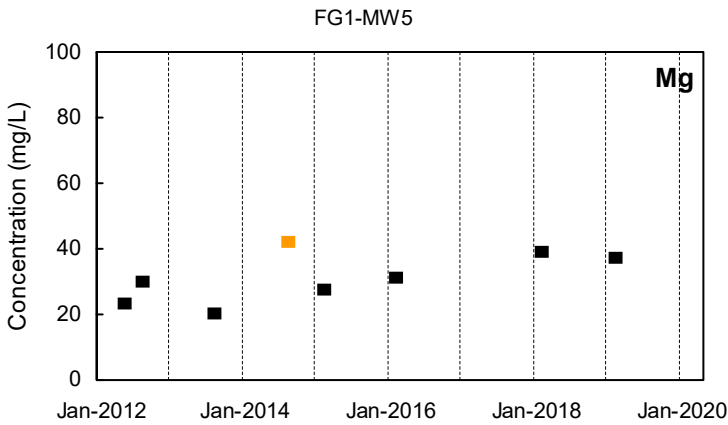
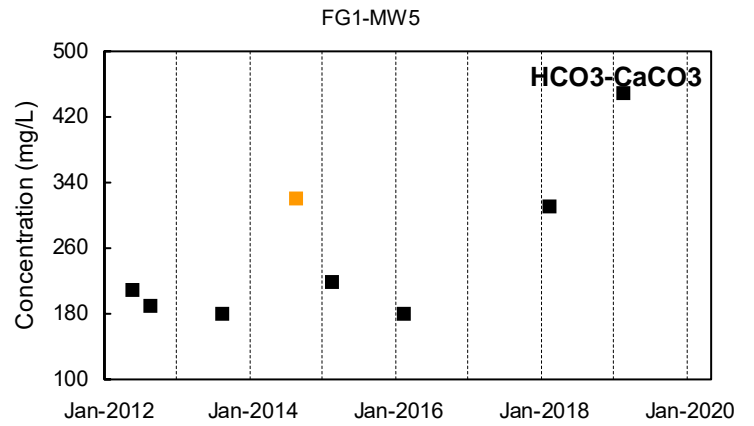
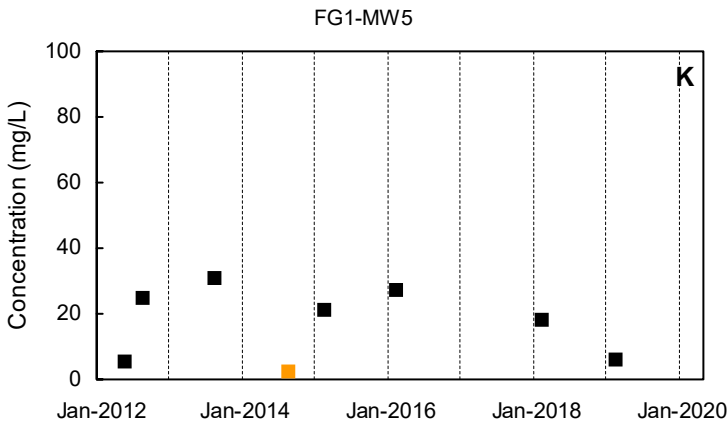
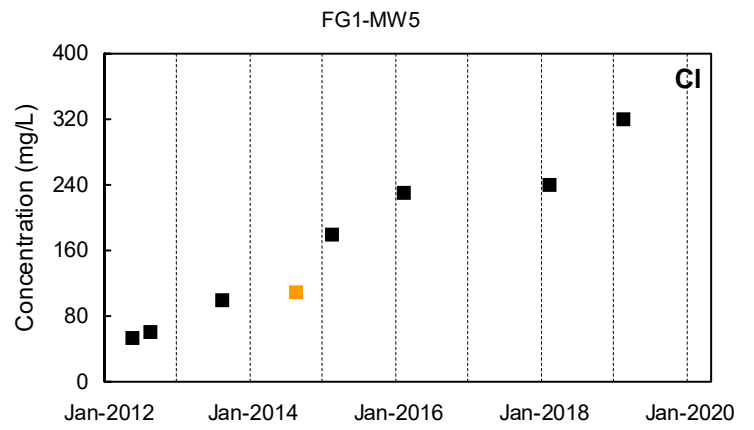
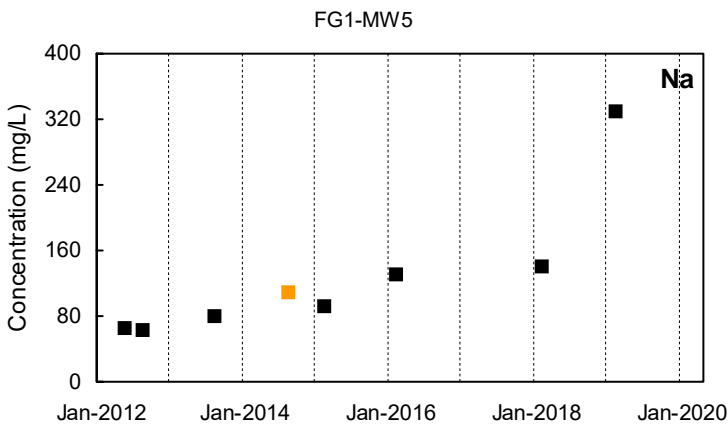

■ Detected Value □ 'J'-Flag (value between reporting limit and detection limit) ■ Non-Detect Range
 ■ Shallow Well shown with black symbols ■ Deep Well shown with orange symbols ■ "dd" Well shown with blue symbols

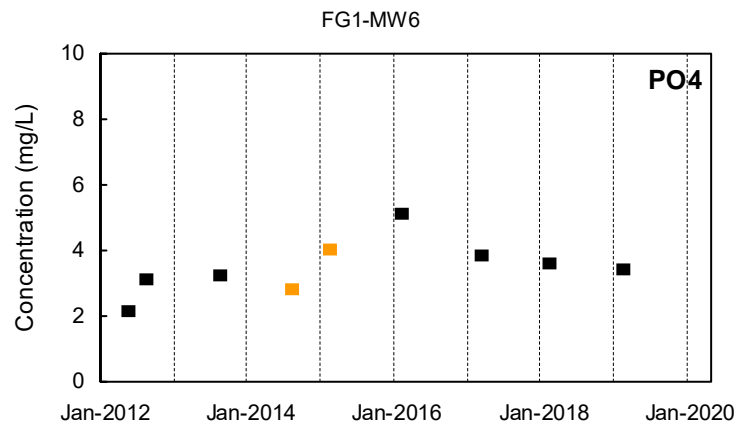
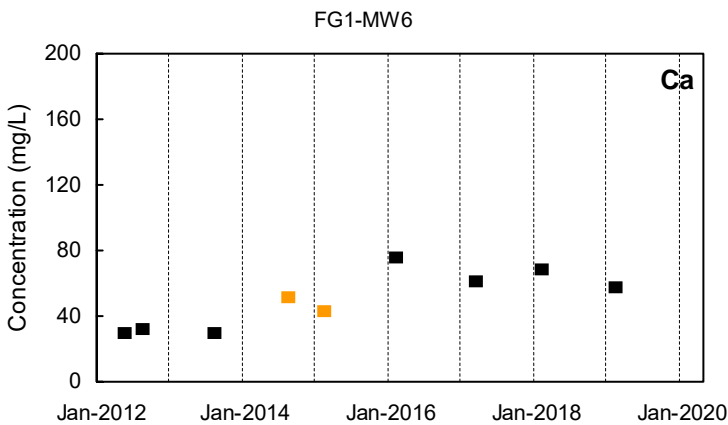
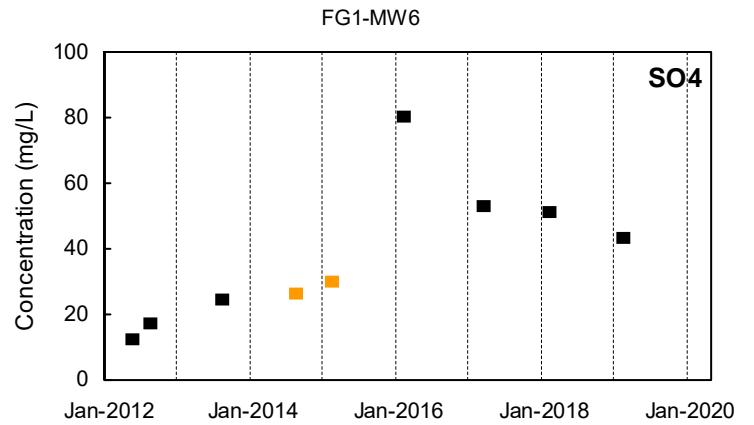
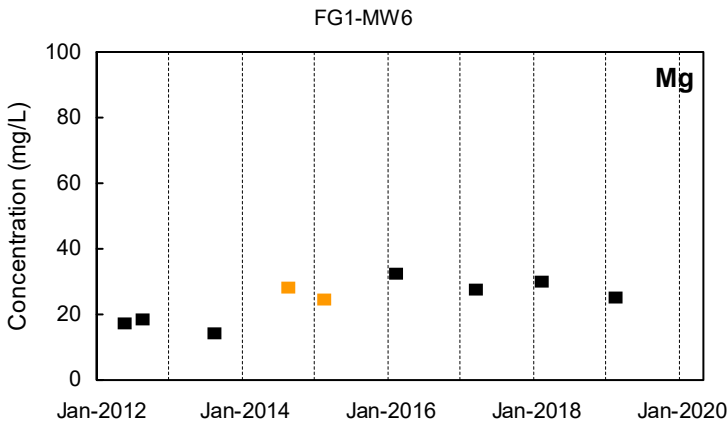
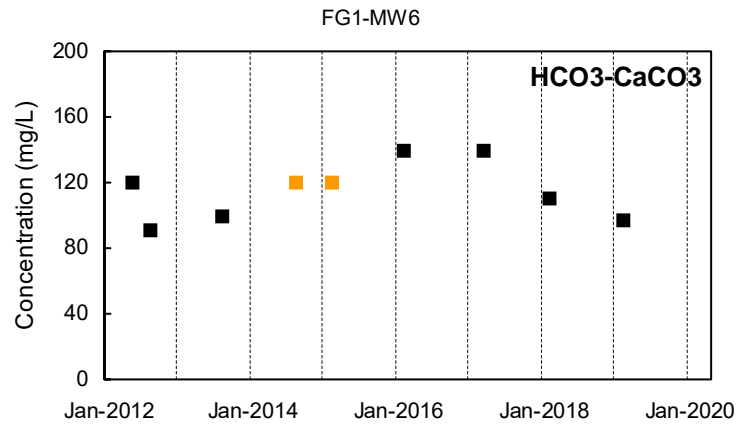
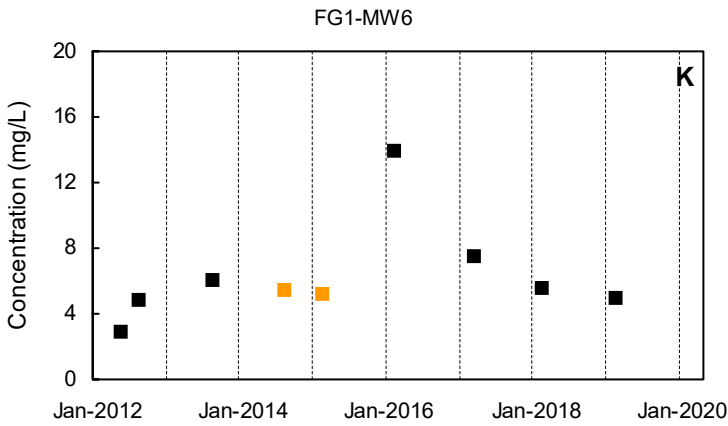
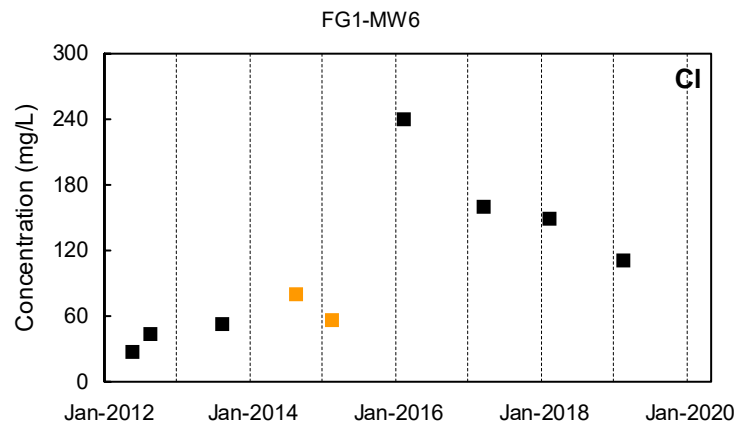
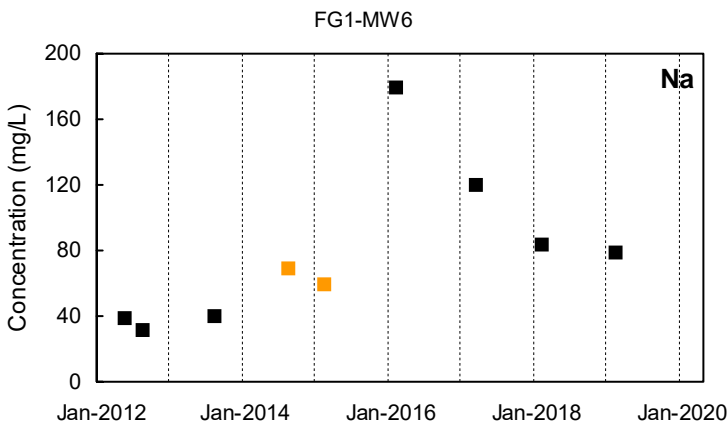

Detected Value
 'J'-Flag (value between reporting limit and detection limit)
 Non-Detect Range
 Shallow Well shown with black symbols Deep Well shown with orange symbols "dd" Well shown with blue symbols

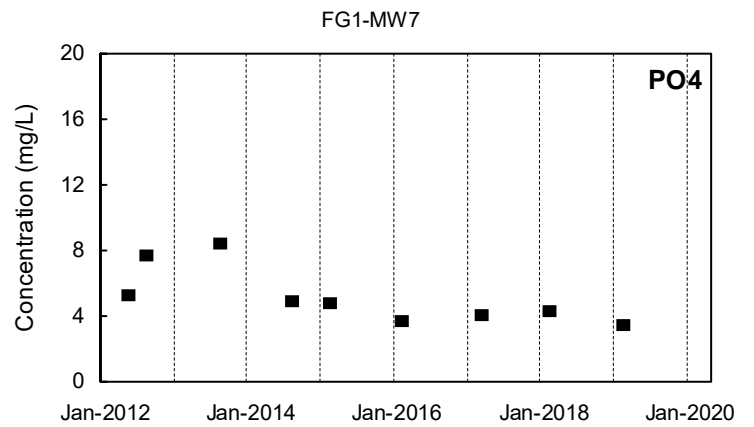
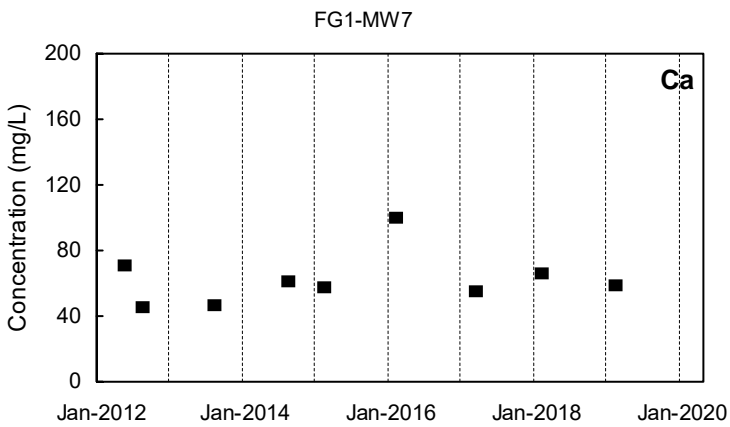
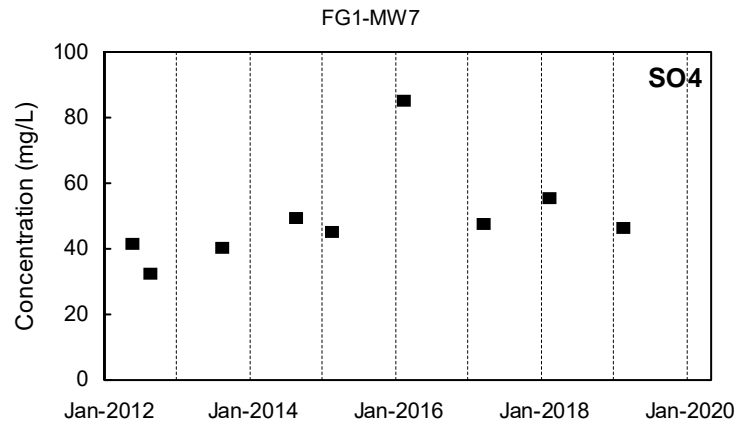
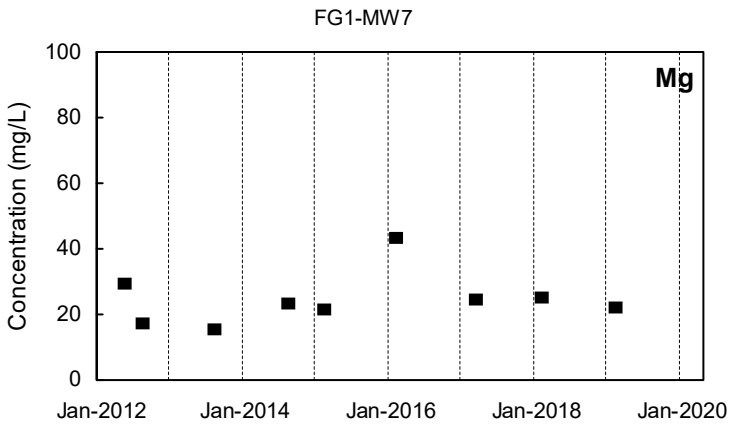
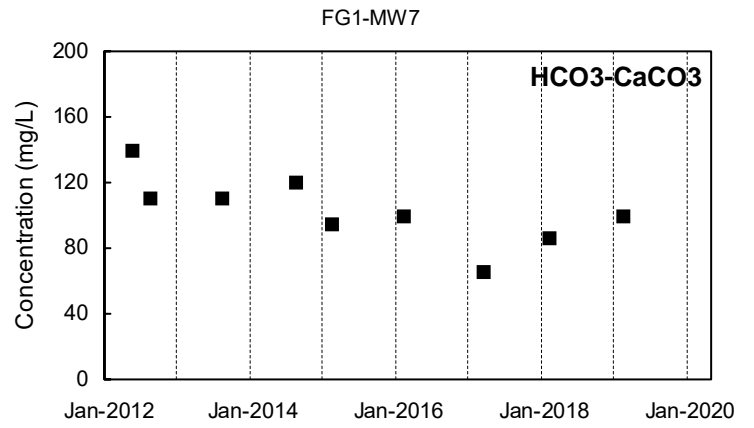
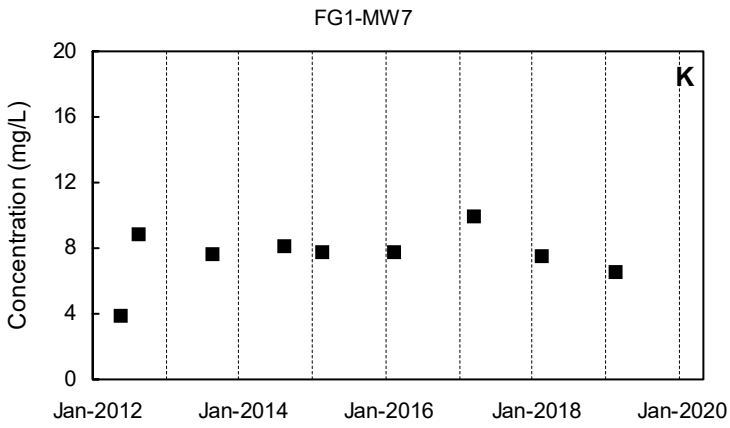
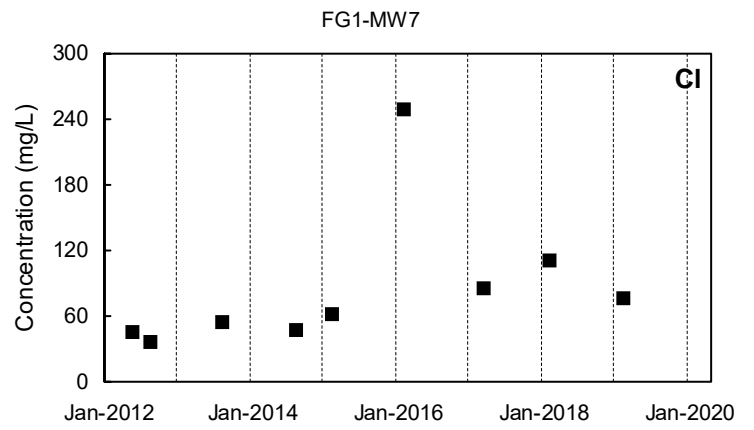
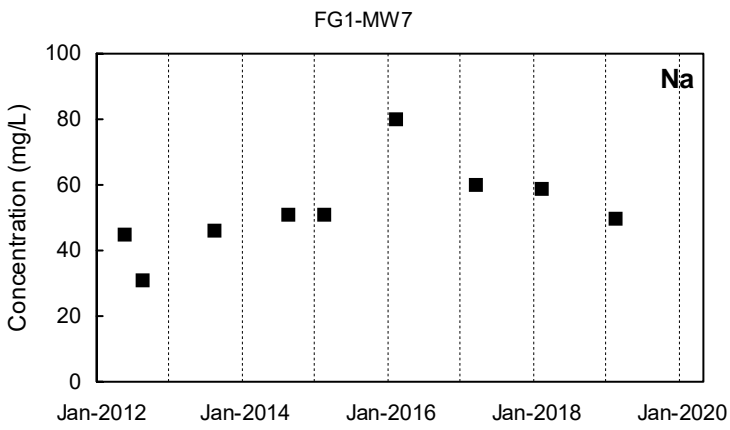

Detected Value
 'J'-Flag (value between reporting limit and detection limit)
 Non-Detect Range
 Shallow Well shown with black symbols
 Deep Well shown with orange symbols
 "dd" Well shown with blue symbols

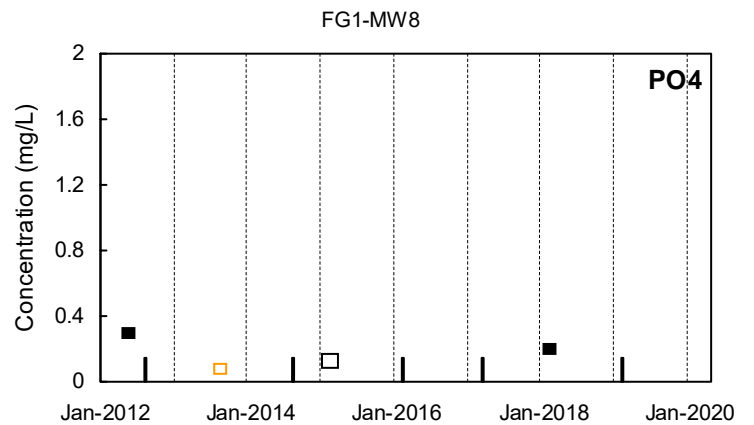
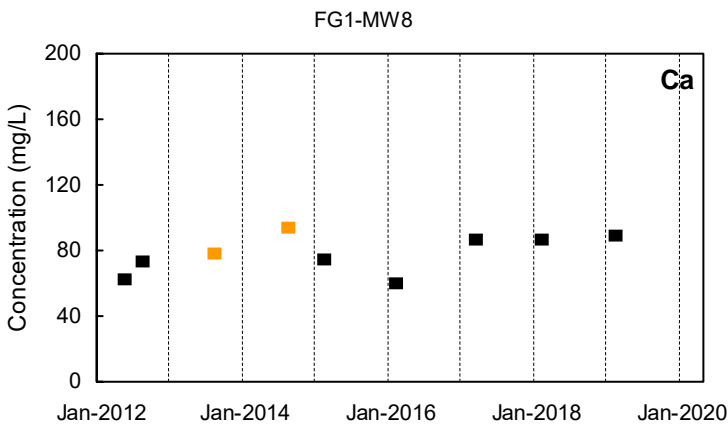
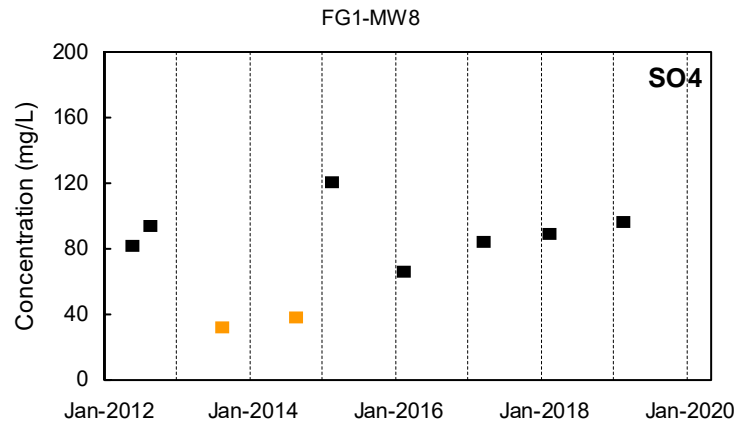
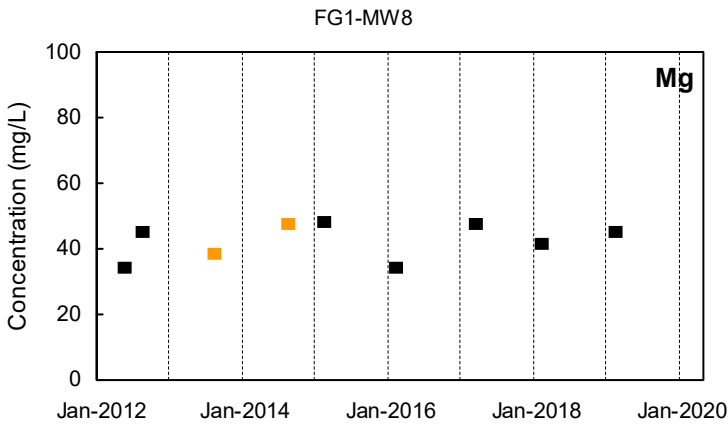
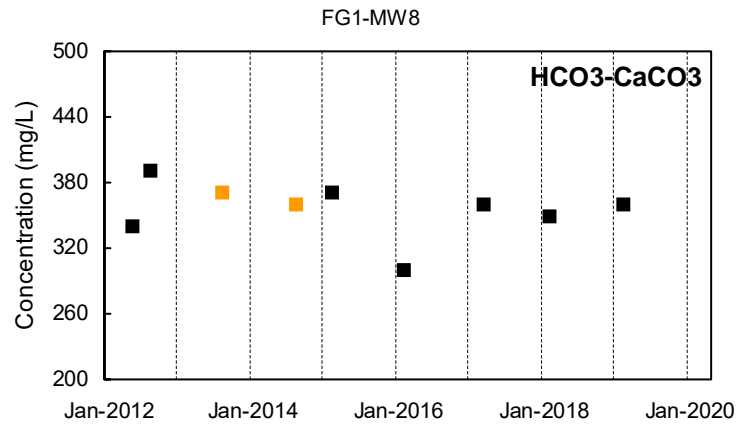
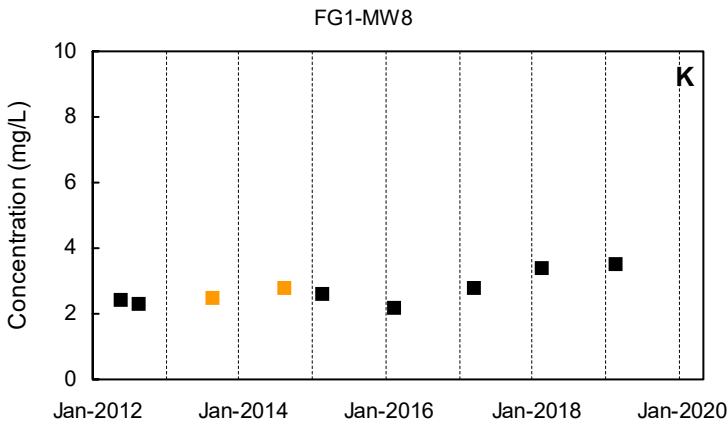
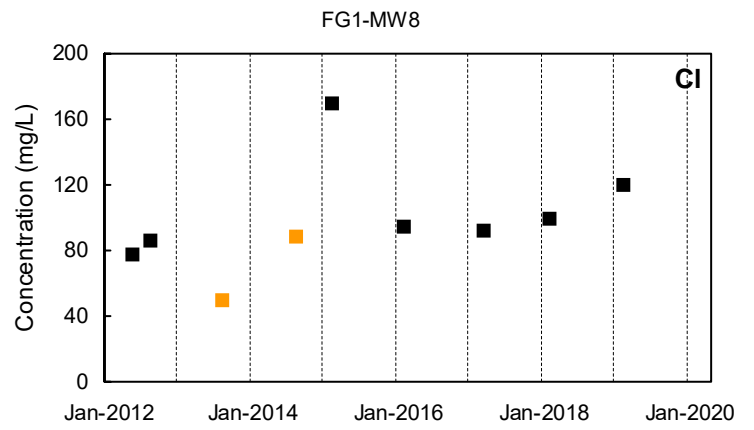
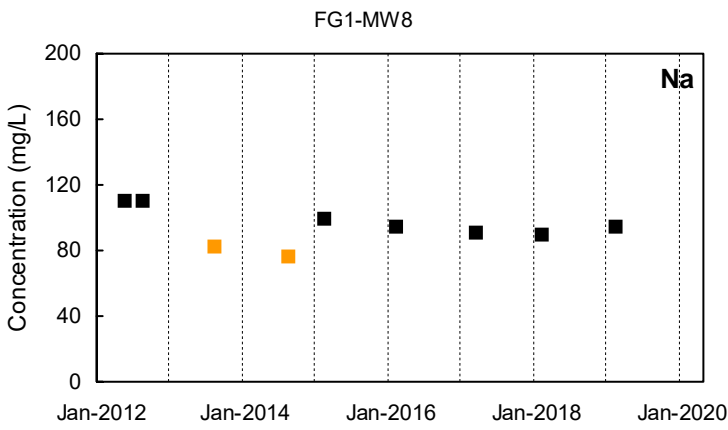

Detected Value
 'J'-Flag (value between reporting limit and detection limit)
 Non-Detect Range
 Shallow Well shown with black symbols Deep Well shown with orange symbols "dd" Well shown with blue symbols

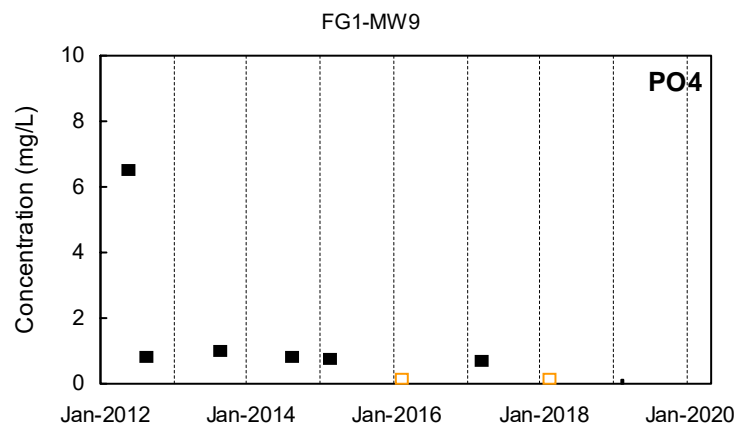
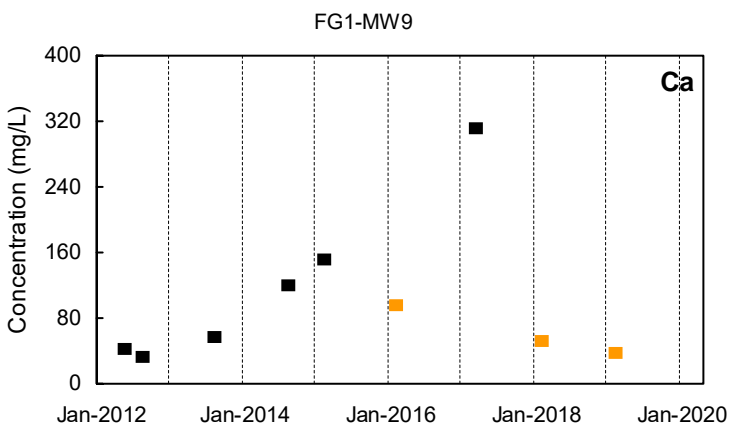
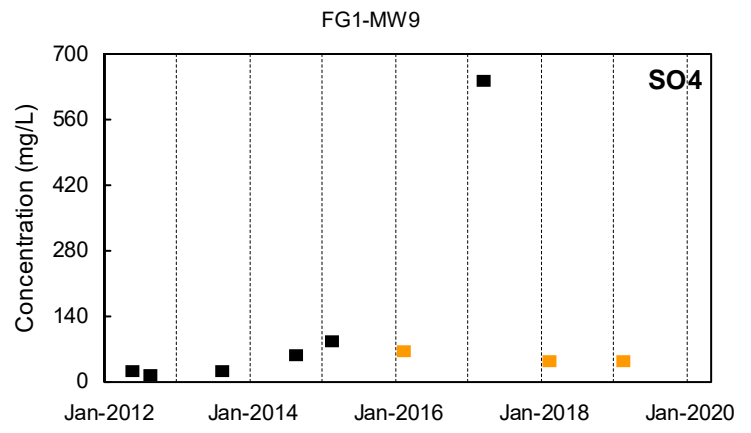
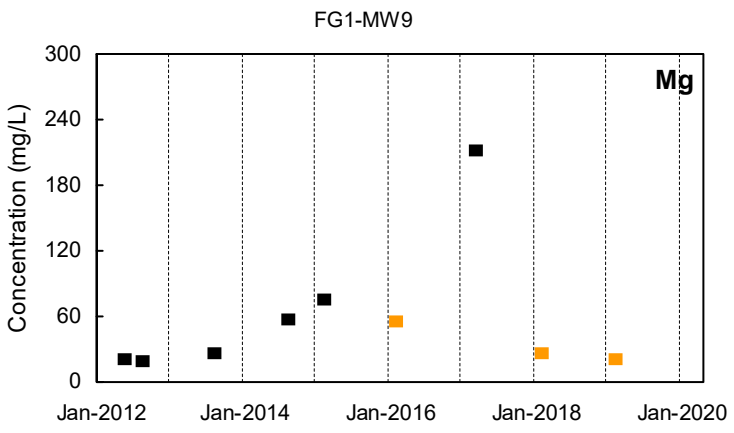
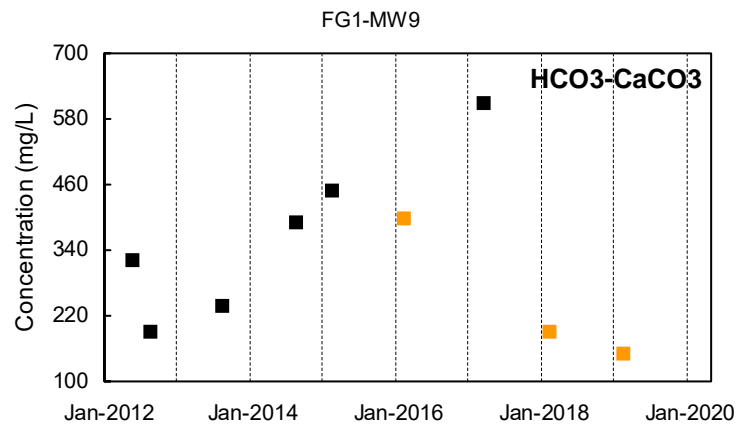
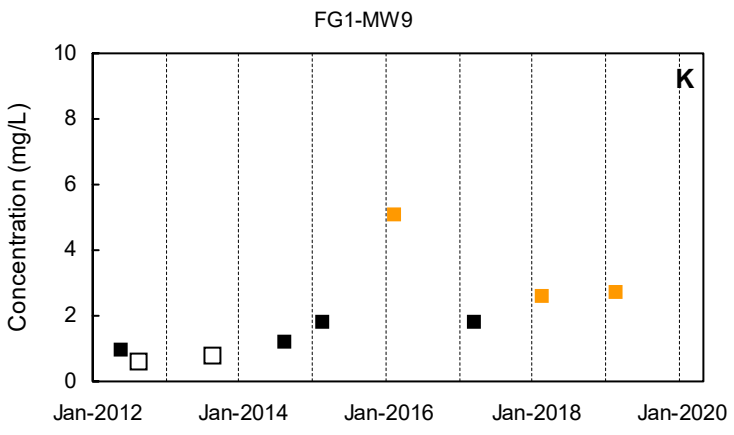
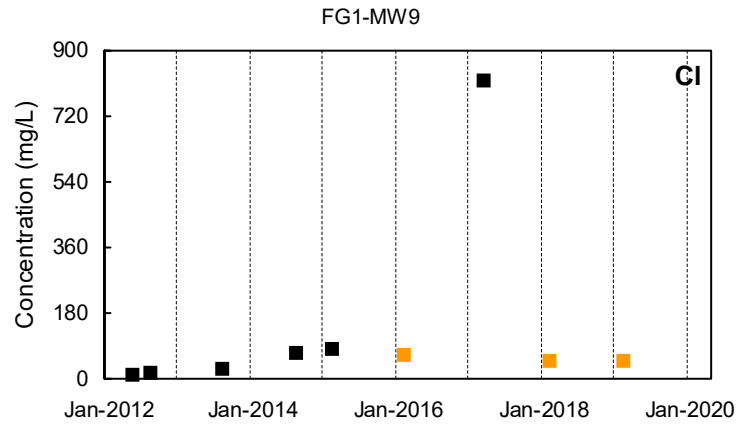
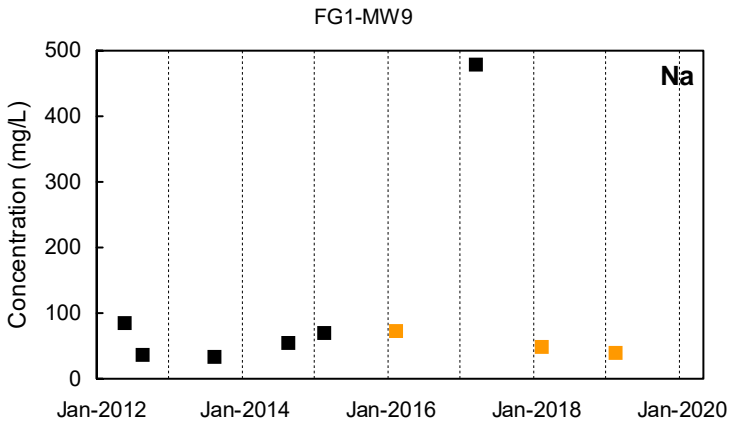

Detected Value
 'J'-Flag (value between reporting limit and detection limit)
 Non-Detect Range
 Shallow Well shown with black symbols
 Deep Well shown with orange symbols
 "dd" Well shown with blue symbols

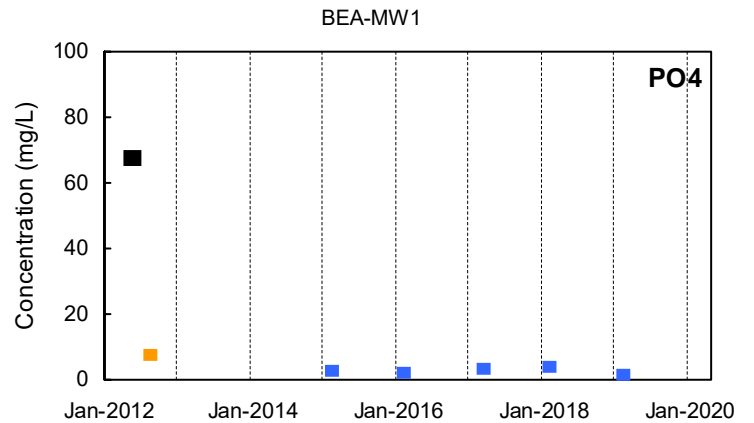
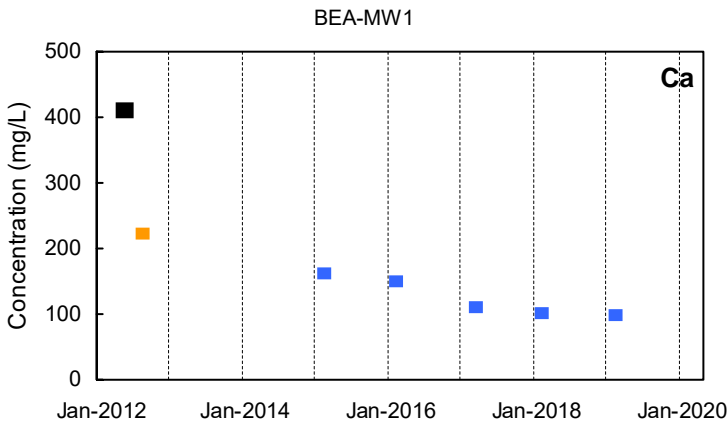
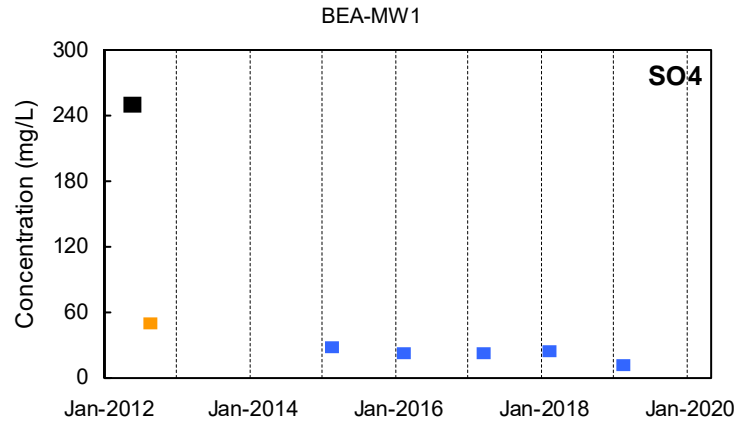
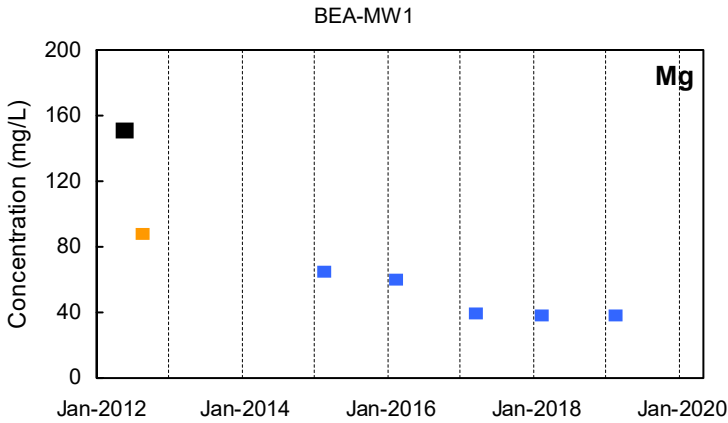
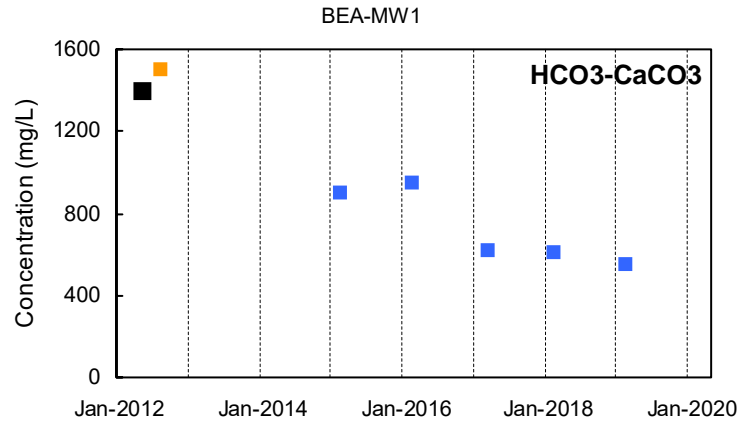
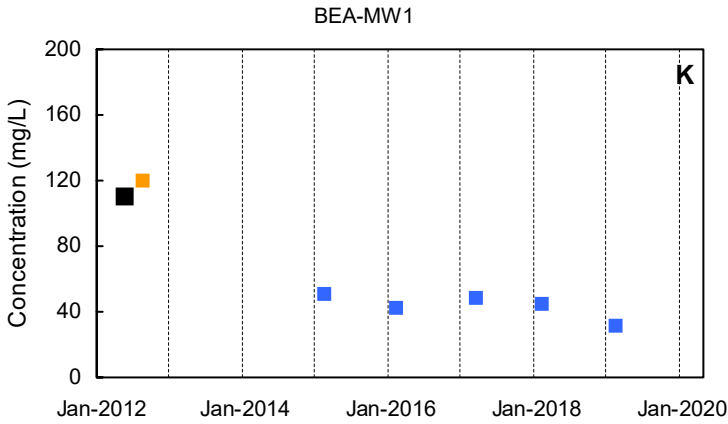
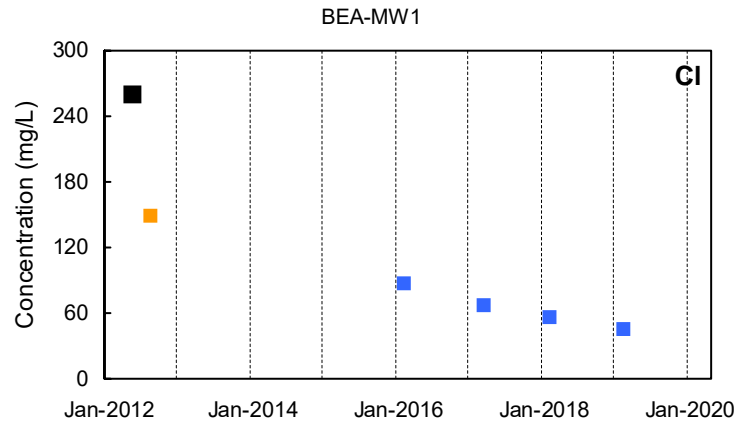
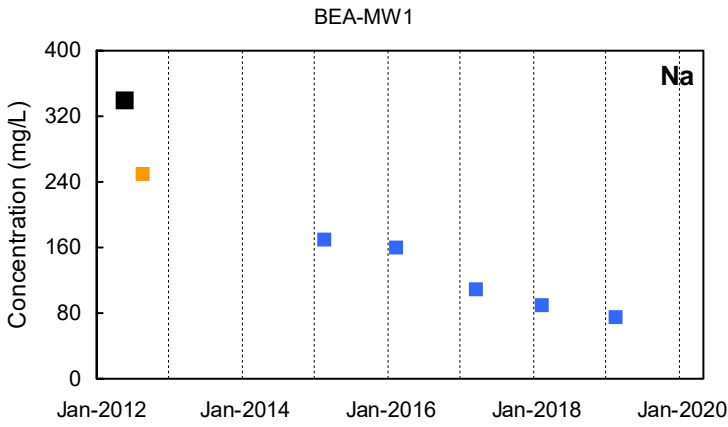

Detected Value
 'J'-Flag (value between reporting limit and detection limit)
 Non-Detect Range
 Shallow Well shown with black symbols
 Deep Well shown with orange symbols
 "dd" Well shown with blue symbols

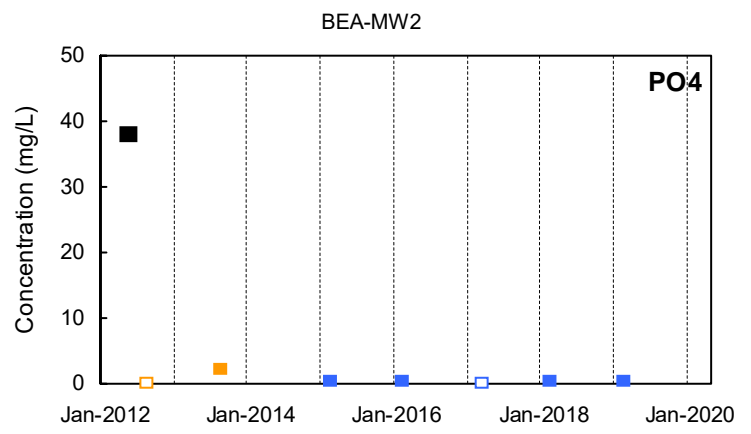
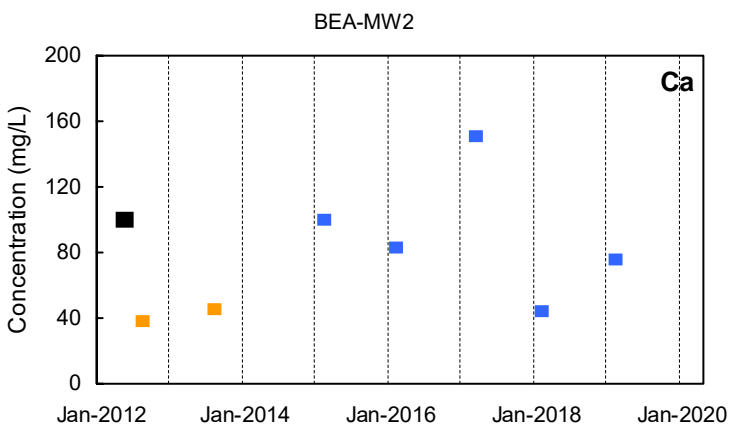
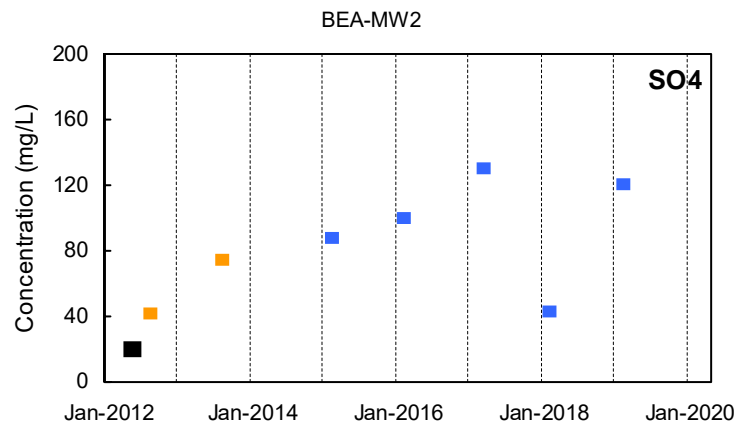
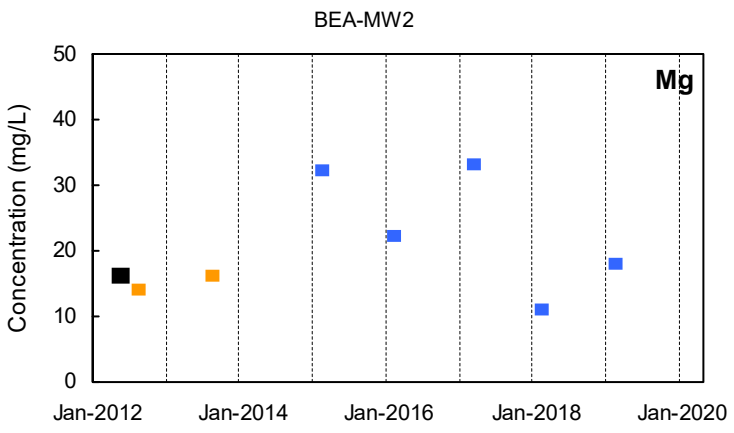
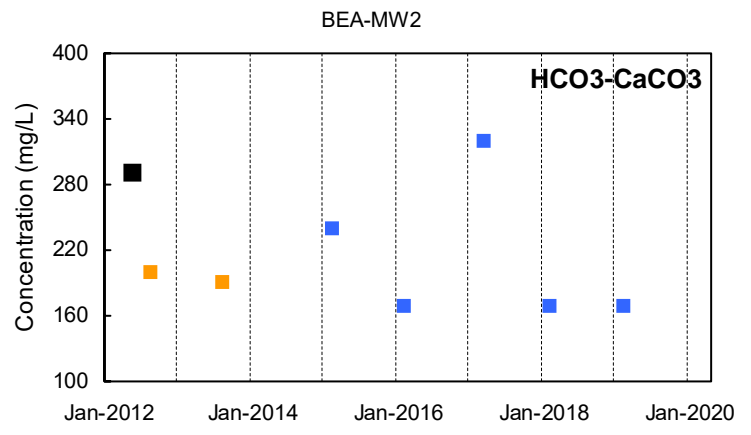
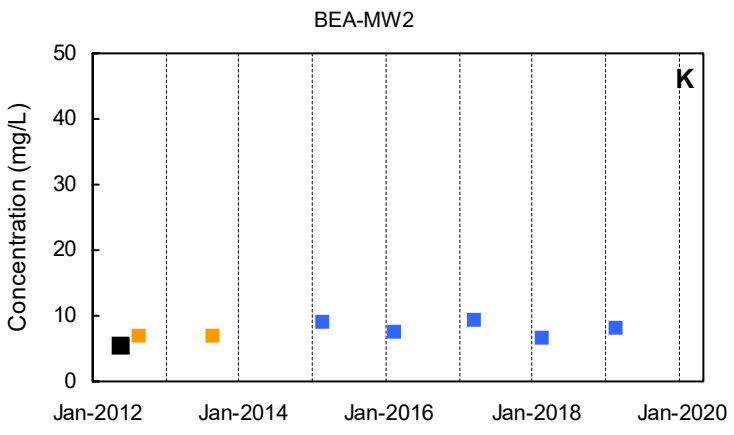
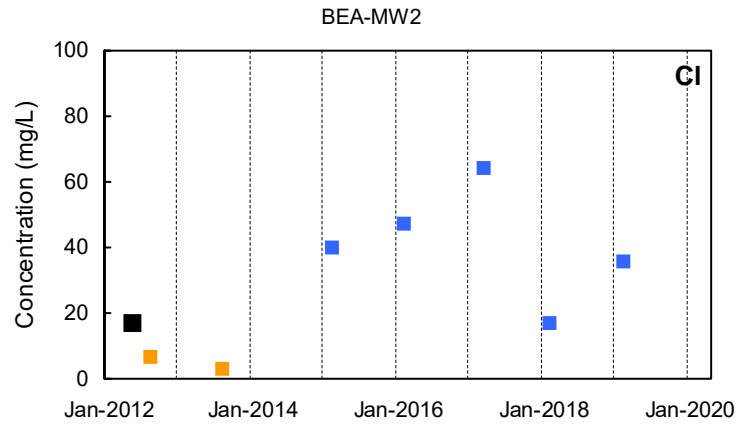
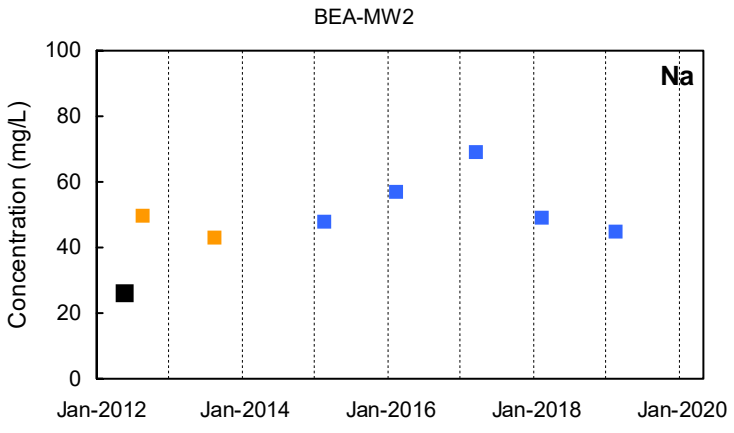

Detected Value
 'J'-Flag (value between reporting limit and detection limit)
 Non-Detect Range
 Shallow Well shown with black symbols
 Deep Well shown with orange symbols
 "dd" Well shown with blue symbols

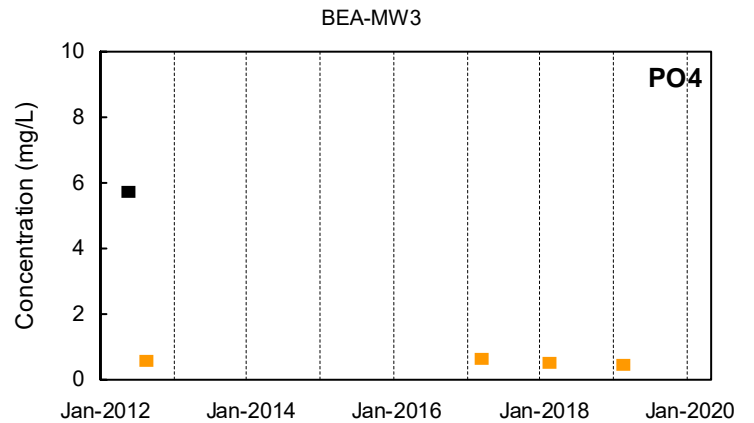
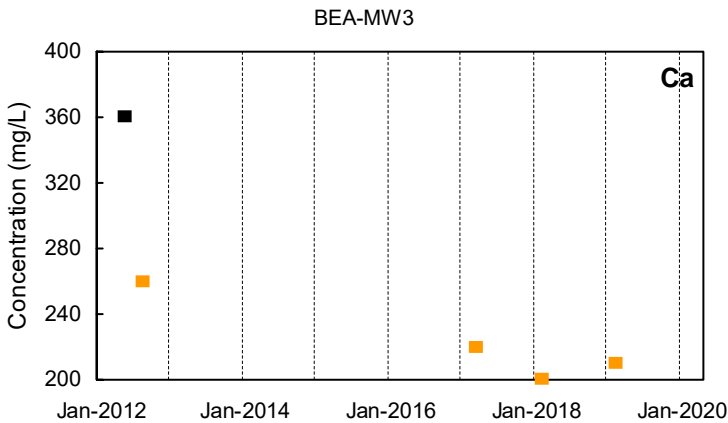
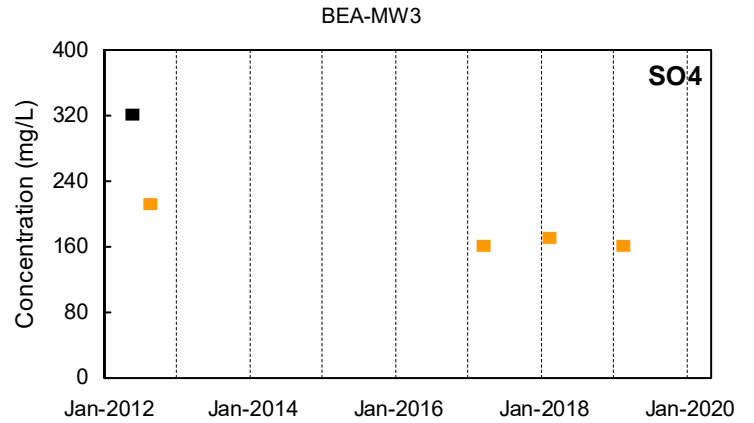
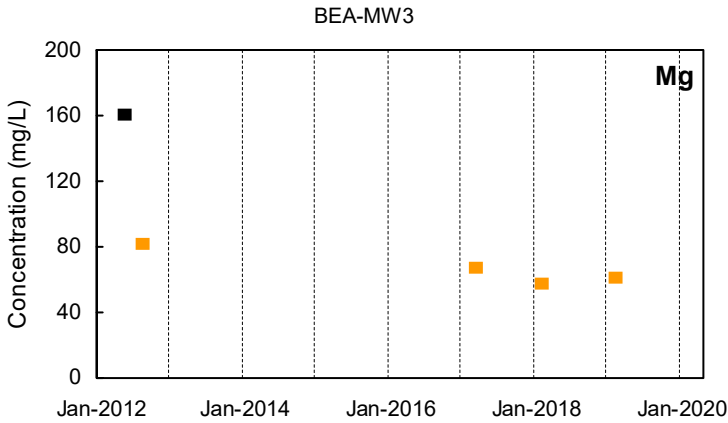
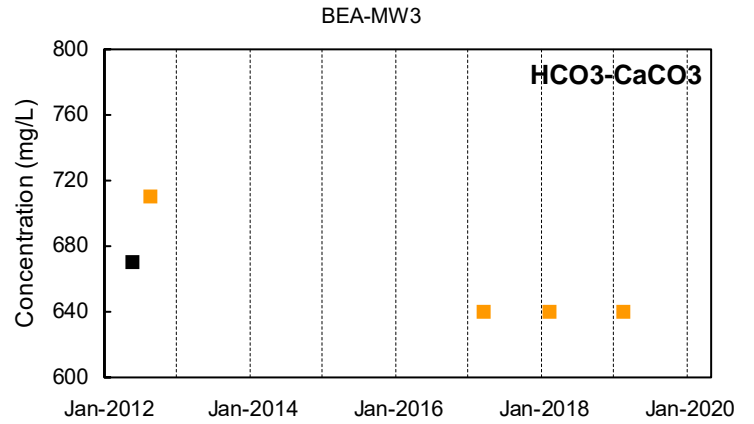
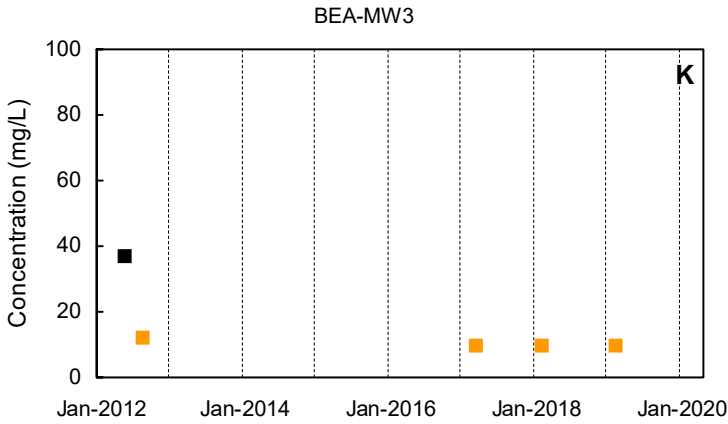
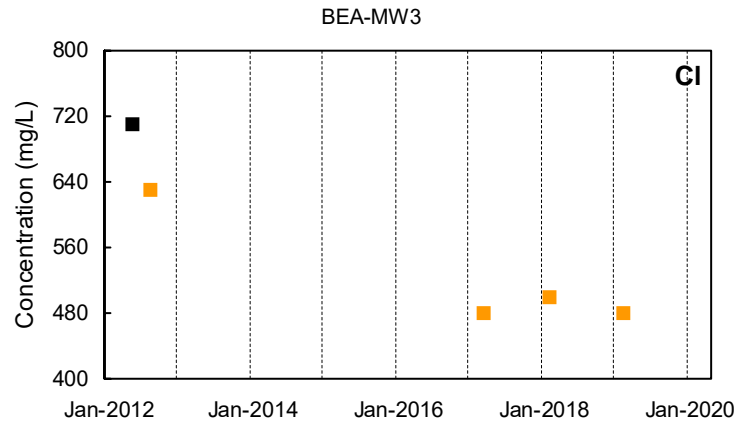
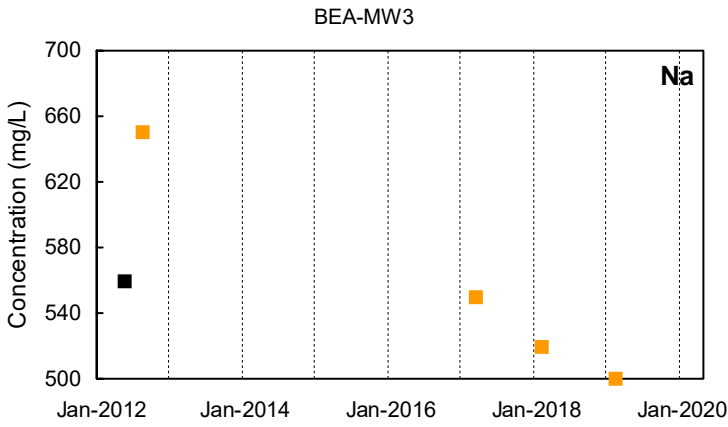

Detected Value
 'J'-Flag (value between reporting limit and detection limit)
 Non-Detect Range

Shallow Well shown with black symbols
Deep Well shown with orange symbols
"dd" Well shown with blue symbols

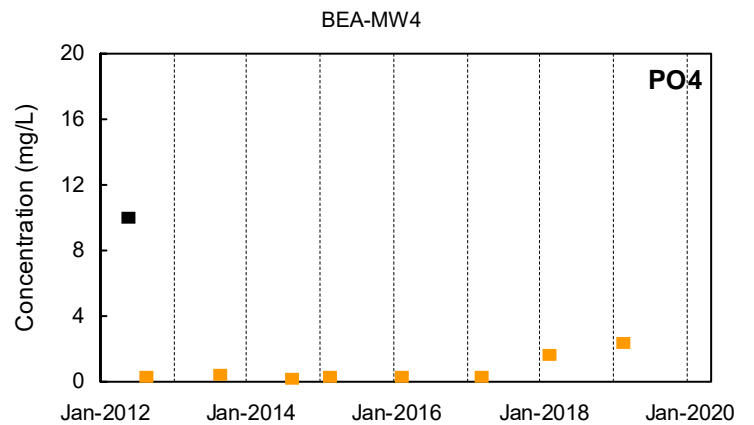
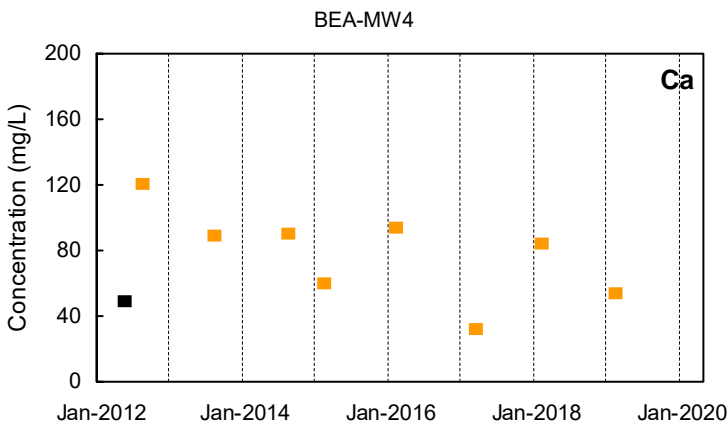
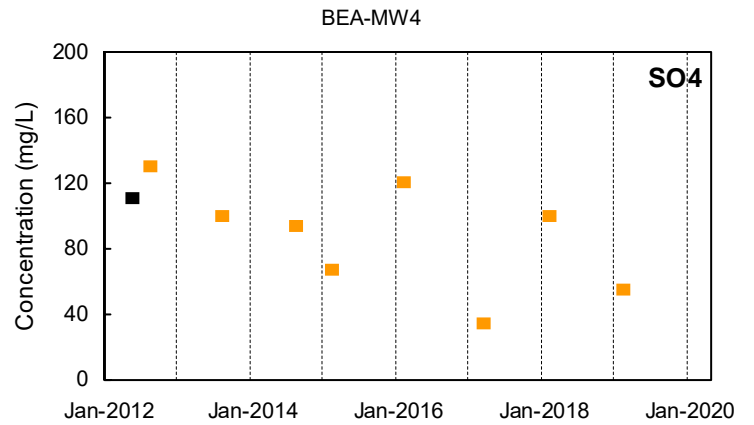
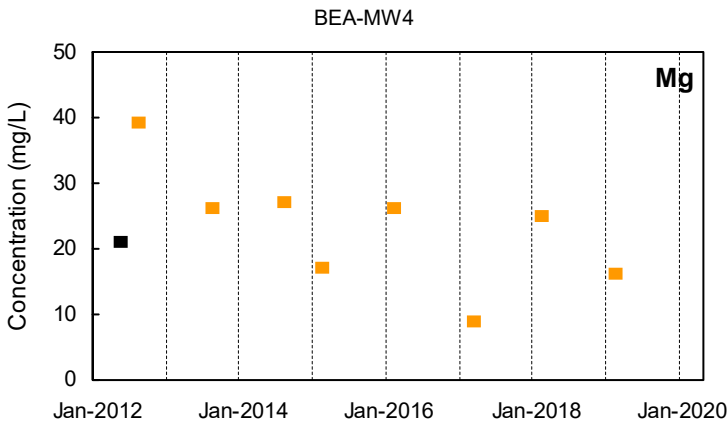
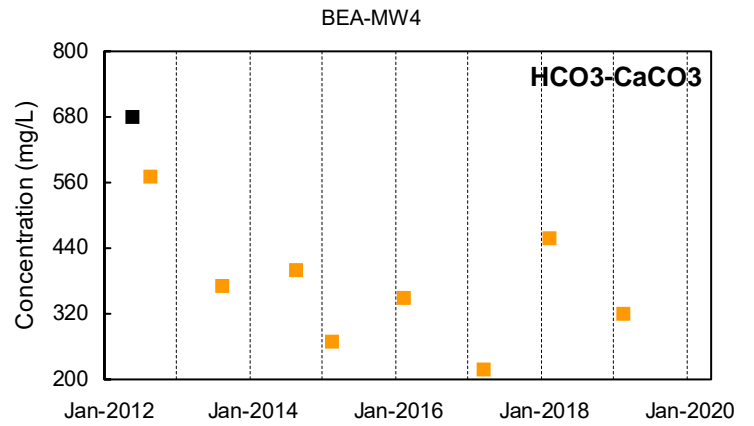
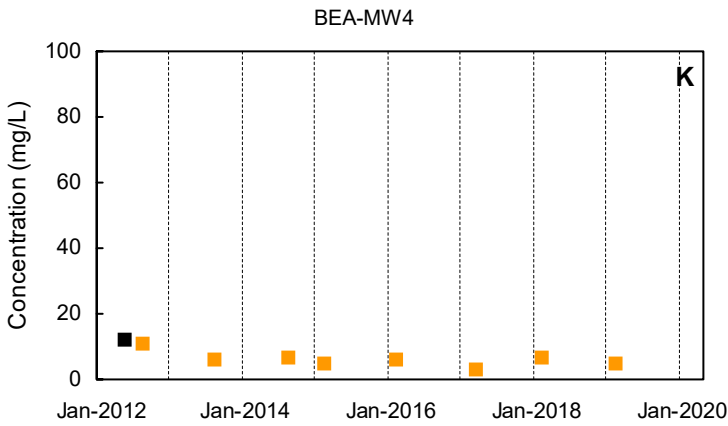
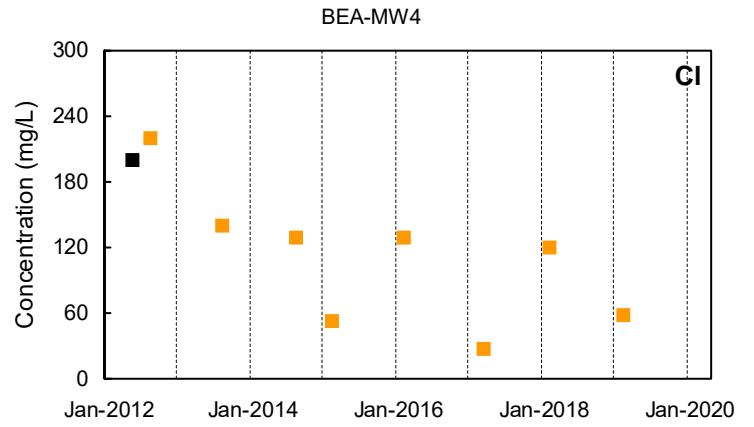
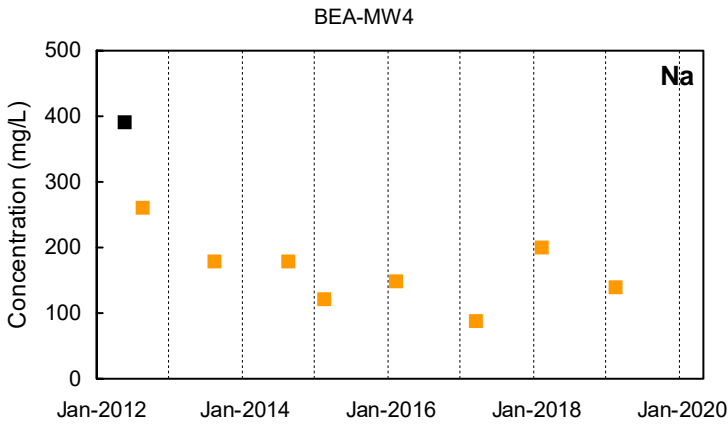

Detected Value
 'J'-Flag (value between reporting limit and detection limit)
 Non-Detect Range

Shallow Well shown with black symbols
Deep Well shown with orange symbols
"dd" Well shown with blue symbols

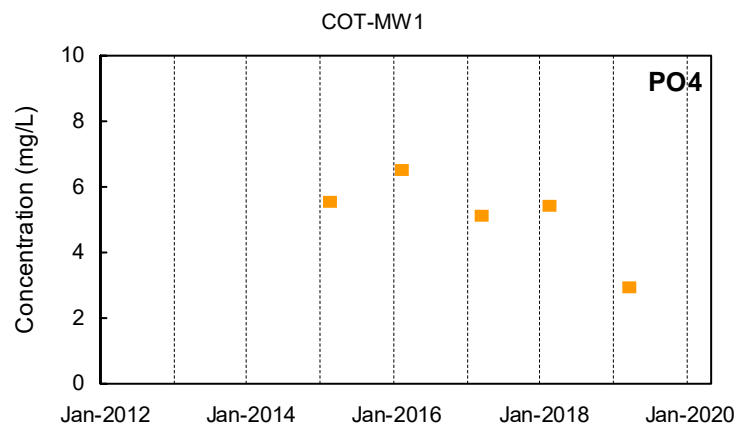
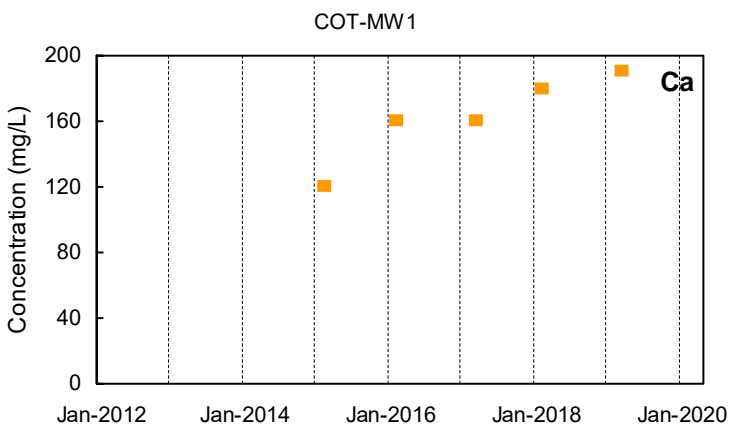
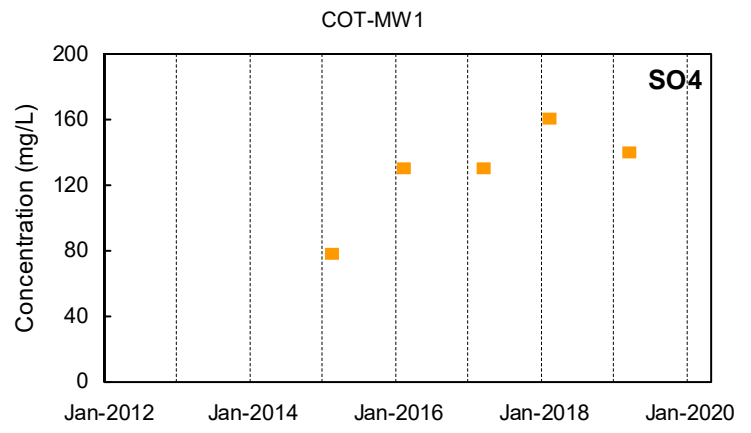
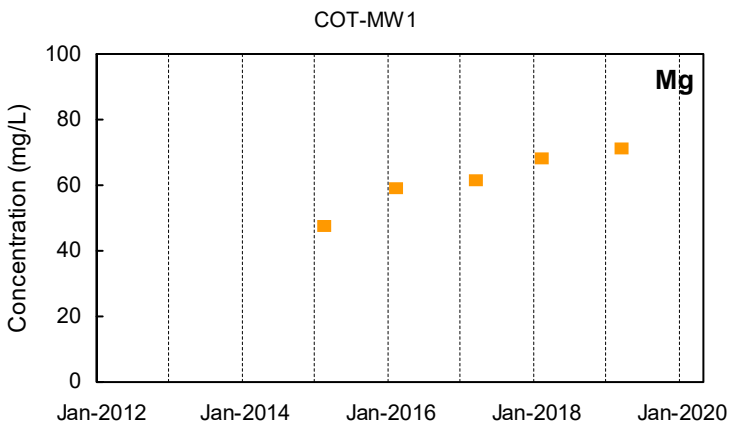
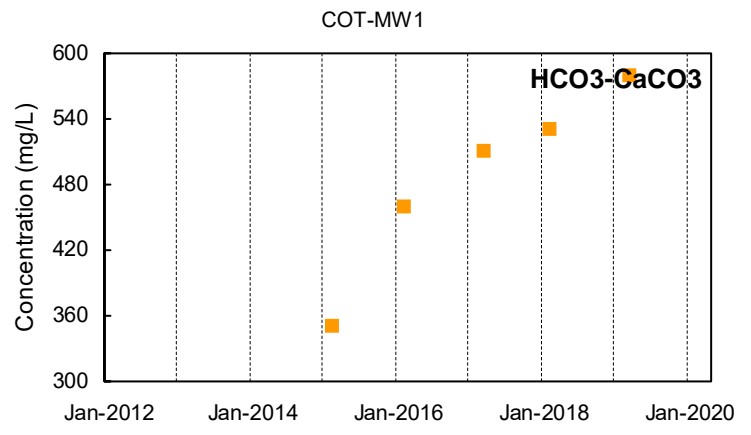
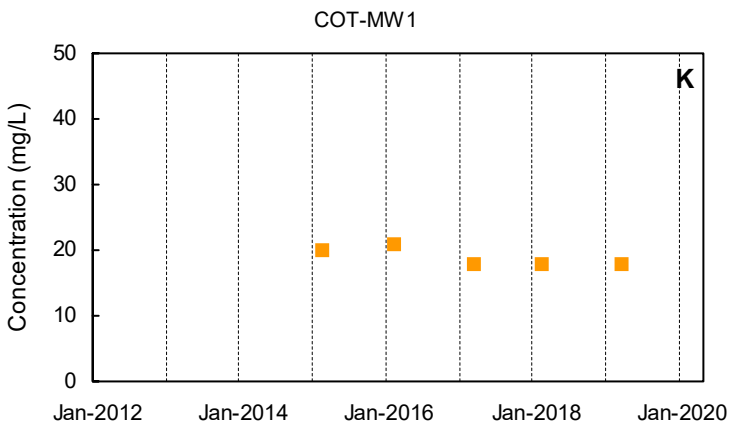
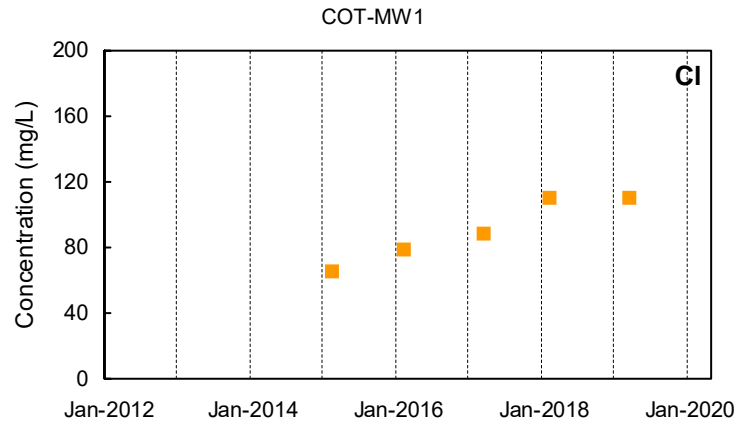
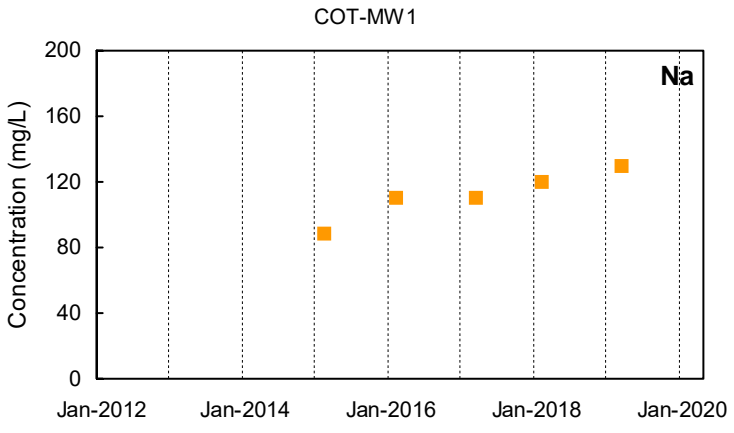

■ Detected Value
 □ 'J'-Flag (value between reporting limit and detection limit)
 Non-Detect Range
 Shallow Well shown with black symbols
 Deep Well shown with orange symbols
 "dd" Well shown with blue symbols

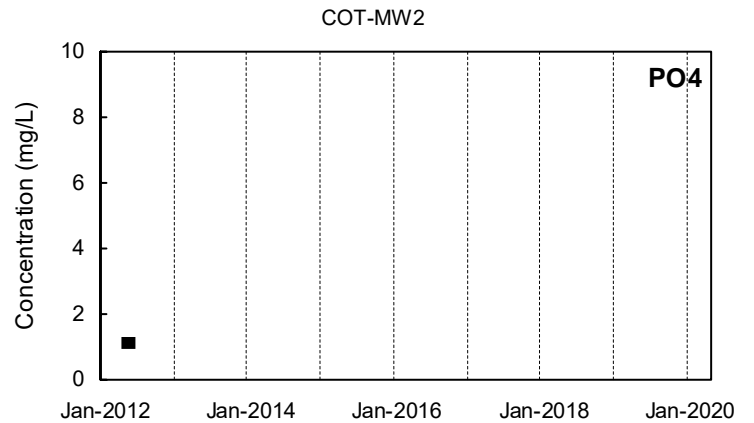
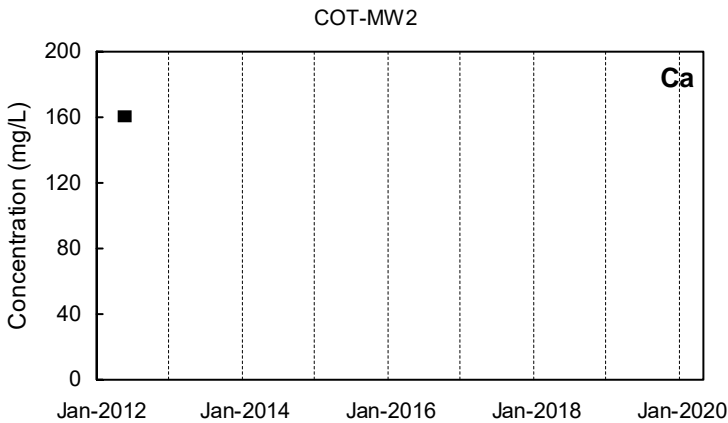
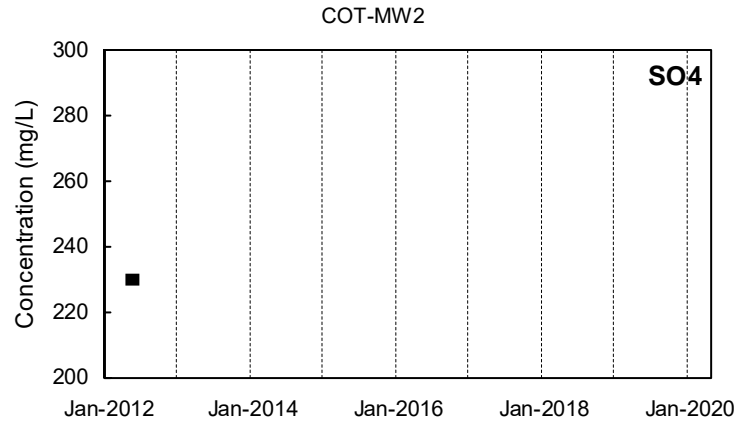
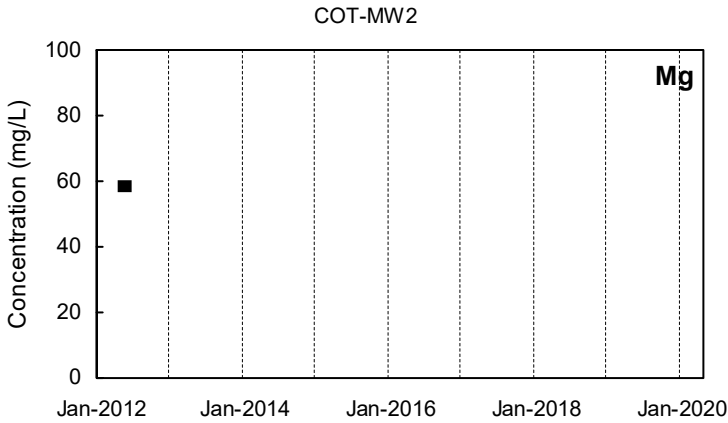
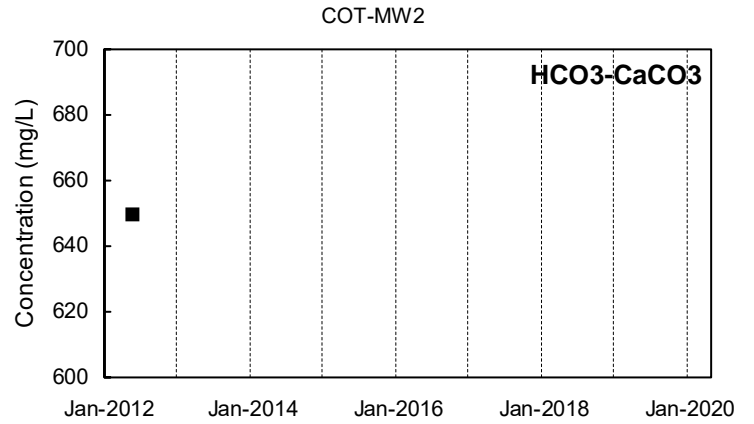
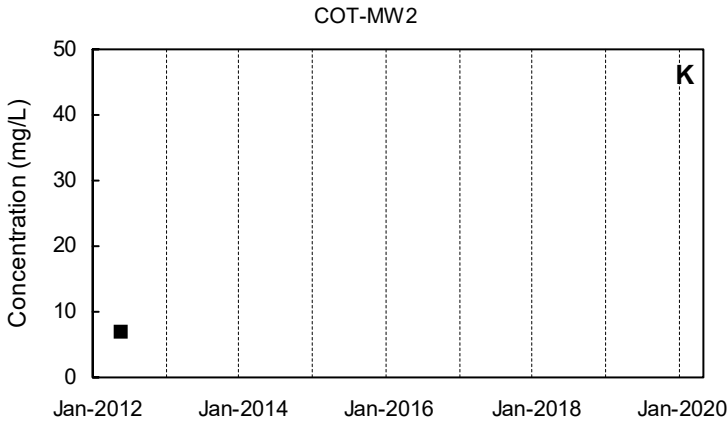
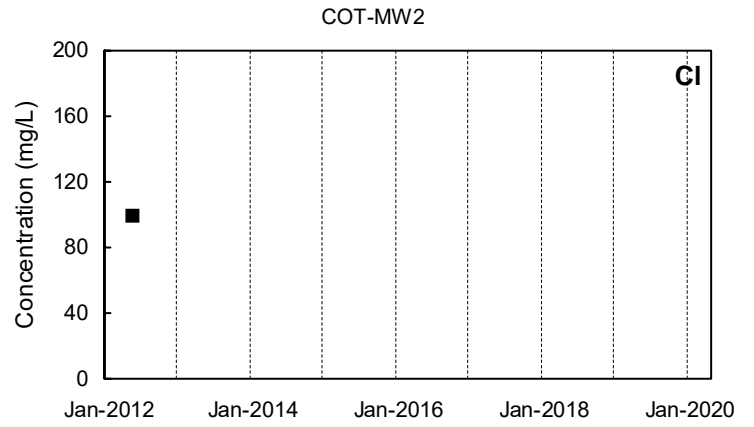
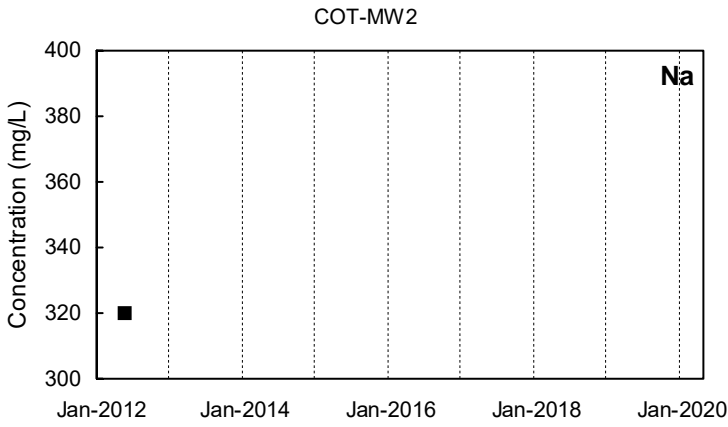

Detected Value
 'J'-Flag (value between reporting limit and detection limit)
 Non-Detect Range
 Shallow Well shown with black symbols
 Deep Well shown with orange symbols
 "dd" Well shown with blue symbols

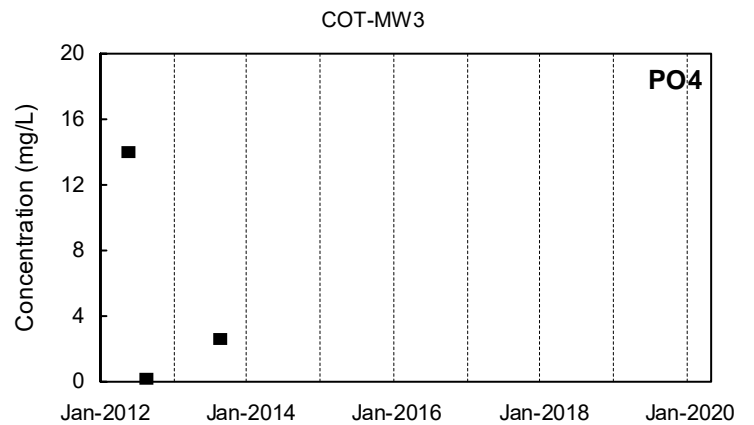
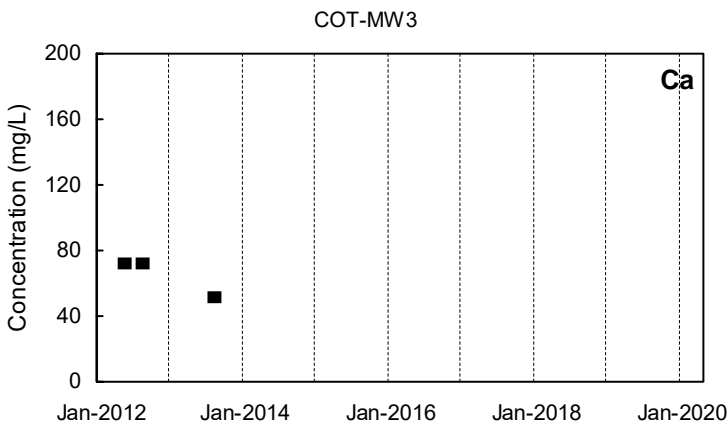
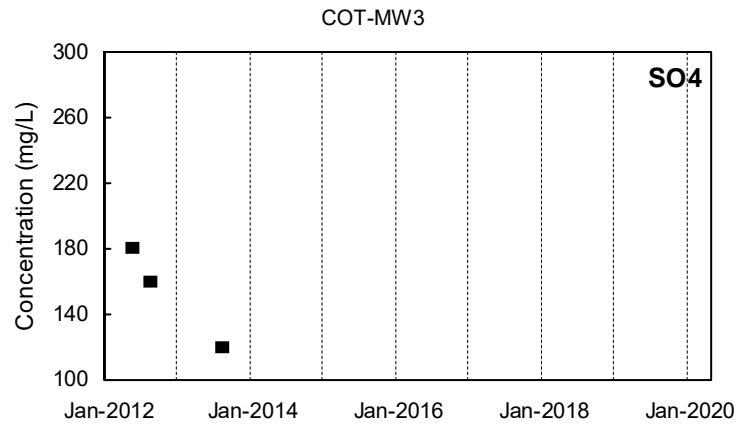
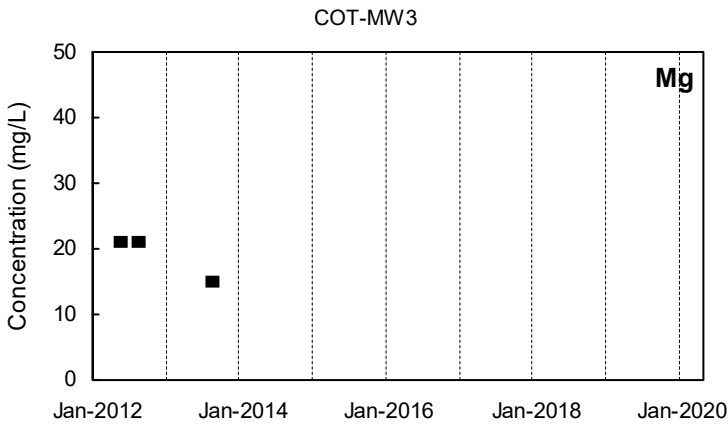
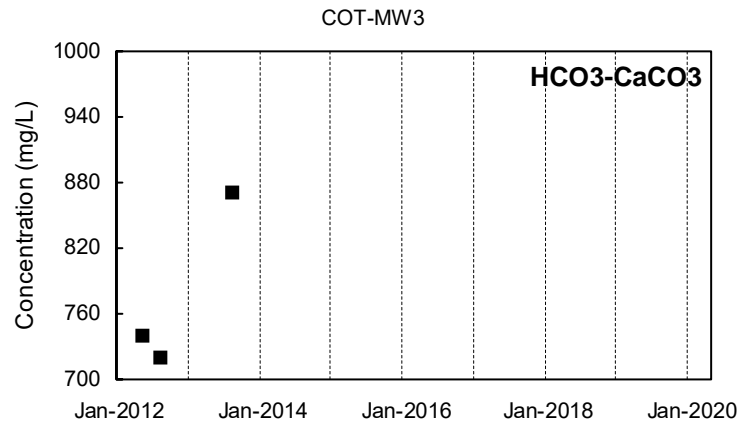
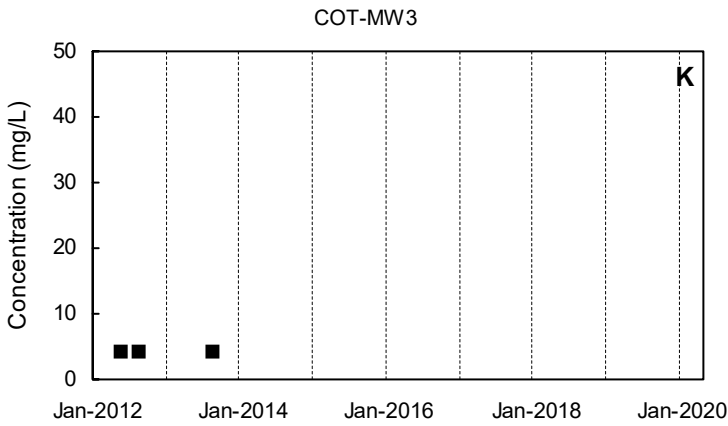
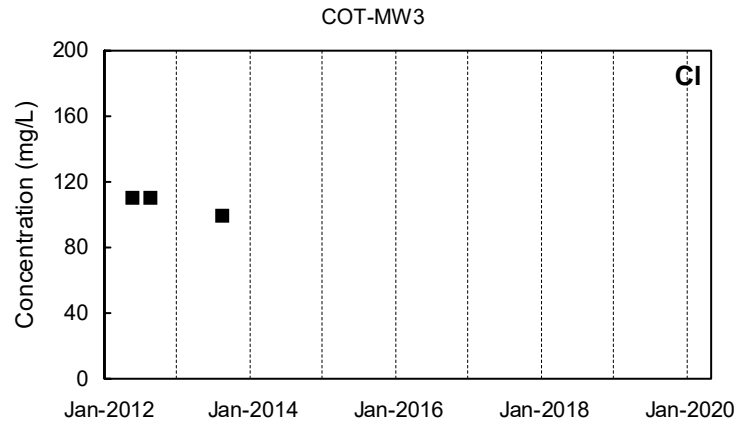
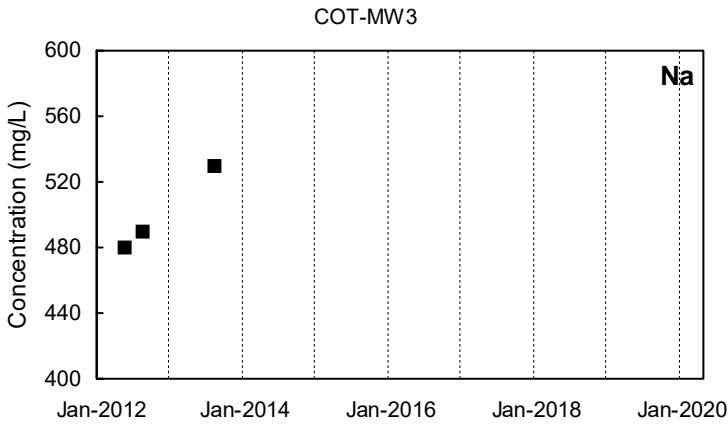

Detected Value
 'J'-Flag (value between reporting limit and detection limit)
 Non-Detect Range
 Shallow Well shown with black symbols
 Deep Well shown with orange symbols
 "dd" Well shown with blue symbols

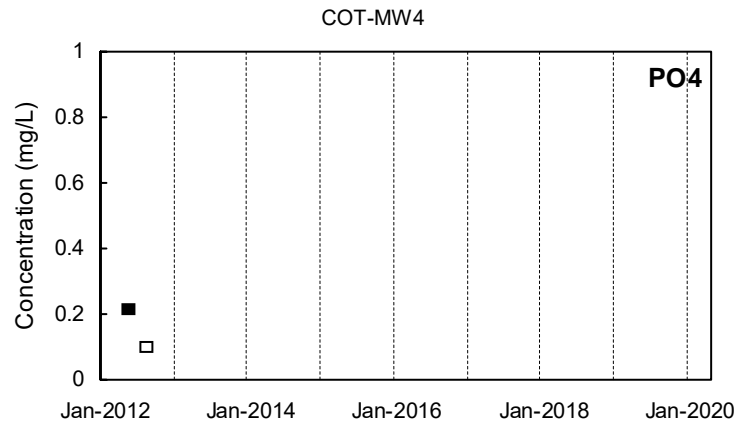
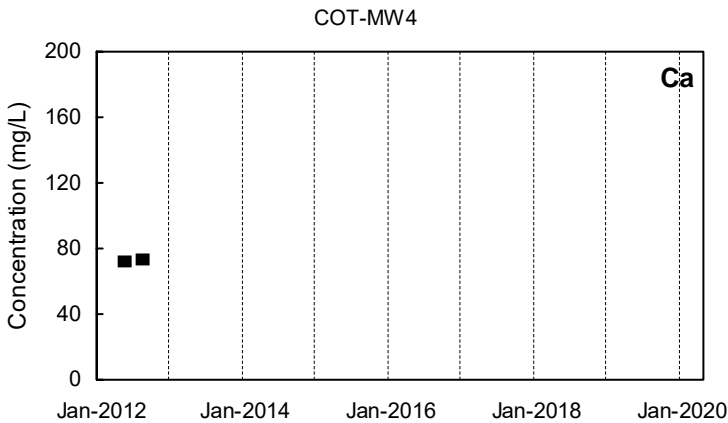
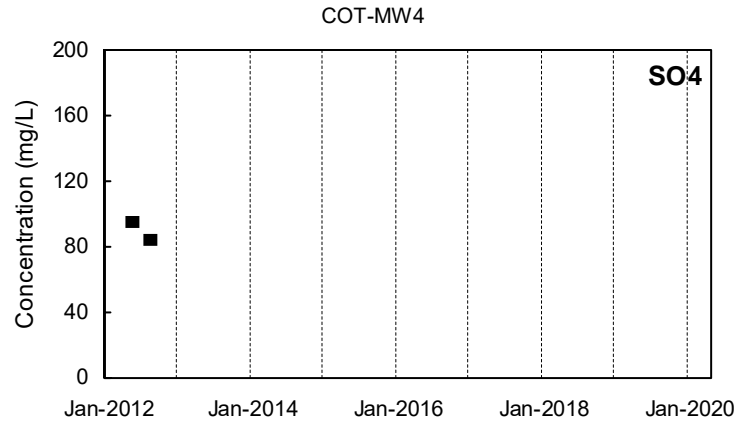
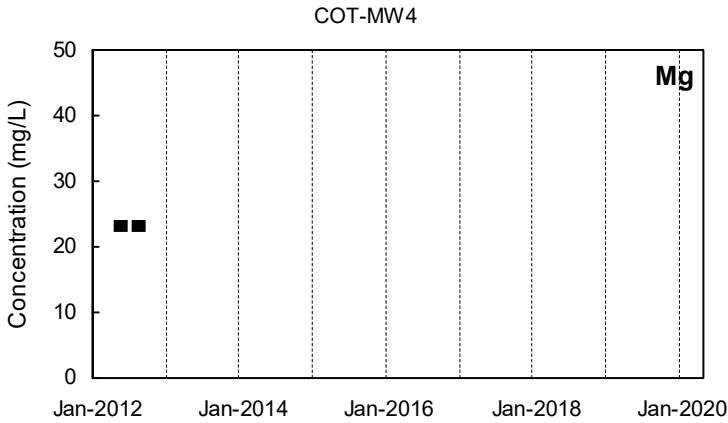
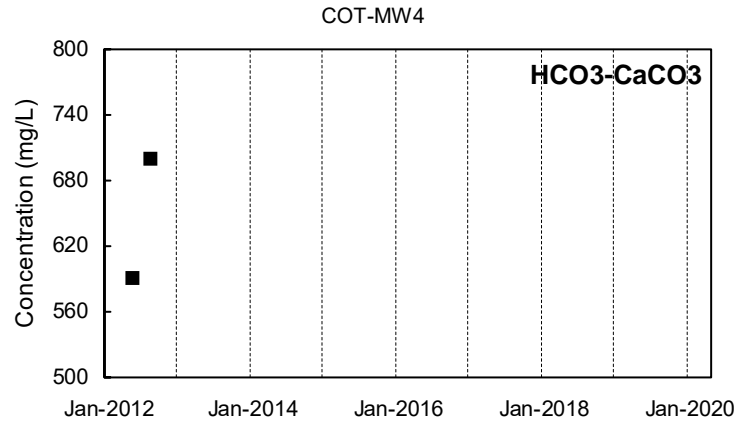
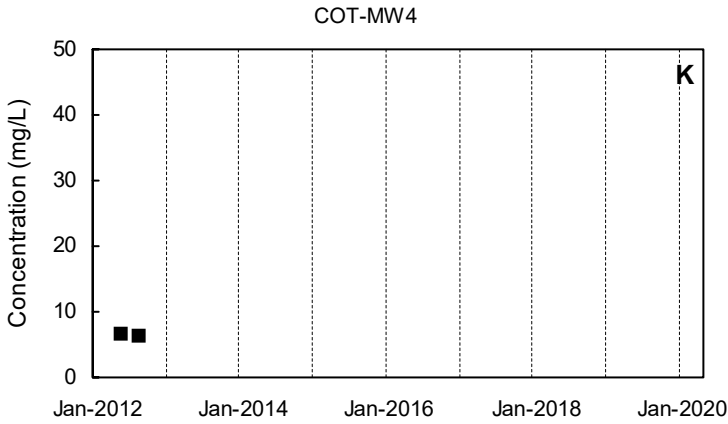
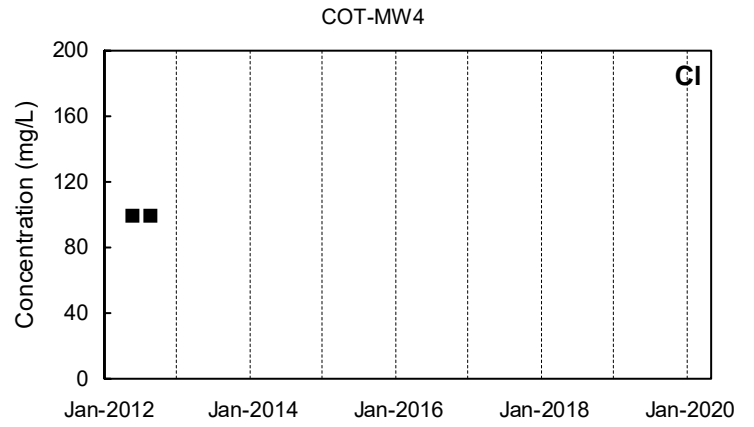
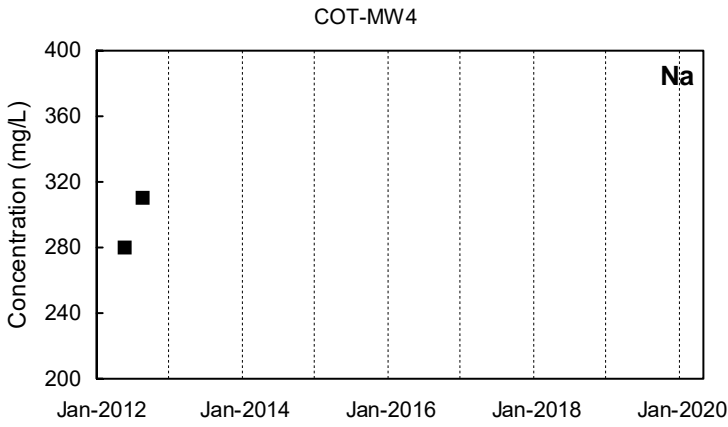

Detected Value
 'J'-Flag (value between reporting limit and detection limit)
 Non-Detect Range
 Shallow Well shown with black symbols
 Deep Well shown with orange symbols
 "dd" Well shown with blue symbols

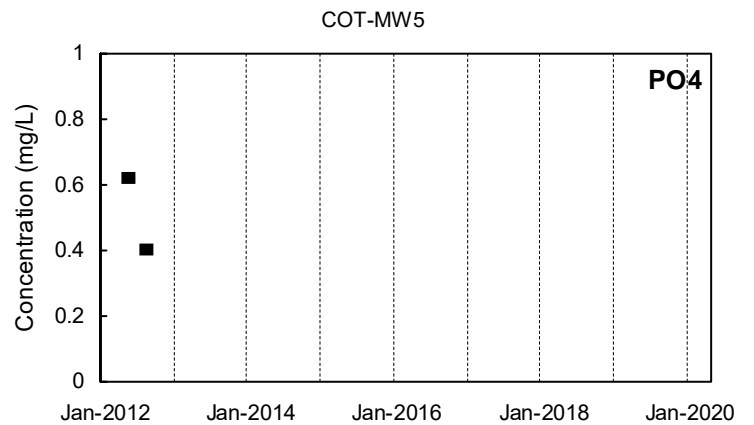
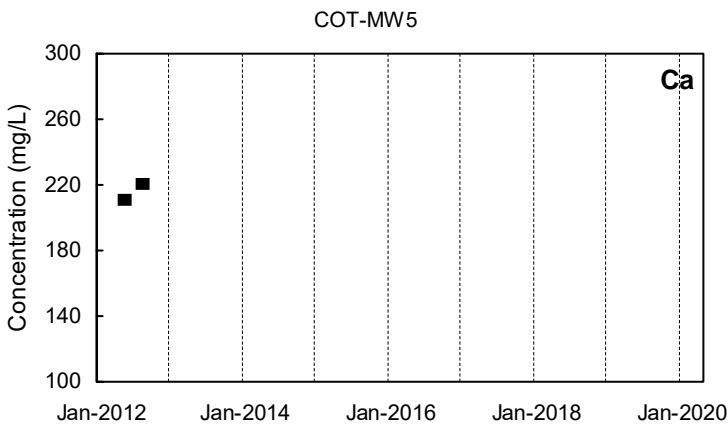
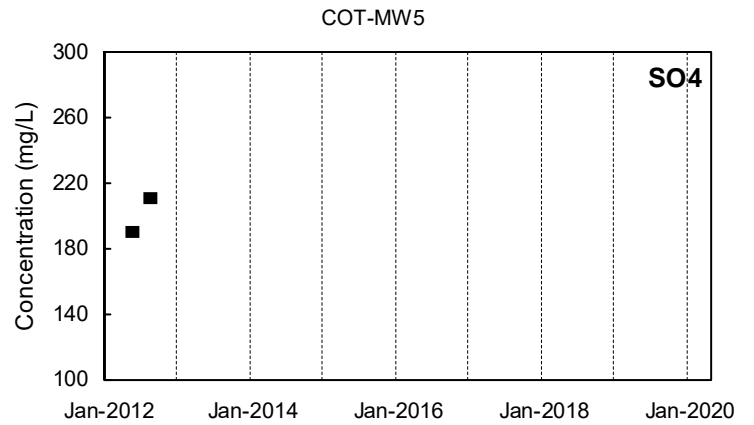
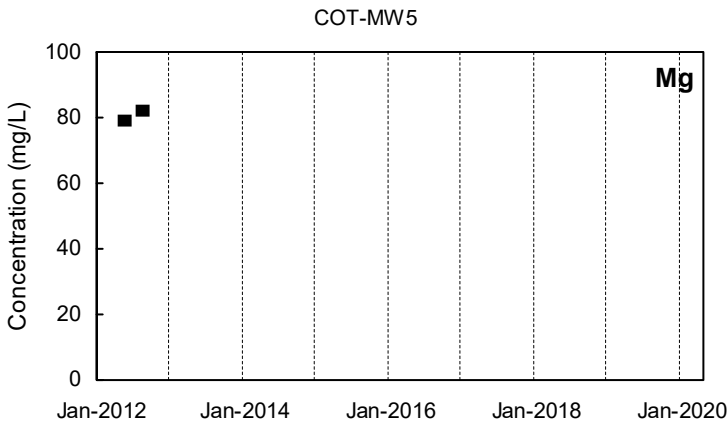
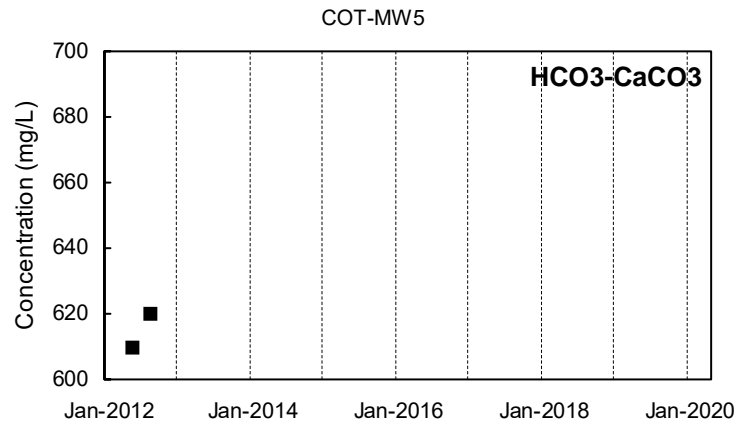
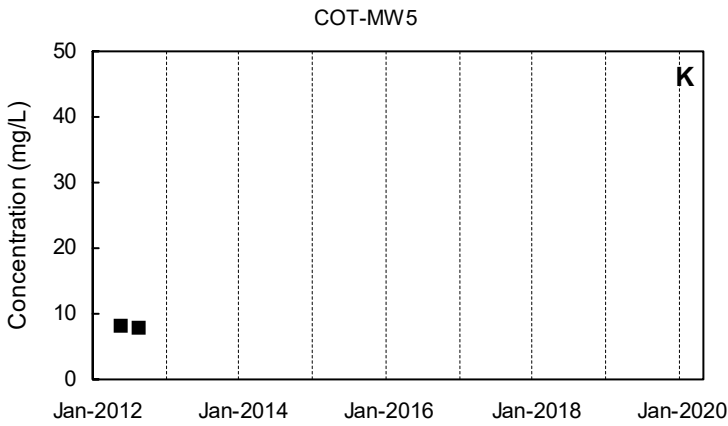
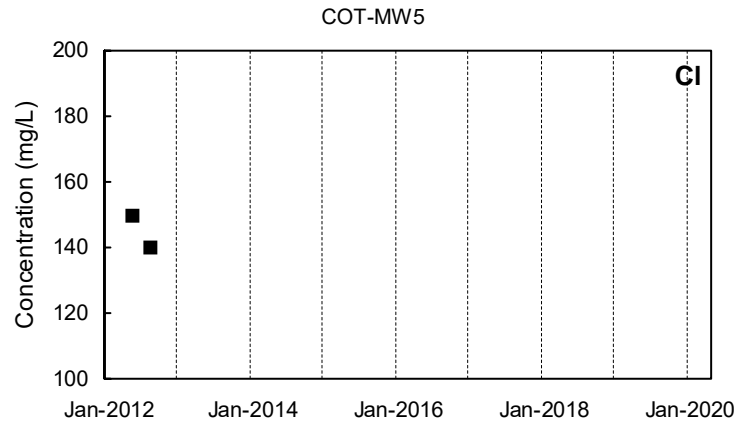
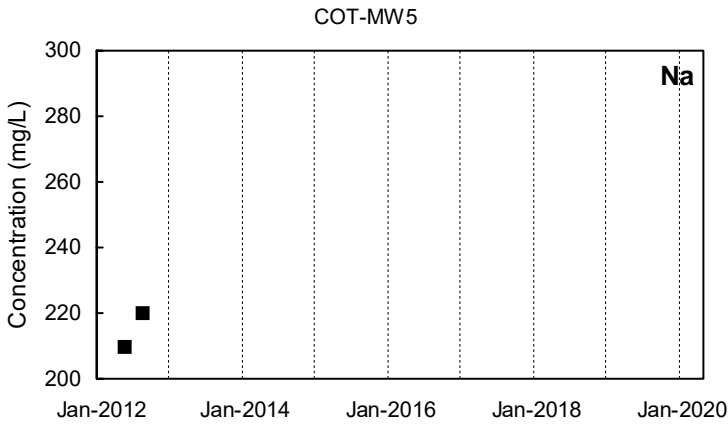

Detected Value
 'J'-Flag (value between reporting limit and detection limit)
 Non-Detect Range
 Shallow Well shown with black symbols Deep Well shown with orange symbols "dd" Well shown with blue symbols

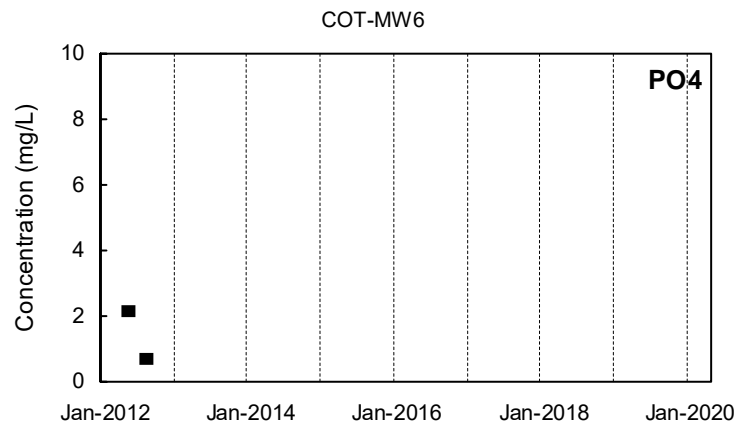
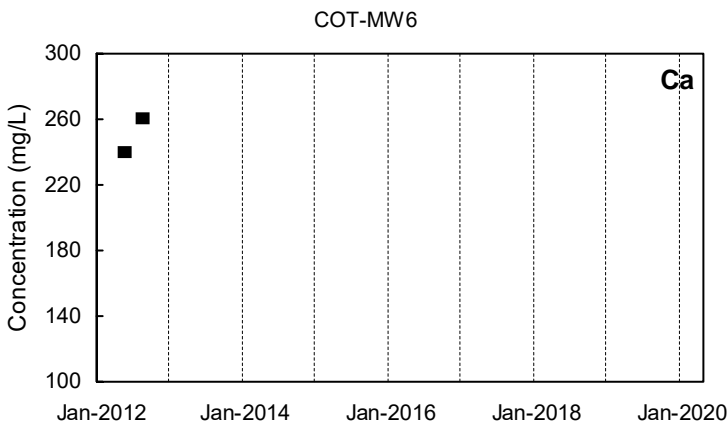
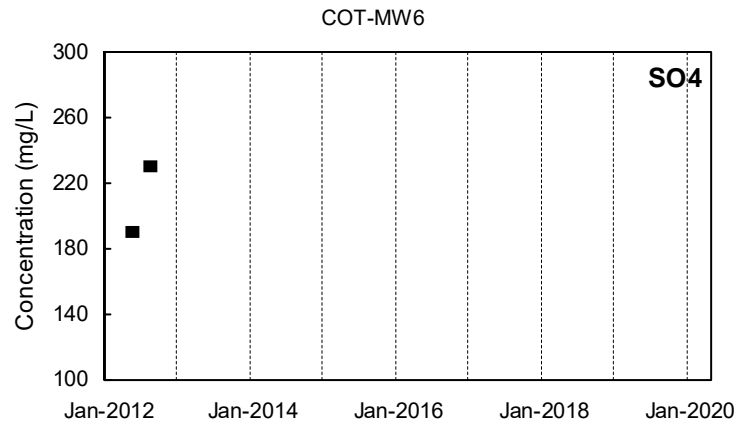
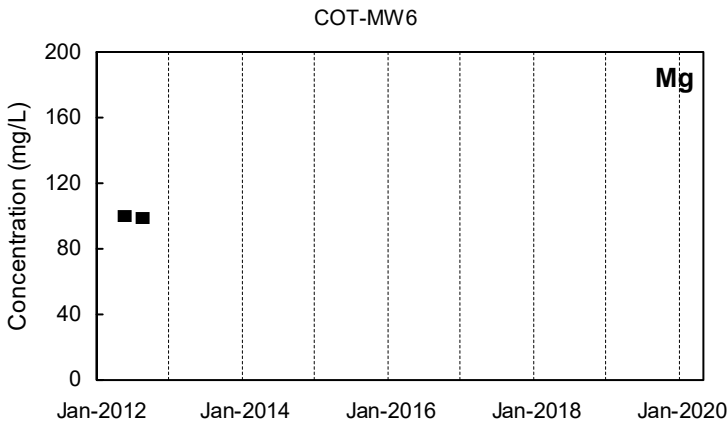
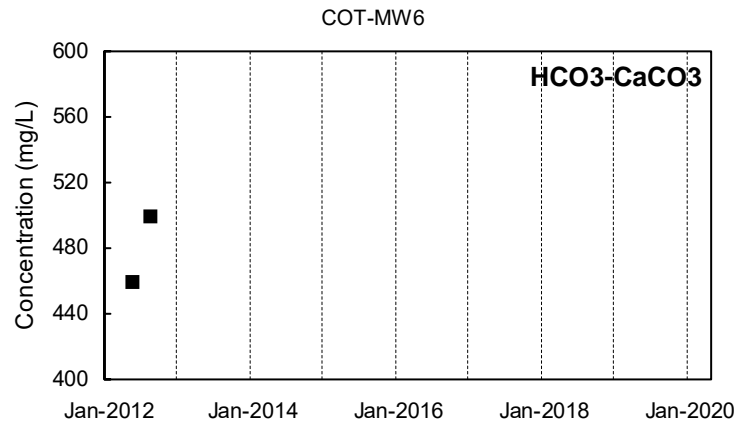
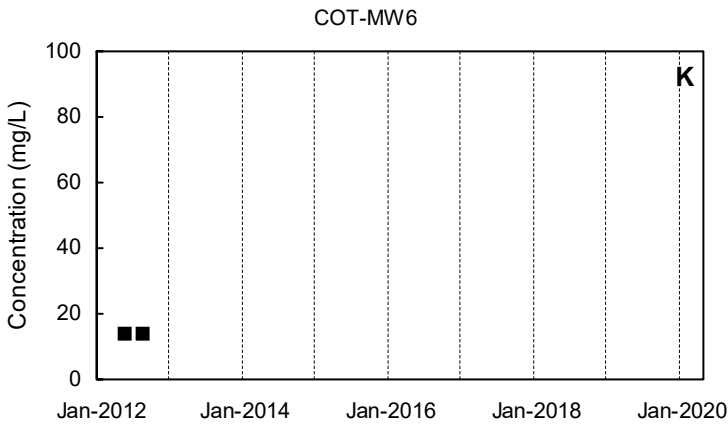
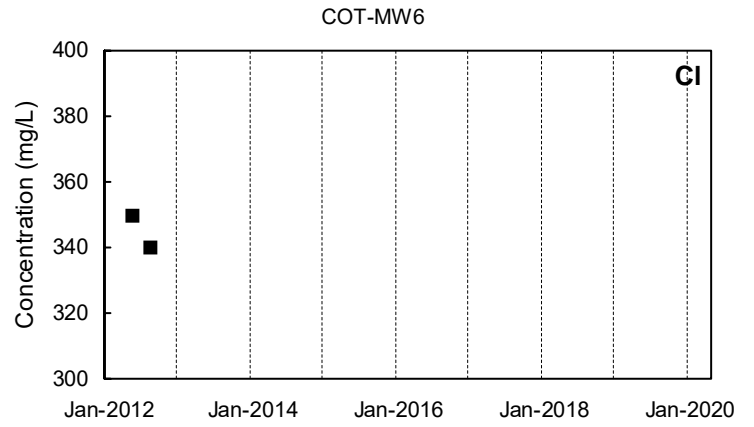
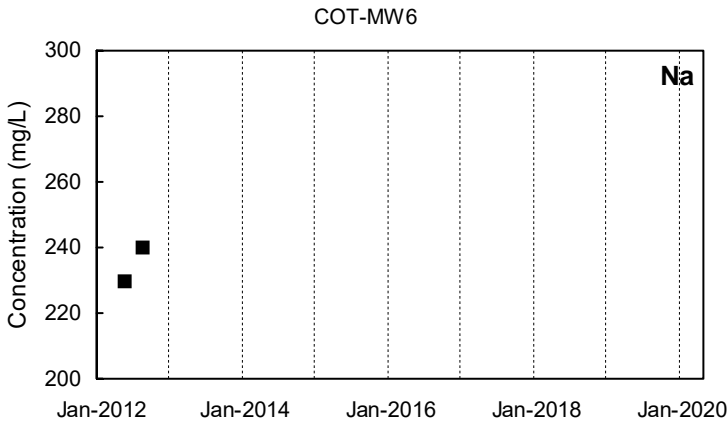

Detected Value
 'J'-Flag (value between reporting limit and detection limit)
 Non-Detect Range

Shallow Well shown with black symbols
Deep Well shown with orange symbols
"dd" Well shown with blue symbols

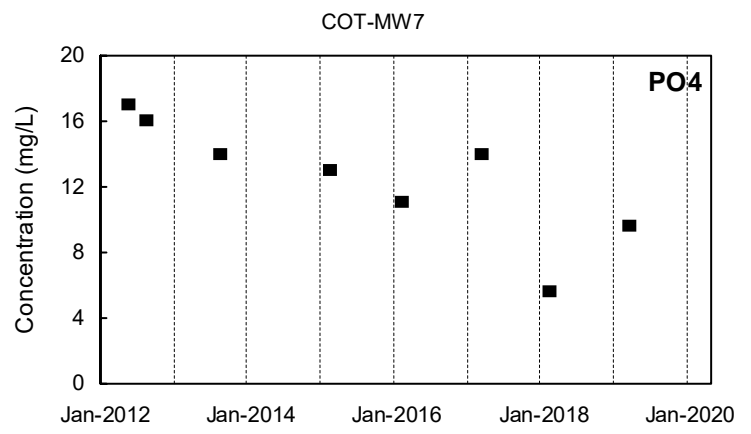
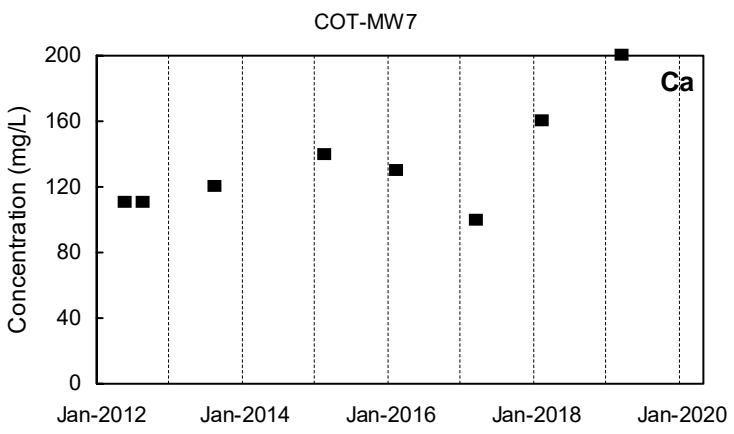
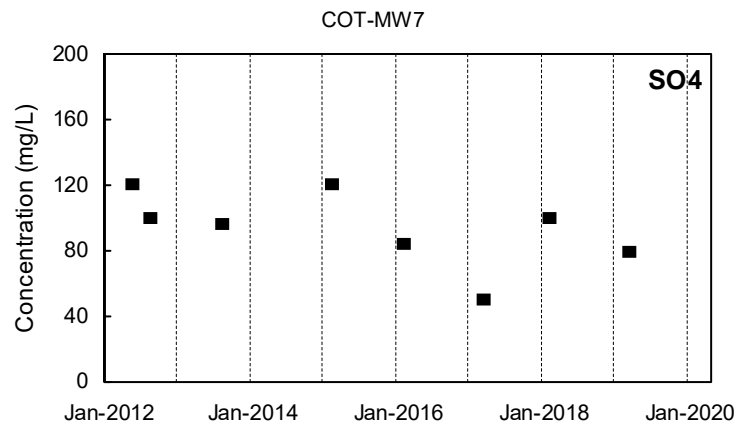
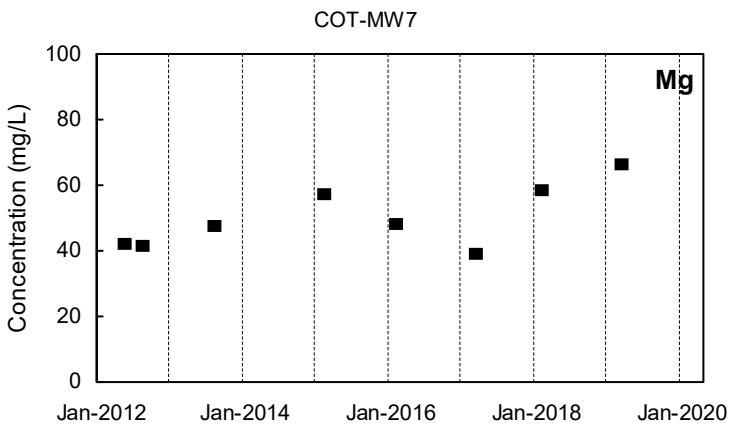
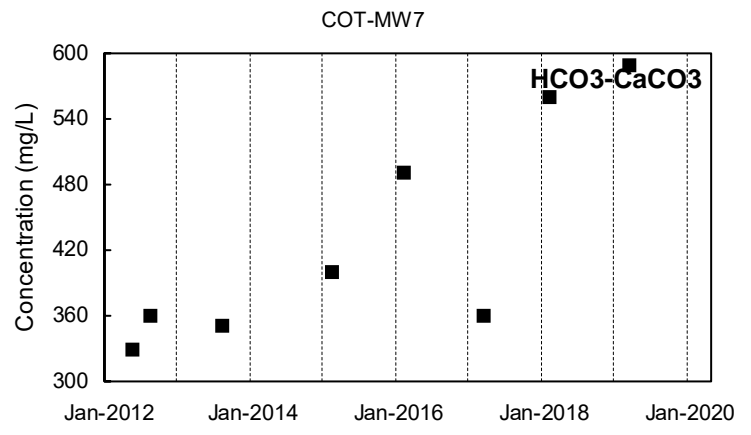
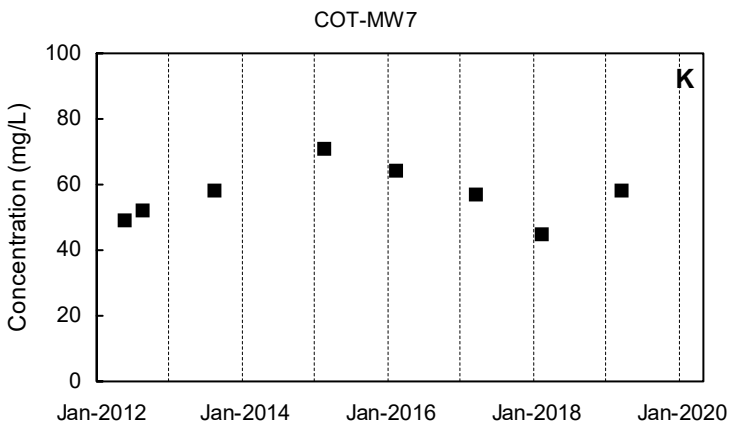
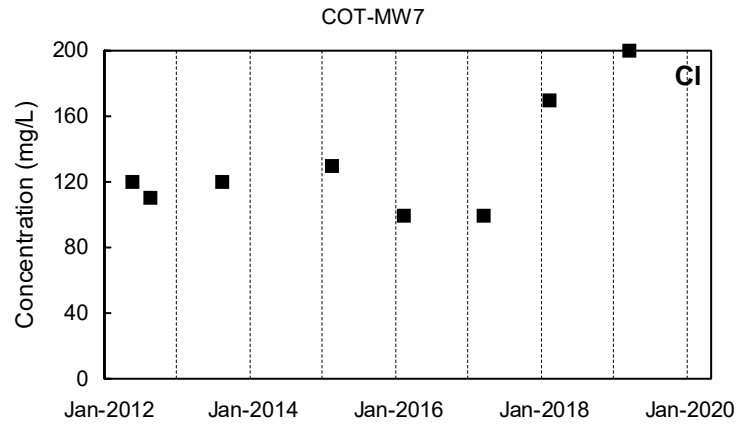
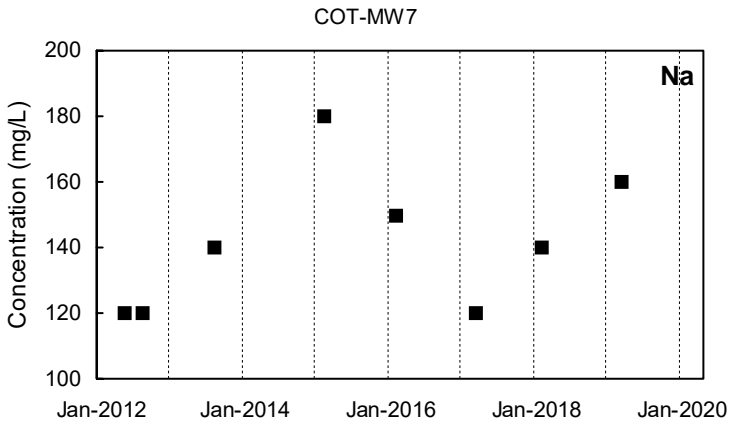

■ Detected Value □ 'J'-Flag (value between reporting limit and detection limit) ■ Non-Detect Range
 Shallow Well shown with black symbols Deep Well shown with orange symbols "dd" Well shown with blue symbols

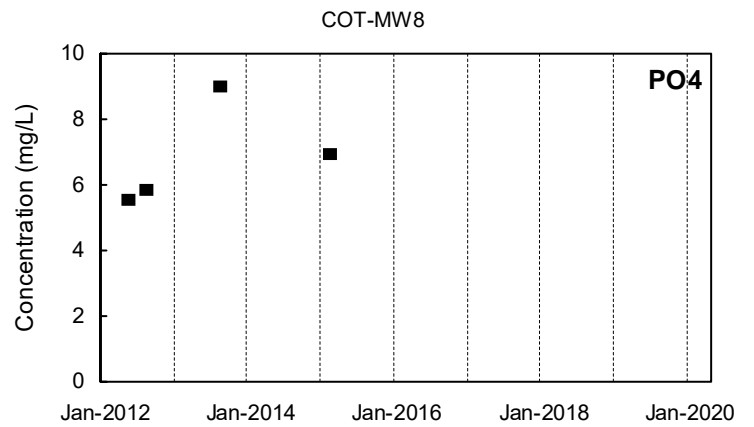
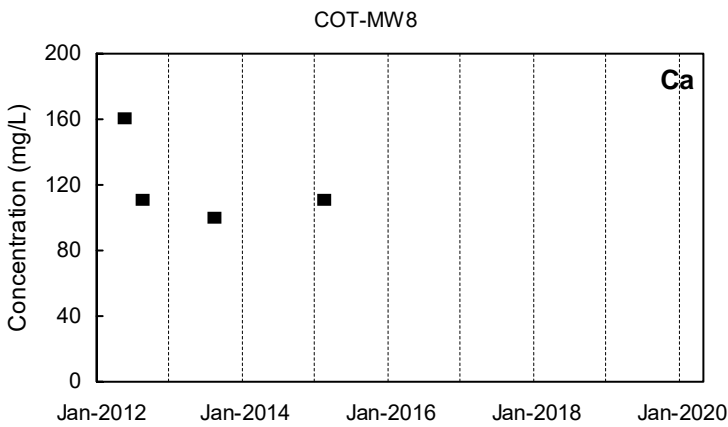
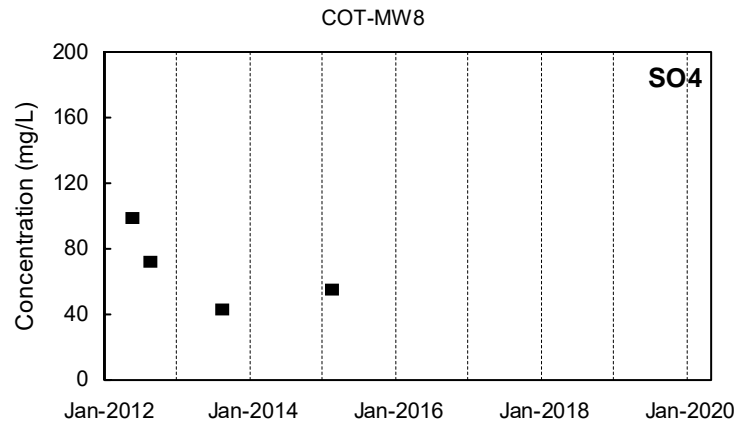
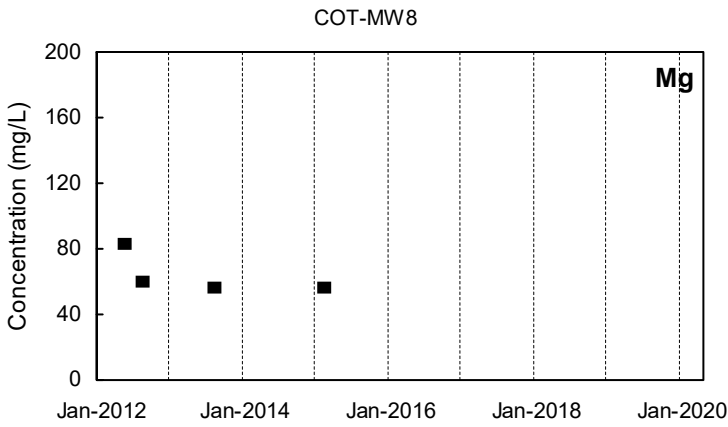
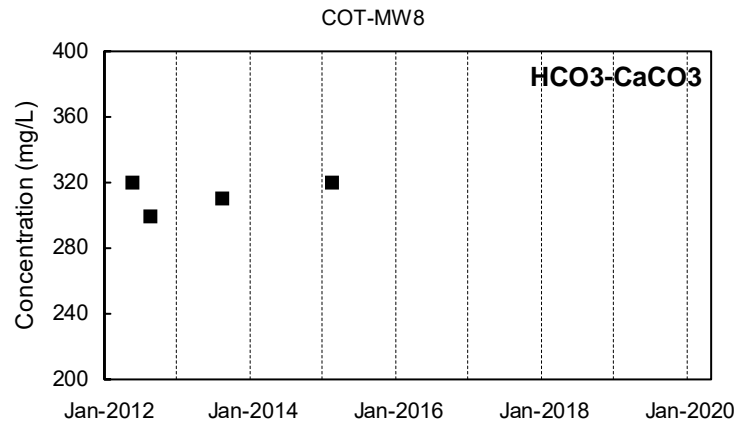
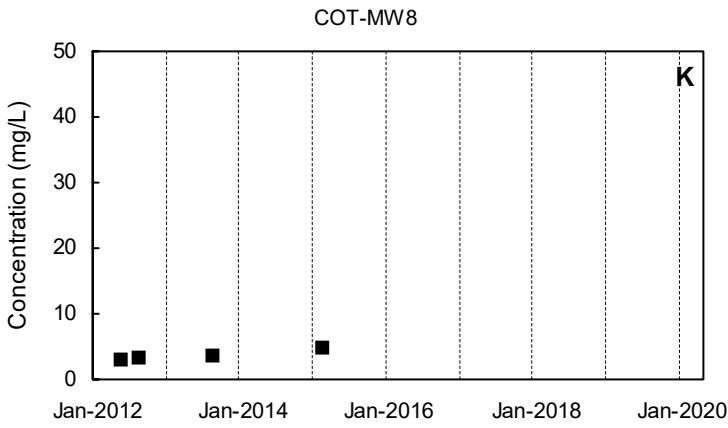
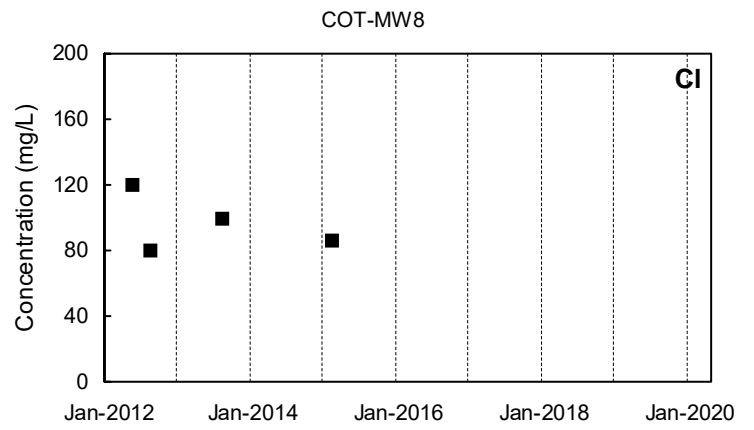
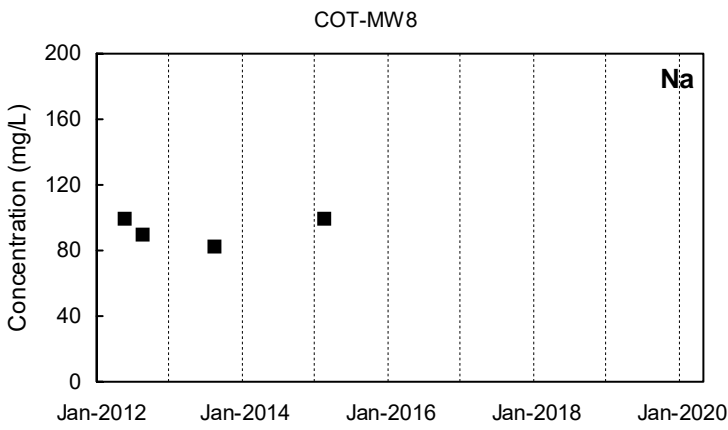

Detected Value
 'J'-Flag (value between reporting limit and detection limit)
 Non-Detect Range
 Shallow Well shown with black symbols
 Deep Well shown with orange symbols
 "dd" Well shown with blue symbols

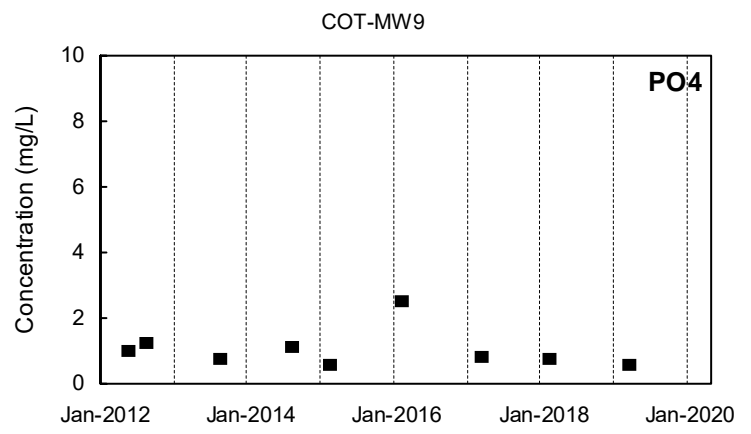
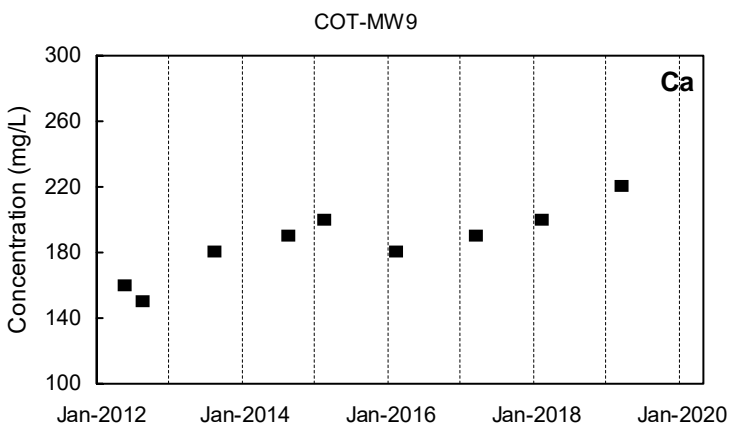
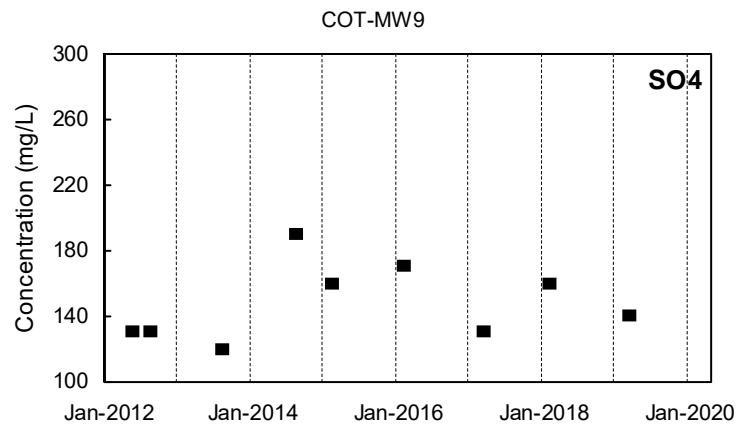
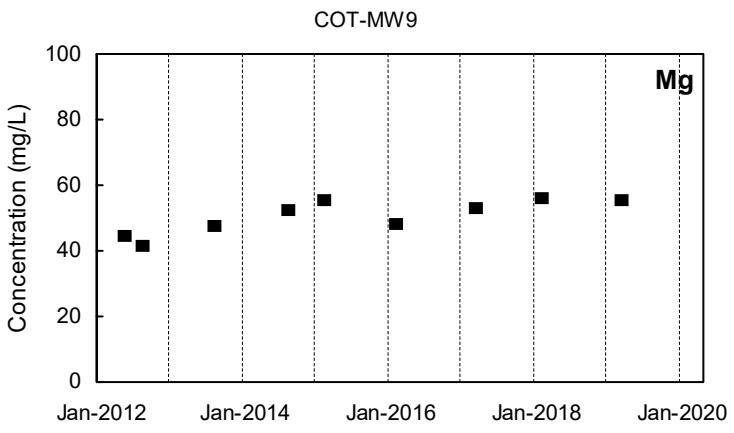
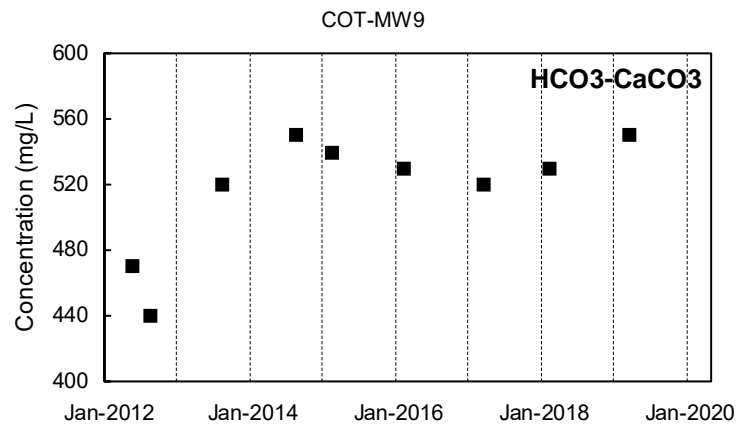
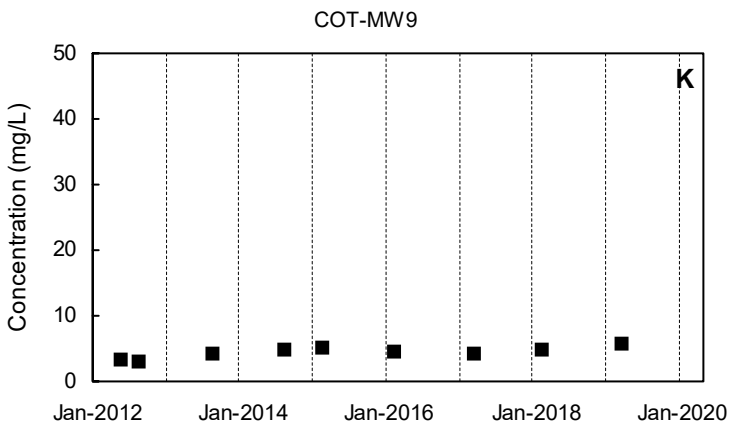
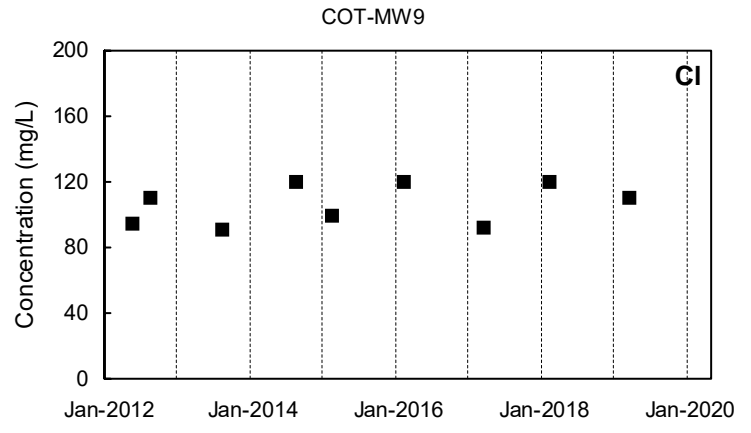
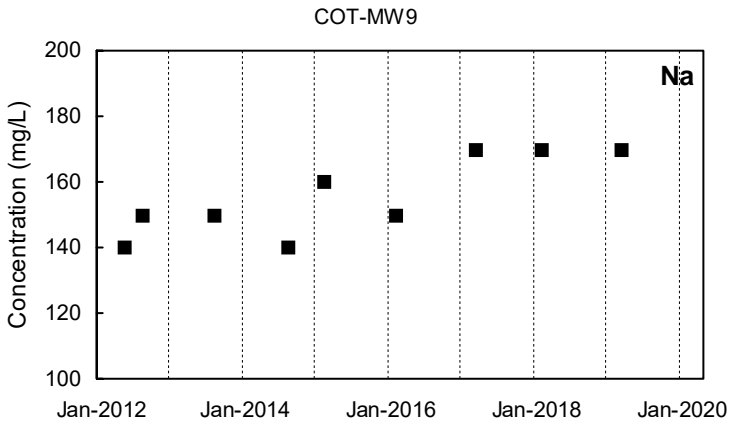

Detected Value
 'J'-Flag (value between reporting limit and detection limit)
 Non-Detect Range
 Shallow Well shown with black symbols
 Deep Well shown with orange symbols
 "dd" Well shown with blue symbols

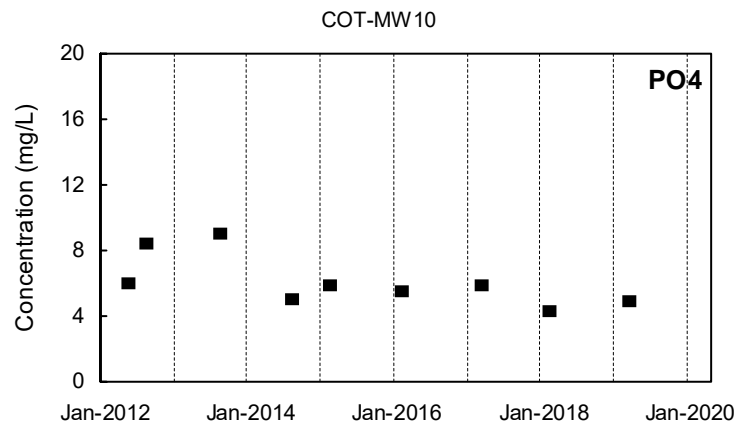
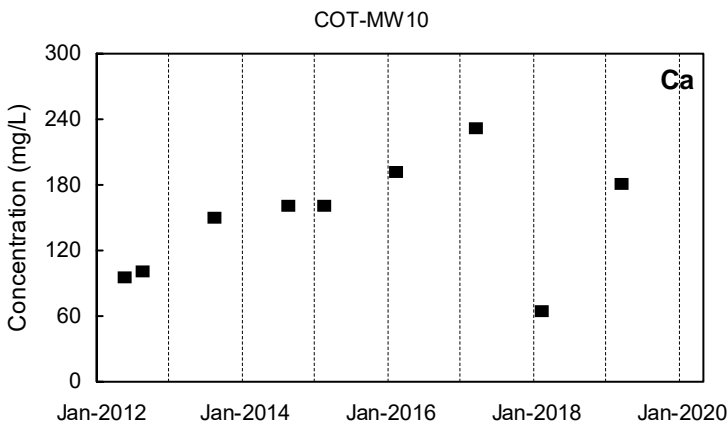
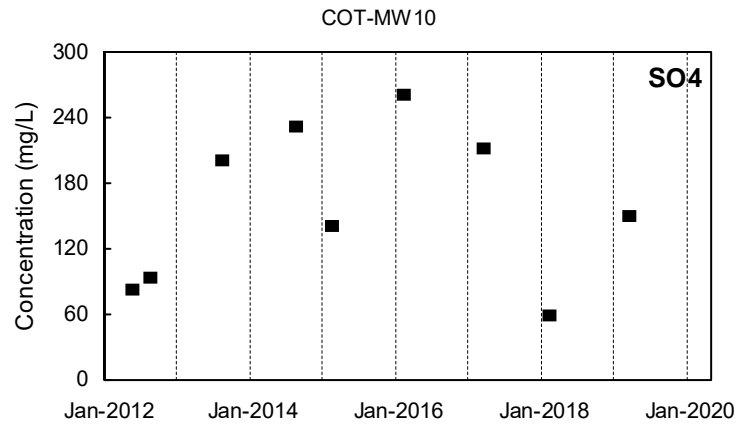
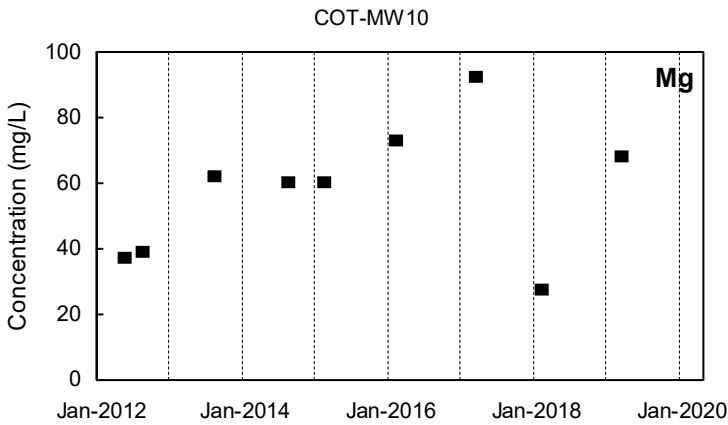
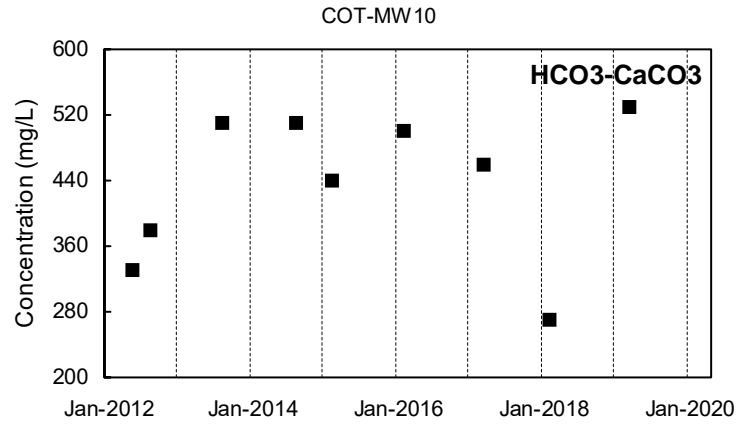
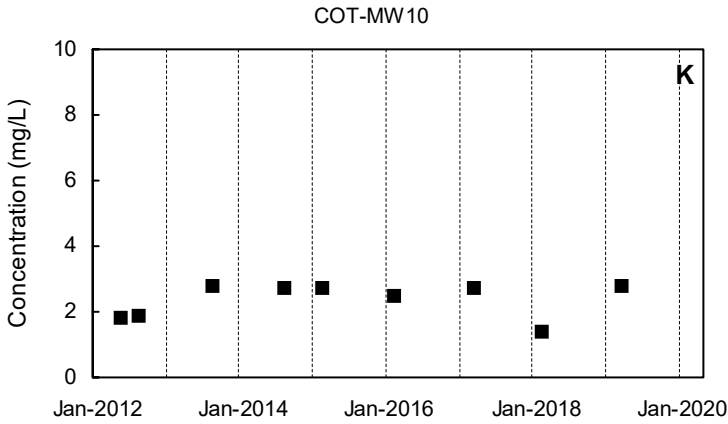
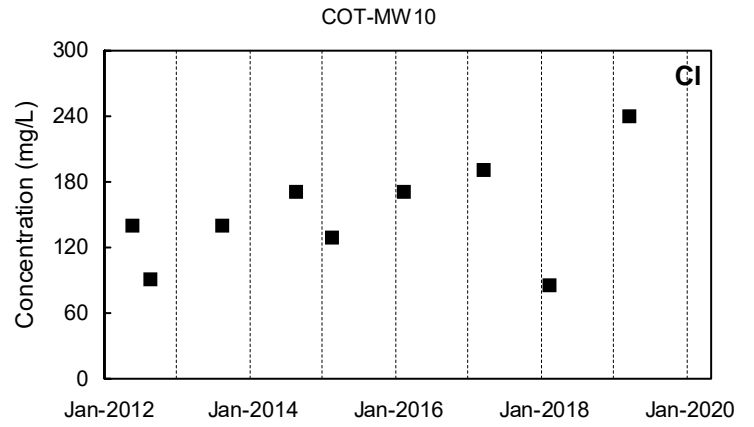
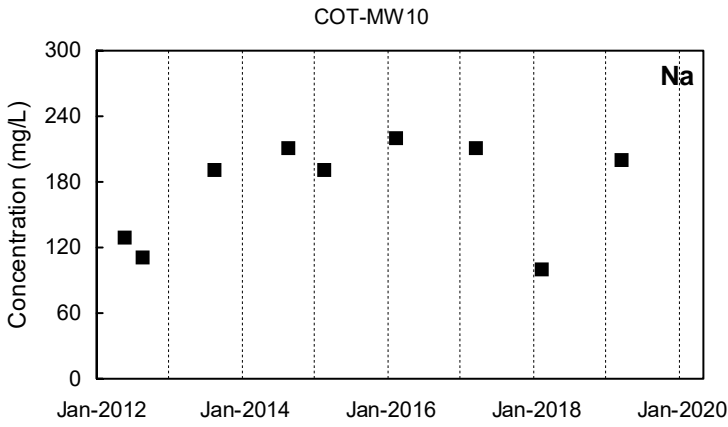

Detected Value
 'J'-Flag (value between reporting limit and detection limit)
 Non-Detect Range
 Shallow Well shown with black symbols
 Deep Well shown with orange symbols
 "dd" Well shown with blue symbols

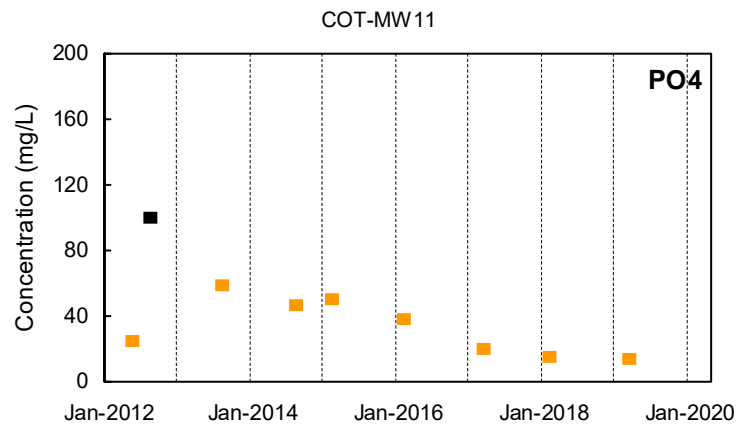
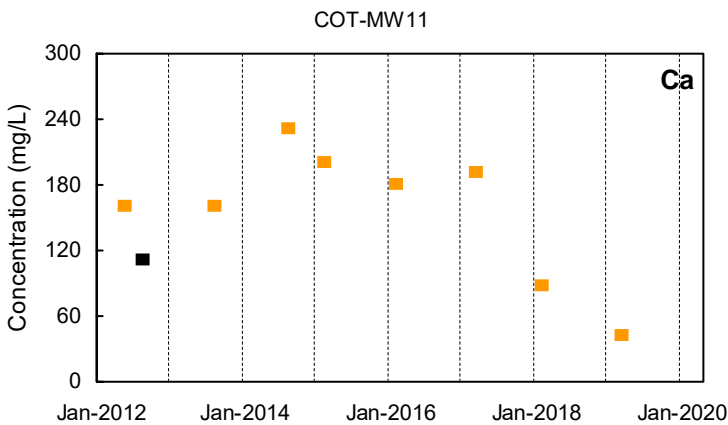
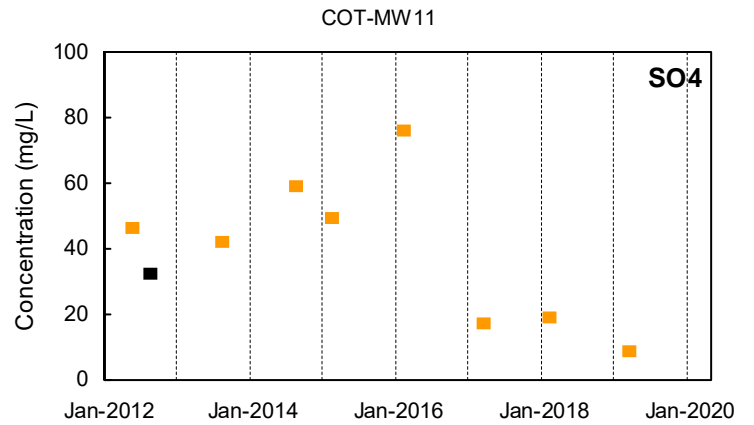
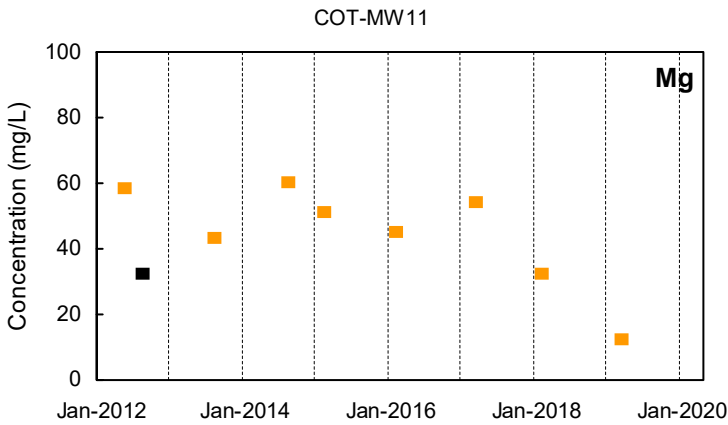
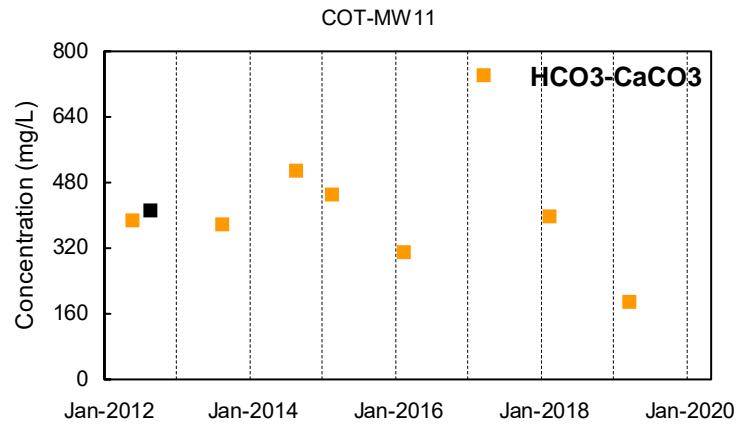
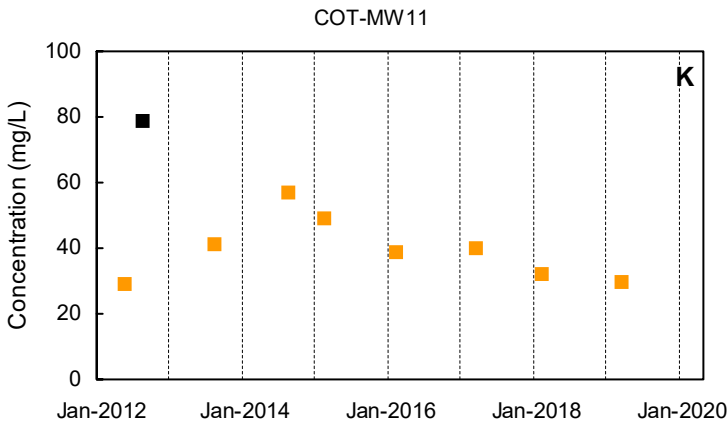
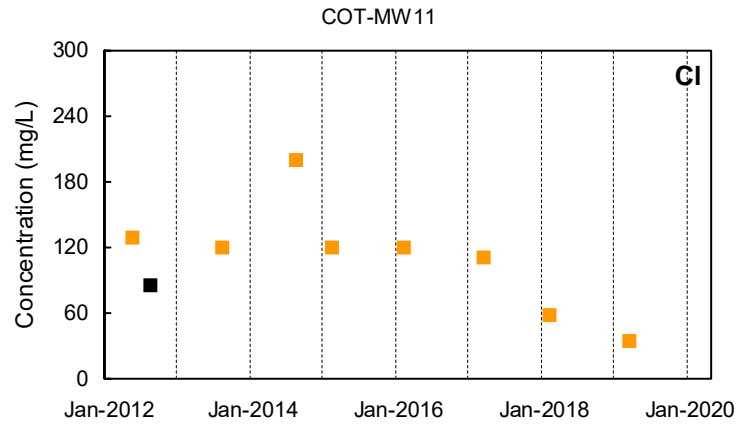
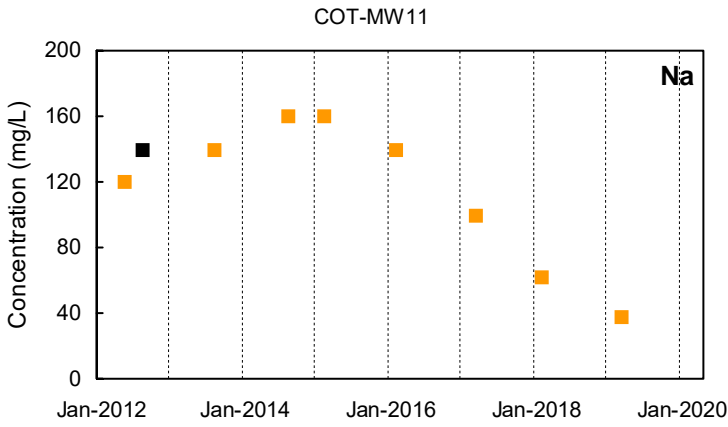

Detected Value
 'J'-Flag (value between reporting limit and detection limit)
 Non-Detect Range
 Shallow Well shown with black symbols
 Deep Well shown with orange symbols
 "dd" Well shown with blue symbols

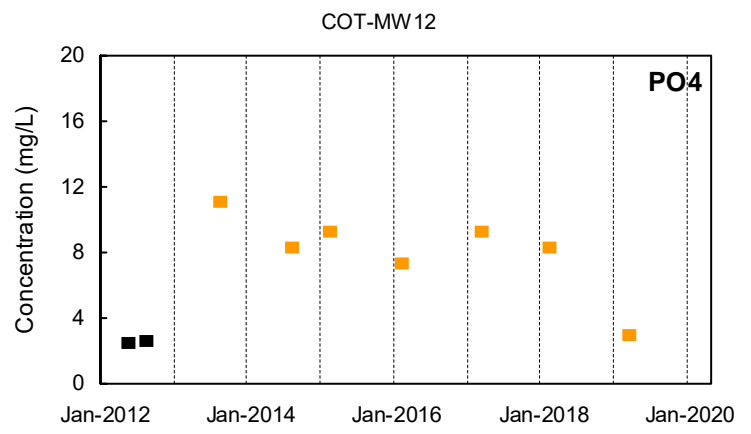
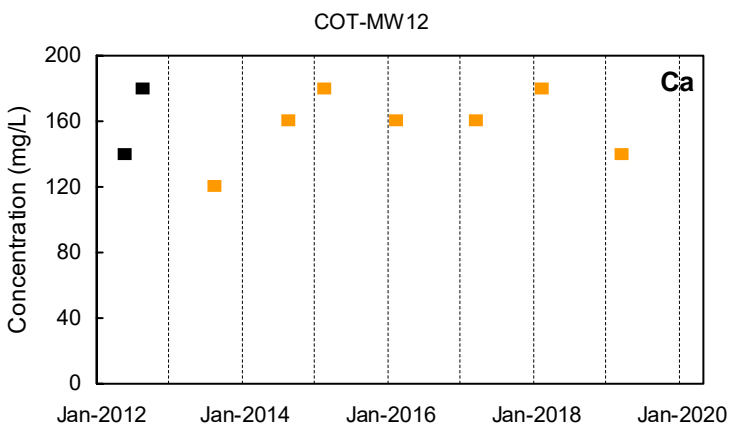
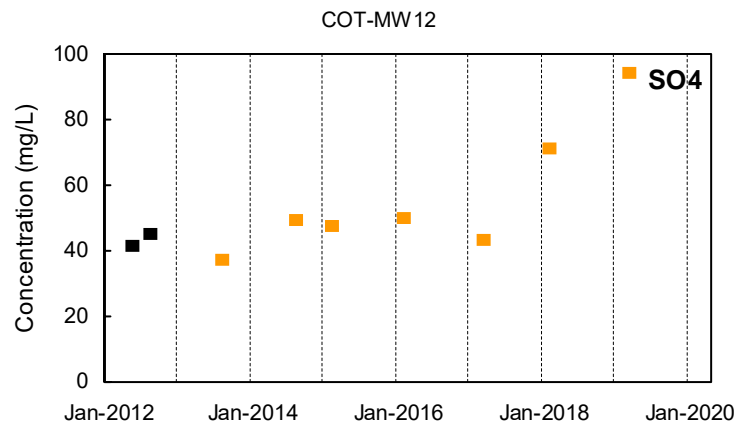
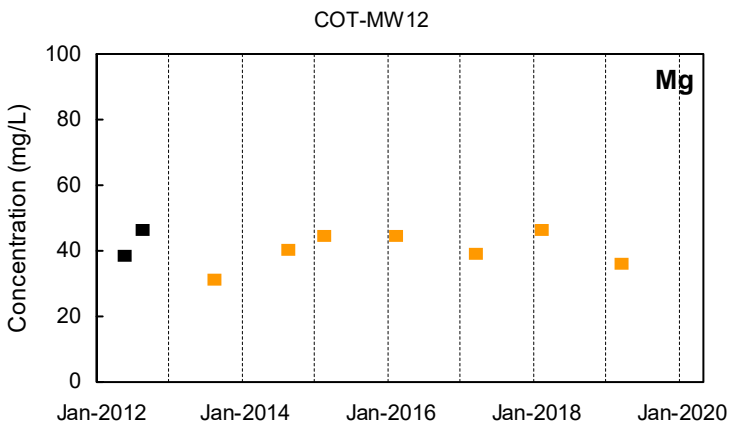
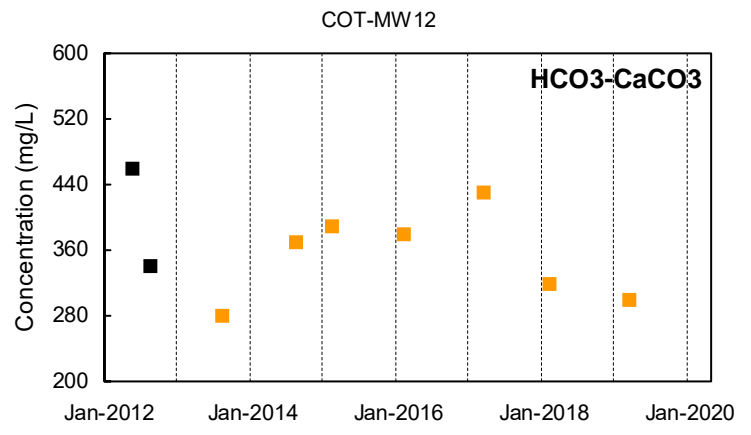
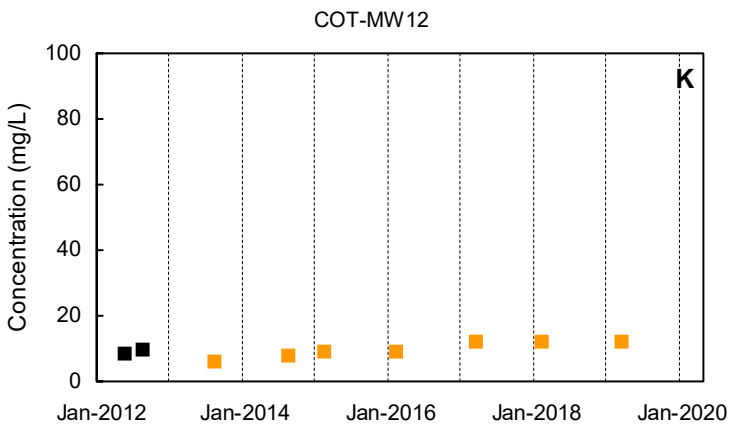
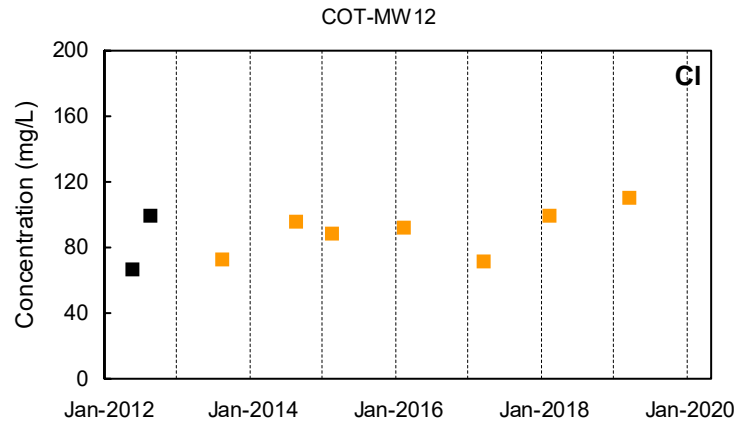
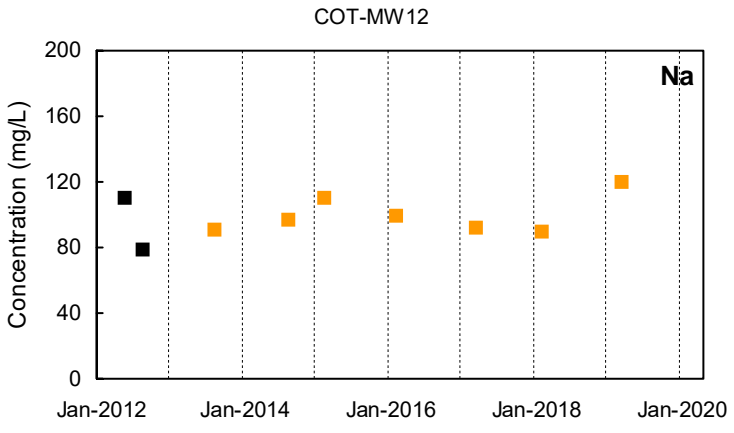

Detected Value
 'J'-Flag (value between reporting limit and detection limit)
 Non-Detect Range
 Shallow Well shown with black symbols
 Deep Well shown with orange symbols
 "dd" Well shown with blue symbols

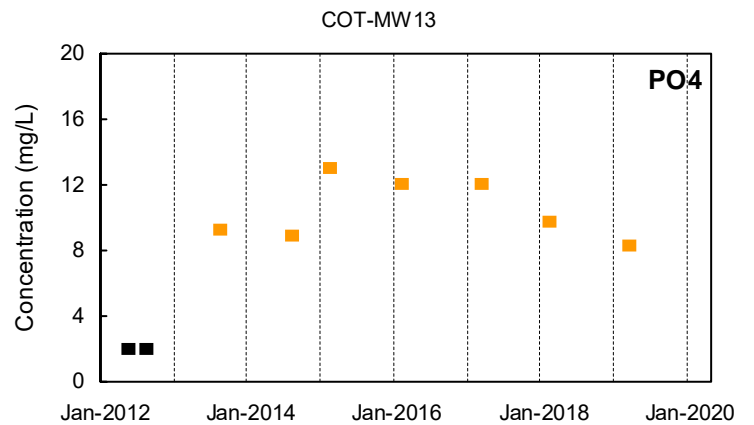
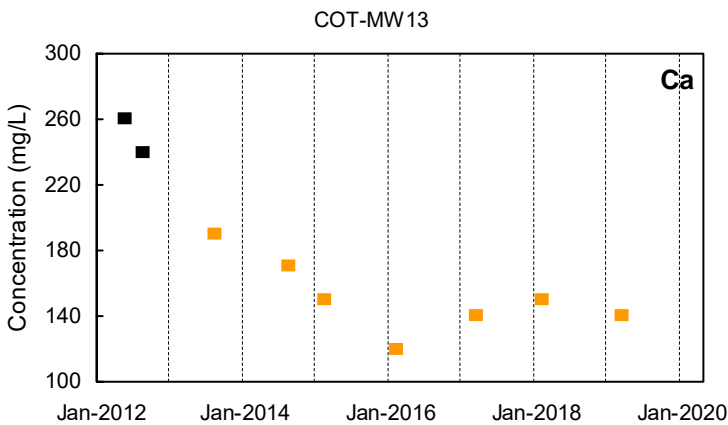
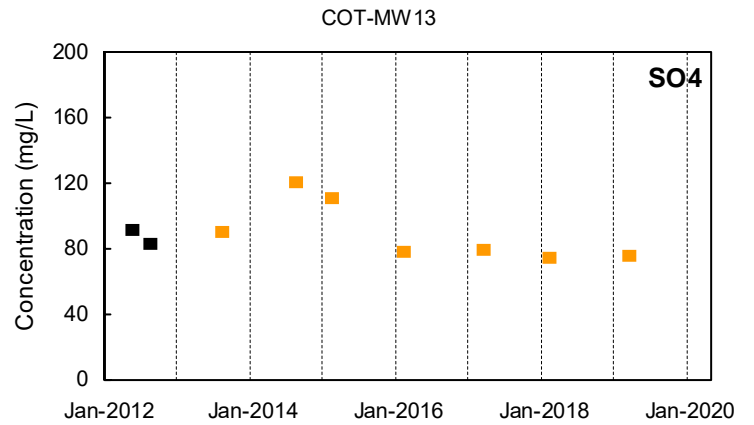
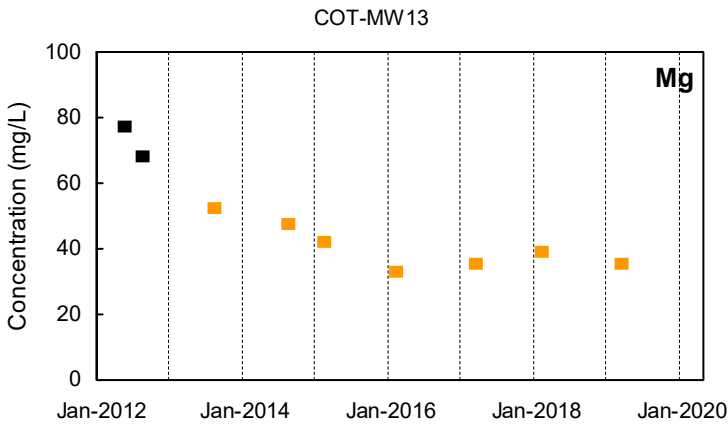
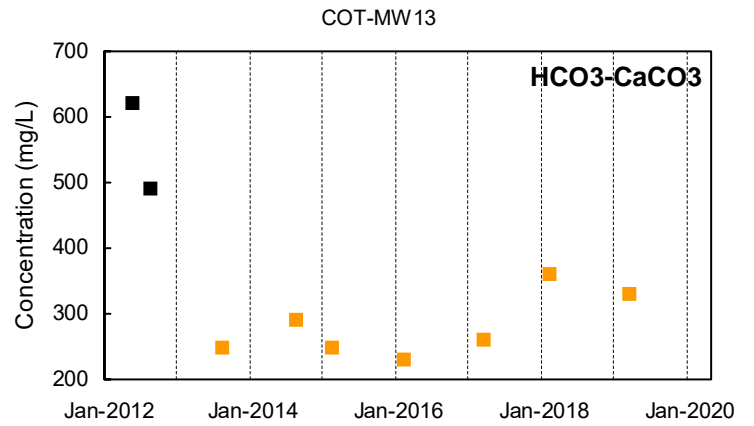
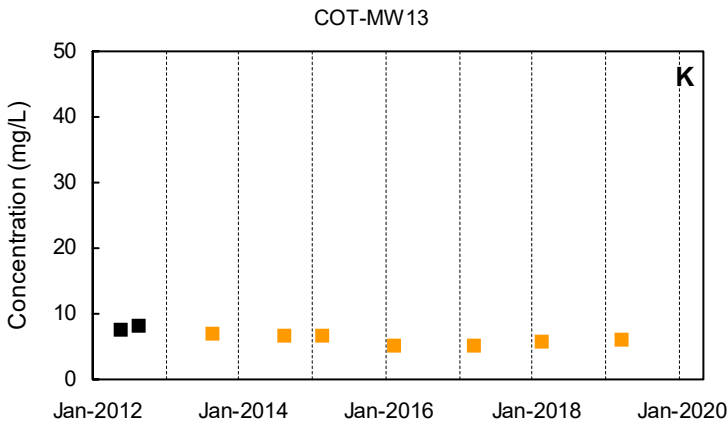
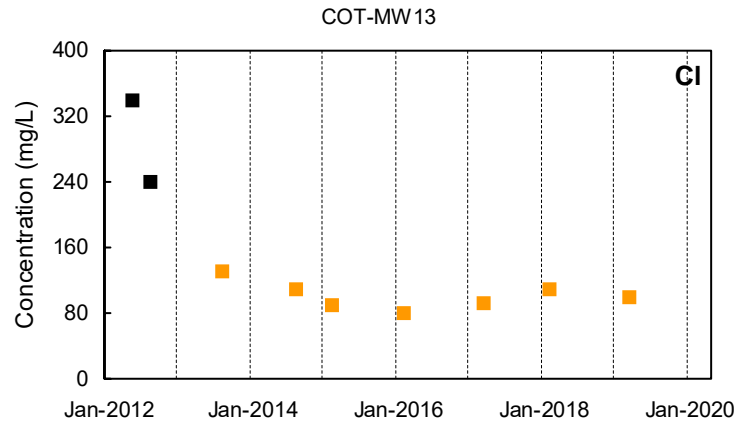
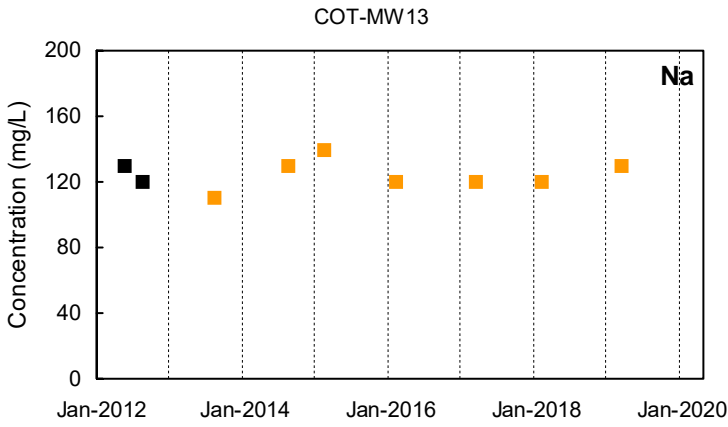

Detected Value
 'J'-Flag (value between reporting limit and detection limit)
 Non-Detect Range
 Shallow Well shown with black symbols Deep Well shown with orange symbols "dd" Well shown with blue symbols

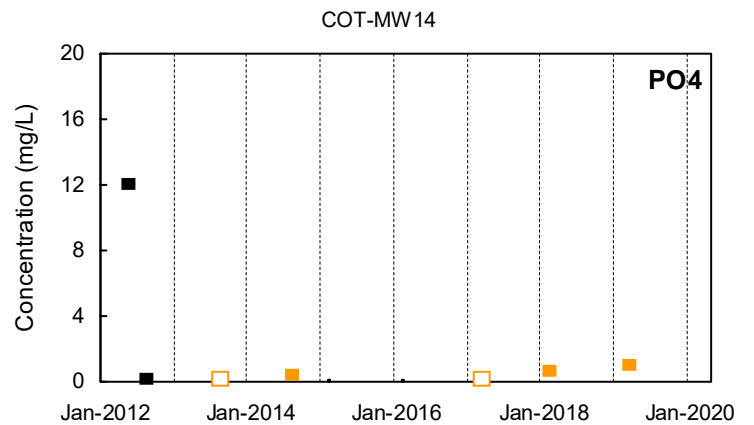
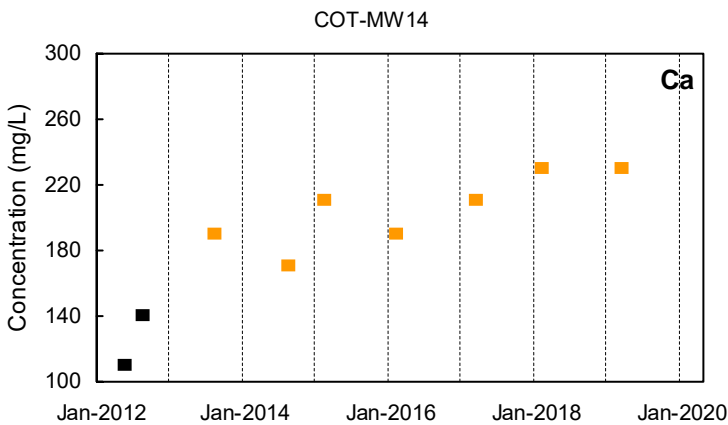
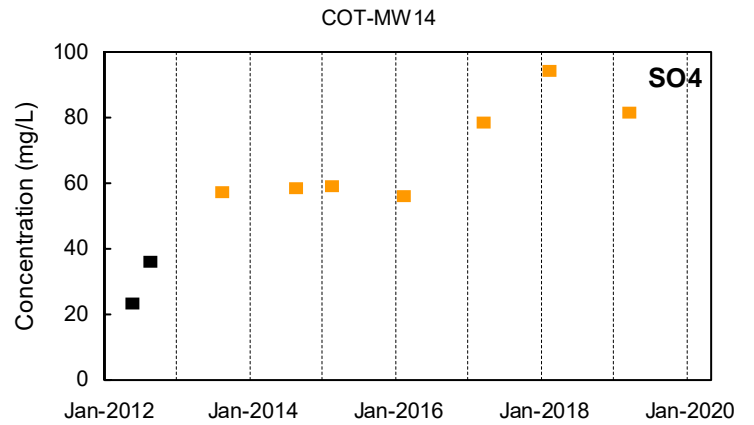
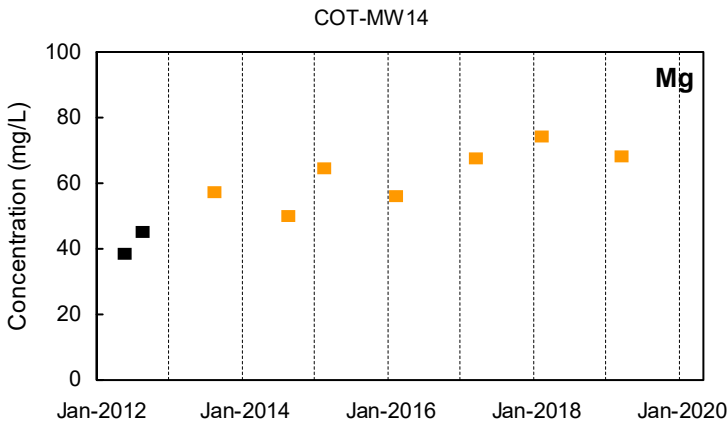
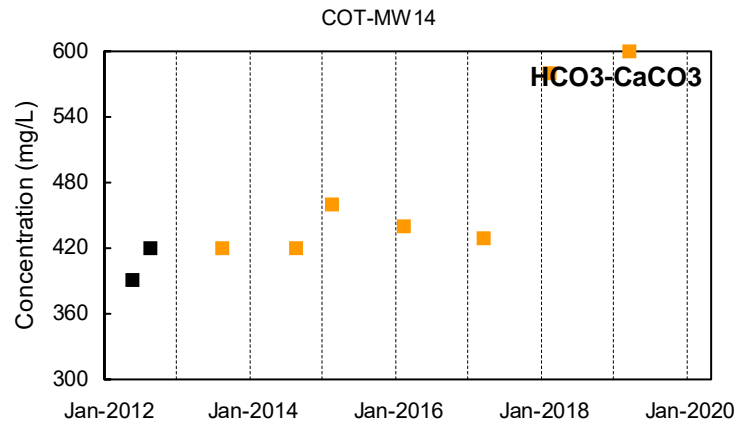
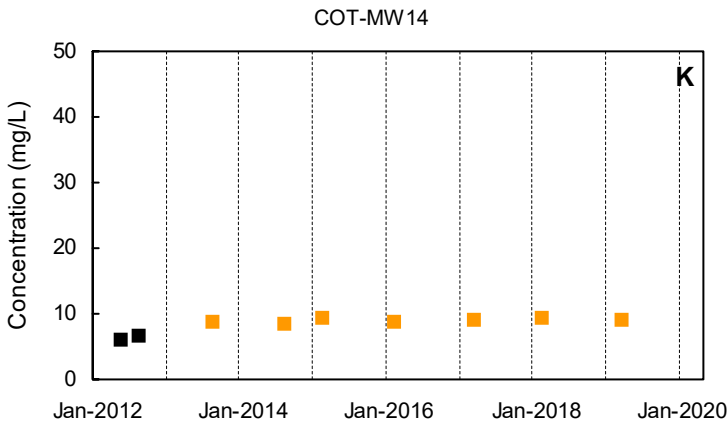
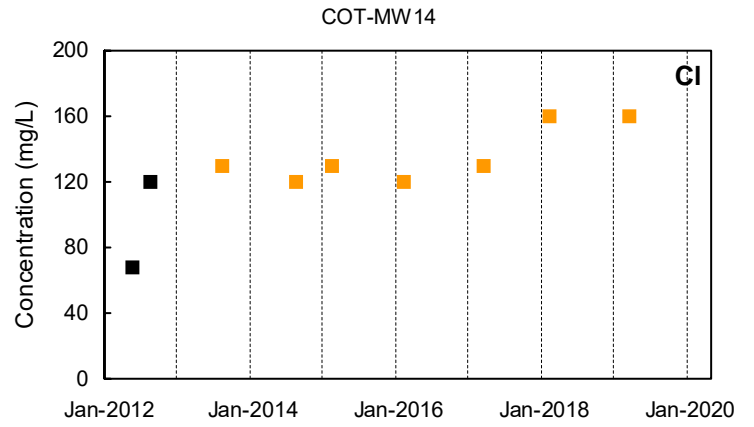
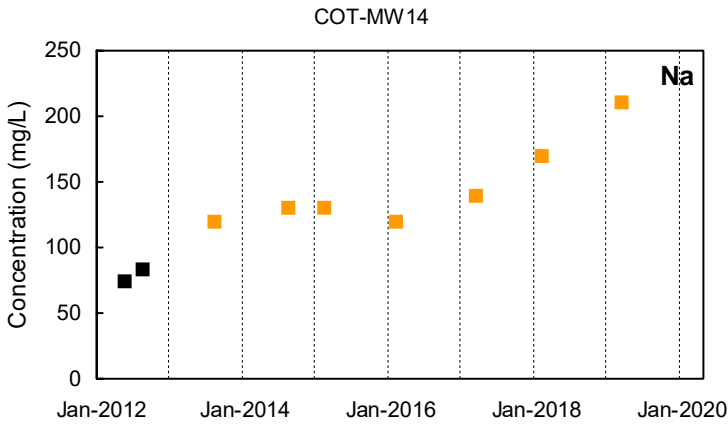

Detected Value
 'J'-Flag (value between reporting limit and detection limit)
 Non-Detect Range
 Shallow Well shown with black symbols Deep Well shown with orange symbols "dd" Well shown with blue symbols

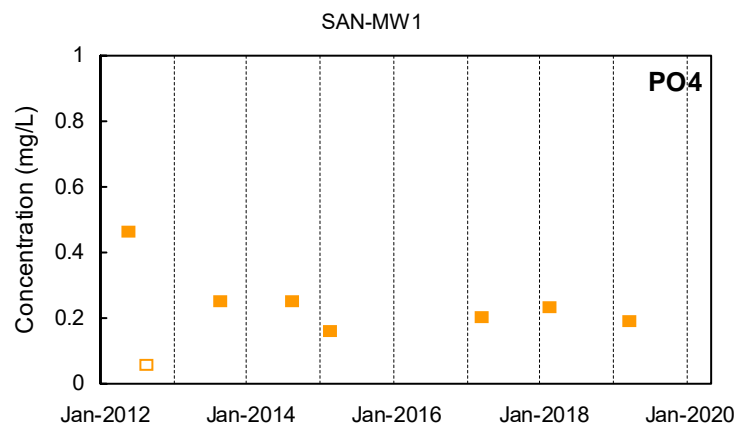
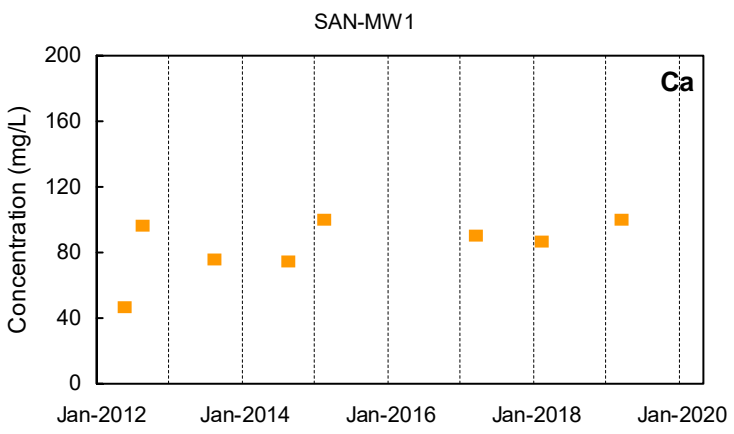
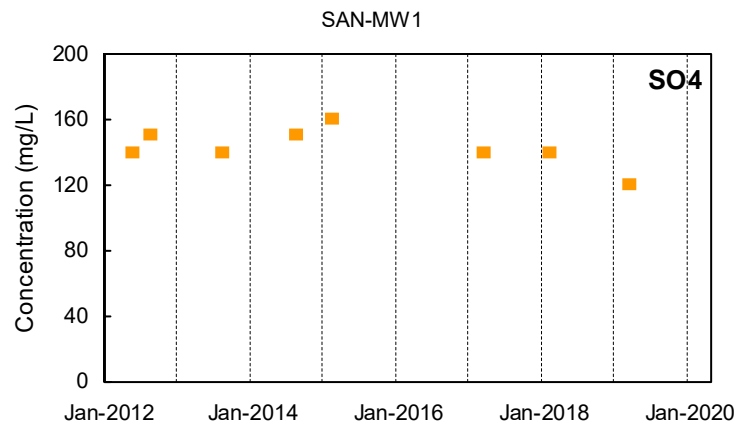
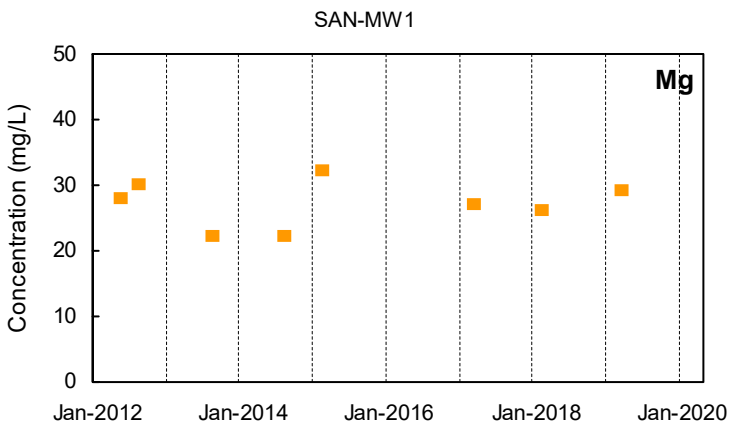
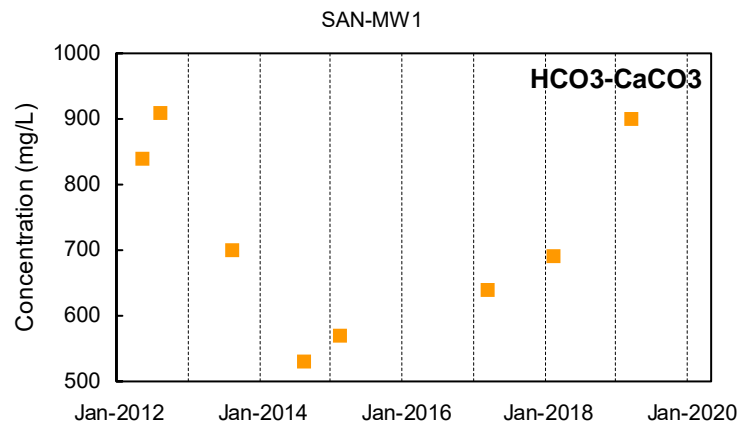
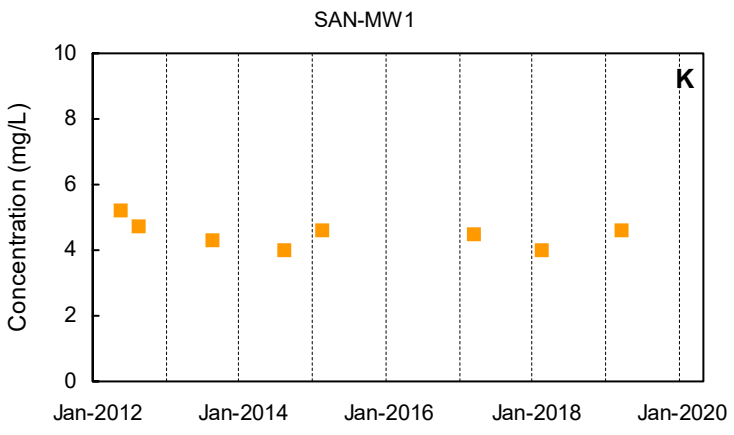
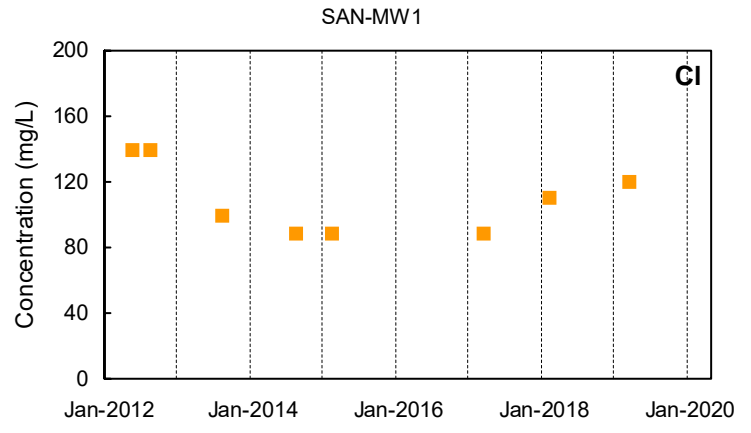
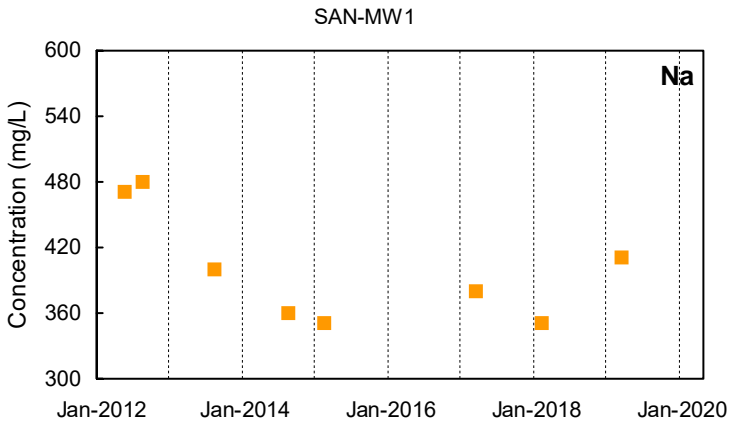

■ Detected Value □ 'J'-Flag (value between reporting limit and detection limit) ■ Non-Detect Range
 Shallow Well shown with black symbols Deep Well shown with orange symbols "dd" Well shown with blue symbols

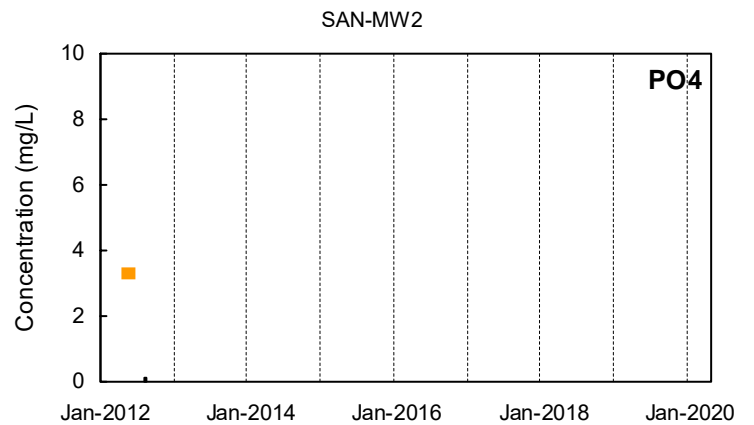
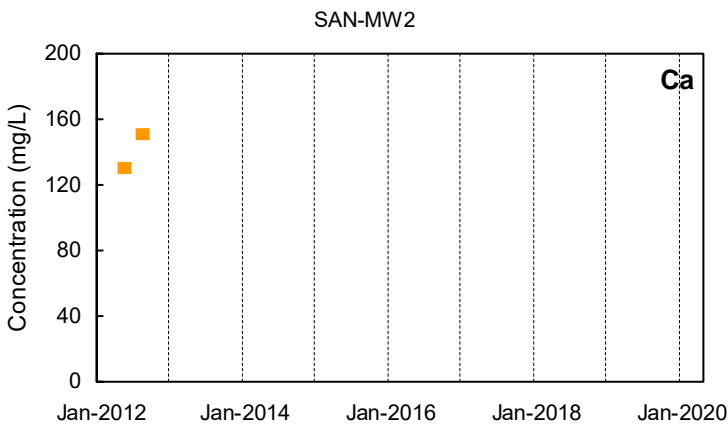
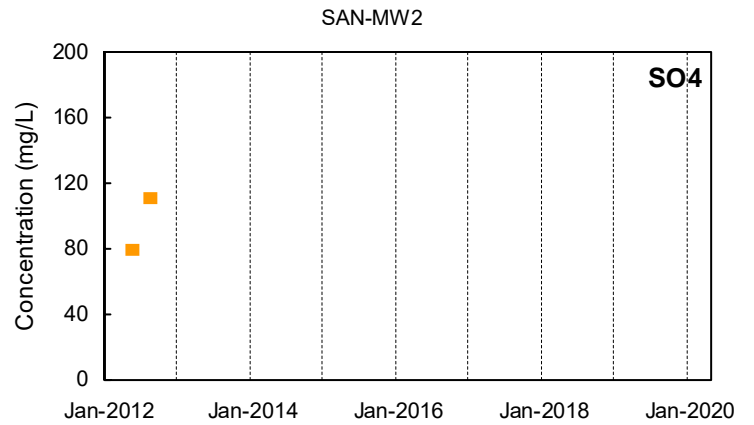
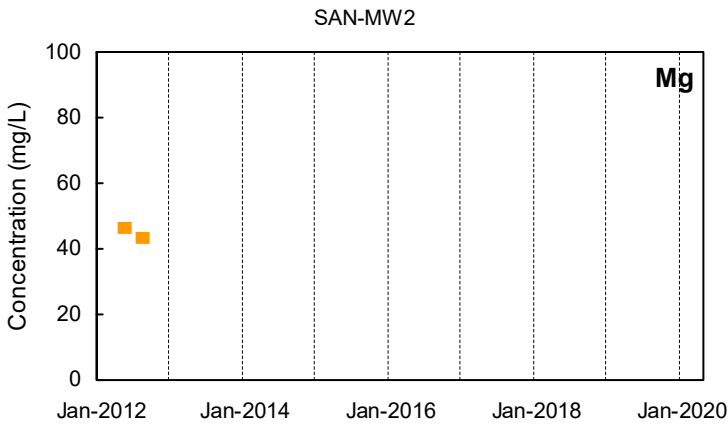
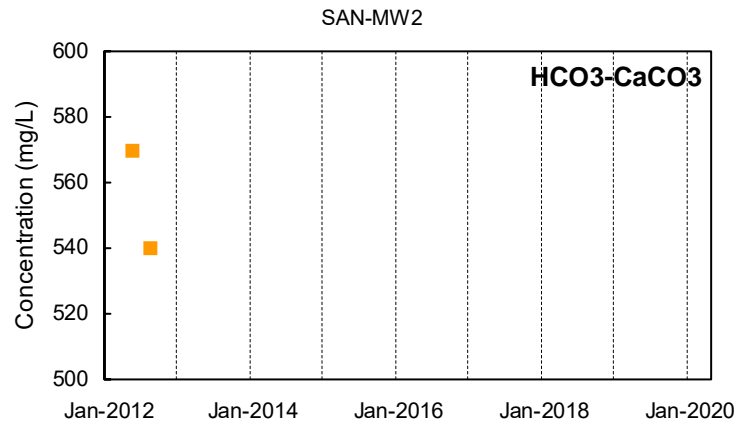
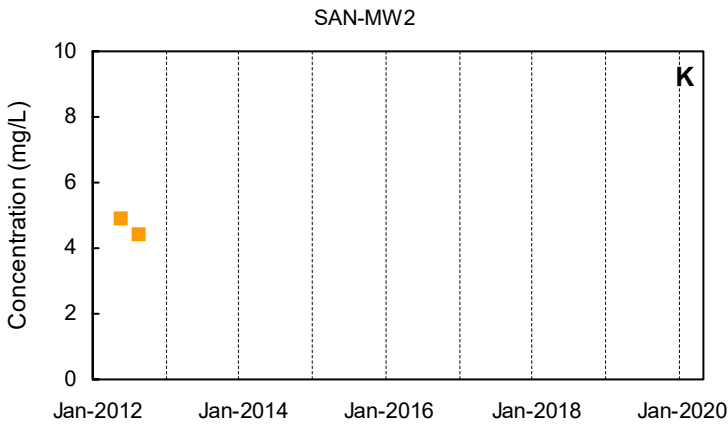
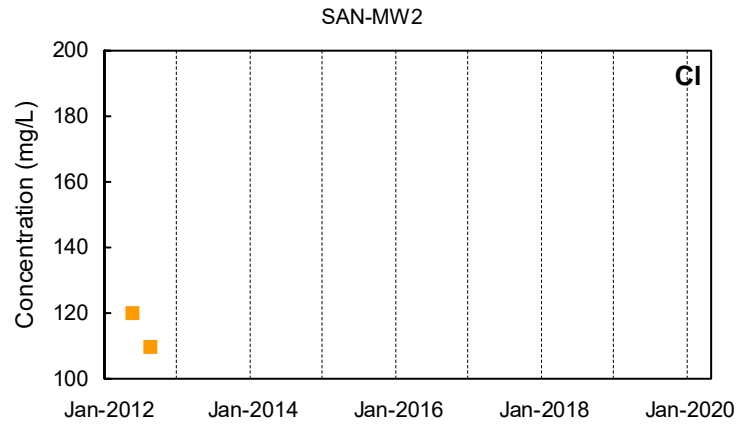
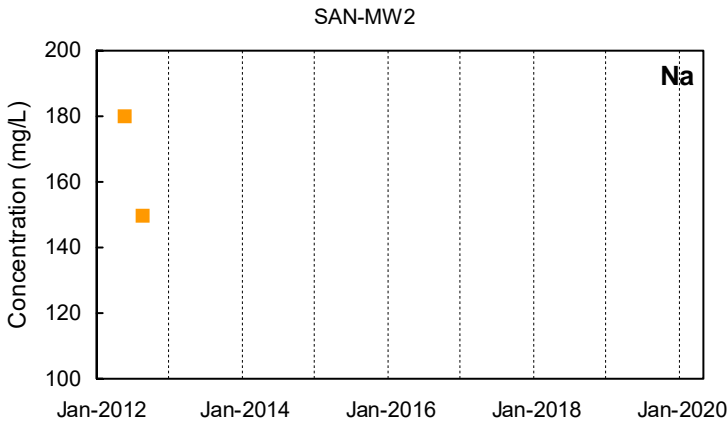

■ Detected Value
 □ 'J'-Flag (value between reporting limit and detection limit)
 Non-Detect Range
■ Shallow Well shown with black symbols
■ Deep Well shown with orange symbols
■ "dd" Well shown with blue symbols

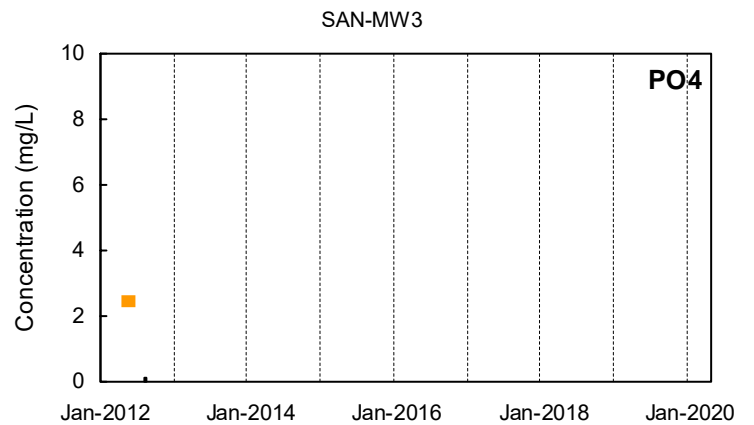
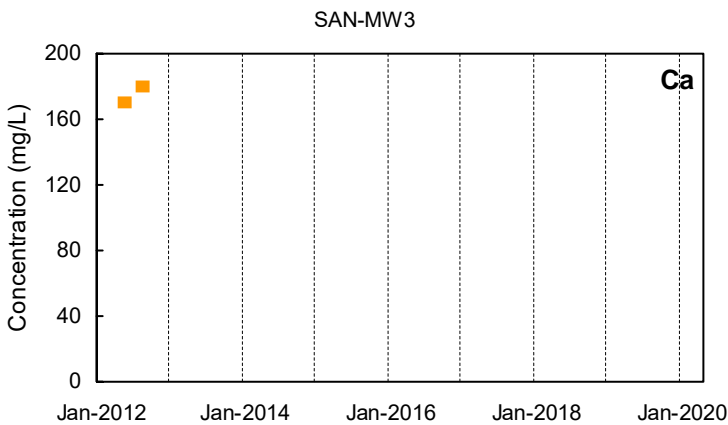
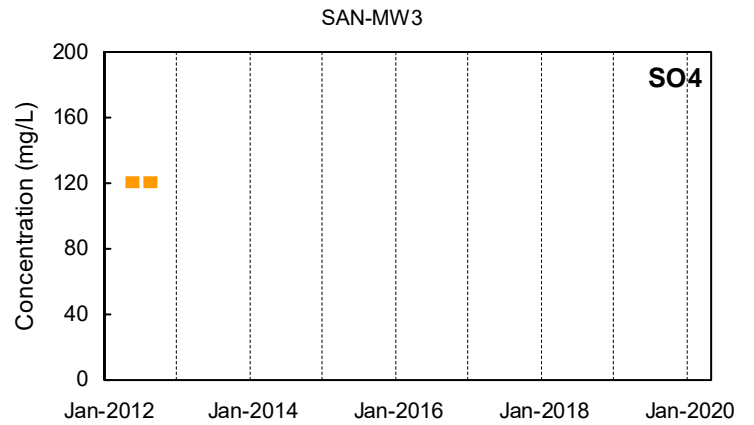
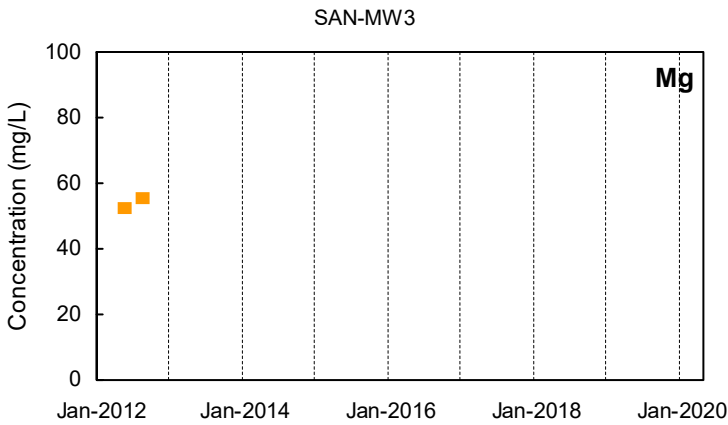
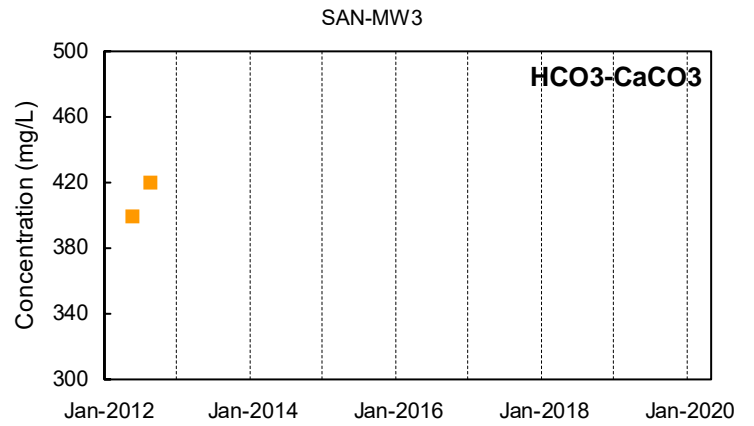
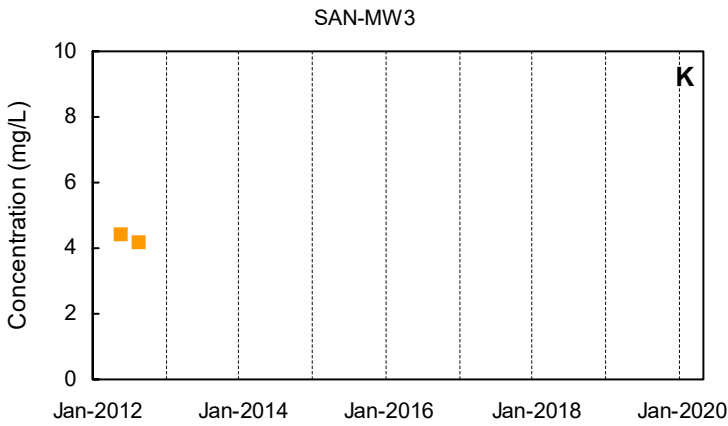
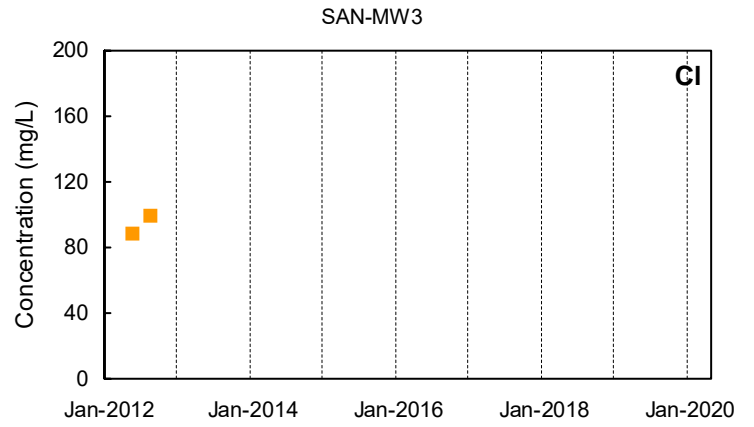
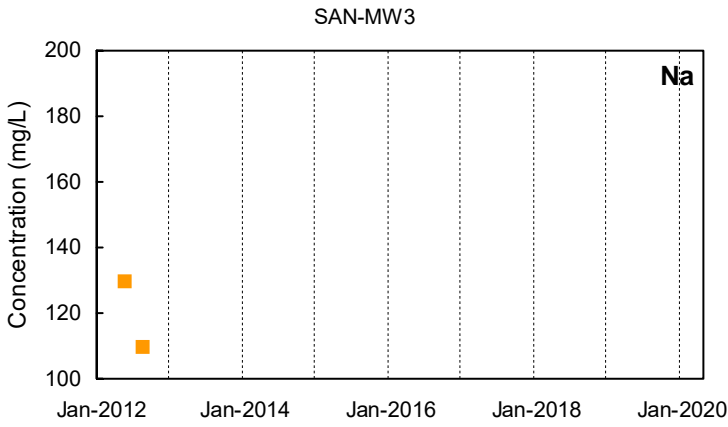

■ Detected Value
 □ 'J'-Flag (value between reporting limit and detection limit)
 Non-Detect Range
■ Shallow Well shown with black symbols
 ■ Deep Well shown with orange symbols
 ■ "dd" Well shown with blue symbols

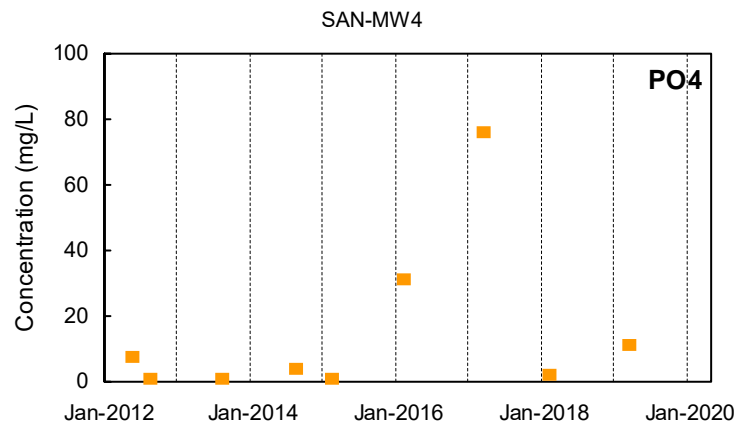
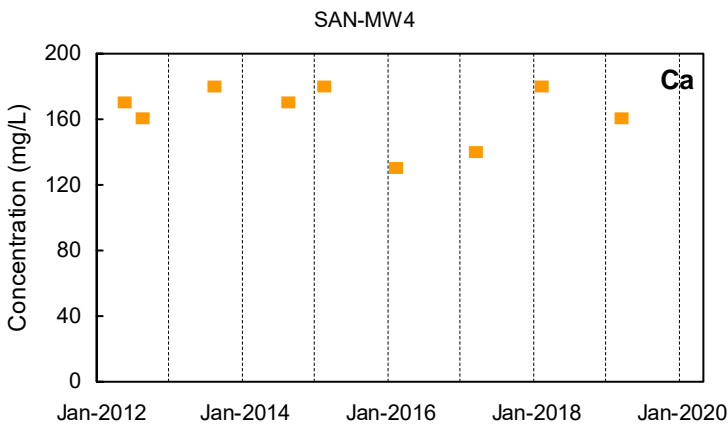
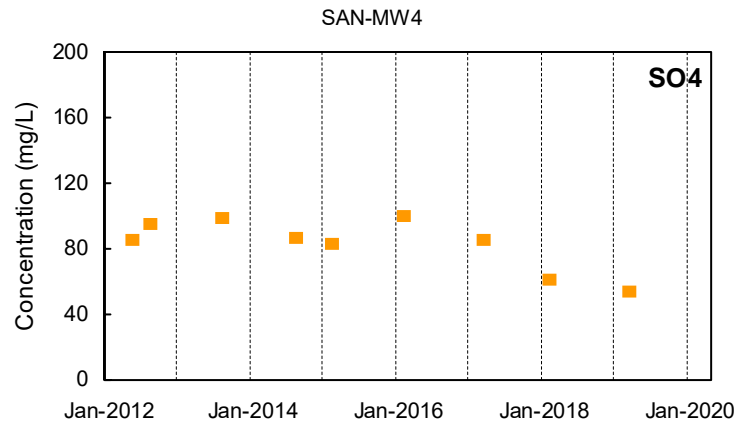
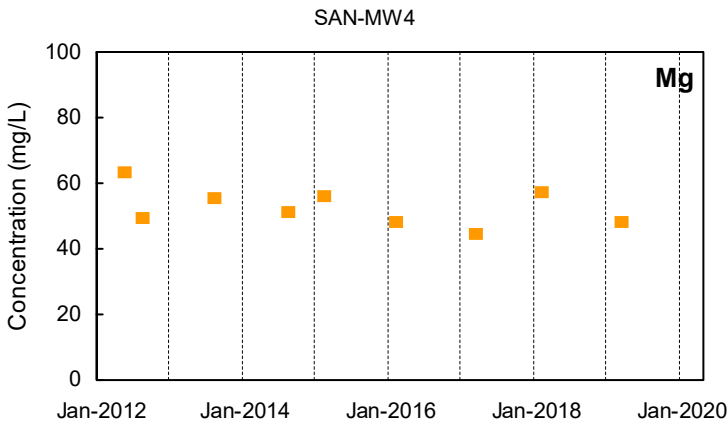
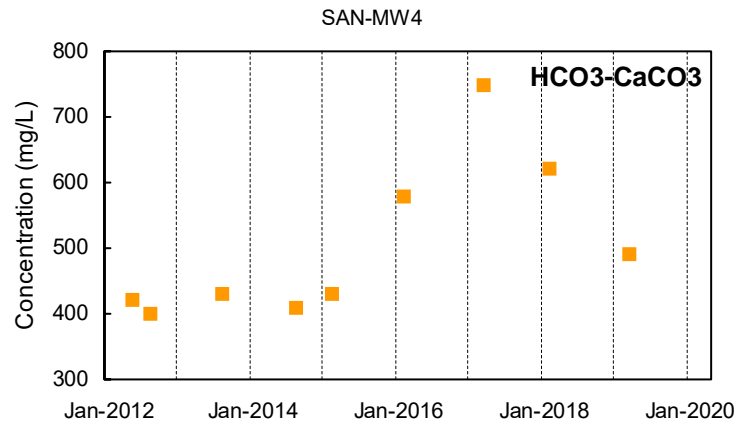
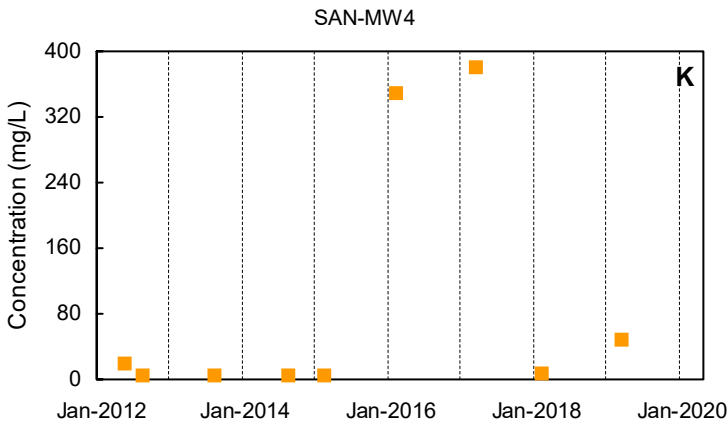
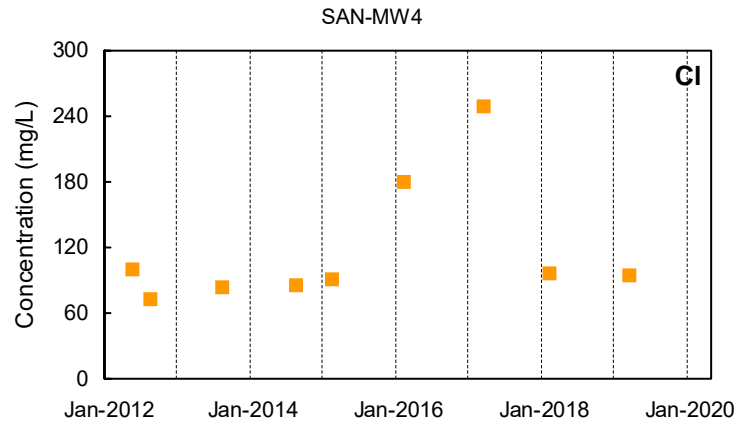
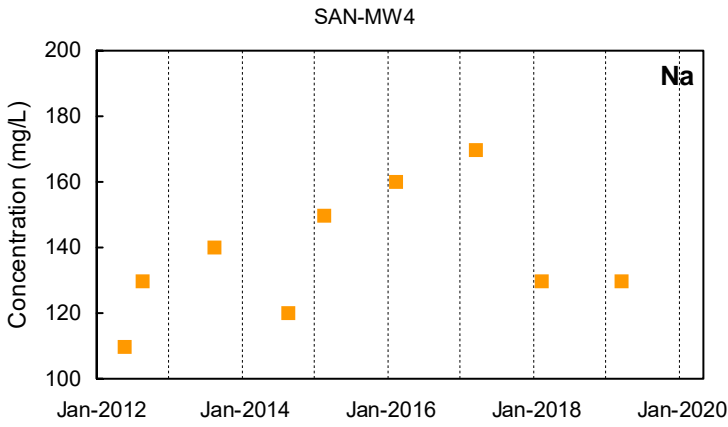

■ Detected Value
 □ 'J'-Flag (value between reporting limit and detection limit)
 Non-Detect Range
■ Shallow Well shown with black symbols
■ Deep Well shown with orange symbols
■ "dd" Well shown with blue symbols

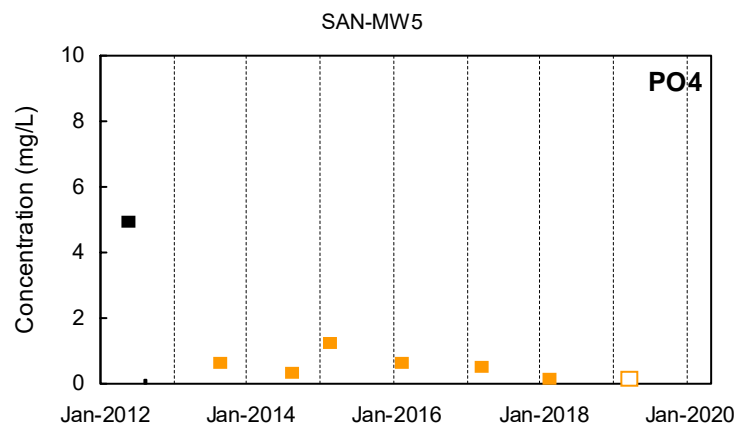
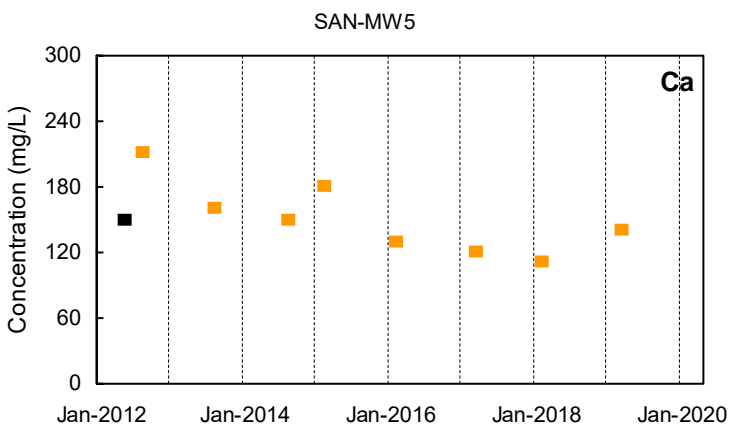
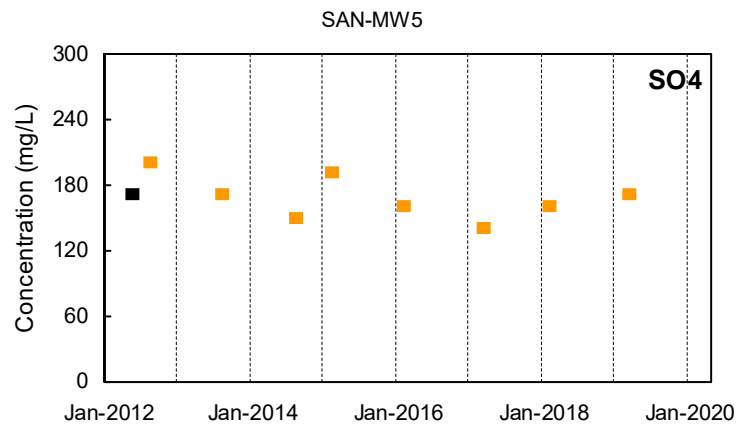
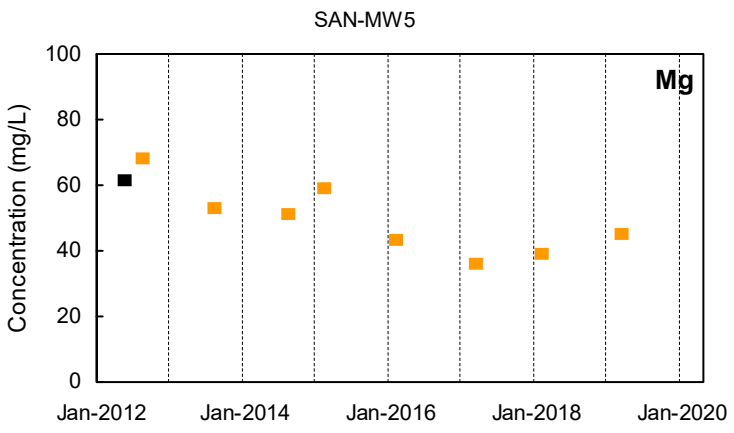
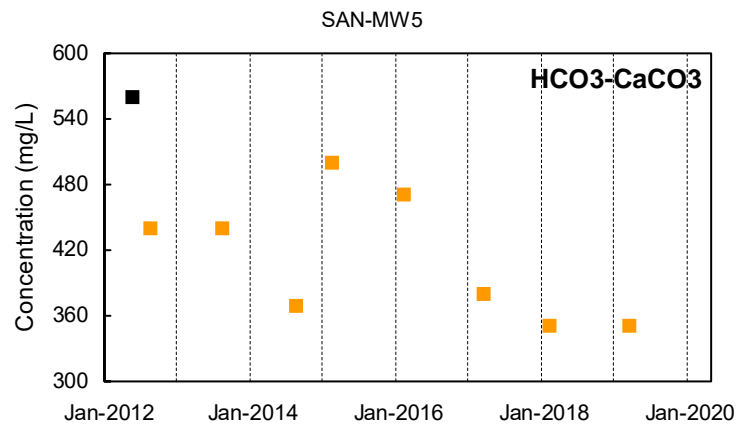
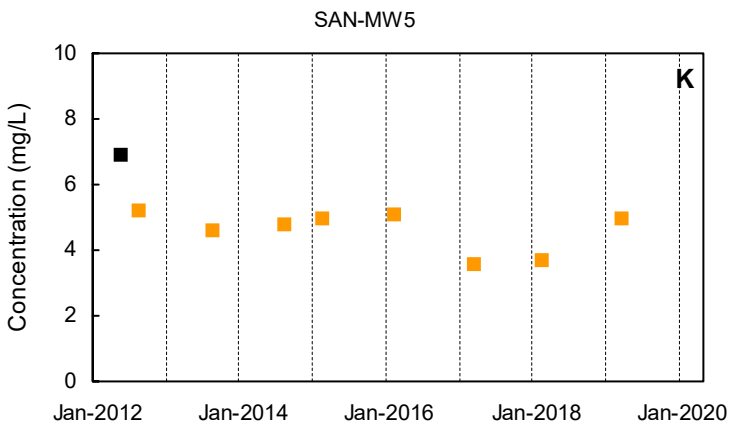
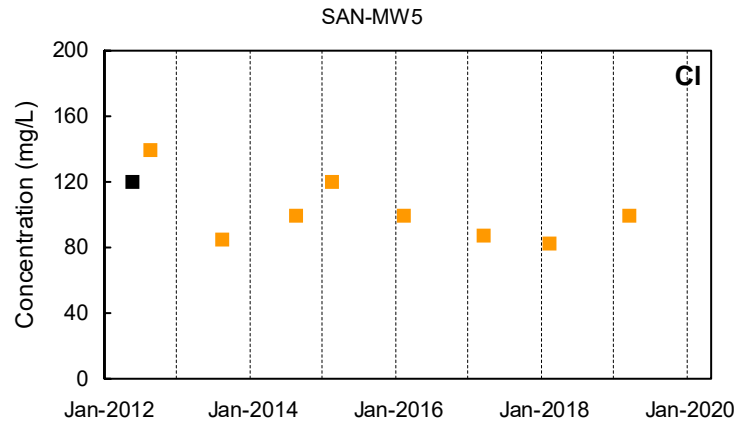
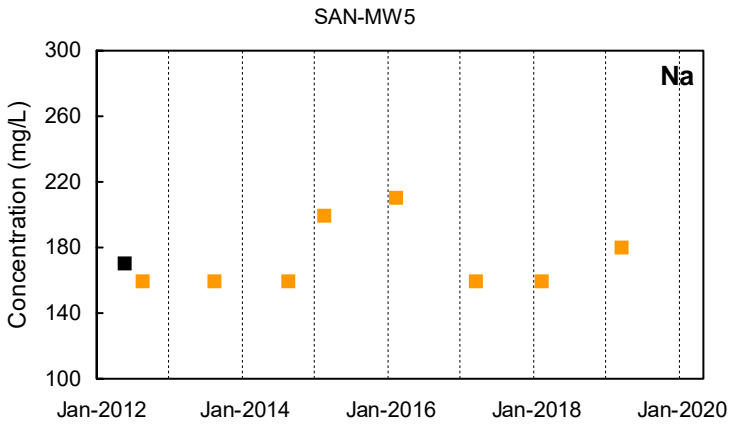

Detected Value
 'J'-Flag (value between reporting limit and detection limit)
 Non-Detect Range
 Shallow Well shown with black symbols
 Deep Well shown with orange symbols
 "dd" Well shown with blue symbols

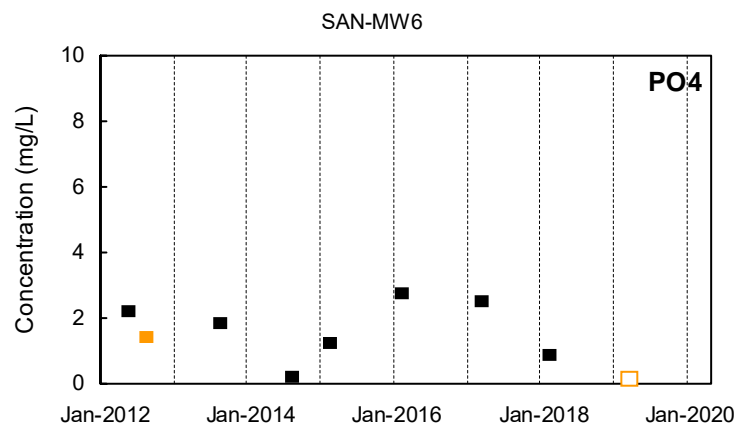
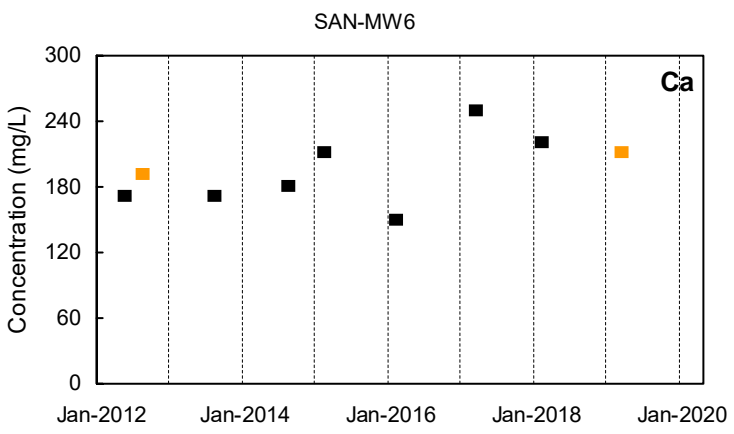
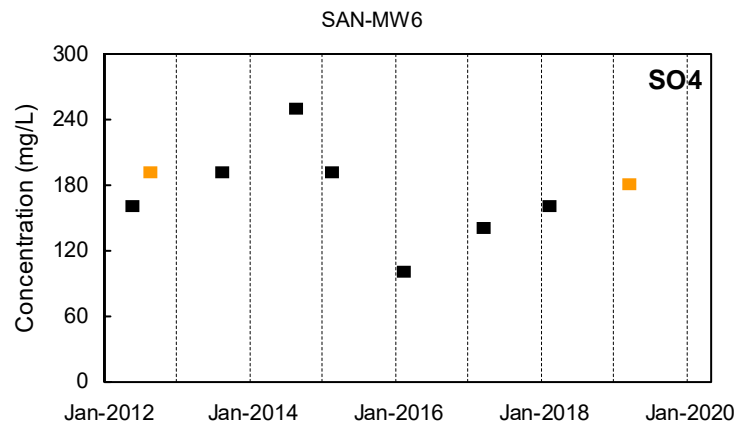
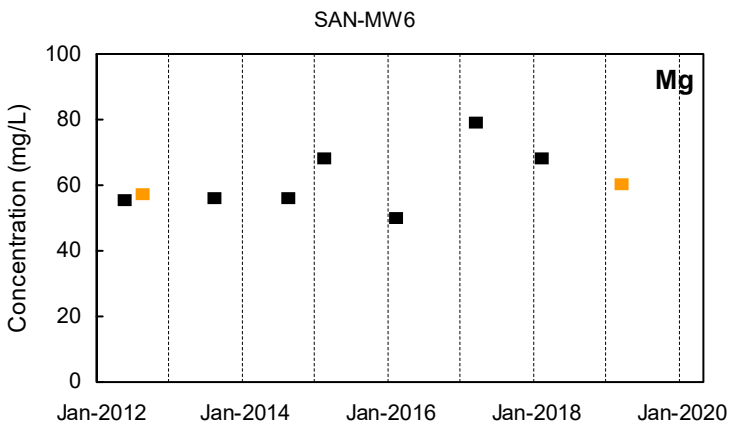
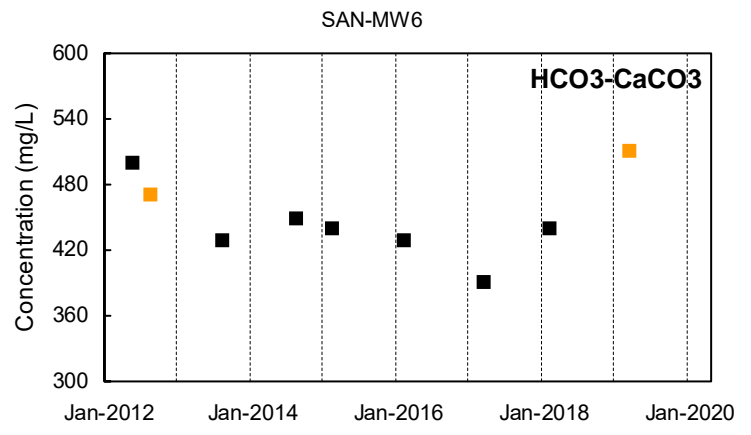
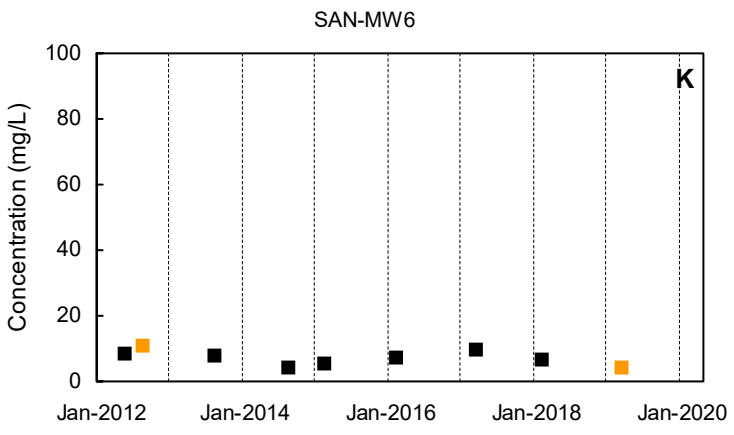
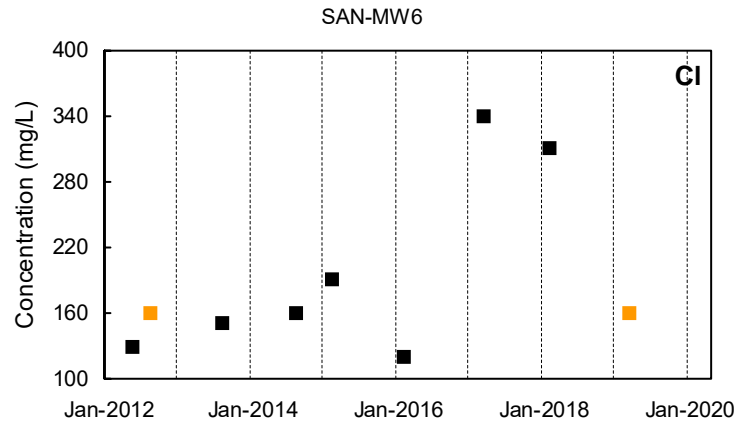
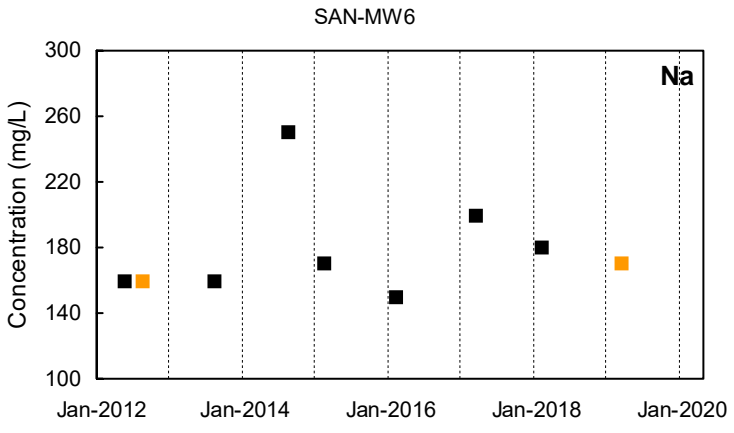

Detected Value
 'J'-Flag (value between reporting limit and detection limit)
 Non-Detect Range
 Shallow Well shown with black symbols
 Deep Well shown with orange symbols
 "dd" Well shown with blue symbols

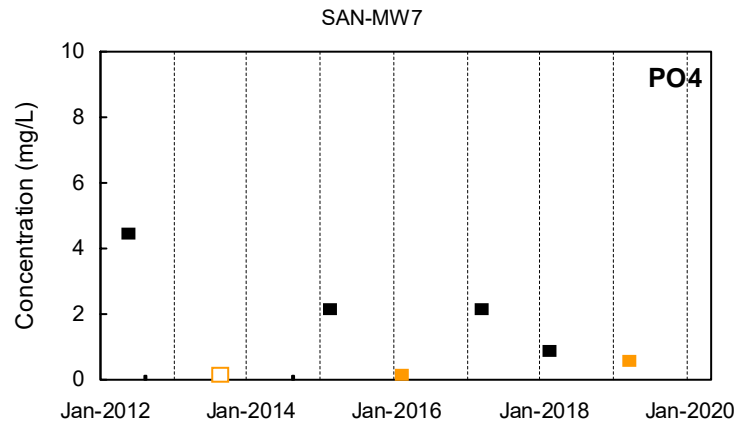
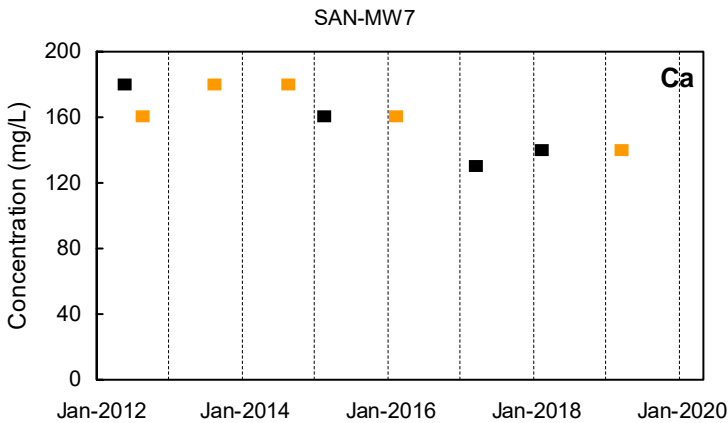
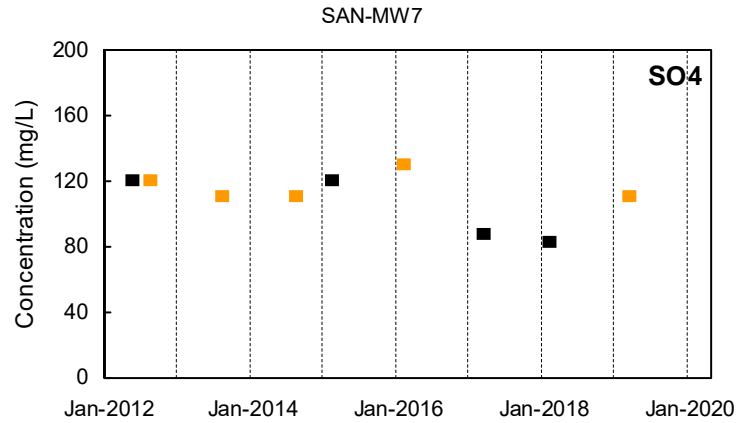
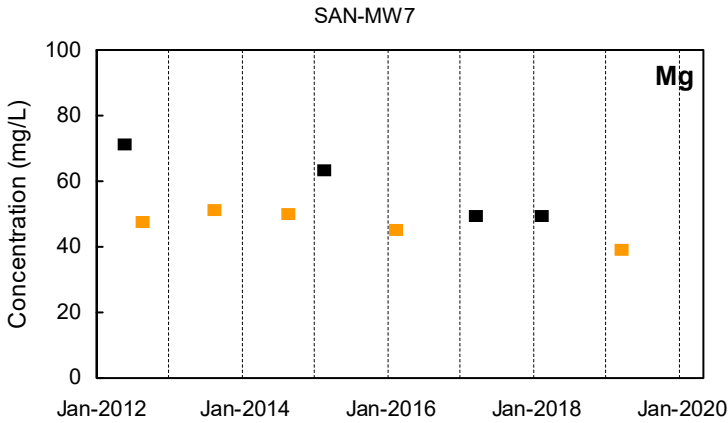
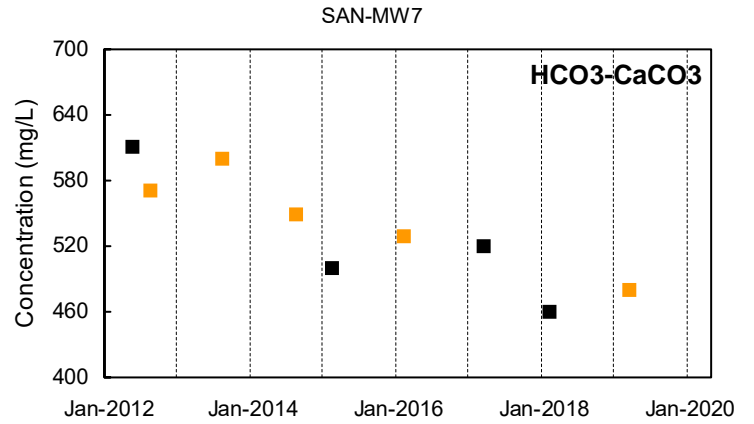
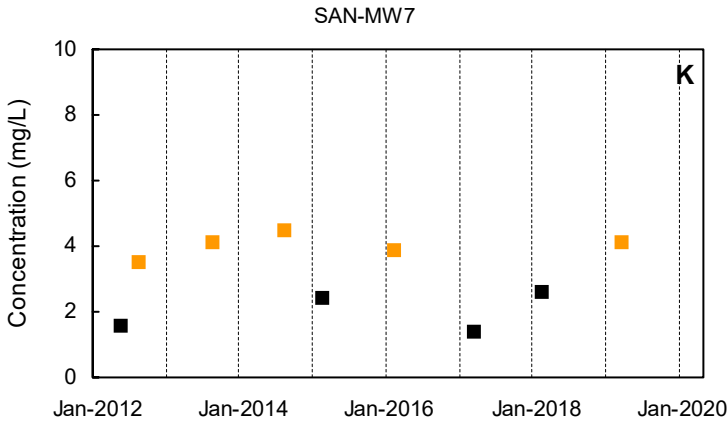
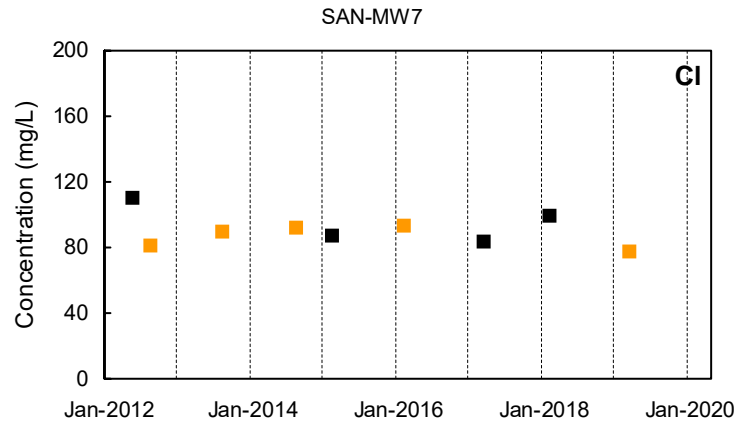
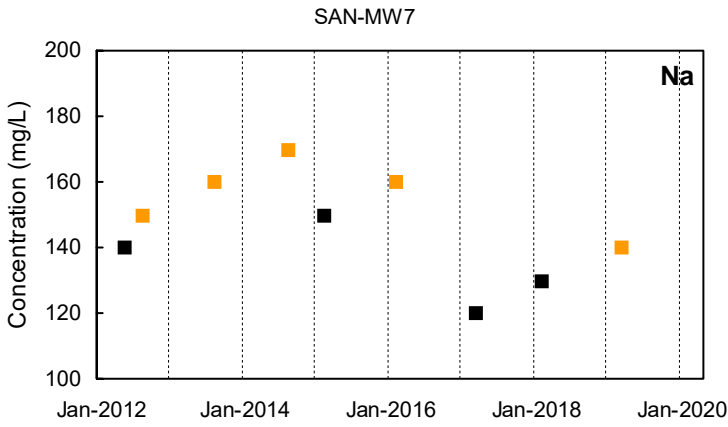

■ Detected Value □ 'J'-Flag (value between reporting limit and detection limit) ■ Non-Detect Range
 ■ Shallow Well shown with black symbols ■ Deep Well shown with orange symbols ■ "dd" Well shown with blue symbols

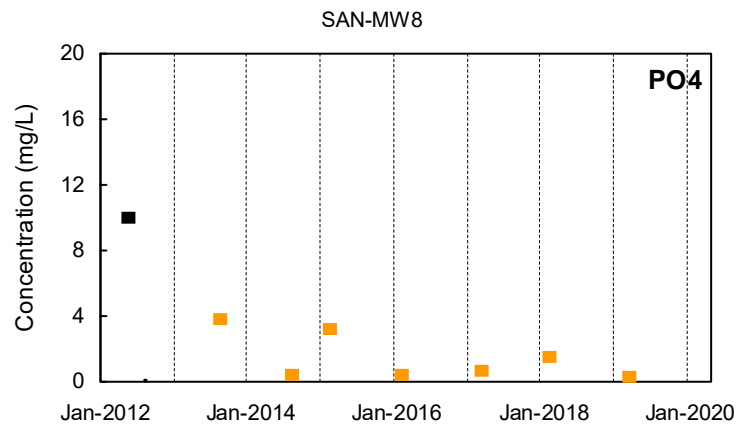
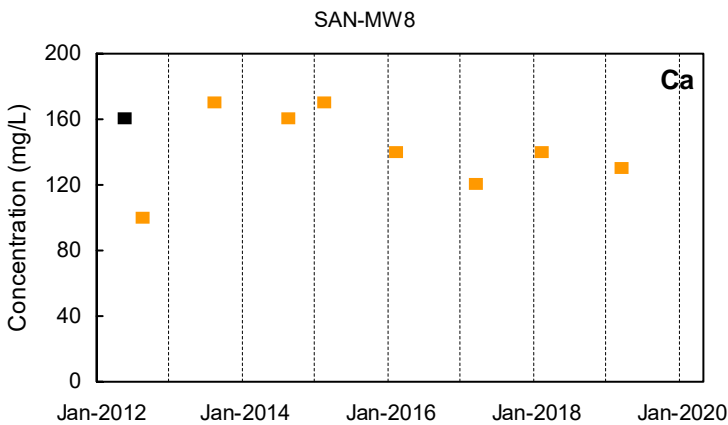
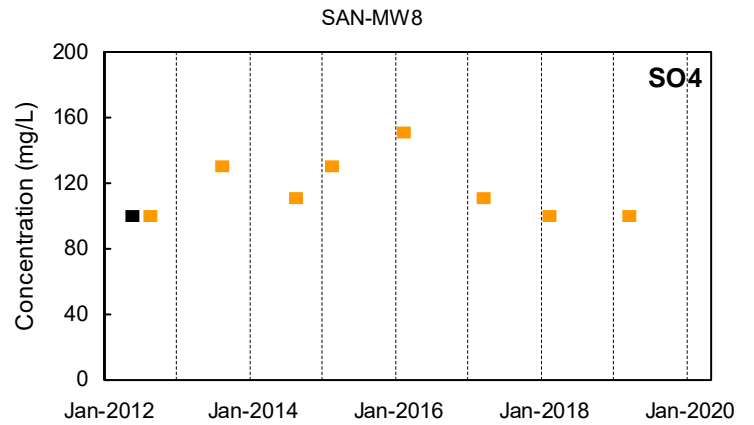
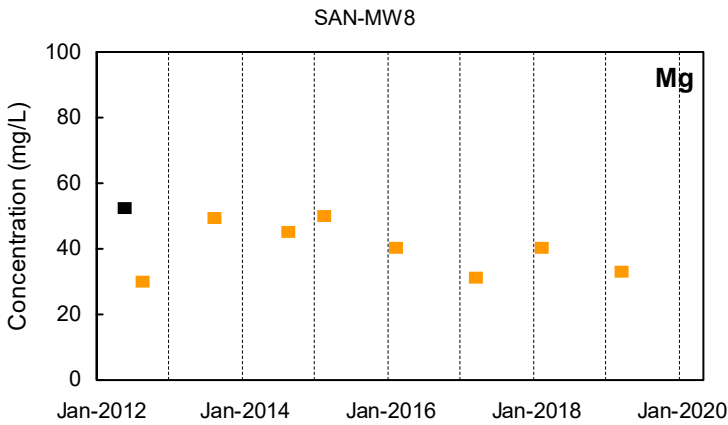
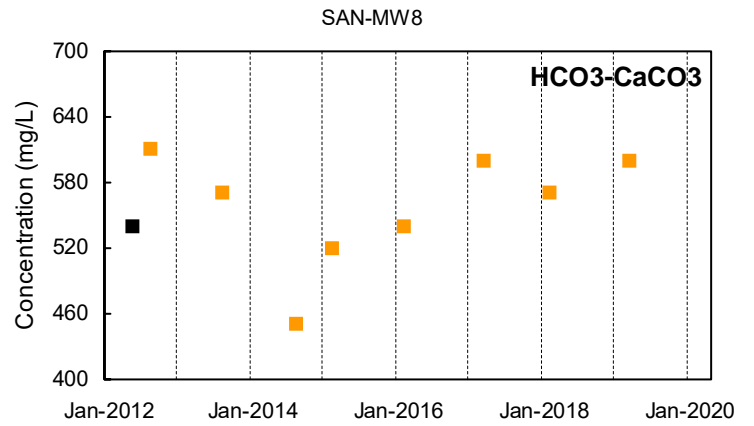
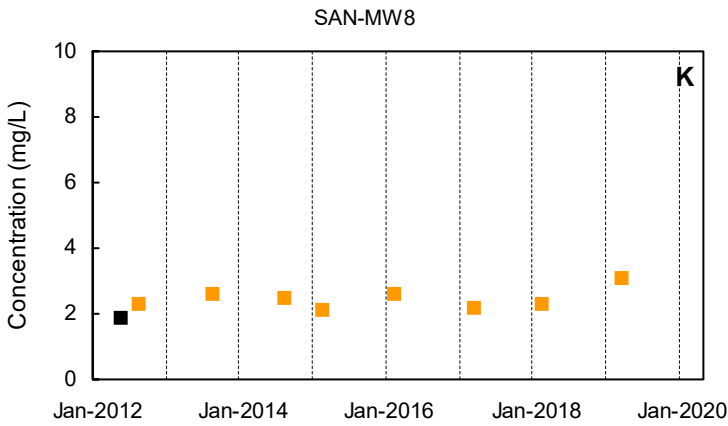
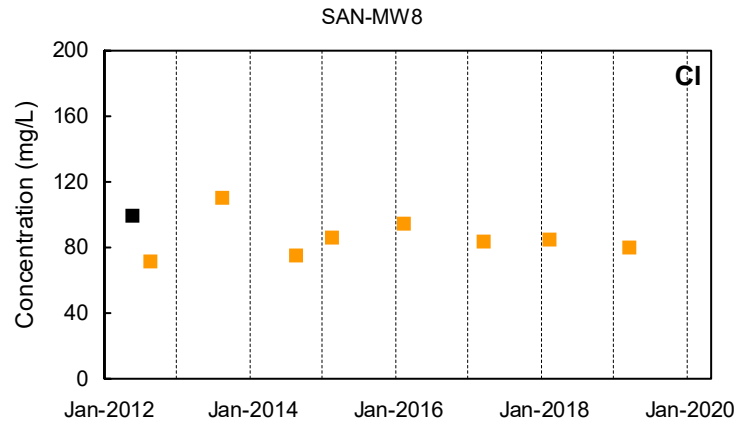
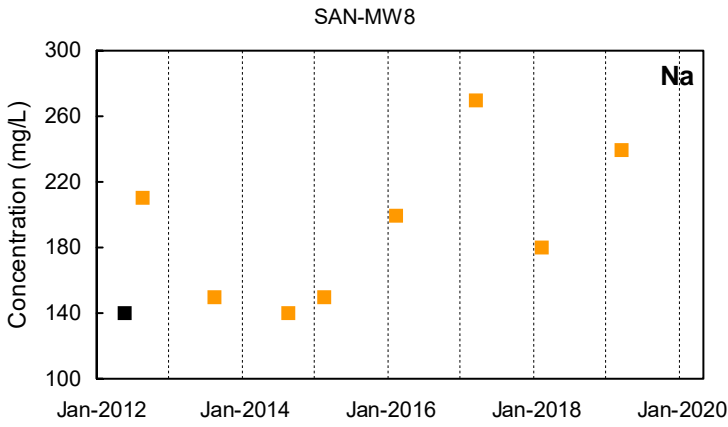

Detected Value
 'J'-Flag (value between reporting limit and detection limit)
 Non-Detect Range

Shallow Well shown with black symbols
Deep Well shown with orange symbols
"dd" Well shown with blue symbols

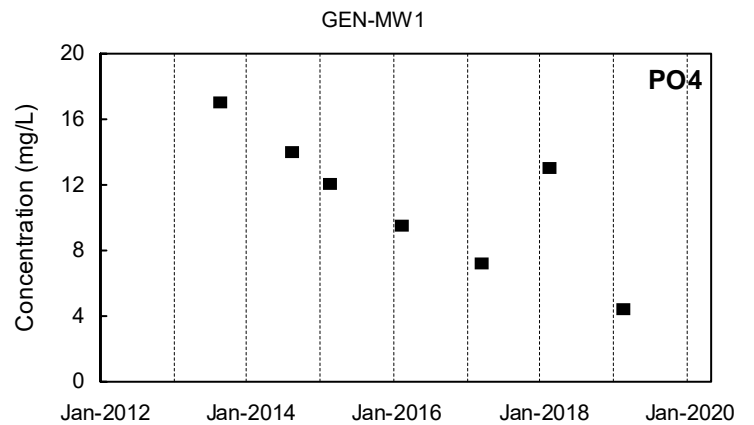
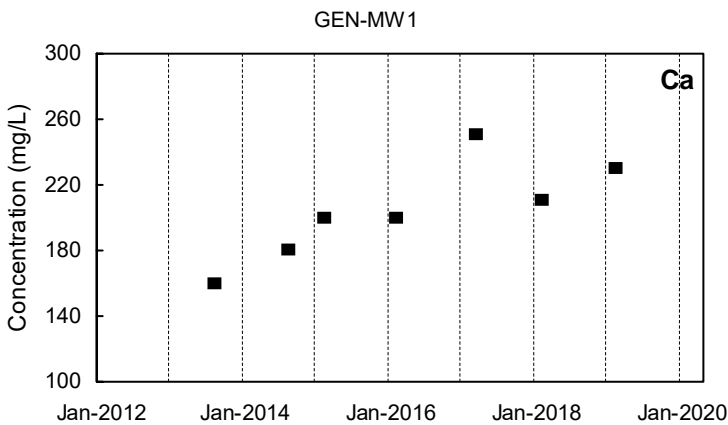
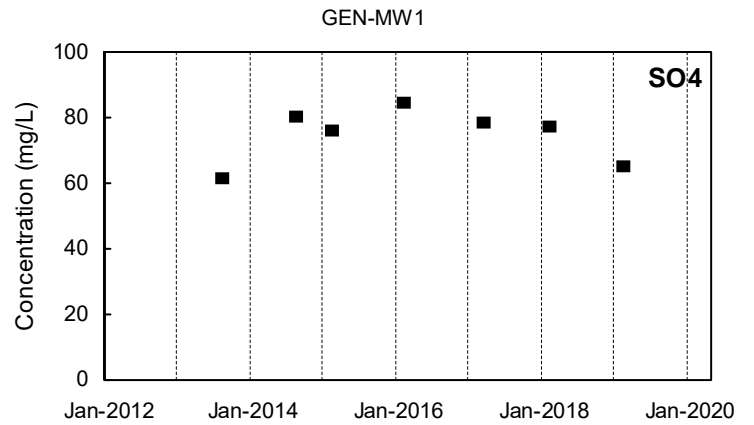
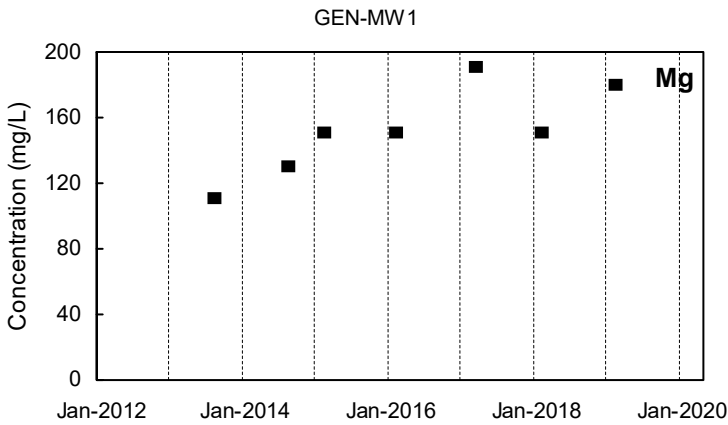
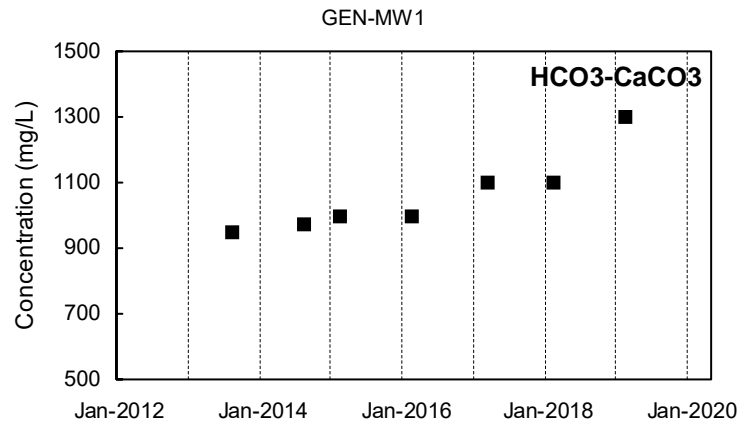
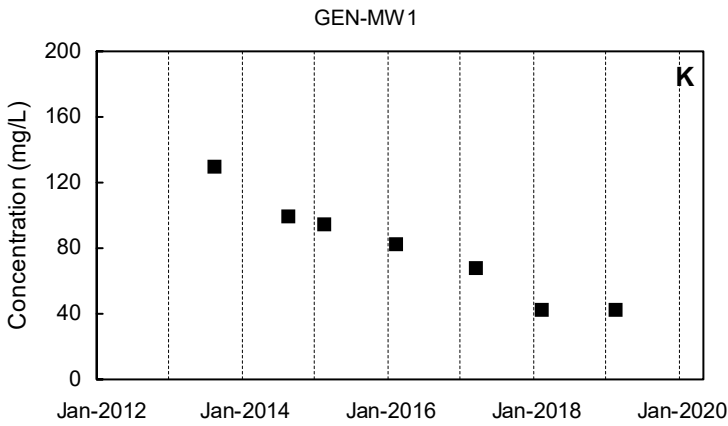
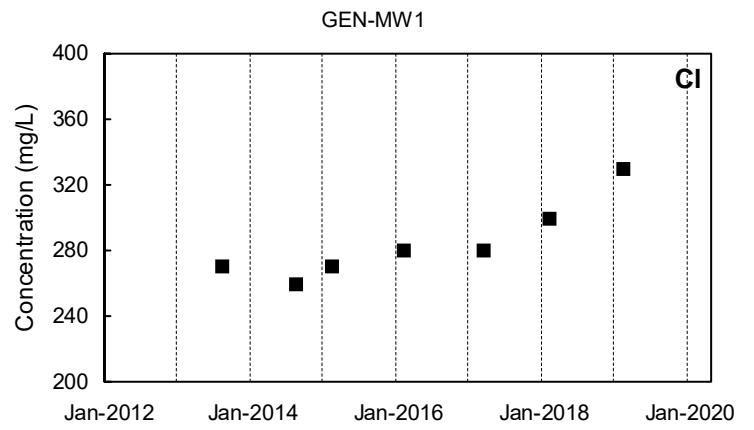
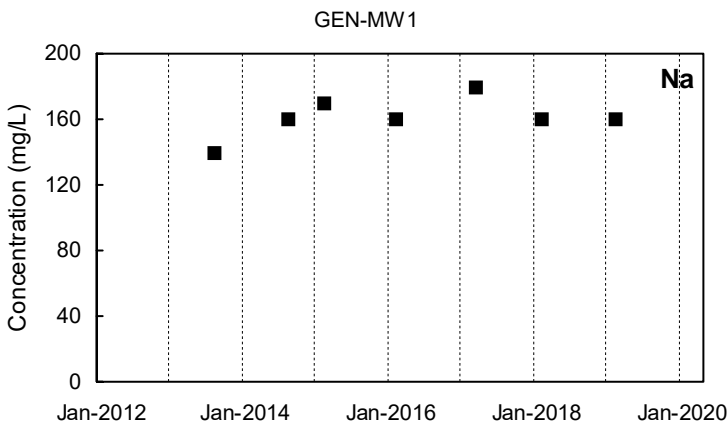

Detected Value
 'J'-Flag (value between reporting limit and detection limit)
 Non-Detect Range
 Shallow Well shown with black symbols
 Deep Well shown with orange symbols
 "dd" Well shown with blue symbols

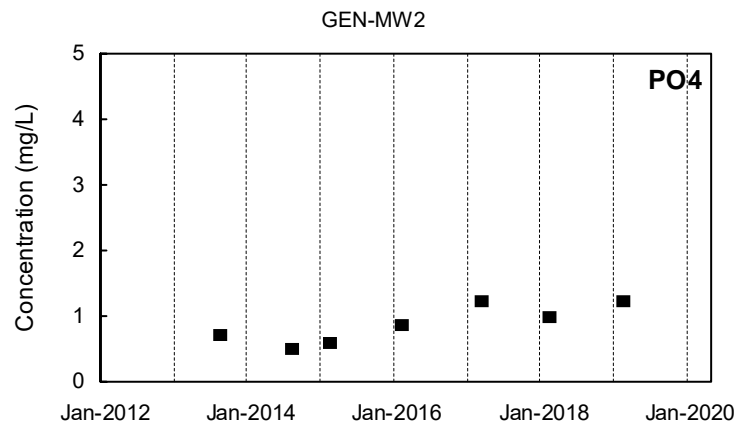
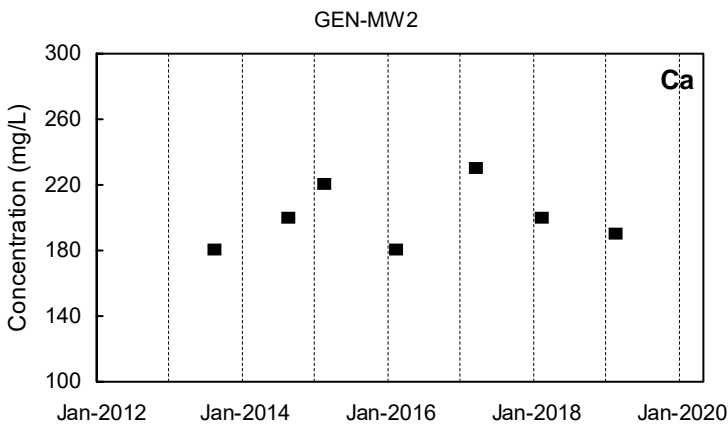
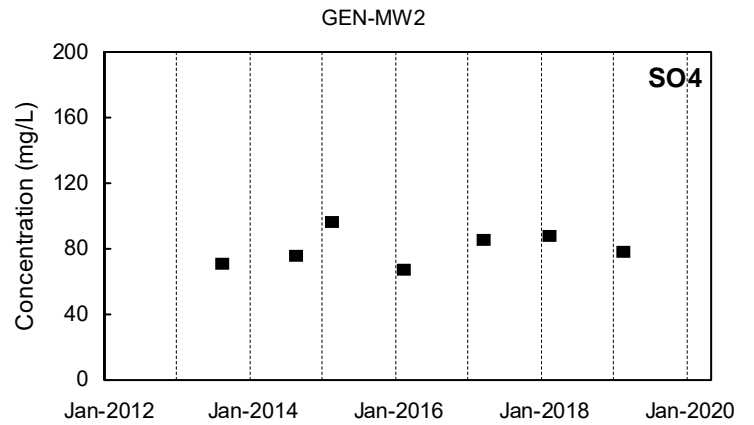
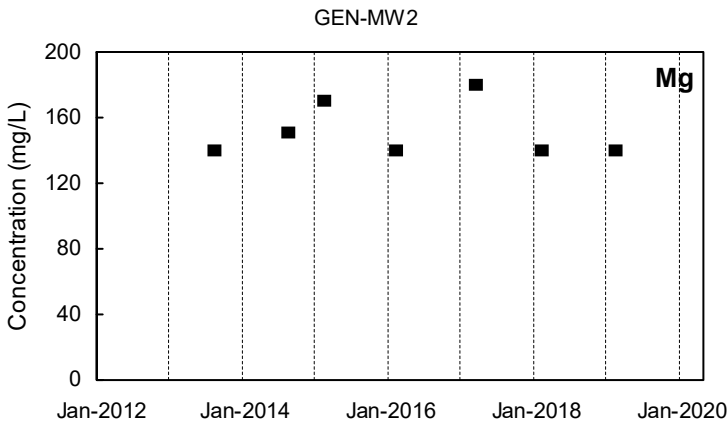
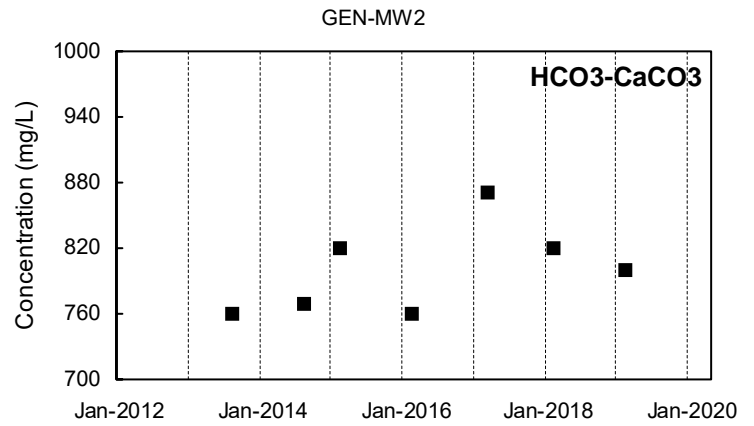
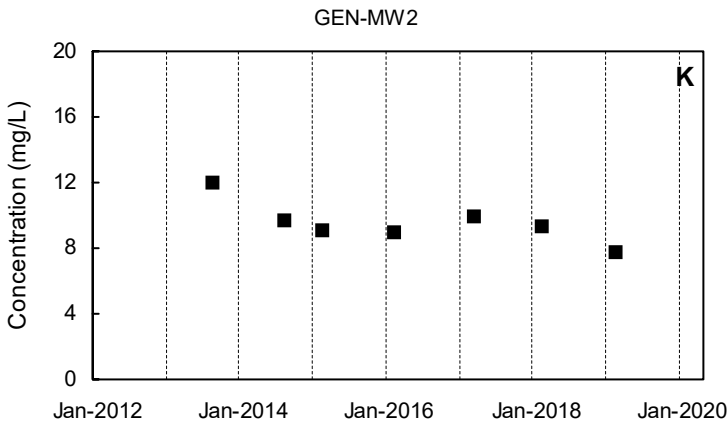
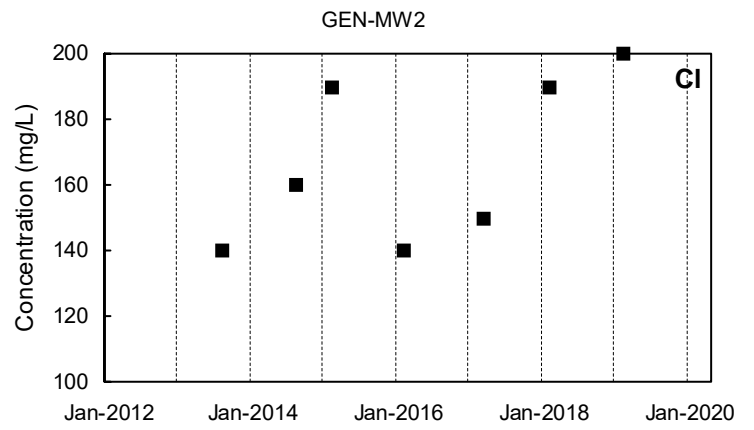
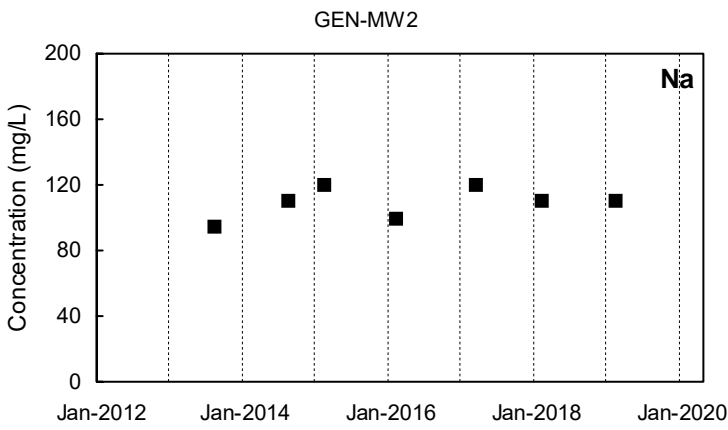

Detected Value
 'J'-Flag (value between reporting limit and detection limit)
 Non-Detect Range

Shallow Well shown with black symbols
Deep Well shown with orange symbols
"dd" Well shown with blue symbols

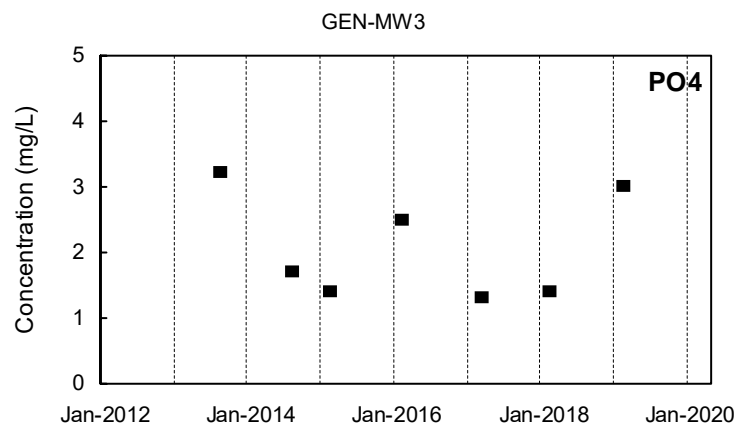
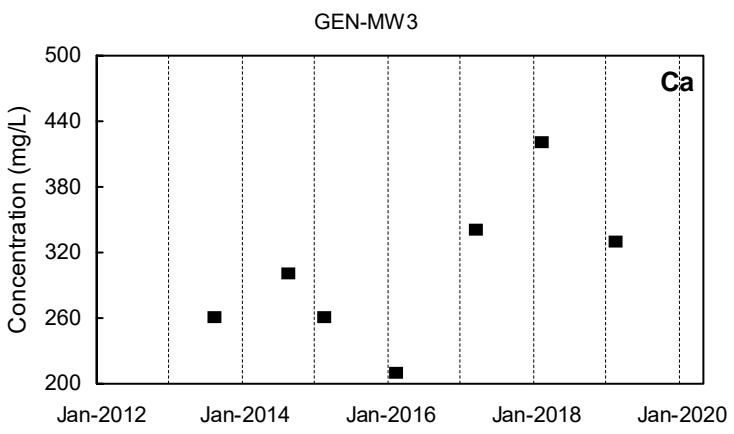
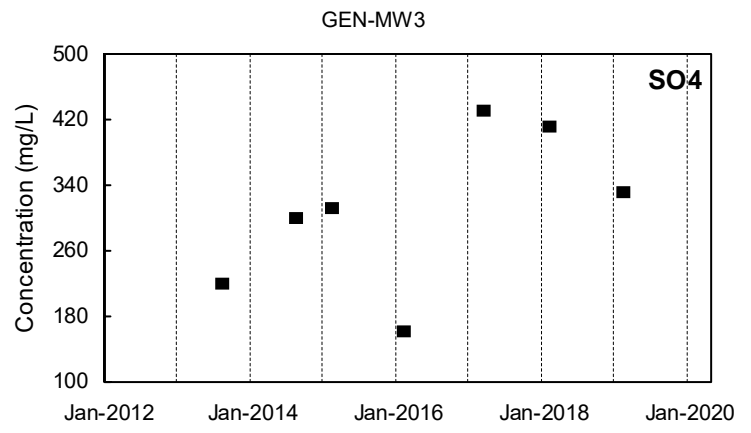
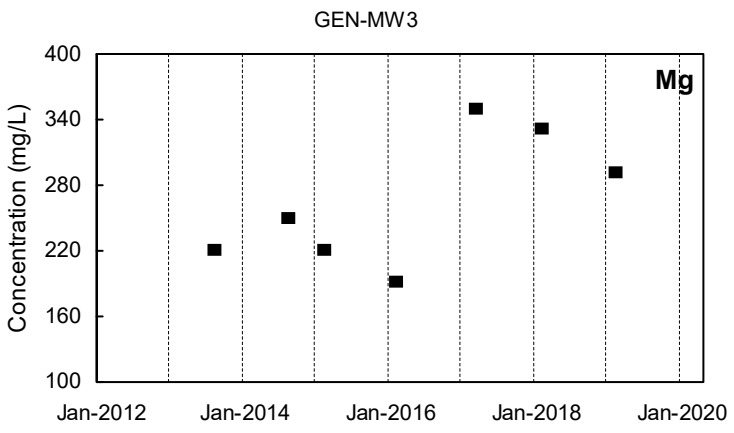
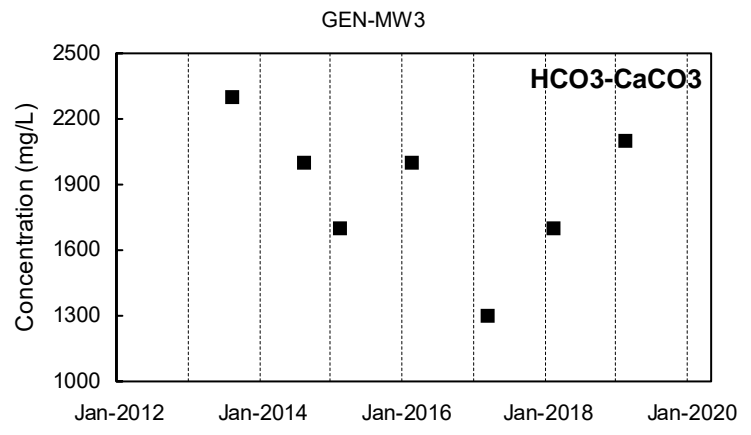
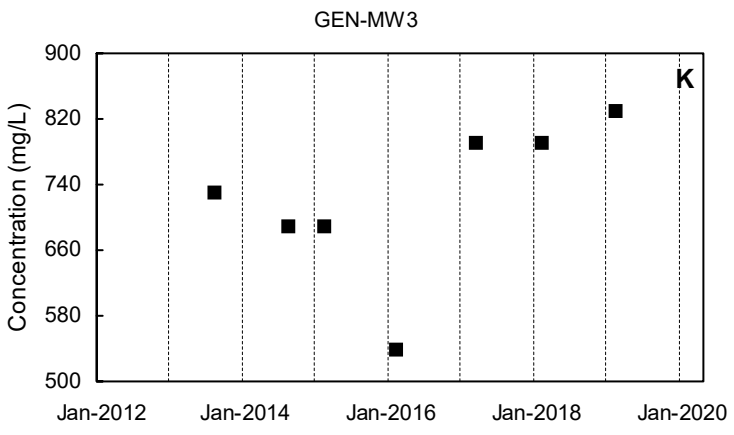
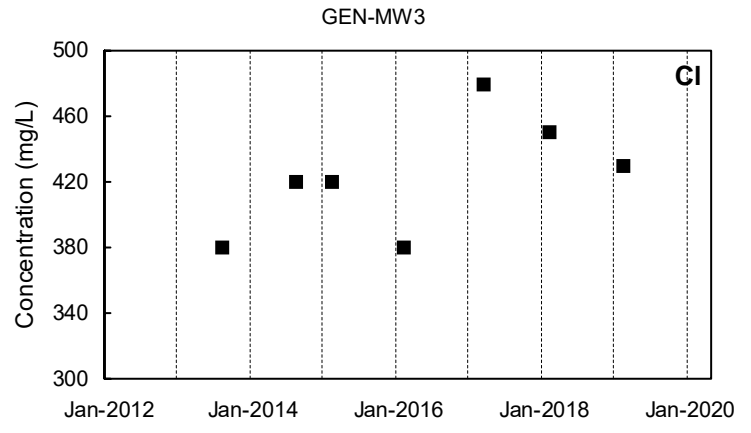
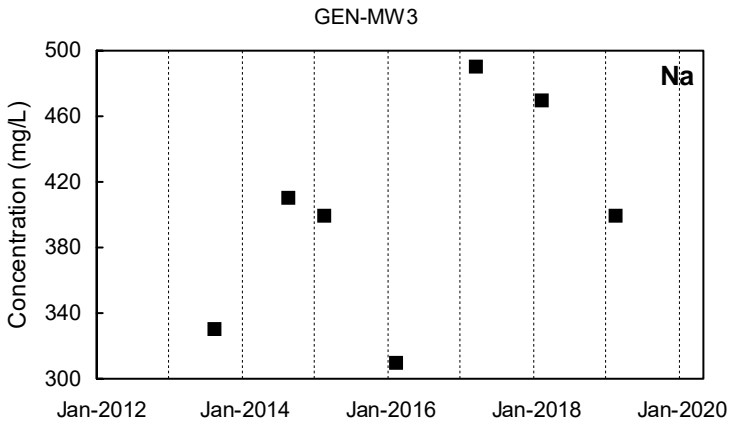

Detected Value
 'J'-Flag (value between reporting limit and detection limit)
 Non-Detect Range
 Shallow Well shown with black symbols
 Deep Well shown with orange symbols
 "dd" Well shown with blue symbols

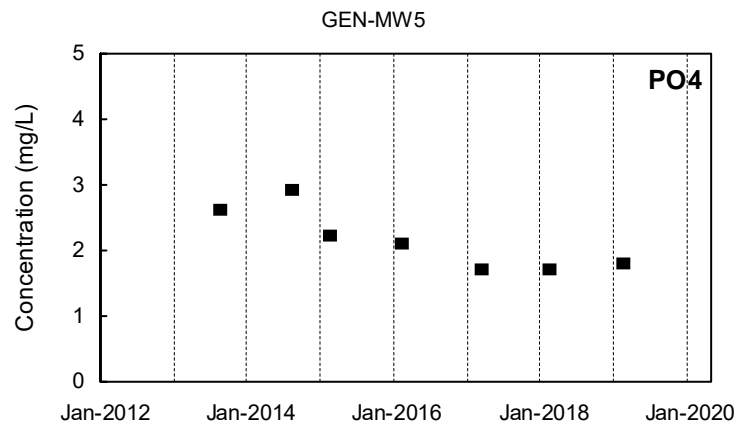
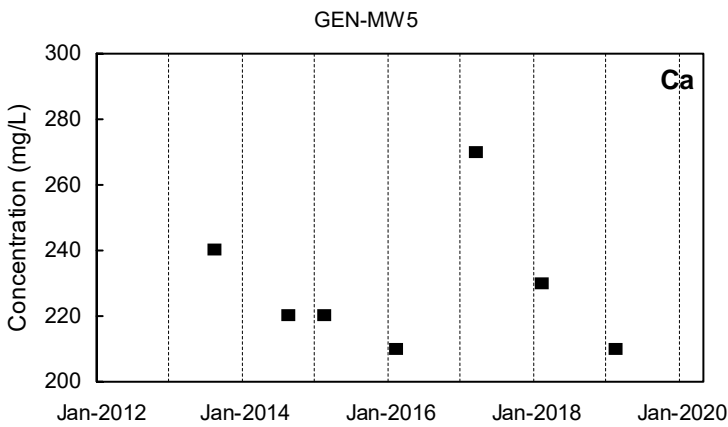
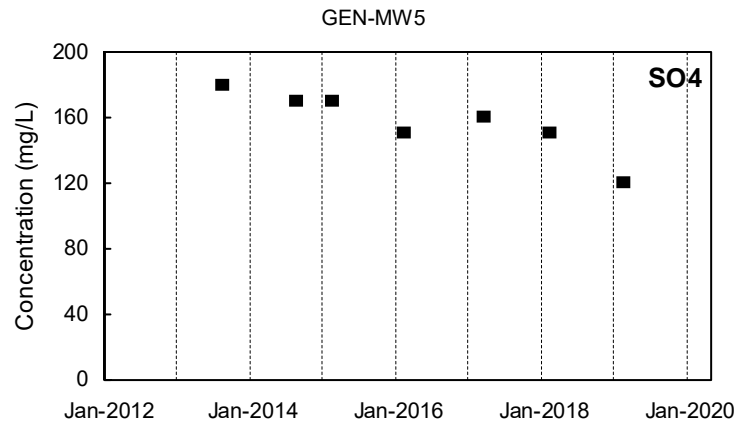
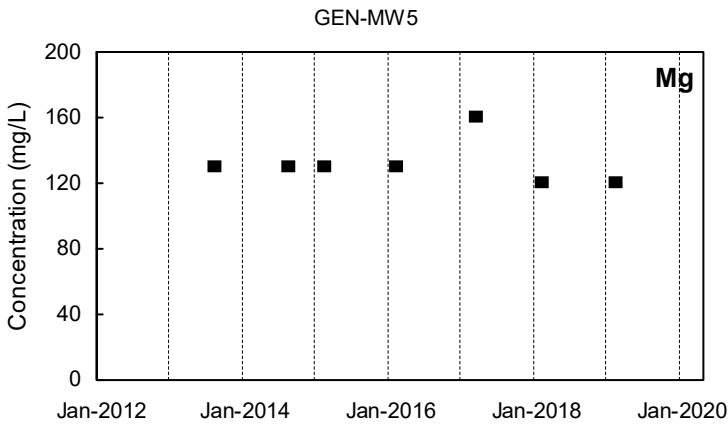
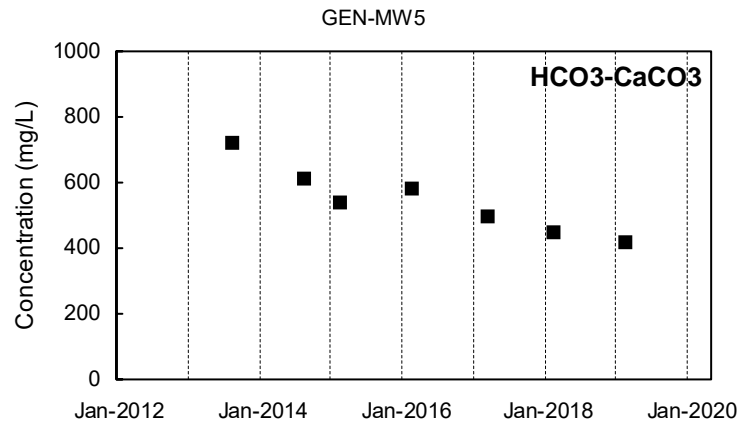
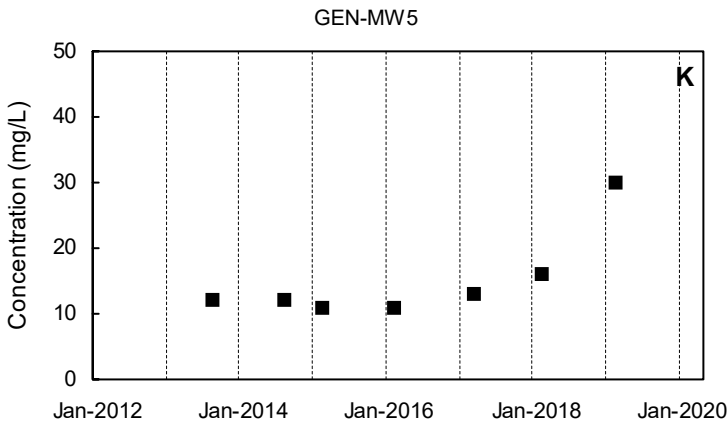
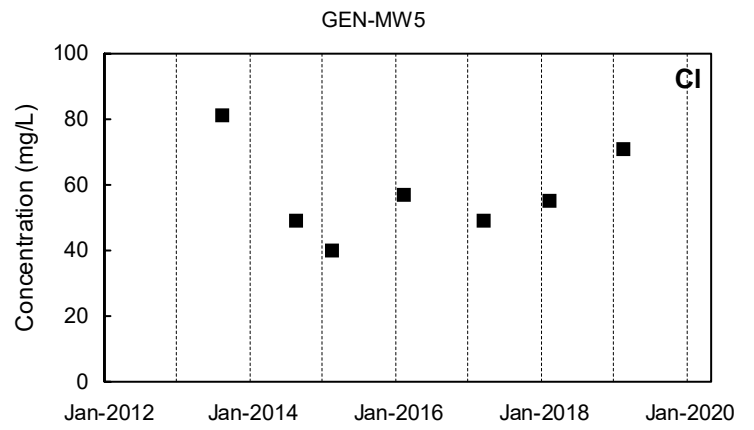
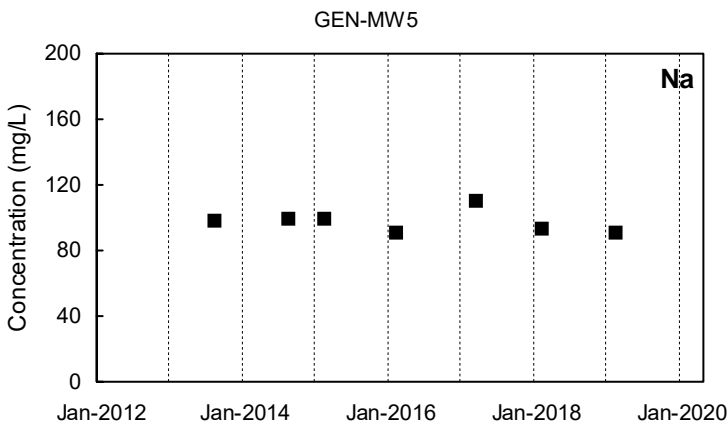

■ Detected Value □ 'J'-Flag (value between reporting limit and detection limit) ■ Non-Detect Range
 Shallow Well shown with black symbols Deep Well shown with orange symbols "dd" Well shown with blue symbols

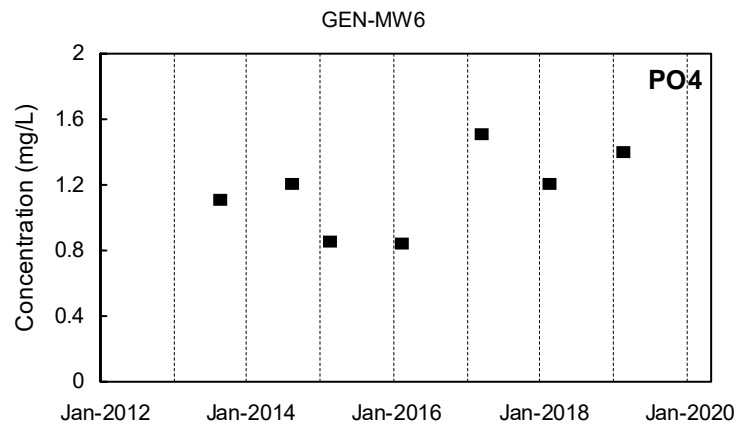
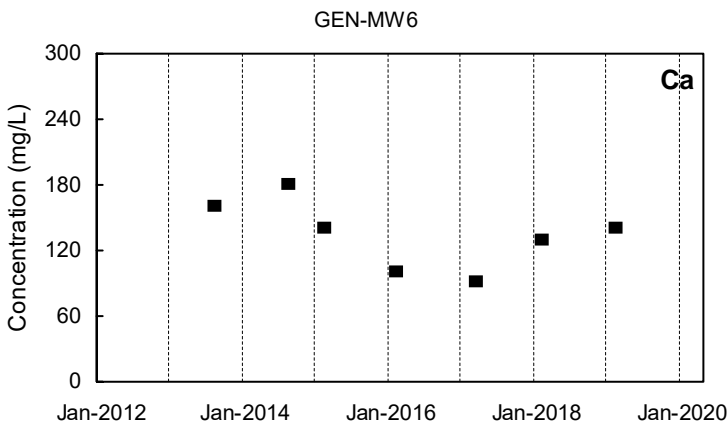
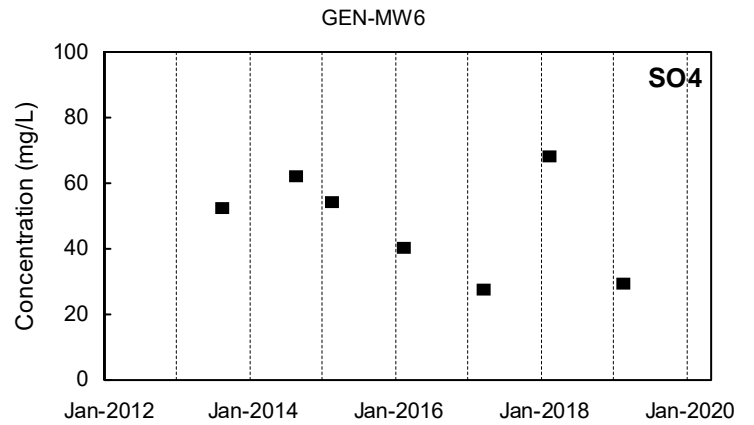
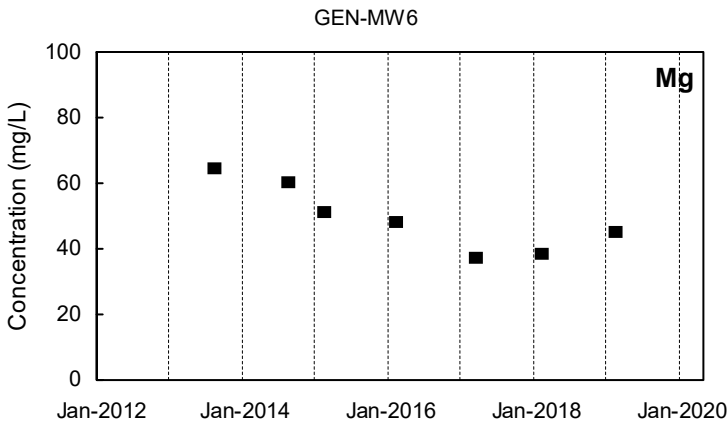
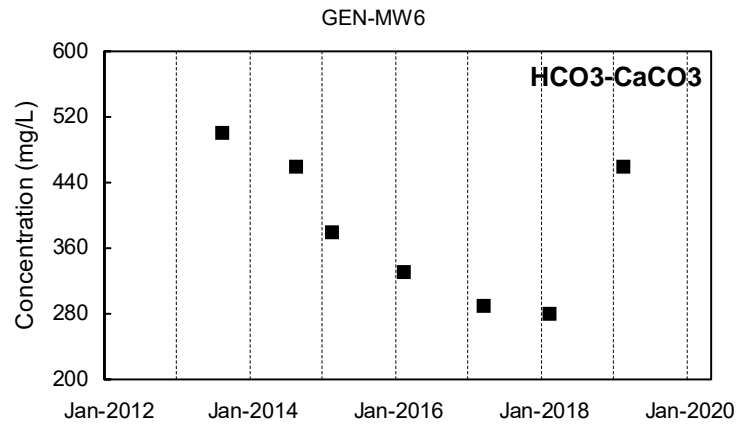
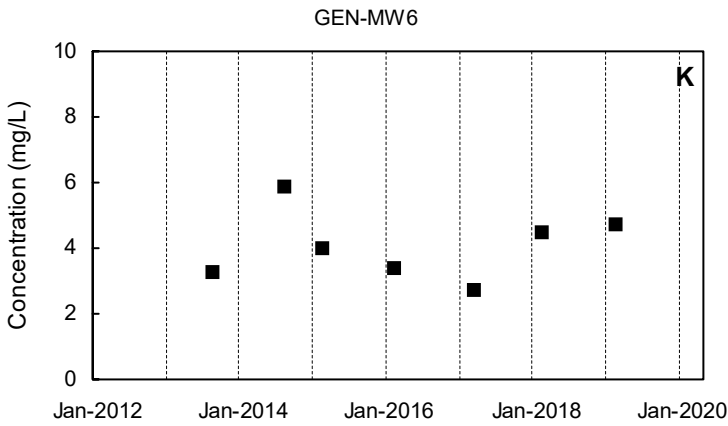
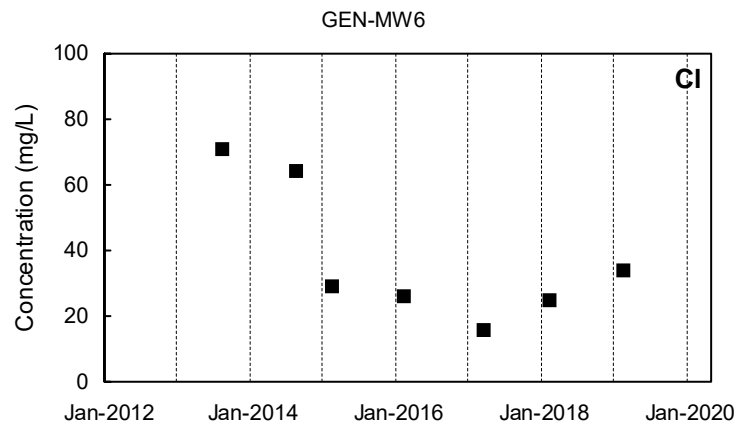
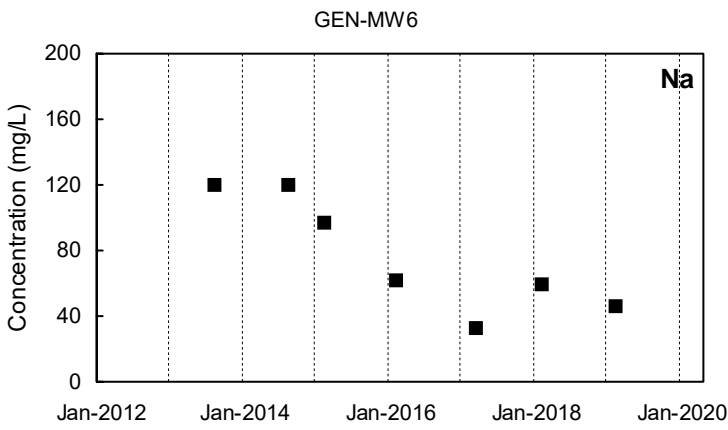

Detected Value
 'J'-Flag (value between reporting limit and detection limit)
 Non-Detect Range
 Shallow Well shown with black symbols
 Deep Well shown with orange symbols
 "dd" Well shown with blue symbols

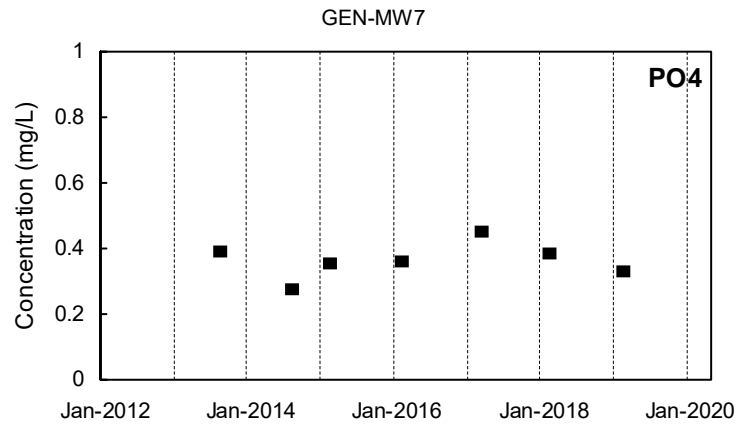
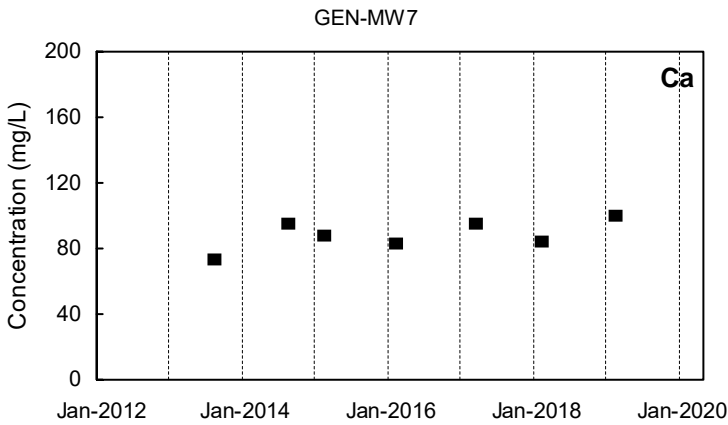
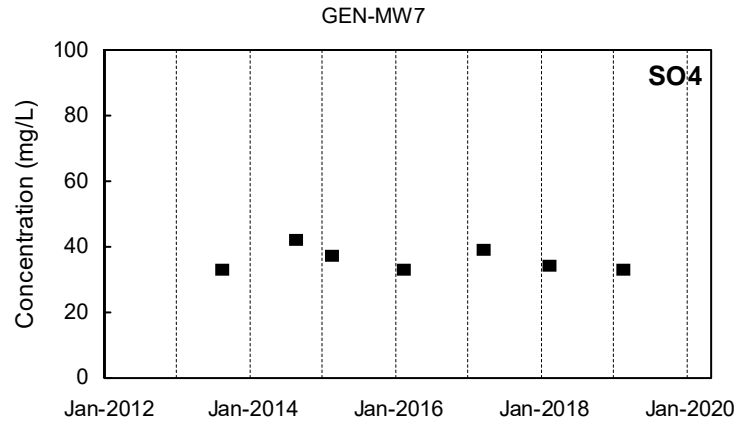
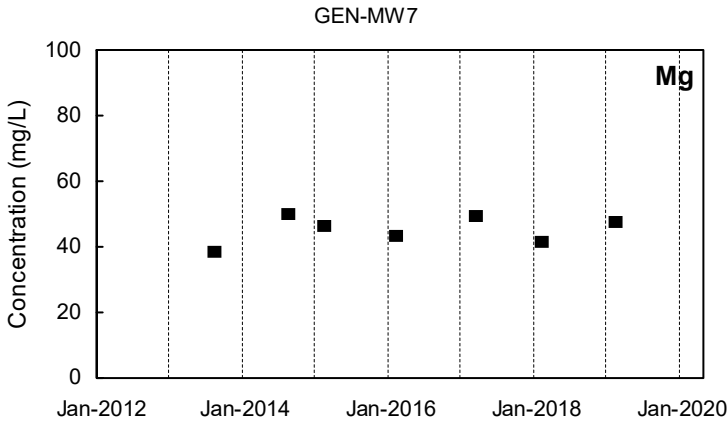
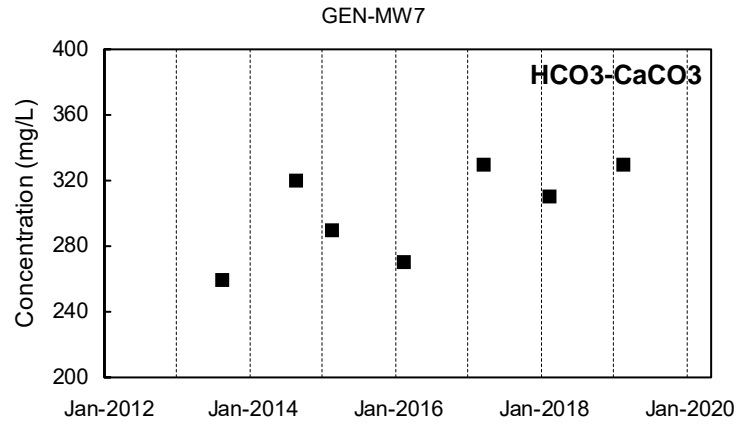
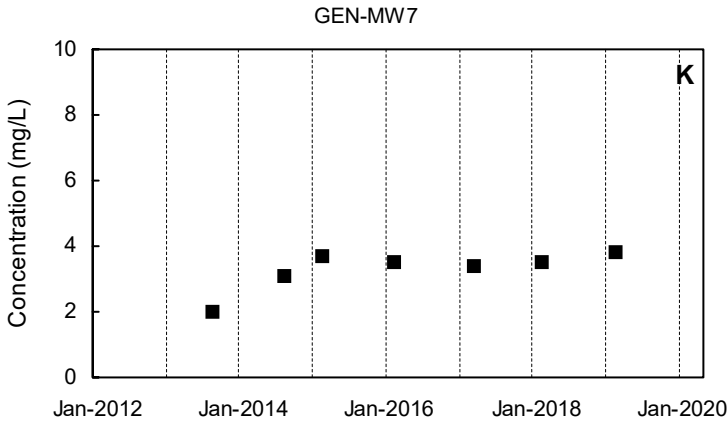
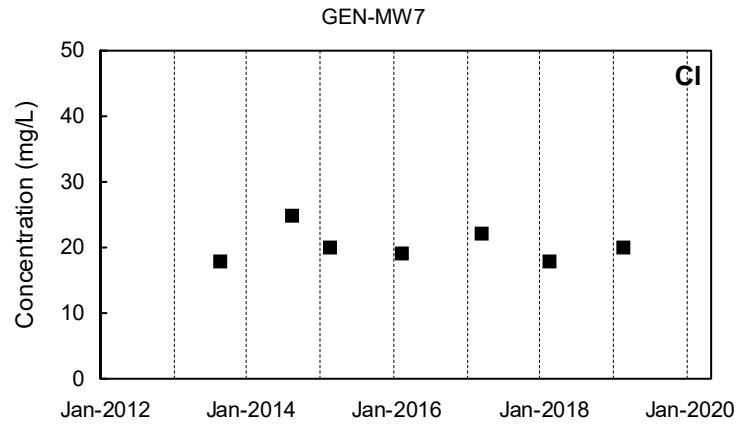
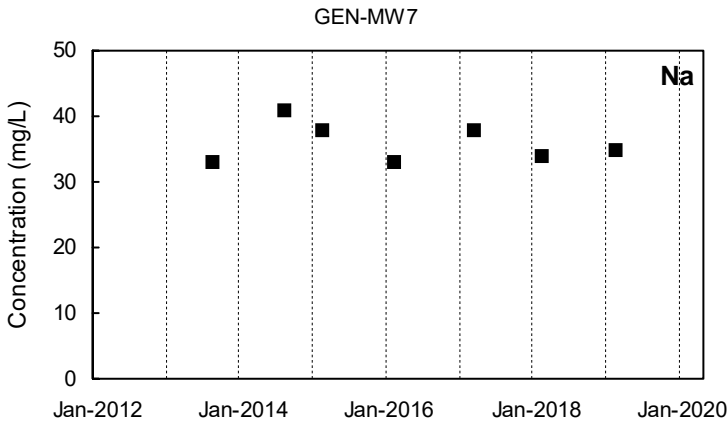

Detected Value
 'J'-Flag (value between reporting limit and detection limit)
 Non-Detect Range
 Shallow Well shown with black symbols
 Deep Well shown with orange symbols
 "dd" Well shown with blue symbols

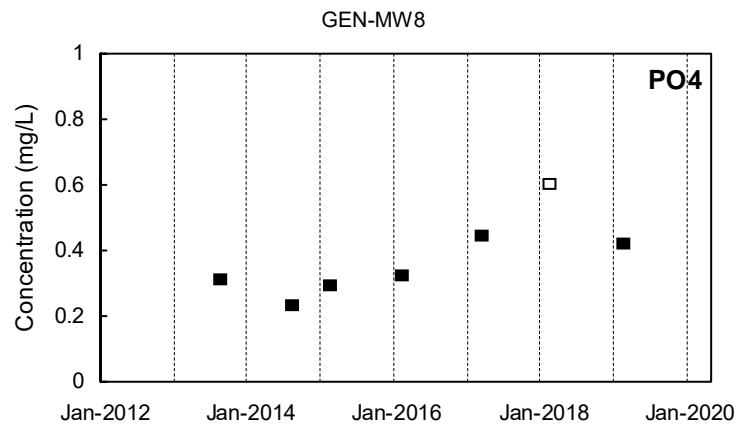
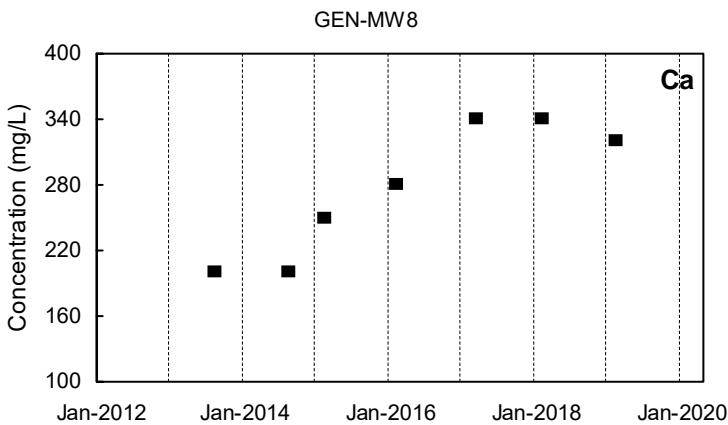
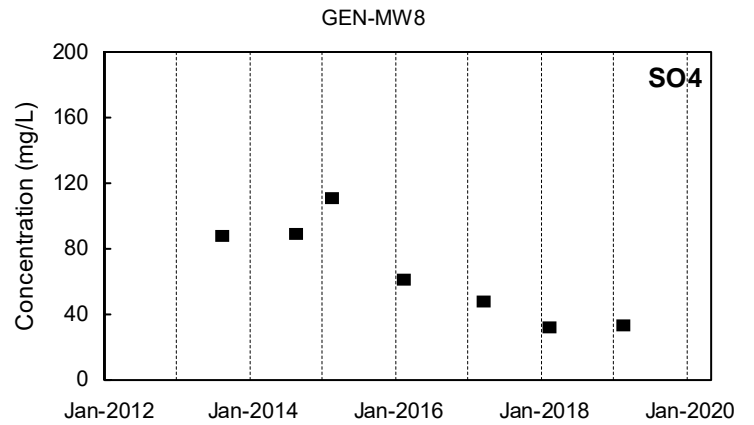
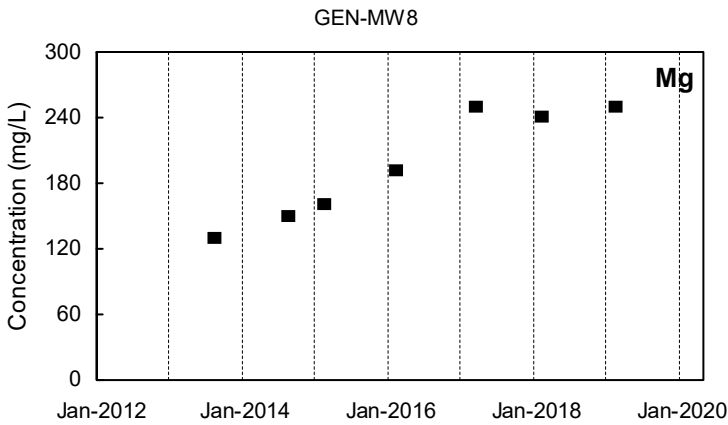
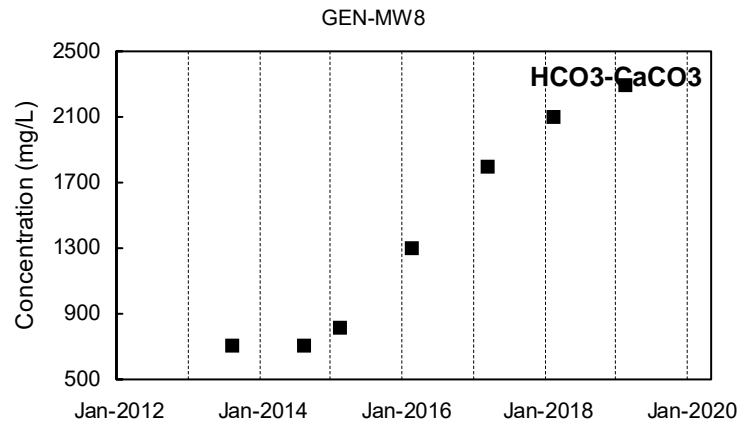
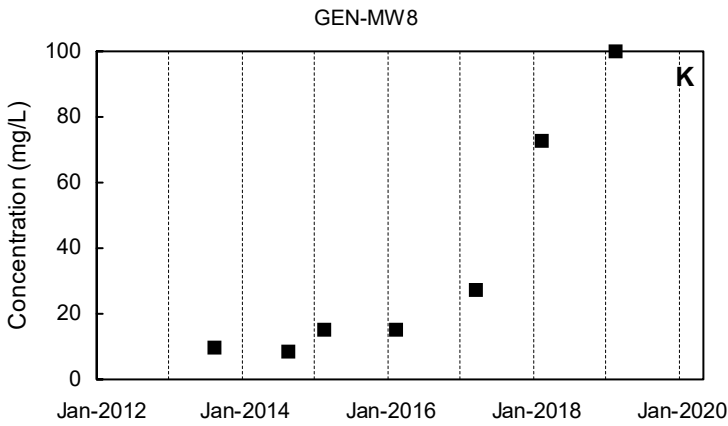
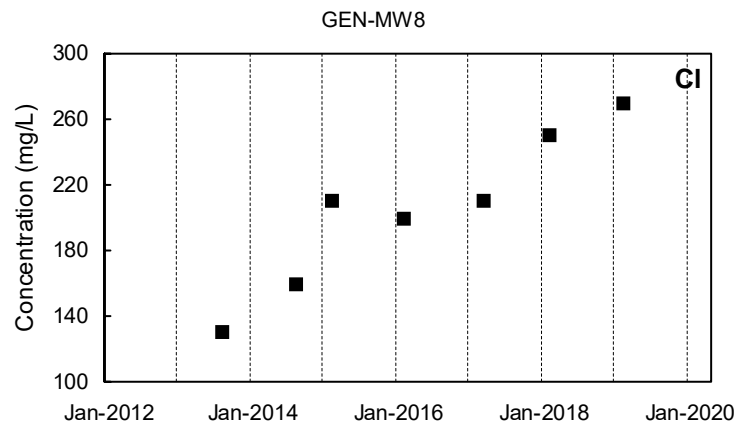
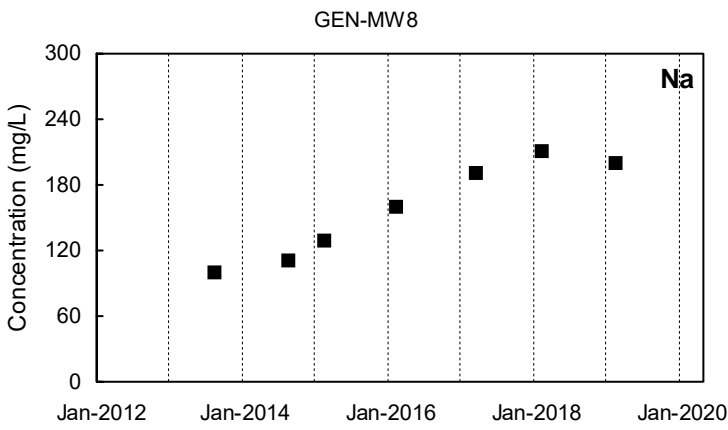

■ Detected Value □ 'J'-Flag (value between reporting limit and detection limit) ■ Non-Detect Range
 Shallow Well shown with black symbols Deep Well shown with orange symbols "dd" Well shown with blue symbols

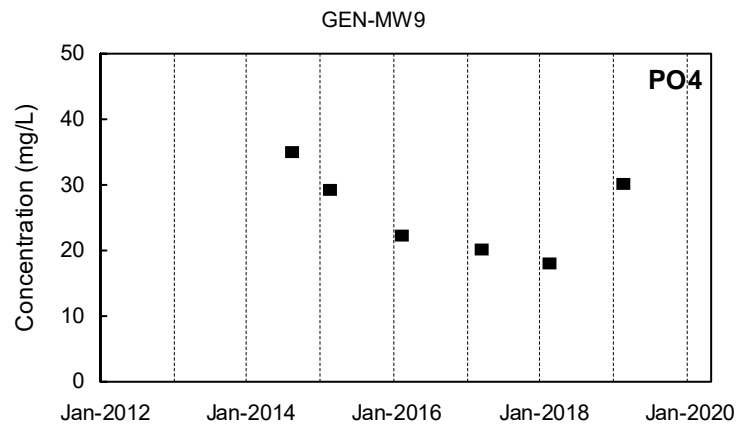
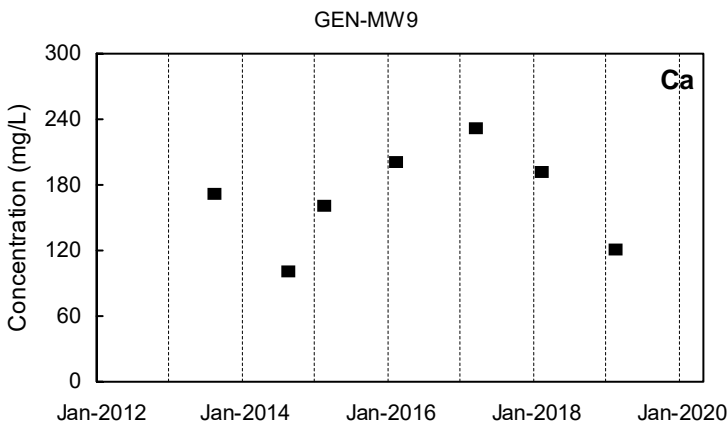
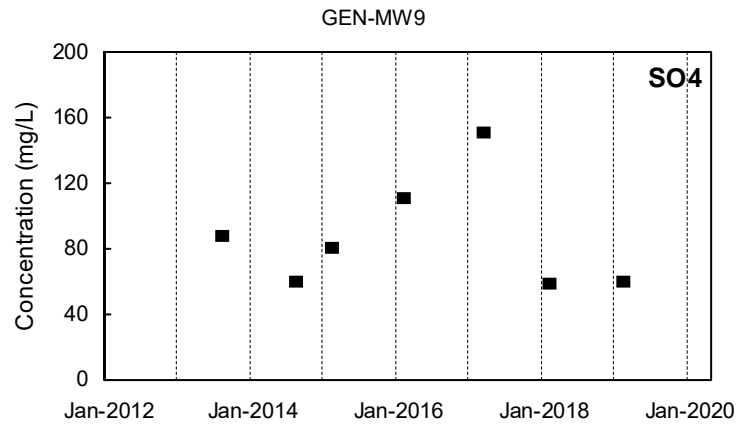
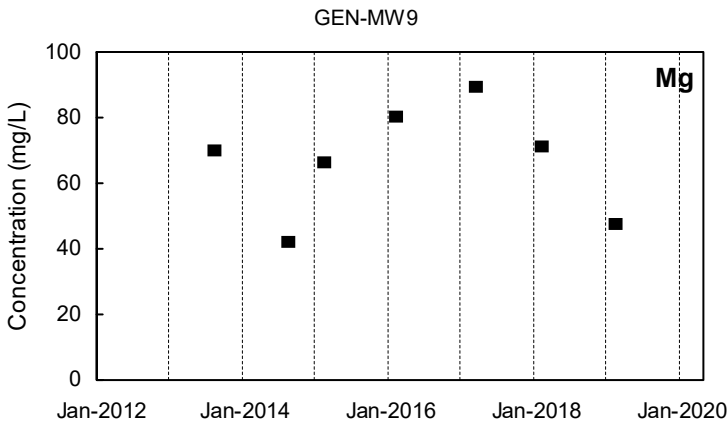
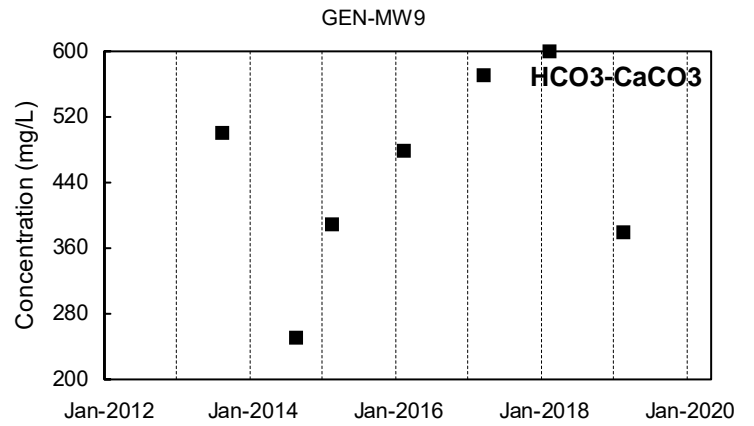
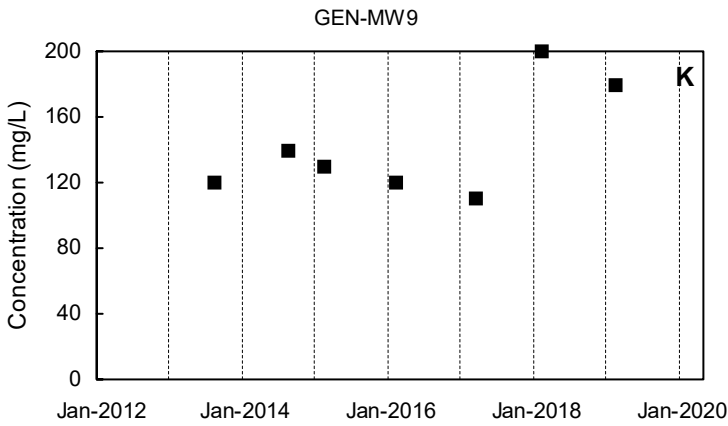
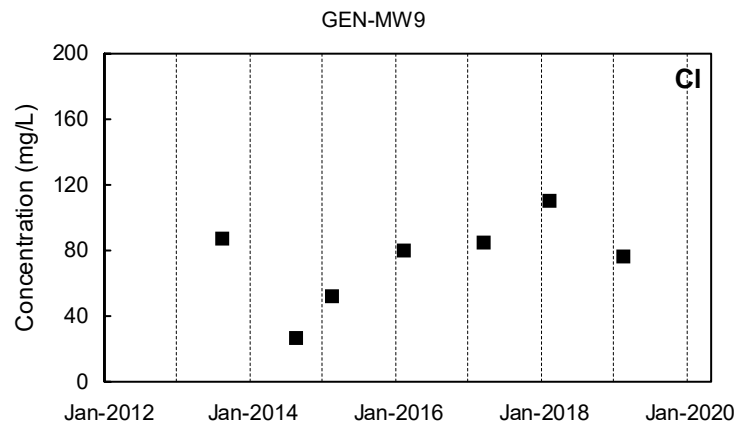
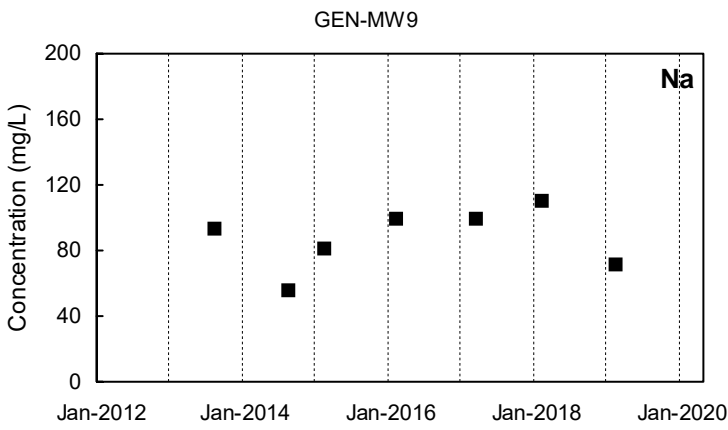

■ Detected Value □ 'J'-Flag (value between reporting limit and detection limit) ■ Non-Detect Range
 Shallow Well shown with black symbols Deep Well shown with orange symbols "dd" Well shown with blue symbols

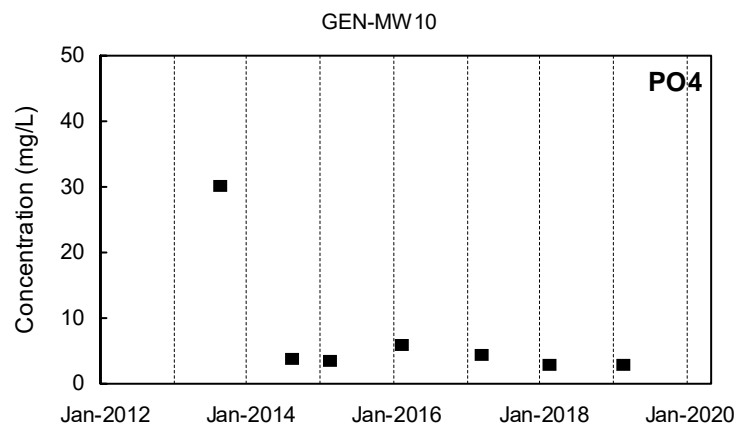
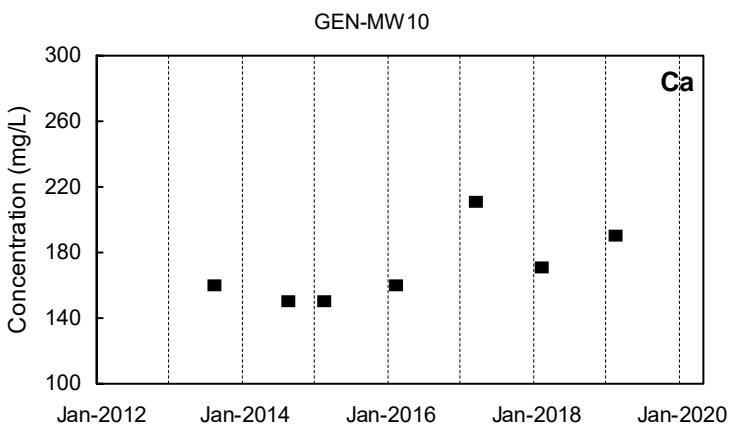
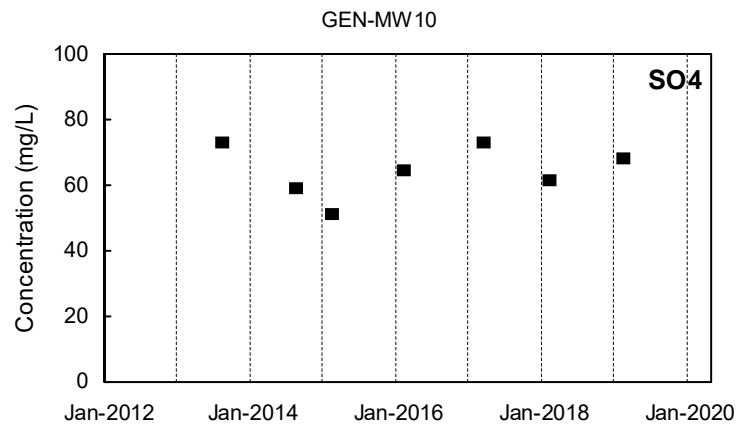
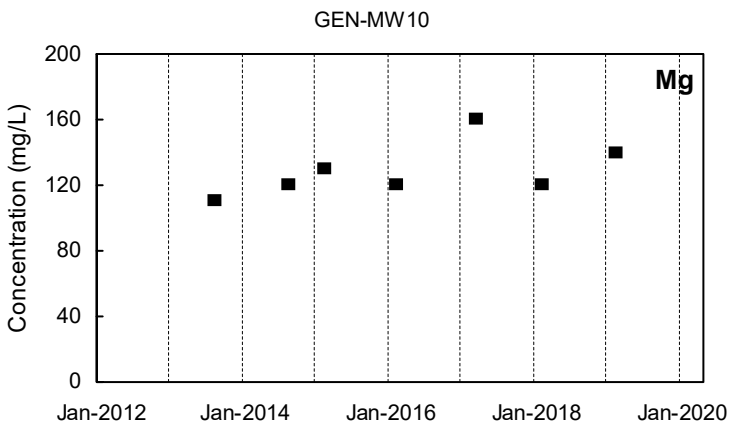
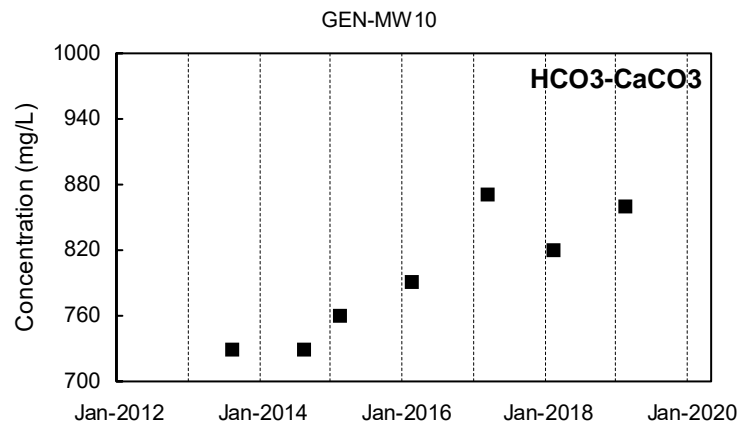
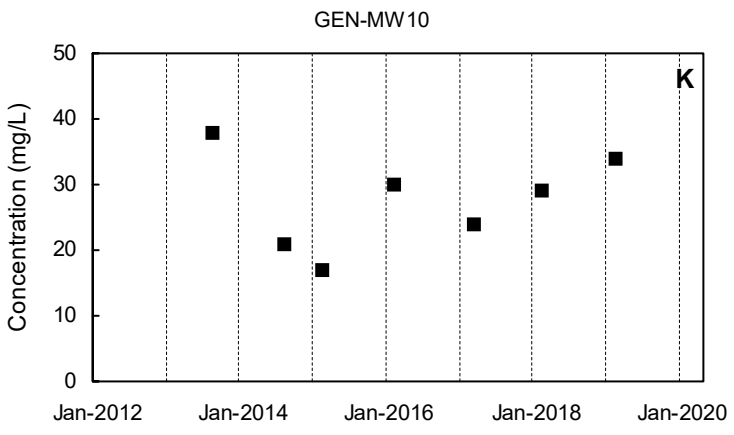
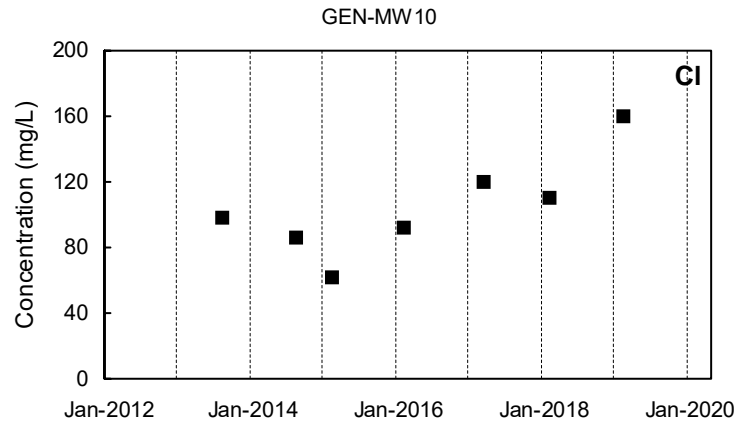
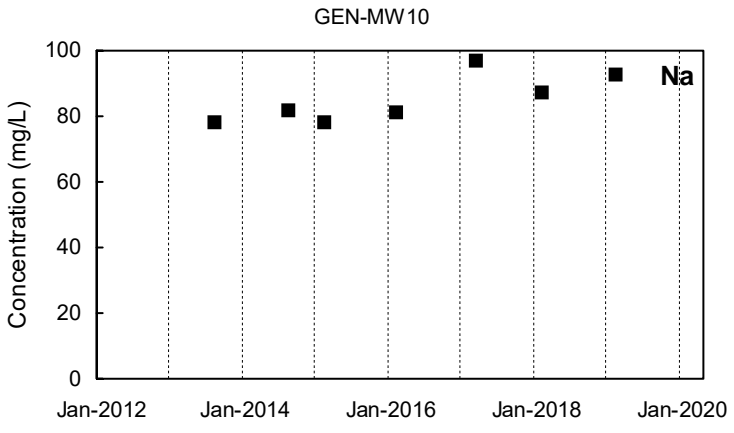

■ Detected Value □ 'J'-Flag (value between reporting limit and detection limit) ■ Non-Detect Range
 Shallow Well shown with black symbols Deep Well shown with orange symbols "dd" Well shown with blue symbols

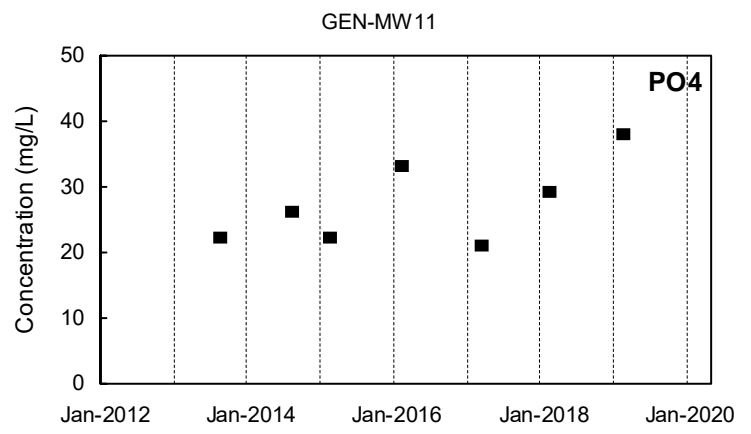
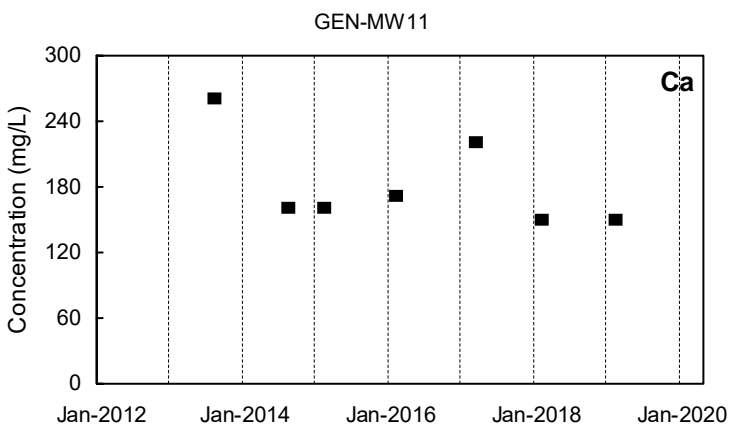
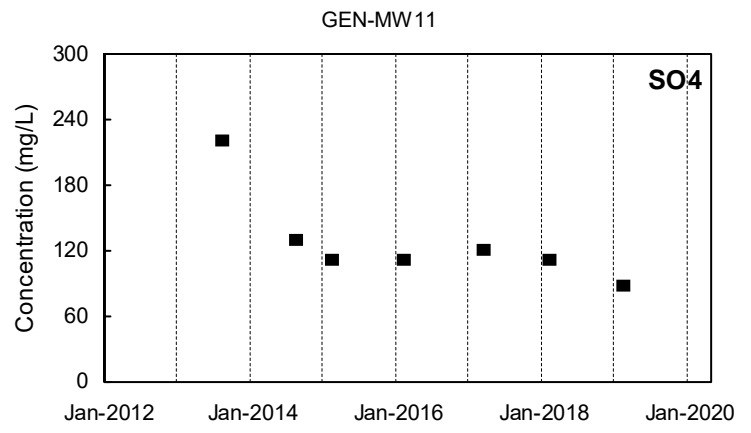
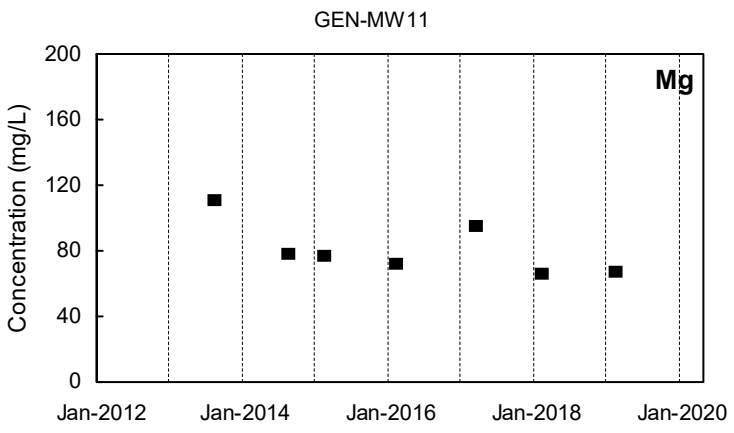
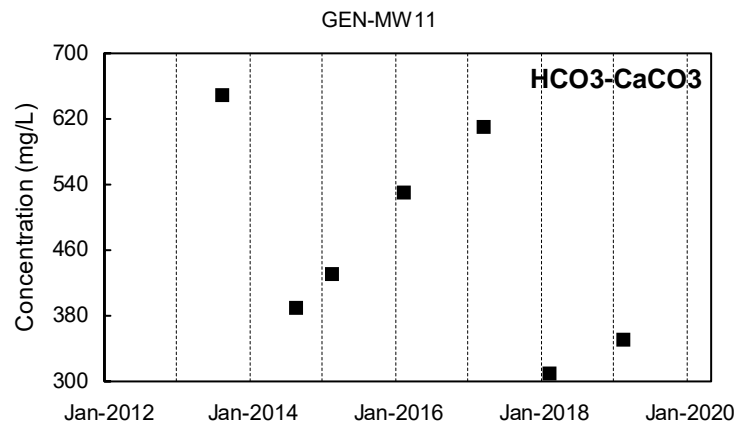
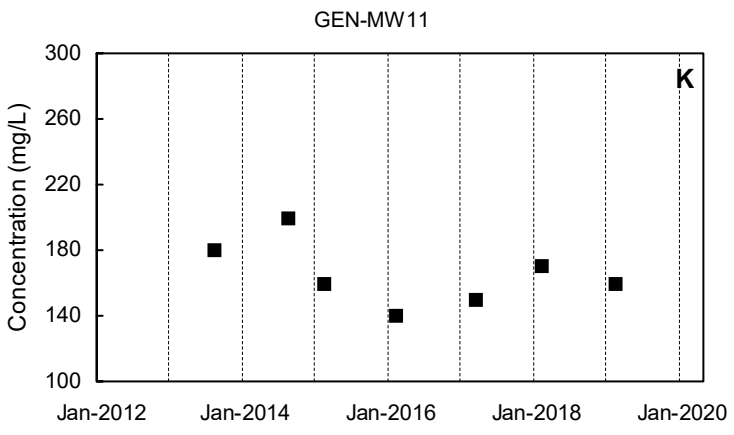
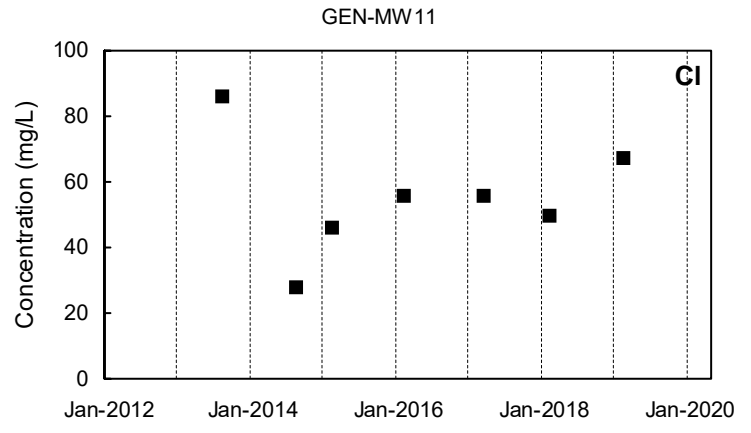
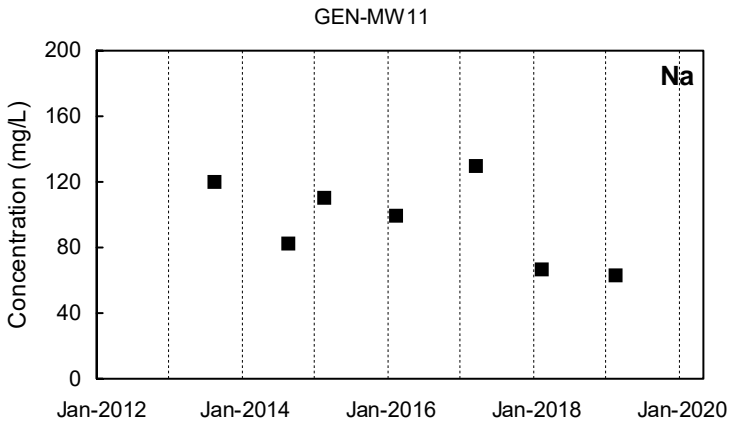

Detected Value
 'J'-Flag (value between reporting limit and detection limit)
 Non-Detect Range
 Shallow Well shown with black symbols
 Deep Well shown with orange symbols
 "dd" Well shown with blue symbols

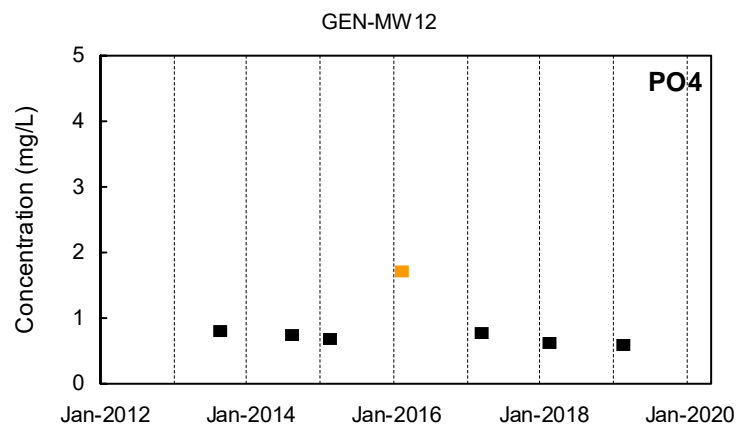
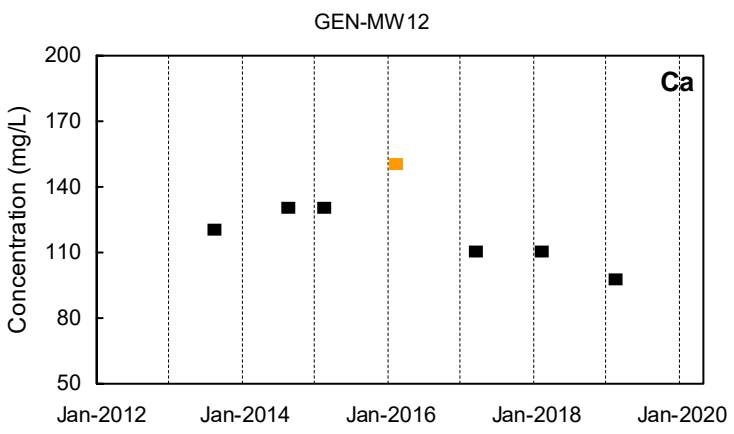
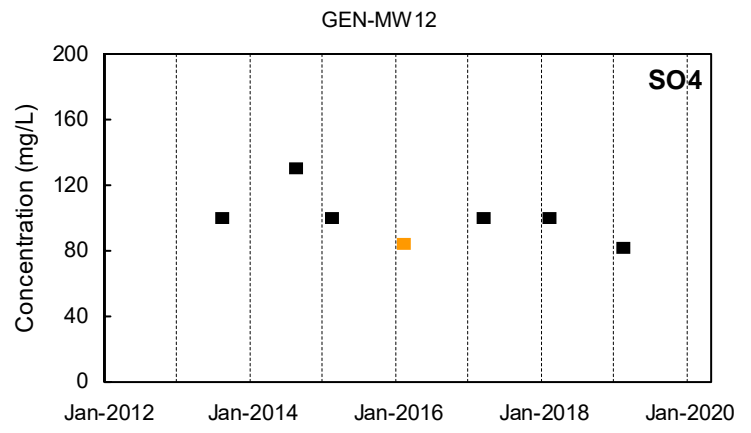
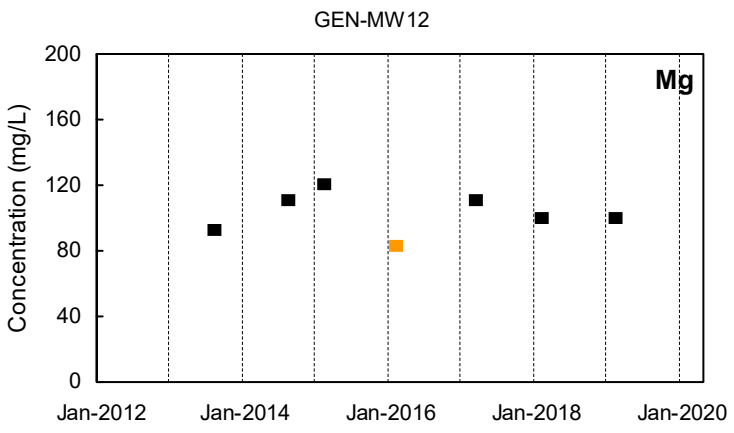
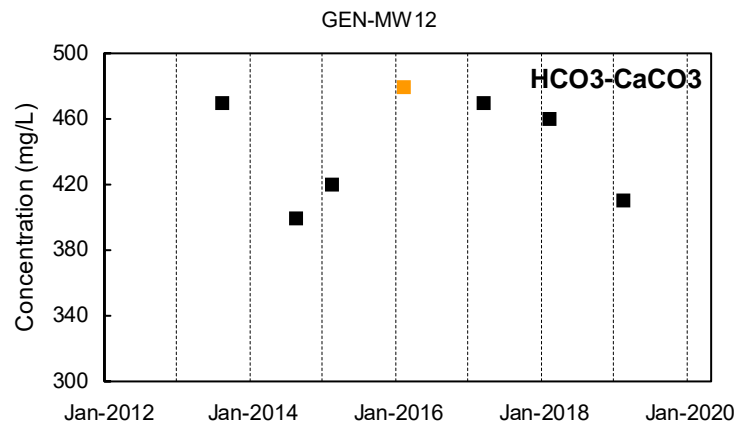
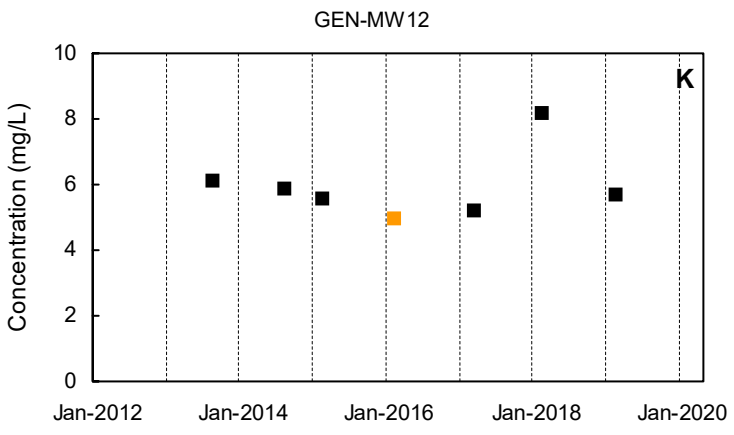
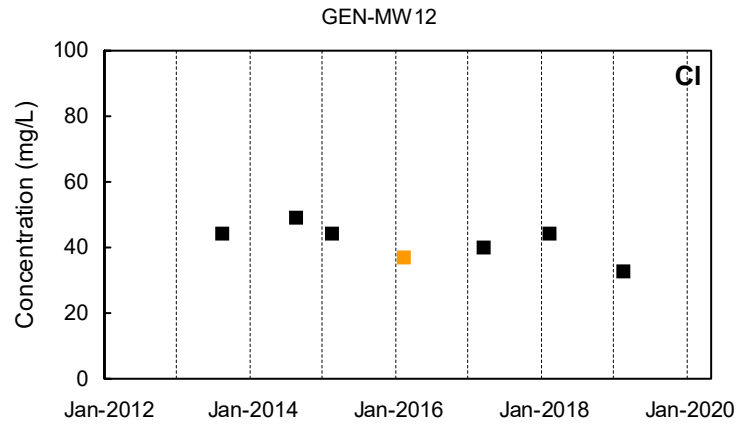
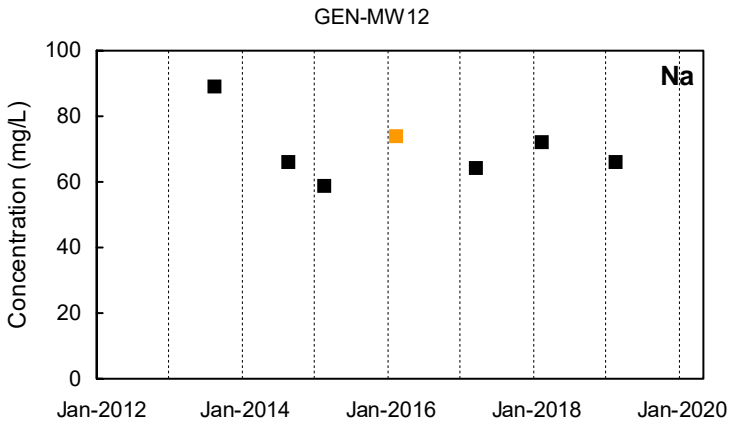

■ Detected Value □ 'J'-Flag (value between reporting limit and detection limit) ■ Non-Detect Range
 Shallow Well shown with black symbols Deep Well shown with orange symbols "dd" Well shown with blue symbols

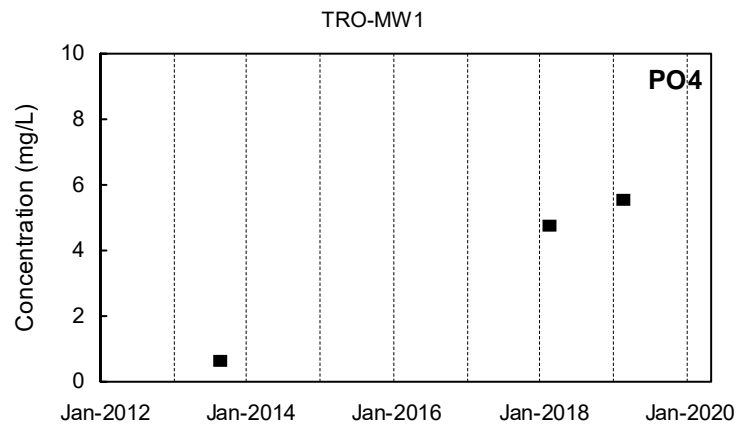
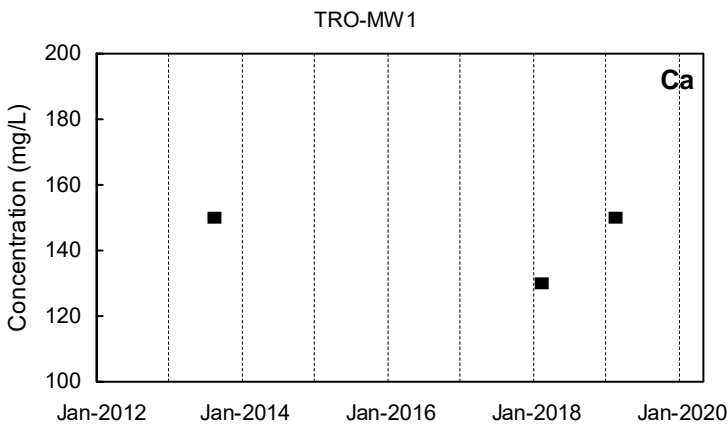
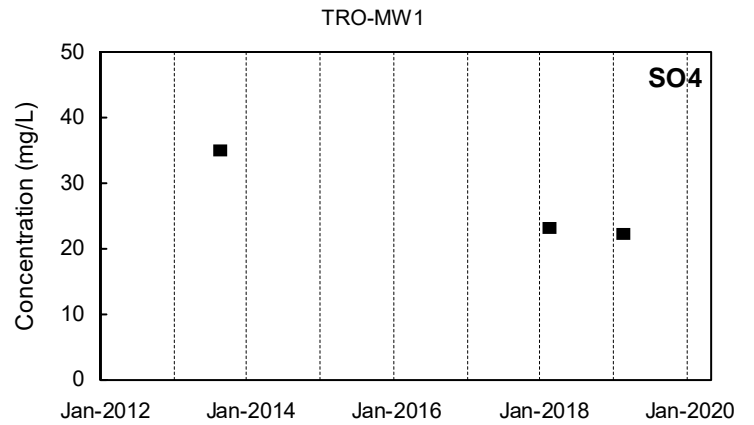
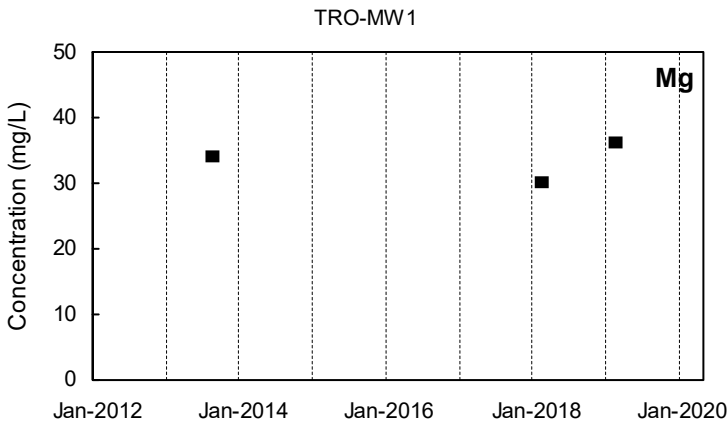
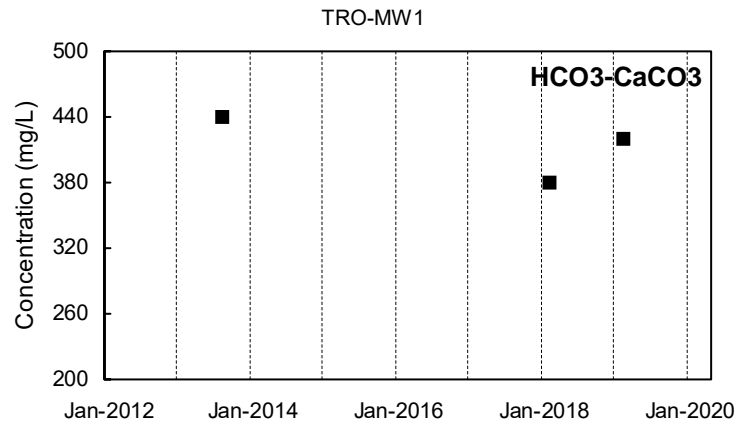
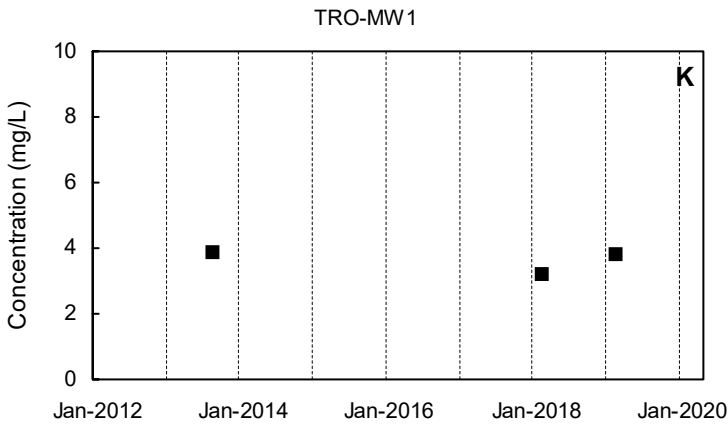
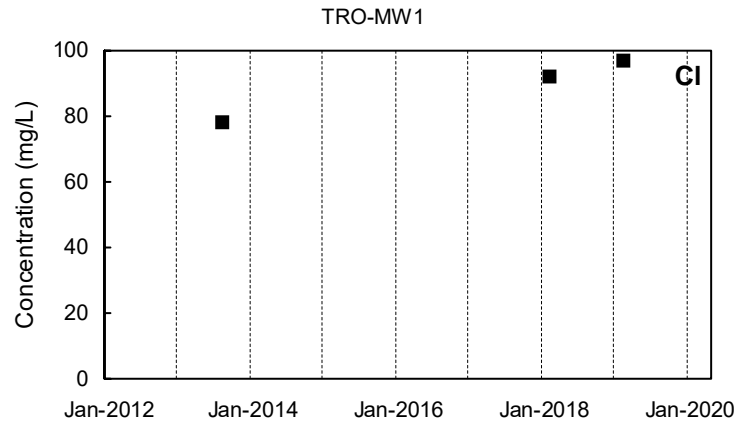
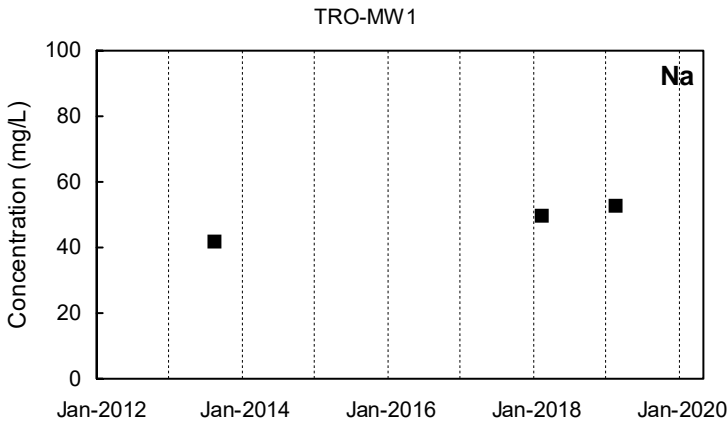

Detected Value
 'J'-Flag (value between reporting limit and detection limit)
 Non-Detect Range
 Shallow Well shown with black symbols Deep Well shown with orange symbols "dd" Well shown with blue symbols

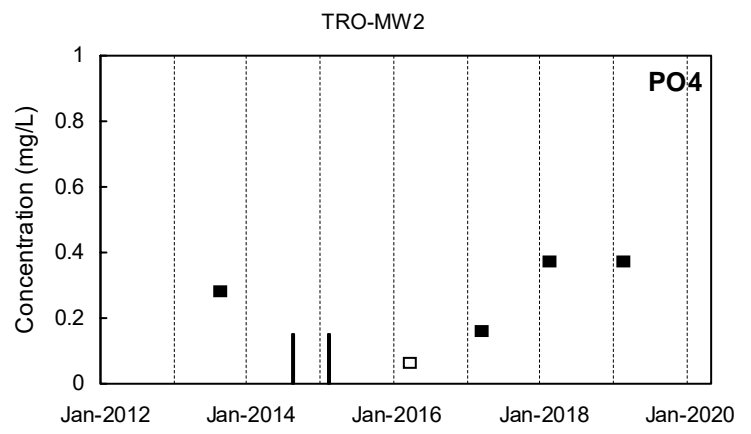
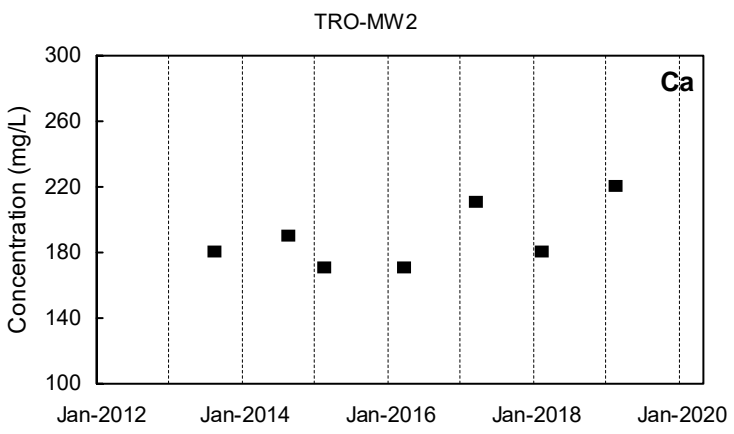
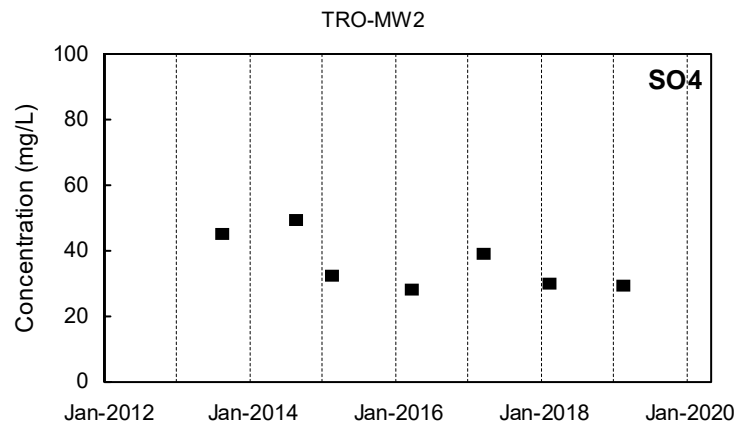
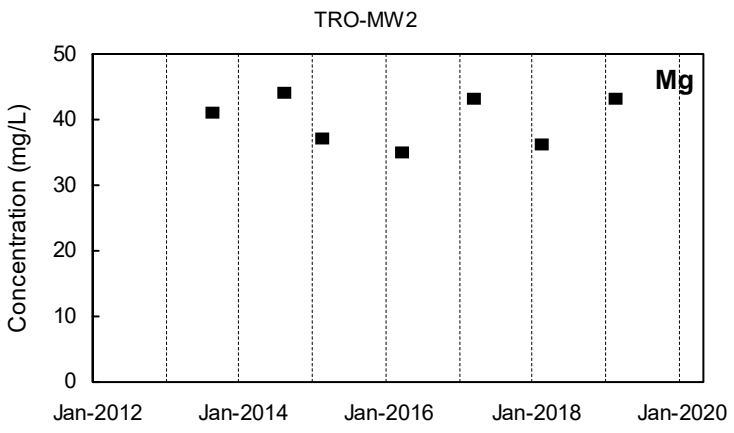
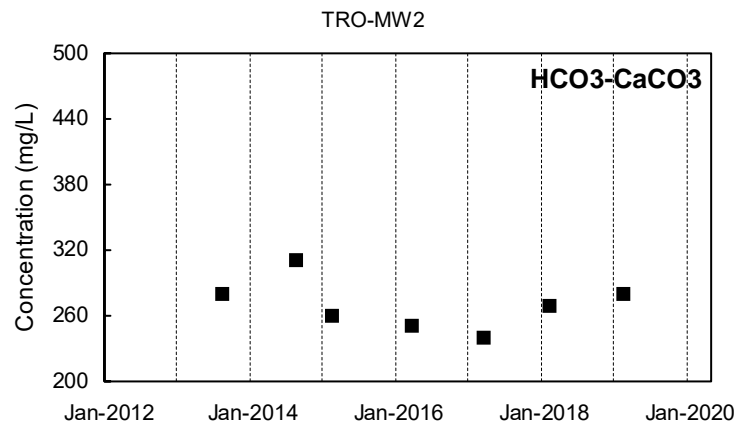
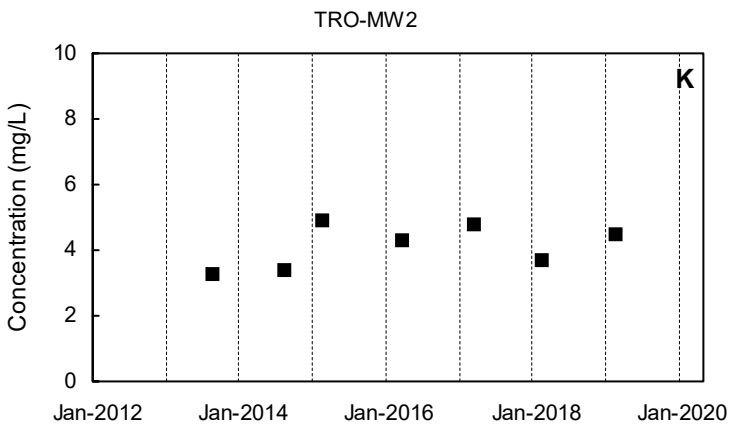
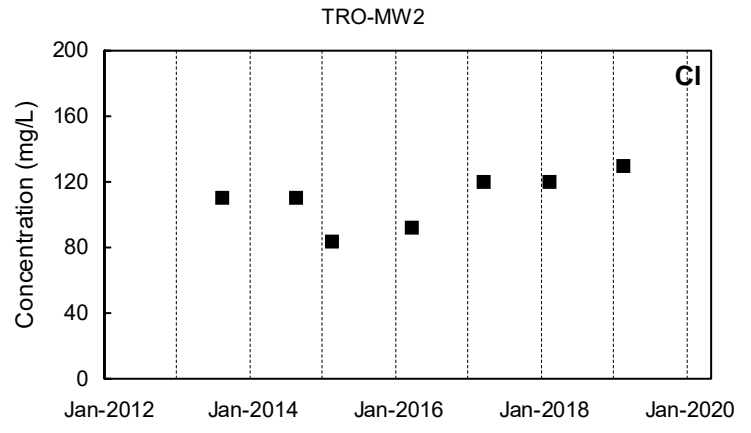
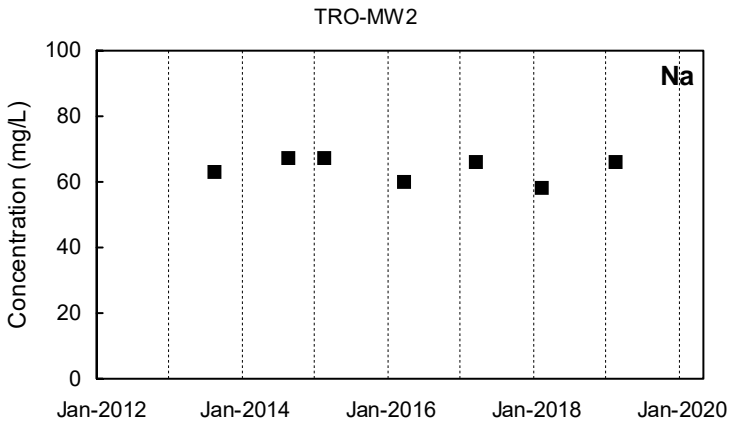

Detected Value
 'J'-Flag (value between reporting limit and detection limit)
 Non-Detect Range
 Shallow Well shown with black symbols
 Deep Well shown with orange symbols
 "dd" Well shown with blue symbols

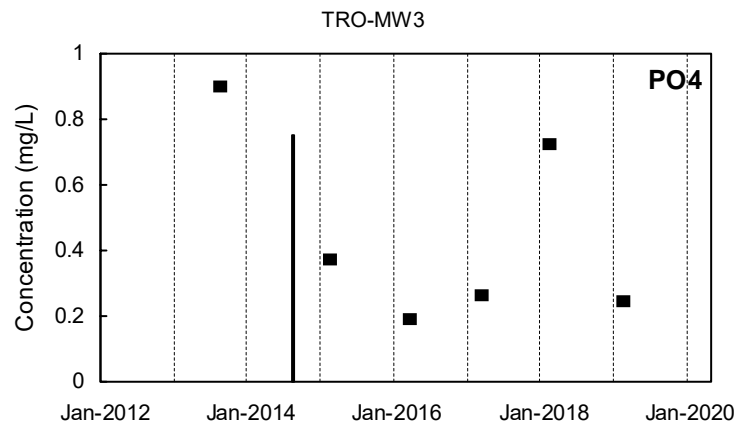
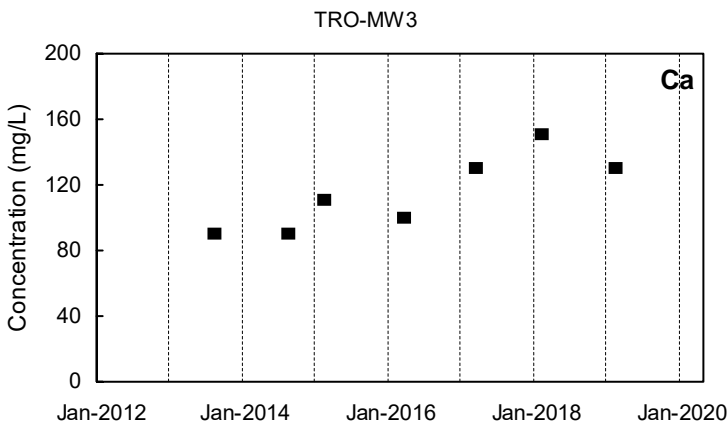
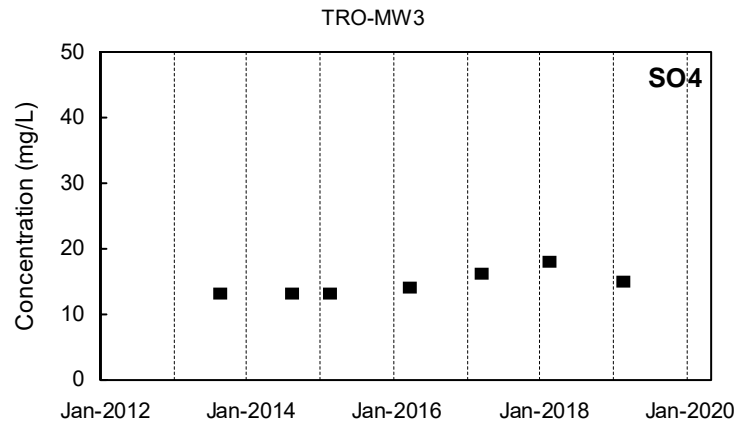
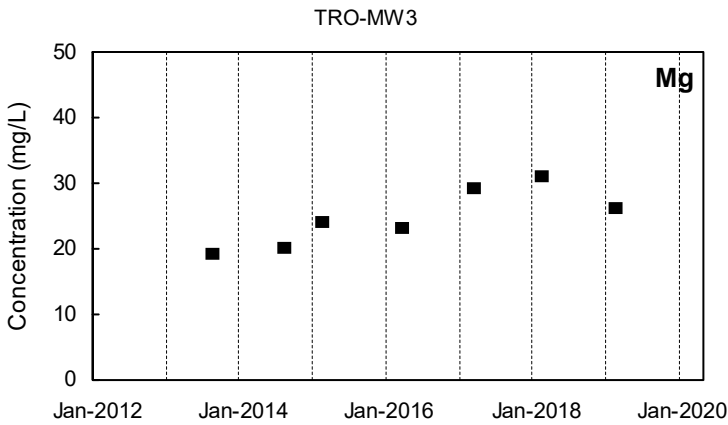
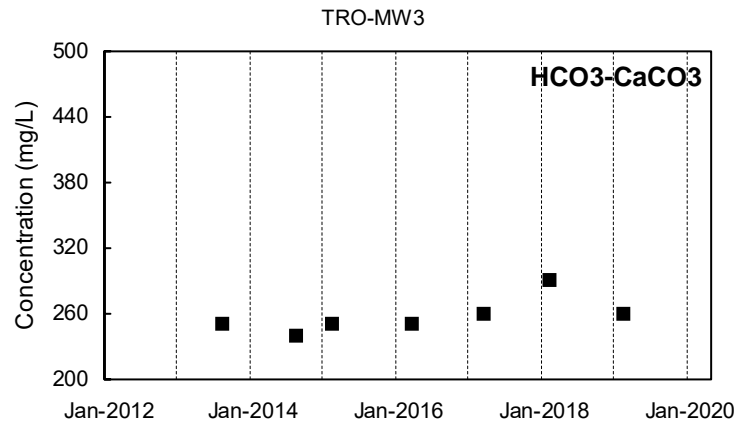
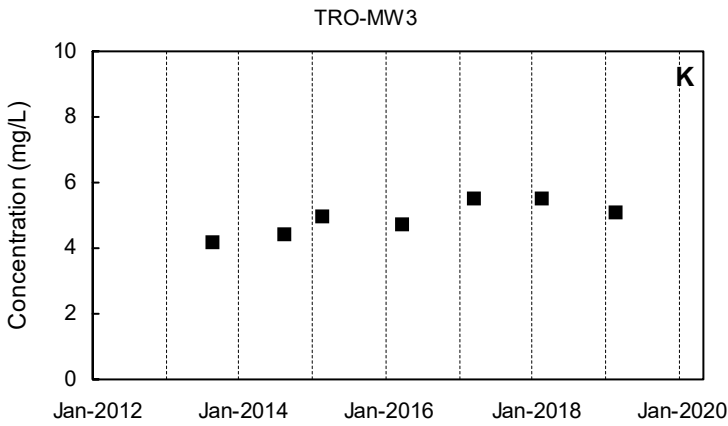
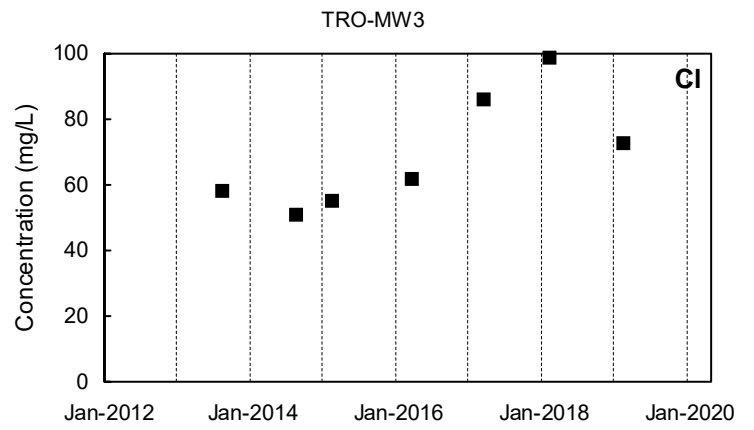
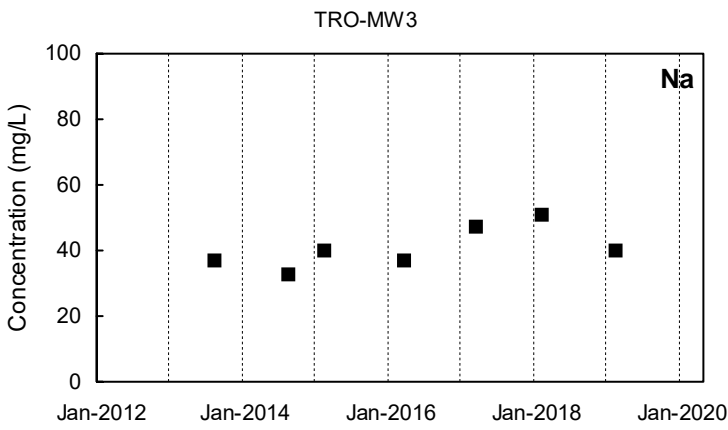

Detected Value
 'J'-Flag (value between reporting limit and detection limit)
 Non-Detect Range
 Shallow Well shown with black symbols
 Deep Well shown with orange symbols
 "dd" Well shown with blue symbols

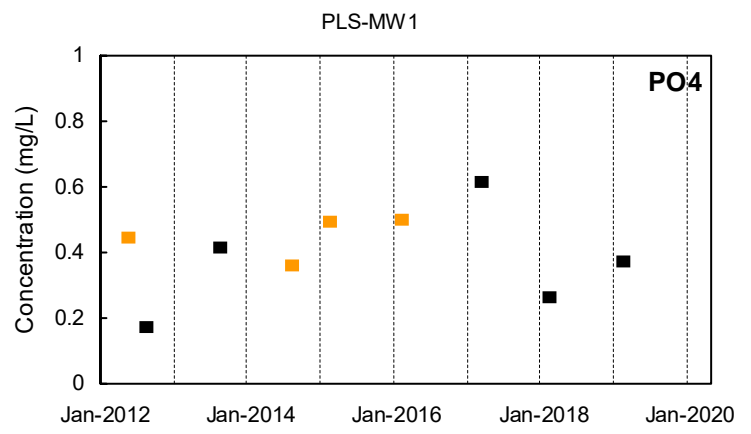
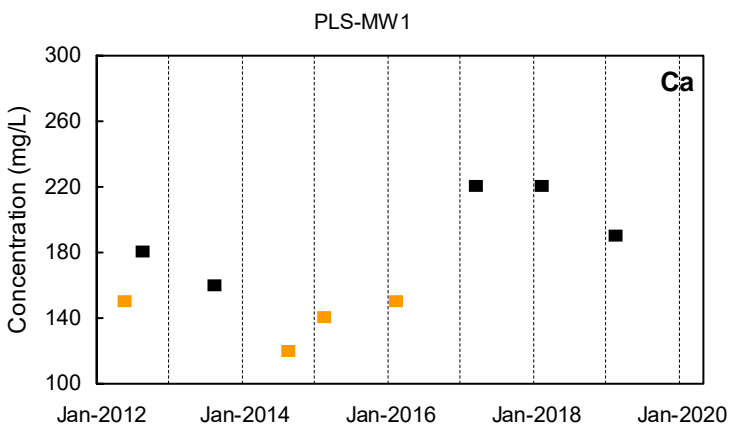
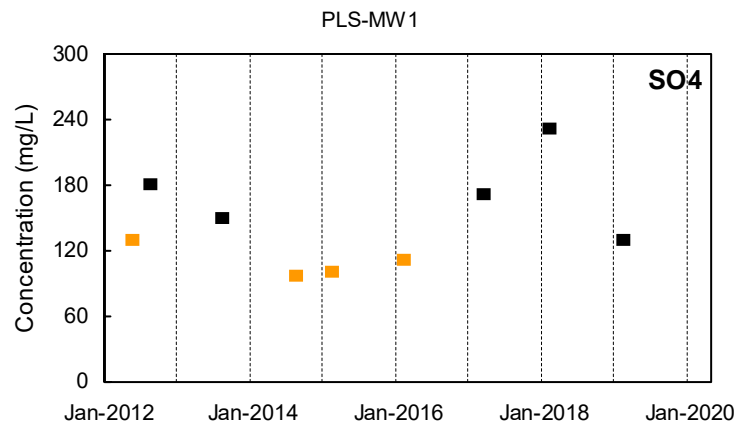
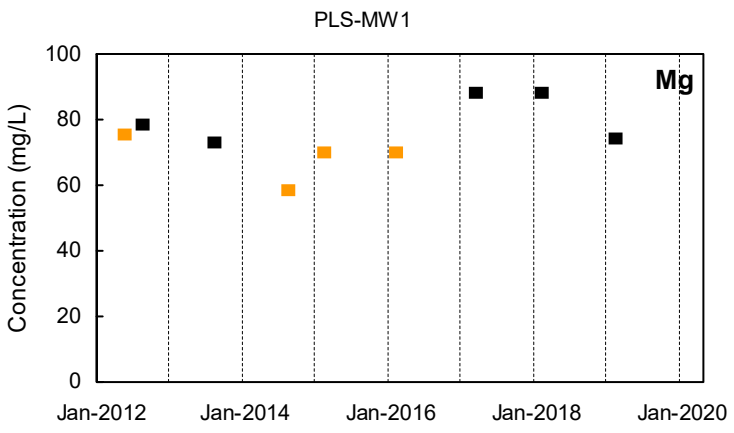
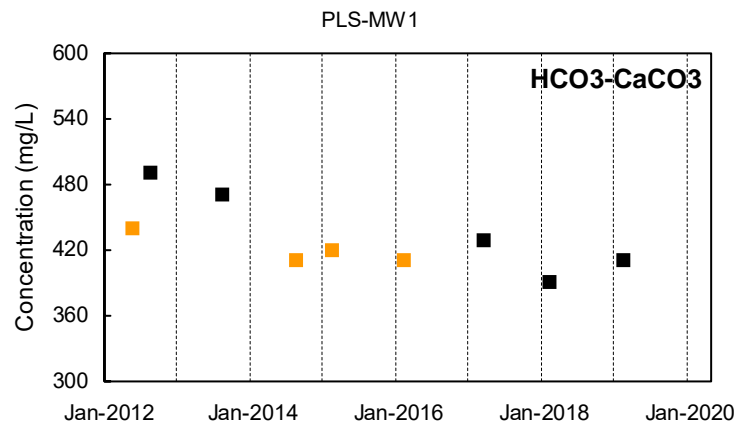
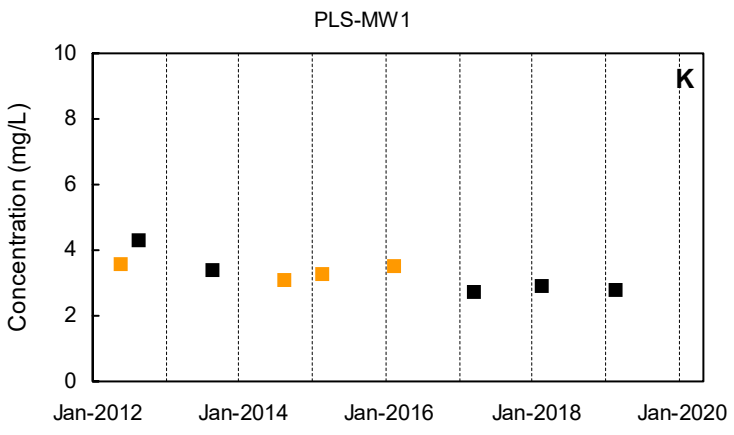
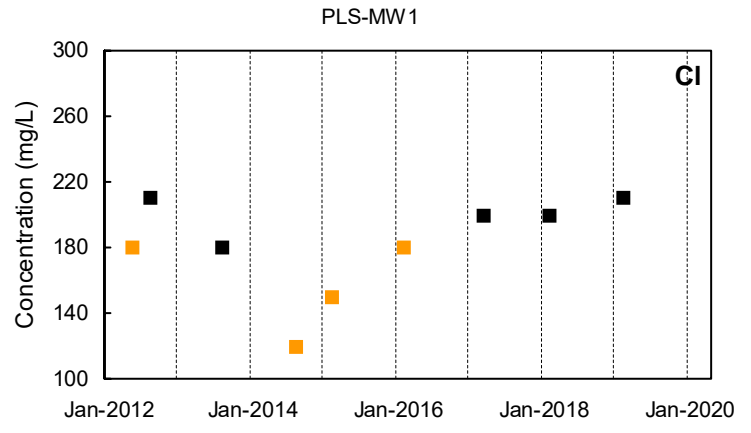
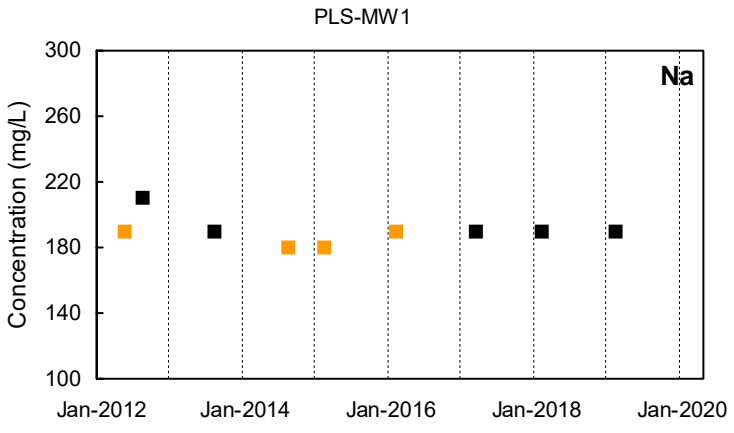

Detected Value
 'J'-Flag (value between reporting limit and detection limit)
 Non-Detect Range
 Shallow Well shown with black symbols Deep Well shown with orange symbols "dd" Well shown with blue symbols

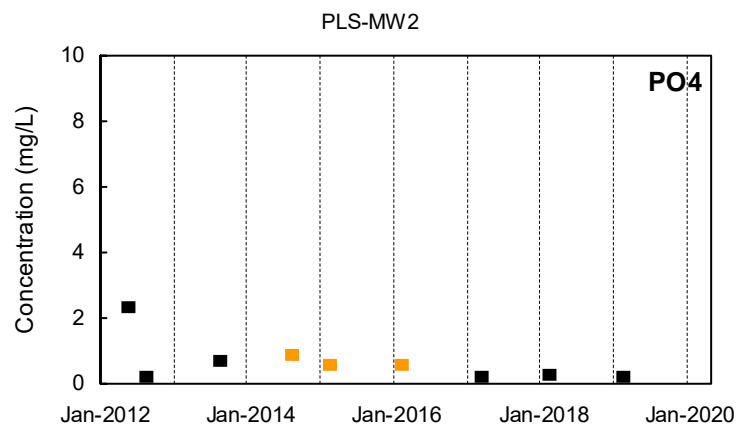
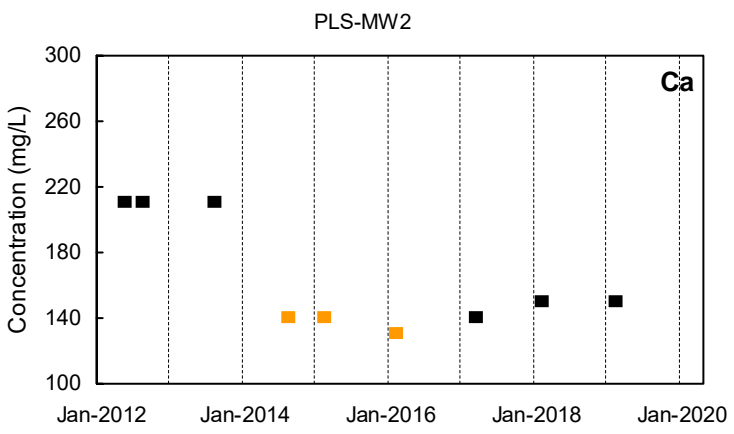
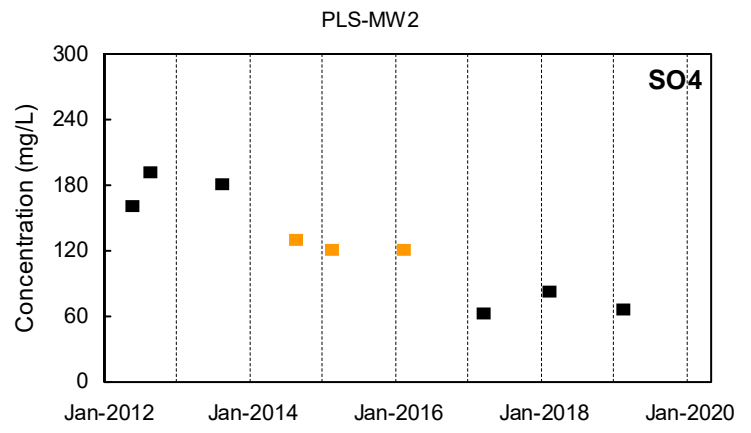
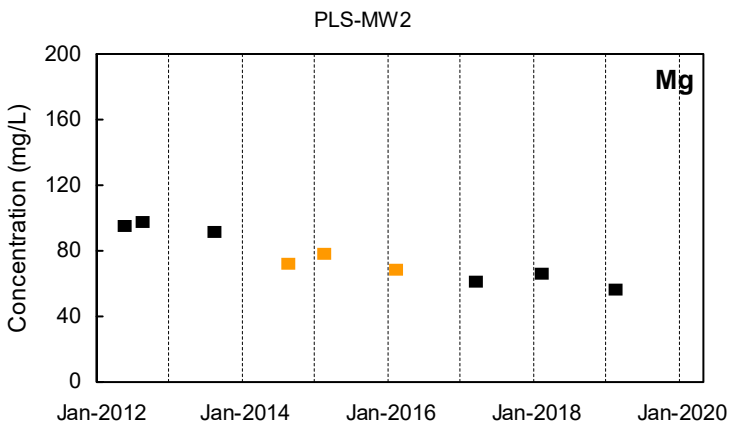
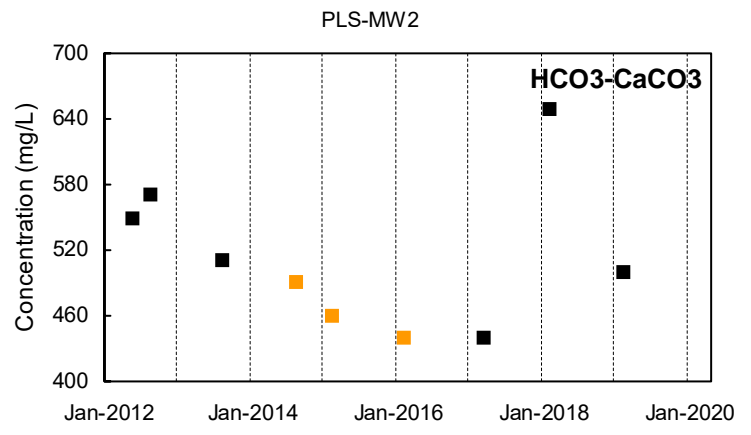
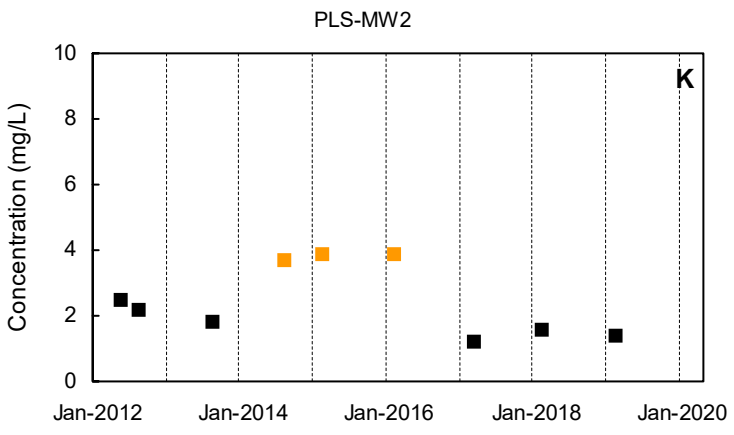
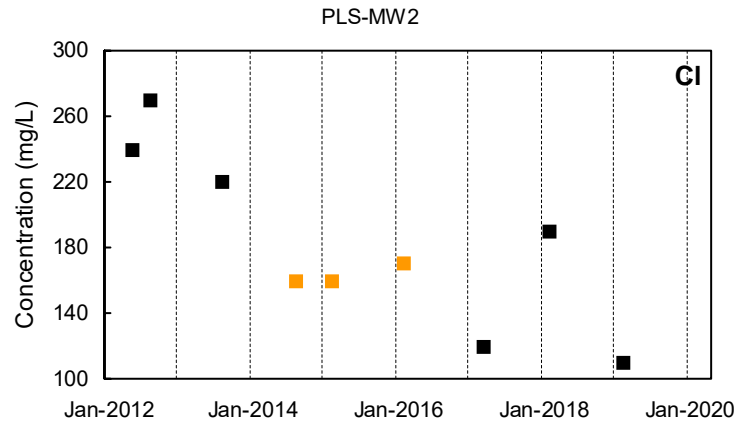
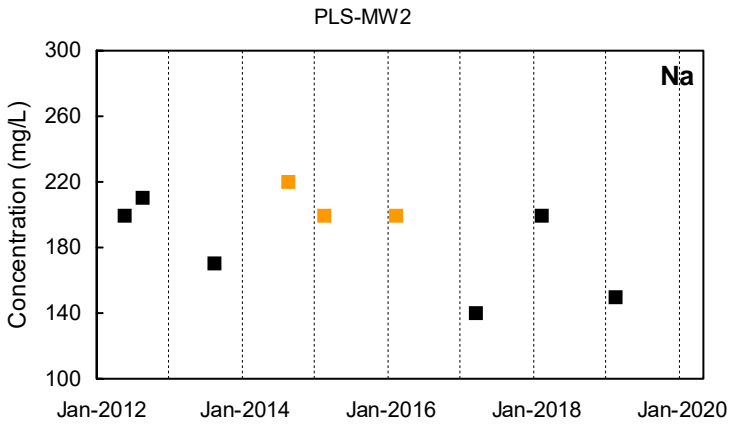

Detected Value
 'J'-Flag (value between reporting limit and detection limit)
 Non-Detect Range
 Shallow Well shown with black symbols Deep Well shown with orange symbols "dd" Well shown with blue symbols

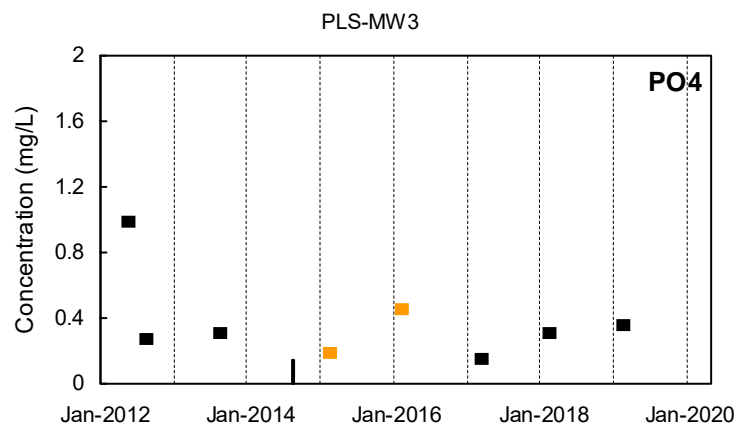
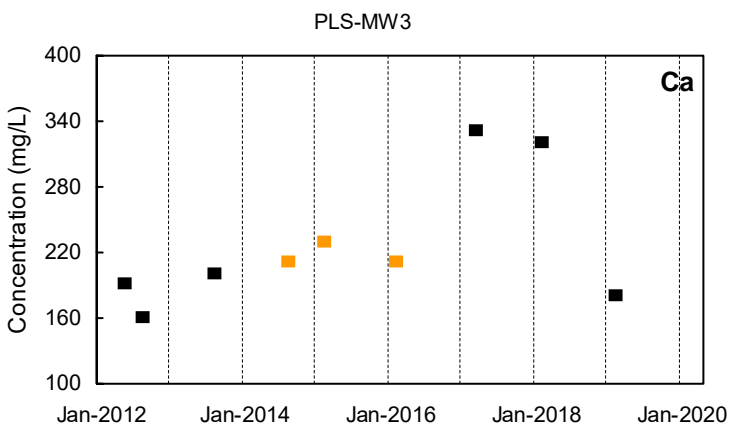
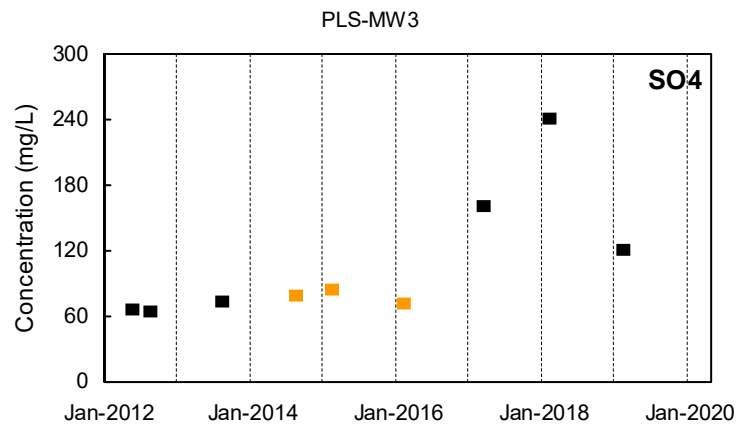
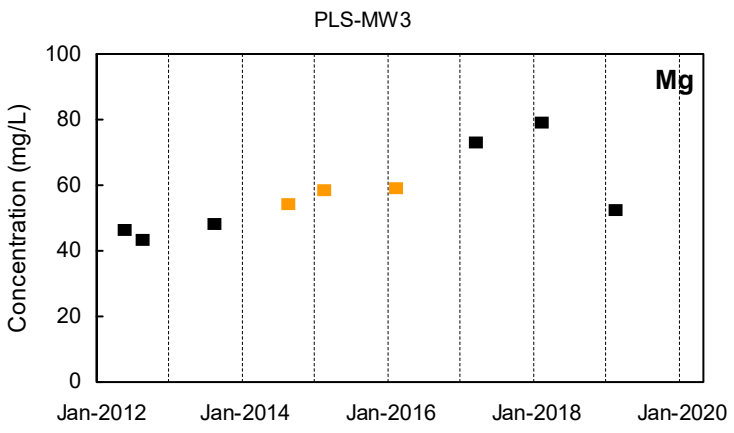
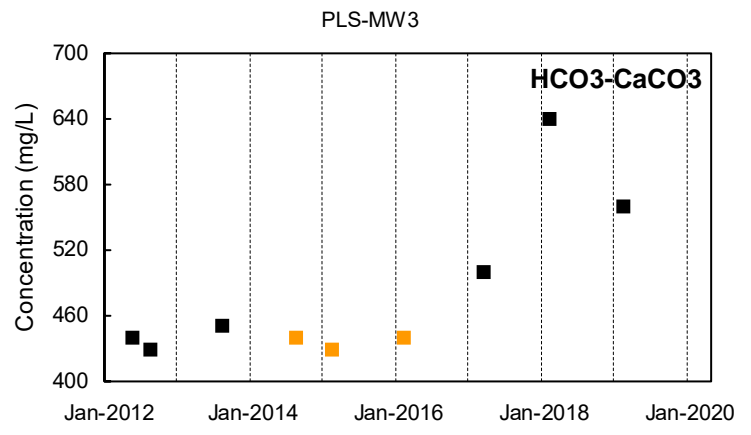
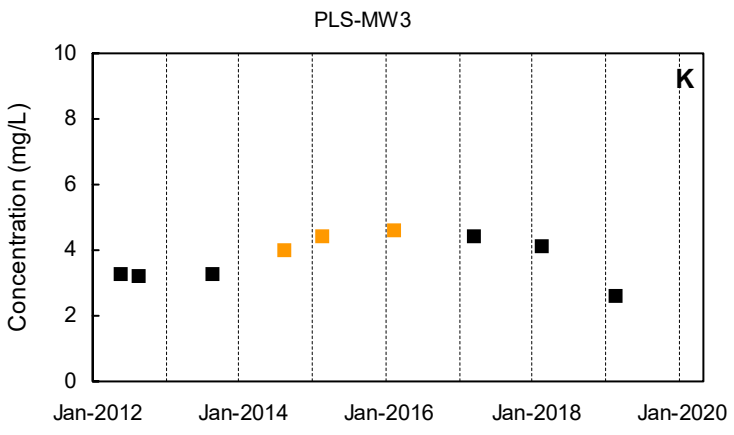
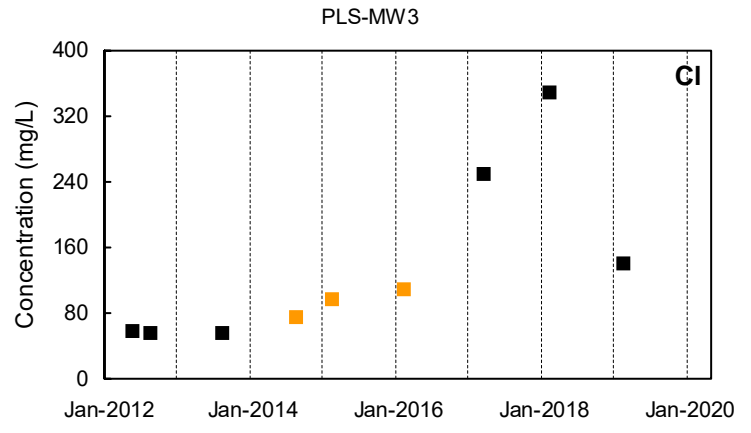
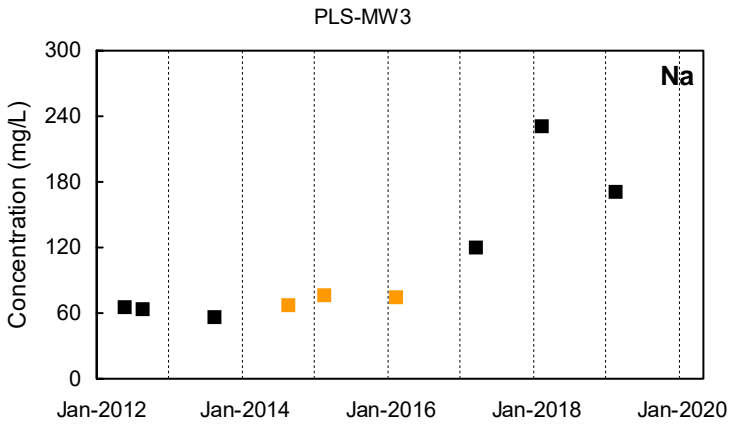

Detected Value
 'J'-Flag (value between reporting limit and detection limit)
 Non-Detect Range
 Shallow Well shown with black symbols Deep Well shown with orange symbols "dd" Well shown with blue symbols

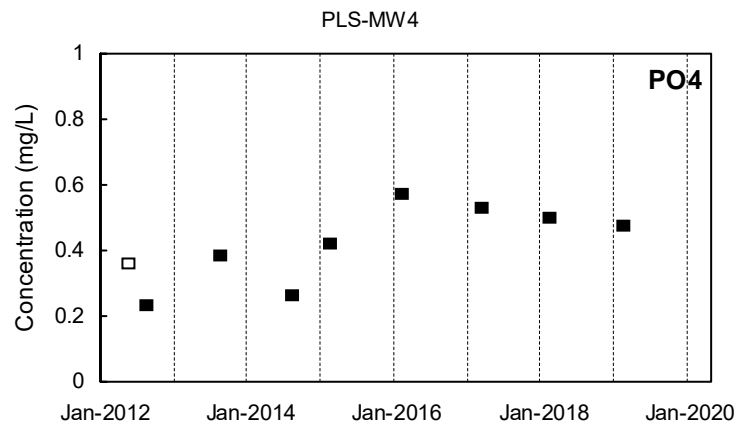
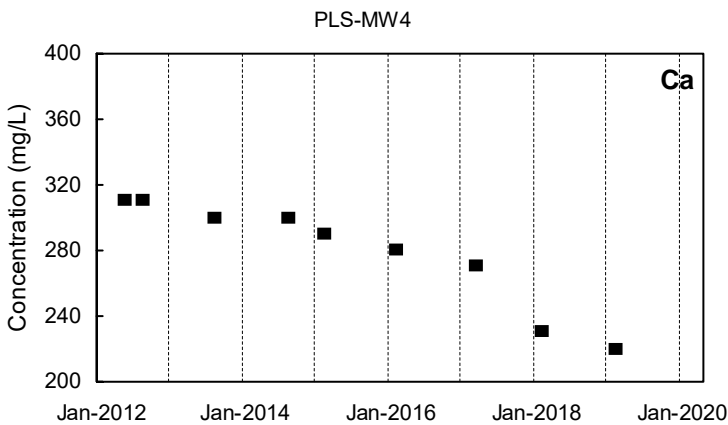
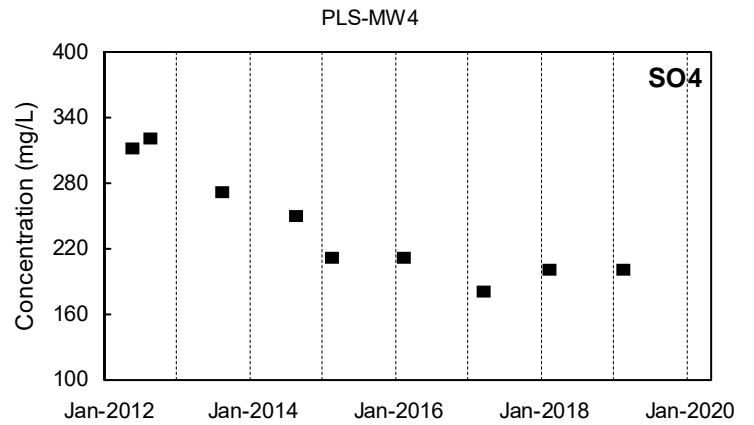
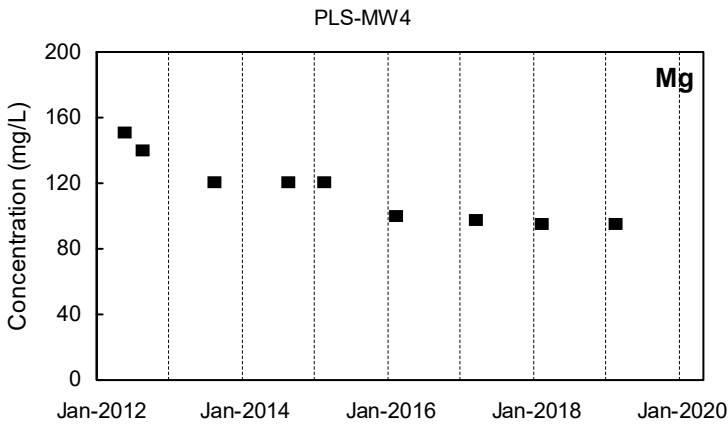
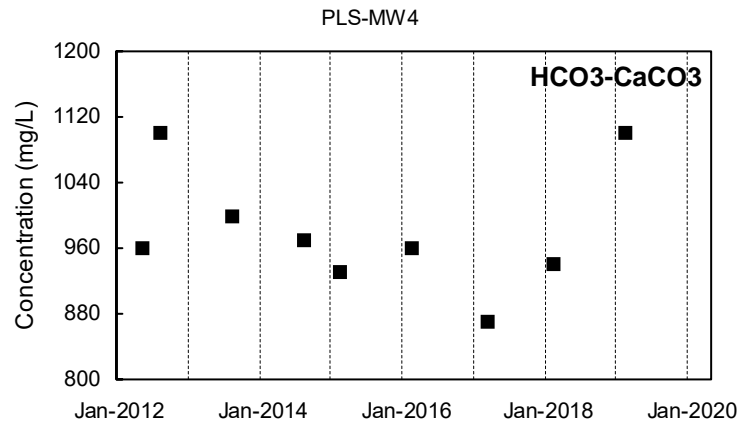
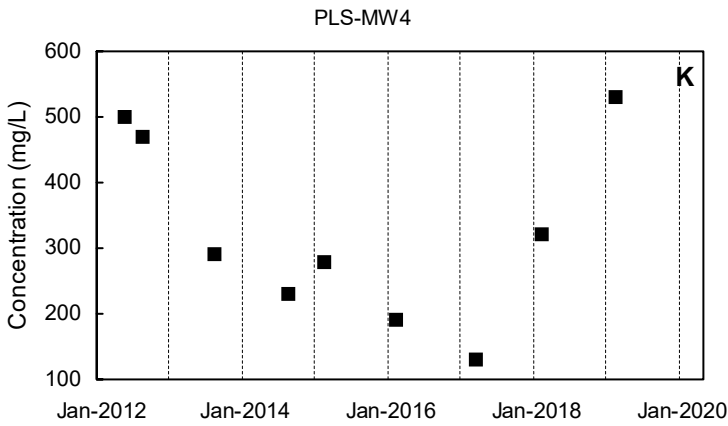
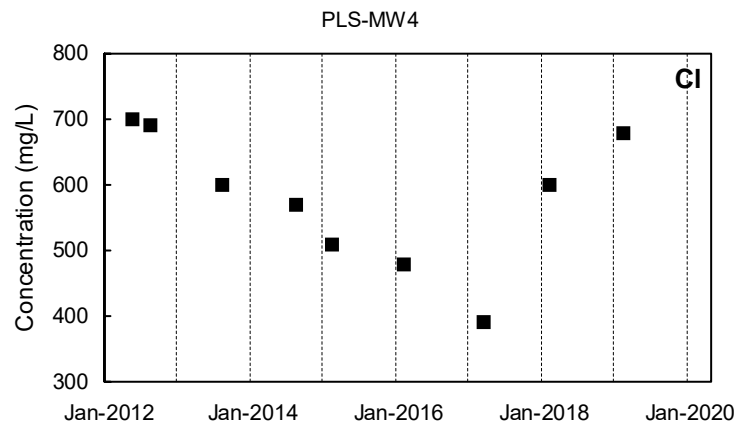
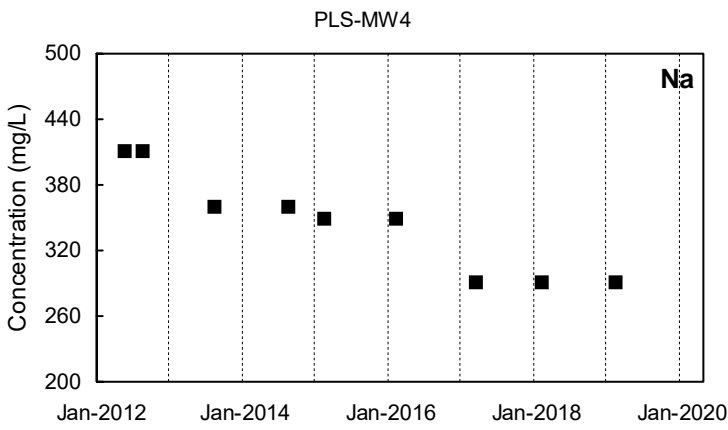

Detected Value
 'J'-Flag (value between reporting limit and detection limit)
 Non-Detect Range
 Shallow Well shown with black symbols
 Deep Well shown with orange symbols
 "dd" Well shown with blue symbols

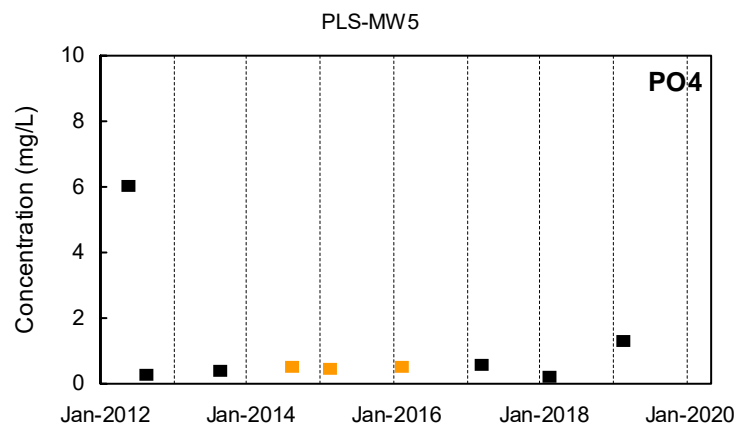
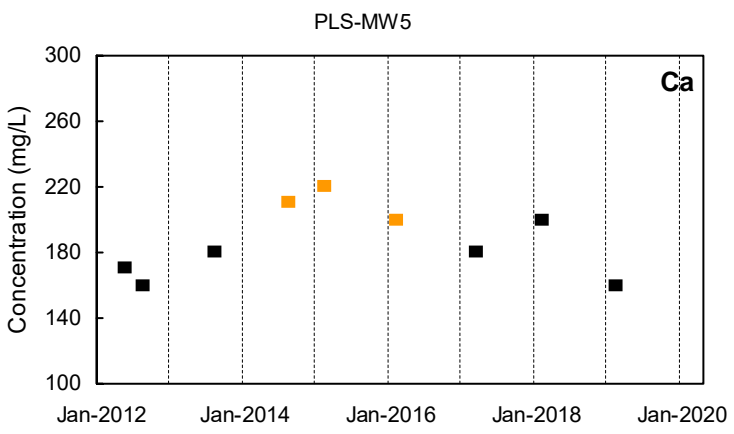
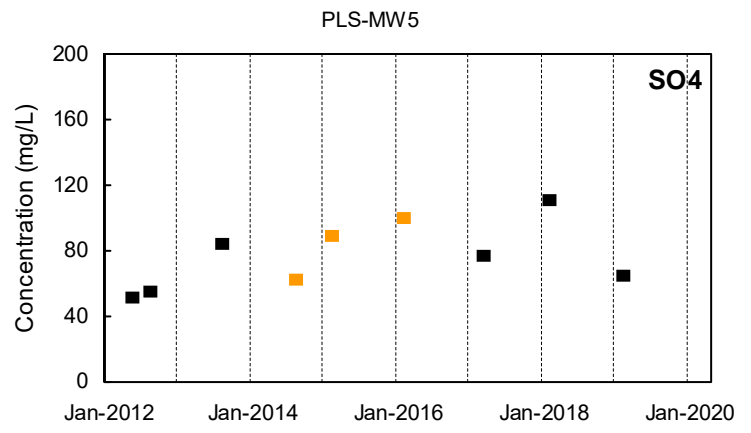
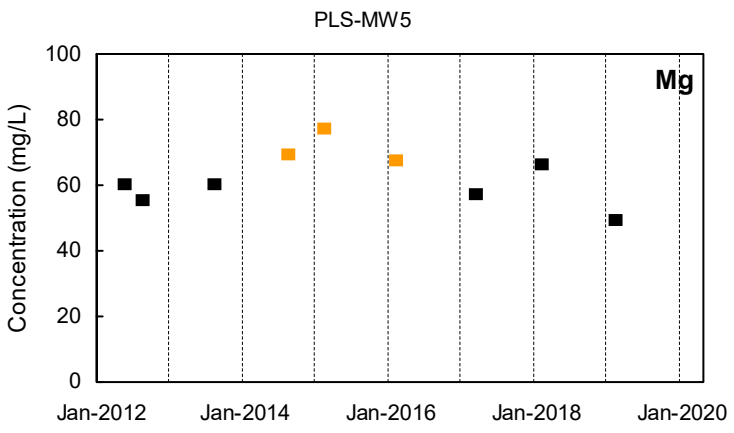
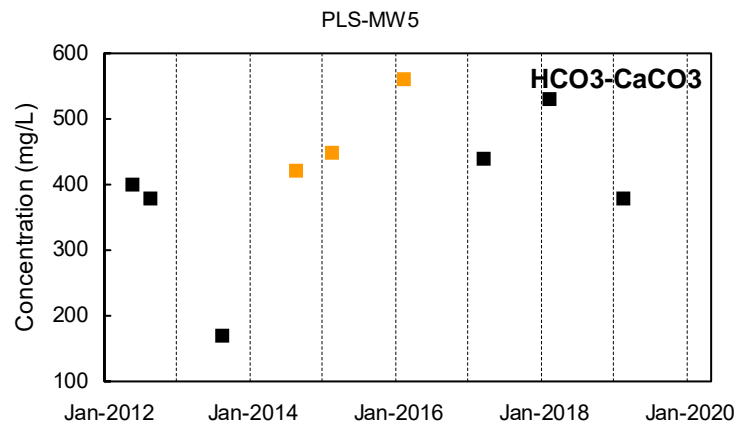
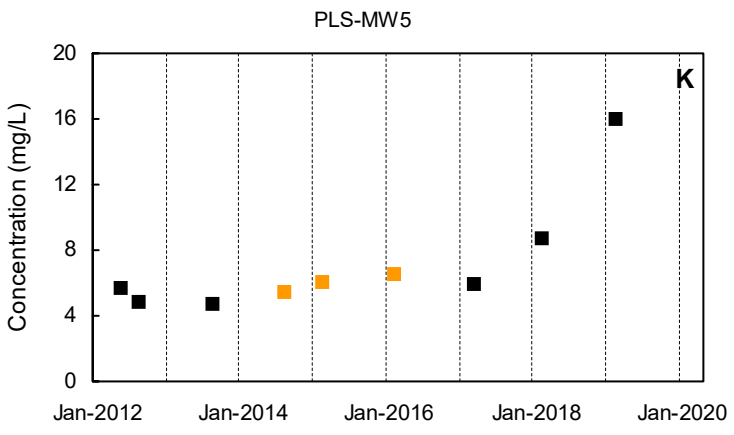
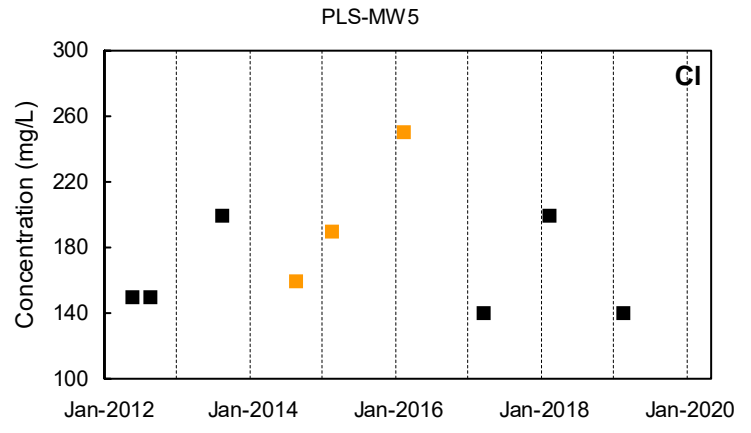
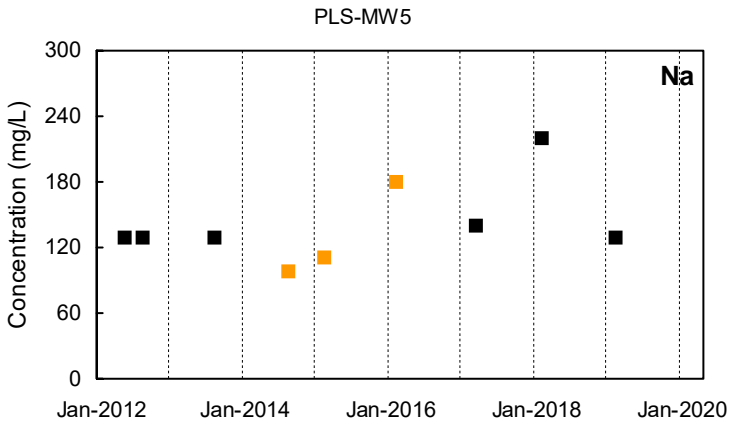

Detected Value
 'J'-Flag (value between reporting limit and detection limit)
 Non-Detect Range
 Shallow Well shown with black symbols
 Deep Well shown with orange symbols
 "dd" Well shown with blue symbols

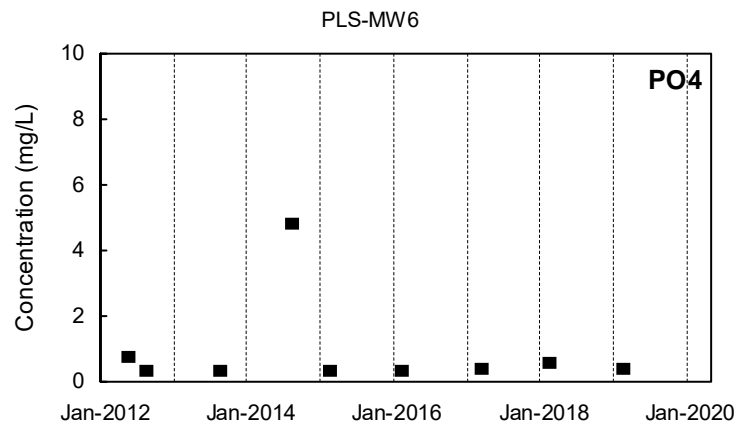
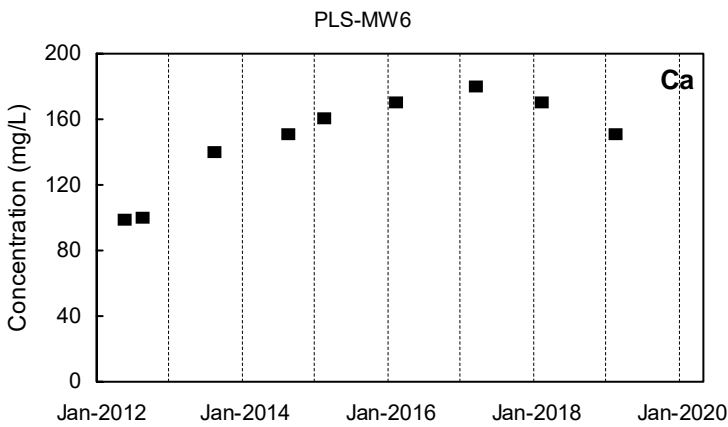
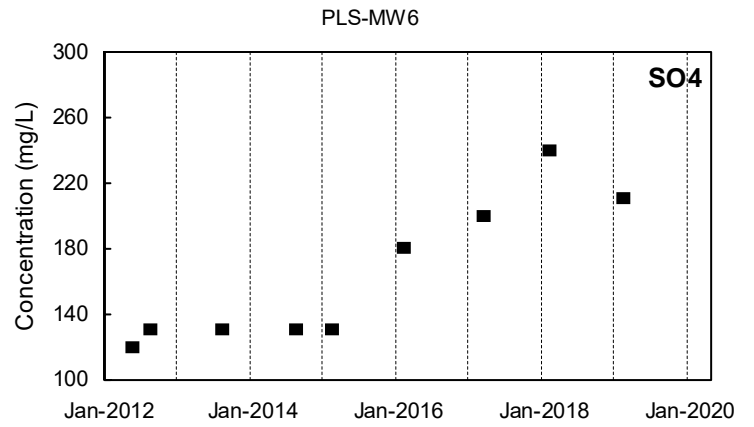
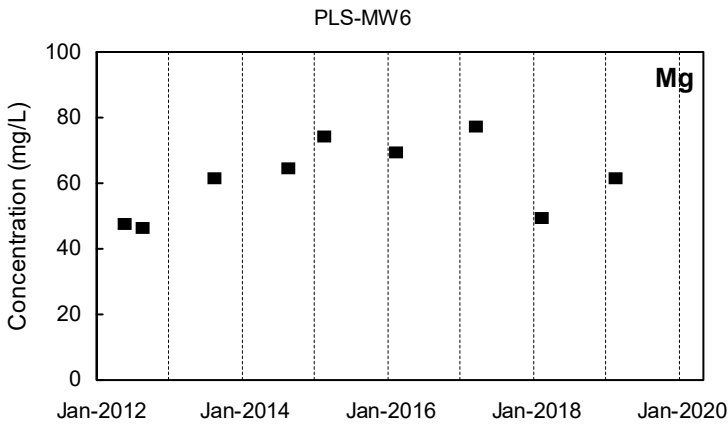
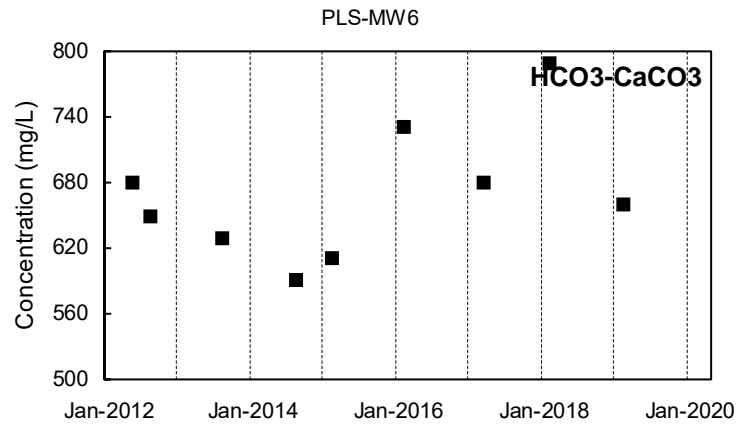
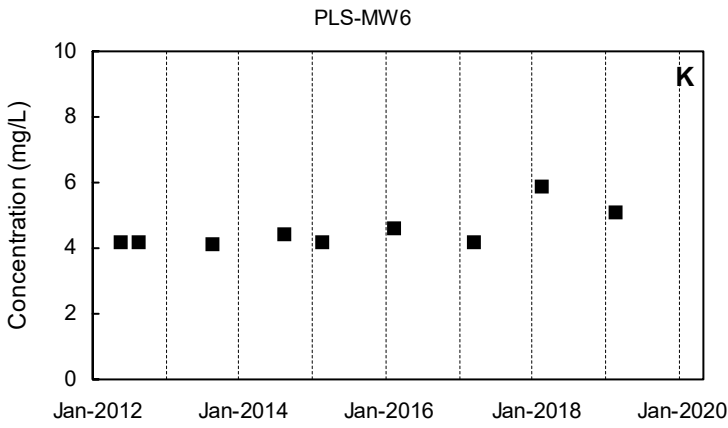
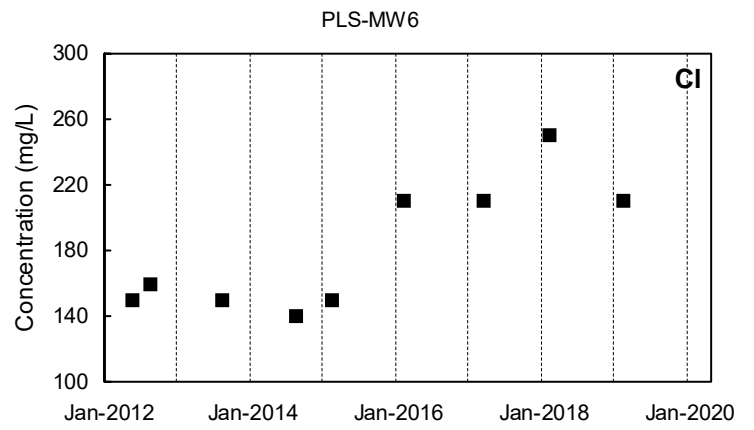
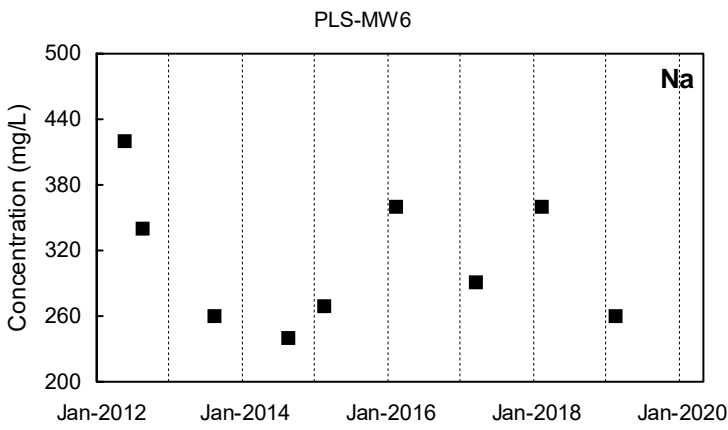

Detected Value
 'J'-Flag (value between reporting limit and detection limit)
 Non-Detect Range
 Shallow Well shown with black symbols
 Deep Well shown with orange symbols
 "dd" Well shown with blue symbols

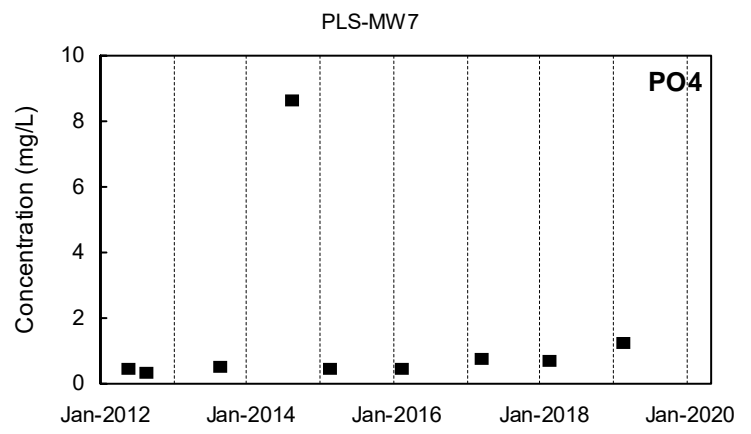
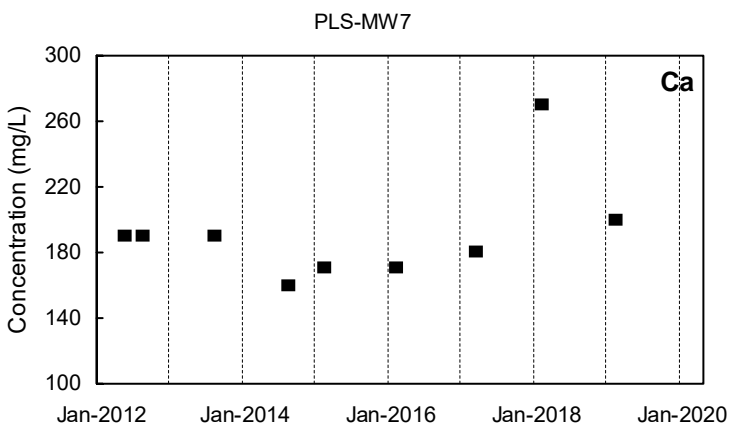
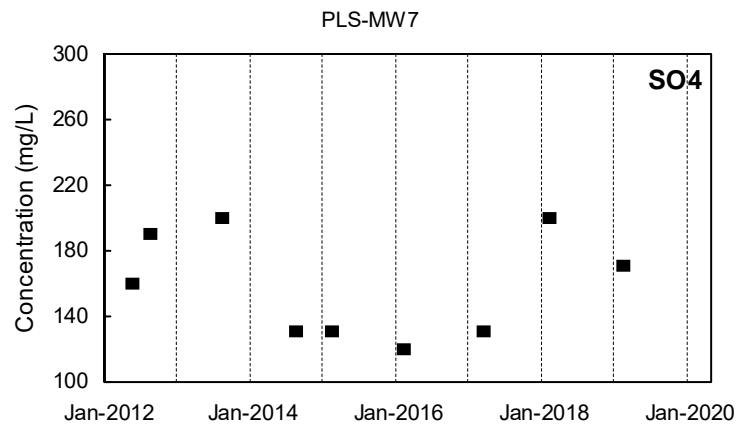
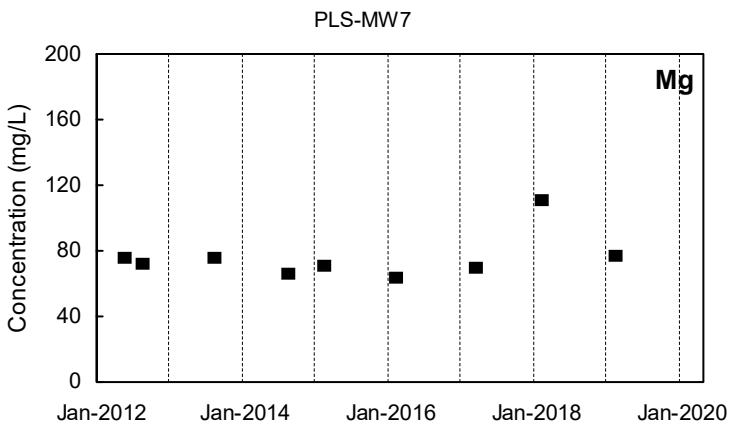
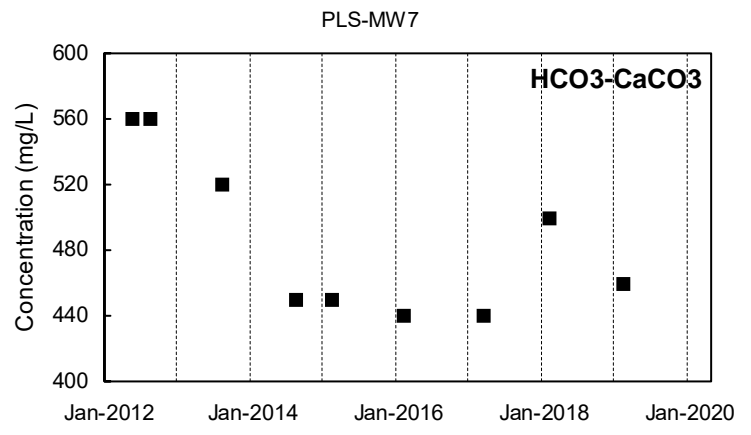
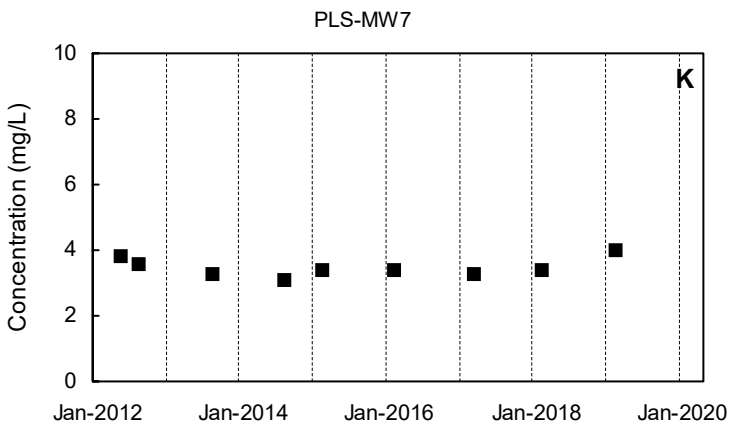
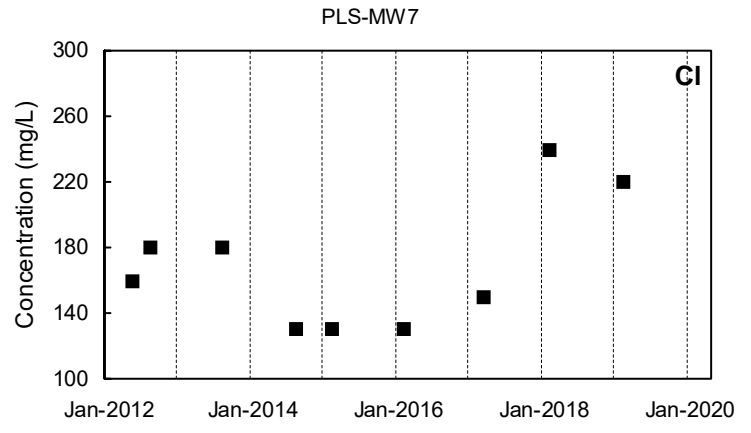
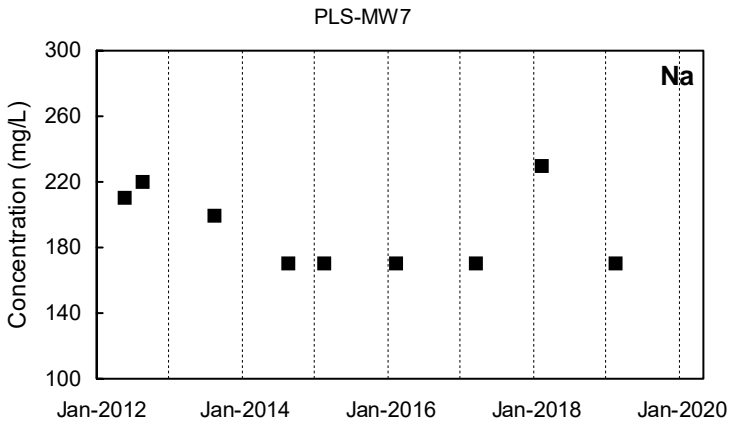

■ Detected Value □ 'J'-Flag (value between reporting limit and detection limit) ■ Non-Detect Range
 Shallow Well shown with black symbols Deep Well shown with orange symbols "dd" Well shown with blue symbols

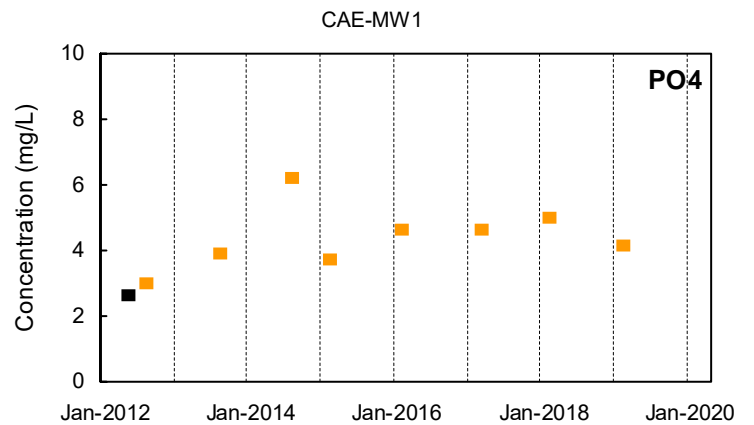
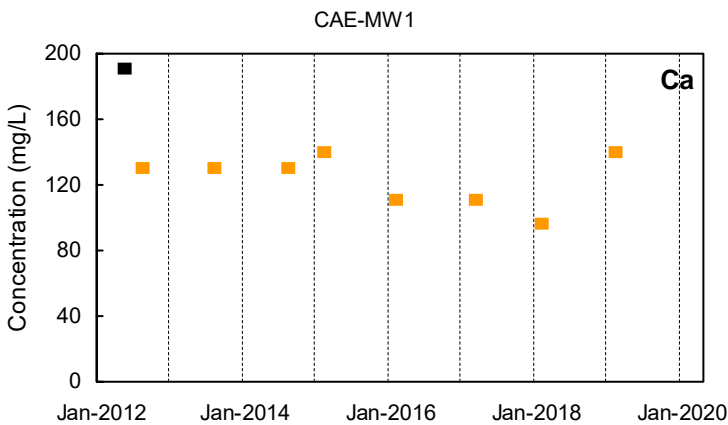
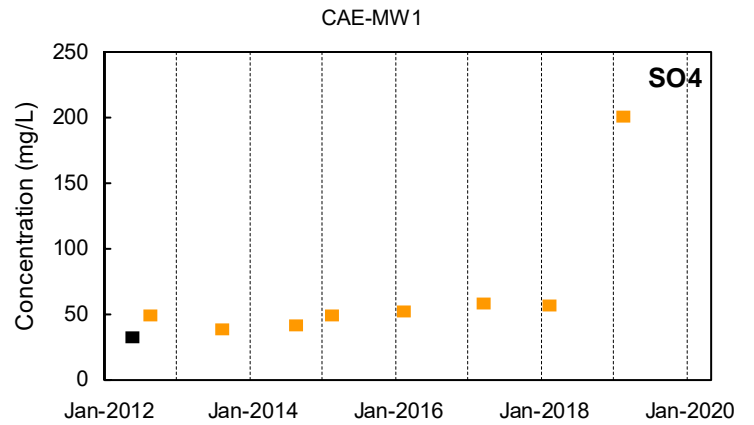
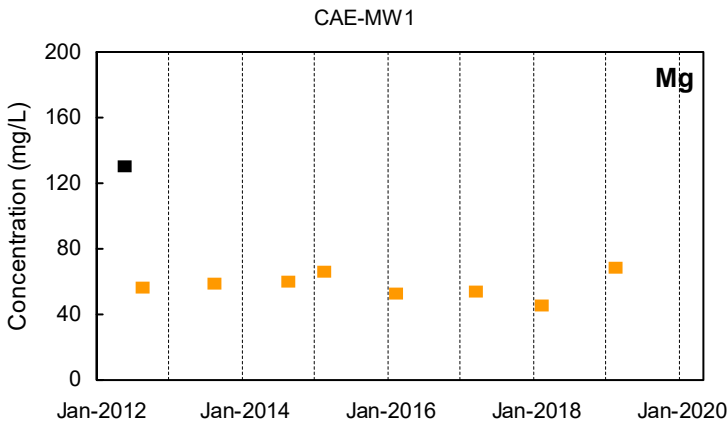
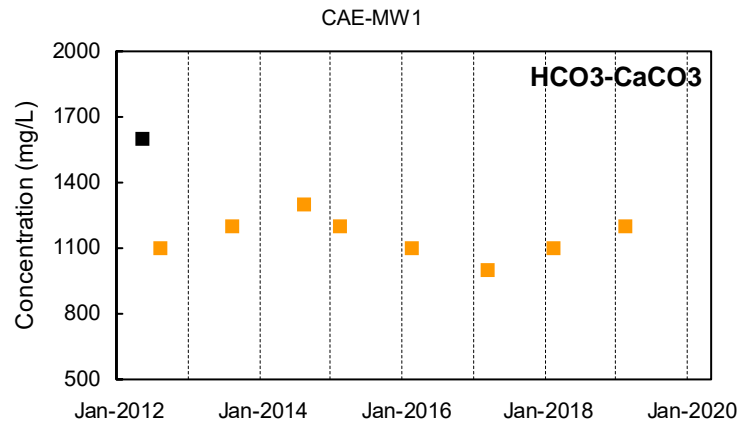
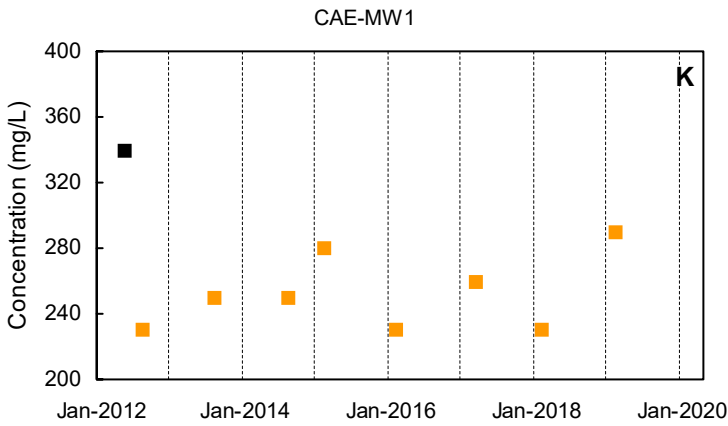
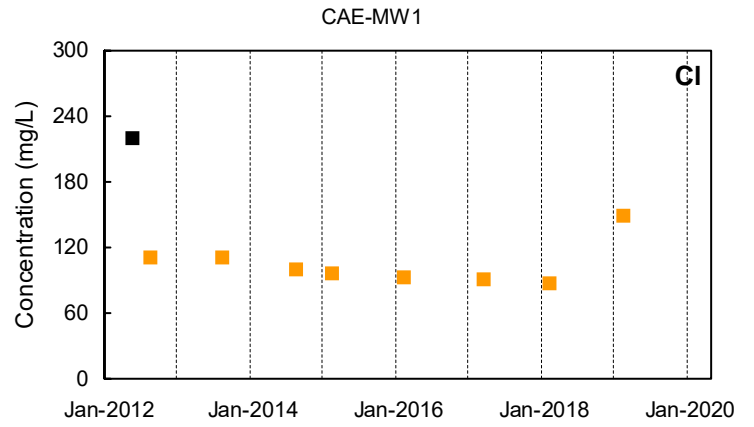
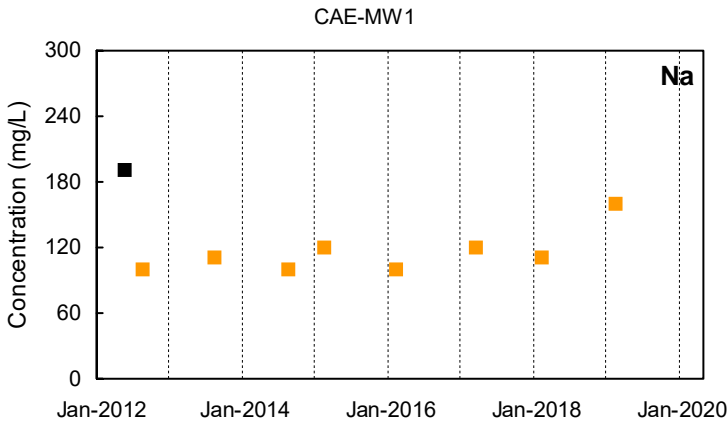

Detected Value
 'J'-Flag (value between reporting limit and detection limit)
 Non-Detect Range
 Shallow Well shown with black symbols Deep Well shown with orange symbols "dd" Well shown with blue symbols

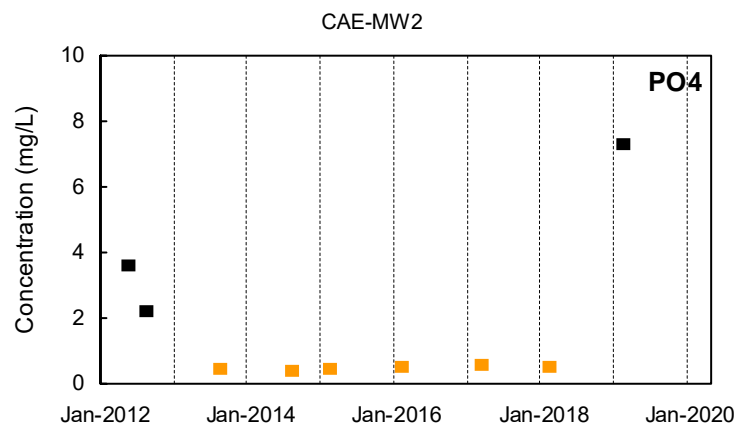
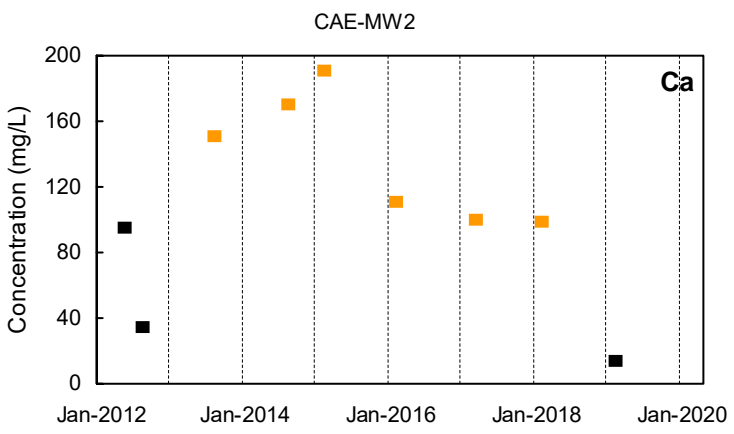
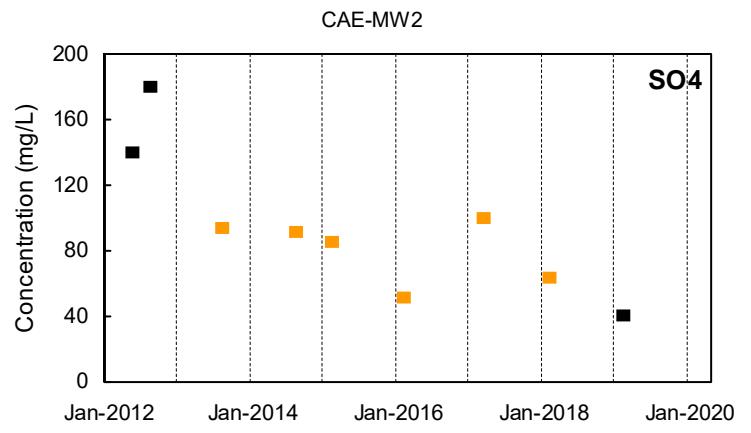
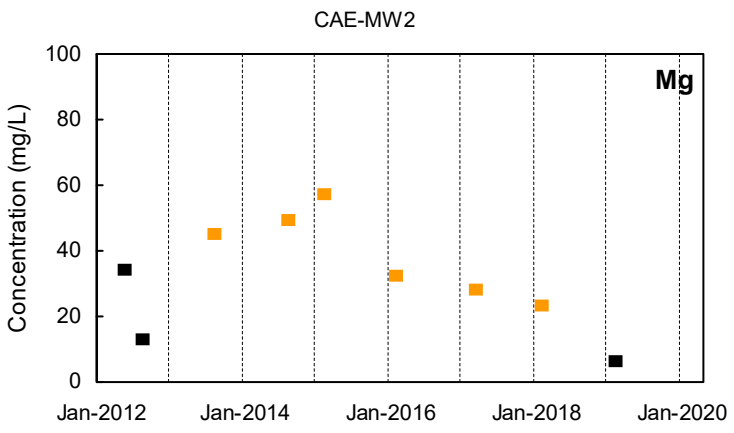
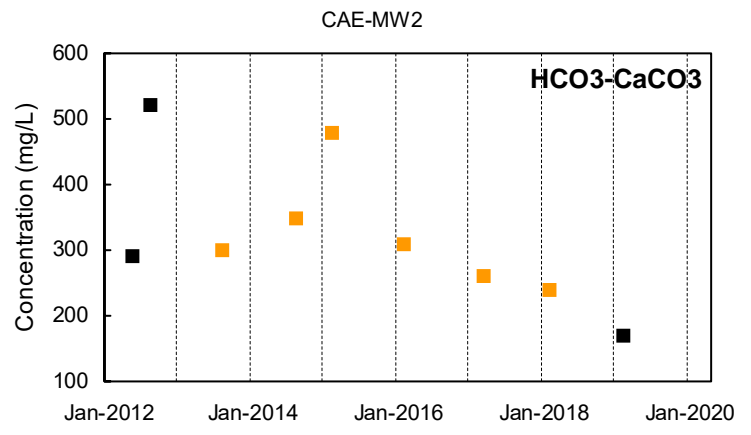
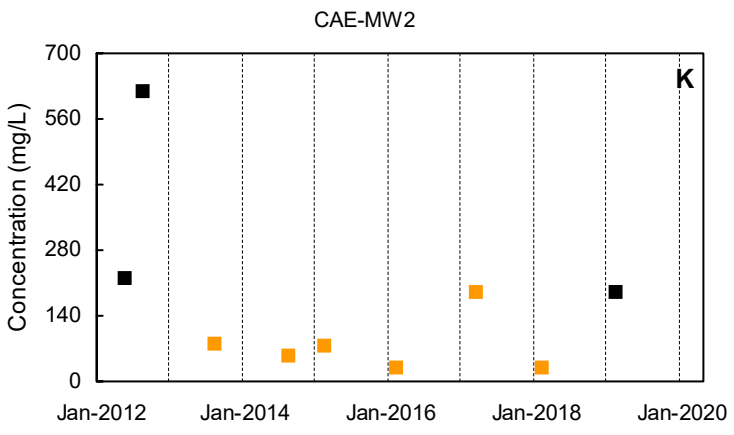
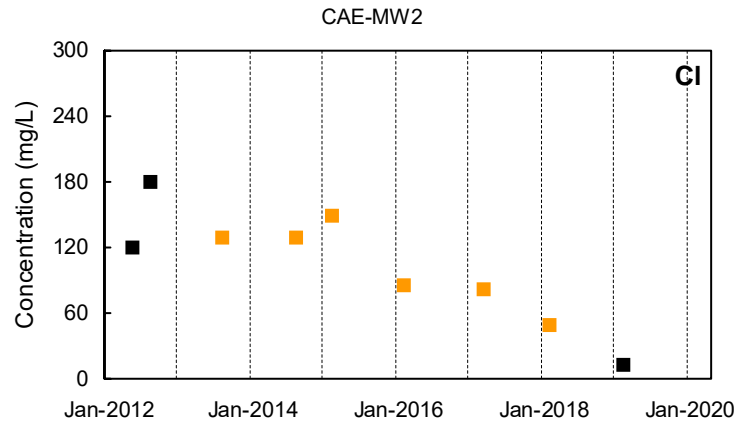
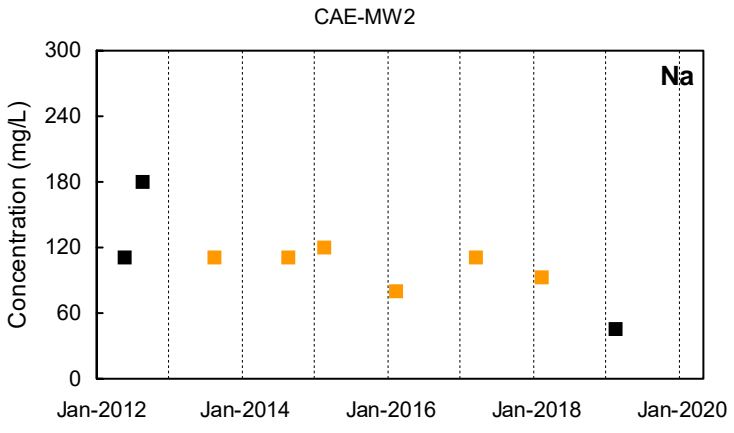

Detected Value
 'J'-Flag (value between reporting limit and detection limit)
 Non-Detect Range
 Shallow Well shown with black symbols
 Deep Well shown with orange symbols
 "dd" Well shown with blue symbols

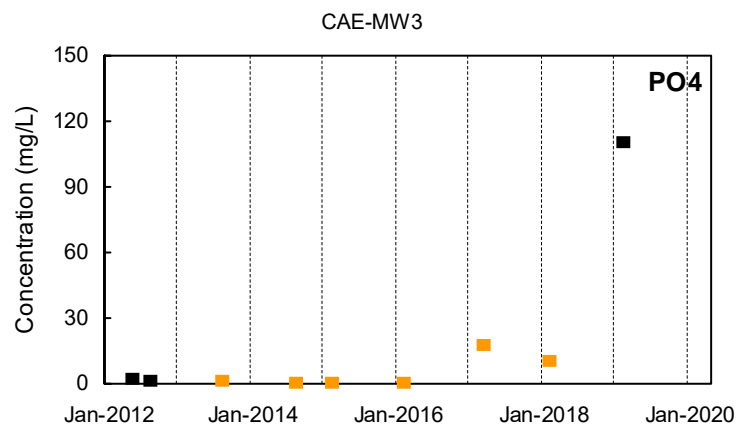
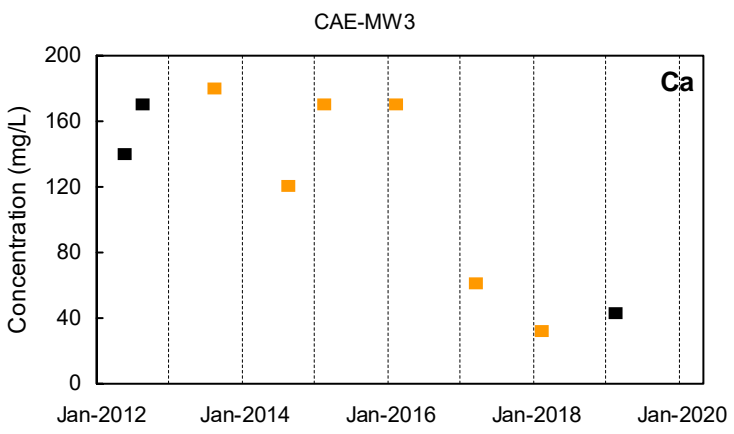
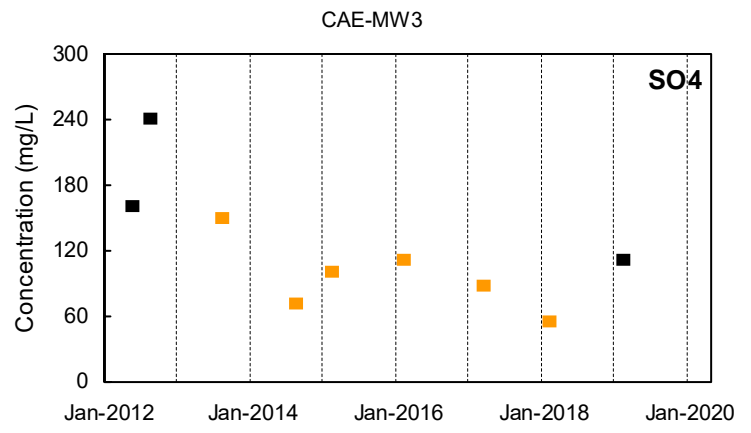
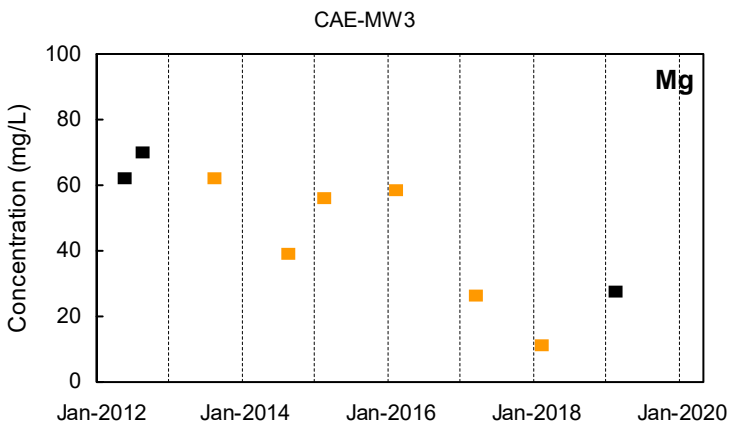
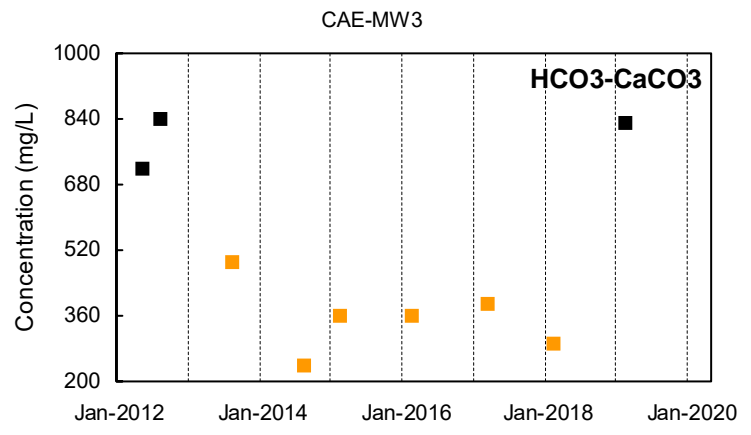
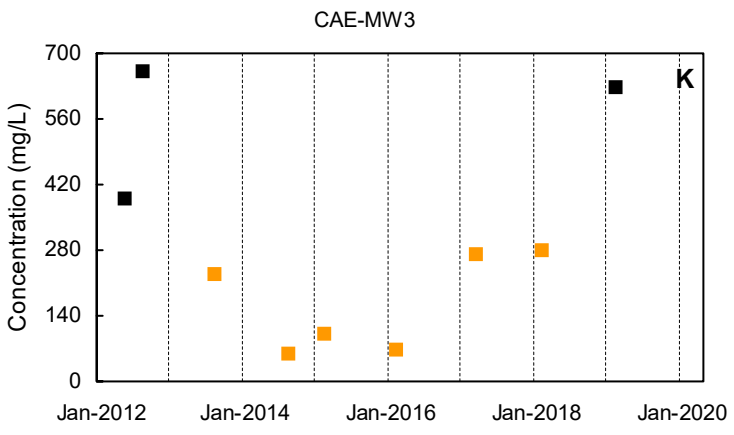
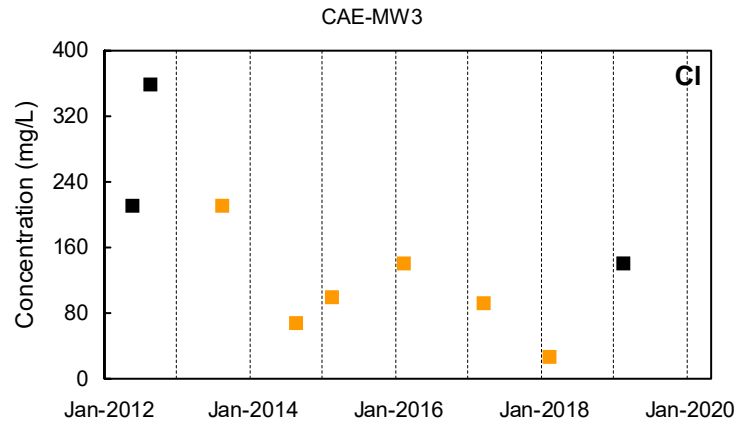
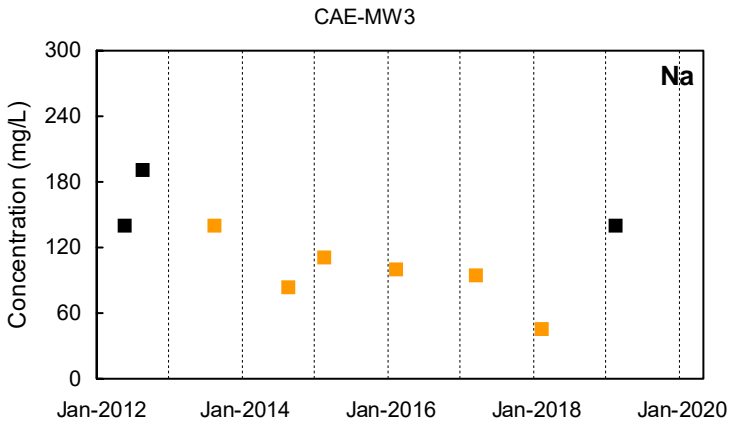

Detected Value
 'J'-Flag (value between reporting limit and detection limit)
 Non-Detect Range
 Shallow Well shown with black symbols
 Deep Well shown with orange symbols
 "dd" Well shown with blue symbols

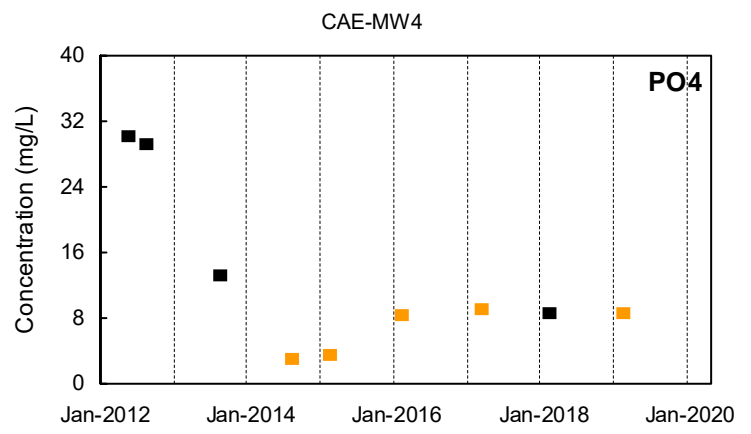
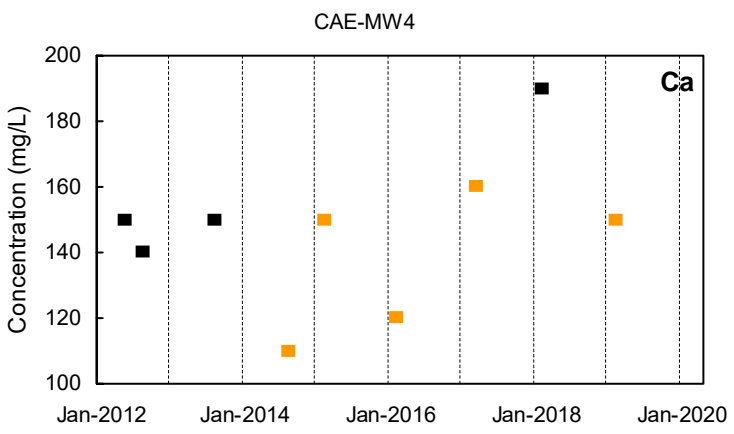
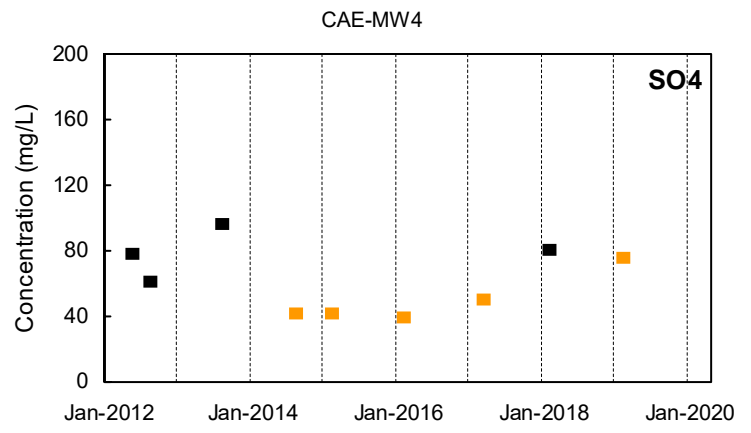
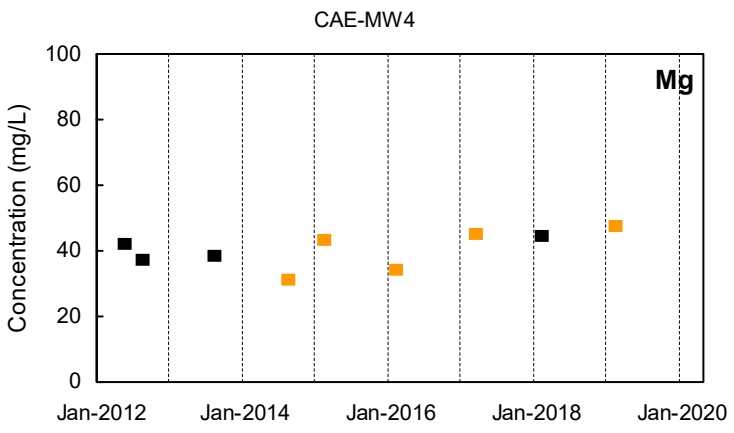
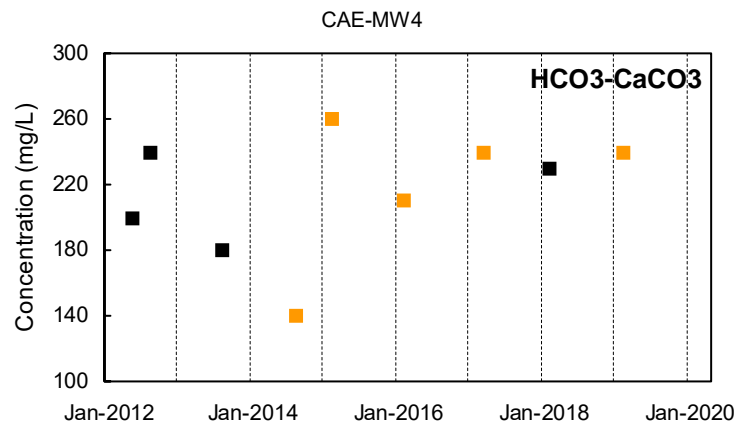
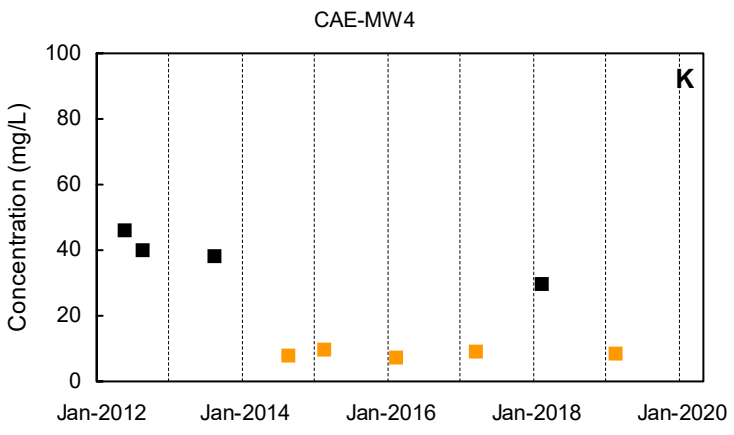
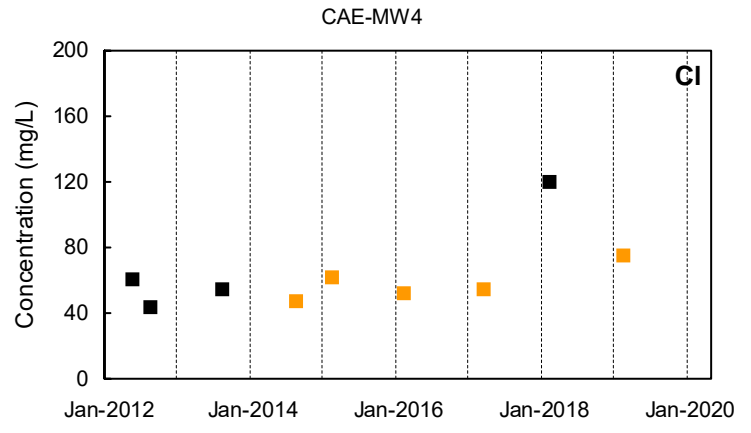
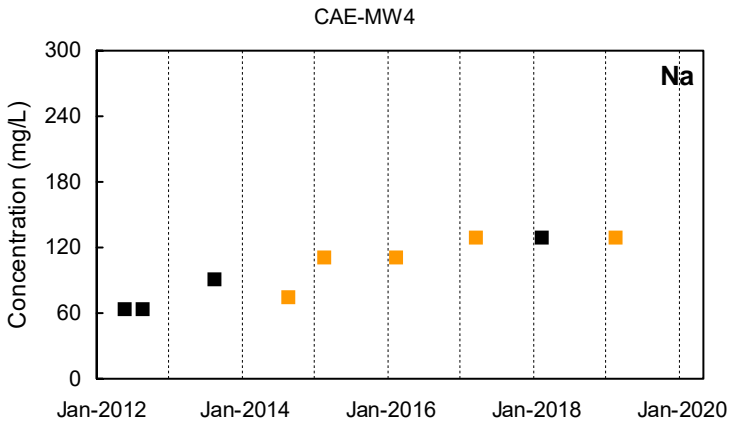

Detected Value
 'J'-Flag (value between reporting limit and detection limit)
 Non-Detect Range
 Shallow Well shown with black symbols Deep Well shown with orange symbols "dd" Well shown with blue symbols

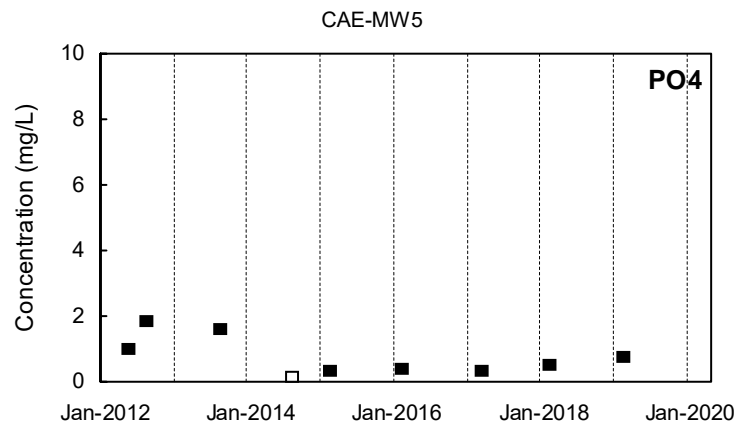
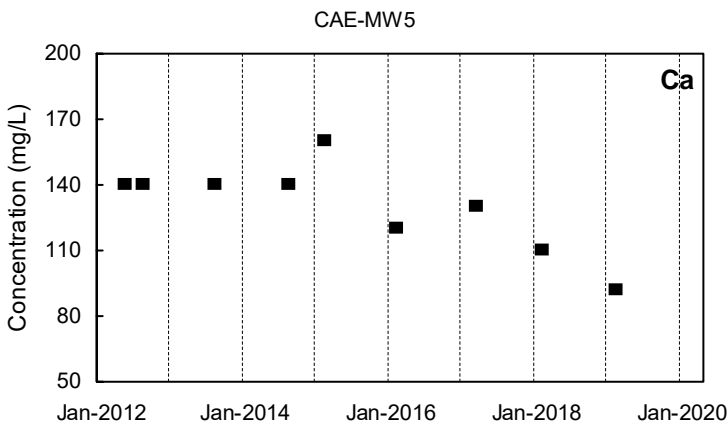
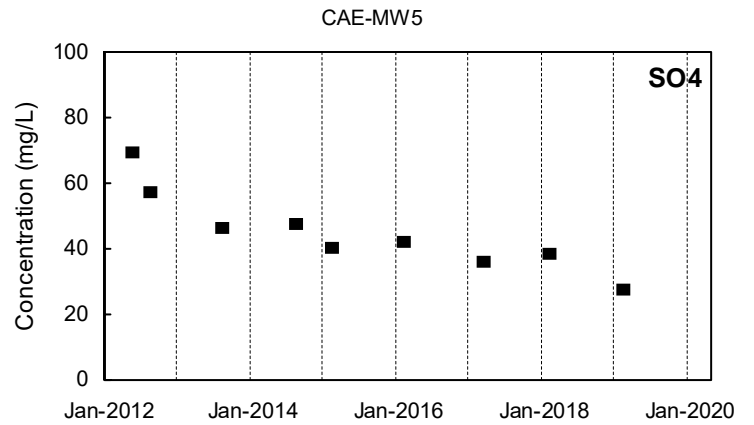
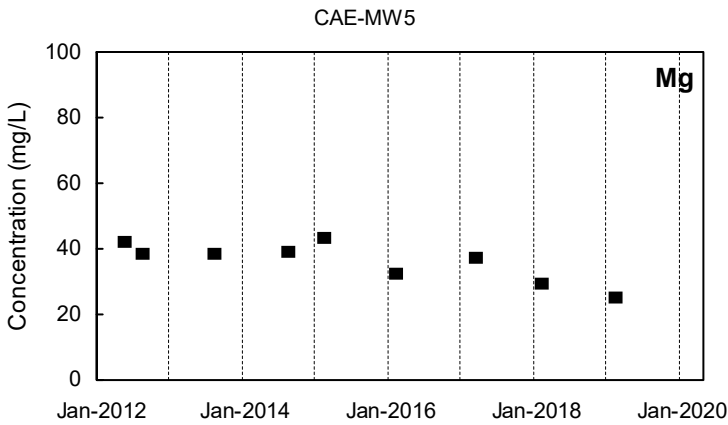
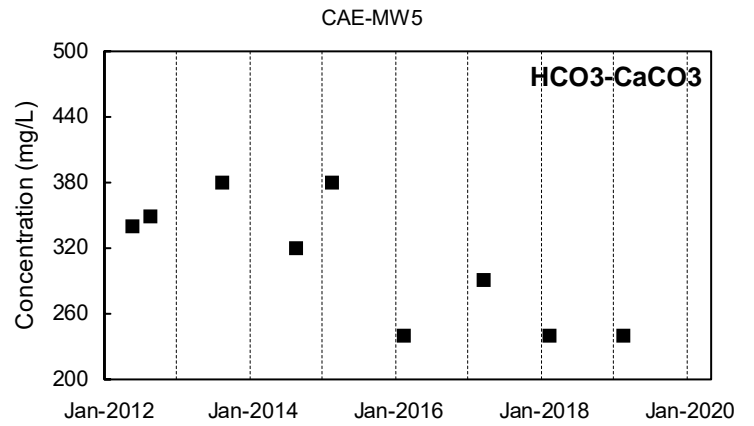
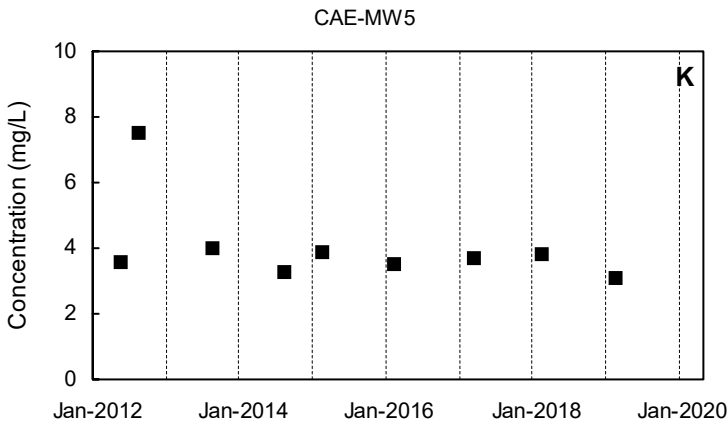
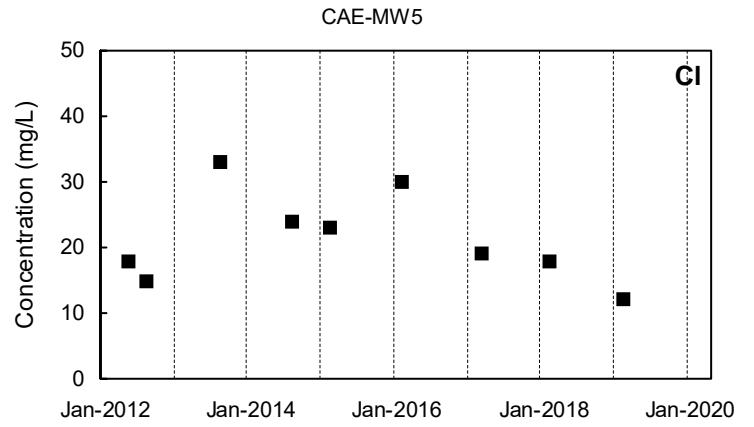
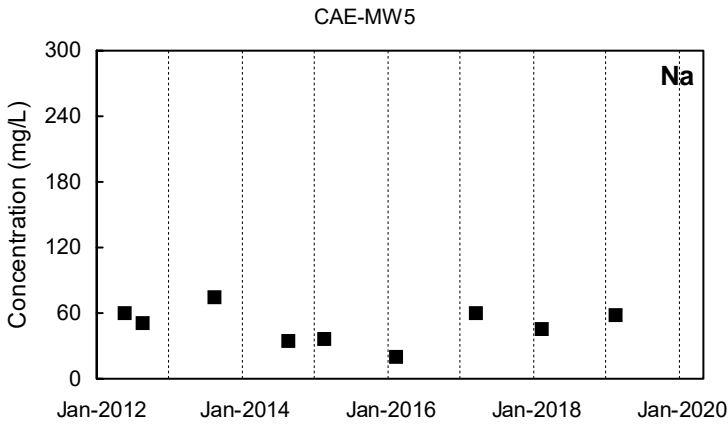

Detected Value
 'J'-Flag (value between reporting limit and detection limit)
 Non-Detect Range
 Shallow Well shown with black symbols
 Deep Well shown with orange symbols
 "dd" Well shown with blue symbols

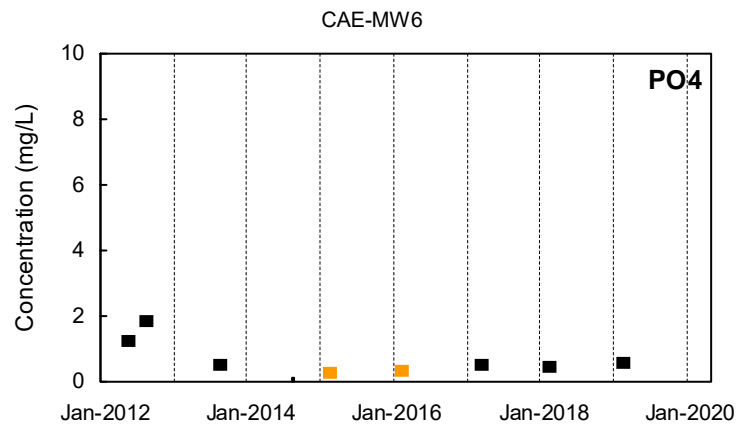
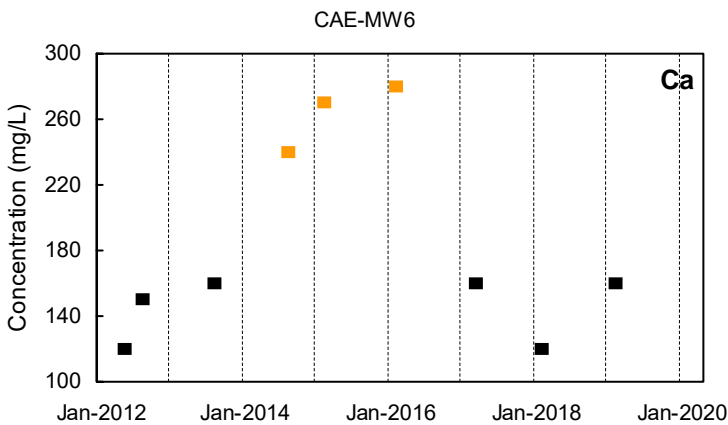
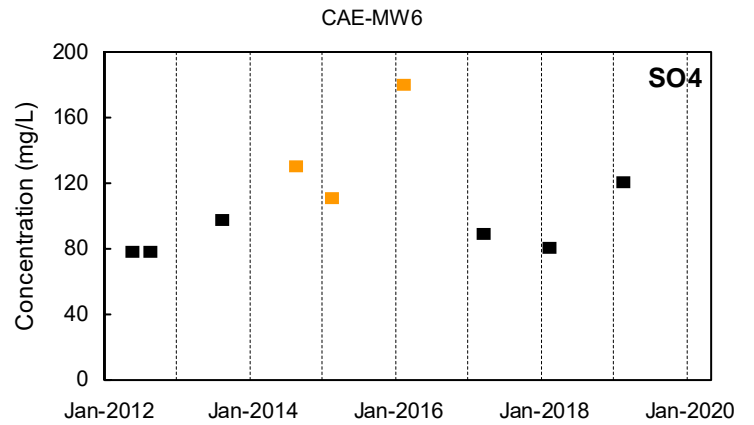
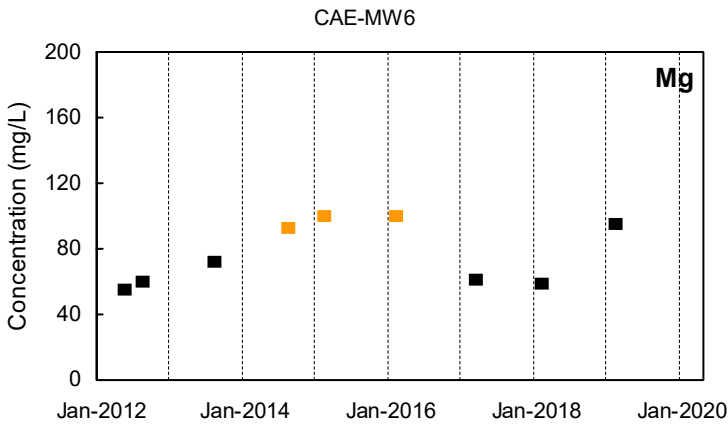
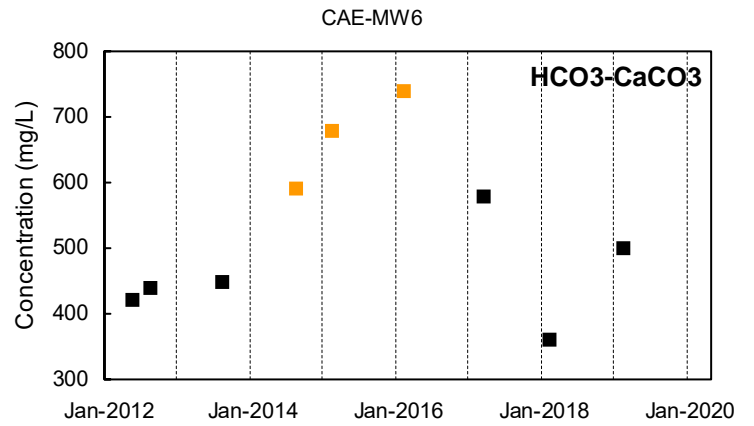
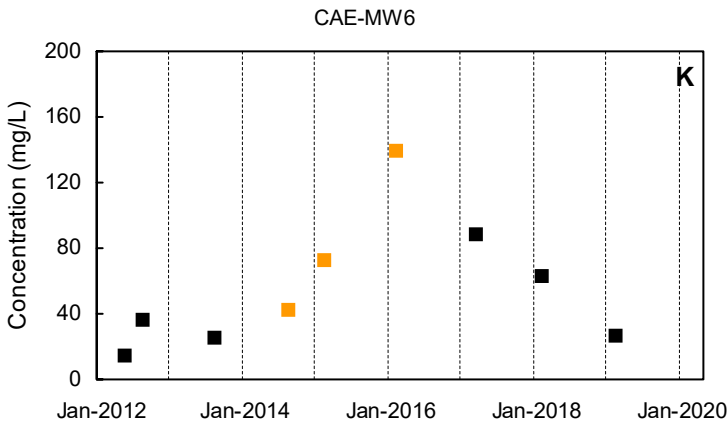
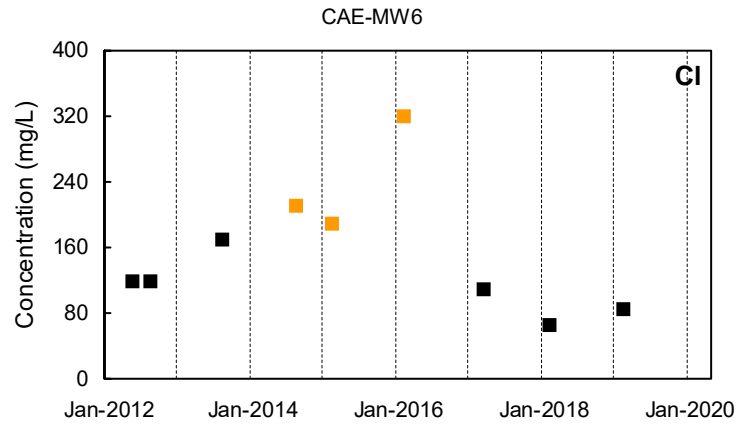
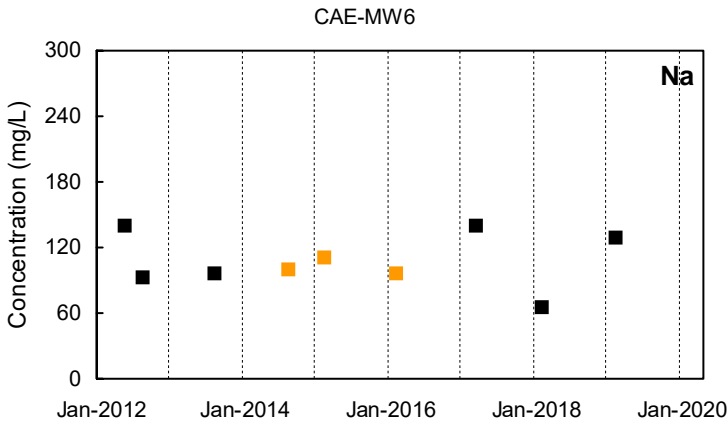

Detected Value
 'J'-Flag (value between reporting limit and detection limit)
 Non-Detect Range
 Shallow Well shown with black symbols Deep Well shown with orange symbols "dd" Well shown with blue symbols

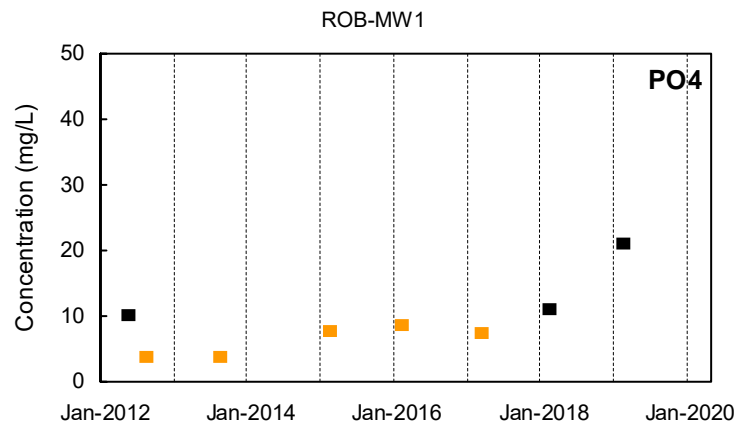
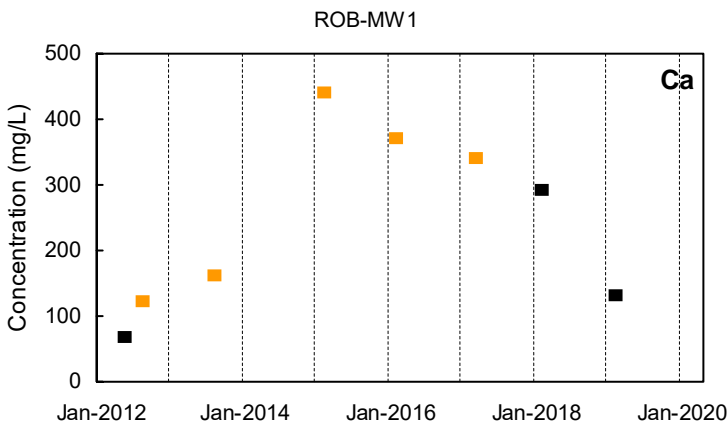
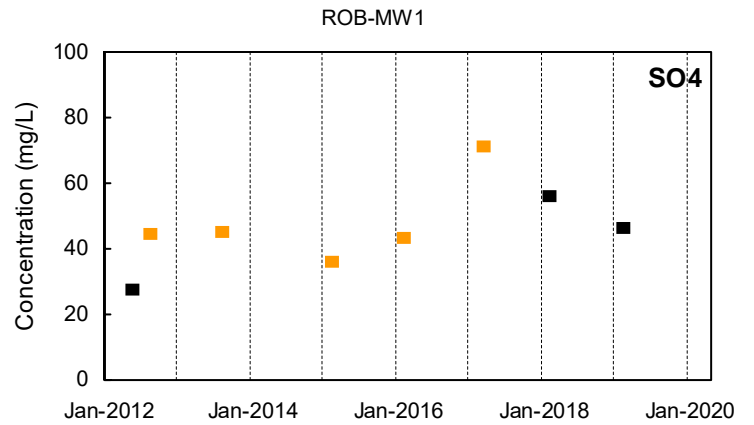
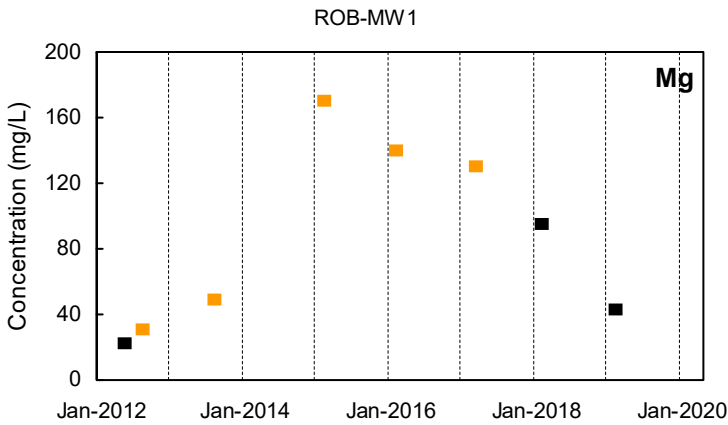
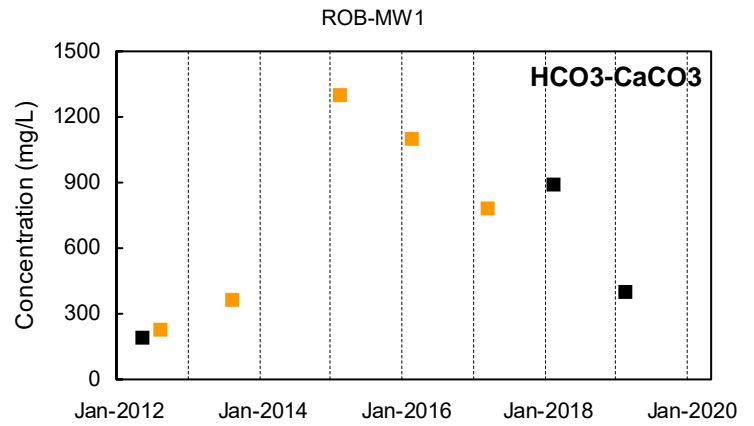
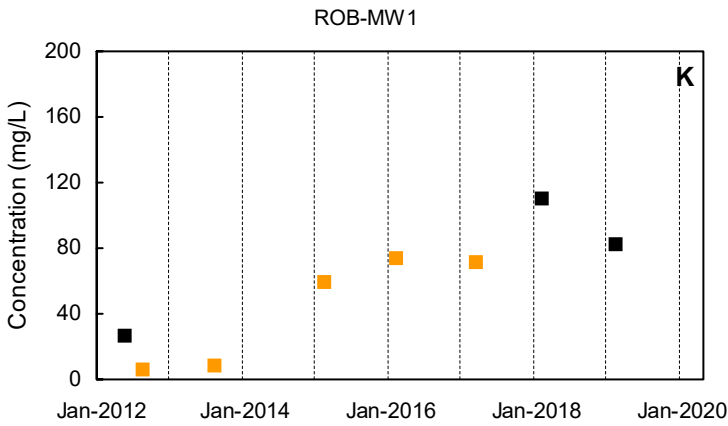
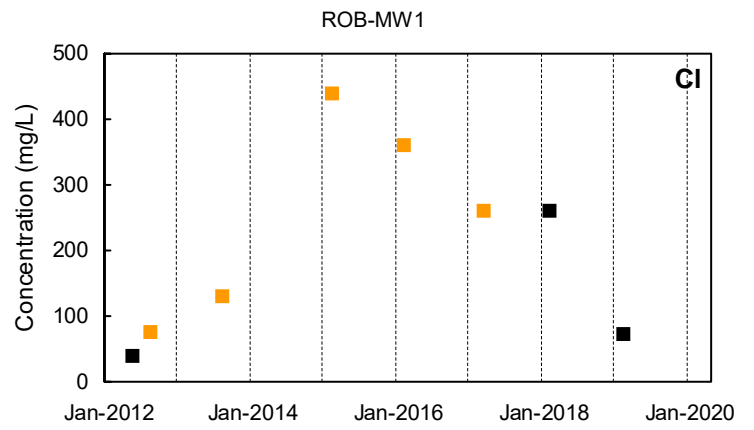
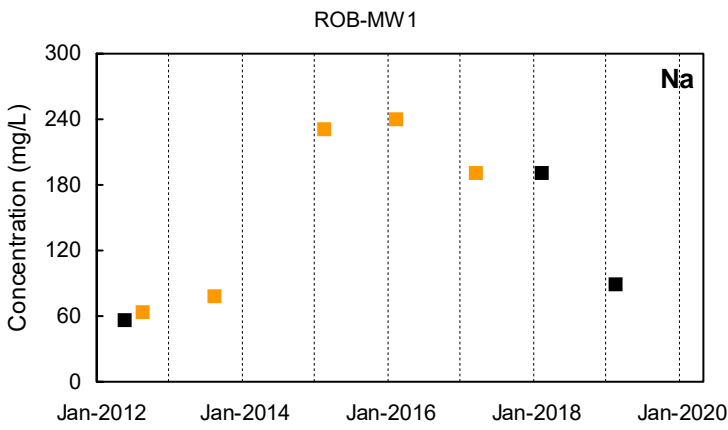

Detected Value
 'J'-Flag (value between reporting limit and detection limit)
 Non-Detect Range

Shallow Well shown with black symbols
 Deep Well shown with orange symbols
 "dd" Well shown with blue symbols

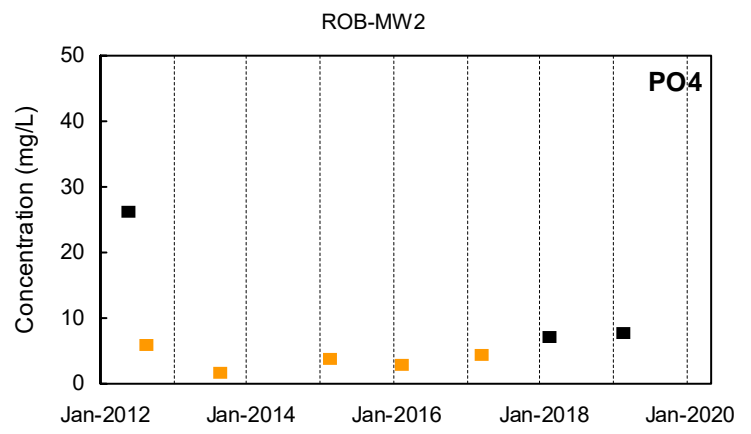
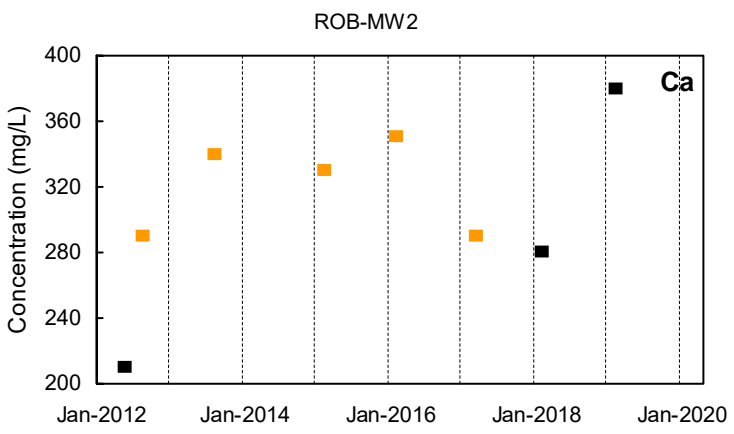
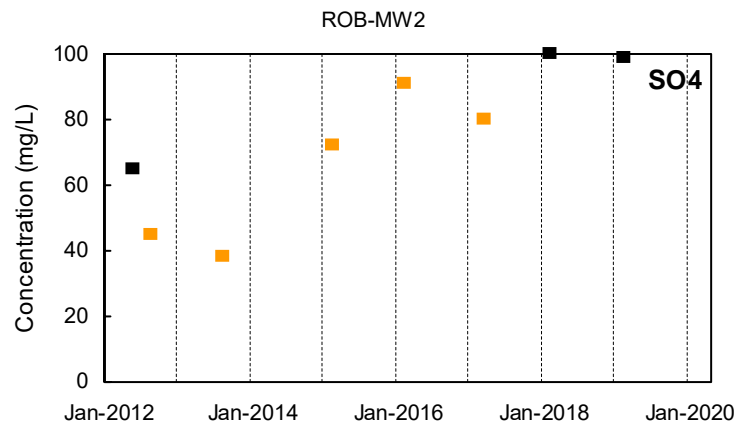
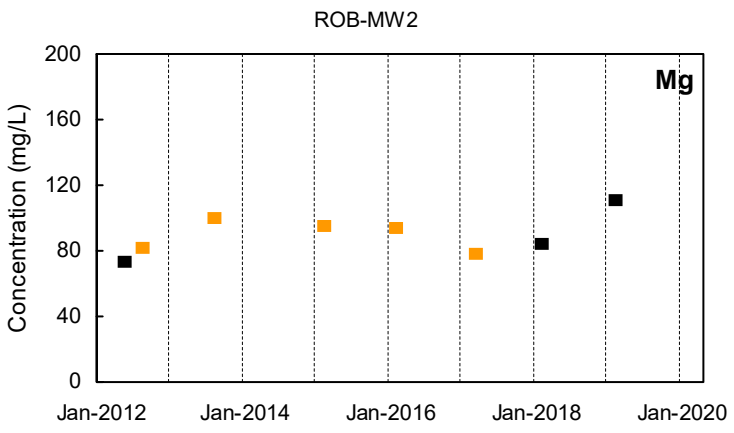
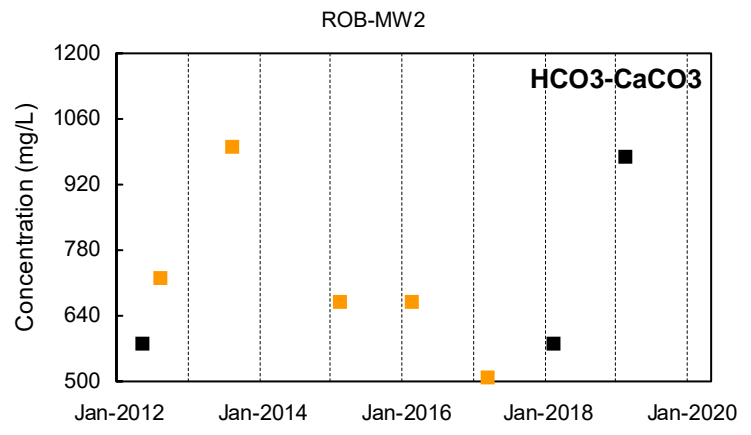
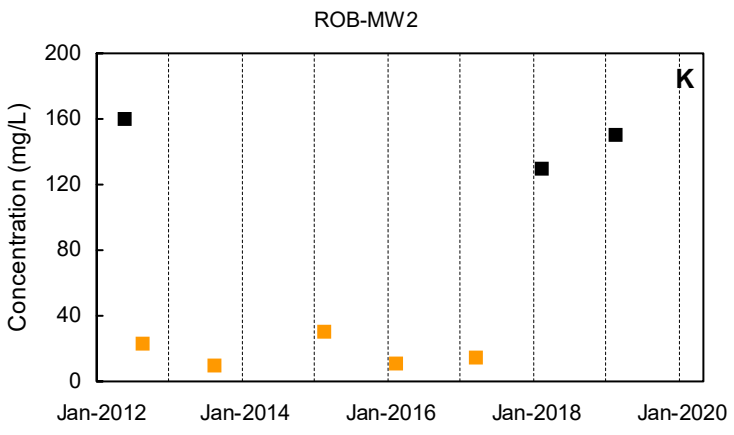
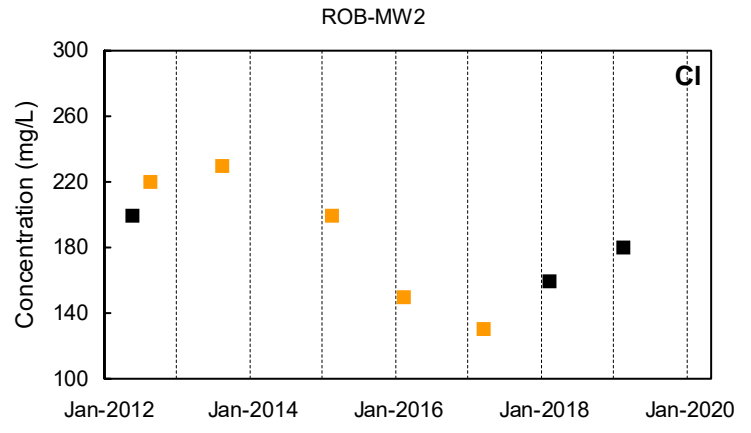
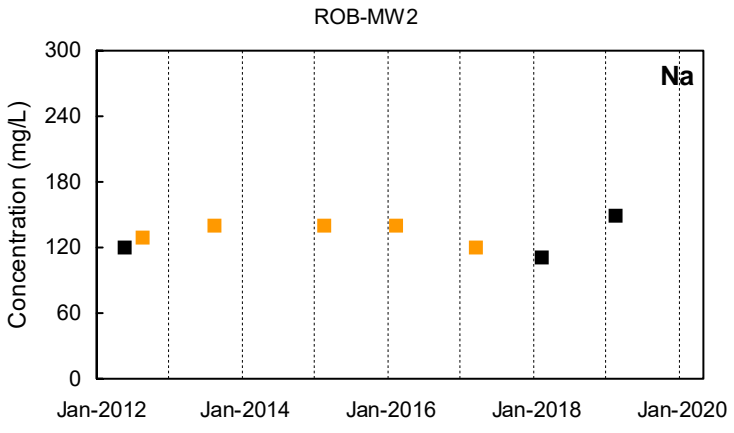

■ Detected Value □ 'J'-Flag (value between reporting limit and detection limit) ■ Non-Detect Range
 ■ Shallow Well shown with black symbols ■ Deep Well shown with orange symbols ■ "dd" Well shown with blue symbols

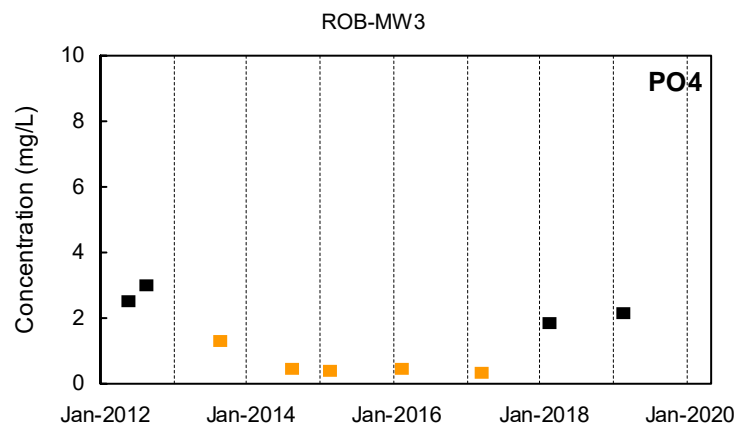
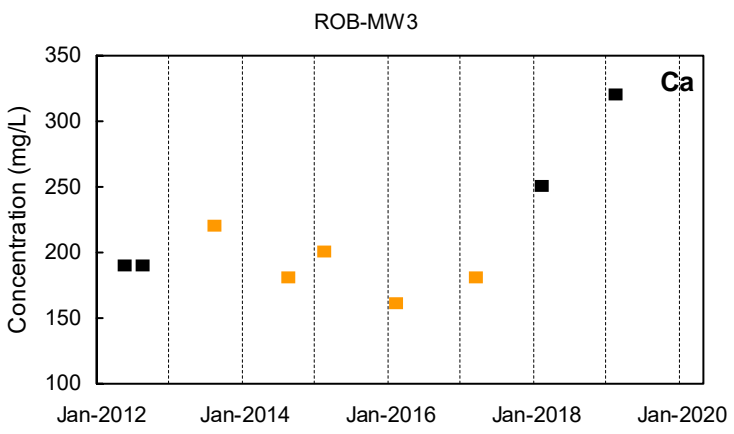
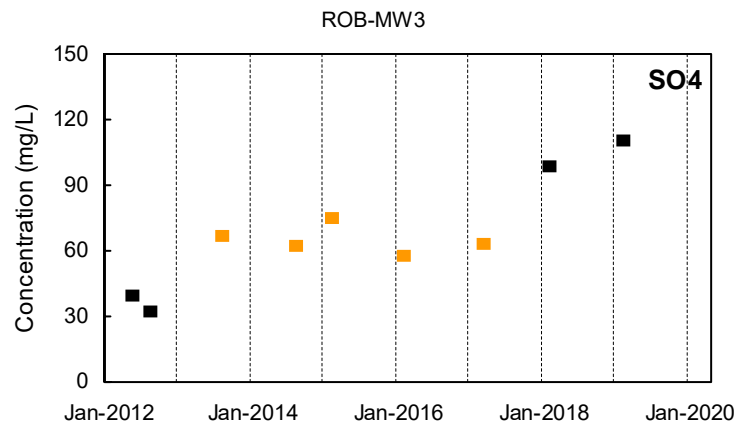
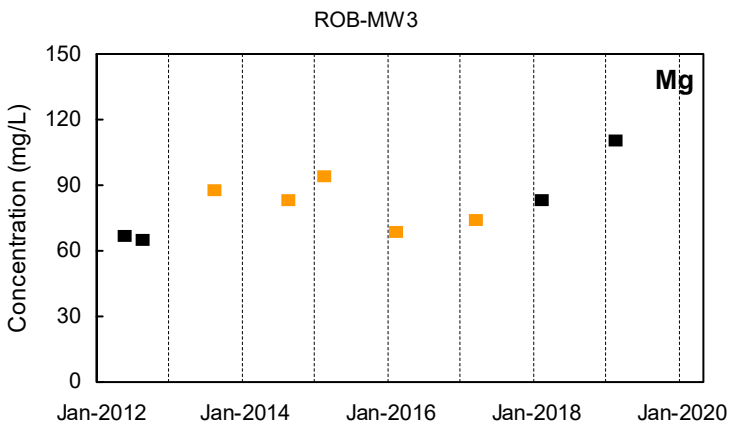
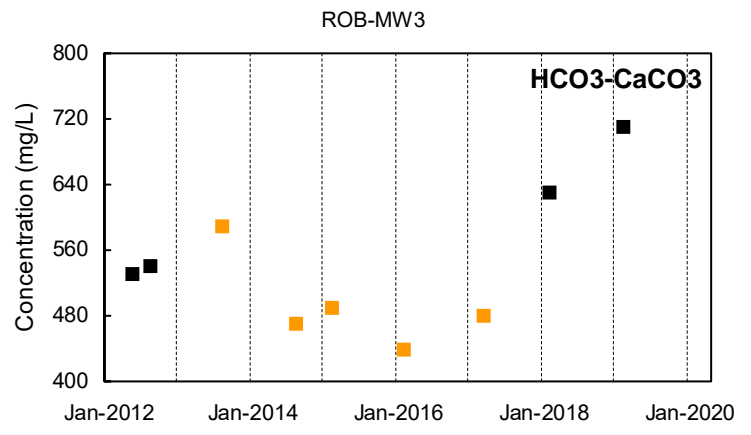
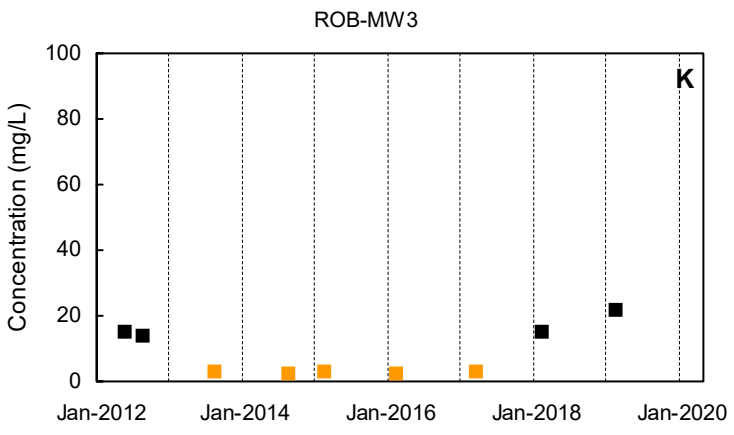
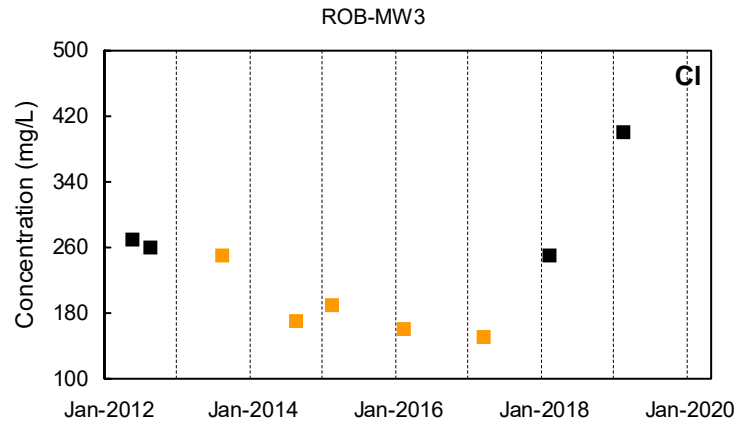
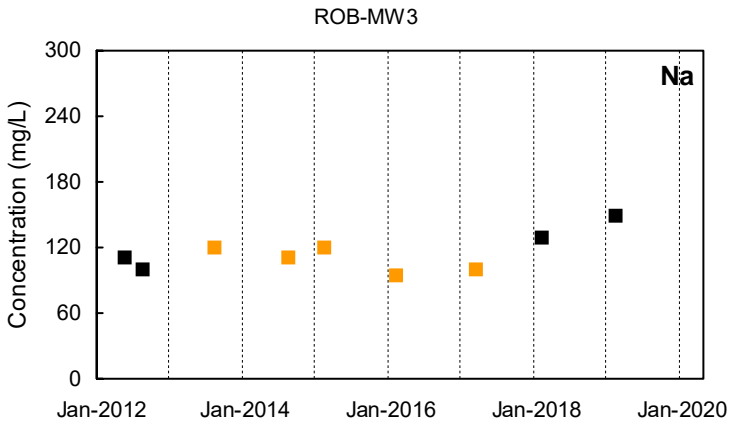

Detected Value
 'J'-Flag (value between reporting limit and detection limit)
 Non-Detect Range
 Shallow Well shown with black symbols
 Deep Well shown with orange symbols
 "dd" Well shown with blue symbols

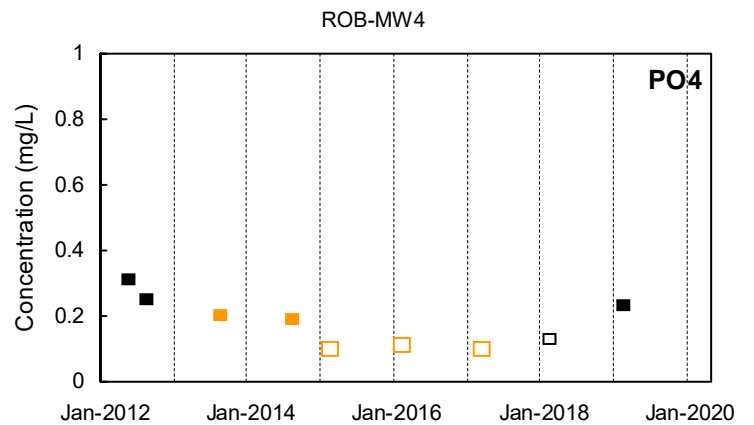
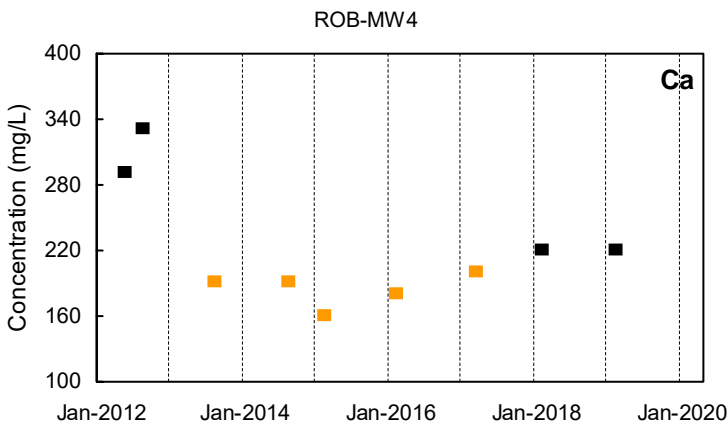
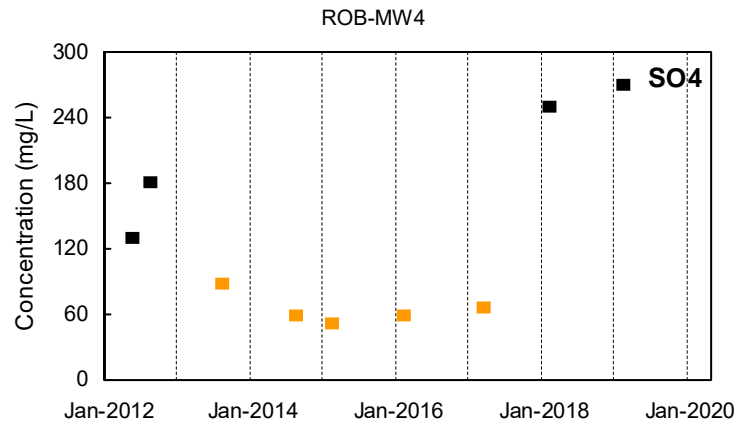
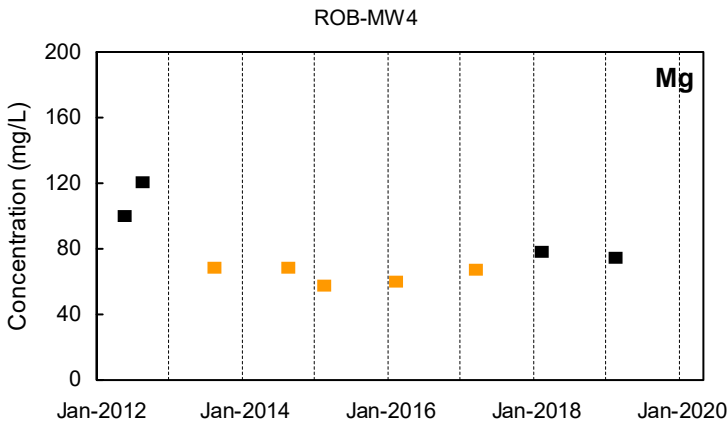
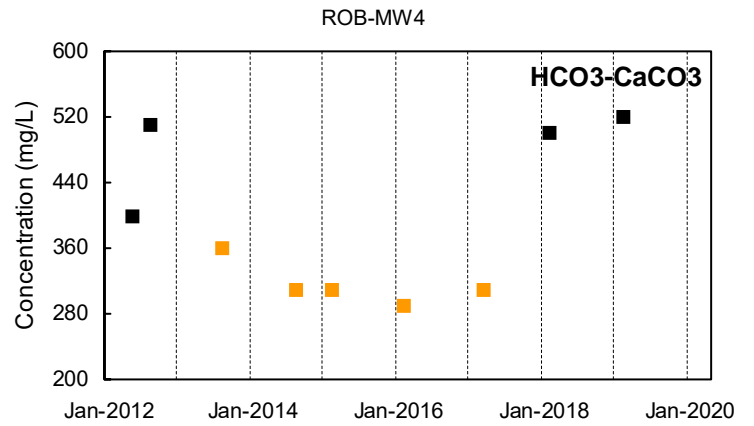
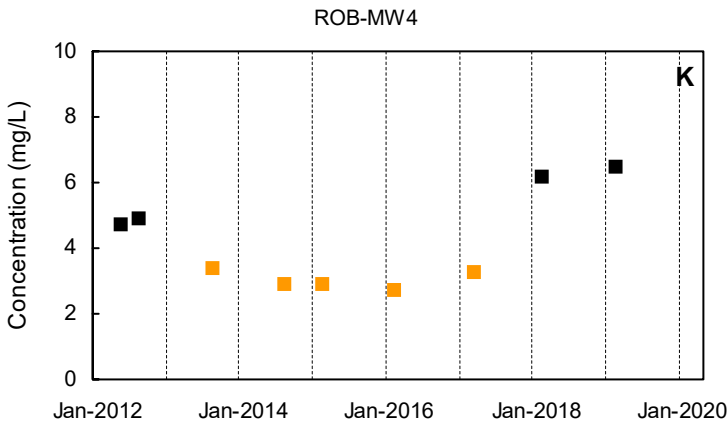
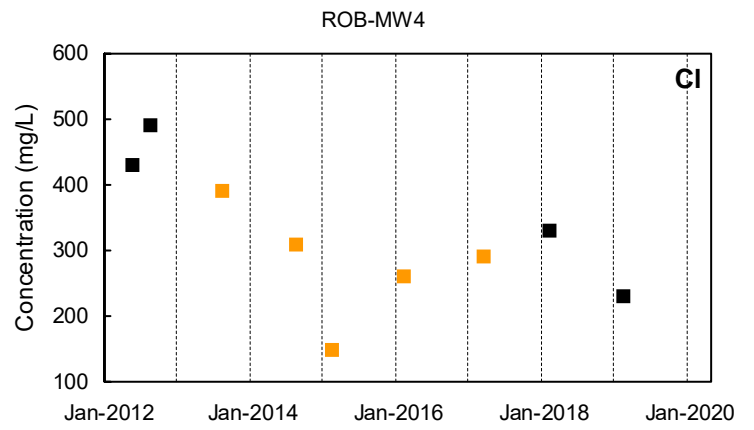
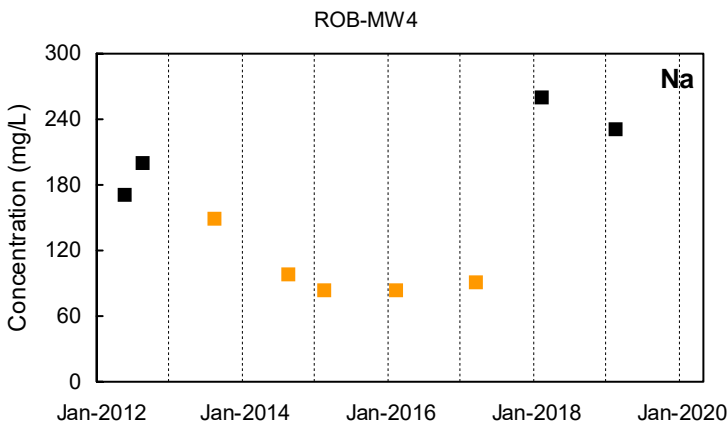

Detected Value
 'J'-Flag (value between reporting limit and detection limit)
 Non-Detect Range

Shallow Well shown with black symbols
 Deep Well shown with orange symbols
 "dd" Well shown with blue symbols

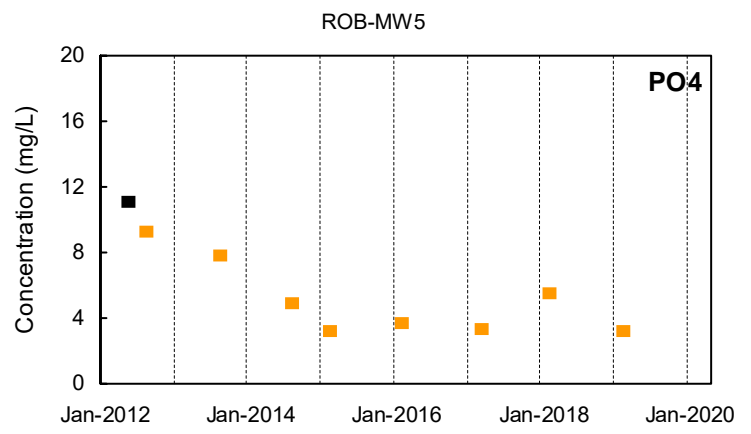
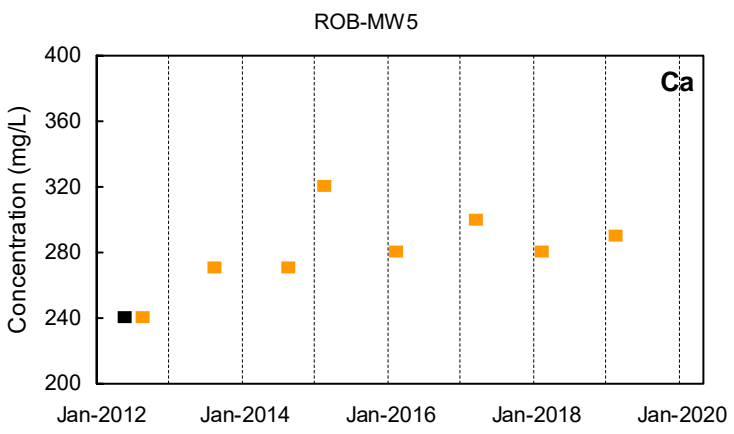
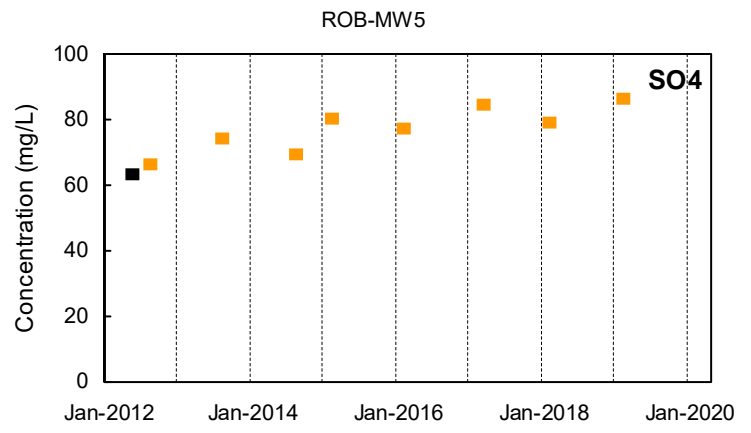
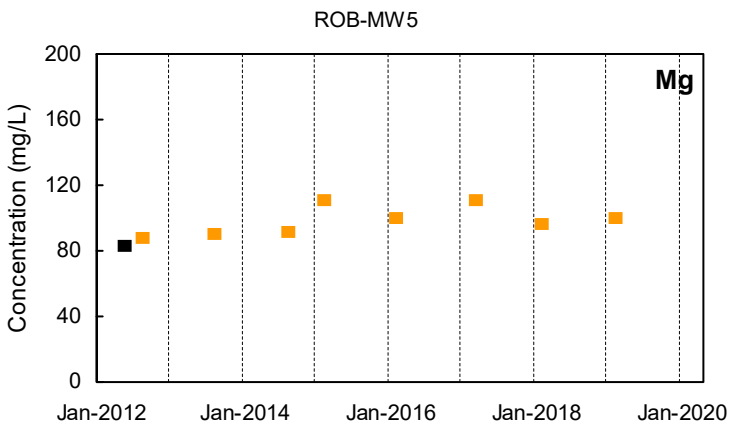
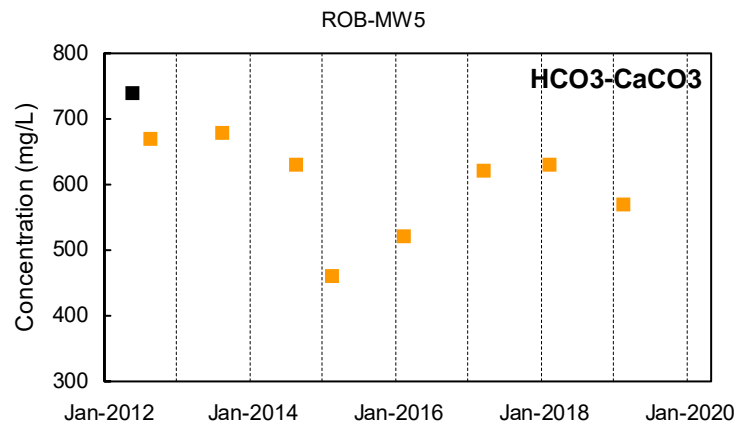
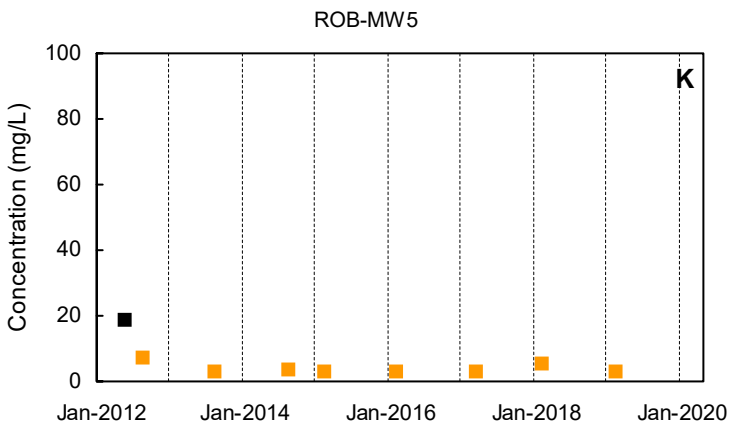
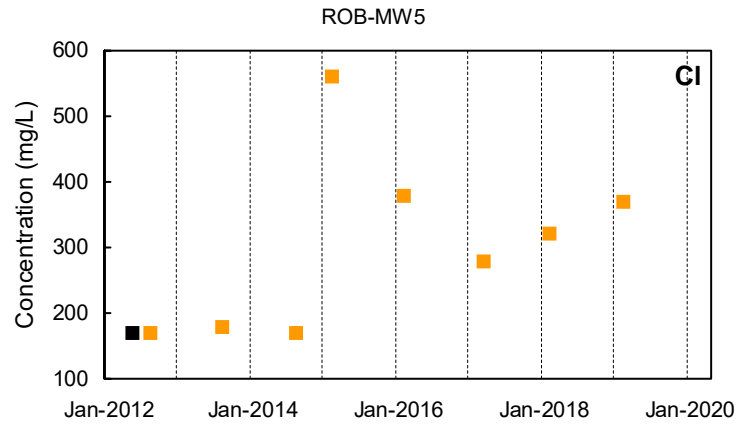
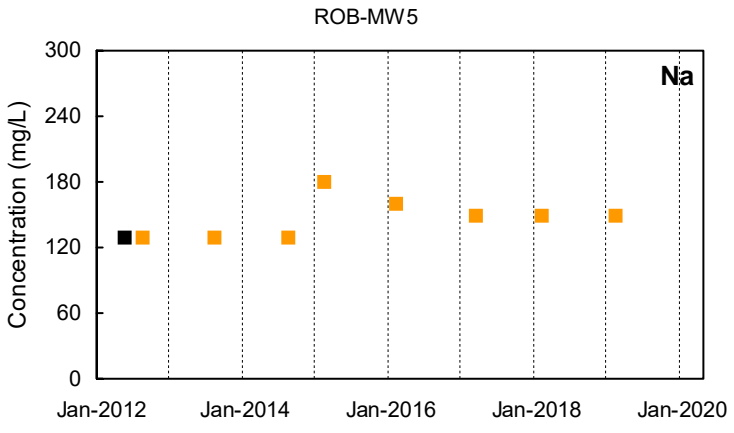

Detected Value
 'J'-Flag (value between reporting limit and detection limit)
 Non-Detect Range
 Shallow Well shown with black symbols
 Deep Well shown with orange symbols
 "dd" Well shown with blue symbols

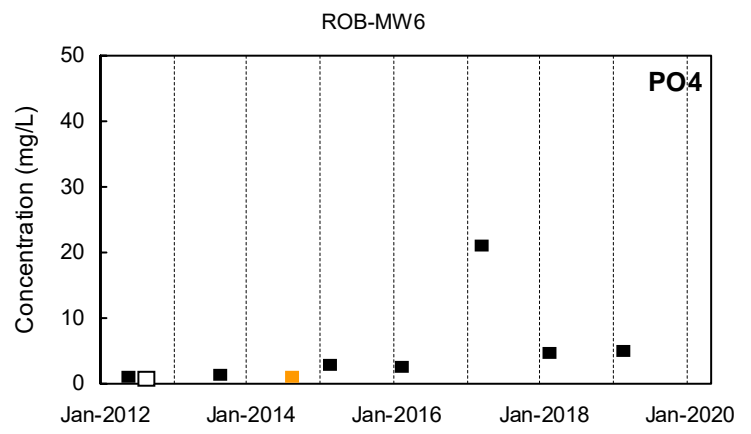
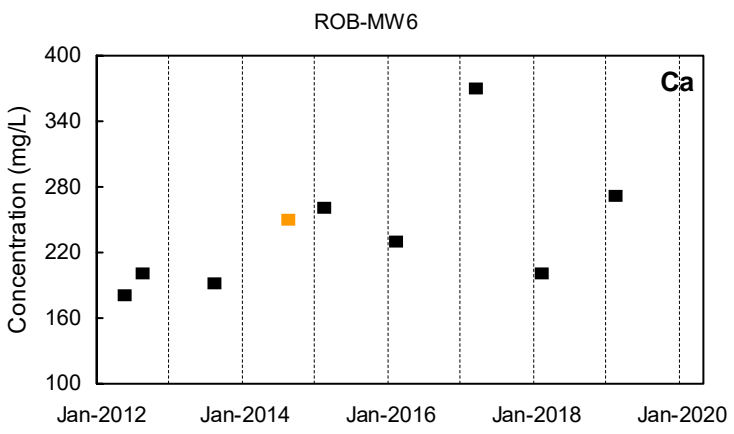
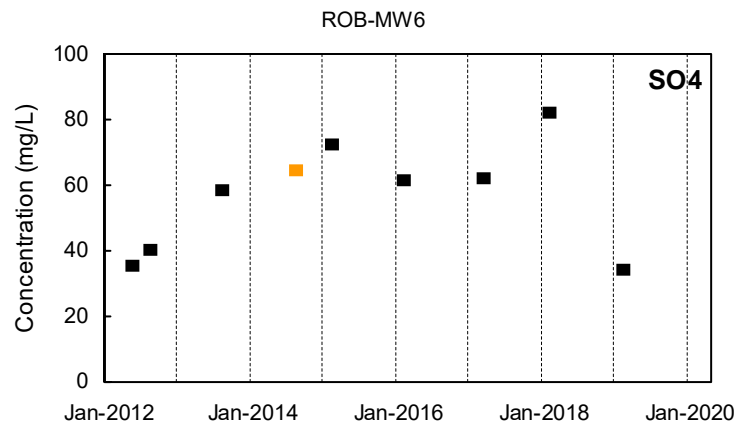
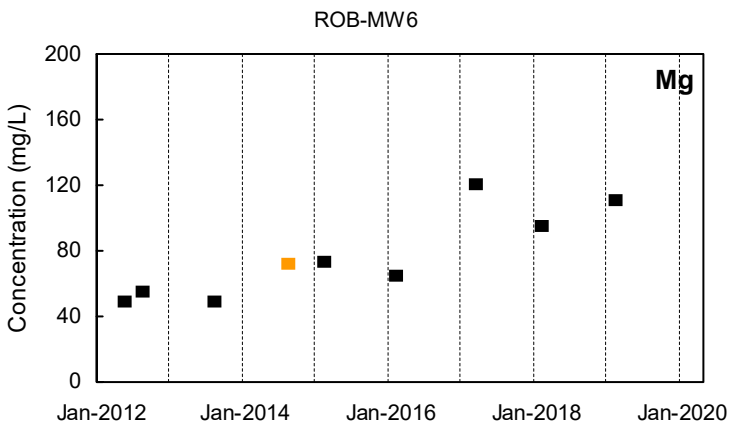
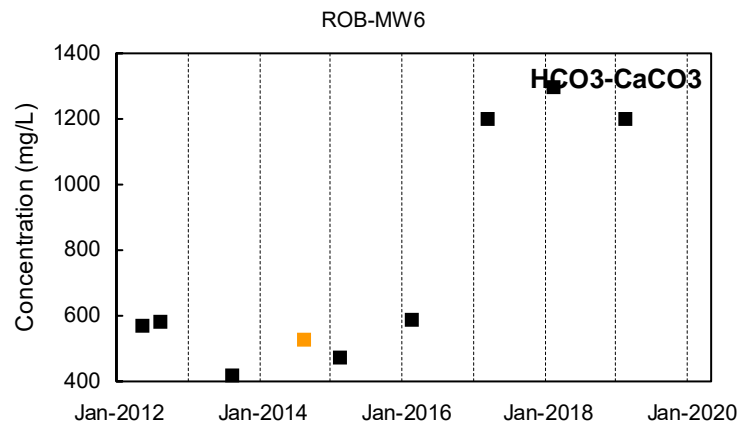
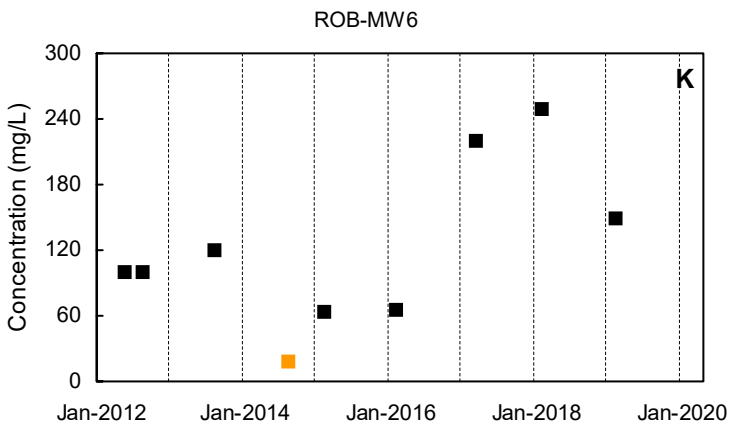
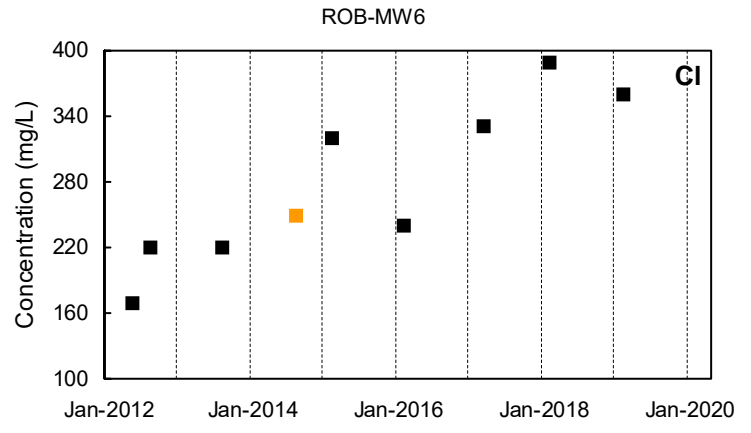
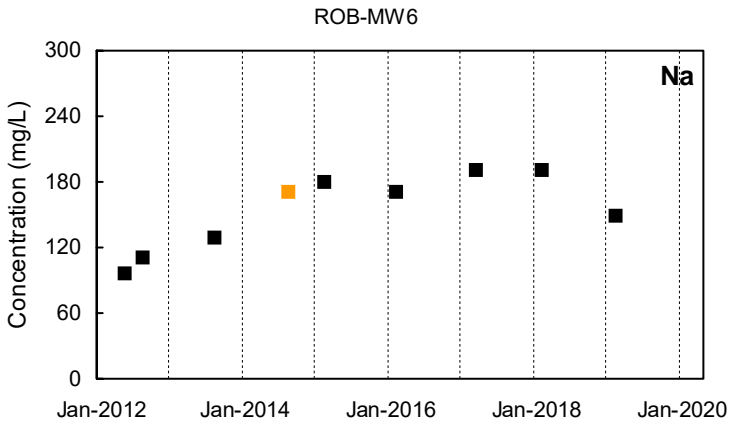

Detected Value
 'J'-Flag (value between reporting limit and detection limit)
 Non-Detect Range
 Shallow Well shown with black symbols
 Deep Well shown with orange symbols
 "dd" Well shown with blue symbols

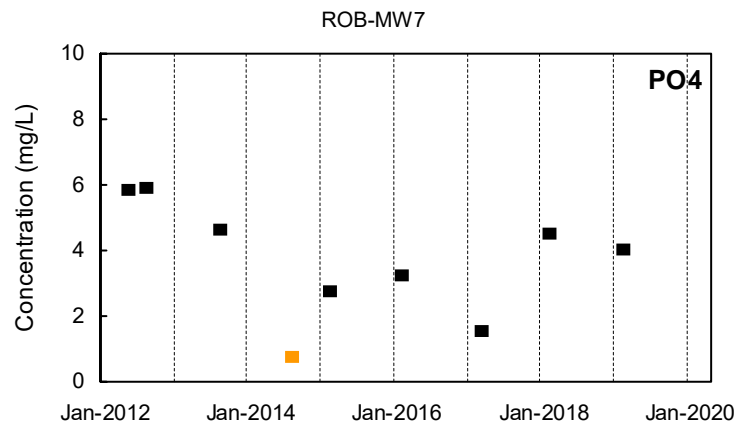
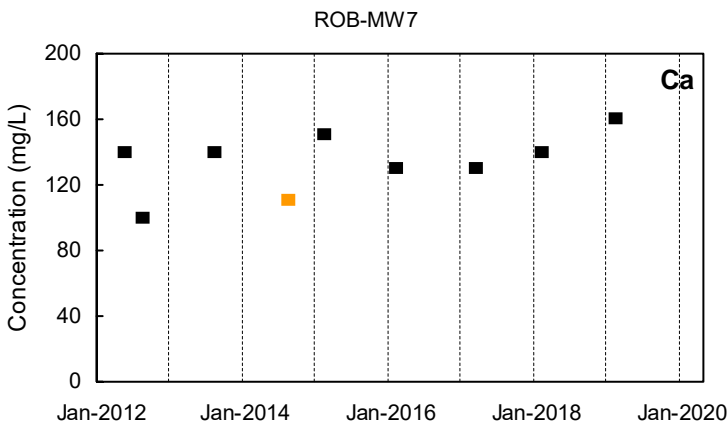
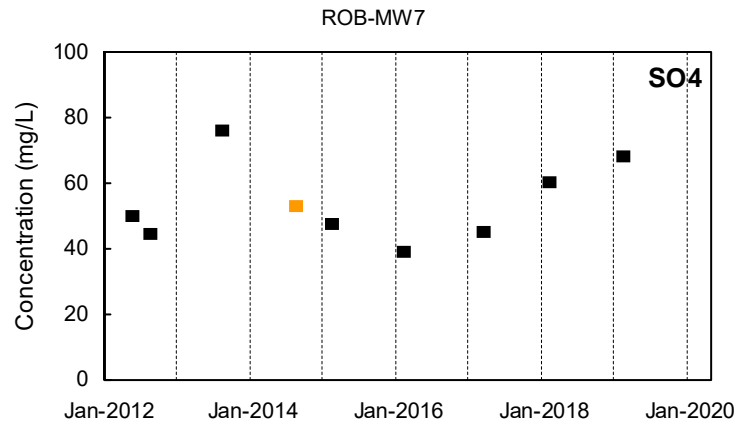
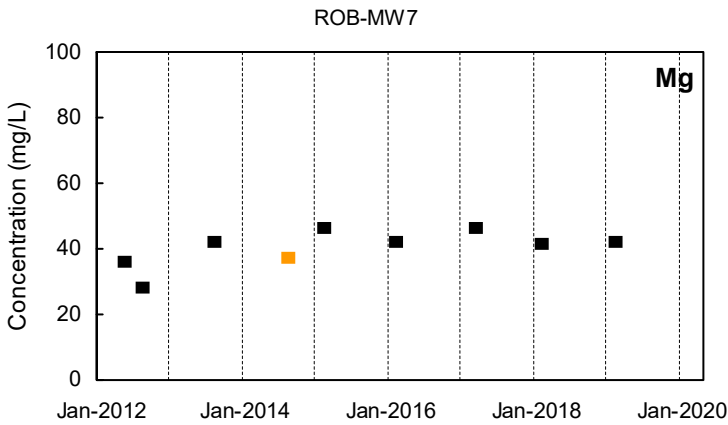
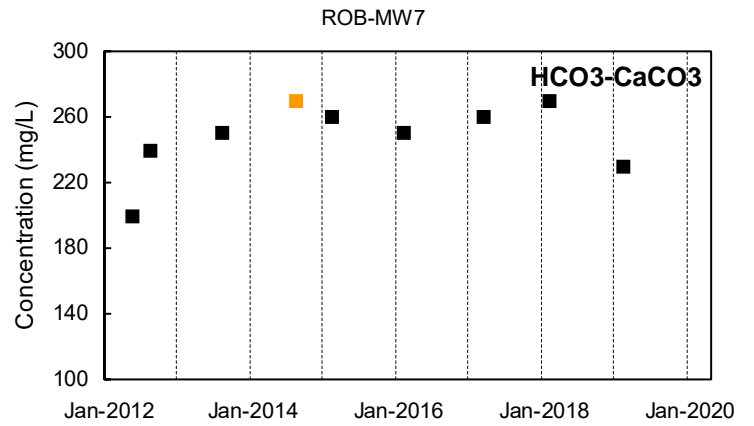
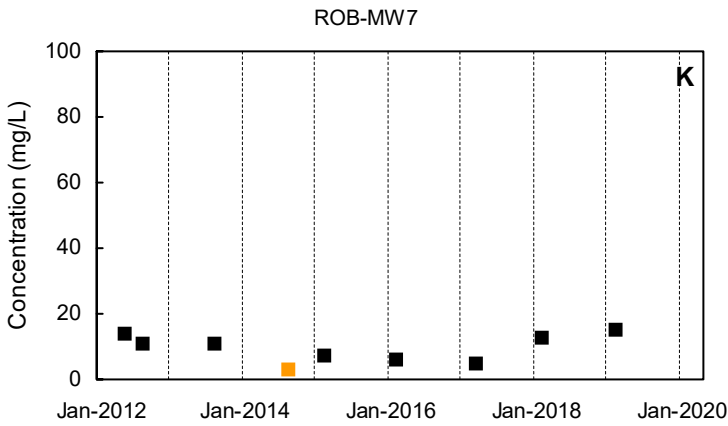
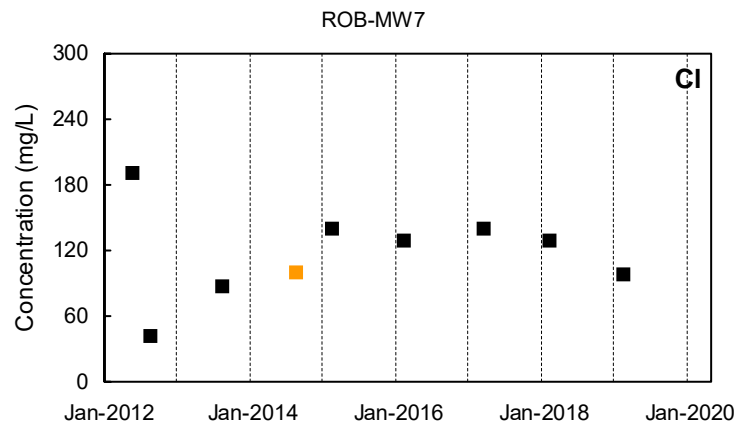
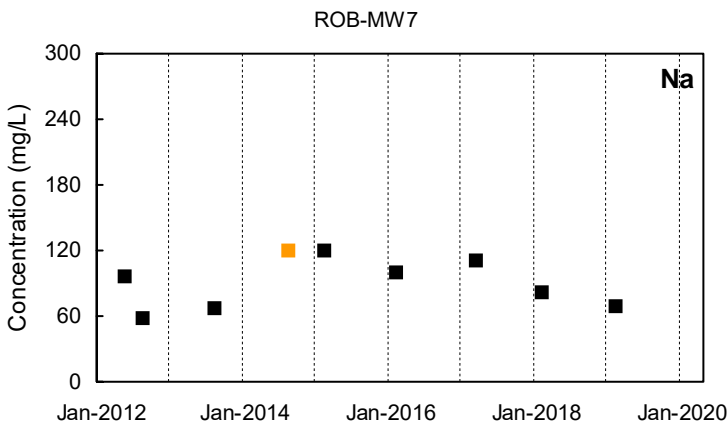

Detected Value
 'J'-Flag (value between reporting limit and detection limit)
 Non-Detect Range
 Shallow Well shown with black symbols
 Deep Well shown with orange symbols
 "dd" Well shown with blue symbols

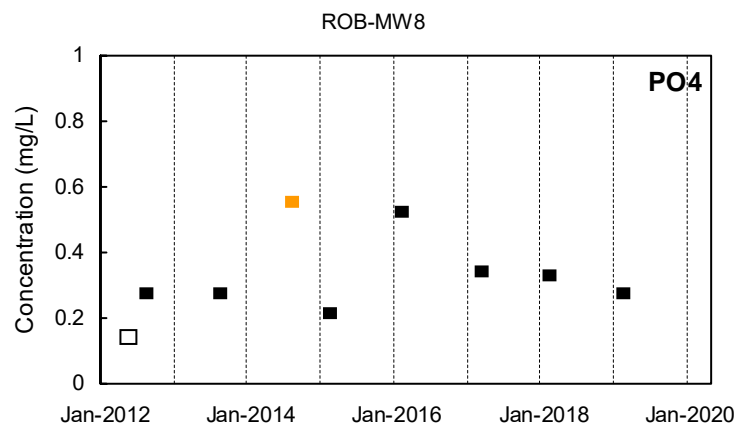
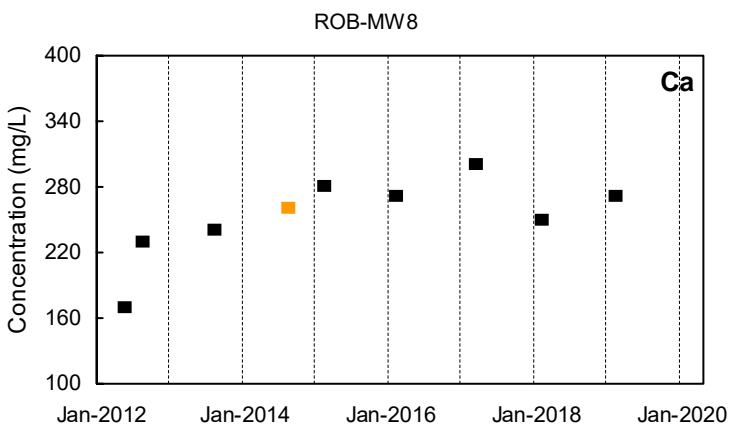
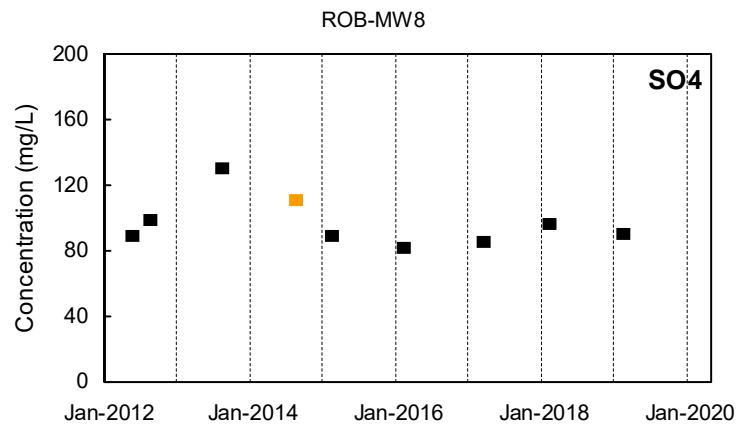
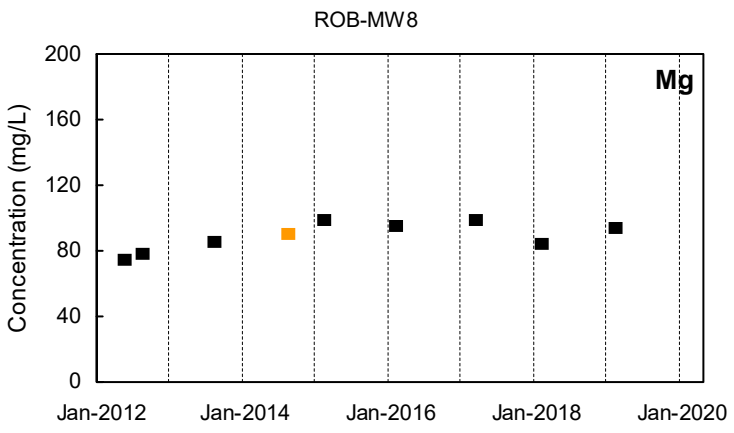
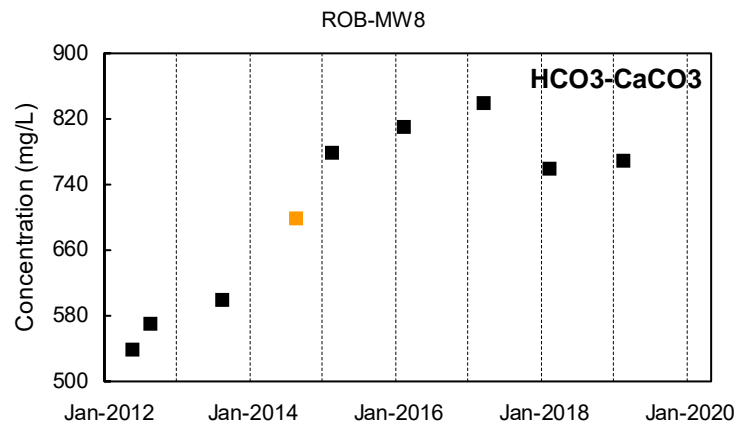
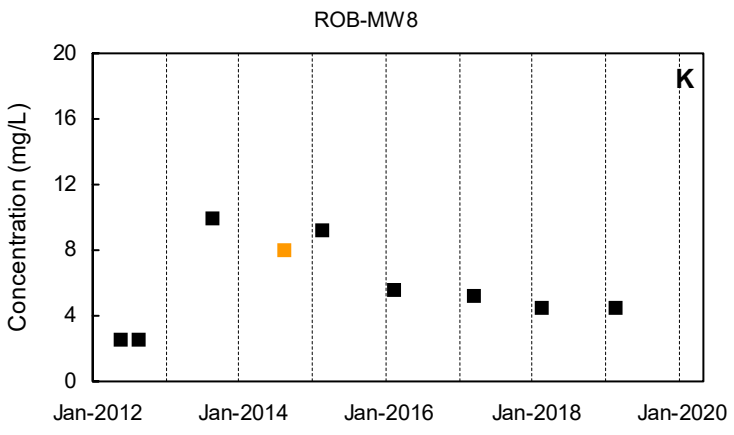
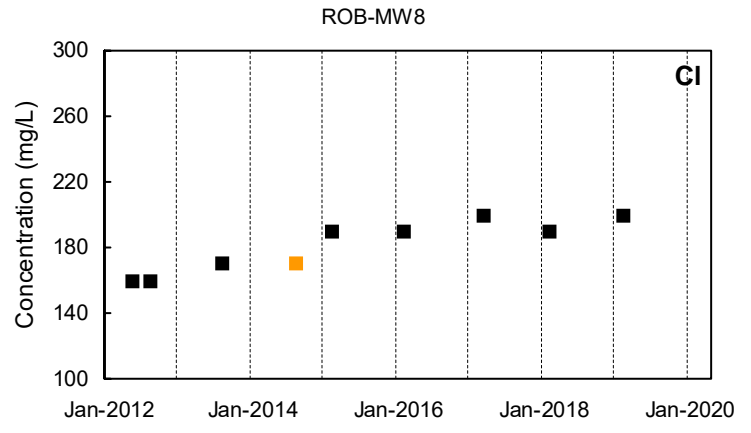
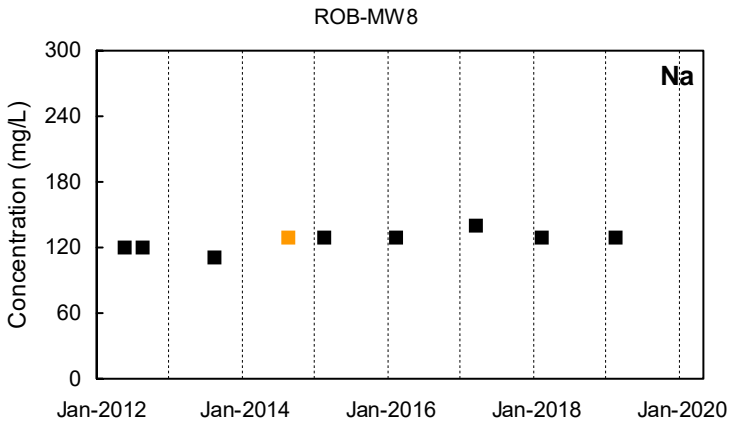

■ Detected Value □ 'J'-Flag (value between reporting limit and detection limit) ■ Non-Detect Range
 Shallow Well shown with black symbols Deep Well shown with orange symbols "dd" Well shown with blue symbols

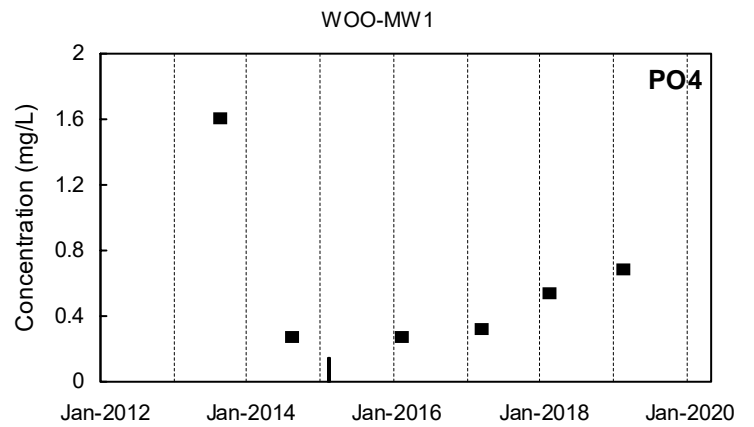
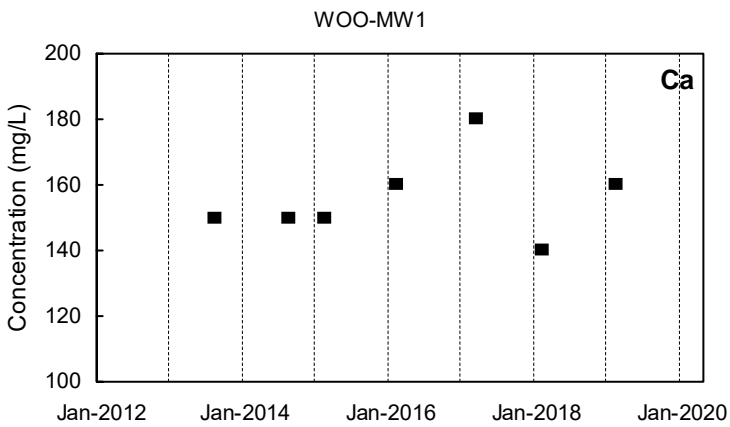
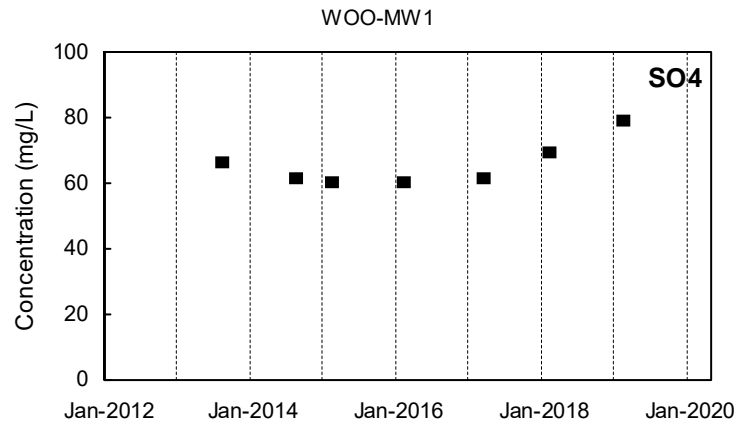
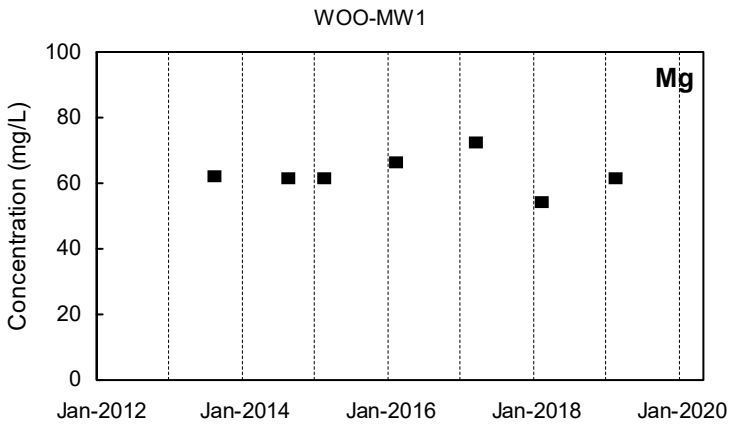
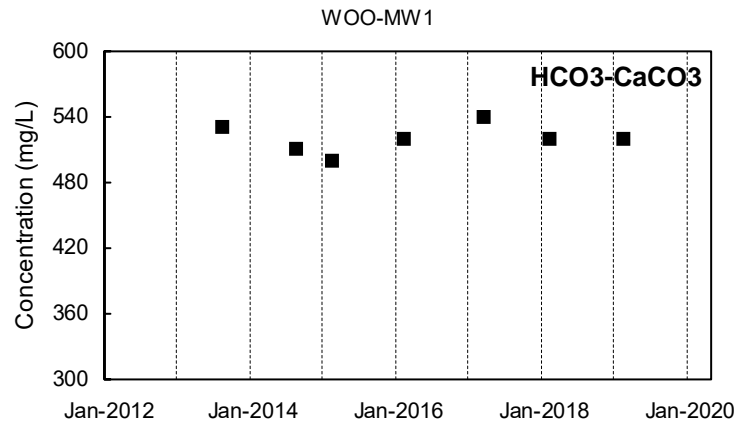
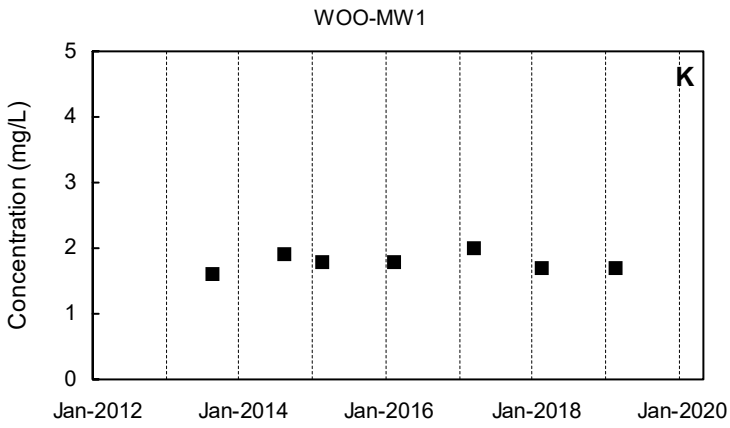
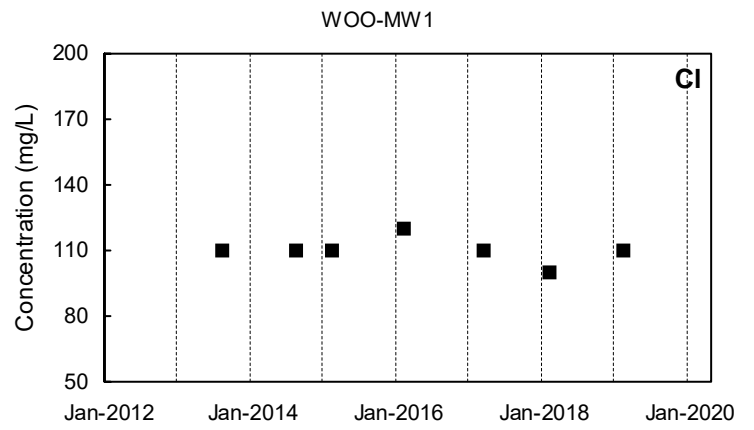
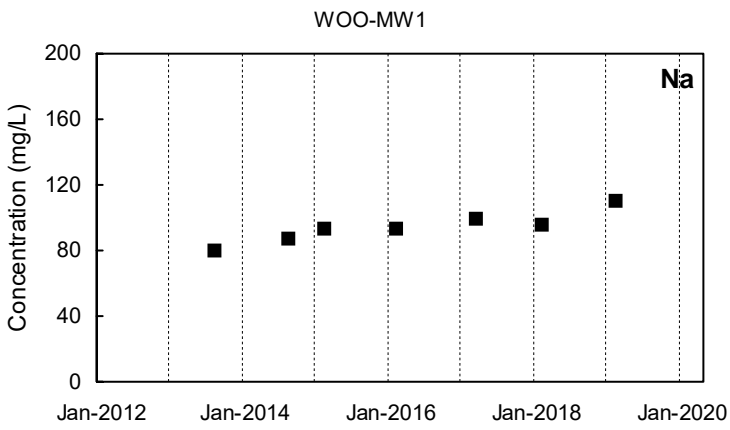

Detected Value
 'J'-Flag (value between reporting limit and detection limit)
 Non-Detect Range
 Shallow Well shown with black symbols
 Deep Well shown with orange symbols
 "dd" Well shown with blue symbols

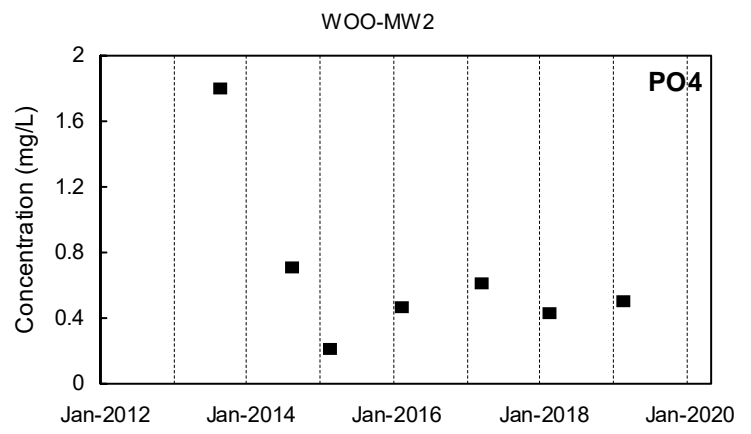
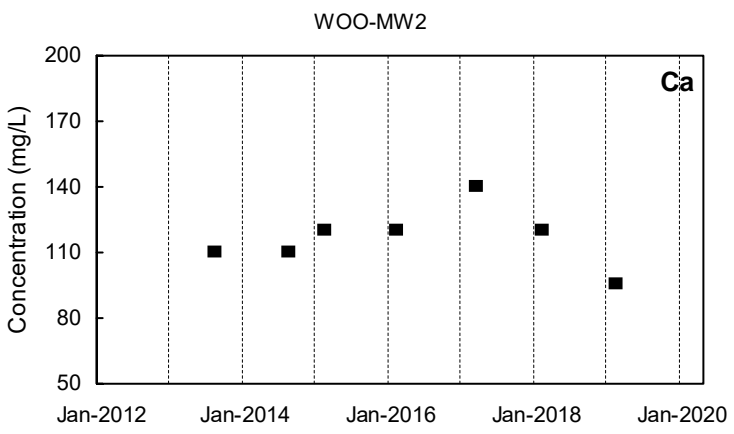
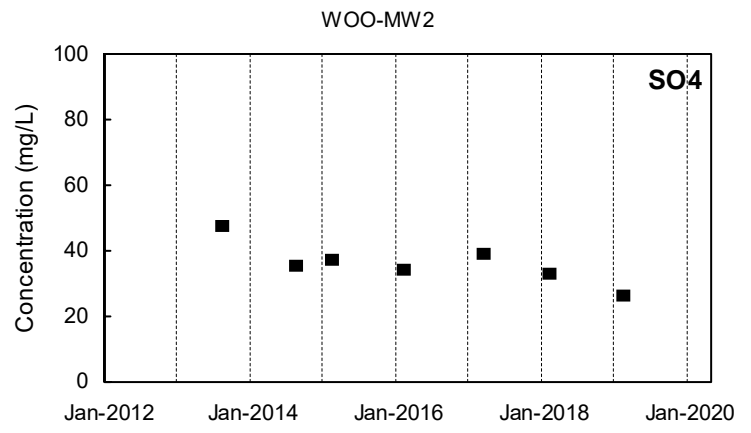
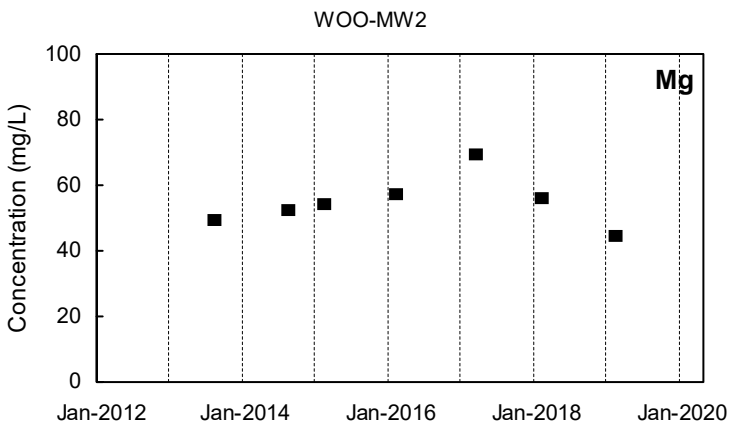
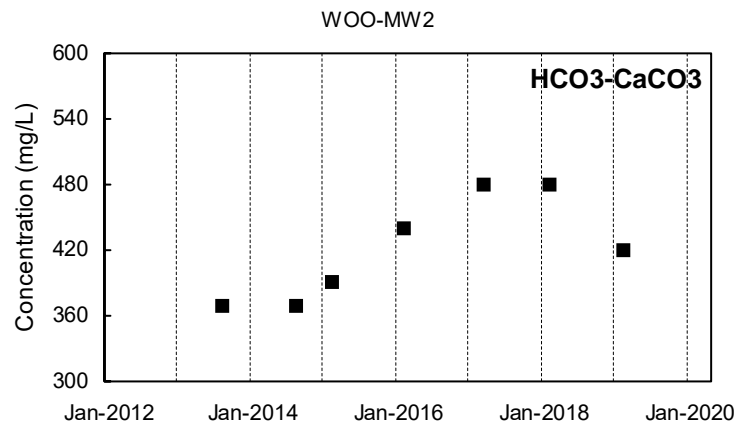
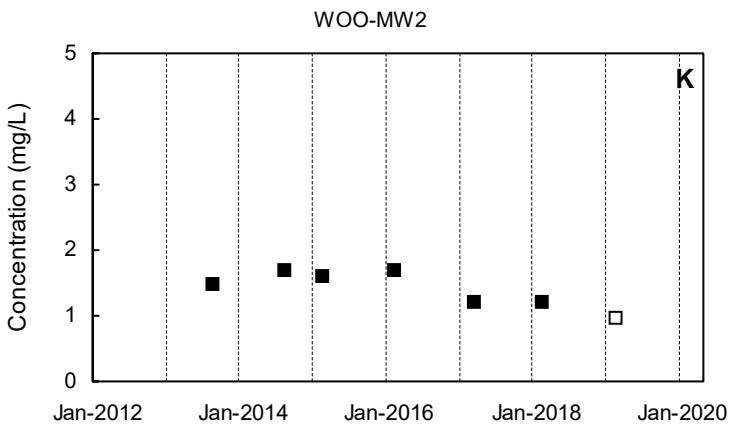
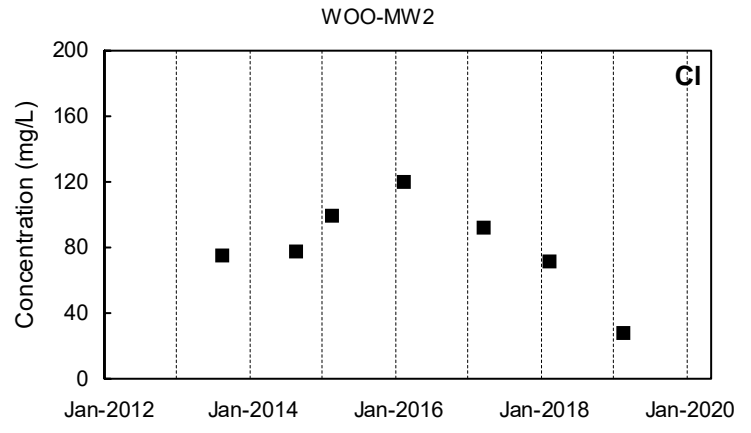
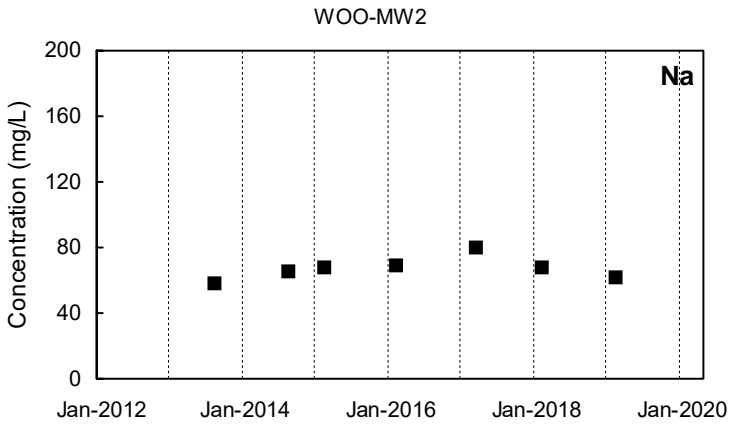

Detected Value
 'J'-Flag (value between reporting limit and detection limit)
 Non-Detect Range

Shallow Well shown with black symbols
 Deep Well shown with orange symbols
 "dd" Well shown with blue symbols

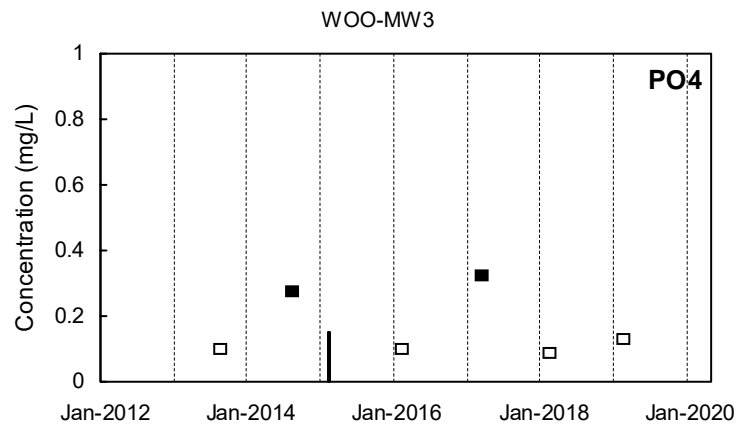
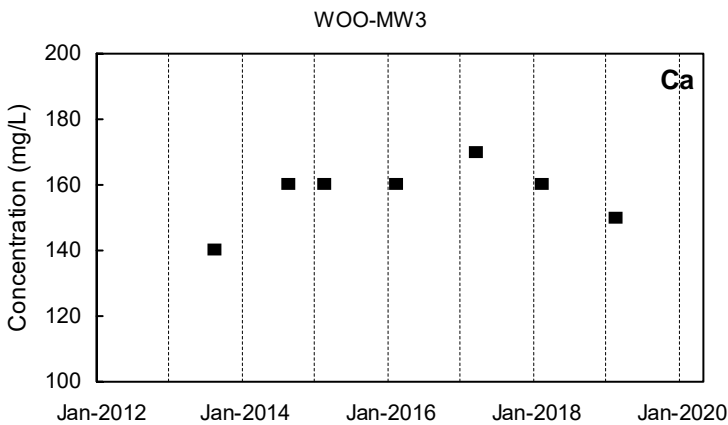
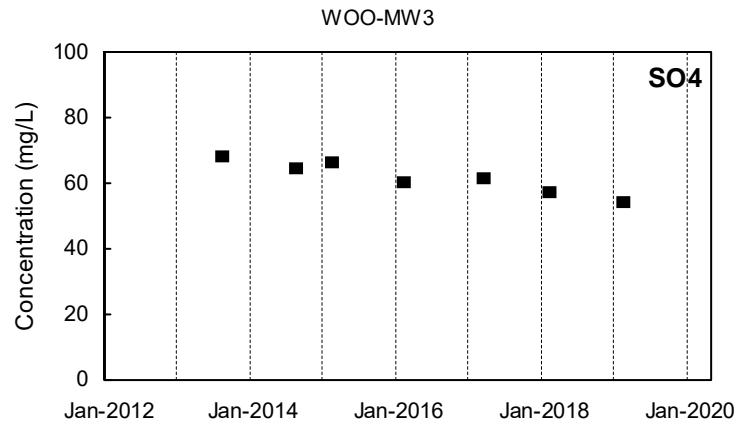
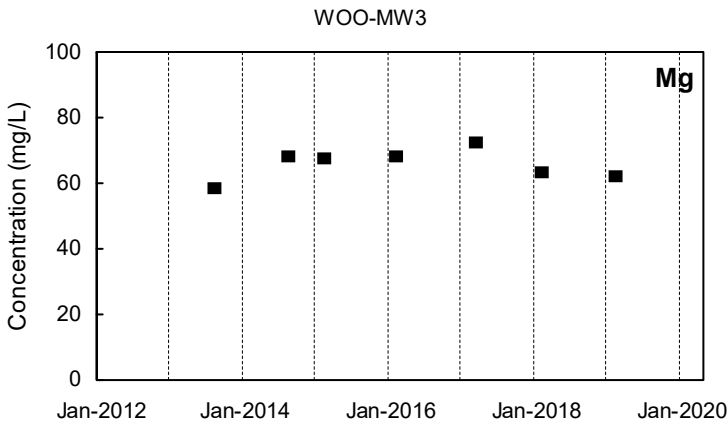
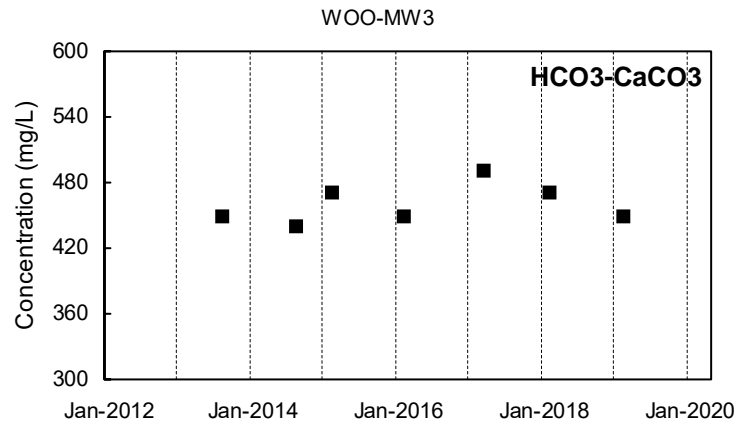
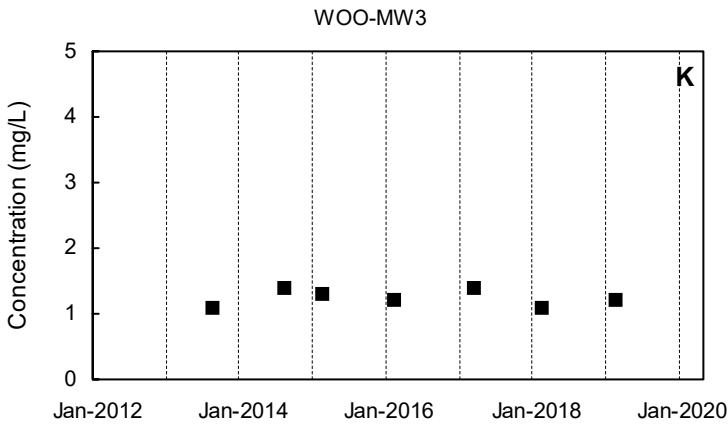
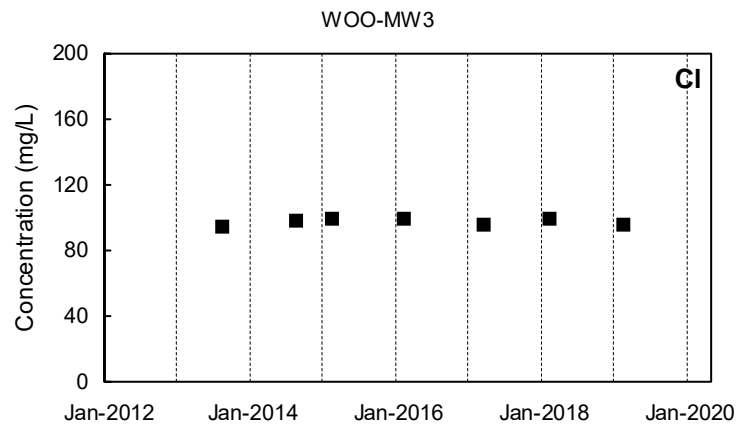
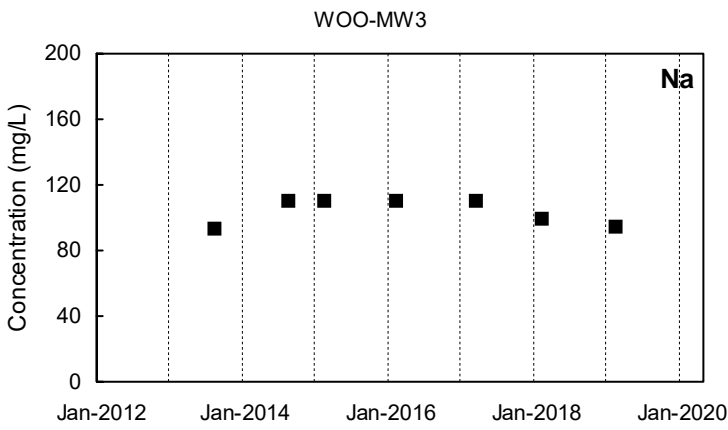

■ Detected Value □ 'J'-Flag (value between reporting limit and detection limit) ■ Non-Detect Range
 Shallow Well shown with black symbols Deep Well shown with orange symbols "dd" Well shown with blue symbols

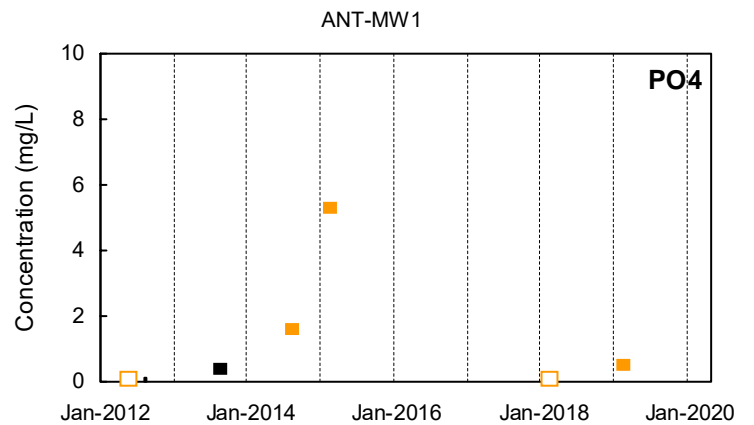
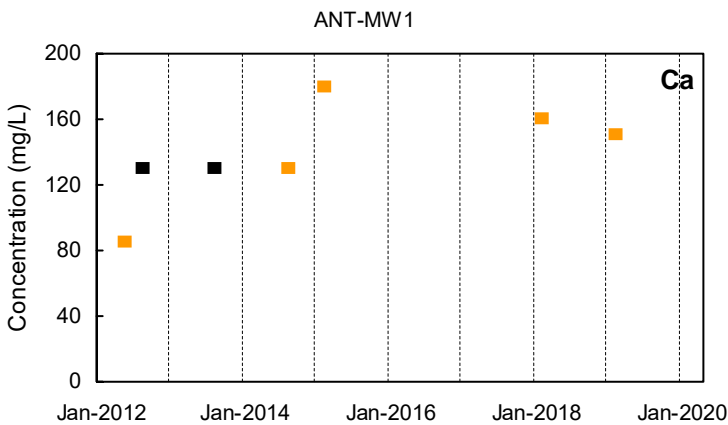
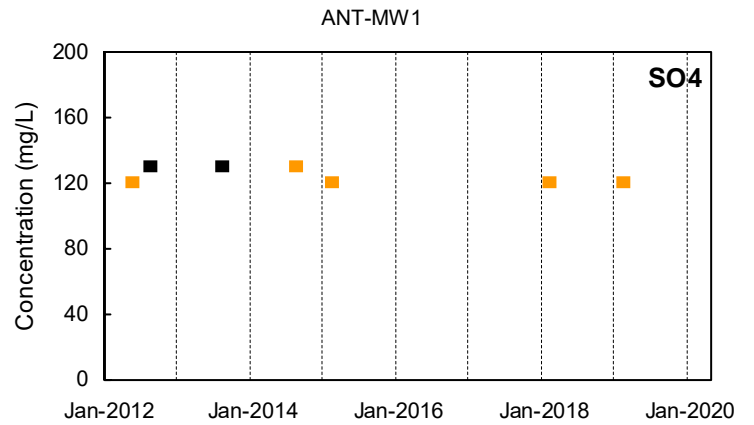
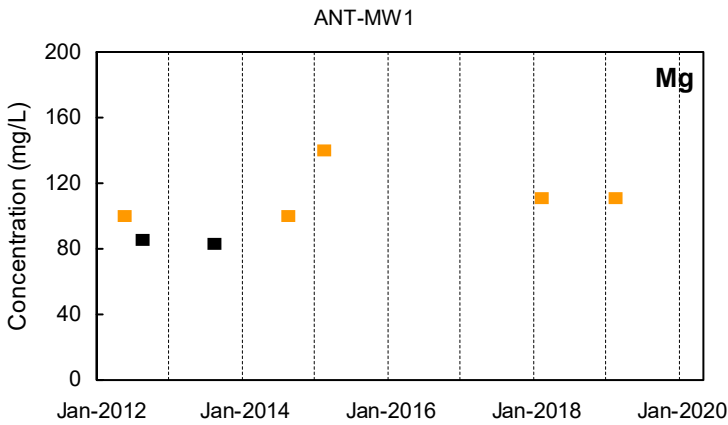
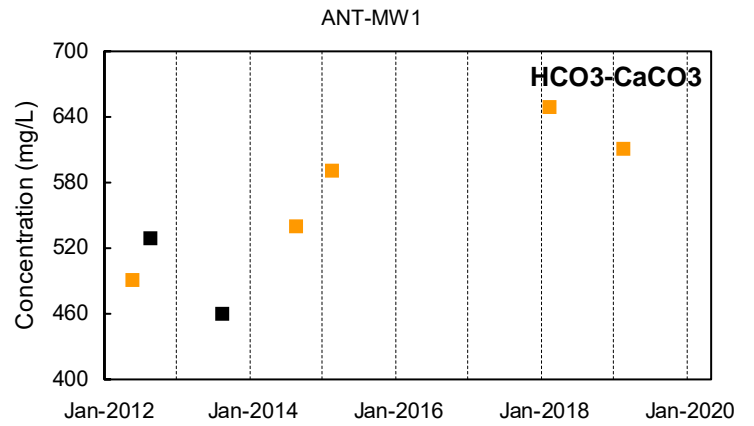
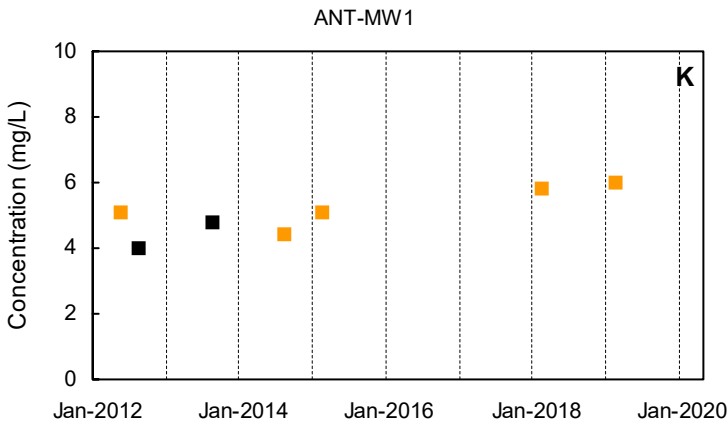
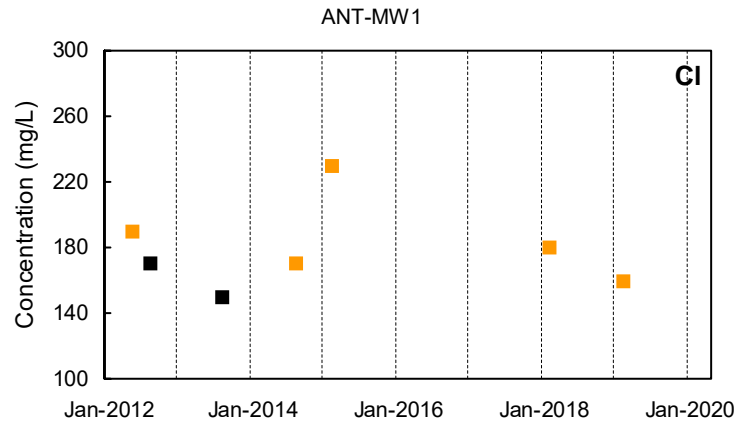
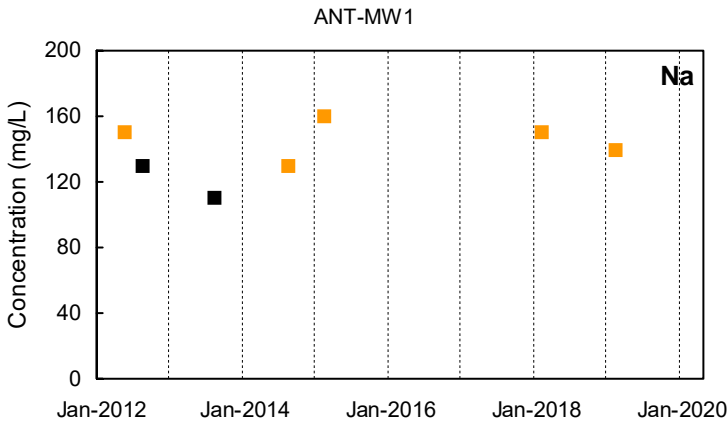

Detected Value
 'J'-Flag (value between reporting limit and detection limit)
 Non-Detect Range
 Shallow Well shown with black symbols Deep Well shown with orange symbols "dd" Well shown with blue symbols

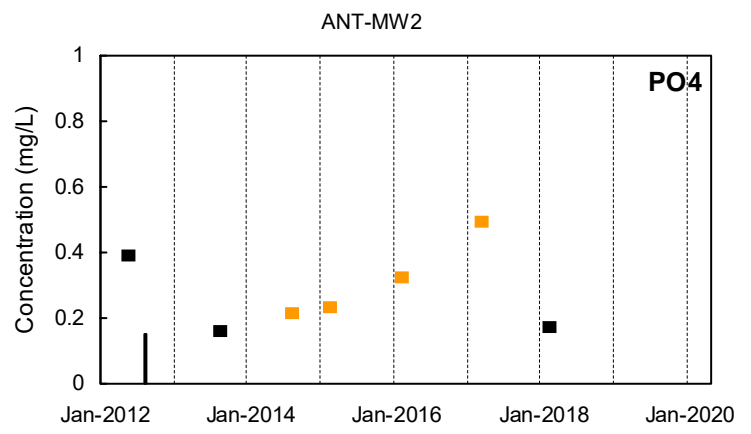
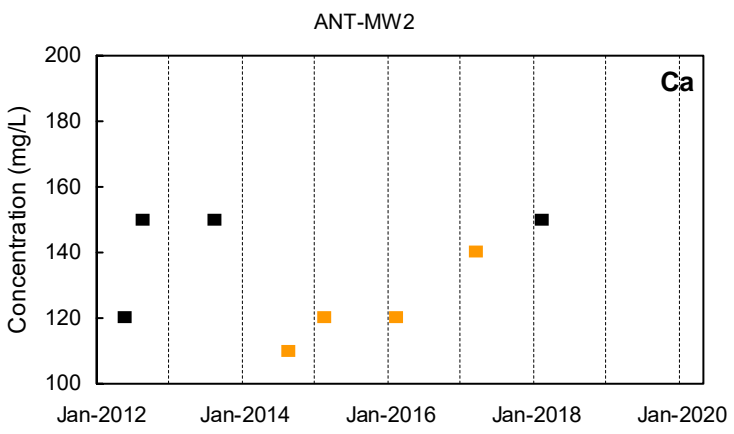
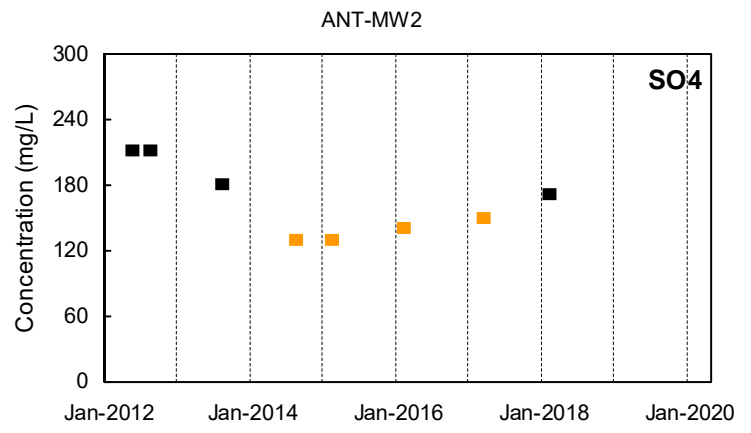
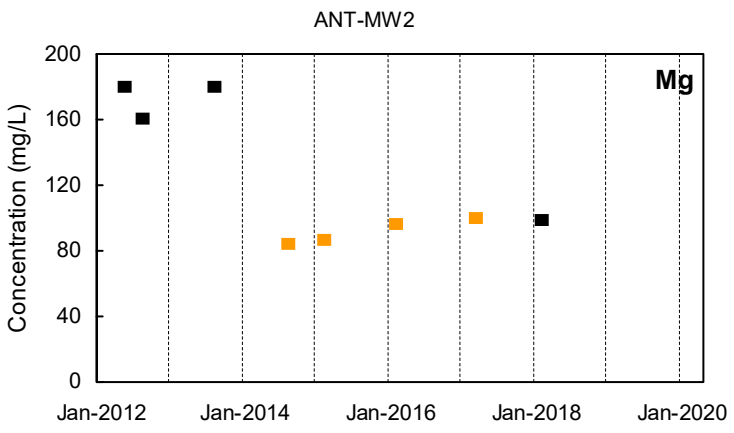
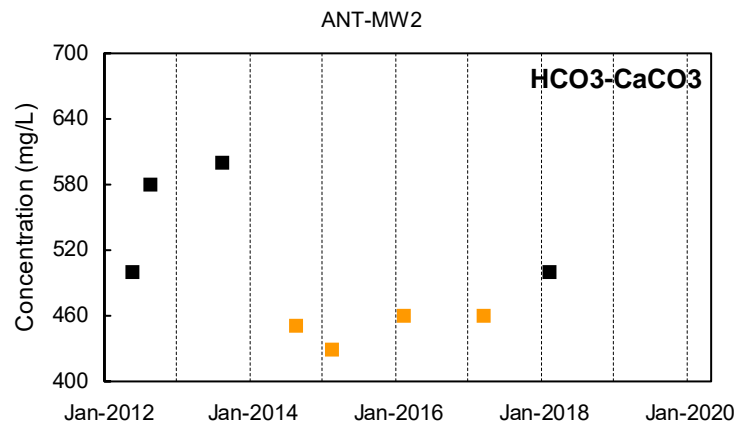
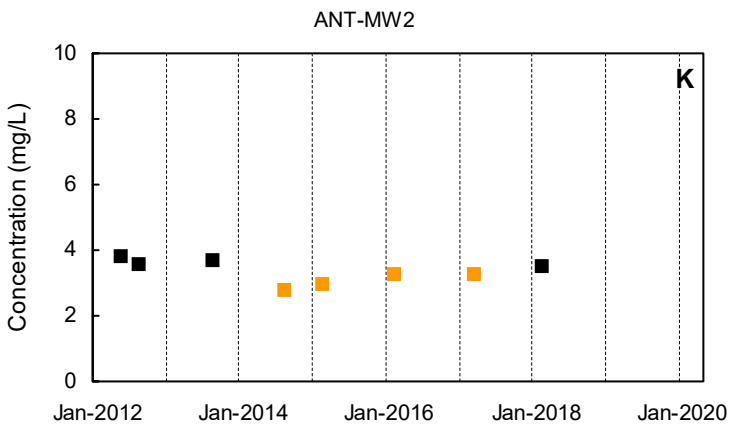
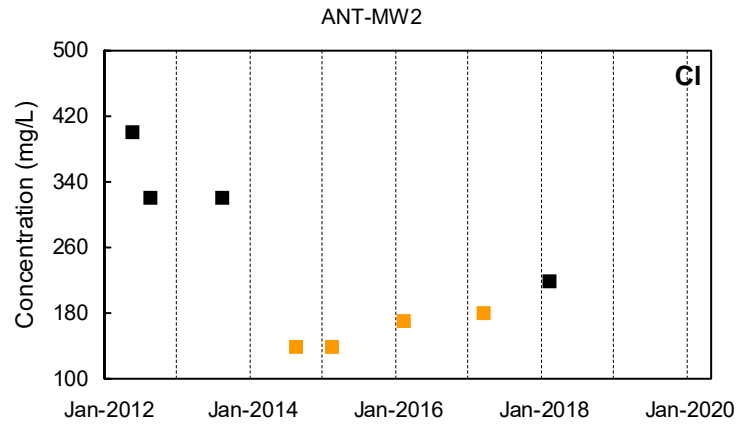
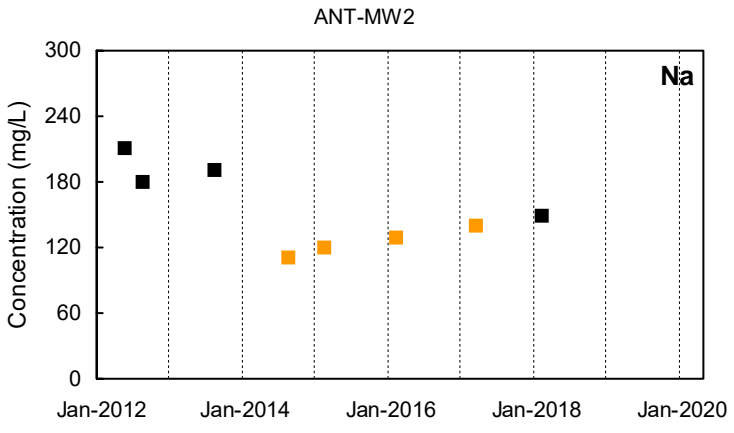

Detected Value
 'J'-Flag (value between reporting limit and detection limit)
 Non-Detect Range
 Shallow Well shown with black symbols Deep Well shown with orange symbols "dd" Well shown with blue symbols

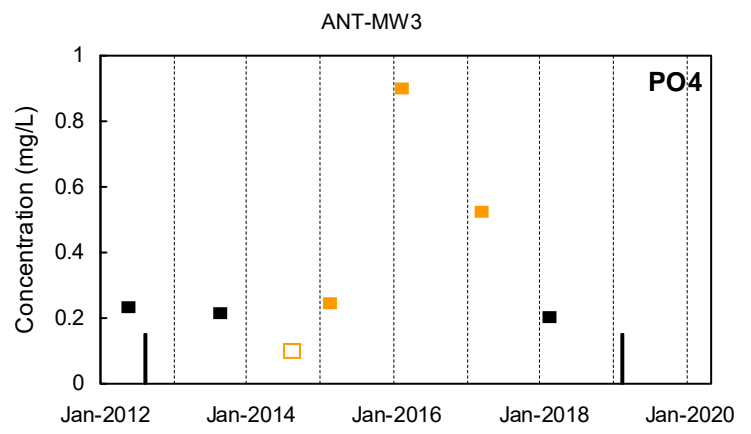
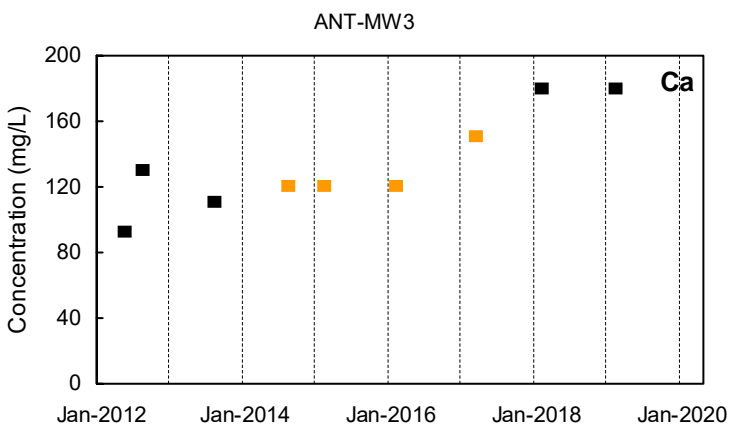
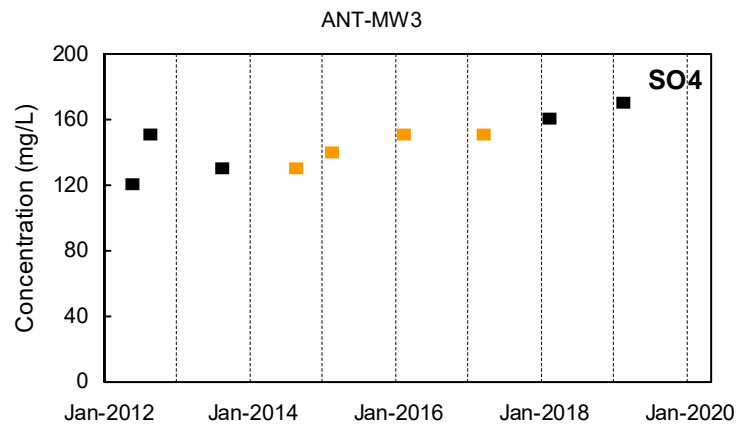
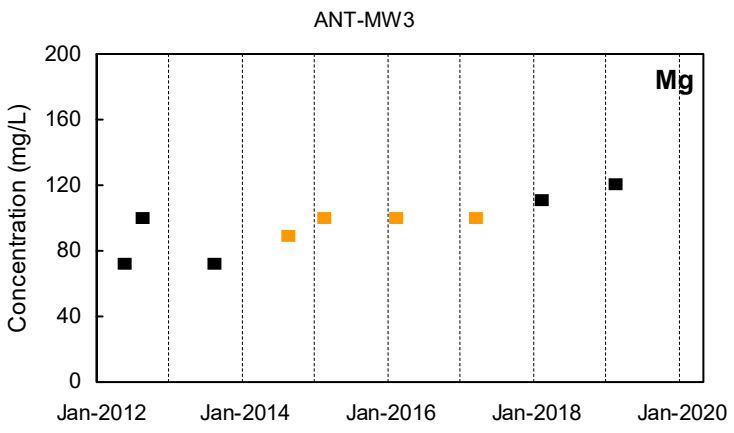
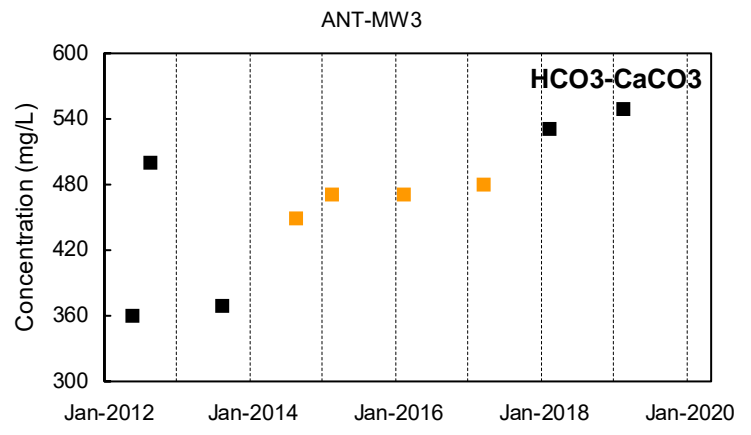
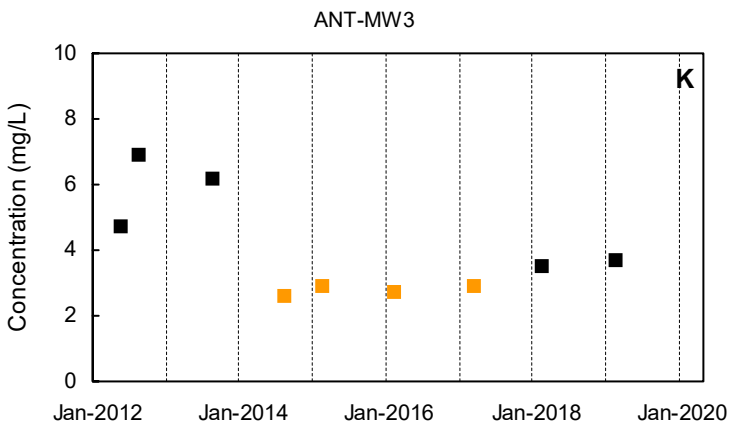
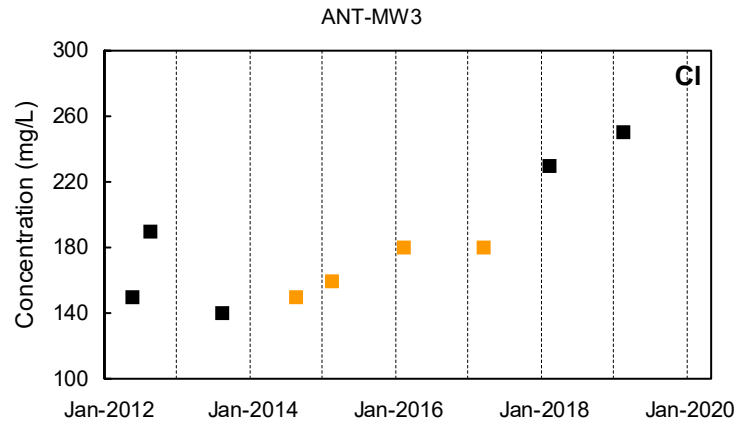
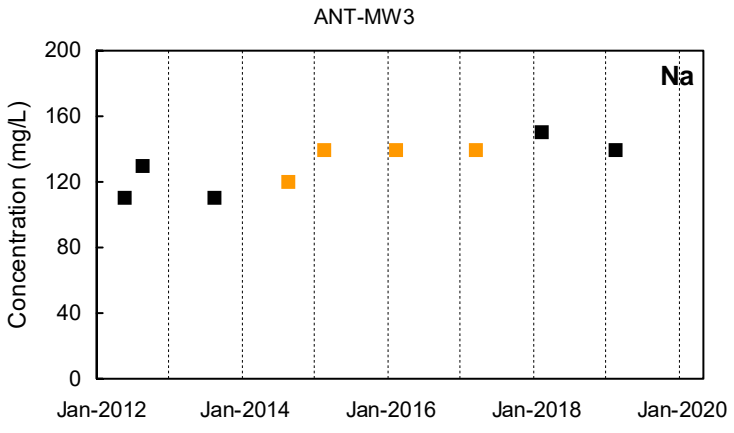

Detected Value
 'J'-Flag (value between reporting limit and detection limit)
 Non-Detect Range

Shallow Well shown with black symbols
 Deep Well shown with orange symbols
 "dd" Well shown with blue symbols

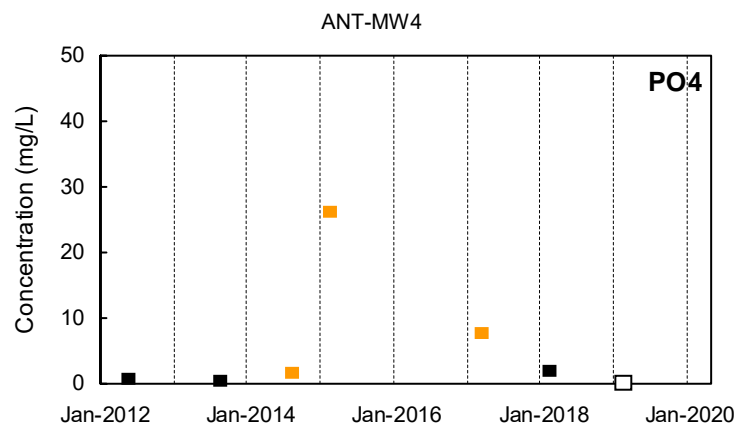
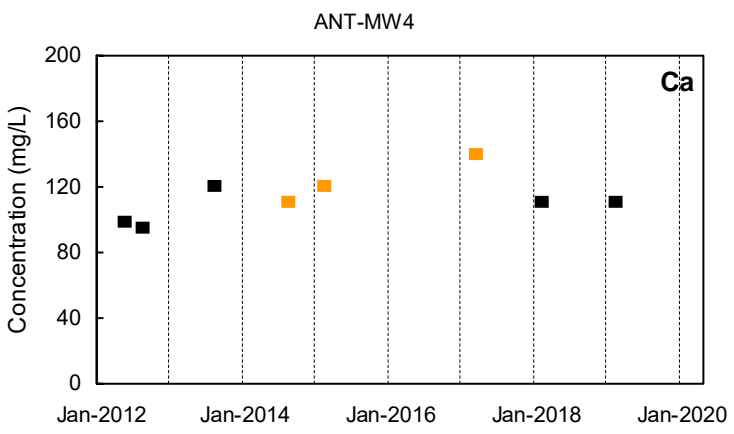
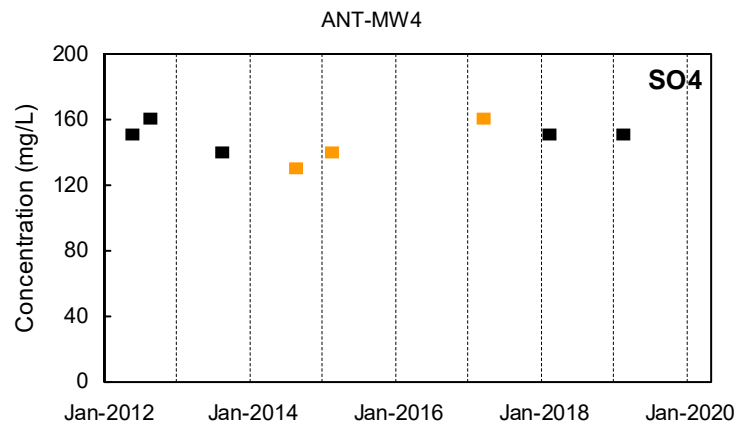
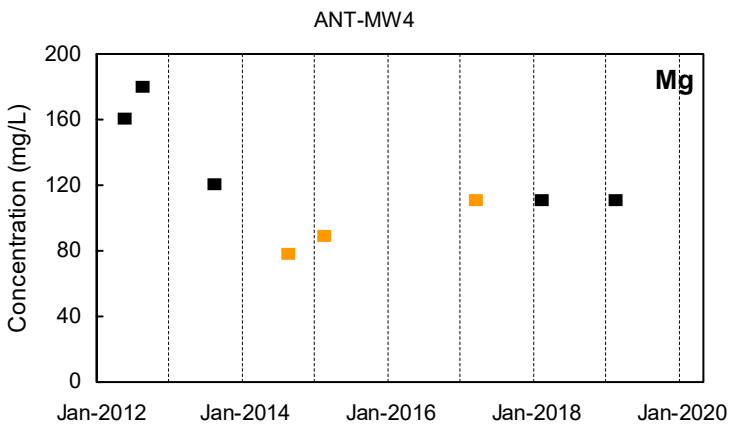
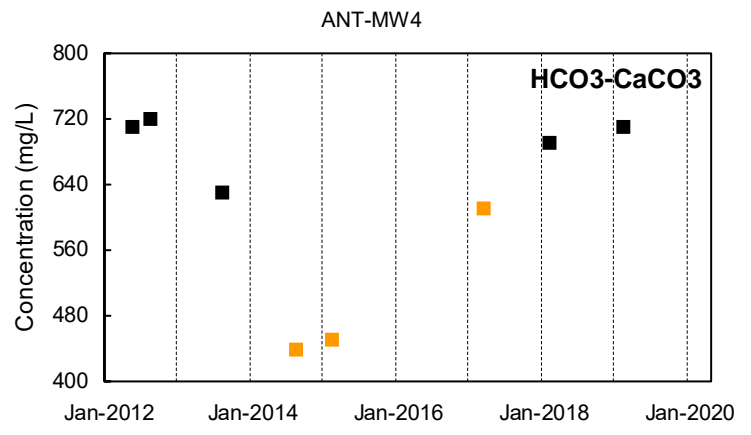
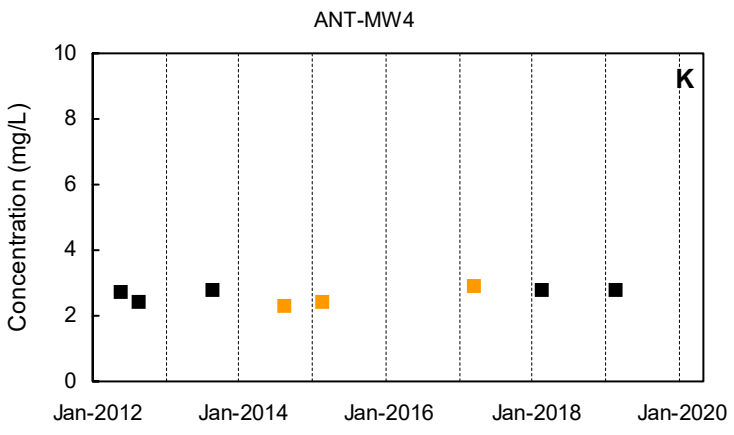
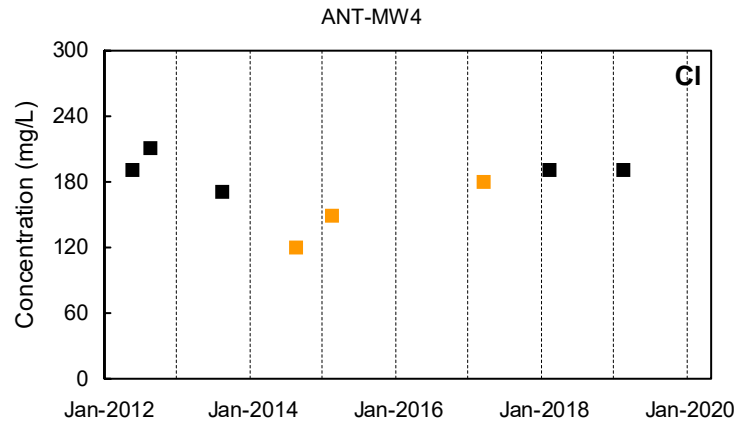
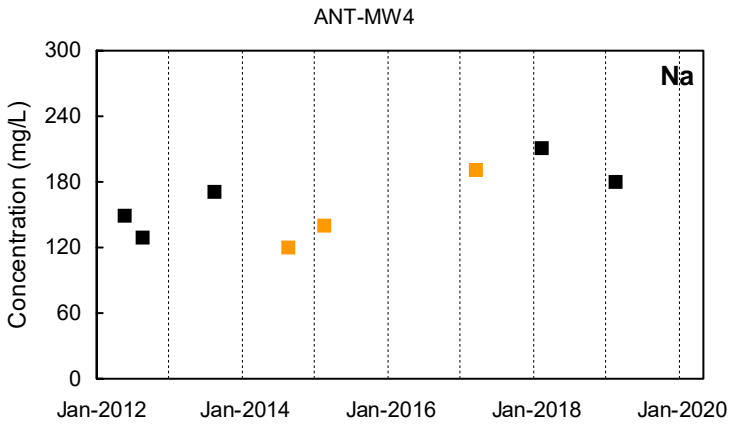

Detected Value
 'J'-Flag (value between reporting limit and detection limit)
 Non-Detect Range
 Shallow Well shown with black symbols Deep Well shown with orange symbols "dd" Well shown with blue symbols

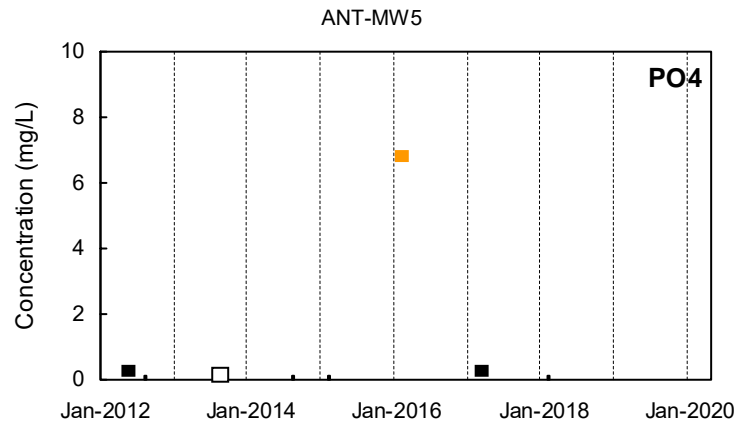
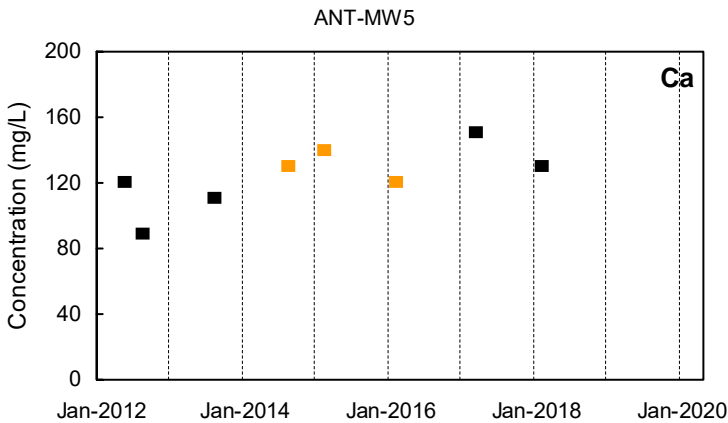
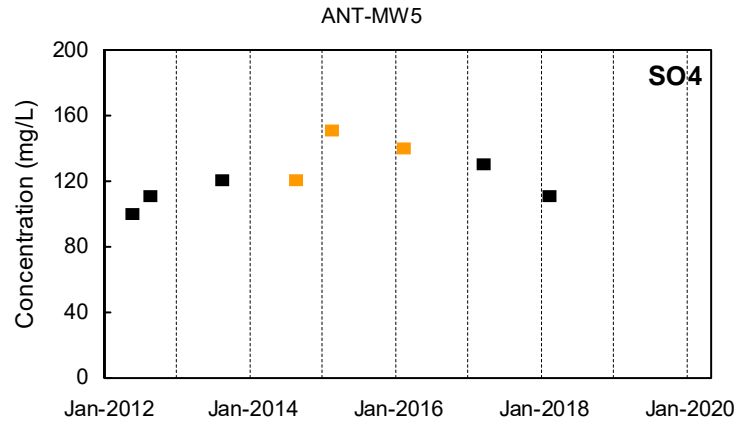
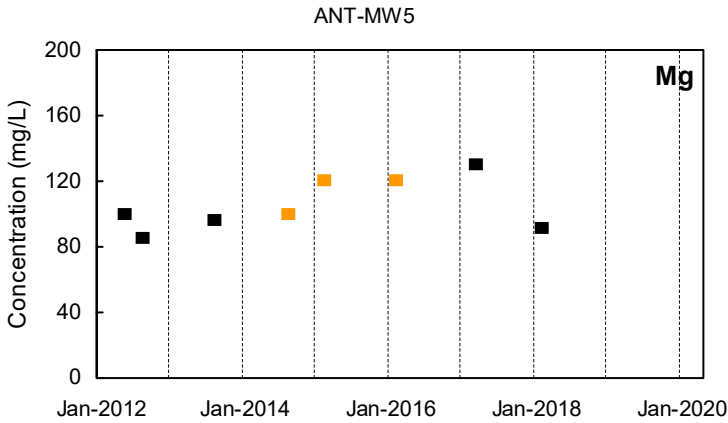
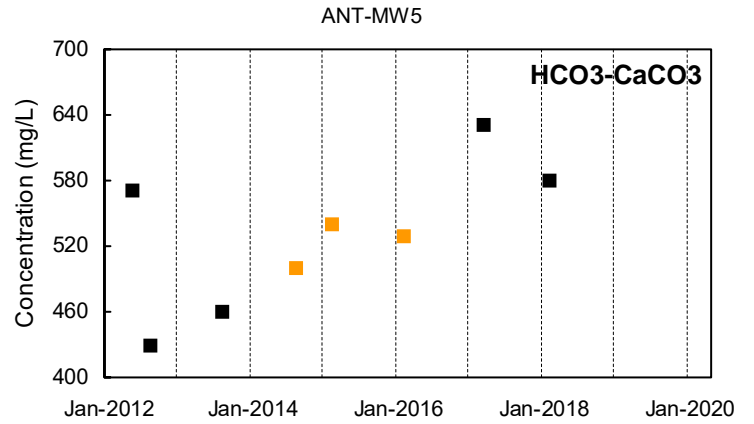
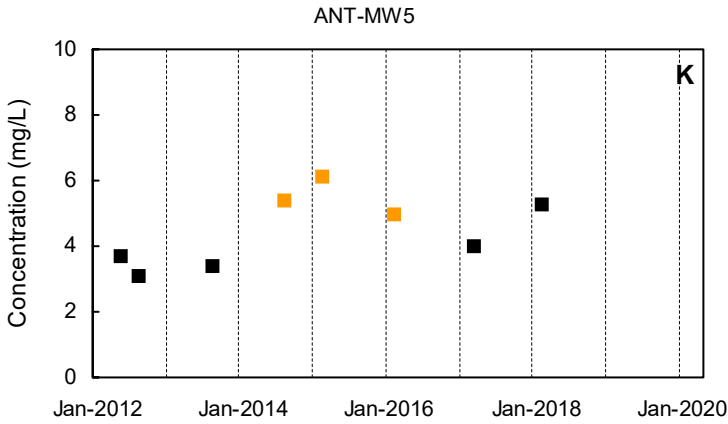
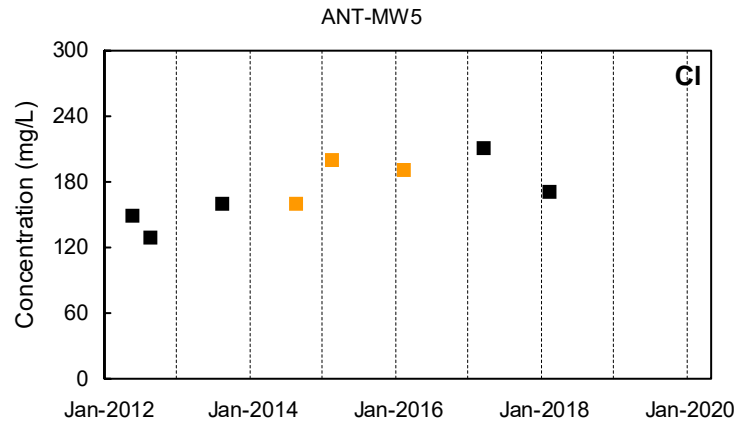
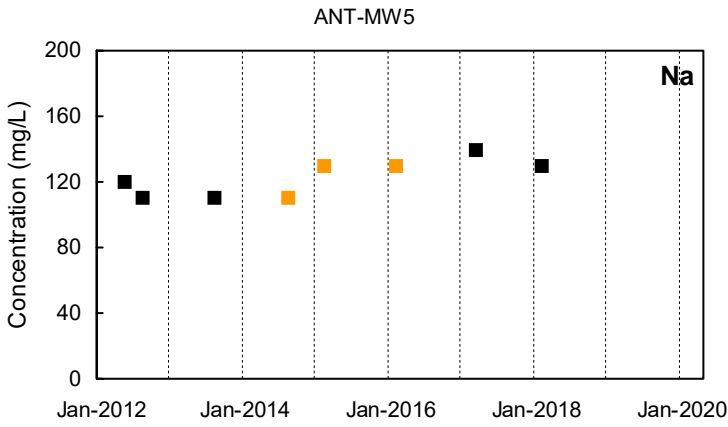

■ Detected Value □ 'J'-Flag (value between reporting limit and detection limit) ■ Non-Detect Range
 Shallow Well shown with black symbols Deep Well shown with orange symbols "dd" Well shown with blue symbols

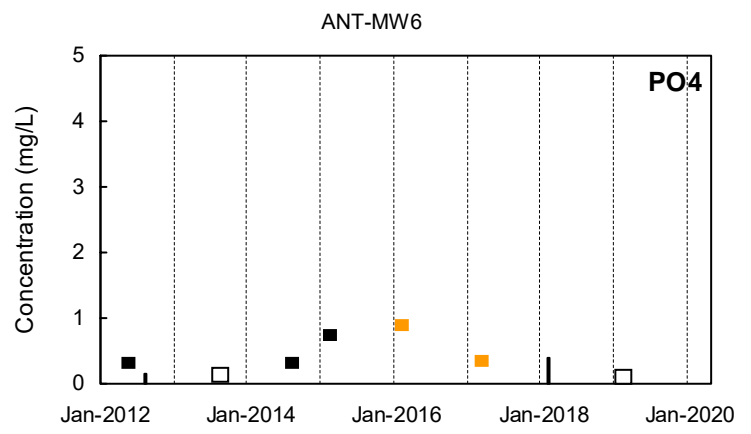
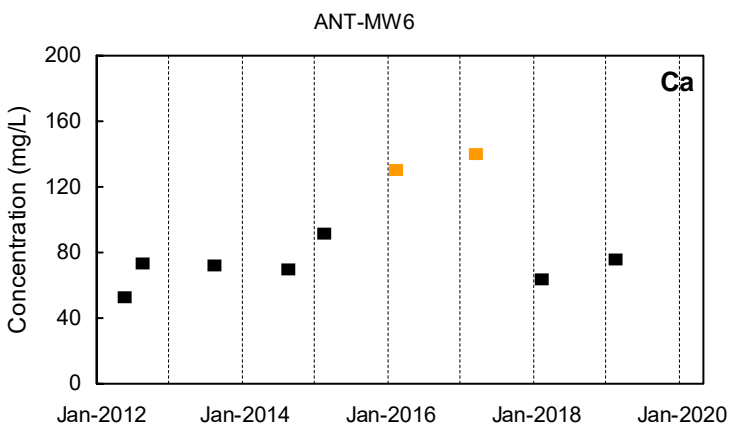
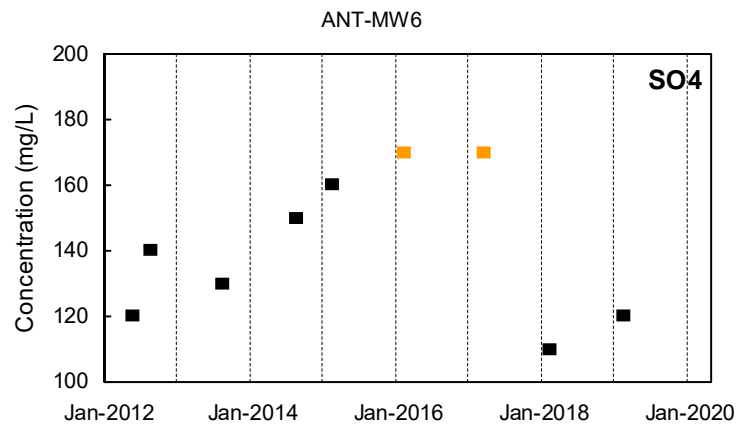
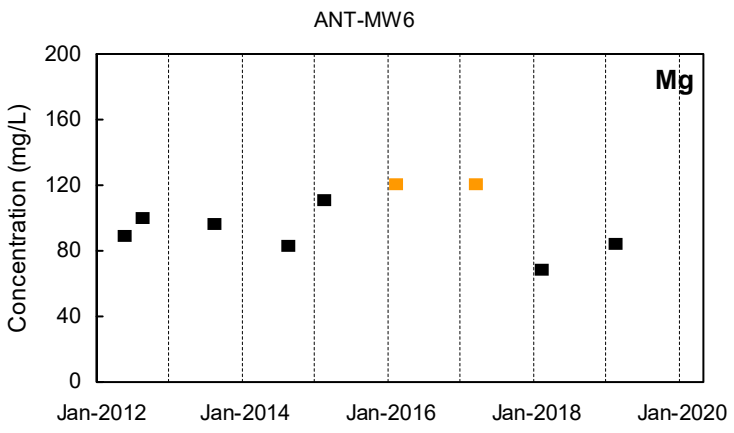
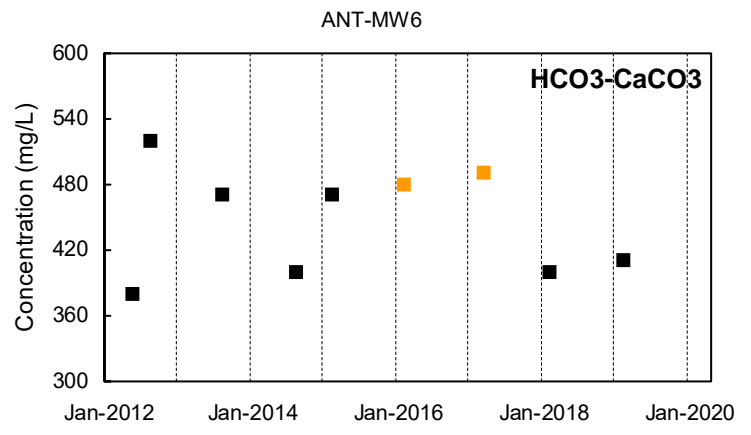
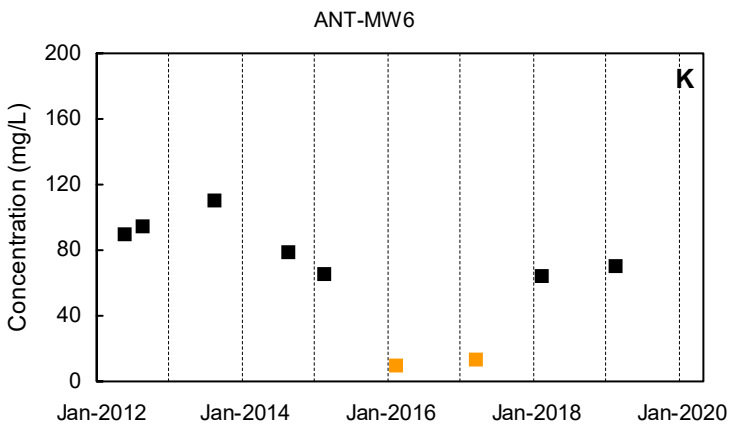
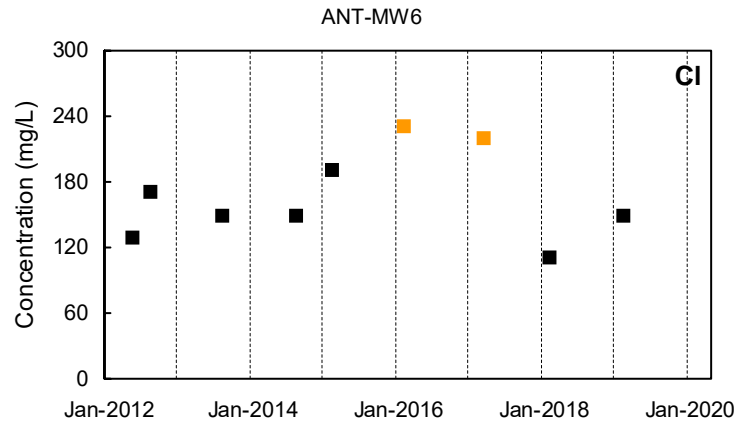
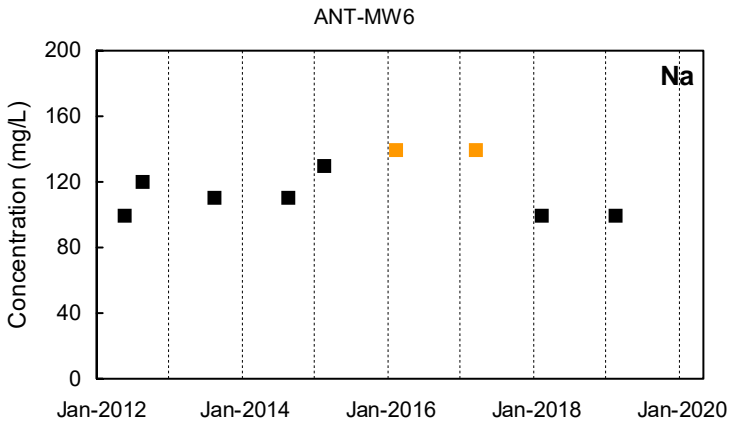

Detected Value
 'J'-Flag (value between reporting limit and detection limit)
 Non-Detect Range
 Shallow Well shown with black symbols Deep Well shown with orange symbols "dd" Well shown with blue symbols

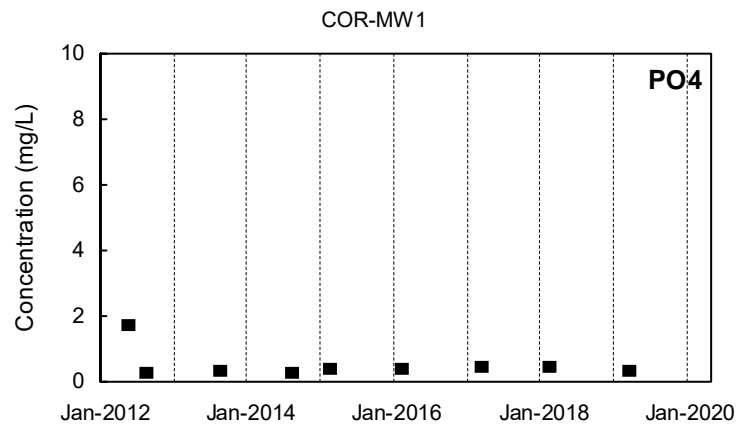
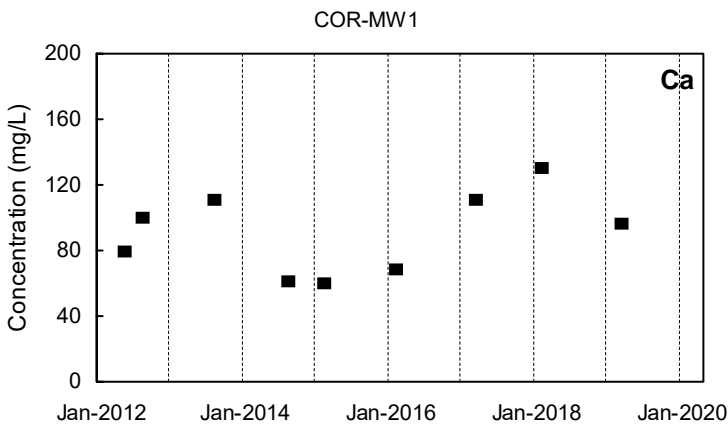
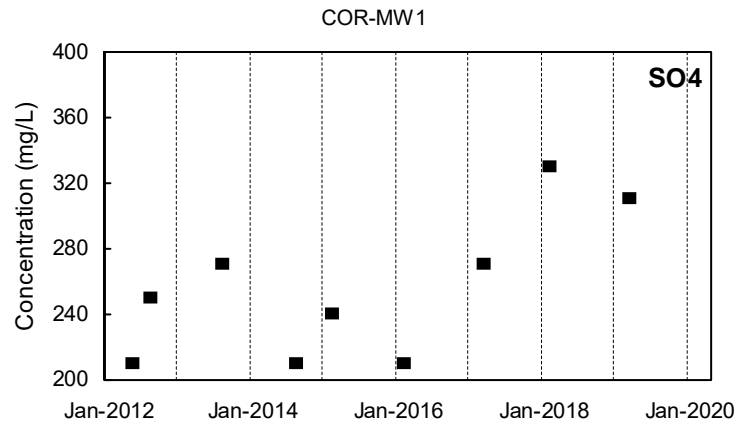
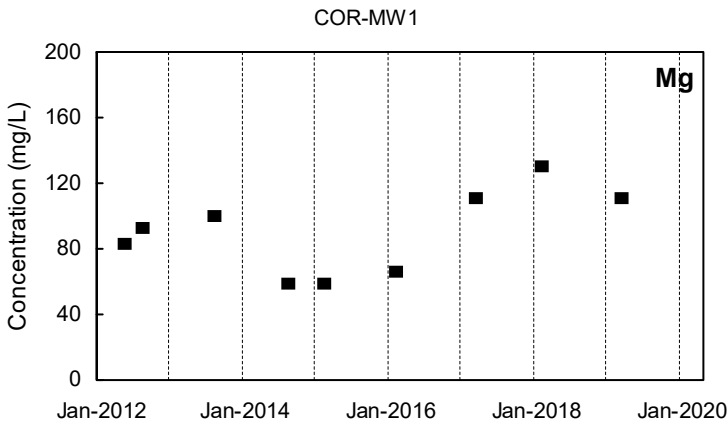
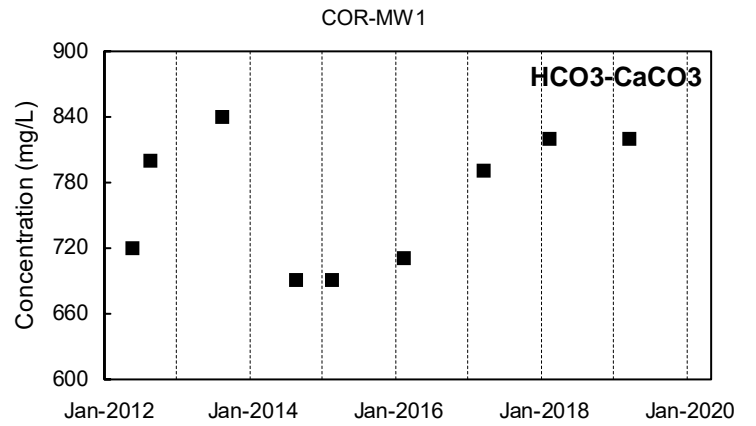
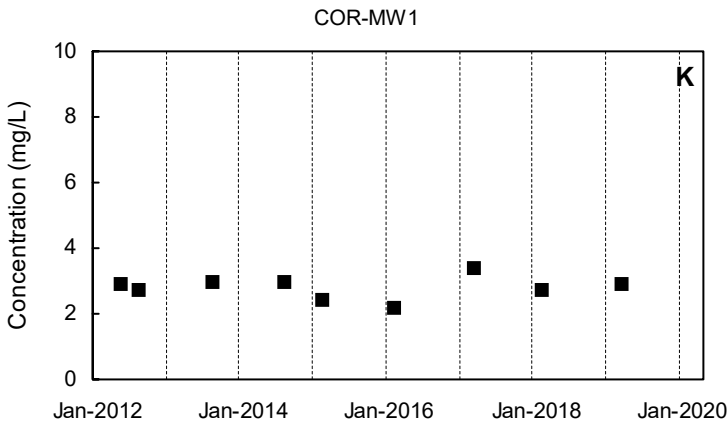
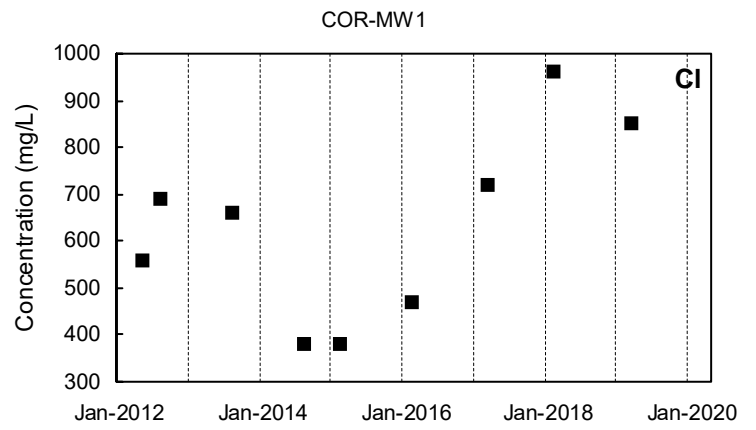
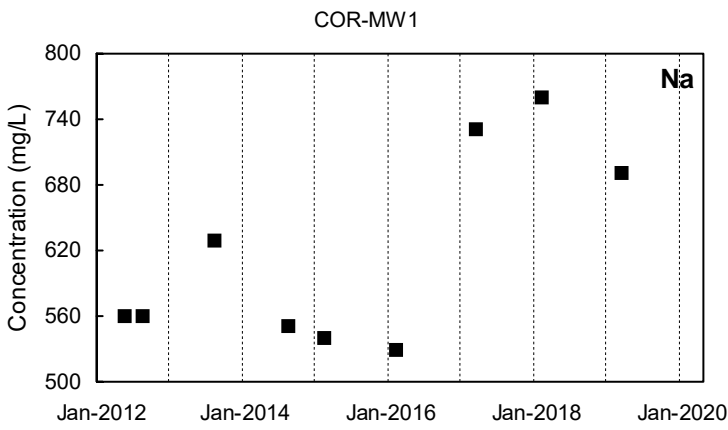

Detected Value
 'J'-Flag (value between reporting limit and detection limit)
 Non-Detect Range
 Shallow Well shown with black symbols
 Deep Well shown with orange symbols
 "dd" Well shown with blue symbols

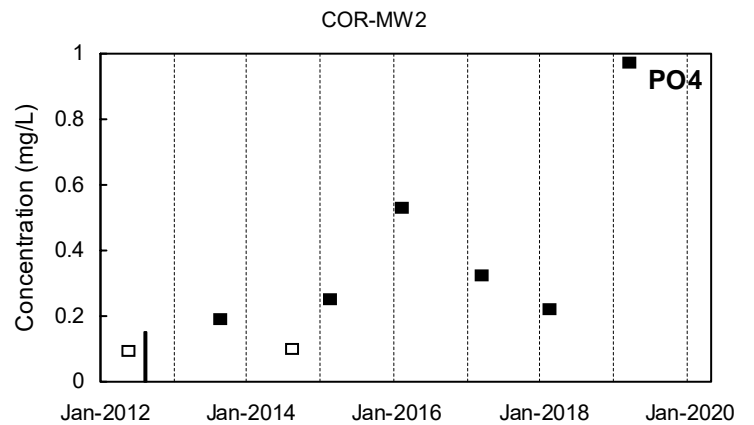
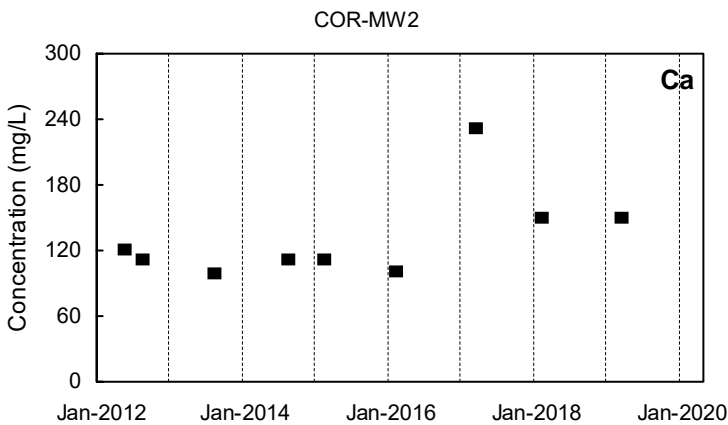
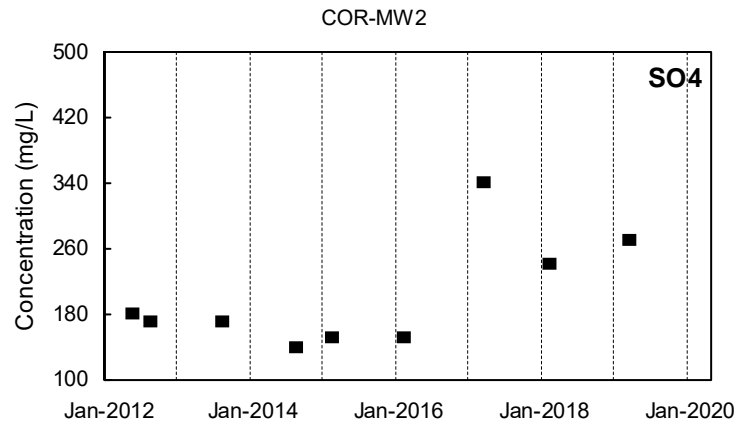
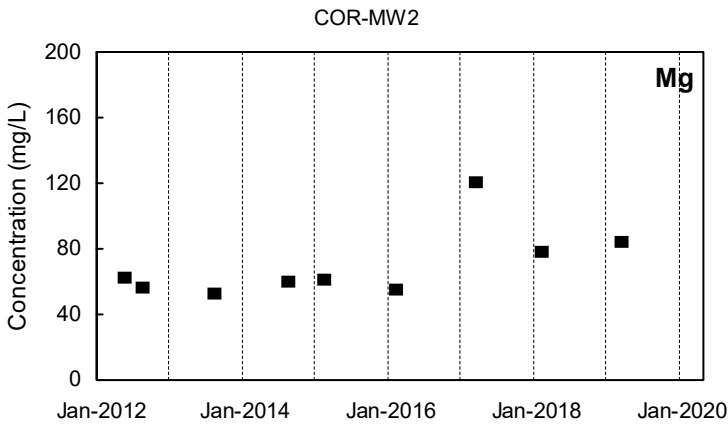
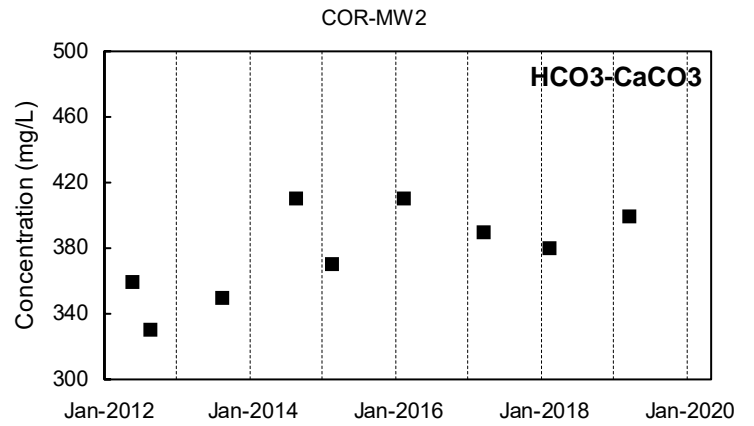
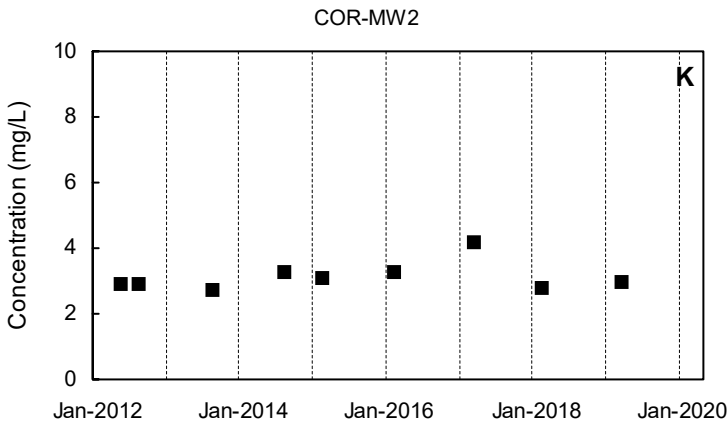
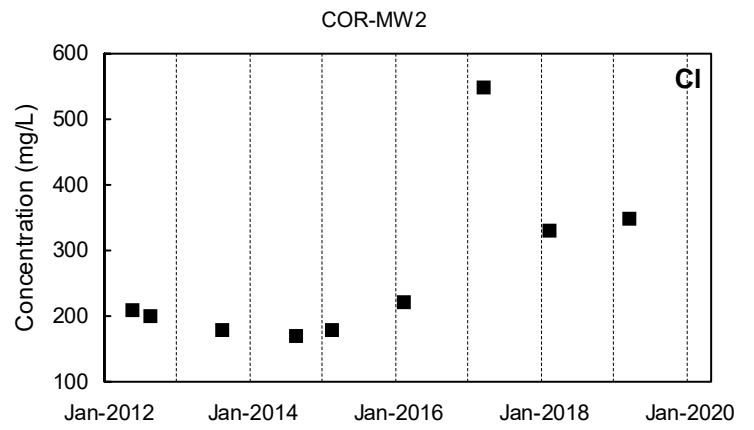
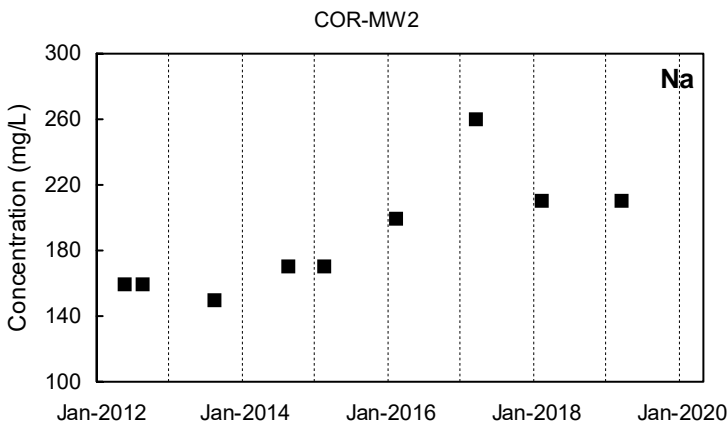

Detected Value
 'J'-Flag (value between reporting limit and detection limit)
 Non-Detect Range
 Shallow Well shown with black symbols
 Deep Well shown with orange symbols
 "dd" Well shown with blue symbols

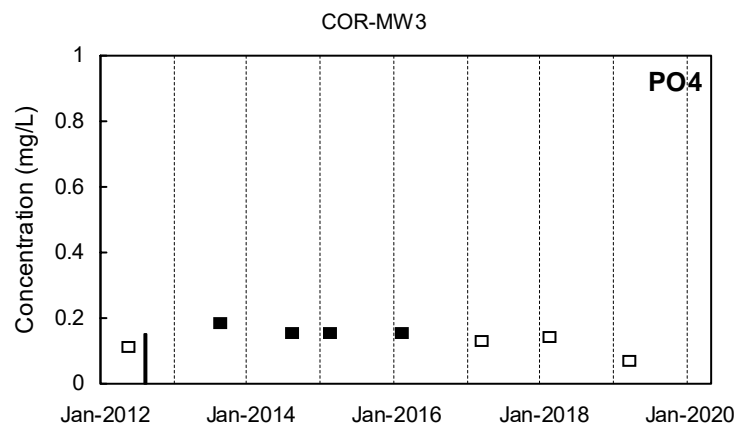
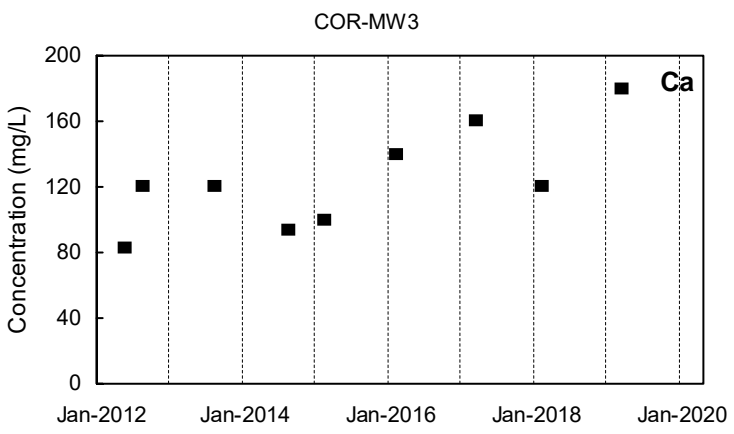
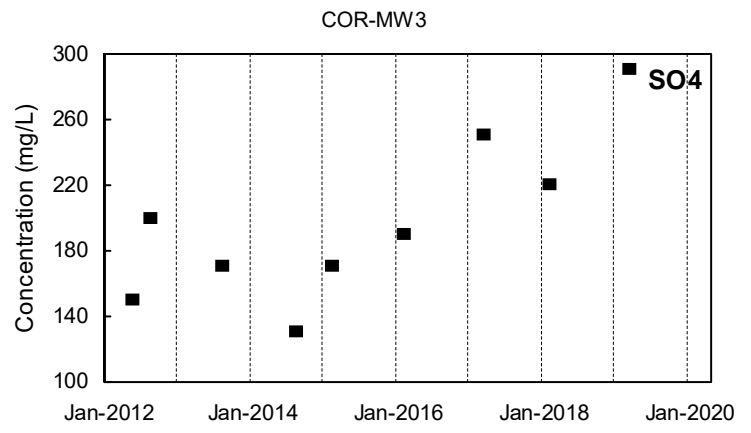
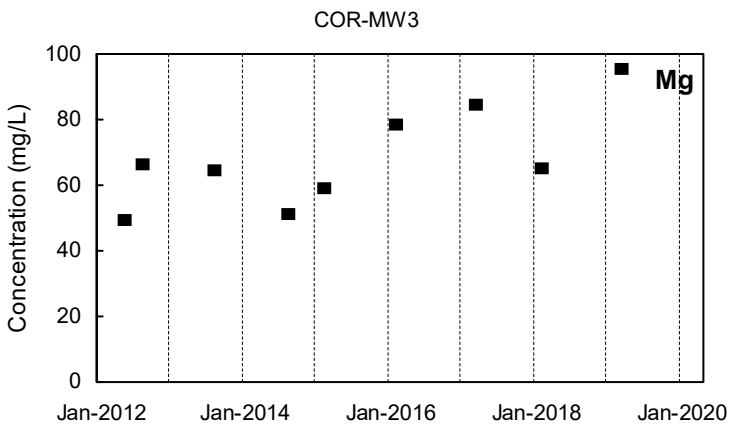
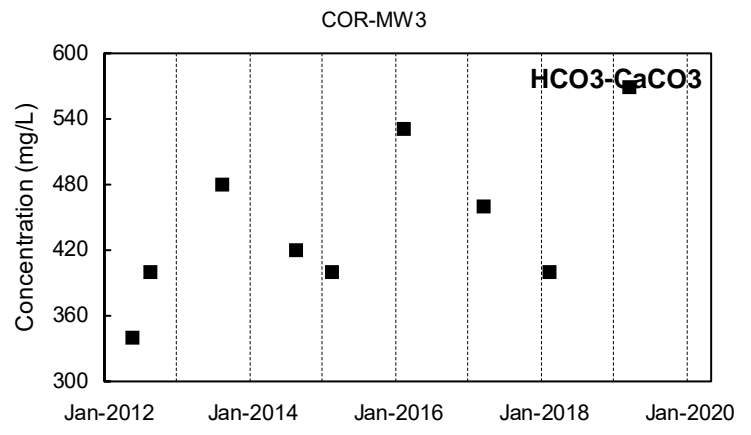
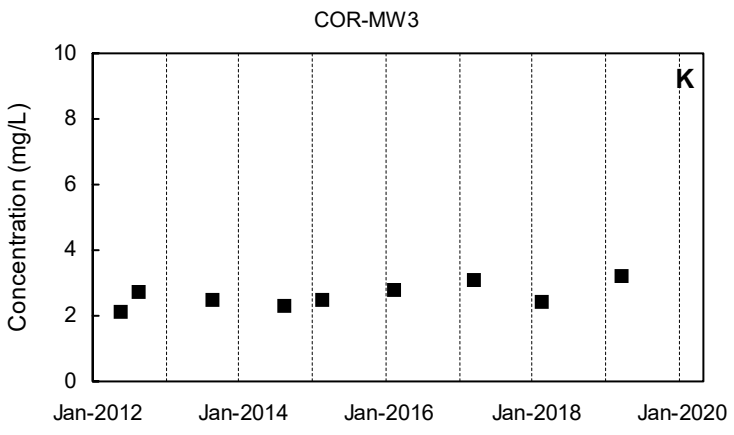
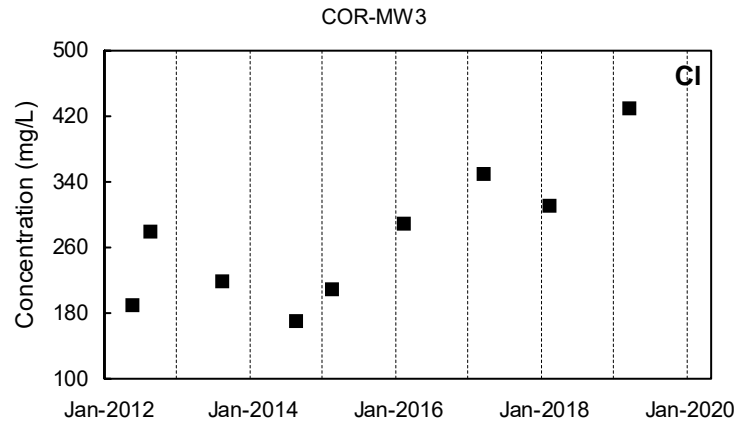
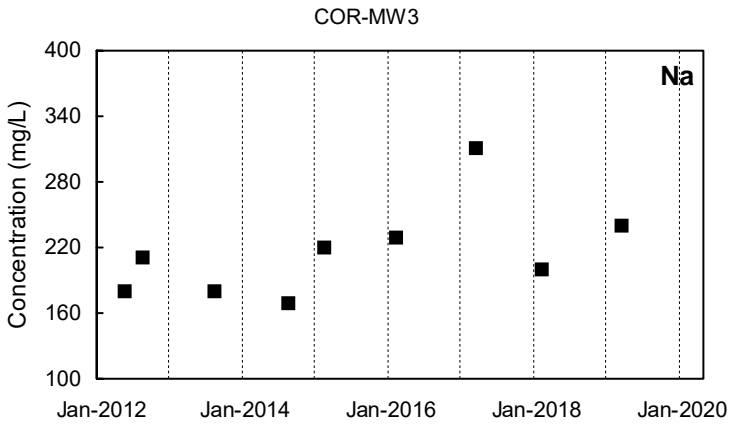

Detected Value
 'J'-Flag (value between reporting limit and detection limit)
 Non-Detect Range
 Shallow Well shown with black symbols
 Deep Well shown with orange symbols
 "dd" Well shown with blue symbols

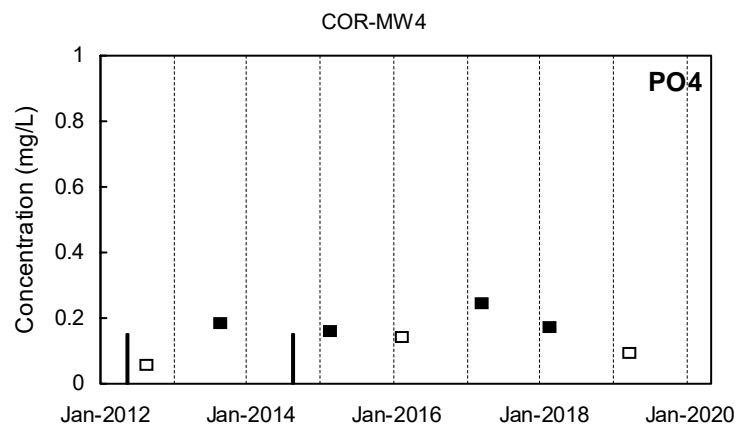
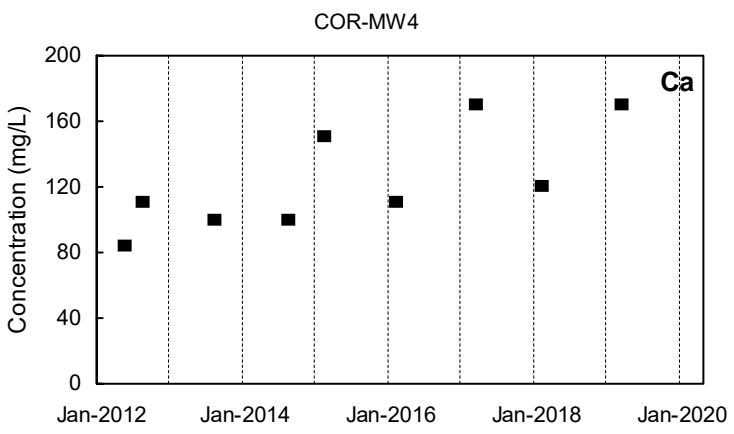
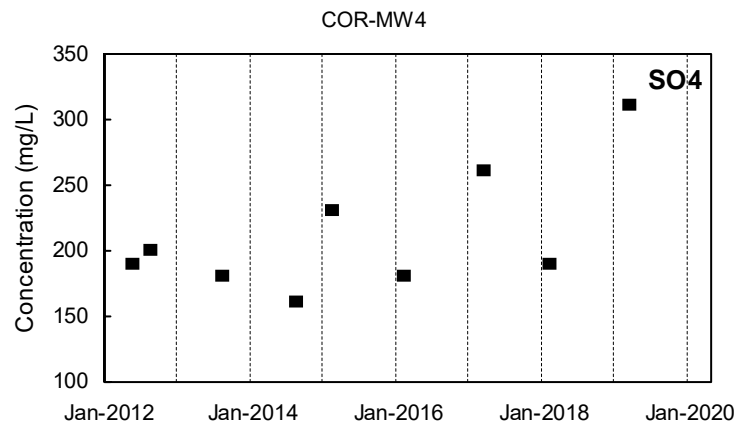
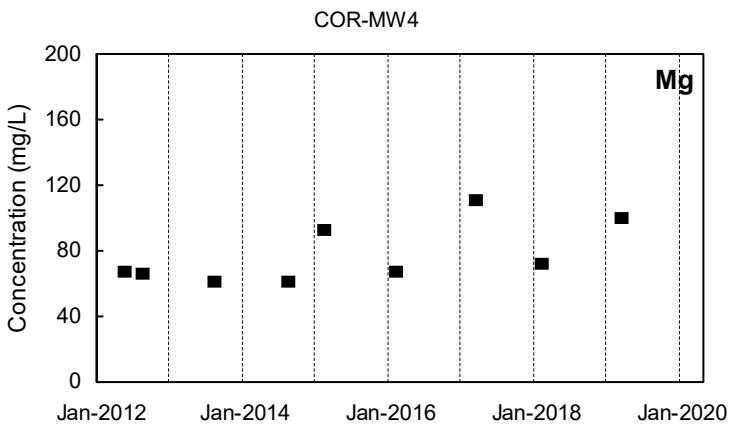
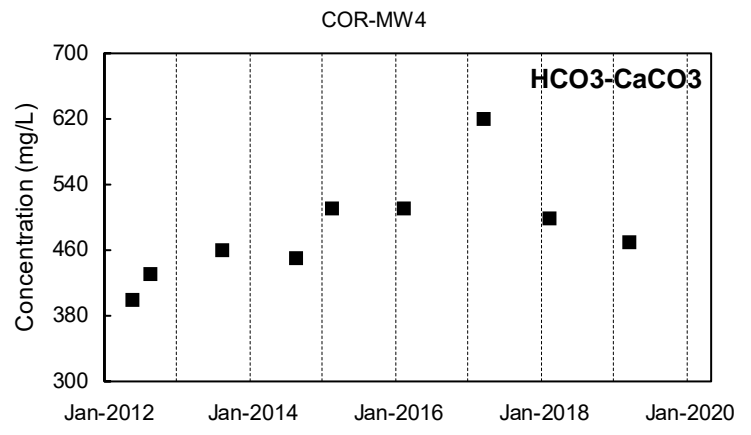
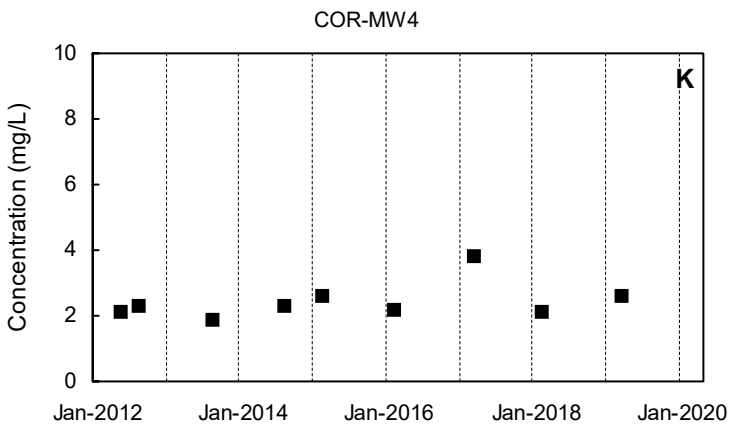
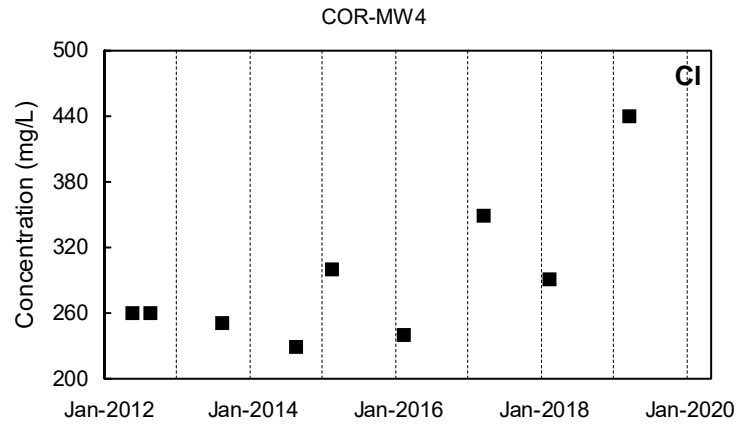
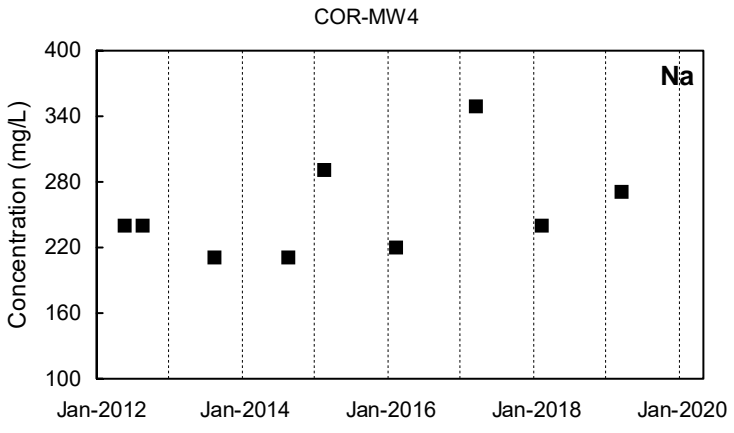

Detected Value
 'J'-Flag (value between reporting limit and detection limit)
 Non-Detect Range
 Shallow Well shown with black symbols
 Deep Well shown with orange symbols
 "dd" Well shown with blue symbols

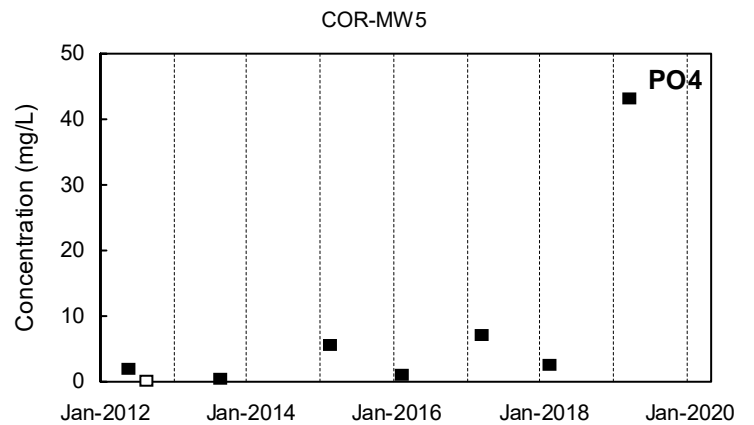
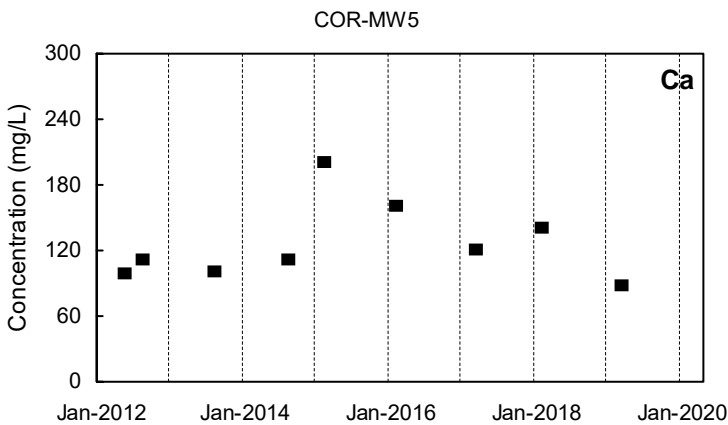
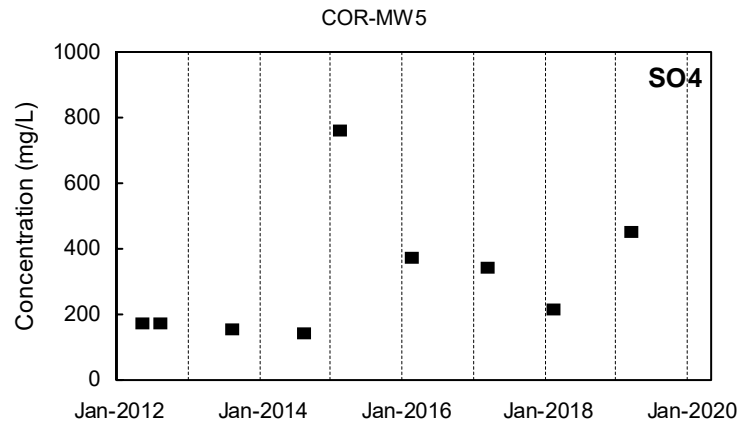
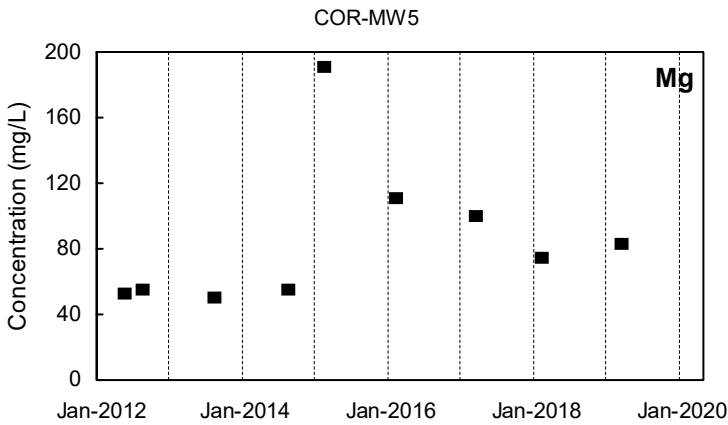
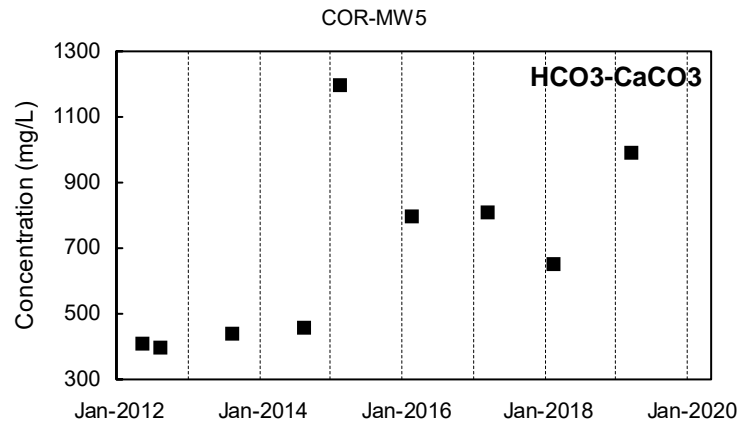
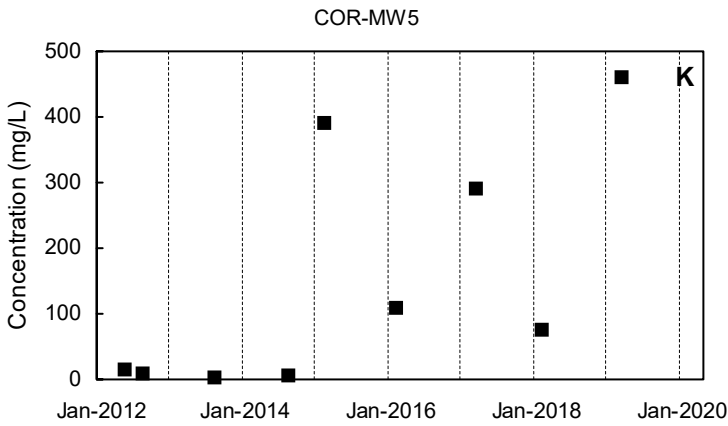
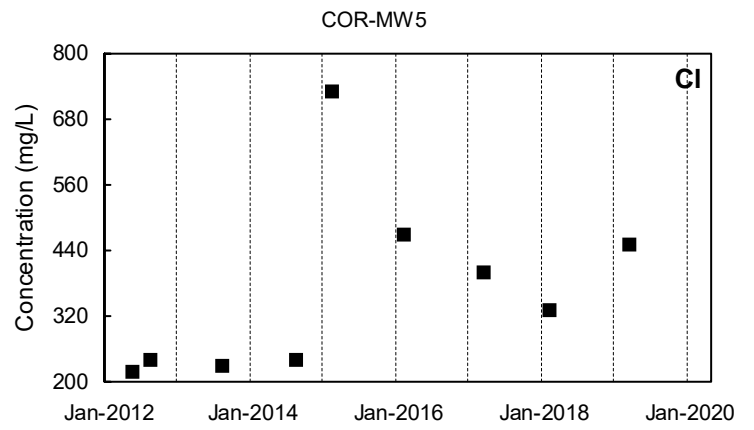
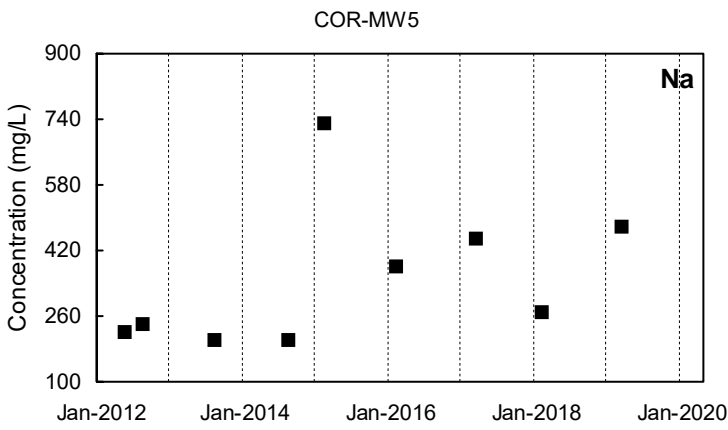

■ Detected Value □ 'J'-Flag (value between reporting limit and detection limit) ■ Non-Detect Range
 Shallow Well shown with black symbols Deep Well shown with orange symbols "dd" Well shown with blue symbols

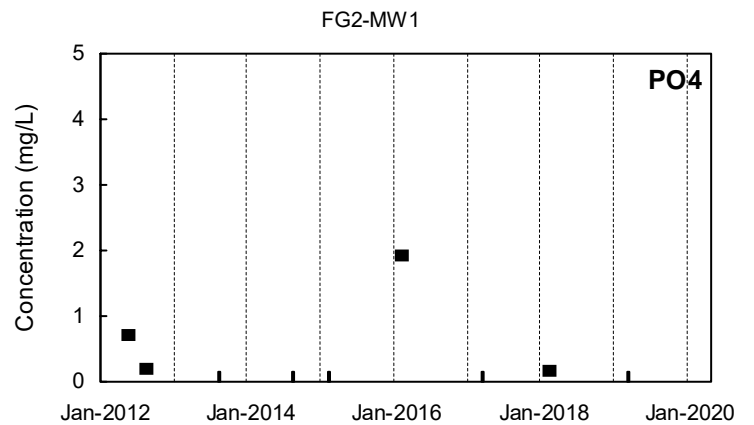
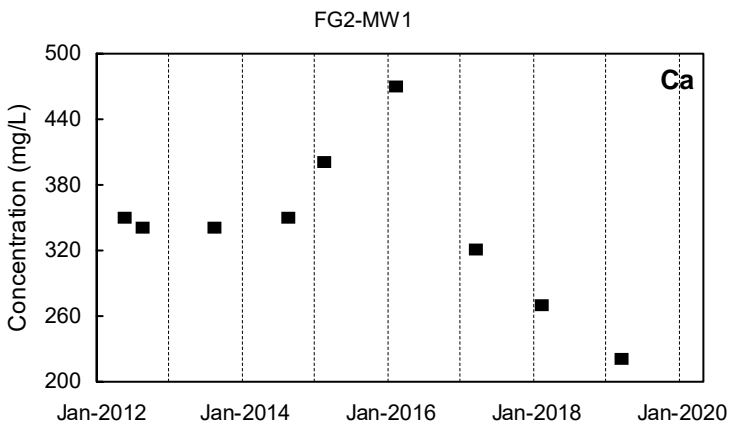
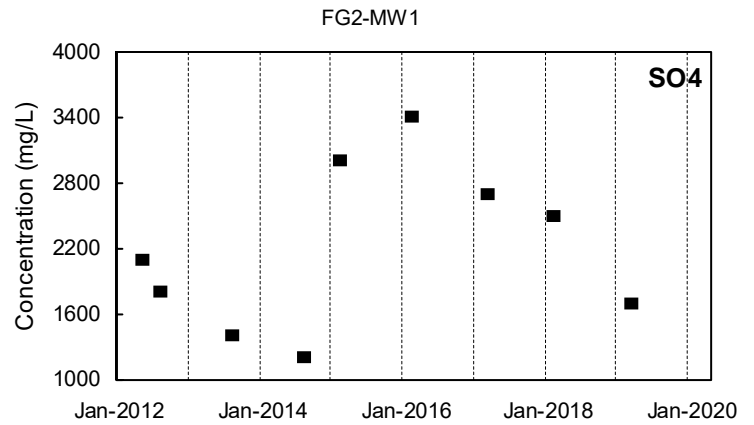
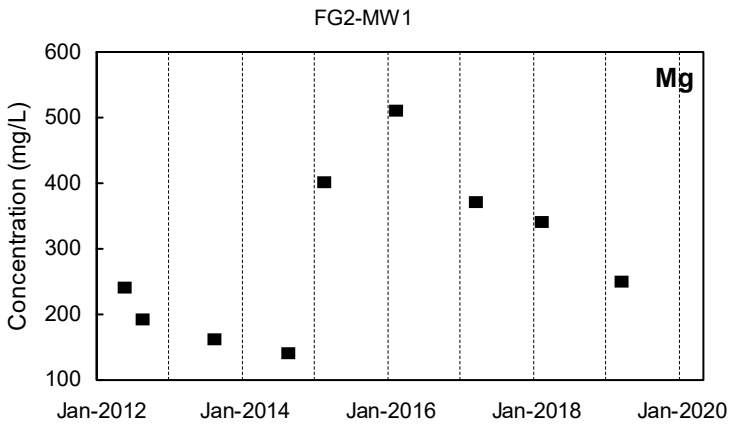
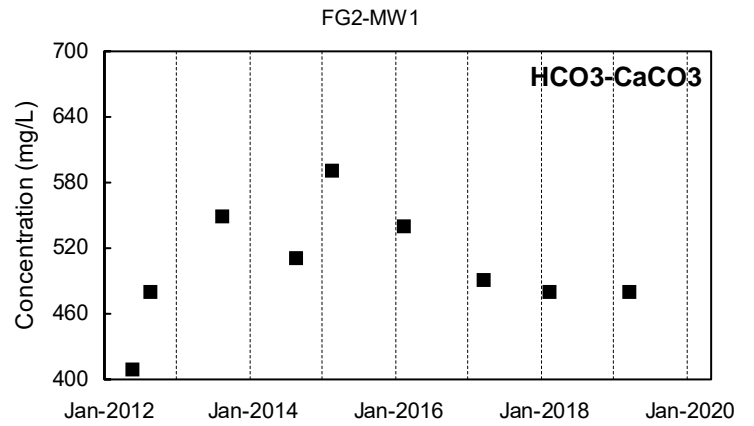
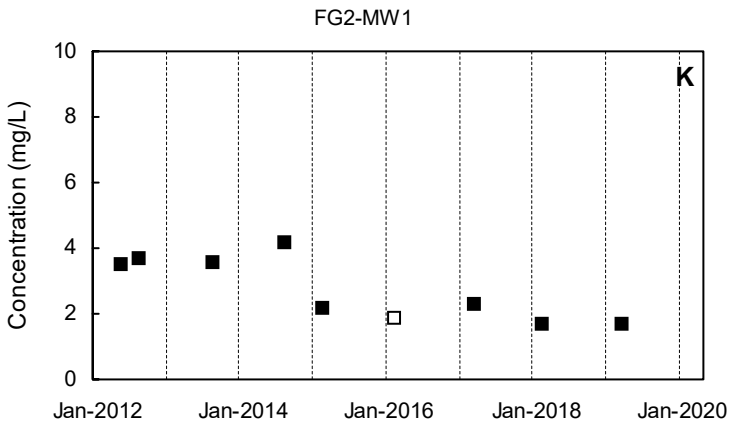
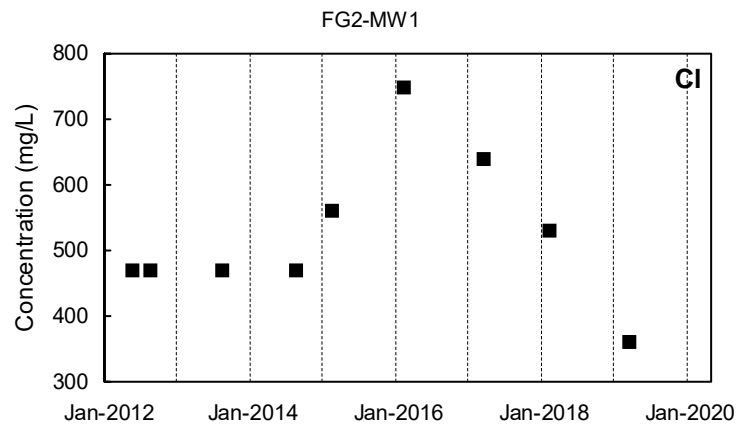
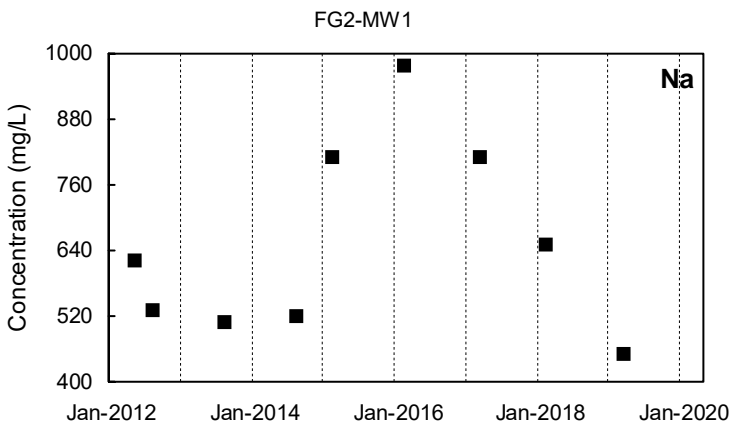

Detected Value
 'J'-Flag (value between reporting limit and detection limit)
 Non-Detect Range
 Shallow Well shown with black symbols Deep Well shown with orange symbols "dd" Well shown with blue symbols

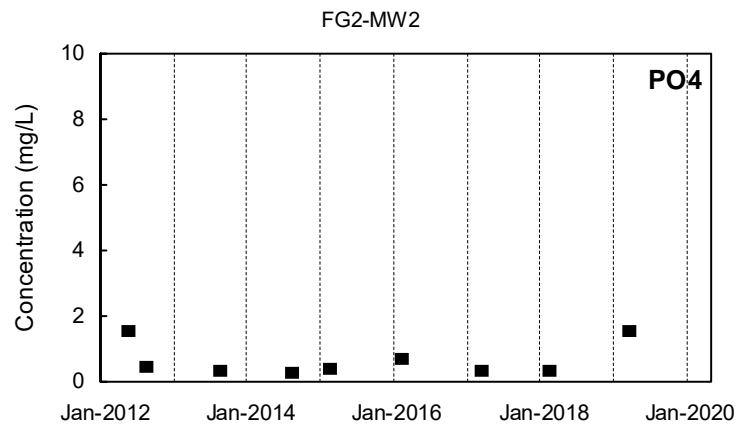
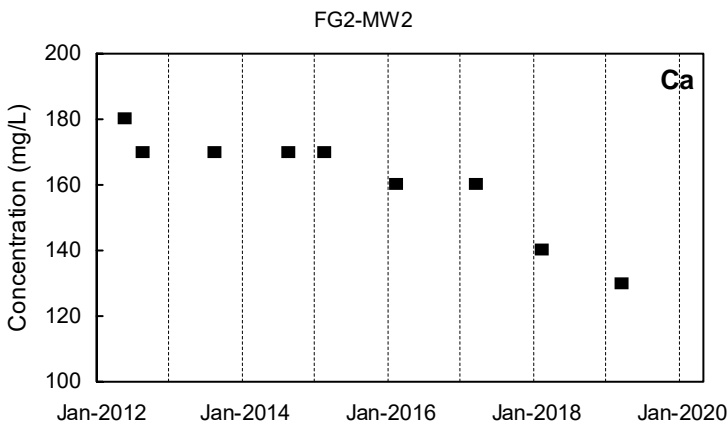
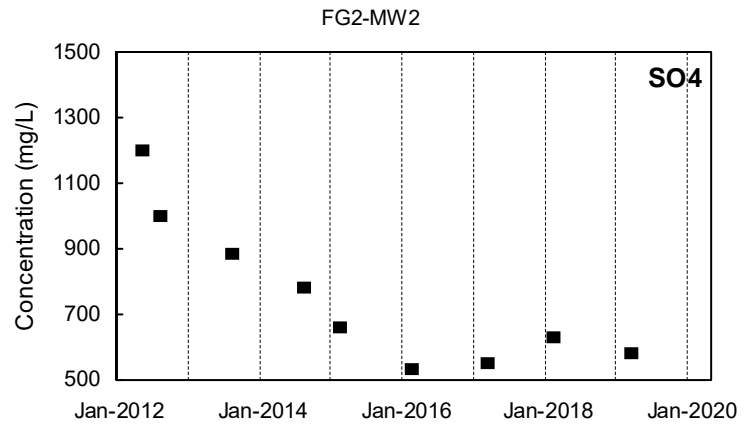
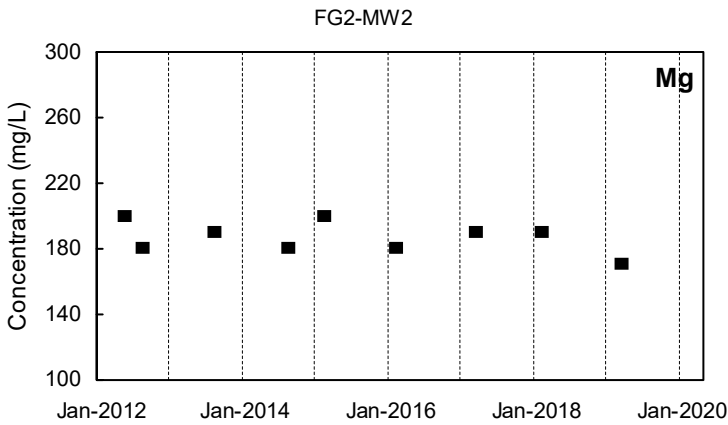
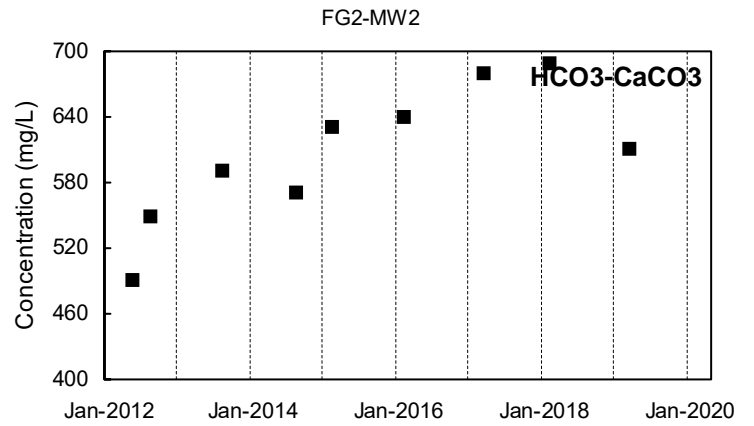
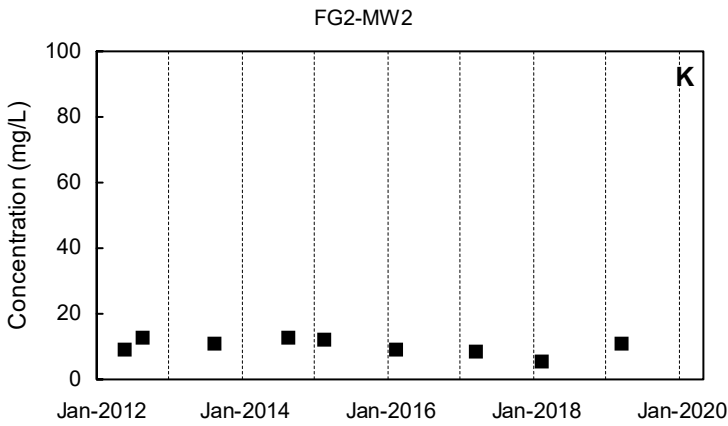
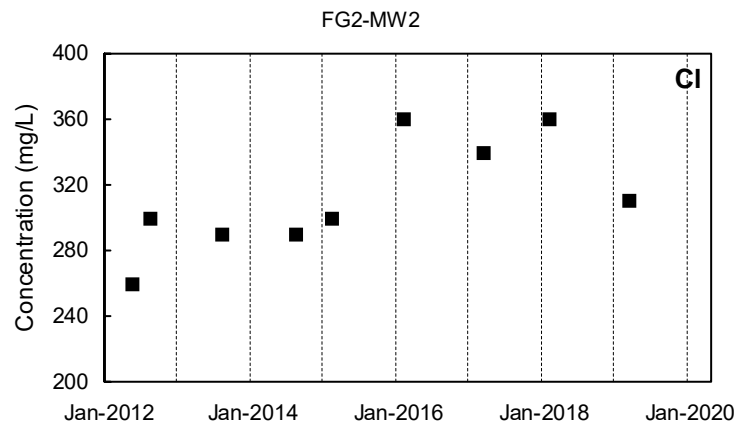
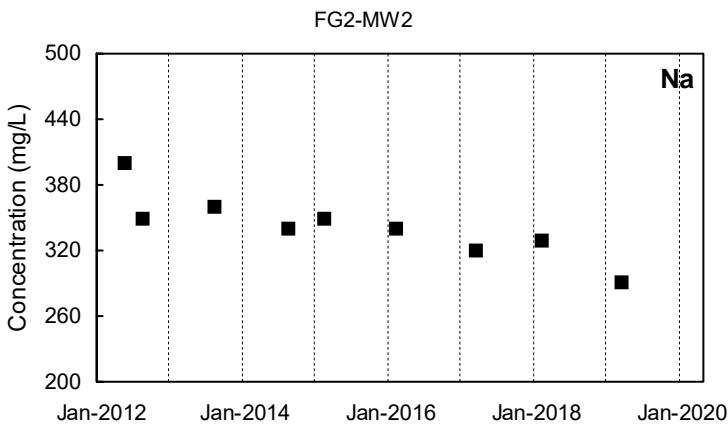

Detected Value
 'J'-Flag (value between reporting limit and detection limit)
 Non-Detect Range

Shallow Well shown with black symbols
 Deep Well shown with orange symbols
 "dd" Well shown with blue symbols

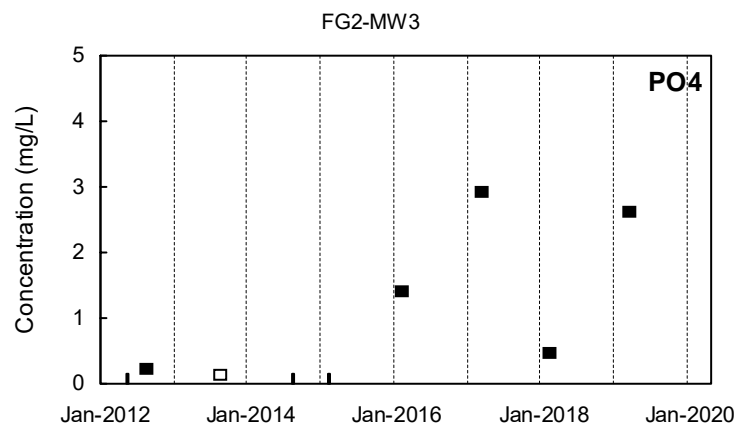
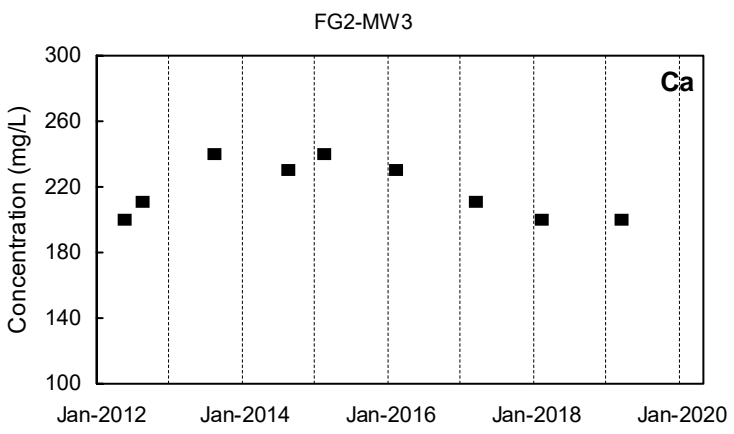
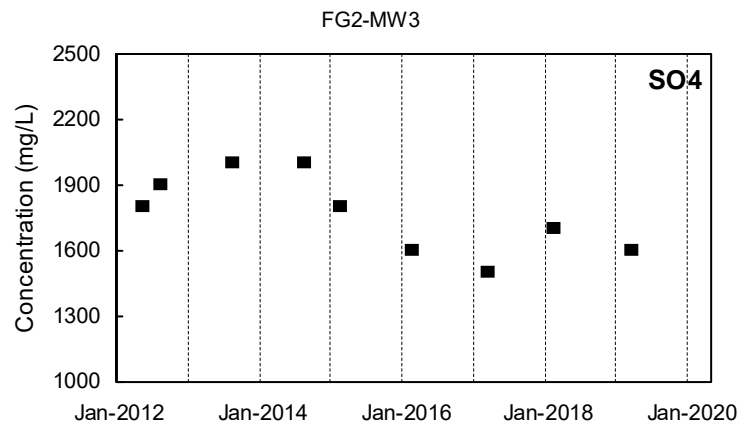
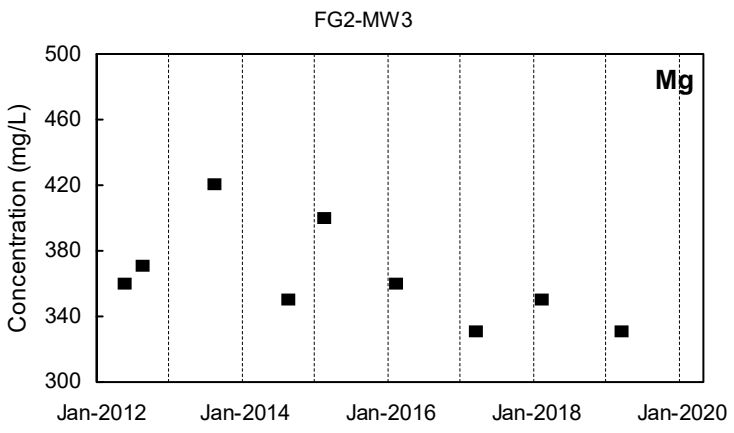
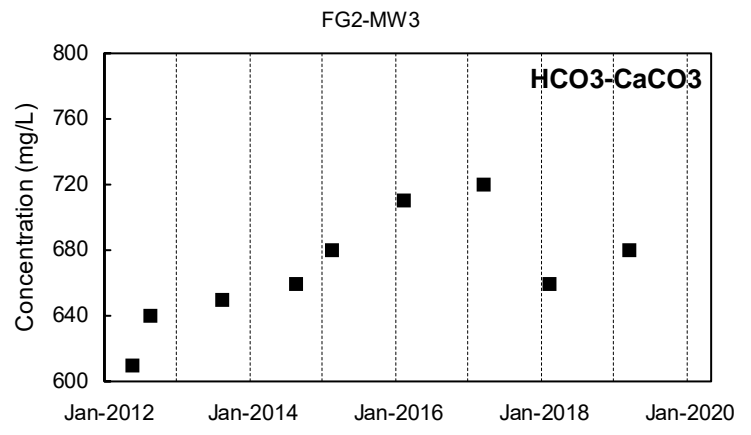
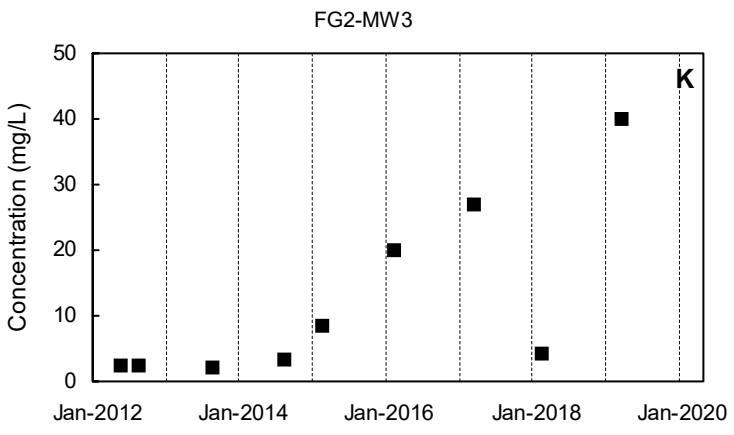
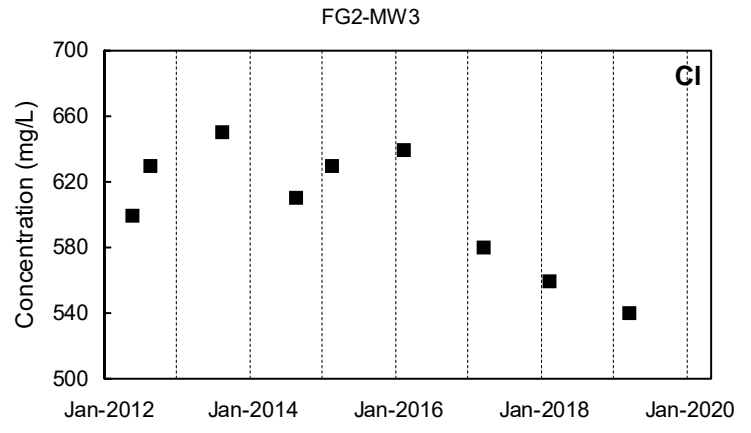
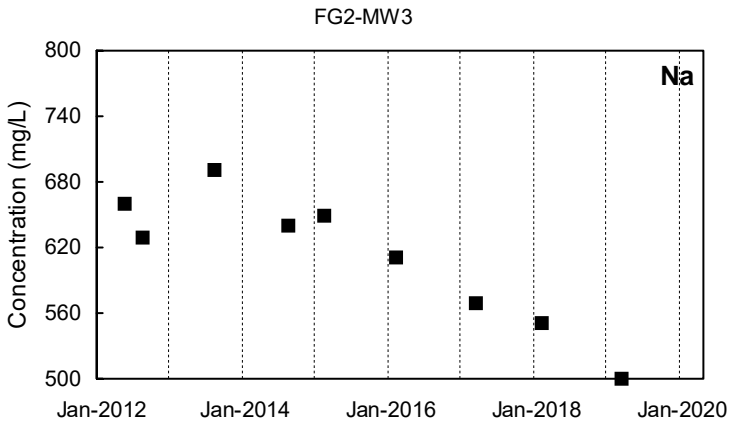

Detected Value
 'J'-Flag (value between reporting limit and detection limit)
 Non-Detect Range
 Shallow Well shown with black symbols
 Deep Well shown with orange symbols
 "dd" Well shown with blue symbols

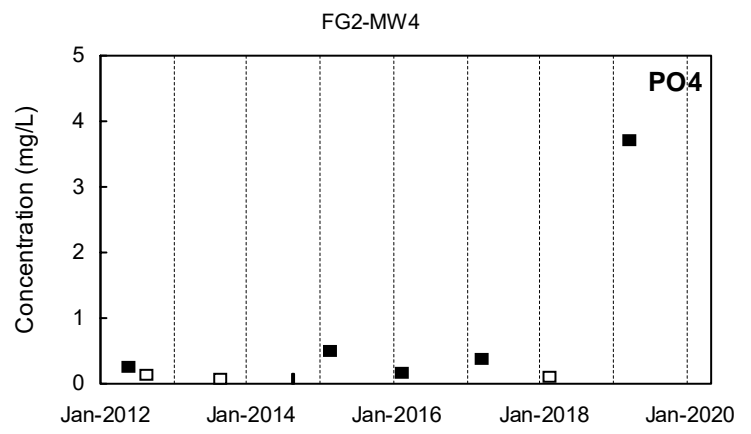
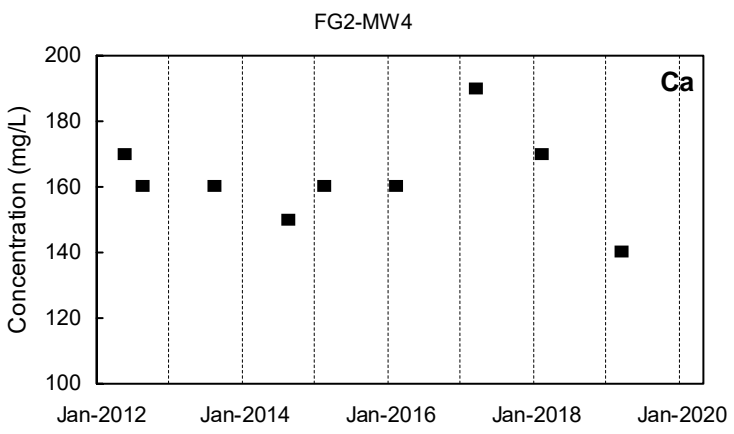
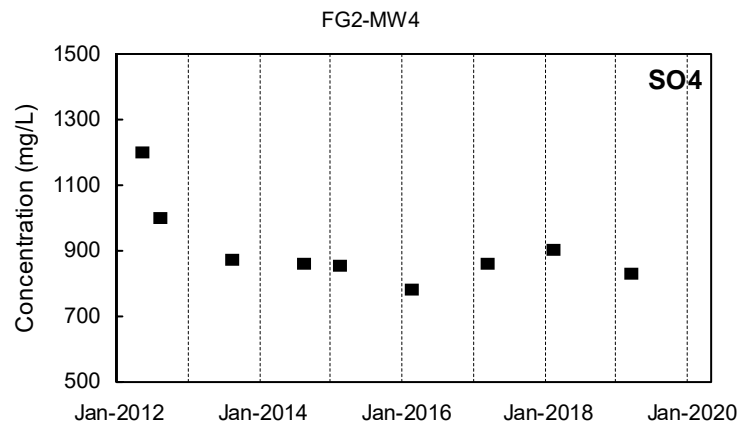
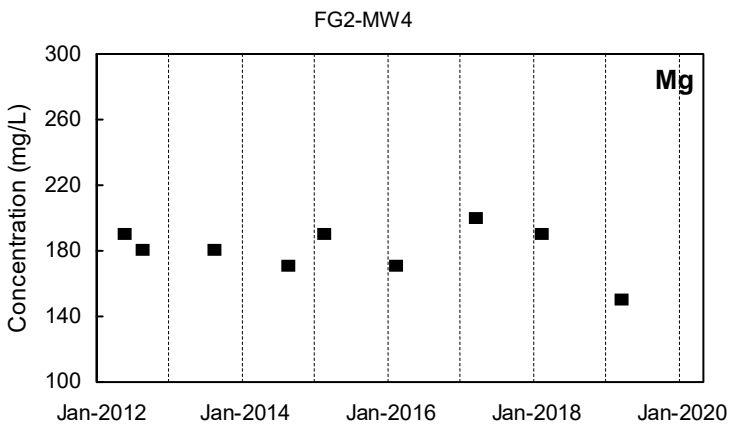
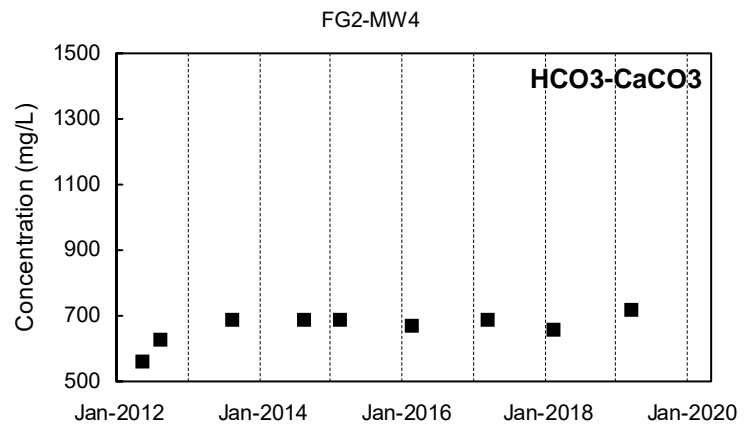
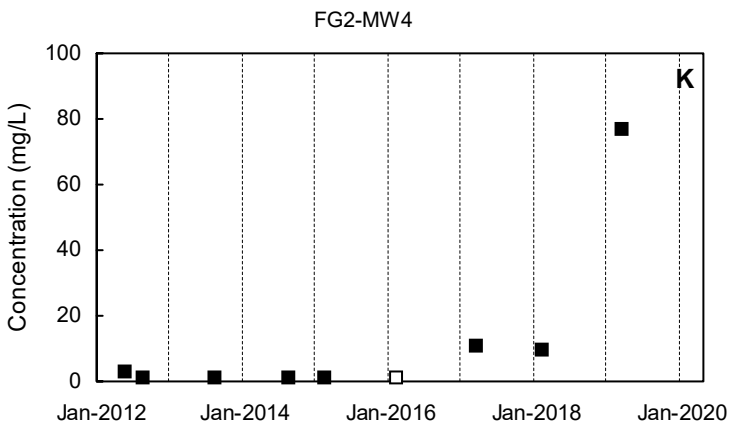
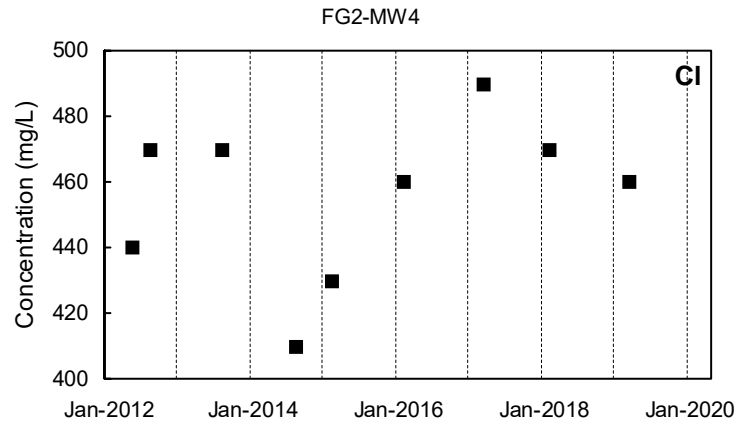
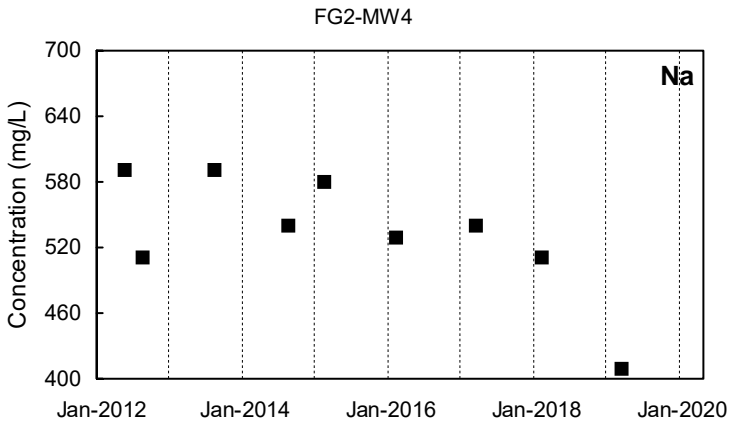

Detected Value
 'J'-Flag (value between reporting limit and detection limit)
 Non-Detect Range
 Shallow Well shown with black symbols
 Deep Well shown with orange symbols
 "dd" Well shown with blue symbols

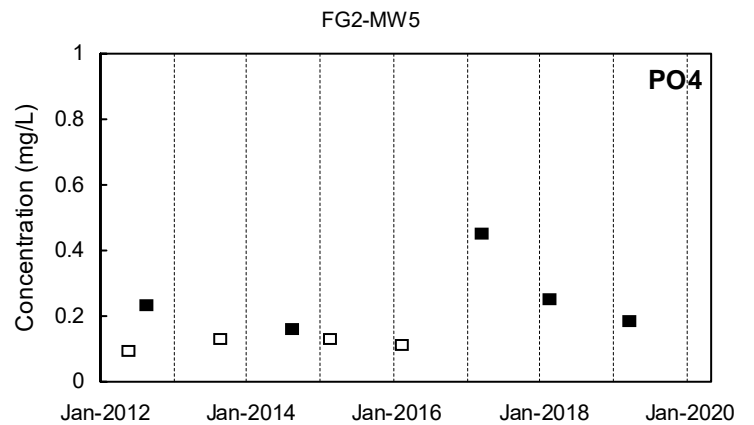
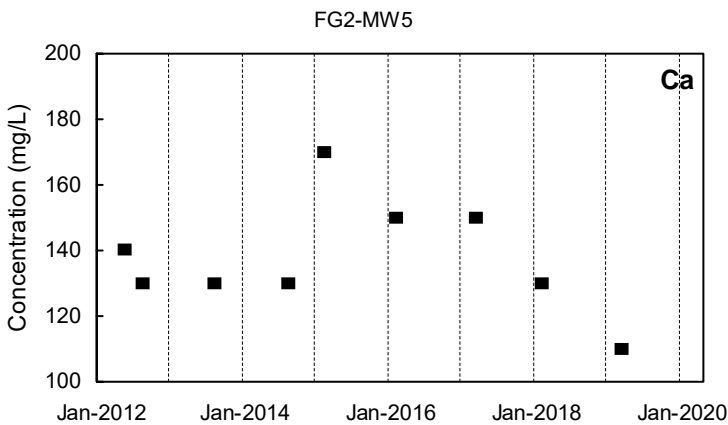
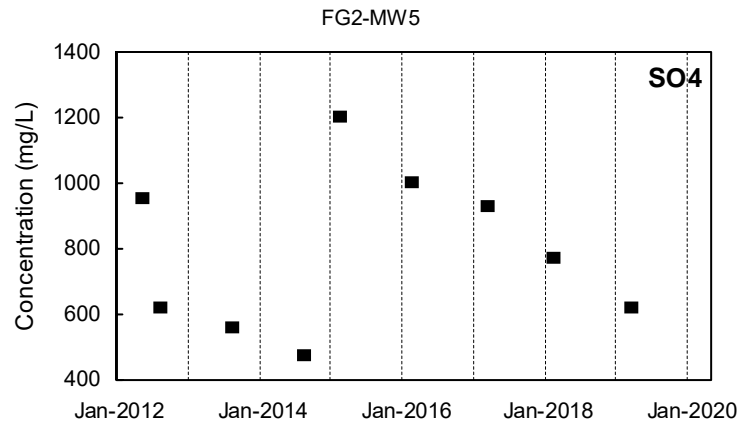
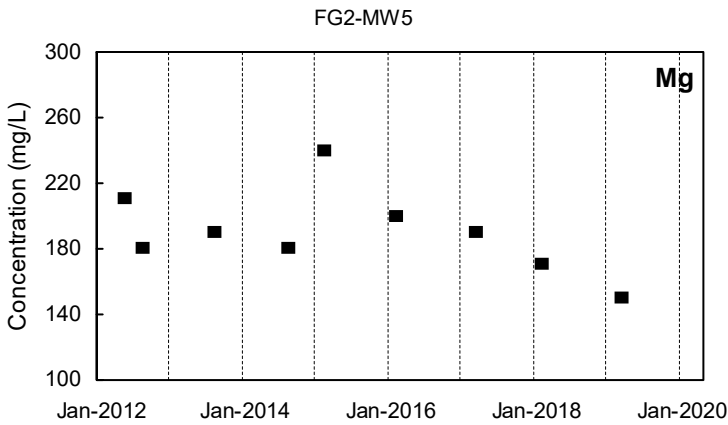
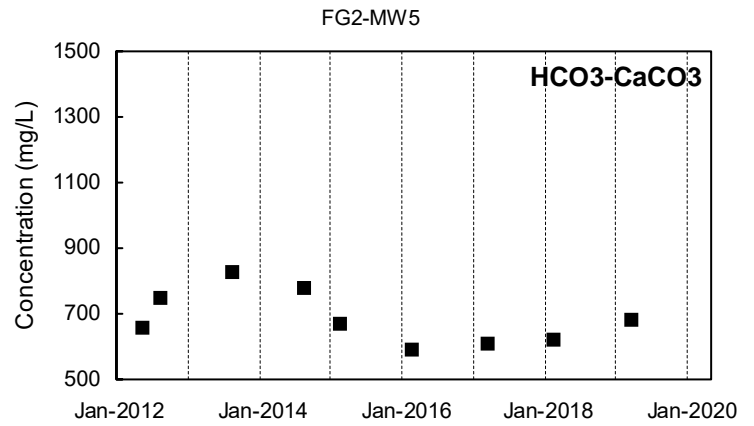
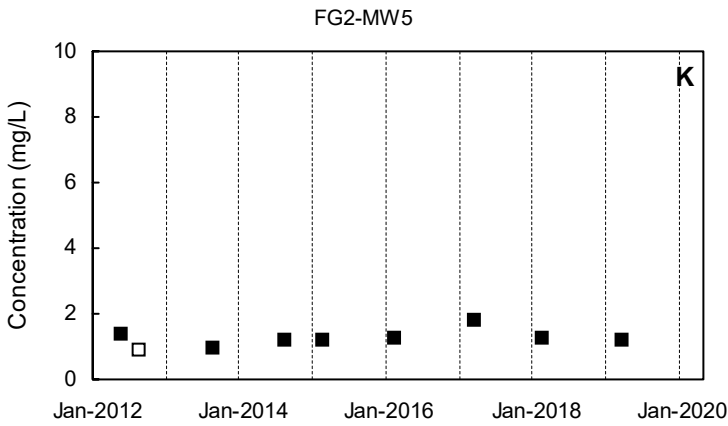
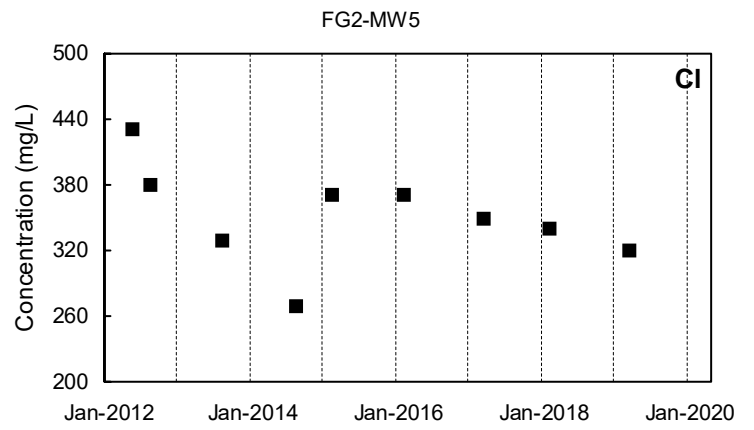
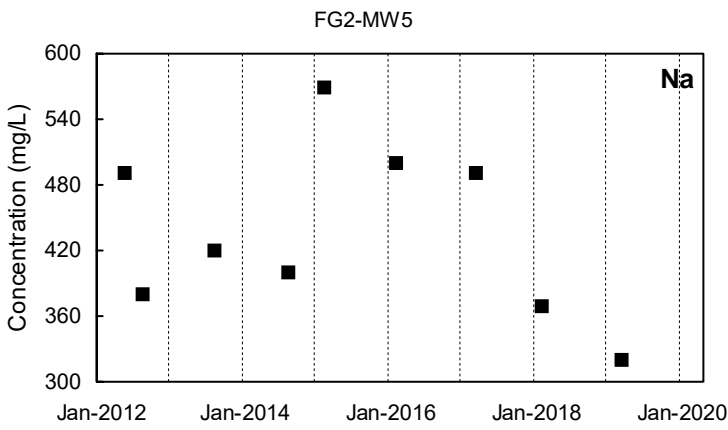

Detected Value
 'J'-Flag (value between reporting limit and detection limit)
 Non-Detect Range
 Shallow Well shown with black symbols Deep Well shown with orange symbols "dd" Well shown with blue symbols

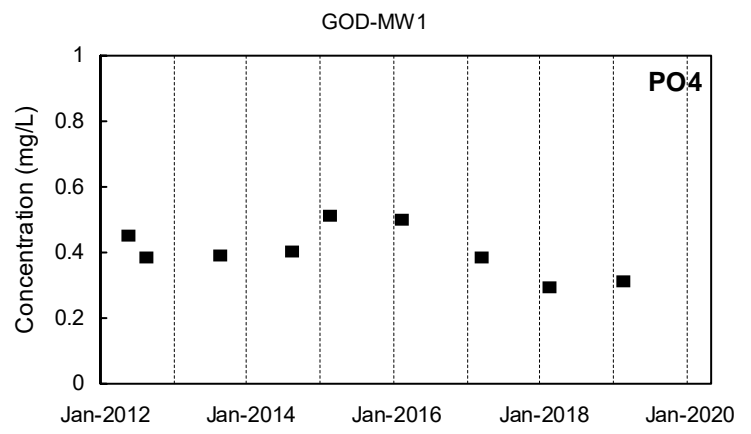
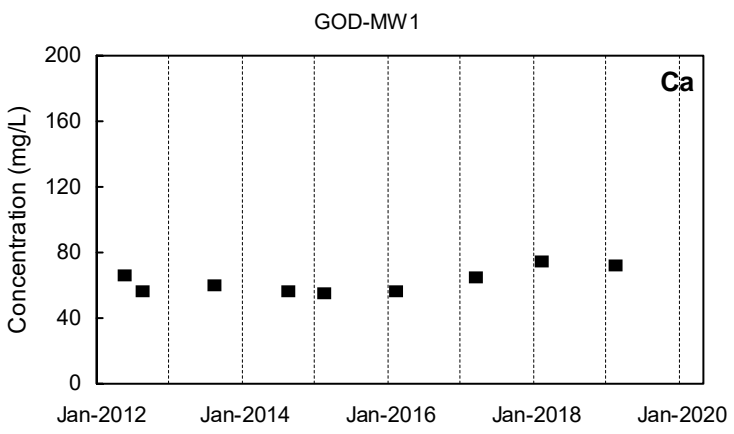
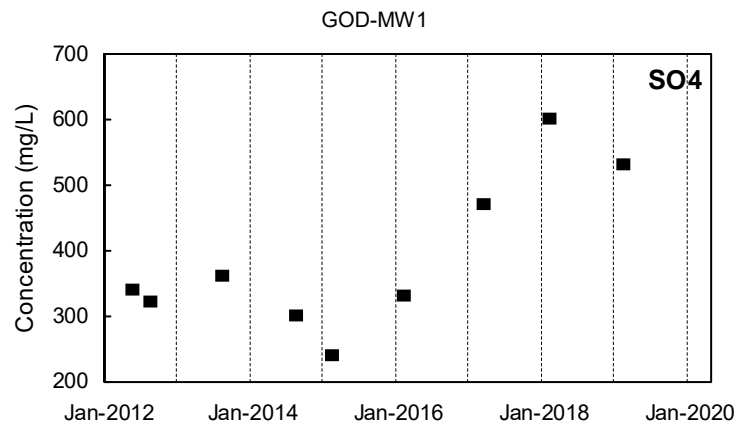
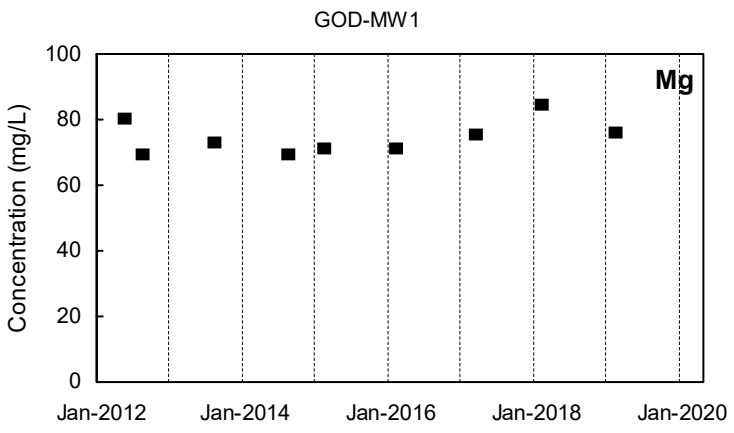
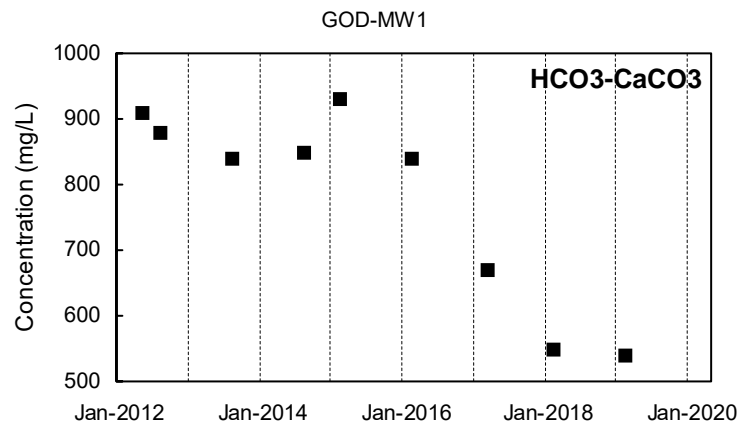
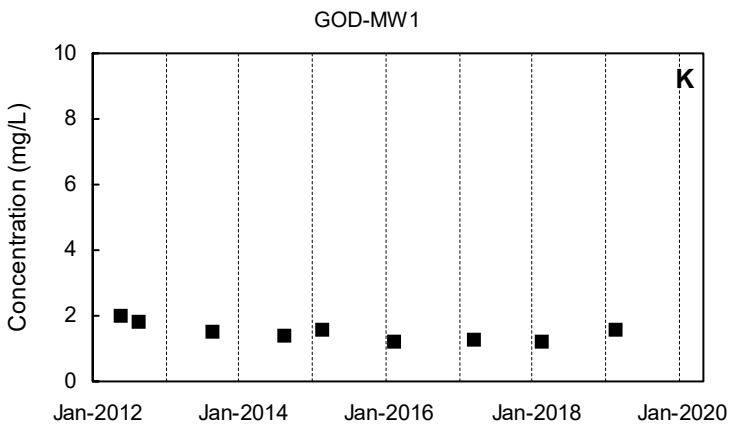
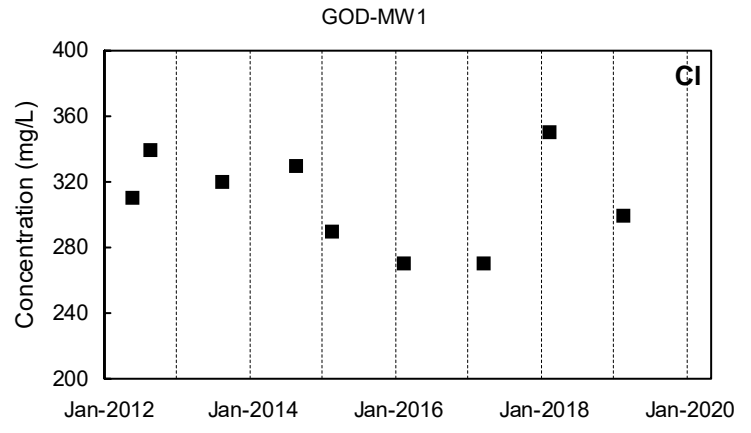
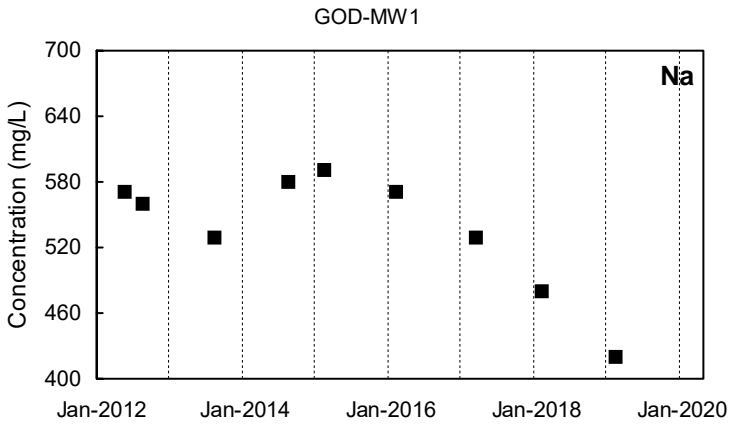

Detected Value
 'J'-Flag (value between reporting limit and detection limit)
 Non-Detect Range
 Shallow Well shown with black symbols
 Deep Well shown with orange symbols
 "dd" Well shown with blue symbols

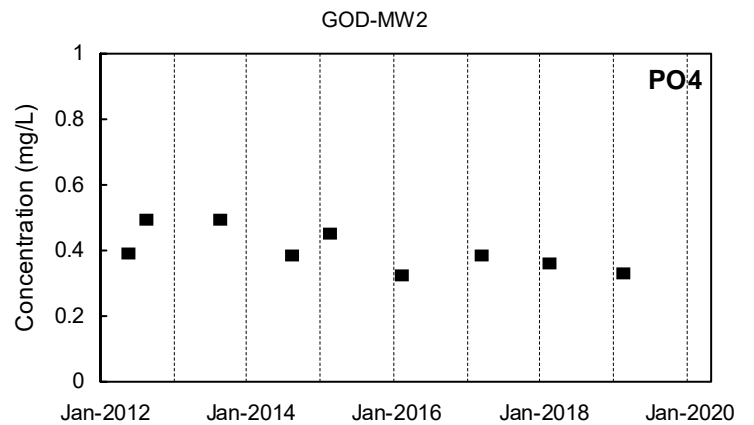
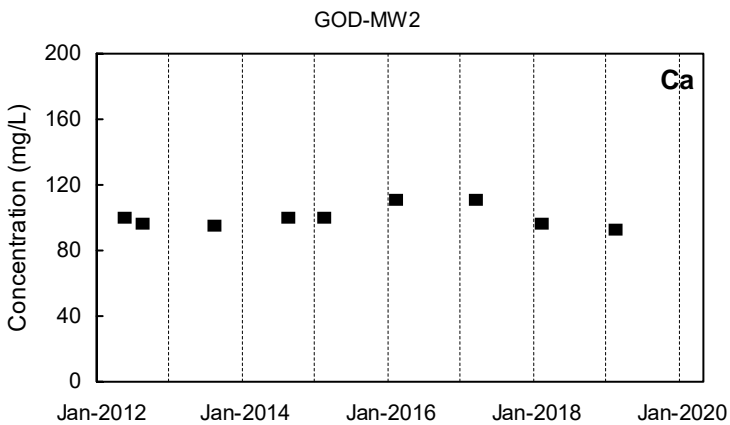
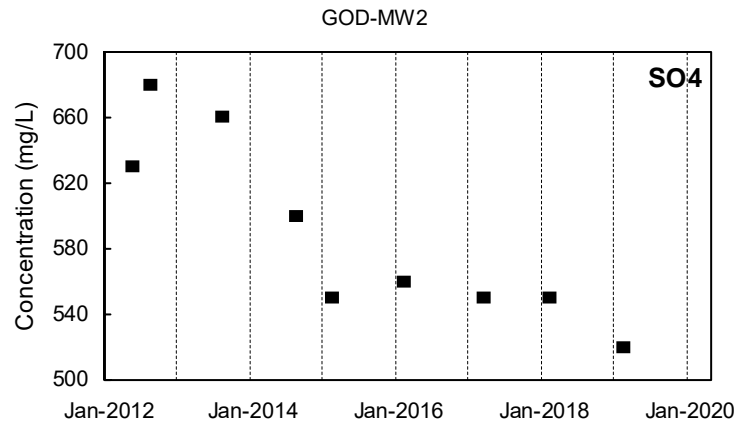
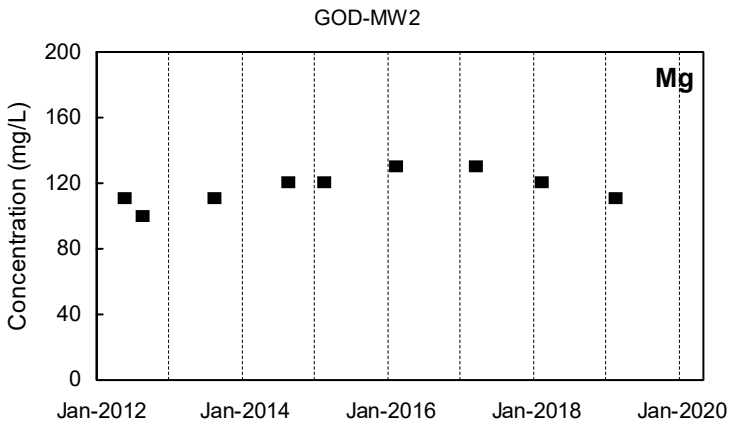
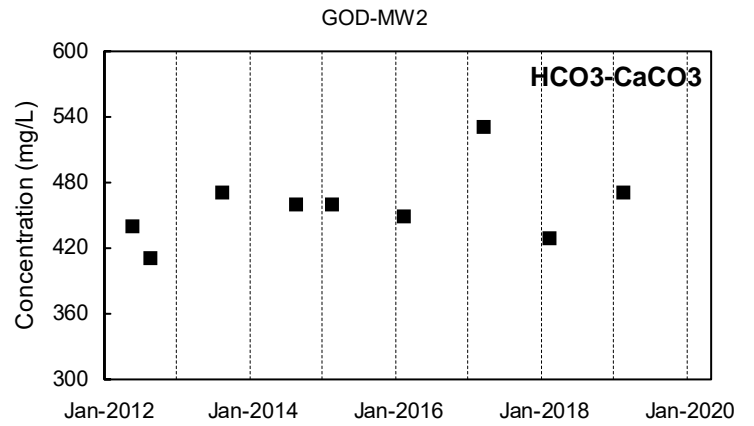
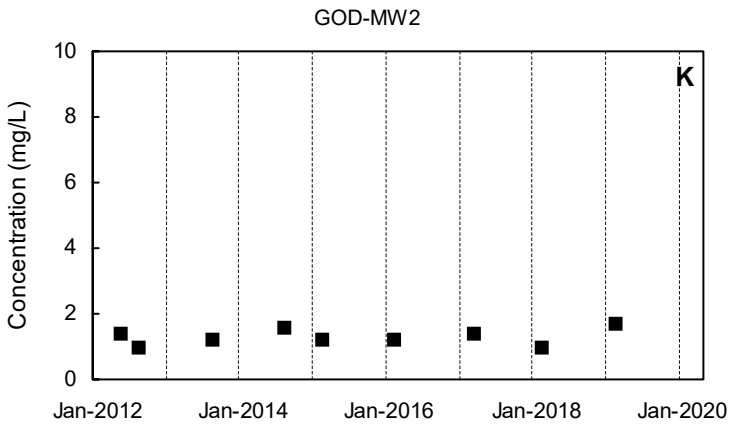
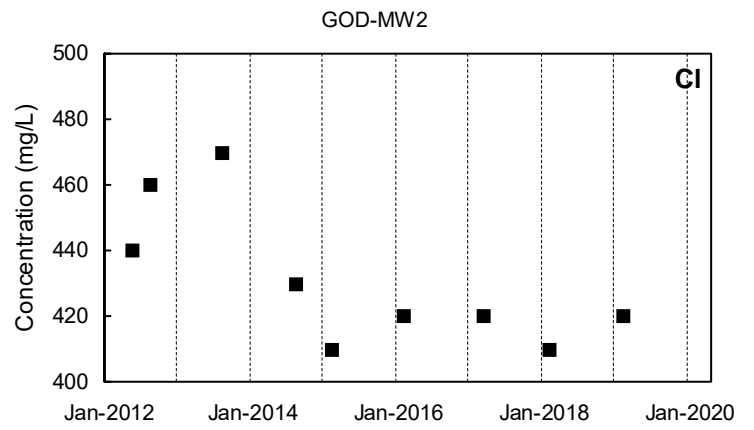
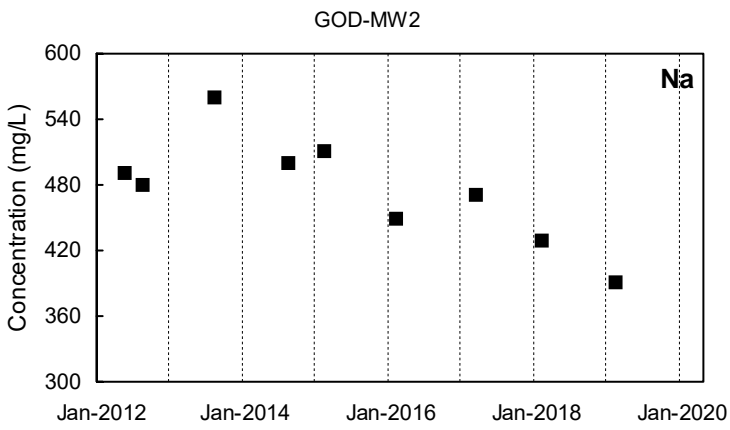

Detected Value
 'J'-Flag (value between reporting limit and detection limit)
 Non-Detect Range

Shallow Well shown with black symbols
Deep Well shown with orange symbols
"dd" Well shown with blue symbols

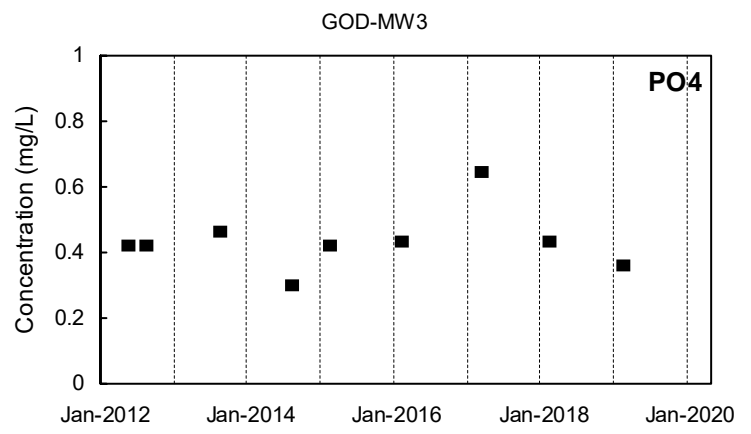
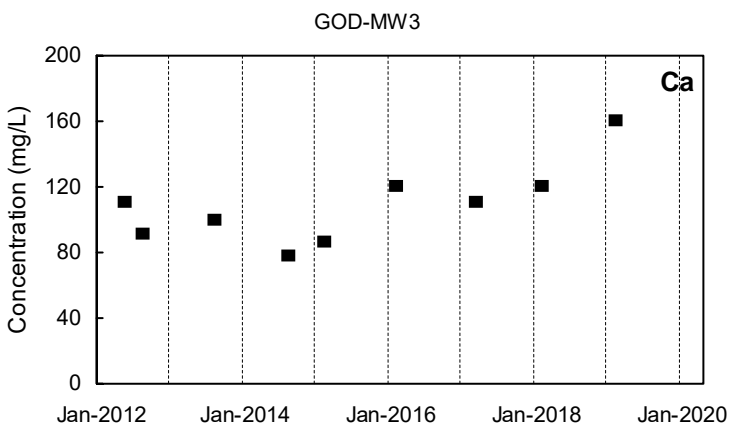
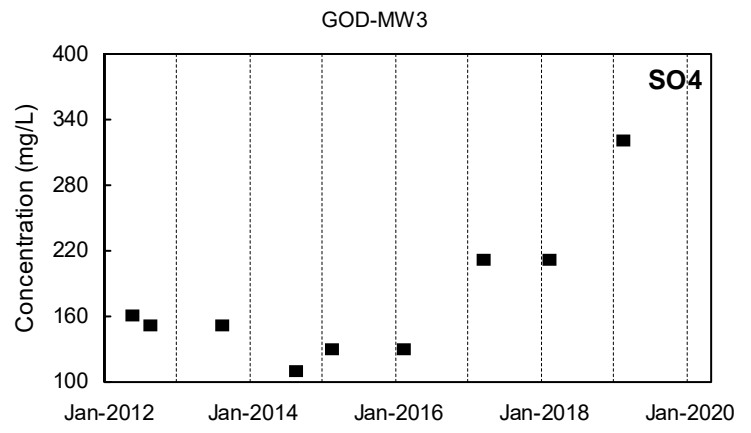
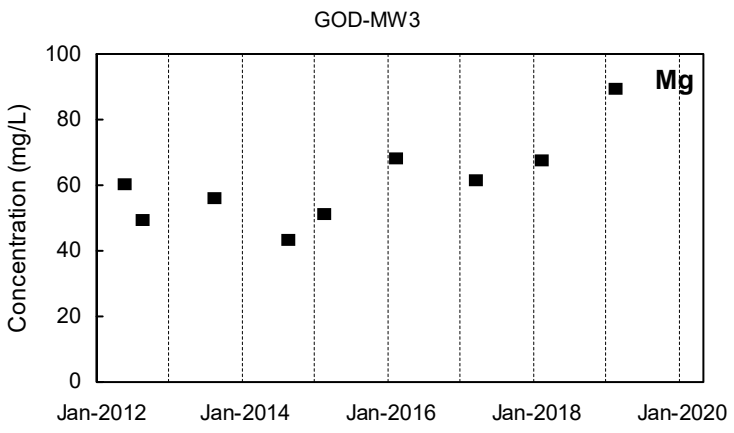
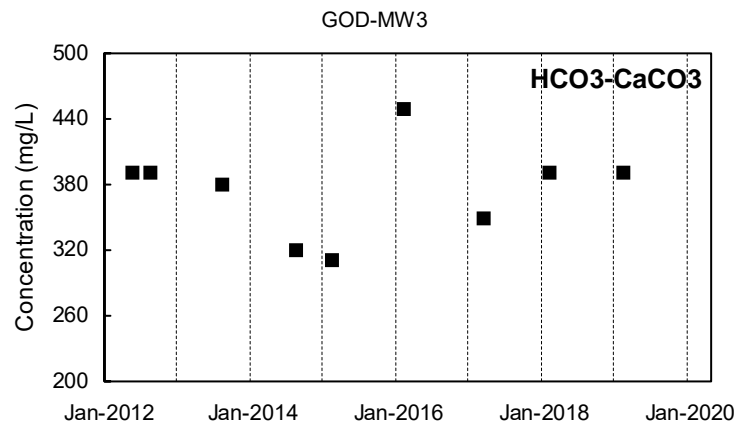
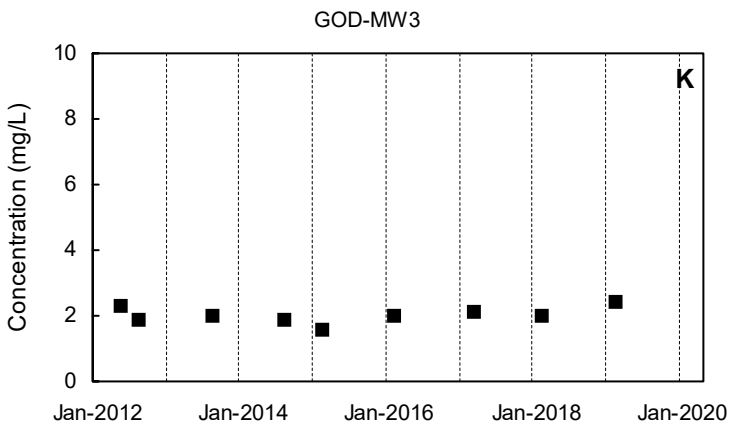
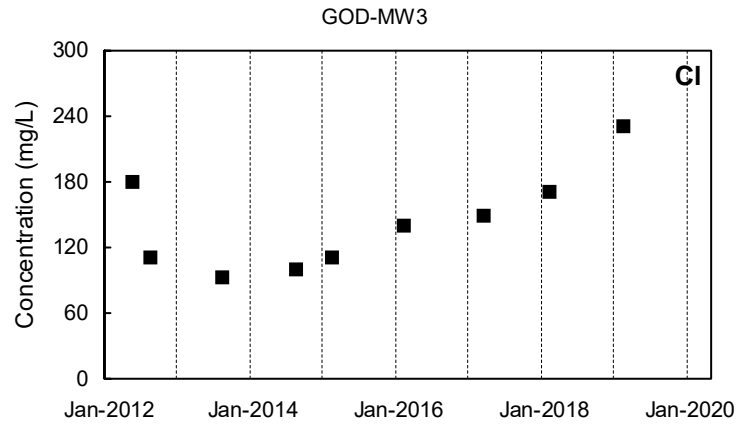
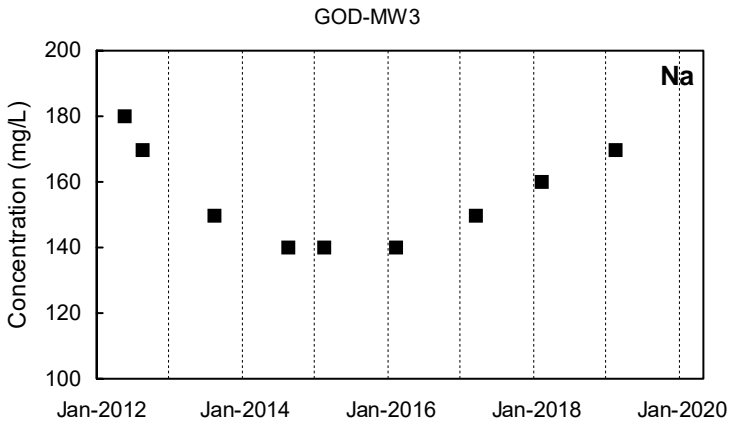

Detected Value
 'J'-Flag (value between reporting limit and detection limit)
 Non-Detect Range
 Shallow Well shown with black symbols
 Deep Well shown with orange symbols
 "dd" Well shown with blue symbols

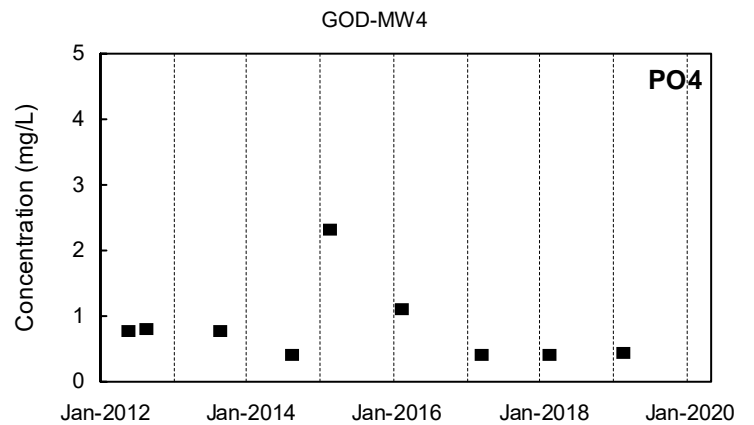
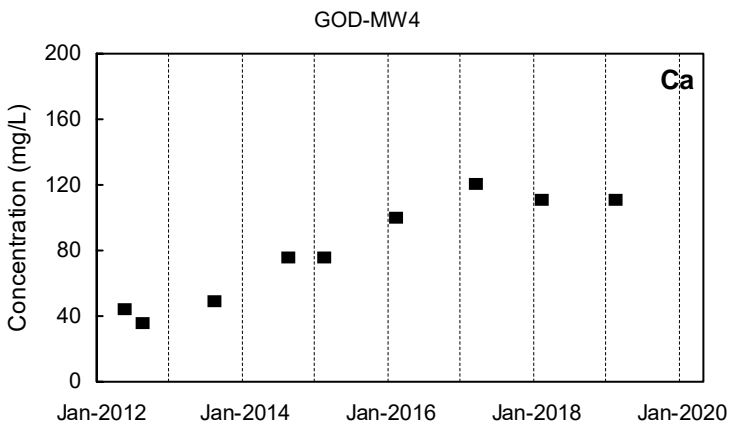
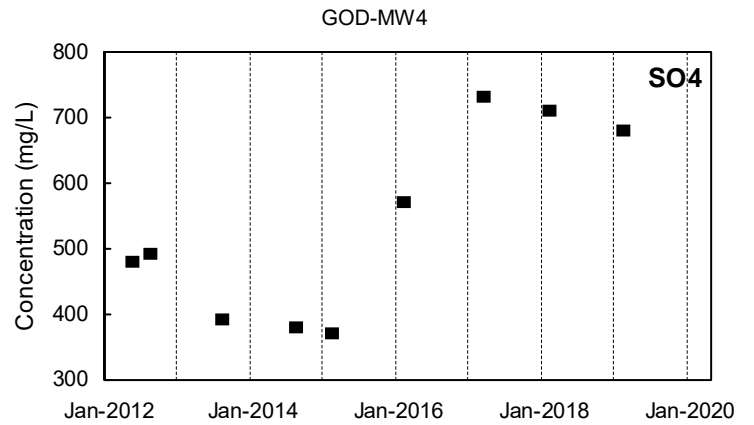
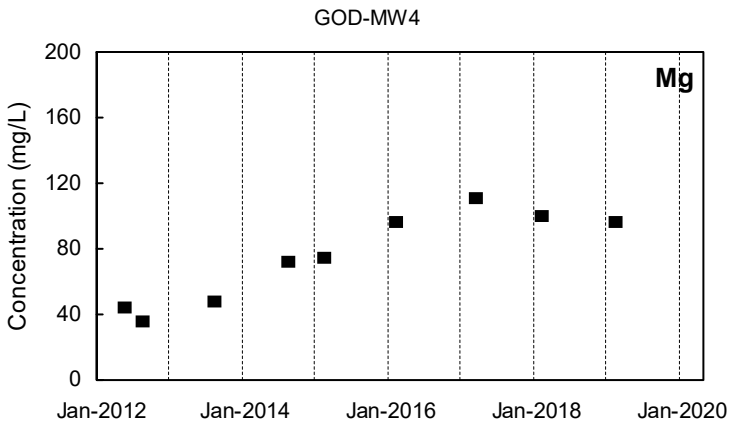
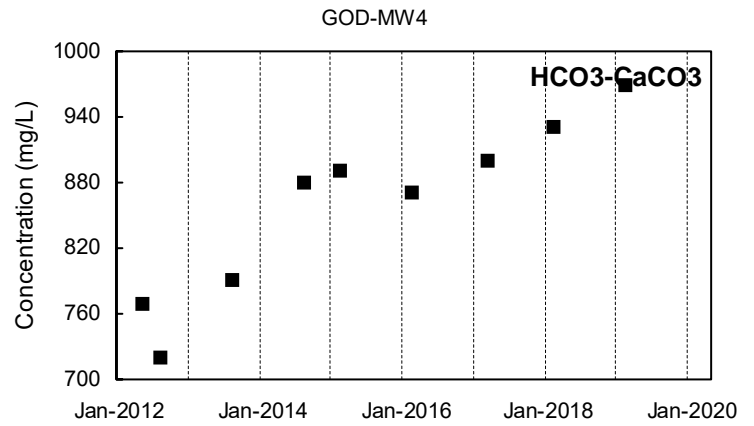
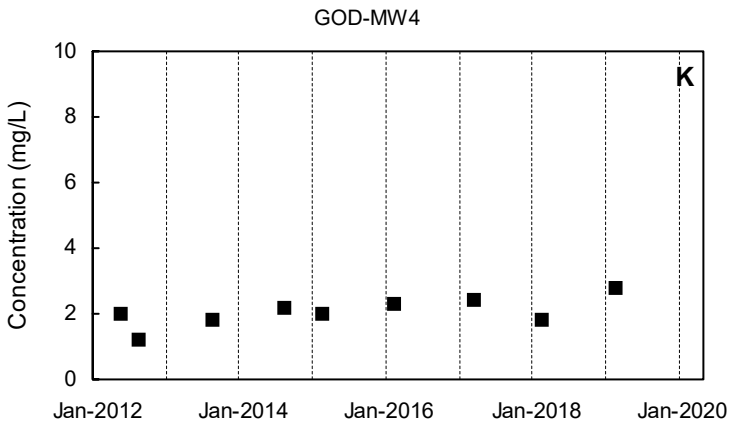
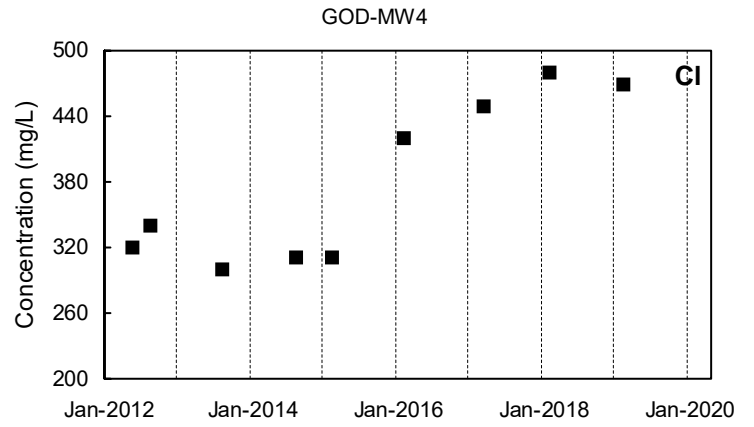
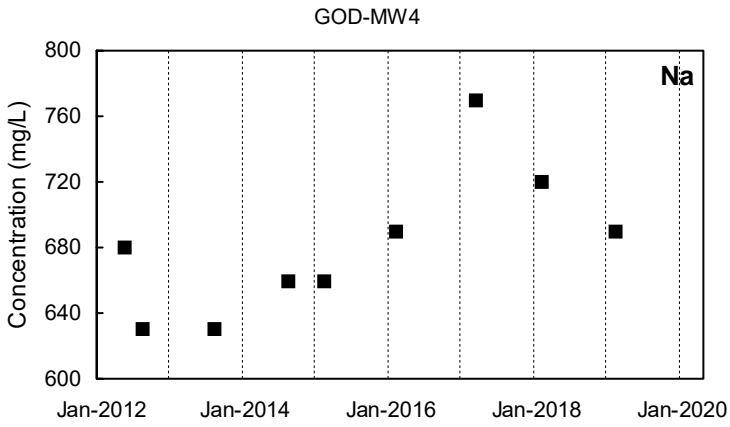

Detected Value
 'J'-Flag (value between reporting limit and detection limit)
 Non-Detect Range
 Shallow Well shown with black symbols
 Deep Well shown with orange symbols
 "dd" Well shown with blue symbols

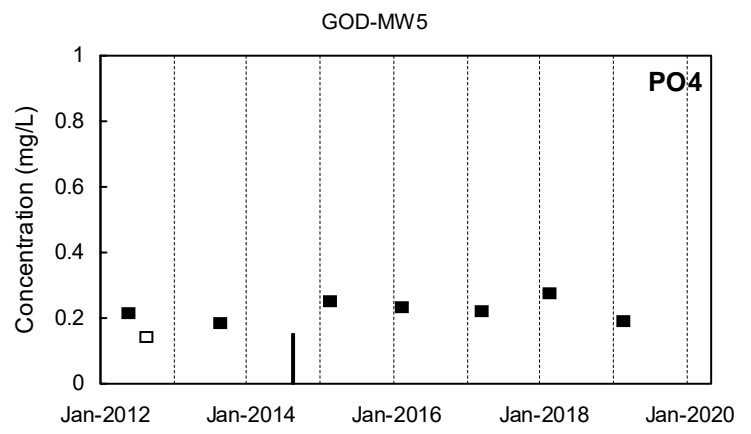
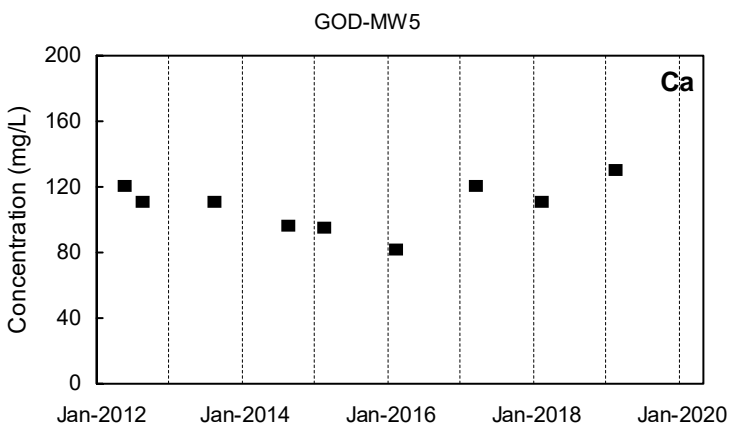
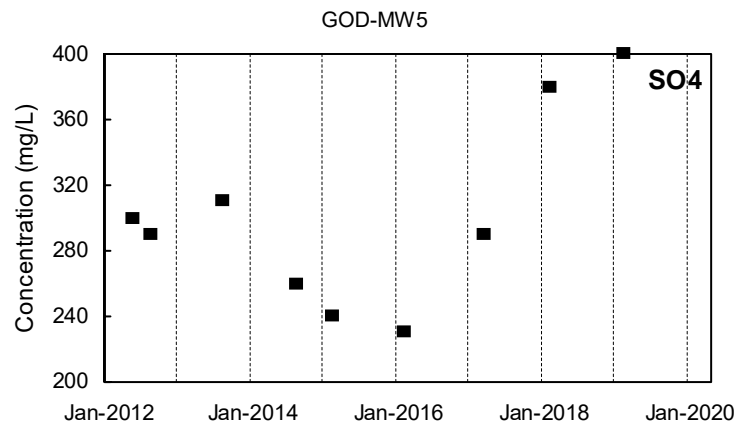
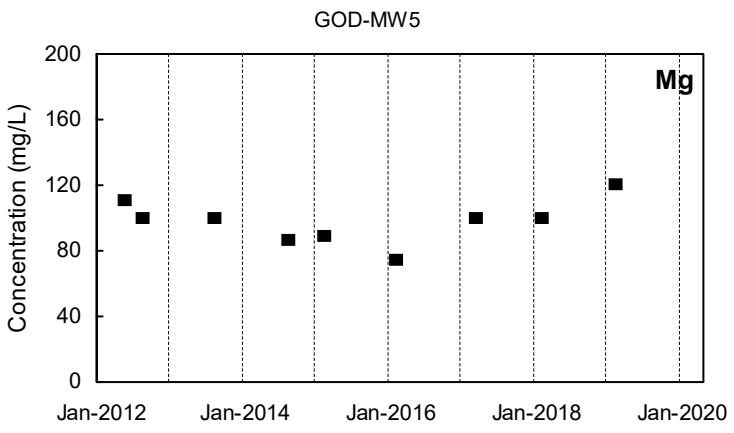
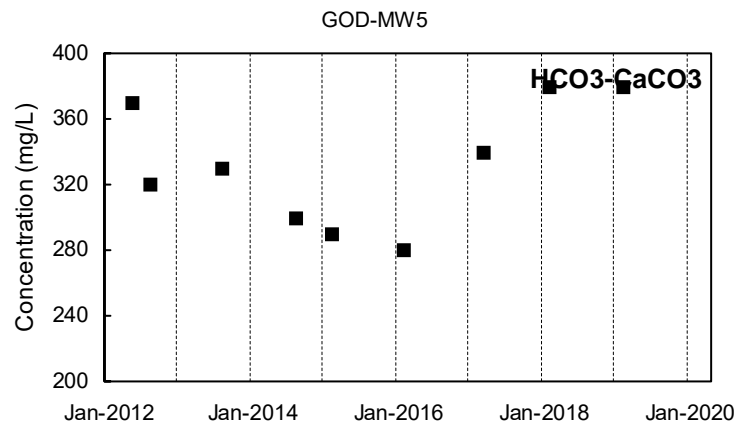
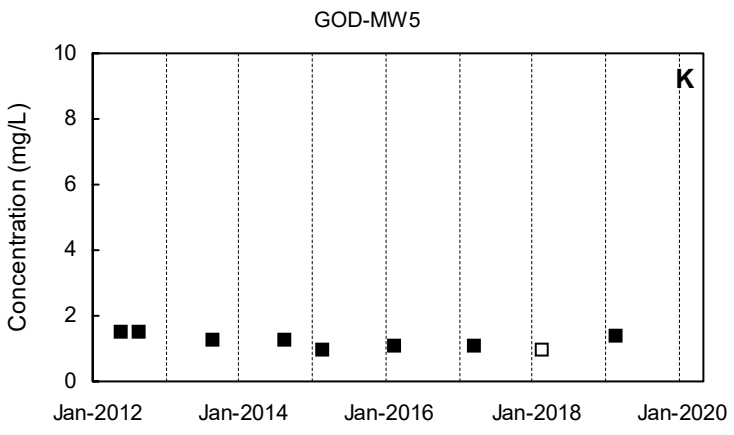
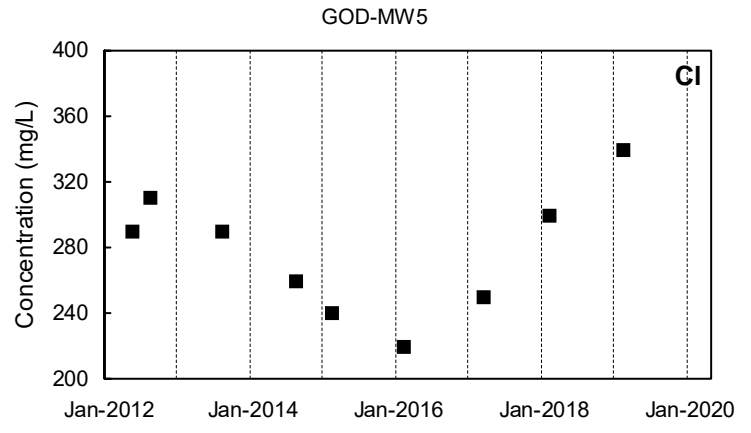
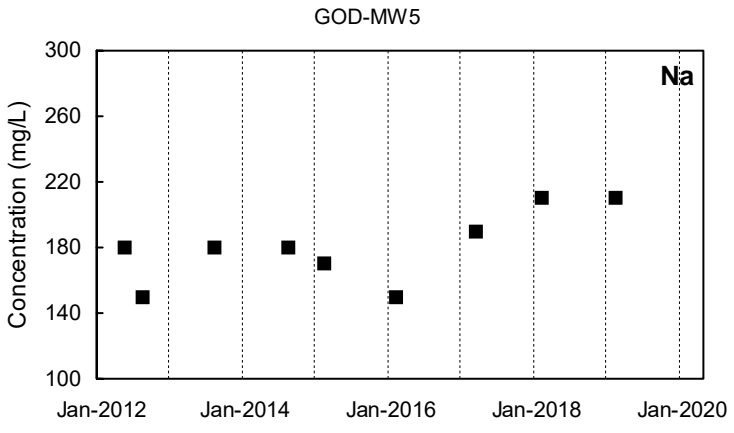

Detected Value
 'J'-Flag (value between reporting limit and detection limit)
 Non-Detect Range
 Shallow Well shown with black symbols
 Deep Well shown with orange symbols
 "dd" Well shown with blue symbols

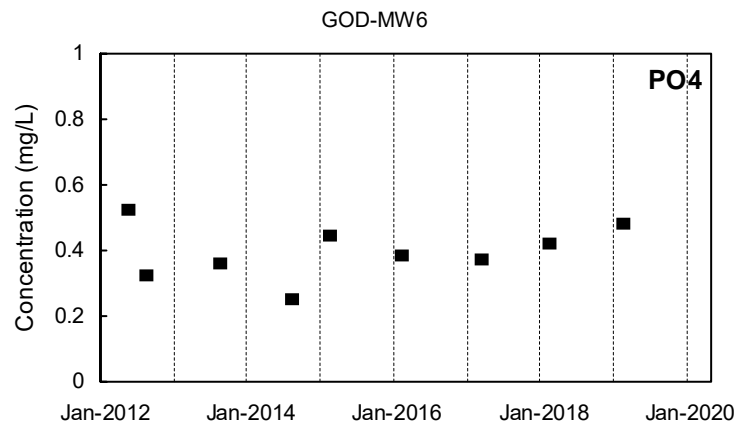
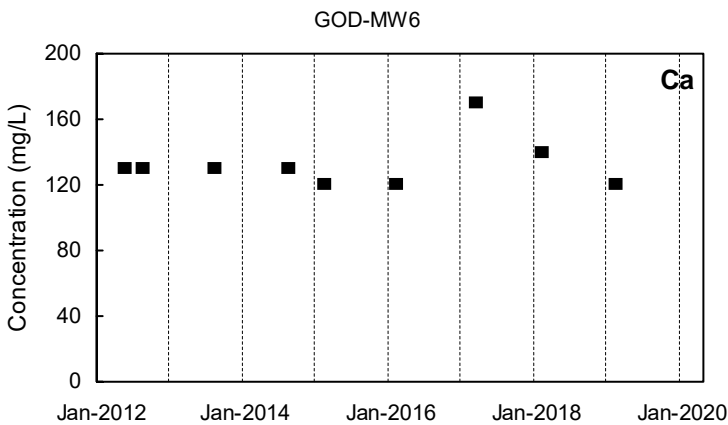
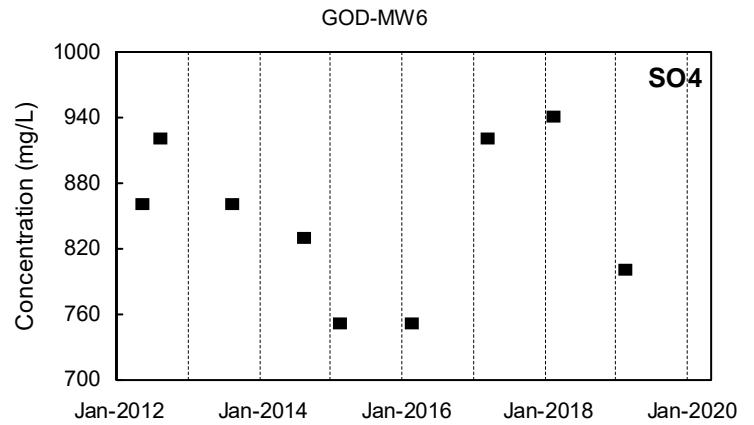
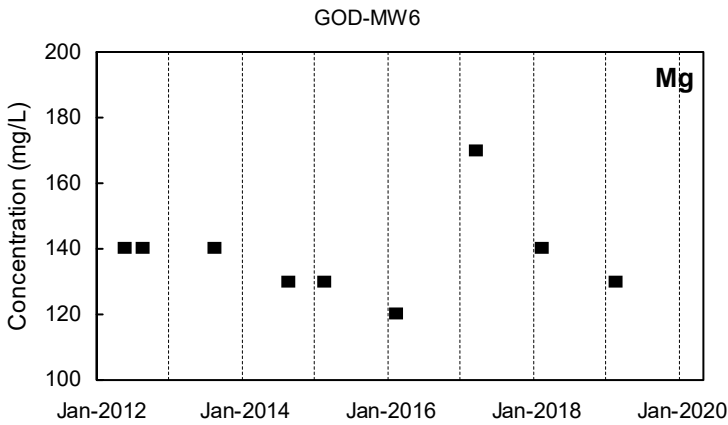
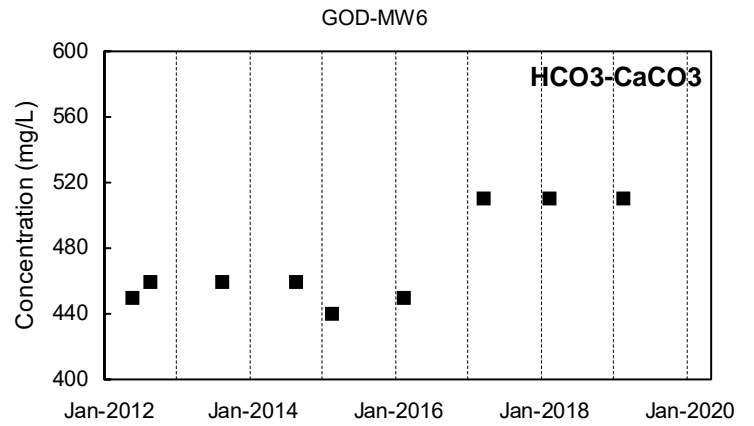
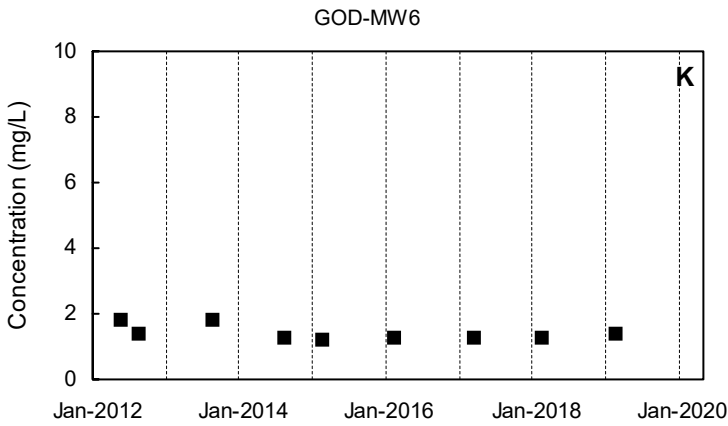
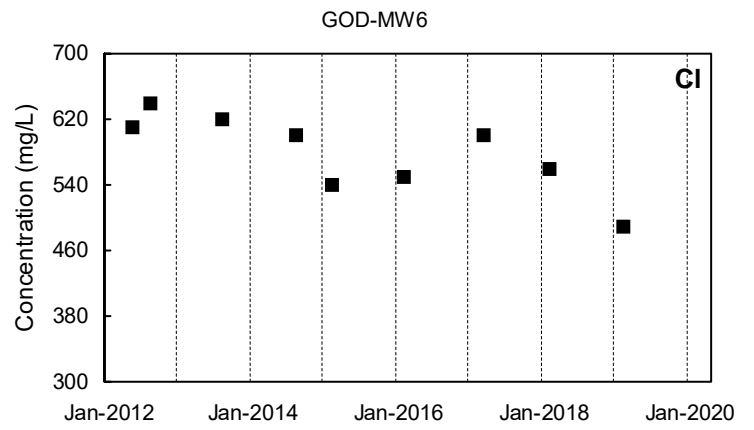
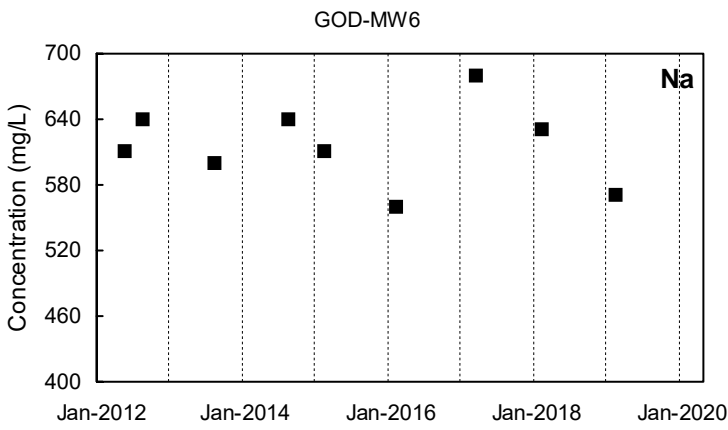

Detected Value
 'J'-Flag (value between reporting limit and detection limit)
 Non-Detect Range
Shallow Well shown with black symbols
Deep Well shown with orange symbols
"dd" Well shown with blue symbols

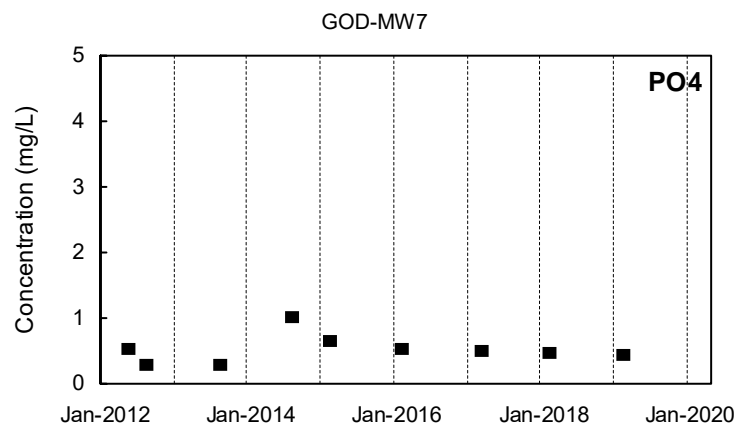
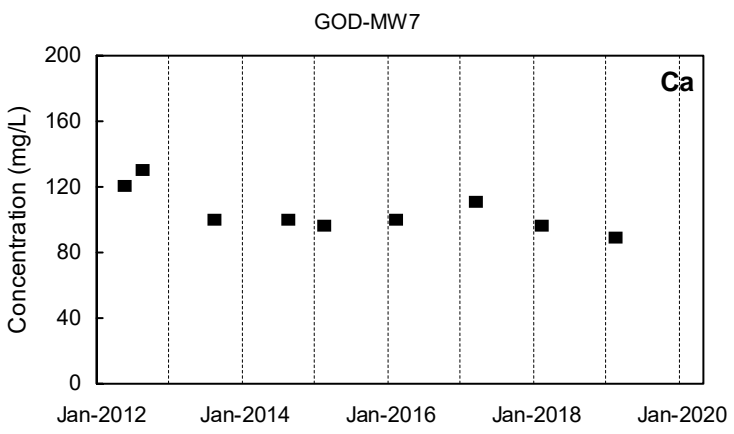
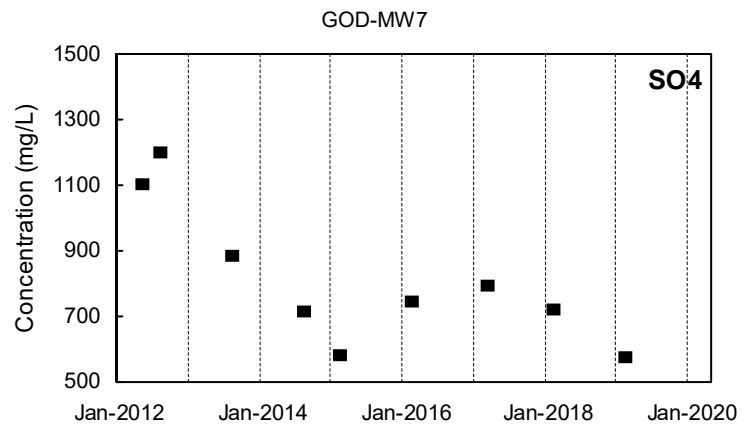
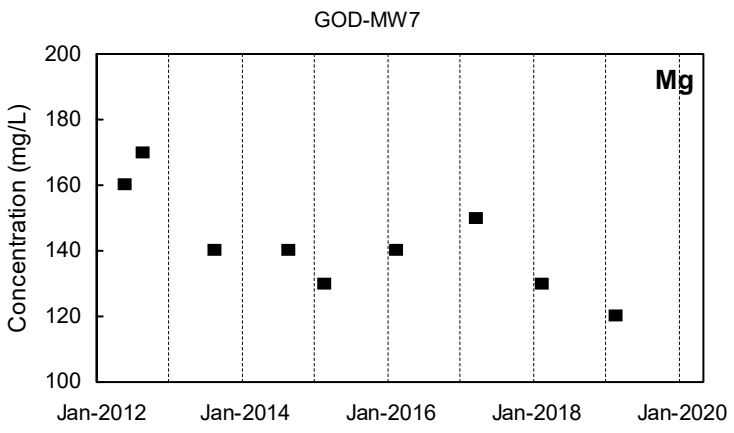
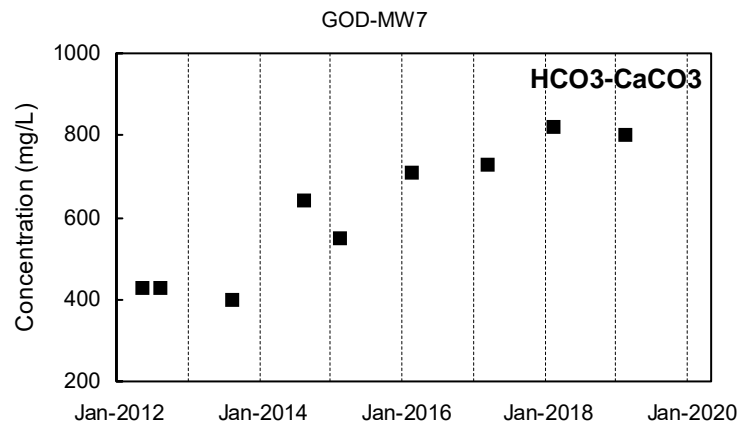
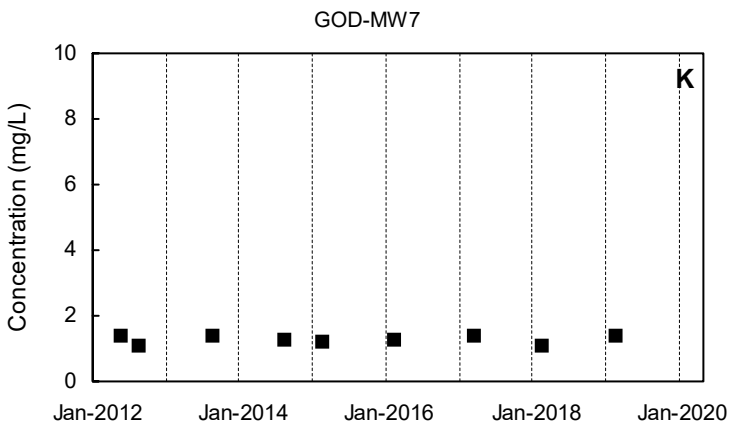
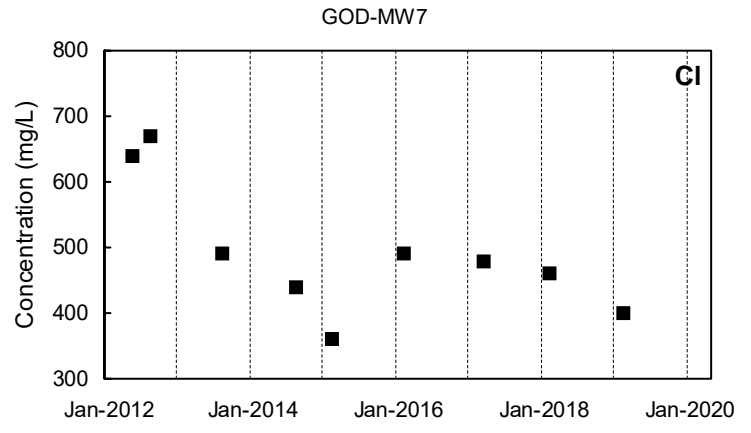
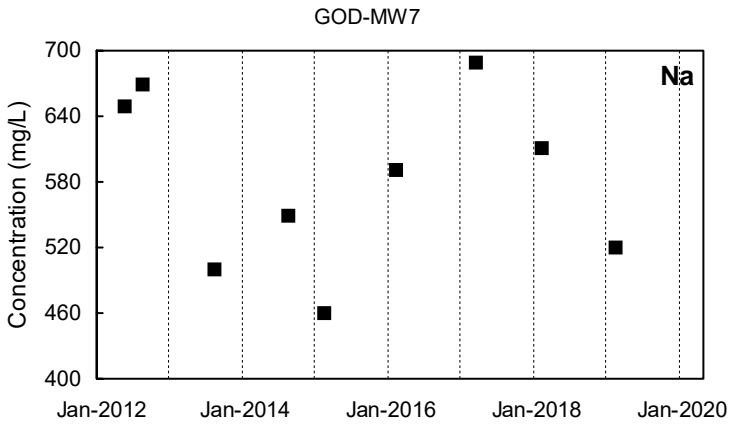

Detected Value
 'J'-Flag (value between reporting limit and detection limit)
 Non-Detect Range
 Shallow Well shown with black symbols
 Deep Well shown with orange symbols
 "dd" Well shown with blue symbols

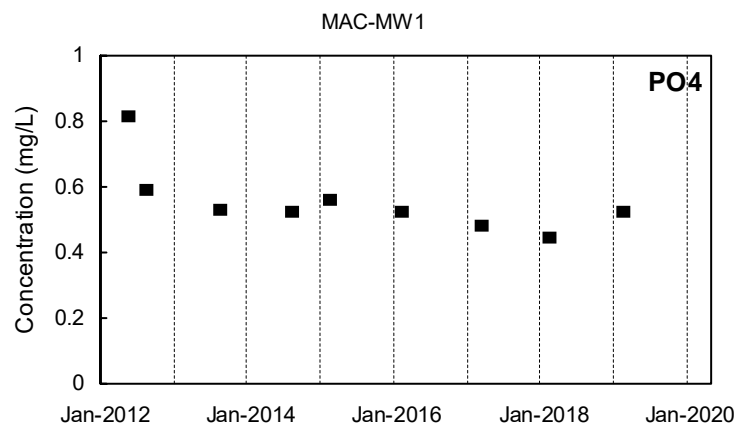
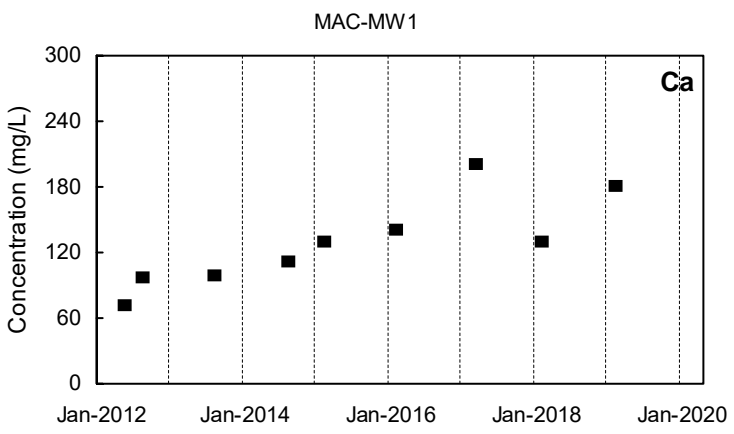
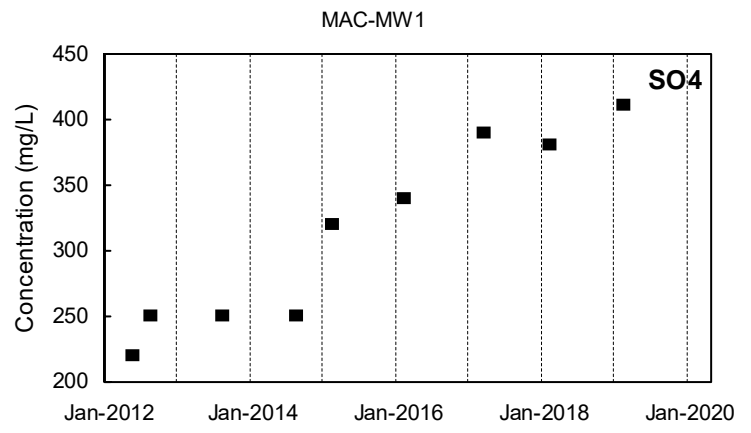
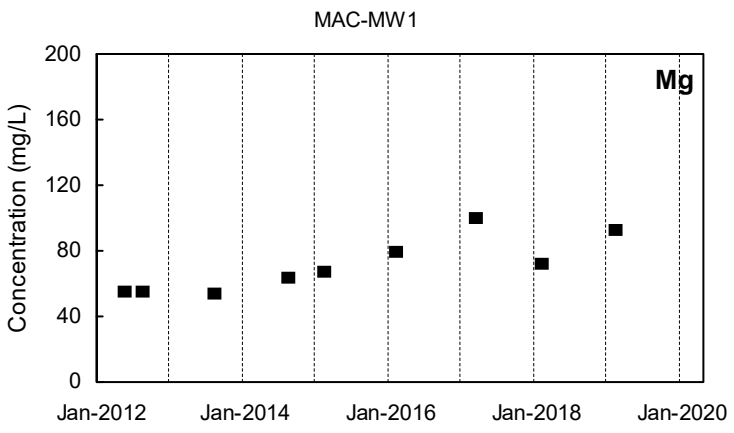
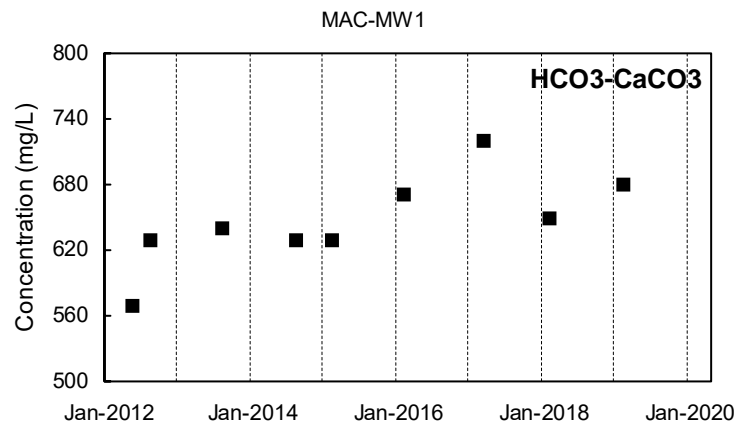
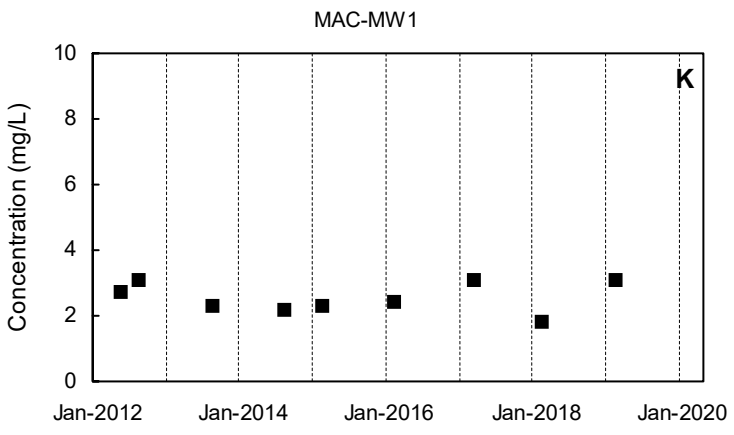
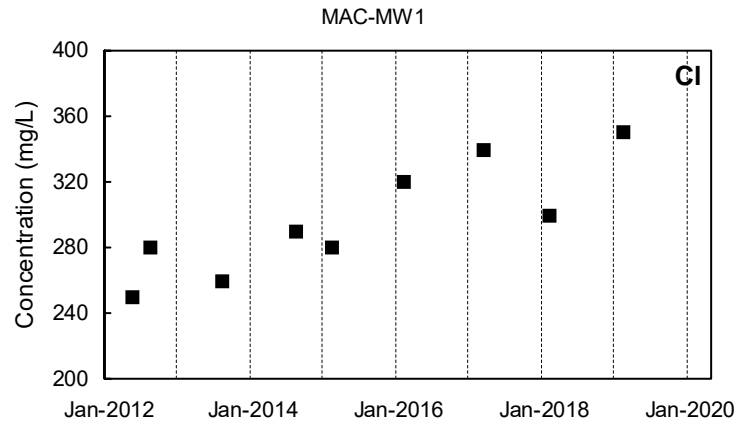
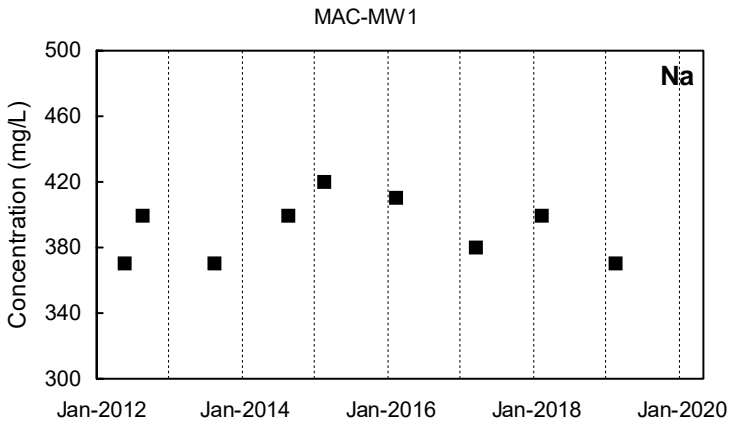

Detected Value
 'J'-Flag (value between reporting limit and detection limit)
 Non-Detect Range
 Shallow Well shown with black symbols
 Deep Well shown with orange symbols
 "dd" Well shown with blue symbols

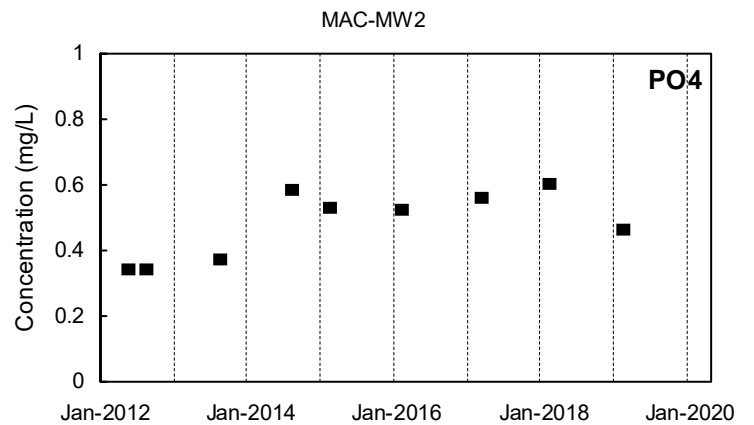
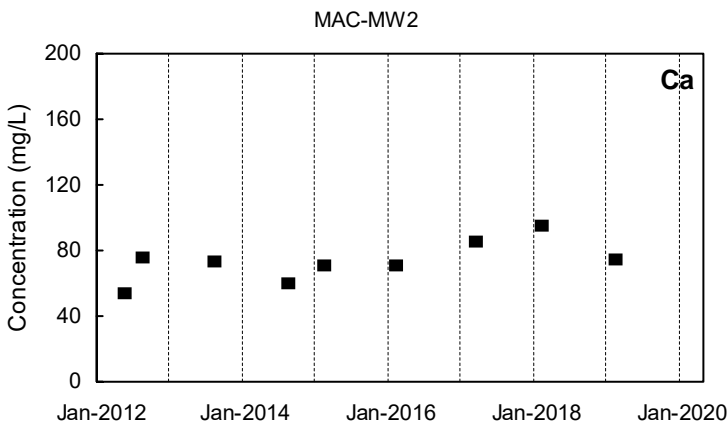
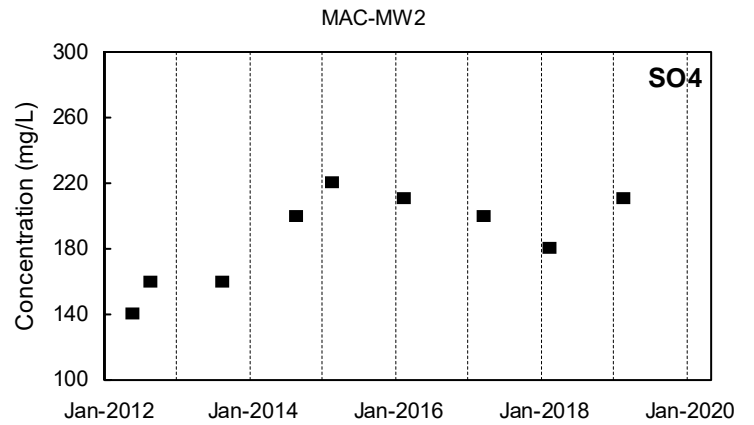
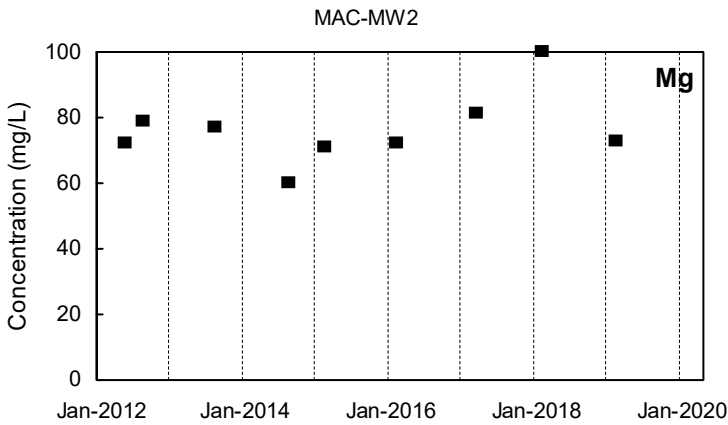
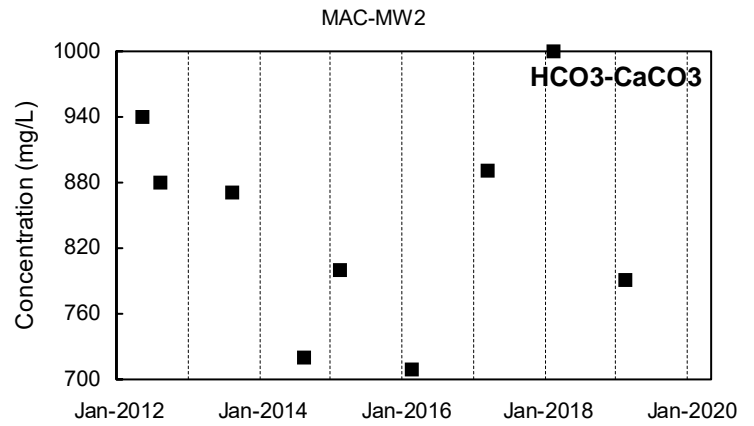
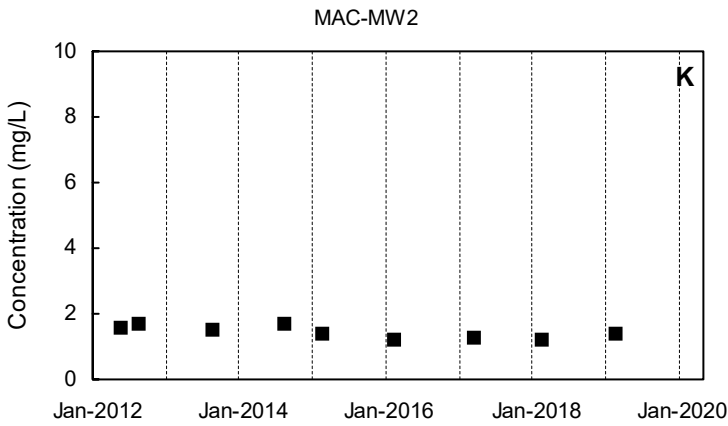
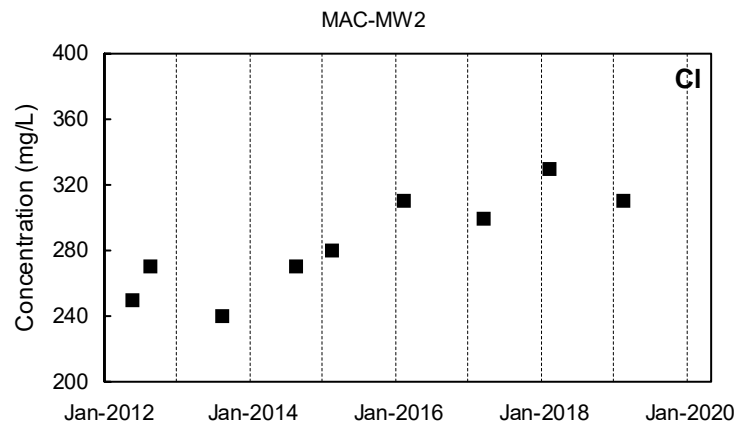
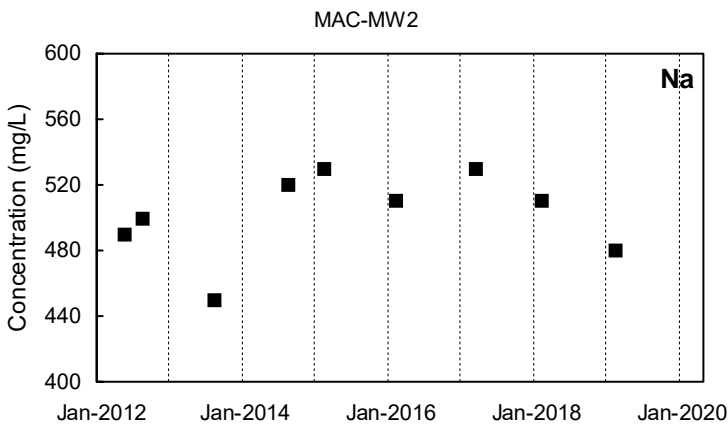

Detected Value
 'J'-Flag (value between reporting limit and detection limit)
 Non-Detect Range
 Shallow Well shown with black symbols
 Deep Well shown with orange symbols
 "dd" Well shown with blue symbols

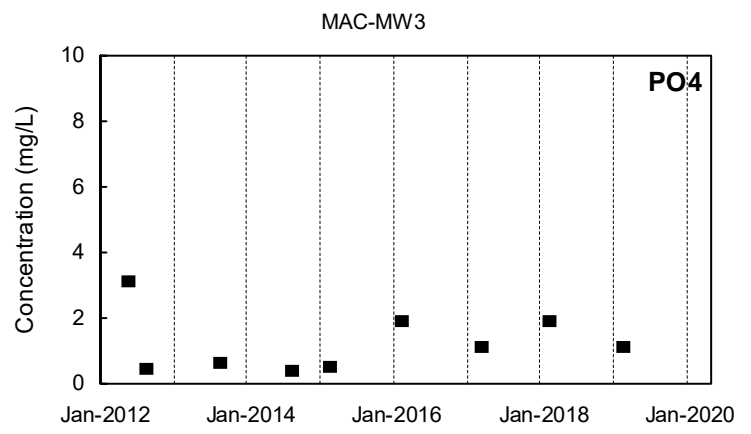
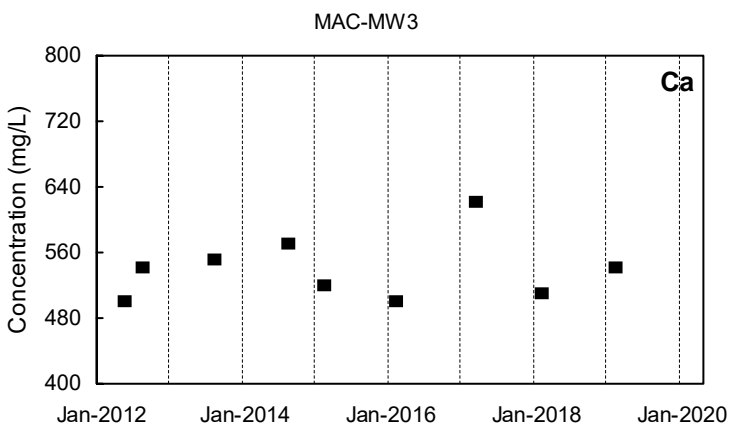
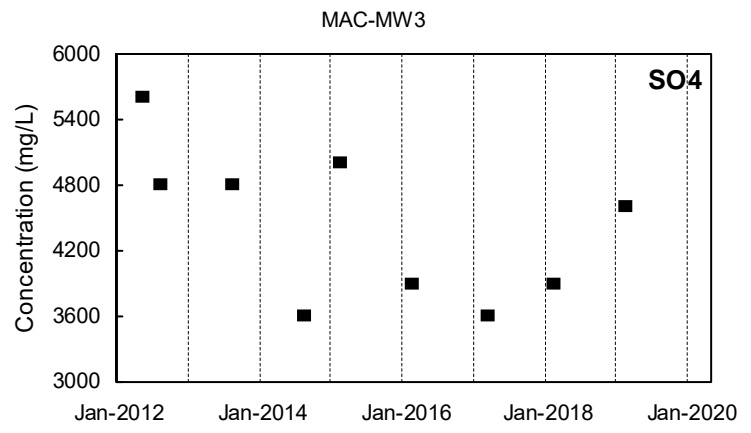
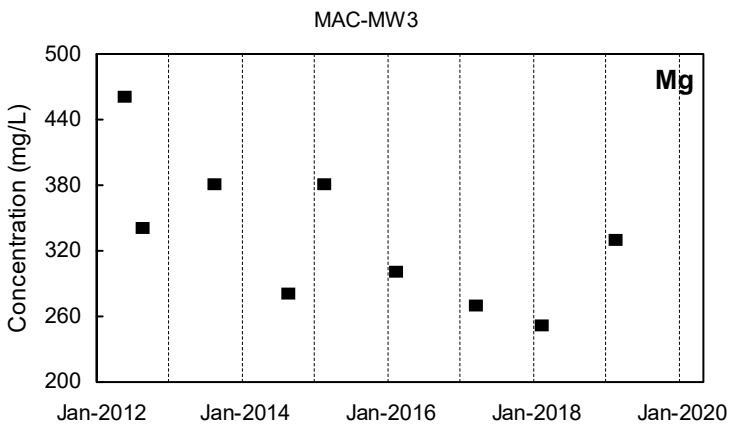
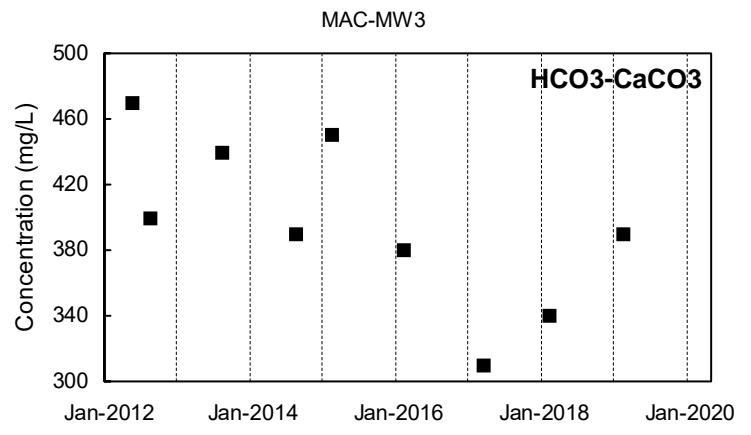
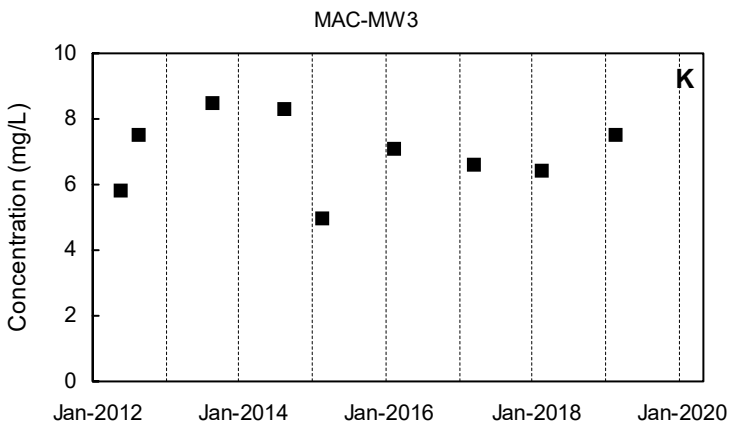
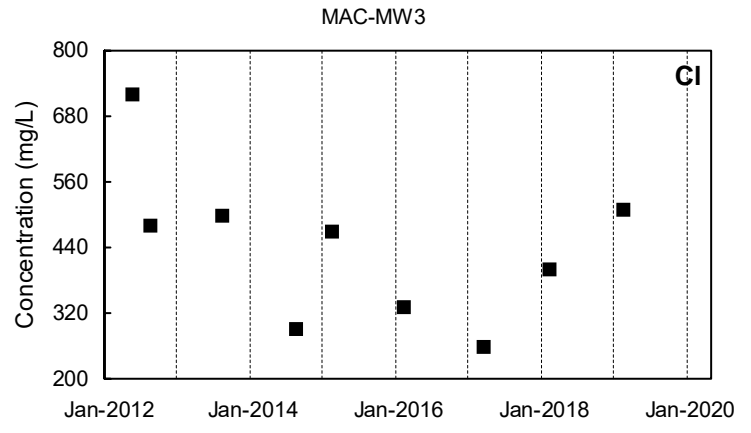
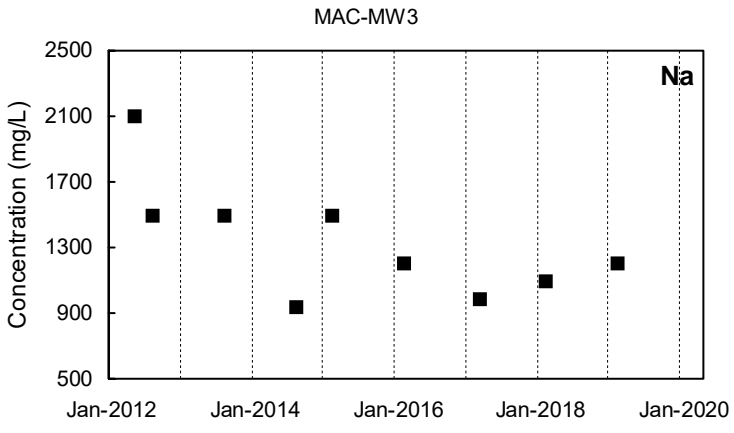

Detected Value
 'J'-Flag (value between reporting limit and detection limit)
 Non-Detect Range
 Shallow Well shown with black symbols
 Deep Well shown with orange symbols
 "dd" Well shown with blue symbols

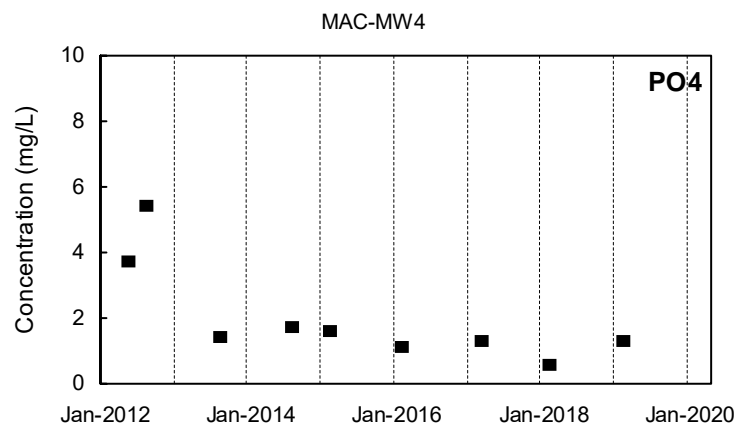
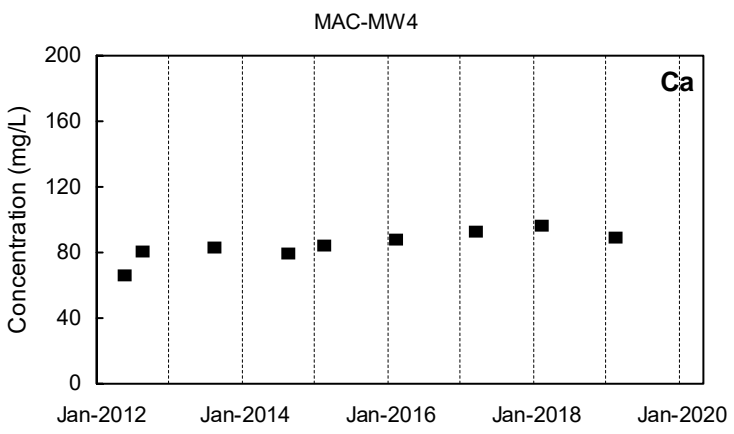
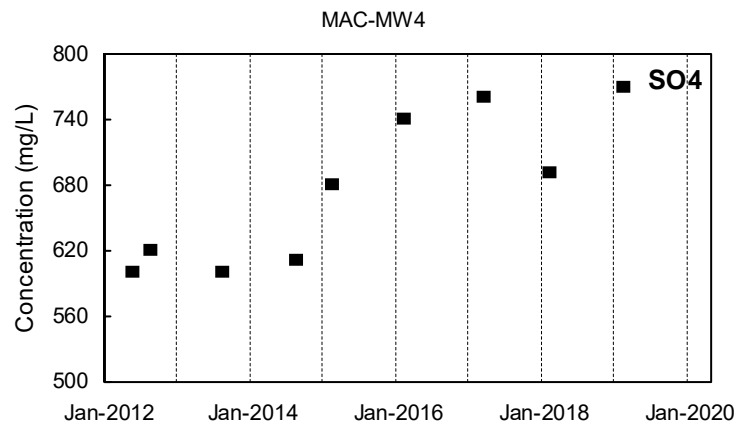
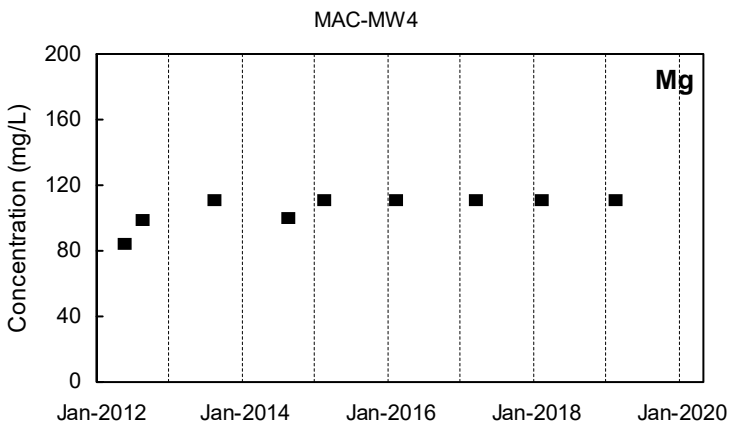
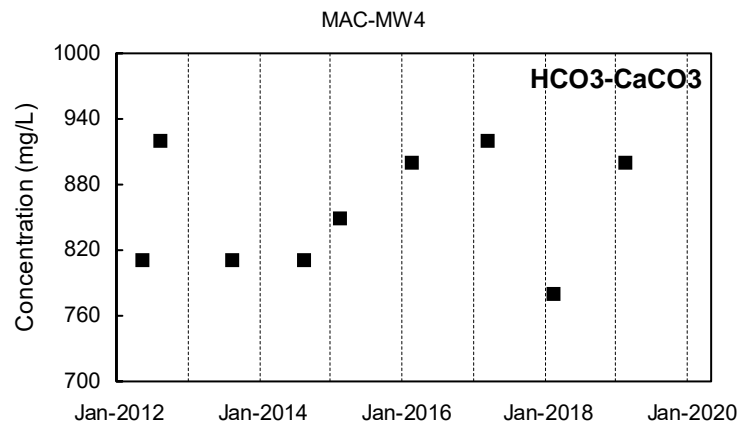
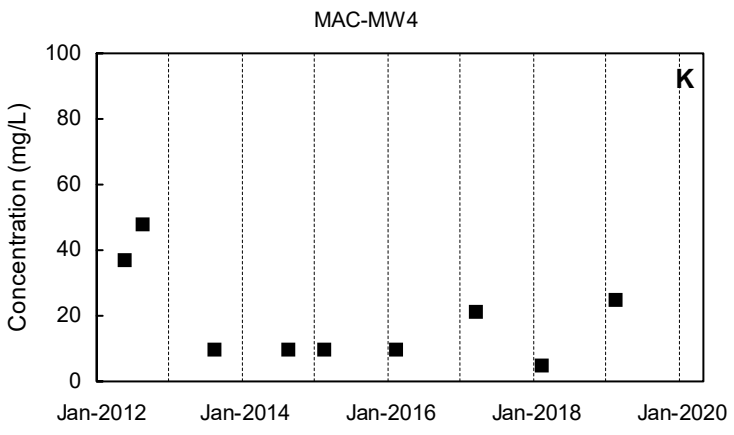
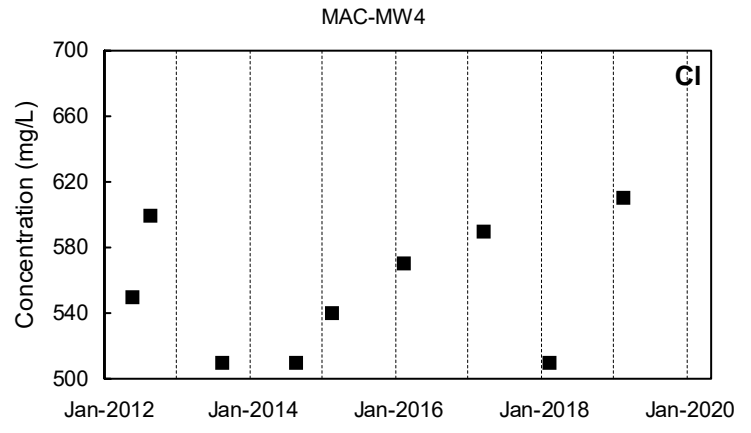
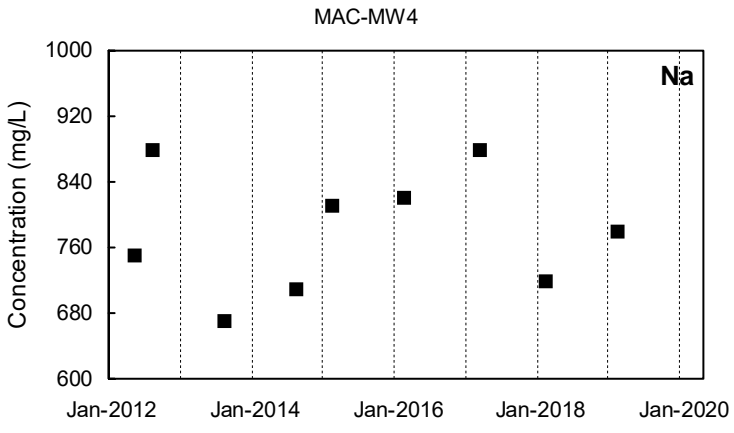

Detected Value
 'J'-Flag (value between reporting limit and detection limit)
 Non-Detect Range
 Shallow Well shown with black symbols
 Deep Well shown with orange symbols
 "dd" Well shown with blue symbols

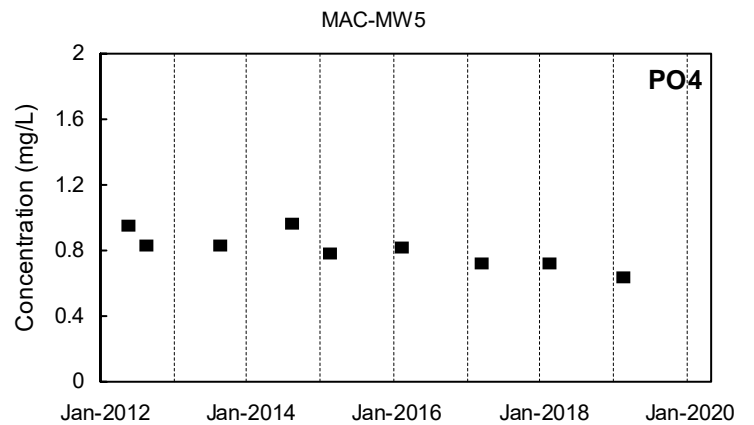
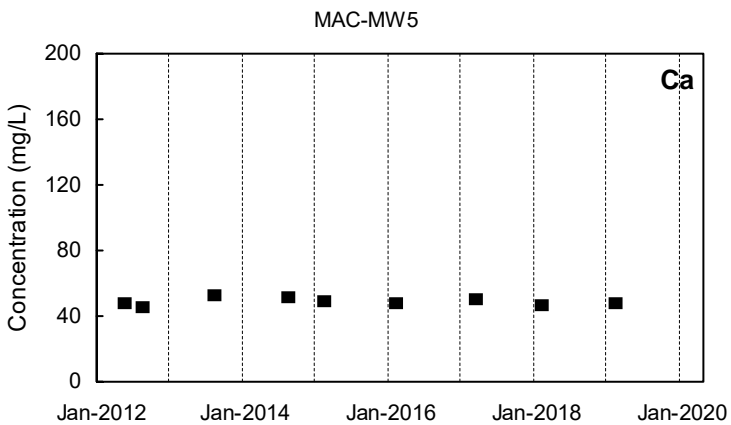
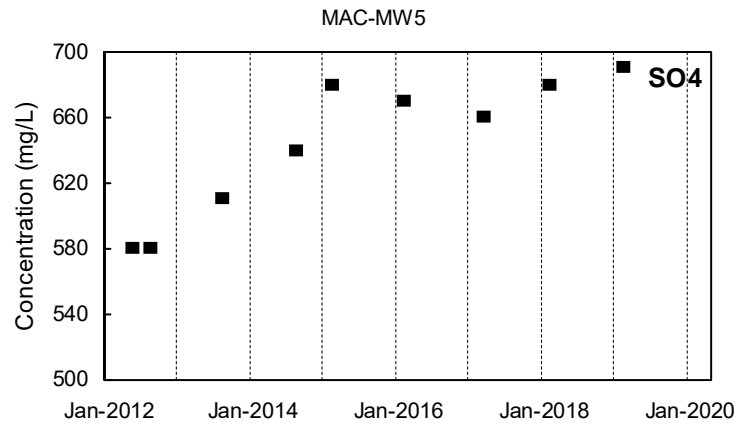
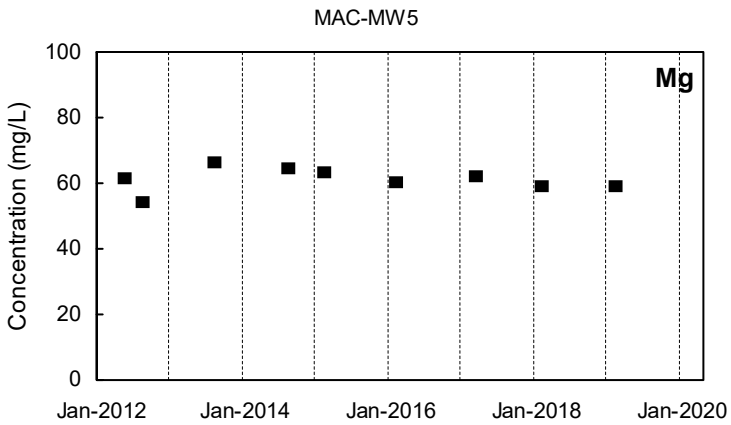
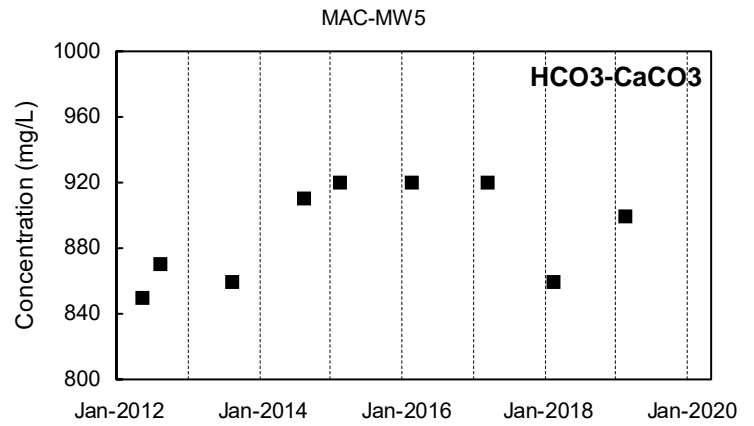
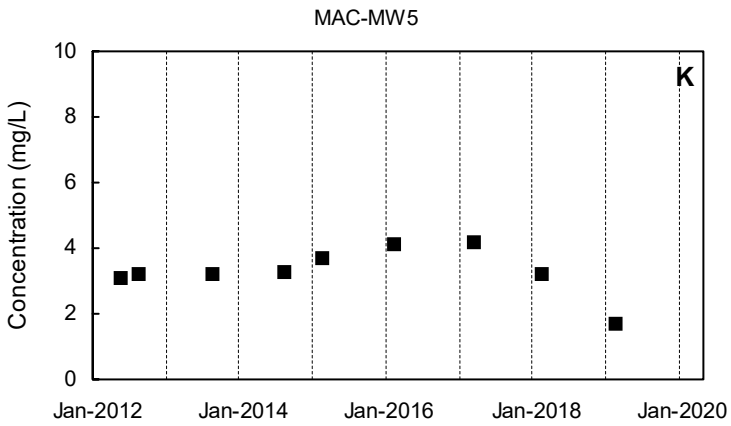
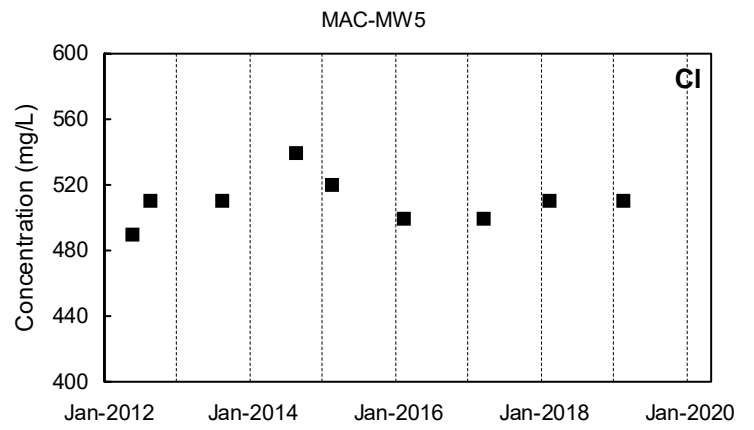
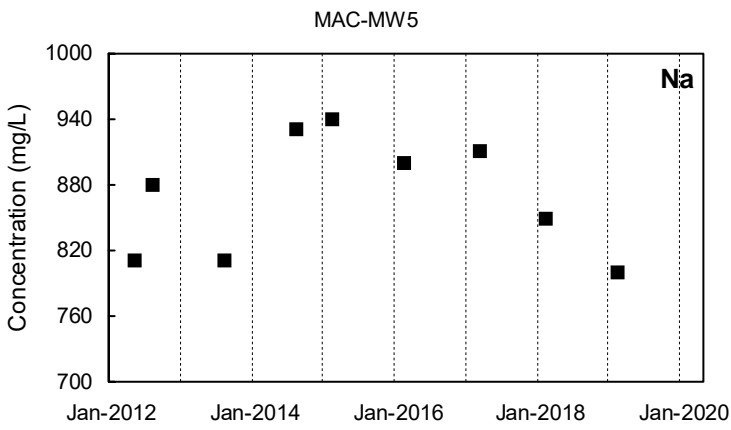

■ Detected Value □ 'J'-Flag (value between reporting limit and detection limit) ■ Non-Detect Range
 Shallow Well shown with black symbols Deep Well shown with orange symbols "dd" Well shown with blue symbols

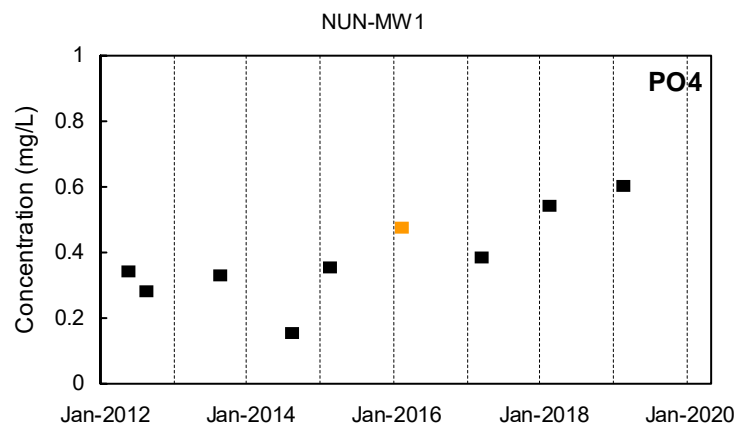
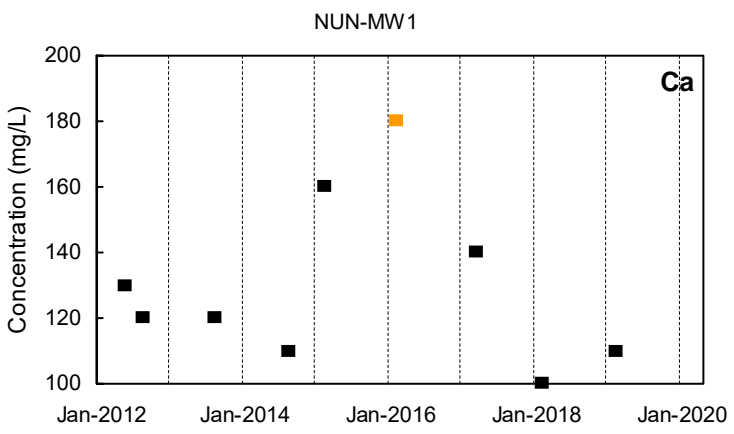
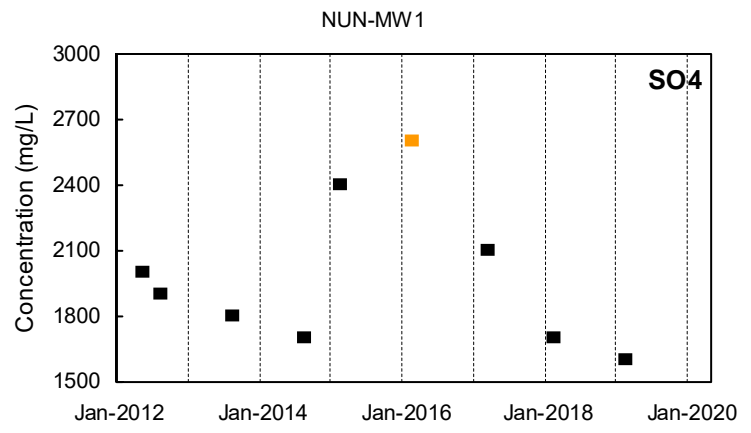
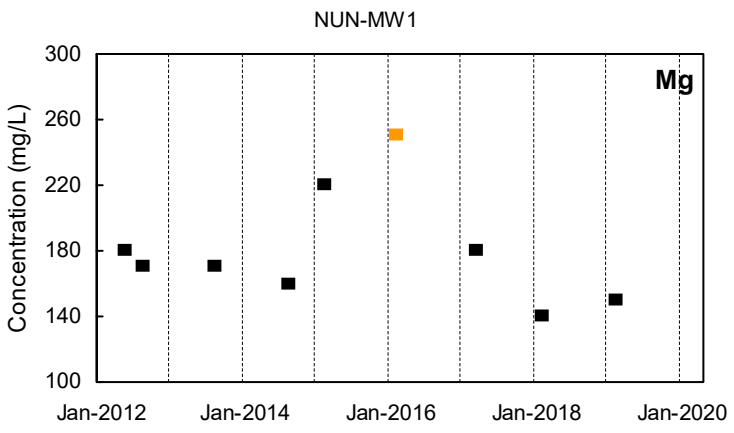
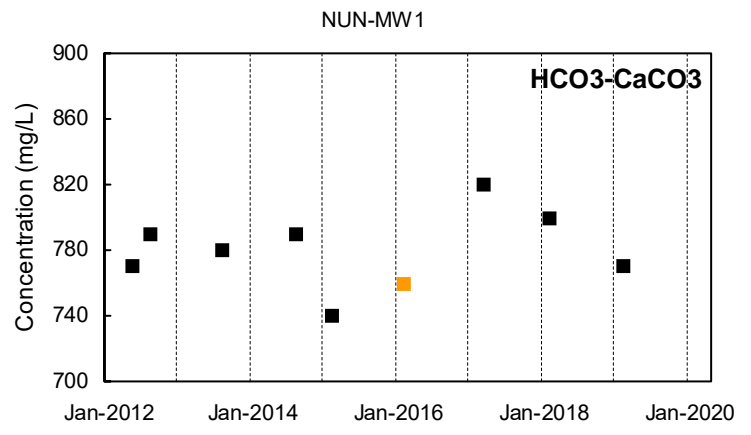
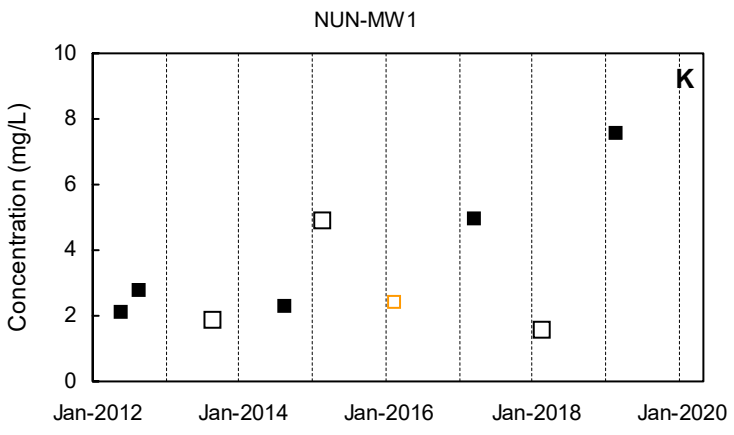
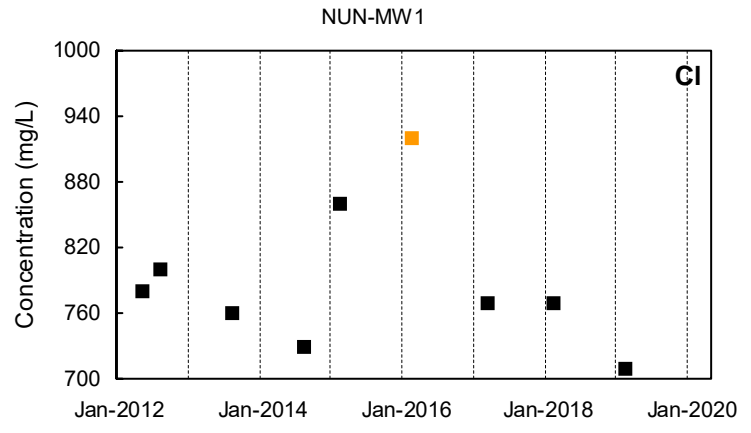
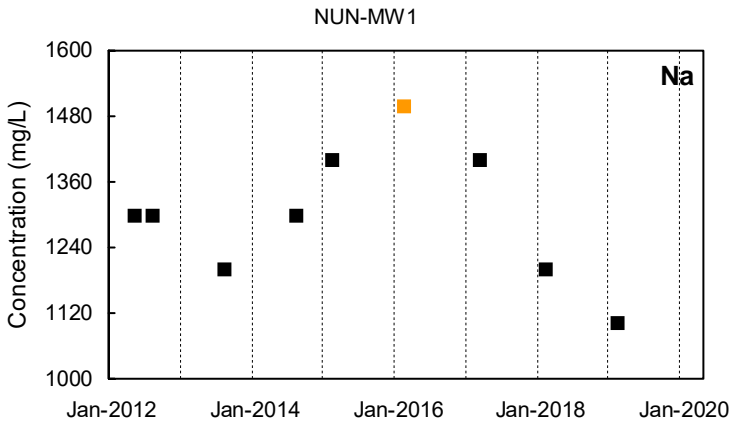

Detected Value
 'J'-Flag (value between reporting limit and detection limit)
 Non-Detect Range
 Shallow Well shown with black symbols
 Deep Well shown with orange symbols
 "dd" Well shown with blue symbols

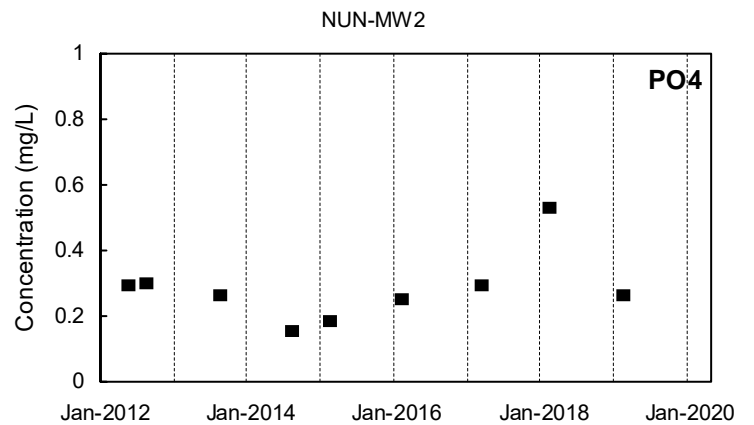
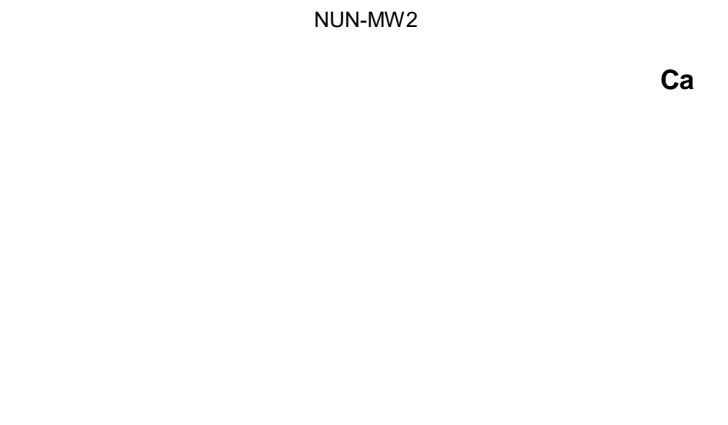
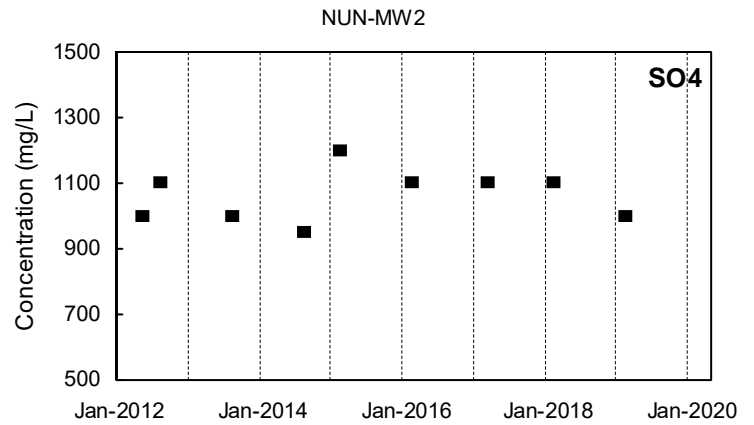
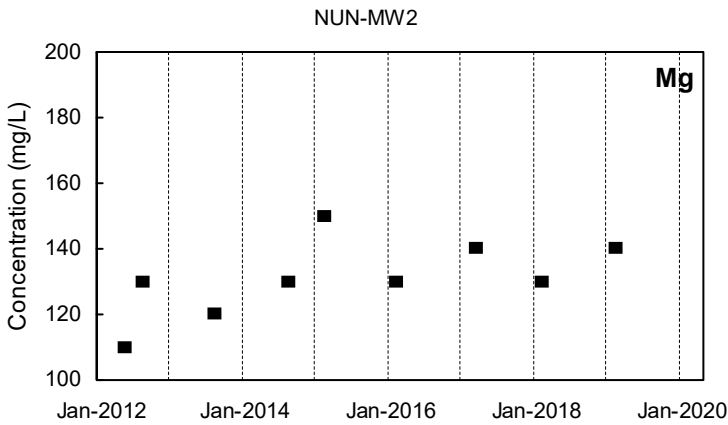
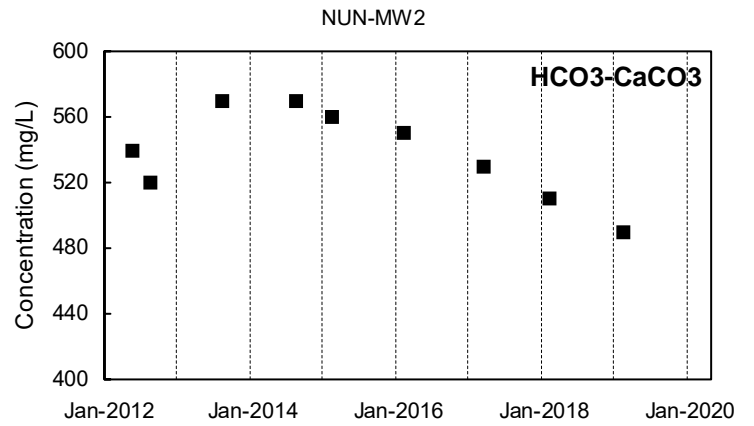
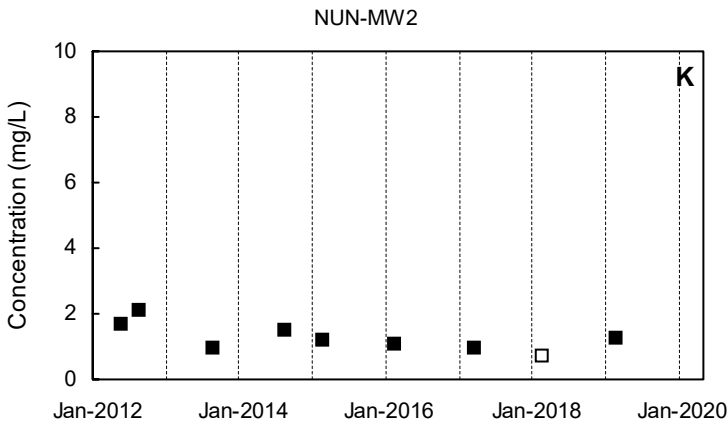
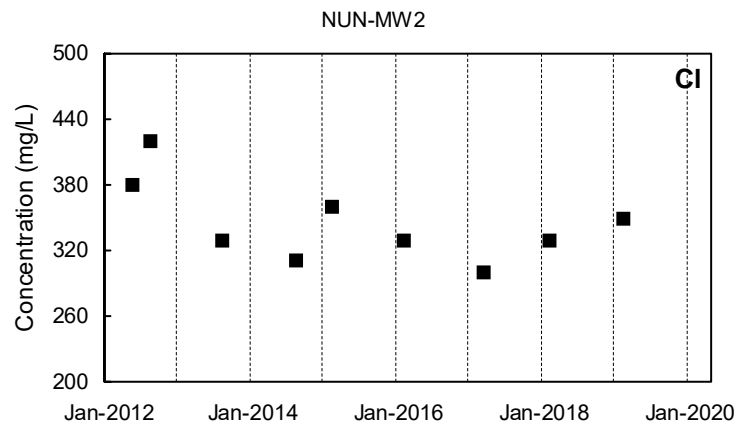
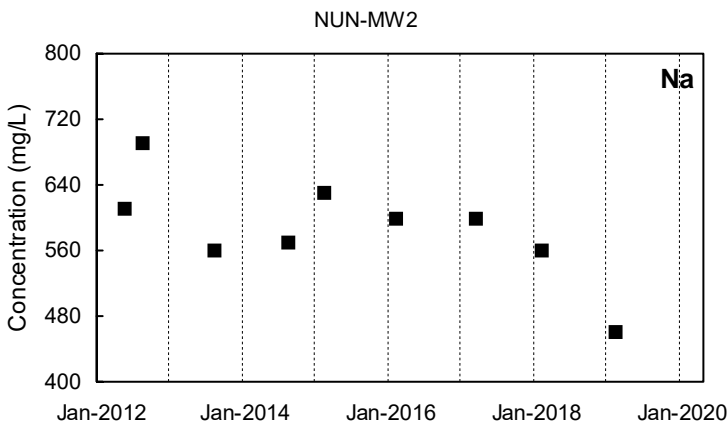

Detected Value
 'J'-Flag (value between reporting limit and detection limit)
 Non-Detect Range
 Shallow Well shown with black symbols Deep Well shown with orange symbols "dd" Well shown with blue symbols

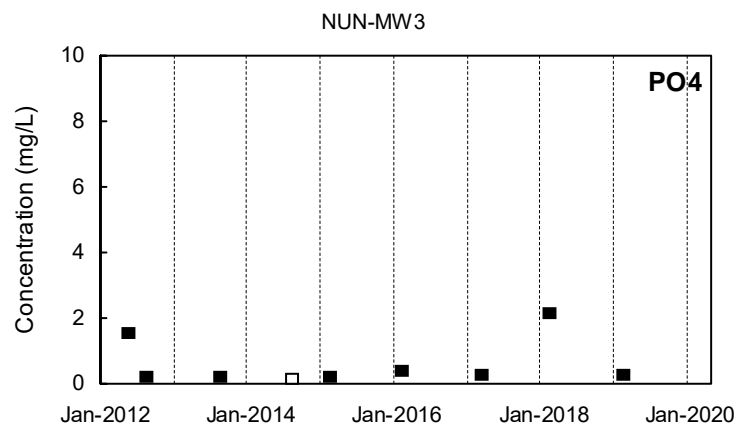
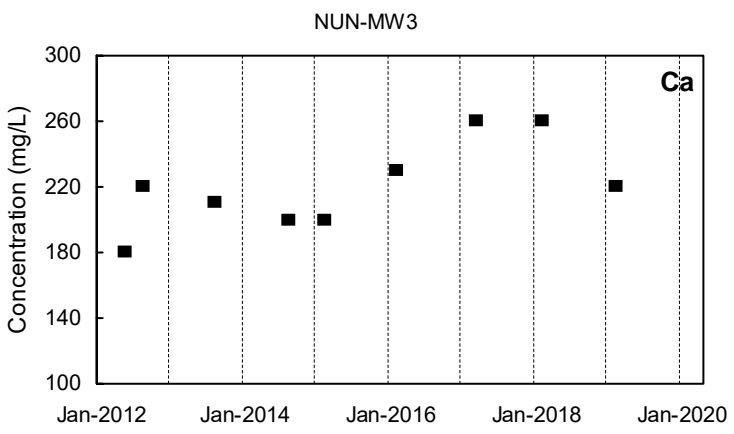
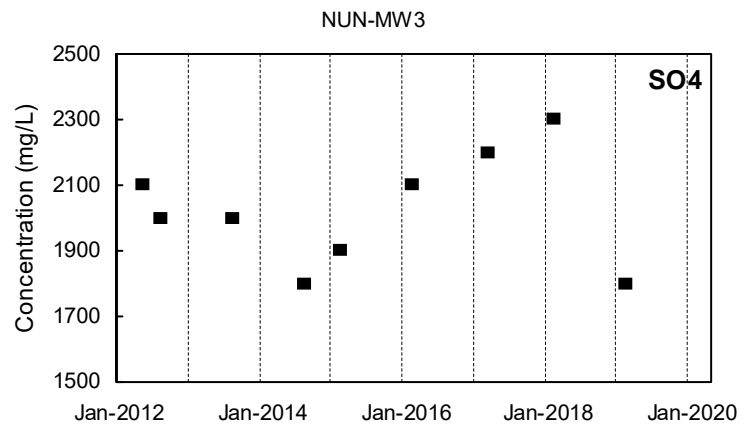
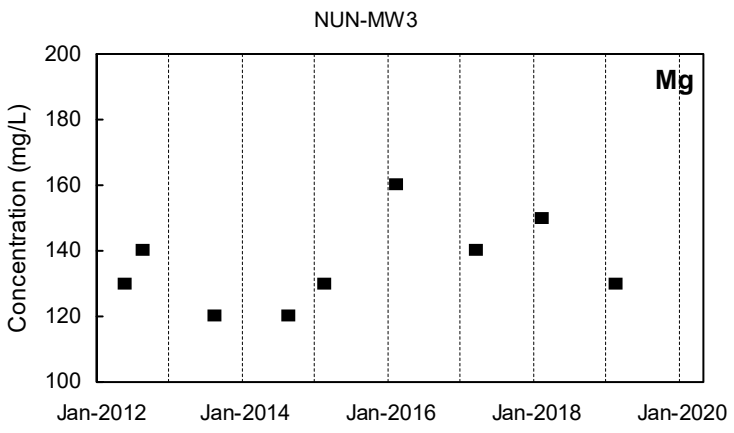
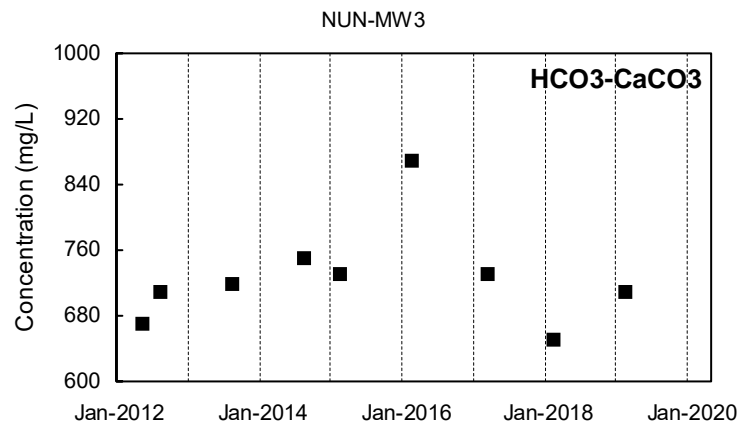
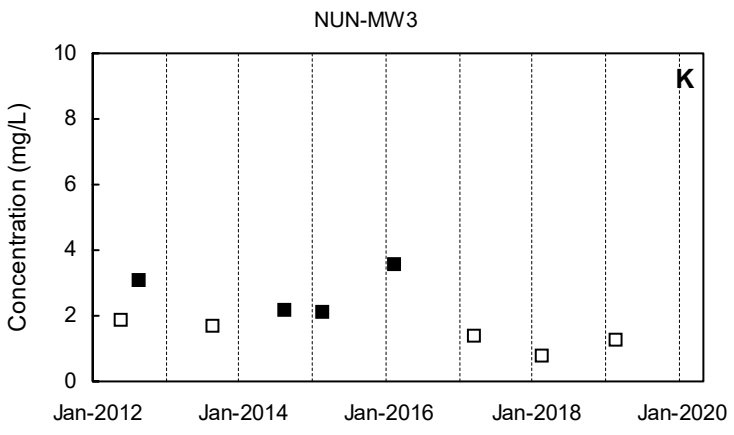
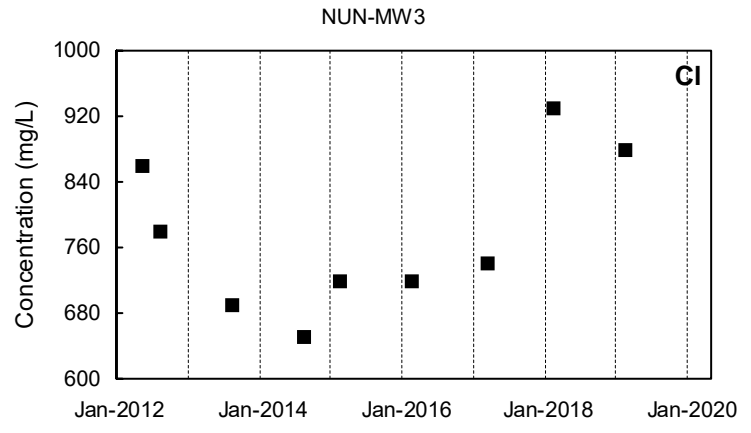
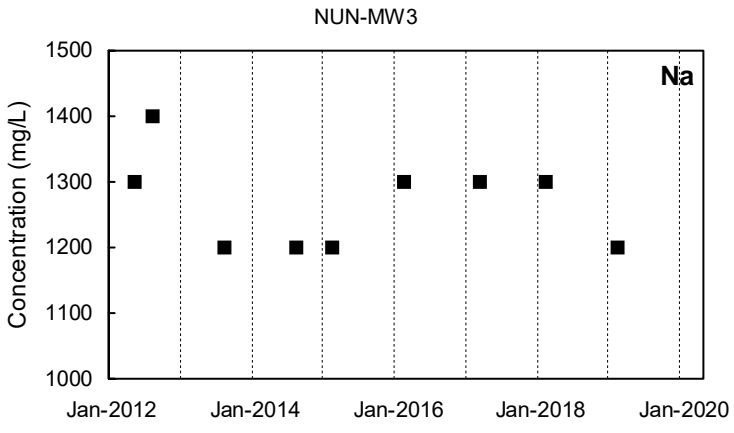

■ Detected Value □ 'J'-Flag (value between reporting limit and detection limit) ■ Non-Detect Range
 Shallow Well shown with black symbols Deep Well shown with orange symbols "dd" Well shown with blue symbols

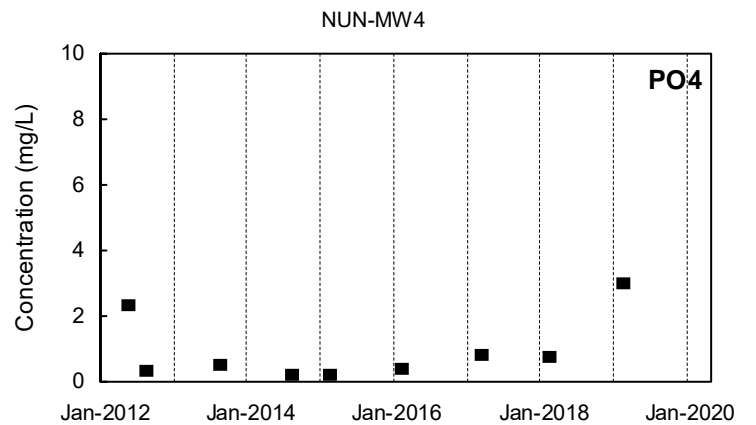
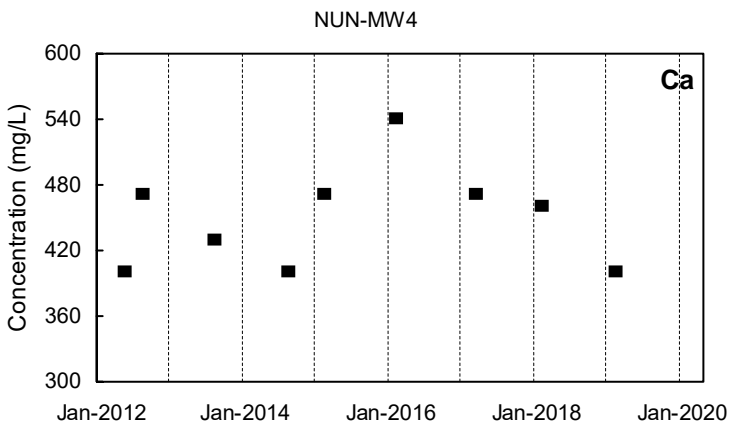
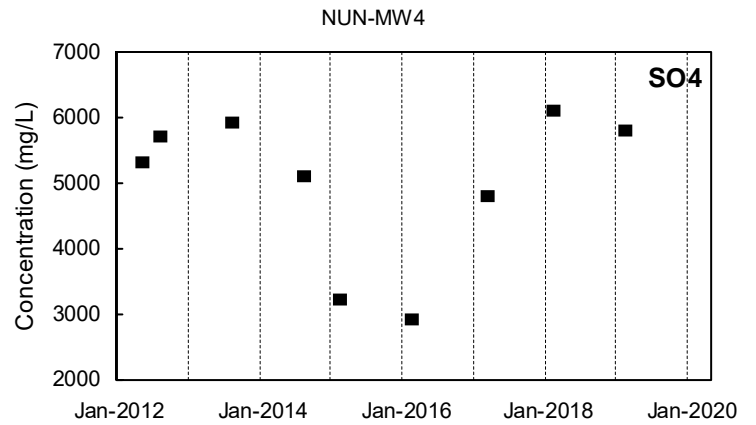
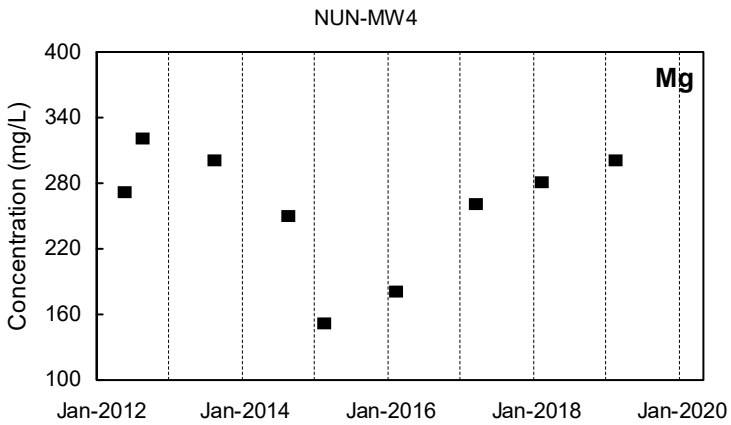
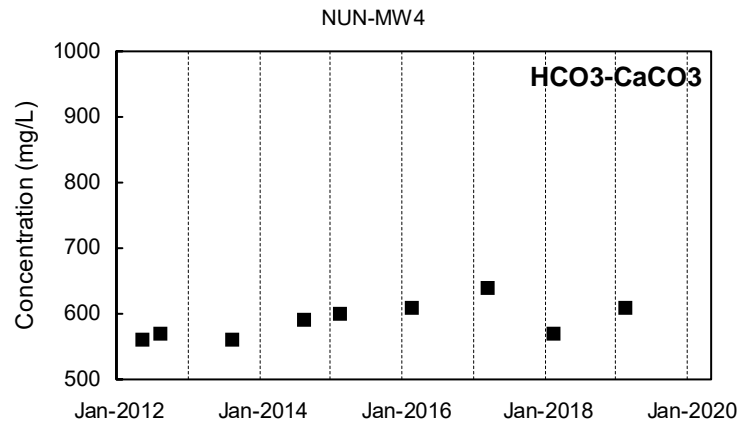
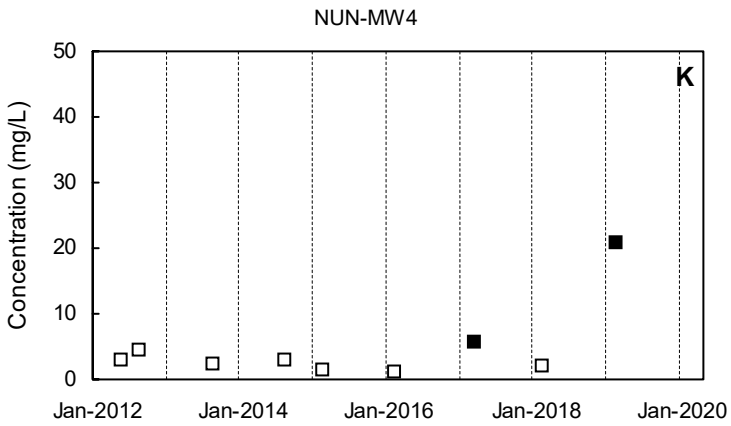
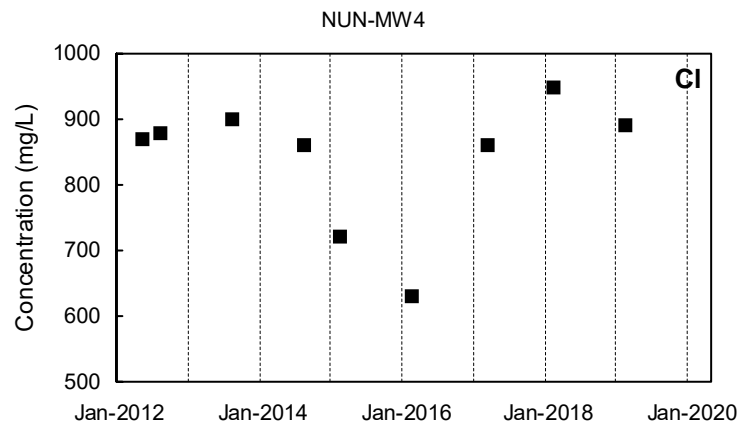
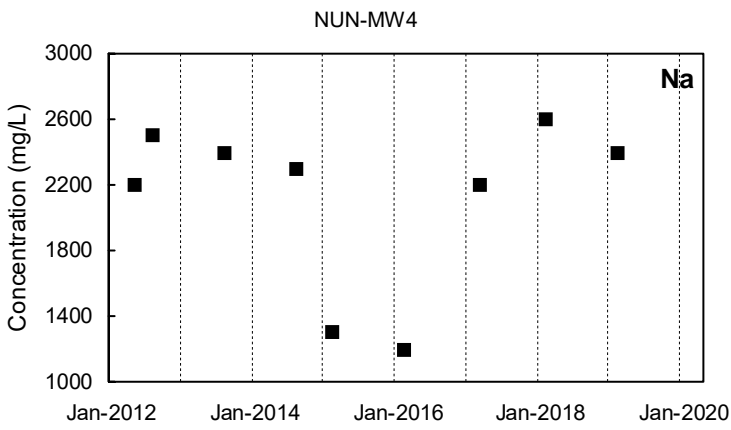

Detected Value
 'J'-Flag (value between reporting limit and detection limit)
 Non-Detect Range
 Shallow Well shown with black symbols Deep Well shown with orange symbols "dd" Well shown with blue symbols

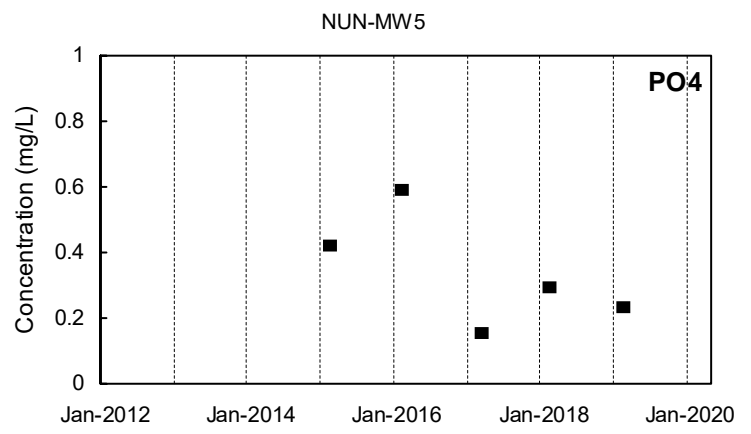
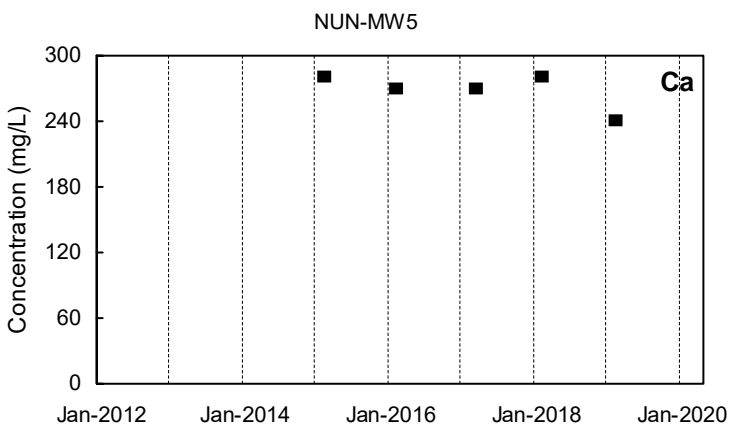
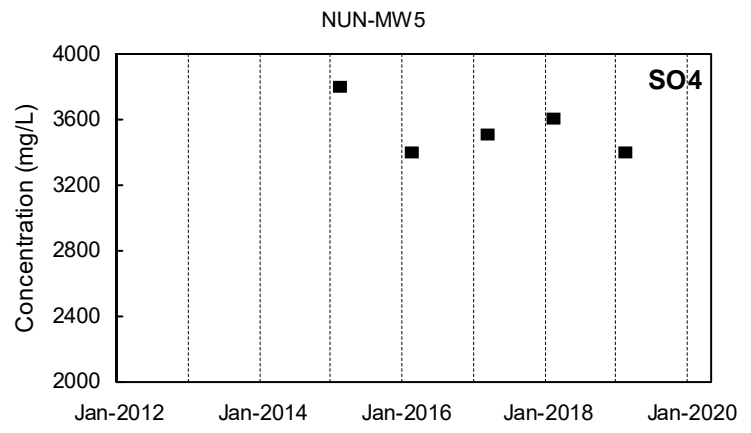
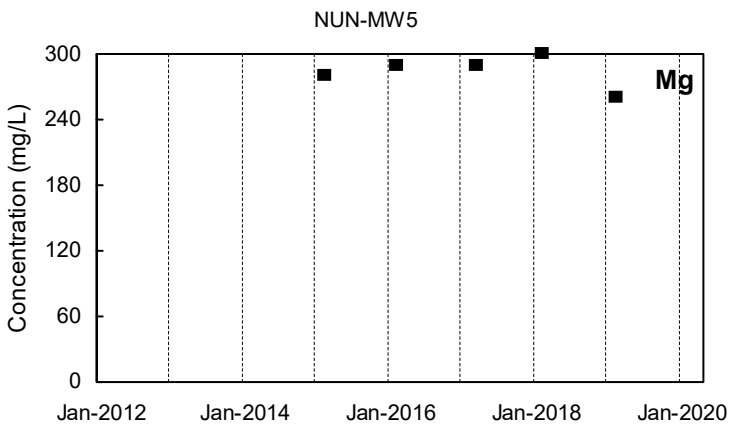
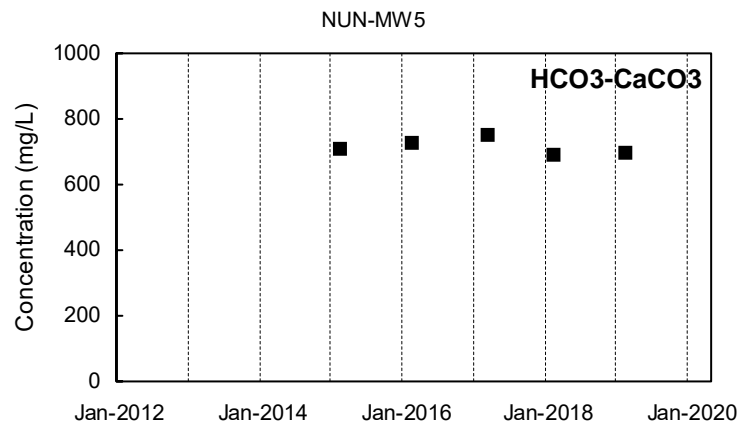
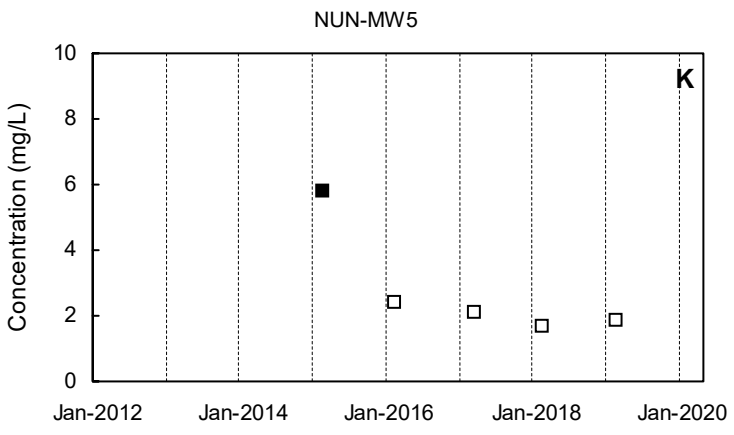
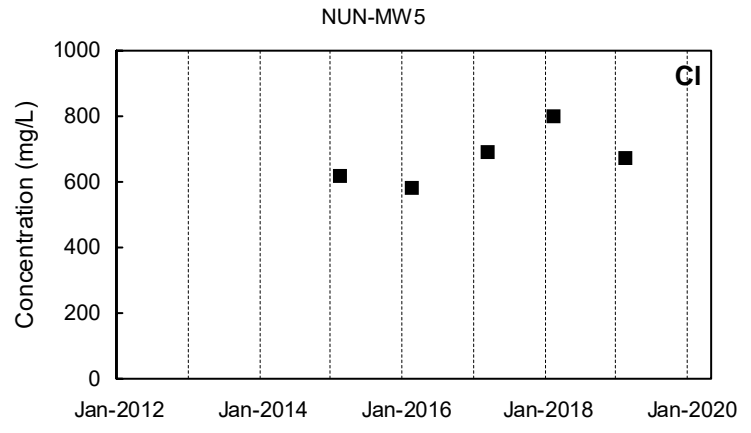
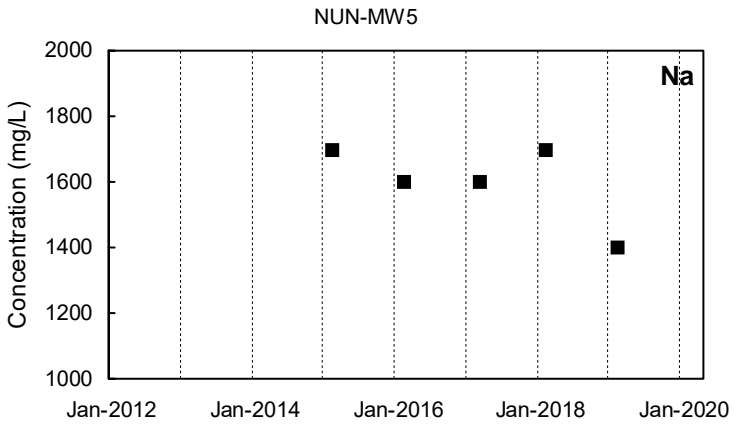

Detected Value
 'J'-Flag (value between reporting limit and detection limit)
 Non-Detect Range
 Shallow Well shown with black symbols Deep Well shown with orange symbols "dd" Well shown with blue symbols

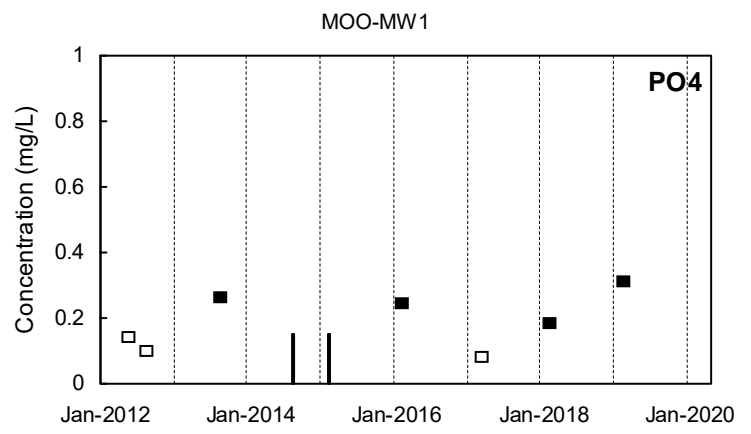
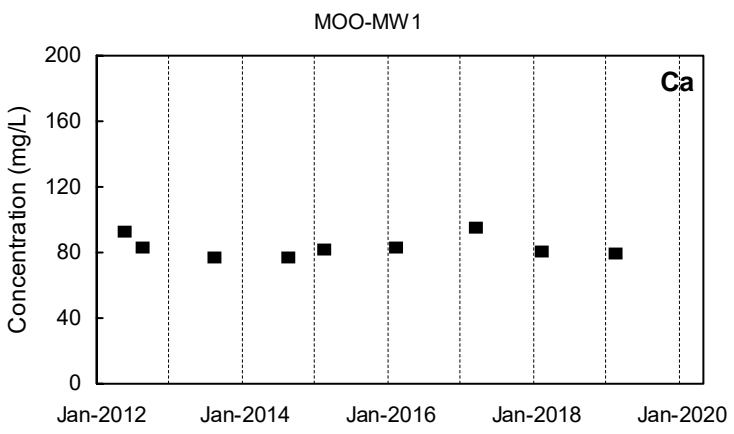
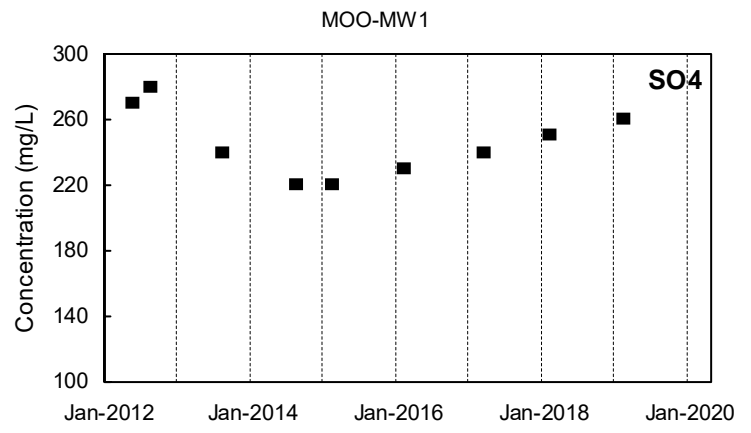
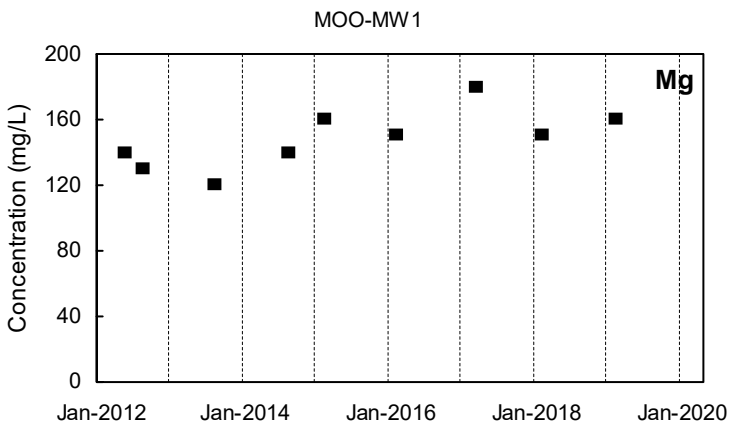
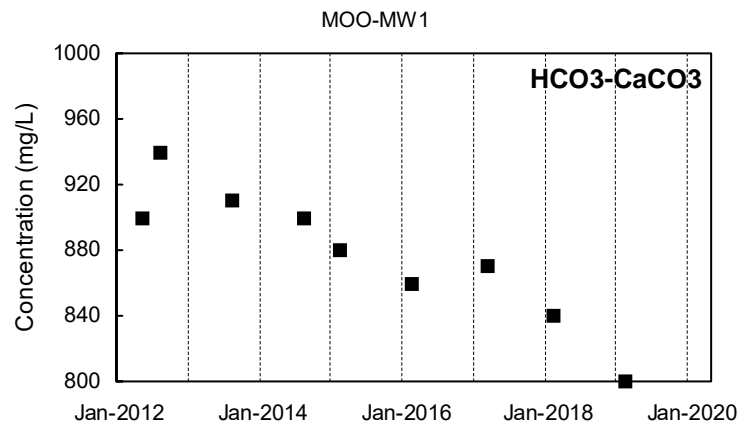
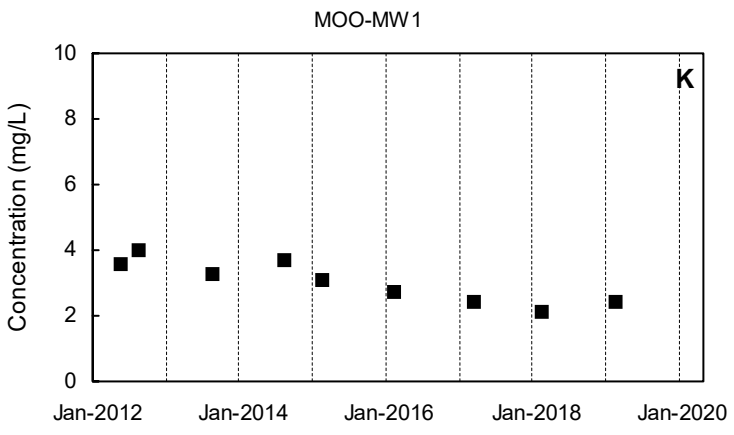
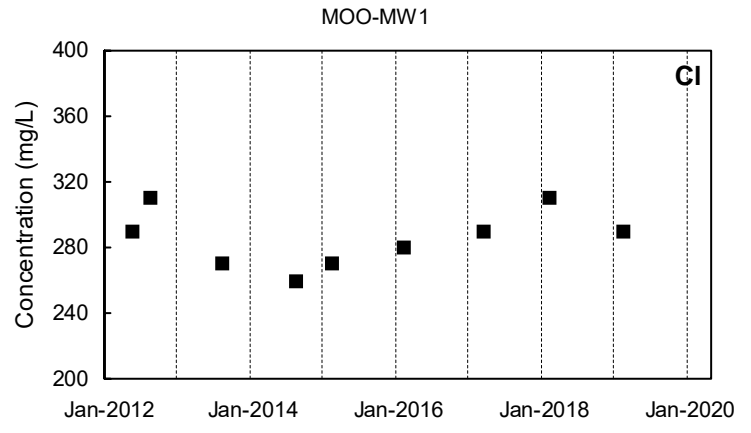
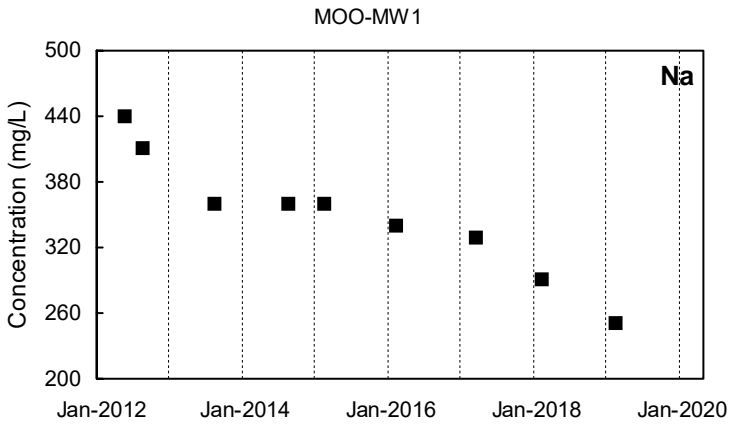

Detected Value
 'J'-Flag (value between reporting limit and detection limit)
 Non-Detect Range
 Shallow Well shown with black symbols
 Deep Well shown with orange symbols
 "dd" Well shown with blue symbols

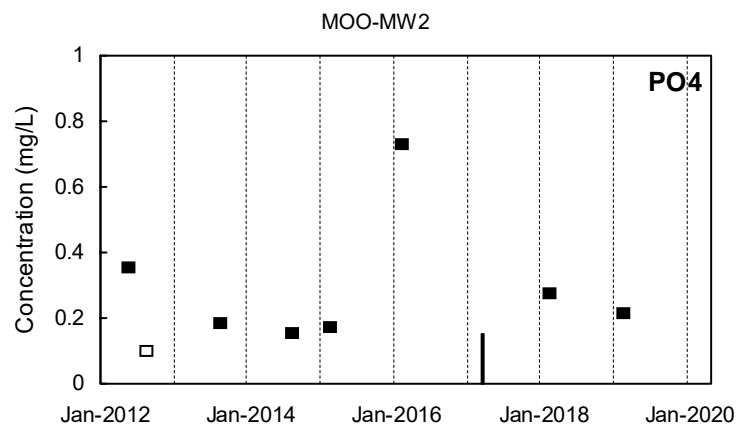
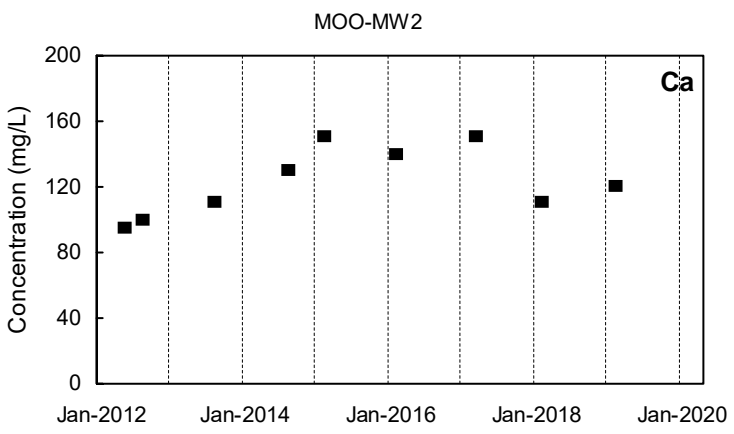
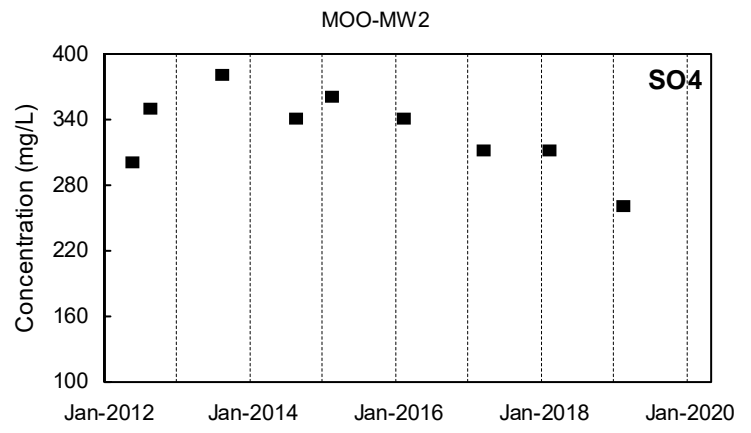
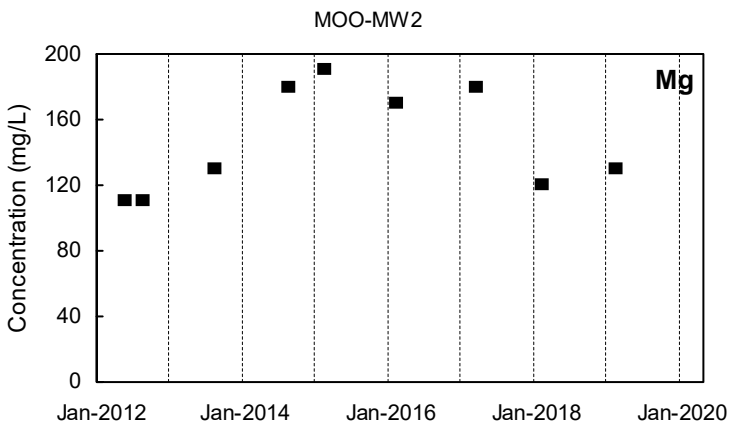
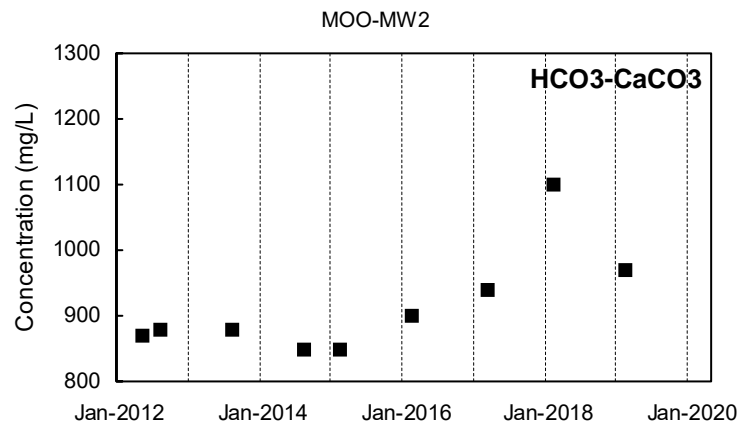
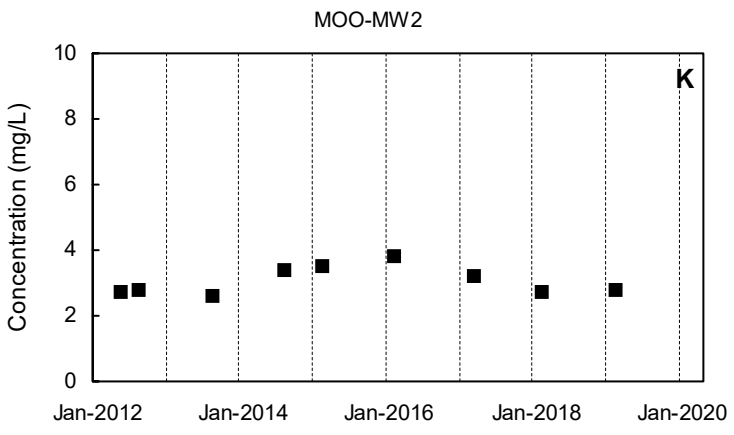
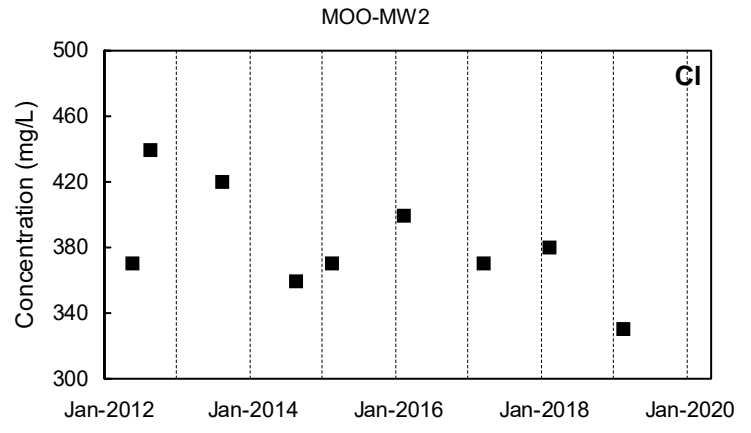
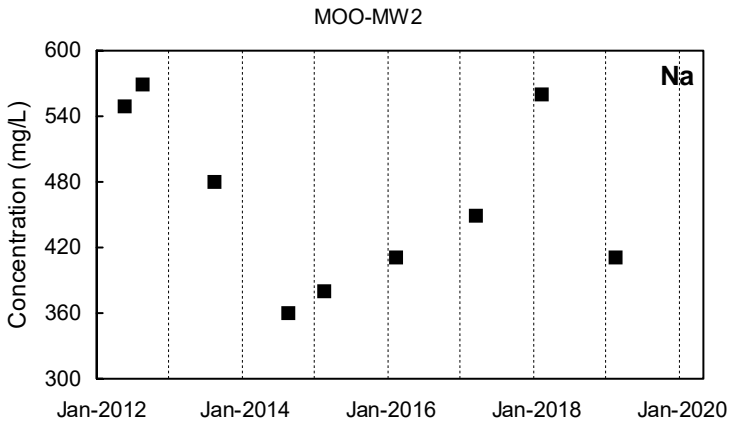

■ Detected Value □ 'J'-Flag (value between reporting limit and detection limit) ■ Non-Detect Range
 Shallow Well shown with black symbols Deep Well shown with orange symbols "dd" Well shown with blue symbols

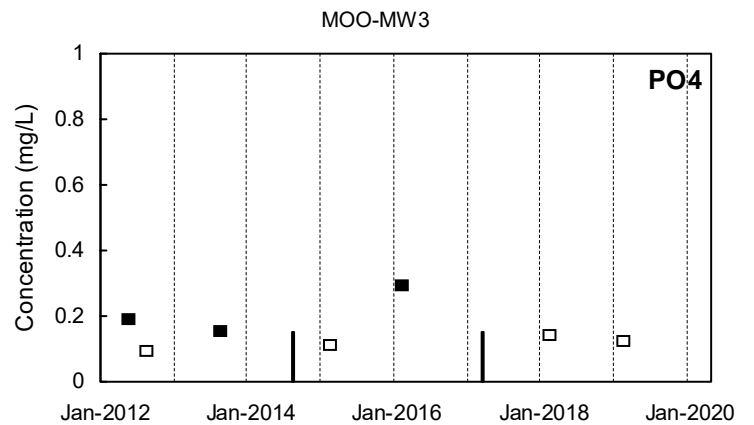
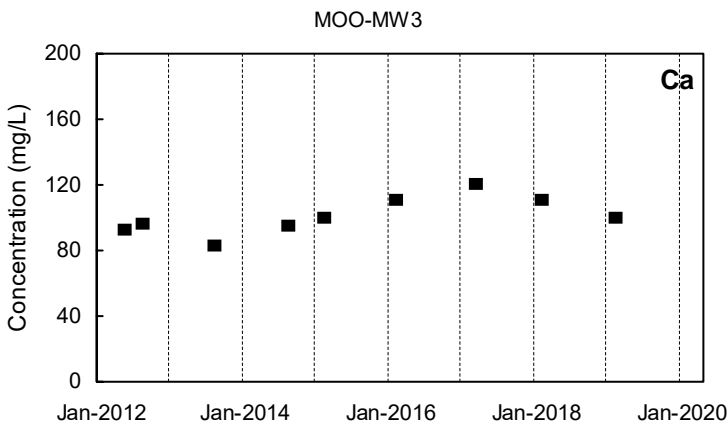
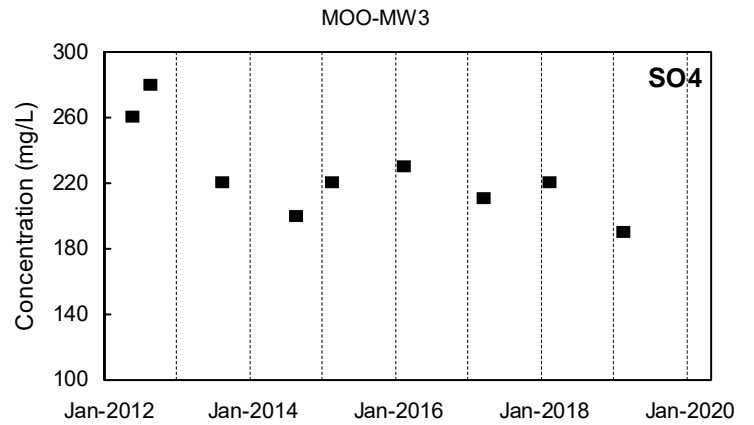
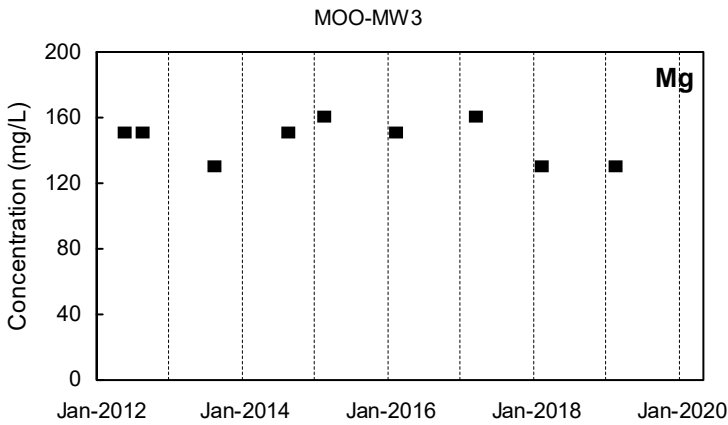
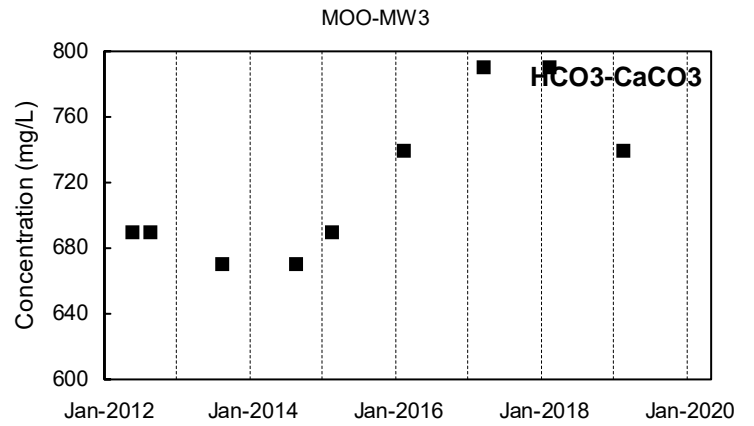
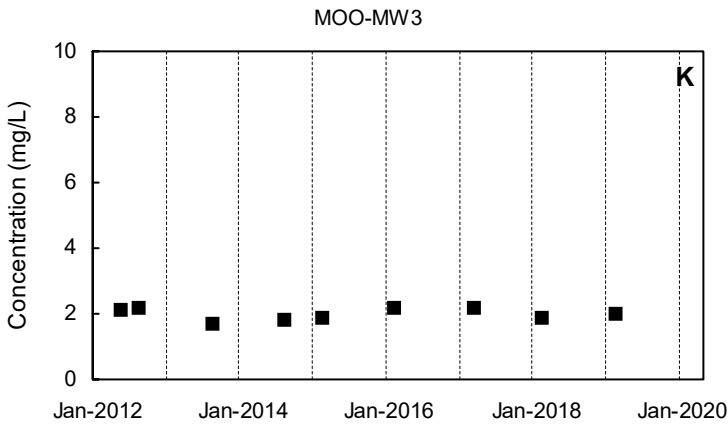
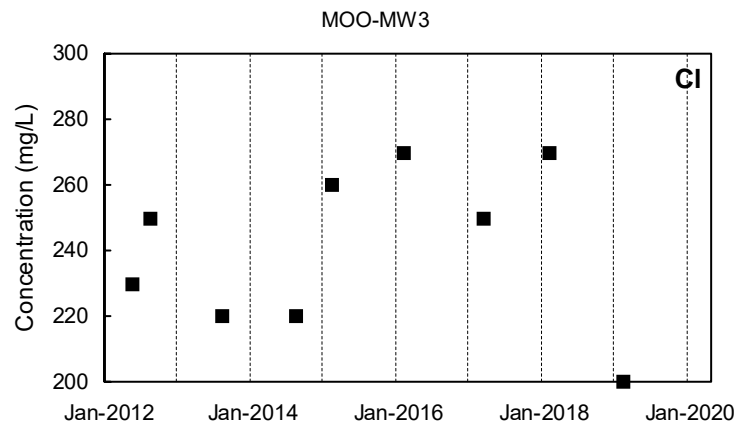
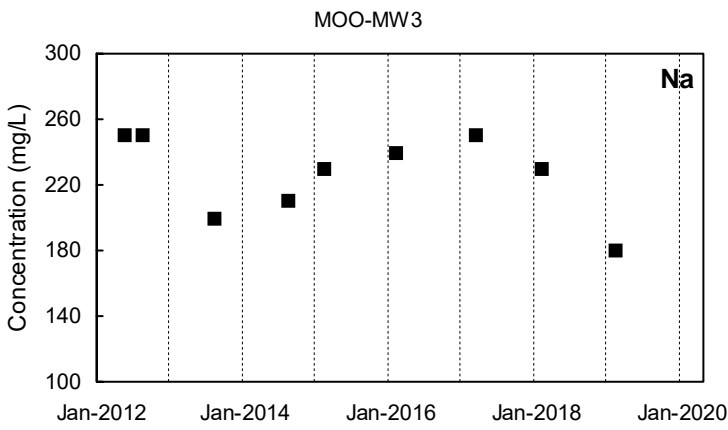

Detected Value
 'J'-Flag (value between reporting limit and detection limit)
 Non-Detect Range
 Shallow Well shown with black symbols
 Deep Well shown with orange symbols
 "dd" Well shown with blue symbols

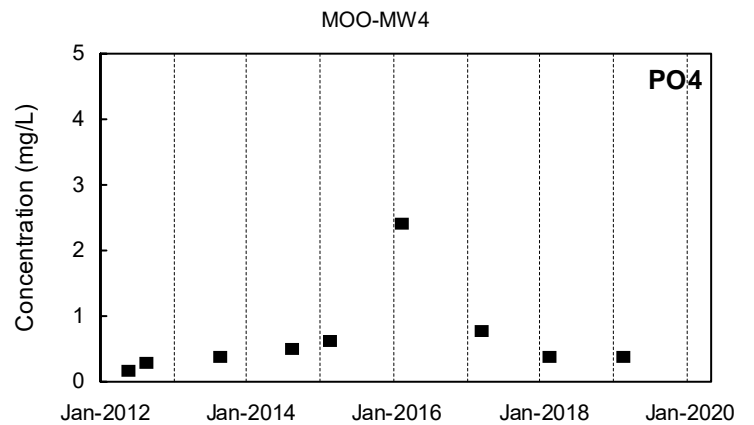
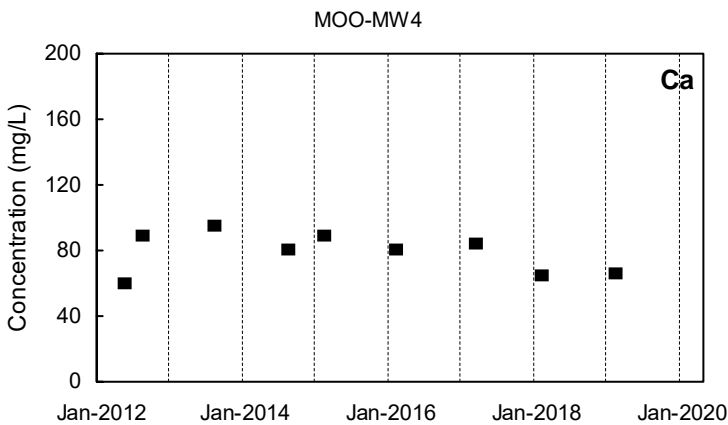
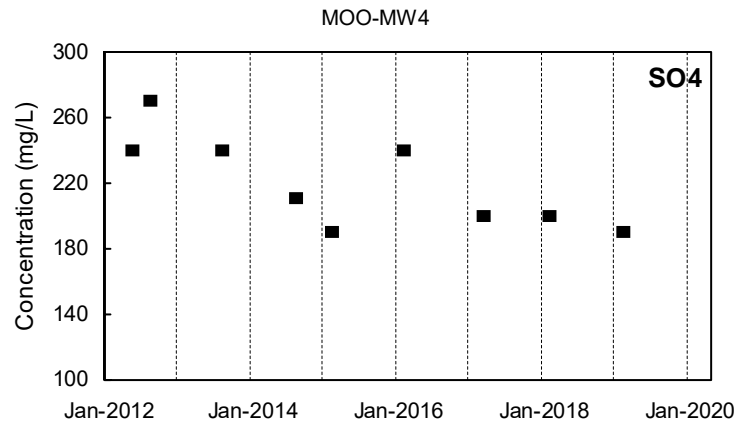
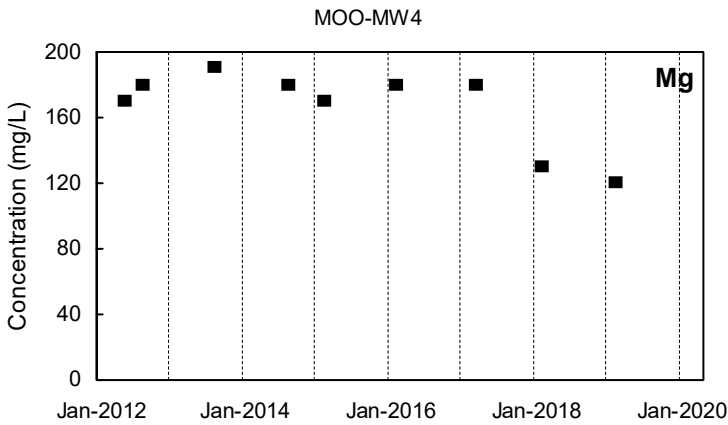
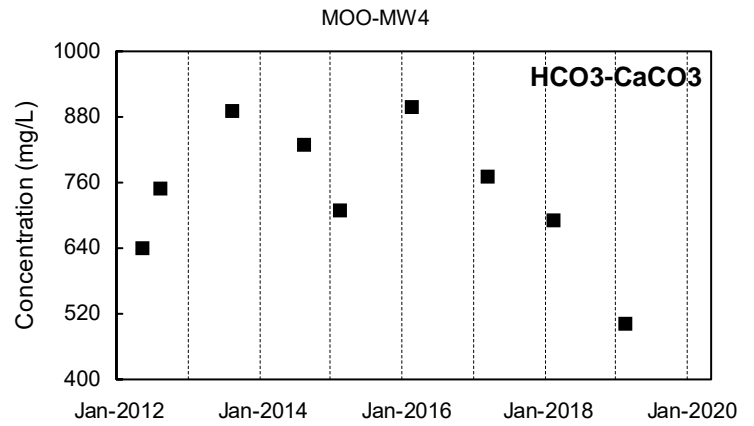
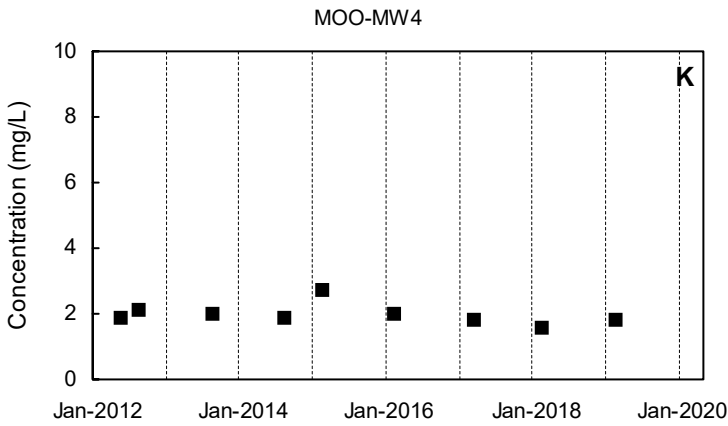
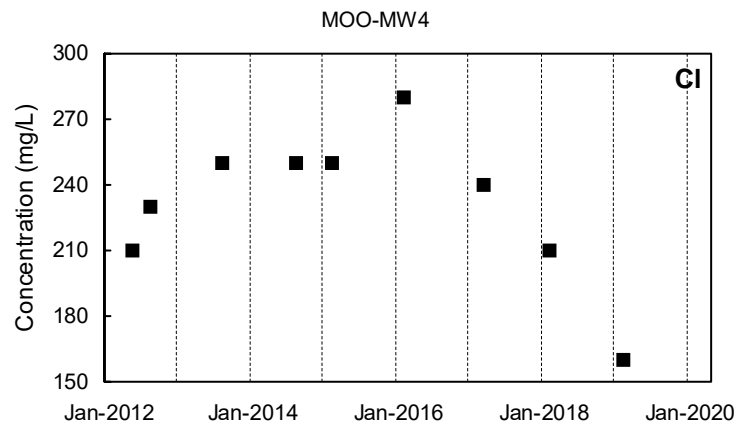
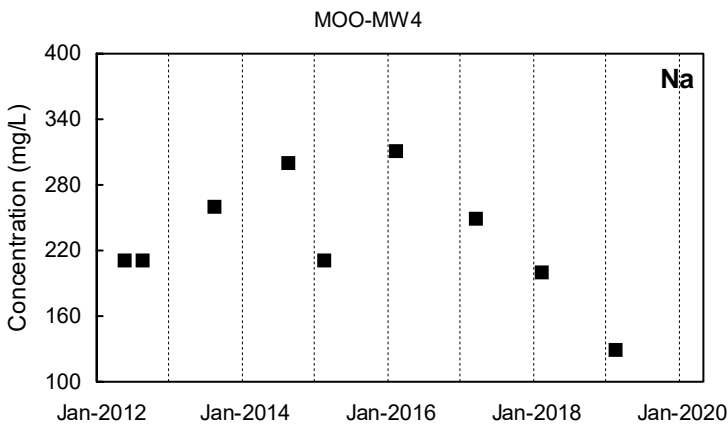

Detected Value
 'J'-Flag (value between reporting limit and detection limit)
 Non-Detect Range
 Shallow Well shown with black symbols
 Deep Well shown with orange symbols
 "dd" Well shown with blue symbols

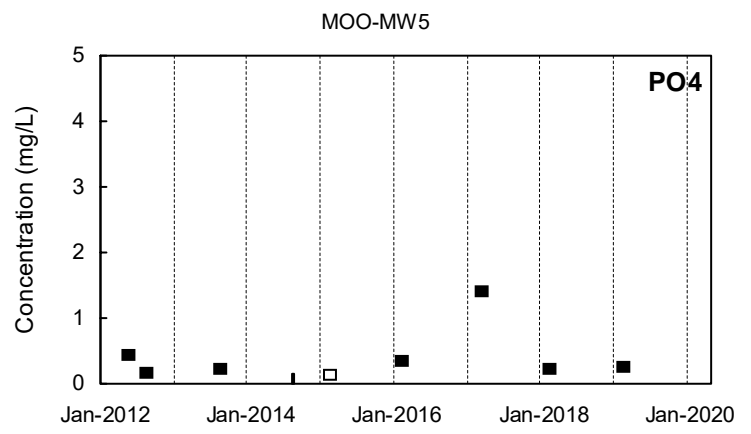
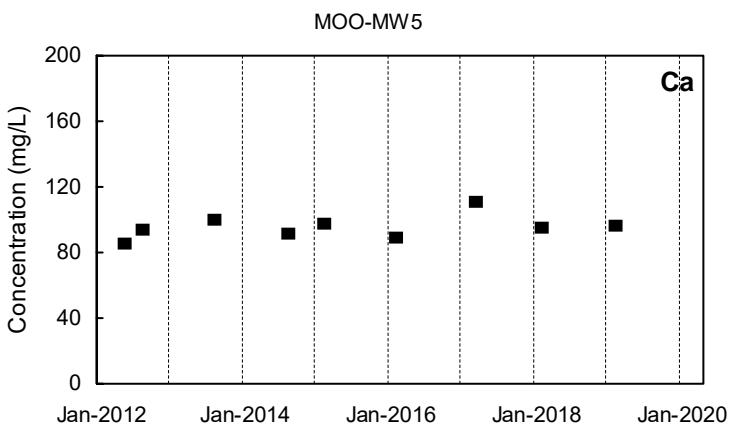
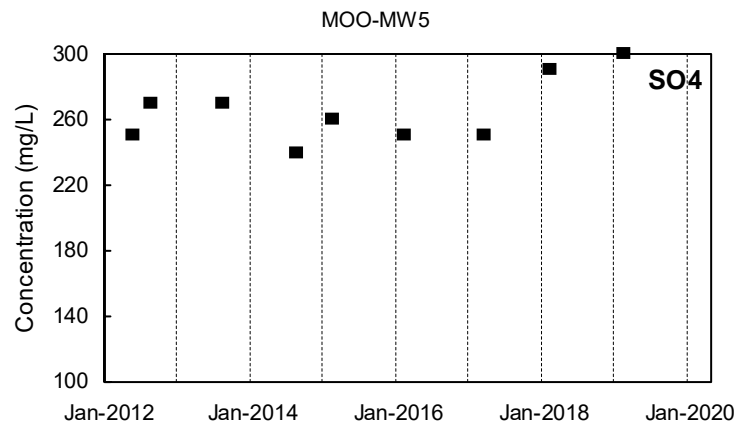
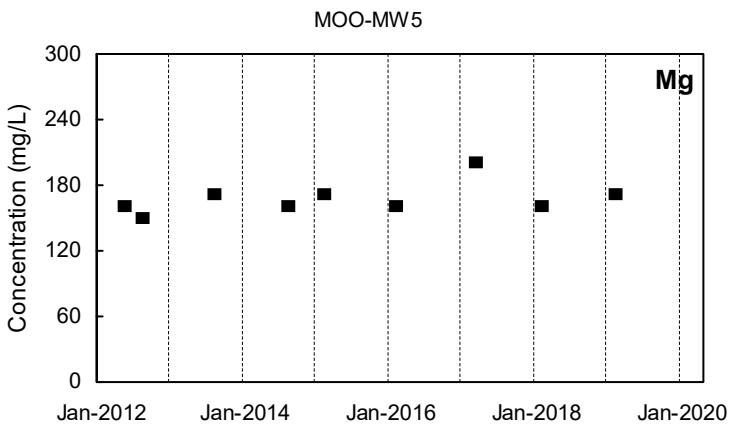
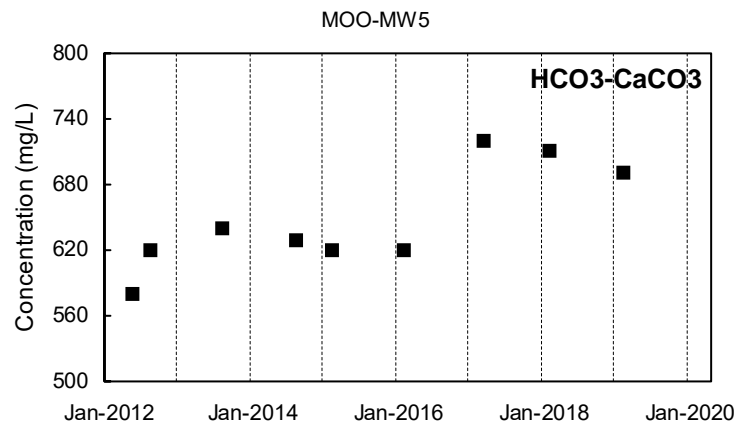
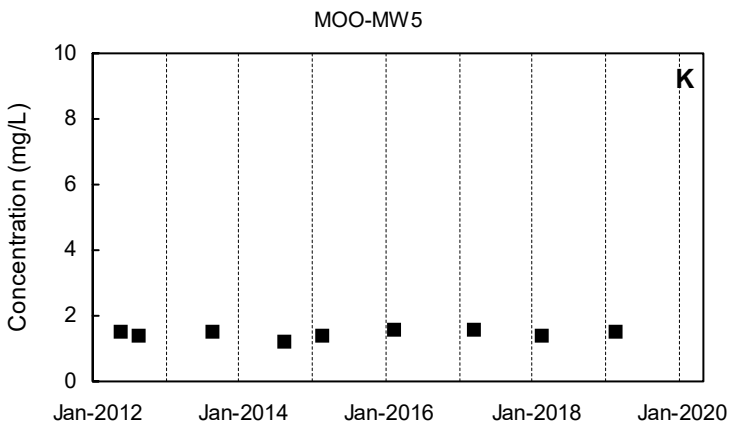
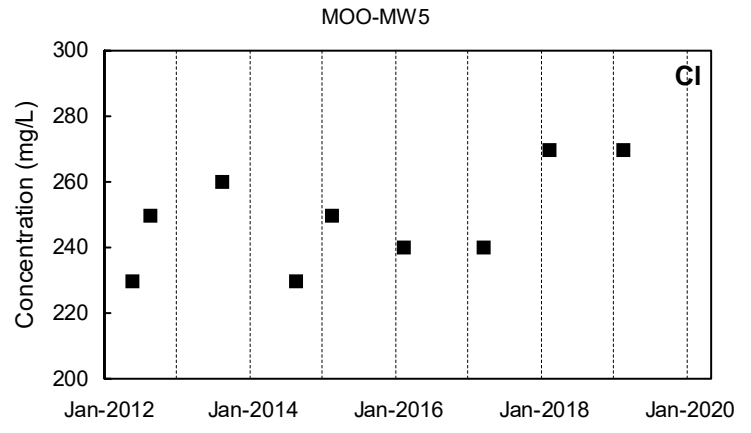
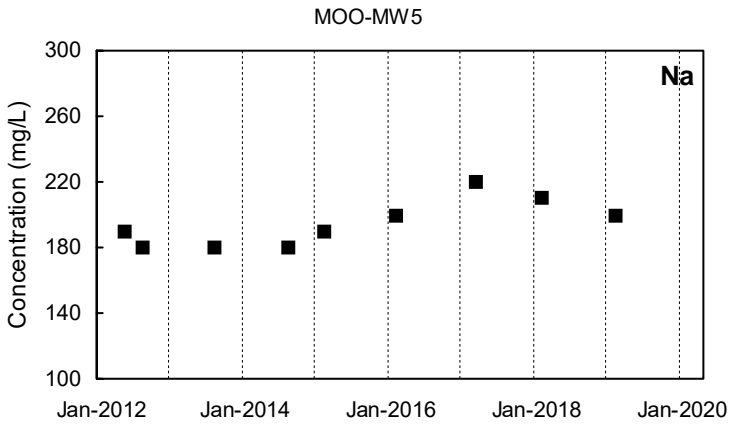

Detected Value
 'J'-Flag (value between reporting limit and detection limit)
 Non-Detect Range
 Shallow Well shown with black symbols
 Deep Well shown with orange symbols
 "dd" Well shown with blue symbols

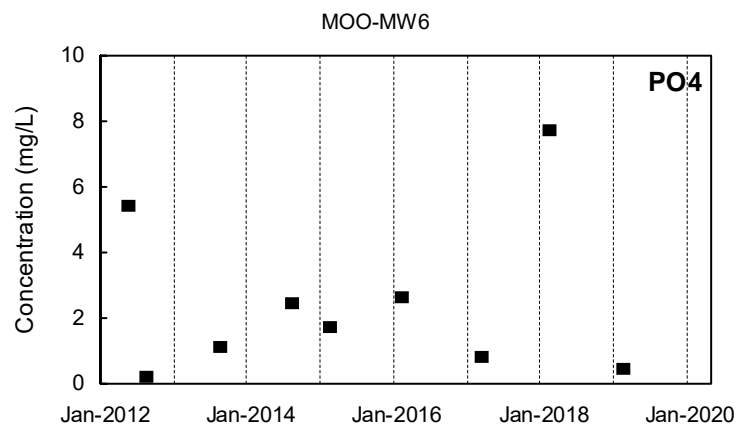
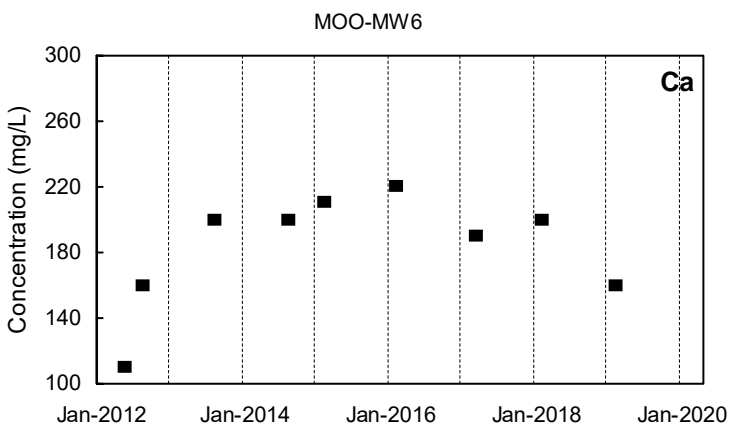
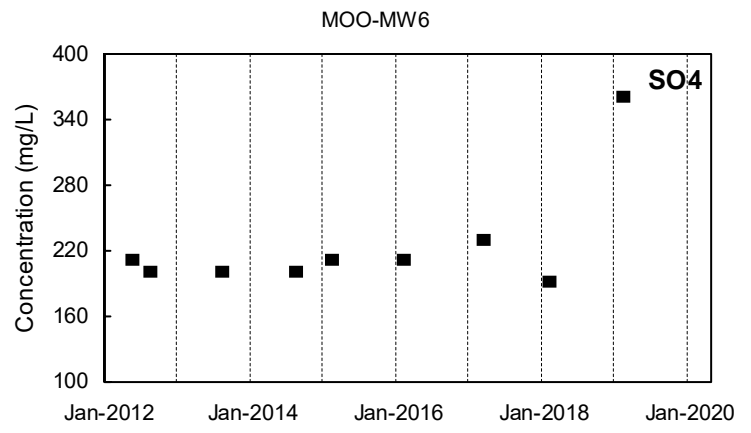
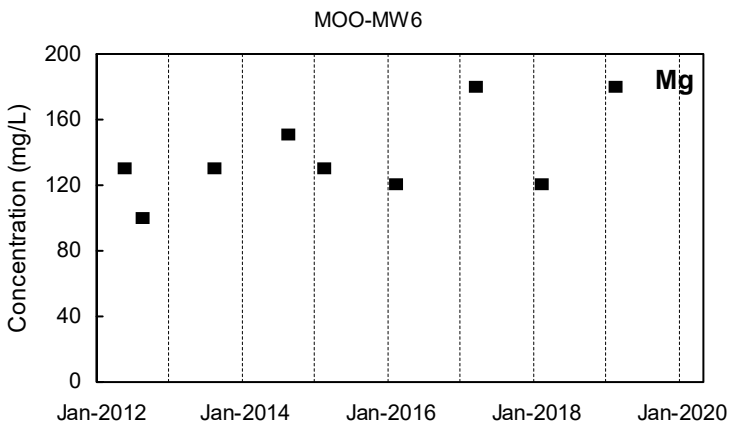
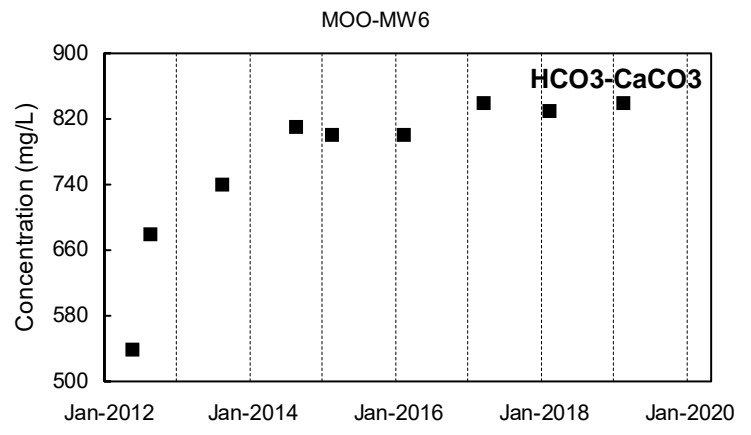
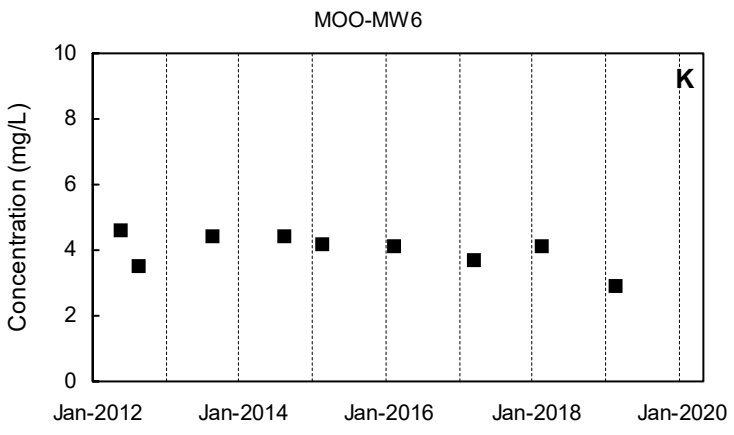
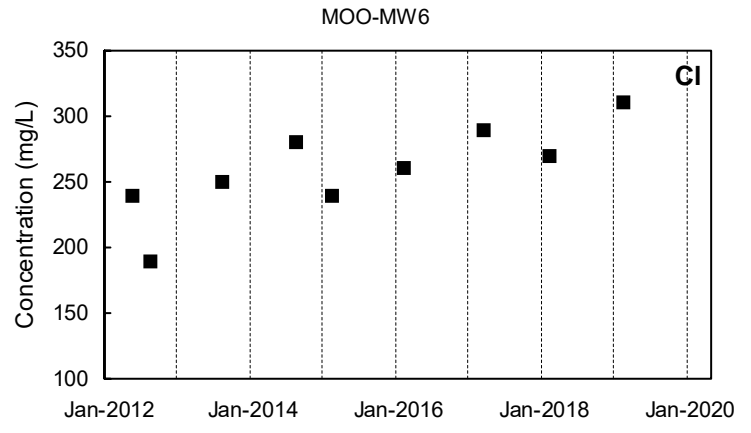
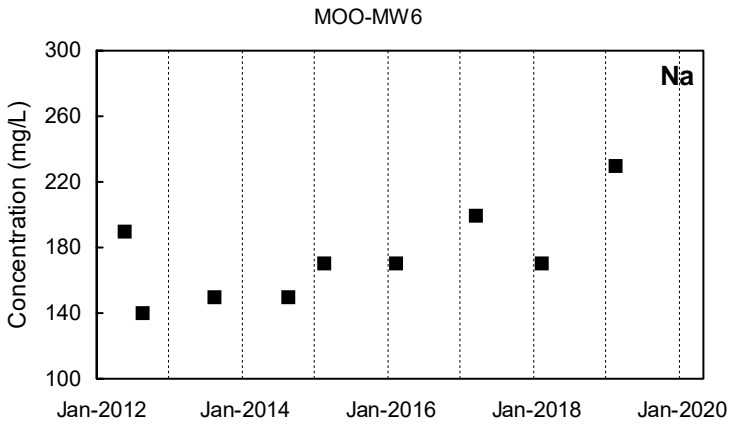

Detected Value
 'J'-Flag (value between reporting limit and detection limit)
 Non-Detect Range
 Shallow Well shown with black symbols
 Deep Well shown with orange symbols
 "dd" Well shown with blue symbols

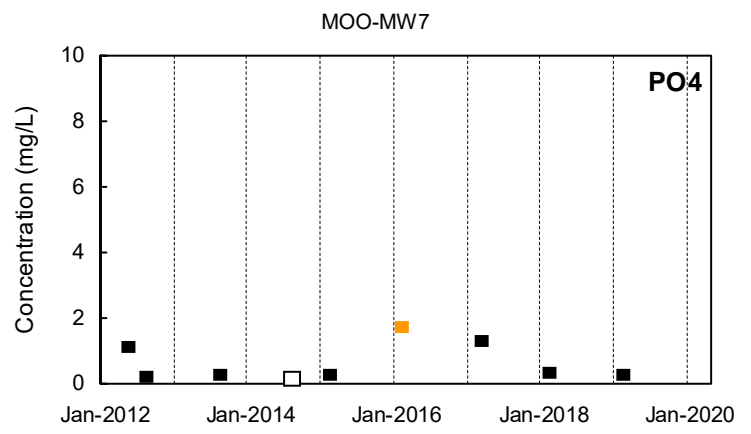
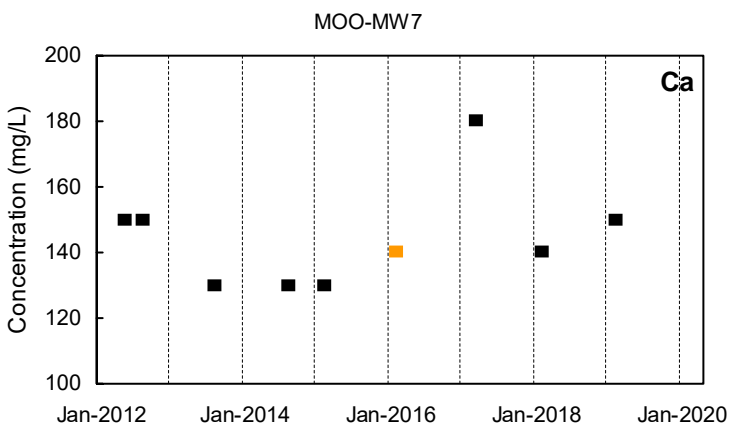
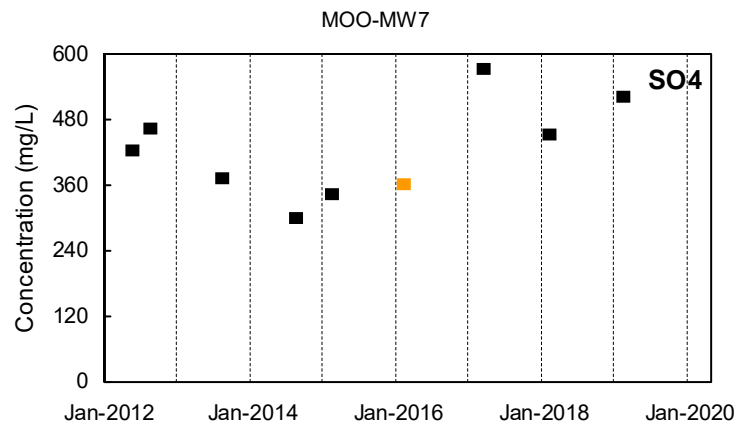
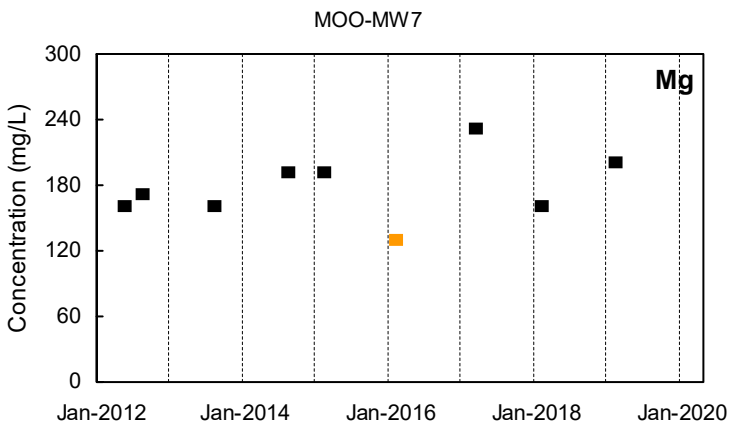
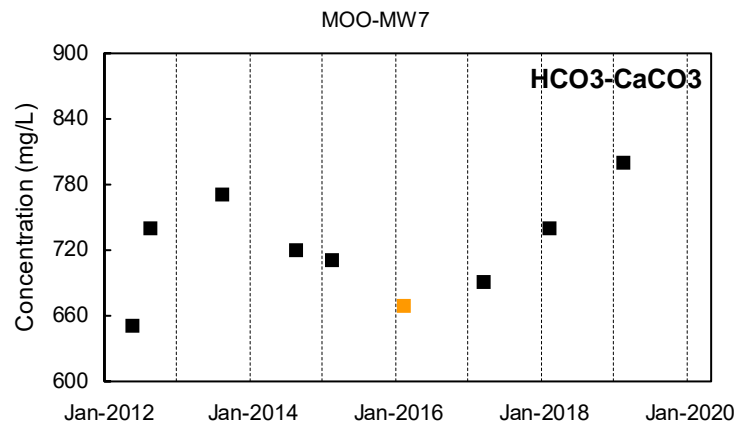
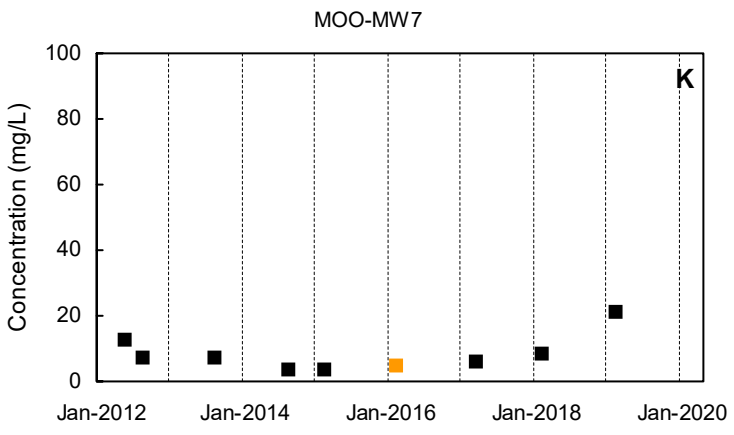
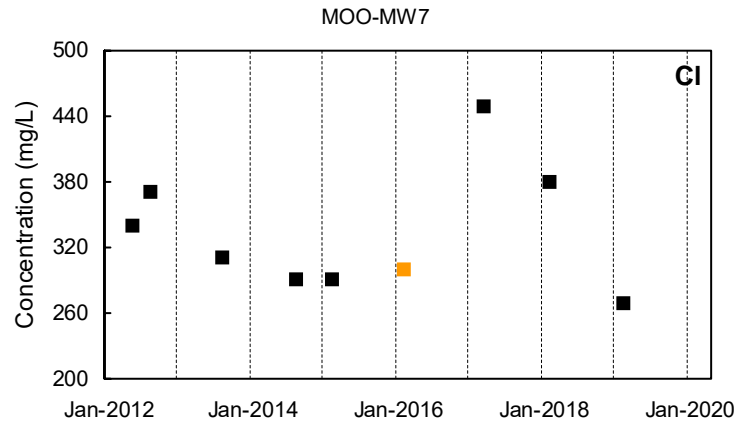
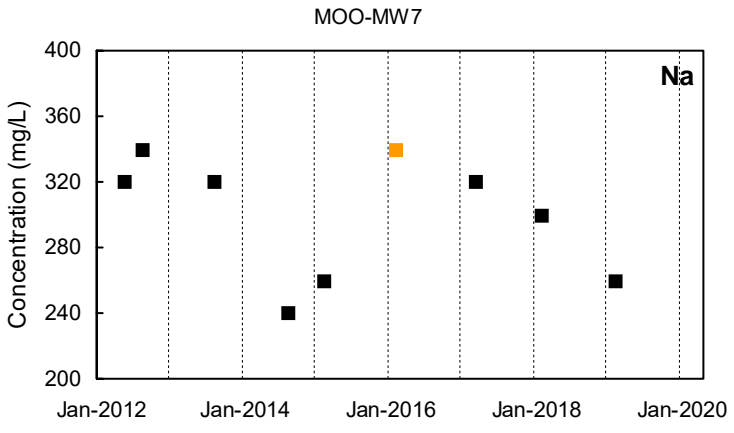

Detected Value
 'J'-Flag (value between reporting limit and detection limit)
 Non-Detect Range
 Shallow Well shown with black symbols
 Deep Well shown with orange symbols
 "dd" Well shown with blue symbols

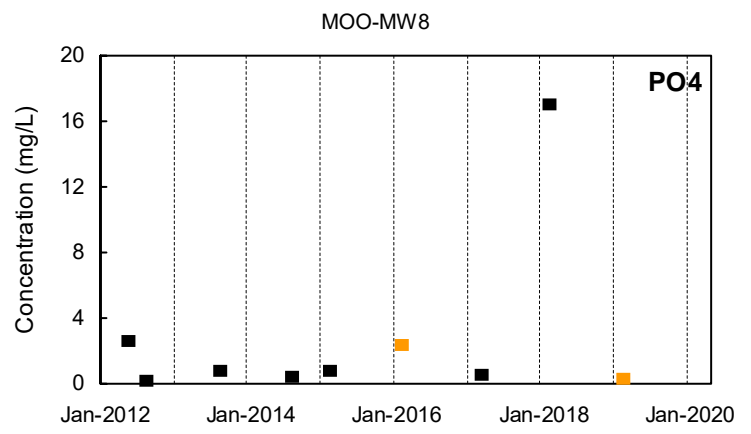
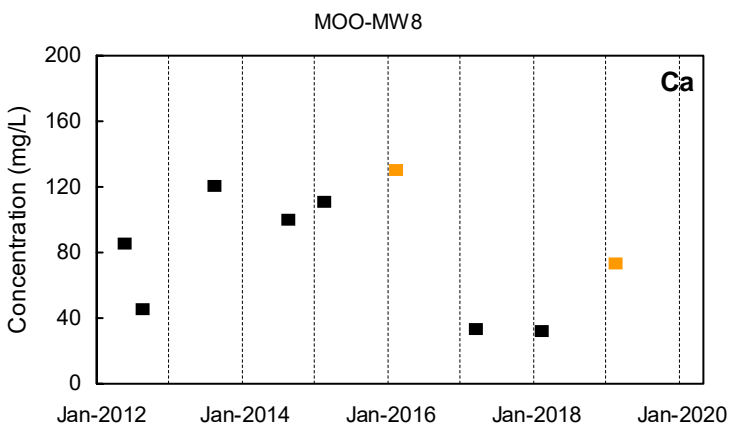
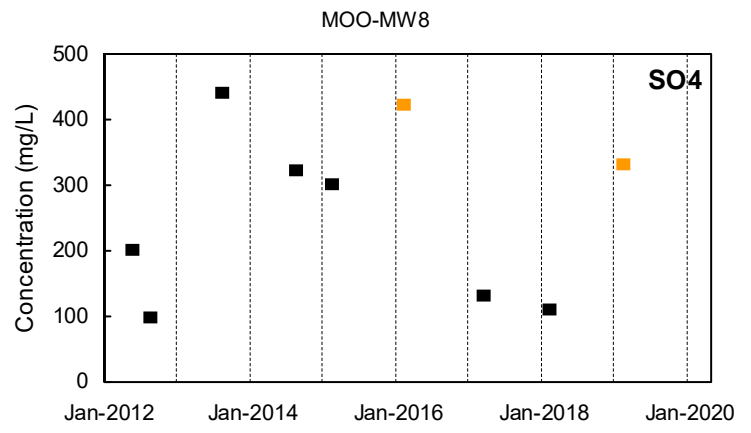
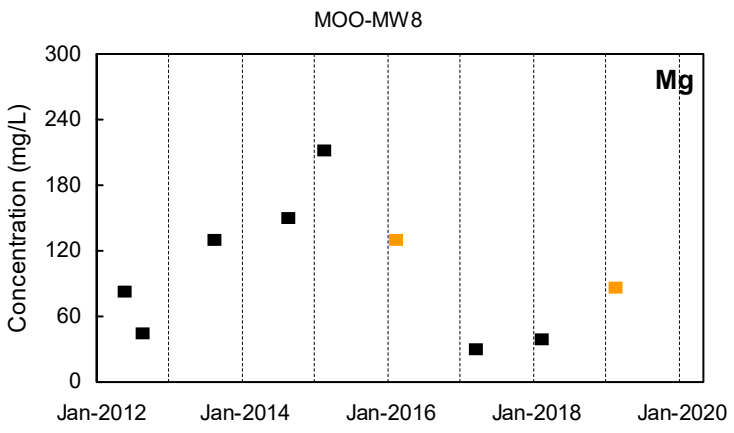
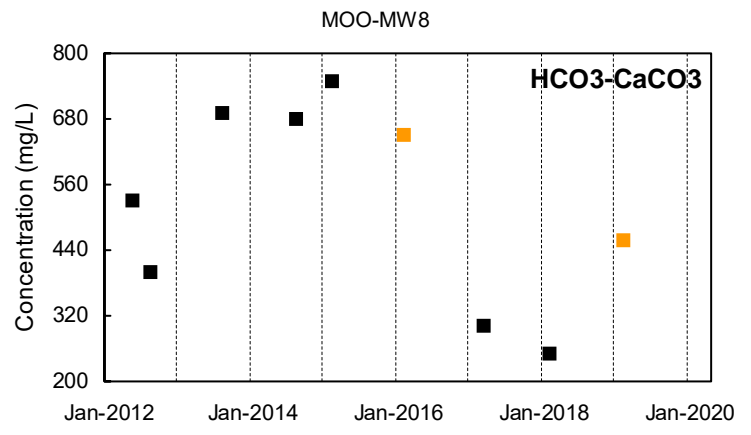
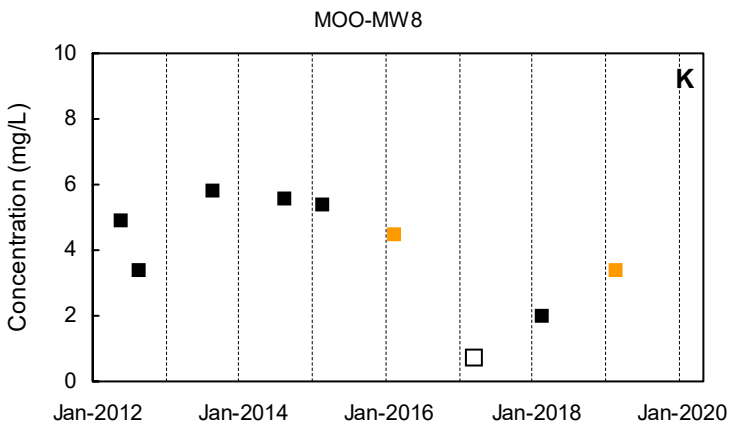
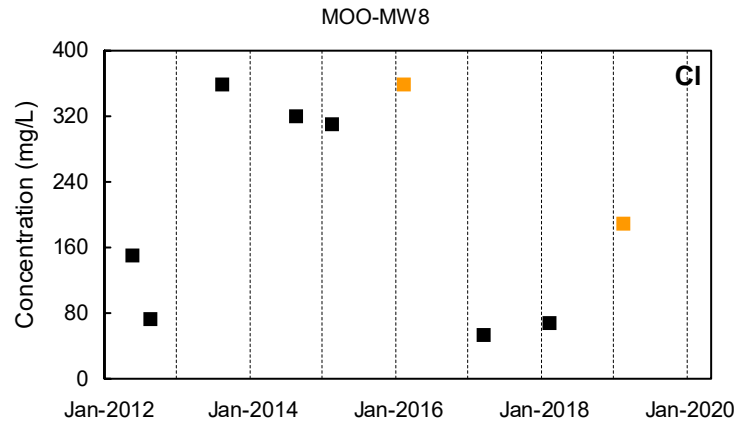
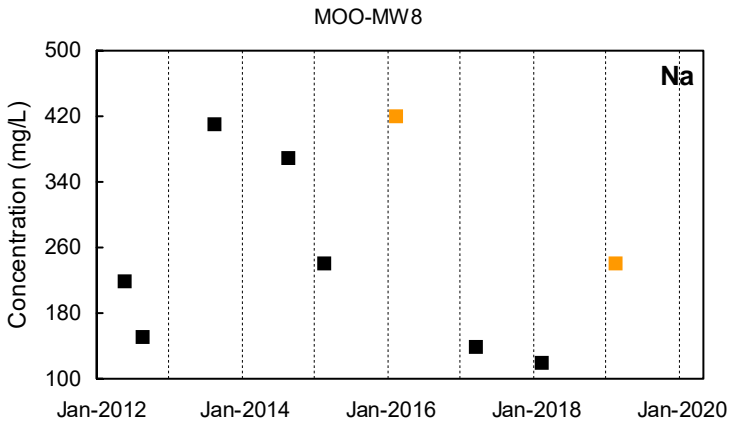

Detected Value
 'J'-Flag (value between reporting limit and detection limit)
 Non-Detect Range
 Shallow Well shown with black symbols
 Deep Well shown with orange symbols
 "dd" Well shown with blue symbols

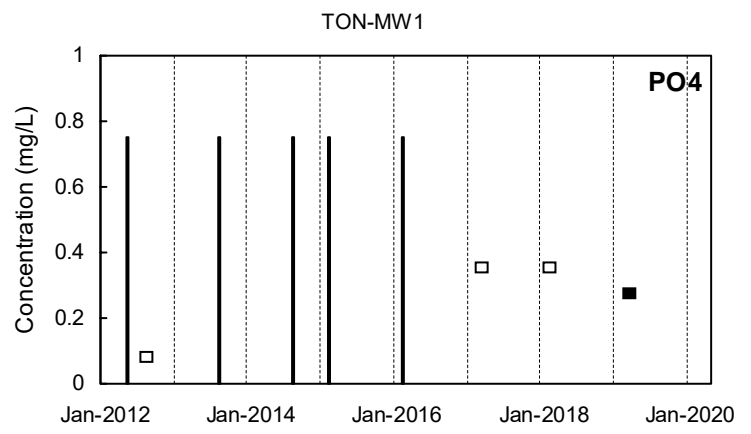
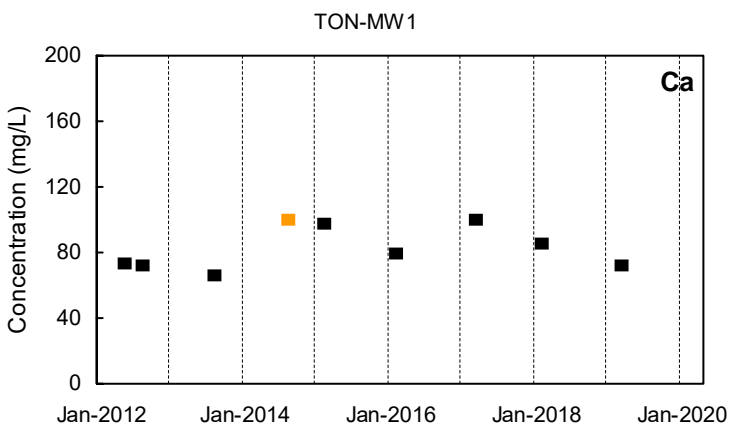
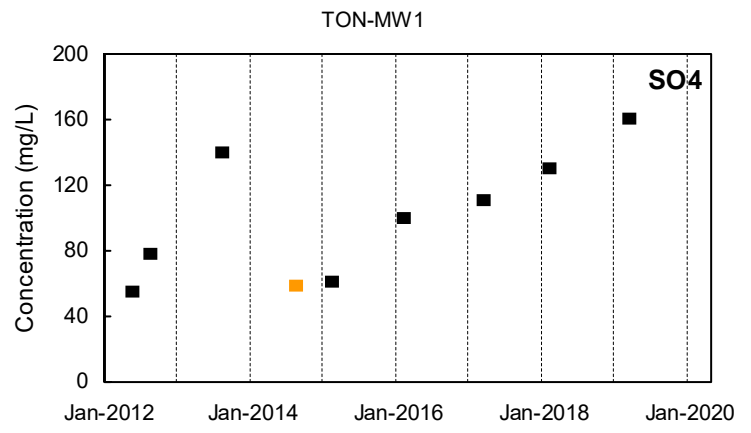
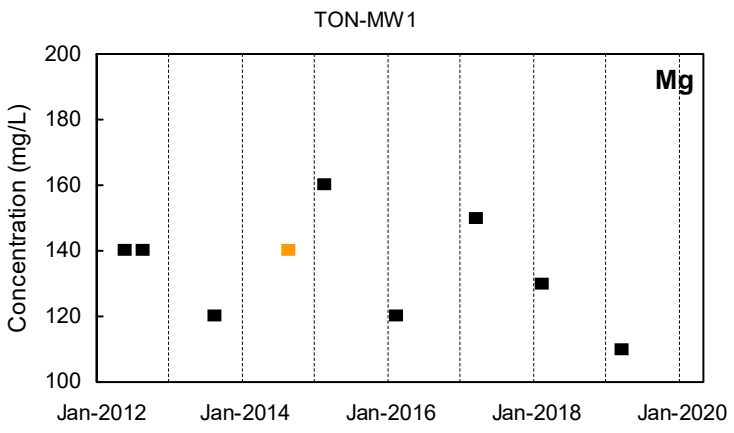
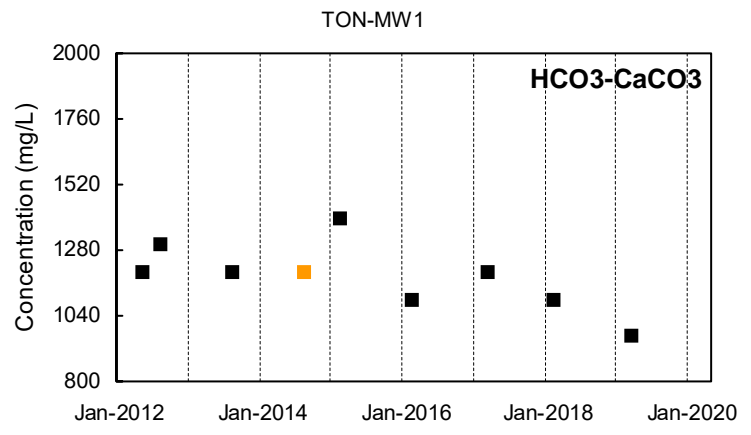
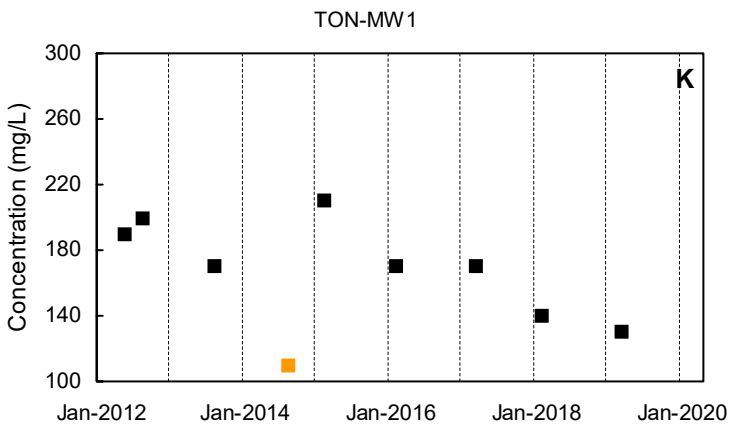
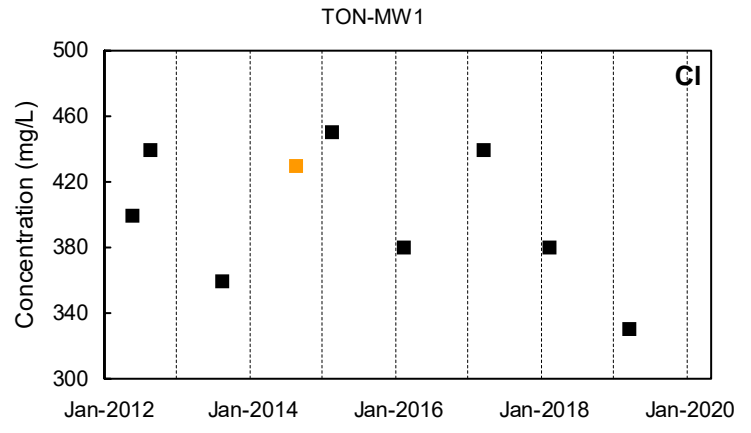
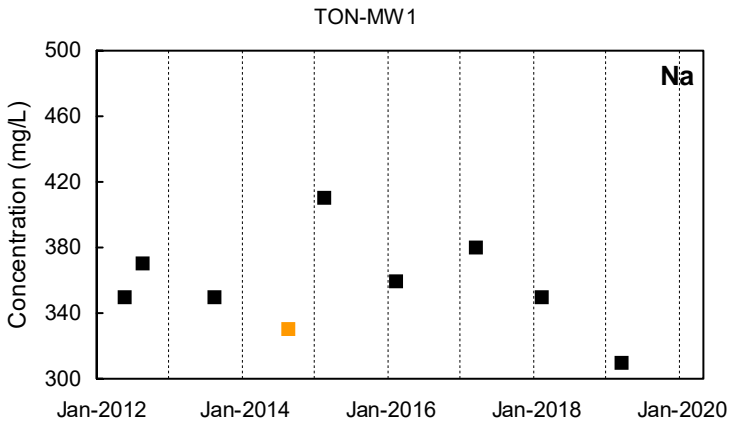

Detected Value
 'J'-Flag (value between reporting limit and detection limit)
 Non-Detect Range
 Shallow Well shown with black symbols
 Deep Well shown with orange symbols
 "dd" Well shown with blue symbols

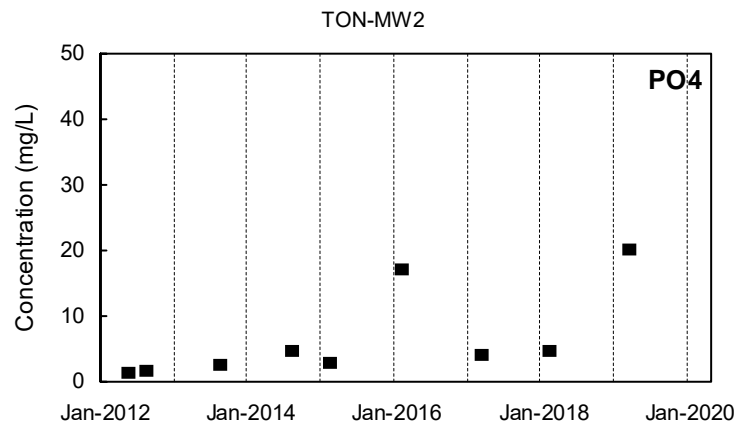
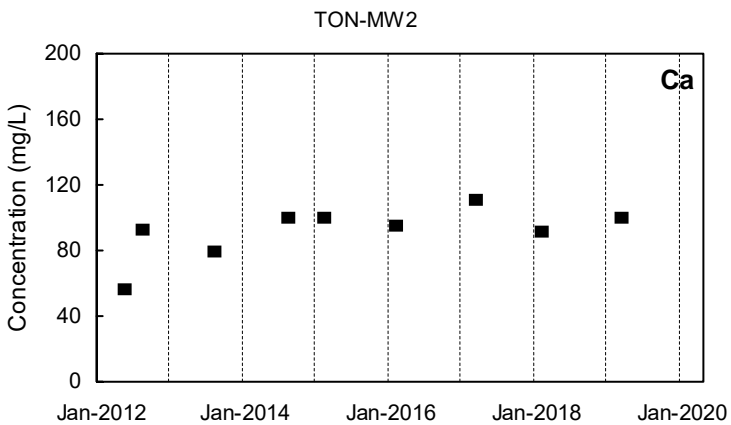
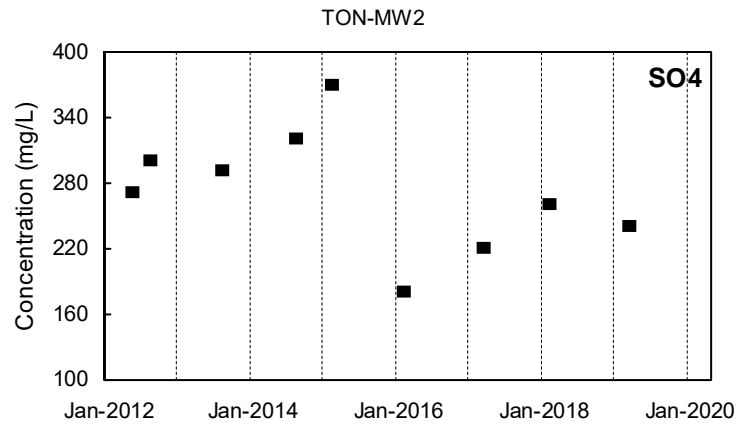
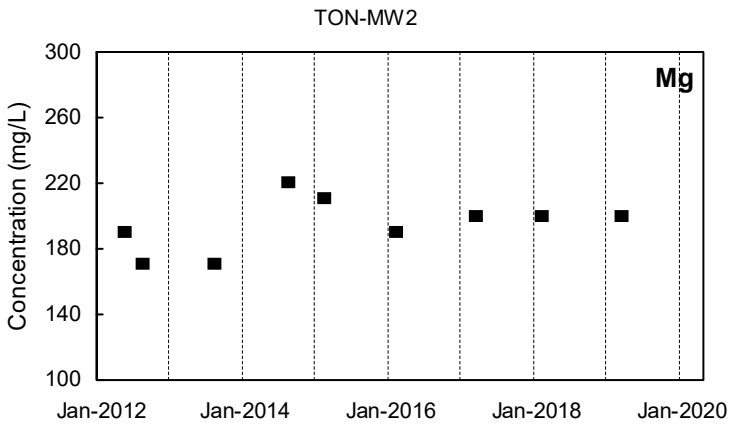
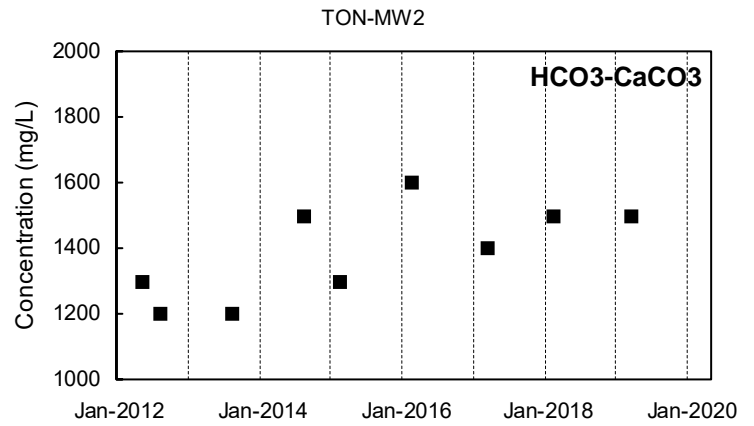
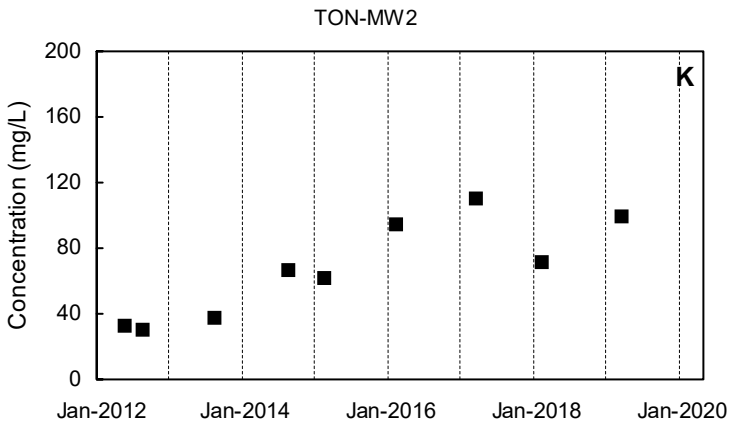
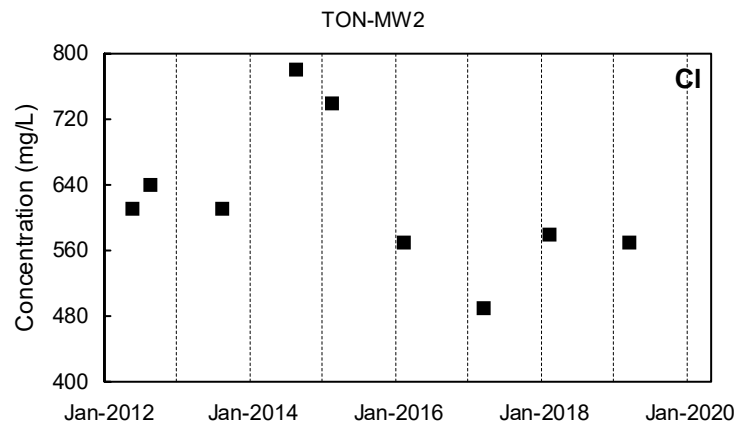
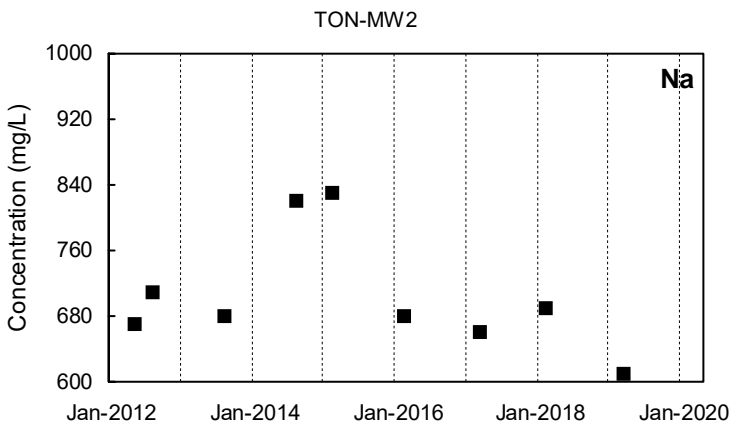

Detected Value
 'J'-Flag (value between reporting limit and detection limit)
 Non-Detect Range
 Shallow Well shown with black symbols
 Deep Well shown with orange symbols
 "dd" Well shown with blue symbols

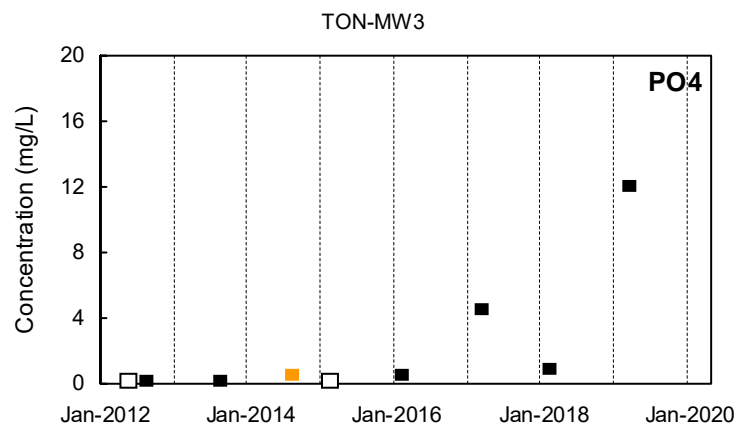
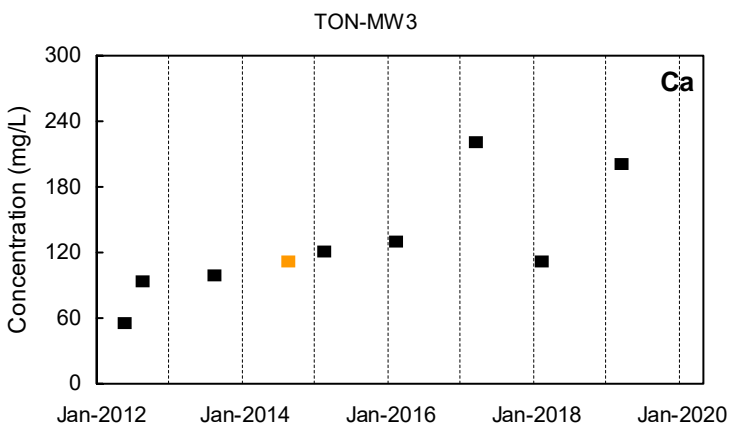
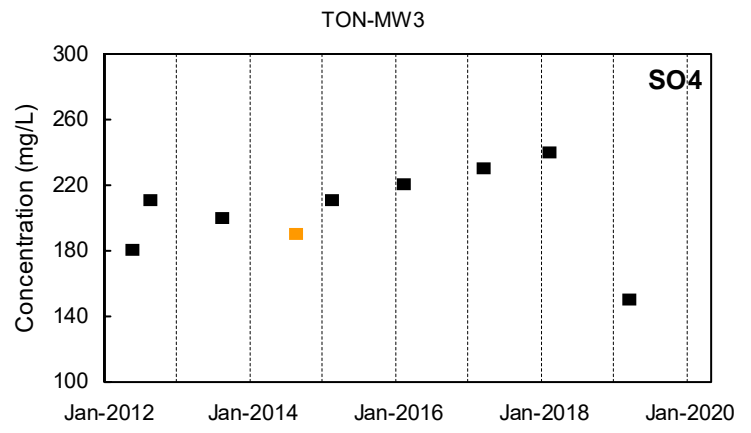
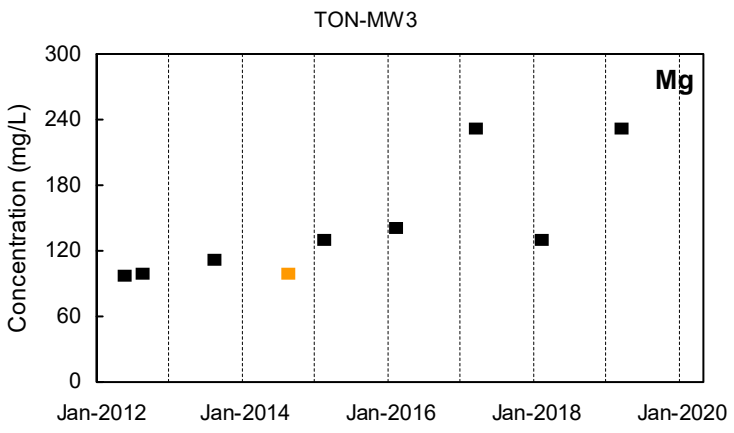
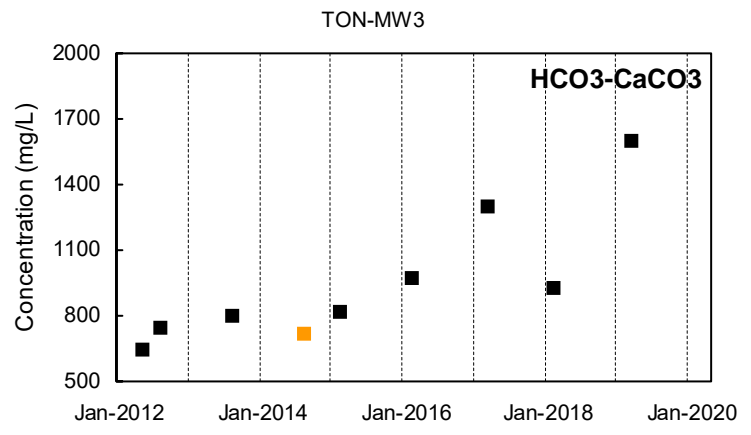
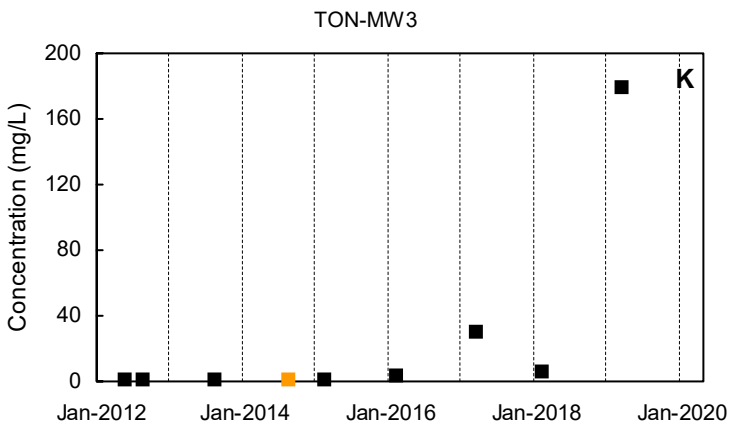
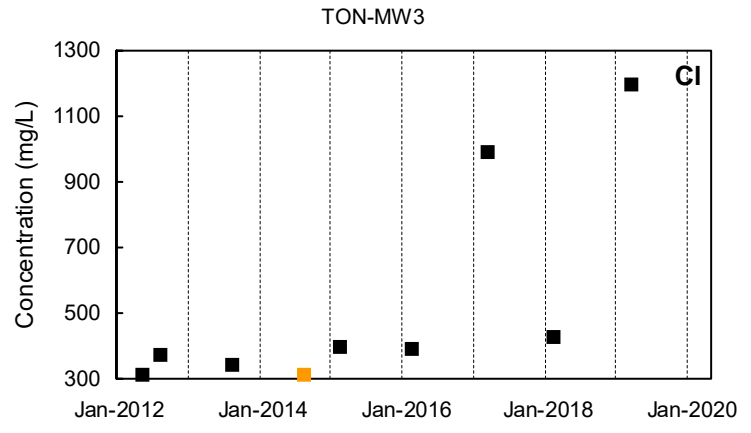
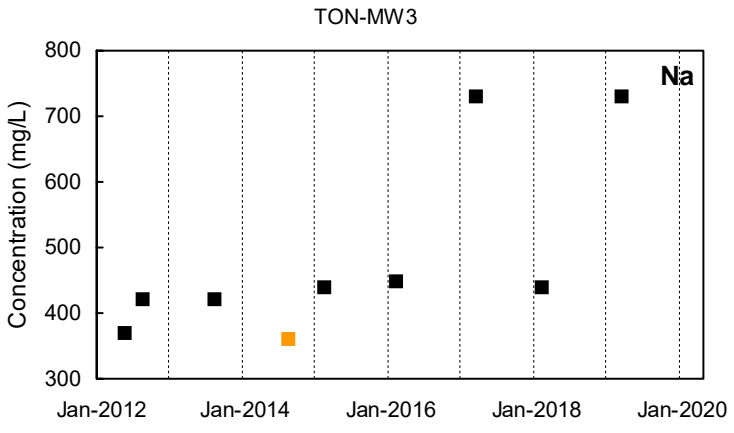

■ Detected Value □ 'J'-Flag (value between reporting limit and detection limit) ■ Non-Detect Range
 Shallow Well shown with black symbols Deep Well shown with orange symbols "dd" Well shown with blue symbols

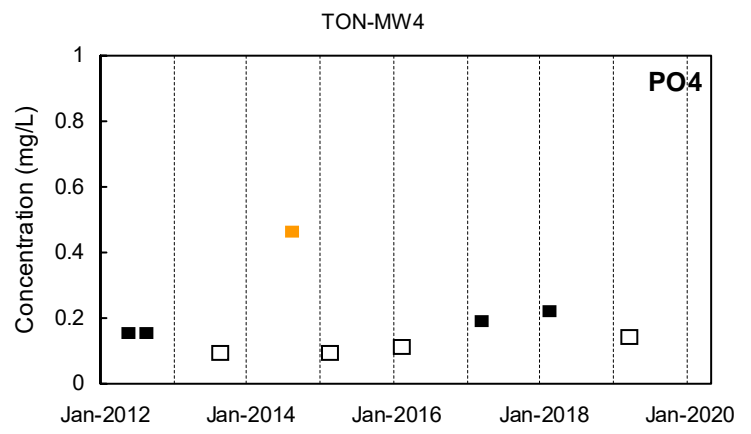
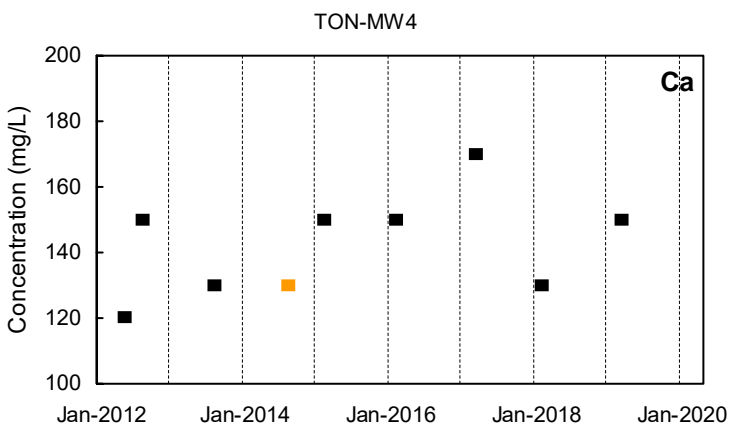
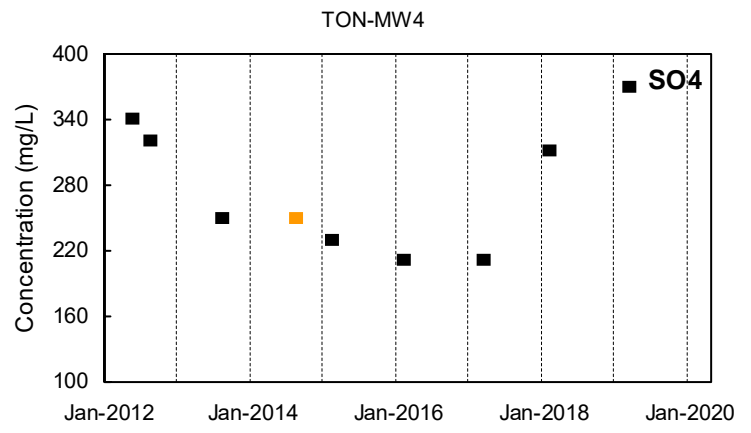
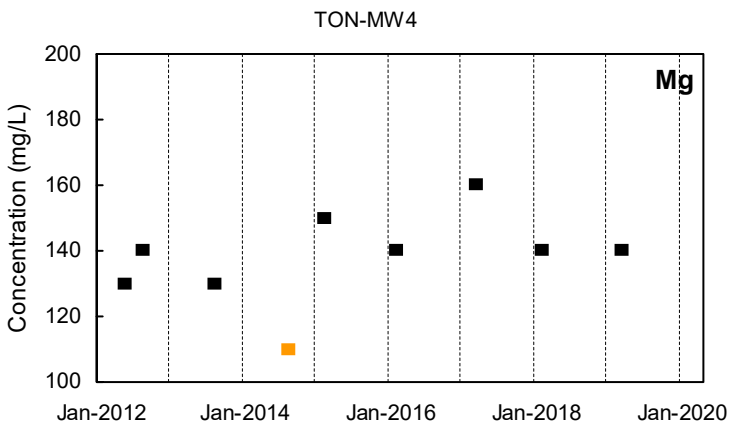
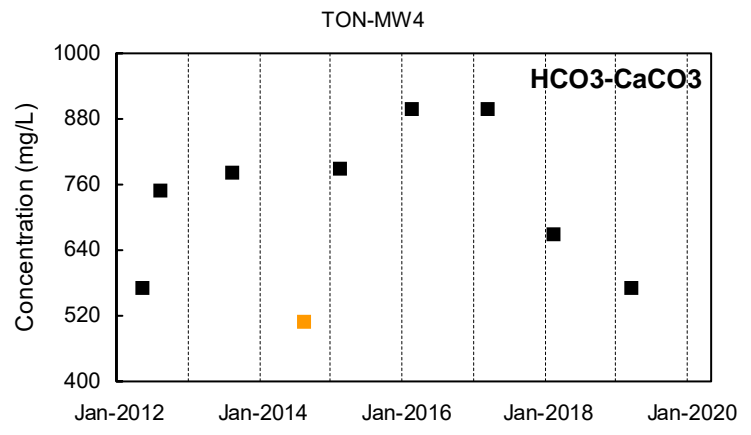
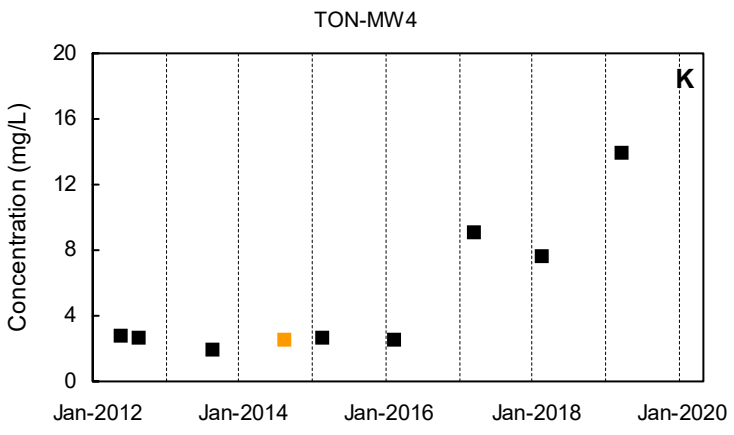
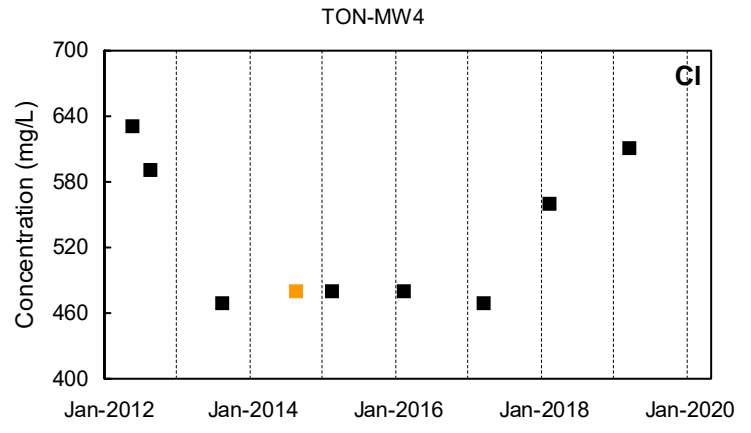
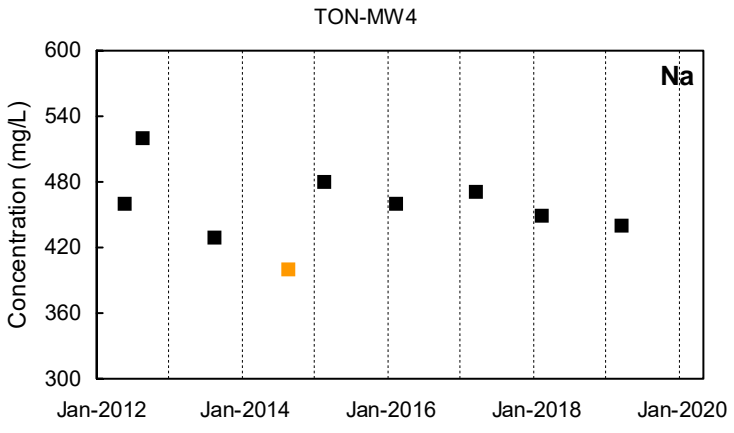

■ Detected Value □ 'J'-Flag (value between reporting limit and detection limit) ■ Non-Detect Range
 Shallow Well shown with black symbols Deep Well shown with orange symbols "dd" Well shown with blue symbols

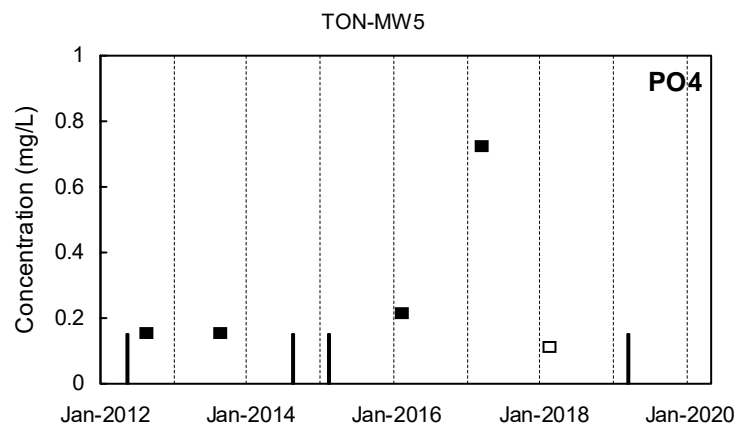
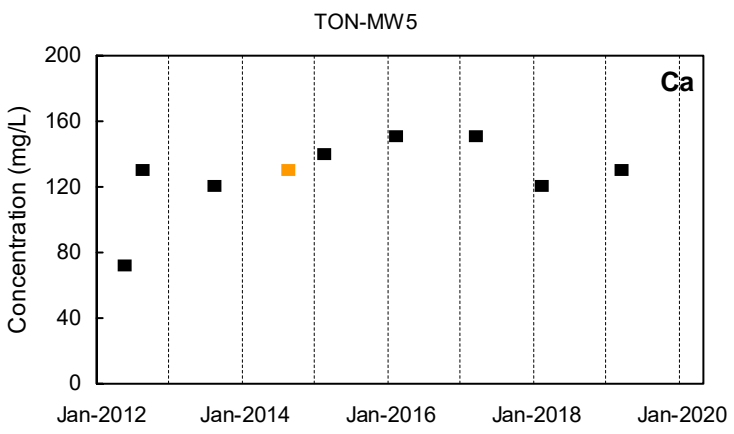
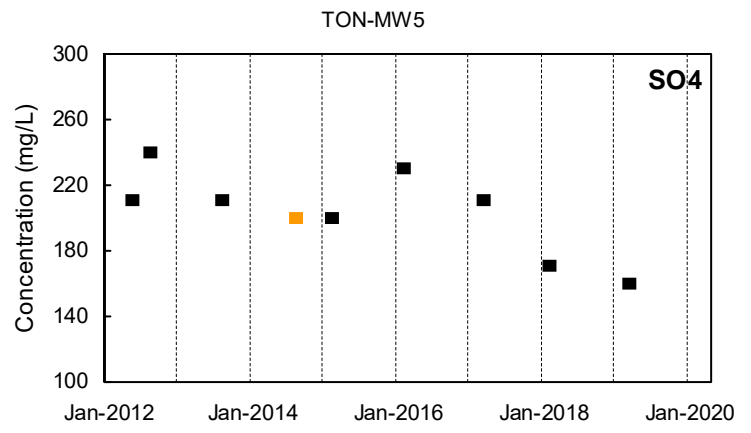
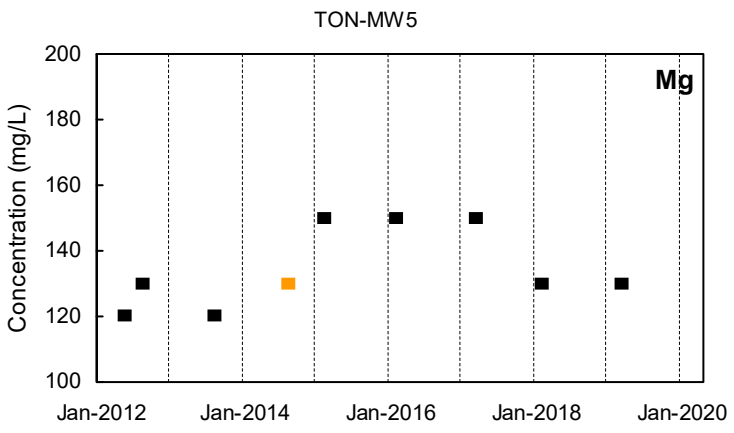
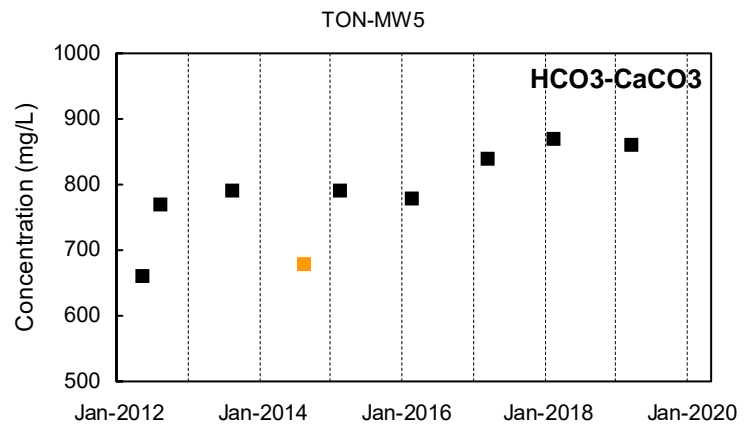
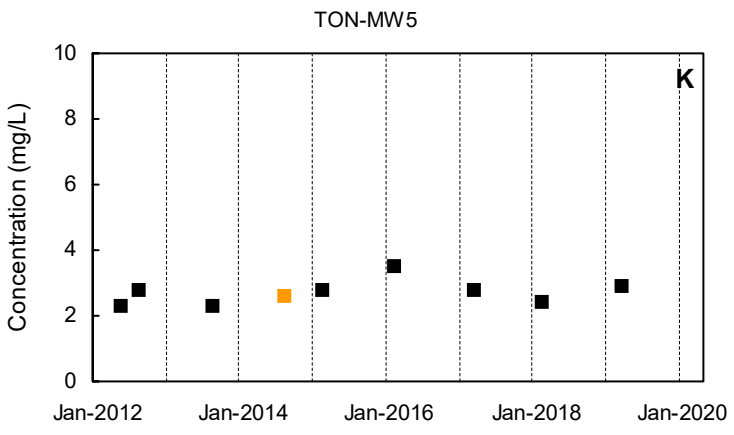
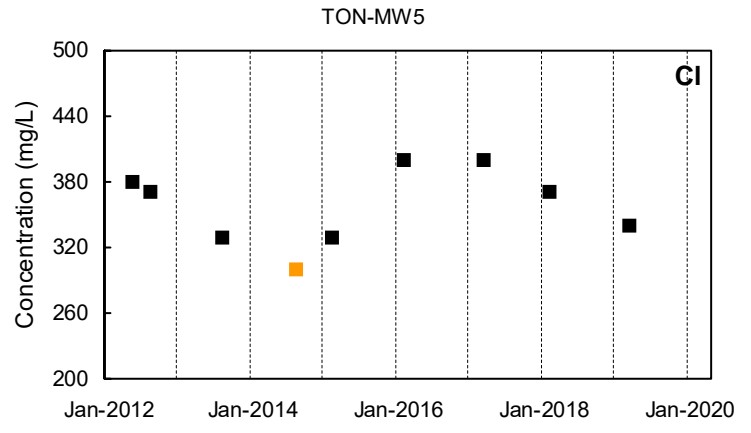
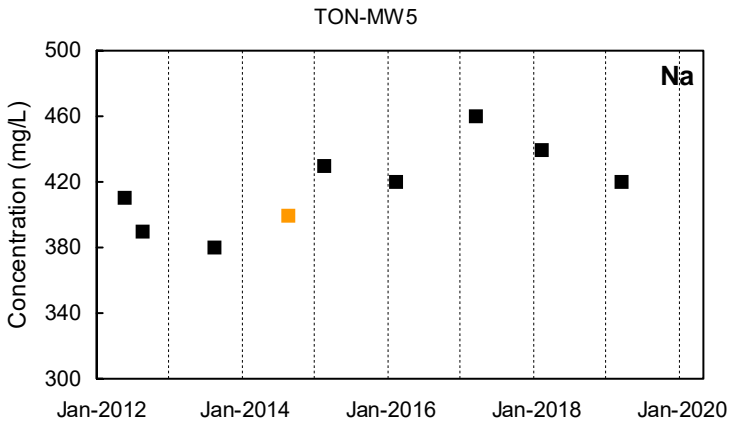

■ Detected Value □ 'J'-Flag (value between reporting limit and detection limit) ■ Non-Detect Range
 Shallow Well shown with black symbols Deep Well shown with orange symbols "dd" Well shown with blue symbols

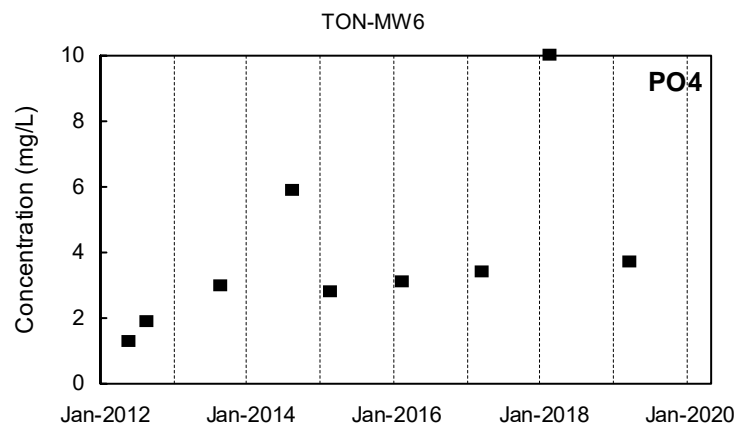
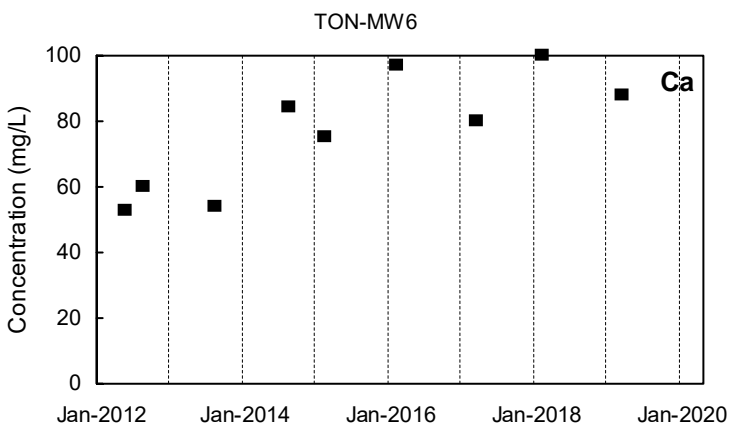
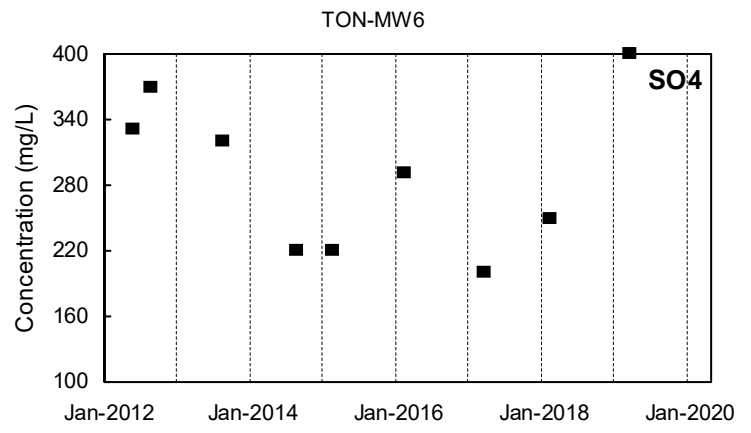
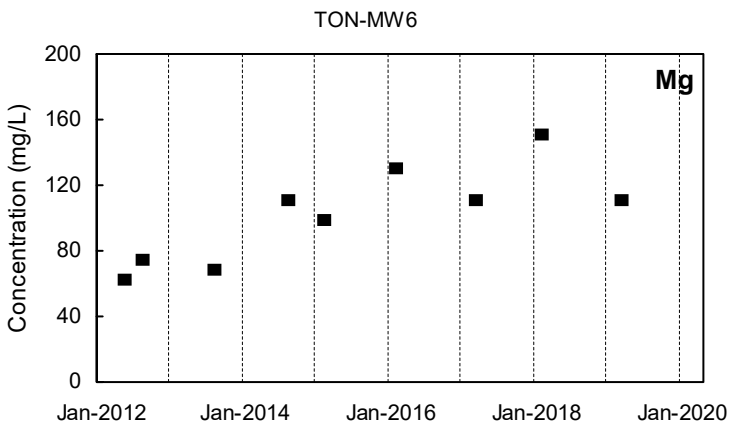
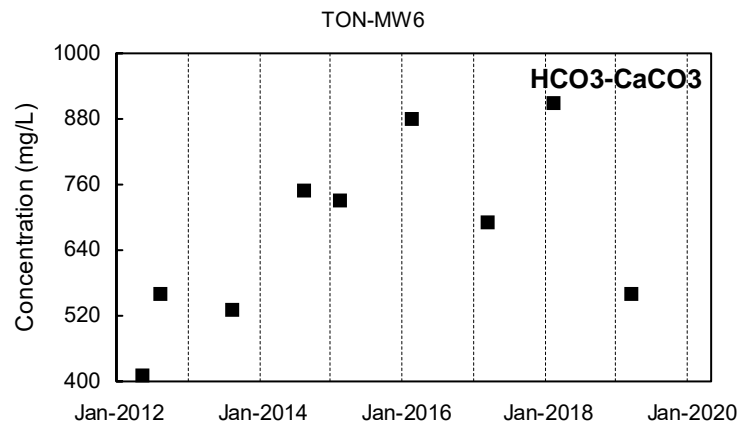
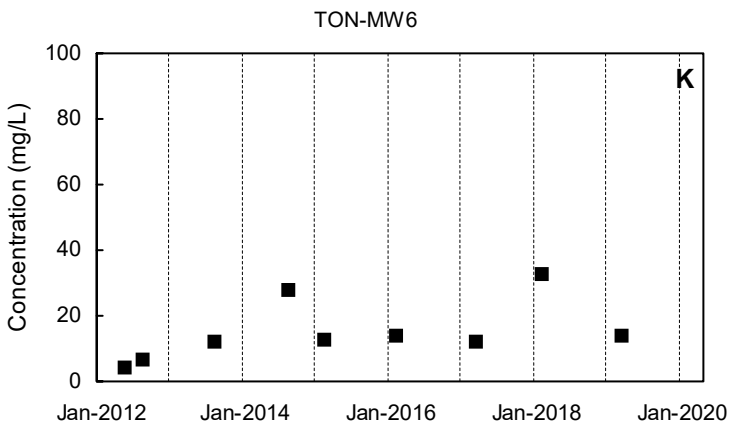
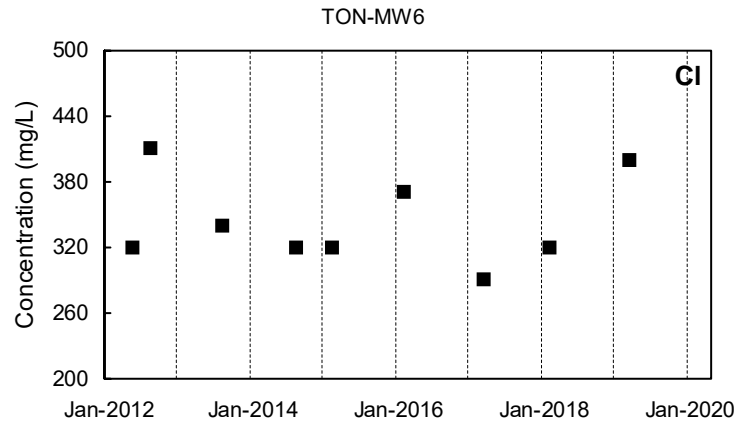
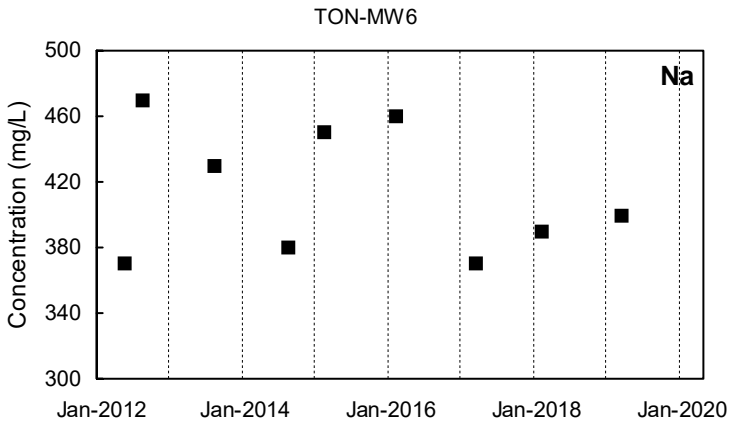

Detected Value
 'J'-Flag (value between reporting limit and detection limit)
 Non-Detect Range
 Shallow Well shown with black symbols
 Deep Well shown with orange symbols
 "dd" Well shown with blue symbols

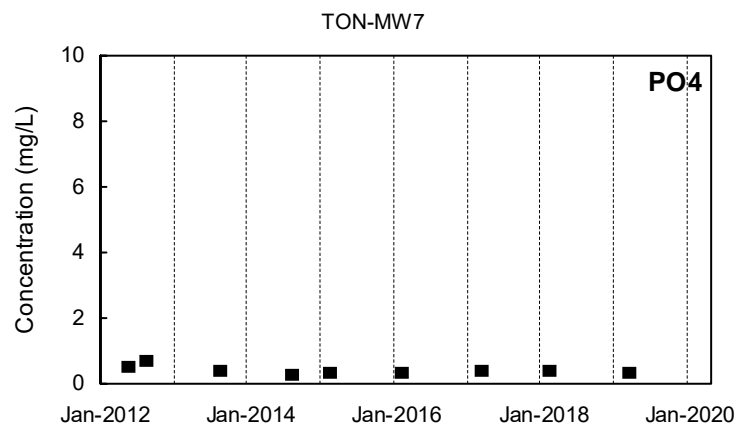
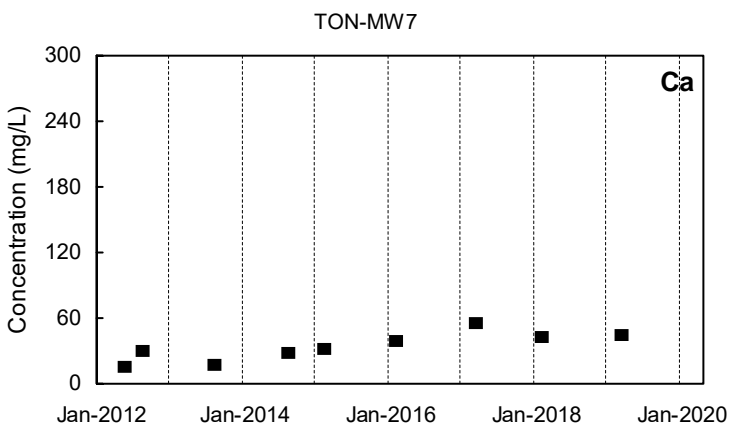
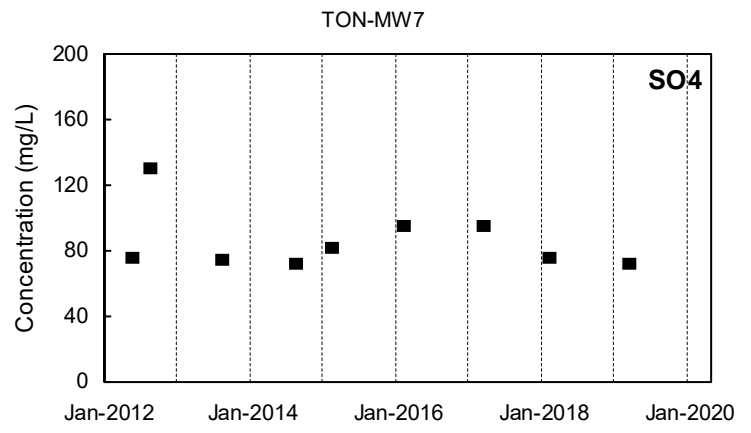
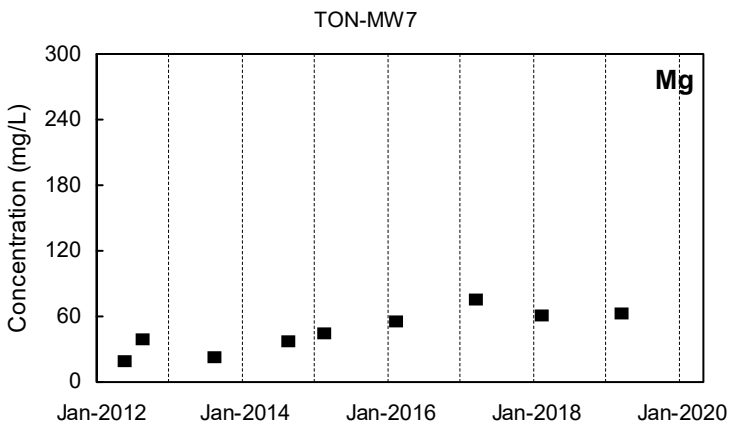
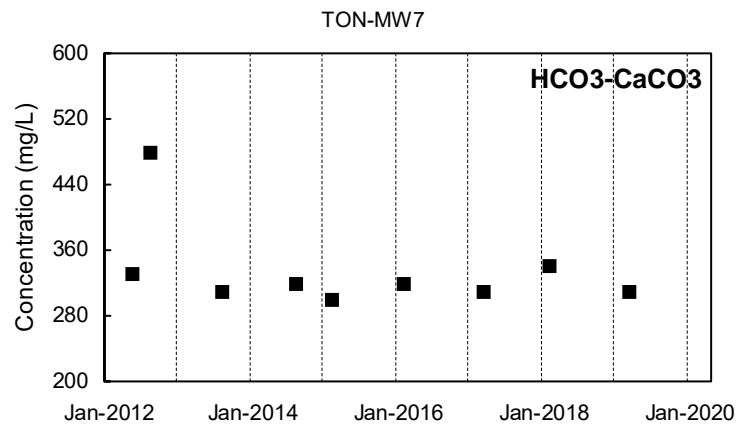
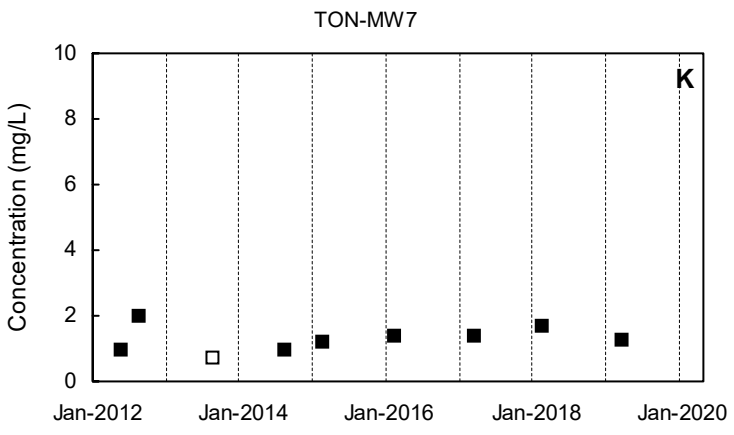
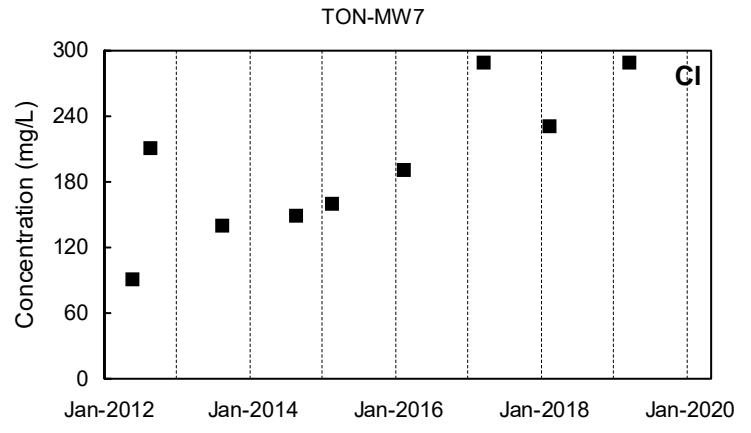
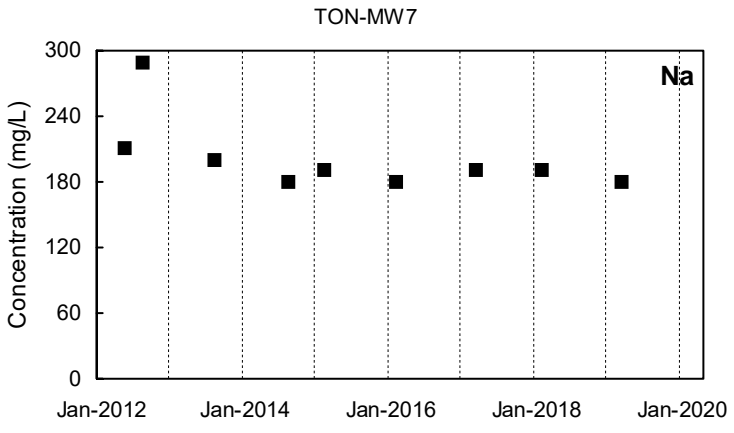

■ Detected Value □ 'J'-Flag (value between reporting limit and detection limit) ■ Non-Detect Range
 Shallow Well shown with black symbols Deep Well shown with orange symbols "dd" Well shown with blue symbols

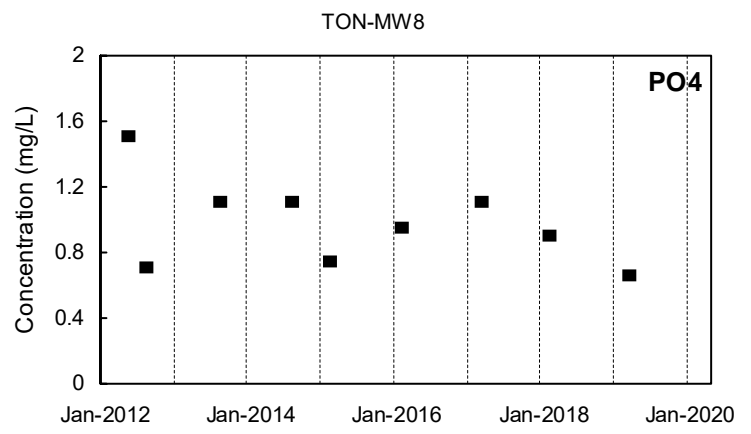
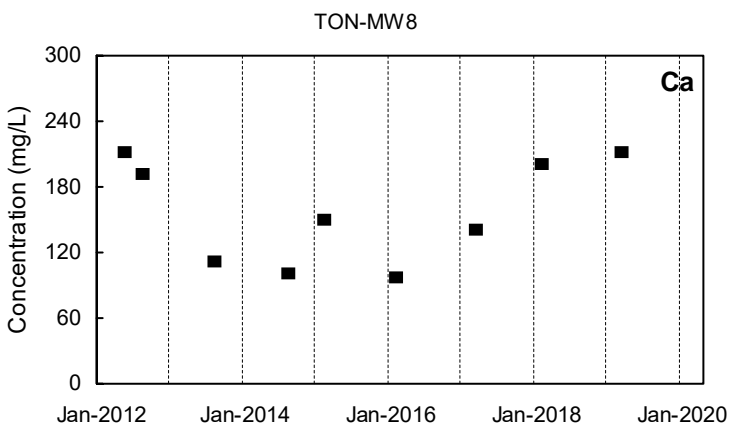
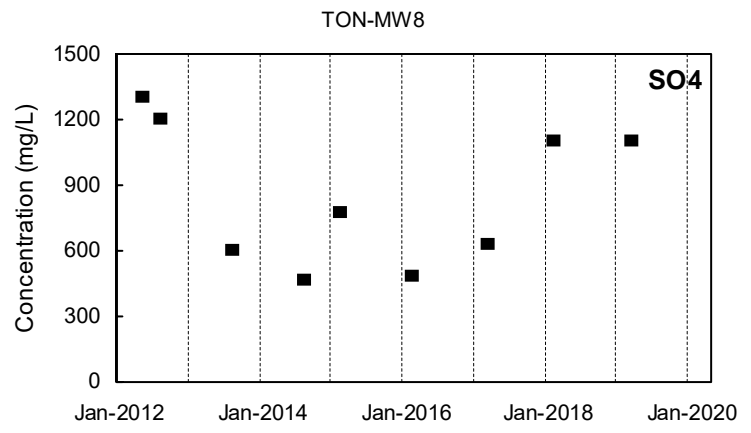
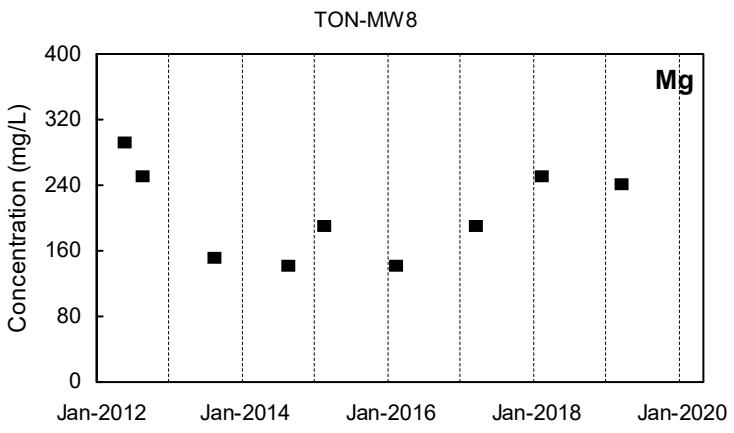
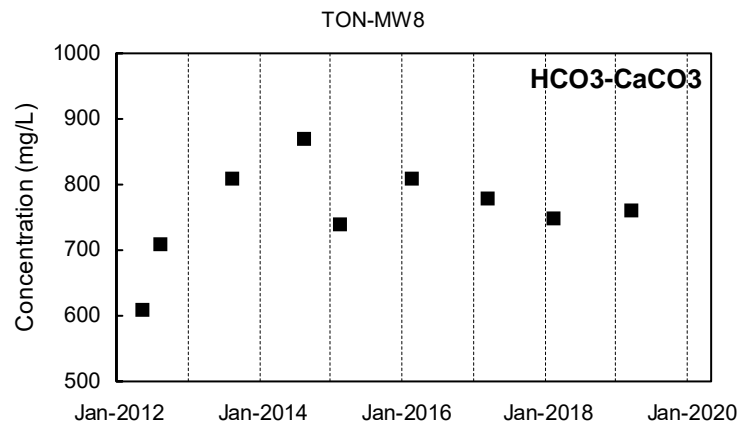
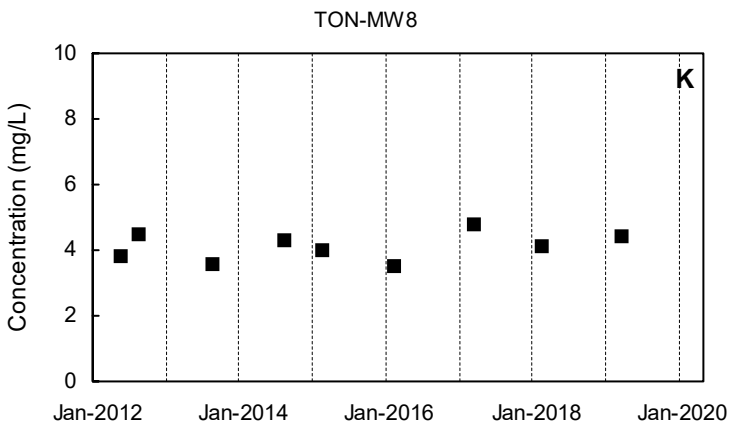
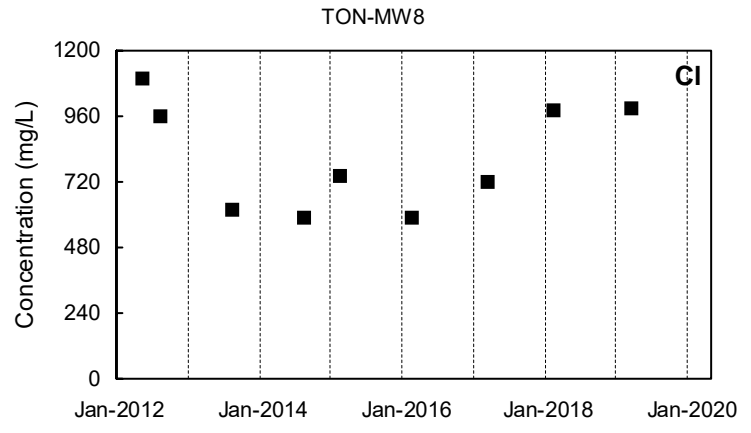
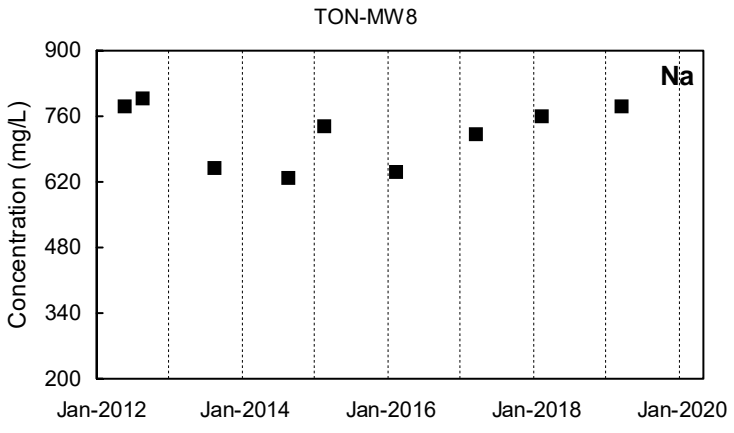

Detected Value
 'J'-Flag (value between reporting limit and detection limit)
 Non-Detect Range
 Shallow Well shown with black symbols
 Deep Well shown with orange symbols
 "dd" Well shown with blue symbols

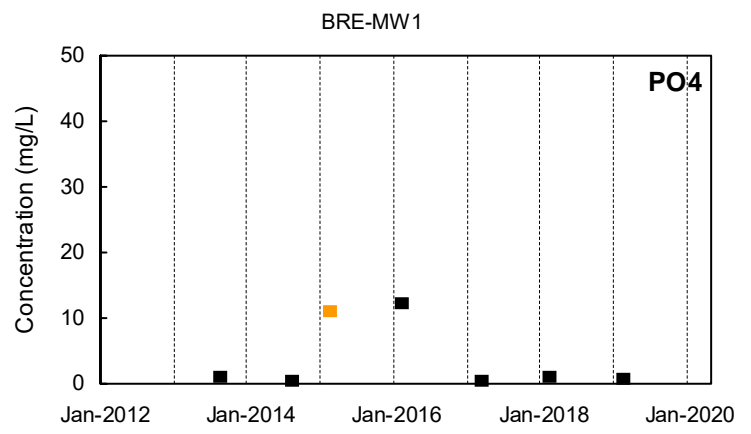
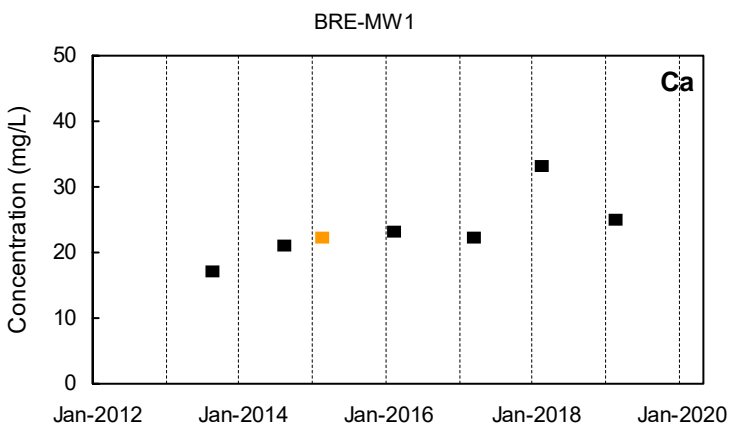
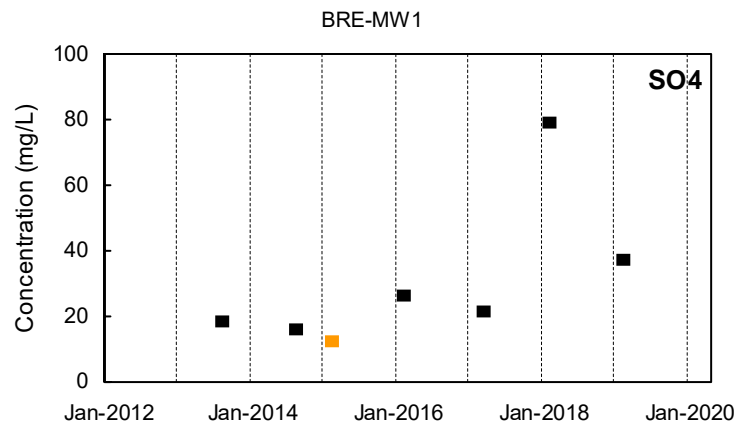
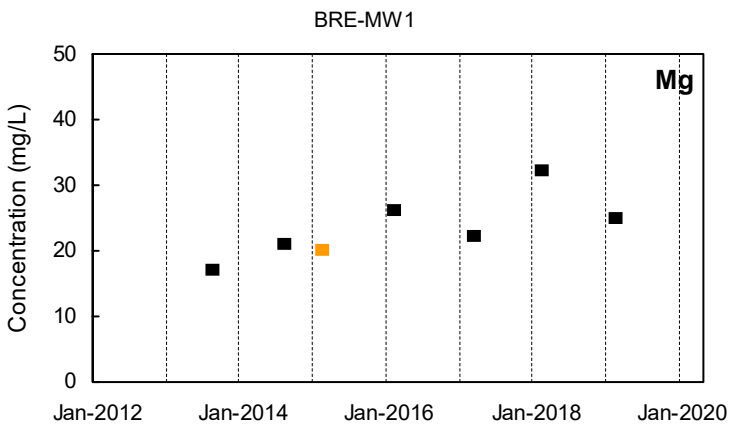
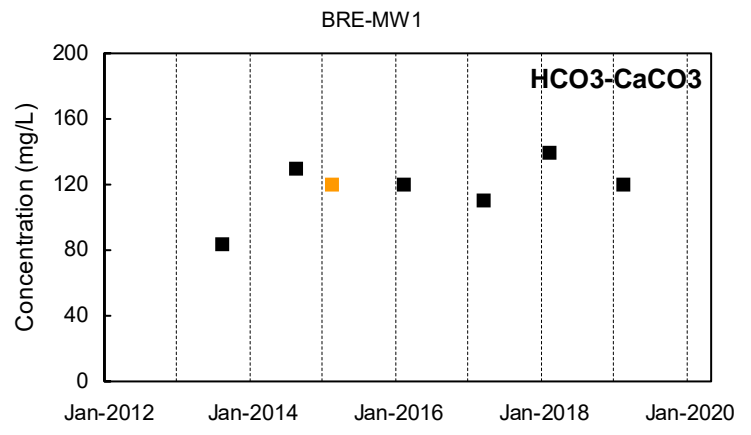
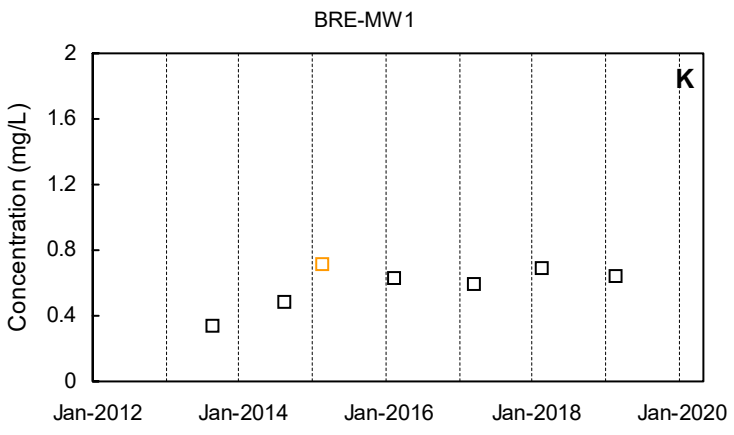
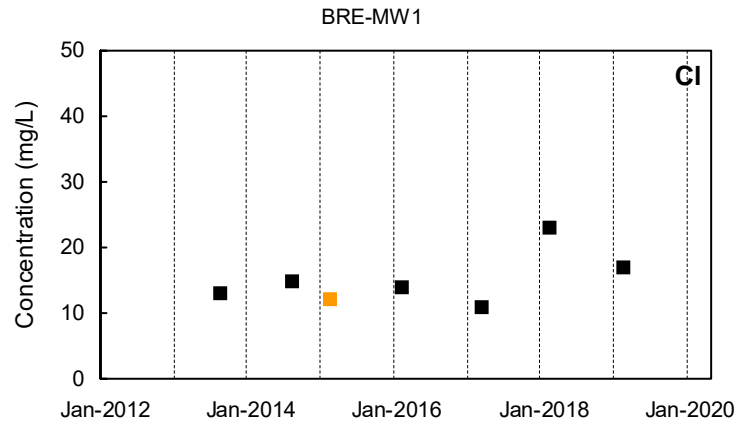
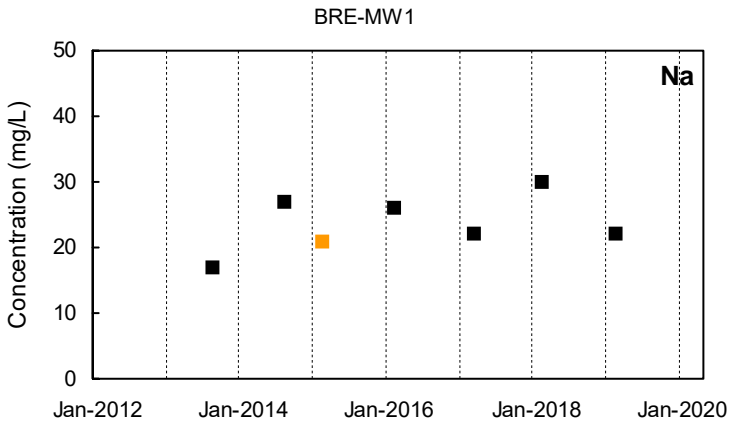

■ Detected Value □ 'J'-Flag (value between reporting limit and detection limit) ■ Non-Detect Range
 Shallow Well shown with black symbols Deep Well shown with orange symbols "dd" Well shown with blue symbols

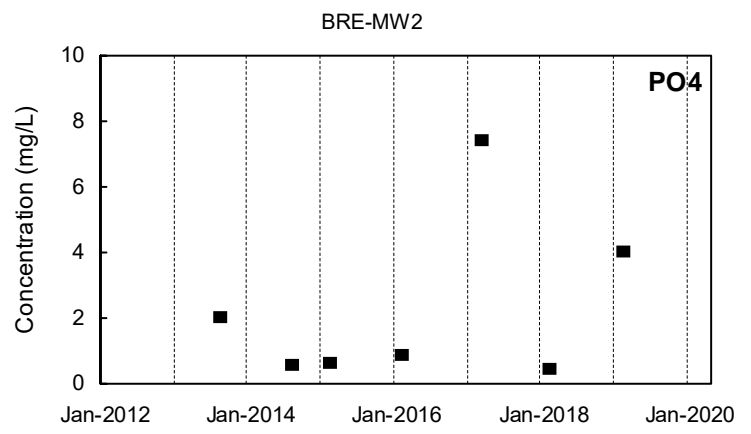
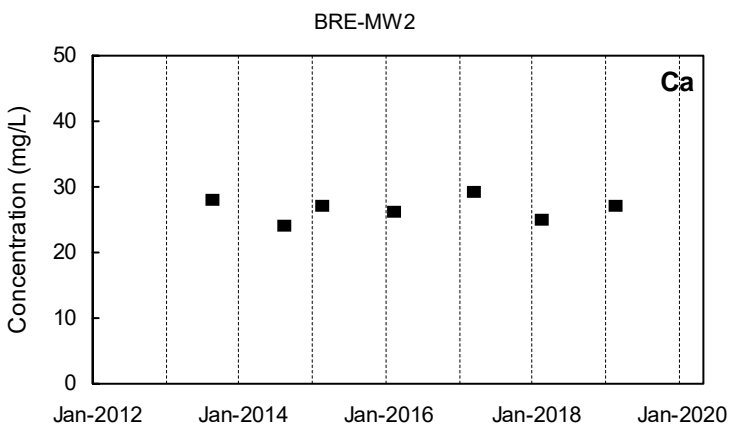
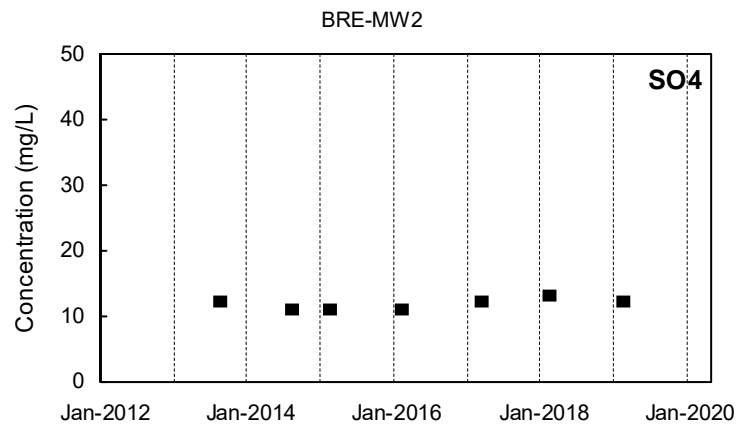
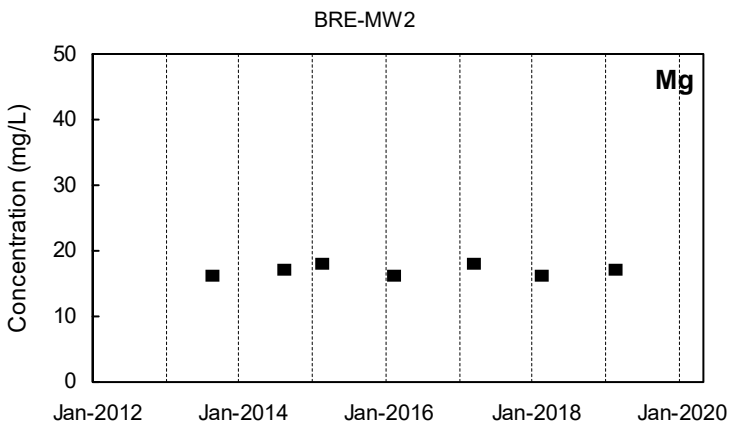
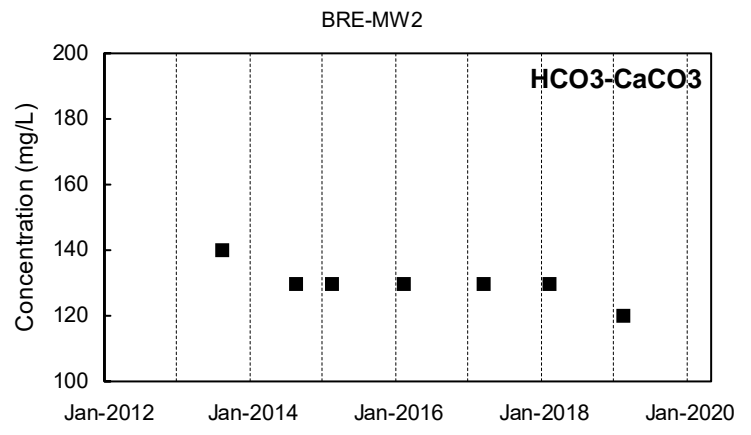
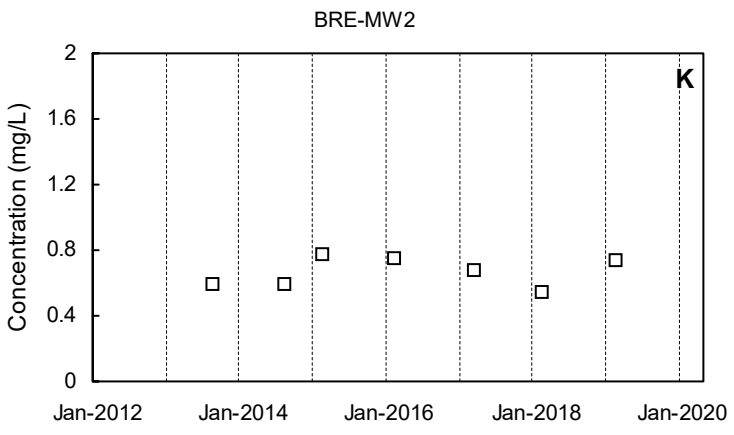
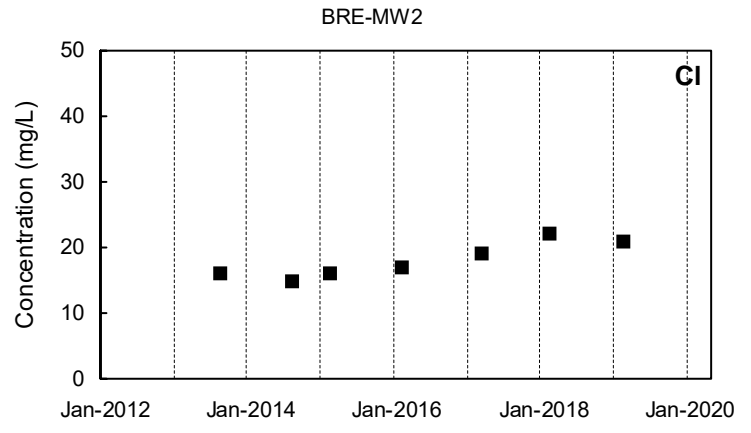
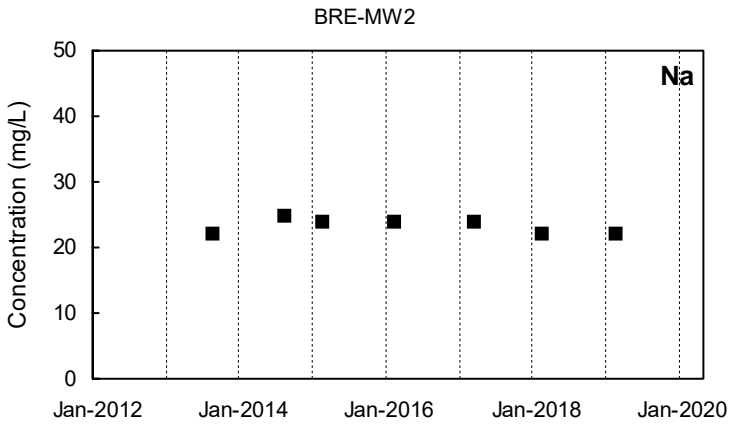

■ Detected Value □ 'J'-Flag (value between reporting limit and detection limit) ■ Non-Detect Range
 Shallow Well shown with black symbols Deep Well shown with orange symbols "dd" Well shown with blue symbols

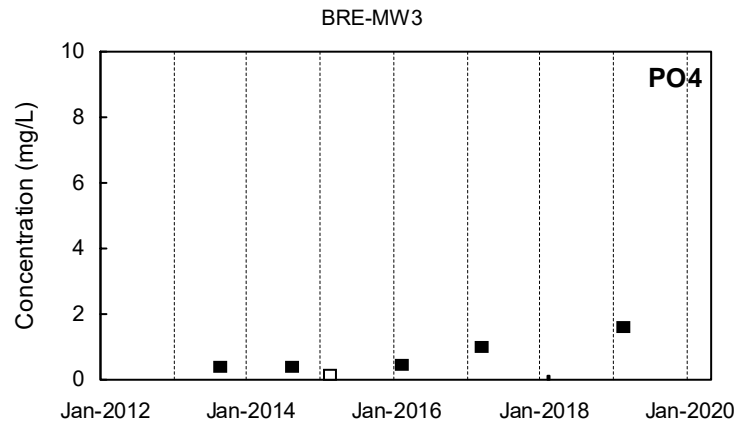
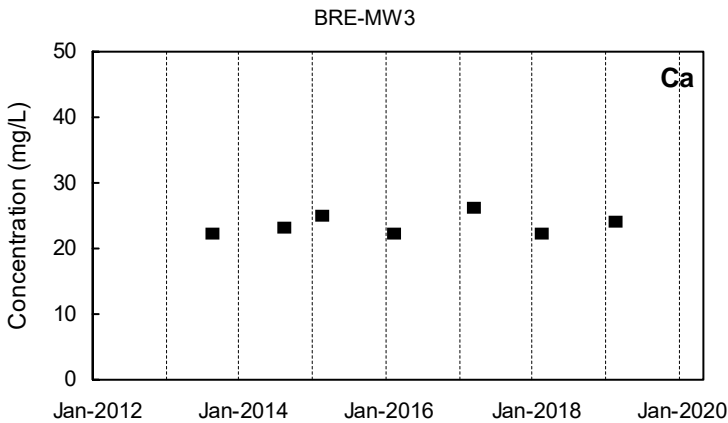
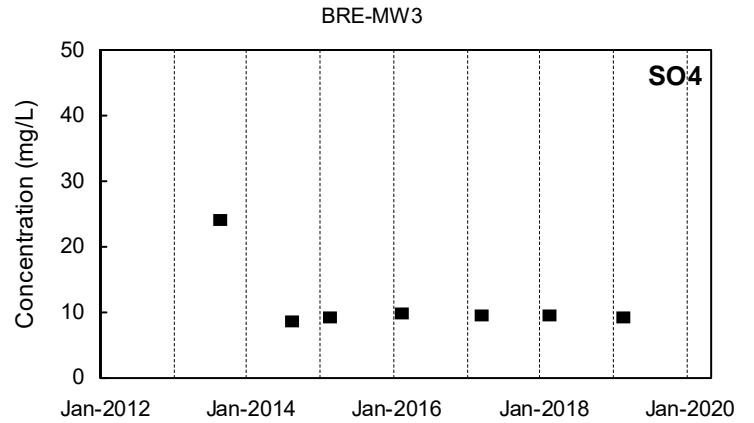
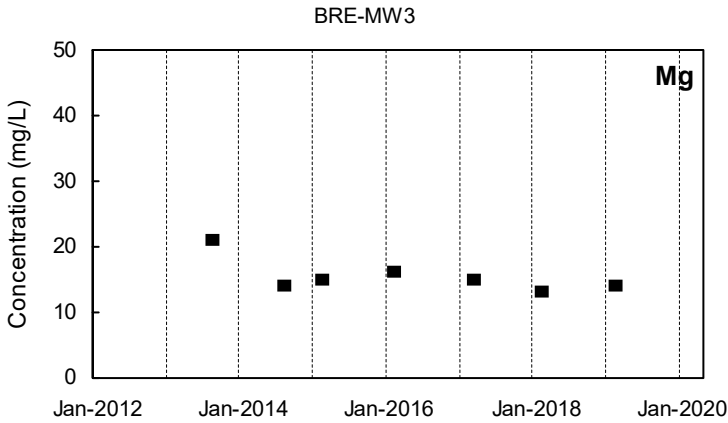
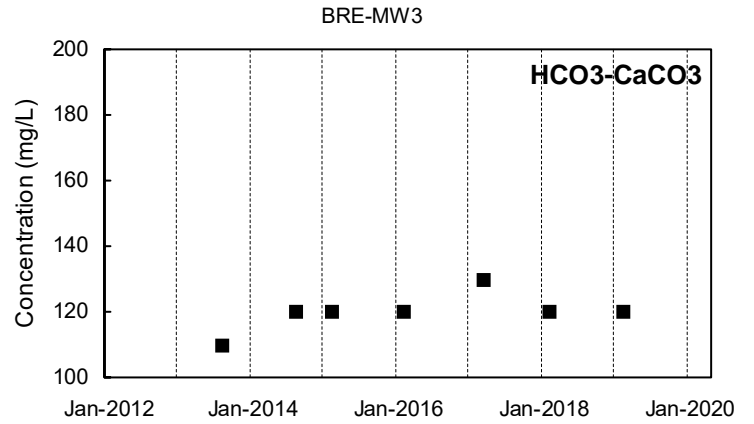
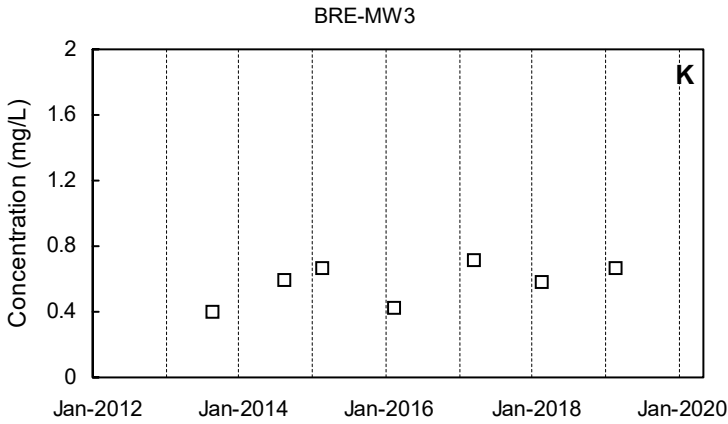
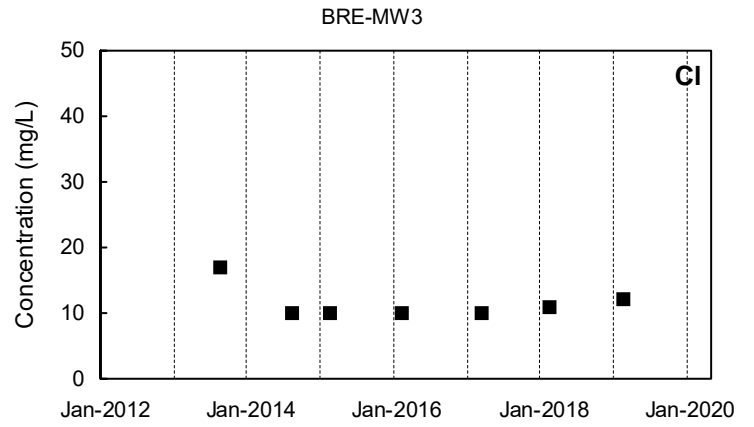
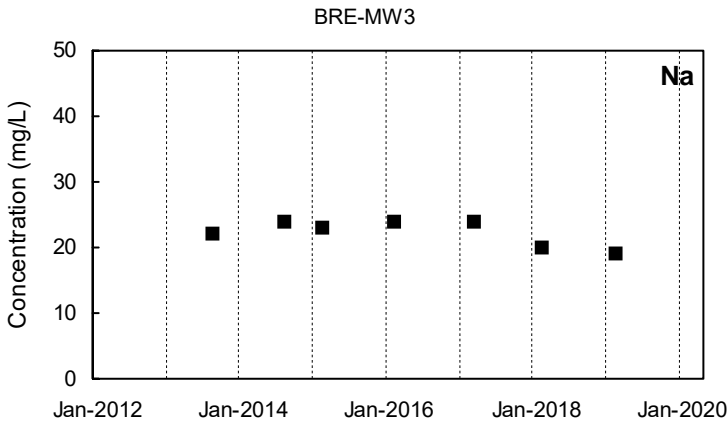

■ Detected Value □ 'J'-Flag (value between reporting limit and detection limit) ■ Non-Detect Range
 Shallow Well shown with black symbols Deep Well shown with orange symbols "dd" Well shown with blue symbols

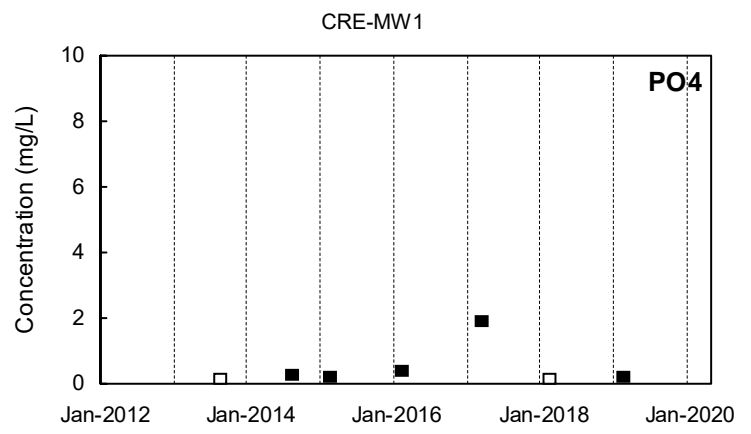
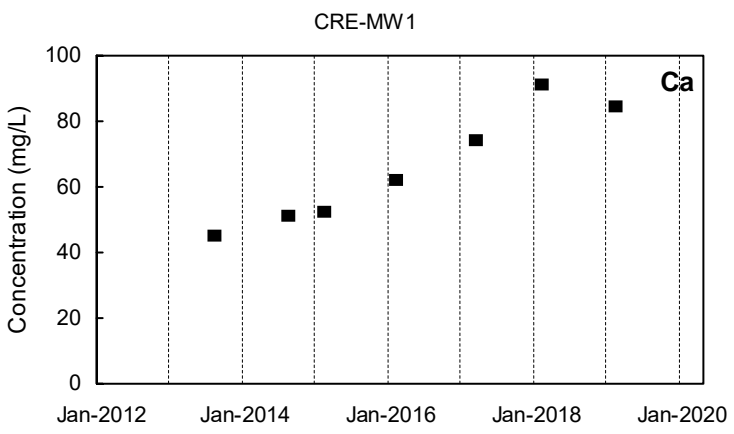
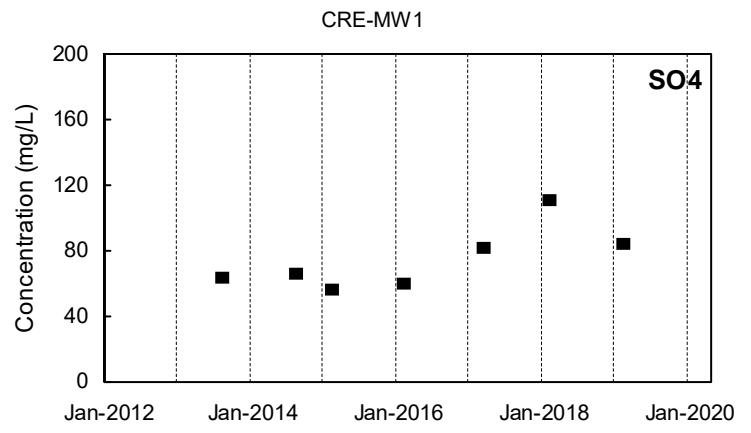
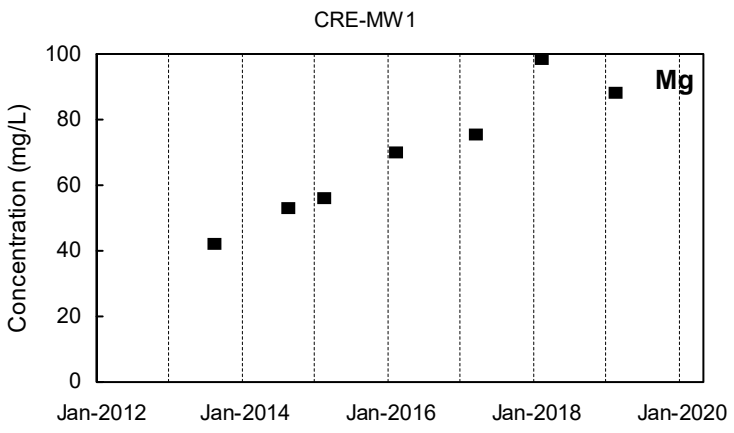
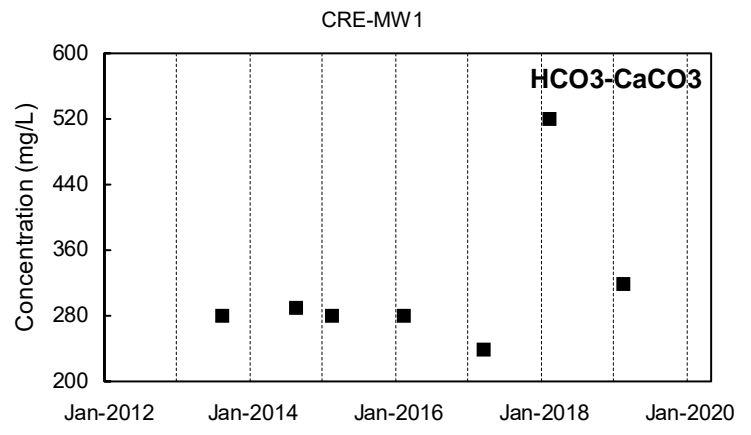
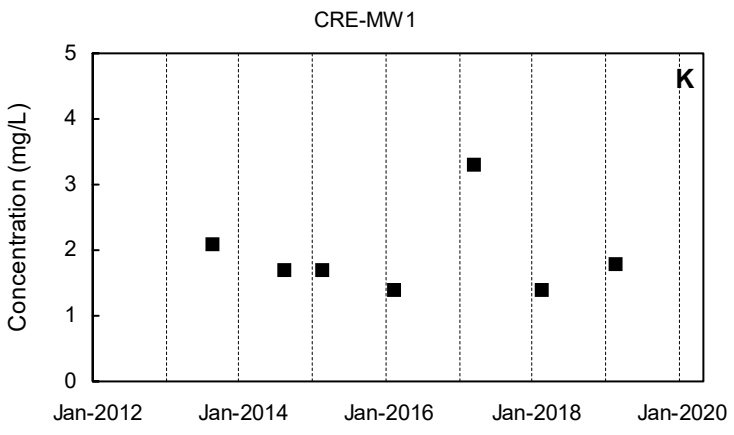
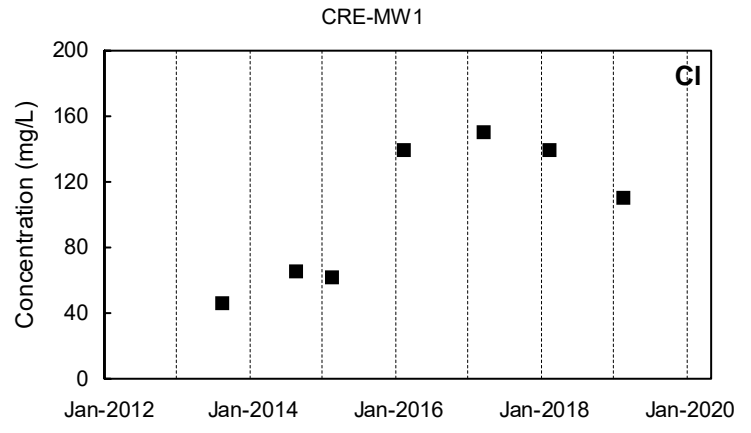
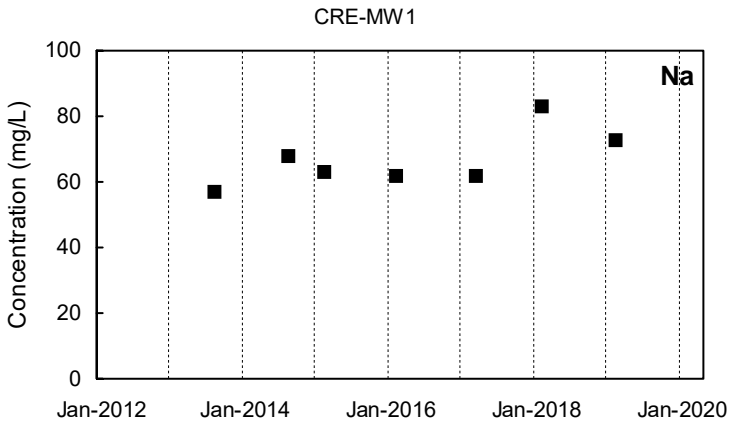

Detected Value
 'J'-Flag (value between reporting limit and detection limit)
 Non-Detect Range
 Shallow Well shown with black symbols
 Deep Well shown with orange symbols
 "dd" Well shown with blue symbols

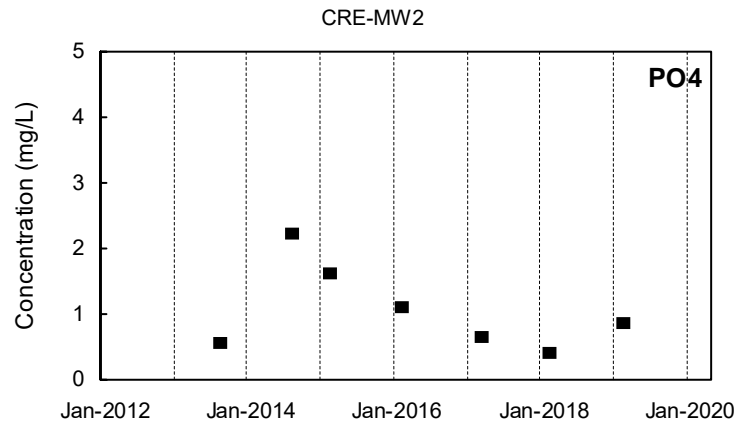
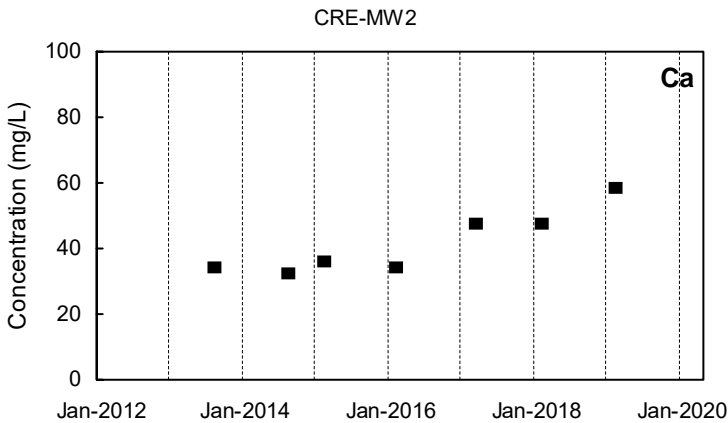
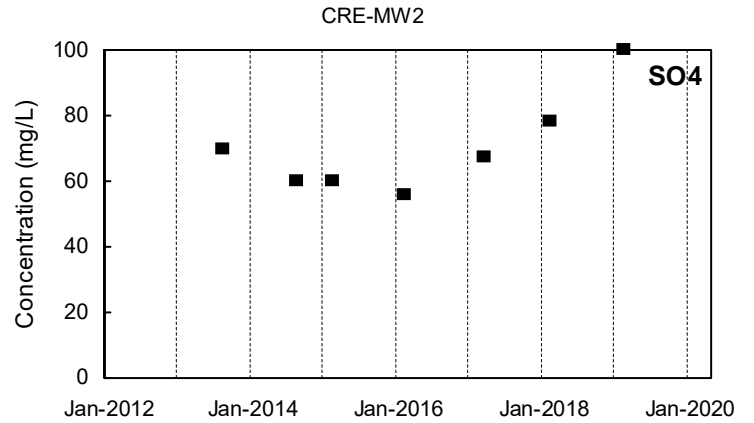
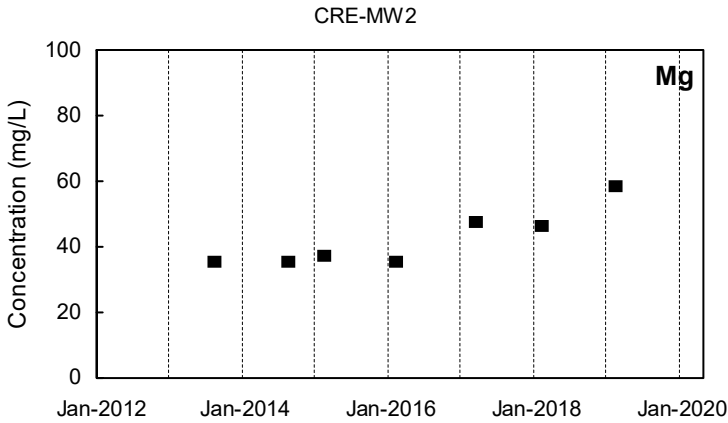
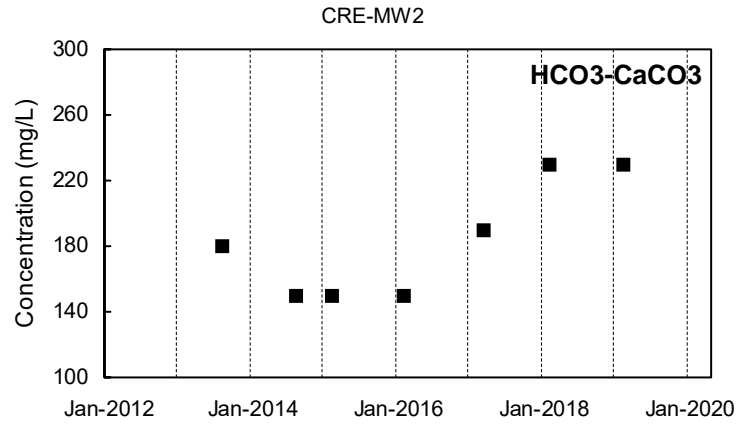
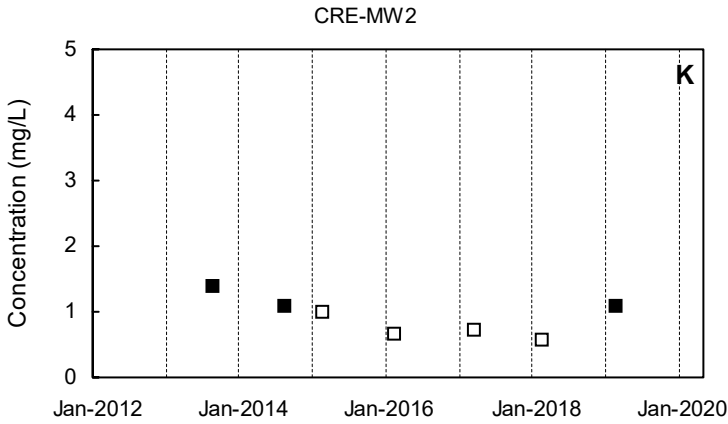
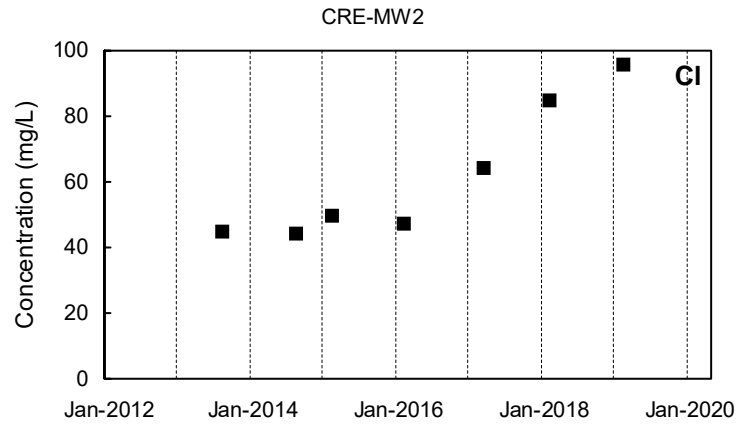
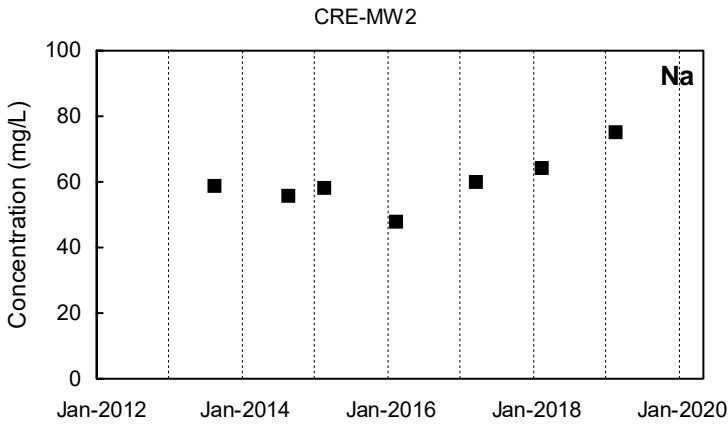

Detected Value
 'J'-Flag (value between reporting limit and detection limit)
 Non-Detect Range
 Shallow Well shown with black symbols Deep Well shown with orange symbols "dd" Well shown with blue symbols

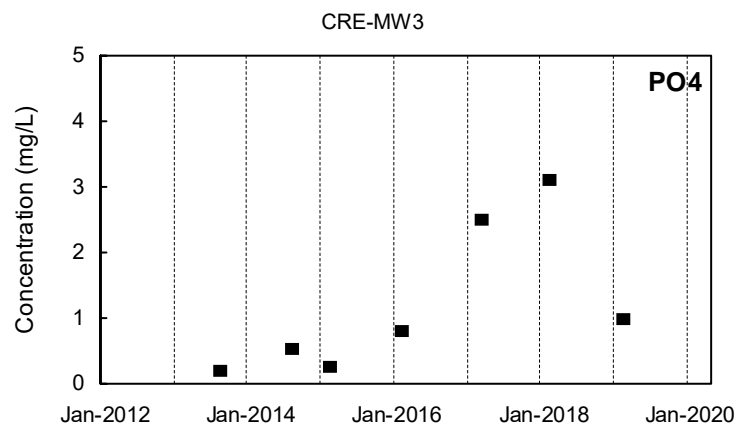
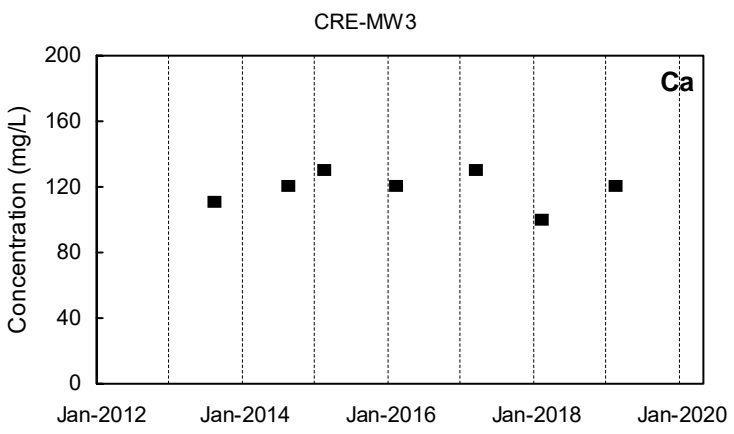
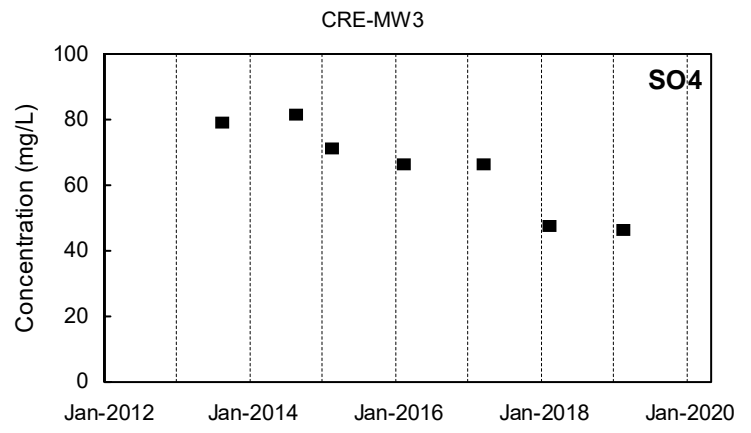
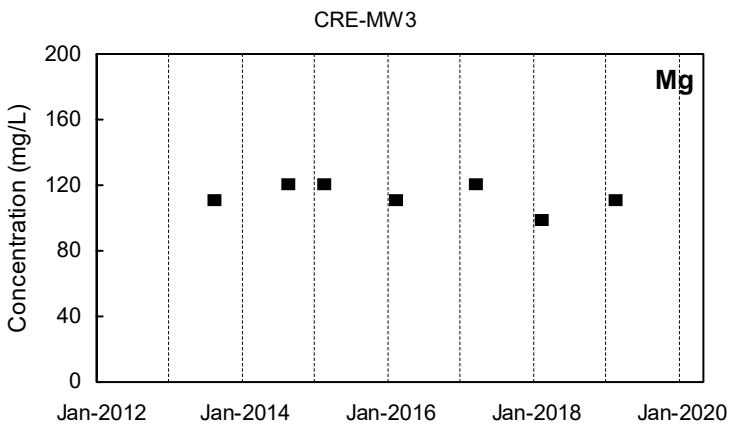
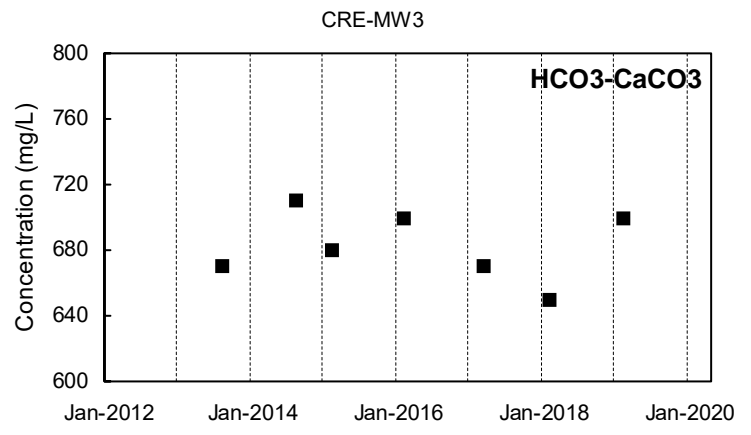
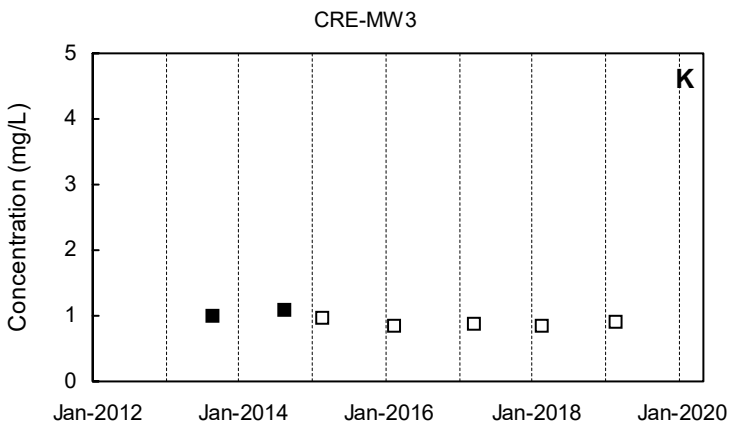
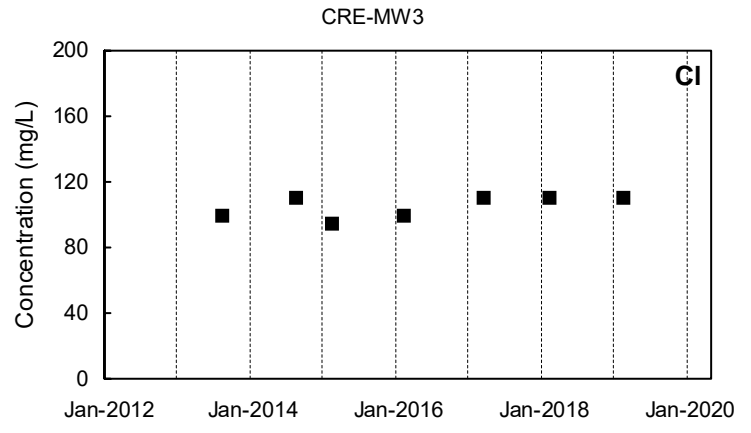
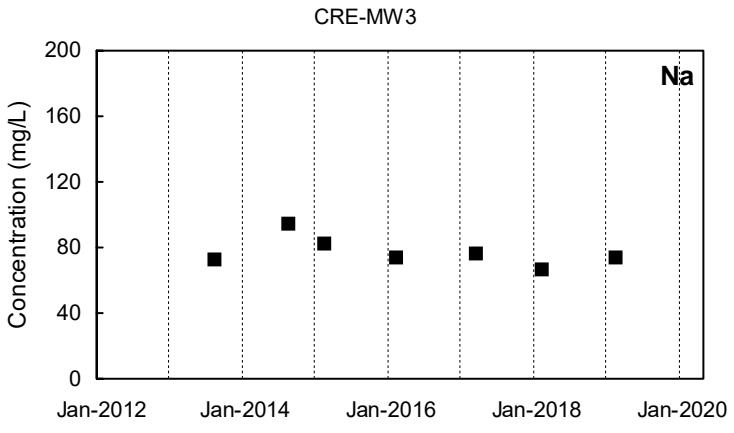

Detected Value
 'J'-Flag (value between reporting limit and detection limit)
 Non-Detect Range
 Shallow Well shown with black symbols
 Deep Well shown with orange symbols
 "dd" Well shown with blue symbols

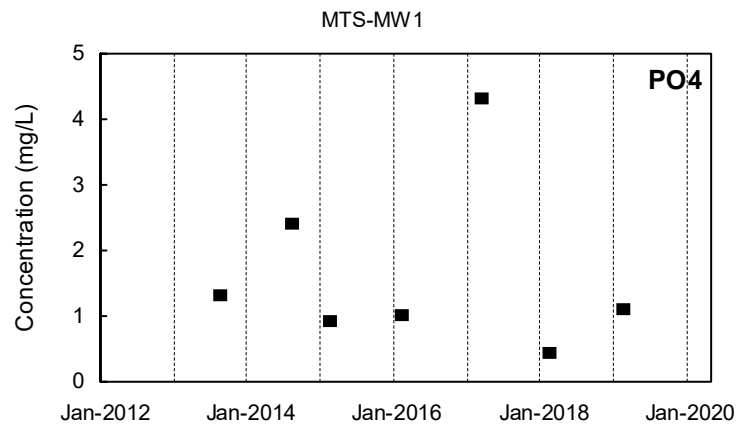
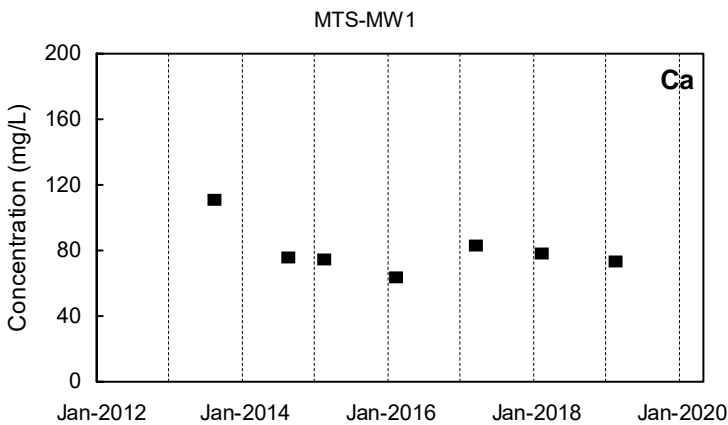
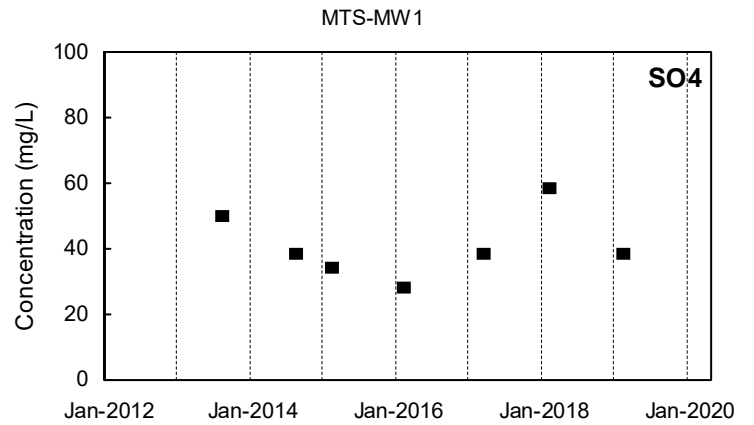
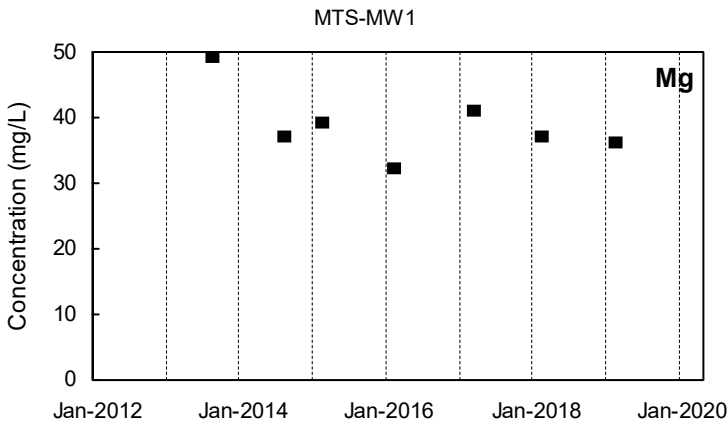
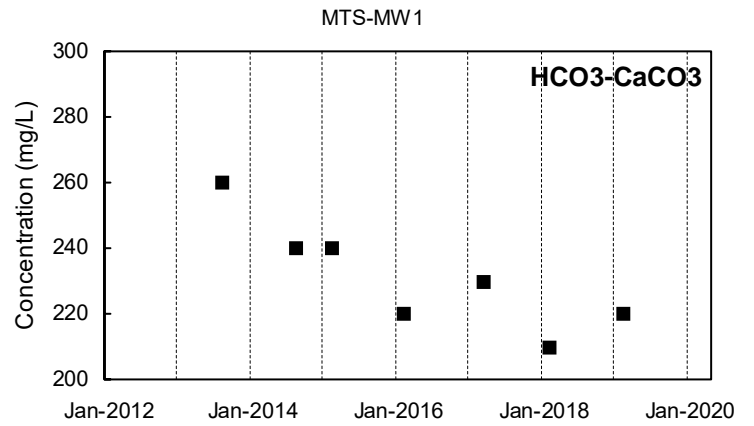
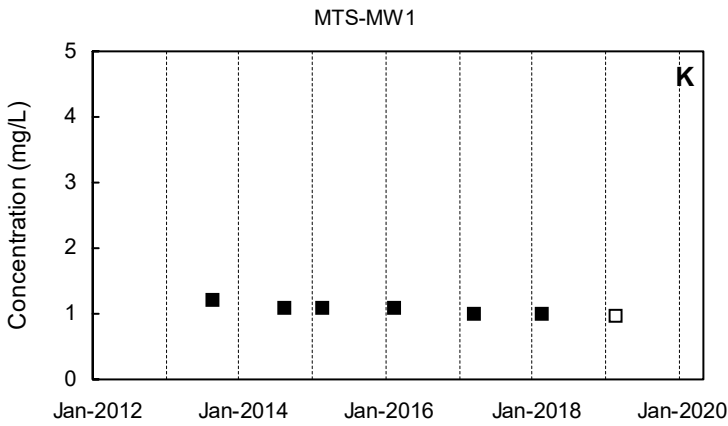
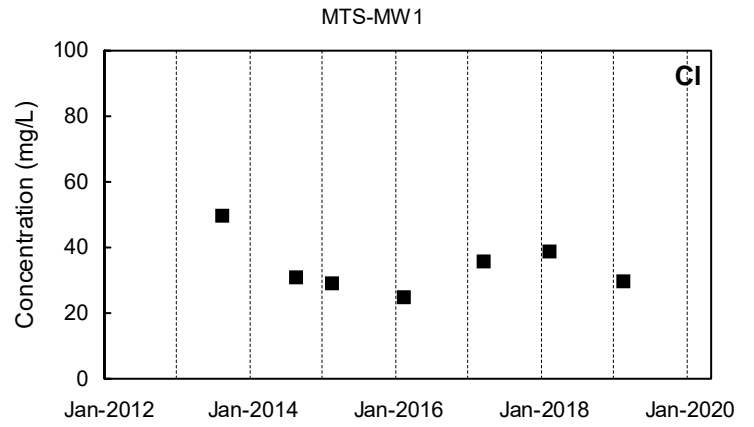
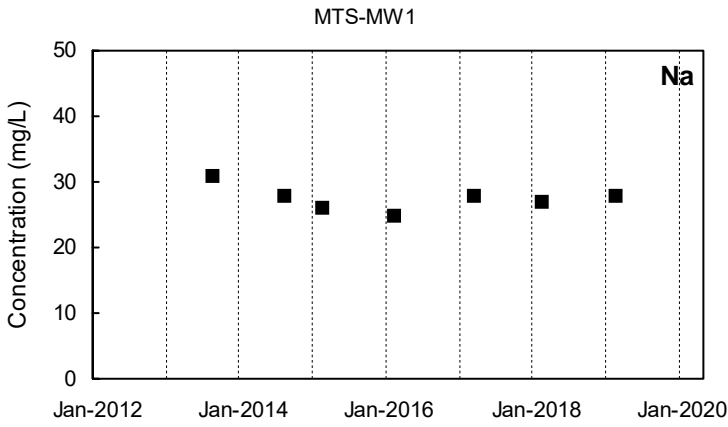

Detected Value
 'J'-Flag (value between reporting limit and detection limit)
 Non-Detect Range
 Shallow Well shown with black symbols
 Deep Well shown with orange symbols
 "dd" Well shown with blue symbols

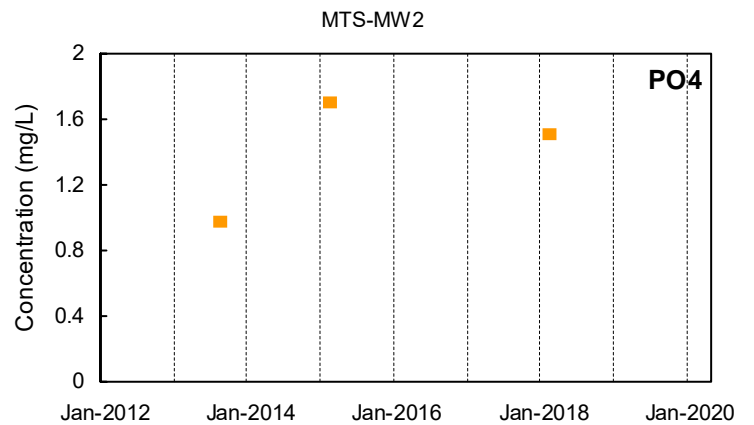
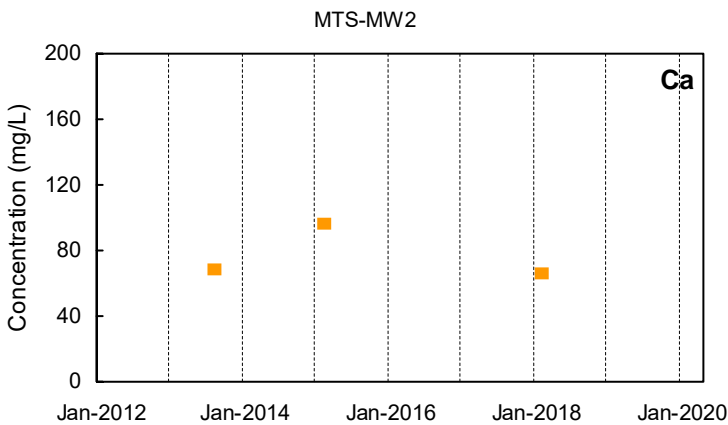
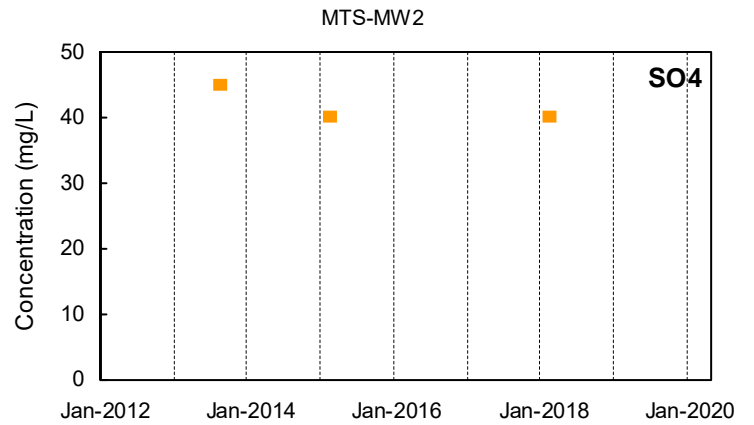
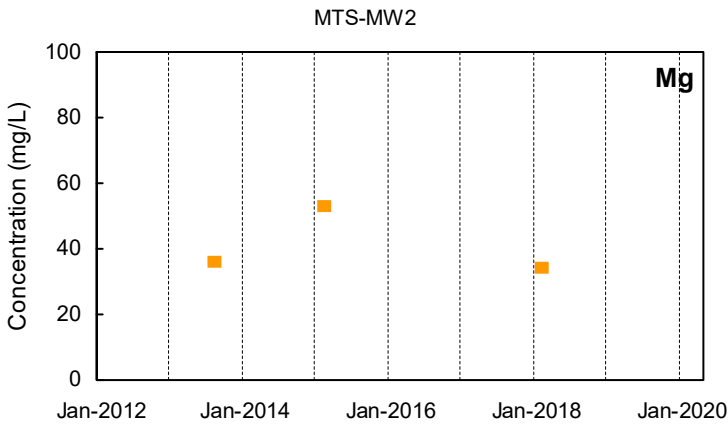
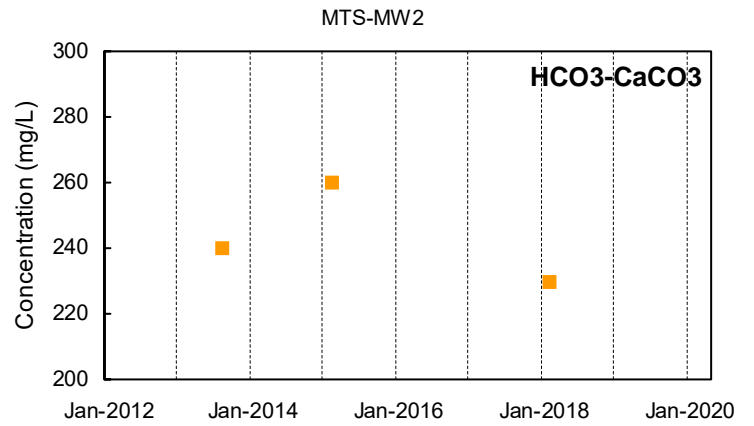
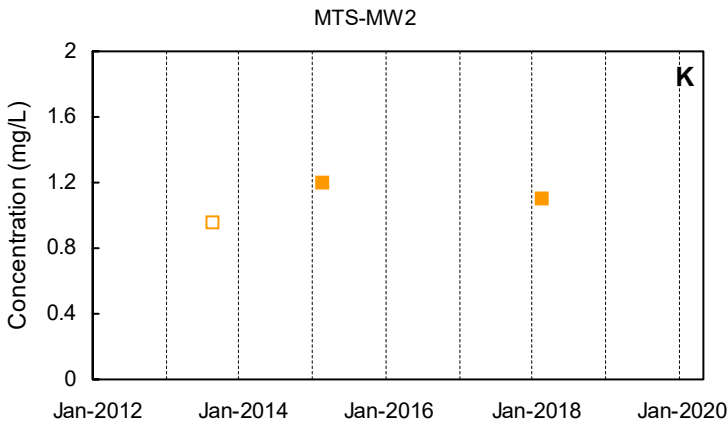
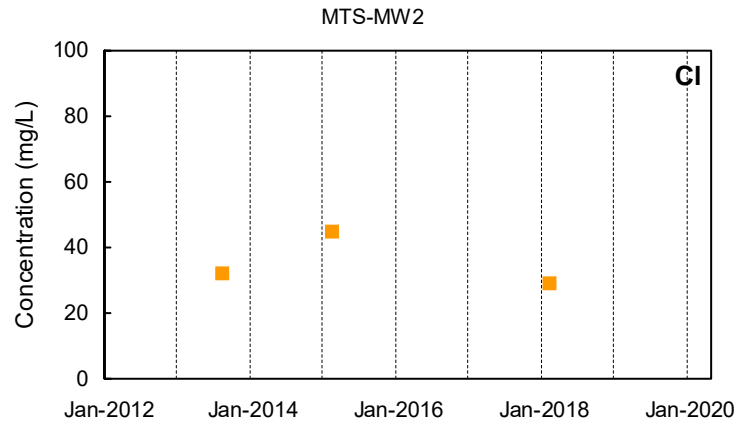
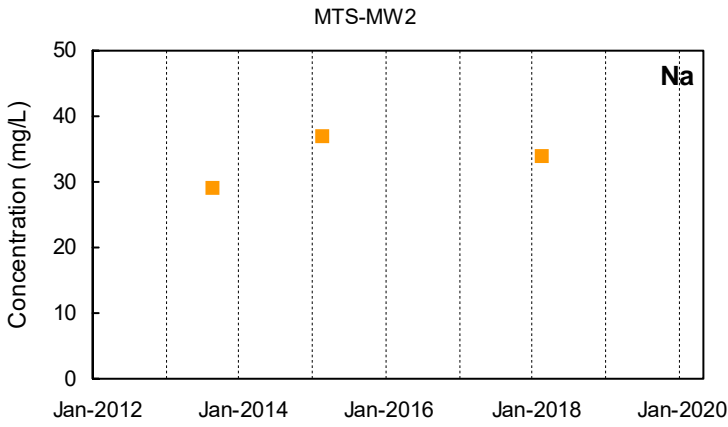

■ Detected Value
 □ 'J'-Flag (value between reporting limit and detection limit)
 Non-Detect Range
■ Shallow Well shown with black symbols
■ Deep Well shown with orange symbols
■ "dd" Well shown with blue symbols

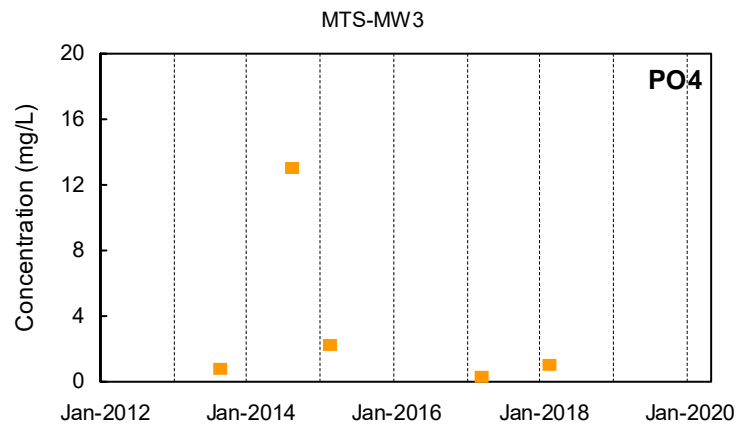
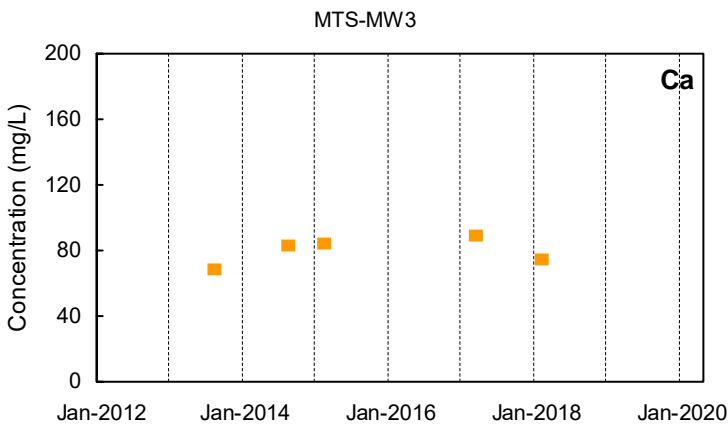
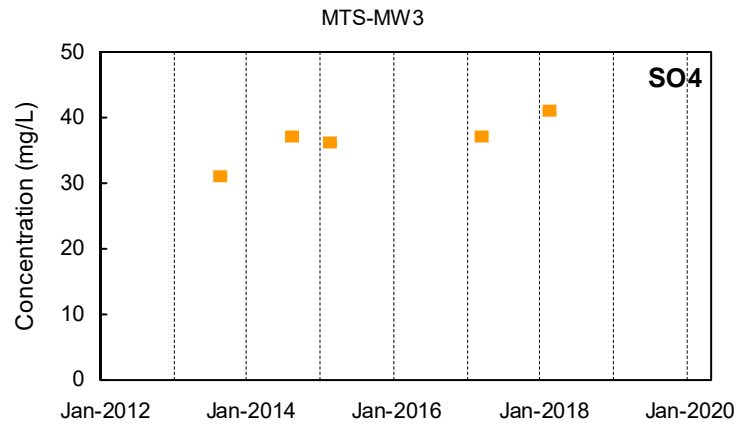
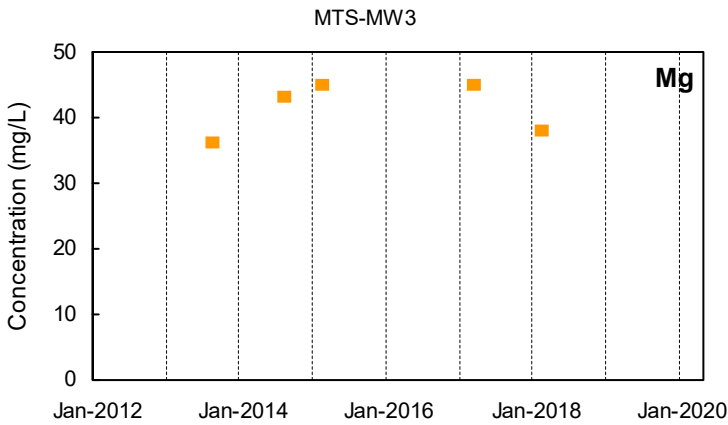
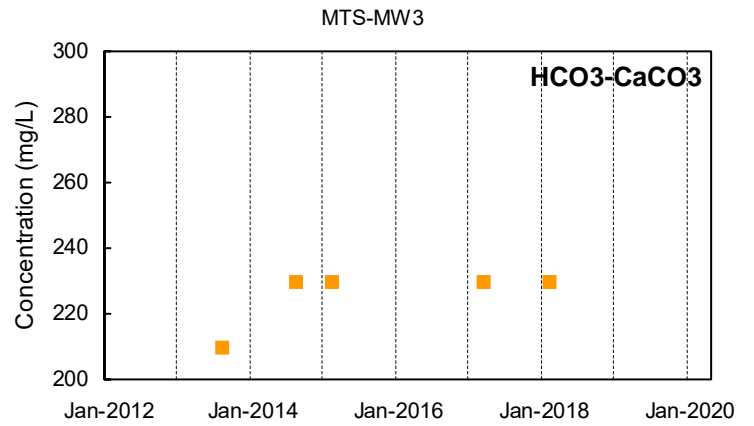
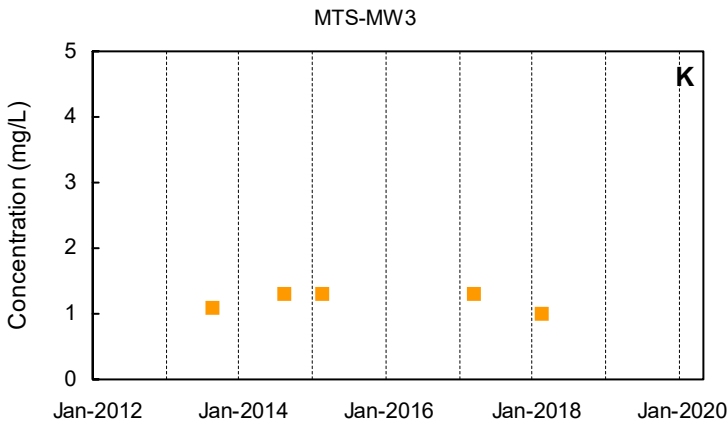
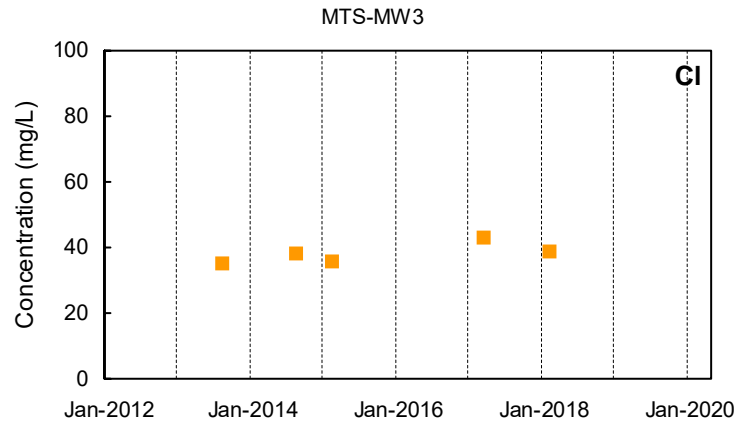
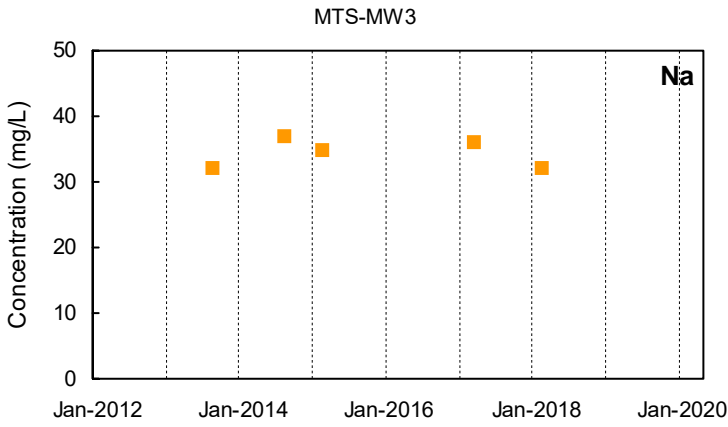

■ Detected Value
 □ 'J'-Flag (value between reporting limit and detection limit)
 Non-Detect Range
■ Shallow Well shown with black symbols
■ Deep Well shown with orange symbols
■ "dd" Well shown with blue symbols

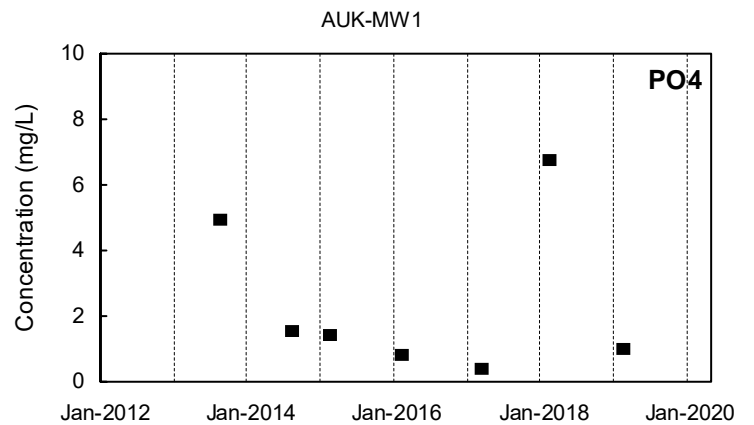
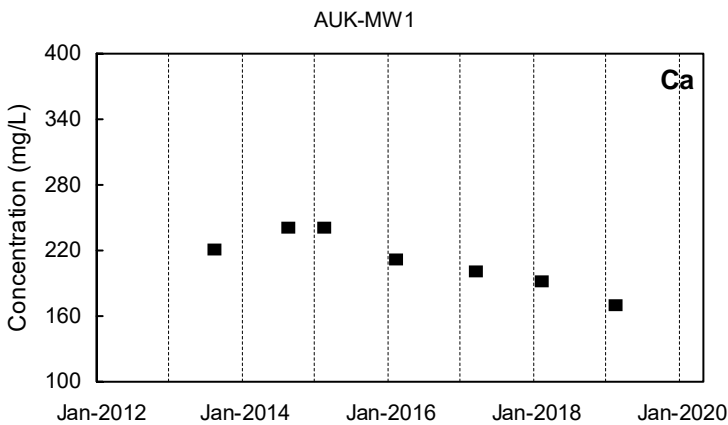
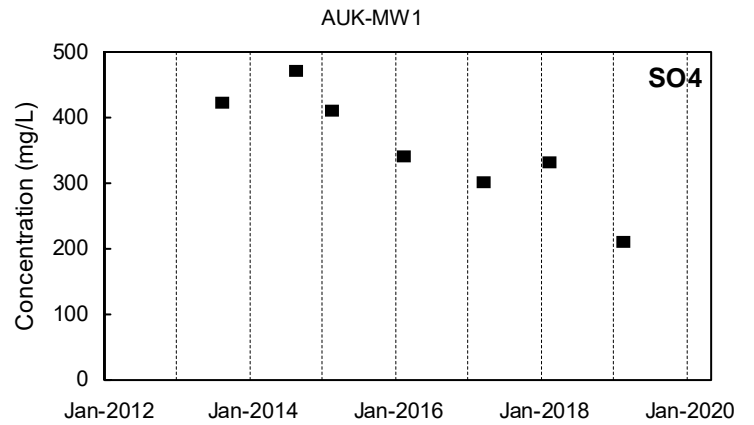
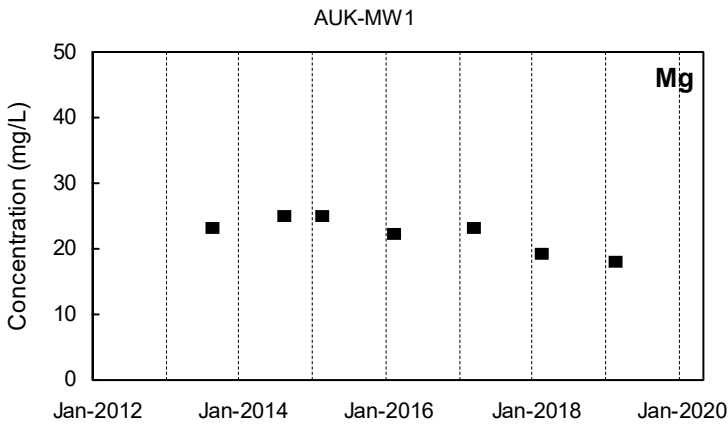
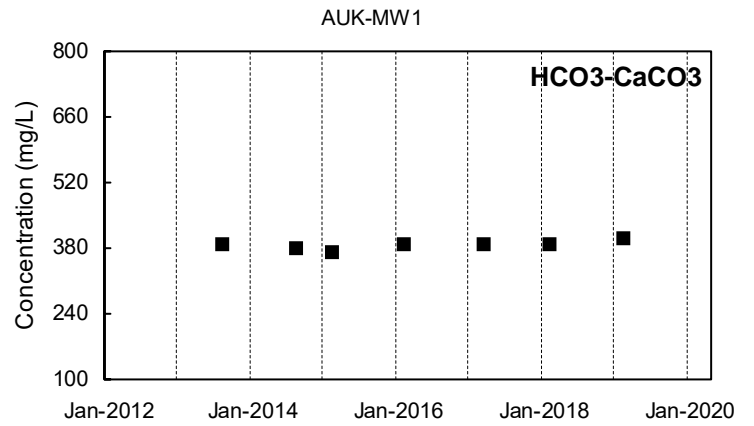
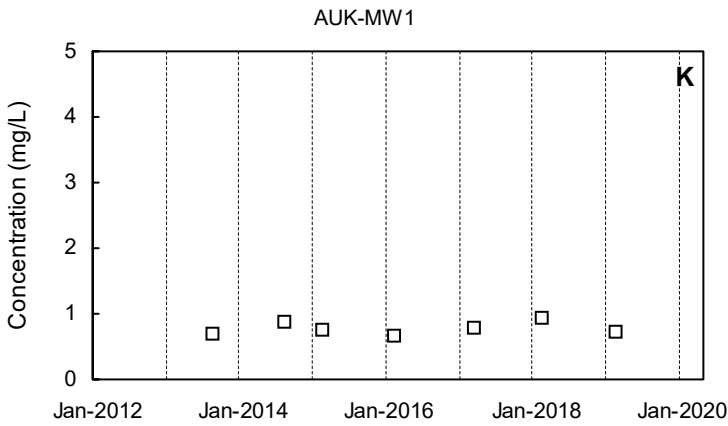
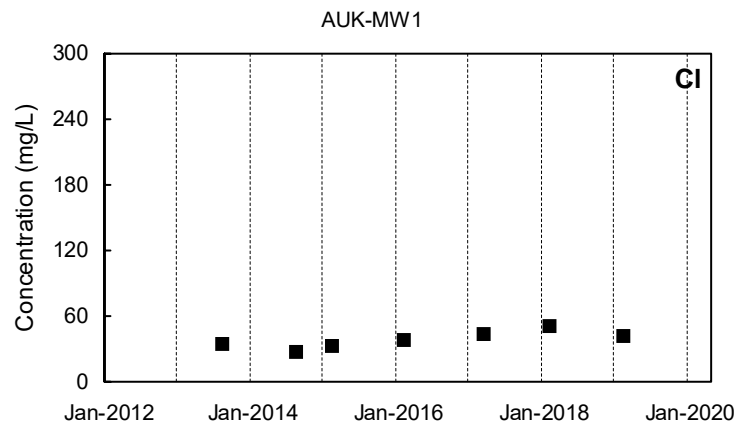
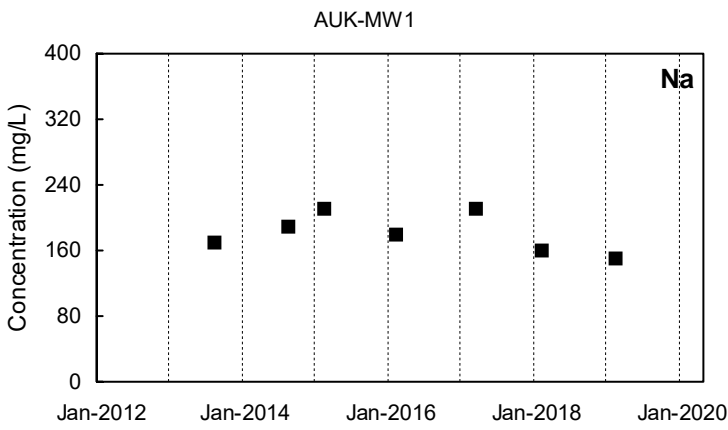

Detected Value
 'J'-Flag (value between reporting limit and detection limit)
 Non-Detect Range
 Shallow Well shown with black symbols
 Deep Well shown with orange symbols
 "dd" Well shown with blue symbols

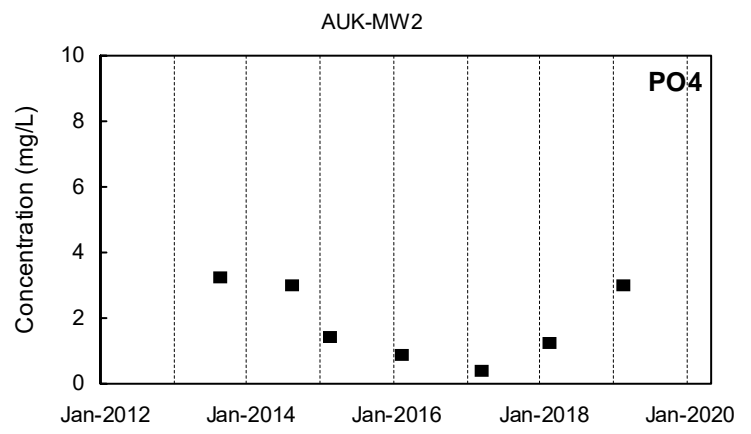
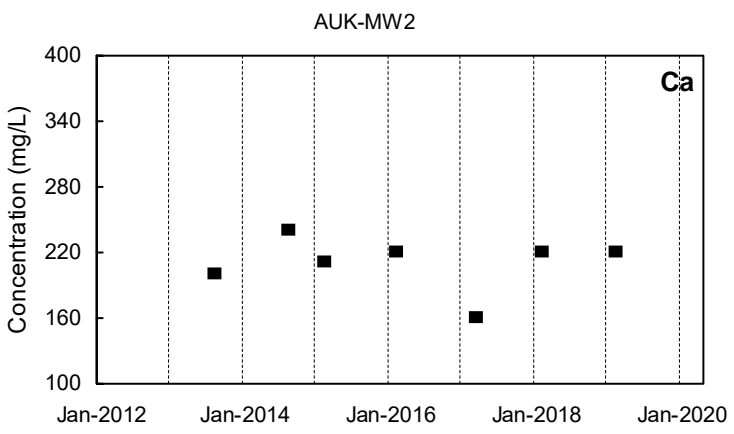
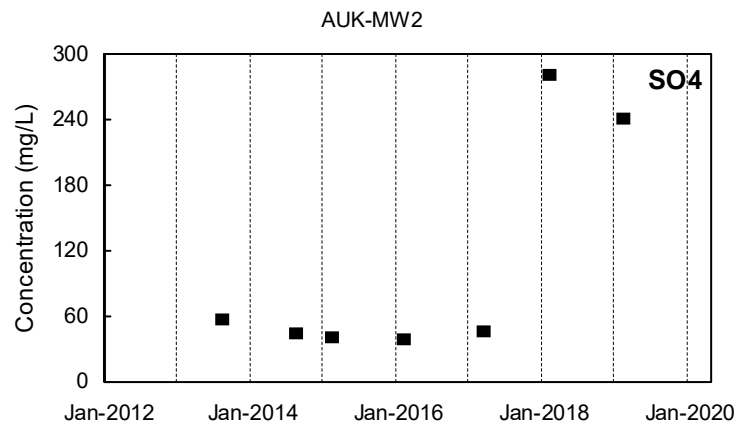
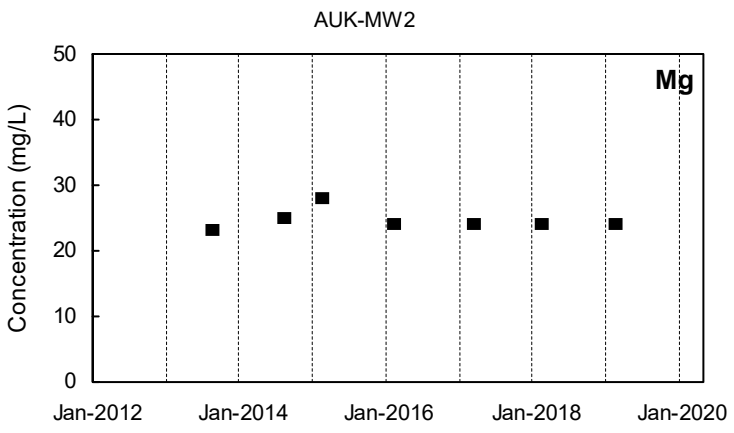
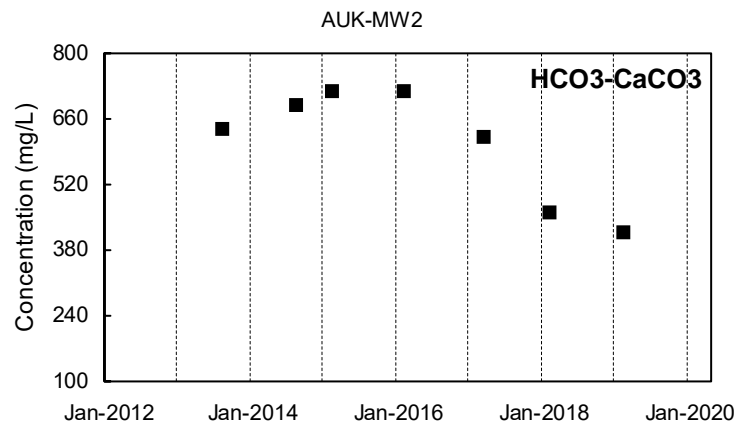
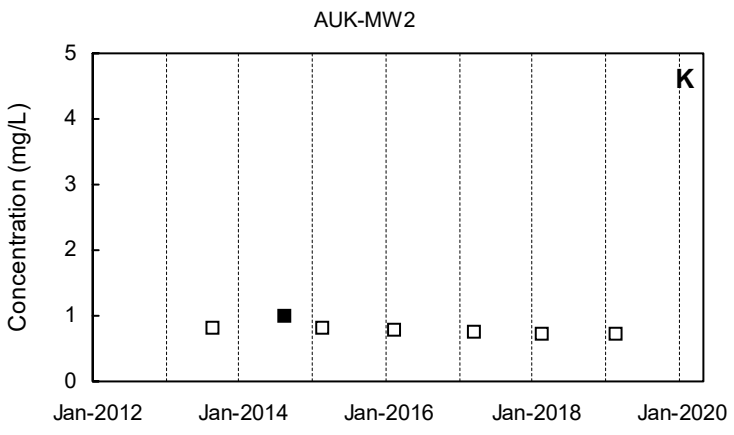
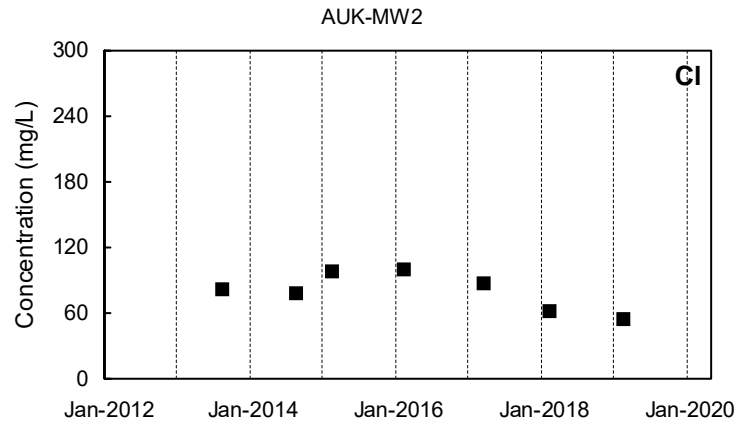
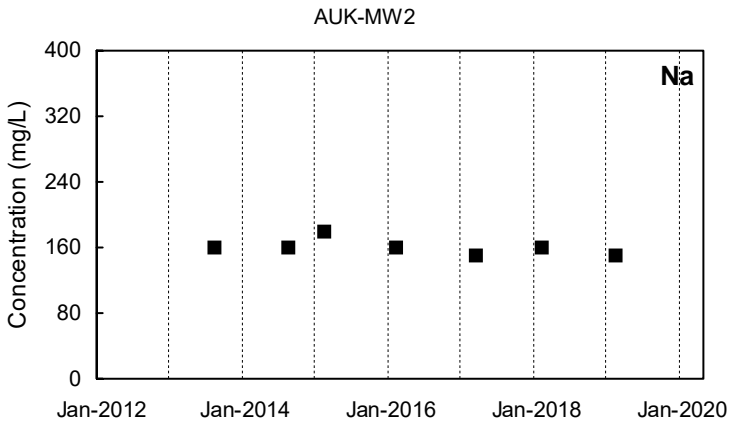

■ Detected Value □ 'J'-Flag (value between reporting limit and detection limit) ■ Non-Detect Range
 Shallow Well shown with black symbols Deep Well shown with orange symbols "dd" Well shown with blue symbols

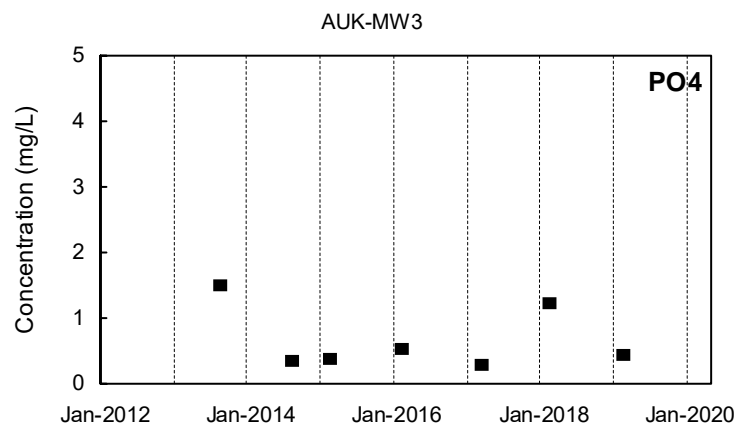
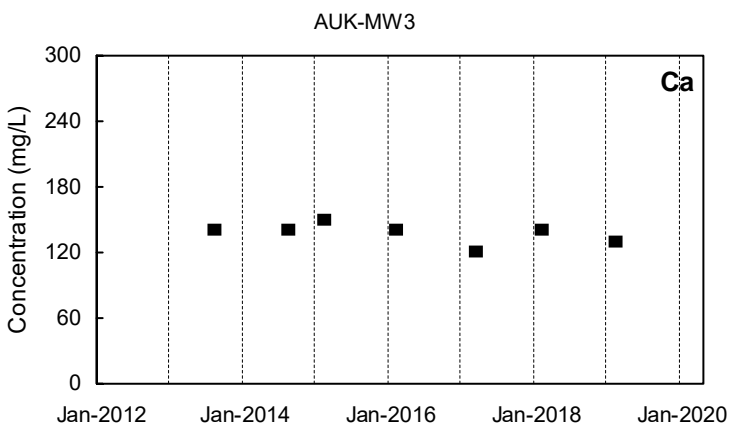
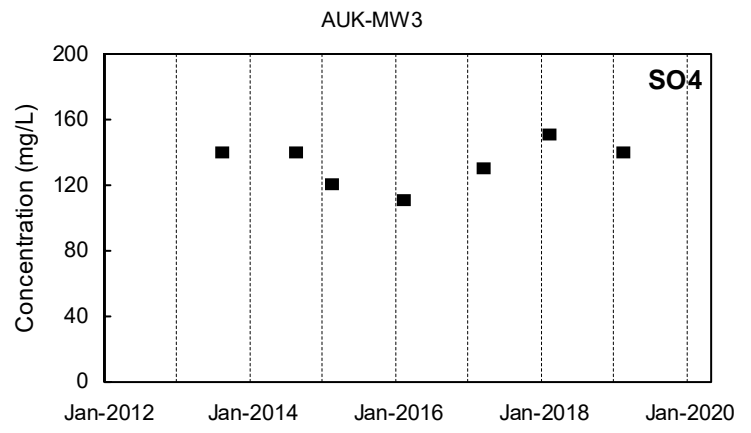
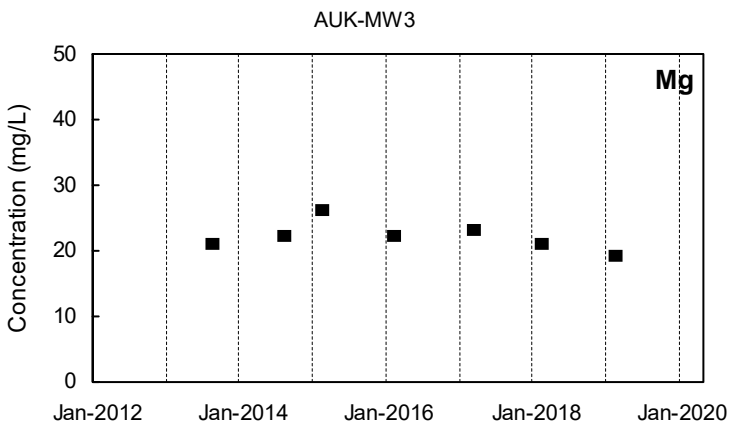
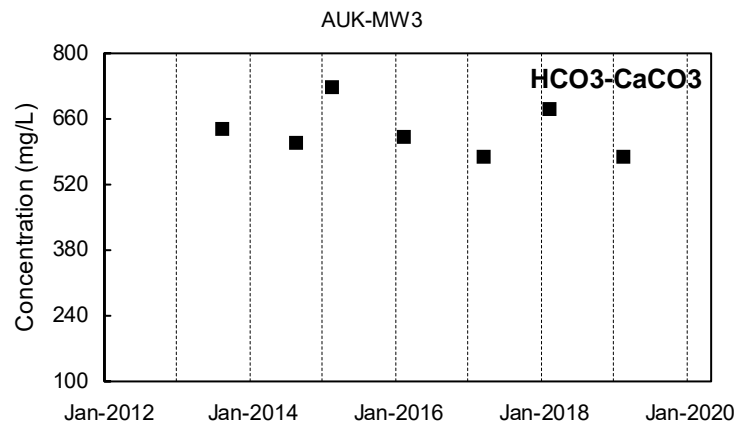
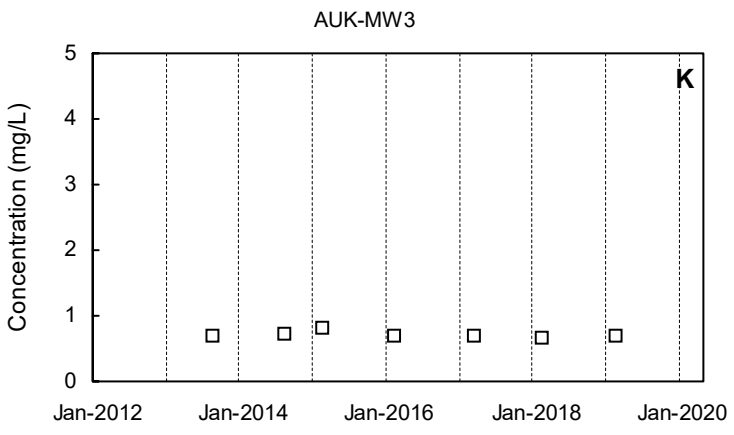
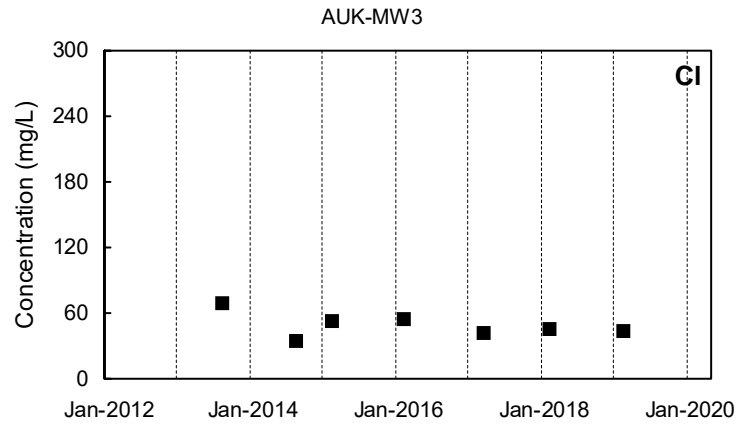
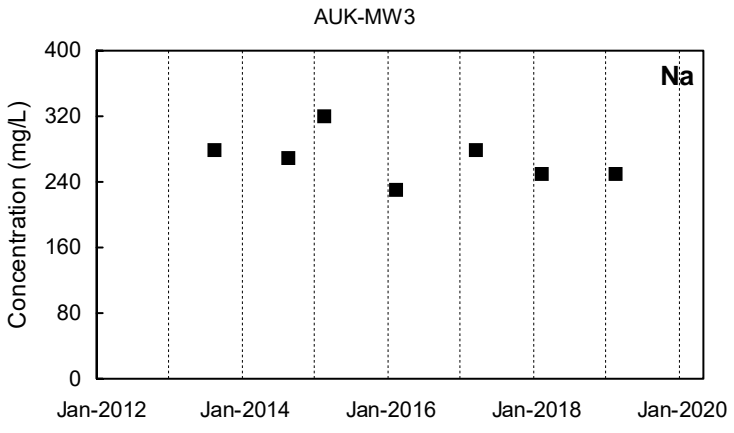

Detected Value
 'J'-Flag (value between reporting limit and detection limit)
 Non-Detect Range
 Shallow Well shown with black symbols
 Deep Well shown with orange symbols
 "dd" Well shown with blue symbols

DLF-MW1

DLF-MW1

Na

Not Sampled

Cl

Not Sampled

DLF-MW1

DLF-MW1

K

Not Sampled

HCO3-CaCO3

Not Sampled

DLF-MW1

DLF-MW1

Mg

Not Sampled

SO4

Not Sampled

DLF-MW1

DLF-MW1

Ca

Not Sampled

PO4

Not Sampled

Detected Value
 'J'-Flag (value between reporting limit and detection limit)
 Non-Detect Range
 Shallow Well shown with black symbols
 Deep Well shown with orange symbols
 "dd" Well shown with blue symbols

DLF-MW2

DLF-MW2

Na

Not Sampled

Cl

Not Sampled

DLF-MW2

DLF-MW2

K

Not Sampled

HCO3-CaCO3

Not Sampled

DLF-MW2

DLF-MW2

Mg

Not Sampled

SO4

Not Sampled

DLF-MW2

DLF-MW2

Ca

Not Sampled

PO4

Not Sampled

Detected Value
 'J'-Flag (value between reporting limit and detection limit)
 Non-Detect Range
 Shallow Well shown with black symbols
 Deep Well shown with orange symbols
 "dd" Well shown with blue symbols

DLF-MW3

DLF-MW3

Na

Not Sampled

Cl

Not Sampled

DLF-MW3

DLF-MW3

K

Not Sampled

HCO3-CaCO3

Not Sampled

DLF-MW3

DLF-MW3

Mg

Not Sampled

SO4

Not Sampled

DLF-MW3

DLF-MW3

Ca

Not Sampled

PO4

Not Sampled

■ Detected Value

□ 'J'-Flag (value between reporting limit and detection limit)



Non-Detect Range

Shallow Well shown with black symbols

Deep Well shown with orange symbols

"dd" Well shown with blue symbols

DLF-MW4A

Na

Not Sampled

DLF-MW4A

Cl

Not Sampled

DLF-MW4A

K

Not Sampled

DLF-MW4A

HCO3-CaCO3

Not Sampled

DLF-MW4A

Mg

Not Sampled

DLF-MW4A

SO4

Not Sampled

DLF-MW4A

Ca

Not Sampled

DLF-MW4A

PO4

Not Sampled

■ Detected Value

□ 'J'-Flag (value between reporting limit and detection limit)



Non-Detect Range

Shallow Well shown with black symbols

Deep Well shown with orange symbols

"dd" Well shown with blue symbols

DLF-MW4B

Na

Not Sampled

DLF-MW4B

Cl

Not Sampled

DLF-MW4B

K

Not Sampled

DLF-MW4B

HCO3-CaCO3

Not Sampled

DLF-MW4B

Mg

Not Sampled

DLF-MW4B

SO4

Not Sampled

DLF-MW4B

Ca

Not Sampled

DLF-MW4B

PO4

Not Sampled

■ Detected Value

□ 'J'-Flag (value between reporting limit and detection limit)



Non-Detect Range

Shallow Well shown with black symbols

Deep Well shown with orange symbols

"dd" Well shown with blue symbols

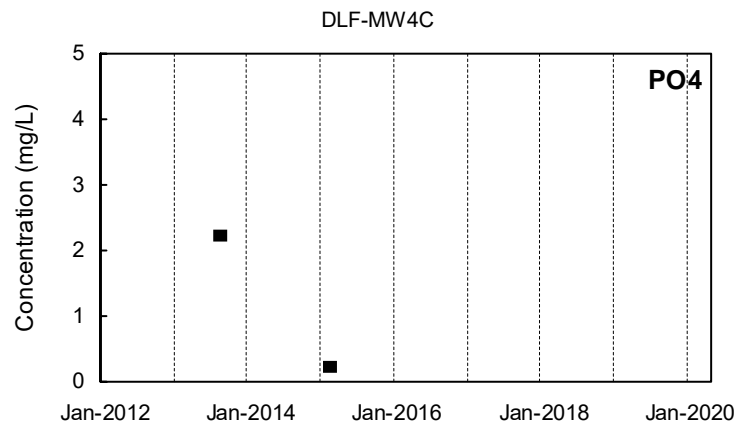
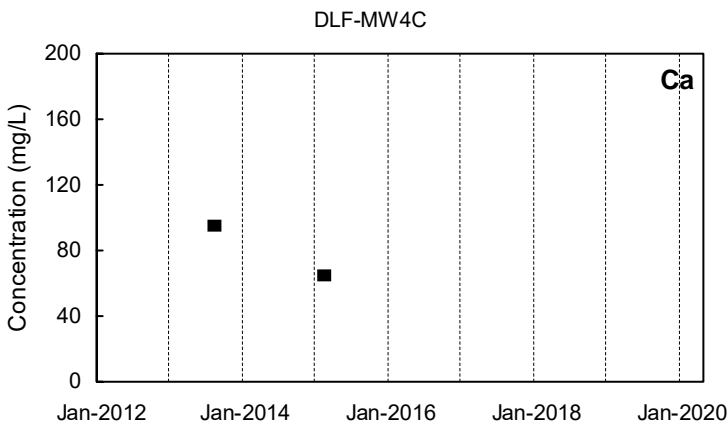
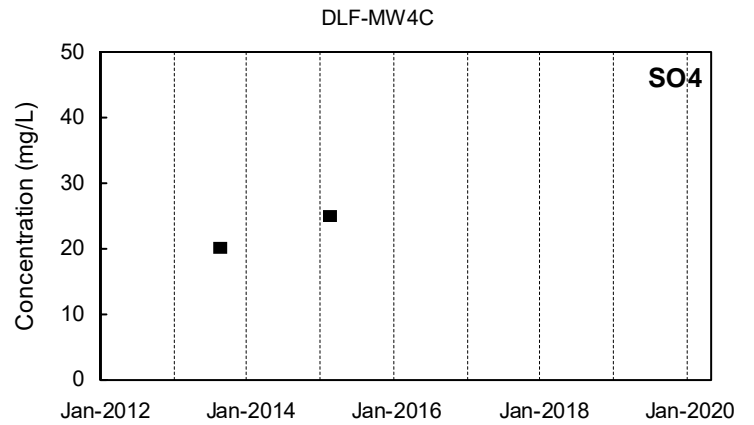
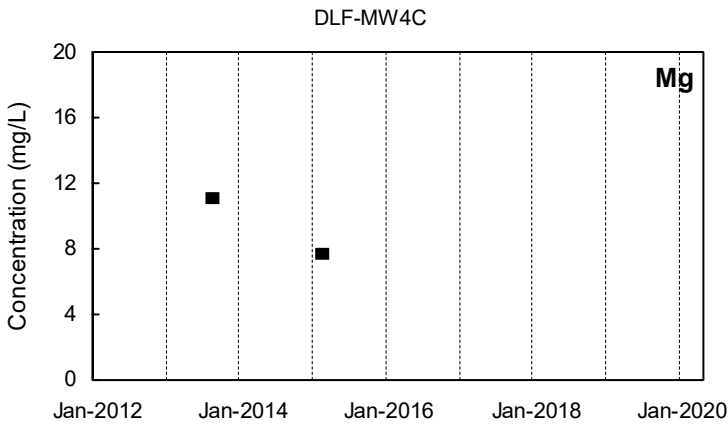
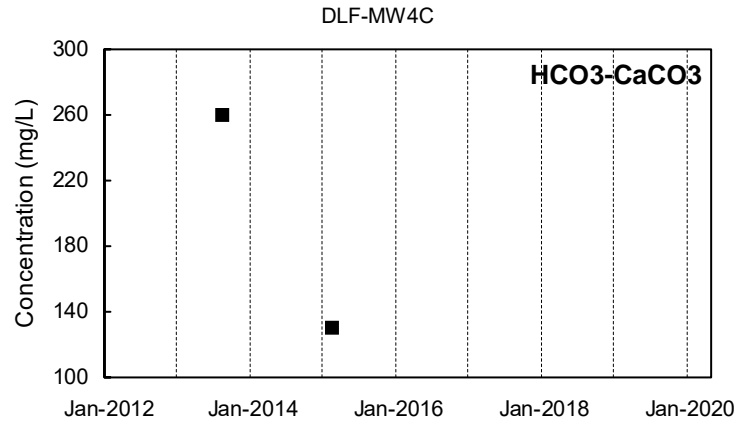
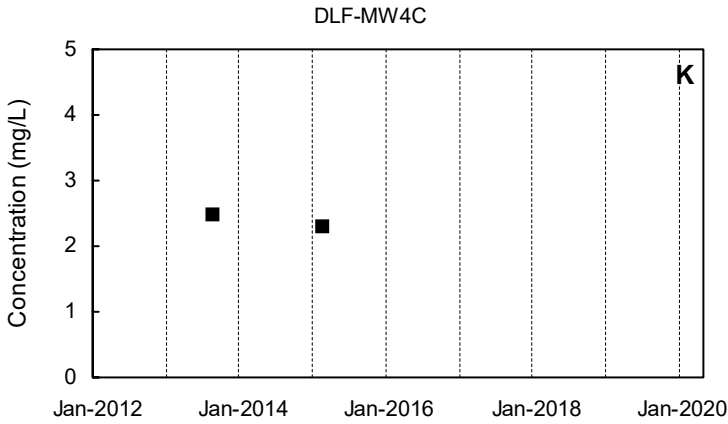
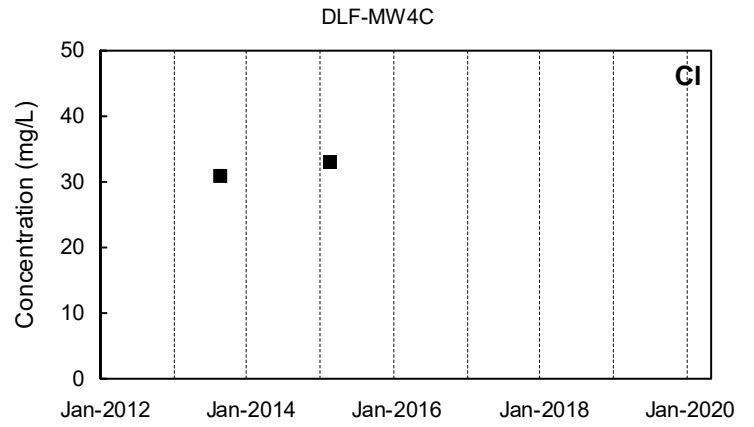
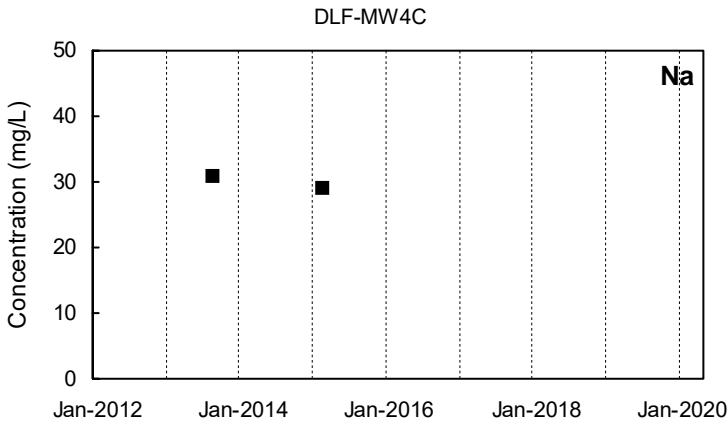

■ Detected Value □ 'J'-Flag (value between reporting limit and detection limit) ■ Non-Detect Range
 Shallow Well shown with black symbols Deep Well shown with orange symbols "dd" Well shown with blue symbols

DLF-MW5A

DLF-MW5A

Na

Cl

Not Sampled

Not Sampled

DLF-MW5A

DLF-MW5A

K

HCO3-CaCO3

Not Sampled

Not Sampled

DLF-MW5A

DLF-MW5A

Mg

SO4

Not Sampled

Not Sampled

DLF-MW5A

DLF-MW5A

Ca

PO4

Not Sampled

Not Sampled

Detected Value
 'J'-Flag (value between reporting limit and detection limit)
 Non-Detect Range
 Shallow Well shown with black symbols
 Deep Well shown with orange symbols
 "dd" Well shown with blue symbols

DLF-MW5B

Na

Not Sampled

DLF-MW5B

Cl

Not Sampled

DLF-MW5B

K

Not Sampled

DLF-MW5B

HCO3-CaCO3

Not Sampled

DLF-MW5B

Mg

Not Sampled

DLF-MW5B

SO4

Not Sampled

DLF-MW5B

Ca

Not Sampled

DLF-MW5B

PO4

Not Sampled

■ Detected Value

□ 'J'-Flag (value between reporting limit and detection limit)



Non-Detect Range

Shallow Well shown with black symbols

Deep Well shown with orange symbols

"dd" Well shown with blue symbols

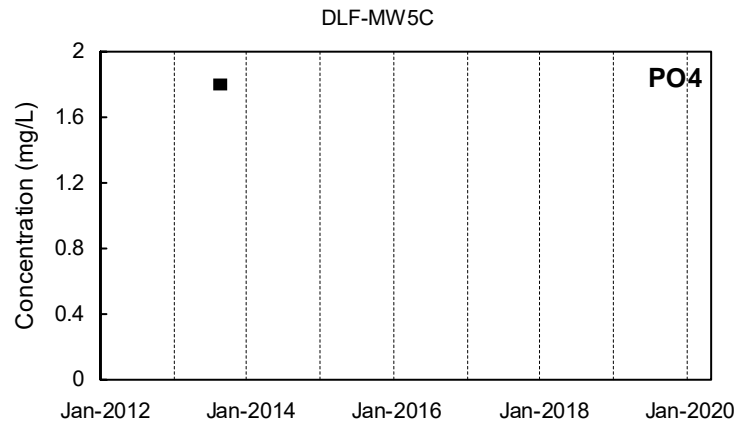
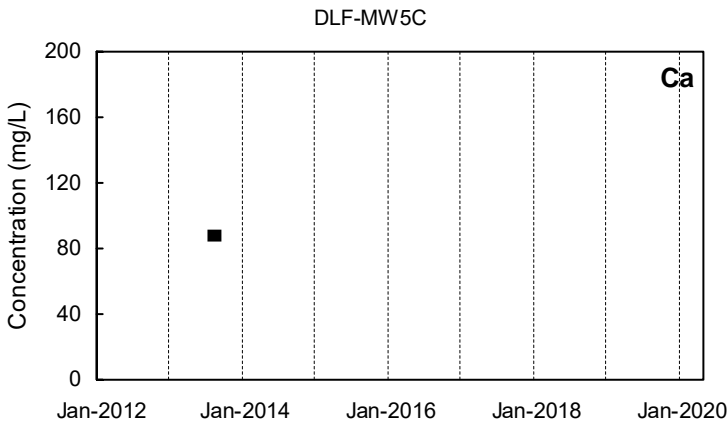
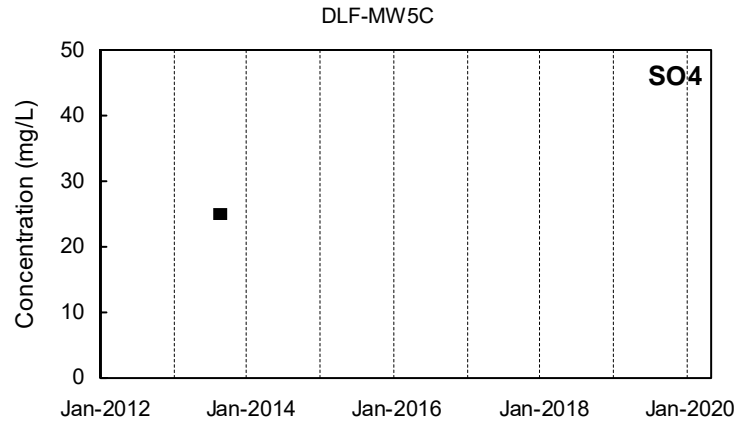
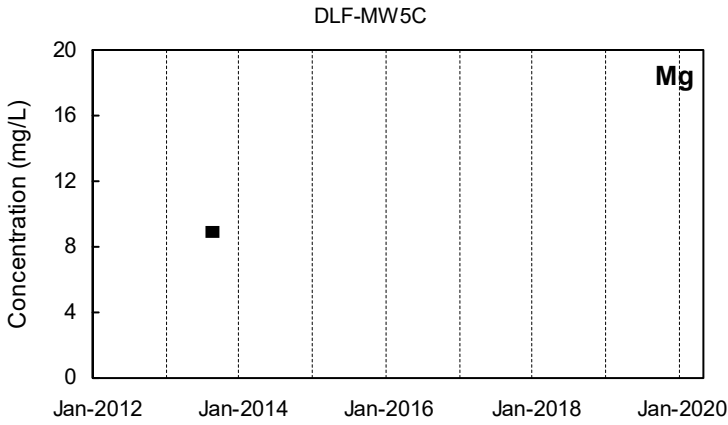
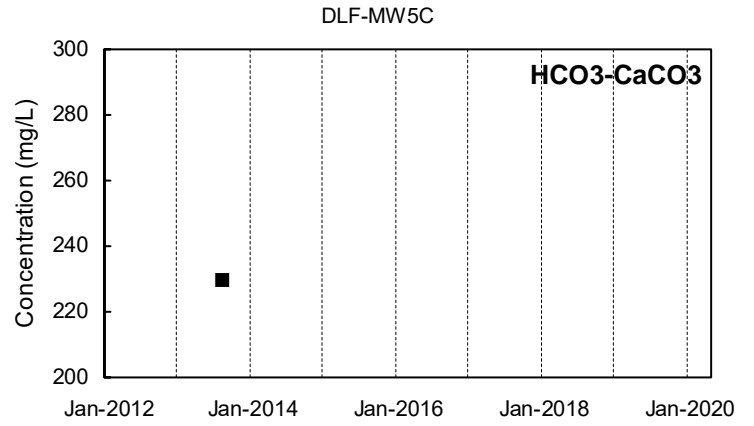
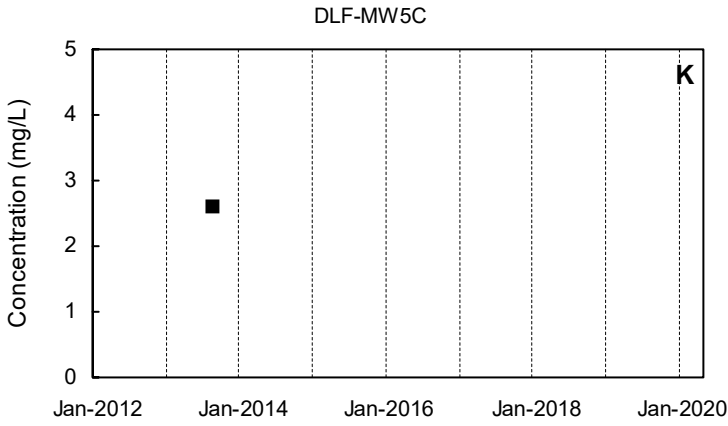
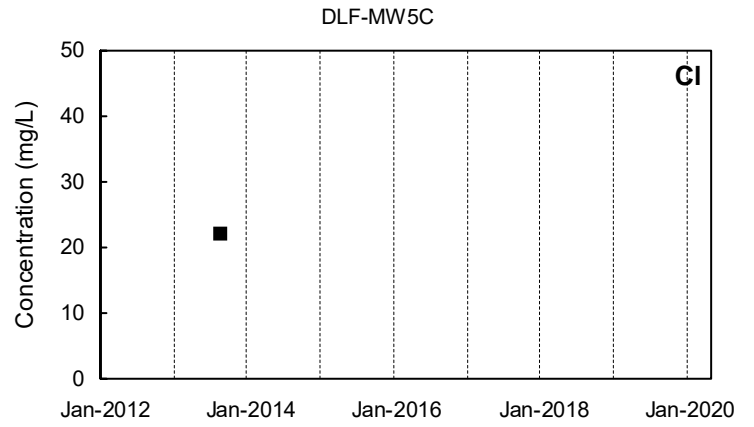
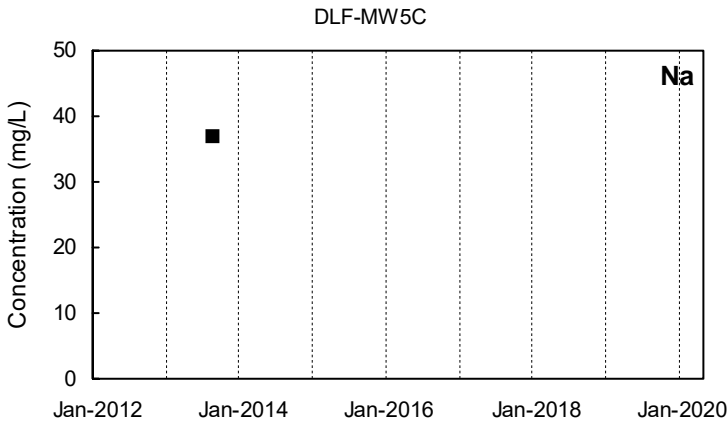

Detected Value
 'J'-Flag (value between reporting limit and detection limit)
 Non-Detect Range
 Shallow Well shown with black symbols
 Deep Well shown with orange symbols
 "dd" Well shown with blue symbols

DLF-MW6A

DLF-MW6A

Na

Not Sampled

Cl

Not Sampled

DLF-MW6A

DLF-MW6A

K

Not Sampled

HCO3-CaCO3

Not Sampled

DLF-MW6A

DLF-MW6A

Mg

Not Sampled

SO4

Not Sampled

DLF-MW6A

DLF-MW6A

Ca

Not Sampled

PO4

Not Sampled

■ Detected Value

□ 'J'-Flag (value between reporting limit and detection limit)



Non-Detect Range

Shallow Well shown with black symbols

Deep Well shown with orange symbols

"dd" Well shown with blue symbols

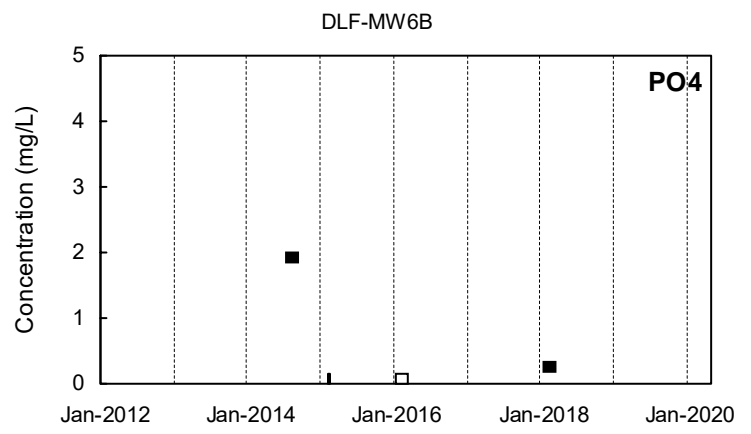
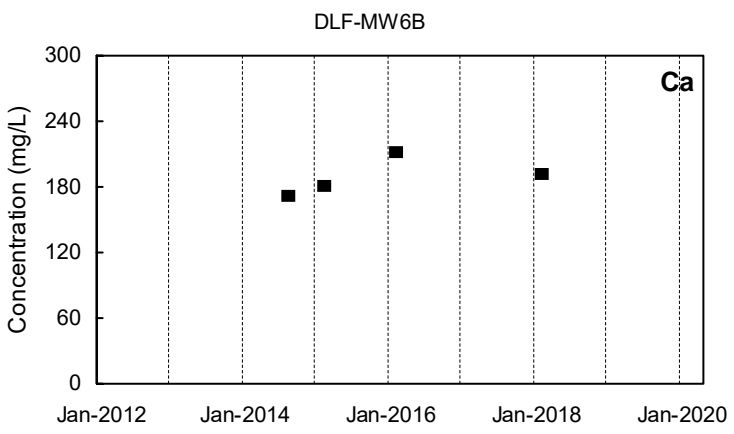
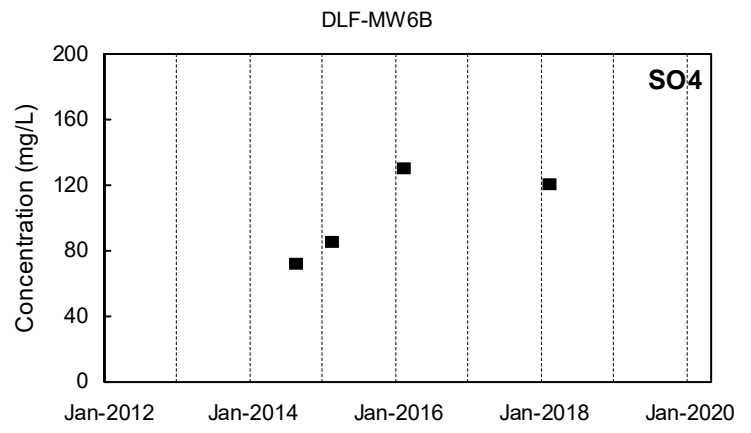
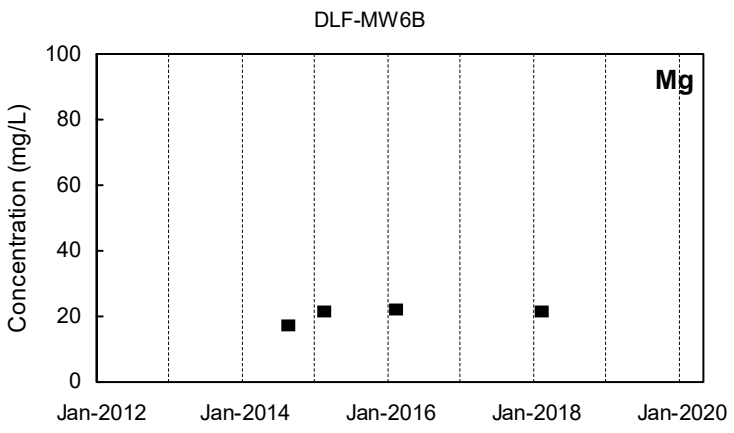
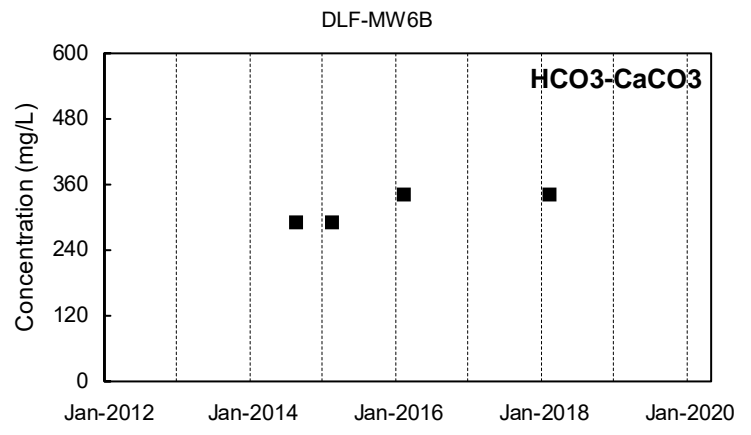
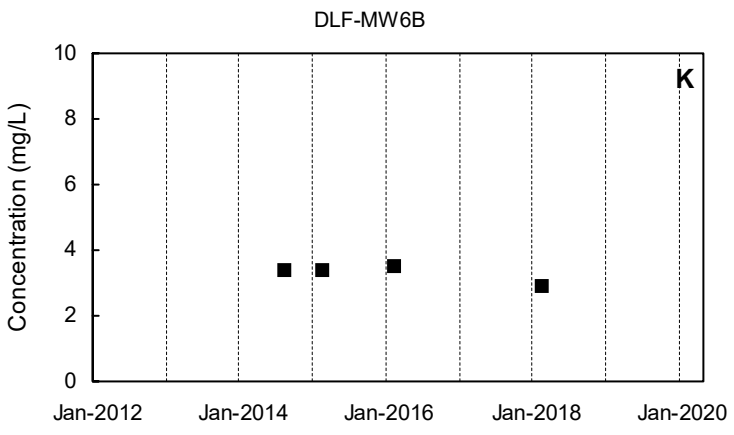
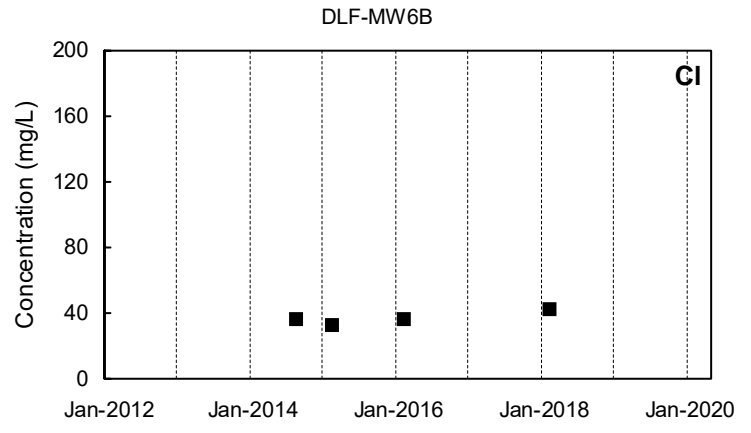
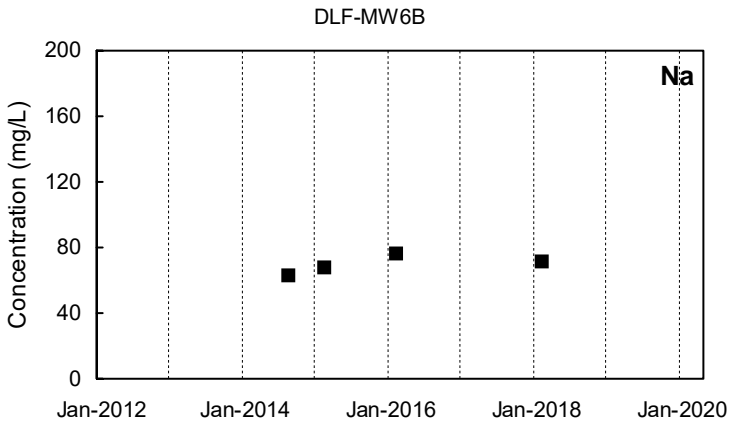

Detected Value
 'J'-Flag (value between reporting limit and detection limit)
 Non-Detect Range
 Shallow Well shown with black symbols
 Deep Well shown with orange symbols
 "dd" Well shown with blue symbols

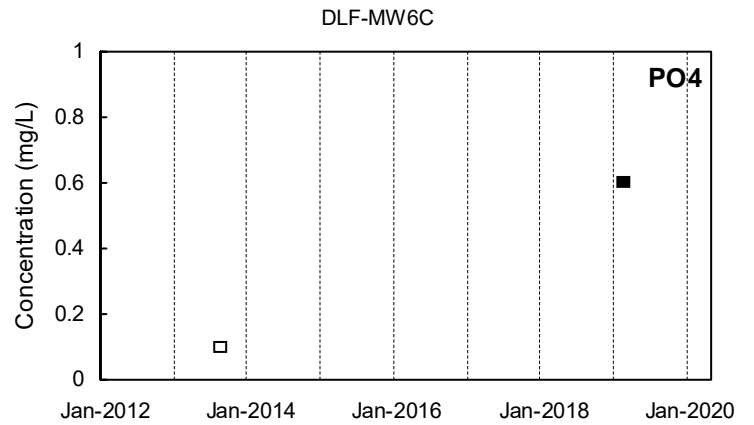
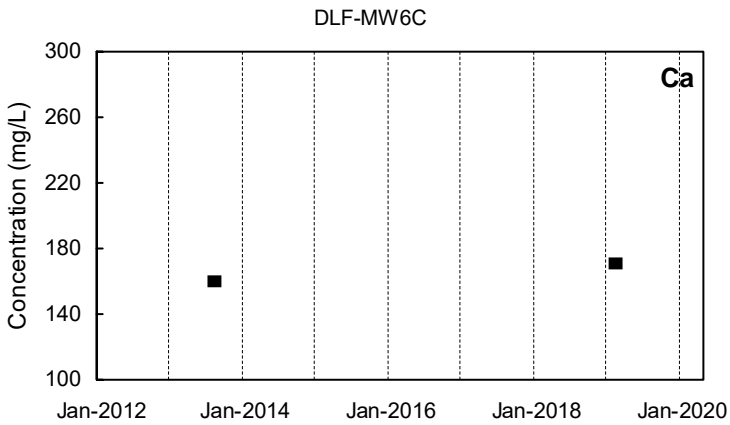
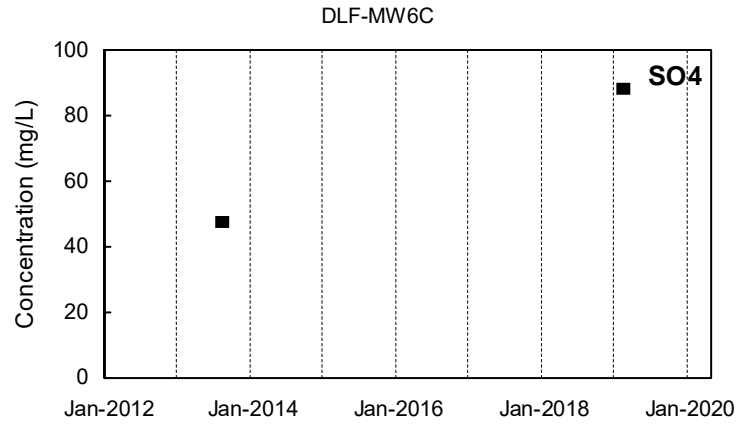
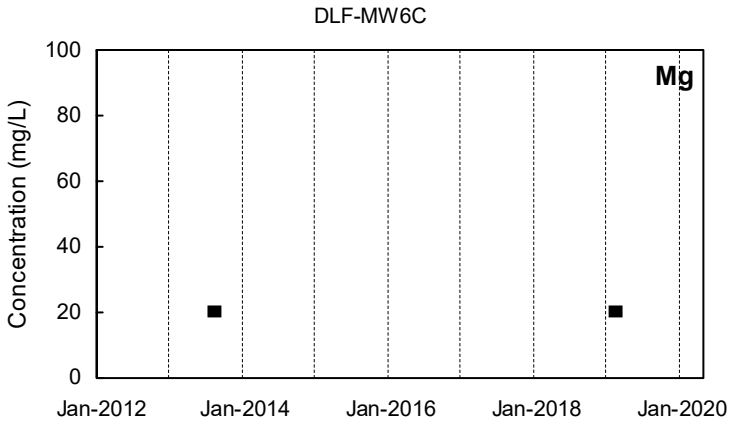
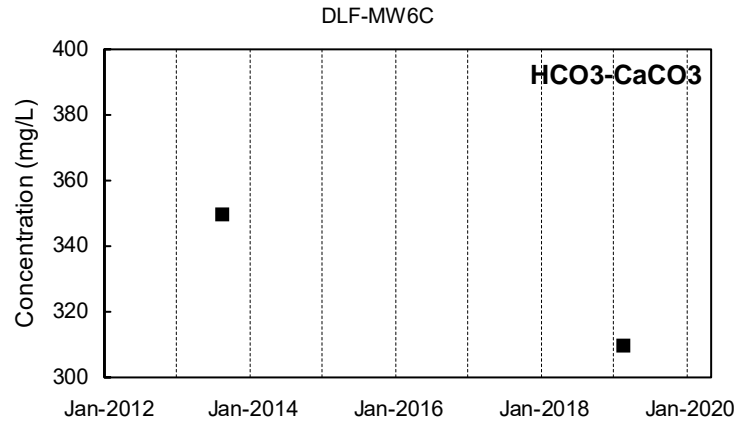
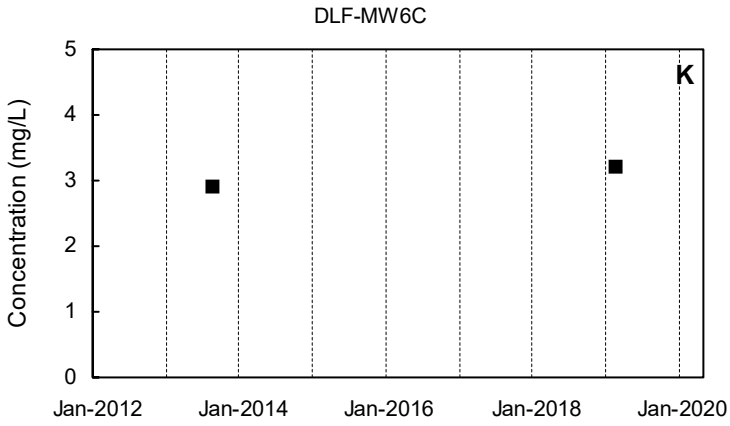
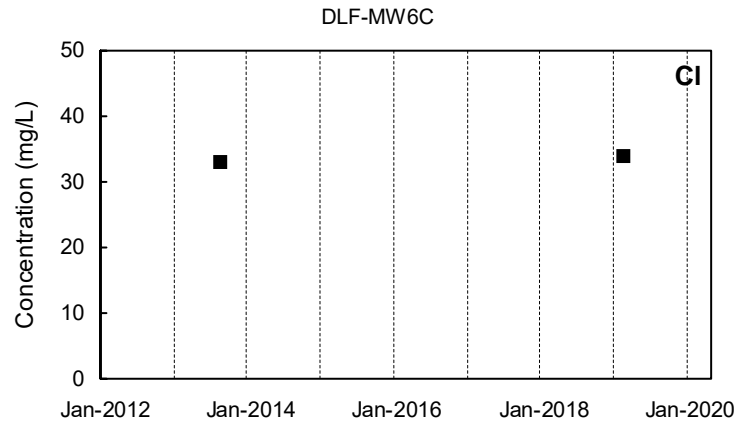
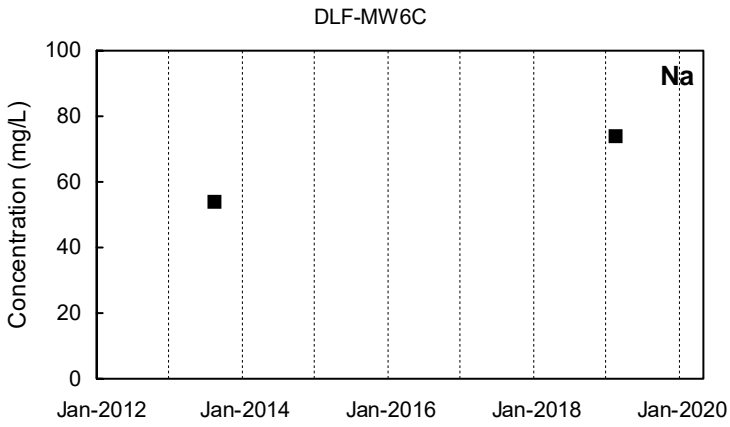

■ Detected Value □ 'J'-Flag (value between reporting limit and detection limit) ■ Non-Detect Range
 Shallow Well shown with black symbols Deep Well shown with orange symbols "dd" Well shown with blue symbols

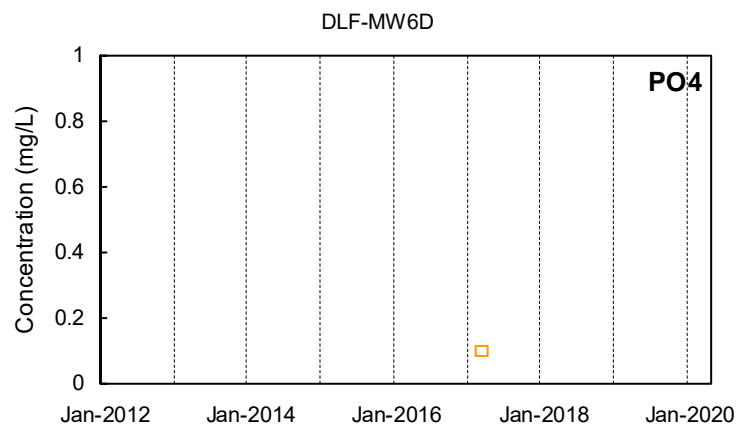
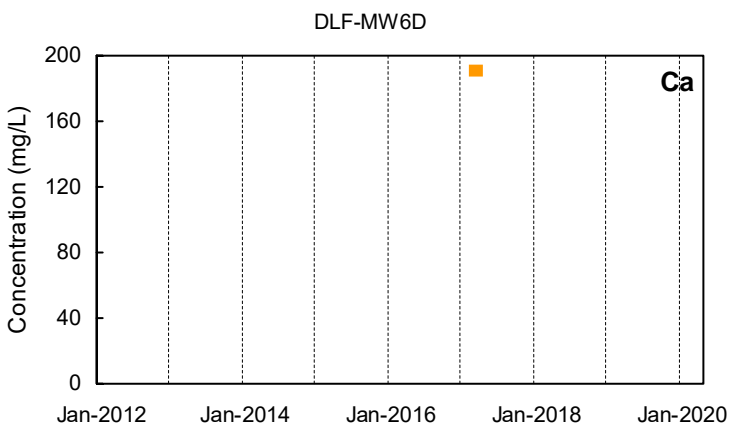
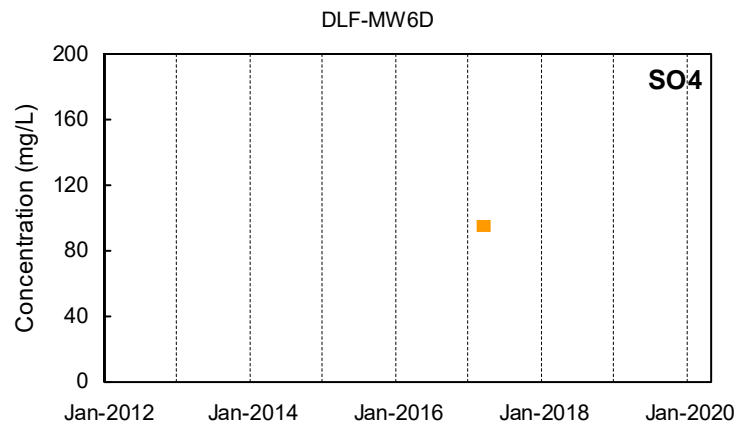
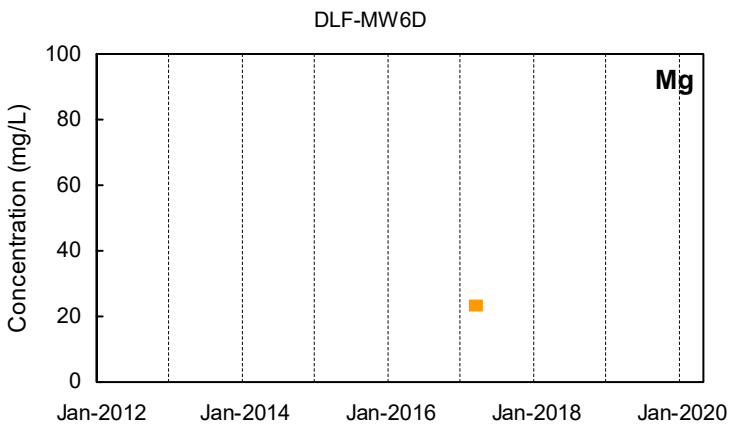
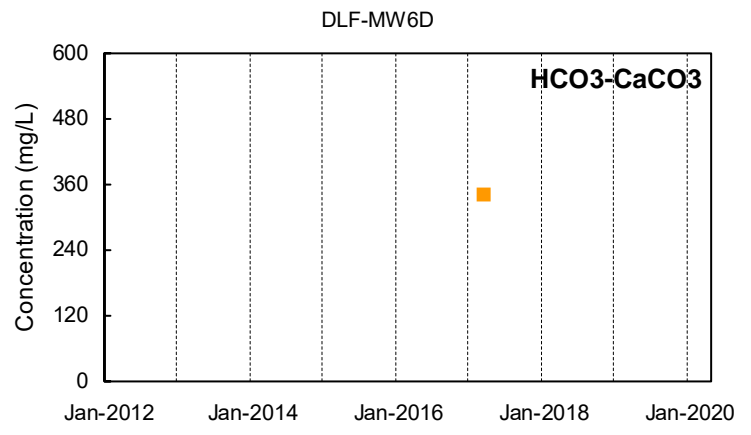
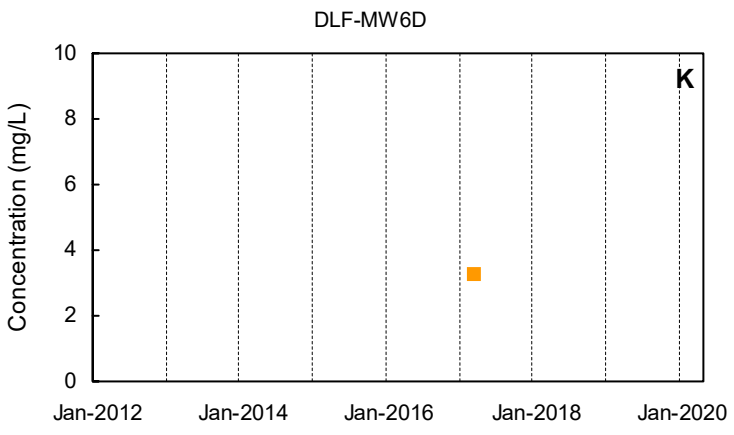
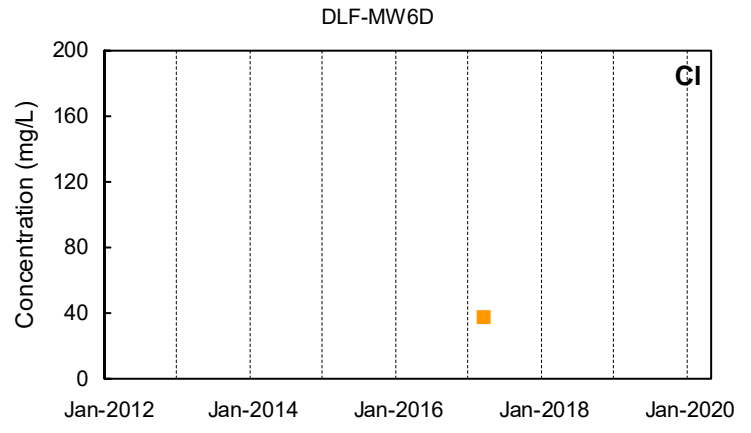
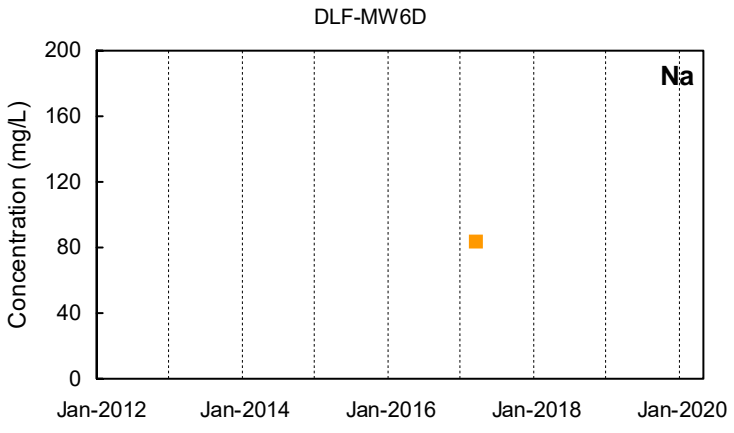

■ Detected Value □ 'J'-Flag (value between reporting limit and detection limit) ■ Non-Detect Range
 Shallow Well shown with black symbols Deep Well shown with orange symbols "dd" Well shown with blue symbols

ELK-MW1

ELK-MW1

Na

Not Sampled

Cl

Not Sampled

ELK-MW1

ELK-MW1

K

Not Sampled

HCO3-CaCO3

Not Sampled

ELK-MW1

ELK-MW1

Mg

Not Sampled

SO4

Not Sampled

ELK-MW1

ELK-MW1

Ca

Not Sampled

PO4

Not Sampled

Detected Value
 'J'-Flag (value between reporting limit and detection limit)
 Non-Detect Range
 Shallow Well shown with black symbols
 Deep Well shown with orange symbols
 "dd" Well shown with blue symbols

ELK-MW2A

ELK-MW2A

Na

Not Sampled

Cl

Not Sampled

ELK-MW2A

ELK-MW2A

K

Not Sampled

HCO3-CaCO3

Not Sampled

ELK-MW2A

ELK-MW2A

Mg

Not Sampled

SO4

Not Sampled

ELK-MW2A

ELK-MW2A

Ca

Not Sampled

PO4

Not Sampled

Detected Value
 'J'-Flag (value between reporting limit and detection limit)
 Non-Detect Range
 Shallow Well shown with black symbols
 Deep Well shown with orange symbols
 "dd" Well shown with blue symbols

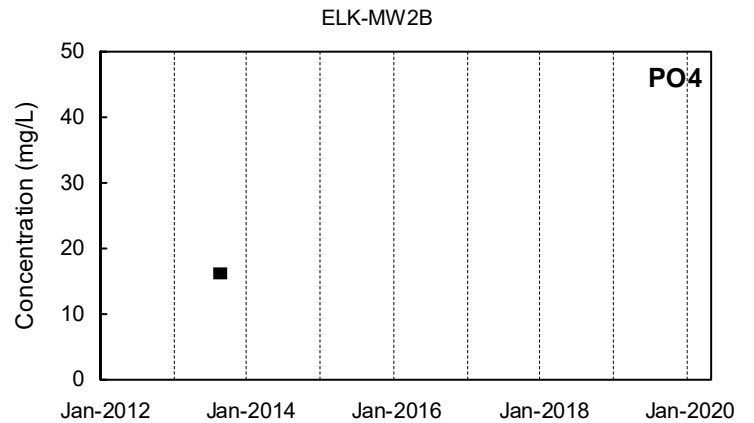
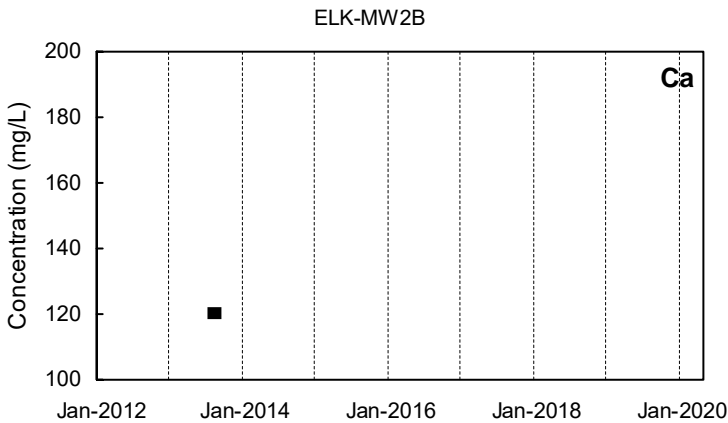
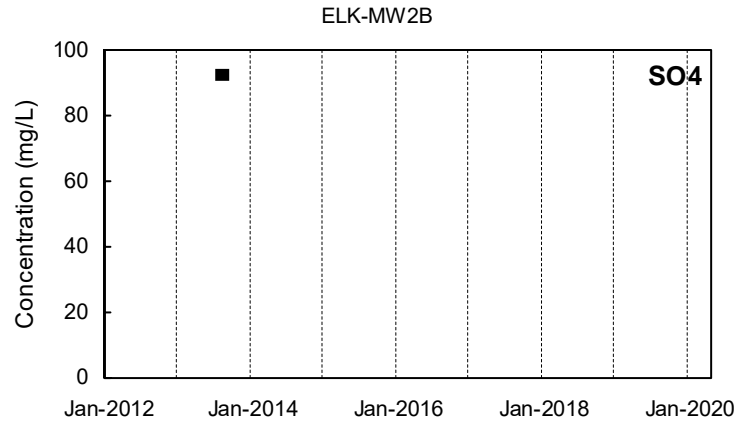
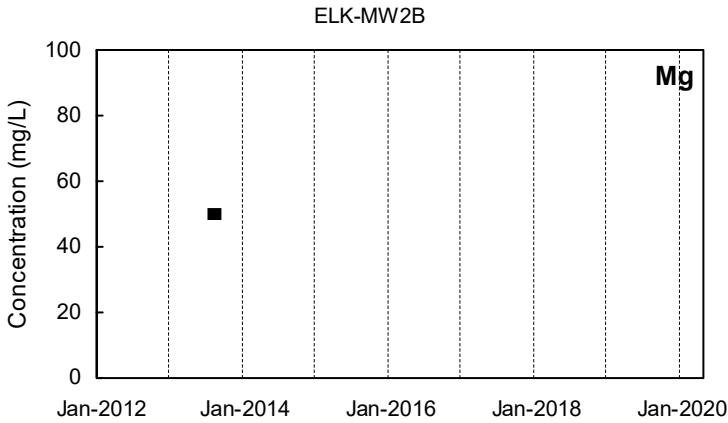
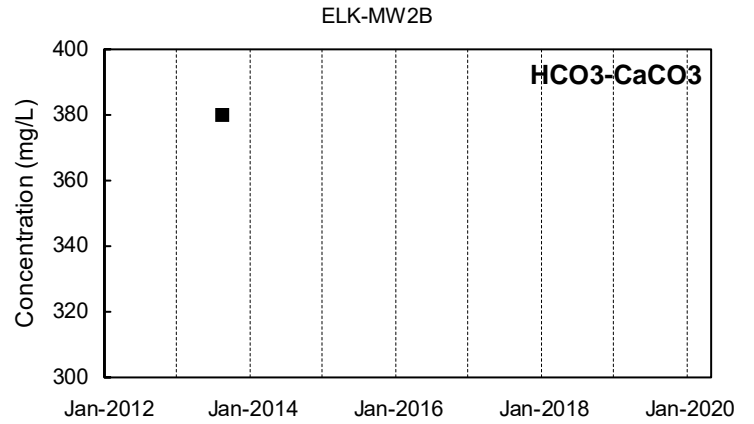
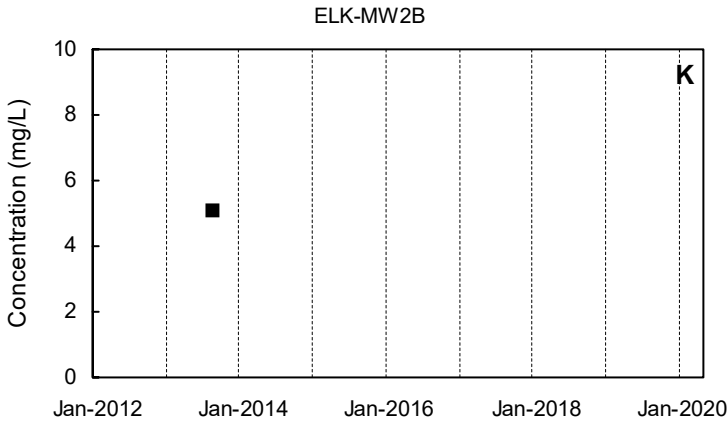
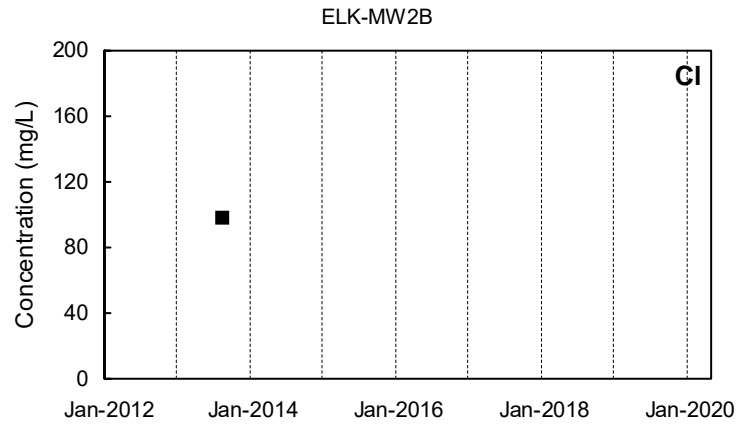
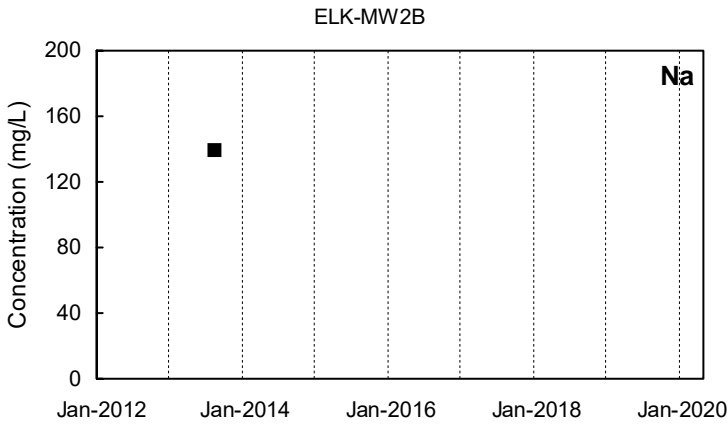

■ Detected Value □ 'J'-Flag (value between reporting limit and detection limit) ■ Non-Detect Range
 Shallow Well shown with black symbols Deep Well shown with orange symbols "dd" Well shown with blue symbols

ELK-MW3A

ELK-MW3A

Na

Not Sampled

Cl

Not Sampled

ELK-MW3A

ELK-MW3A

K

Not Sampled

HCO3-CaCO3

Not Sampled

ELK-MW3A

ELK-MW3A

Mg

Not Sampled

SO4

Not Sampled

ELK-MW3A

ELK-MW3A

Ca

Not Sampled

PO4

Not Sampled

Detected Value
 'J'-Flag (value between reporting limit and detection limit)
 Non-Detect Range
 Shallow Well shown with black symbols
 Deep Well shown with orange symbols
 "dd" Well shown with blue symbols

ELK-MW3B

ELK-MW3B

Na

Cl

Not Sampled

Not Sampled

ELK-MW3B

ELK-MW3B

K

HCO3-CaCO3

Not Sampled

Not Sampled

ELK-MW3B

ELK-MW3B

Mg

SO4

Not Sampled

Not Sampled

ELK-MW3B

ELK-MW3B

Ca

PO4

Not Sampled

Not Sampled

Detected Value
 'J'-Flag (value between reporting limit and detection limit)
 Non-Detect Range
 Shallow Well shown with black symbols
 Deep Well shown with orange symbols
 "dd" Well shown with blue symbols

ELK-MW4

ELK-MW4

Na

Not Sampled

Cl

Not Sampled

ELK-MW4

ELK-MW4

K

Not Sampled

HCO3-CaCO3

Not Sampled

ELK-MW4

ELK-MW4

Mg

Not Sampled

SO4

Not Sampled

ELK-MW4

ELK-MW4

Ca

Not Sampled

PO4

Not Sampled

■ Detected Value

□ 'J'-Flag (value between reporting limit and detection limit)



Non-Detect Range

Shallow Well shown with black symbols

Deep Well shown with orange symbols

"dd" Well shown with blue symbols

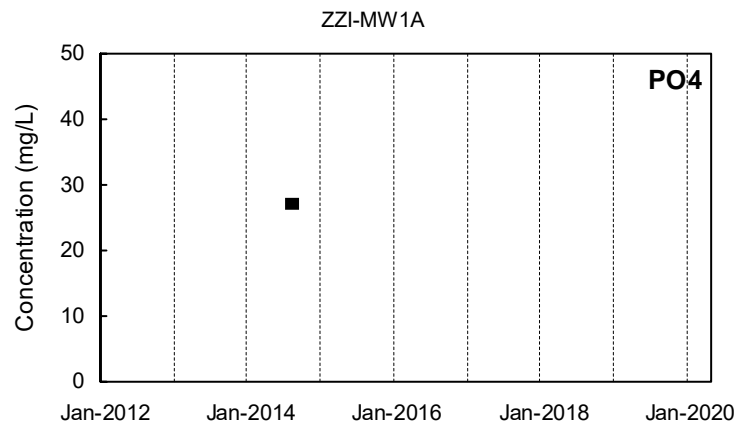
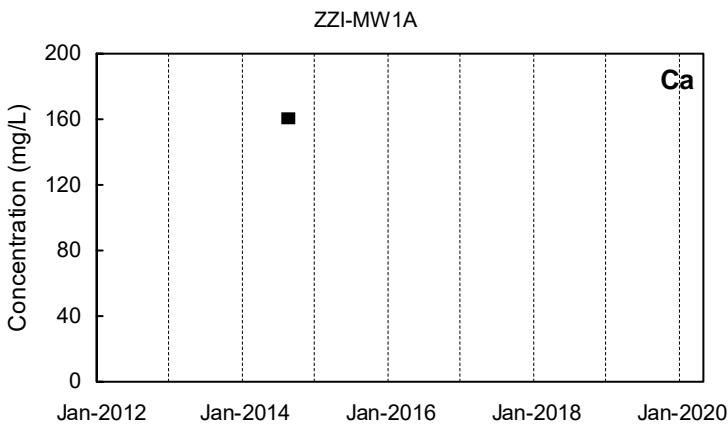
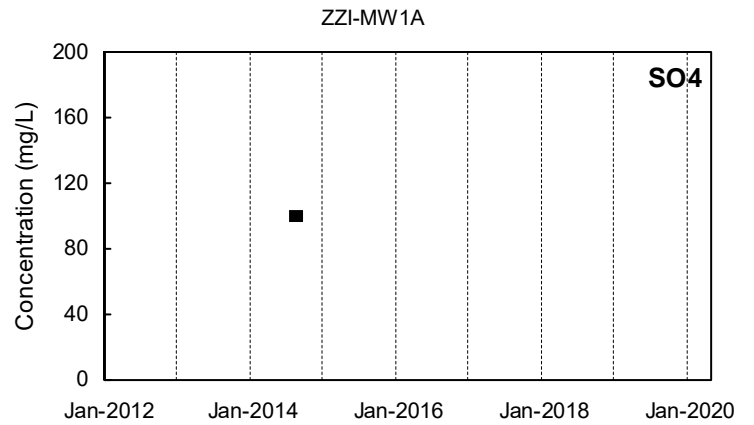
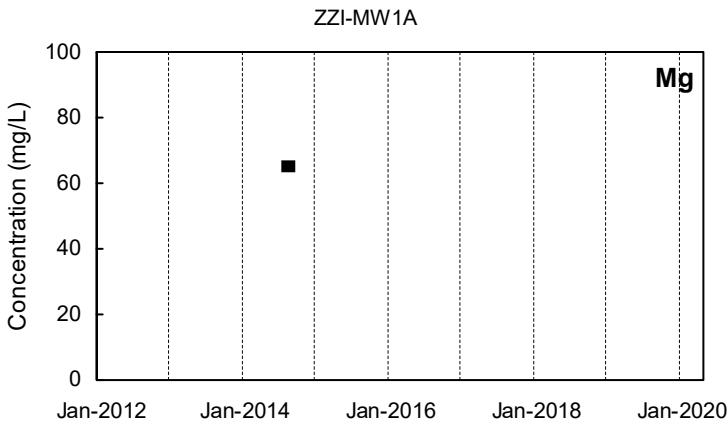
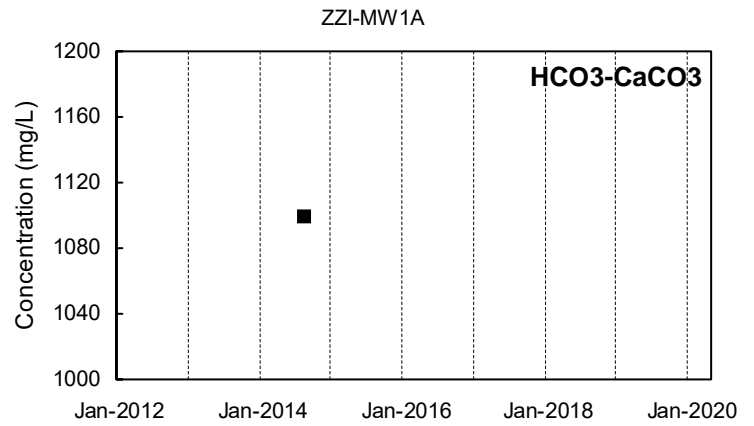
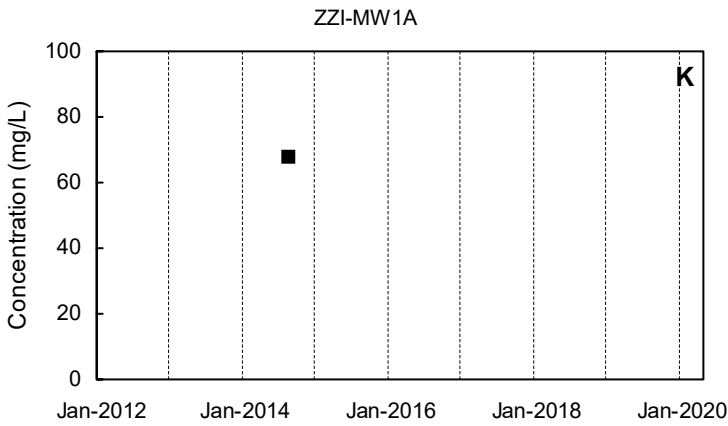
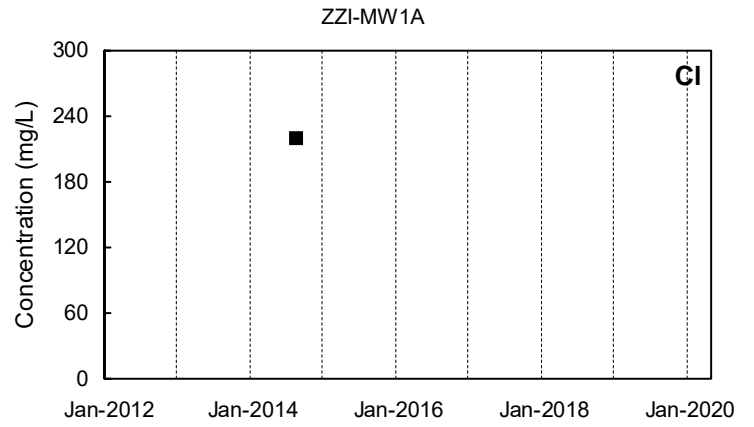
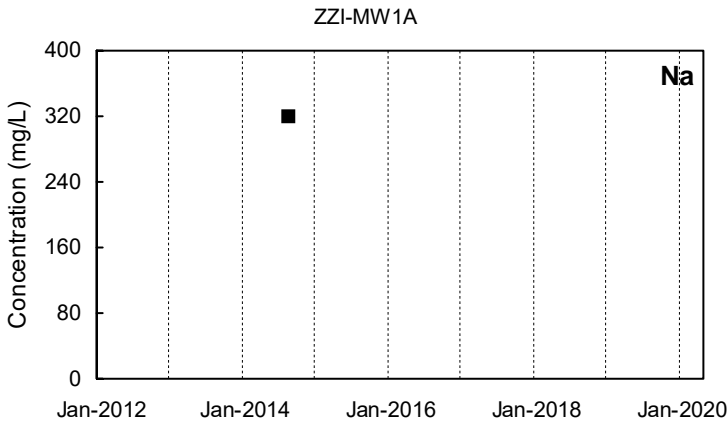

■ Detected Value □ 'J'-Flag (value between reporting limit and detection limit) ■ Non-Detect Range
 ■ Shallow Well shown with black symbols ■ Deep Well shown with orange symbols ■ "dd" Well shown with blue symbols

ZZI-MW1B

ZZI-MW1B

Na

Cl

Not Sampled

Not Sampled

ZZI-MW1B

ZZI-MW1B

K

HCO3-CaCO3

Not Sampled

Not Sampled

ZZI-MW1B

ZZI-MW1B

Mg

SO4

Not Sampled

Not Sampled

ZZI-MW1B

ZZI-MW1B

Ca

PO4

Not Sampled

Not Sampled

Detected Value
 'J'-Flag (value between reporting limit and detection limit)
 Non-Detect Range
 Shallow Well shown with black symbols
 Deep Well shown with orange symbols
 "dd" Well shown with blue symbols

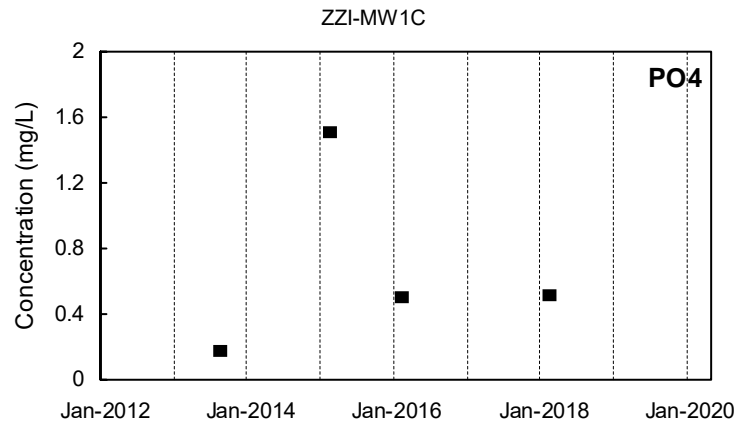
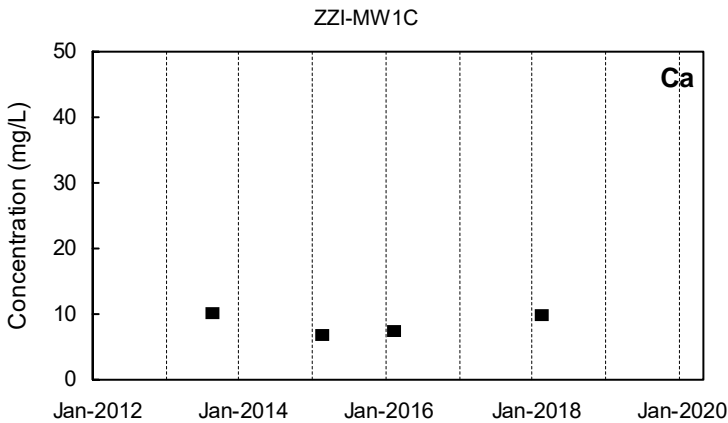
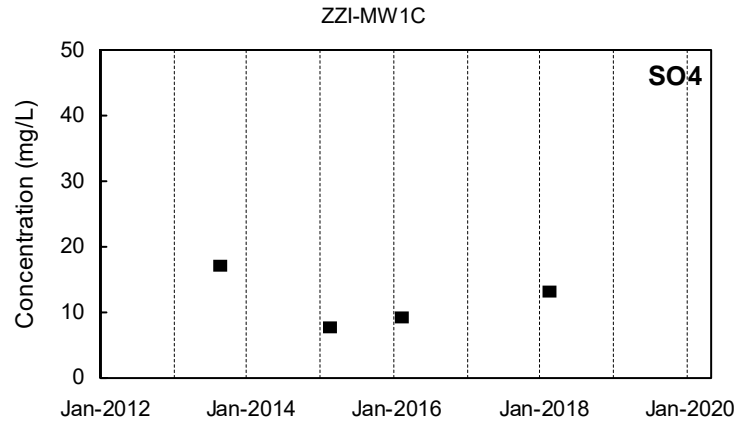
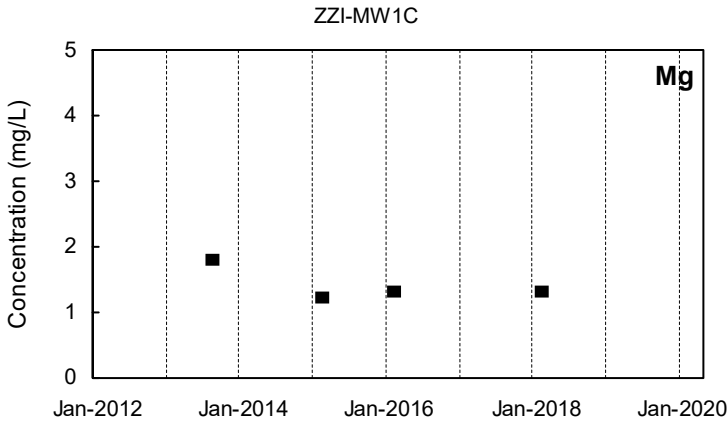
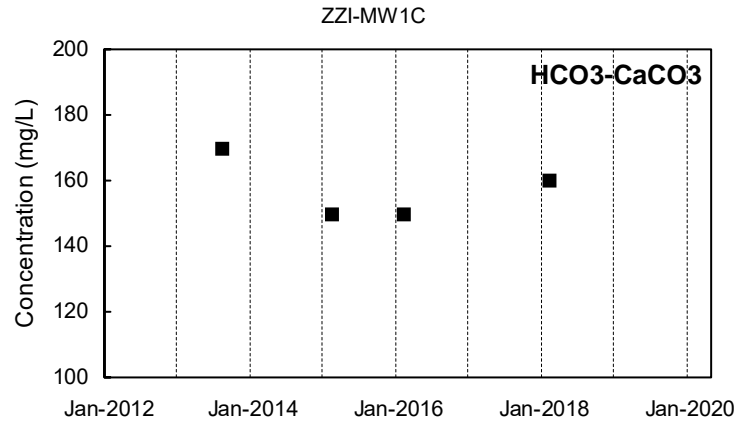
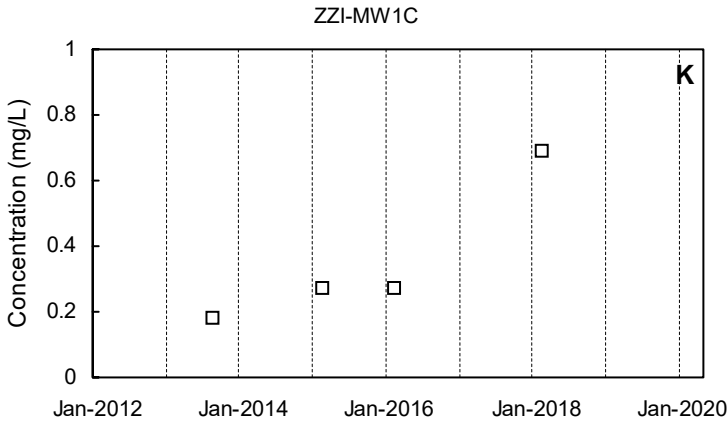
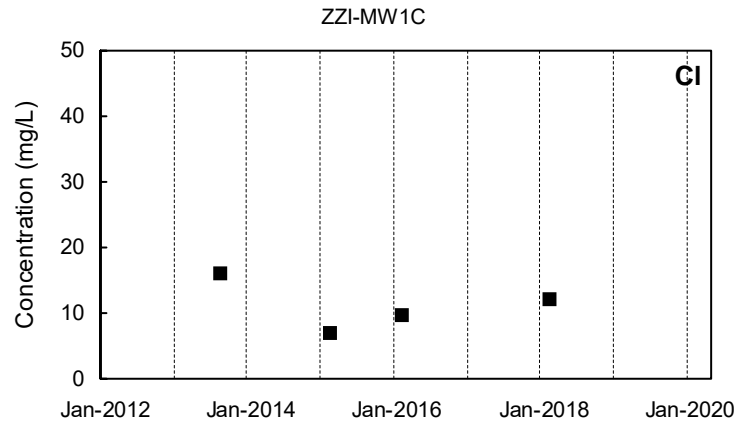
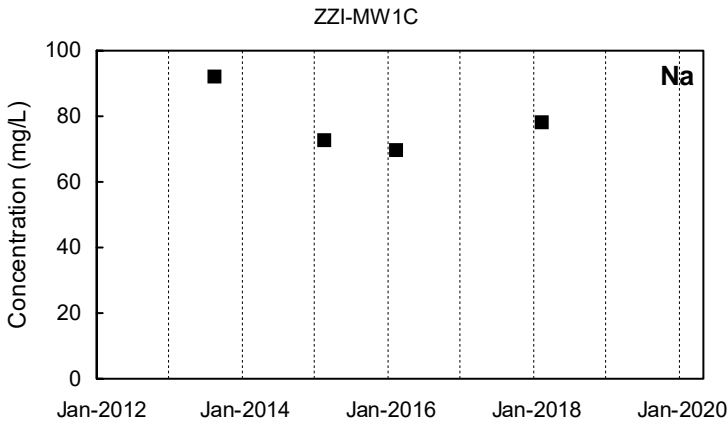

■ Detected Value □ 'J'-Flag (value between reporting limit and detection limit) ■ Non-Detect Range
 Shallow Well shown with black symbols Deep Well shown with orange symbols "dd" Well shown with blue symbols

ZZI-MW1D

ZZI-MW1D

Na

Cl

Not Sampled

Not Sampled

ZZI-MW1D

ZZI-MW1D

K

HCO3-CaCO3

Not Sampled

Not Sampled

ZZI-MW1D

ZZI-MW1D

Mg

SO4

Not Sampled

Not Sampled

ZZI-MW1D

ZZI-MW1D

Ca

PO4

Not Sampled

Not Sampled

Detected Value
 'J'-Flag (value between reporting limit and detection limit)
 Non-Detect Range
 Shallow Well shown with black symbols
 Deep Well shown with orange symbols
 "dd" Well shown with blue symbols

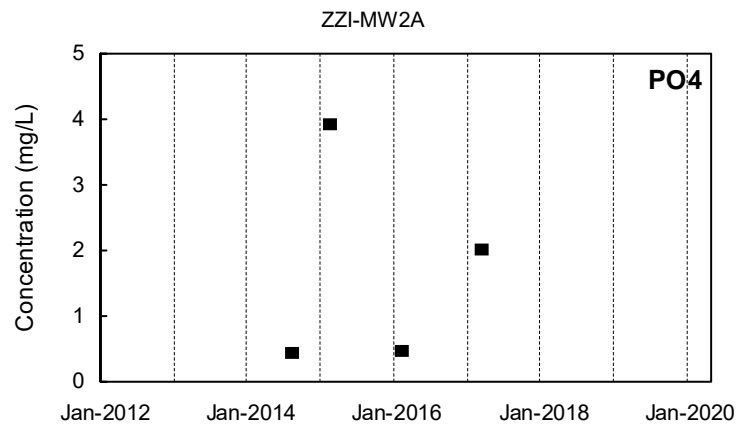
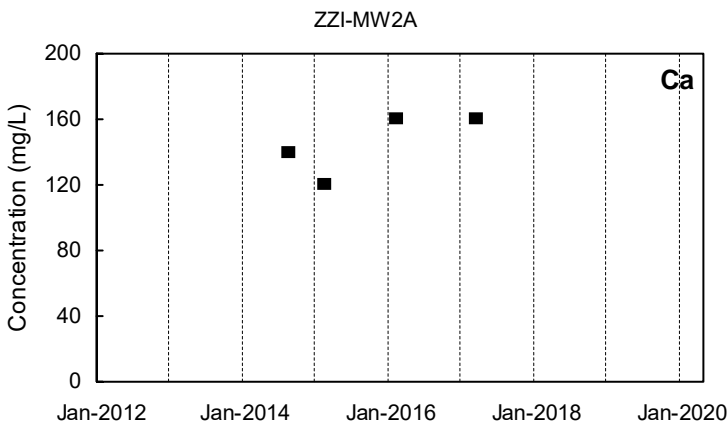
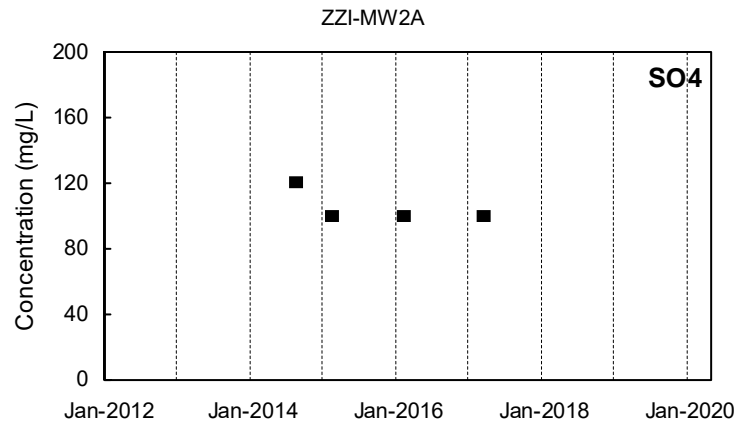
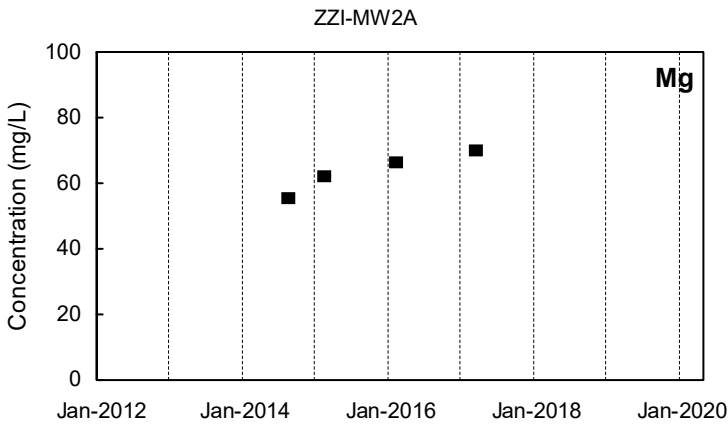
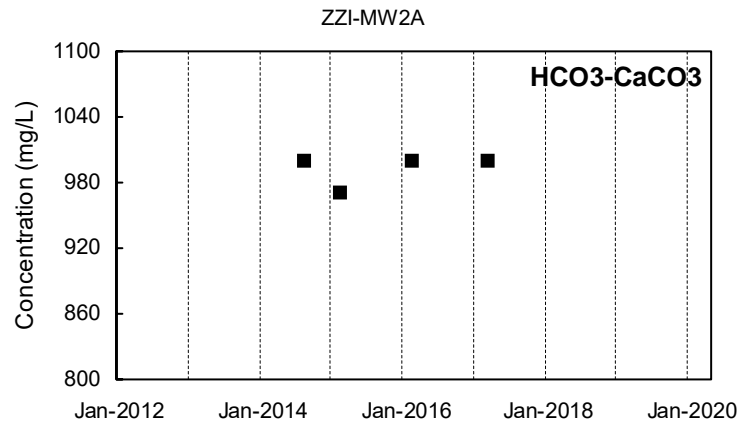
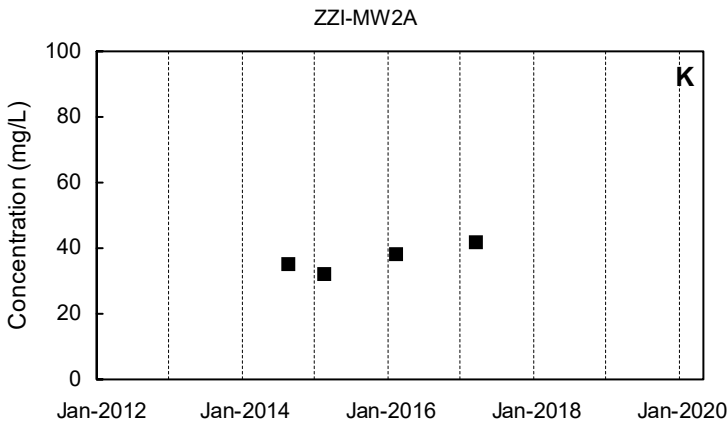
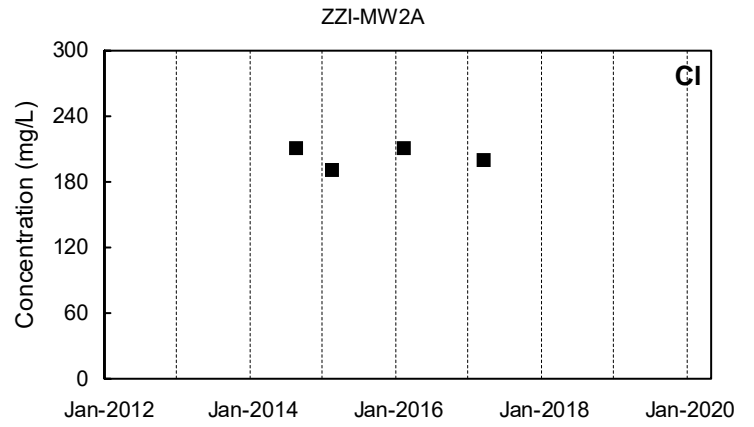
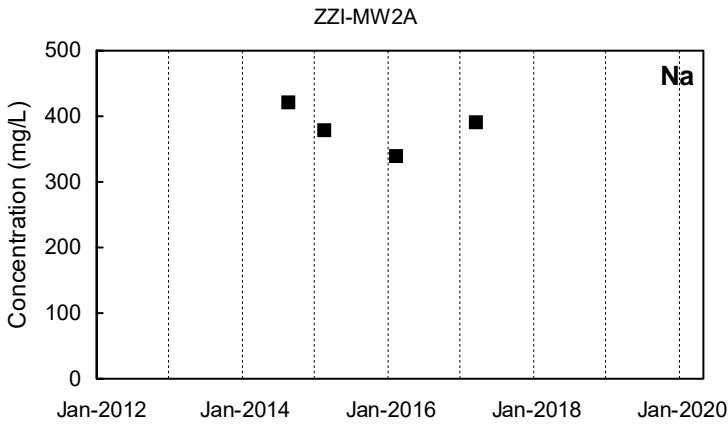

■ Detected Value □ 'J'-Flag (value between reporting limit and detection limit) ■ Non-Detect Range
 Shallow Well shown with black symbols Deep Well shown with orange symbols "dd" Well shown with blue symbols

ZZI-MW2B

ZZI-MW2B

Na

Cl

Not Sampled

Not Sampled

ZZI-MW2B

ZZI-MW2B

K

HCO3-CaCO3

Not Sampled

Not Sampled

ZZI-MW2B

ZZI-MW2B

Mg

SO4

Not Sampled

Not Sampled

ZZI-MW2B

ZZI-MW2B

Ca

PO4

Not Sampled

Not Sampled

Detected Value
 'J'-Flag (value between reporting limit and detection limit)
 Non-Detect Range

Shallow Well shown with black symbols
 Deep Well shown with orange symbols
 "dd" Well shown with blue symbols

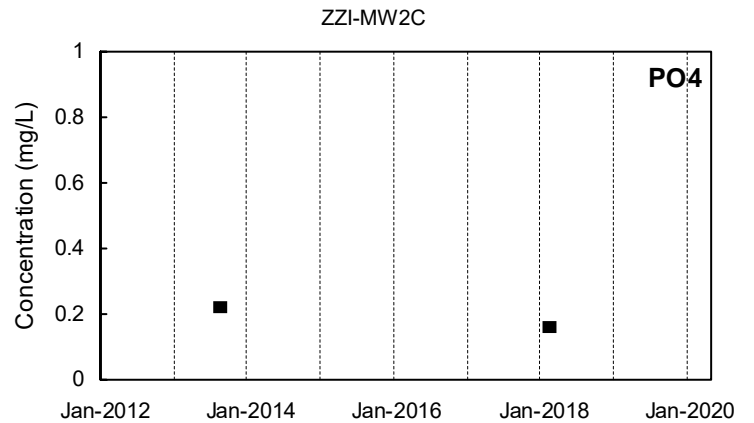
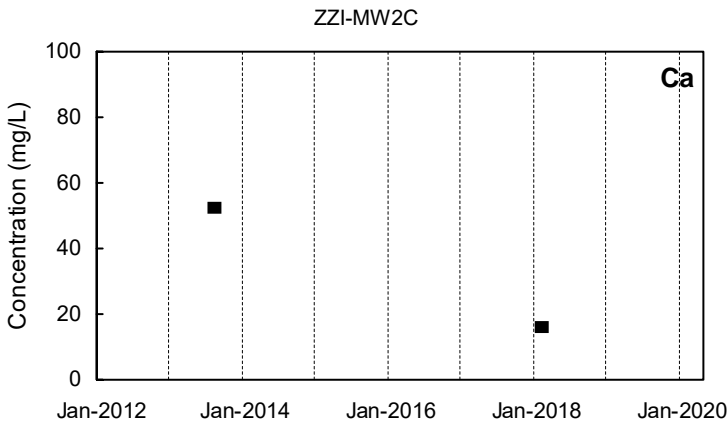
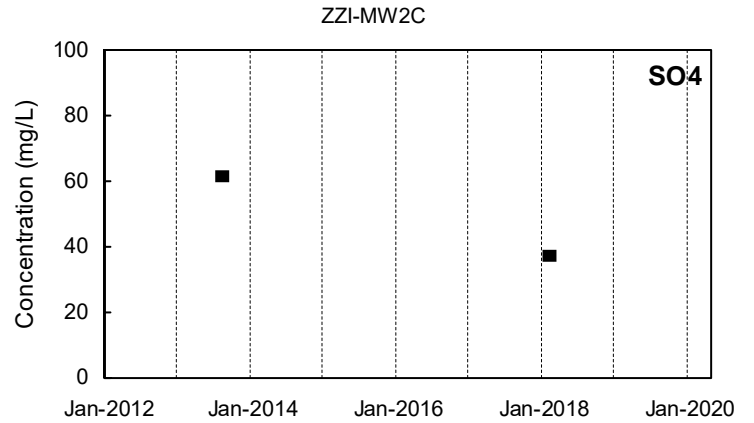
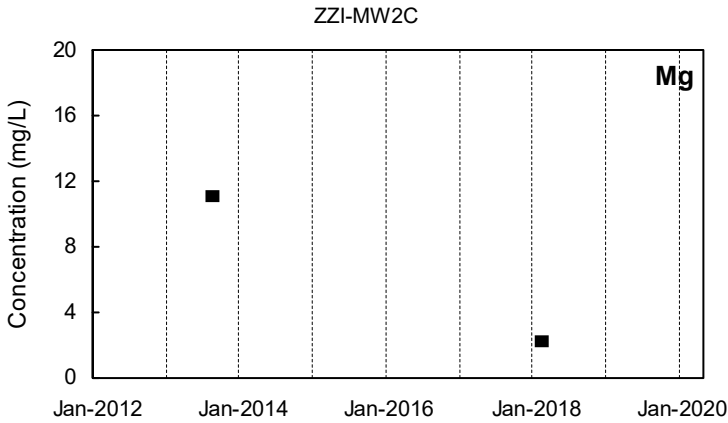
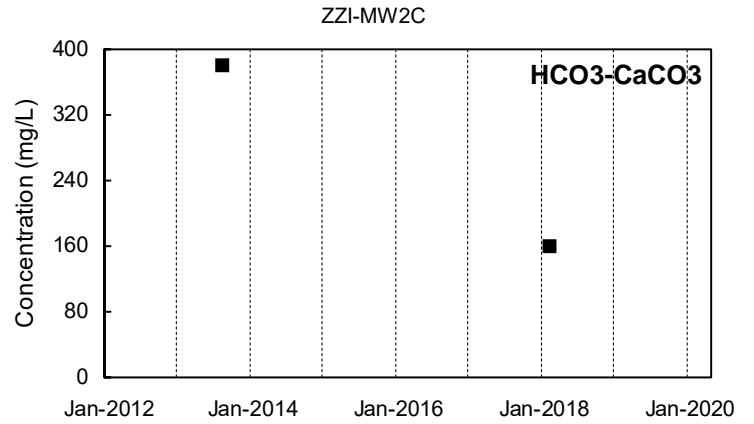
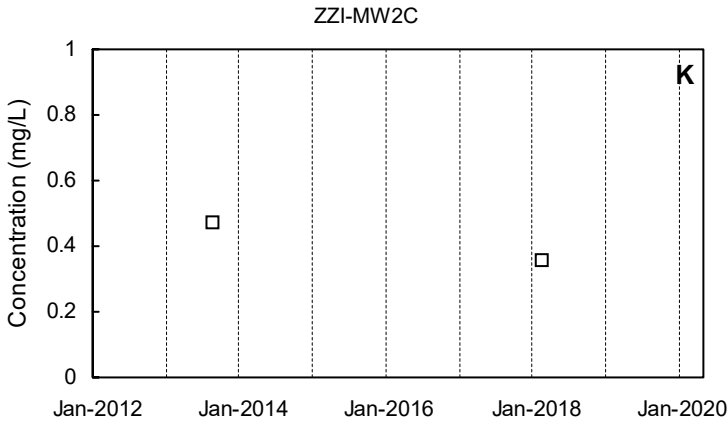
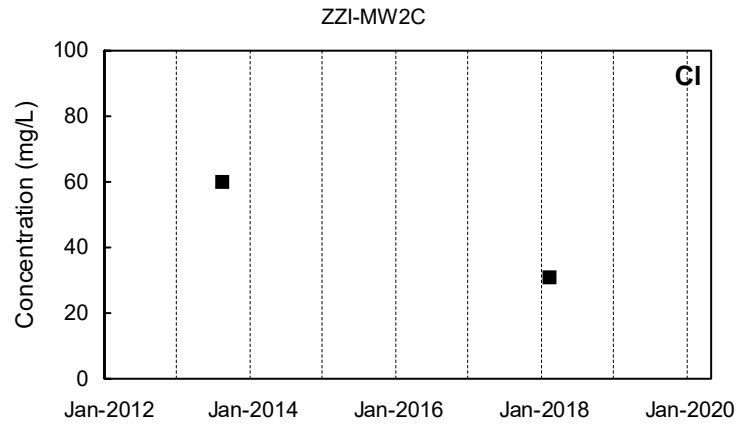
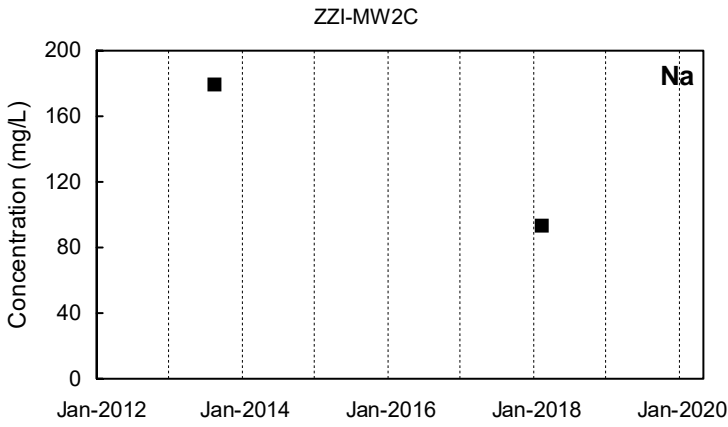

Detected Value
 'J'-Flag (value between reporting limit and detection limit)
 Non-Detect Range
 Shallow Well shown with black symbols Deep Well shown with orange symbols "dd" Well shown with blue symbols

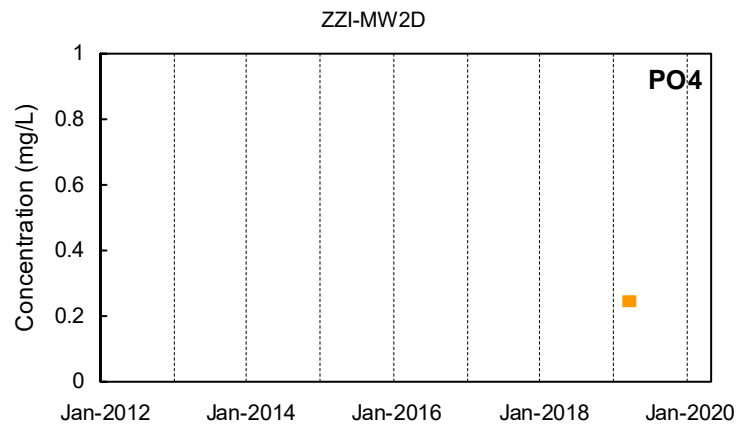
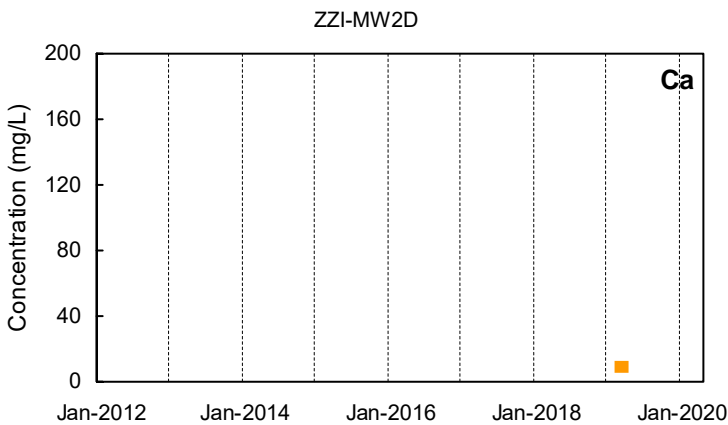
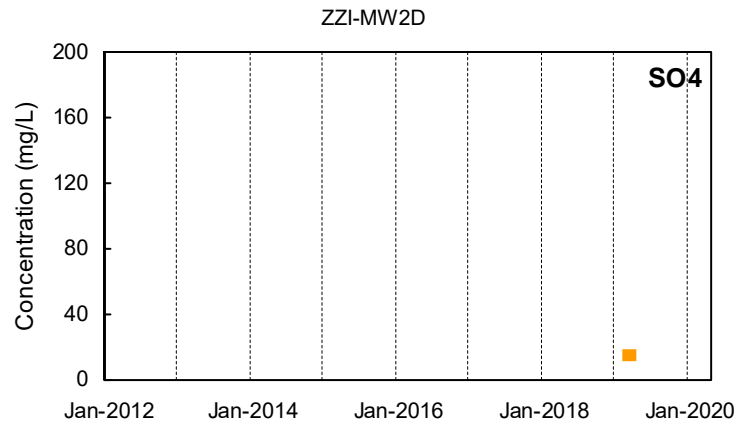
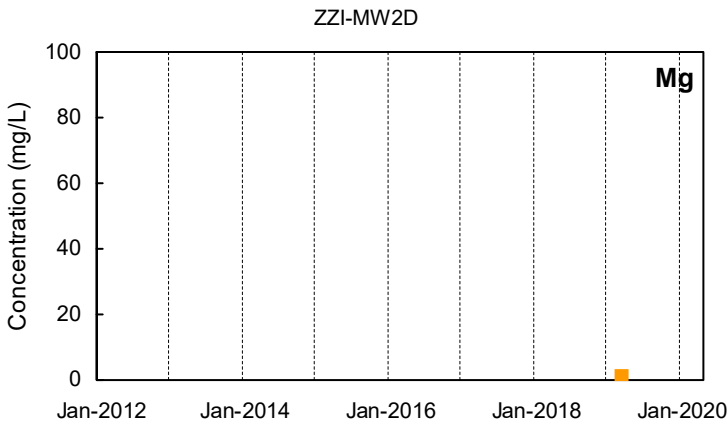
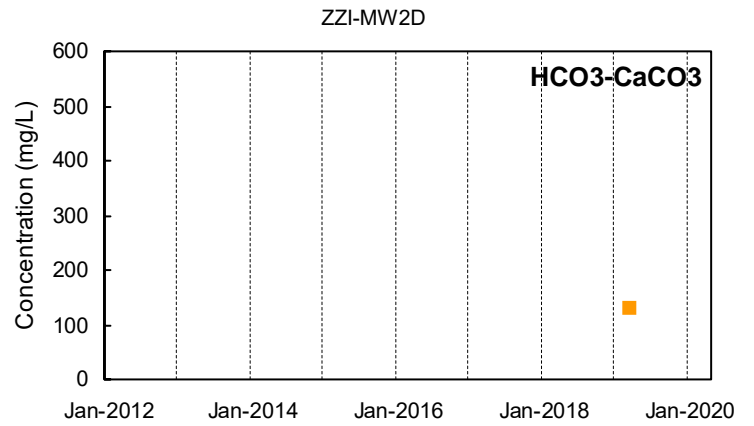
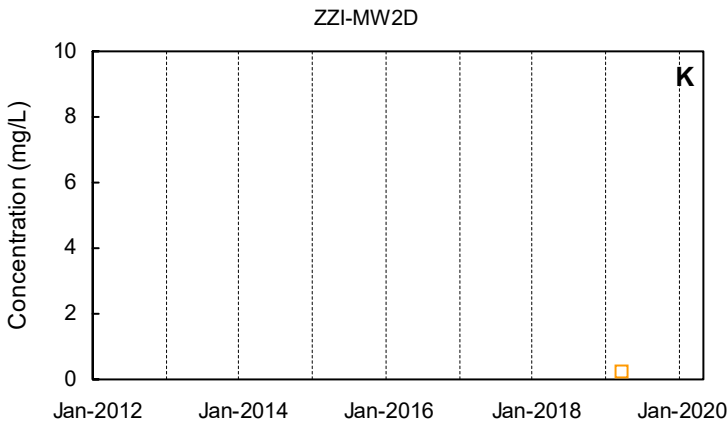
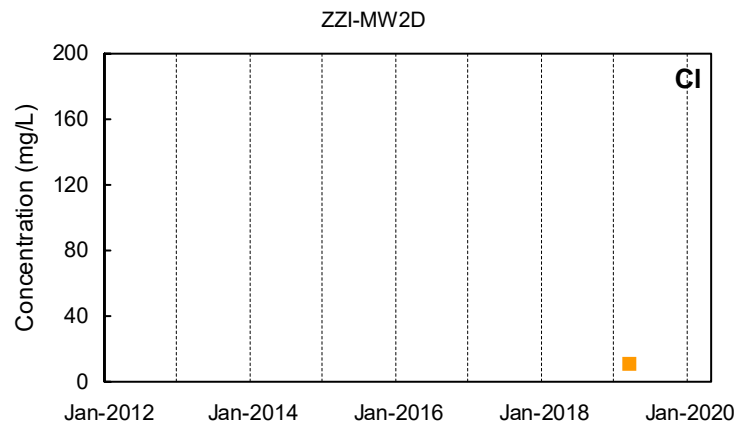
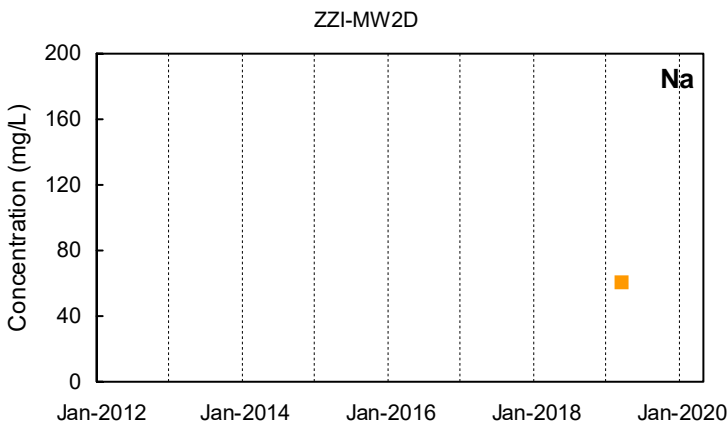

■ Detected Value □ 'J'-Flag (value between reporting limit and detection limit) ■ Non-Detect Range
 Shallow Well shown with black symbols Deep Well shown with orange symbols "dd" Well shown with blue symbols

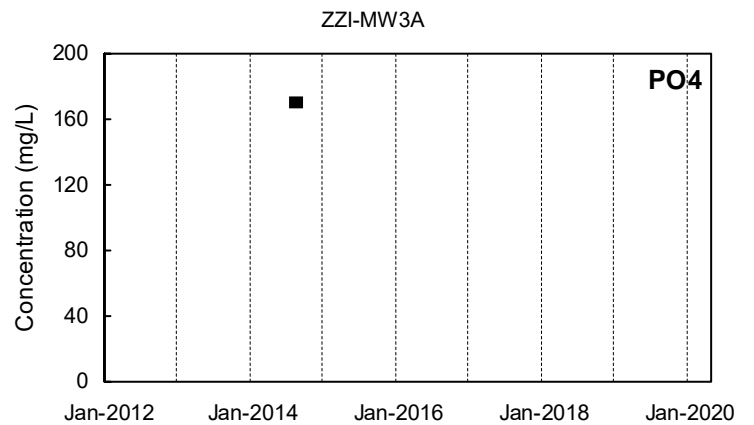
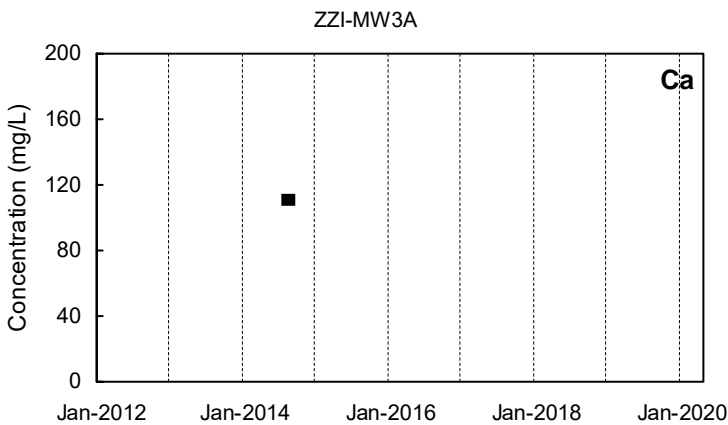
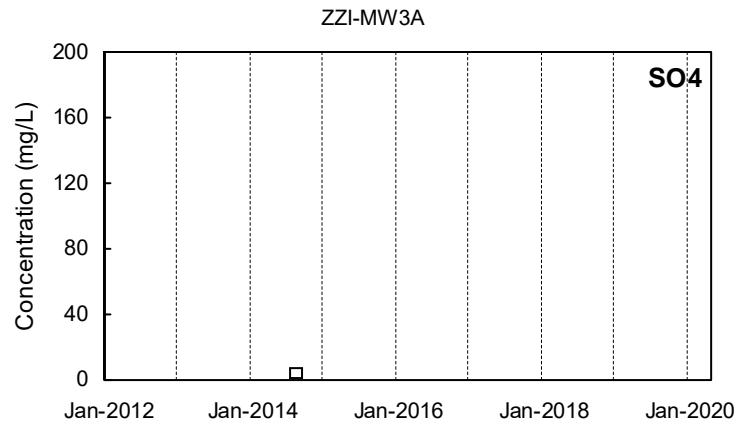
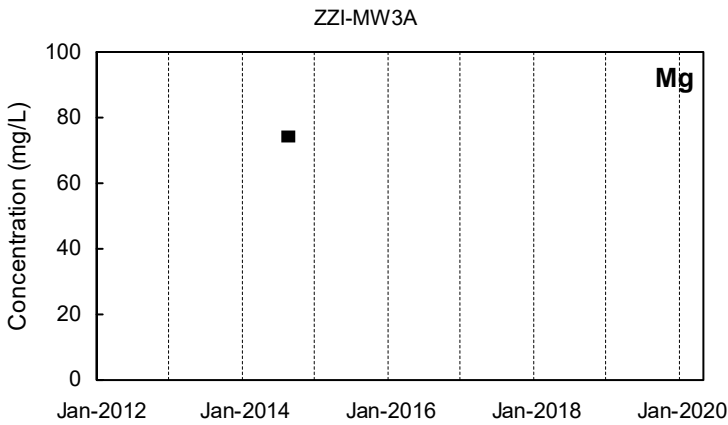
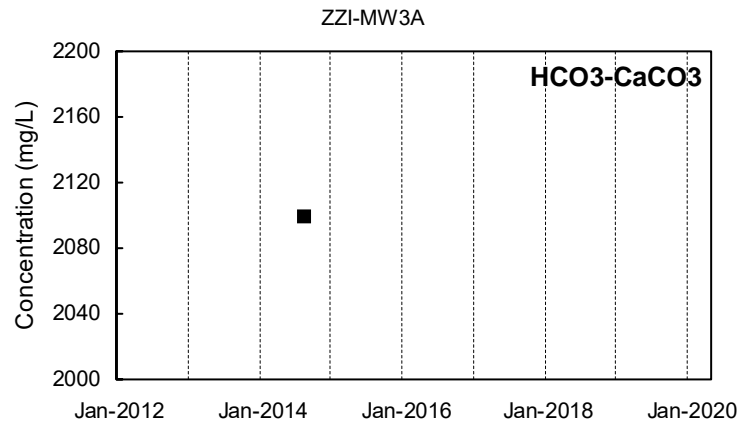
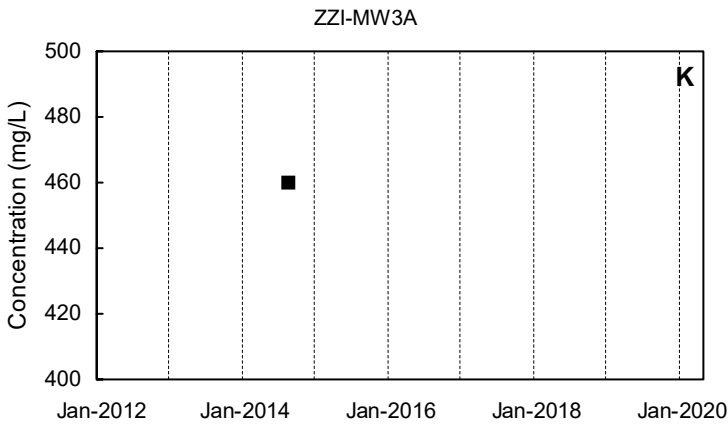
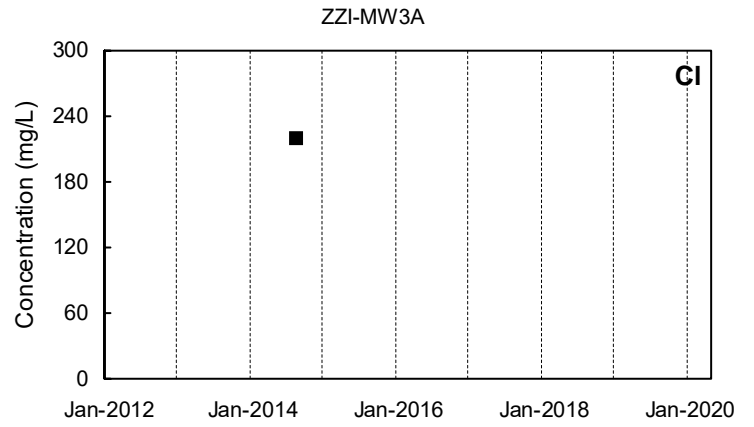
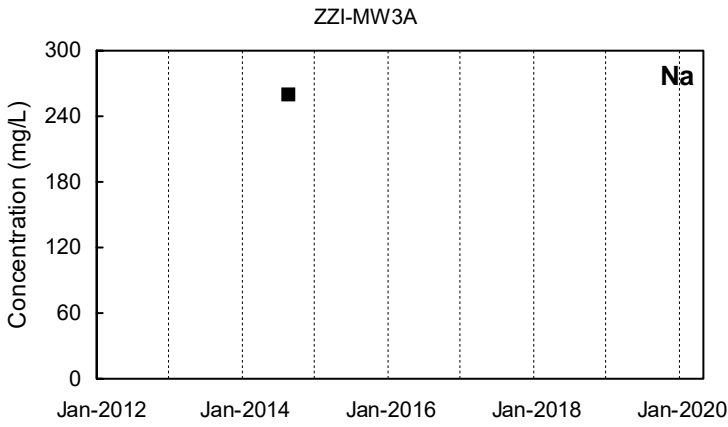

■ Detected Value □ 'J'-Flag (value between reporting limit and detection limit) ■ Non-Detect Range
 Shallow Well shown with black symbols Deep Well shown with orange symbols "dd" Well shown with blue symbols

ZZI-MW3AA

ZZI-MW3AA

Na

Cl

Not Sampled

Not Sampled

ZZI-MW3AA

ZZI-MW3AA

K

HCO3-CaCO3

Not Sampled

Not Sampled

ZZI-MW3AA

ZZI-MW3AA

Mg

SO4

Not Sampled

Not Sampled

ZZI-MW3AA

ZZI-MW3AA

Ca

PO4

Not Sampled

Not Sampled

Detected Value
 'J'-Flag (value between reporting limit and detection limit)
 Non-Detect Range
 Shallow Well shown with black symbols
 Deep Well shown with orange symbols
 "dd" Well shown with blue symbols

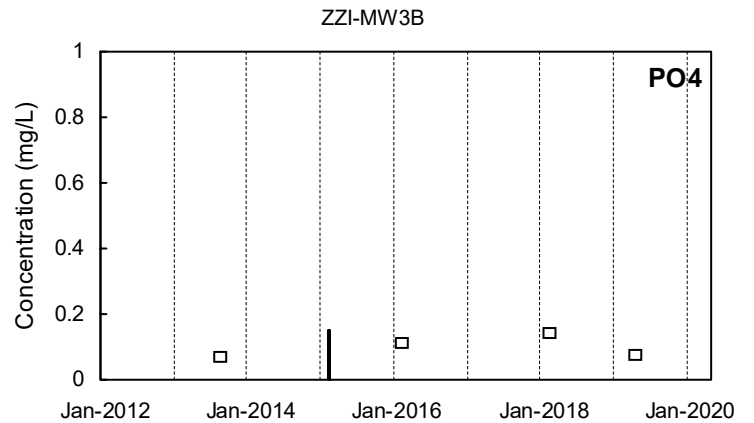
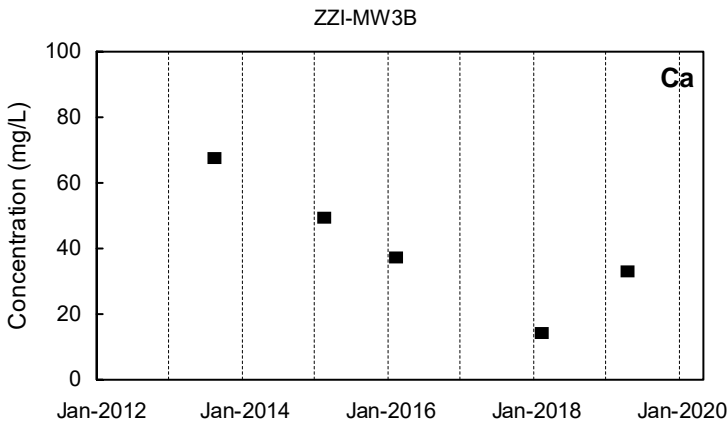
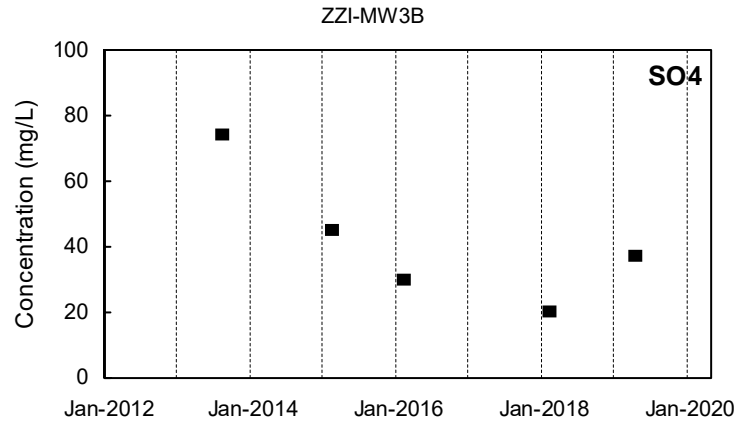
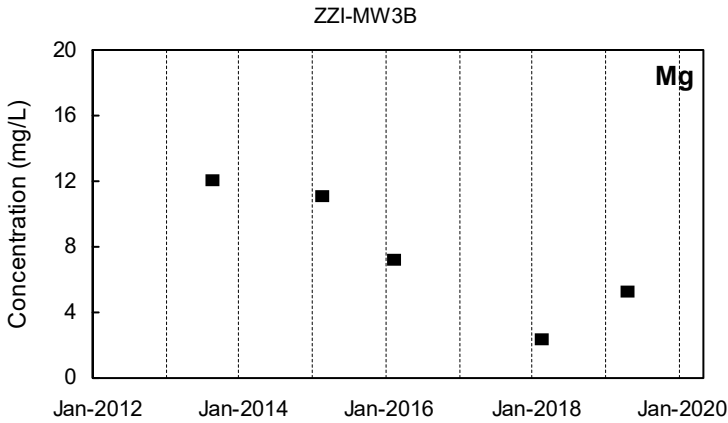
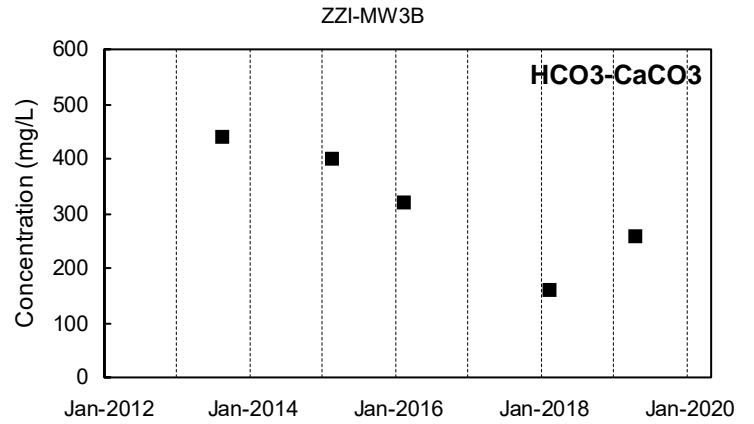
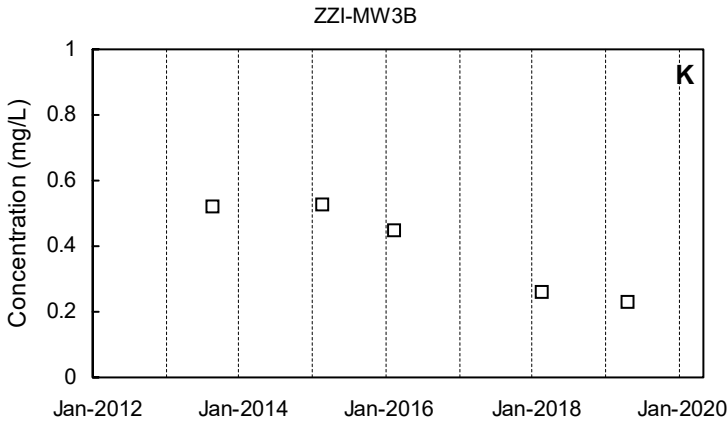
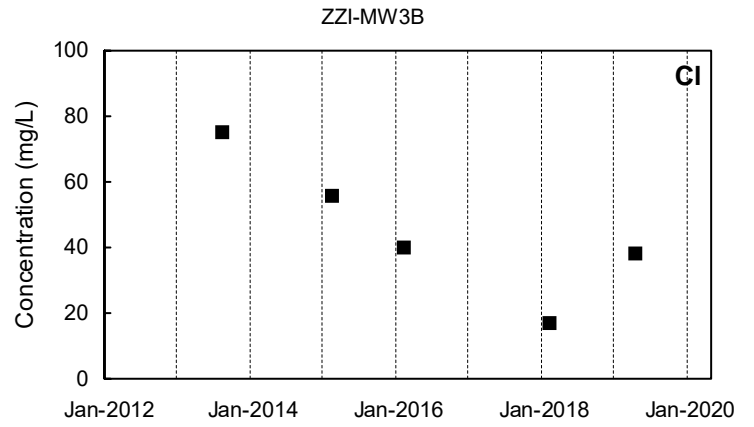
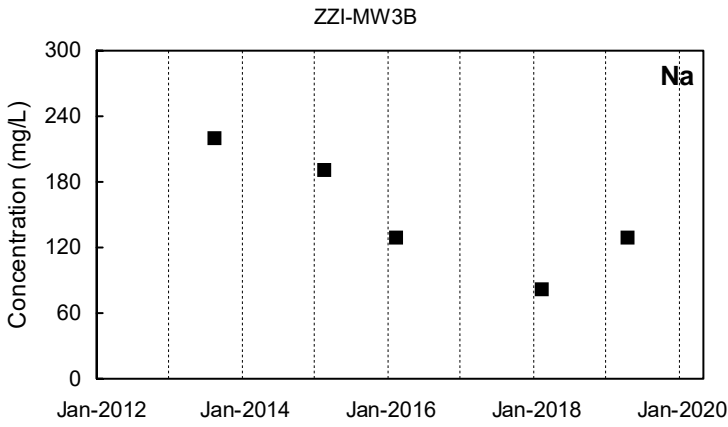

Detected Value
 'J'-Flag (value between reporting limit and detection limit)
 Non-Detect Range
 Shallow Well shown with black symbols Deep Well shown with orange symbols "dd" Well shown with blue symbols

ZZI-MW5A

ZZI-MW5A

Na

Cl

Not Sampled

Not Sampled

ZZI-MW5A

ZZI-MW5A

K

HCO3-CaCO3

Not Sampled

Not Sampled

ZZI-MW5A

ZZI-MW5A

Mg

SO4

Not Sampled

Not Sampled

ZZI-MW5A

ZZI-MW5A

Ca

PO4

Not Sampled

Not Sampled

Detected Value
 'J'-Flag (value between reporting limit and detection limit)
 Non-Detect Range

Shallow Well shown with black symbols
 Deep Well shown with orange symbols
 "dd" Well shown with blue symbols

ZZI-MW5B

ZZI-MW5B

Na

Cl

Not Sampled

Not Sampled

ZZI-MW5B

ZZI-MW5B

K

HCO3-CaCO3

Not Sampled

Not Sampled

ZZI-MW5B

ZZI-MW5B

Mg

SO4

Not Sampled

Not Sampled

ZZI-MW5B

ZZI-MW5B

Ca

PO4

Not Sampled

Not Sampled

Detected Value
 'J'-Flag (value between reporting limit and detection limit)
 Non-Detect Range

Shallow Well shown with black symbols
 Deep Well shown with orange symbols
 "dd" Well shown with blue symbols

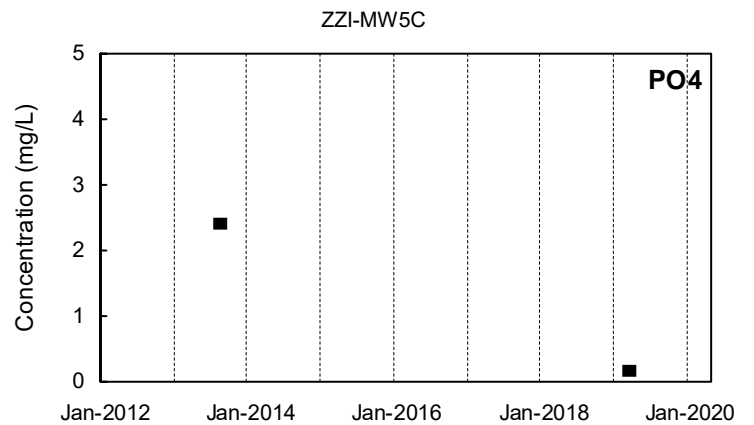
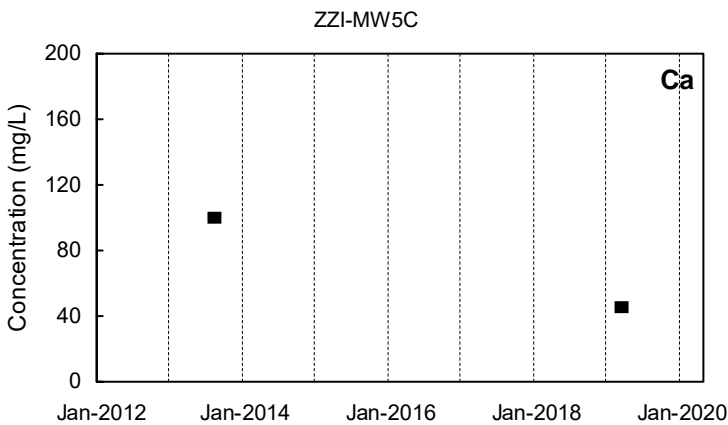
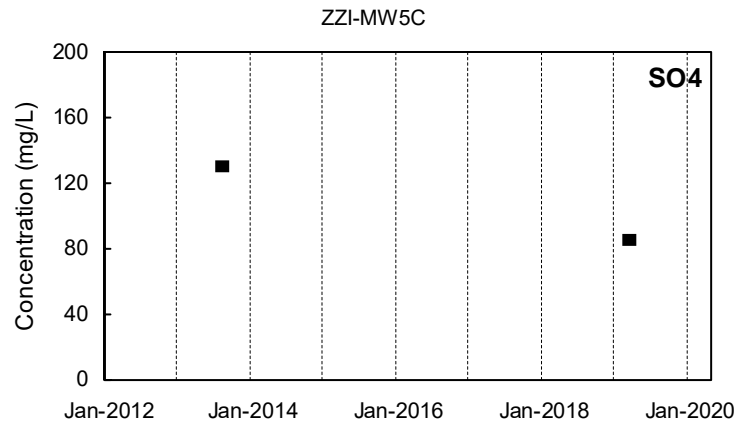
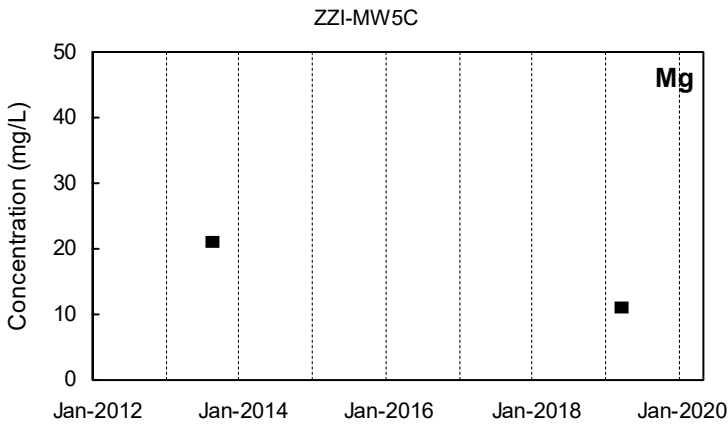
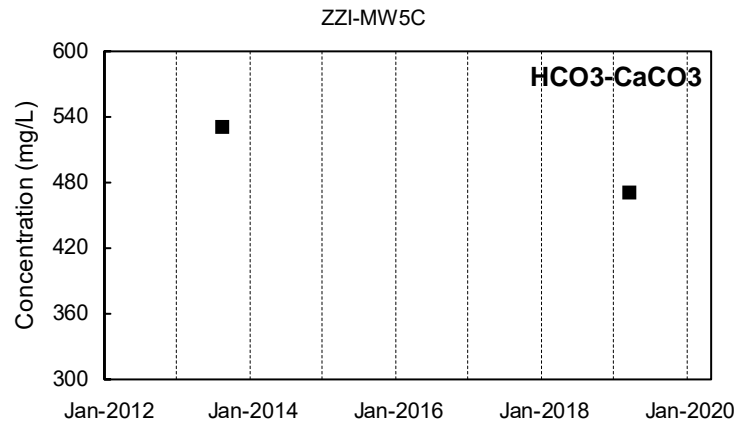
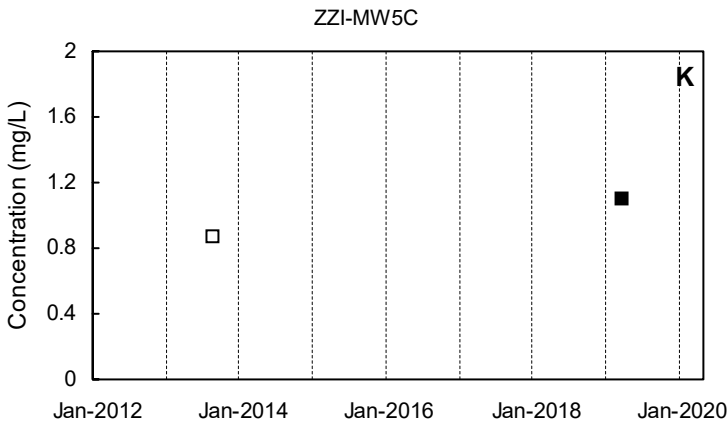
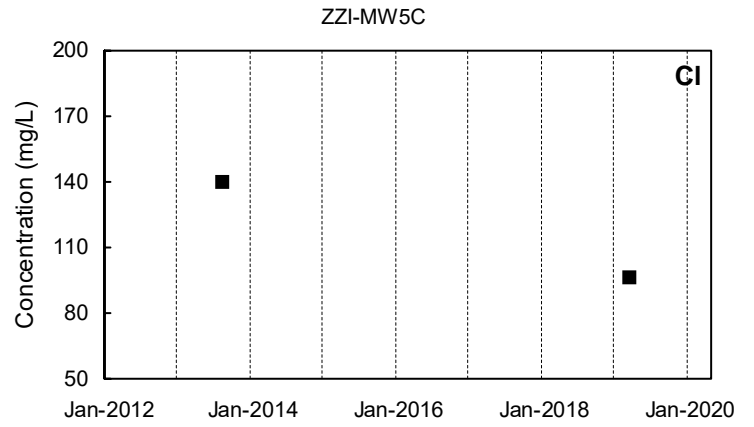
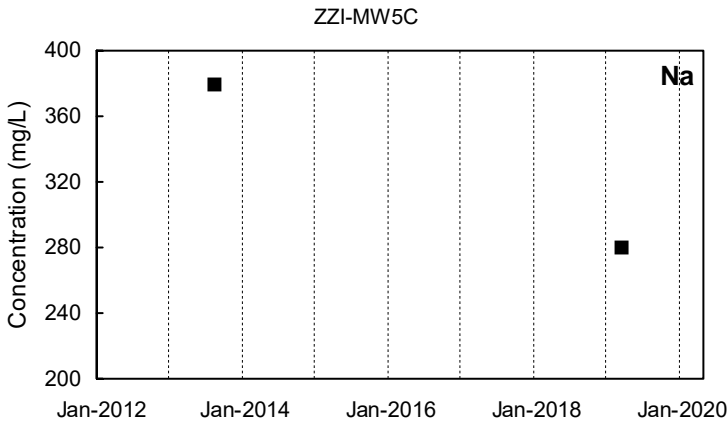

■ Detected Value □ 'J'-Flag (value between reporting limit and detection limit) [] Non-Detect Range
 Shallow Well shown with black symbols Deep Well shown with orange symbols "dd" Well shown with blue symbols

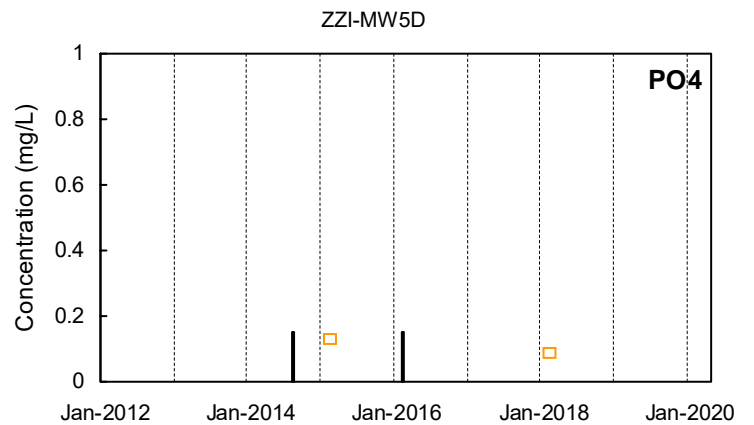
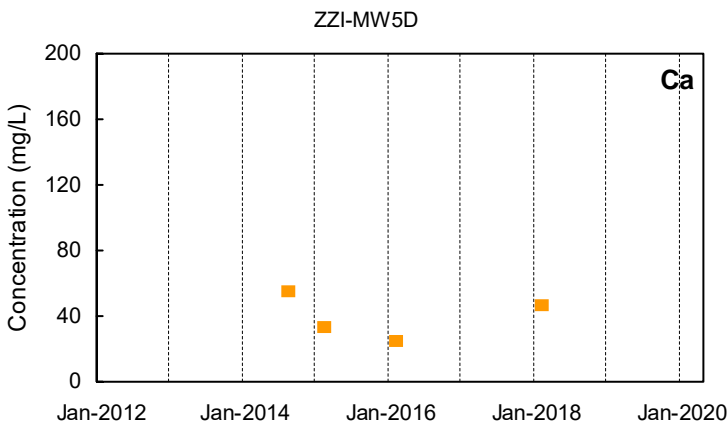
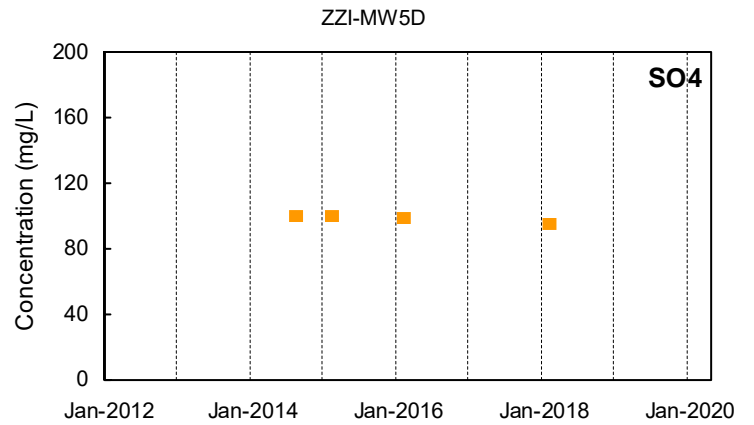
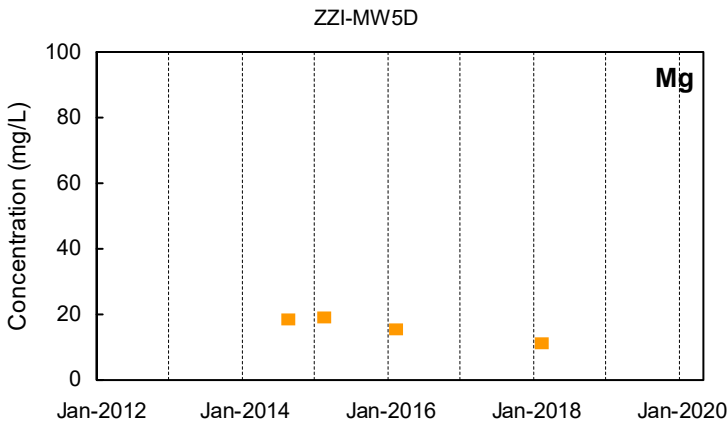
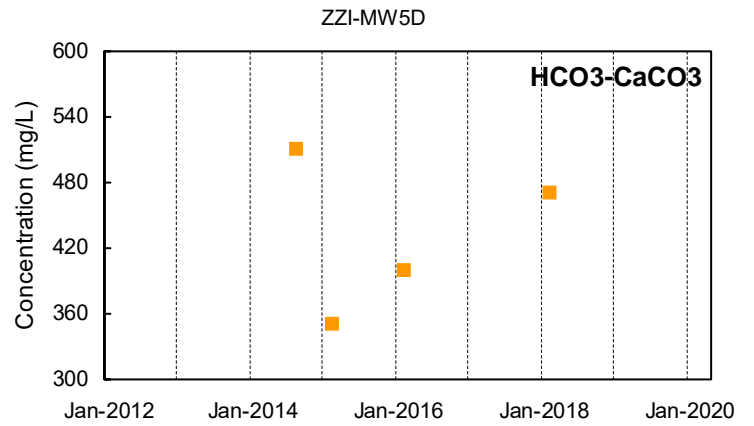
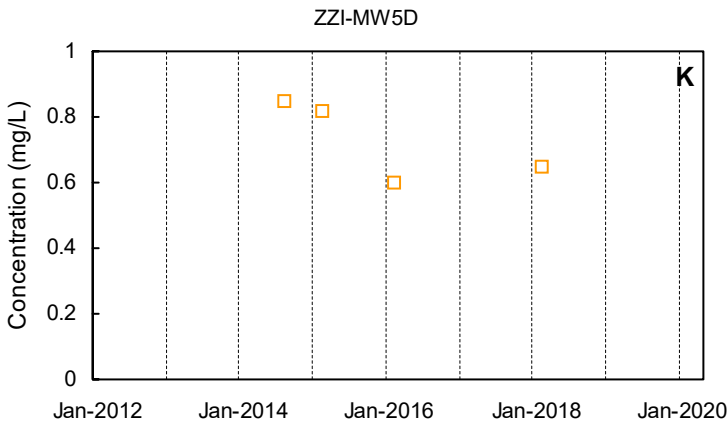
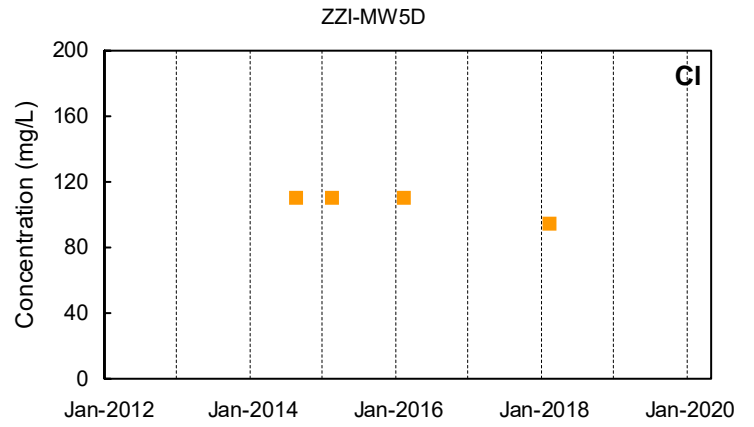
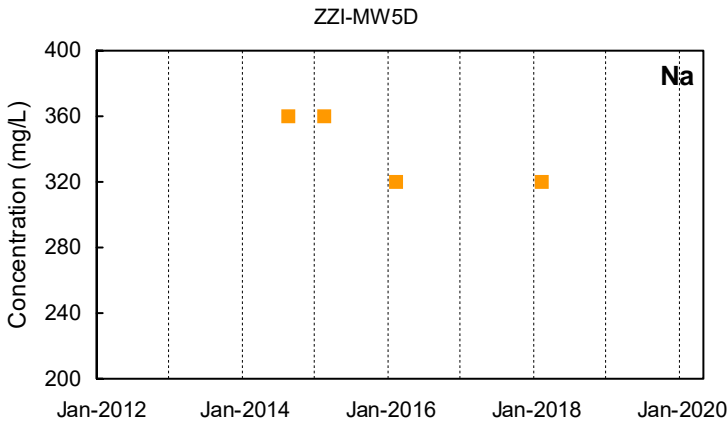

■ Detected Value
 □ 'J'-Flag (value between reporting limit and detection limit)
 Non-Detect Range
 Shallow Well shown with black symbols
 Deep Well shown with orange symbols
 "dd" Well shown with blue symbols

ZZI-MW6A

ZZI-MW6A

Na

Cl

Not Sampled

Not Sampled

ZZI-MW6A

ZZI-MW6A

K

HCO3-CaCO3

Not Sampled

Not Sampled

ZZI-MW6A

ZZI-MW6A

Mg

SO4

Not Sampled

Not Sampled

ZZI-MW6A

ZZI-MW6A

Ca

PO4

Not Sampled

Not Sampled

Detected Value
 'J'-Flag (value between reporting limit and detection limit)
 Non-Detect Range
 Shallow Well shown with black symbols
 Deep Well shown with orange symbols
 "dd" Well shown with blue symbols

ZZI-MW6B

ZZI-MW6B

Na

Cl

Not Sampled

Not Sampled

ZZI-MW6B

ZZI-MW6B

K

HCO3-CaCO3

Not Sampled

Not Sampled

ZZI-MW6B

ZZI-MW6B

Mg

SO4

Not Sampled

Not Sampled

ZZI-MW6B

ZZI-MW6B

Ca

PO4

Not Sampled

Not Sampled

Detected Value
 'J'-Flag (value between reporting limit and detection limit)
 Non-Detect Range

Shallow Well shown with black symbols
 Deep Well shown with orange symbols
 "dd" Well shown with blue symbols

ZZI-MW6C

ZZI-MW6C

Na

Cl

Not Sampled

Not Sampled

ZZI-MW6C

ZZI-MW6C

K

HCO3-CaCO3

Not Sampled

Not Sampled

ZZI-MW6C

ZZI-MW6C

Mg

SO4

Not Sampled

Not Sampled

ZZI-MW6C

ZZI-MW6C

Ca

PO4

Not Sampled

Not Sampled

Detected Value
 'J'-Flag (value between reporting limit and detection limit)
 Non-Detect Range
 Shallow Well shown with black symbols
 Deep Well shown with orange symbols
 "dd" Well shown with blue symbols

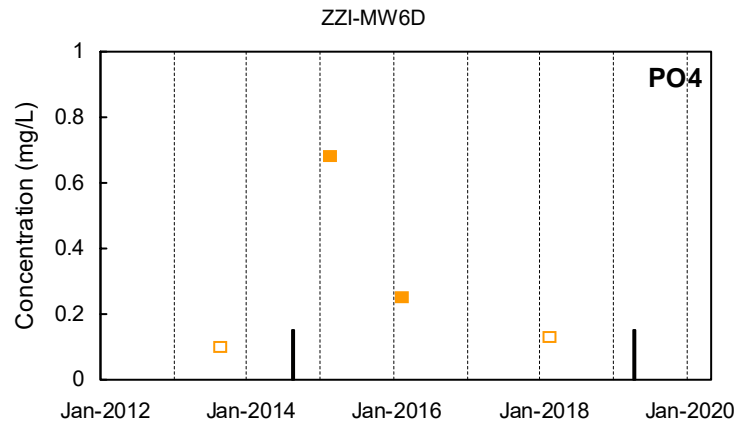
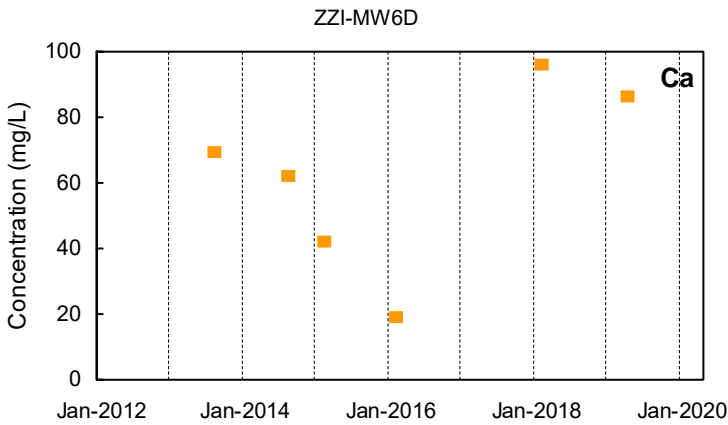
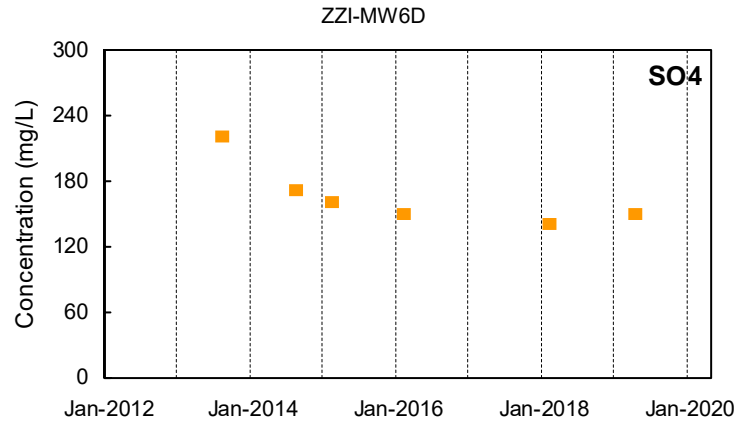
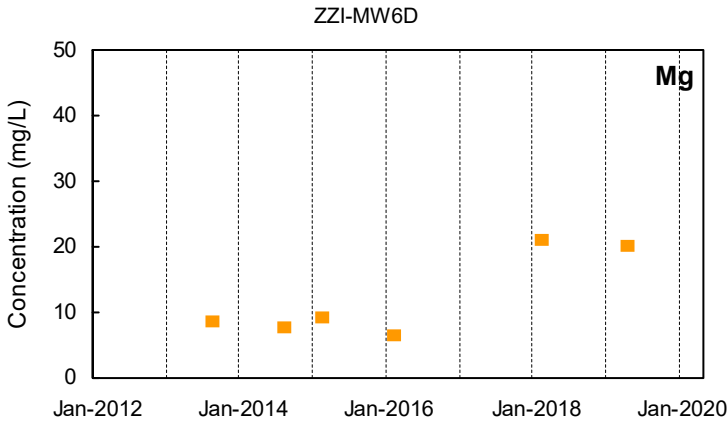
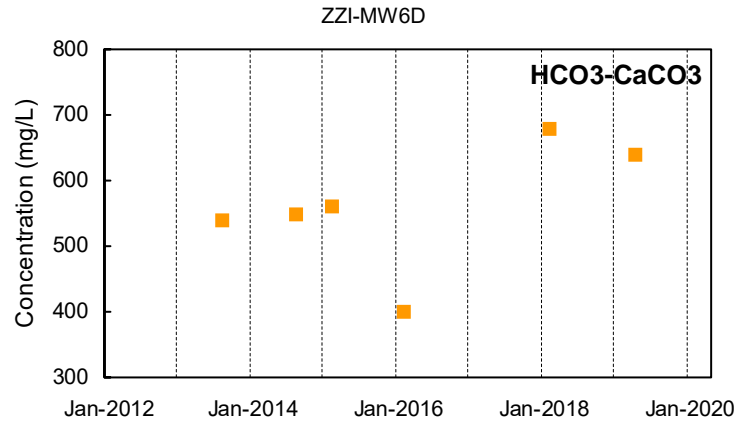
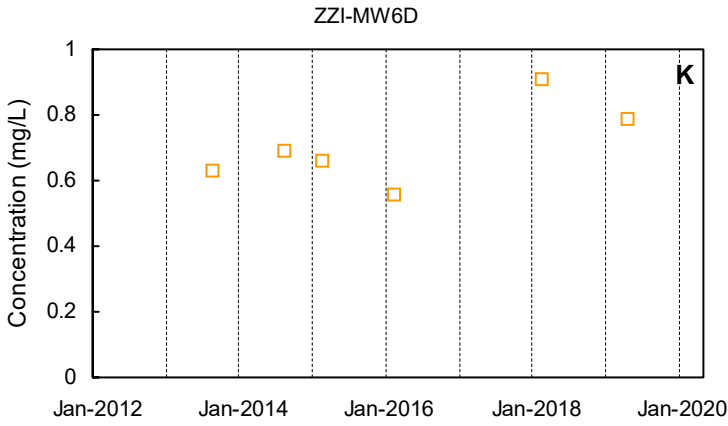
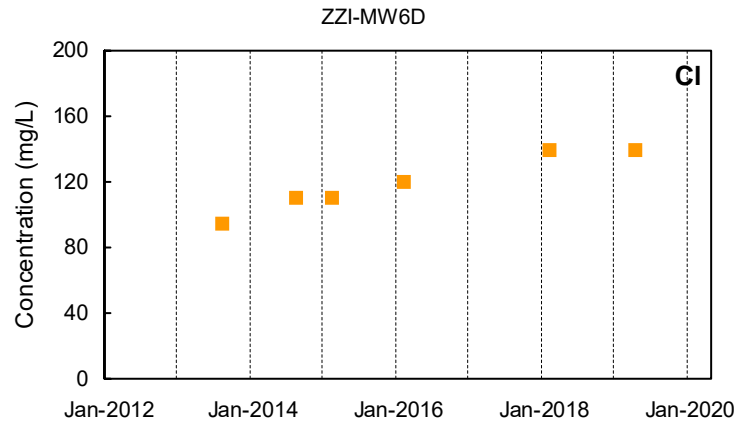
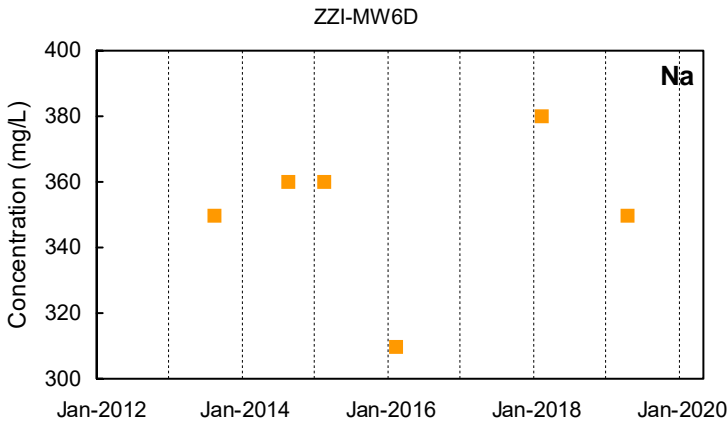

■ Detected Value
 □ 'J'-Flag (value between reporting limit and detection limit)
 Non-Detect Range
■ Shallow Well shown with black symbols
■ Deep Well shown with orange symbols
■ "dd" Well shown with blue symbols

ZZI-MW7A

ZZI-MW7A

Na

Not Sampled

Cl

Not Sampled

ZZI-MW7A

ZZI-MW7A

K

Not Sampled

HCO3-CaCO3

Not Sampled

ZZI-MW7A

ZZI-MW7A

Mg

Not Sampled

SO4

Not Sampled

ZZI-MW7A

ZZI-MW7A

Ca

Not Sampled

PO4

Not Sampled

■ Detected Value

□ 'J'-Flag (value between reporting limit and detection limit)



Non-Detect Range

Shallow Well shown with black symbols

Deep Well shown with orange symbols

"dd" Well shown with blue symbols

ZZI-MW7B

ZZI-MW7B

Na

Cl

Not Sampled

Not Sampled

ZZI-MW7B

ZZI-MW7B

K

HCO3-CaCO3

Not Sampled

Not Sampled

ZZI-MW7B

ZZI-MW7B

Mg

SO4

Not Sampled

Not Sampled

ZZI-MW7B

ZZI-MW7B

Ca

PO4

Not Sampled

Not Sampled

Detected Value
 'J'-Flag (value between reporting limit and detection limit)
 Non-Detect Range

Shallow Well shown with black symbols
 Deep Well shown with orange symbols
 "dd" Well shown with blue symbols

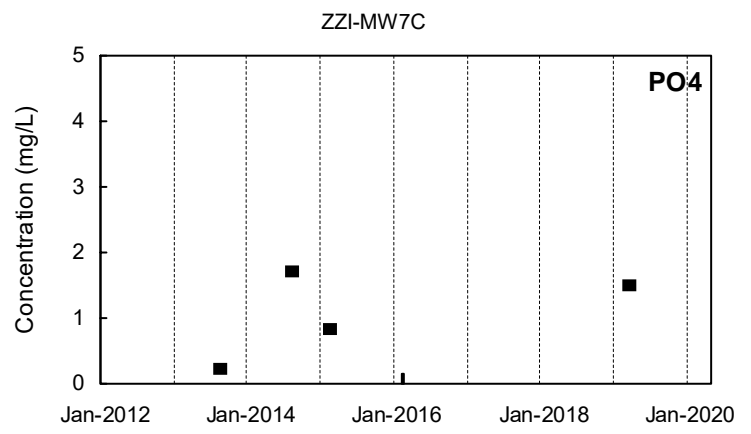
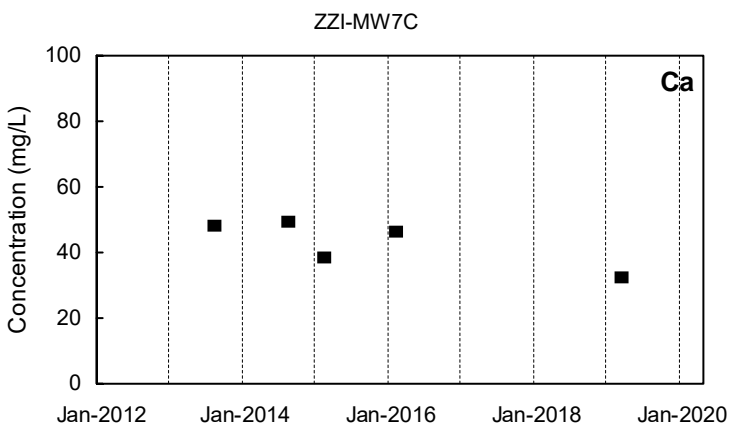
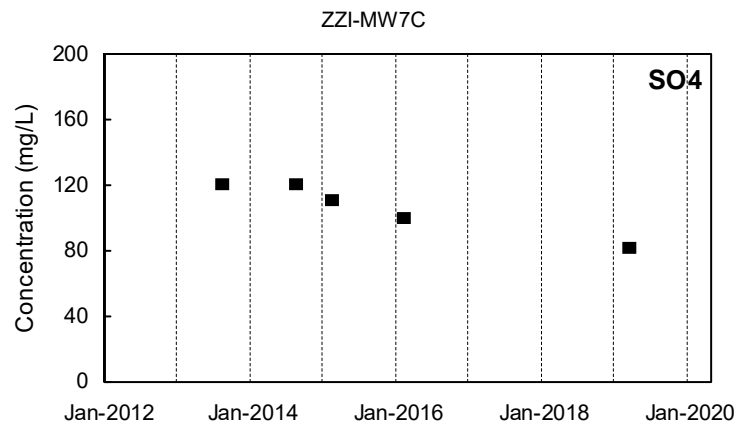
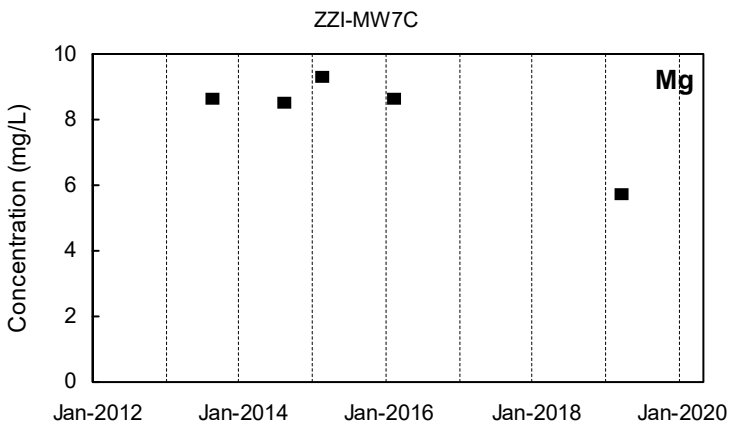
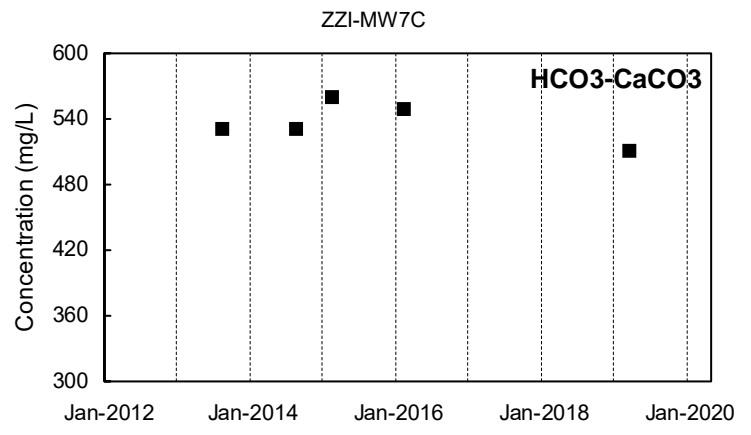
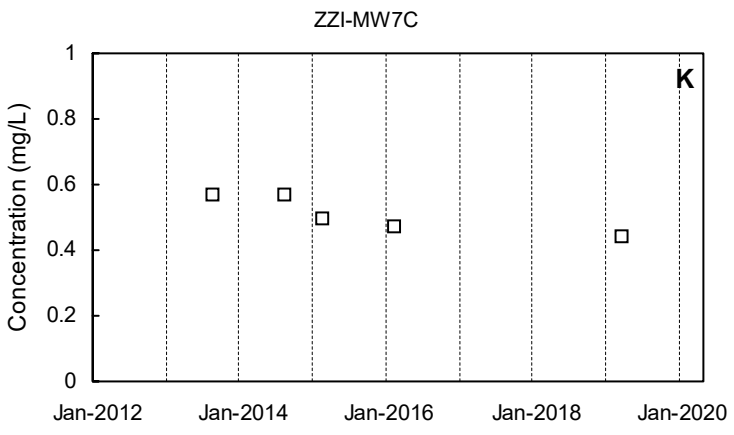
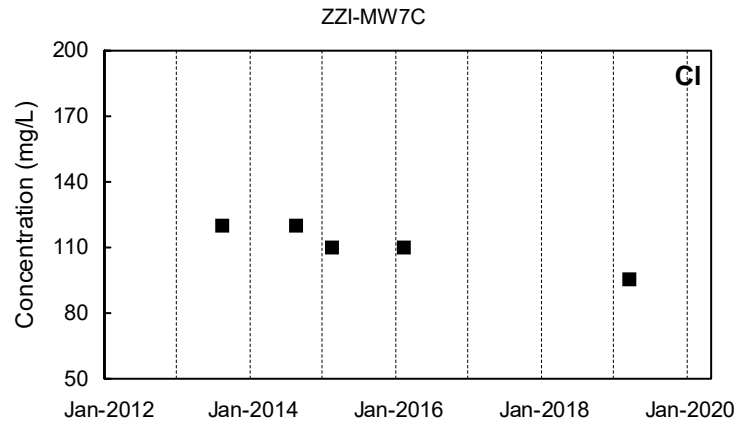
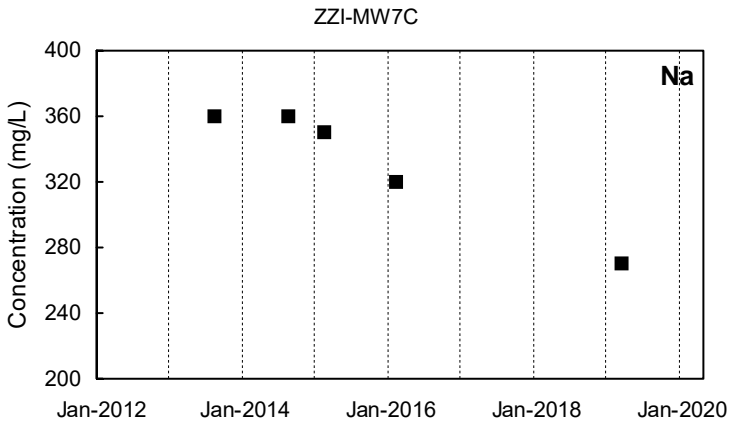

■ Detected Value □ 'J'-Flag (value between reporting limit and detection limit) ■ Non-Detect Range
 Shallow Well shown with black symbols Deep Well shown with orange symbols "dd" Well shown with blue symbols

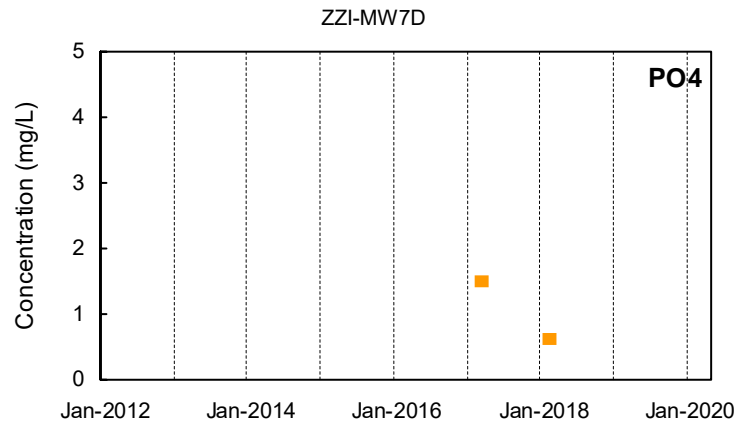
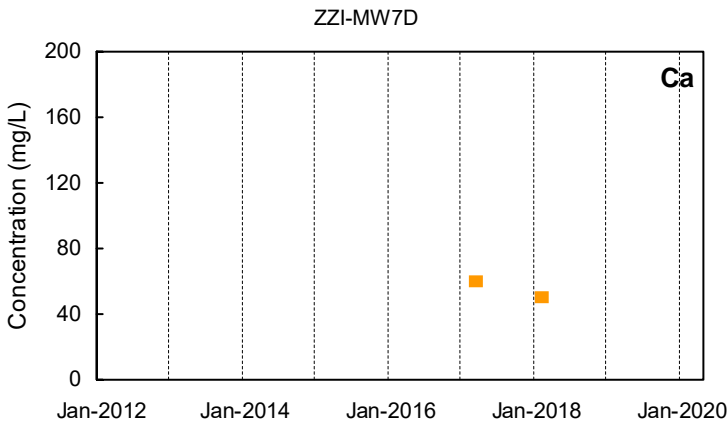
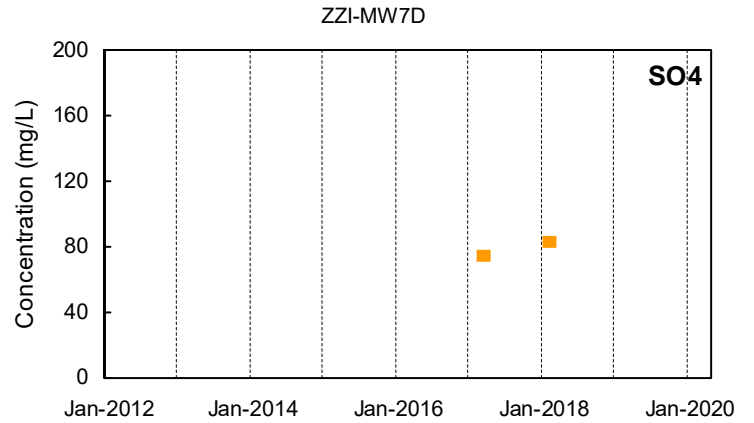
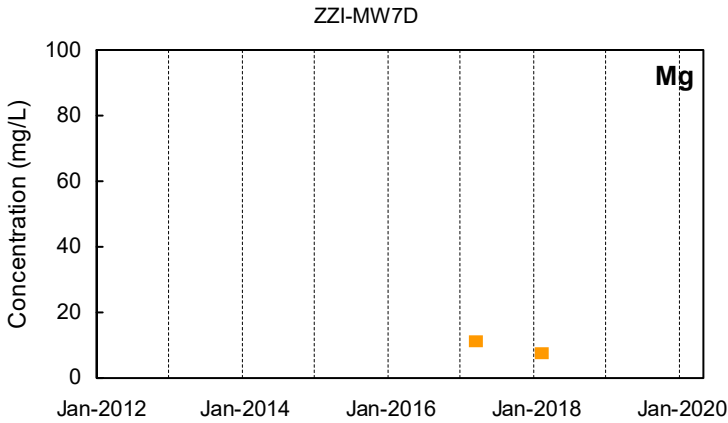
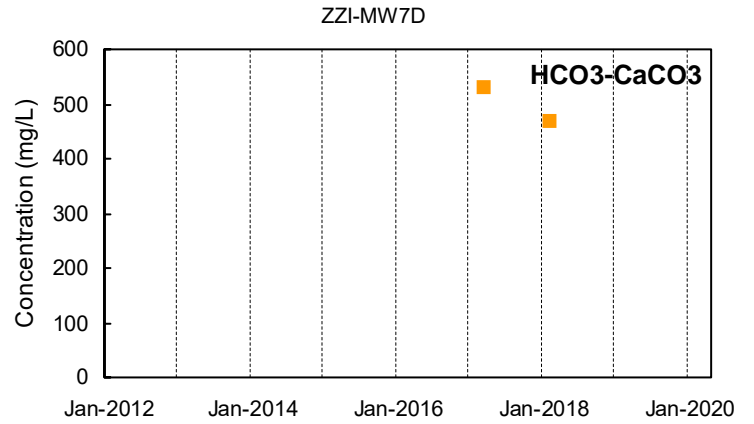
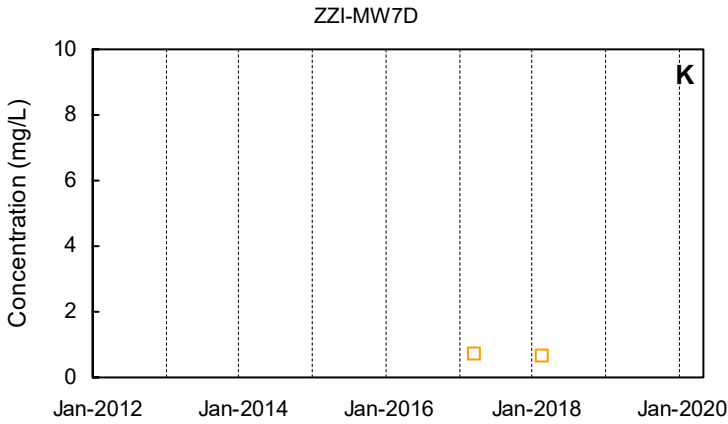
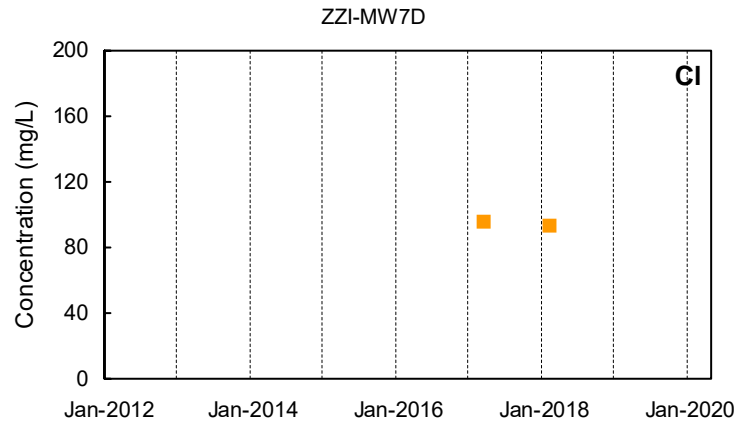
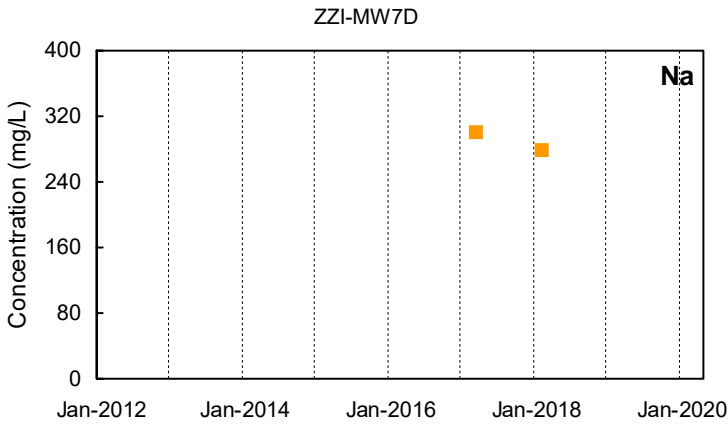

■ Detected Value
 □ 'J'-Flag (value between reporting limit and detection limit)
 Non-Detect Range
 Shallow Well shown with black symbols
 Deep Well shown with orange symbols
 "dd" Well shown with blue symbols

ZZI-MW9A

ZZI-MW9A

Na

Cl

Not Sampled

Not Sampled

ZZI-MW9A

ZZI-MW9A

K

HCO3-CaCO3

Not Sampled

Not Sampled

ZZI-MW9A

ZZI-MW9A

Mg

SO4

Not Sampled

Not Sampled

ZZI-MW9A

ZZI-MW9A

Ca

PO4

Not Sampled

Not Sampled

Detected Value
 'J'-Flag (value between reporting limit and detection limit)
 Non-Detect Range

Shallow Well shown with black symbols
 Deep Well shown with orange symbols
 "dd" Well shown with blue symbols

ZZI-MW9B

ZZI-MW9B

Na

Cl

Not Sampled

Not Sampled

ZZI-MW9B

ZZI-MW9B

K

HCO3-CaCO3

Not Sampled

Not Sampled

ZZI-MW9B

ZZI-MW9B

Mg

SO4

Not Sampled

Not Sampled

ZZI-MW9B

ZZI-MW9B

Ca

PO4

Not Sampled

Not Sampled

■ Detected Value

□ 'J'-Flag (value between reporting limit and detection limit)

■ Non-Detect Range

Shallow Well shown with black symbols

Deep Well shown with orange symbols

"dd" Well shown with blue symbols

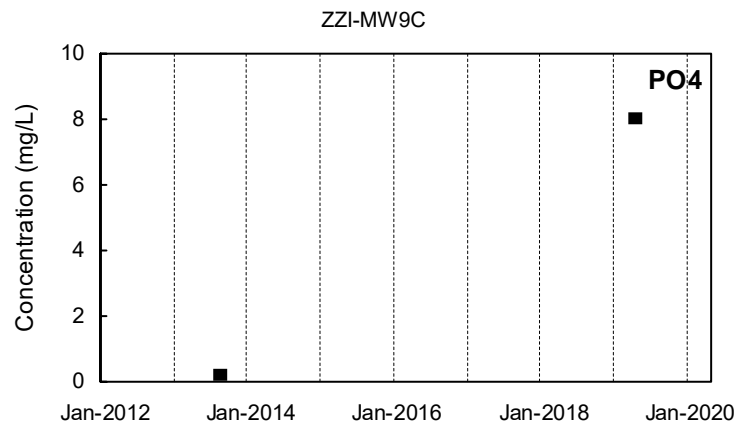
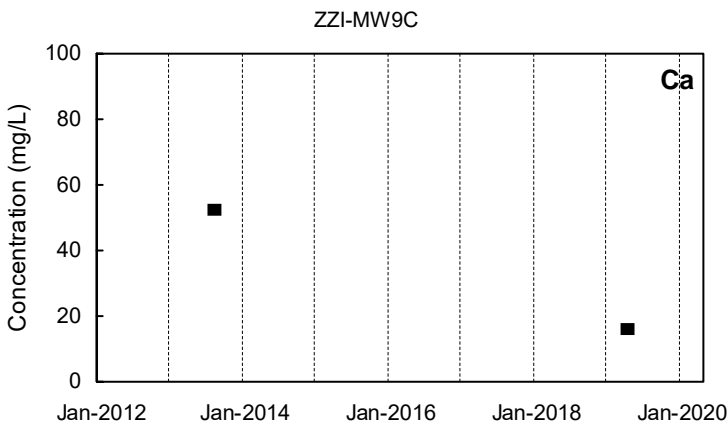
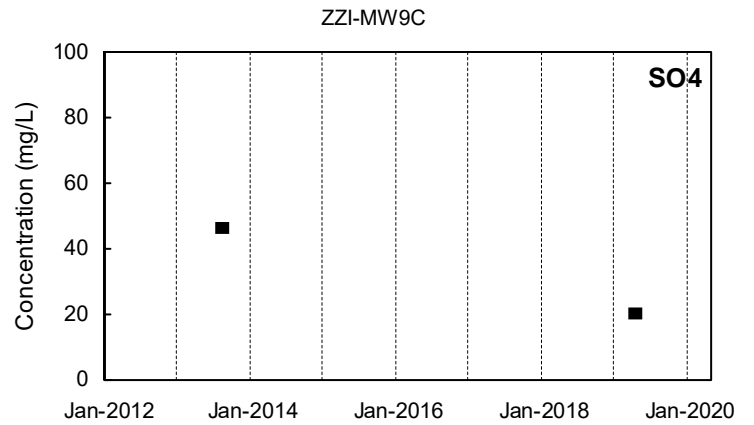
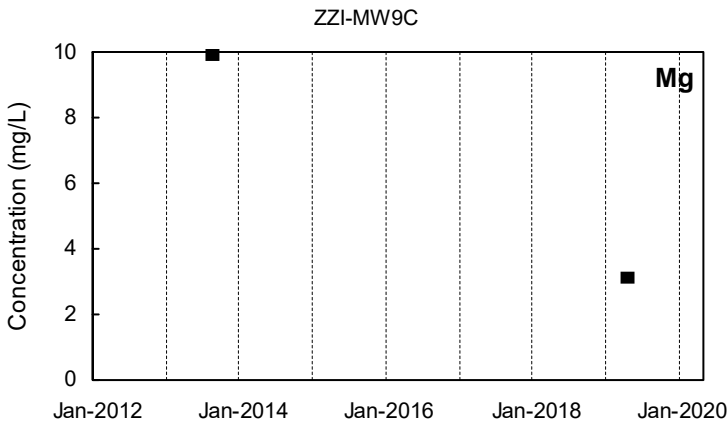
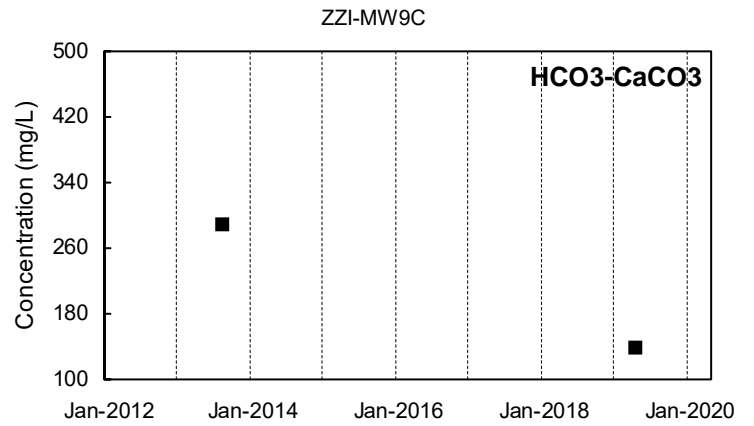
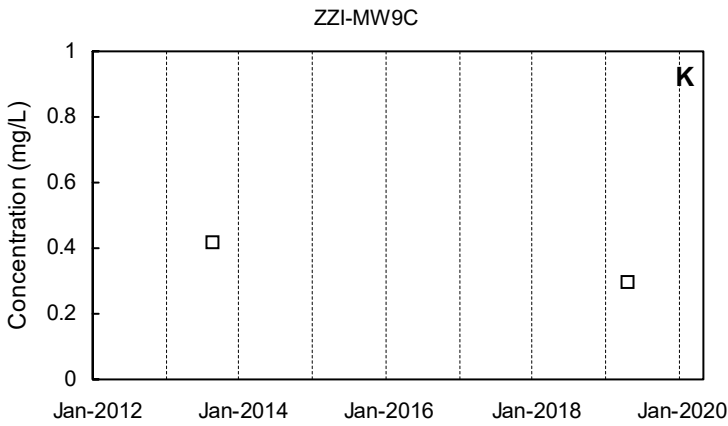
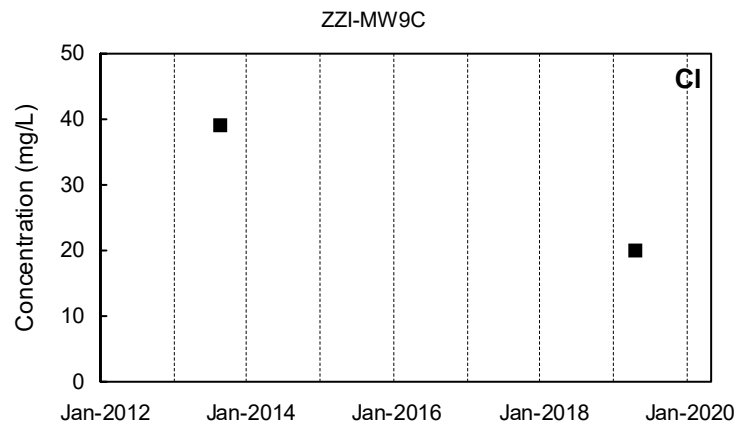
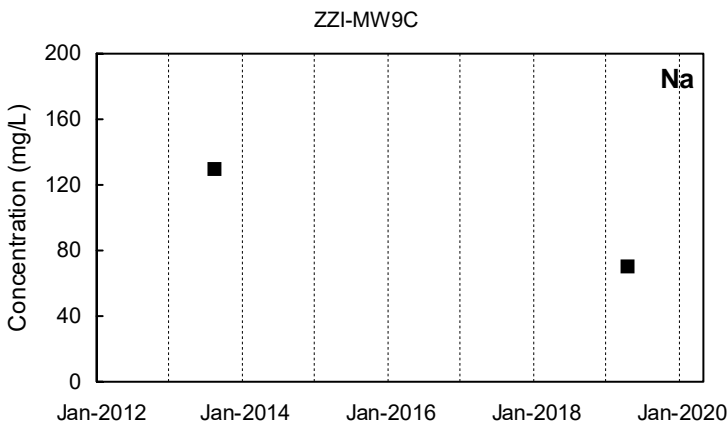

■ Detected Value □ 'J'-Flag (value between reporting limit and detection limit) ■ Non-Detect Range
 Shallow Well shown with black symbols Deep Well shown with orange symbols "dd" Well shown with blue symbols

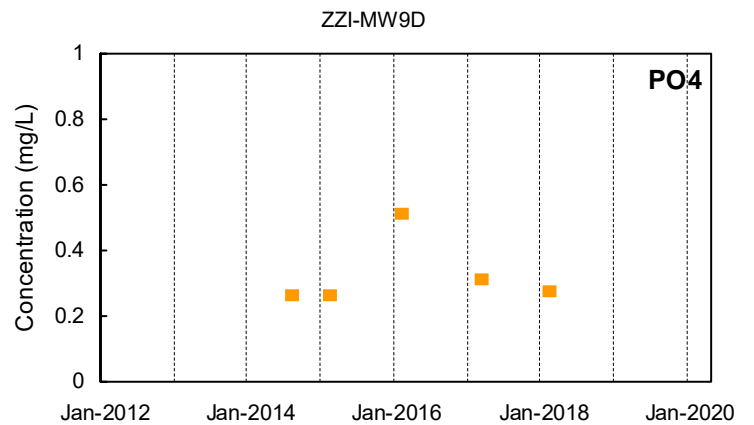
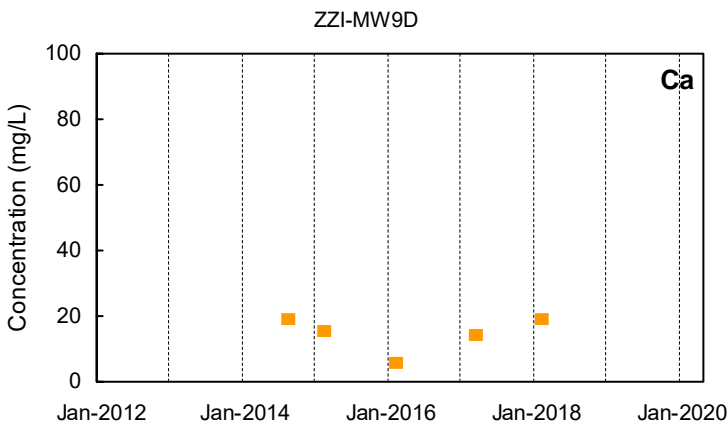
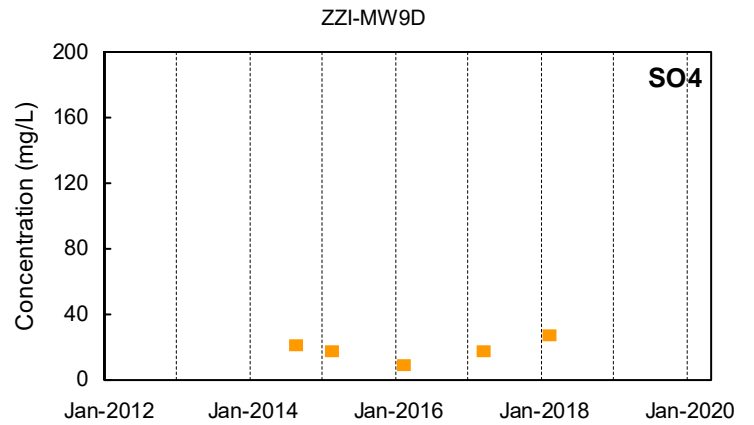
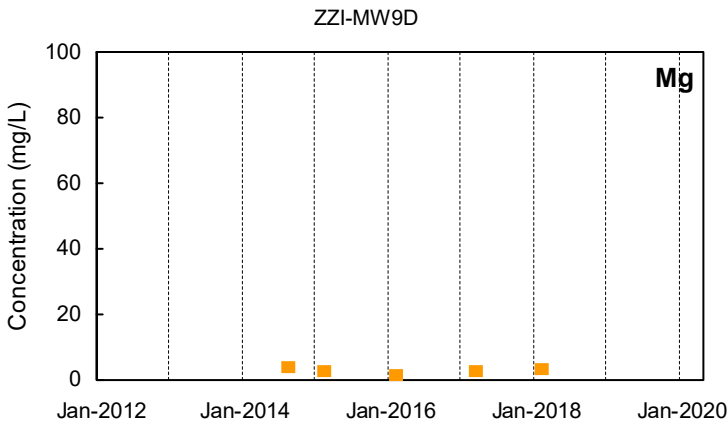
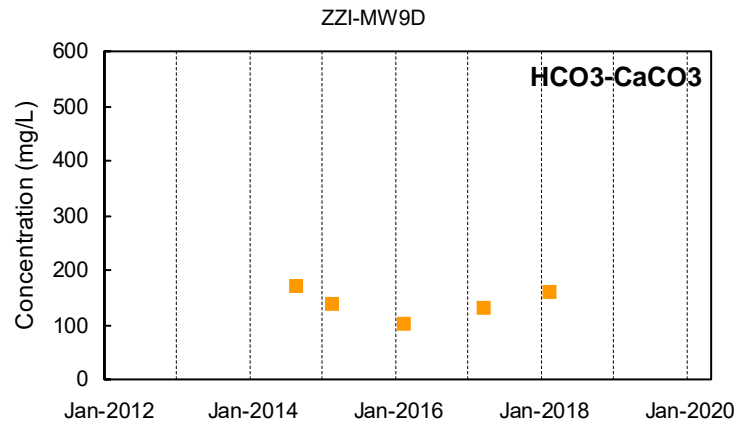
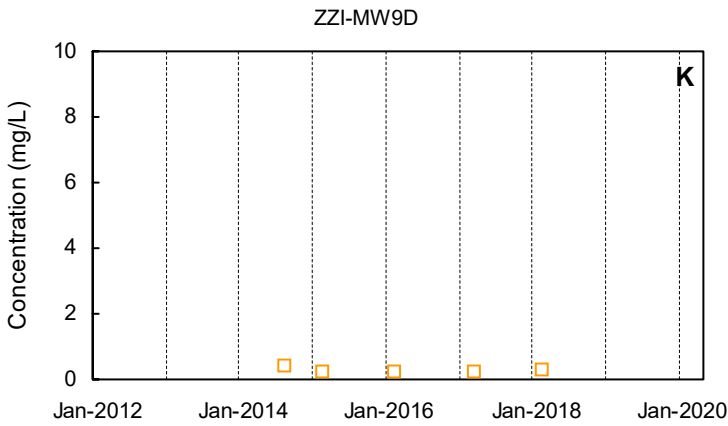
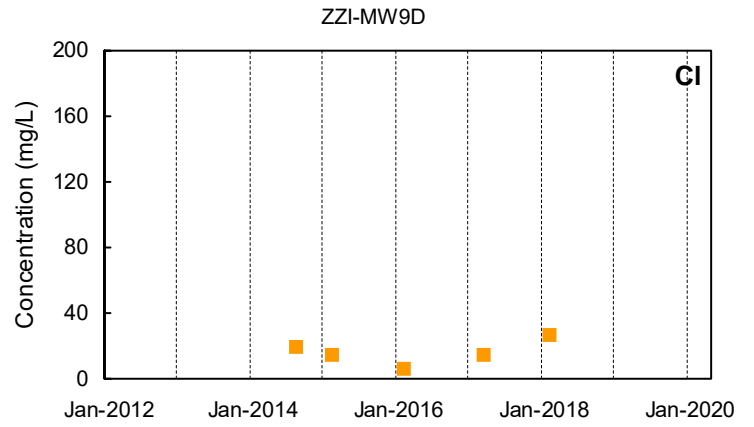
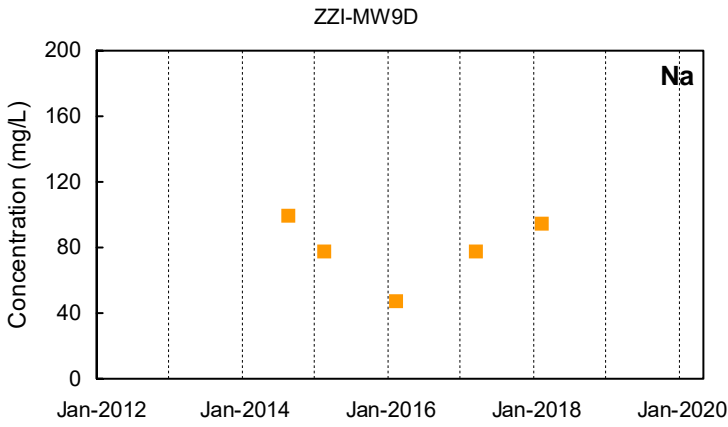

■ Detected Value
 □ 'J'-Flag (value between reporting limit and detection limit)
 Non-Detect Range
 Shallow Well shown with black symbols
 Deep Well shown with orange symbols
 "dd" Well shown with blue symbols

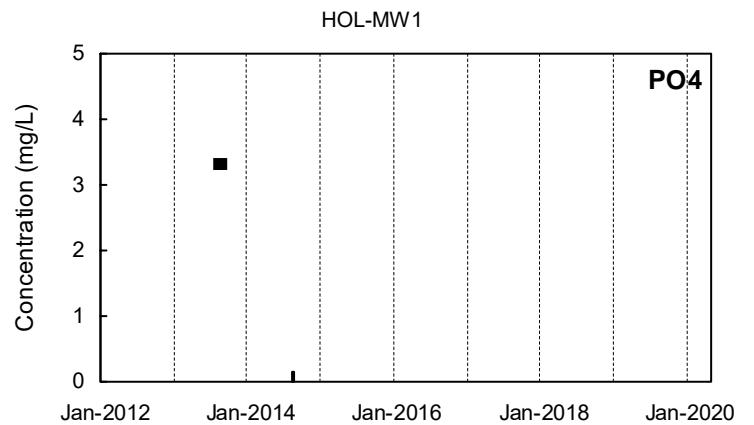
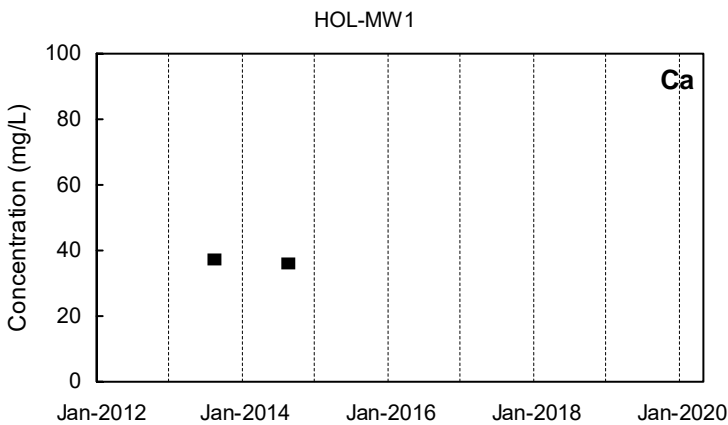
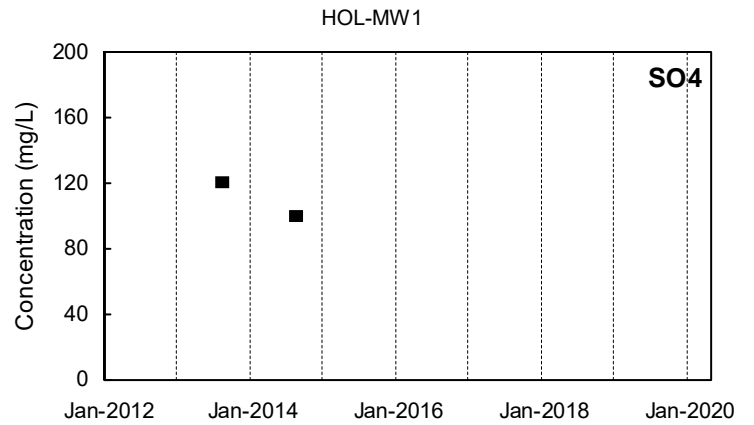
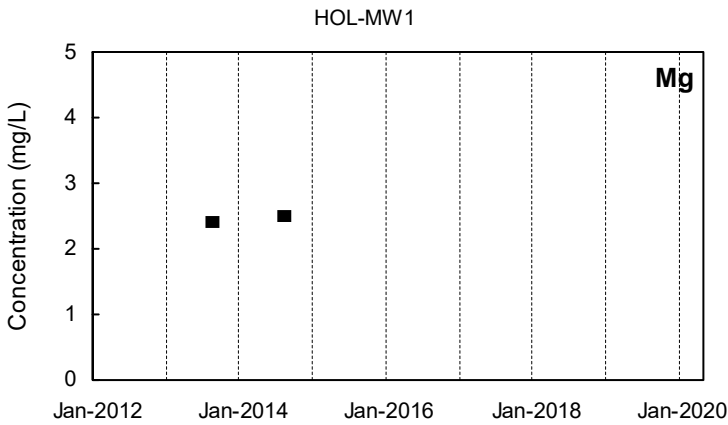
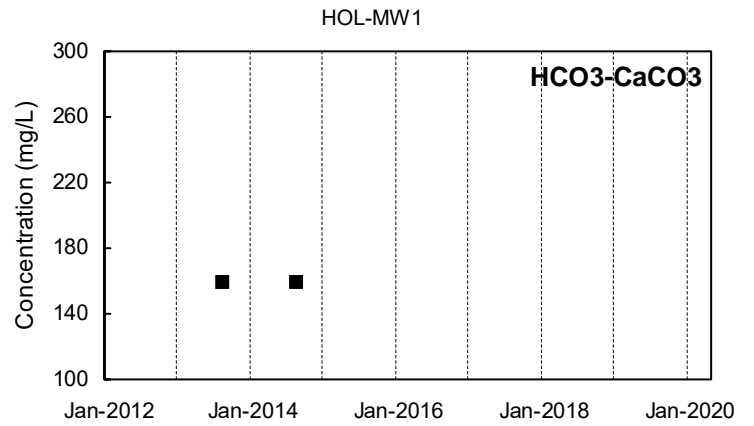
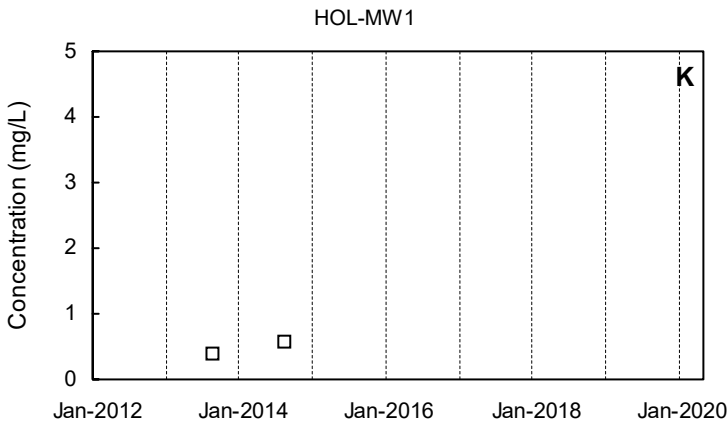
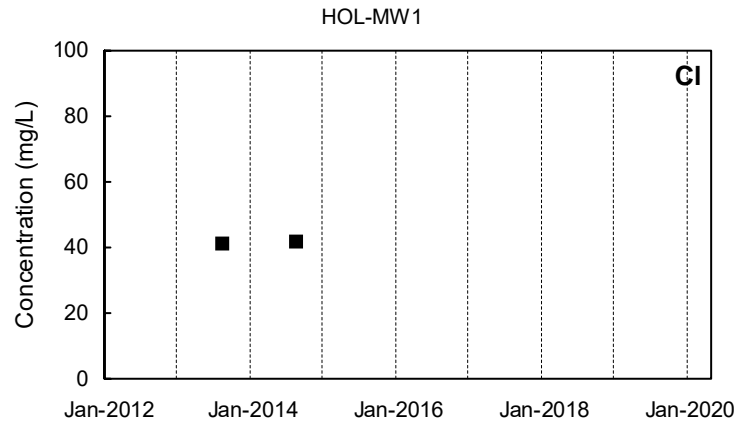
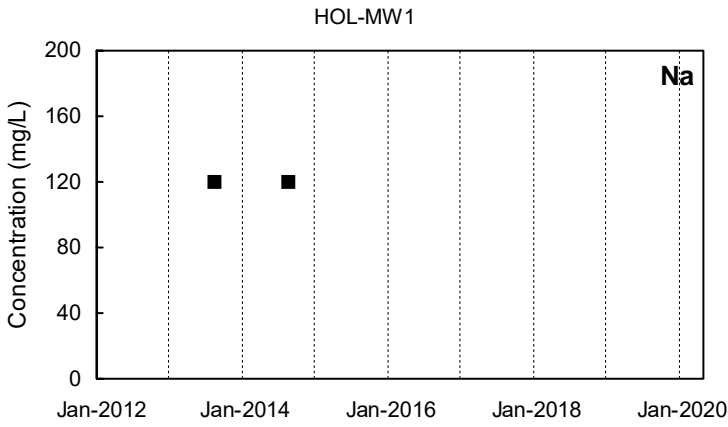

■ Detected Value □ 'J'-Flag (value between reporting limit and detection limit) ■ Non-Detect Range
 Shallow Well shown with black symbols Deep Well shown with orange symbols "dd" Well shown with blue symbols

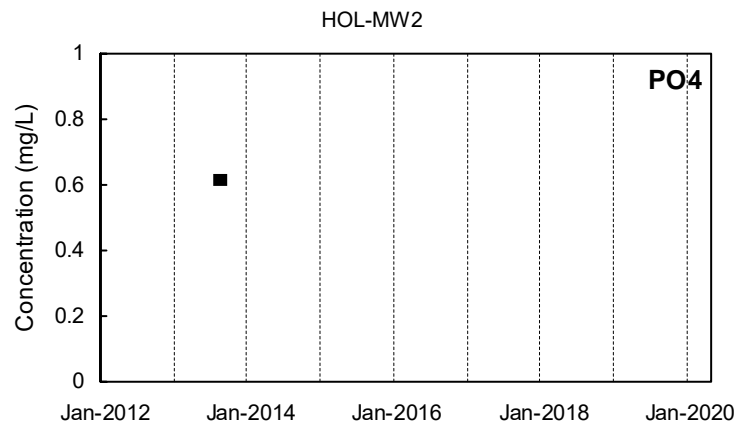
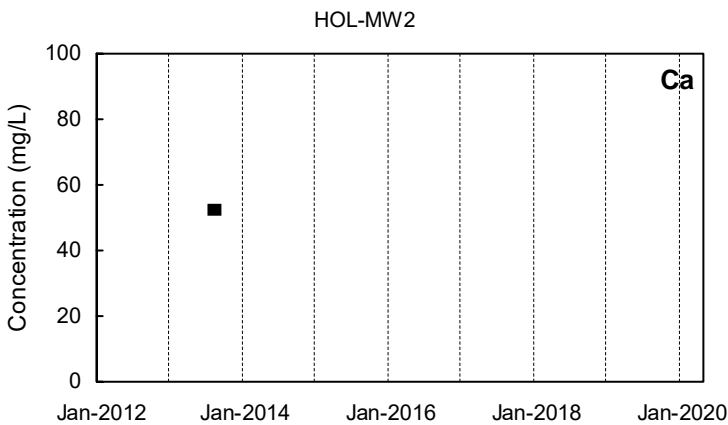
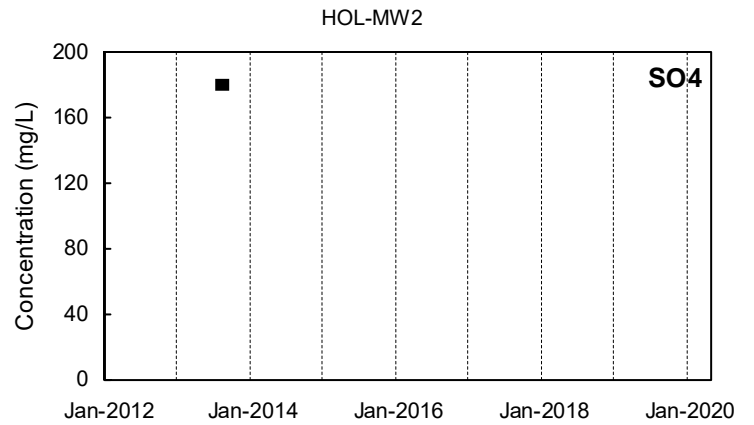
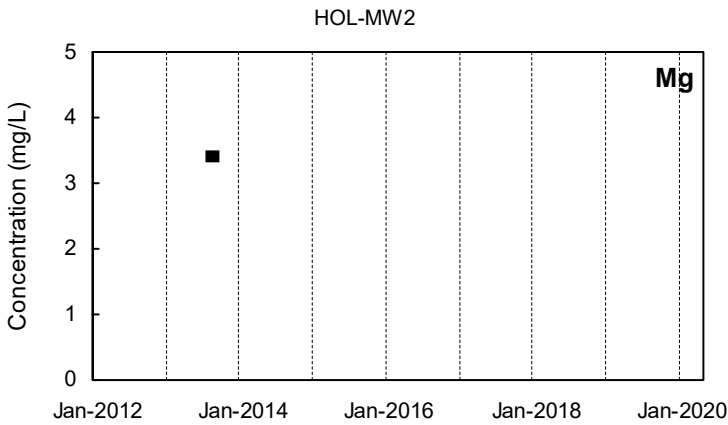
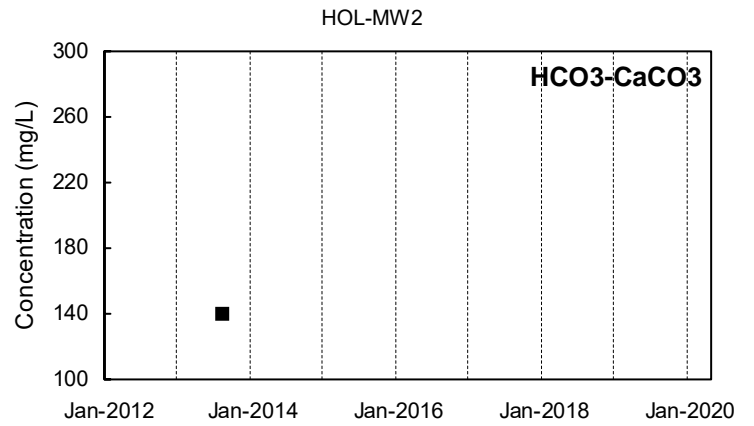
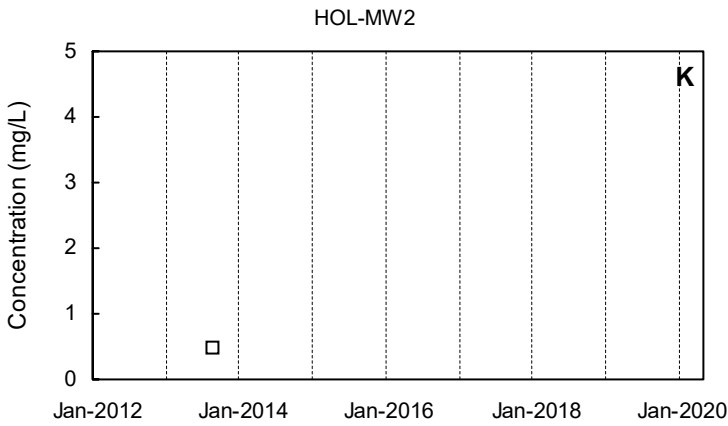
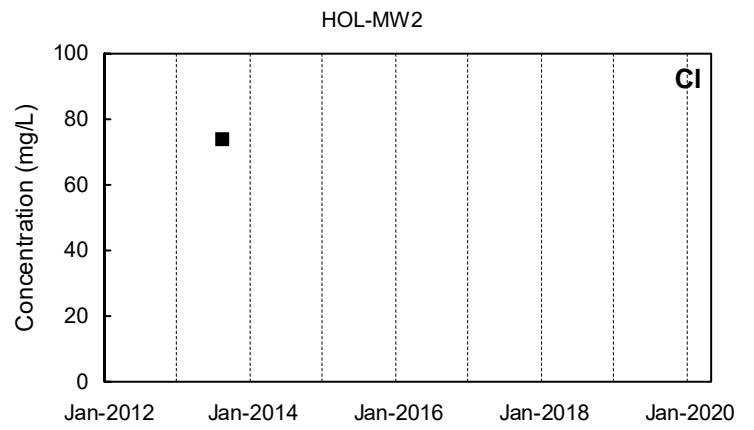
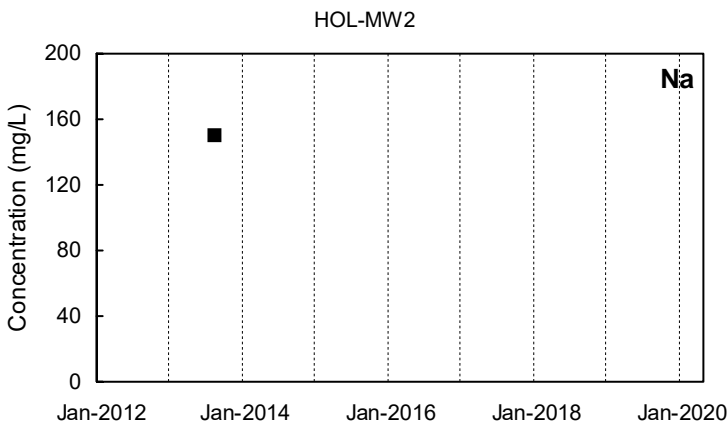

■ Detected Value □ 'J'-Flag (value between reporting limit and detection limit) ■ Non-Detect Range
 Shallow Well shown with black symbols Deep Well shown with orange symbols "dd" Well shown with blue symbols

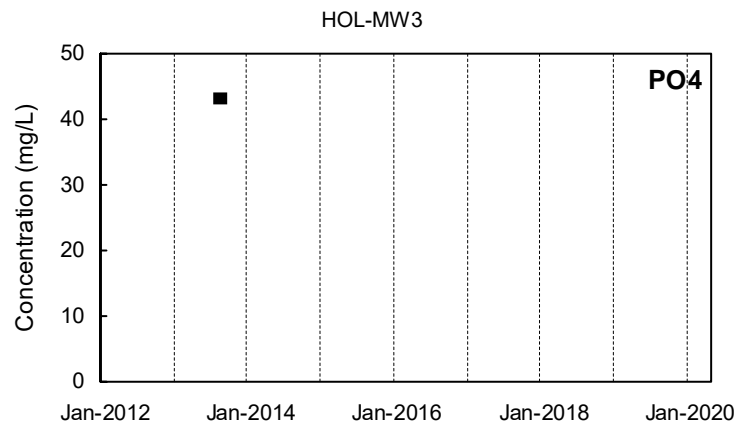
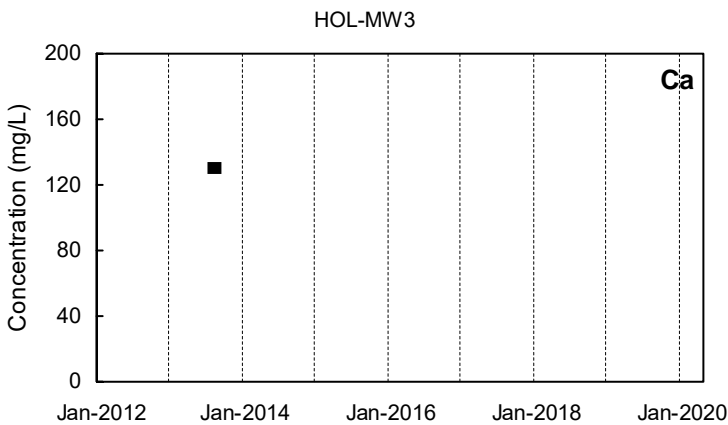
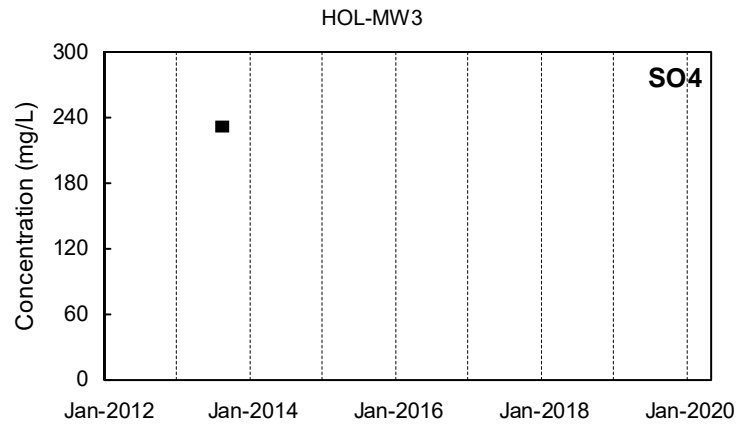
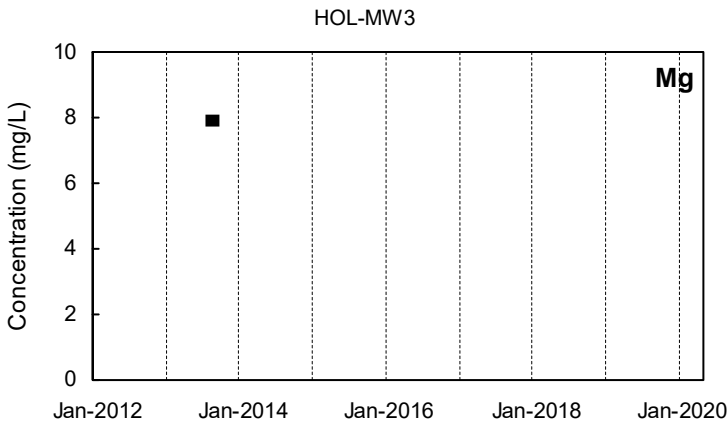
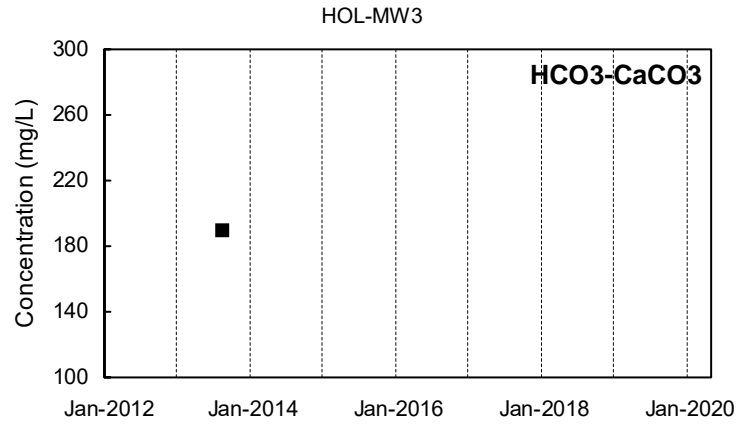
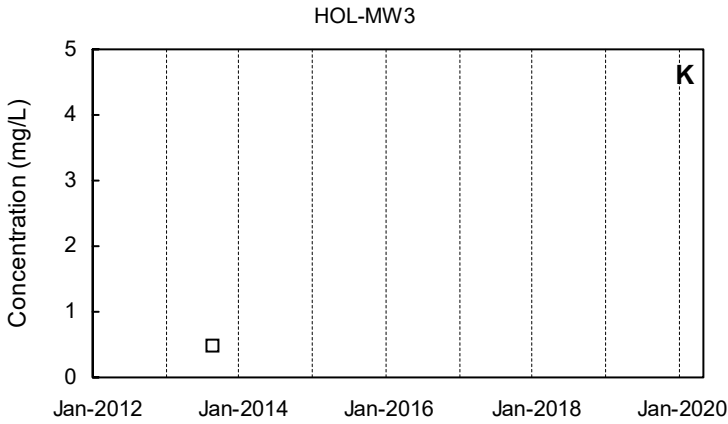
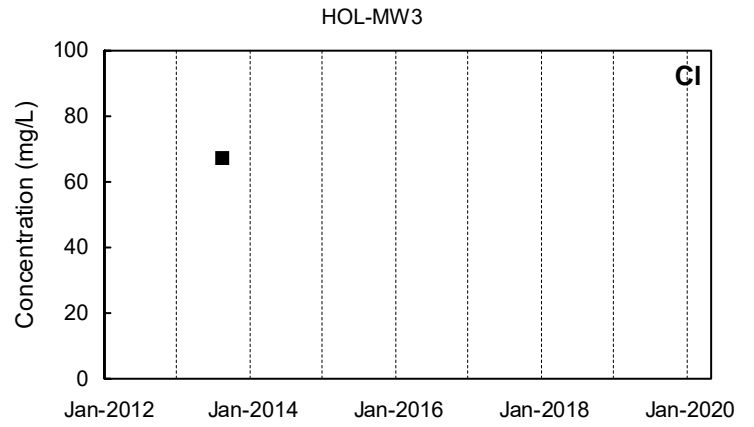
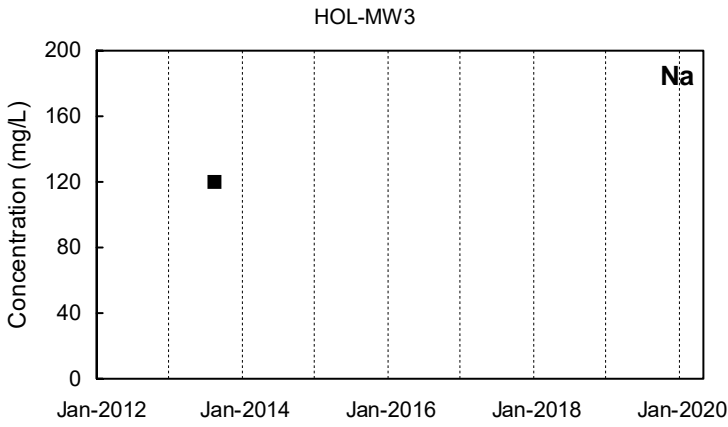

Detected Value
 'J'-Flag (value between reporting limit and detection limit)
 Non-Detect Range

Shallow Well shown with black symbols
 Deep Well shown with orange symbols
 "dd" Well shown with blue symbols

HYN-MW3

HYN-MW3

Na

Not Sampled

Cl

Not Sampled

HYN-MW3

HYN-MW3

K

Not Sampled

HCO3-CaCO3

Not Sampled

HYN-MW3

HYN-MW3

Mg

Not Sampled

SO4

Not Sampled

HYN-MW3

HYN-MW3

Ca

Not Sampled

PO4

Not Sampled

Detected Value
 'J'-Flag (value between reporting limit and detection limit)
 Non-Detect Range
 Shallow Well shown with black symbols
 Deep Well shown with orange symbols
 "dd" Well shown with blue symbols

HYN-MW4

HYN-MW4

Na

Not Sampled

Cl

Not Sampled

HYN-MW4

HYN-MW4

K

Not Sampled

HCO3-CaCO3

Not Sampled

HYN-MW4

HYN-MW4

Mg

Not Sampled

SO4

Not Sampled

HYN-MW4

HYN-MW4

Ca

Not Sampled

PO4

Not Sampled

Detected Value
 'J'-Flag (value between reporting limit and detection limit)
 Non-Detect Range

Shallow Well shown with black symbols
 Deep Well shown with orange symbols
 "dd" Well shown with blue symbols

HYN-MW5

HYN-MW5

Na

Cl

Not Sampled

Not Sampled

HYN-MW5

HYN-MW5

K

HCO3-CaCO3

Not Sampled

Not Sampled

HYN-MW5

HYN-MW5

Mg

SO4

Not Sampled

Not Sampled

HYN-MW5

HYN-MW5

Ca

PO4

Not Sampled

Not Sampled

Detected Value
 'J'-Flag (value between reporting limit and detection limit)
 Non-Detect Range
 Shallow Well shown with black symbols
 Deep Well shown with orange symbols
 "dd" Well shown with blue symbols

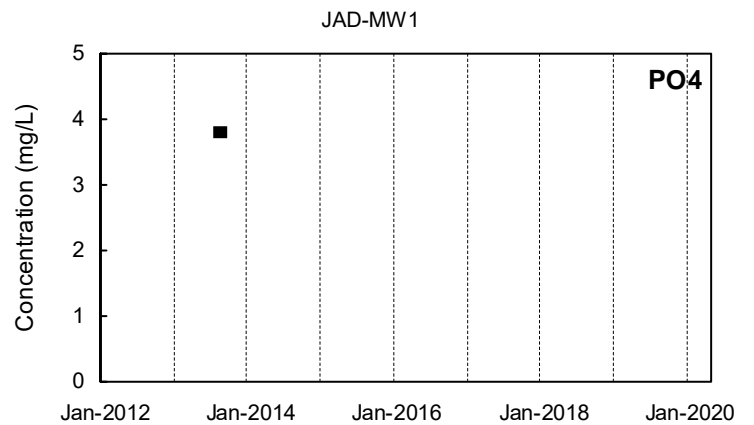
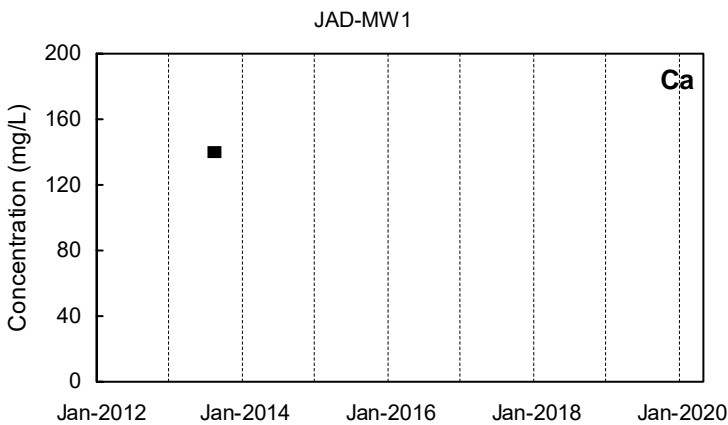
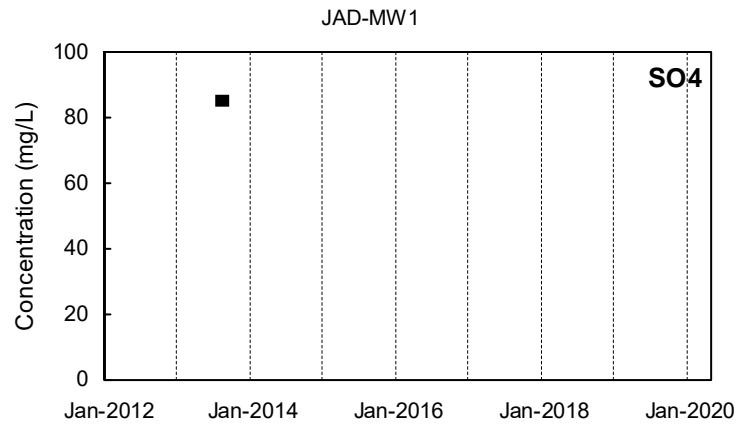
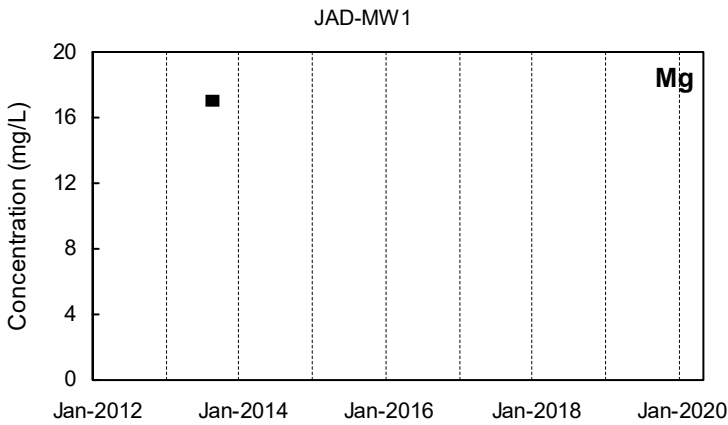
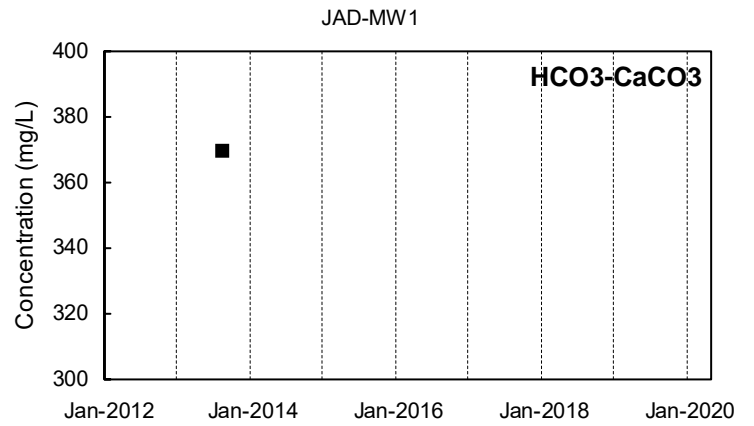
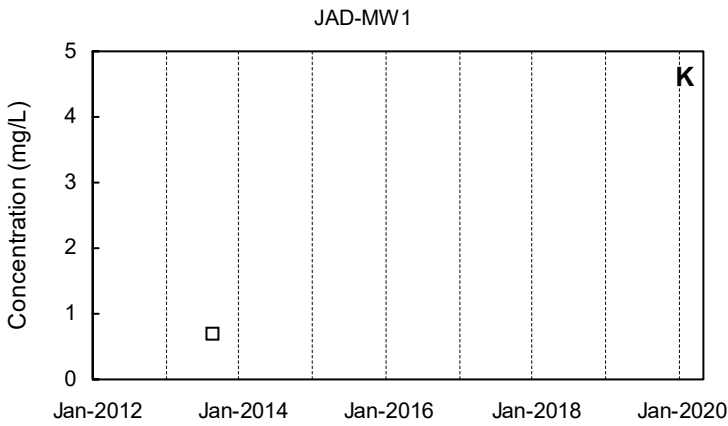
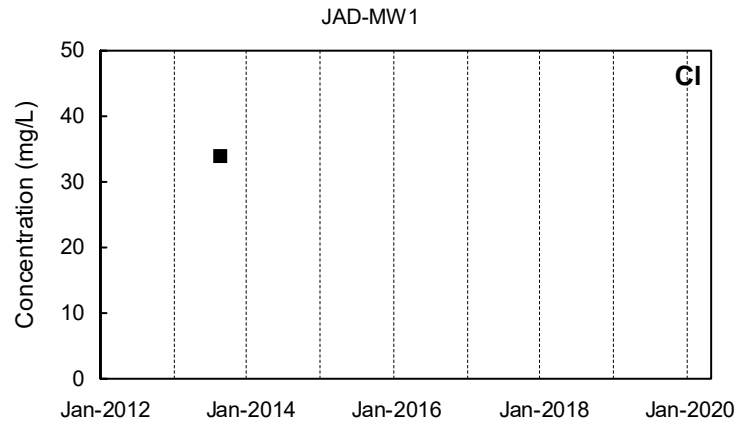
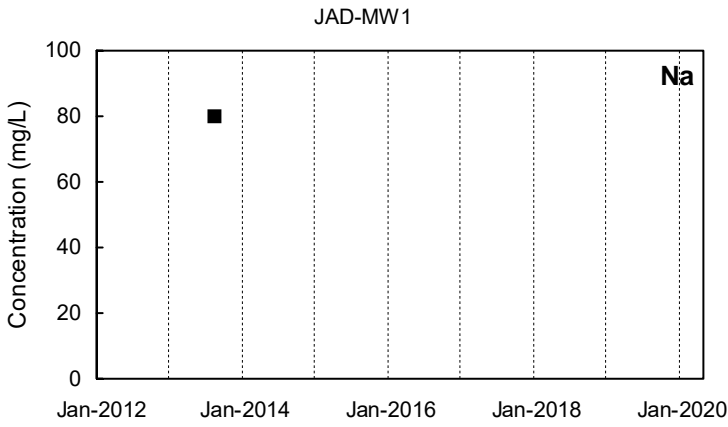

Detected Value
 'J'-Flag (value between reporting limit and detection limit)
 Non-Detect Range

Shallow Well shown with black symbols
Deep Well shown with orange symbols
"dd" Well shown with blue symbols

JAD-MW2

JAD-MW2

Na

Not Sampled

Cl

Not Sampled

JAD-MW2

JAD-MW2

K

Not Sampled

HCO3-CaCO3

Not Sampled

JAD-MW2

JAD-MW2

Mg

Not Sampled

SO4

Not Sampled

JAD-MW2

JAD-MW2

Ca

Not Sampled

PO4

Not Sampled

■ Detected Value

□ 'J'-Flag (value between reporting limit and detection limit)



Non-Detect Range

Shallow Well shown with black symbols

Deep Well shown with orange symbols

"dd" Well shown with blue symbols

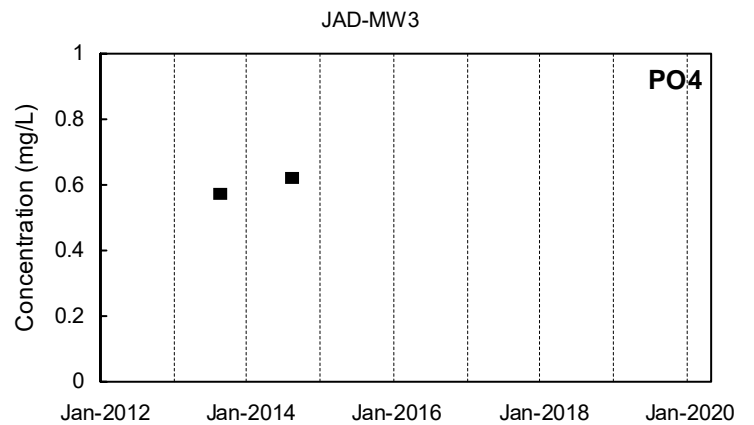
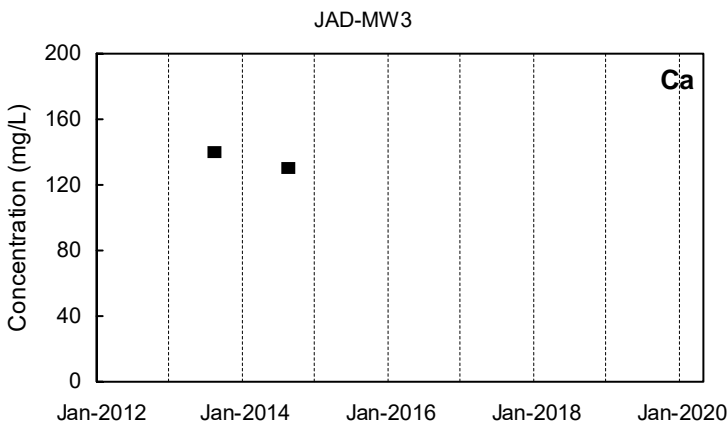
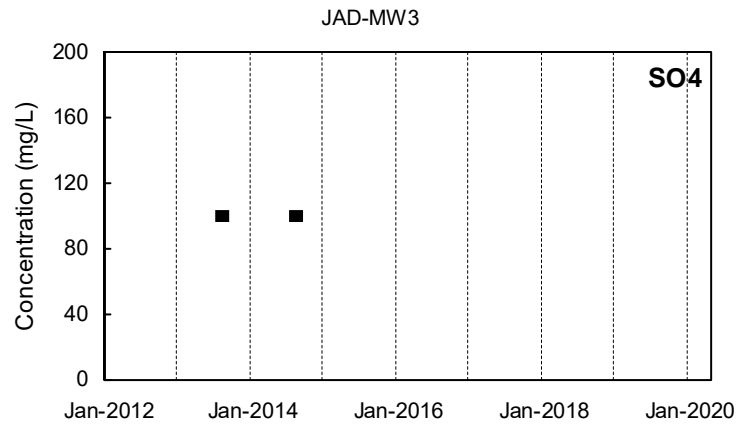
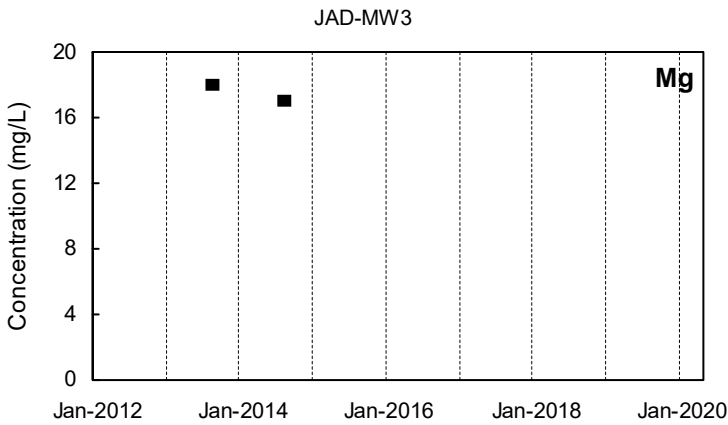
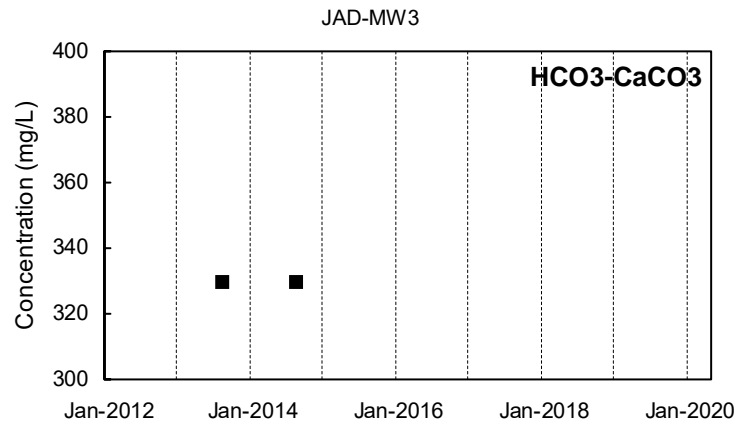
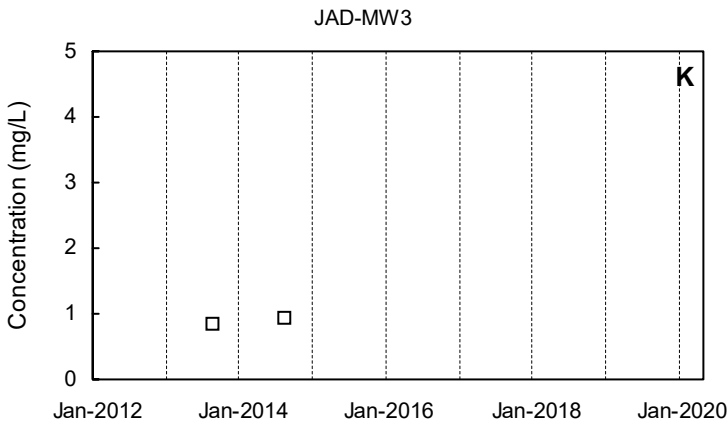
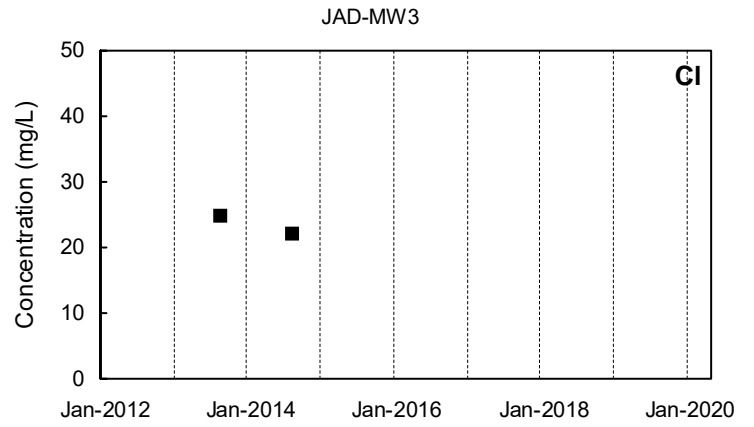
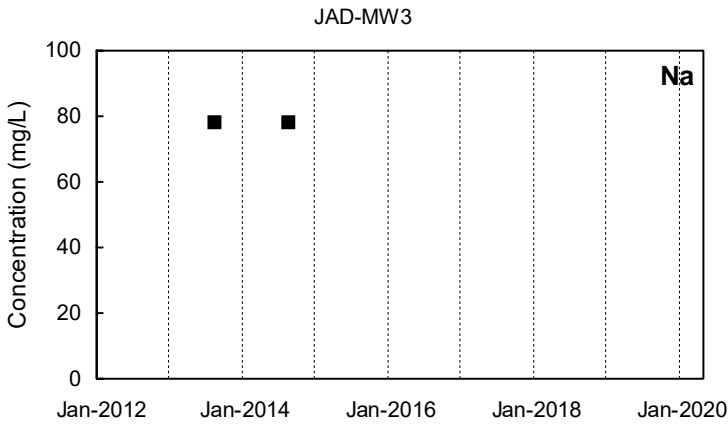

Detected Value
 'J'-Flag (value between reporting limit and detection limit)
 Non-Detect Range

Shallow Well shown with black symbols
Deep Well shown with orange symbols
"dd" Well shown with blue symbols

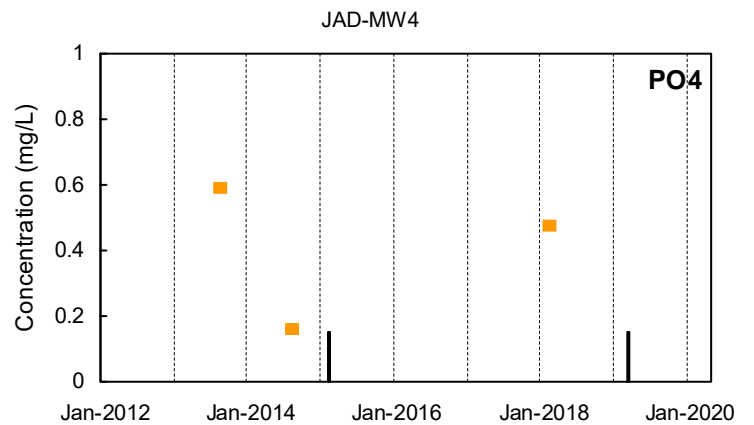
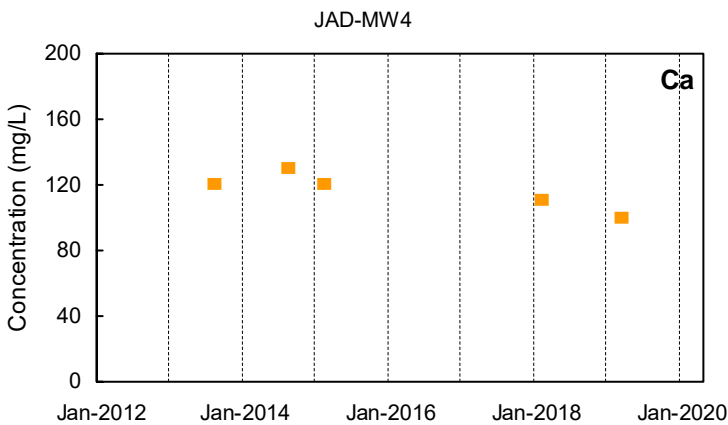
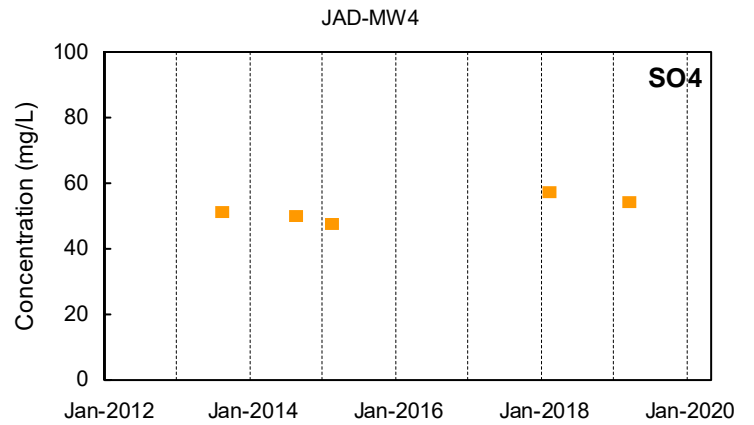
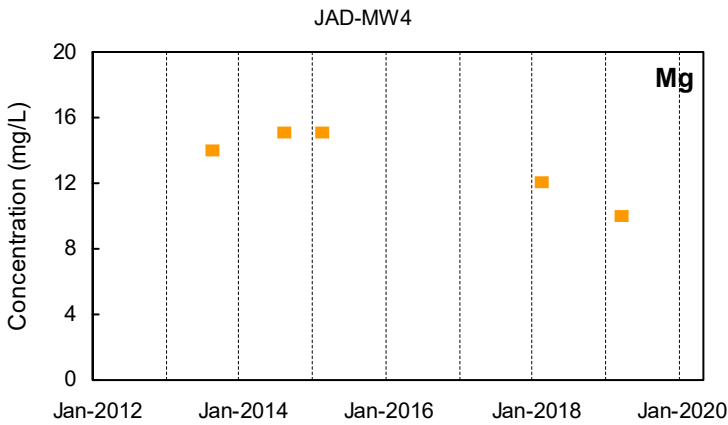
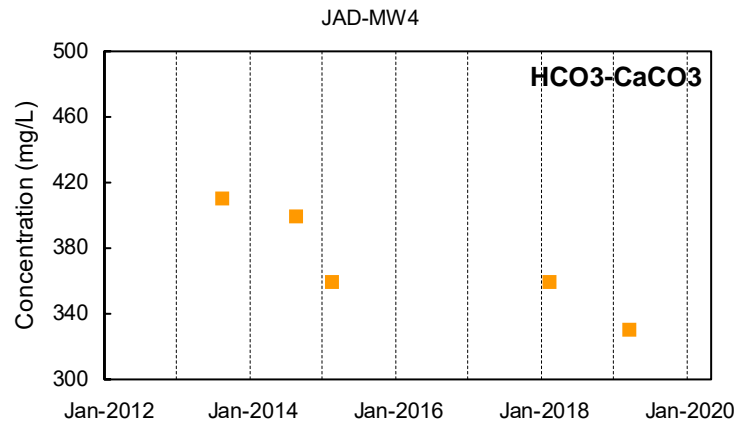
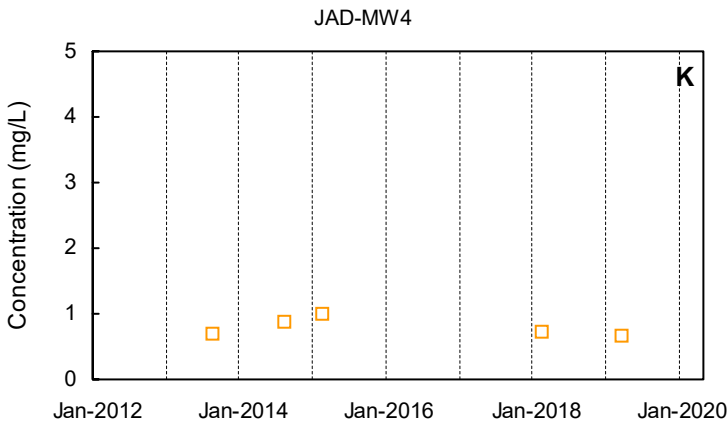
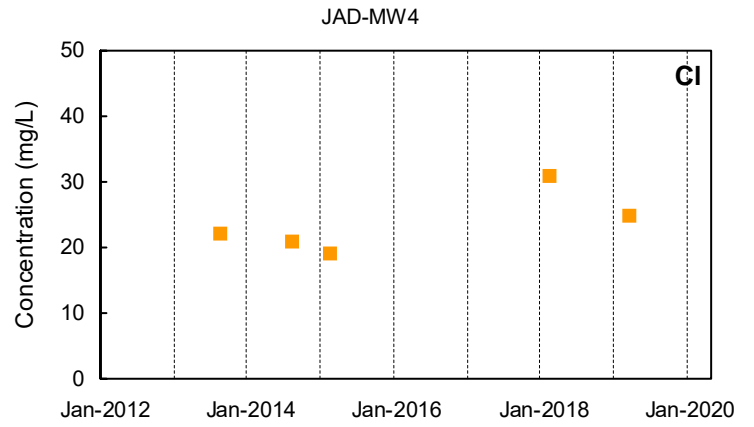
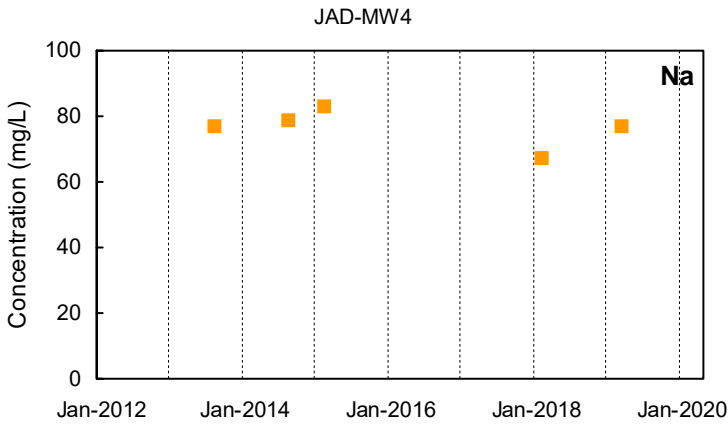

■ Detected Value
 □ 'J'-Flag (value between reporting limit and detection limit)
 Non-Detect Range
 Shallow Well shown with black symbols
 Deep Well shown with orange symbols
 "dd" Well shown with blue symbols

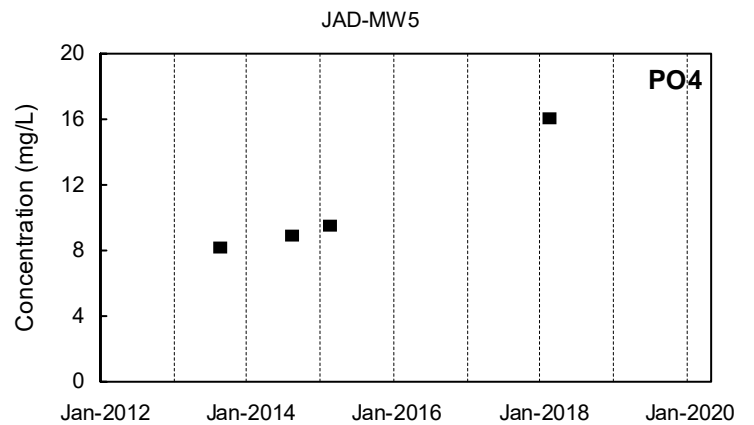
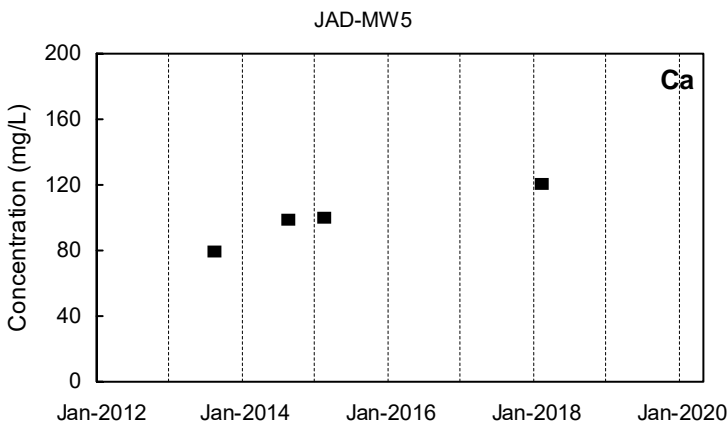
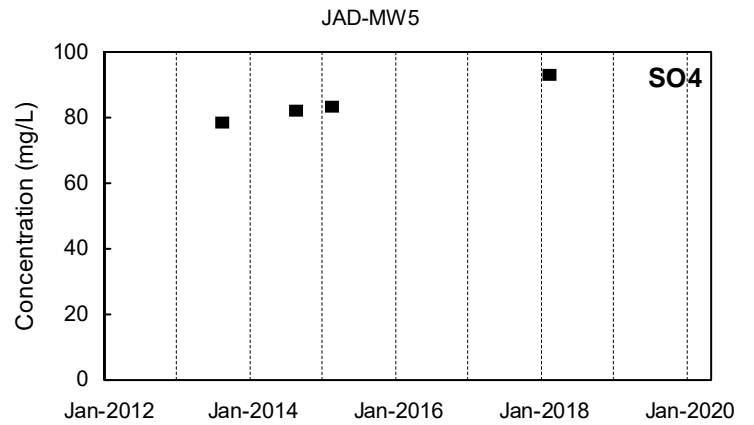
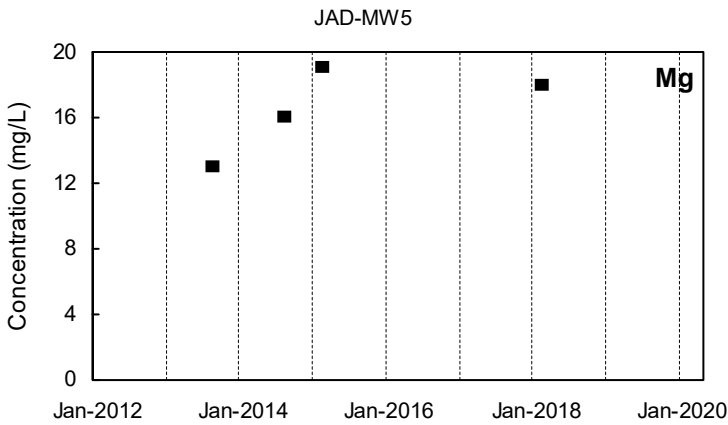
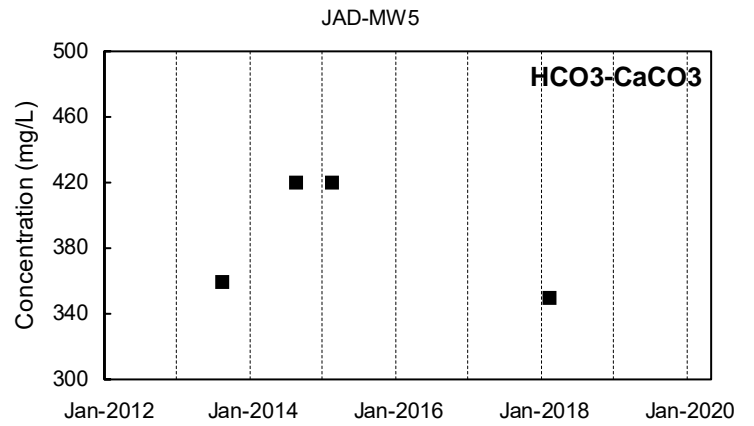
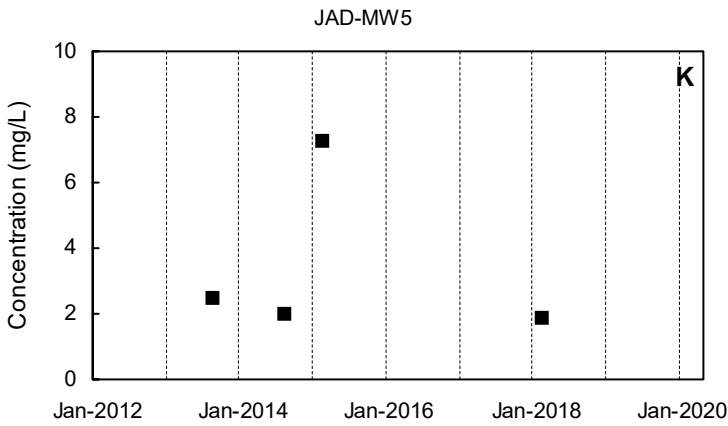
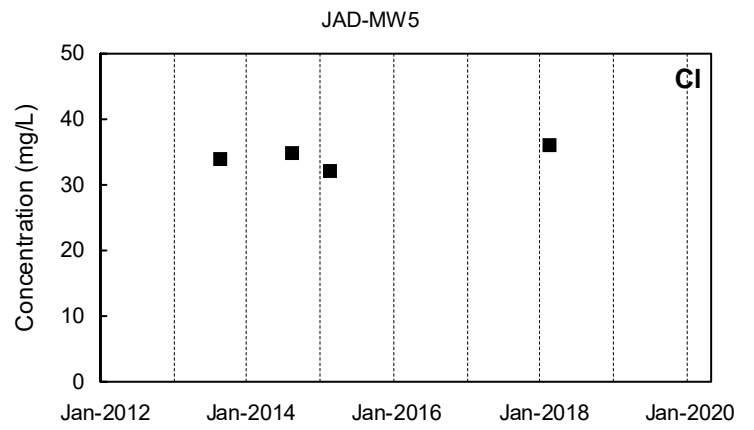
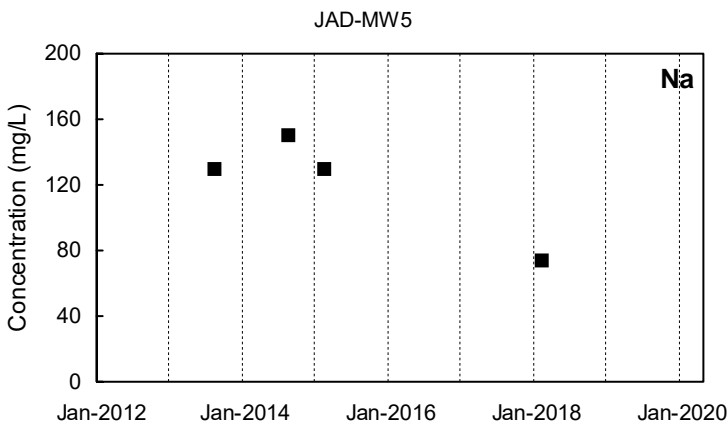

Detected Value
 'J'-Flag (value between reporting limit and detection limit)
 Non-Detect Range
 Shallow Well shown with black symbols
 Deep Well shown with orange symbols
 "dd" Well shown with blue symbols

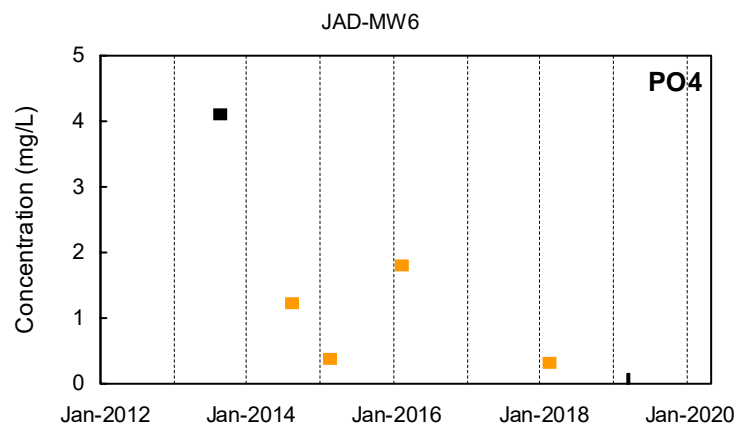
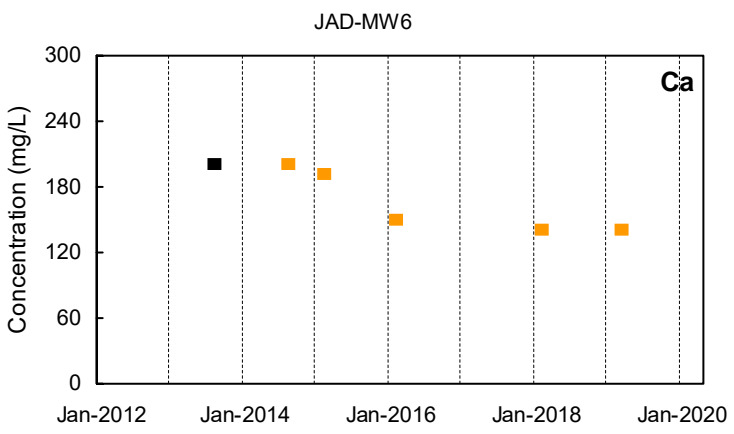
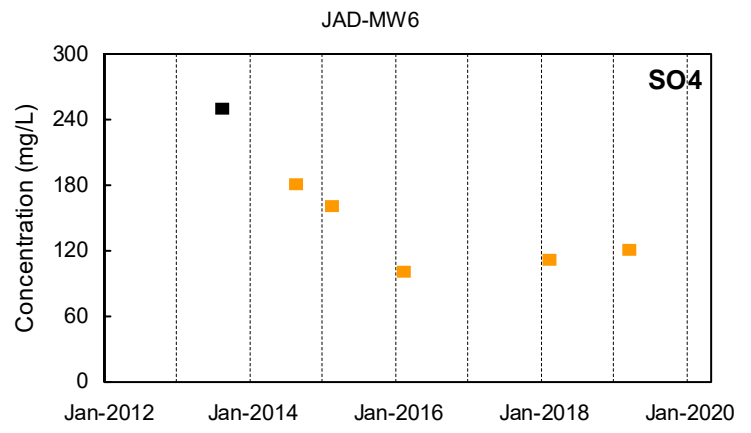
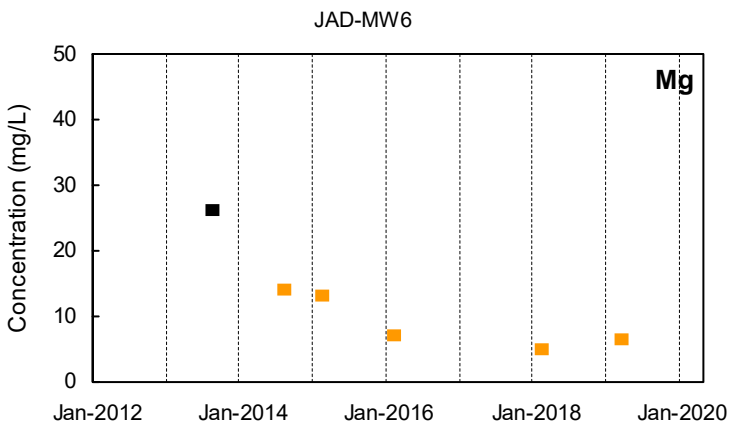
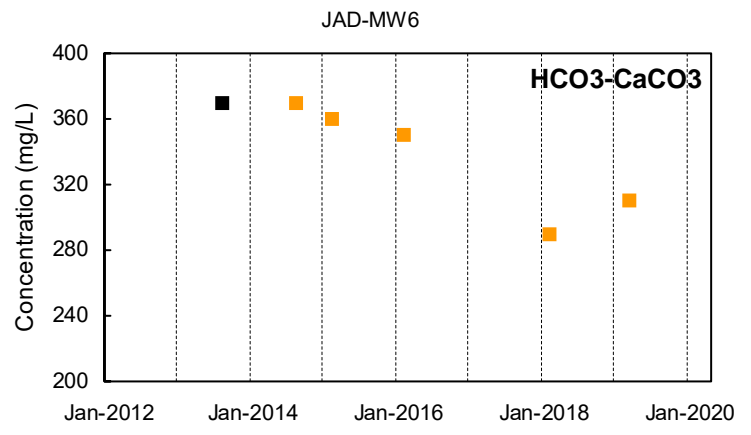
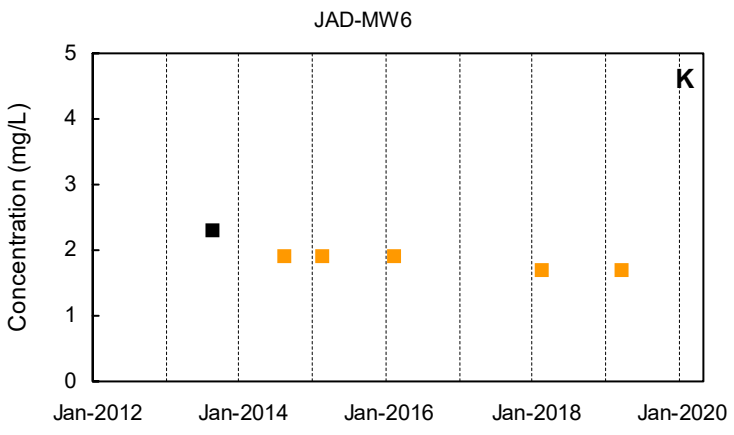
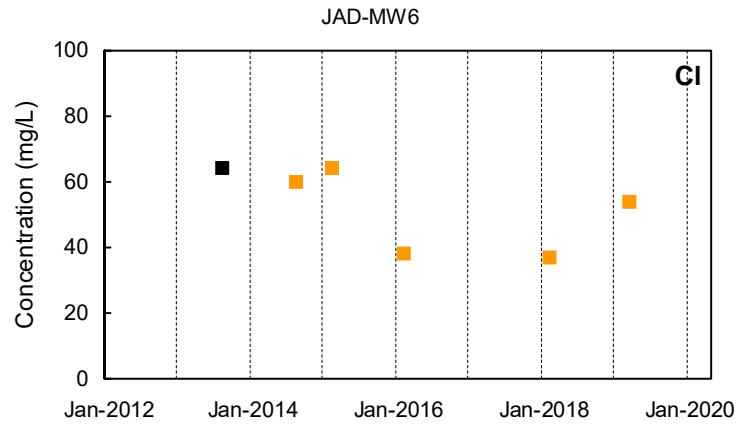
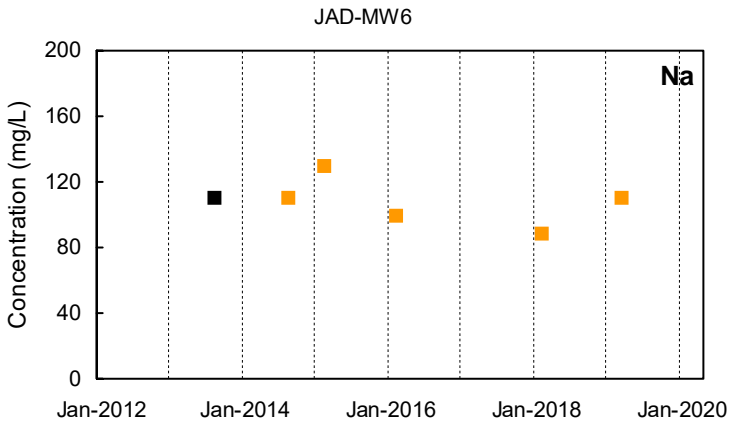

Detected Value
 'J'-Flag (value between reporting limit and detection limit)
 Non-Detect Range
 Shallow Well shown with black symbols
 Deep Well shown with orange symbols
 "dd" Well shown with blue symbols

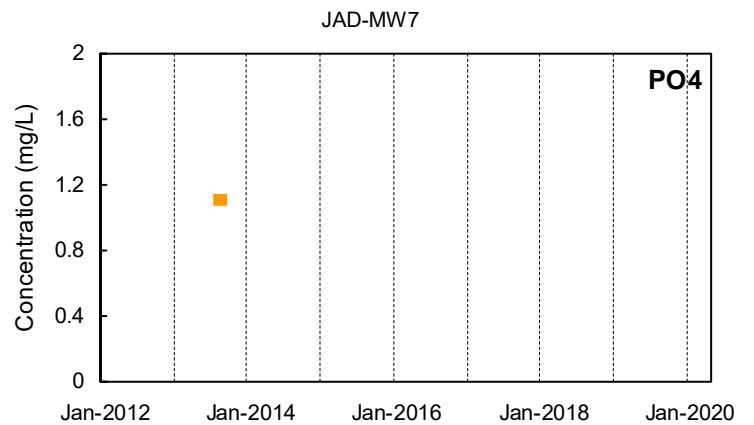
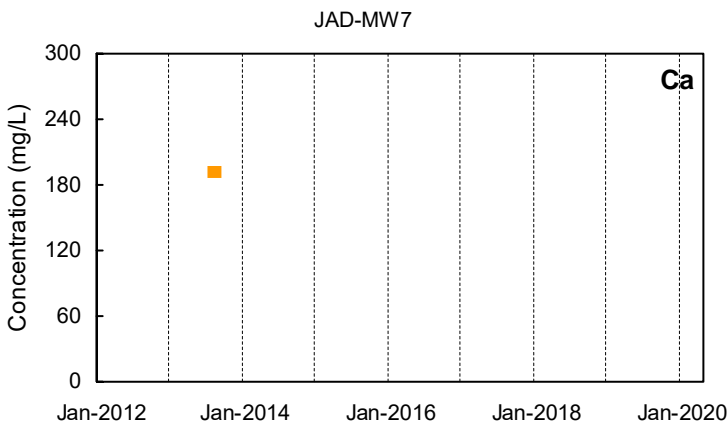
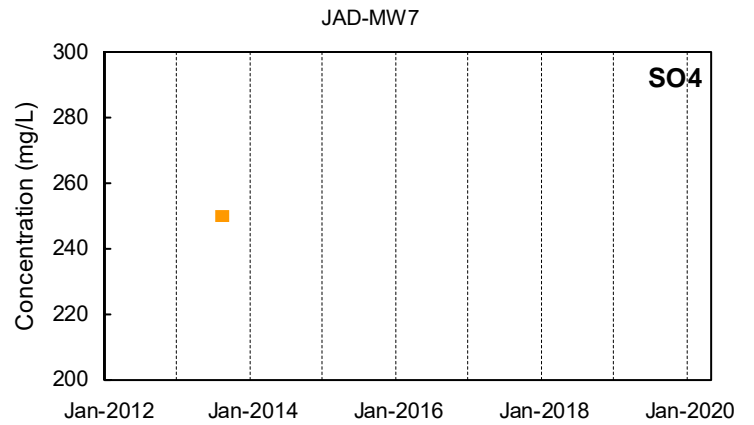
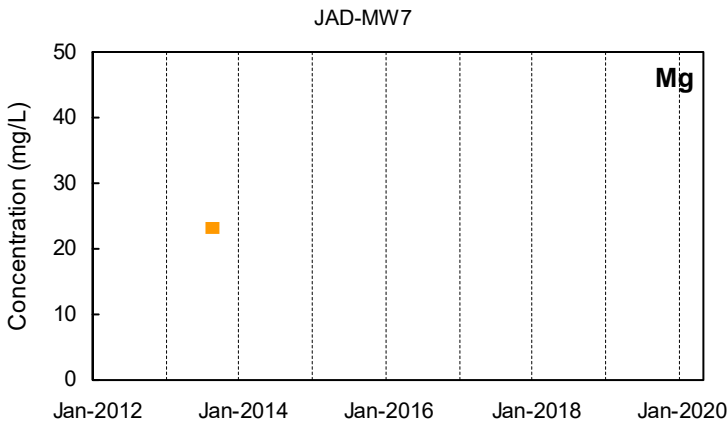
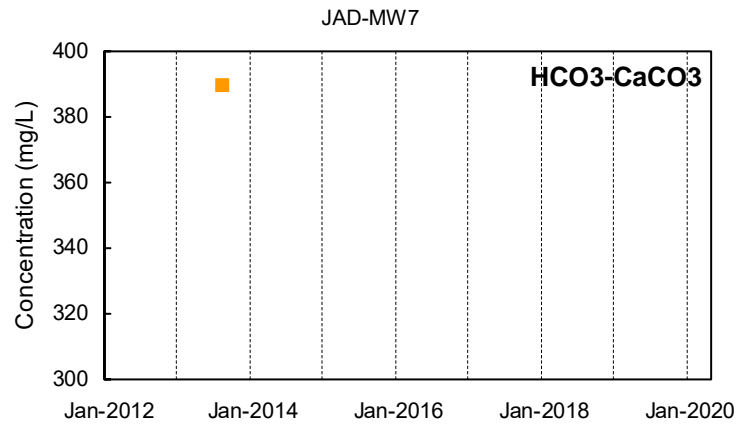
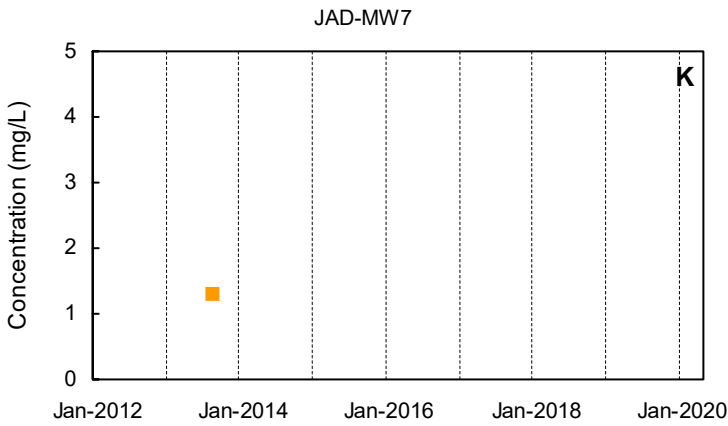
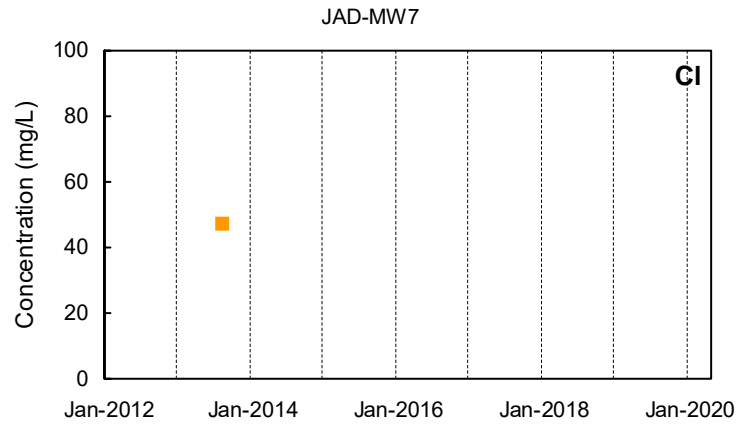
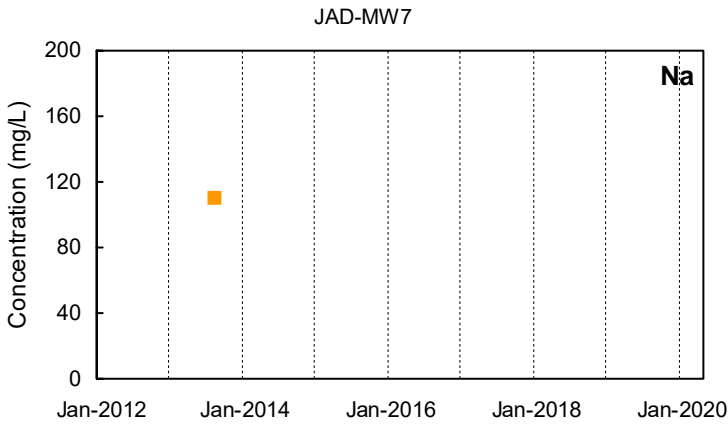

■ Detected Value
 □ 'J'-Flag (value between reporting limit and detection limit)
 Non-Detect Range
■ Shallow Well shown with black symbols
■ Deep Well shown with orange symbols
■ "dd" Well shown with blue symbols

LON-MW1A

LON-MW1A

Na

Not Sampled

Cl

Not Sampled

LON-MW1A

LON-MW1A

K

Not Sampled

HCO3-CaCO3

Not Sampled

LON-MW1A

LON-MW1A

Mg

Not Sampled

SO4

Not Sampled

LON-MW1A

LON-MW1A

Ca

Not Sampled

PO4

Not Sampled

■ Detected Value

□ 'J'-Flag (value between reporting limit and detection limit)



Non-Detect Range

Shallow Well shown with black symbols

Deep Well shown with orange symbols

"dd" Well shown with blue symbols

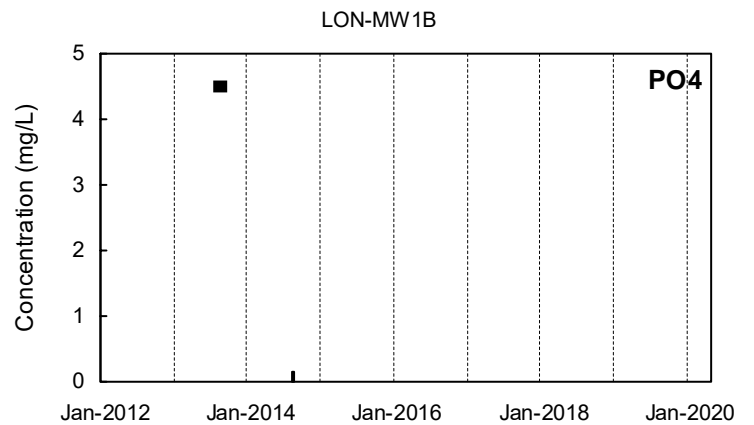
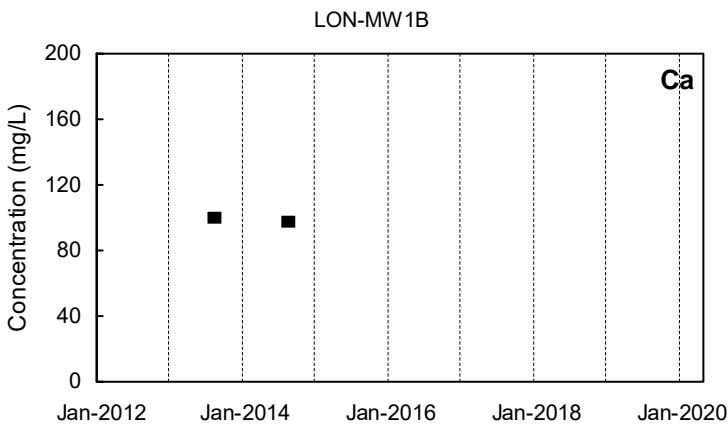
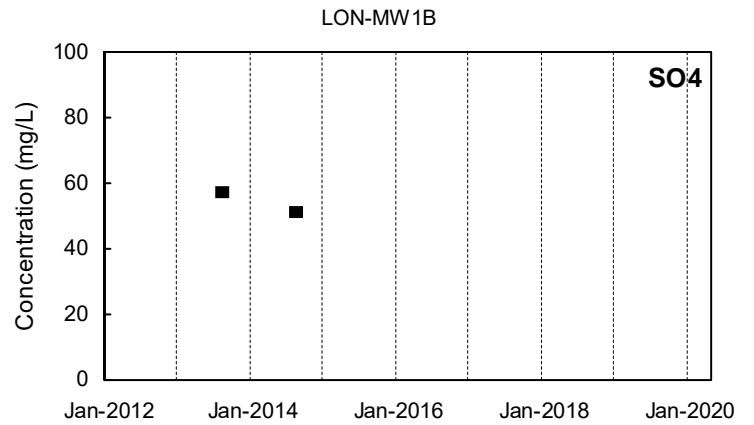
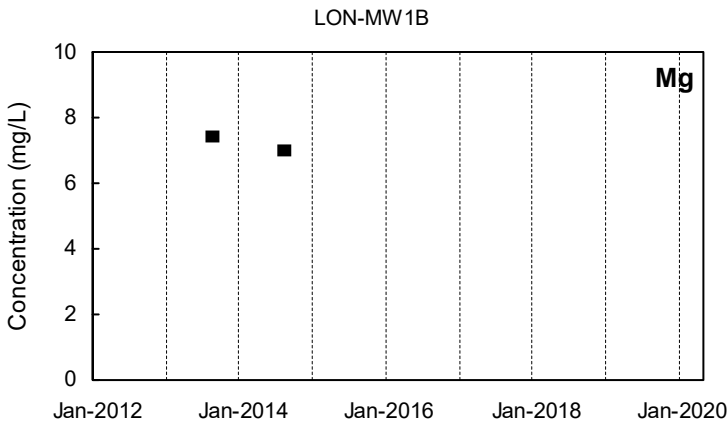
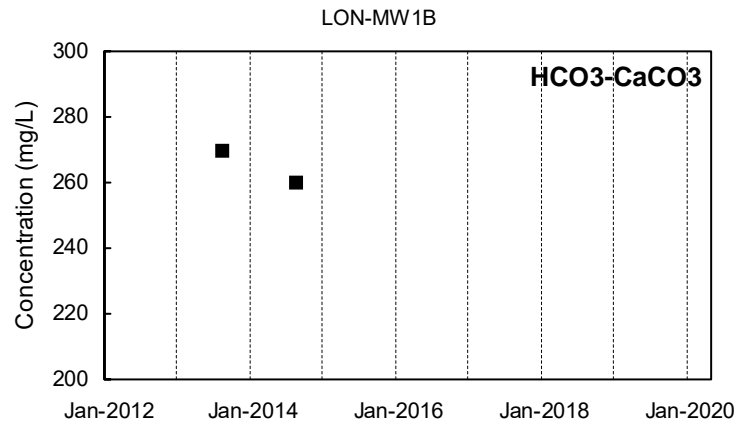
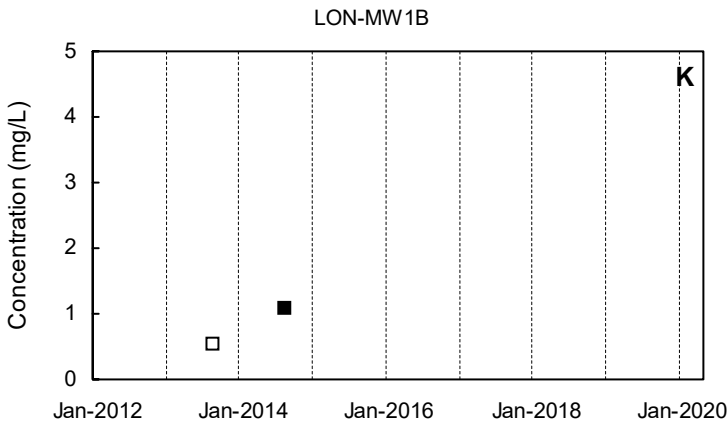
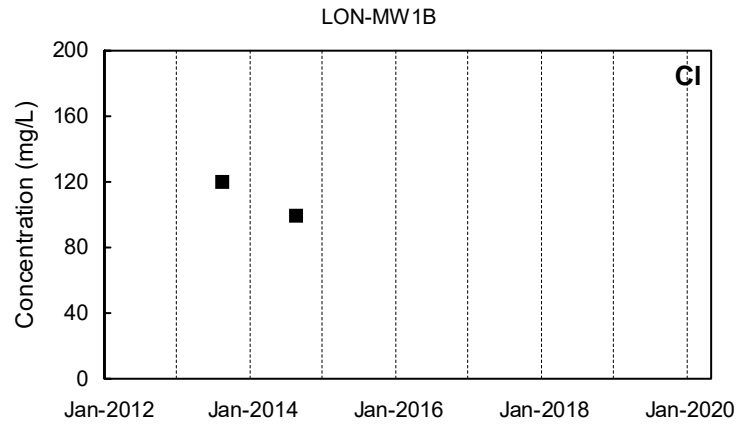
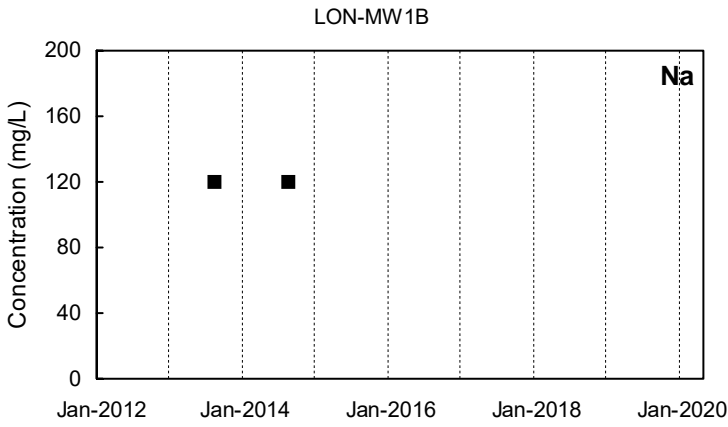

■ Detected Value □ 'J'-Flag (value between reporting limit and detection limit) ■ Non-Detect Range
 Shallow Well shown with black symbols Deep Well shown with orange symbols "dd" Well shown with blue symbols

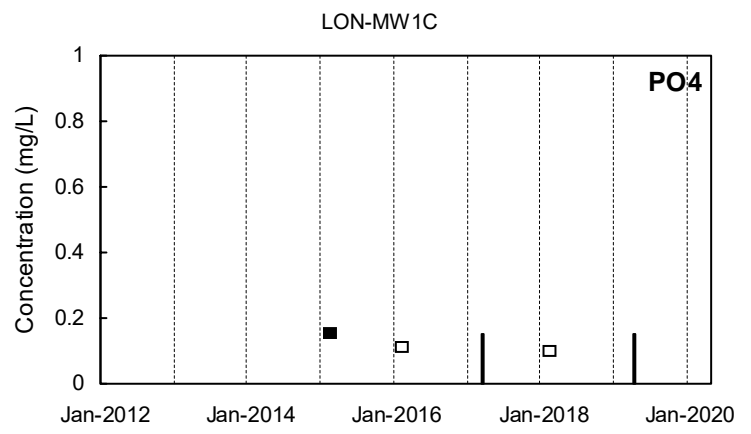
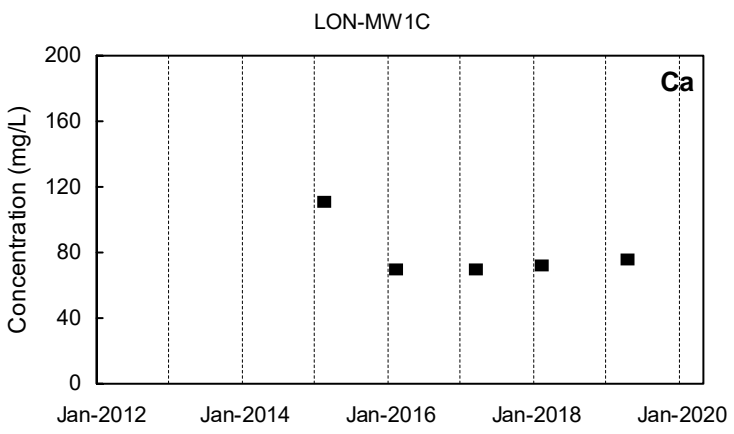
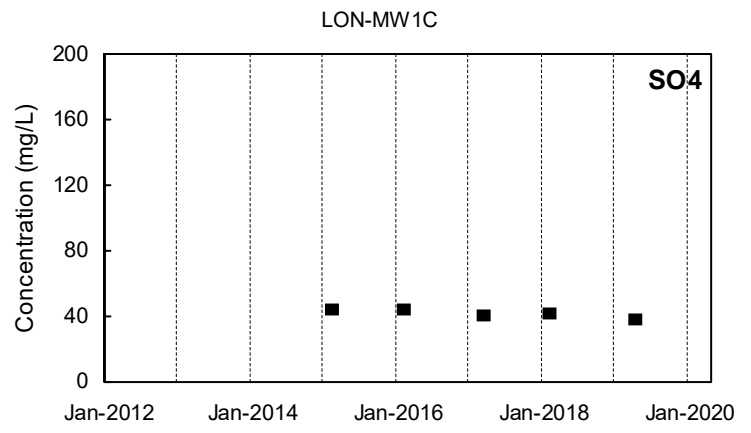
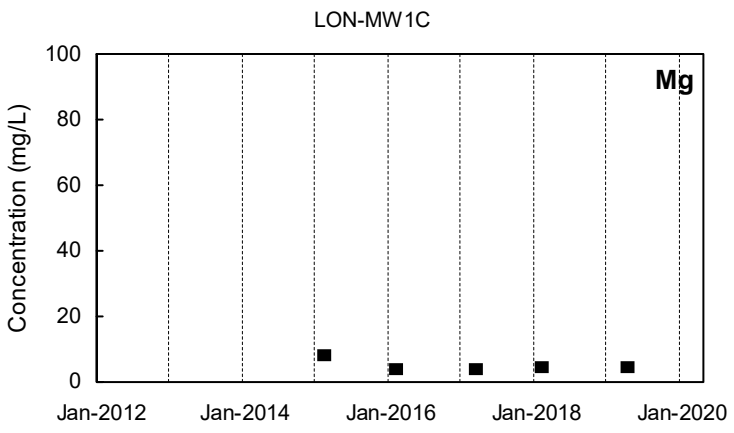
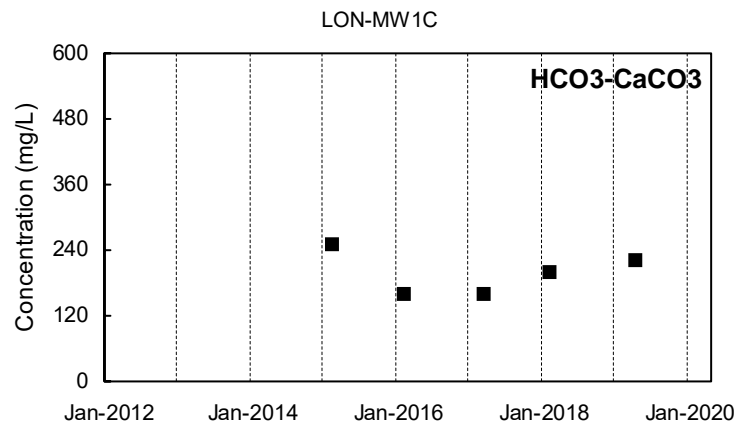
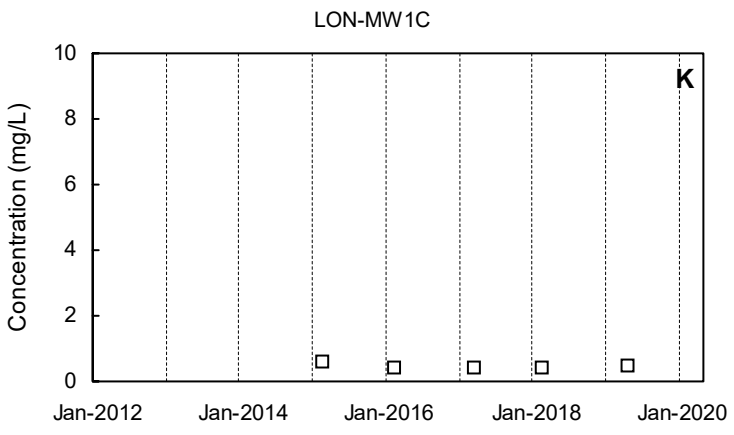
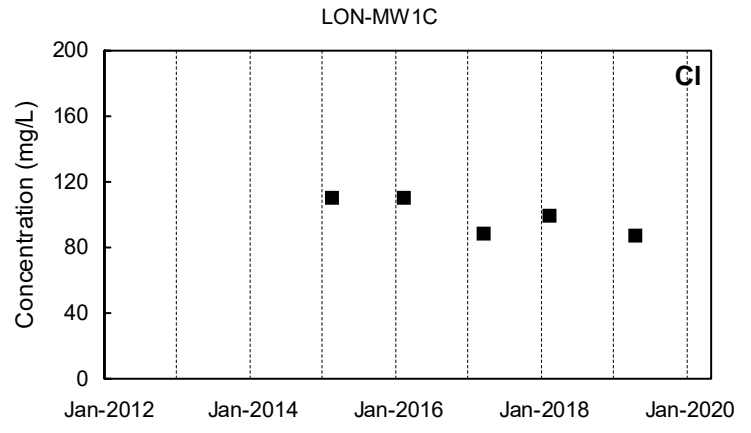
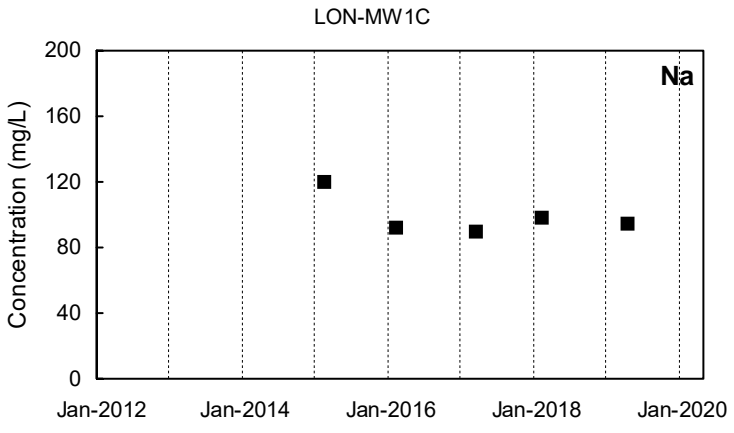

Detected Value
 'J'-Flag (value between reporting limit and detection limit)
 Non-Detect Range
 Shallow Well shown with black symbols Deep Well shown with orange symbols "dd" Well shown with blue symbols

LON-MW2A

LON-MW2A

Na

Cl

Not Sampled

Not Sampled

LON-MW2A

LON-MW2A

K

HCO3-CaCO3

Not Sampled

Not Sampled

LON-MW2A

LON-MW2A

Mg

SO4

Not Sampled

Not Sampled

LON-MW2A

LON-MW2A

Ca

PO4

Not Sampled

Not Sampled

■ Detected Value

□ 'J'-Flag (value between reporting limit and detection limit)



Non-Detect Range

Shallow Well shown with black symbols

Deep Well shown with orange symbols

"dd" Well shown with blue symbols

LON-MW2B

LON-MW2B

Na

Not Sampled

Cl

Not Sampled

LON-MW2B

LON-MW2B

K

Not Sampled

HCO3-CaCO3

Not Sampled

LON-MW2B

LON-MW2B

Mg

Not Sampled

SO4

Not Sampled

LON-MW2B

LON-MW2B

Ca

Not Sampled

PO4

Not Sampled

■ Detected Value

□ 'J'-Flag (value between reporting limit and detection limit)



Non-Detect Range

Shallow Well shown with black symbols

Deep Well shown with orange symbols

"dd" Well shown with blue symbols

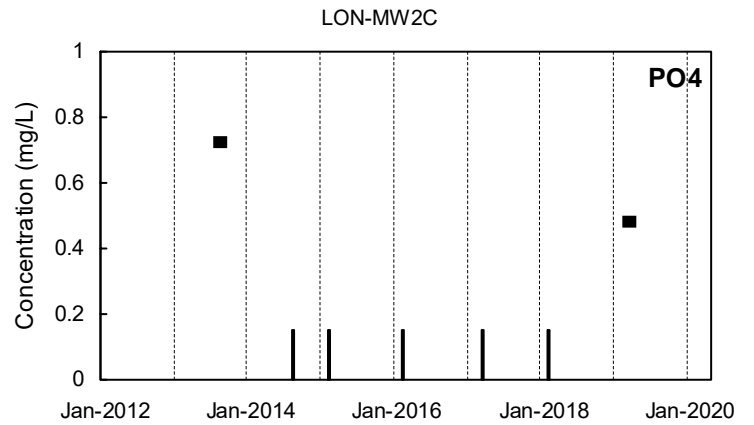
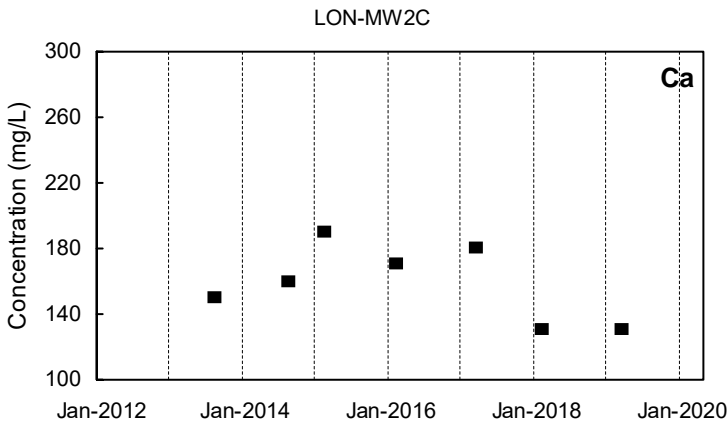
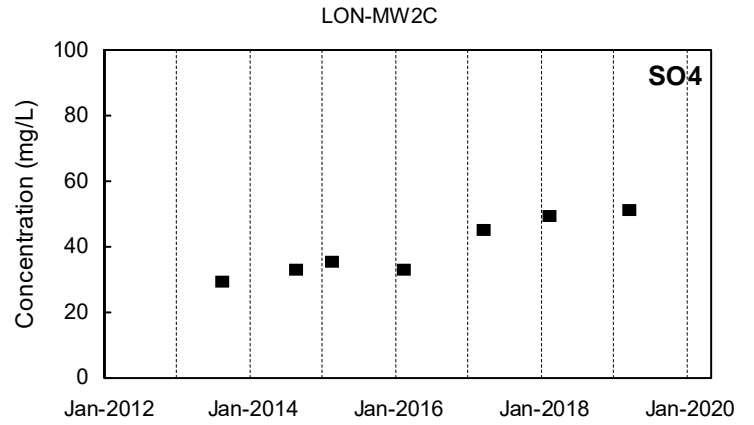
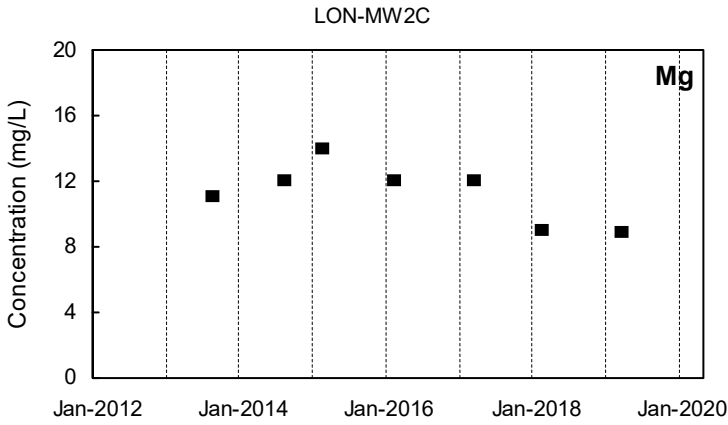
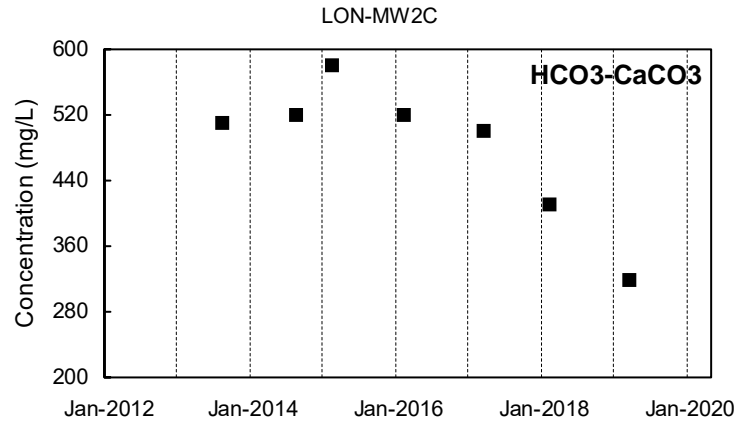
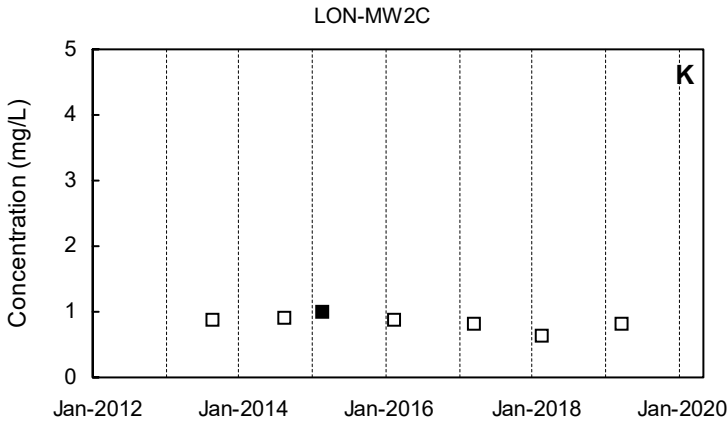
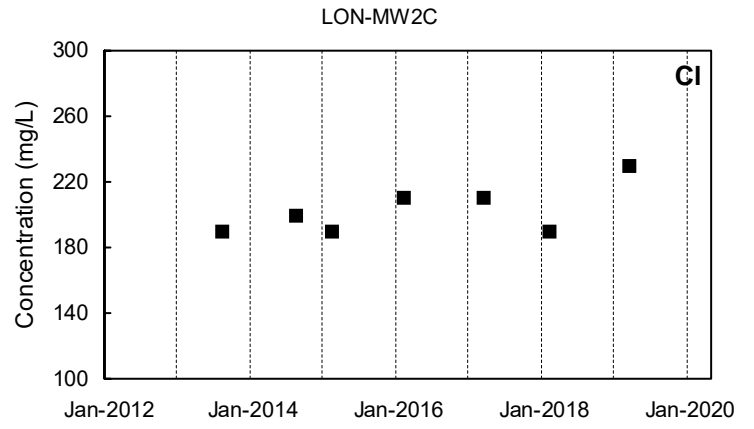
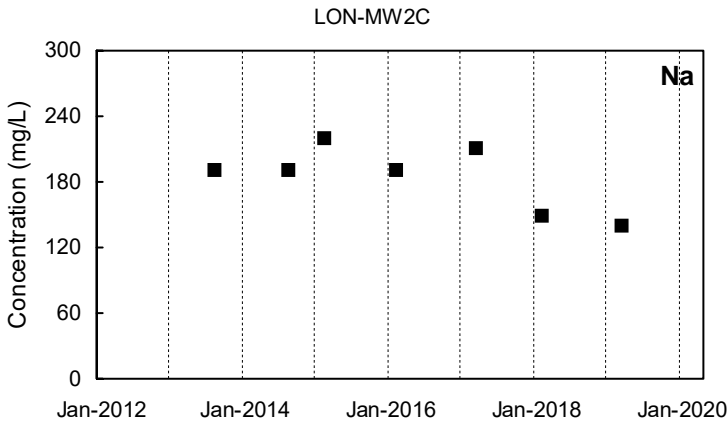

Detected Value
 'J'-Flag (value between reporting limit and detection limit)
 Non-Detect Range
 Shallow Well shown with black symbols
 Deep Well shown with orange symbols
 "dd" Well shown with blue symbols

LON-MW3A

LON-MW3A

Na

Not Sampled

Cl

Not Sampled

LON-MW3A

LON-MW3A

K

Not Sampled

HCO3-CaCO3

Not Sampled

LON-MW3A

LON-MW3A

Mg

Not Sampled

SO4

Not Sampled

LON-MW3A

LON-MW3A

Ca

Not Sampled

PO4

Not Sampled

■ Detected Value

□ 'J'-Flag (value between reporting limit and detection limit)



Non-Detect Range

Shallow Well shown with black symbols

Deep Well shown with orange symbols

"dd" Well shown with blue symbols

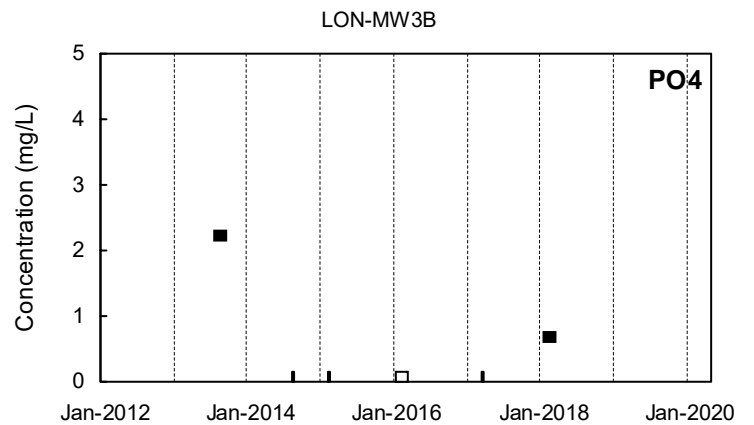
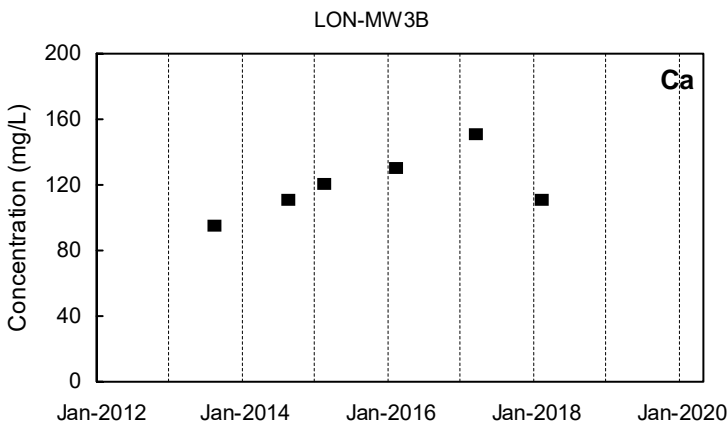
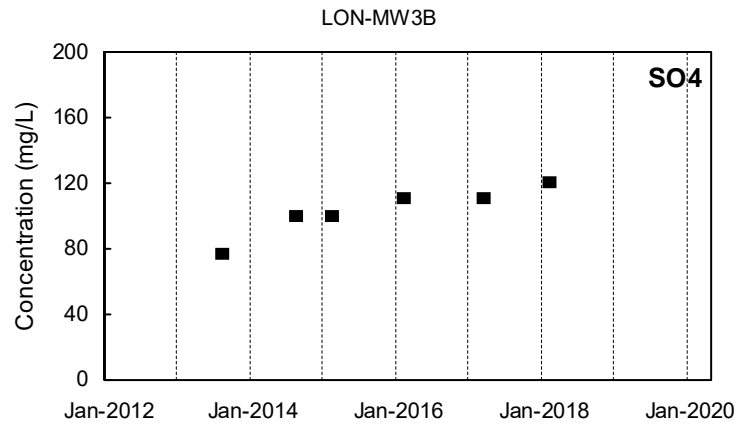
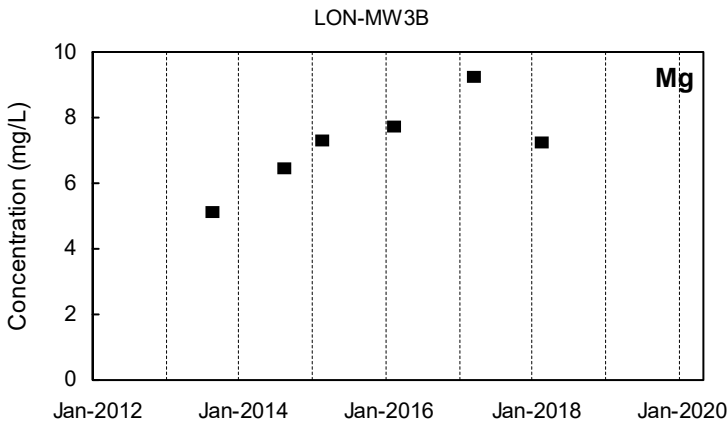
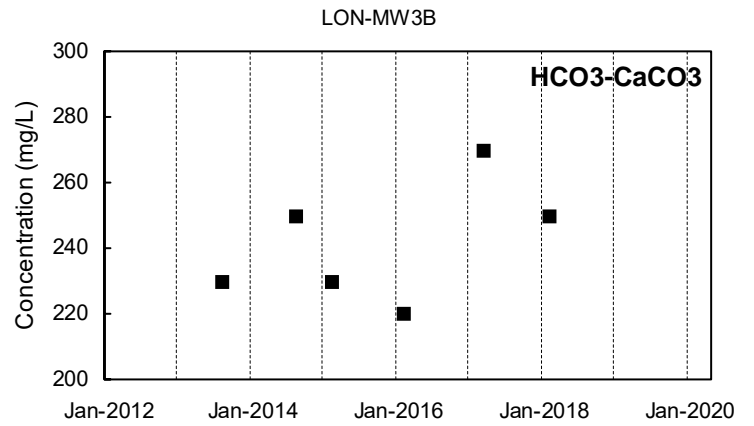
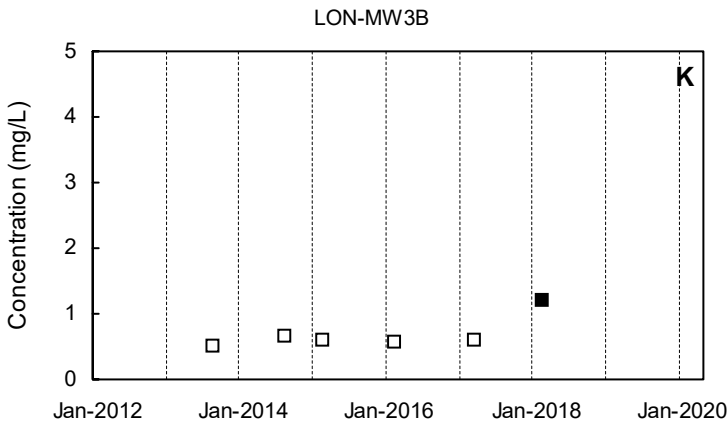
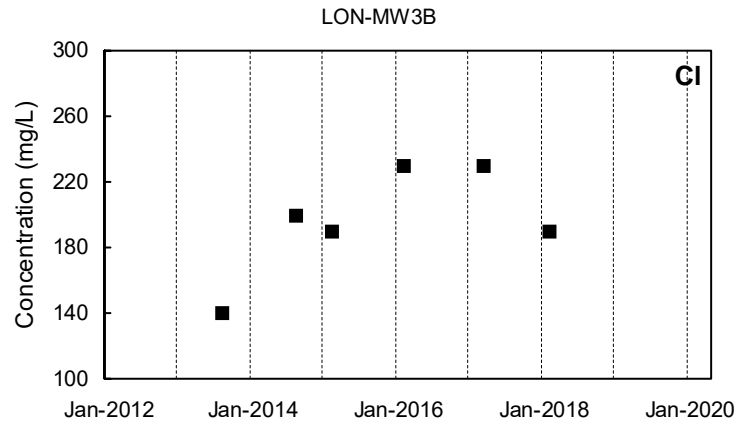
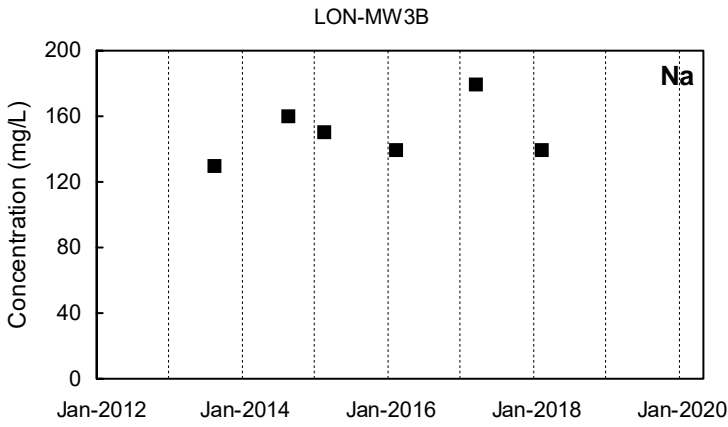

Detected Value
 'J'-Flag (value between reporting limit and detection limit)
 Non-Detect Range
 Shallow Well shown with black symbols
 Deep Well shown with orange symbols
 "dd" Well shown with blue symbols

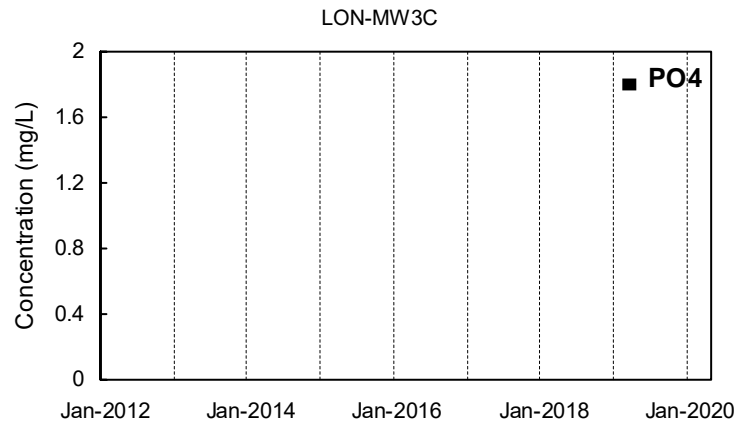
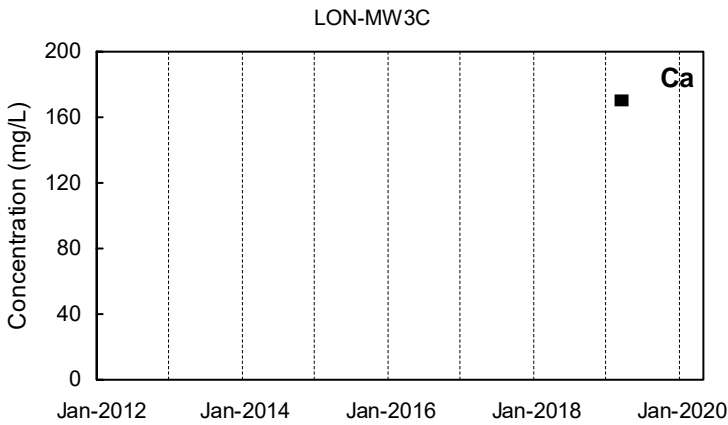
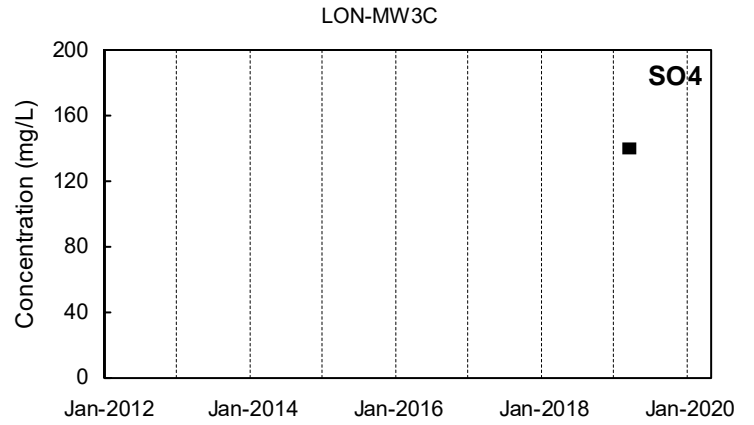
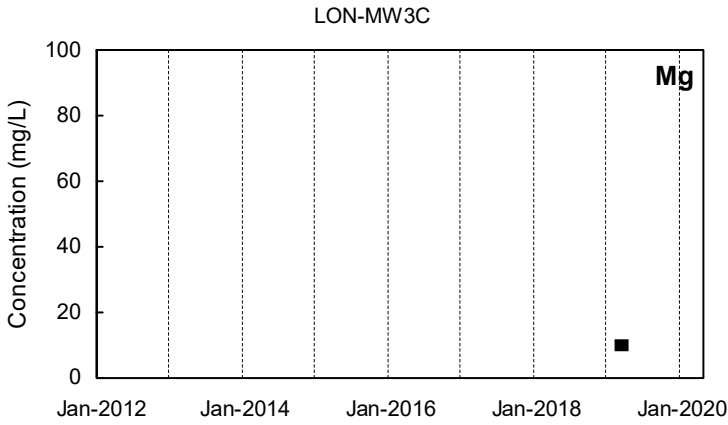
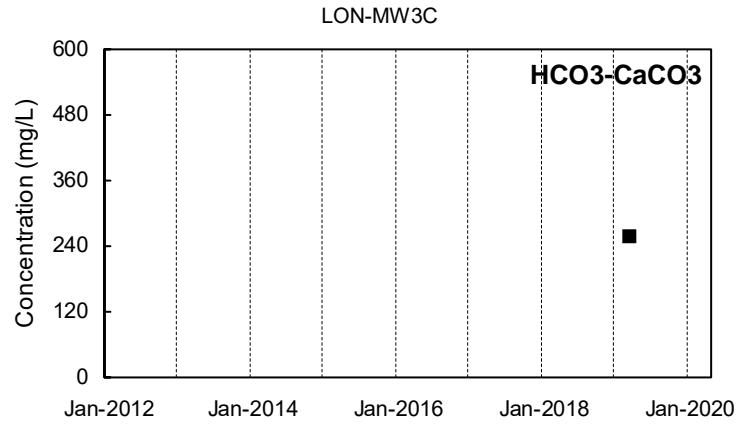
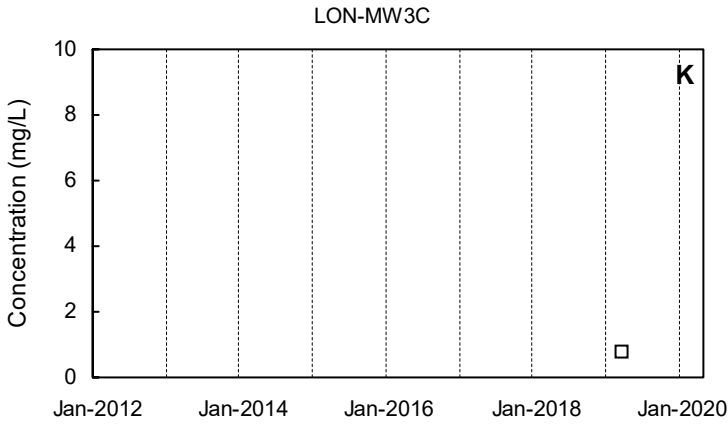
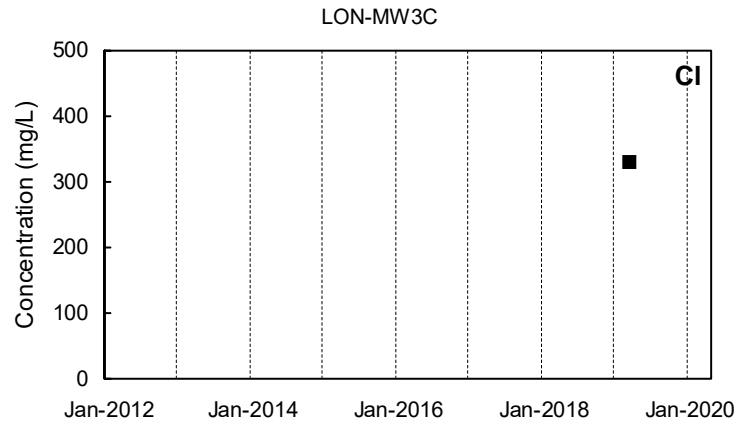
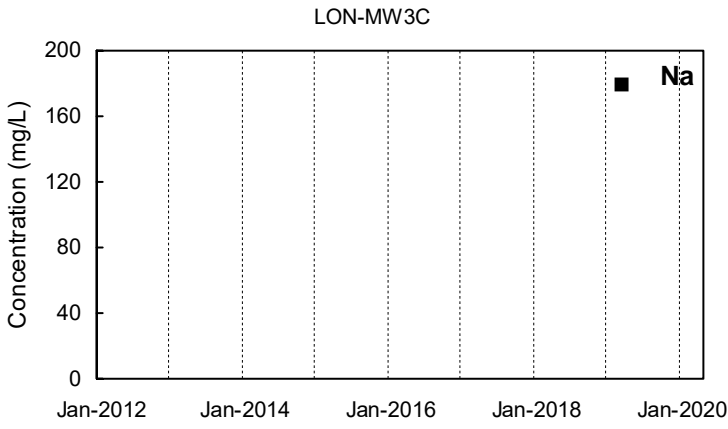

■ Detected Value □ 'J'-Flag (value between reporting limit and detection limit) ■ Non-Detect Range
 Shallow Well shown with black symbols Deep Well shown with orange symbols "dd" Well shown with blue symbols

LON-MW4A

LON-MW4A

Na

Not Sampled

Cl

Not Sampled

LON-MW4A

LON-MW4A

K

Not Sampled

HCO3-CaCO3

Not Sampled

LON-MW4A

LON-MW4A

Mg

Not Sampled

SO4

Not Sampled

LON-MW4A

LON-MW4A

Ca

Not Sampled

PO4

Not Sampled

Detected Value
 'J'-Flag (value between reporting limit and detection limit)
 Non-Detect Range
 Shallow Well shown with black symbols
 Deep Well shown with orange symbols
 "dd" Well shown with blue symbols

LON-MW4B

LON-MW4B

Na

Not Sampled

Cl

Not Sampled

LON-MW4B

LON-MW4B

K

Not Sampled

HCO3-CaCO3

Not Sampled

LON-MW4B

LON-MW4B

Mg

Not Sampled

SO4

Not Sampled

LON-MW4B

LON-MW4B

Ca

Not Sampled

PO4

Not Sampled

■ Detected Value

□ 'J'-Flag (value between reporting limit and detection limit)



Non-Detect Range

Shallow Well shown with black symbols

Deep Well shown with orange symbols

"dd" Well shown with blue symbols

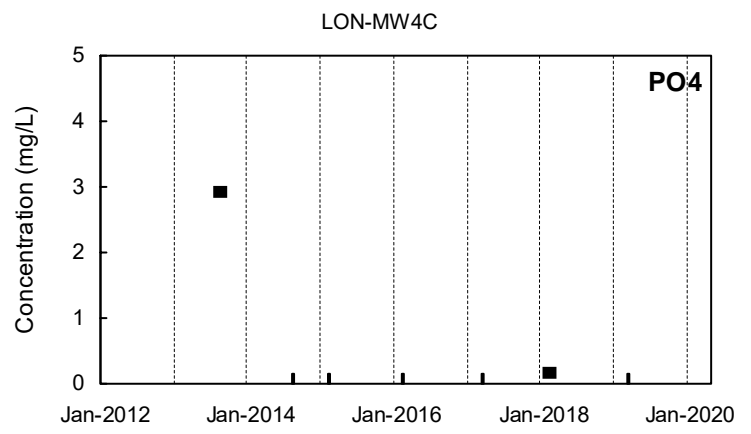
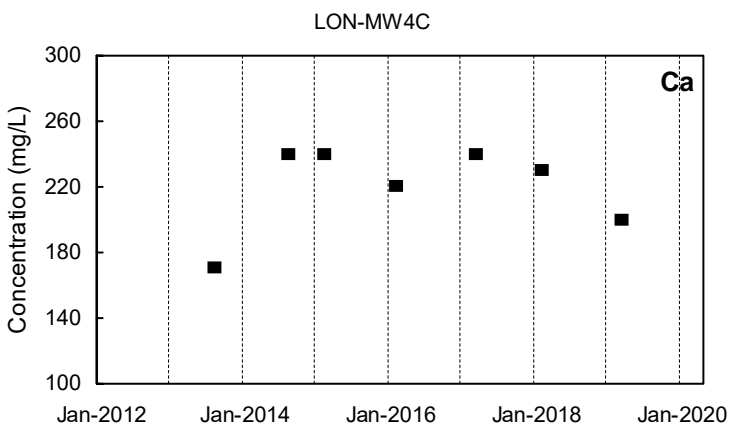
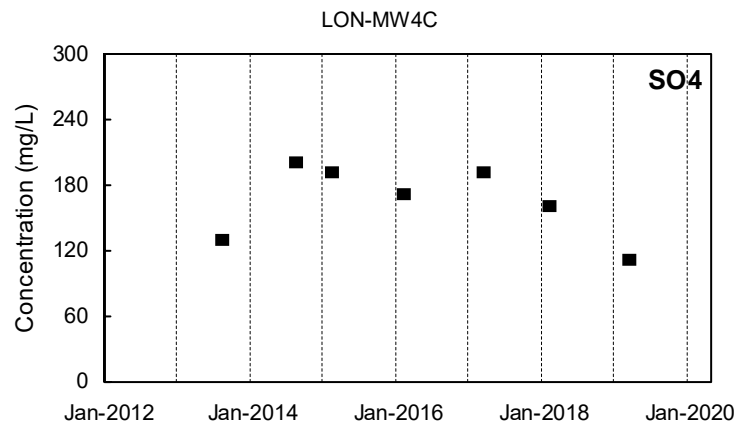
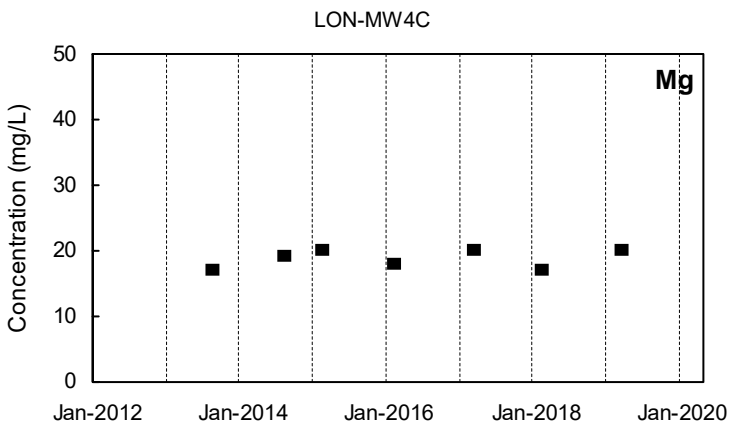
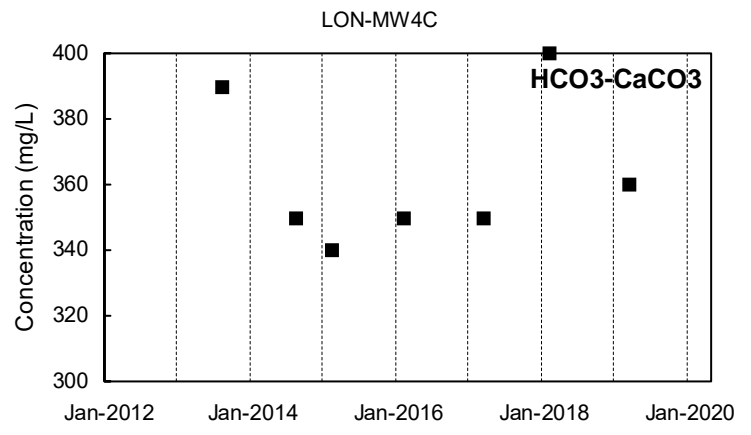
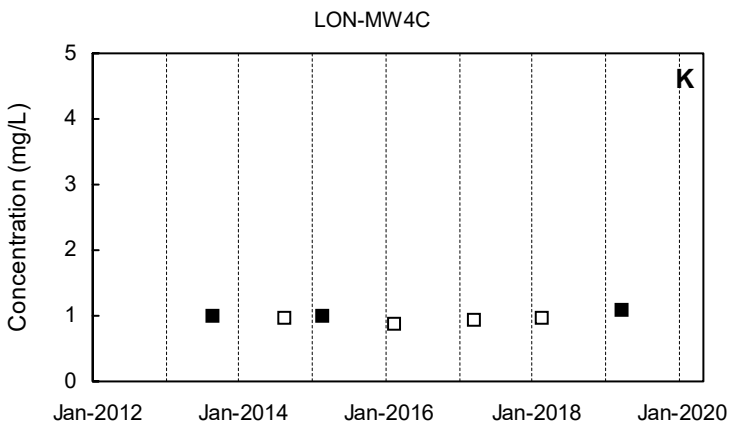
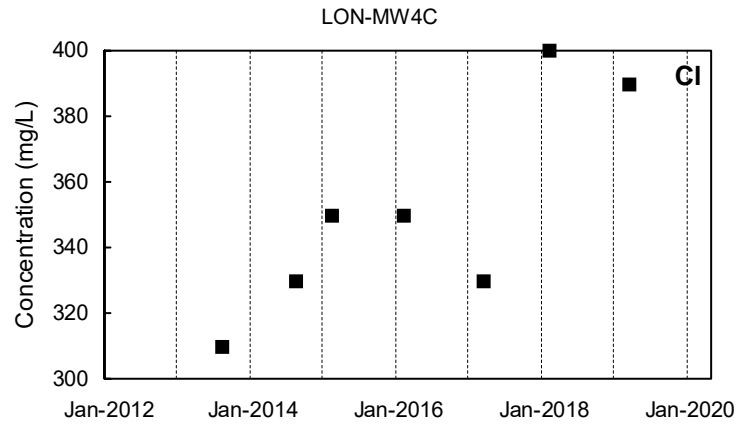
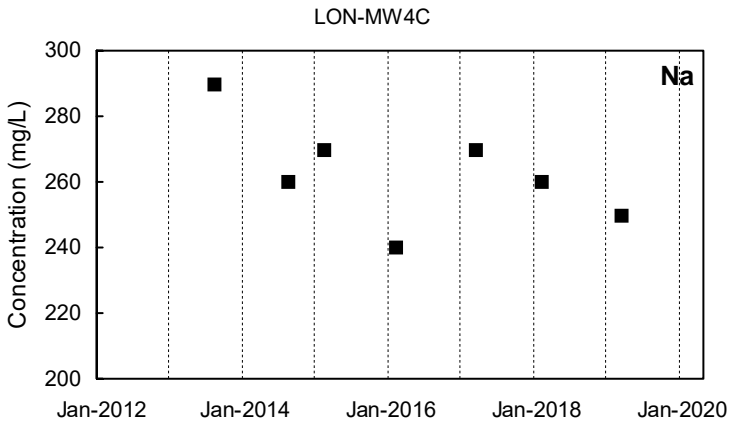

■ Detected Value □ 'J'-Flag (value between reporting limit and detection limit) ■ Non-Detect Range
 Shallow Well shown with black symbols Deep Well shown with orange symbols "dd" Well shown with blue symbols

LON-MW4D

LON-MW4D

Na

Not Sampled

Cl

Not Sampled

LON-MW4D

LON-MW4D

K

Not Sampled

HCO3-CaCO3

Not Sampled

LON-MW4D

LON-MW4D

Mg

Not Sampled

SO4

Not Sampled

LON-MW4D

LON-MW4D

Ca

Not Sampled

PO4

Not Sampled

■ Detected Value

□ 'J'-Flag (value between reporting limit and detection limit)



Non-Detect Range

Shallow Well shown with black symbols

Deep Well shown with orange symbols

"dd" Well shown with blue symbols

LON-MW5A

Na

Not Sampled

LON-MW5A

Cl

Not Sampled

LON-MW5A

K

Not Sampled

LON-MW5A

HCO3-CaCO3

Not Sampled

LON-MW5A

Mg

Not Sampled

LON-MW5A

SO4

Not Sampled

LON-MW5A

Ca

Not Sampled

LON-MW5A

PO4

Not Sampled

■ Detected Value

□ 'J'-Flag (value between reporting limit and detection limit)



Non-Detect Range

Shallow Well shown with black symbols

Deep Well shown with orange symbols

"dd" Well shown with blue symbols

LON-MW5B

LON-MW5B

Na

Not Sampled

Cl

Not Sampled

LON-MW5B

LON-MW5B

K

Not Sampled

HCO3-CaCO3

Not Sampled

LON-MW5B

LON-MW5B

Mg

Not Sampled

SO4

Not Sampled

LON-MW5B

LON-MW5B

Ca

Not Sampled

PO4

Not Sampled

■ Detected Value

□ 'J'-Flag (value between reporting limit and detection limit)



Non-Detect Range

Shallow Well shown with black symbols

Deep Well shown with orange symbols

"dd" Well shown with blue symbols

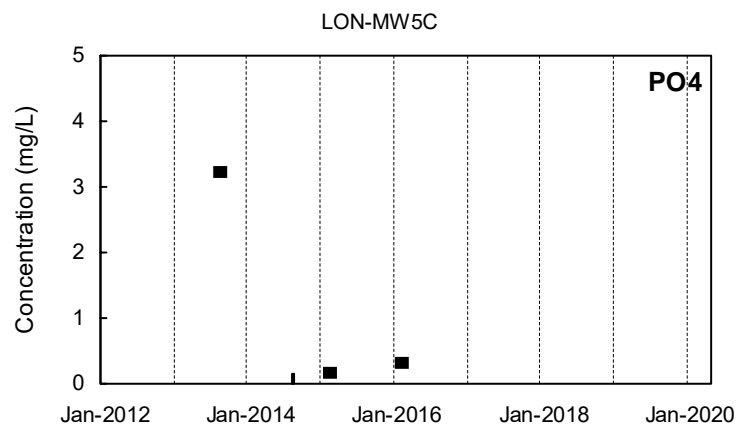
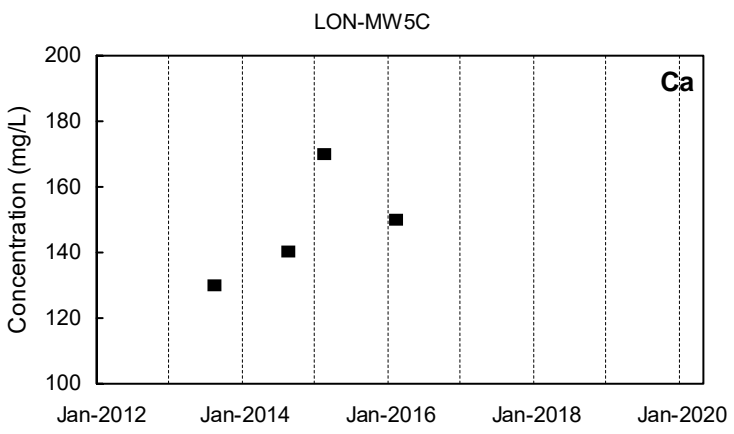
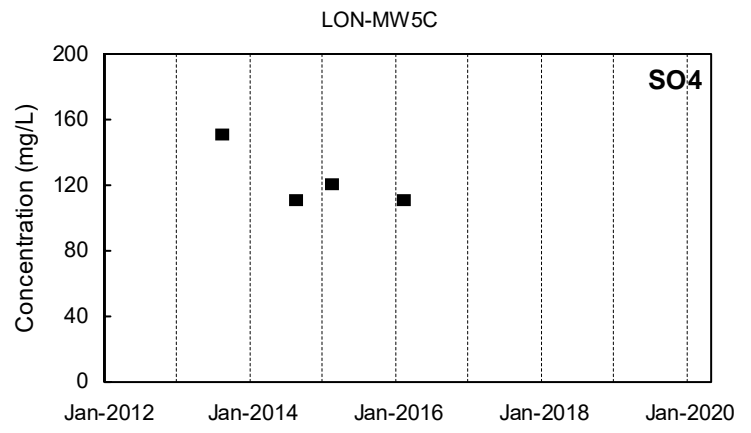
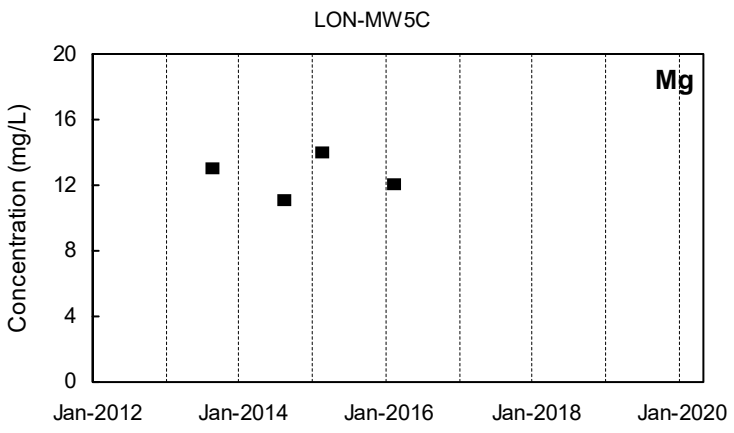
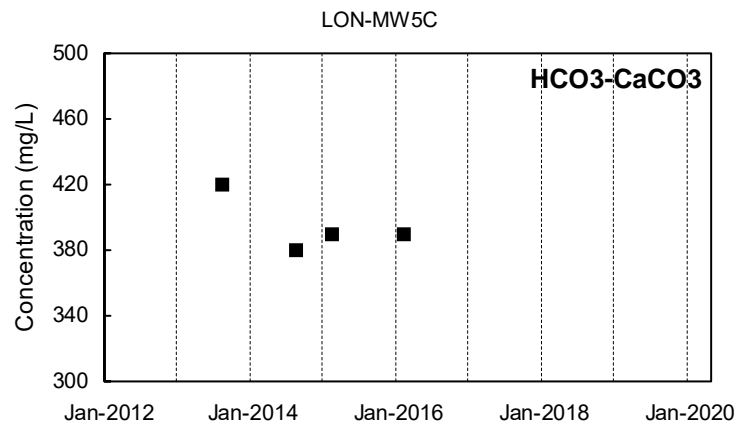
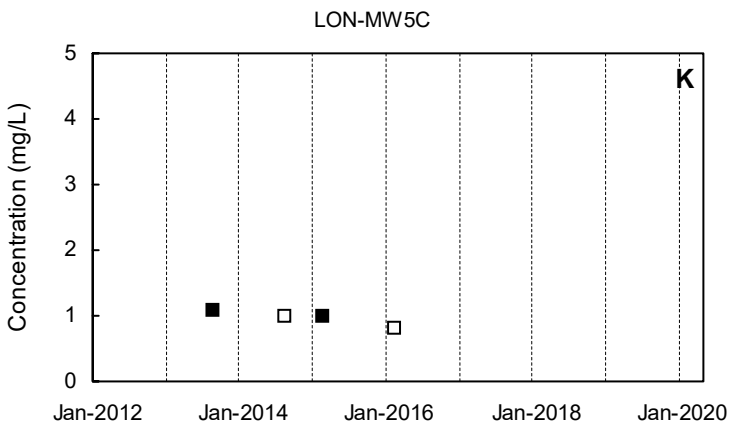
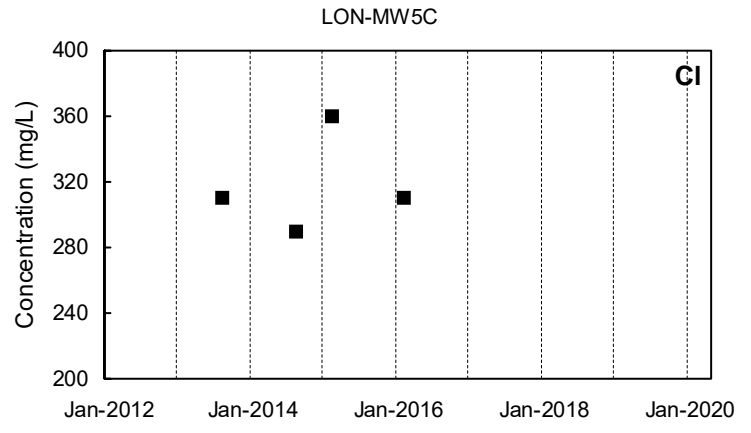
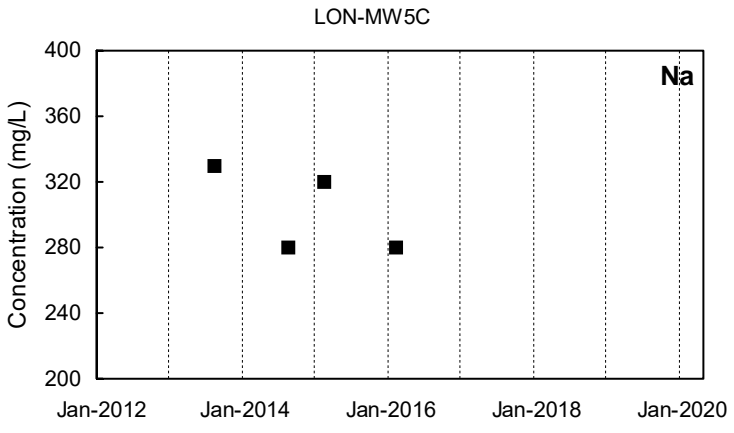

Detected Value
 'J'-Flag (value between reporting limit and detection limit)
 Non-Detect Range
 Shallow Well shown with black symbols
 Deep Well shown with orange symbols
 "dd" Well shown with blue symbols

LON-MW6A

LON-MW6A

Na

Cl

Not Sampled

Not Sampled

LON-MW6A

LON-MW6A

K

HCO3-CaCO3

Not Sampled

Not Sampled

LON-MW6A

LON-MW6A

Mg

SO4

Not Sampled

Not Sampled

LON-MW6A

LON-MW6A

Ca

PO4

Not Sampled

Not Sampled

Detected Value
 'J'-Flag (value between reporting limit and detection limit)
 Non-Detect Range

Shallow Well shown with black symbols
 Deep Well shown with orange symbols
 "dd" Well shown with blue symbols

LON-MW6B

LON-MW6B

Na

Not Sampled

Cl

Not Sampled

LON-MW6B

LON-MW6B

K

Not Sampled

HCO3-CaCO3

Not Sampled

LON-MW6B

LON-MW6B

Mg

Not Sampled

SO4

Not Sampled

LON-MW6B

LON-MW6B

Ca

Not Sampled

PO4

Not Sampled

Detected Value
 'J'-Flag (value between reporting limit and detection limit)
 Non-Detect Range

Shallow Well shown with black symbols
 Deep Well shown with orange symbols
 "dd" Well shown with blue symbols

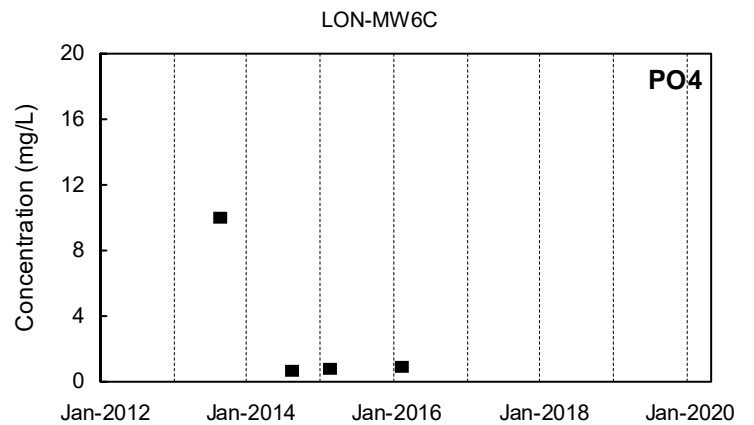
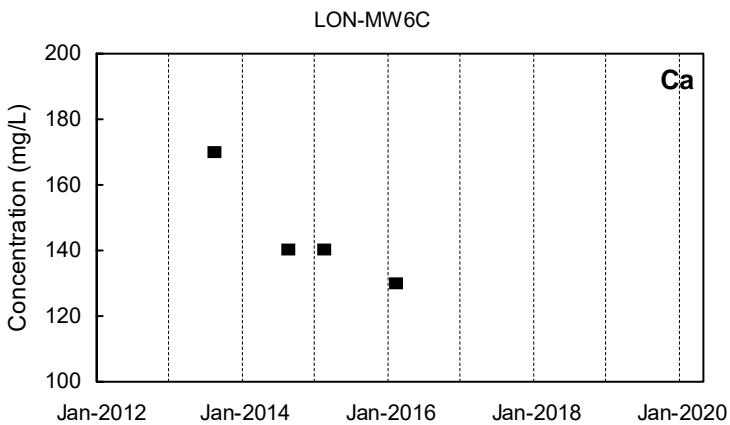
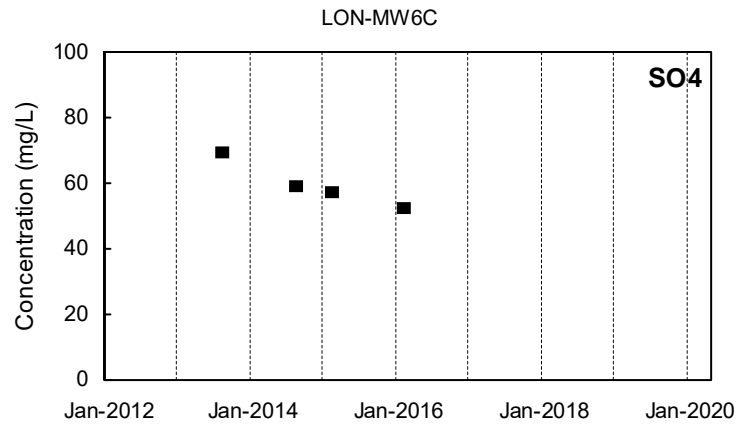
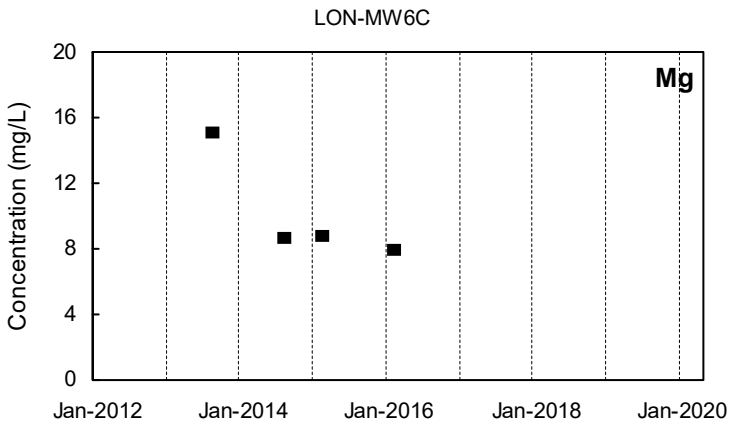
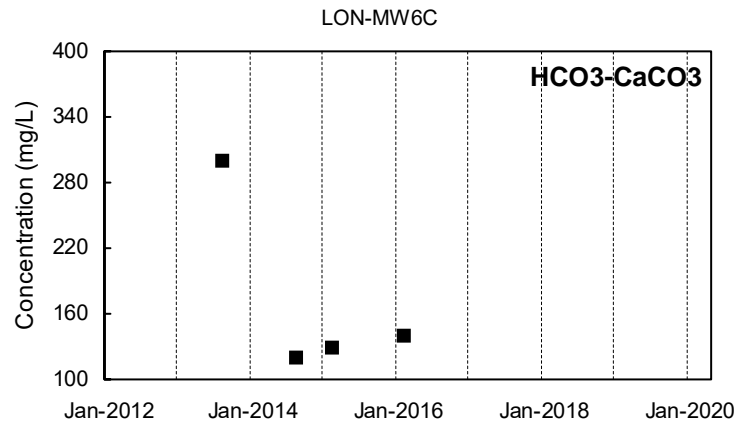
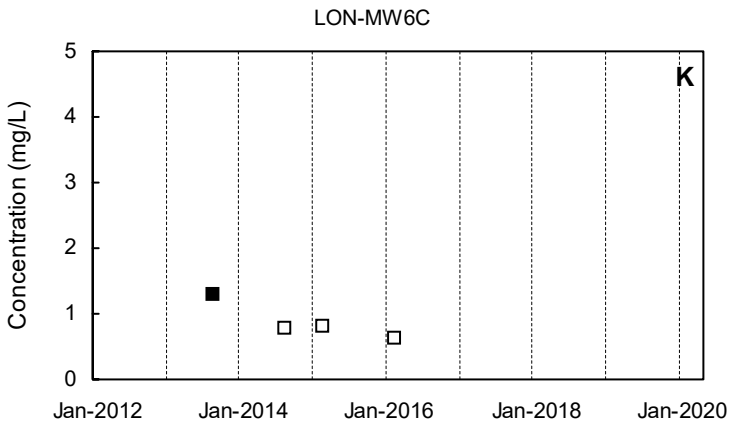
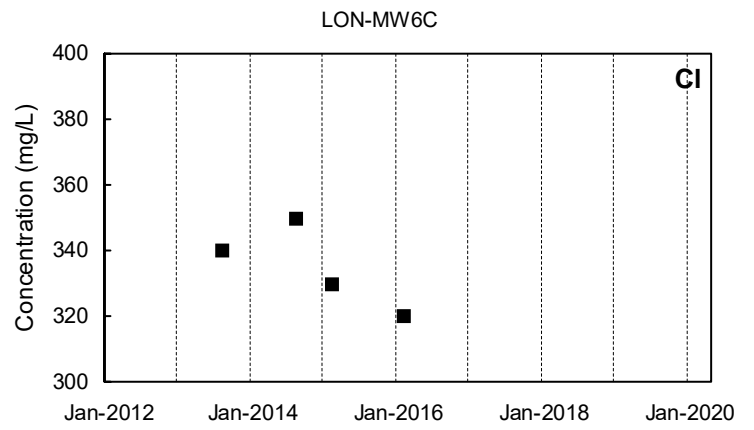
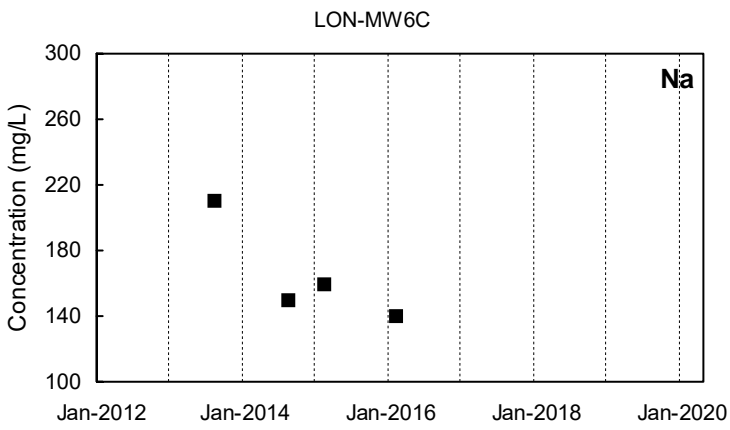

Detected Value
 'J'-Flag (value between reporting limit and detection limit)
 Non-Detect Range
 Shallow Well shown with black symbols
 Deep Well shown with orange symbols
 "dd" Well shown with blue symbols

LON-MW7A

LON-MW7A

Na

Not Sampled

Cl

Not Sampled

LON-MW7A

LON-MW7A

K

Not Sampled

HCO3-CaCO3

Not Sampled

LON-MW7A

LON-MW7A

Mg

Not Sampled

SO4

Not Sampled

LON-MW7A

LON-MW7A

Ca

Not Sampled

PO4

Not Sampled

■ Detected Value

□ 'J'-Flag (value between reporting limit and detection limit)



Non-Detect Range

Shallow Well shown with black symbols

Deep Well shown with orange symbols

"dd" Well shown with blue symbols

LON-MW7B

Na

Not Sampled

LON-MW7B

Cl

Not Sampled

LON-MW7B

K

Not Sampled

LON-MW7B

HCO3-CaCO3

Not Sampled

LON-MW7B

Mg

Not Sampled

LON-MW7B

SO4

Not Sampled

LON-MW7B

Ca

Not Sampled

LON-MW7B

PO4

Not Sampled

■ Detected Value

□ 'J'-Flag (value between reporting limit and detection limit)



Non-Detect Range

Shallow Well shown with black symbols

Deep Well shown with orange symbols

"dd" Well shown with blue symbols

LON-MW7C

LON-MW7C

Na

Cl

Not Sampled

Not Sampled

LON-MW7C

LON-MW7C

K

HCO3-CaCO3

Not Sampled

Not Sampled

LON-MW7C

LON-MW7C

Mg

SO4

Not Sampled

Not Sampled

LON-MW7C

LON-MW7C

Ca

PO4

Not Sampled

Not Sampled

Detected Value
 'J'-Flag (value between reporting limit and detection limit)
 Non-Detect Range
 Shallow Well shown with black symbols
 Deep Well shown with orange symbols
 "dd" Well shown with blue symbols

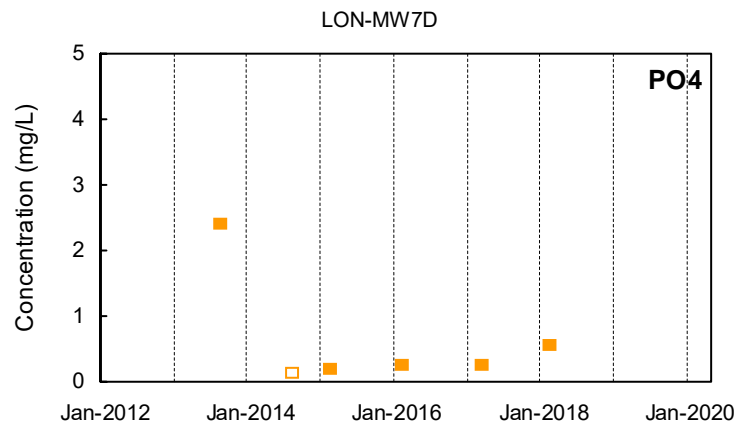
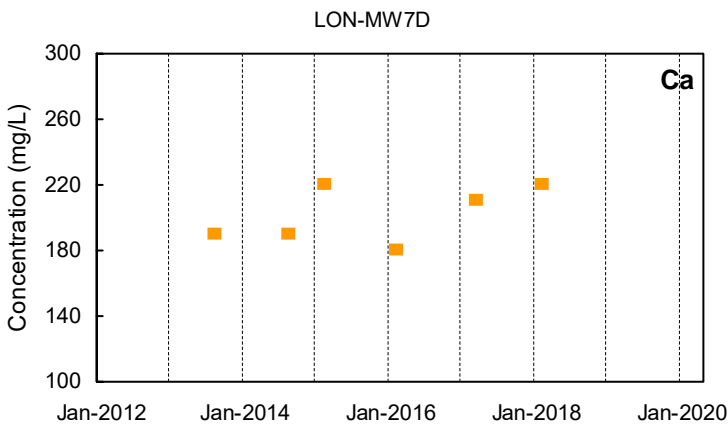
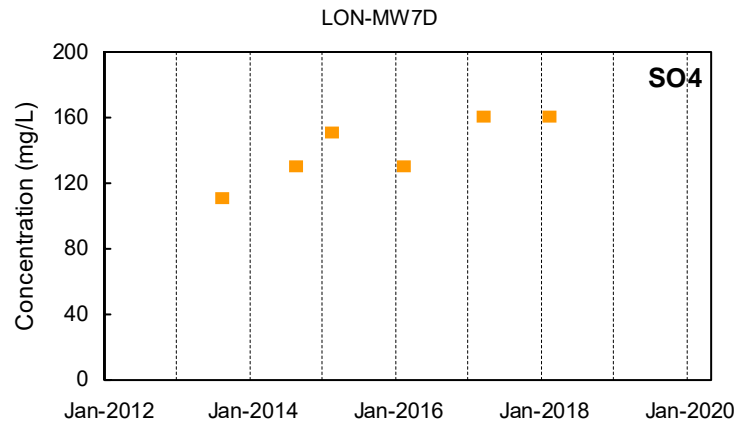
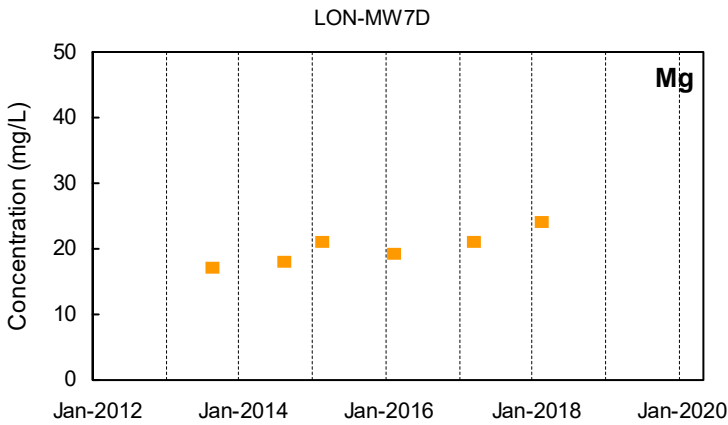
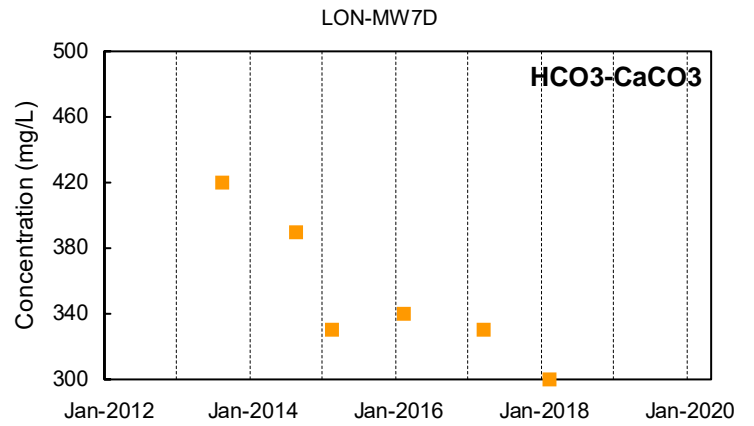
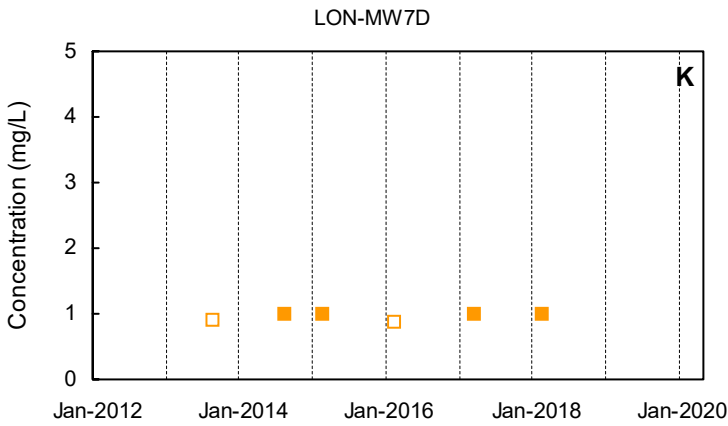
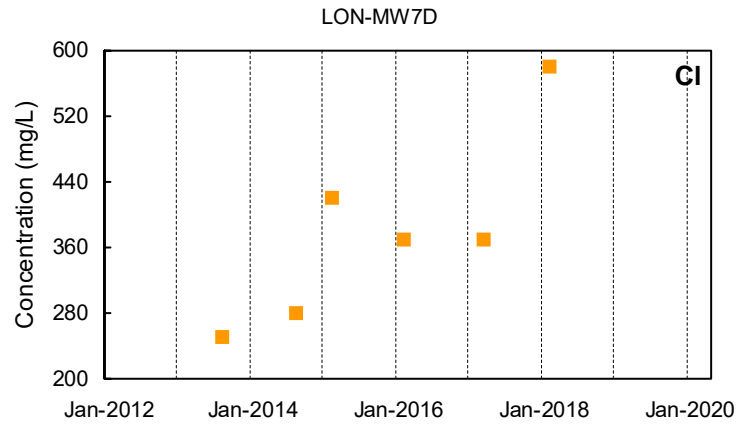
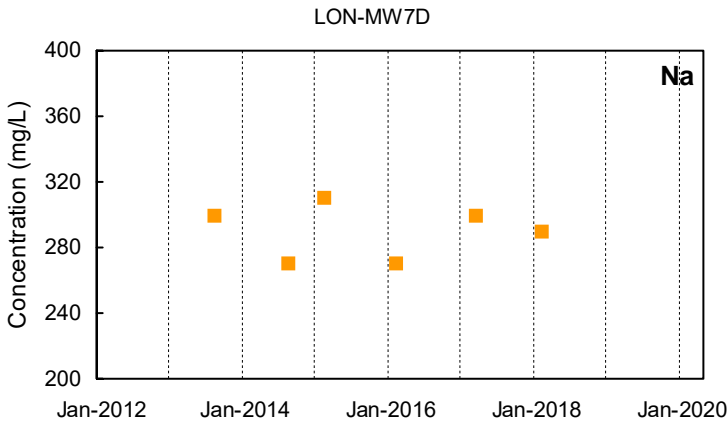

■ Detected Value
 'J'-Flag (value between reporting limit and detection limit)
 Non-Detect Range
■ Shallow Well shown with black symbols
 ■ Deep Well shown with orange symbols
 ■ "dd" Well shown with blue symbols

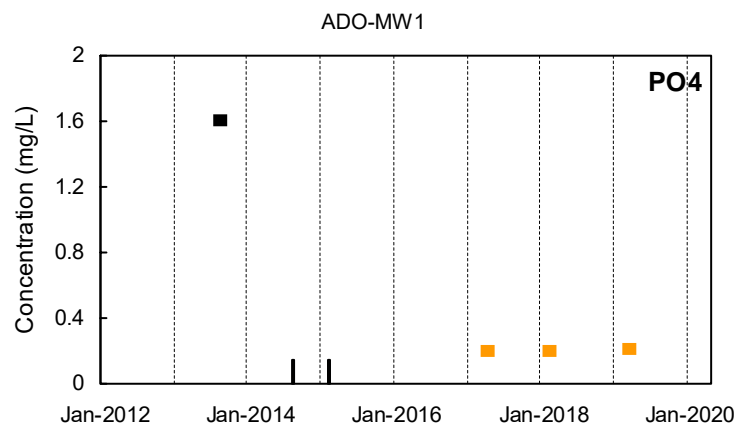
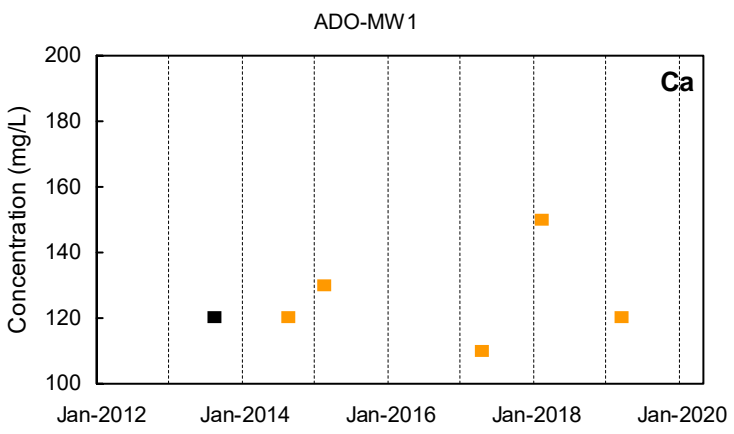
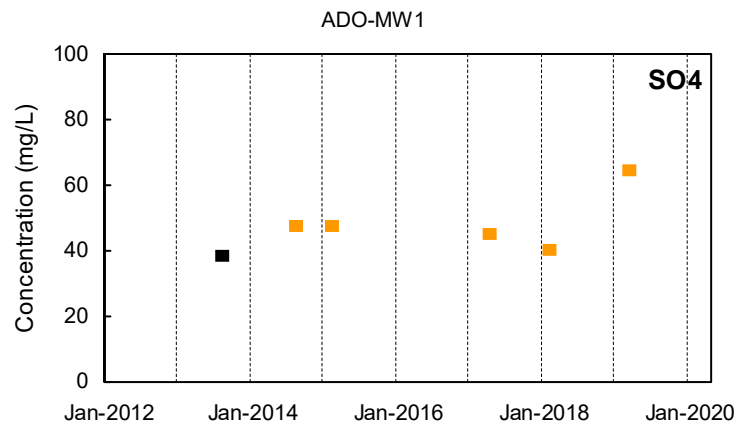
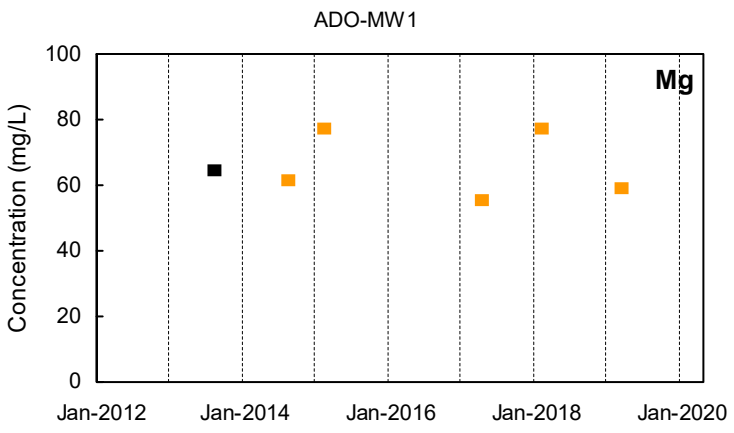
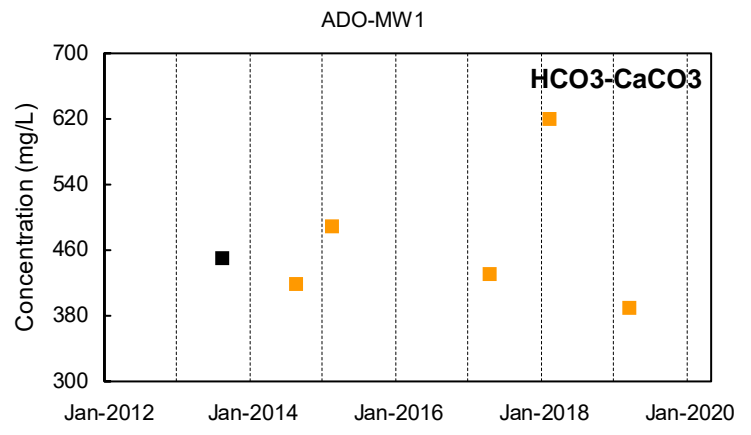
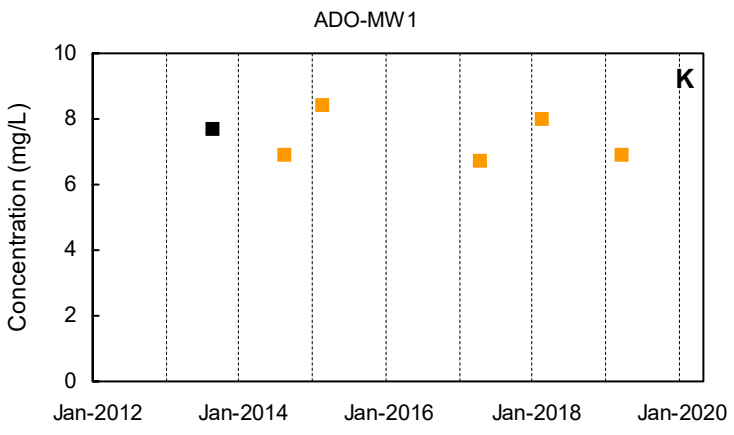
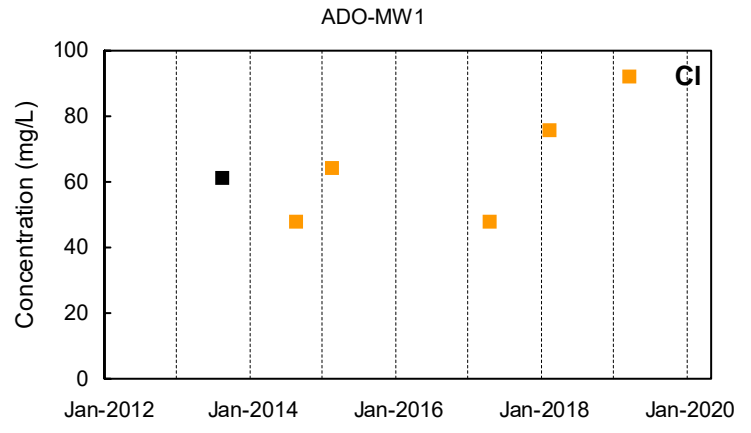
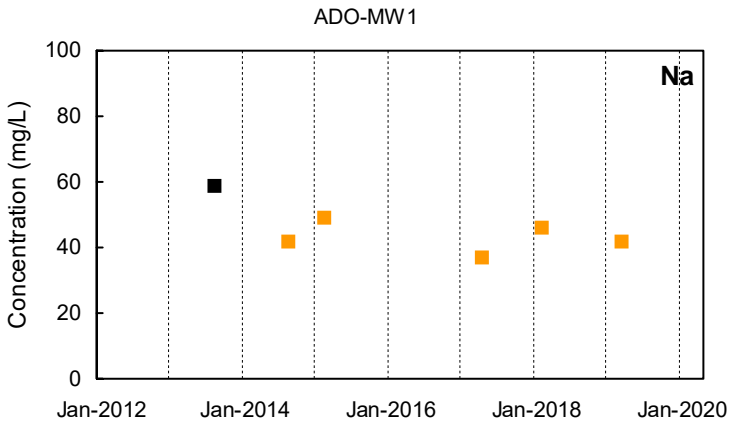

Detected Value
 'J'-Flag (value between reporting limit and detection limit)
 Non-Detect Range
 Shallow Well shown with black symbols Deep Well shown with orange symbols "dd" Well shown with blue symbols

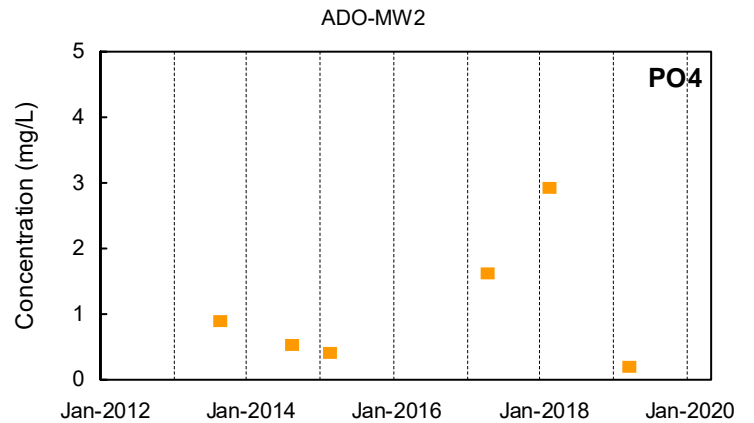
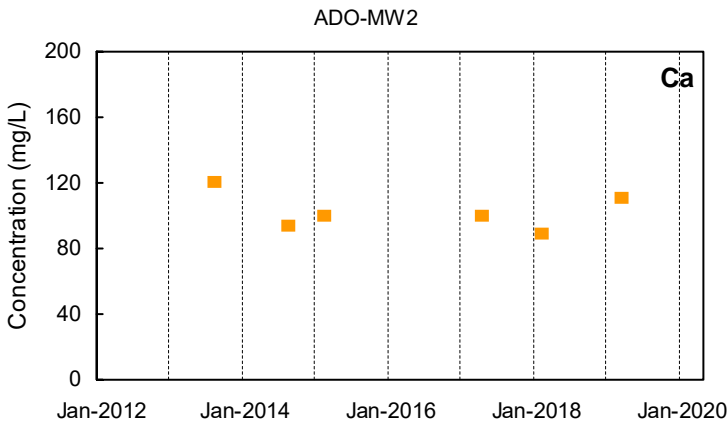
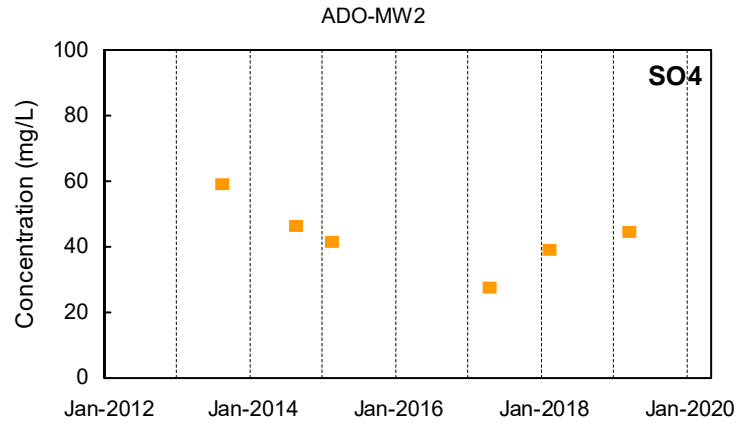
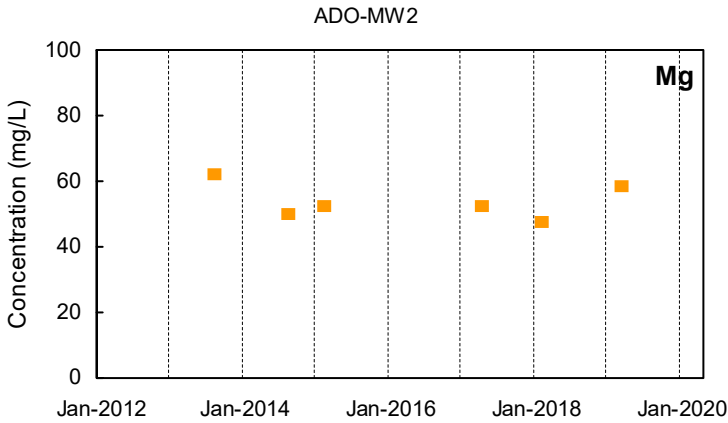
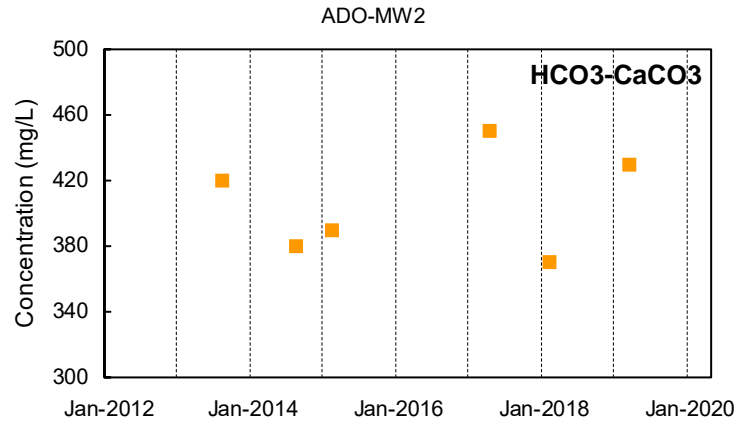
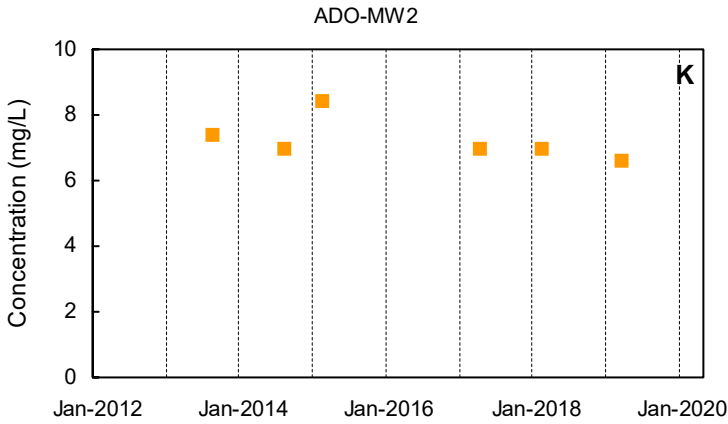
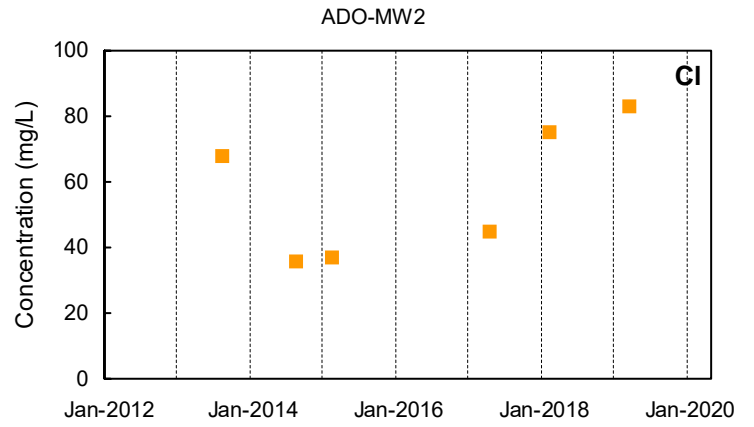
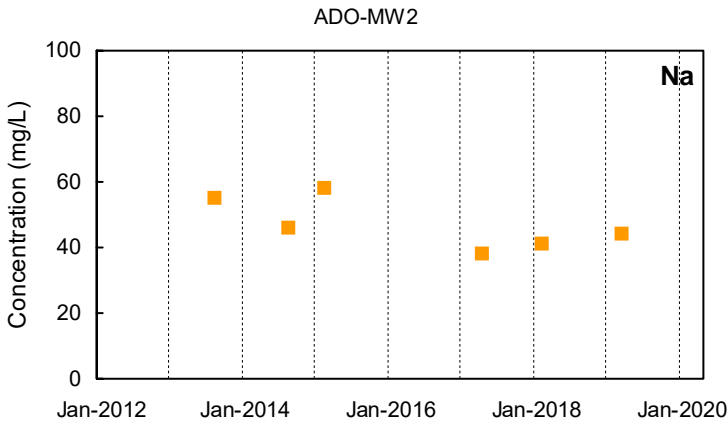

■ Detected Value
 □ 'J'-Flag (value between reporting limit and detection limit)
 Non-Detect Range
 Shallow Well shown with black symbols
 Deep Well shown with orange symbols
 "dd" Well shown with blue symbols

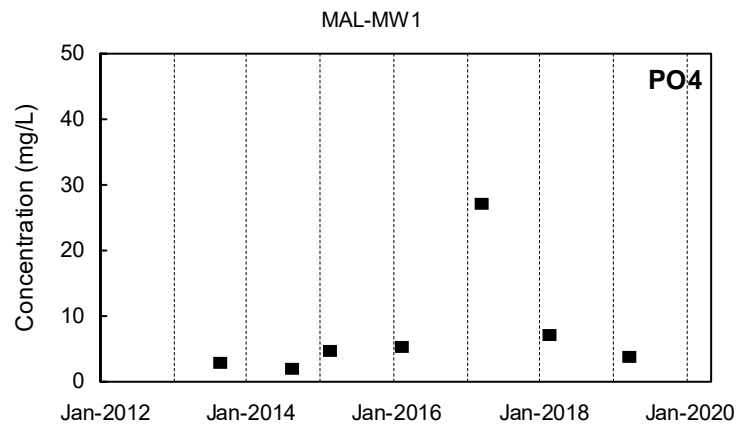
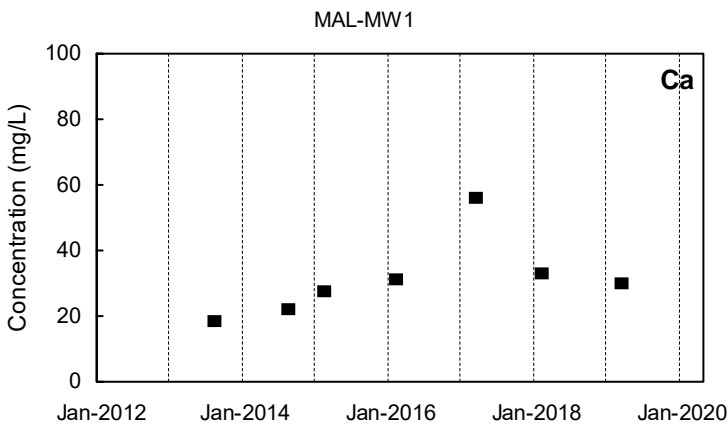
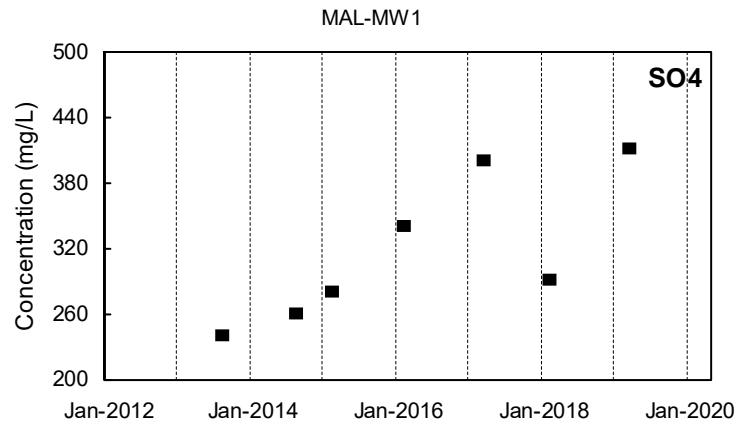
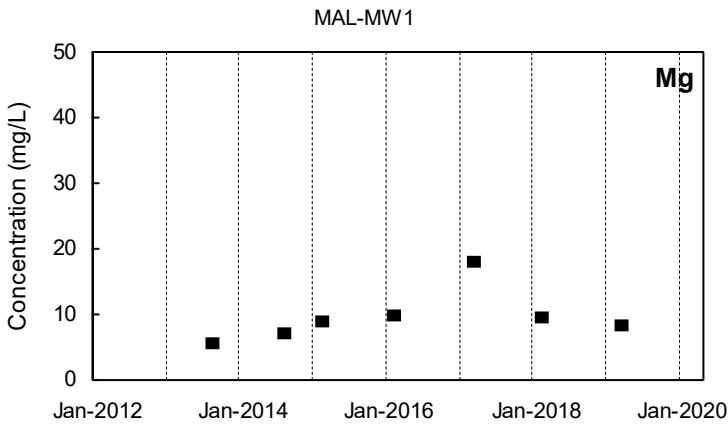
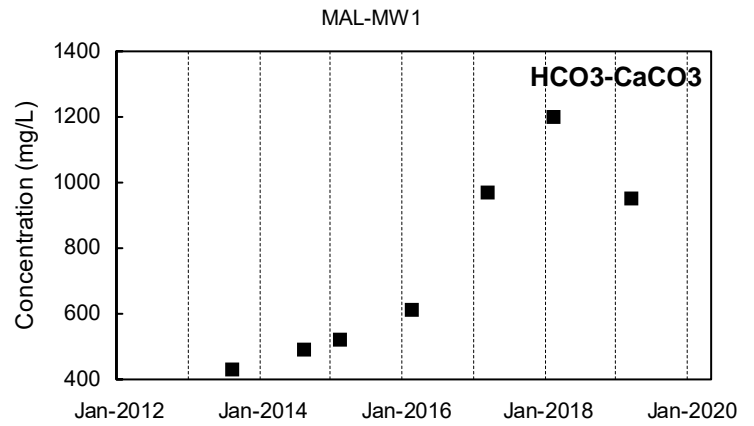
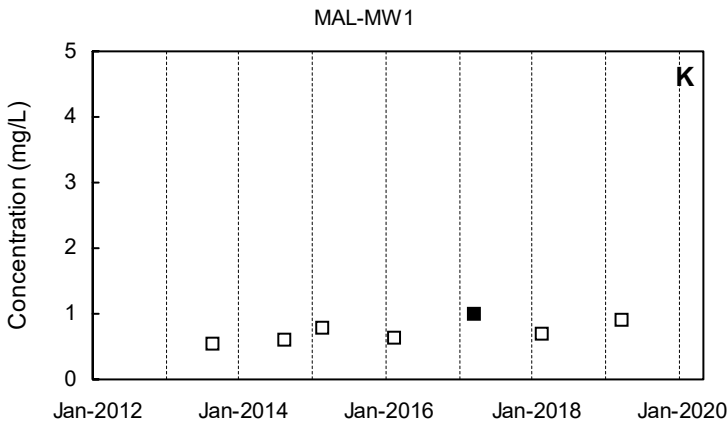
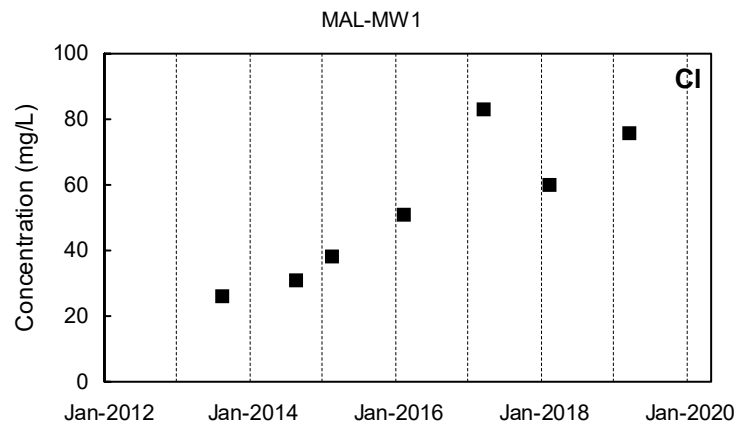
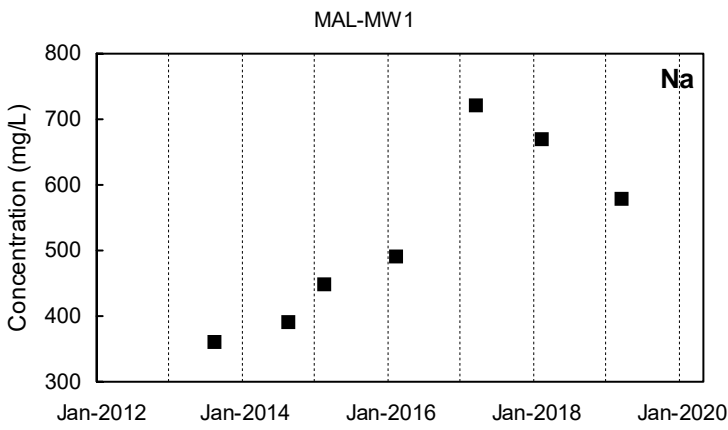

Detected Value
 'J'-Flag (value between reporting limit and detection limit)
 Non-Detect Range
 Shallow Well shown with black symbols Deep Well shown with orange symbols "dd" Well shown with blue symbols

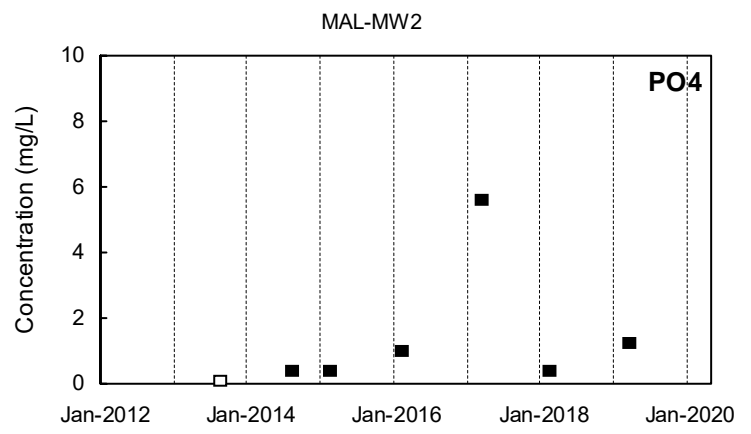
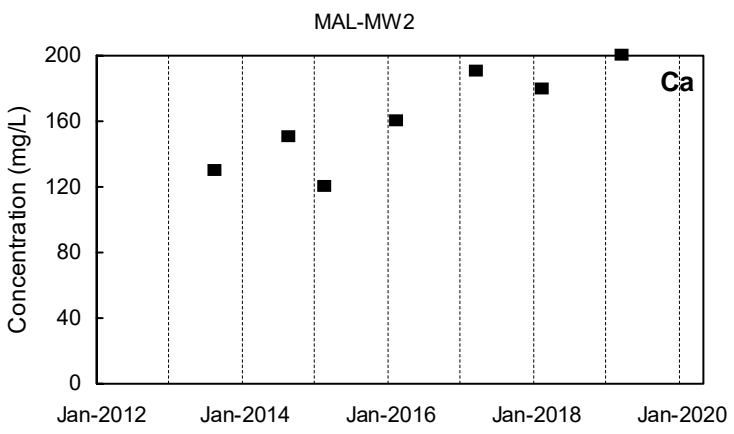
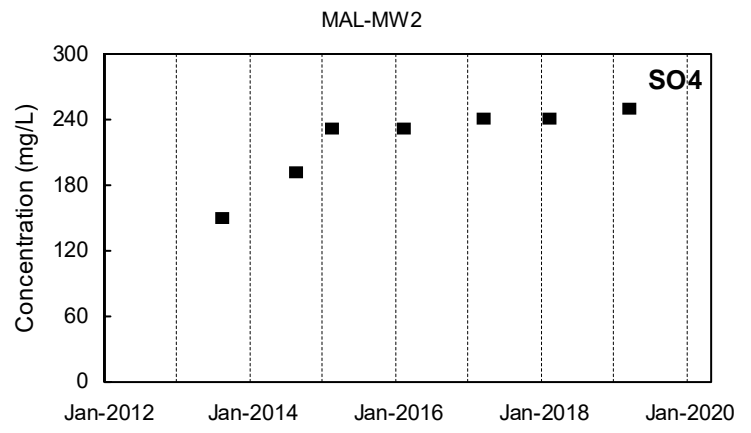
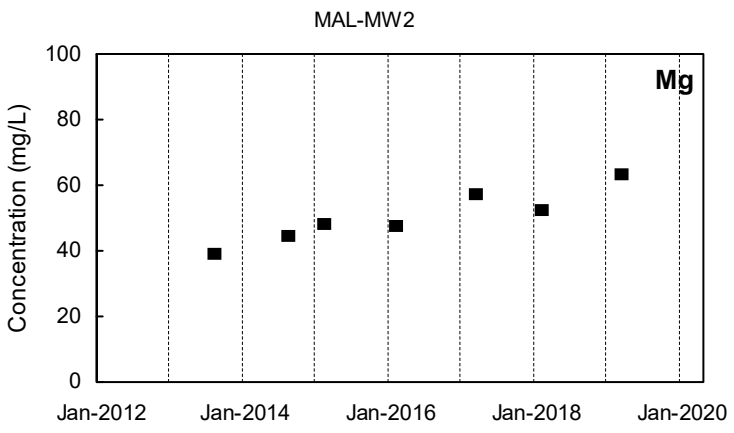
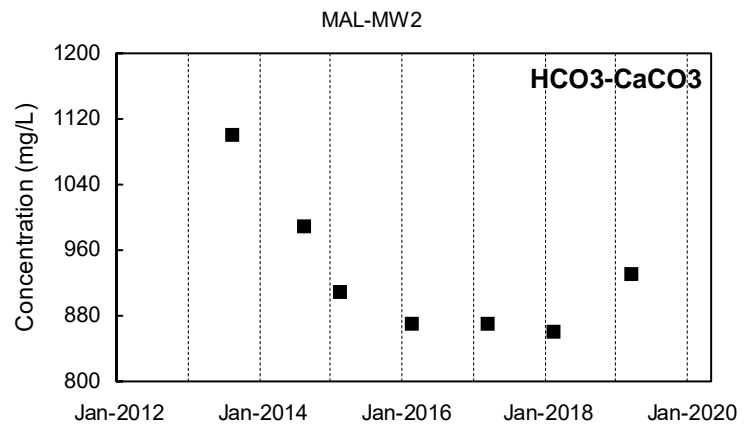
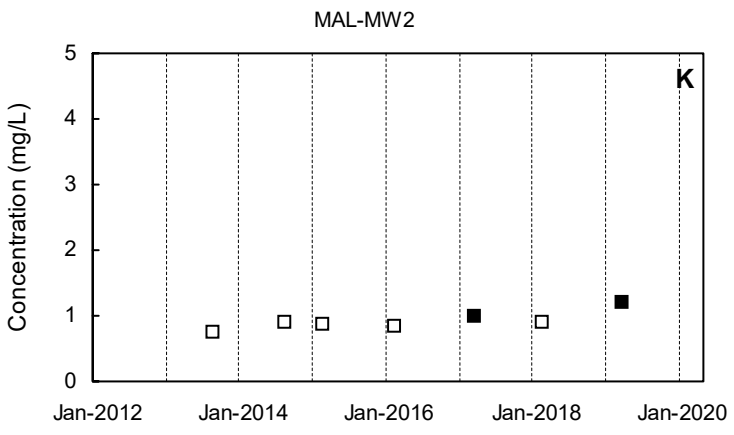
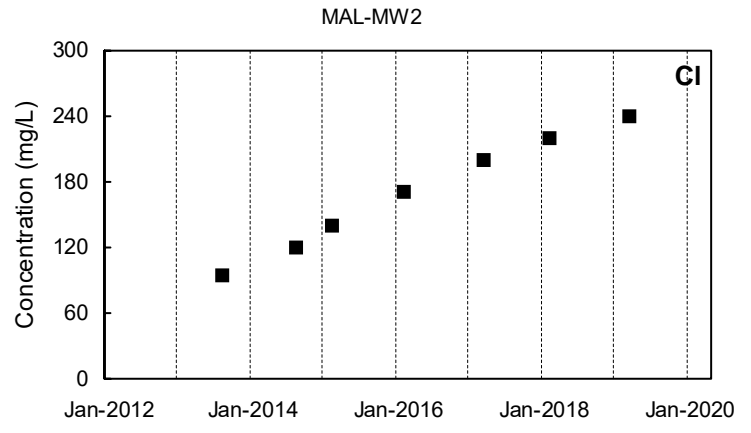
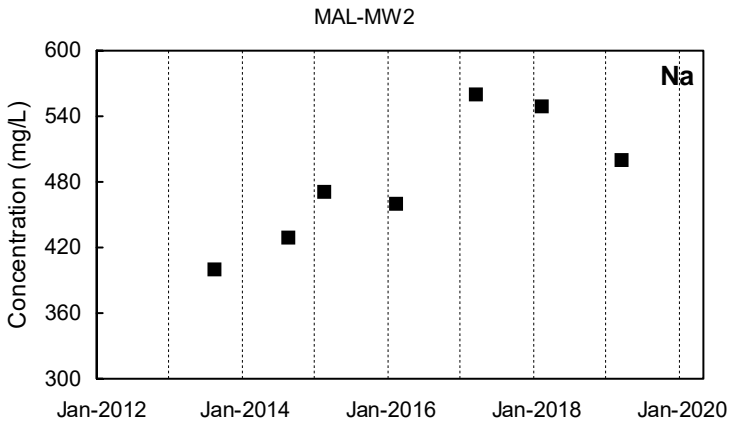

■ Detected Value □ 'J'-Flag (value between reporting limit and detection limit) ■ Non-Detect Range
 Shallow Well shown with black symbols Deep Well shown with orange symbols "dd" Well shown with blue symbols

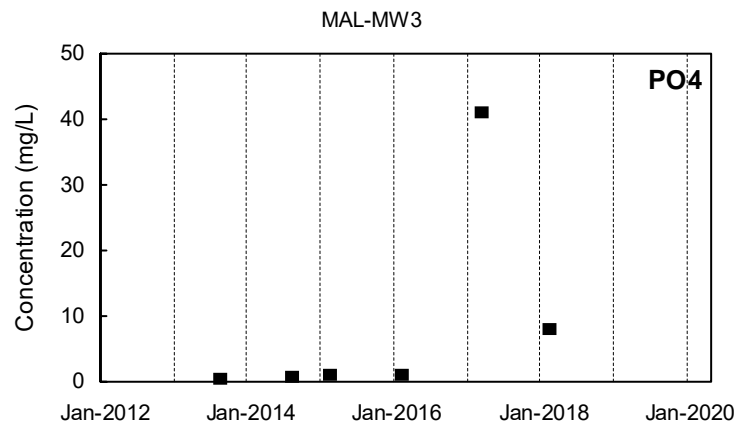
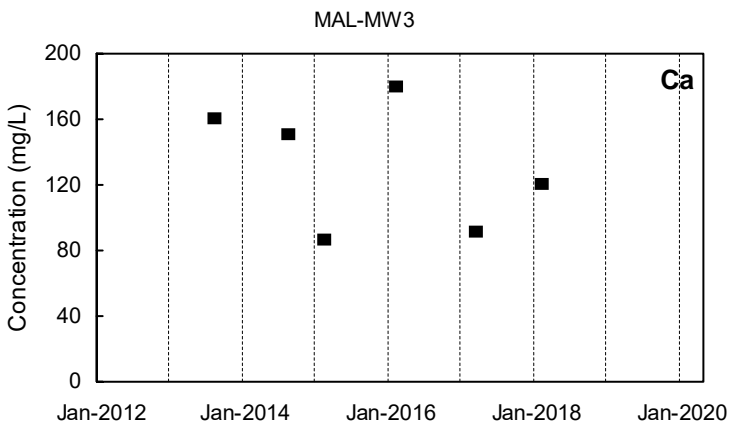
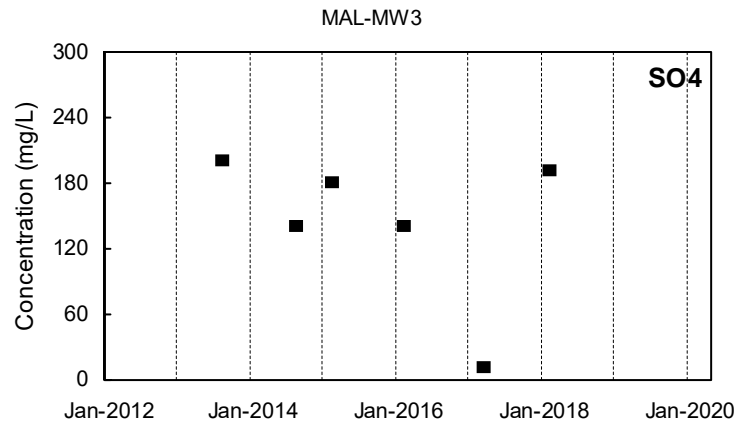
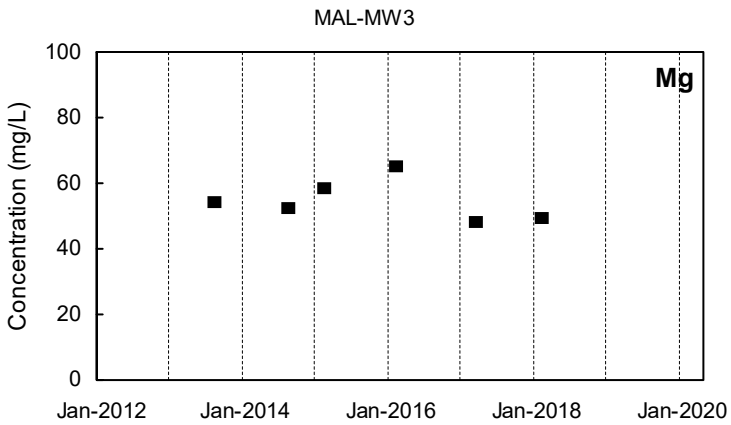
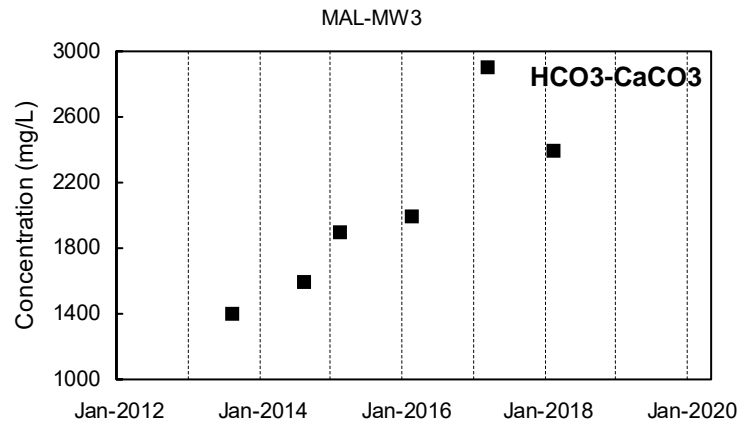
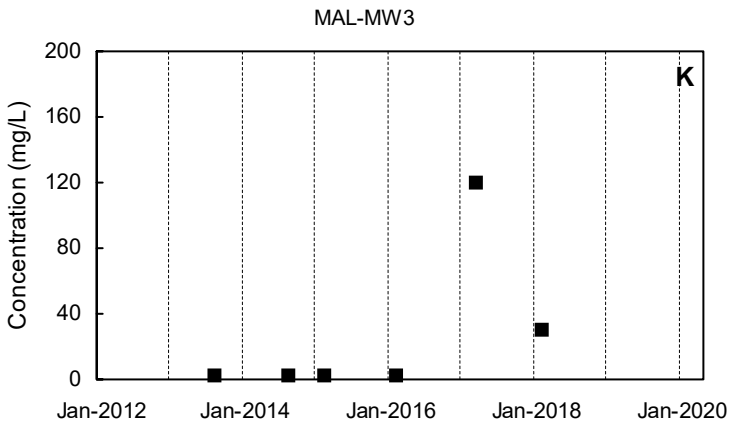
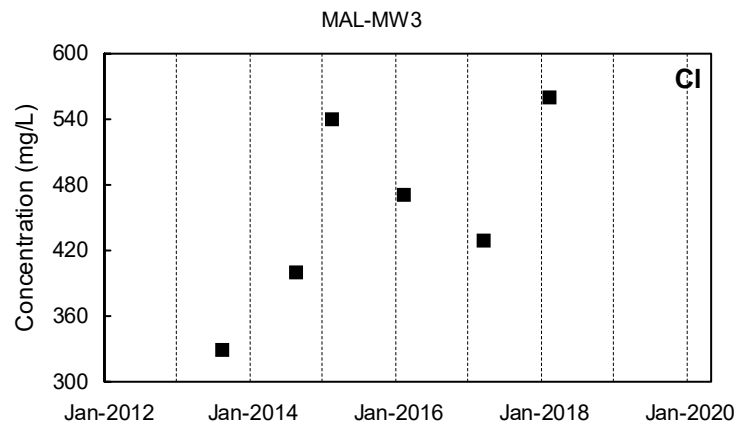
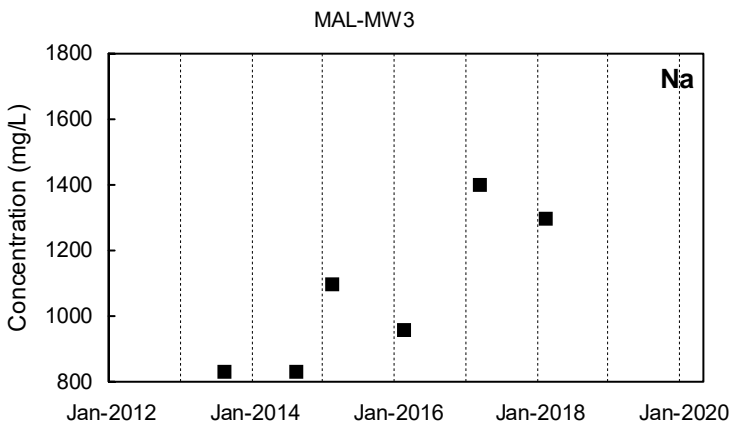

Detected Value
 'J'-Flag (value between reporting limit and detection limit)
 Non-Detect Range
 Shallow Well shown with black symbols
 Deep Well shown with orange symbols
 "dd" Well shown with blue symbols

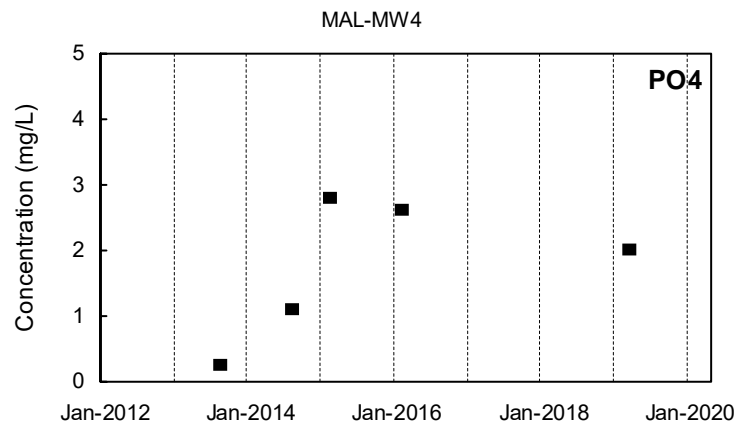
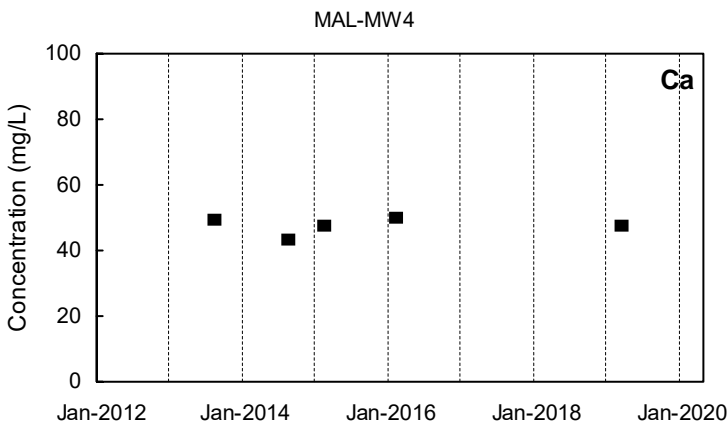
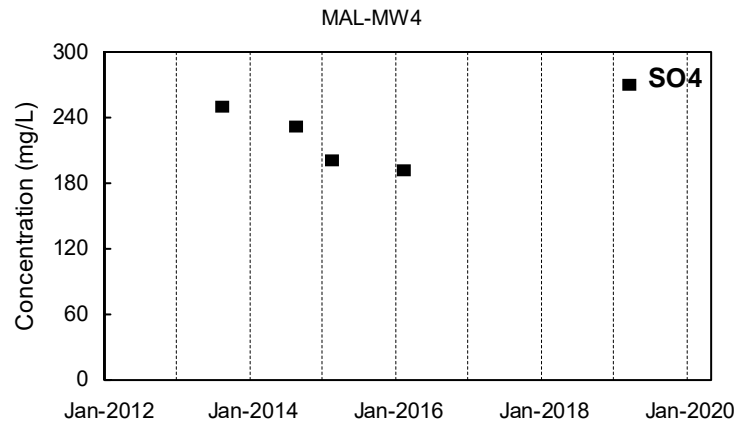
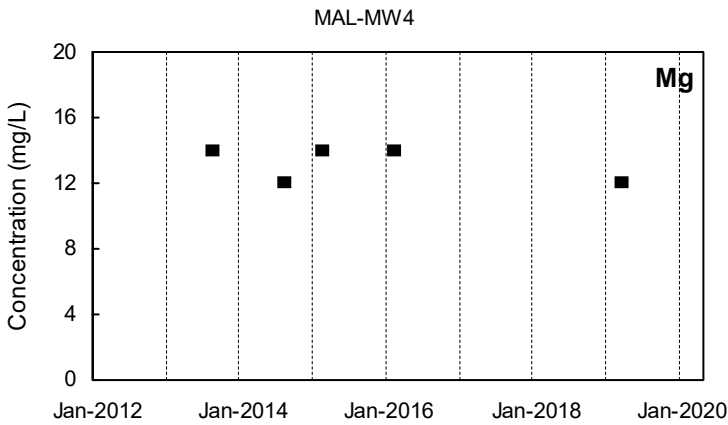
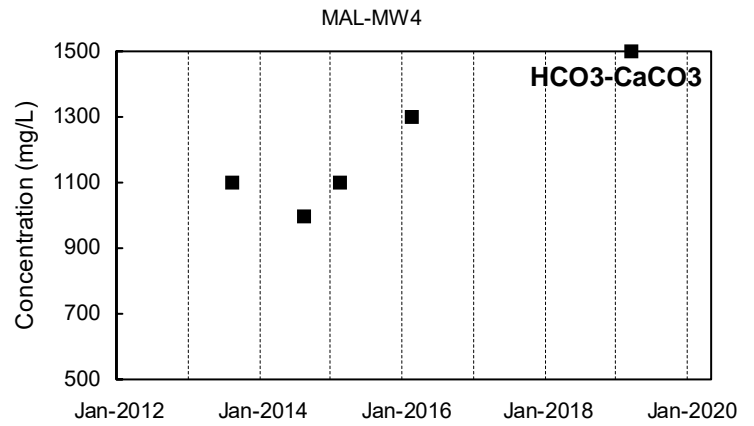
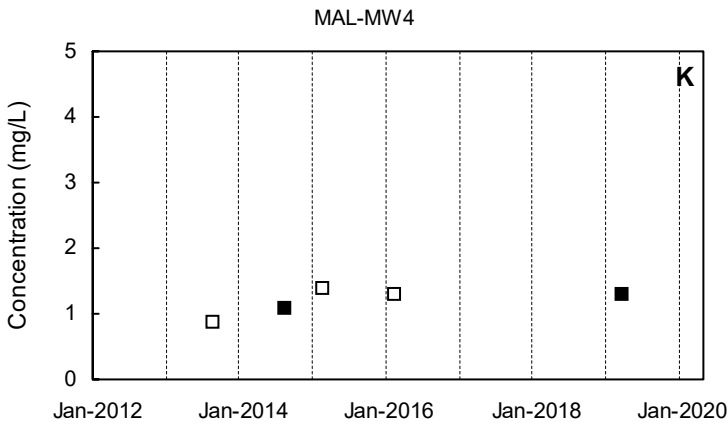
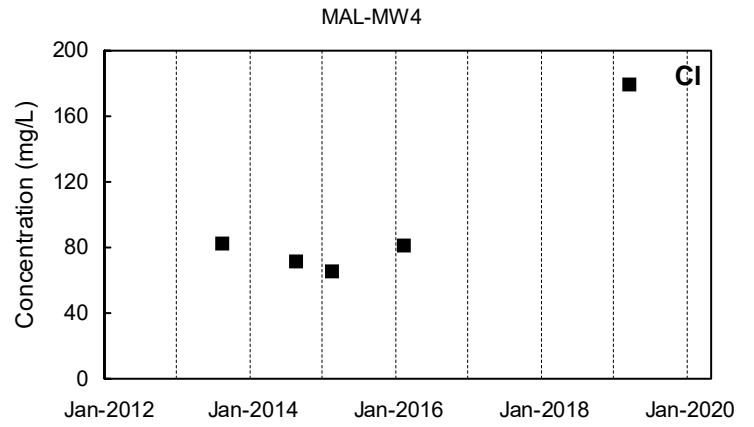
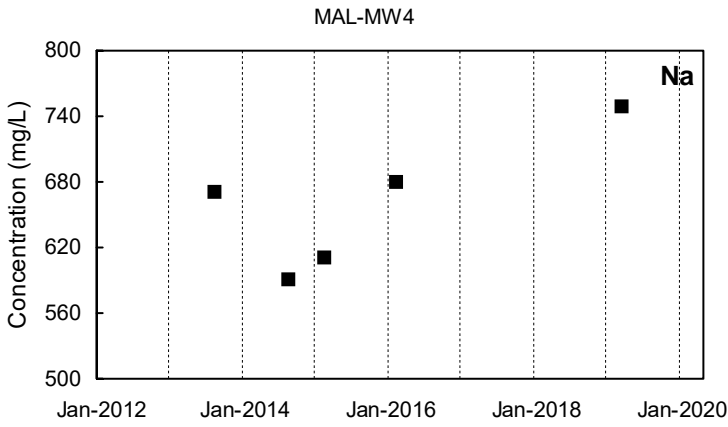

Detected Value
 'J'-Flag (value between reporting limit and detection limit)
 Non-Detect Range
 Shallow Well shown with black symbols Deep Well shown with orange symbols "dd" Well shown with blue symbols

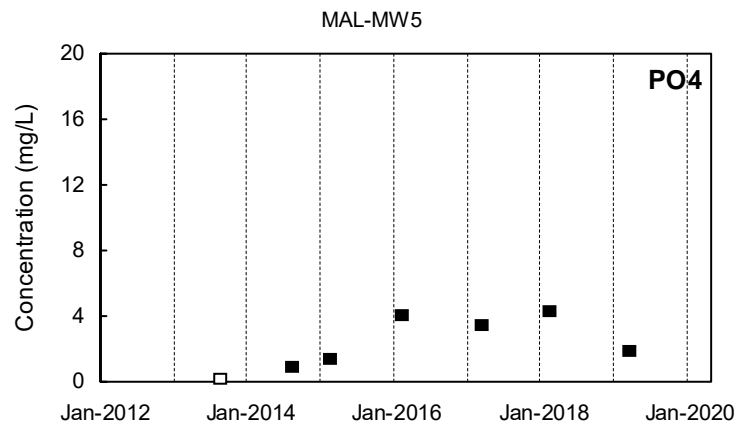
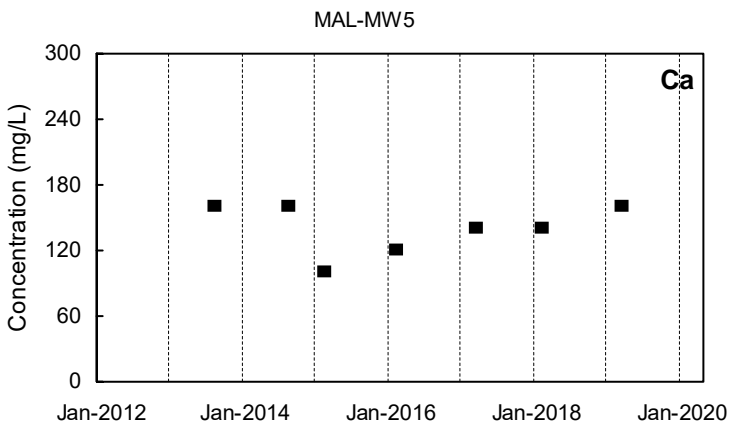
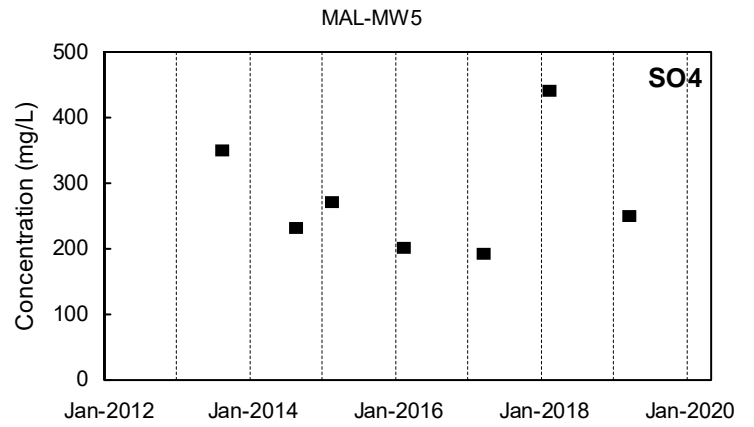
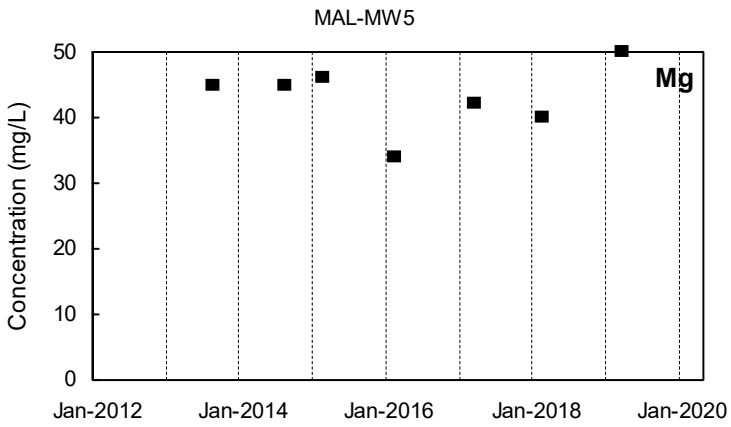
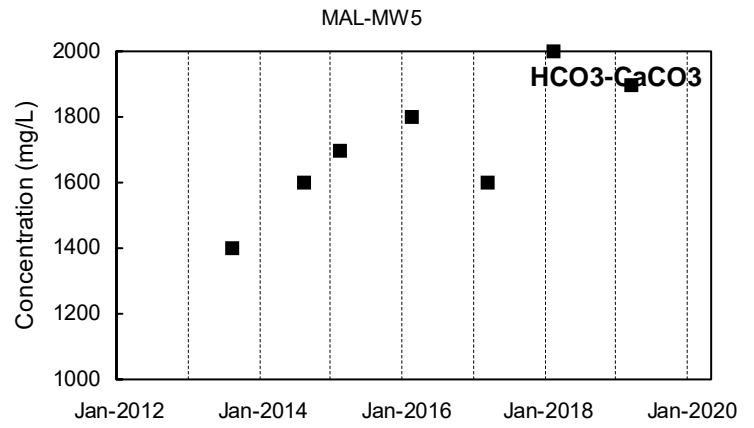
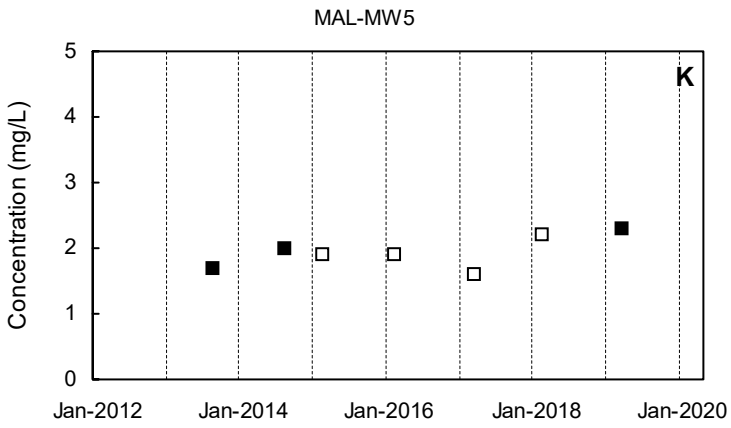
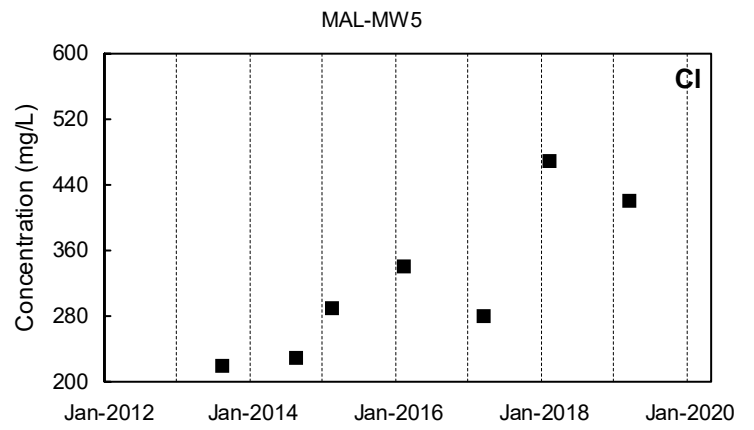
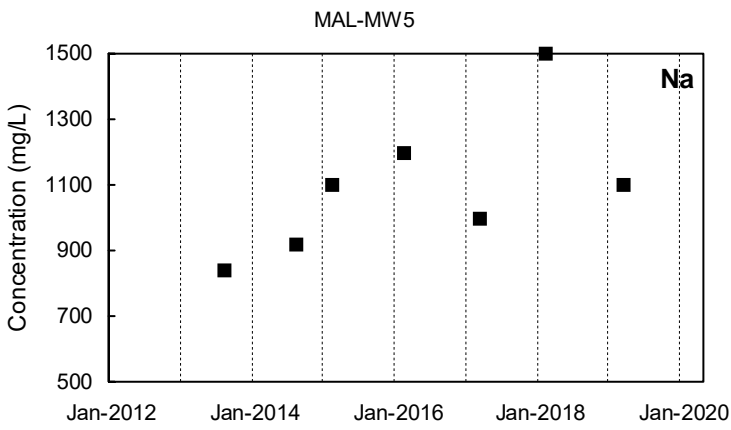

■ Detected Value □ 'J'-Flag (value between reporting limit and detection limit) ■ Non-Detect Range
 Shallow Well shown with black symbols Deep Well shown with orange symbols "dd" Well shown with blue symbols

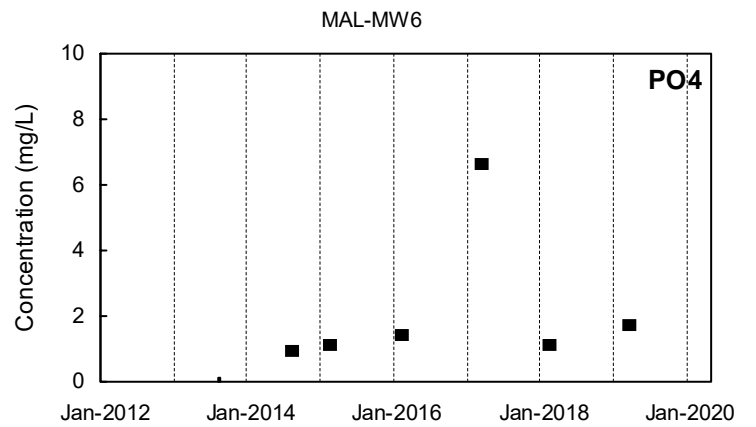
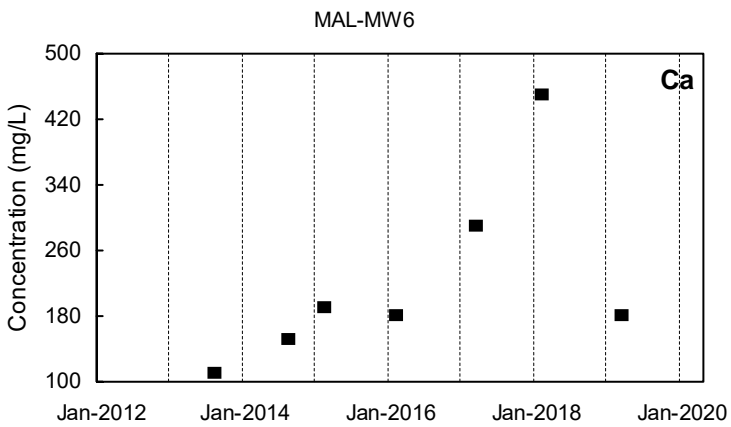
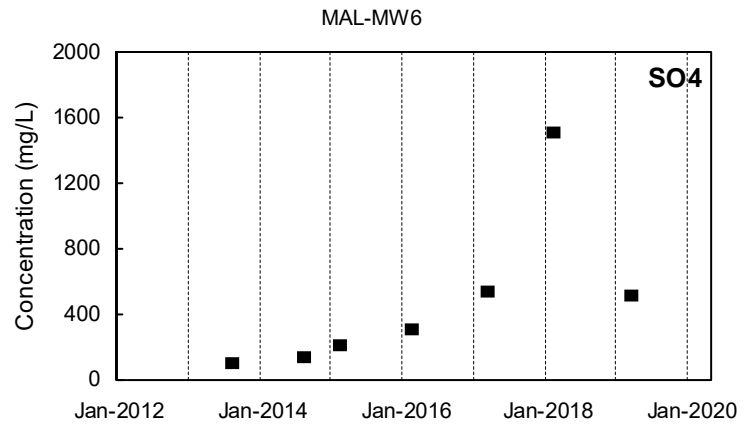
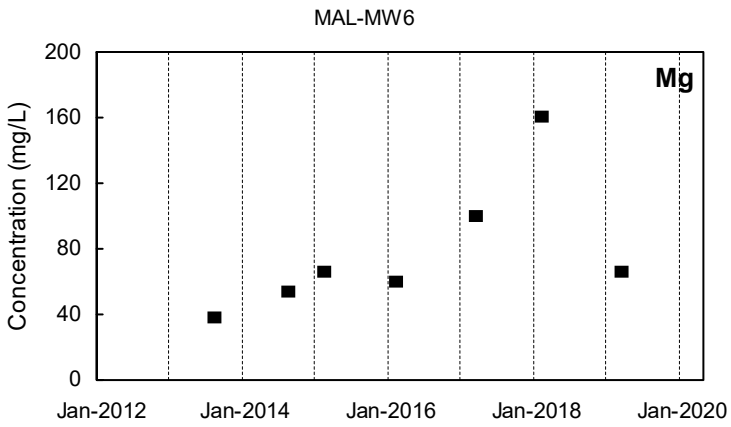
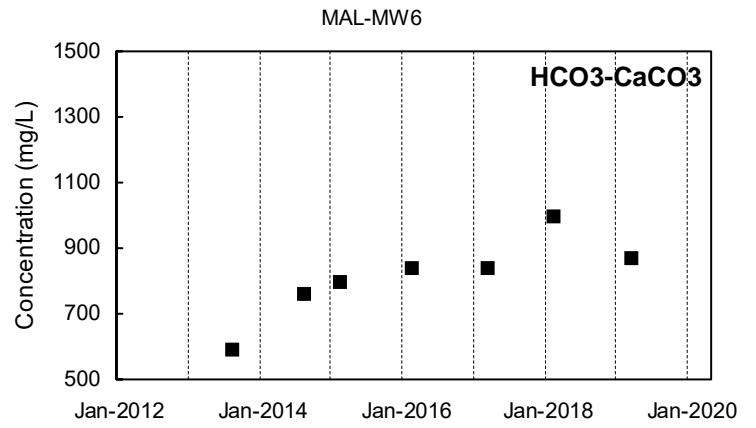
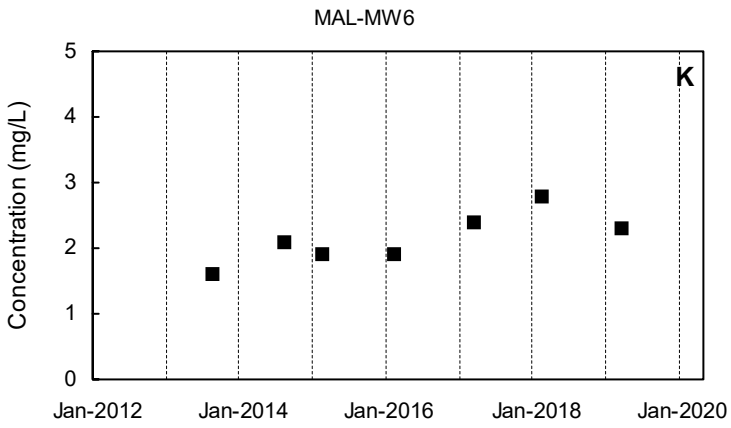
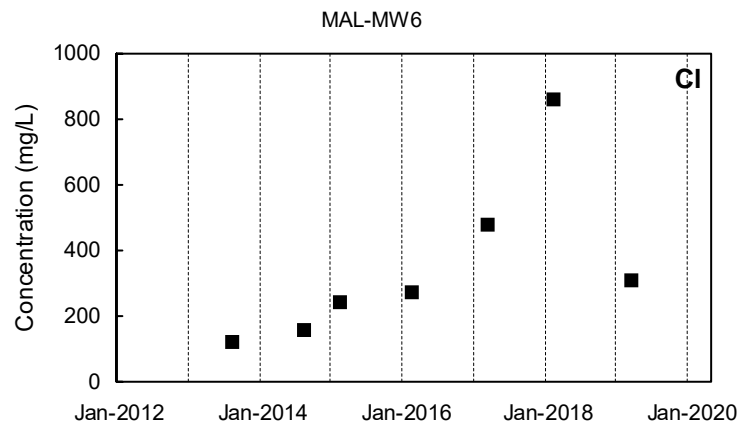
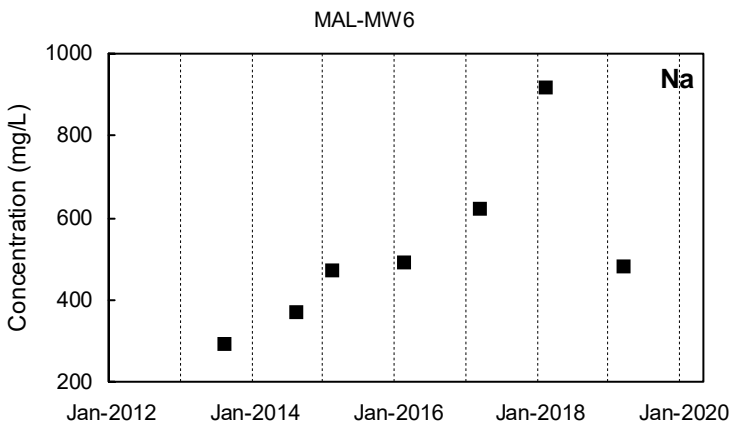

■ Detected Value □ 'J'-Flag (value between reporting limit and detection limit) ■ Non-Detect Range
 Shallow Well shown with black symbols Deep Well shown with orange symbols "dd" Well shown with blue symbols

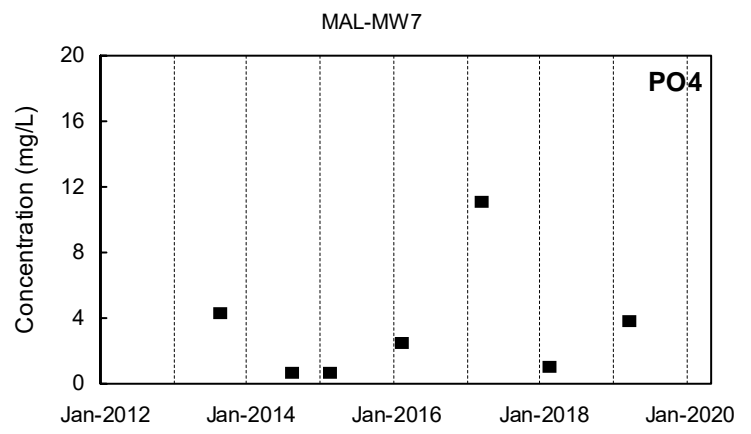
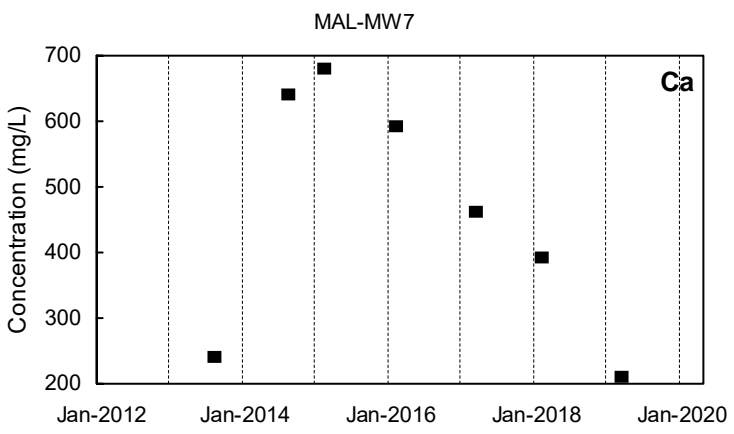
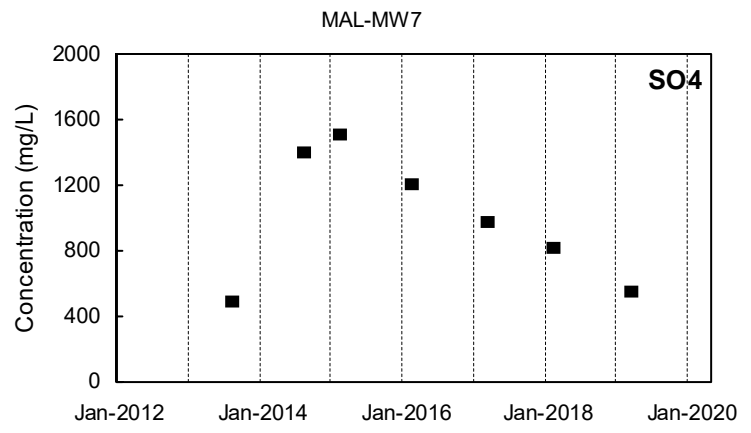
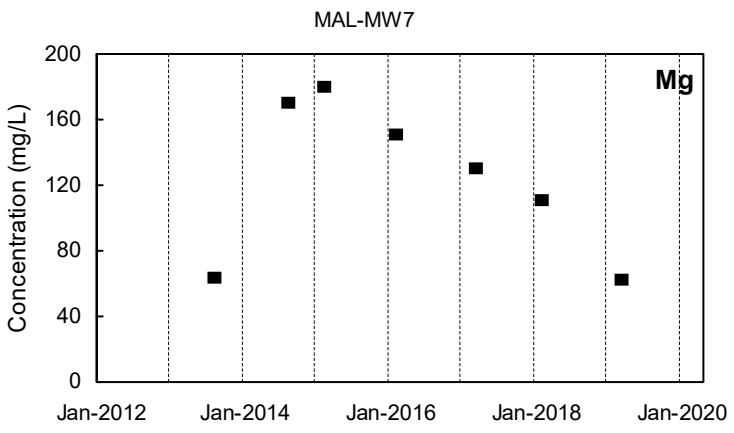
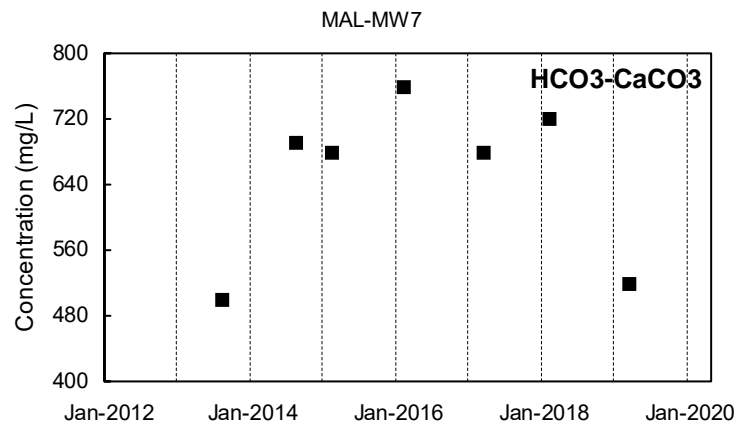
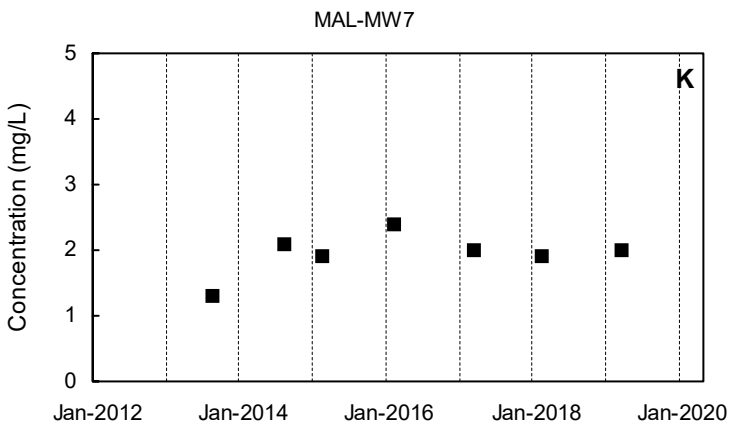
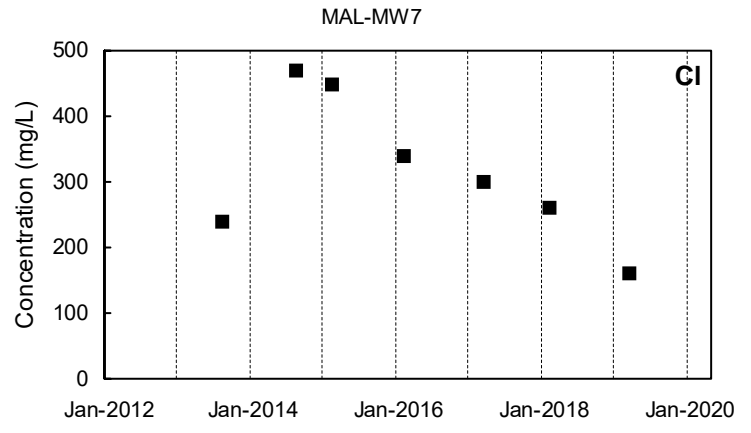
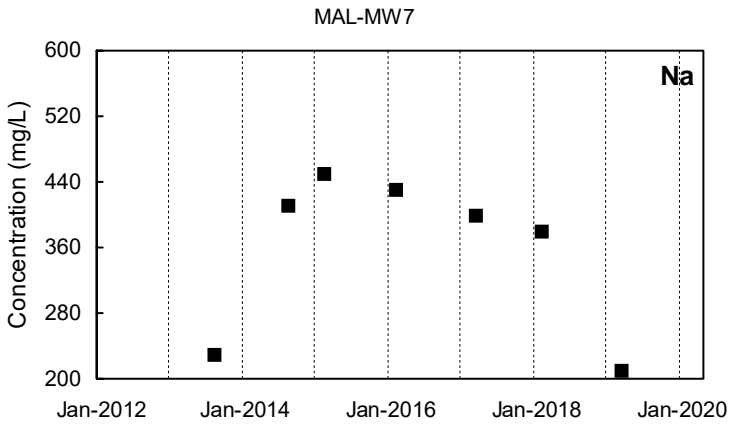

Detected Value
 'J'-Flag (value between reporting limit and detection limit)
 Non-Detect Range
 Shallow Well shown with black symbols
 Deep Well shown with orange symbols
 "dd" Well shown with blue symbols

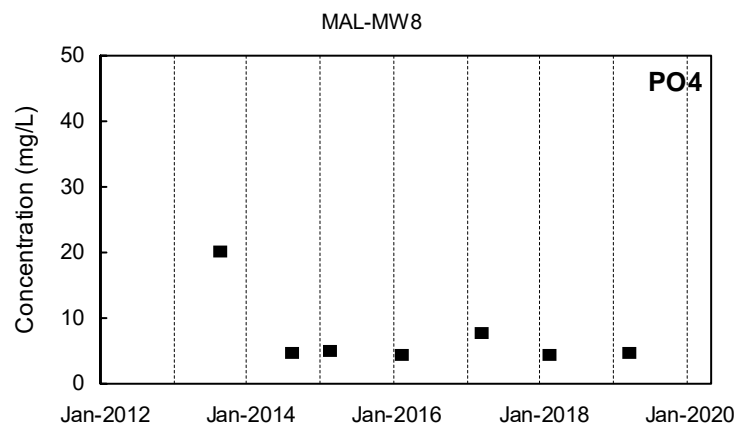
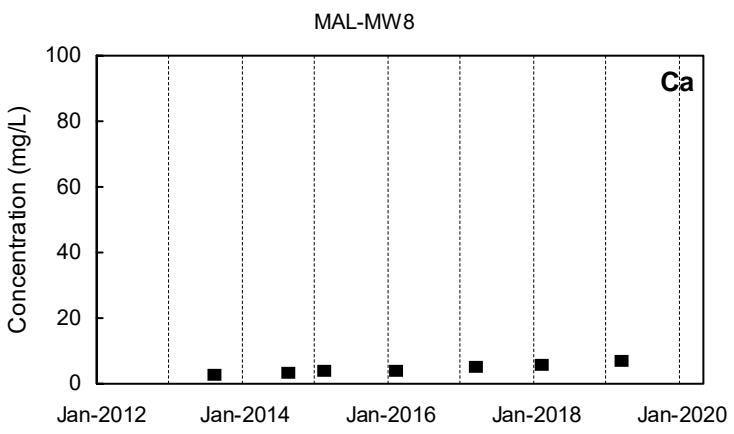
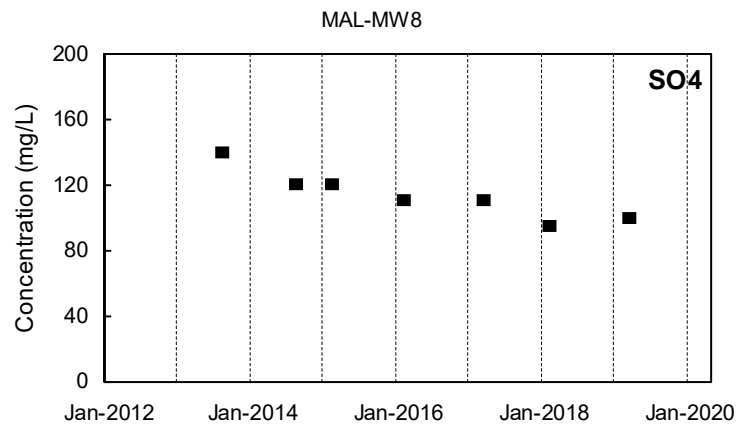
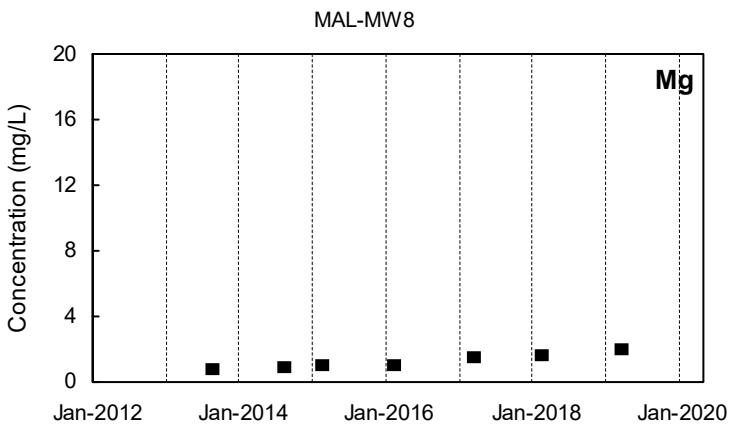
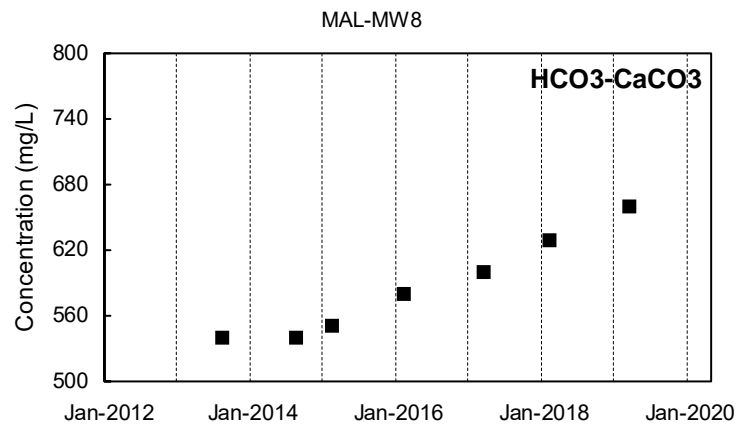
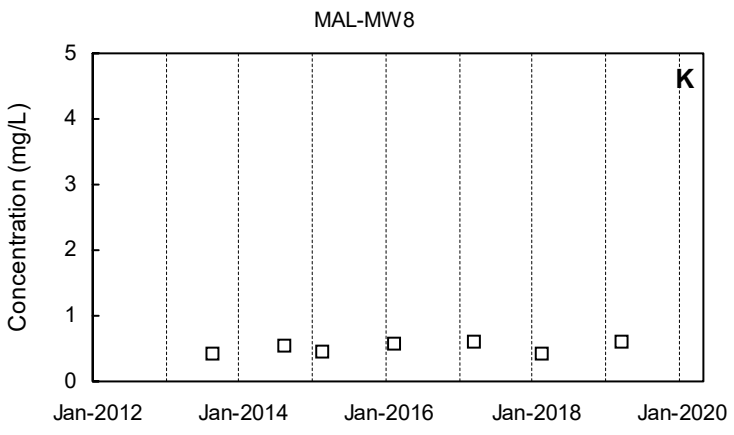
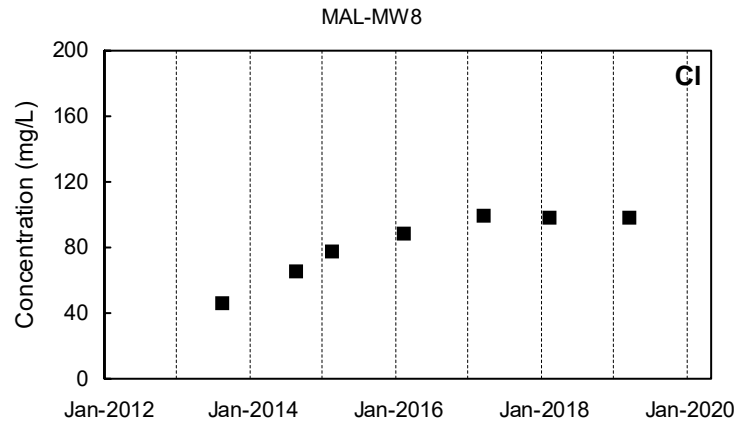
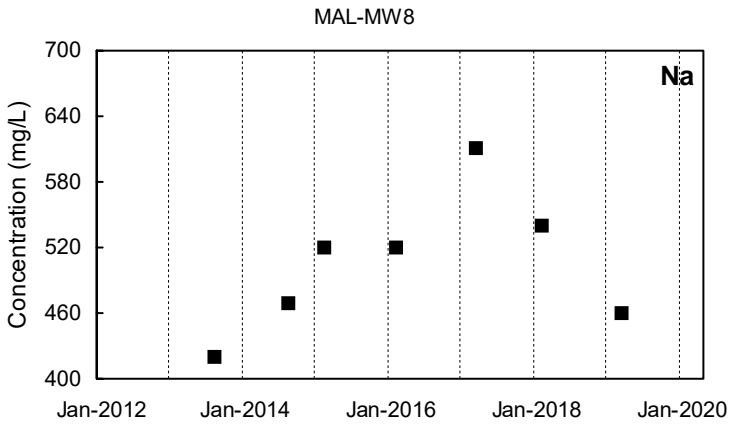

■ Detected Value □ 'J'-Flag (value between reporting limit and detection limit) [] Non-Detect Range
 Shallow Well shown with black symbols Deep Well shown with orange symbols "dd" Well shown with blue symbols

MAP-MW8

MAP-MW8

Na

Not Sampled

Cl

Not Sampled

MAP-MW8

MAP-MW8

K

Not Sampled

HCO3-CaCO3

Not Sampled

MAP-MW8

MAP-MW8

Mg

Not Sampled

SO4

Not Sampled

MAP-MW8

MAP-MW8

Ca

Not Sampled

PO4

Not Sampled

Detected Value
 'J'-Flag (value between reporting limit and detection limit)
 Non-Detect Range

Shallow Well shown with black symbols
 Deep Well shown with orange symbols
 "dd" Well shown with blue symbols

MAP-MW9

Na

Not Sampled

MAP-MW9

Cl

Not Sampled

MAP-MW9

K

Not Sampled

MAP-MW9

HCO3-CaCO3

Not Sampled

MAP-MW9

Mg

Not Sampled

MAP-MW9

SO4

Not Sampled

MAP-MW9

Ca

Not Sampled

MAP-MW9

PO4

Not Sampled

■ Detected Value

□ 'J'-Flag (value between reporting limit and detection limit)



Non-Detect Range

Shallow Well shown with black symbols

Deep Well shown with orange symbols

"dd" Well shown with blue symbols

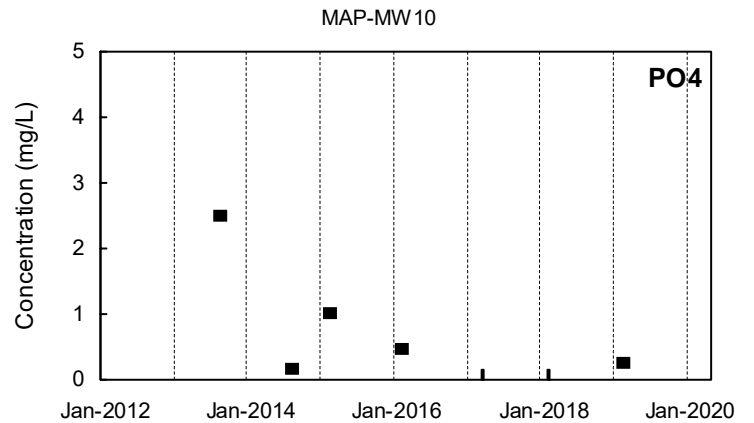
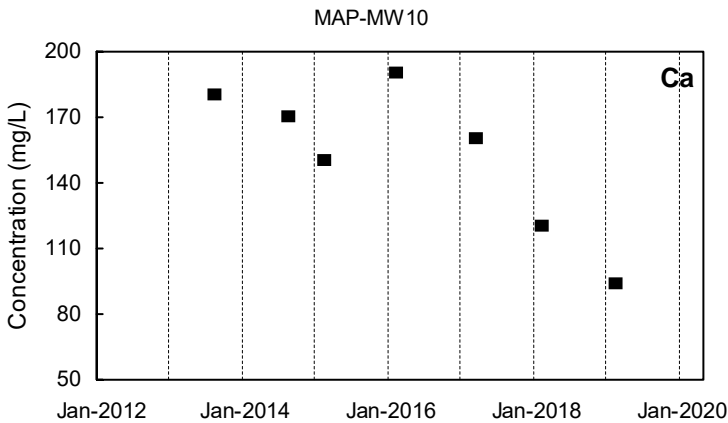
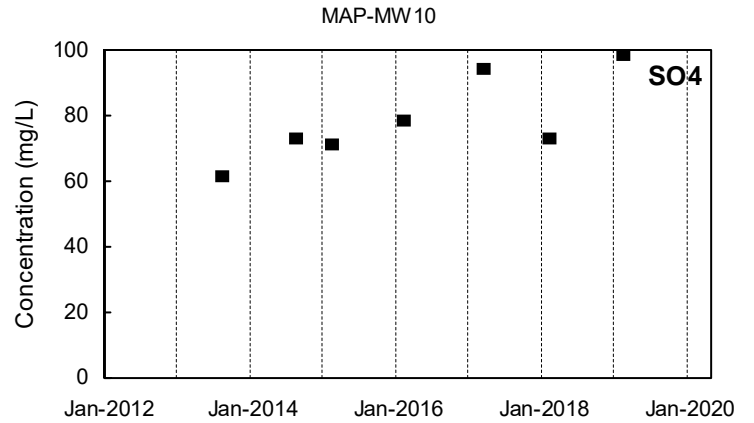
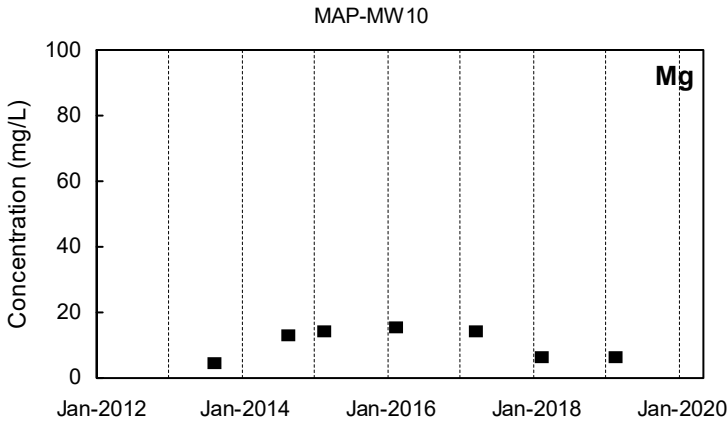
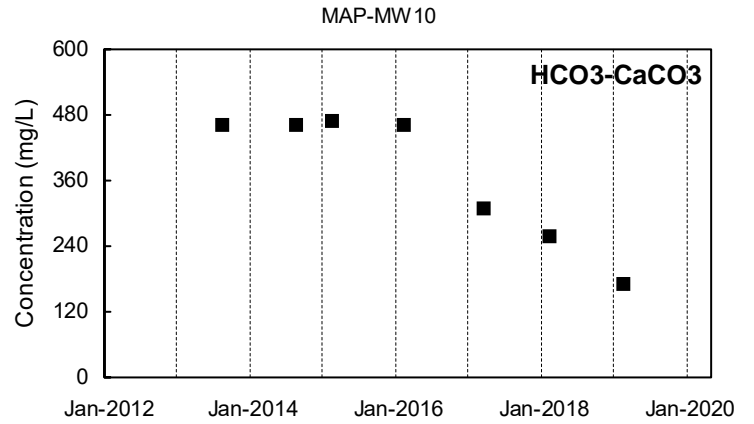
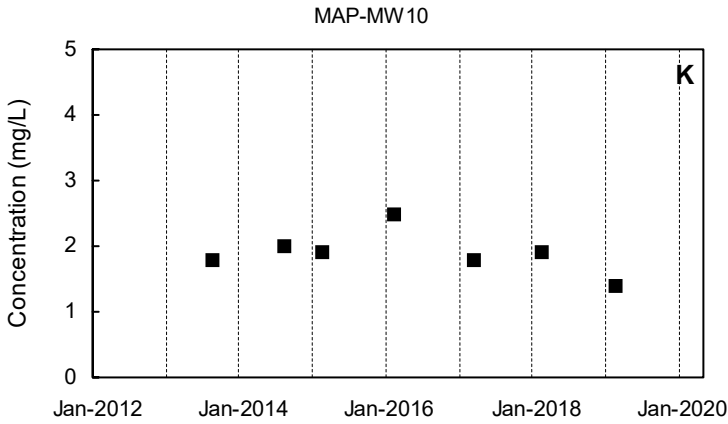
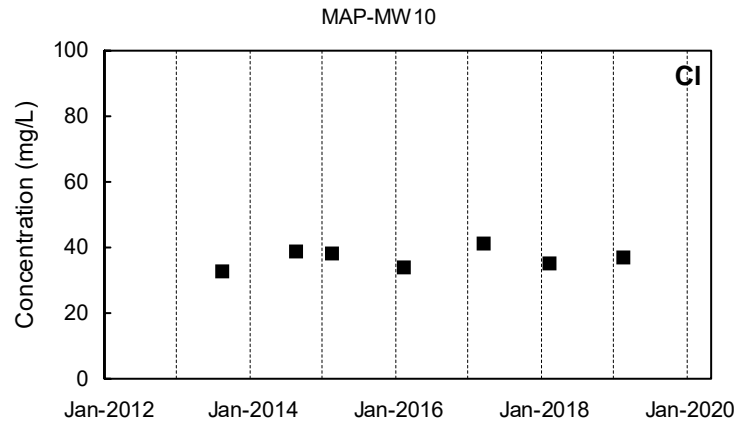
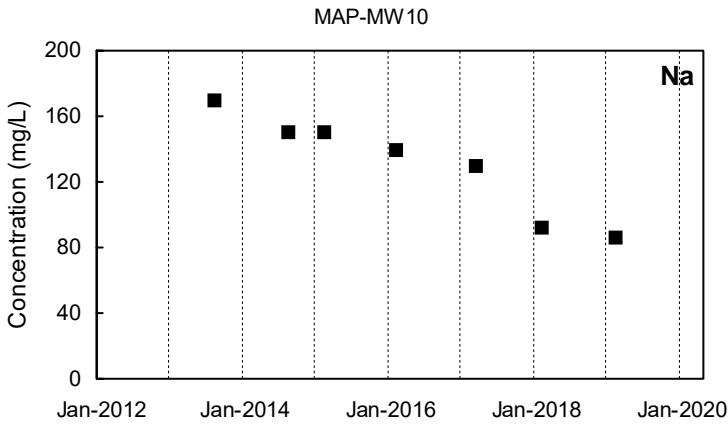

Detected Value
 'J'-Flag (value between reporting limit and detection limit)
 Non-Detect Range
 Shallow Well shown with black symbols
 Deep Well shown with orange symbols
 "dd" Well shown with blue symbols

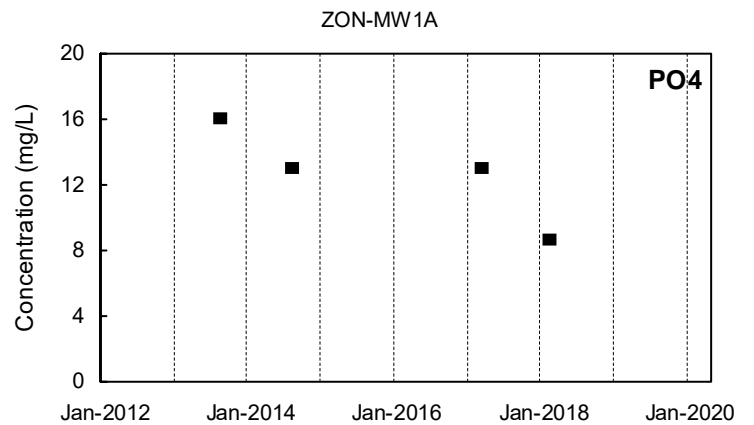
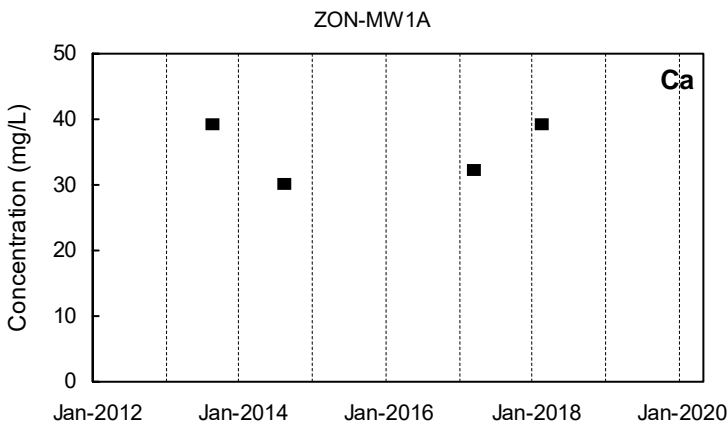
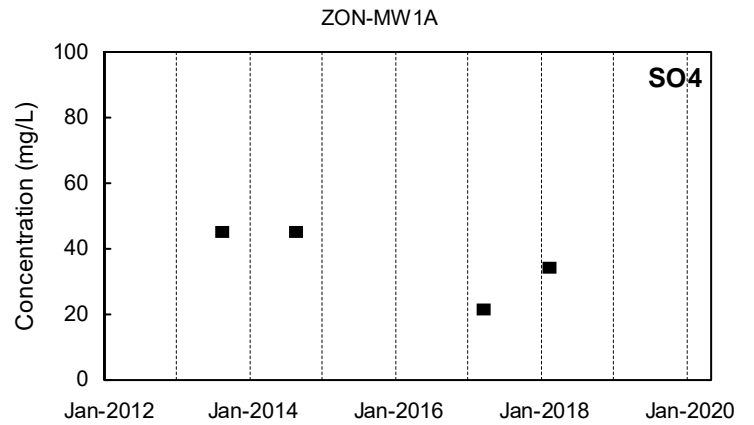
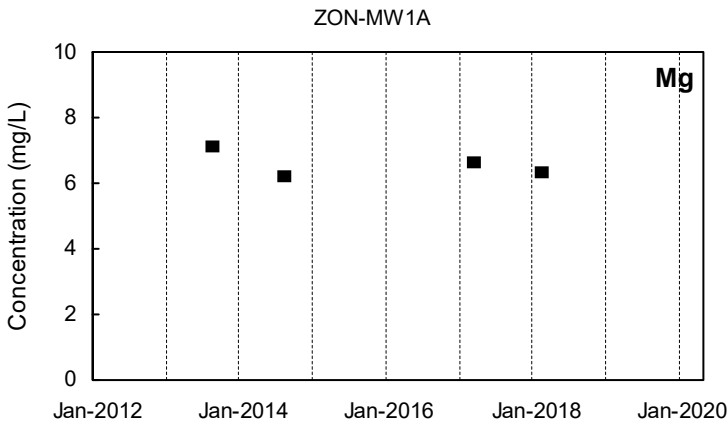
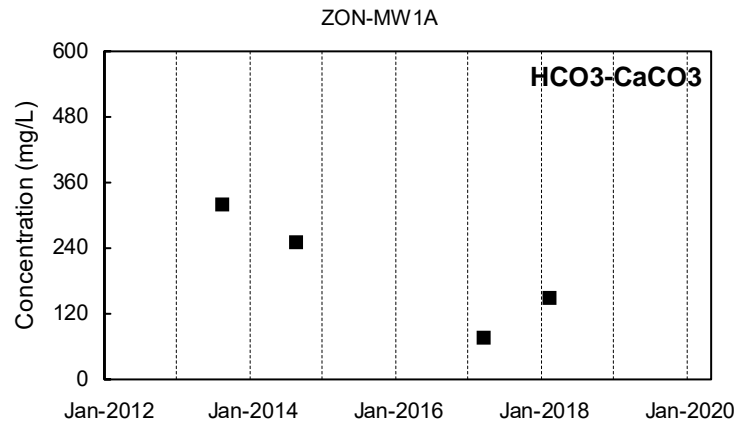
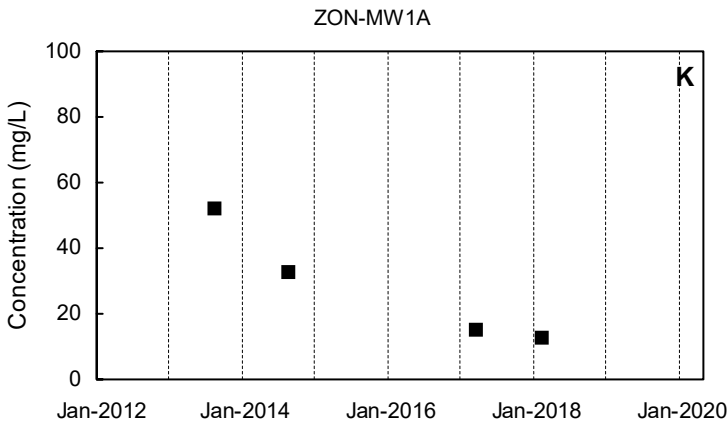
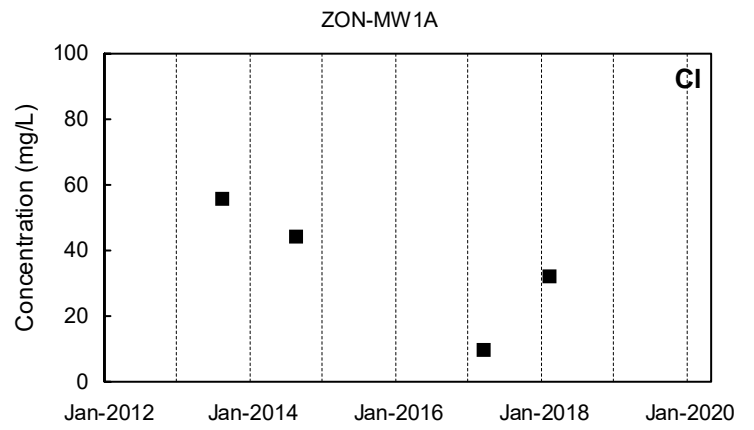
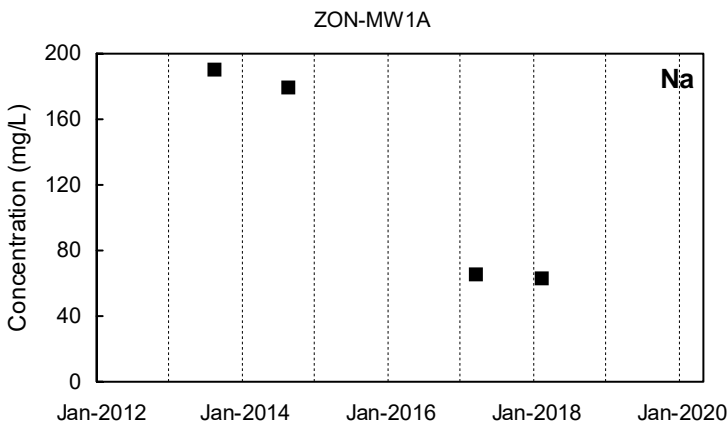

■ Detected Value □ 'J'-Flag (value between reporting limit and detection limit) ■ Non-Detect Range
 Shallow Well shown with black symbols Deep Well shown with orange symbols "dd" Well shown with blue symbols

ZON-MW1B

ZON-MW1B

Na

Not Sampled

Cl

Not Sampled

ZON-MW1B

ZON-MW1B

K

Not Sampled

HCO3-CaCO3

Not Sampled

ZON-MW1B

ZON-MW1B

Mg

Not Sampled

SO4

Not Sampled

ZON-MW1B

ZON-MW1B

Ca

Not Sampled

PO4

Not Sampled

Detected Value
 'J'-Flag (value between reporting limit and detection limit)
 Non-Detect Range
 Shallow Well shown with black symbols
 Deep Well shown with orange symbols
 "dd" Well shown with blue symbols

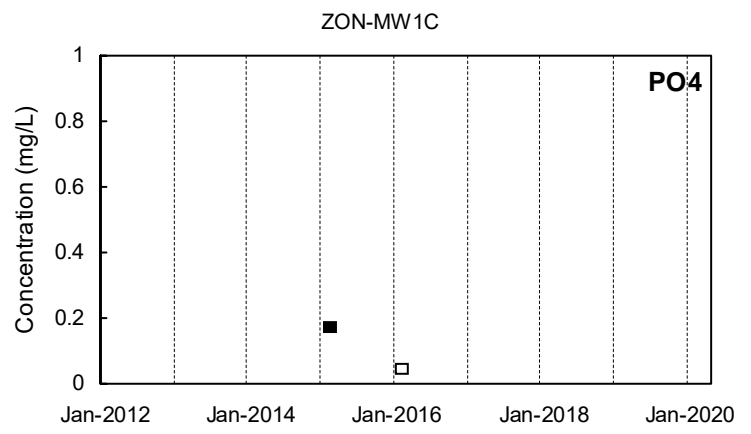
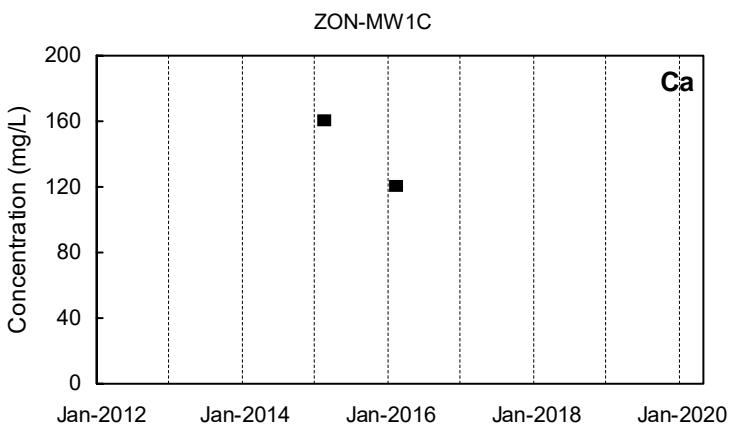
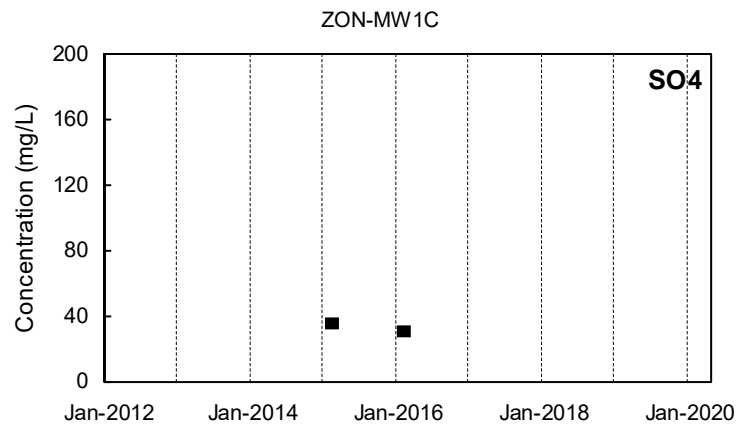
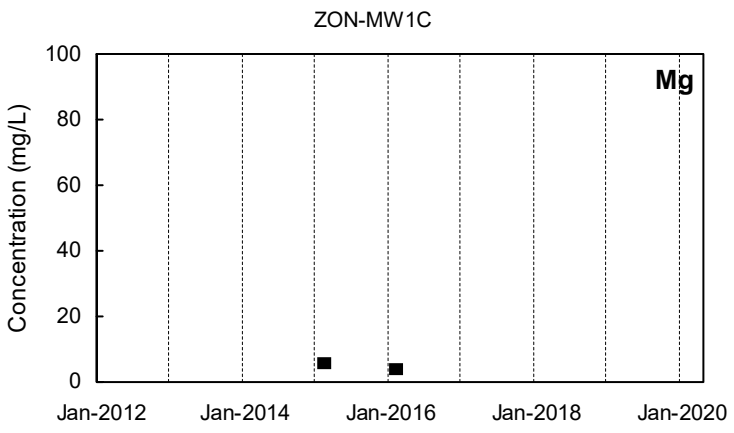
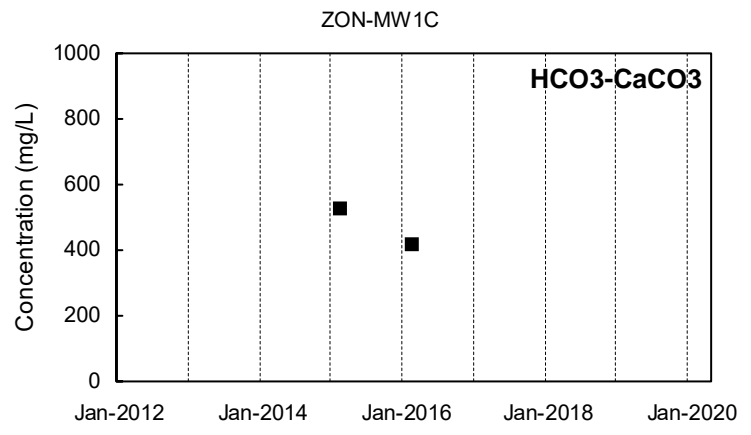
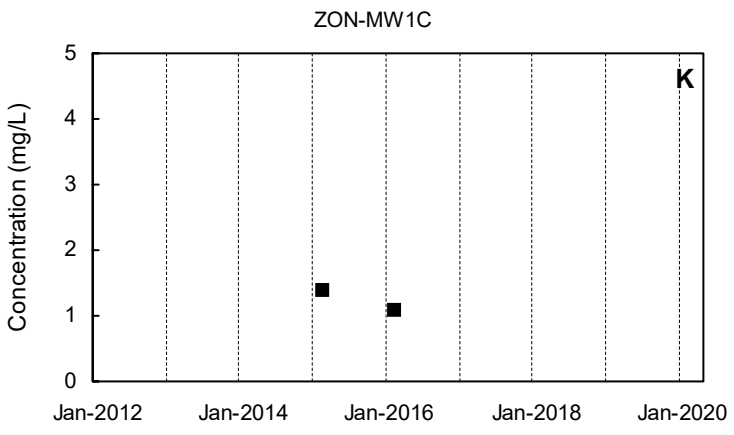
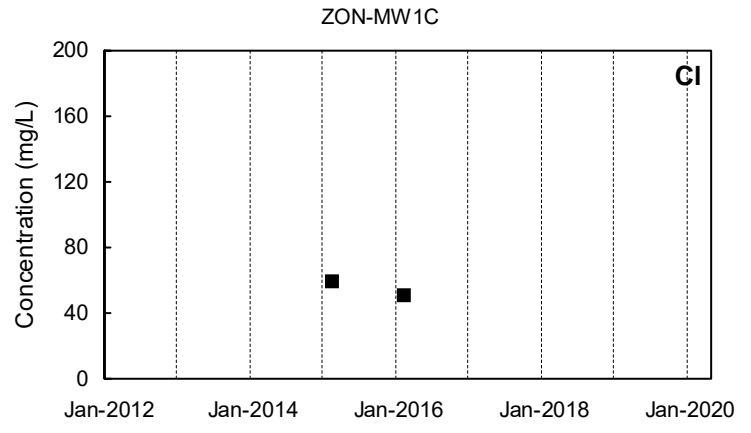
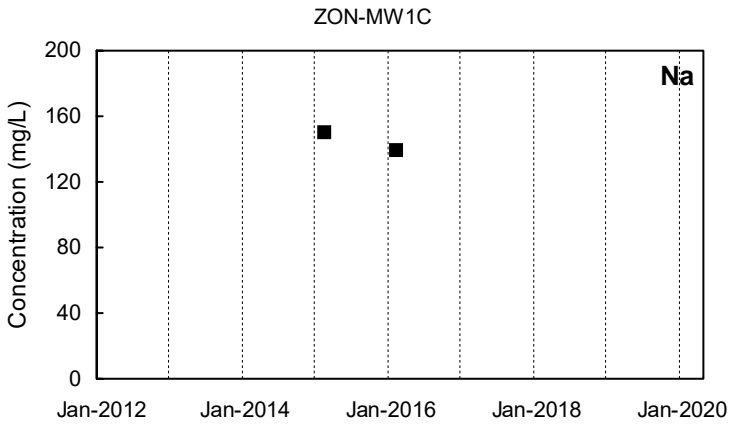

Detected Value
 'J'-Flag (value between reporting limit and detection limit)
 Non-Detect Range

Shallow Well shown with black symbols
Deep Well shown with orange symbols
"dd" Well shown with blue symbols

ZON-MW2A

ZON-MW2A

Na

Not Sampled

Cl

Not Sampled

ZON-MW2A

ZON-MW2A

K

Not Sampled

HCO3-CaCO3

Not Sampled

ZON-MW2A

ZON-MW2A

Mg

Not Sampled

SO4

Not Sampled

ZON-MW2A

ZON-MW2A

Ca

Not Sampled

PO4

Not Sampled

Detected Value
 'J'-Flag (value between reporting limit and detection limit)
 Non-Detect Range
 Shallow Well shown with black symbols
 Deep Well shown with orange symbols
 "dd" Well shown with blue symbols

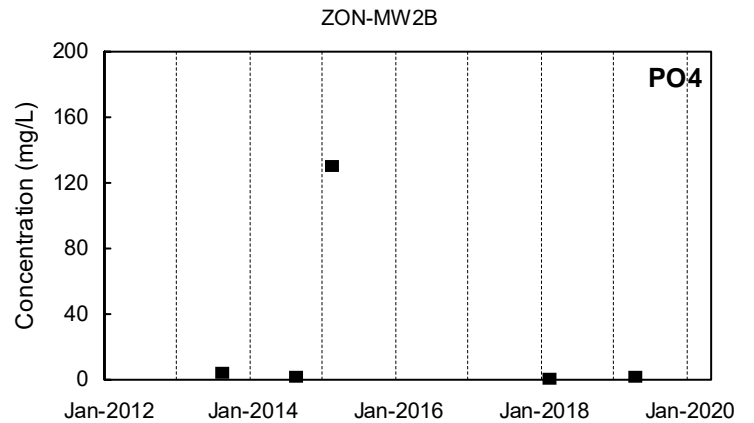
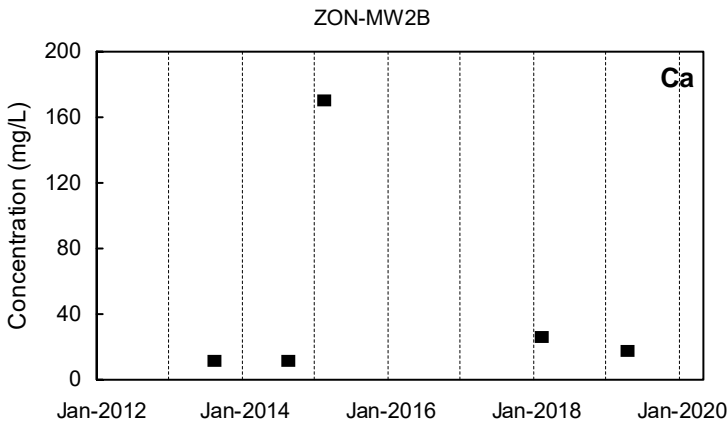
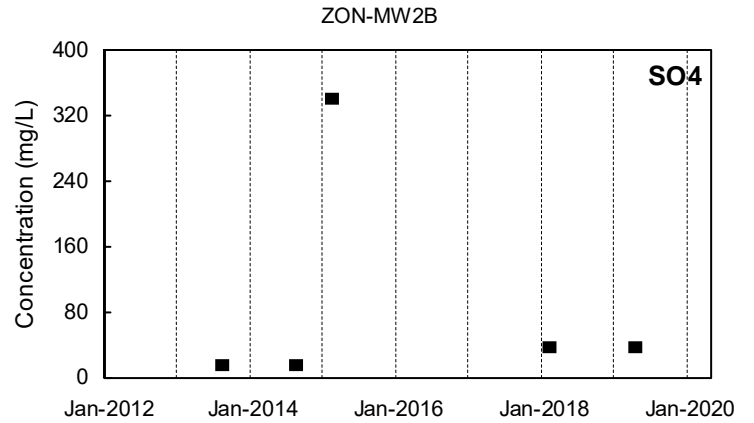
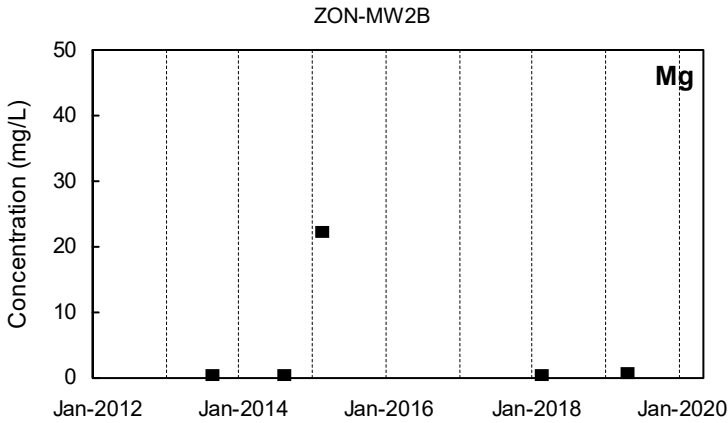
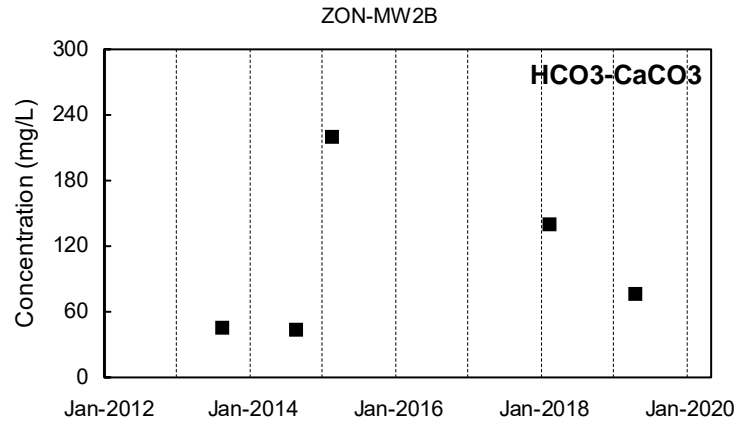
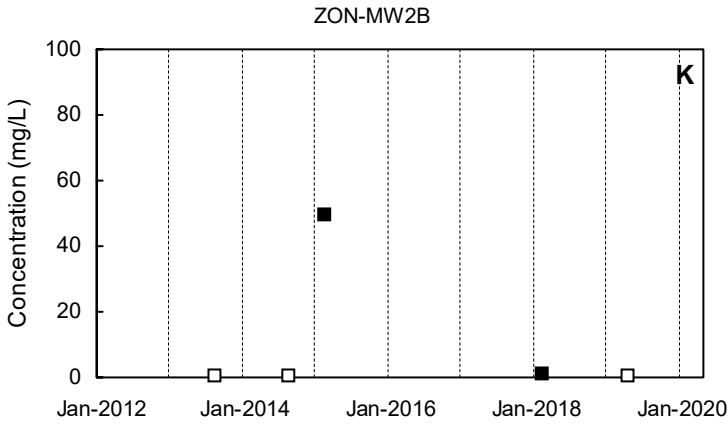
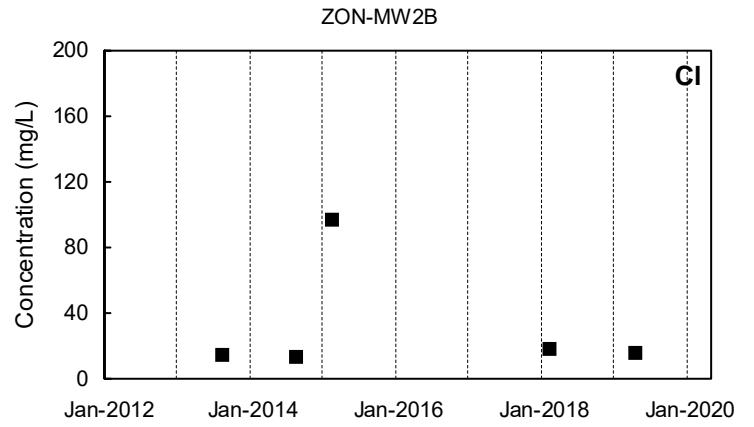
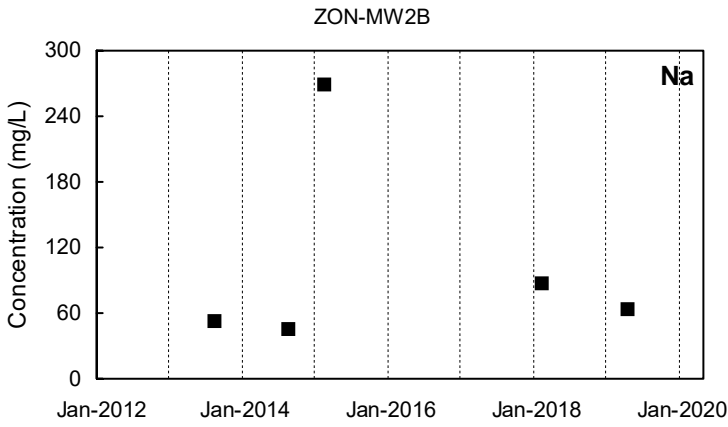

■ Detected Value □ 'J'-Flag (value between reporting limit and detection limit) ■ Non-Detect Range
 Shallow Well shown with black symbols Deep Well shown with orange symbols "dd" Well shown with blue symbols

ZON-MW3A

ZON-MW3A

Na

Not Sampled

Cl

Not Sampled

ZON-MW3A

ZON-MW3A

K

Not Sampled

HCO3-CaCO3

Not Sampled

ZON-MW3A

ZON-MW3A

Mg

Not Sampled

SO4

Not Sampled

ZON-MW3A

ZON-MW3A

Ca

Not Sampled

PO4

Not Sampled

■ Detected Value

□ 'J'-Flag (value between reporting limit and detection limit)



Non-Detect Range

Shallow Well shown with black symbols

Deep Well shown with orange symbols

"dd" Well shown with blue symbols

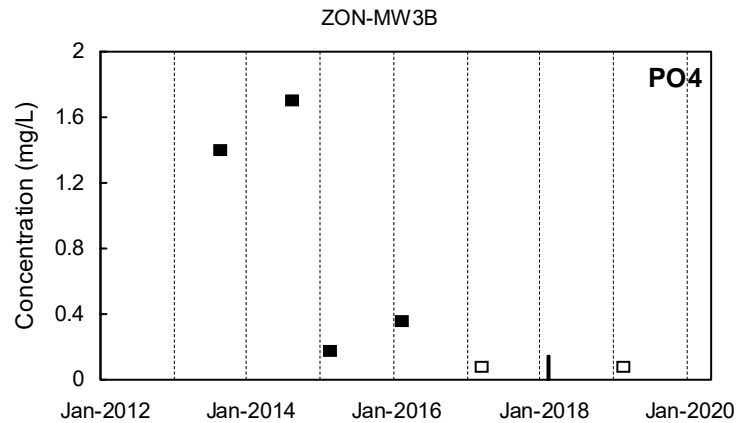
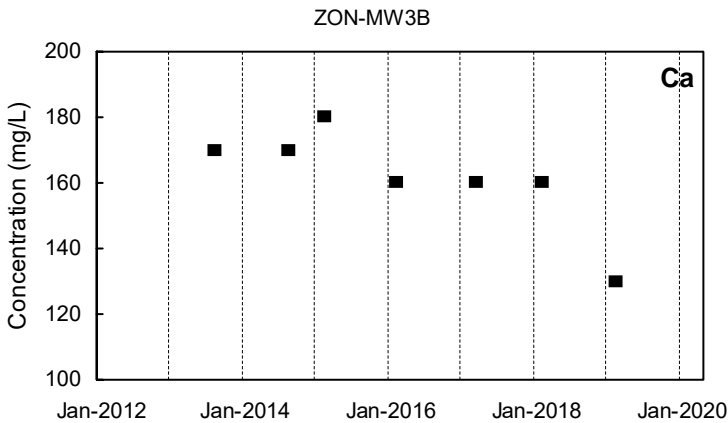
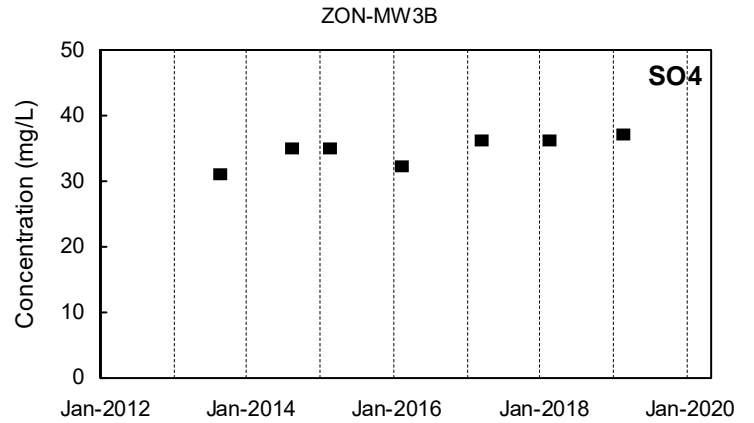
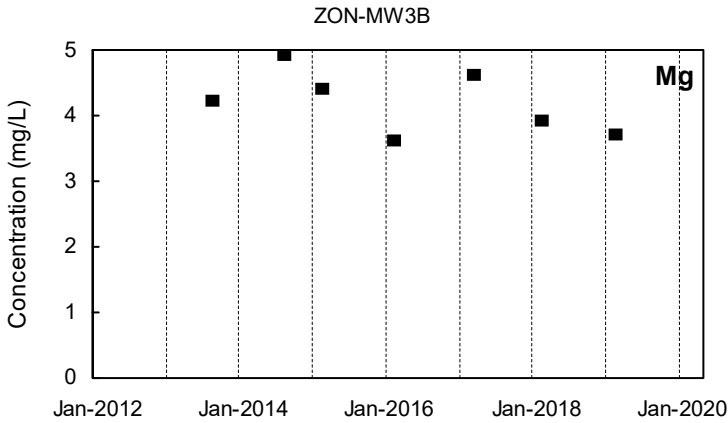
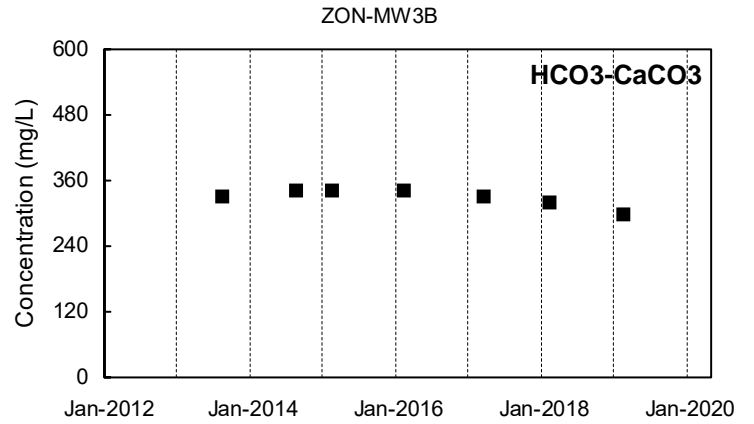
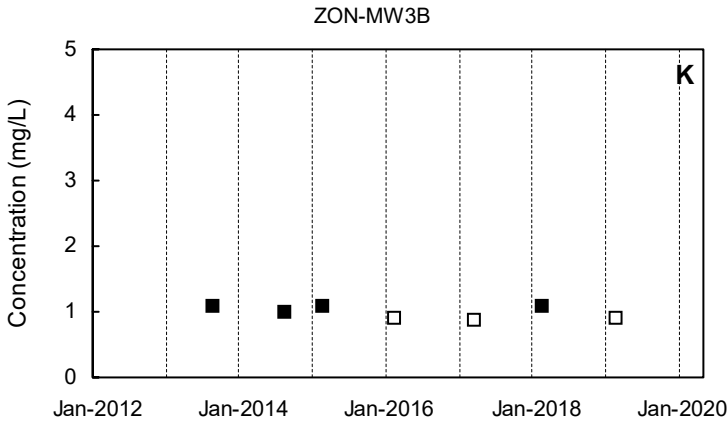
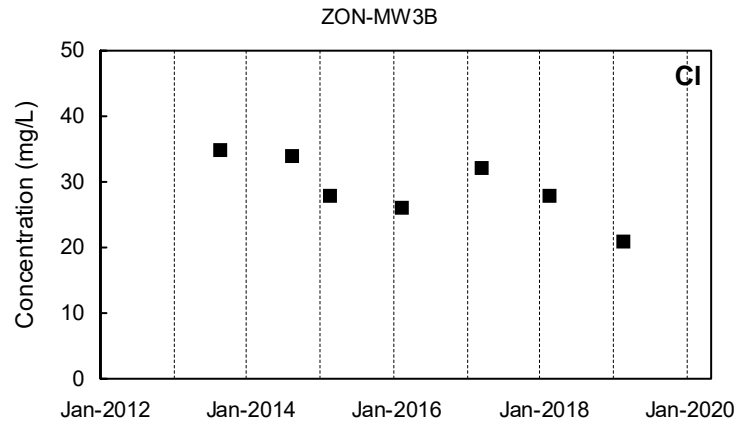
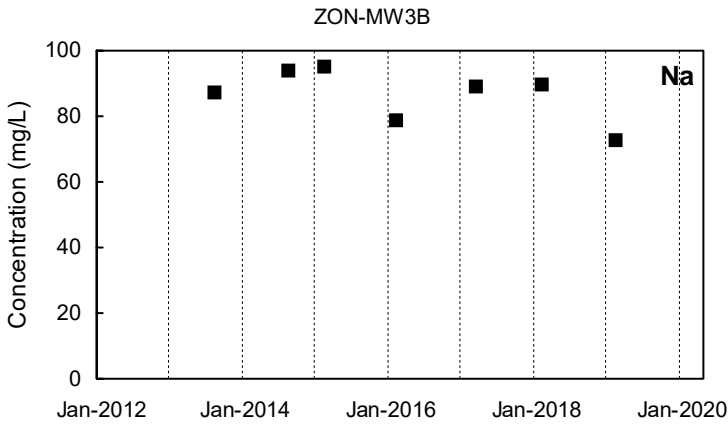

■ Detected Value □ 'J'-Flag (value between reporting limit and detection limit) ■ Non-Detect Range
 Shallow Well shown with black symbols Deep Well shown with orange symbols "dd" Well shown with blue symbols

ZON-MW4A

ZON-MW4A

Na

Cl

Not Sampled

Not Sampled

ZON-MW4A

ZON-MW4A

K

HCO3-CaCO3

Not Sampled

Not Sampled

ZON-MW4A

ZON-MW4A

Mg

SO4

Not Sampled

Not Sampled

ZON-MW4A

ZON-MW4A

Ca

PO4

Not Sampled

Not Sampled

Detected Value
 'J'-Flag (value between reporting limit and detection limit)
 Non-Detect Range
 Shallow Well shown with black symbols
 Deep Well shown with orange symbols
 "dd" Well shown with blue symbols

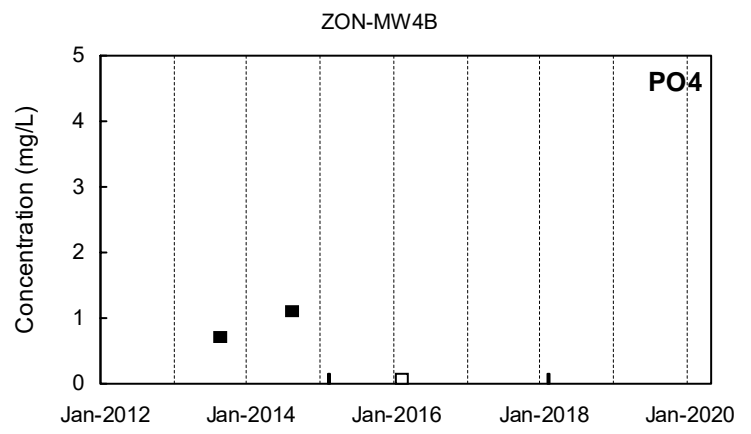
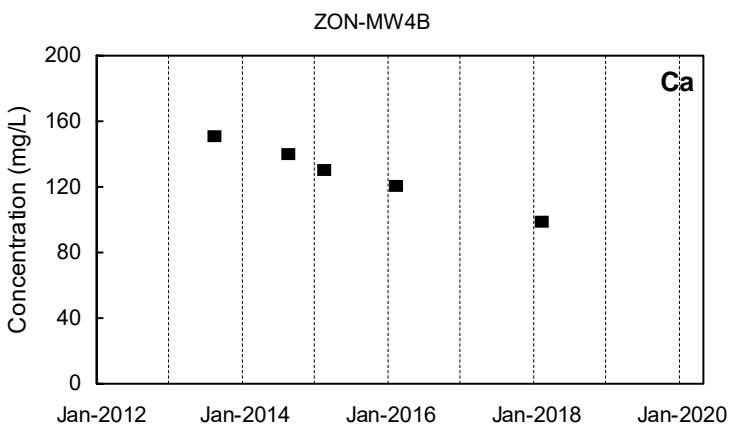
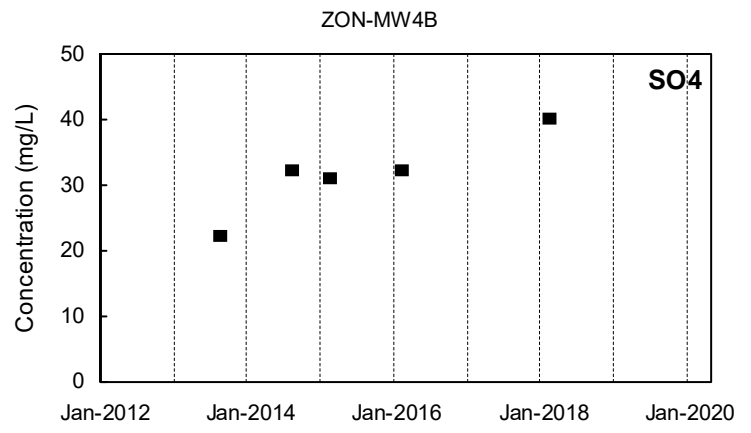
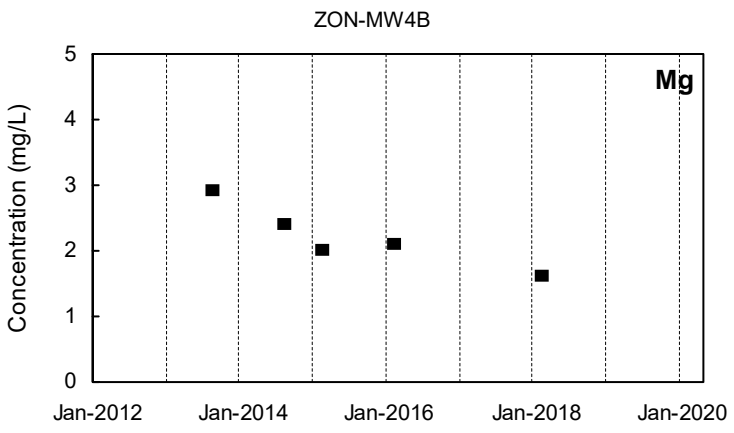
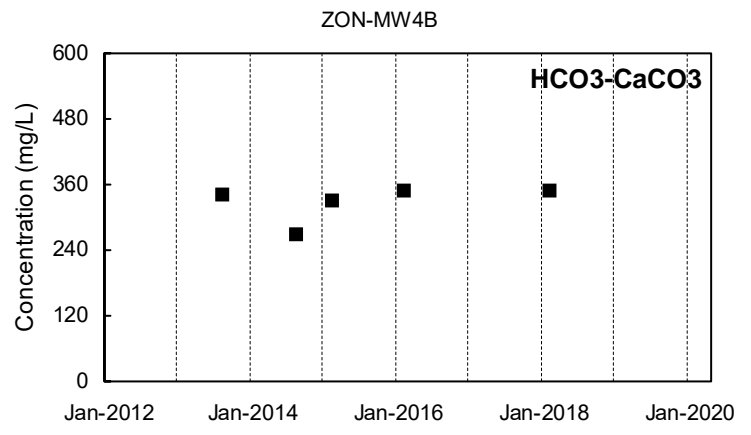
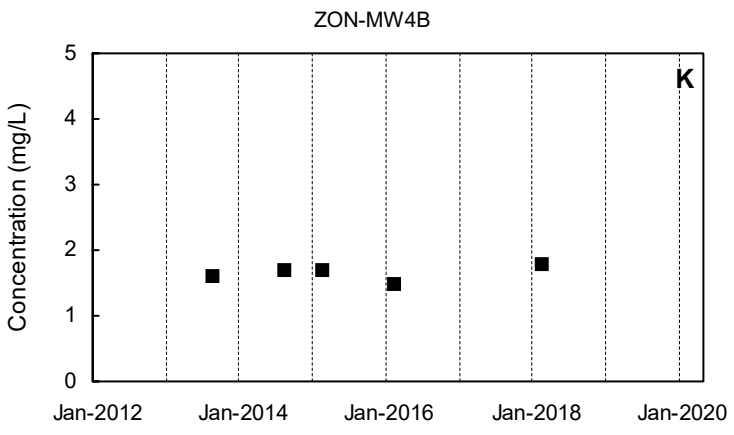
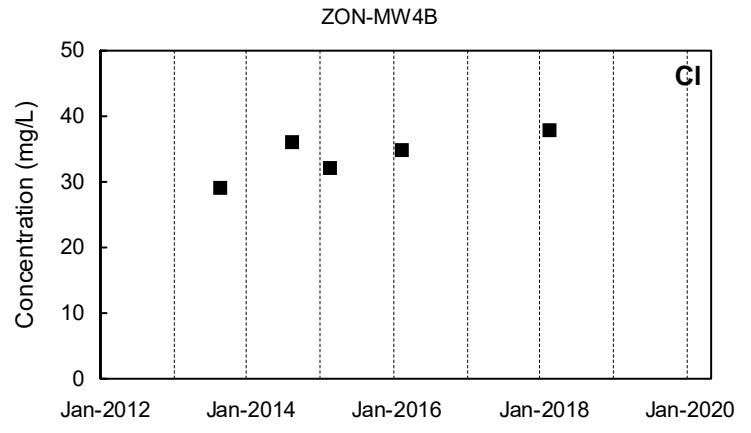
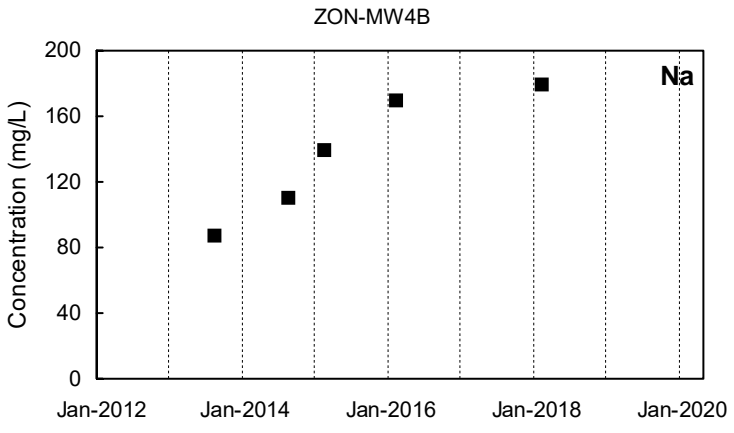

■ Detected Value □ 'J'-Flag (value between reporting limit and detection limit) ■ Non-Detect Range
 Shallow Well shown with black symbols Deep Well shown with orange symbols "dd" Well shown with blue symbols

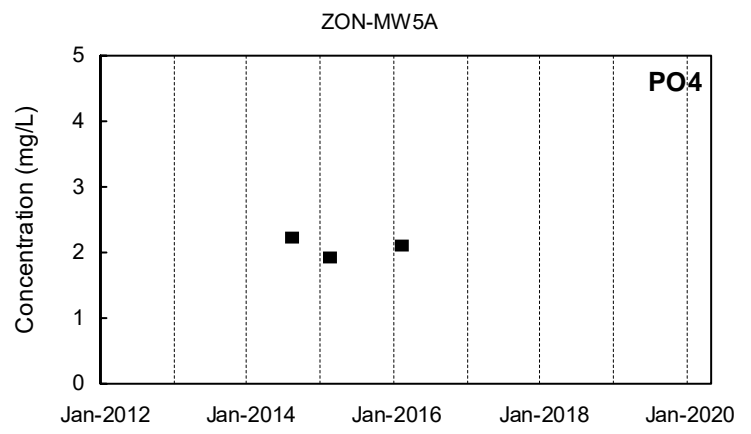
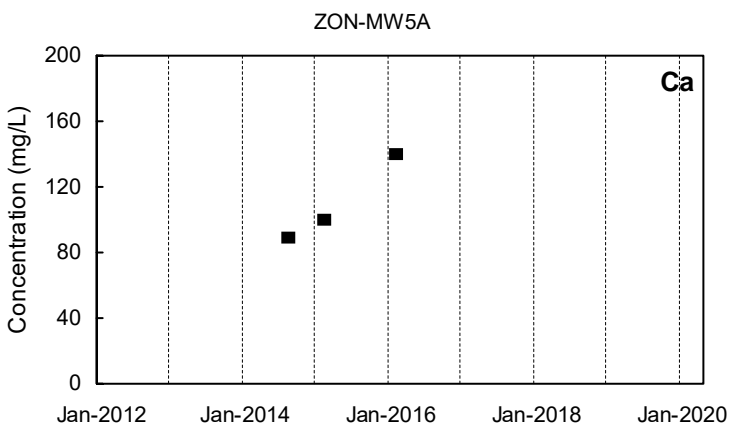
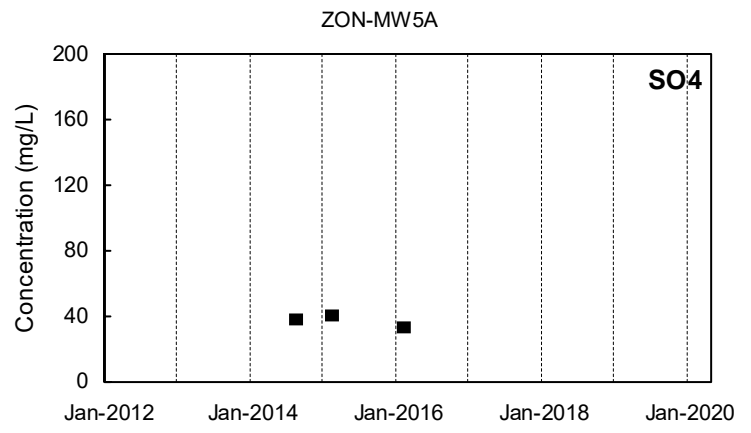
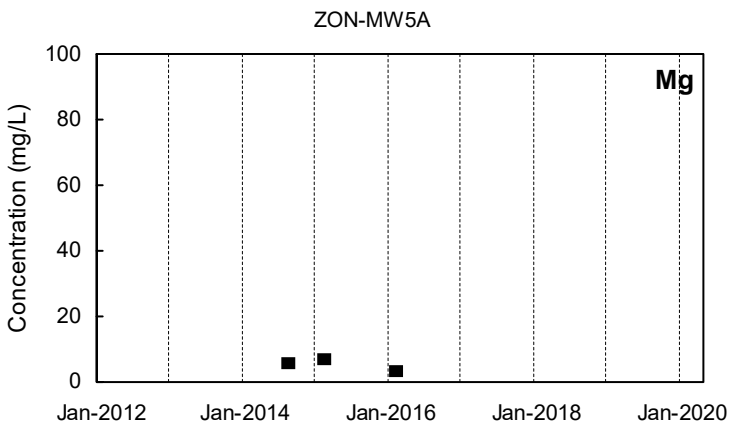
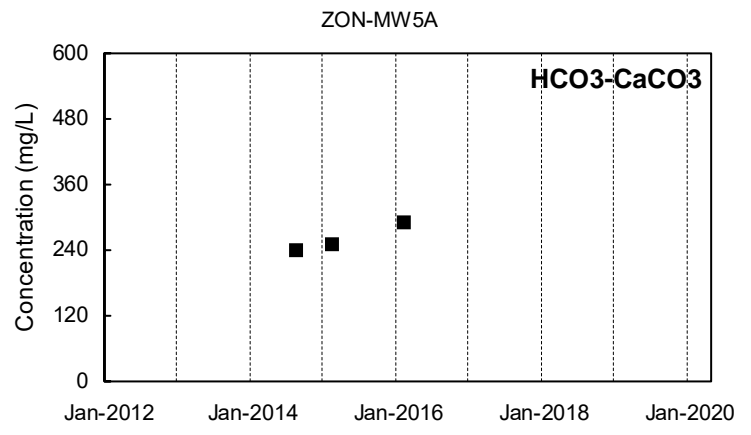
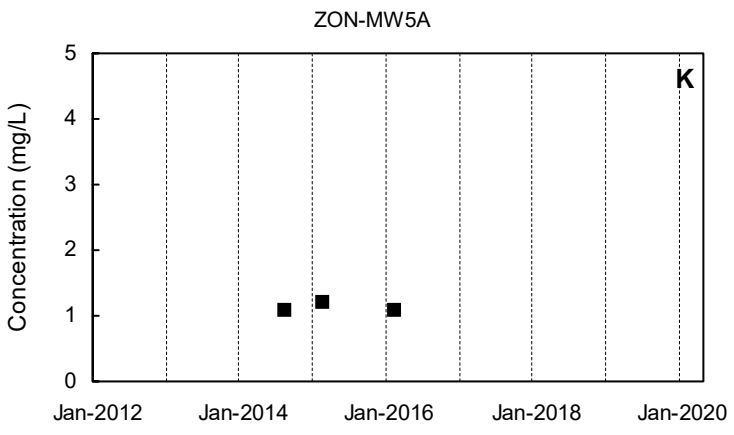
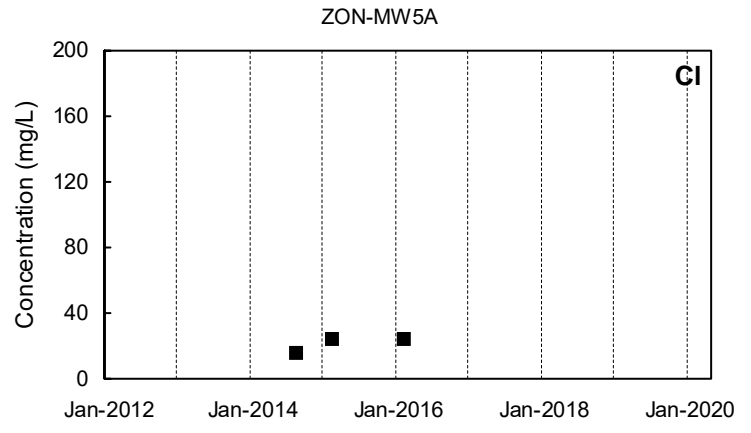
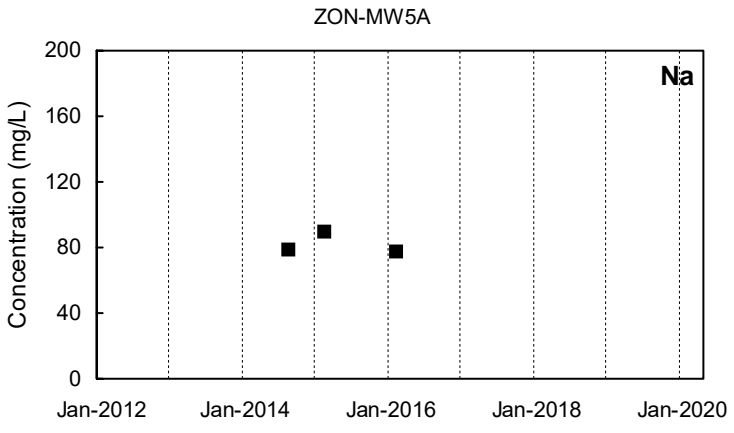

■ Detected Value □ 'J'-Flag (value between reporting limit and detection limit) ■ Non-Detect Range
 Shallow Well shown with black symbols Deep Well shown with orange symbols "dd" Well shown with blue symbols

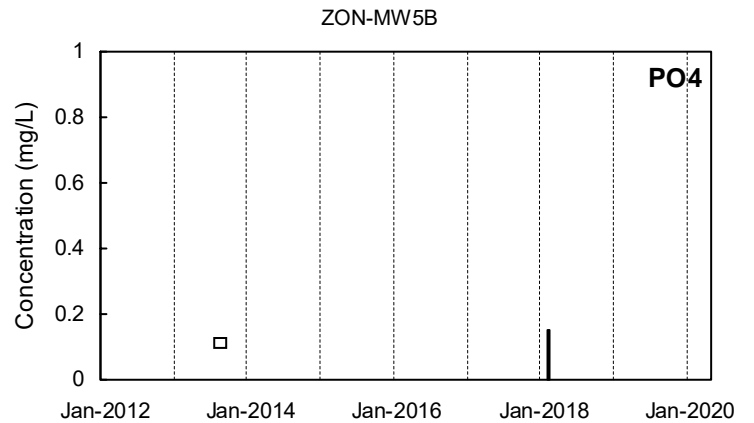
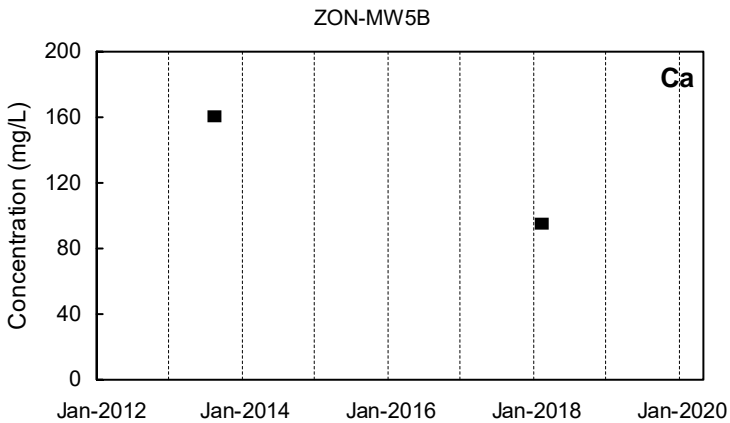
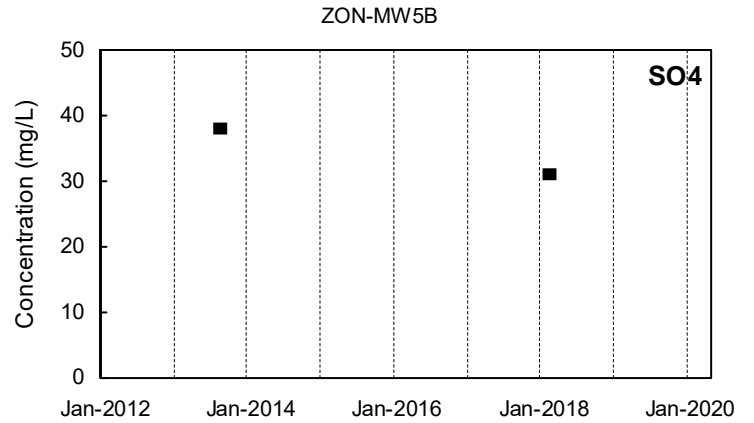
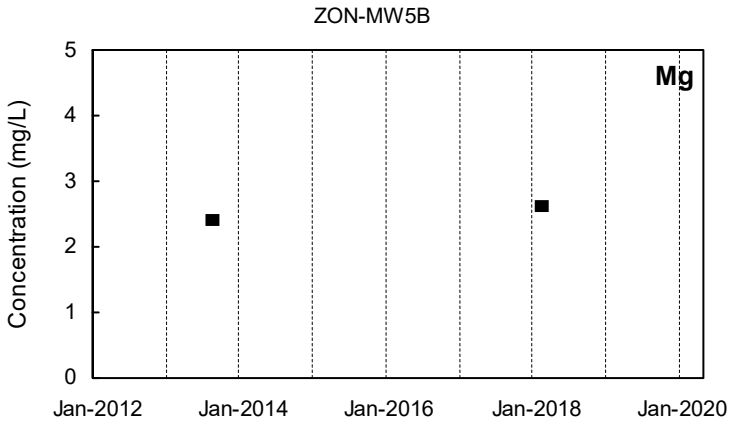
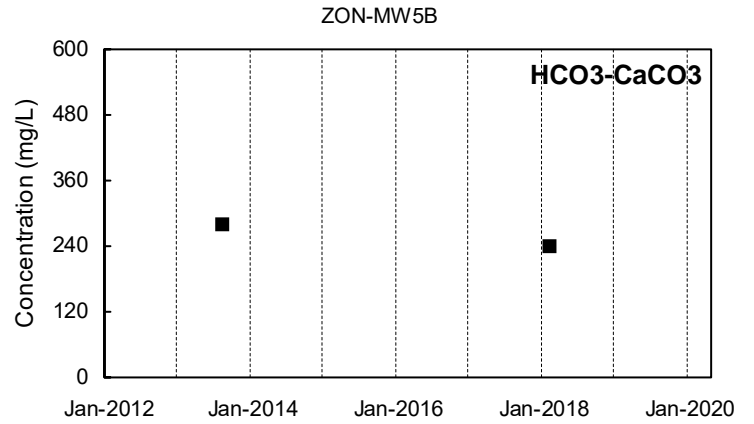
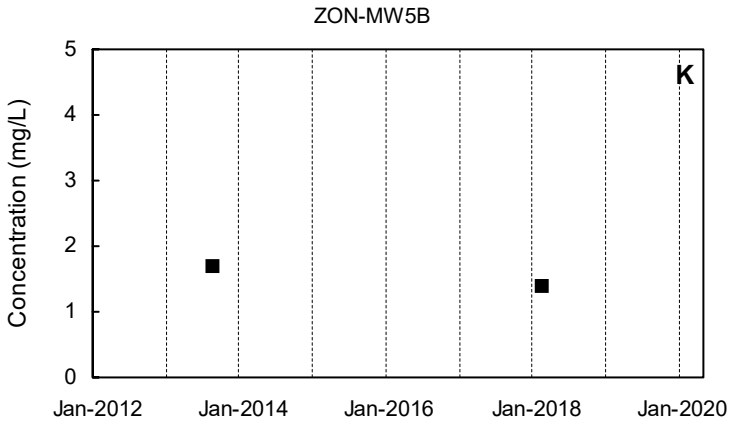
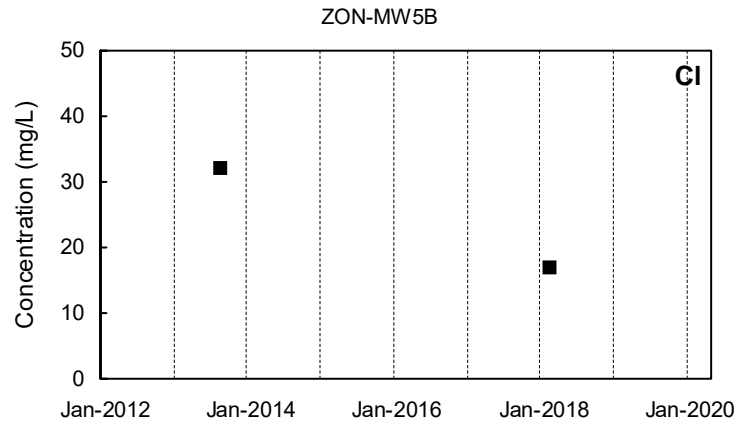
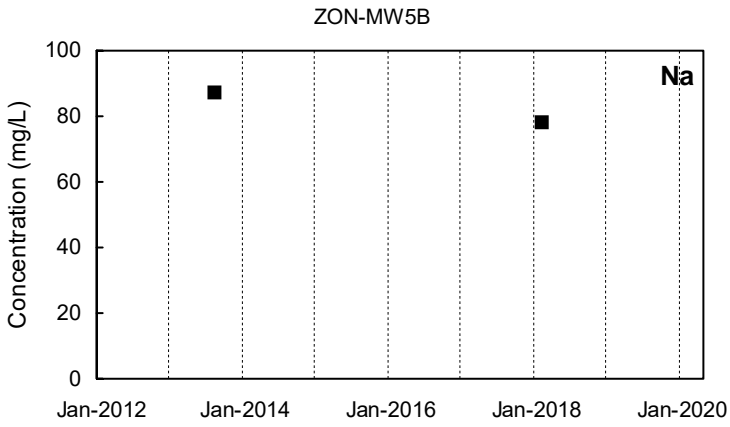

Detected Value
 'J'-Flag (value between reporting limit and detection limit)
 Non-Detect Range
 Shallow Well shown with black symbols
 Deep Well shown with orange symbols
 "dd" Well shown with blue symbols

ZON-MW7

ZON-MW7

Na

Not Sampled

Cl

Not Sampled

ZON-MW7

ZON-MW7

K

Not Sampled

HCO3-CaCO3

Not Sampled

ZON-MW7

ZON-MW7

Mg

Not Sampled

SO4

Not Sampled

ZON-MW7

ZON-MW7

Ca

Not Sampled

PO4

Not Sampled

Detected Value
 'J'-Flag (value between reporting limit and detection limit)
 Non-Detect Range
 Shallow Well shown with black symbols
 Deep Well shown with orange symbols
 "dd" Well shown with blue symbols

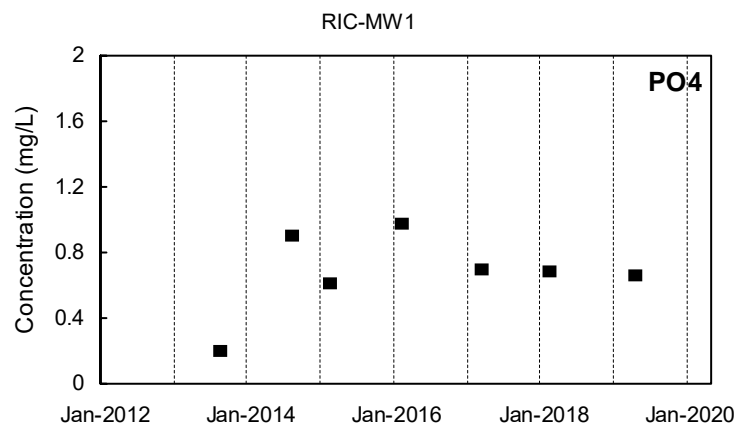
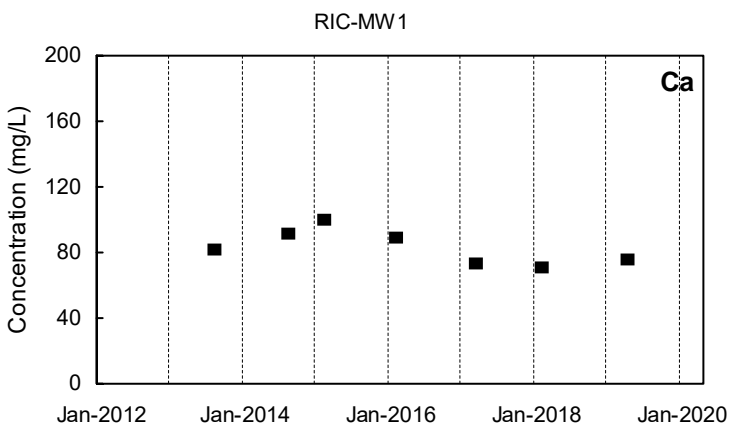
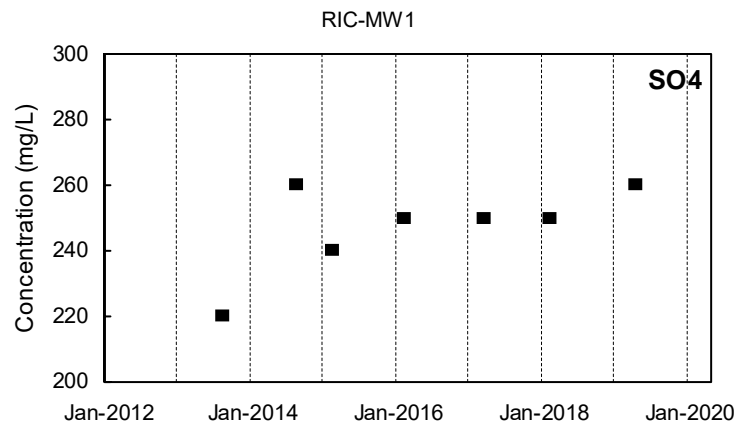
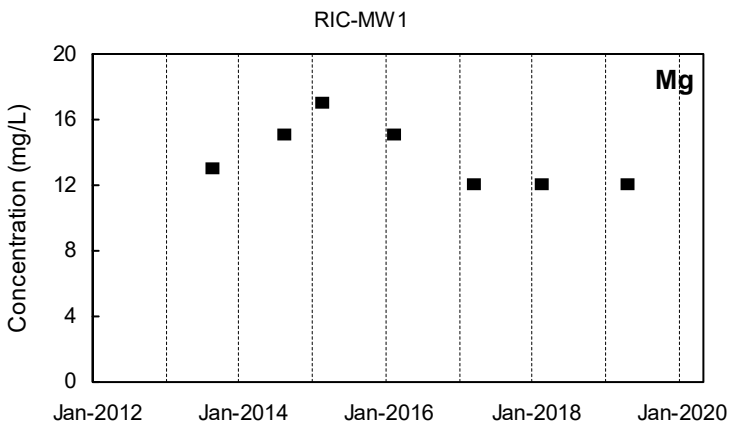
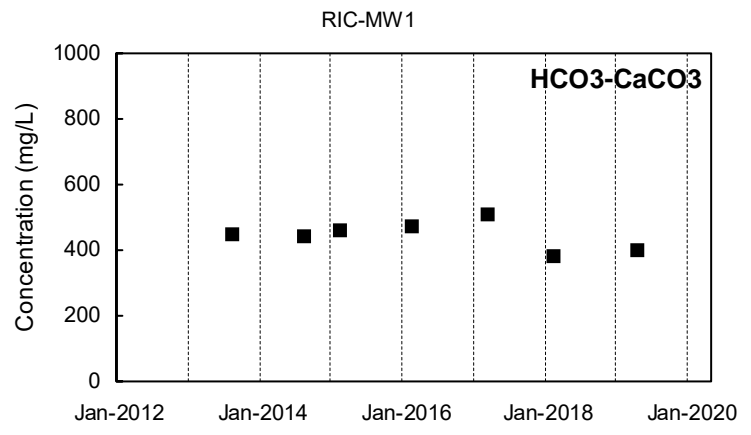
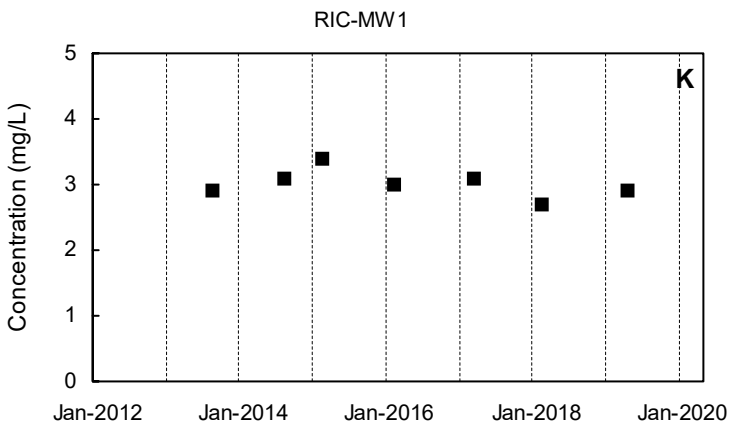
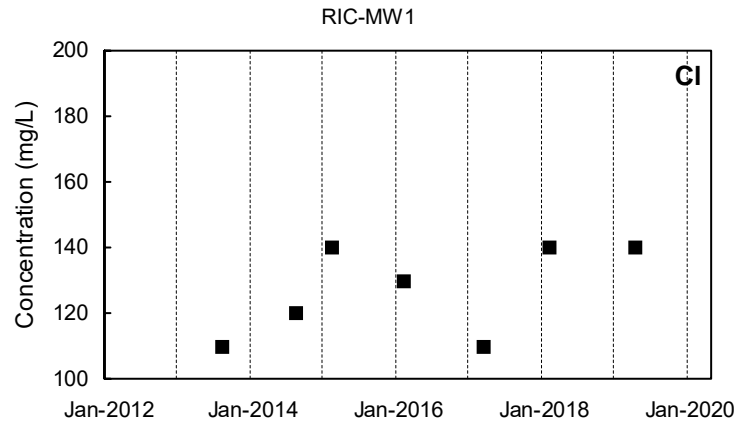
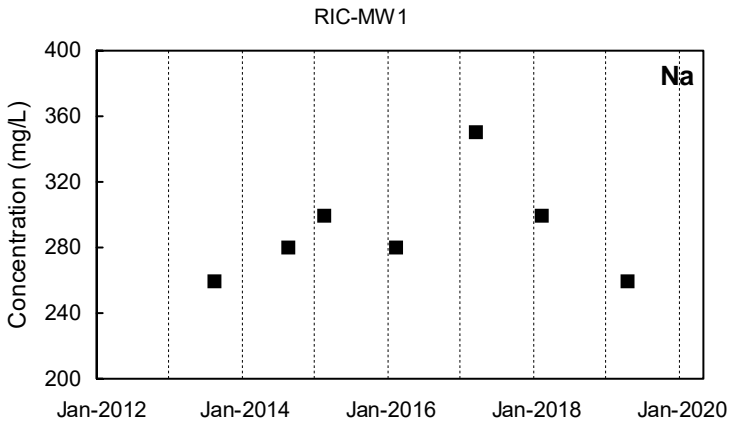

■ Detected Value □ 'J'-Flag (value between reporting limit and detection limit) ■ Non-Detect Range
 Shallow Well shown with black symbols Deep Well shown with orange symbols "dd" Well shown with blue symbols

RIC-MW2

RIC-MW2

Na

Cl

Not Sampled

Not Sampled

RIC-MW2

RIC-MW2

K

HCO3-CaCO3

Not Sampled

Not Sampled

RIC-MW2

RIC-MW2

Mg

SO4

Not Sampled

Not Sampled

RIC-MW2

RIC-MW2

Ca

PO4

Not Sampled

Not Sampled

Detected Value
 'J'-Flag (value between reporting limit and detection limit)
 Non-Detect Range
 Shallow Well shown with black symbols
 Deep Well shown with orange symbols
 "dd" Well shown with blue symbols

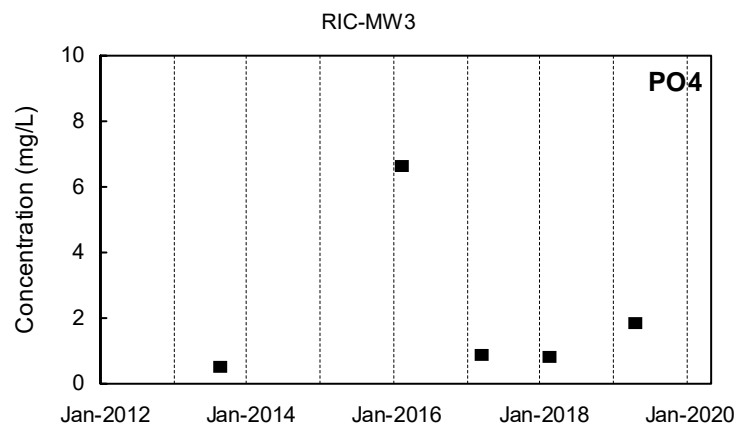
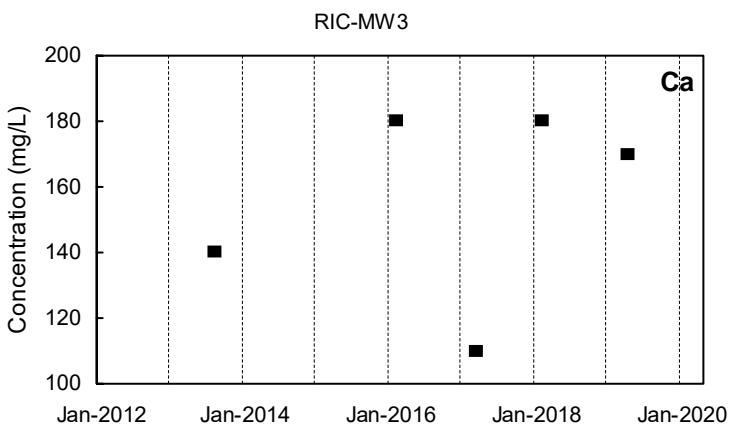
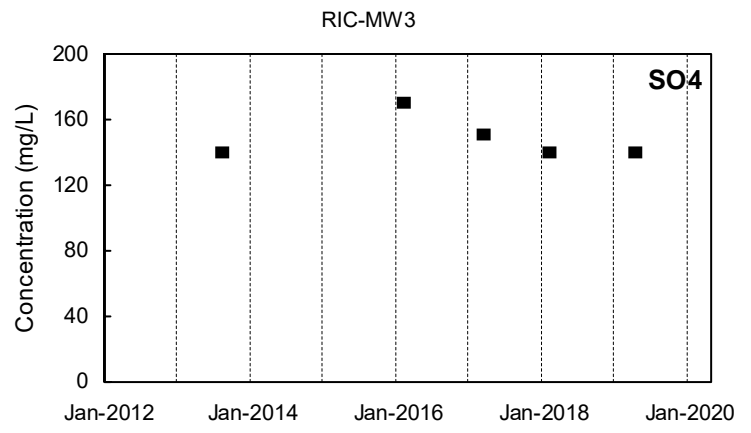
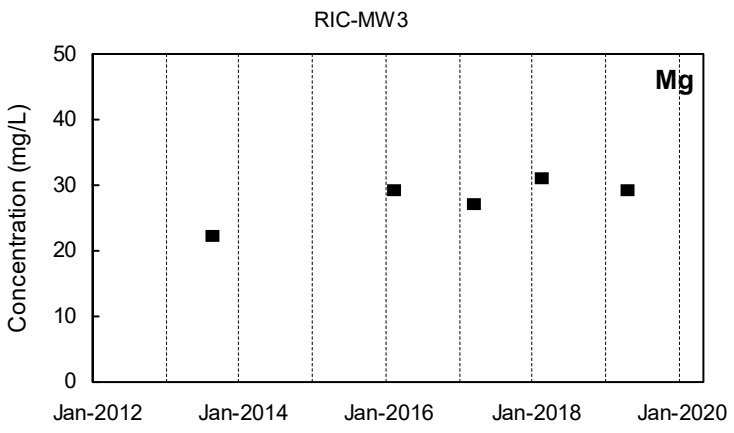
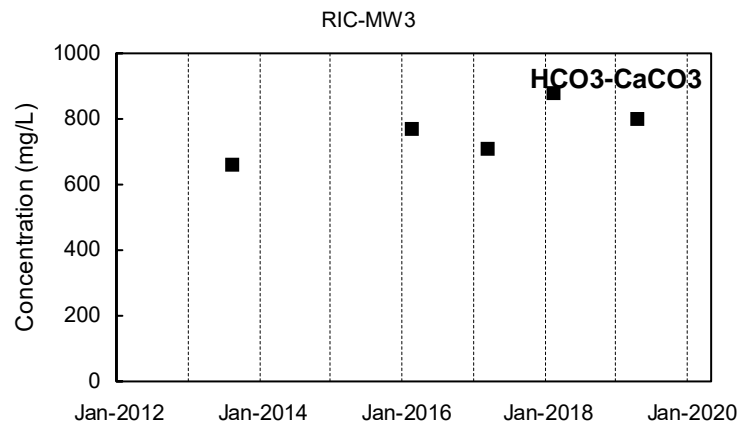
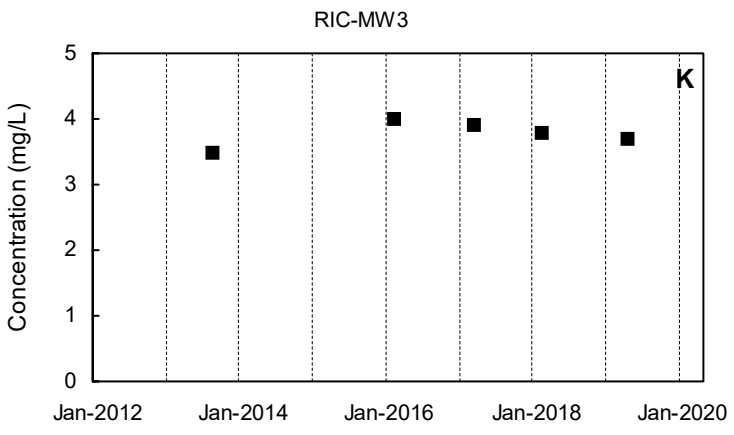
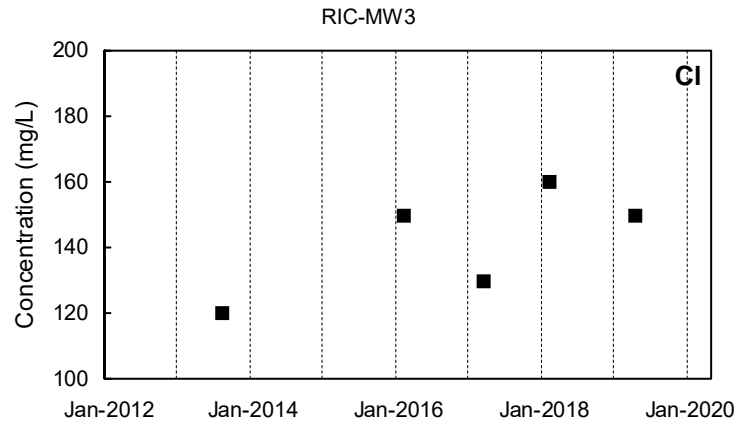
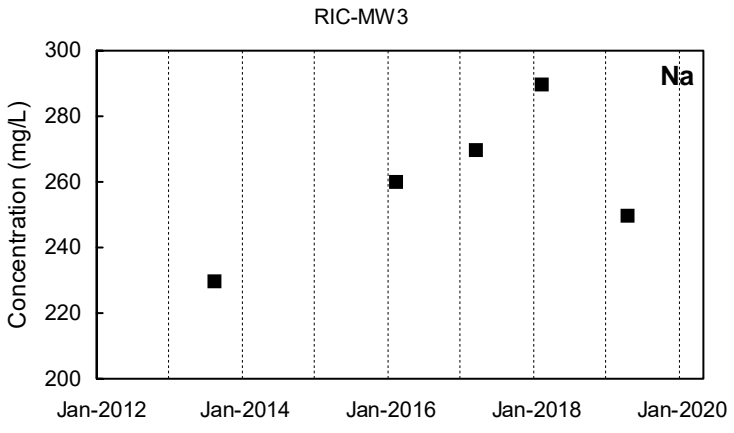

Detected Value
 'J'-Flag (value between reporting limit and detection limit)
 Non-Detect Range
 Shallow Well shown with black symbols
 Deep Well shown with orange symbols
 "dd" Well shown with blue symbols

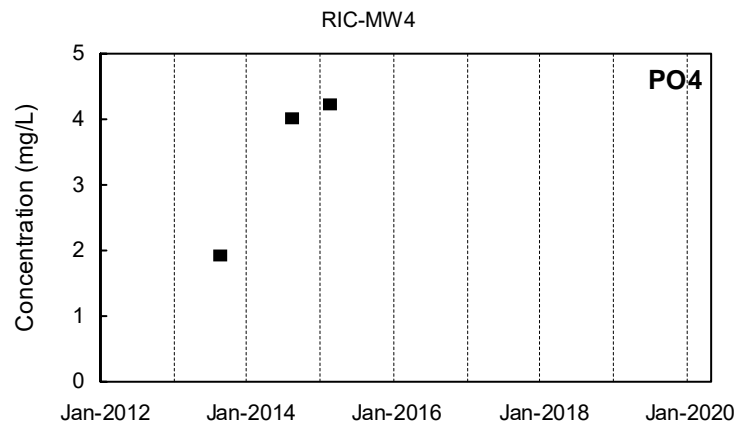
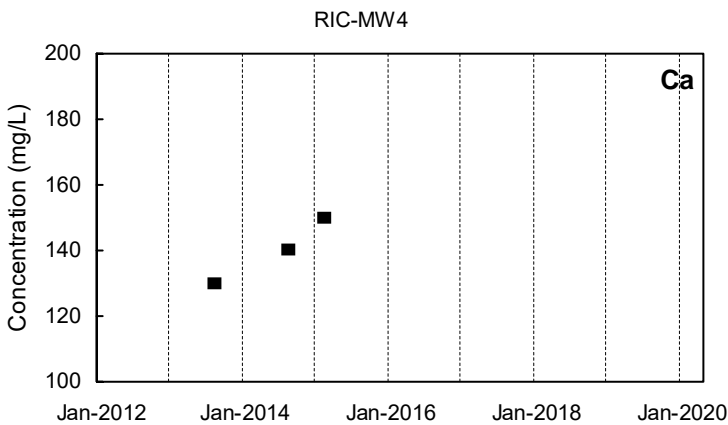
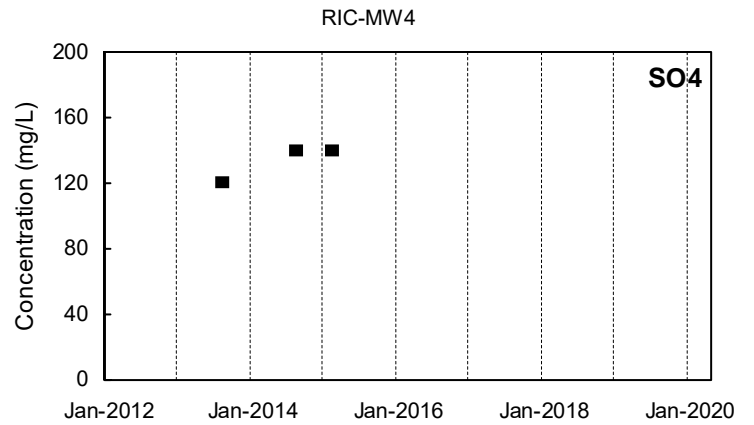
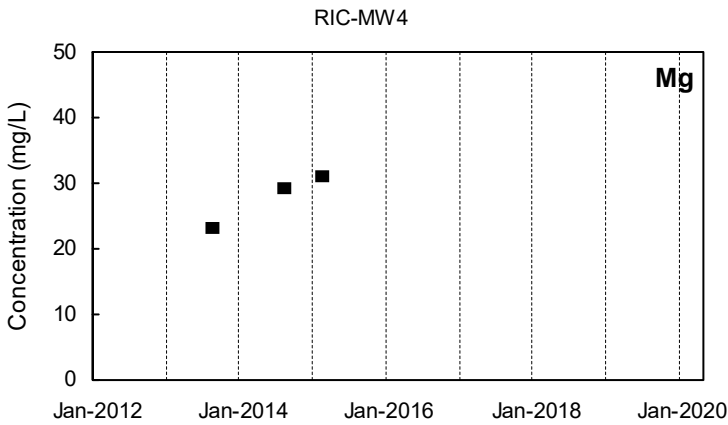
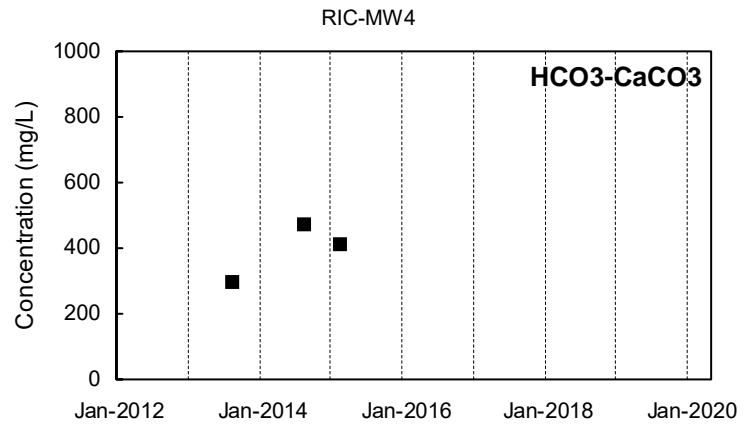
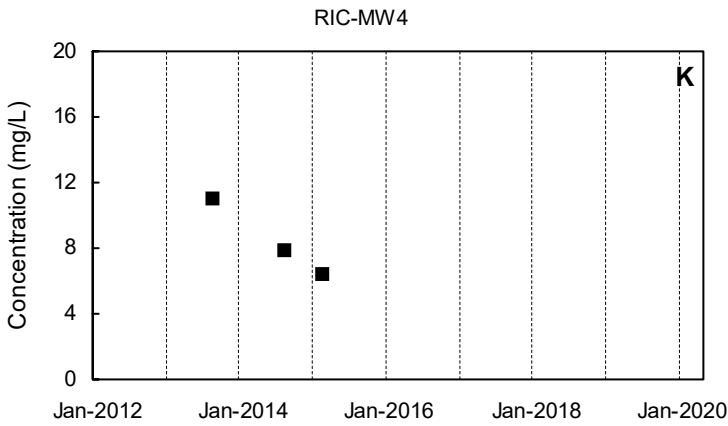
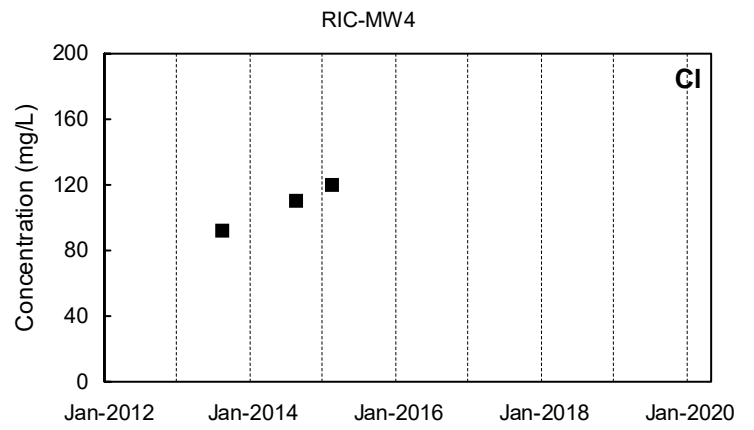
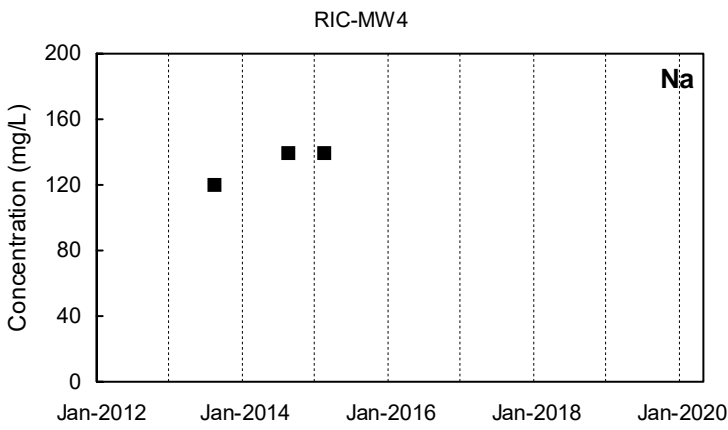

Detected Value
 'J'-Flag (value between reporting limit and detection limit)
 Non-Detect Range

Shallow Well shown with black symbols
Deep Well shown with orange symbols
"dd" Well shown with blue symbols

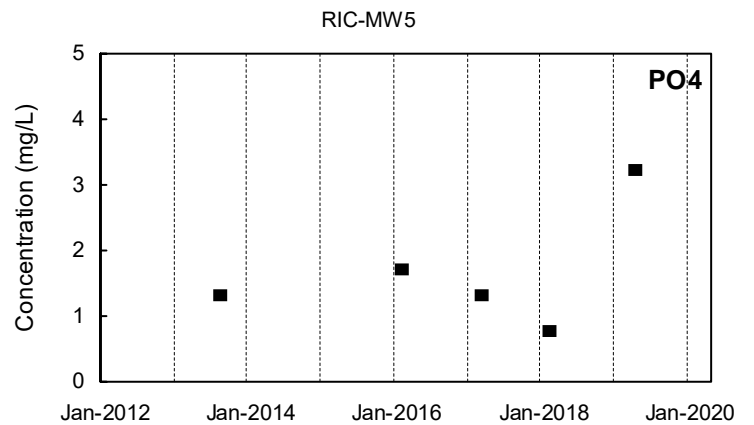
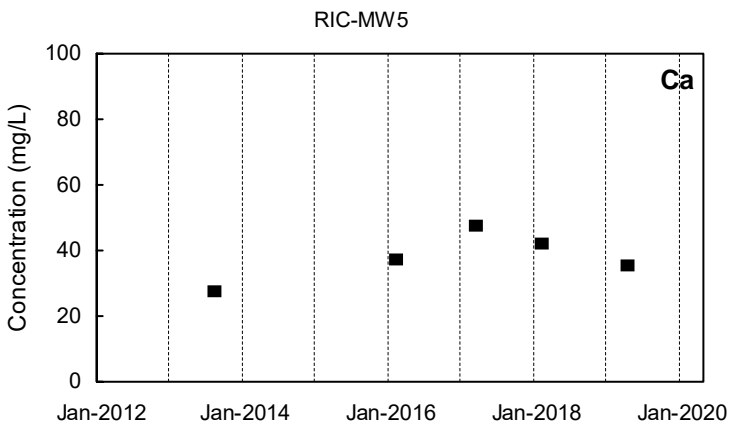
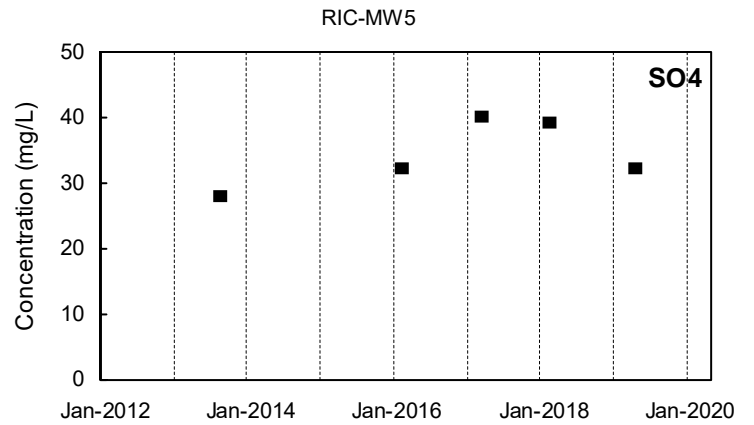
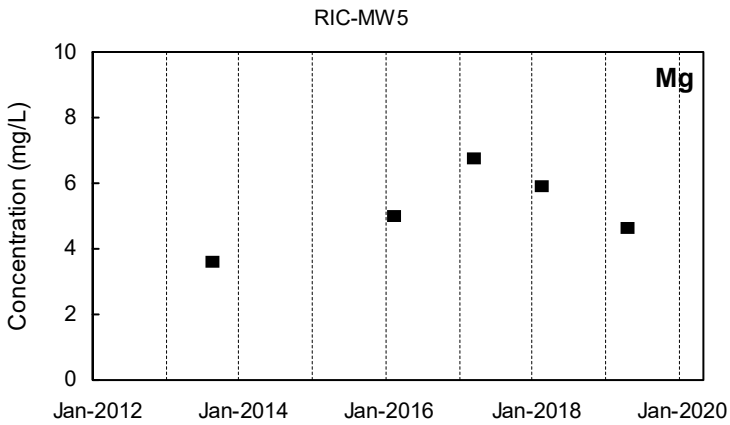
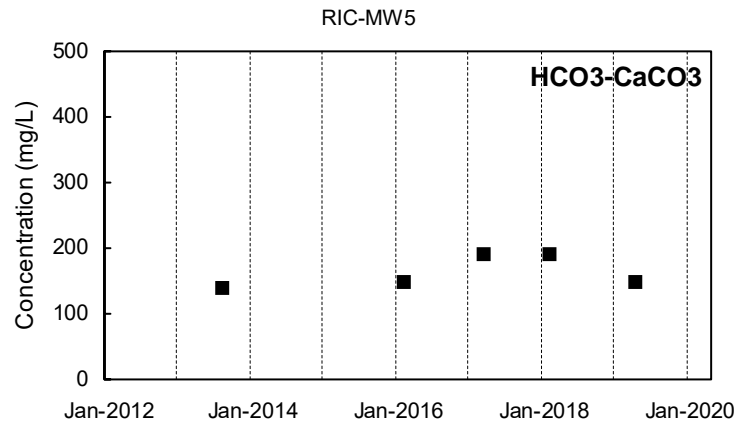
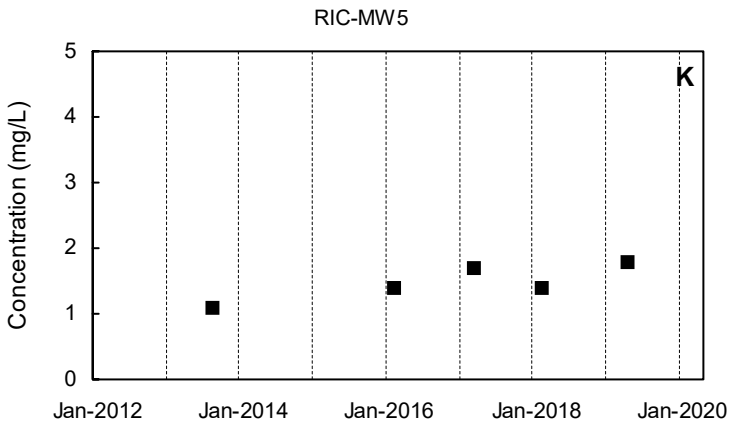
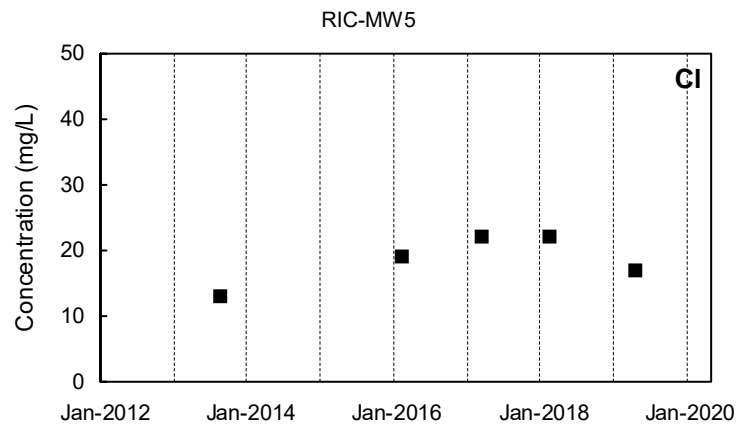
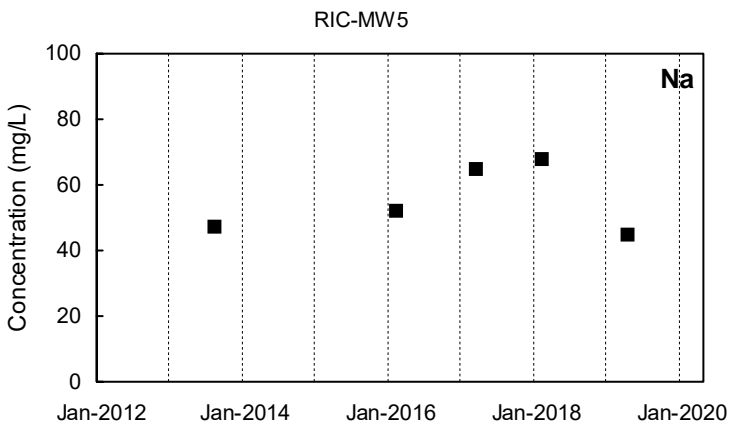

Detected Value
 'J'-Flag (value between reporting limit and detection limit)
 Non-Detect Range
 Shallow Well shown with black symbols
 Deep Well shown with orange symbols
 "dd" Well shown with blue symbols

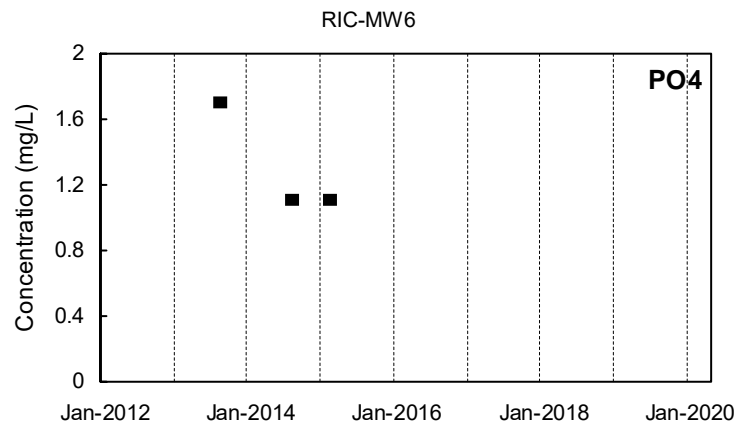
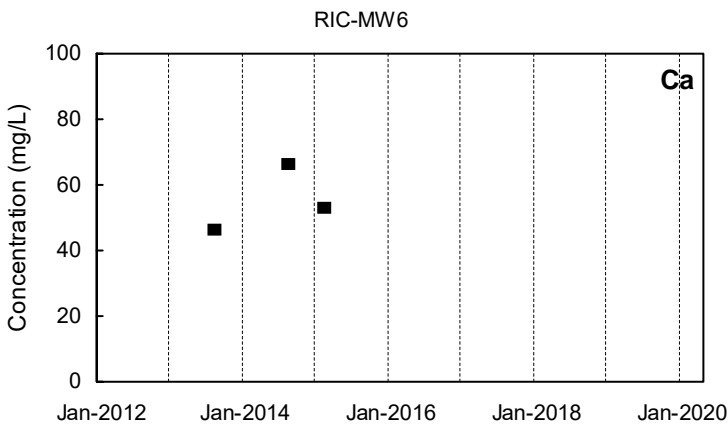
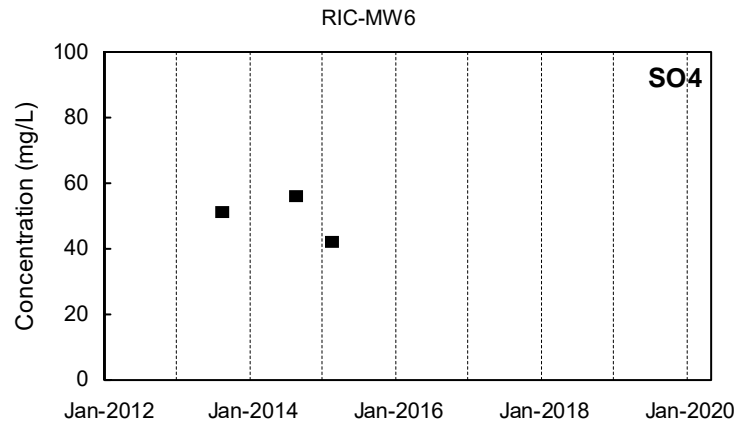
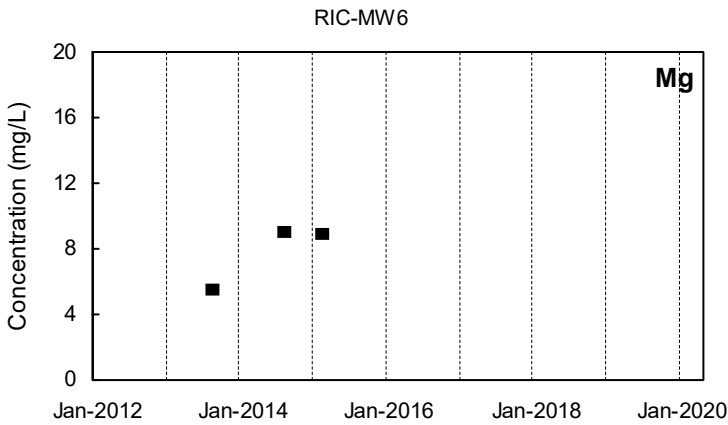
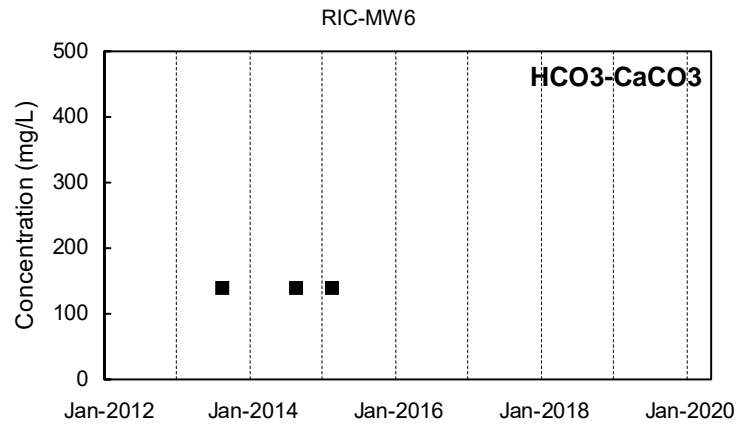
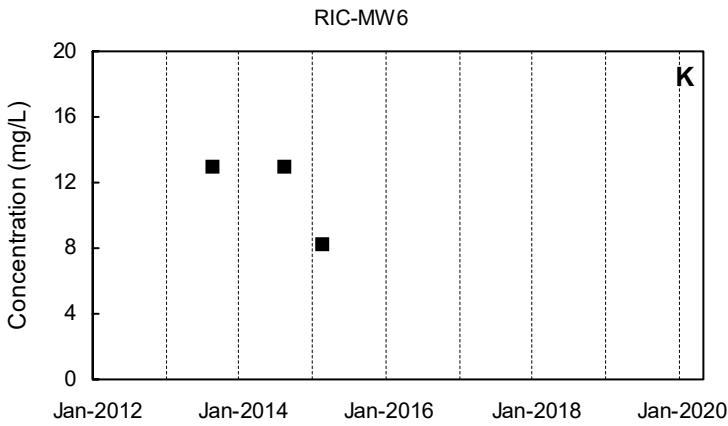
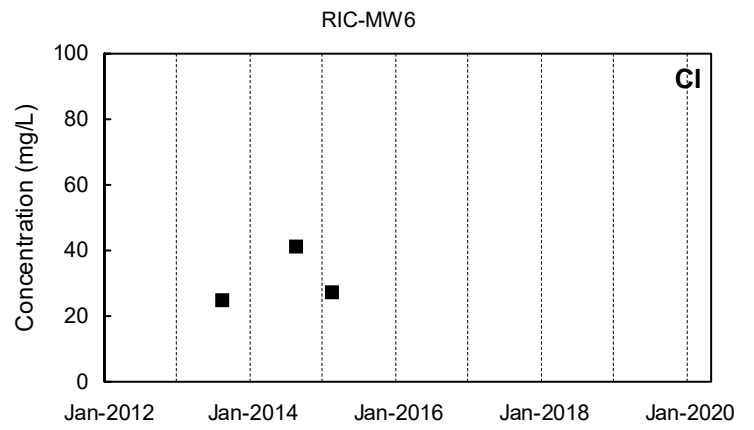
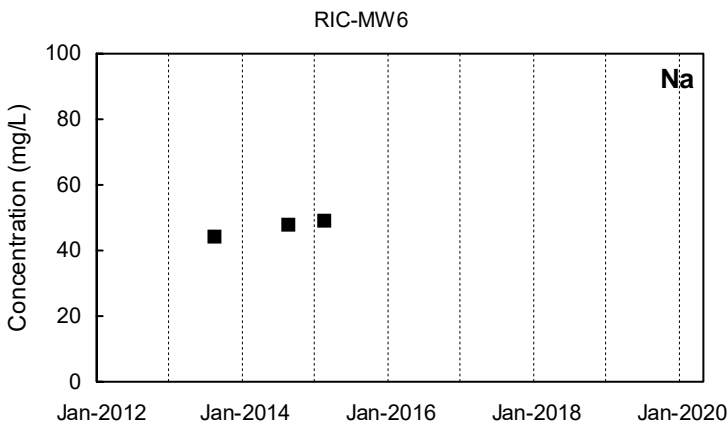

■ Detected Value □ 'J'-Flag (value between reporting limit and detection limit) ■ Non-Detect Range
 ■ Shallow Well shown with black symbols ■ Deep Well shown with orange symbols ■ "dd" Well shown with blue symbols

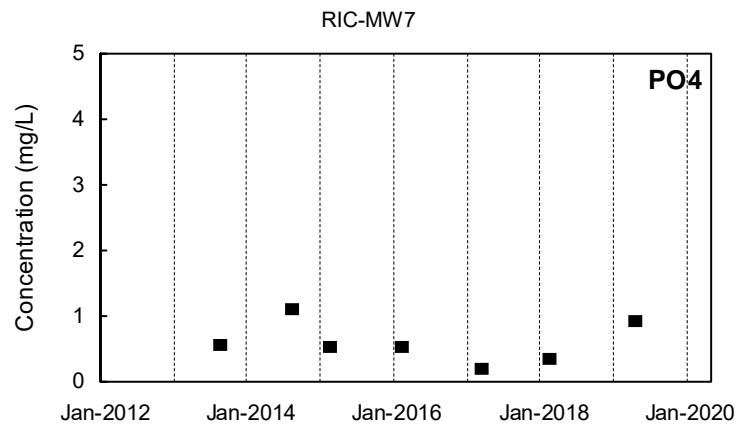
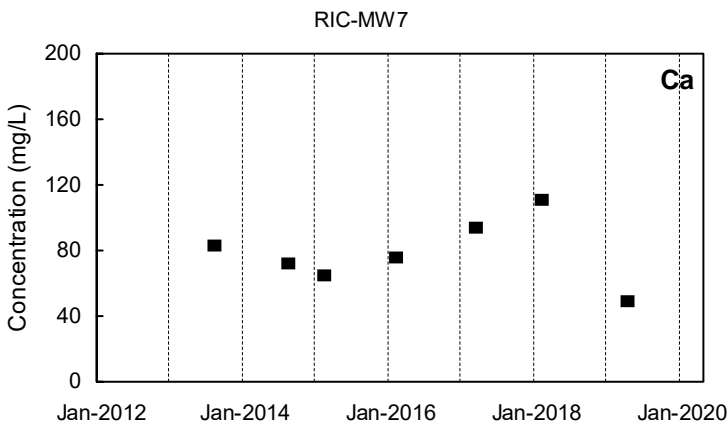
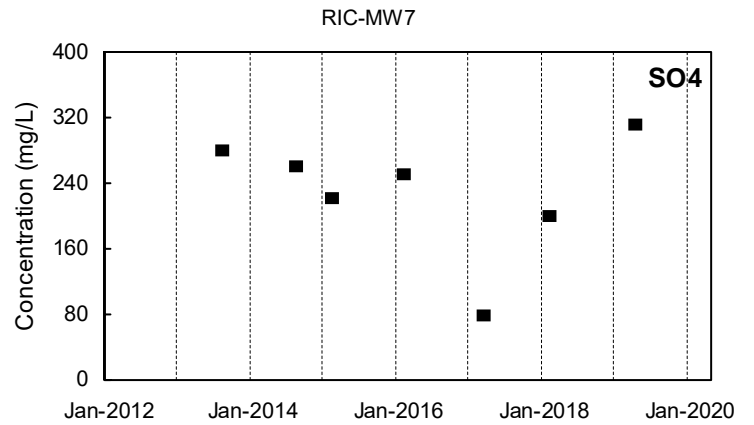
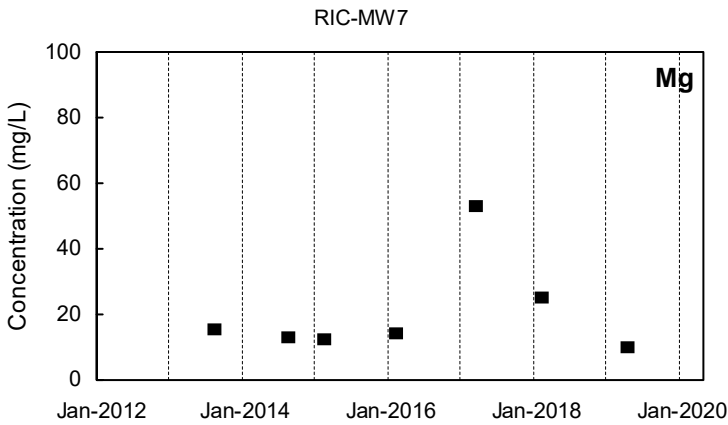
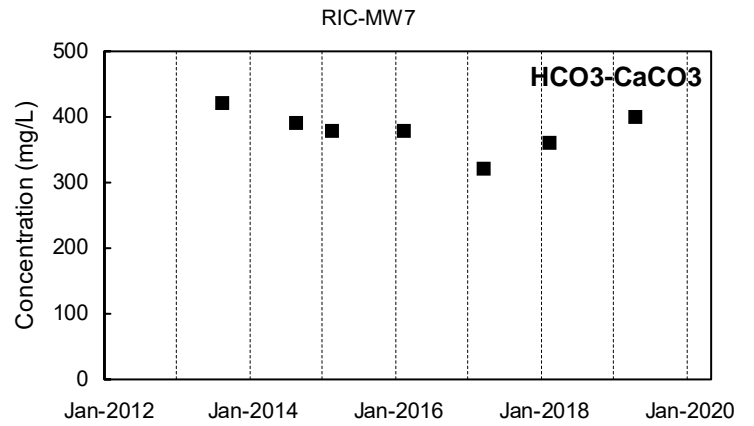
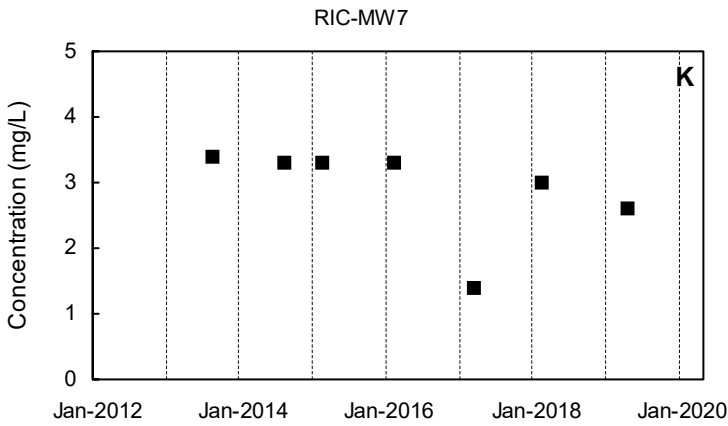
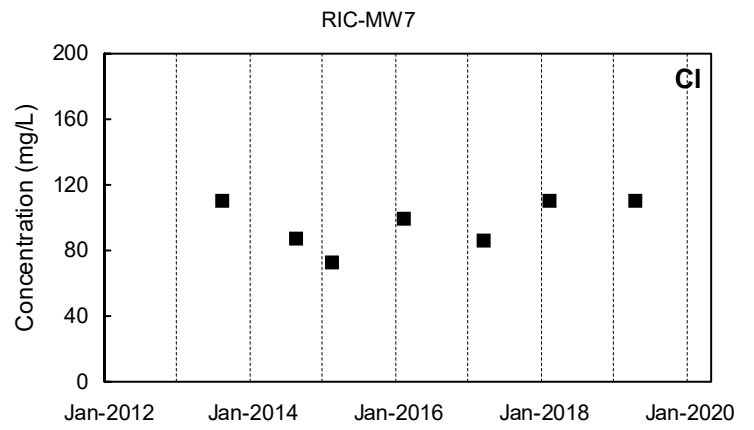
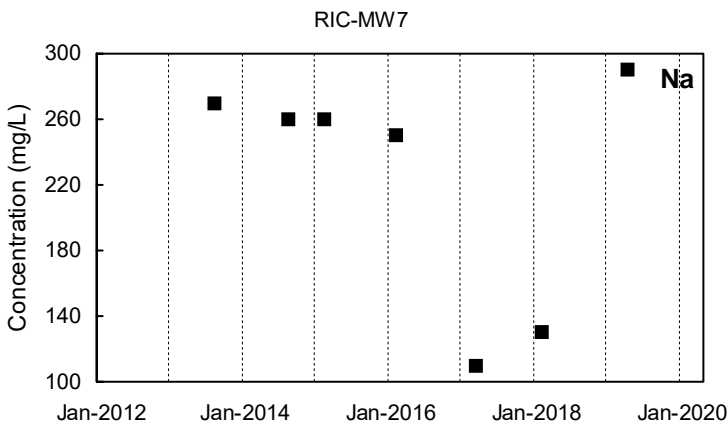

Detected Value
 'J'-Flag (value between reporting limit and detection limit)
 Non-Detect Range
 Shallow Well shown with black symbols
 Deep Well shown with orange symbols
 "dd" Well shown with blue symbols

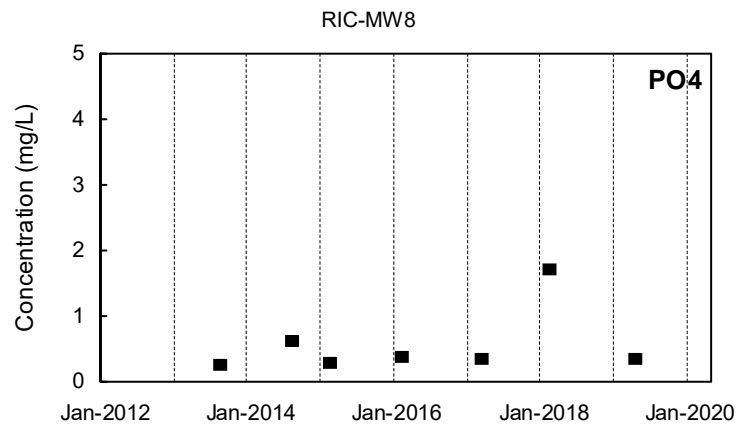
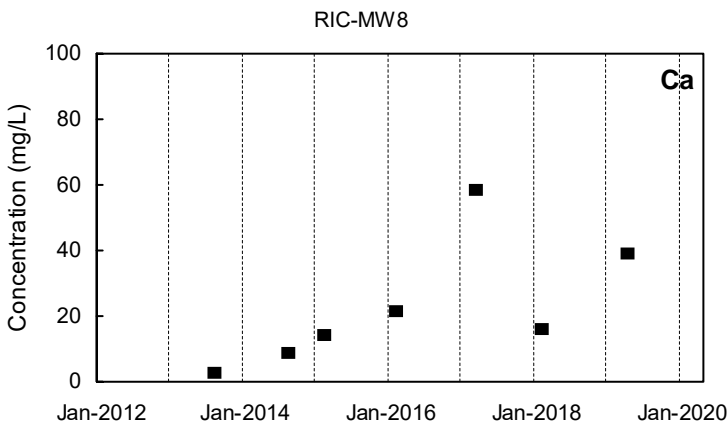
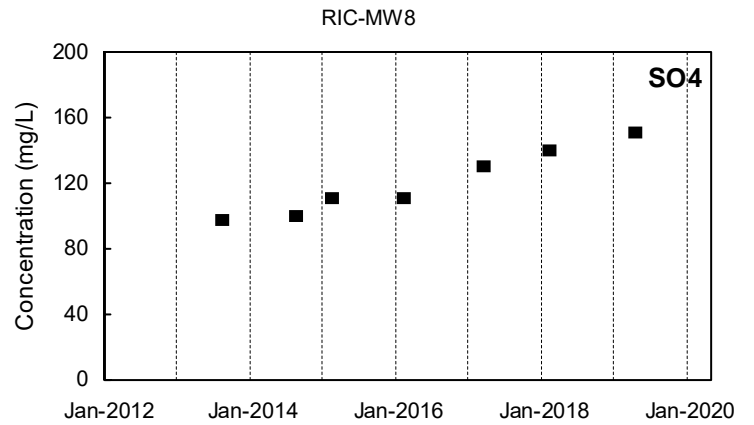
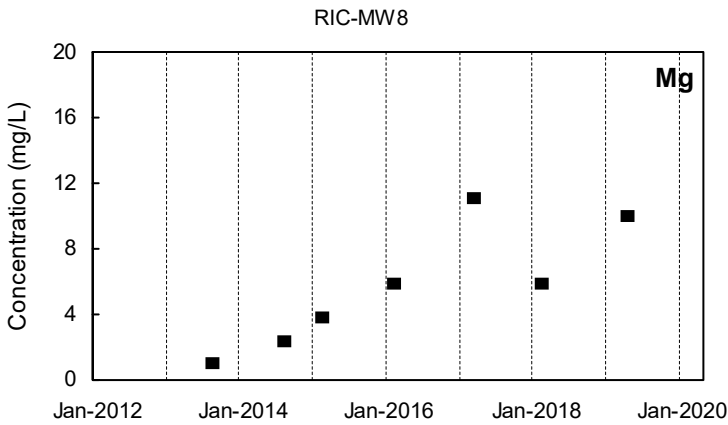
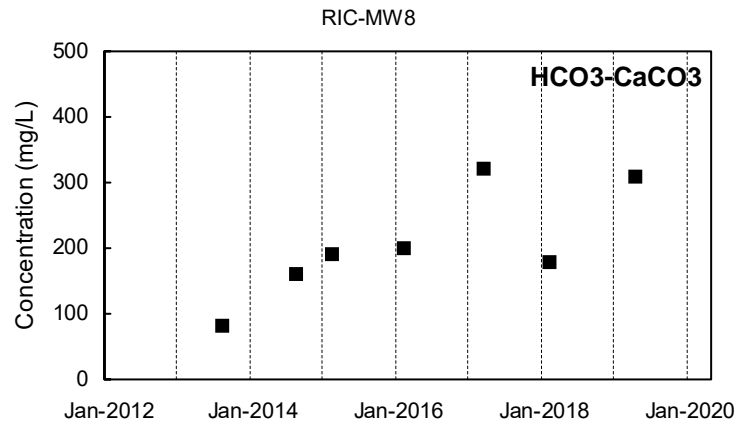
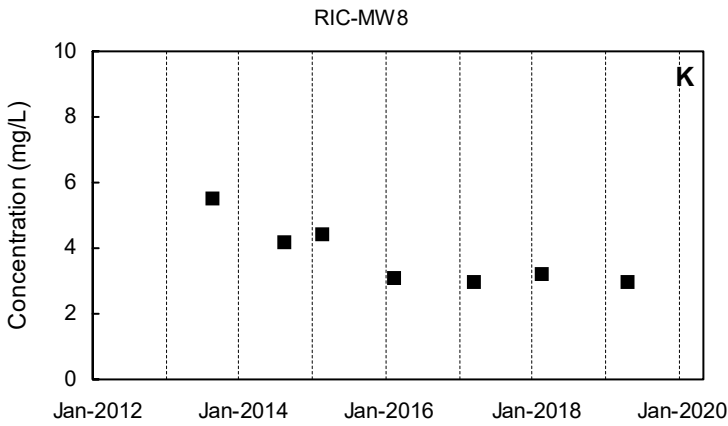
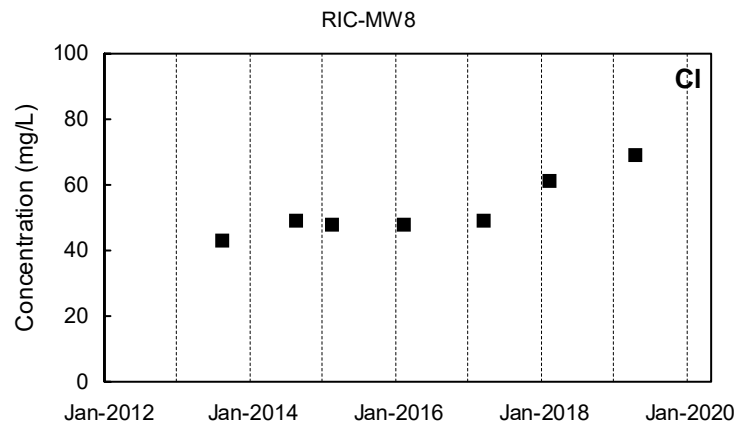
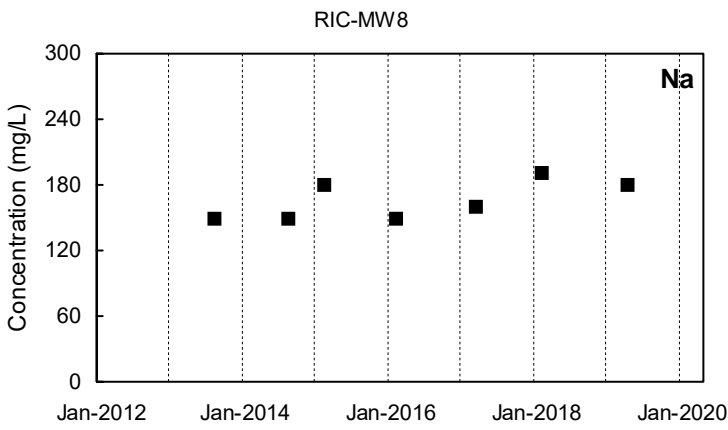

Detected Value
 'J'-Flag (value between reporting limit and detection limit)
 Non-Detect Range
 Shallow Well shown with black symbols
 Deep Well shown with orange symbols
 "dd" Well shown with blue symbols

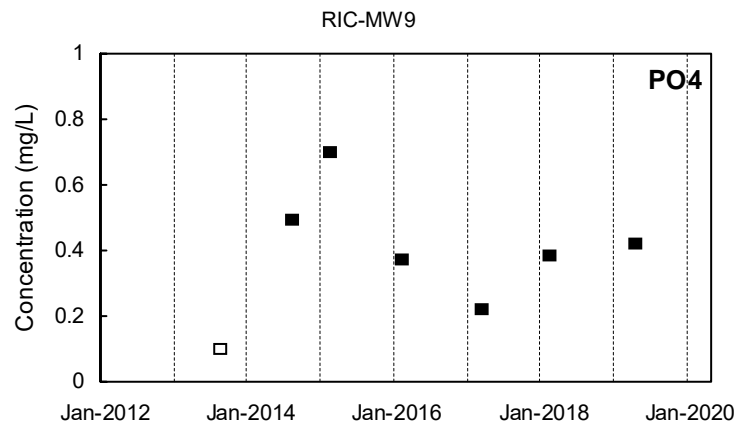
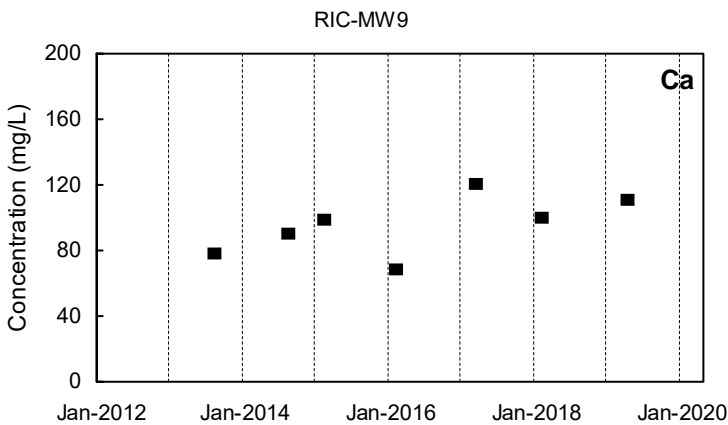
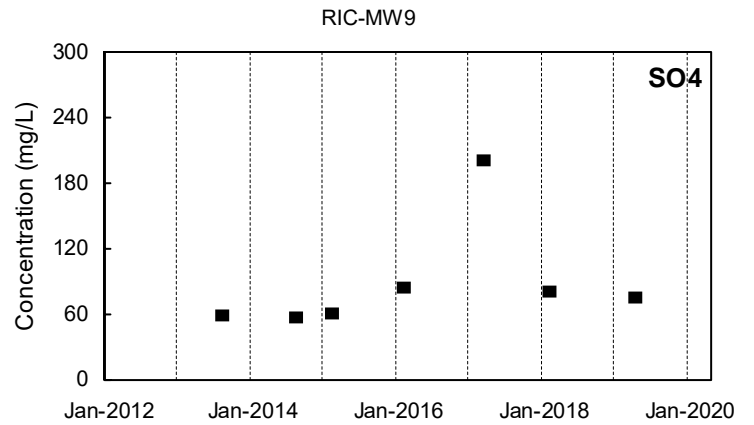
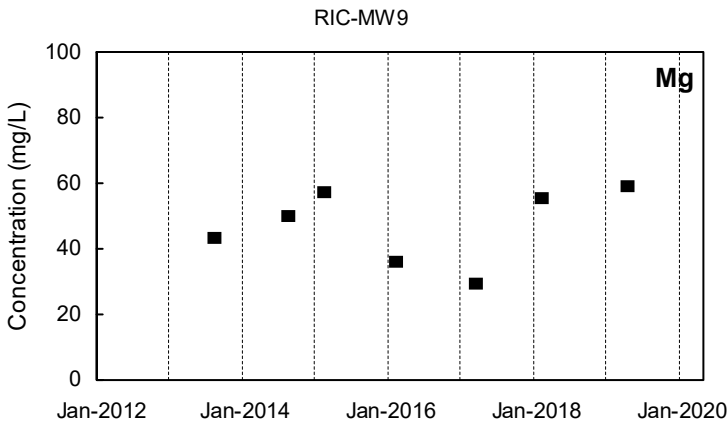
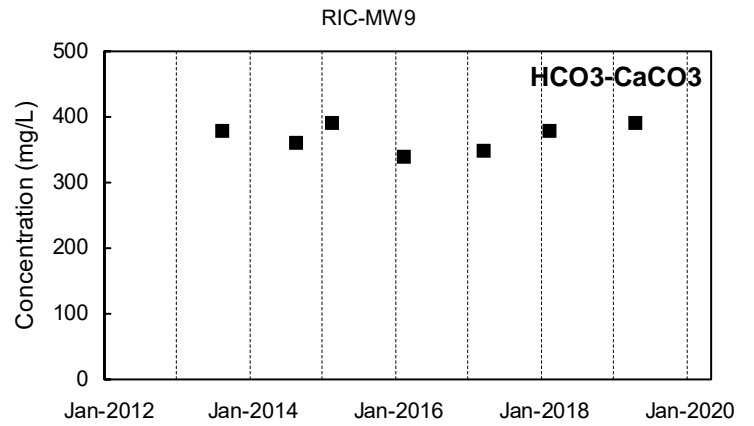
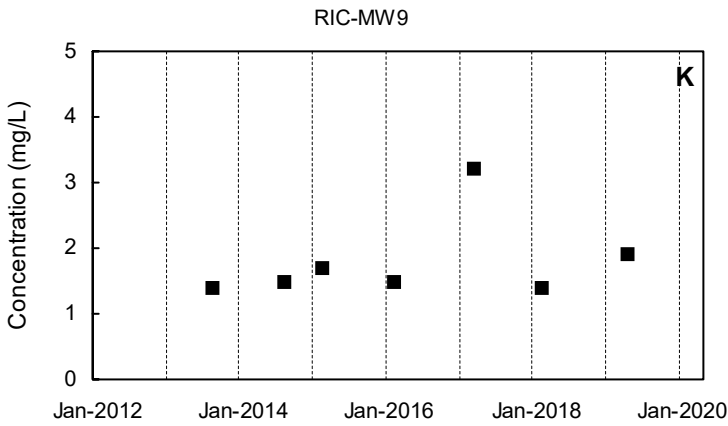
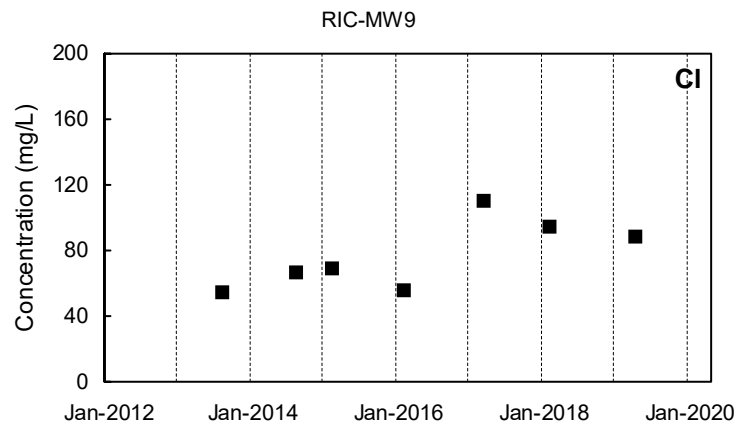
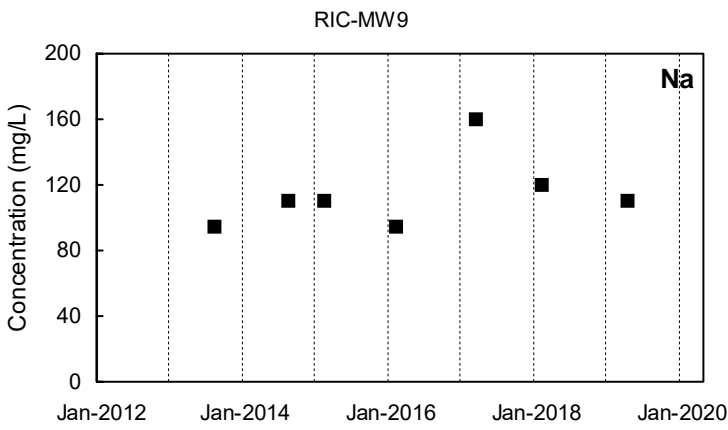

■ Detected Value □ 'J'-Flag (value between reporting limit and detection limit) ■ Non-Detect Range
 Shallow Well shown with black symbols Deep Well shown with orange symbols "dd" Well shown with blue symbols

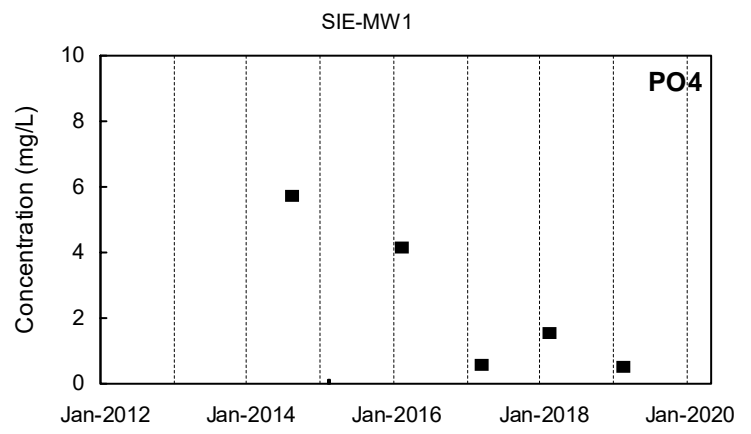
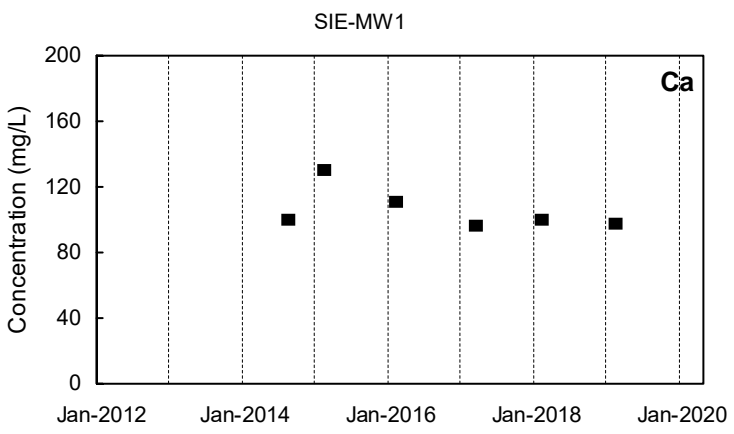
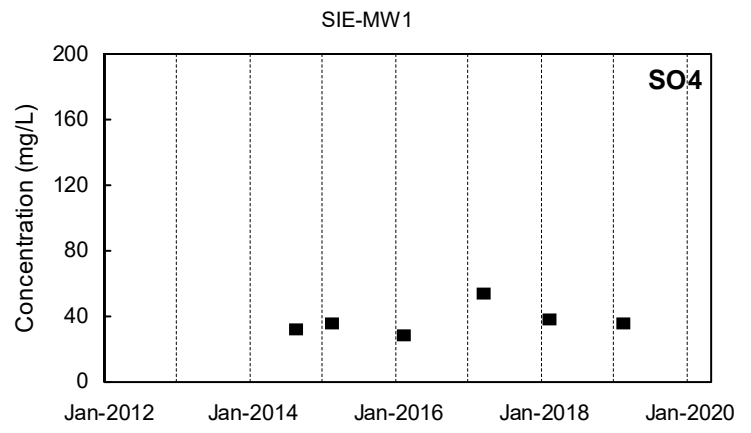
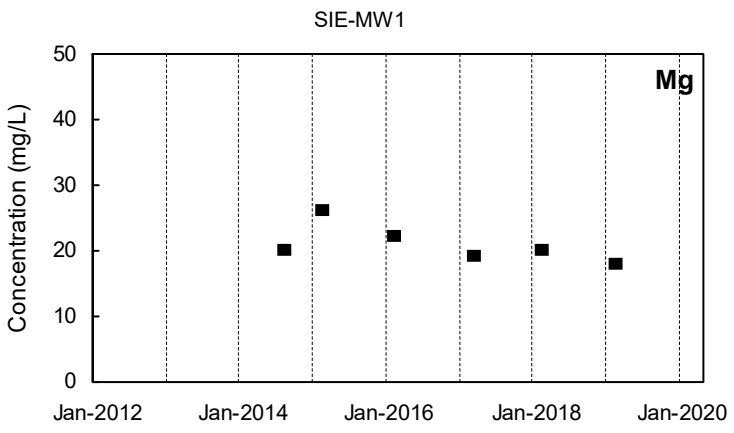
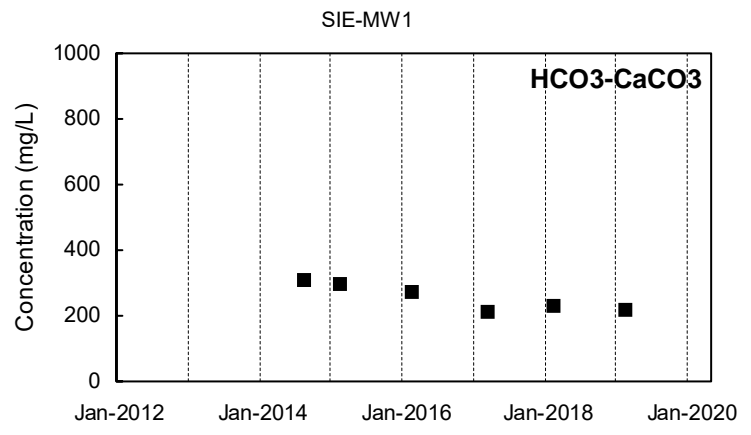
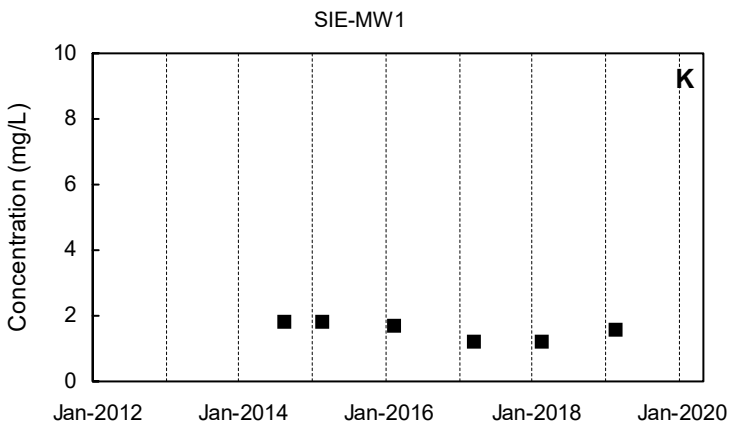
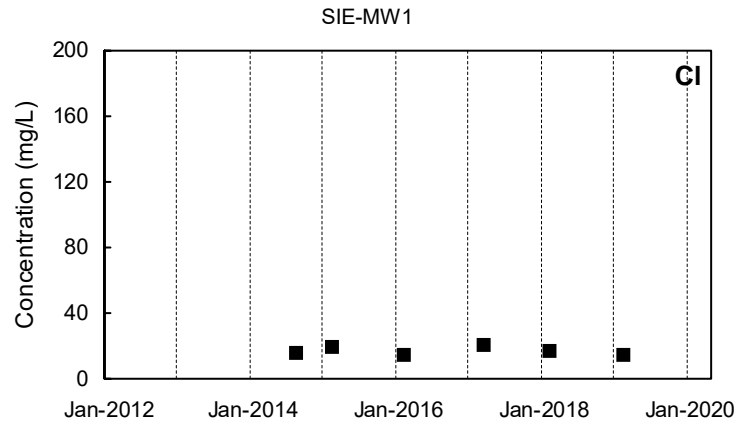
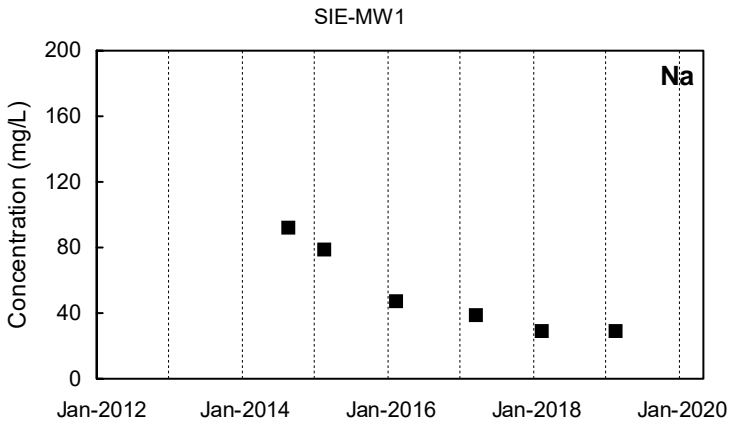

■ Detected Value □ 'J'-Flag (value between reporting limit and detection limit) ■ Non-Detect Range
 Shallow Well shown with black symbols Deep Well shown with orange symbols "dd" Well shown with blue symbols

SIE-MW2

SIE-MW2

Na

Cl

Not Sampled

Not Sampled

SIE-MW2

SIE-MW2

K

HCO3-CaCO3

Not Sampled

Not Sampled

SIE-MW2

SIE-MW2

Mg

SO4

Not Sampled

Not Sampled

SIE-MW2

SIE-MW2

Ca

PO4

Not Sampled

Not Sampled

Detected Value
 'J'-Flag (value between reporting limit and detection limit)
 Non-Detect Range
 Shallow Well shown with black symbols
 Deep Well shown with orange symbols
 "dd" Well shown with blue symbols

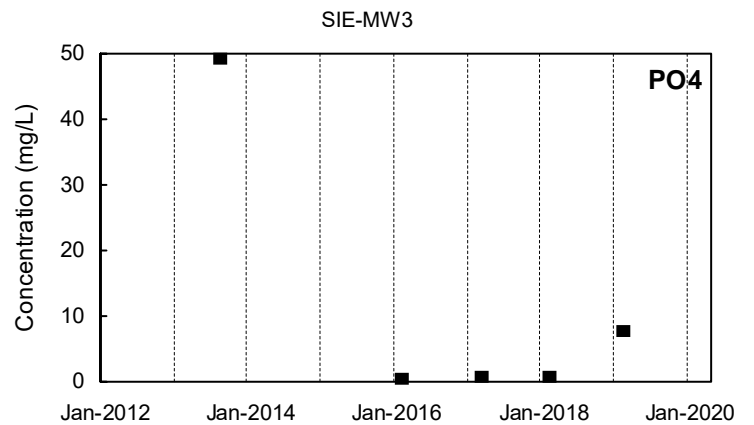
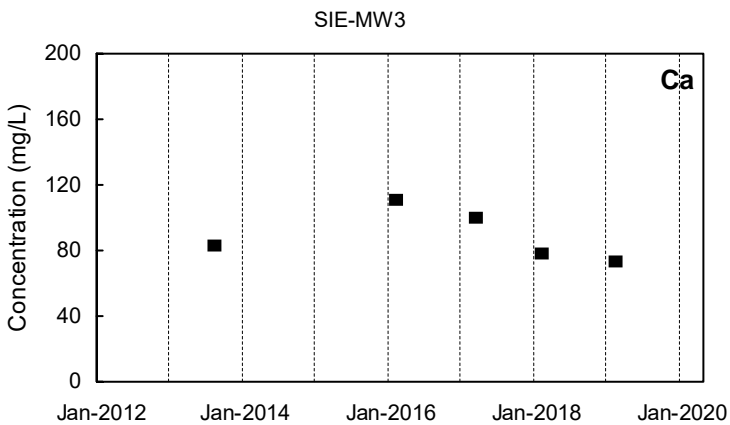
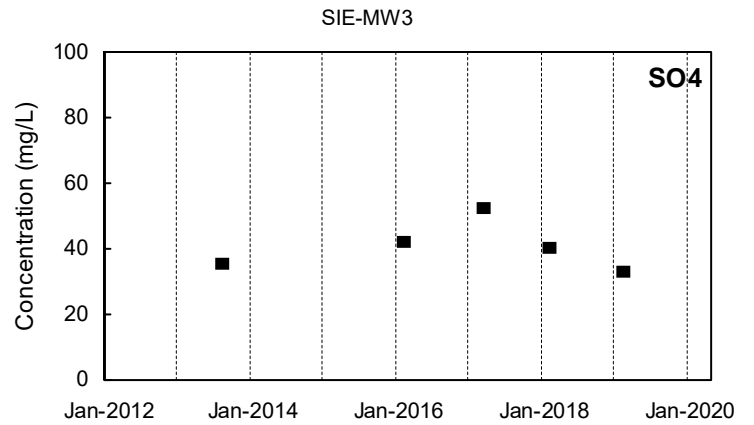
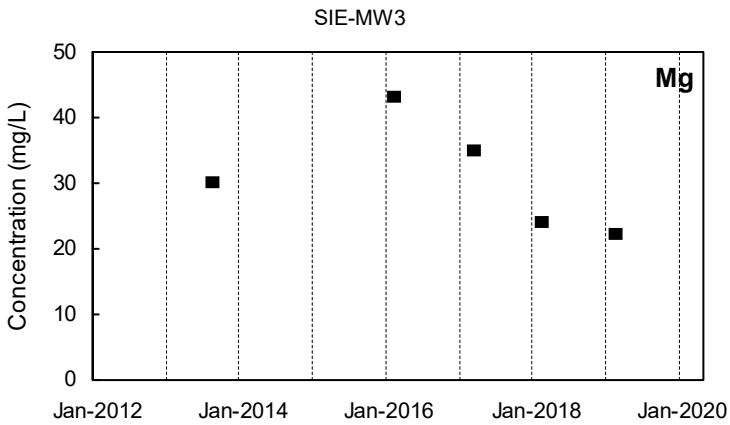
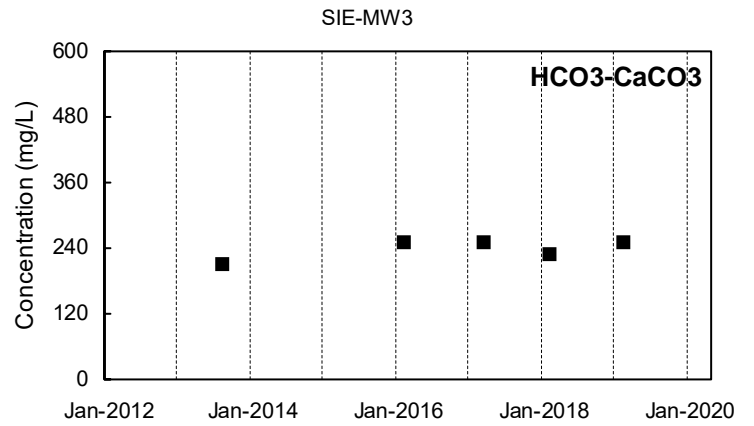
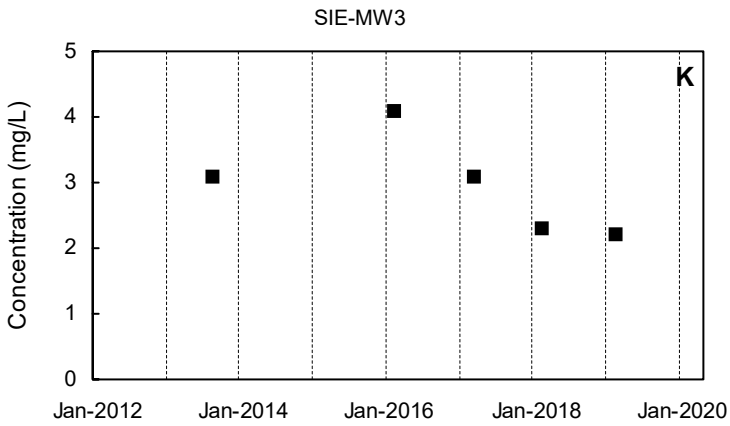
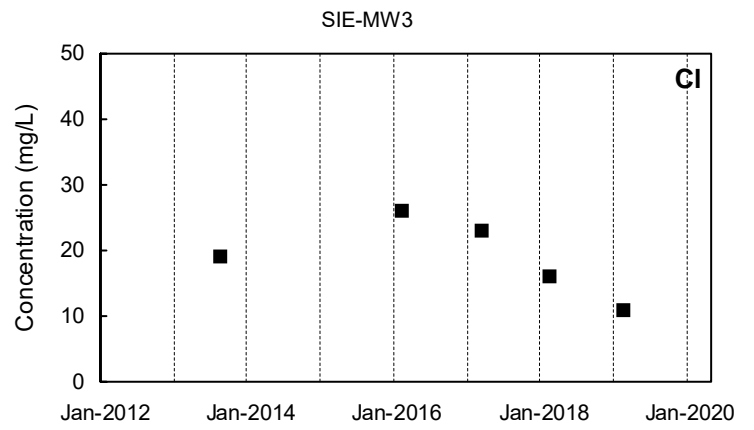
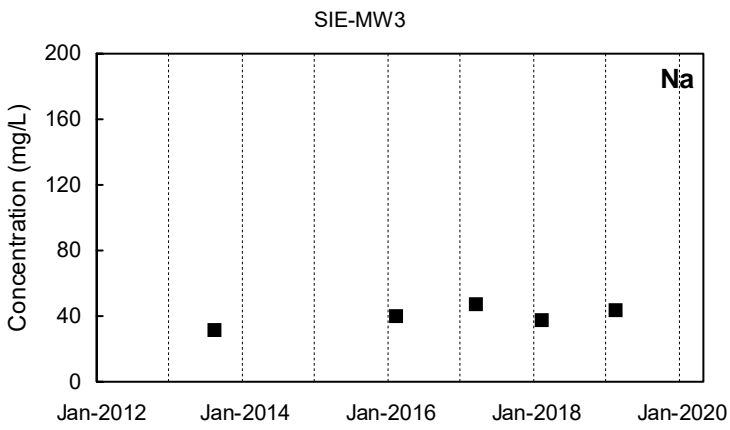

■ Detected Value □ 'J'-Flag (value between reporting limit and detection limit) ■ Non-Detect Range
 Shallow Well shown with black symbols Deep Well shown with orange symbols "dd" Well shown with blue symbols

SIE-MW4

SIE-MW4

Na

Not Sampled

Cl

Not Sampled

SIE-MW4

SIE-MW4

K

Not Sampled

HCO3-CaCO3

Not Sampled

SIE-MW4

SIE-MW4

Mg

Not Sampled

SO4

Not Sampled

SIE-MW4

SIE-MW4

Ca

Not Sampled

PO4

Not Sampled

■ Detected Value

□ 'J'-Flag (value between reporting limit and detection limit)



Non-Detect Range

Shallow Well shown with black symbols

Deep Well shown with orange symbols

"dd" Well shown with blue symbols

SO2-MW1

SO2-MW1

Na

Cl

Not Sampled

Not Sampled

SO2-MW1

SO2-MW1

K

HCO3-CaCO3

Not Sampled

Not Sampled

SO2-MW1

SO2-MW1

Mg

SO4

Not Sampled

Not Sampled

SO2-MW1

SO2-MW1

Ca

PO4

Not Sampled

Not Sampled

Detected Value
 'J'-Flag (value between reporting limit and detection limit)
 Non-Detect Range
 Shallow Well shown with black symbols
 Deep Well shown with orange symbols
 "dd" Well shown with blue symbols

SO2-MW2

SO2-MW2

Na

Not Sampled

Cl

Not Sampled

SO2-MW2

SO2-MW2

K

Not Sampled

HCO3-CaCO3

Not Sampled

SO2-MW2

SO2-MW2

Mg

Not Sampled

SO4

Not Sampled

SO2-MW2

SO2-MW2

Ca

Not Sampled

PO4

Not Sampled

■ Detected Value

□ 'J'-Flag (value between reporting limit and detection limit)

■ Non-Detect Range

Shallow Well shown with black symbols

Deep Well shown with orange symbols

"dd" Well shown with blue symbols

SO2-MW3

SO2-MW3

Na

Cl

Not Sampled

Not Sampled

SO2-MW3

SO2-MW3

K

HCO3-CaCO3

Not Sampled

Not Sampled

SO2-MW3

SO2-MW3

Mg

SO4

Not Sampled

Not Sampled

SO2-MW3

SO2-MW3

Ca

PO4

Not Sampled

Not Sampled

Detected Value
 'J'-Flag (value between reporting limit and detection limit)
 Non-Detect Range
 Shallow Well shown with black symbols
 Deep Well shown with orange symbols
 "dd" Well shown with blue symbols

SO2-MW4

SO2-MW4

Na

Not Sampled

Cl

Not Sampled

SO2-MW4

SO2-MW4

K

Not Sampled

HCO3-CaCO3

Not Sampled

SO2-MW4

SO2-MW4

Mg

Not Sampled

SO4

Not Sampled

SO2-MW4

SO2-MW4

Ca

Not Sampled

PO4

Not Sampled

Detected Value
 'J'-Flag (value between reporting limit and detection limit)
 Non-Detect Range
 Shallow Well shown with black symbols
 Deep Well shown with orange symbols
 "dd" Well shown with blue symbols

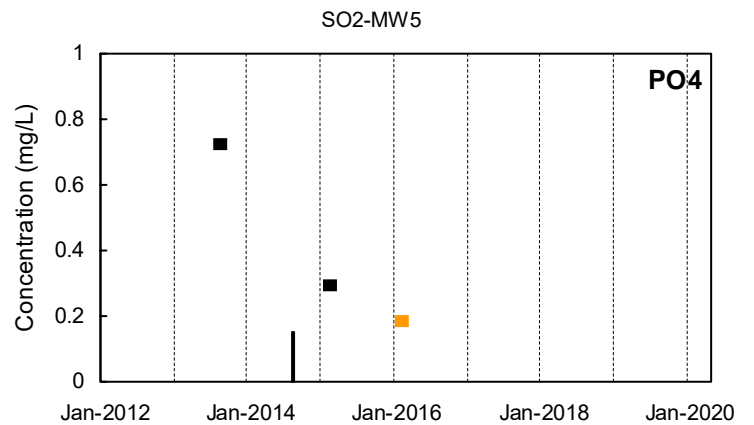
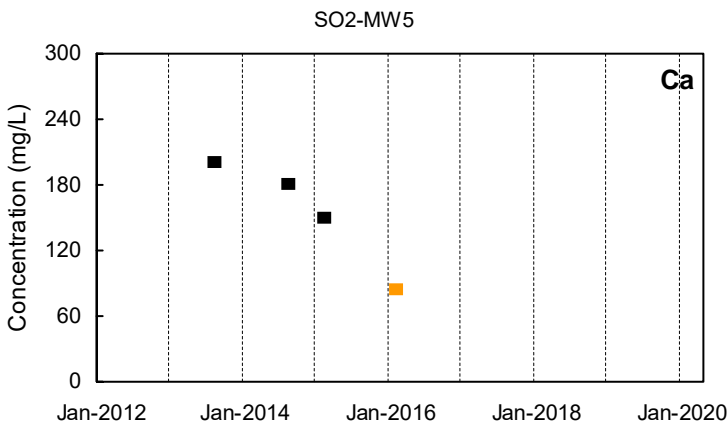
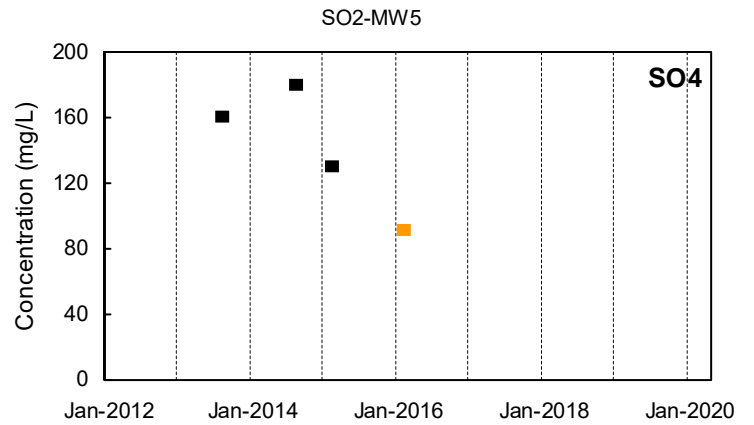
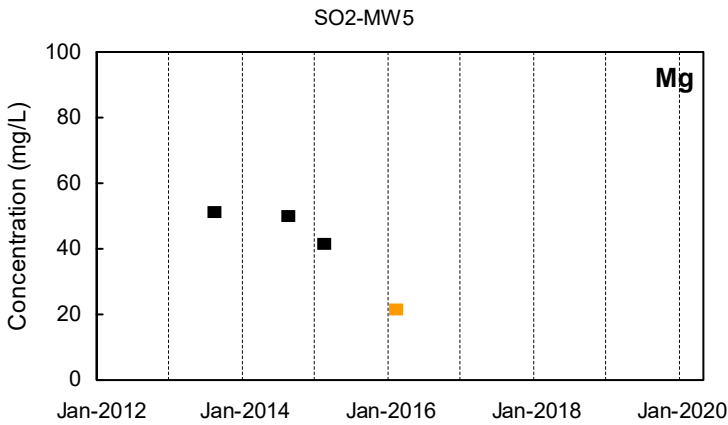
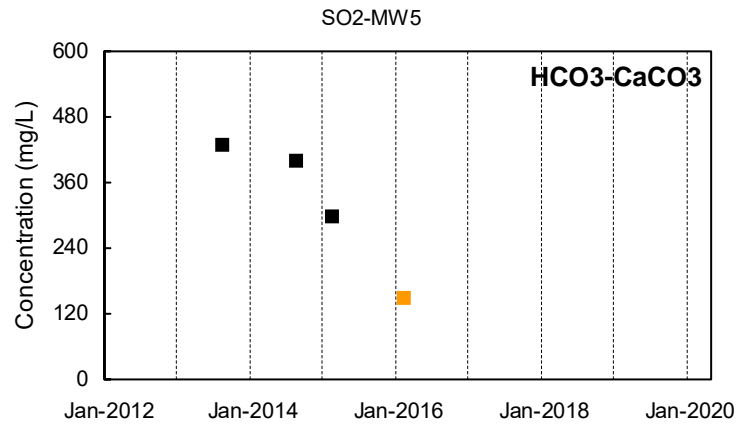
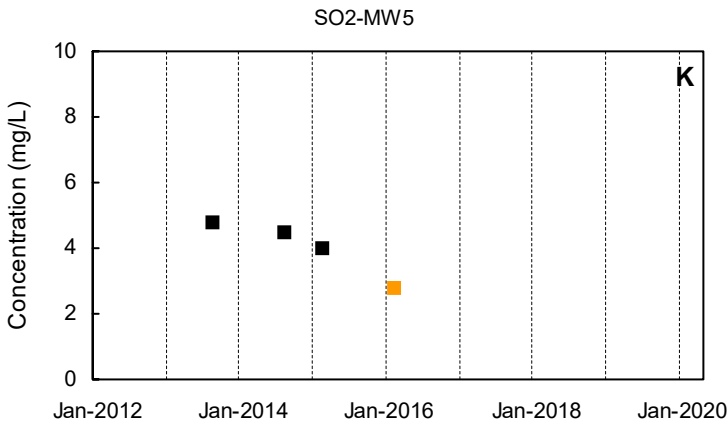
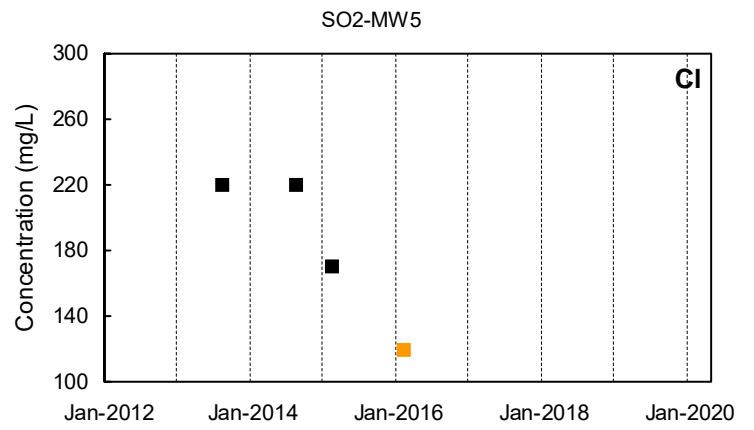
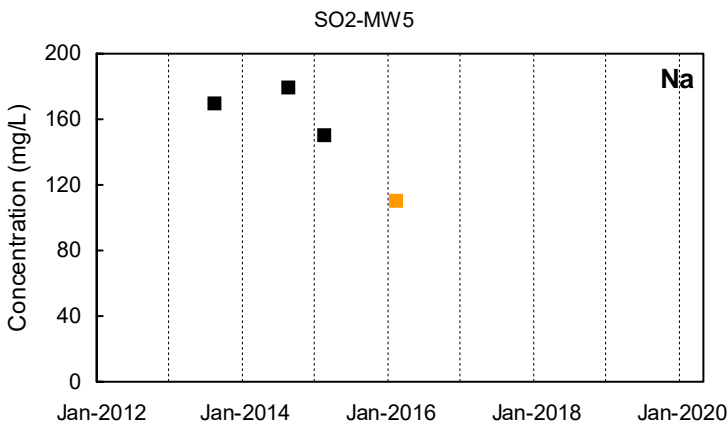

■ Detected Value □ 'J'-Flag (value between reporting limit and detection limit) ■ Non-Detect Range
 Shallow Well shown with black symbols Deep Well shown with orange symbols "dd" Well shown with blue symbols

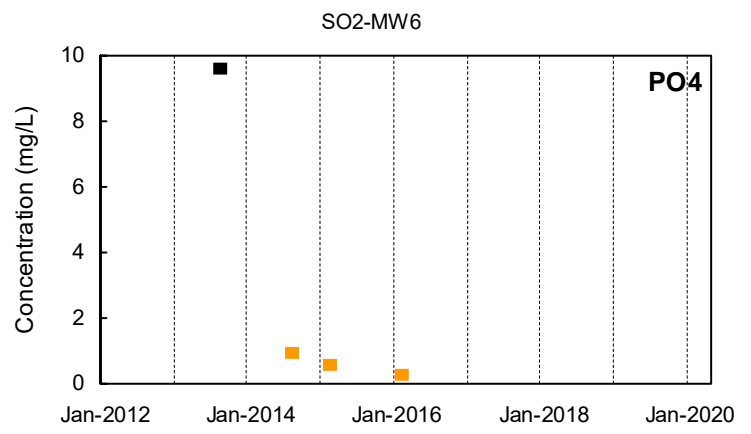
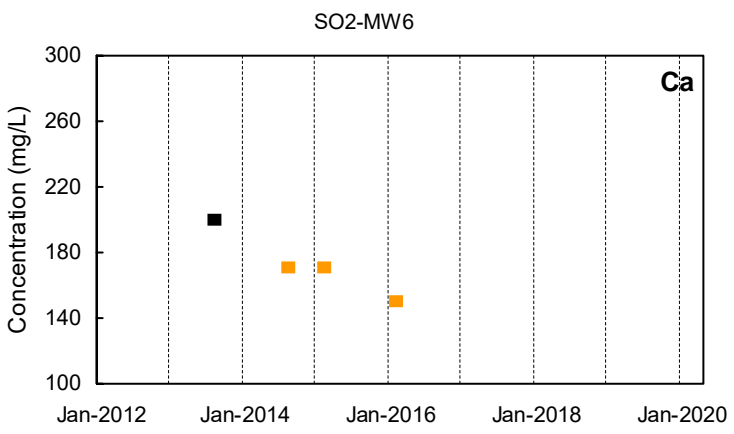
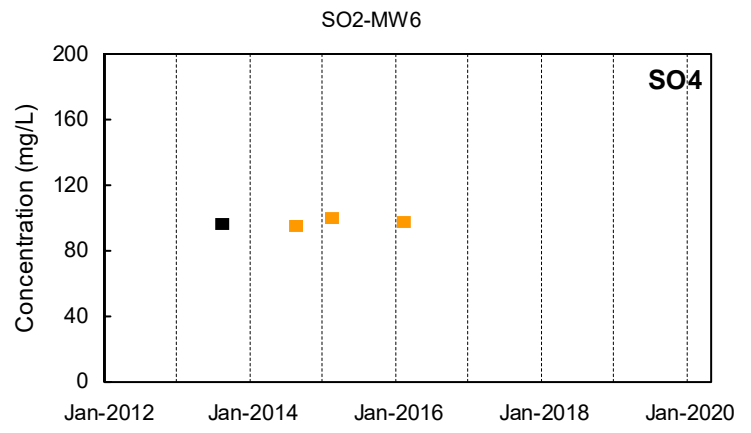
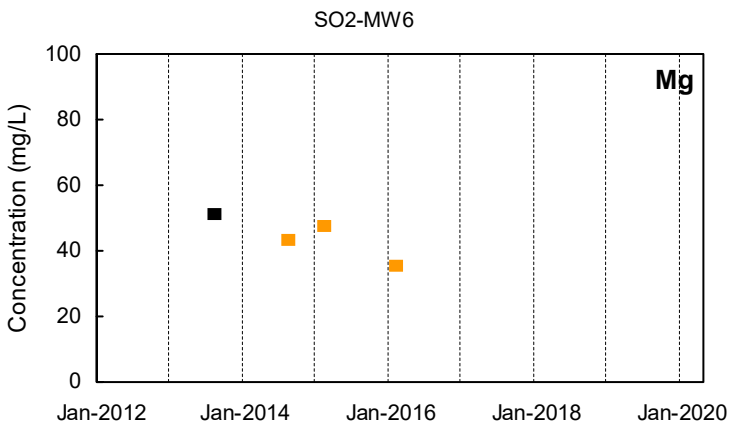
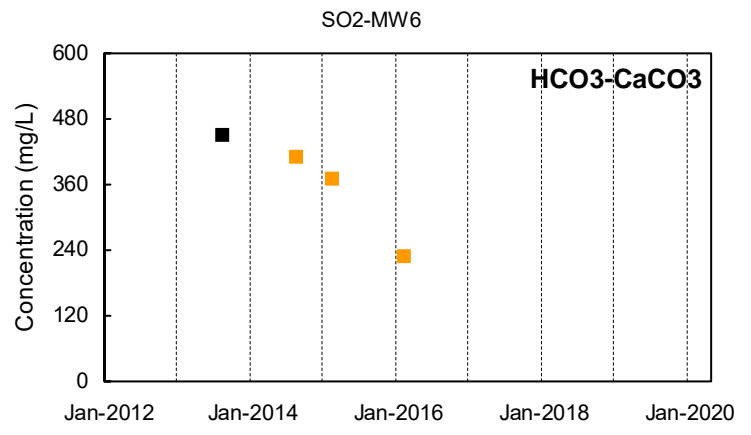
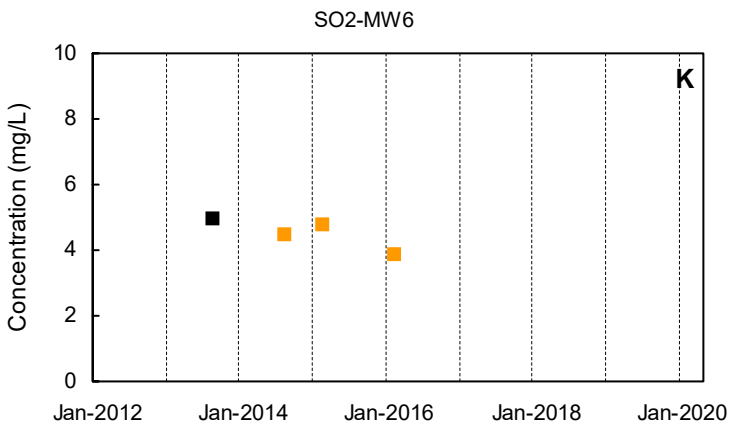
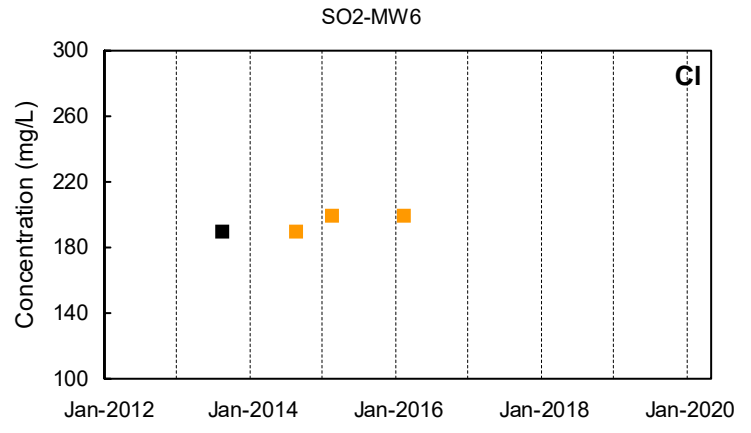
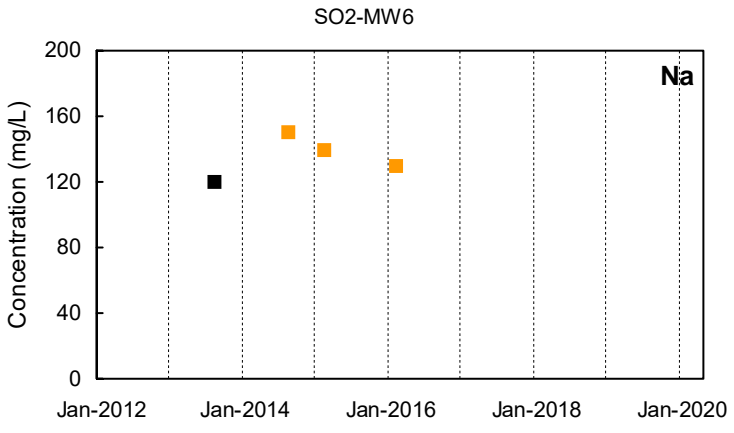

Detected Value
 'J'-Flag (value between reporting limit and detection limit)
 Non-Detect Range
 Shallow Well shown with black symbols
 Deep Well shown with orange symbols
 "dd" Well shown with blue symbols

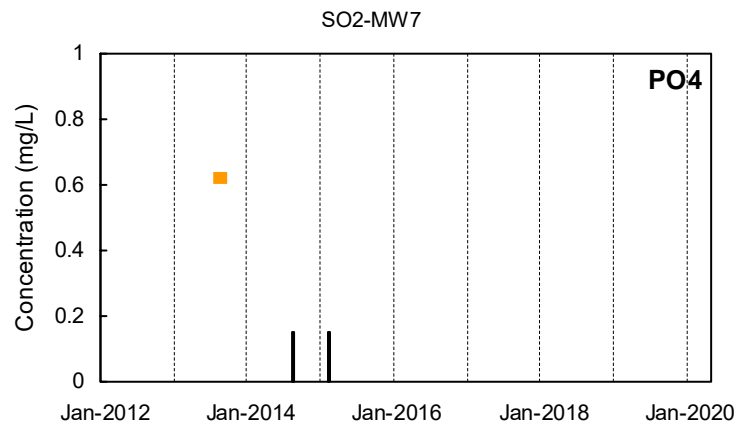
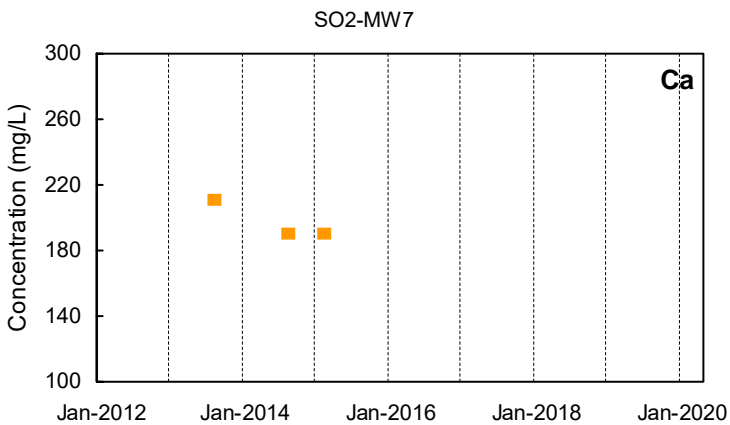
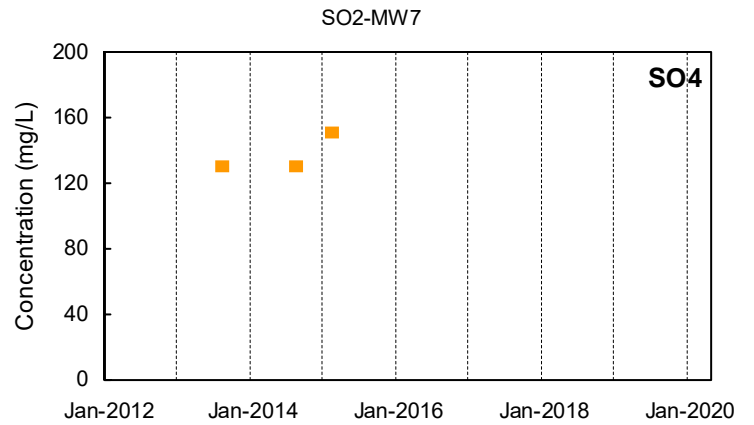
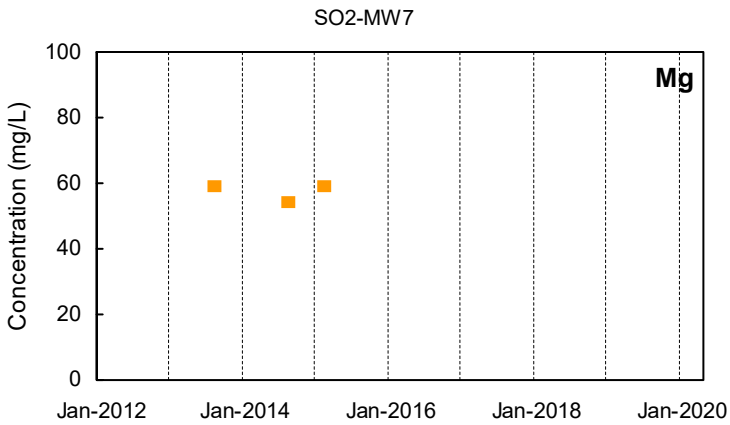
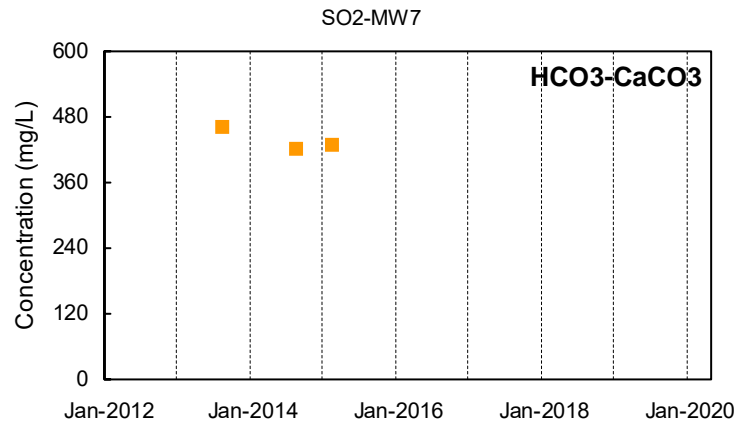
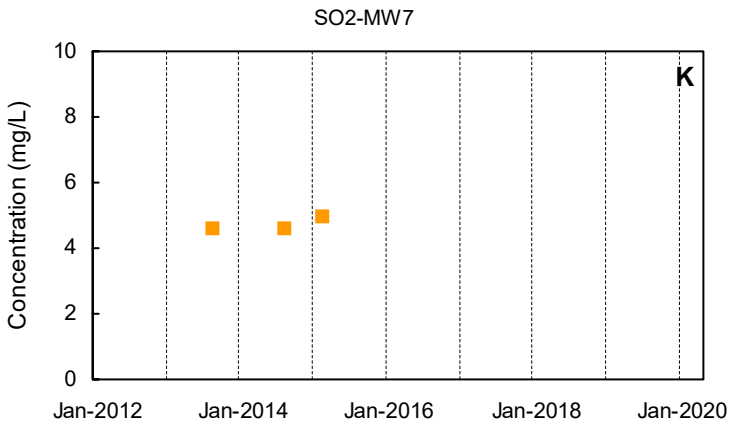
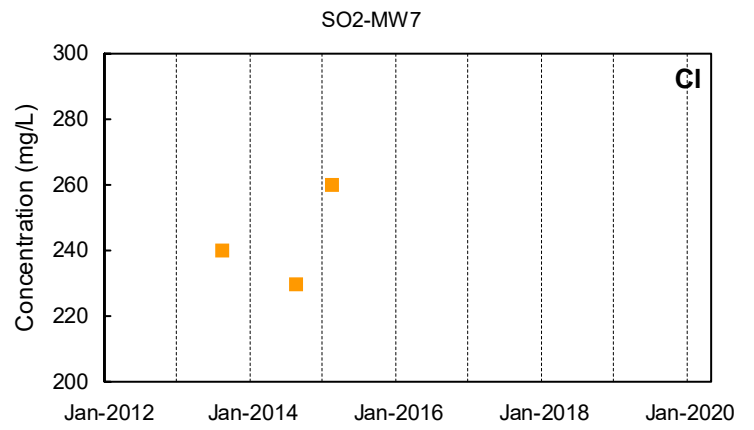
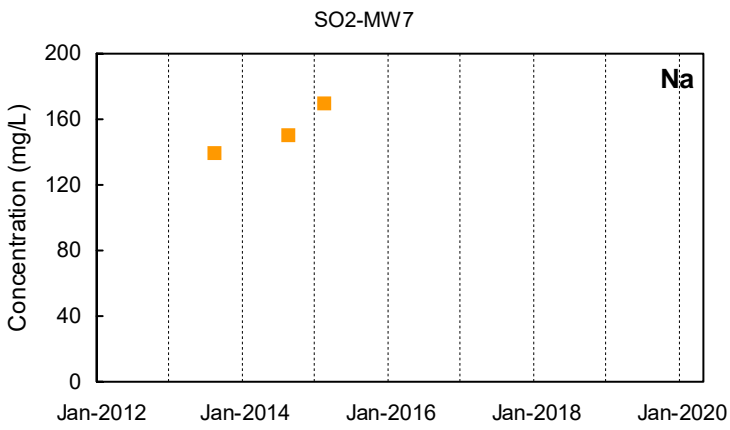

■ Detected Value □ 'J'-Flag (value between reporting limit and detection limit) ■ Non-Detect Range
 ■ Shallow Well shown with black symbols ■ Deep Well shown with orange symbols ■ "dd" Well shown with blue symbols

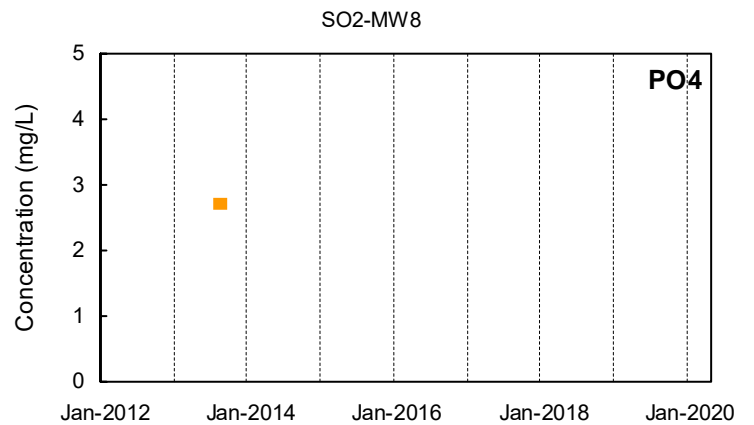
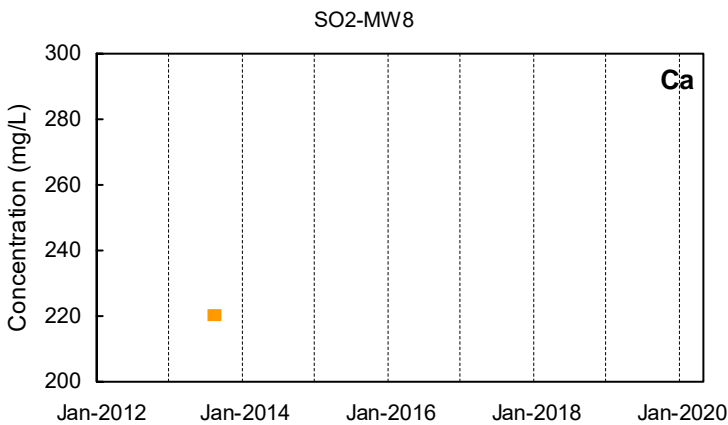
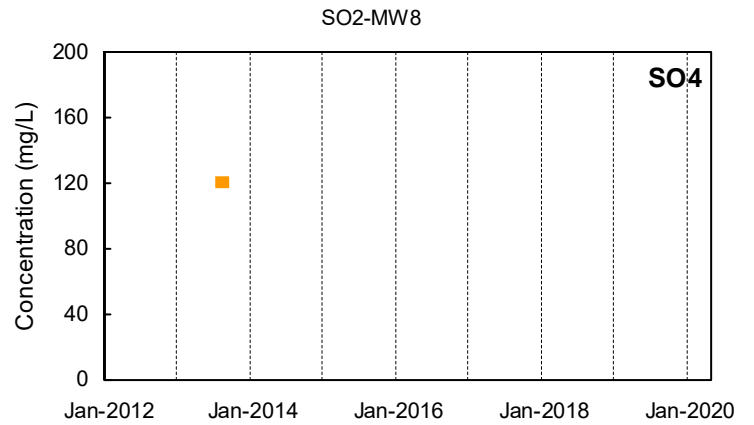
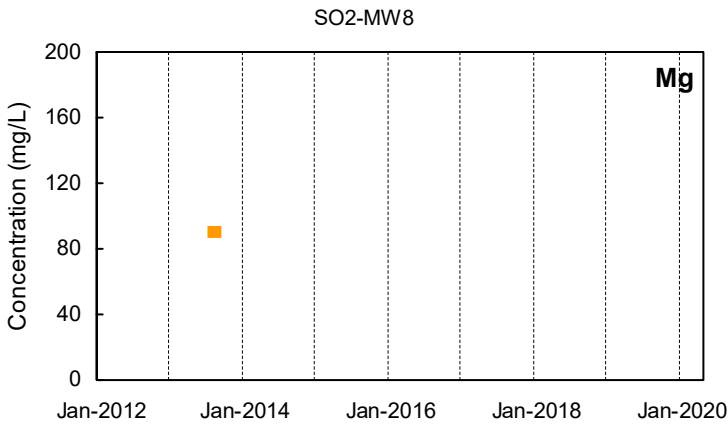
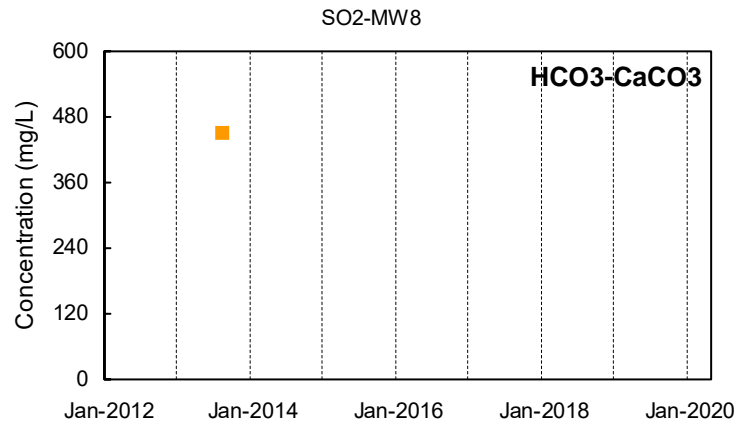
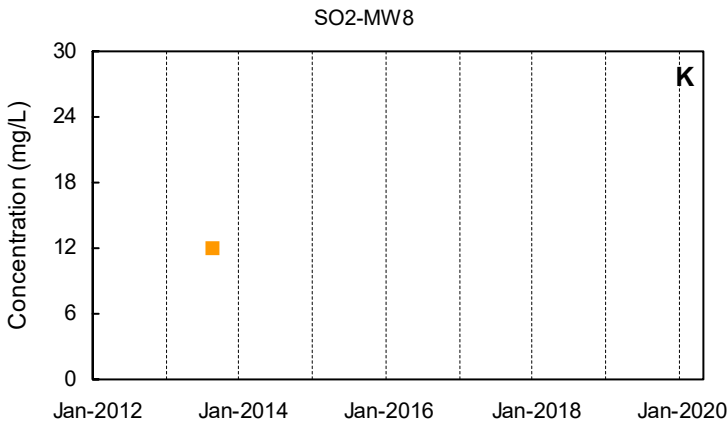
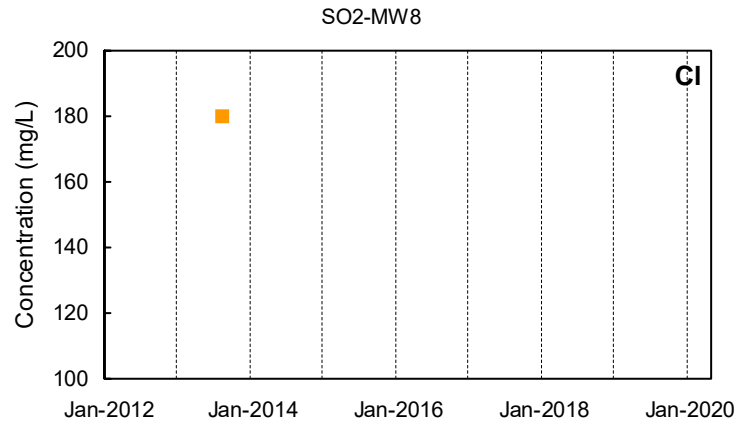
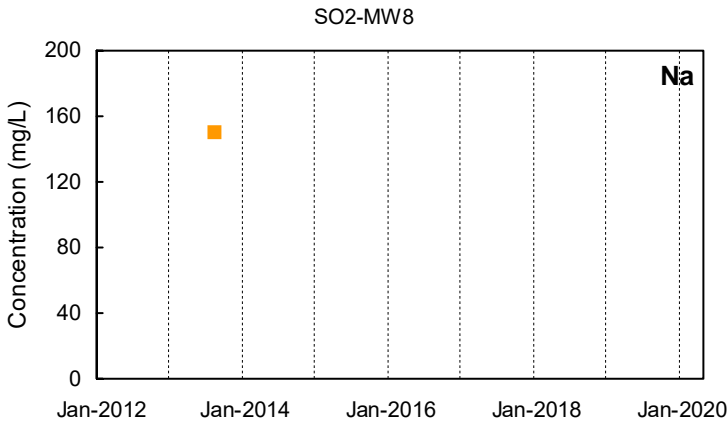

■ Detected Value □ 'J'-Flag (value between reporting limit and detection limit) ■ Non-Detect Range
 Shallow Well shown with black symbols Deep Well shown with orange symbols "dd" Well shown with blue symbols

SOJ-MW1

SOJ-MW1

Na

Not Sampled

Cl

Not Sampled

SOJ-MW1

SOJ-MW1

K

Not Sampled

HCO3-CaCO3

Not Sampled

SOJ-MW1

SOJ-MW1

Mg

Not Sampled

SO4

Not Sampled

SOJ-MW1

SOJ-MW1

Ca

Not Sampled

PO4

Not Sampled

■ Detected Value

□ 'J'-Flag (value between reporting limit and detection limit)



Non-Detect Range

Shallow Well shown with black symbols

Deep Well shown with orange symbols

"dd" Well shown with blue symbols

SOJ-MW2

SOJ-MW2

Na

Not Sampled

Cl

Not Sampled

SOJ-MW2

SOJ-MW2

K

Not Sampled

HCO3-CaCO3

Not Sampled

SOJ-MW2

SOJ-MW2

Mg

Not Sampled

SO4

Not Sampled

SOJ-MW2

SOJ-MW2

Ca

Not Sampled

PO4

Not Sampled

■ Detected Value

□ 'J'-Flag (value between reporting limit and detection limit)



Non-Detect Range

Shallow Well shown with black symbols

Deep Well shown with orange symbols

"dd" Well shown with blue symbols

SOJ-MW3

Na

Not Sampled

SOJ-MW3

Cl

Not Sampled

SOJ-MW3

K

Not Sampled

SOJ-MW3

HCO3-CaCO3

Not Sampled

SOJ-MW3

Mg

Not Sampled

SOJ-MW3

SO4

Not Sampled

SOJ-MW3

Ca

Not Sampled

SOJ-MW3

PO4

Not Sampled

■ Detected Value

□ 'J'-Flag (value between reporting limit and detection limit)

■ Non-Detect Range

Shallow Well shown with black symbols

Deep Well shown with orange symbols

"dd" Well shown with blue symbols

SOJ-MW4

SOJ-MW4

Na

Not Sampled

Cl

Not Sampled

SOJ-MW4

SOJ-MW4

K

Not Sampled

HCO3-CaCO3

Not Sampled

SOJ-MW4

SOJ-MW4

Mg

Not Sampled

SO4

Not Sampled

SOJ-MW4

SOJ-MW4

Ca

Not Sampled

PO4

Not Sampled

Detected Value
 'J'-Flag (value between reporting limit and detection limit)
 Non-Detect Range
 Shallow Well shown with black symbols
 Deep Well shown with orange symbols
 "dd" Well shown with blue symbols

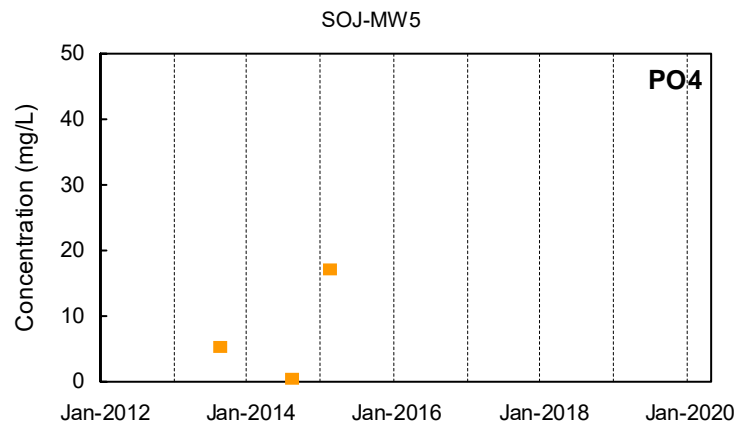
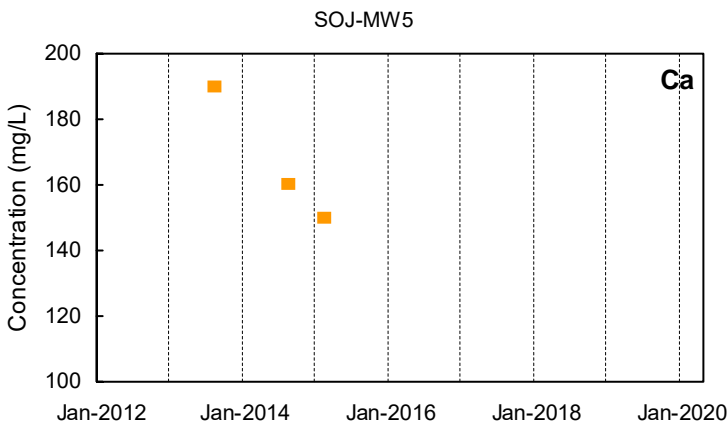
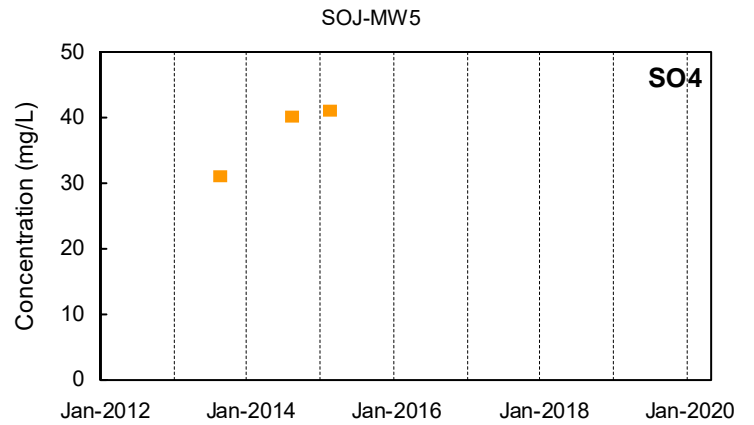
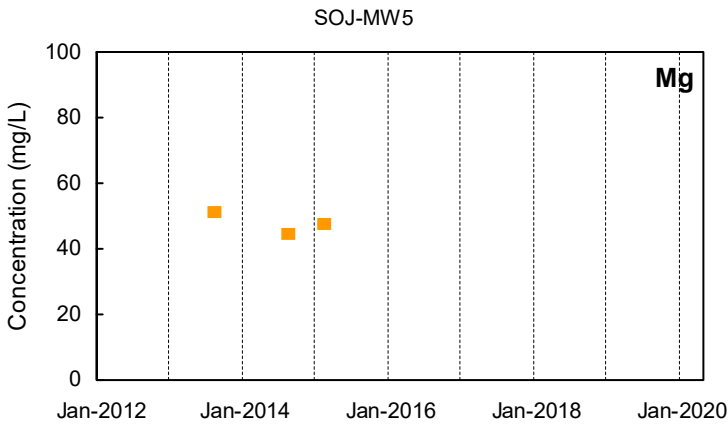
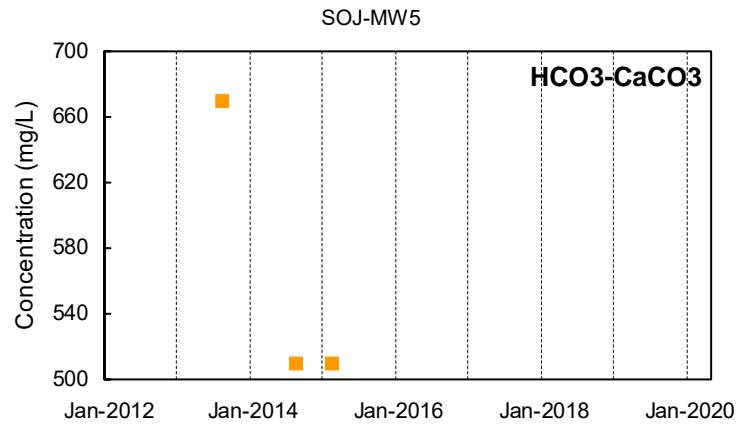
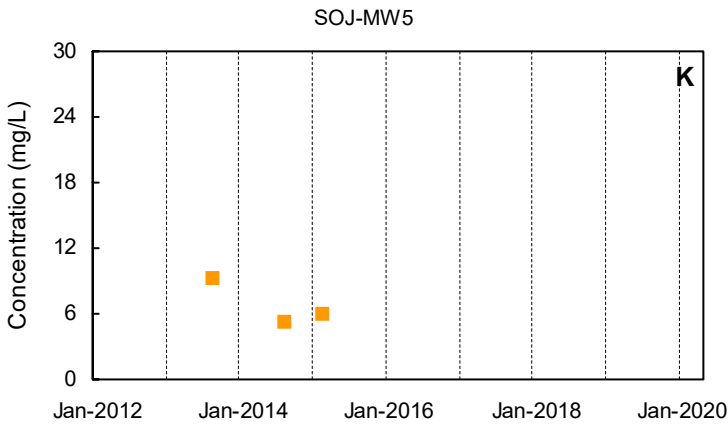
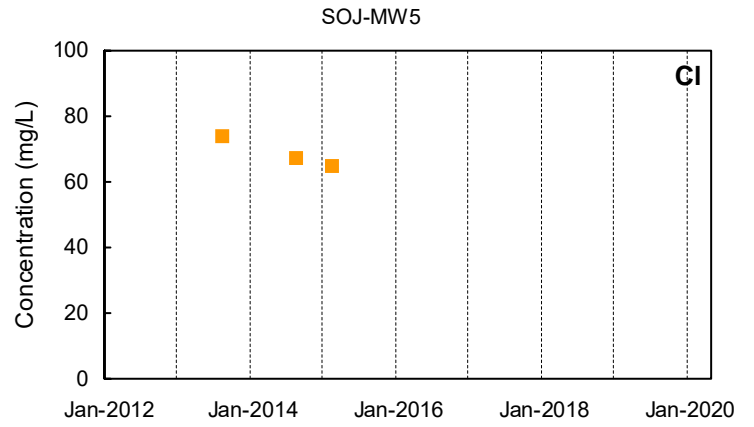
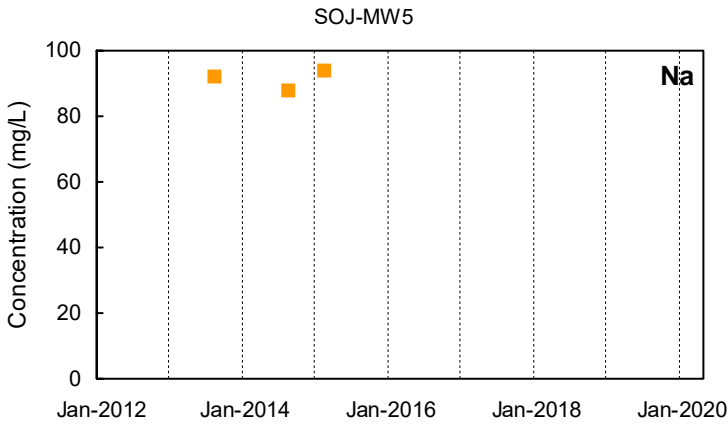

■ Detected Value □ 'J'-Flag (value between reporting limit and detection limit) ■ Non-Detect Range
 Shallow Well shown with black symbols Deep Well shown with orange symbols "dd" Well shown with blue symbols

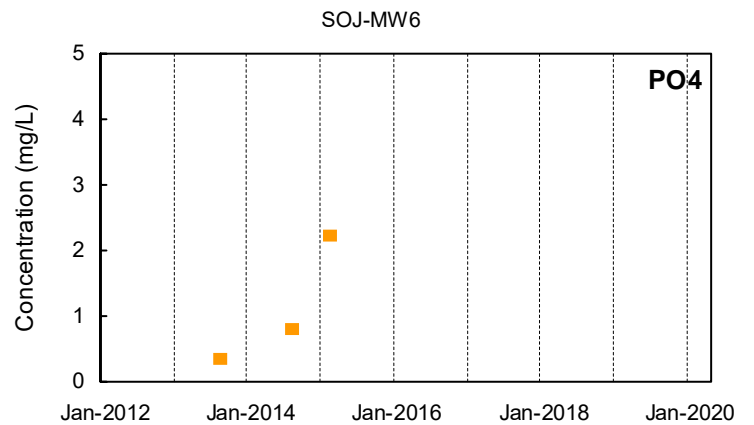
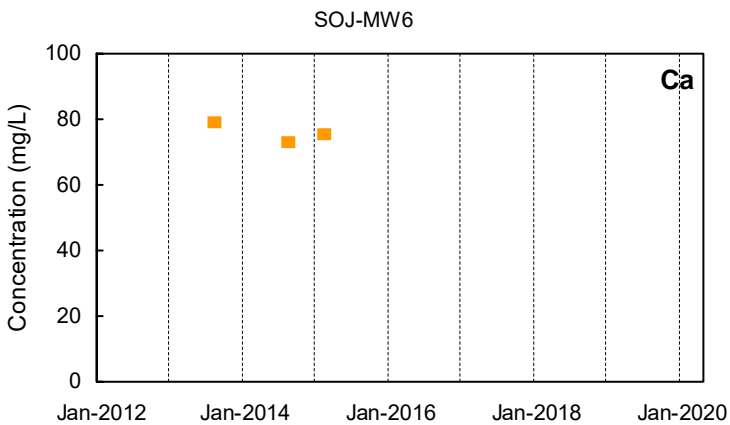
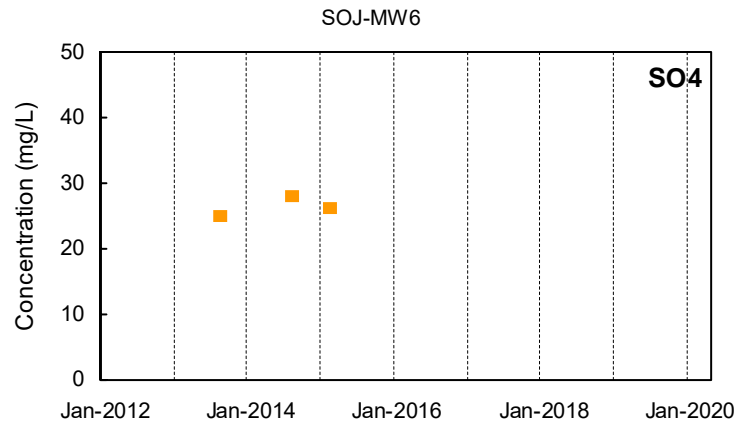
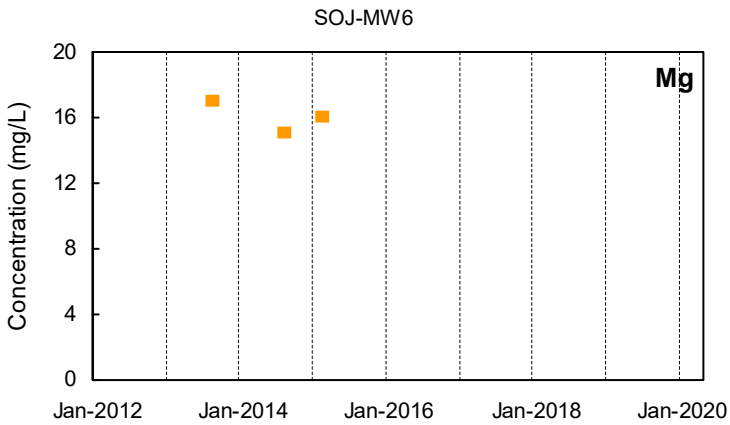
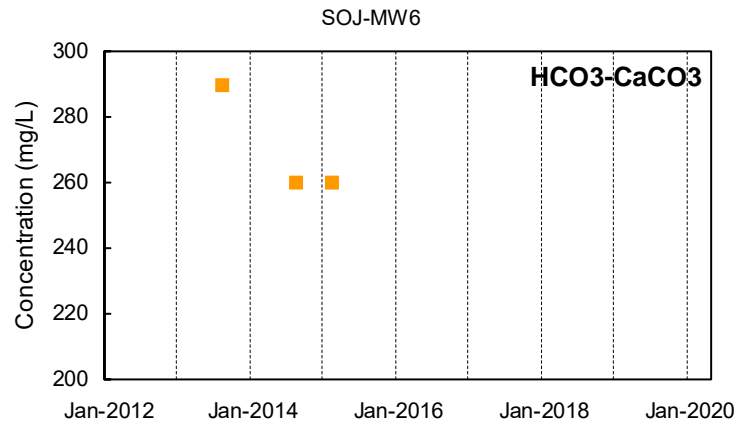
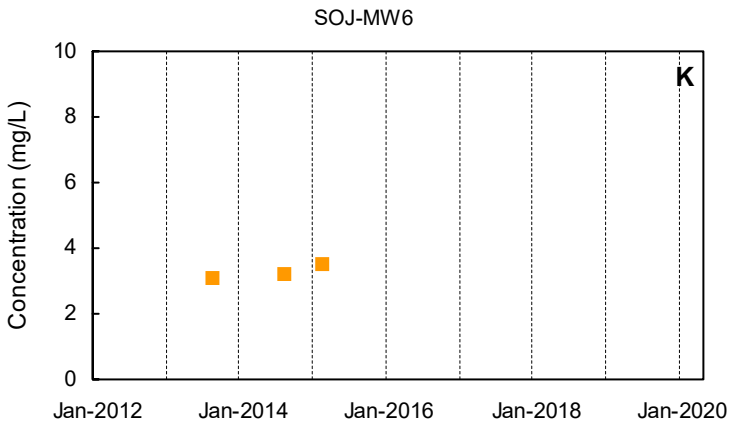
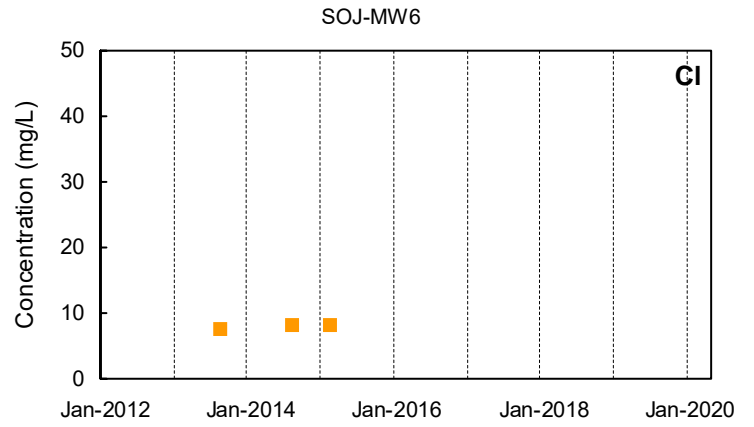
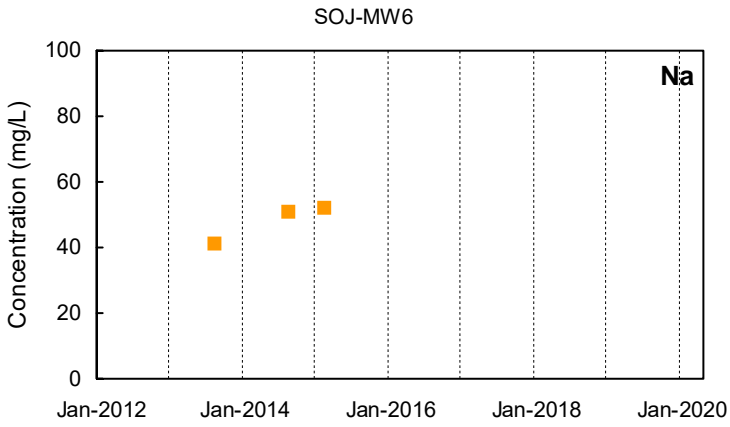

■ Detected Value
 □ 'J'-Flag (value between reporting limit and detection limit)
 Non-Detect Range
■ Shallow Well shown with black symbols
■ Deep Well shown with orange symbols
■ "dd" Well shown with blue symbols

Attachment A10

Groundwater Chemical Characteristics – Bar Charts

A10-8 SOJ – stacked bar graphs, proportional distribution of cations and anions in groundwater samples, August 2014 104

A10-9 SOJ – stacked bar graphs, proportional distribution of cations and anions in groundwater samples, February 2015 104

MEN

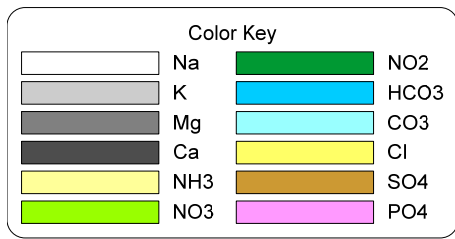
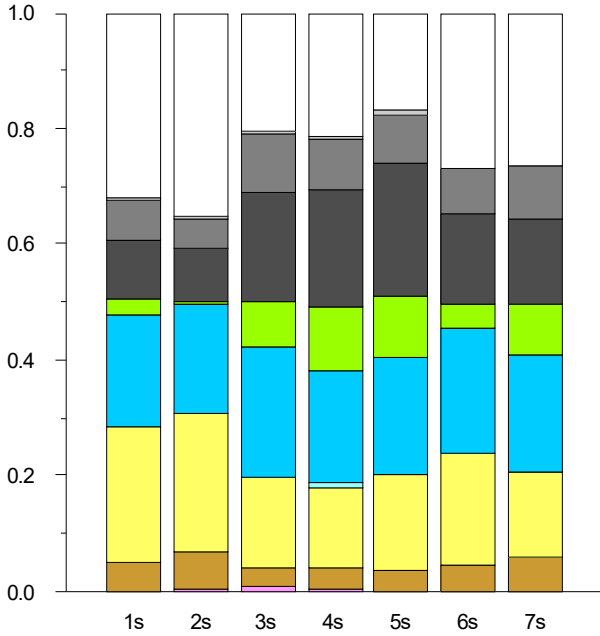

A10-1 MEN – stacked bar graph, proportional distribution of cations and anions in groundwater samples, May 2012

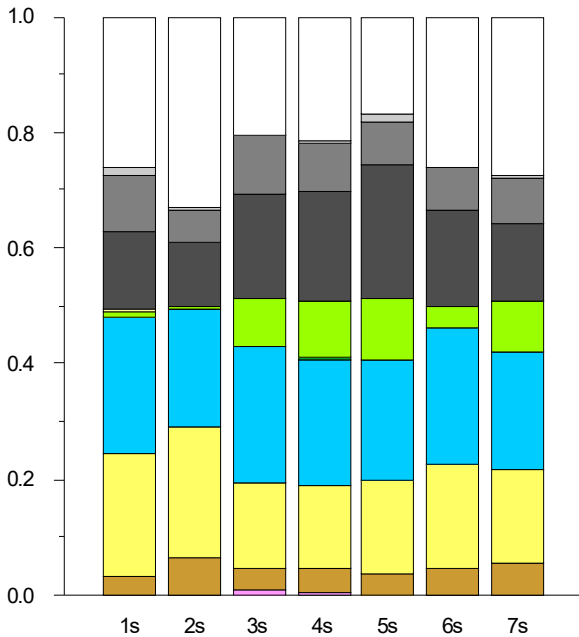

A10-2 MEN – stacked bar graph, proportional distribution of cations and anions in groundwater samples, August 2012

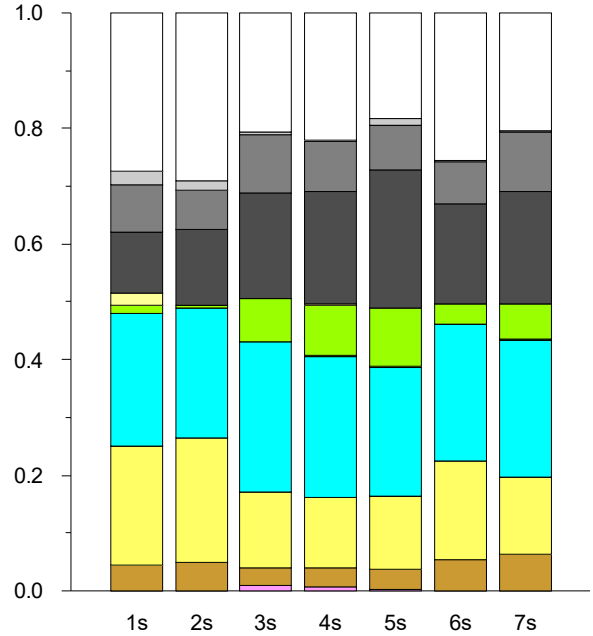

A10-3 MEN – stacked bar graph, proportional distribution of cations and anions in groundwater samples, August 2013

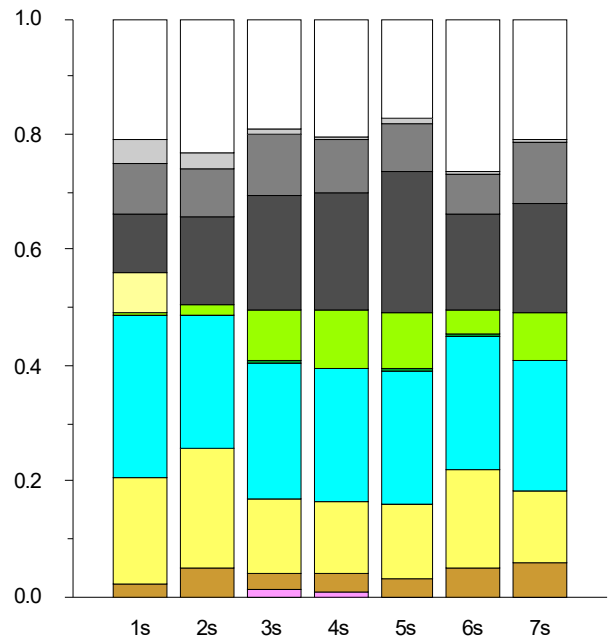

A10-4 MEN – stacked bar graph, proportional distribution of cations and anions in groundwater samples, August 2013

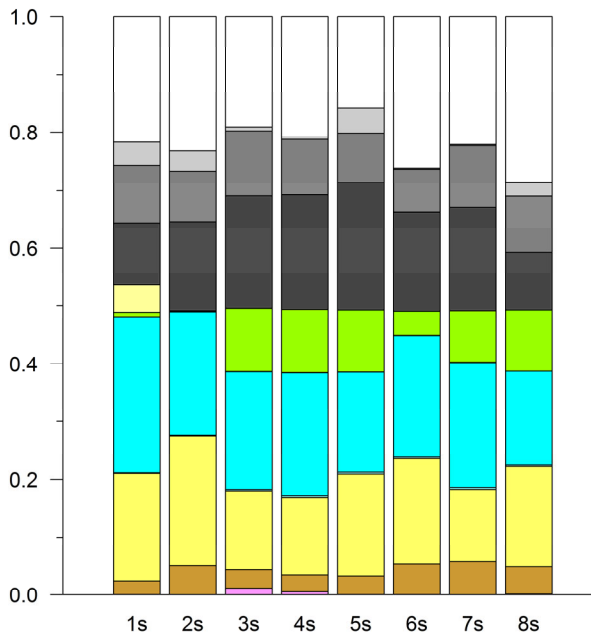

A10-5 MEN – stacked bar graph, proportional distribution of cations and anions in groundwater samples, February 2015

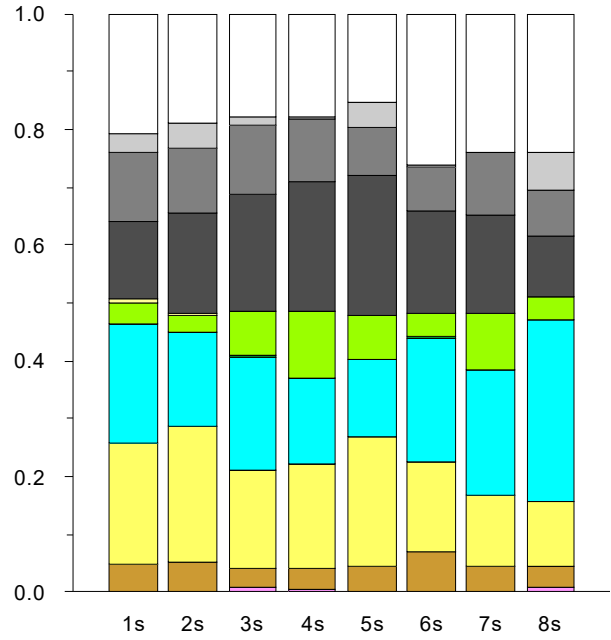

A10-7 MEN – stacked bar graph, proportional distribution of cations and anions in groundwater samples, March 2017

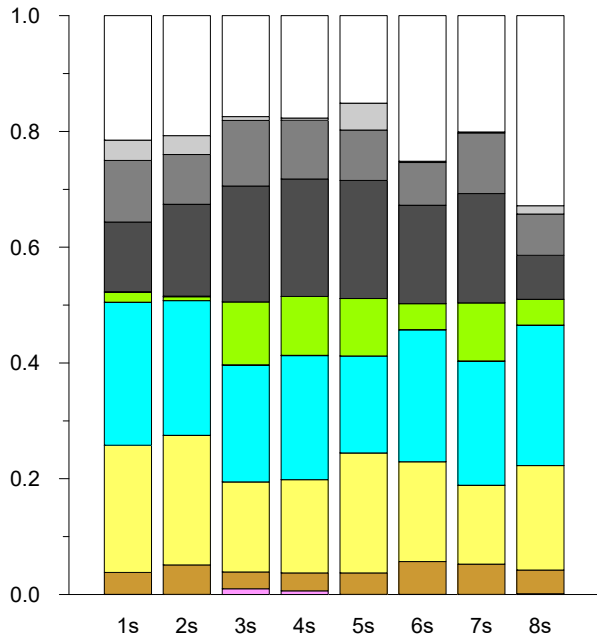

A10-6 MEN – stacked bar graph, proportional distribution of cations and anions in groundwater samples, February 2016

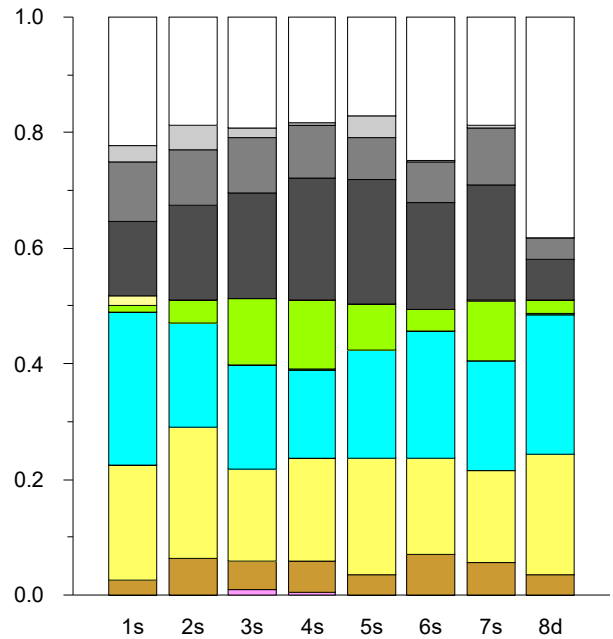

A10-8 MEN – stacked bar graph, proportional distribution of cations and anions in groundwater samples, February 2018

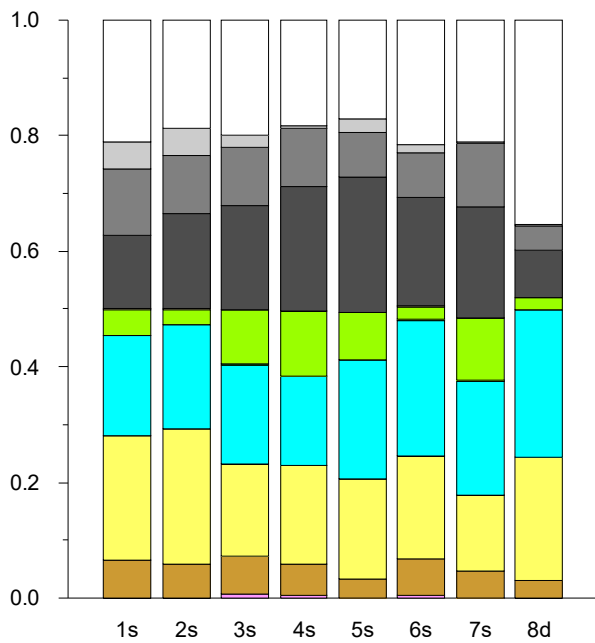

A10-9 MEN – stacked bar graph, proportional distribution of cations and anions in groundwater samples, February 2019

ANC

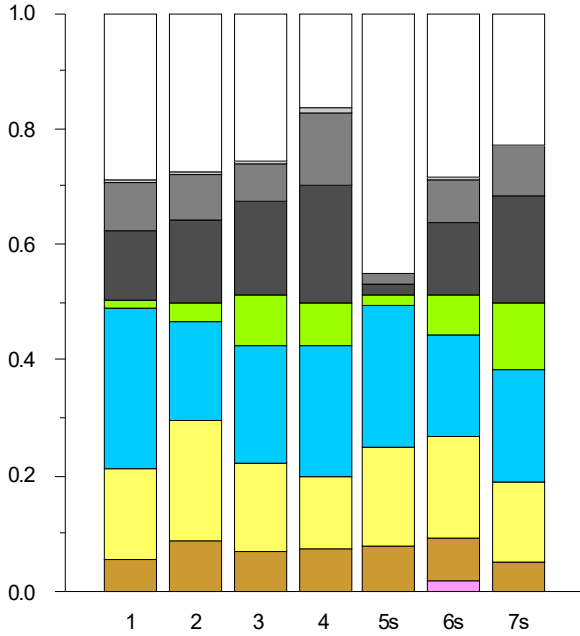

A10-10 ANC – stacked bar graph, proportional distribution of cations and anions in groundwater samples, May 2012

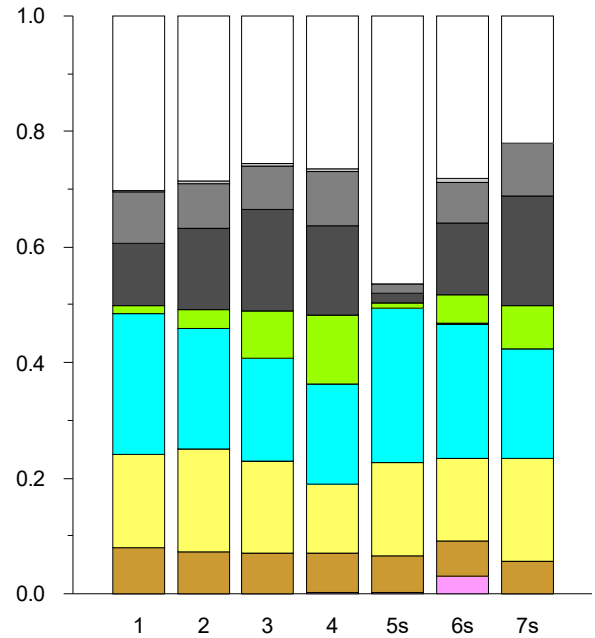

A10-12 ANC – stacked bar graph, proportional distribution of cations and anions in groundwater samples, August 2013

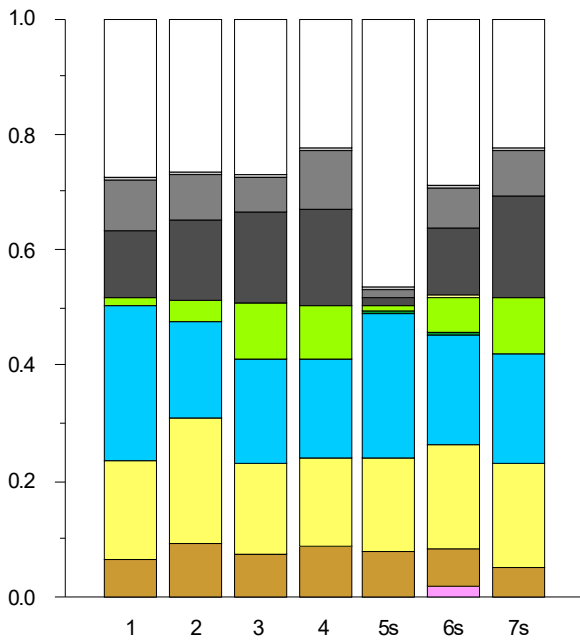

A10-11 ANC – stacked bar graph, proportional distribution of cations and anions in groundwater samples, August 2012

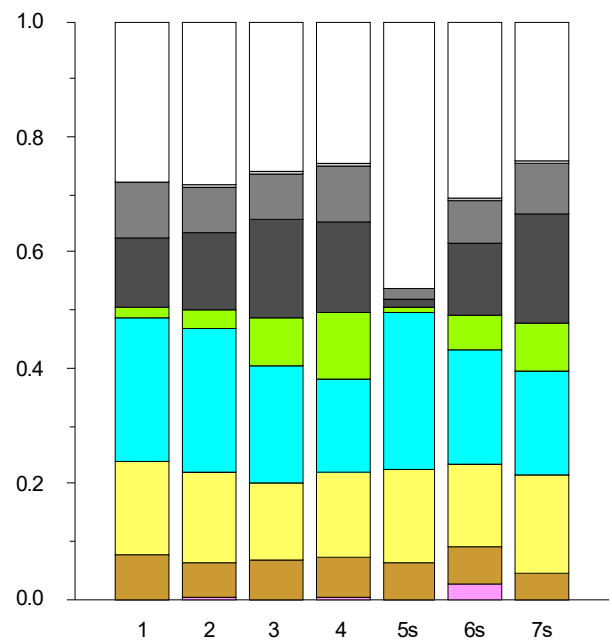

A10-13 ANC – stacked bar graph, proportional distribution of cations and anions in groundwater samples, August 2014

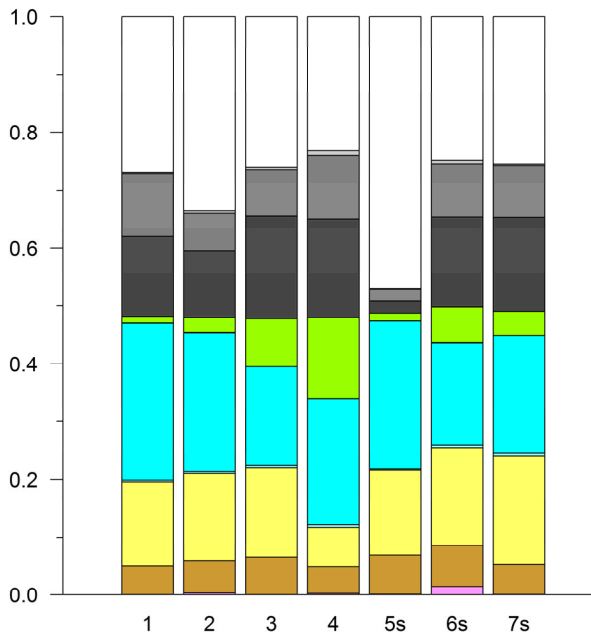

A10-14 ANC – stacked bar graph, proportional distribution of cations and anions in groundwater samples, February 2015

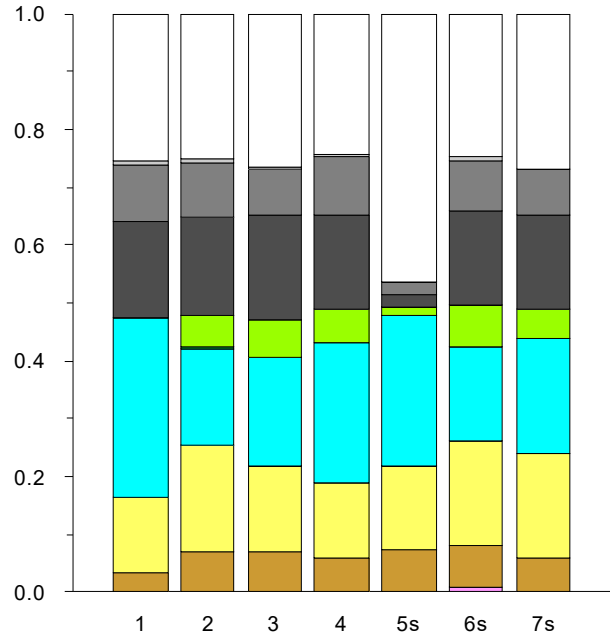

A10-16 ANC – stacked bar graph, proportional distribution of cations and anions in groundwater samples, March 2017

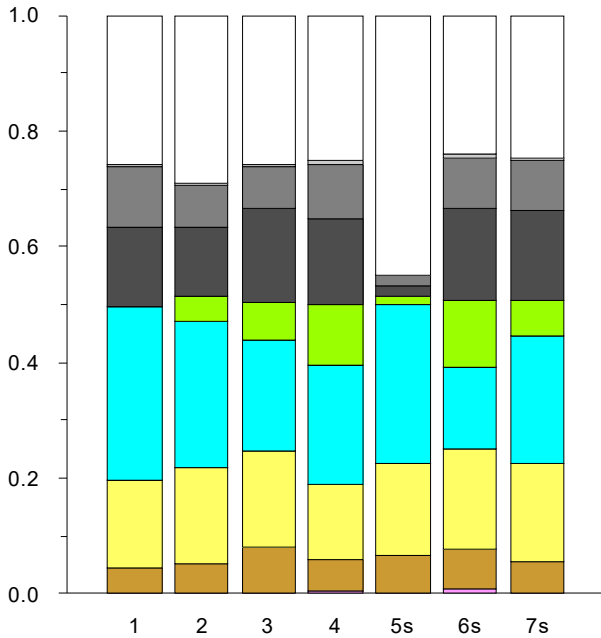

A10-15 ANC – stacked bar graph, proportional distribution of cations and anions in groundwater samples, February 2016

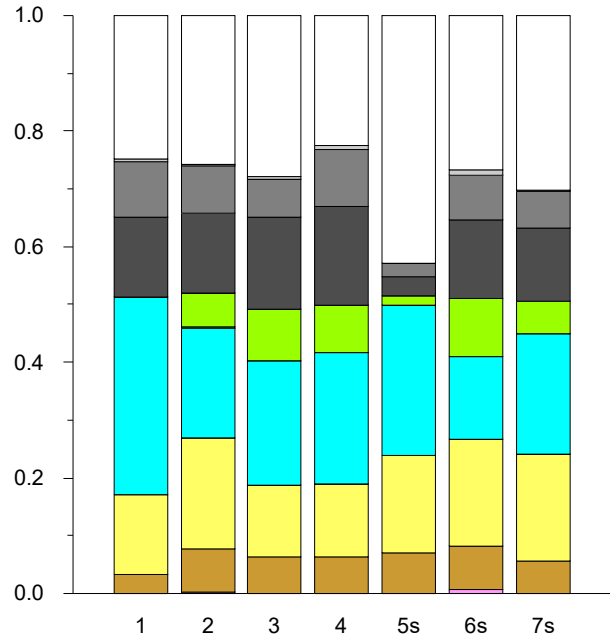

A10-17 ANC – stacked bar graph, proportional distribution of cations and anions in groundwater samples, February 2018

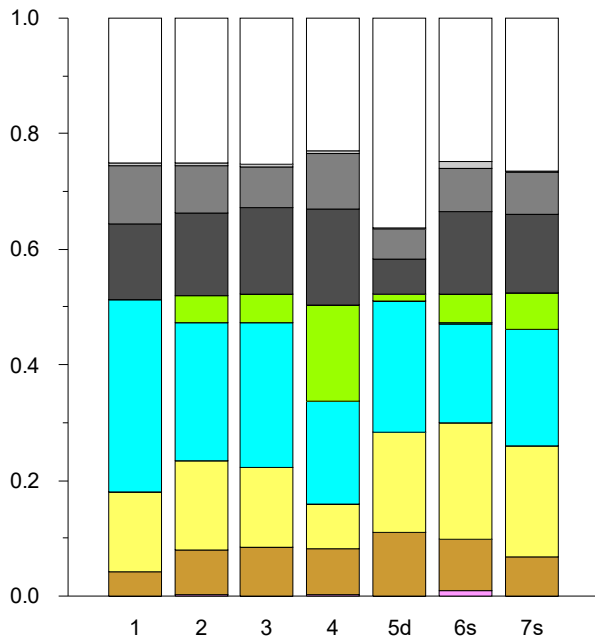

A10-18 ANC – stacked bar graph, proportional distribution of cations and anions in groundwater samples, February 2019

BET

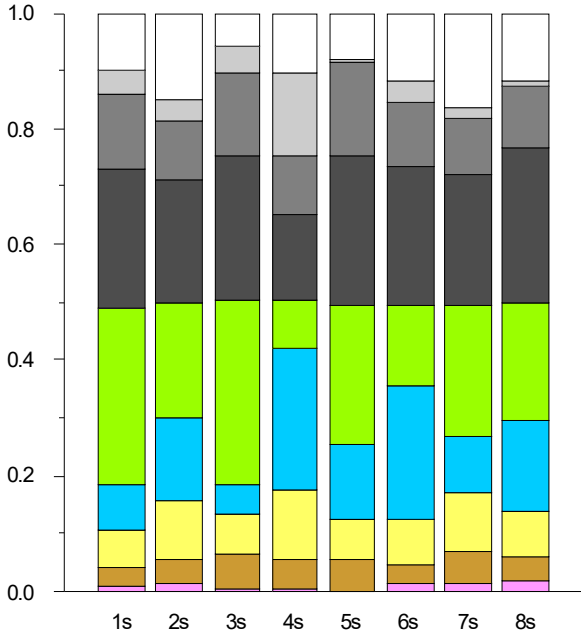

A10-19 BET - stacked bar graph, proportional distribution of cations and anions in groundwater samples, May 2012

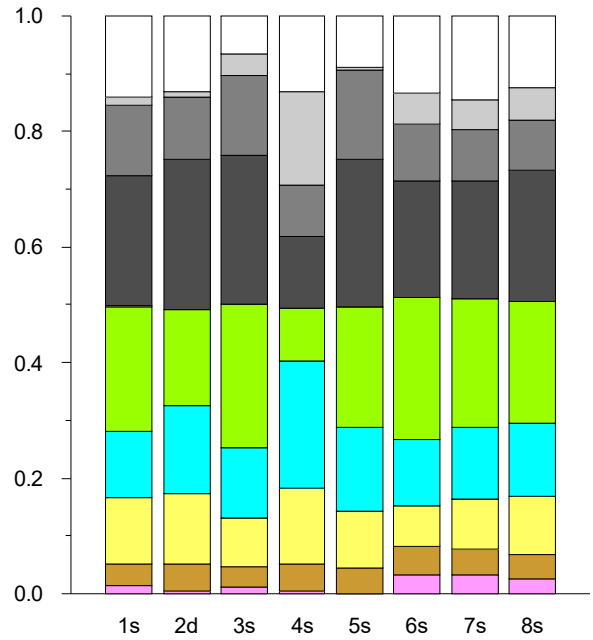

A10-21 BET - stacked bar graph, proportional distribution of cations and anions in groundwater samples, August 2013

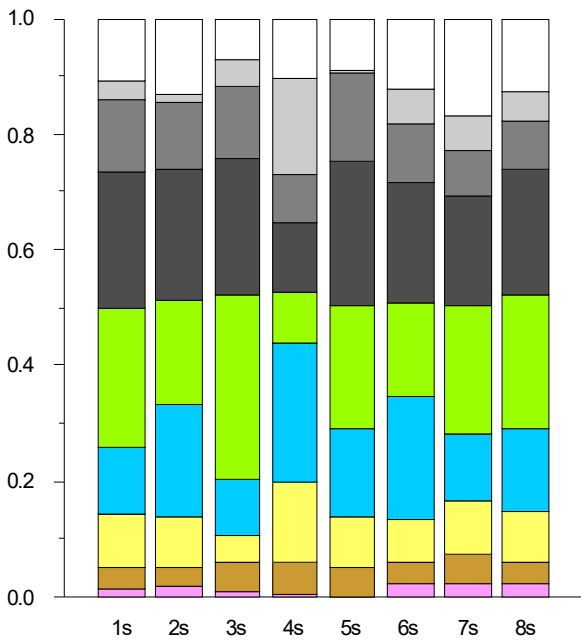

A10-20 BET - stacked bar graph, proportional distribution of cations and anions in groundwater samples, August 2012

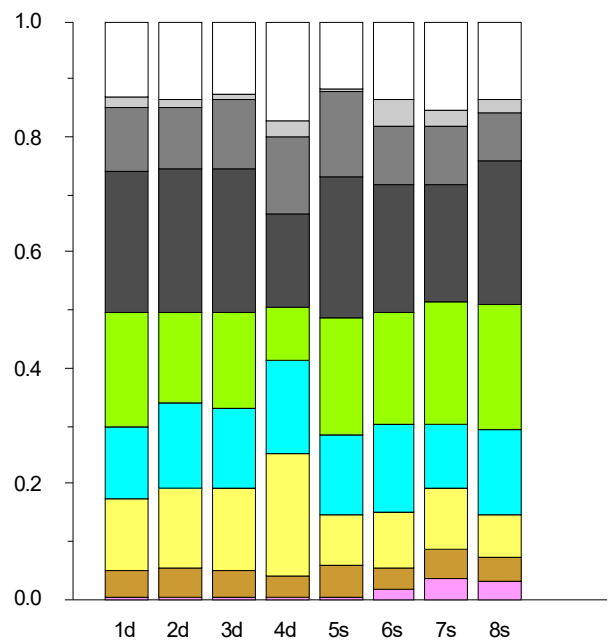

A10-22 BET - stacked bar graph, proportional distribution of cations and anions in groundwater samples, August 2014

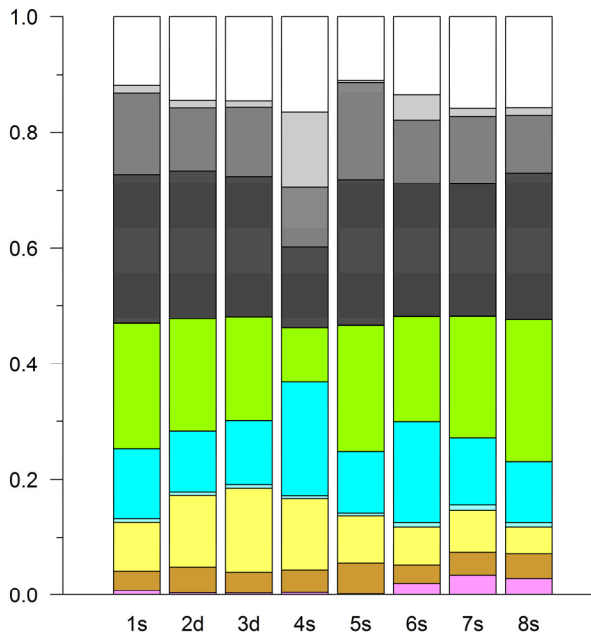

A10-23 BET – stacked bar graph, proportional distribution of cations and anions in groundwater samples, February 2015

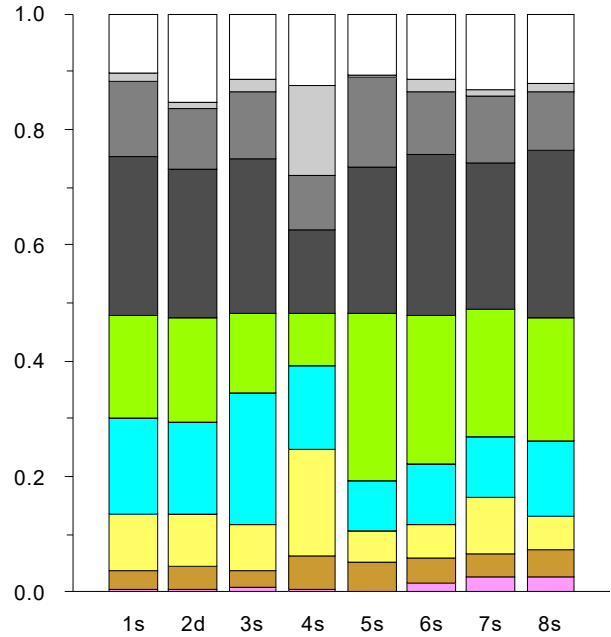

A10-25 BET – stacked bar graph, proportional distribution of cations and anions in groundwater samples, March 2017

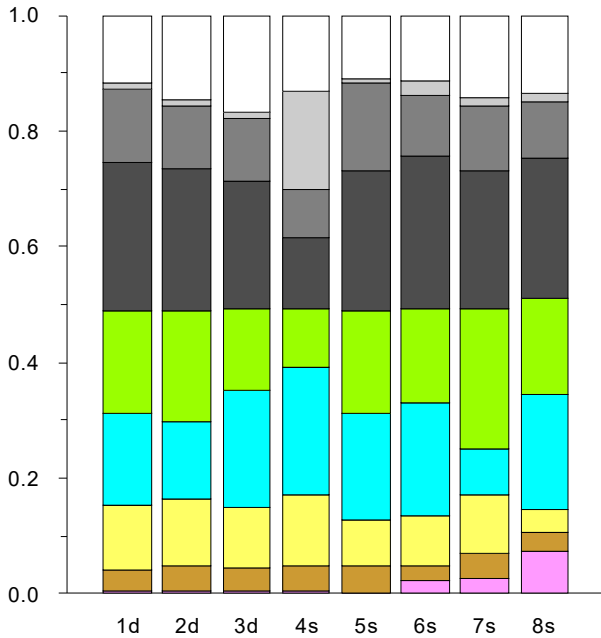

A10-24 BET – stacked bar graph, proportional distribution of cations and anions in groundwater samples, February 2016

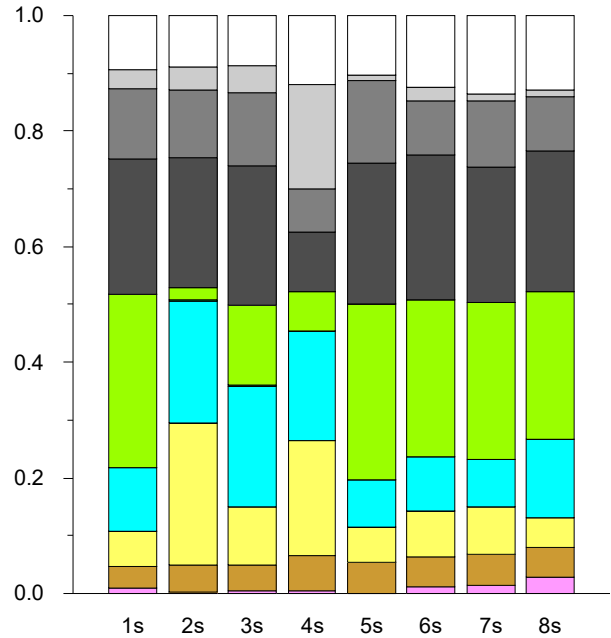

A10-26 BET – stacked bar graph, proportional distribution of cations and anions in groundwater samples, February 2018

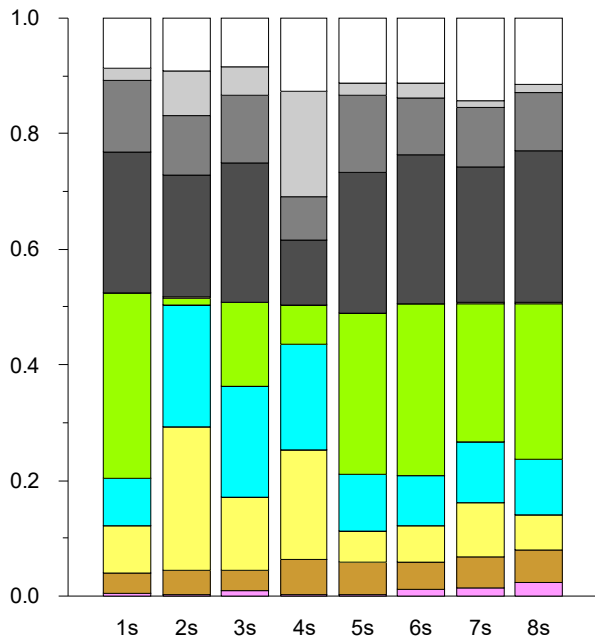

A10-27 BET – stacked bar graph, proportional distribution of cations and anions in groundwater samples, February 2019

DIE

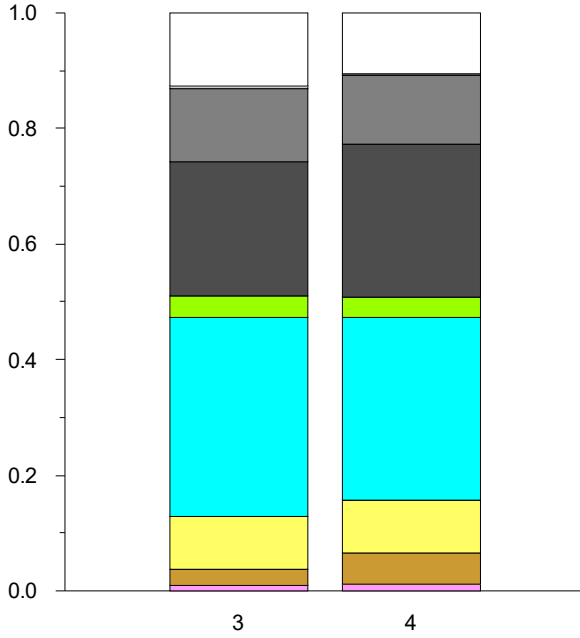

A10-28 DIE - stacked bar graph, proportional distribution of cations and anions in groundwater samples, August 2013

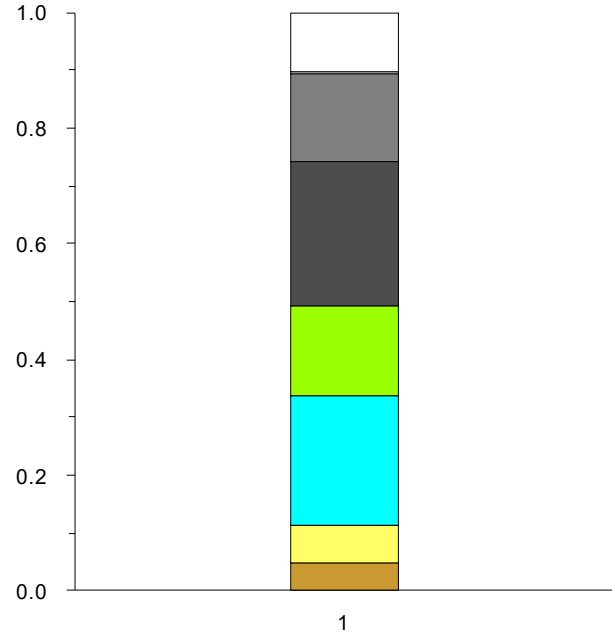

A10-30 DIE – stacked bar graph, proportional distribution of cations and anions in groundwater samples, February 2016

No data for 2014 – All wells dry

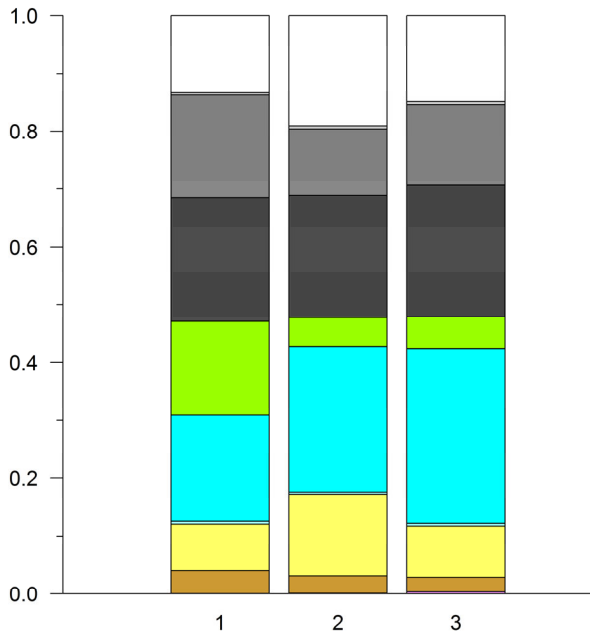

A10-29 DIE - stacked bar graph, proportional distribution of cations and anions in groundwater samples, February 2015

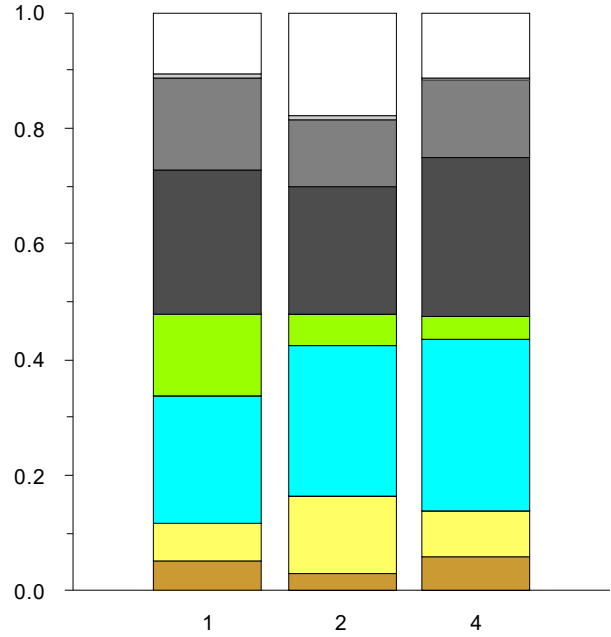

A10-31 DIE – stacked bar graph, proportional distribution of cations and anions in groundwater samples, March 2017

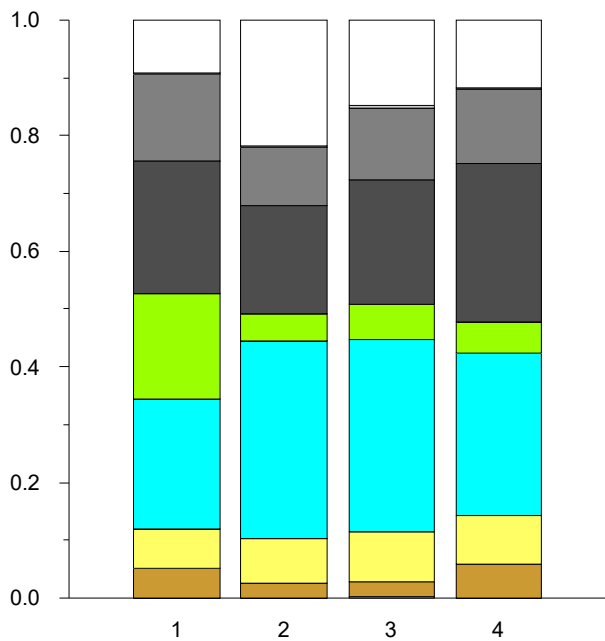

A10-32 DIE - stacked bar graph, proportional distribution of cations and anions in groundwater samples, February 2018

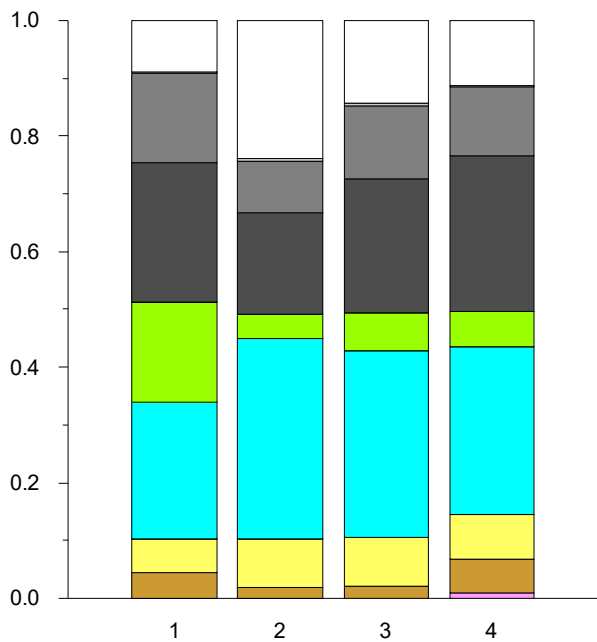

A10-33 DIE - stacked bar graph, proportional distribution of cations and anions in groundwater samples, February 2019

DUR

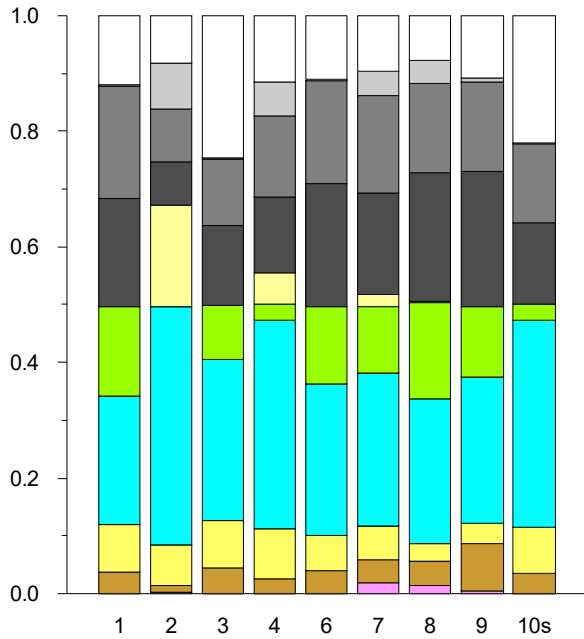

A10-34 DUR - stacked bar graph, proportional distribution of cations and anions in groundwater samples, August 2013

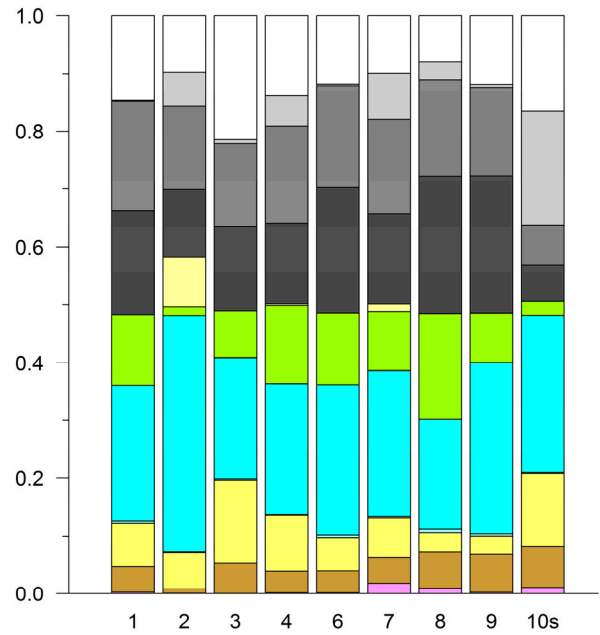

A10-36 DUR – stacked bar graph, proportional distribution of cations and anions in groundwater samples, February 2015

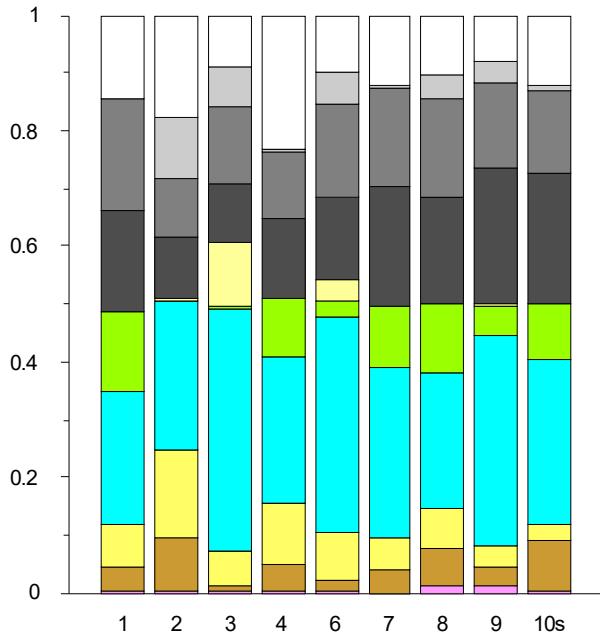

A10-35 DUR – stacked bar graph, proportional distribution of cations and anions in groundwater samples, August 2014

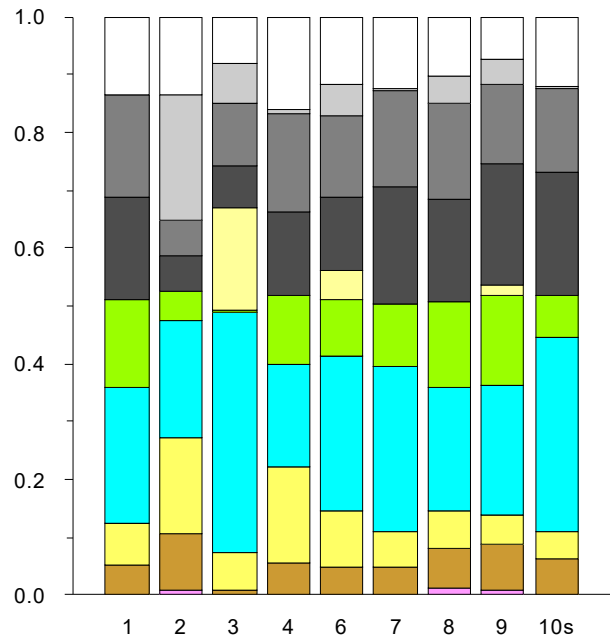

A10-37 DUR – stacked bar graph, proportional distribution of cations and anions in groundwater samples, February 2016

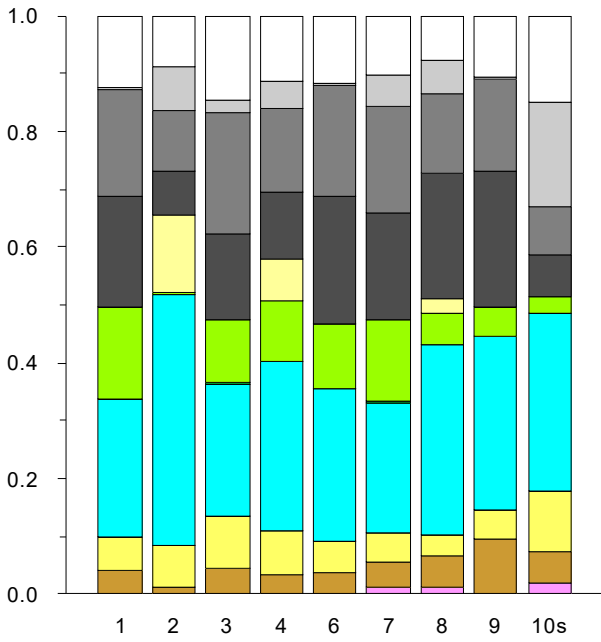

A10-1 DUR – stacked bar graph, proportional distribution of cations and anions in groundwater samples, March 2017

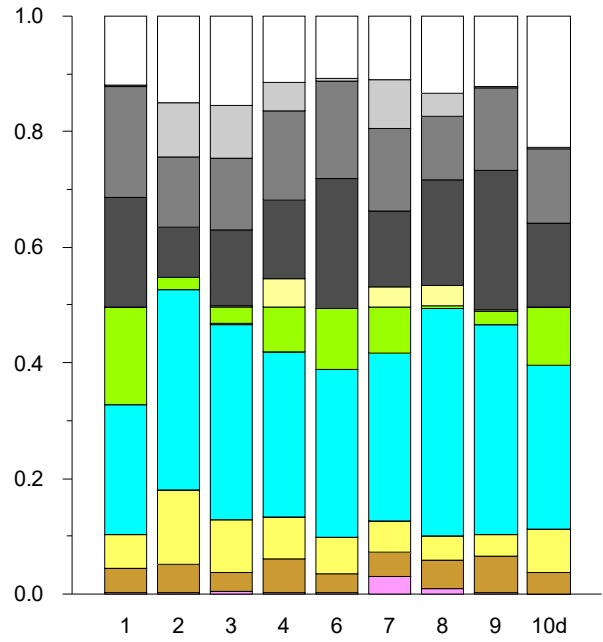

A10-3 DUR – stacked bar graph, proportional distribution of cations and anions in groundwater samples, February 2019

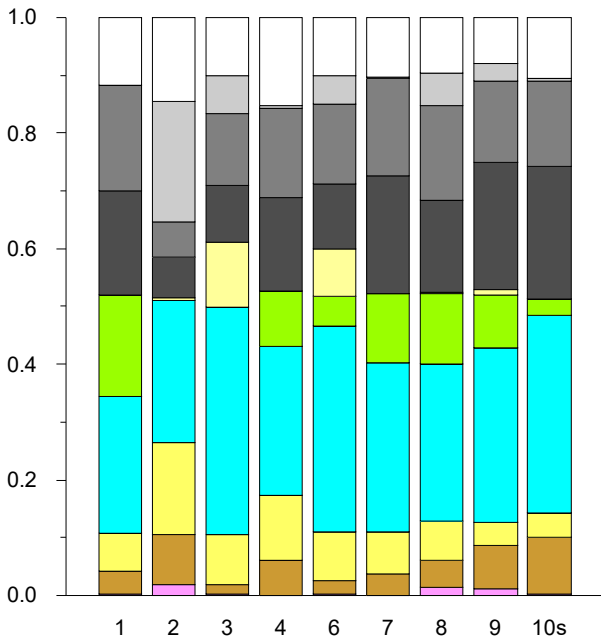

A10-2 DUR – stacked bar graph, proportional distribution of cations and anions in groundwater samples, February 2018

FG1

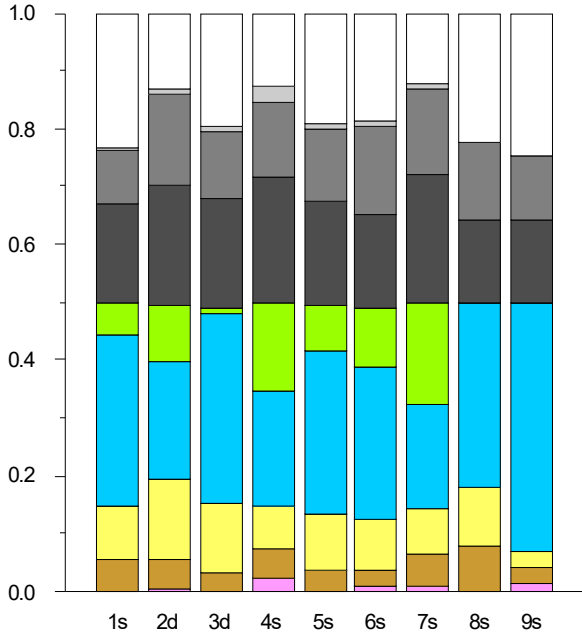

A10-5 FG1 - stacked bar graph, proportional distribution of cations and anions in groundwater samples, May 2012

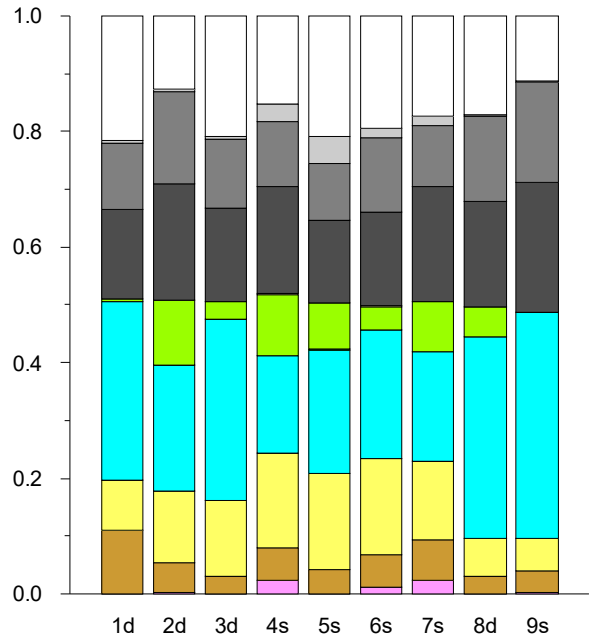

A10-7 FG1 - stacked bar graph, proportional distribution of cations and anions in groundwater samples, August 2013

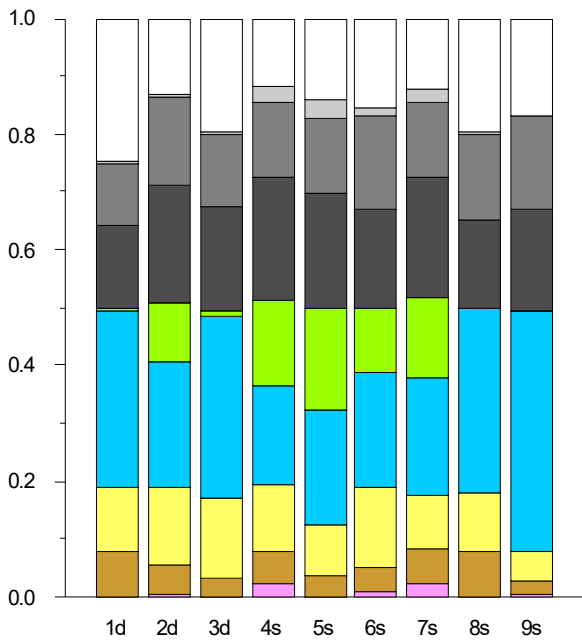

A10-6 FG1 - stacked bar graph, proportional distribution of cations and anions in groundwater samples, August 2012

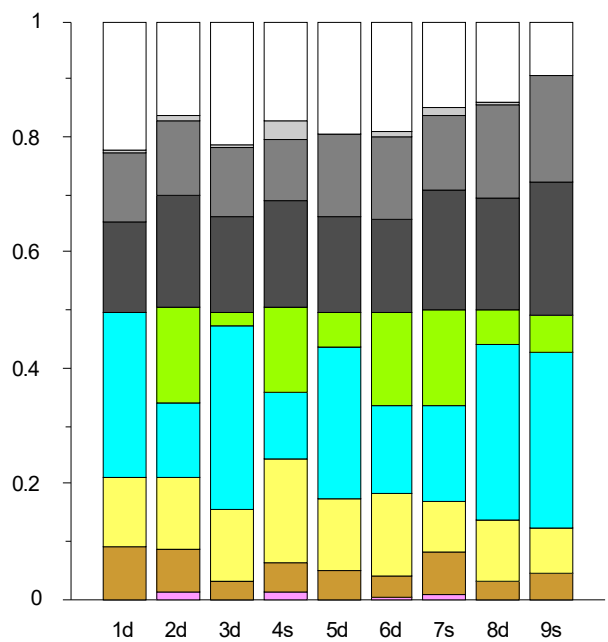

A10-8 FG1 - stacked graph, proportional distribution of cations and anions in groundwater samples, August 2014

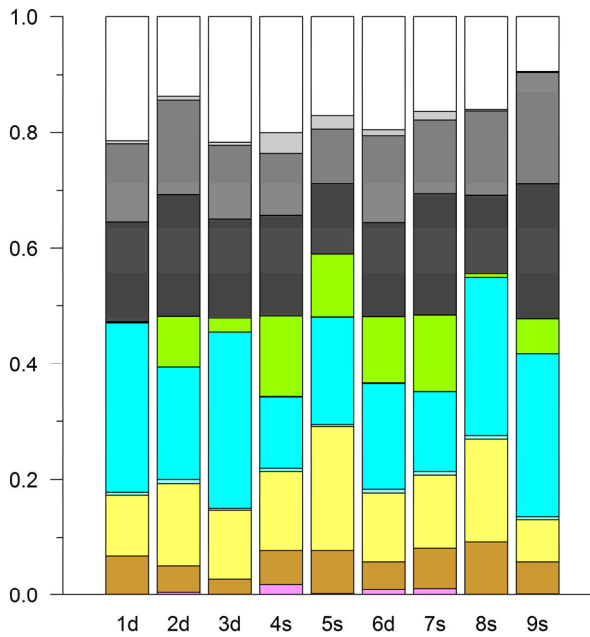

A10-9 FG1 – stacked graph, proportional distribution of cations and anions in groundwater samples, February 2015

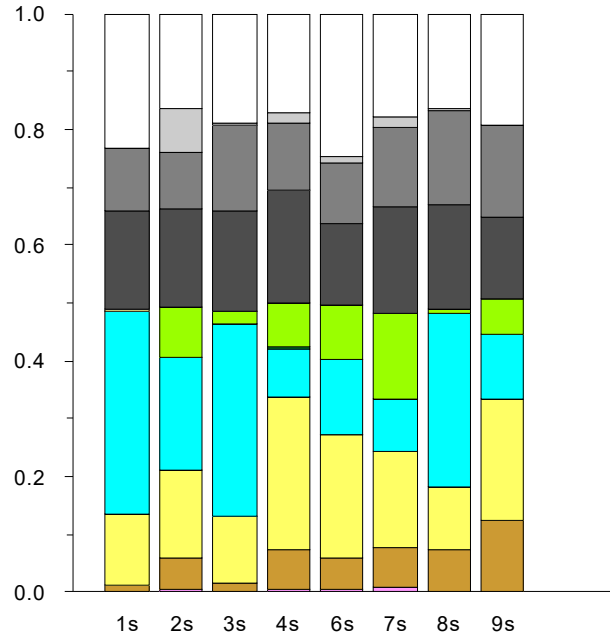

A10-11 FG1 – stacked graph, proportional distribution of cations and anions in groundwater samples, March 2017

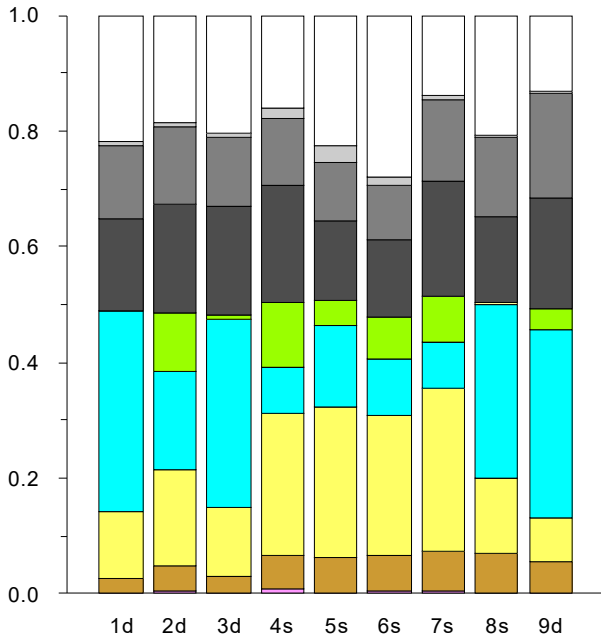

A10-10 FG1 – stacked graph, proportional distribution of cations and anions in groundwater samples, February 2016

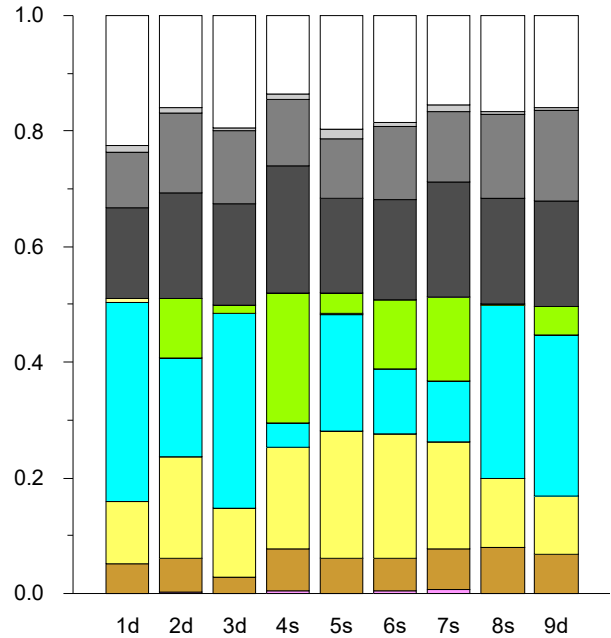

A10-1 FG1 – stacked graph, proportional distribution of cations and anions in groundwater samples, February 2018

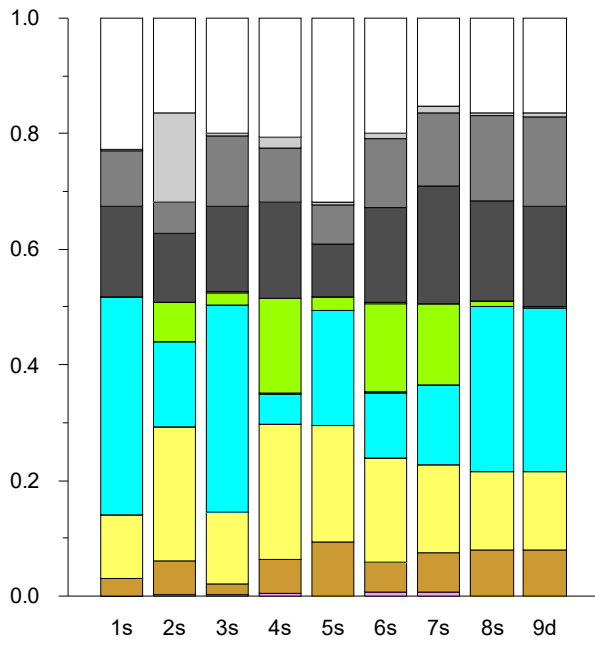

A10-2 FG1 – stacked graph, proportional distribution of cations and anions in groundwater samples, February 2019

BEA

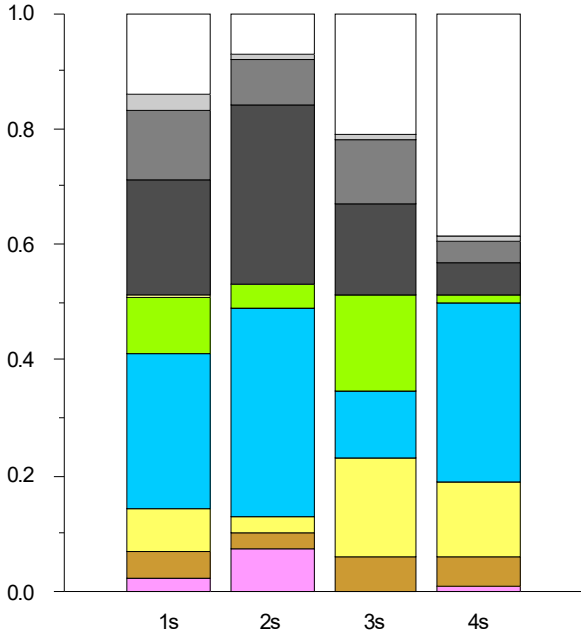

A10-3 BEA – stacked bar graph, proportional distribution of cations and anions in groundwater samples, May 2012

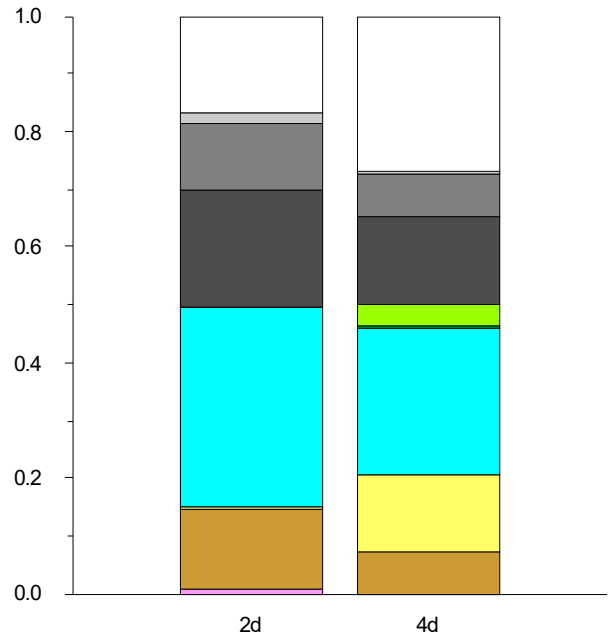

A10-5 BEA – stacked bar graph, proportional distribution of cations and anions in groundwater samples, August 2013

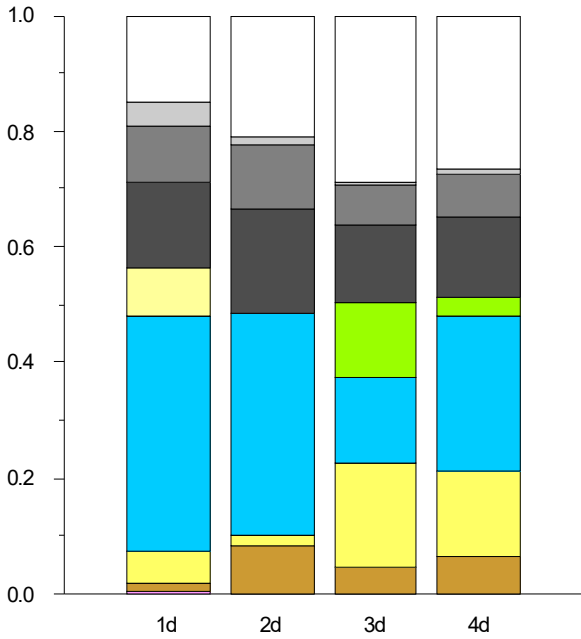

A10-4 BEA – stacked bar graph, proportional distribution of cations and anions in groundwater samples, August 2012

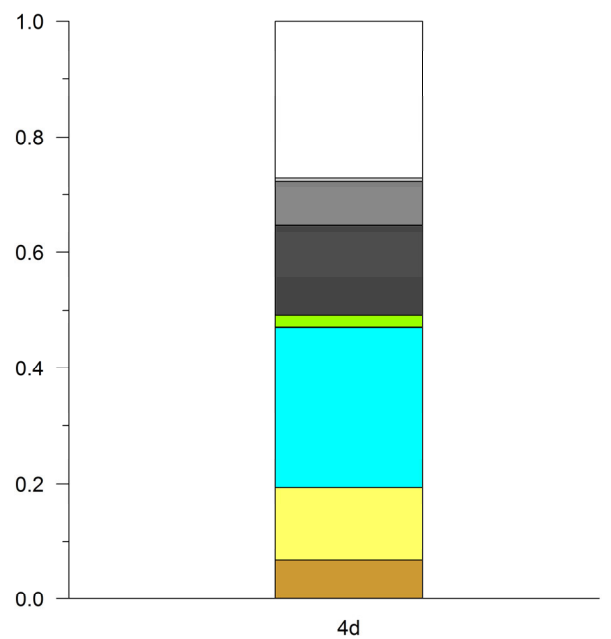

A10-6 BEA – stacked bar graph, proportional distribution of cations and anions in groundwater samples, August 2014

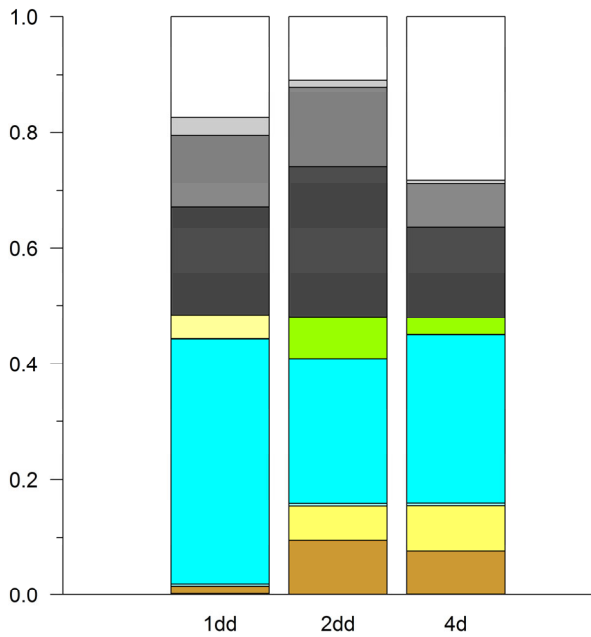

A10-7 BEA – stacked bar graph, proportional distribution of cations and anions in groundwater samples, February 2015

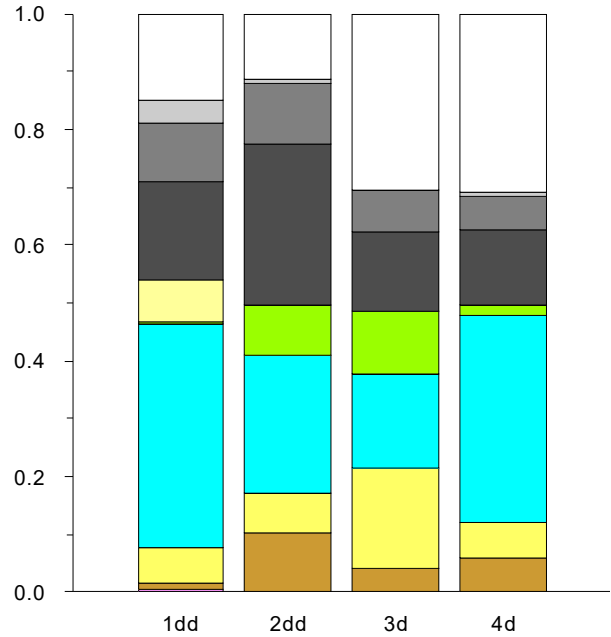

A10-9 BEA – stacked bar graph, proportional distribution of cations and anions in groundwater samples, March 2017

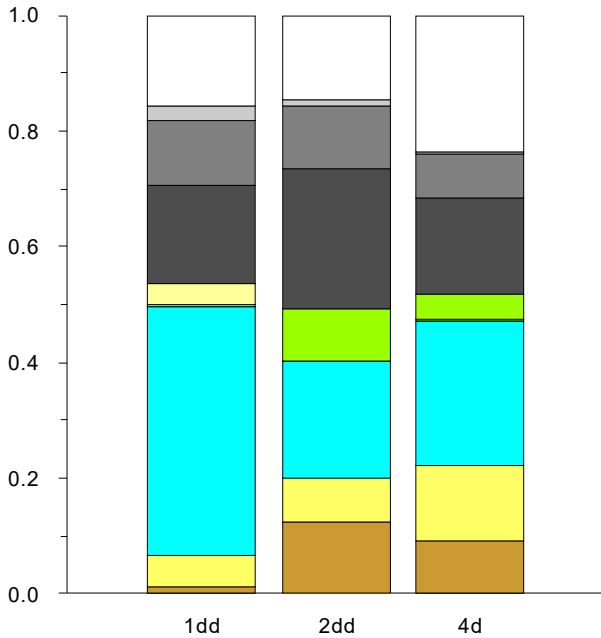

A10-8 BEA – stacked bar graph, proportional distribution of cations and anions in groundwater samples, February 2016

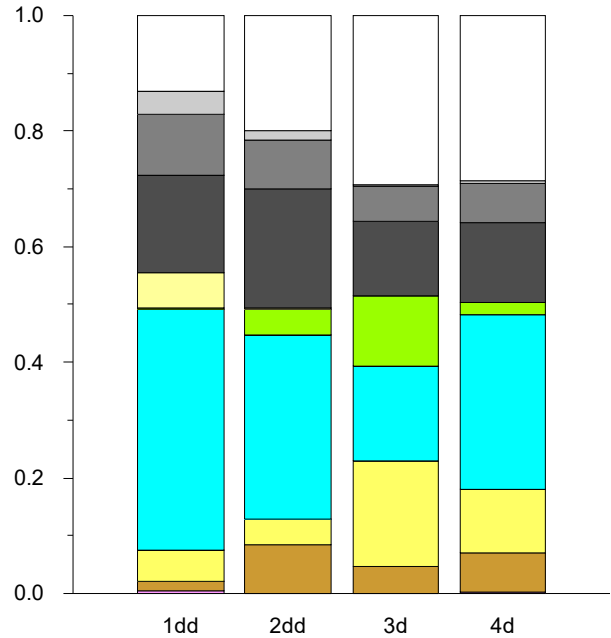

A10-1 BEA – stacked bar graph, proportional distribution of cations and anions in groundwater samples, February 2018

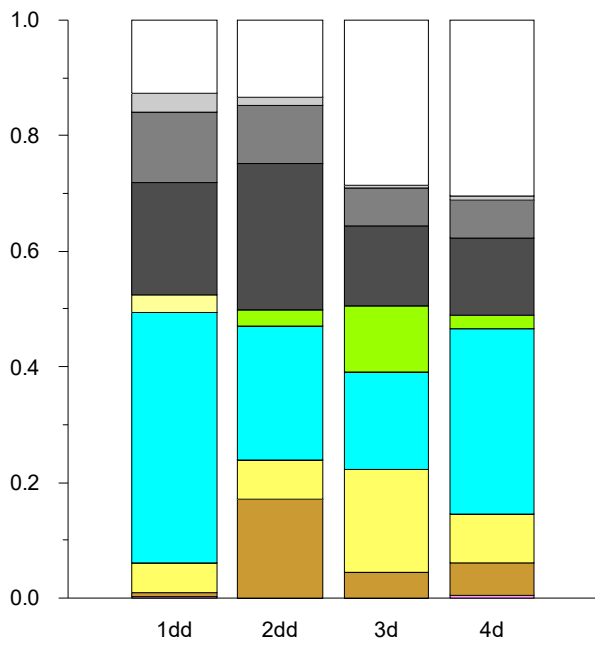

A10-2 BEA – stacked bar graph, proportional distribution of cations and anions in groundwater samples, February 2019

COT

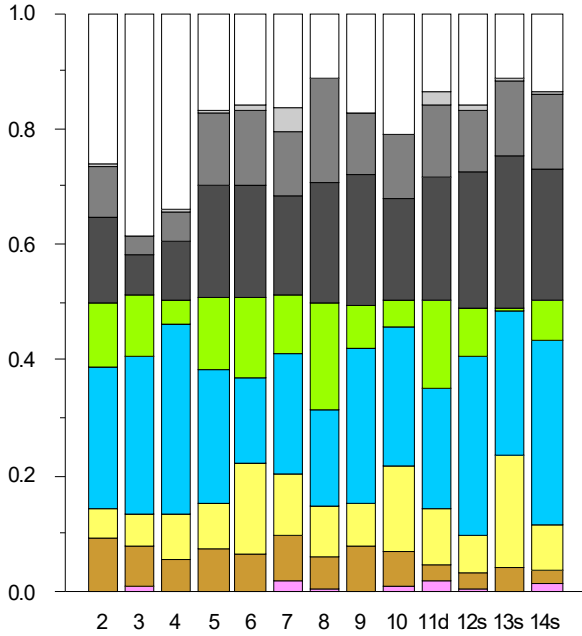

A10-3 COT – stacked bar graph, proportional distribution of cations and anions in groundwater samples, May 2012

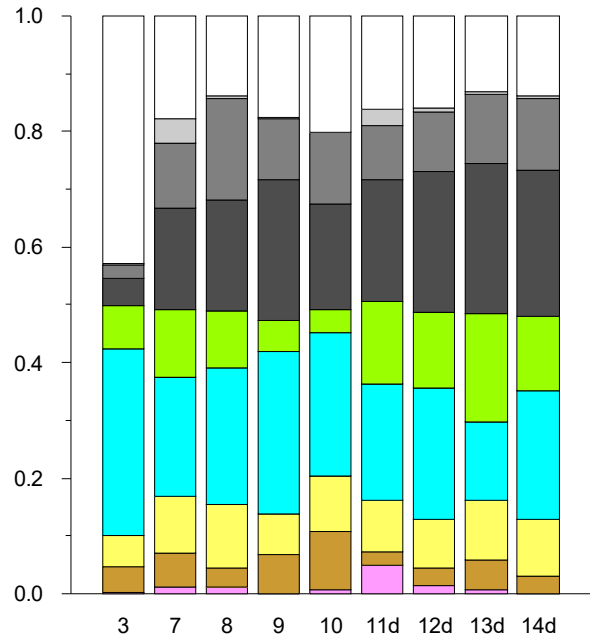

A10-5 COT – stacked bar graph, proportional distribution of cations and anions in groundwater samples, August 2013

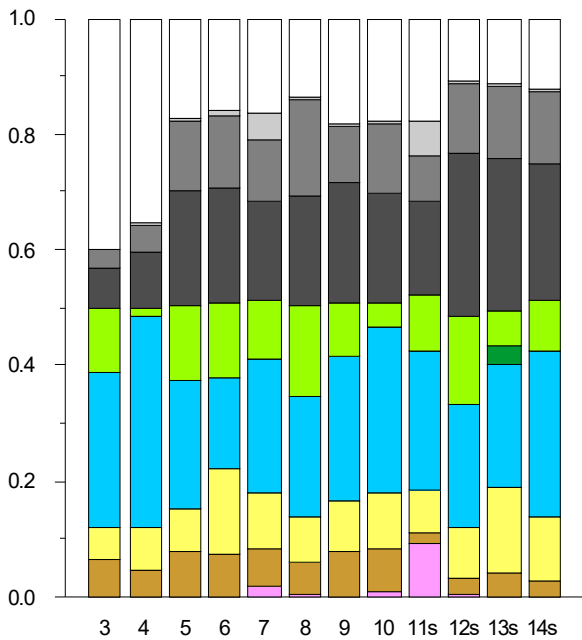

A10-4 COT – stacked bar graph, proportional distribution of cations and anions in groundwater samples, August 2012

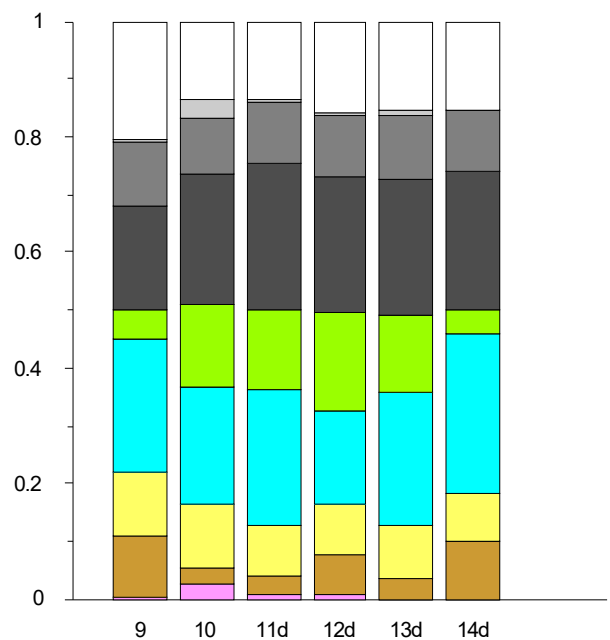

A10-6 COT – stacked bar graph, proportional distribution of cations and anions in groundwater samples, August 2014

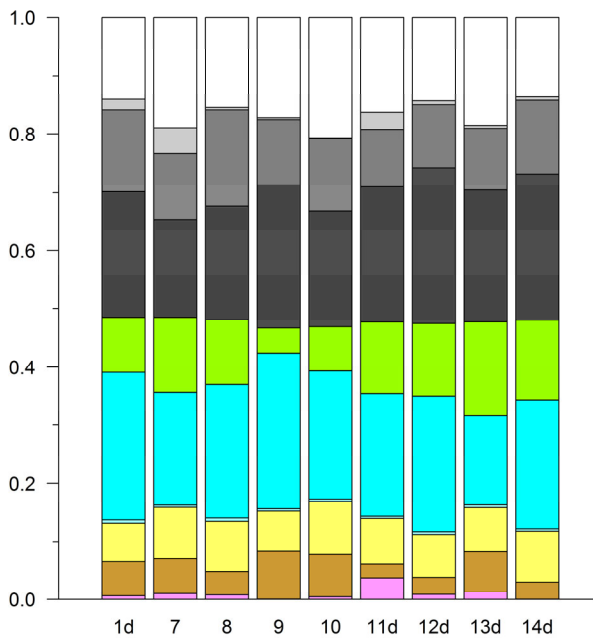

A10-7 COT – stacked bar graph, proportional distribution of cations and anions in groundwater samples, February 2015

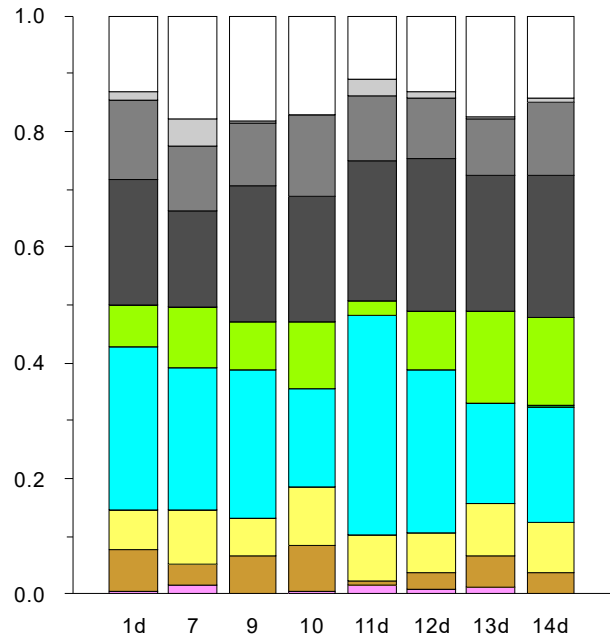

A10-9 COT – stacked bar graph, proportional distribution of cations and anions in groundwater samples, March 2017

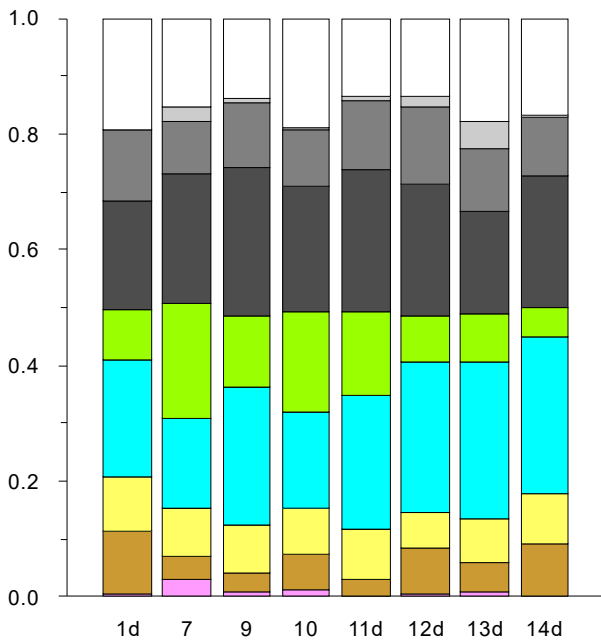

A10-8 COT – stacked bar graph, proportional distribution of cations and anions in groundwater samples, February 2016

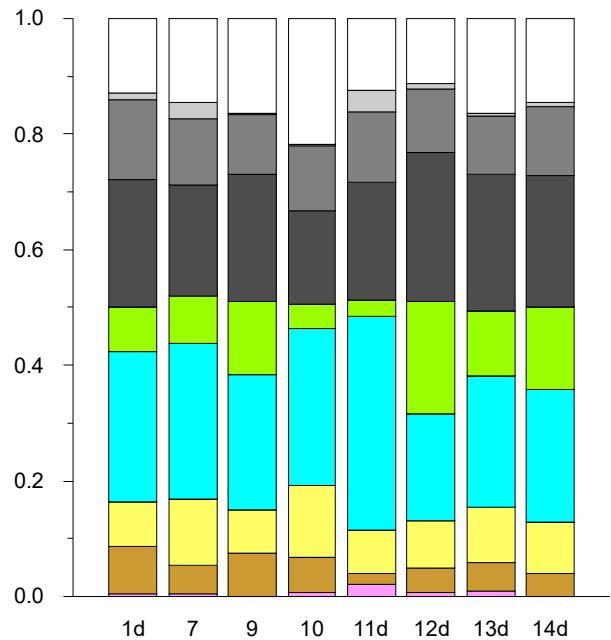

A10-10 COT – stacked bar graph, proportional distribution of cations and anions in groundwater samples, February 2018

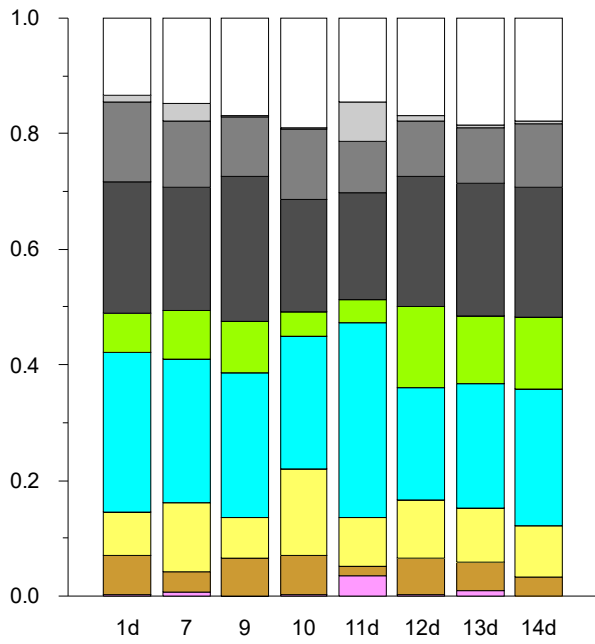

A10-11 COT – stacked bar graph, proportional distribution of cations and anions in groundwater samples, February 2019

SAN

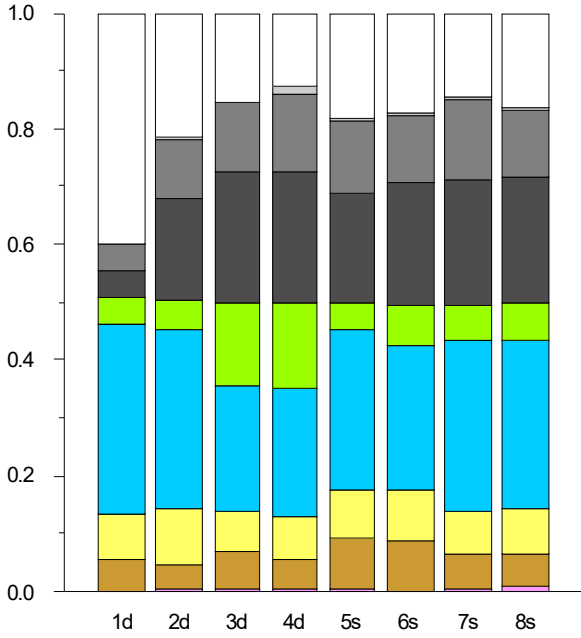

A10-12 SAN - stacked bar graph, proportional distribution of cations and anions in groundwater samples, May 2012

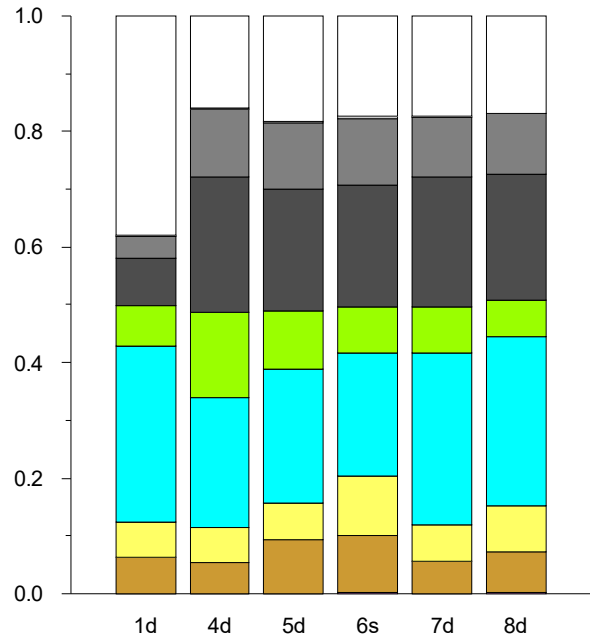

A10-14 SAN - stacked bar graph, proportional distribution of cations and anions in groundwater samples, August 2013

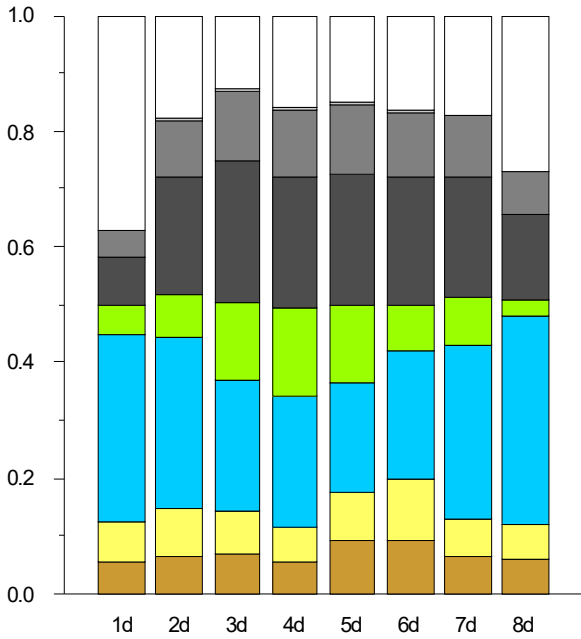

A10-13 SAN - stacked bar graph, proportional distribution of cations and anions in groundwater samples, August 2012

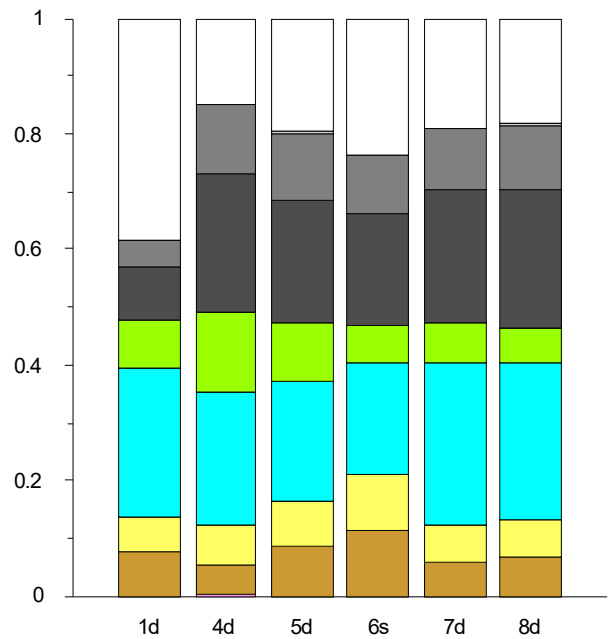

A10-15 SAN - stacked bar graph, proportional distribution of cations and anions in groundwater samples, August 2014

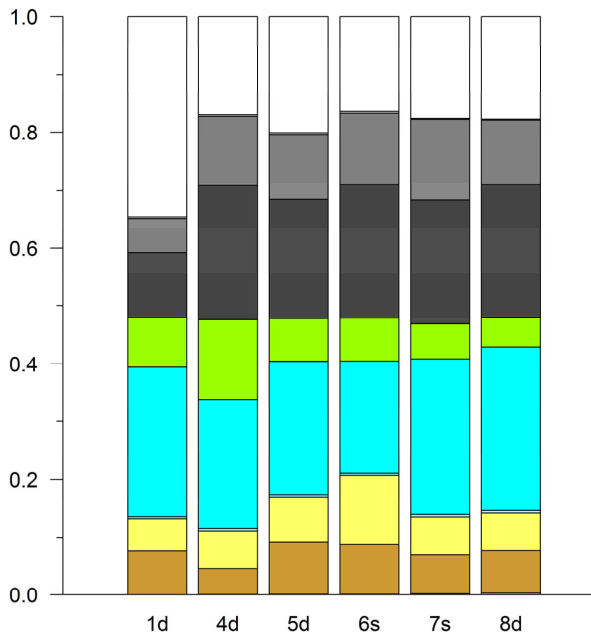

A10-16 SAN – stacked bar graph, proportional distribution of cations and anions in groundwater samples, February 2015

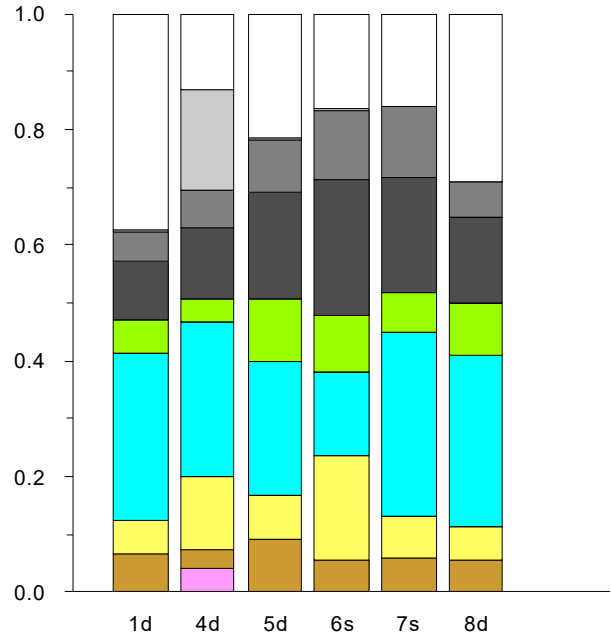

A10-18 SAN – stacked bar graph, proportional distribution of cations and anions in groundwater samples, March 2017

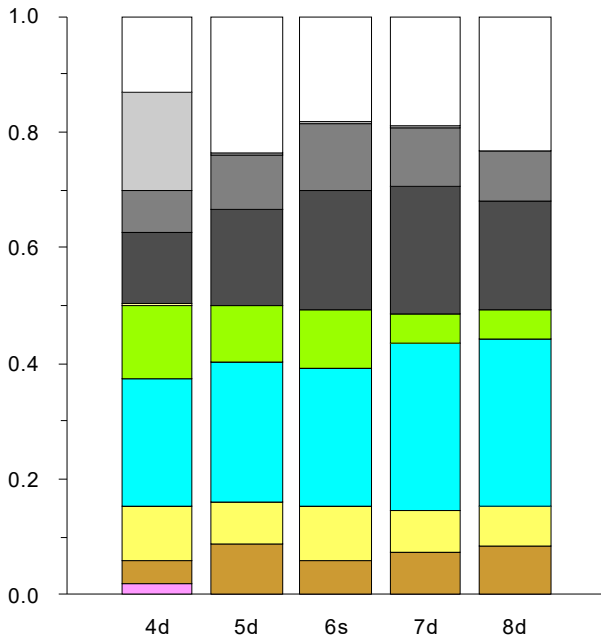

A10-17 SAN – stacked bar graph, proportional distribution of cations and anions in groundwater samples, February 2016

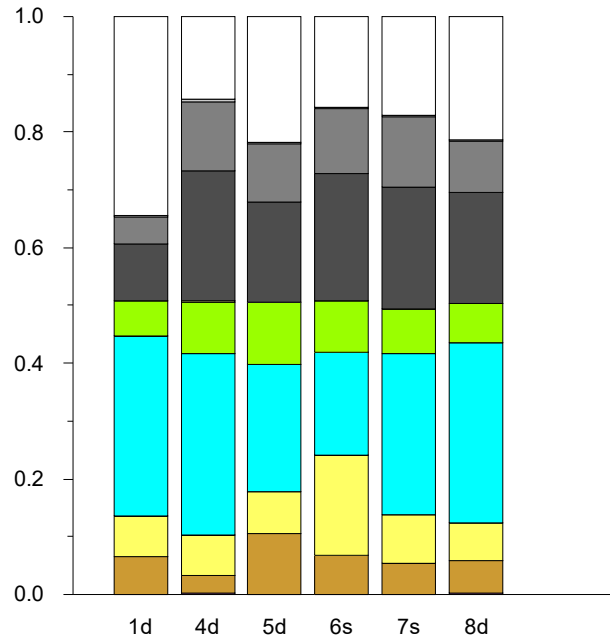

A10-19 SAN – stacked bar graph, proportional distribution of cations and anions in groundwater samples, February 2018

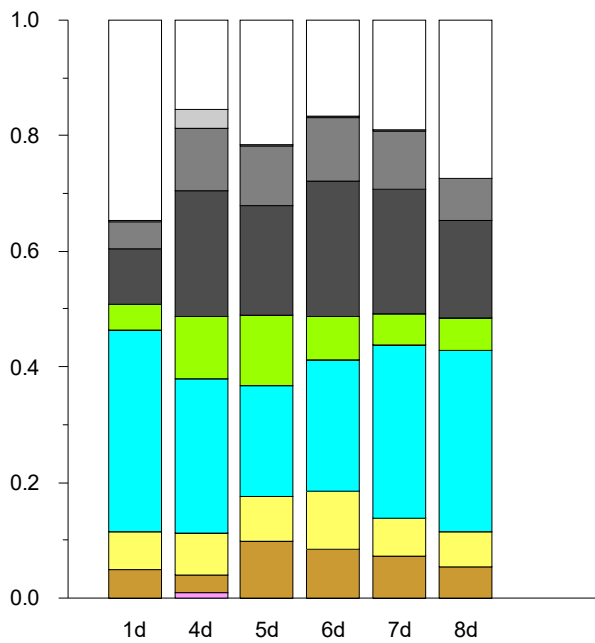

A10-20 SAN – stacked bar graph, proportional distribution of cations and anions in groundwater samples, February 2019

GEN

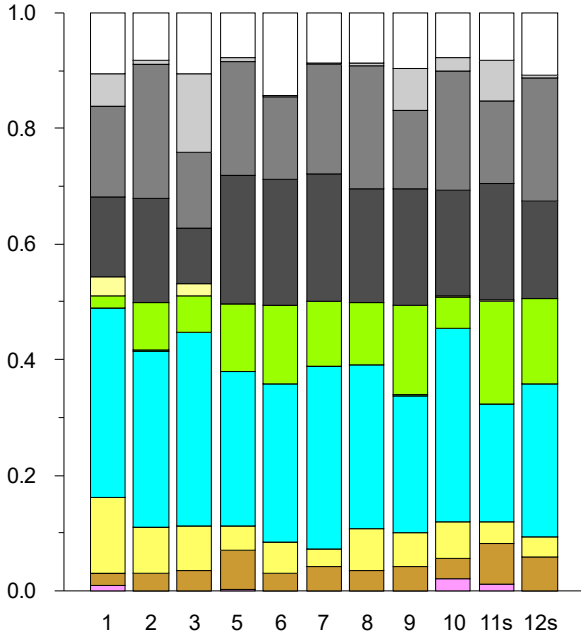

A10-21 GEN - stacked bar graph, proportional distribution of cations and anions in groundwater samples, August 2013

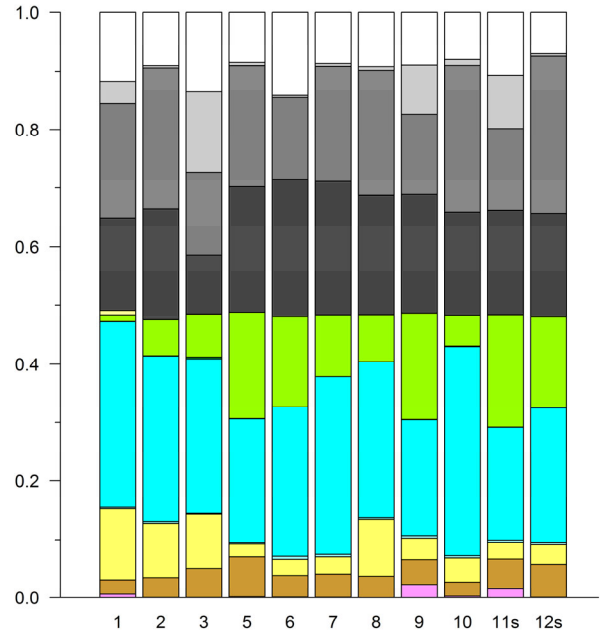

A10-23 GEN - stacked bar graph, proportional distribution of cations and anions in groundwater samples, February 2015

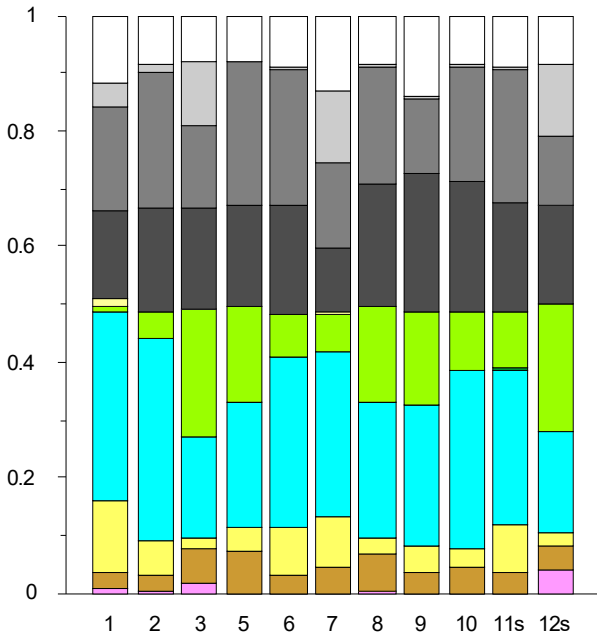

A10-22 GEN - stacked bar graph, proportional distribution of cations and anions in groundwater samples, August 2014

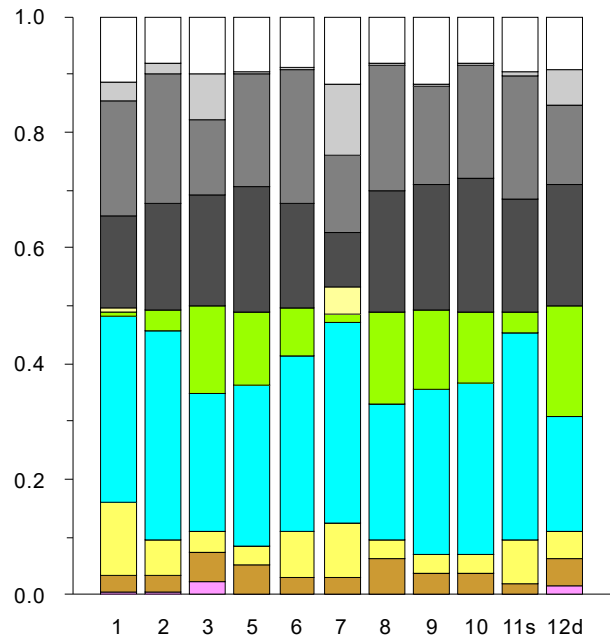

A10-24 GEN - stacked bar graph, proportional distribution of cations and anions in groundwater samples, February 2016

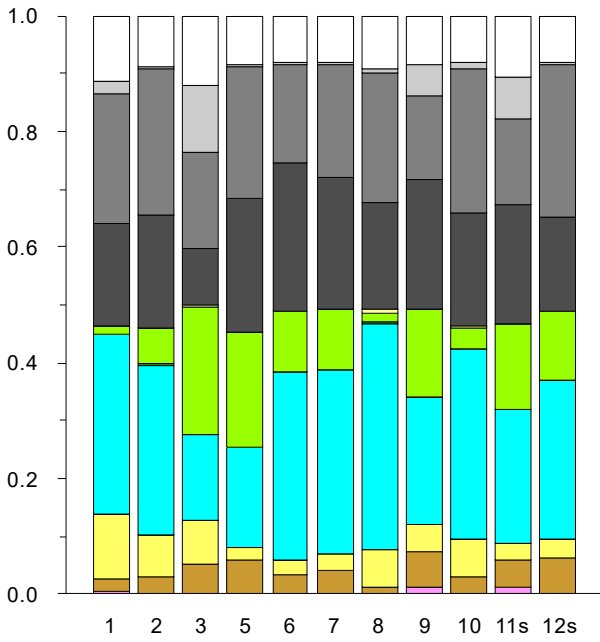

A10-25 GEN – stacked bar graph, proportional distribution of cations and anions in groundwater samples, March 2017

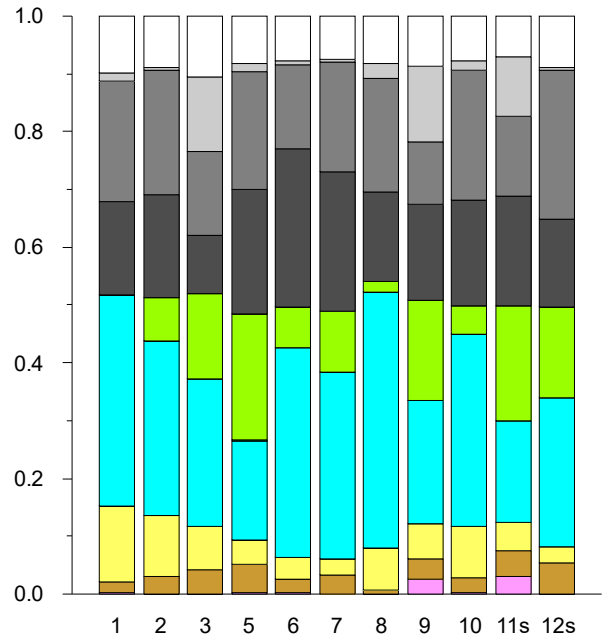

A10-2 GEN – stacked bar graph, proportional distribution of cations and anions in groundwater samples, February 2019

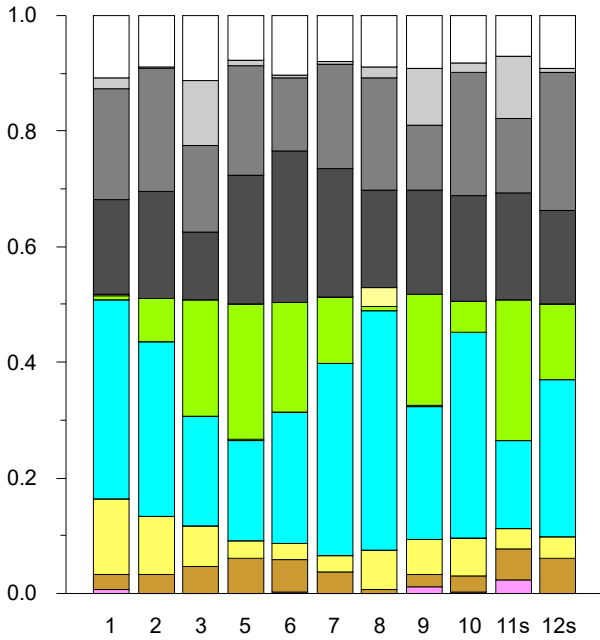

A10-1 GEN – stacked bar graph, proportional distribution of cations and anions in groundwater samples, February 2018

TRO

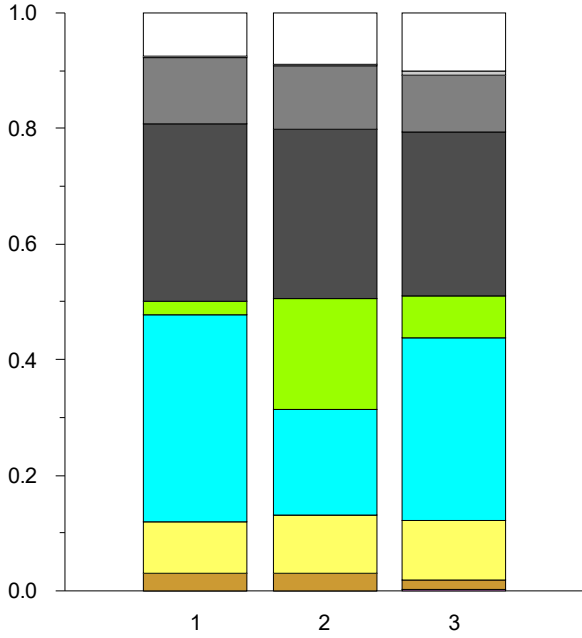

A10-3 TRO - stacked bar graph, proportional distribution of cations and anions in groundwater samples, August 2013

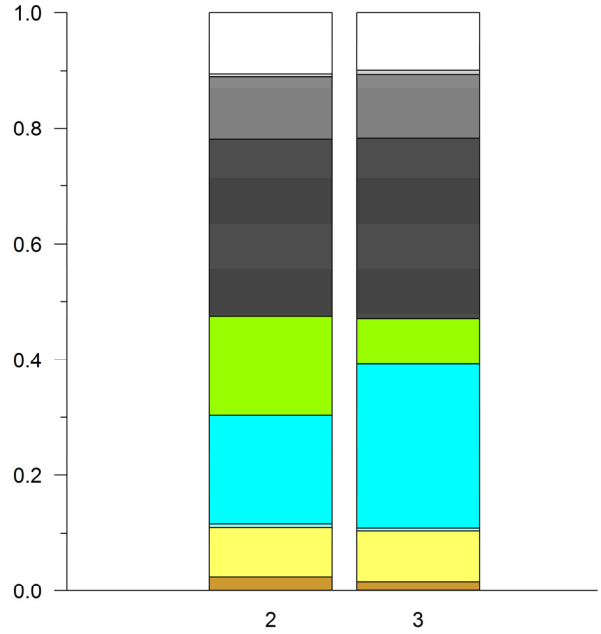

A10-5 TRO - stacked bar graph, proportional distribution of cations and anions in groundwater samples, February 2015

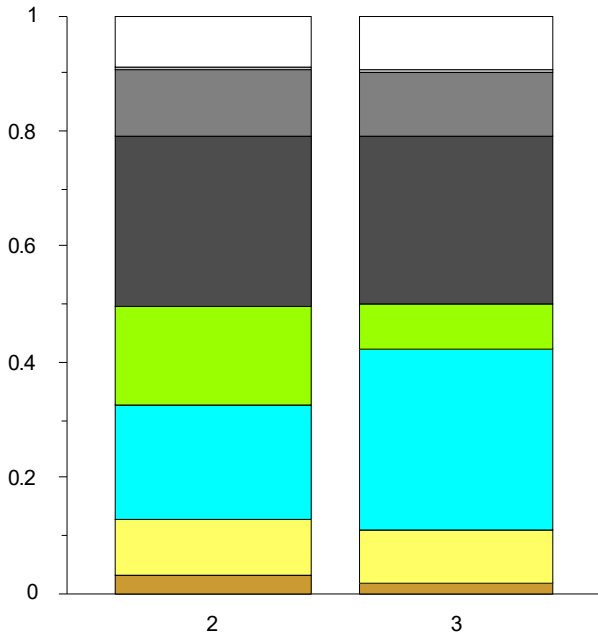

A10-4 TRO - stacked bar graph, proportional distribution of cations and anions in groundwater samples, August 2014

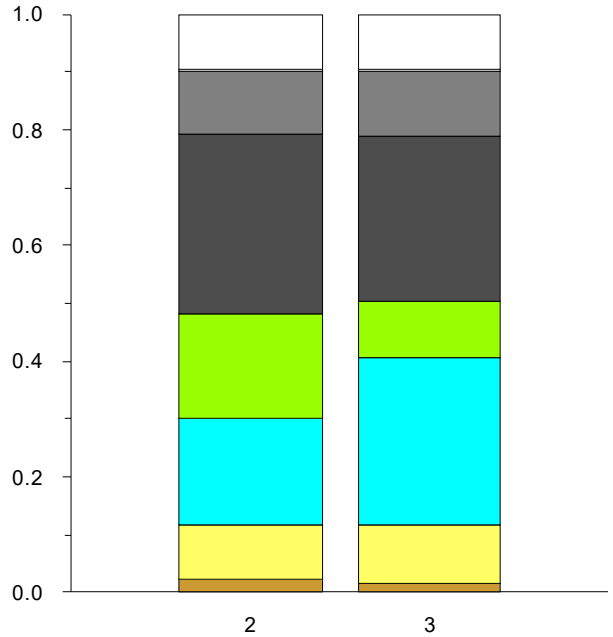

A10-6 TRO - stacked bar graph, proportional distribution of cations and anions in groundwater samples, February 2016

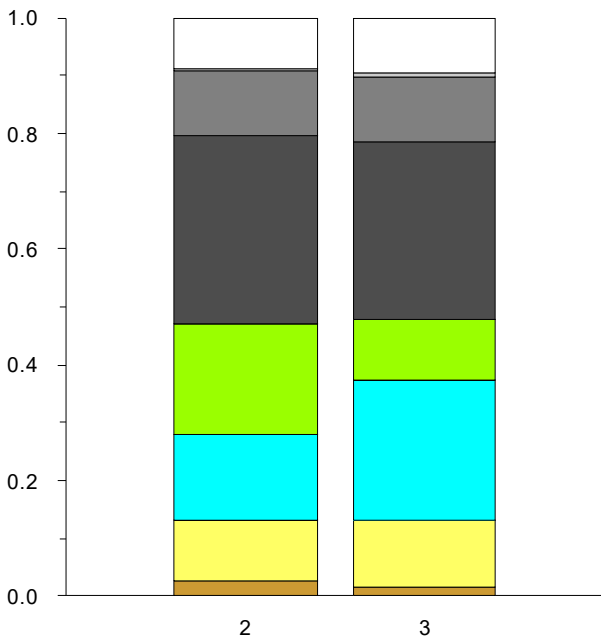

A10-1 TRO – stacked bar graph, proportional distribution of cations and anions in groundwater samples, March 2017

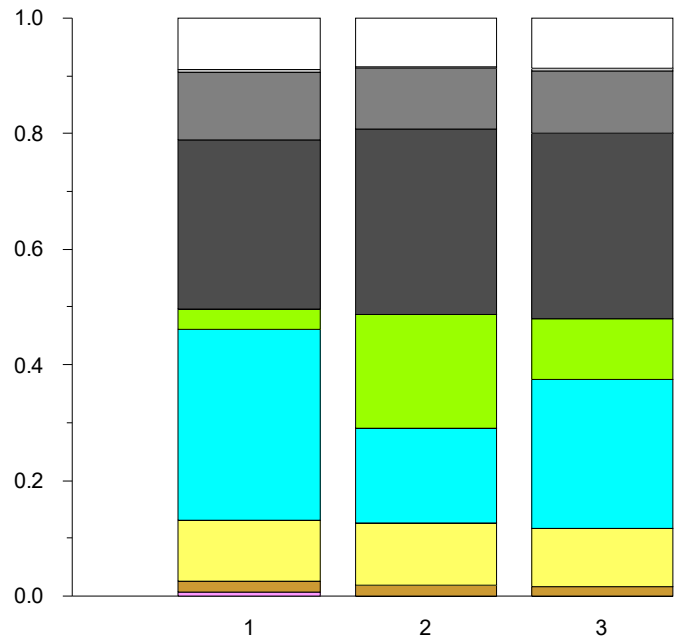

A10-2 TRO – stacked bar graph, proportional distribution of cations and anions in groundwater samples, February 2019

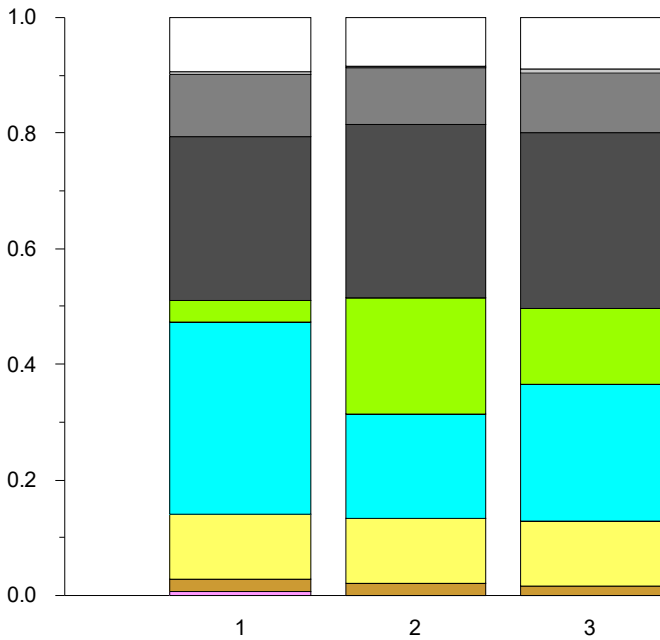

A10-1 TRO – stacked bar graph, proportional distribution of cations and anions in groundwater samples, February 2018

PLS

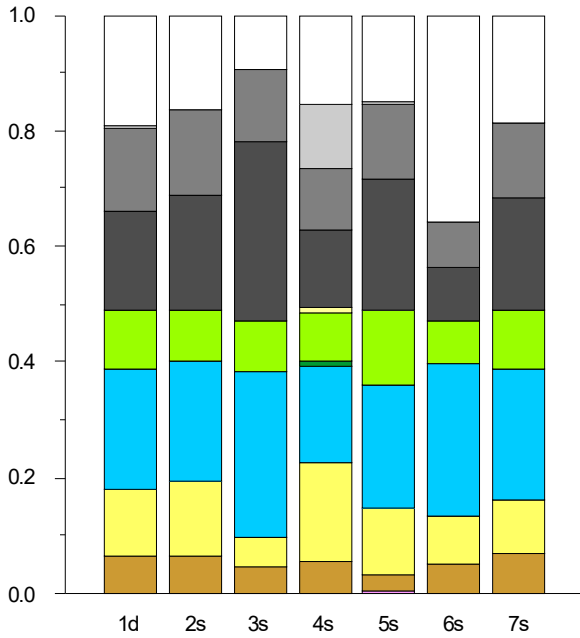

A10-3 PLS - stacked bar graph, proportional distribution of cations and anions in groundwater samples, May 2012

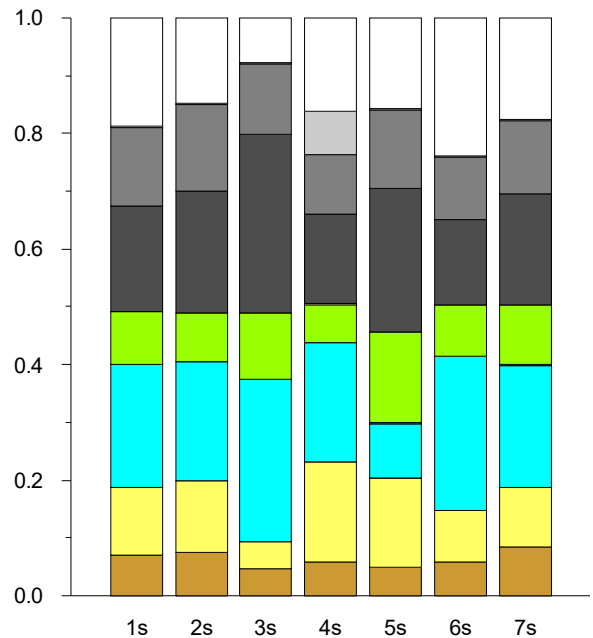

A10-5 PLS - stacked bar graph, proportional distribution of cations and anions in groundwater samples, August 2013

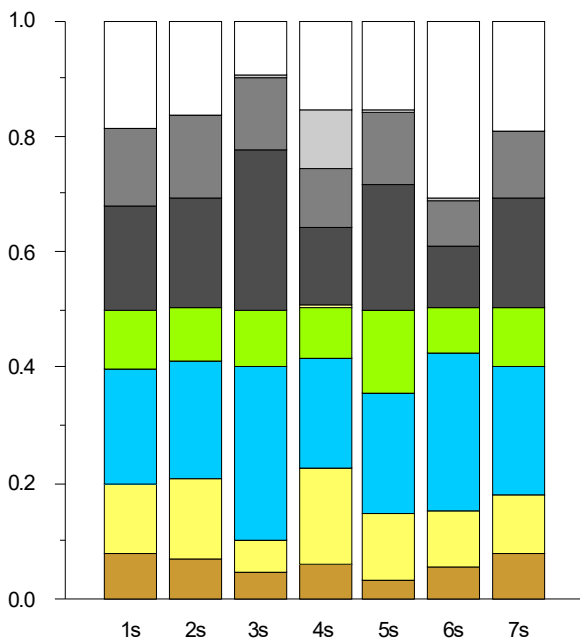

A10-4 PLS - stacked bar graph, proportional distribution of cations and anions in groundwater samples, August 2012

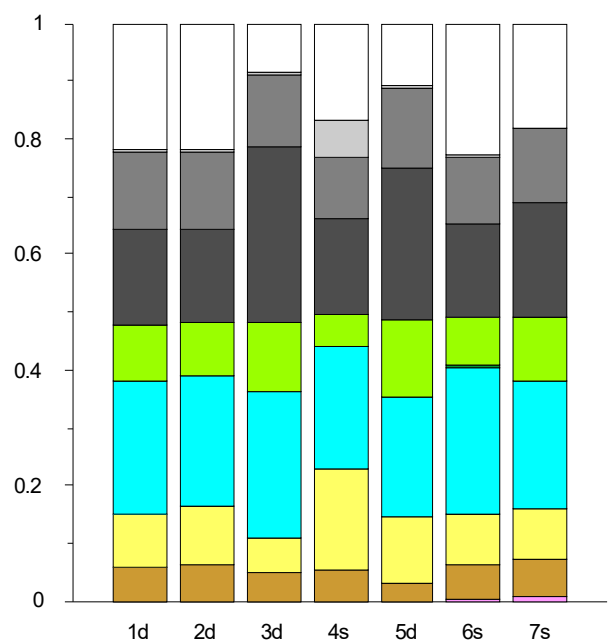

A10-6 PLS - stacked bar graph, proportional distribution of cations and anions in groundwater samples, August 2014

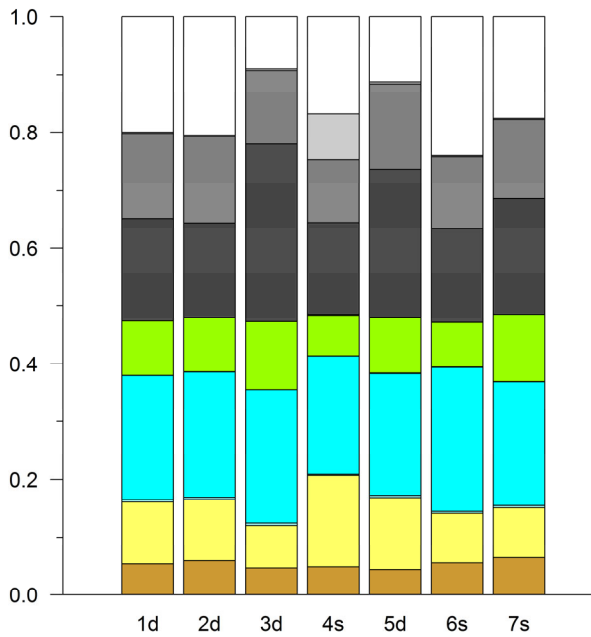

A10-7 PLS – stacked bar graph, proportional distribution of cations and anions in groundwater samples, February 2015

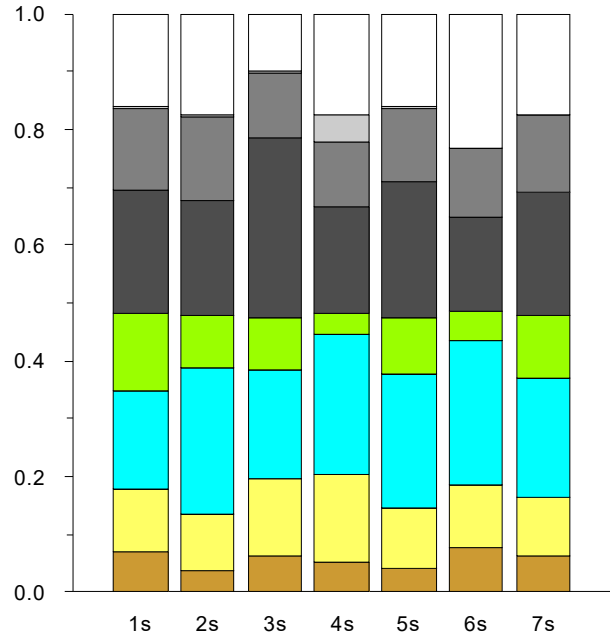

A10-9 PLS – stacked bar graph, proportional distribution of cations and anions in groundwater samples, February 2015

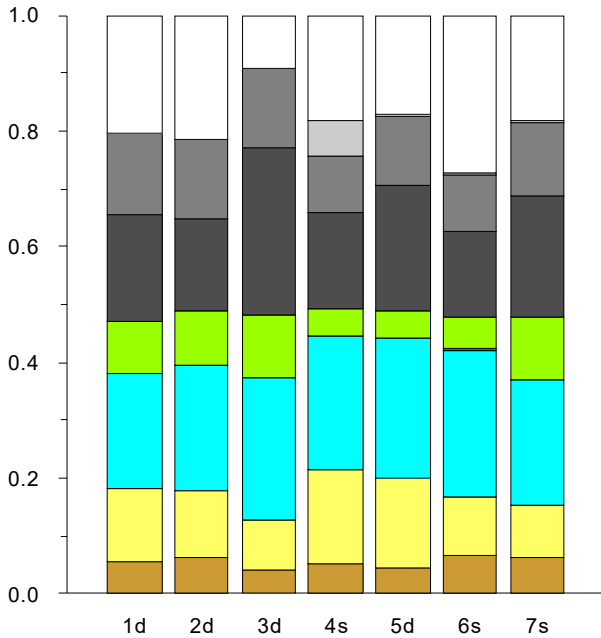

A10-8 PLS – stacked bar graph, proportional distribution of cations and anions in groundwater samples, February 2016

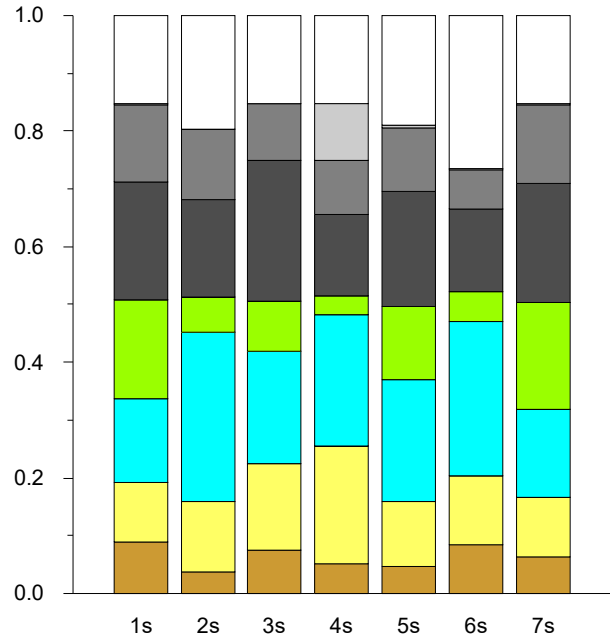

A10-1 PLS – stacked bar graph, proportional distribution of cations and anions in groundwater samples, February 2018

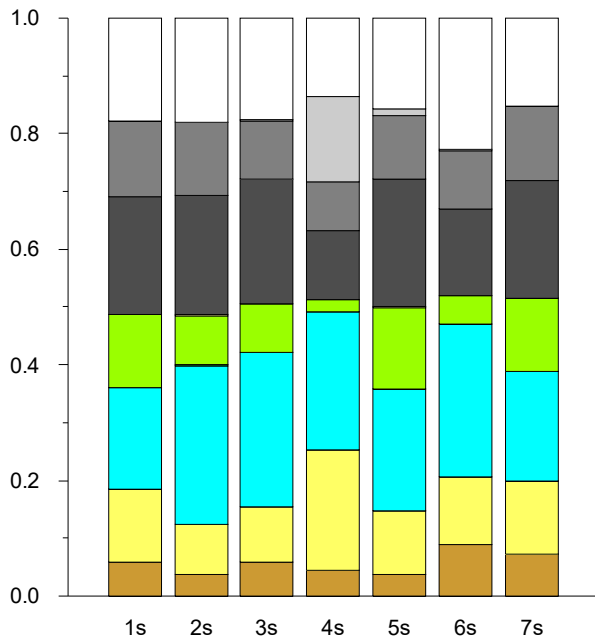

A10-2 PLS – stacked bar graph, proportional distribution of cations and anions in groundwater samples, February 2019

CAE

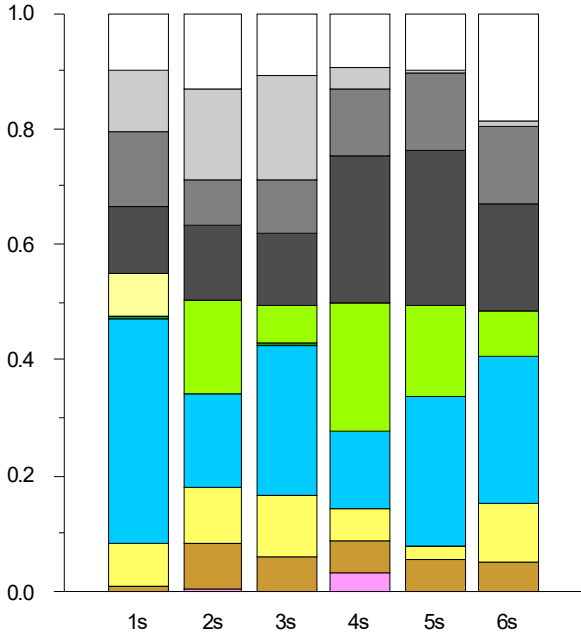

A10-3 CAE - stacked bar graph, proportional distribution of cations and anions in groundwater samples, May 2012

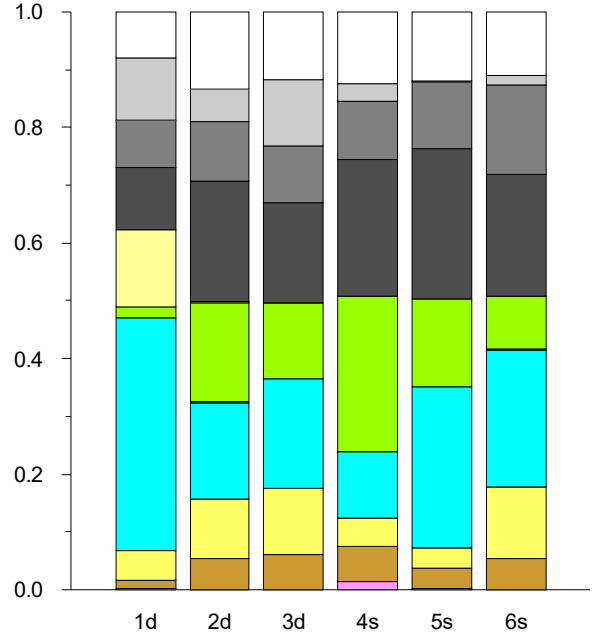

A10-5 CAE - stacked bar graph, proportional distribution of cations and anions in groundwater samples, August 2013

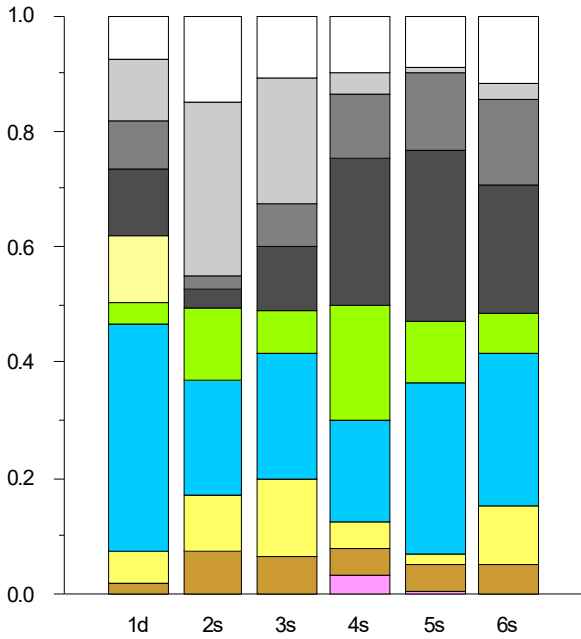

A10-4 CAE - stacked bar graph, proportional distribution of cations and anions in groundwater samples, August 2012

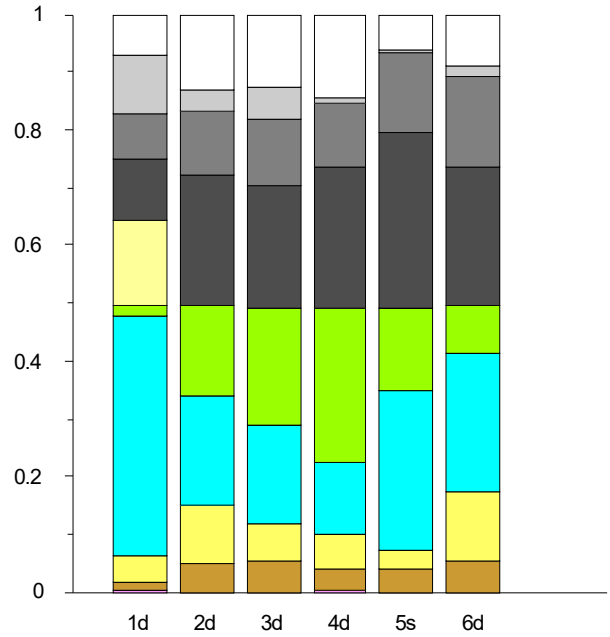

A10-6 CAE - stacked bar graph, proportional distribution of cations and anions in groundwater samples, August 2014

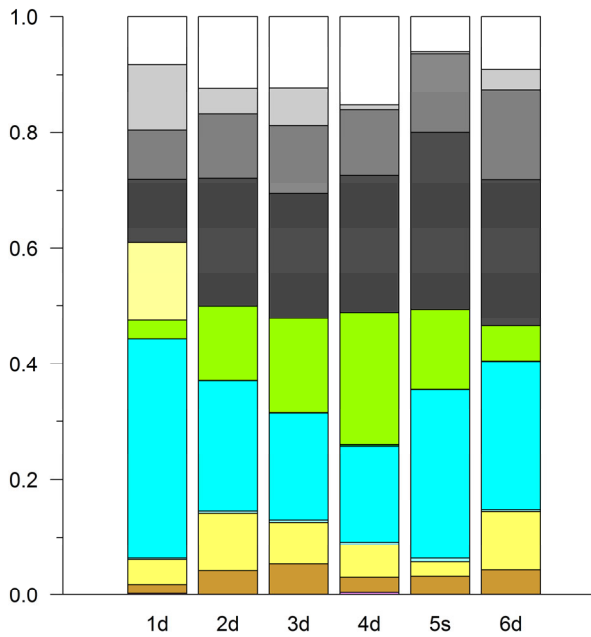

A10-7 CAE – stacked bar graph, proportional distribution of cations and anions in groundwater samples, February 2015

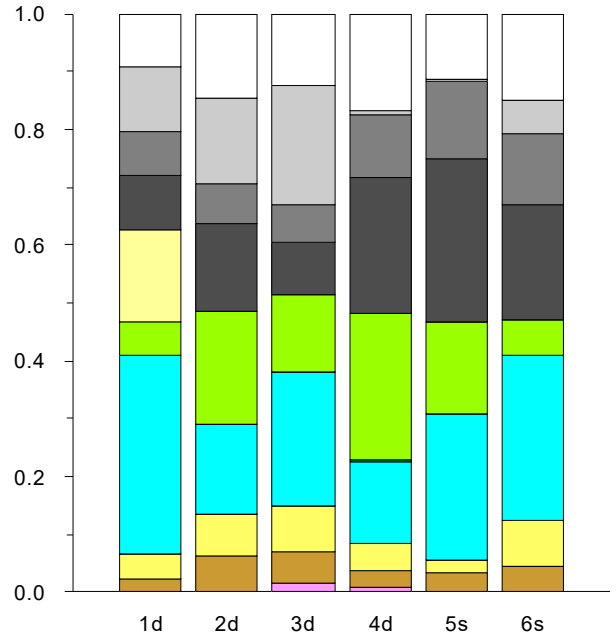

A10-9 CAE – stacked bar graph, proportional distribution of cations and anions in groundwater samples, February 2015

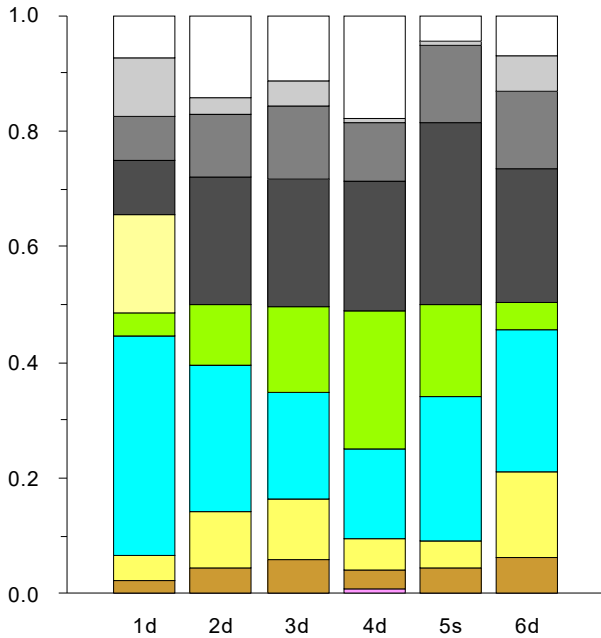

A10-8 CAE – stacked bar graph, proportional distribution of cations and anions in groundwater samples, February 2016

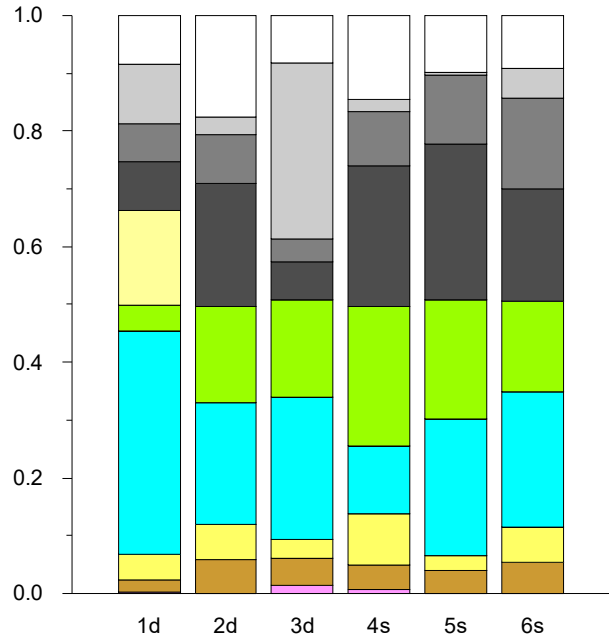

A10-1 CAE – stacked bar graph, proportional distribution of cations and anions in groundwater samples, February 2018

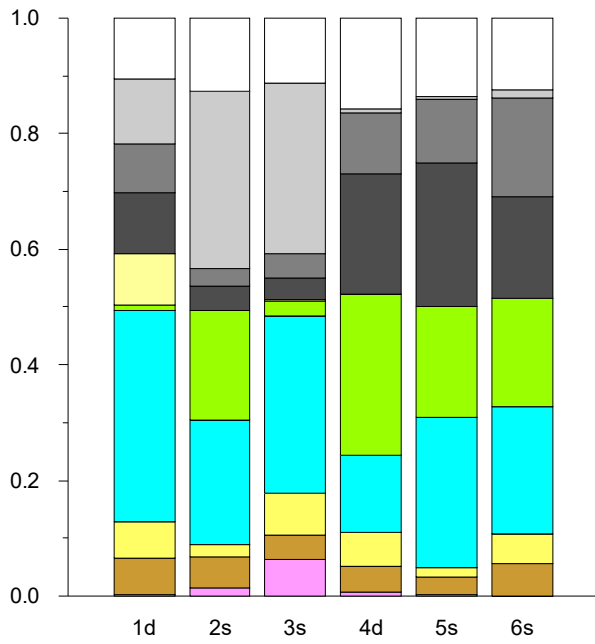

A10-2 CAE – stacked bar graph, proportional distribution of cations and anions in groundwater samples, February 2019

ROB

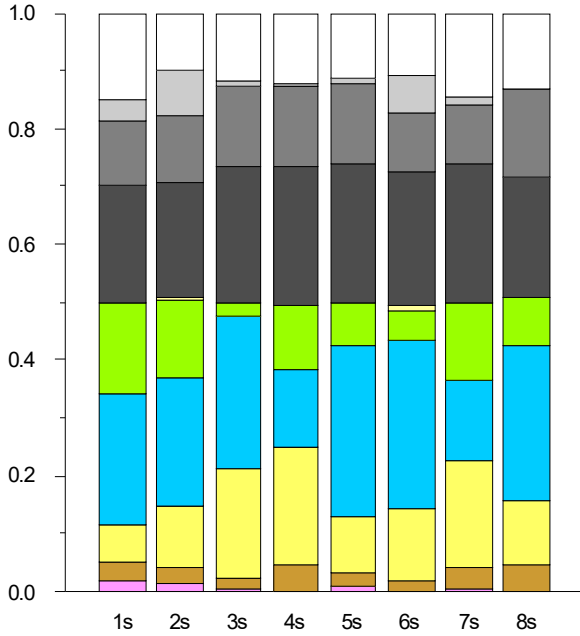

A10-3 ROB - stacked bar graph, proportional distribution of cations and anions in groundwater samples, May 2012

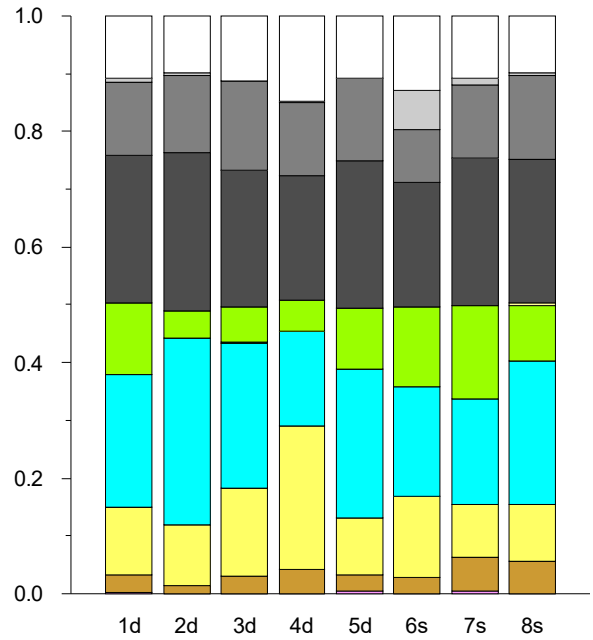

A10-5 ROB - stacked bar graph, proportional distribution of cations and anions in groundwater samples, August 2013

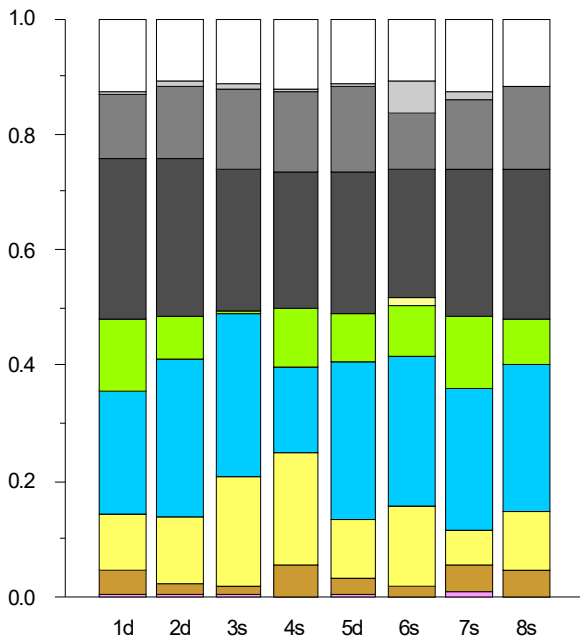

A10-4 ROB - stacked bar graph, proportional distribution of cations and anions in groundwater samples, August 2012

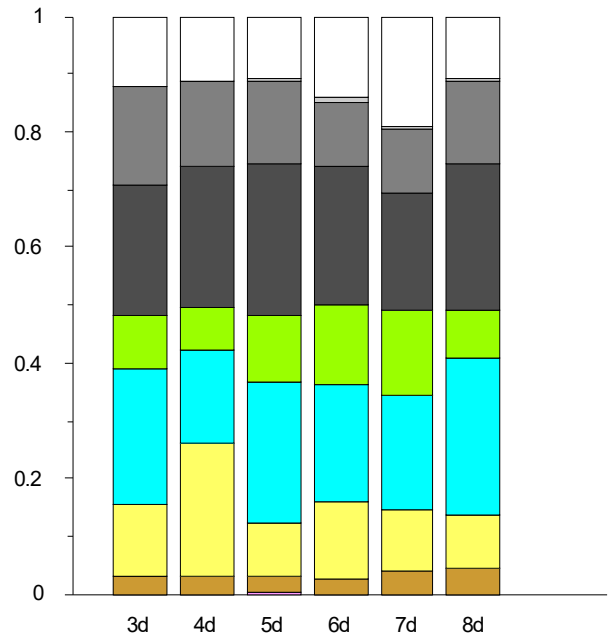

A10-6 ROB - stacked bar graph, proportional distribution of cations and anions in groundwater samples, August 2014

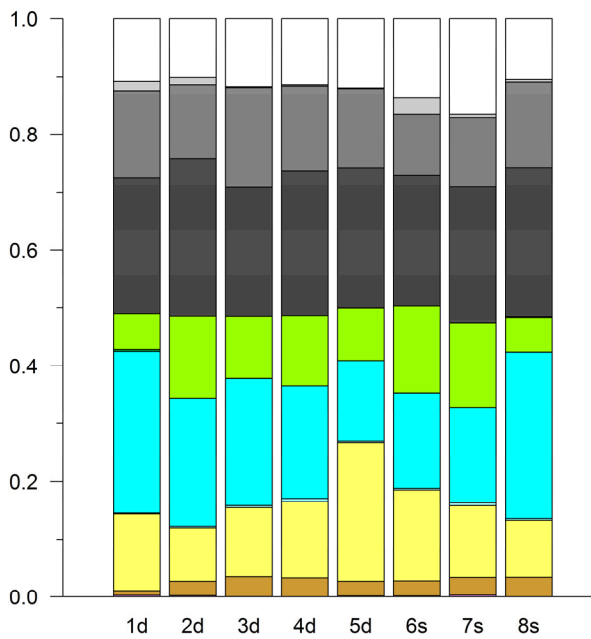

A10-7 ROB – stacked bar graph, proportional distribution of cations and anions in groundwater samples, February 2015

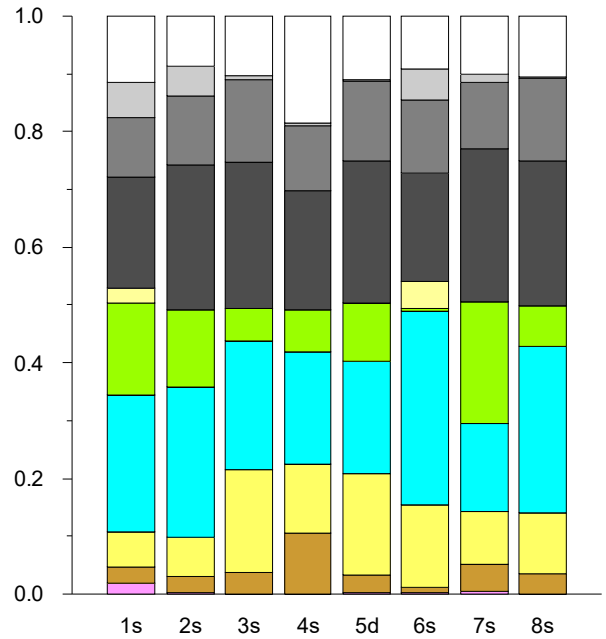

A10-9 ROB – stacked bar graph, proportional distribution of cations and anions in groundwater samples, March 2017

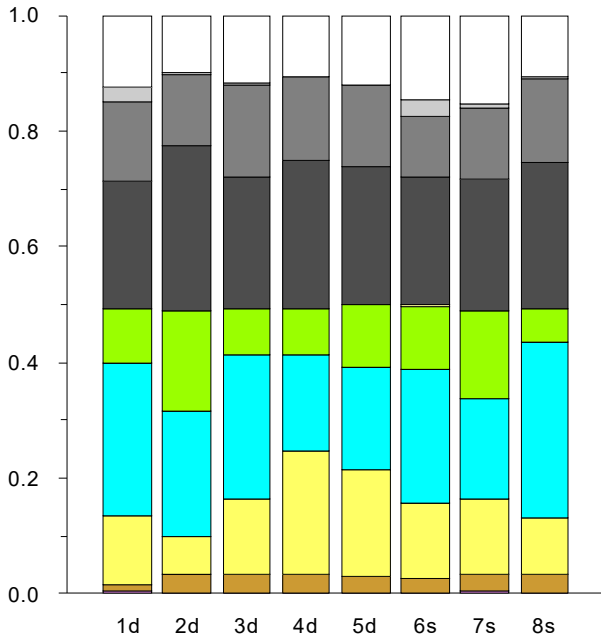

A10-8 ROB – stacked bar graph, proportional distribution of cations and anions in groundwater samples, February 2016

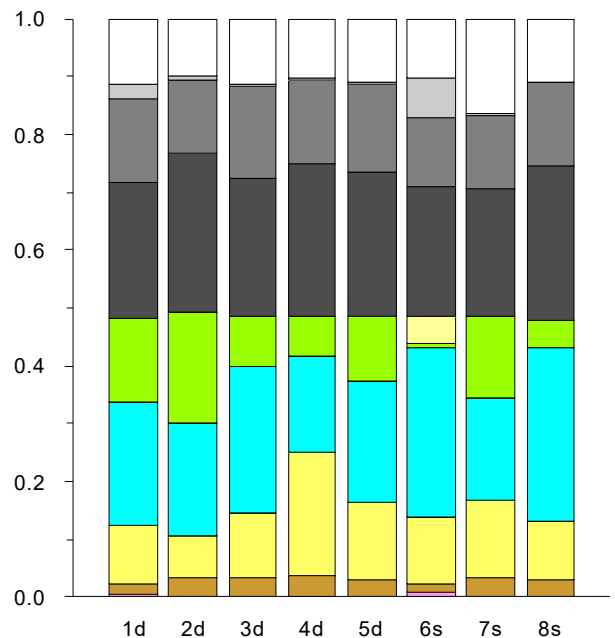

A10-10 ROB – stacked bar graph, proportional distribution of cations and anions in groundwater samples, February 2018

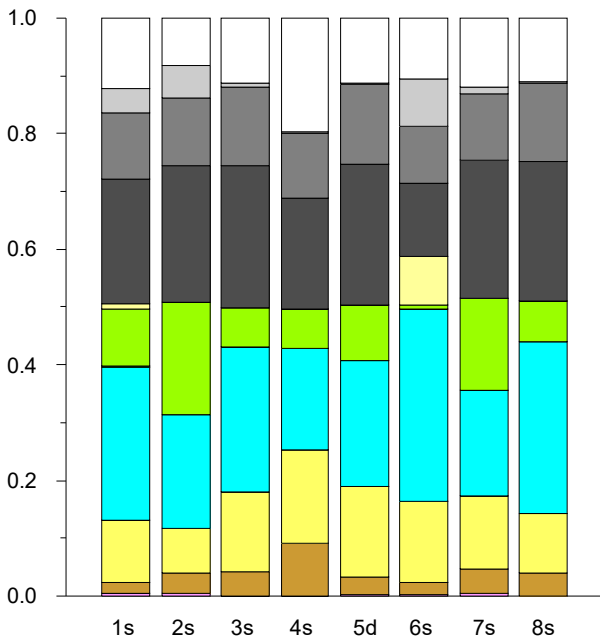

A10-1 ROB – stacked bar graph, proportional distribution of cations and anions in groundwater samples, February 2019

WOO

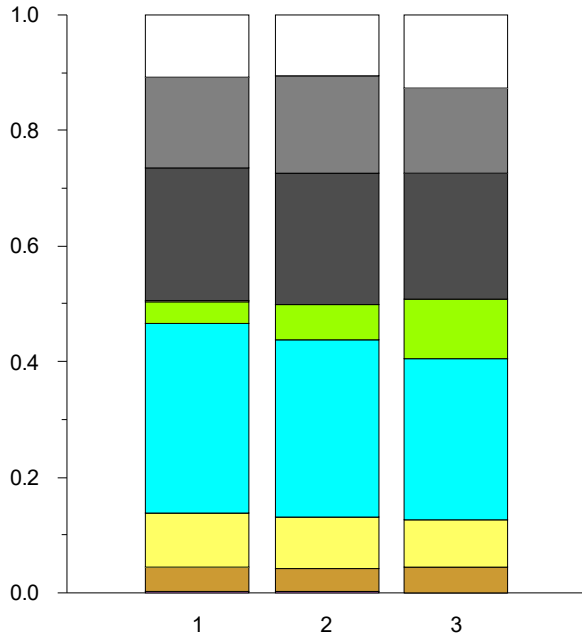

A10-2 WOO – stacked bar graph, proportional distribution of cations and anions in groundwater samples, August 2013

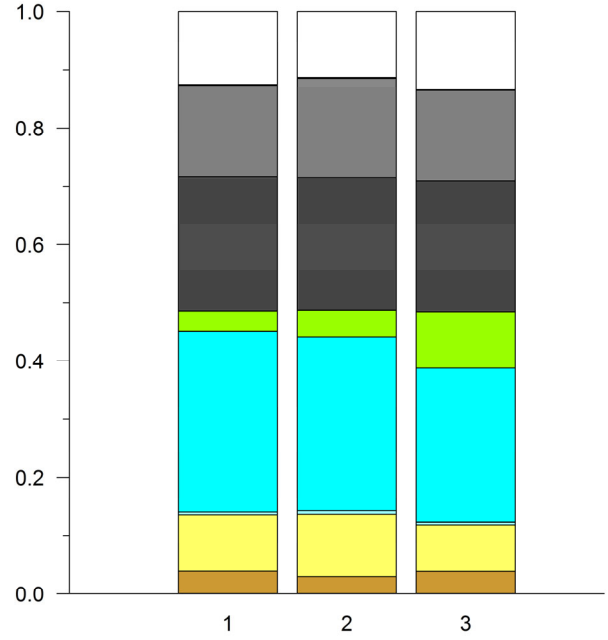

A10-4 WOO – stacked bar graph, proportional distribution of cations and anions in groundwater samples, February 2015

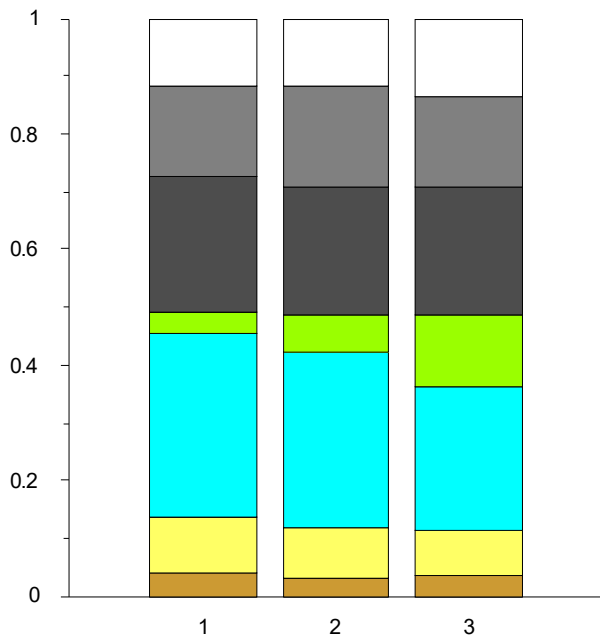

A10-3 WOO – stacked bar graph, proportional distribution of cations and anions in groundwater samples, August 2014

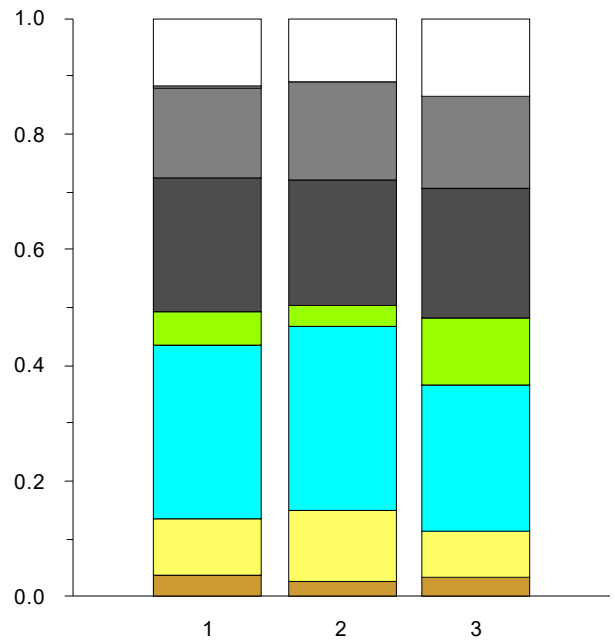

A10-5 WOO – stacked bar graph, proportional distribution of cations and anions in groundwater samples, February 2016

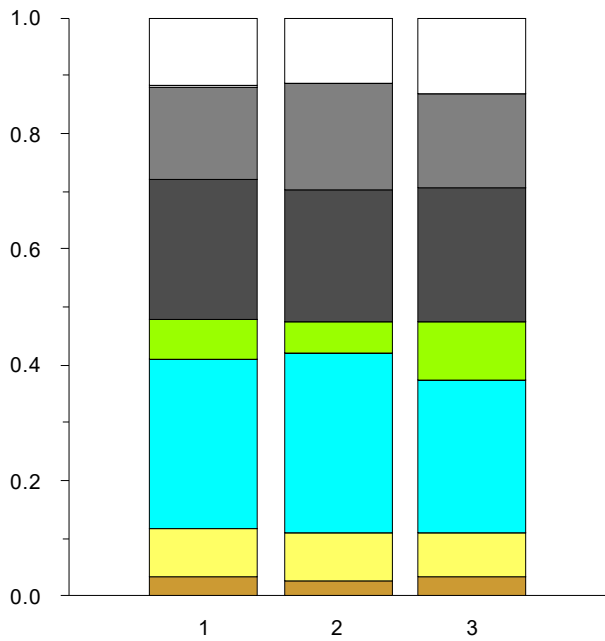

A10-6 WOO – stacked bar graph, proportional distribution of cations and anions in groundwater samples, March 2017

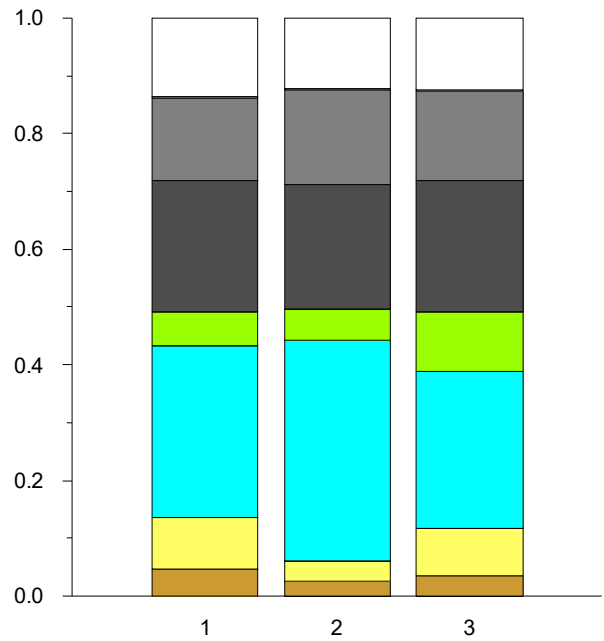

A10-2 WOO – stacked bar graph, proportional distribution of cations and anions in groundwater samples, February 2019

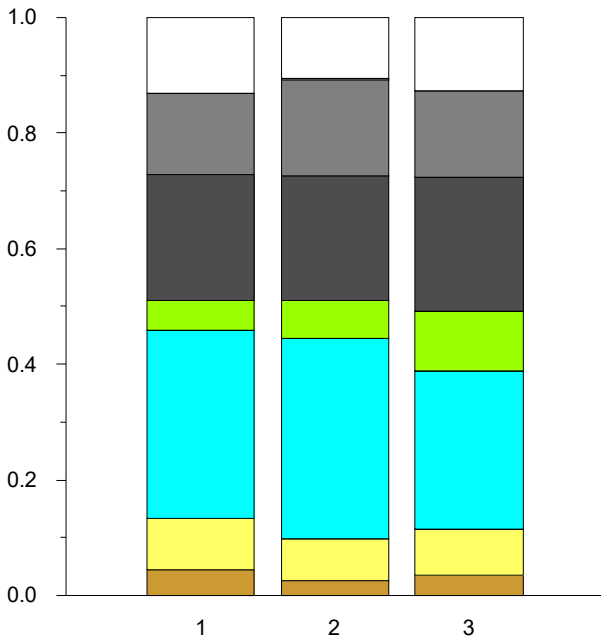

A10-1 WOO – stacked bar graph, proportional distribution of cations and anions in groundwater samples, February 2018

ANT

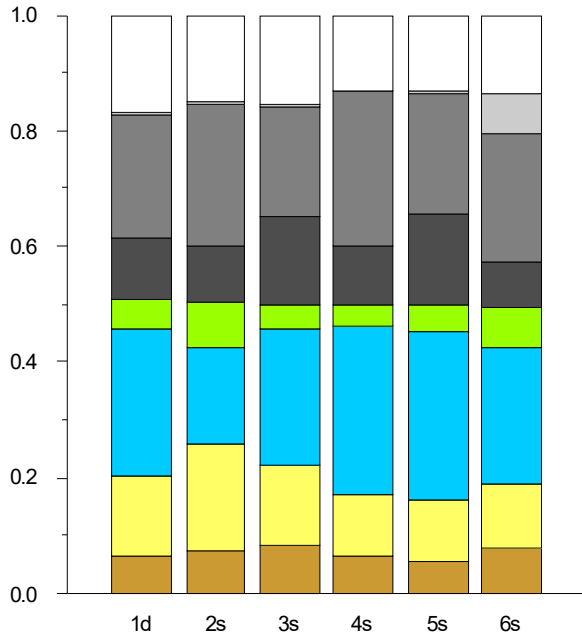

A10-3 ANT – stacked bar graph, proportional distribution of cations and anions in groundwater samples, May 2012

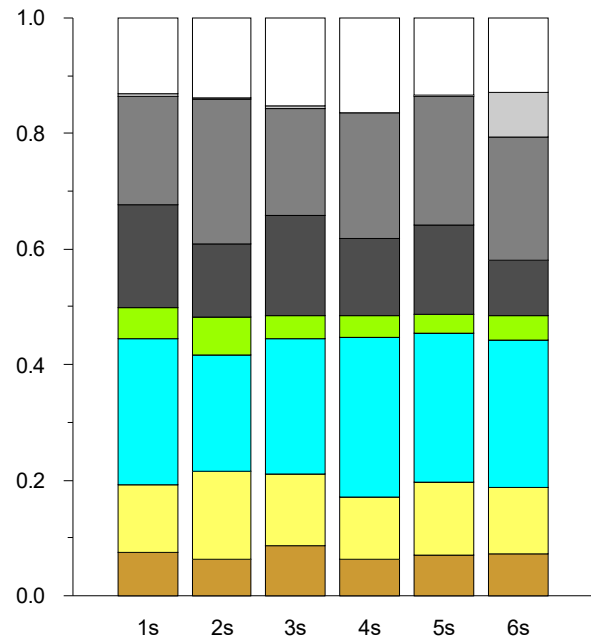

A10-5 ANT – stacked bar graph, proportional distribution of cations and anions in groundwater samples, August 2013

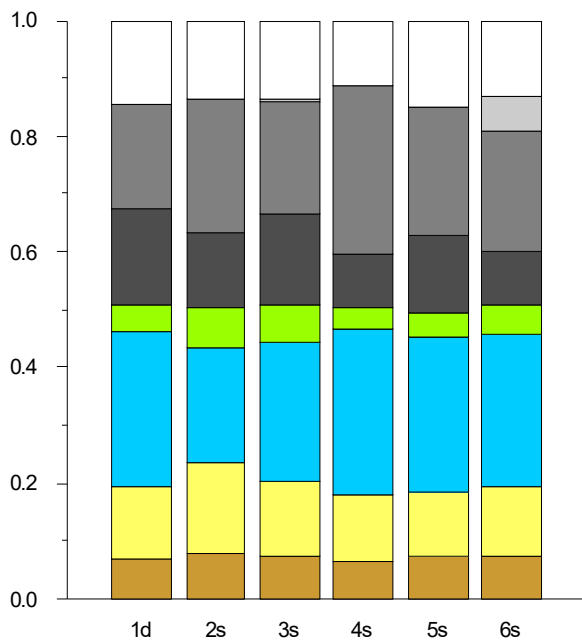

A10-4 ANT – stacked bar graph, proportional distribution of cations and anions in groundwater samples, August 2012

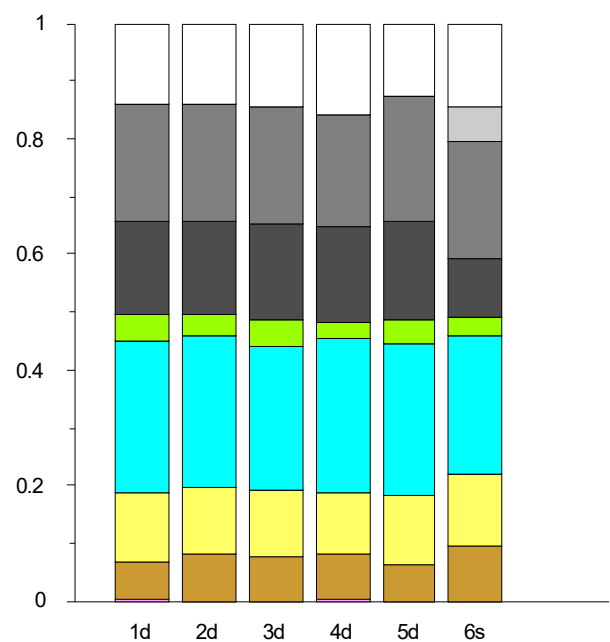

A10-6 ANT – stacked bar graphs, proportional distribution of cations and anions in groundwater samples, August 2014

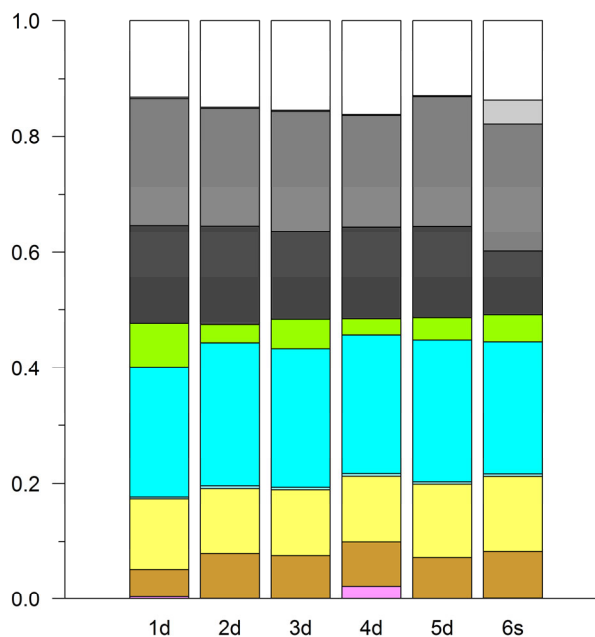

A10-7 ANT – stacked bar graphs, proportional distribution of cations and anions in groundwater samples, February 2015

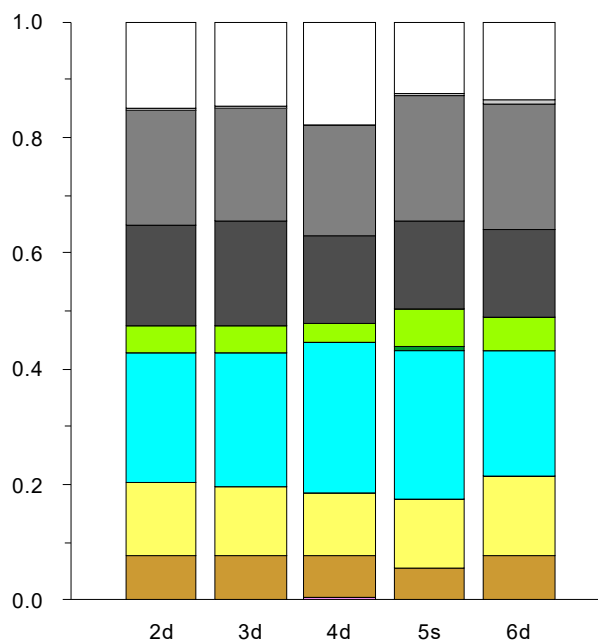

A10-9 ANT – stacked bar graphs, proportional distribution of cations and anions in groundwater samples, March 2017

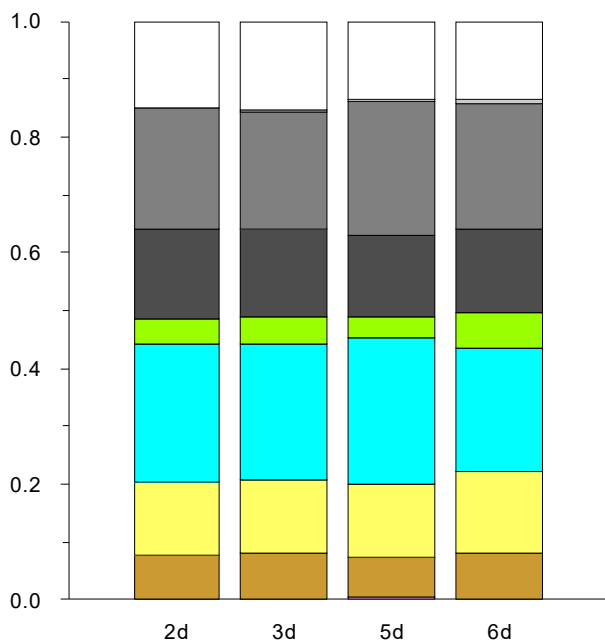

A10-8 ANT – stacked bar graphs, proportional distribution of cations and anions in groundwater samples, February 2016

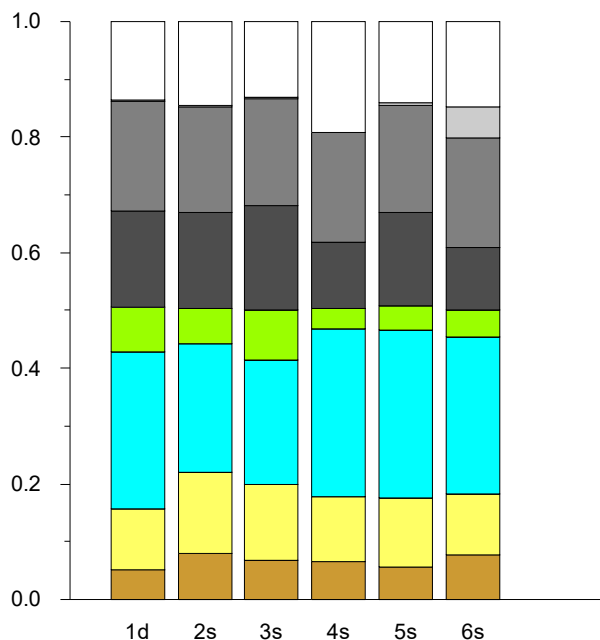

A10-1 ANT – stacked bar graphs, proportional distribution of cations and anions in groundwater samples, February 2018

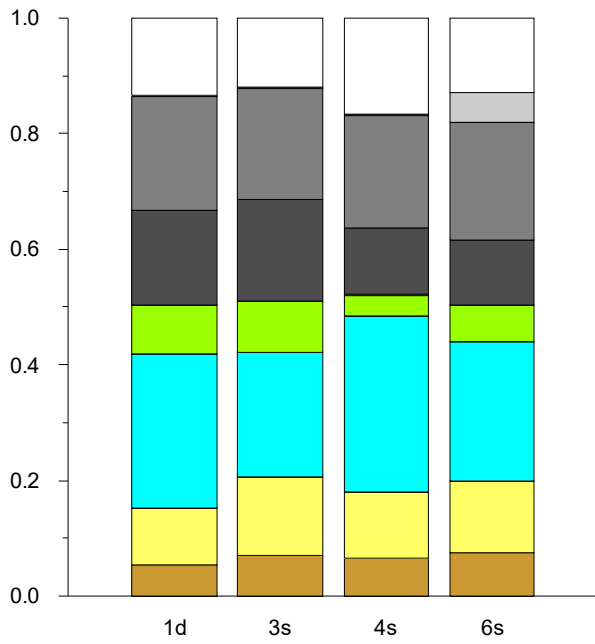

A10-2 ANT – stacked bar graphs, proportional distribution of cations and anions in groundwater samples, February 2019

COR

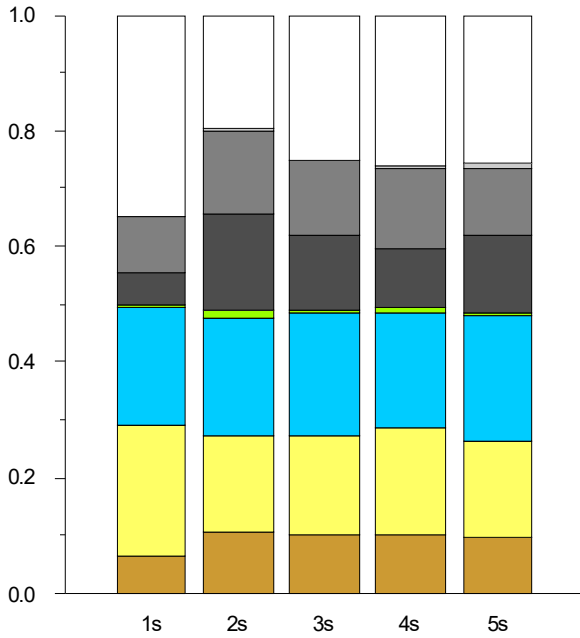

A10-3 COR – stacked bar graph, proportional distribution of cations and anions in groundwater samples, May 2012

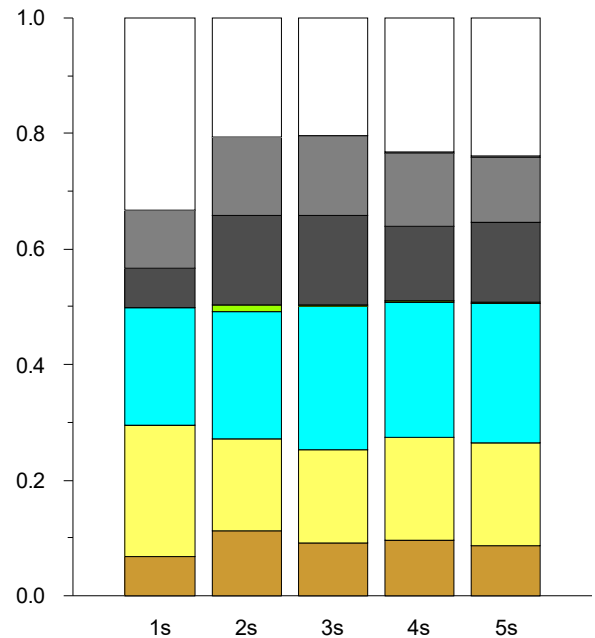

A10-5 COR – stacked bar graph, proportional distribution of cations and anions in groundwater samples, August 2013

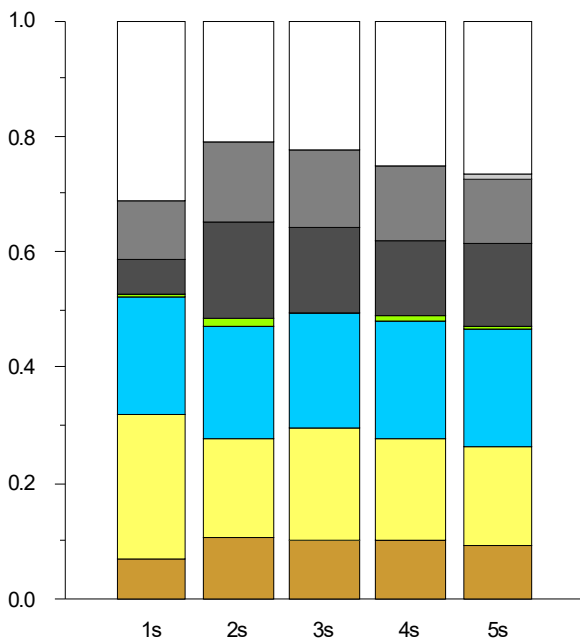

A10-4 COR – stacked bar graph, proportional distribution of cations and anions in groundwater samples, August 2012

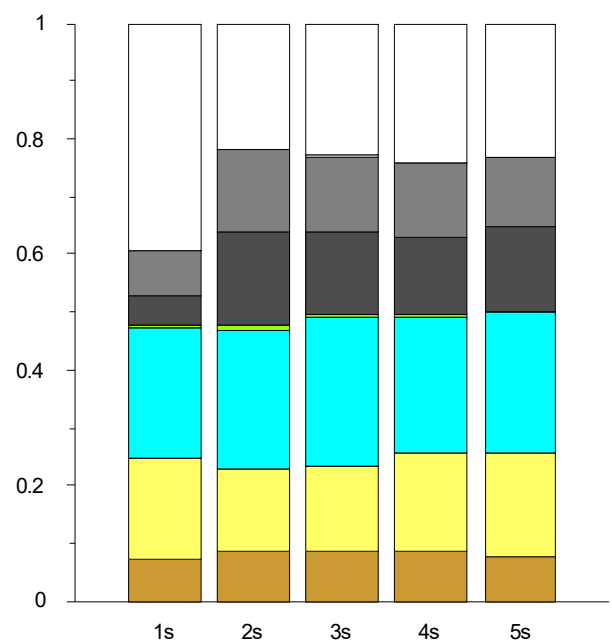

A10-6 COR – stacked bar graph, proportional distribution of cations and anions in groundwater samples, August 2014

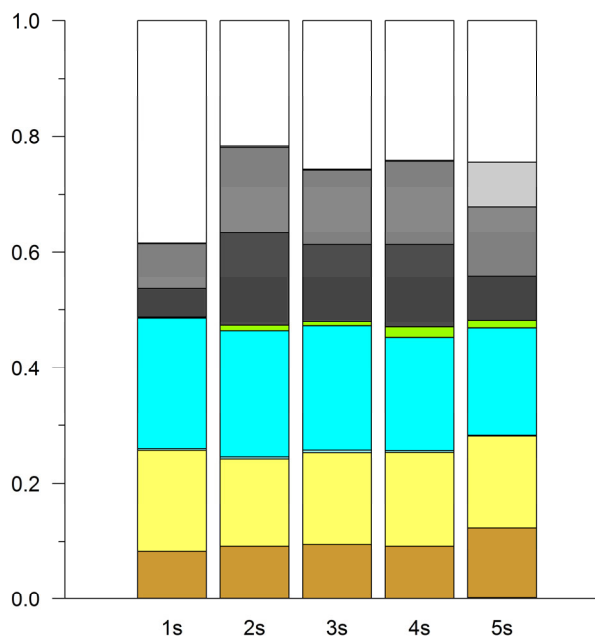

A10-7 COR – stacked bar graph, proportional distribution of cations and anions in groundwater samples, February 2015

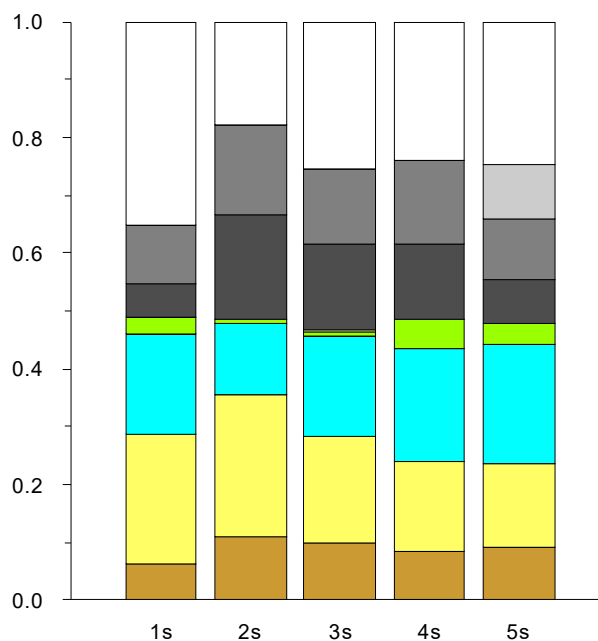

A10-9 COR – stacked bar graph, proportional distribution of cations and anions in groundwater samples, March 2017

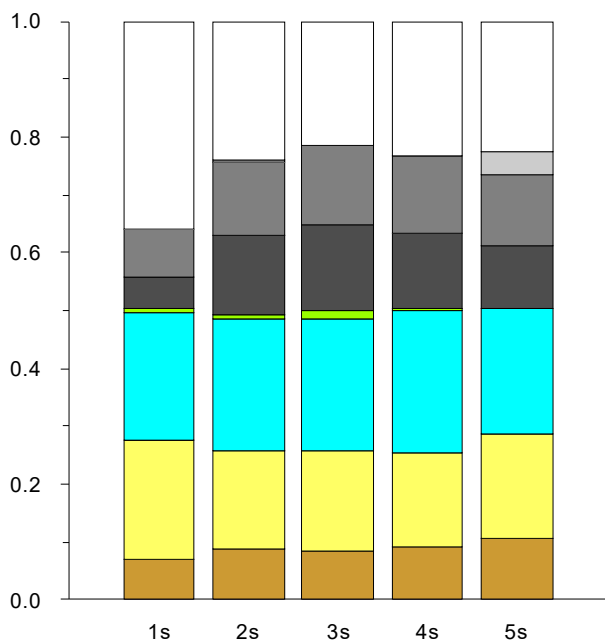

A10-8 COR – stacked bar graph, proportional distribution of cations and anions in groundwater samples, February 2016

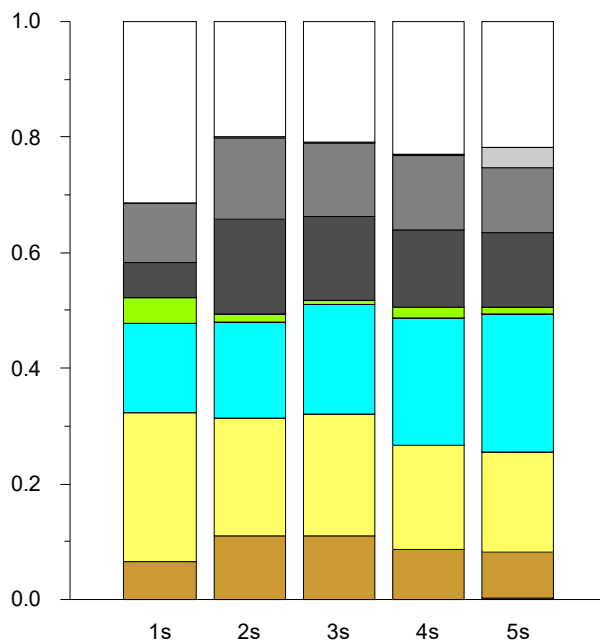

A10-1 COR – stacked bar graph, proportional distribution of cations and anions in groundwater samples, February 2018

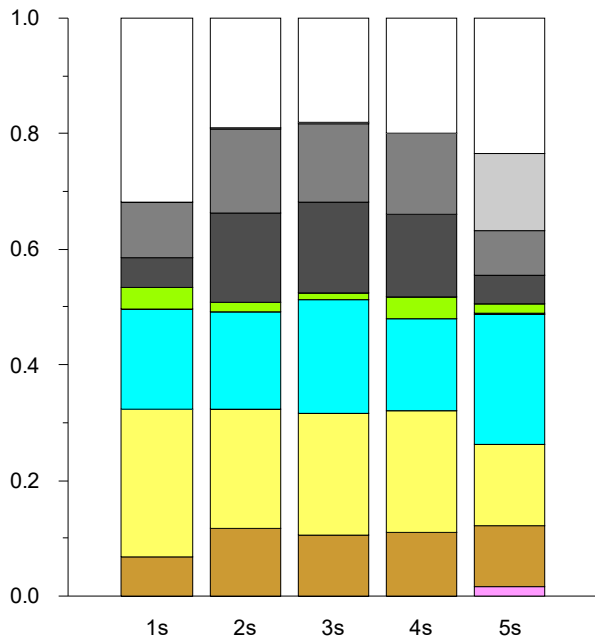

A10-2 COR – stacked bar graph, proportional distribution of cations and anions in groundwater samples, February 2019

FG2

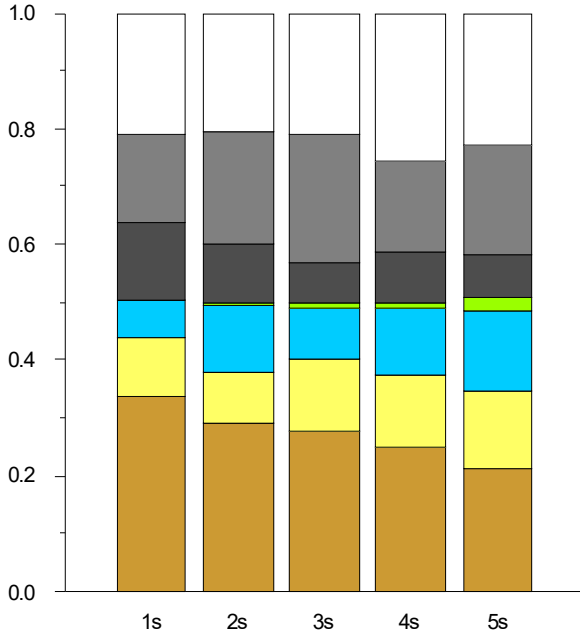

A10-3 FG2 - stacked bar graph, proportional distribution of cations and anions in groundwater samples, May 2012

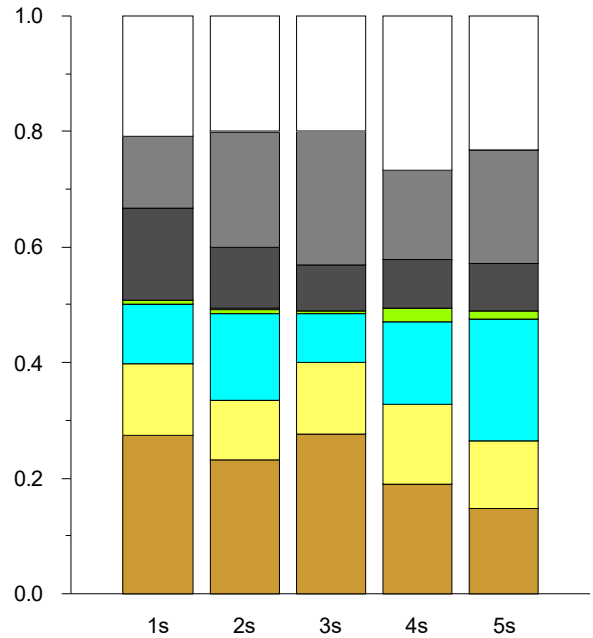

A10-5 FG2 - stacked bar graph, proportional distribution of cations and anions in groundwater samples, August 2013

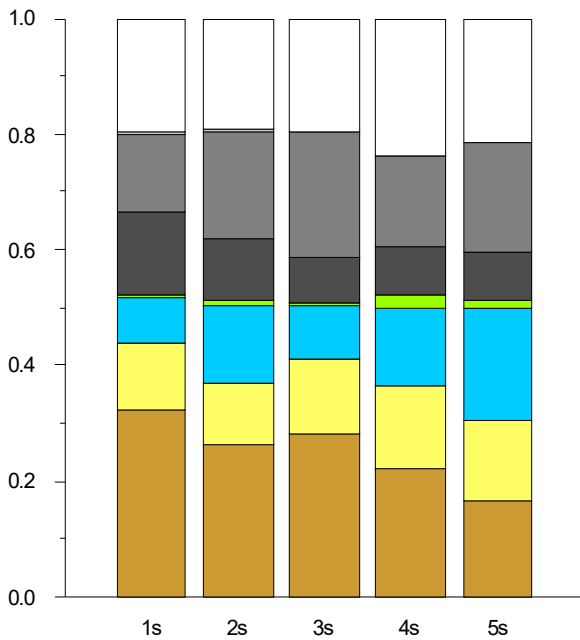

A10-4 FG2 - stacked bar graph, proportional distribution of cations and anions in groundwater samples, August 2012

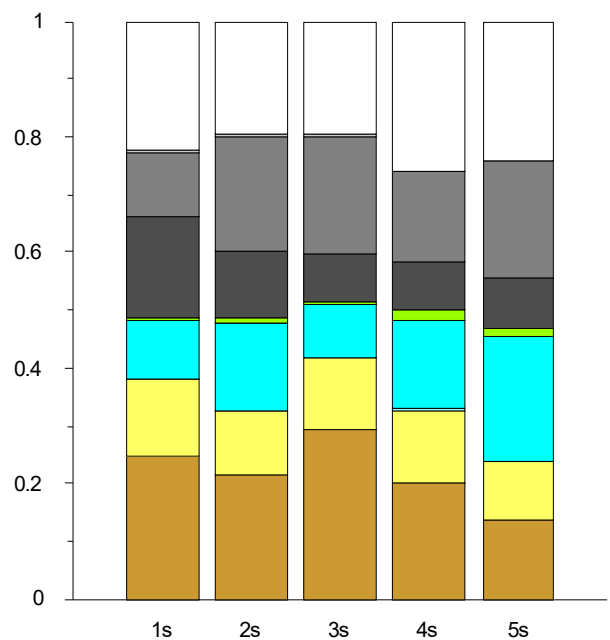

A10-6 FG2 - stacked bar graph, proportional distribution of cations and anions in groundwater samples, August 2014

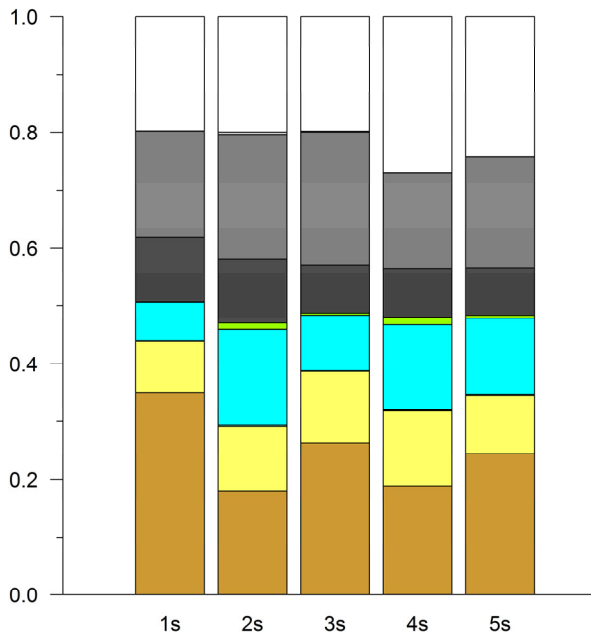

A10-7 FG2 – stacked bar graph, proportional distribution of cations and anions in groundwater samples, February 2015

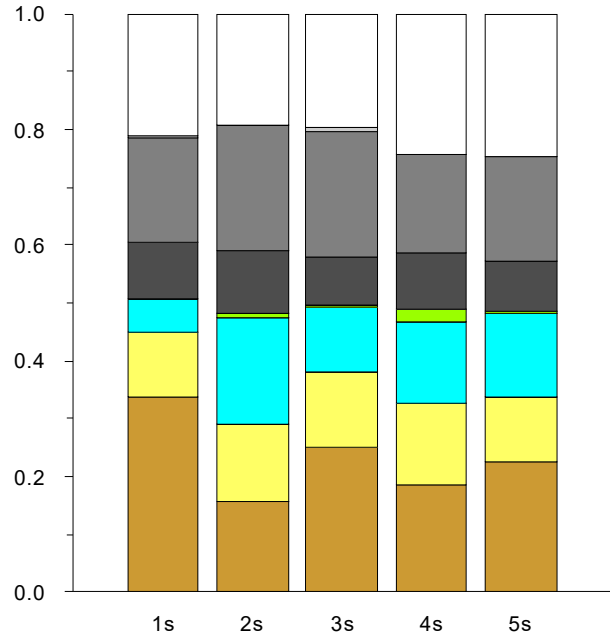

A10-9 FG2 – stacked bar graph, proportional distribution of cations and anions in groundwater samples, March 2017

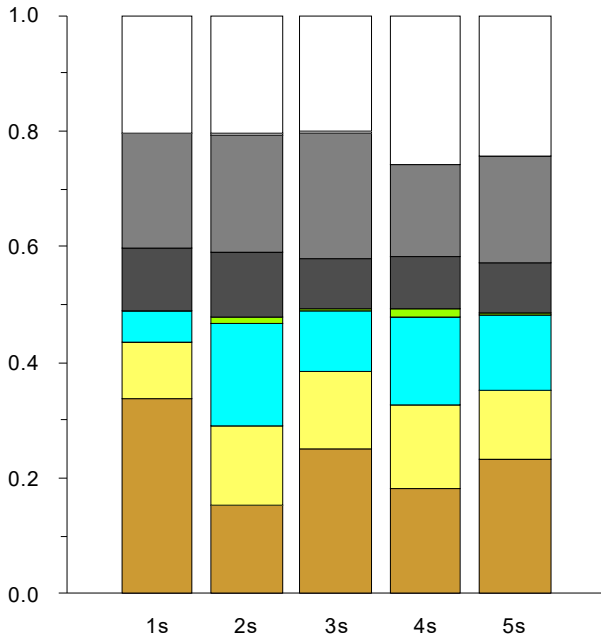

A10-8 FG2 – stacked bar graph, proportional distribution of cations and anions in groundwater samples, February 2016

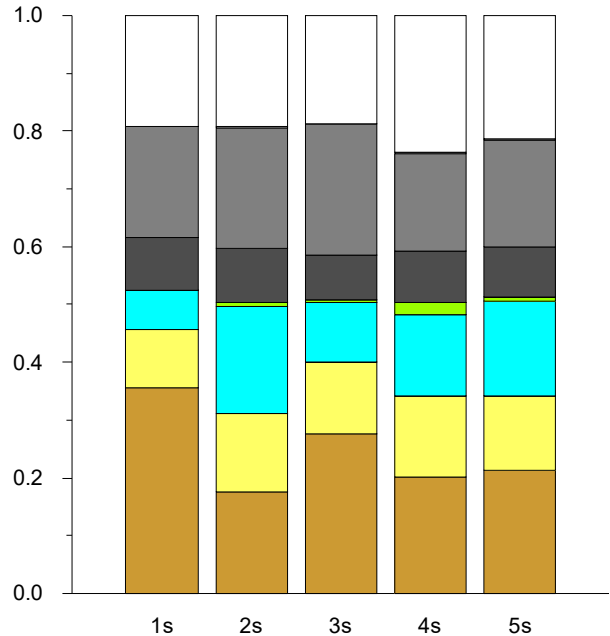

A10-1 FG2 – stacked bar graph, proportional distribution of cations and anions in groundwater samples, February 2018

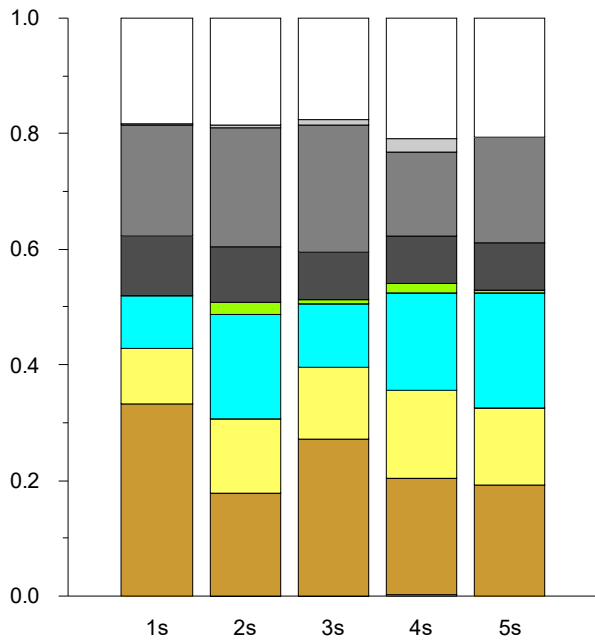

A10-2 FG2 – stacked bar graph, proportional distribution of cations and anions in groundwater samples, February 2019

GOD

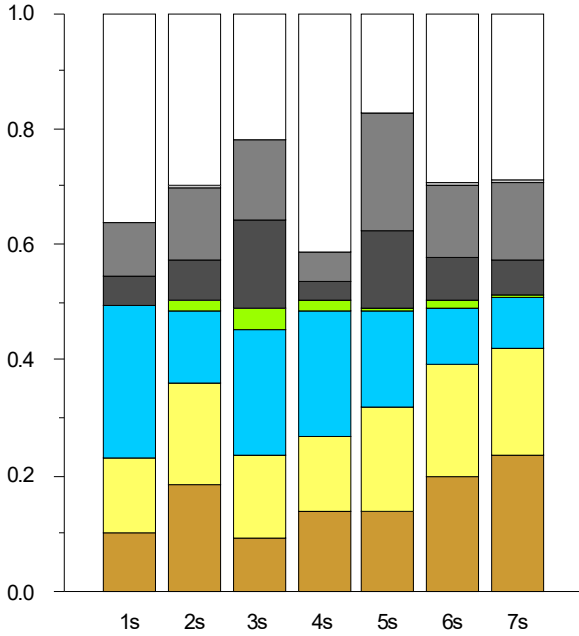

A10-3 GOD - stacked bar graph, proportional distribution of cations and anions in groundwater samples, May 2012

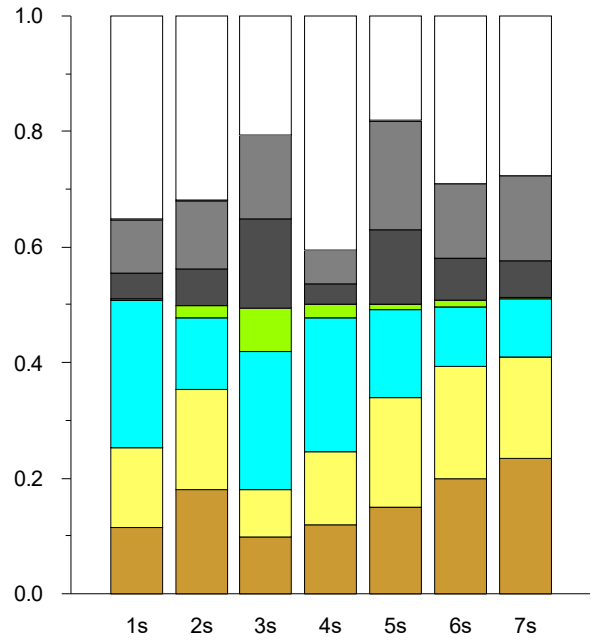

A10-5 GOD - stacked bar graph, proportional distribution of cations and anions in groundwater samples, August 2013

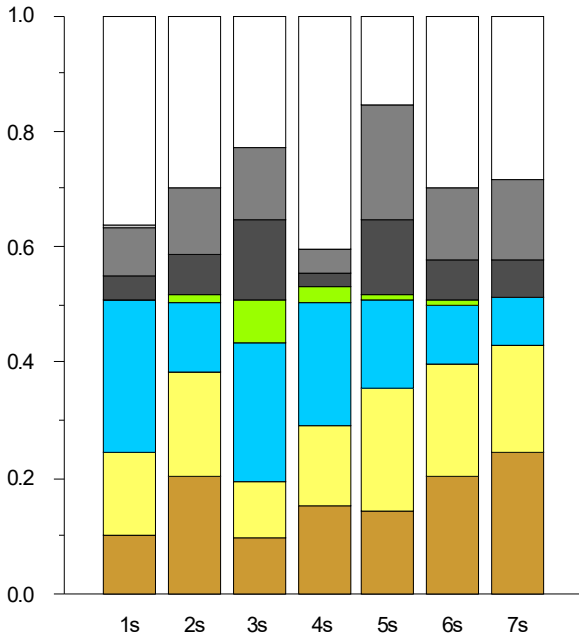

A10-4 GOD - stacked bar graph, proportional distribution of cations and anions in groundwater samples, August 2012

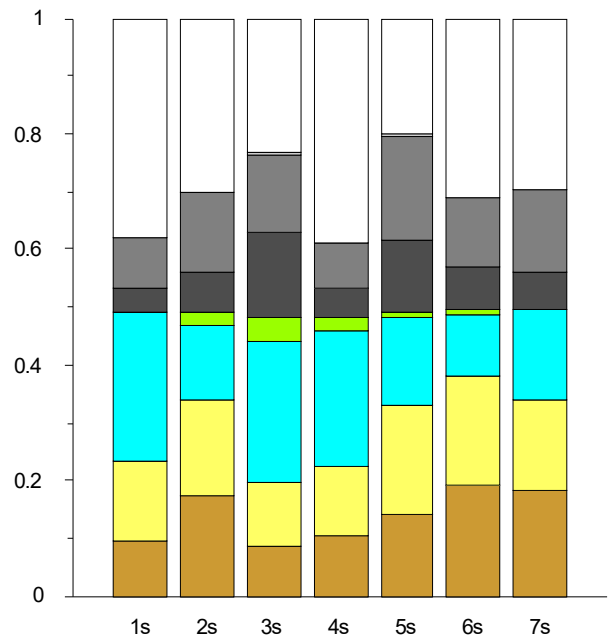

A10-6 GOD - stacked bar graph, proportional distribution of cations and anions in groundwater samples, August 2014

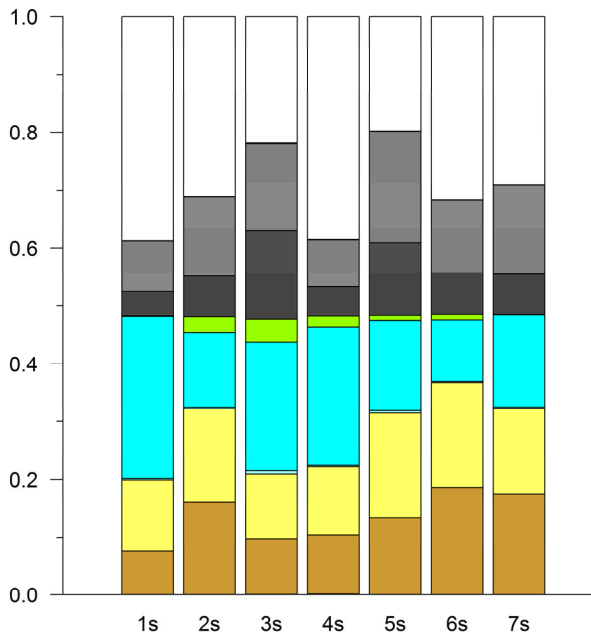

A10-7 GOD – stacked bar graph, proportional distribution of cations and anions in groundwater samples, February 2015

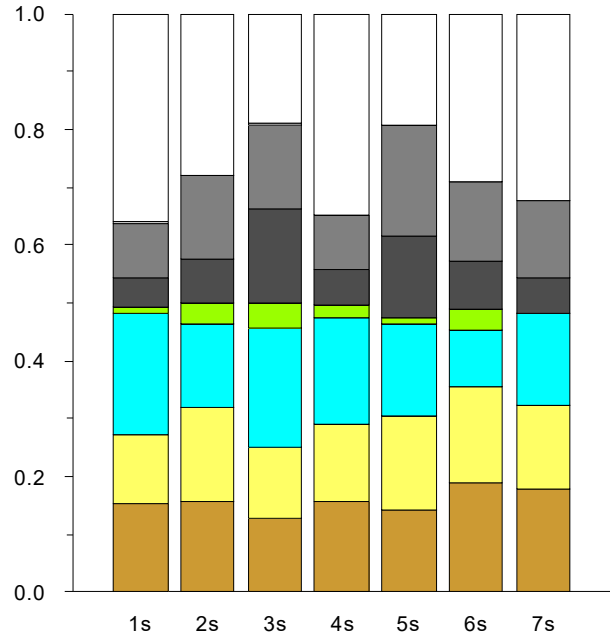

A10-9 GOD – stacked bar graph, proportional distribution of cations and anions in groundwater samples, March 2017

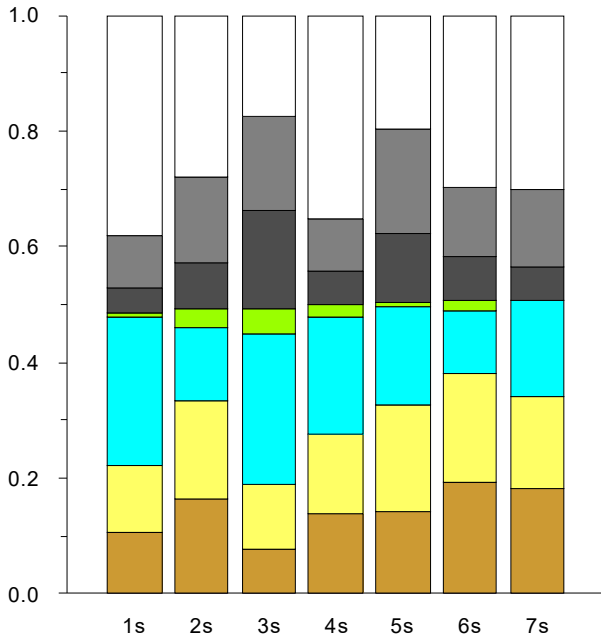

A10-8 GOD – stacked bar graph, proportional distribution of cations and anions in groundwater samples, February 2016

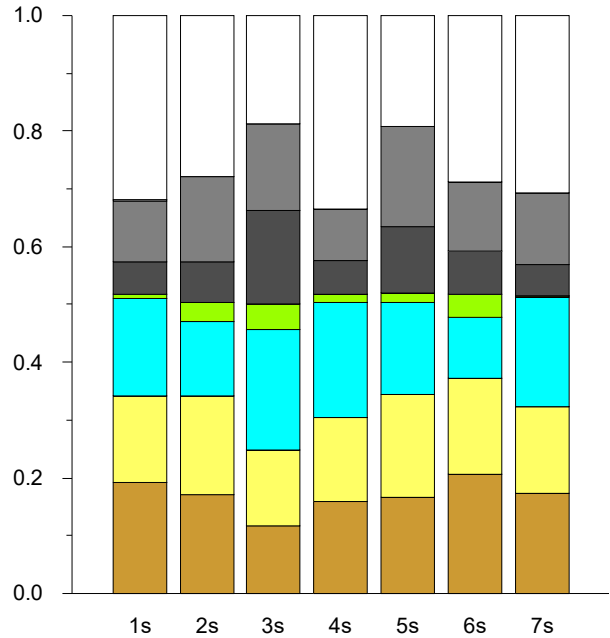

A10-1 GOD – stacked bar graph, proportional distribution of cations and anions in groundwater samples, February 2018

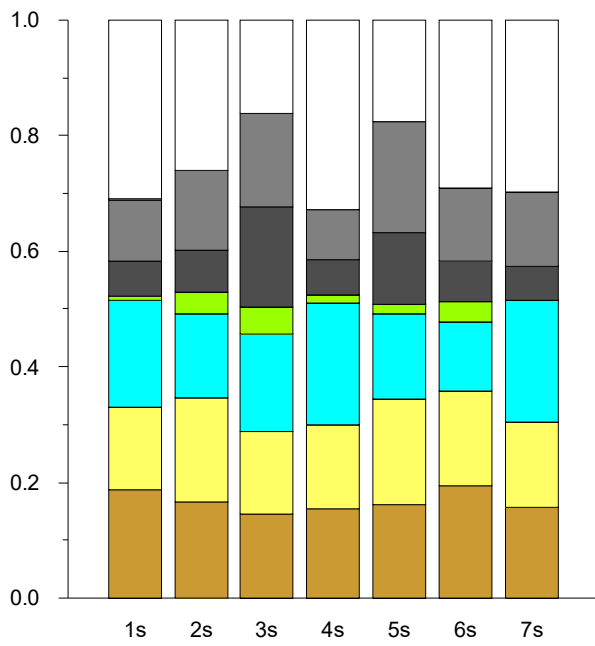

A10-2 GOD – stacked bar graph, proportional distribution of cations and anions in groundwater samples, February 2019

MAC

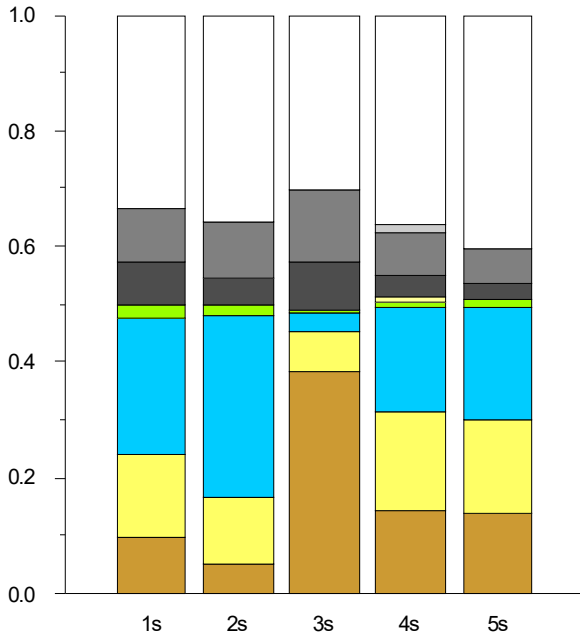

A10-3 MAC - stacked bar graph, proportional distribution of cations and anions in groundwater samples, May 2012

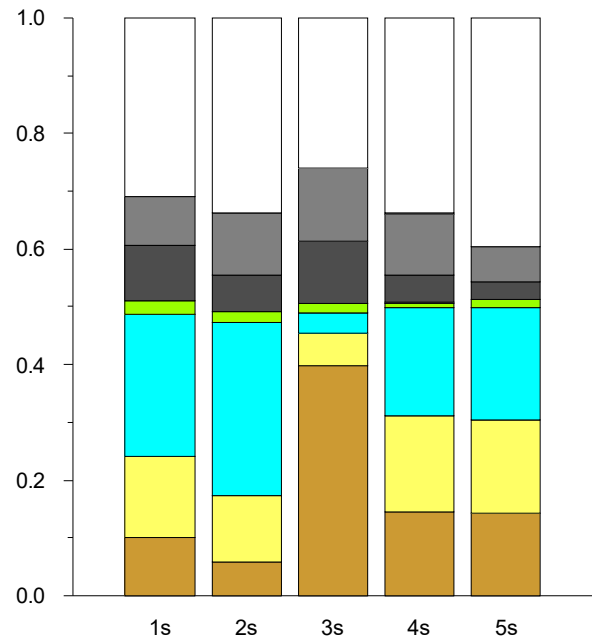

A10-5 MAC - stacked bar graph, proportional distribution of cations and anions in groundwater samples, August 2013

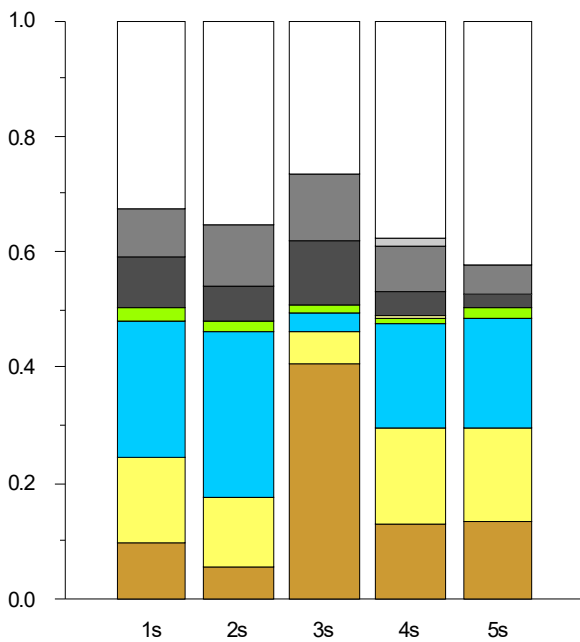

A10-4 MAC - stacked bar graph, proportional distribution of cations and anions in groundwater samples, August 2012

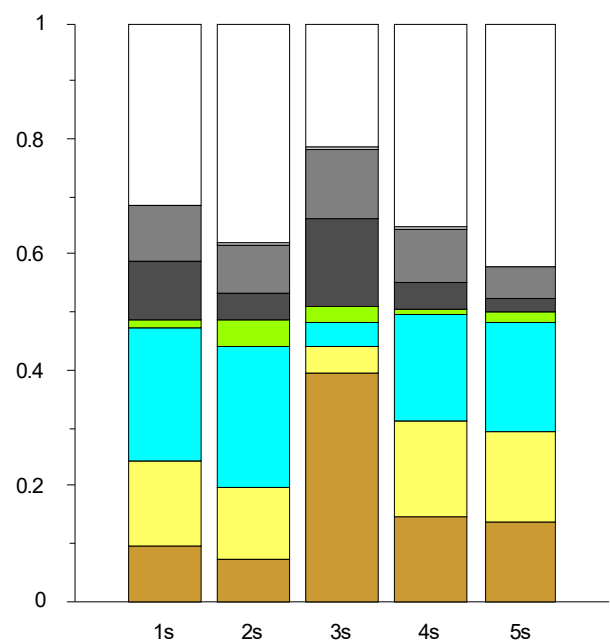

A10-6 MAC - stacked bar graph, proportional distribution of cations and anions in groundwater samples, August 2014

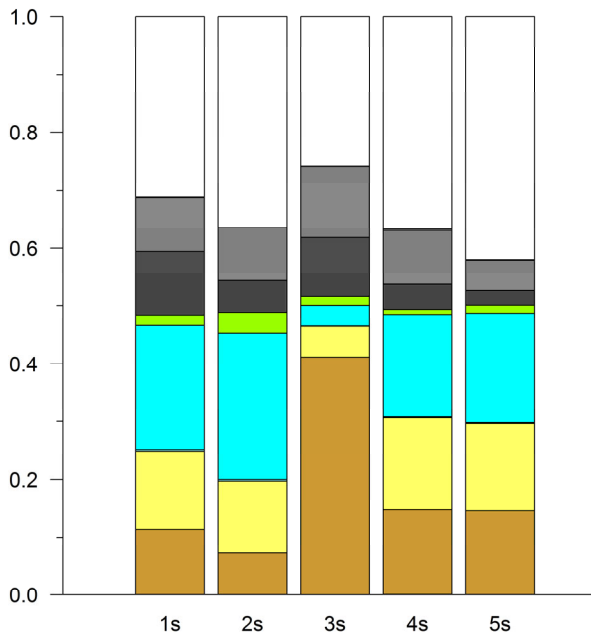

A10-7 MAC – stacked bar graph, proportional distribution of cations and anions in groundwater samples, February 2015

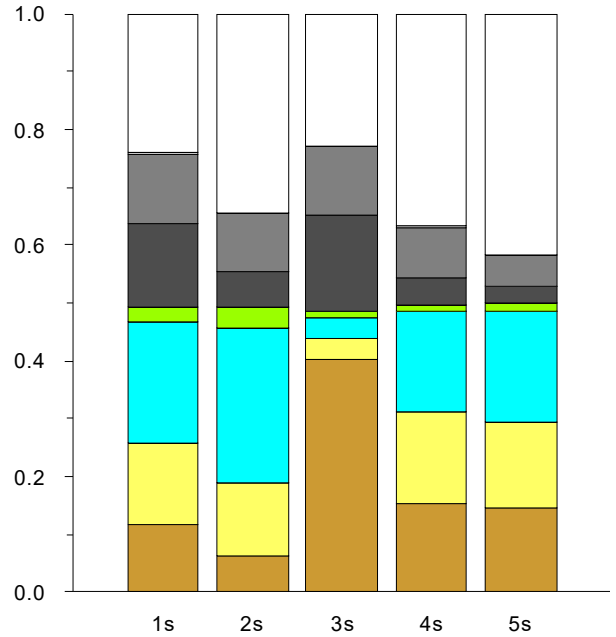

A10-9 MAC – stacked bar graph, proportional distribution of cations and anions in groundwater samples, March 2017

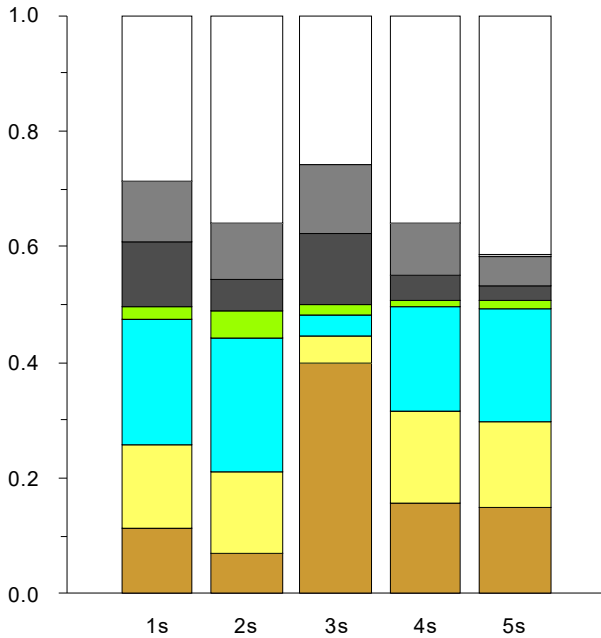

A10-8 MAC – stacked bar graph, proportional distribution of cations and anions in groundwater samples, February 2016

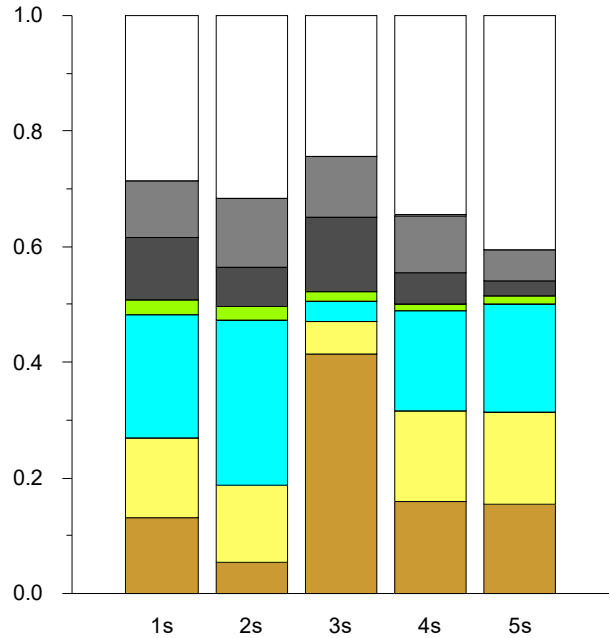

A10-1 MAC – stacked bar graph, proportional distribution of cations and anions in groundwater samples, February 2018

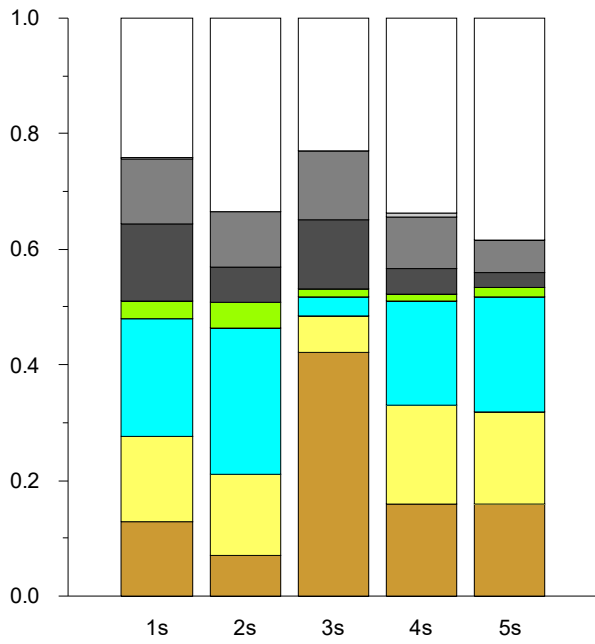

A10-2 MAC – stacked bar graph, proportional distribution of cations and anions in groundwater samples, February 2019

NUN

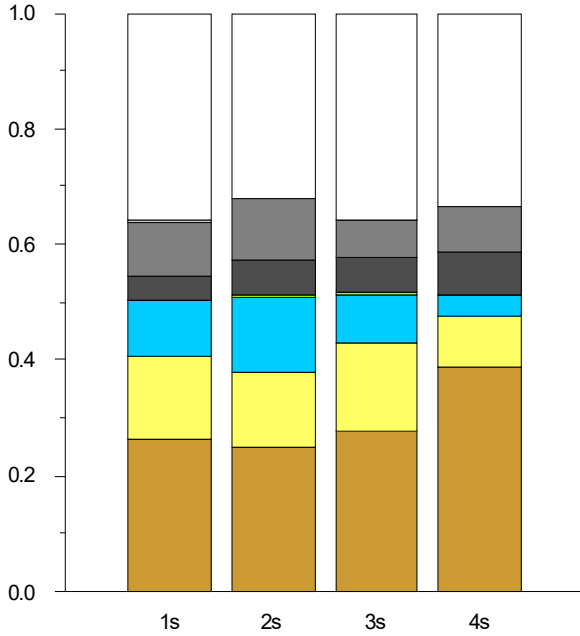

A10-3 NUN - stacked bar graph, proportional distribution of cations and anions in groundwater samples, May 2012

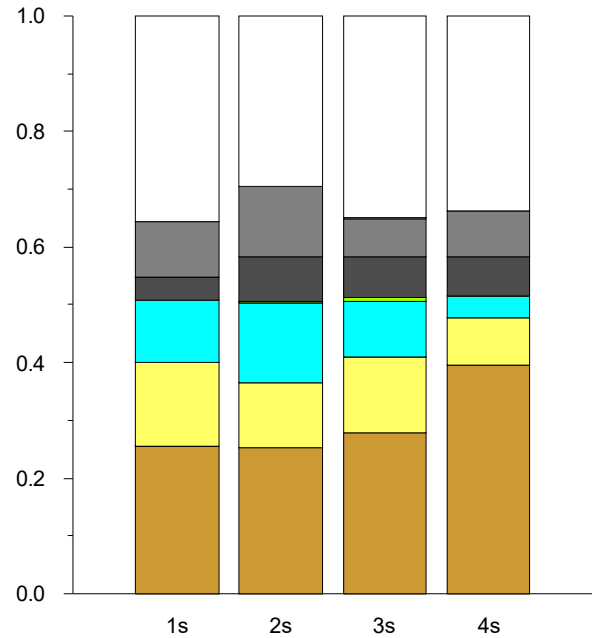

A10-5 NUN - stacked bar graph, proportional distribution of cations and anions in groundwater samples, August 2013

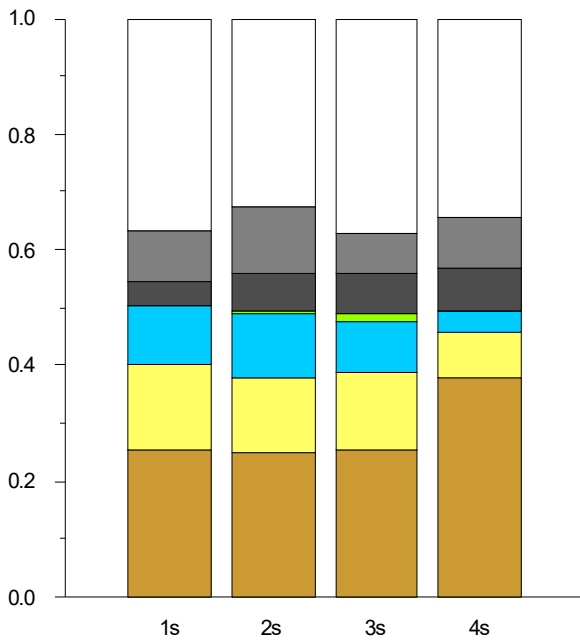

A10-4 NUN - stacked bar graph, proportional distribution of cations and anions in groundwater samples, August 2012

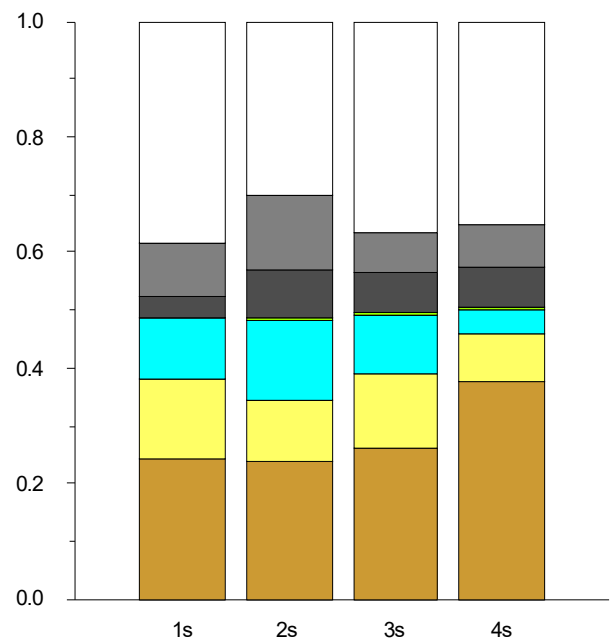

A10-6 NUN - stacked bar graph, proportional distribution of cations and anions in groundwater samples, August 2014

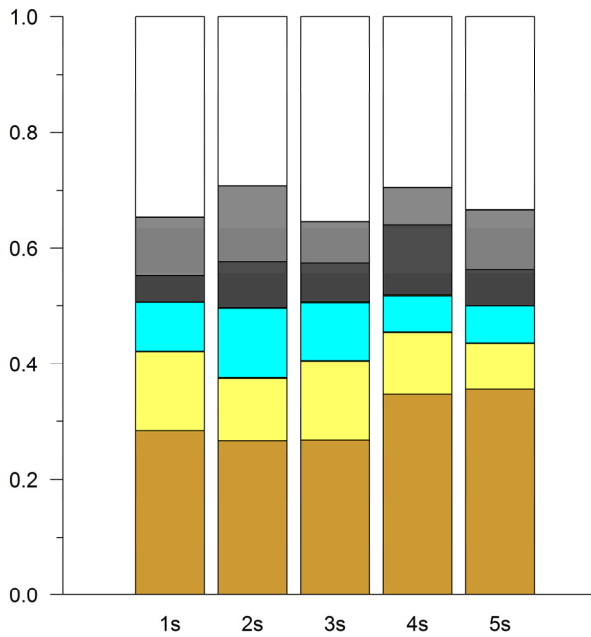

A10-7 NUN – stacked bar graph, proportional distribution of cations and anions in groundwater samples, February 2015

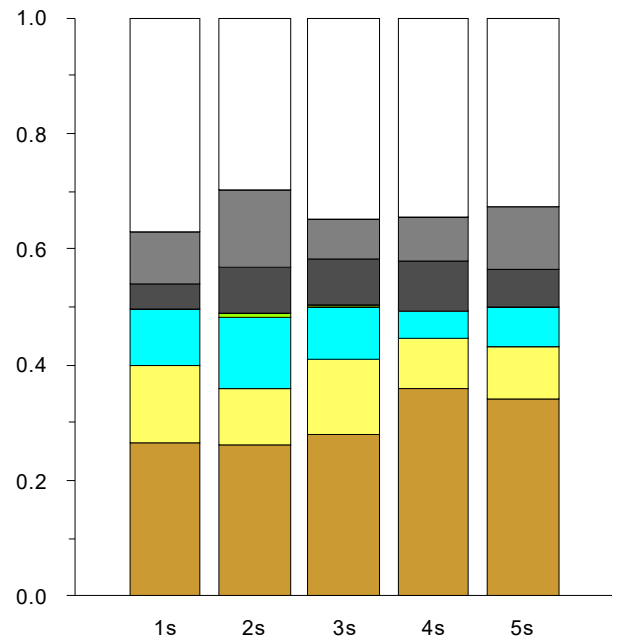

A10-9 NUN – stacked bar graph, proportional distribution of cations and anions in groundwater samples, March 2017

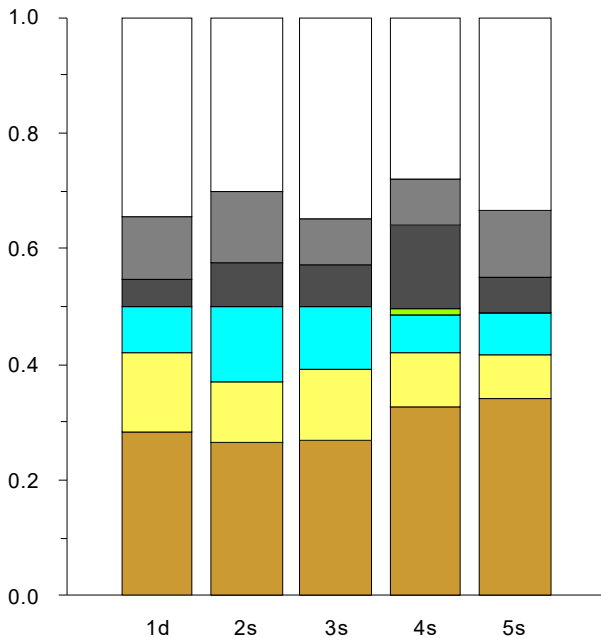

A10-8 NUN – stacked bar graph, proportional distribution of cations and anions in groundwater samples, February 2016

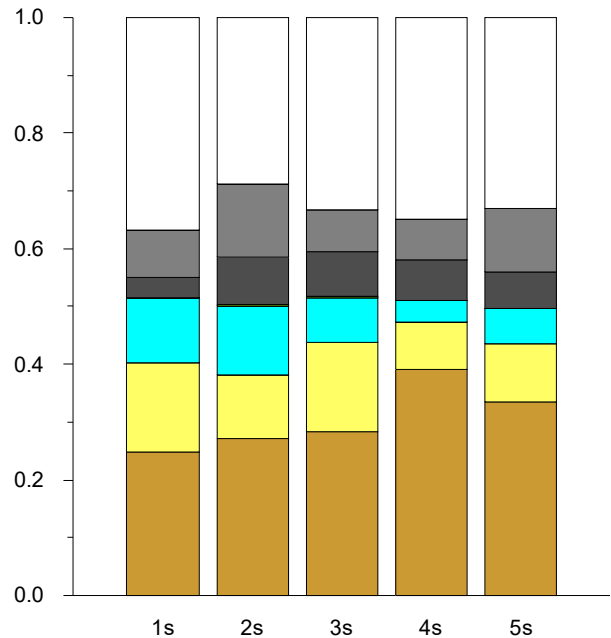

A10-1 NUN – stacked bar graph, proportional distribution of cations and anions in groundwater samples, February 2018

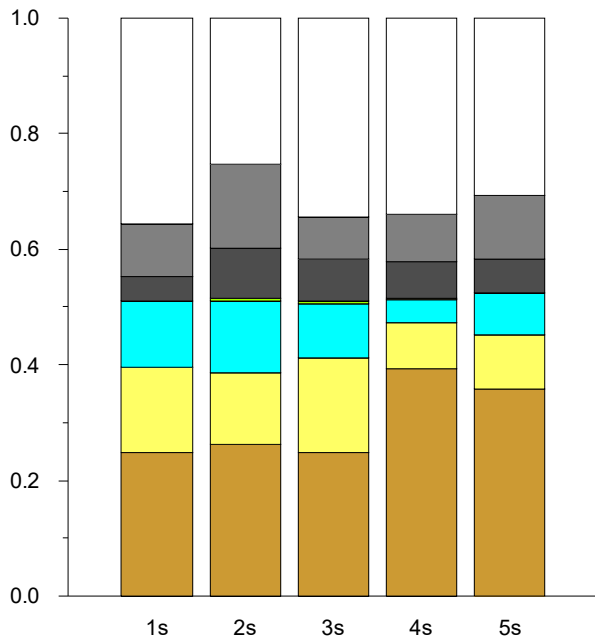

A10-2 NUN – stacked bar graph, proportional distribution of cations and anions in groundwater samples, February 2019

MOO

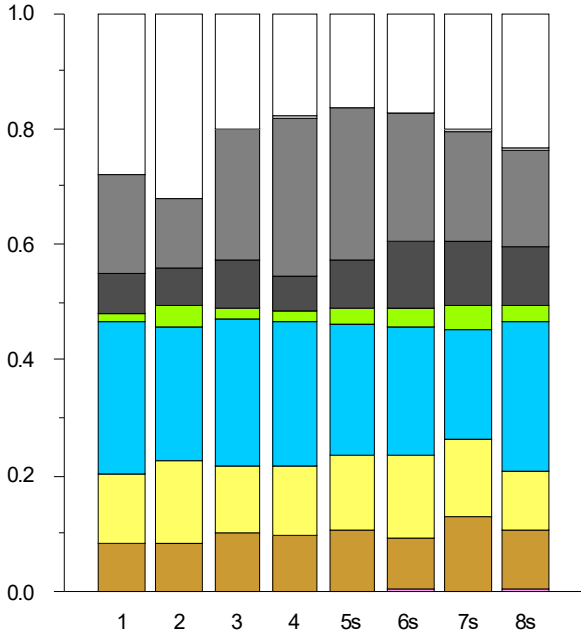

A10-3 MOO - stacked bar graph, proportional distribution of cations and anions in groundwater samples, May 2012

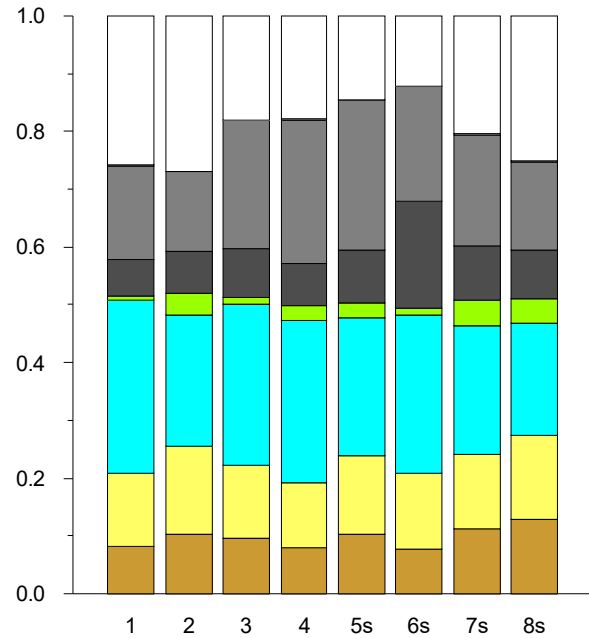

A10-5 MOO - stacked bar graph, proportional distribution of cations and anions in groundwater samples, August 2013

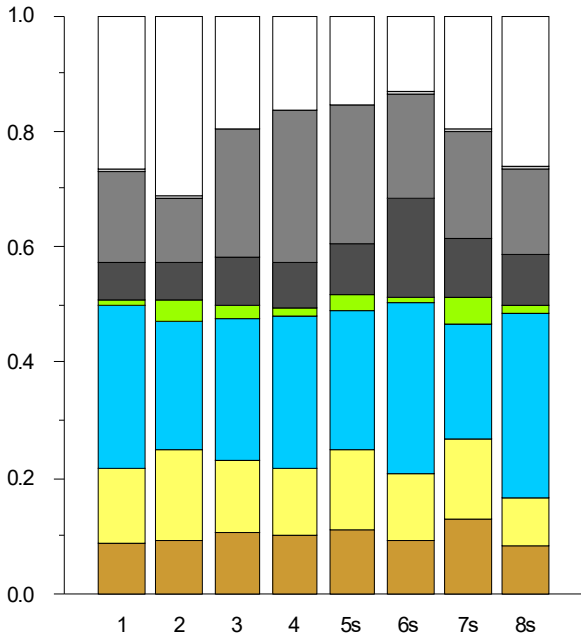

A10-4 MOO - stacked bar graph, proportional distribution of cations and anions in groundwater samples, August 2012

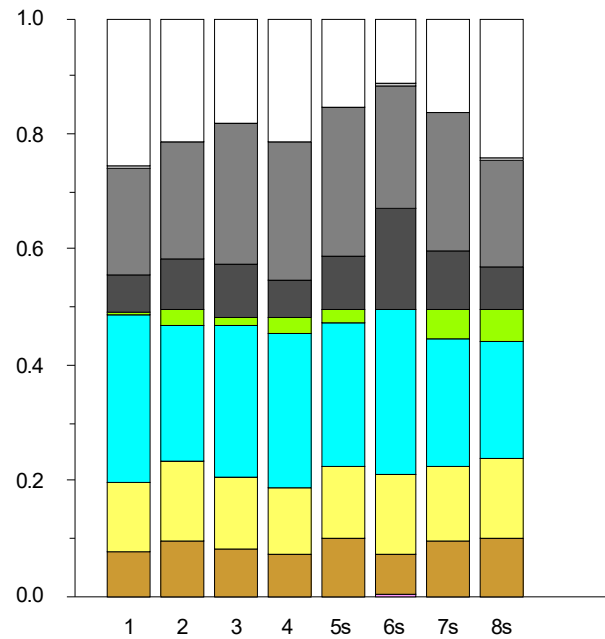

A10-6 MOO - stacked bar graph, proportional distribution of cations and anions in groundwater samples, August 2014

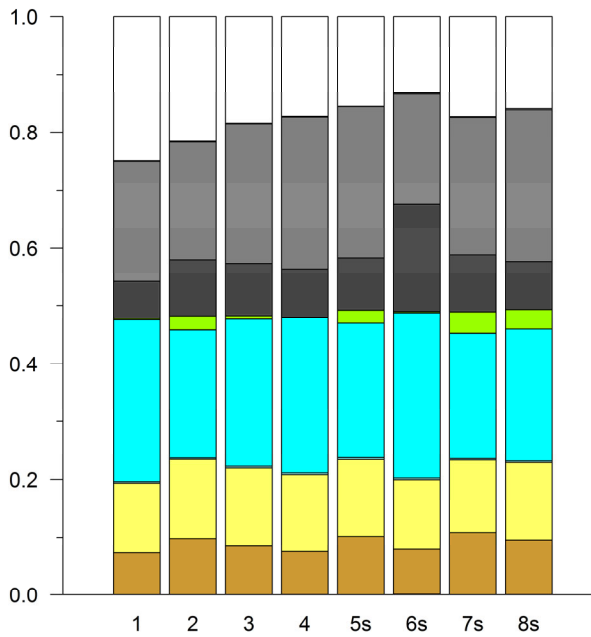

A10-7 MOO – stacked bar graph, proportional distribution of cations and anions in groundwater samples, February 2015

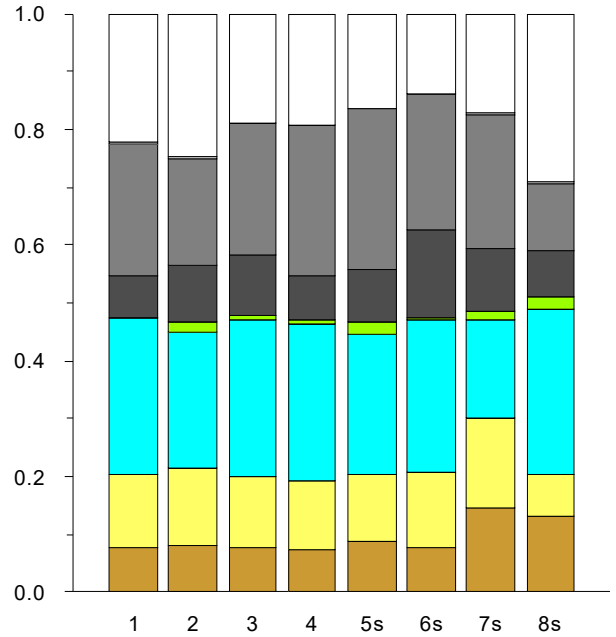

A10-9 MOO – stacked bar graph, proportional distribution of cations and anions in groundwater samples, March 2017

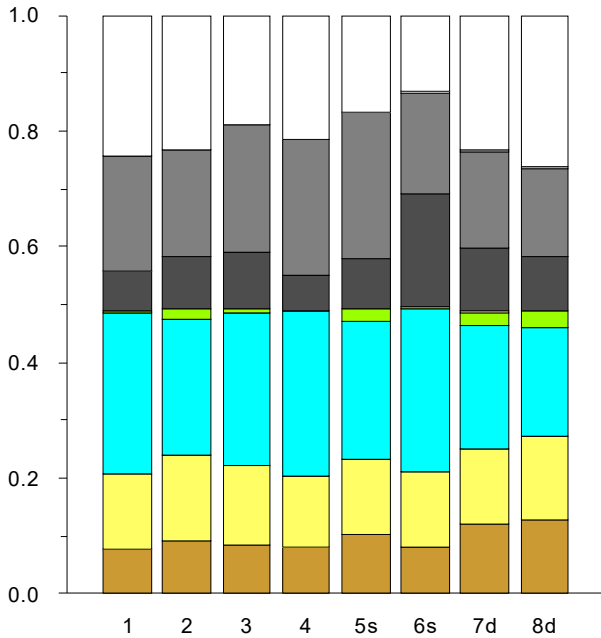

A10-8 MOO – stacked bar graph, proportional distribution of cations and anions in groundwater samples, February 2016

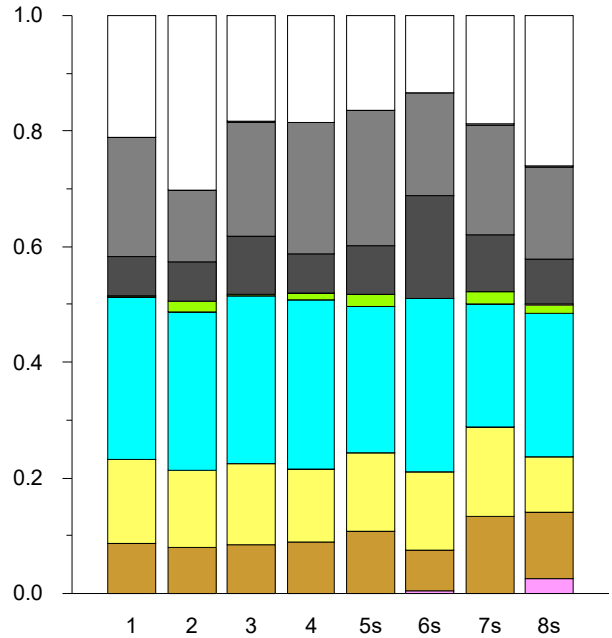

A10-1 MOO – stacked bar graph, proportional distribution of cations and anions in groundwater samples, February 2018

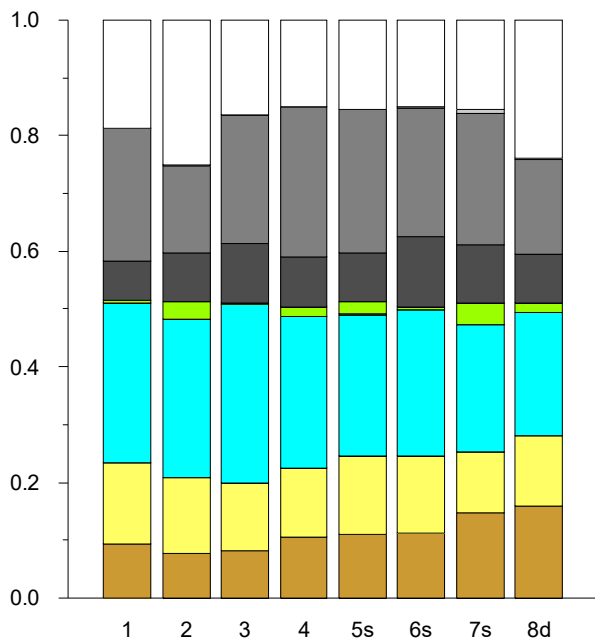

A10-2 MOO – stacked bar graph, proportional distribution of cations and anions in groundwater samples, February 2019

TON

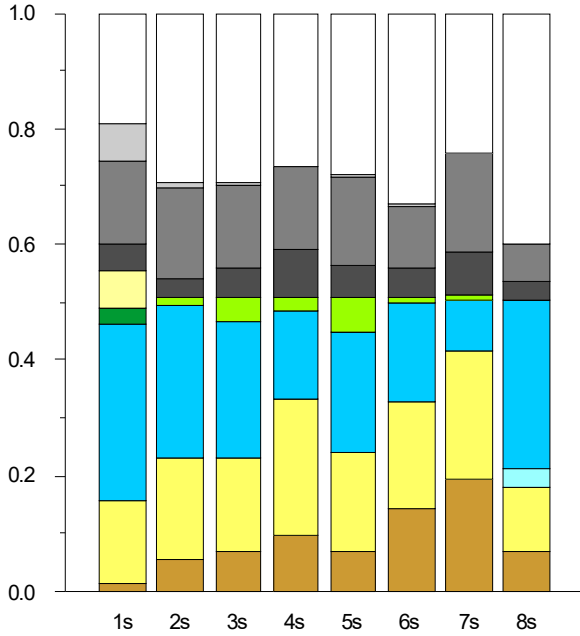

A10-3 TON - stacked bar graph, proportional distribution of cations and anions in groundwater samples, May 2012

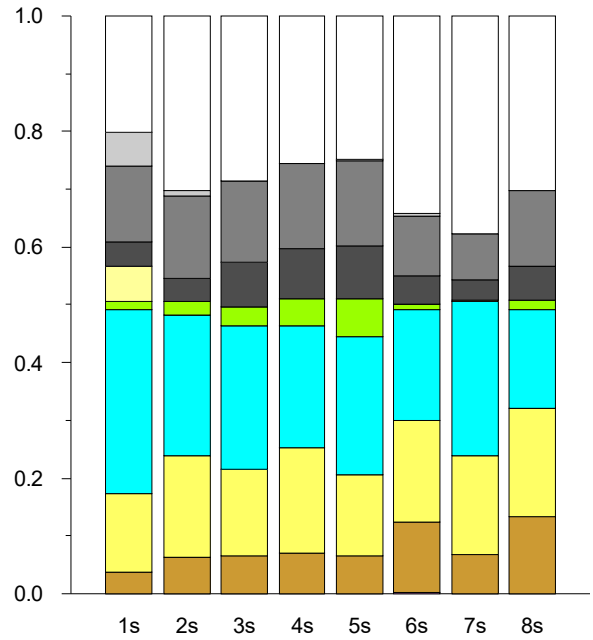

A10-5 TON - stacked bar graph, proportional distribution of cations and anions in groundwater samples, August 2013

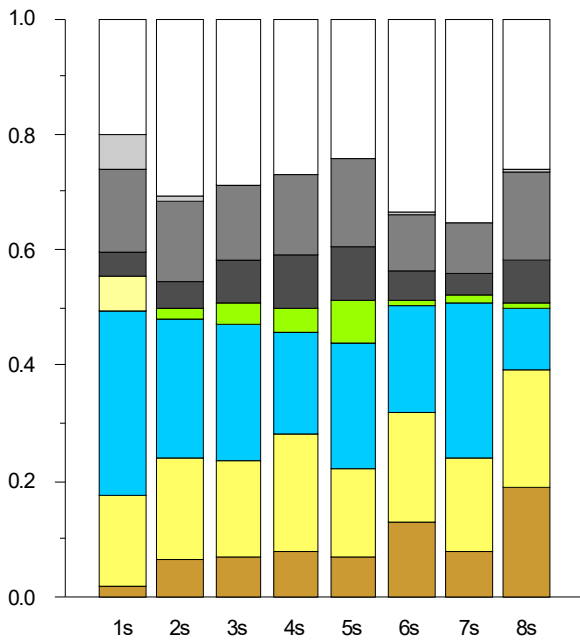

A10-4 TON - stacked bar graph, proportional distribution of cations and anions in groundwater samples, August 2012

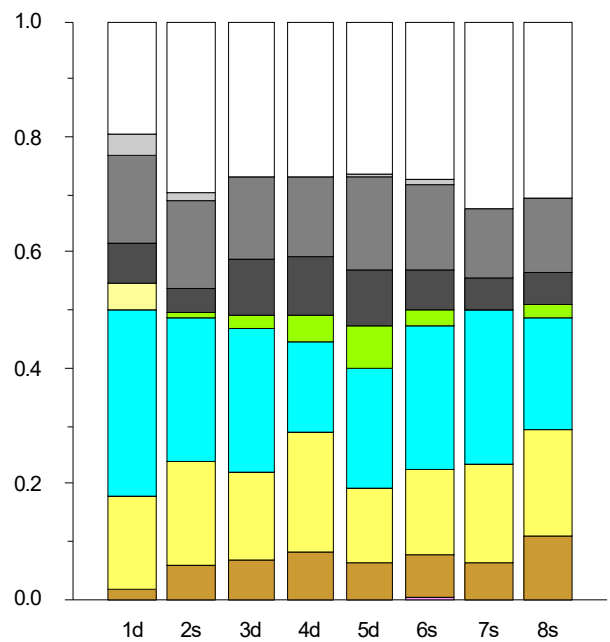

A10-6 TON - stacked bar graph, proportional distribution of cations and anions in groundwater samples, August 2014

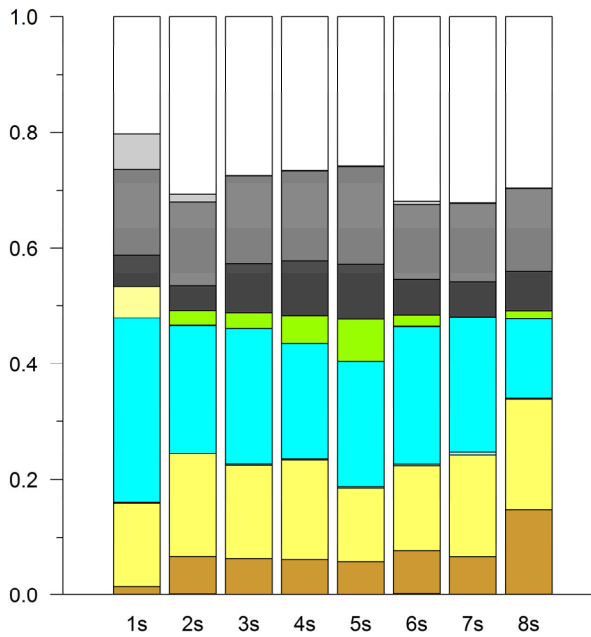

A10-7 TON – stacked bar graph, proportional distribution of cations and anions in groundwater samples, February 2015

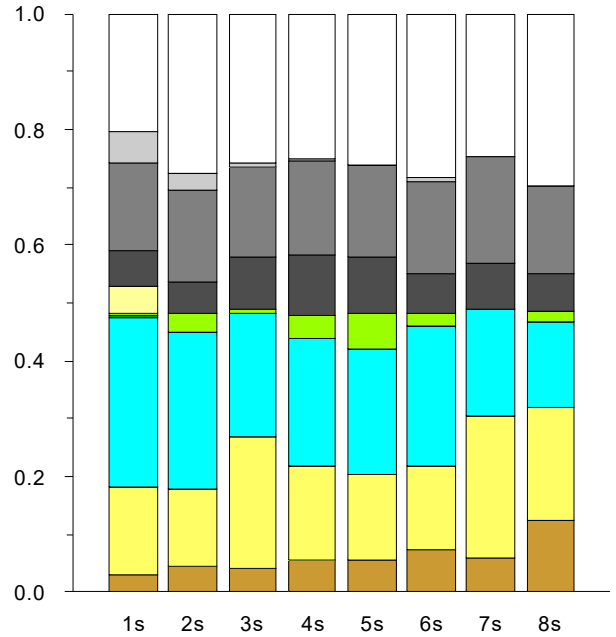

A10-9 TON – stacked bar graph, proportional distribution of cations and anions in groundwater samples, March 2017

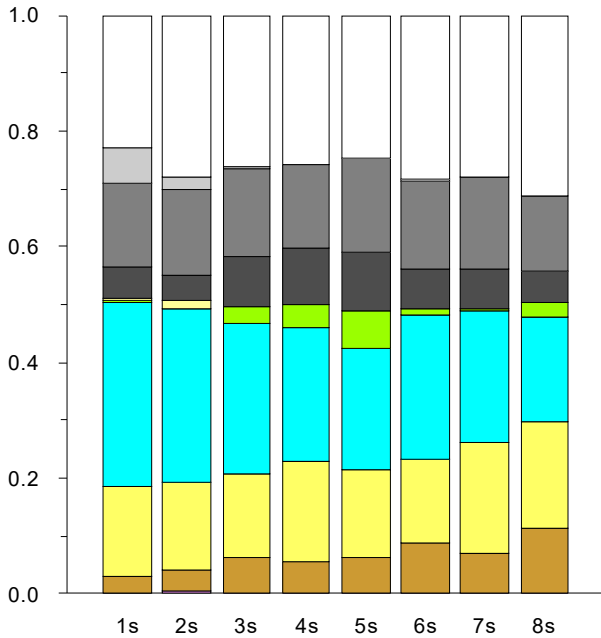

A10-8 TON – stacked bar graph, proportional distribution of cations and anions in groundwater samples, February 2016

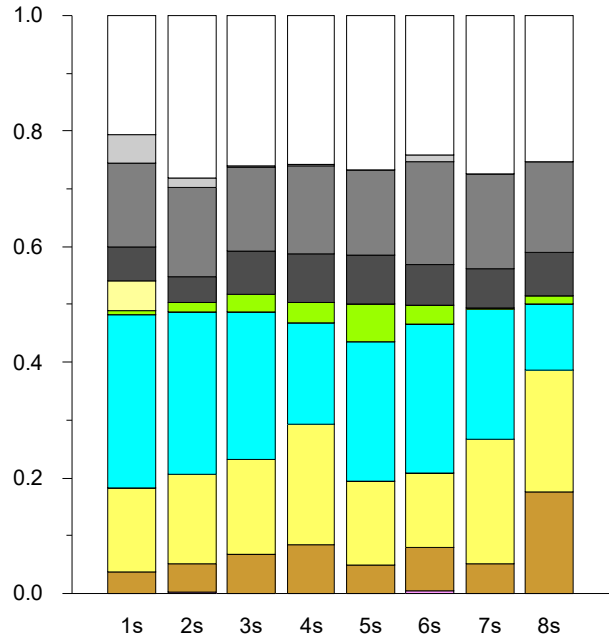

A10-1 TON – stacked bar graph, proportional distribution of cations and anions in groundwater samples, February 2018

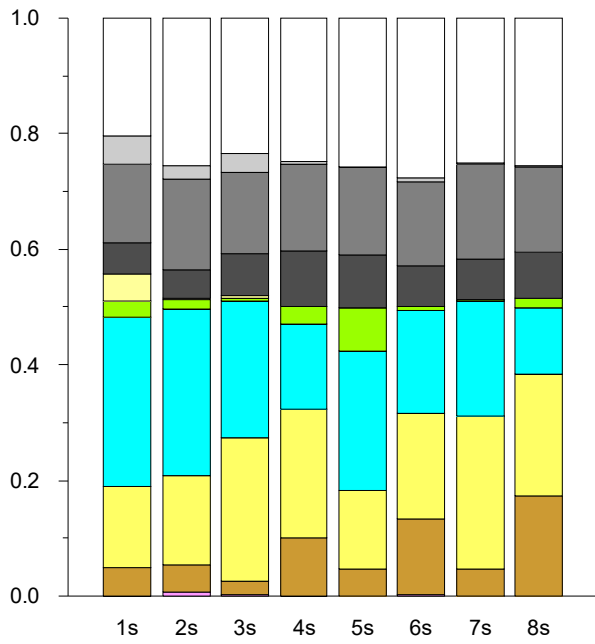

A10-2 TON – stacked bar graph, proportional distribution of cations and anions in groundwater samples, February 2019

BRE

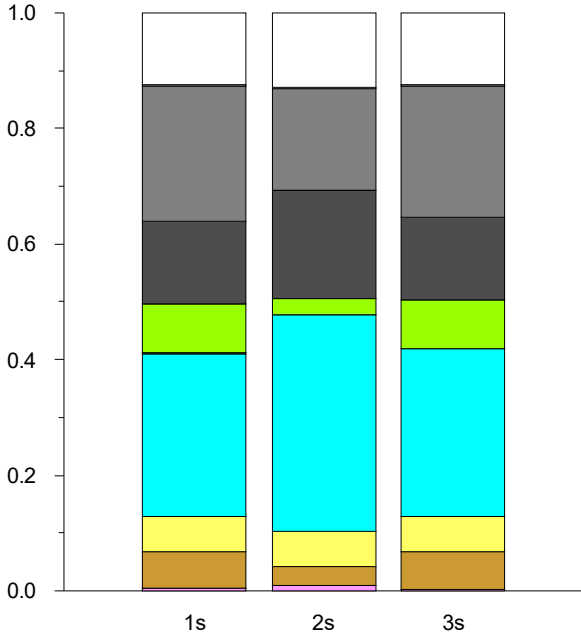

A10-3 BRE - stacked bar graph, proportional distribution of cations and anions in groundwater samples, August 2013

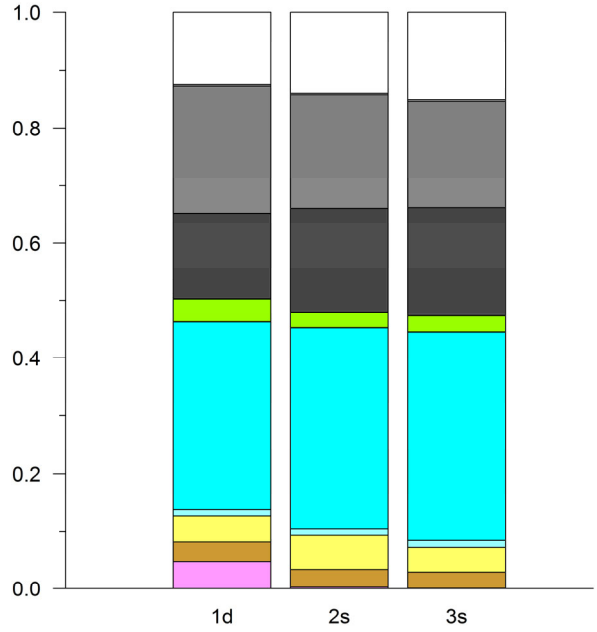

A10-5 BRE – stacked bar graph, proportional distribution of cations and anions in groundwater samples, February 2015

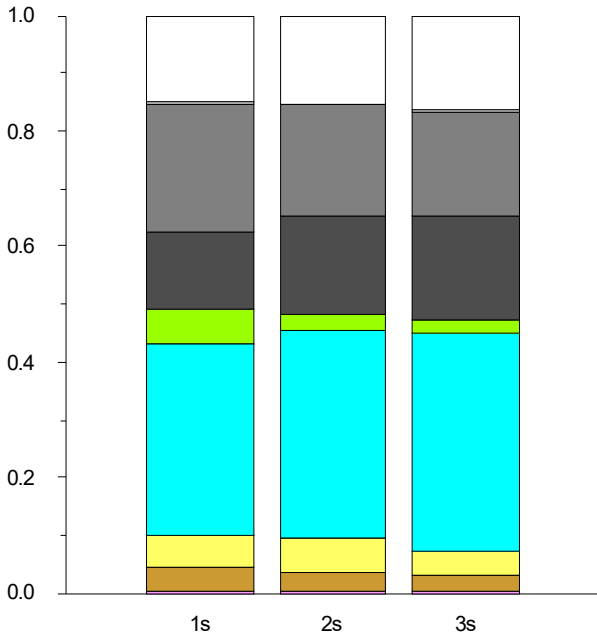

A10-4 BRE – stacked bar graph, proportional distribution of cations and anions in groundwater samples, August 2014

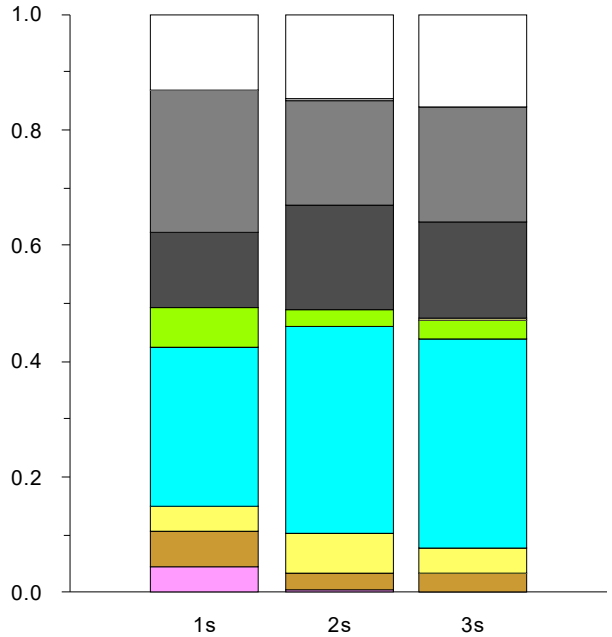

A10-6 BRE – stacked bar graph, proportional distribution of cations and anions in groundwater samples, February 2016

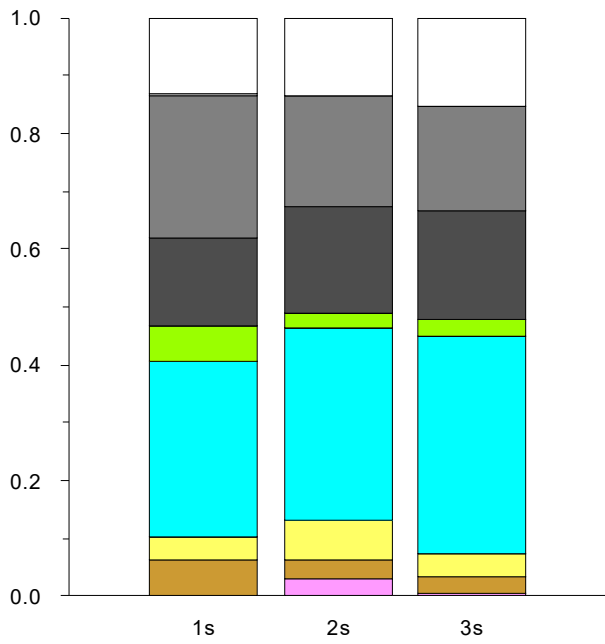

A10-7 BRE – stacked bar graph, proportional distribution of cations and anions in groundwater samples, March 2017

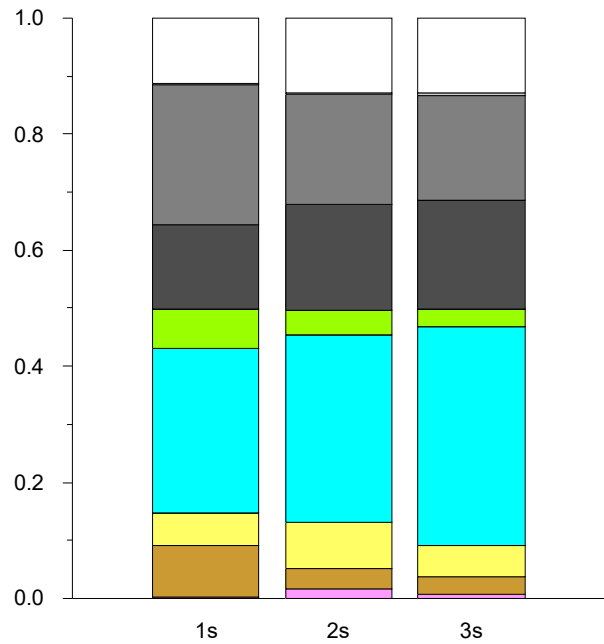

A10-2 BRE – stacked bar graph, proportional distribution of cations and anions in groundwater samples, February 2019

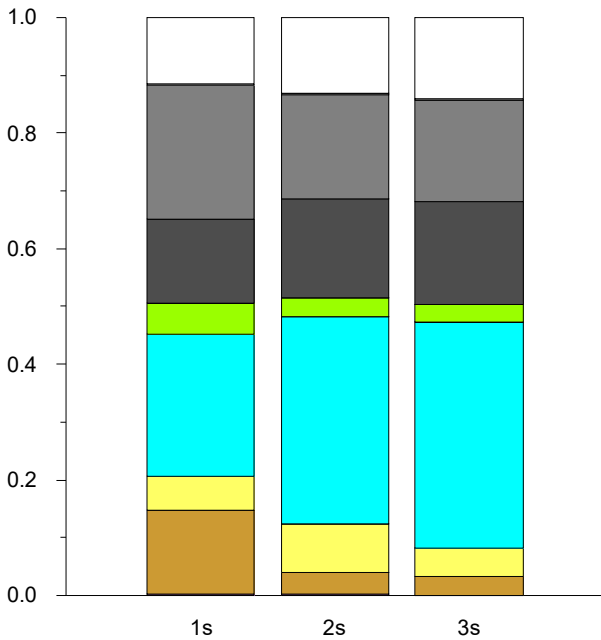

A10-1 BRE – stacked bar graph, proportional distribution of cations and anions in groundwater samples, February 2018

CRE

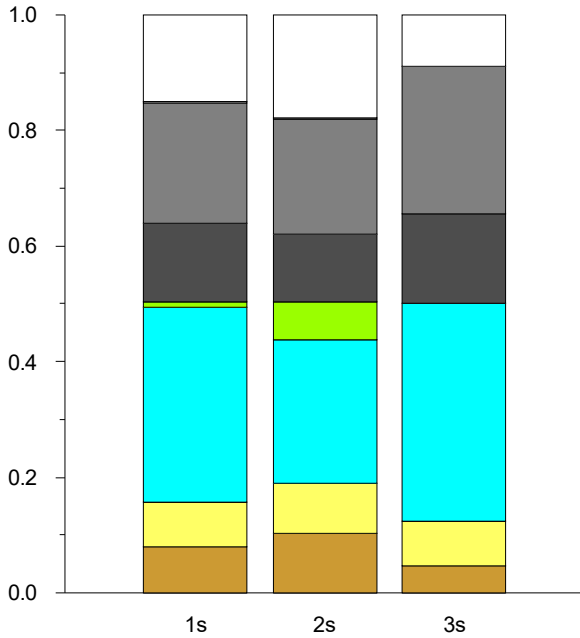

A10-3 CRE - stacked bar graph, proportional distribution of cations and anions in groundwater samples, August 2013

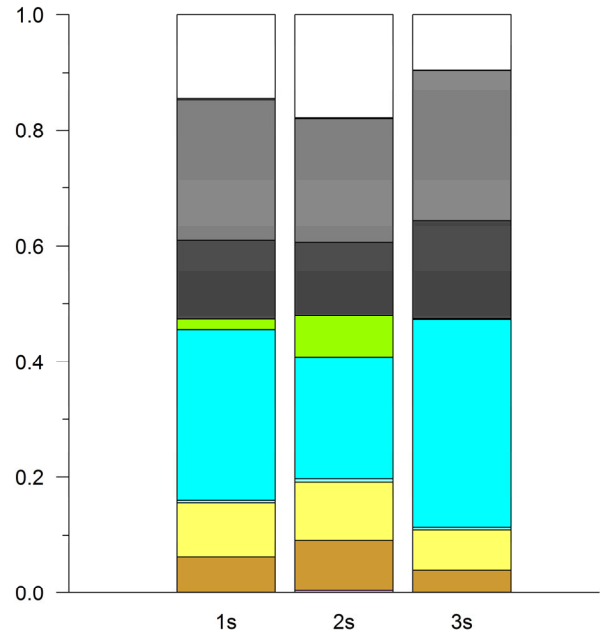

A10-5 CRE - stacked bar graph, proportional distribution of cations and anions in groundwater samples, February 2015

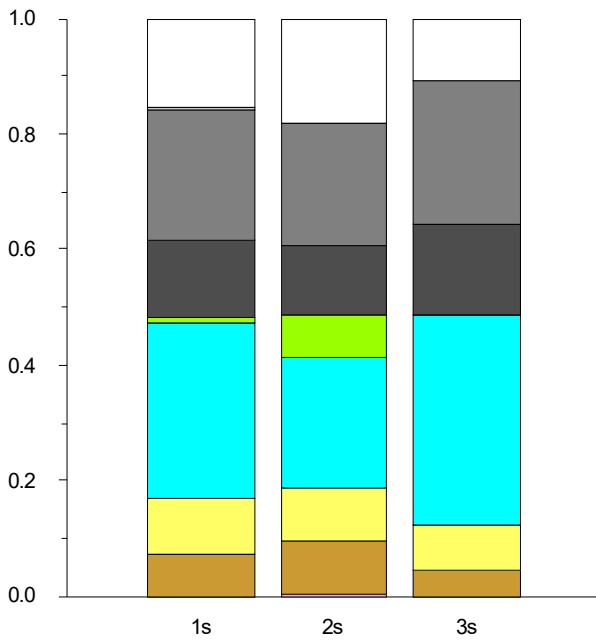

A10-4 CRE - stacked bar graph, proportional distribution of cations and anions in groundwater samples, August 2014

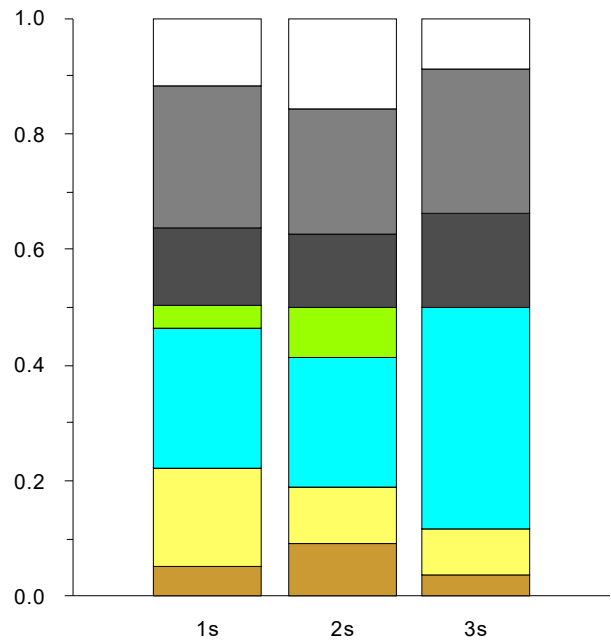

A10-6 CRE - stacked bar graph, proportional distribution of cations and anions in groundwater samples, February 2016

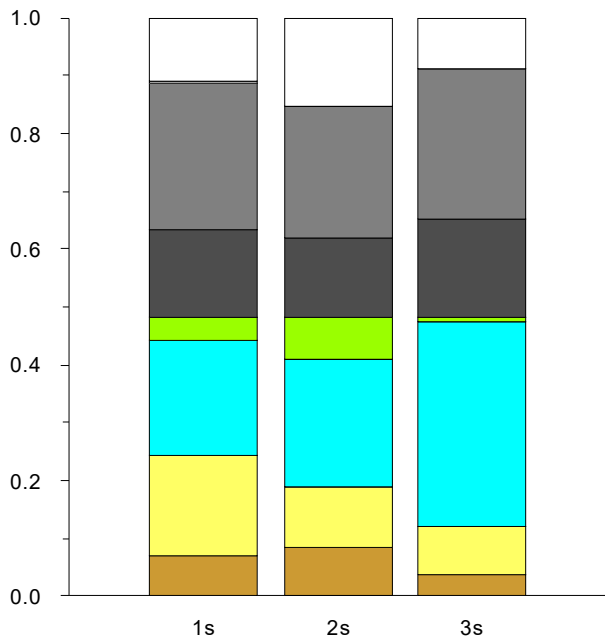

A10-7 CRE – stacked bar graph, proportional distribution of cations and anions in groundwater samples, March 2017

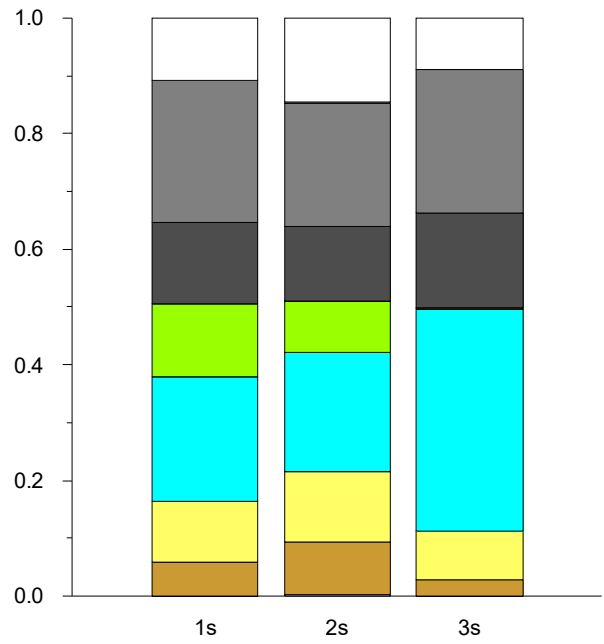

A10-2 CRE – stacked bar graph, proportional distribution of cations and anions in groundwater samples, February 2018

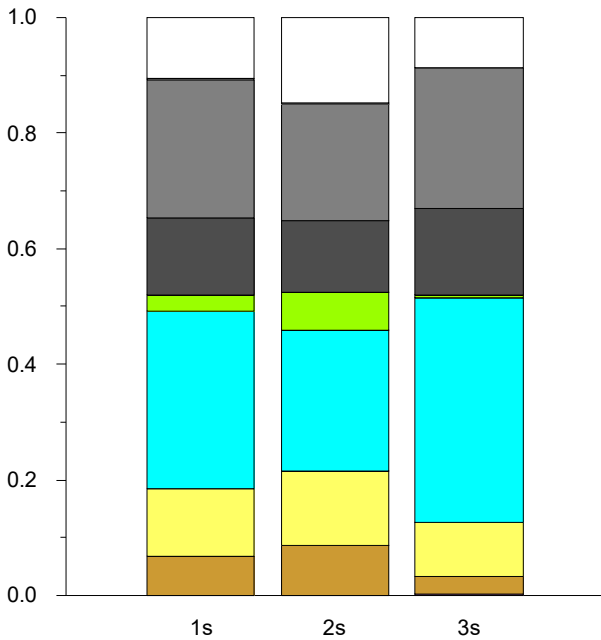

A10-1 CRE – stacked bar graph, proportional distribution of cations and anions in groundwater samples, February 2018

MTS

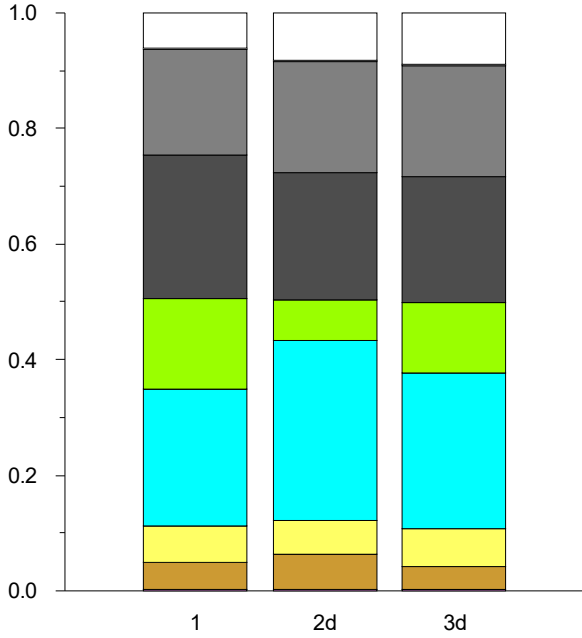

A10-3 MTS - stacked bar graph, proportional distribution of cations and anions in groundwater samples, August 2013

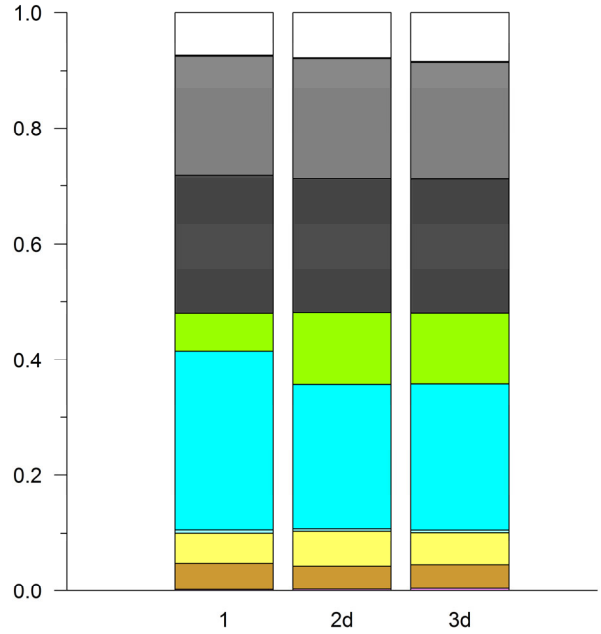

A10-5 MTS – stacked bar graph, proportional distribution of cations and anions in groundwater samples, February 2015

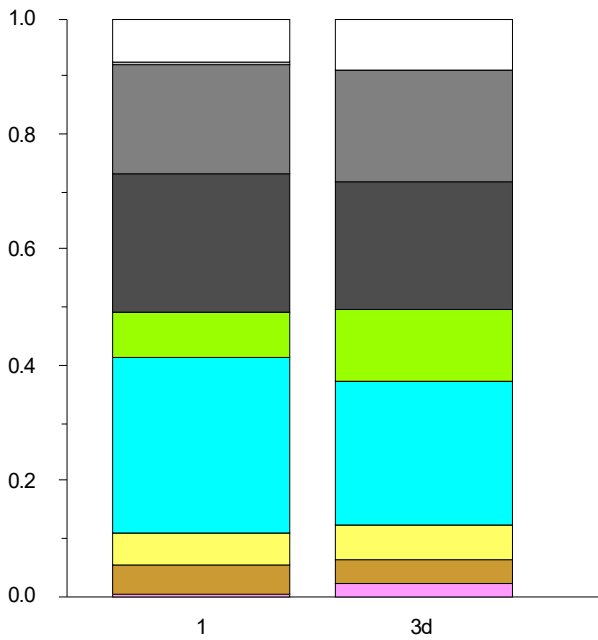

A10-4 MTS – stacked bar graph, proportional distribution of cations and anions in groundwater samples, August 2014

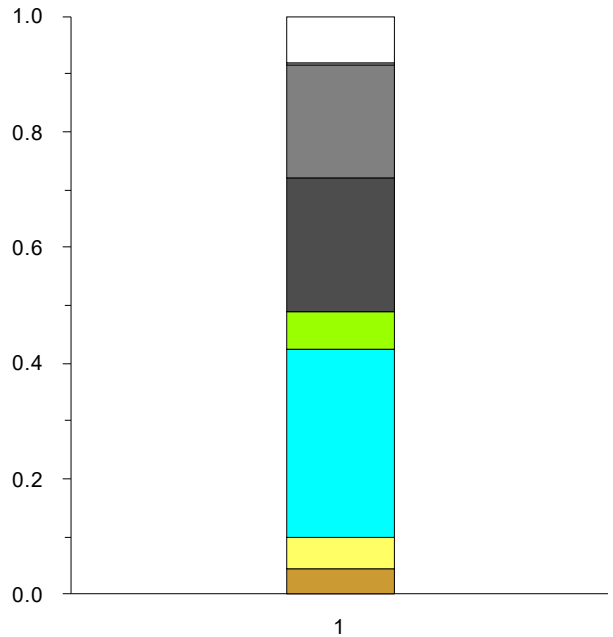

A10-6 MTS – stacked bar graph, proportional distribution of cations and anions in groundwater samples, February 2016

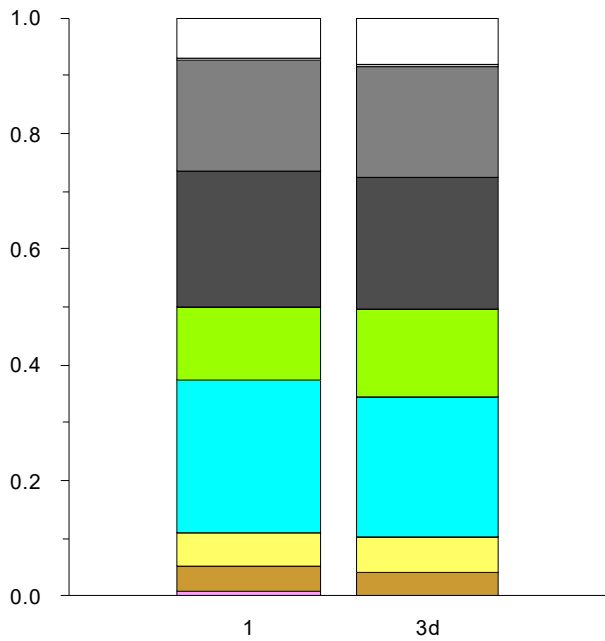

A10-7 MTS – stacked bar graph, proportional distribution of cations and anions in groundwater samples, March 2017

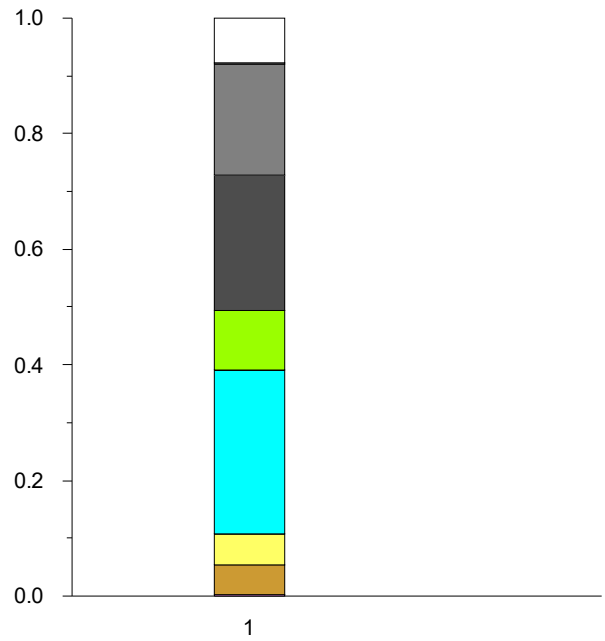

A10-2 MTS – stacked bar graph, proportional distribution of cations and anions in groundwater samples, February 2019

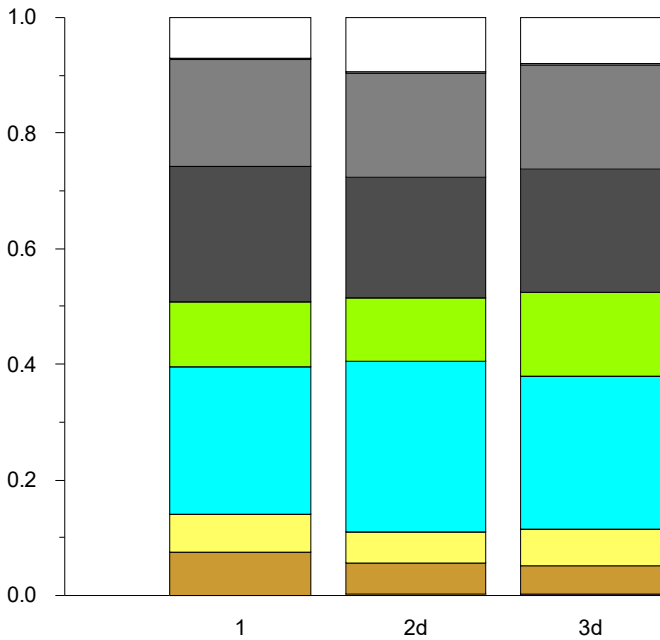

A10-1 MTS – stacked bar graph, proportional distribution of cations and anions in groundwater samples, February 2018

AUK

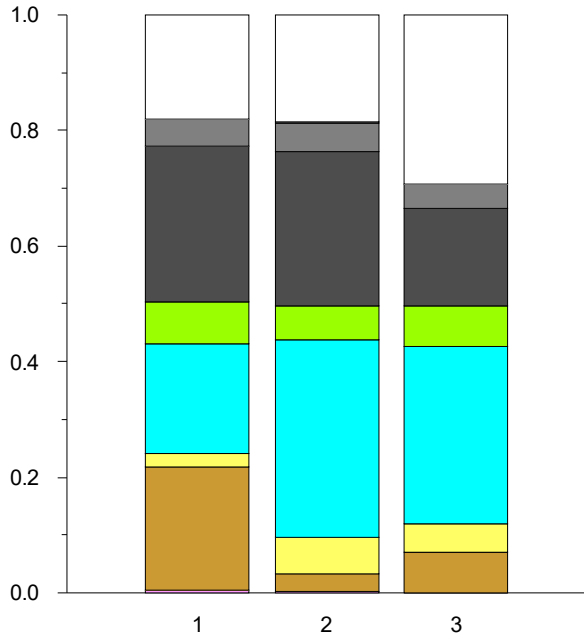

A10-3 AUK - stacked bar graph, proportional distribution of cations and anions in groundwater samples, August 2013

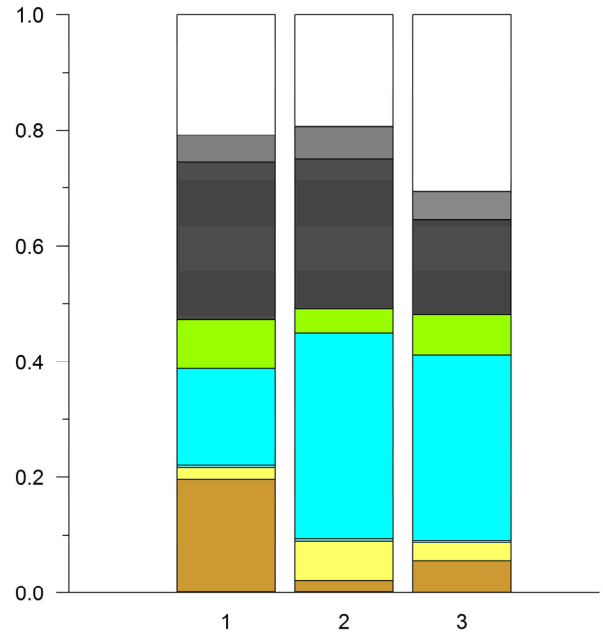

A10-5 AUK – stacked bar graph, proportional distribution of cations and anions in groundwater samples, February 2015

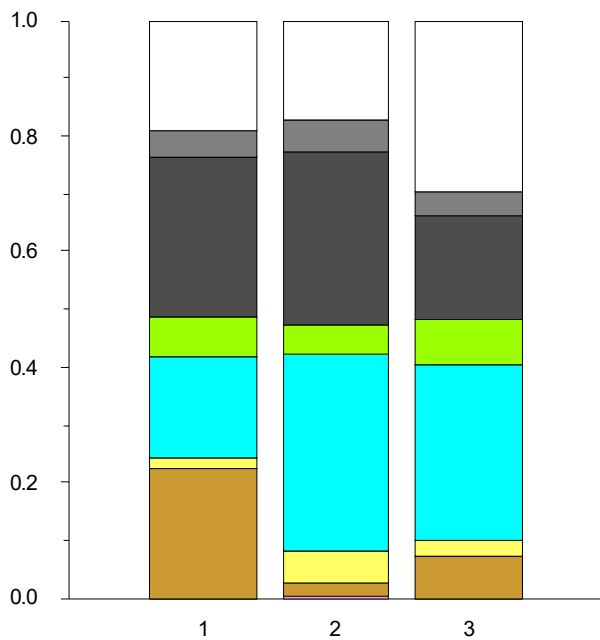

A10-4 AUK – stacked bar graph, proportional distribution of cations and anions in groundwater samples August 2014

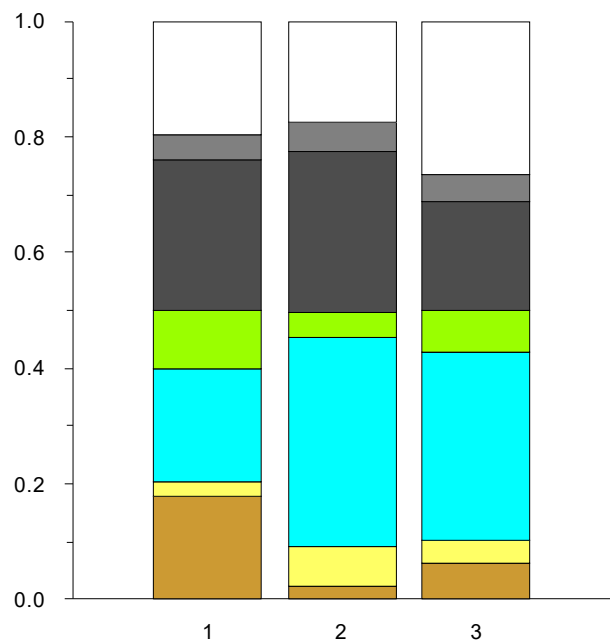

A10-6 AUK – stacked bar graph, proportional distribution of cations and anions in groundwater samples, February 2016

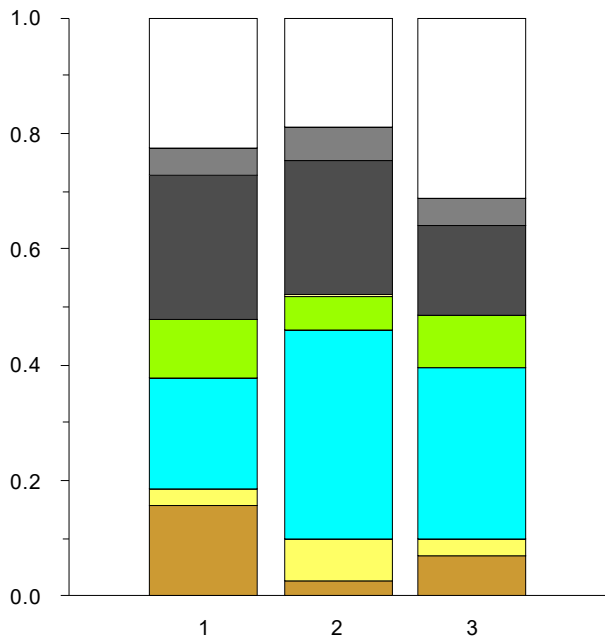

A10-7 AUK – stacked bar graph, proportional distribution of cations and anions in groundwater samples, March 2017

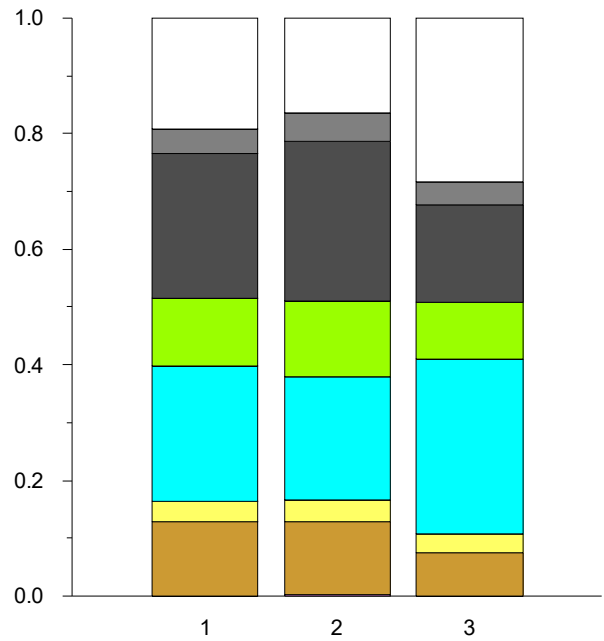

A10-2 AUK – stacked bar graph, proportional distribution of cations and anions in groundwater samples, February 2019

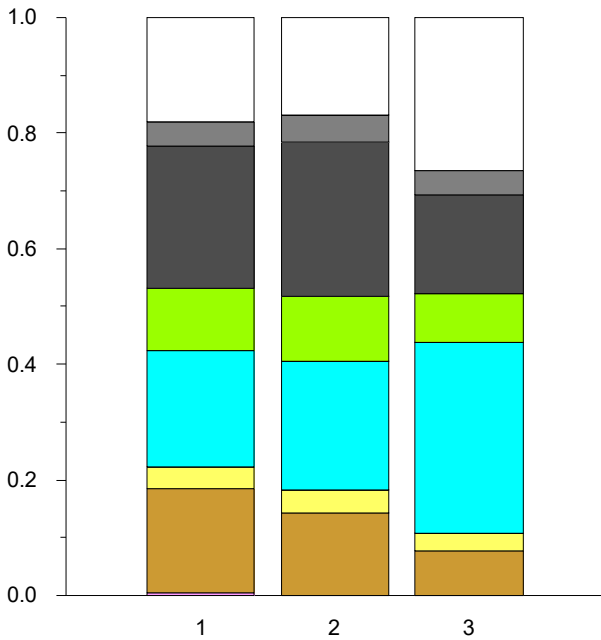

A10-1 AUK – stacked bar graph, proportional distribution of cations and anions in groundwater samples, February 2018

DLF

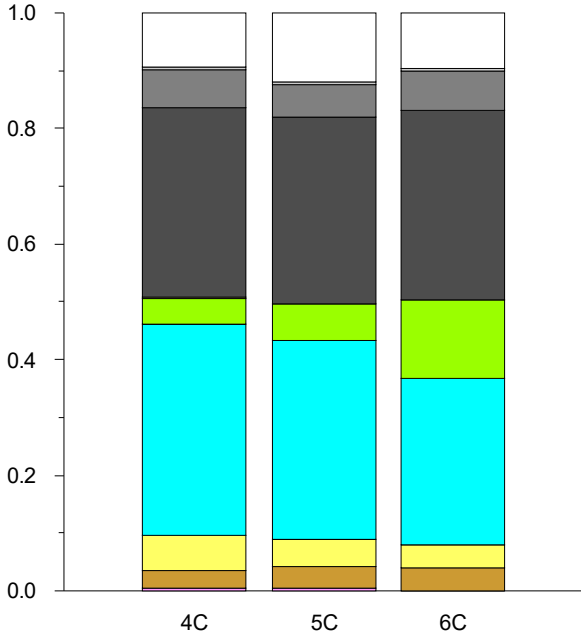

A10-3 DLF - stacked bar graph, proportional distribution of cations and anions in groundwater samples, August 2013

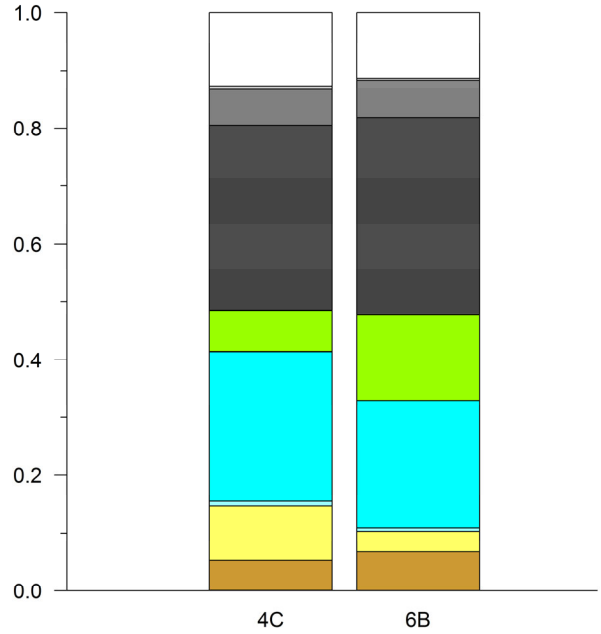

A10-5 DLF - stacked bar graph, proportional distribution of cations and anions in groundwater samples, February 2015

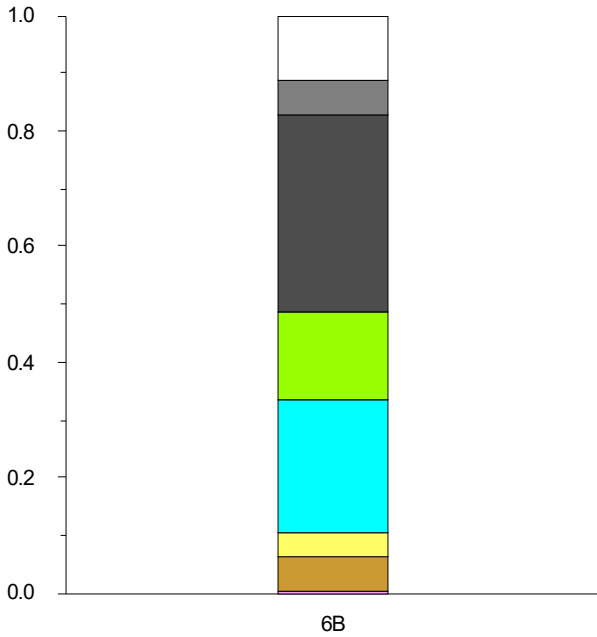

A10-4 DLF - stacked bar graph, proportional distribution of cations and anions in groundwater samples, August 2014

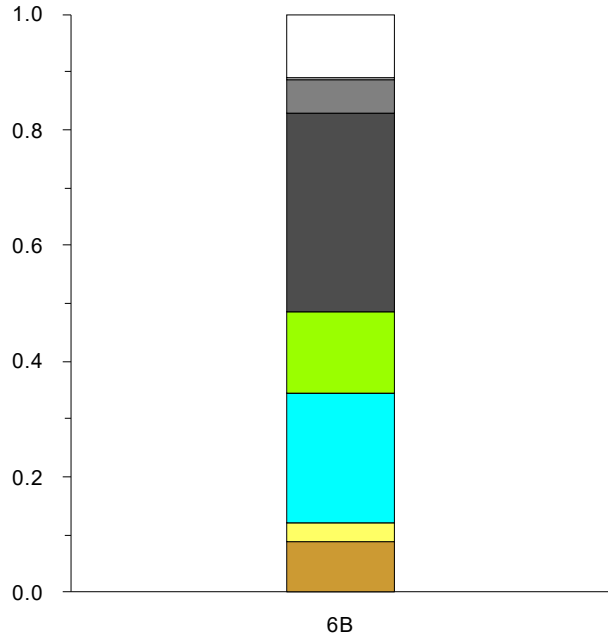

A10-6 DLF - stacked bar graph, proportional distribution of cations and anions in groundwater samples, February 2016

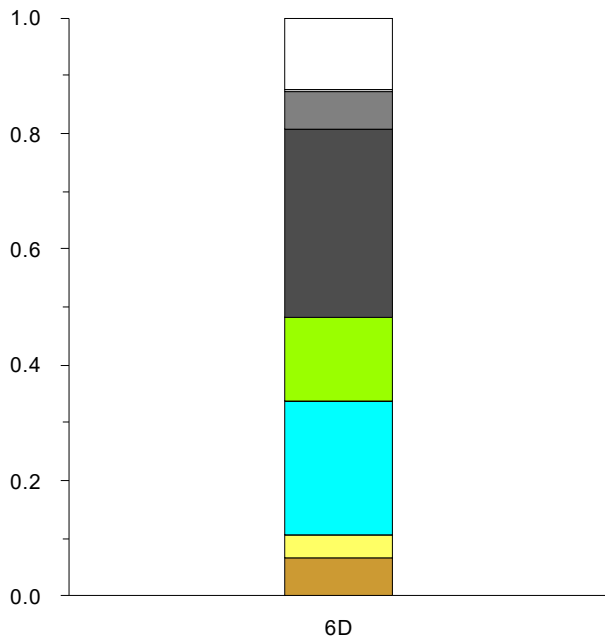

A10-7 DLF – stacked bar graph, proportional distribution of cations and anions in groundwater samples, March 2017

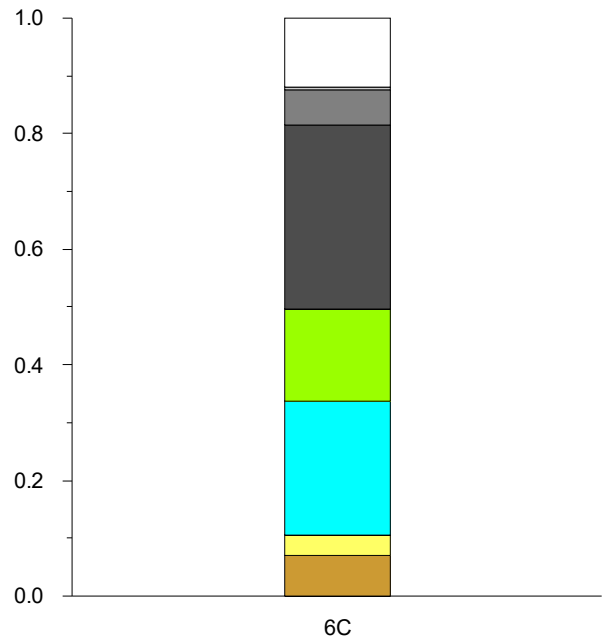

A10-2 DLF – stacked bar graph, proportional distribution of cations and anions in groundwater samples, February 2019

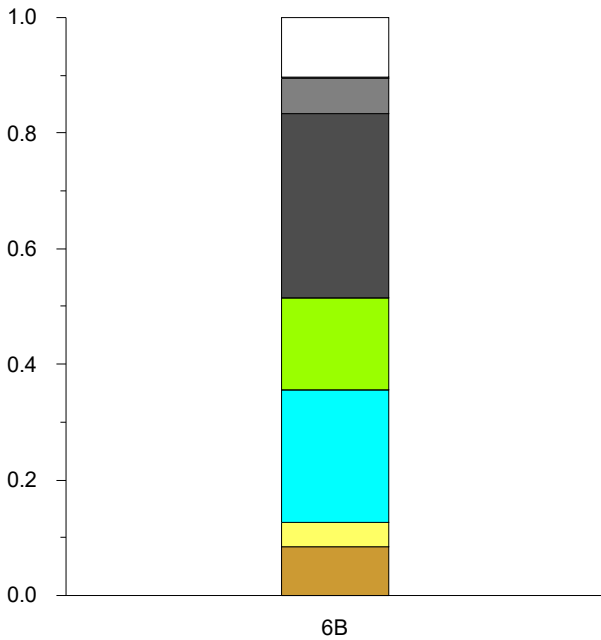

A10-1 DLF – stacked bar graph, proportional distribution of cations and anions in groundwater samples, February 2018

ELK

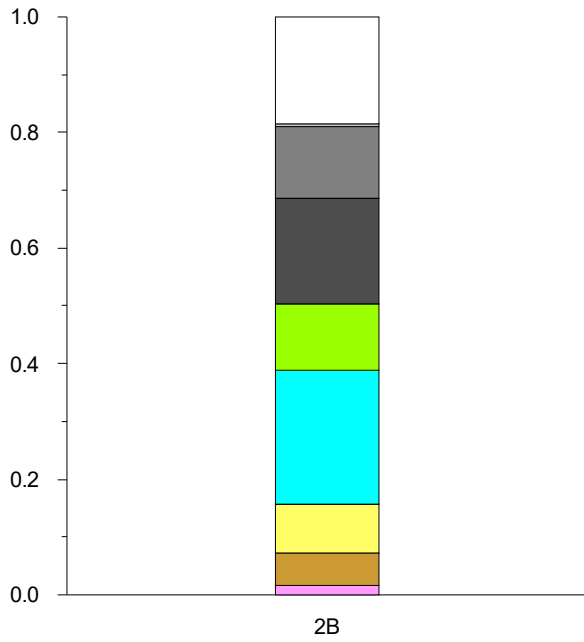

A10-3 ELK - stacked bar graph, proportional distribution of cations and anions in groundwater samples, August 2013

ZZI

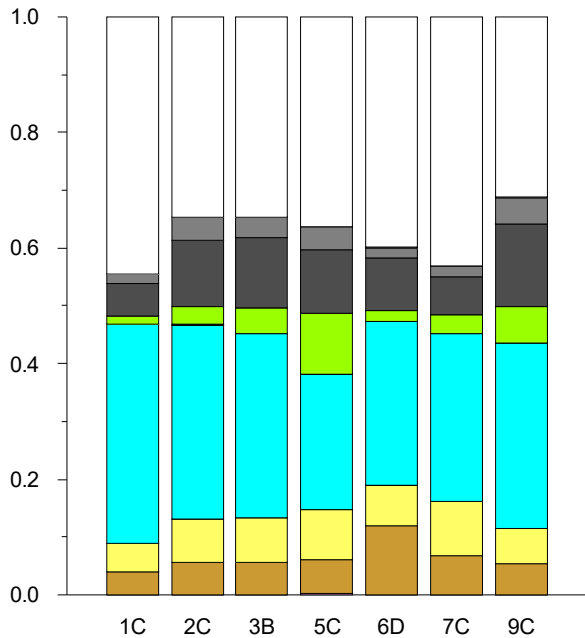

A10-4 ZZI - stacked bar graph, proportional distribution of cations and anions in groundwater samples, August 2013

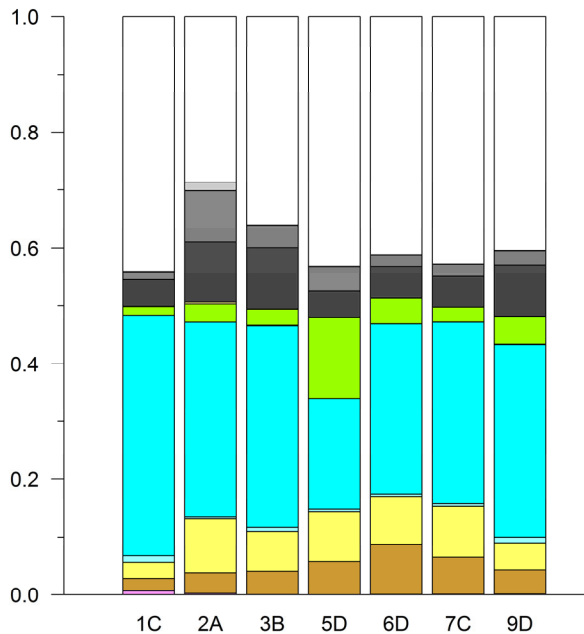

A10-6 ZZI - stacked bar graph, proportional distribution of cations and anions in groundwater samples, February 2015

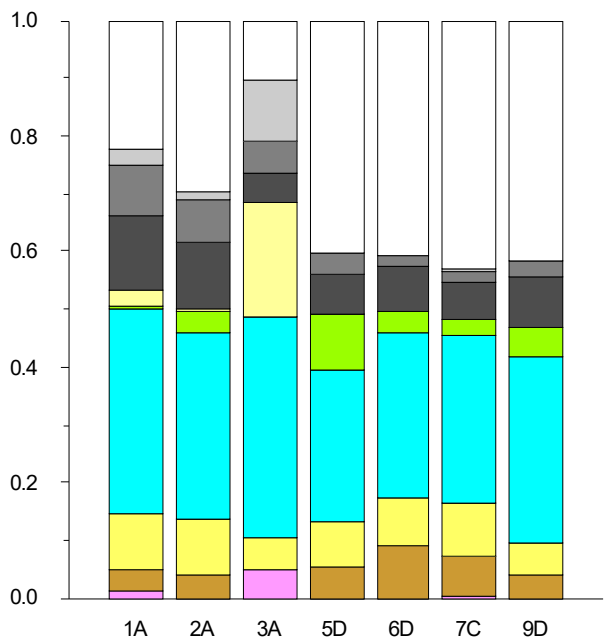

A10-5 ZZI - stacked bar graph, proportional distribution of cations and anions in groundwater samples, August 2014

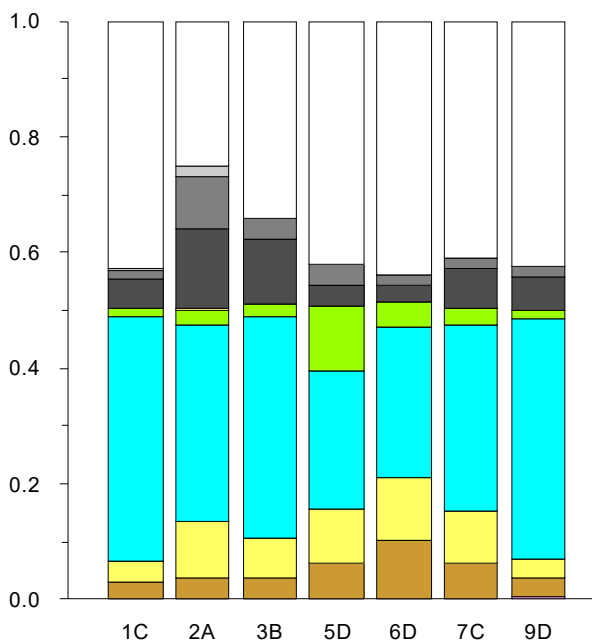

A10-7 ZZI - stacked bar graph, proportional distribution of cations and anions in groundwater samples, February 2016

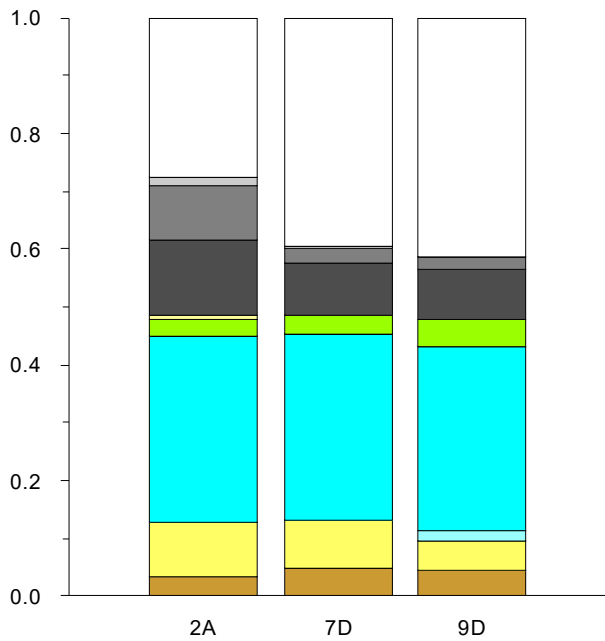

A10-8 ZZI – stacked bar graph, proportional distribution of cations and anions in groundwater samples, March 2017

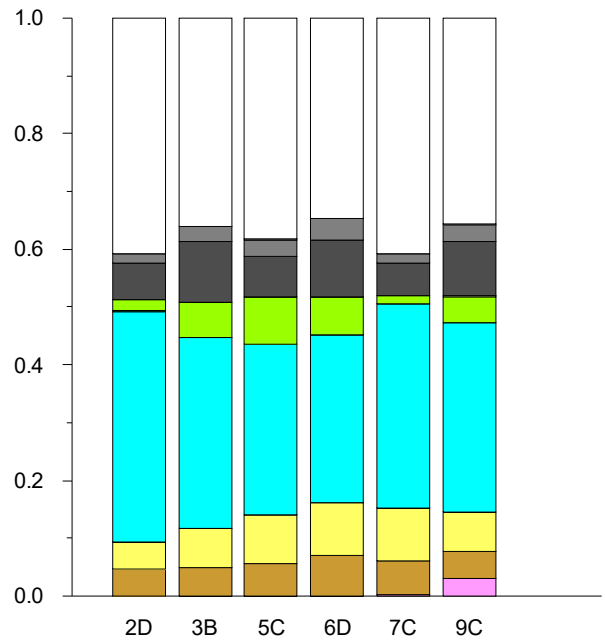

A10-2 ZZI – stacked bar graph, proportional distribution of cations and anions in groundwater samples, February 2019

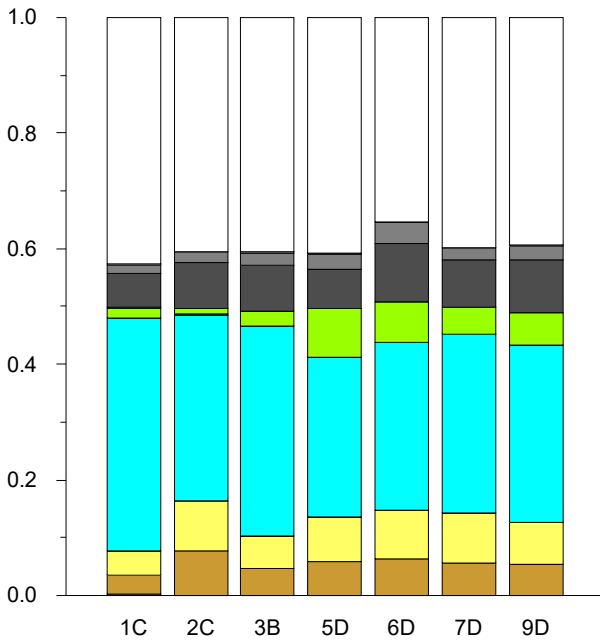

A10-1 ZZI – stacked bar graph, proportional distribution of cations and anions in groundwater samples, February 2018

HOL

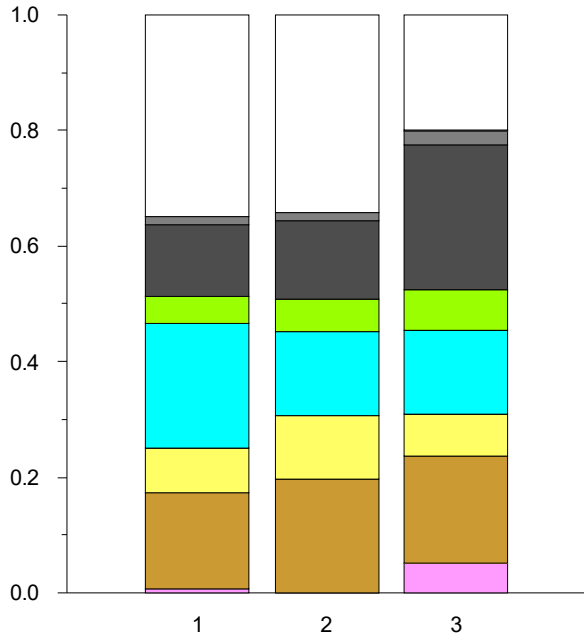

A10-3 HOL - stacked bar graph, proportional distribution of cations and anions in groundwater samples, August 2013

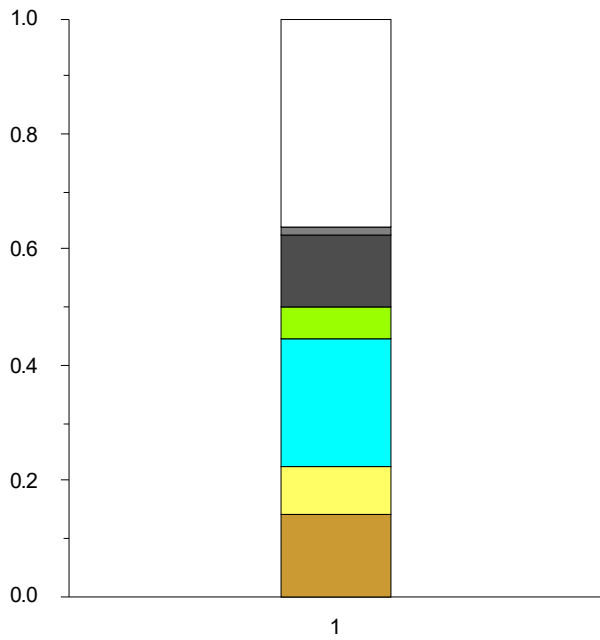

A10-4 HOL – stacked bar graph, proportional distribution of cations and anions in groundwater samples, August 2014

HYN

All wells were dry – no data.

JAD

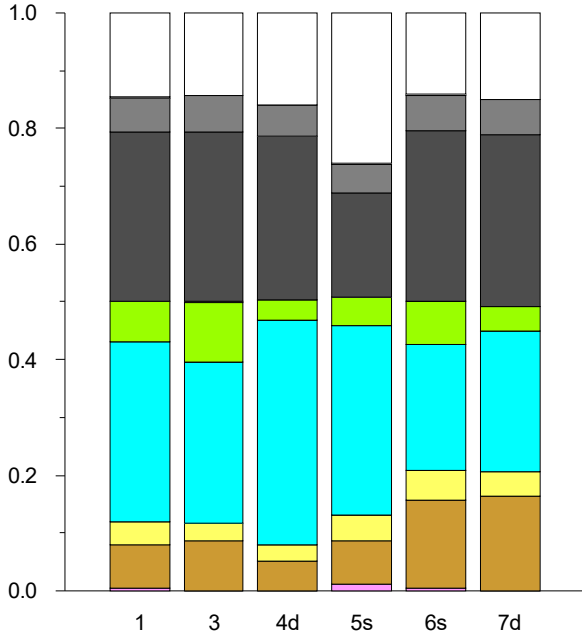

A10-5 JAD - stacked bar graph, proportional distribution of cations and anions in groundwater samples, August 2013

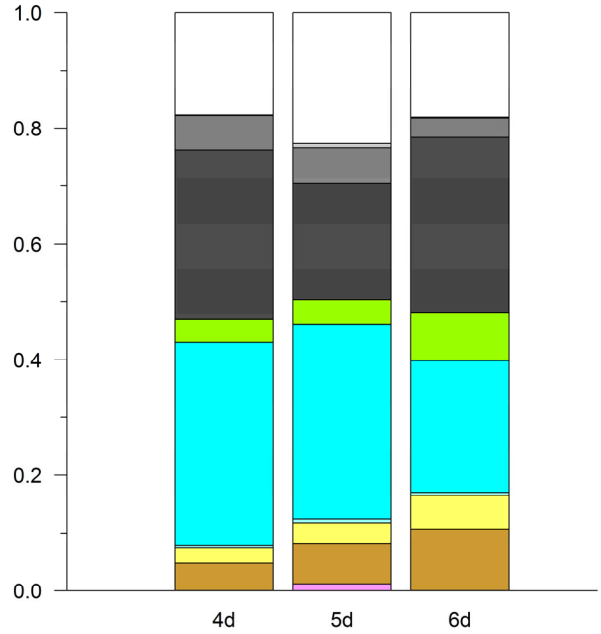

A10-7 JAD – stacked bar graph, proportional distribution of cations and anions in groundwater samples, February 2015

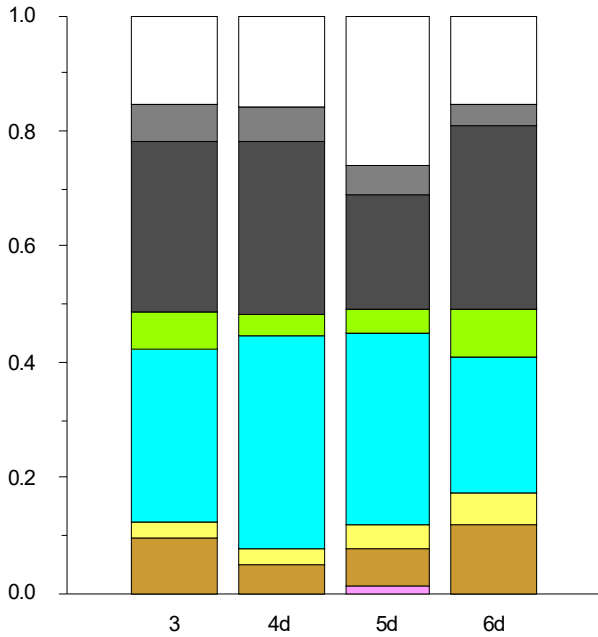

A10-6 JAD – stacked bar graph, proportional distribution of cations and anions in groundwater samples, August 2014

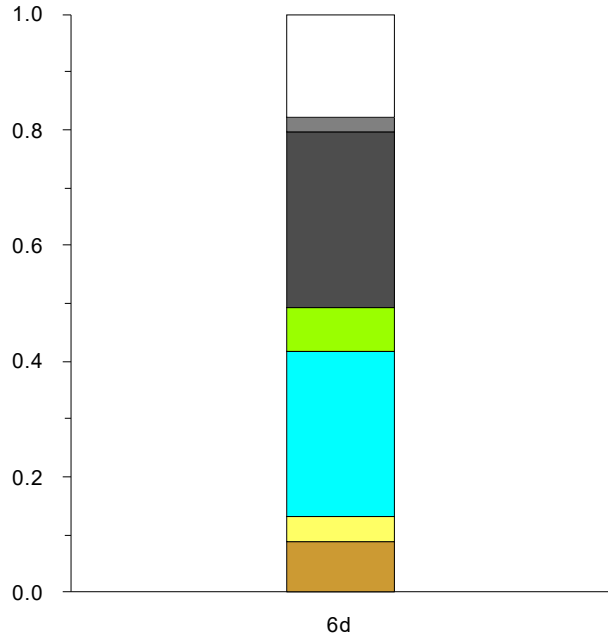

A10-8 JAD – stacked bar graph, proportional distribution of cations and anions in groundwater samples, February 2016

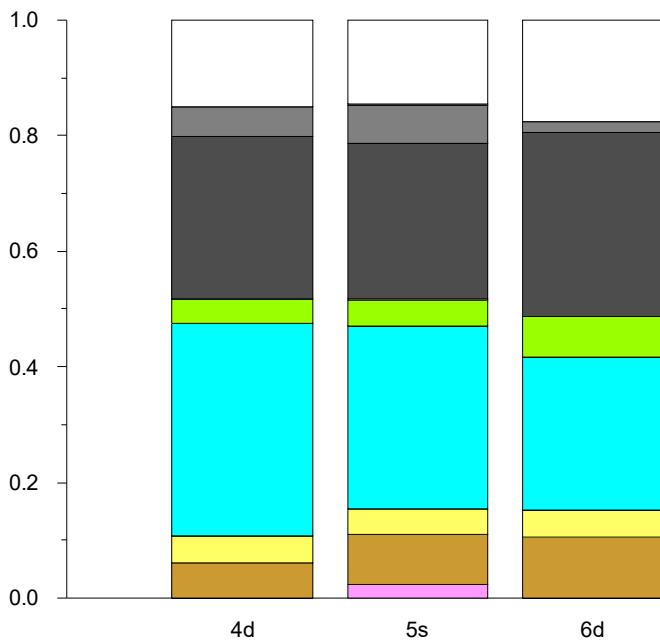

A10-1 JAD – stacked bar graph, proportional distribution of cations and anions in groundwater samples, February 2018

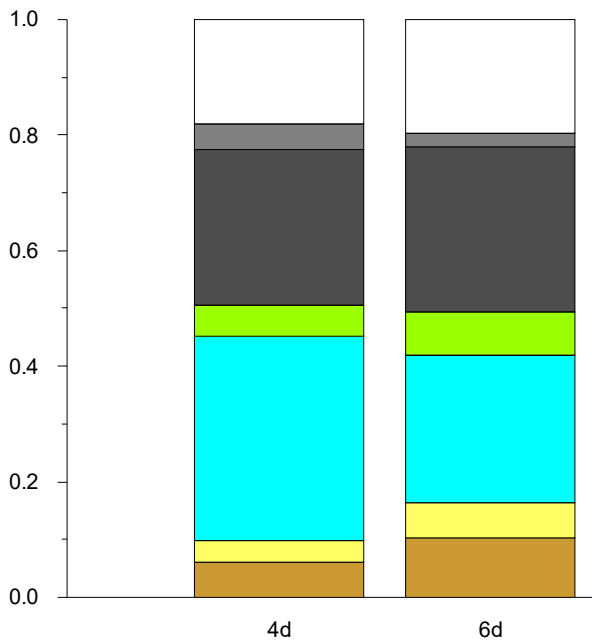

A10-2 JAD – stacked bar graph, proportional distribution of cations and anions in groundwater samples, February 2019

LON

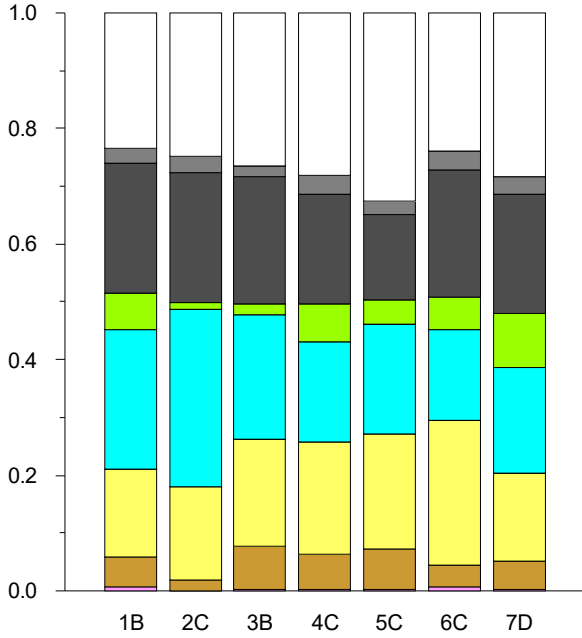

A10-3 LON - stacked bar graph, proportional distribution of cations and anions in groundwater samples, August 2013

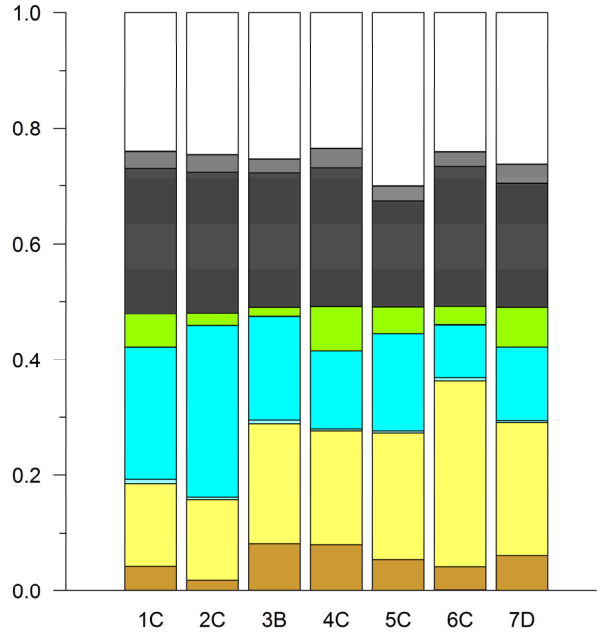

A10-5 LON - stacked bar graph, proportional distribution of cations and anions in groundwater samples, February 2015

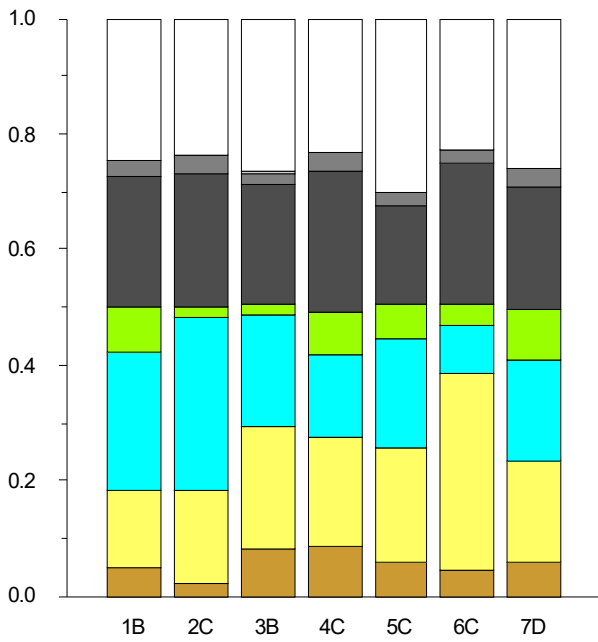

A10-4 LON - stacked bar graph, proportional distribution of cations and anions in groundwater samples, August 2014

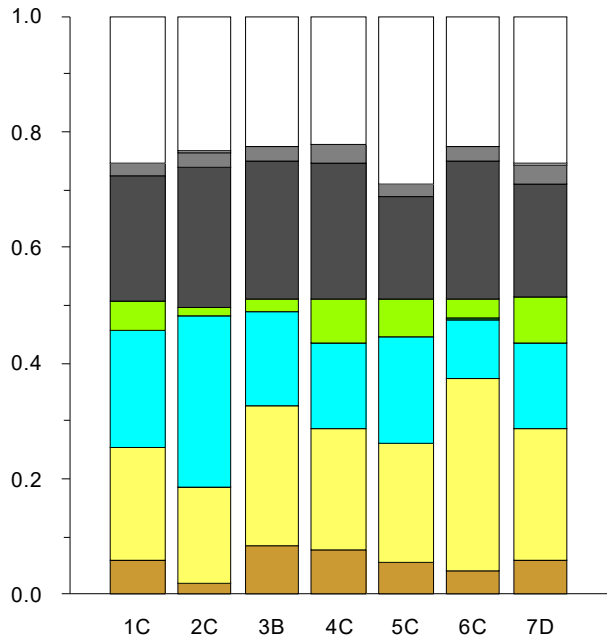

A10-6 LON - stacked bar graph, proportional distribution of cations and anions in groundwater samples, February 2016

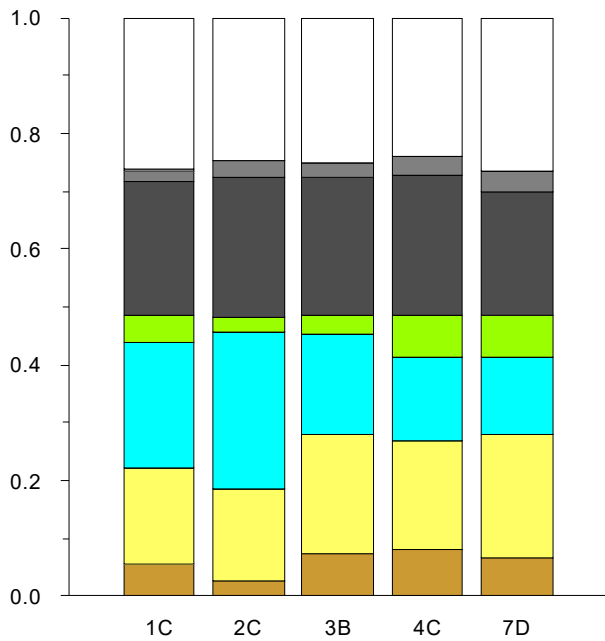

A10-7 LON – stacked bar graph, proportional distribution of cations and anions in groundwater samples, March 2017

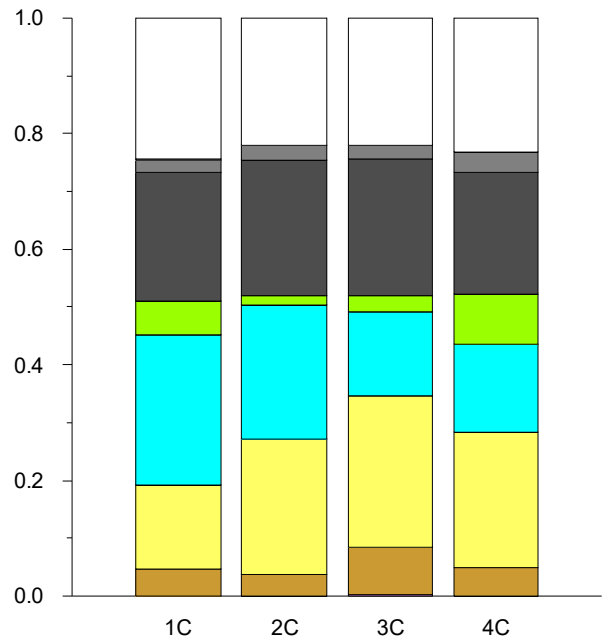

A10-2 LON – stacked bar graph, proportional distribution of cations and anions in groundwater samples, February 2019

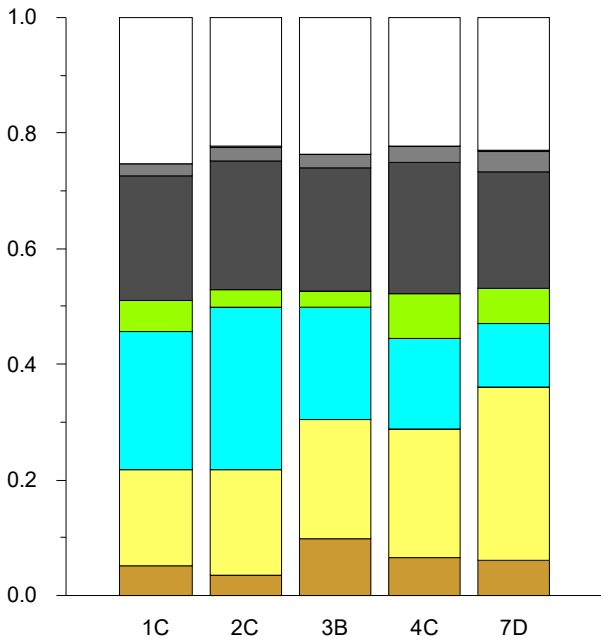

A10-1 LON – stacked bar graph, proportional distribution of cations and anions in groundwater samples, February 2018

ADO

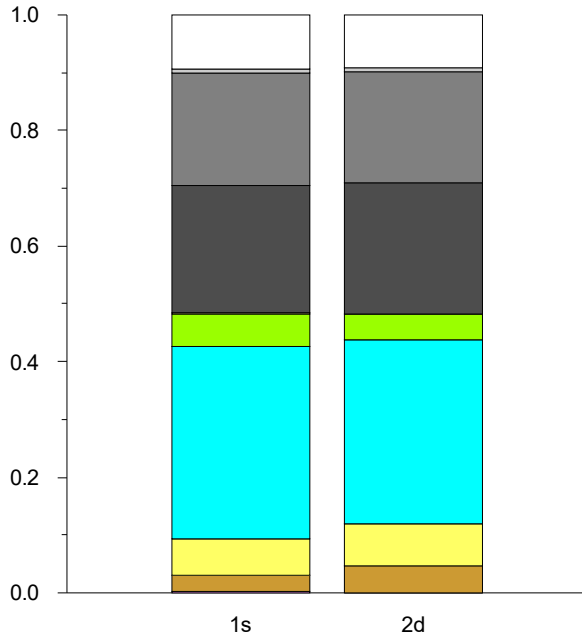

A10-3 ADO - stacked bar graph, proportional distribution of cations and anions in groundwater samples, August 2013

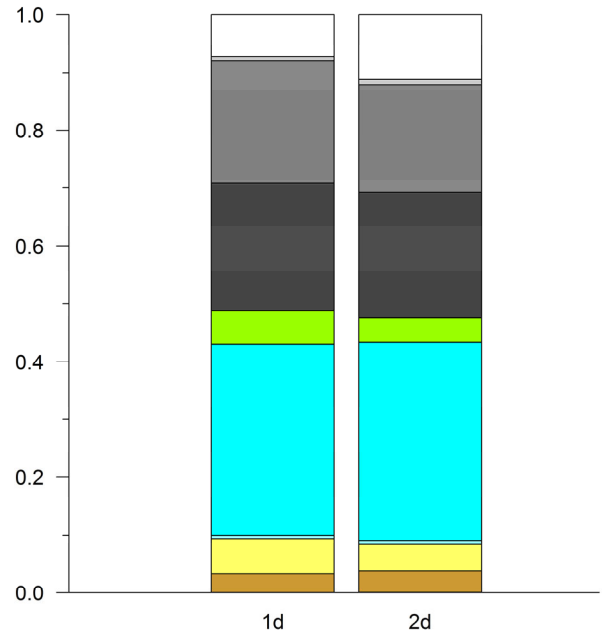

A10-5 ADO – stacked bar graph, proportional distribution of cations and anions in groundwater samples, February 2015

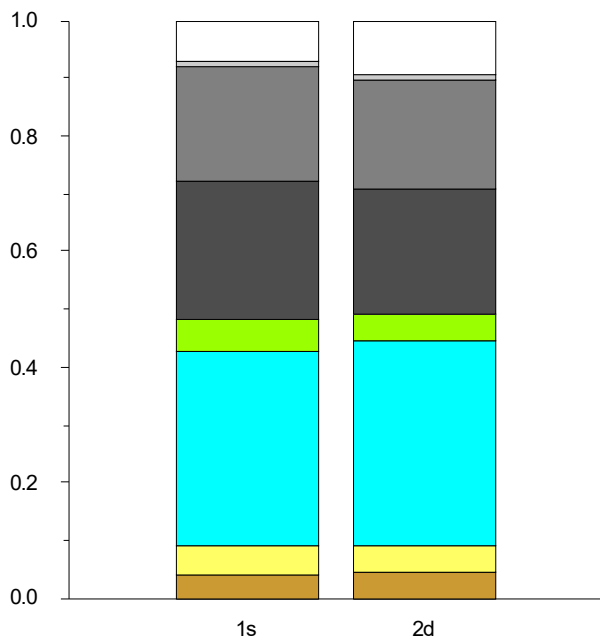

A10-4 ADO – stacked bar graph, proportional distribution of cations and anions in groundwater samples, August 2014

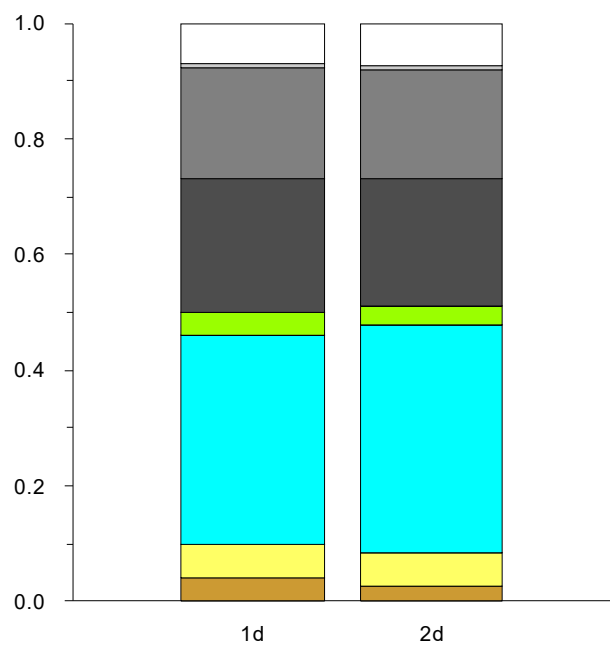

A10-6 ADO – stacked bar graph, proportional distribution of cations and anions in groundwater samples, April 2017

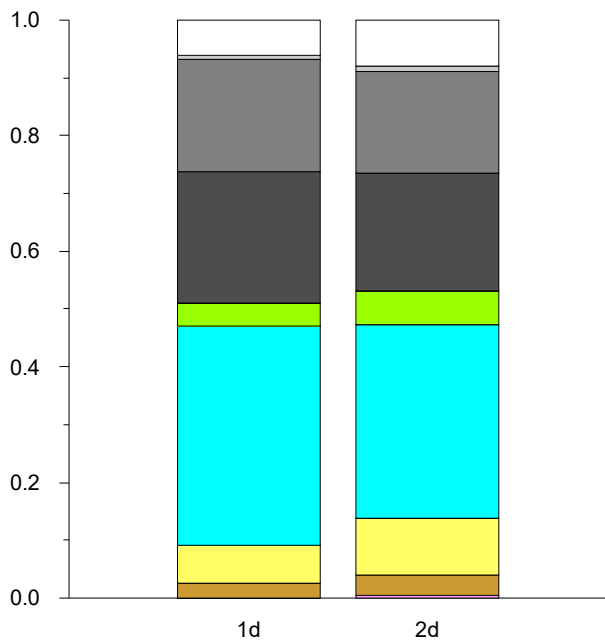

A10-7 ADO – stacked bar graph, proportional distribution of cations and anions in groundwater samples, February 2018

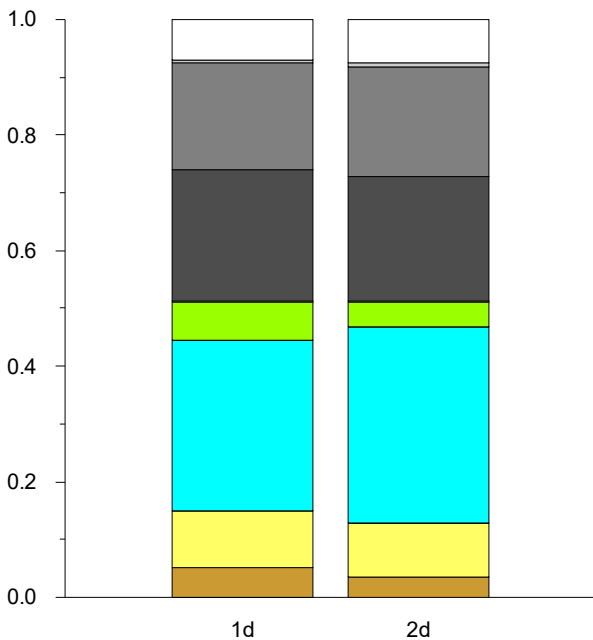

A10-1 ADO – stacked bar graph, proportional distribution of cations and anions in groundwater samples, February 2019

MAL

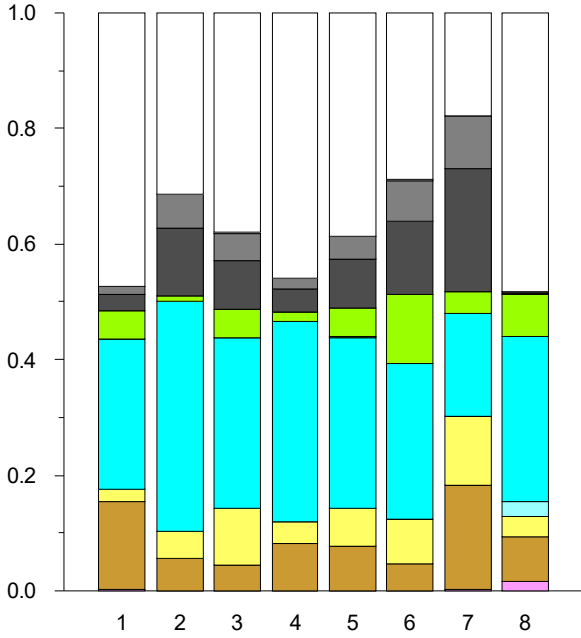

A10-2 MAL - stacked bar graph, proportional distribution of cations and anions in groundwater samples, August 2013

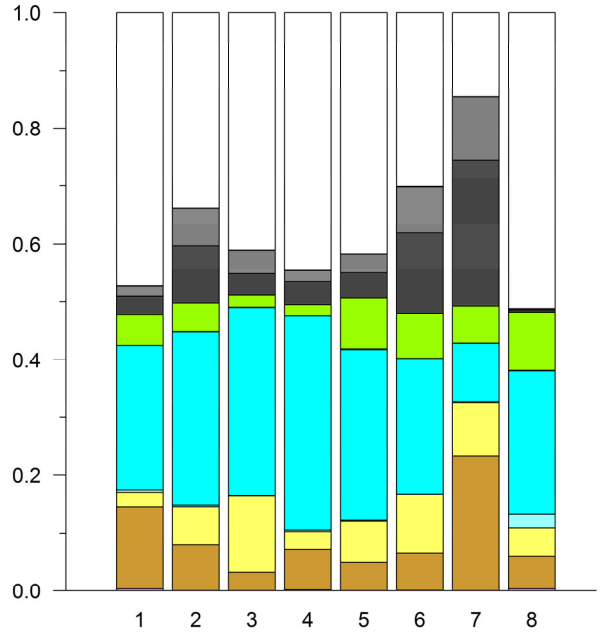

A10-4 MAL - stacked bar graph, proportional distribution of cations and anions in groundwater samples, February 2015

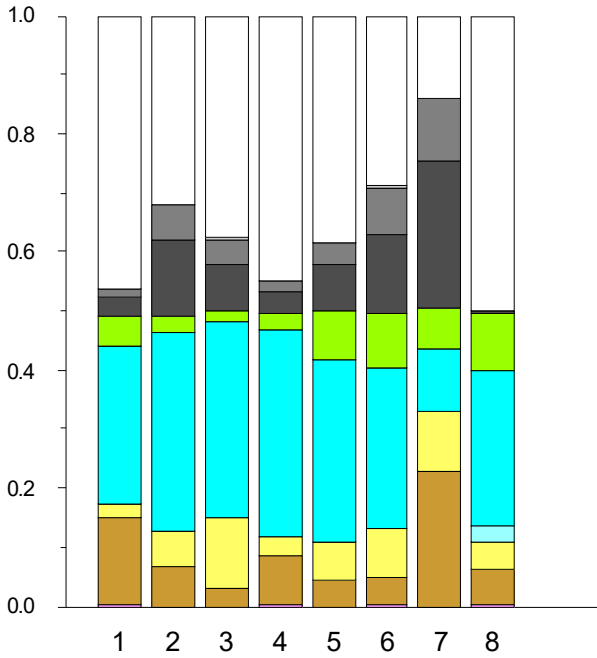

A10-3 MAL - stacked bar graph, proportional distribution of cations and anions in groundwater samples, August 2014

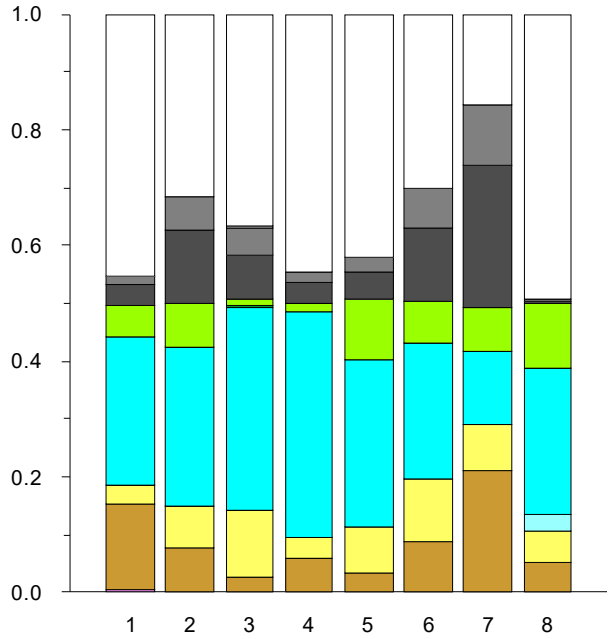

A10-5 MAL - stacked bar graph, proportional distribution of cations and anions in groundwater samples, February 2016

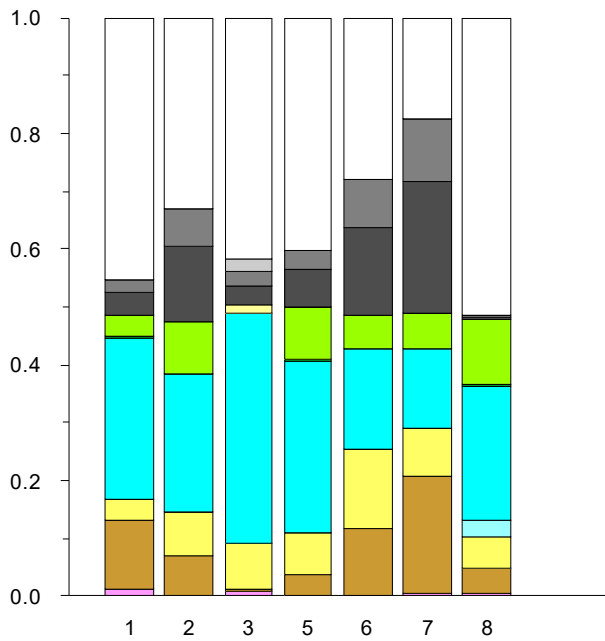

A10-1 MAL – stacked bar graph, proportional distribution of cations and anions in groundwater samples, March 2017

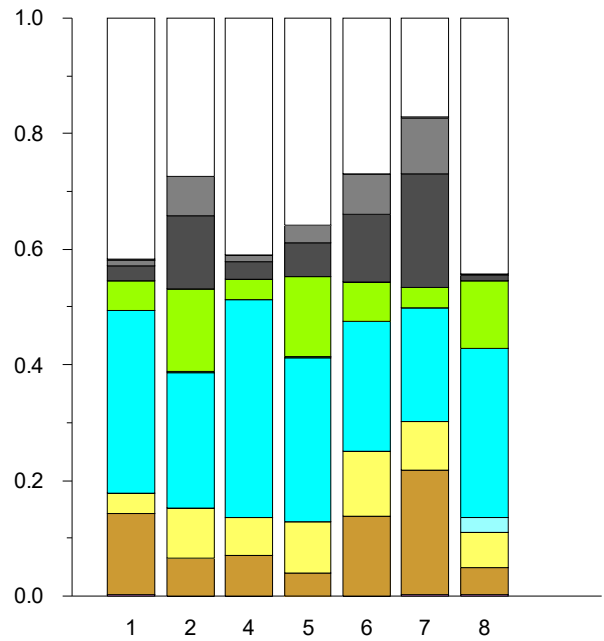

A10-3 MAL – stacked bar graph, proportional distribution of cations and anions in groundwater samples, February 2018

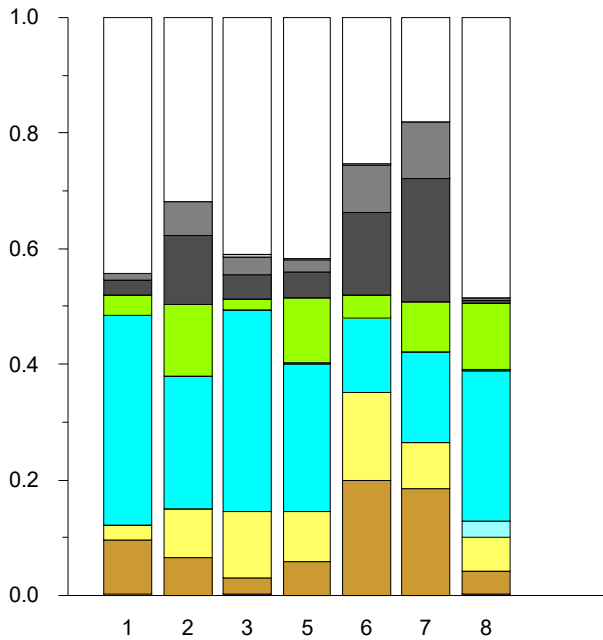

A10-2 MAL – stacked bar graph, proportional distribution of cations and anions in groundwater samples, February 2018

MAP

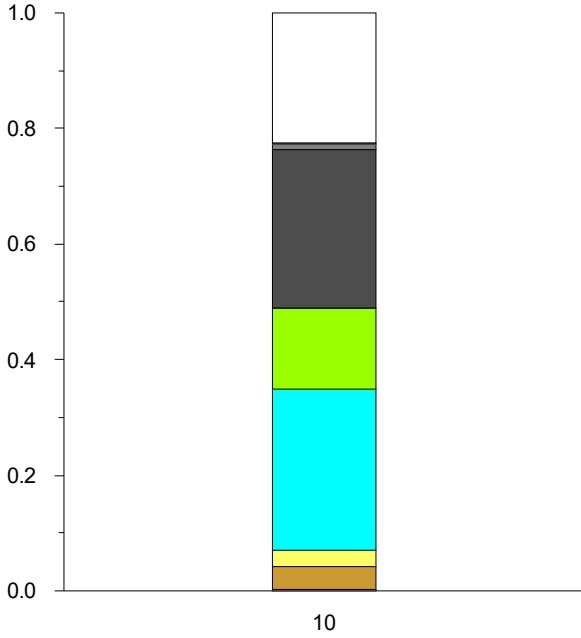

A10-4 MAP - stacked bar graph, proportional distribution of cations and anions in groundwater samples, August 2013

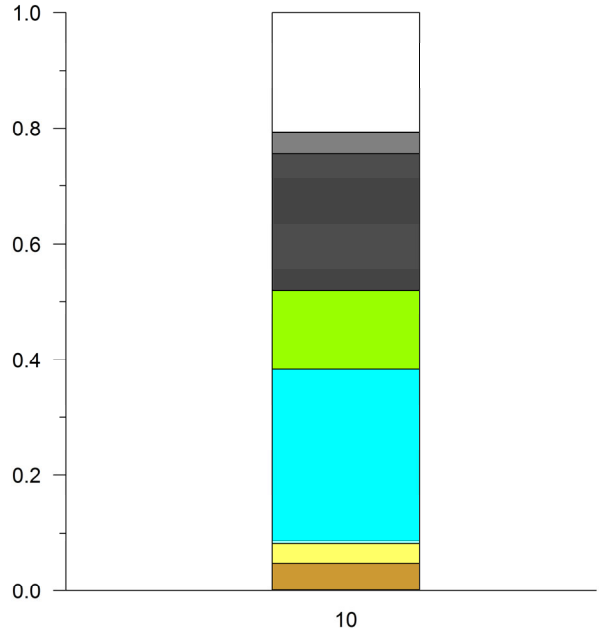

A10-6 MAP - stacked bar graph, proportional distribution of cations and anions in groundwater samples, February 2015

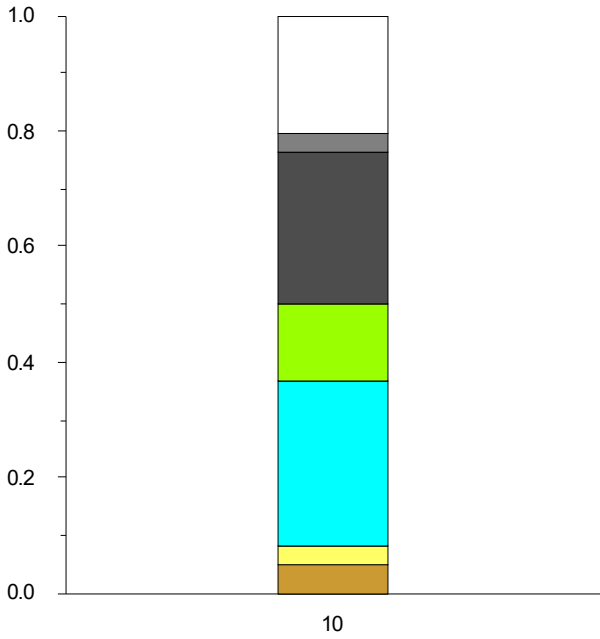

A10-5 MAP - stacked bar graph, proportional distribution of cations and anions in groundwater samples, August 2014

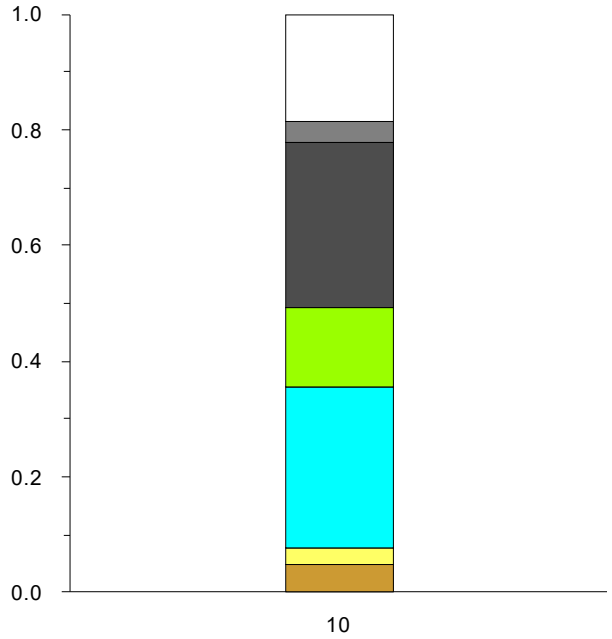

A10-7 MAP - stacked bar graph, proportional distribution of cations and anions in groundwater samples, February 2016

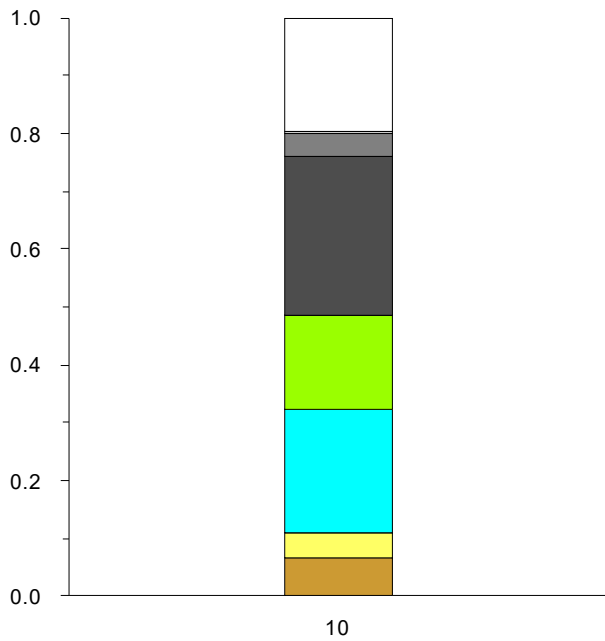

A10-8 MAP – stacked bar graph, proportional distribution of cations and anions in groundwater samples, March 2017

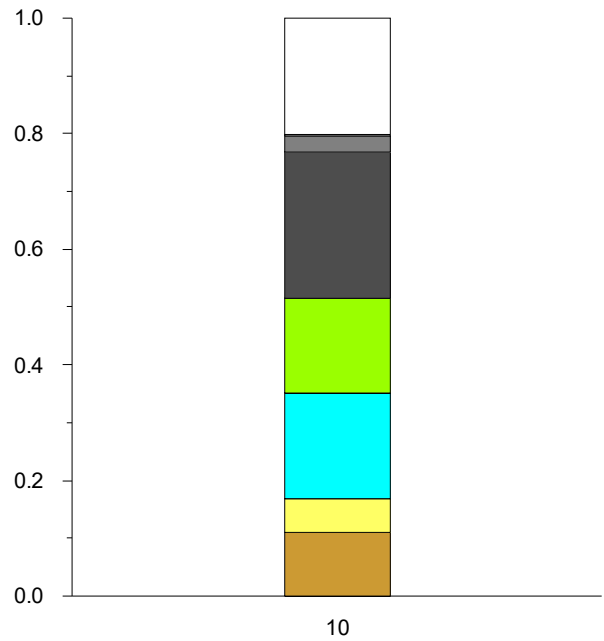

A10-2 MAP – stacked bar graph, proportional distribution of cations and anions in groundwater samples, February 2019

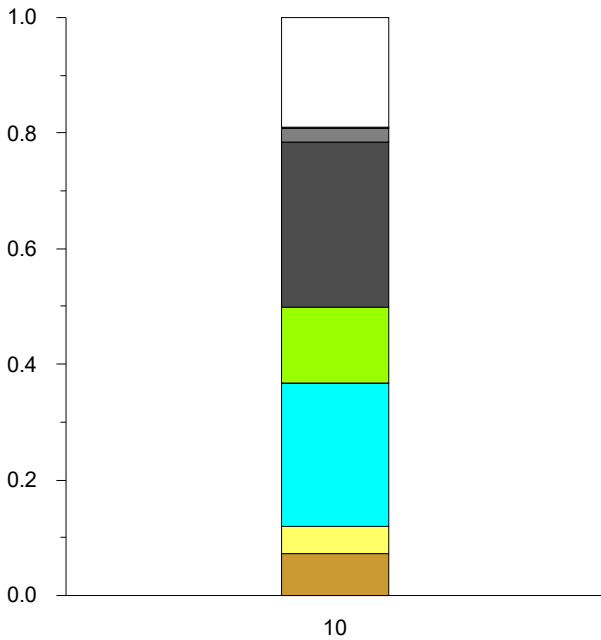

A10-1 MAP – stacked bar graph, proportional distribution of cations and anions in groundwater samples, February 2018

ZON

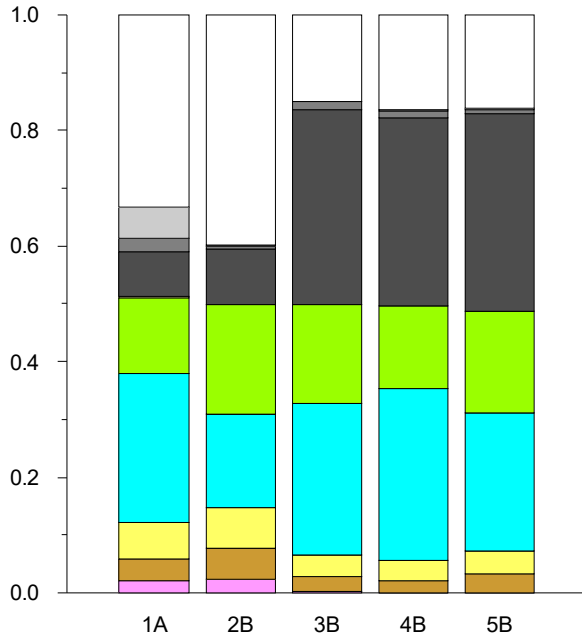

A10-3 ZON - stacked bar graph, proportional distribution of cations and anions in groundwater samples, August 2013

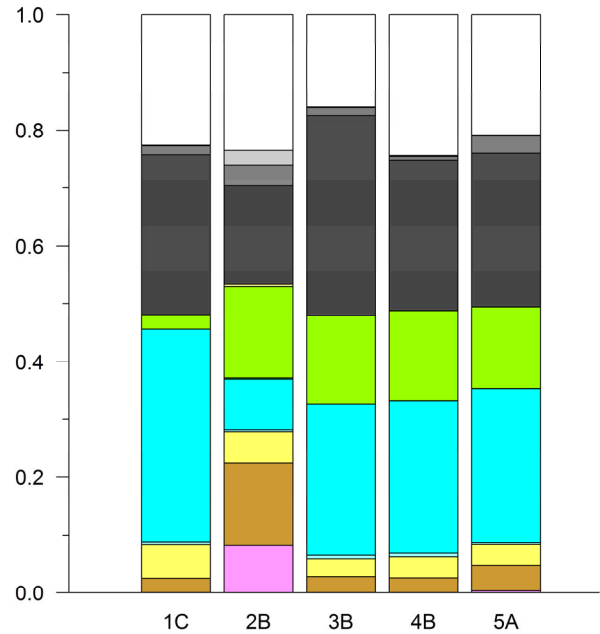

A10-5 ZON - stacked bar graph, proportional distribution of cations and anions in groundwater samples, February 2015

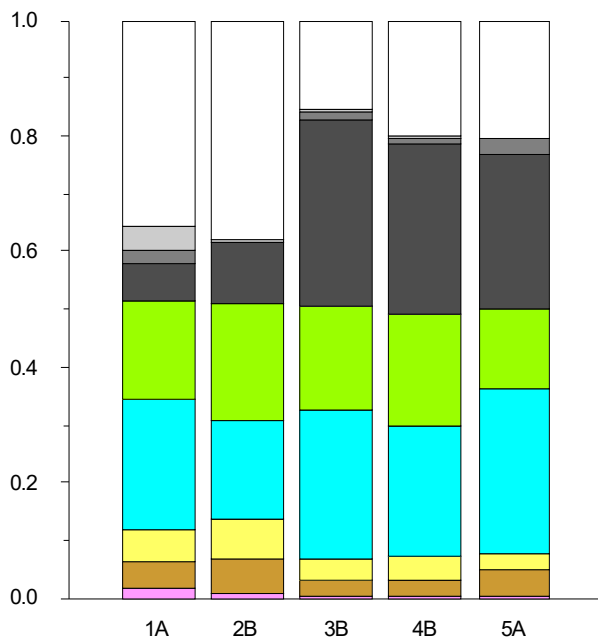

A10-4 ZON - stacked bar graph, proportional distribution of cations and anions in groundwater samples, August 2014

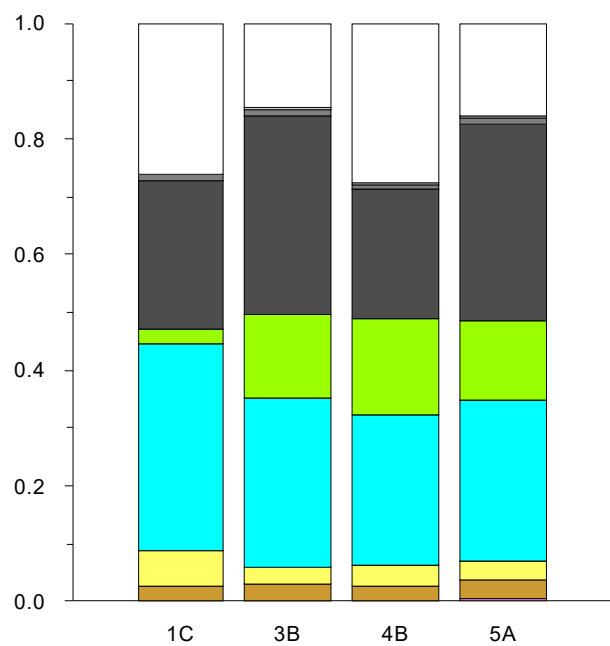

A10-6 ZON - stacked bar graph, proportional distribution of cations and anions in groundwater samples, February 2016

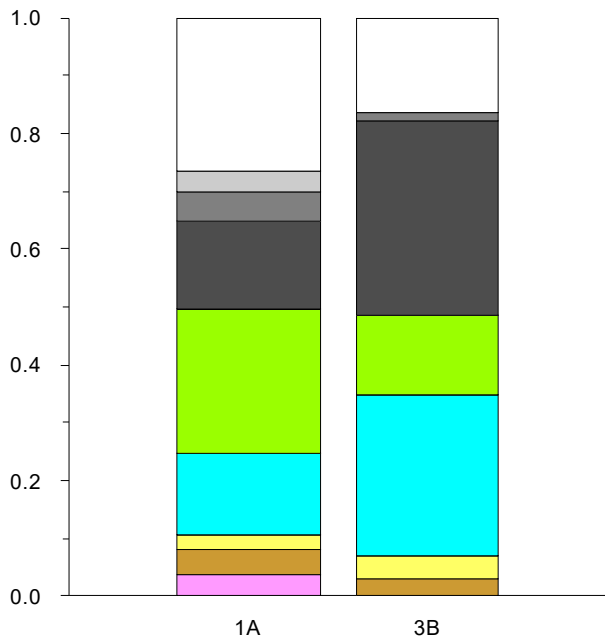

A10-7 ZON – stacked bar graph, proportional distribution of cations and anions in groundwater samples, March 2017

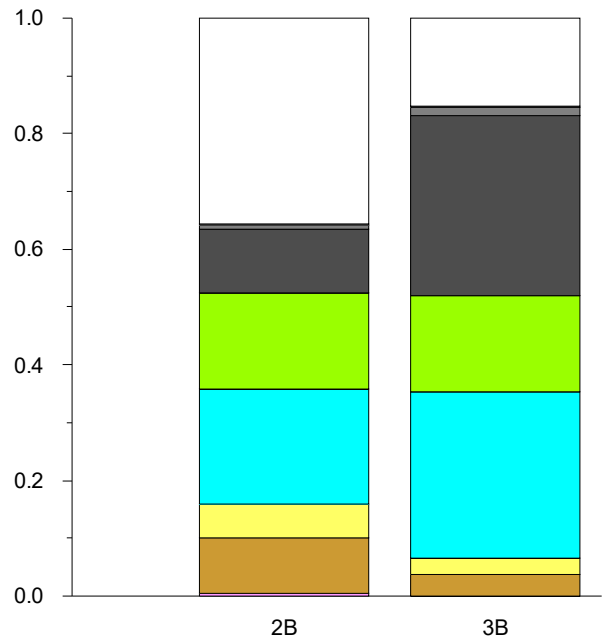

A10-2 ZON – stacked bar graph, proportional distribution of cations and anions in groundwater samples, February 2019

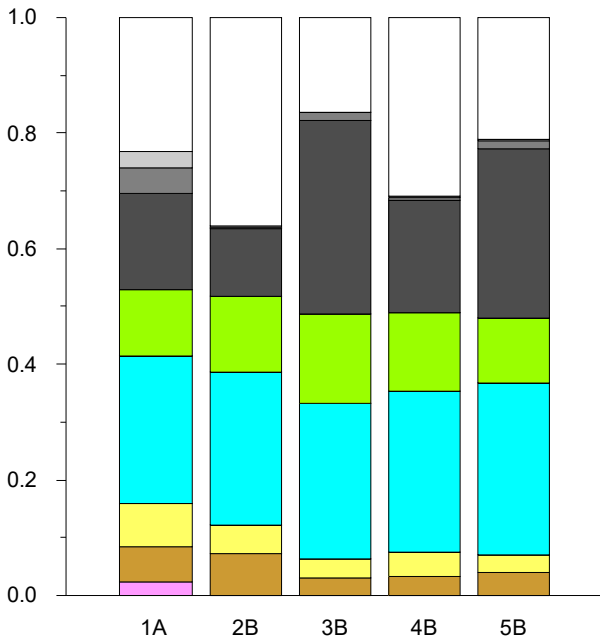

A10-1 ZON – stacked bar graph, proportional distribution of cations and anions in groundwater samples, February 2018

RIC

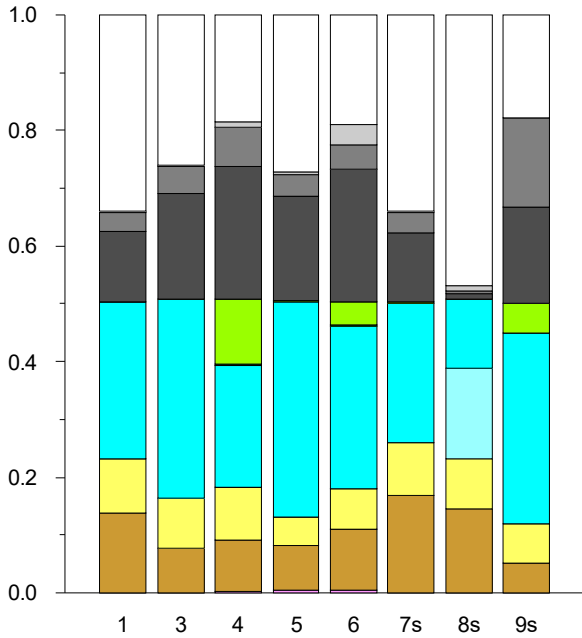

A10-3 RIC - stacked bar graph, proportional distribution of cations and anions in groundwater samples, August 2013

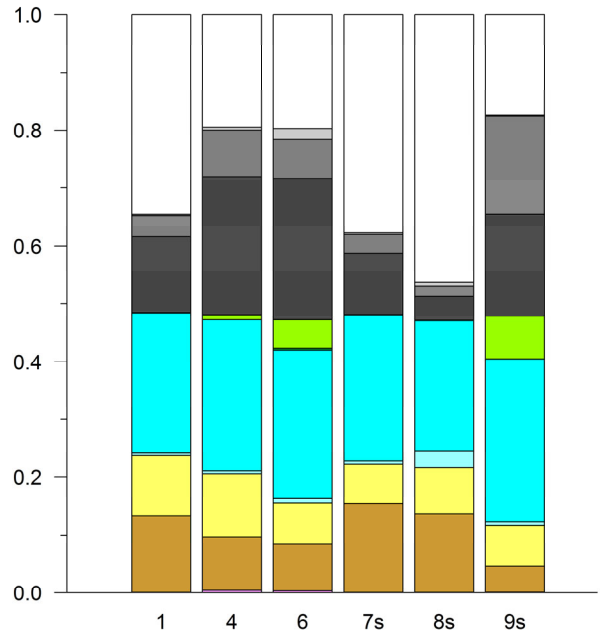

A10-5 RIC – stacked graph, proportional distribution of cations and anions in groundwater samples, February 2015

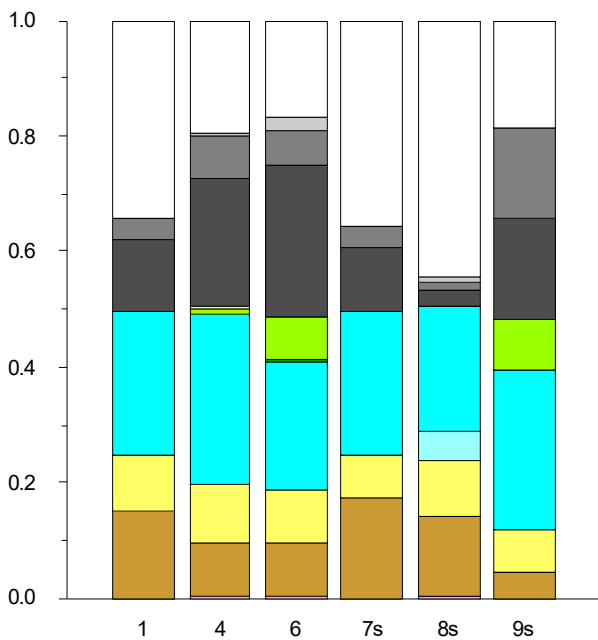

A10-4 RIC – stacked graph, proportional distribution of cations and anions in groundwater samples, August 2014

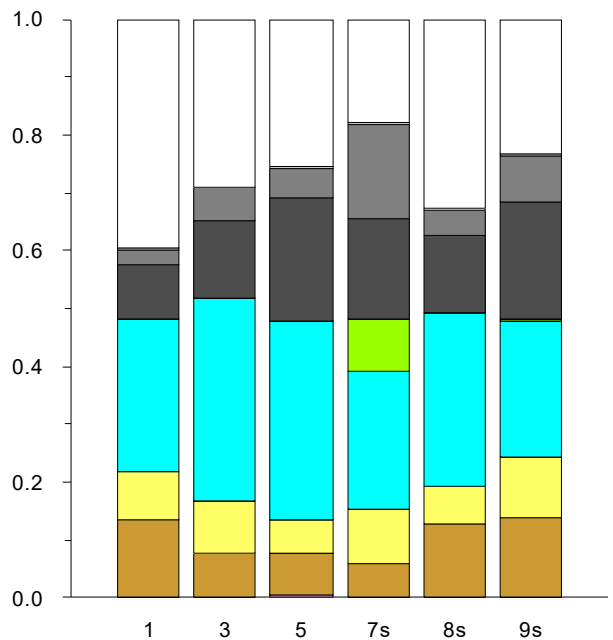

A10-6 RIC – stacked graph, proportional distribution of cations and anions in groundwater samples, March 2017

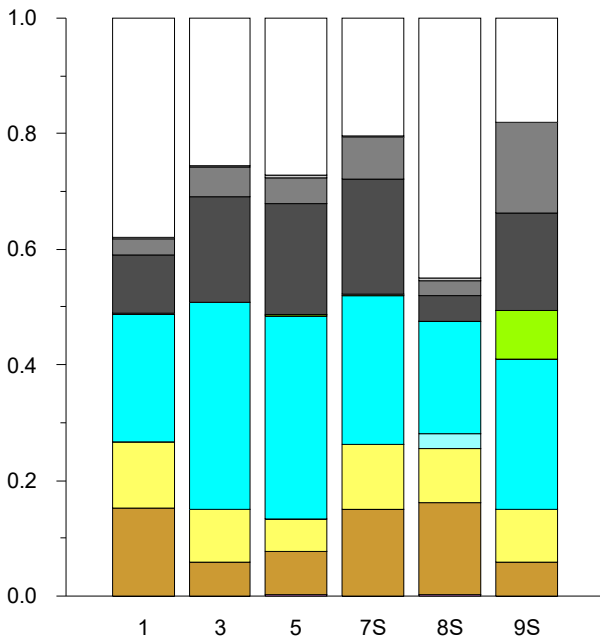

A10-1 RIC – stacked graph, proportional distribution of cations and anions in groundwater samples, February 2018

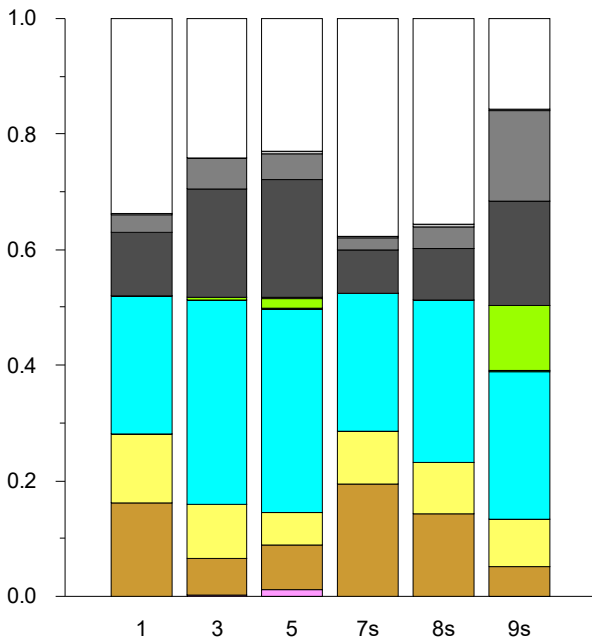

A10-2 RIC – stacked graph, proportional distribution of cations and anions in groundwater samples, February 2019

SIE

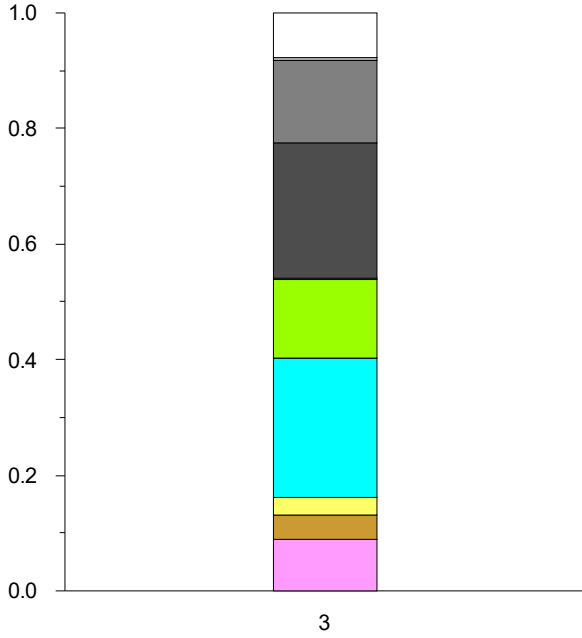

A10-3 SIE - stacked bar graph, proportional distribution of cations and anions in groundwater samples, August 2013

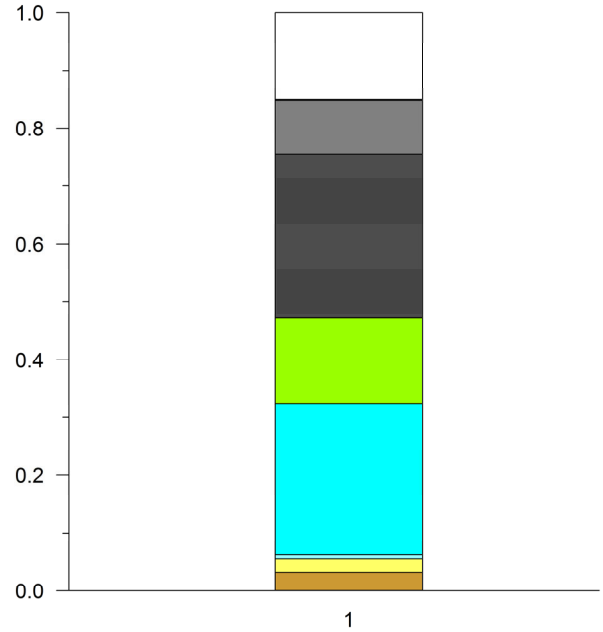

A10-5 SIE – stacked bar graph, proportional distribution of cations and anions in groundwater samples, February 2015

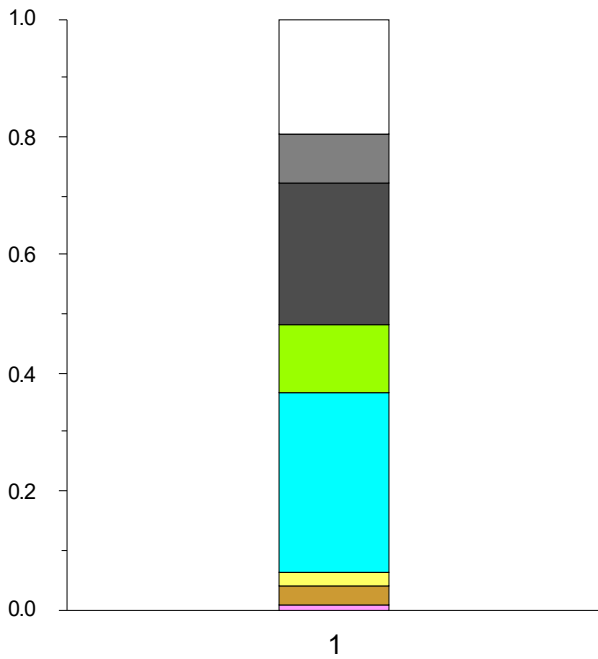

A10-4 SIE – stacked bar graph, proportional distribution of cations and anions in groundwater samples, August 2014

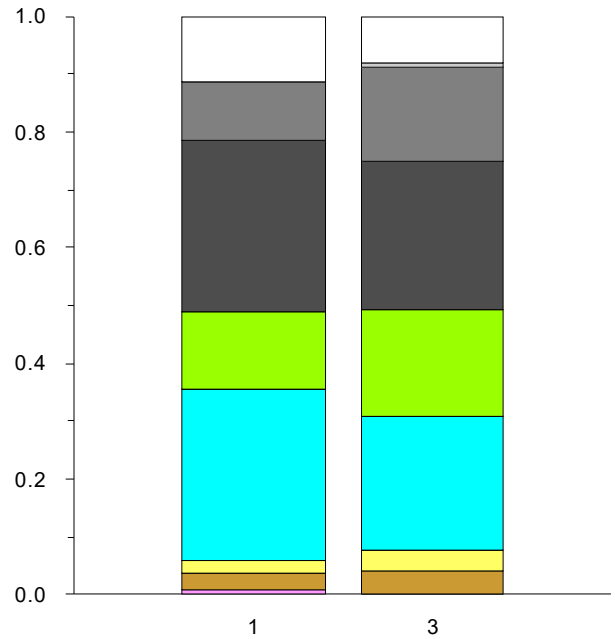

A10-6 SIE – stacked bar graph, proportional distribution of cations and anions in groundwater samples, February 2016

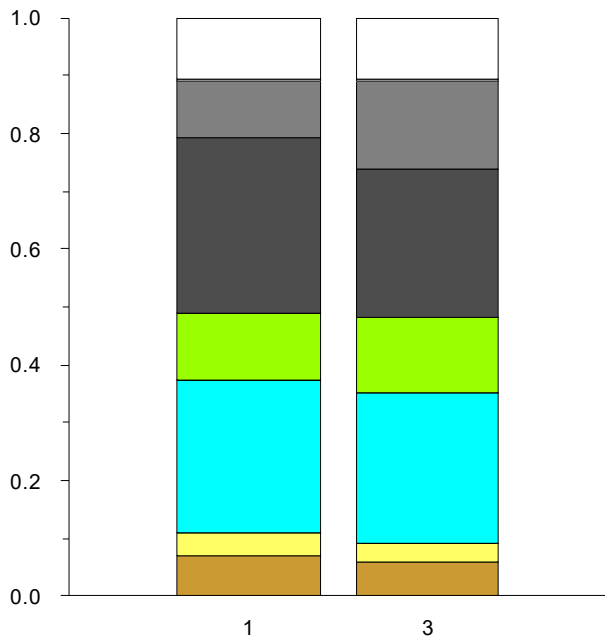

A10-7 SIE – stacked bar graph, proportional distribution of cations and anions in groundwater samples, March 2017

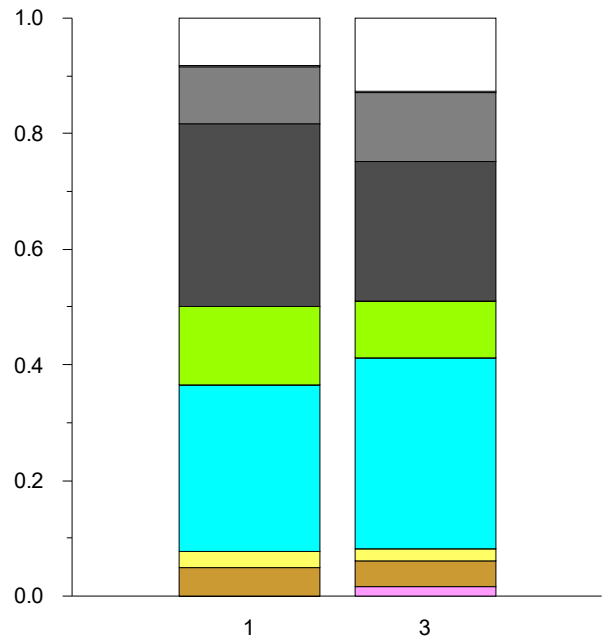

A10-2 SIE – stacked bar graph, proportional distribution of cations and anions in groundwater samples, February 2019

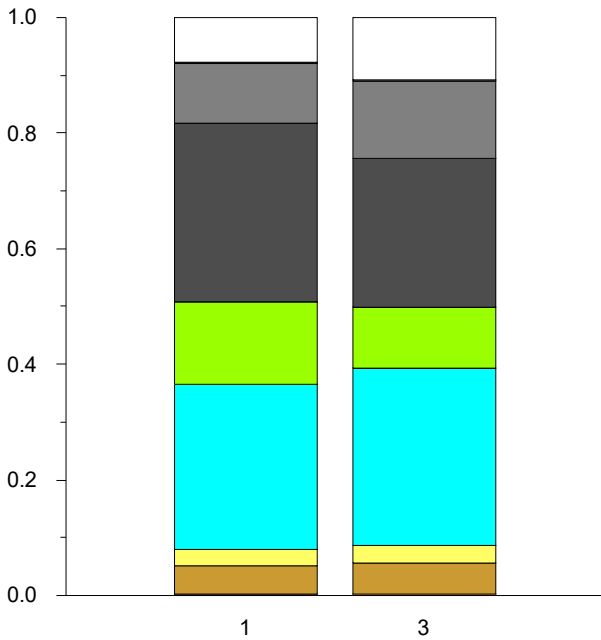

A10-1 SIE – stacked bar graph, proportional distribution of cations and anions in groundwater samples, February 2018

SO2

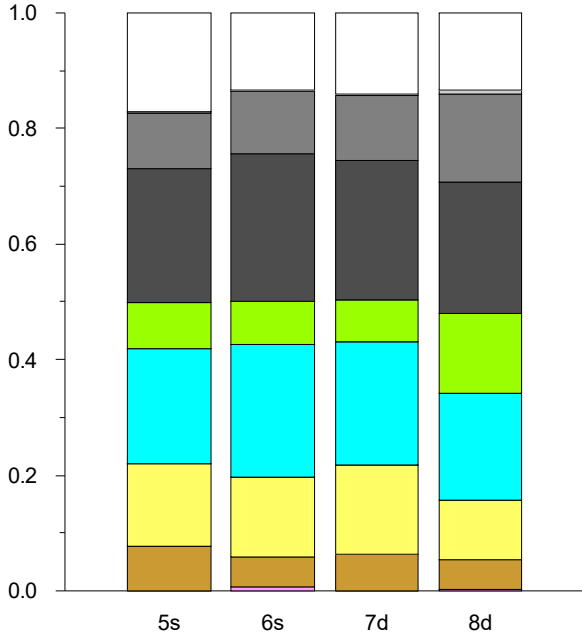

A10-3 SO2 - stacked bar graph, proportional distribution of cations and anions in groundwater samples, August 2013

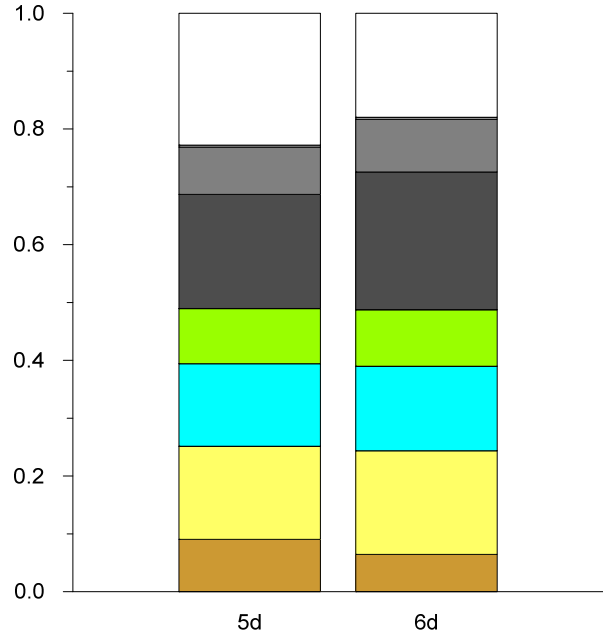

A10-5 SO2 - stacked bar graph, proportional distribution of cations and anions in groundwater samples, February 2015

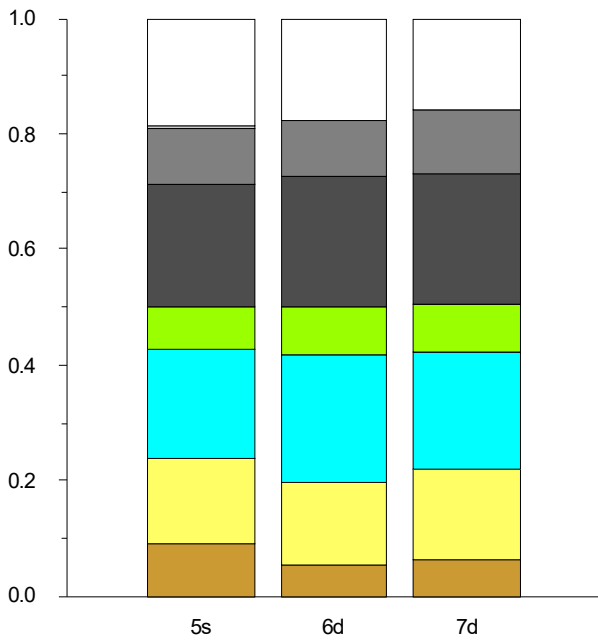

A10-4 SO2 - stacked bar graph, proportional distribution of cations and anions in groundwater samples, August 2014

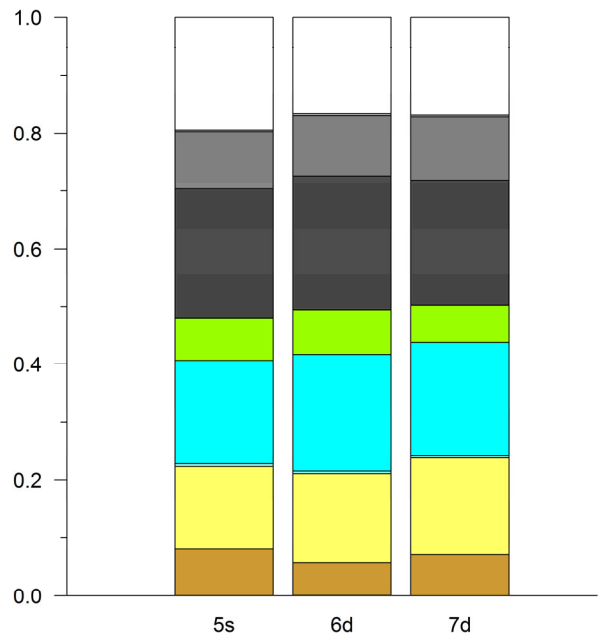

A10-6 SO2 - stacked bar graph, proportional distribution of cations and anions in groundwater samples, February 2016

SOJ

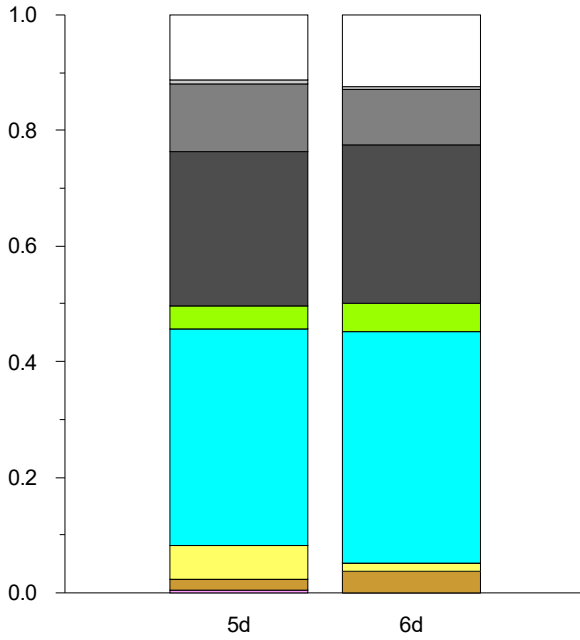

A10-7 SOJ - stacked bar graph, proportional distribution of cations and anions in groundwater samples, August 2013

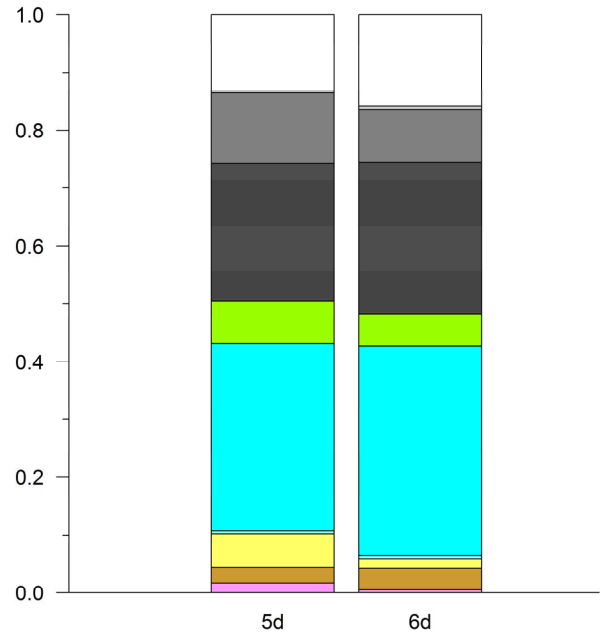

A10-9 SOJ – stacked bar graphs, proportional distribution of cations and anions in groundwater samples, February 2015

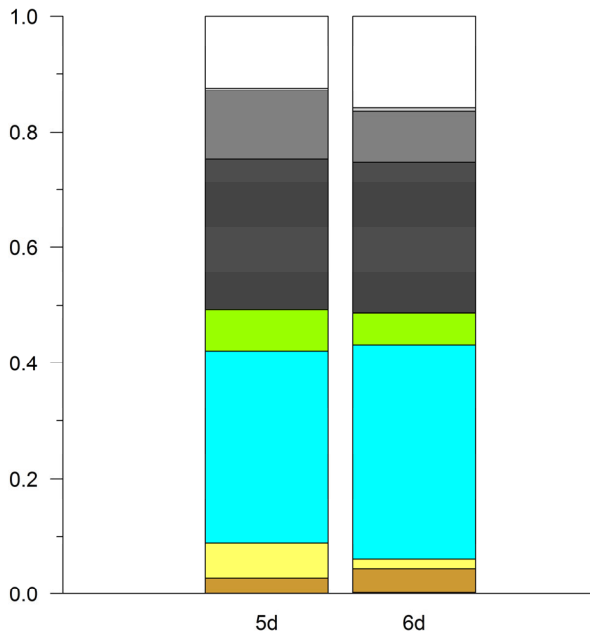

A10-8 SOJ – stacked bar graphs, proportional distribution of cations and anions in groundwater samples, August 2014

Attachment A11

Groundwater Chemical Characteristics – Stiff Diagrams

Table of Figures

A11-1	MEN – Stiff diagrams, May 2012.....	5	A11-41	FG1 – Stiff diagrams, May 2012.....	27
A11-2	MEN – Stiff diagrams, August 2012.....	5	A11-42	FG1 – Stiff diagrams, August 2012.....	28
A11-3	MEN – Stiff diagrams, August 2013.....	6	A11-43	FG1 – Stiff diagrams, August 2013.....	28
A11-4	MEN – Stiff diagrams, August 2014.....	6	A11-44	FG1 – Stiff diagrams, August 2014.....	29
A11-5	MEN – Stiff diagrams, February 2015.....	7	A11-45	FG1 – Stiff diagrams, February 2016.....	30
A11-6	MEN – Stiff diagrams, February 2016.....	7	A11-46	FG1 – Stiff diagrams, March 2017.....	30
A11-7	MEN – Stiff diagrams, March 2017.....	8	A11-47	FG1 – Stiff diagrams, February 2018.....	31
A11-8	MEN – Stiff diagrams, February 2018.....	8	A11-48	FG1 – Stiff diagrams, February 2019.....	31
A11-9	MEN – Stiff diagrams, February 2019.....	9	A11-49	BEA – Stiff diagrams, May 2012.....	32
A11-10	ANC – Stiff diagrams, May 2012.....	10	A11-50	BEA – Stiff diagrams, August 2012.....	32
A11-11	ANC – Stiff diagrams, August 2012.....	10	A11-51	BEA – Stiff diagrams, August 2013.....	32
A11-12	ANC – Stiff diagrams, August 2013.....	11	A11-52	BEA – Stiff diagrams, August 2014.....	32
A11-13	ANC – Stiff diagrams, August 2014.....	11	A11-53	BEA – Stiff diagrams, February 2015.....	32
A11-14	ANC – Stiff diagrams, February 2015.....	12	A11-54	BEA – Stiff diagrams, February 2016.....	33
A11-15	ANC – Stiff diagrams, February 2016.....	12	A11-55	BEA – Stiff diagrams, March 2017.....	33
A11-16	ANC – Stiff diagrams, March 2017.....	13	A11-56	BEA – Stiff diagrams, February 2018.....	33
A11-17	ANC – Stiff diagrams, February 2018.....	13	A11-57	BEA – Stiff diagrams, February 2019.....	33
A11-18	ANC – Stiff diagrams, February 2019.....	14	A11-58	COT – Stiff diagrams, May 2012.....	34
A11-19	BET – Stiff diagrams, May 2012.....	15	A11-59	COT – Stiff diagrams, August 2012.....	35
A11-20	BET – Stiff diagrams, August 2012.....	15	A11-60	COT – Stiff diagrams, August 2013.....	36
A11-21	BET – Stiff diagrams, August 2013.....	16	A11-61	COT – Stiff diagrams, August 2014.....	36
A11-22	BET – Stiff diagrams, August 2014.....	16	A11-62	COT – Stiff diagrams, February 2015.....	37
A11-23	BET – Stiff diagrams, February 2015.....	17	A11-63	COT – Stiff diagrams, February 2016.....	37
A11-24	BET – Stiff diagrams, February 2016.....	17	A11-64	COT – Stiff diagrams, March 2017.....	38
A11-25	BET – Stiff diagrams, March 2017.....	18	A11-65	COT – Stiff diagrams, February 2018.....	38
A11-26	BET – Stiff diagrams, February 2018.....	18	A11-66	COT – Stiff diagrams, February 2019.....	39
A11-27	BET – Stiff diagrams, February 2019.....	19	A11-67	SAN – Stiff diagrams, May 2012.....	40
A11-28	DIE – Stiff diagrams, August 2013.....	20	A11-68	SAN – Stiff diagrams, August 2012.....	40
A11-29	DIE – Stiff diagrams, February 2015.....	20	A11-69	SAN – Stiff diagrams, August 2013.....	41
A11-30	DIE – Stiff diagrams, February 2016.....	20	A11-70	SAN – Stiff diagrams, August 2014.....	41
A11-31	DIE – Stiff diagrams, March 2017.....	20	A11-71	SAN – Stiff diagrams, February 2015.....	42
A11-32	DIE – Stiff diagrams, February 2018.....	21	A11-72	SAN – Stiff diagrams, February 2016.....	42
A11-33	DIE – Stiff diagrams, February 2019.....	21	A11-73	SAN – Stiff diagrams, March 2017.....	42
A11-34	DUR – Stiff diagrams, August 2013.....	22	A11-74	SAN – Stiff diagrams, February 2018.....	43
A11-35	DUR – Stiff diagrams, August 2014.....	23	A11-75	SAN – Stiff diagrams, February 2019.....	43
A11-36	DUR – Stiff diagrams, February 2015.....	23	A11-76	GEN – Stiff diagrams, August 2013.....	44
A11-37	DUR – Stiff diagrams, February 2016.....	24	A11-77	GEN – Stiff diagrams, August 2014.....	45
A11-38	DUR – Stiff diagrams, March 2017.....	25	A11-78	GEN – Stiff diagrams, February 2015.....	46
A11-39	DUR – Stiff diagrams, February 2018.....	25	A11-79	GEN – Stiff diagrams, February 2016.....	46
A11-40	DUR – Stiff diagrams, February 2019.....	26	A11-80	GEN – Stiff diagrams, March 2017.....	47
			A11-81	GEN – Stiff diagrams, February 2018.....	48
			A11-82	GEN – Stiff diagrams, February 2019.....	49

A11-83	TRO – Stiff diagrams, August 2013	50	A11-125	ANT – Stiff diagrams, August 2012	68
A11-84	TRO – Stiff diagrams, August 2014	50	A11-126	ANT – Stiff diagrams, August 2013	69
A11-85	TRO – Stiff diagrams, February 2015	50	A11-127	ANT – Stiff diagrams, August 2014	69
A11-86	TRO – Stiff diagrams, February 2016	50	A11-128	ANT – Stiff diagrams, February 2015	69
A11-87	TRO – Stiff diagrams, March 2017	50	A11-129	ANT – Stiff diagrams, February 2016	70
A11-88	TRO – Stiff diagrams, February 2018	51	A11-130	ANT – Stiff diagrams, March 2017	70
A11-89	TRO – Stiff diagrams, February 2019	51	A11-131	ANT – Stiff diagrams, February 2018	70
A11-90	PLS – Stiff diagrams, May 2012	52	A11-132	ANT – Stiff diagrams, February 2019	70
A11-91	PLS – Stiff diagrams, August 2012	52	A11-133	COR – Stiff diagrams, May 2012	71
A11-92	PLS – Stiff diagrams, August 2013	53	A11-134	COR – Stiff diagrams, August 2012	71
A11-93	PLS – Stiff diagrams, August 2014	53	A11-135	COR – Stiff diagrams, August 2013	72
A11-94	PLS – Stiff diagrams, February 2015	54	A11-136	COR – Stiff diagrams, August 2014	72
A11-95	PLS – Stiff diagrams, February 2016	54	A11-137	COR – Stiff diagrams, February 2015	72
A11-96	PLS – Stiff diagrams, March 2017	55	A11-138	COR – Stiff diagrams, February 2016	73
A11-97	PLS – Stiff diagrams, February 2018	55	A11-139	COR – Stiff diagrams, March 2017	73
A11-98	PLS – Stiff diagrams, February 2019	56	A11-140	COR – Stiff diagrams, February 2018	73
A11-99	CAE – Stiff diagrams, May 2012	57	A11-141	COR – Stiff diagrams, February 2019	74
A11-100	CAE – Stiff diagrams, August 2012	57	A11-142	FG2 – Stiff diagrams, May 2012	74
A11-101	CAE – Stiff diagrams, August 2013	58	A11-143	FG2 – Stiff diagrams, August 2012	75
A11-102	CAE – Stiff diagrams, August 2014	58	A11-144	FG2 – Stiff diagrams, August 2013	75
A11-103	CAE – Stiff diagrams, February 2015	58	A11-145	FG2 – Stiff diagrams, August 2014	75
A11-104	CAE – Stiff diagrams, February 2016	59	A11-146	FG2 – Stiff diagrams, February 2015	76
A11-105	CAE – Stiff diagrams, March 2017	59	A11-147	FG2 – Stiff diagrams, February 2016	76
A11-106	CAE – Stiff diagrams, February 2018	59	A11-148	FG2 – Stiff diagrams, March 2017	76
A11-107	CAE – Stiff diagrams, February 2019	60	A11-149	FG2 – Stiff diagrams, March 2017	77
A11-108	ROB – Stiff diagrams, May 2012	61	A11-150	FG2 – Stiff diagrams, February 2019	77
A11-109	ROB – Stiff diagrams, August 2012	61	A11-151	GOD – Stiff diagrams, May 2012	78
A11-110	ROB – Stiff diagrams, August 2013	62	A11-152	GOD – Stiff diagrams, August 2012	78
A11-111	ROB – Stiff diagrams, August 2014	62	A11-153	GOD – Stiff diagrams, August 2013	79
A11-112	ROB – Stiff diagrams, February 2015	63	A11-154	GOD – Stiff diagrams, August 2014	79
A11-113	ROB – Stiff diagrams, February 2016	63	A11-155	GOD – Stiff diagrams, February 2015	80
A11-114	ROB – Stiff diagrams, March 2017	64	A11-156	GOD – Stiff diagrams, February 2016	80
A11-115	ROB – Stiff diagrams, February 2018	64	A11-157	GOD – Stiff diagrams, March 2017	81
A11-116	ROB – Stiff diagrams, February 2019	65	A11-158	GOD – Stiff diagrams, February 2018	81
A11-117	WOO – Stiff diagrams, August 2013	66	A11-159	GOD – Stiff diagrams, February 2019	82
A11-118	WOO – Stiff diagrams, August 2014	66	A11-160	MAC – Stiff diagrams, May 2012	83
A11-119	WOO – Stiff diagrams, February 2015	66	A11-161	MAC – Stiff diagrams, August 2012	83
A11-120	WOO – Stiff diagrams, February 2016	66	A11-162	MAC – Stiff diagrams, August 2013	84
A11-121	WOO – Stiff diagrams, March 2017	67	A11-163	MAC – Stiff diagrams, August 2014	84
A11-122	WOO – Stiff diagrams, February 2018	67	A11-164	MAC – Stiff diagrams, February 2015	84
A11-123	WOO – Stiff diagrams, February 2019	67	A11-165	MAC – Stiff diagrams, February 2016	85
A11-124	ANT – Stiff diagrams, May 2012	68	A11-166	MAC – Stiff diagrams, March 2017	85

A11-167	MAC – Stiff diagrams, February 2018.....	85	A11-209	CRE – Stiff diagrams, February 2019.....	104
A11-168	MAC – Stiff diagrams, February 2019.....	86	A11-210	MTS – Stiff diagrams, August 2013.....	105
A11-169	NUN – Stiff diagrams, May 2012.....	86	A11-211	MTS – Stiff diagrams, August 2014.....	105
A11-170	NUN – Stiff diagrams, August 2012.....	86	A11-212	MTS – Stiff diagrams, February 2015.....	105
A11-171	NUN – Stiff diagrams, August 2013.....	87	A11-213	MTS – Stiff diagrams, February 2016.....	105
A11-172	NUN – Stiff diagrams, in August 2014.....	87	A11-214	MTS – Stiff diagrams, March 2017.....	106
A11-173	NUN – Stiff diagrams, in February 2015.....	87	A11-215	MTS – Stiff diagrams, February 2018.....	106
A11-174	NUN – Stiff diagrams, February 2016.....	88	A11-216	MTS – Stiff diagrams, February 2019.....	106
A11-175	NUN – Stiff diagrams, March 2017.....	89	A11-217	AUK – Stiff diagrams, August 2013.....	107
A11-176	NUN – Stiff diagrams, February 2018.....	89	A11-218	AUK – Stiff diagrams, August 2014.....	107
A11-177	NUN – Stiff diagrams, February 2019.....	90	A11-219	AUK – Stiff diagrams, February 2015.....	107
A11-178	MOO – Stiff diagrams, May 2012.....	91	A11-220	AUK – Stiff diagrams, February 2016.....	107
A11-179	MOO – Stiff diagrams, August 2012.....	91	A11-221	AUK – Stiff diagrams, March 2017.....	108
A11-180	MOO – Stiff diagrams, August 2013.....	92	A11-222	AUK – Stiff diagrams, February 2018.....	108
A11-181	MOO – Stiff diagrams, August 2014.....	92	A11-223	AUK – Stiff diagrams, February 2019.....	108
A11-182	MOO – Stiff diagrams, February 2015.....	93	A11-224	DLF – Stiff diagrams, August 2013.....	108
A11-183	MOO – Stiff diagrams, February 2016.....	93	A11-225	DLF – Stiff diagrams, August 2014.....	109
A11-184	MOO – Stiff diagrams, March 2017.....	94	A11-226	DLF – Stiff diagrams, February 2015.....	109
A11-185	MOO – Stiff diagrams, February 2018.....	94	A11-227	DLF – Stiff diagrams, February 2016.....	109
A11-186	MOO – Stiff diagrams, February 2019.....	95	A11-228	DLF – Stiff diagrams, March 2017.....	109
A11-187	TON – Stiff diagrams, May 2012.....	96	A11-229	DLF – Stiff diagrams, February 2018.....	109
A11-188	TON – Stiff diagrams, August 2012.....	96	A11-230	DLF – Stiff diagrams, February 2019.....	109
A11-189	TON – Stiff diagrams, August 2013.....	97	A11-231	ELK – Stiff diagrams, August 2013.....	110
A11-190	TON – Stiff diagrams, August 2014.....	97	A11-232	ZZI – Stiff diagrams, August 2013.....	111
A11-191	TON – Stiff diagrams, February 2015.....	98	A11-233	ZZI – Stiff diagrams, August 2014.....	111
A11-192	TON – Stiff diagrams, February 2016.....	98	A11-234	ZZI – Stiff diagrams, February 2015.....	112
A11-193	TON – Stiff diagrams, March 2017.....	99	A11-235	ZZI – Stiff diagrams, February 2016.....	112
A11-194	TON – Stiff diagrams, February 2018.....	99	A11-236	ZZI – Stiff diagrams, March 2017.....	113
A11-195	TON – Stiff diagrams, February 2019.....	100	A11-237	ZZI – Stiff diagrams, February 2018.....	113
A11-196	BRE – Stiff diagrams, August 2013.....	101	A11-238	ZZI – Stiff diagrams, February 2019.....	114
A11-197	BRE – Stiff diagrams, August 2014.....	101	A11-239	HOL – Stiff diagrams, August 2013.....	115
A11-198	BRE – Stiff diagrams, February 2015.....	101	A11-240	HOL – Stiff diagrams, August 2014.....	115
A11-199	BRE – Stiff diagrams, February 2016.....	101	A11-241	JAD – Stiff diagrams, August 2013.....	117
A11-200	BRE – Stiff diagrams, March 2017.....	102	A11-242	JAD – Stiff diagrams, August 2014.....	117
A11-201	BRE – Stiff diagrams, February 2018.....	102	A11-243	JAD – Stiff diagrams, February 2015.....	117
A11-202	BRE – Stiff diagrams, February 2019.....	102	A11-244	JAD – Stiff diagrams, February 2016.....	118
A11-203	CRE – Stiff diagrams, August 2013.....	103	A11-245	JAD – Stiff diagrams, February 2018.....	118
A11-204	CRE – Stiff diagrams, August 2014.....	103	A11-246	LON – Stiff diagrams, August 2013.....	119
A11-205	CRE – Stiff diagrams, February 2015.....	103	A11-247	LON – Stiff diagrams, August 2014.....	119
A11-206	CRE – Stiff diagrams, February 2016.....	103	A11-248	LON – Stiff diagrams, February 2015.....	120
A11-207	CRE – Stiff diagrams, March 2017.....	104	A11-249	LON – Stiff diagrams, February 2016.....	120
A11-208	CRE – Stiff diagrams, February 2018.....	104	A11-250	LON – Stiff diagrams, March 2017.....	121

A11-251	LON – Stiff diagrams, February 2018	121	A11-294	SIE – Stiff diagrams, February 2019.....	135
A11-252	LON – Stiff diagrams, February 2019	121	A11-295	SO2 – Stiff diagrams, August 2013	136
A11-253	ADO – Stiff diagrams, August 2013	122	A11-296	SO2 – Stiff diagrams, August 2014	136
A11-254	ADO – Stiff diagrams, August 2014	122	A11-297	SO2 – Stiff diagrams, February 2015	136
A11-255	ADO – Stiff diagrams, February 2015.....	122	A11-298	SO2 – Stiff diagrams, February 2016	136
A11-256	ADO – Stiff diagrams, April 2017	122	A11-299	SOJ – Stiff diagrams, August 2013.....	137
A11-257	ADO – Stiff diagrams, February 2018.....	122	A11-300	SOJ – Stiff diagrams, August 2014.....	137
A11-258	ADO – Stiff diagrams, February 2018.....	122	A11-301	SOJ – Stiff diagrams, February 2015	137
A11-259	MAL – Stiff diagrams, August 2013	123			
A11-260	MAL – Stiff diagrams, August 2014	124			
A11-261	MAL – Stiff diagrams, February 2015	124			
A11-262	MAL – Stiff diagrams, February 2016	124			
A11-263	MAL – Stiff diagrams, March 2017.....	125			
A11-264	MAL – Stiff diagrams, February 2018	125			
A11-265	MAL – Stiff diagrams, February 2019	126			
A11-266	MAP – Stiff diagrams, August 2013	127			
A11-267	MAP – Stiff diagrams, August 2014	127			
A11-268	MAP – Stiff diagrams, February 2015.....	127			
A11-269	MAP – Stiff diagrams, February 2016.....	127			
A11-270	MAP – Stiff diagrams, March 2017	127			
A11-271	MAP – Stiff diagrams, February 2018.....	127			
A11-272	MAP – Stiff diagrams, February 2018.....	128			
A11-273	ZON – Stiff diagrams, August 2013	129			
A11-274	ZON – Stiff diagrams, August 2014	129			
A11-275	ZON – Stiff diagrams, February 2015.....	130			
A11-276	ZON – Stiff diagrams, February 2016.....	130			
A11-277	ZON – Stiff diagrams, March 2017	130			
A11-278	ZON – Stiff diagrams, February 2018.....	130			
A11-280	ZON – Stiff diagrams, February 2019.....	131			
A11-281	RIC – Stiff diagrams, August 2013.....	131			
A11-282	RIC – Stiff diagrams, August 2014.....	132			
A11-283	RIC – Stiff diagrams, February 2015	132			
A11-284	RIC – Stiff diagrams, February 2016	132			
A11-285	RIC – Stiff diagrams, March 2017.....	133			
A11-286	RIC – Stiff diagrams, February 2018	133			
A11-287	RIC – Stiff diagrams, February 2019	133			
A11-288	SIE – Stiff diagrams, August 2013.....	134			
A11-289	SIE – Stiff diagrams, August 2014	134			
A11-290	SIE – Stiff diagrams, February 2015.....	134			
A11-291	SIE – Stiff diagrams, February 2016.....	134			
A11-292	SIE – Stiff diagrams, March 2017	134			
A11-293	SIE – Stiff diagrams, February 2018.....	134			

MEN

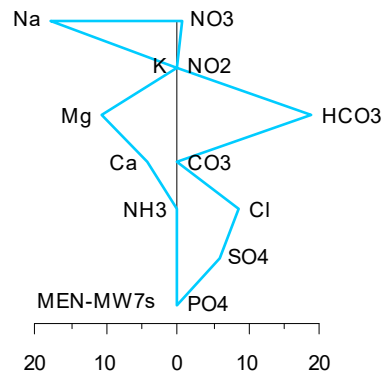
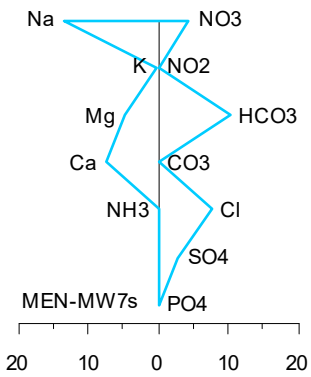
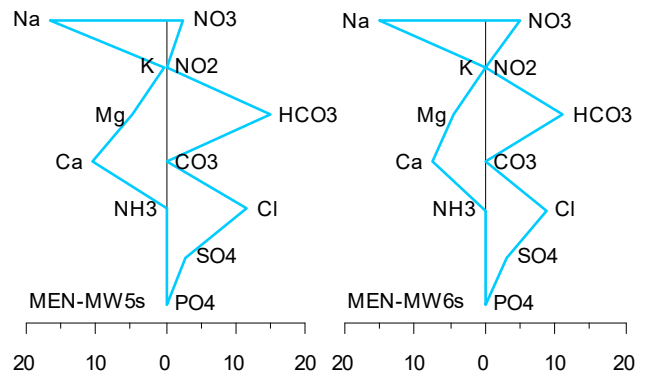
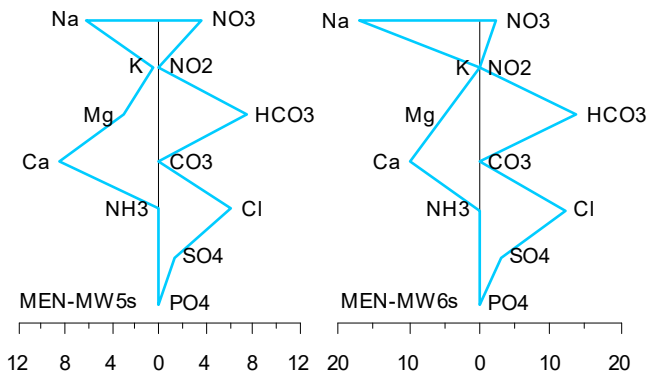
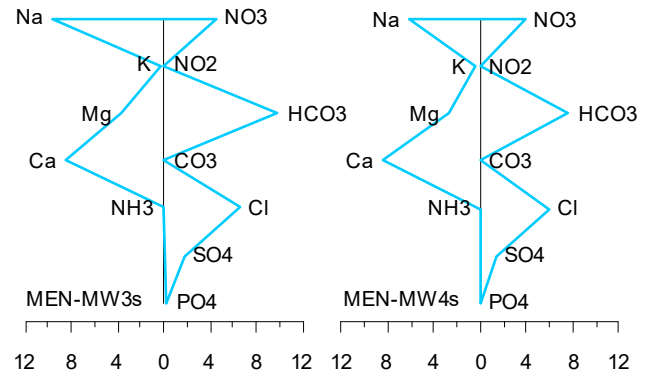
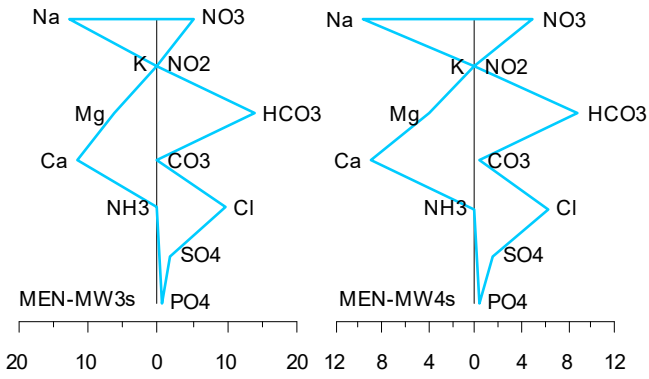
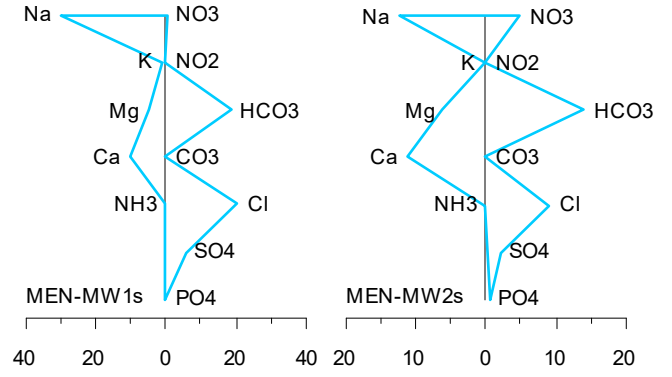
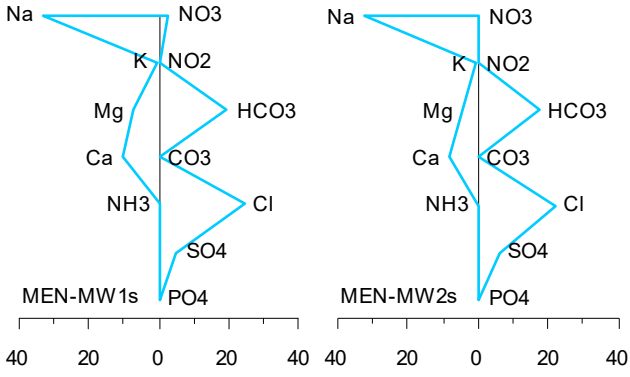

A11-1 MEN – Stiff diagrams, May 2012

A11-2 MEN – Stiff diagrams, August 2012

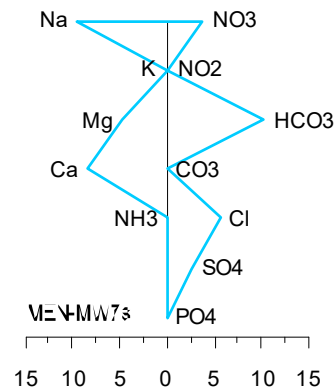
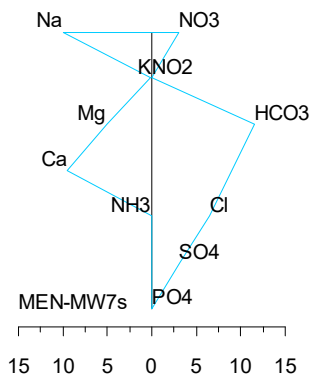
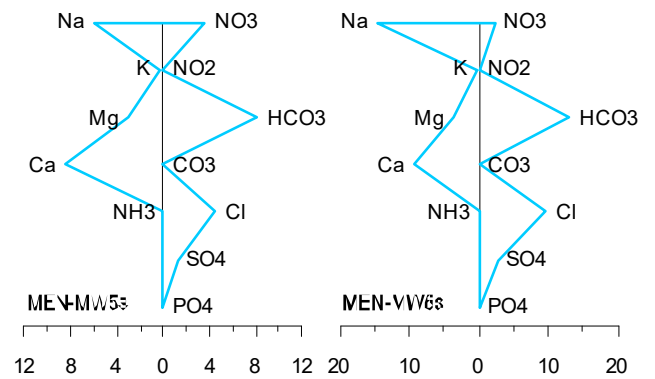
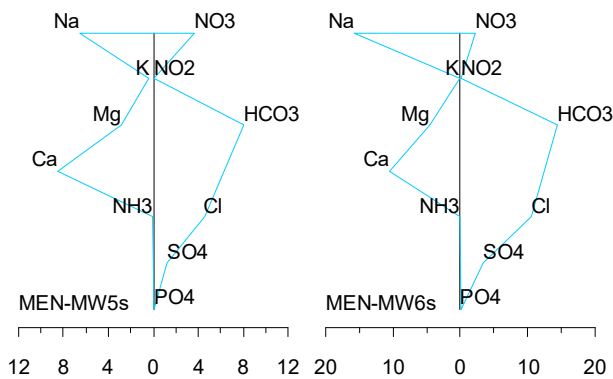
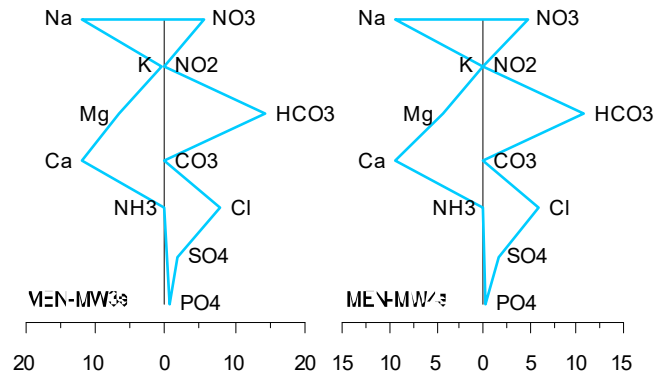
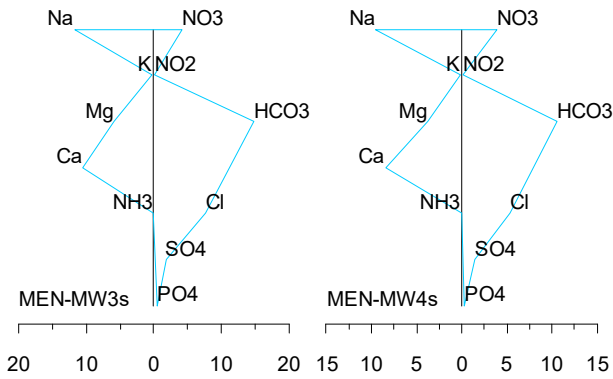
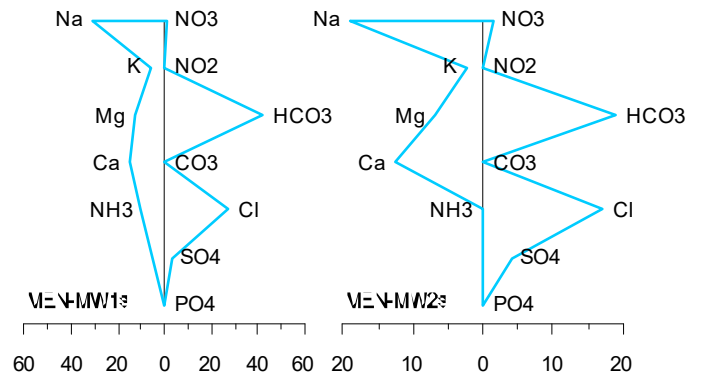
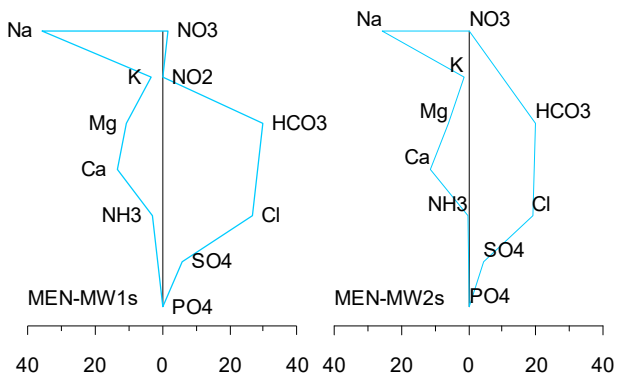

A11-3 MEN – Stiff diagrams, August 2013

A11-4 MEN – Stiff diagrams, August 2014

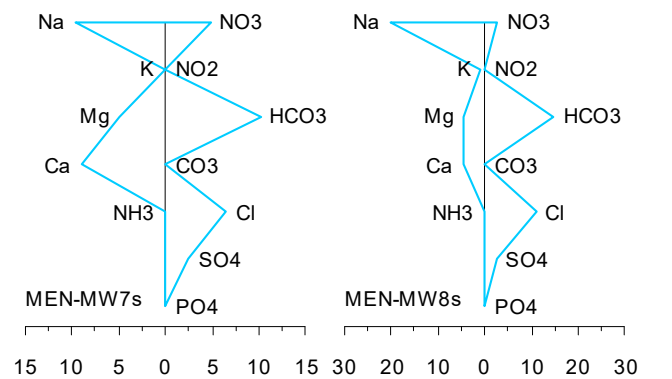
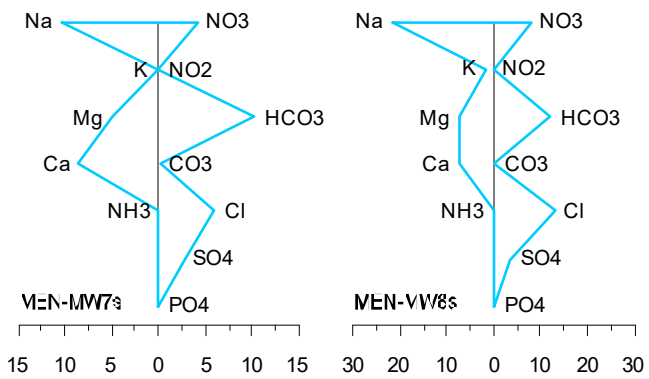
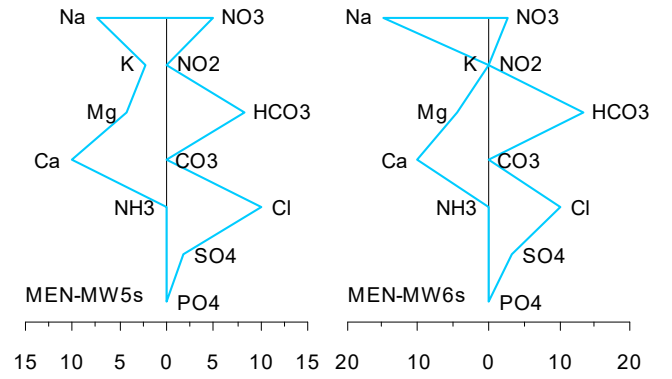
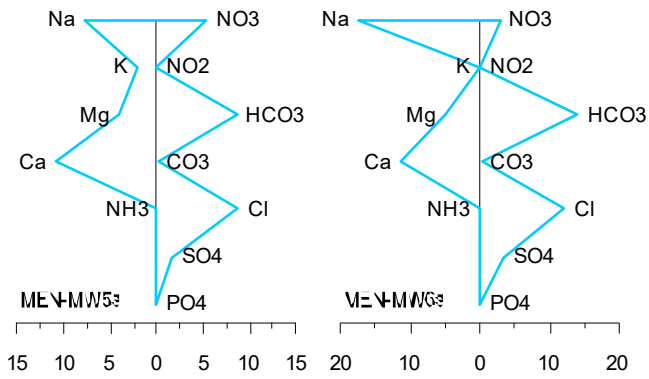
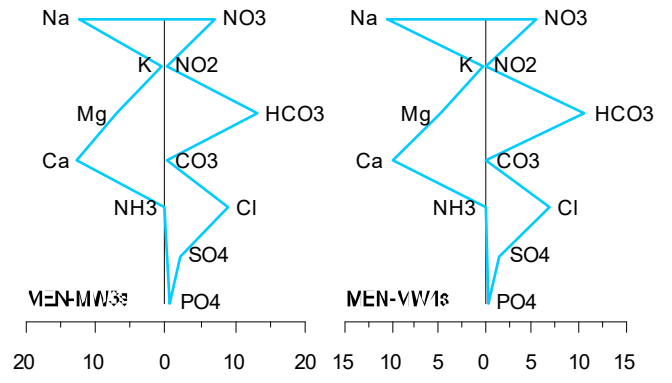
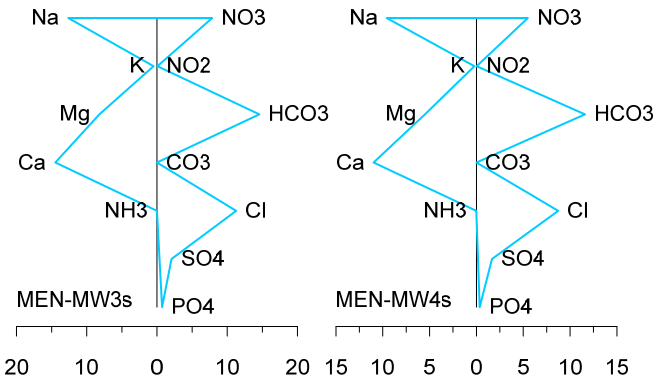
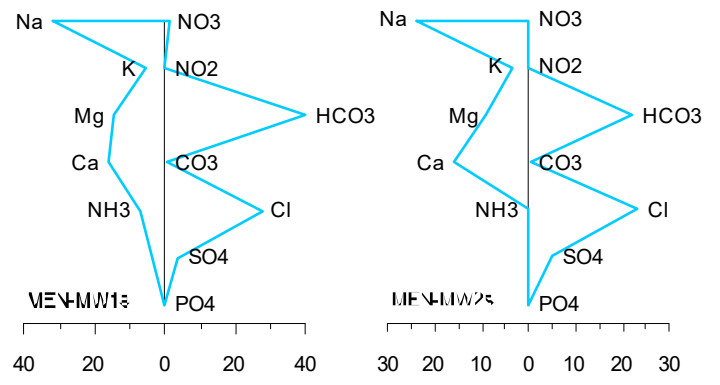
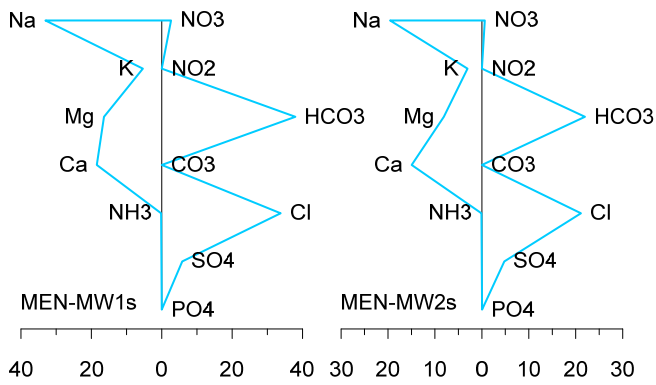

A11-5 MEN – Stiff diagrams, February 2015

A11-6 MEN – Stiff diagrams, February 2016

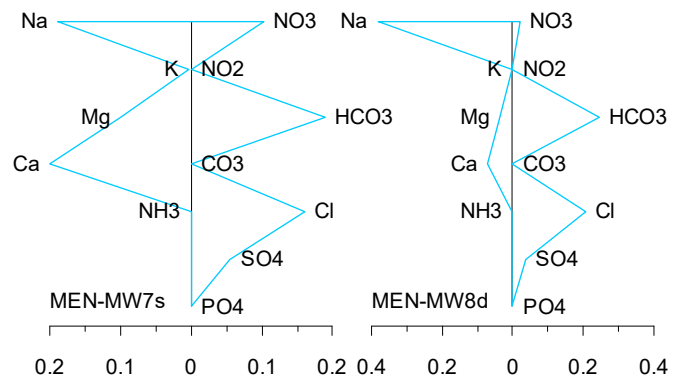
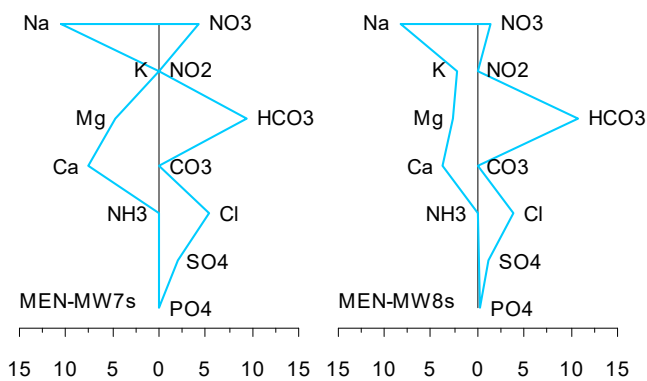
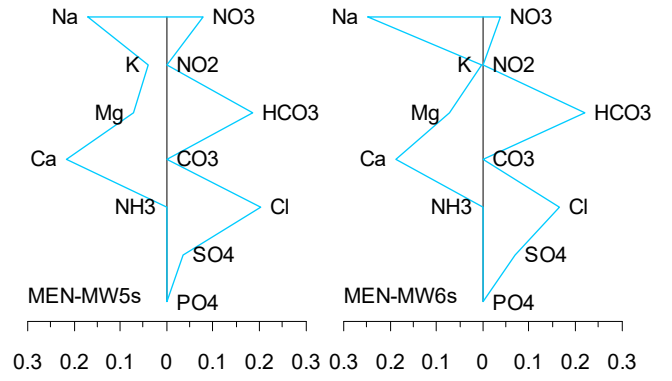
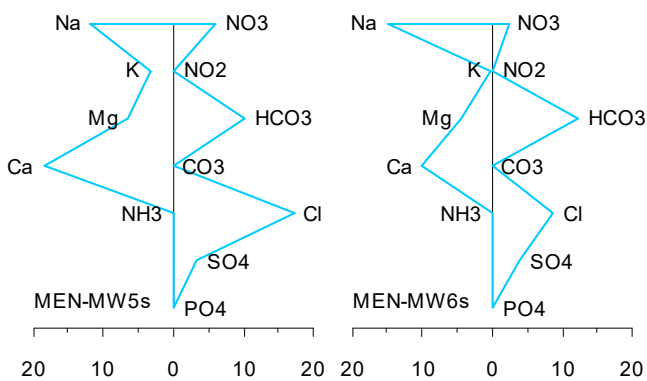
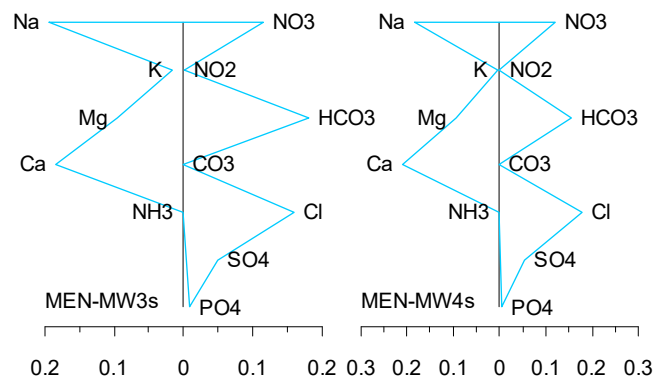
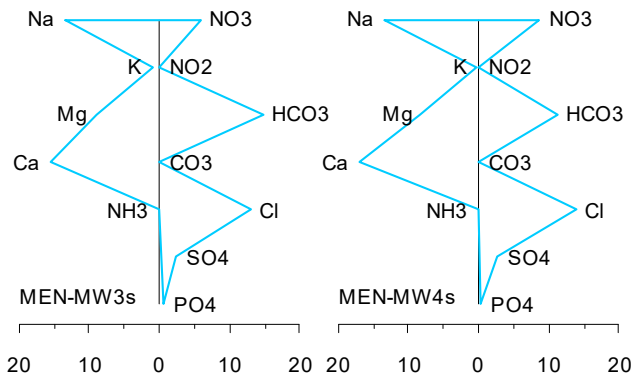
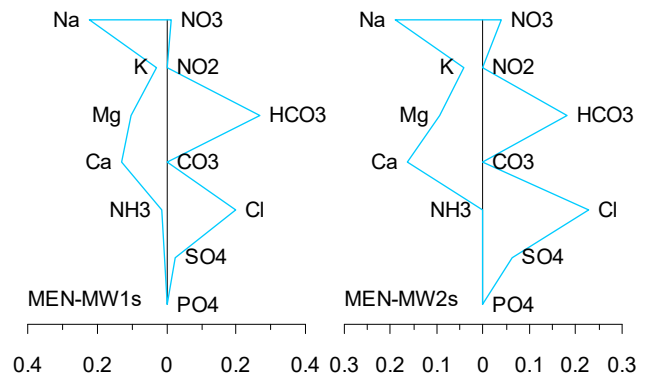
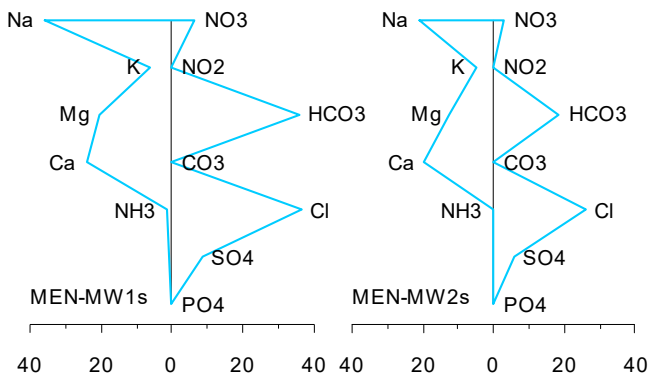

A11-7 MEN – Stiff diagrams, March 2017

A11-8 MEN – Stiff diagrams, February 2018

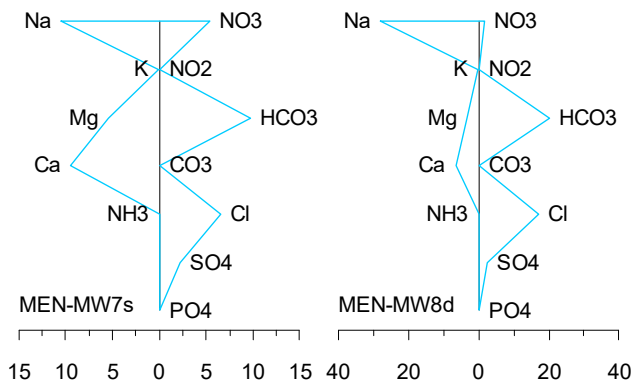
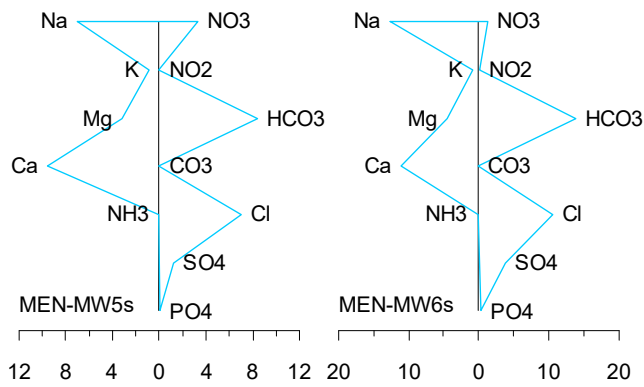
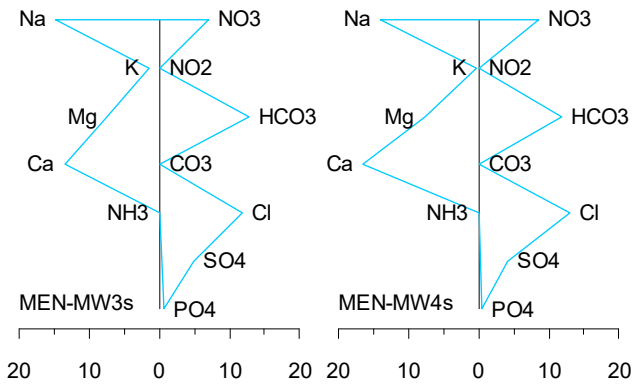
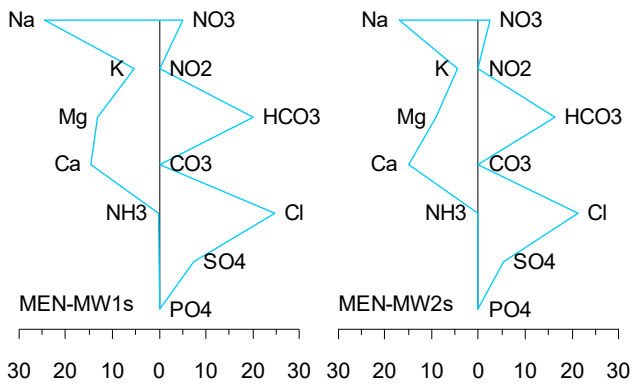

A11-9 MEN – Stiff diagrams, February 2019

ANC

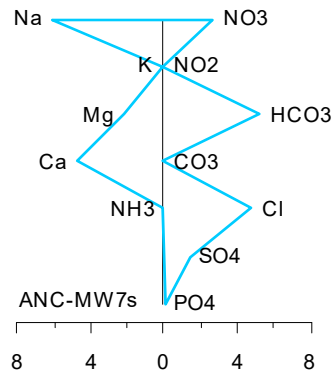
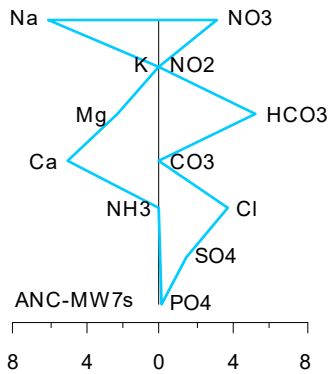
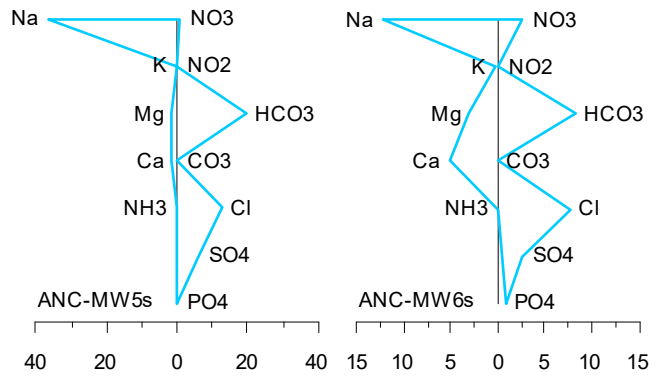
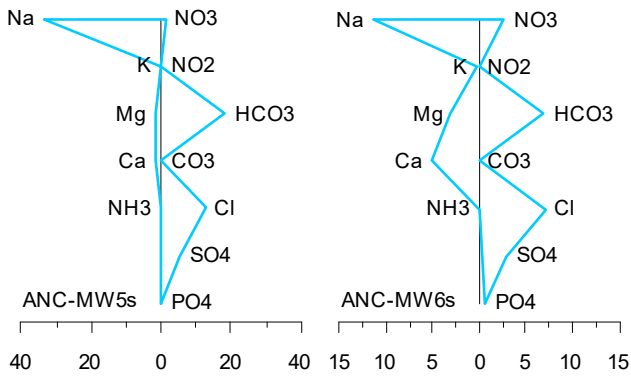
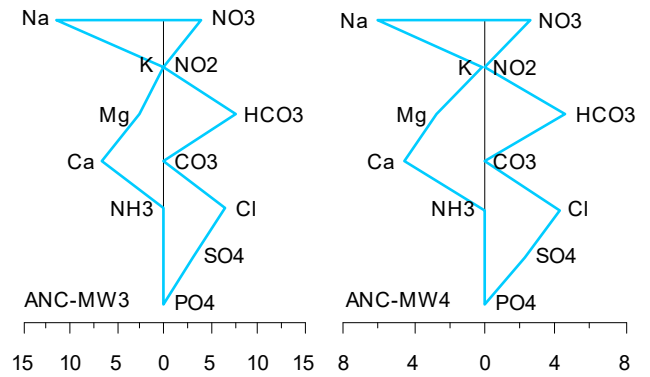
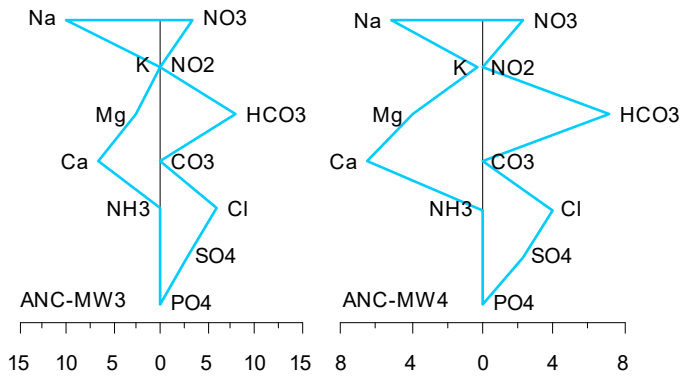
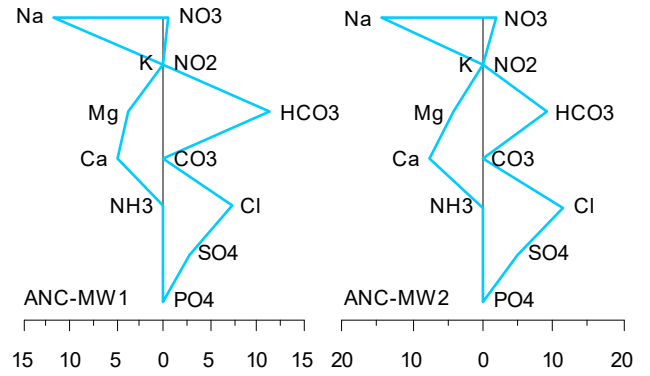
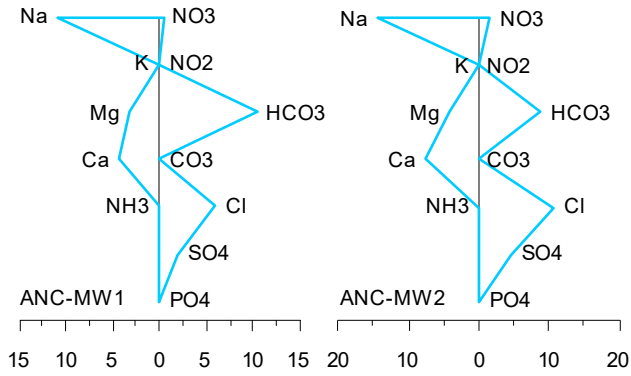

A11-10 ANC – Stiff diagrams, May 2012

A11-11 ANC – Stiff diagrams, August 2012

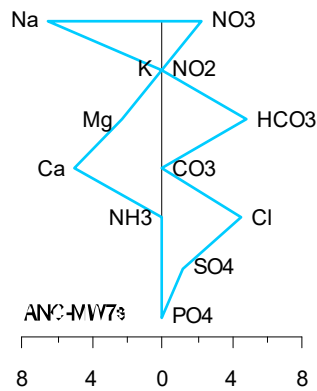
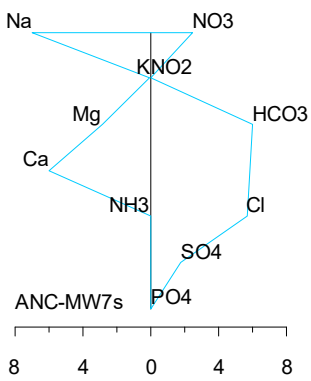
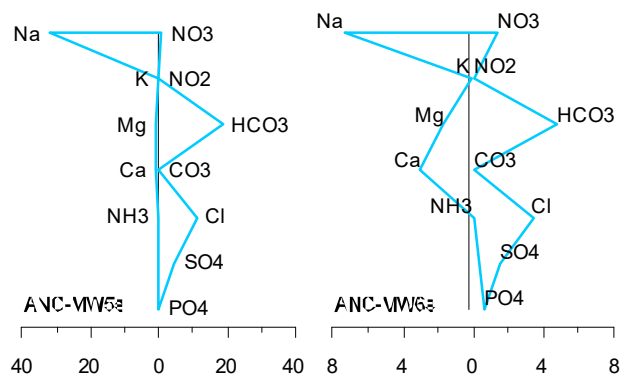
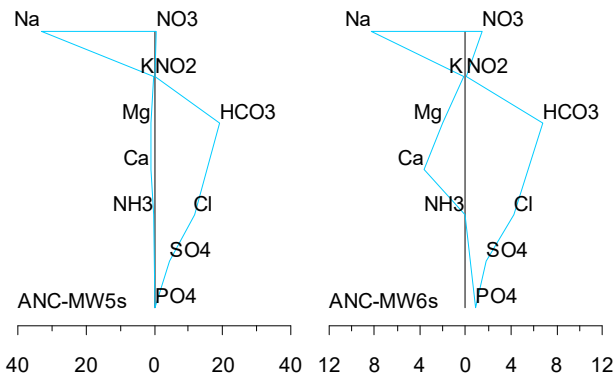
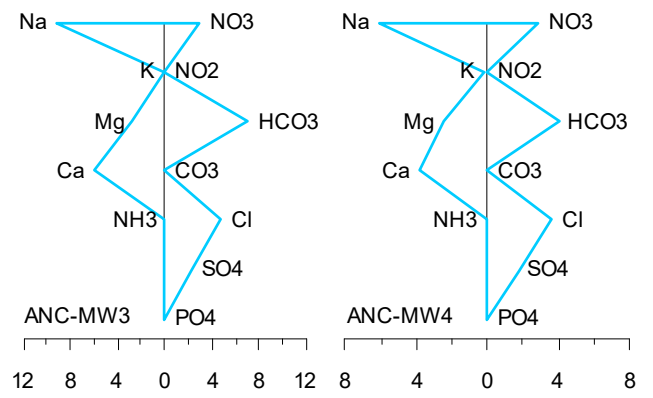
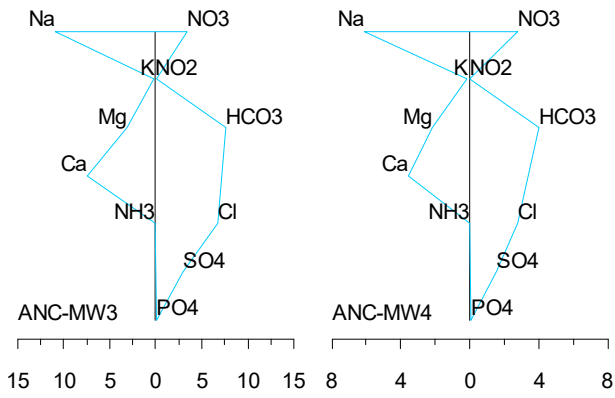
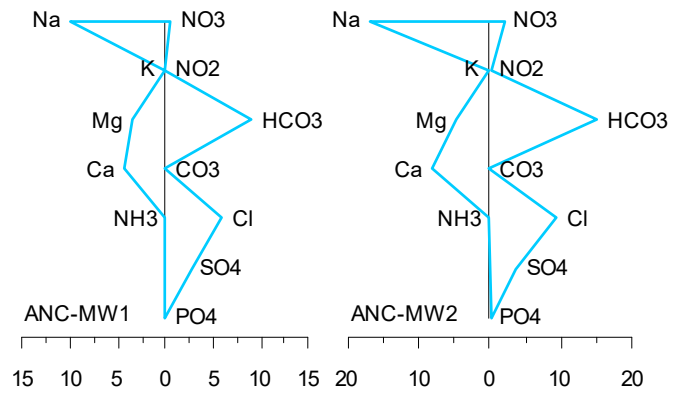
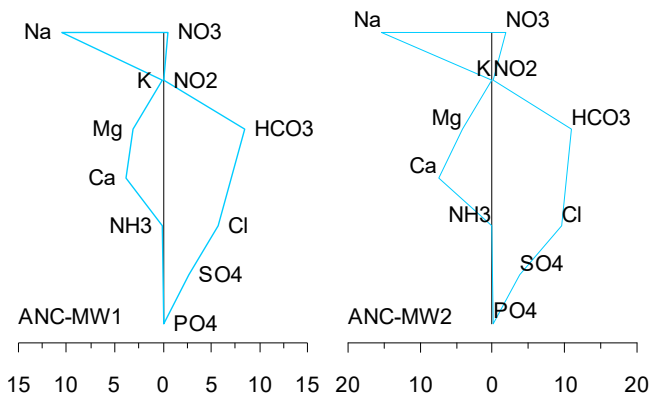

A11-12 ANC – Stiff diagrams, August 2013

A11-13 ANC – Stiff diagrams, August 2014

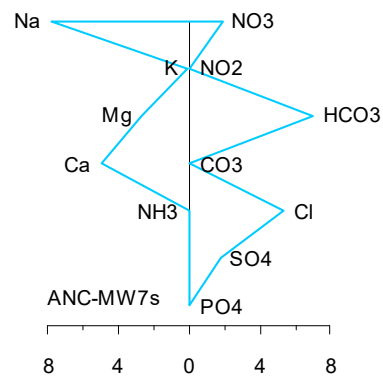
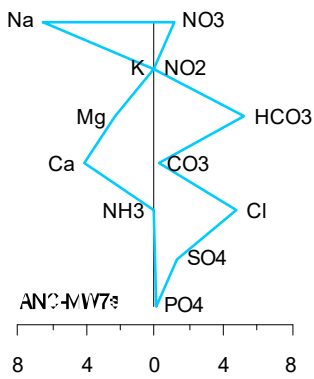
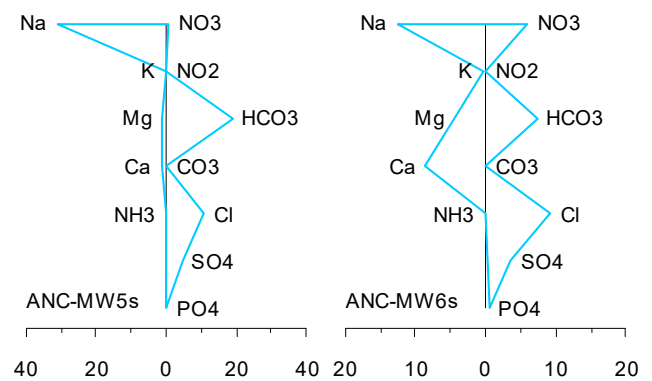
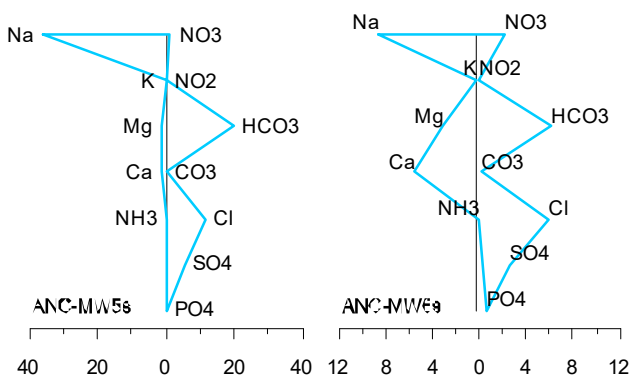
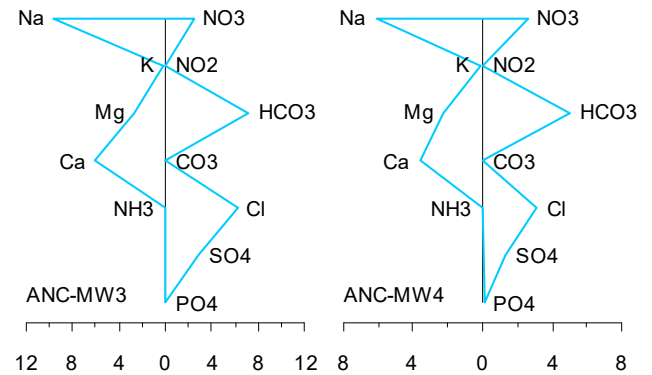
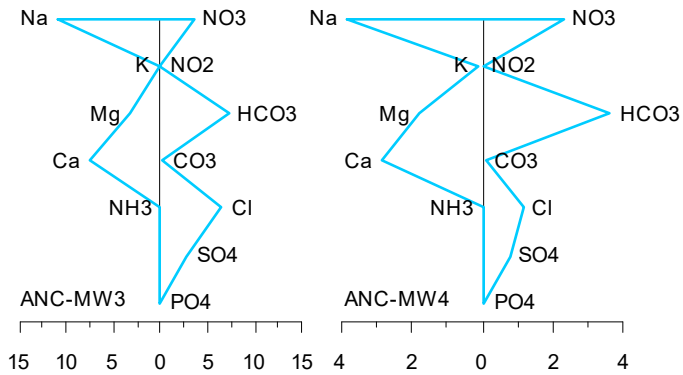
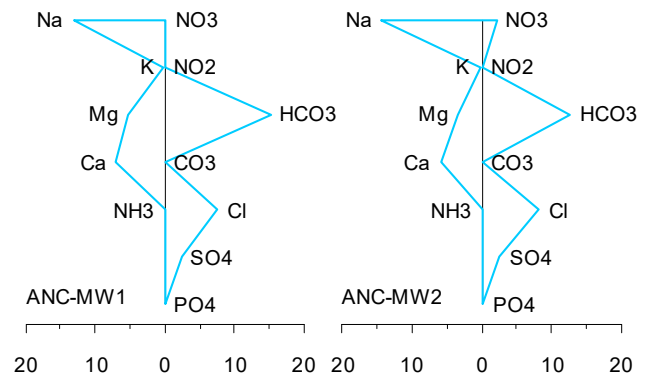
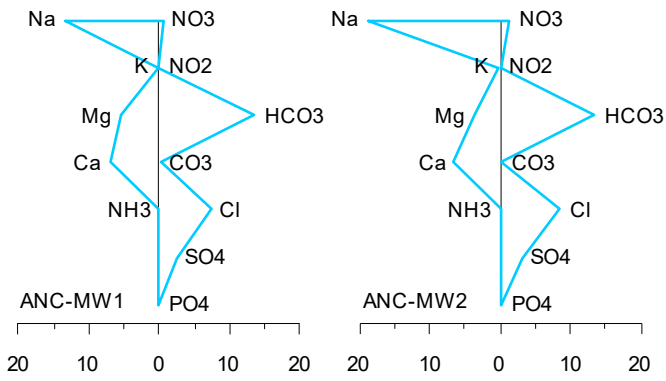

A11-14 ANC – Stiff diagrams, February 2015

A11-15 ANC – Stiff diagrams, February 2016

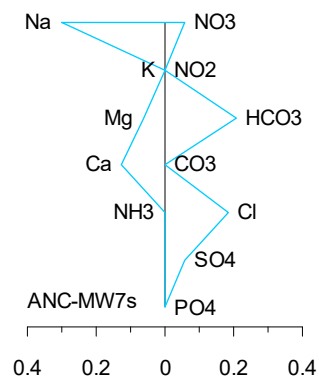
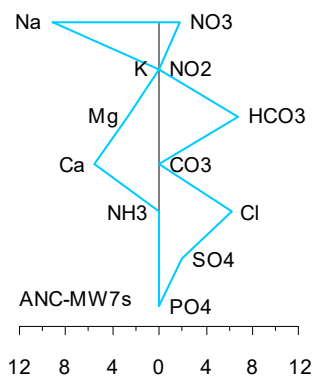
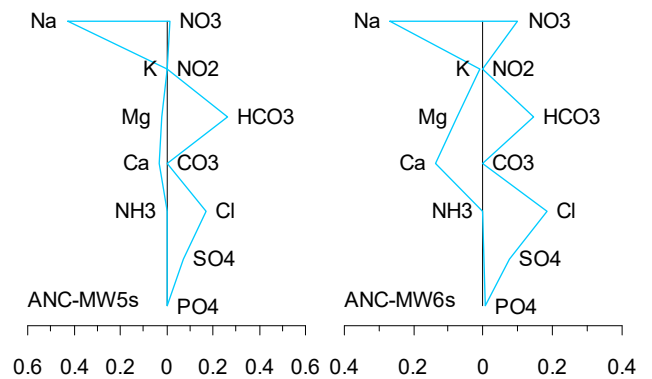
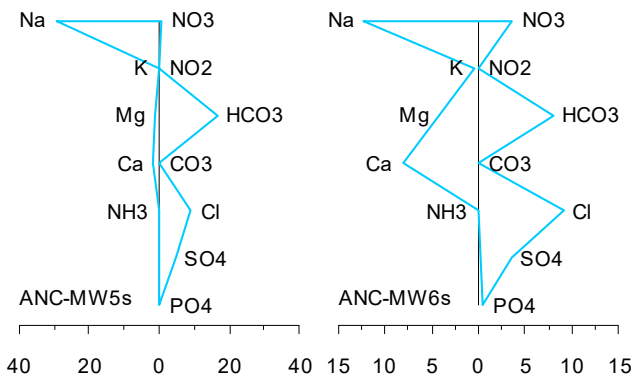
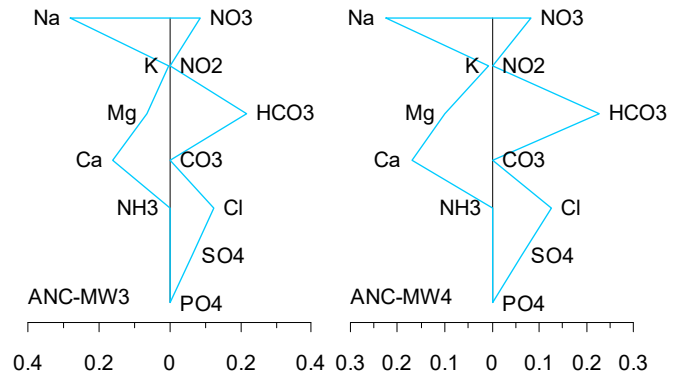
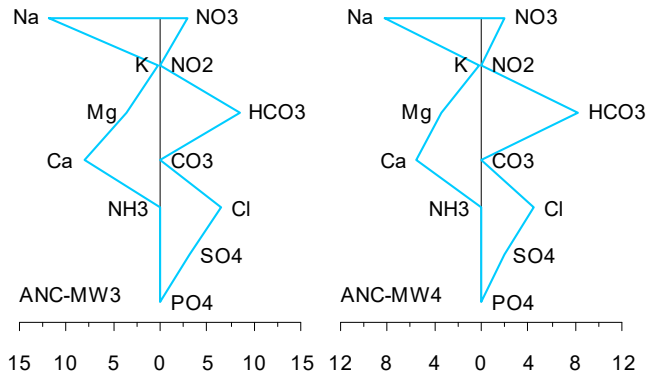
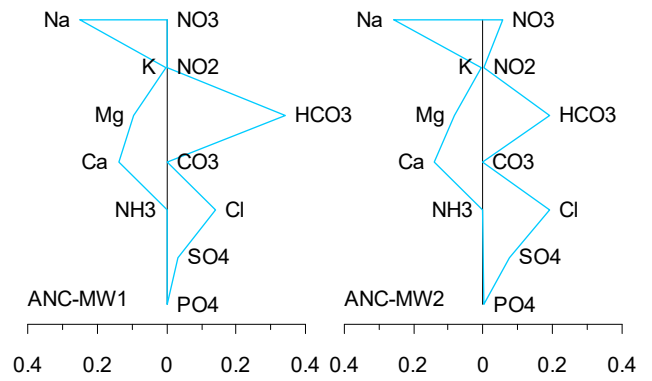
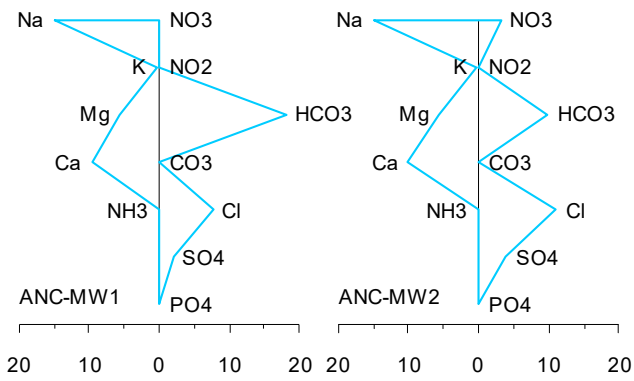

A11-16 ANC – Stiff diagrams, March 2017

A11-17 ANC – Stiff diagrams, February 2018

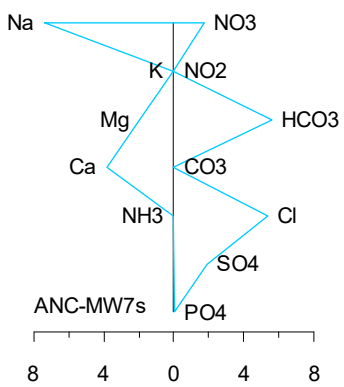
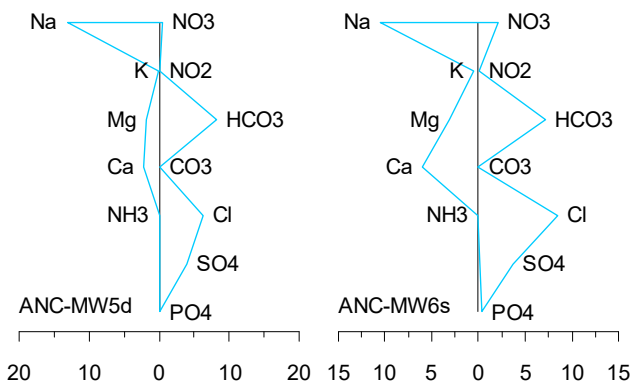
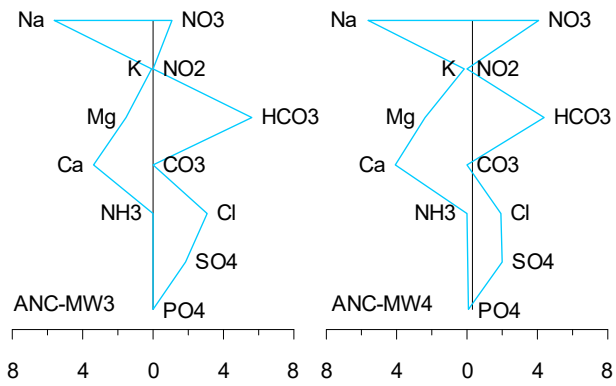
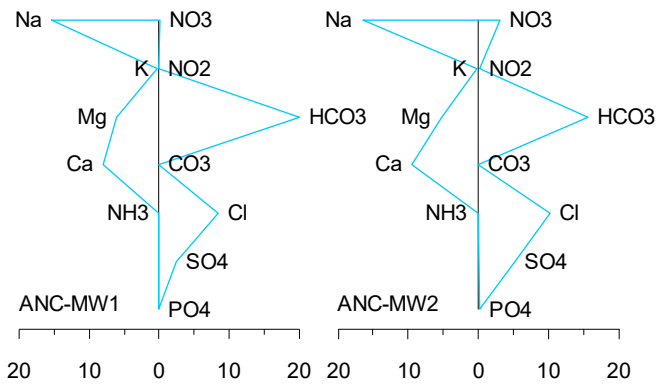

A11-18 ANC – Stiff diagrams, February 2019

BET

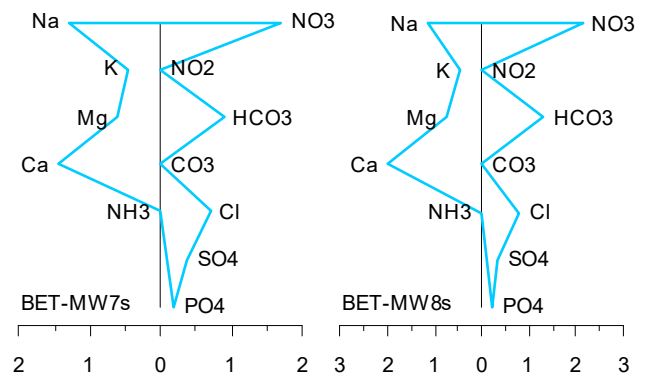
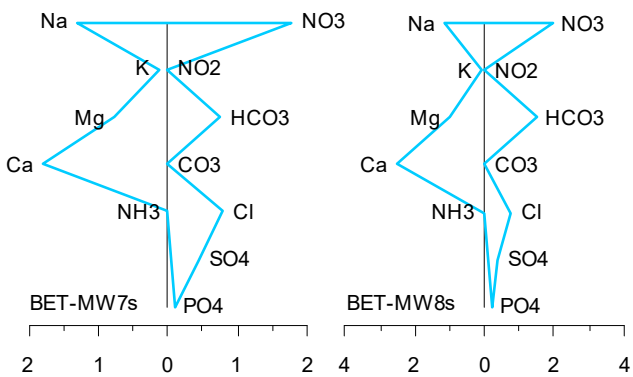
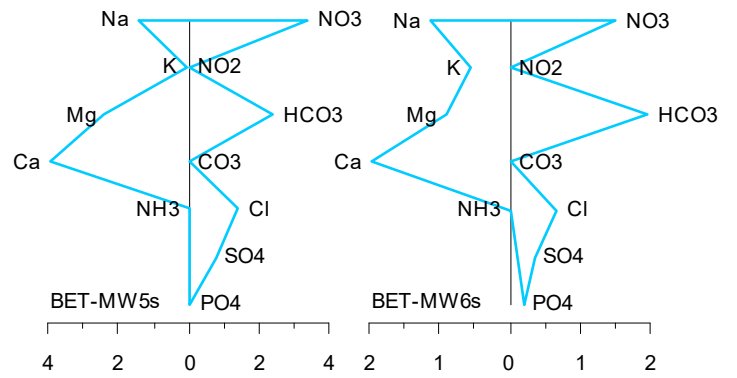
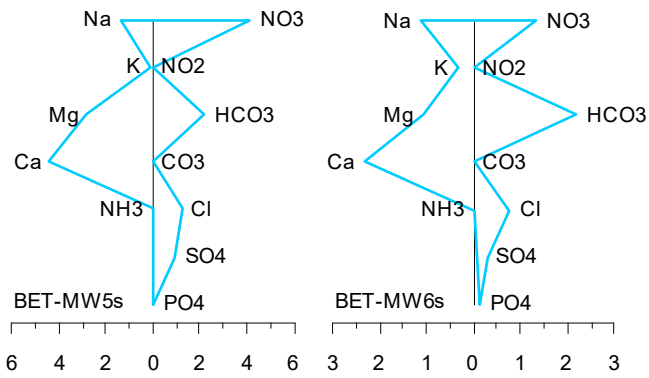
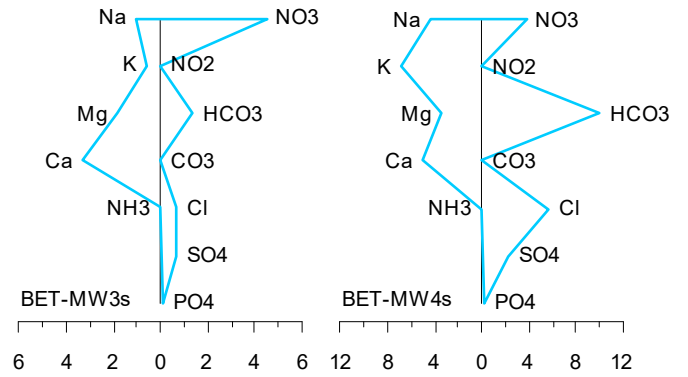
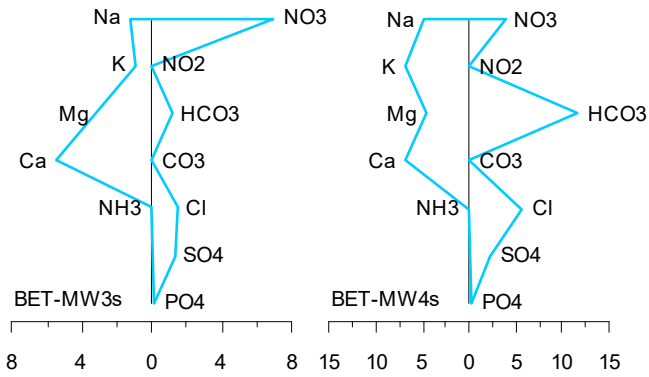
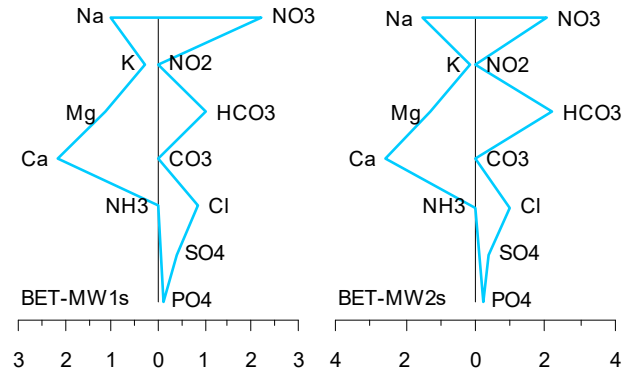
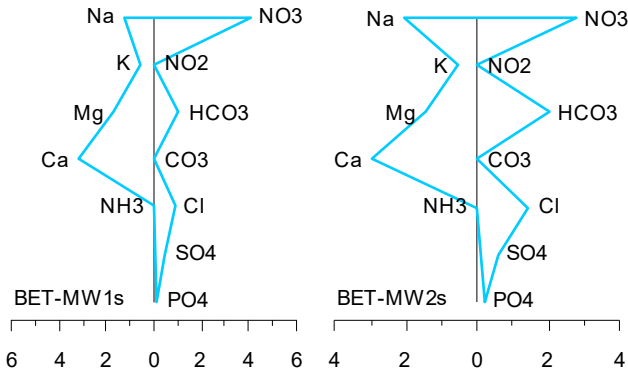

A11-19 BET – Stiff diagrams, May 2012

A11-20 BET – Stiff diagrams, August 2012

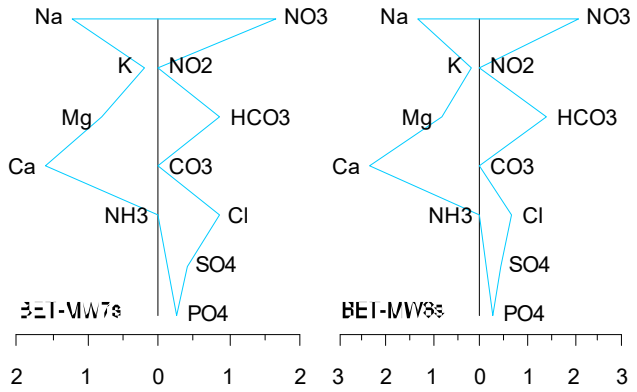
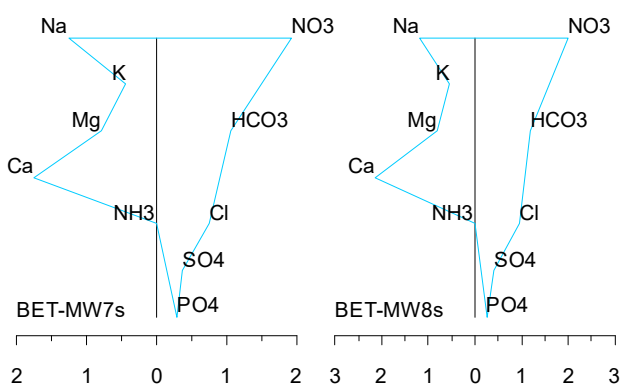
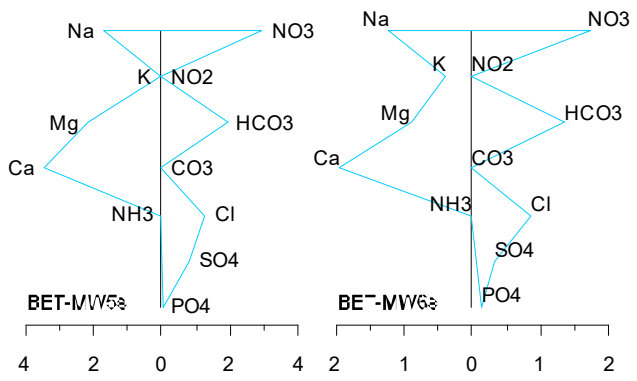
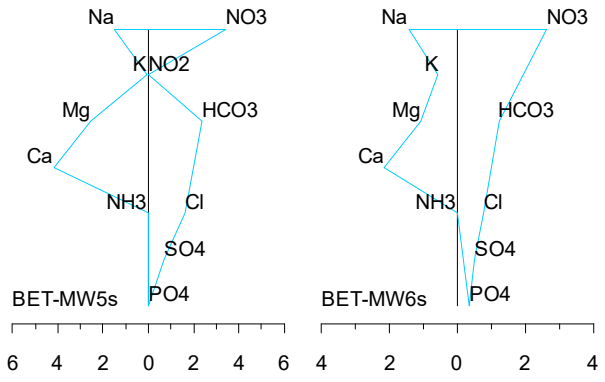
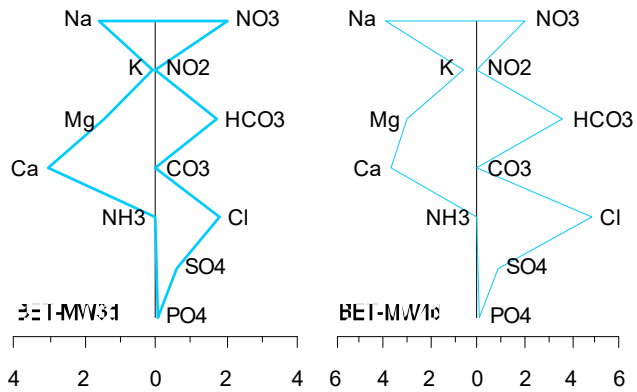
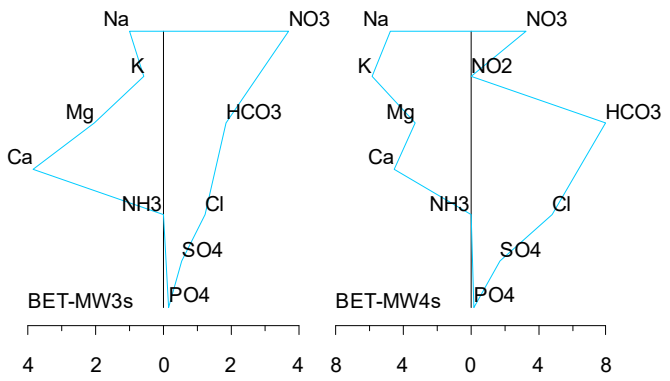
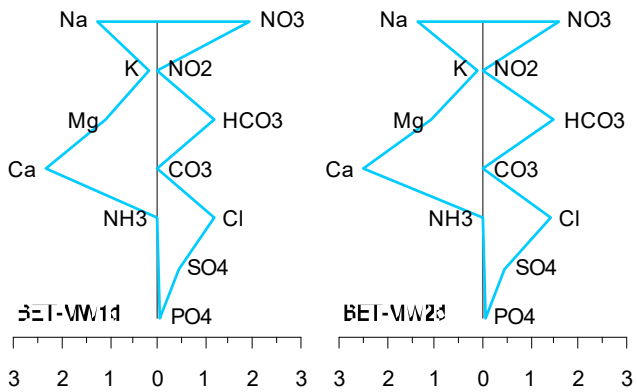
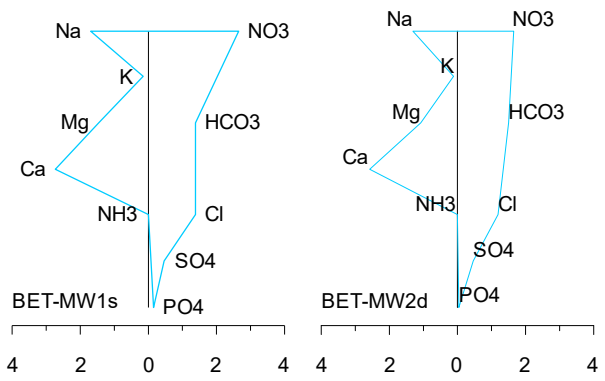

A11-21 BET – Stiff diagrams, August 2013

A11-22 BET – Stiff diagrams, August 2014

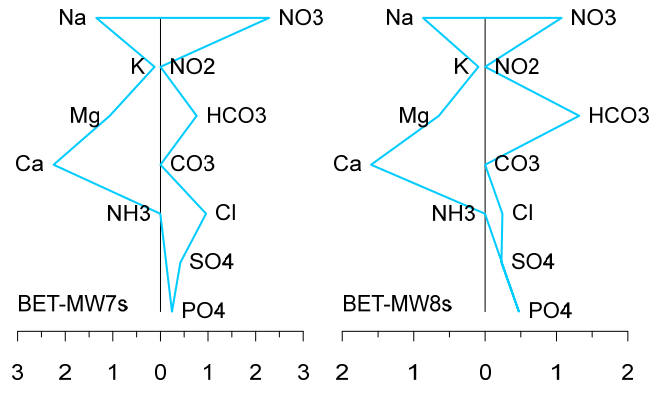
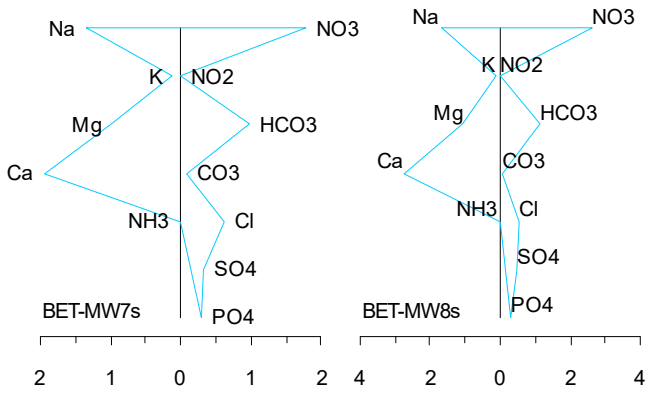
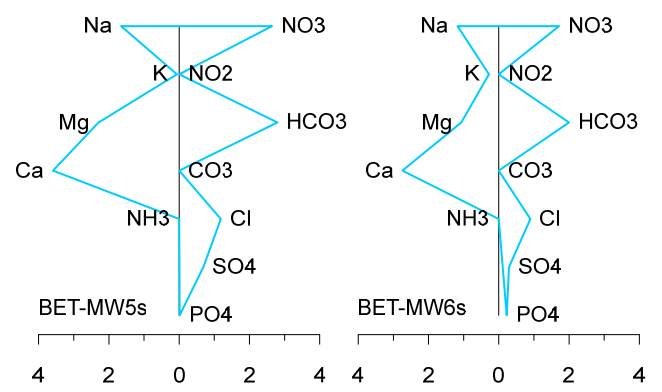
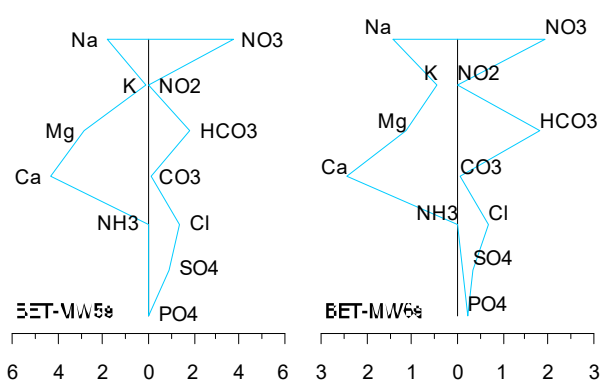
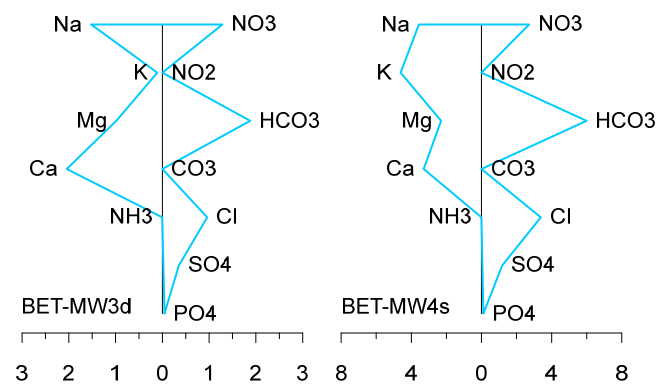
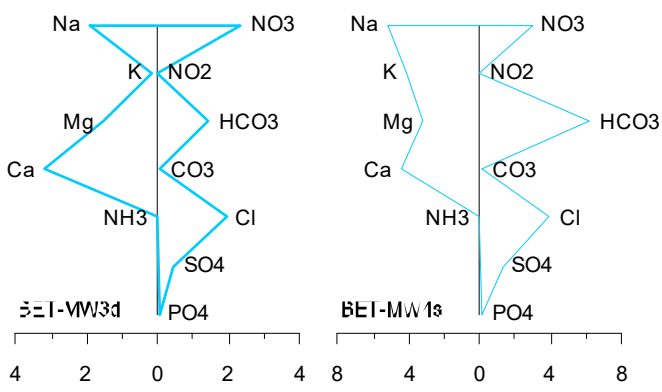
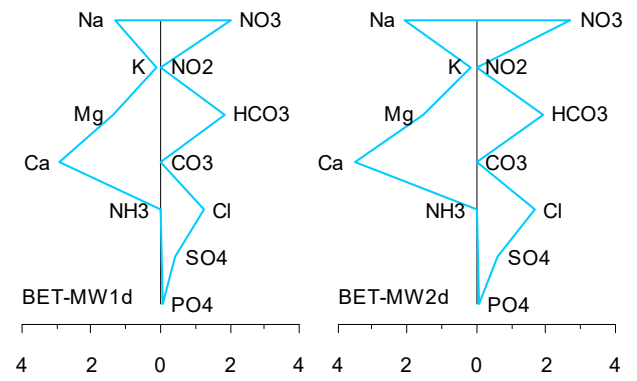
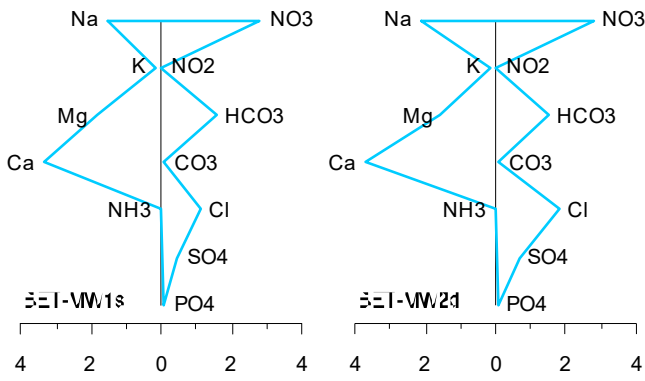

A11-23 BET – Stiff diagrams, February 2015

A11-24 BET – Stiff diagrams, February 2016

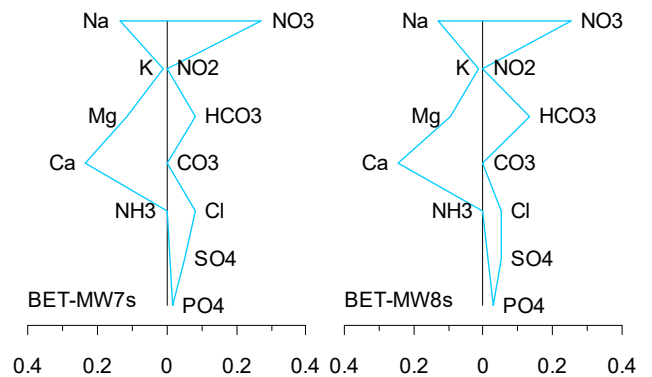
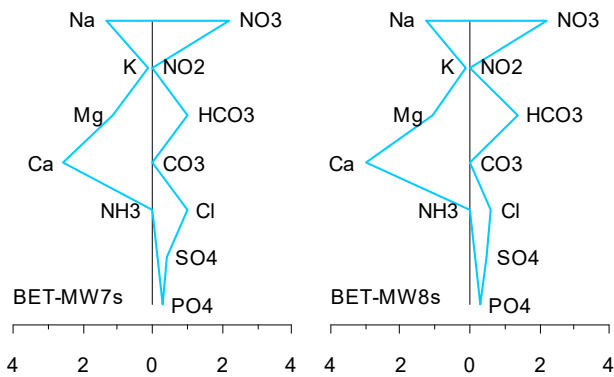
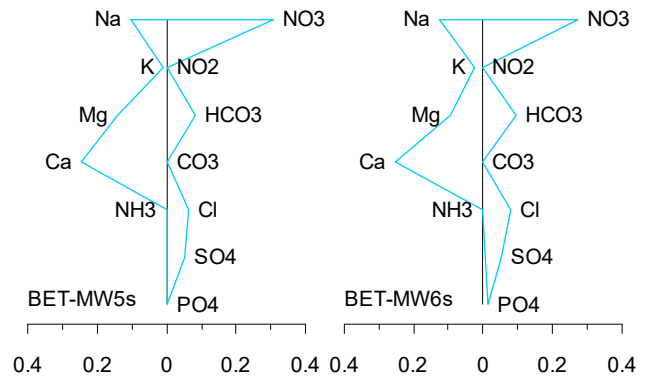
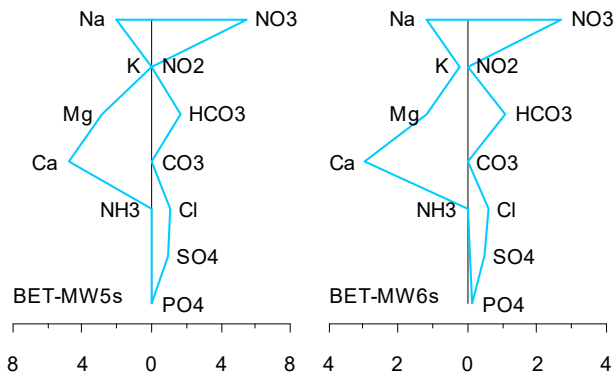
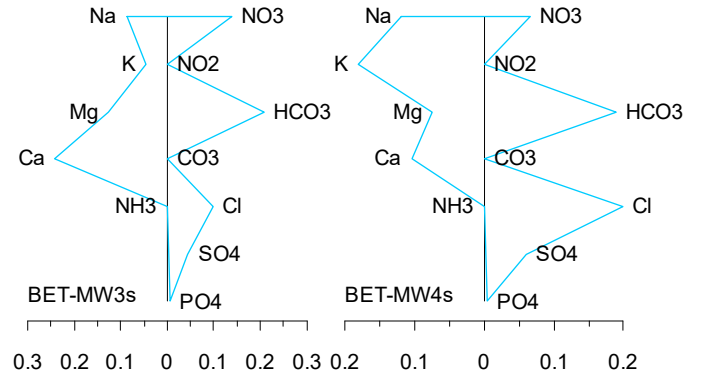
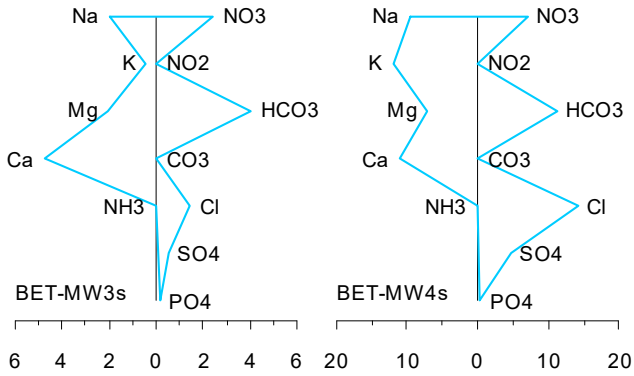
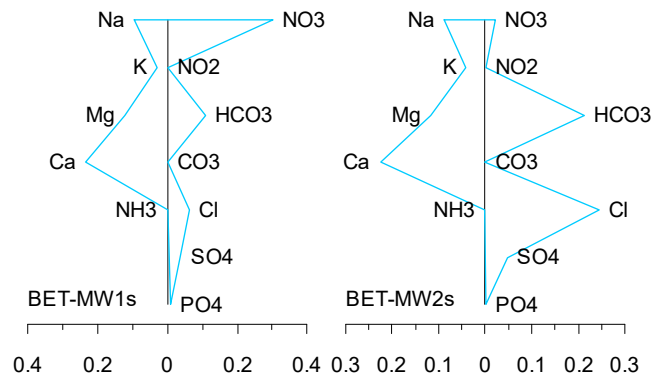
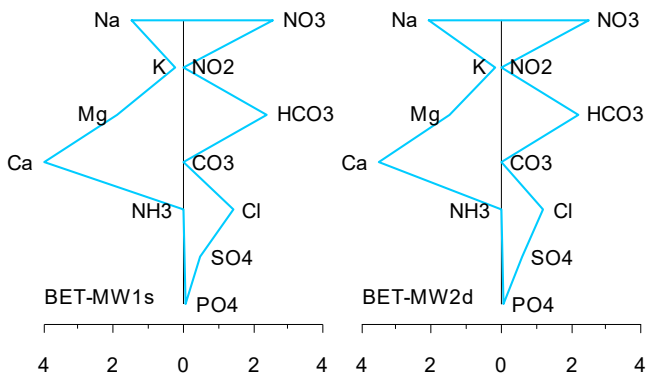

A11-25 BET – Stiff diagrams, March 2017

A11-26 BET – Stiff diagrams, February 2018

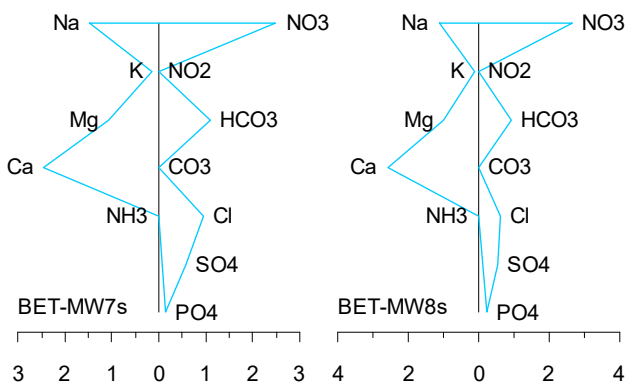
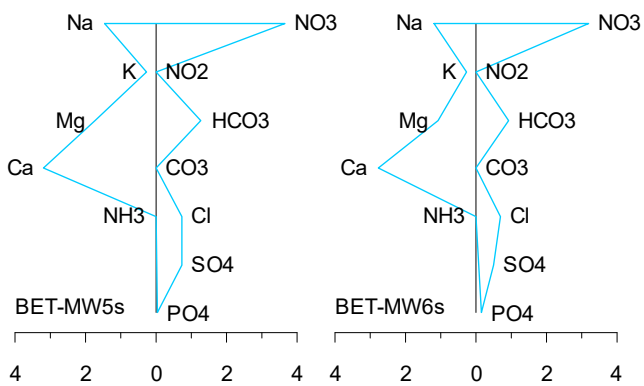
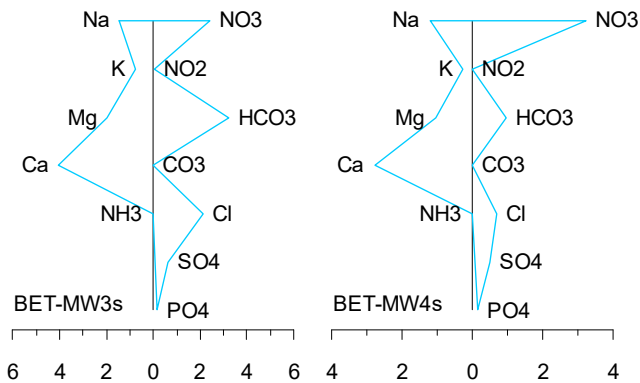
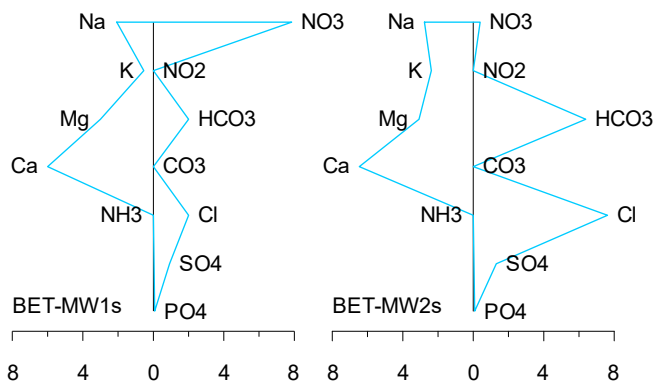

A11-27 BET – Stiff diagrams, February 2019

DIE

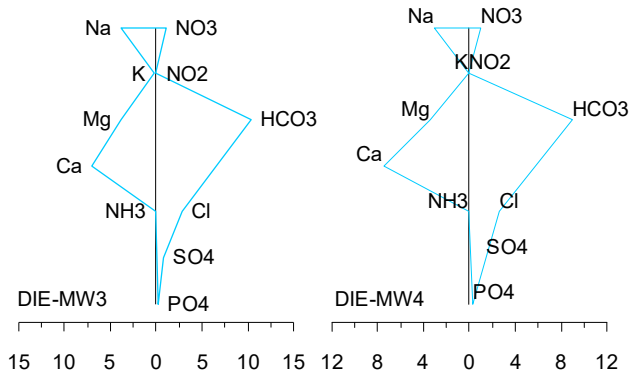

A11-28 DIE – Stiff diagrams, August 2013

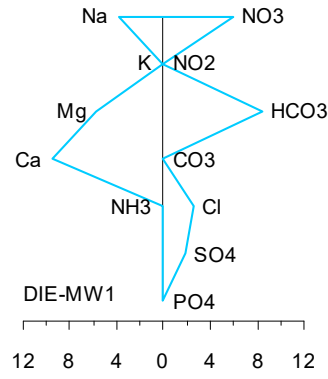

A11-30 DIE – Stiff diagrams, February 2016

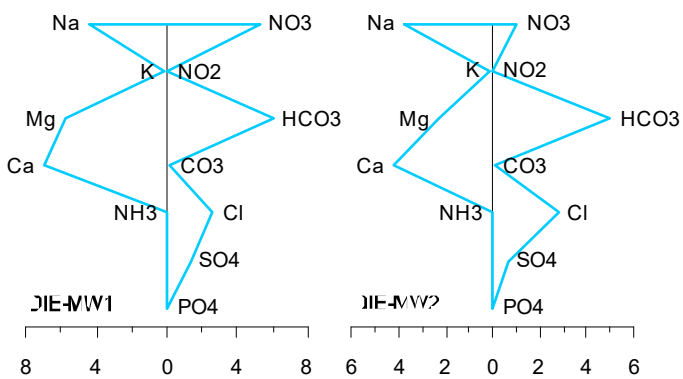

A11-29 DIE – Stiff diagrams, February 2015

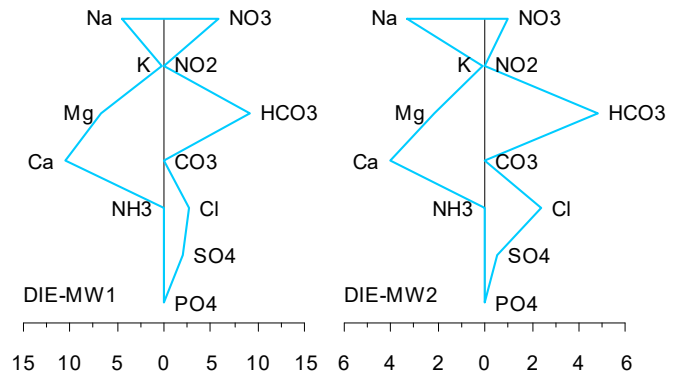

A11-31 DIE – Stiff diagrams, March 2017

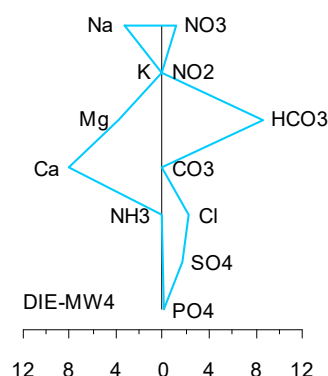
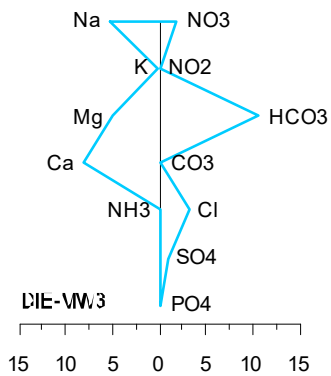

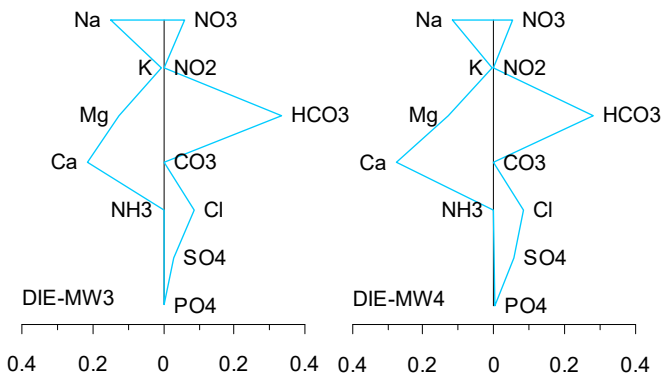
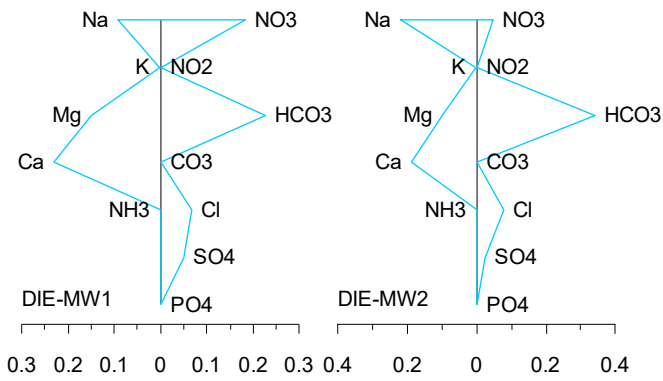

A11-32 DIE – Stiff diagrams, February 2018

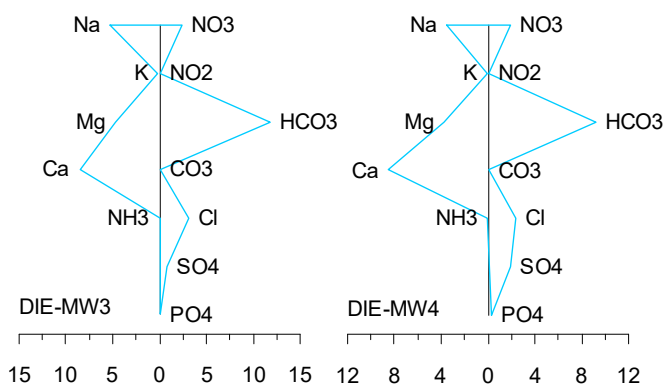
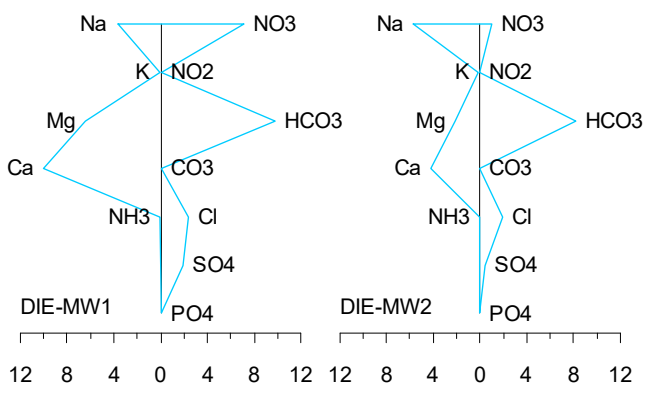

A11-33 DIE – Stiff diagrams, February 2019

DUR

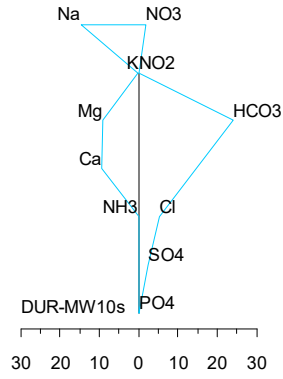
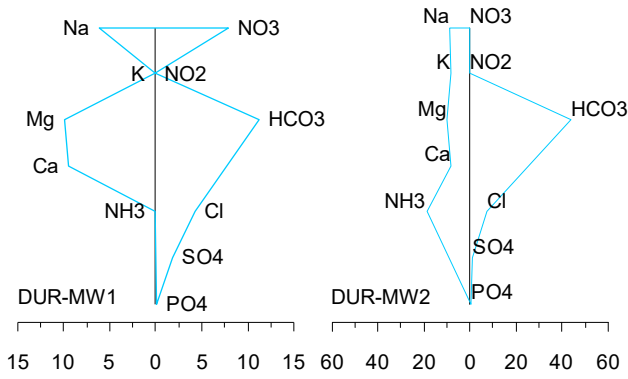

A11-34 DUR – Stiff diagrams, August 2013

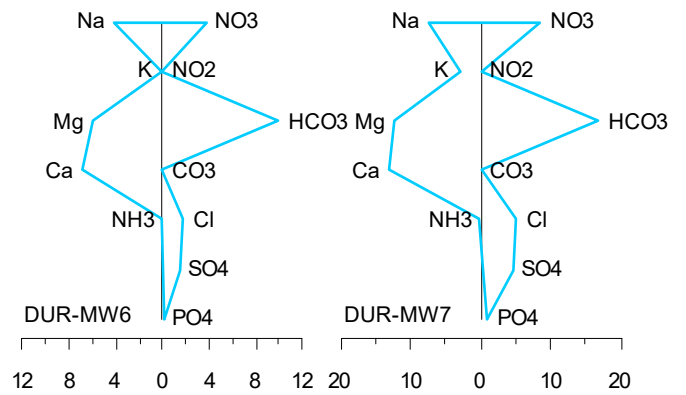
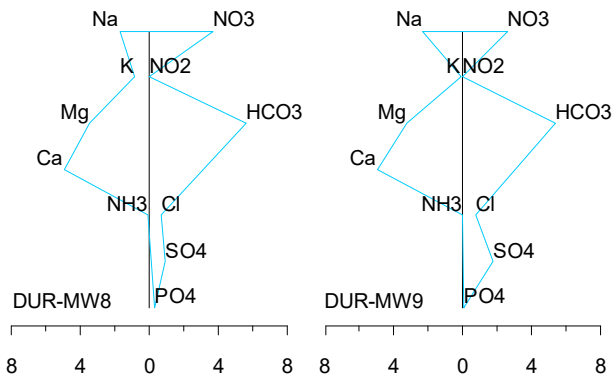
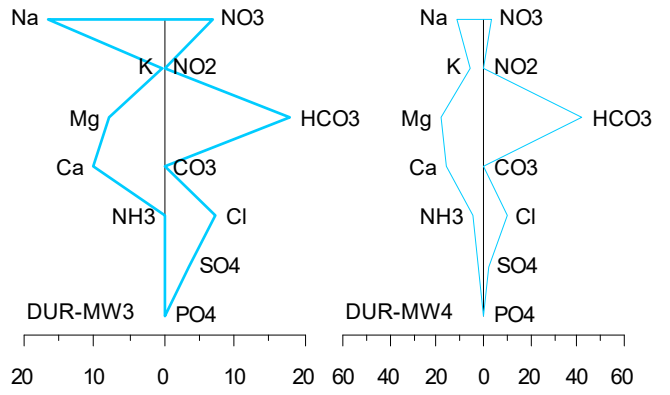
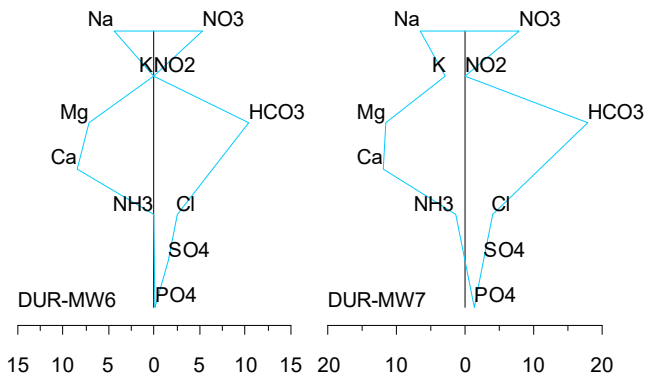
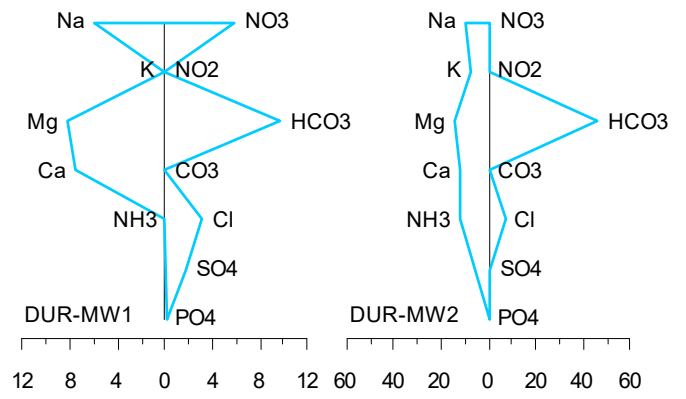
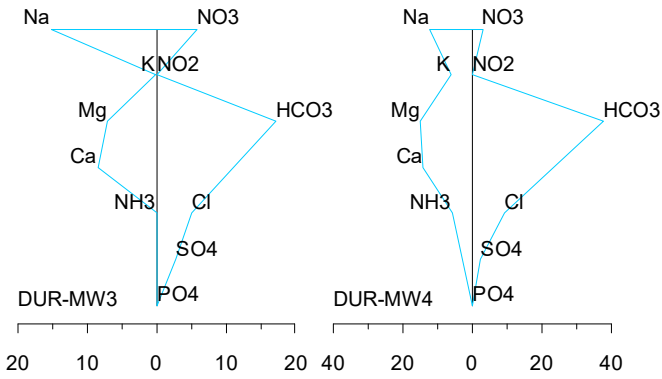

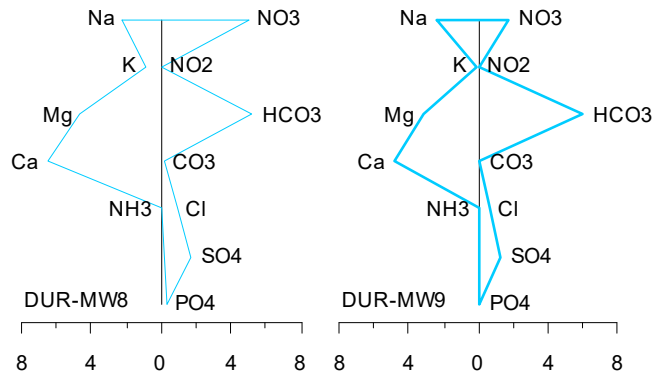
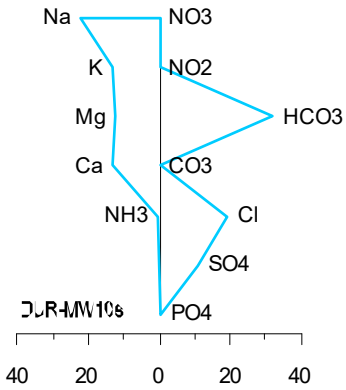
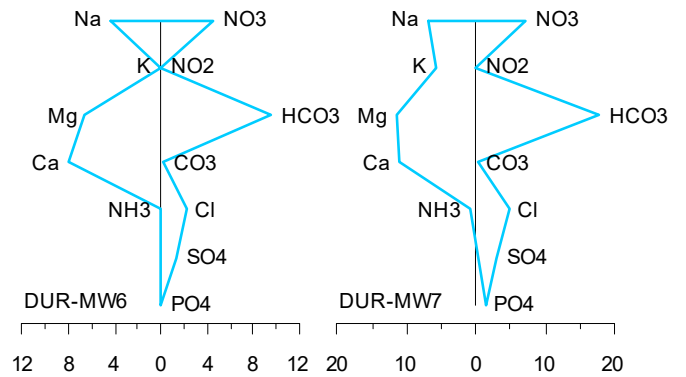
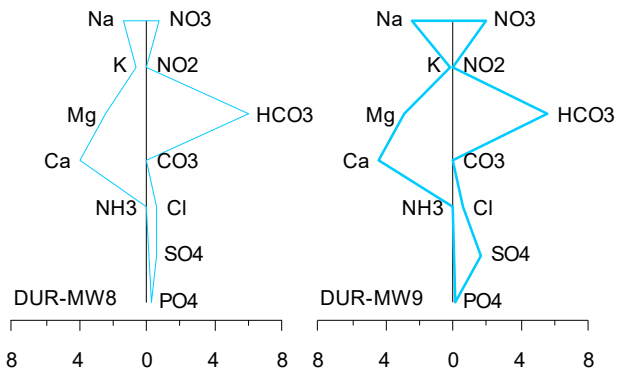

A11-35 DUR – Stiff diagrams, August 2014

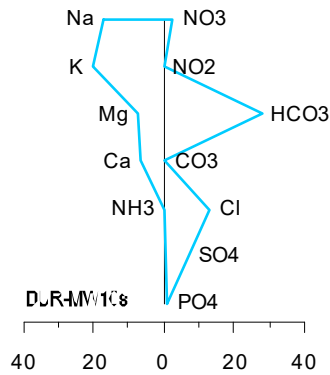
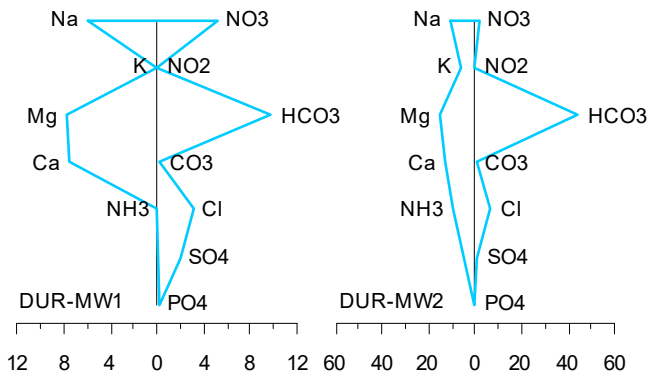

A11-36 DUR – Stiff diagrams, February 2015

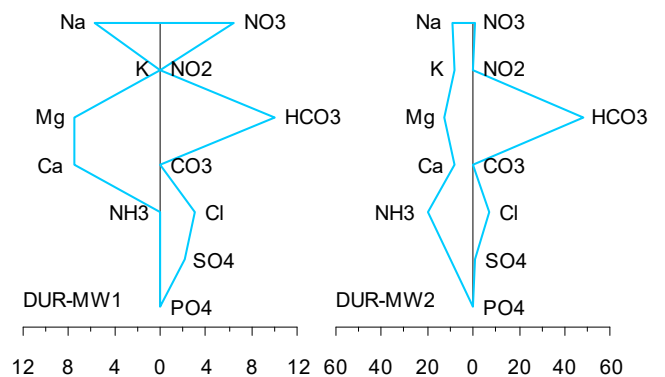
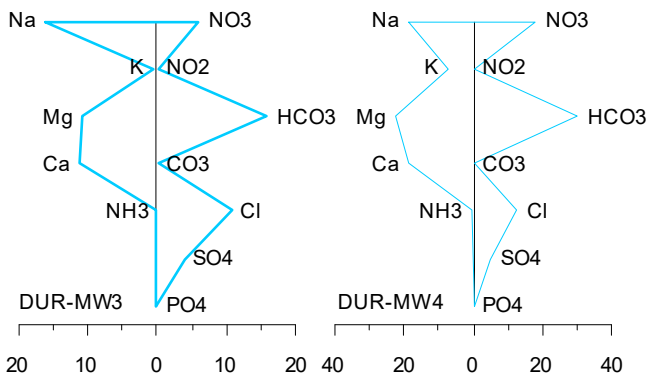

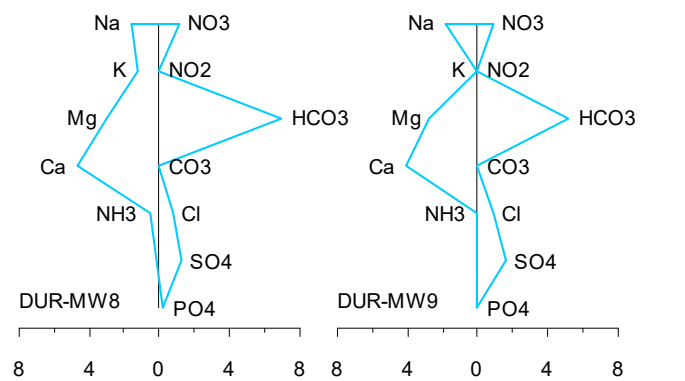
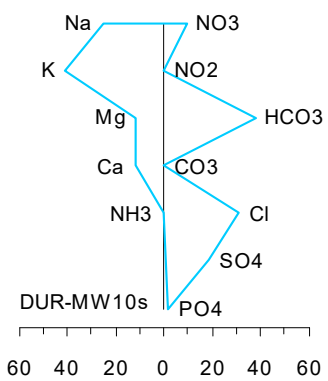
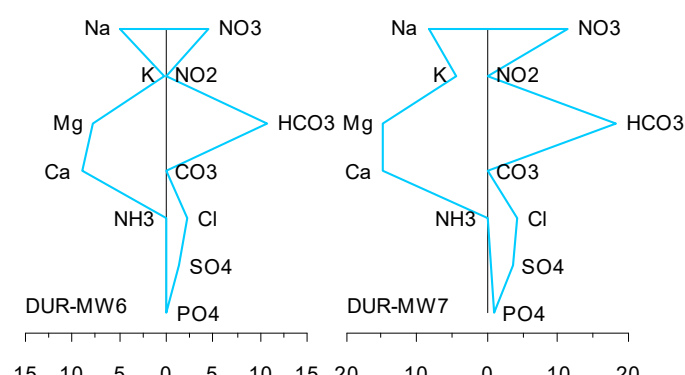
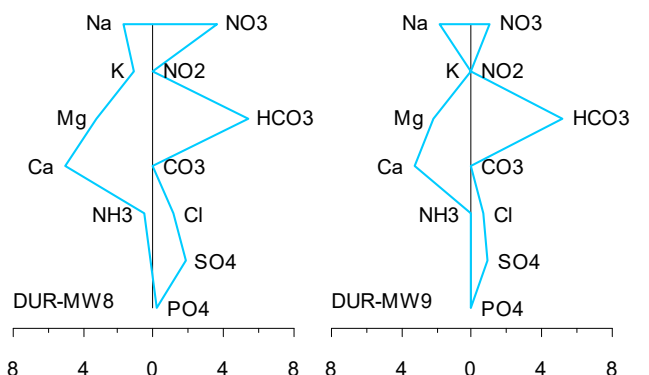
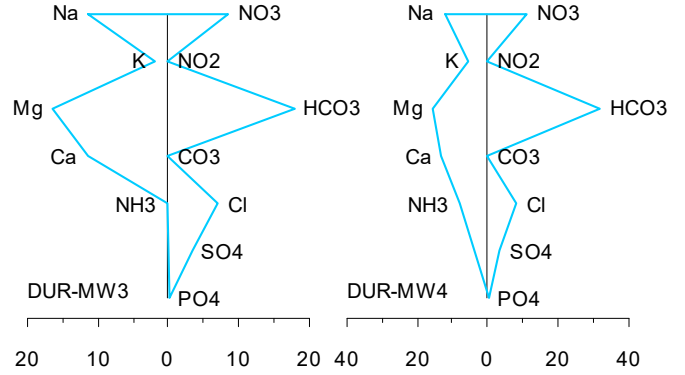
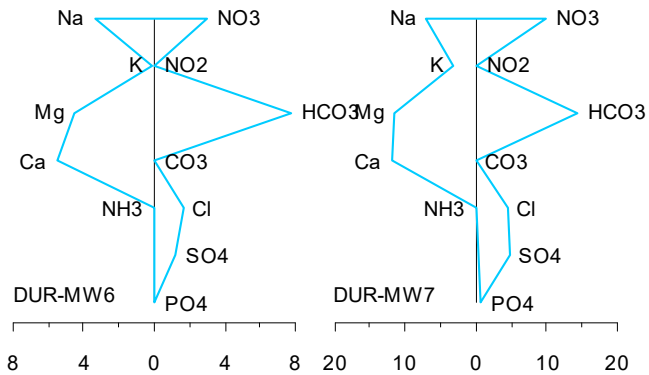
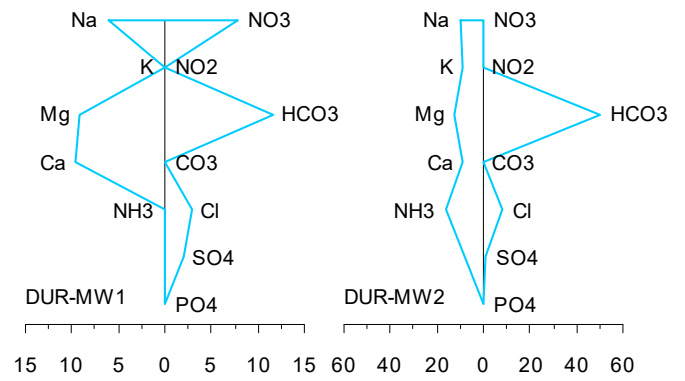
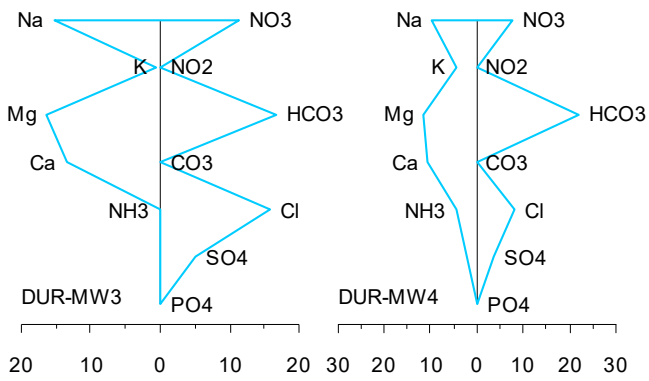

A11-37 DUR – Stiff diagrams, February 2016

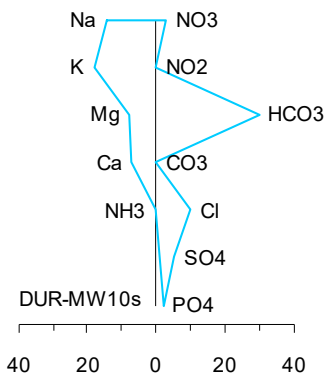

A11-38 DUR – Stiff diagrams, March 2017

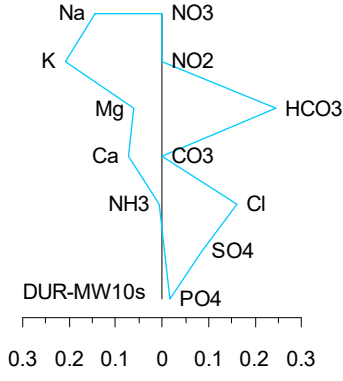
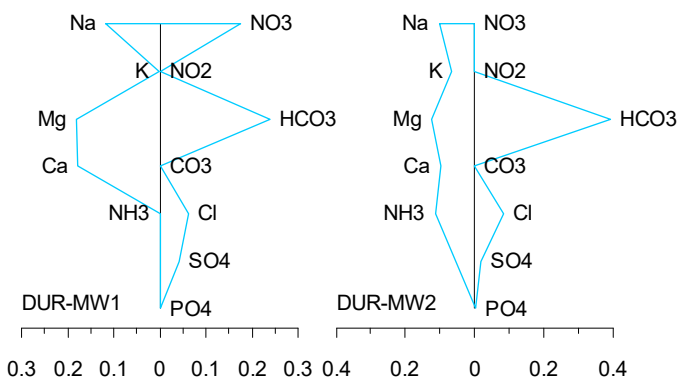
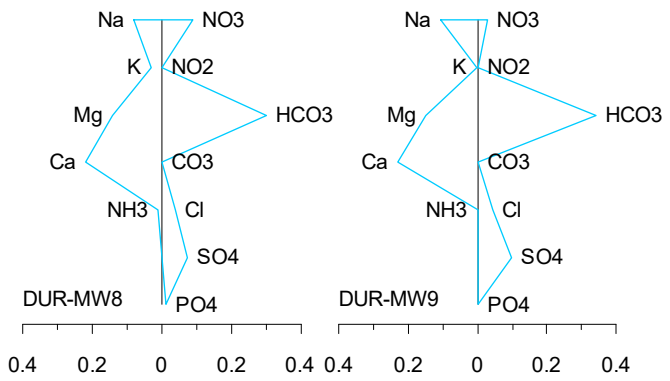

A11-39 DUR – Stiff diagrams, February 2018

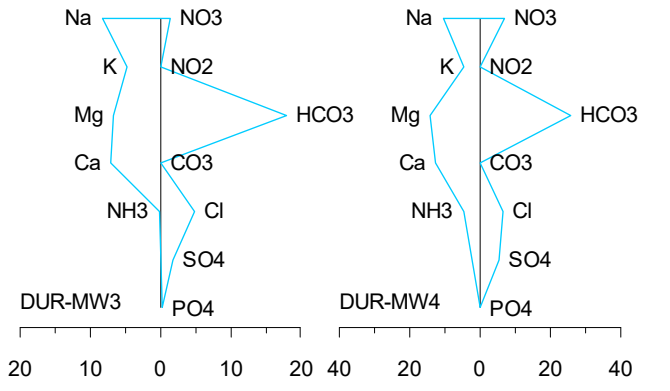
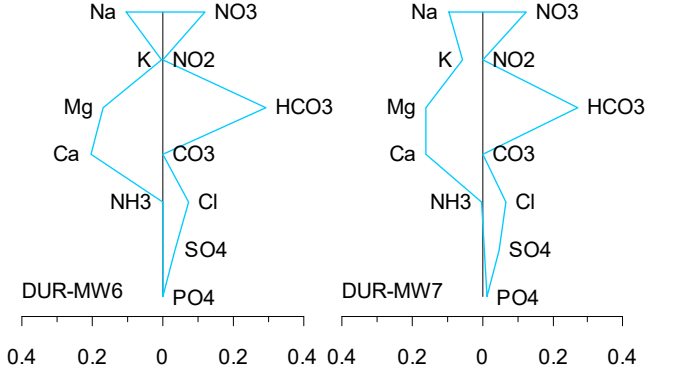
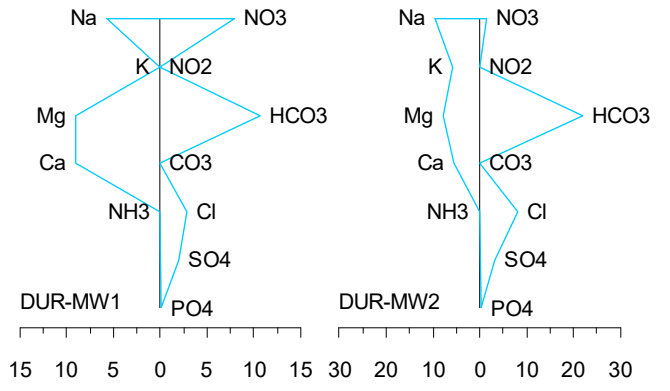
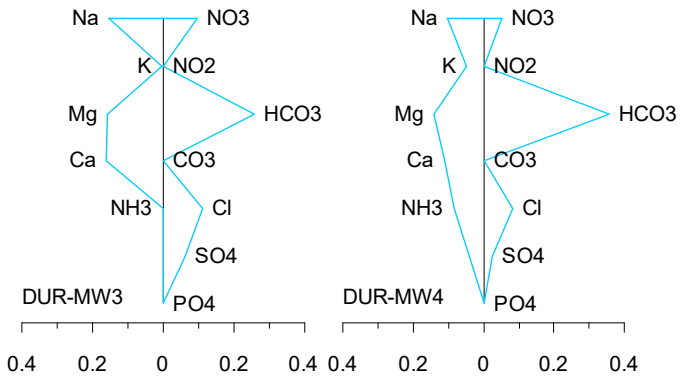

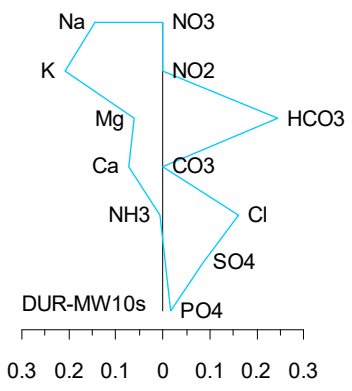
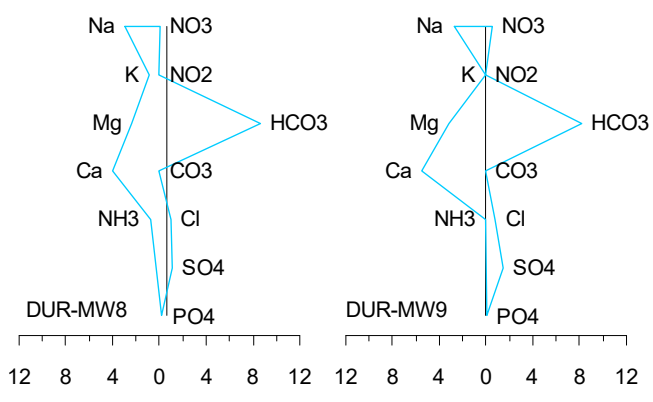
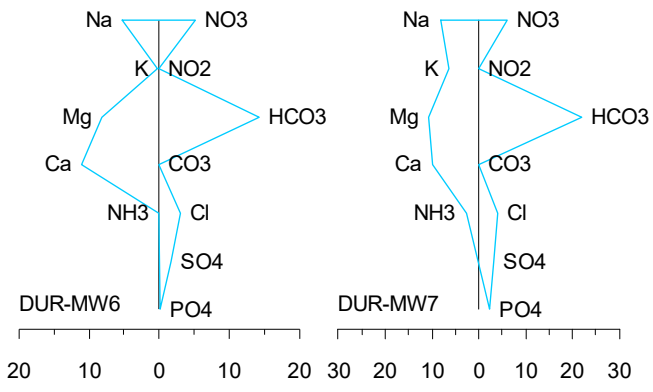

A11-40 DUR – Stiff diagrams, February 2019

FG1

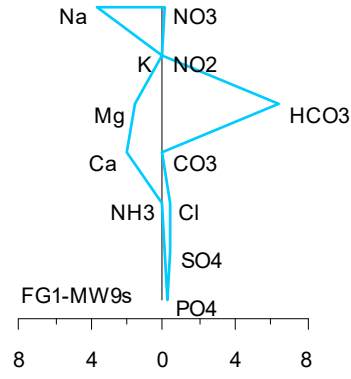
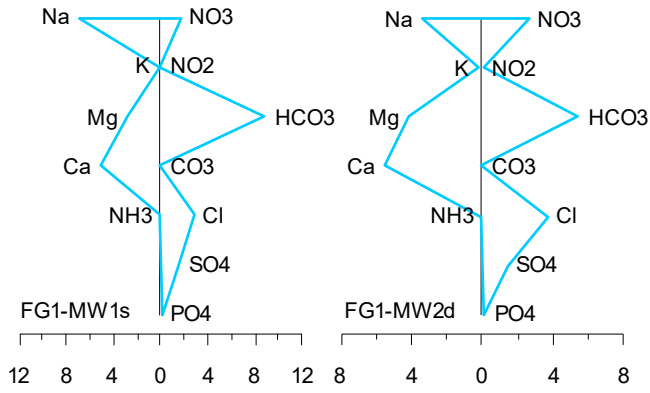

A11-41 FG1 – Stiff diagrams, May 2012

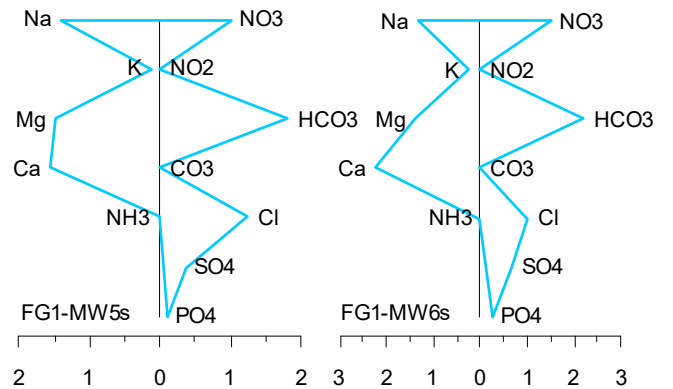
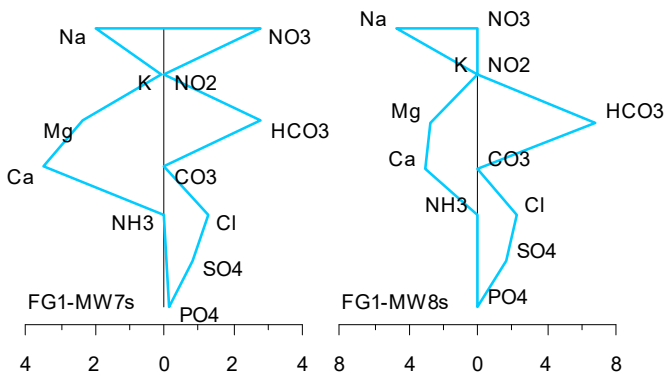
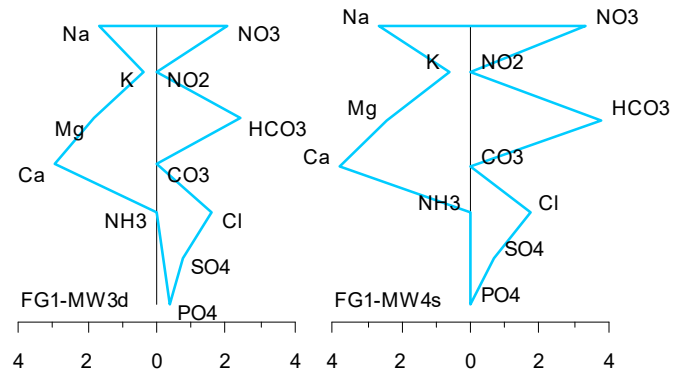
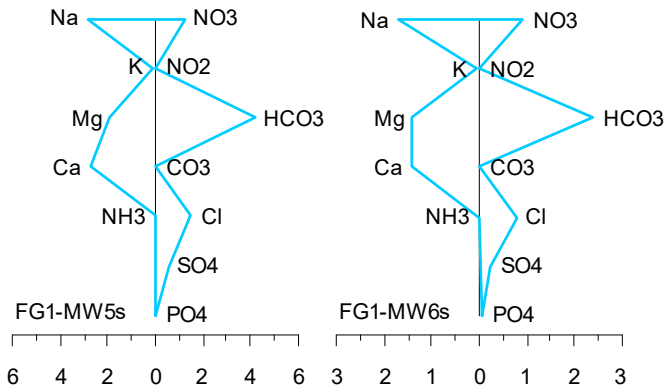
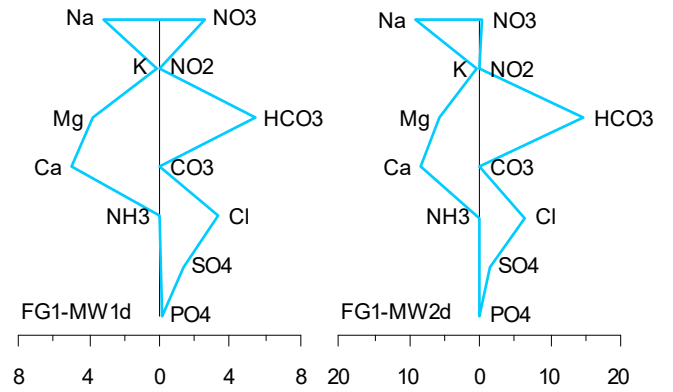
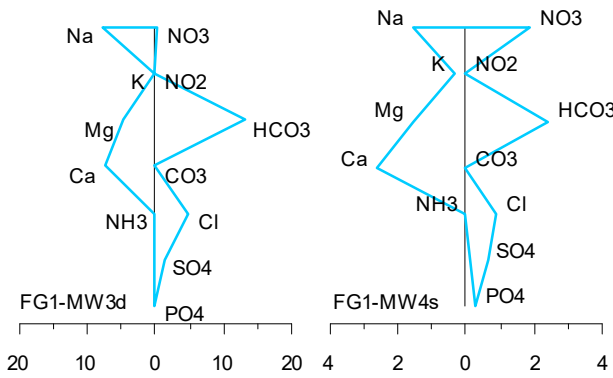

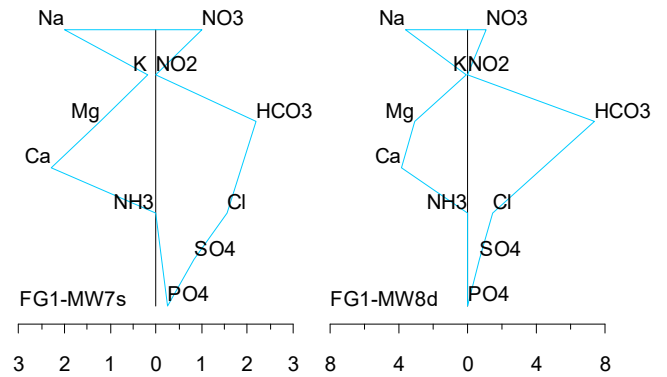
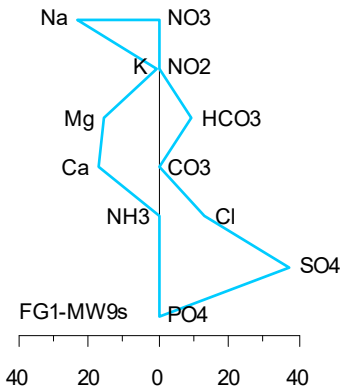
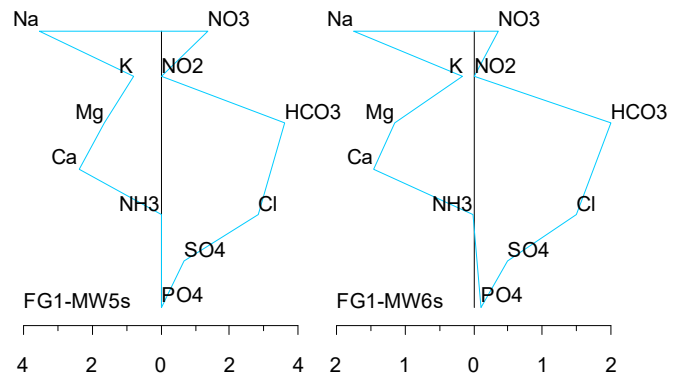
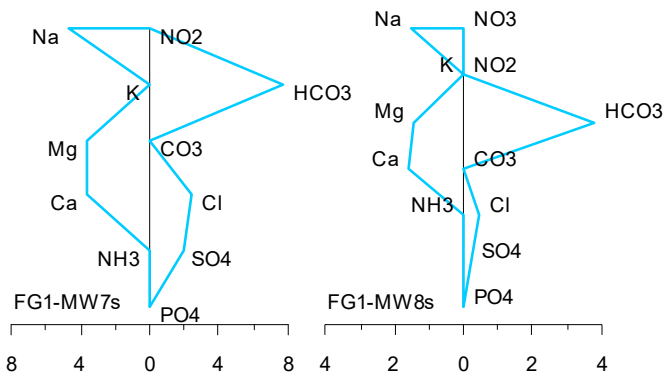

A11-42 FG1 – Stiff diagrams, August 2012

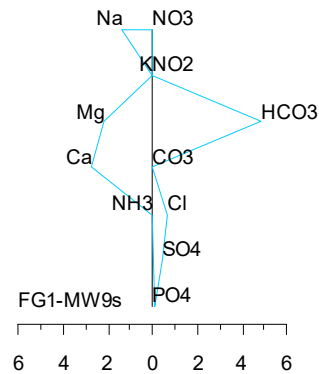
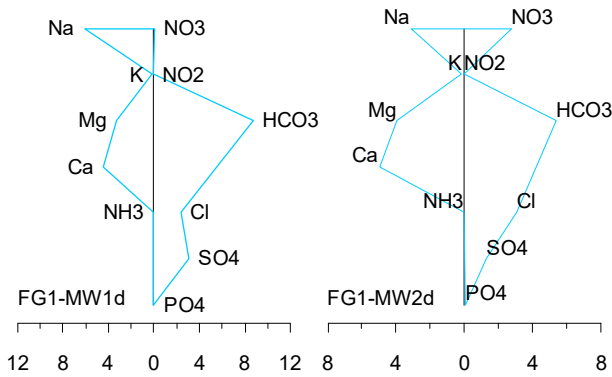

A11-43 FG1 – Stiff diagrams, August 2013

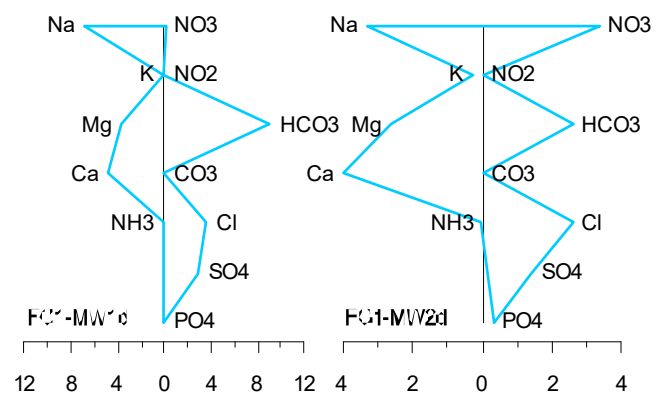
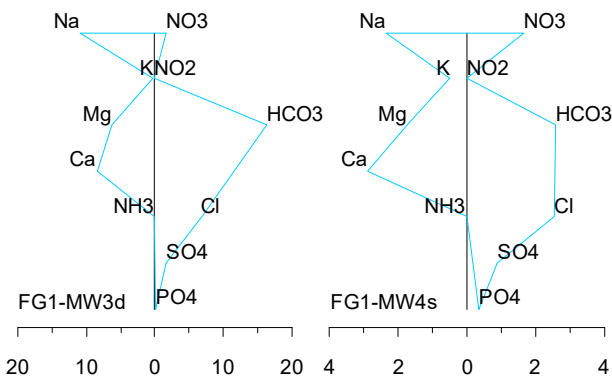

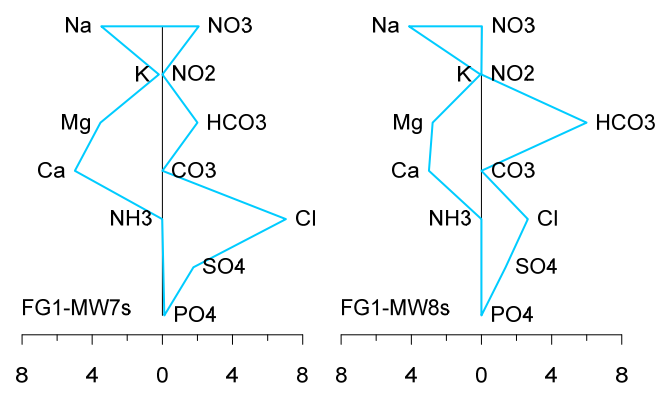
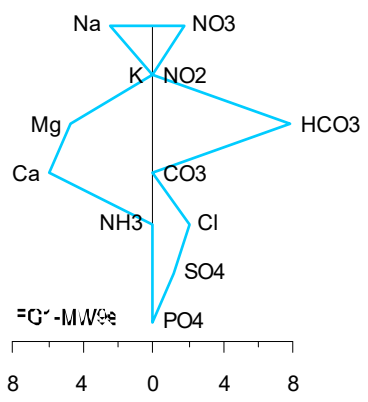
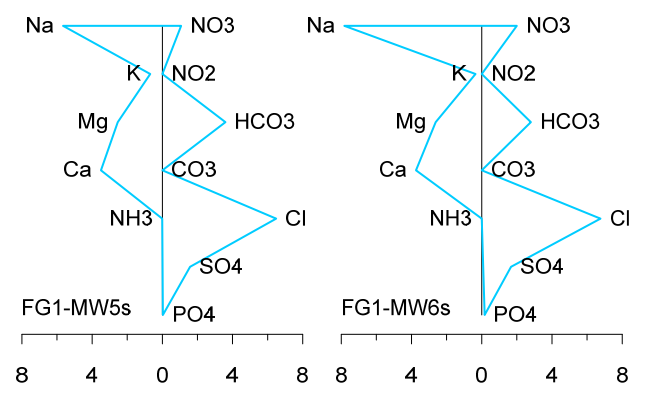
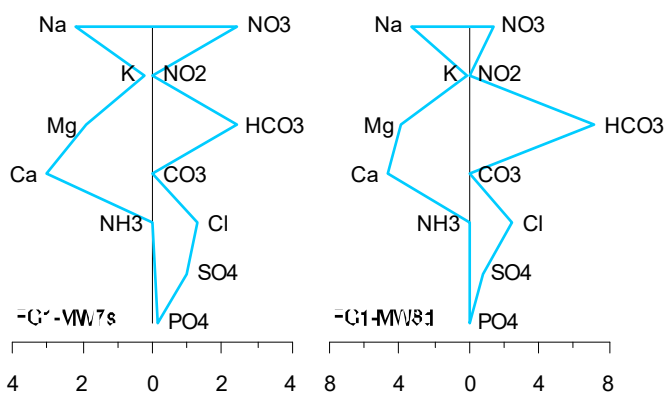
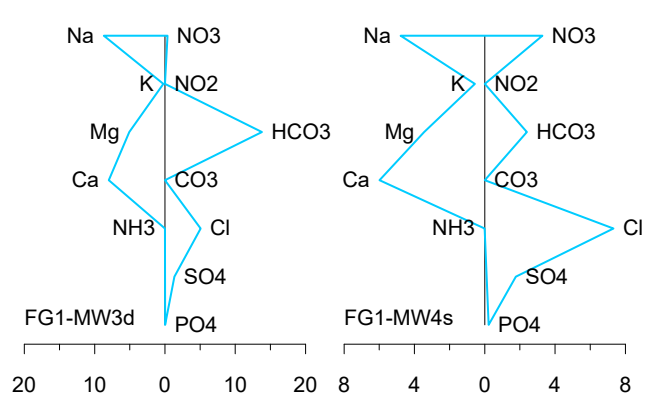
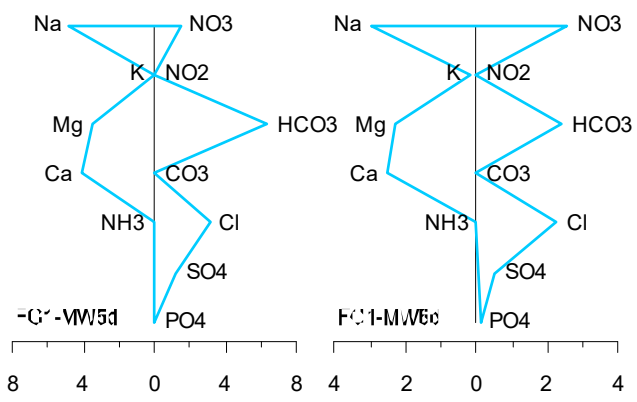
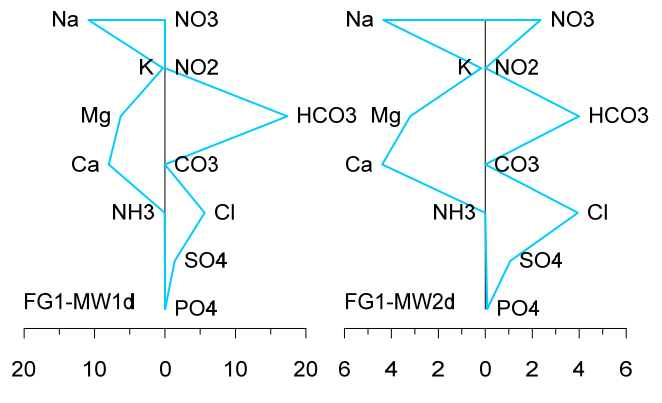
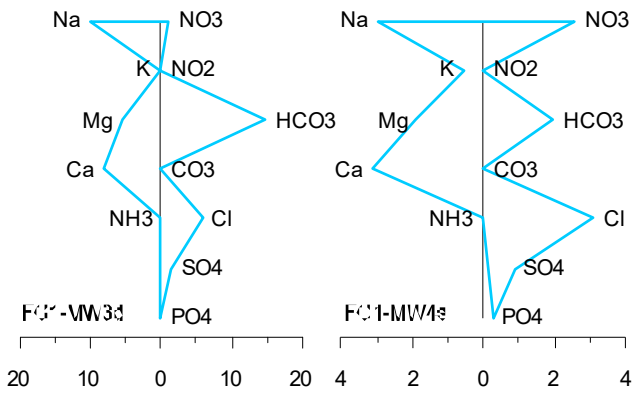

A11-44 FG1 – Stiff diagrams, August 2014

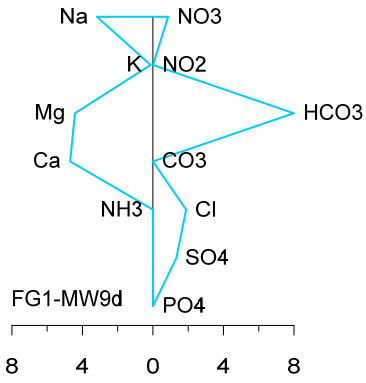

A11-45 FG1 – Stiff diagrams, February 2016

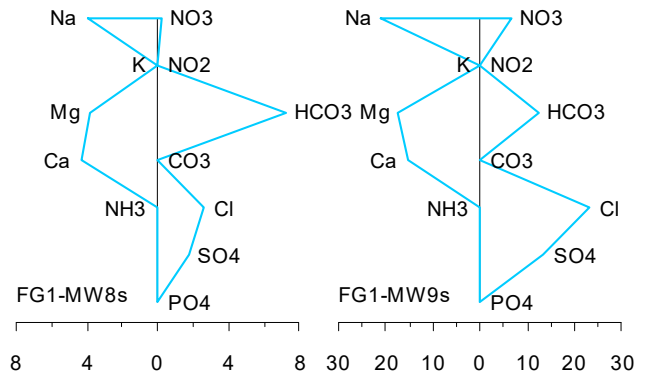

A11-46 FG1 – Stiff diagrams, March 2017

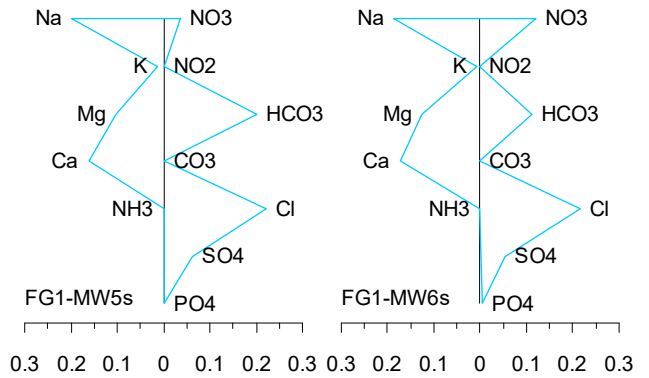
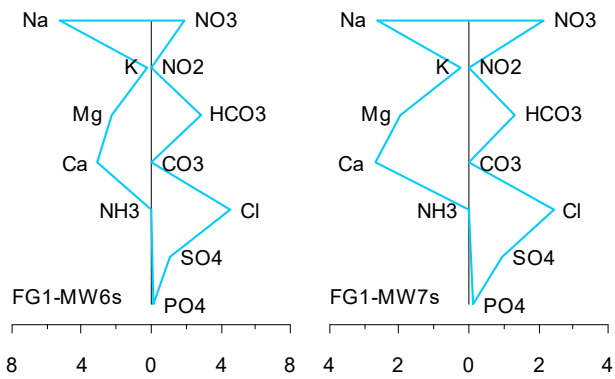
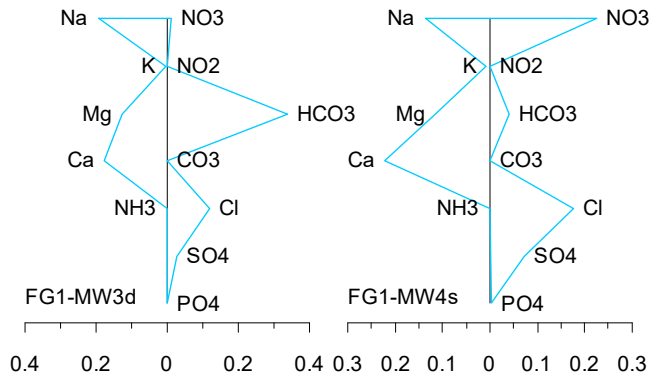
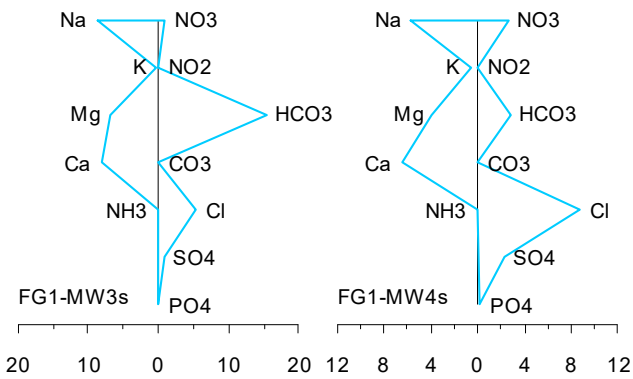
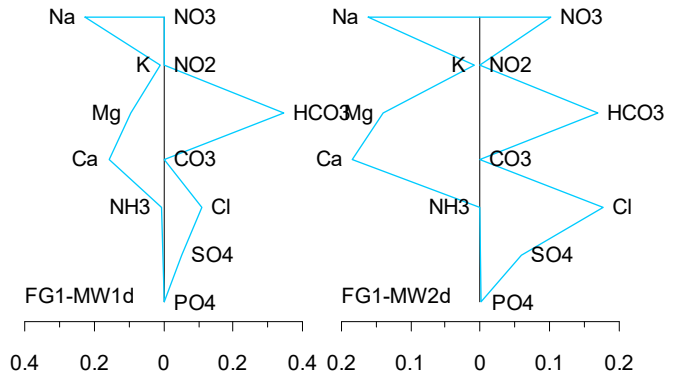
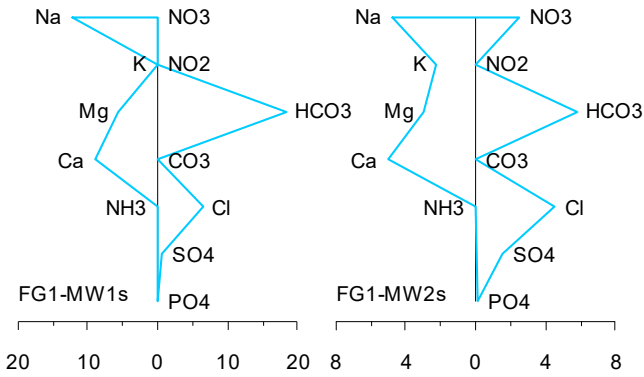

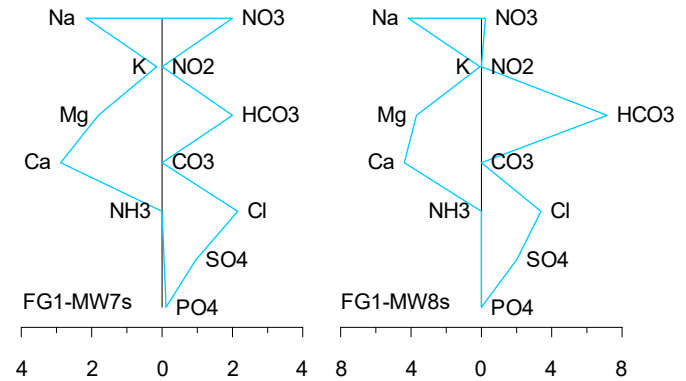
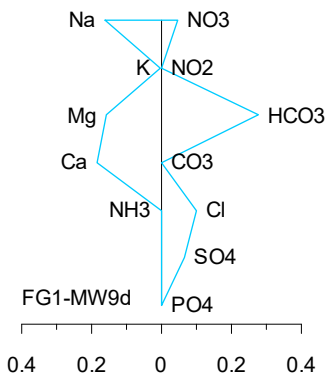
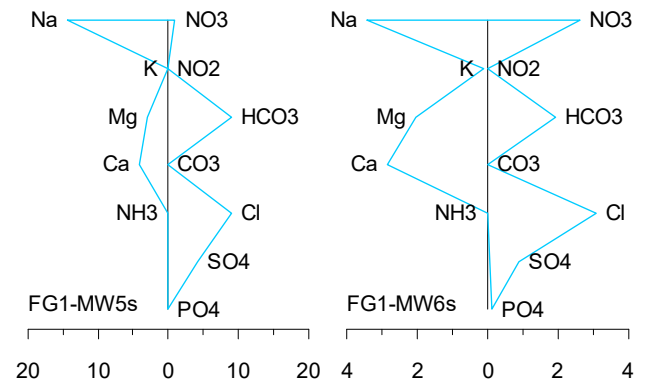
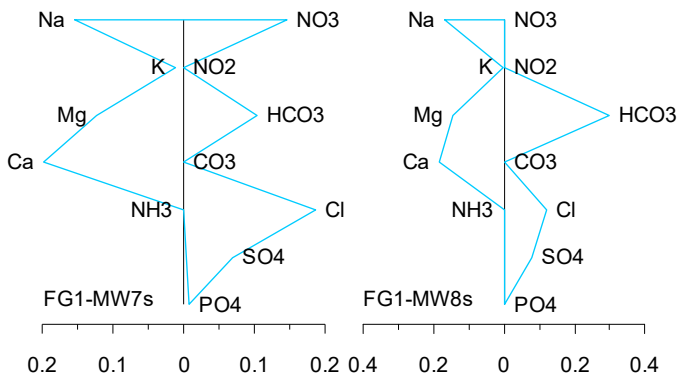

A11-47 FG1 – Stiff diagrams, February 2018

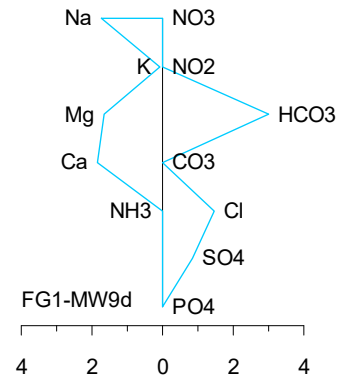
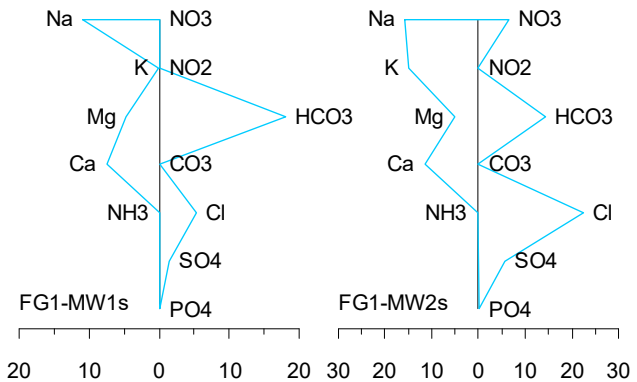

A11-48 FG1 – Stiff diagrams, February 2019

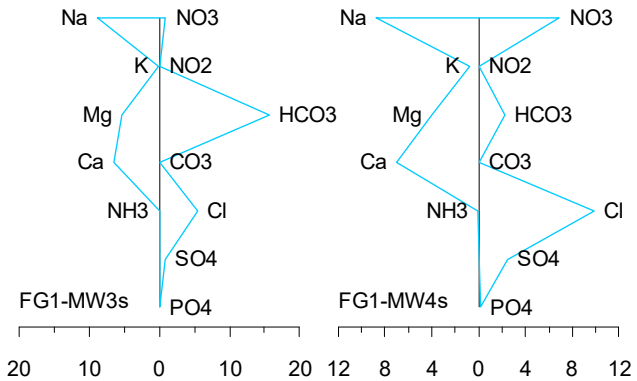

BEA

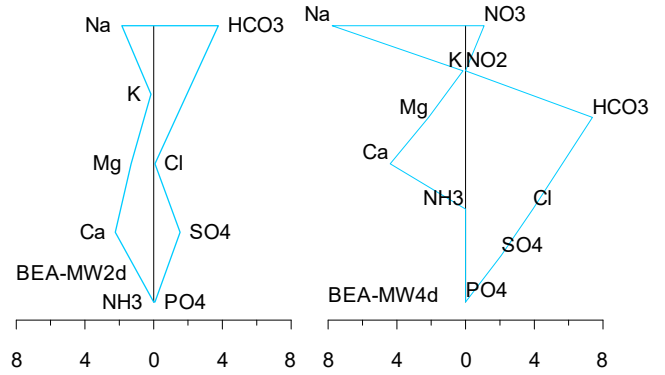
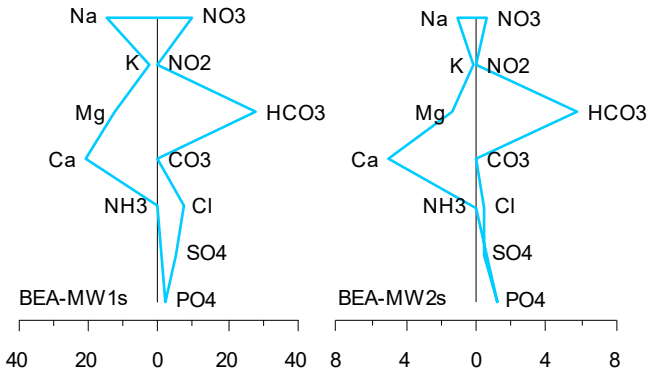

A11-51 BEA – Stiff diagrams, August 2013

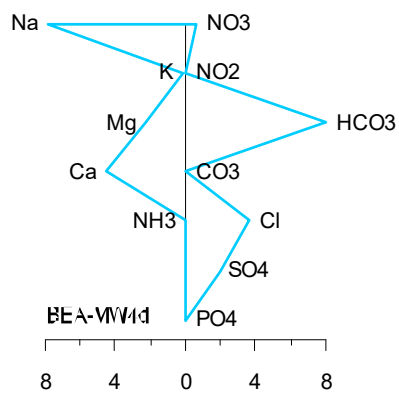
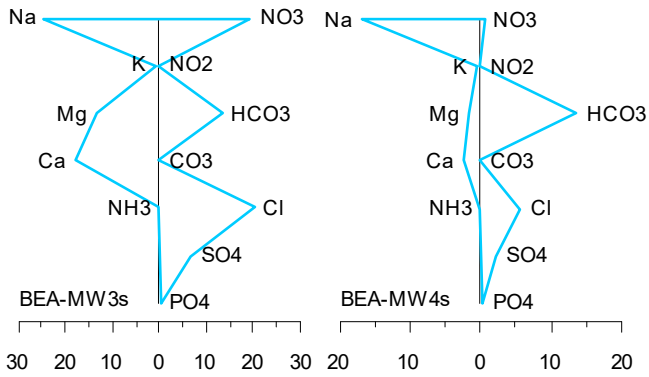

A11-52 BEA – Stiff diagrams, August 2014

A11-49 BEA – Stiff diagrams, May 2012

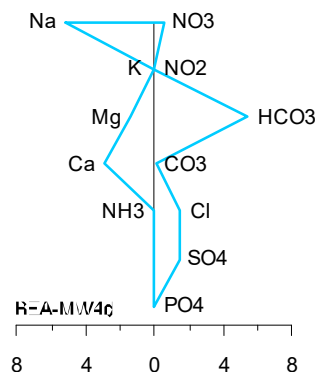
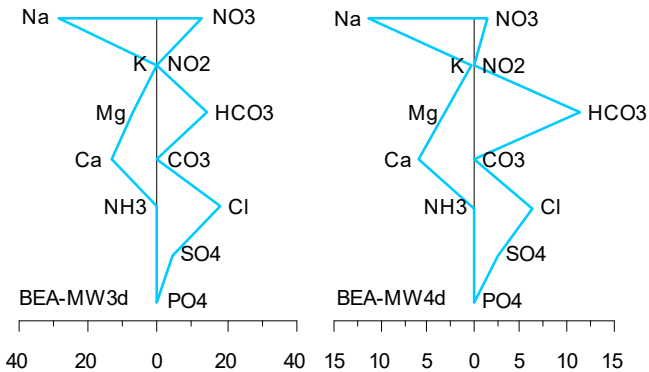
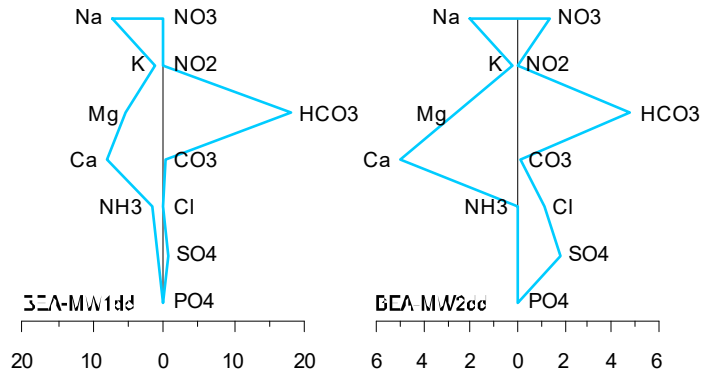
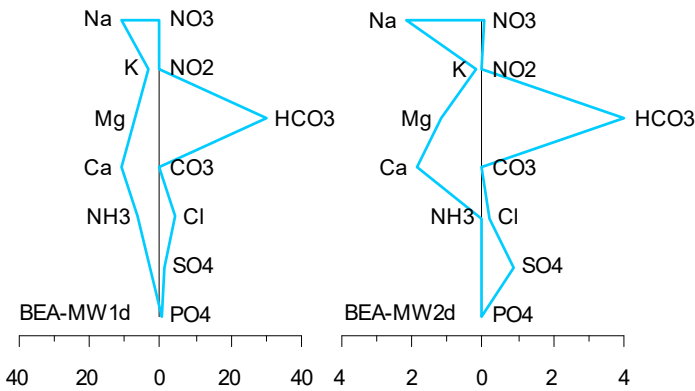

A11-50 BEA – Stiff diagrams, August 2012

A11-53 BEA – Stiff diagrams, February 2015

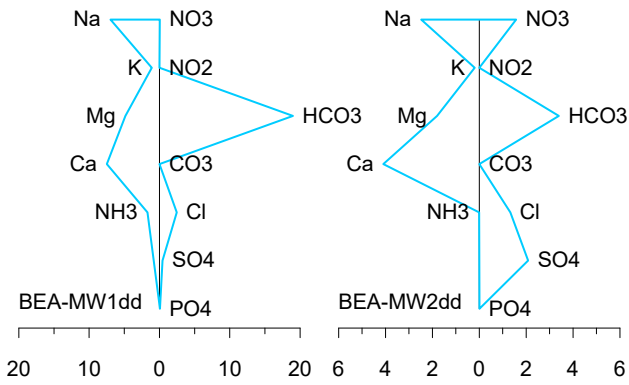

A11-54 BEA – Stiff diagrams, February 2016

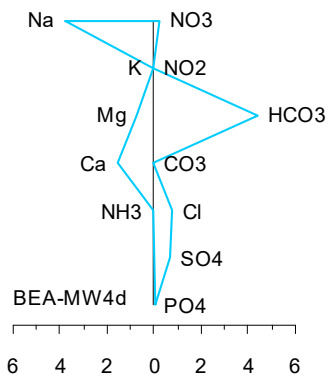
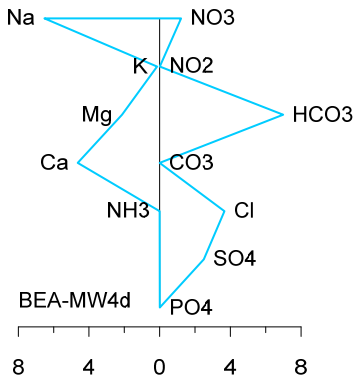
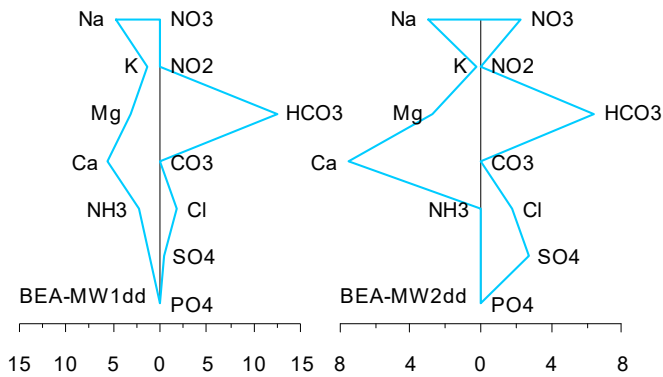

A11-55 BEA – Stiff diagrams, March 2017

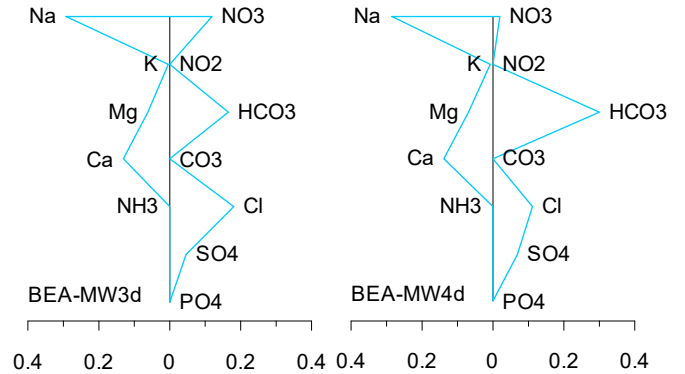
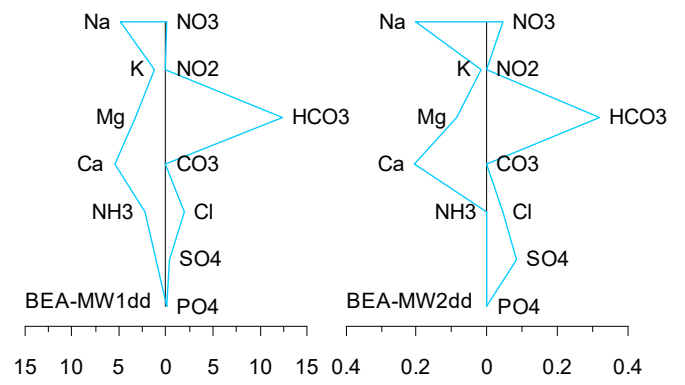

A11-56 BEA – Stiff diagrams, February 2018

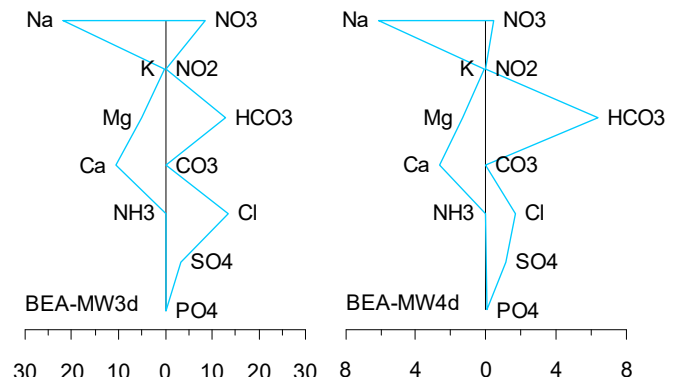
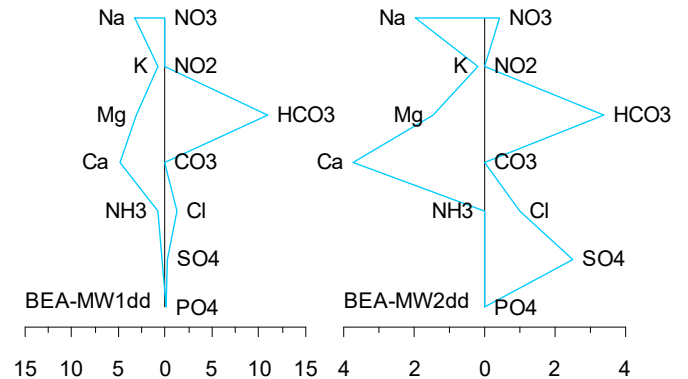

A11-57 BEA – Stiff diagrams, February 2019

COT

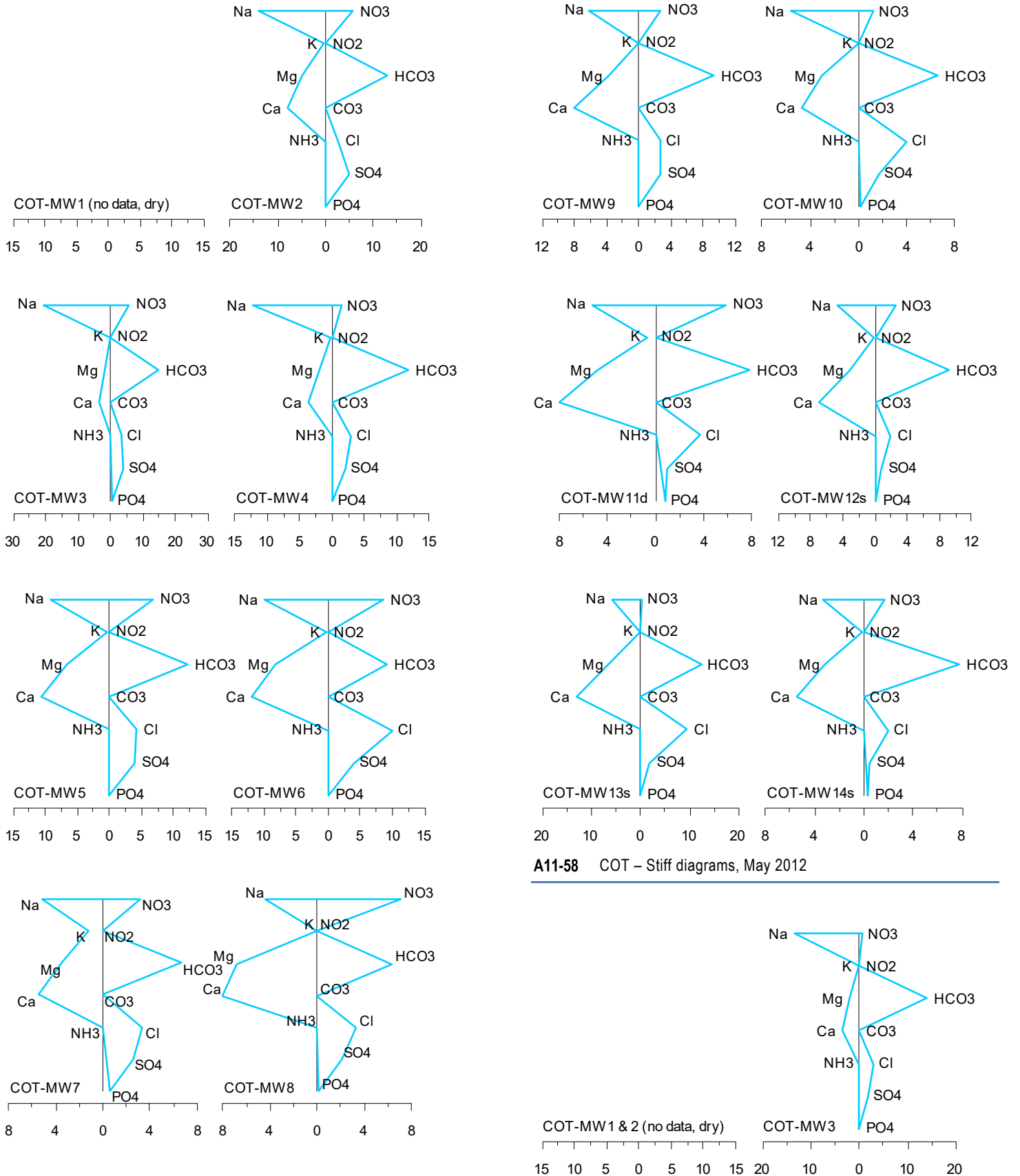

A11-58 COT – Stiff diagrams, May 2012

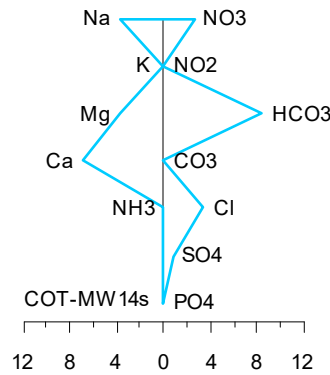
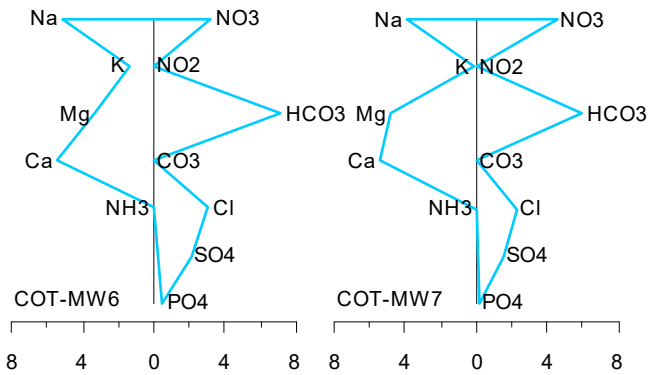
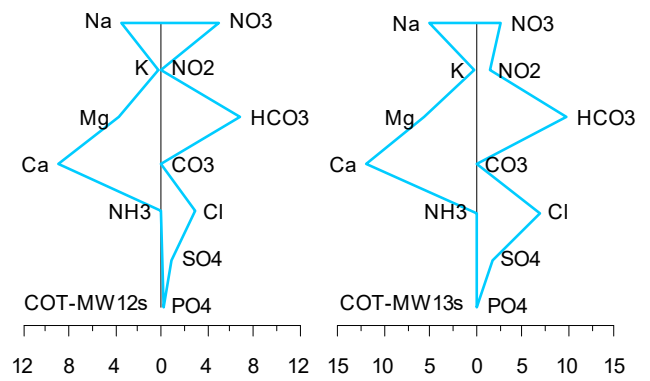
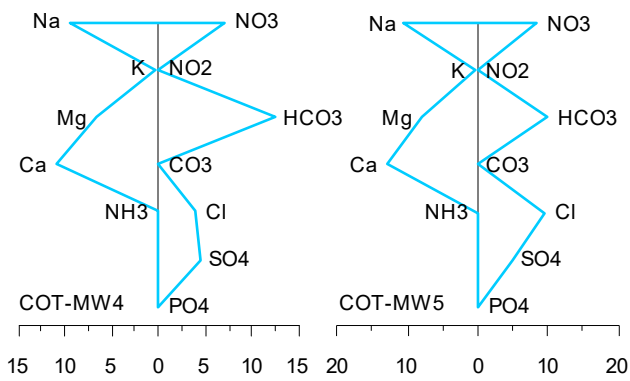

A11-59 COT – Stiff diagrams, August 2012

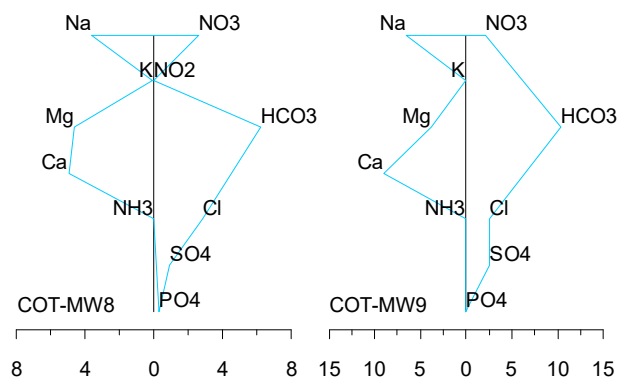
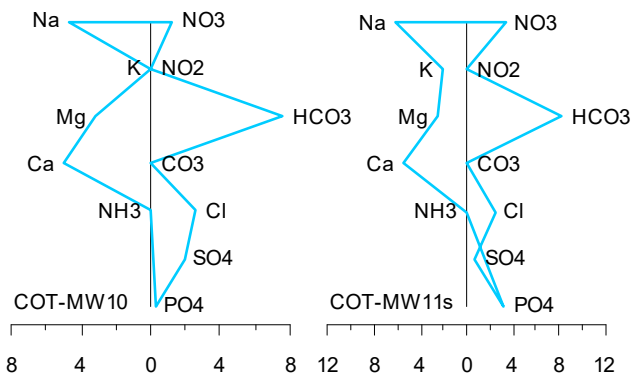
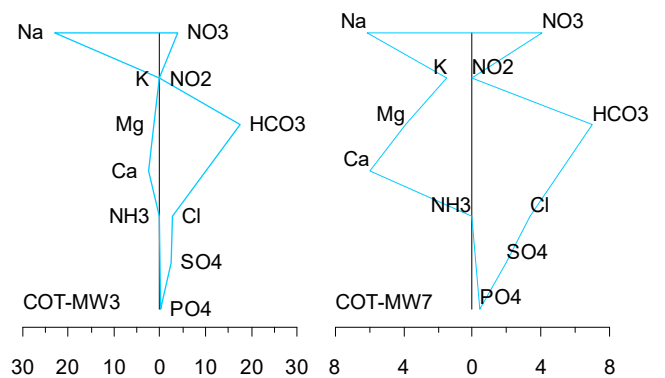
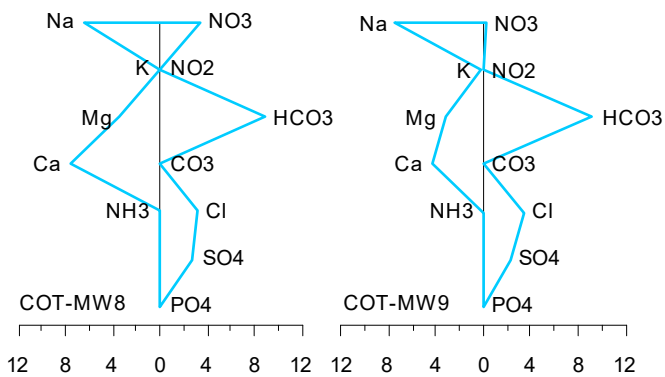

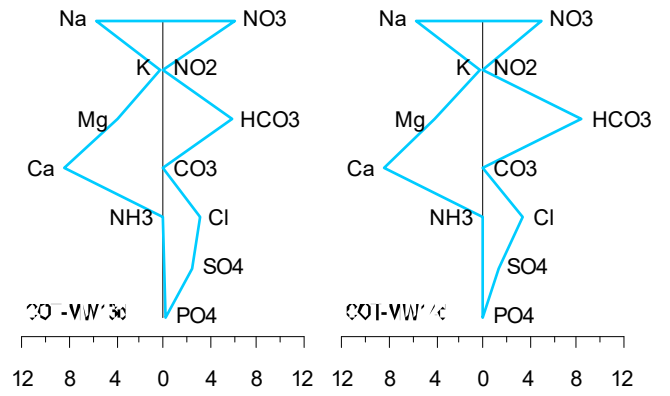
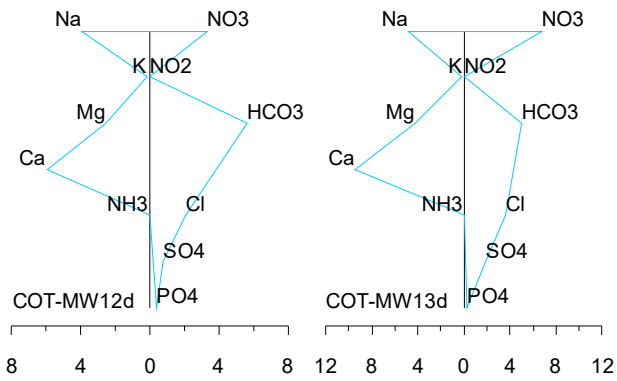
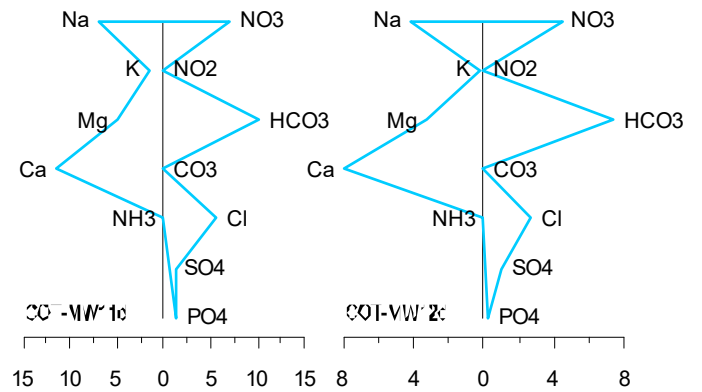
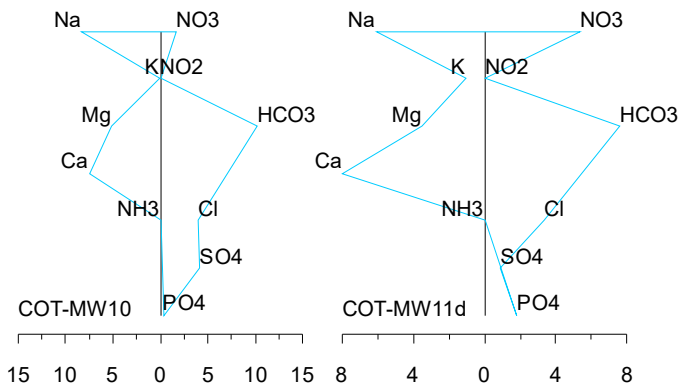

A11-61 COT – Stiff diagrams, August 2014

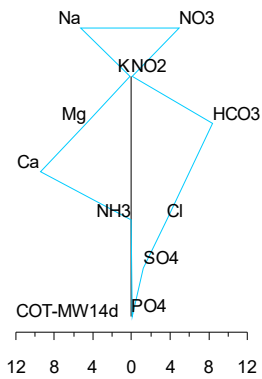

A11-60 COT – Stiff diagrams, August 2013

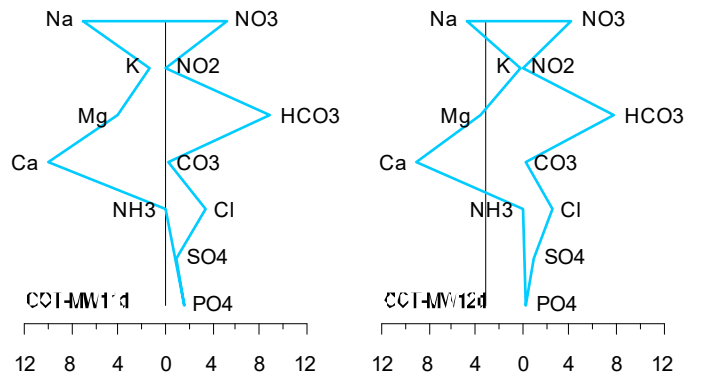
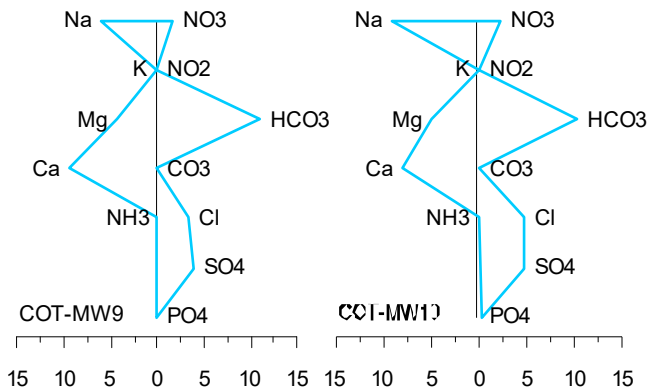
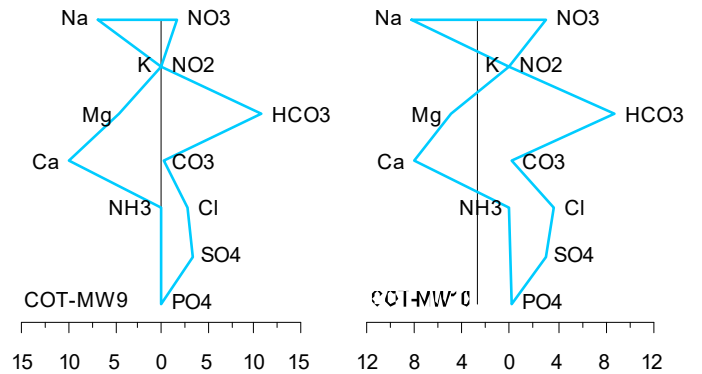

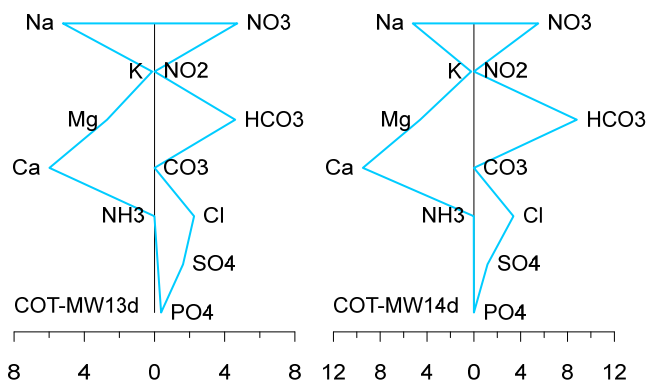
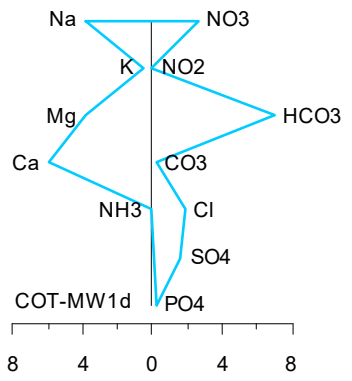
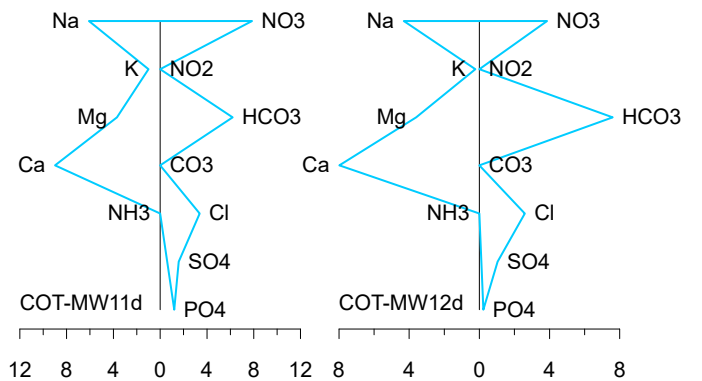
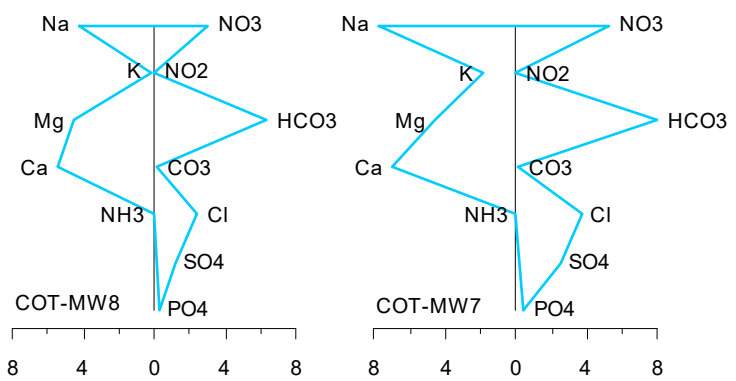
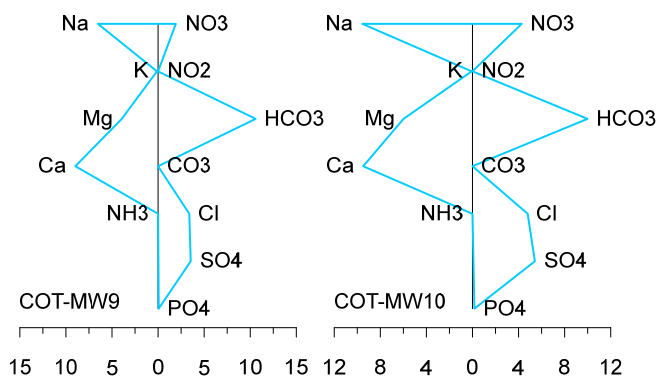
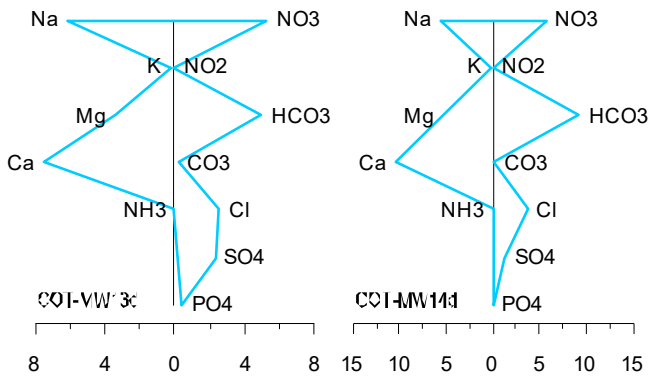

A11-62 COT – Stiff diagrams, February 2015

A11-63 COT – Stiff diagrams, February 2016

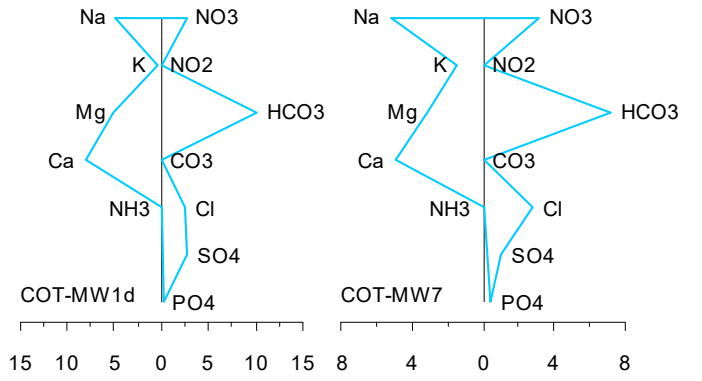
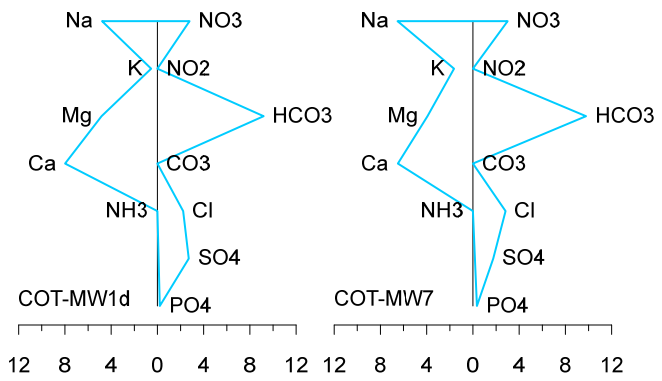

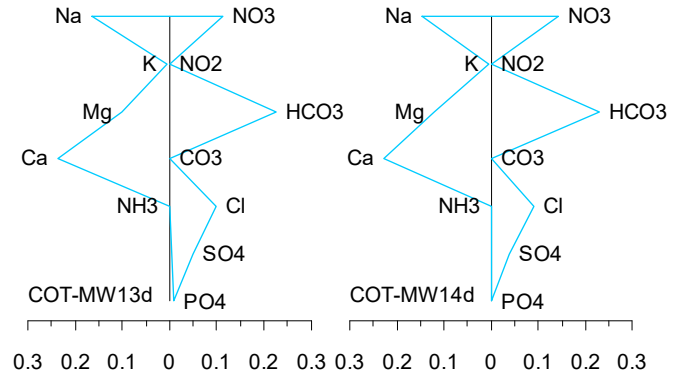
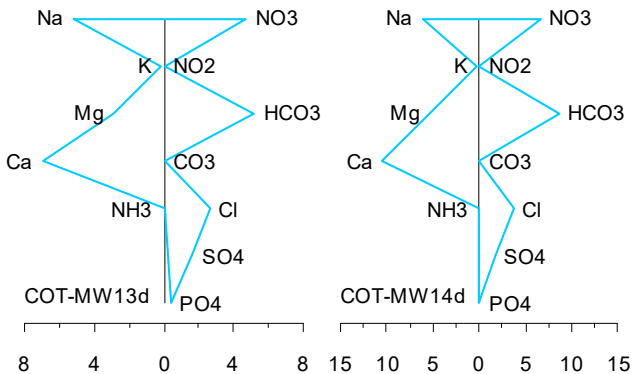
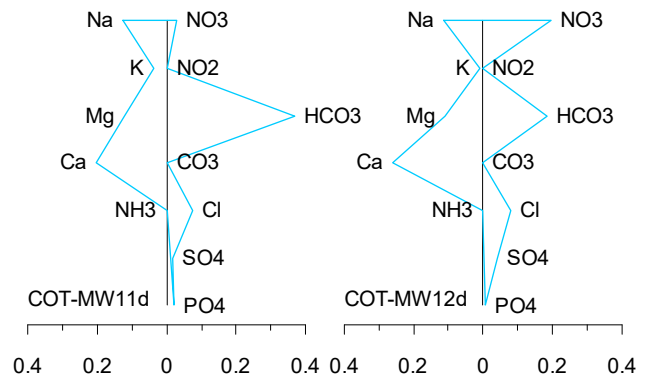
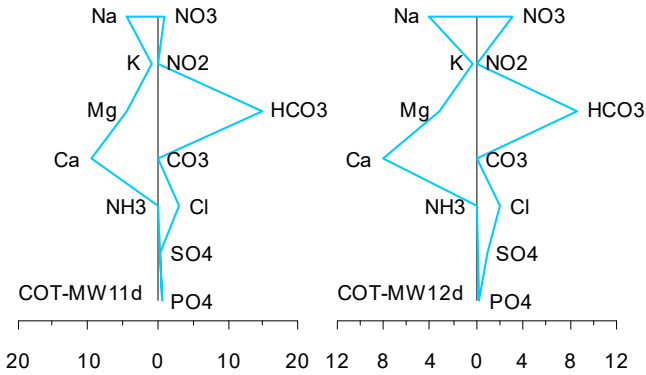
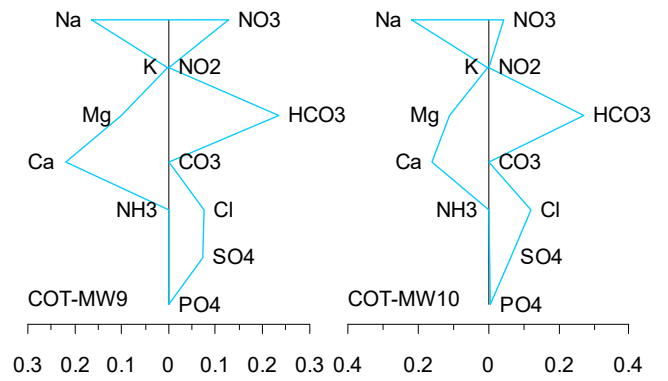
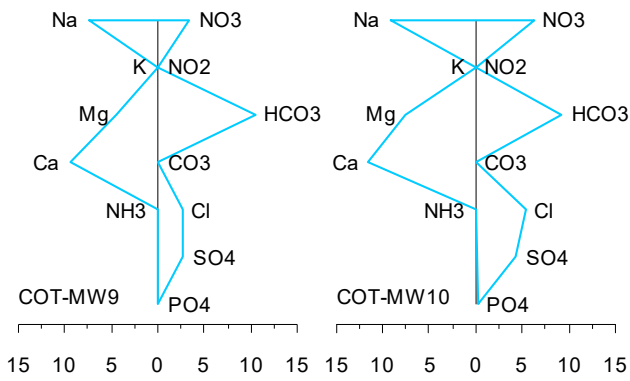

A11-64 COT – Stiff diagrams, March 2017

A11-65 COT – Stiff diagrams, February 2018

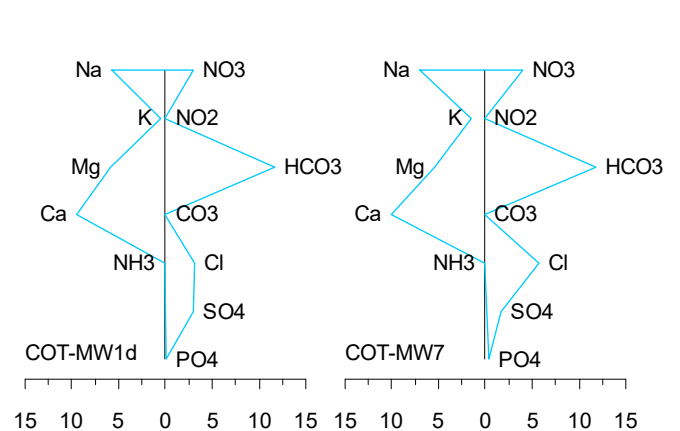
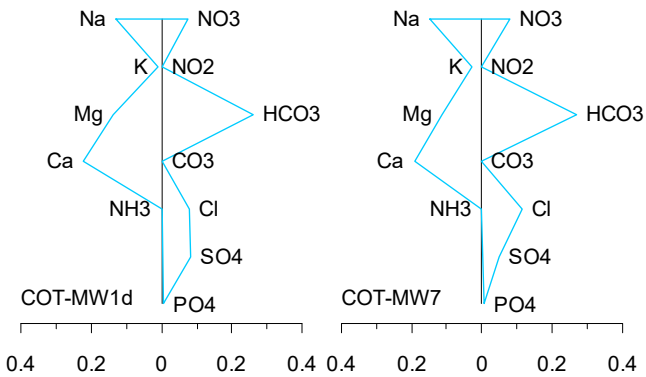

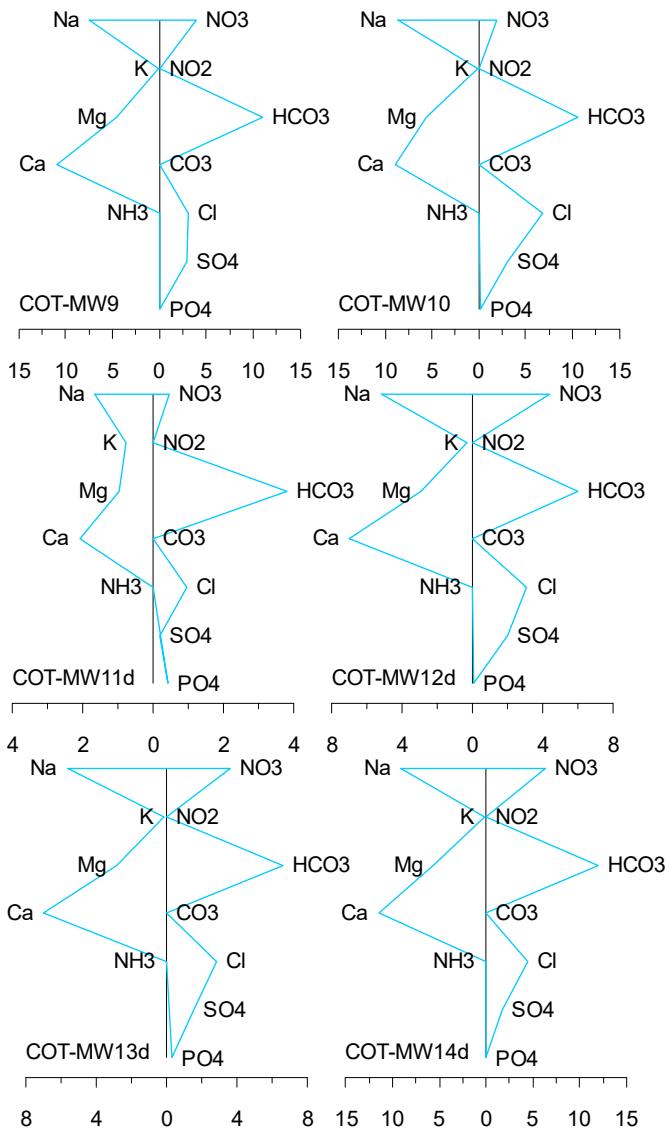

A11-66 COT – Stiff diagrams, February 2019

SAN

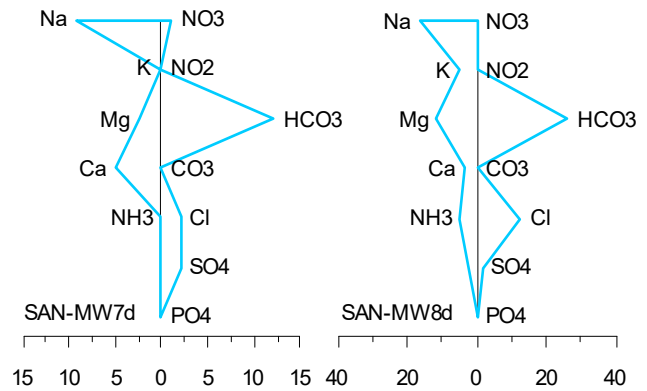
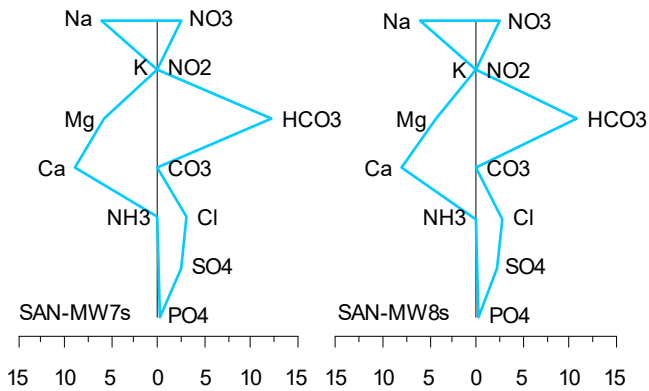
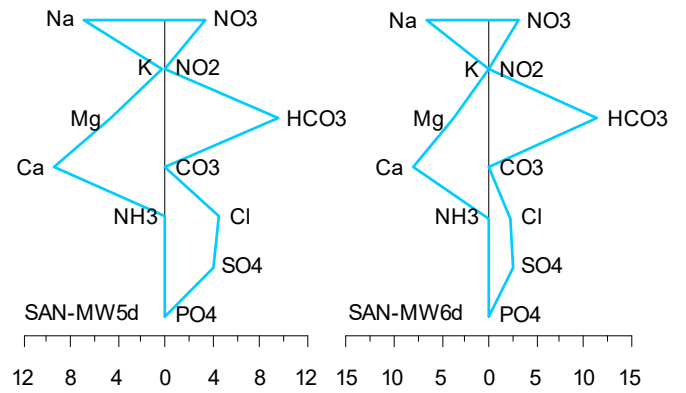
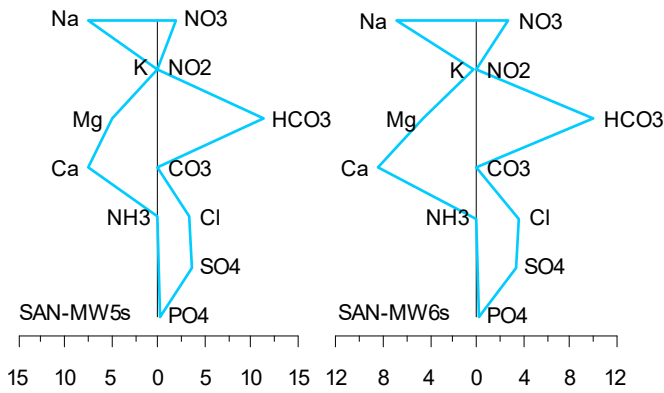
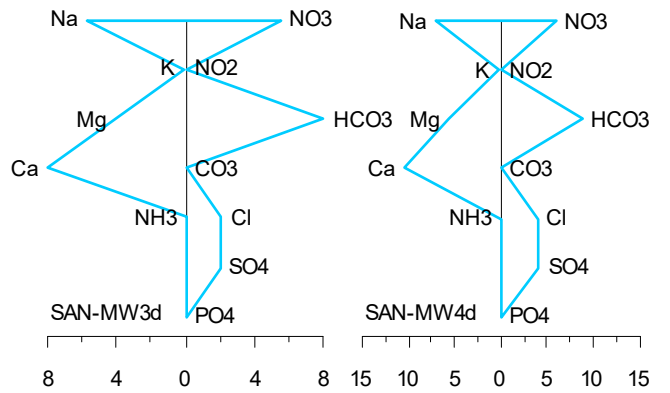
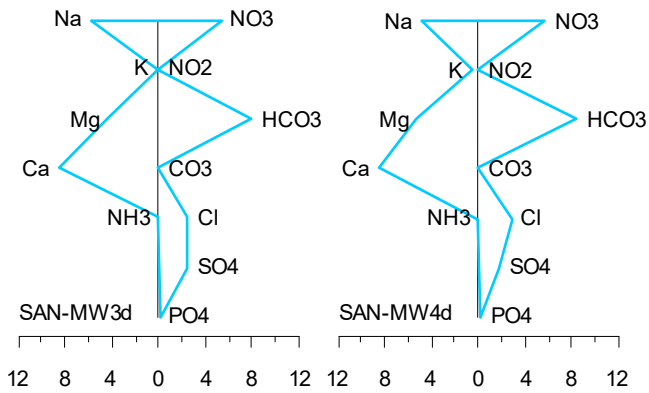
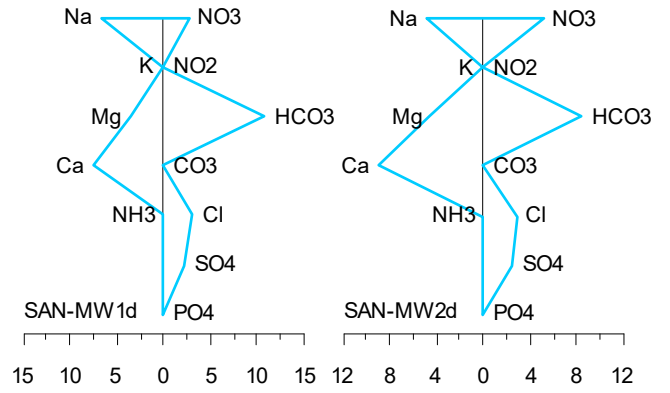
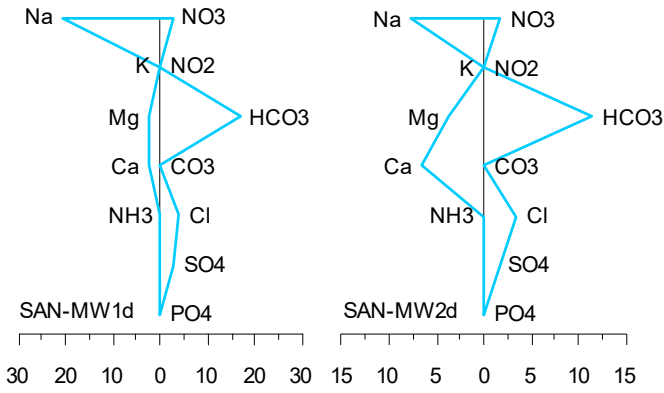

A11-67 SAN – Stiff diagrams, May 2012

A11-68 SAN – Stiff diagrams, August 2012

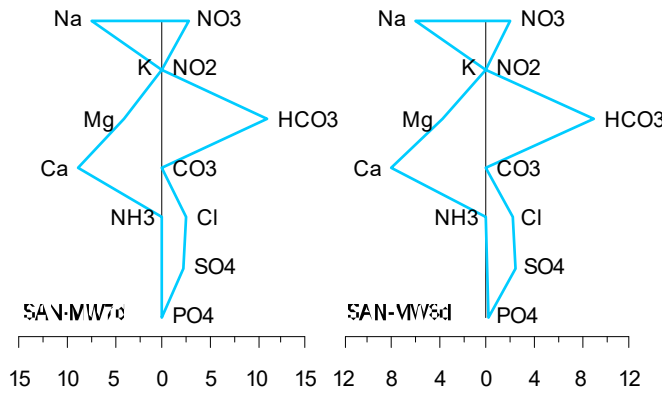
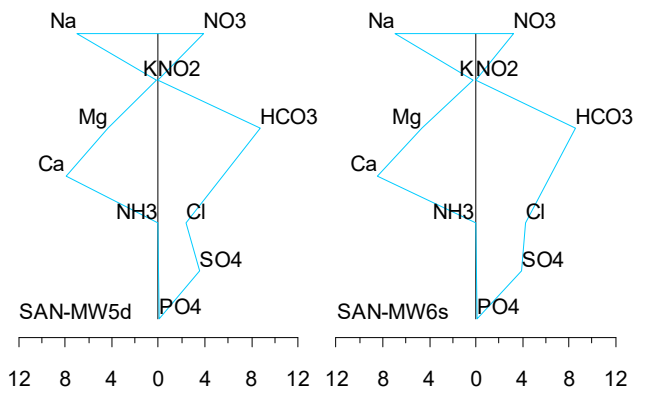
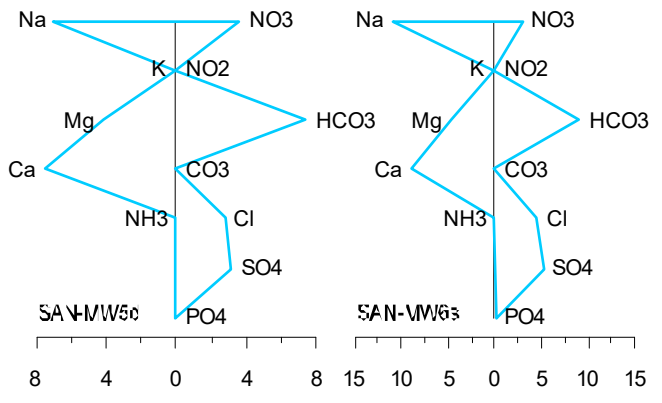
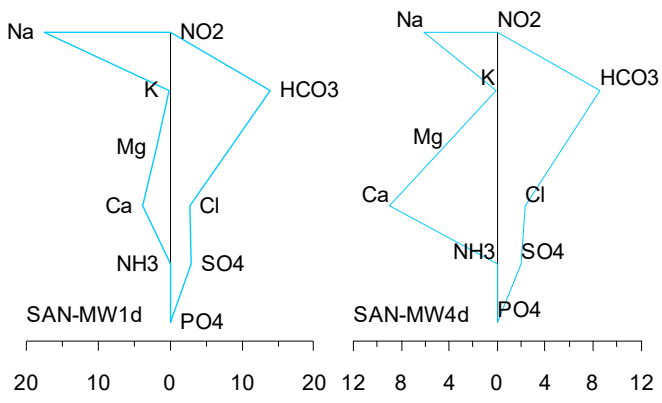

A11-70 SAN – Stiff diagrams, August 2014

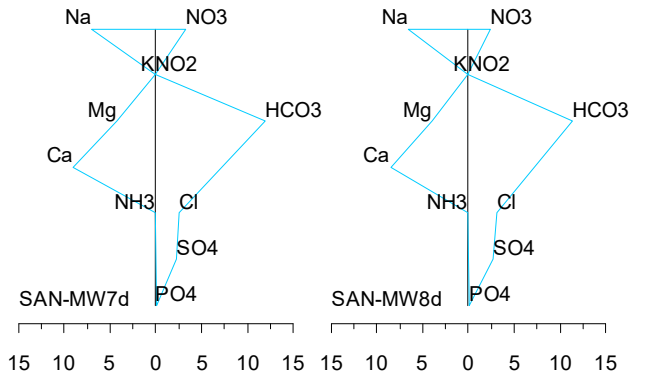

A11-69 SAN – Stiff diagrams, August 2013

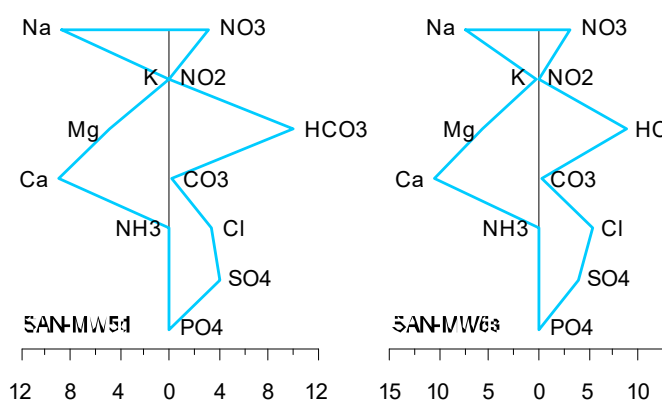
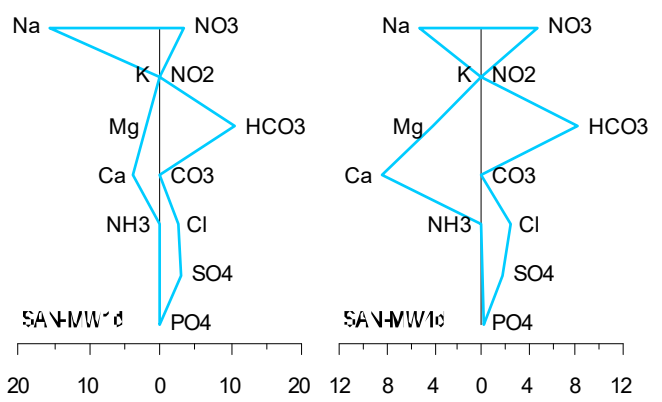
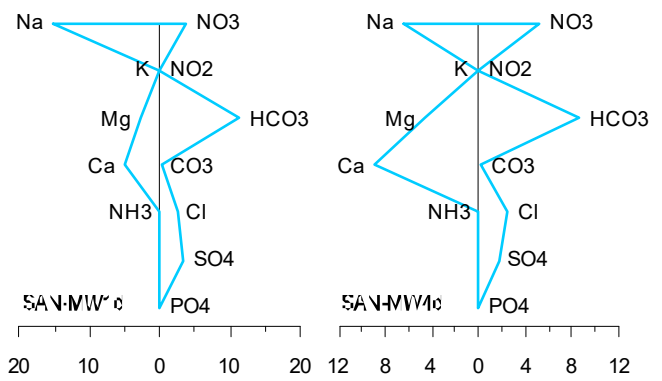

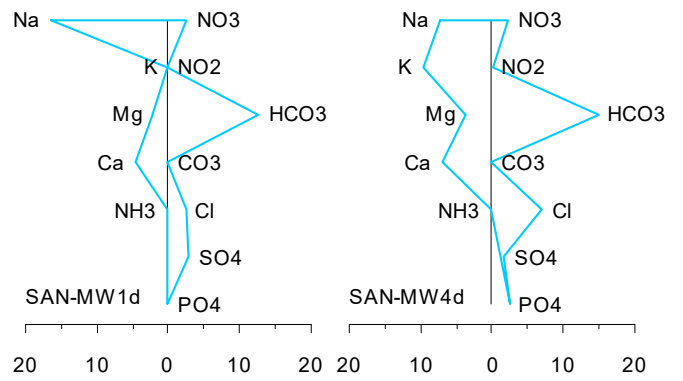
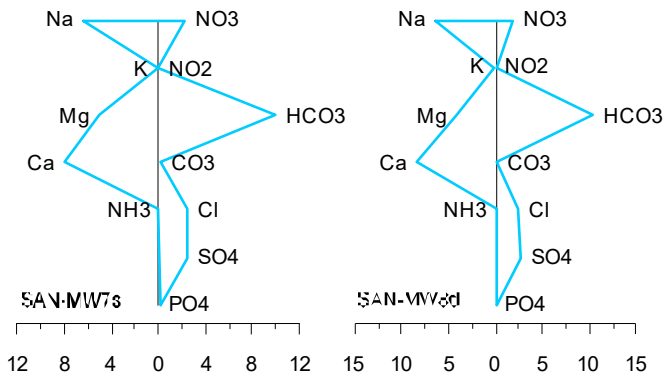

A11-71 SAN – Stiff diagrams, February 2015

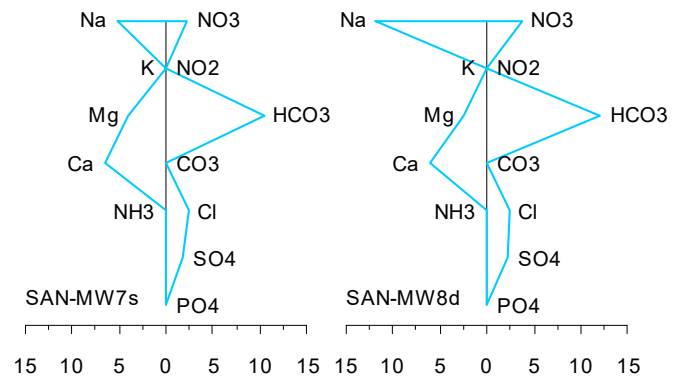
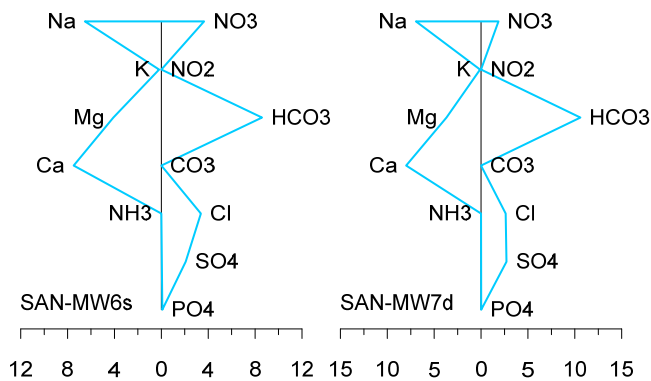
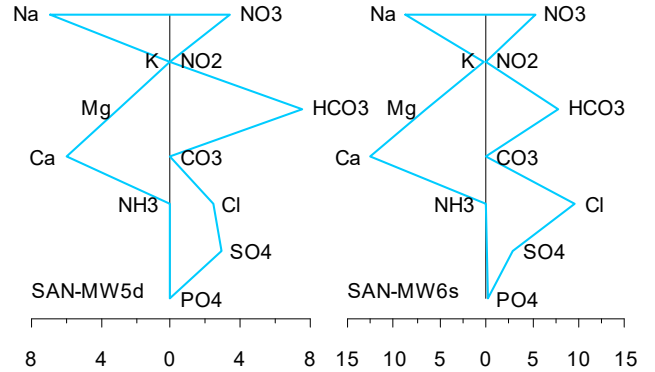
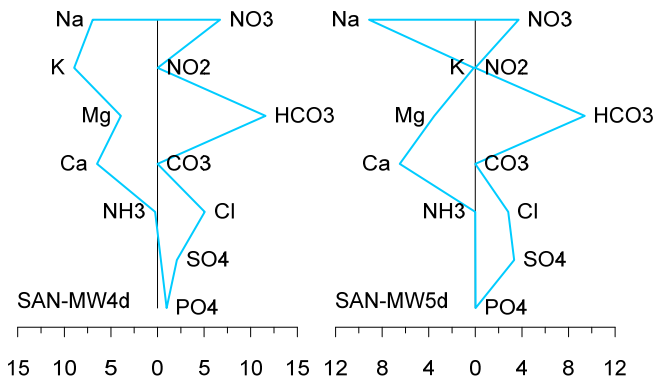

A11-73 SAN – Stiff diagrams, March 2017

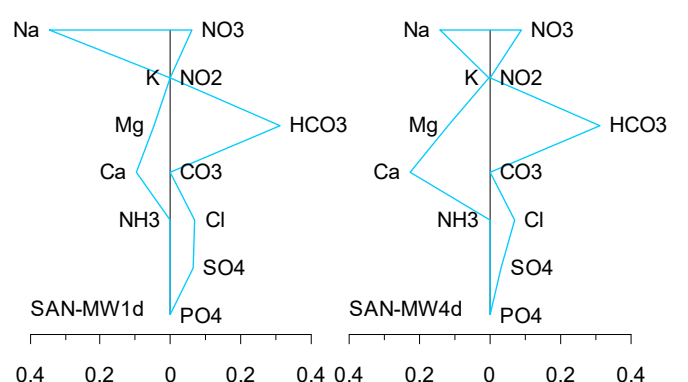
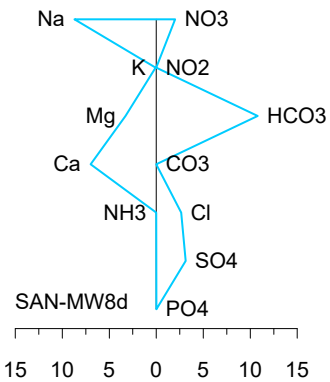

A11-72 SAN – Stiff diagrams, February 2016

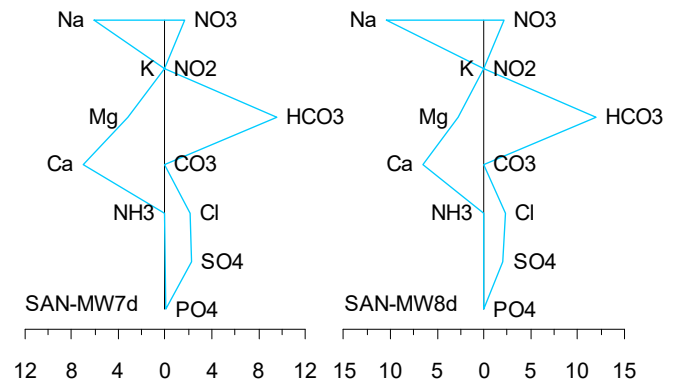
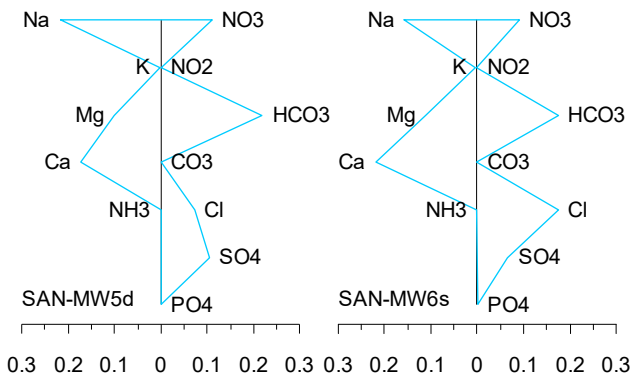

A11-75 SAN – Stiff diagrams, February 2019

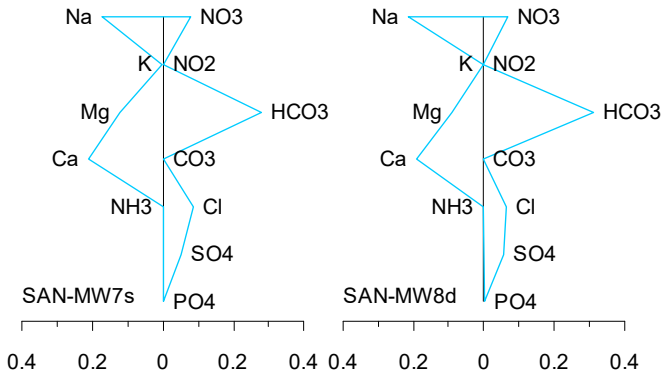

A11-74 SAN – Stiff diagrams, February 2018

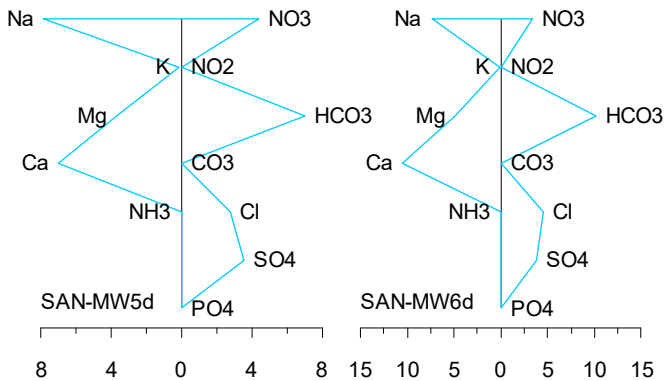
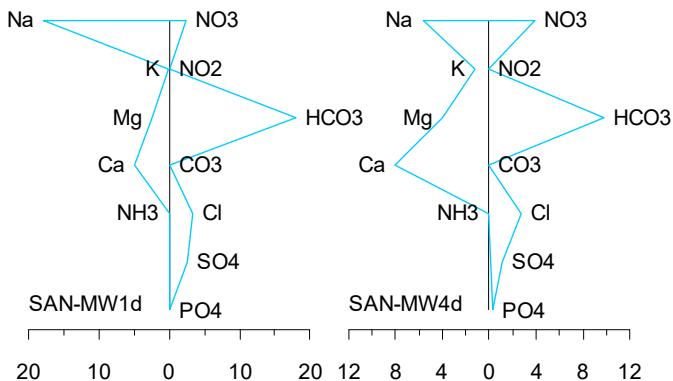

GEN

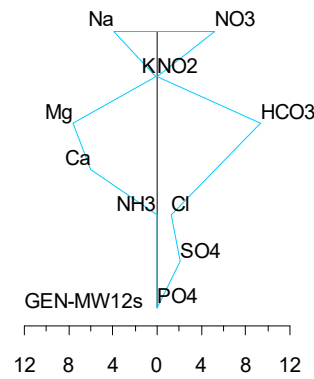
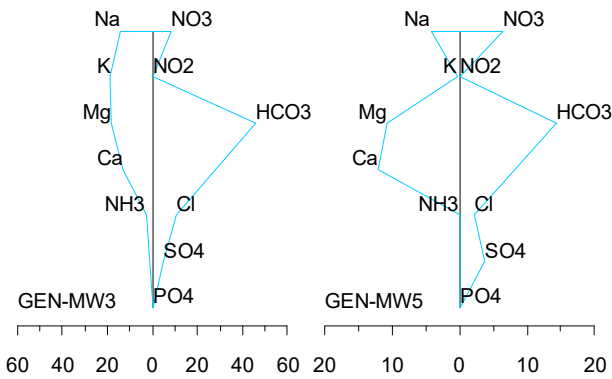
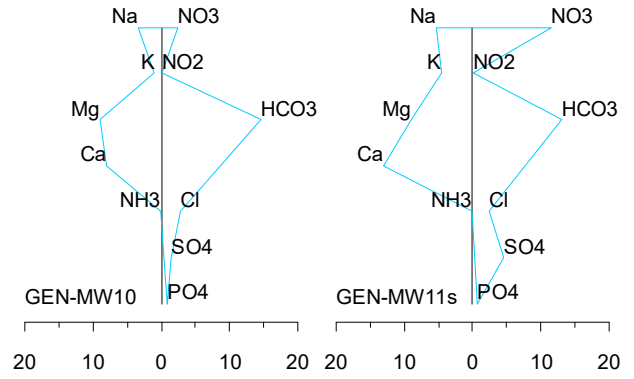
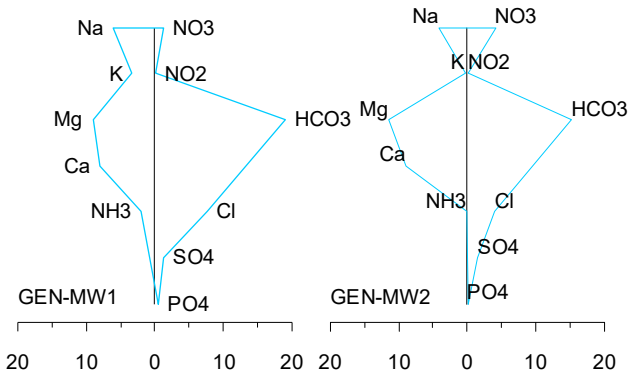

A11-76 GEN – Stiff diagrams, August 2013

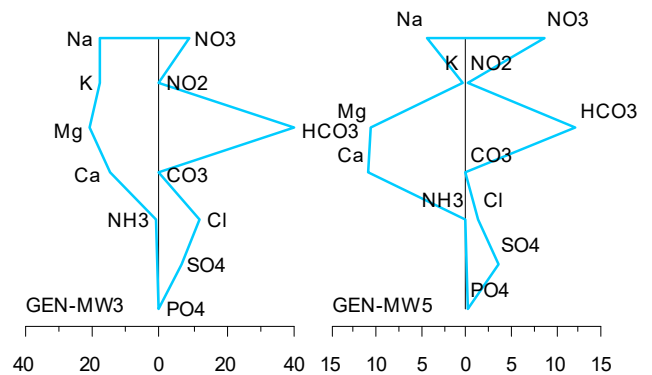
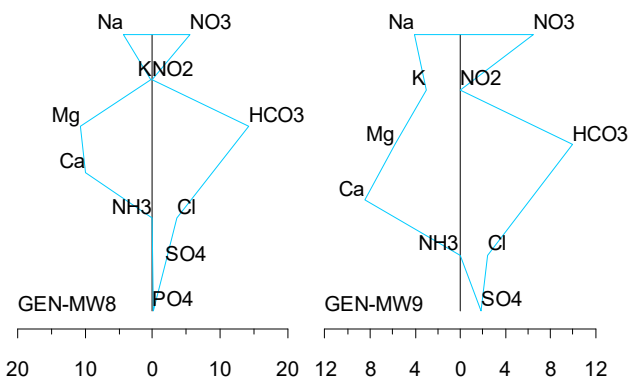
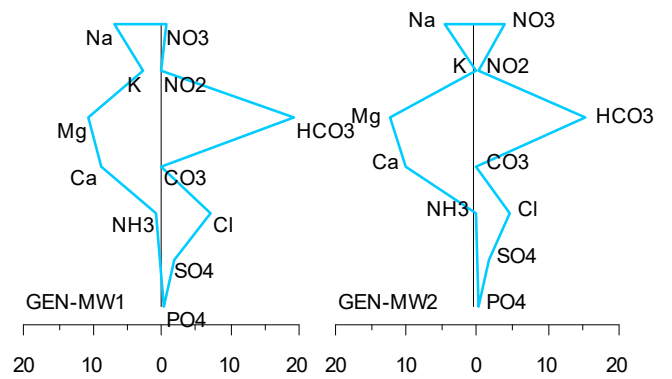
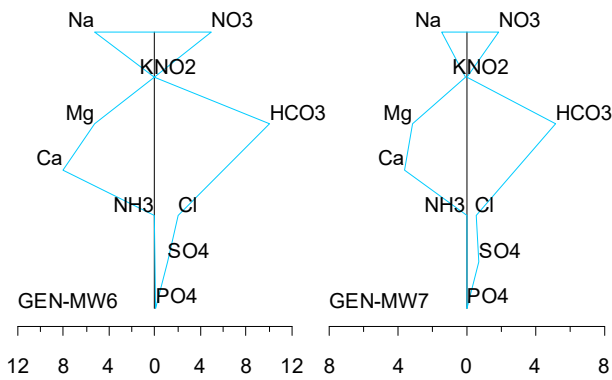

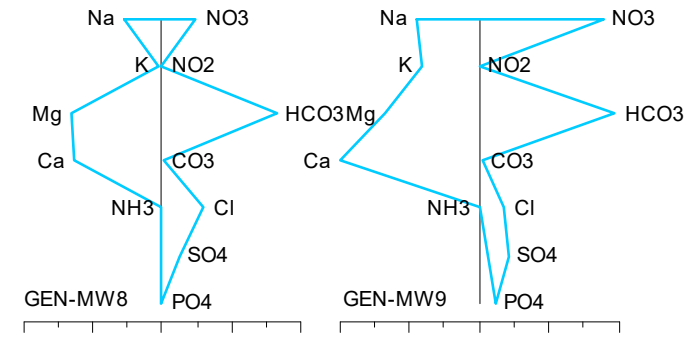
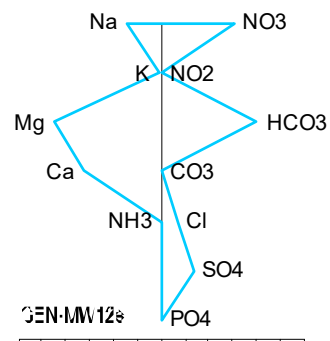
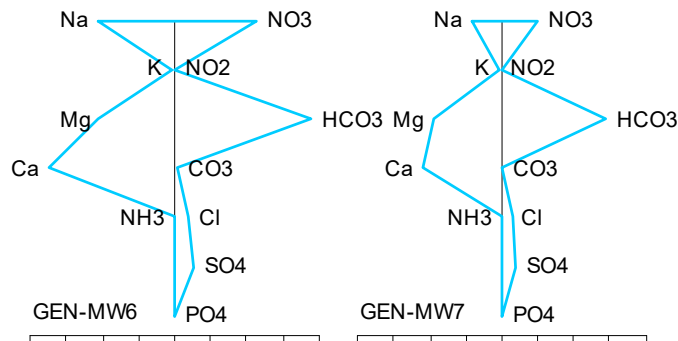
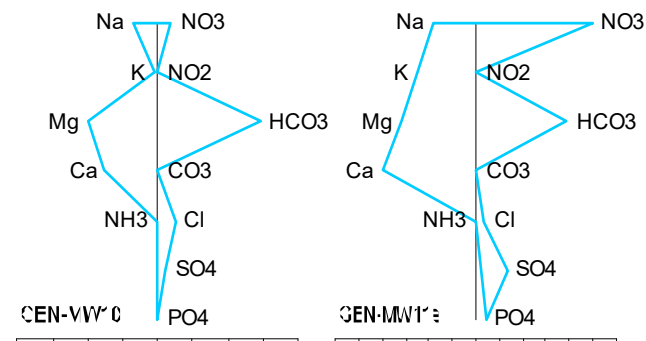
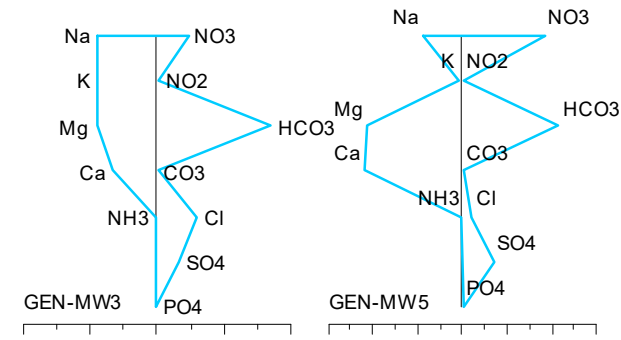
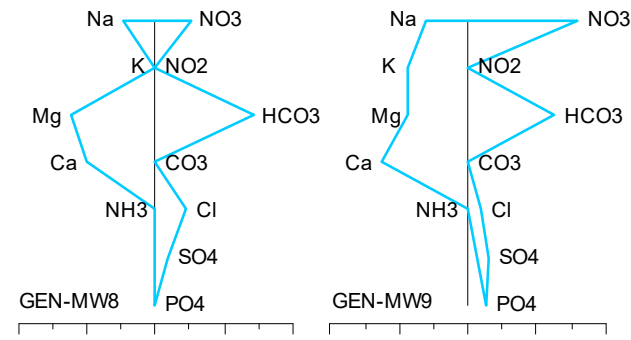
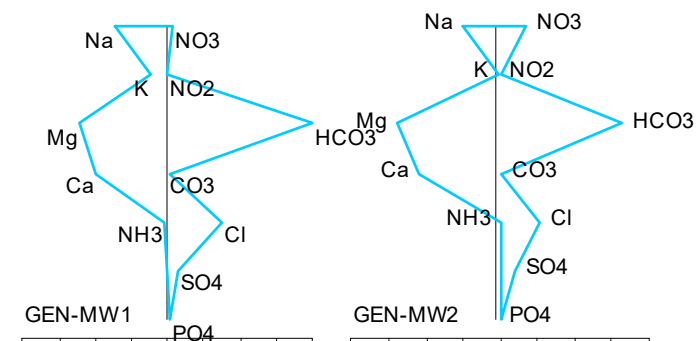
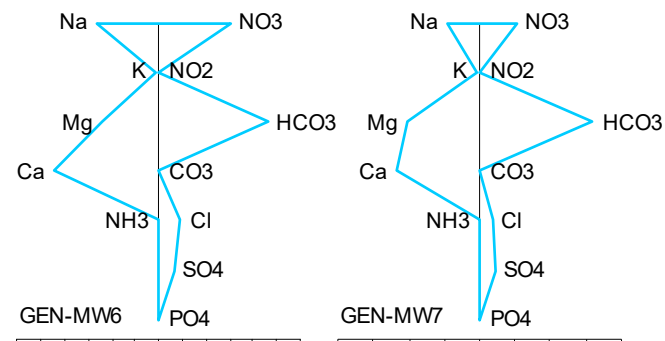

A11-77 GEN – Stiff diagrams, August 2014

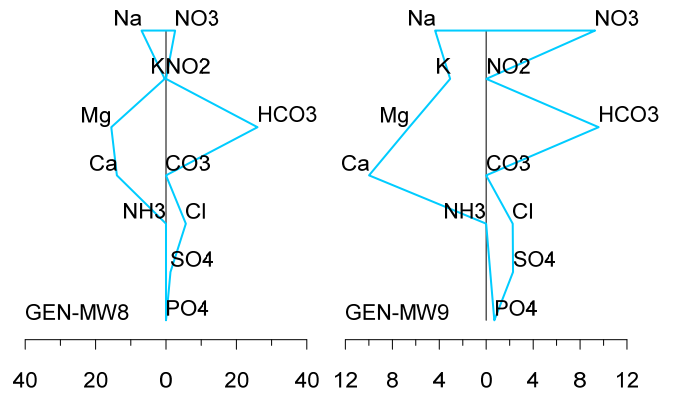
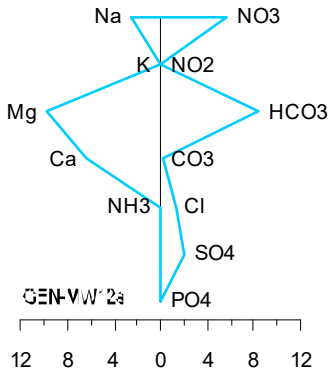
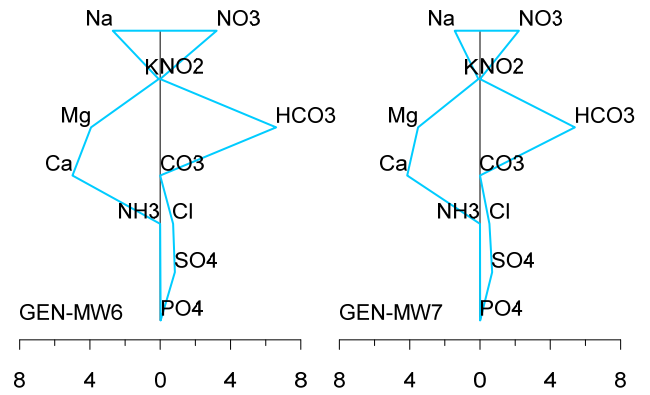
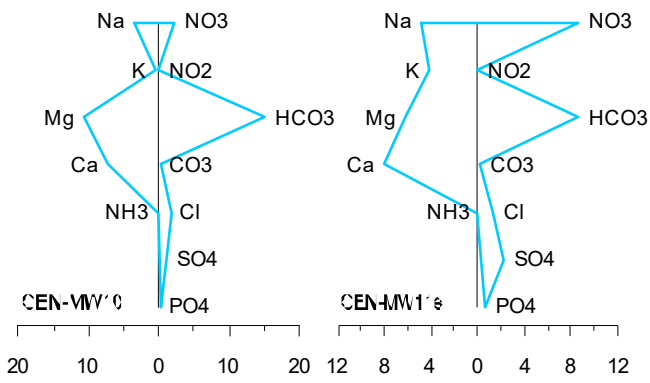

A11-78 GEN – Stiff diagrams, February 2015

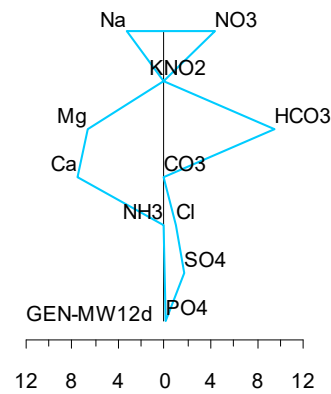
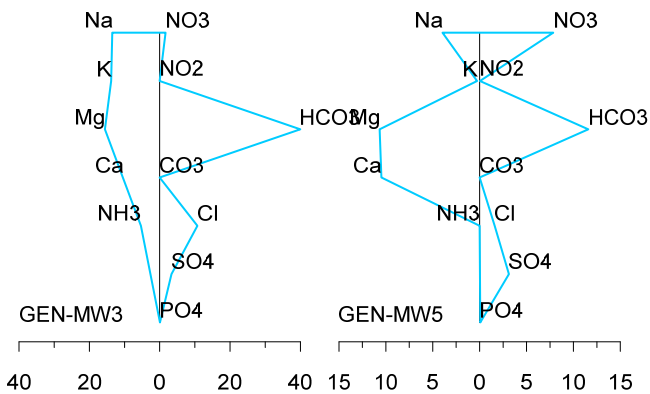
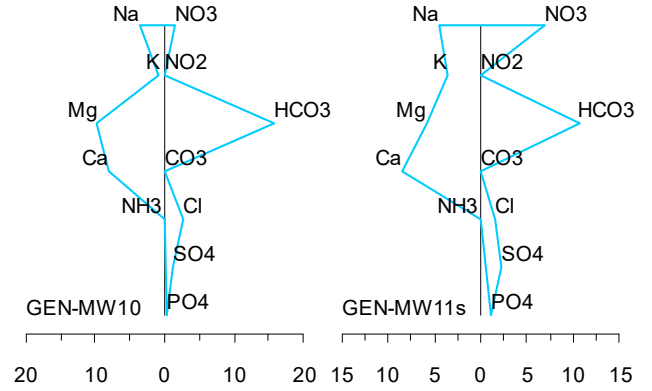
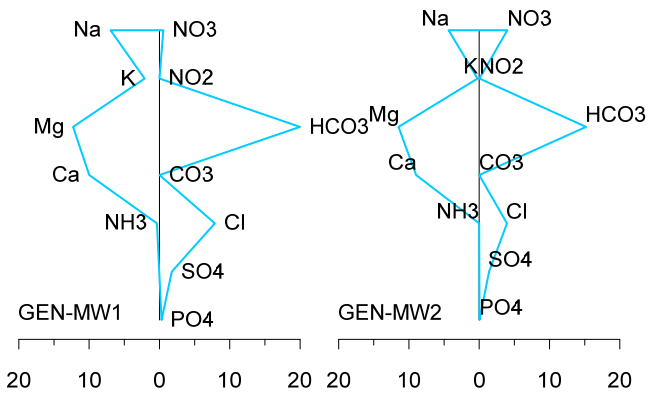

A11-79 GEN – Stiff diagrams, February 2016

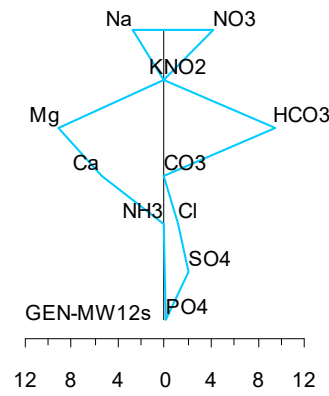
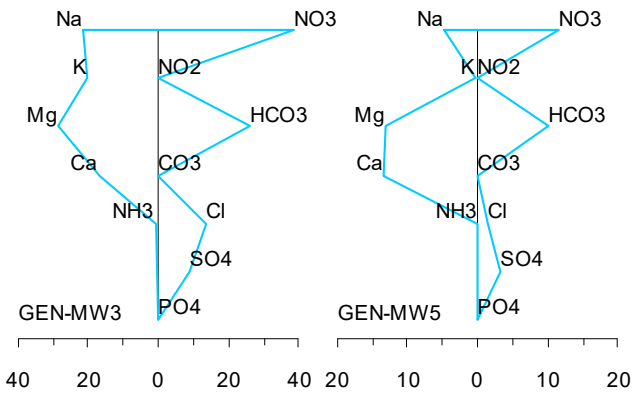
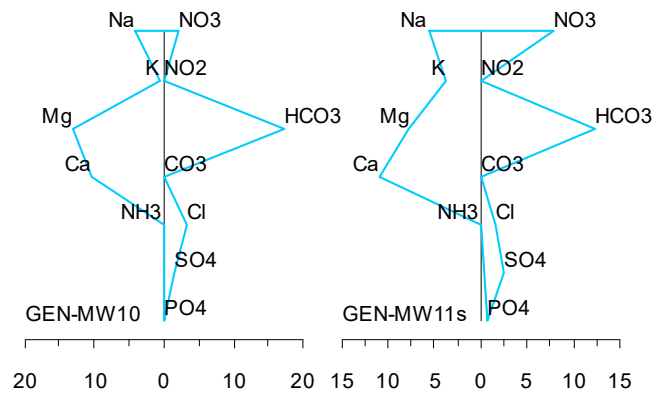
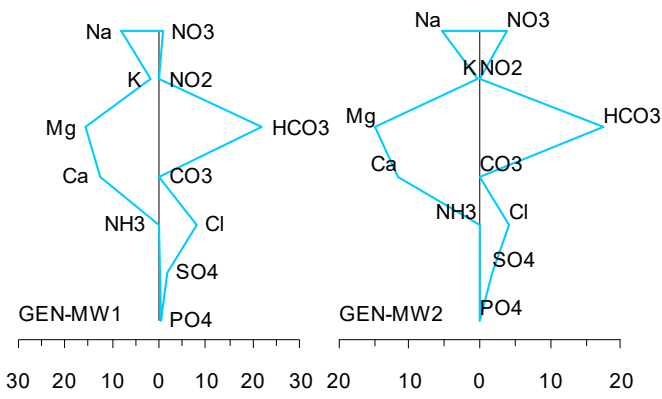

A11-80 GEN – Stiff diagrams, March 2017

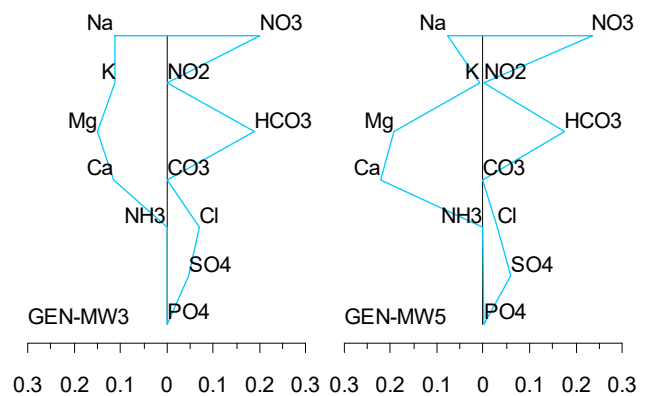
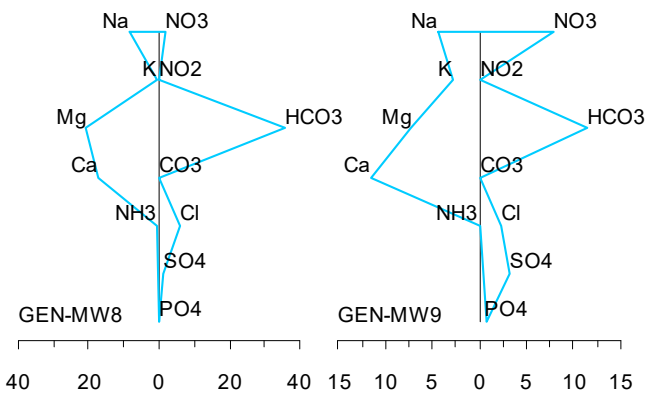
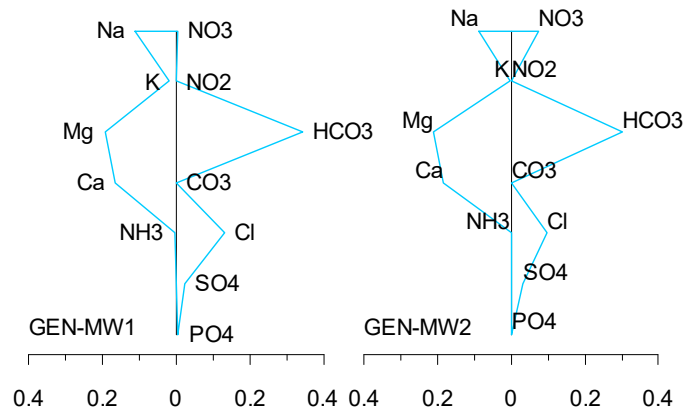
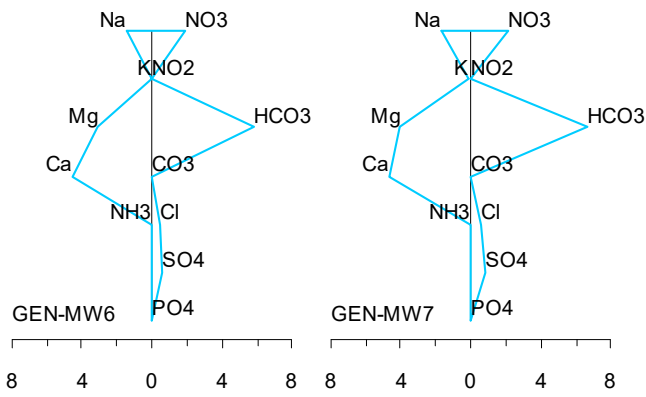

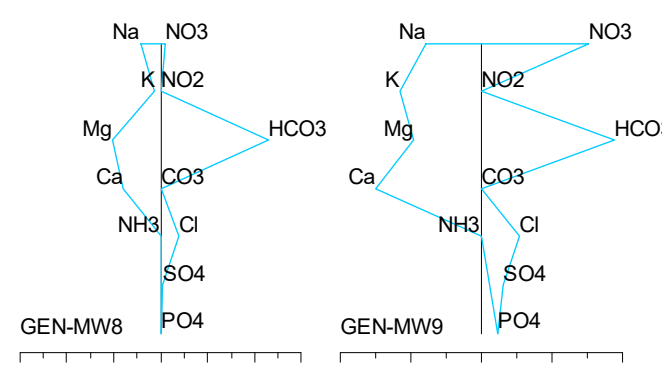
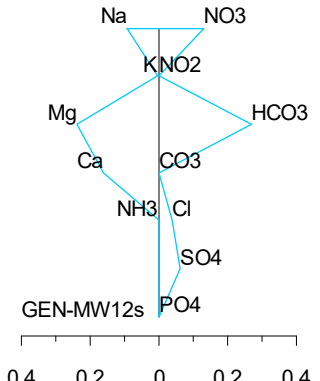
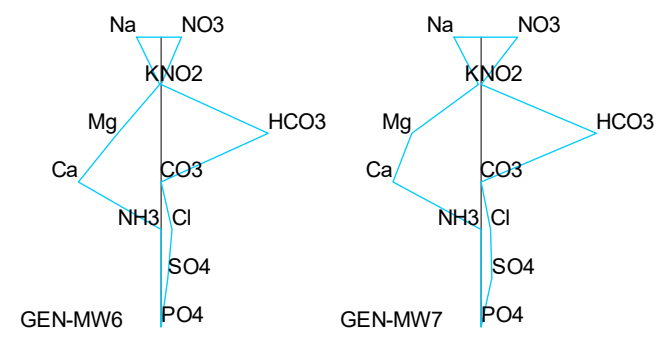
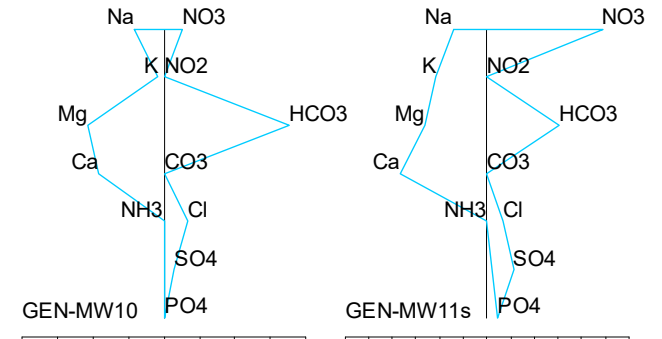
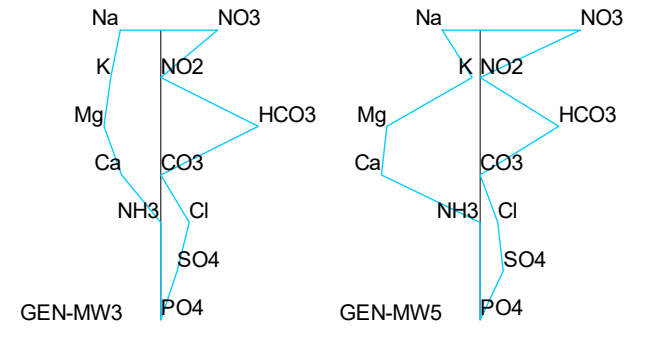
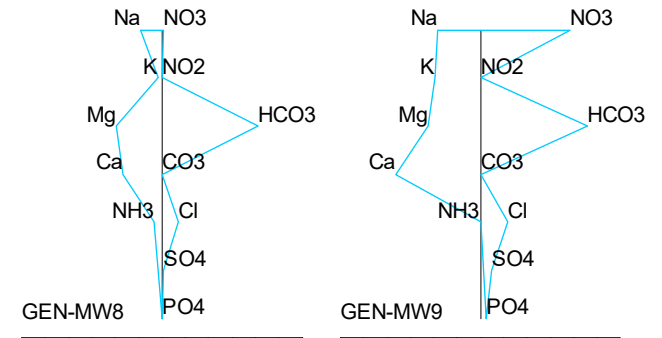
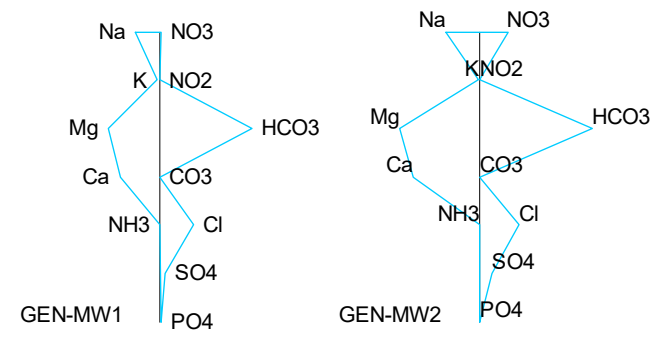
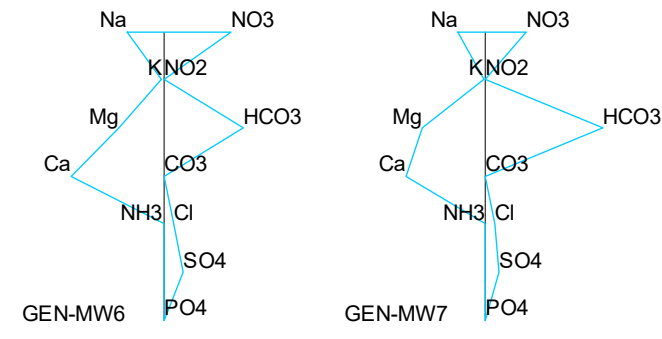

A11-81 GEN – Stiff diagrams, February 2018

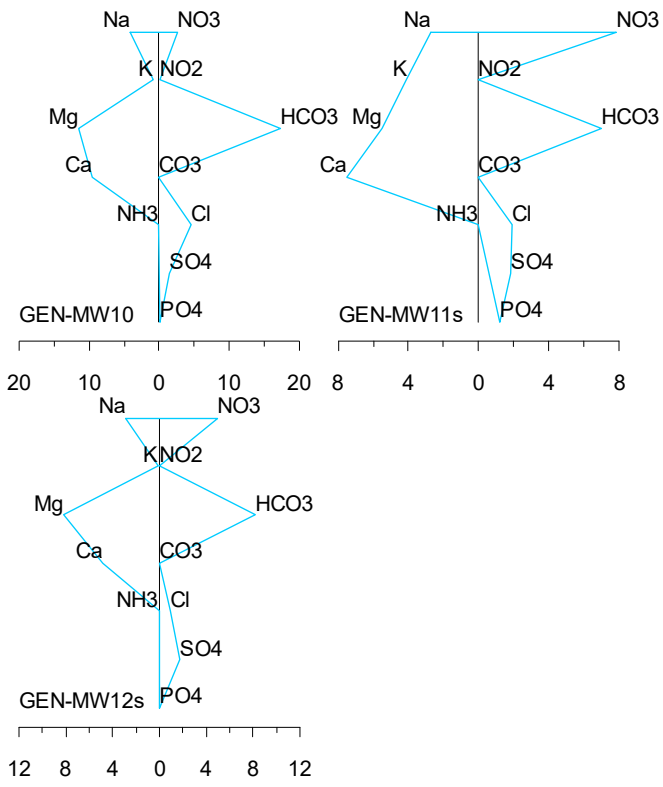

A11-82 GEN – Stiff diagrams, February 2019

TRO

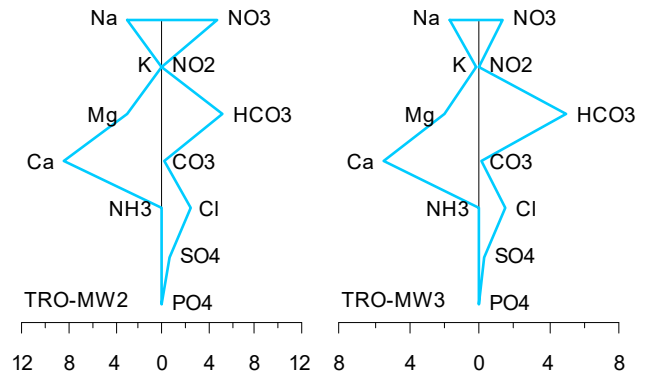
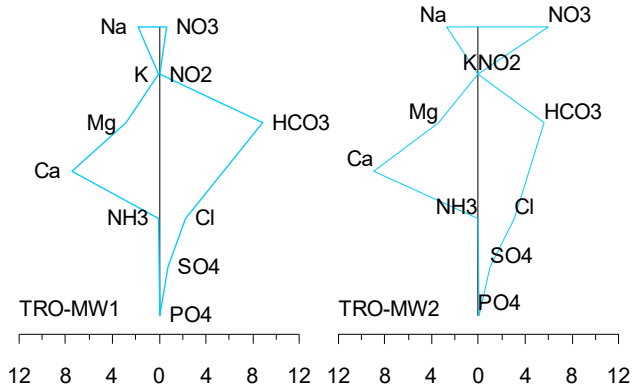

A11-85 TRO – Stiff diagrams, February 2015

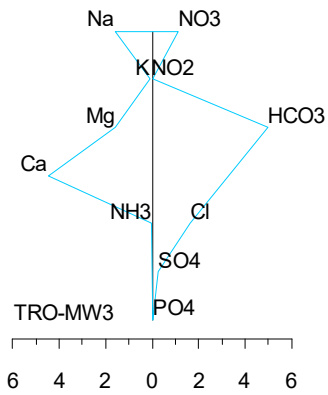

A11-83 TRO – Stiff diagrams, August 2013

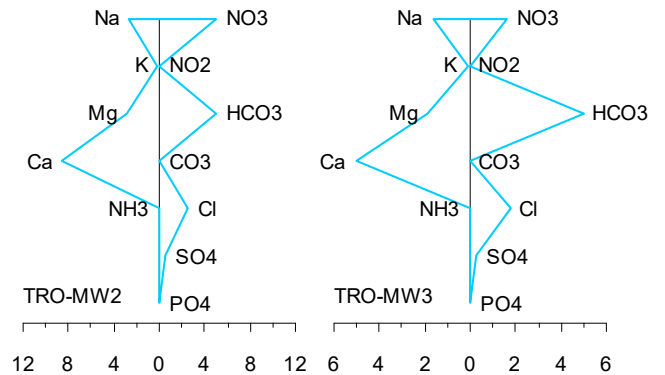

A11-86 TRO – Stiff diagrams, February 2016

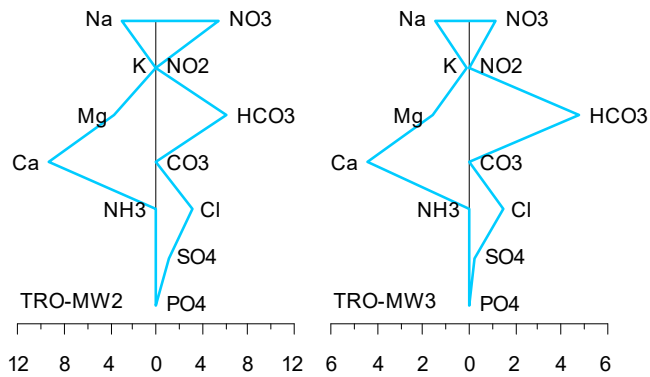

A11-84 TRO – Stiff diagrams, August 2014

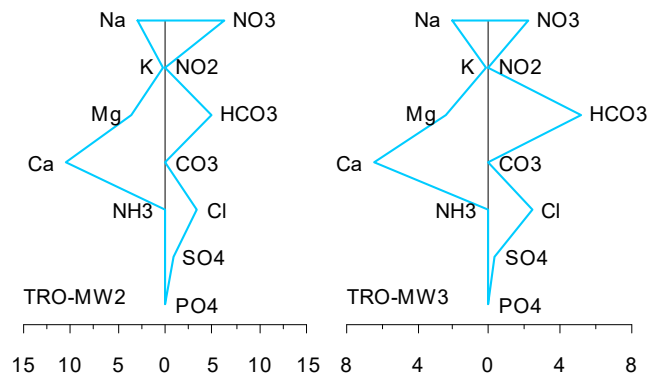

A11-87 TRO – Stiff diagrams, March 2017

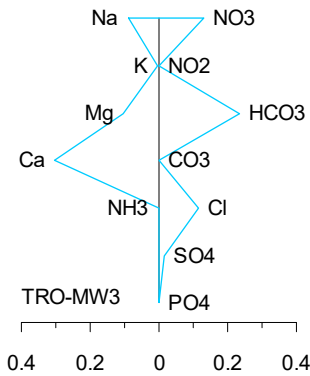
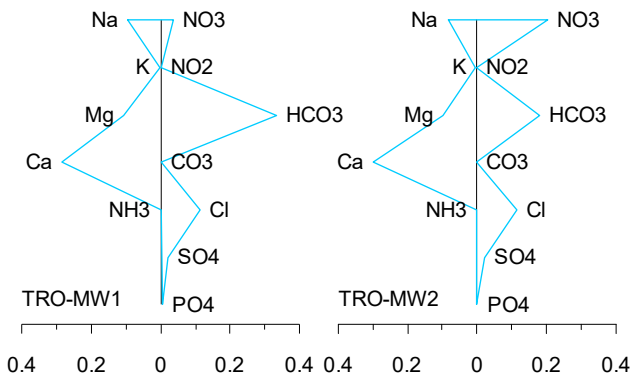

A11-88 TRO – Stiff diagrams, February 2018

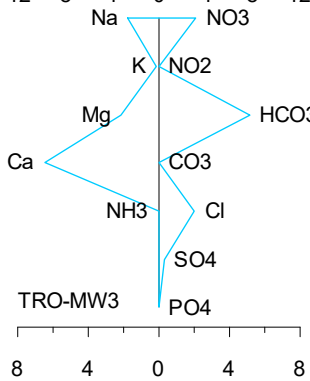
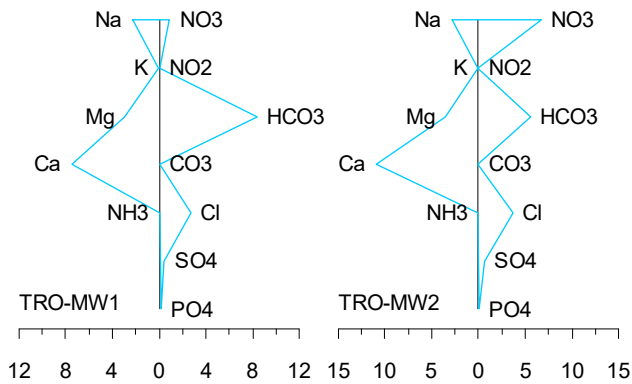

A11-89 TRO – Stiff diagrams, February 2019

PLS

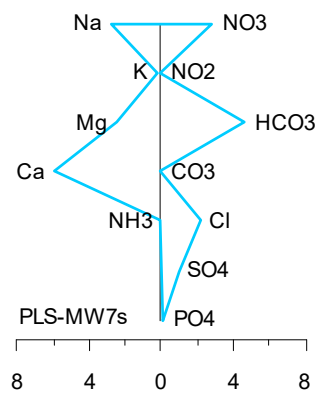
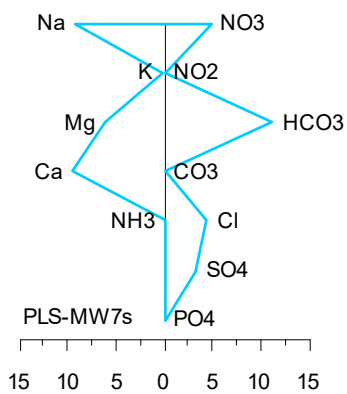
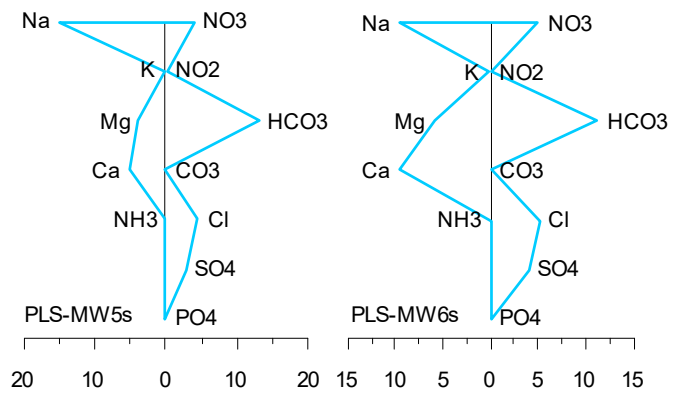
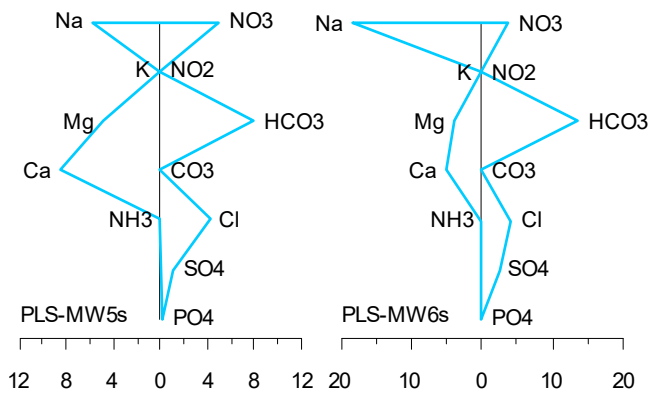
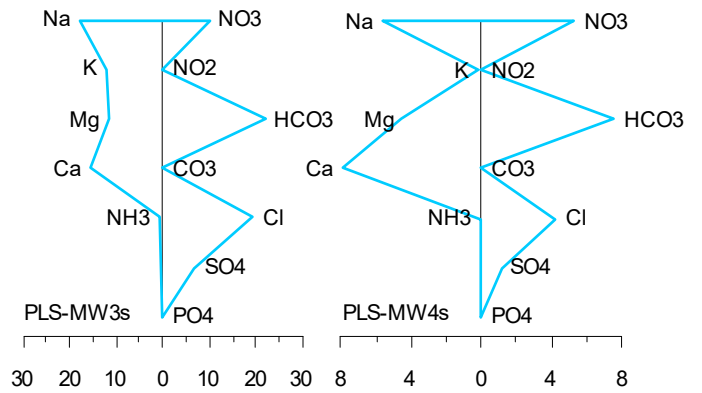
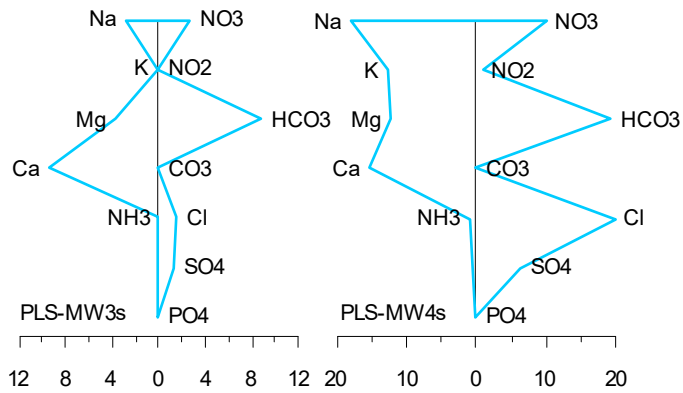
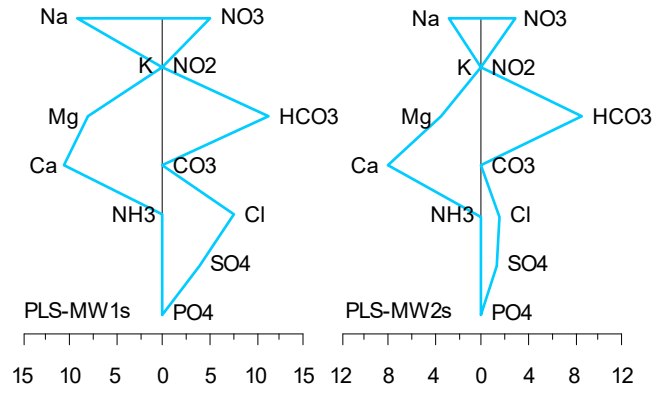
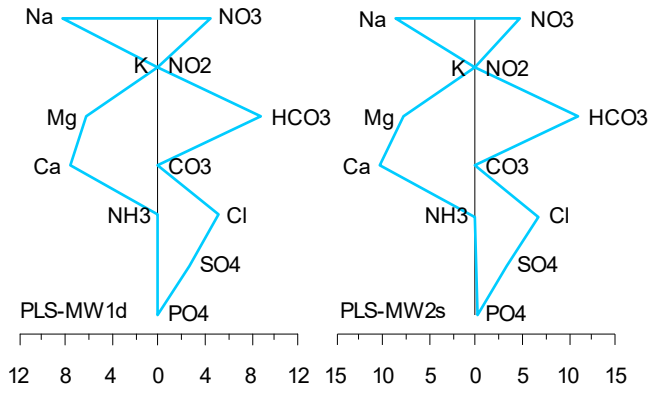

A11-90 PLS – Stiff diagrams, May 2012

A11-91 PLS – Stiff diagrams, August 2012

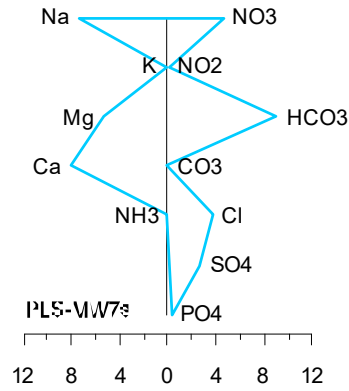
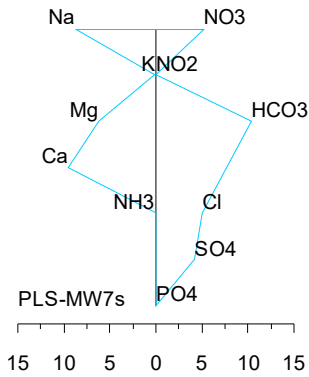
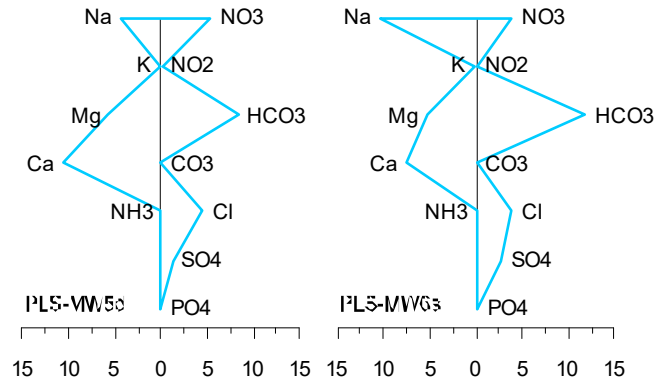
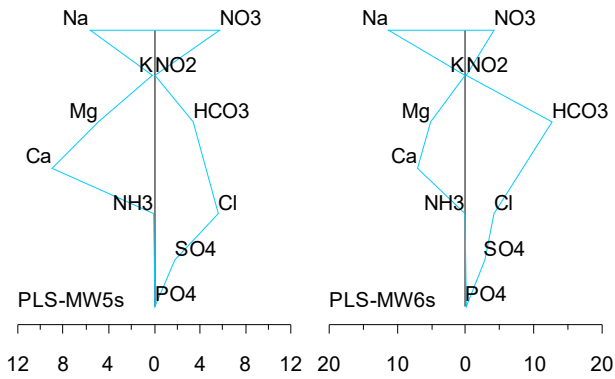
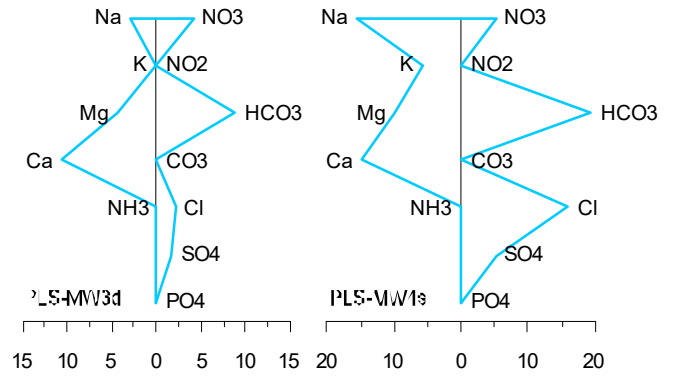
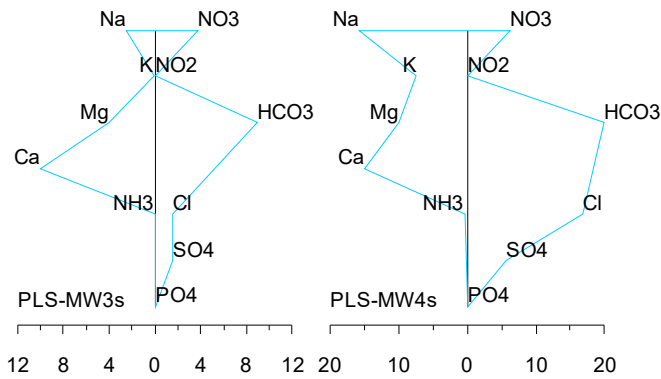
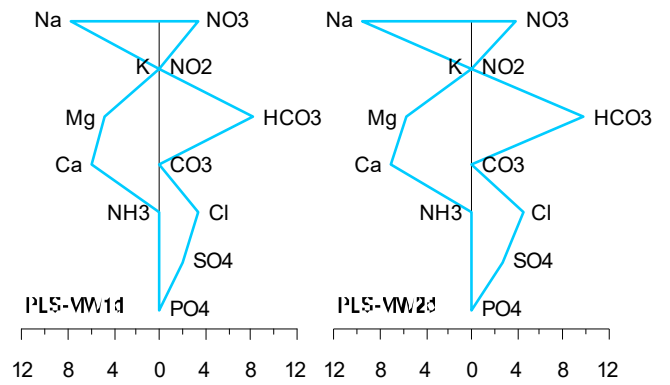
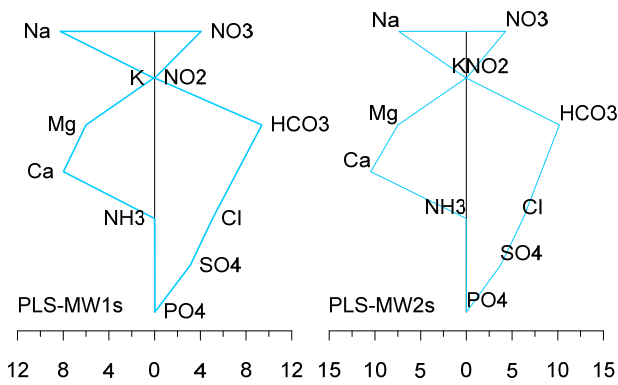

A11-92 PLS – Stiff diagrams, August 2013

A11-93 PLS – Stiff diagrams, August 2014

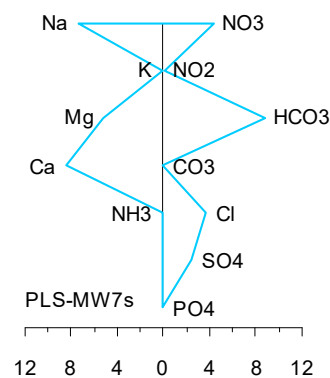
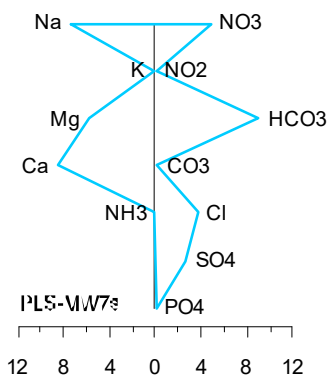
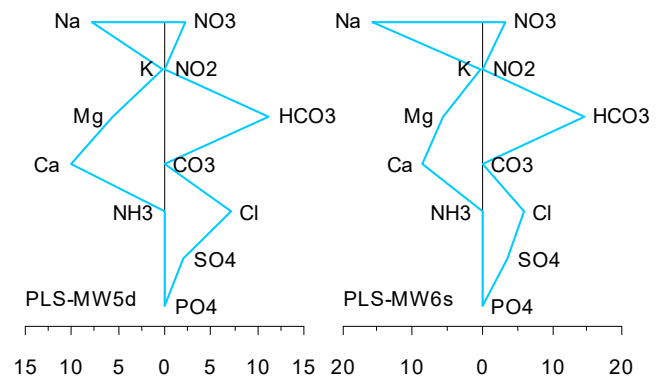
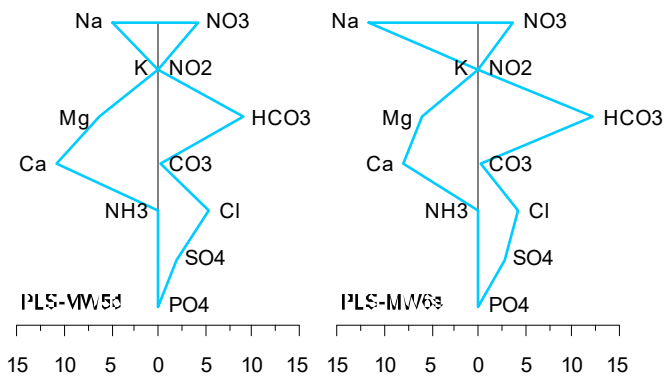
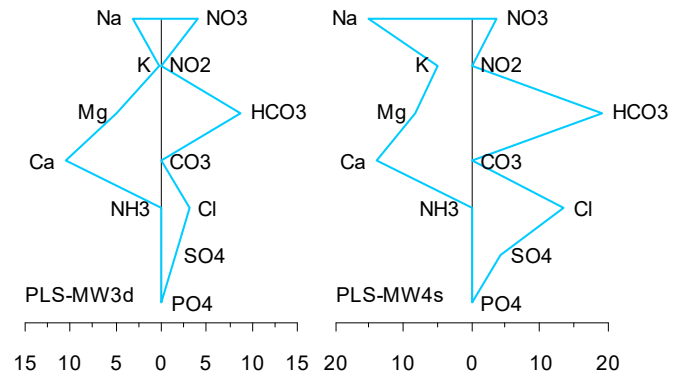
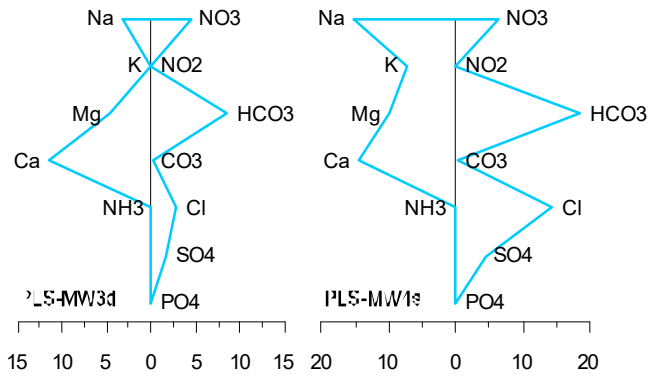
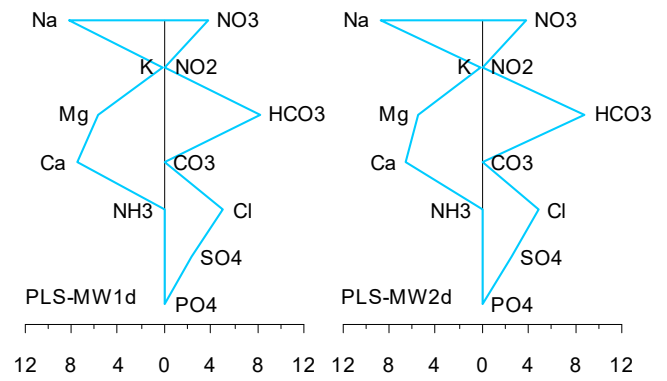
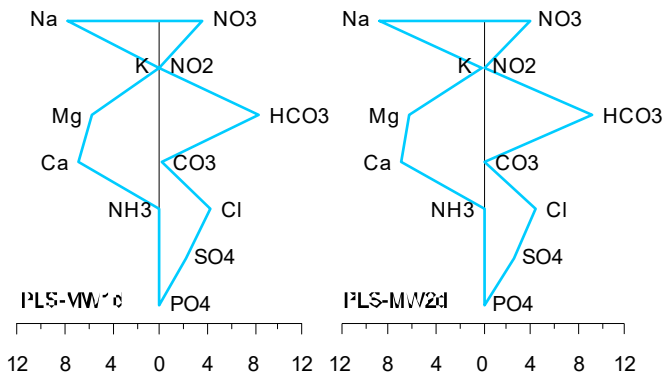

A11-94 PLS – Stiff diagrams, February 2015

A11-95 PLS – Stiff diagrams, February 2016

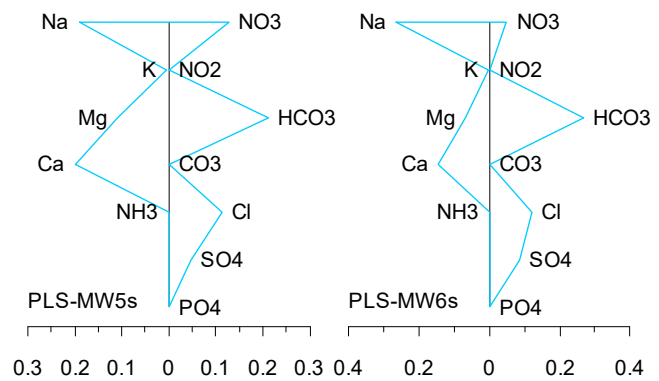
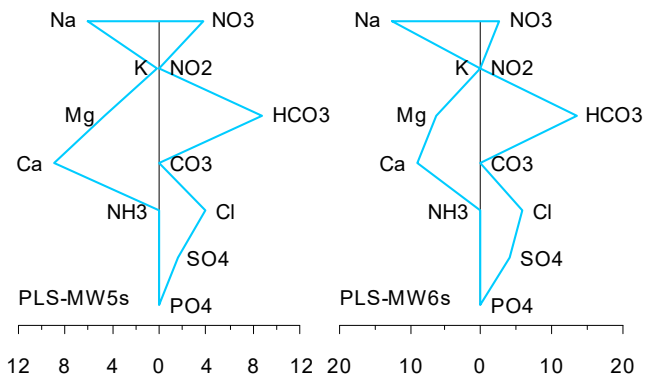
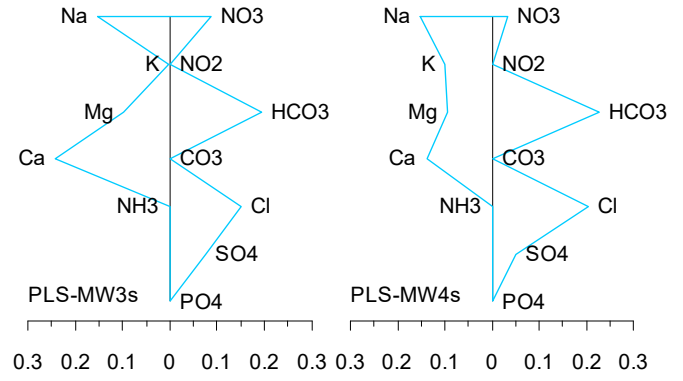
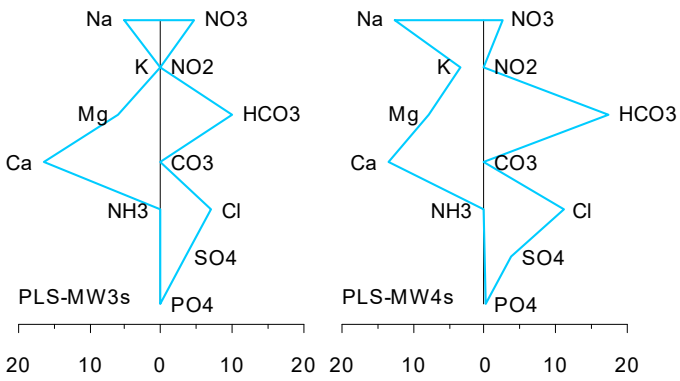
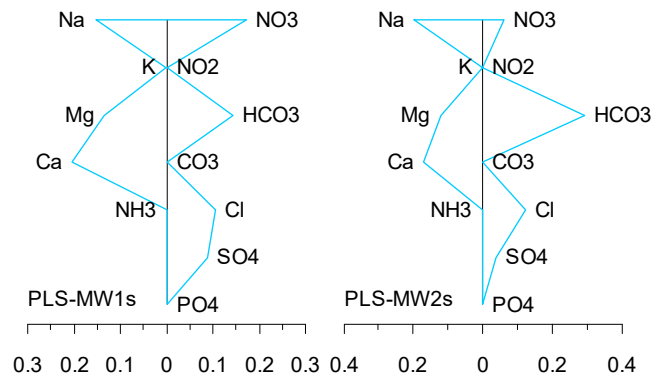
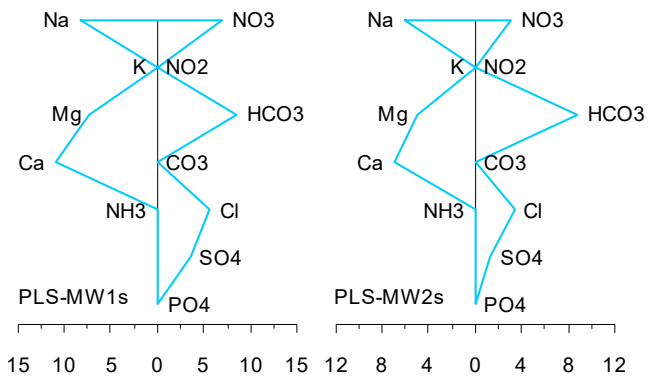

A11-97 PLS – Stiff diagrams, February 2018

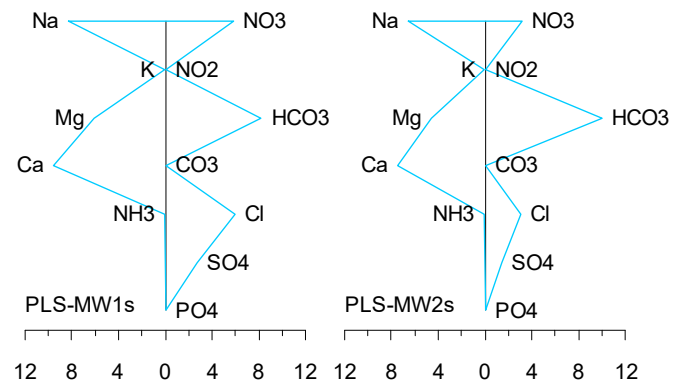
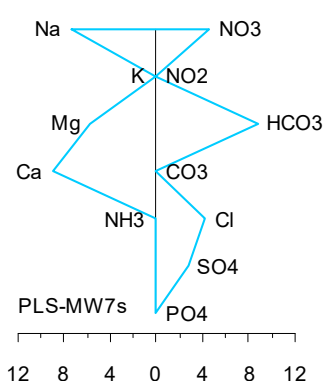

A11-96 PLS – Stiff diagrams, March 2017

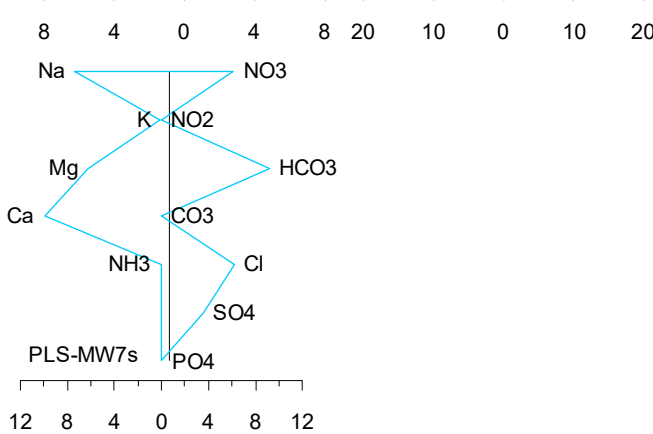
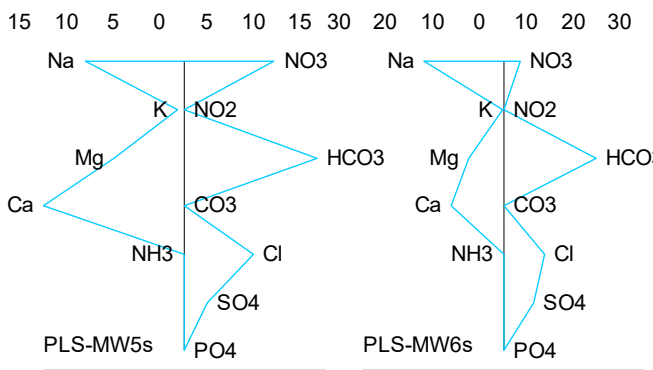
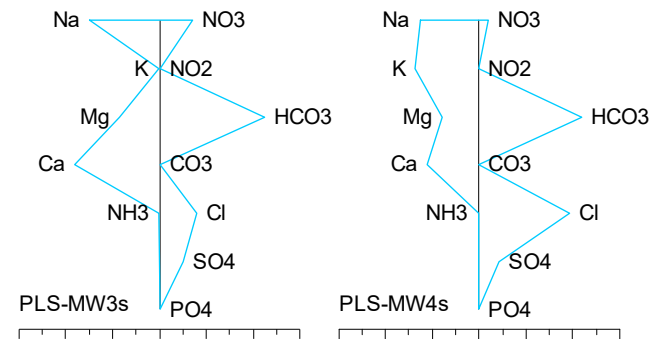

A11-98 PLS – Stiff diagrams, February 2019

CAE

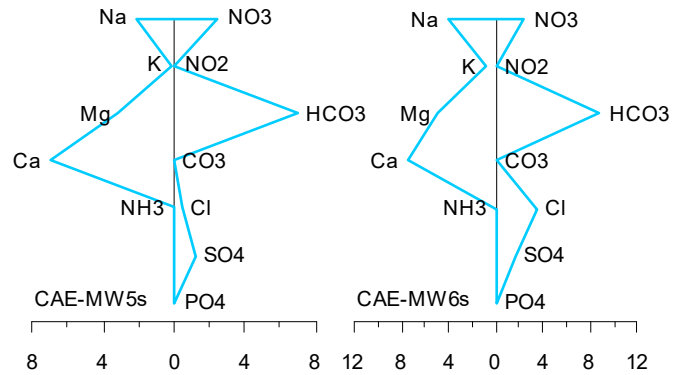
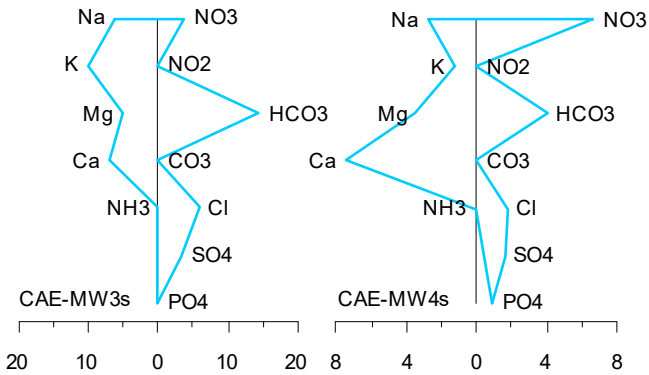
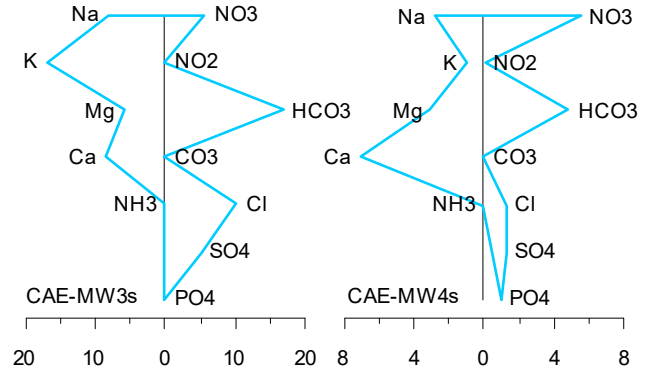
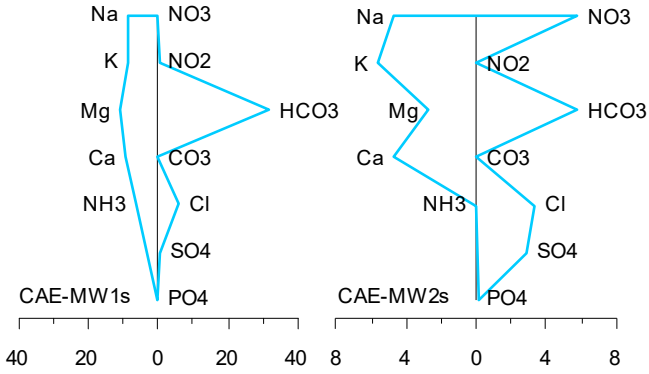

A11-100 CAE – Stiff diagrams, August 2012

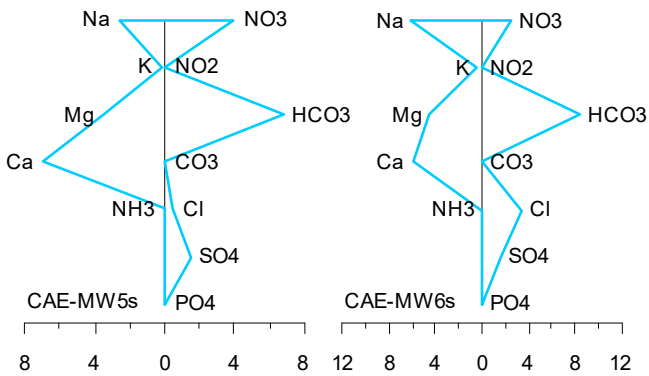

A11-99 CAE – Stiff diagrams, May 2012

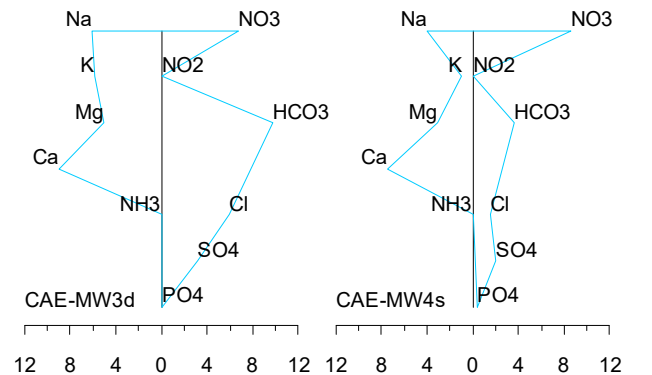
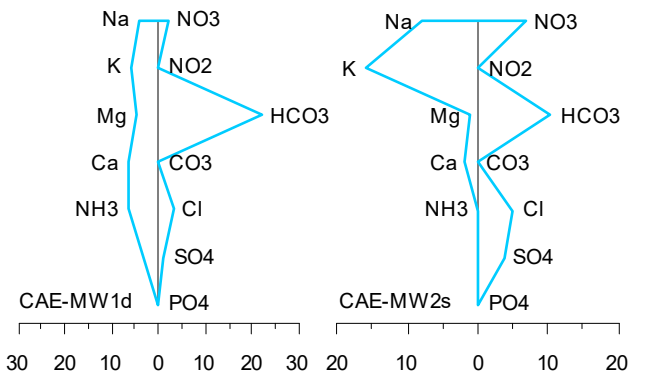
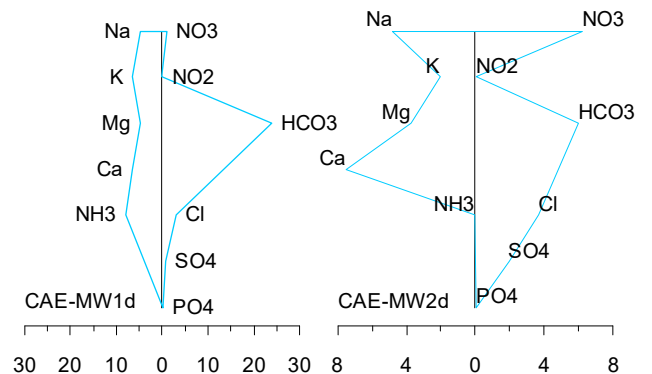

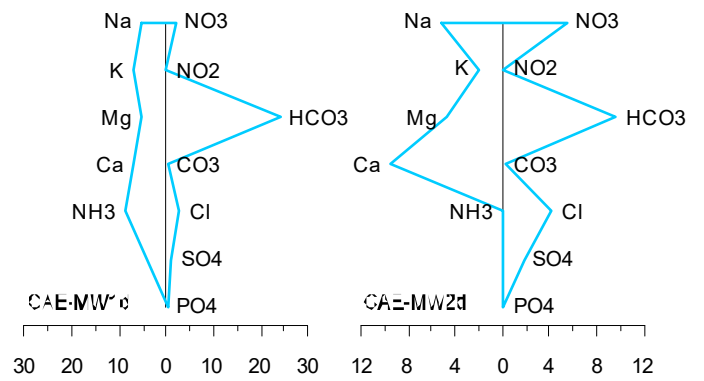
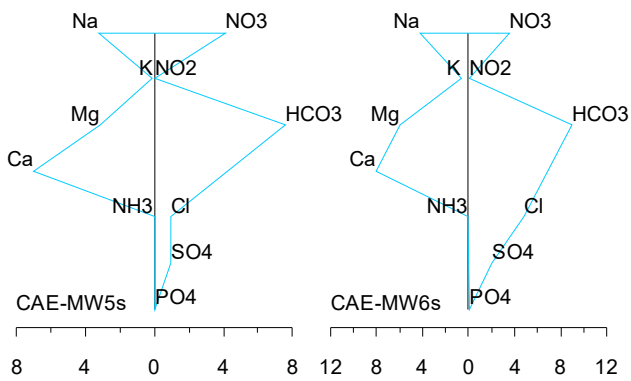

A11-101 CAE – Stiff diagrams, August 2013

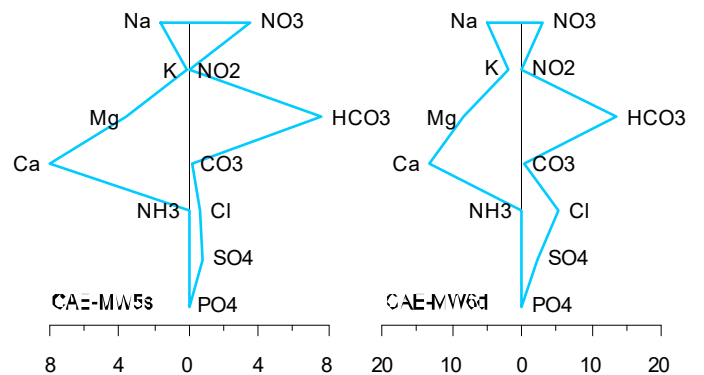
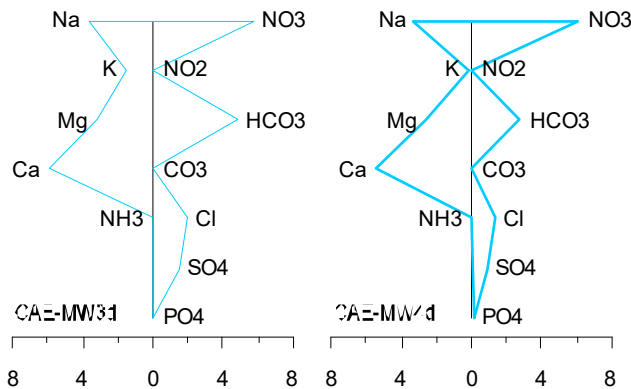
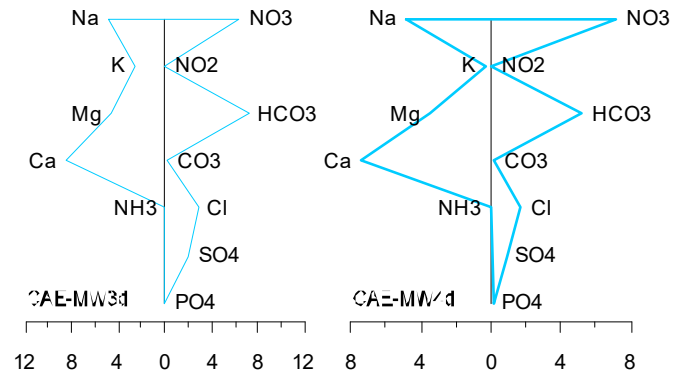
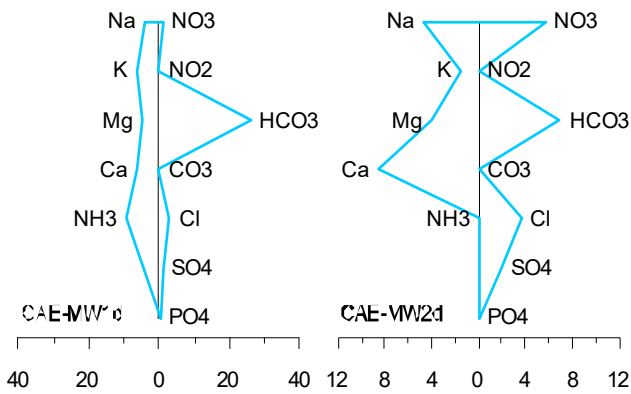

A11-103 CAE – Stiff diagrams, February 2015

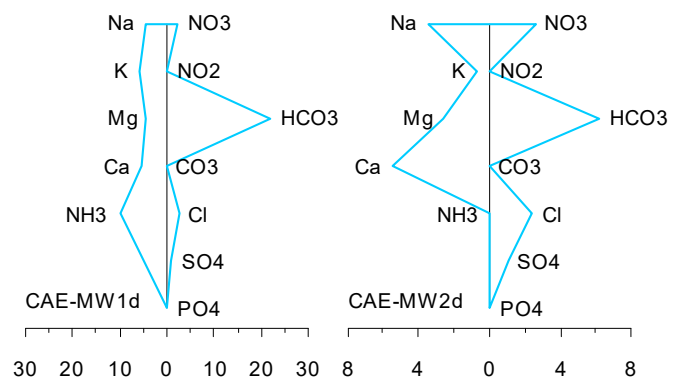
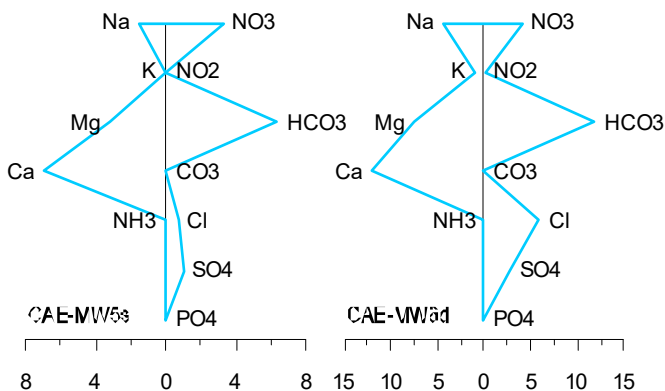

A11-102 CAE – Stiff diagrams, August 2014

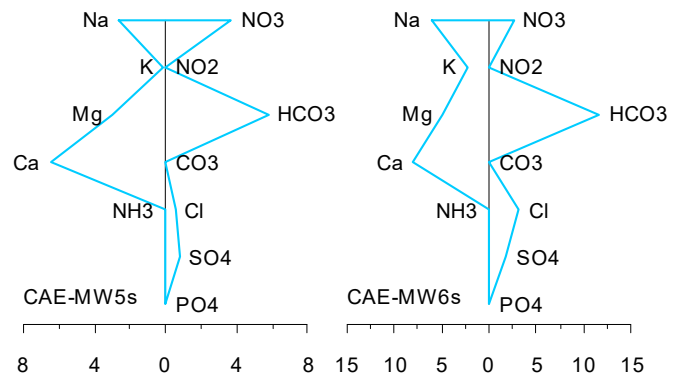
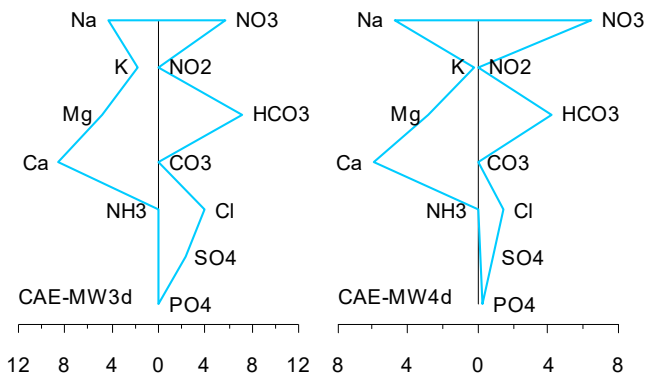

A11-105 CAE – Stiff diagrams, March 2017

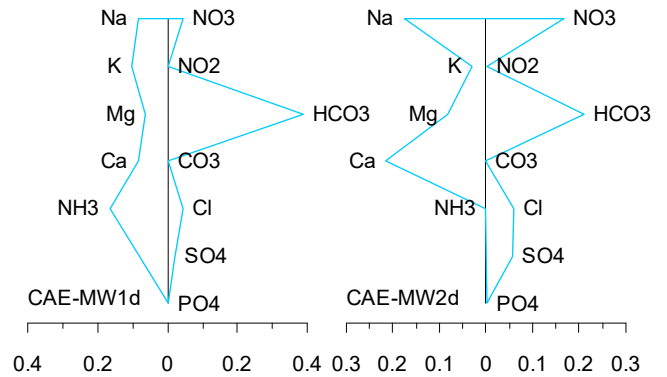
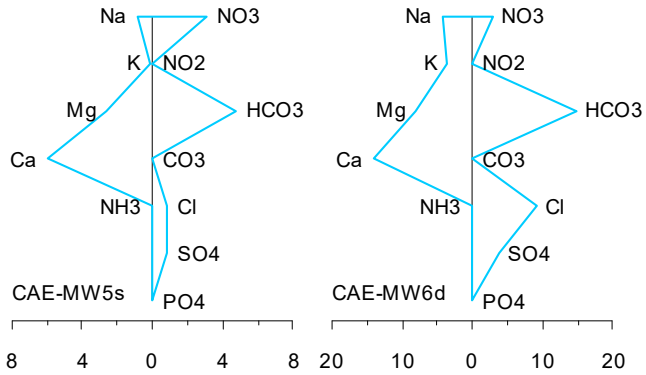

A11-104 CAE – Stiff diagrams, February 2016

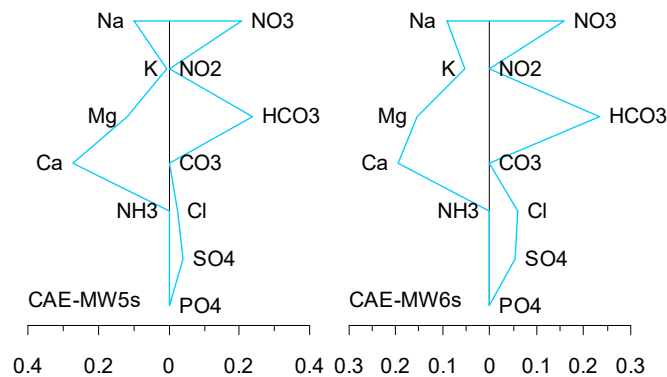
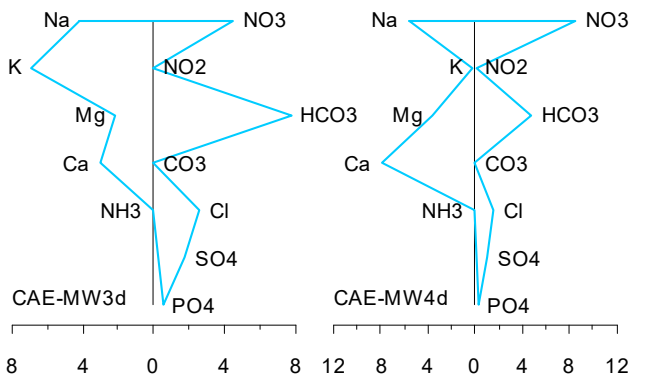
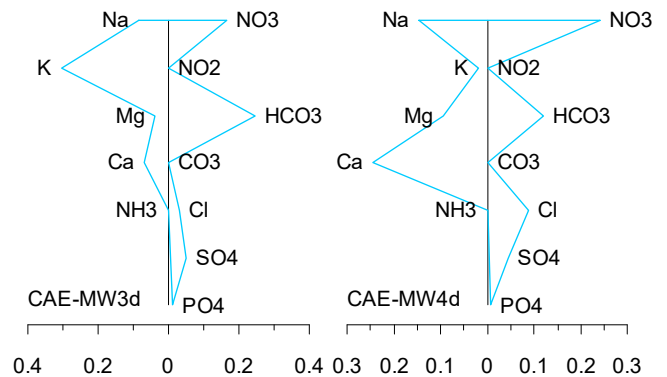
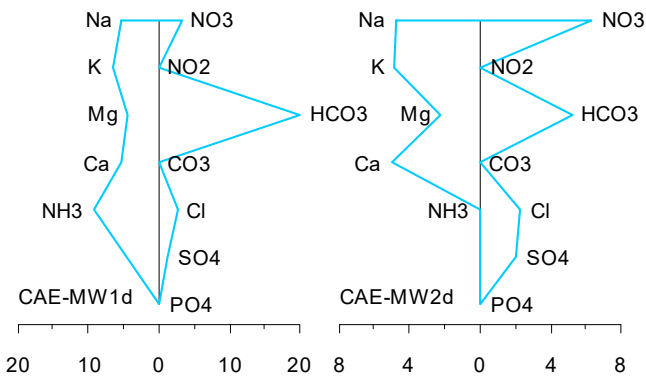

A11-106 CAE – Stiff diagrams, February 2018

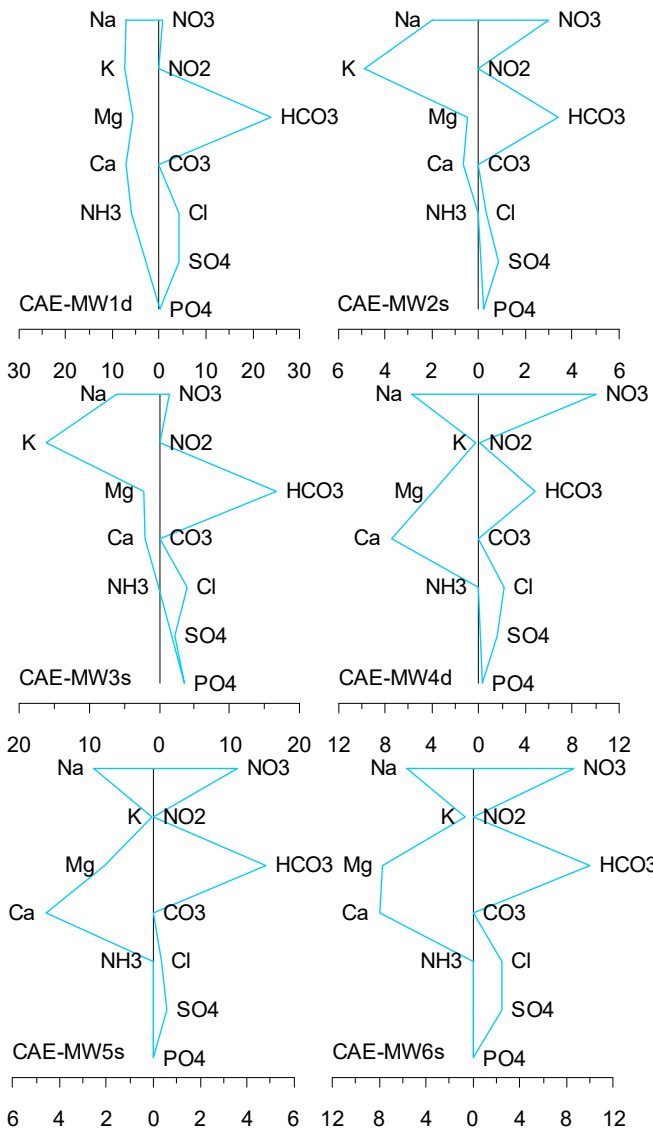

A11-107 CAE – Stiff diagrams, February 2019

ROB

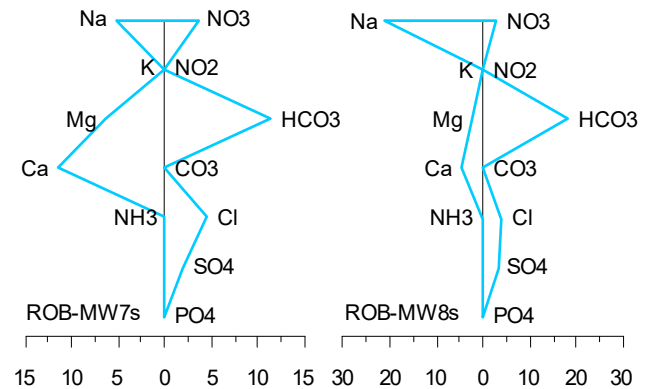
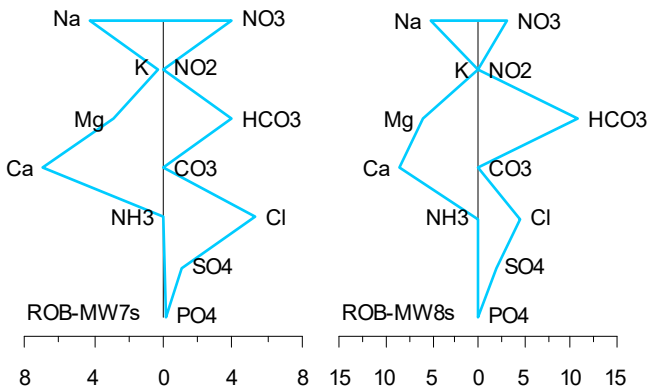
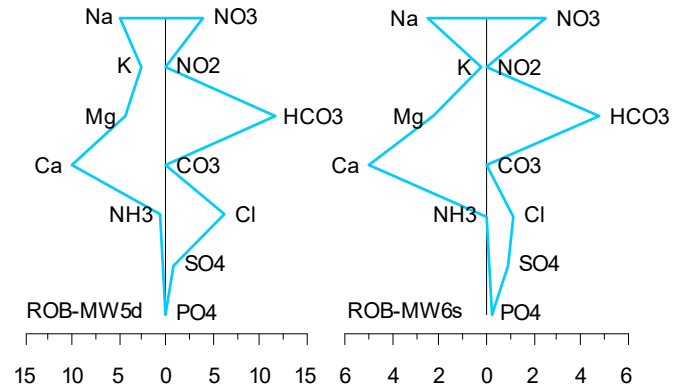
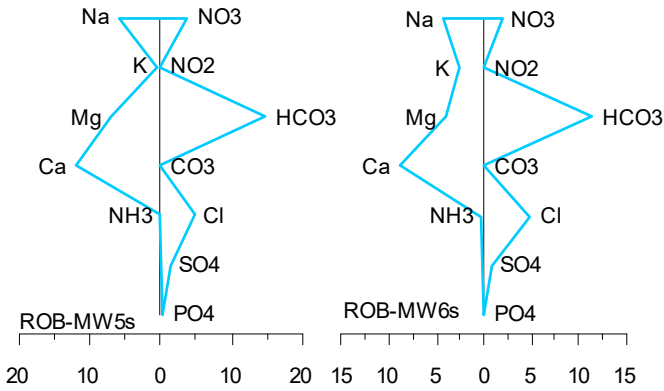
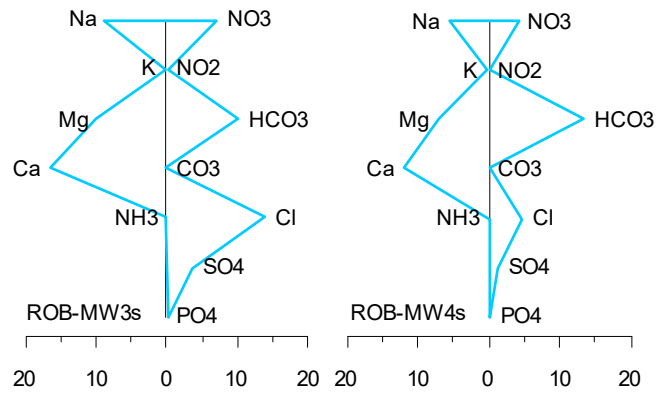
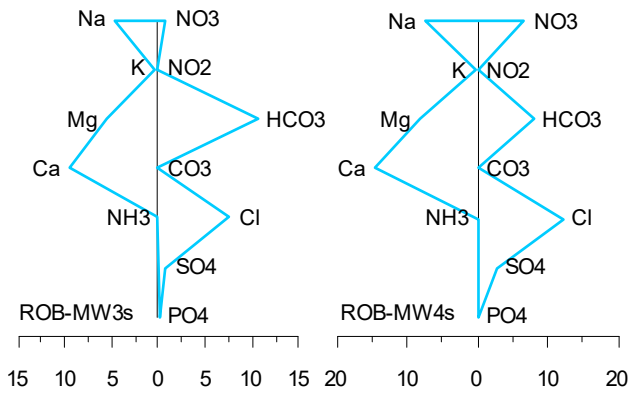
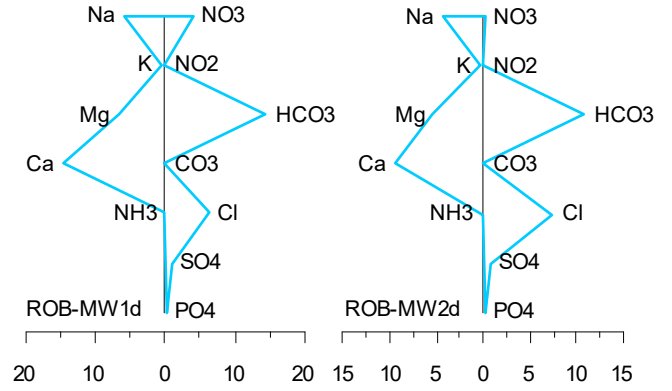
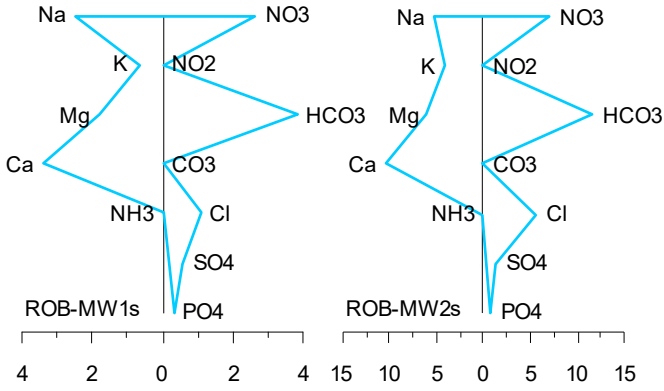

A11-108 ROB – Stiff diagrams, May 2012

A11-109 ROB – Stiff diagrams, August 2012

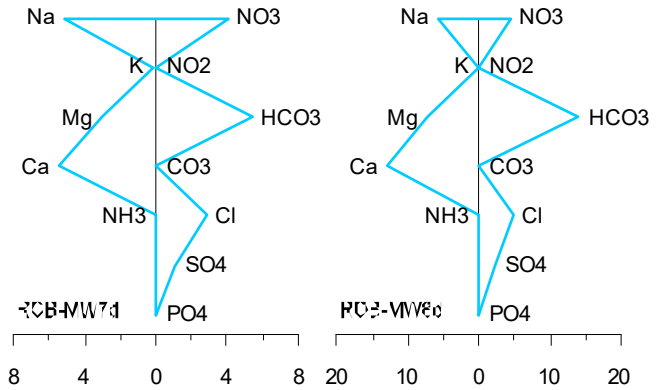
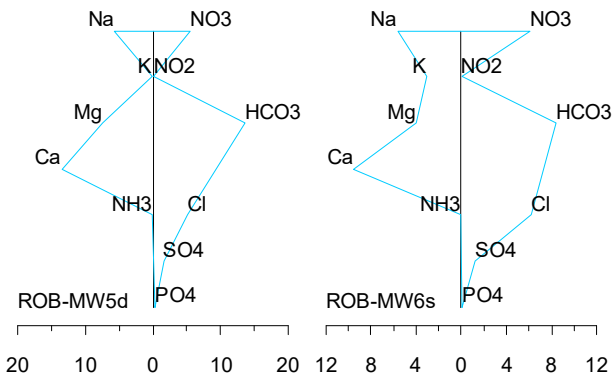
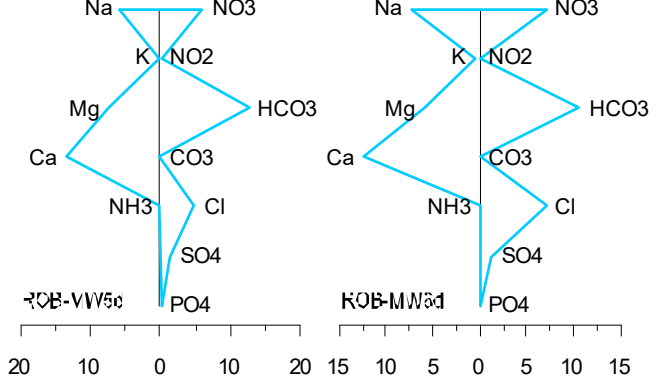
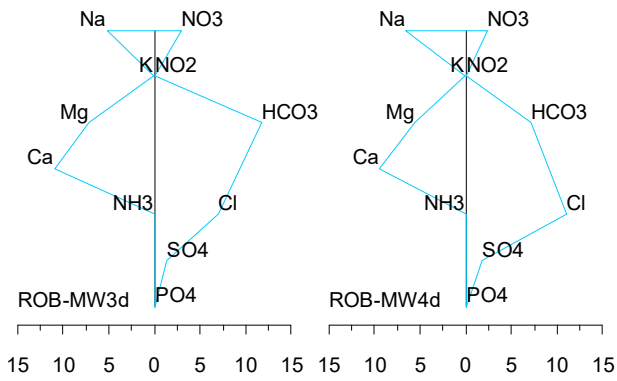
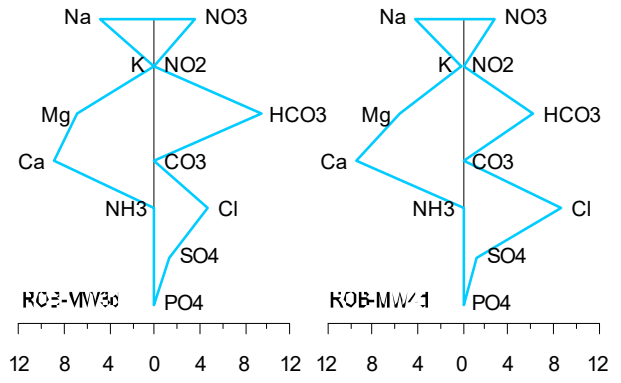
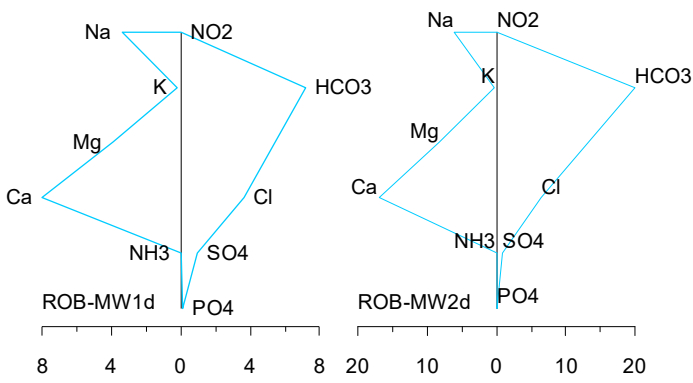

A11-111 ROB – Stiff diagrams, August 2014

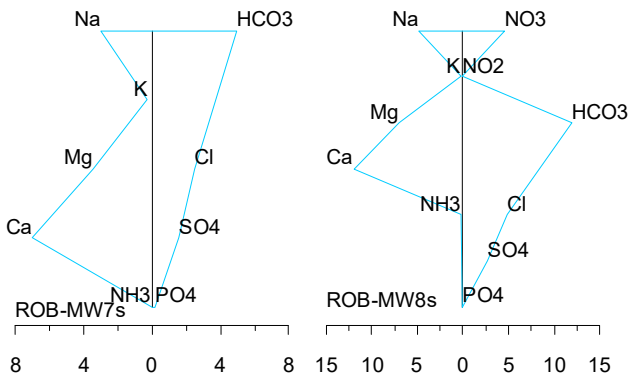

A11-110 ROB – Stiff diagrams, August 2013

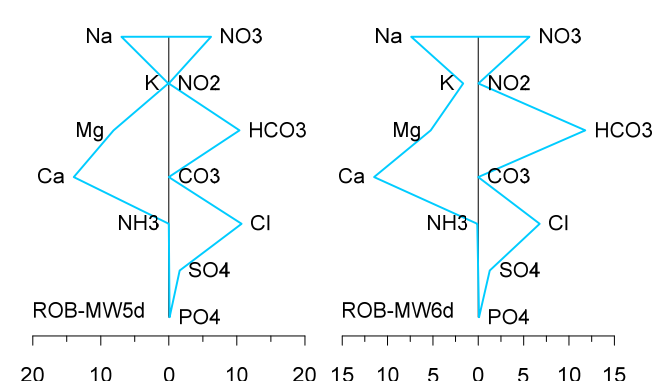
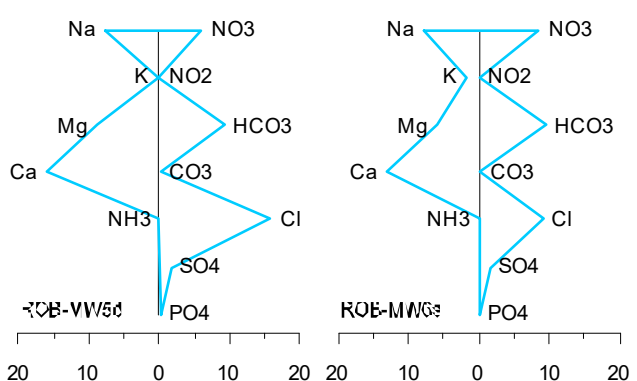
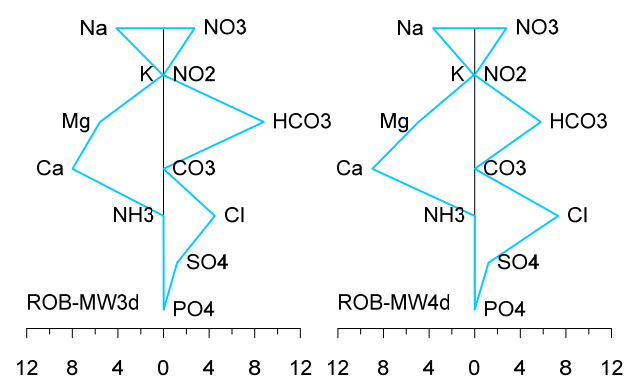
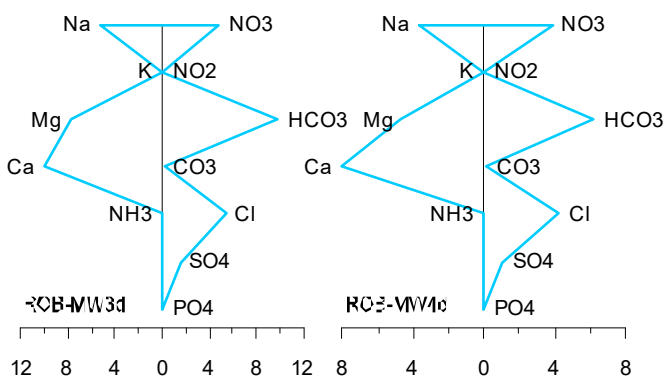
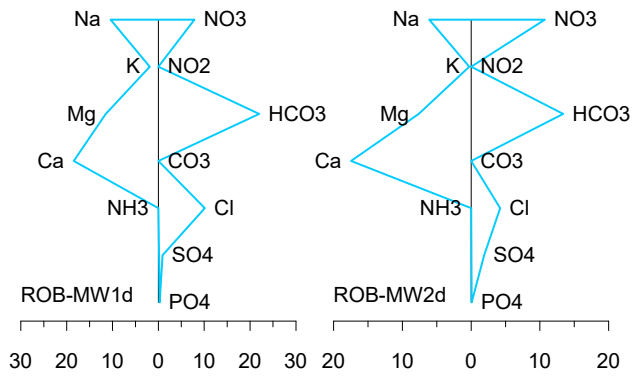
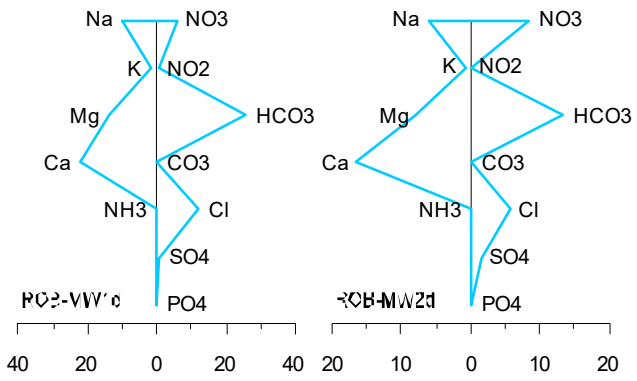

A11-113 ROB – Stiff diagrams, February 2016

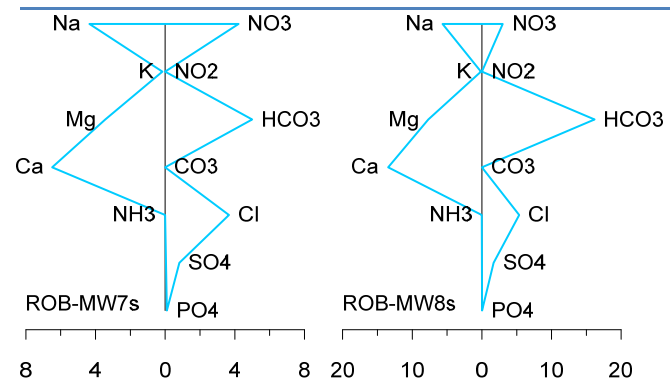
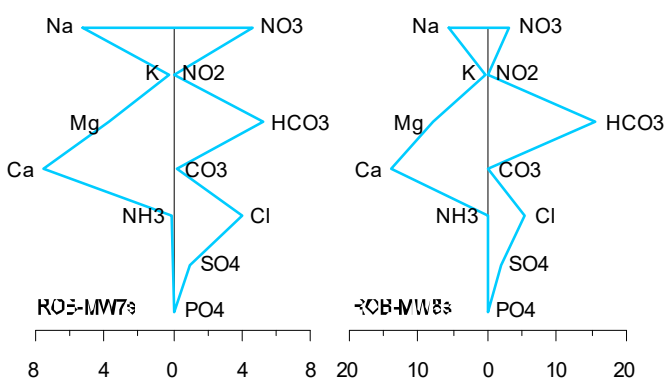

A11-112 ROB – Stiff diagrams, February 2015

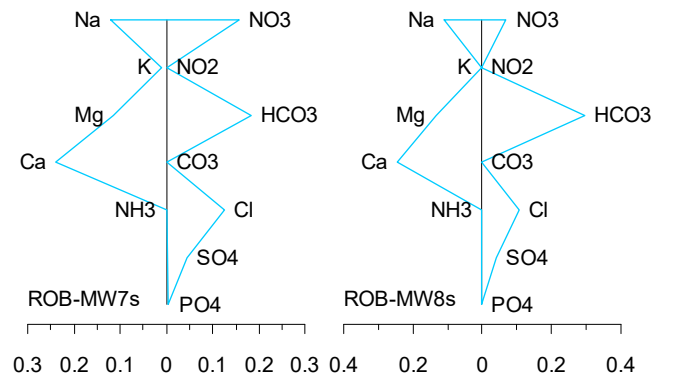
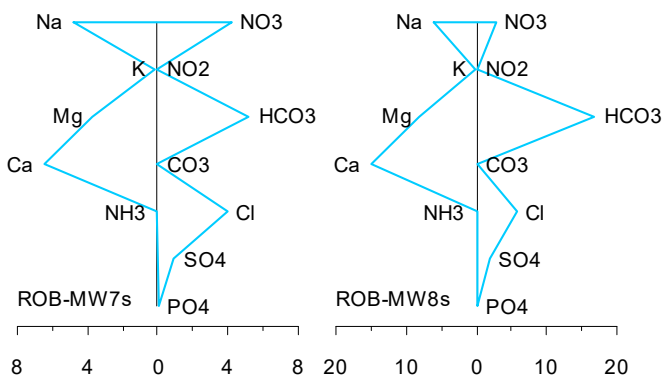
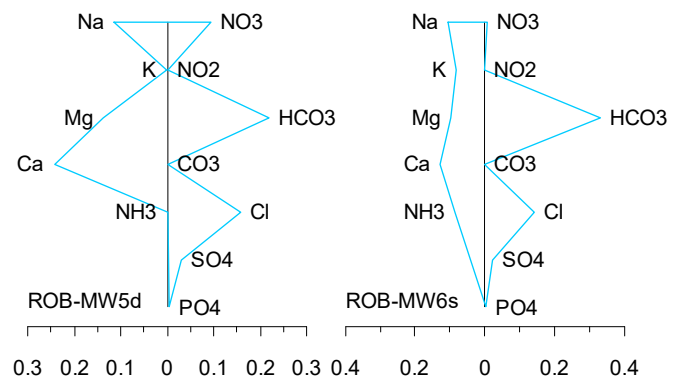
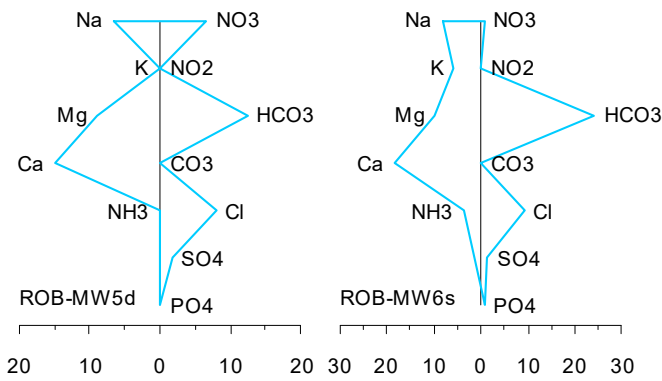
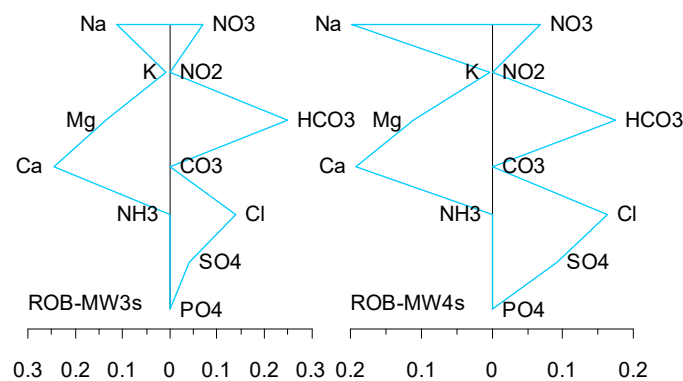
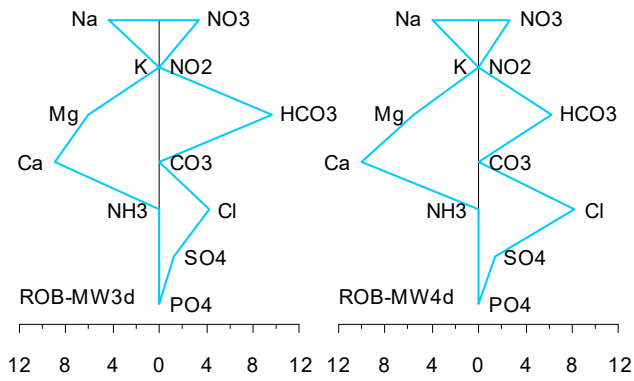
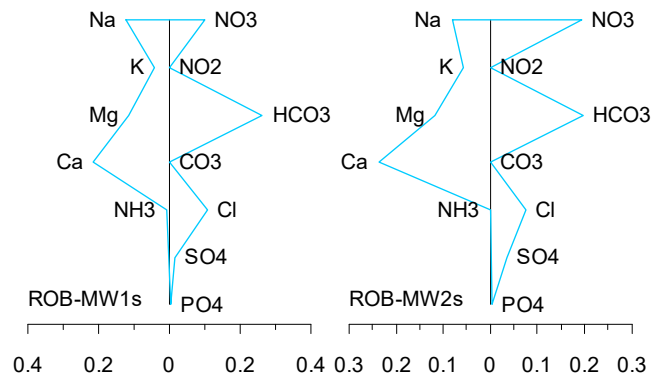
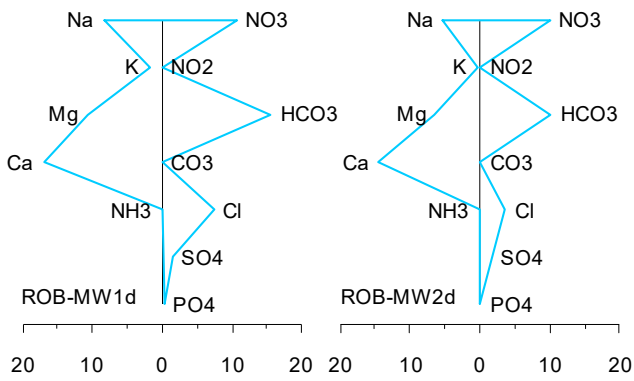

A11-114 ROB – Stiff diagrams, March 2017

A11-115 ROB – Stiff diagrams, February 2018

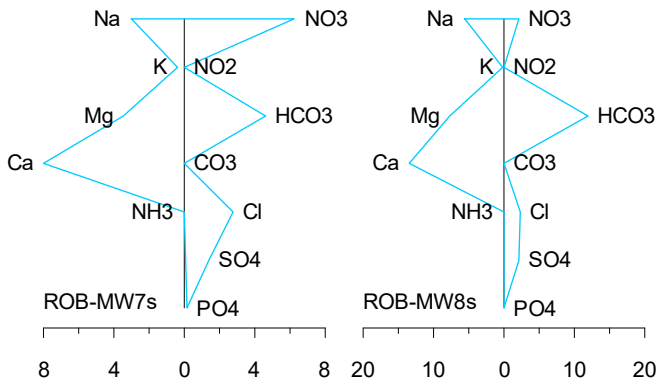
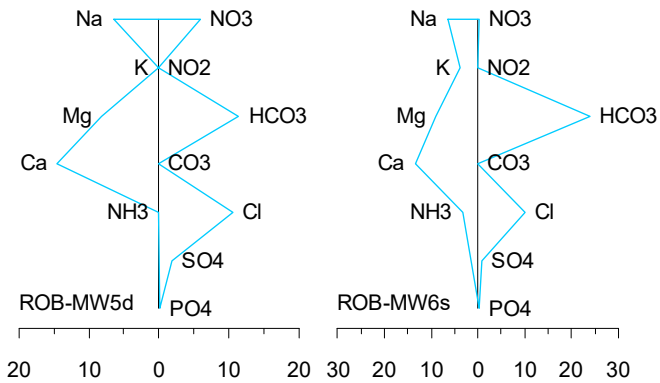
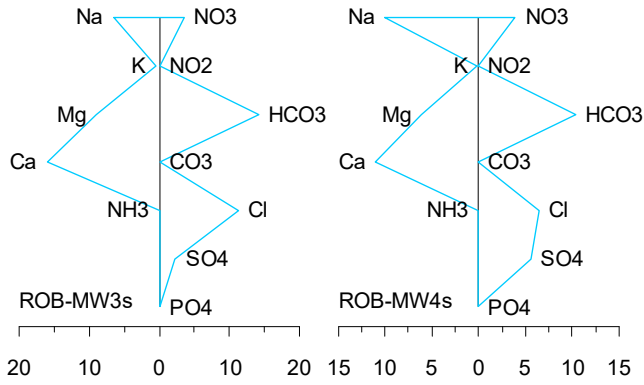
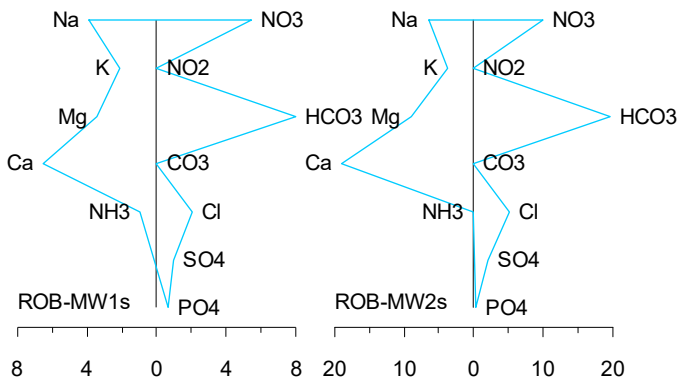

A11-116 ROB – Stiff diagrams, February 2019

WOO

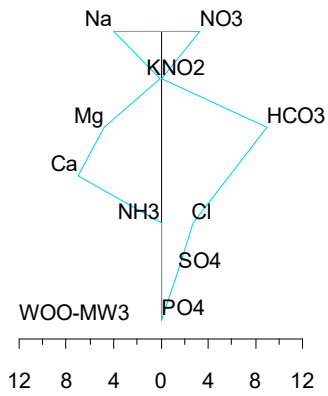
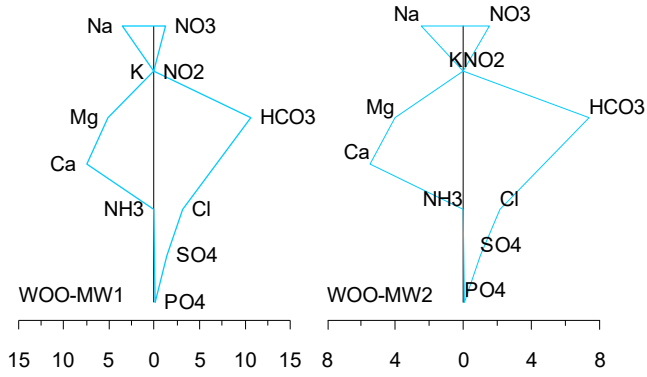

A11-117 WOO – Stiff diagrams, August 2013

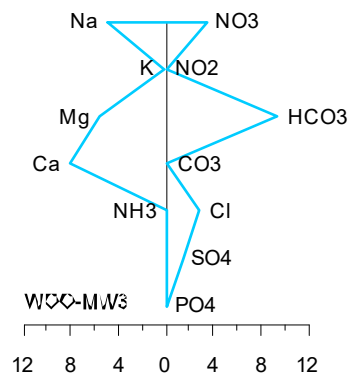
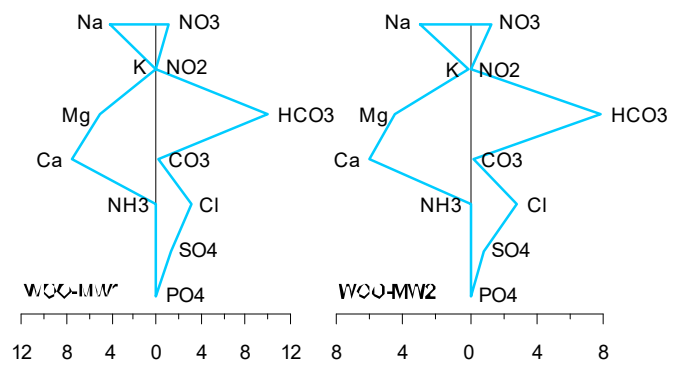

A11-119 WOO – Stiff diagrams, February 2015

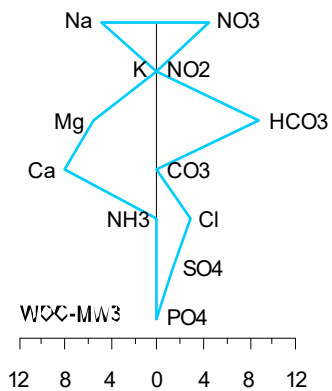
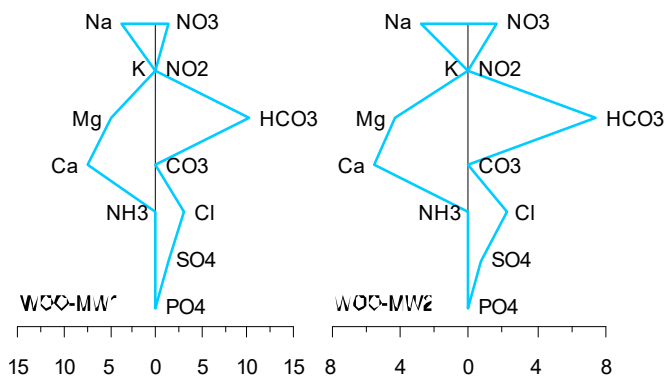

A11-118 WOO – Stiff diagrams, August 2014

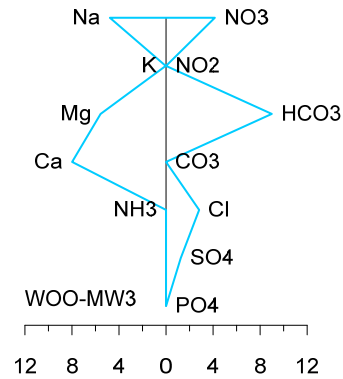
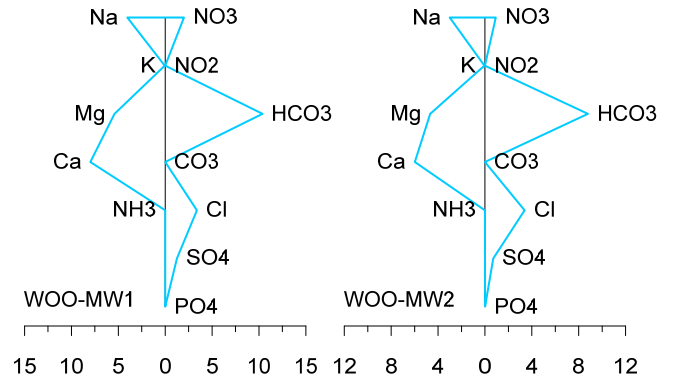

A11-120 WOO – Stiff diagrams, February 2016

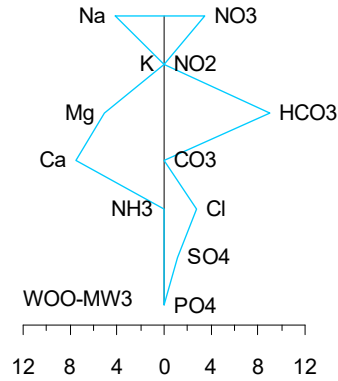
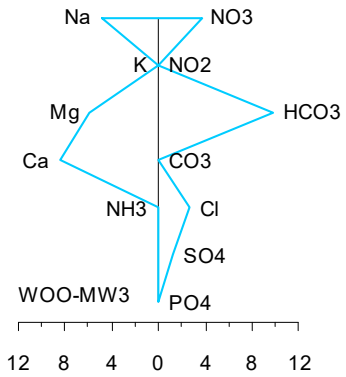
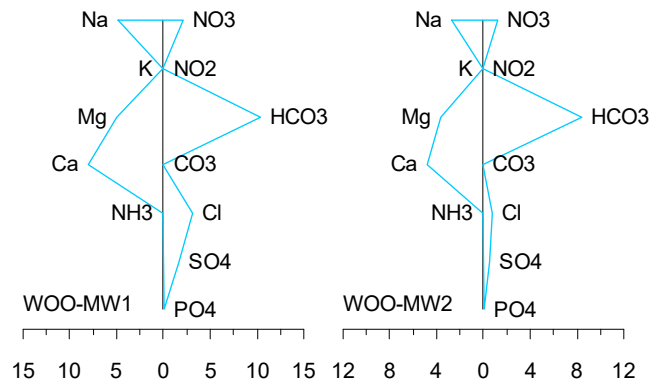
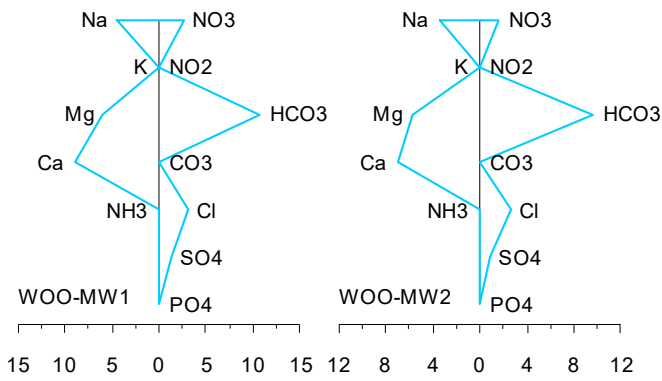

A11-121 WOO – Stiff diagrams, March 2017

A11-123 WOO – Stiff diagrams, February 2019

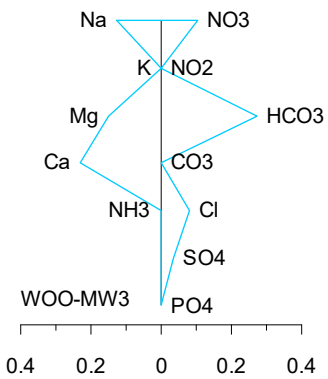
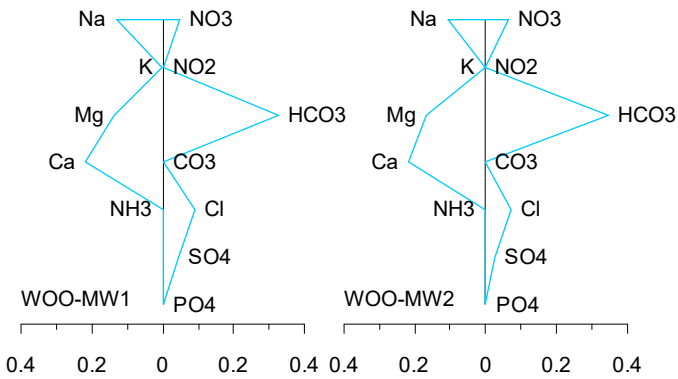

A11-122 WOO – Stiff diagrams, February 2018

ANT

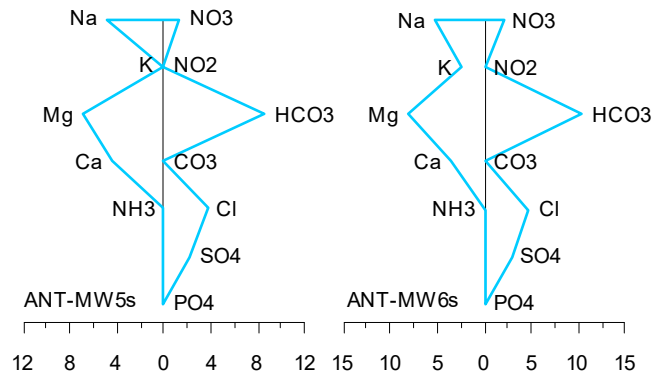
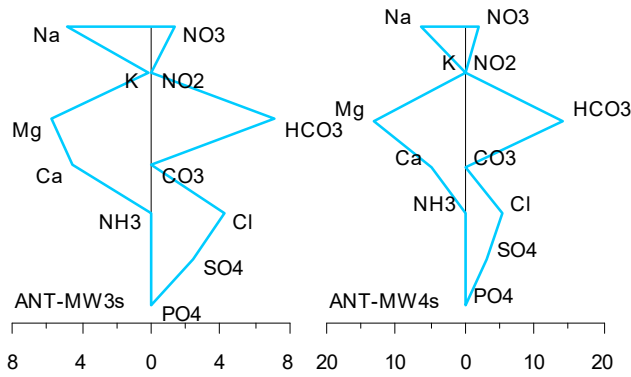
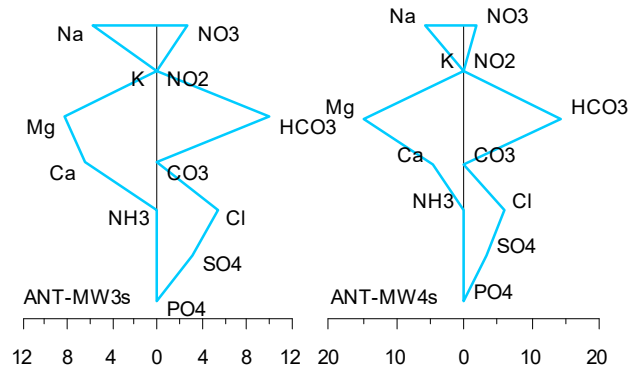
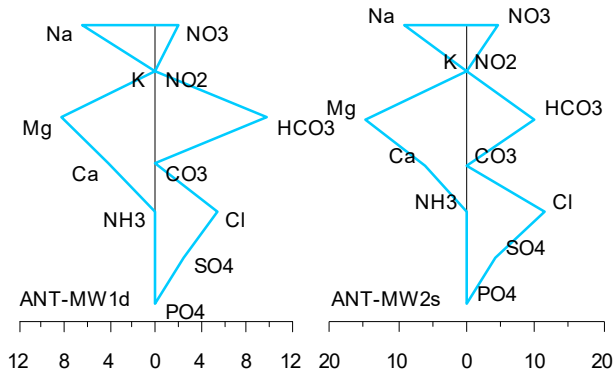

A11-125 ANT – Stiff diagrams, August 2012

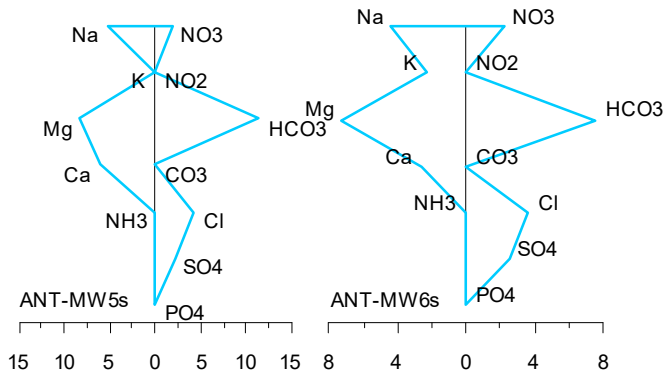

A11-124 ANT – Stiff diagrams, May 2012

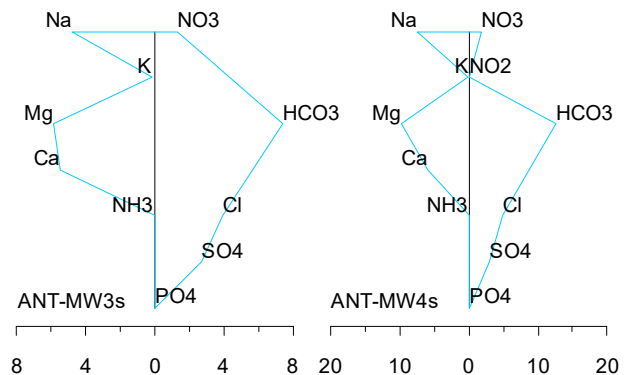
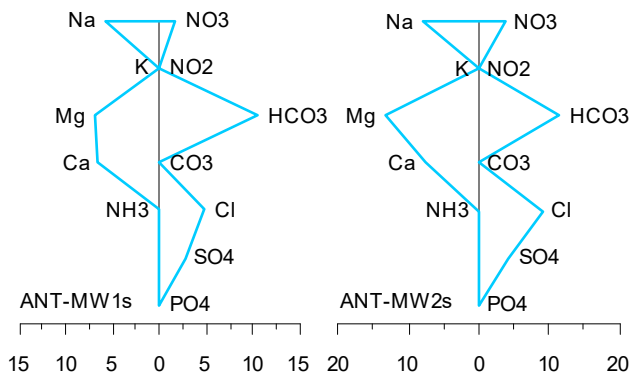
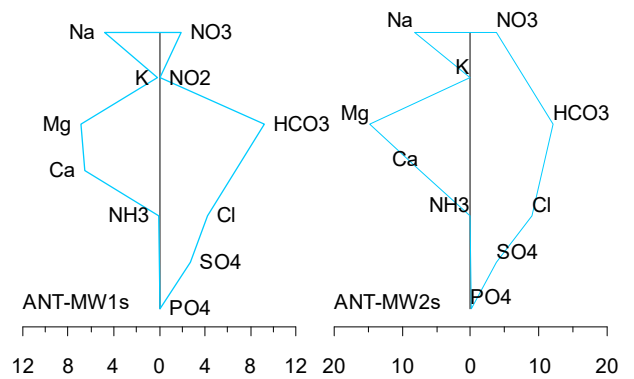

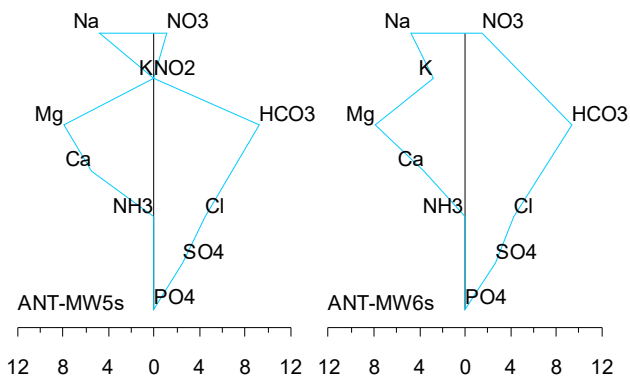

A11-126 ANT – Stiff diagrams, August 2013

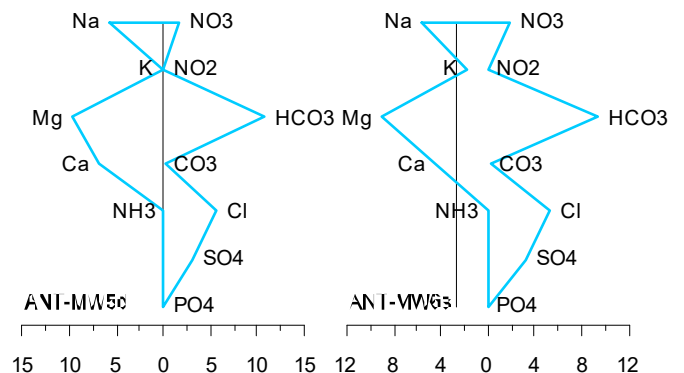
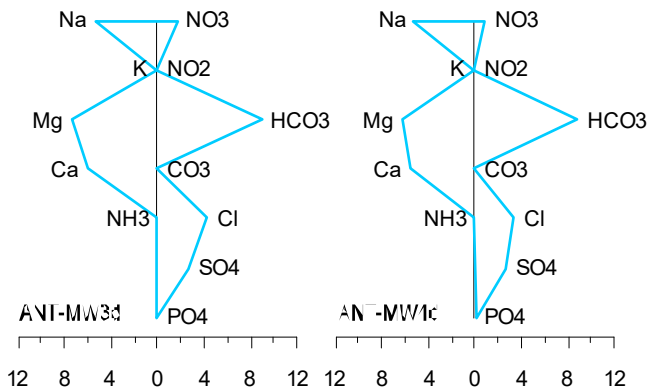
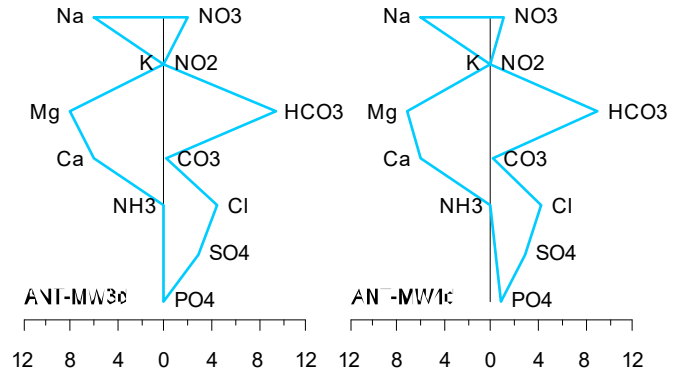
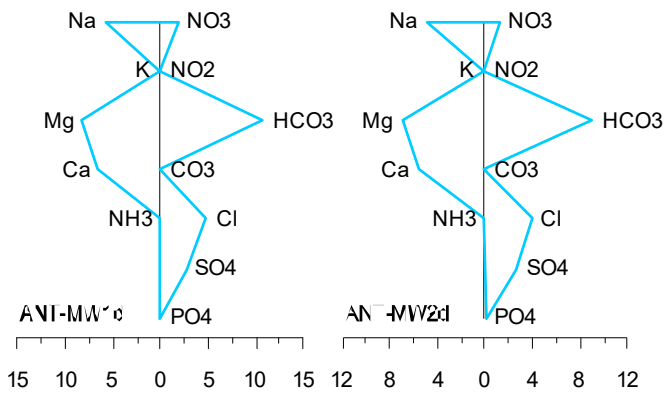
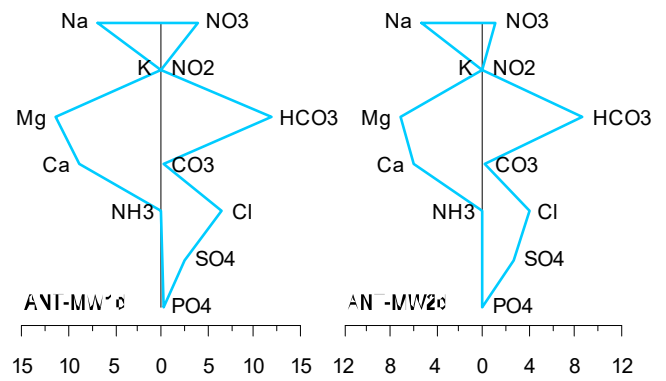

A11-128 ANT – Stiff diagrams, February 2015

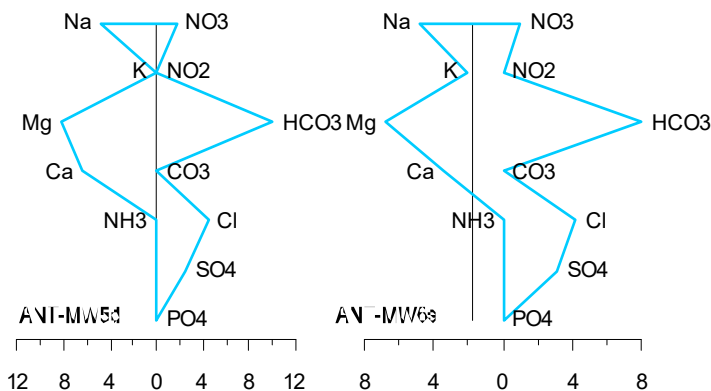

A11-127 ANT – Stiff diagrams, August 2014

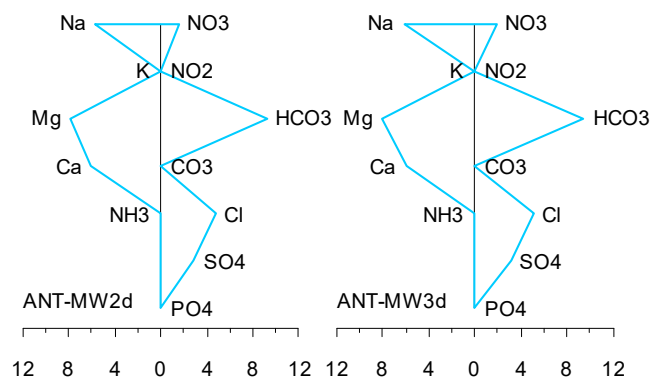

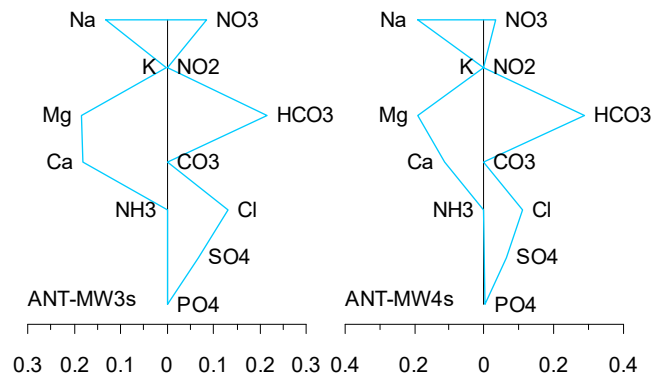
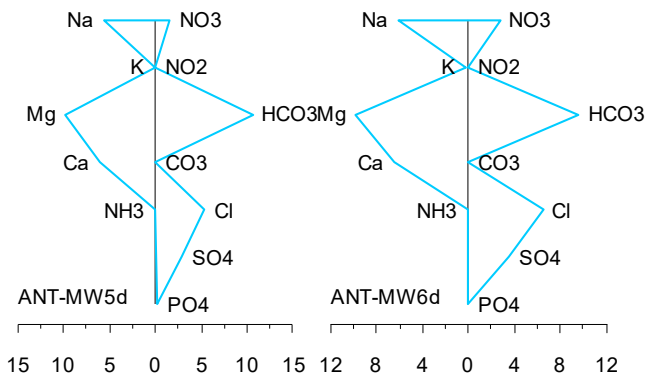

A11-129 ANT – Stiff diagrams, February 2016

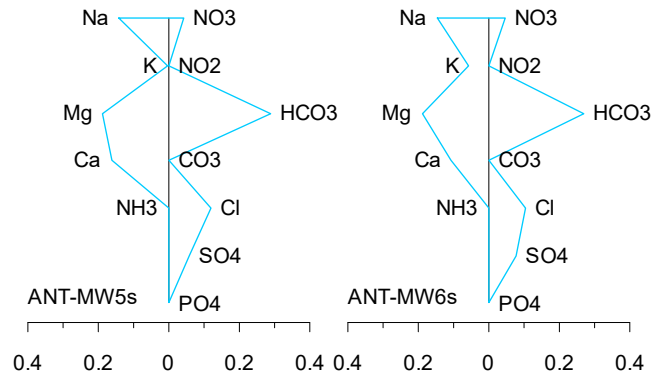
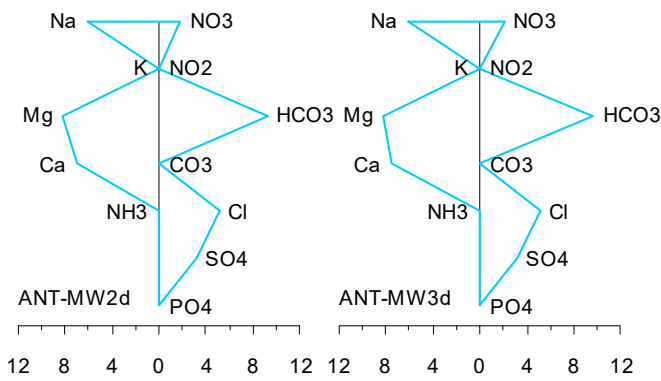

A11-131 ANT – Stiff diagrams, February 2018

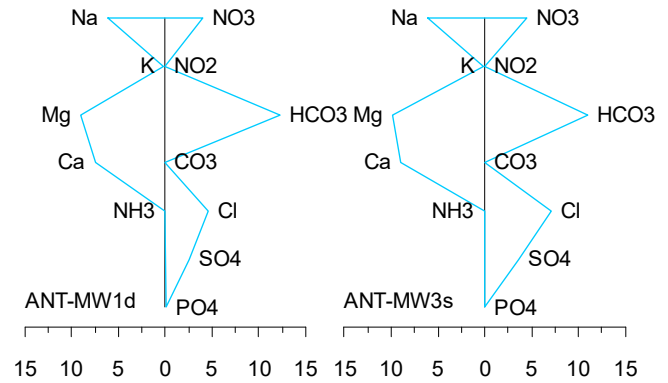
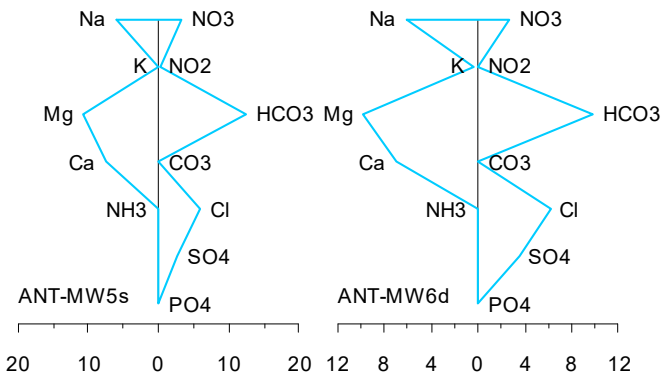

A11-130 ANT – Stiff diagrams, March 2017

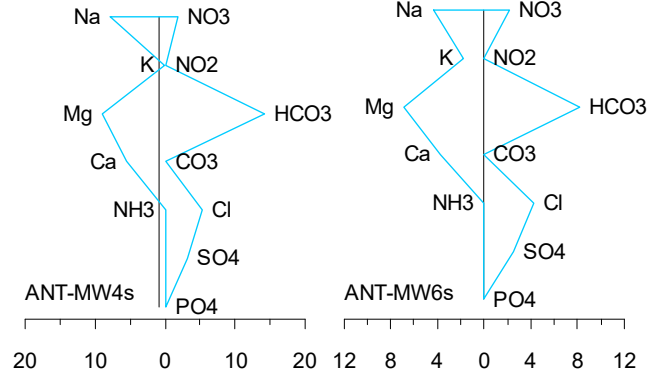
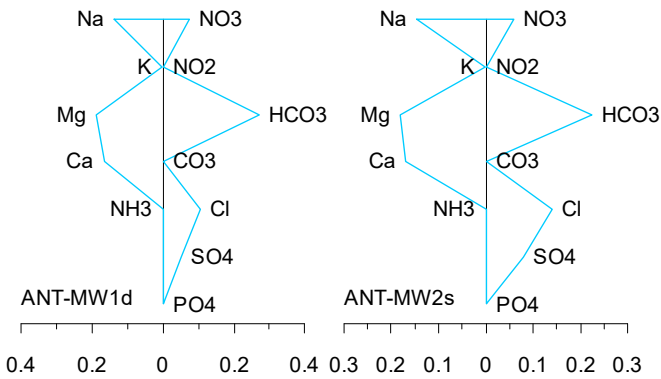

A11-132 ANT – Stiff diagrams, February 2019

COR

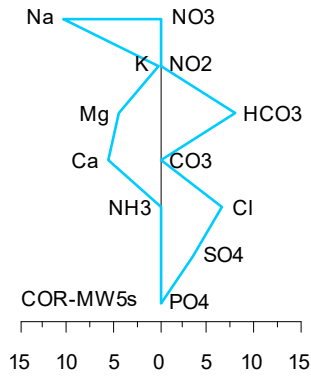
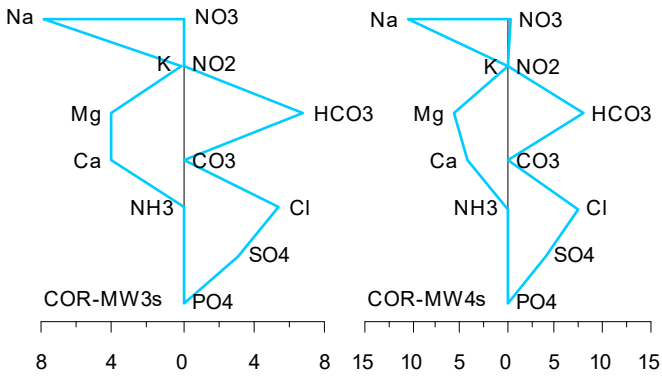
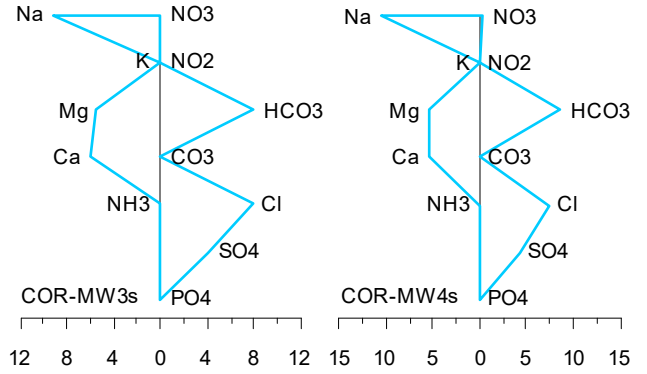
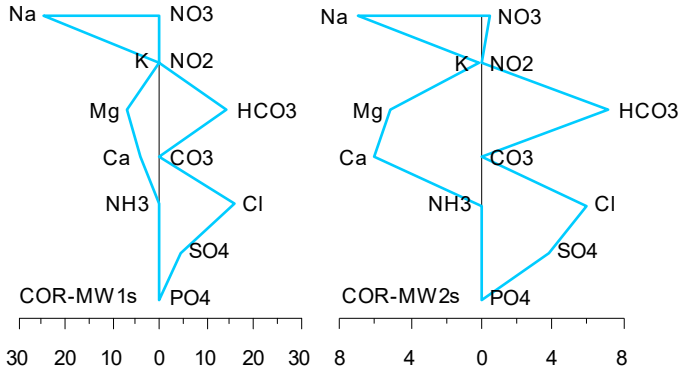

A11-134 COR – Stiff diagrams, August 2012

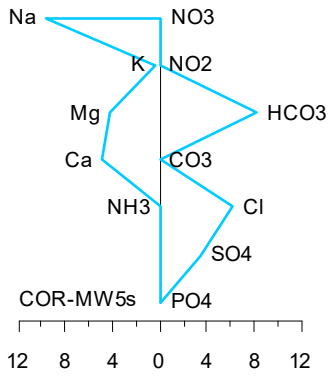

A11-133 COR – Stiff diagrams, May 2012

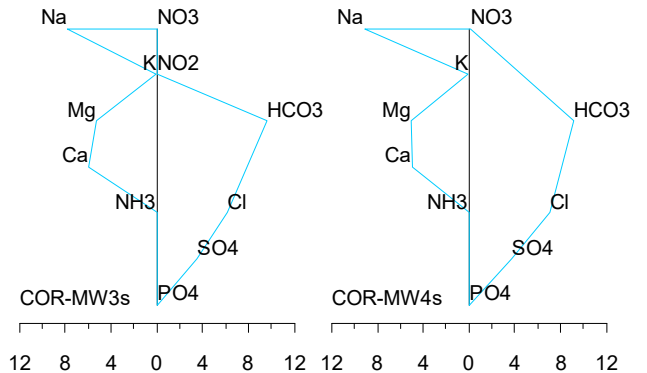
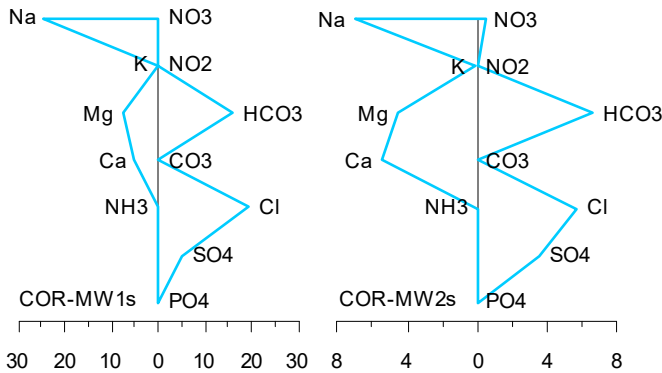
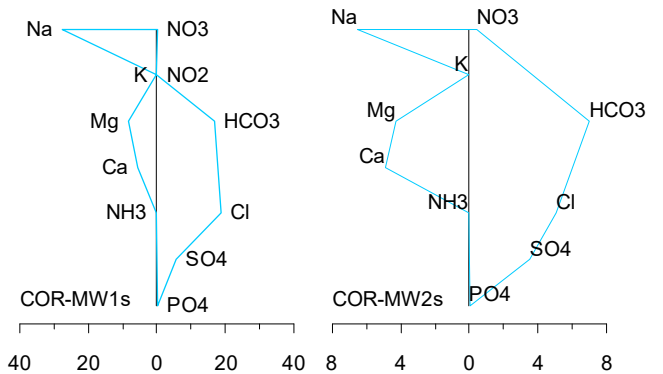

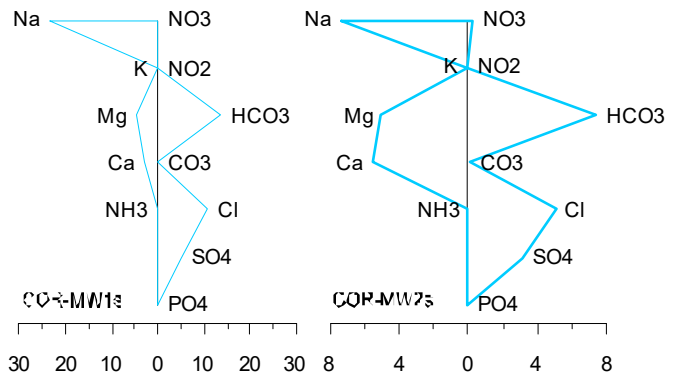
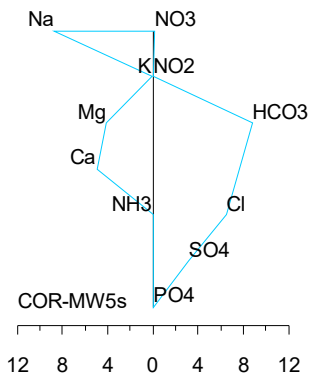

A11-135 COR – Stiff diagrams, August 2013

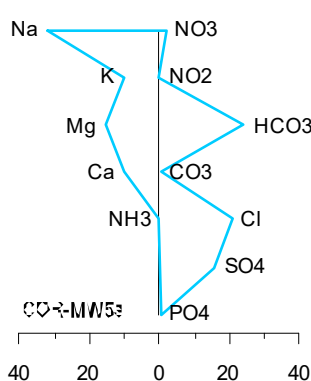
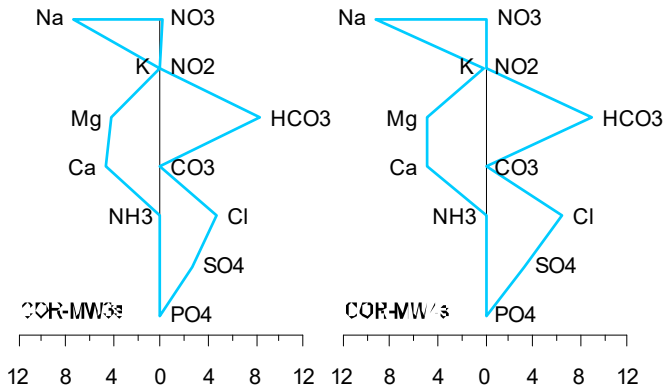
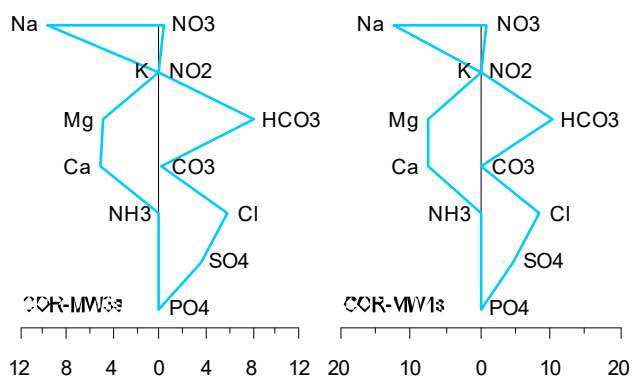
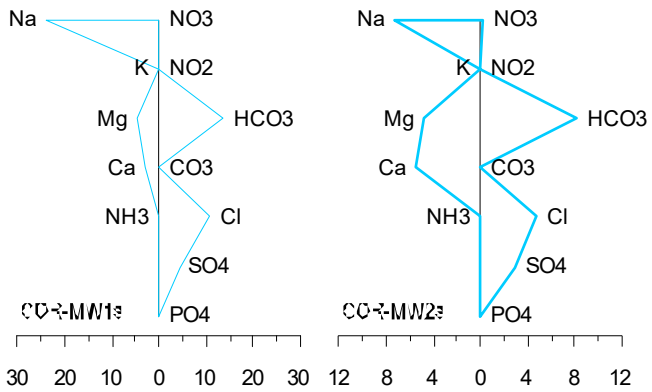

A11-137 COR – Stiff diagrams, February 2015

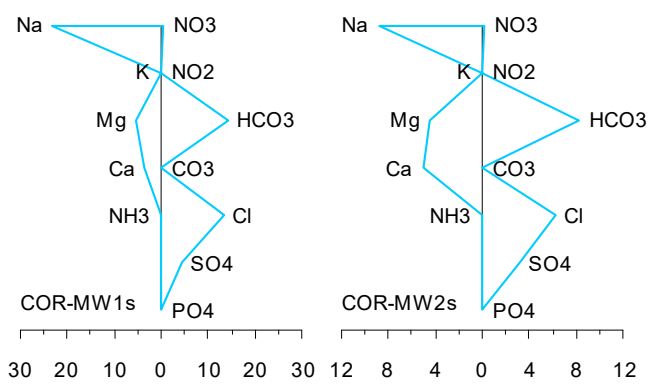
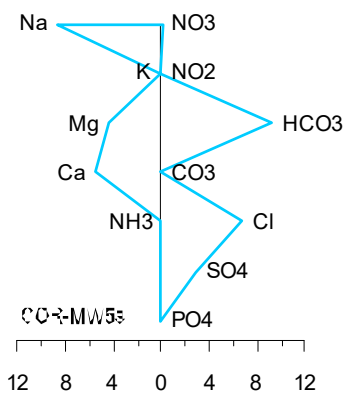

A11-136 COR – Stiff diagrams, August 2014

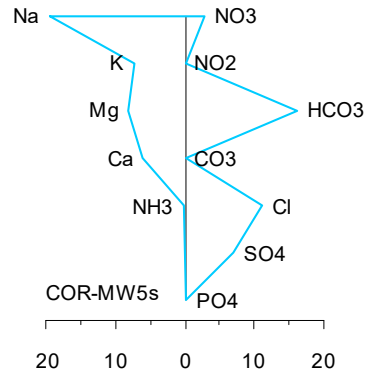
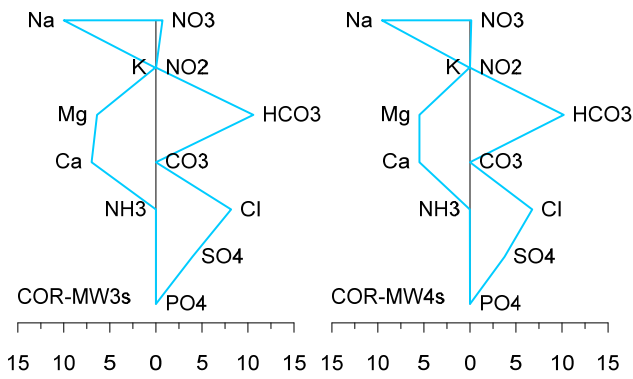

A11-139 COR – Stiff diagrams, March 2017

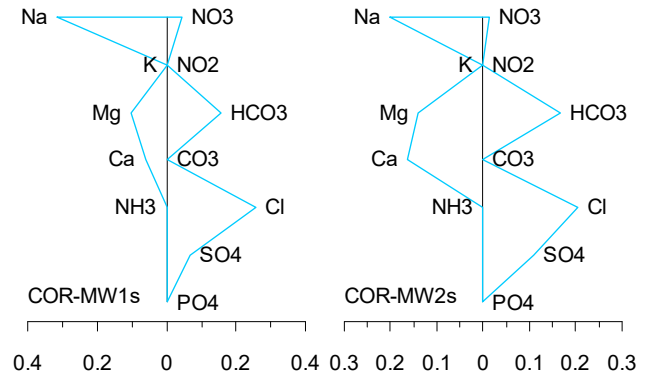
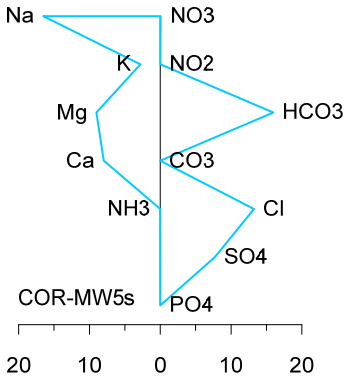

A11-138 COR – Stiff diagrams, February 2016

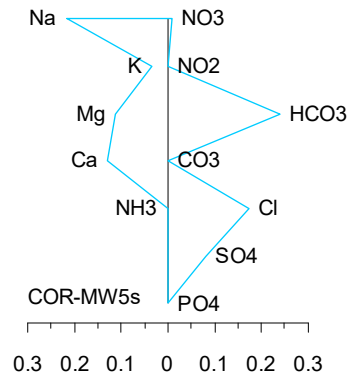
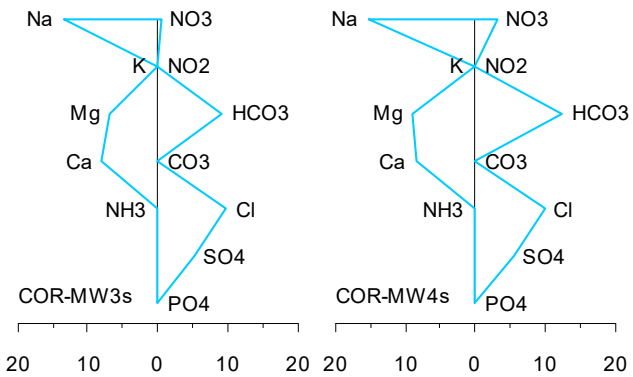
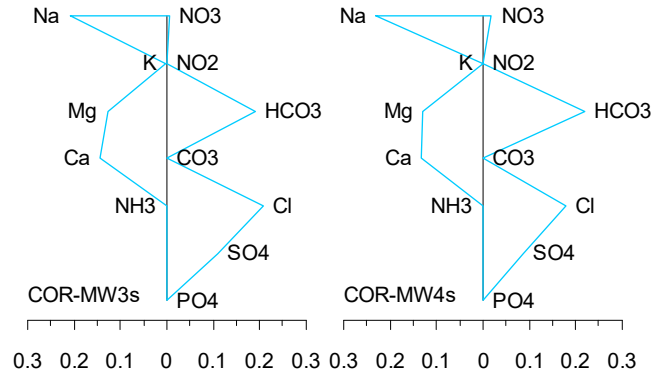
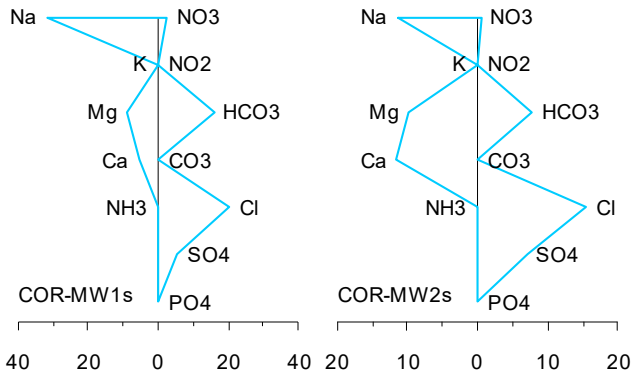

A11-140 COR – Stiff diagrams, February 2018

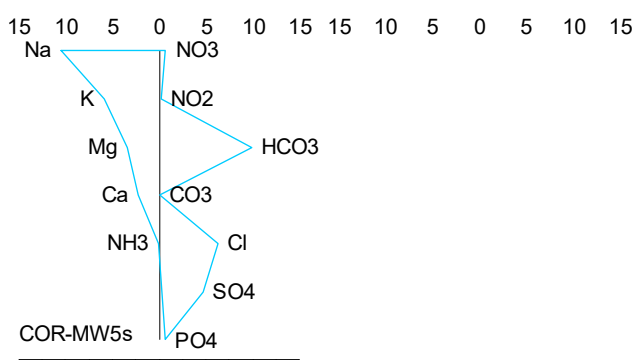
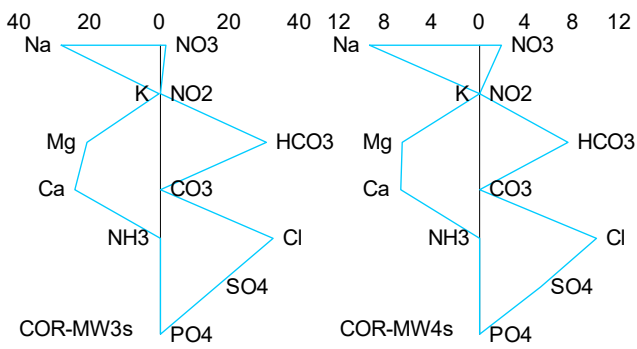
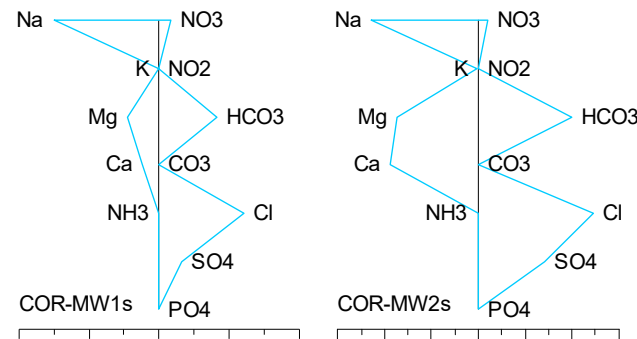

A11-141 COR – Stiff diagrams, February 2019

FG2

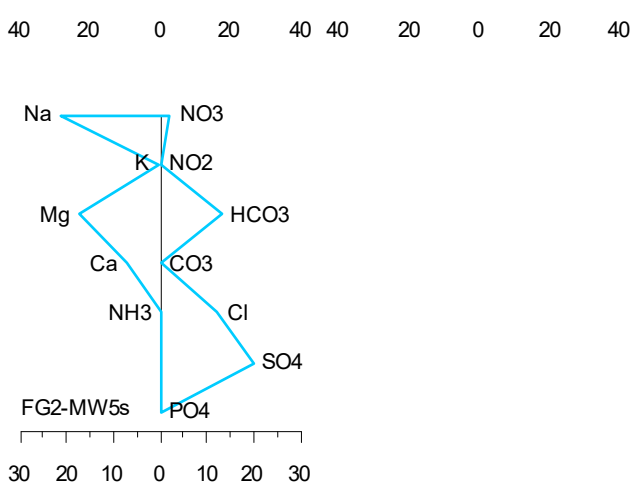
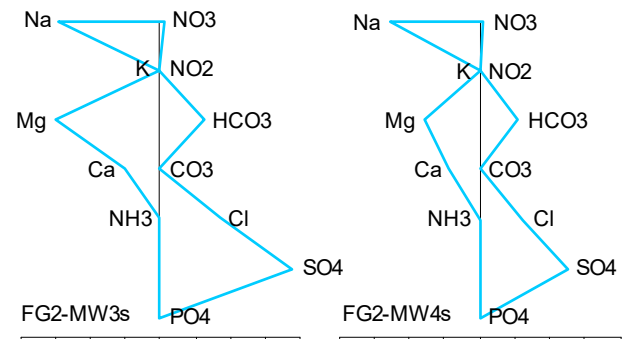
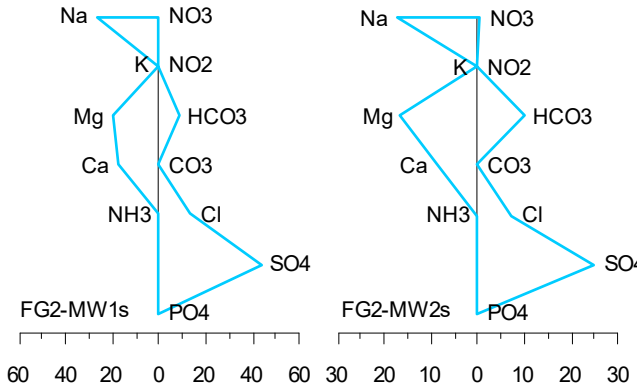

A11-142 FG2 – Stiff diagrams, May 2012

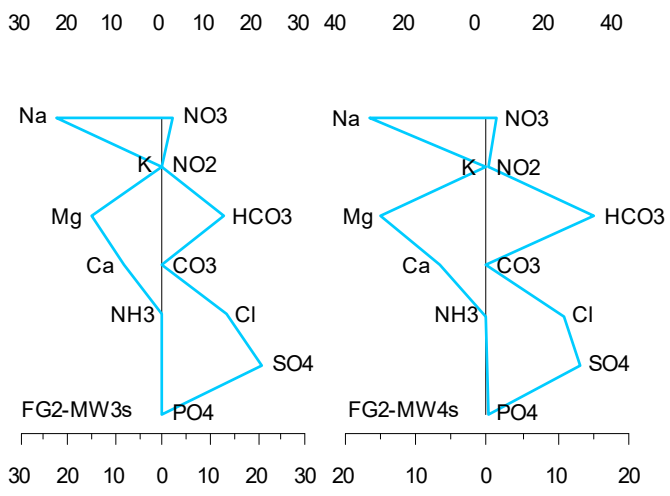
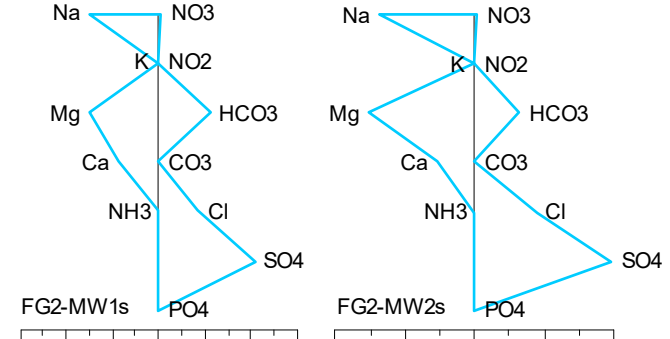

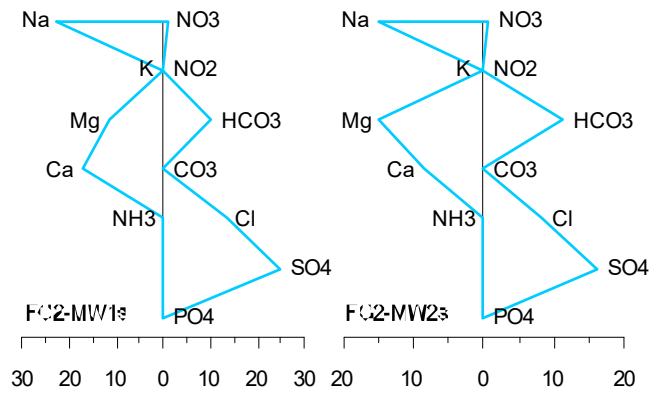
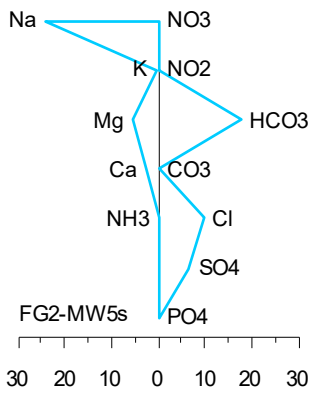

A11-143 FG2 – Stiff diagrams, August 2012

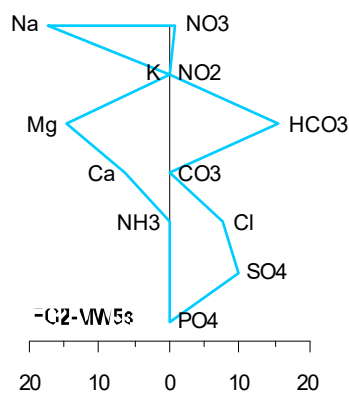
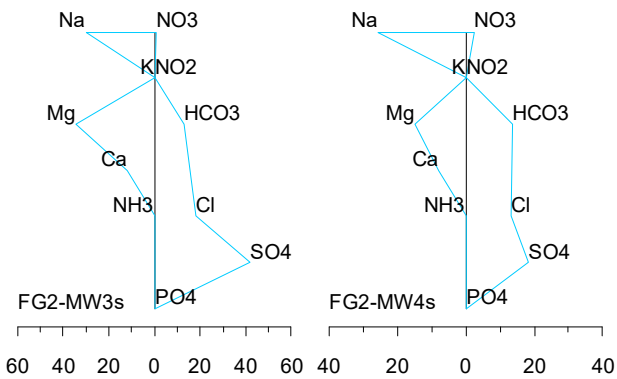
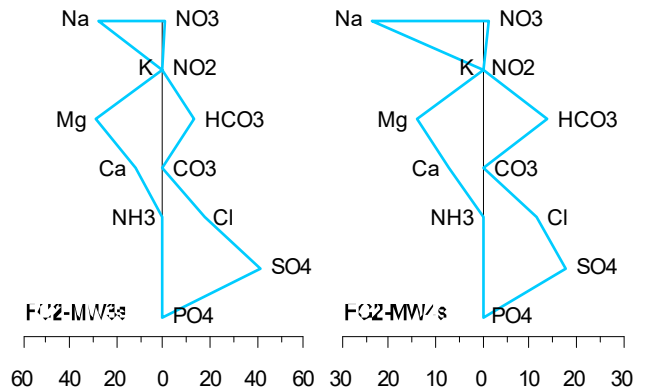
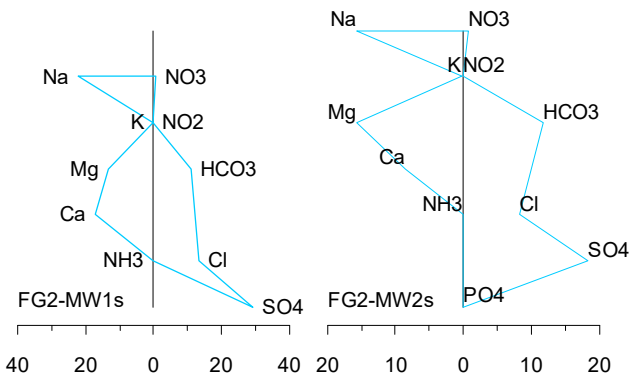

A11-145 FG2 – Stiff diagrams, August 2014

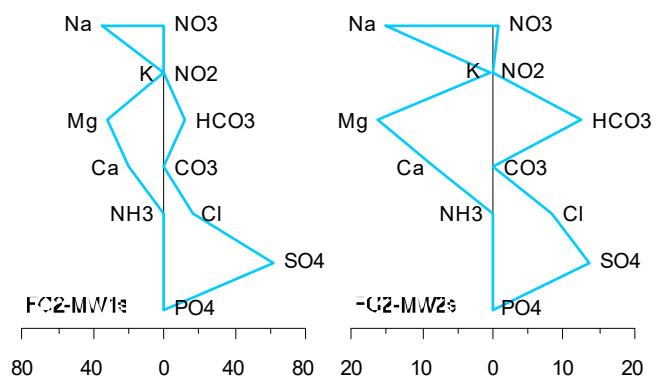
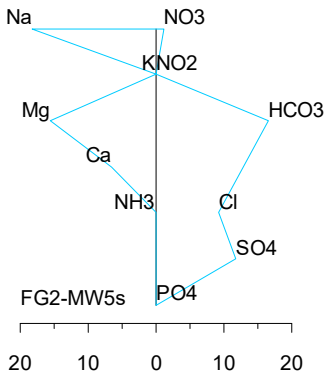

A11-144 FG2 – Stiff diagrams, August 2013

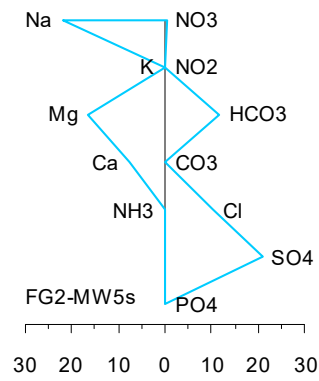
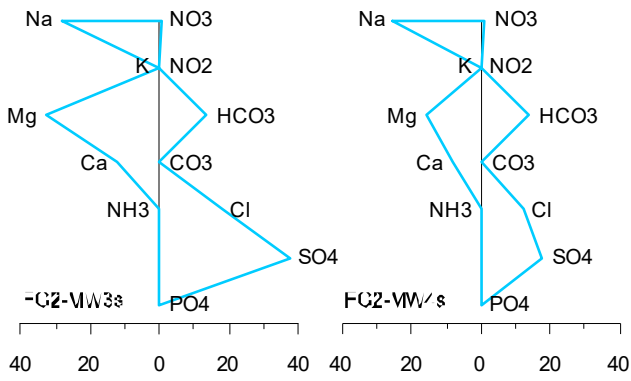

A11-147 FG2 – Stiff diagrams, February 2016

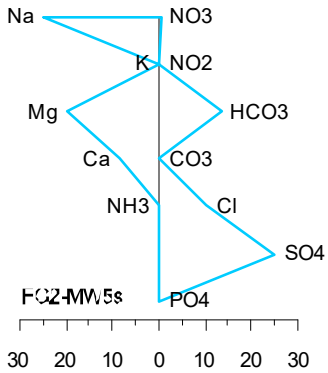

A11-146 FG2 – Stiff diagrams, February 2015

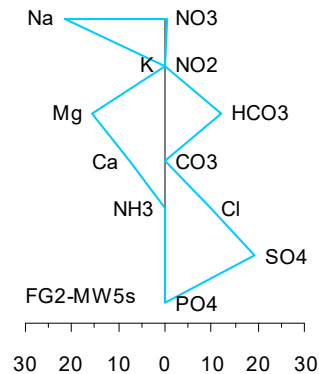
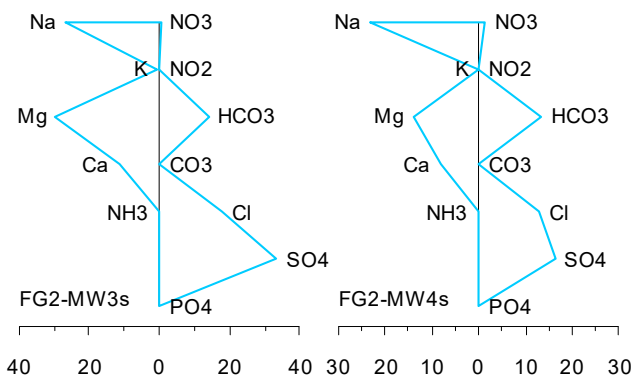
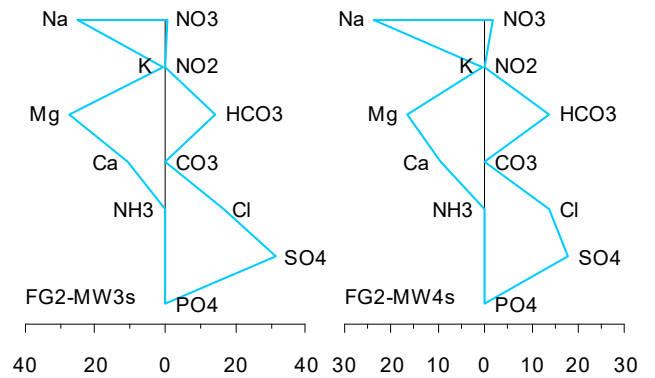
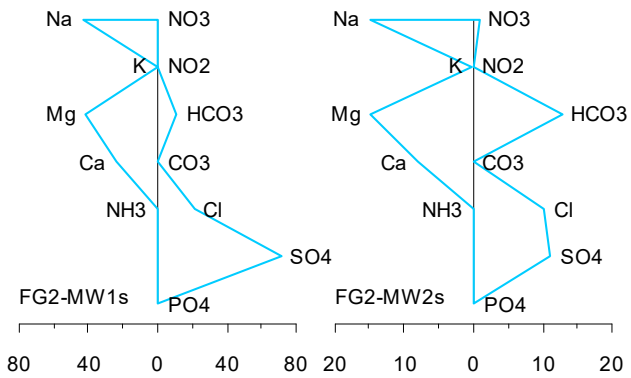
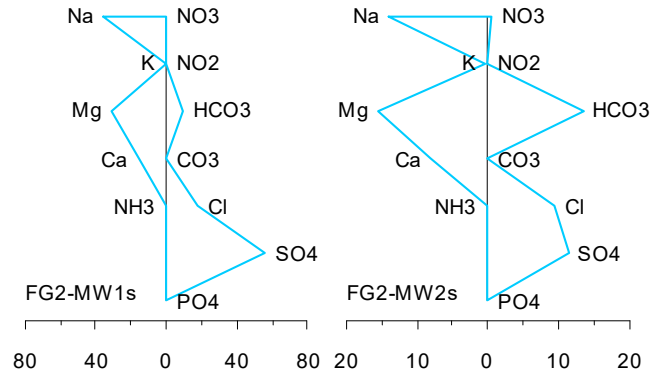

A11-148 FG2 – Stiff diagrams, March 2017

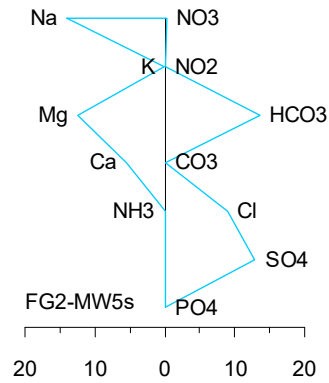
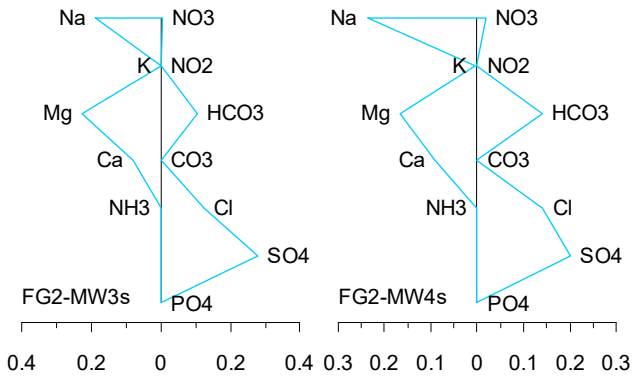
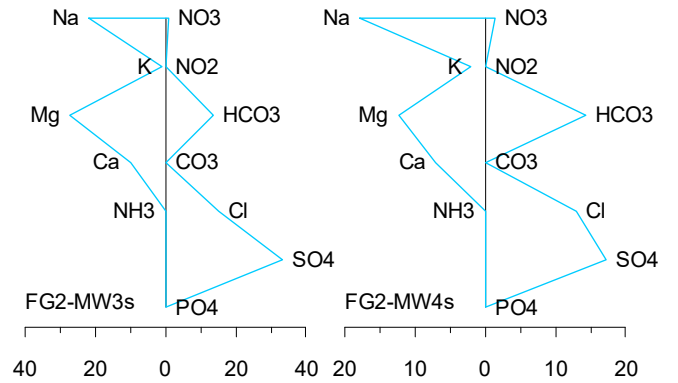
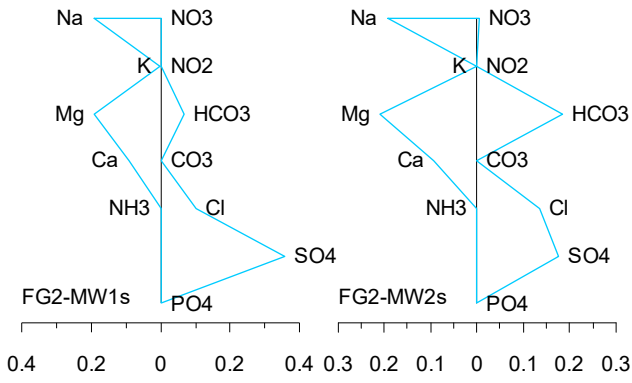

A11-150 FG2 – Stiff diagrams, February 2019

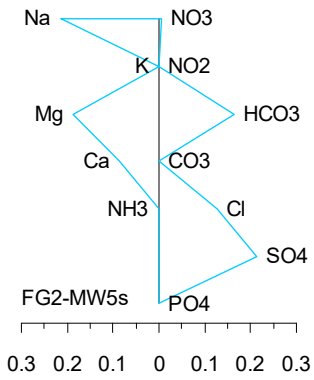

A11-149 FG2 – Stiff diagrams, March 2017

GOD

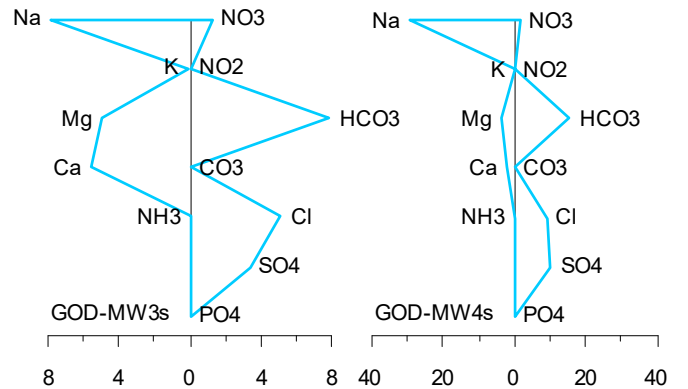
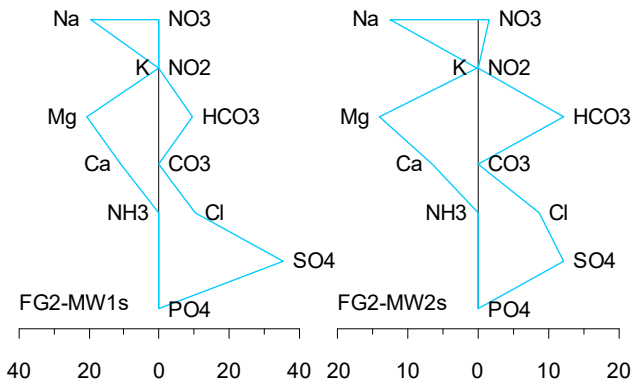
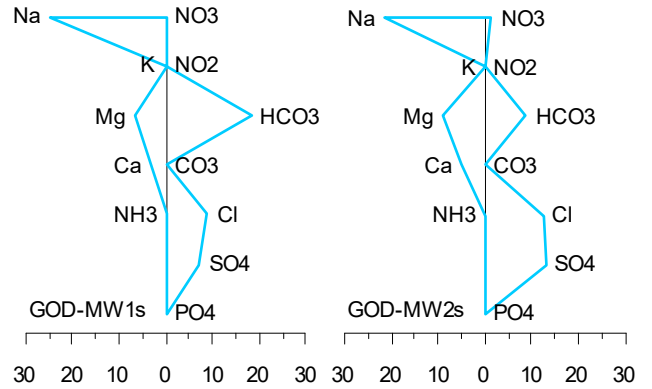

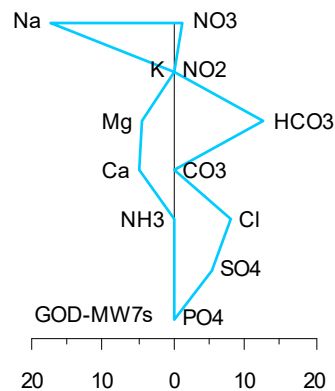
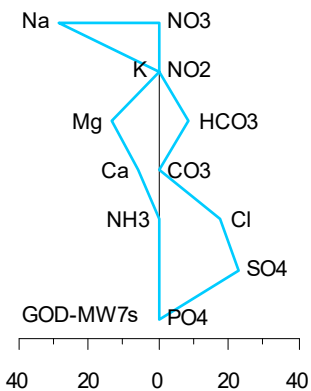
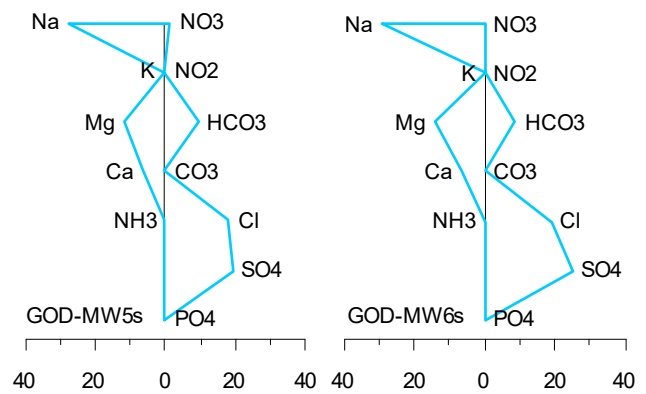
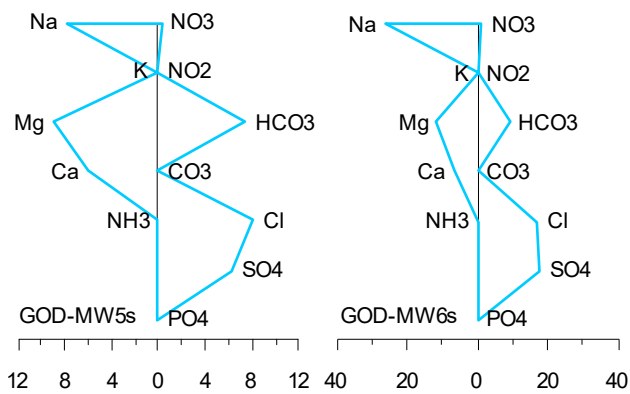

A11-151 GOD – Stiff diagrams, May 2012

A11-152 GOD – Stiff diagrams, August 2012

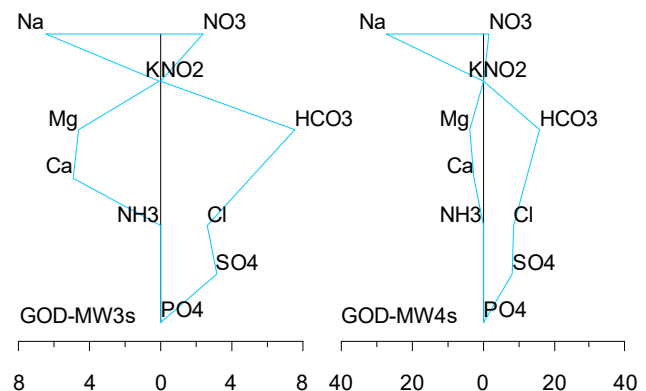
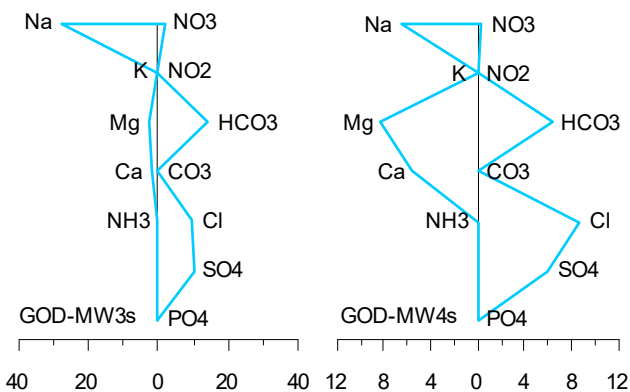
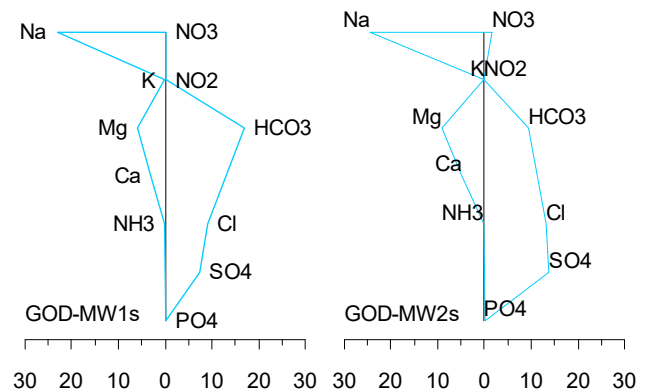
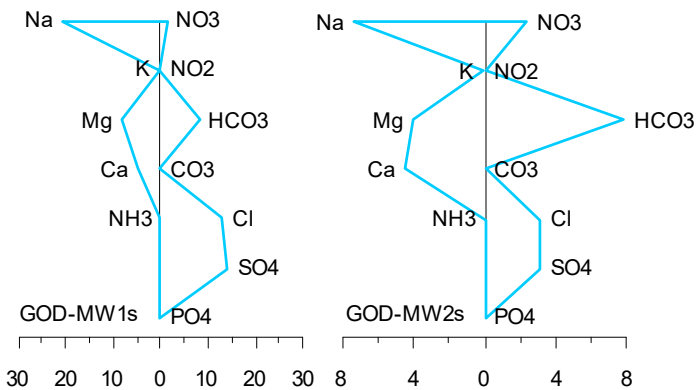

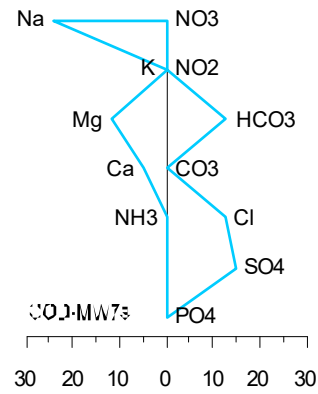
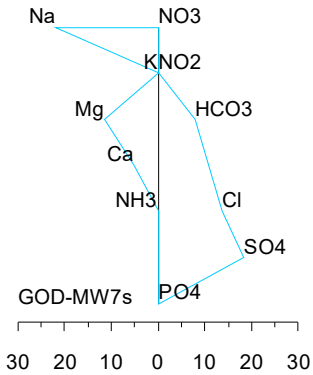
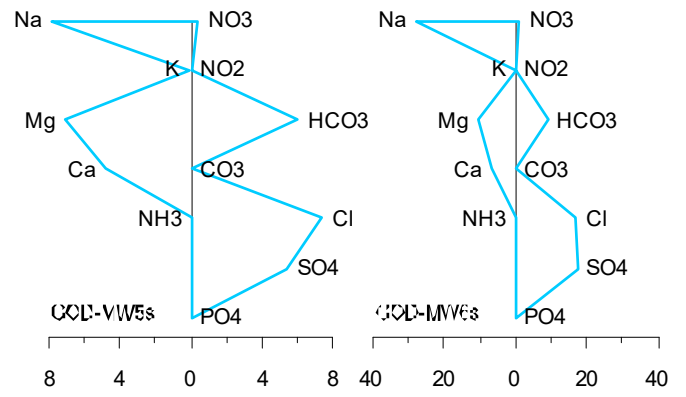
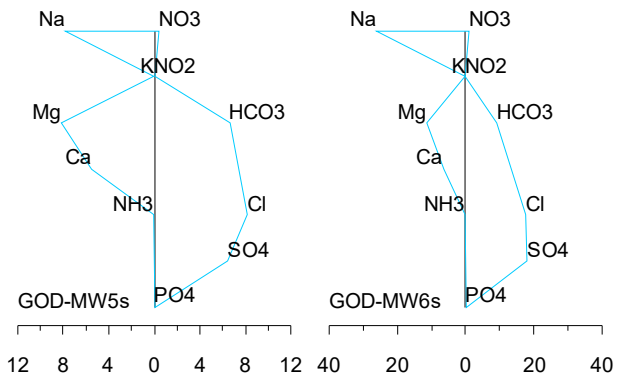

A11-153 GOD – Stiff diagrams, August 2013

A11-154 GOD – Stiff diagrams, August 2014

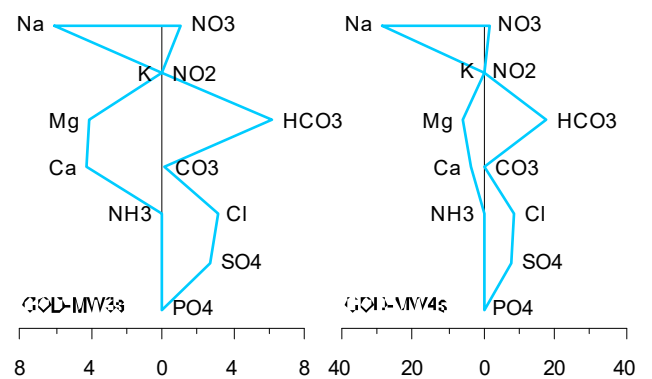
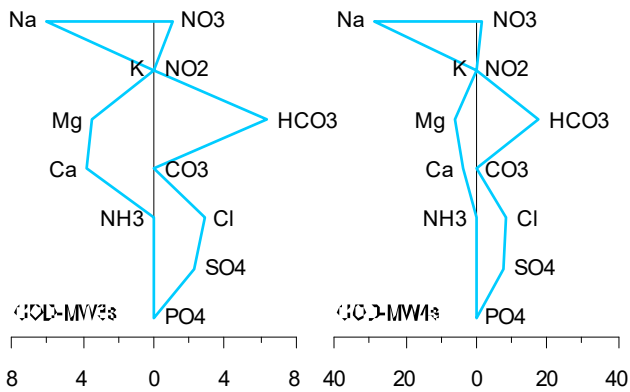
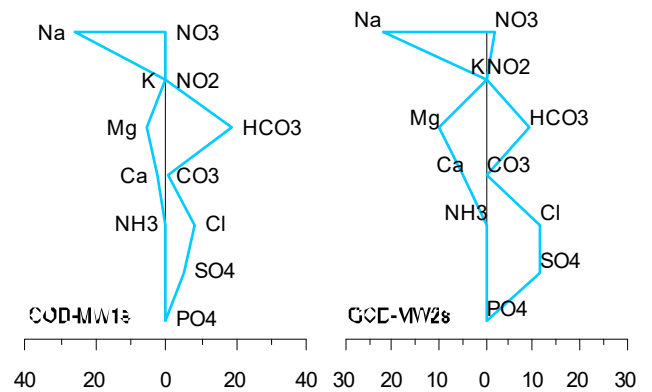
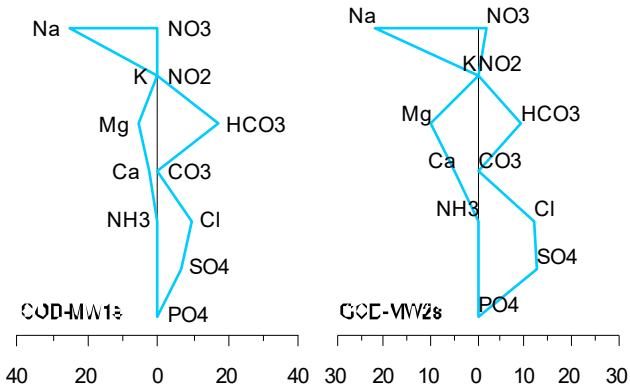

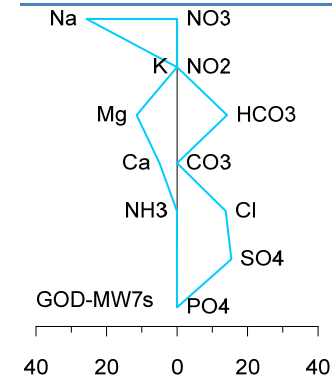
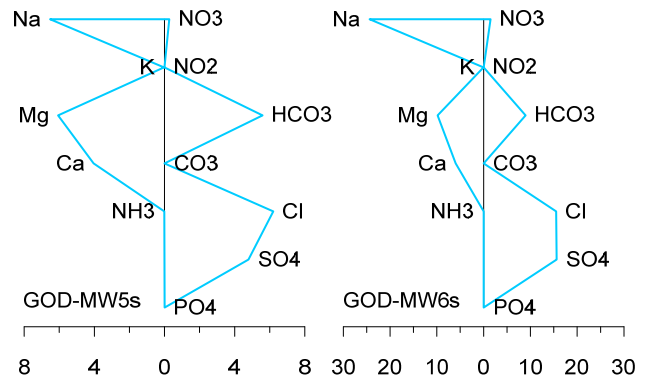
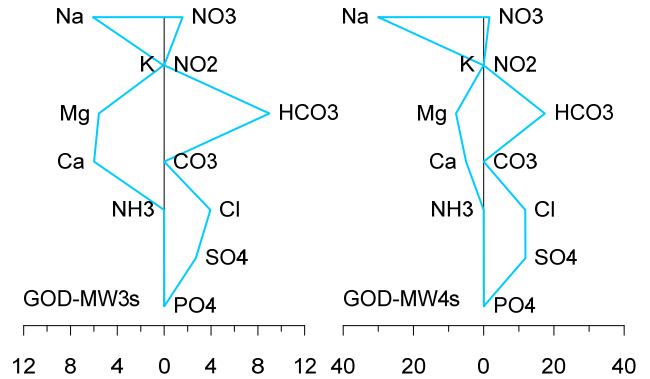
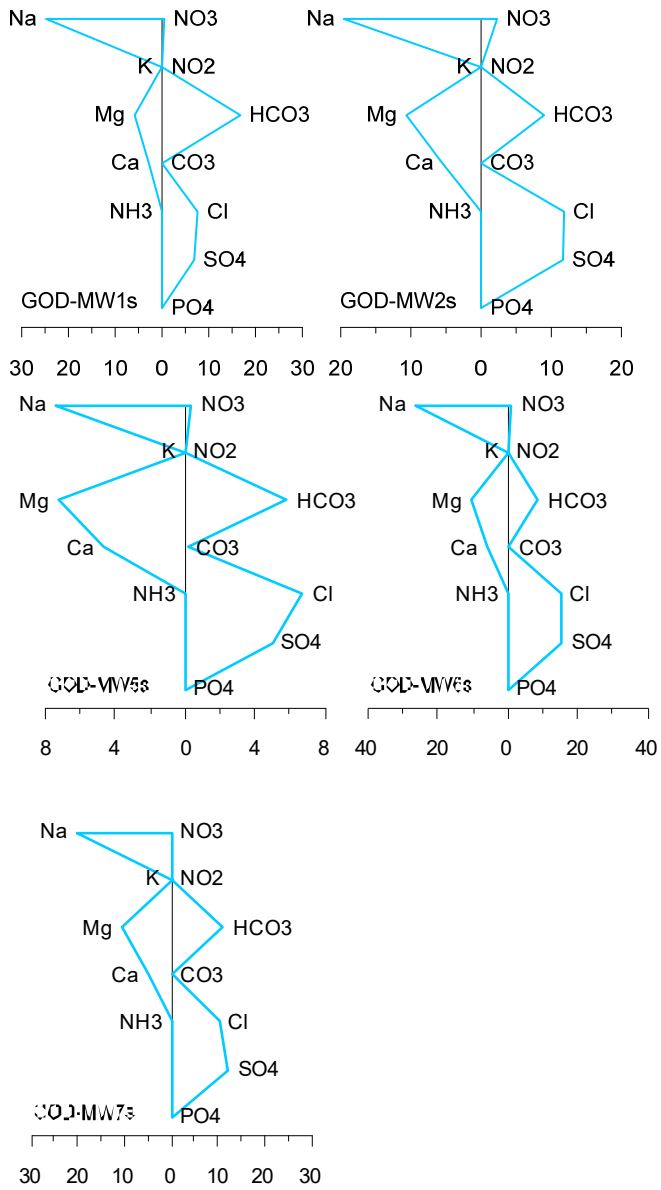

A11-155 GOD – Stiff diagrams, February 2015

A11-156 GOD – Stiff diagrams, February 2016

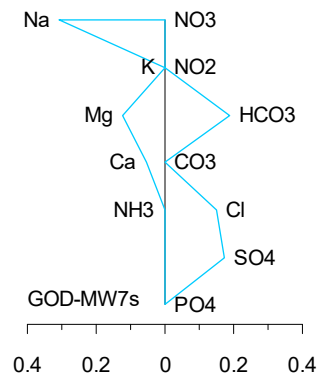
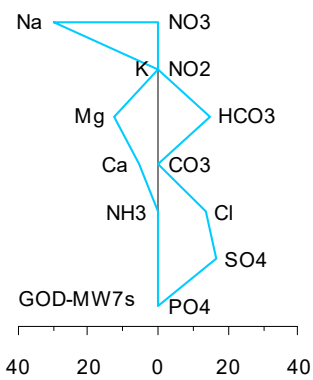
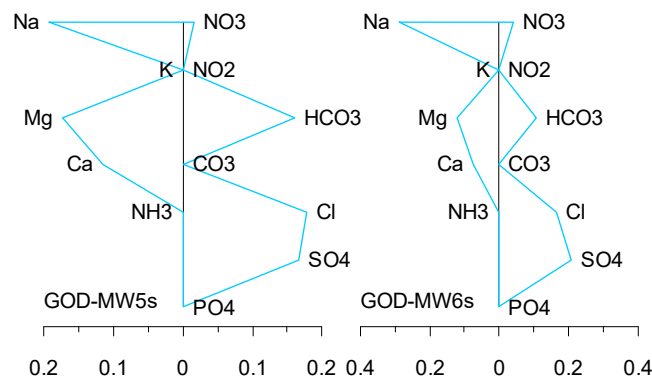
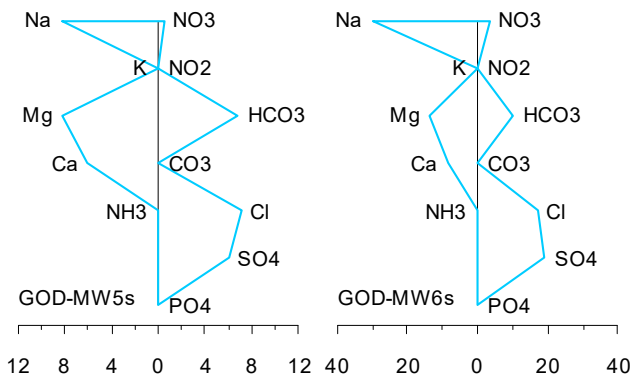
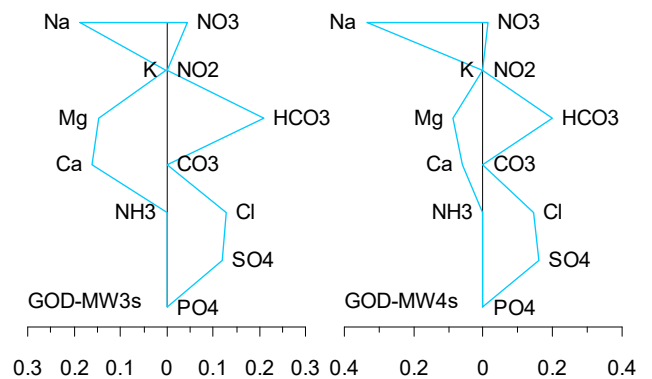
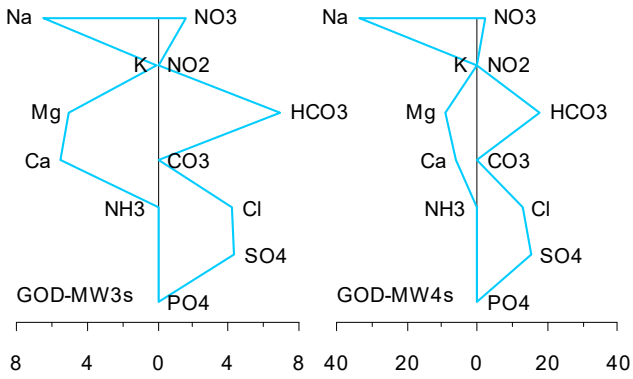
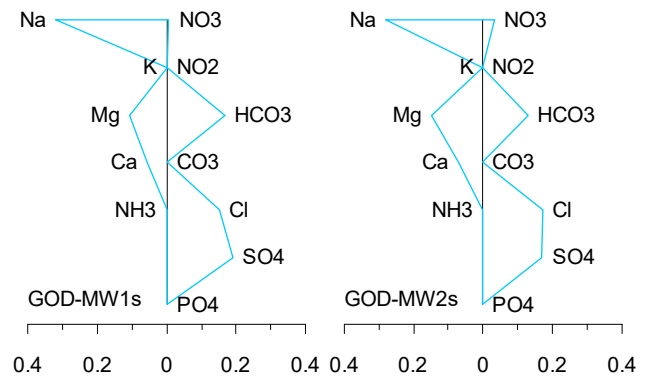
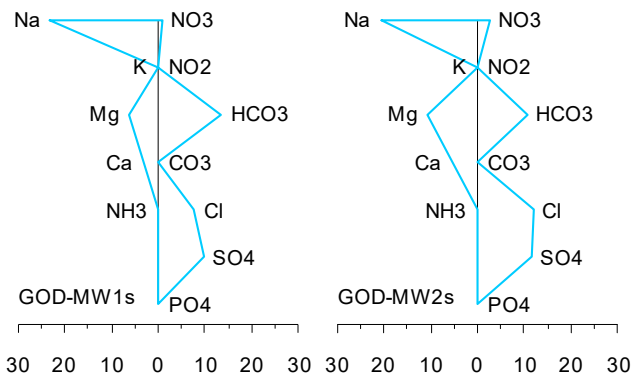

A11-157 GOD – Stiff diagrams, March 2017

A11-158 GOD – Stiff diagrams, February 2018

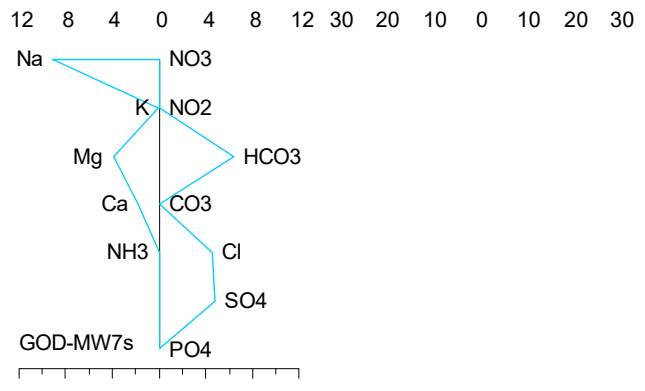
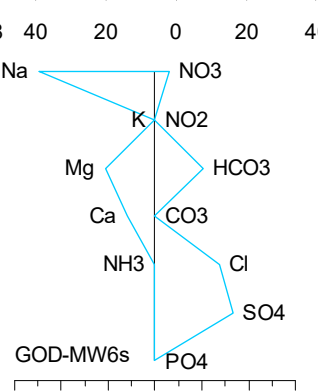
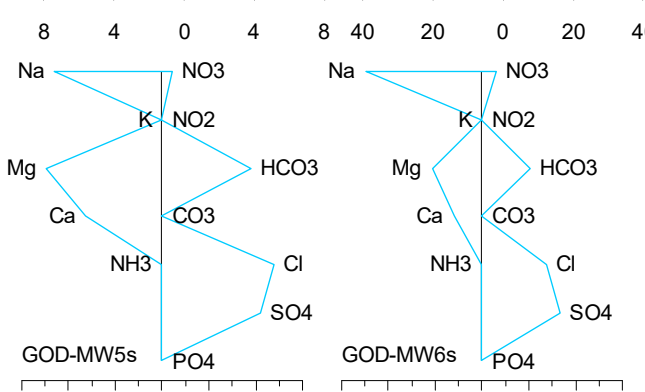
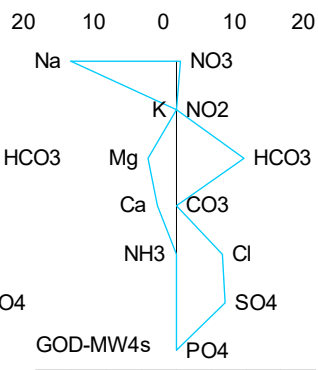
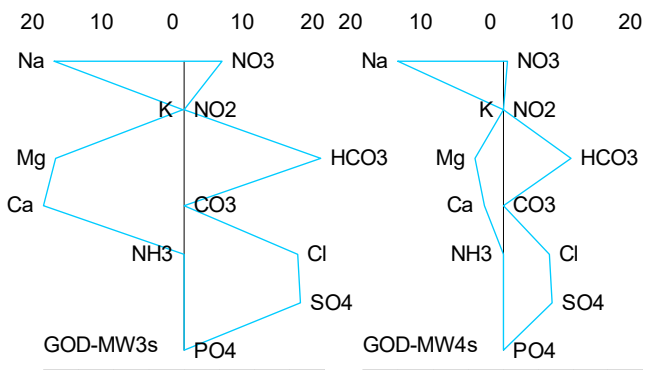
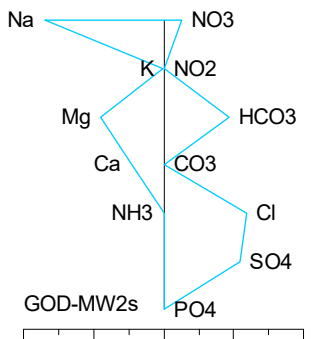
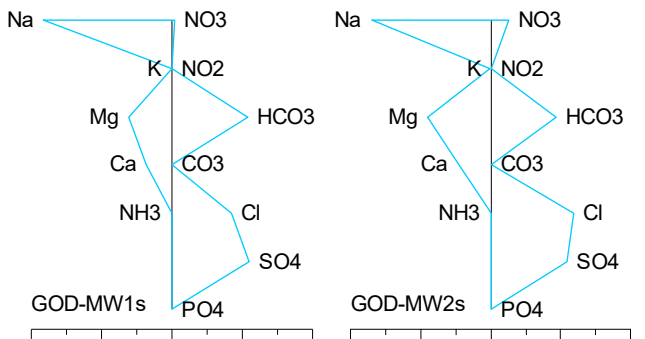

A11-159 GOD – Stiff diagrams, February 2019

MAC

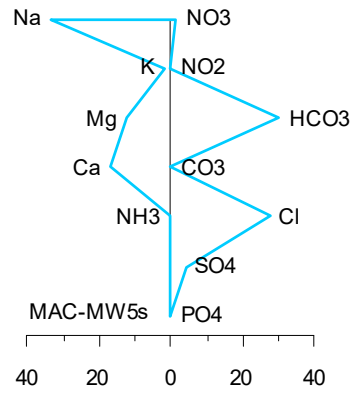
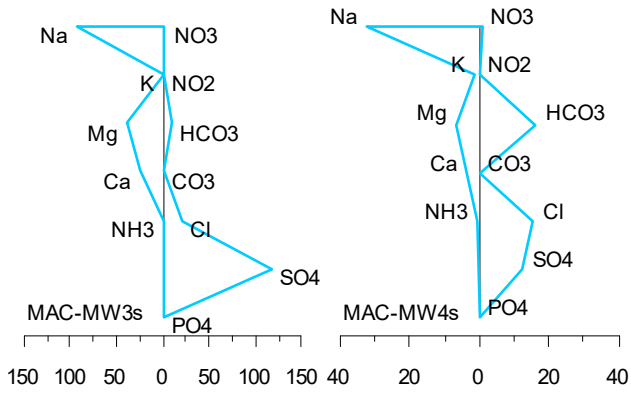
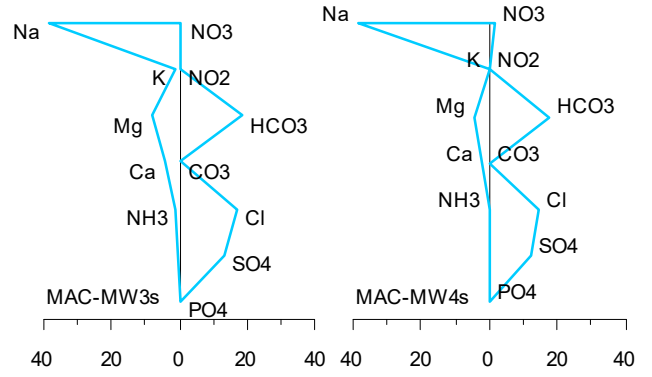
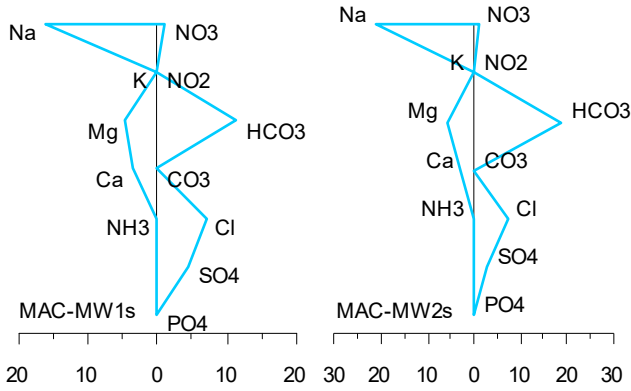

A11-161 MAC – Stiff diagrams, August 2012

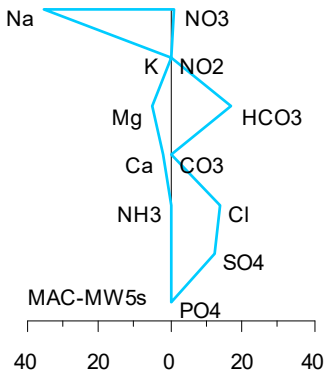

A11-160 MAC – Stiff diagrams, May 2012

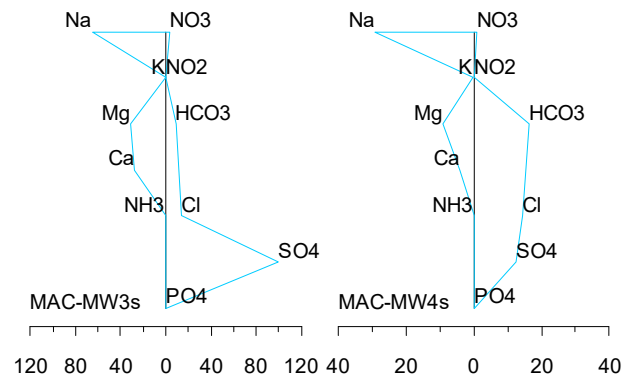
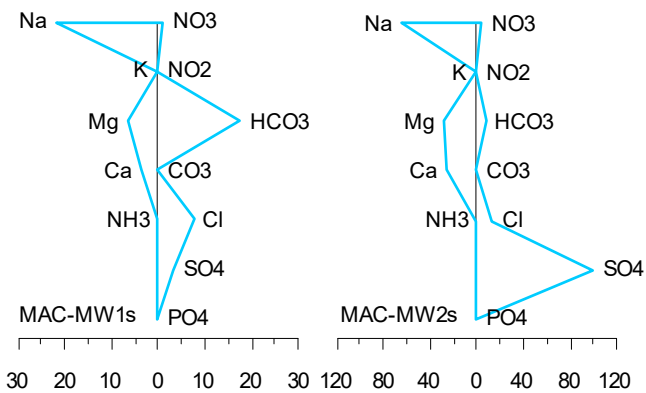
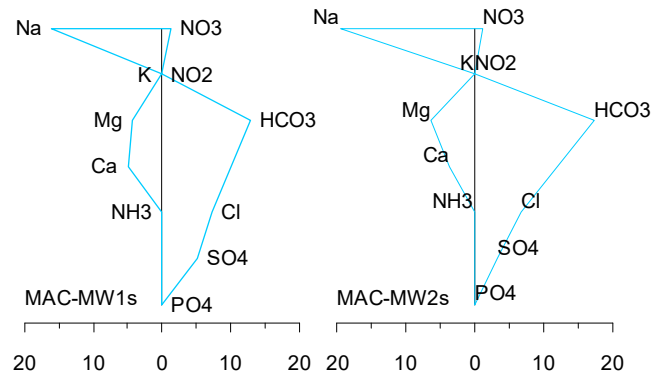

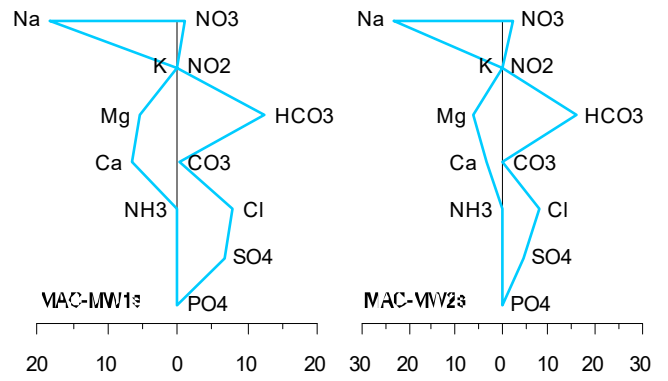
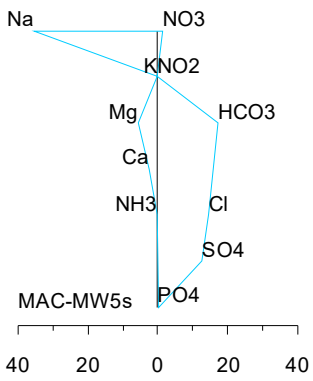

A11-162 MAC – Stiff diagrams, August 2013

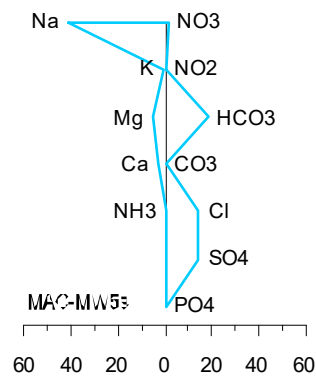
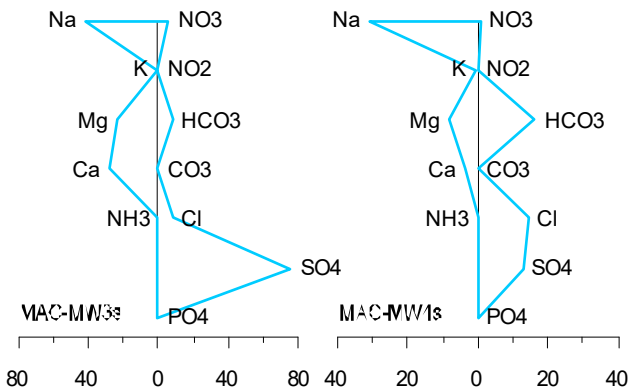
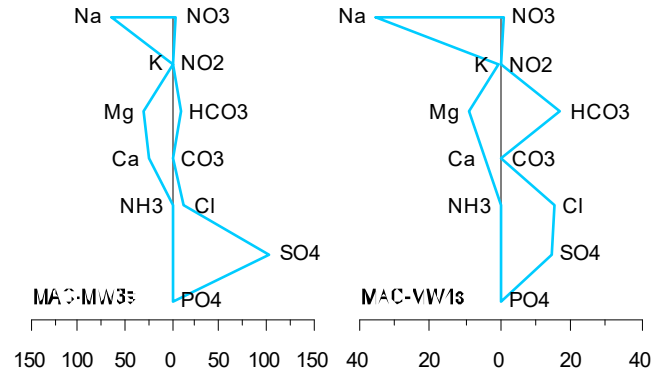
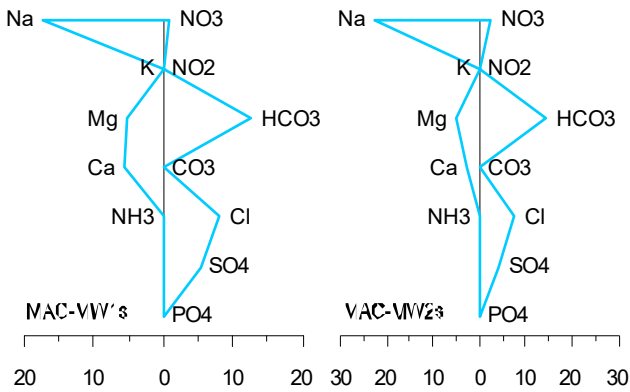

A11-164 MAC – Stiff diagrams, February 2015

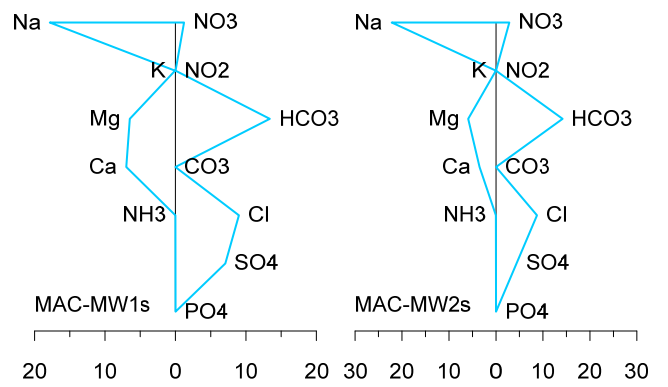
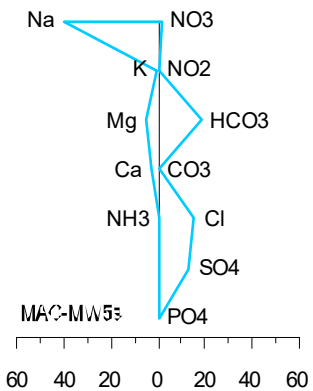

A11-163 MAC – Stiff diagrams, August 2014

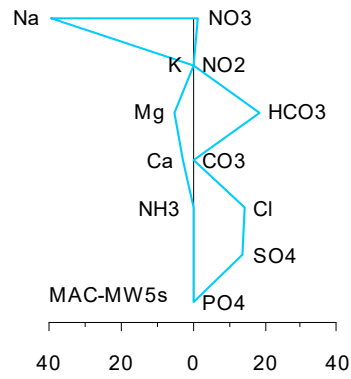
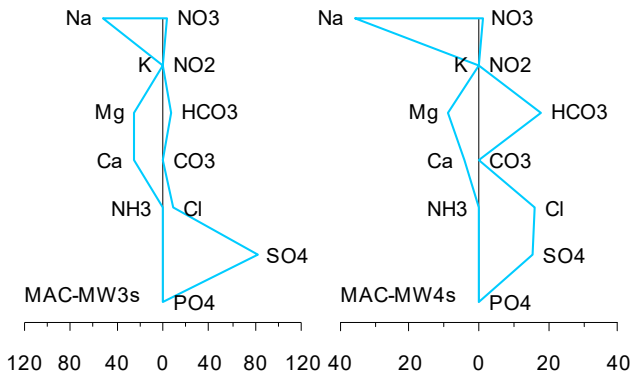

A11-166 MAC – Stiff diagrams, March 2017

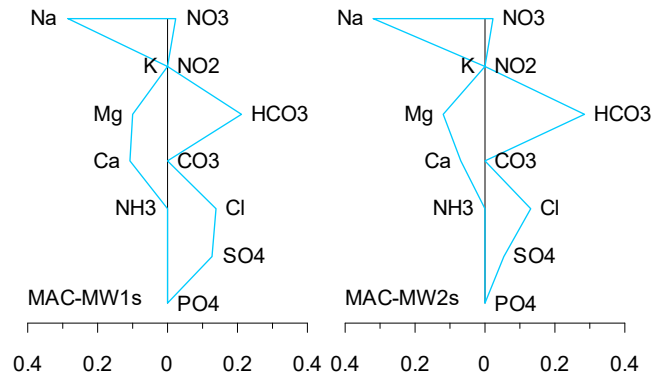
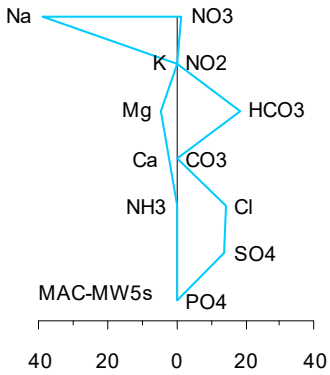

A11-165 MAC – Stiff diagrams, February 2016

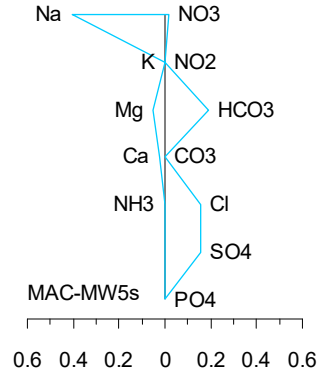
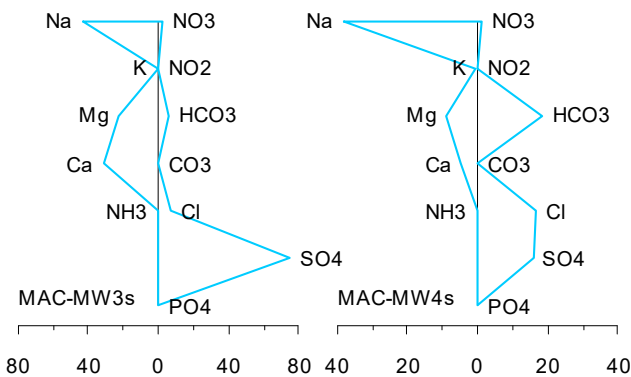
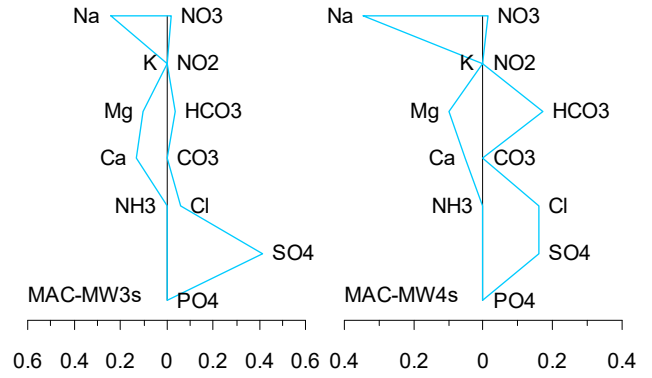
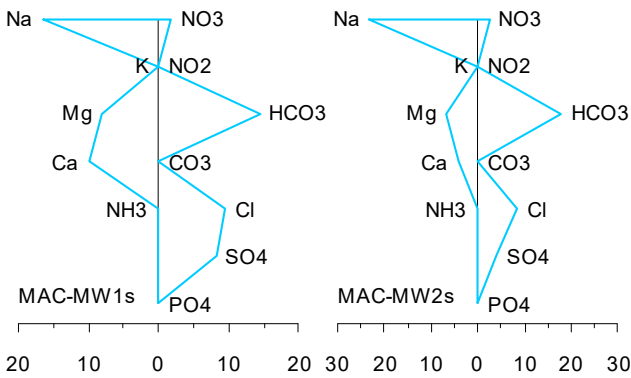

A11-167 MAC – Stiff diagrams, February 2018

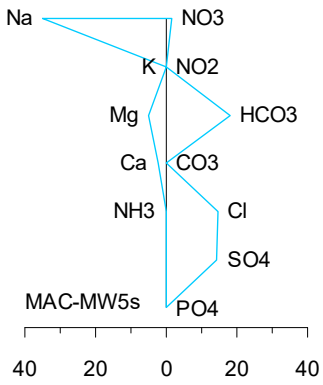
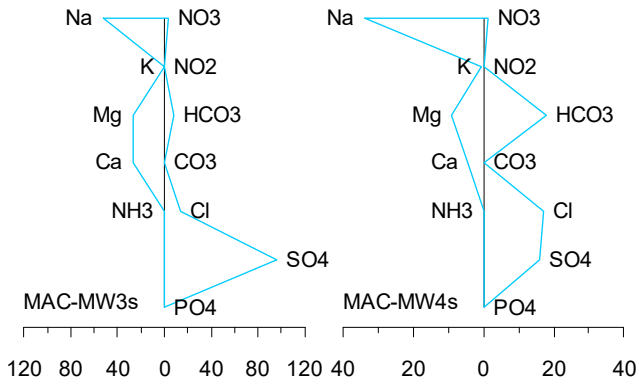
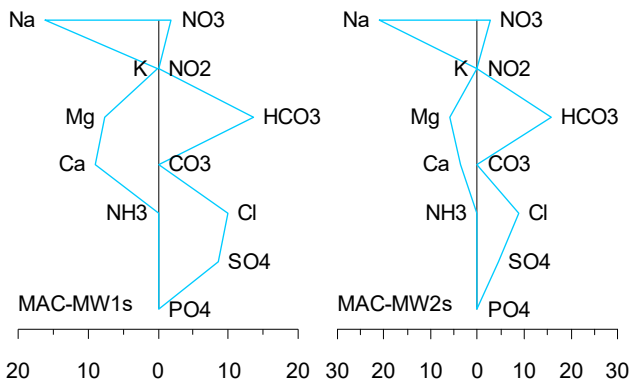

A11-168 MAC – Stiff diagrams, February 2019

NUN

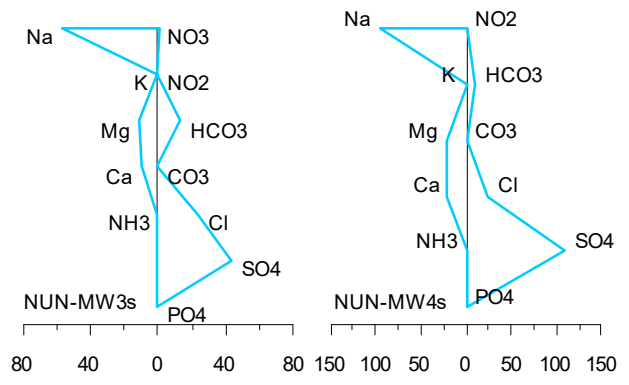
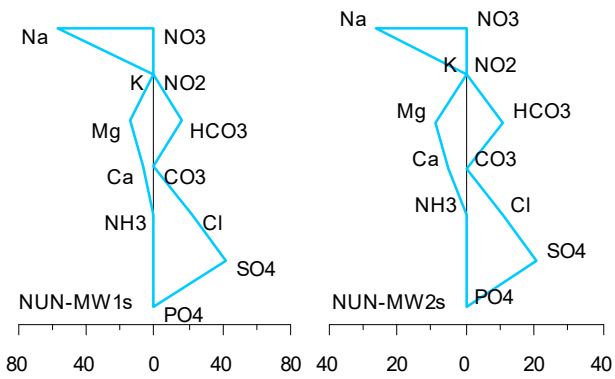

A11-169 NUN – Stiff diagrams, May 2012

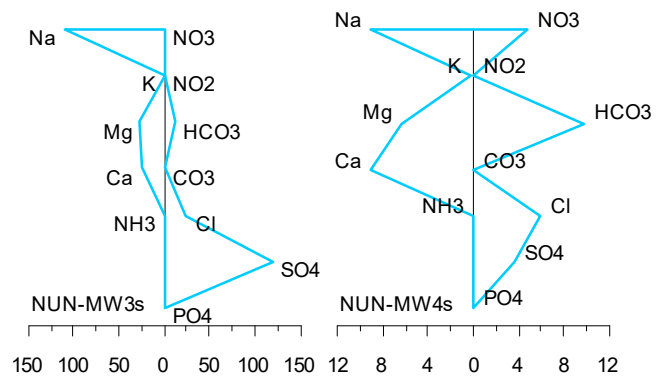
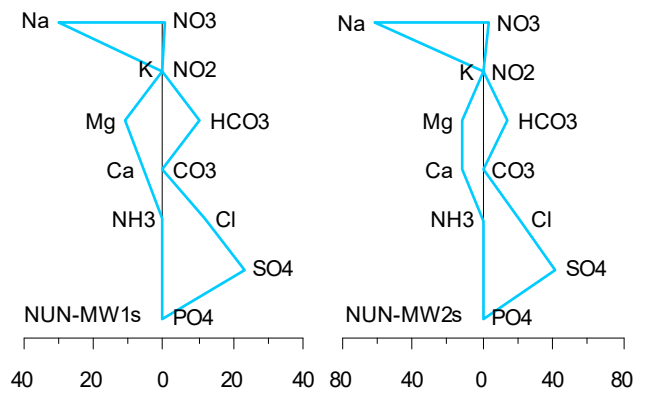

A11-170 NUN – Stiff diagrams, August 2012

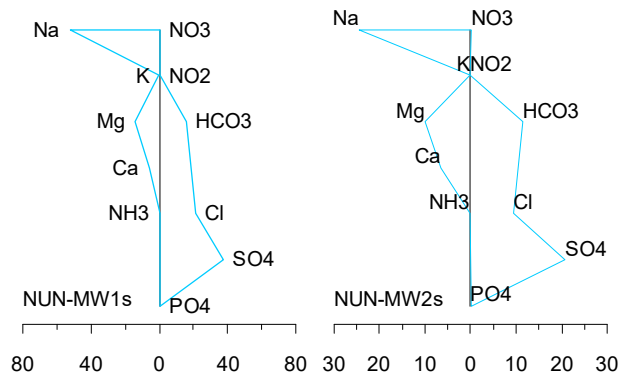

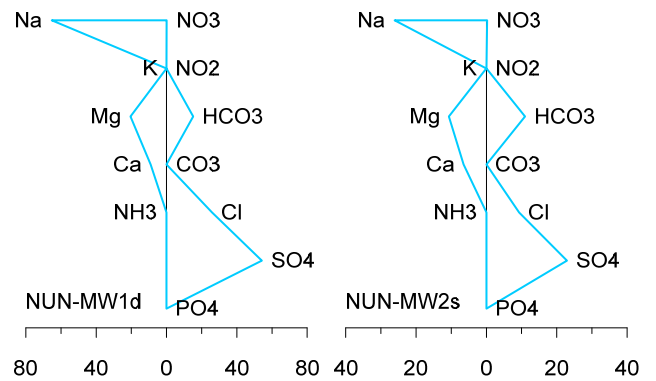
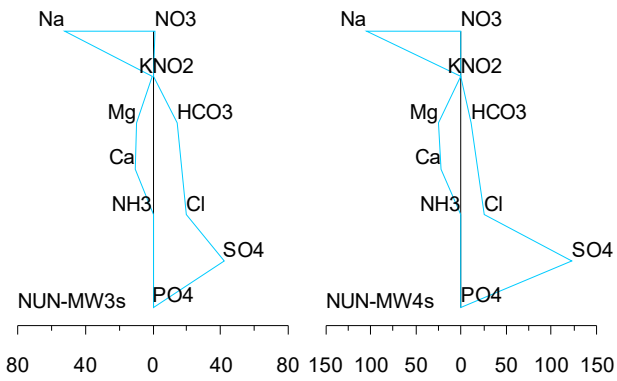

A11-171 NUN – Stiff diagrams, August 2013

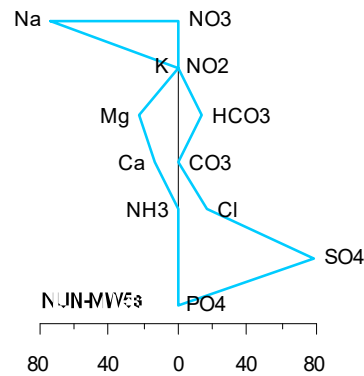
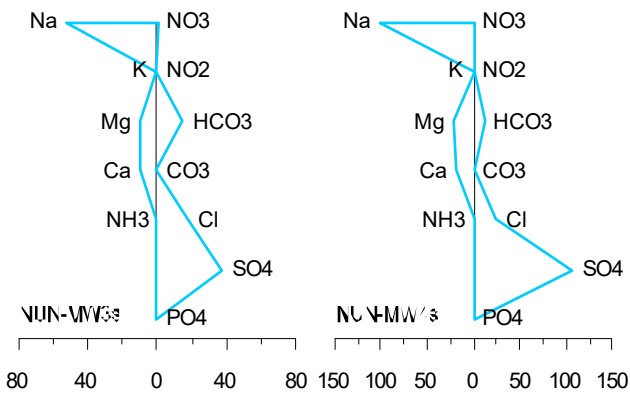
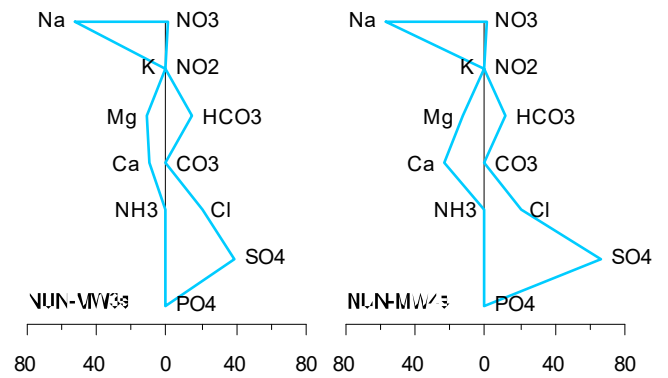
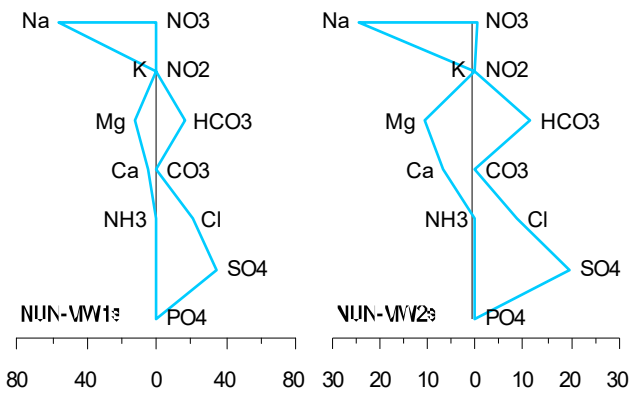

A11-173 NUN – Stiff diagrams, in February 2015

A11-172 NUN – Stiff diagrams, in August 2014

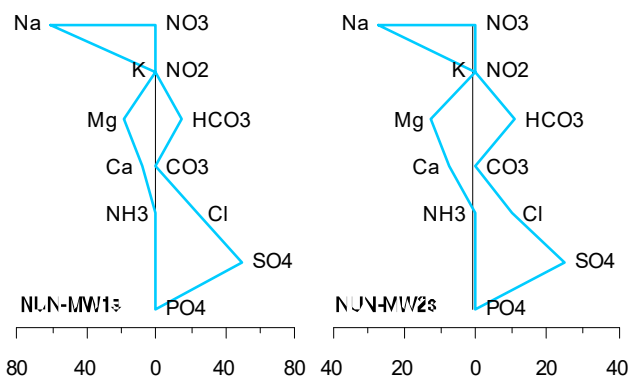

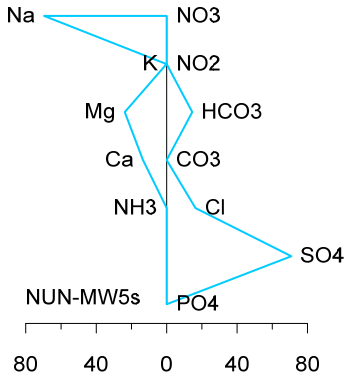
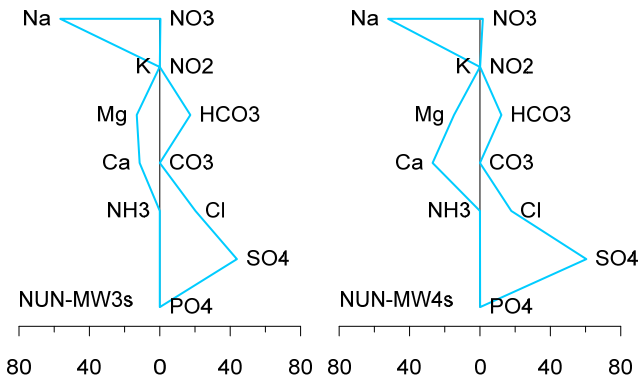

A11-174 NUN – Stiff diagrams, February 2016

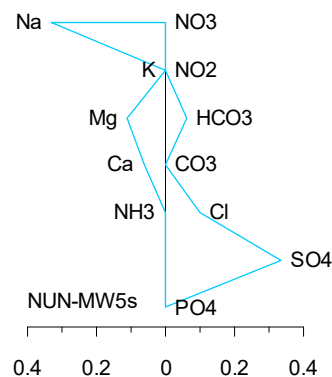
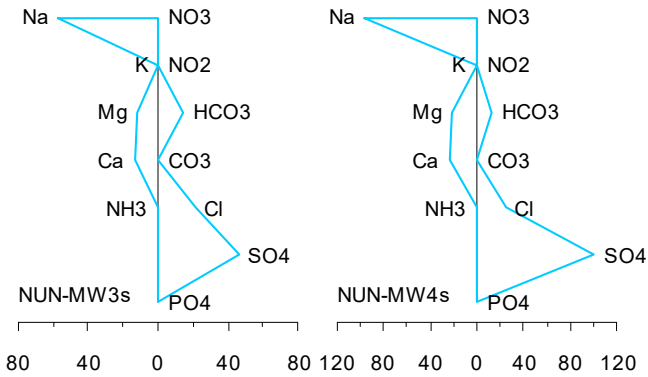
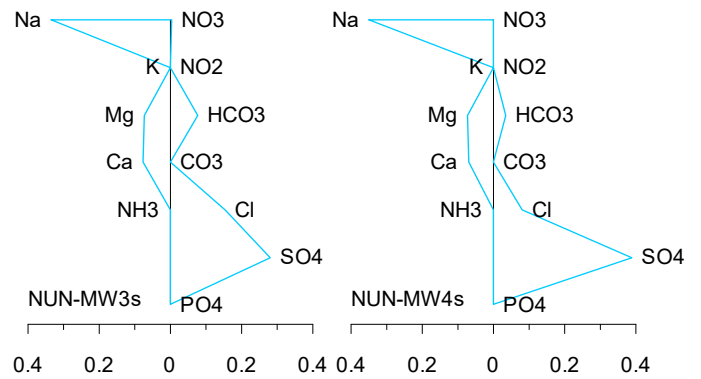
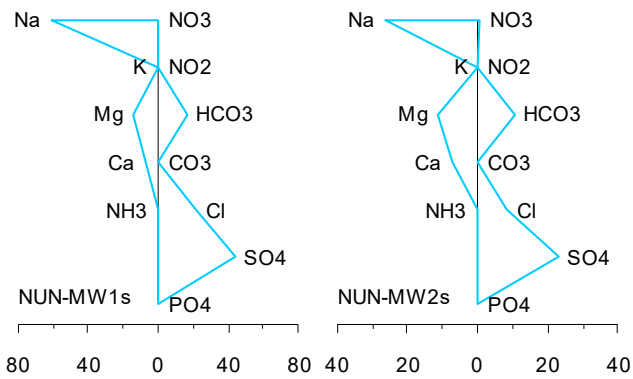

A11-176 NUN – Stiff diagrams, February 2018

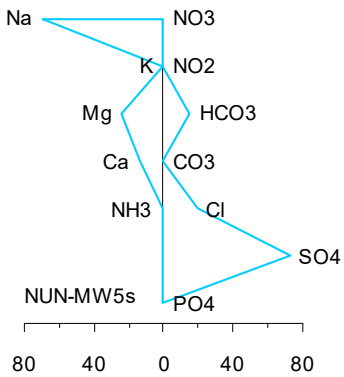

A11-175 NUN – Stiff diagrams, March 2017

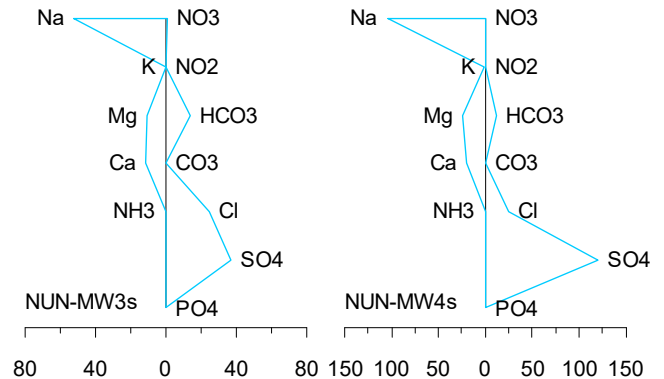
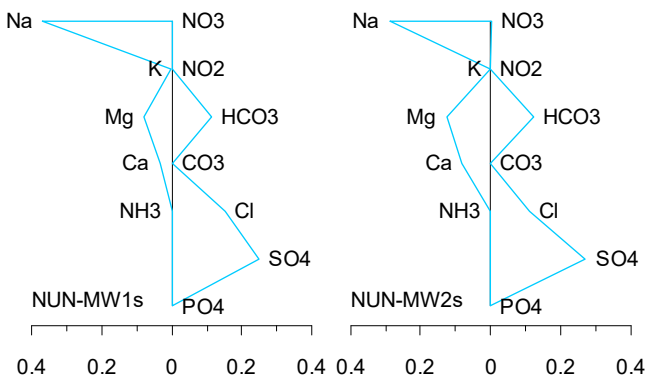
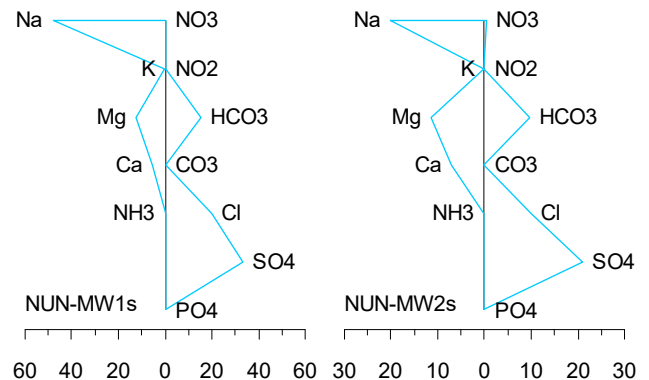

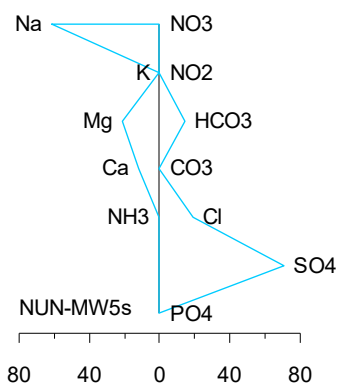

A11-177 NUN – Stiff diagrams, February 2019

MOO

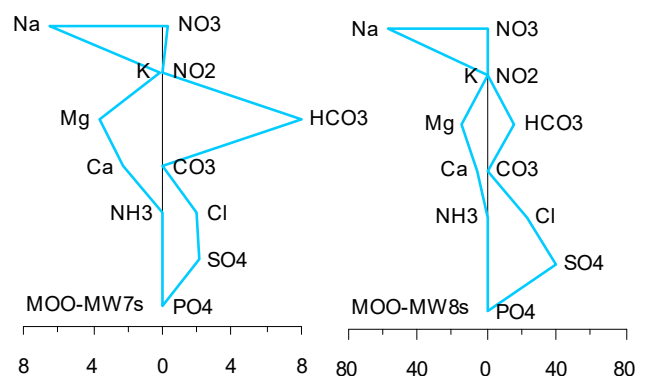
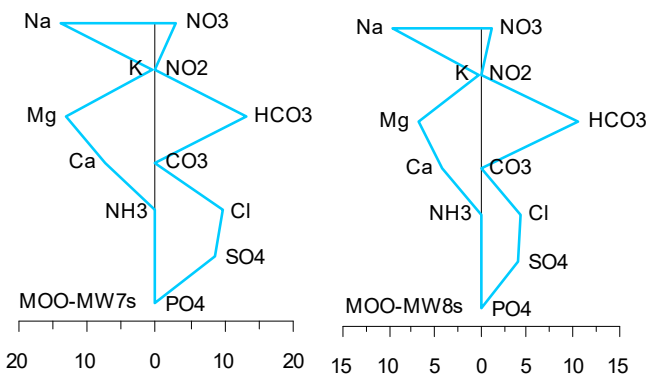
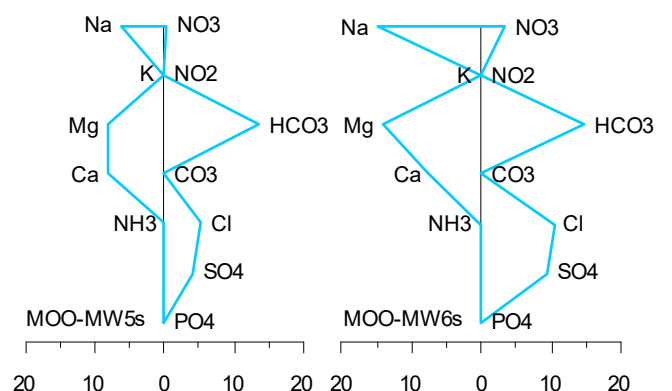
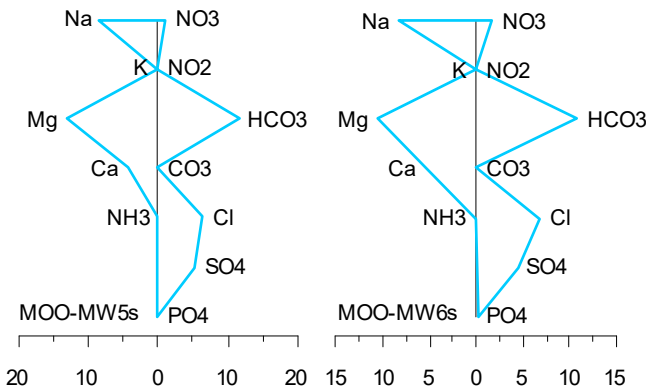
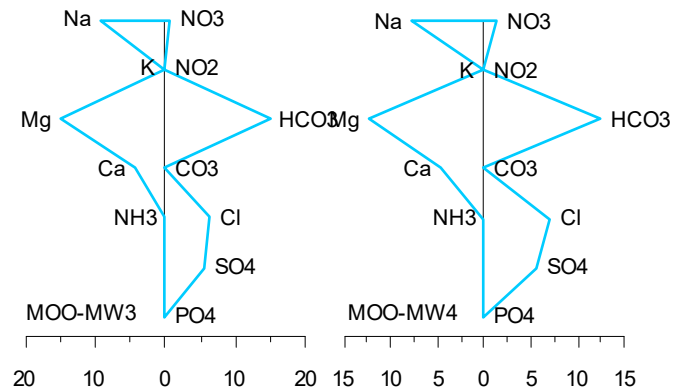
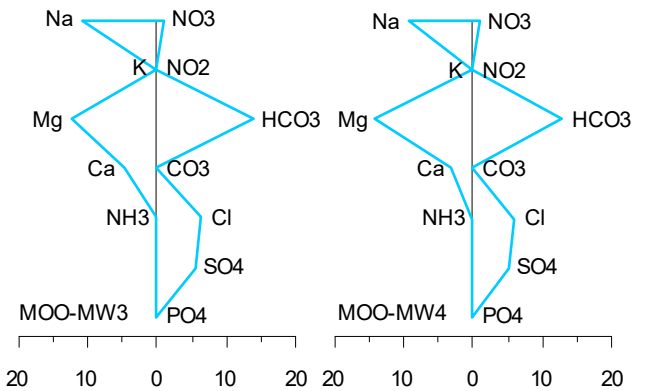
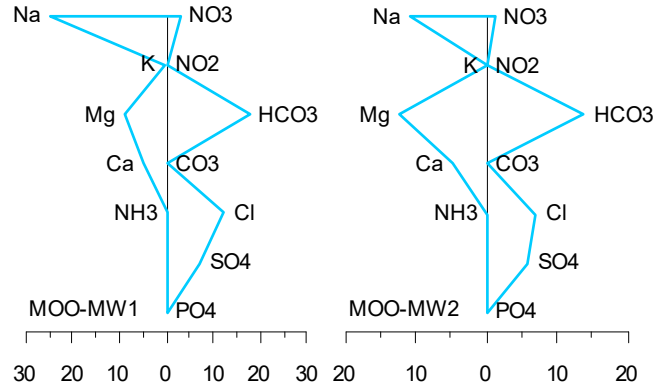
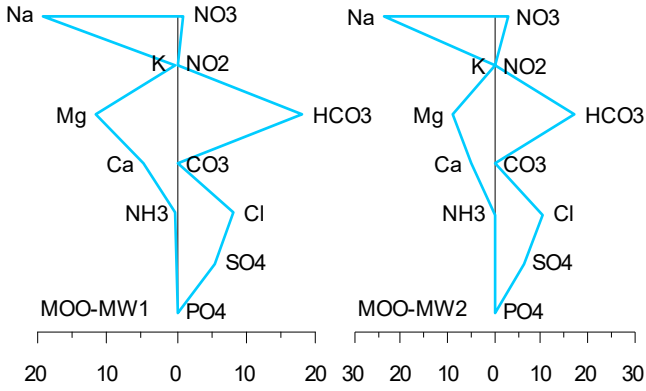

A11-178 MOO – Stiff diagrams, May 2012

A11-179 MOO – Stiff diagrams, August 2012

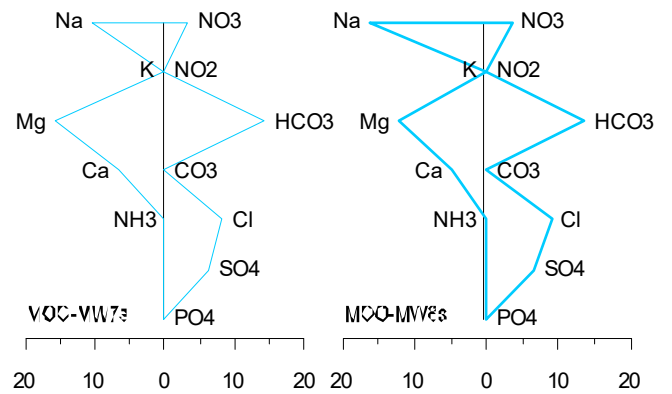
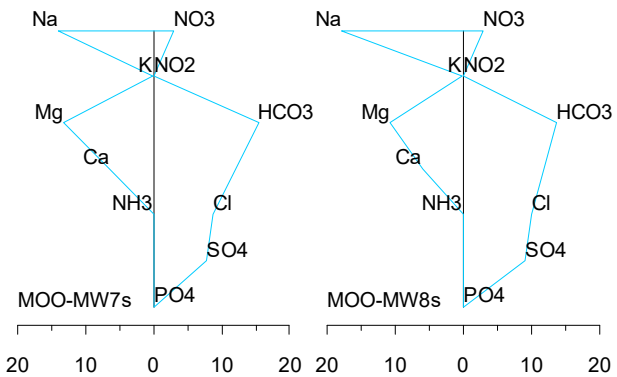
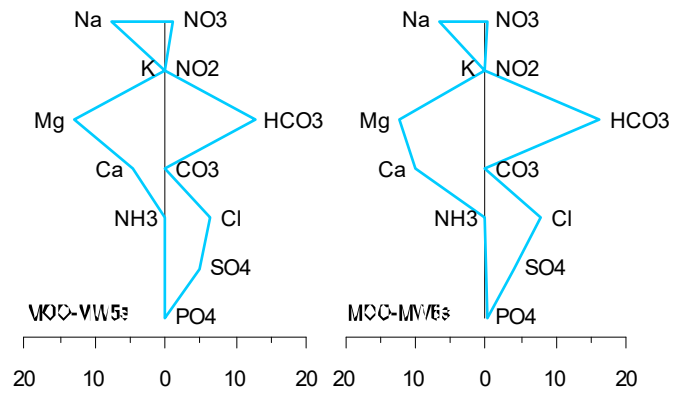
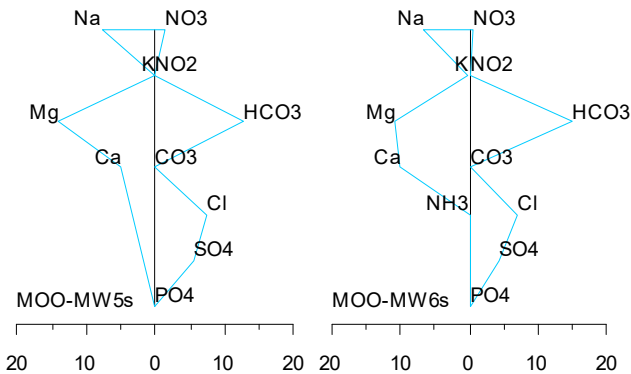
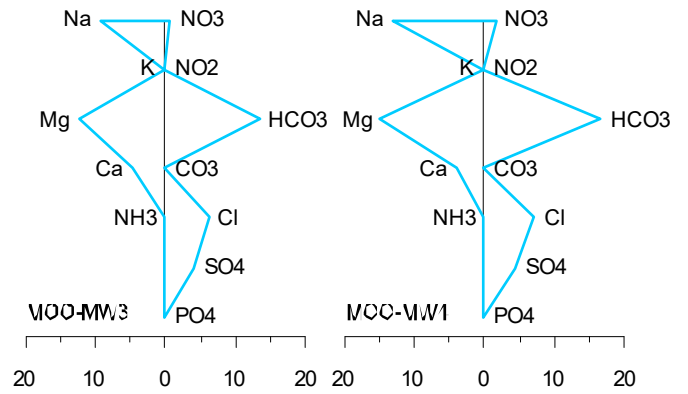
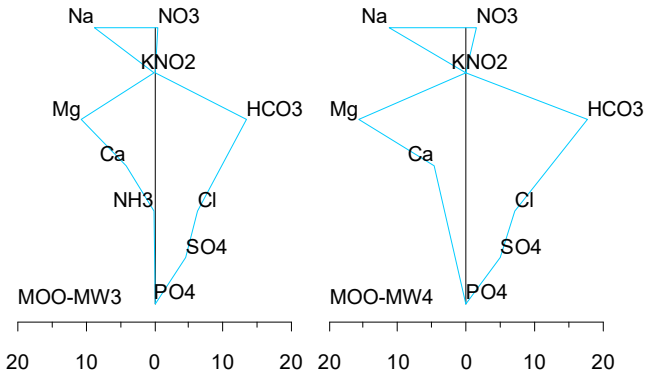
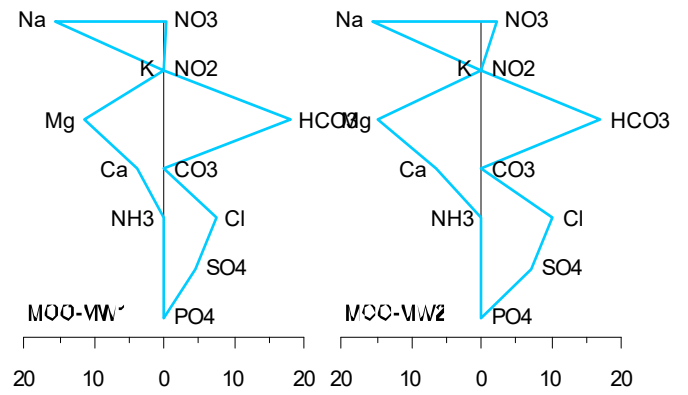
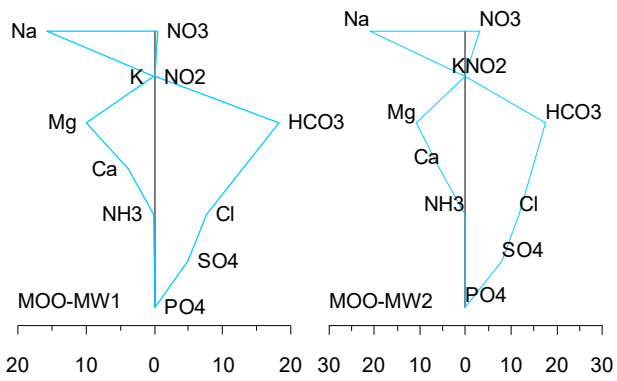

A11-180 MOO – Stiff diagrams, August 2013

A11-181 MOO – Stiff diagrams, August 2014

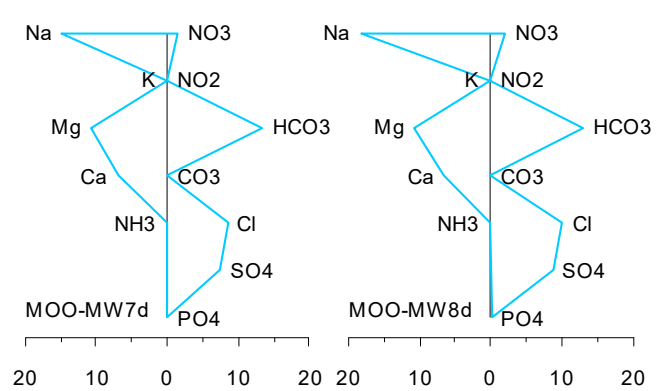
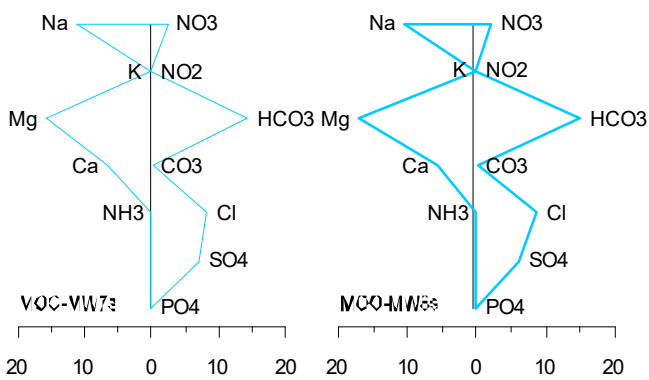
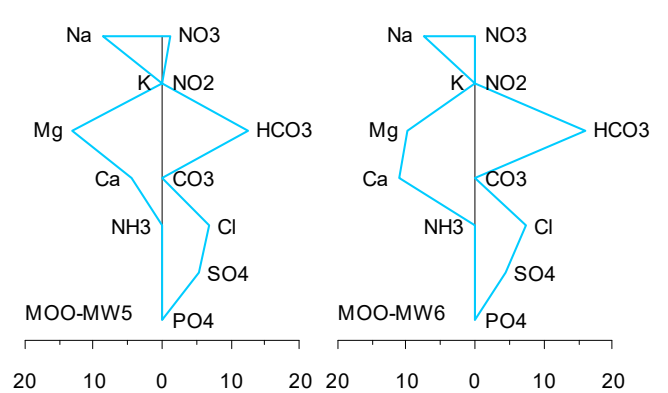
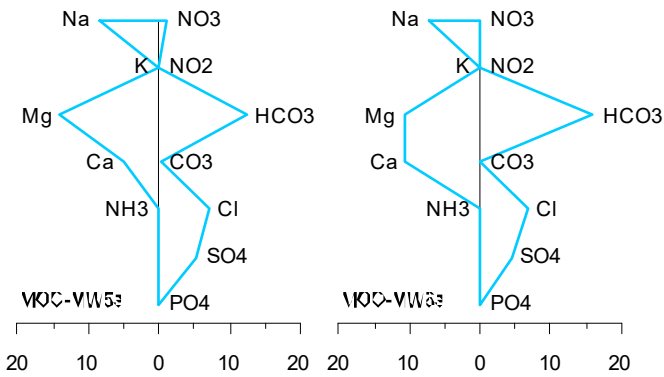
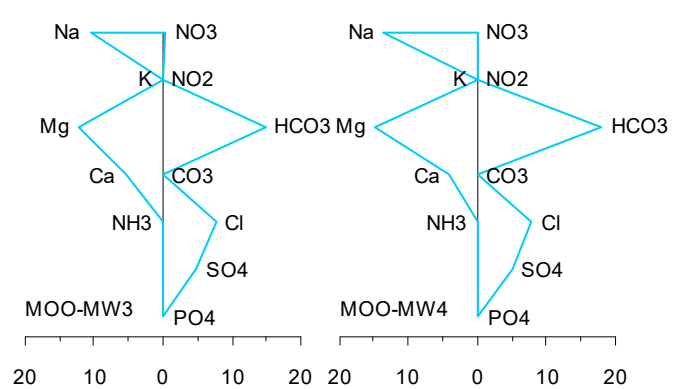
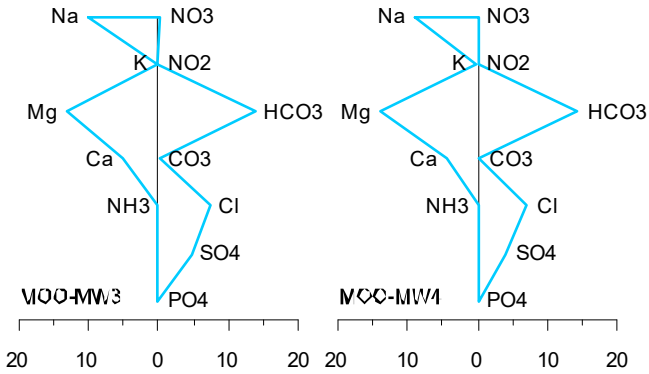
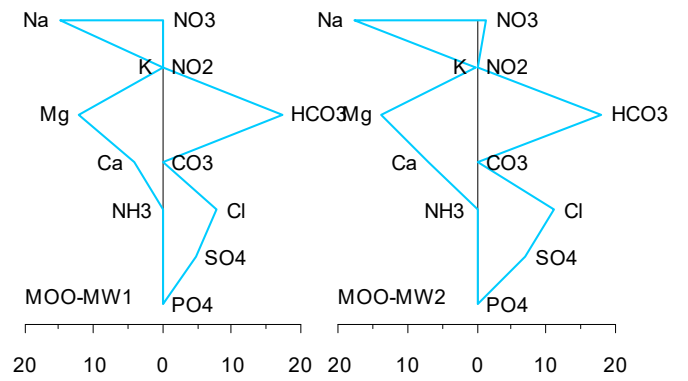
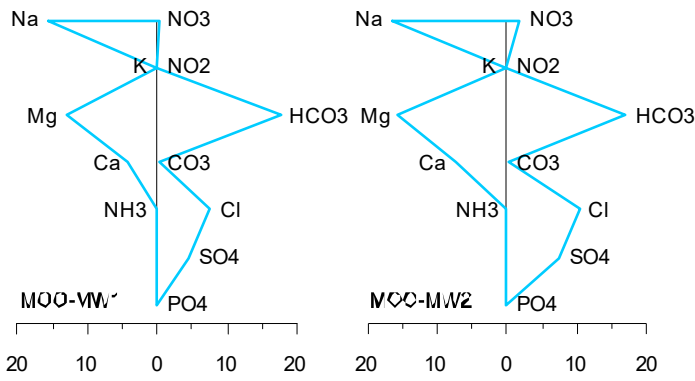

A11-182 MOO – Stiff diagrams, February 2015

A11-183 MOO – Stiff diagrams, February 2016

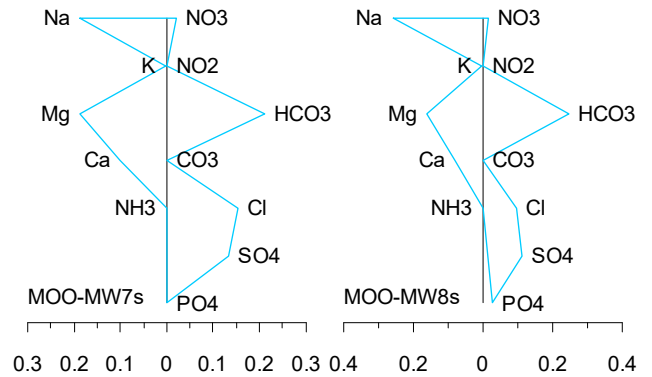
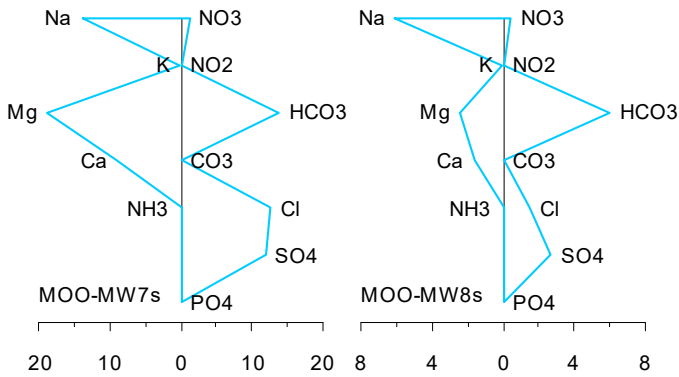
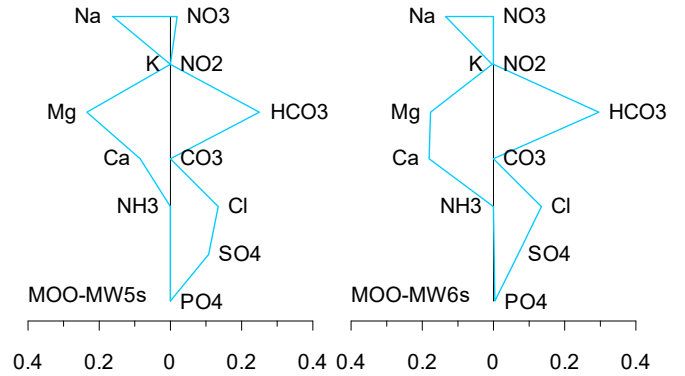
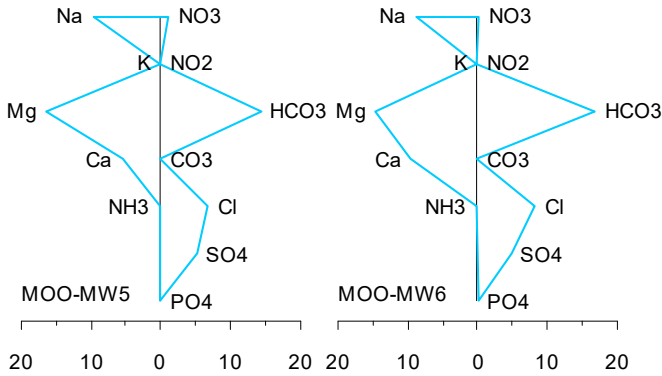
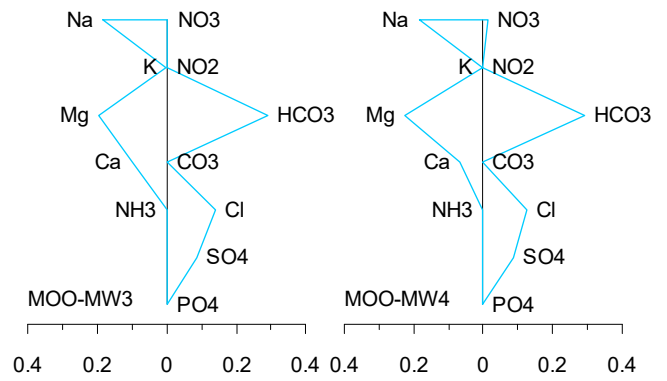
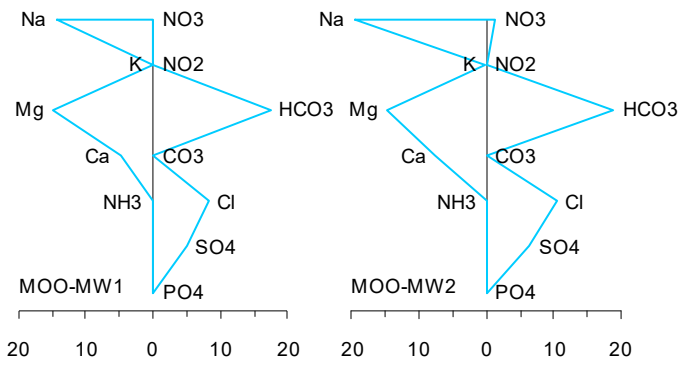

A11-184 MOO – Stiff diagrams, March 2017

A11-185 MOO – Stiff diagrams, February 2018

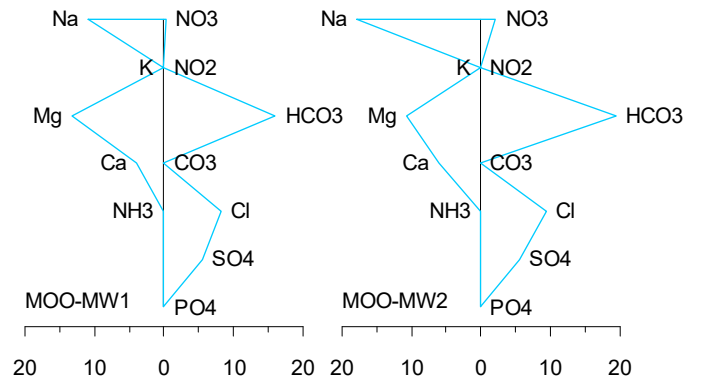
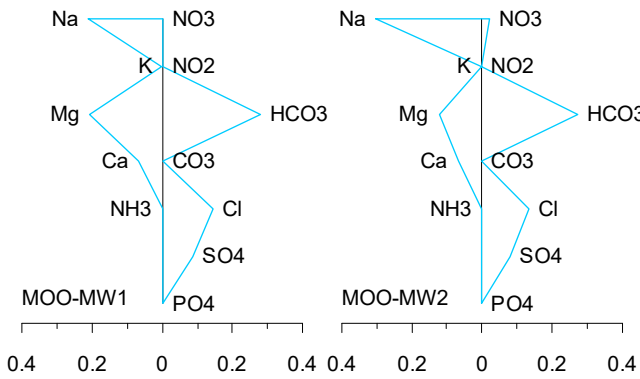

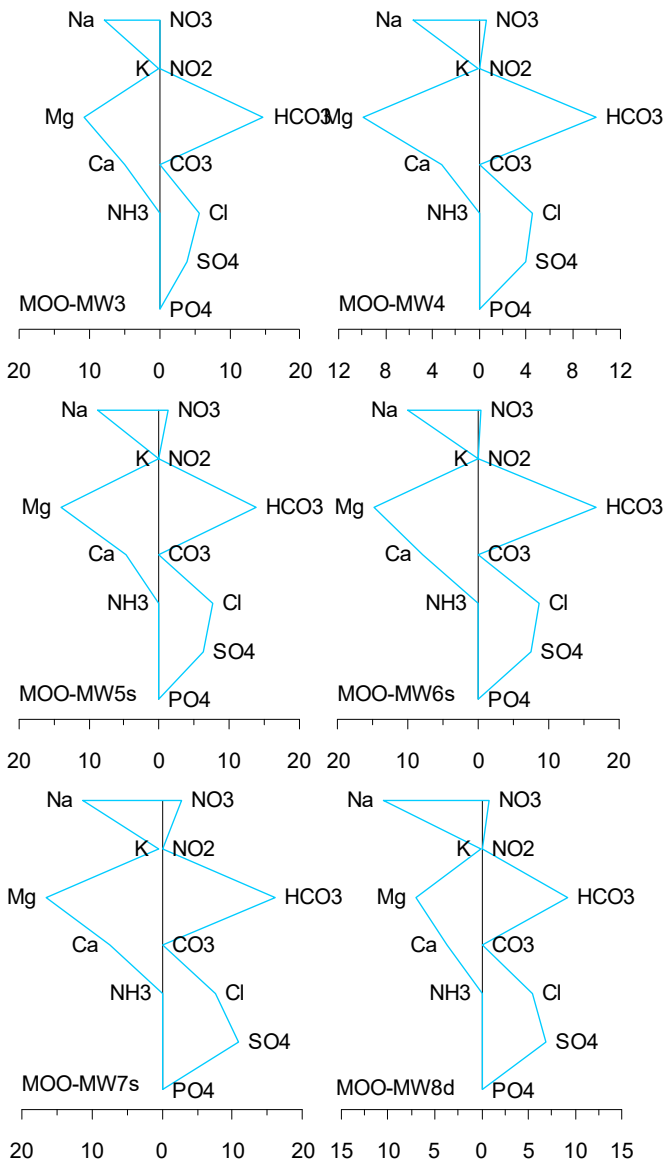

A11-186 MOO – Stiff diagrams, February 2019

TON

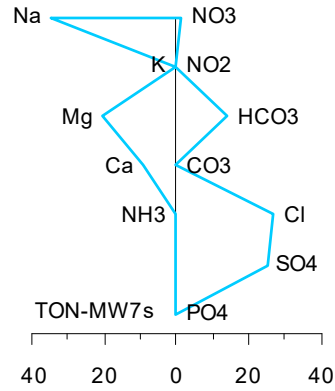
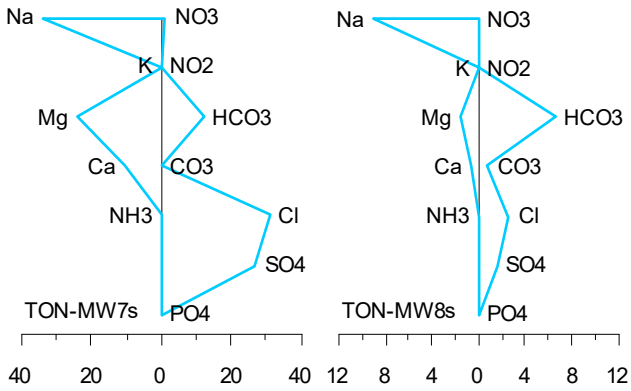
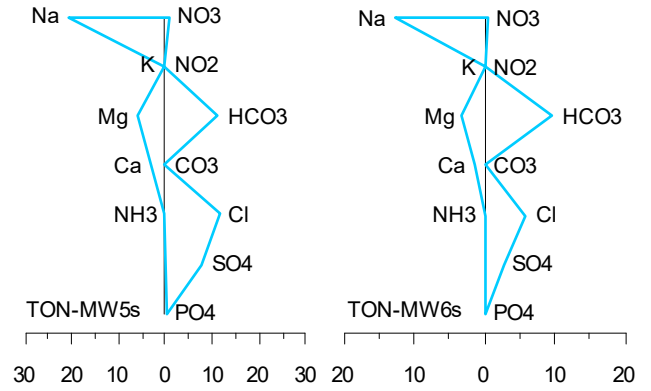
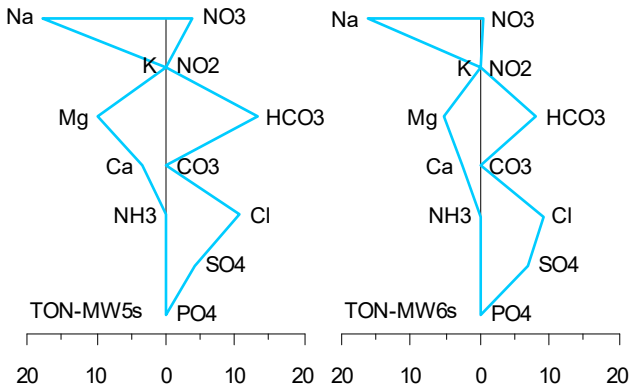
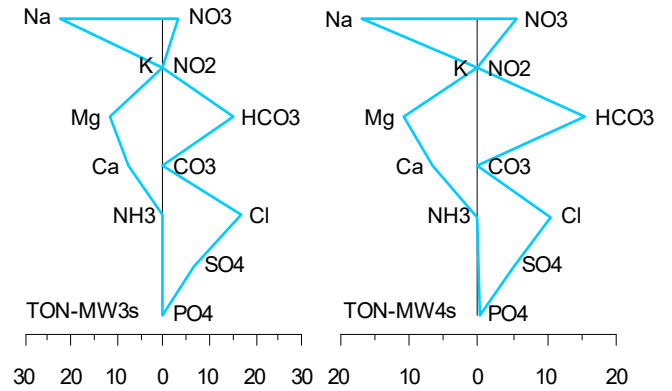
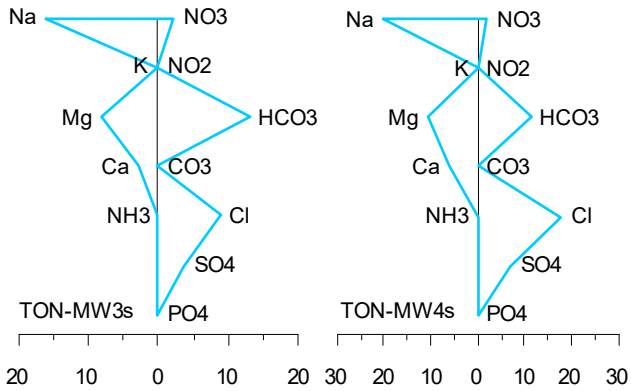
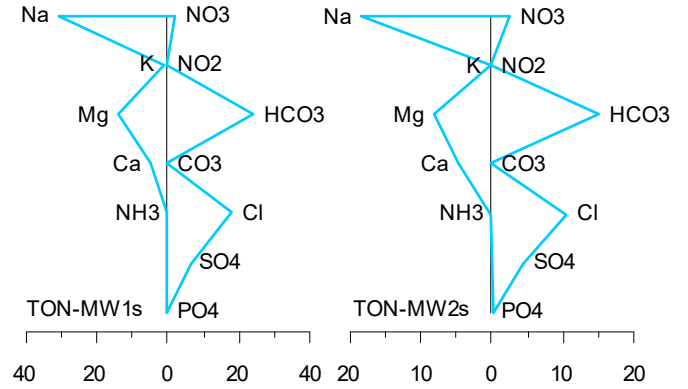
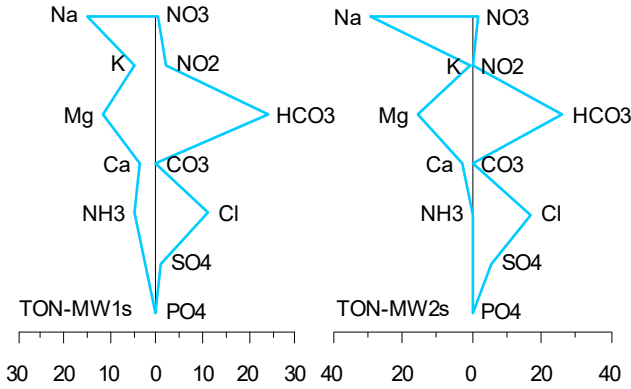

A11-187 TON – Stiff diagrams, May 2012

A11-188 TON – Stiff diagrams, August 2012

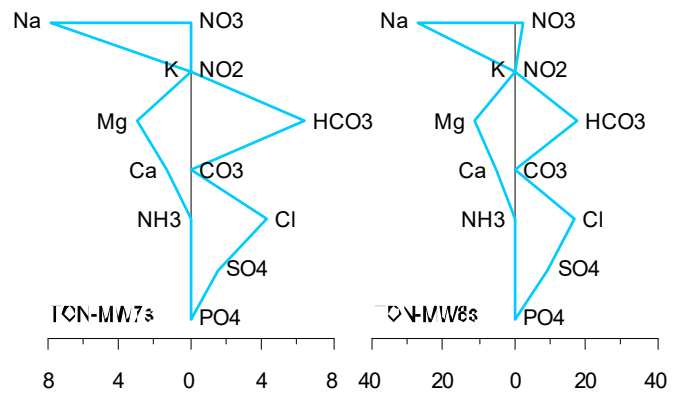
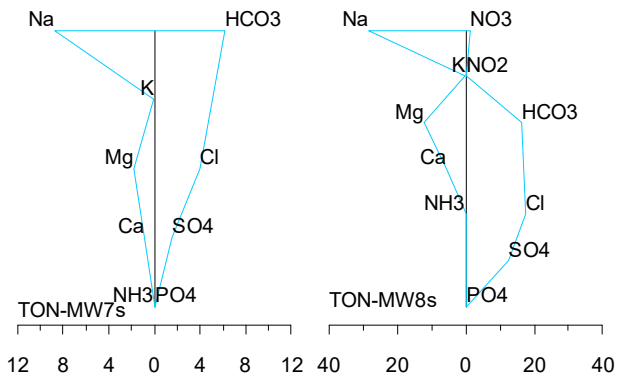
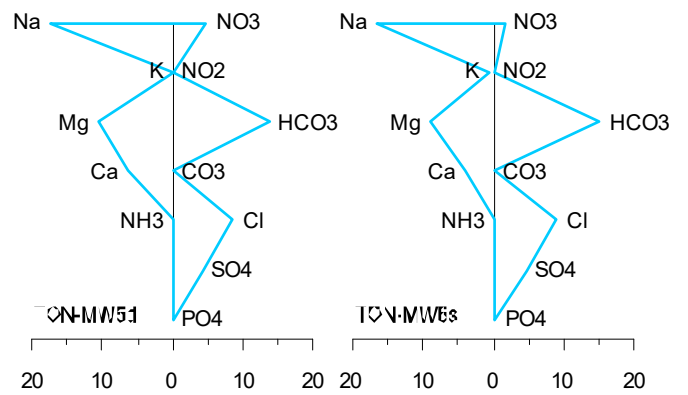
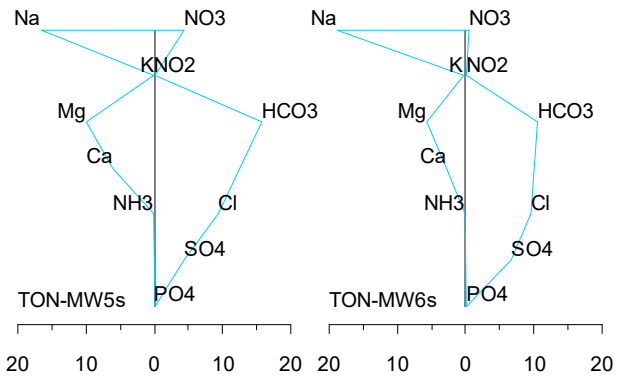
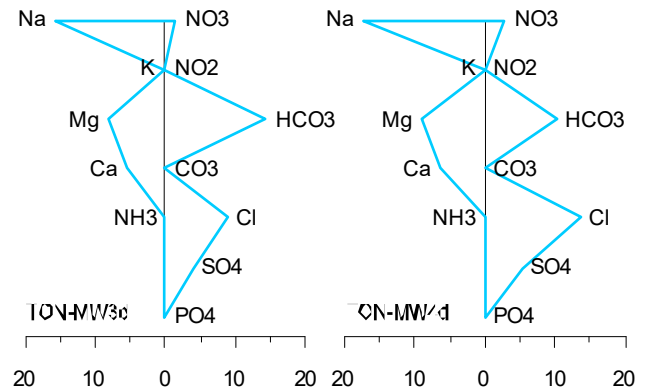
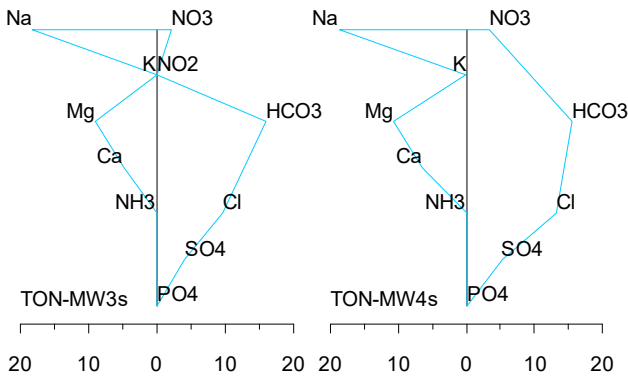
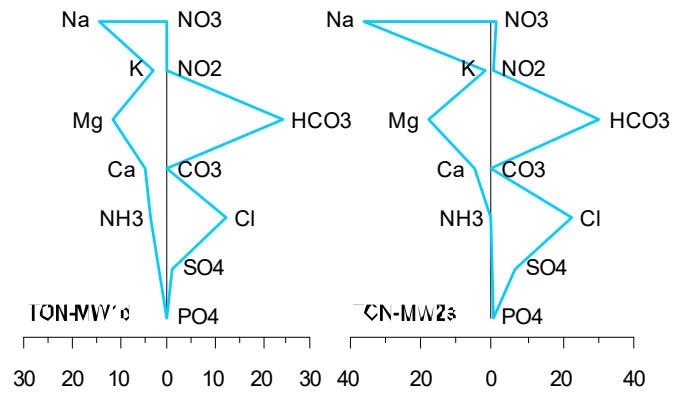
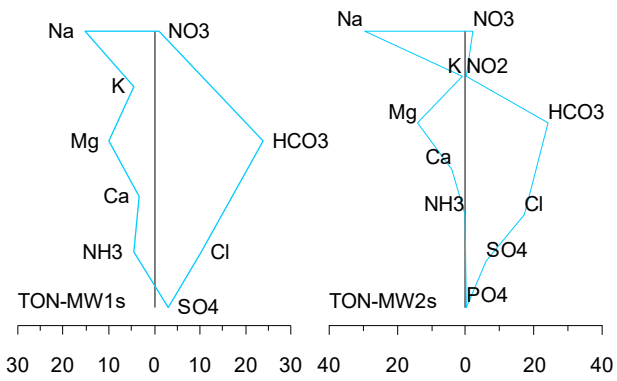

A11-189 TON – Stiff diagrams, August 2013

A11-190 TON – Stiff diagrams, August 2014

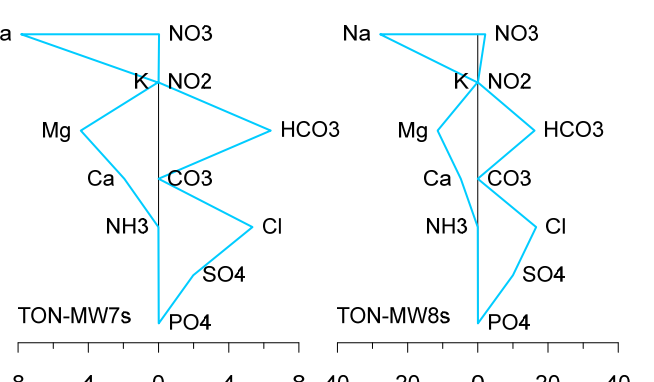
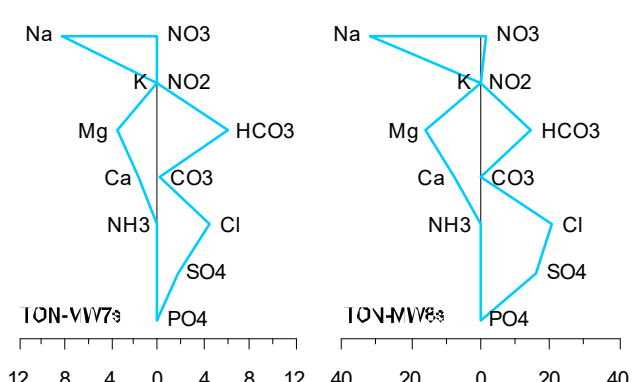
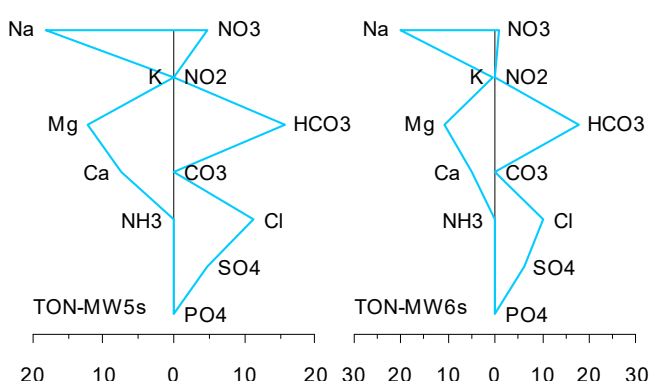
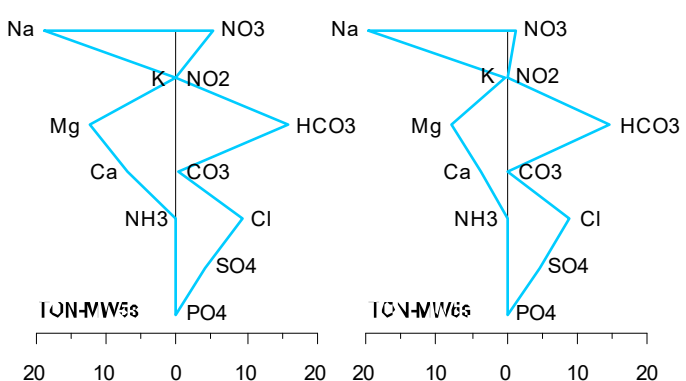
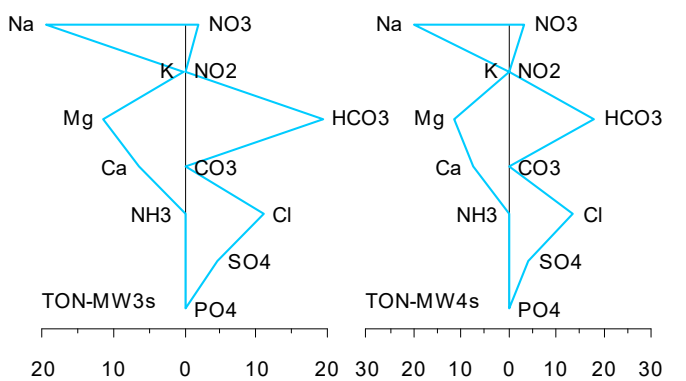
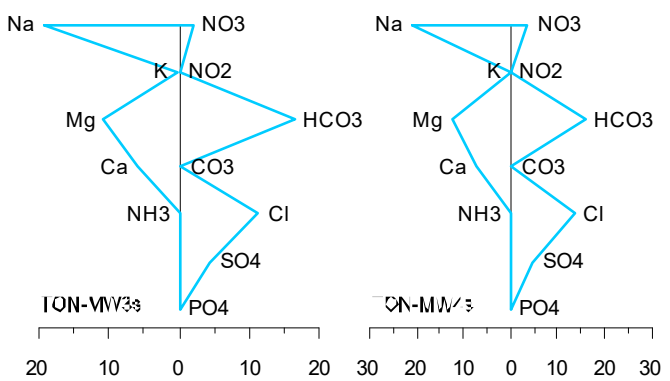
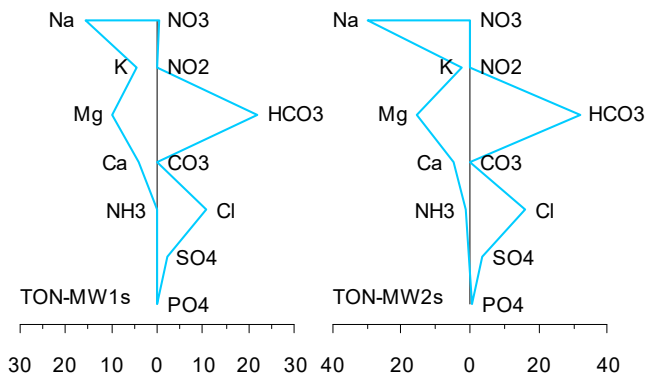
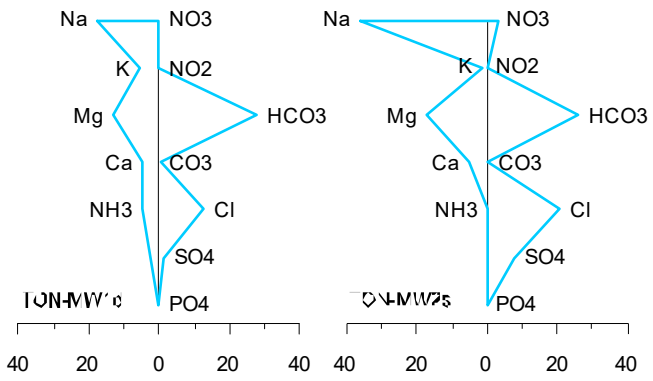

A11-191 TON – Stiff diagrams, February 2015

A11-192 TON – Stiff diagrams, February 2016

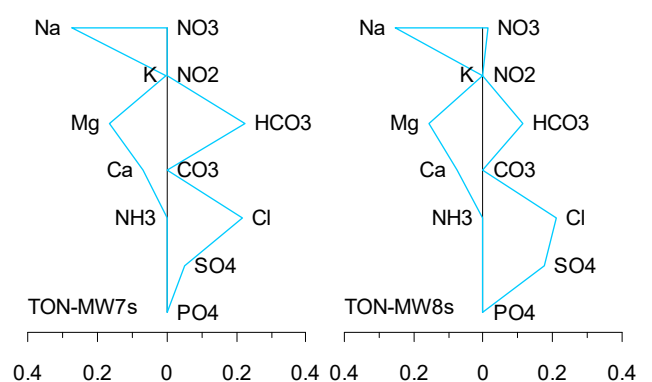
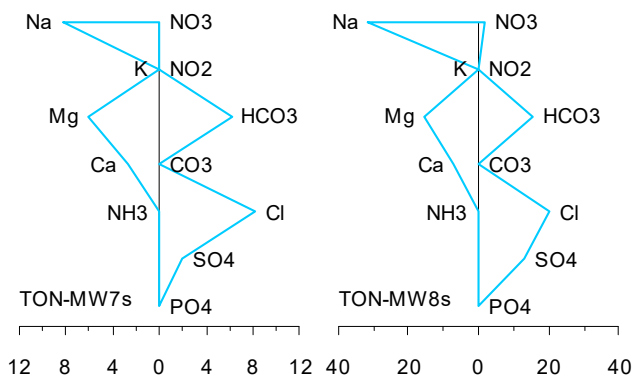
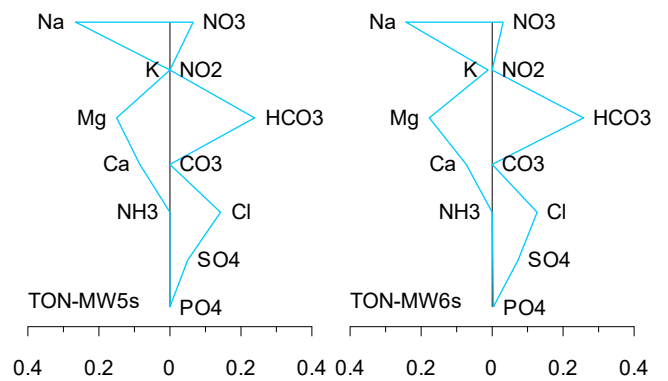
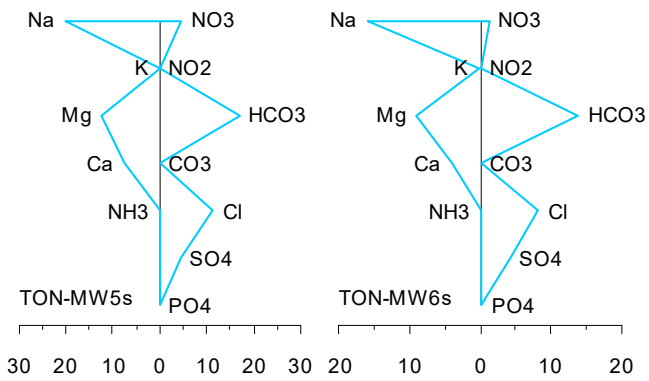
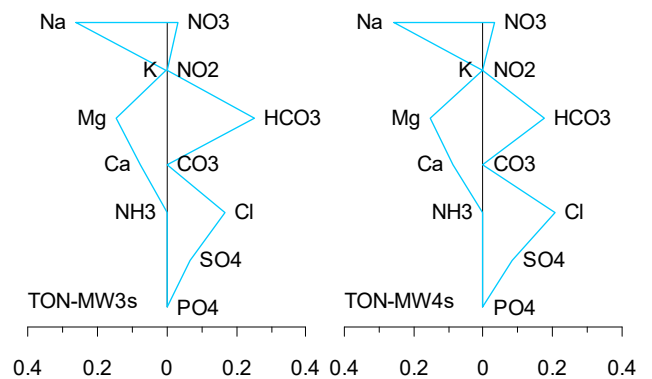
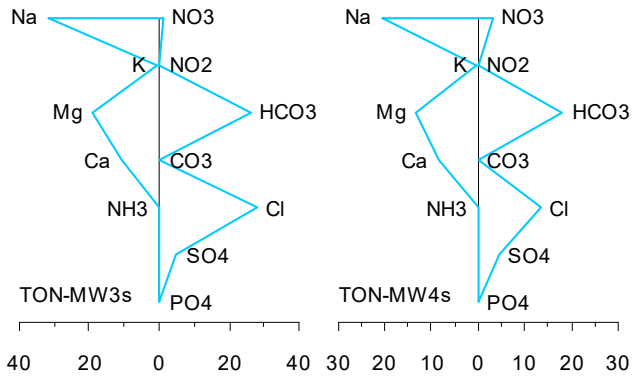
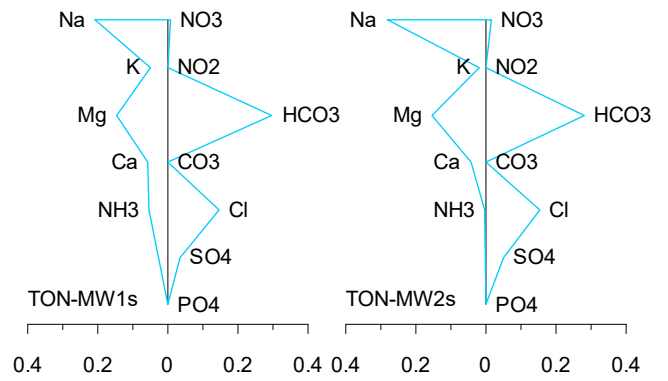
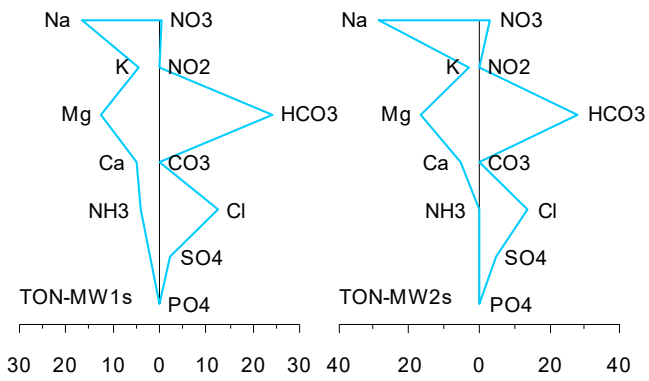

A11-193 TON – Stiff diagrams, March 2017

A11-194 TON – Stiff diagrams, February 2018

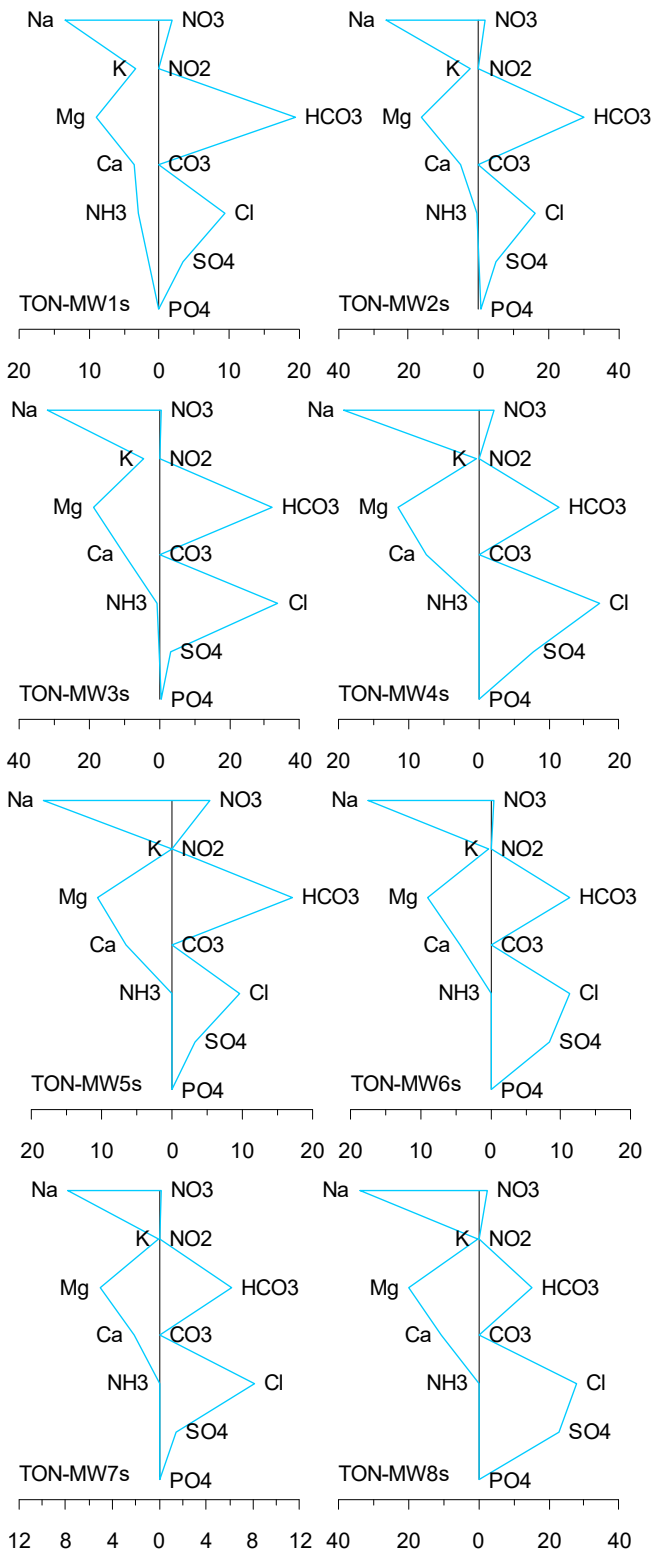

A11-195 TON – Stiff diagrams, February 2019

BRE

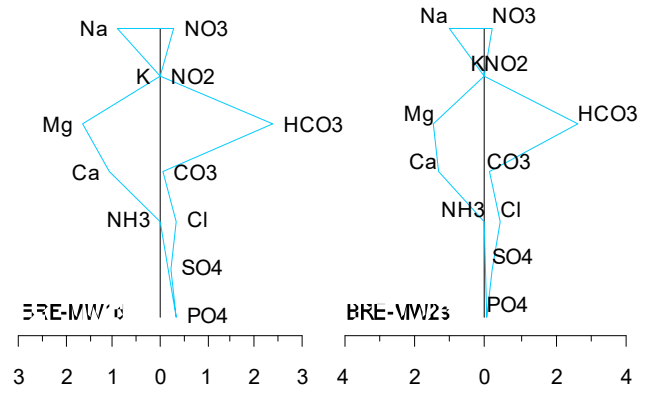
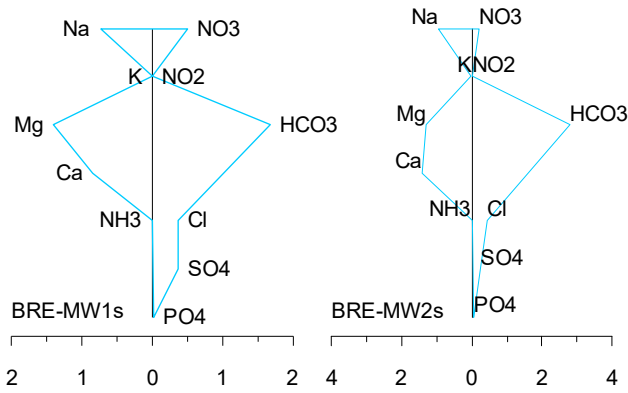

A11-196 BRE – Stiff diagrams, August 2013

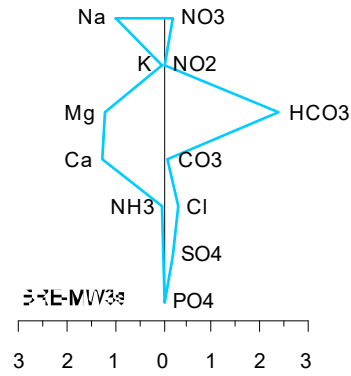
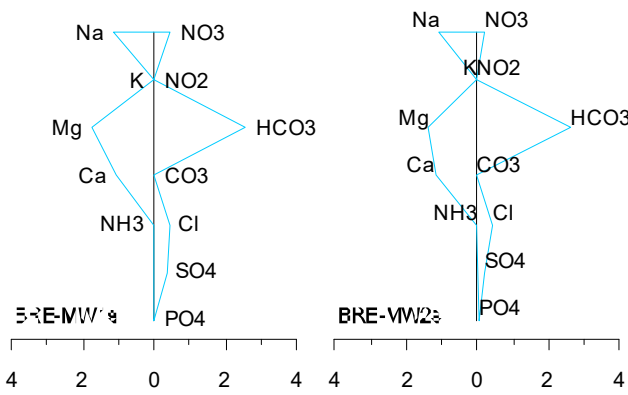

A11-198 BRE – Stiff diagrams, February 2015

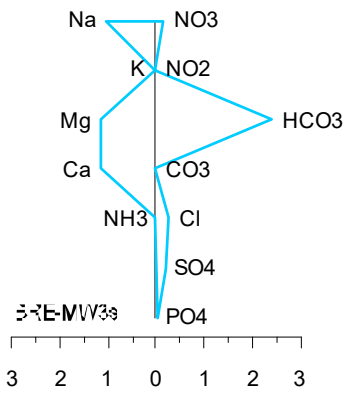

A11-197 BRE – Stiff diagrams, August 2014

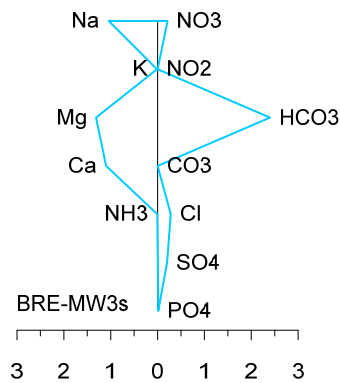
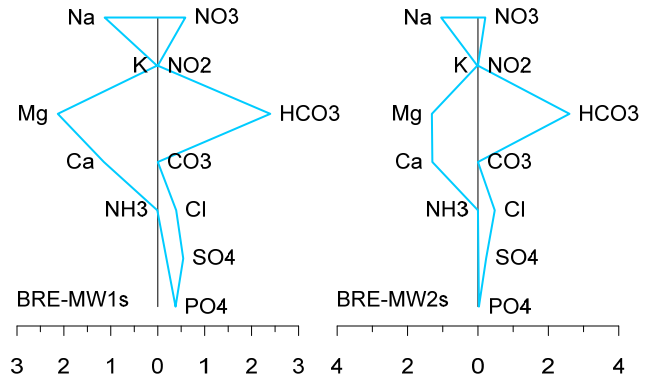

A11-199 BRE – Stiff diagrams, February 2016

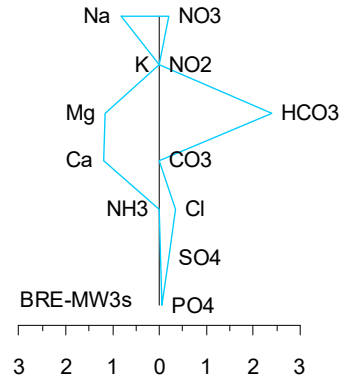
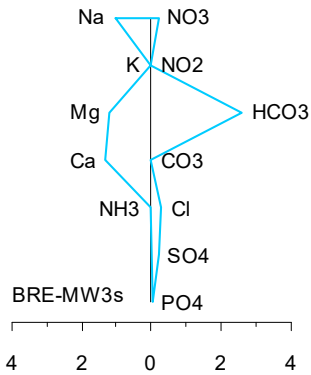
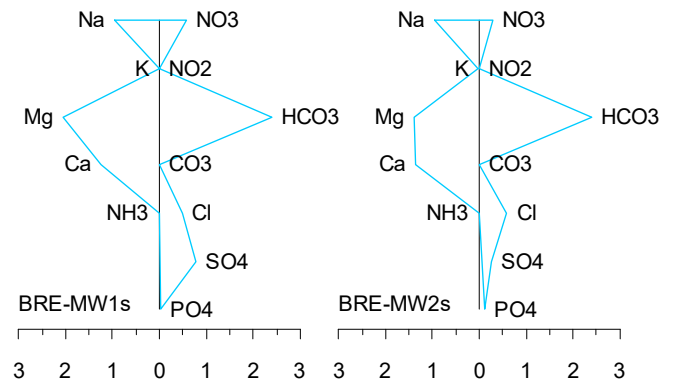
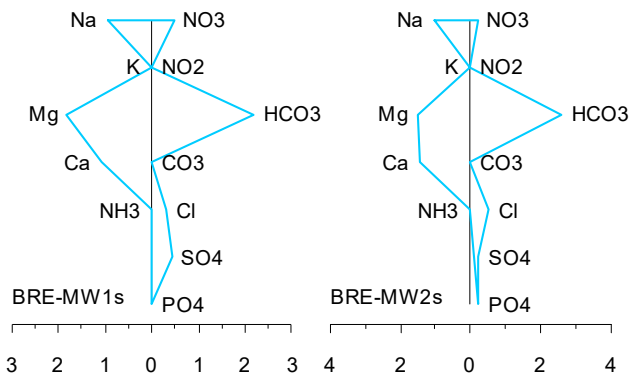

A11-200 BRE – Stiff diagrams, March 2017

A11-202 BRE – Stiff diagrams, February 2019

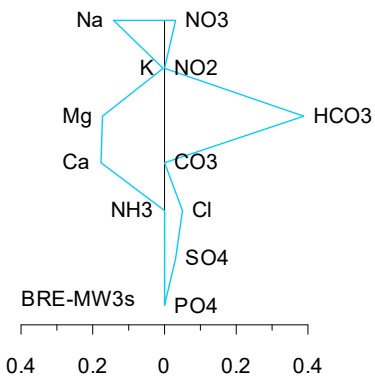
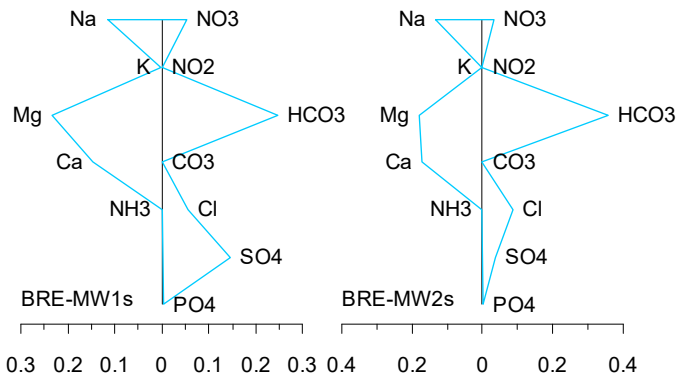

A11-201 BRE – Stiff diagrams, February 2018

CRE

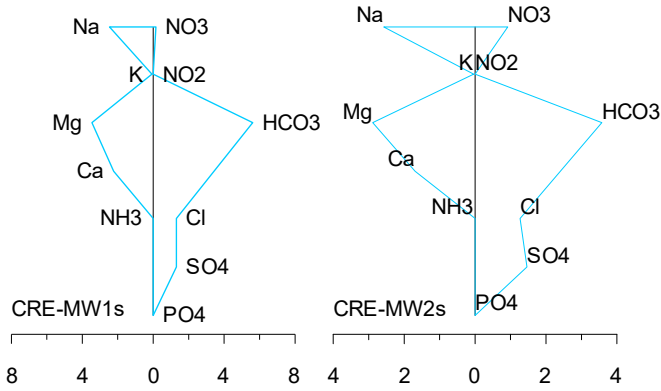

A11-203 CRE – Stiff diagrams, August 2013

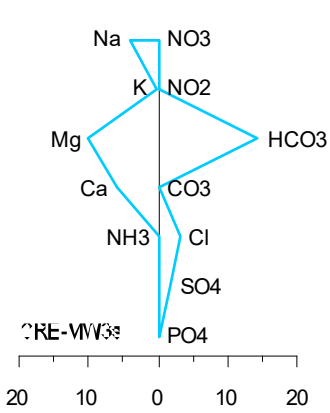
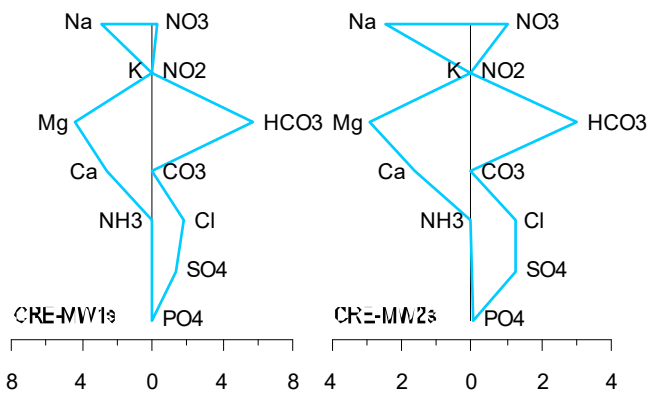
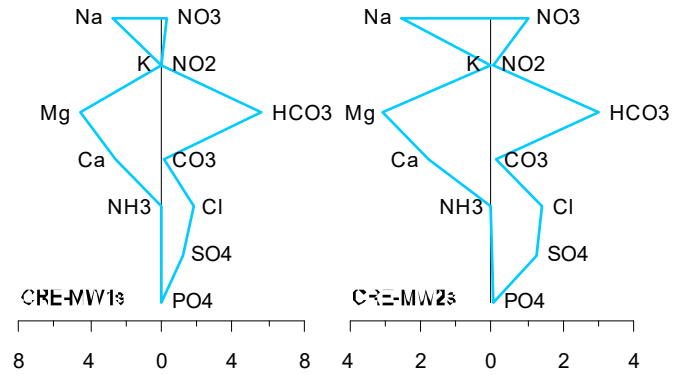

A11-204 CRE – Stiff diagrams, August 2014

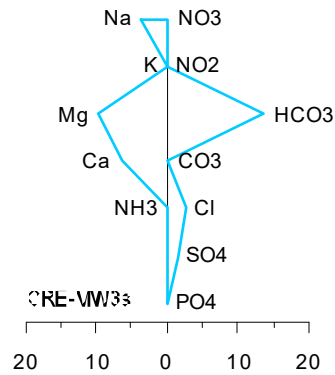

A11-205 CRE – Stiff diagrams, February 2015

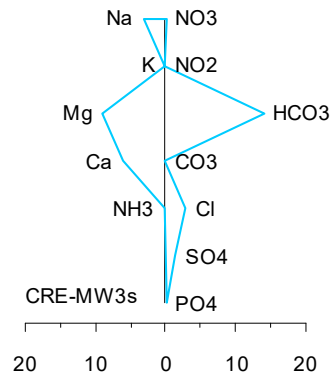
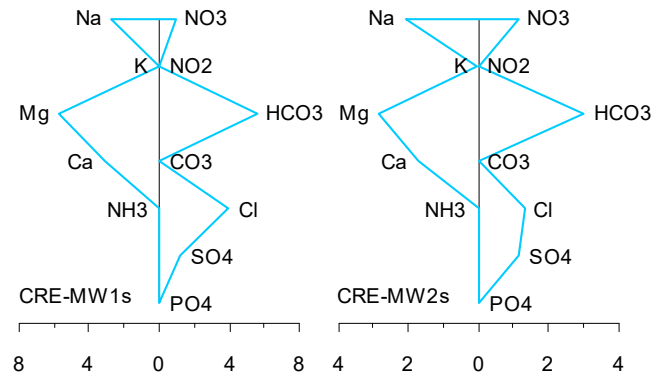

A11-206 CRE – Stiff diagrams, February 2016

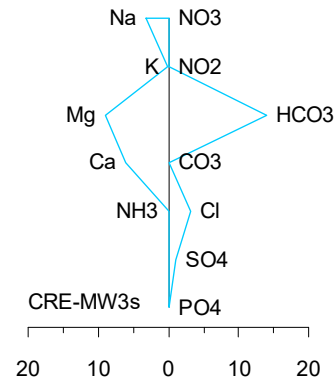
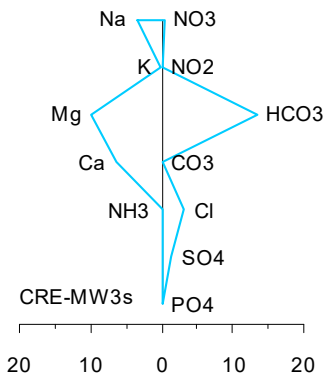
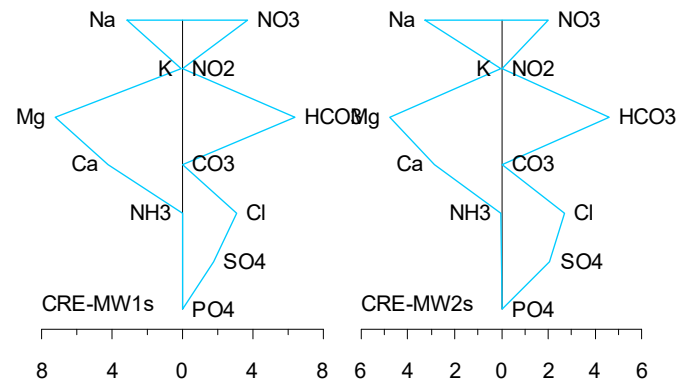
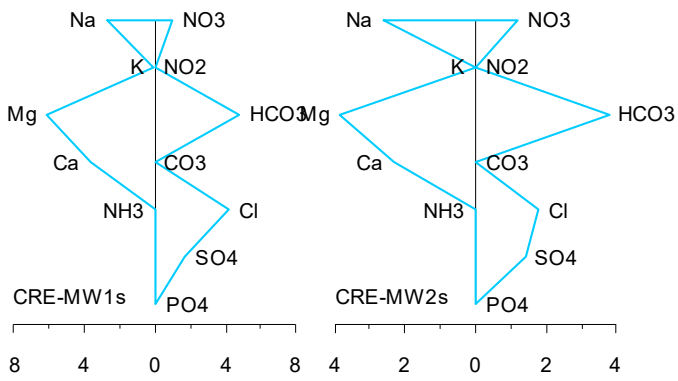

A11-207 CRE – Stiff diagrams, March 2017

A11-209 CRE – Stiff diagrams, February 2019

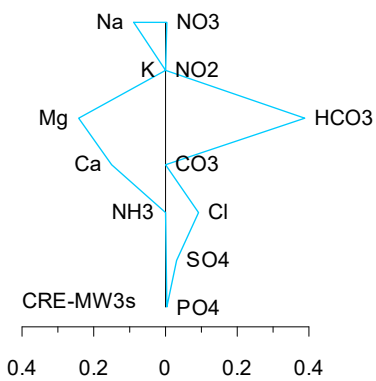
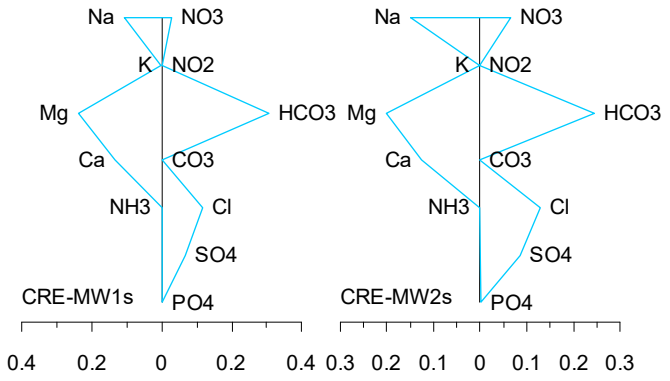

A11-208 CRE – Stiff diagrams, February 2018

MTS

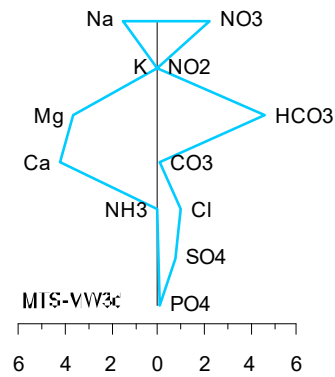
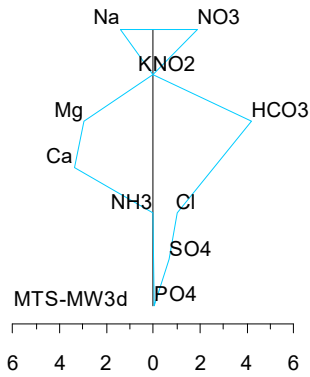
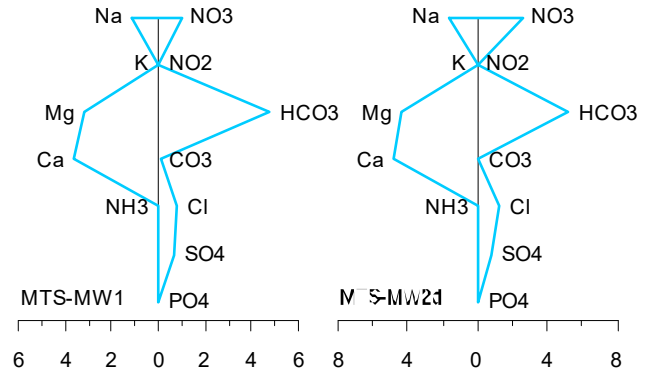
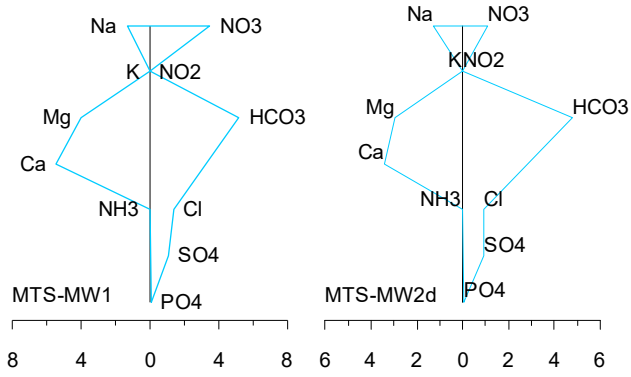

A11-210 MTS – Stiff diagrams, August 2013

A11-212 MTS – Stiff diagrams, February 2015

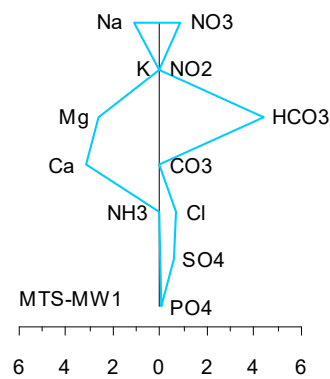
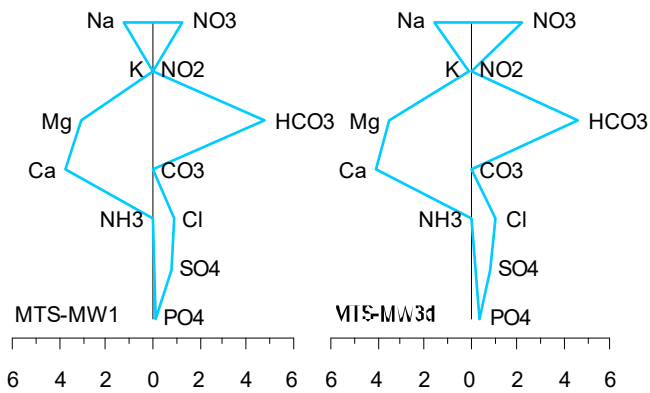

A11-211 MTS – Stiff diagrams, August 2014

A11-213 MTS – Stiff diagrams, February 2016

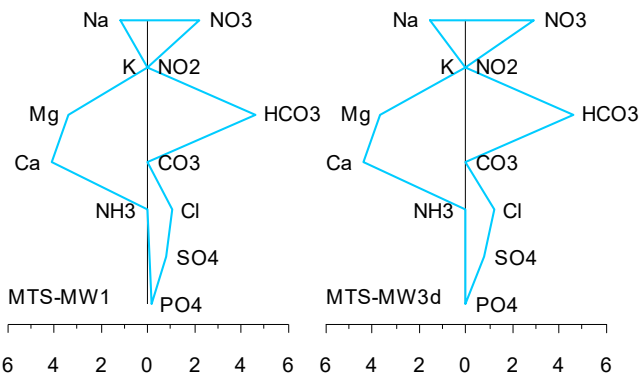

A11-214 MTS – Stiff diagrams, March 2017

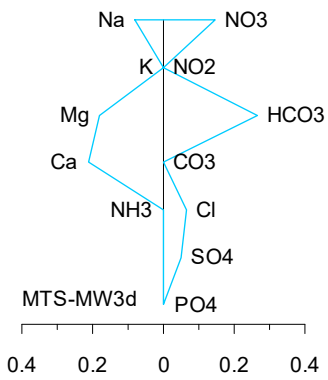
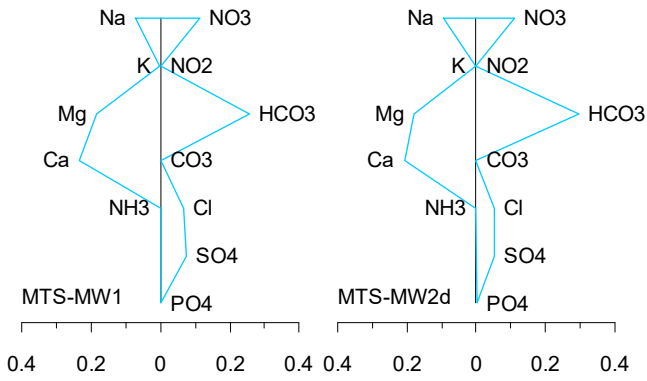

A11-215 MTS – Stiff diagrams, February 2018

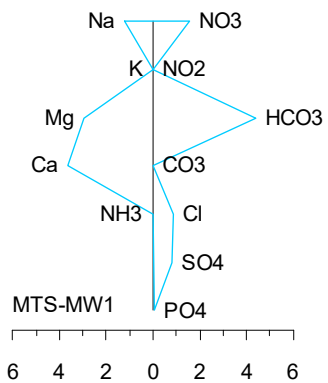

A11-216 MTS – Stiff diagrams, February 2019

AUK

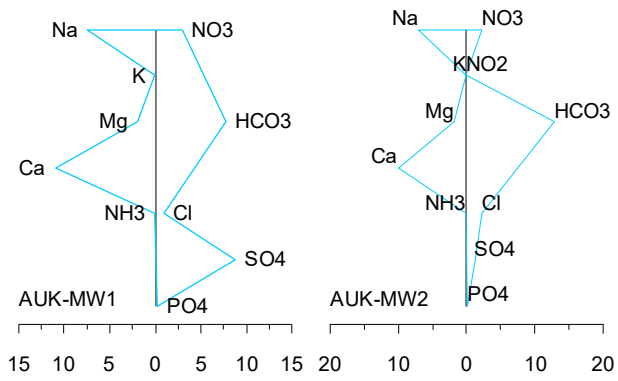

A11-217 AUK – Stiff diagrams, August 2013

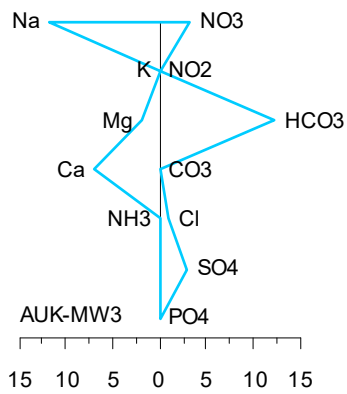
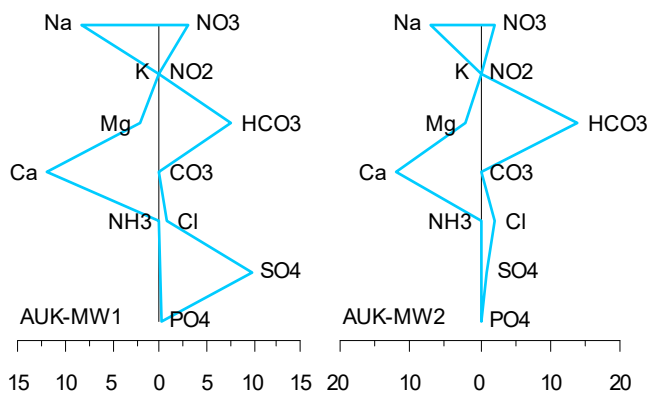
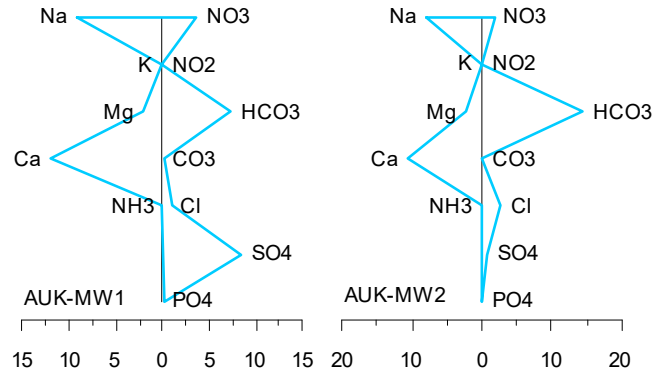

A11-218 AUK – Stiff diagrams, August 2014

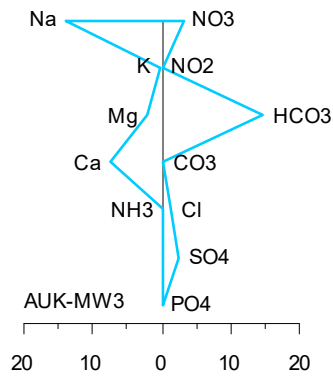

A11-219 AUK – Stiff diagrams, February 2015

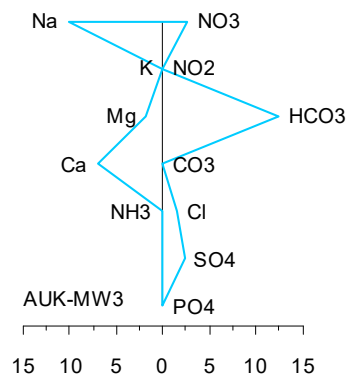
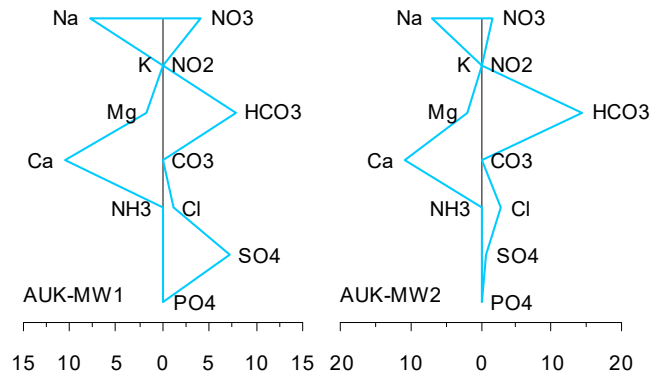

A11-220 AUK – Stiff diagrams, February 2016

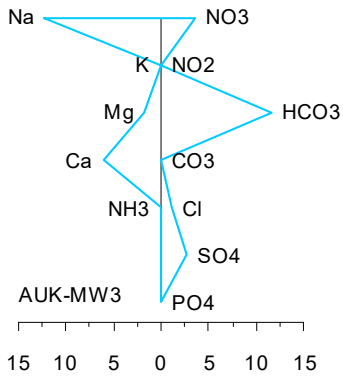
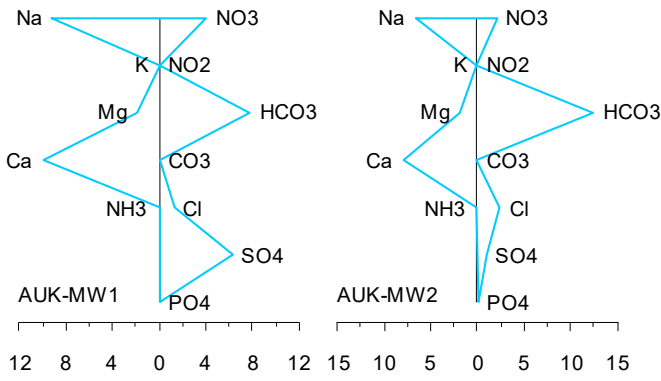

A11-221 AUK – Stiff diagrams, March 2017

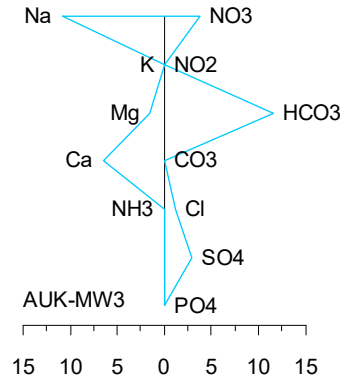
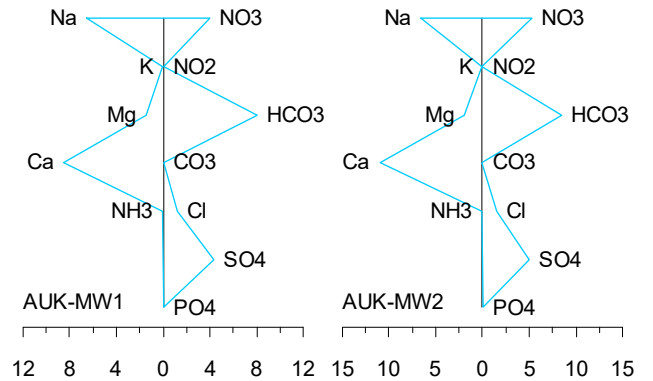

A11-223 AUK – Stiff diagrams, February 2019

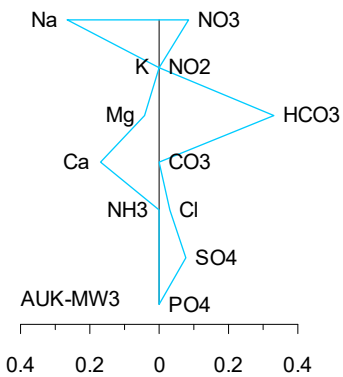
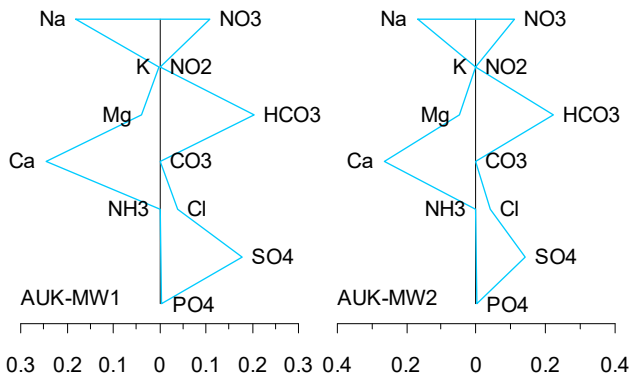

A11-222 AUK – Stiff diagrams, February 2018

DLF

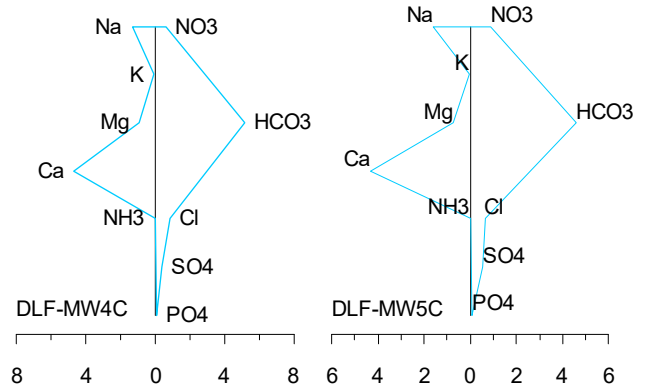

A11-224 DLF – Stiff diagrams, August 2013

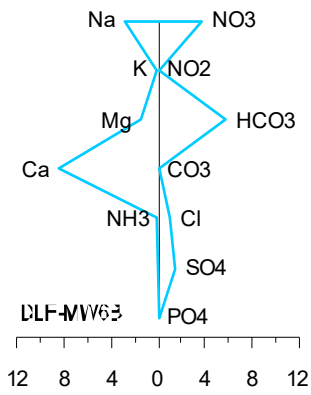

A11-225 DLF – Stiff diagrams, August 2014

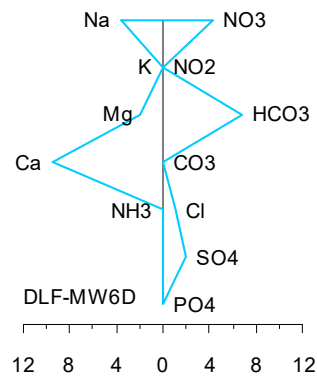

A11-228 DLF – Stiff diagrams, March 2017

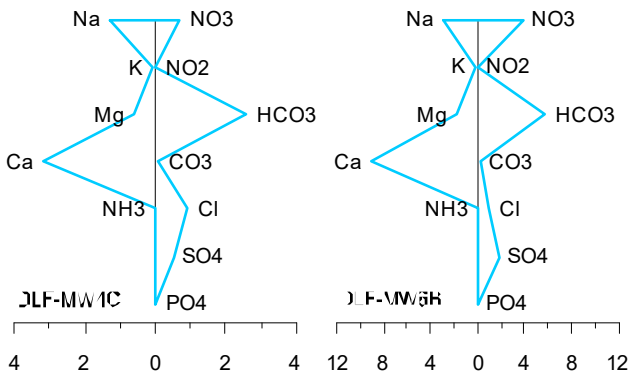

A11-226 DLF – Stiff diagrams, February 2015

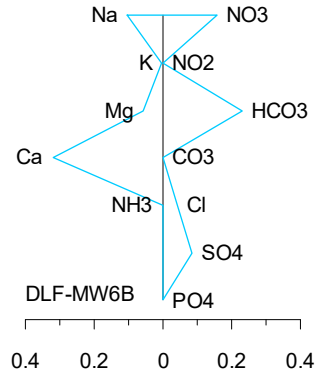

A11-229 DLF – Stiff diagrams, February 2018

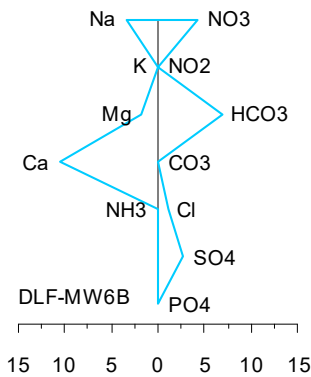

A11-227 DLF – Stiff diagrams, February 2016

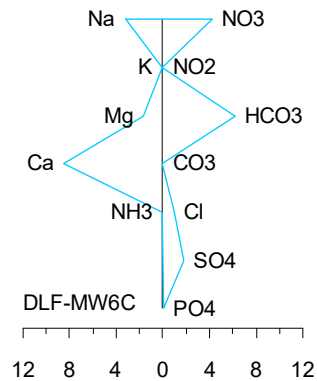

A11-230 DLF – Stiff diagrams, February 2019

ELK

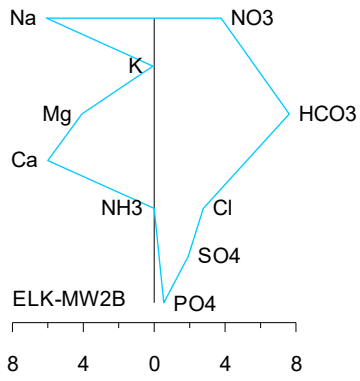

A11-231 ELK – Stiff diagrams, August 2013

- No data for 2014 – All wells dry
- No data for 2015 – All wells dry
- No data for 2016 – All wells dry
- No data for 2017 – All wells dry
- No data for 2018 – All wells dry
- No data for 2019 – All wells dry

ZZI

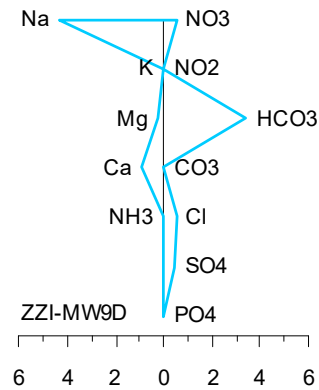
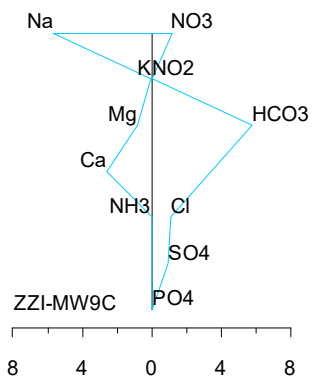
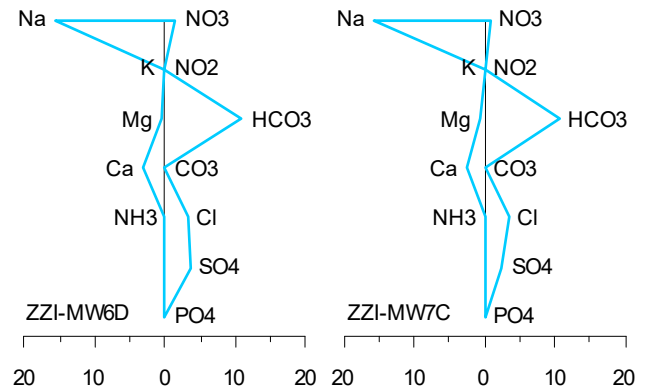
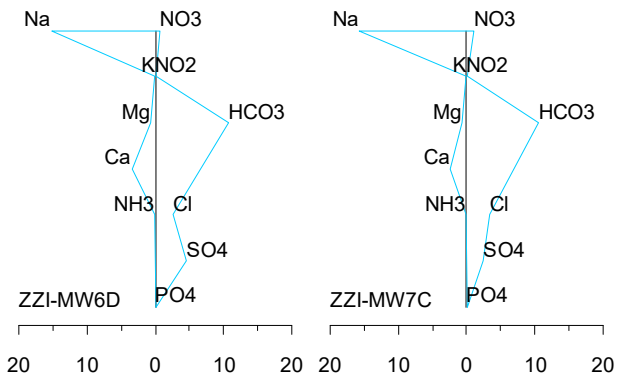
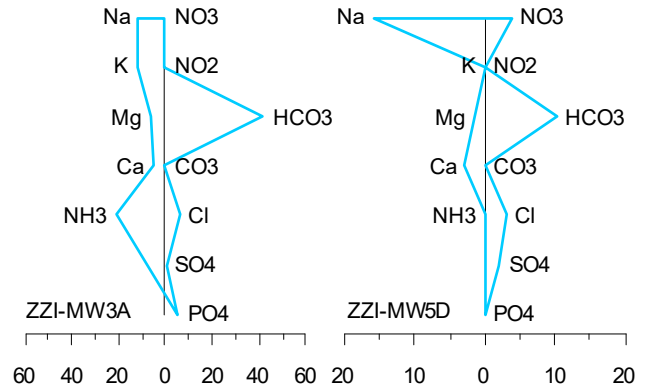
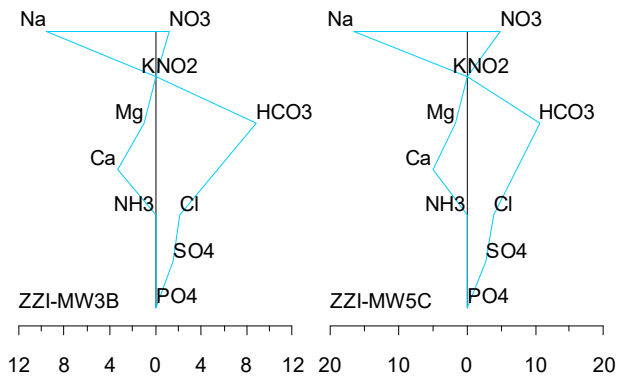
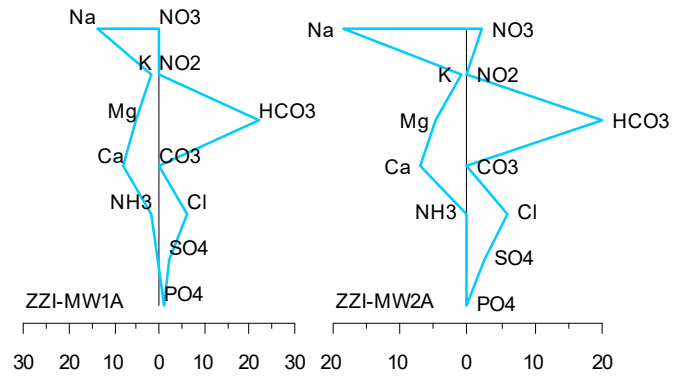
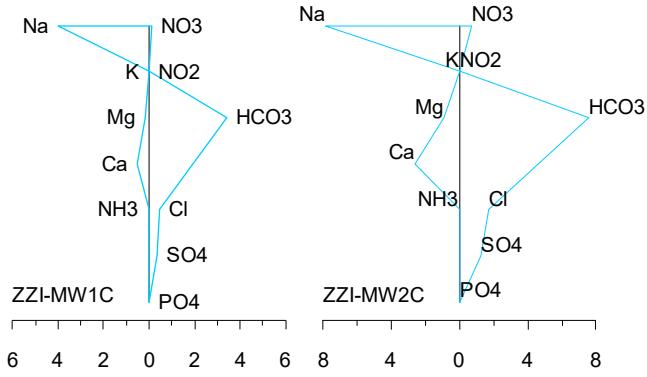

A11-232 ZZI – Stiff diagrams, August 2013

A11-233 ZZI – Stiff diagrams, August 2014

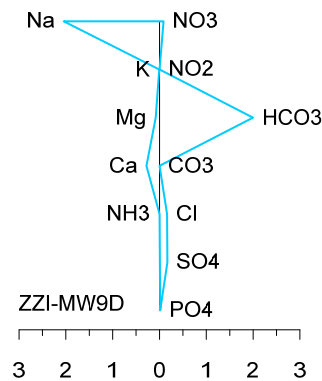
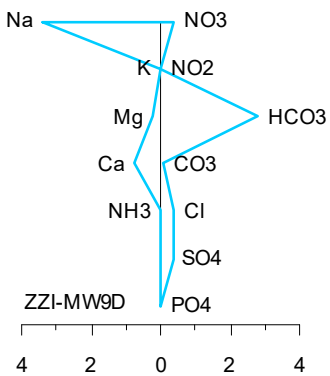
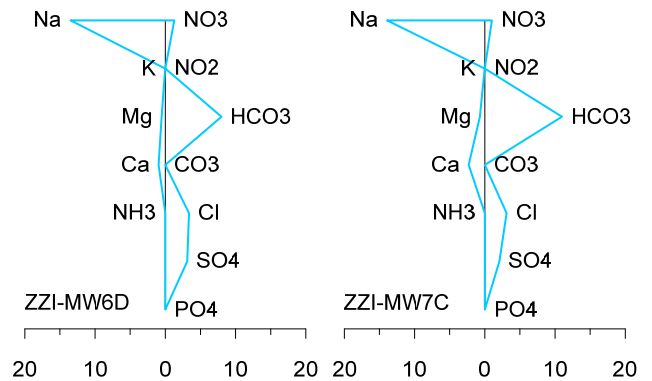
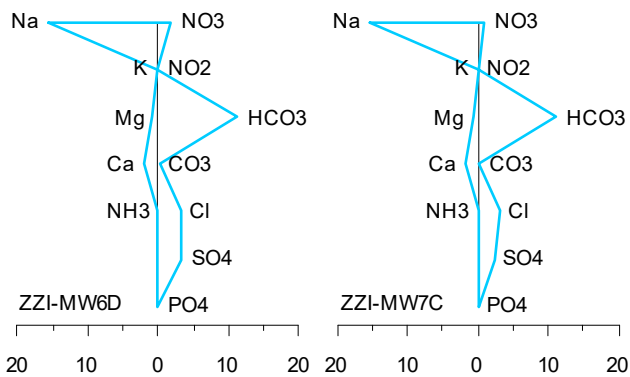
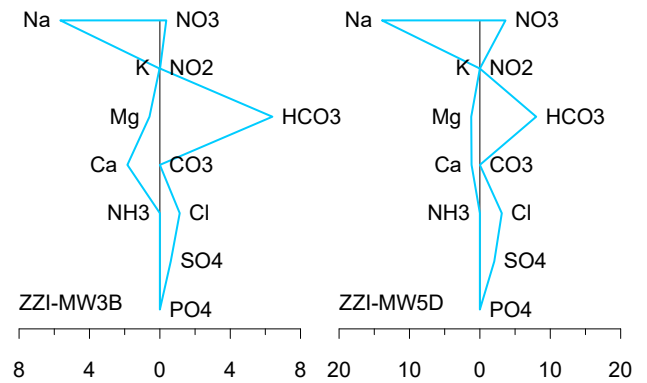
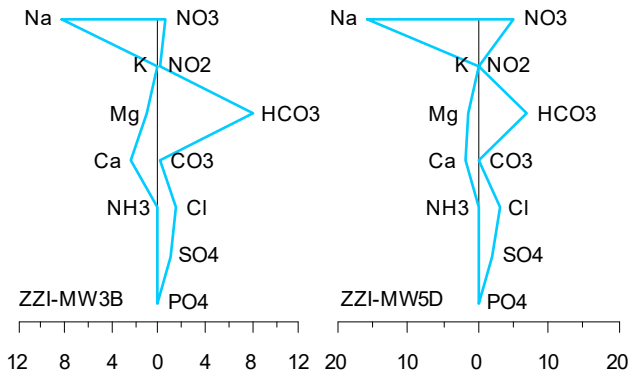
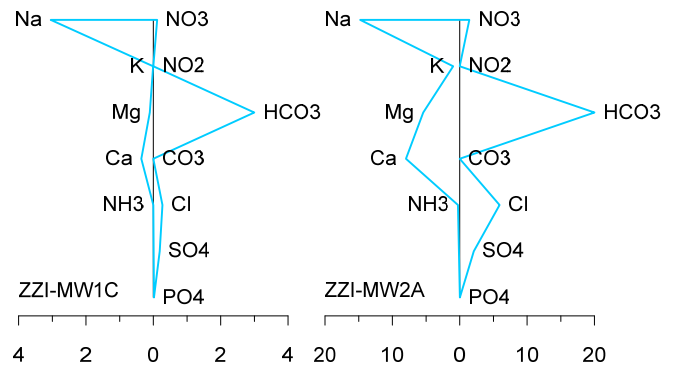
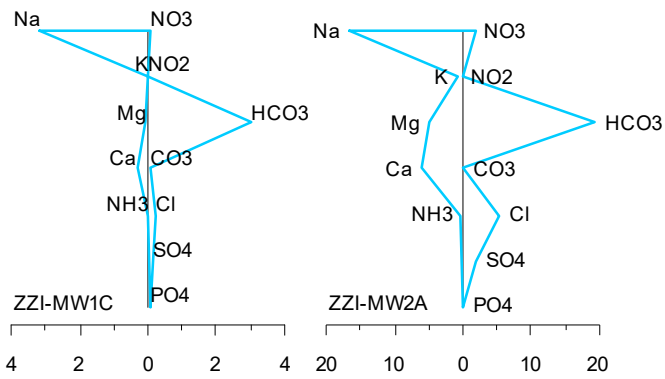

A11-234 ZZI – Stiff diagrams, February 2015

A11-235 ZZI – Stiff diagrams, February 2016

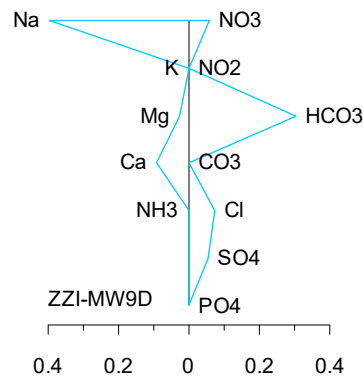
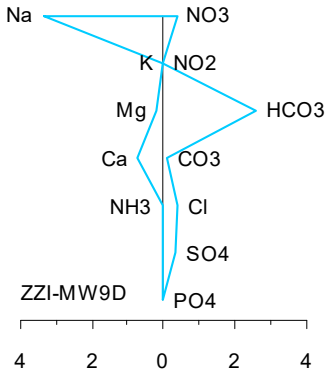
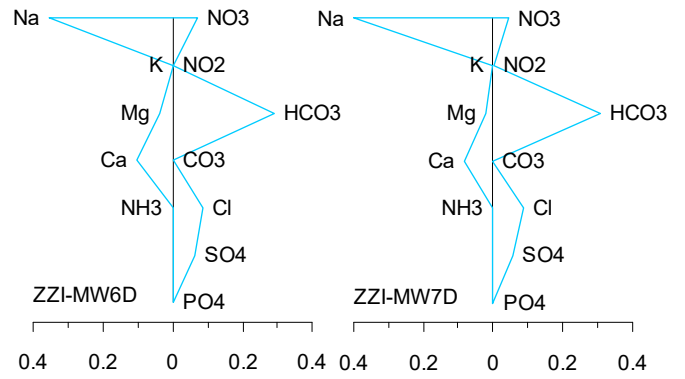
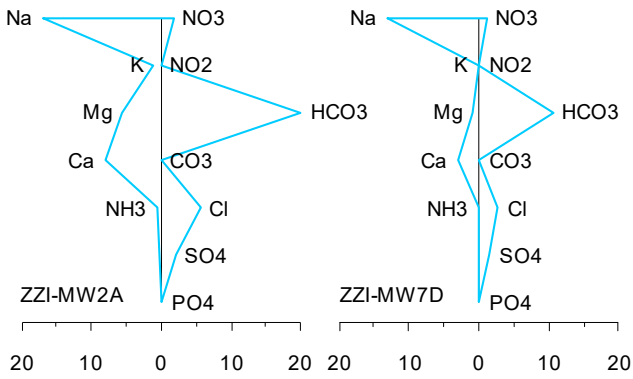

A11-236 ZZI – Stiff diagrams, March 2017

A11-237 ZZI – Stiff diagrams, February 2018

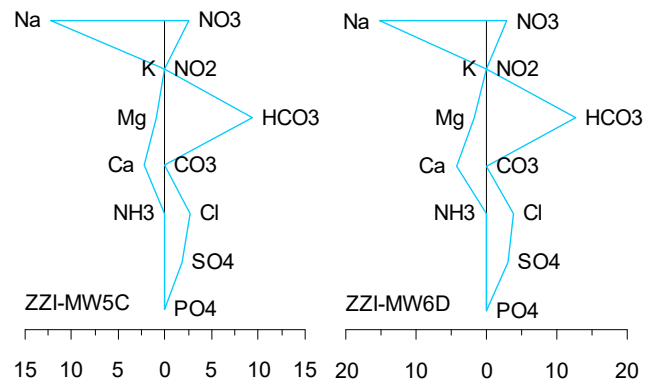
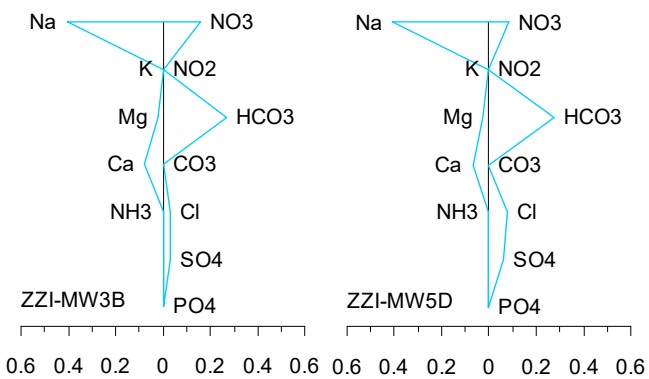
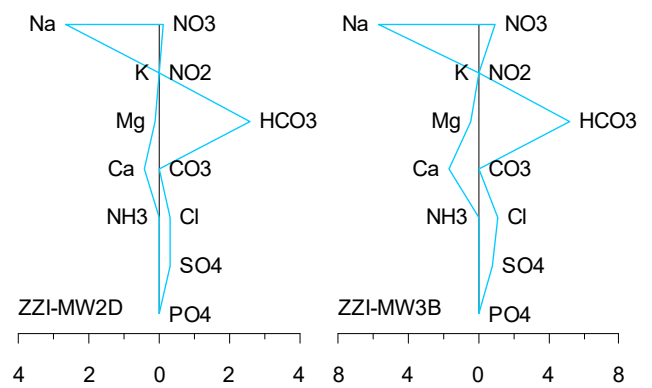
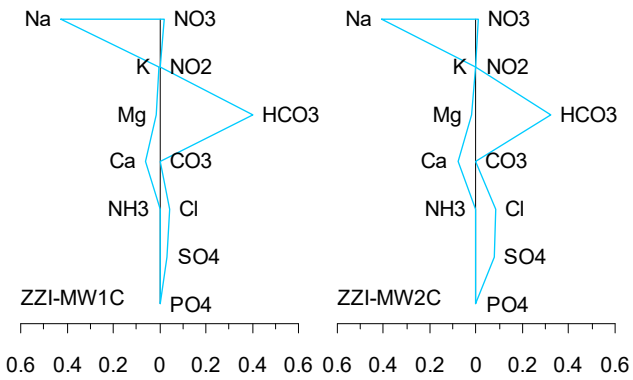

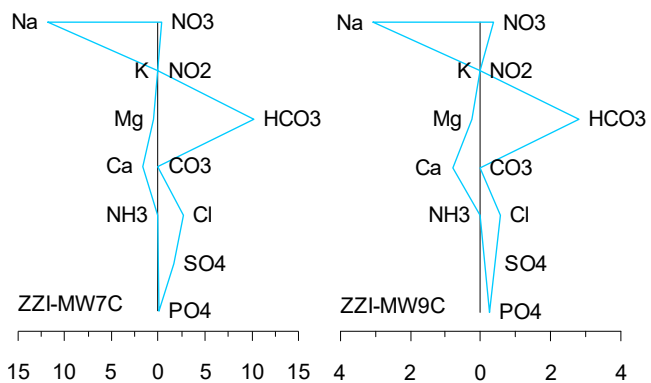

A11-238 ZZI – Stiff diagrams, February 2019

HOL

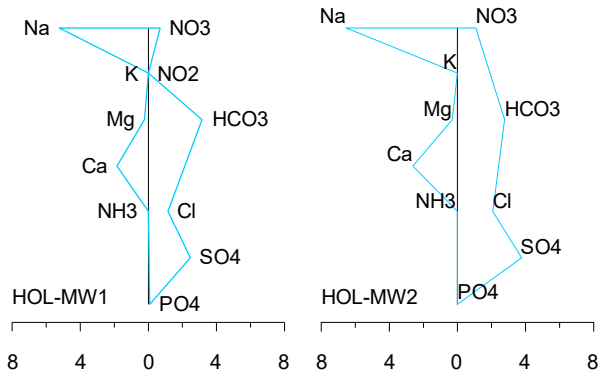

A11-239 HOL – Stiff diagrams, August 2013

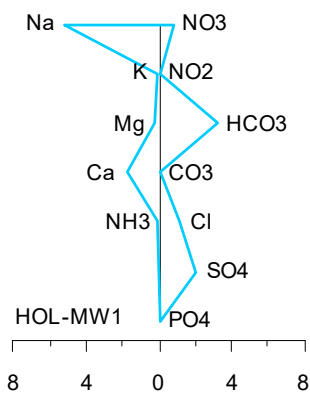

A11-240 HOL – Stiff diagrams, August 2014

HYN

All wells were dry – no data.

JAD

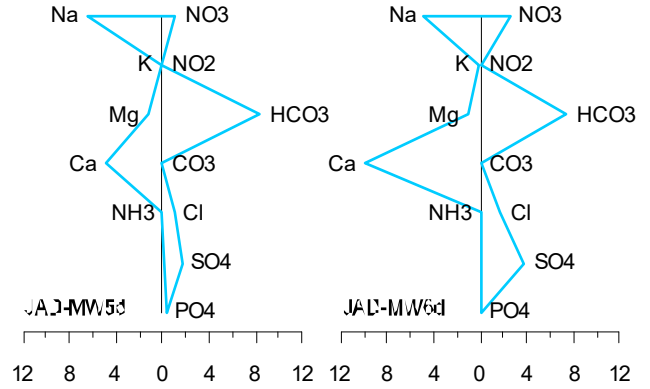
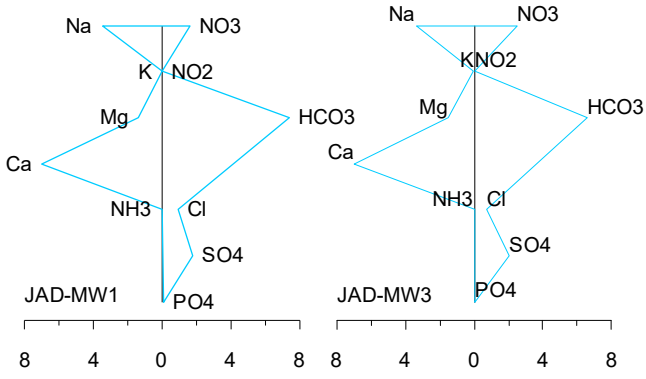

A11-242 JAD – Stiff diagrams, August 2014

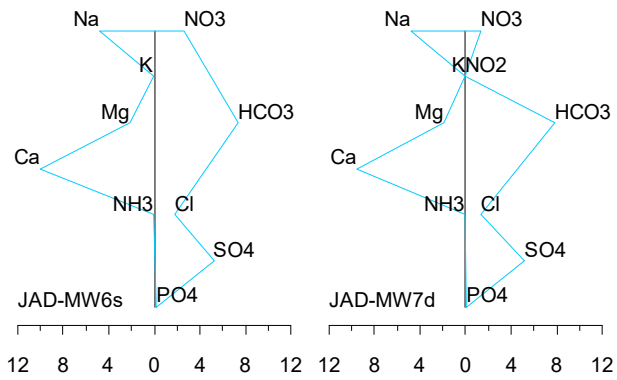
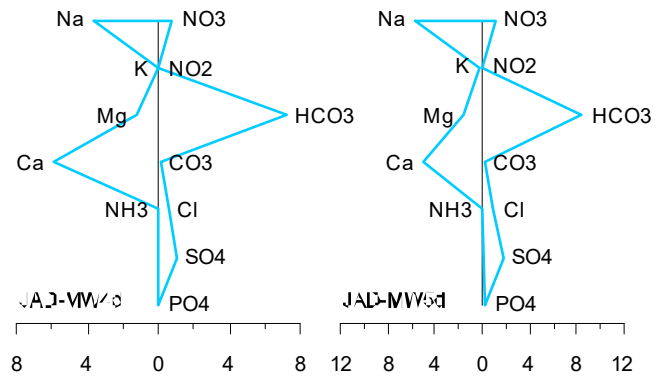
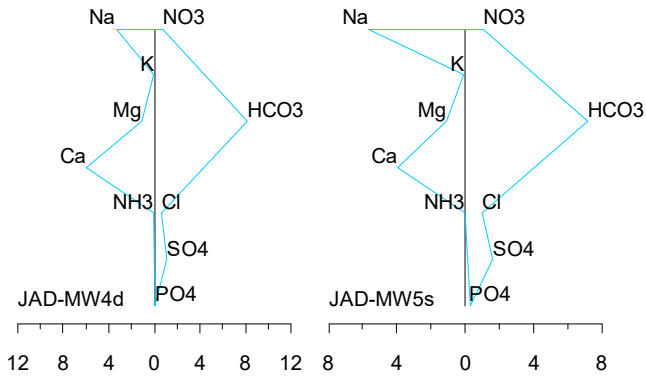

A11-241 JAD – Stiff diagrams, August 2013

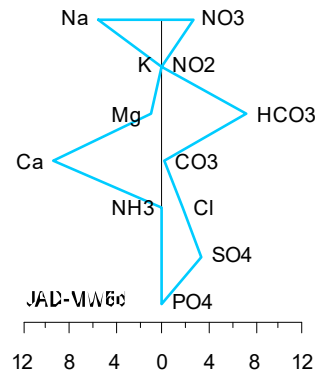

A11-243 JAD – Stiff diagrams, February 2015

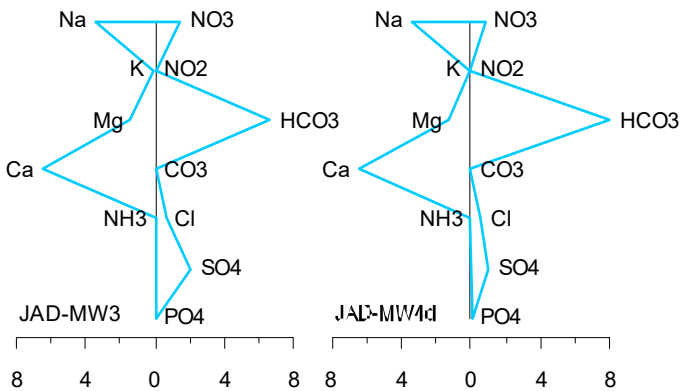

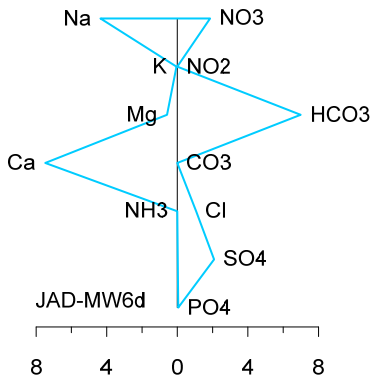

A11-244 JAD – Stiff diagrams, February 2016

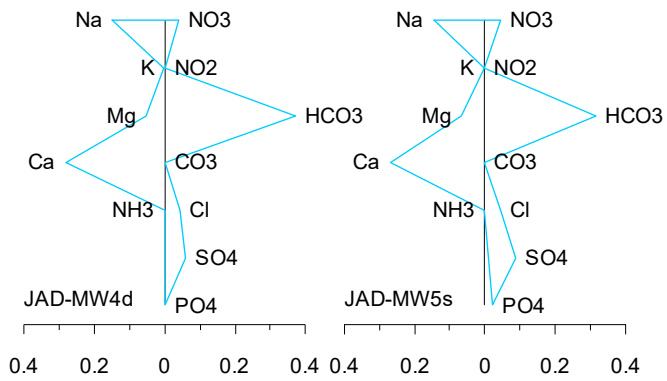

A11-245 JAD – Stiff diagrams, February 2018

LON

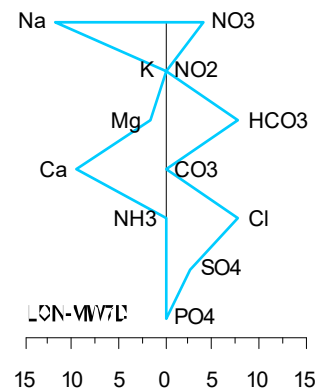
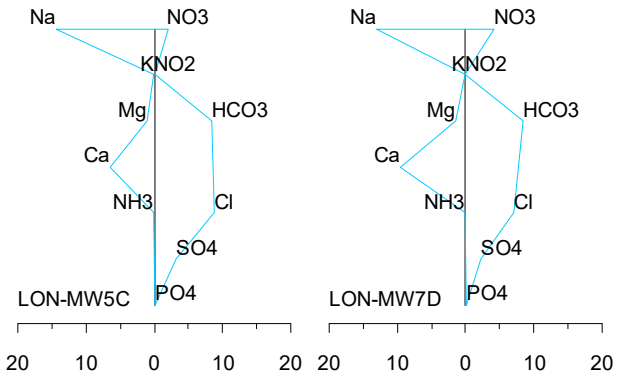
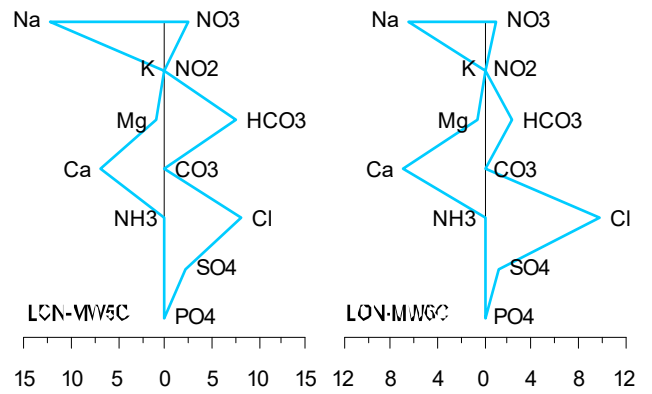
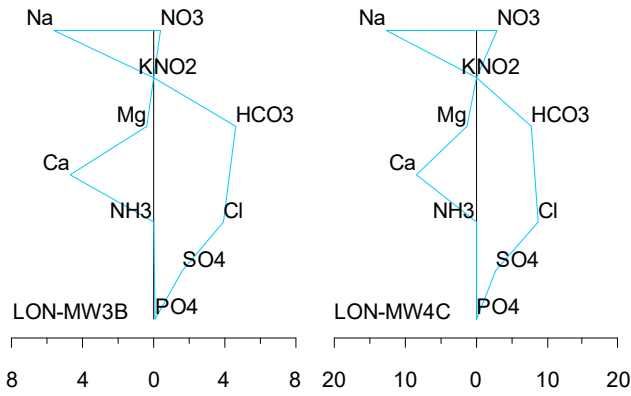
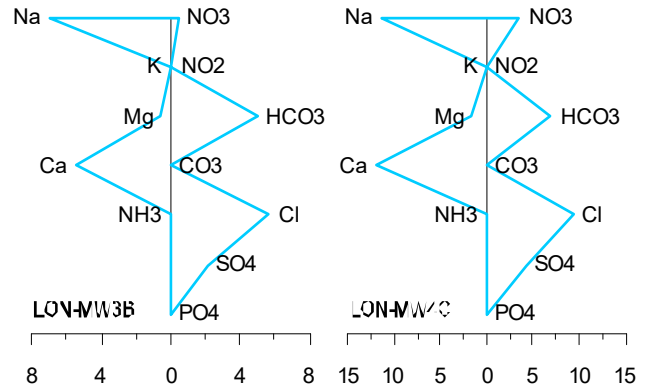
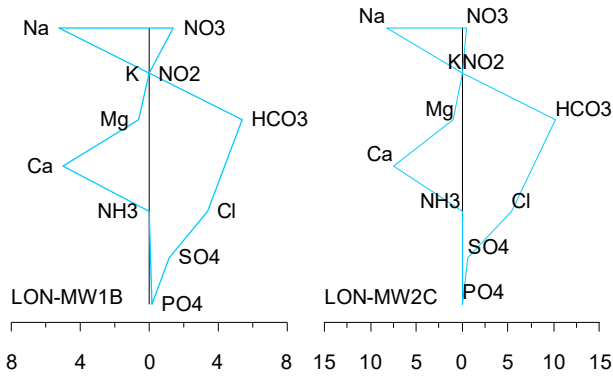

A11-246 LON – Stiff diagrams, August 2013

A11-247 LON – Stiff diagrams, August 2014

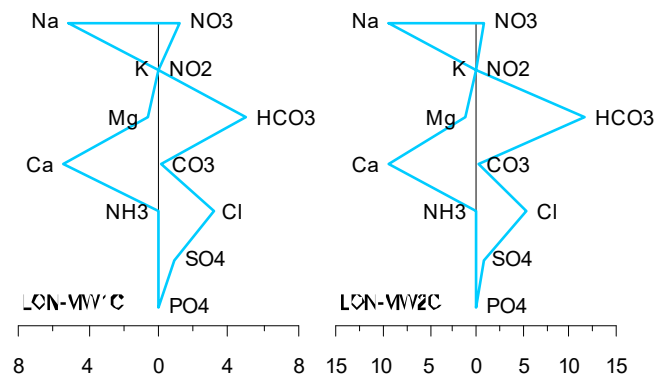
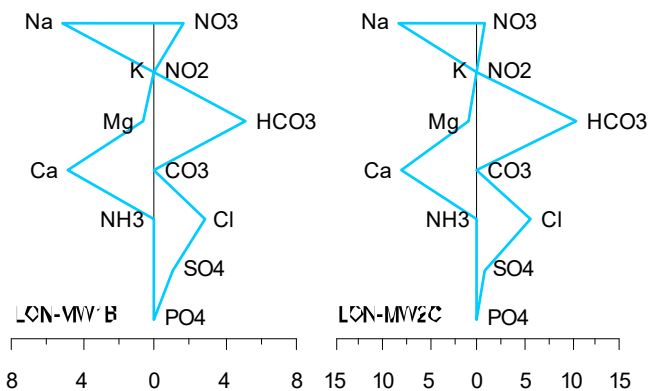

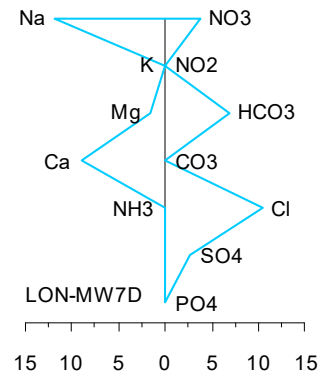
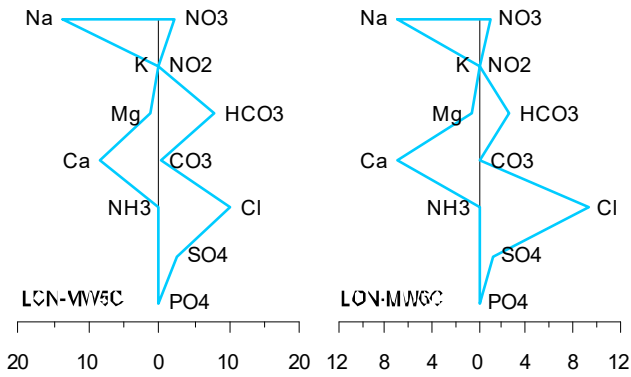
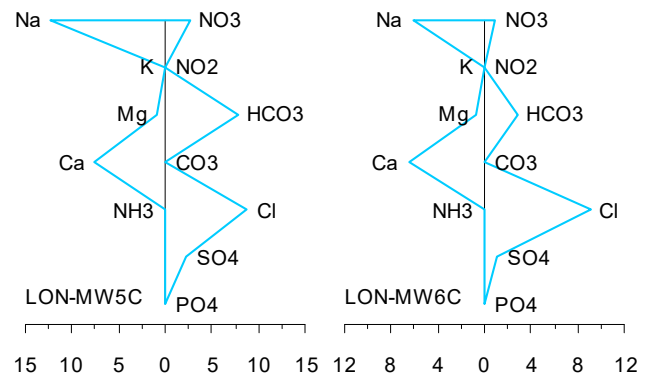
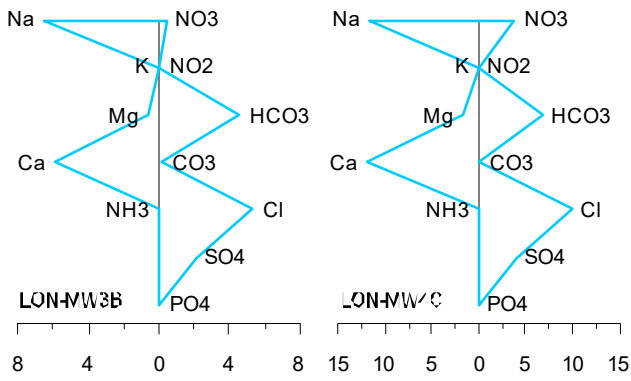

A11-249 LON – Stiff diagrams, February 2016

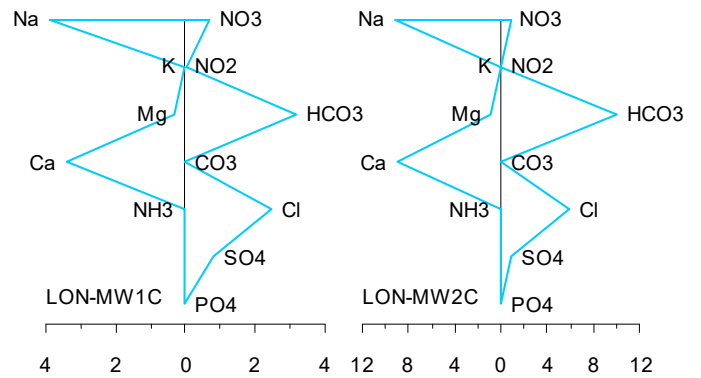
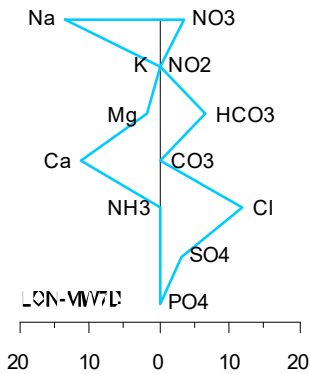

A11-248 LON – Stiff diagrams, February 2015

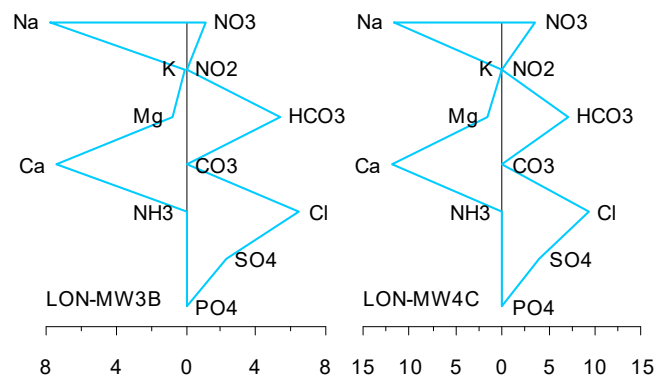
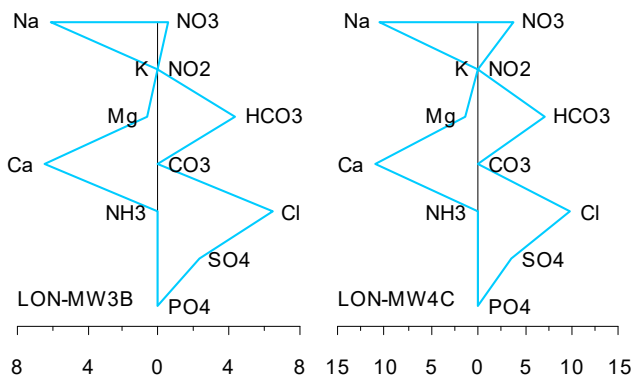

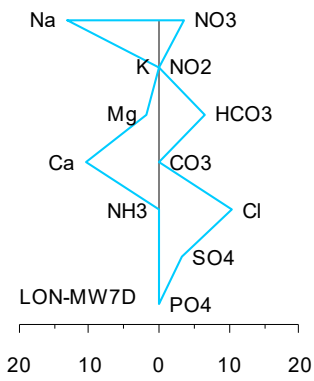

A11-250 LON – Stiff diagrams, March 2017

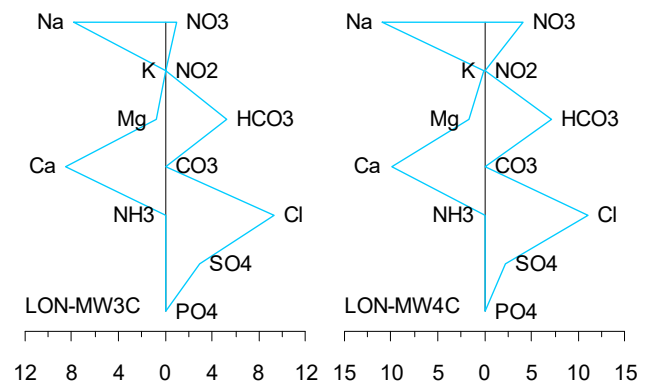
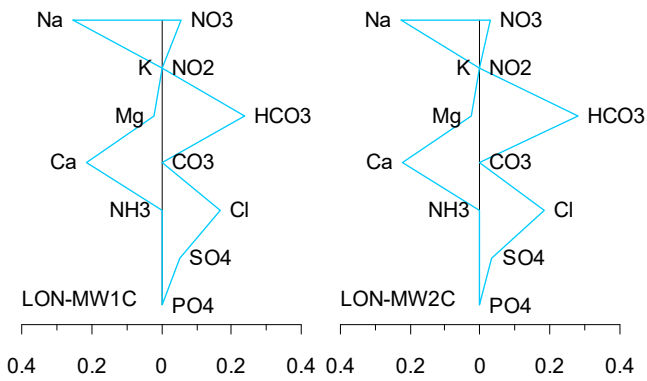
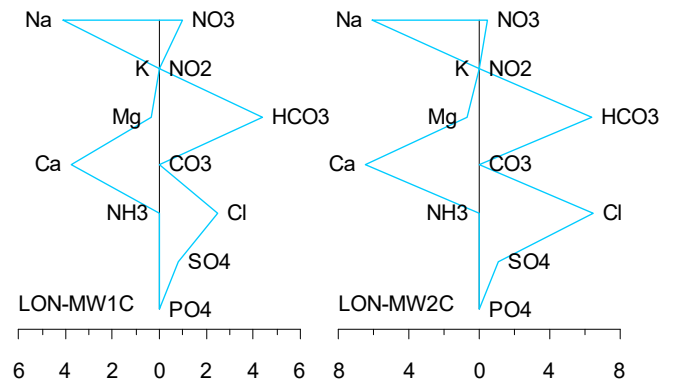

A11-252 LON – Stiff diagrams, February 2019

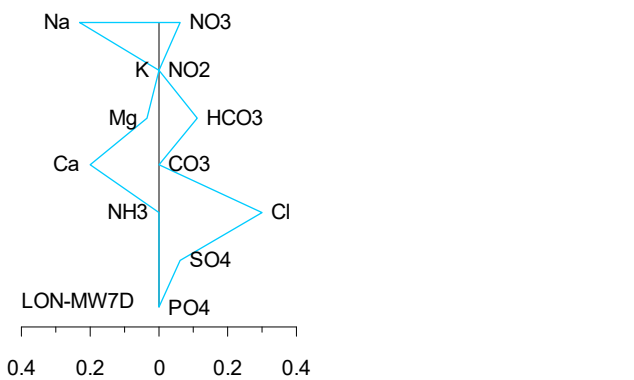
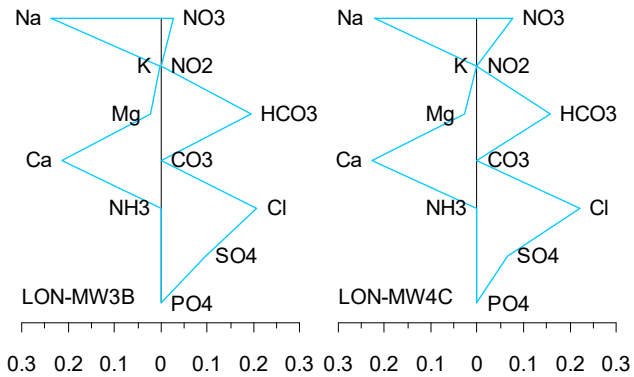

A11-251 LON – Stiff diagrams, February 2018

ADO

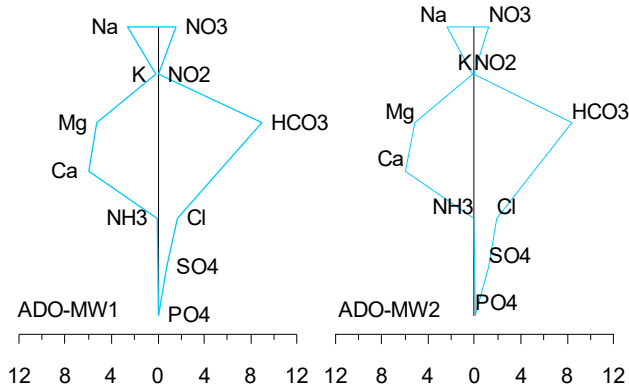

A11-253 ADO – Stiff diagrams, August 2013

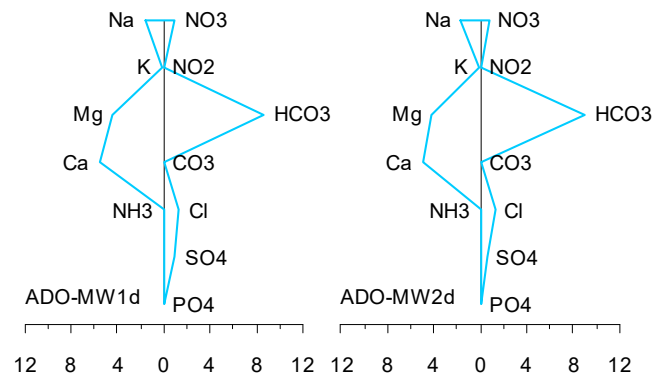

A11-256 ADO – Stiff diagrams, April 2017

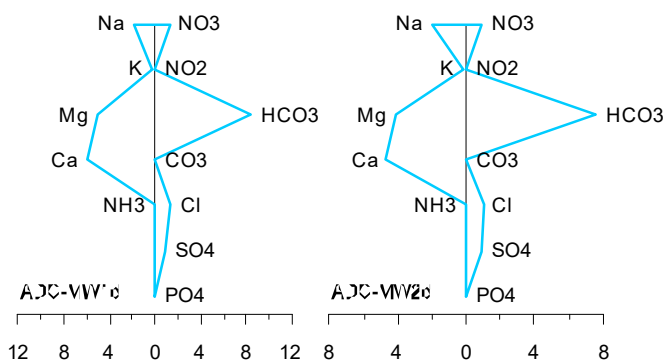

A11-254 ADO – Stiff diagrams, August 2014

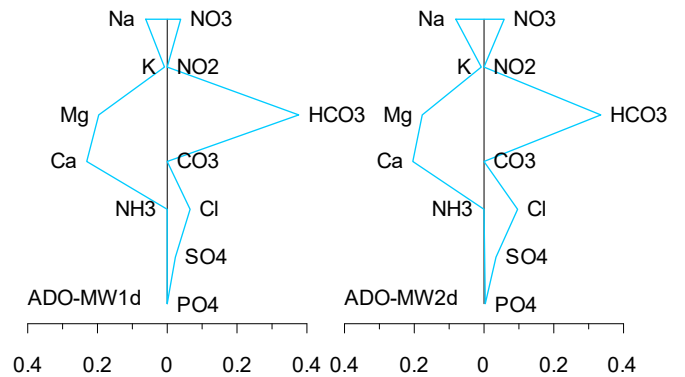

A11-257 ADO – Stiff diagrams, February 2018

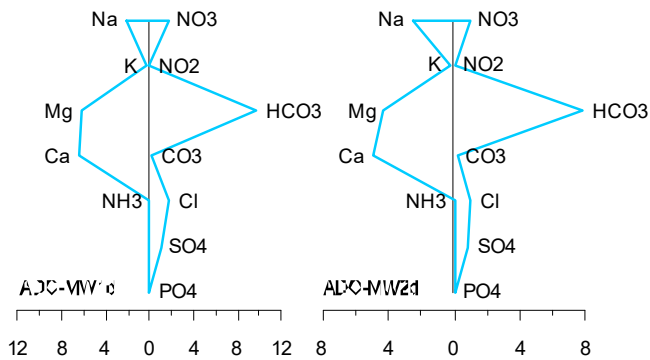

A11-255 ADO – Stiff diagrams, February 2015

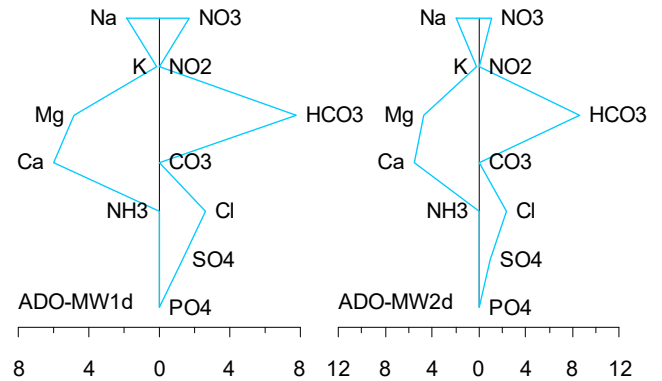

A11-258 ADO – Stiff diagrams, February 2018

MAL

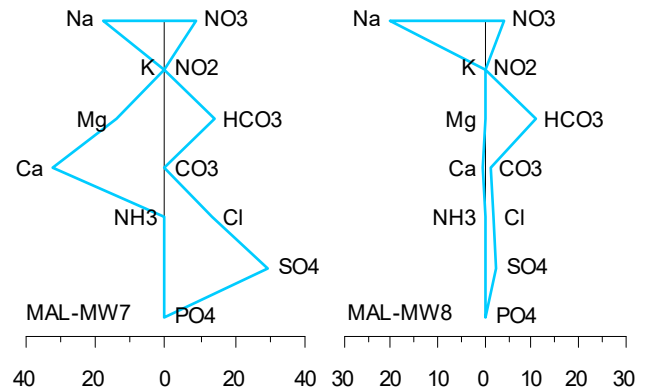
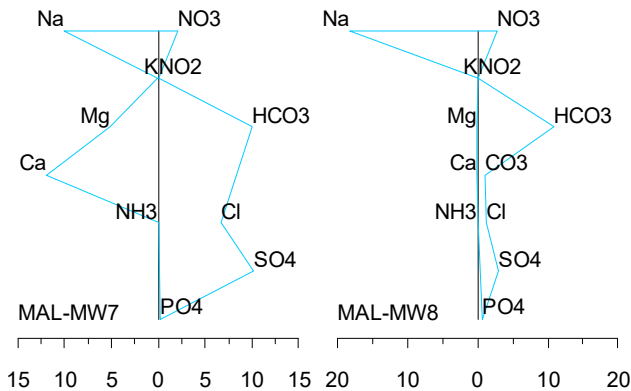
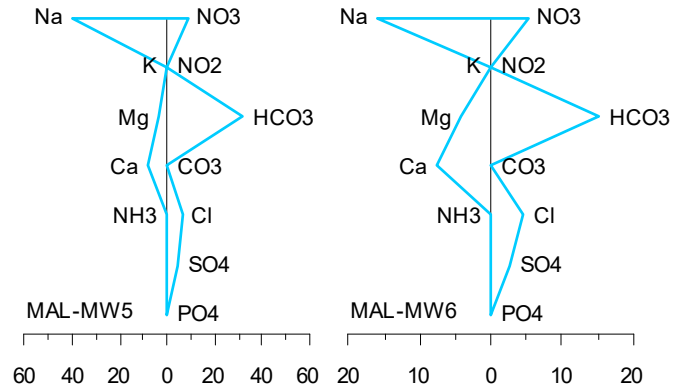
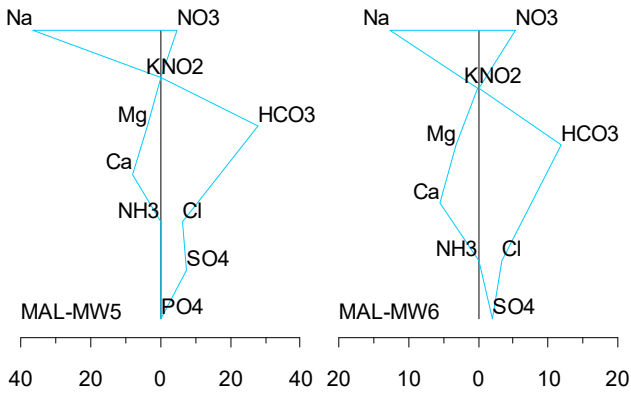
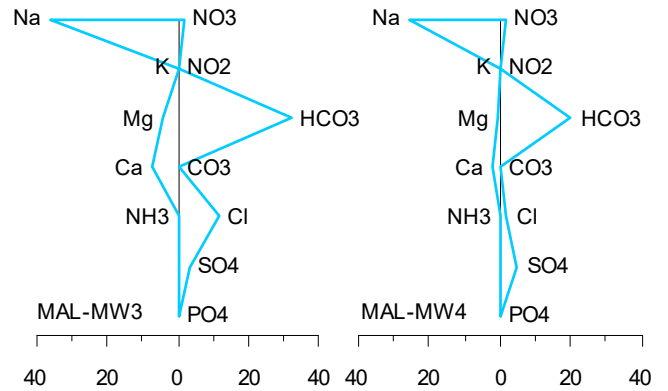
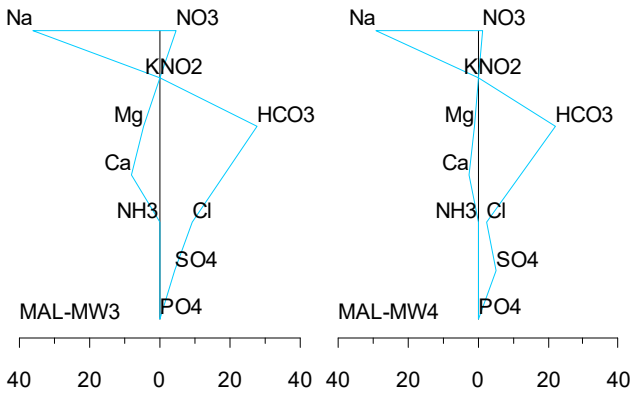
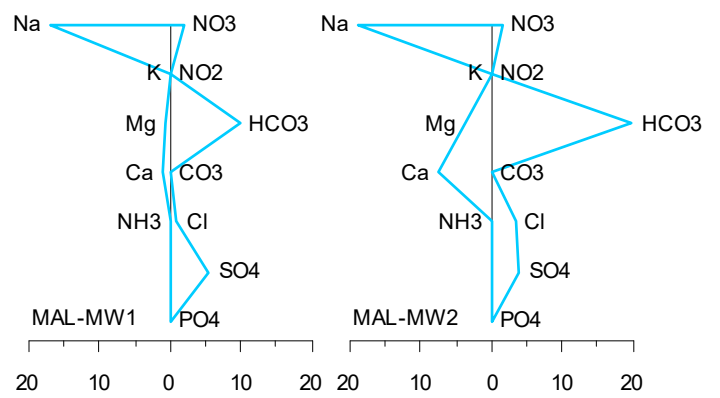
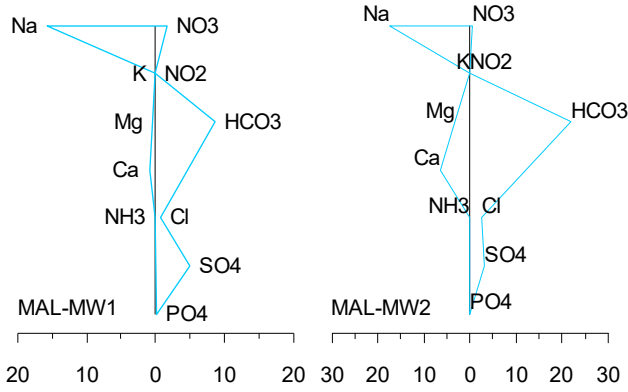

A11-259 MAL – Stiff diagrams, August 2013

A11-260 MAL – Stiff diagrams, August 2014

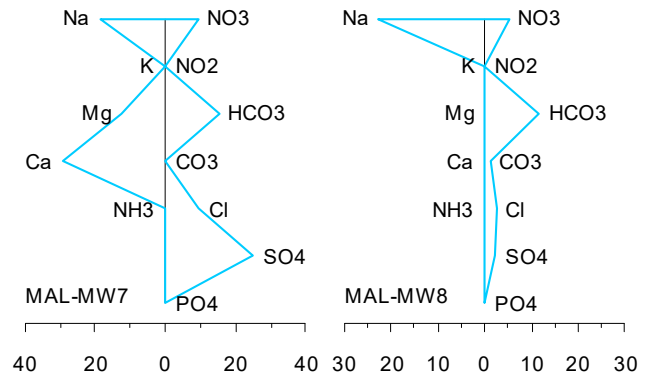
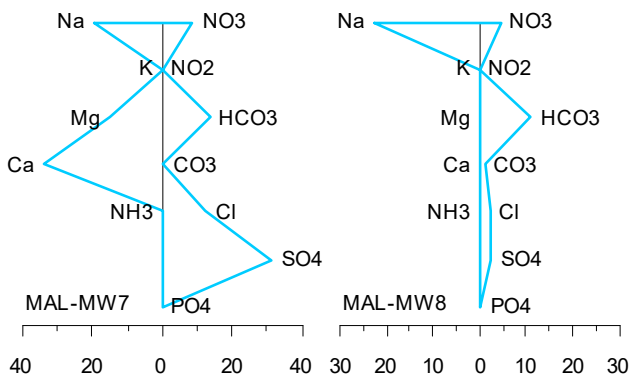
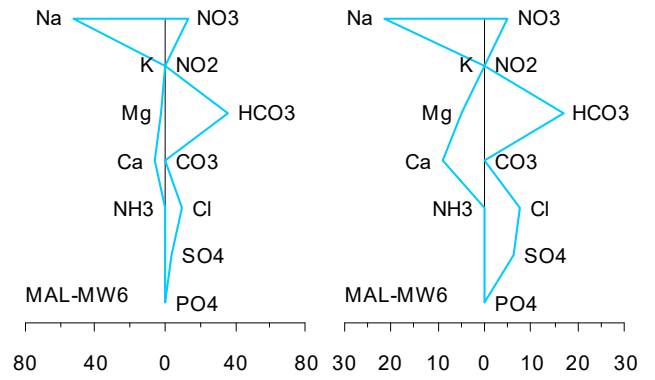
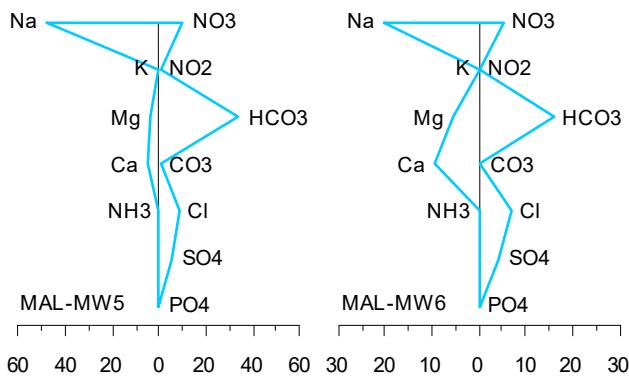
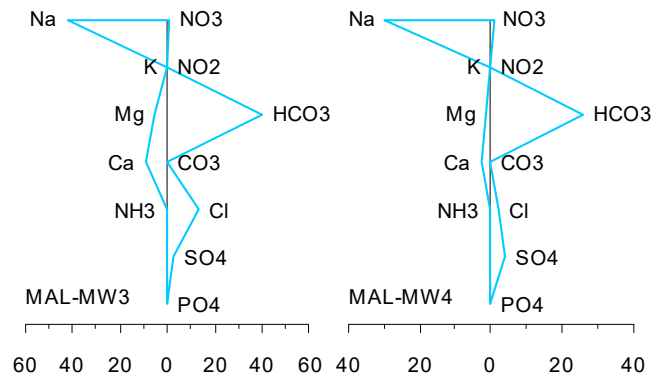
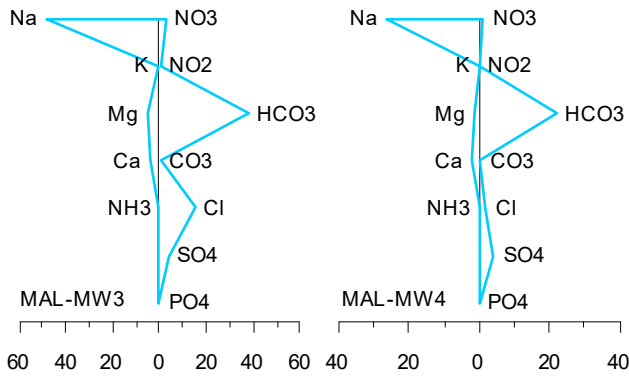
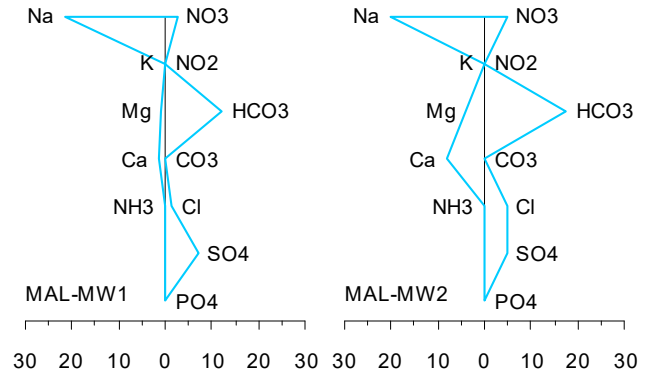
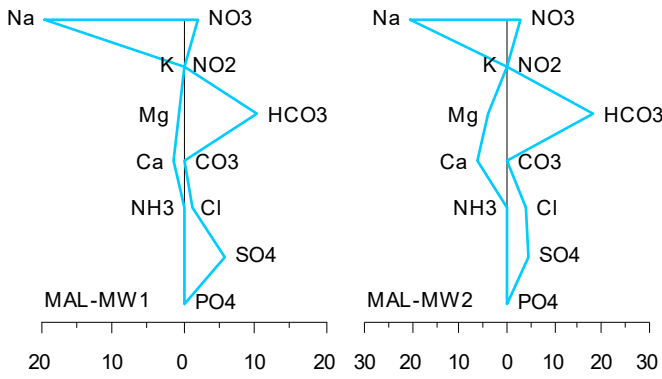

A11-261 MAL – Stiff diagrams, February 2015

A11-262 MAL – Stiff diagrams, February 2016

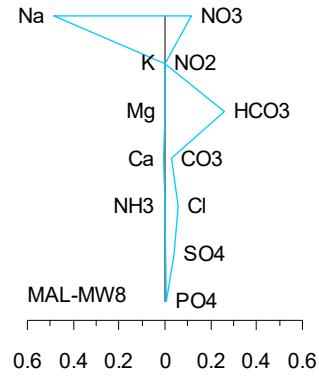
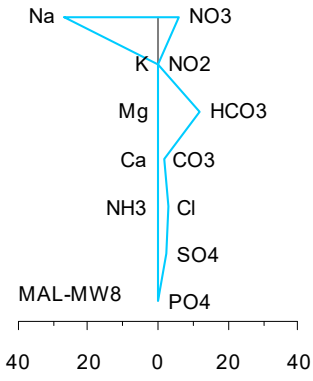
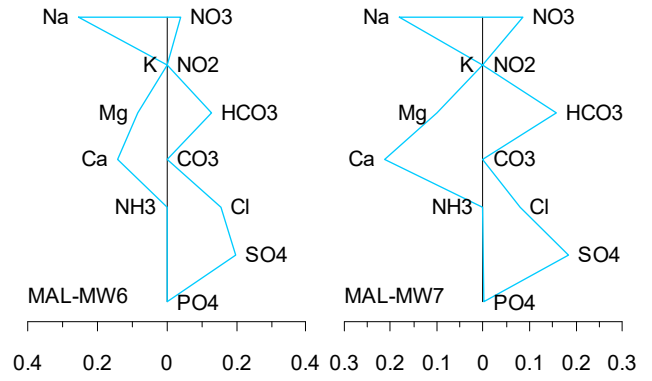
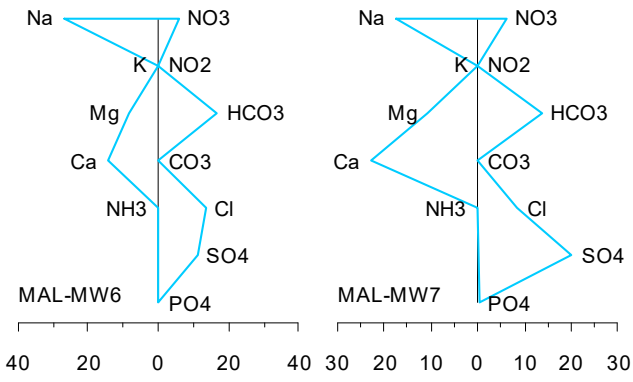
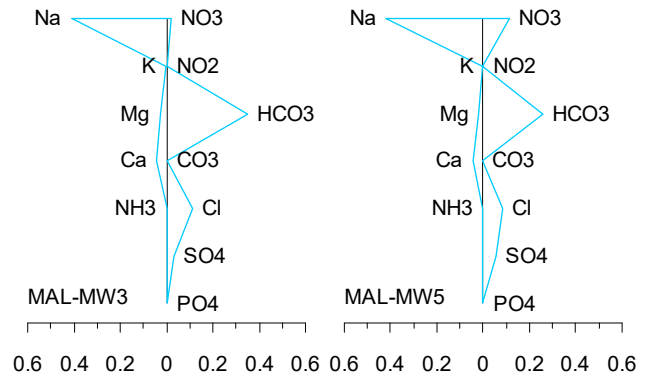
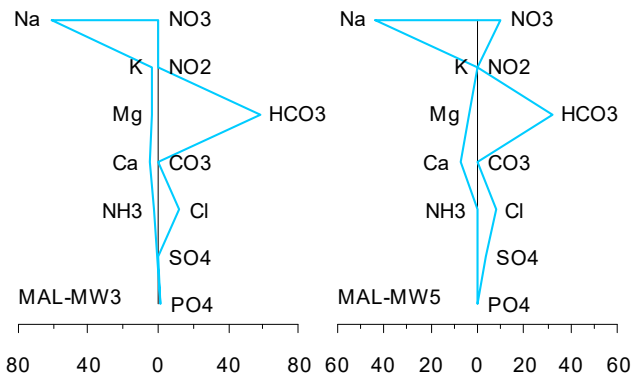
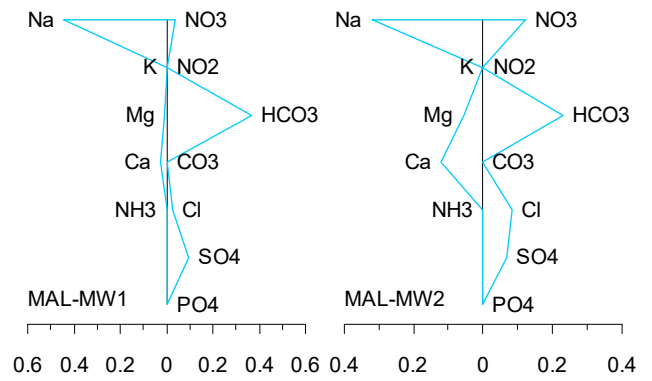
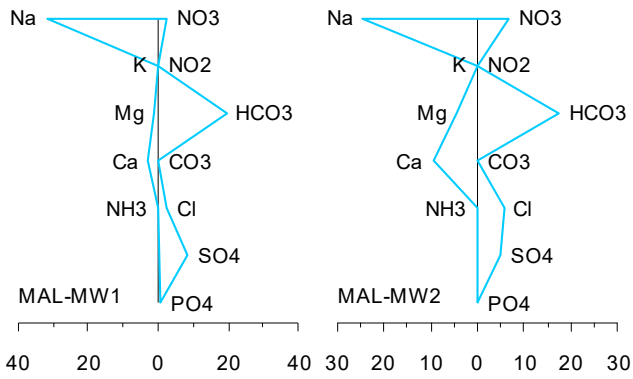

A11-264 MAL – Stiff diagrams, February 2018

A11-263 MAL – Stiff diagrams, March 2017

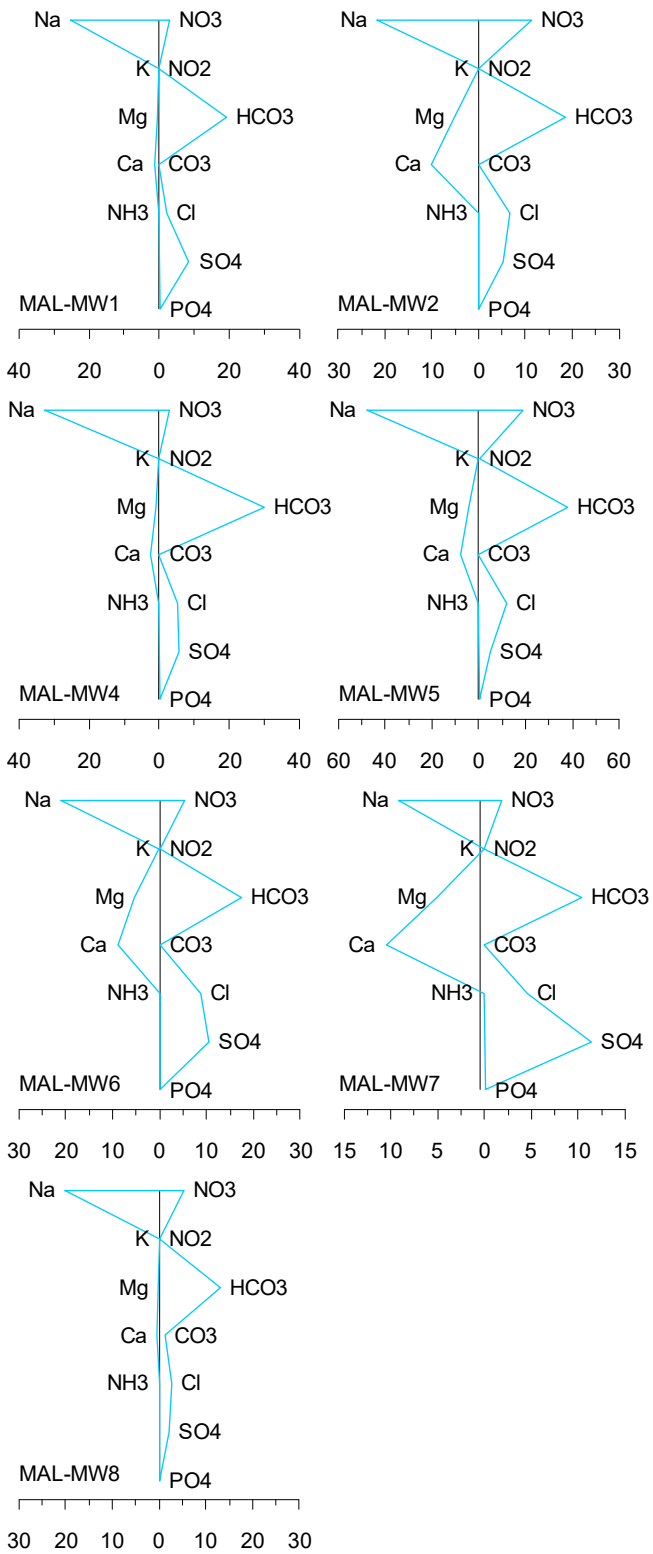

A11-265 MAL – Stiff diagrams, February 2019

MAP

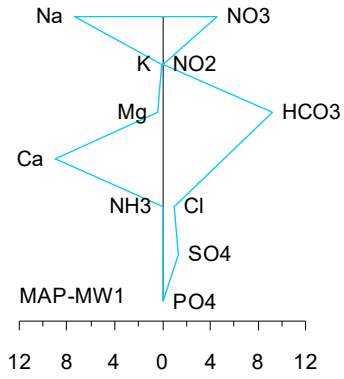

A11-266 MAP – Stiff diagrams, August 2013

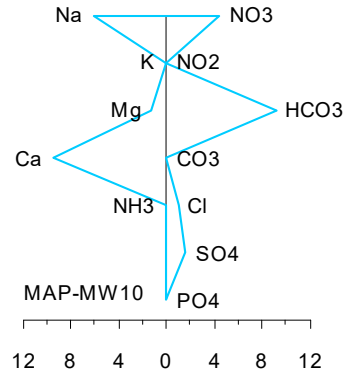

A11-269 MAP – Stiff diagrams, February 2016

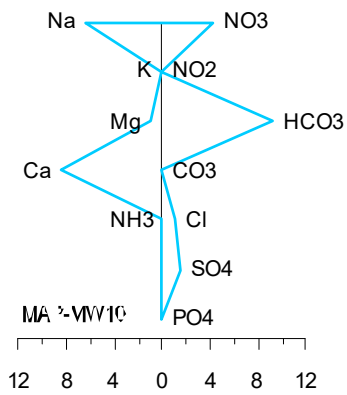

A11-267 MAP – Stiff diagrams, August 2014

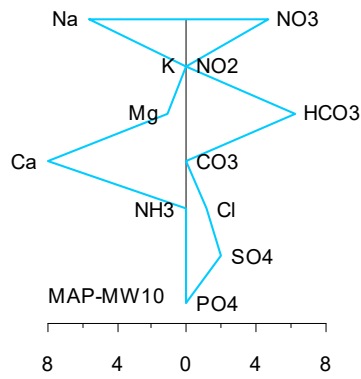

A11-270 MAP – Stiff diagrams, March 2017

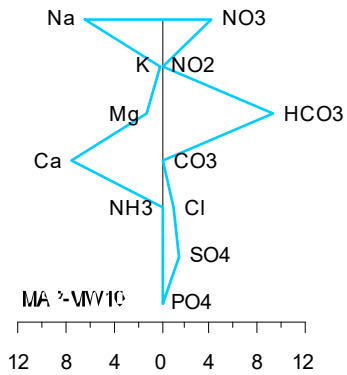

A11-268 MAP – Stiff diagrams, February 2015

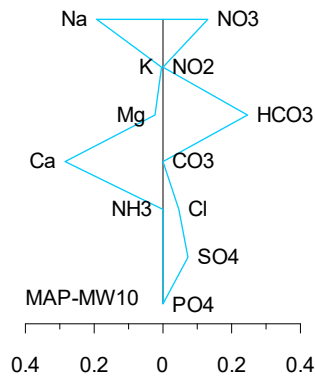

A11-271 MAP – Stiff diagrams, February 2018

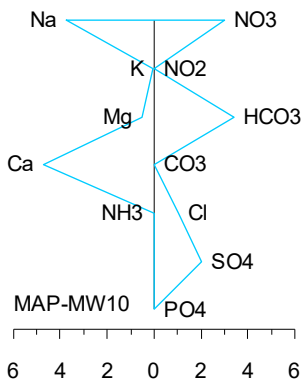

A11-272 MAP – Stiff diagrams, February 2018

ZON

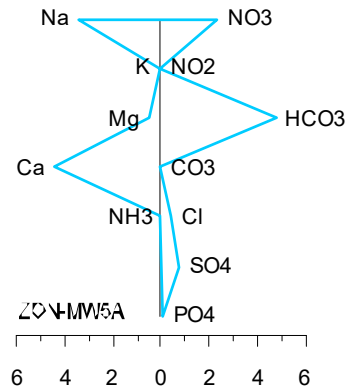
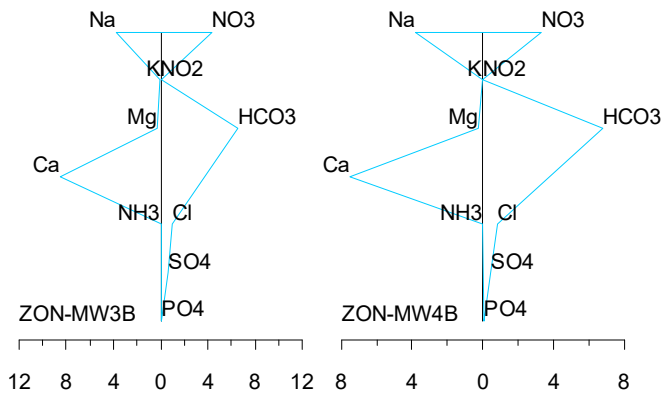
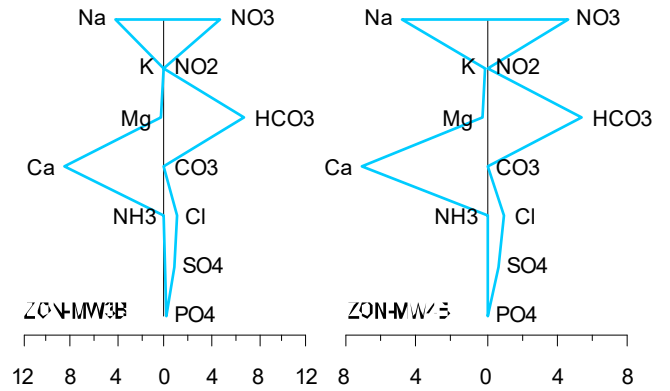
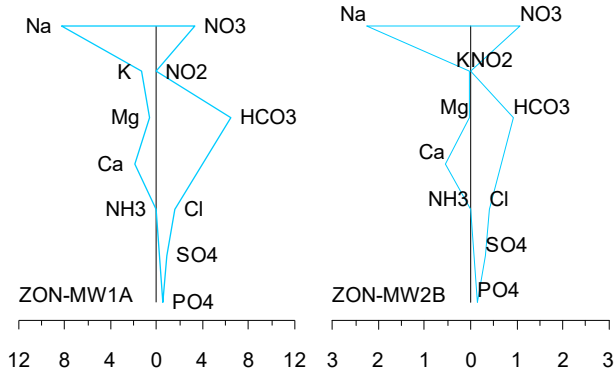

A11-274 ZON – Stiff diagrams, August 2014

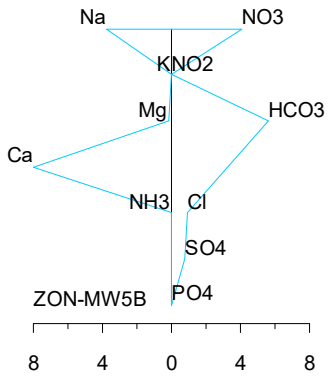

A11-273 ZON – Stiff diagrams, August 2013

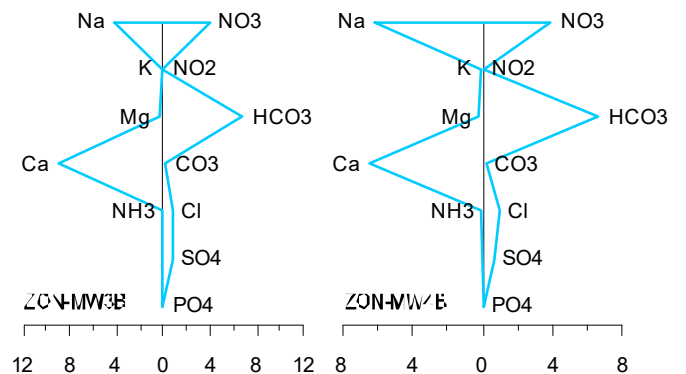
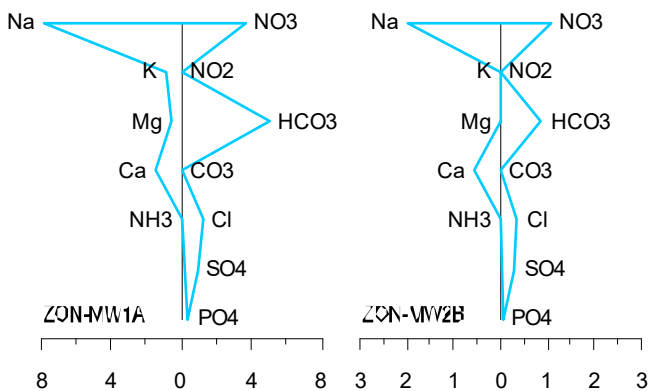
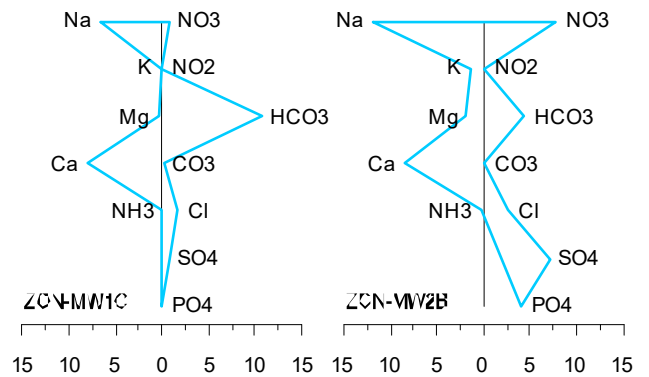

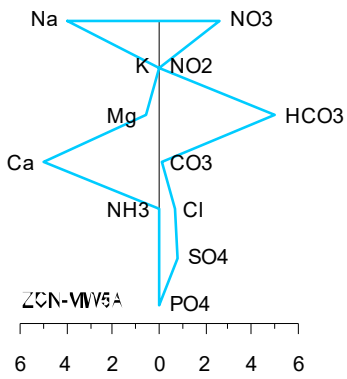

A11-275 ZON – Stiff diagrams, February 2015

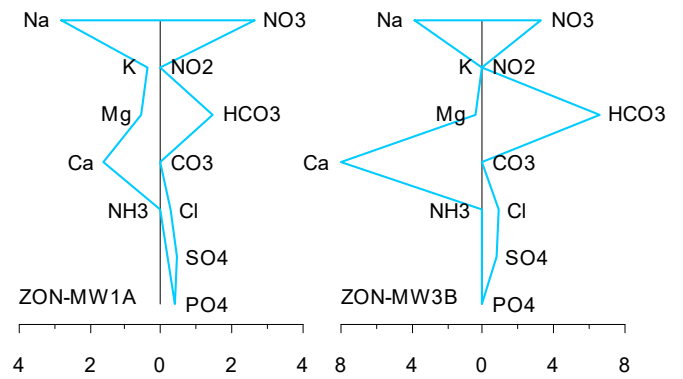

A11-277 ZON – Stiff diagrams, March 2017

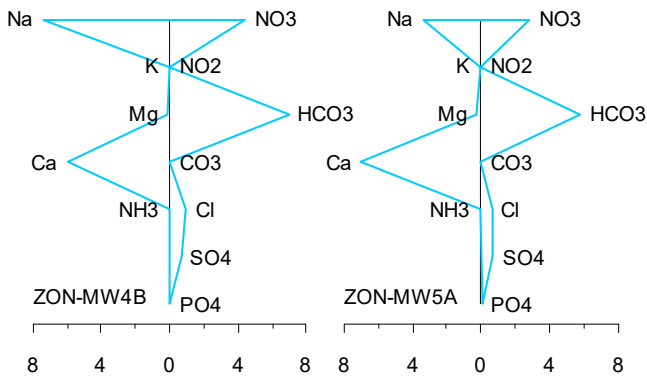
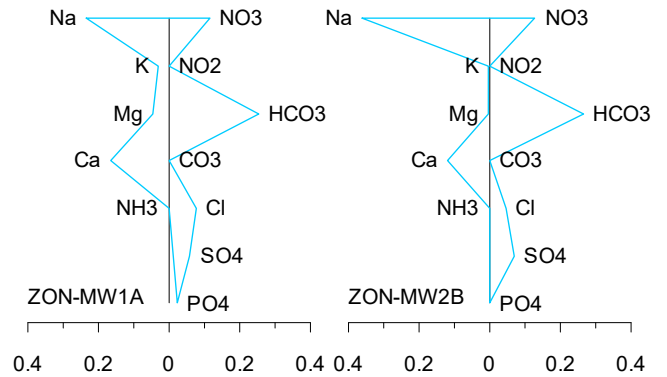
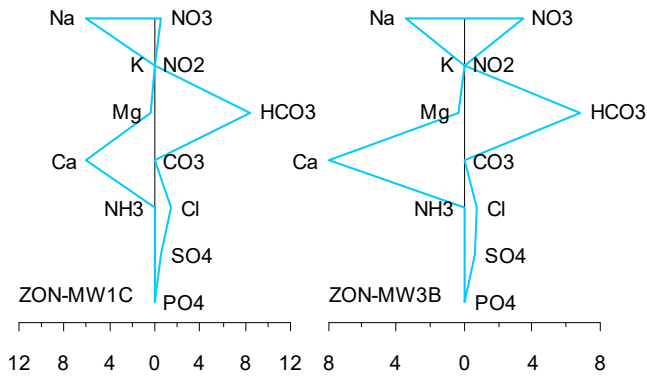

A11-276 ZON – Stiff diagrams, February 2016

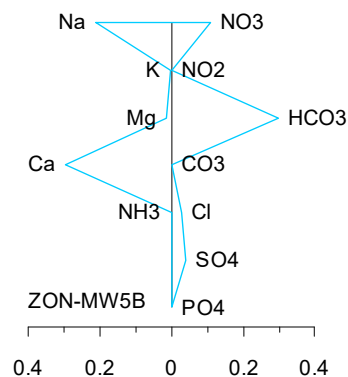
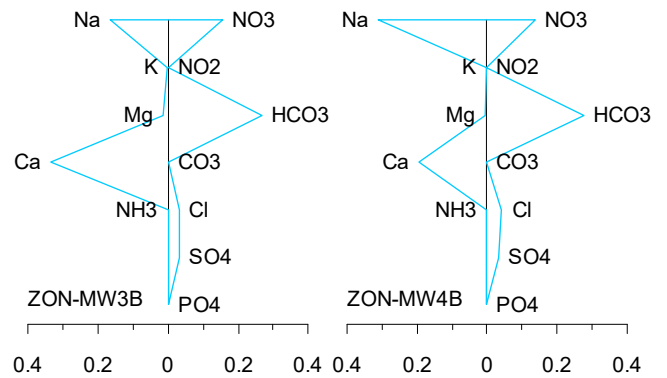

A11-278 ZON – Stiff diagrams, February 2018

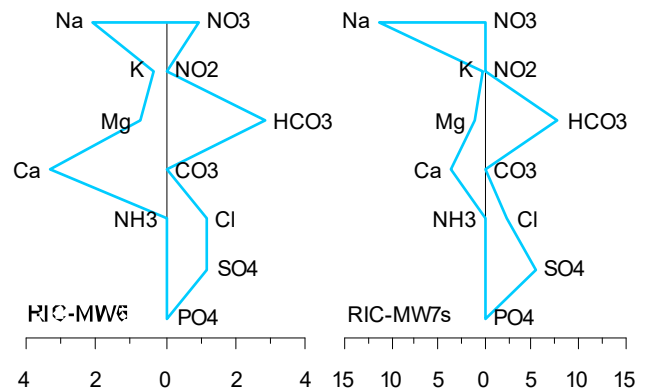
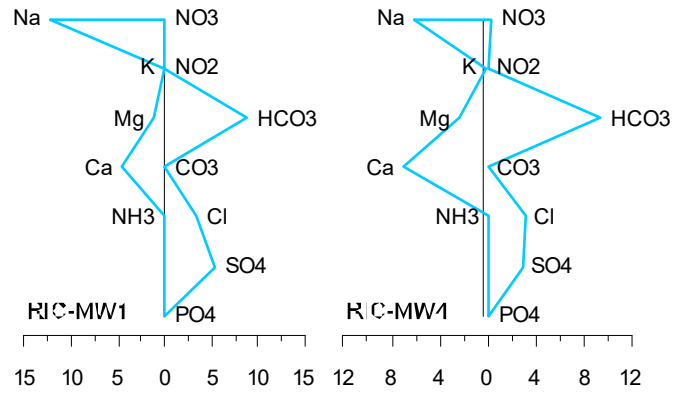
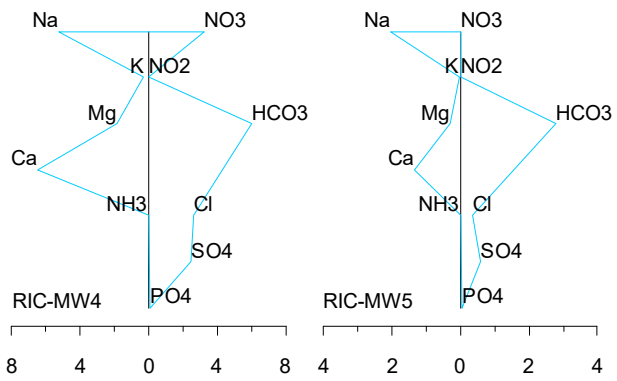
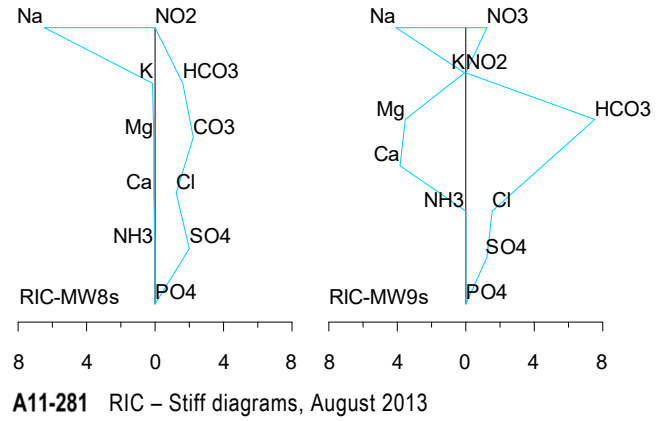
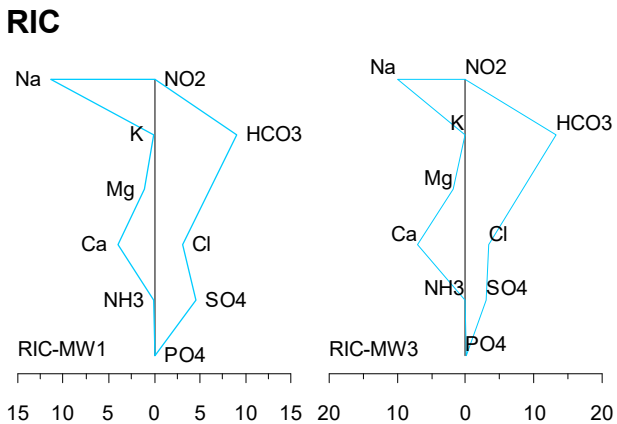
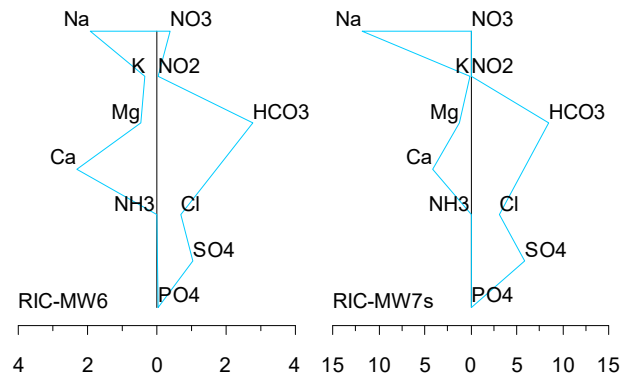
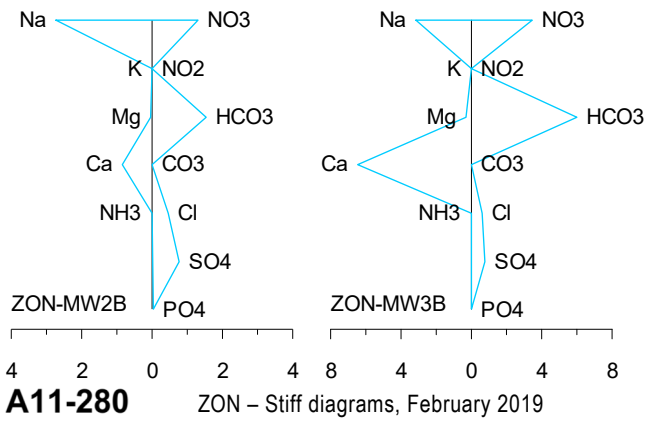

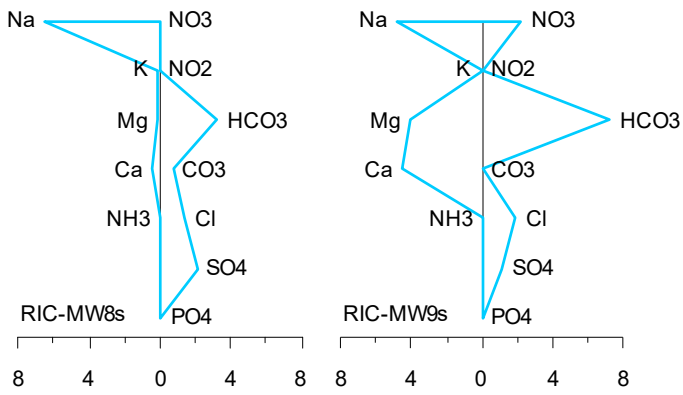

A11-282 RIC – Stiff diagrams, August 2014

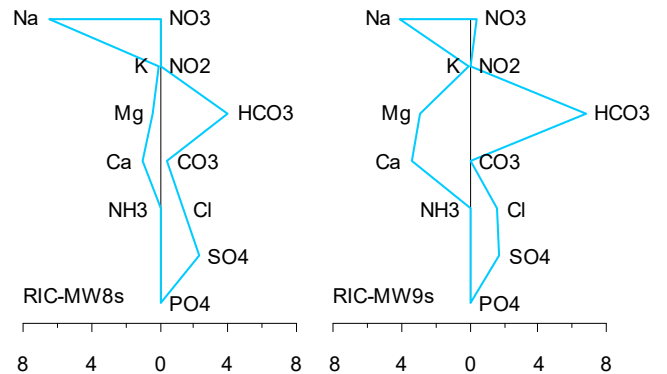
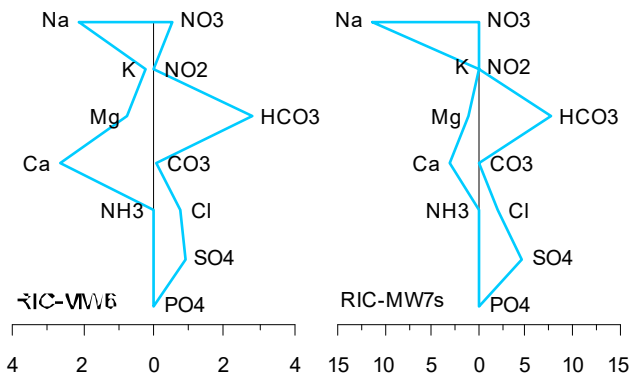
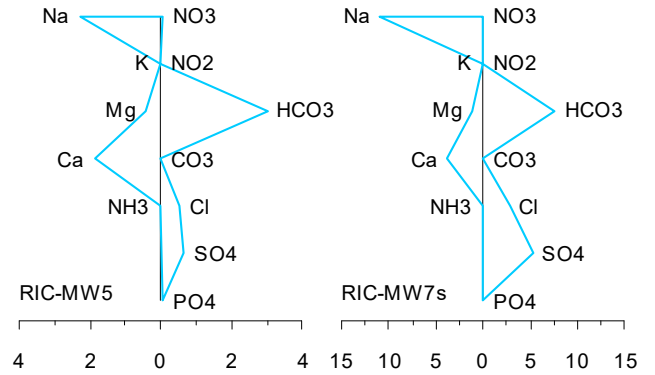
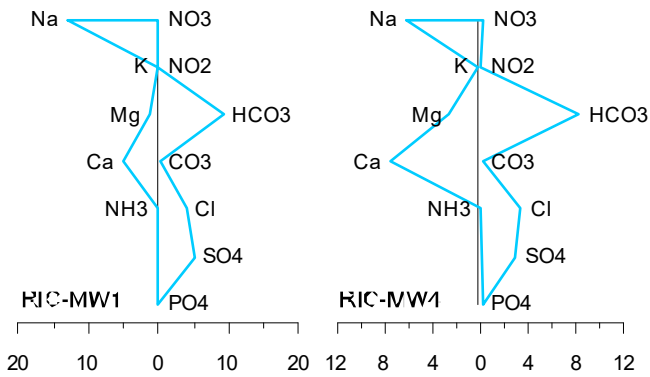
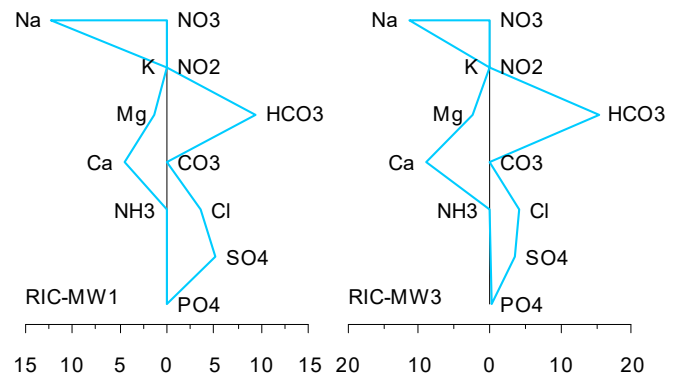

A11-284 RIC – Stiff diagrams, February 2016

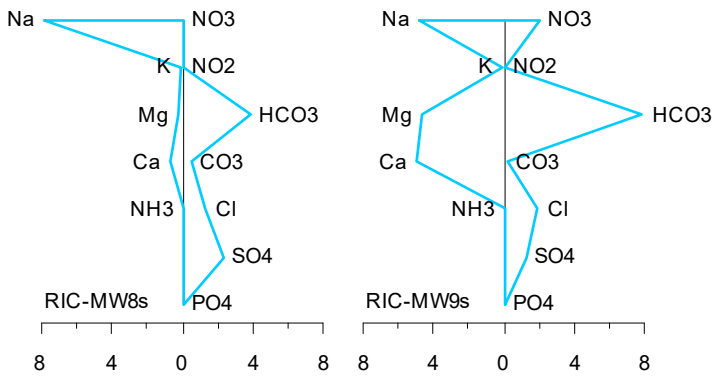

A11-283 RIC – Stiff diagrams, February 2015

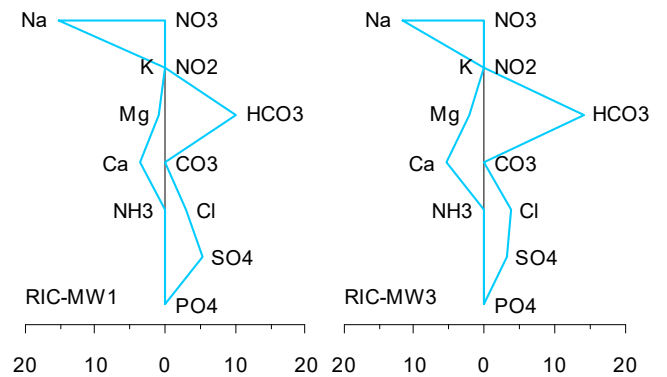

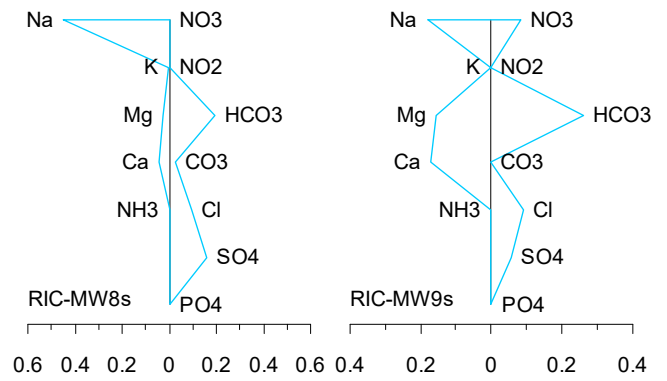
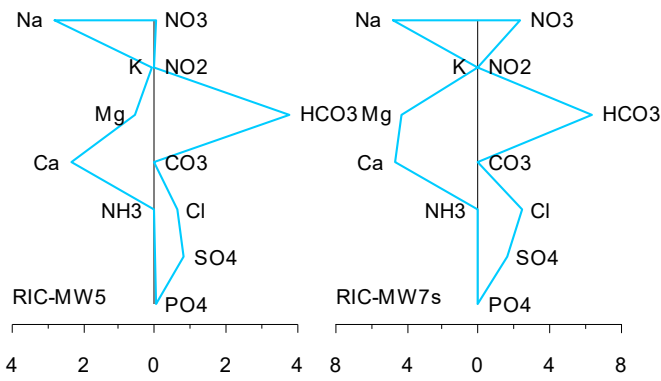

A11-286 RIC – Stiff diagrams, February 2018

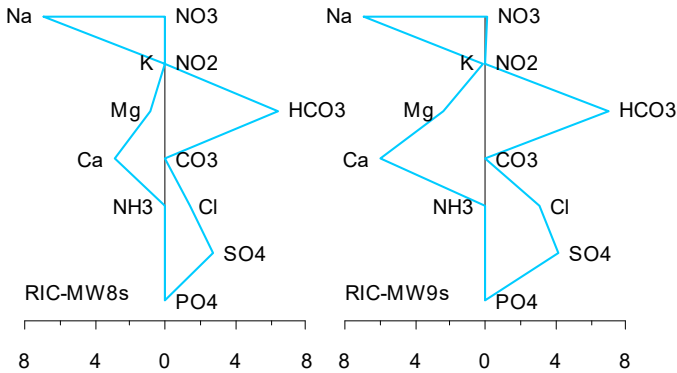

A11-285 RIC – Stiff diagrams, March 2017

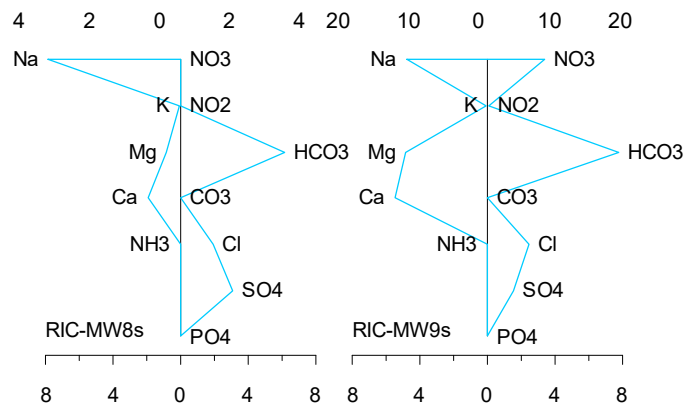
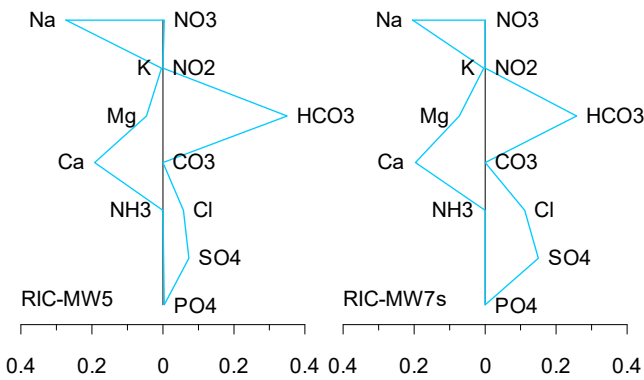
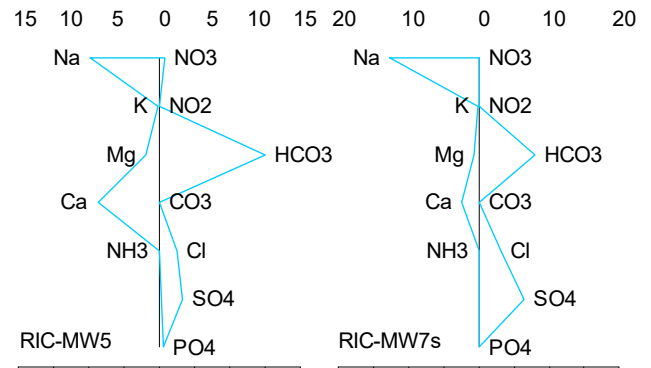
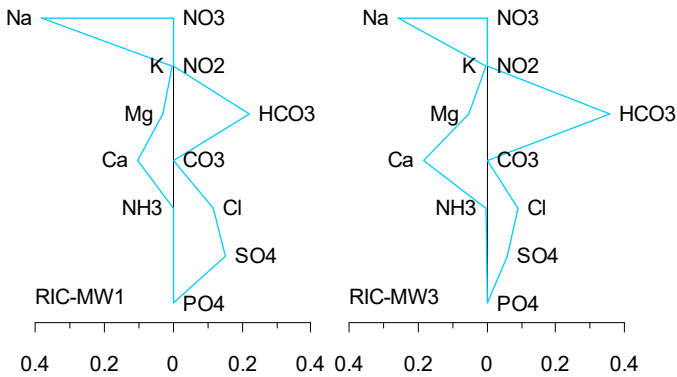
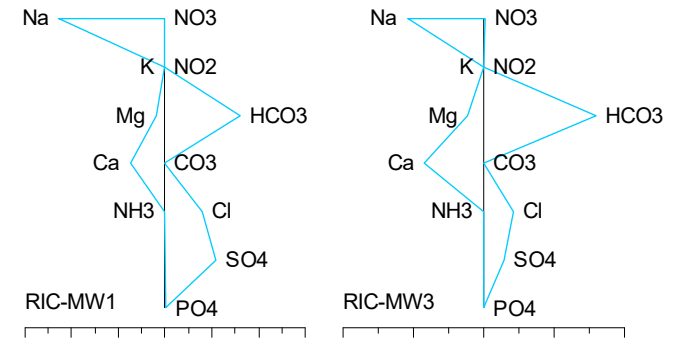

A11-287 RIC – Stiff diagrams, February 2019

SIE

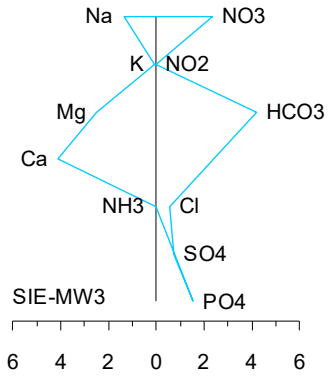

A11-288 SIE – Stiff diagrams, August 2013

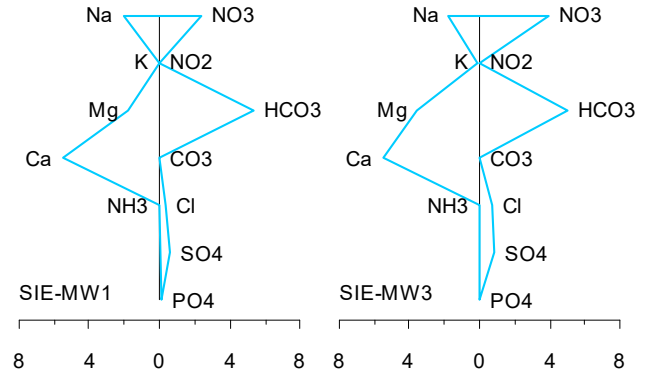

A11-291 SIE – Stiff diagrams, February 2016

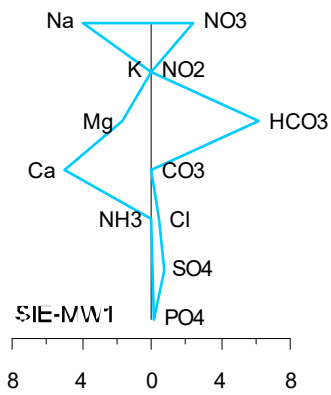

A11-289 SIE – Stiff diagrams, August 2014

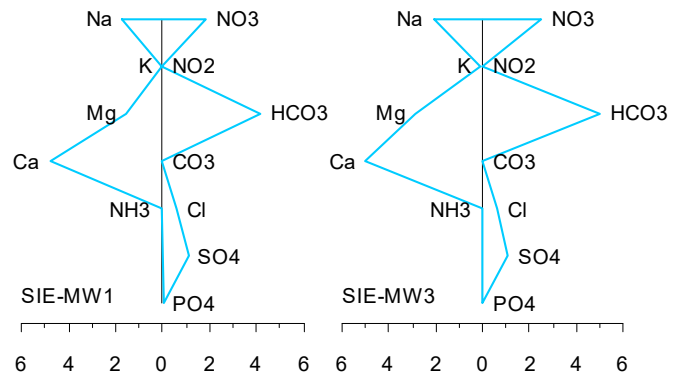

A11-292 SIE – Stiff diagrams, March 2017

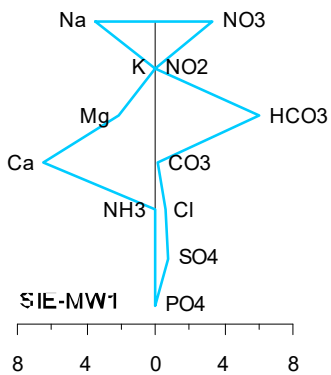

A11-290 SIE – Stiff diagrams, February 2015

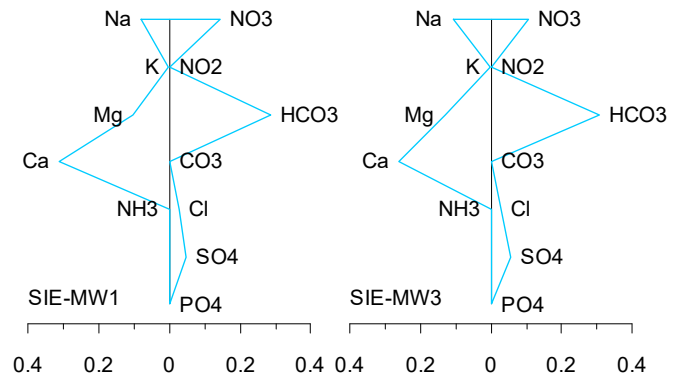

A11-293 SIE – Stiff diagrams, February 2018

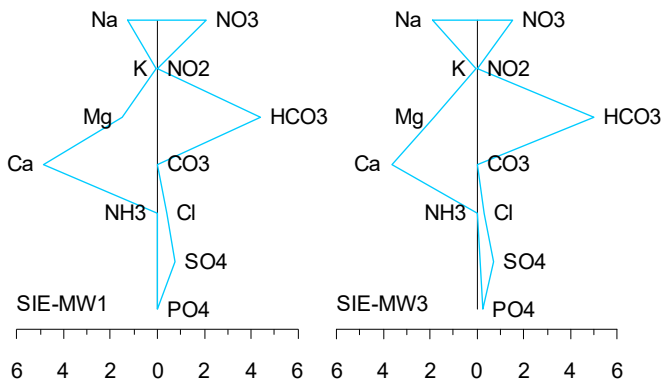

A11-294 SIE – Stiff diagrams, February 2019

SO2

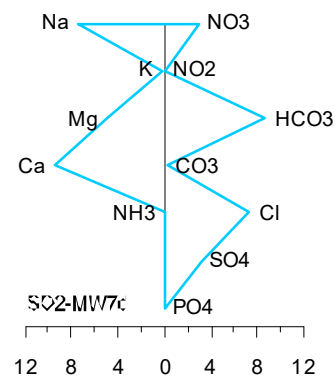
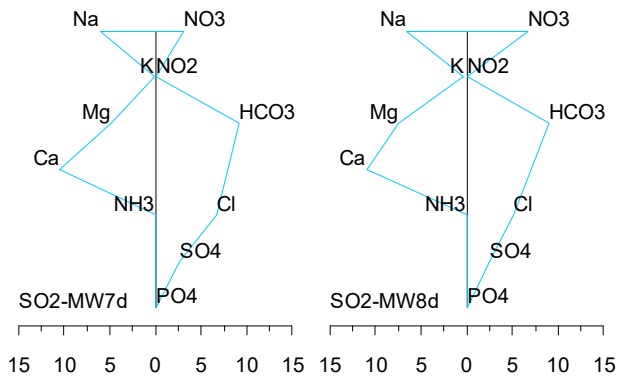
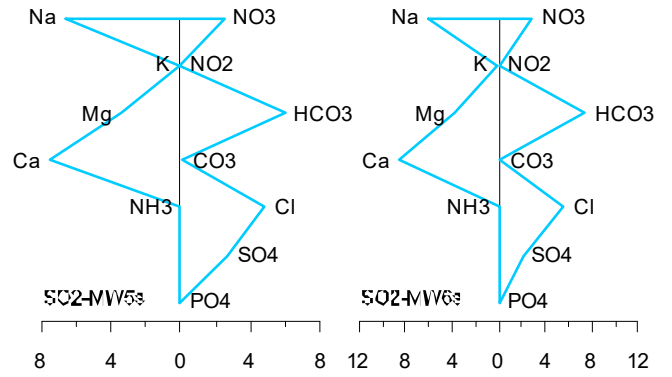
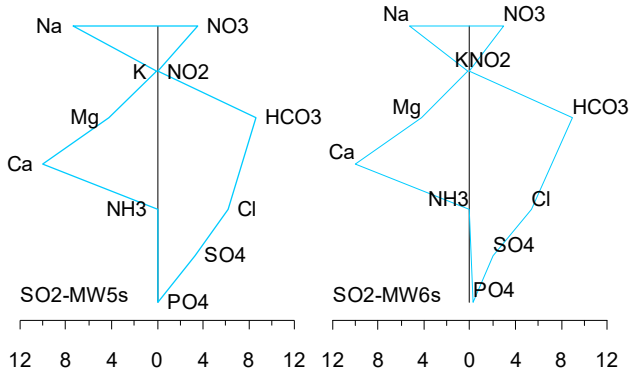

A11-295 SO2 – Stiff diagrams, August 2013

A11-297 SO2 – Stiff diagrams, February 2015

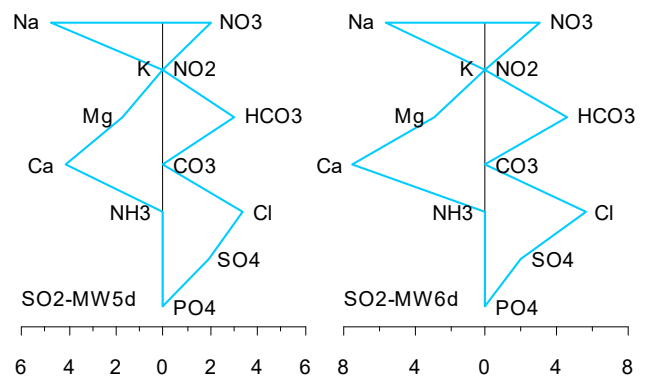
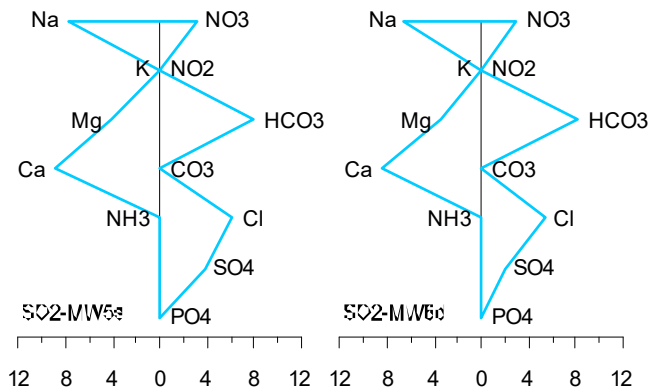

A11-298 SO2 – Stiff diagrams, February 2016

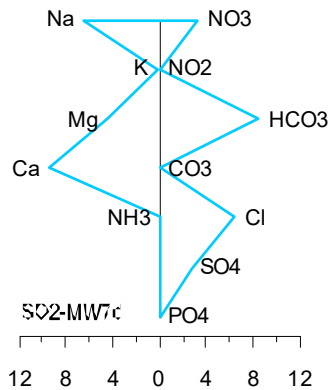

A11-296 SO2 – Stiff diagrams, August 2014

SOJ

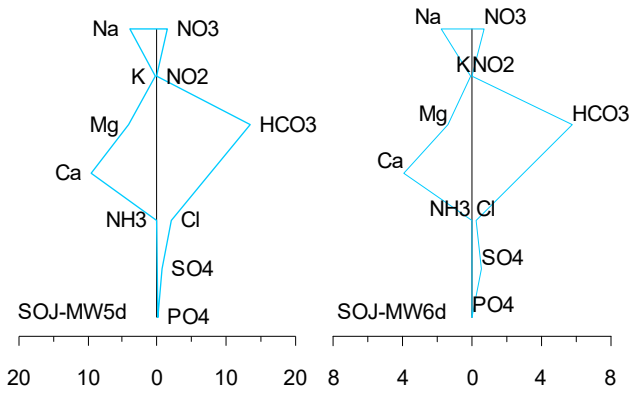

A11-299 SOJ – Stiff diagrams, August 2013

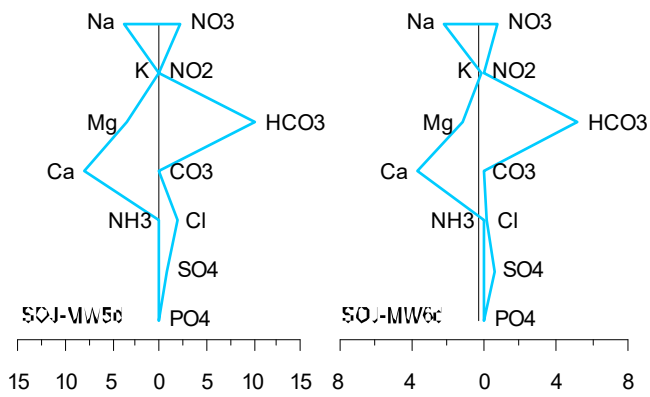

A11-300 SOJ – Stiff diagrams, August 2014

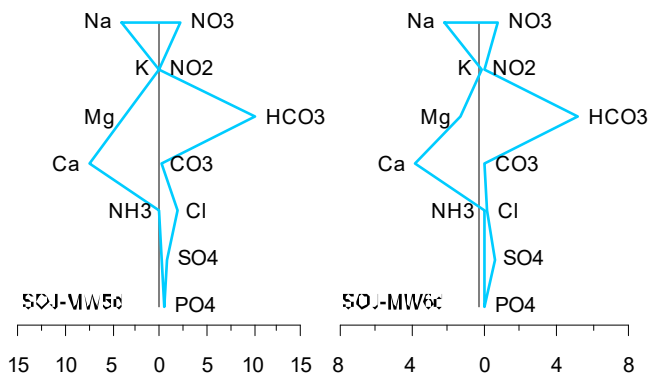

A11-301 SOJ – Stiff diagrams, February 2015

All wells dry – February 2016

Attachment A12

Groundwater Chemical Characteristics – Piper Diagrams

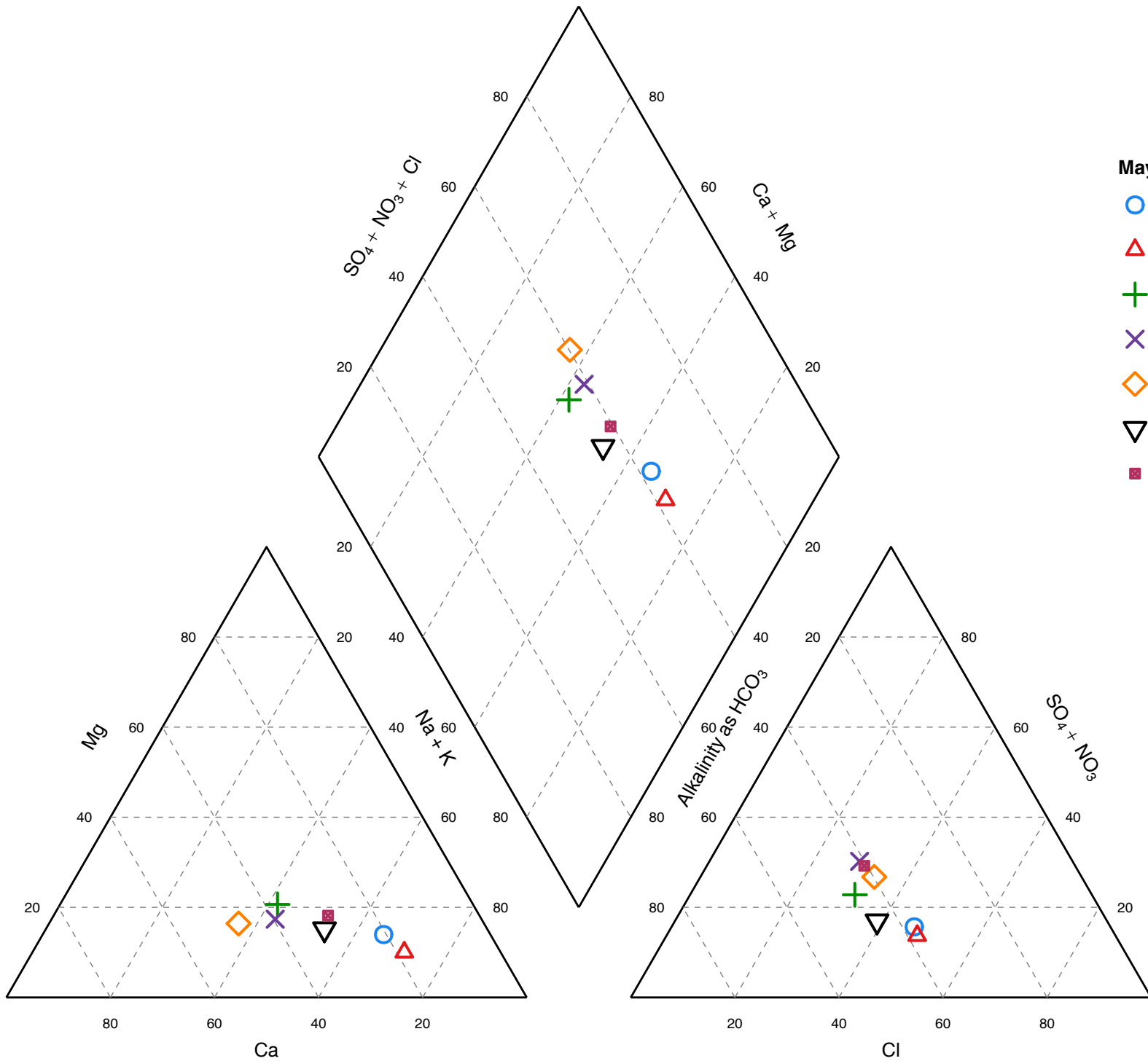

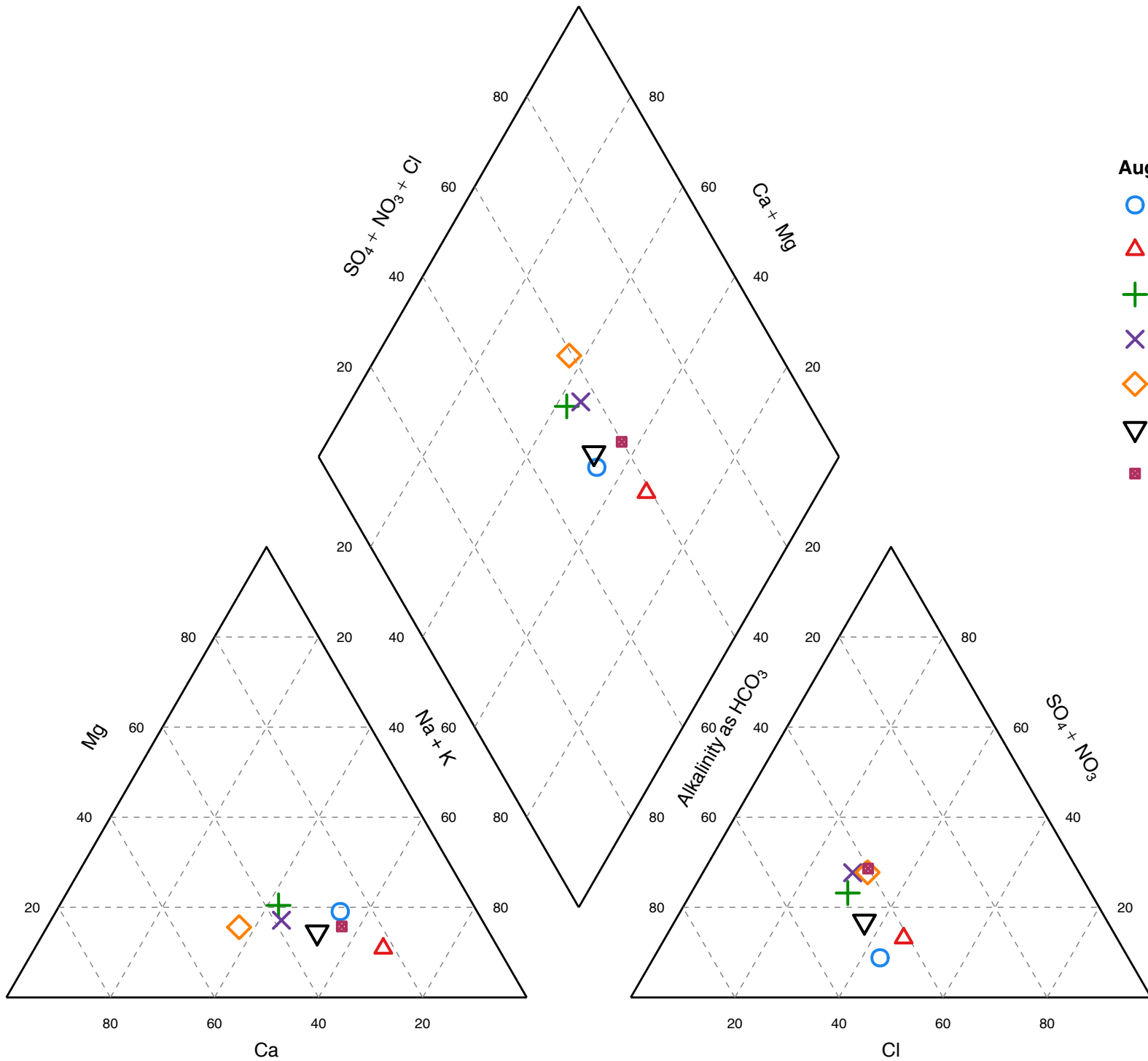

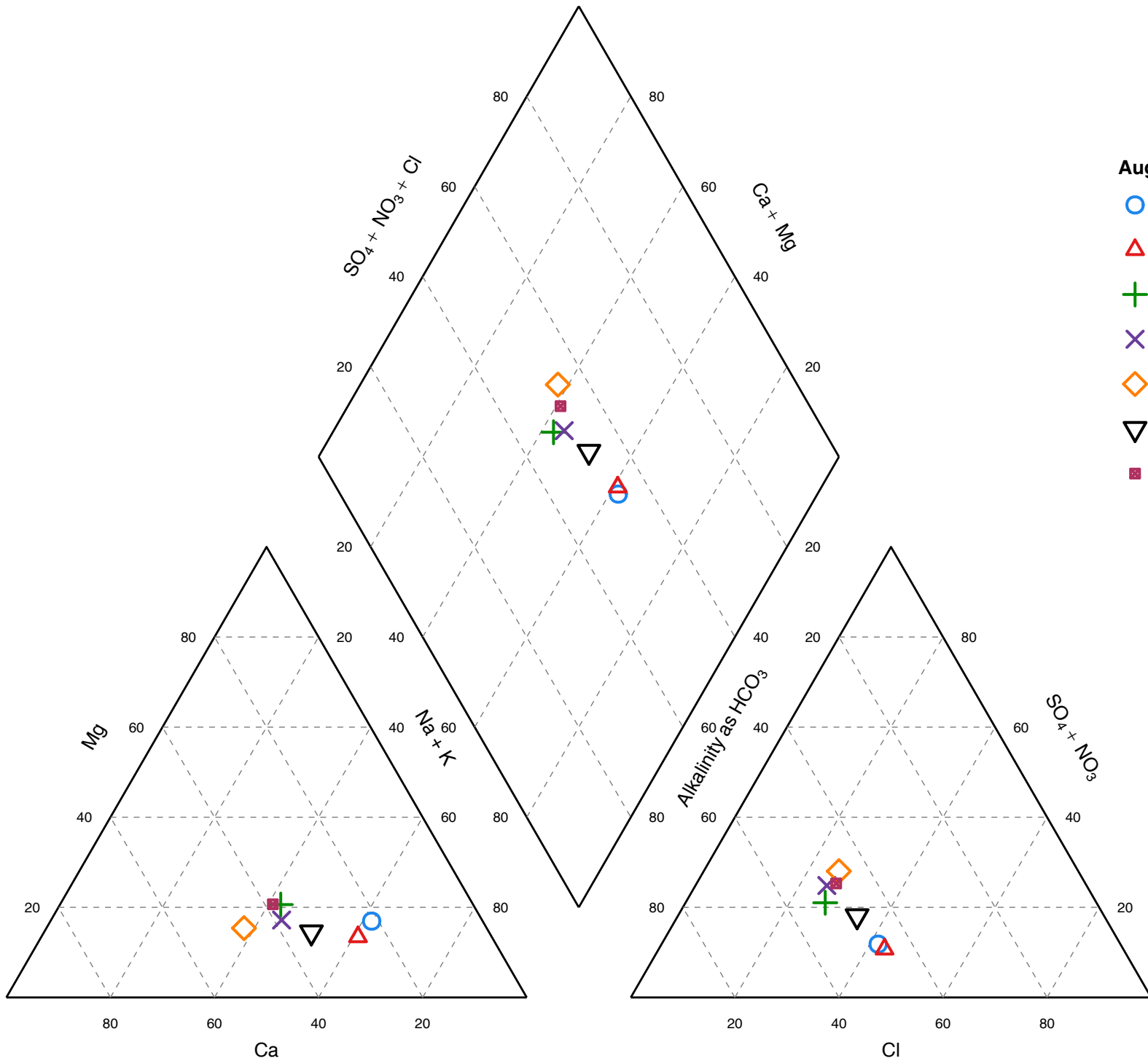

August 2013

- MEN-MW1s
- △ MEN-MW2s
- + MEN-MW3s
- × MEN-MW4s
- ◇ MEN-MW5s
- ▽ MEN-MW6s
- MEN-MW7s

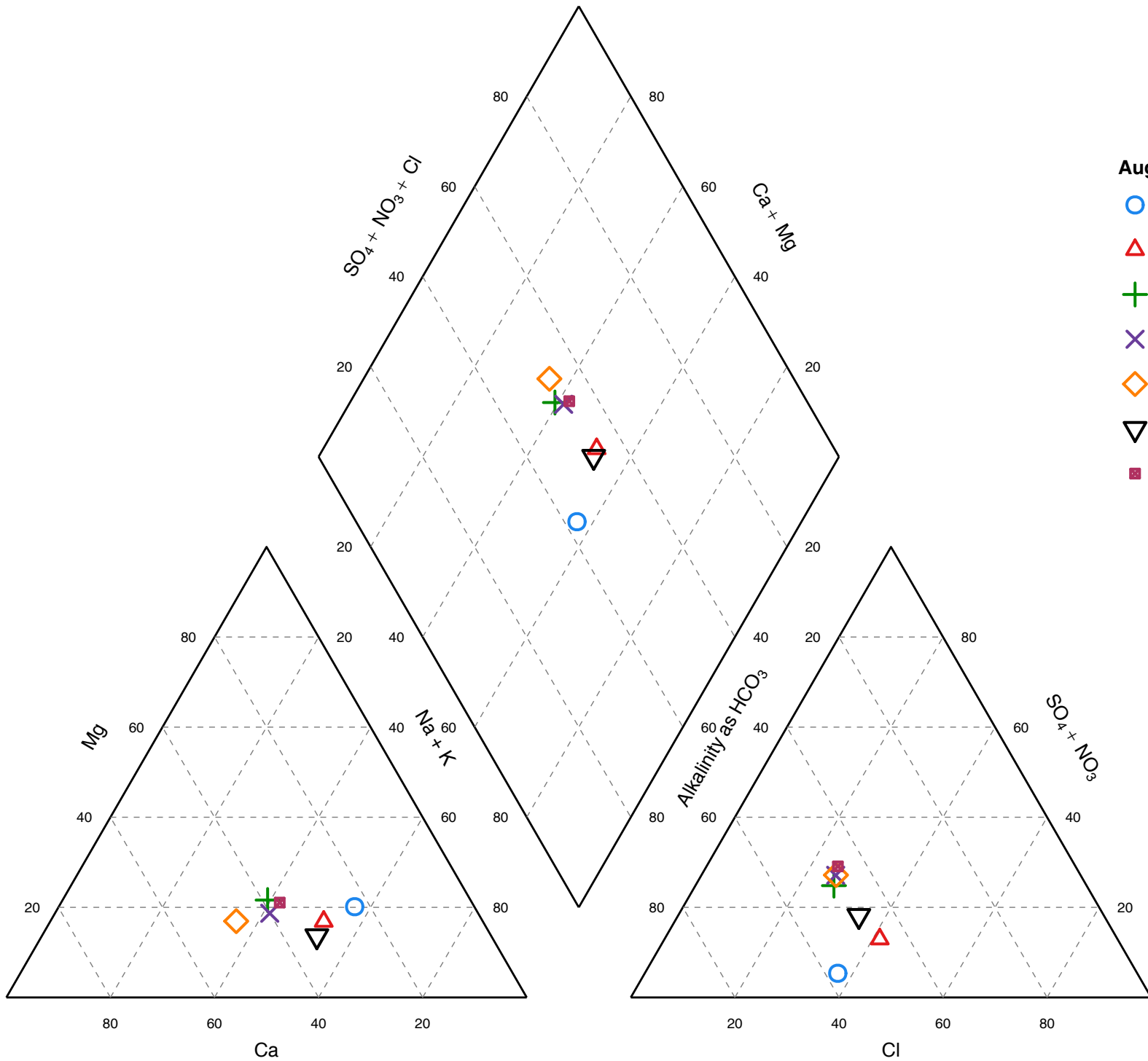

August 2014

- MEN-MW1s
- △ MEN-MW2s
- + MEN-MW3s
- × MEN-MW4s
- ◇ MEN-MW5s
- ▽ MEN-MW6s
- MEN-MW7s

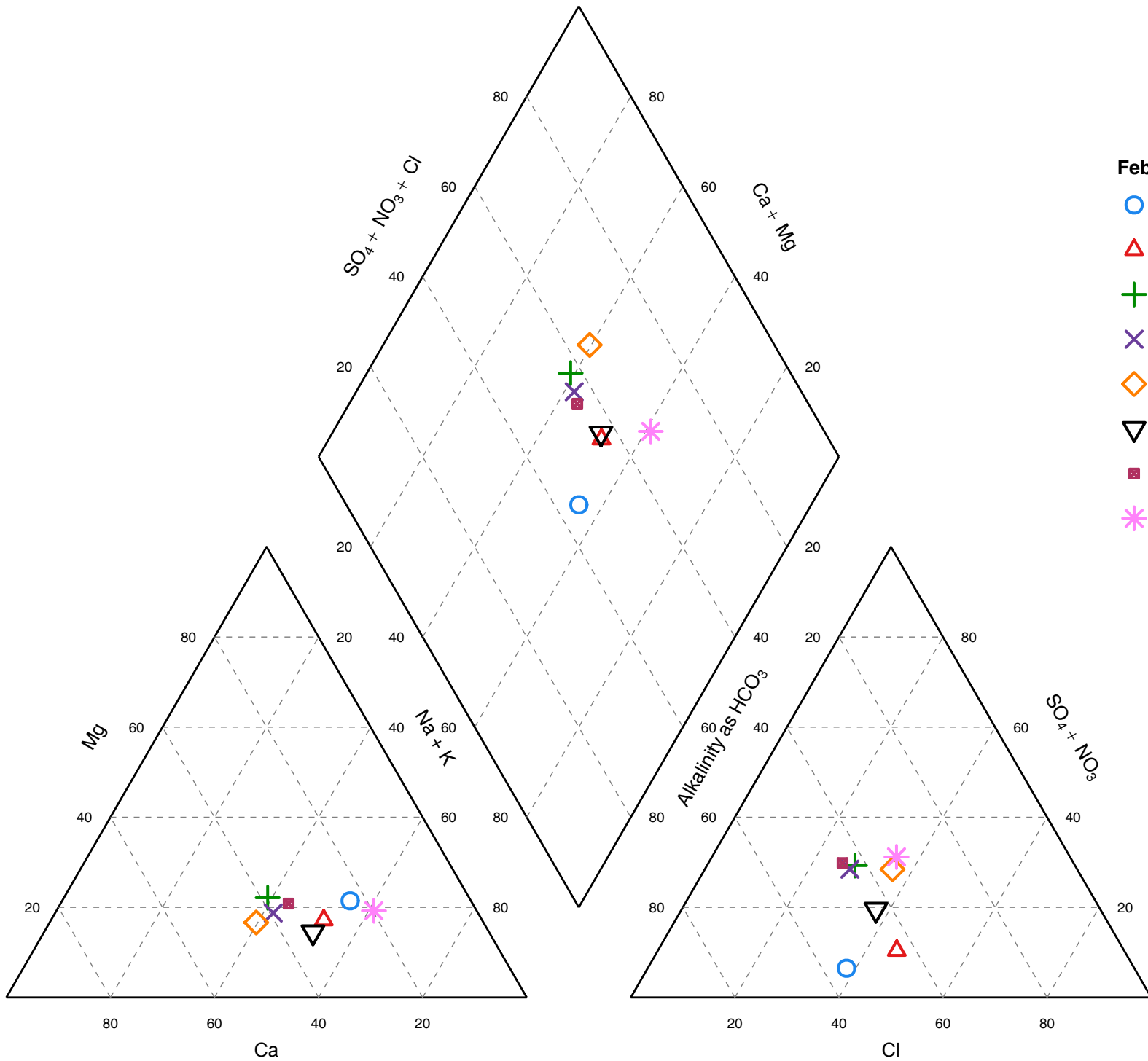

February 2015

- MEN-MW1s
- △ MEN-MW2s
- + MEN-MW3s
- × MEN-MW4s
- ◇ MEN-MW5s
- ▽ MEN-MW6s
- MEN-MW7s
- * MEN-MW8s

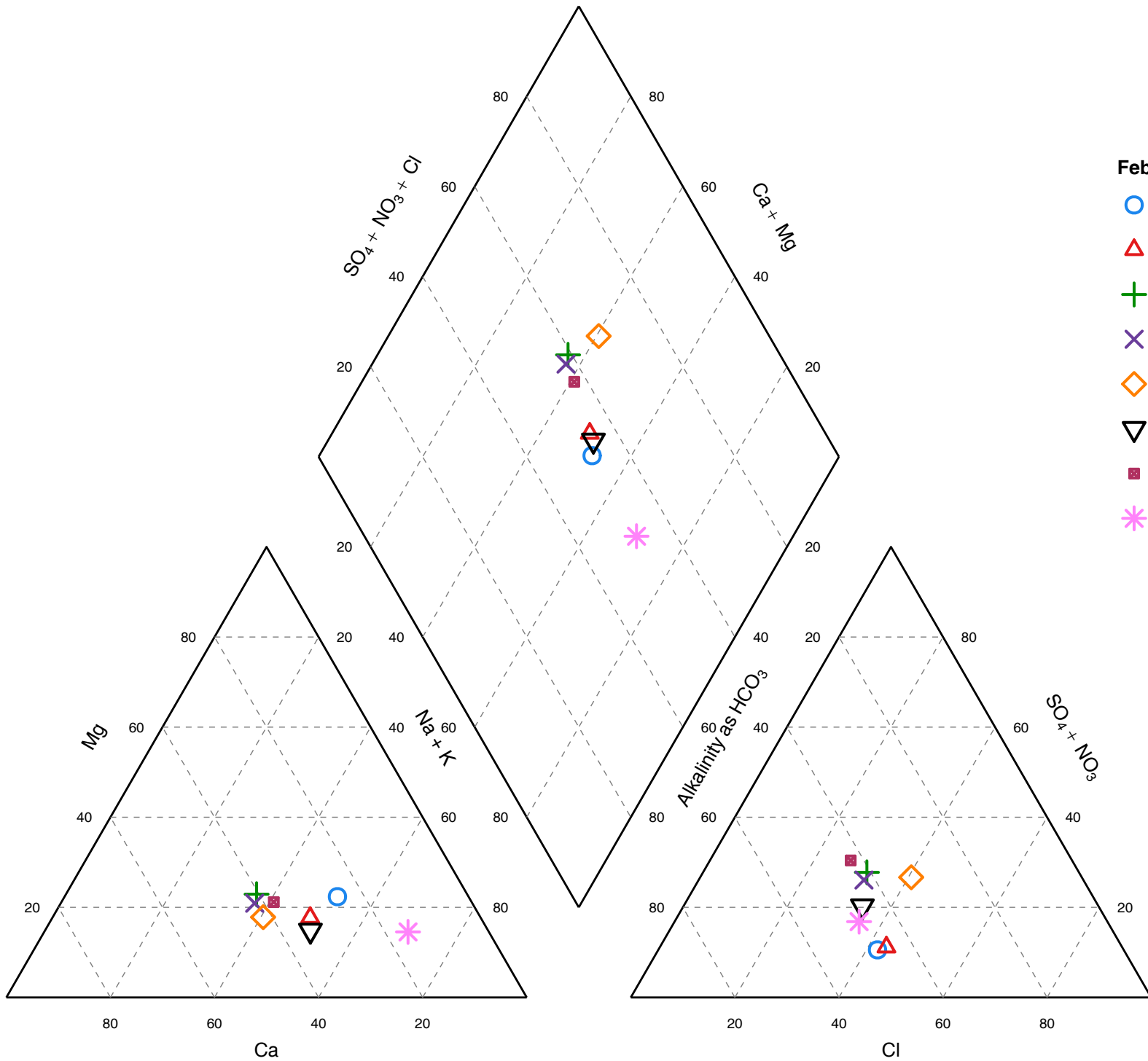

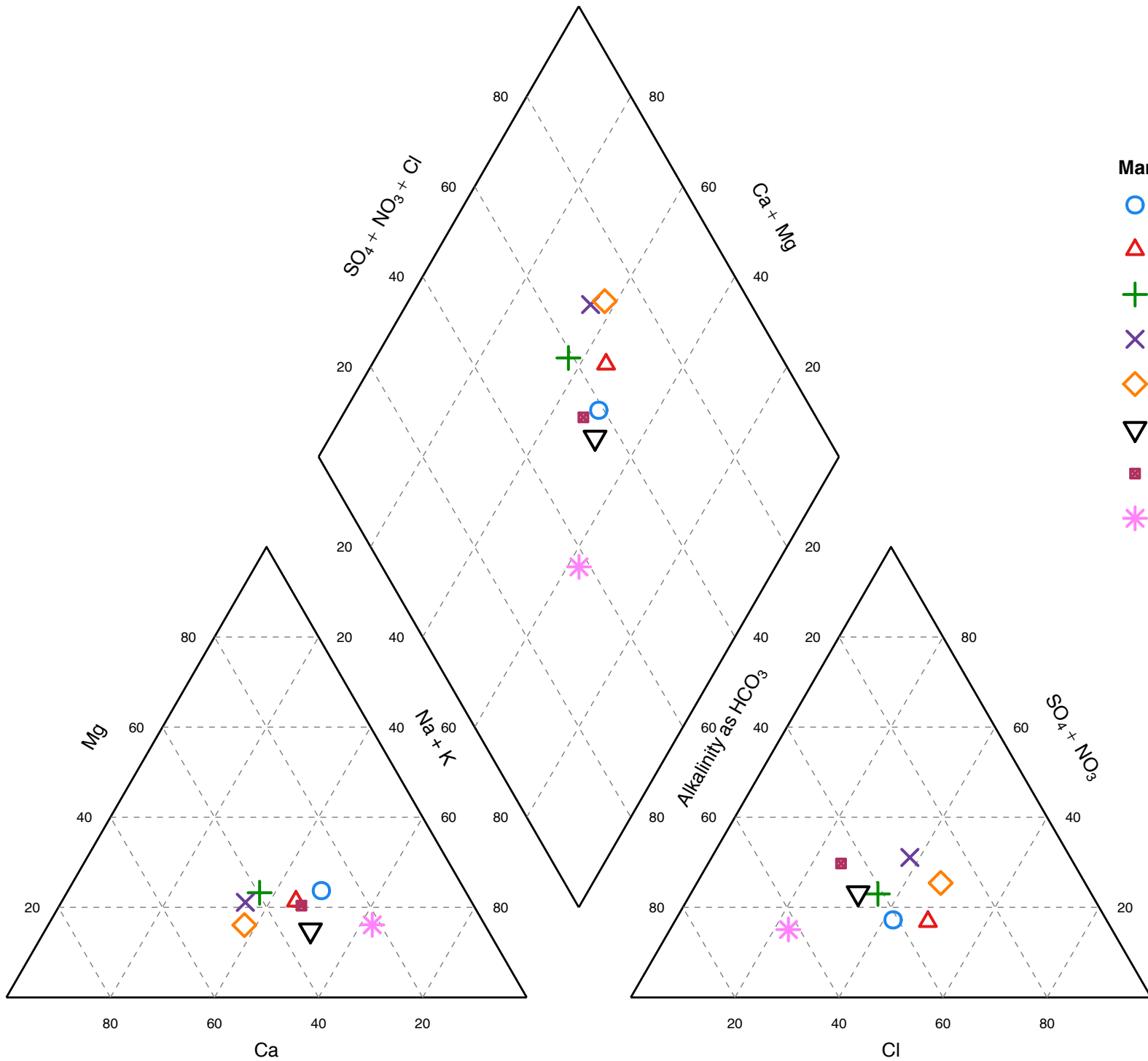

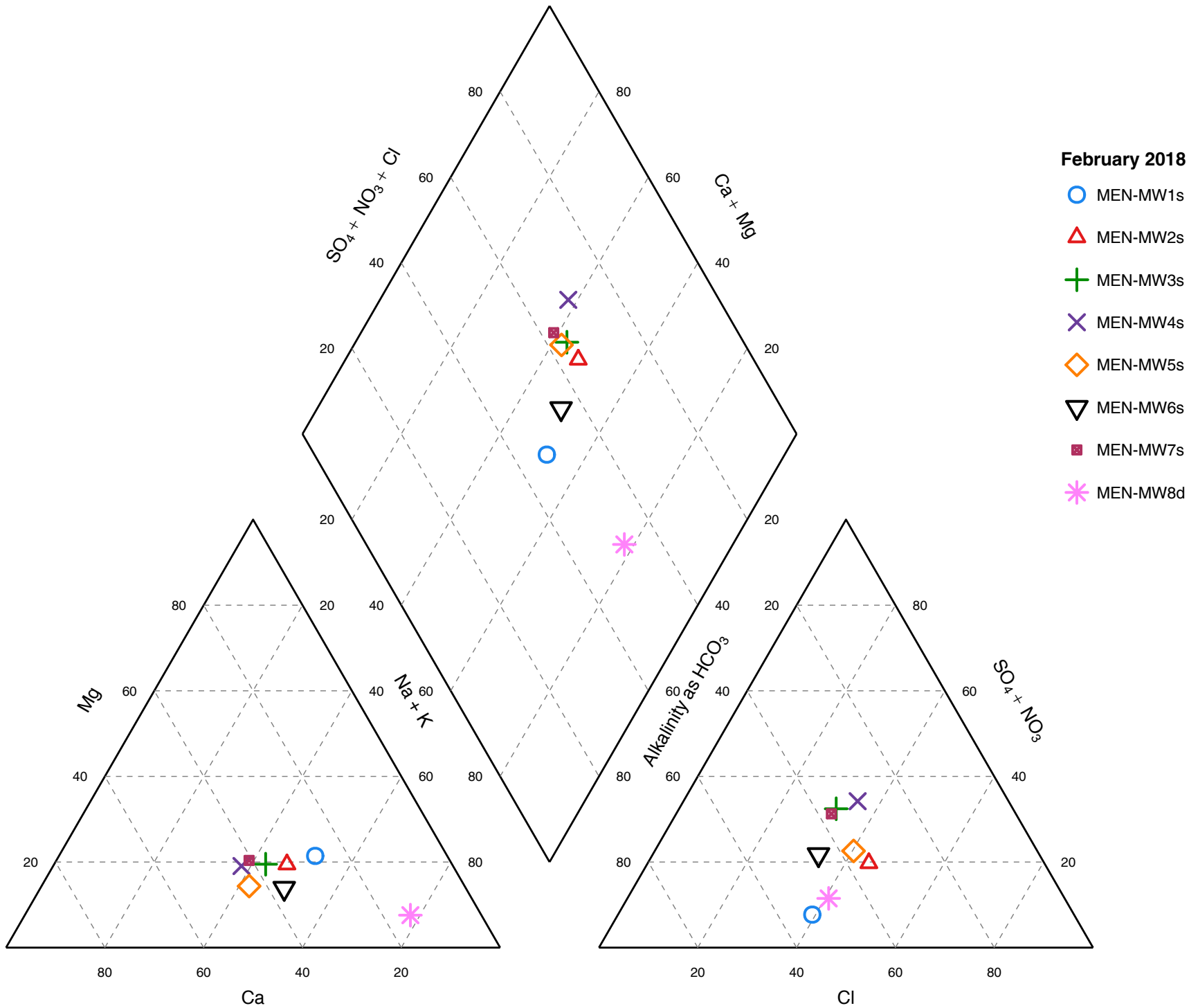

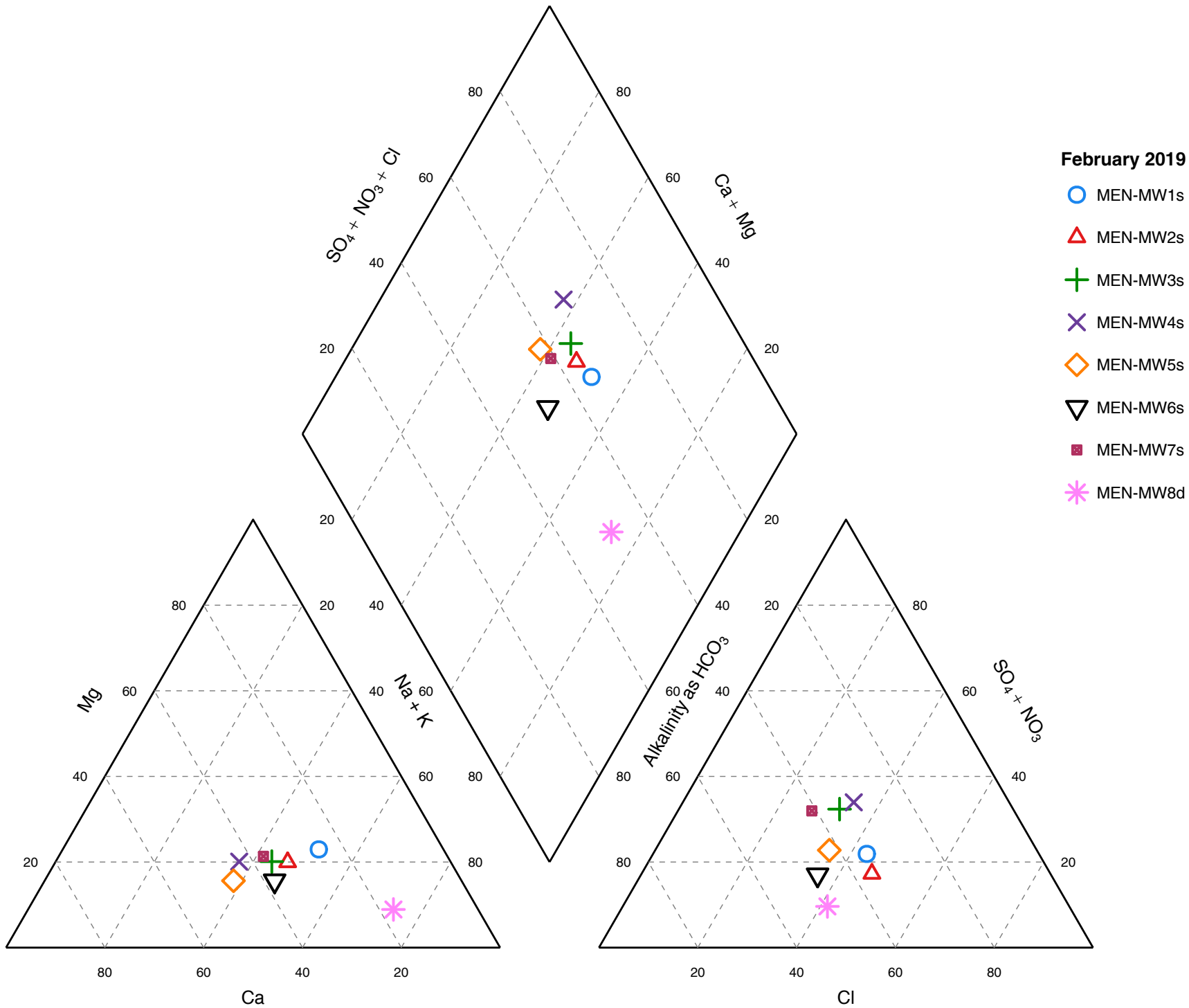

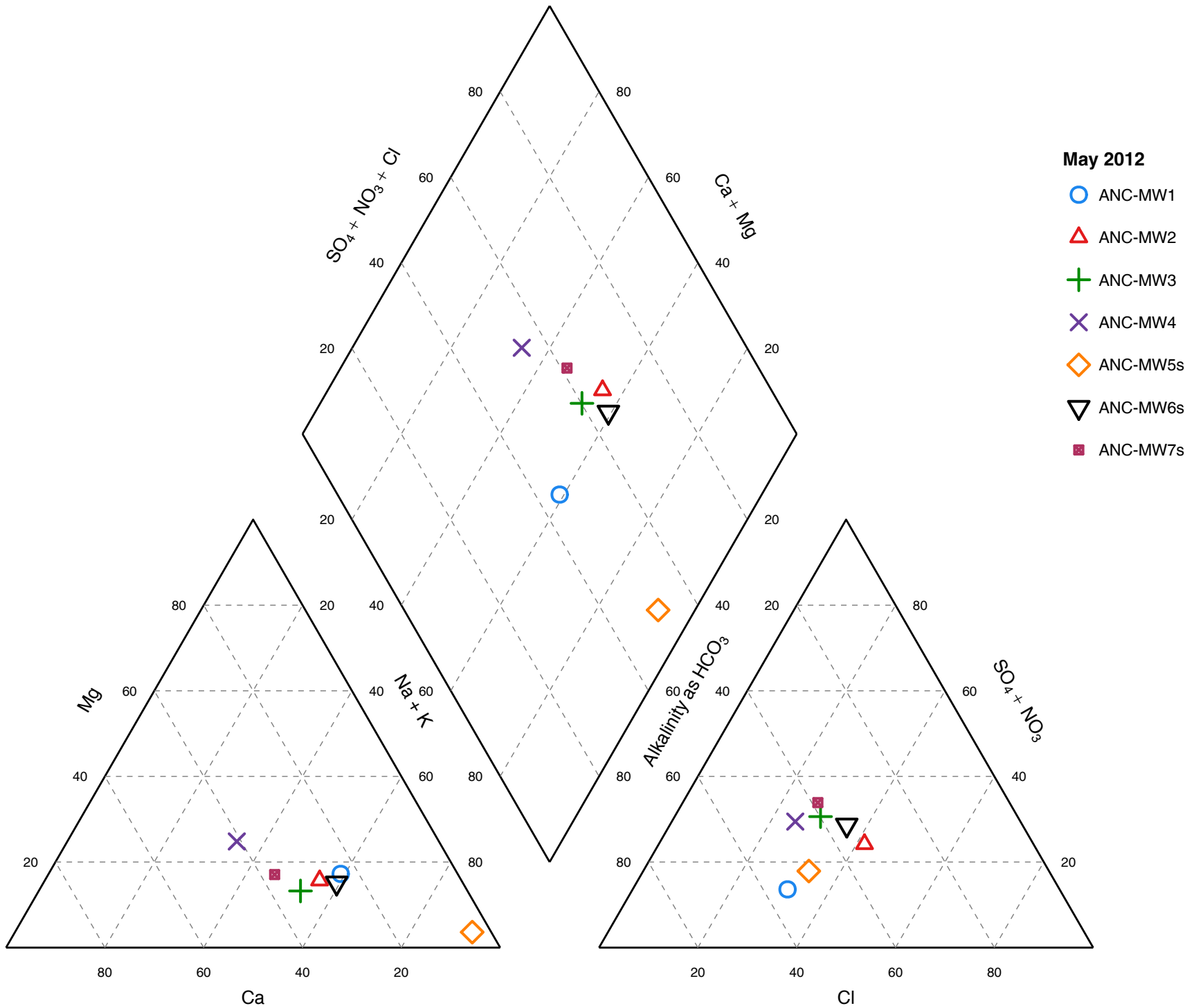

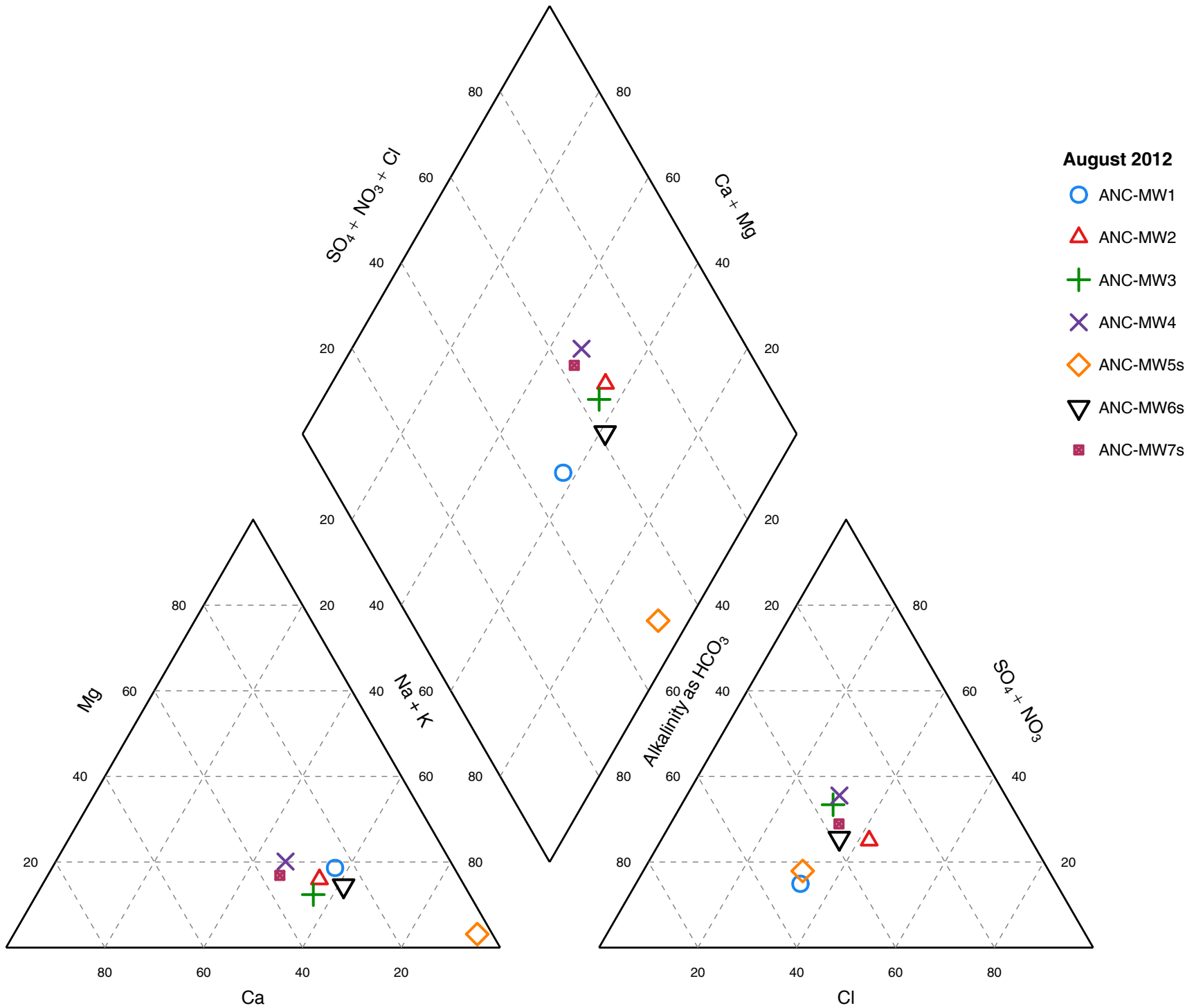

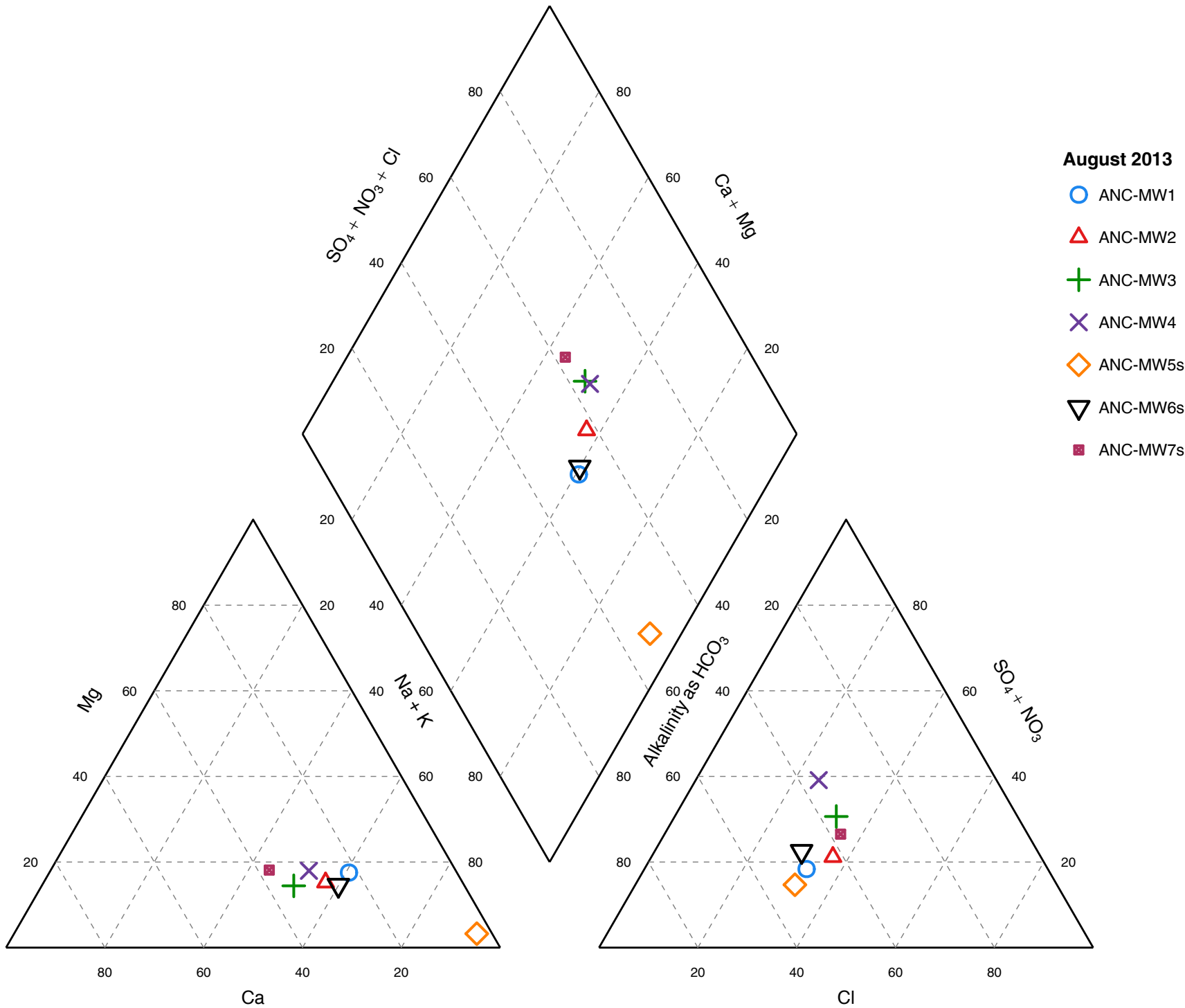

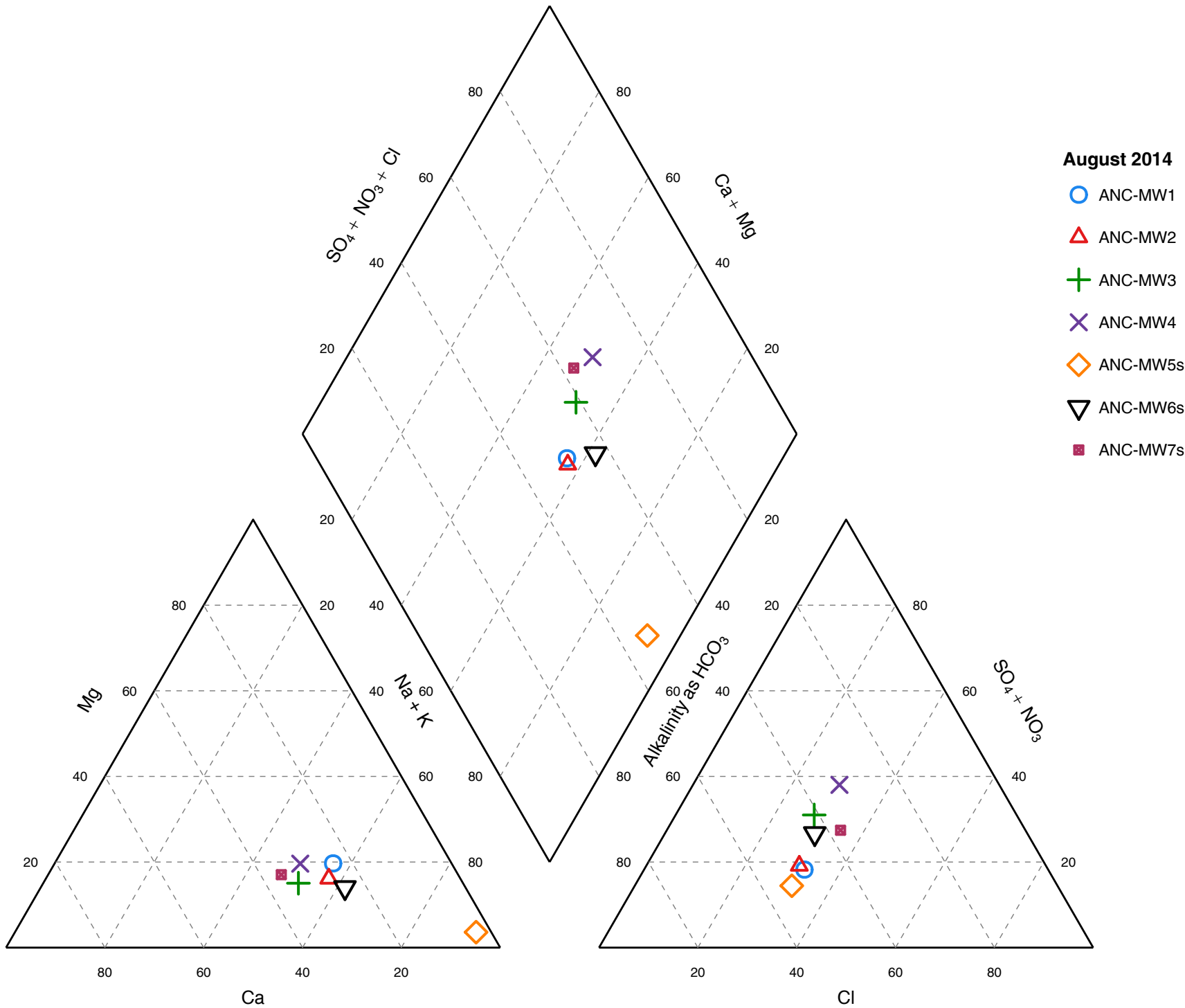

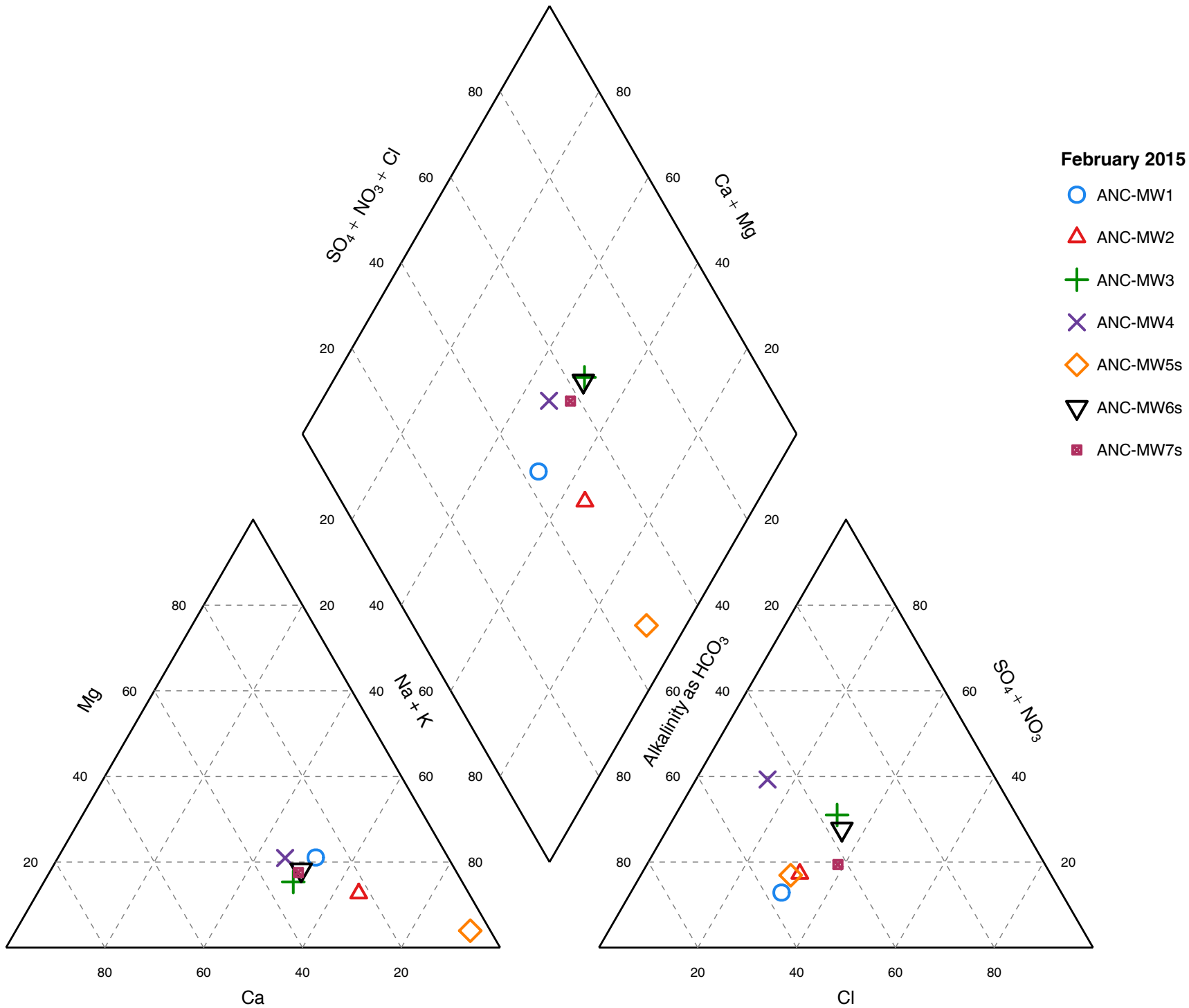

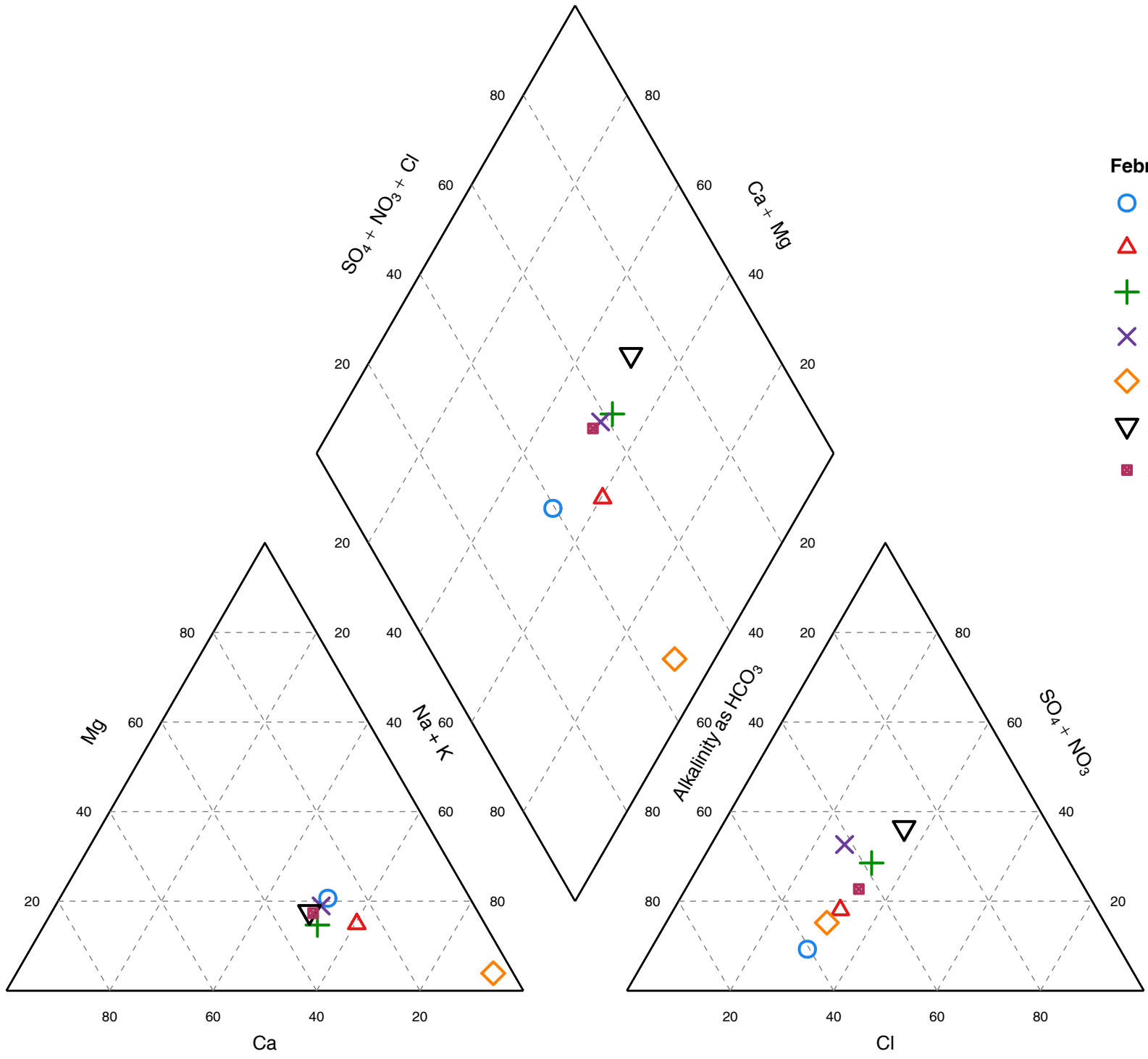

February 2016

- ANC-MW1
- △ ANC-MW2
- + ANC-MW3
- × ANC-MW4
- ◇ ANC-MW5s
- ▽ ANC-MW6s
- ANC-MW7s

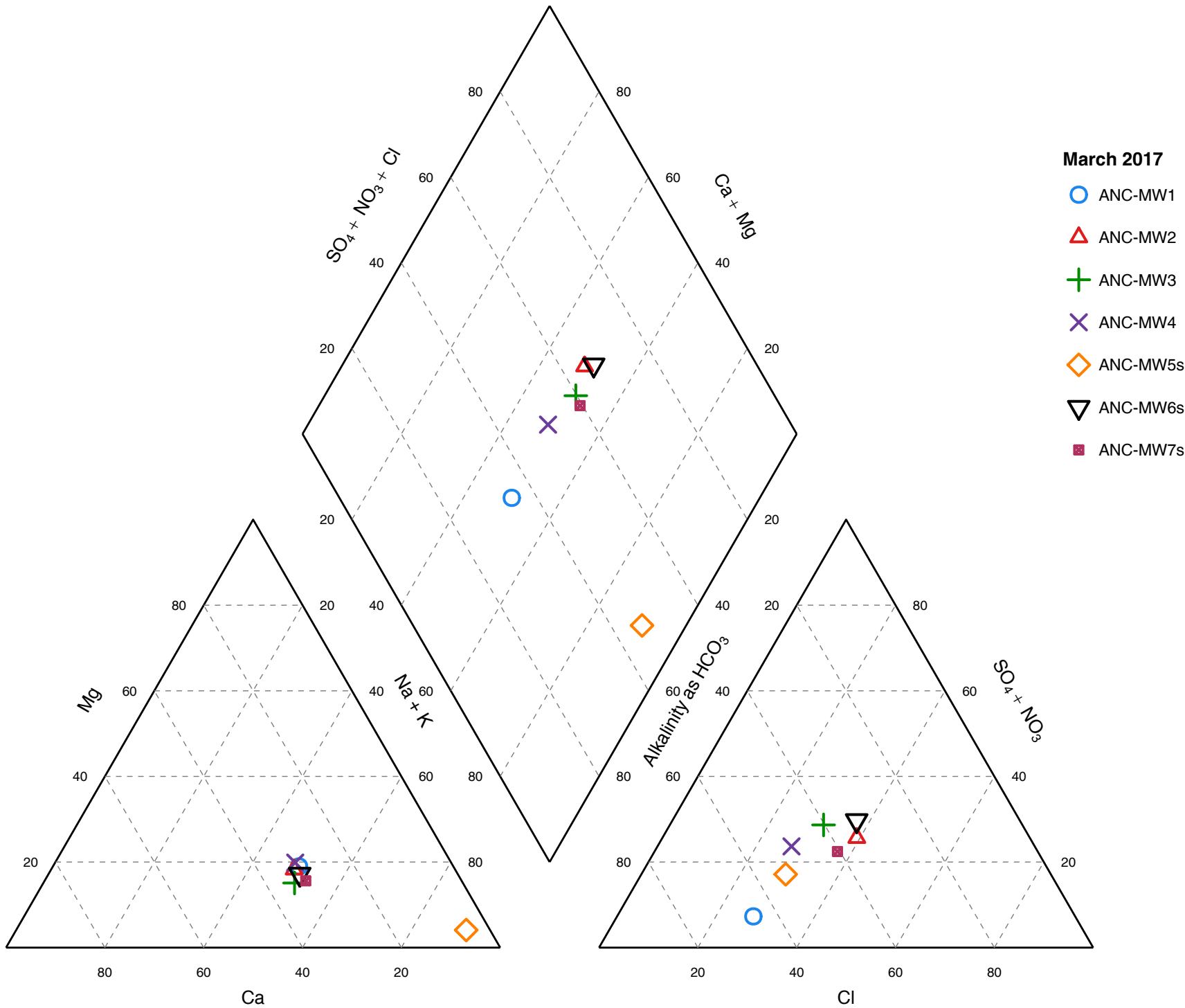

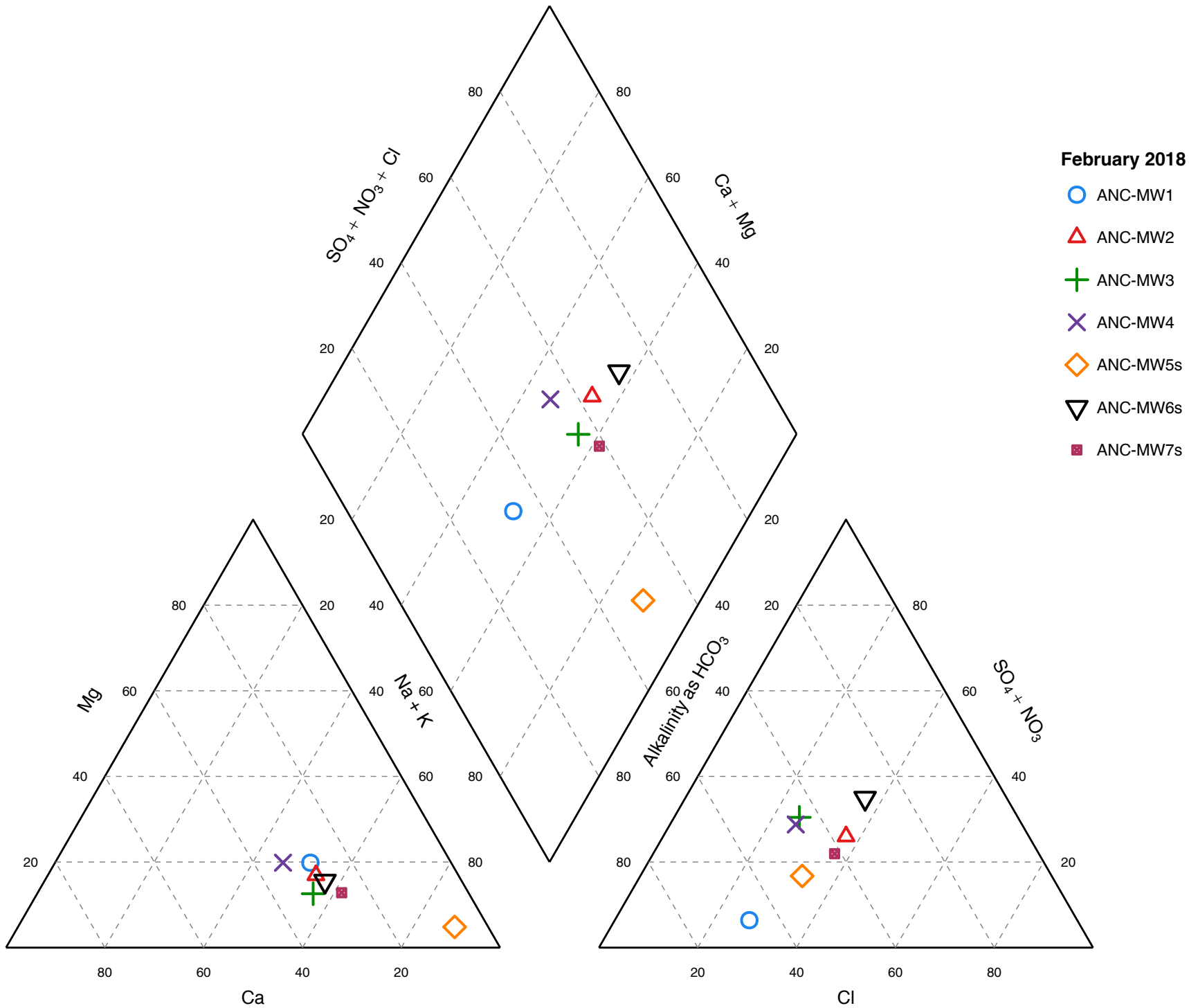

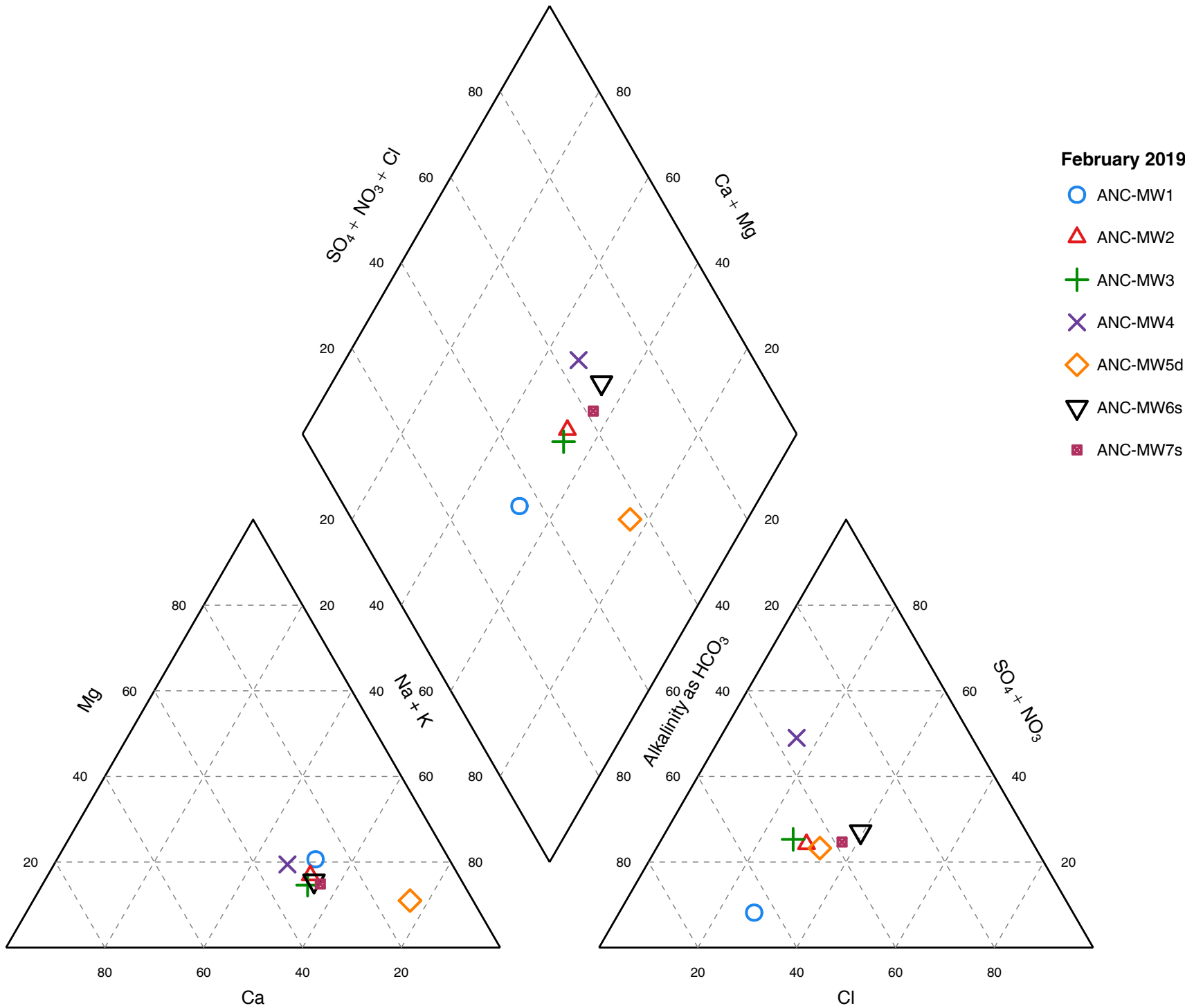

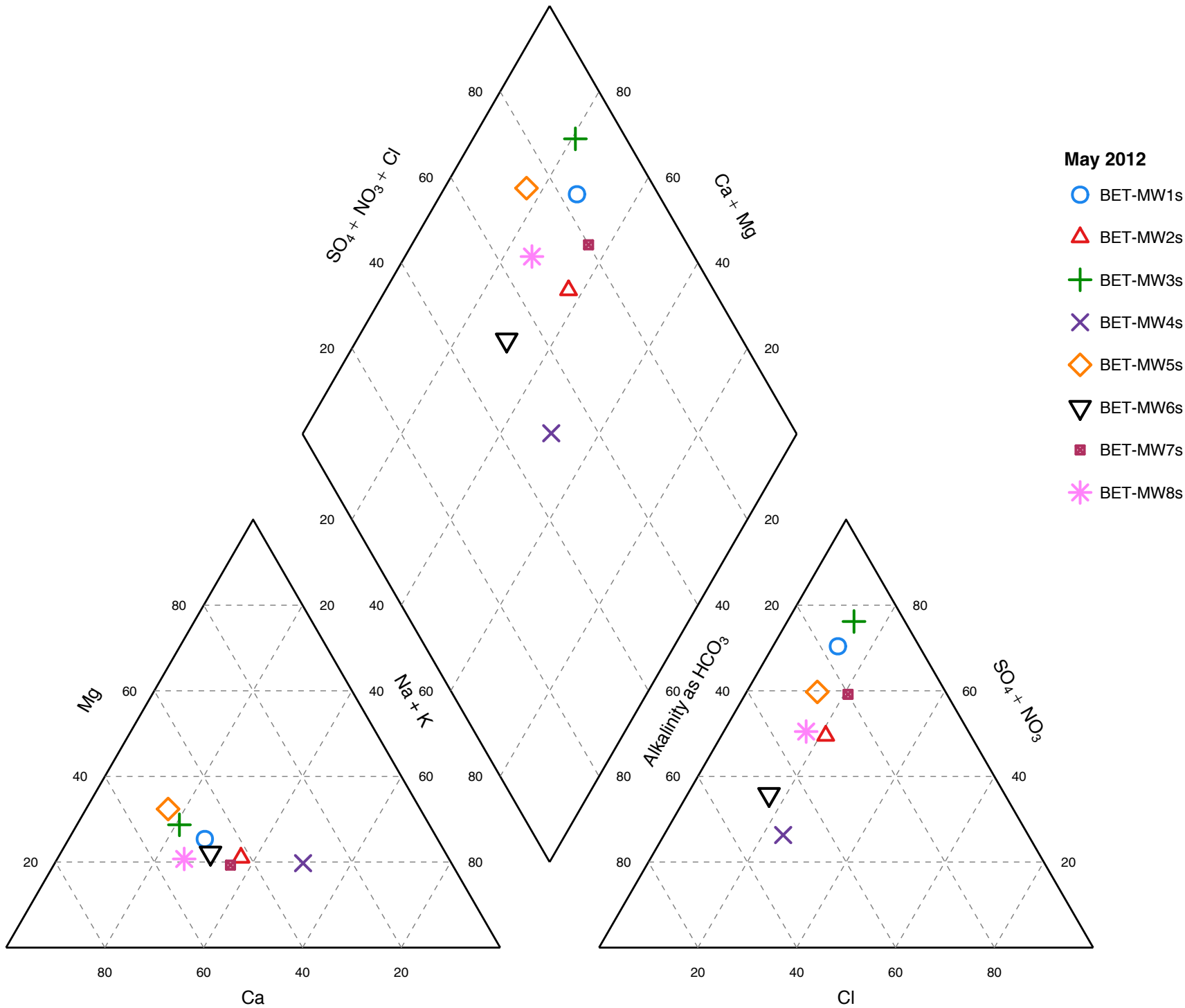

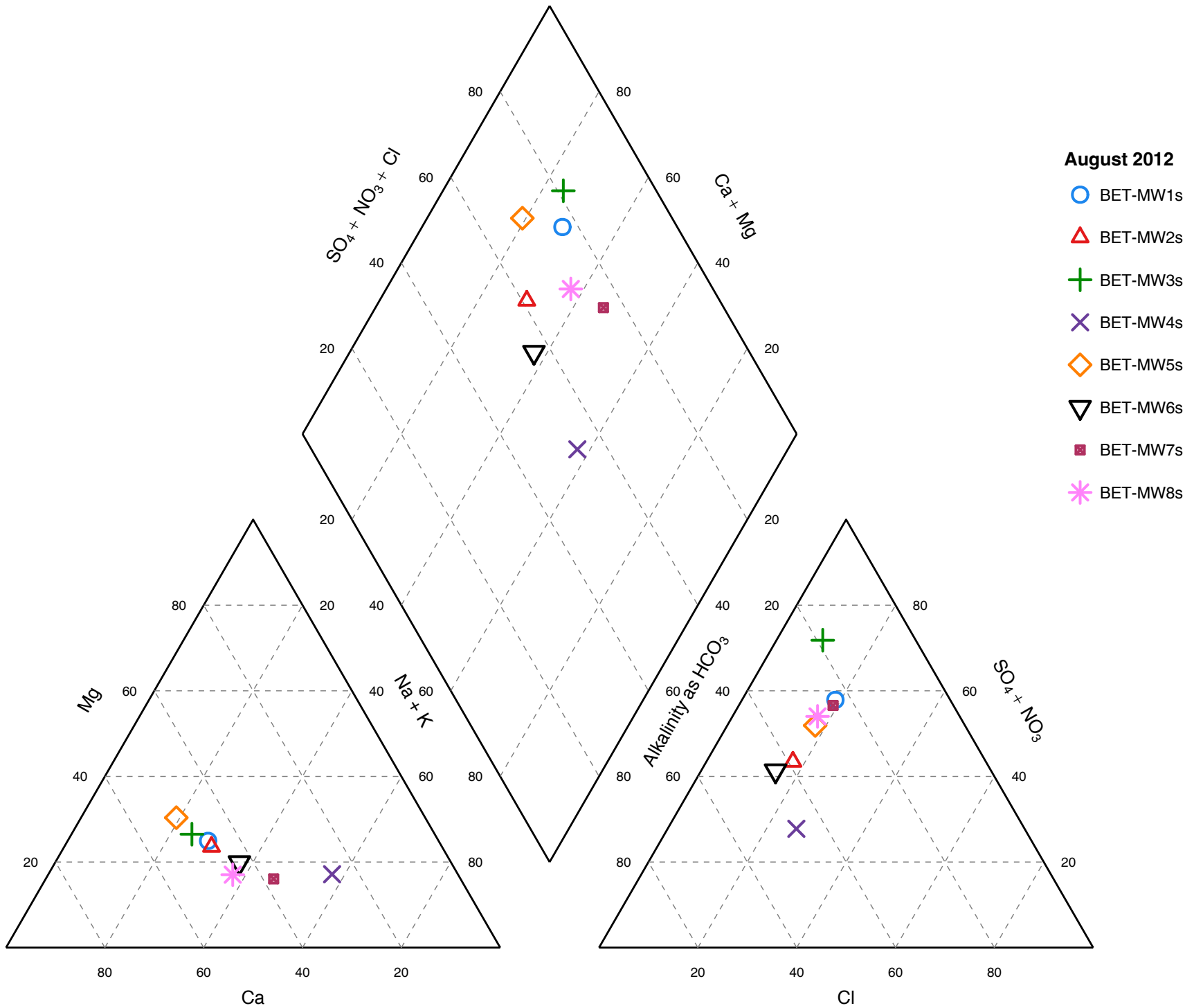

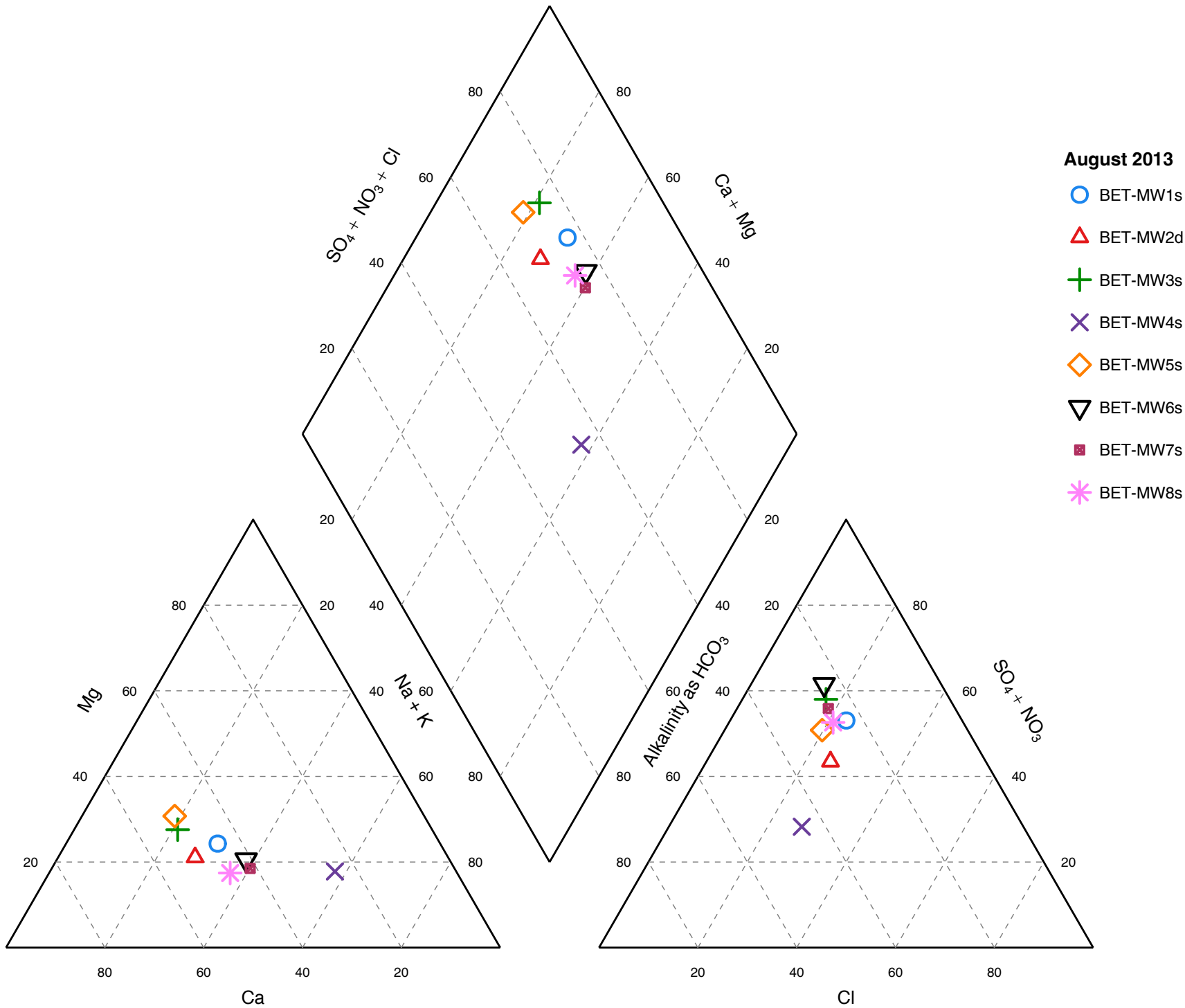

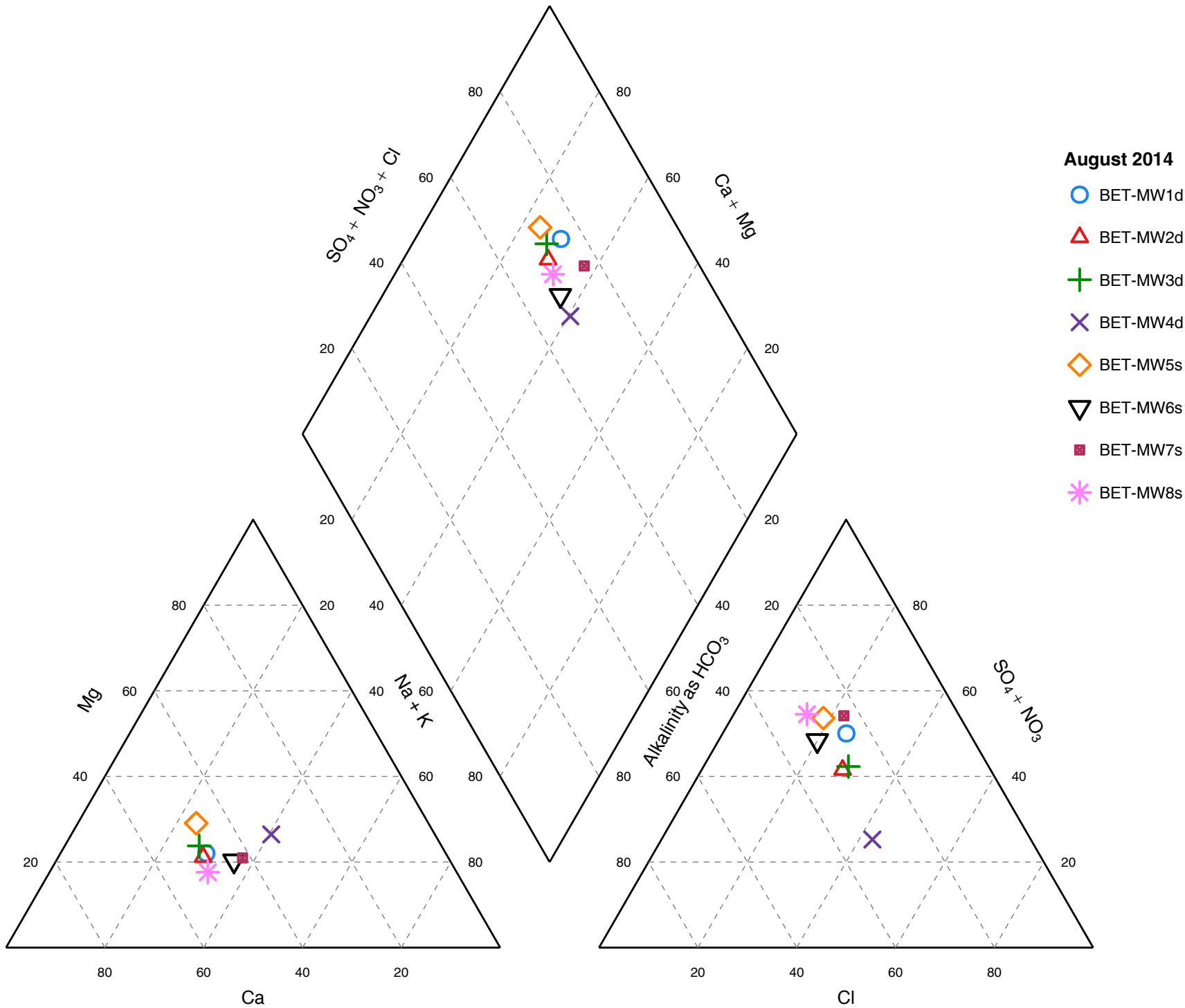

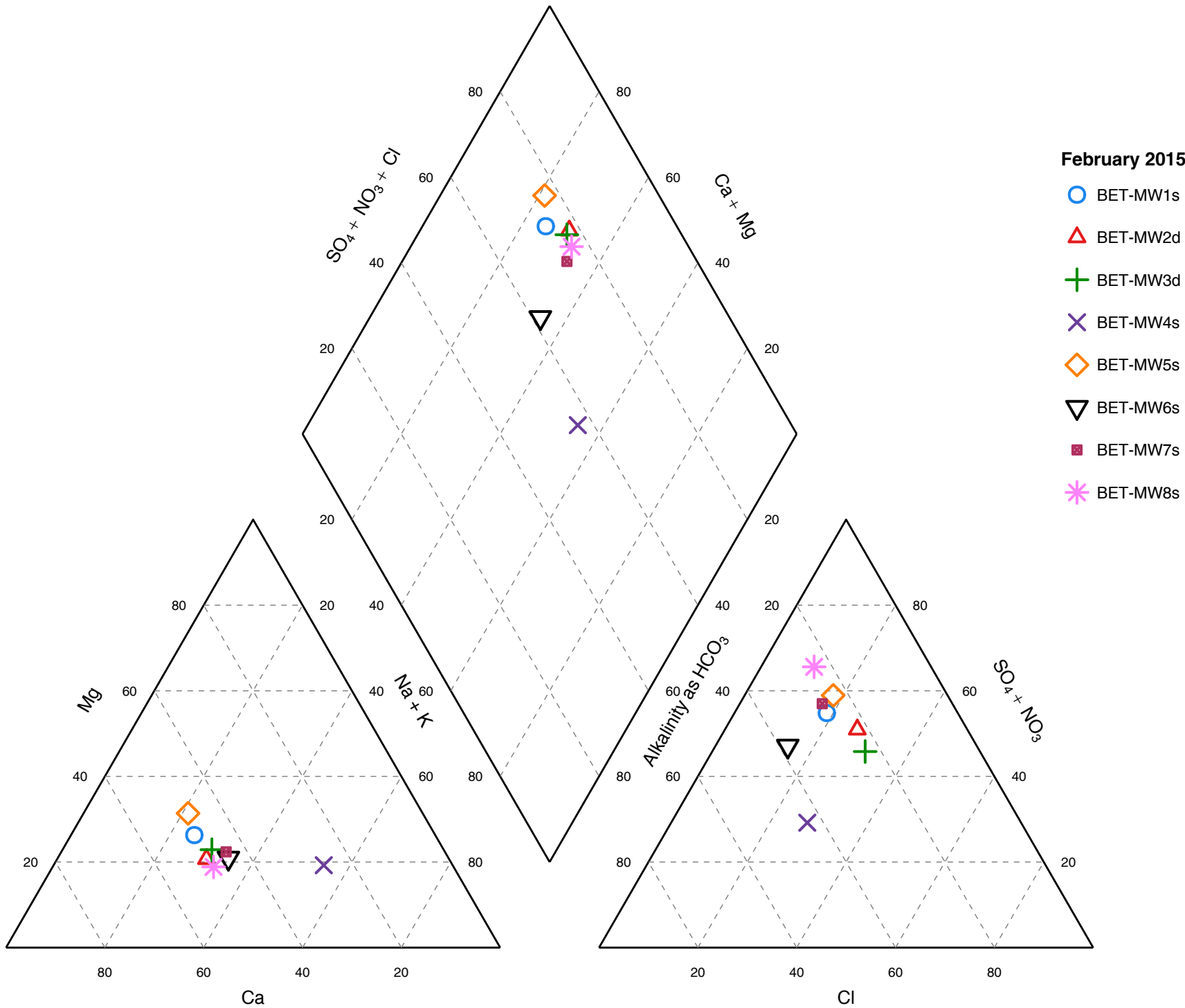

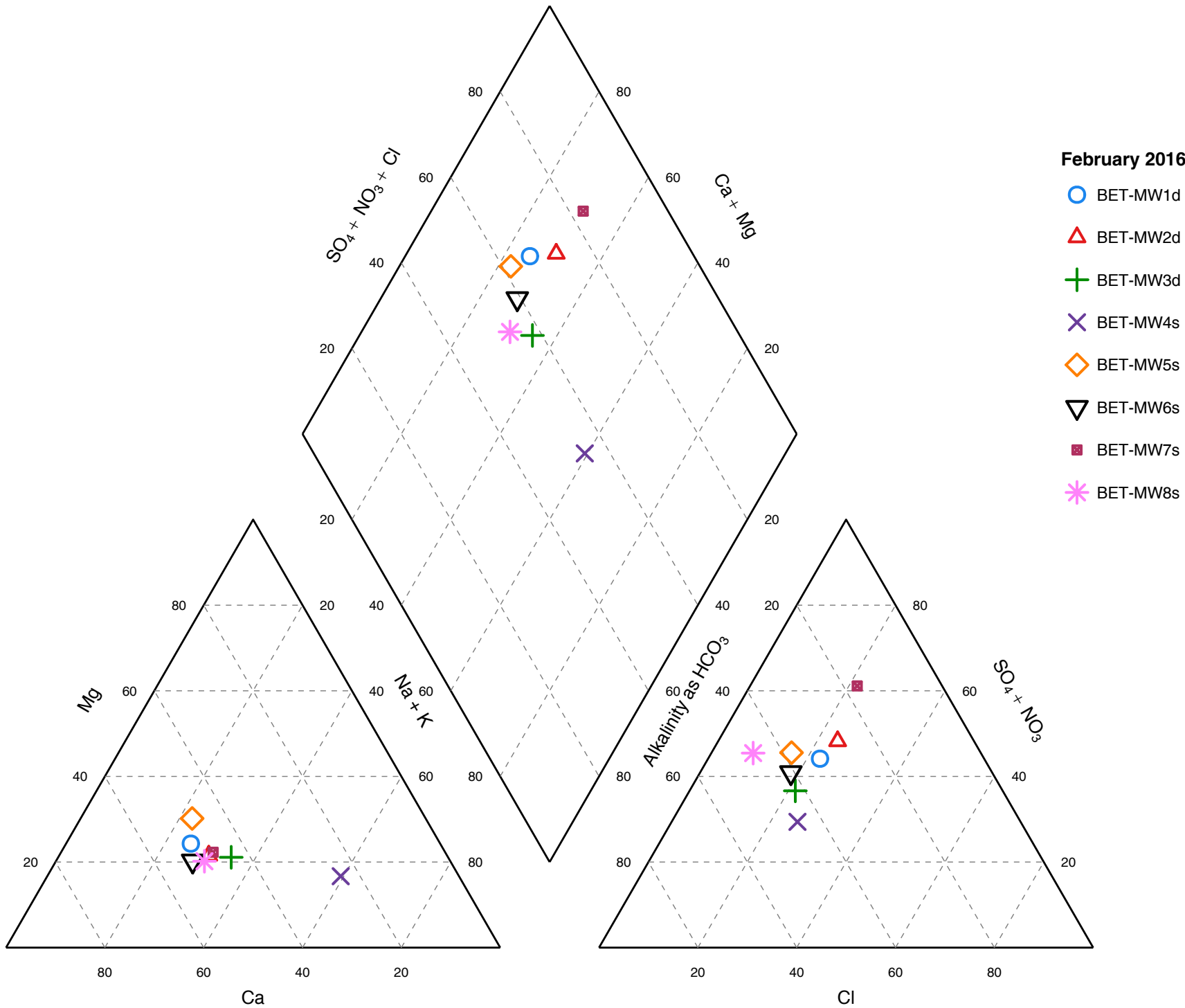

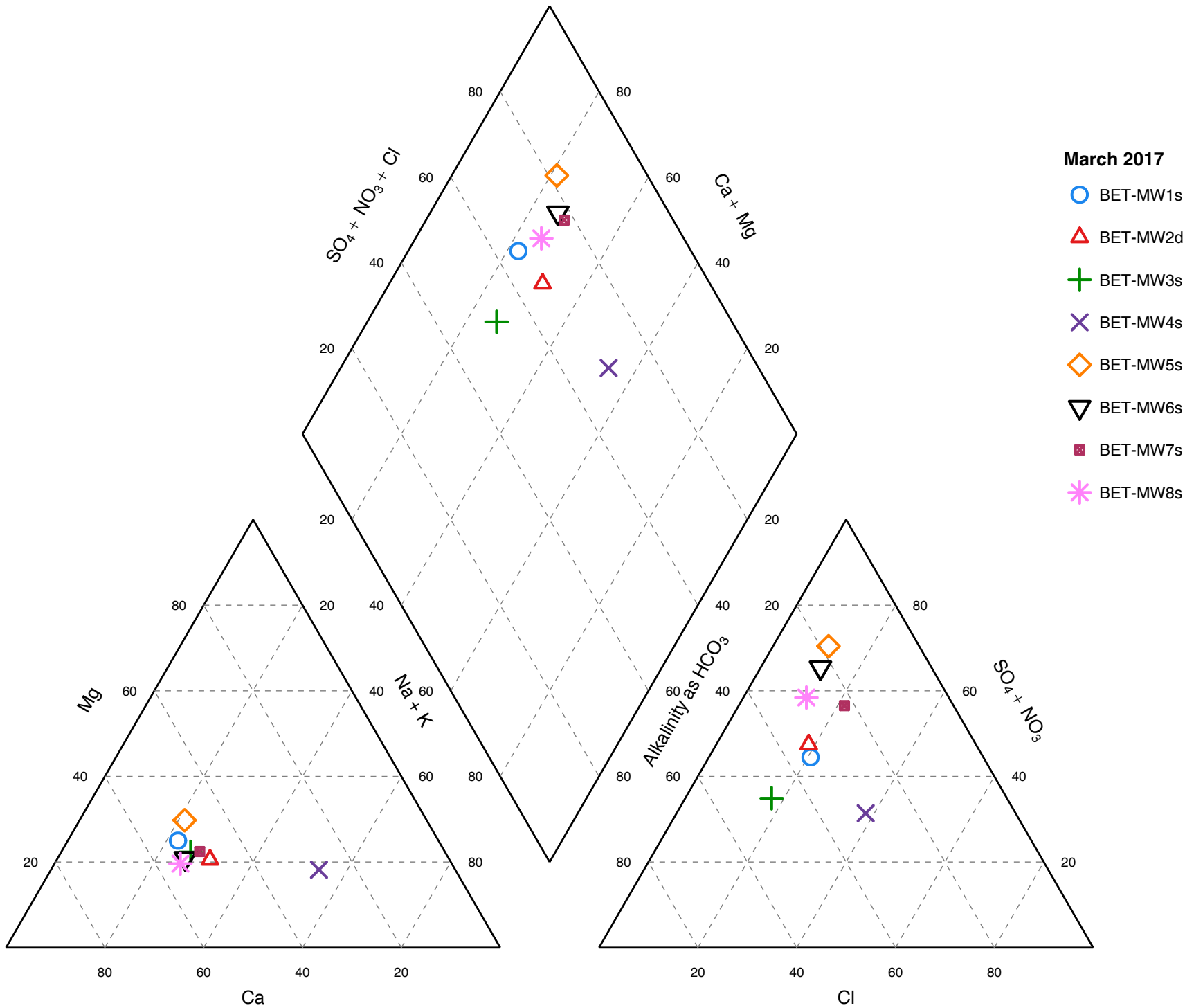

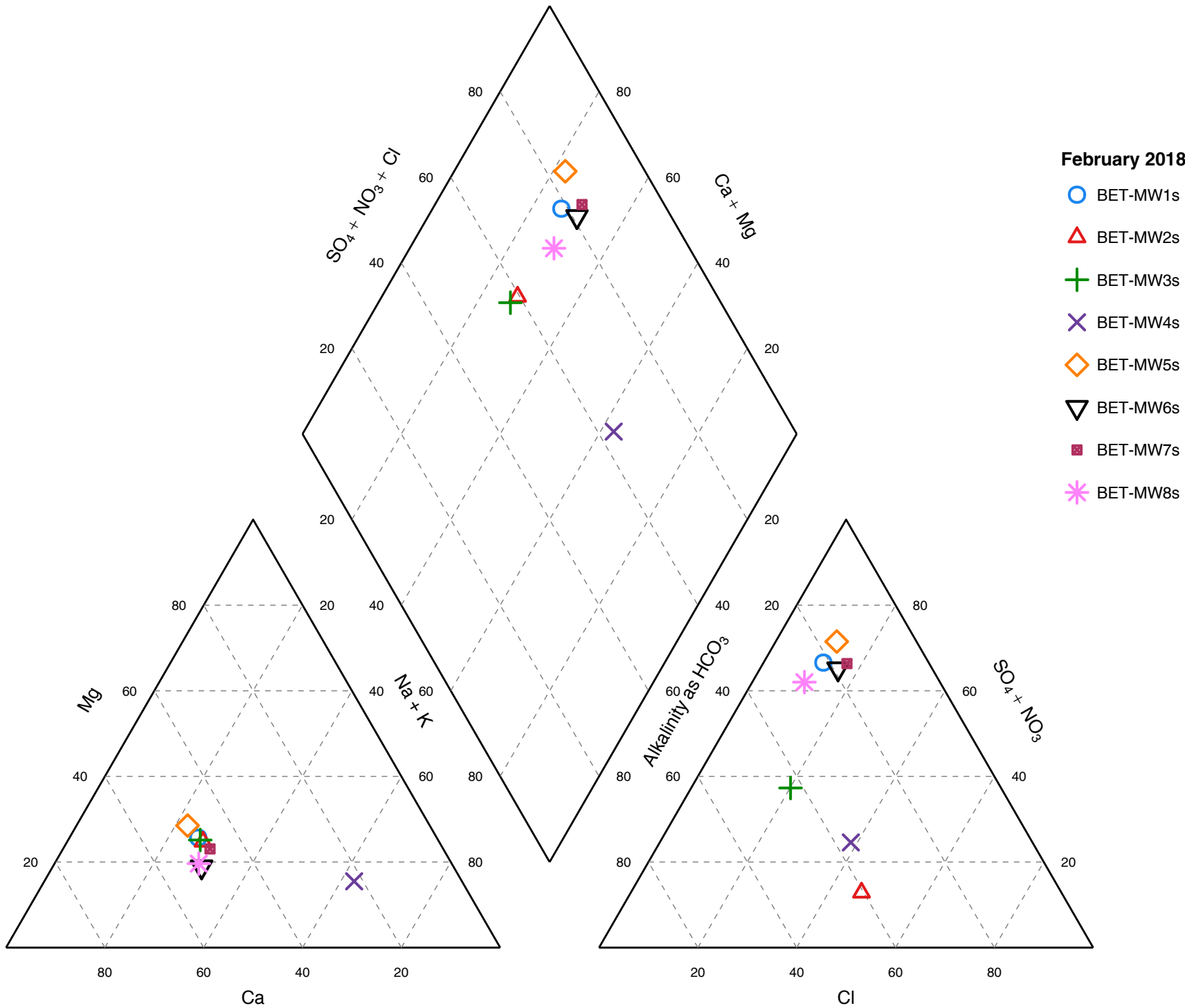

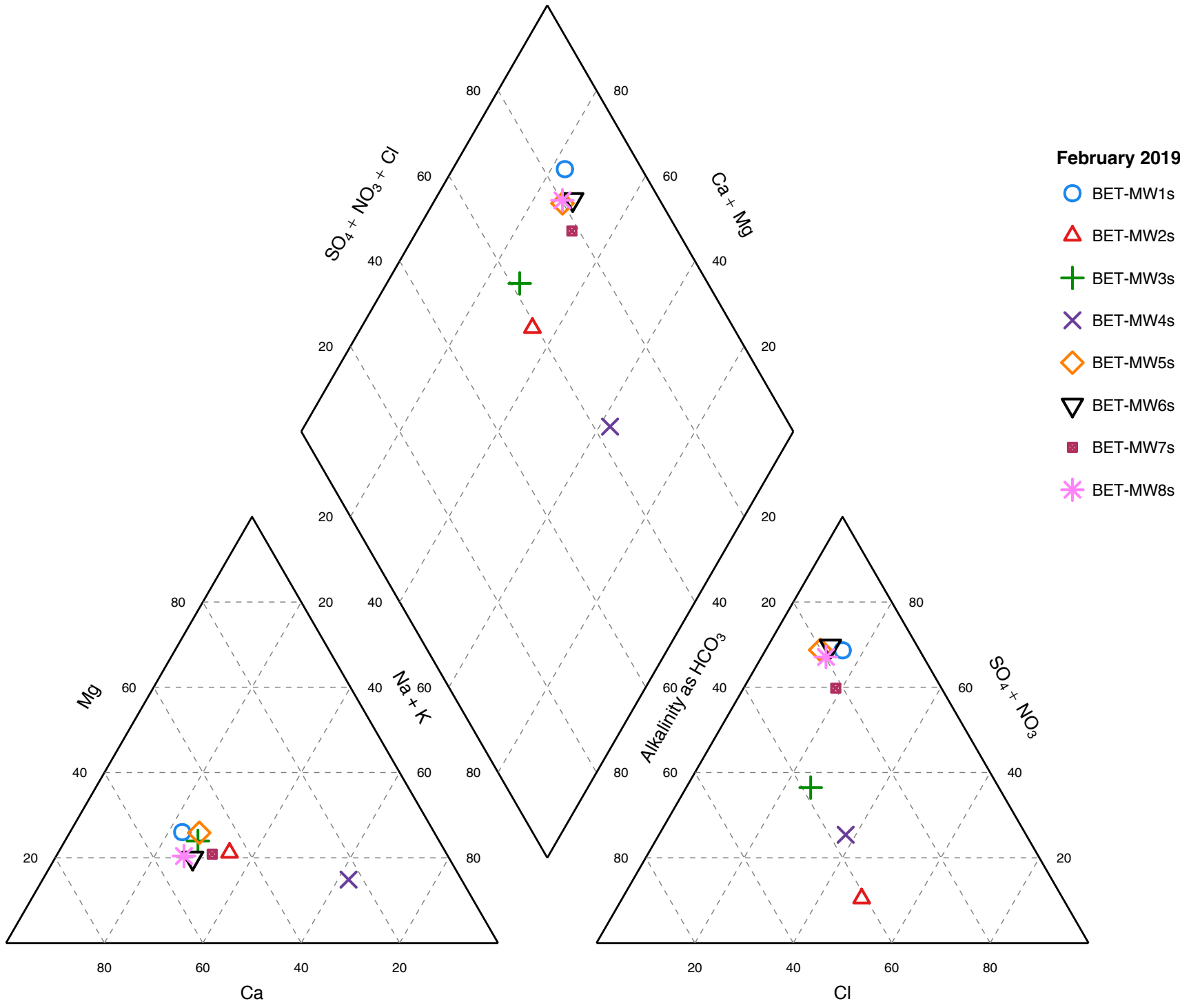

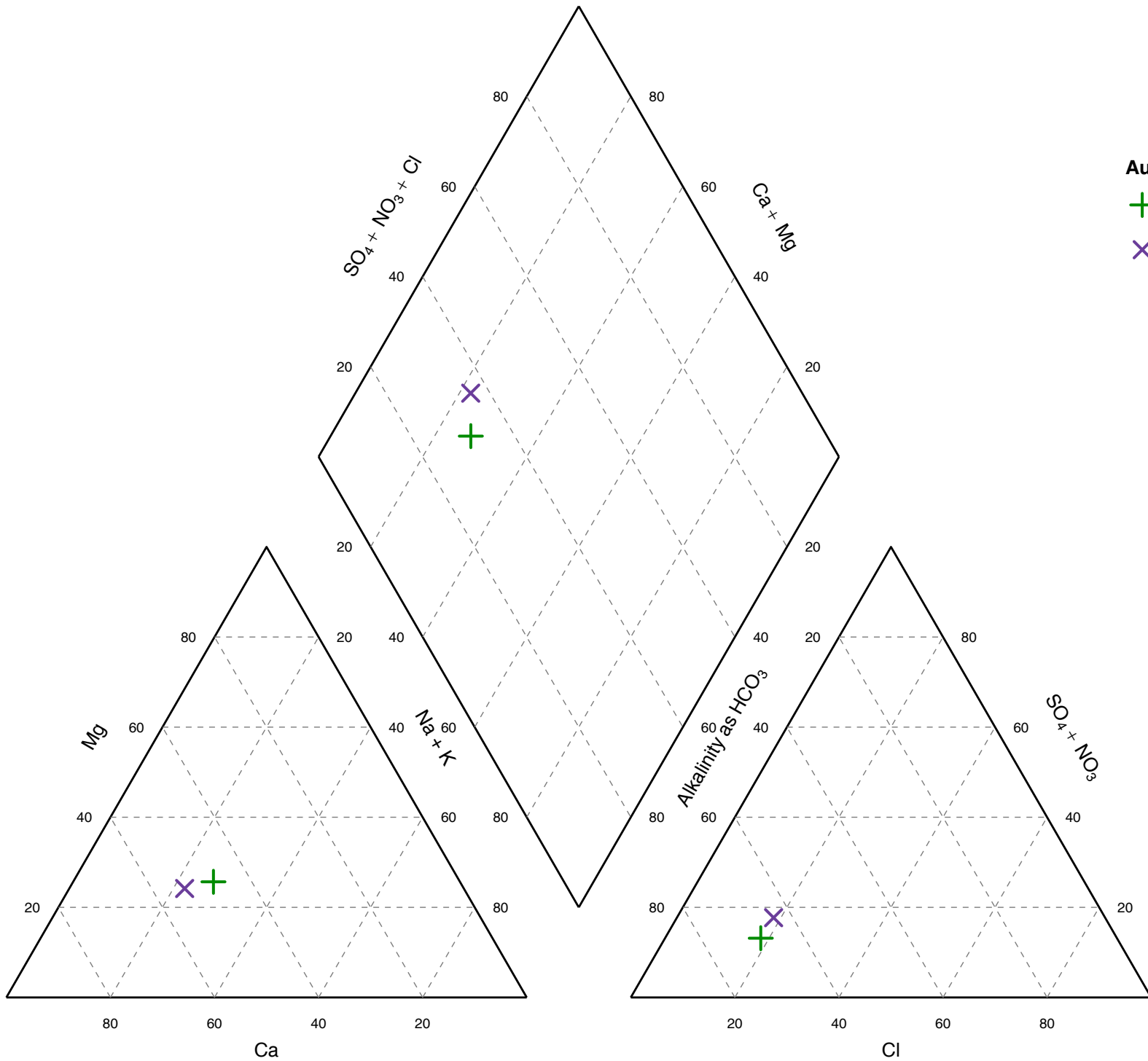

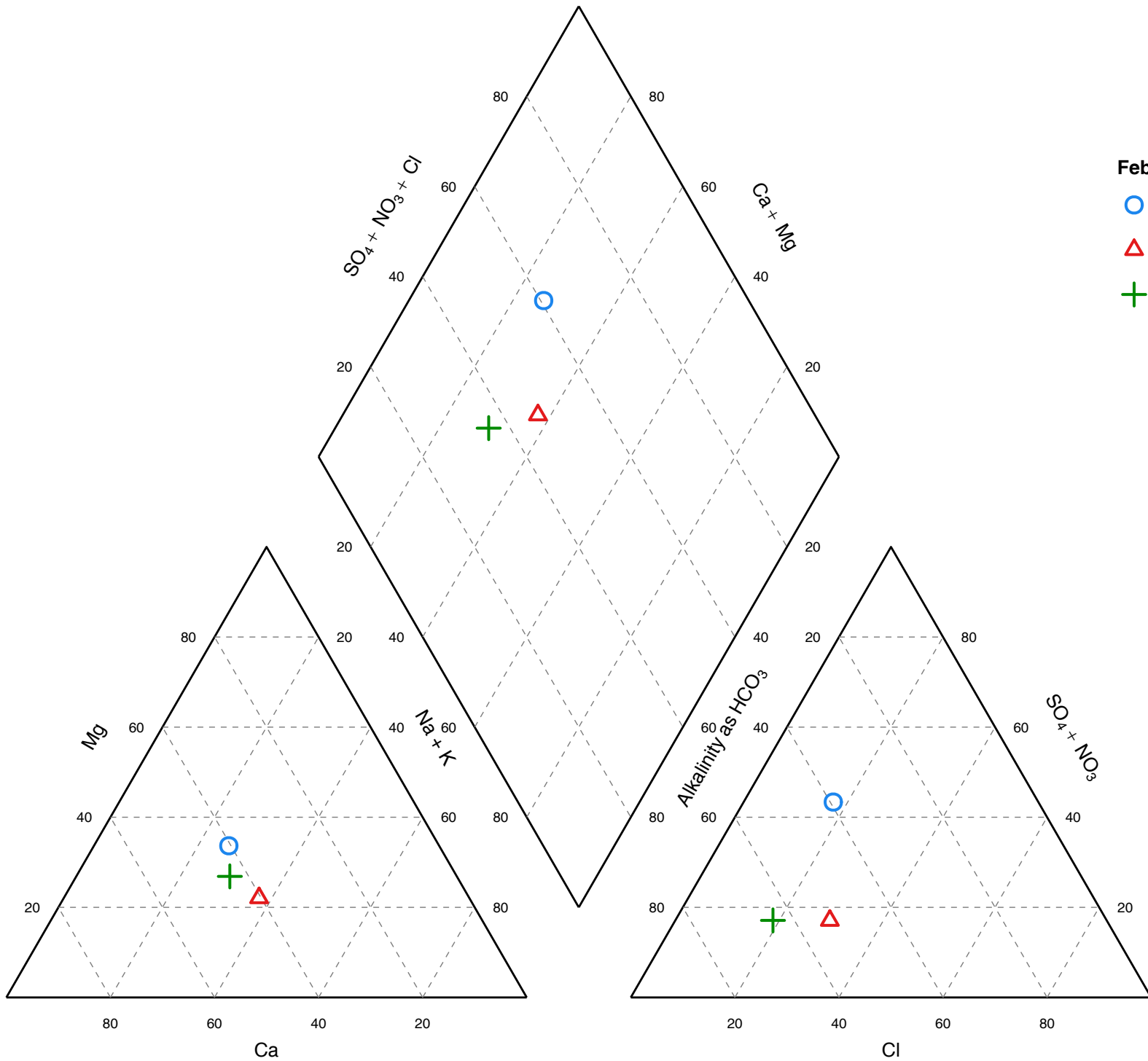

February 2015

○ DIE-MW1

△ DIE-MW2

+ DIE-MW3

February 2016

○ DIE-MW1

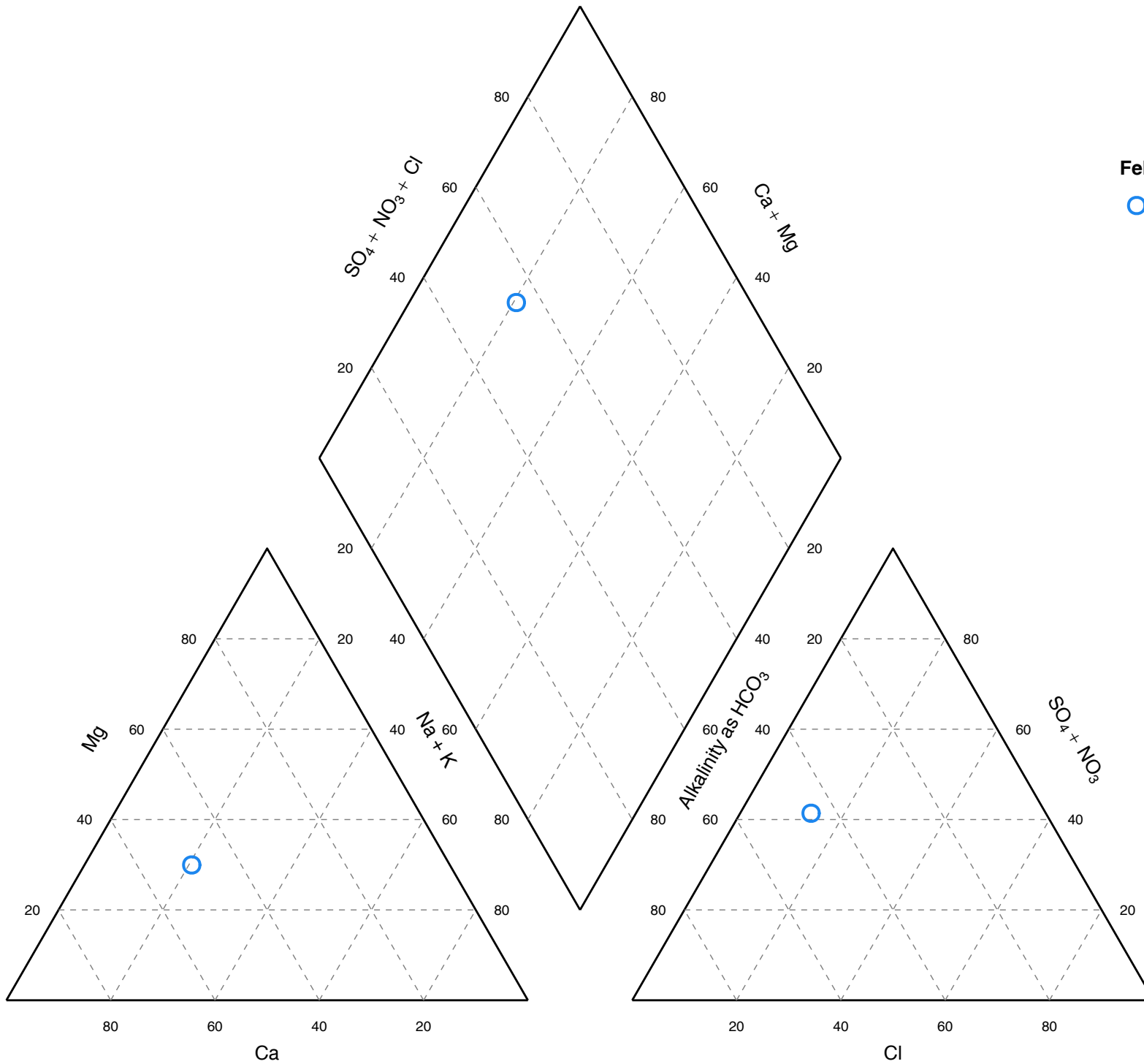

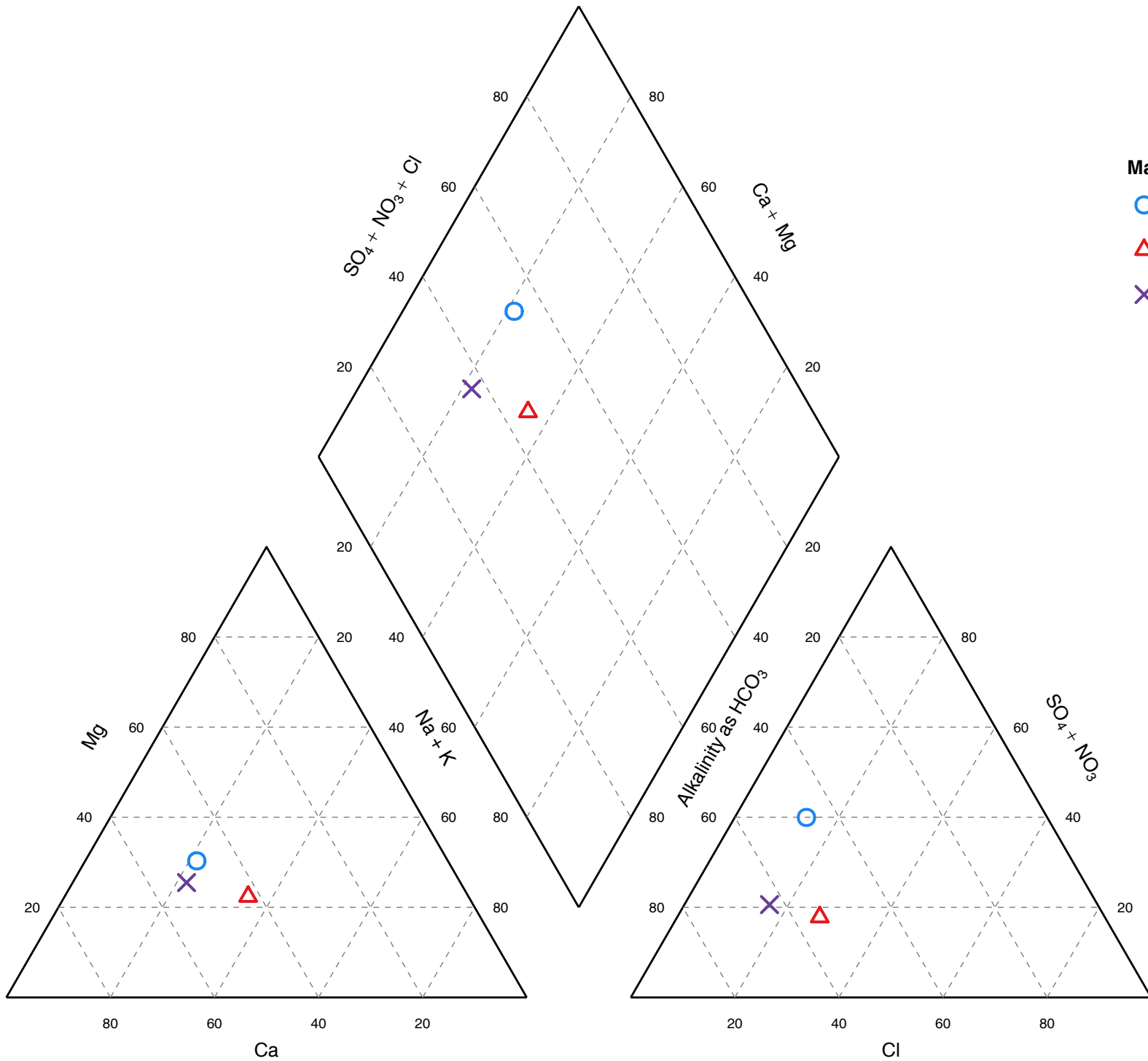

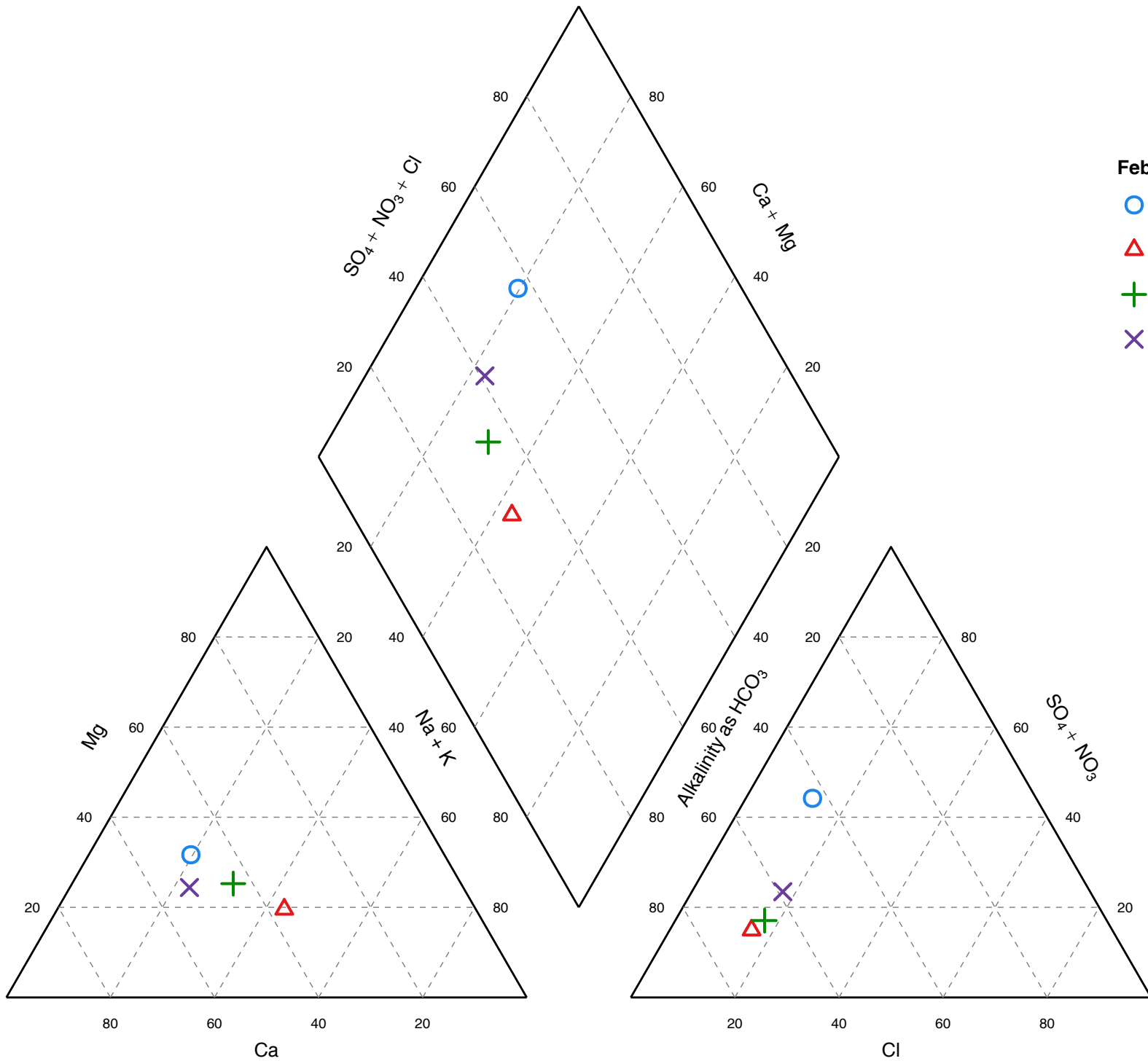

February 2018

○ DIE-MW1

△ DIE-MW2

+ DIE-MW3

× DIE-MW4

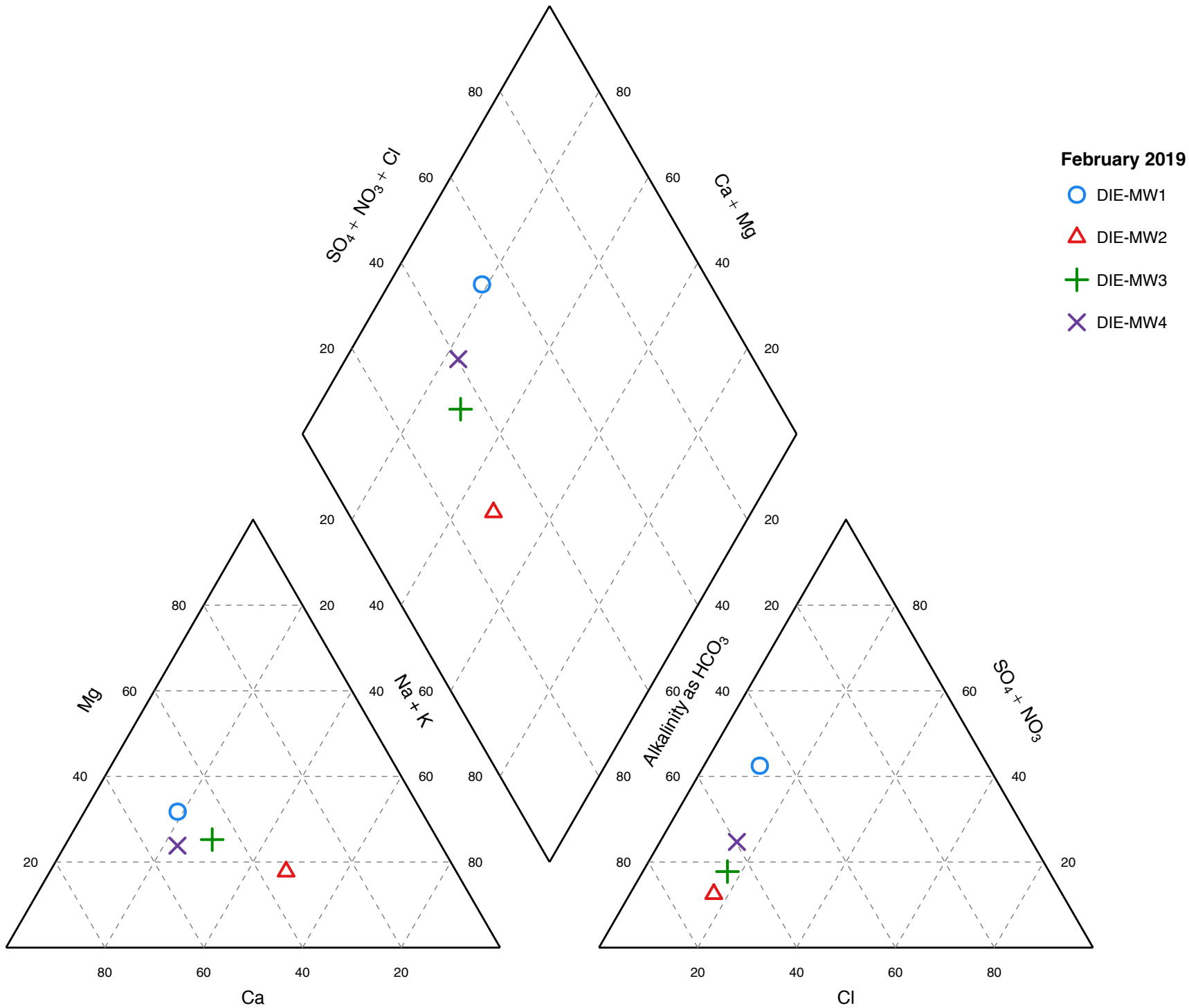

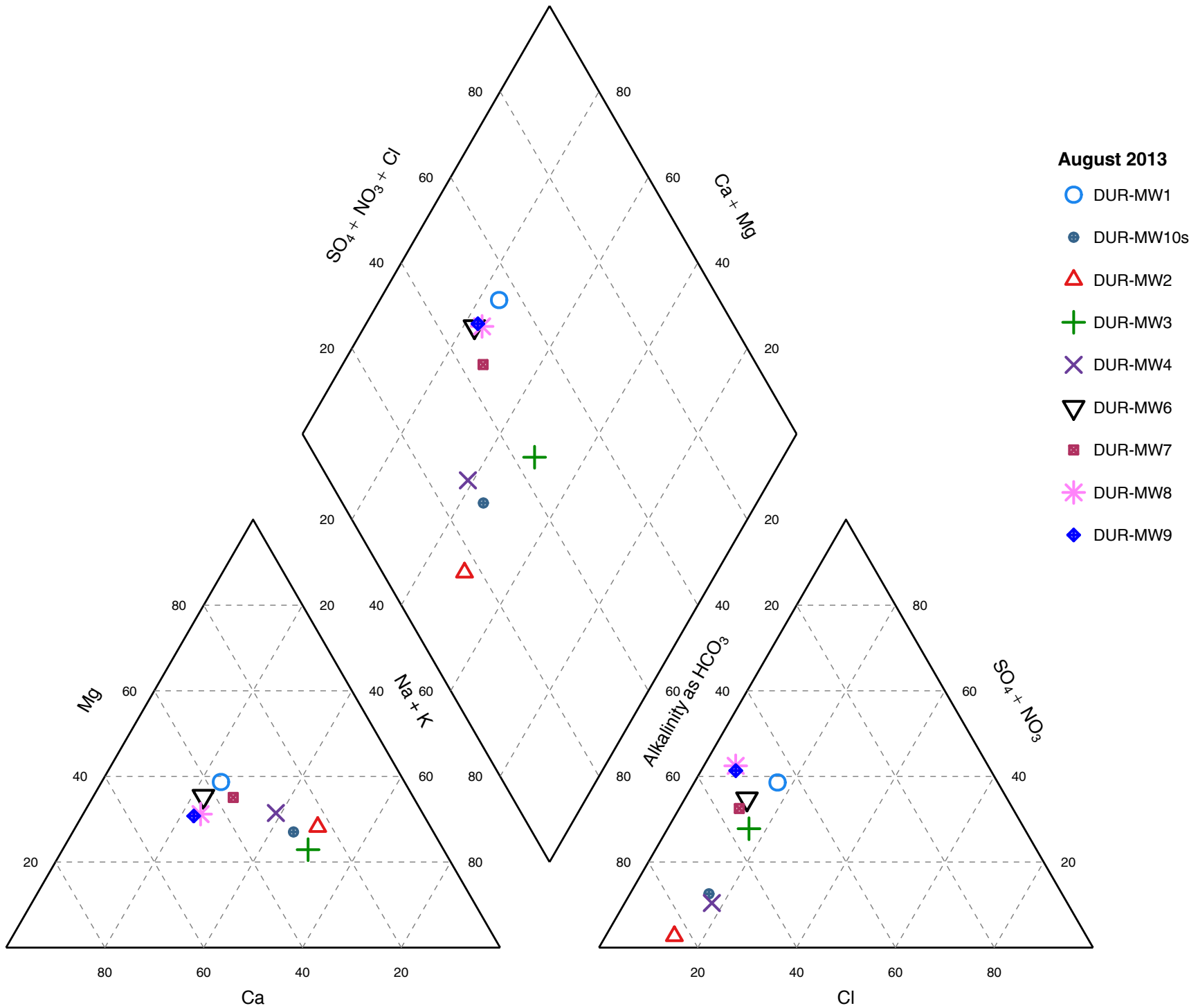

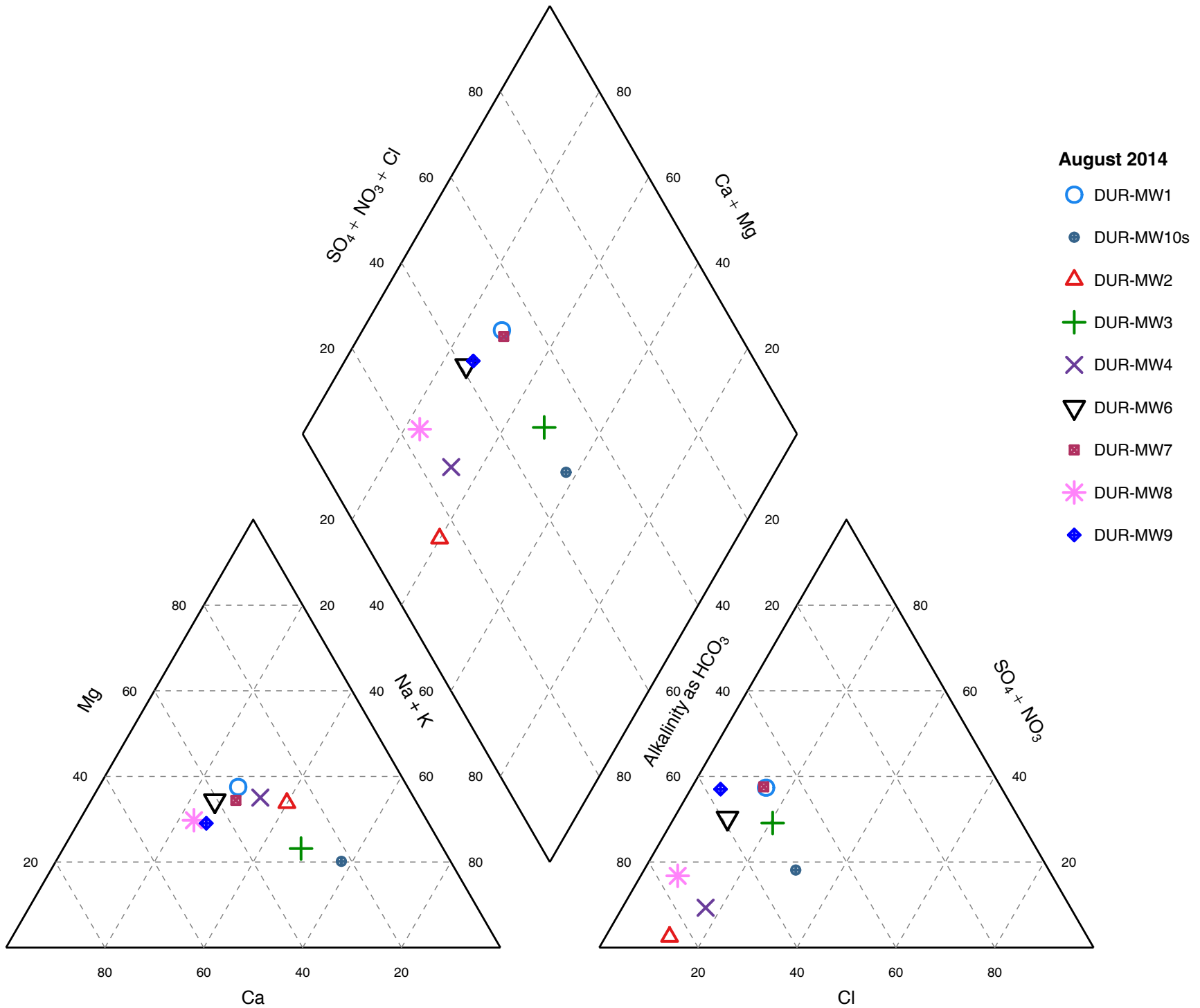

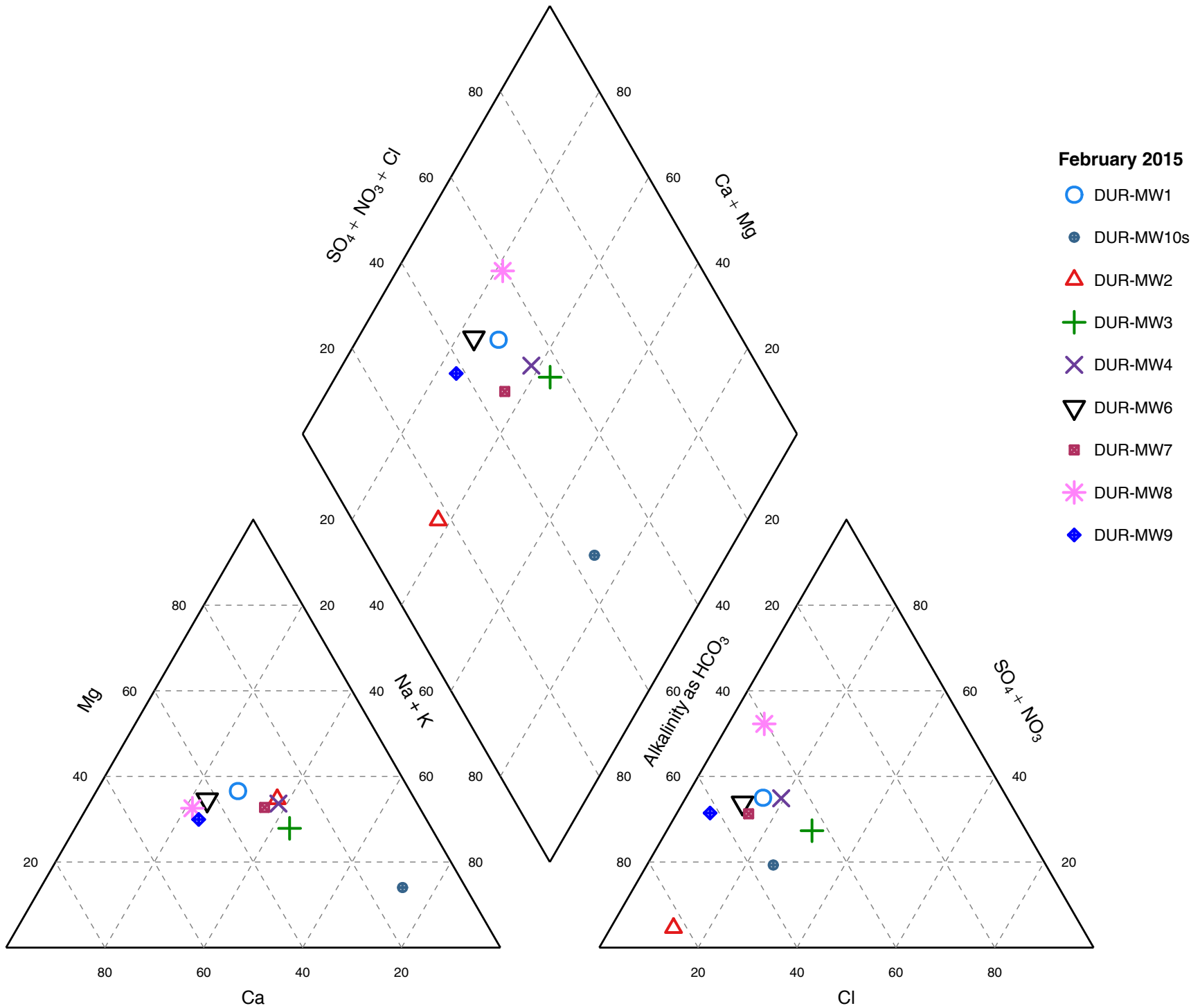

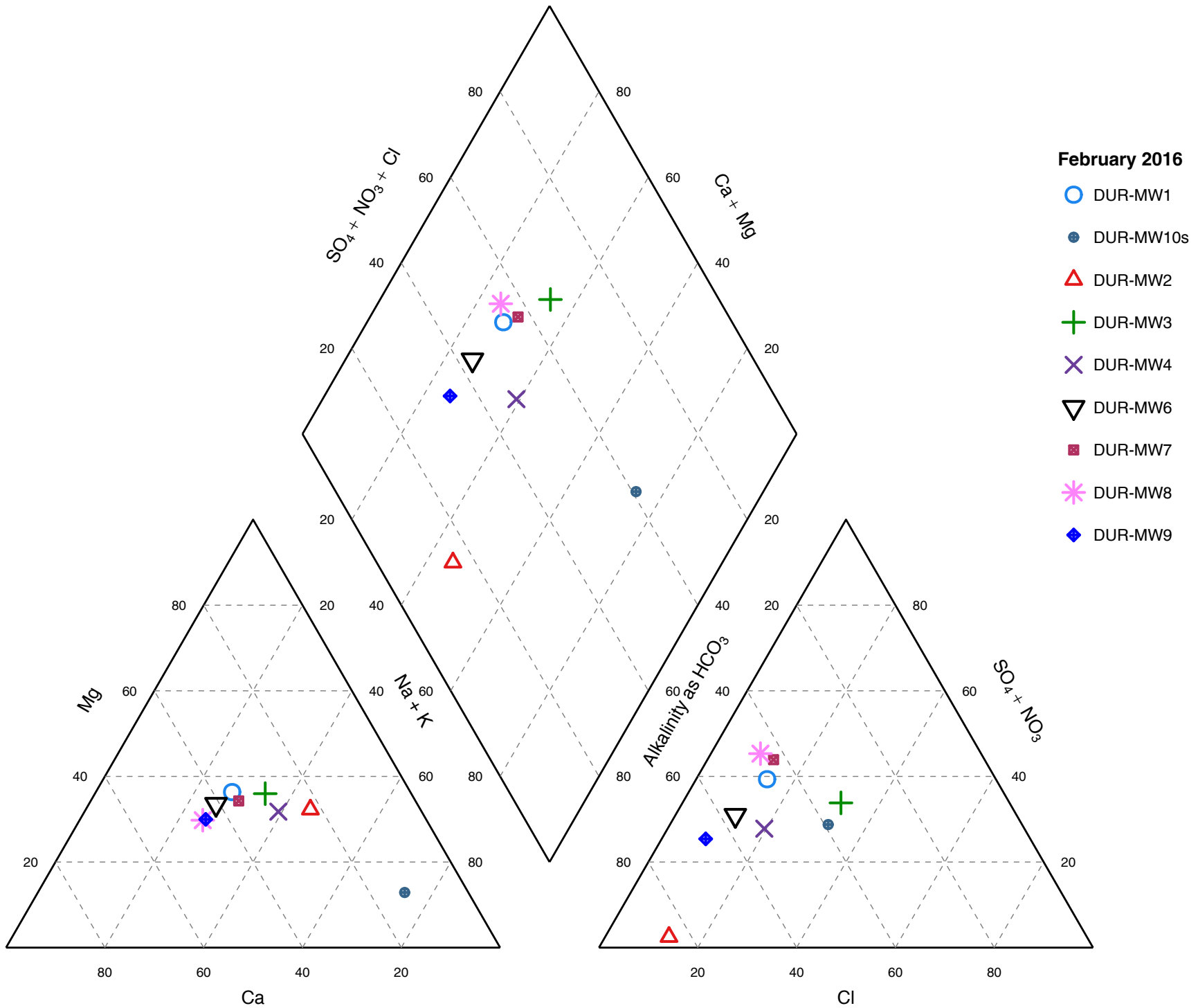

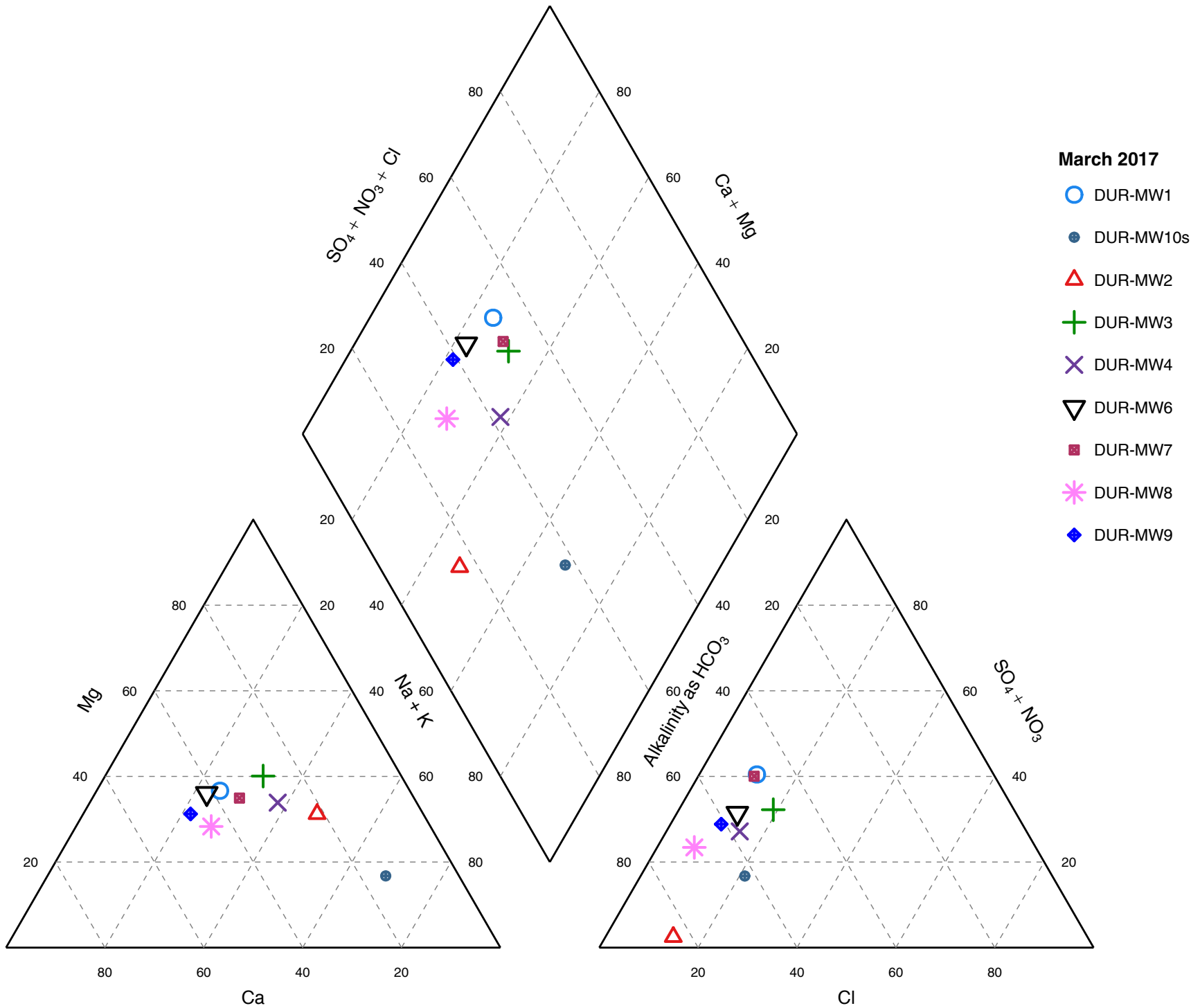

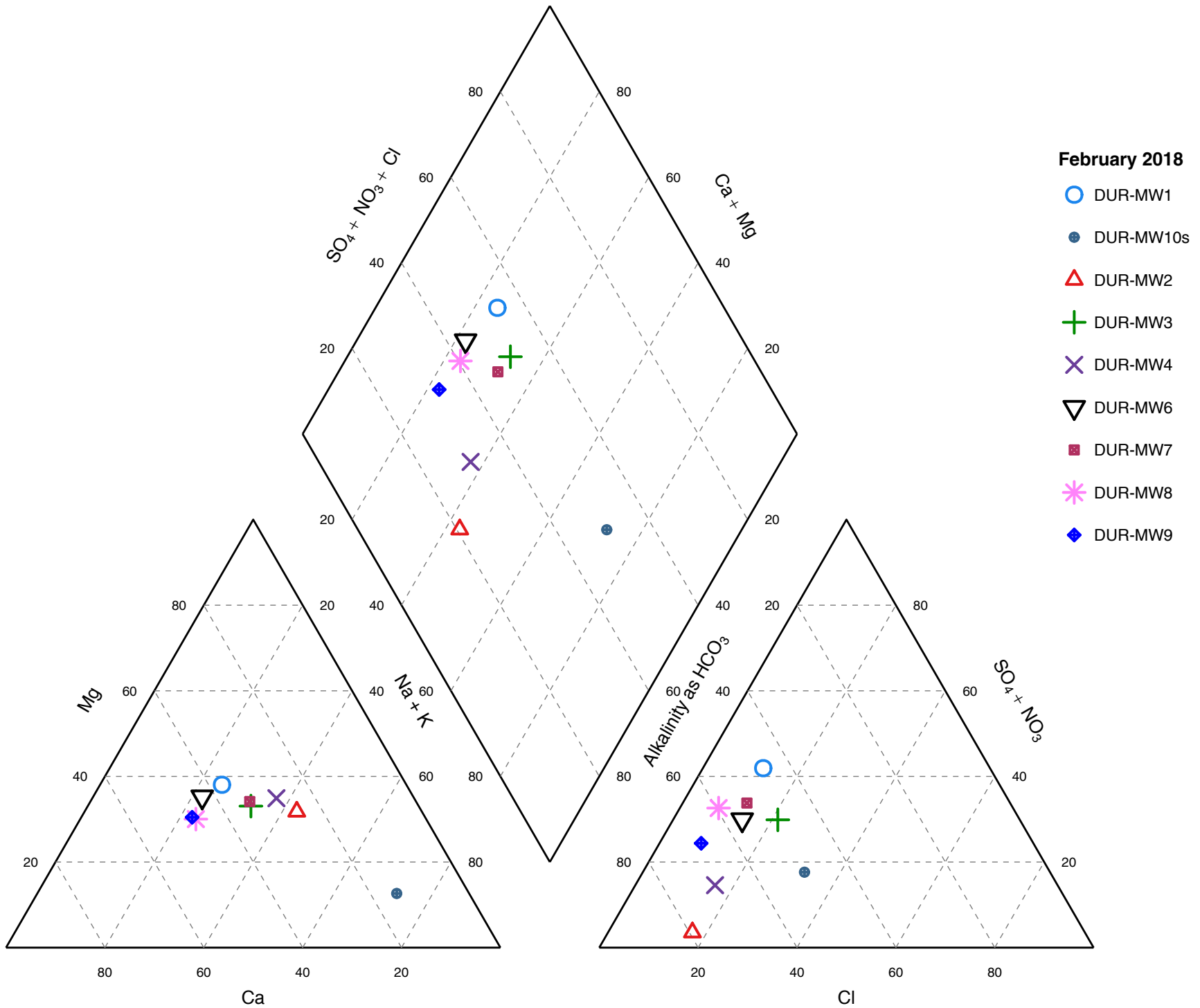

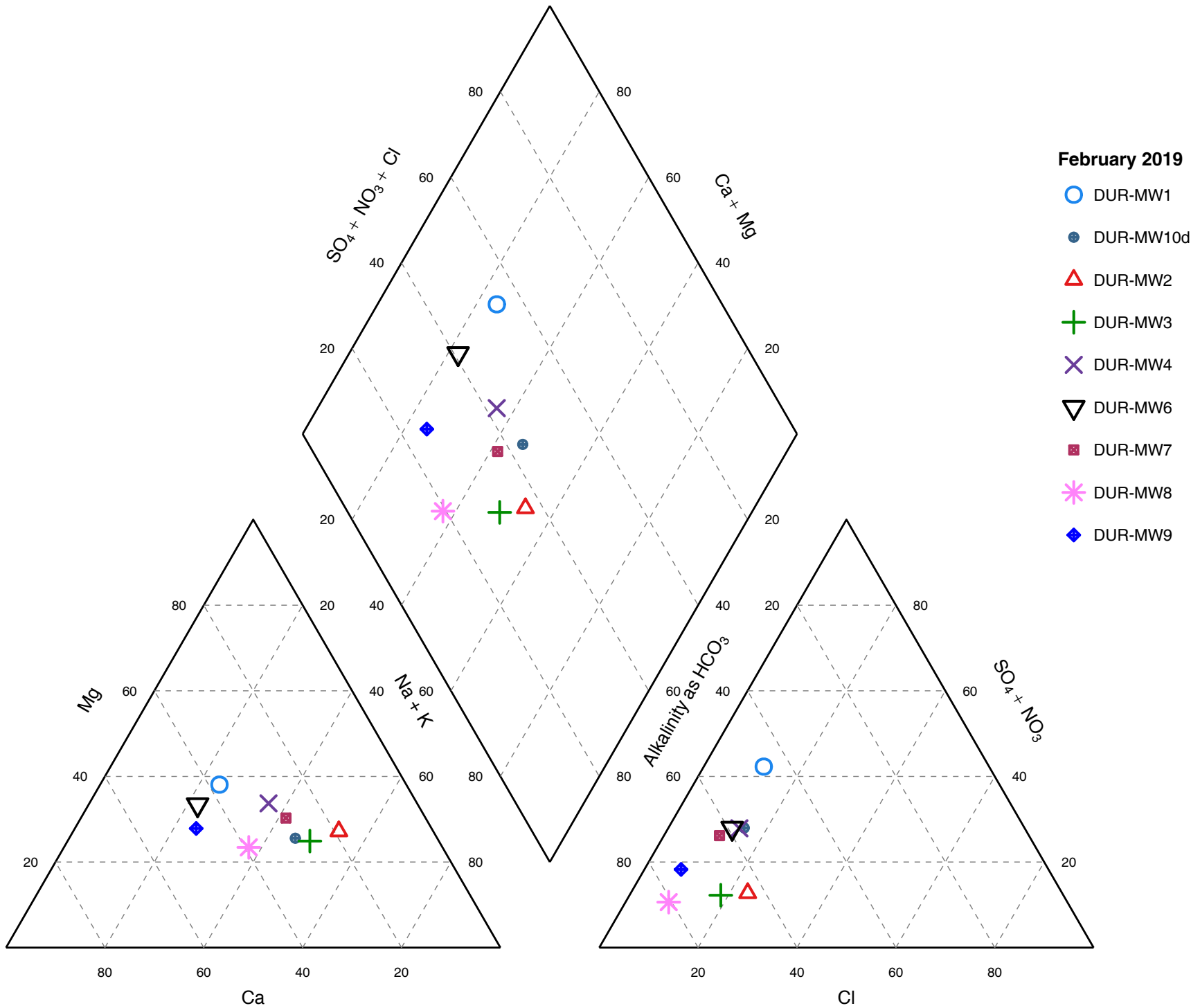

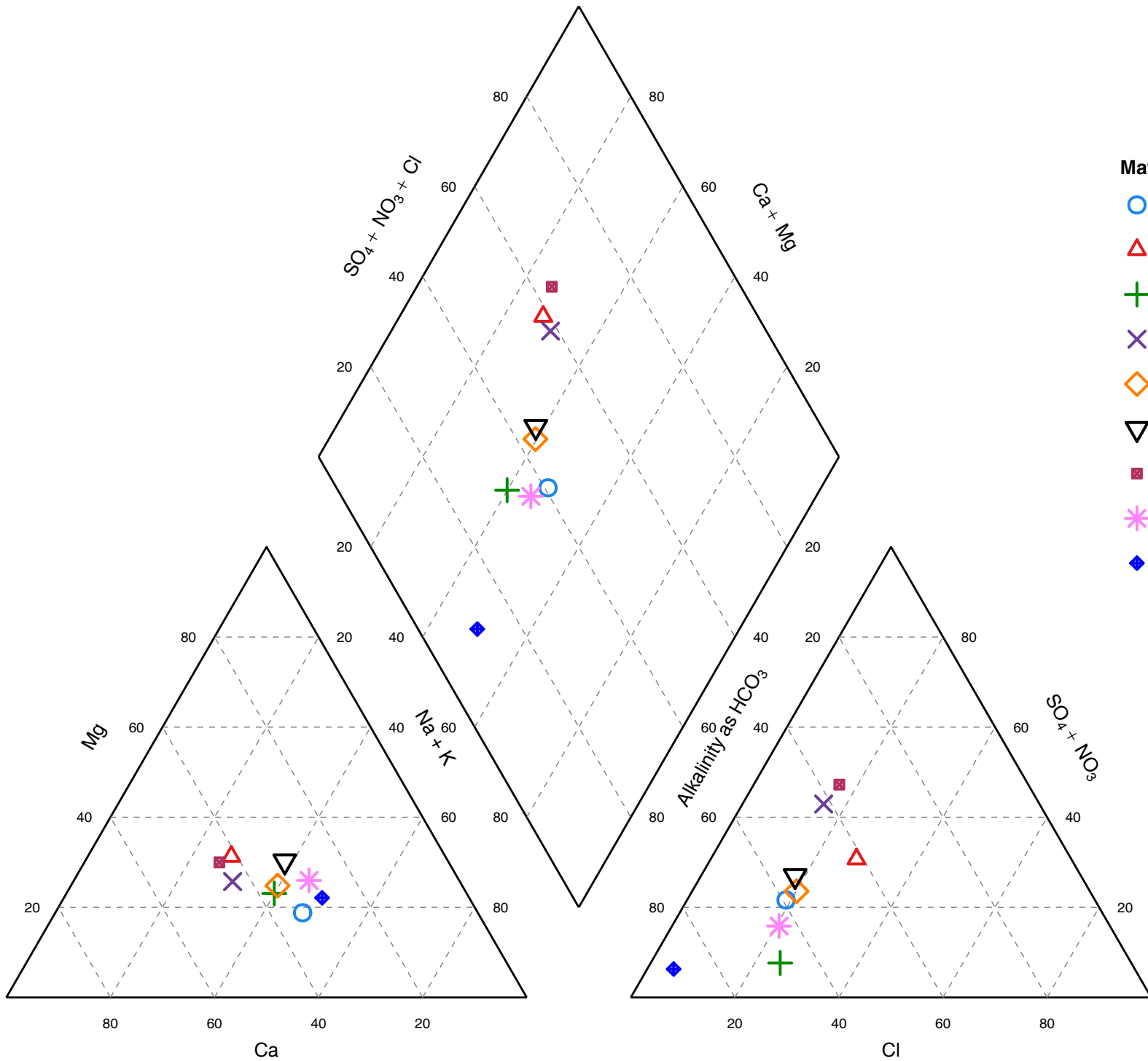

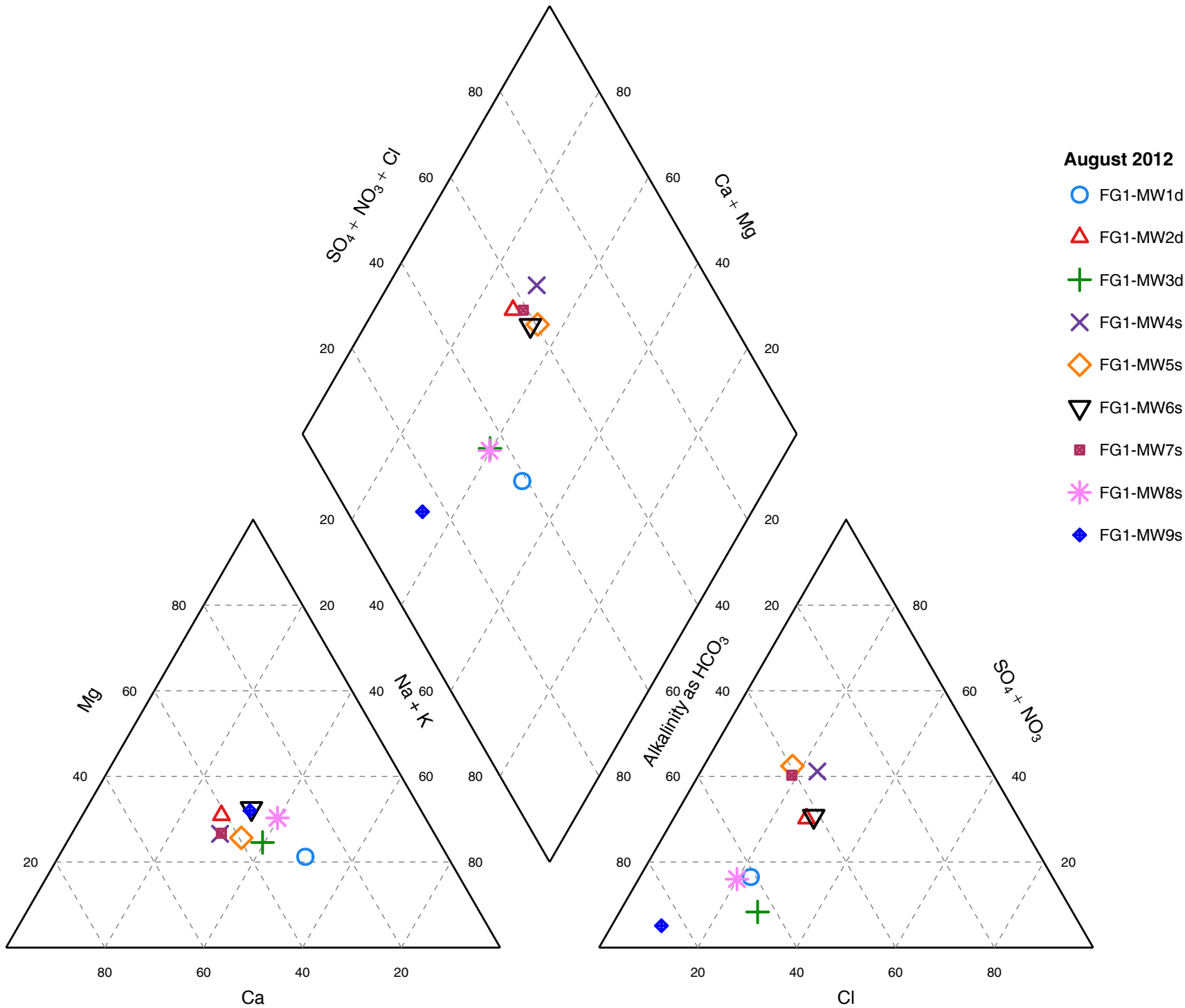

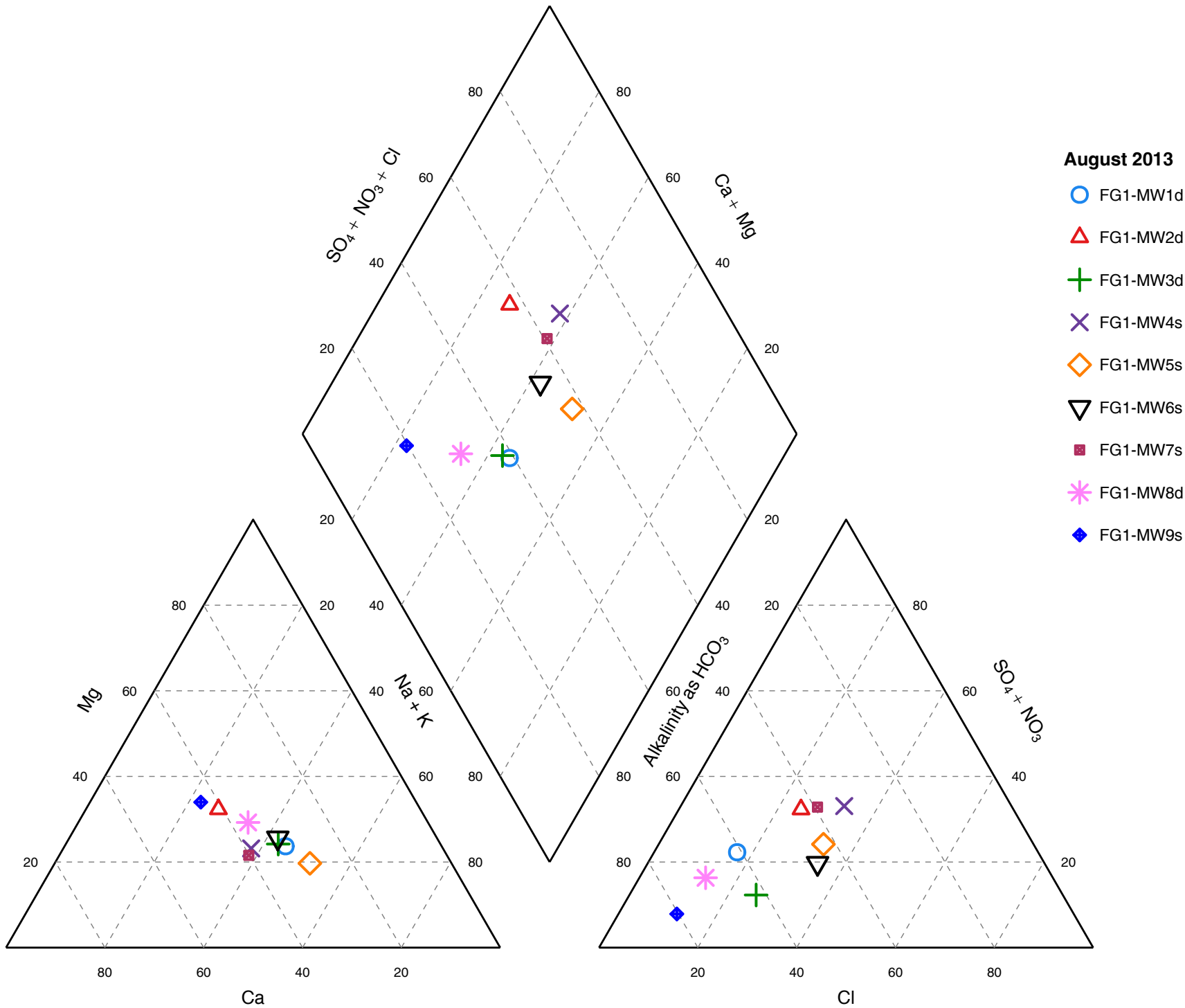

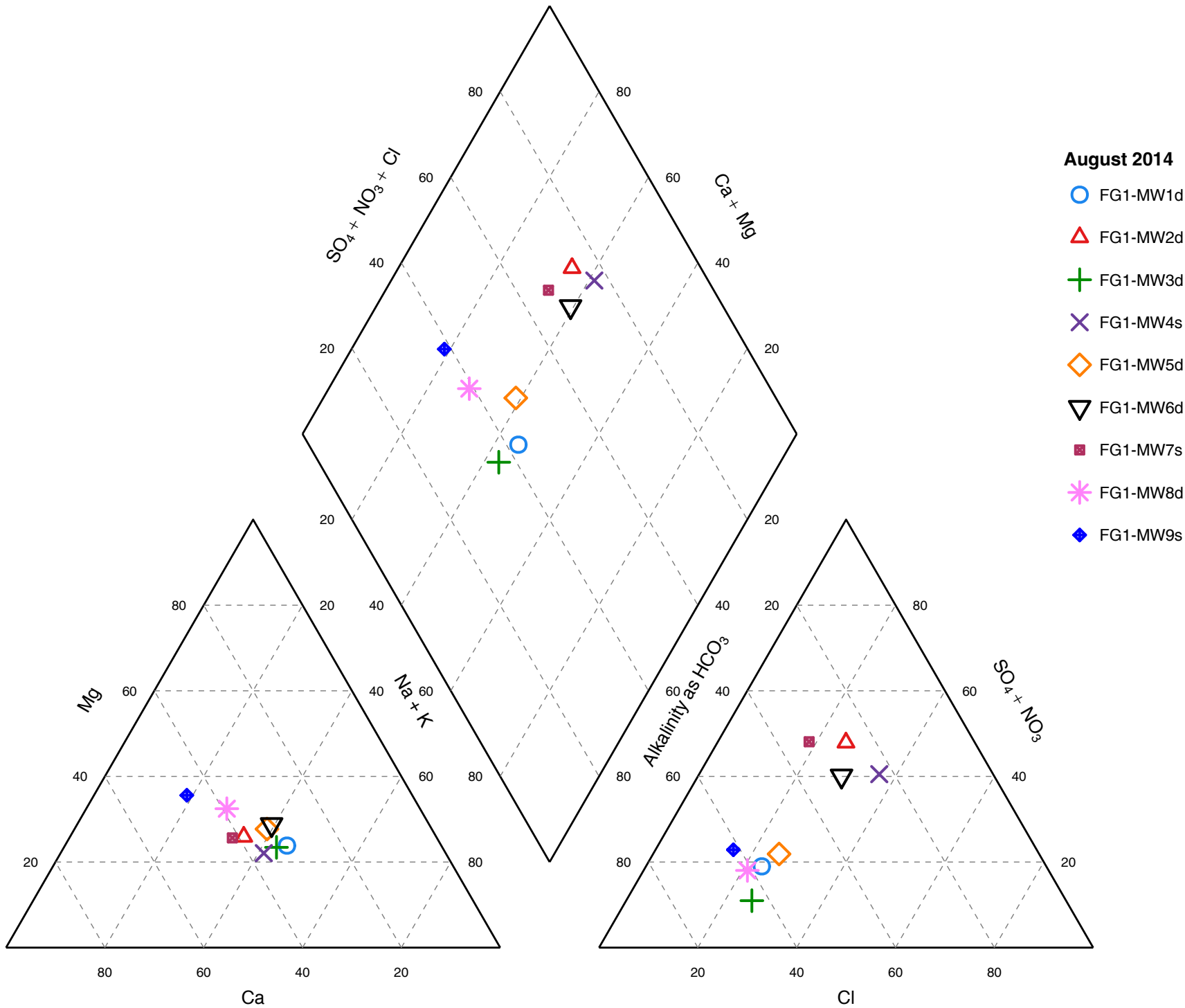

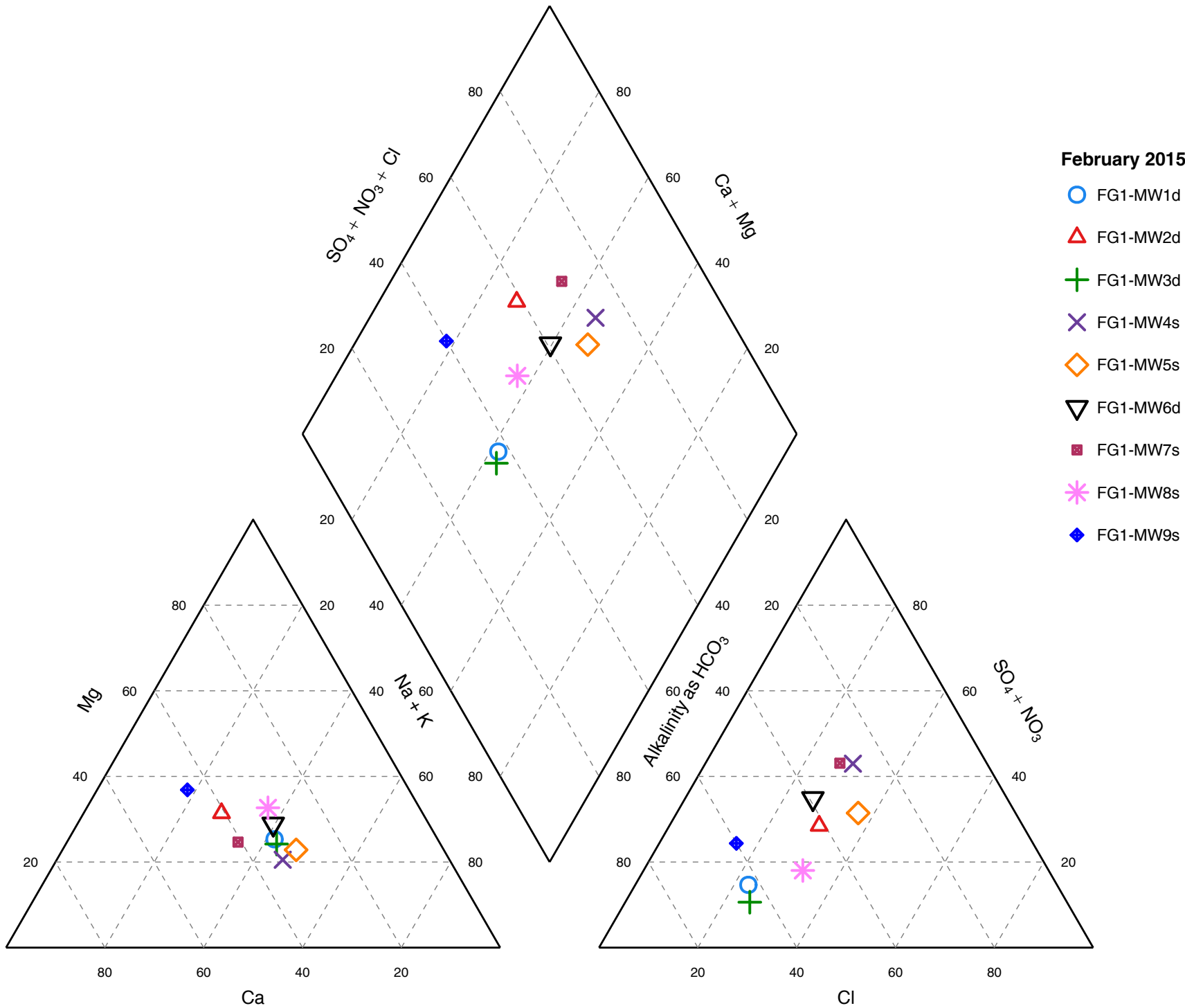

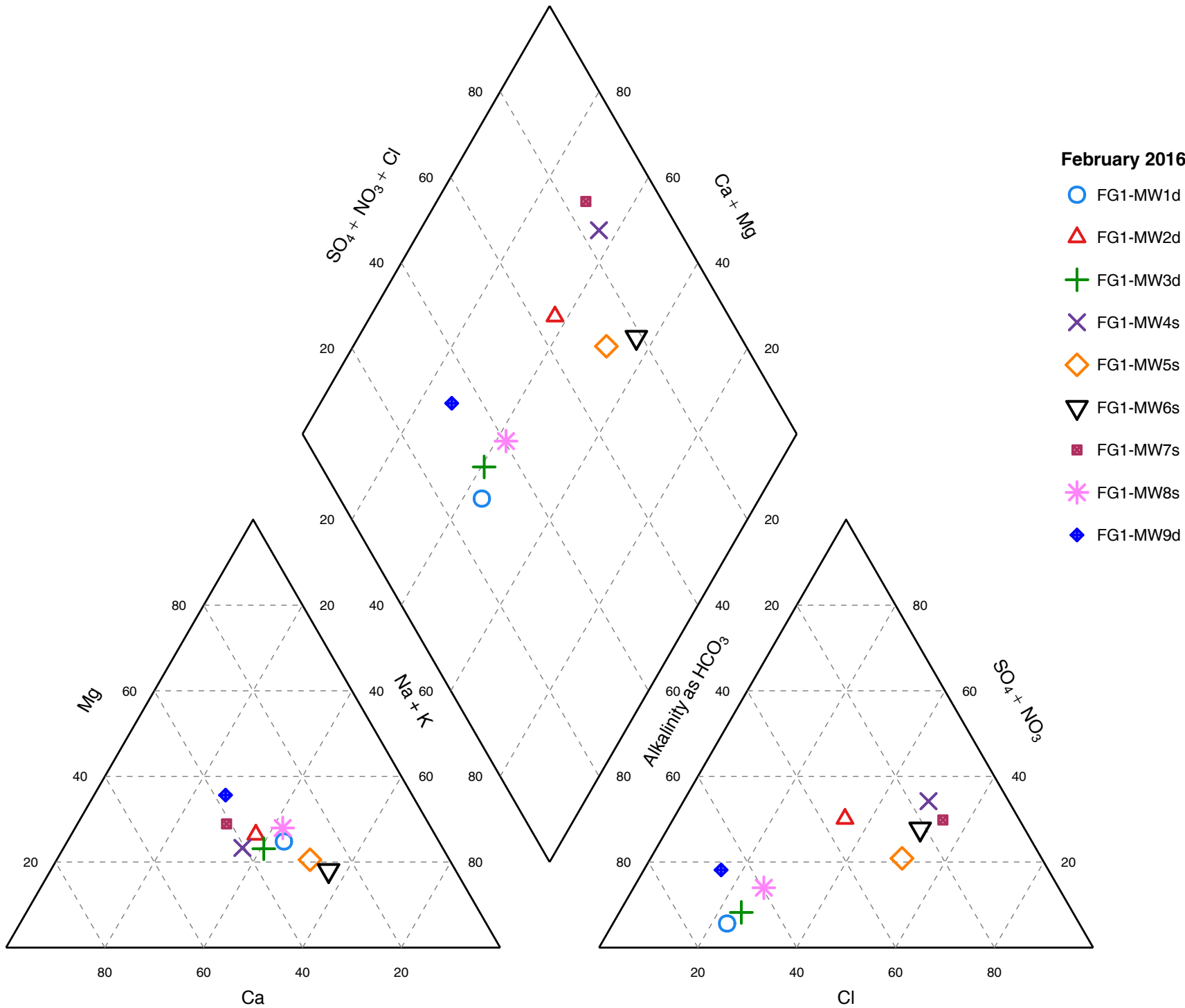

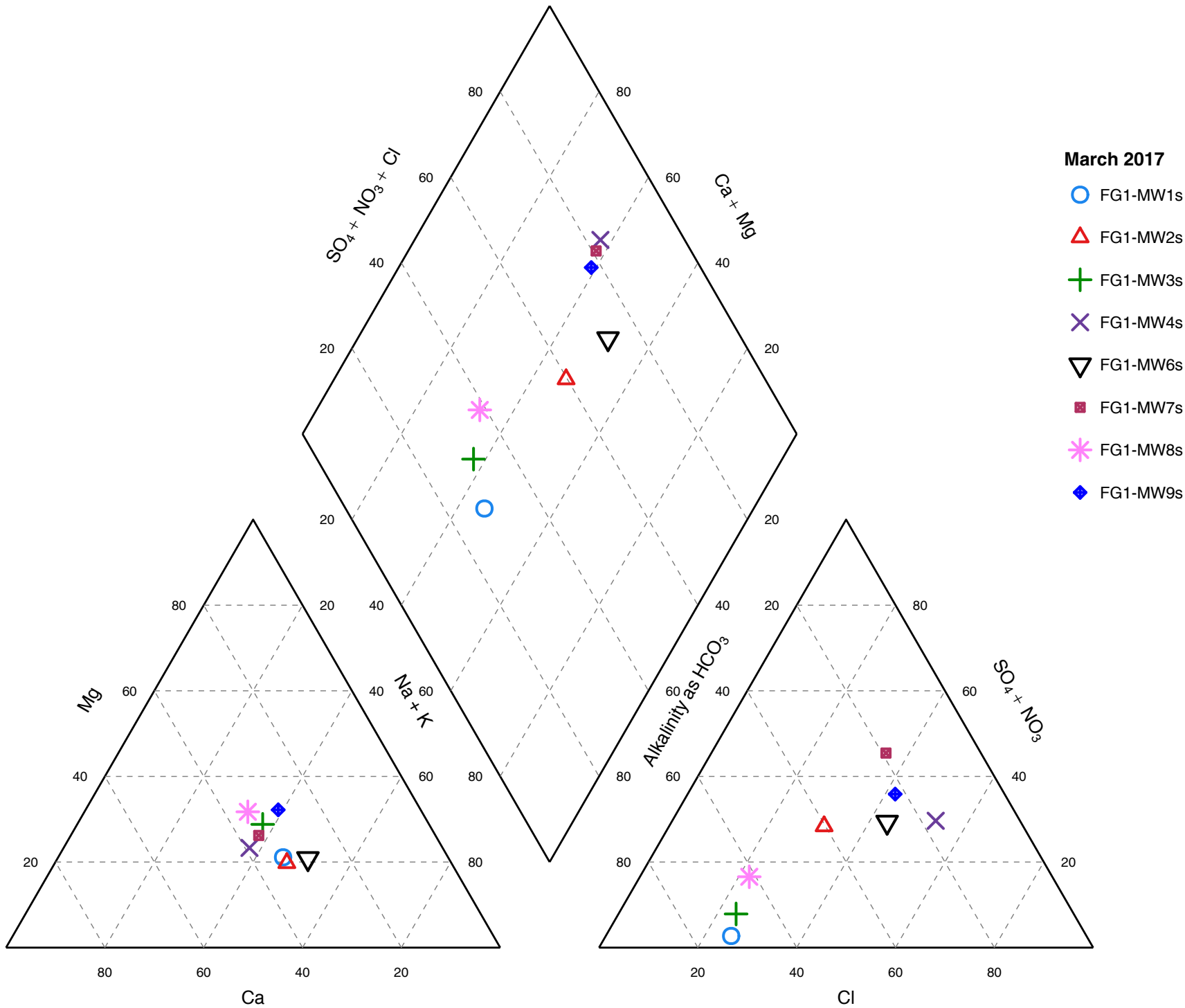

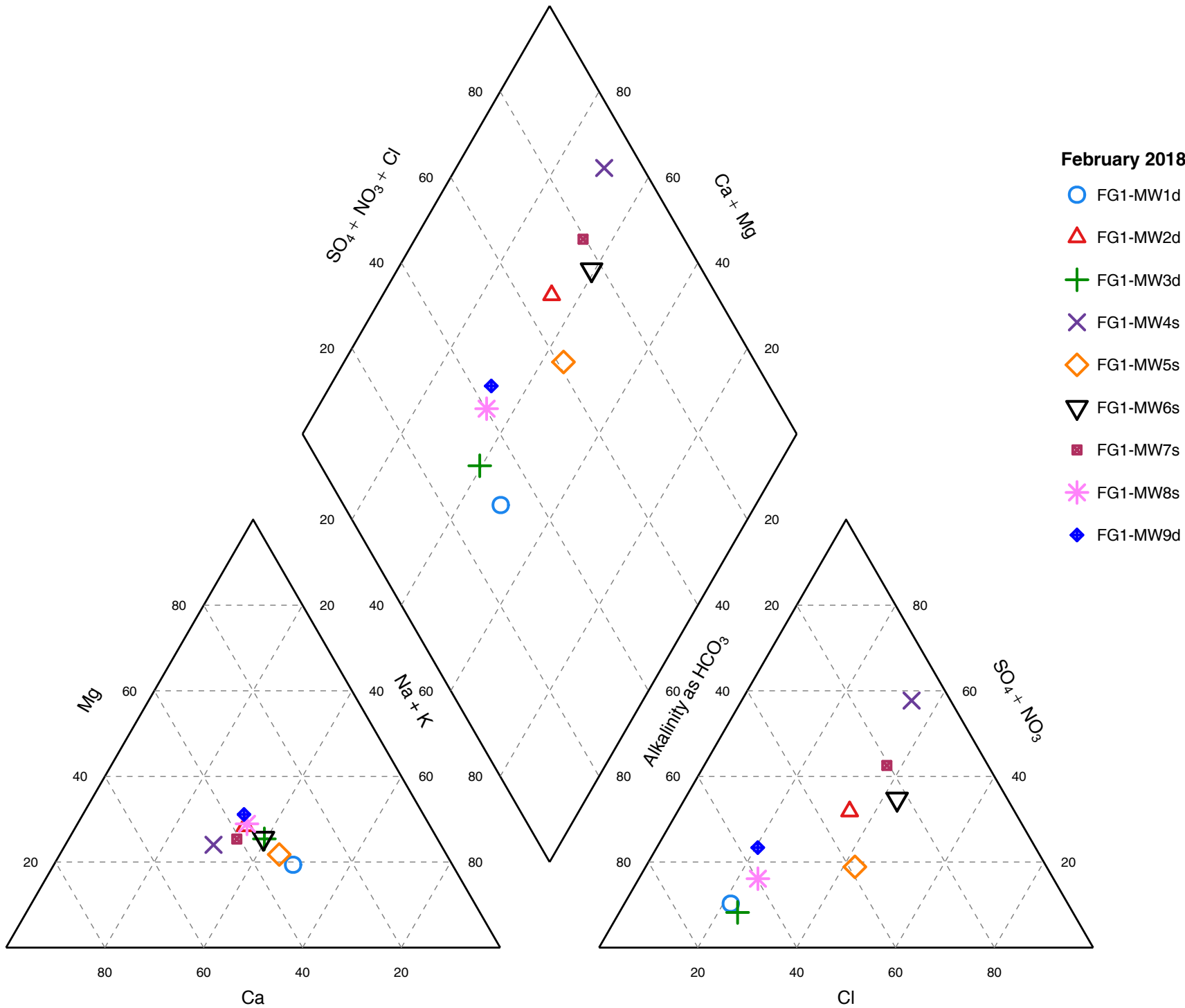

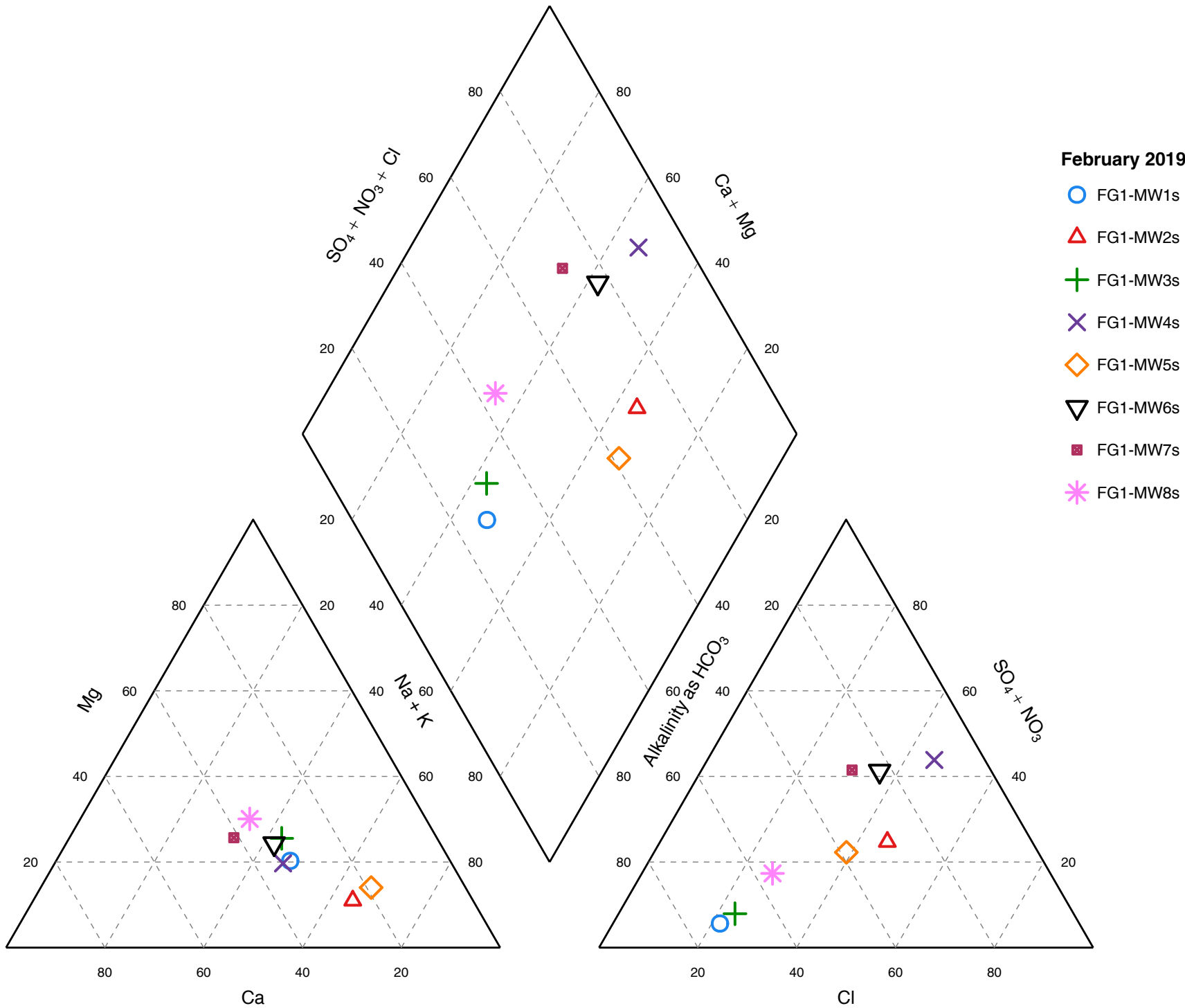

March 2019

◆ FG1-MW9d

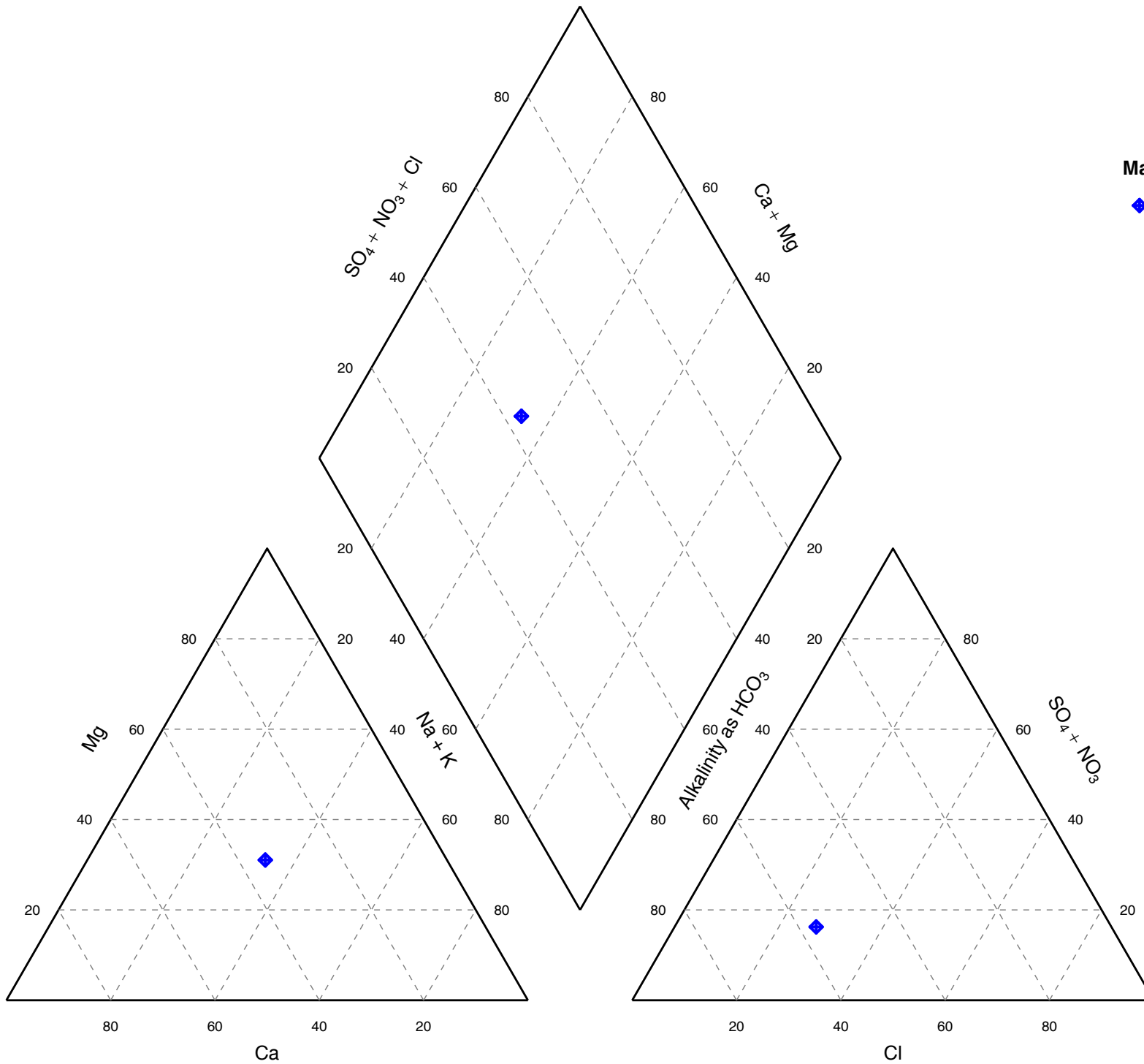

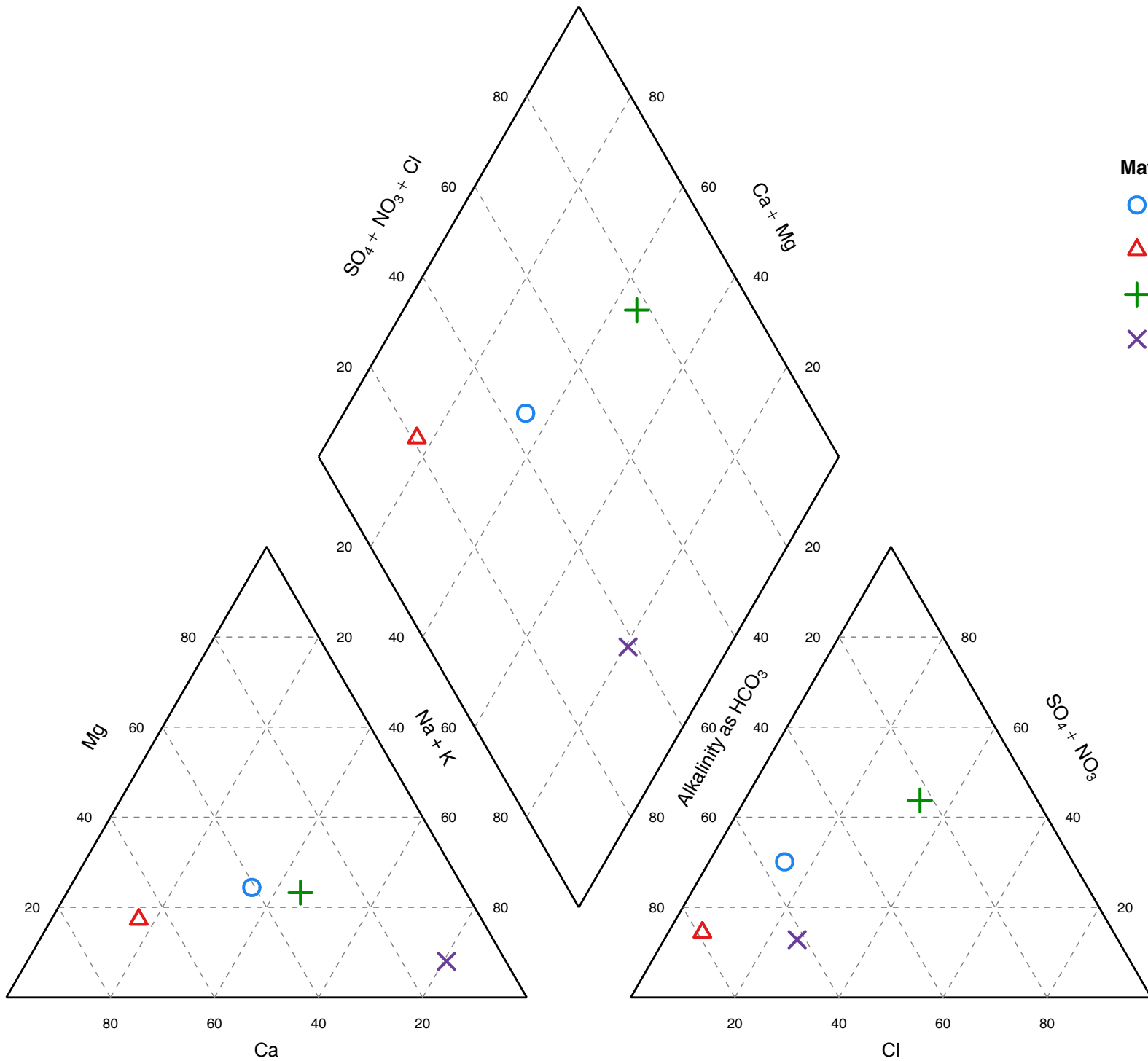

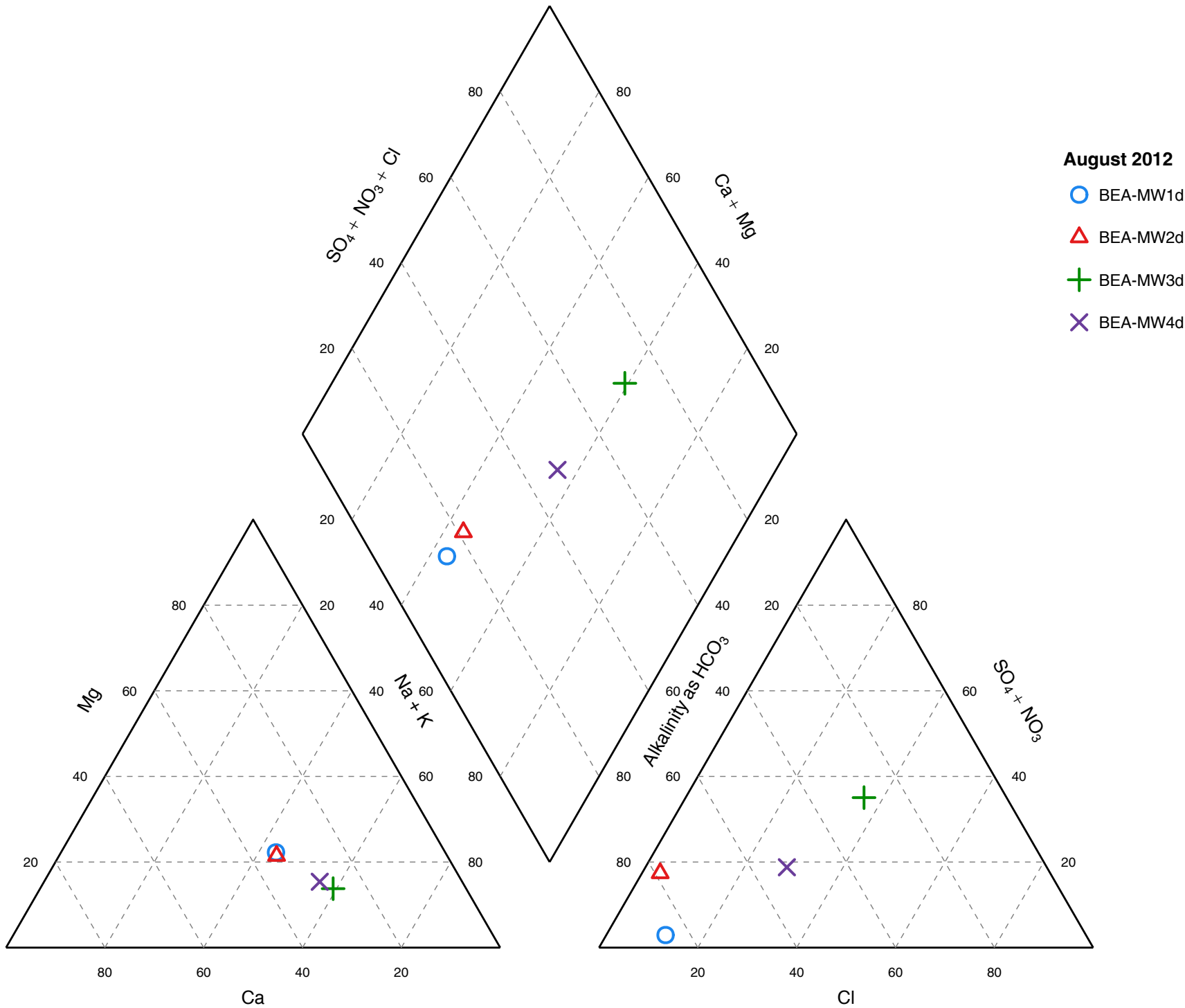

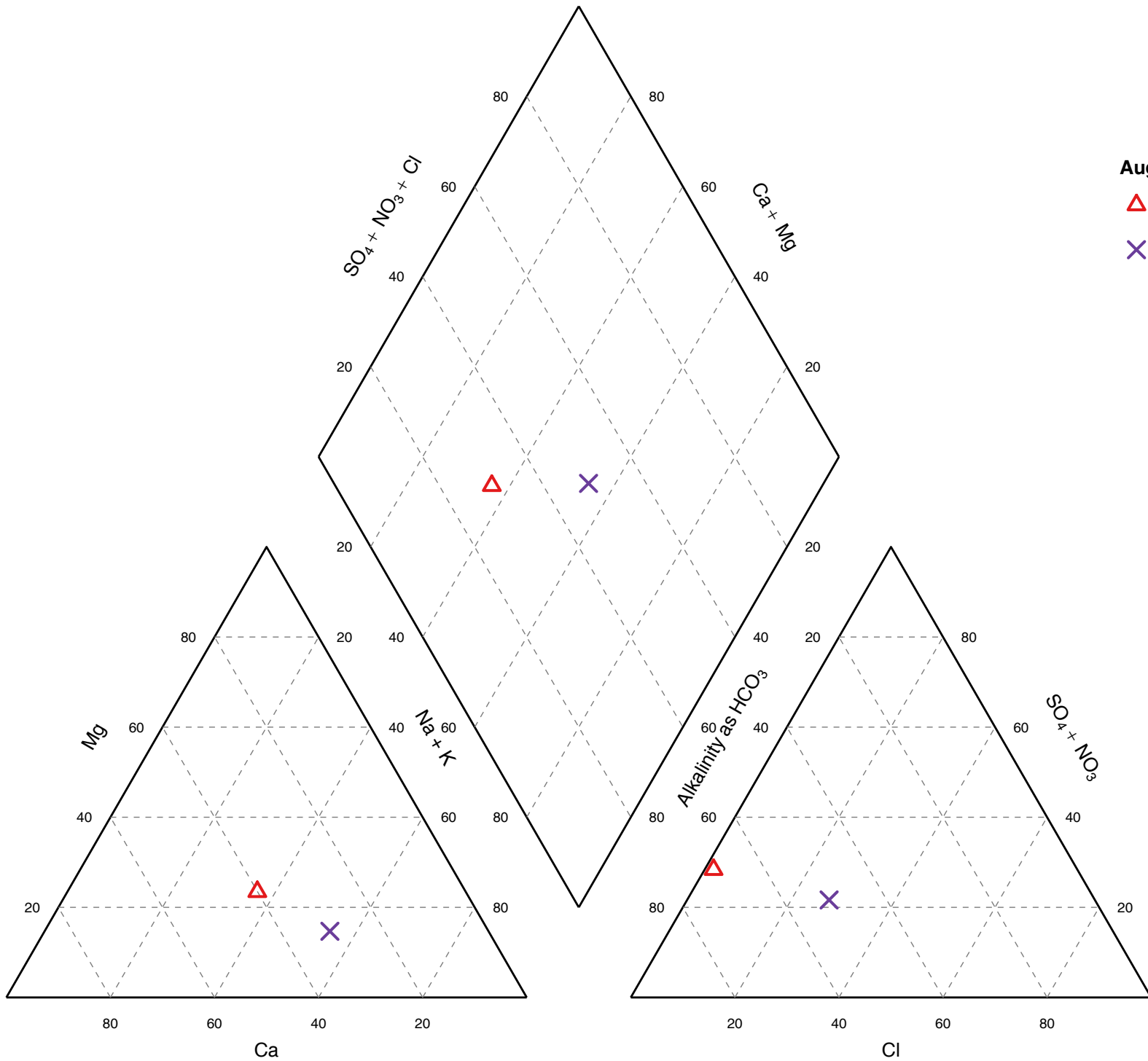

August 2013

△ BEA-MW2d

× BEA-MW4d

August 2014

✕ BEA-MW4d

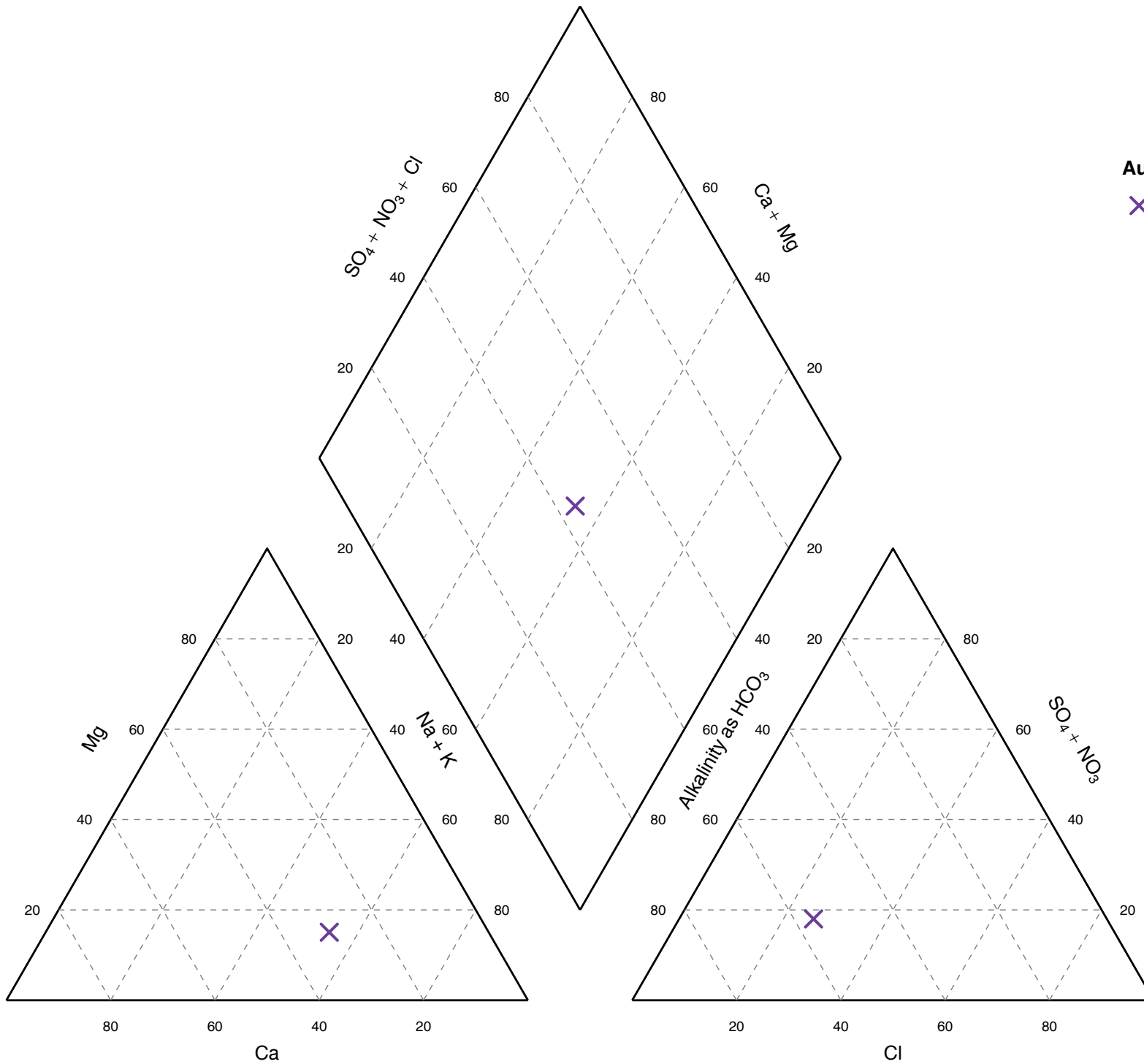

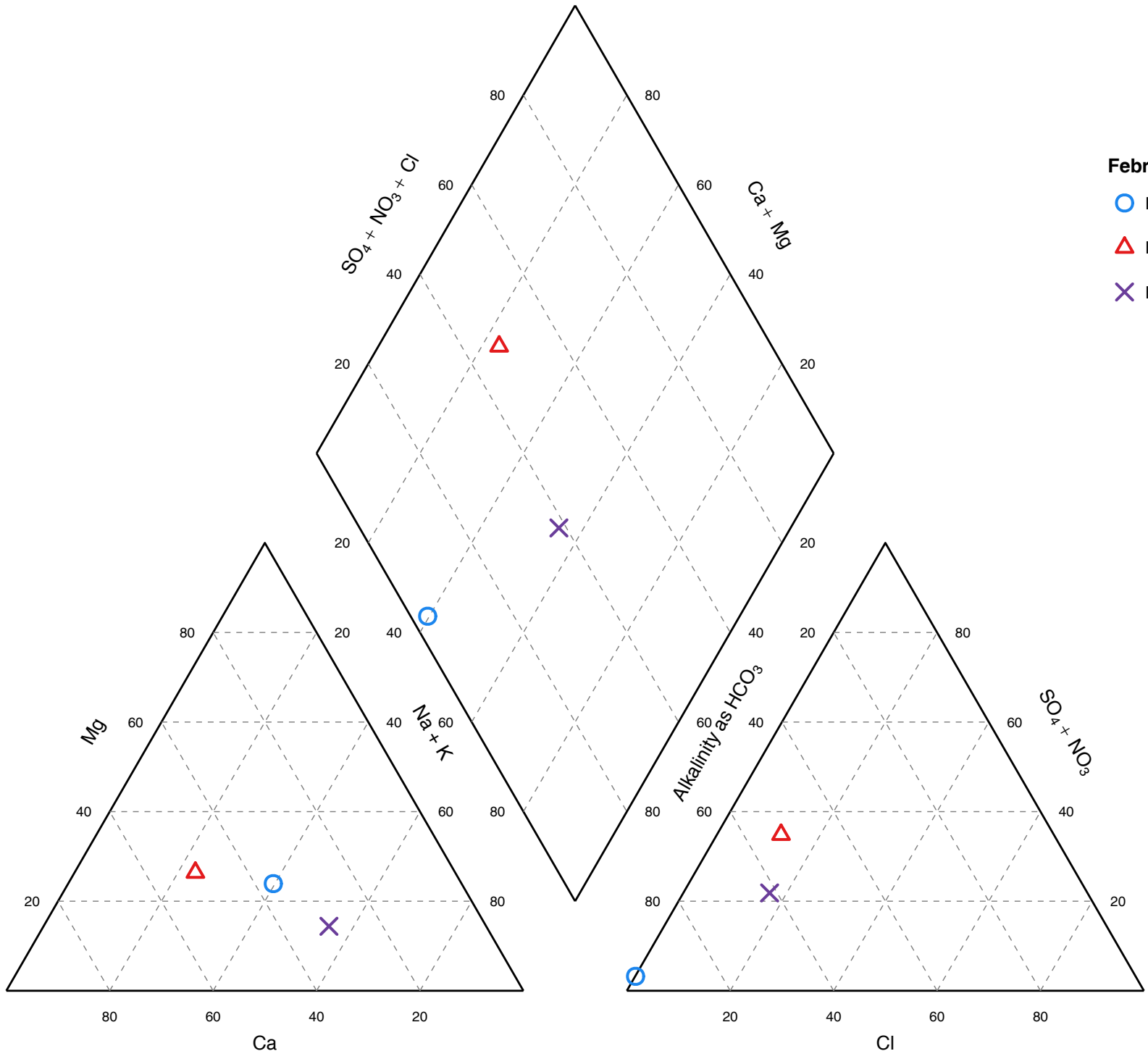

February 2015

- BEA-MW1dd
- △ BEA-MW2dd
- × BEA-MW4d

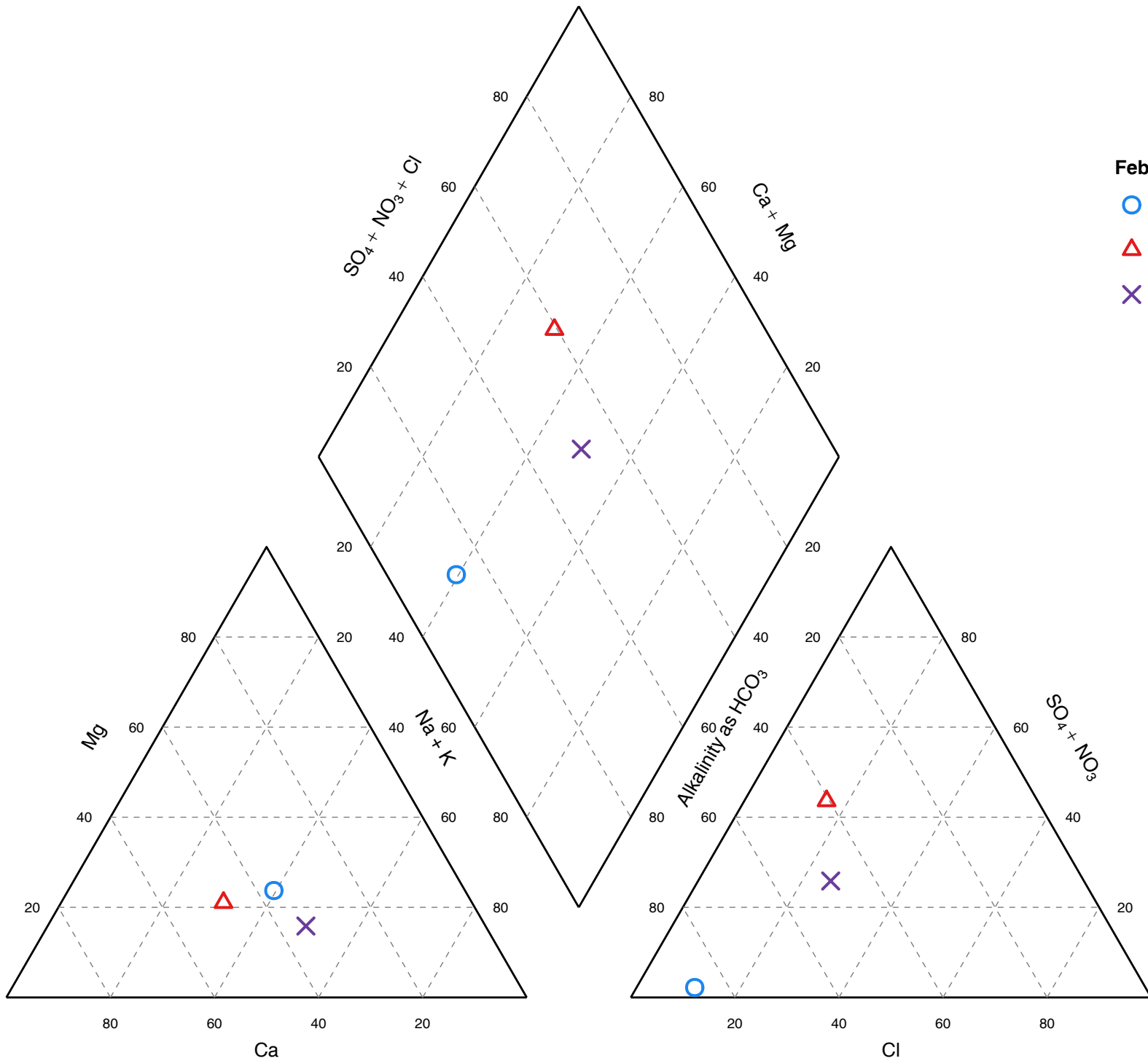

February 2016

○ BEA-MW1dd

△ BEA-MW2dd

× BEA-MW4d

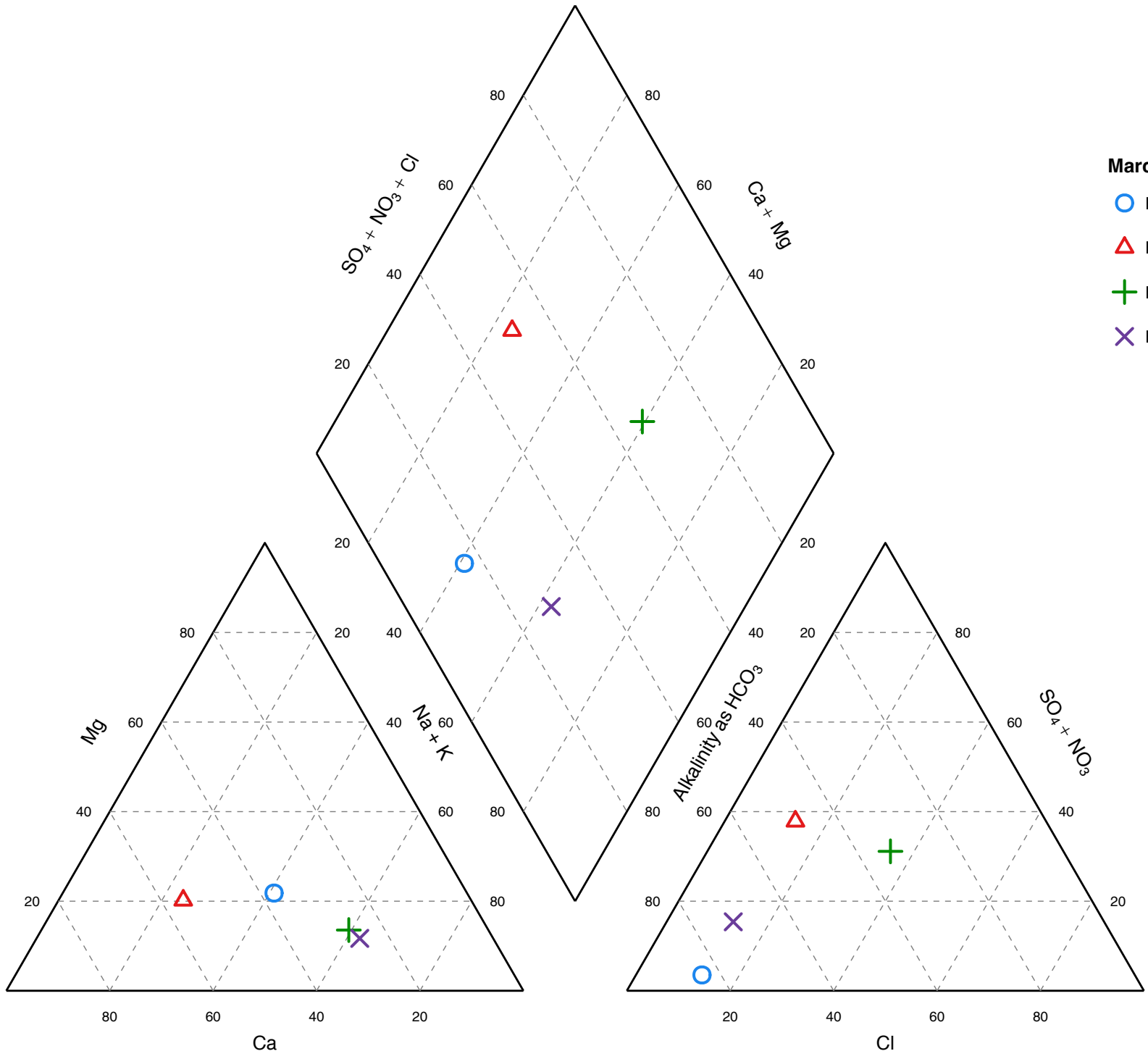

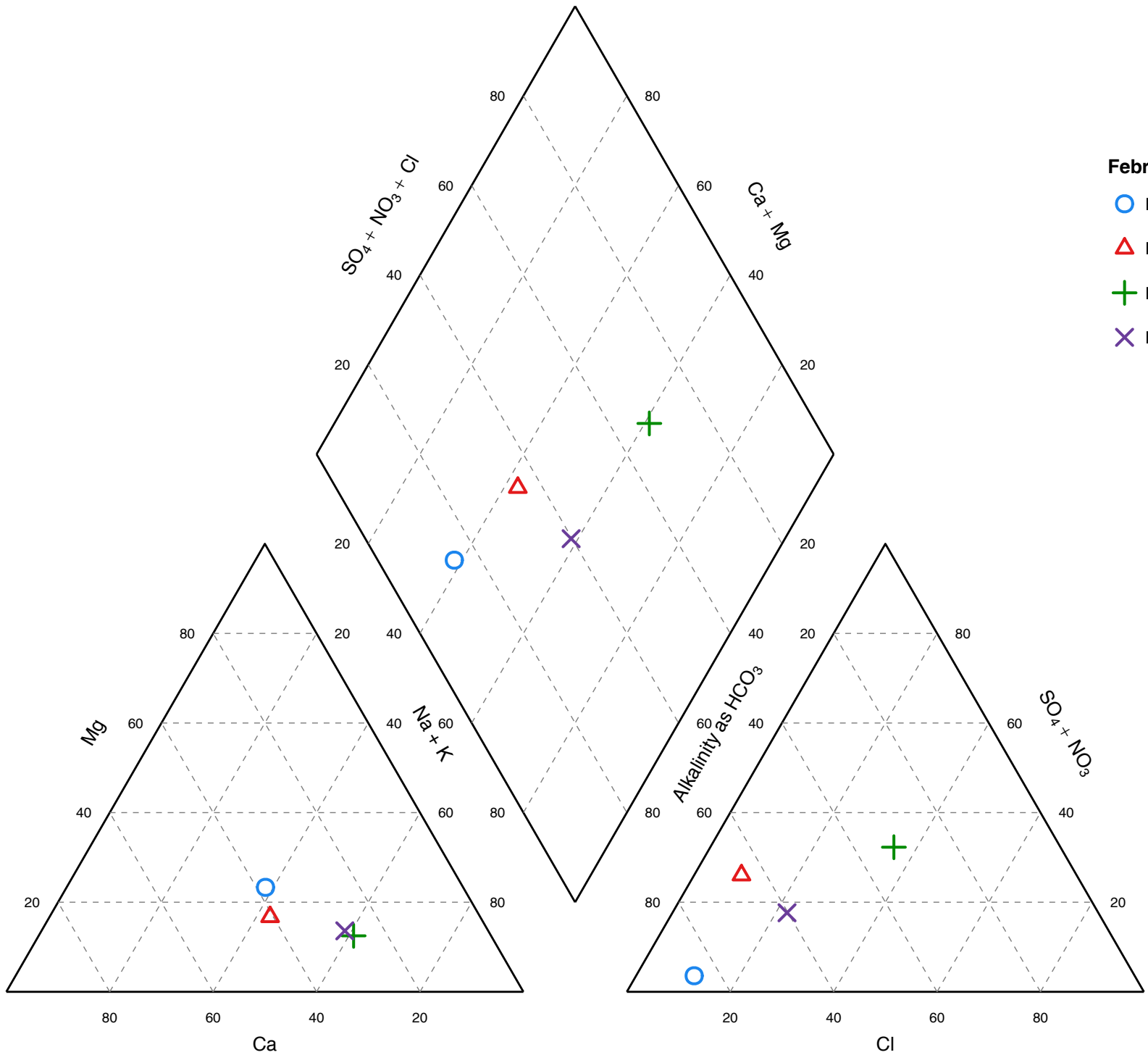

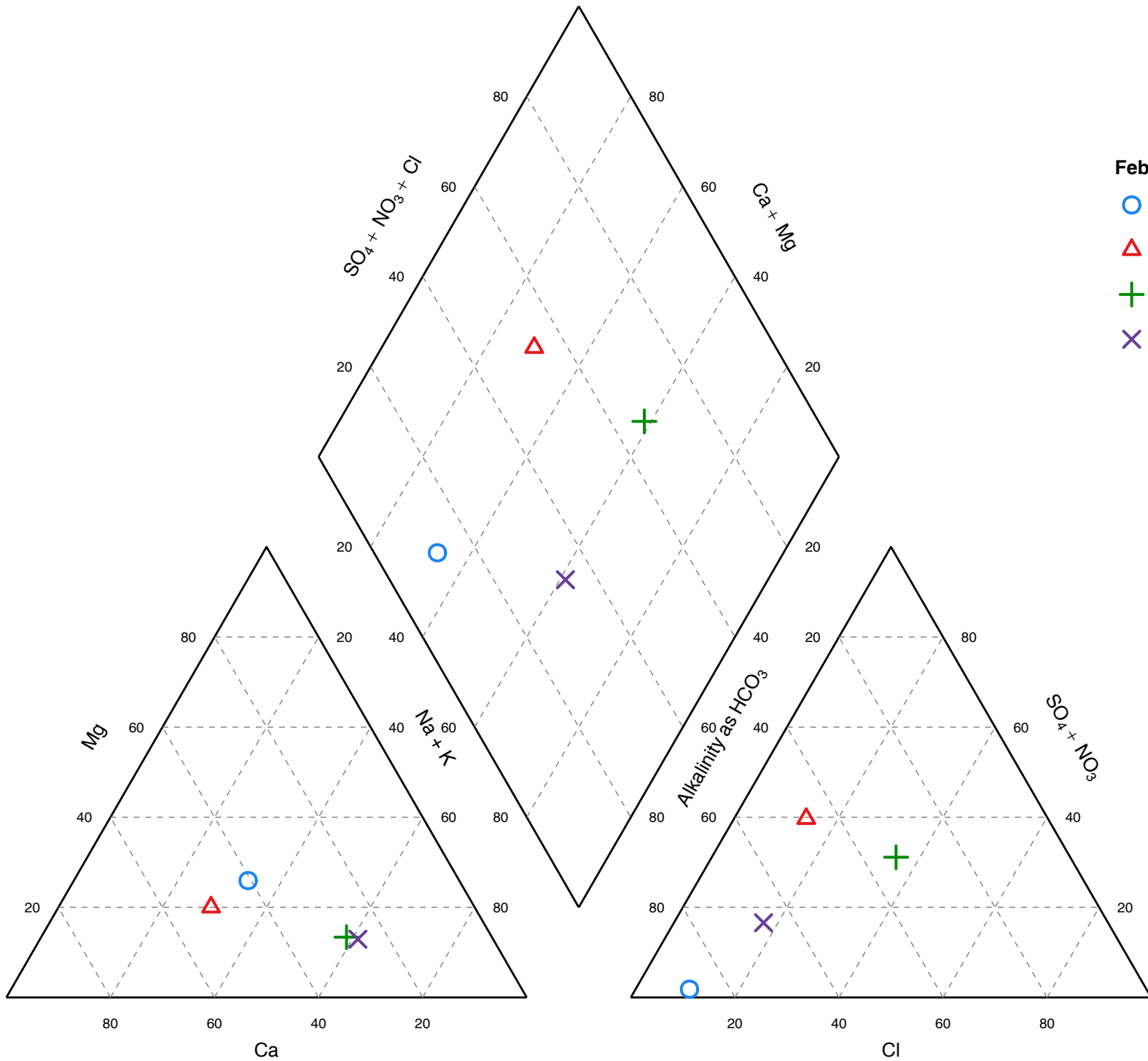

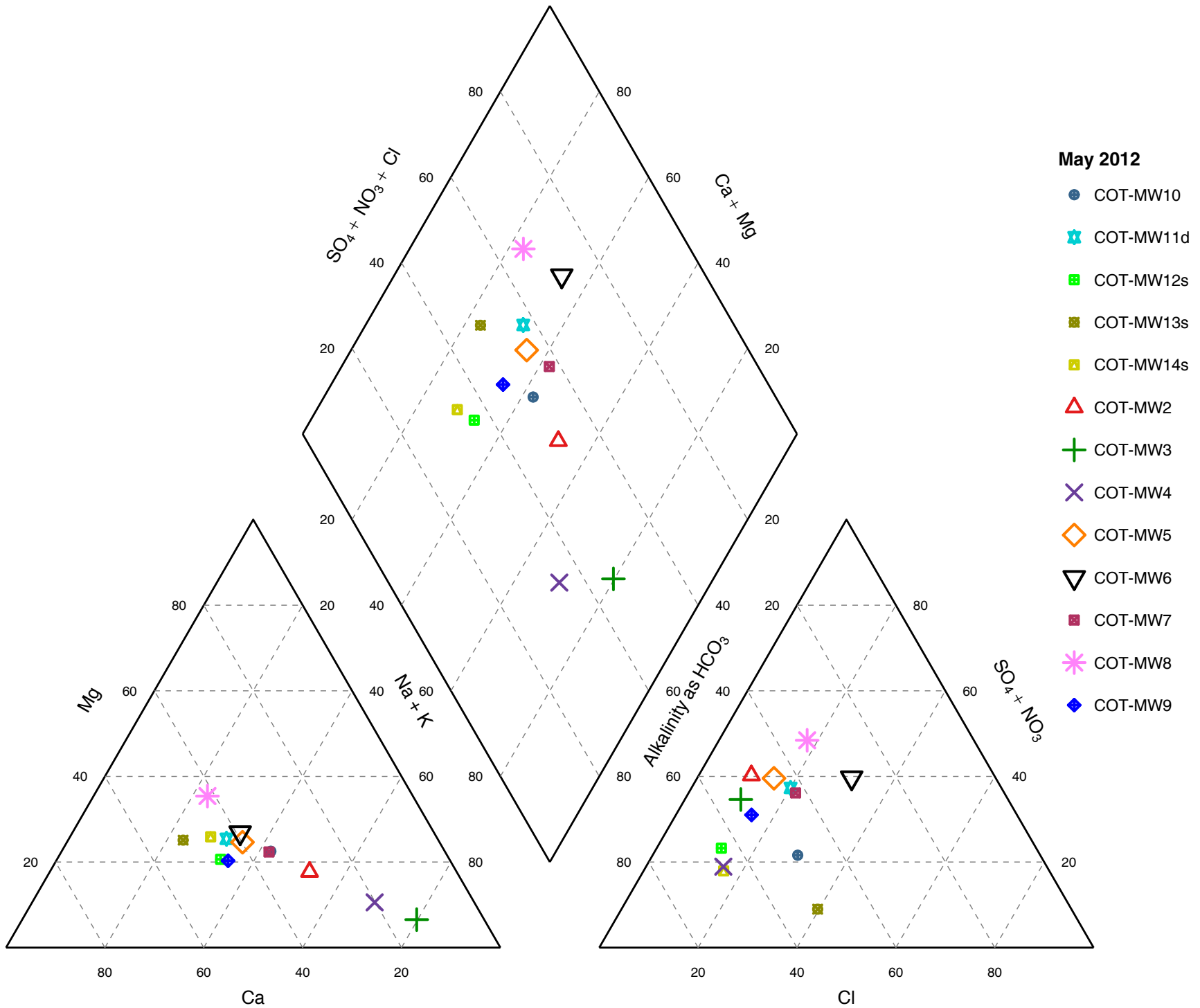

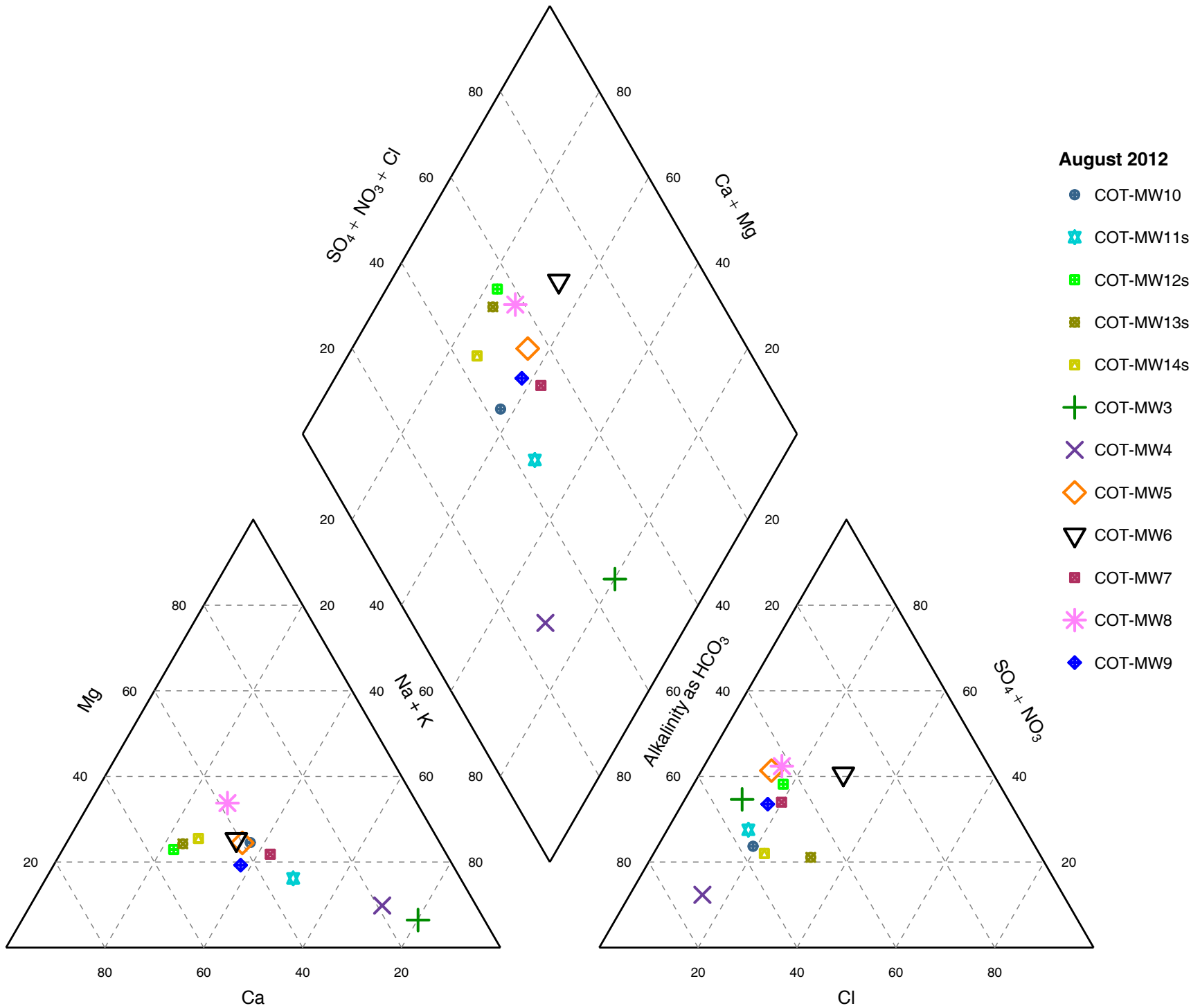

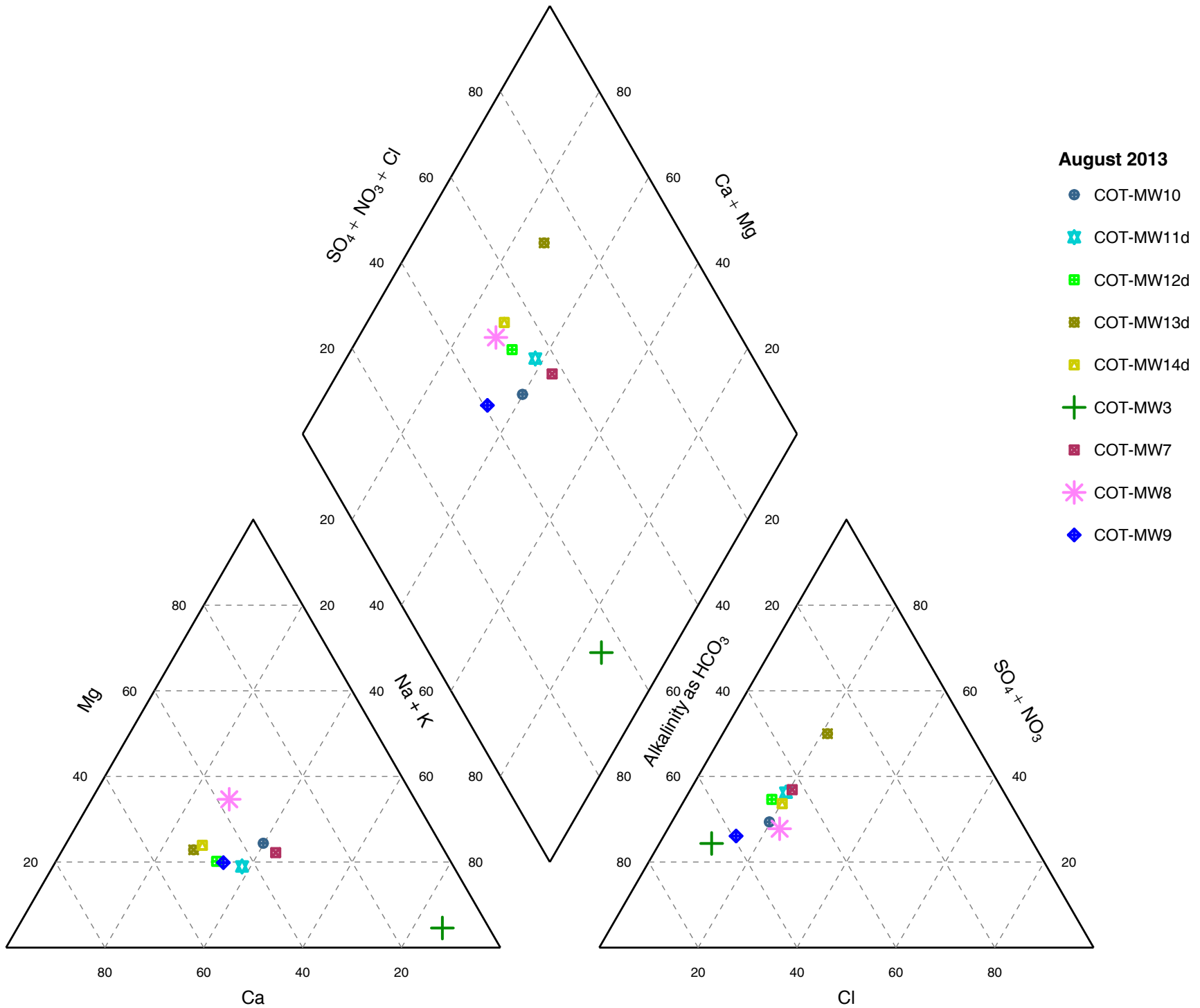

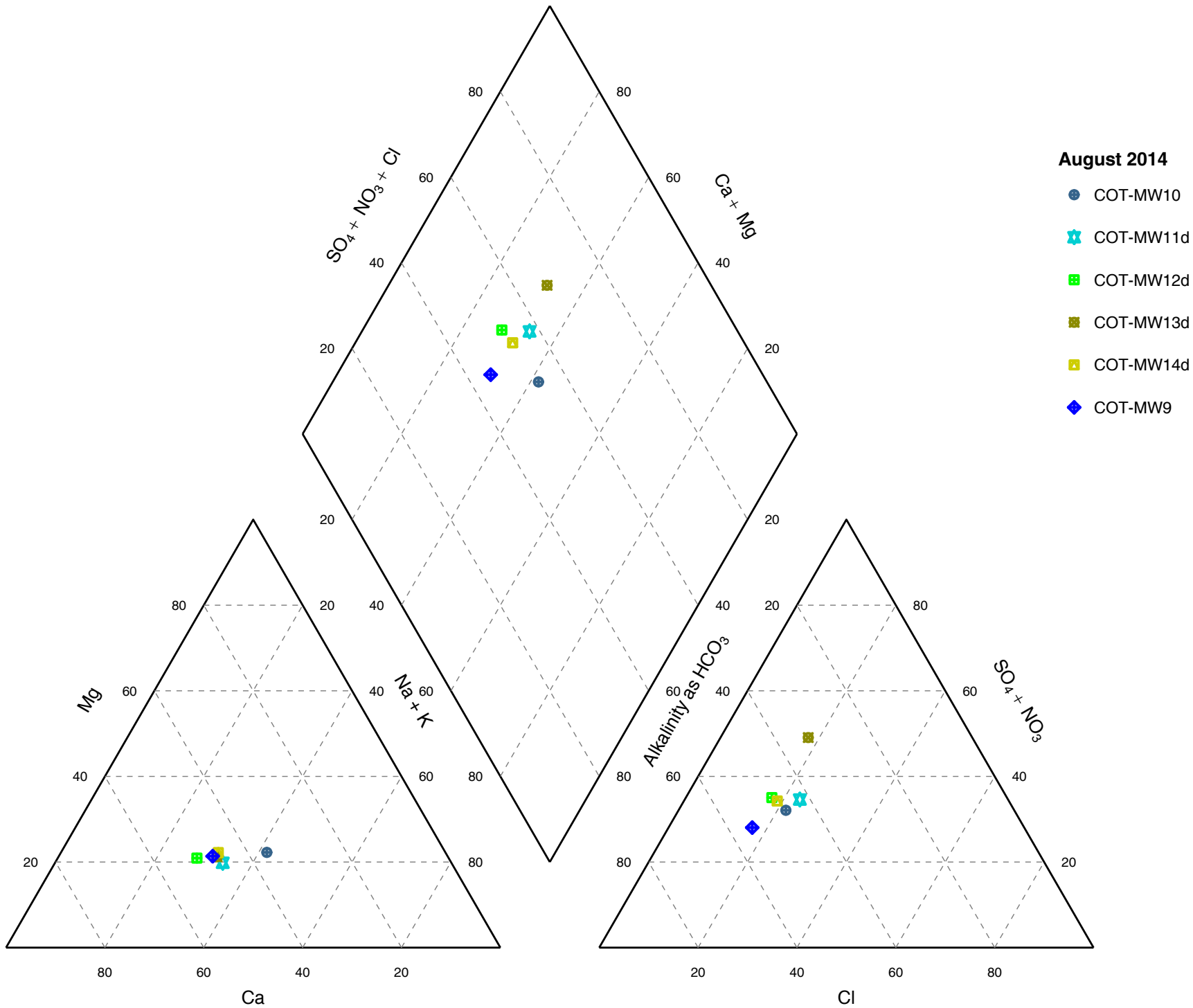

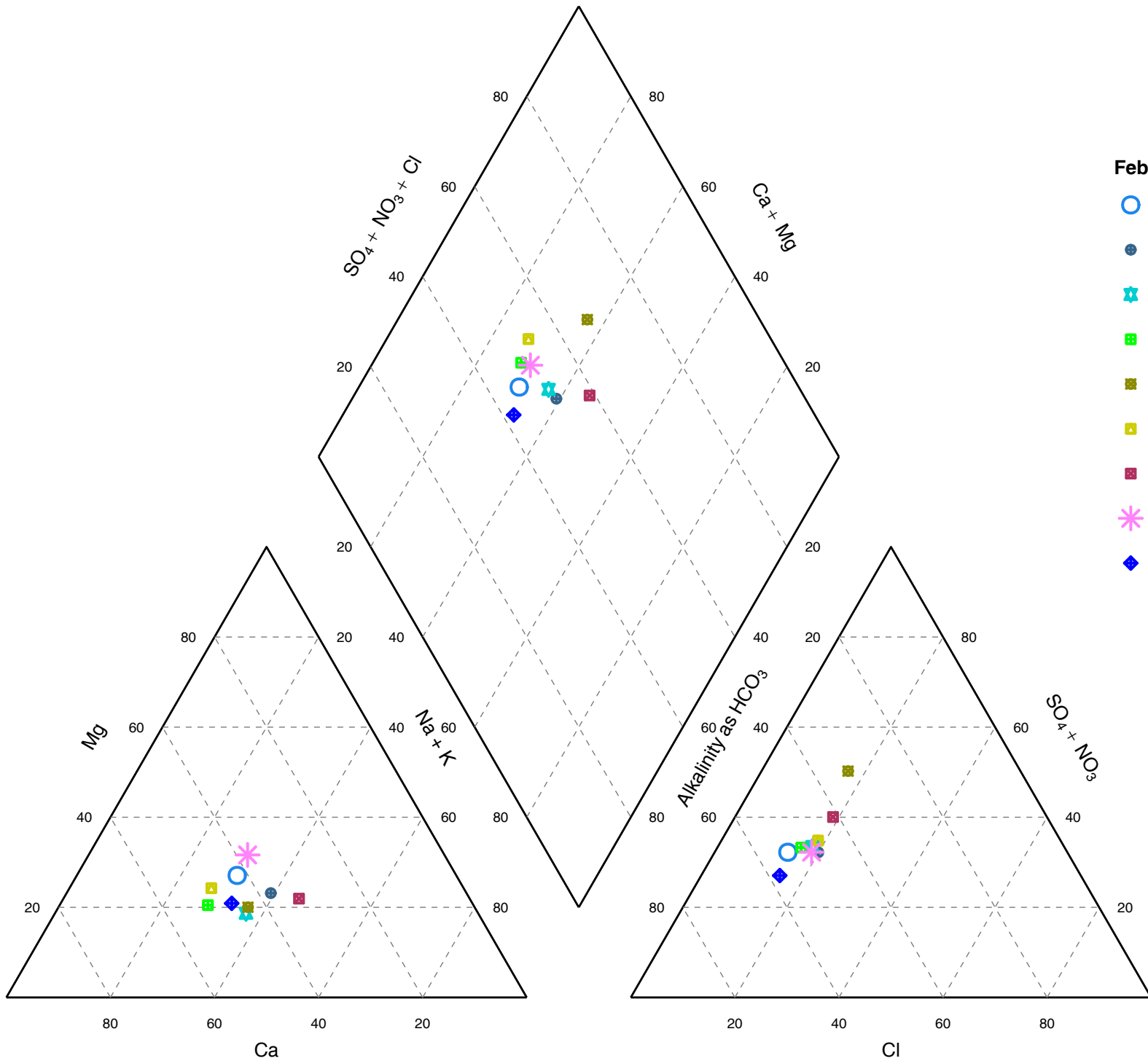

February 2015

- COT-MW1d
- COT-MW10
- ★ COT-MW11d
- COT-MW12d
- COT-MW13d
- COT-MW14d
- COT-MW7
- ✱ COT-MW8
- ◆ COT-MW9

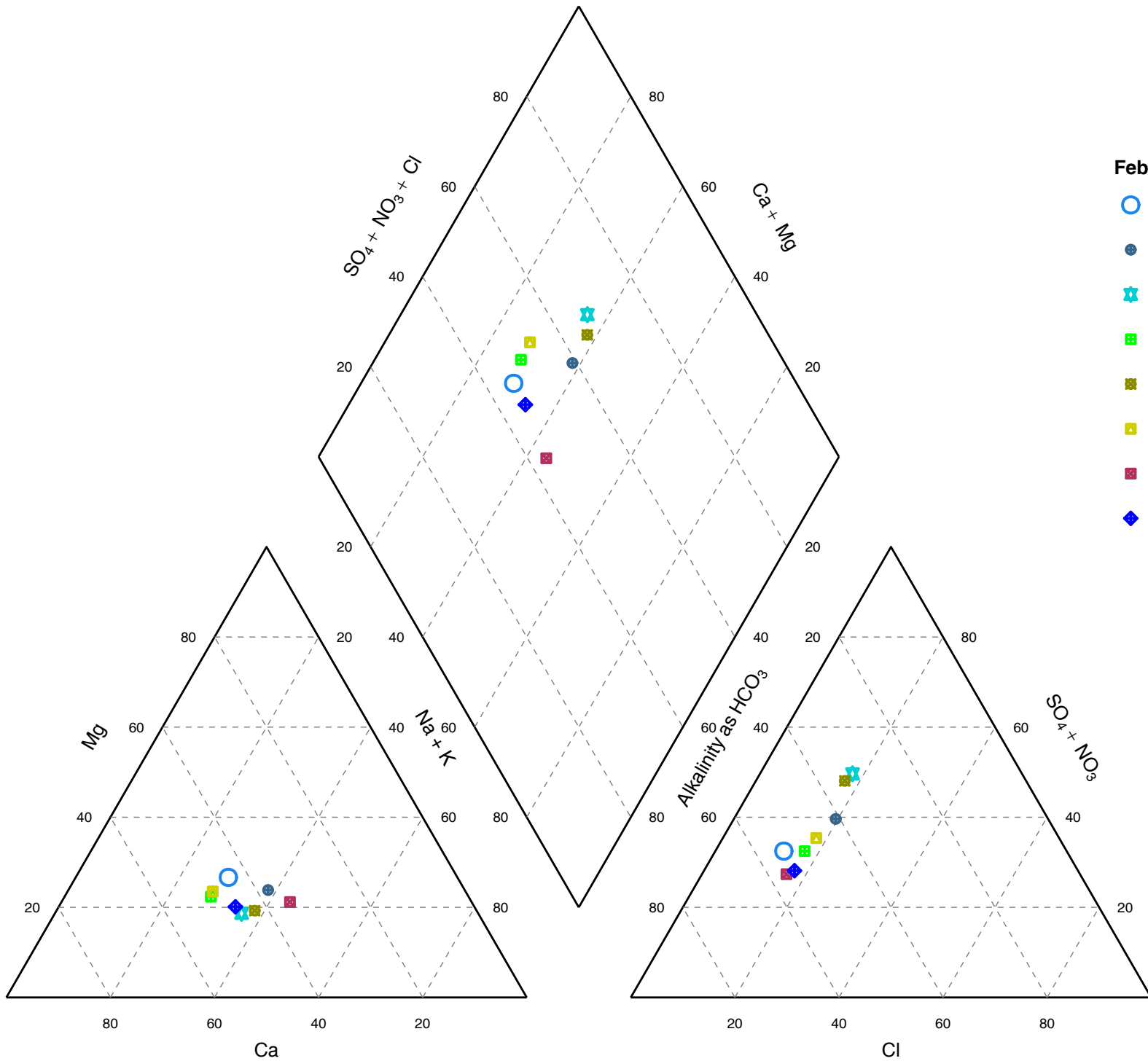

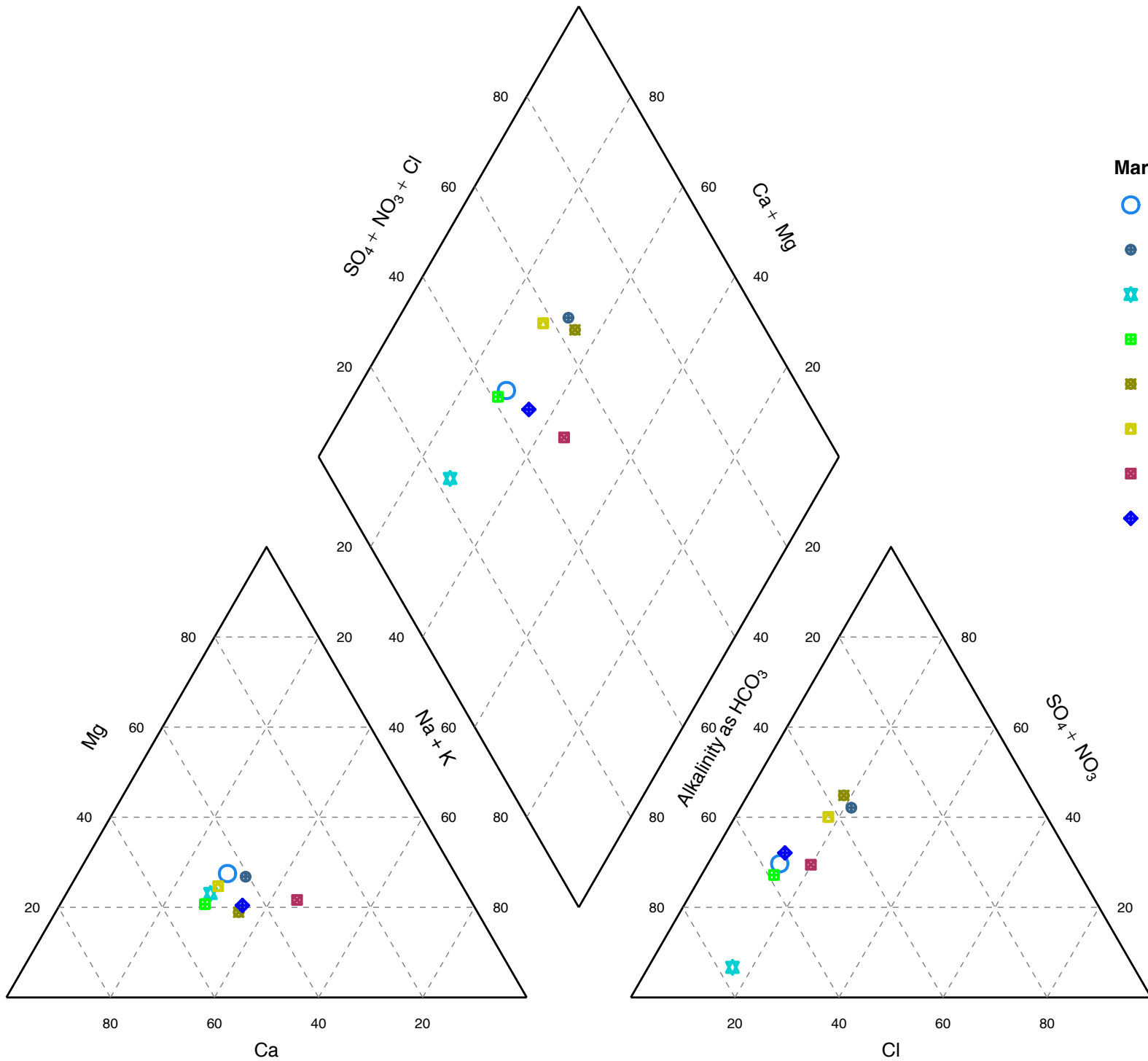

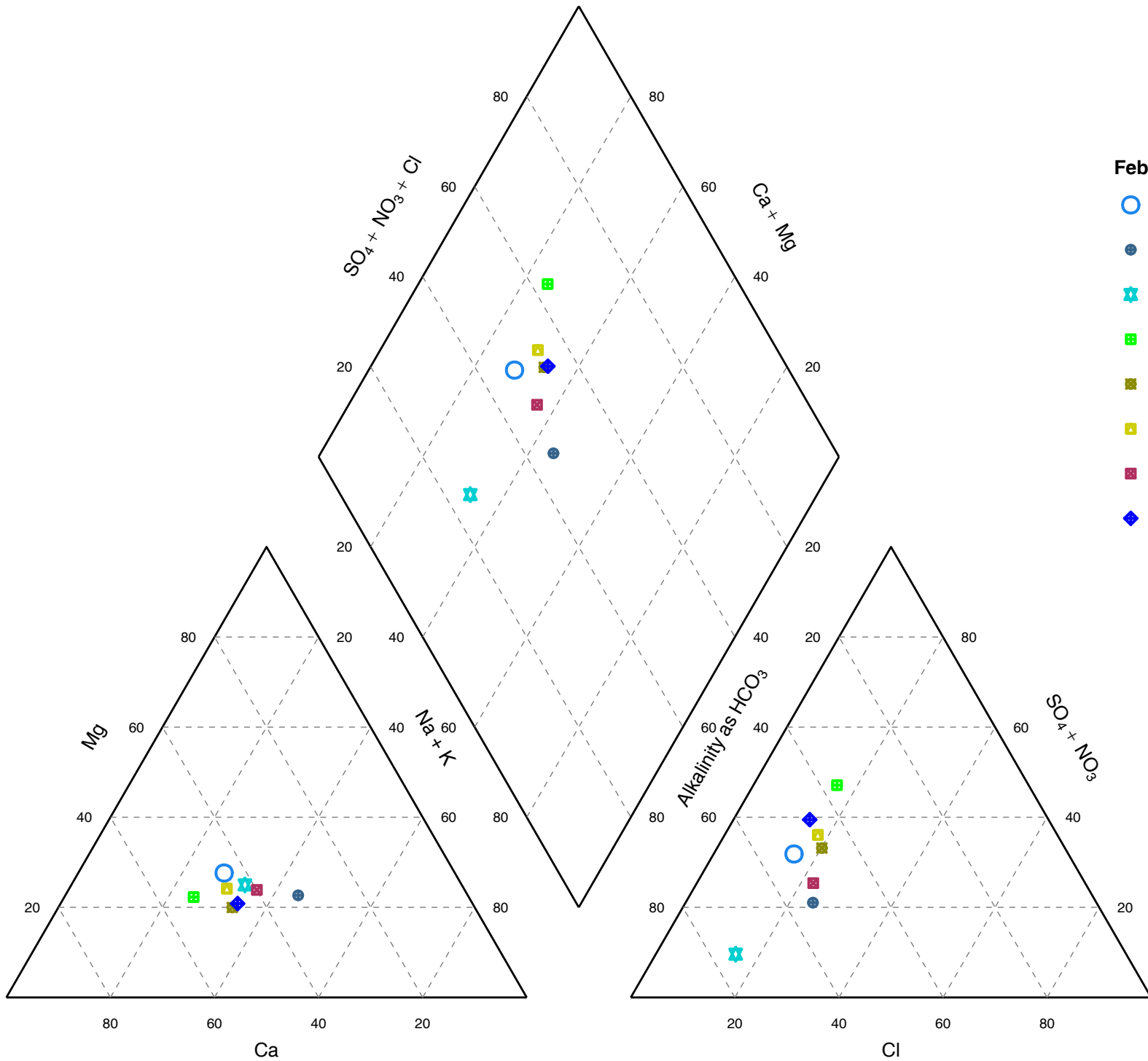

February 2019

◆ COT-MW9

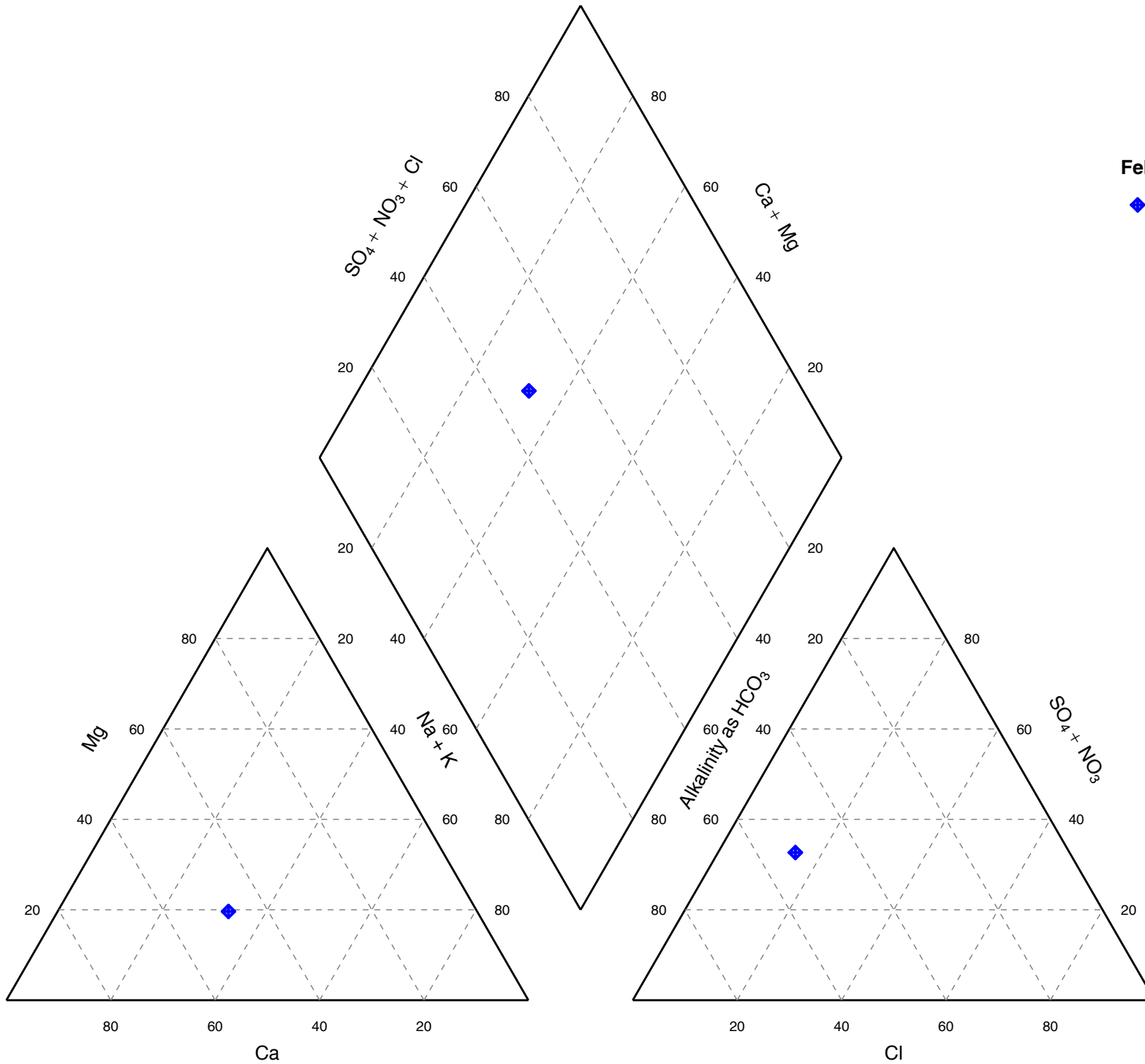

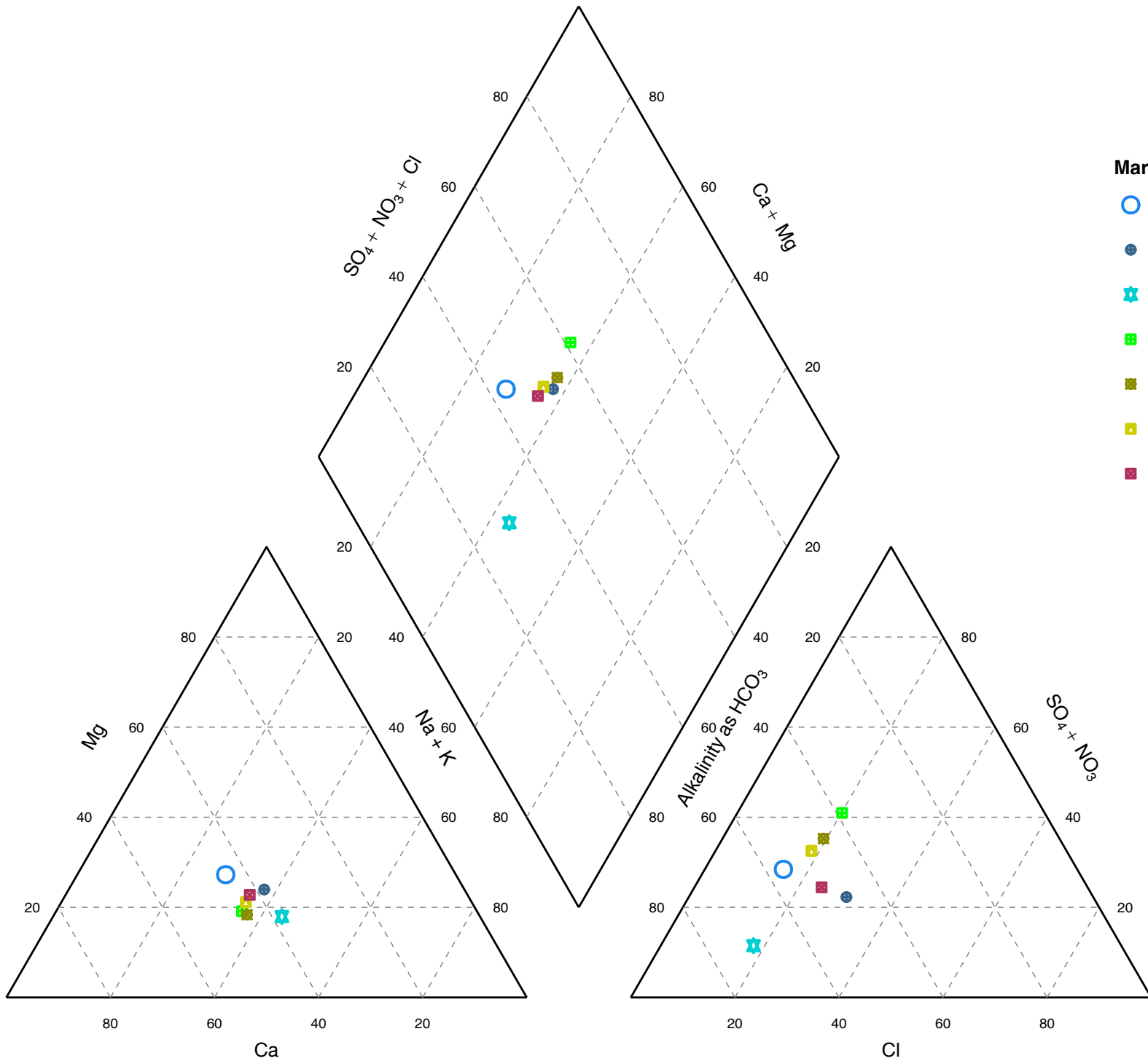

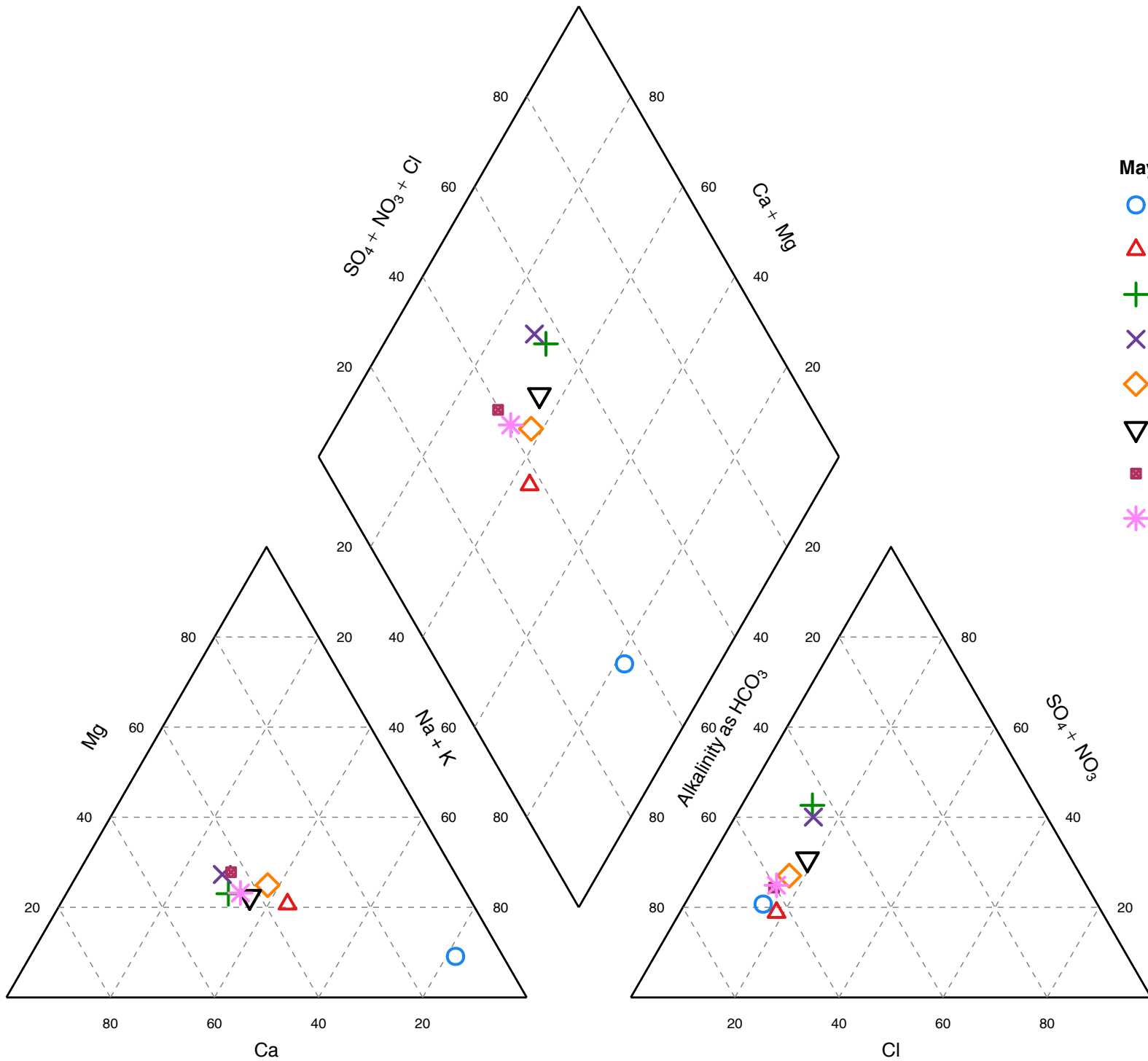

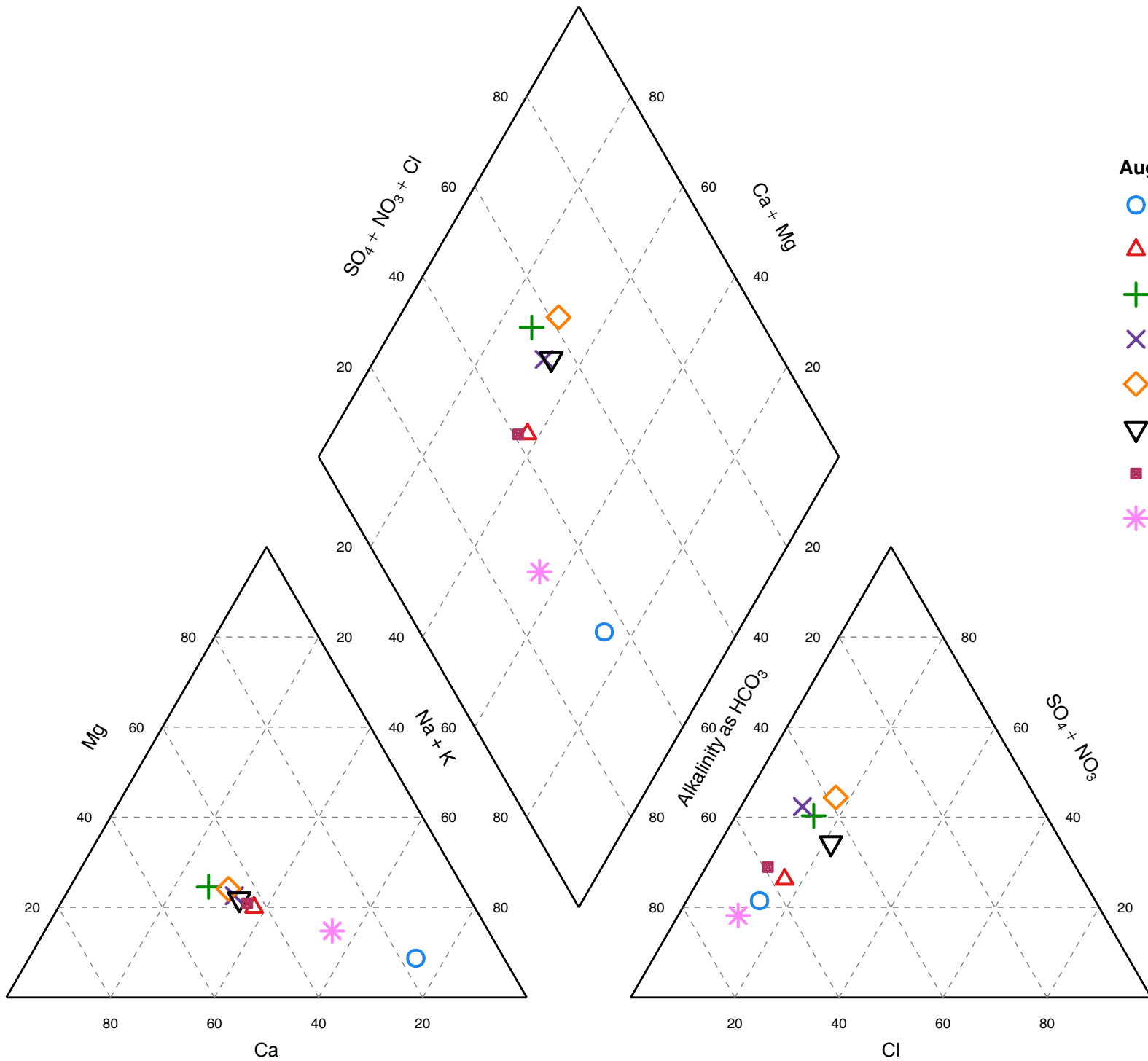

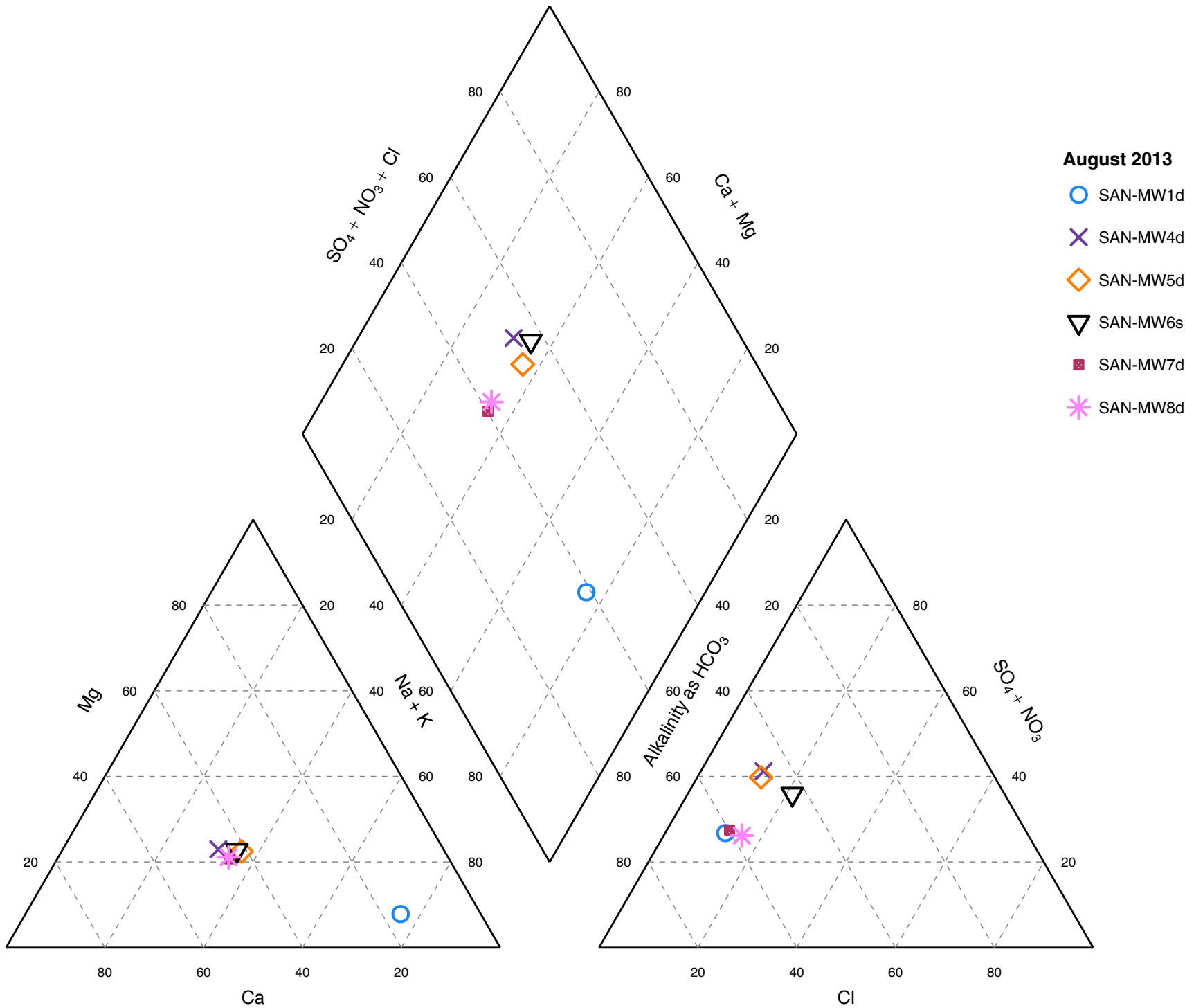

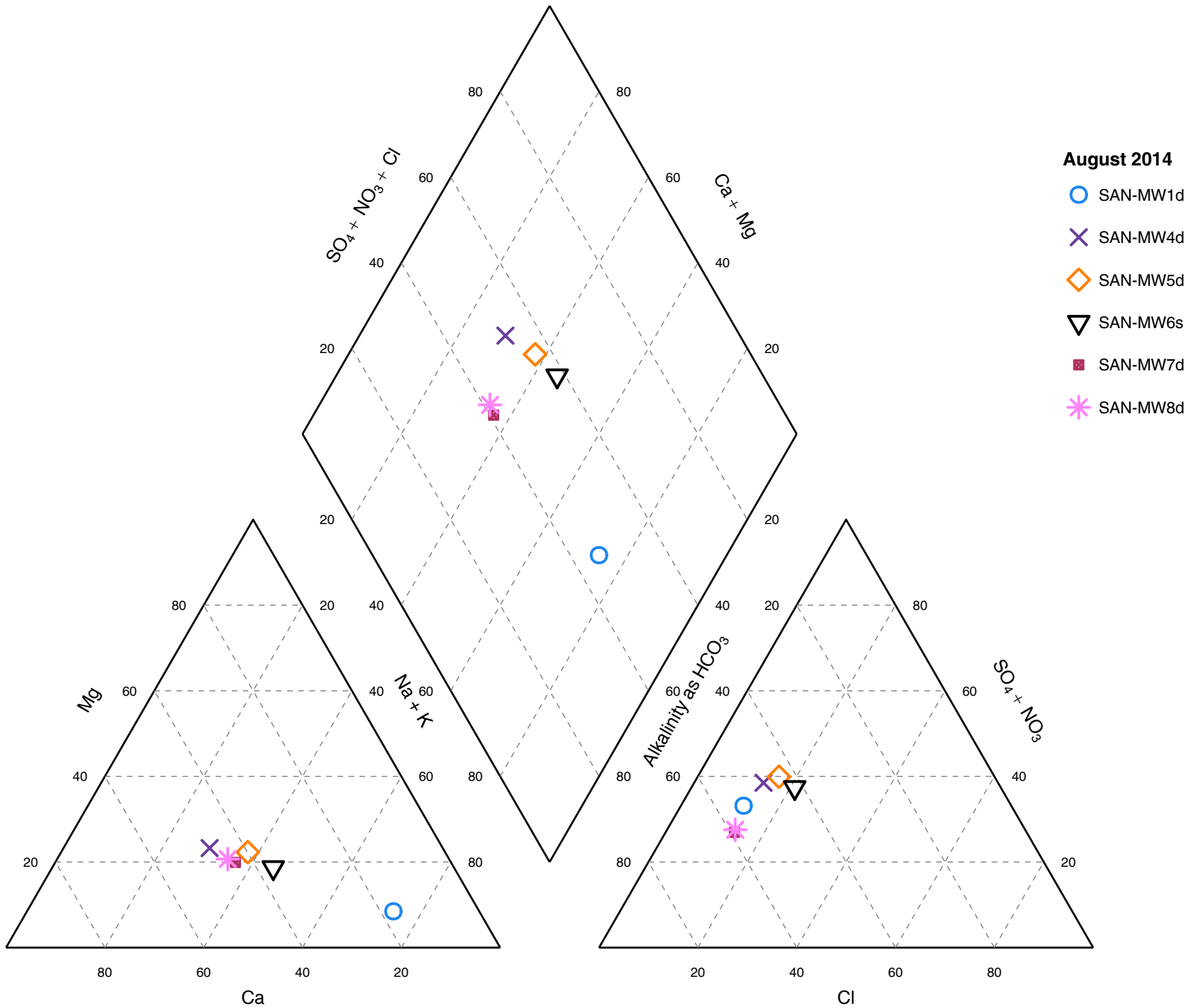

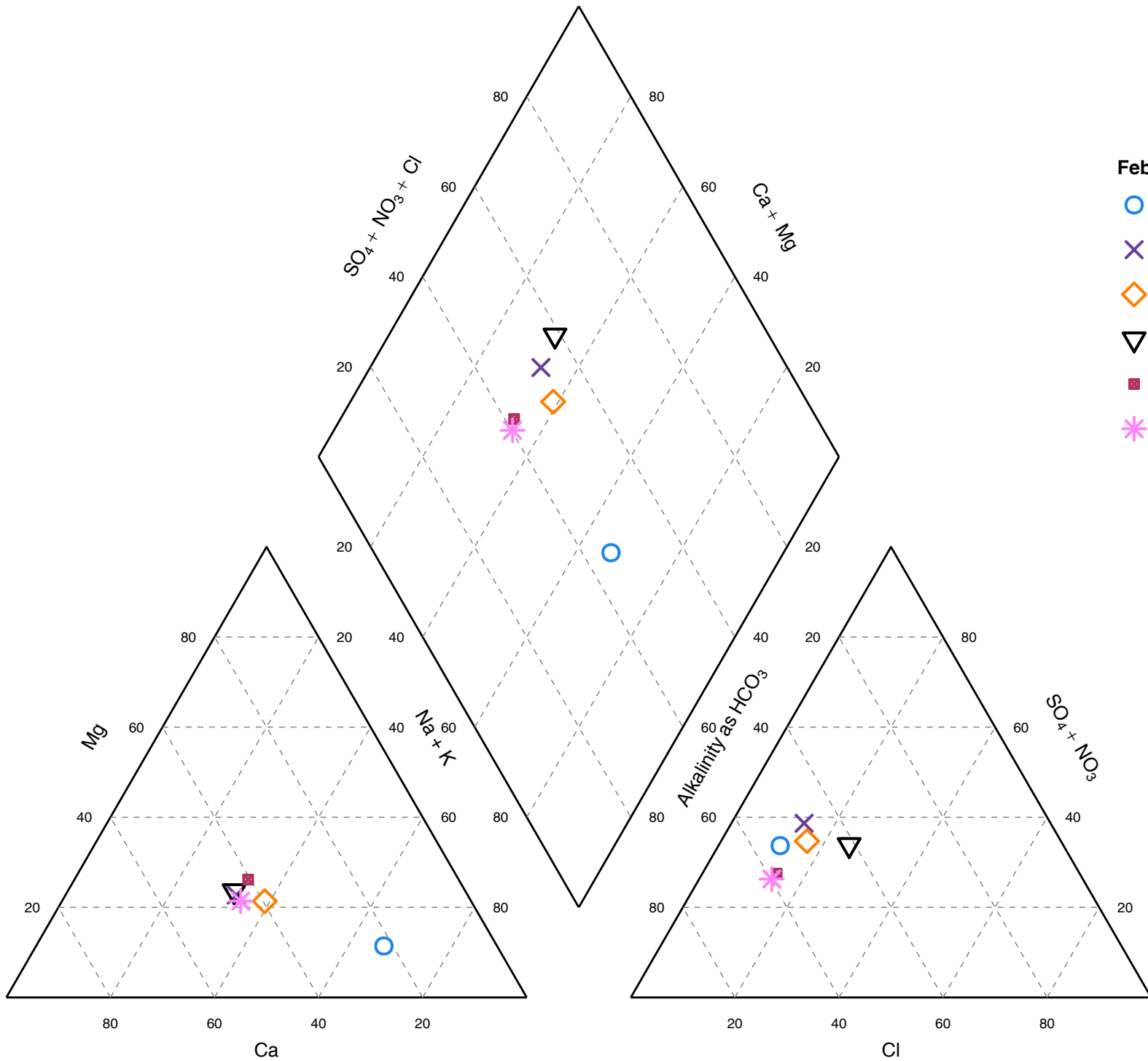

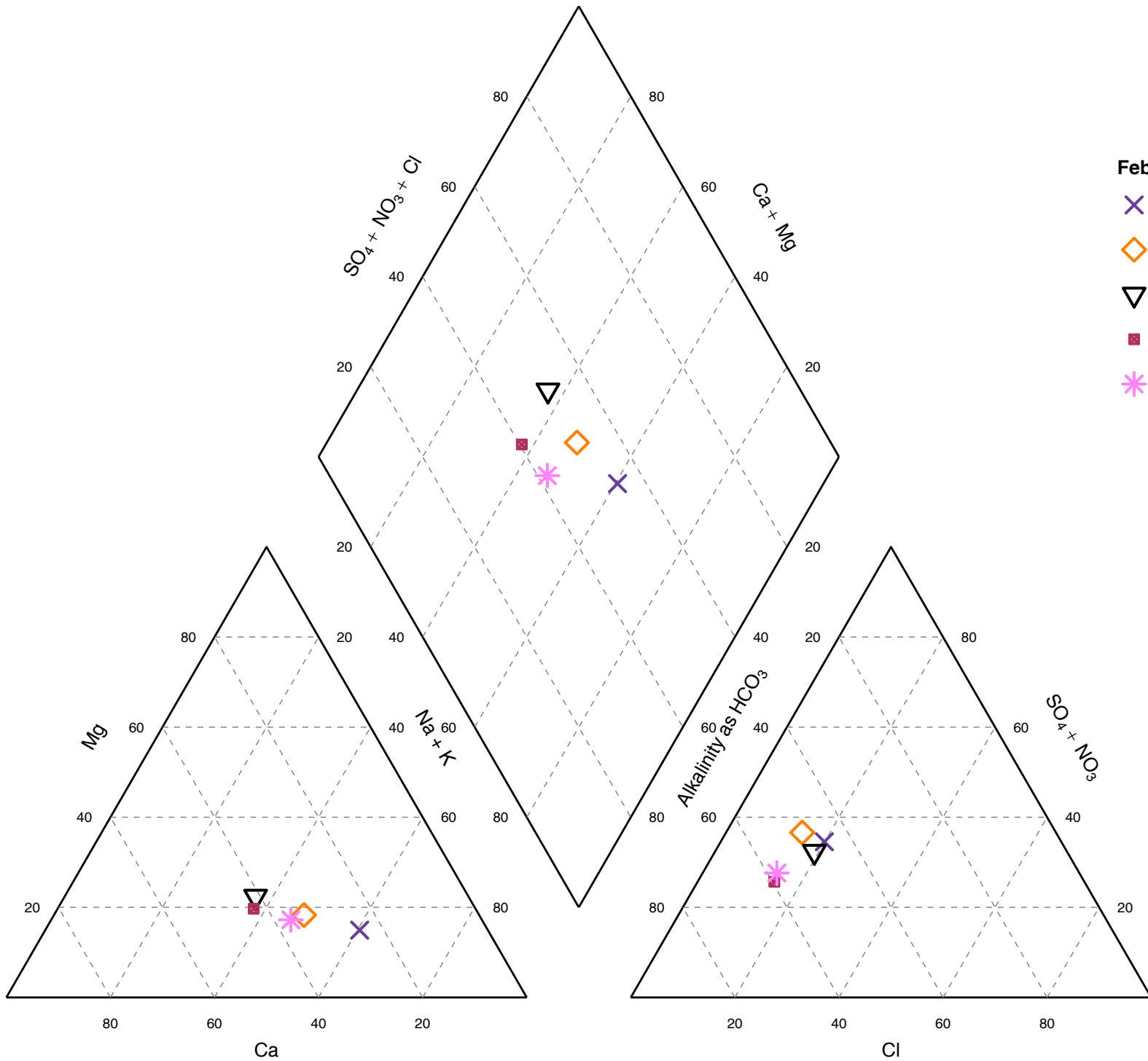

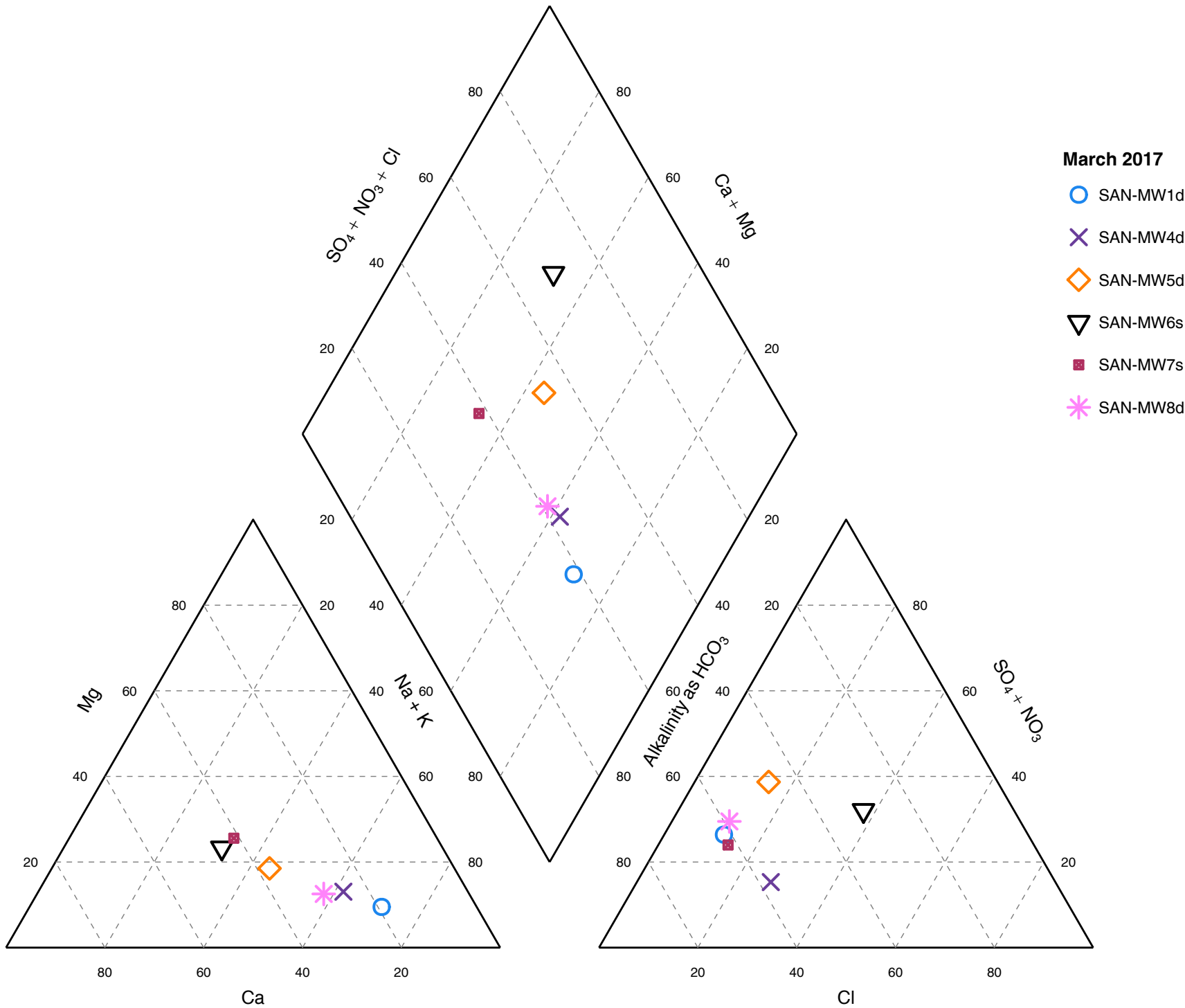

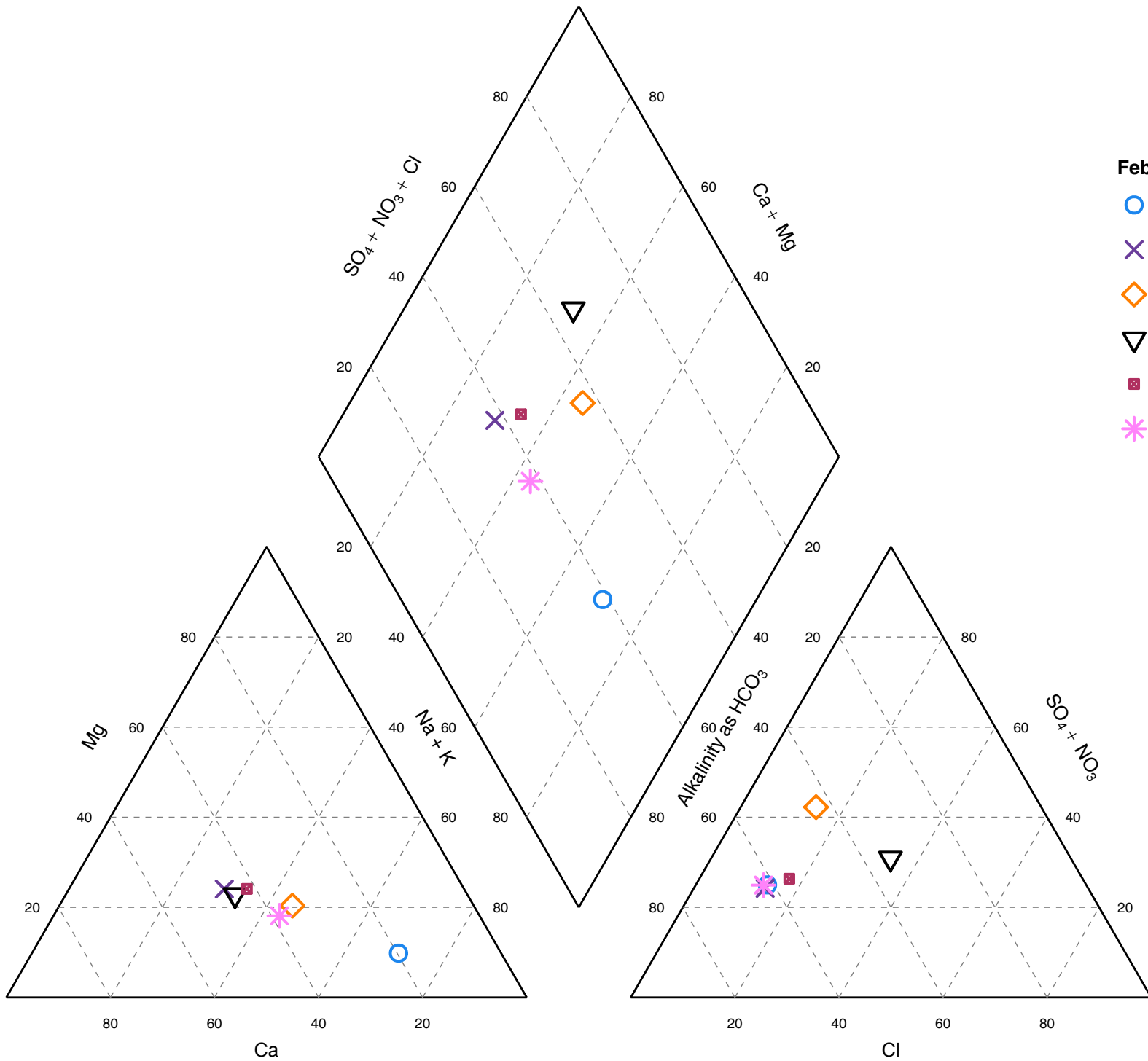

February 2018

- SAN-MW1d
- × SAN-MW4d
- ◇ SAN-MW5d
- ▽ SAN-MW6s
- SAN-MW7s
- * SAN-MW8d

February 2019

* SAN-MW8d

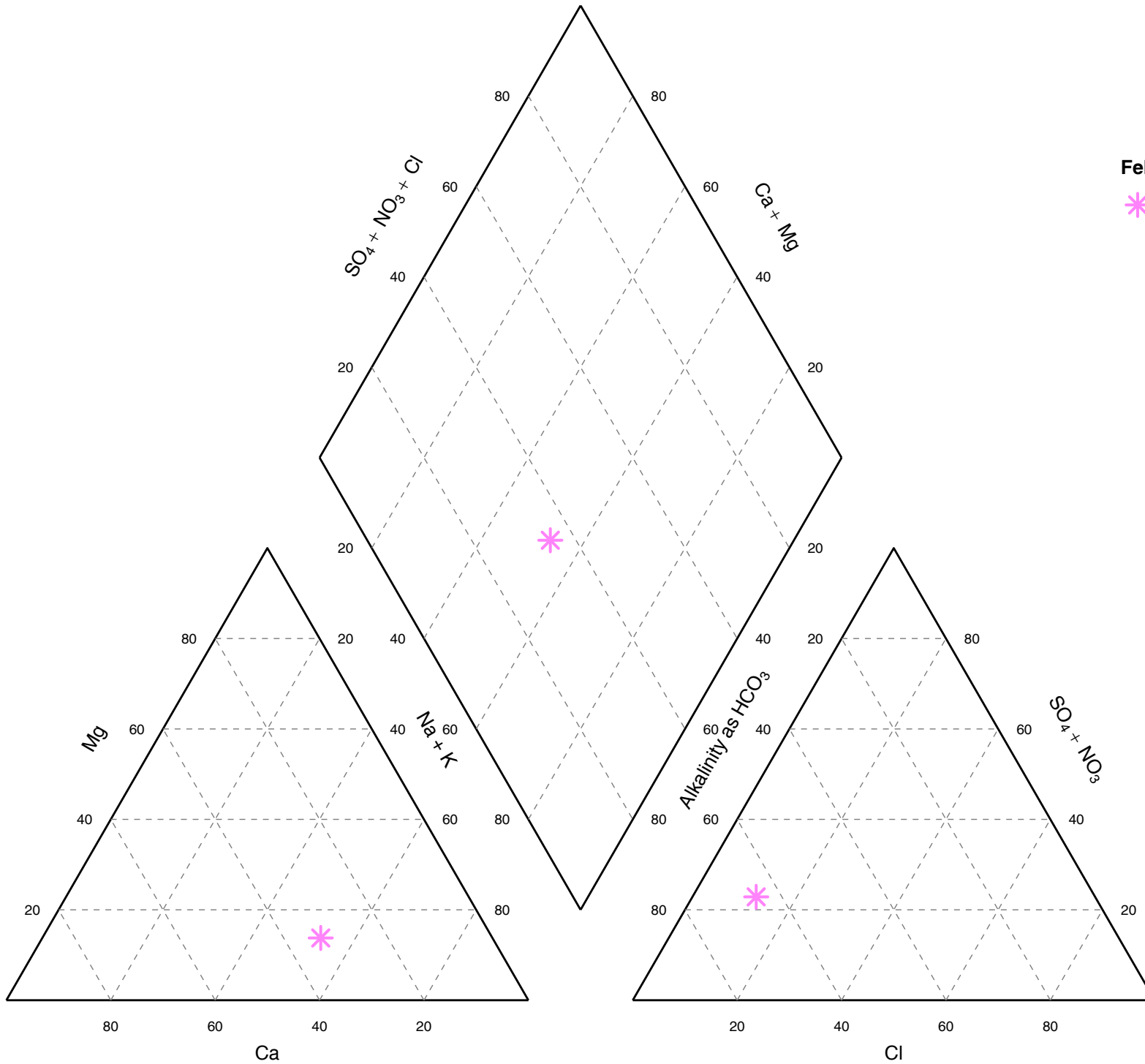

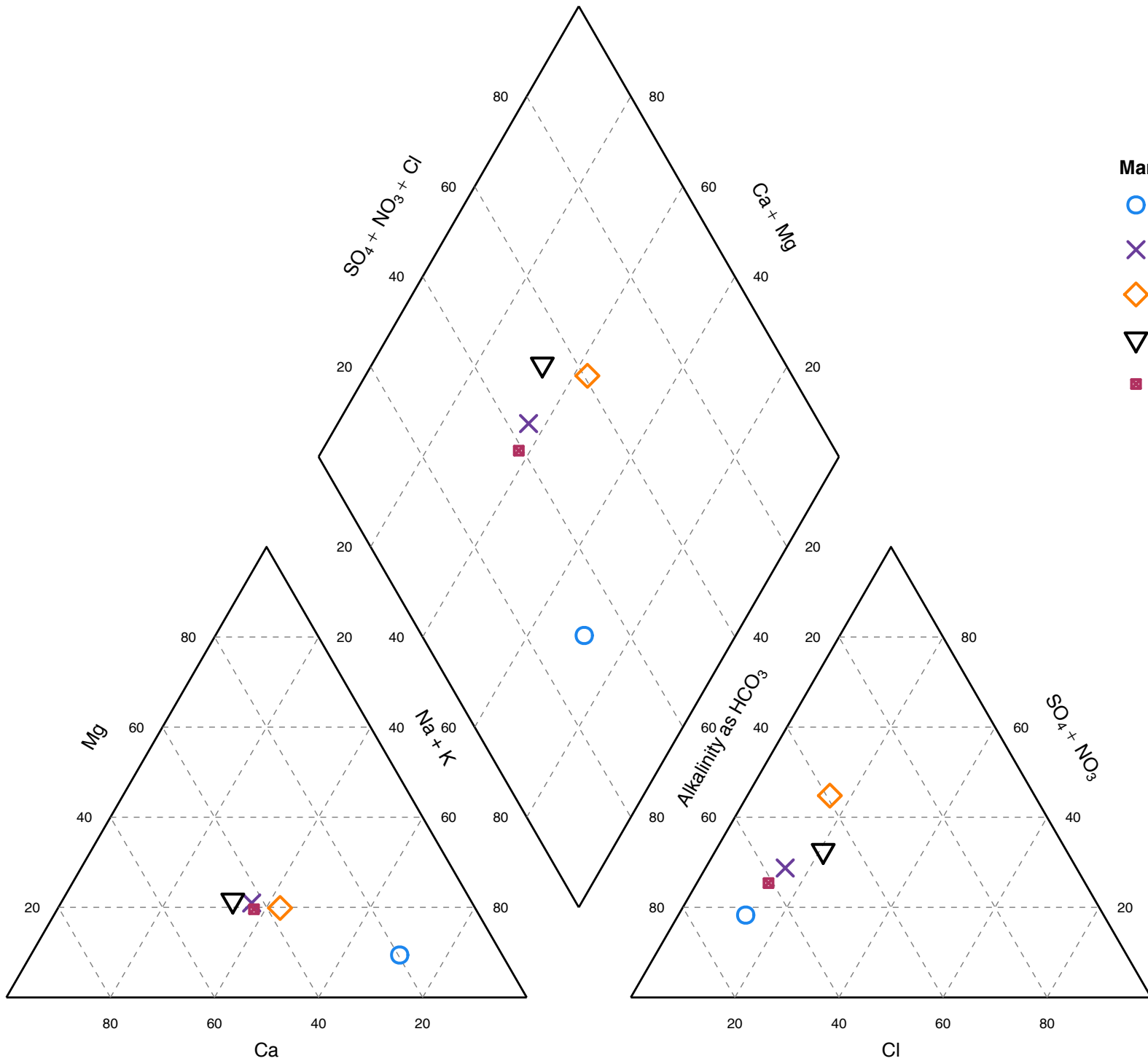

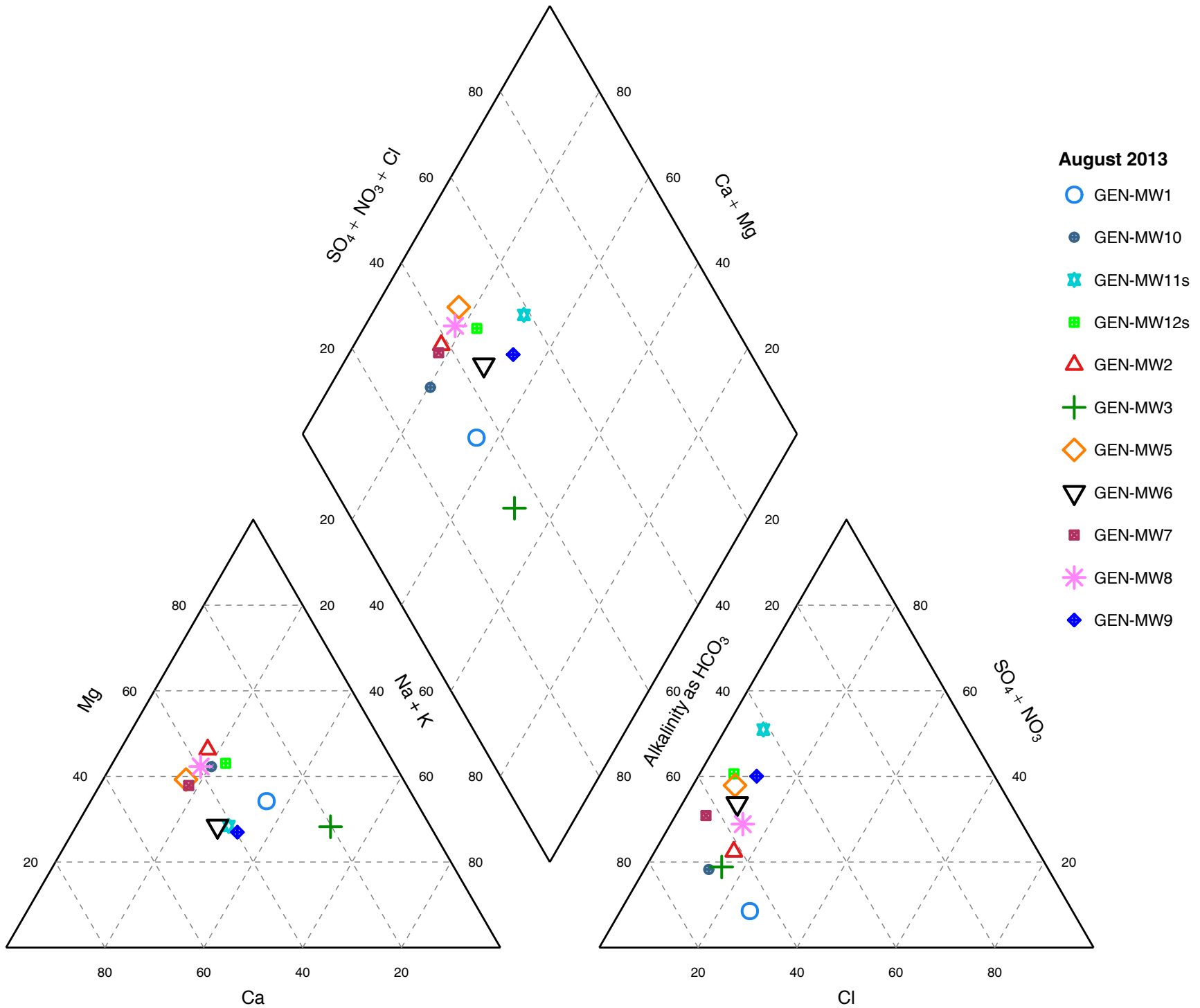

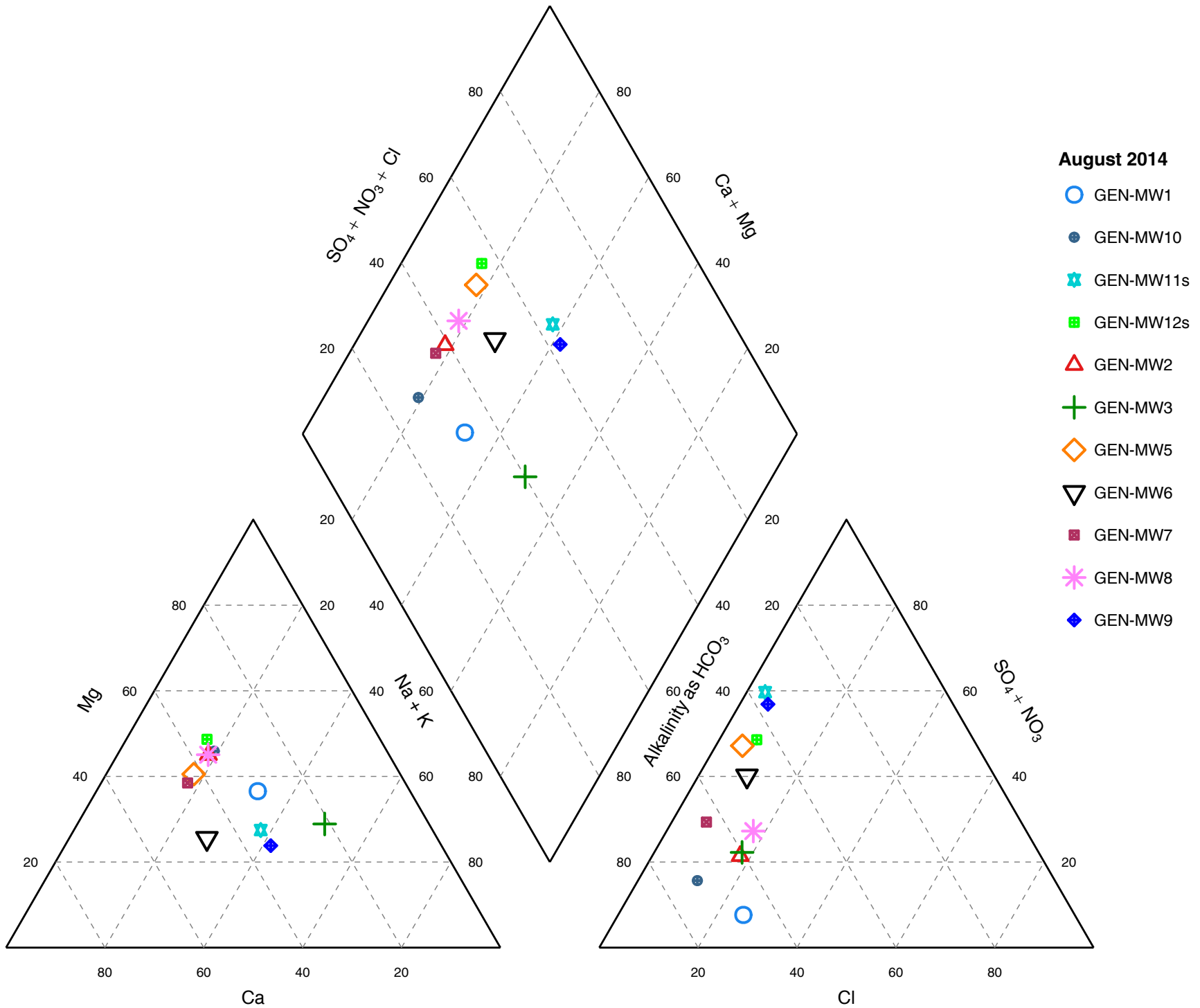

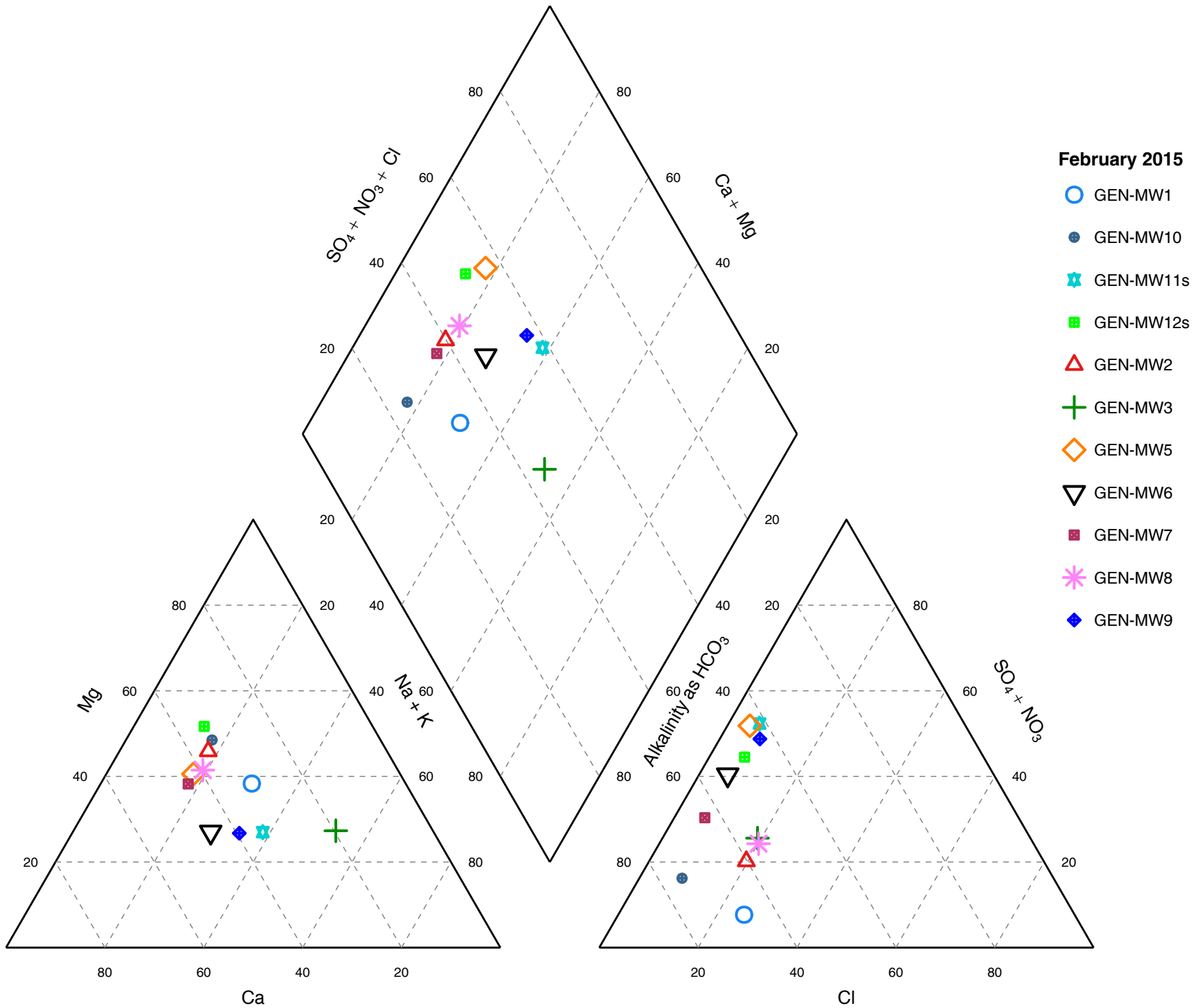

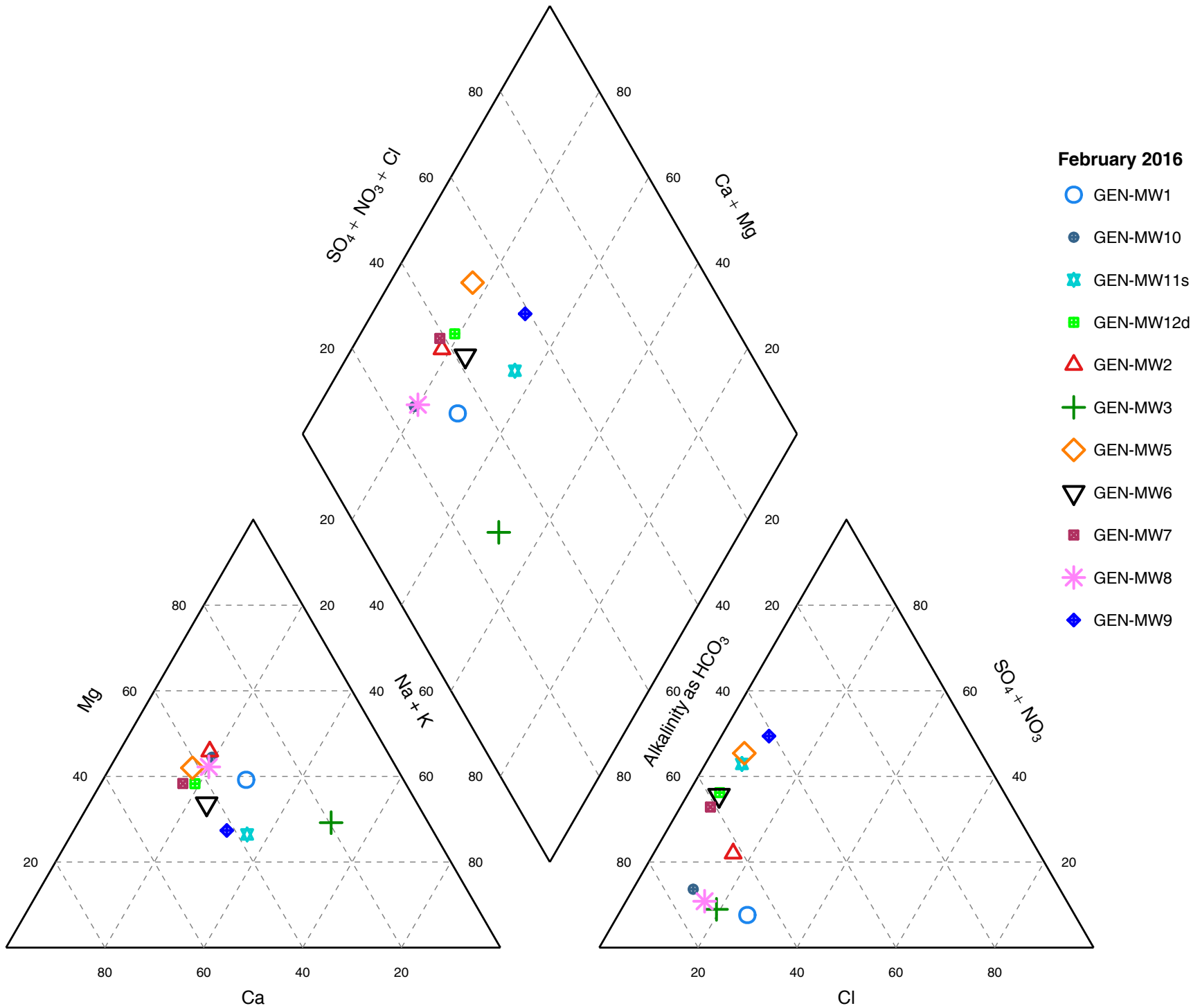

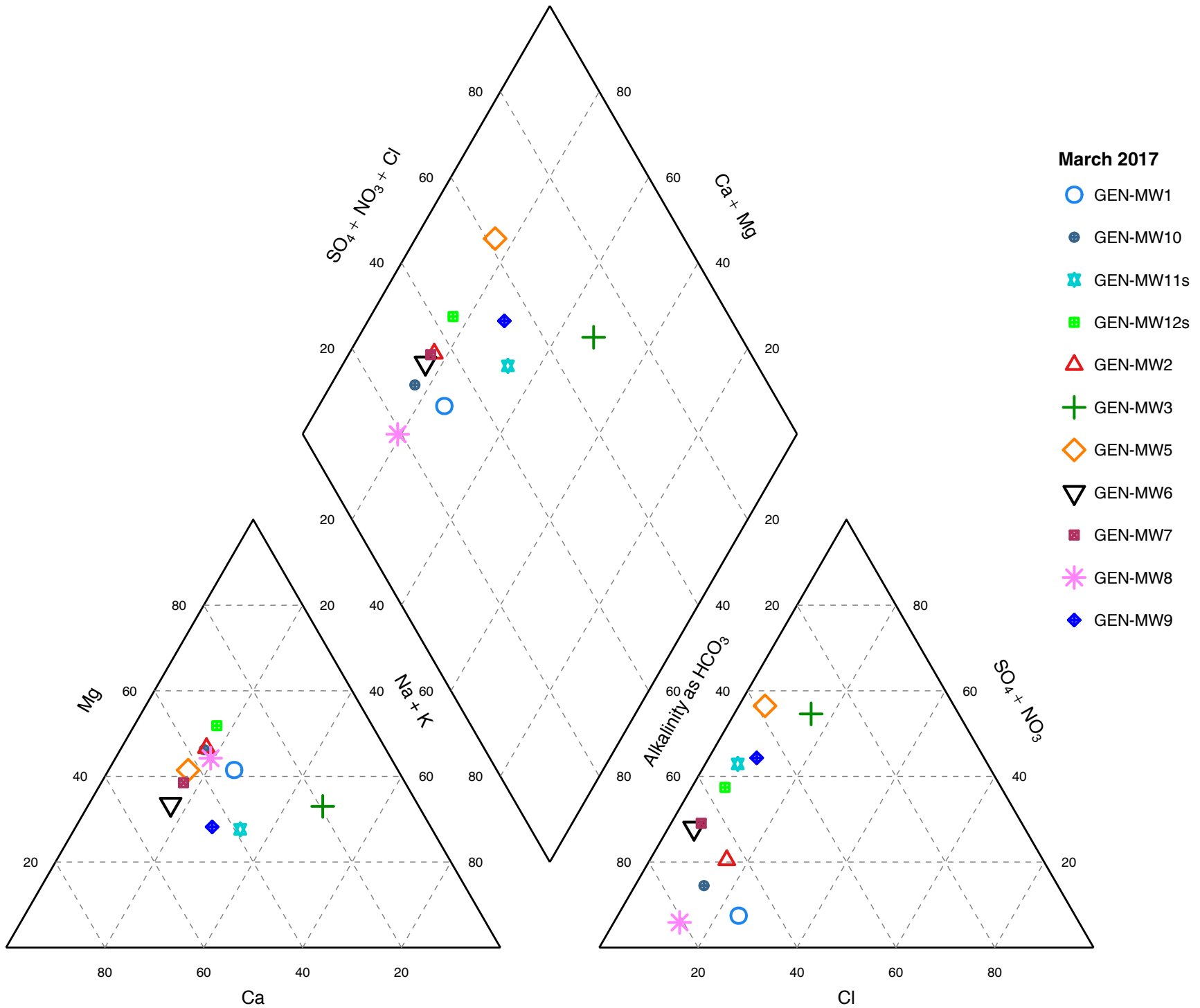

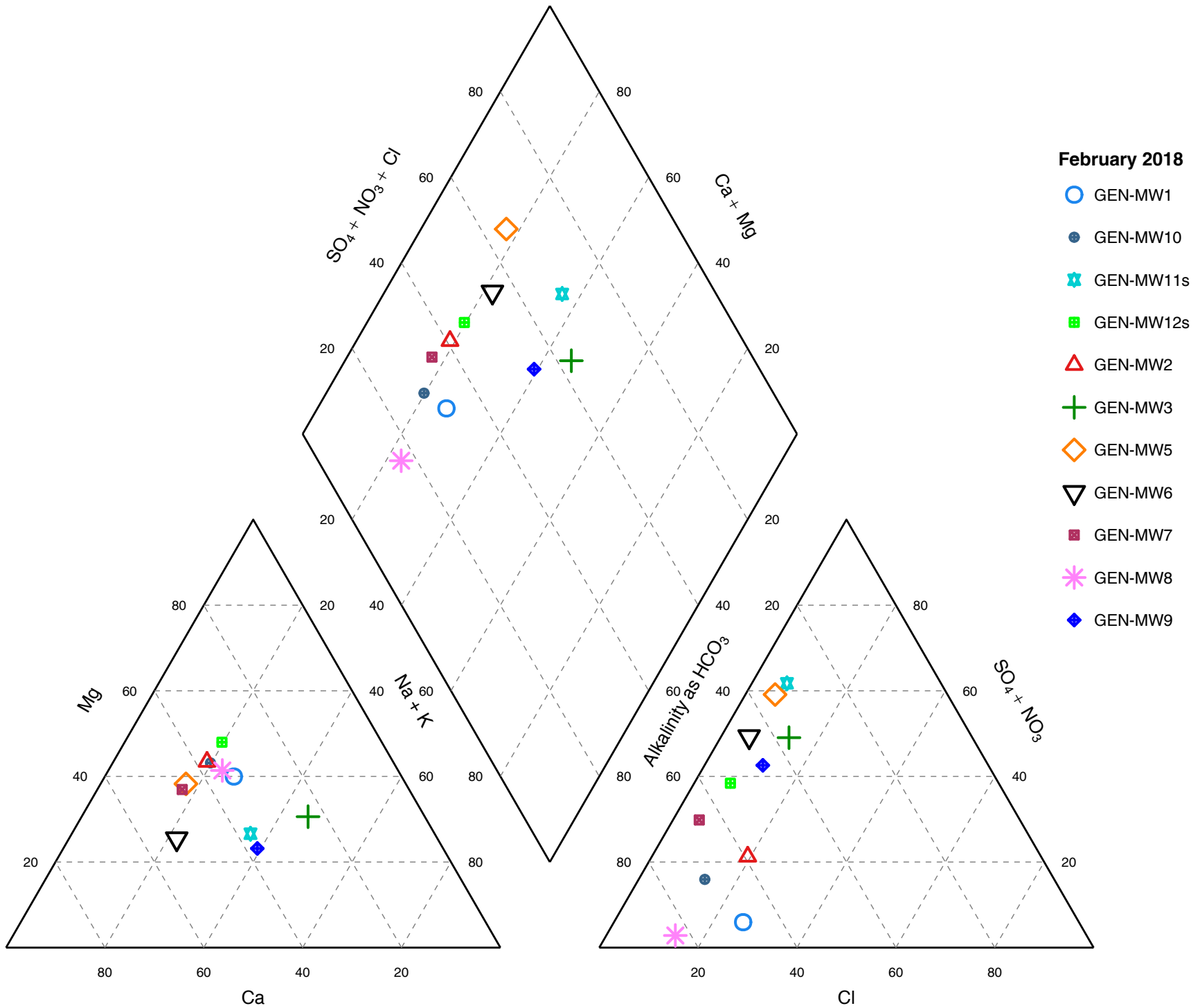

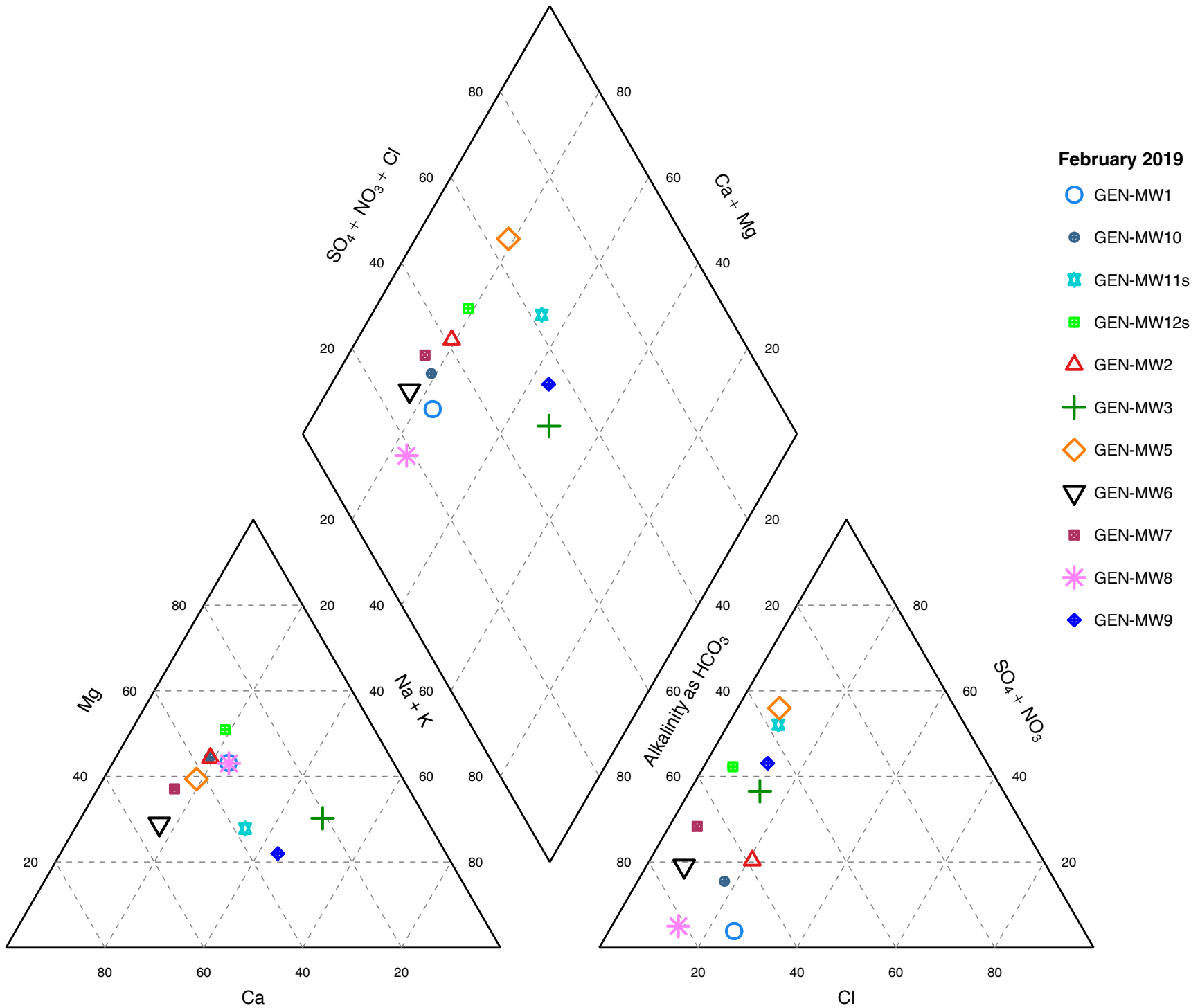

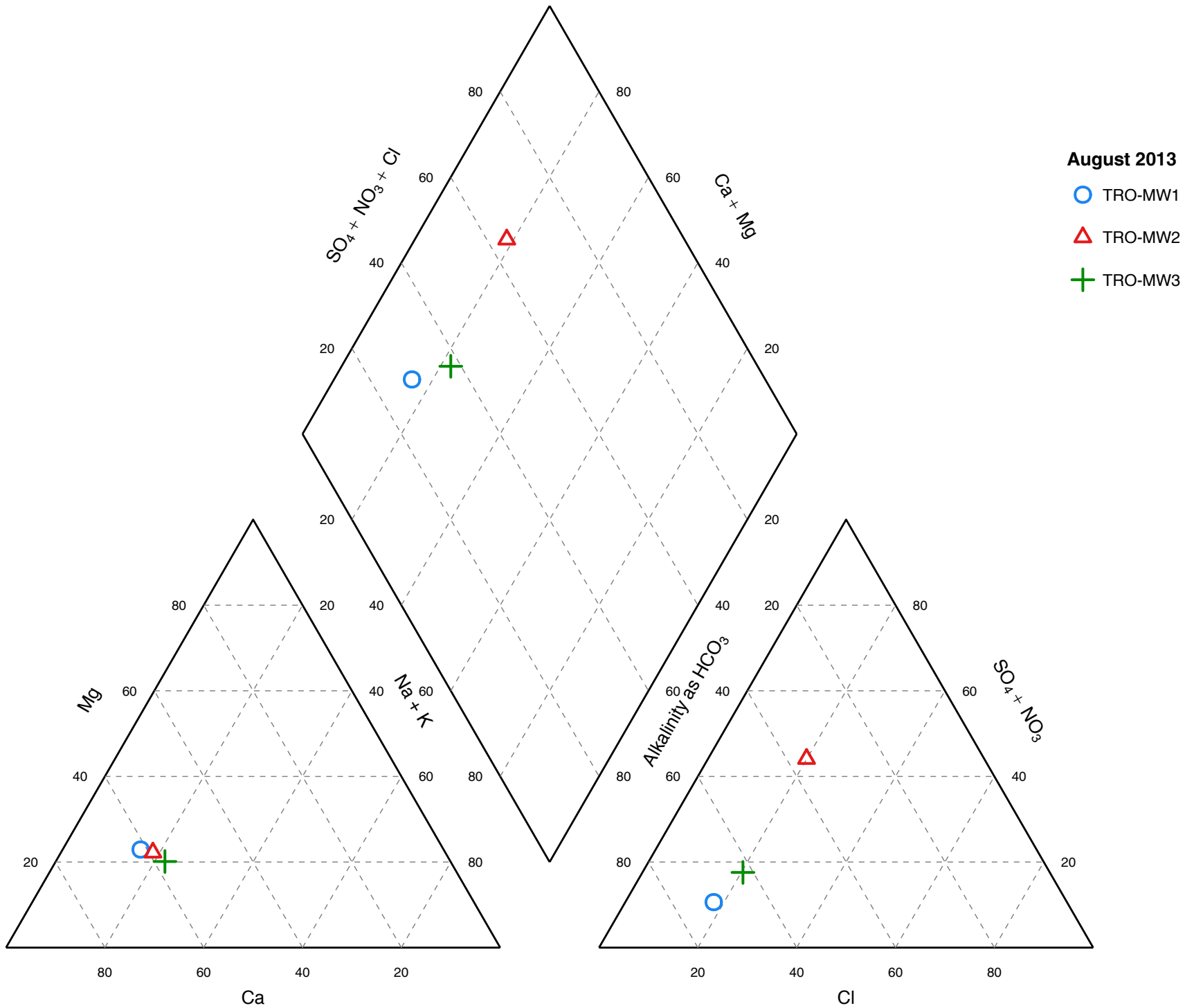

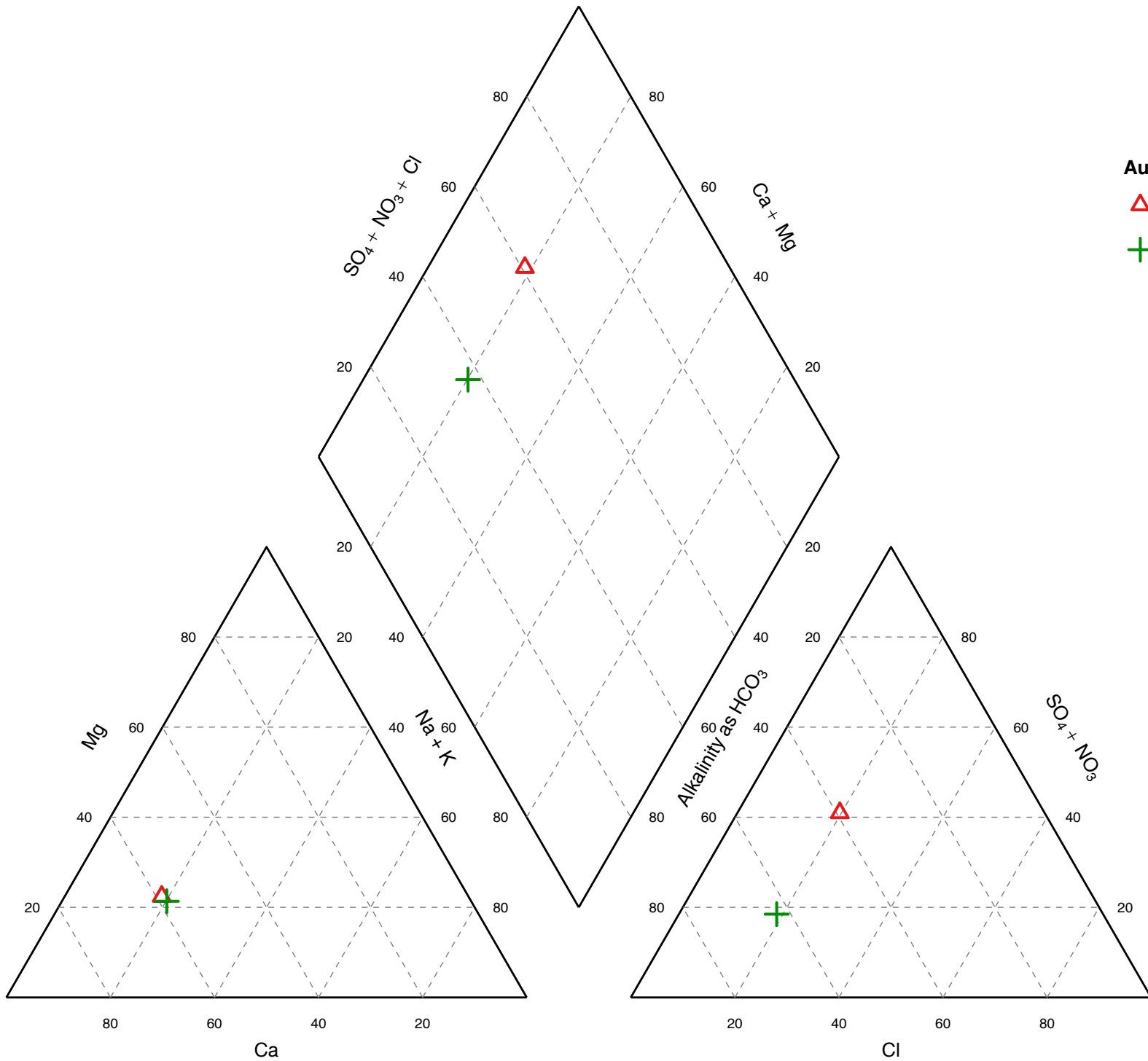

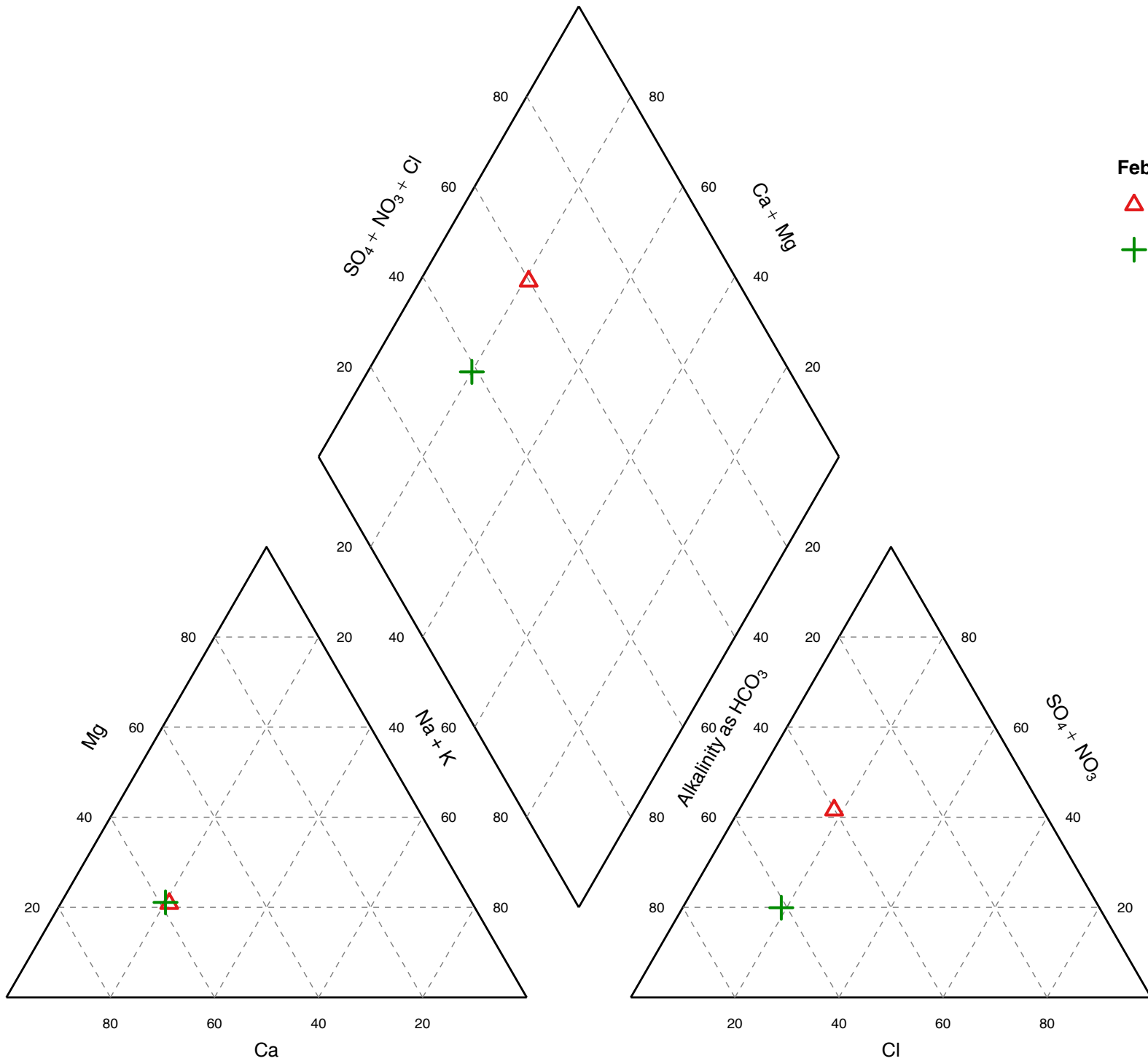

February 2015

△ TRO-MW2

+ TRO-MW3

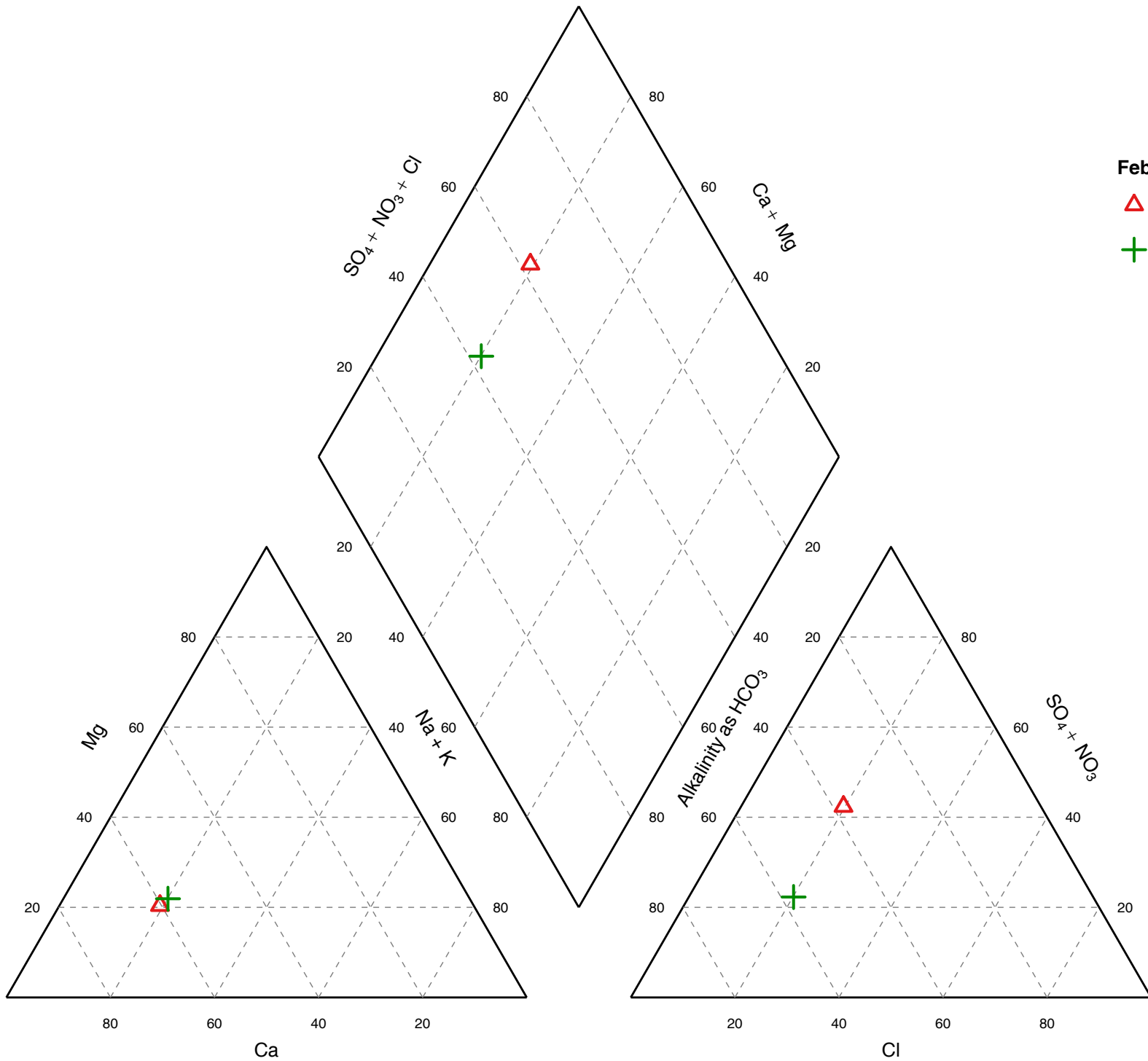

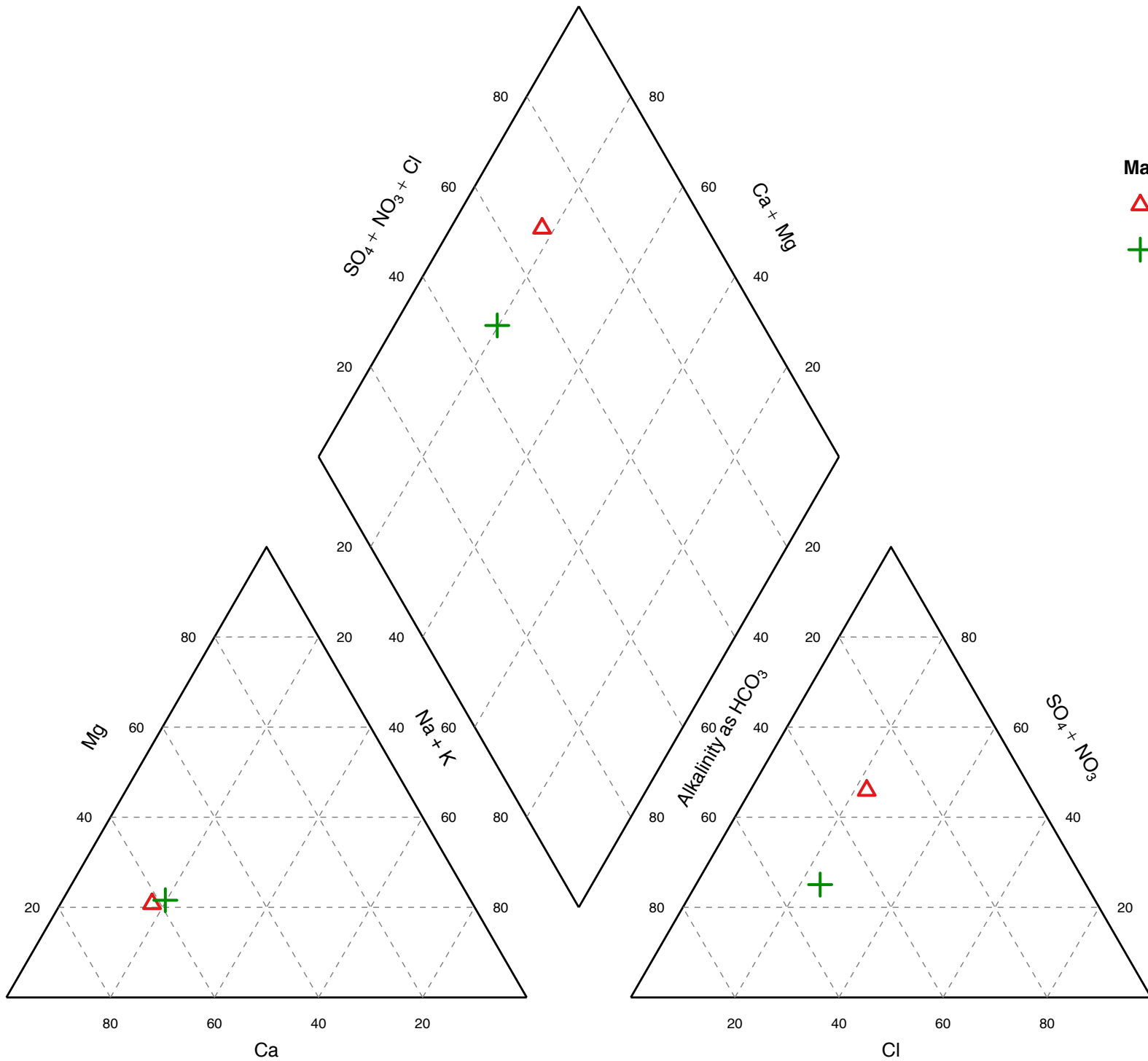

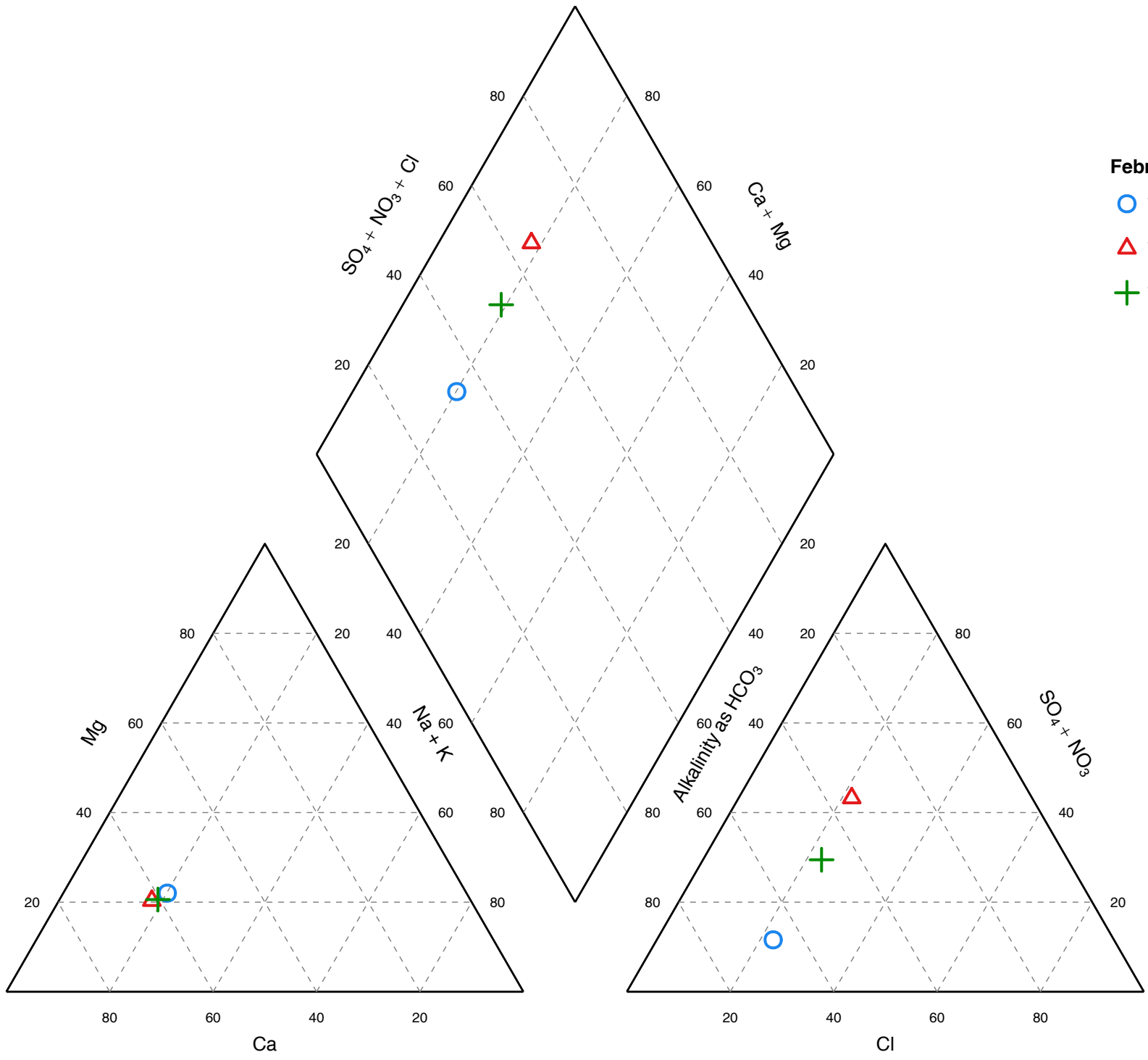

February 2018

- TRO-MW1
- △ TRO-MW2
- ⊕ TRO-MW3

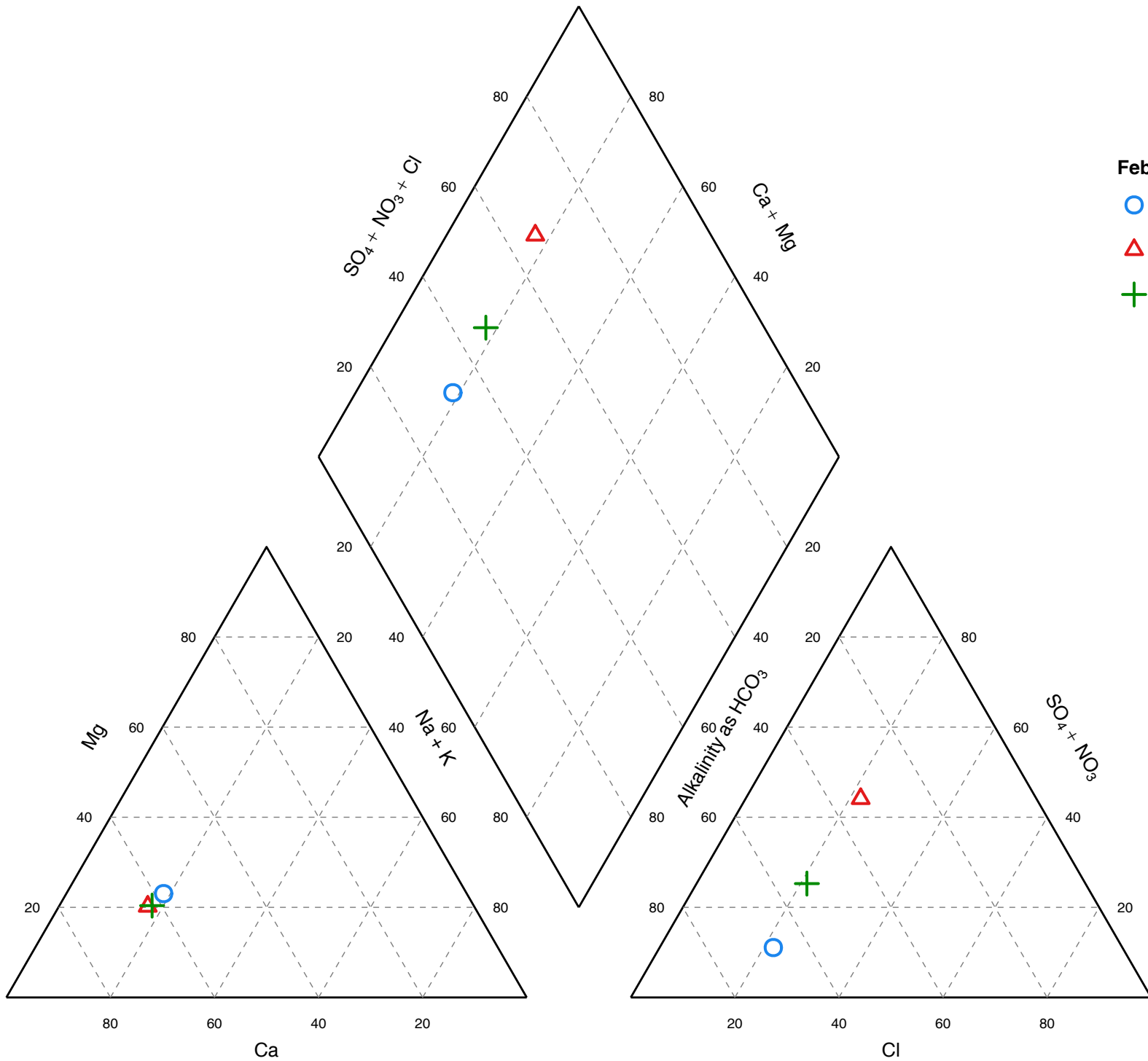

February 2019

○ TRO-MW1

△ TRO-MW2

+ TRO-MW3

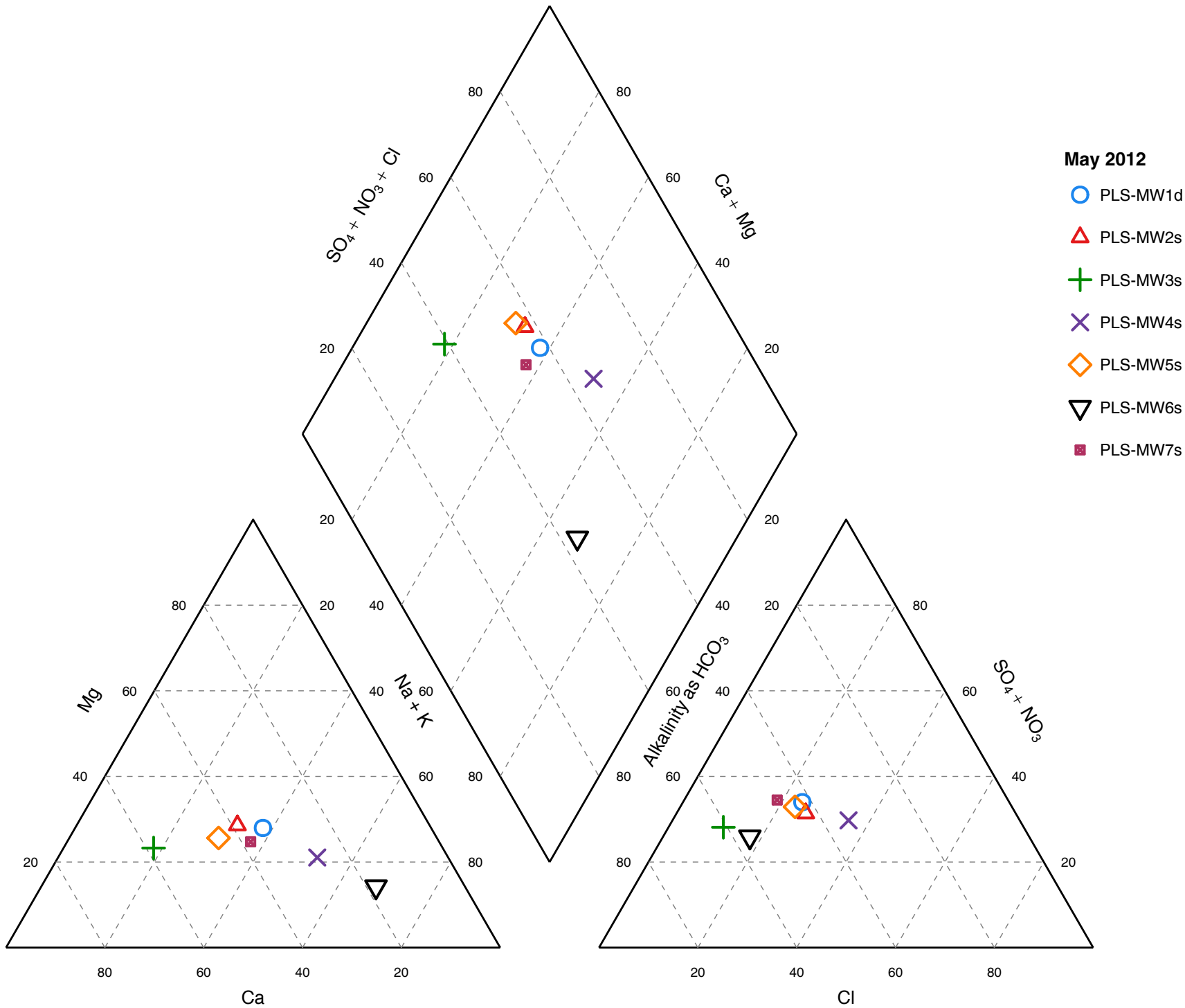

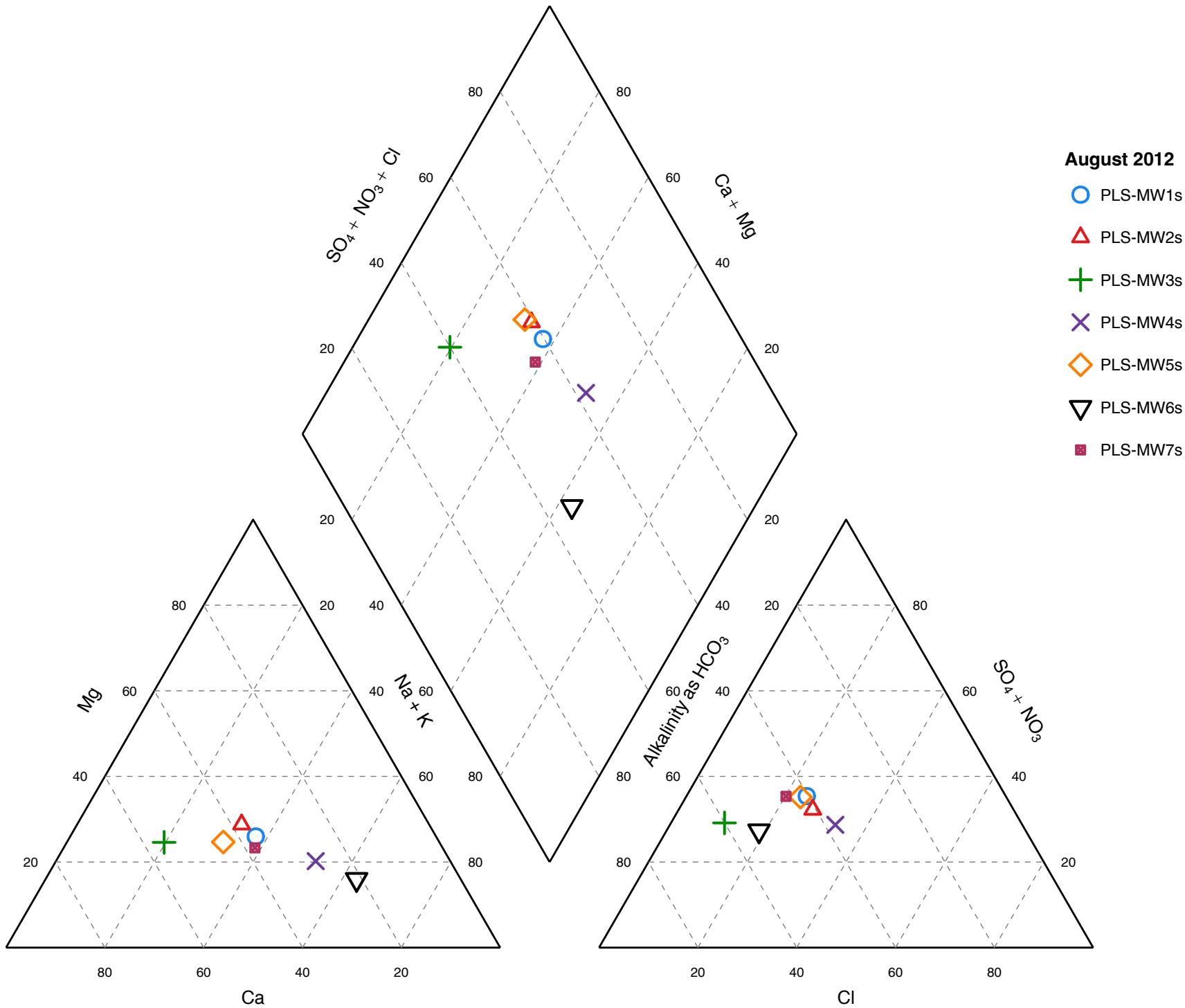

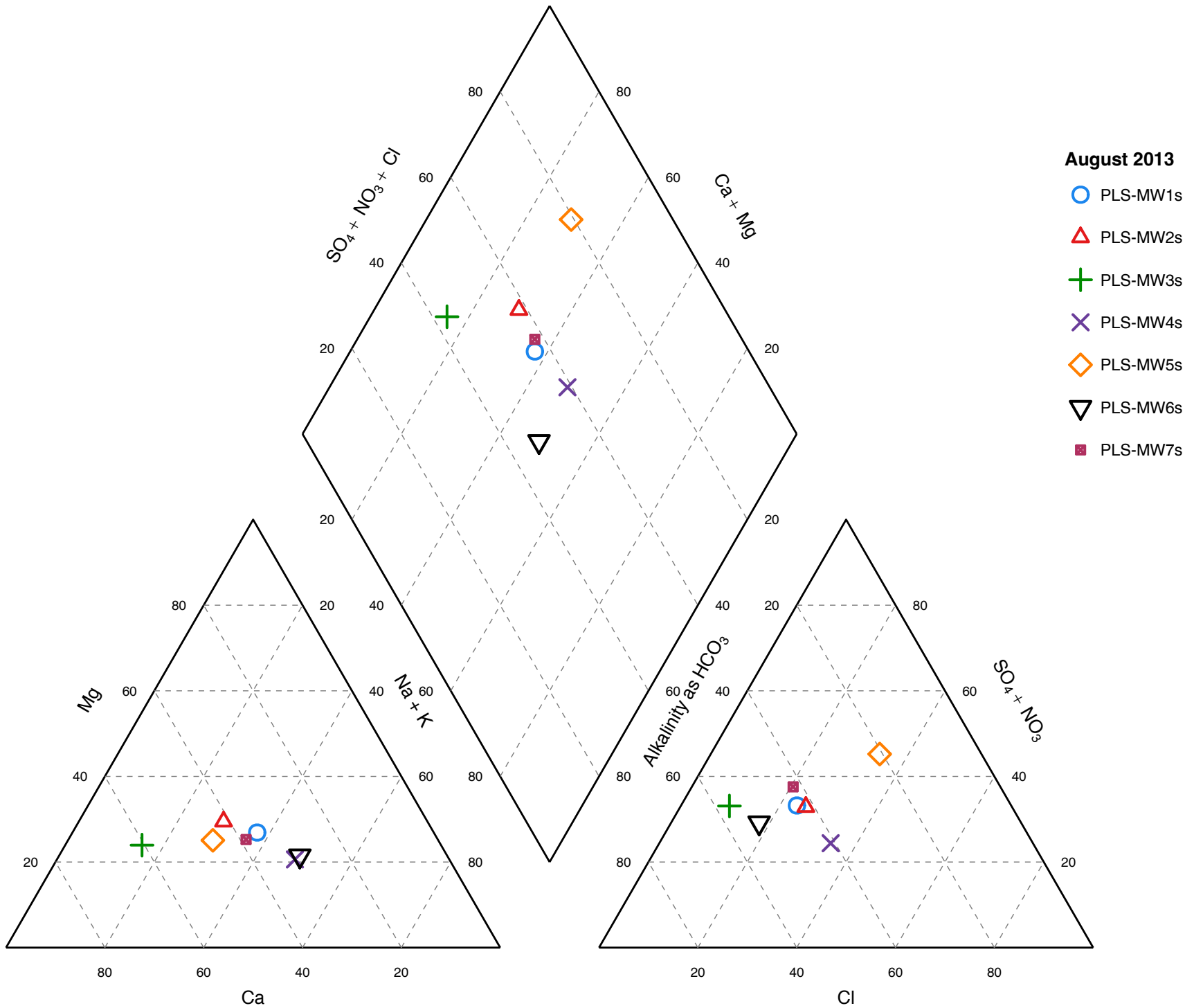

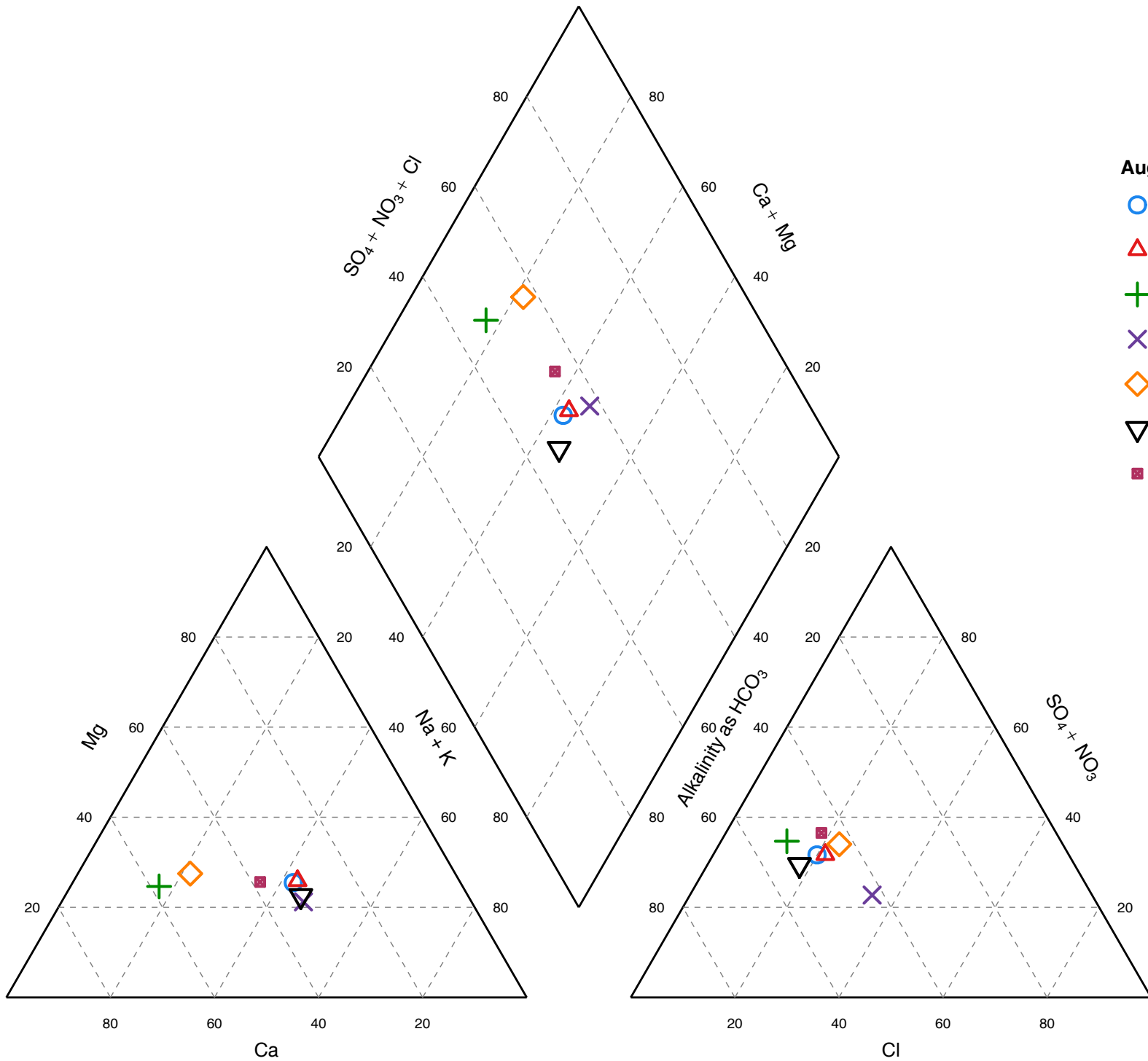

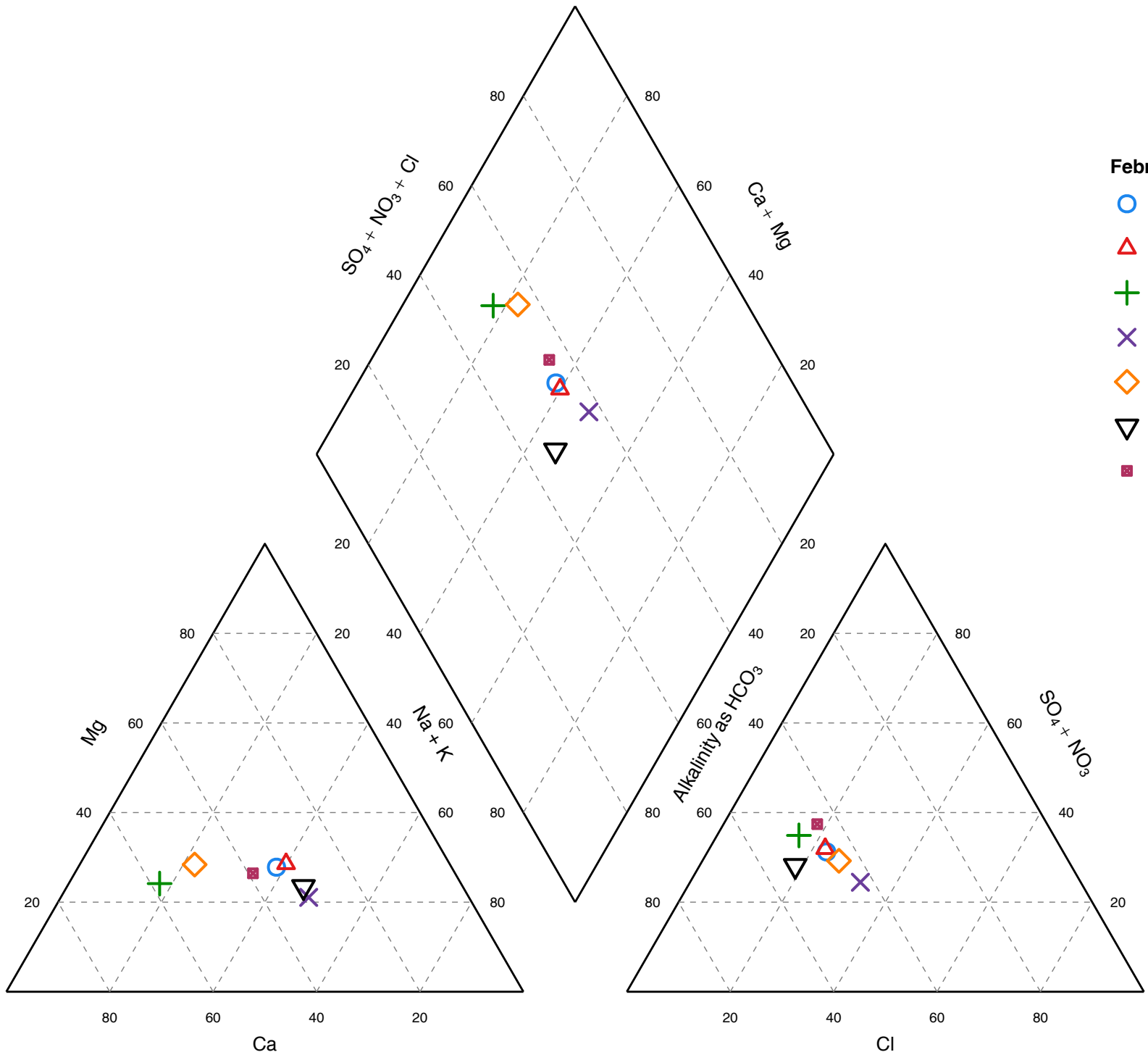

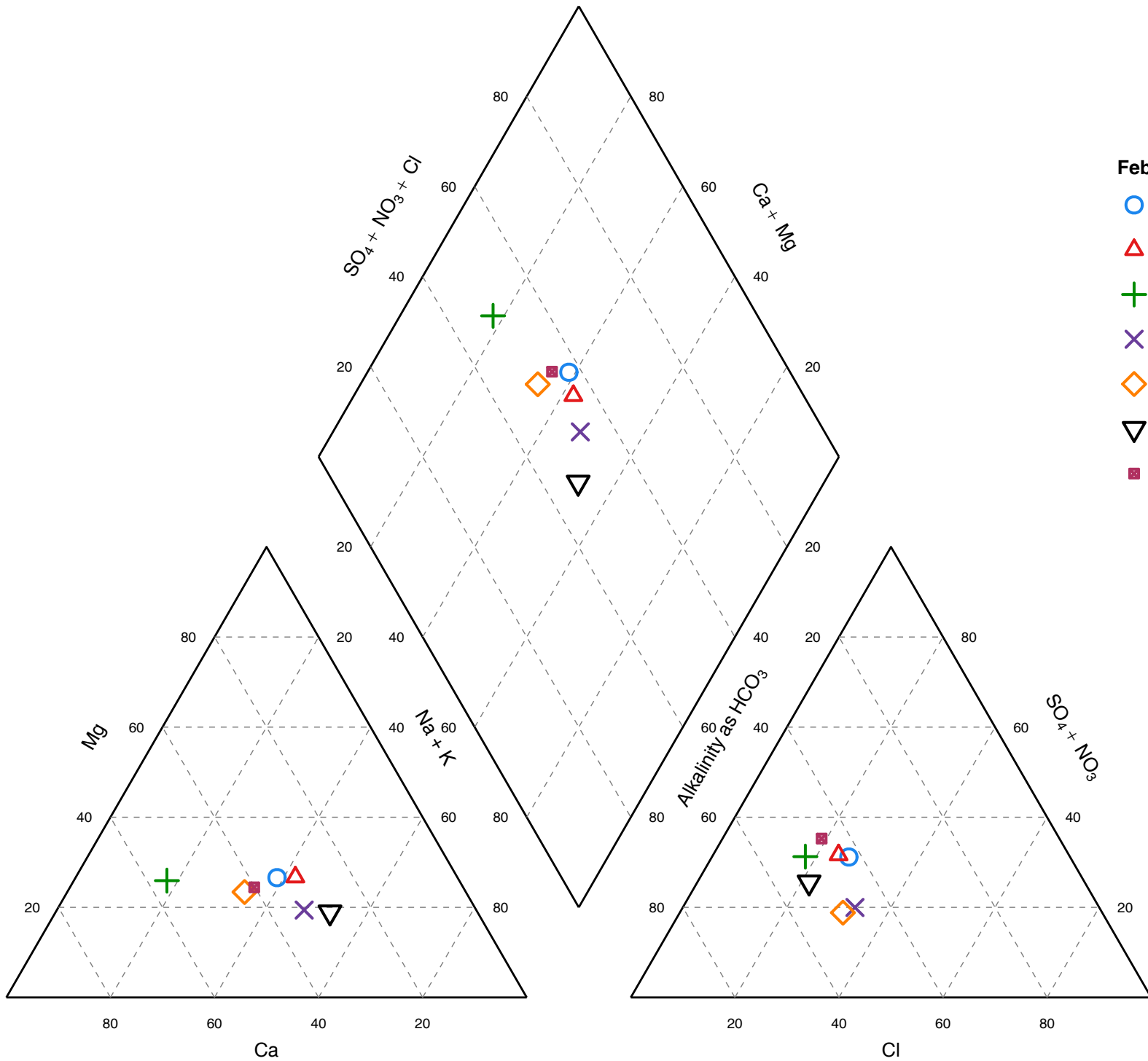

February 2016

- PLS-MW1d
- △ PLS-MW2d
- + PLS-MW3d
- × PLS-MW4s
- ◇ PLS-MW5d
- ▽ PLS-MW6s
- PLS-MW7s

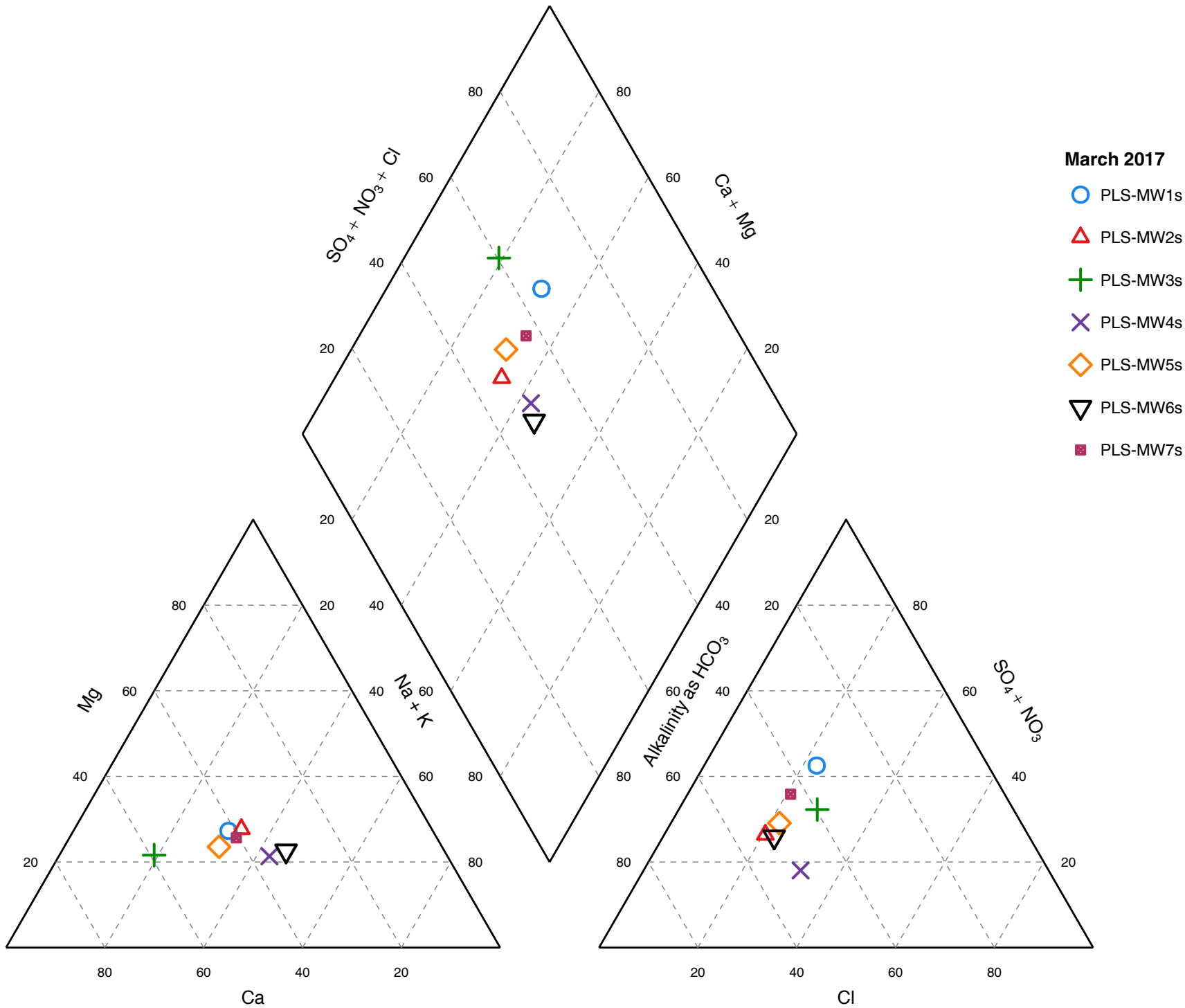

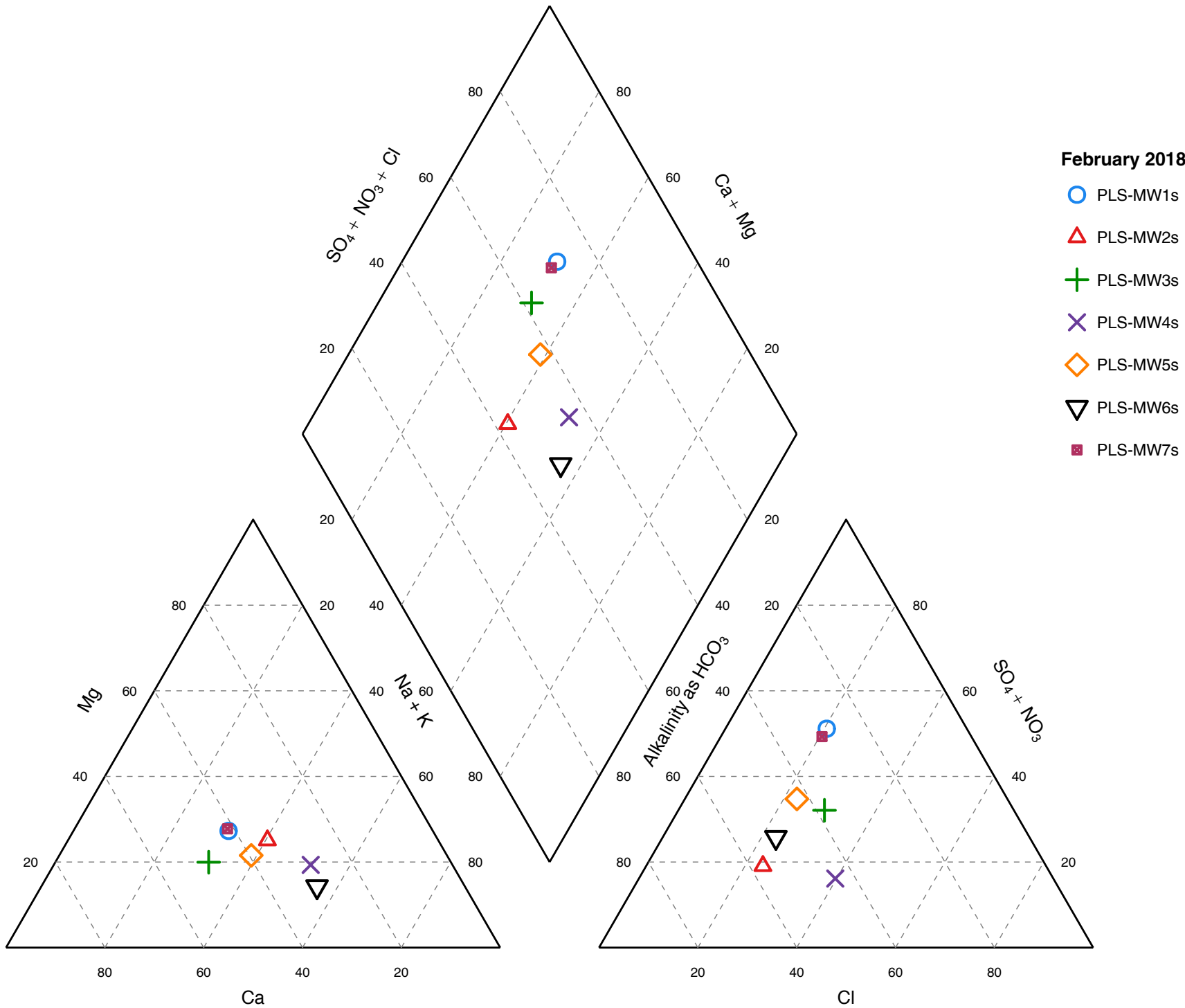

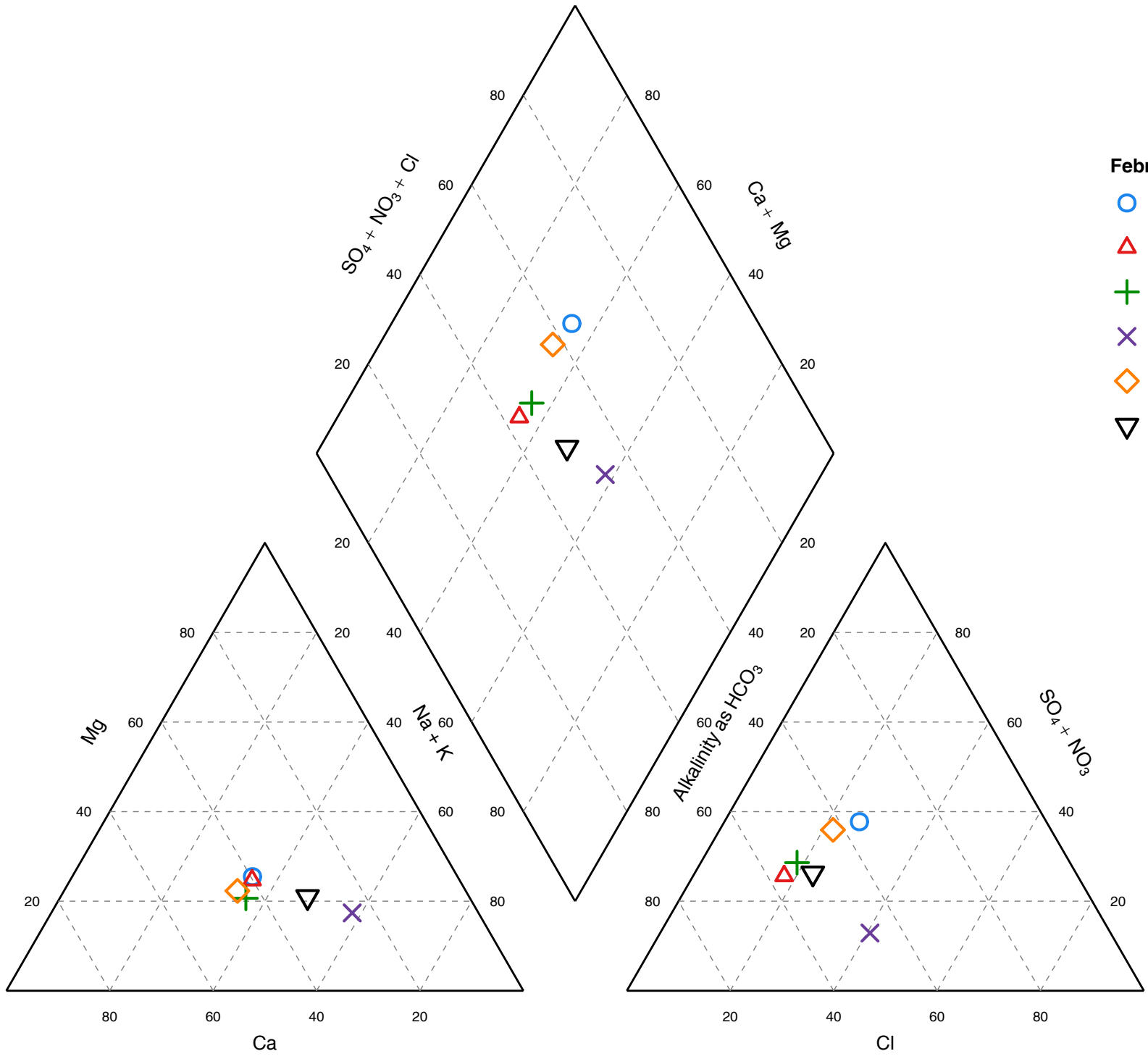

February 2019

- PLS-MW1s
- △ PLS-MW2s
- + PLS-MW3s
- × PLS-MW4s
- ◇ PLS-MW5s
- ▽ PLS-MW6s

April 2019

■ PLS-MW7s

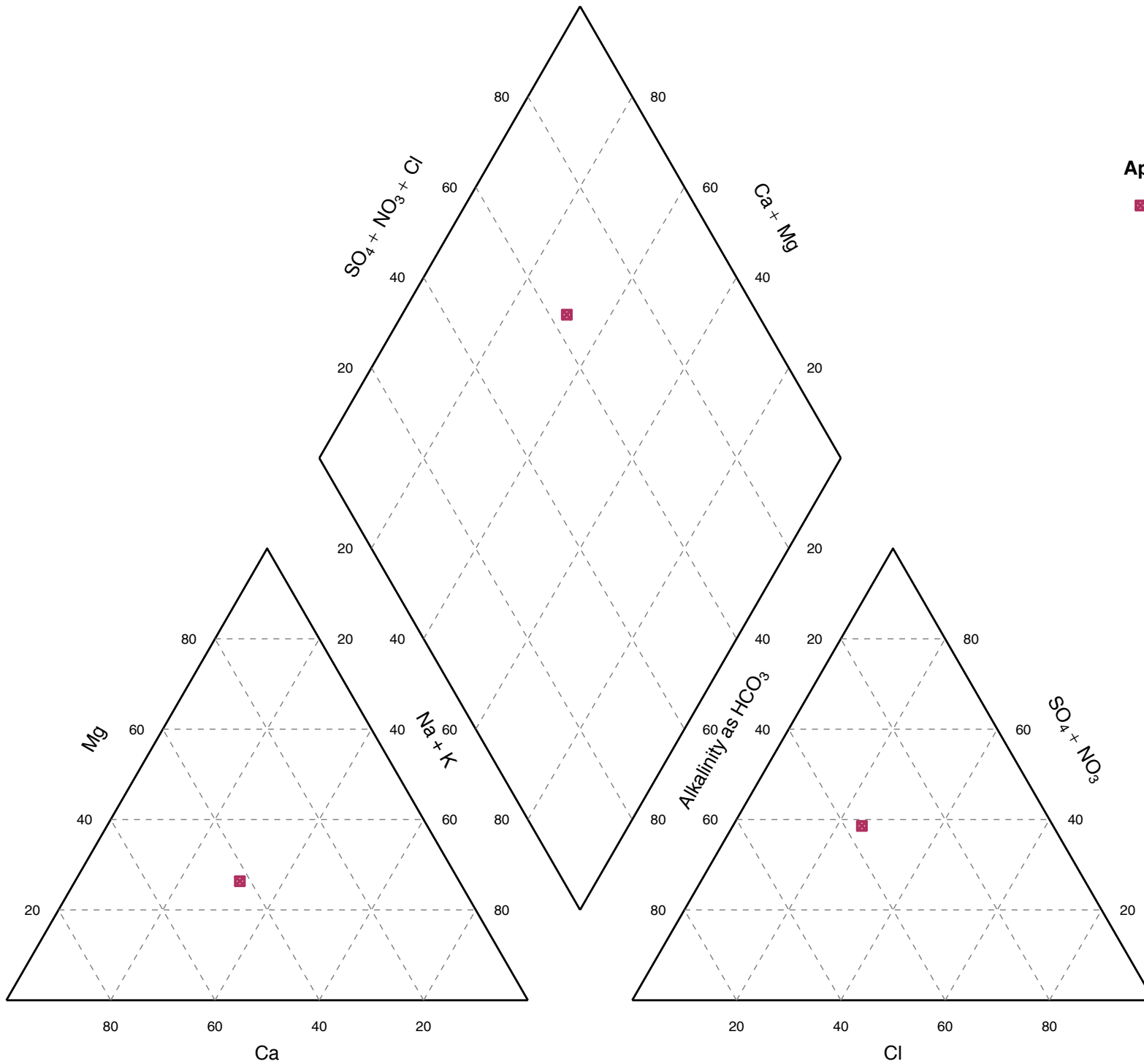

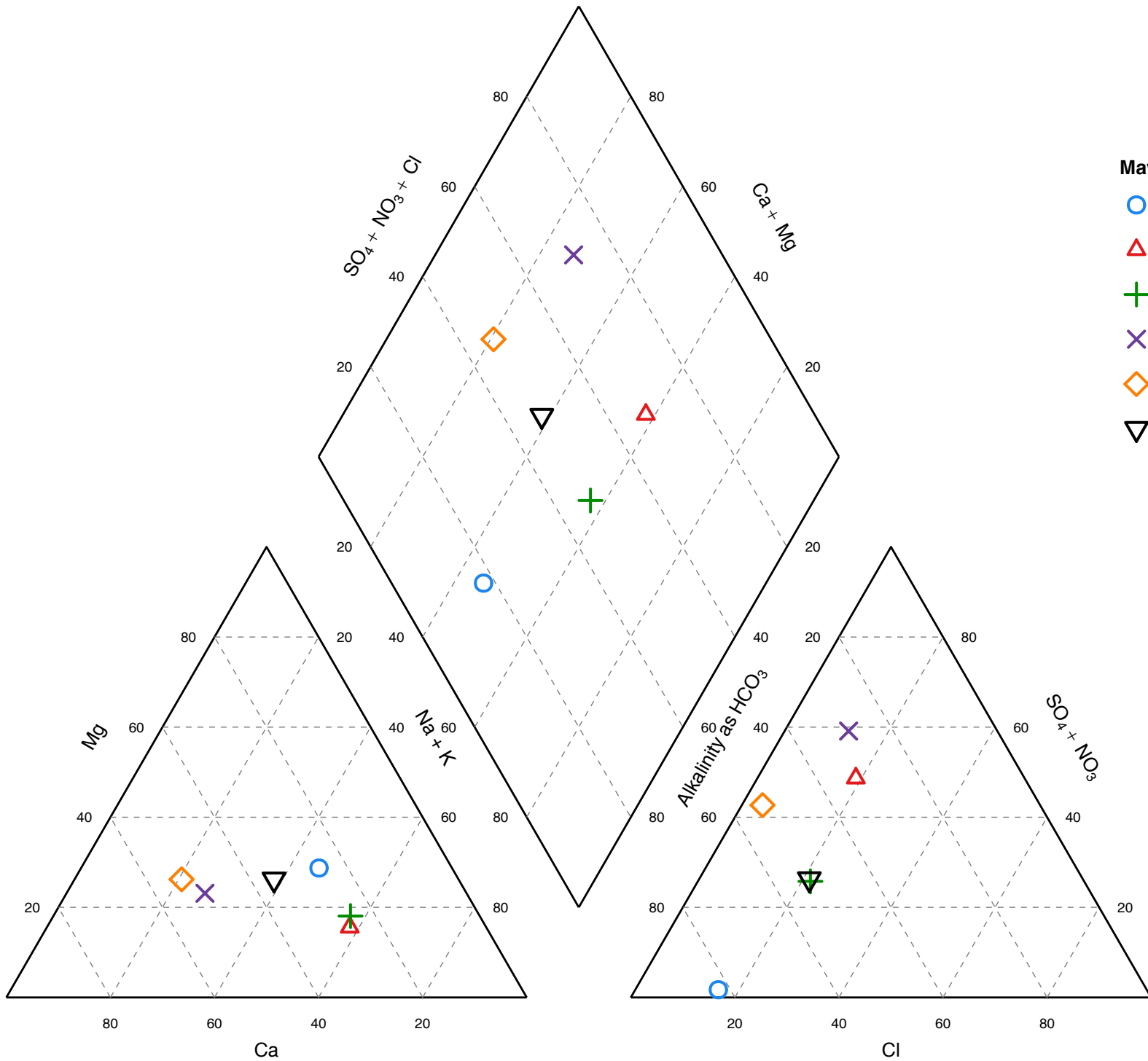

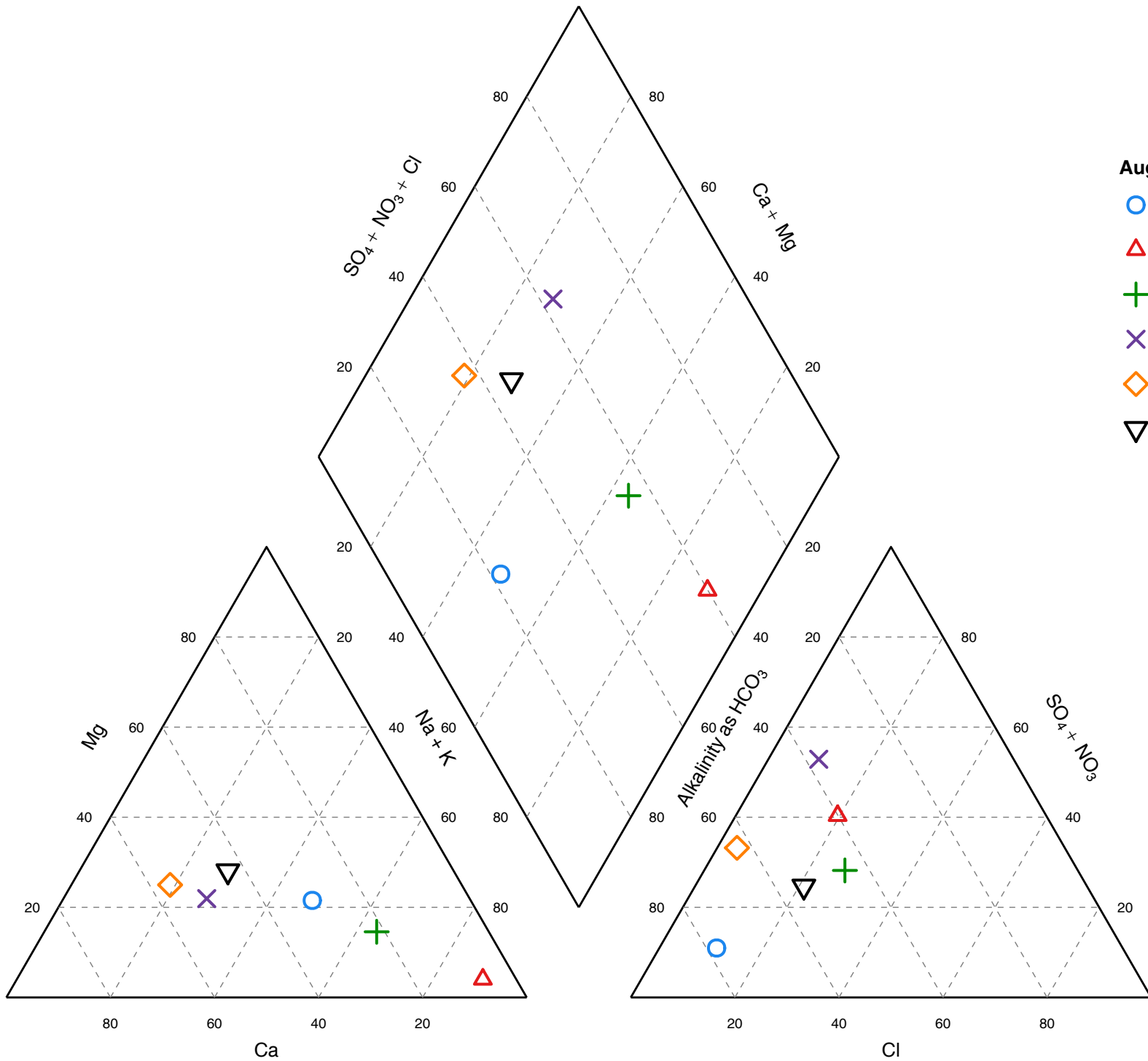

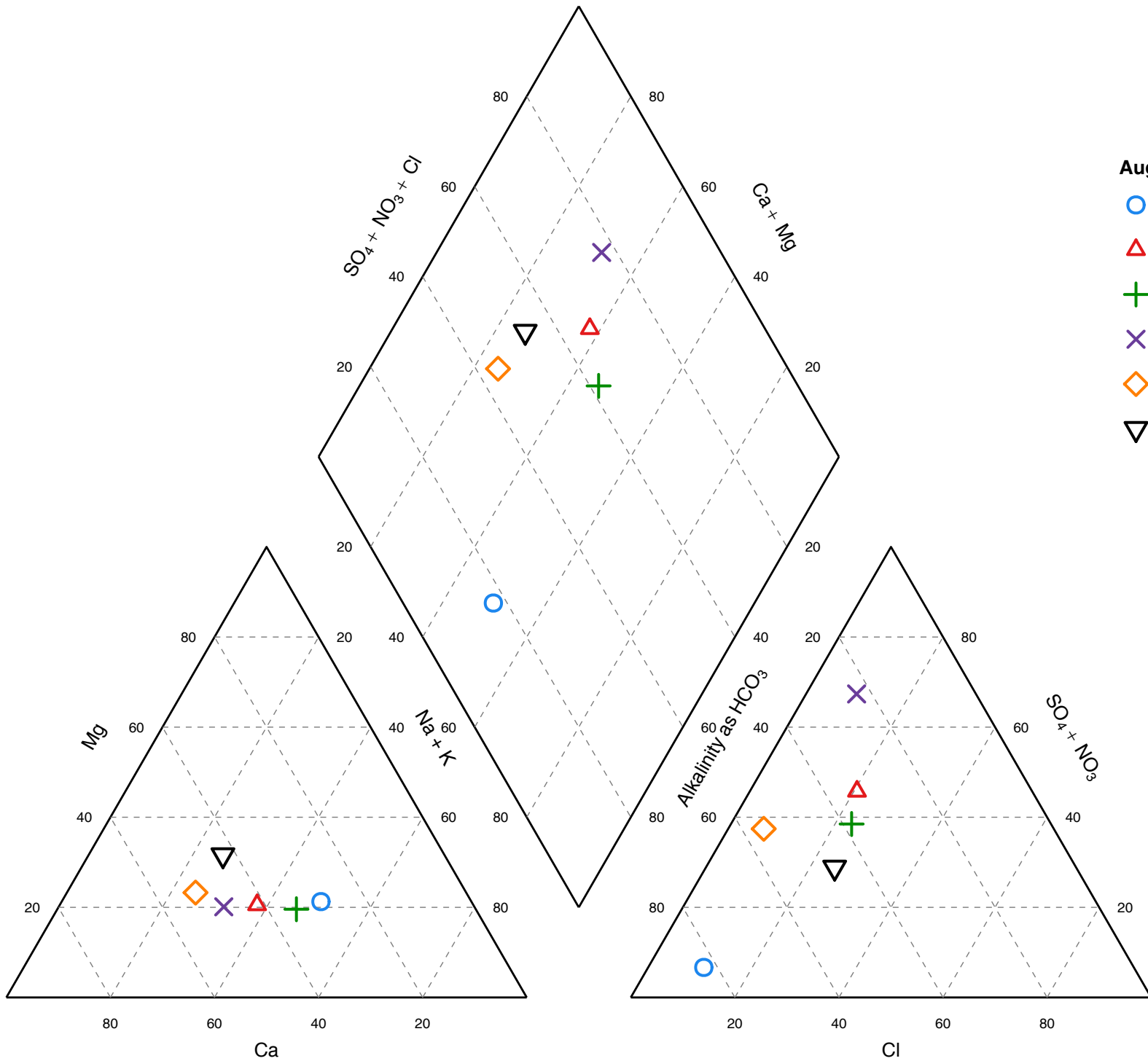

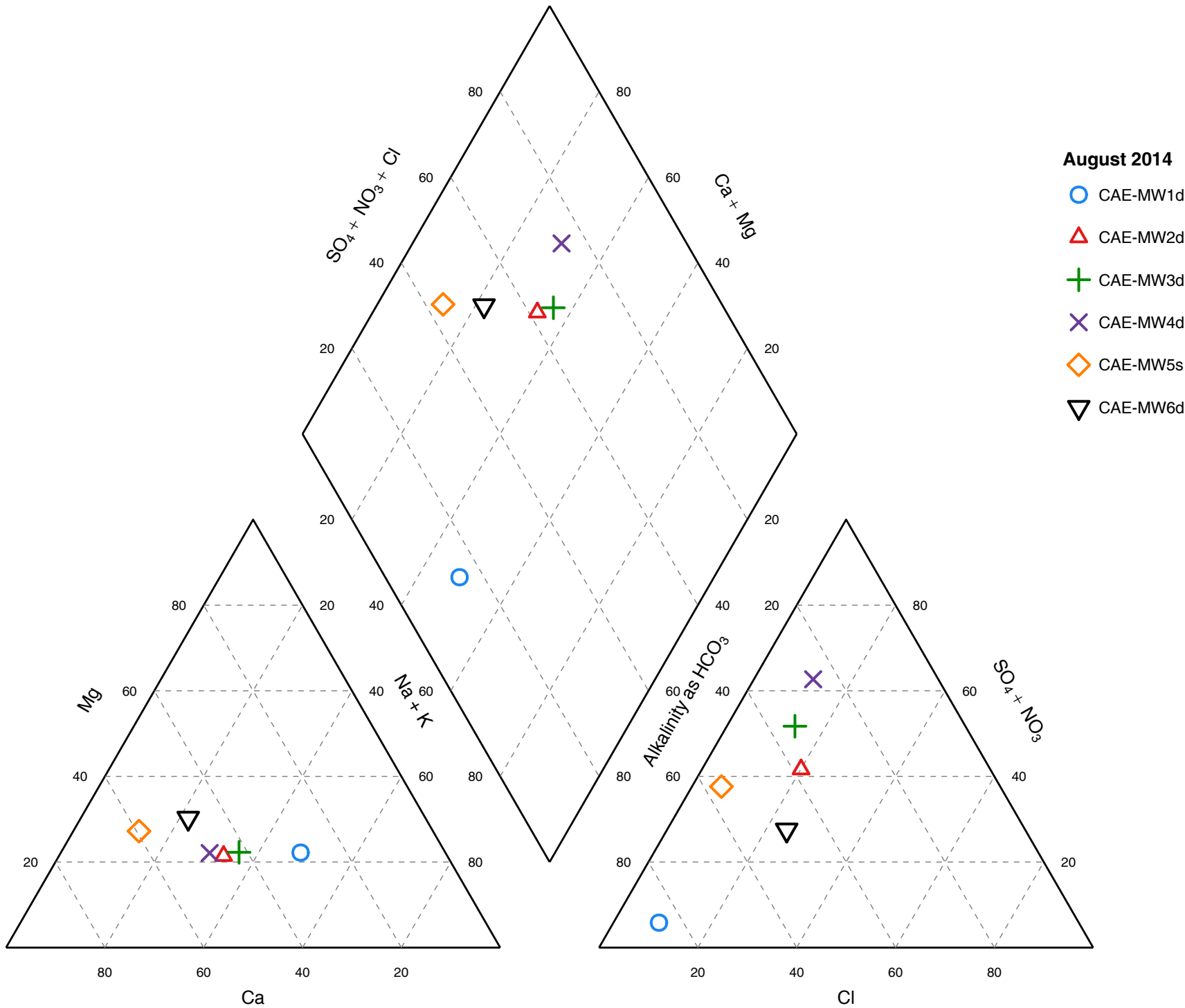

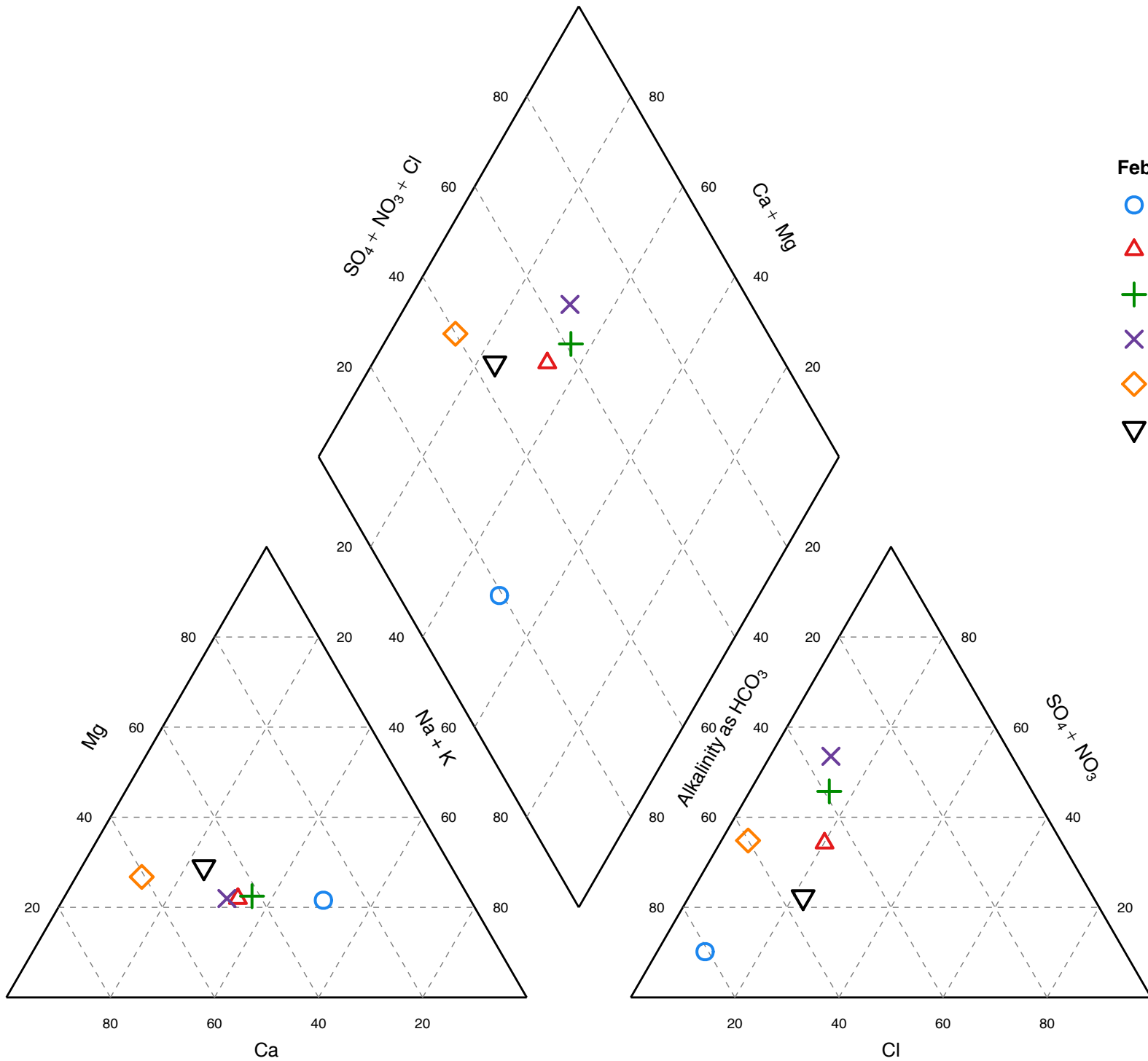

February 2015

- CAE-MW1d
- △ CAE-MW2d
- + CAE-MW3d
- × CAE-MW4d
- ◇ CAE-MW5s
- ▽ CAE-MW6d

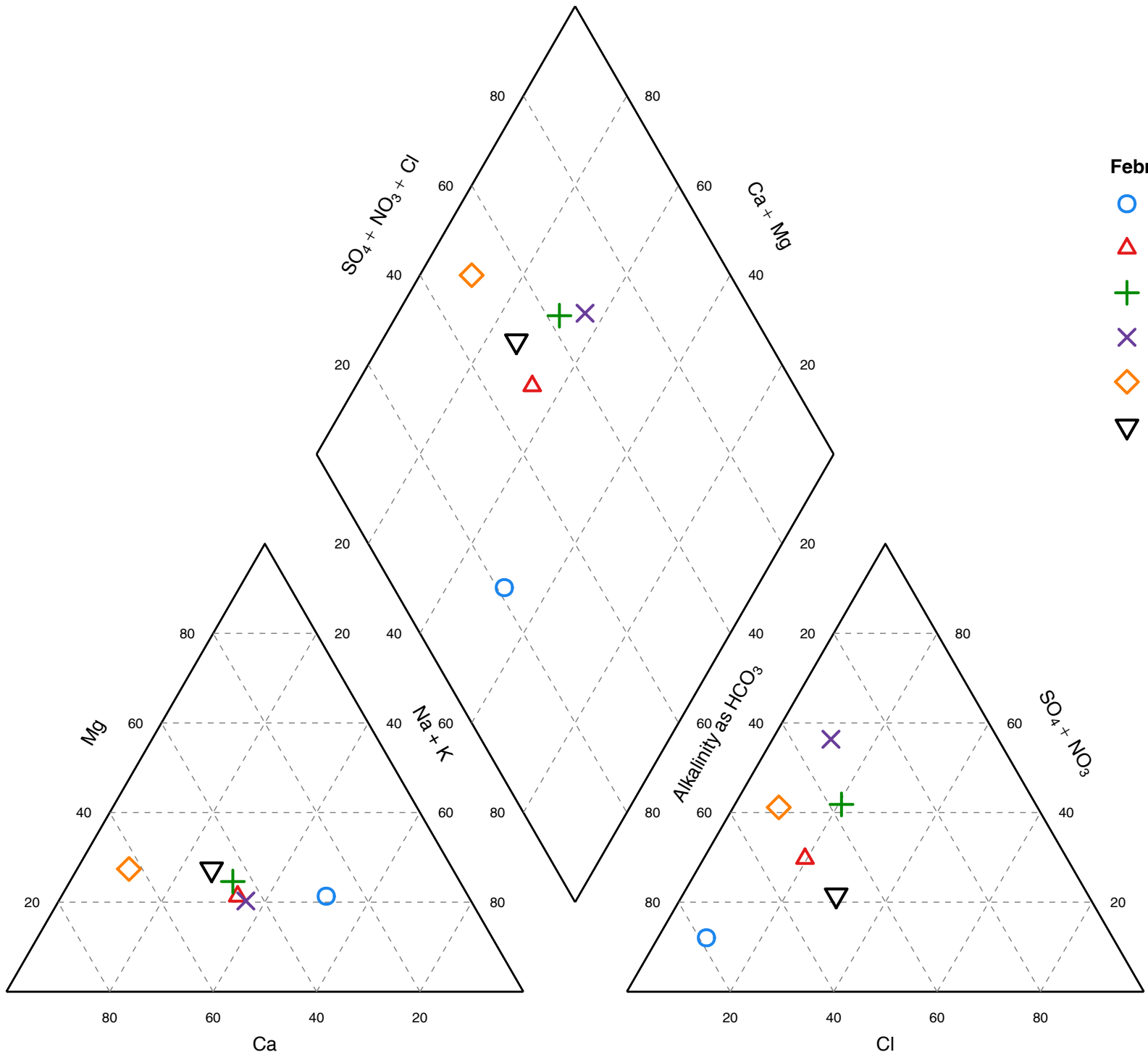

February 2016

- CAE-MW1d
- △ CAE-MW2d
- + CAE-MW3d
- × CAE-MW4d
- ◇ CAE-MW5s
- ▽ CAE-MW6d

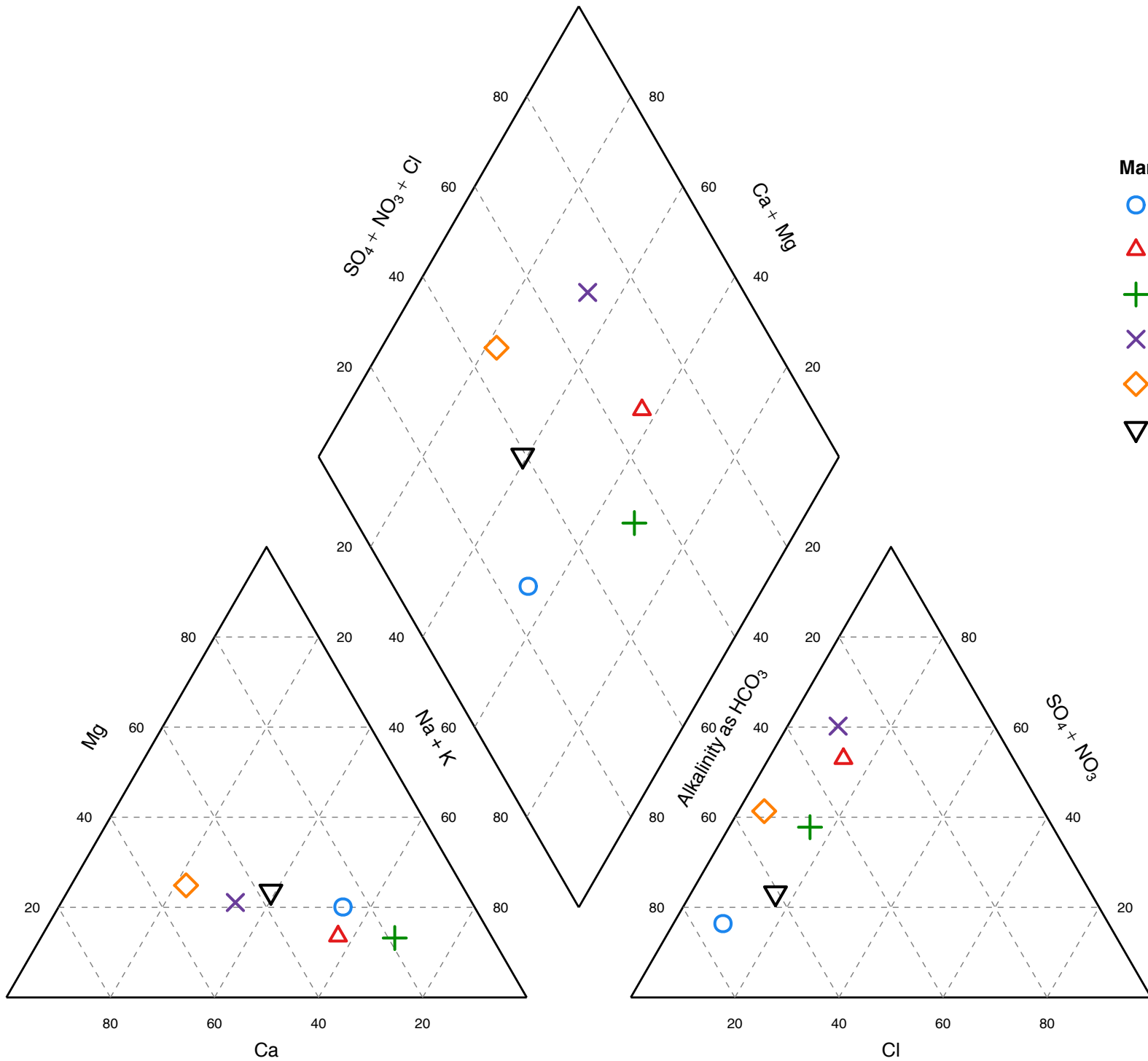

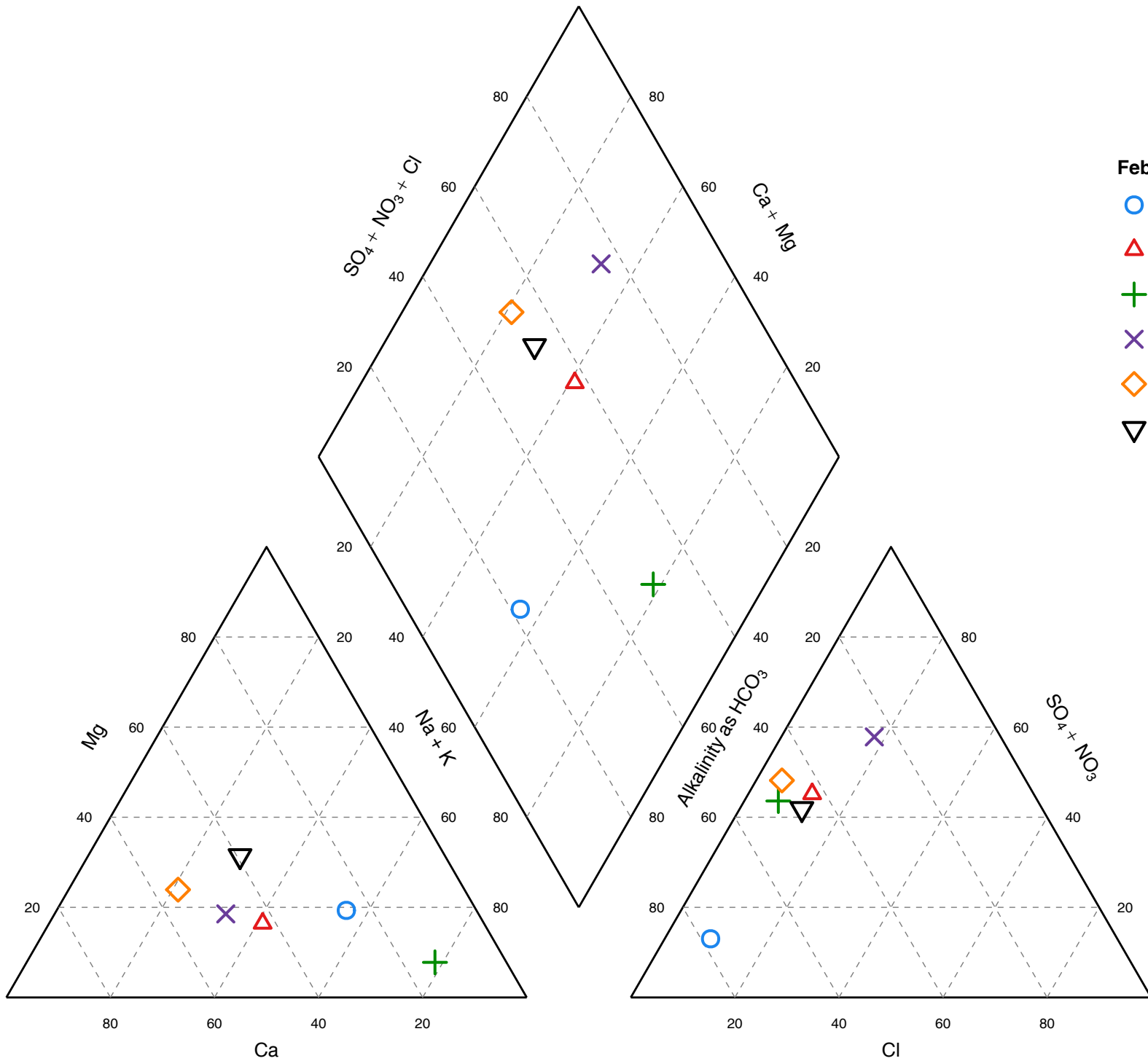

February 2018

- CAE-MW1d
- △ CAE-MW2d
- ⊕ CAE-MW3d
- ⊗ CAE-MW4s
- ◇ CAE-MW5s
- ▽ CAE-MW6s

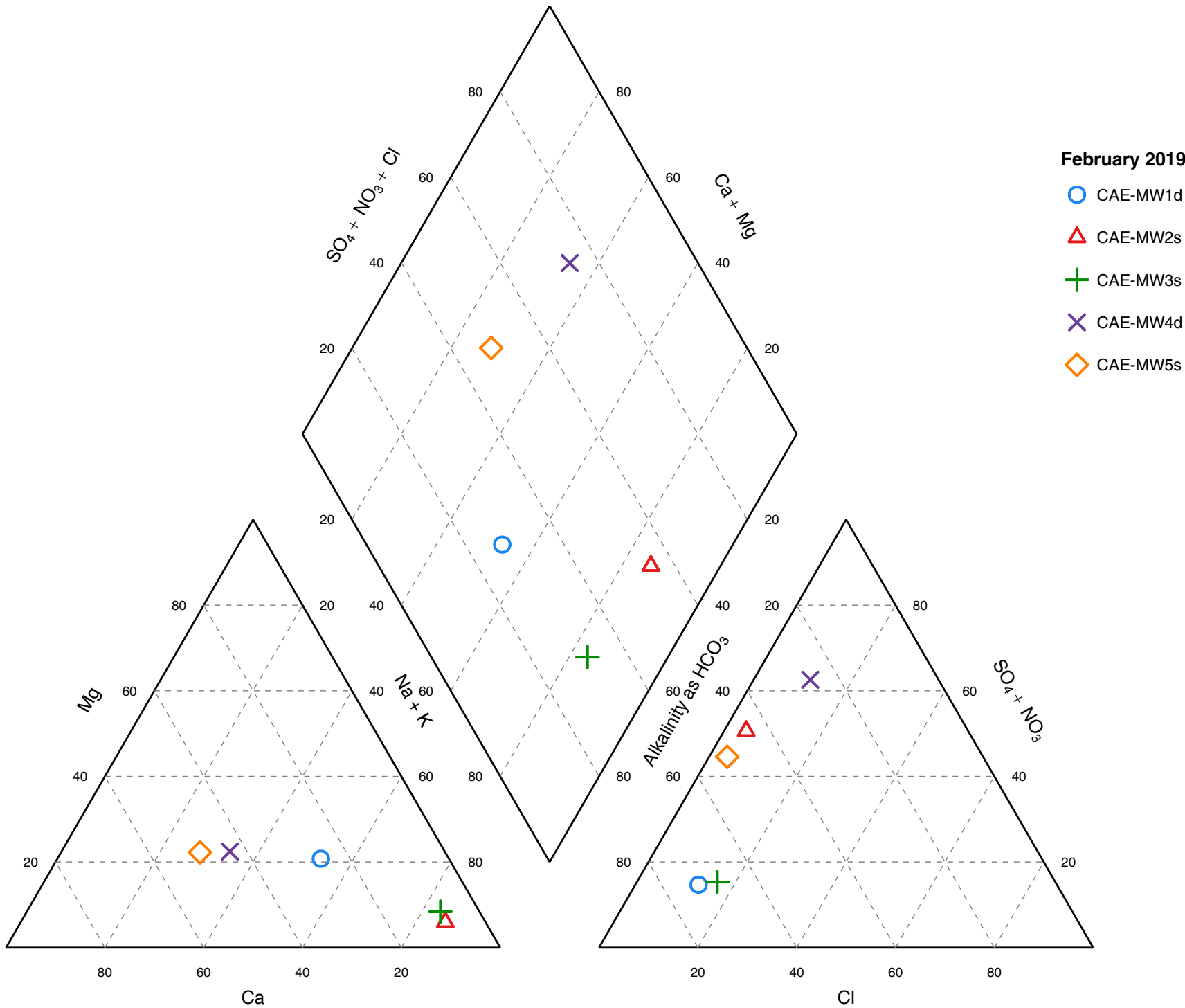

March 2019

▽ CAE-MW6s

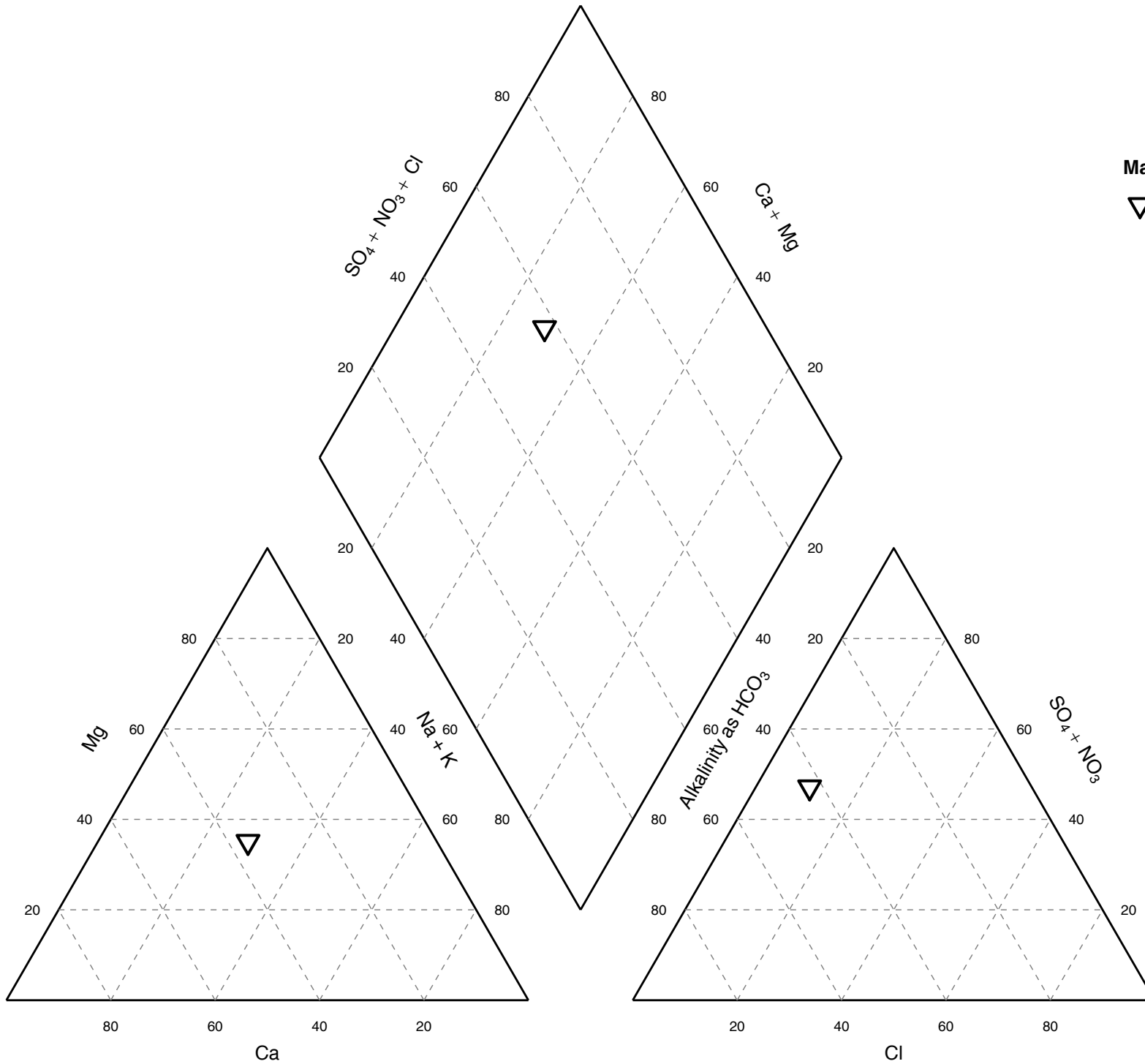

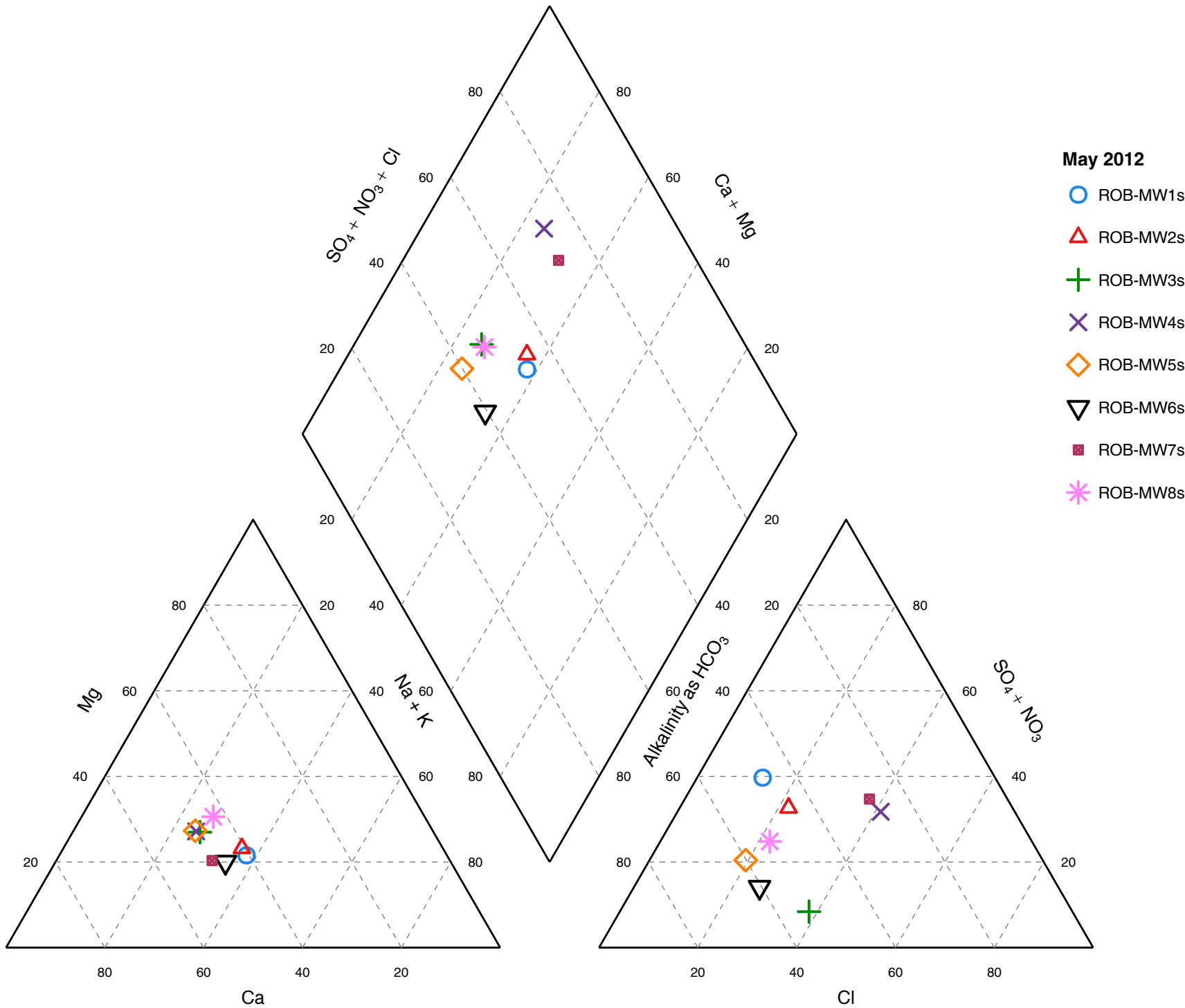

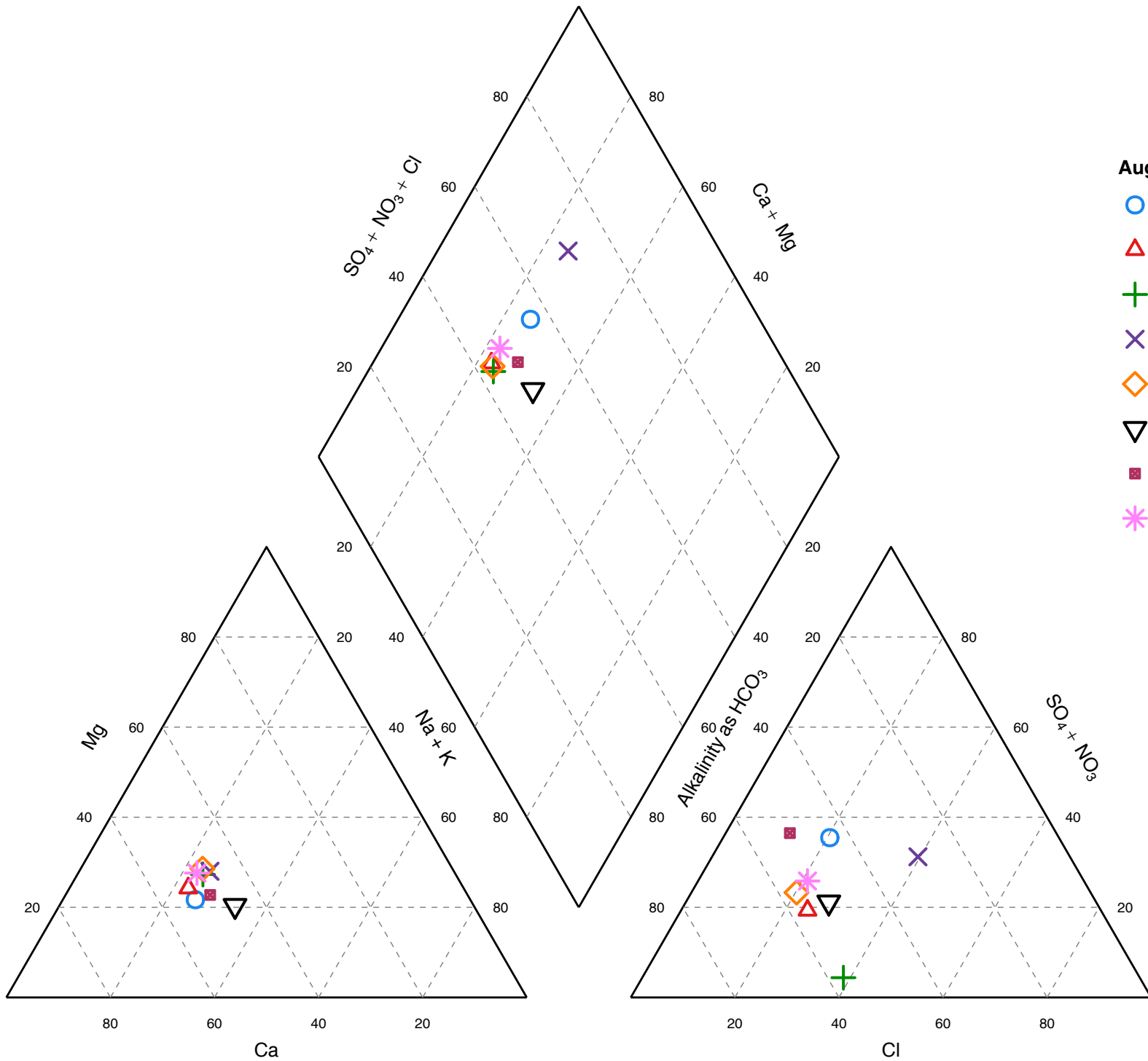

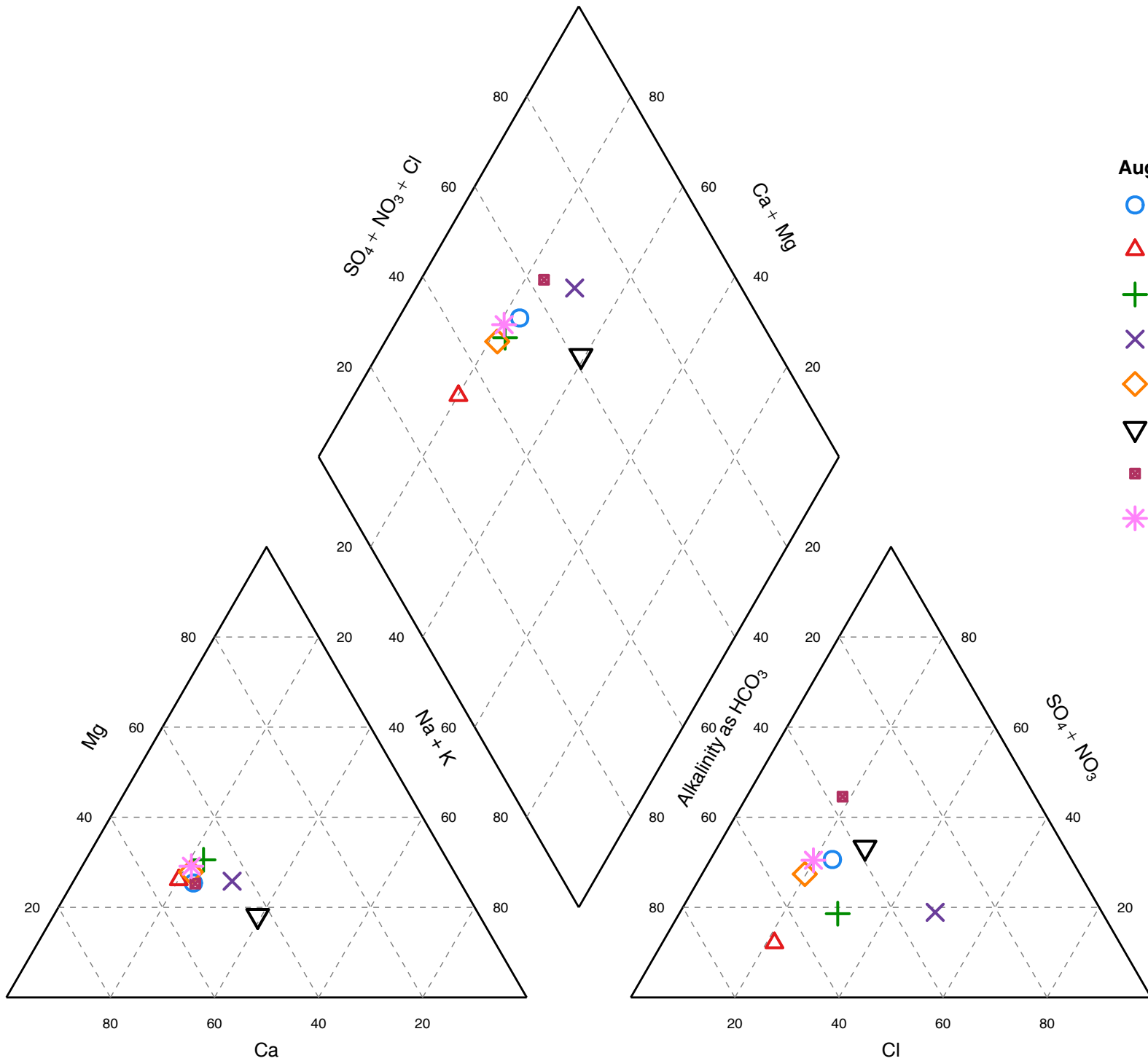

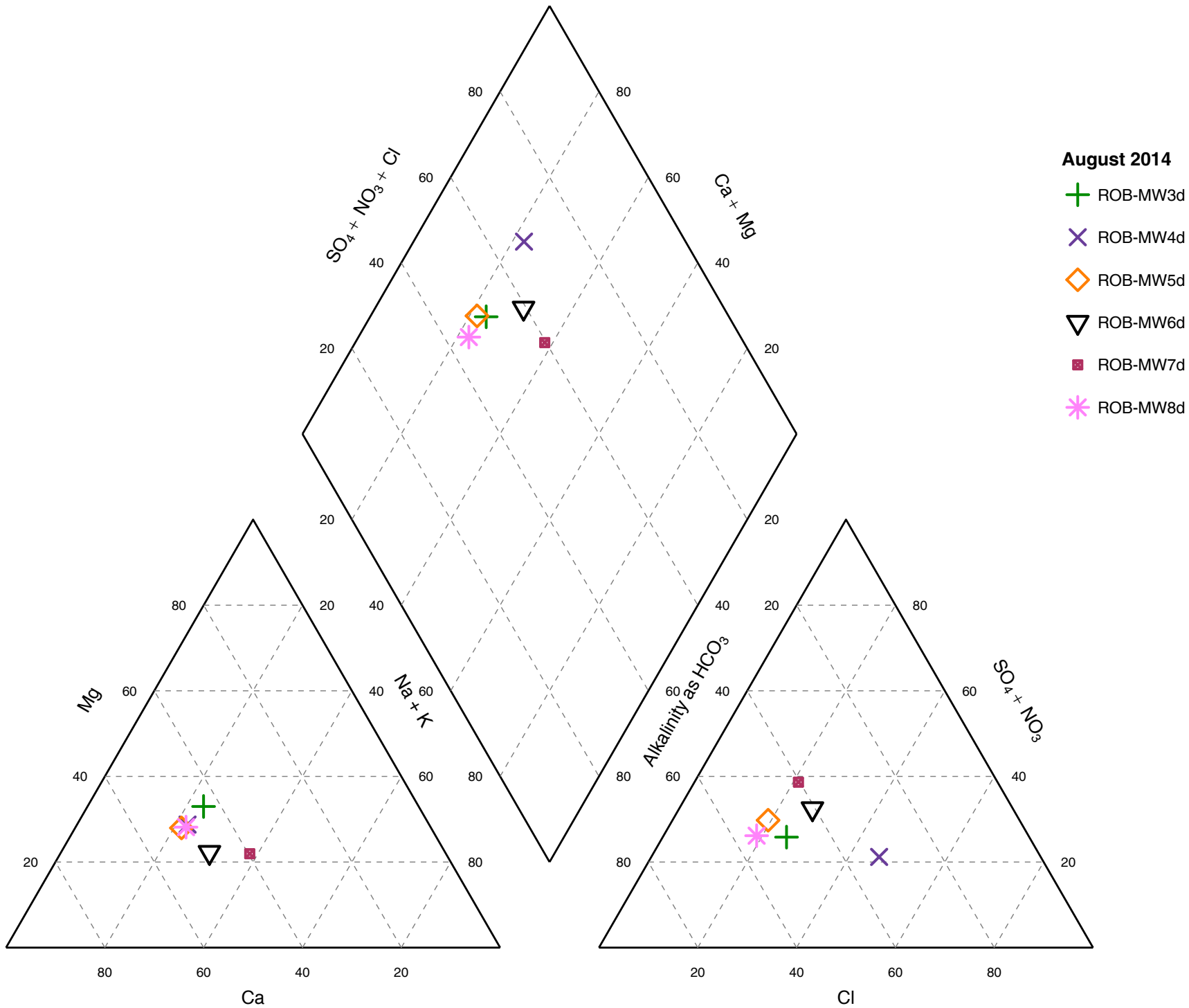

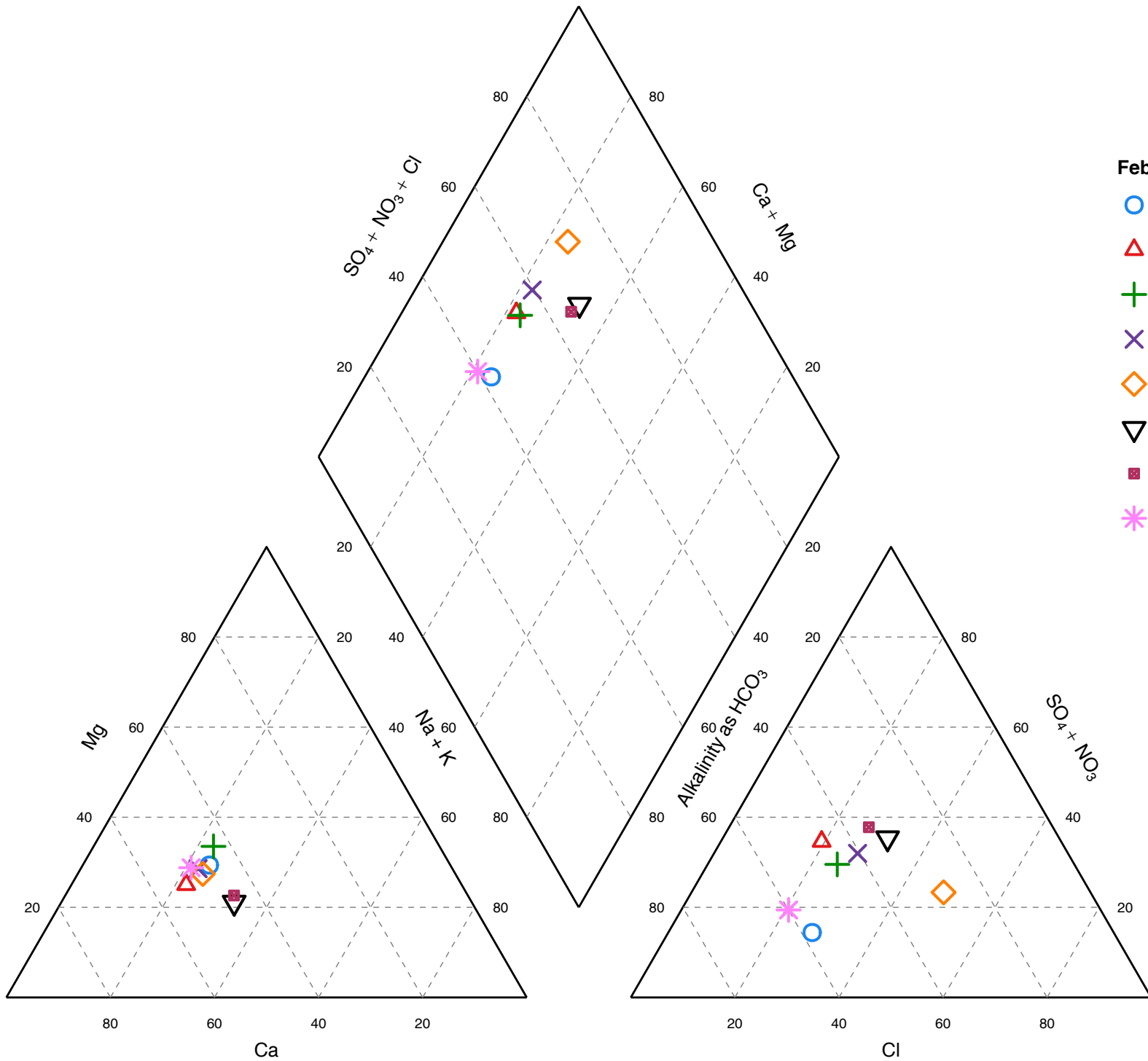

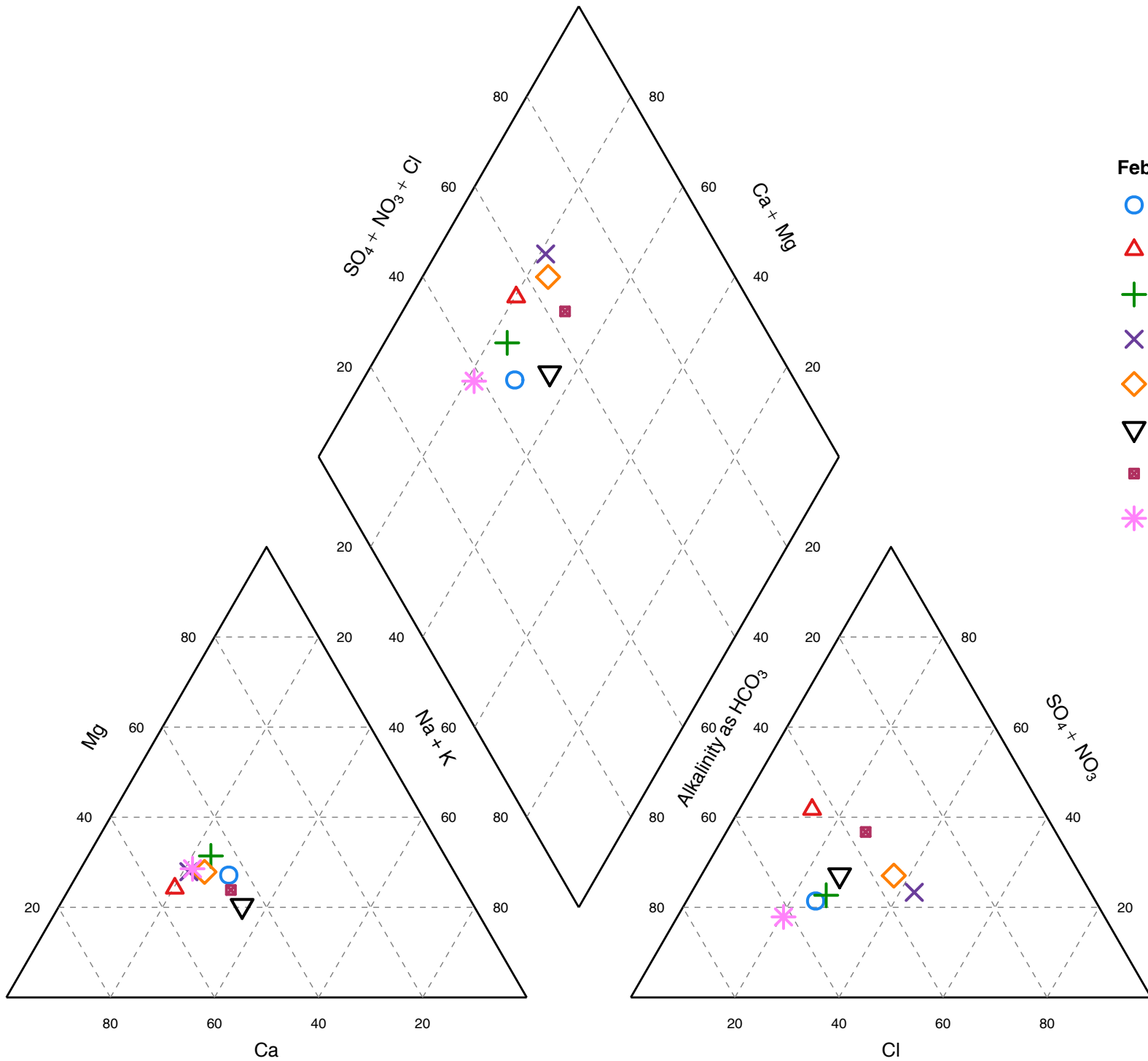

February 2016

- ROB-MW1d
- △ ROB-MW2d
- + ROB-MW3d
- × ROB-MW4d
- ◇ ROB-MW5d
- ▽ ROB-MW6s
- ROB-MW7s
- * ROB-MW8s

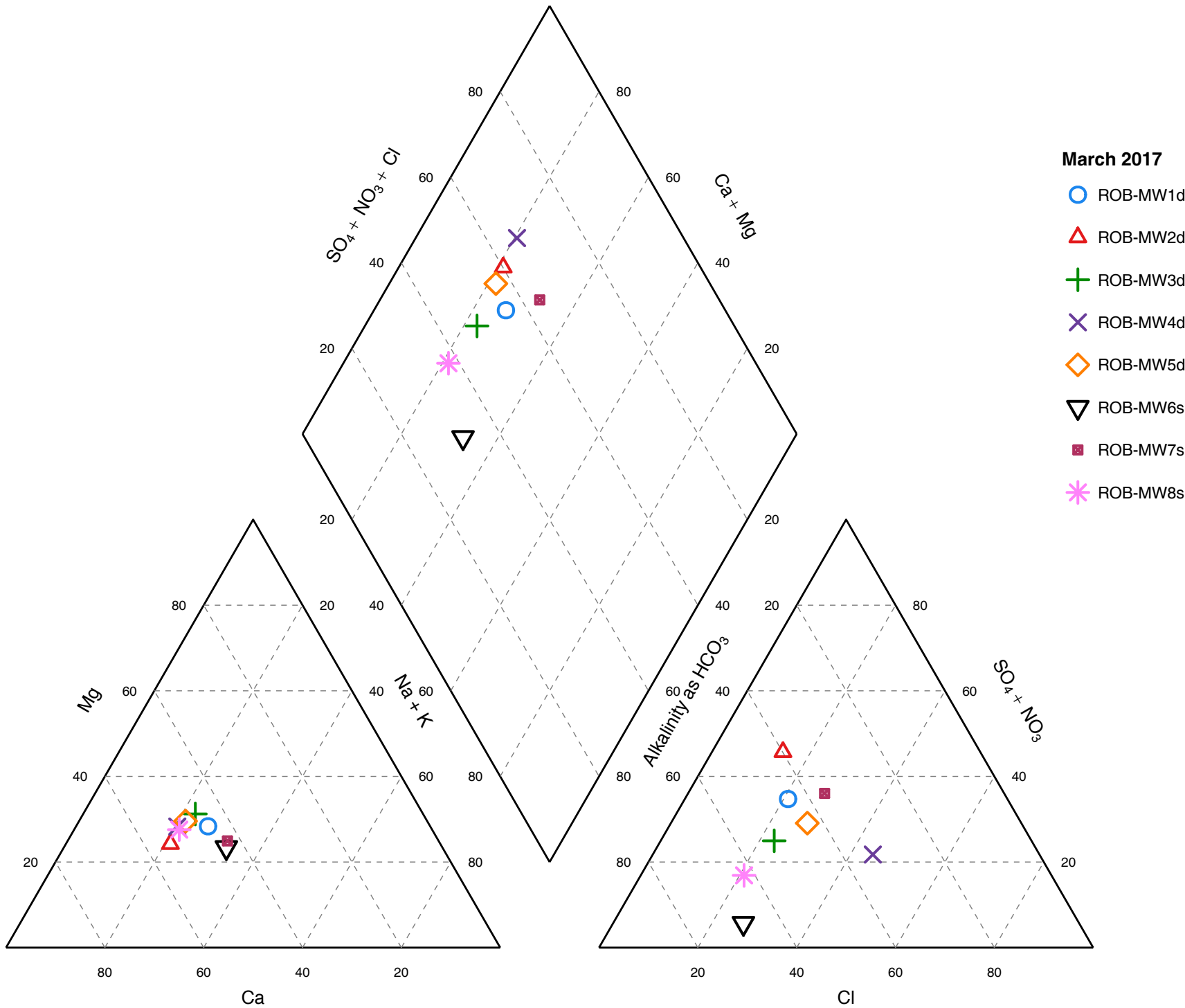

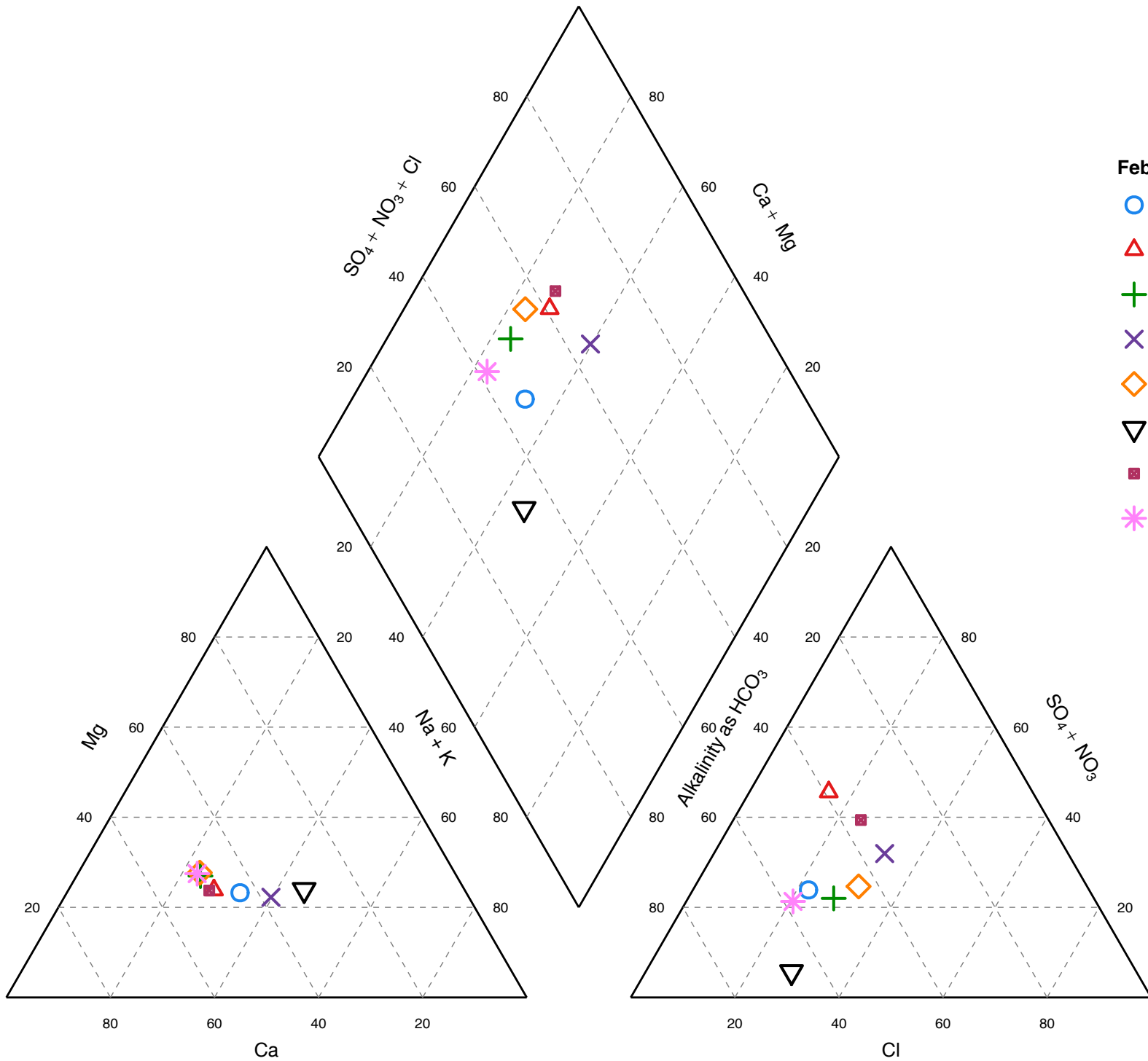

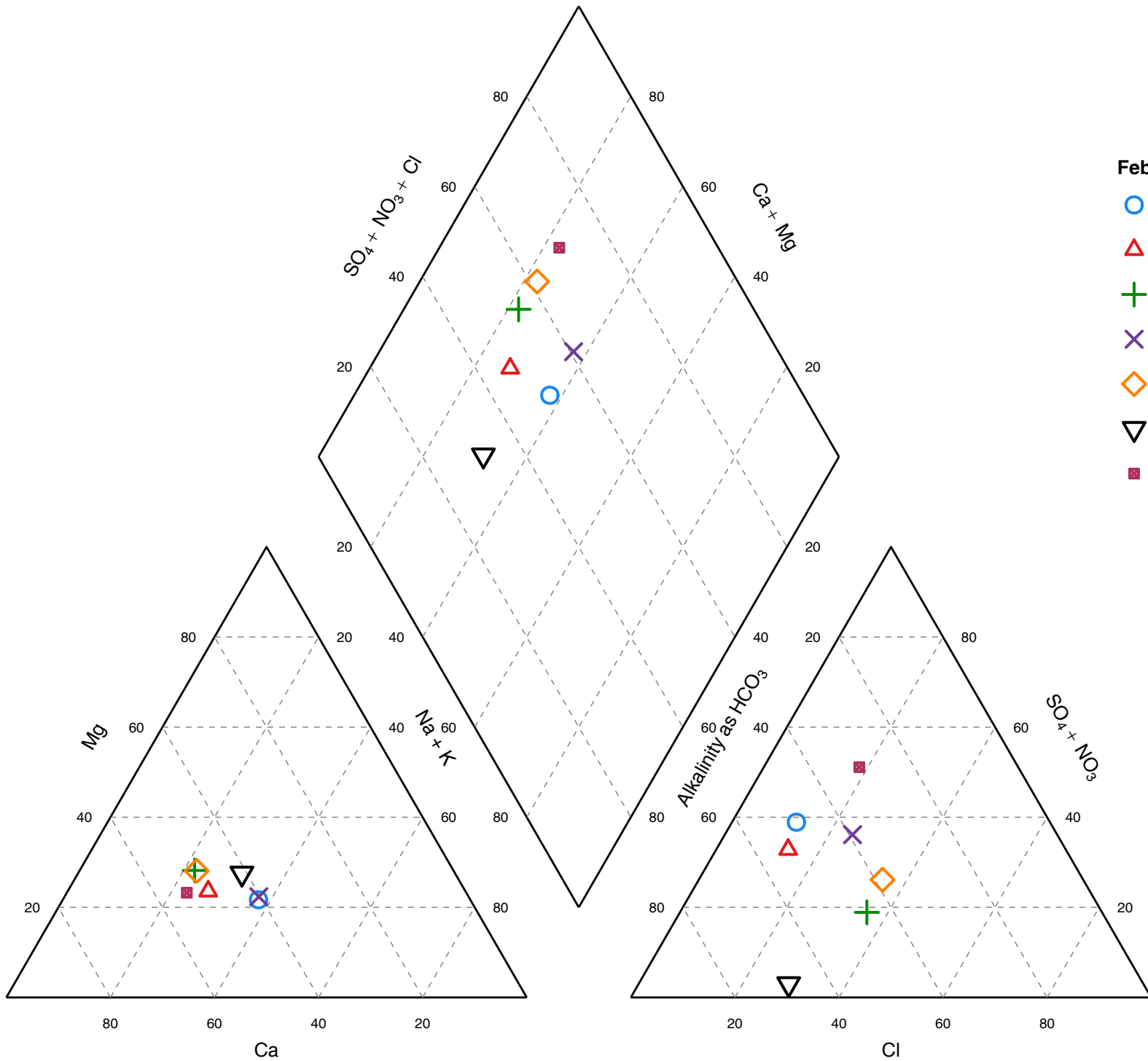

March 2019

* ROB-MW8s

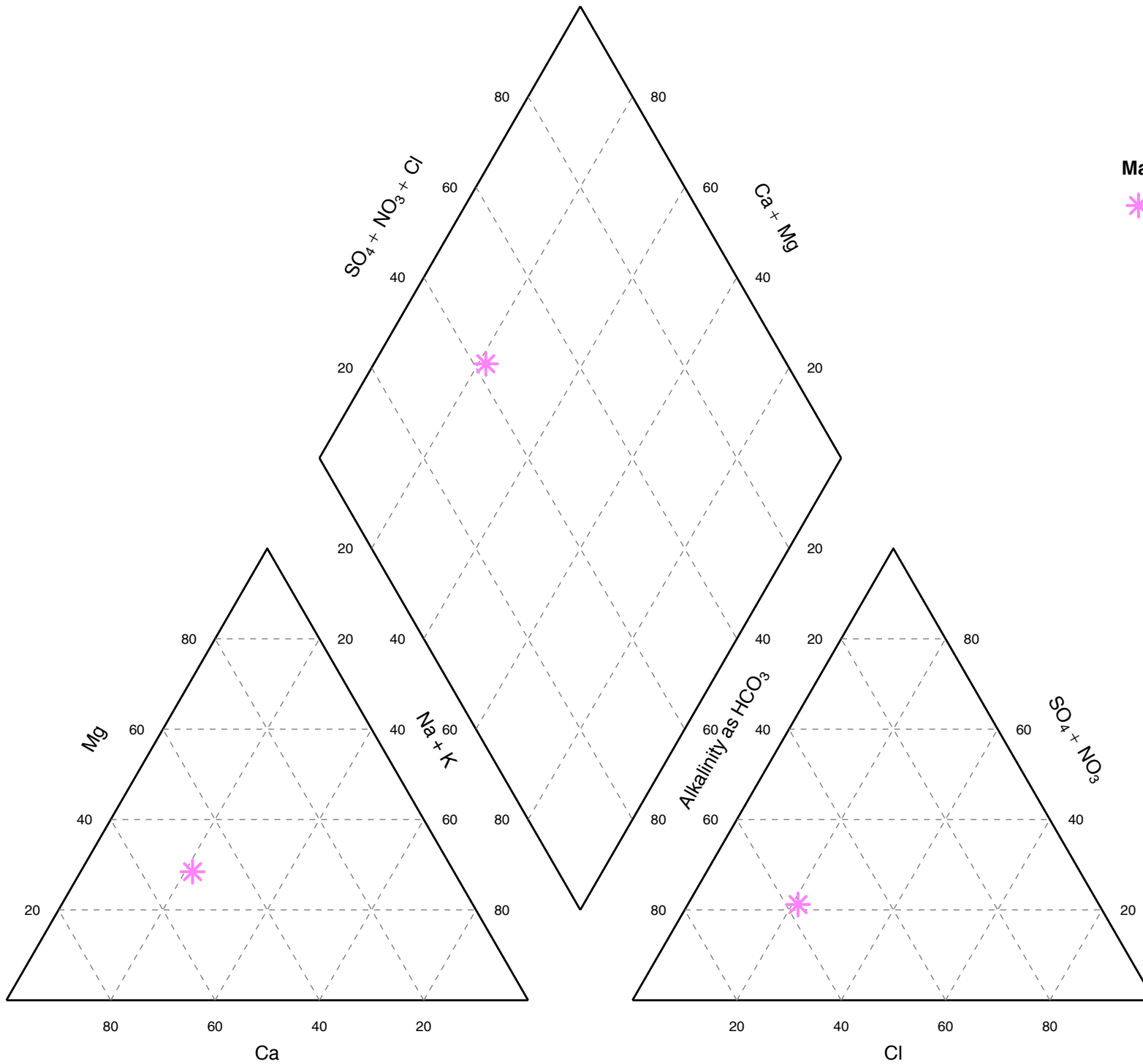

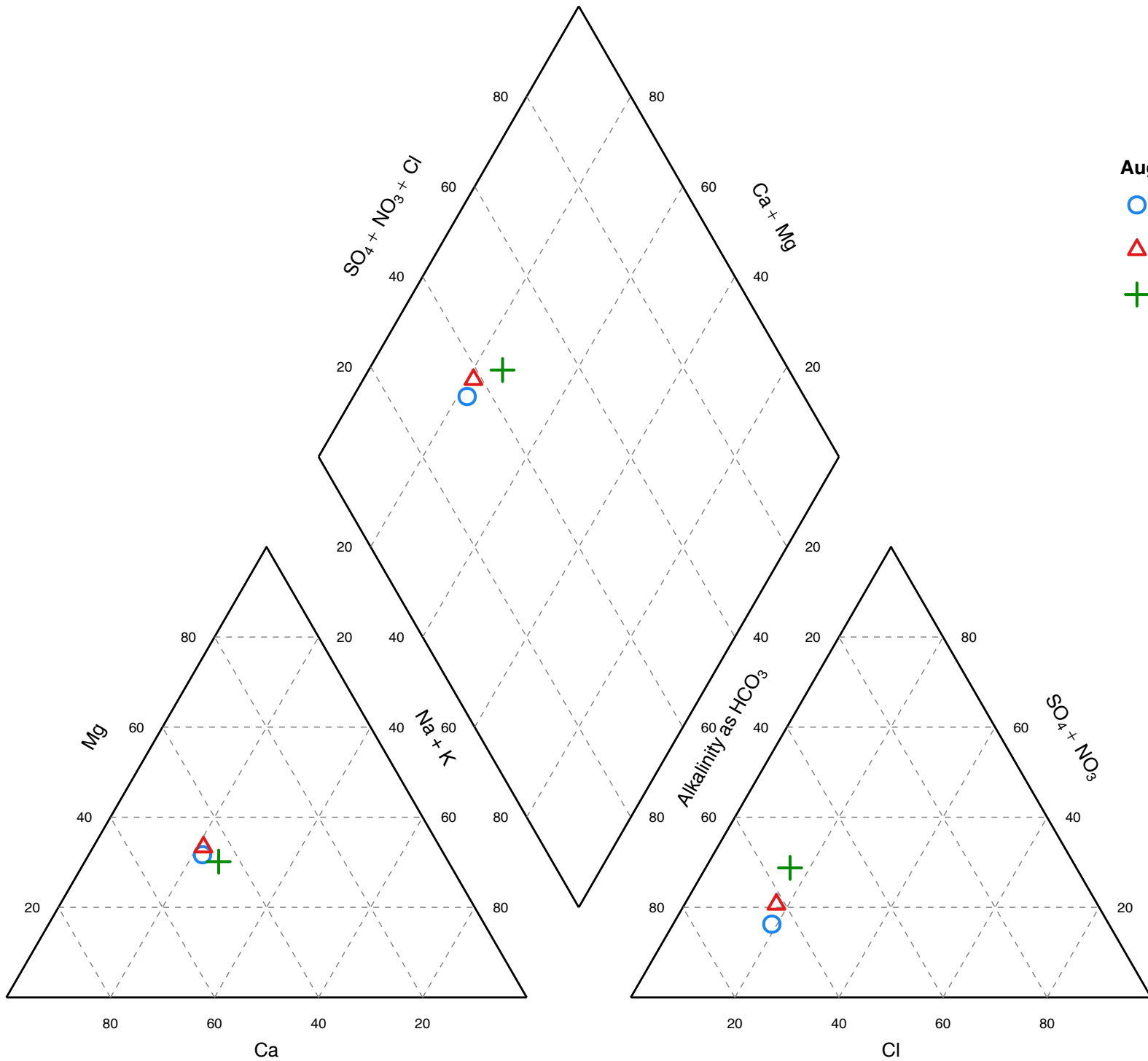

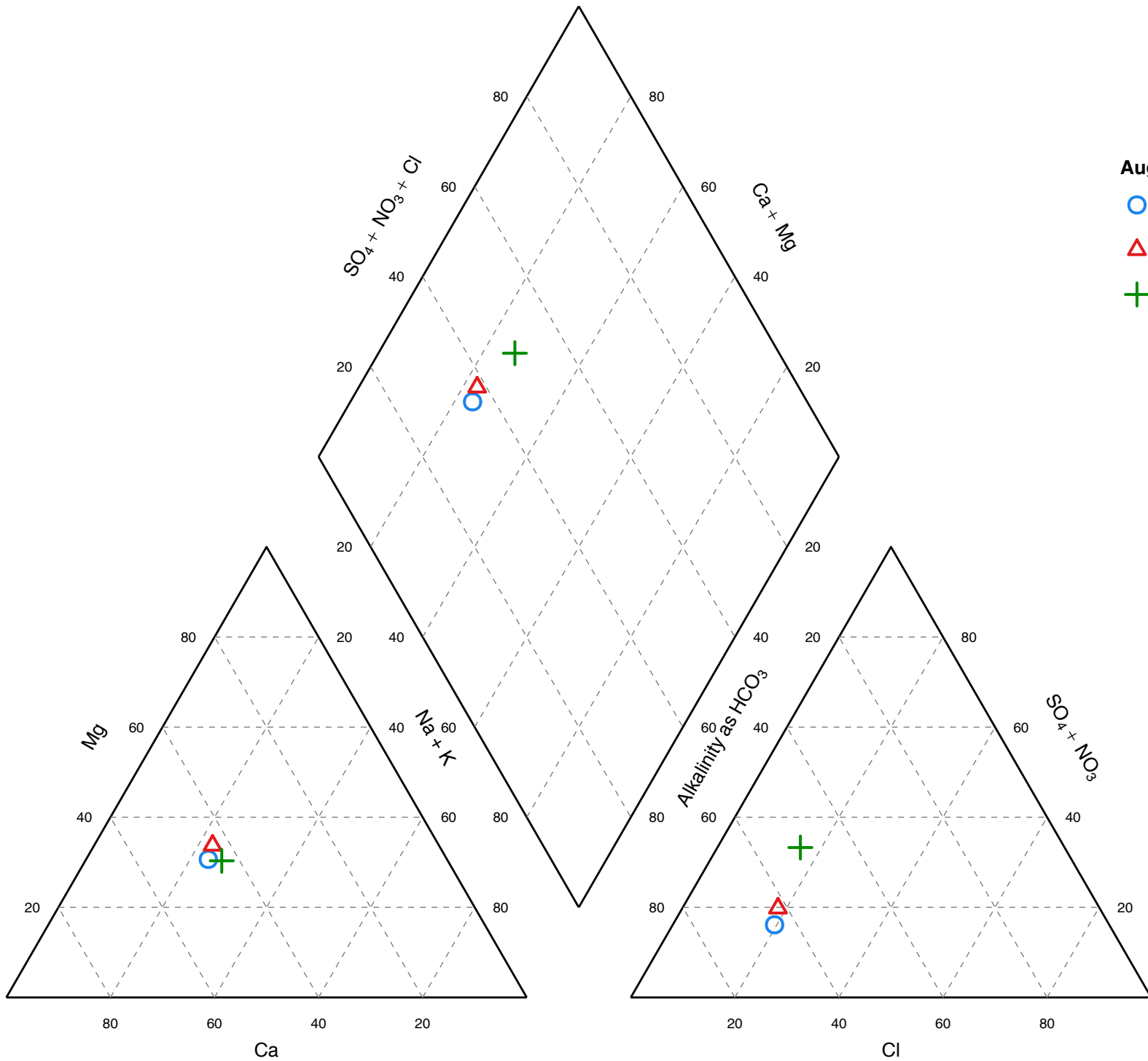

August 2014

○ WOO-MW1

△ WOO-MW2

+ WOO-MW3

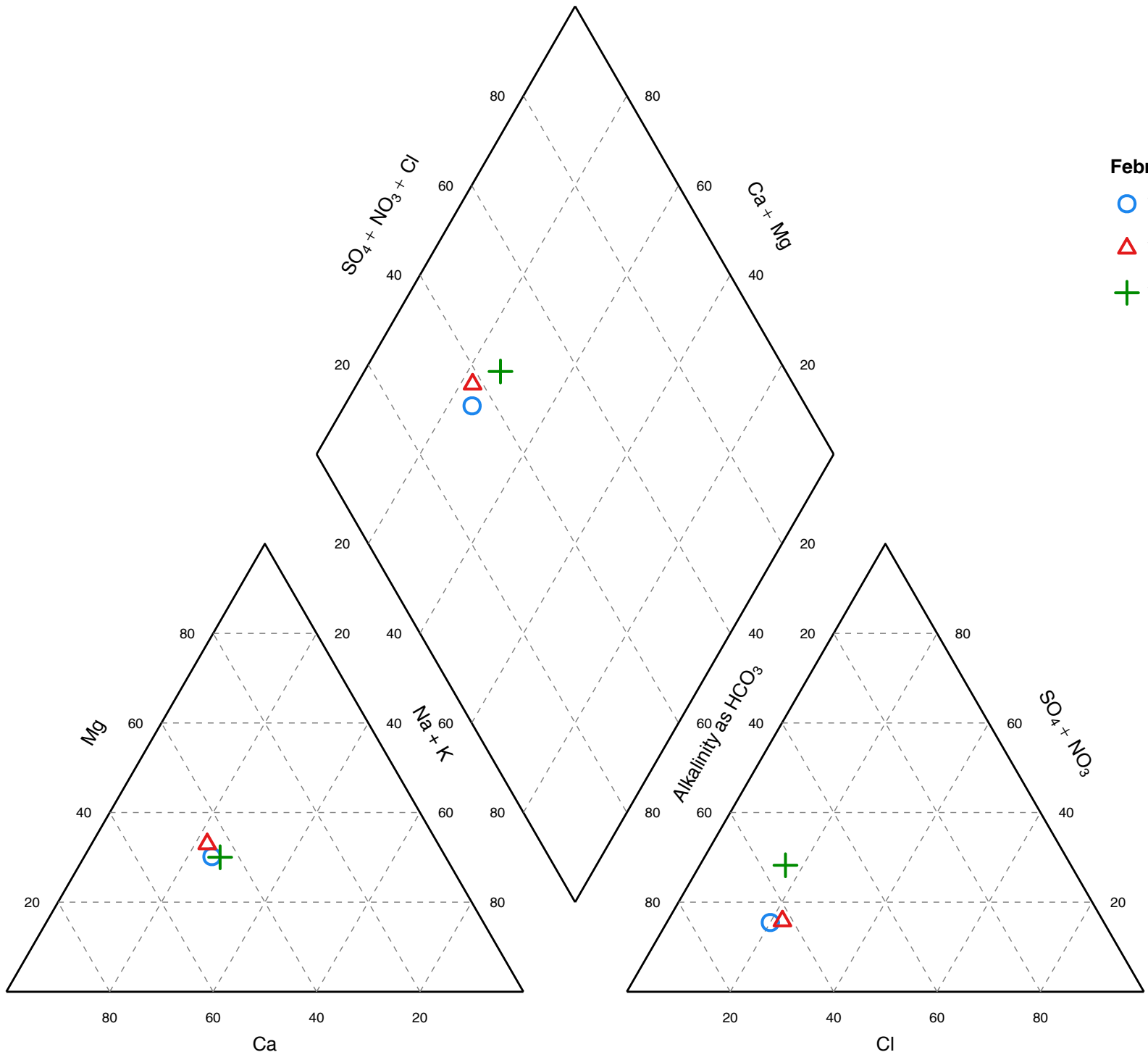

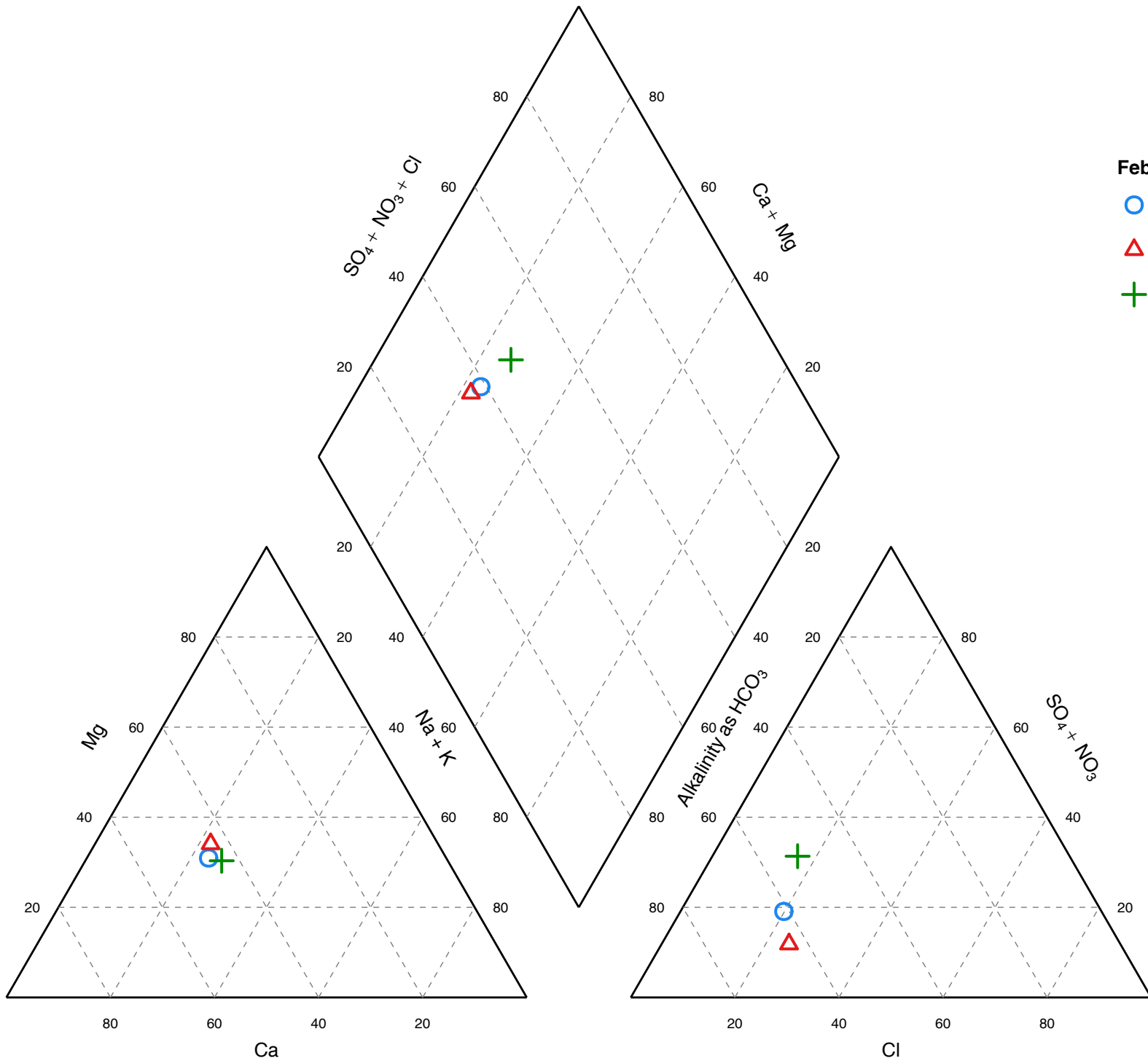

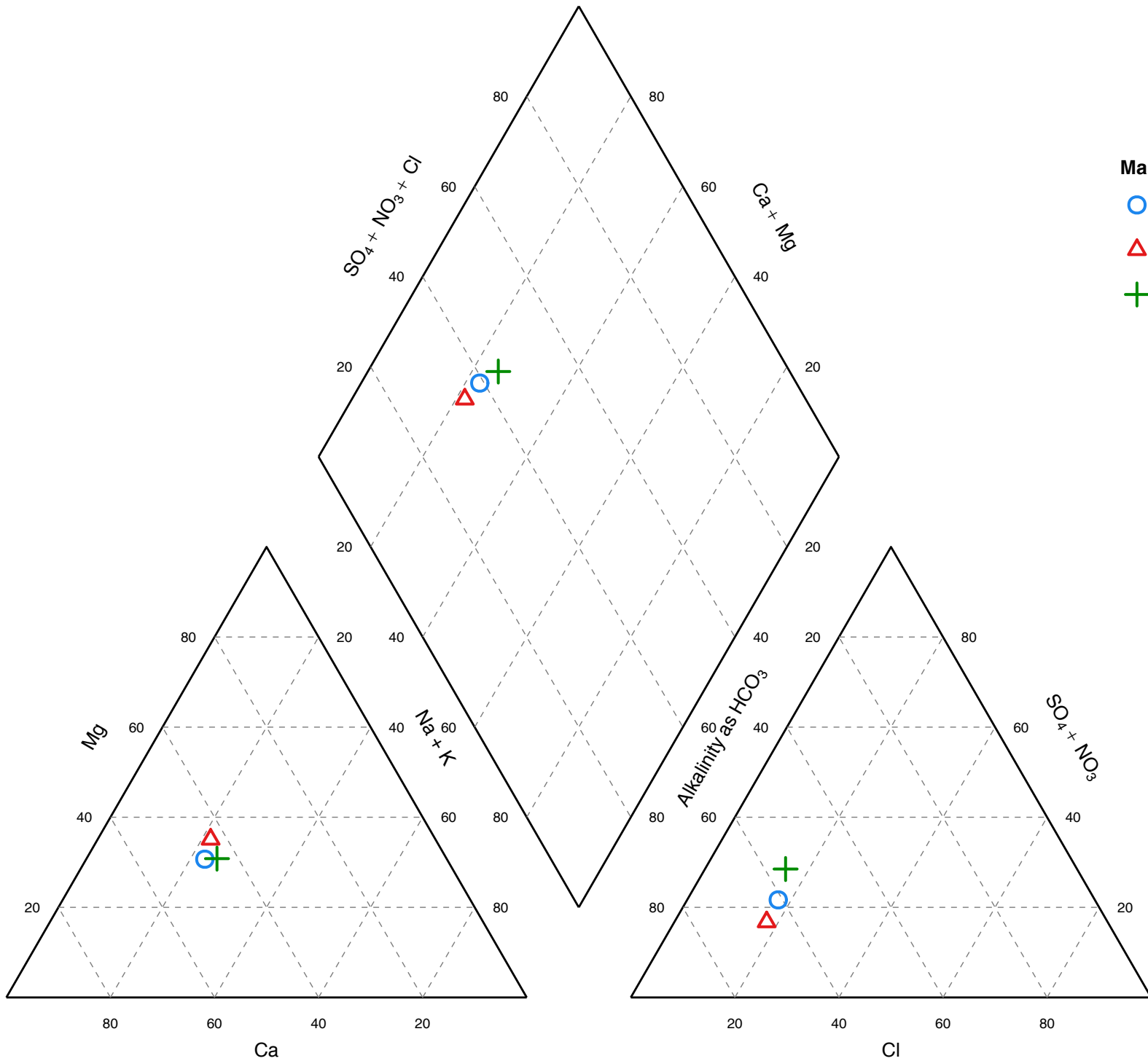

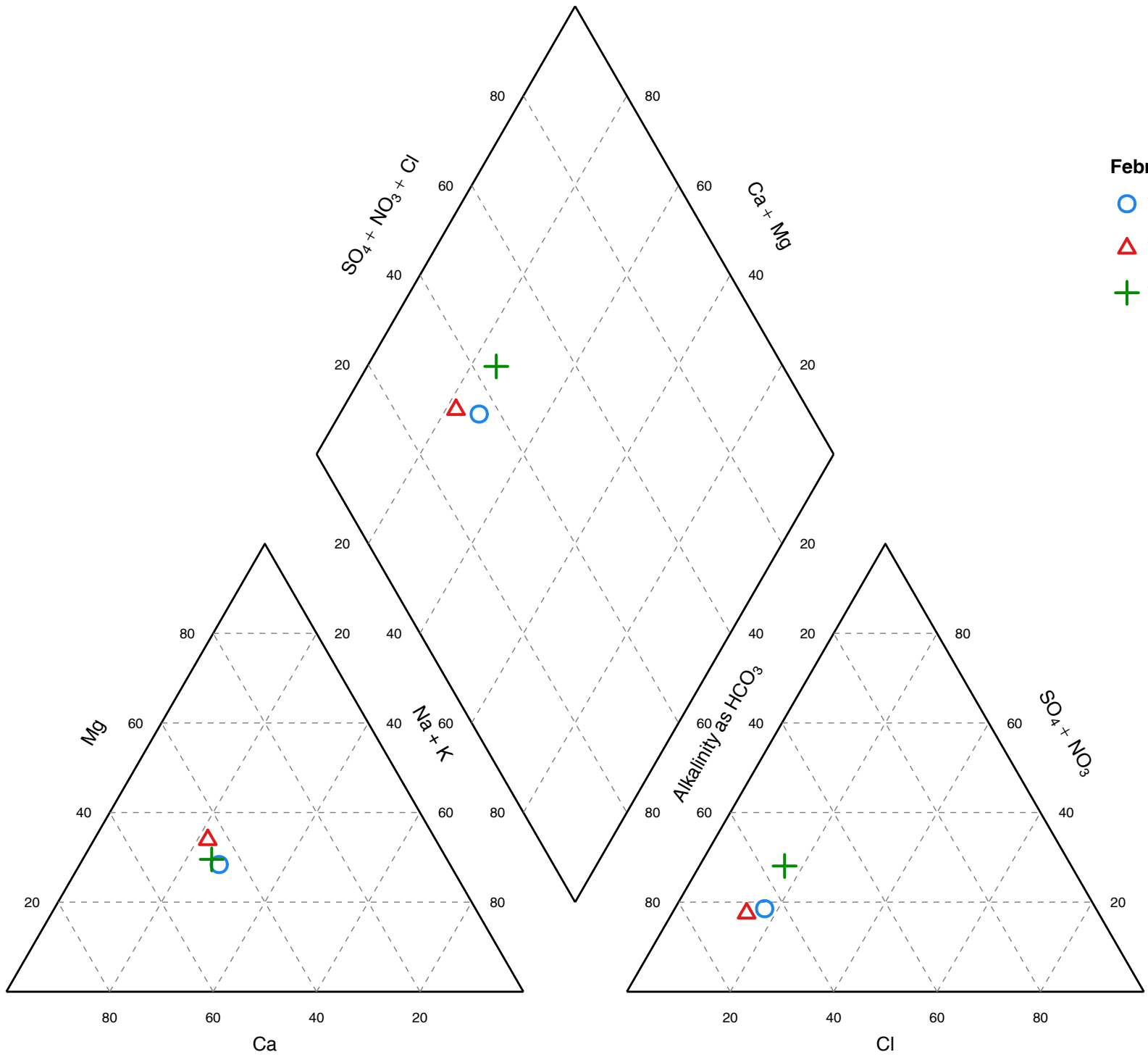

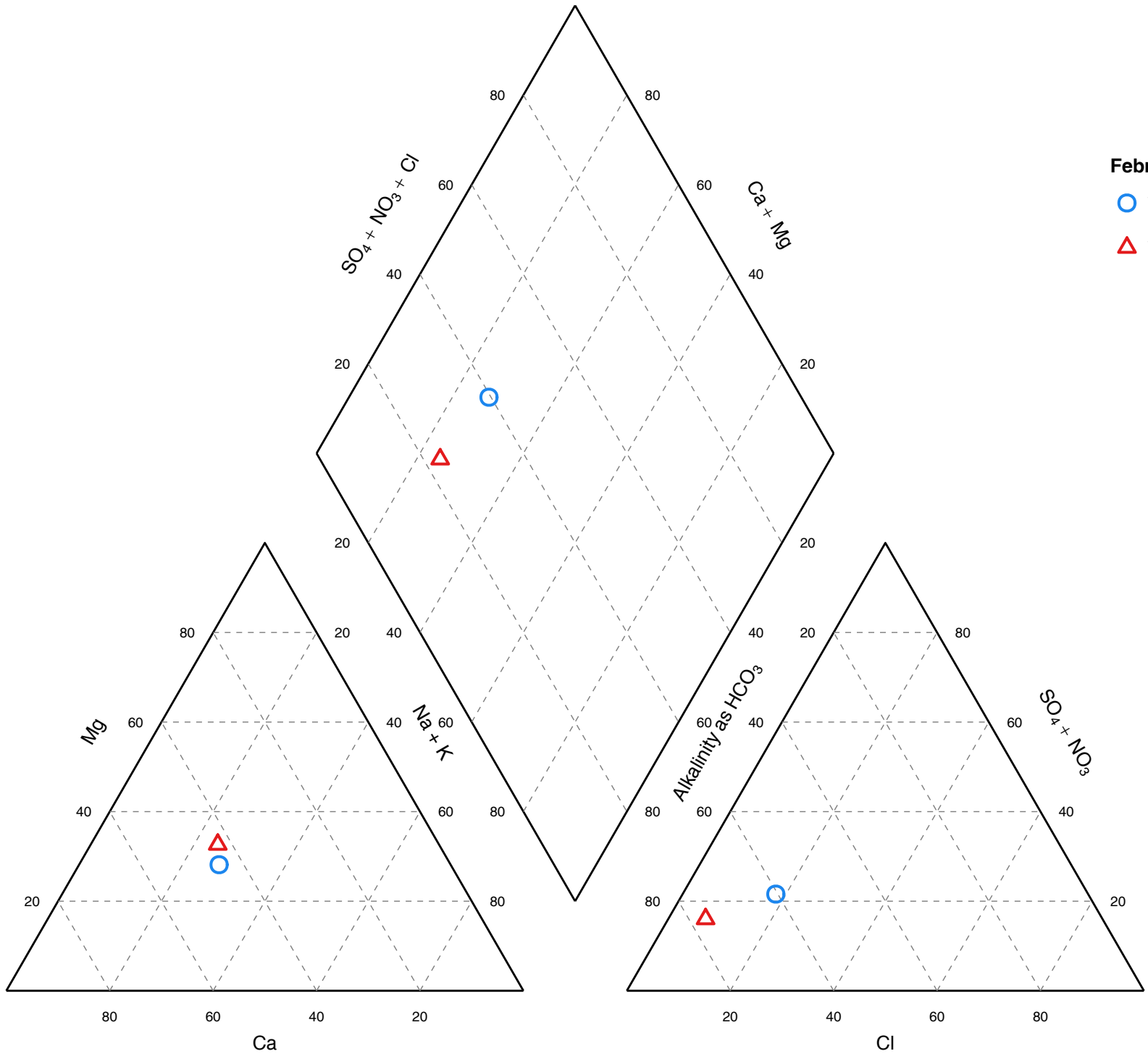

February 2019

○ WOO-MW1

△ WOO-MW2

April 2019

+ WOO-MW3

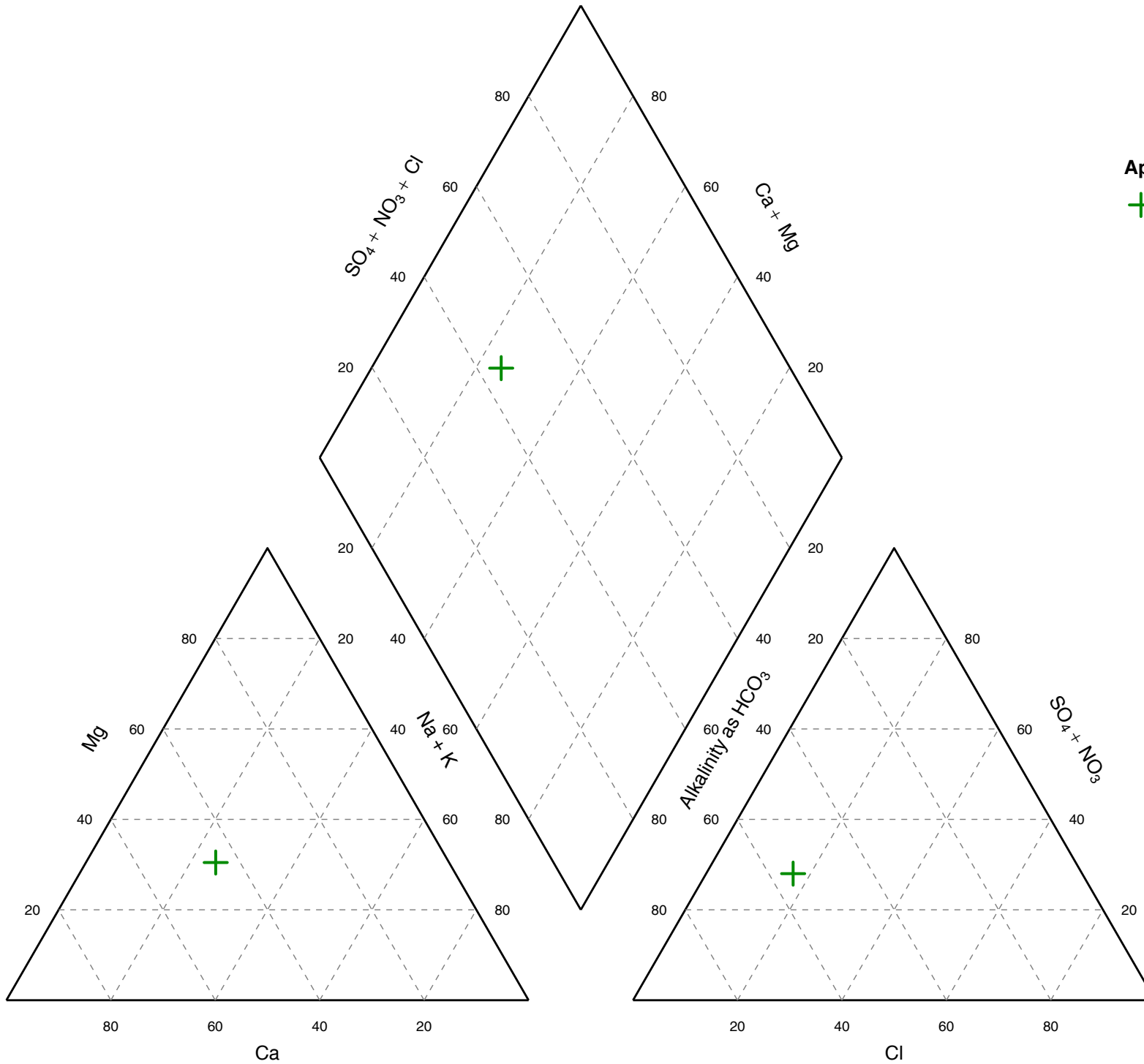

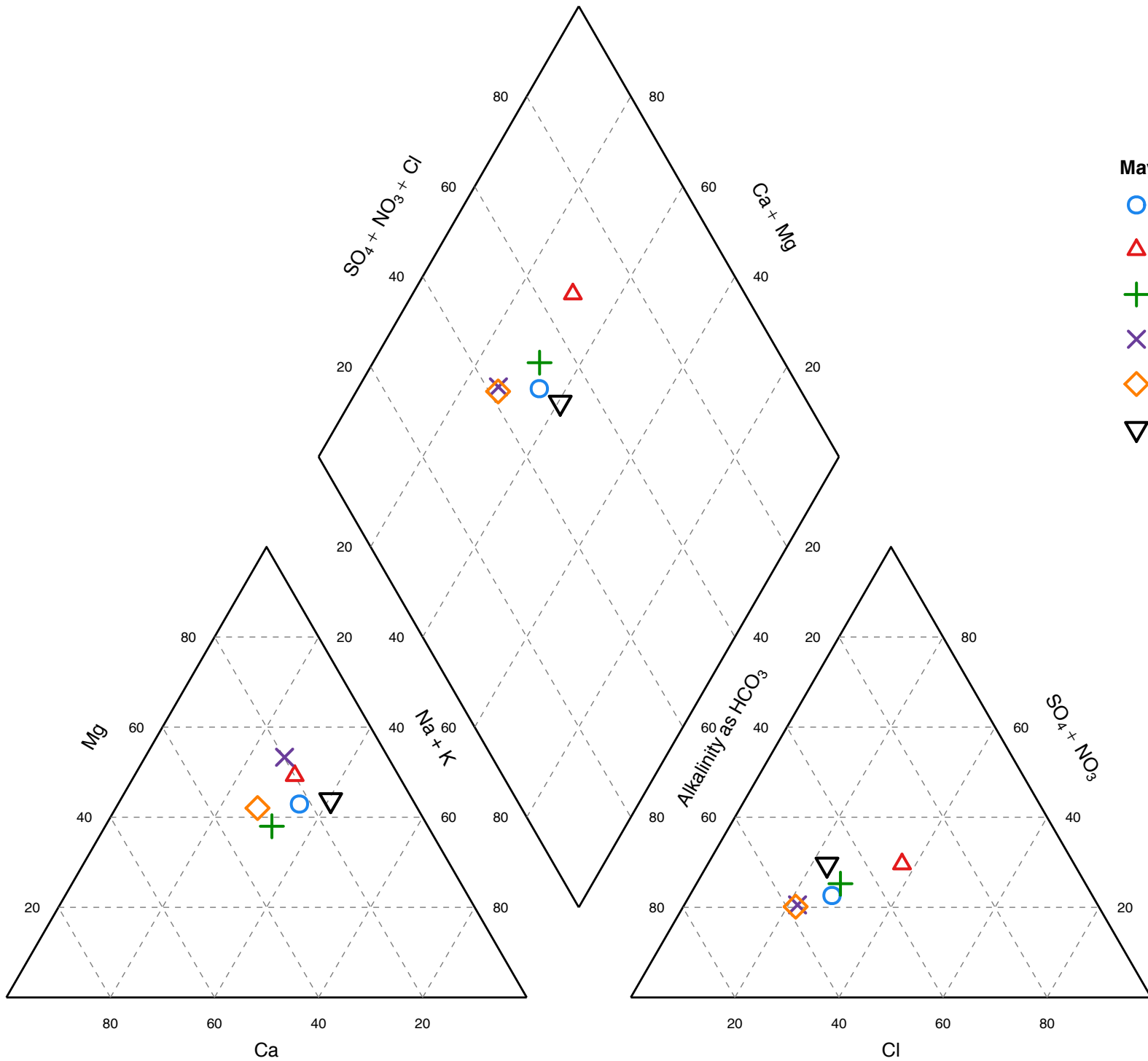

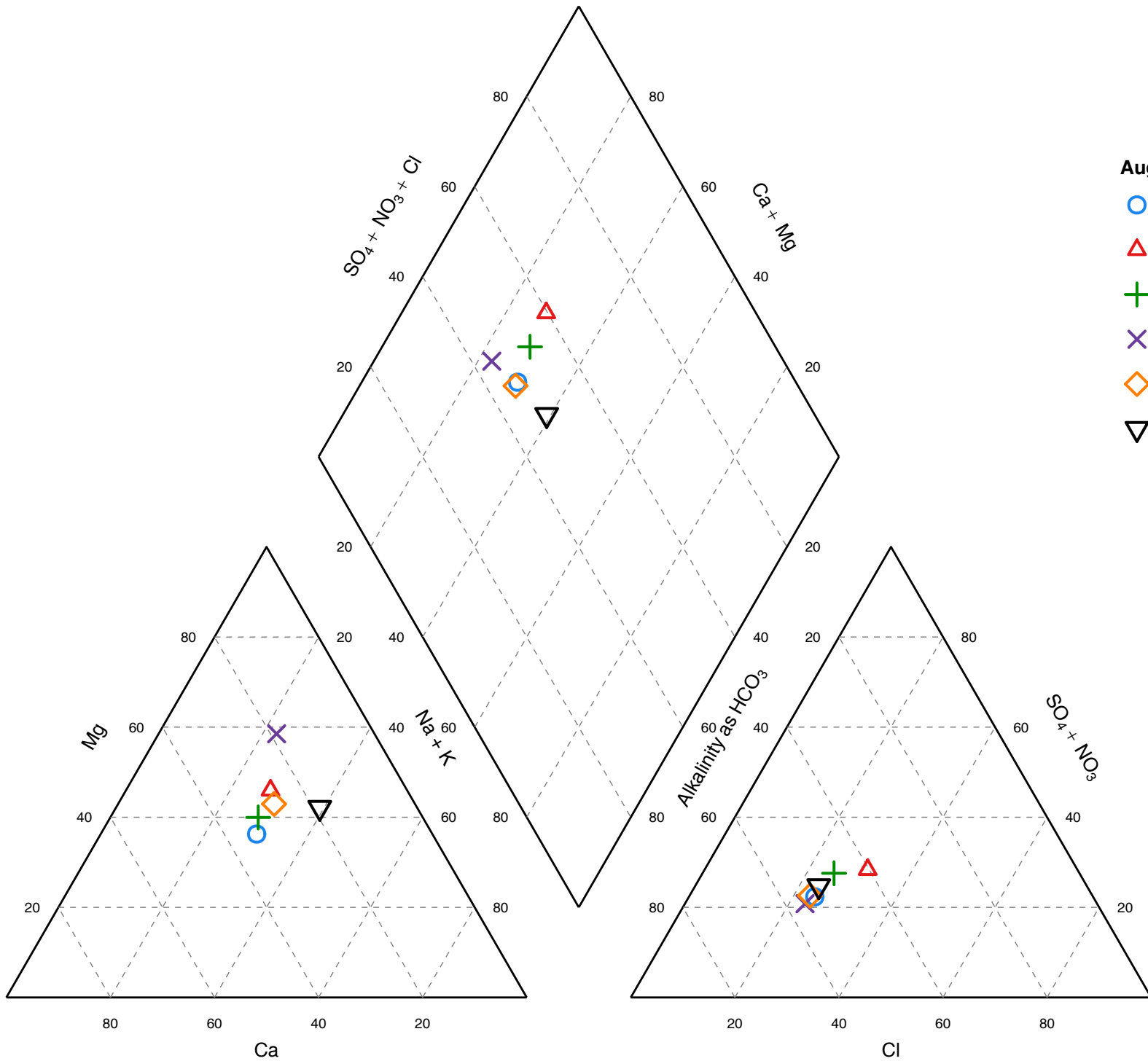

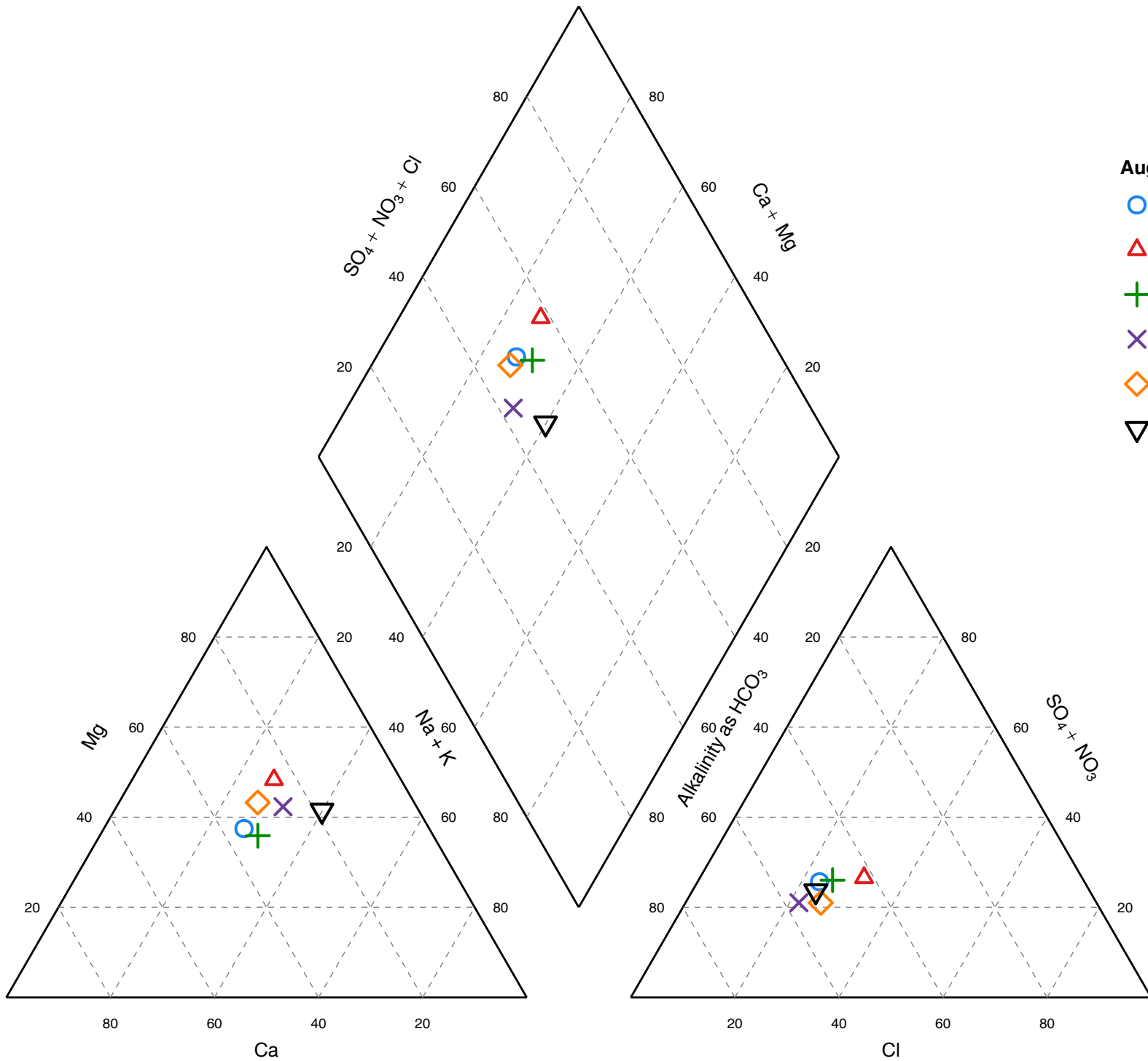

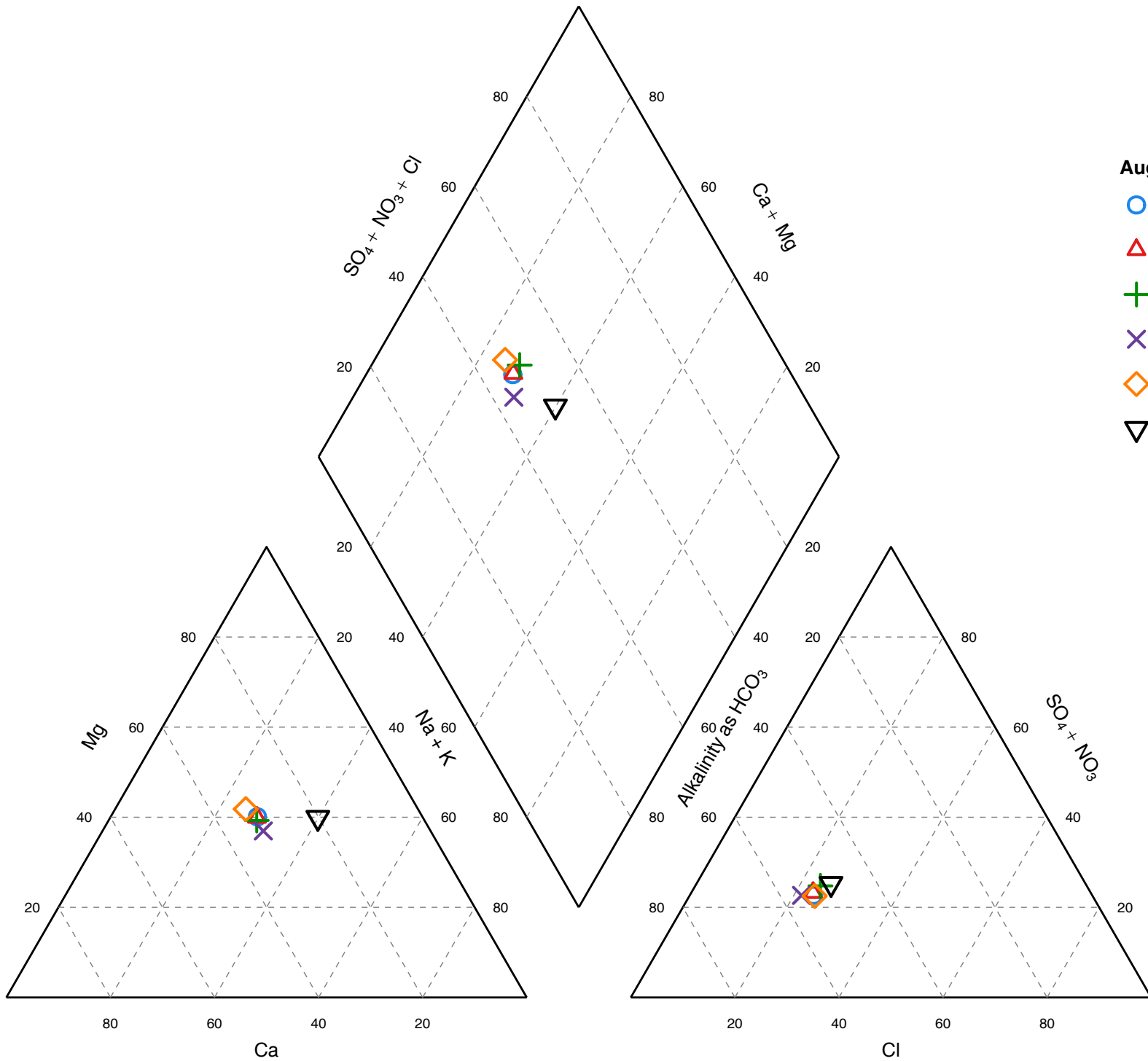

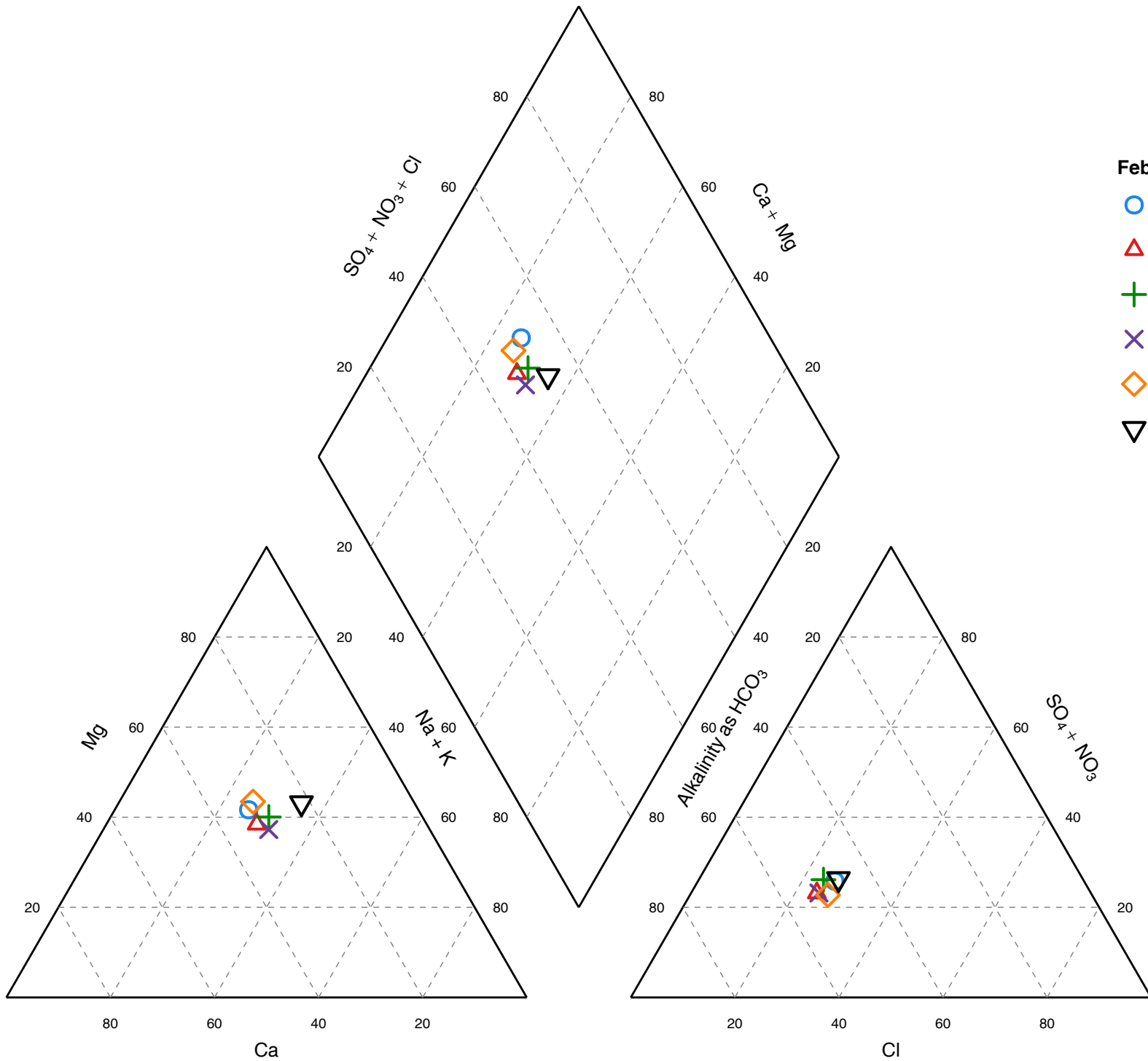

February 2015

- ANT-MW1d
- △ ANT-MW2d
- + ANT-MW3d
- × ANT-MW4d
- ◇ ANT-MW5d
- ▽ ANT-MW6s

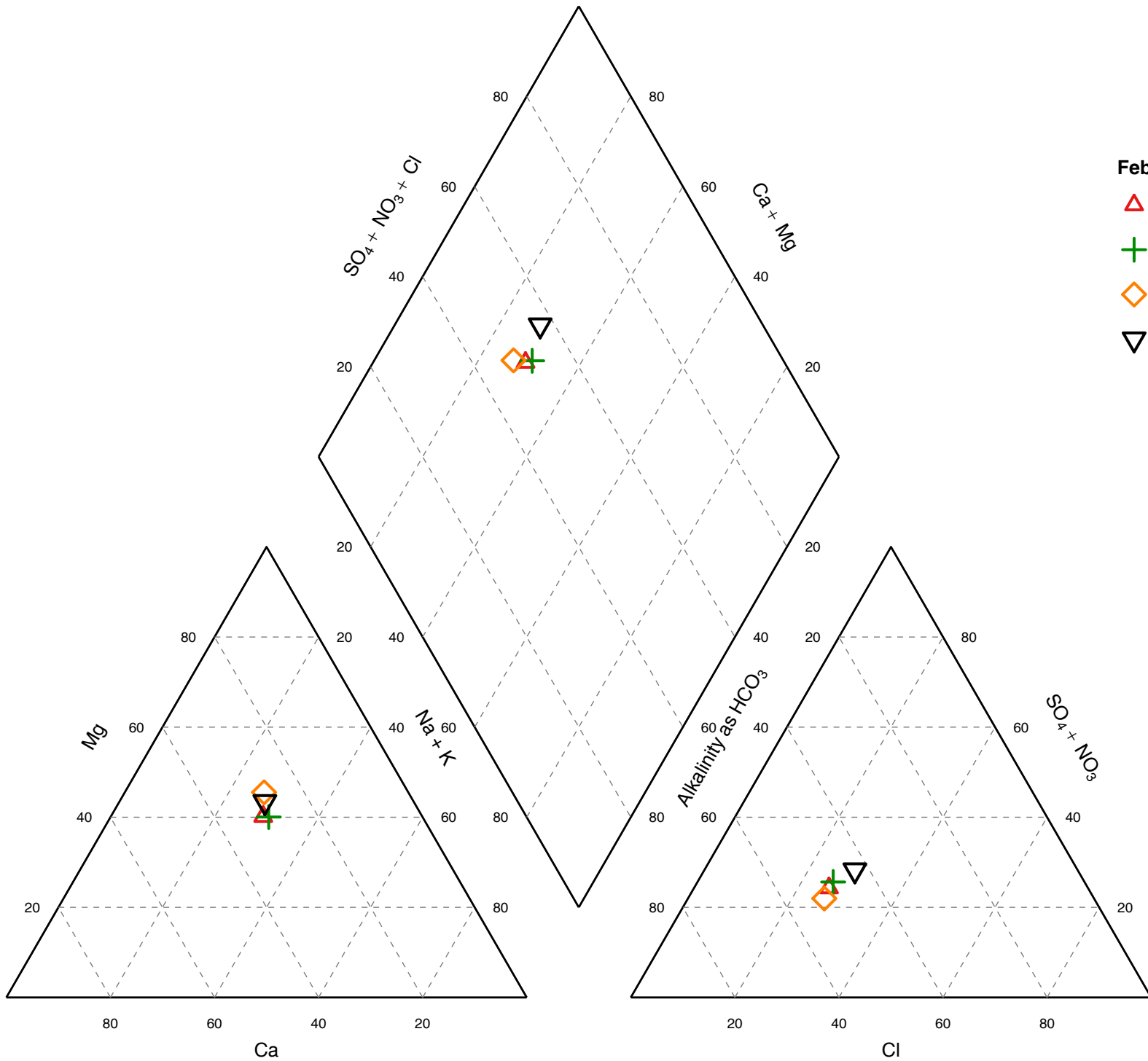

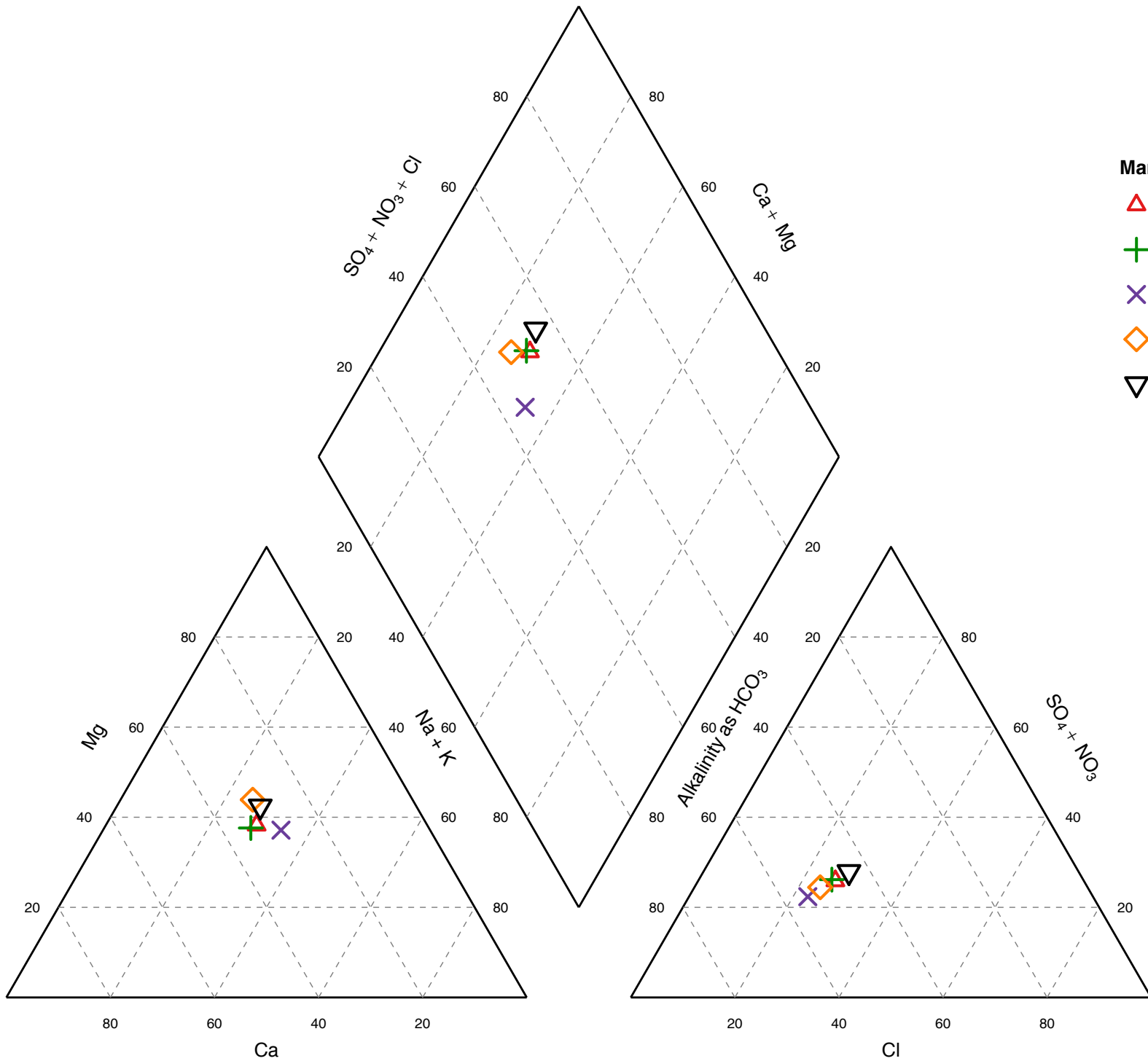

March 2017

- △ ANT-MW2d
- + ANT-MW3d
- × ANT-MW4d
- ◇ ANT-MW5s
- ▽ ANT-MW6d

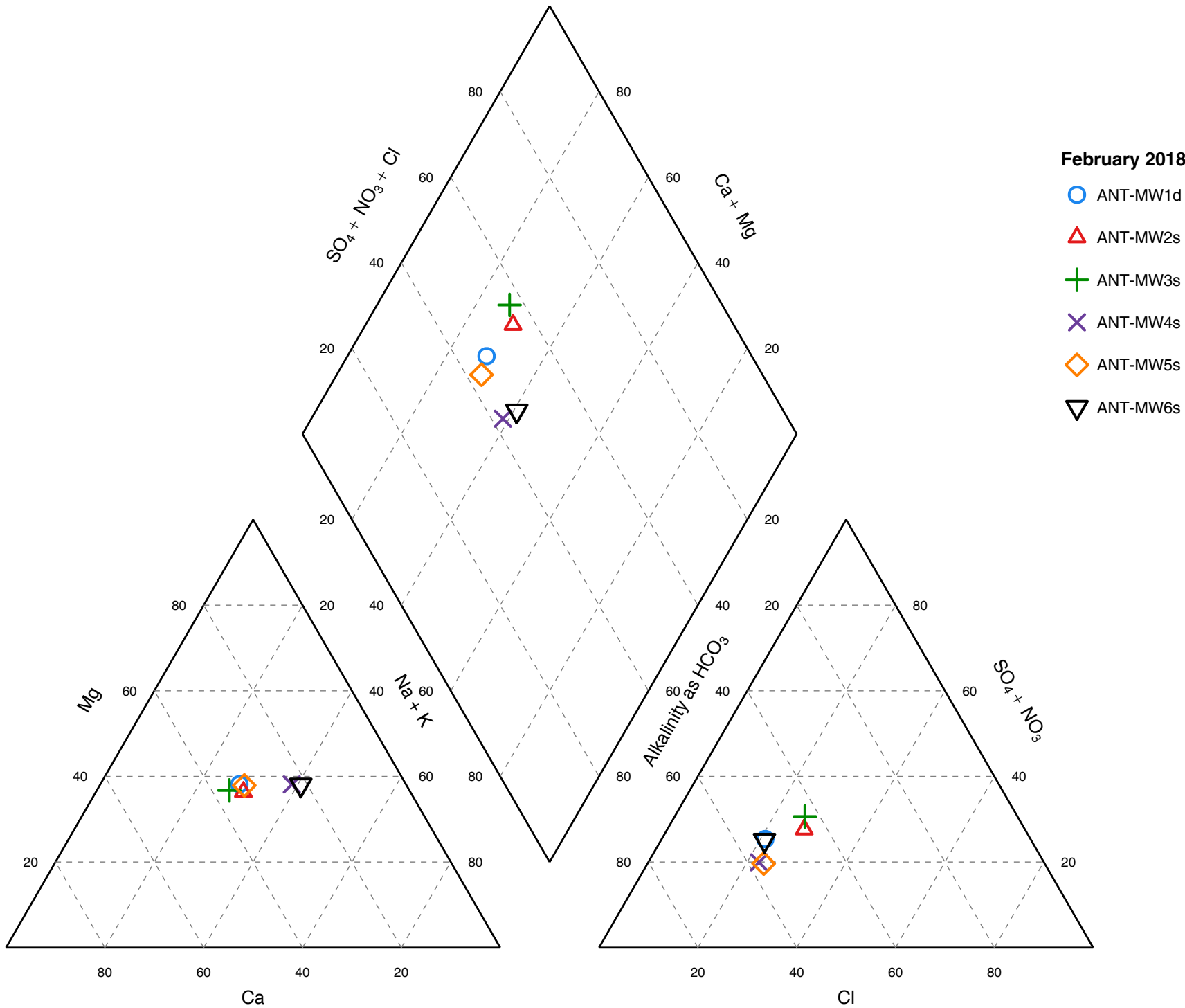

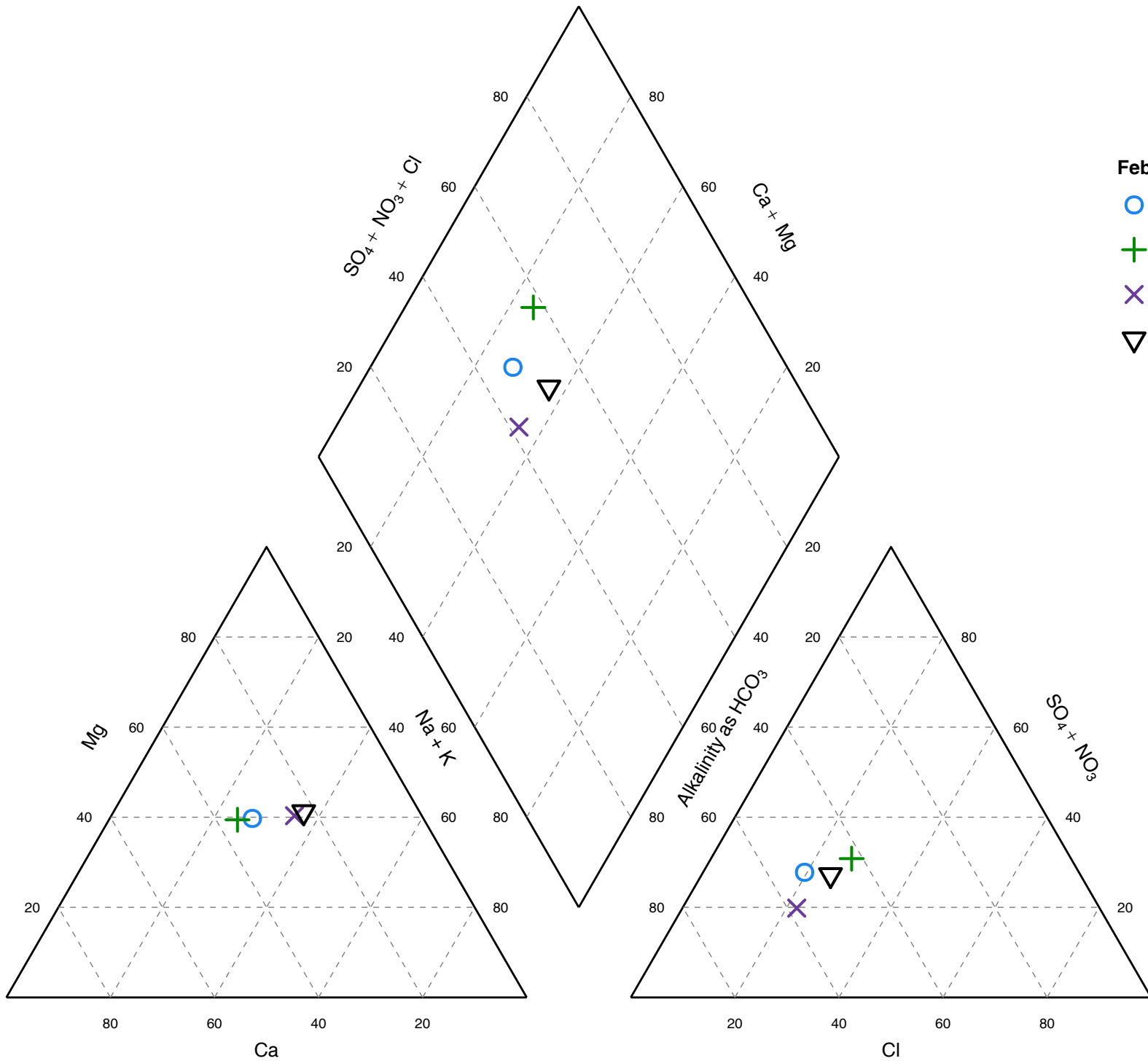

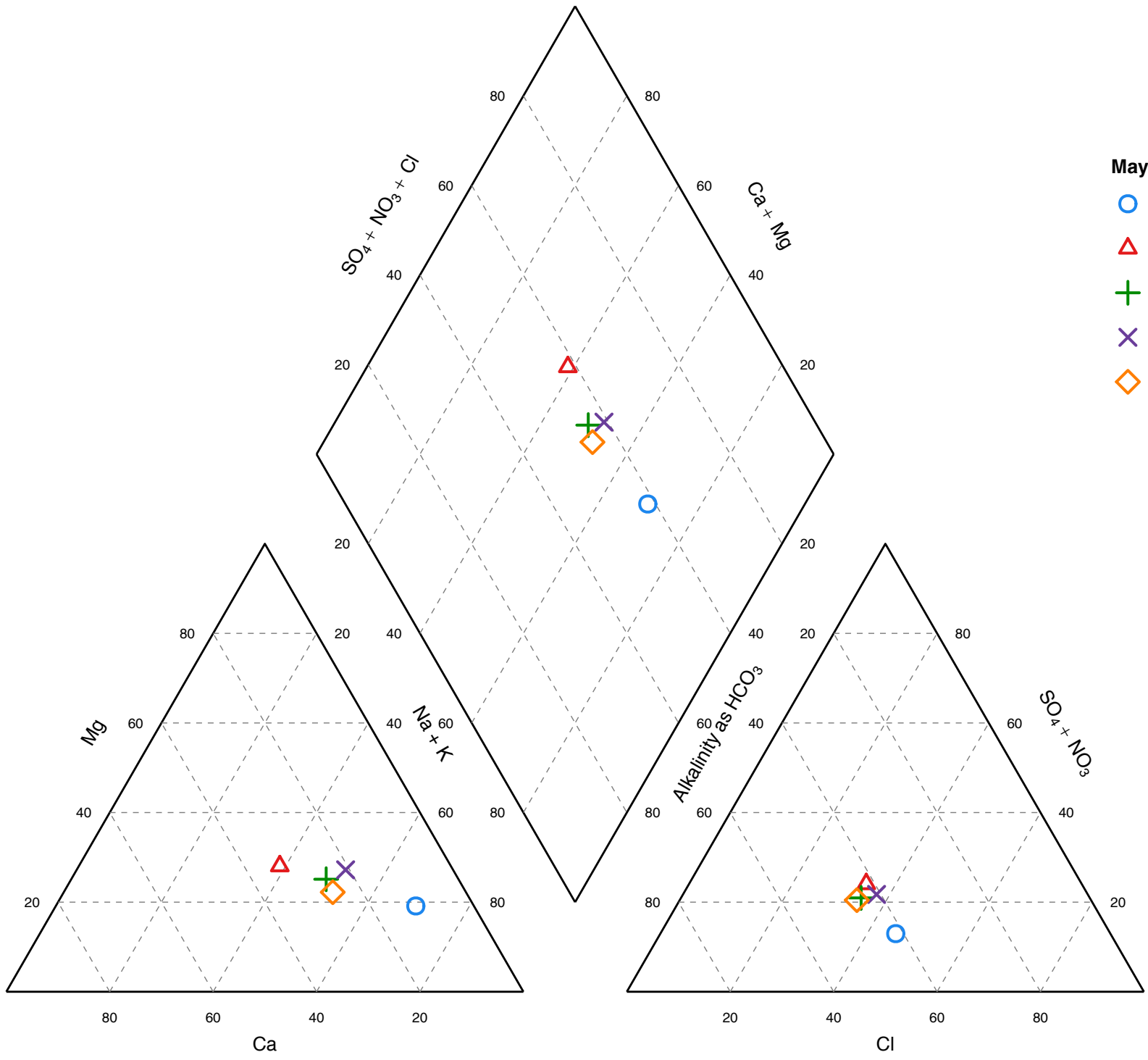

May 2012

- COR-MW1s
- △ COR-MW2s
- + COR-MW3s
- × COR-MW4s
- ◇ COR-MW5s

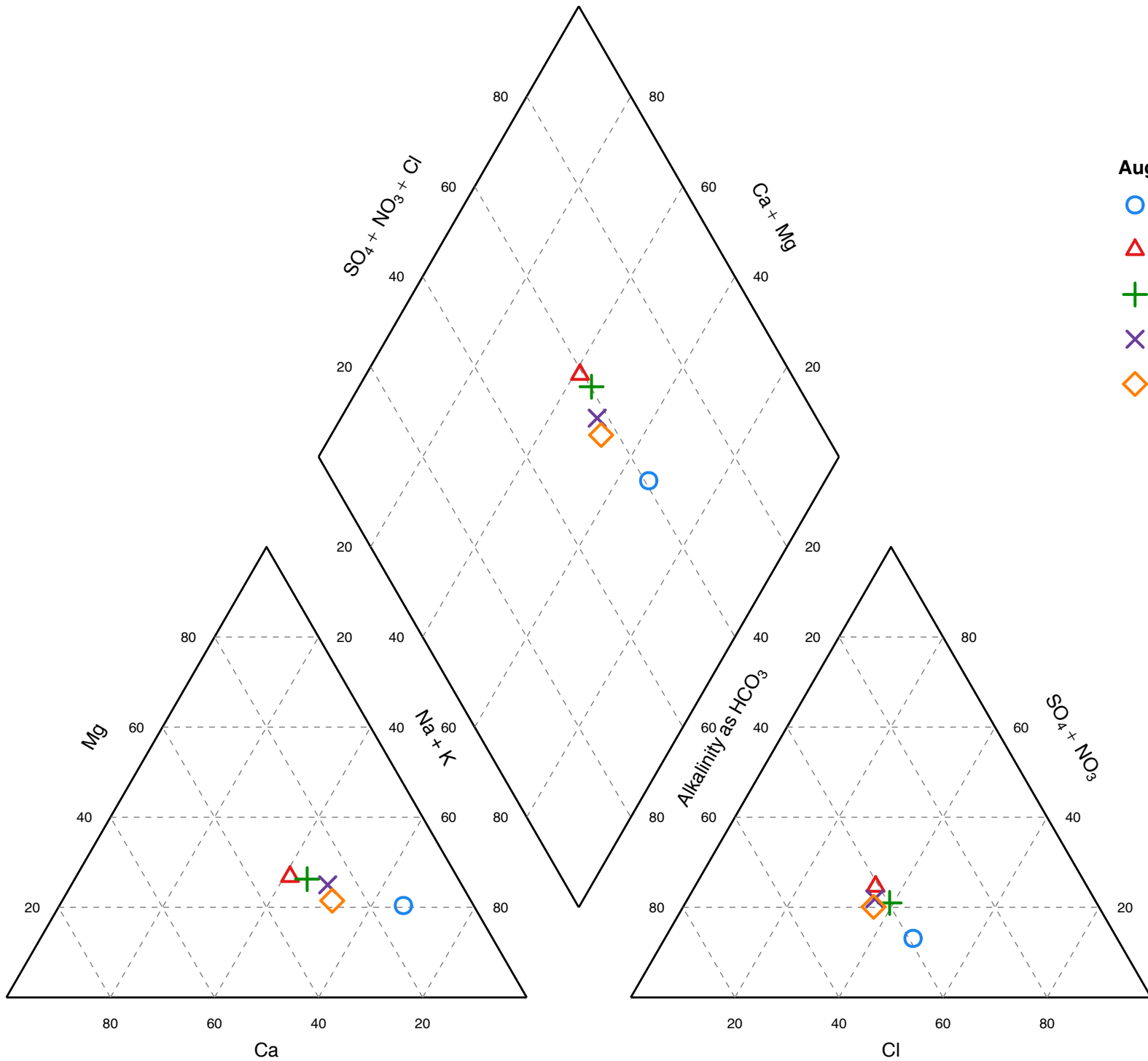

August 2012

- COR-MW1s
- △ COR-MW2s
- + COR-MW3s
- × COR-MW4s
- ◇ COR-MW5s

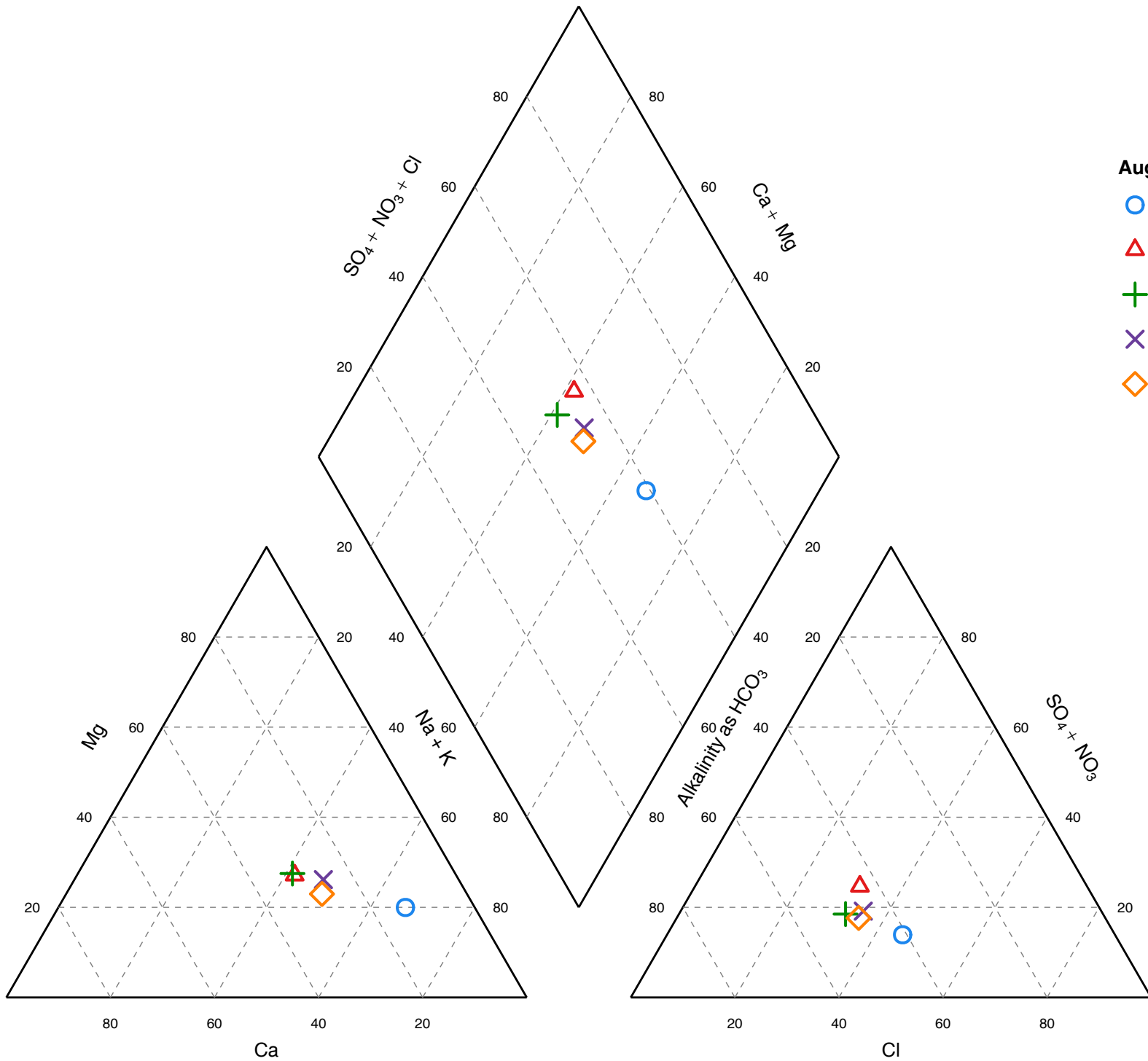

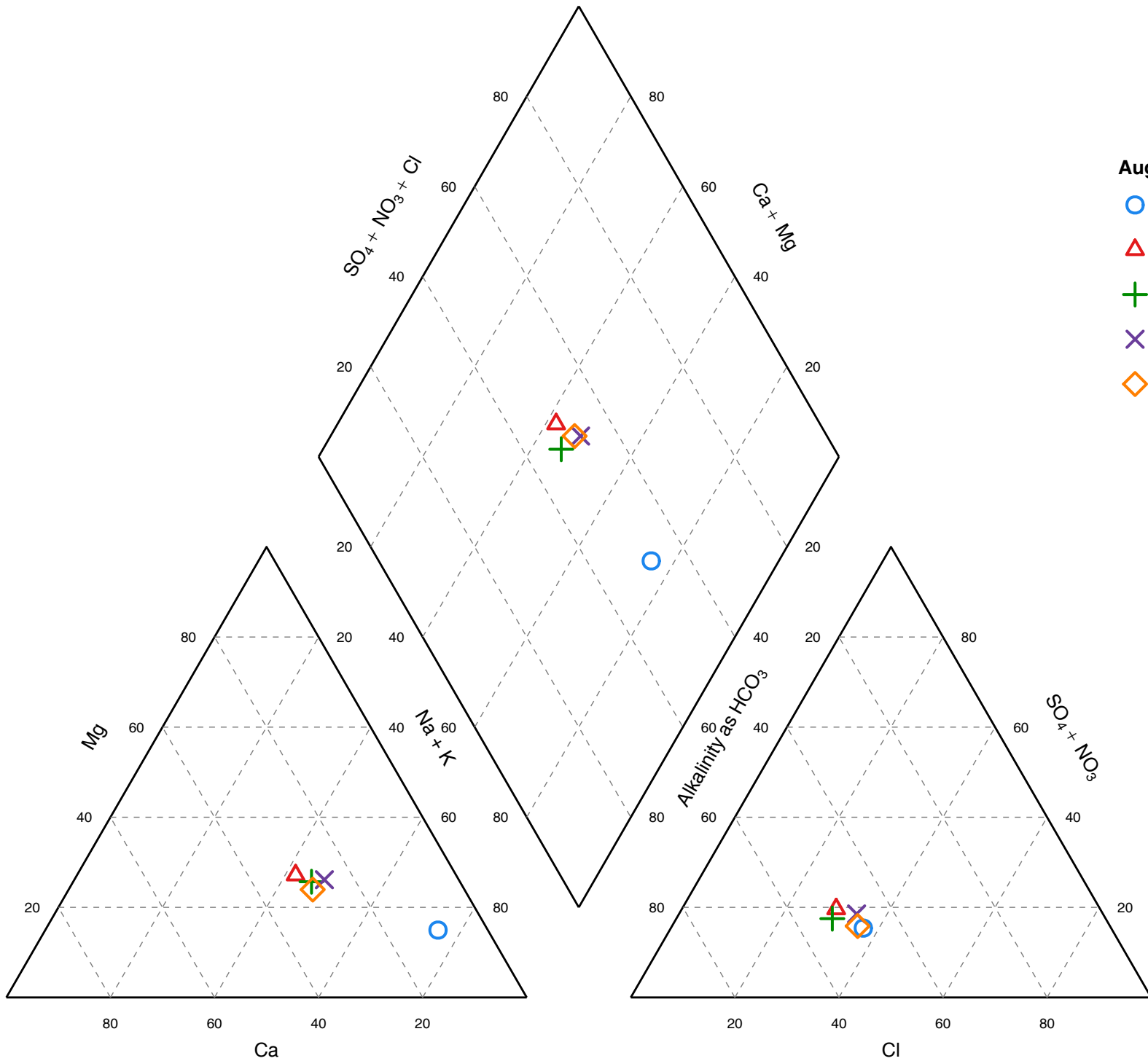

August 2014

- COR-MW1s
- △ COR-MW2s
- + COR-MW3s
- × COR-MW4s
- ◇ COR-MW5s

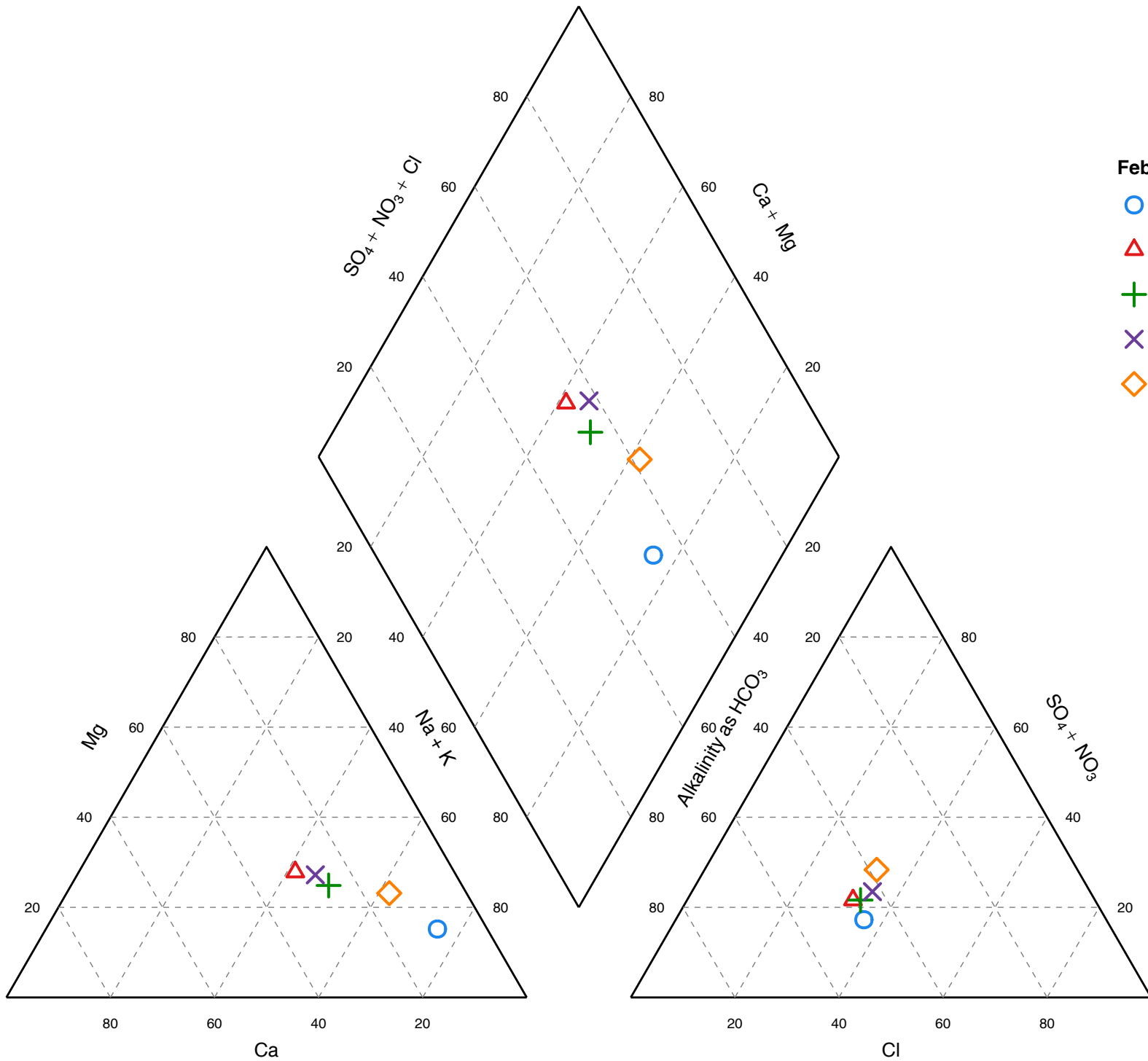

February 2015

- COR-MW1s
- △ COR-MW2s
- + COR-MW3s
- × COR-MW4s
- ◇ COR-MW5s

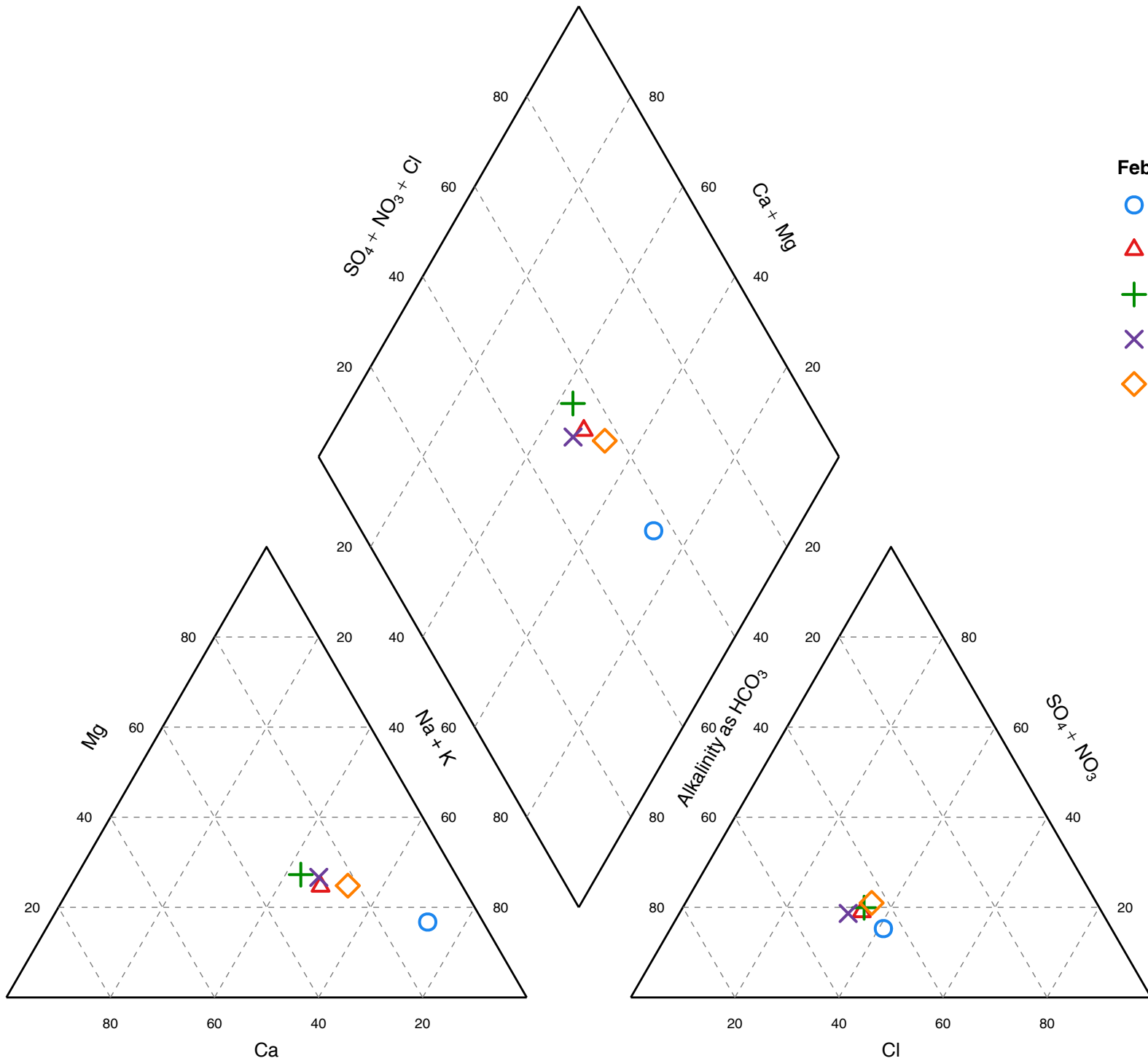

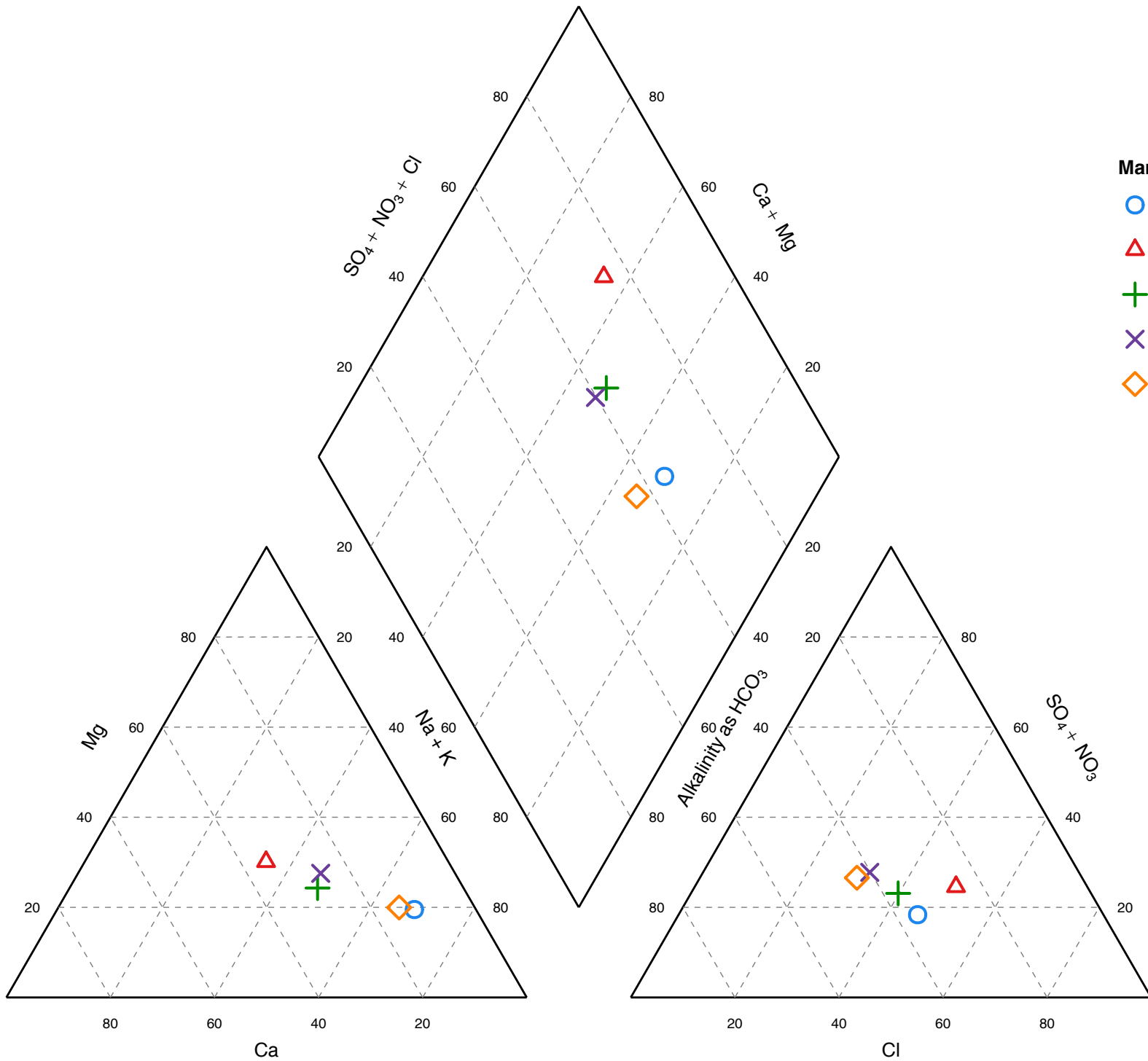

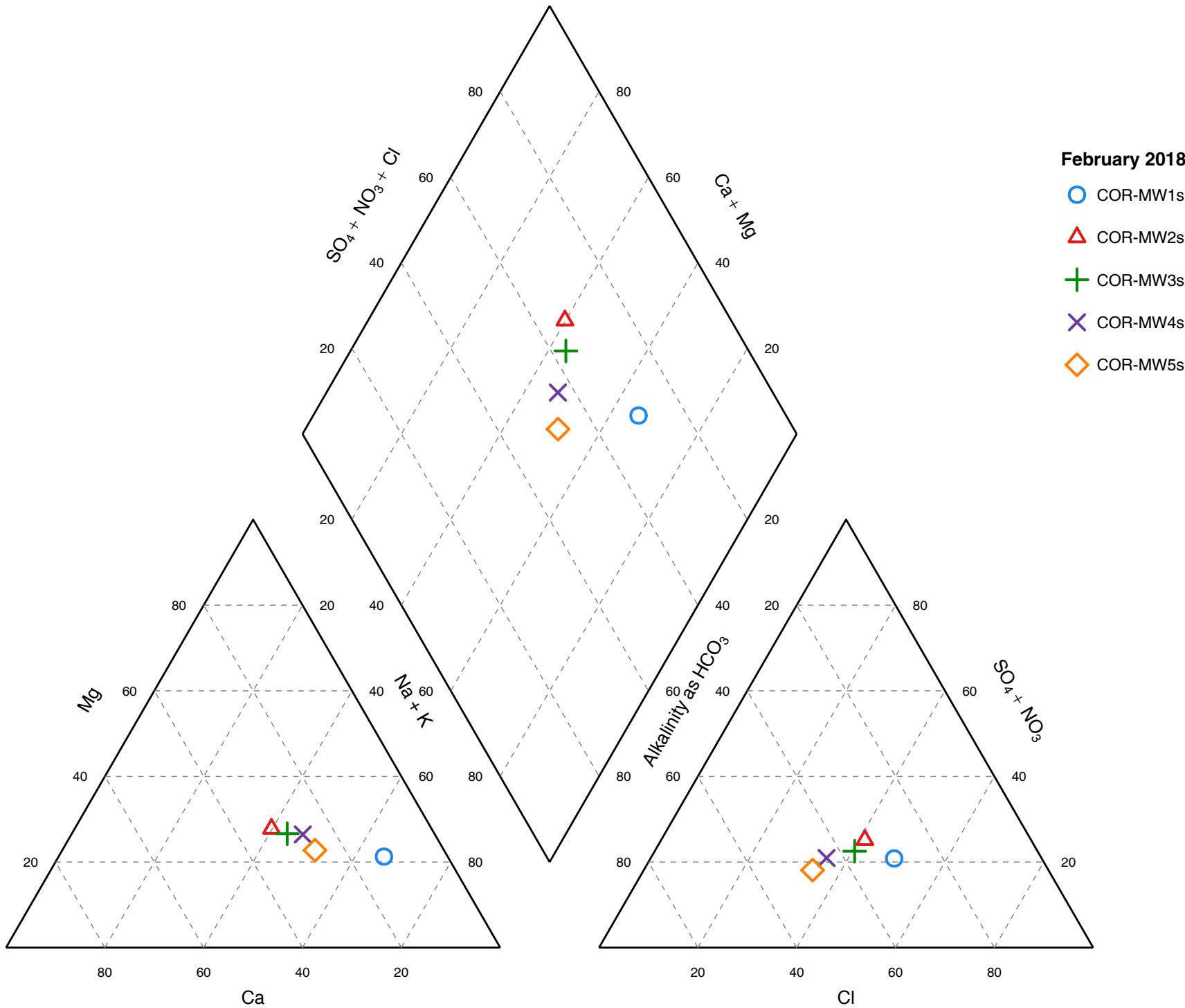

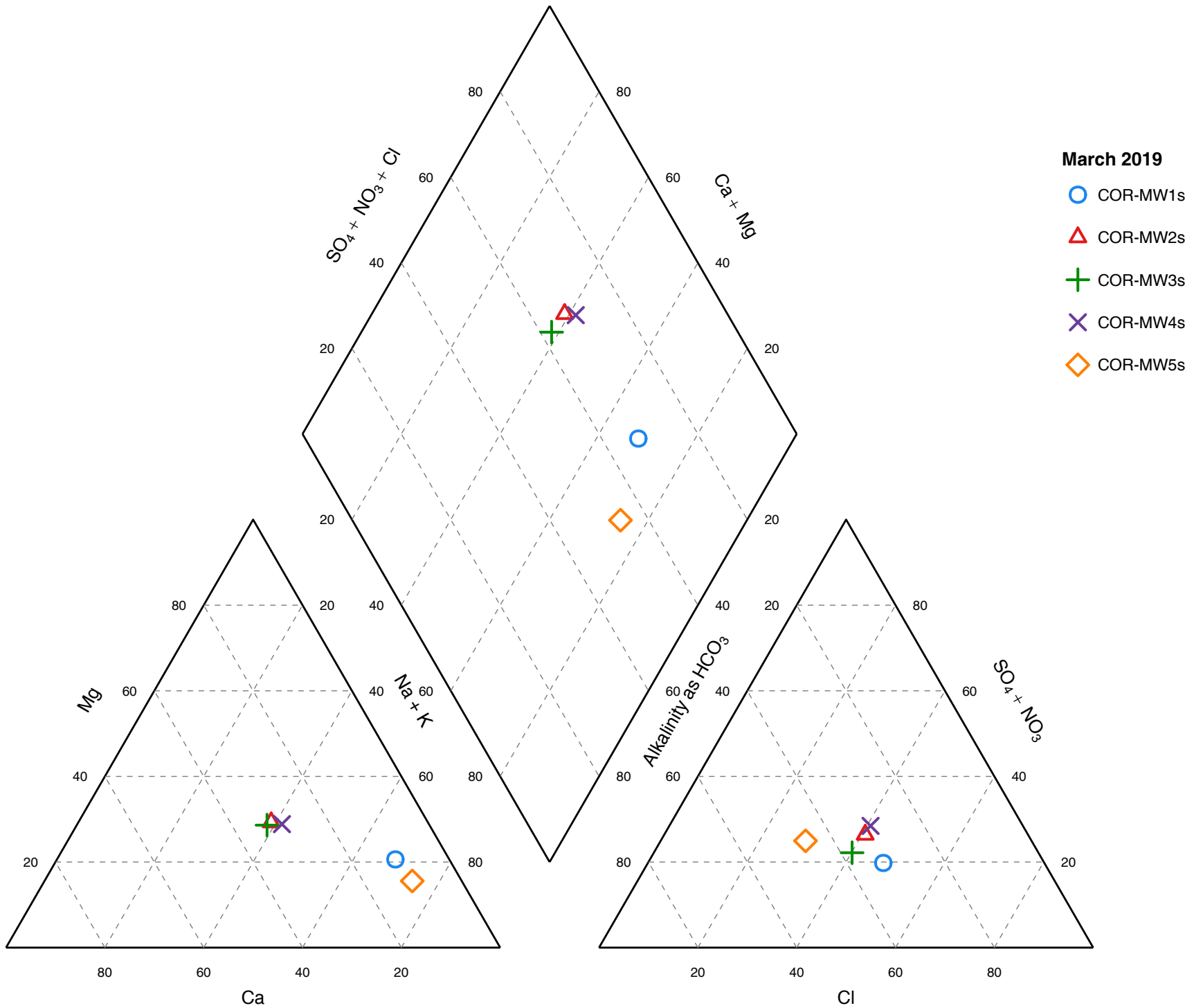

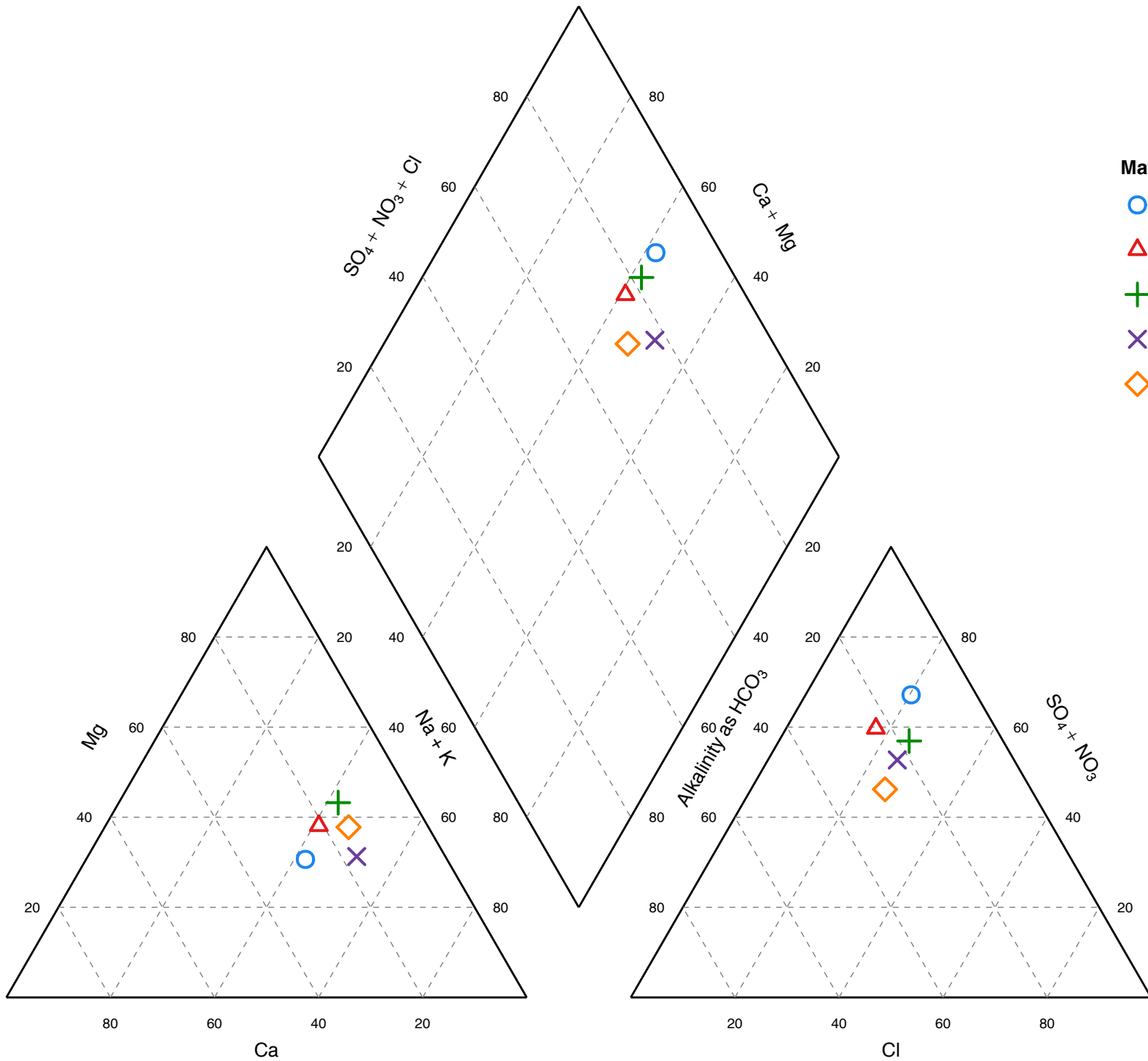

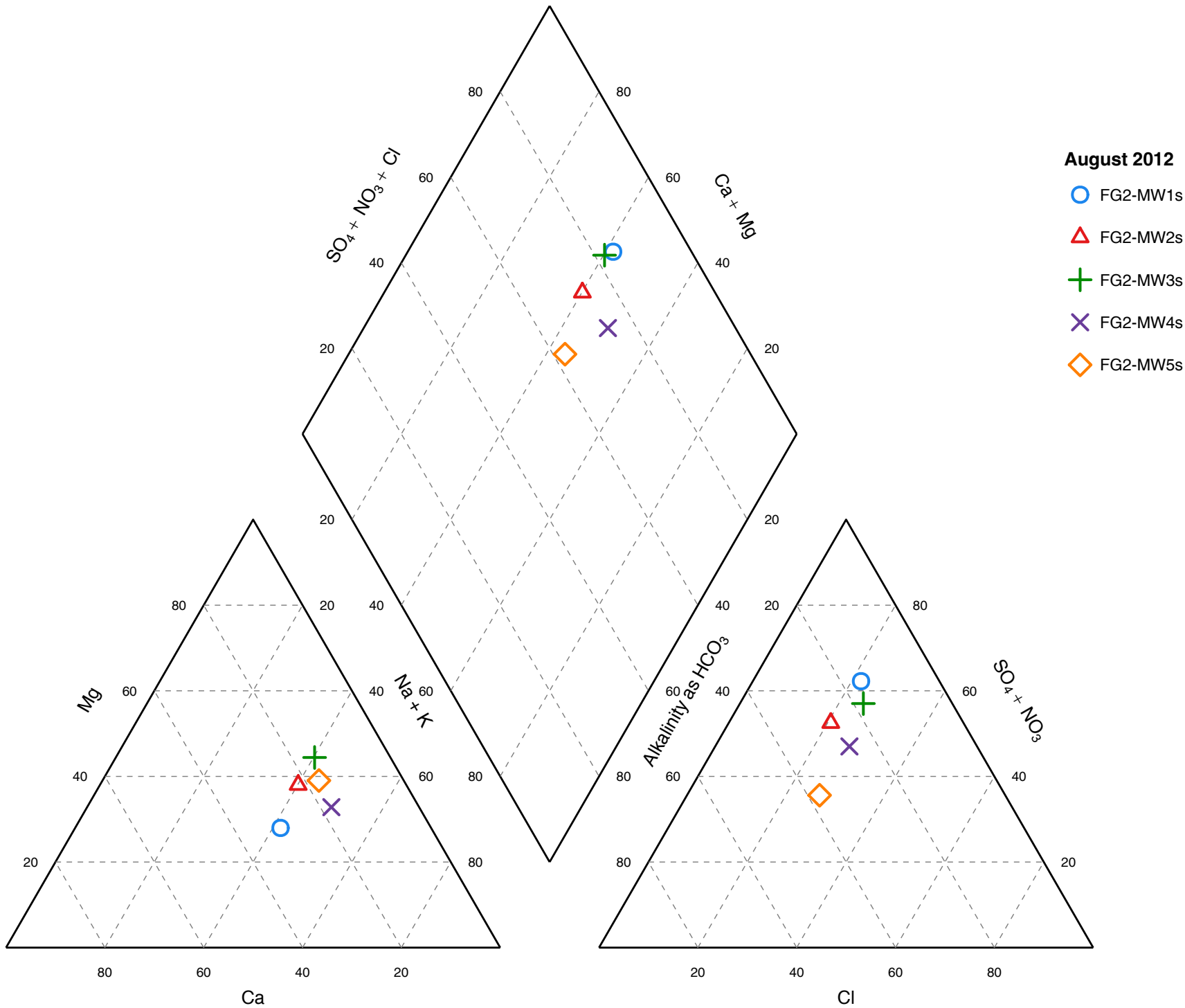

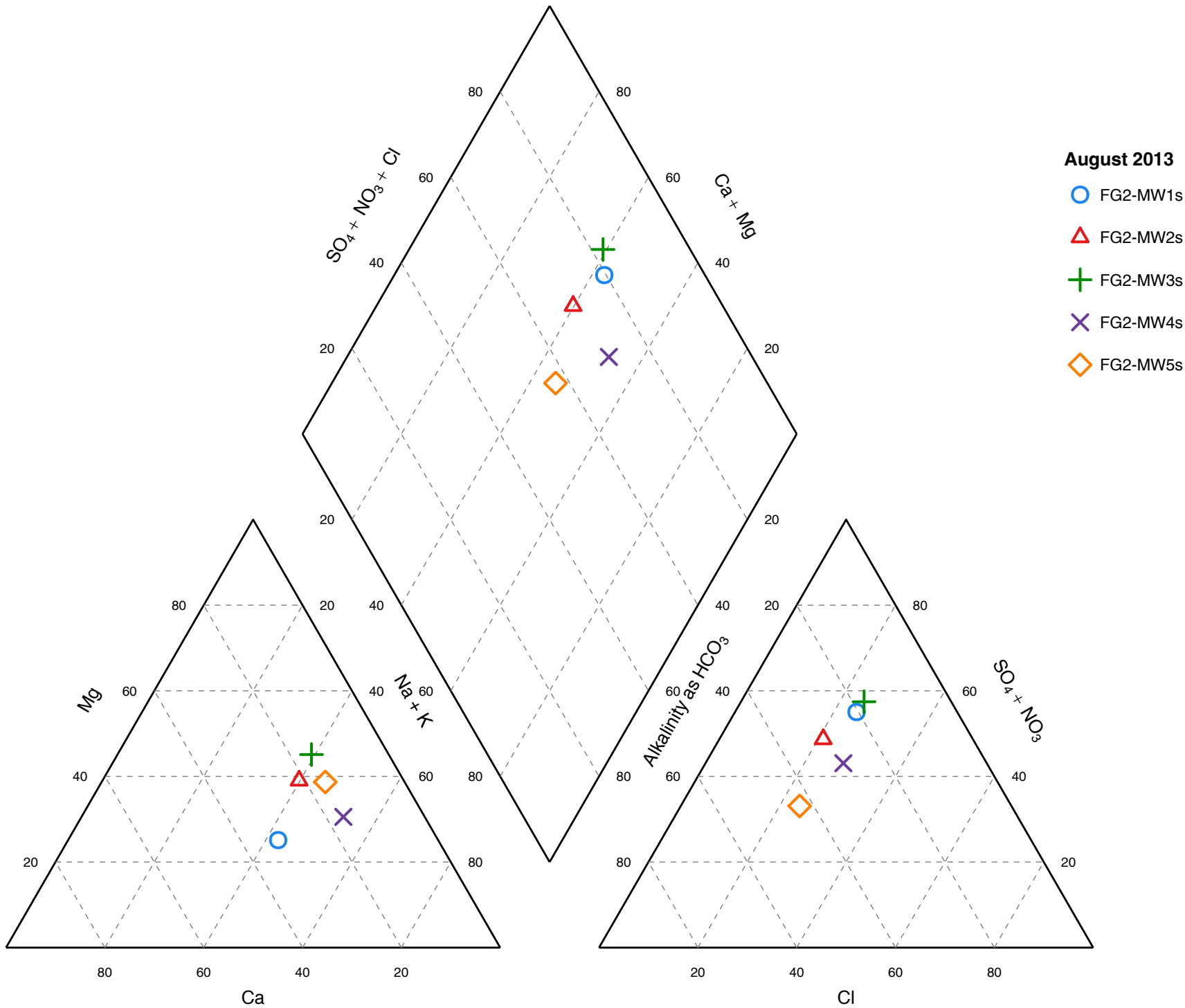

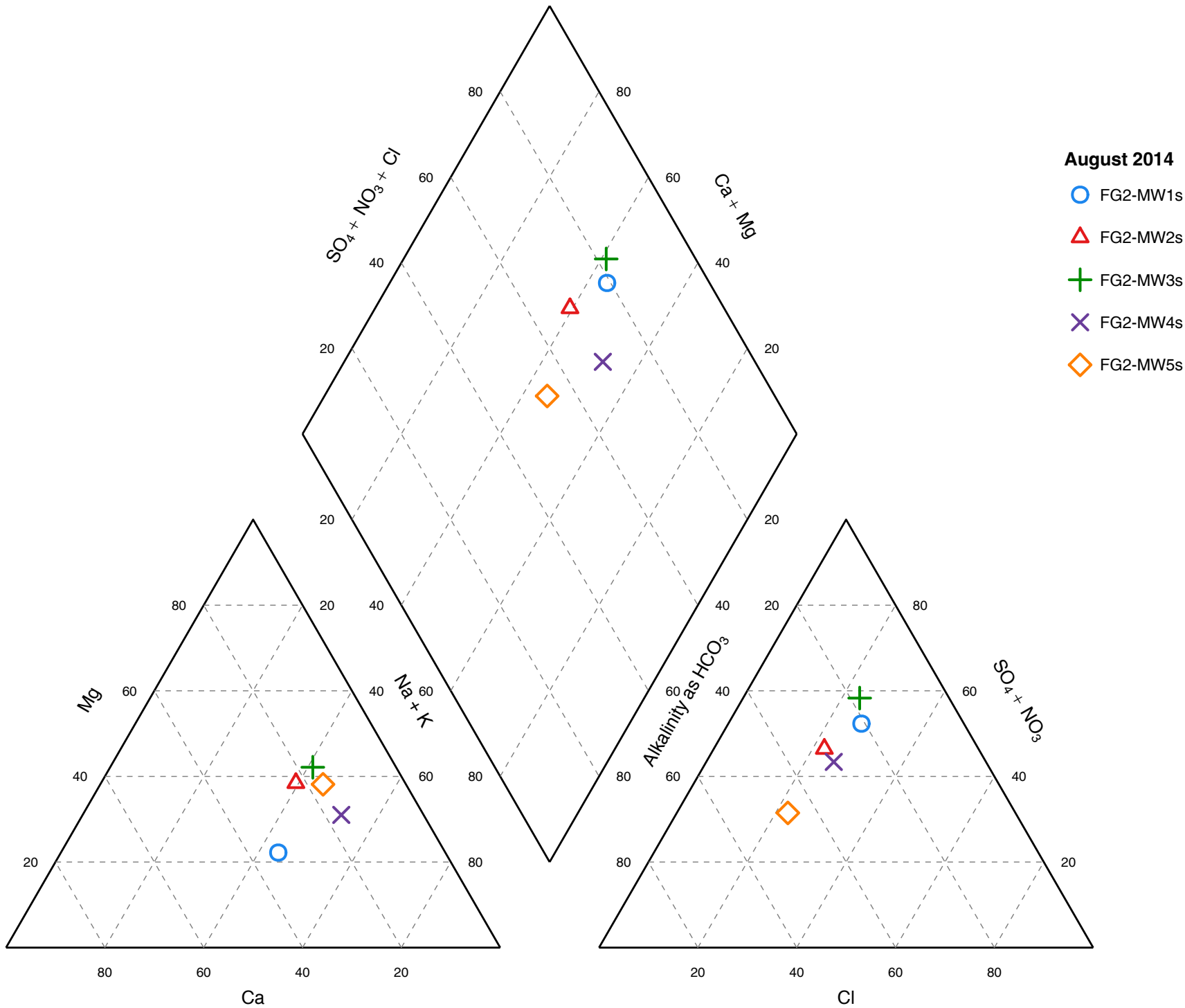

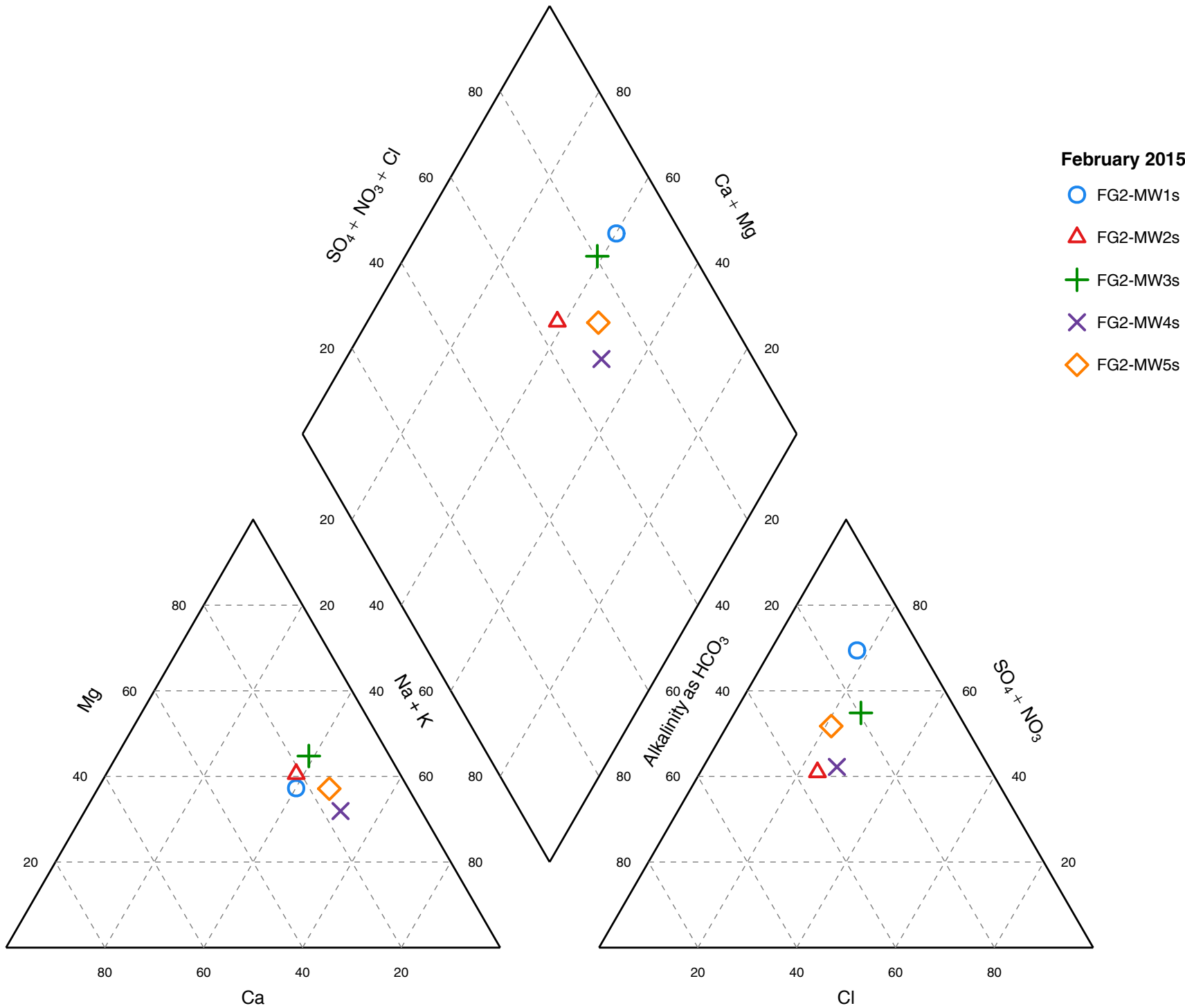

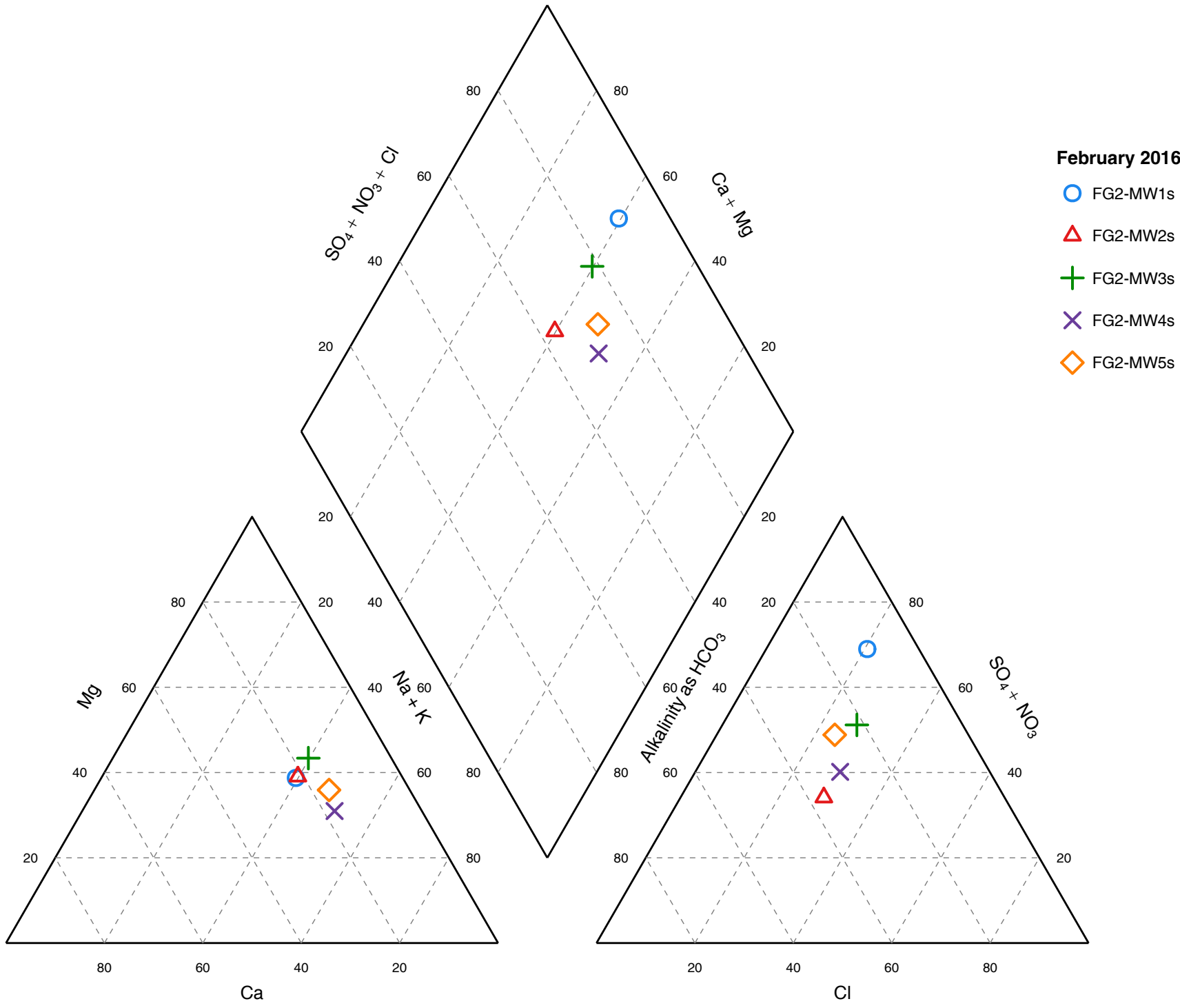

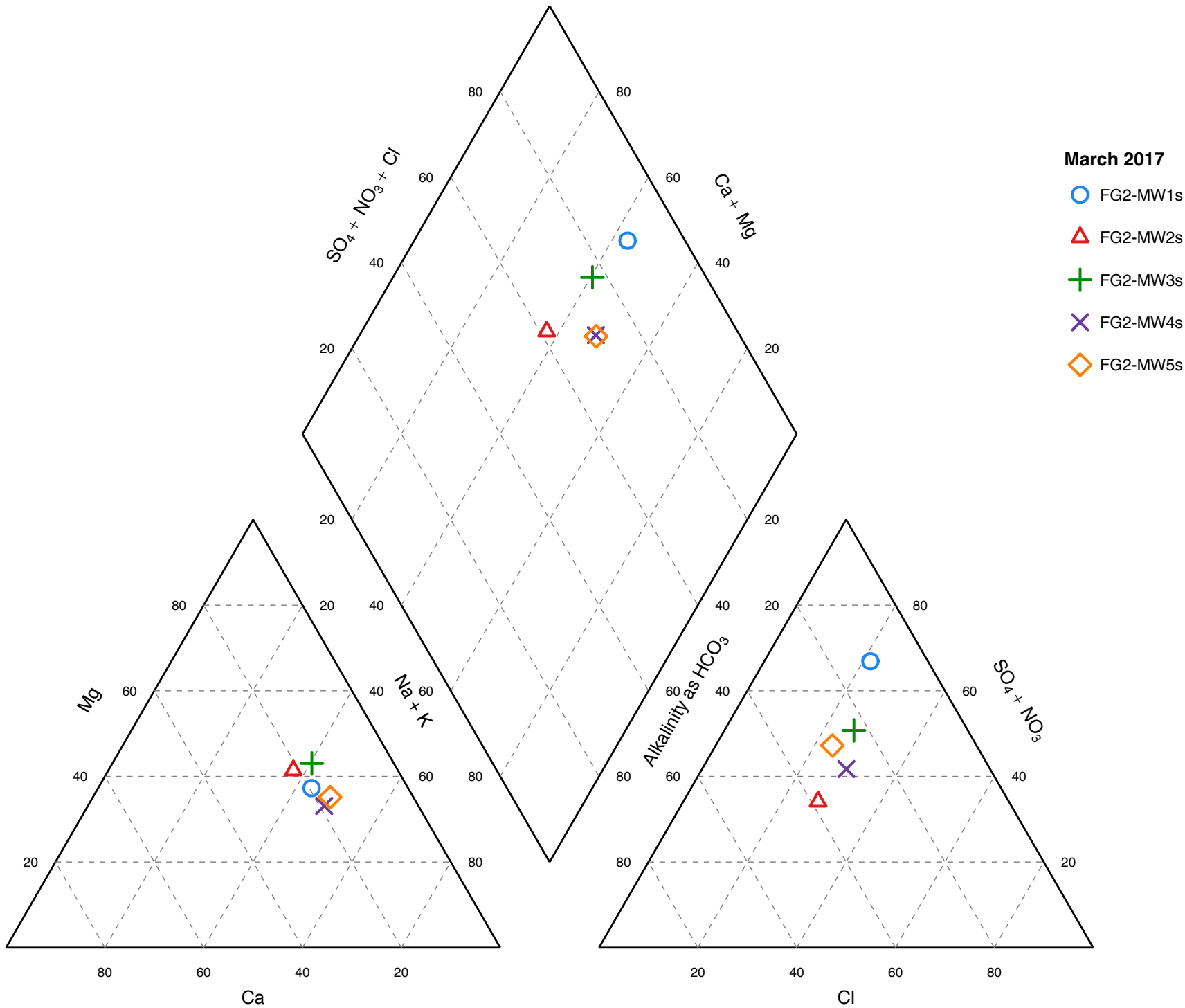

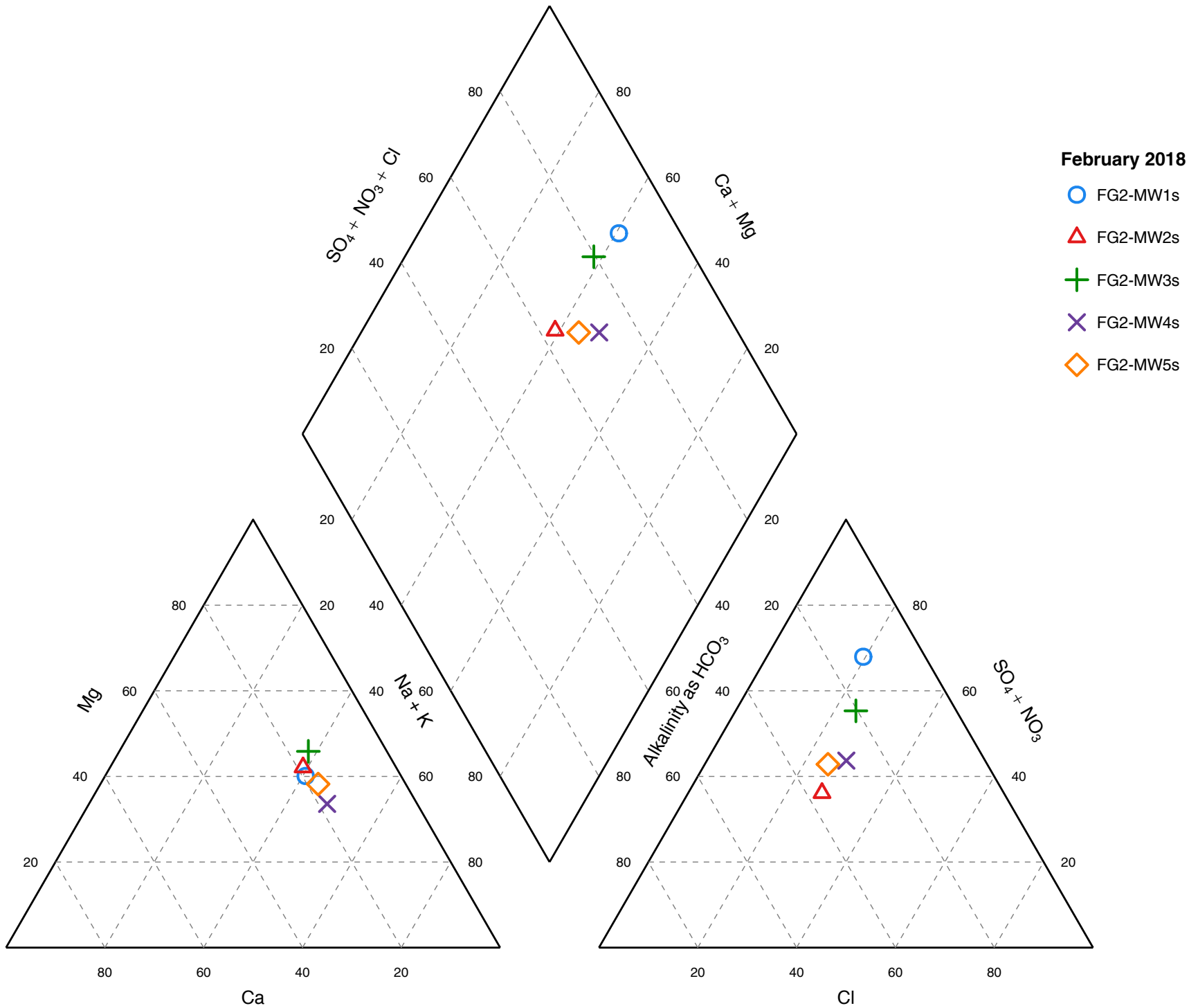

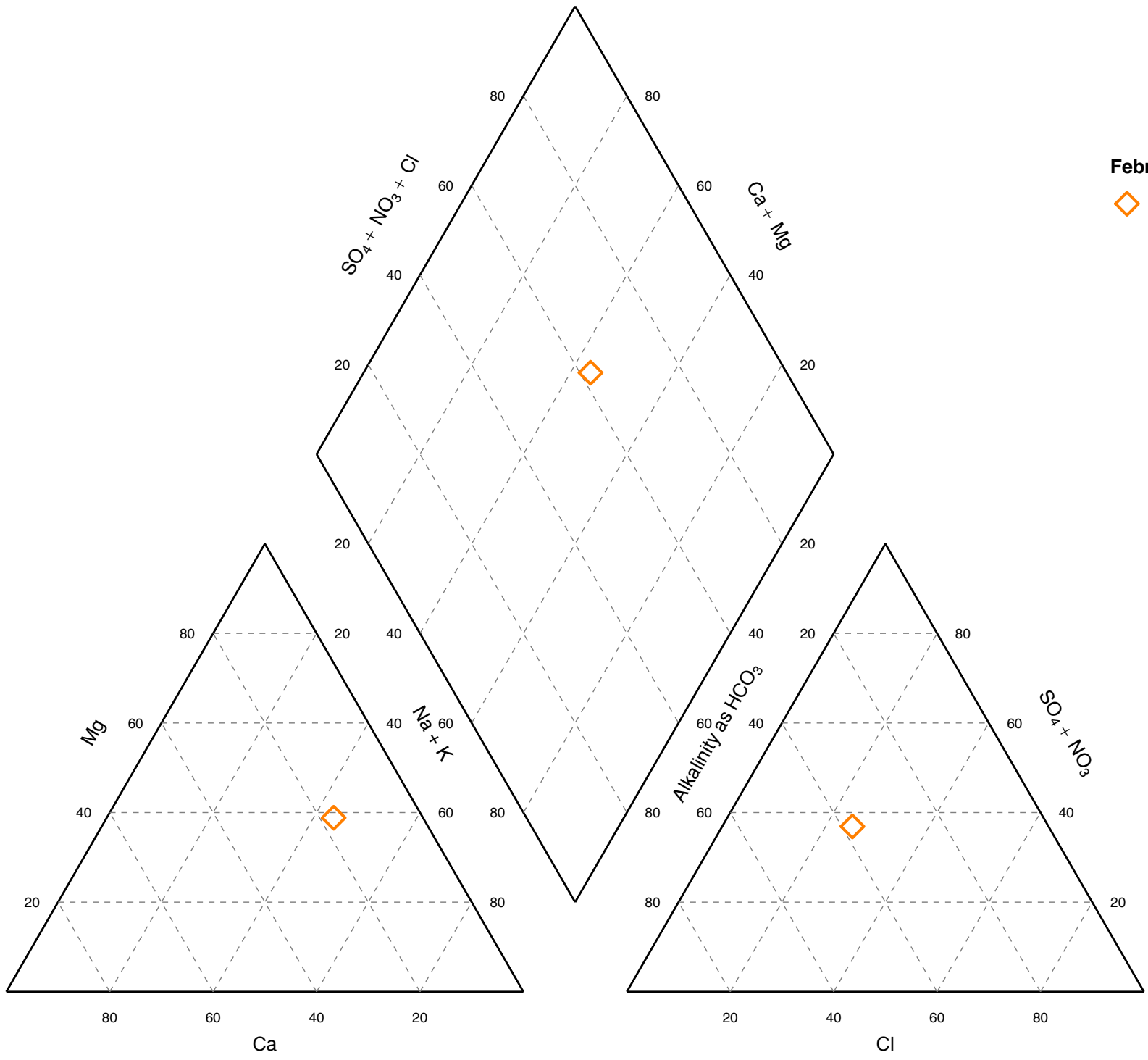

February 2019

FG2-MW5s

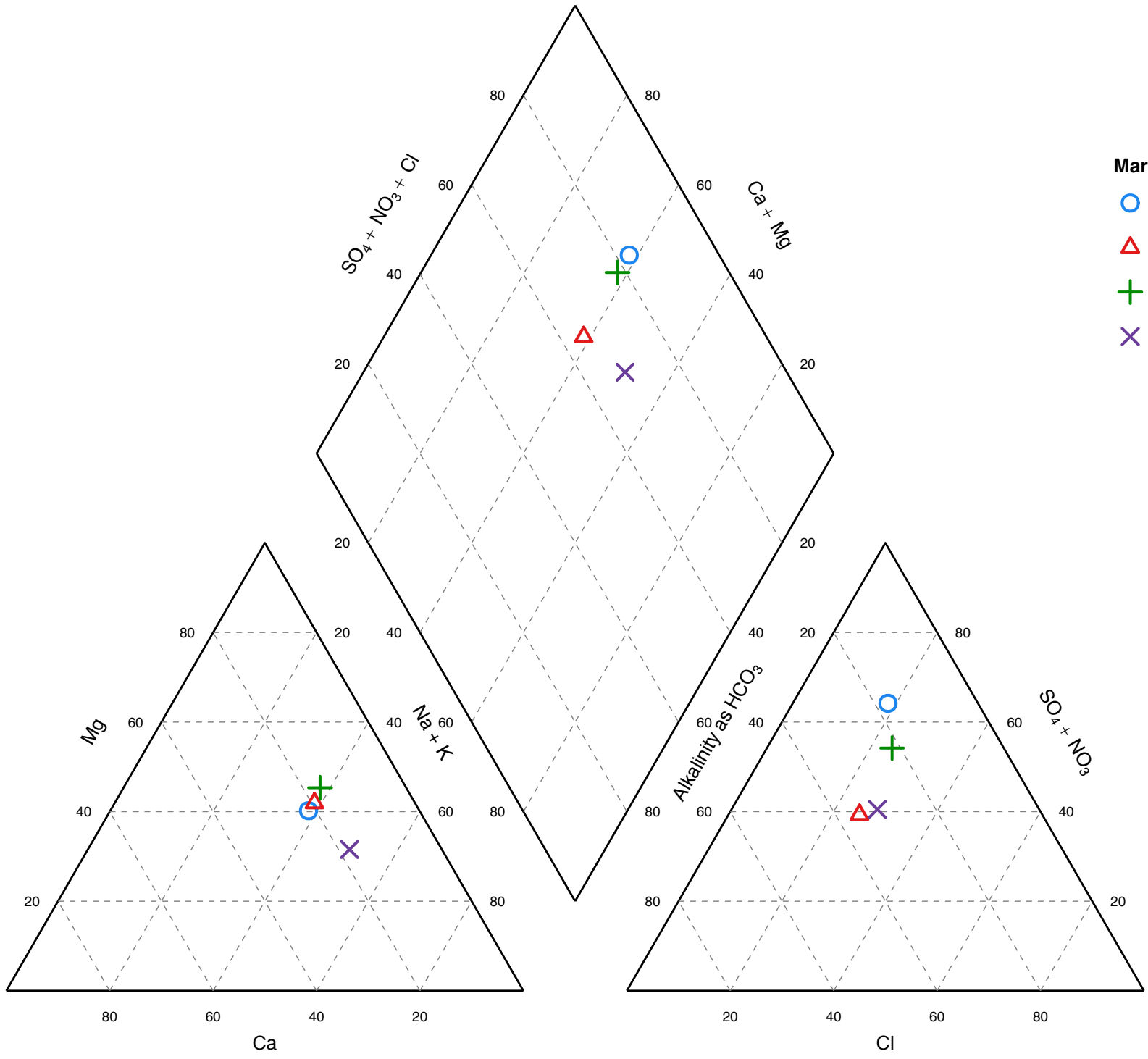

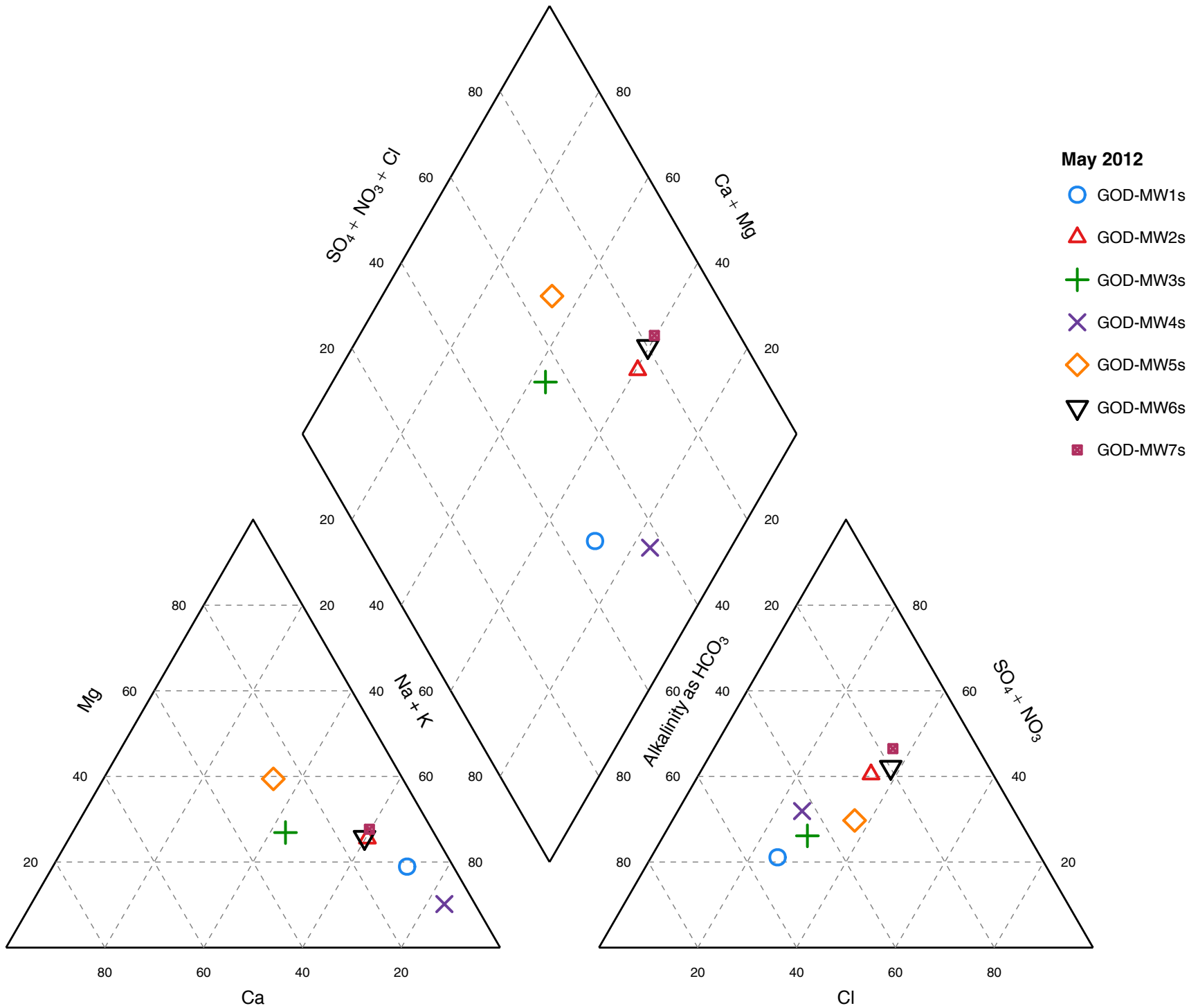

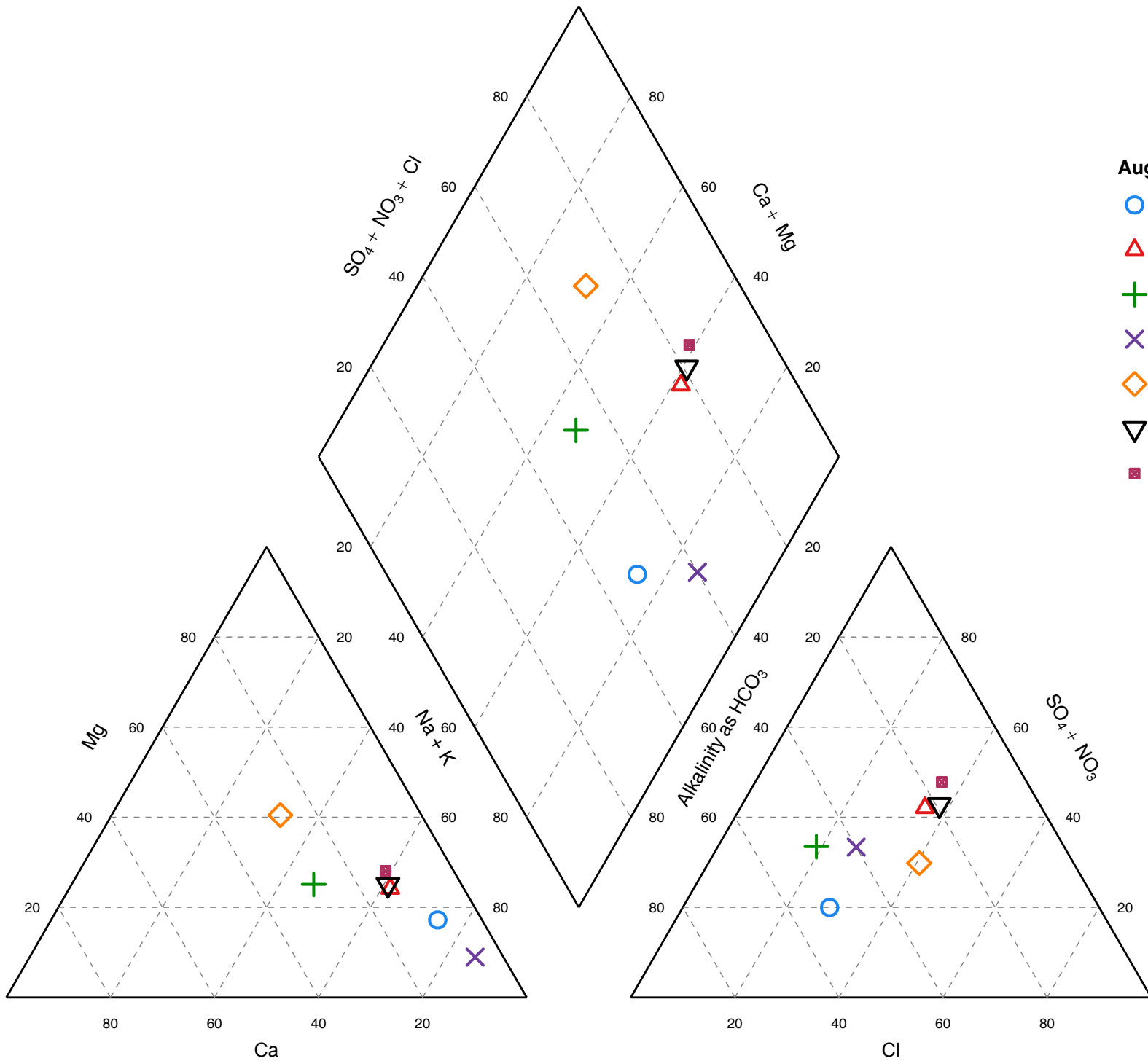

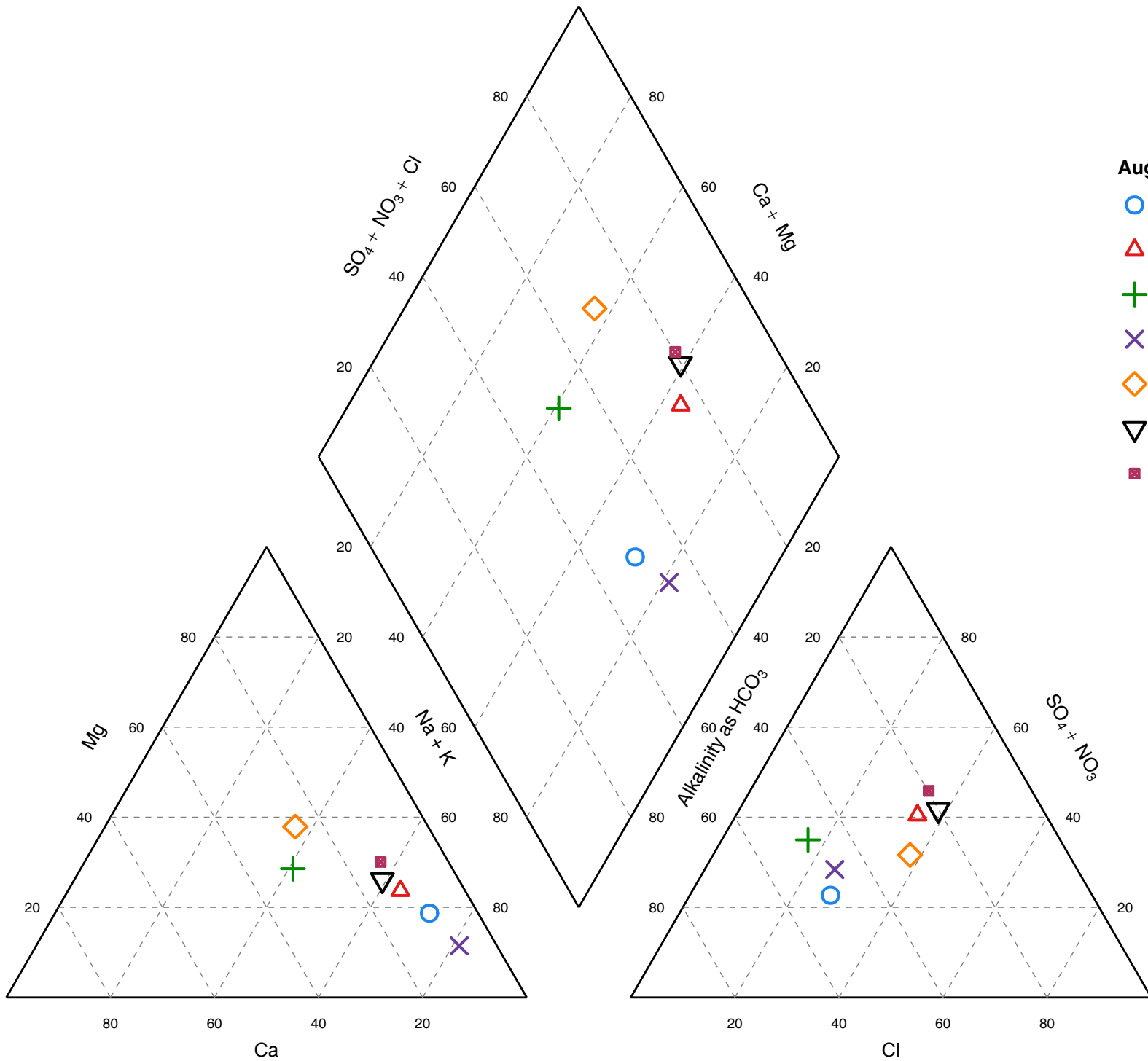

August 2013

- GOD-MW1s
- △ GOD-MW2s
- + GOD-MW3s
- × GOD-MW4s
- ◇ GOD-MW5s
- ▽ GOD-MW6s
- GOD-MW7s

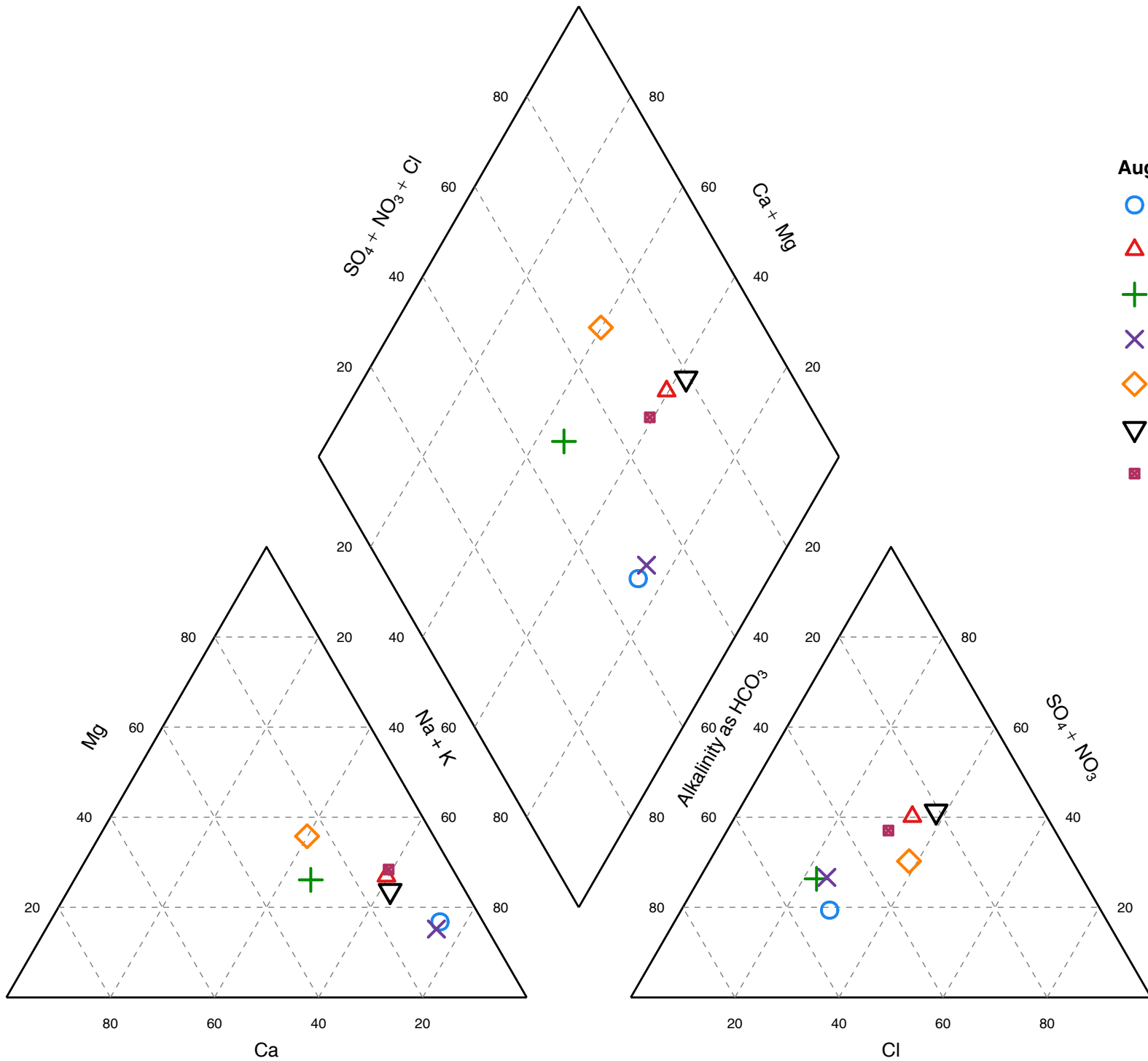

August 2014

- GOD-MW1s
- △ GOD-MW2s
- ⊕ GOD-MW3s
- ⊗ GOD-MW4s
- ◇ GOD-MW5s
- ▽ GOD-MW6s
- GOD-MW7s

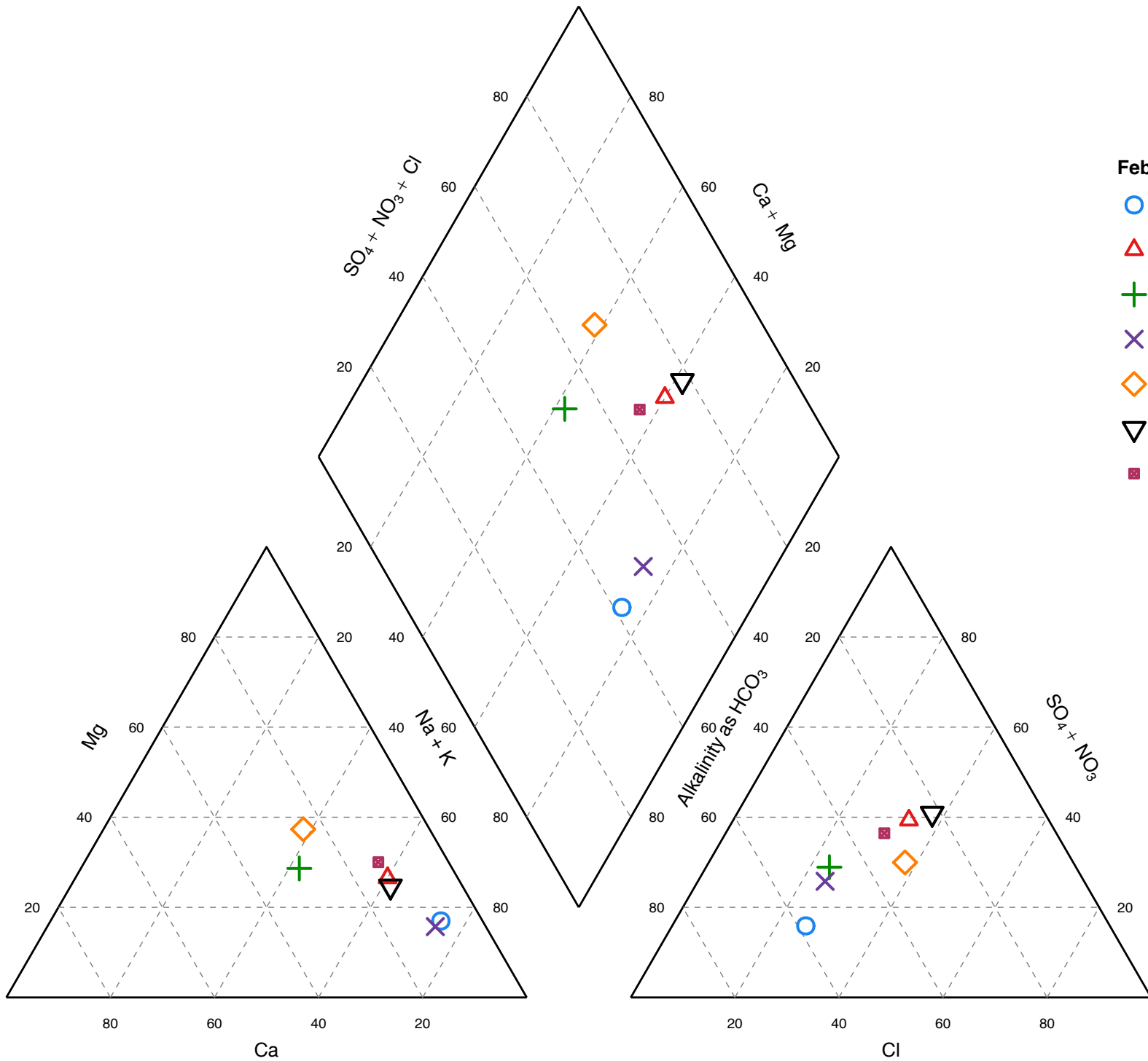

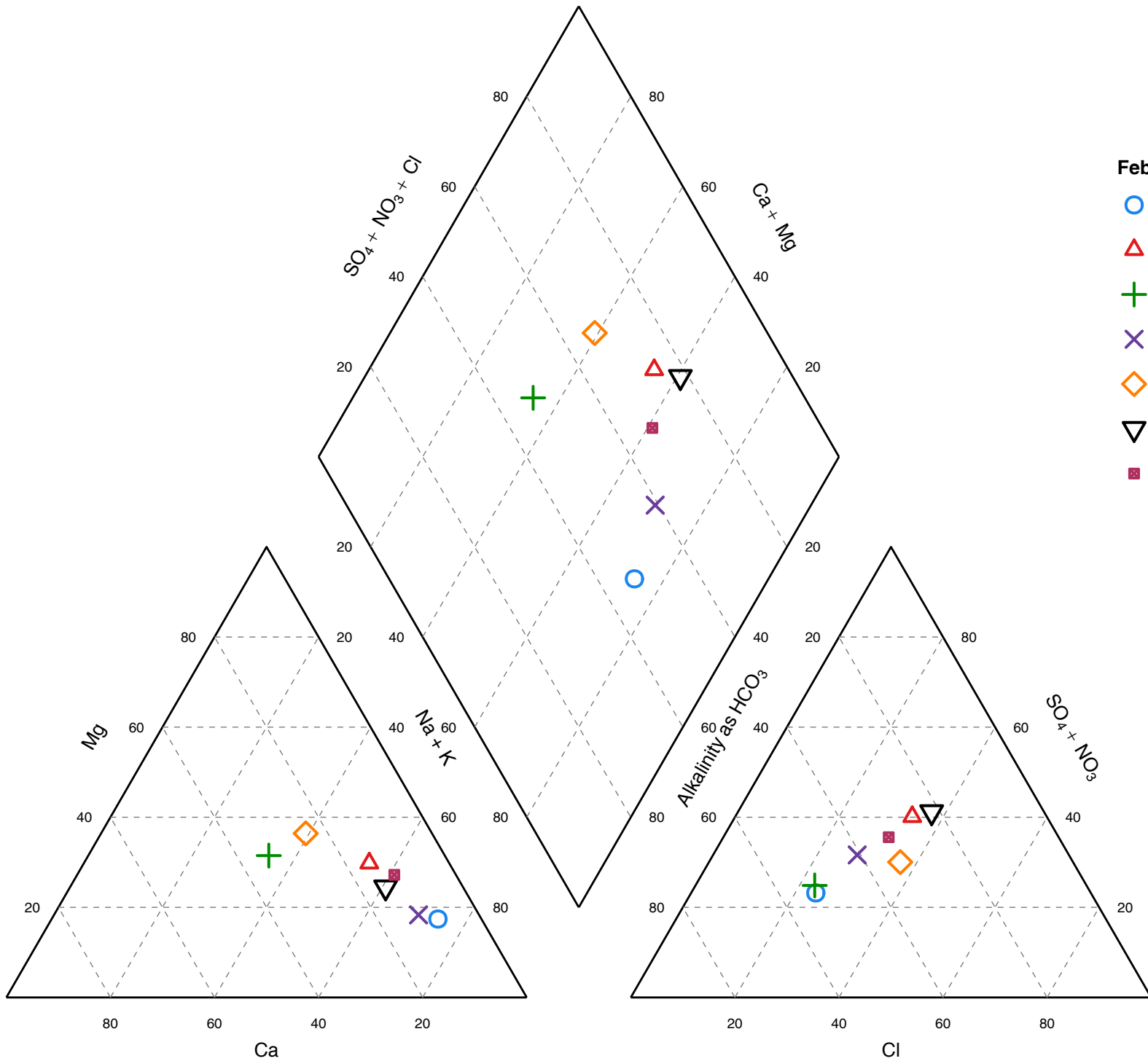

February 2016

- GOD-MW1s
- △ GOD-MW2s
- + GOD-MW3s
- × GOD-MW4s
- ◇ GOD-MW5s
- ▽ GOD-MW6s
- GOD-MW7s

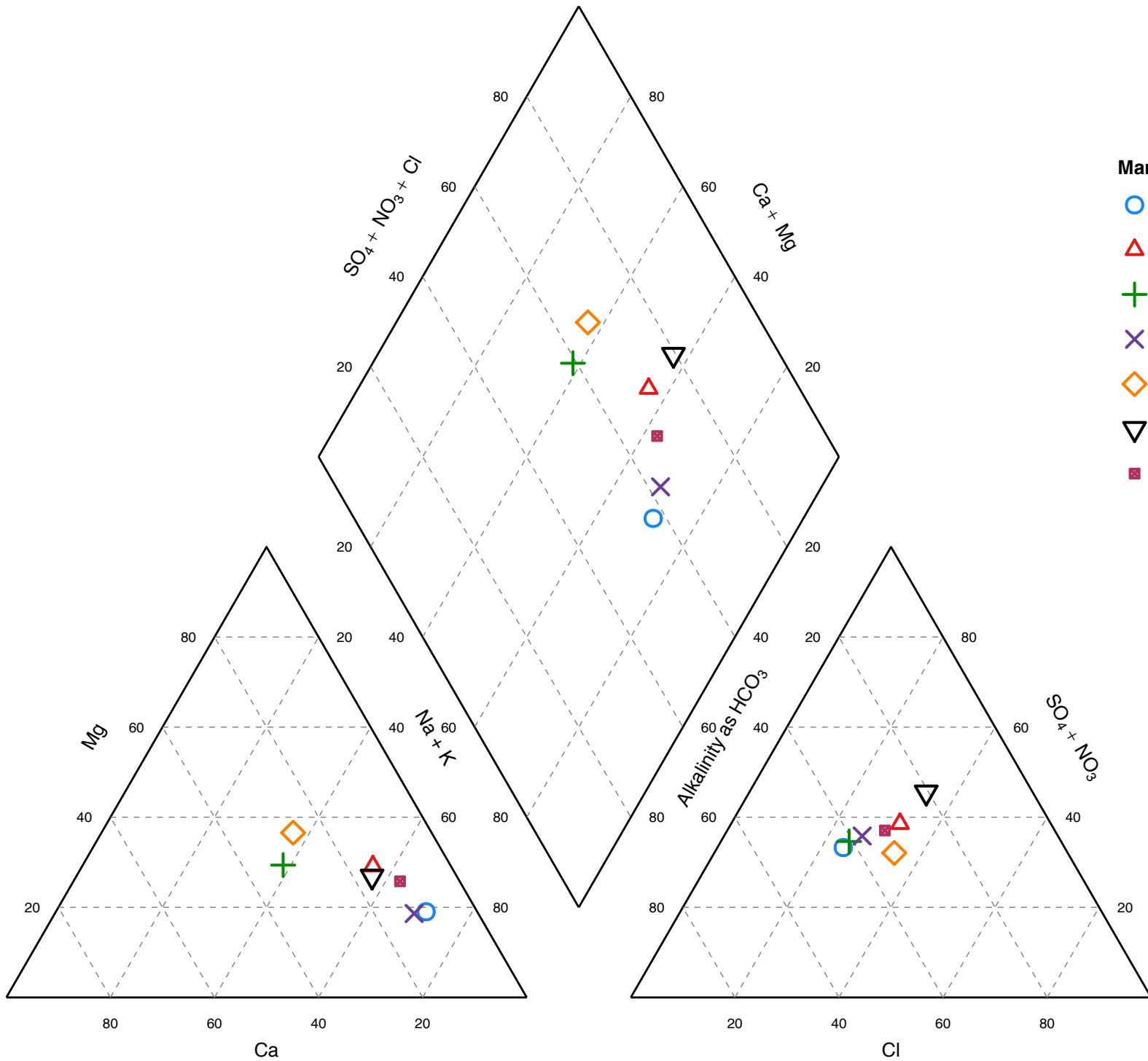

March 2017

- GOD-MW1s
- △ GOD-MW2s
- + GOD-MW3s
- × GOD-MW4s
- ◇ GOD-MW5s
- ▽ GOD-MW6s
- GOD-MW7s

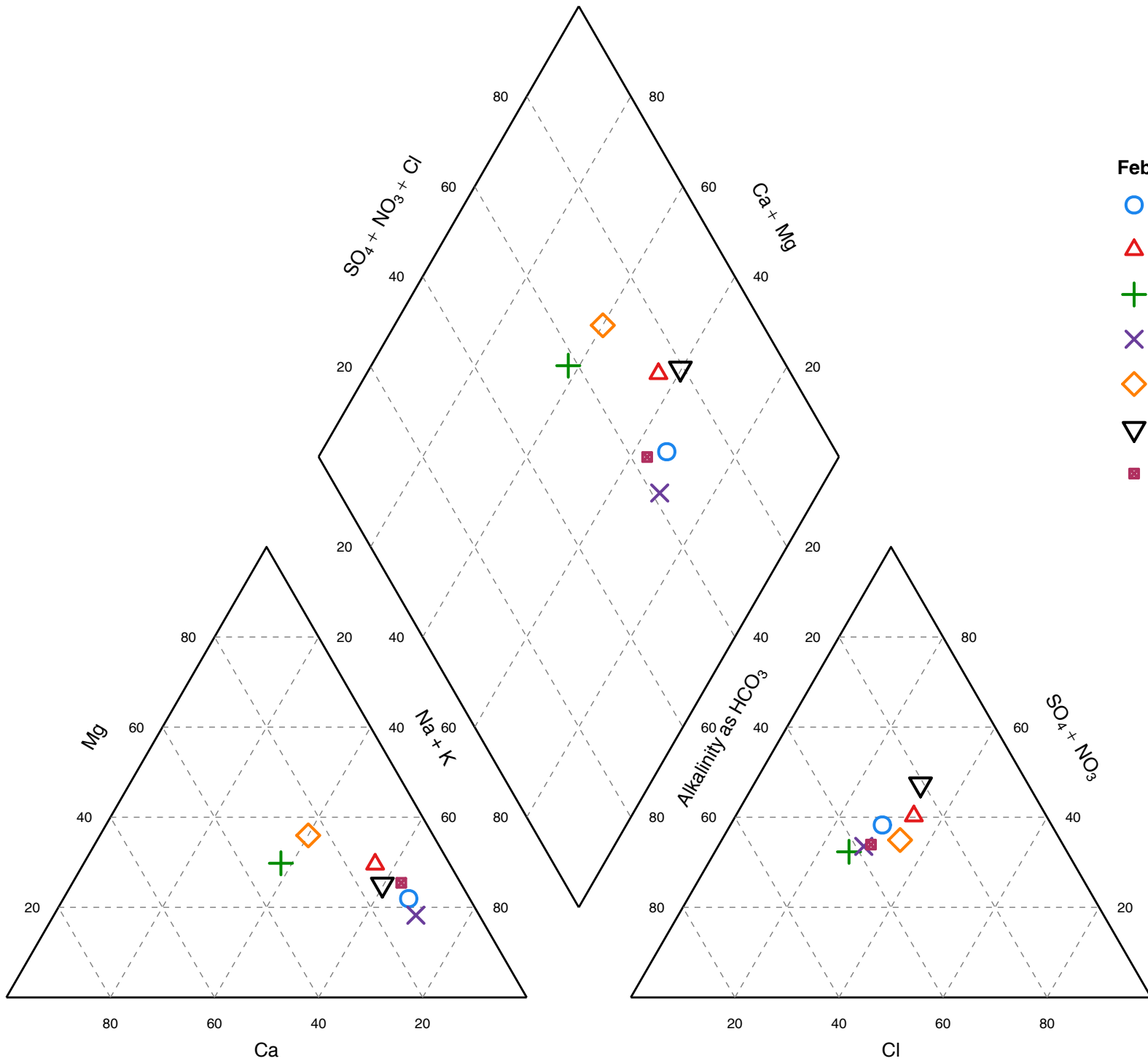

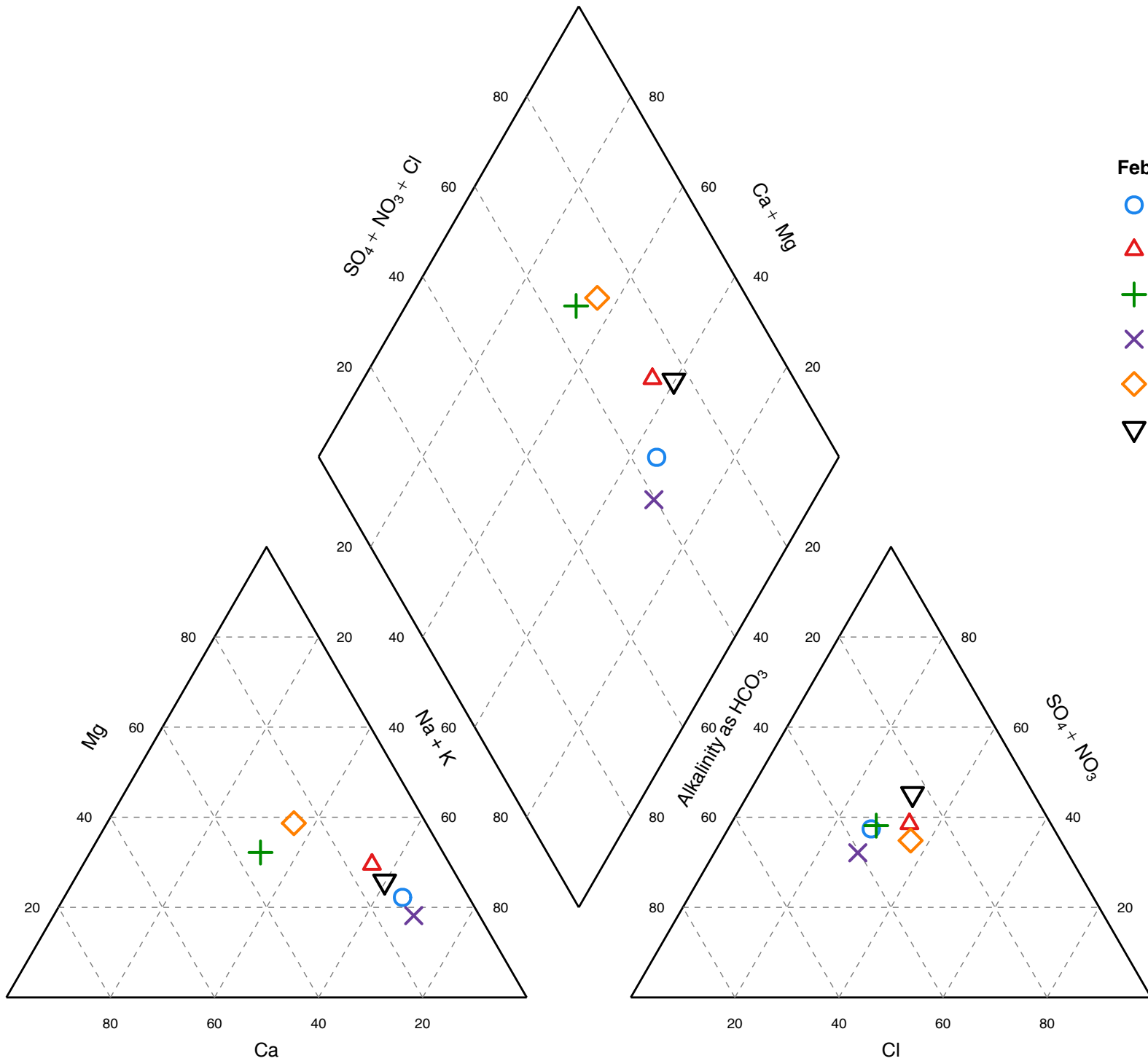

February 2019

- GOD-MW1s
- △ GOD-MW2s
- + GOD-MW3s
- × GOD-MW4s
- ◇ GOD-MW5s
- ▽ GOD-MW6s

March 2019

■ GOD-MW7s

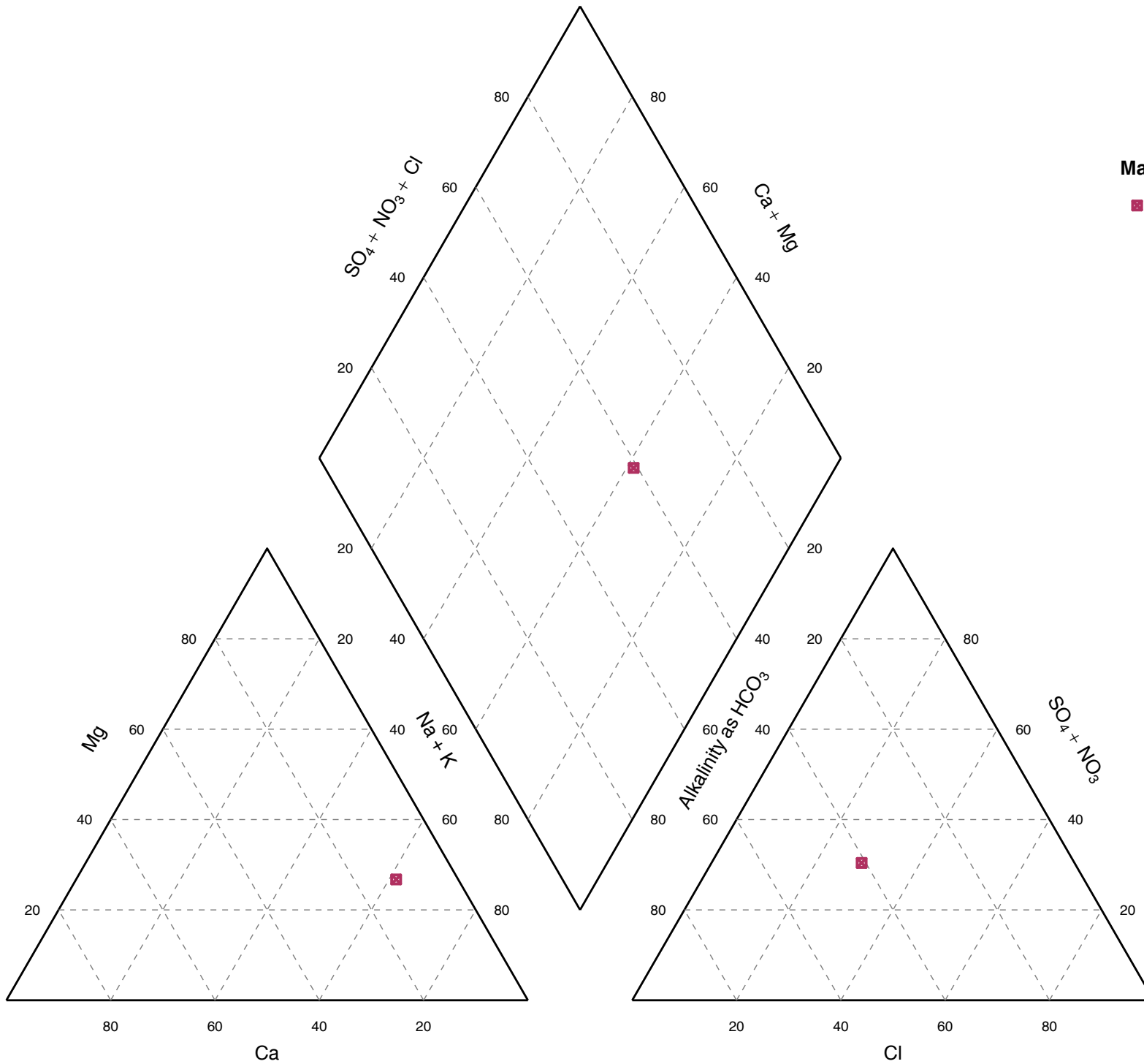

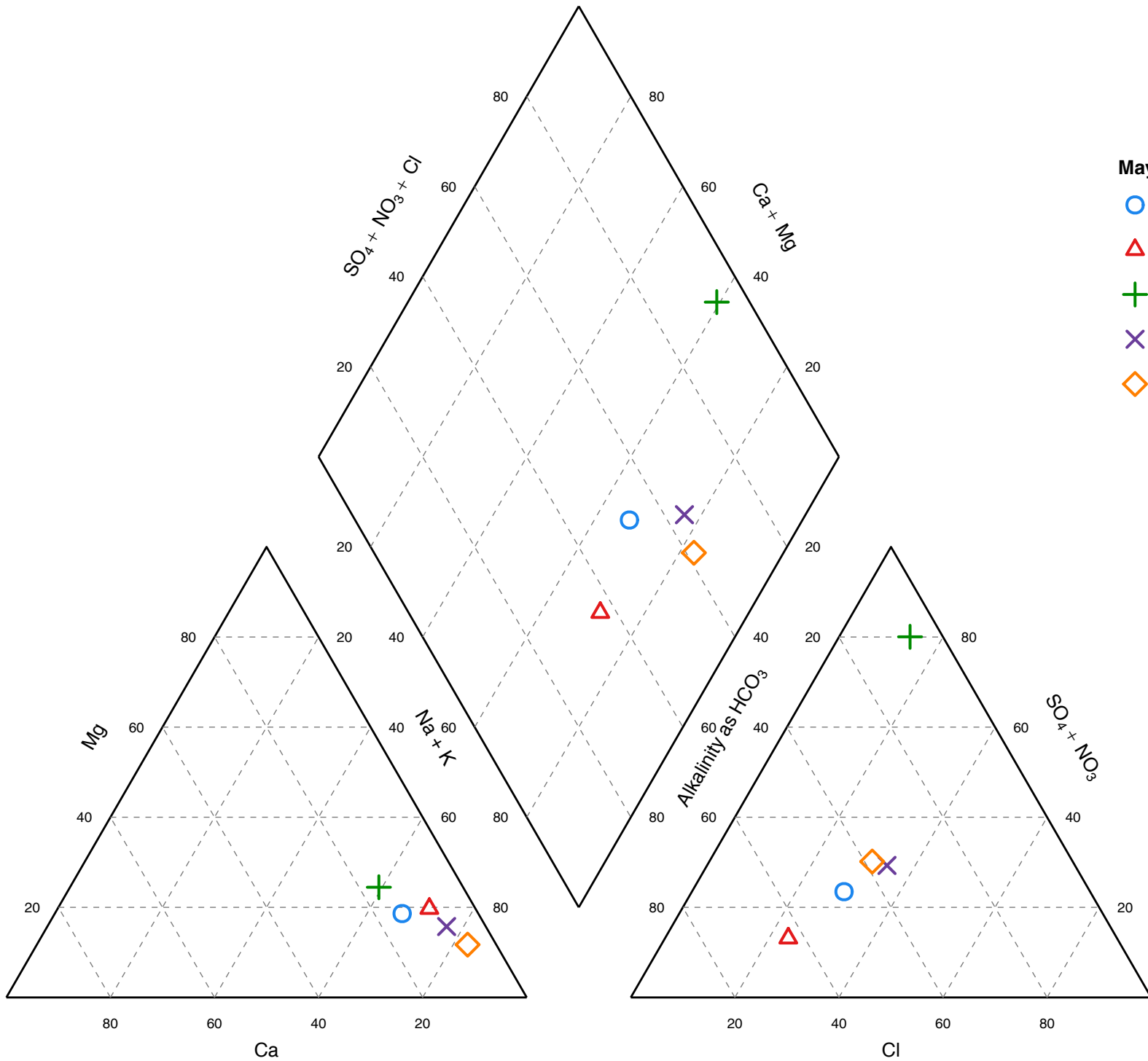

May 2012

- MAC-MW1s
- △ MAC-MW2s
- + MAC-MW3s
- × MAC-MW4s
- ◇ MAC-MW5s

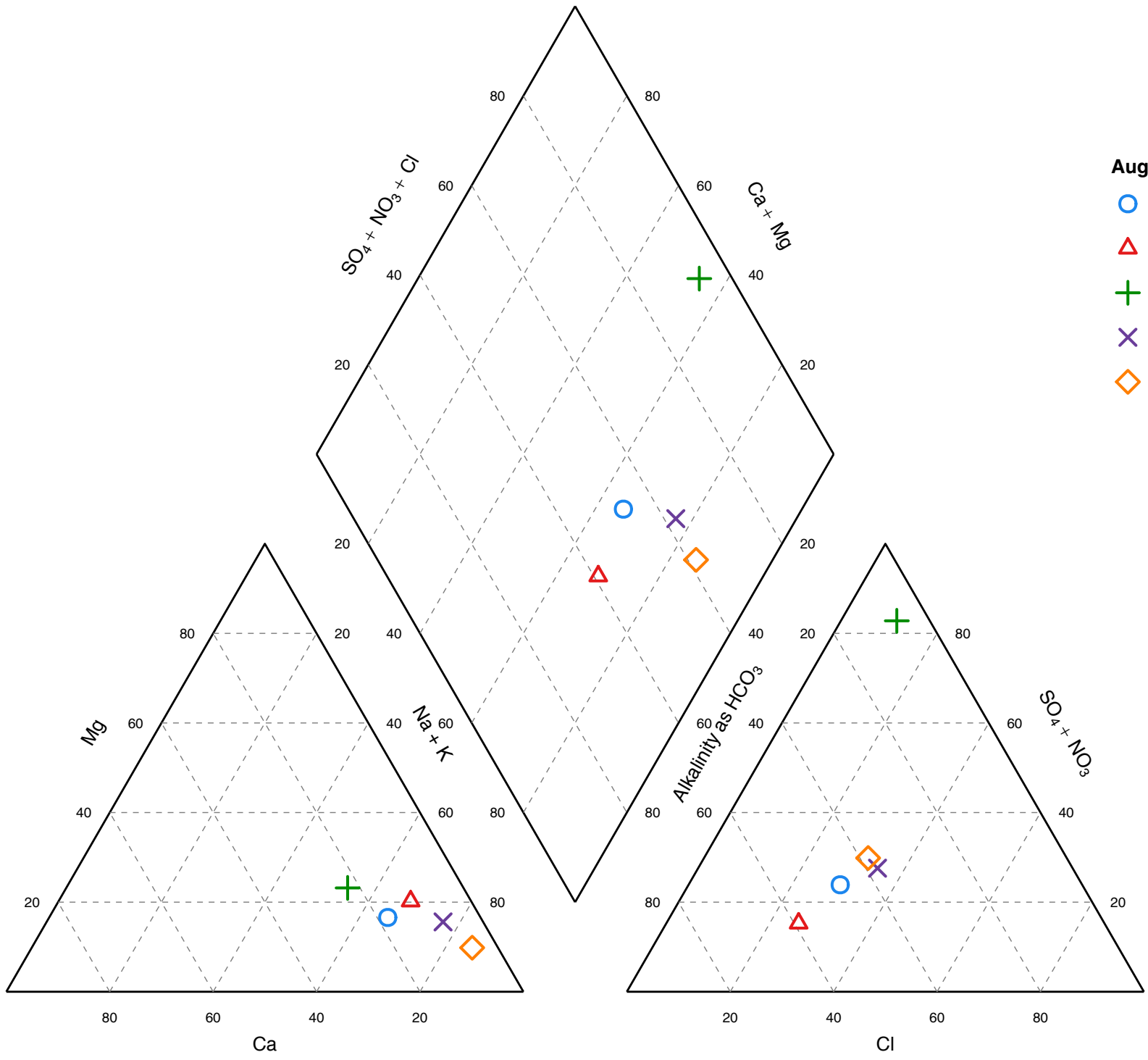

August 2012

- MAC-MW1s
- △ MAC-MW2s
- + MAC-MW3s
- × MAC-MW4s
- ◇ MAC-MW5s

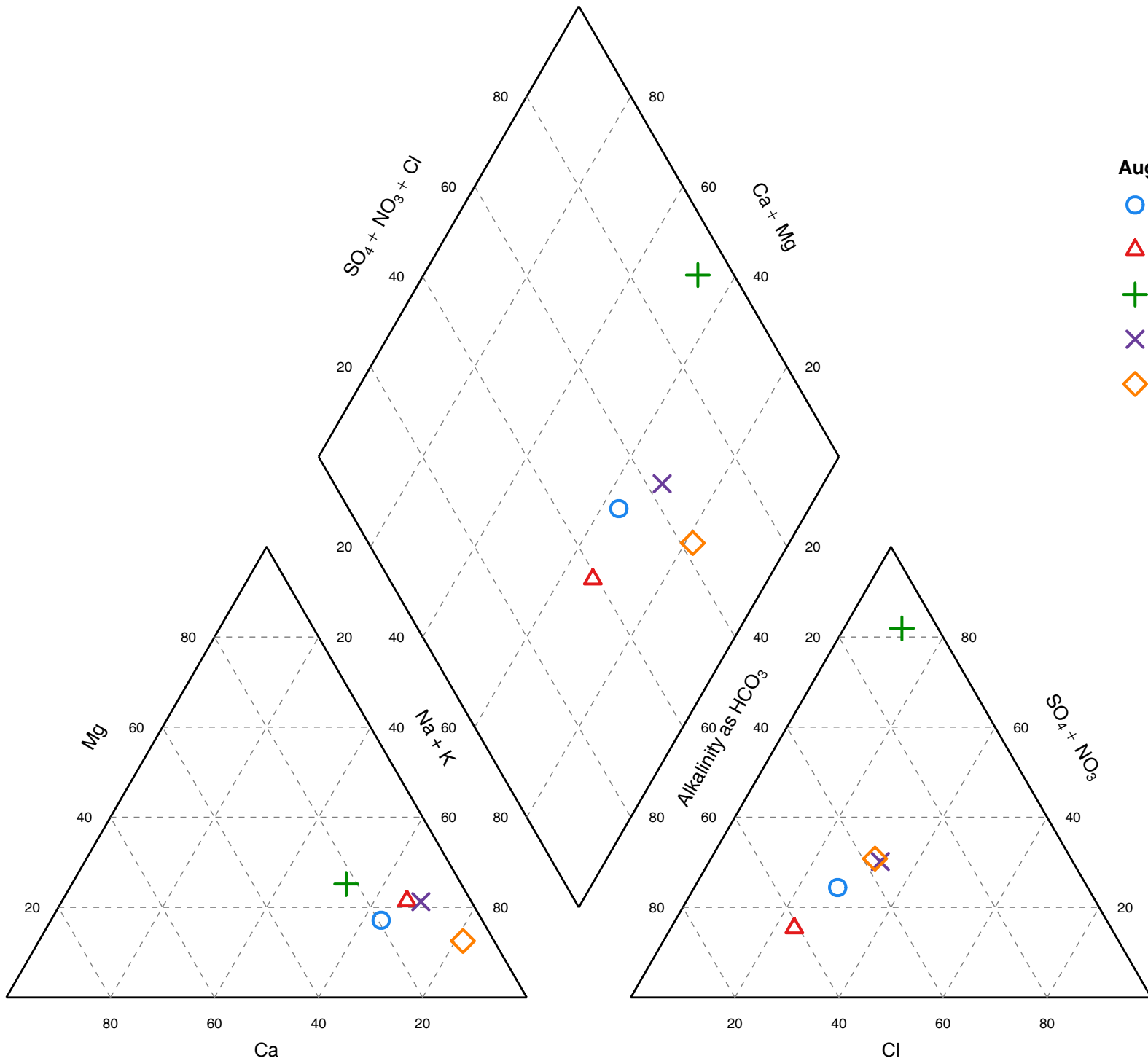

August 2013

- MAC-MW1s
- △ MAC-MW2s
- ⊕ MAC-MW3s
- ⊗ MAC-MW4s
- ◇ MAC-MW5s

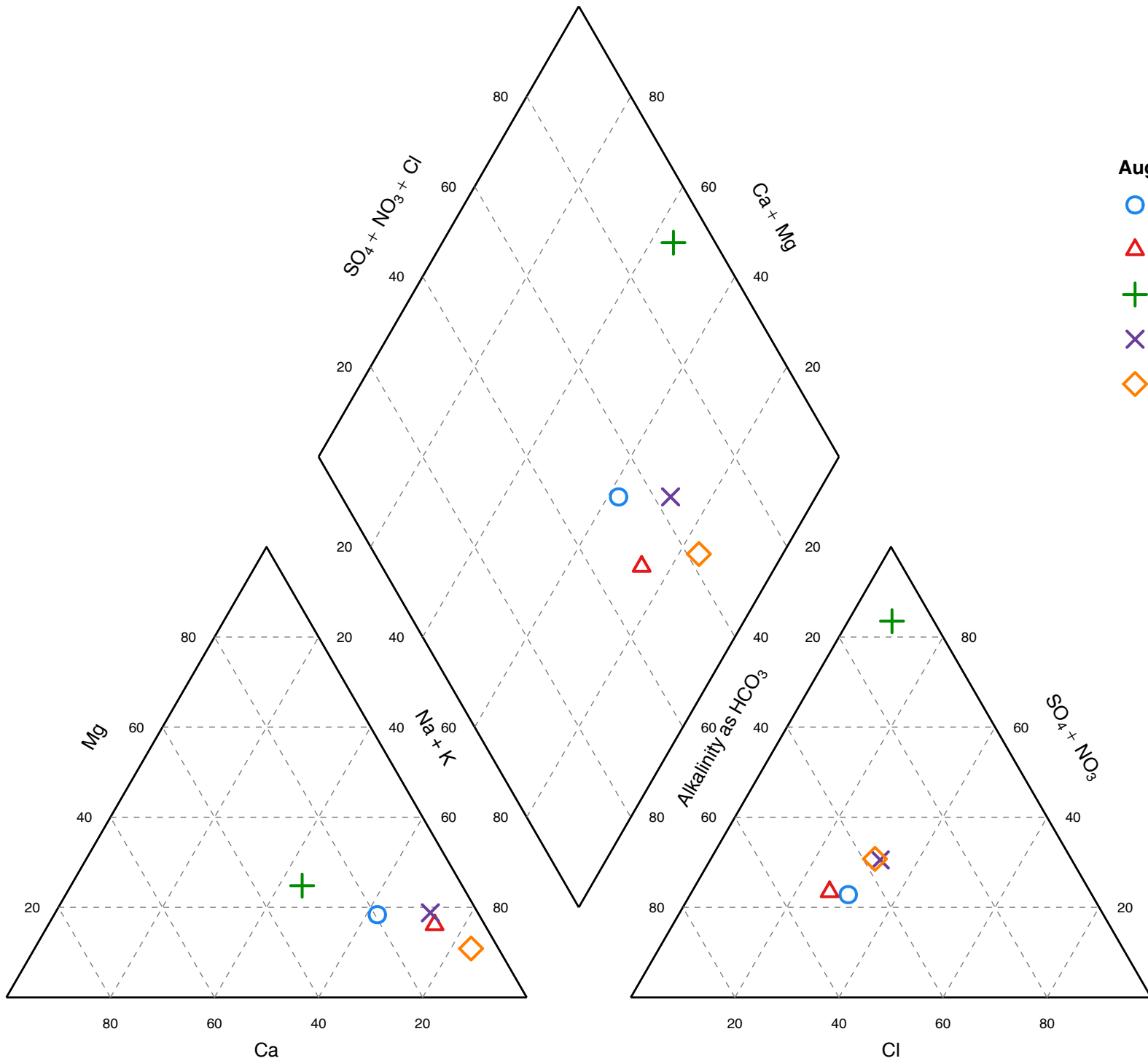

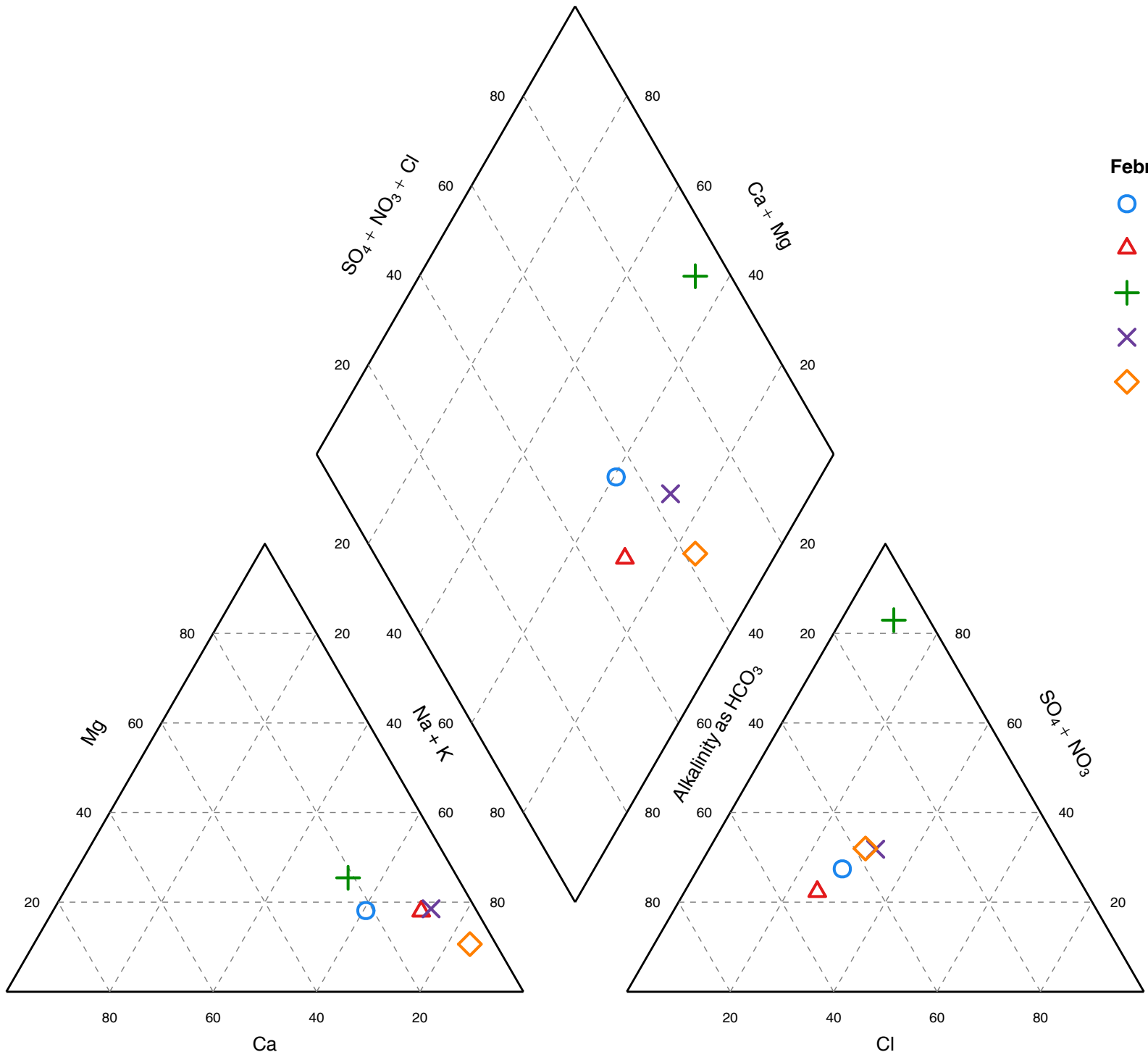

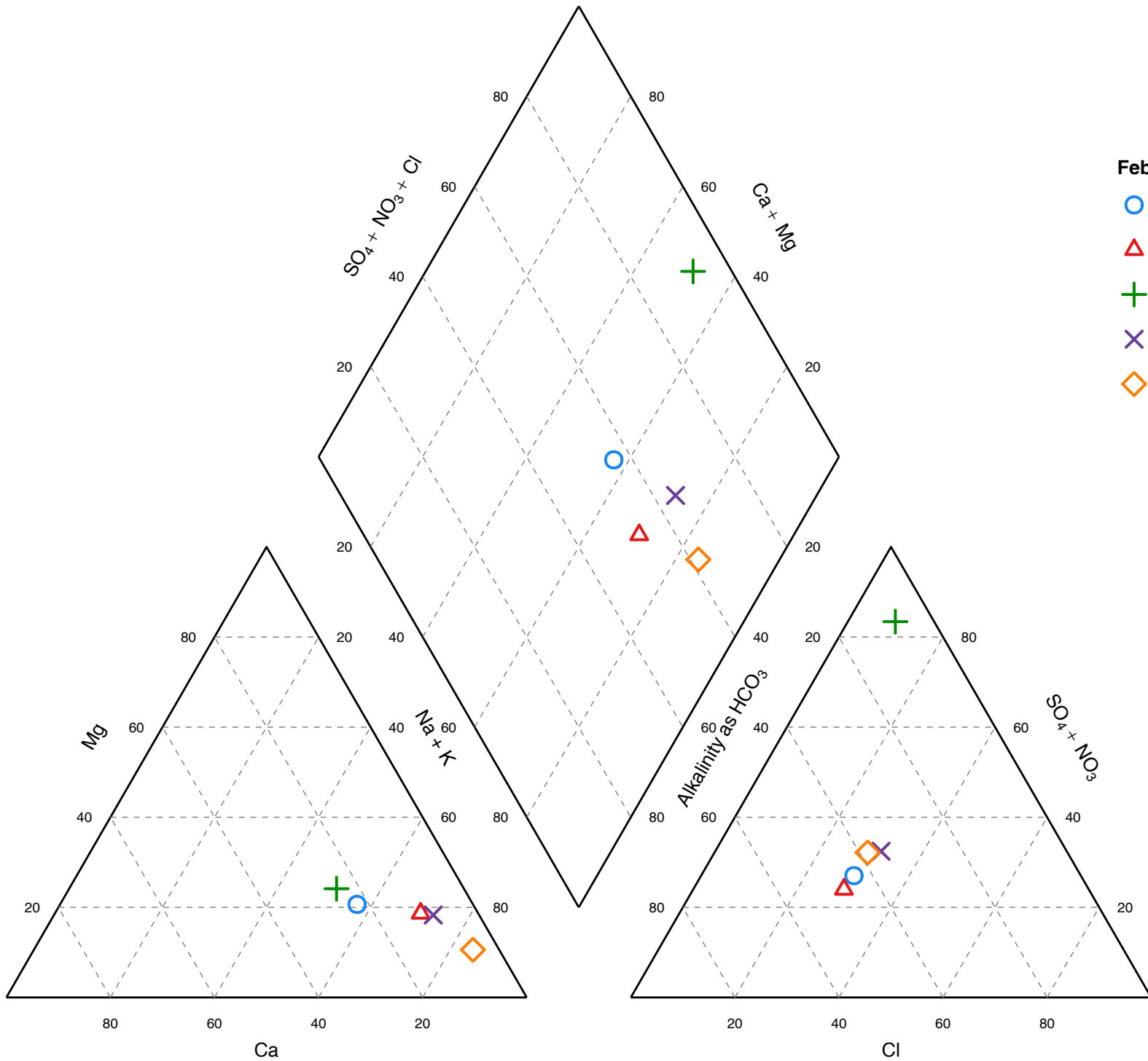

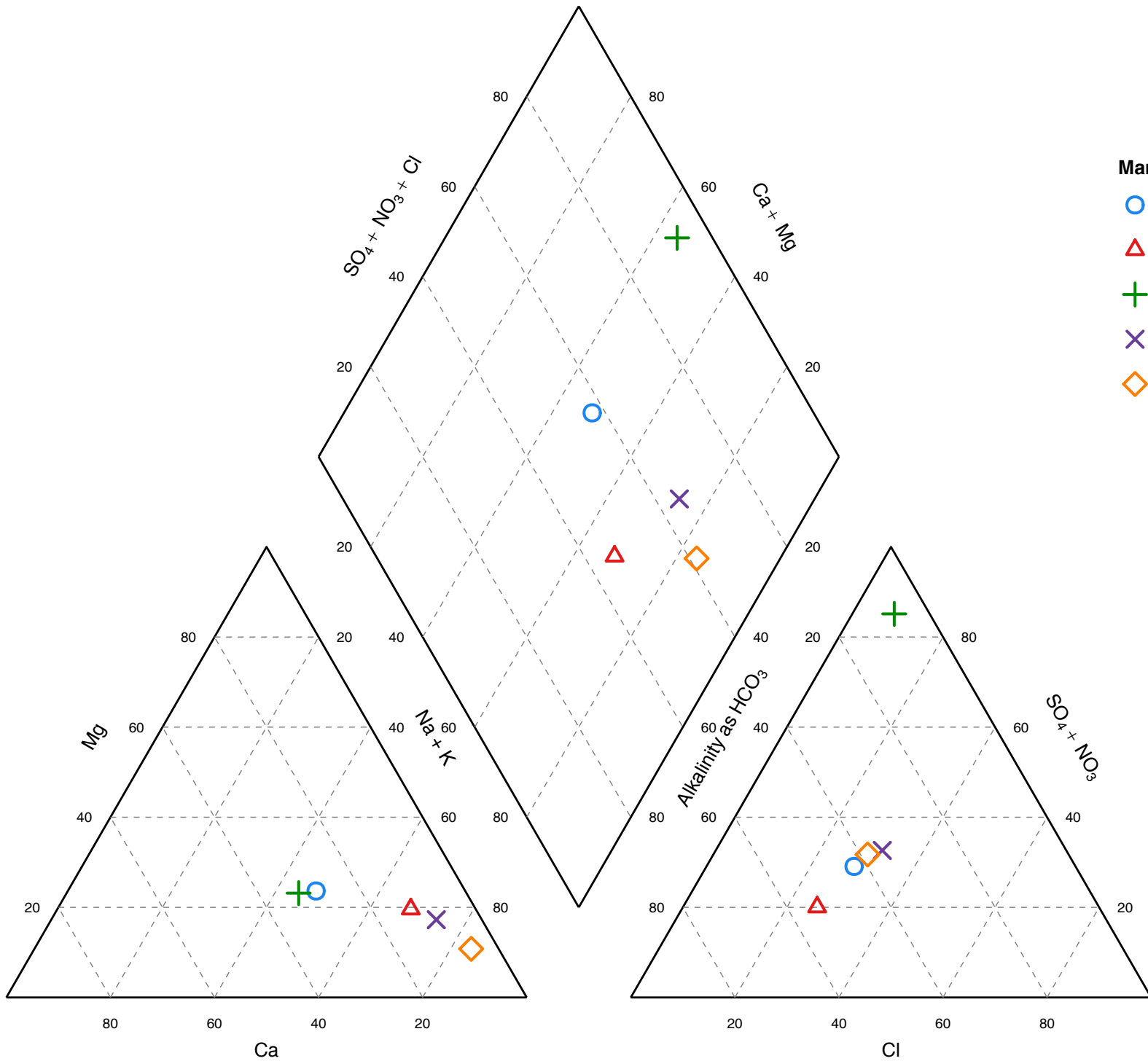

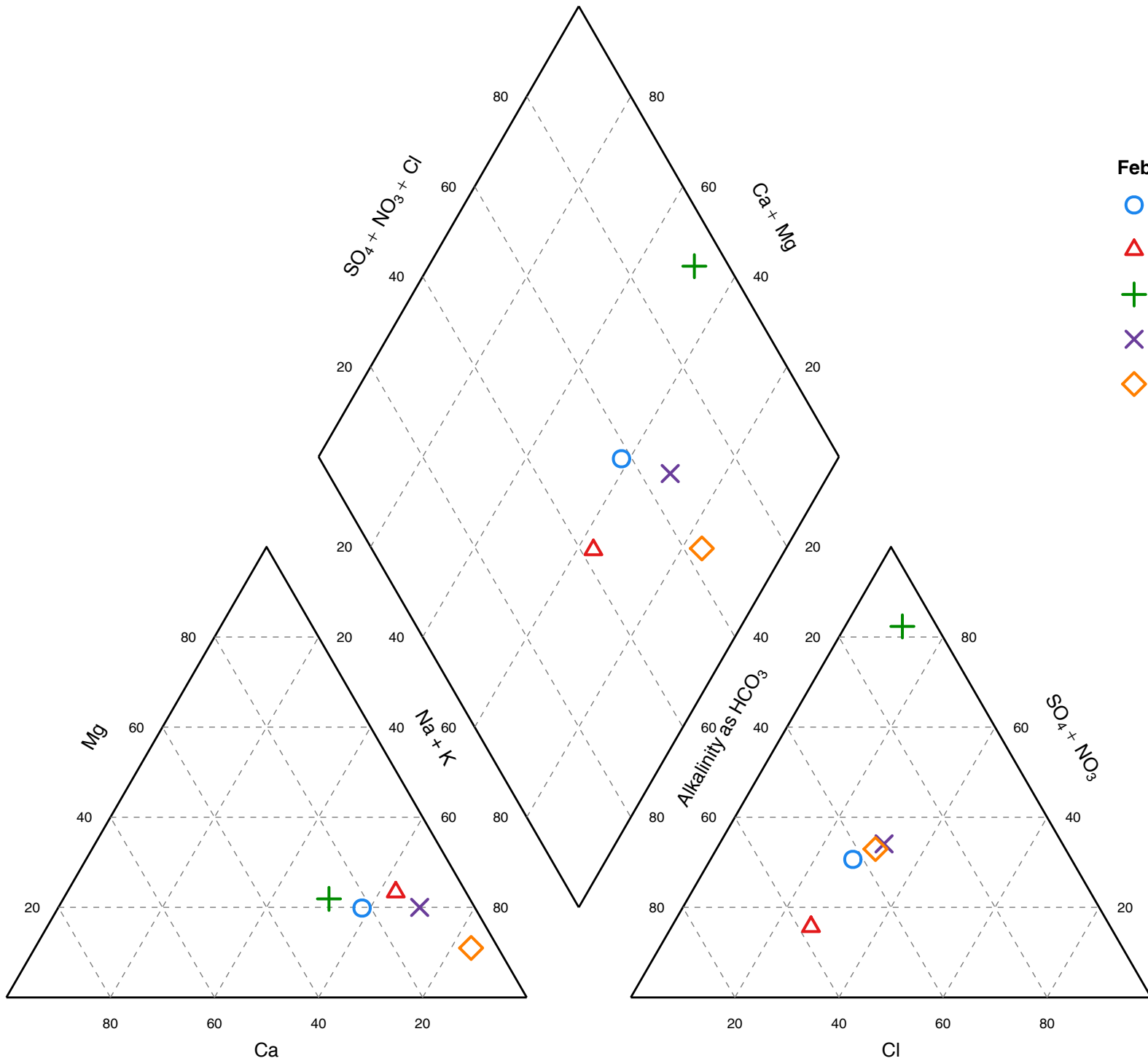

February 2018

- MAC-MW1s
- △ MAC-MW2s
- + MAC-MW3s
- × MAC-MW4s
- ◇ MAC-MW5s

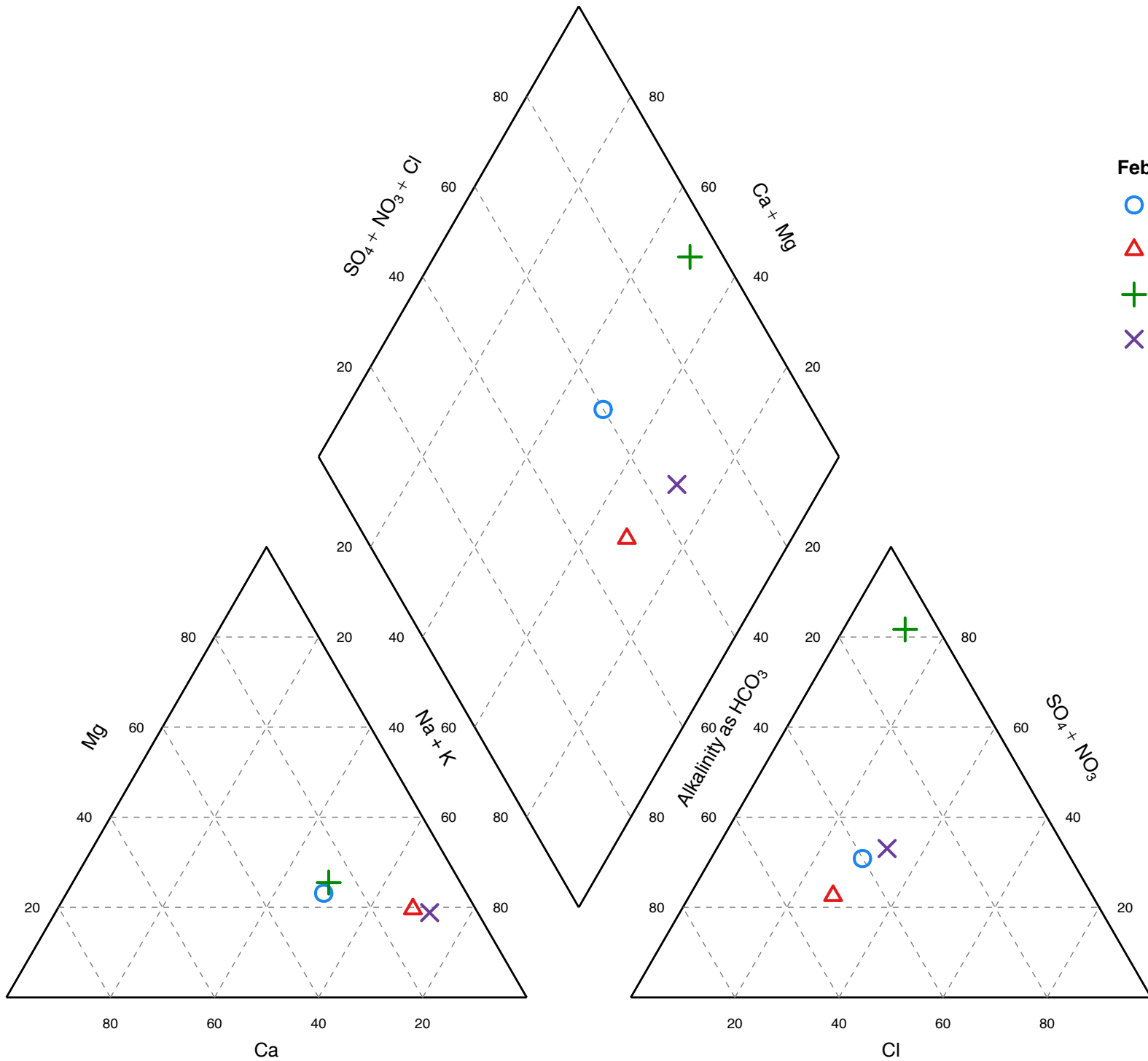

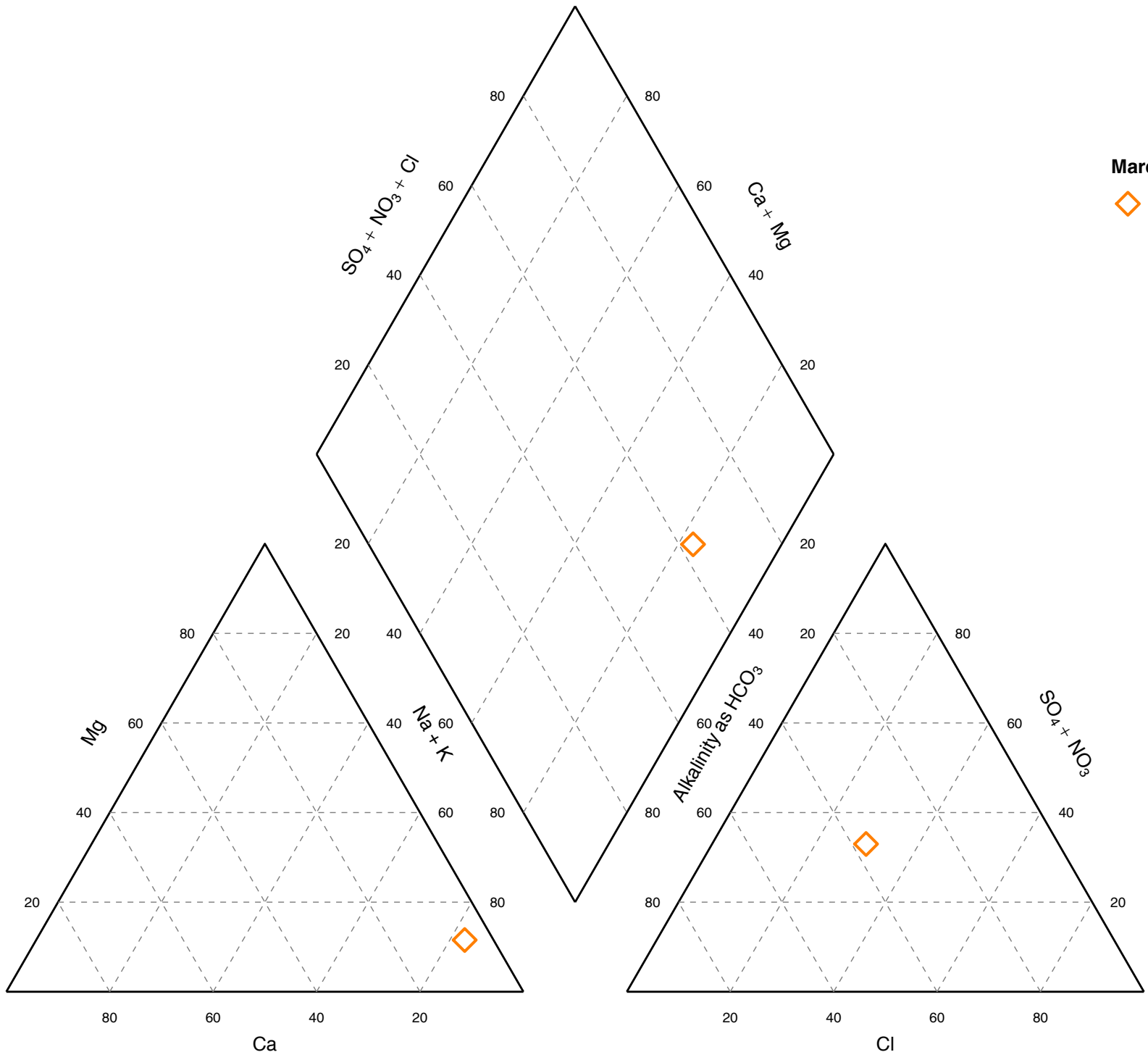

March 2019

MAC-MW5s

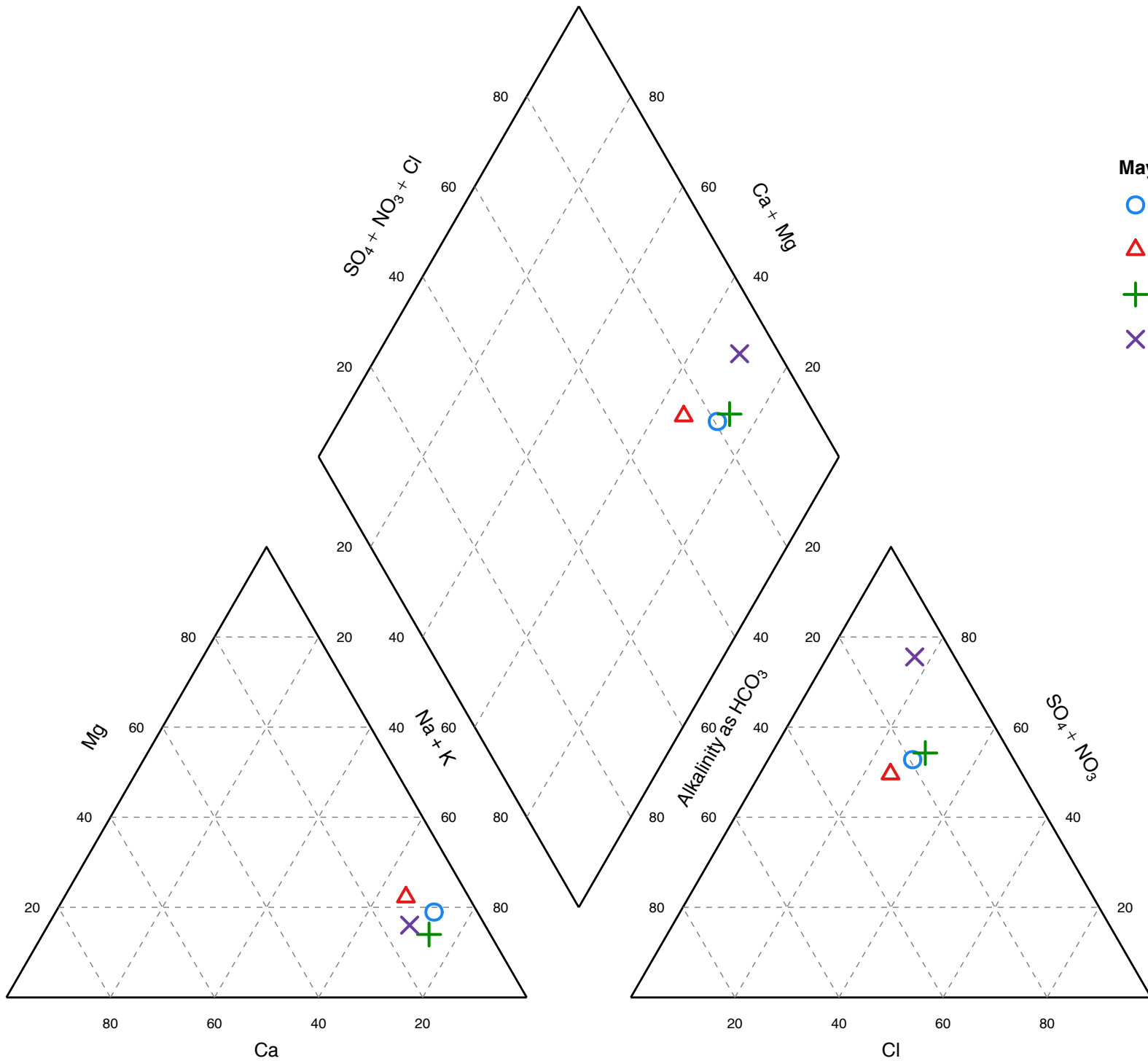

May 2012

- NUN-MW1s
- △ NUN-MW2s
- ⊕ NUN-MW3s
- ⊗ NUN-MW4s

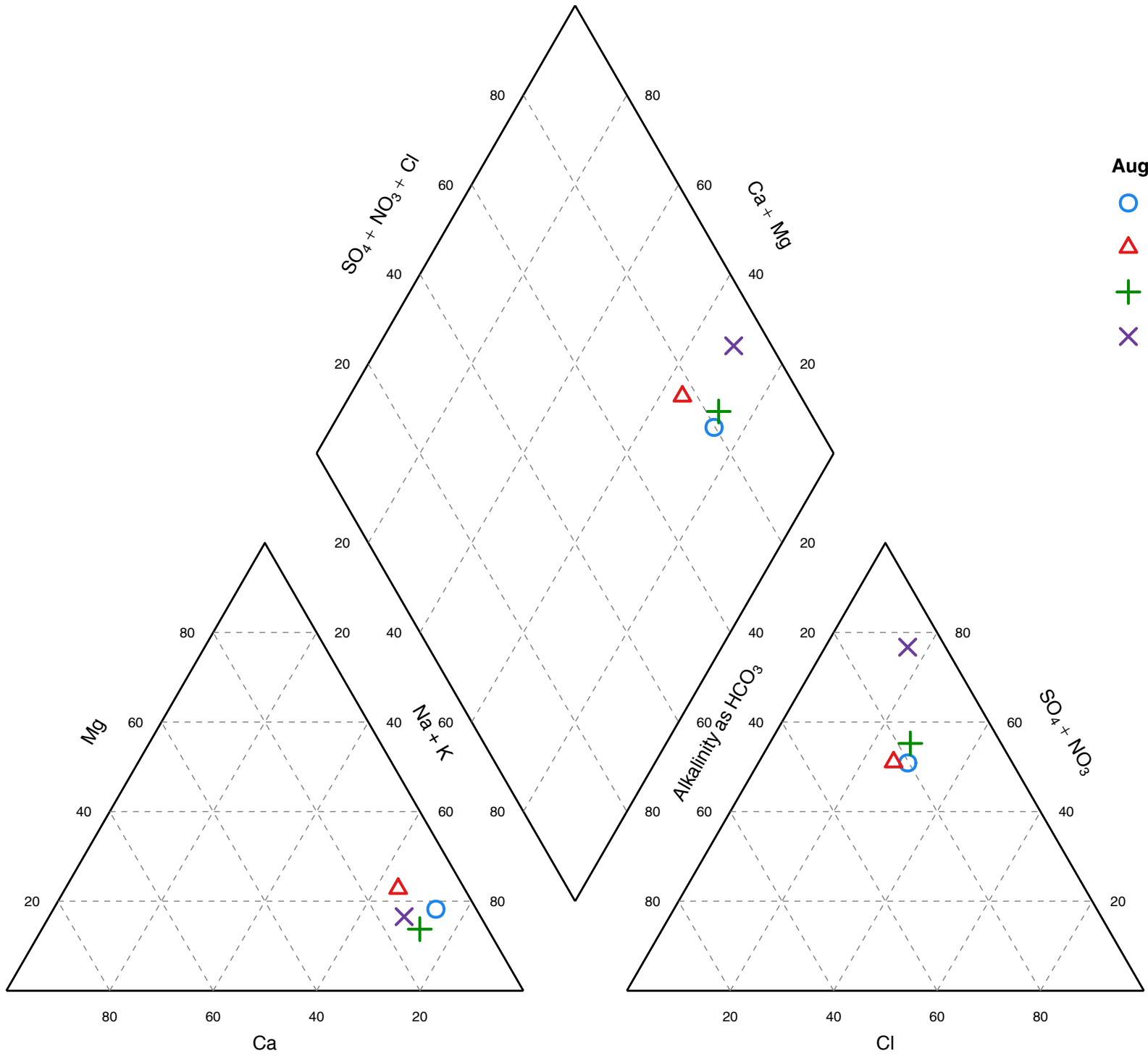

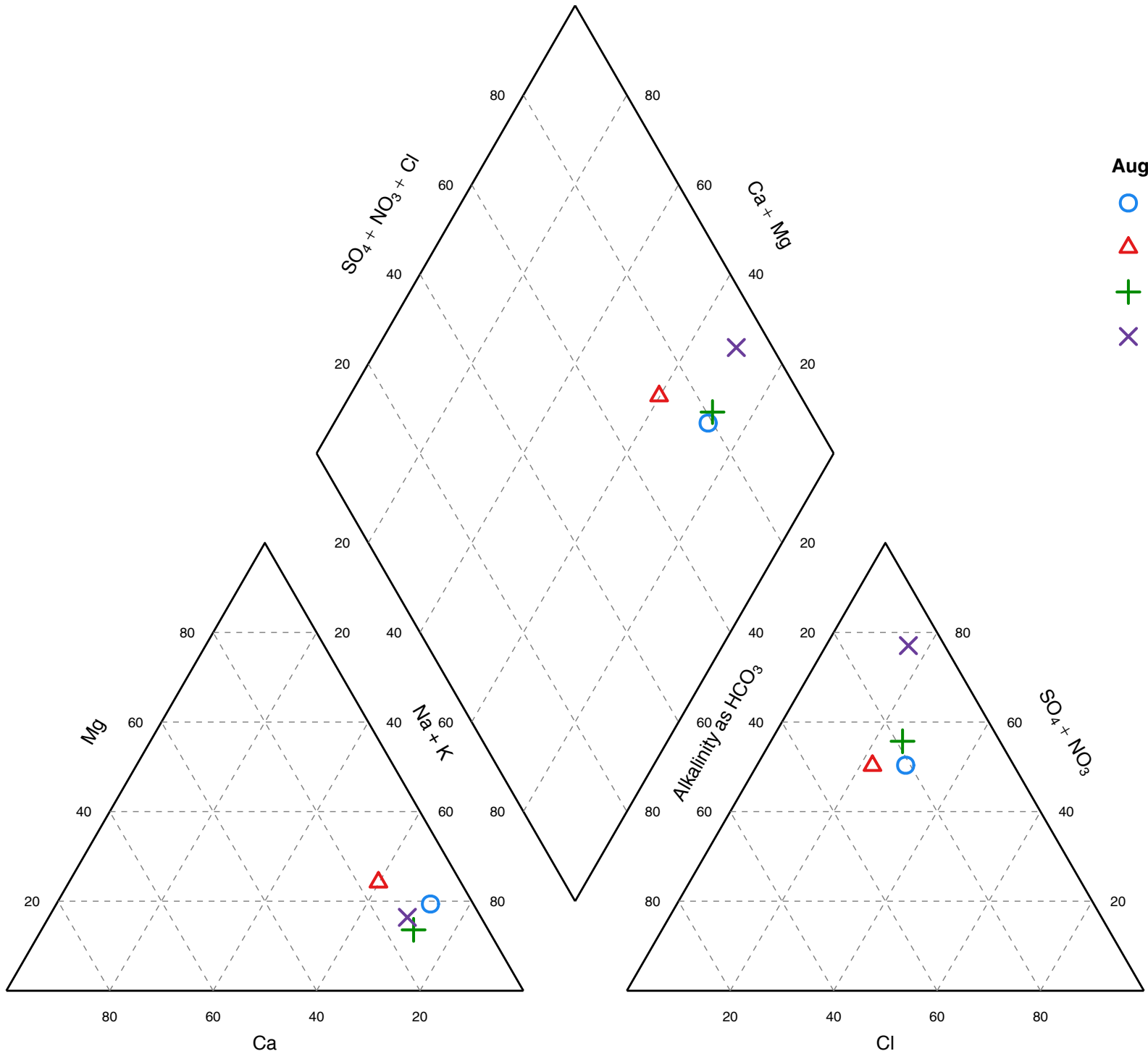

August 2013

- NUN-MW1s
- △ NUN-MW2s
- ⊕ NUN-MW3s
- ⊗ NUN-MW4s

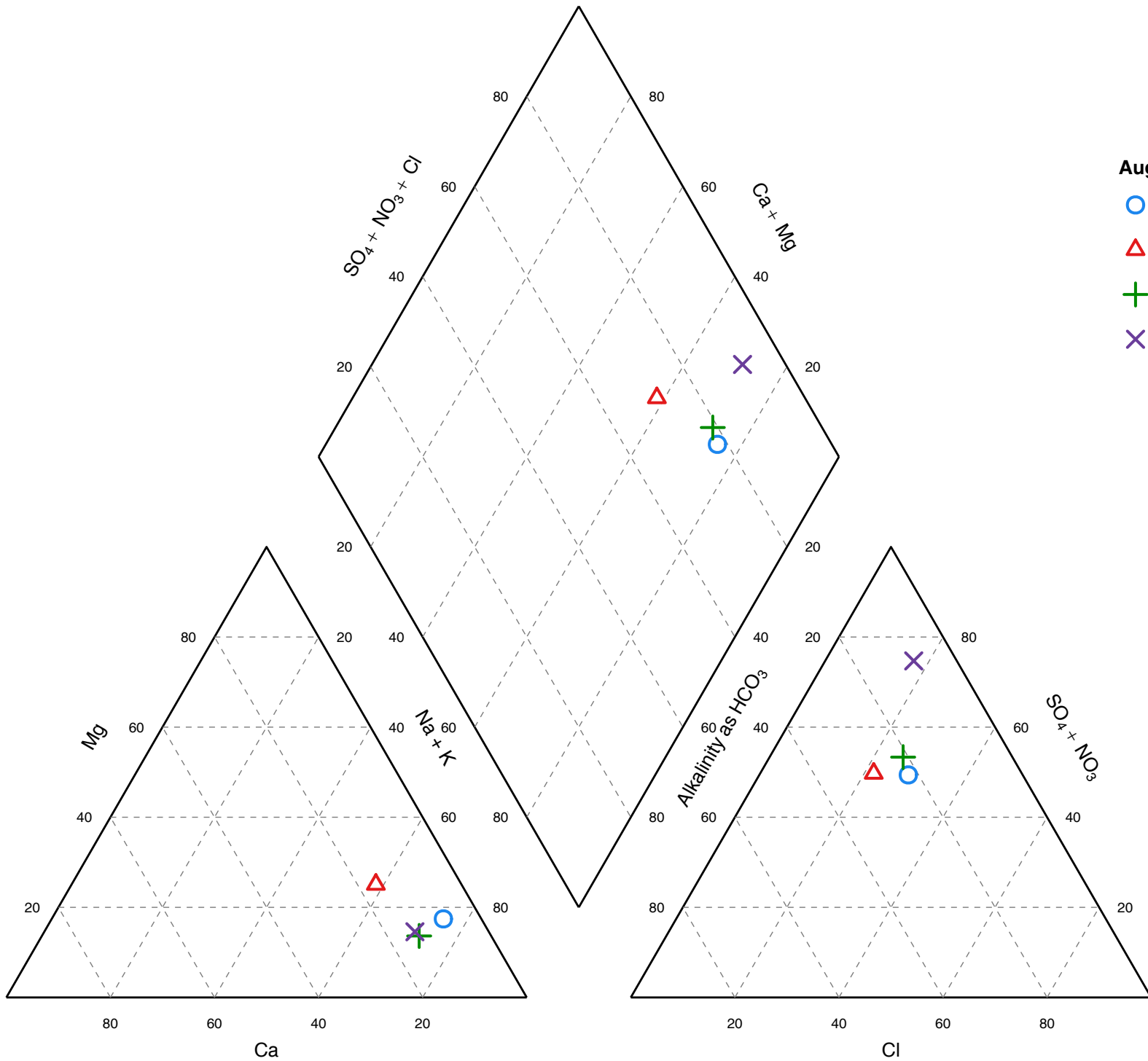

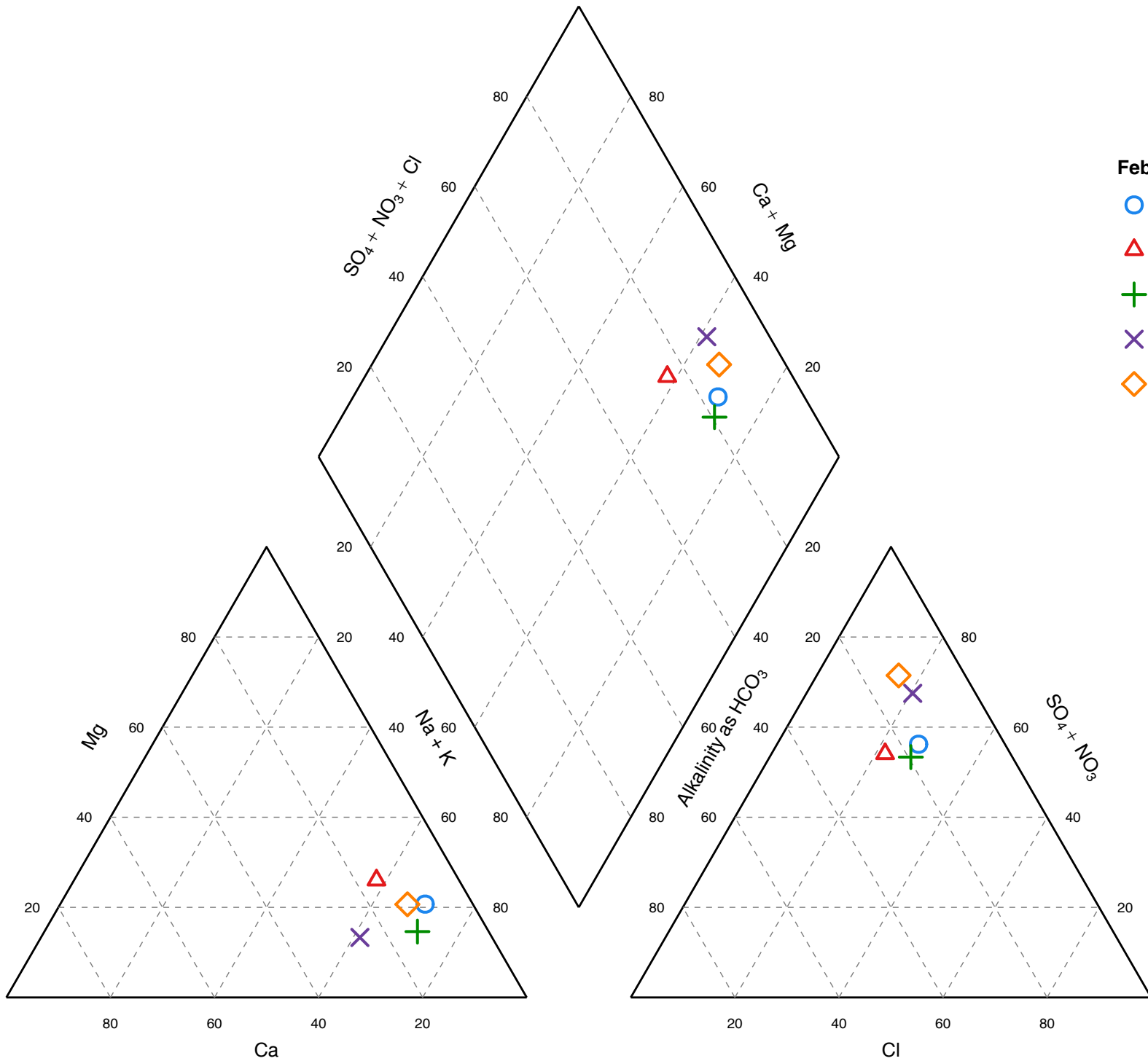

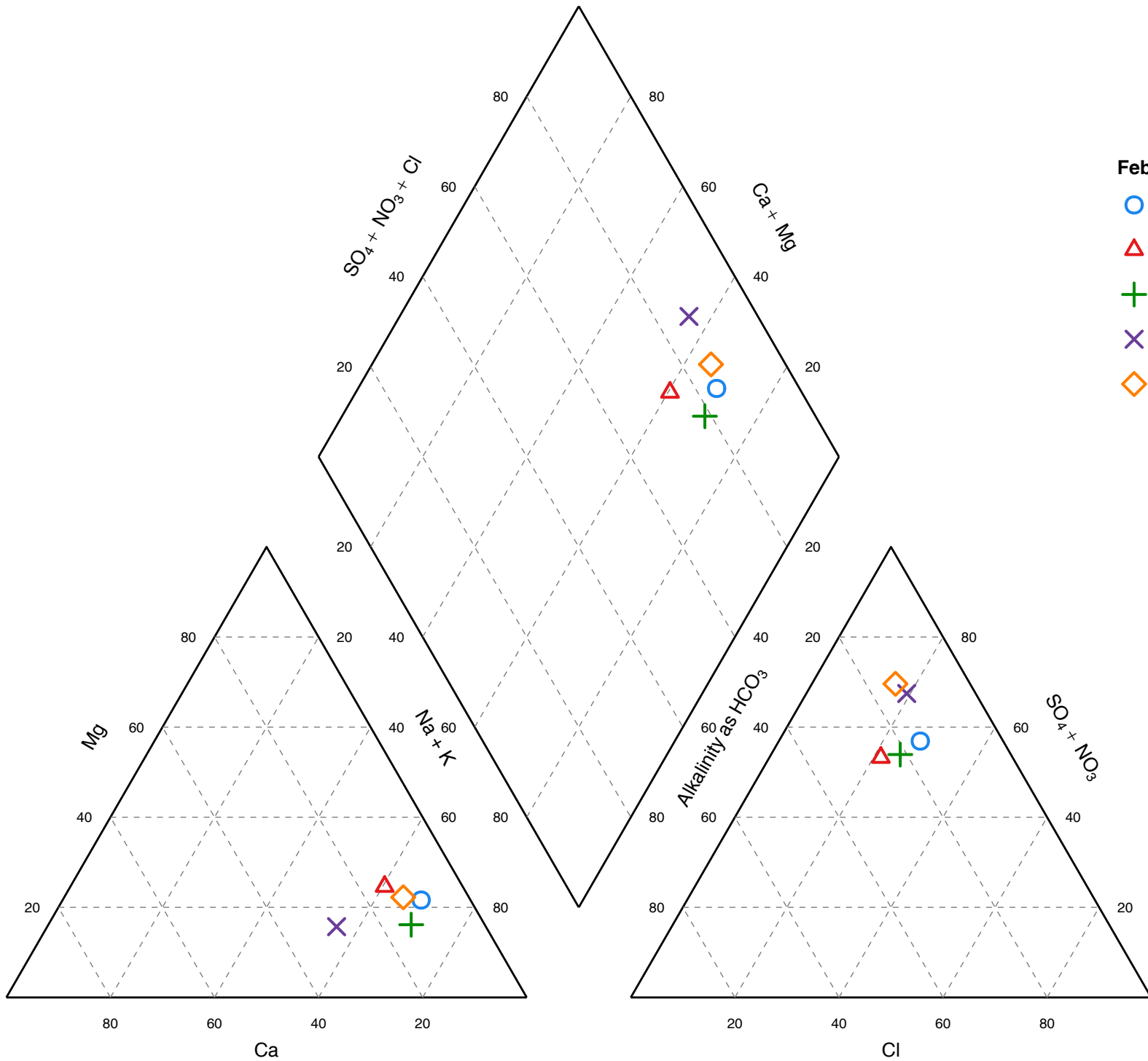

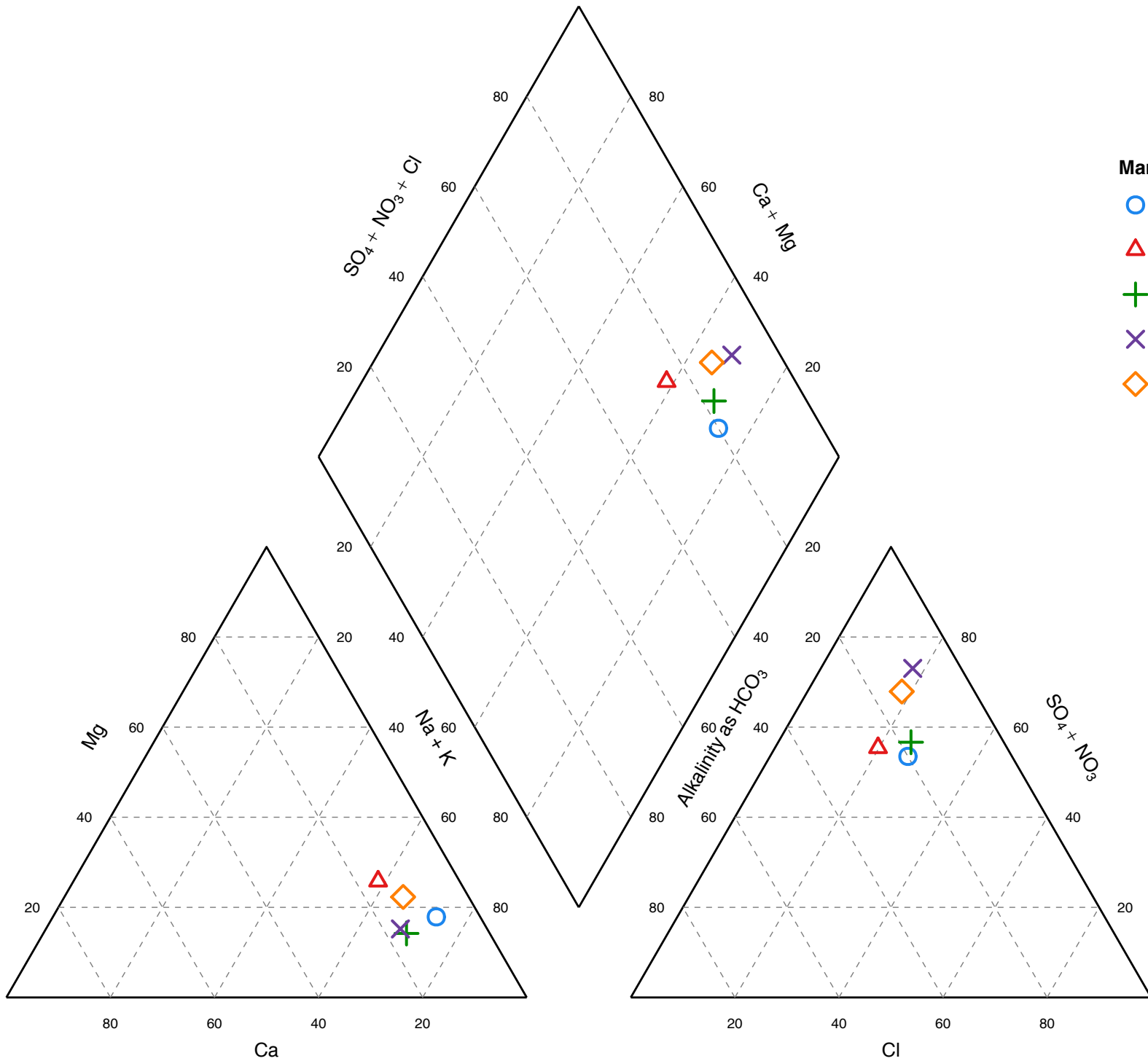

March 2017

- NUN-MW1s
- △ NUN-MW2s
- + NUN-MW3s
- × NUN-MW4s
- ◇ NUN-MW5s

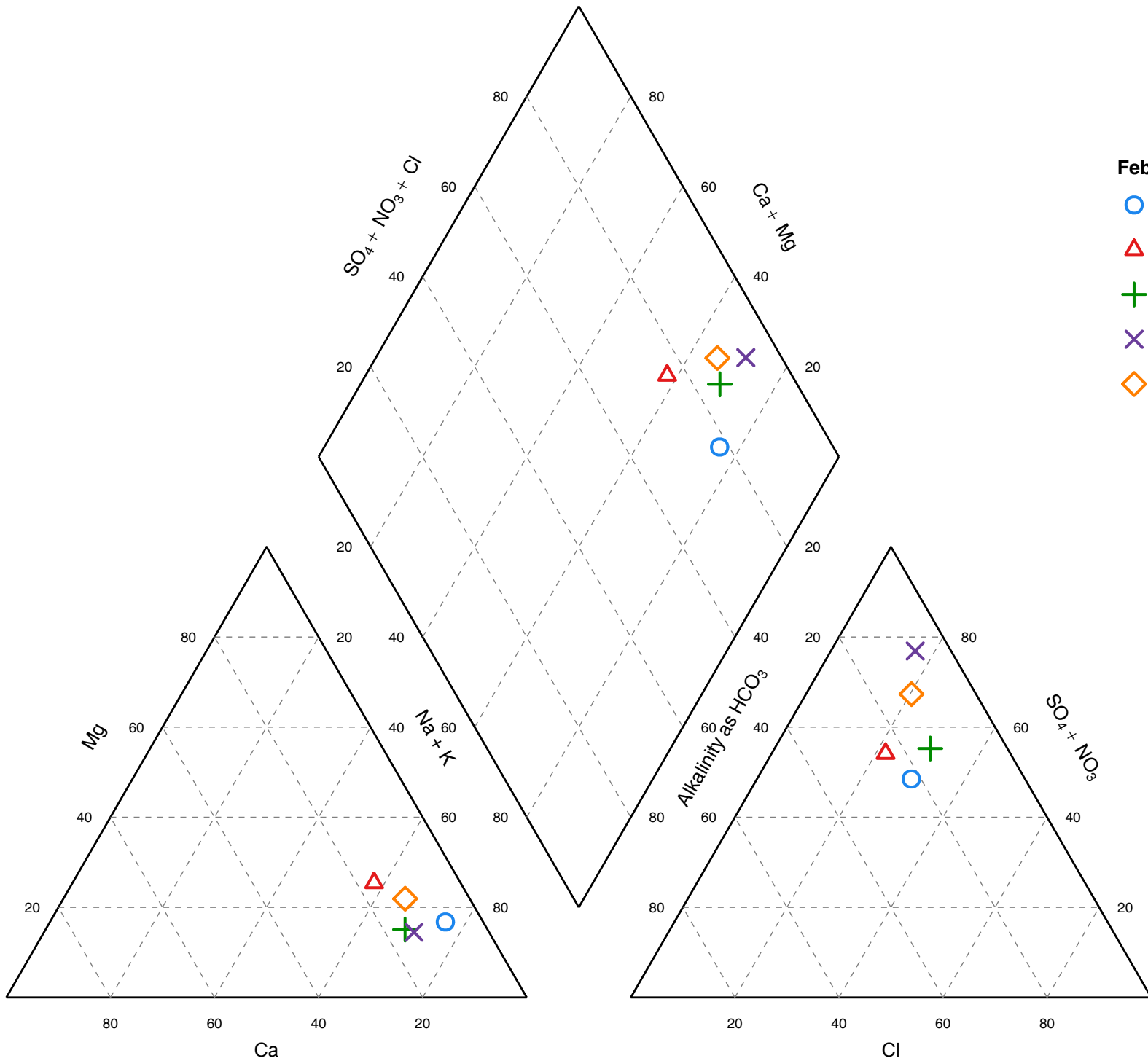

February 2018

- NUN-MW1s
- △ NUN-MW2s
- ⊕ NUN-MW3s
- ⊗ NUN-MW4s
- ◇ NUN-MW5s

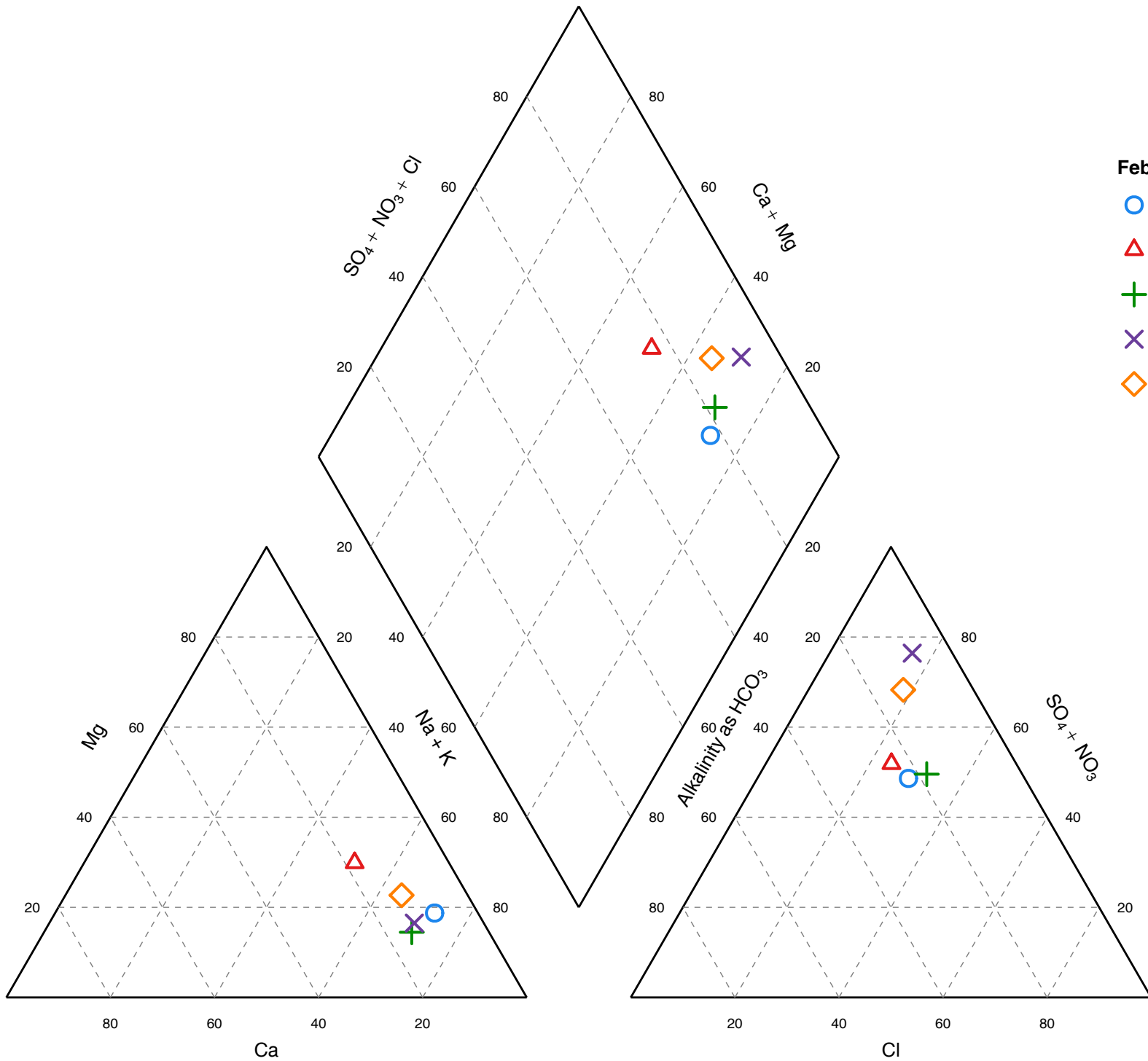

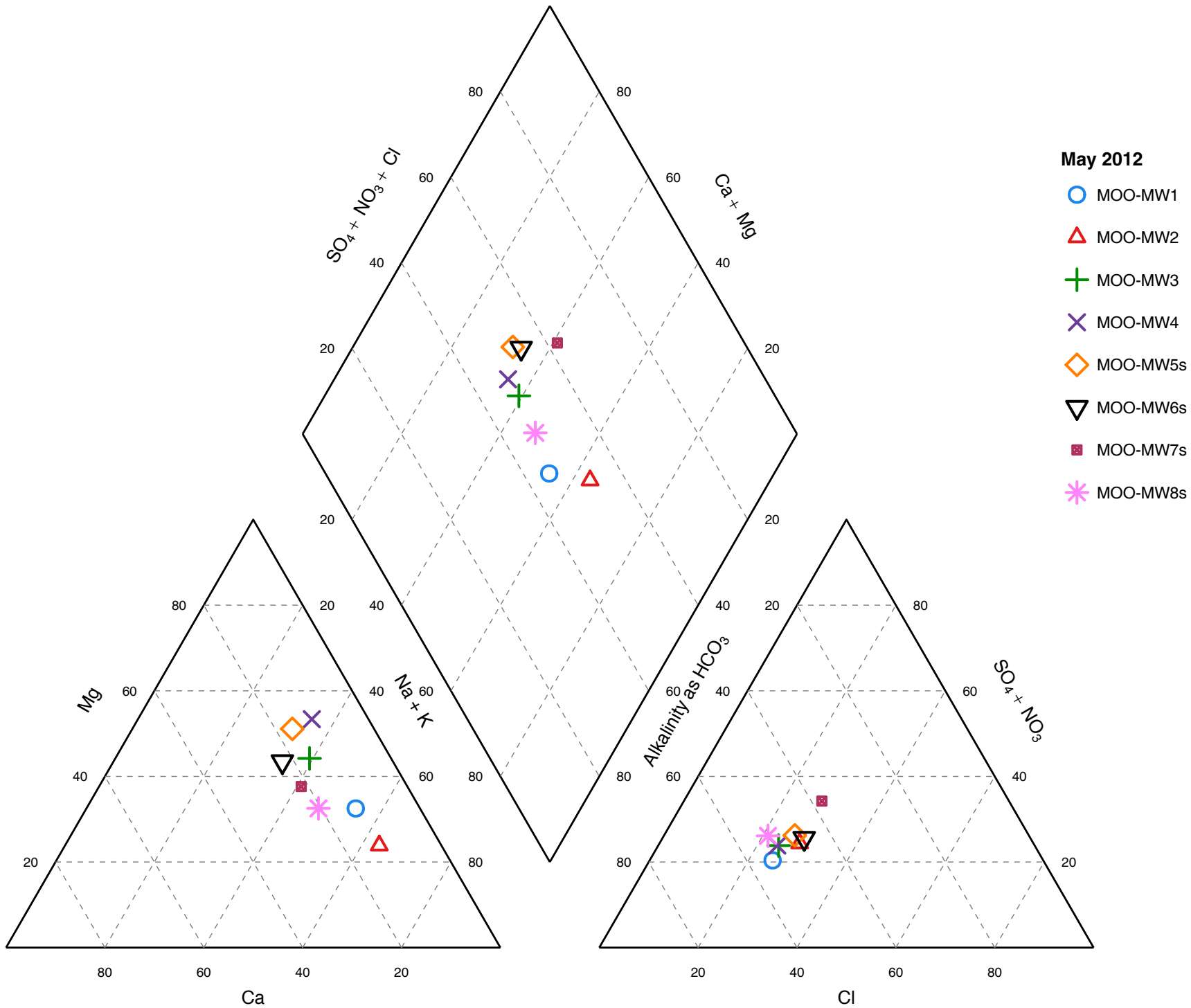

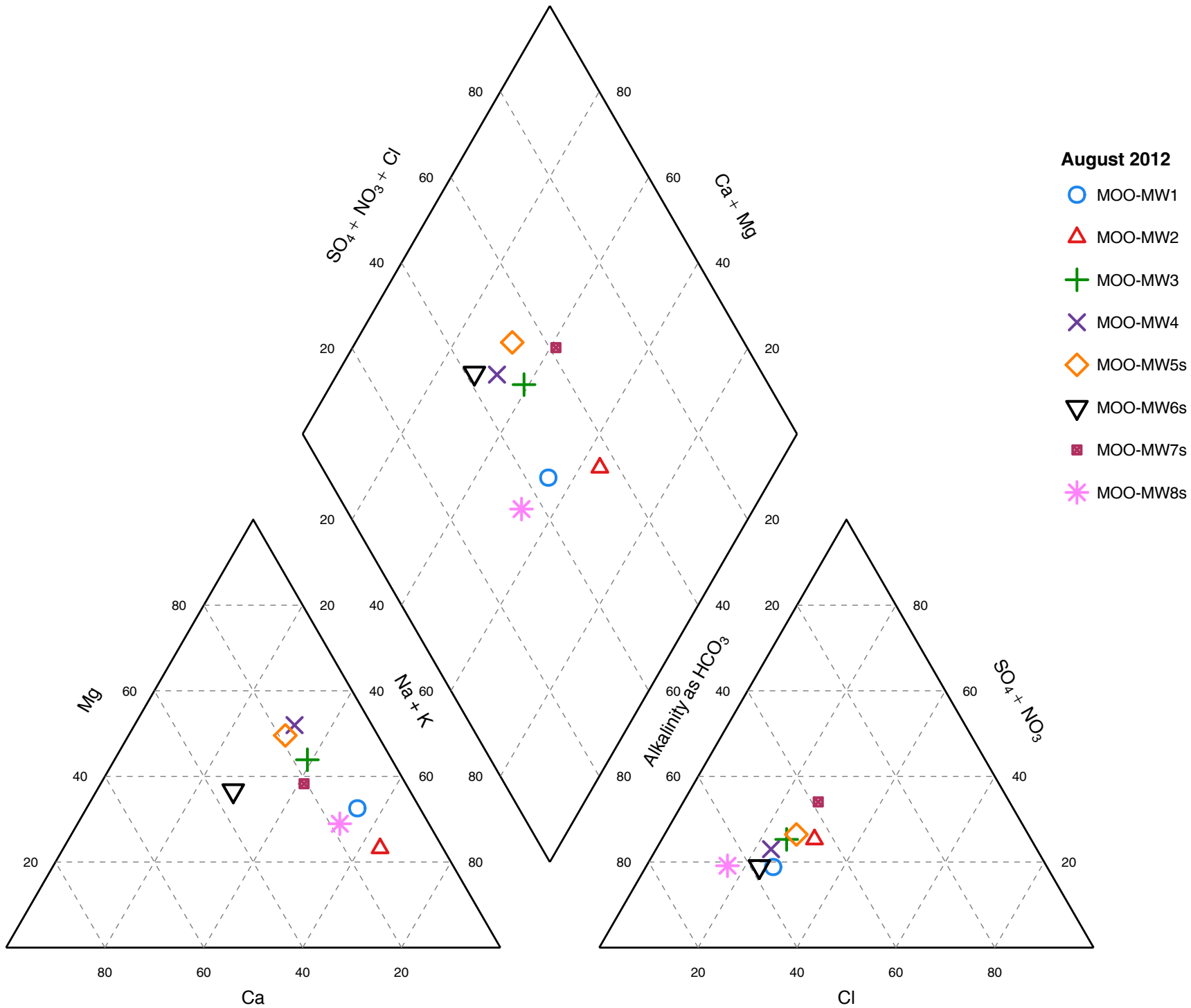

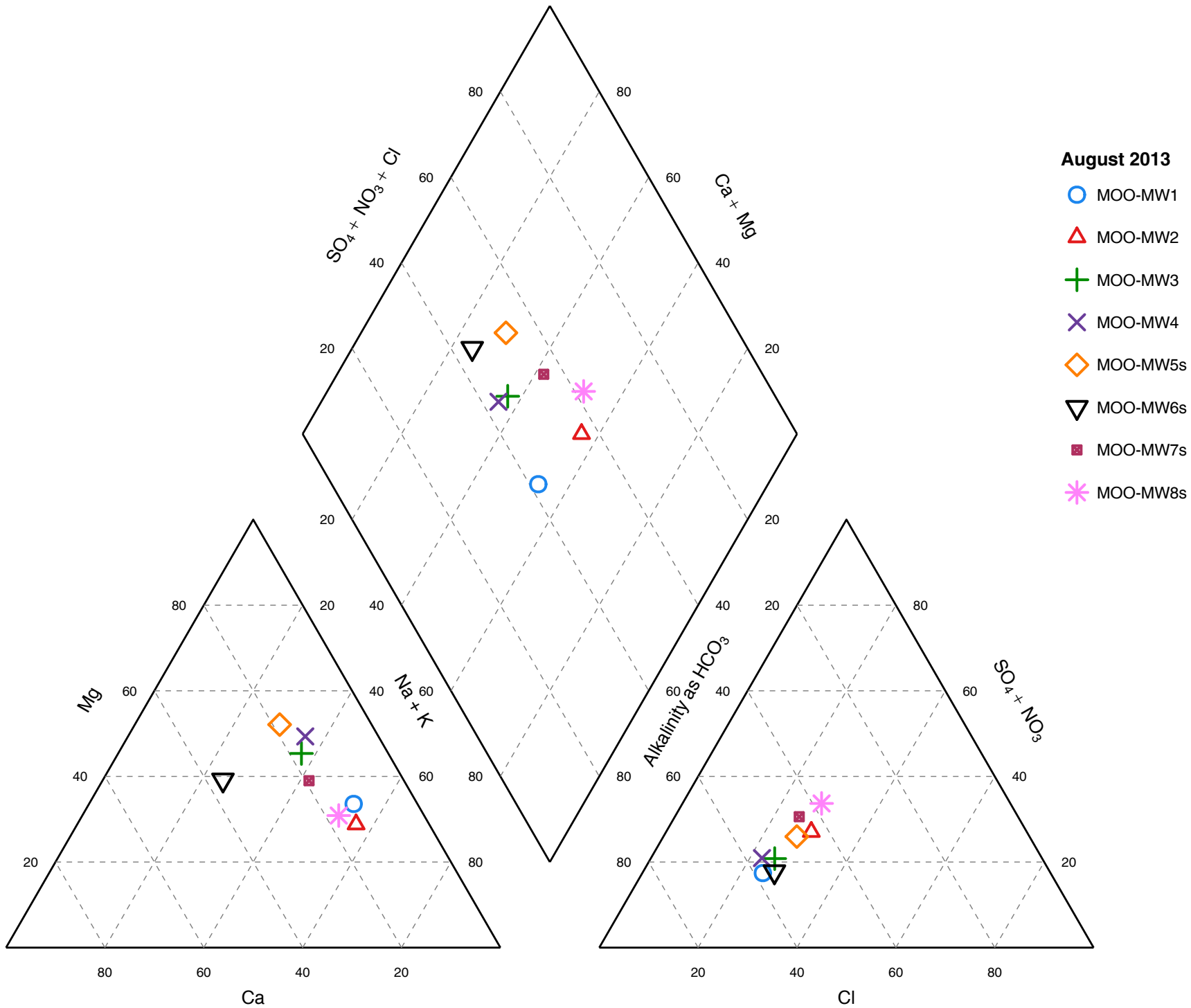

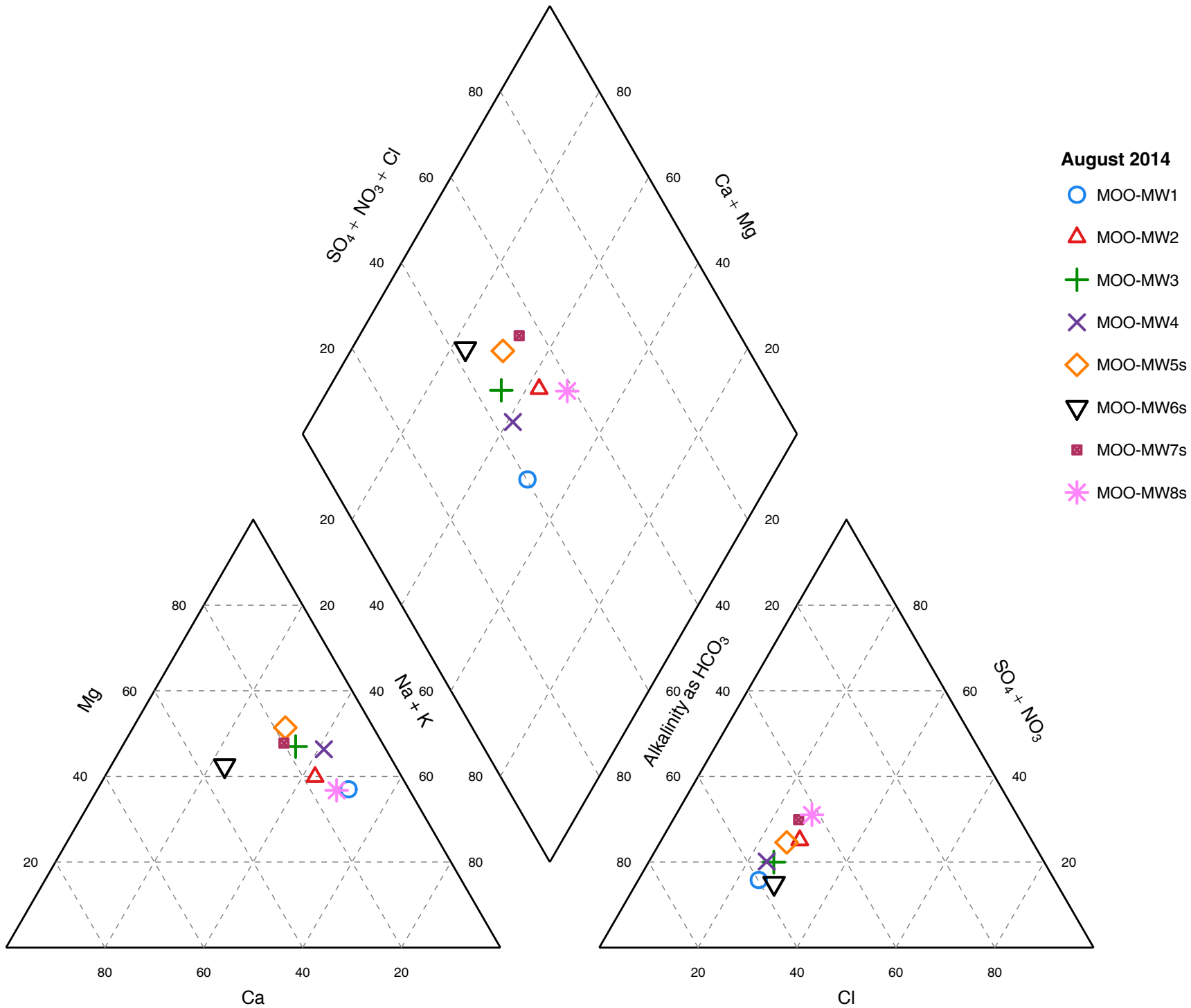

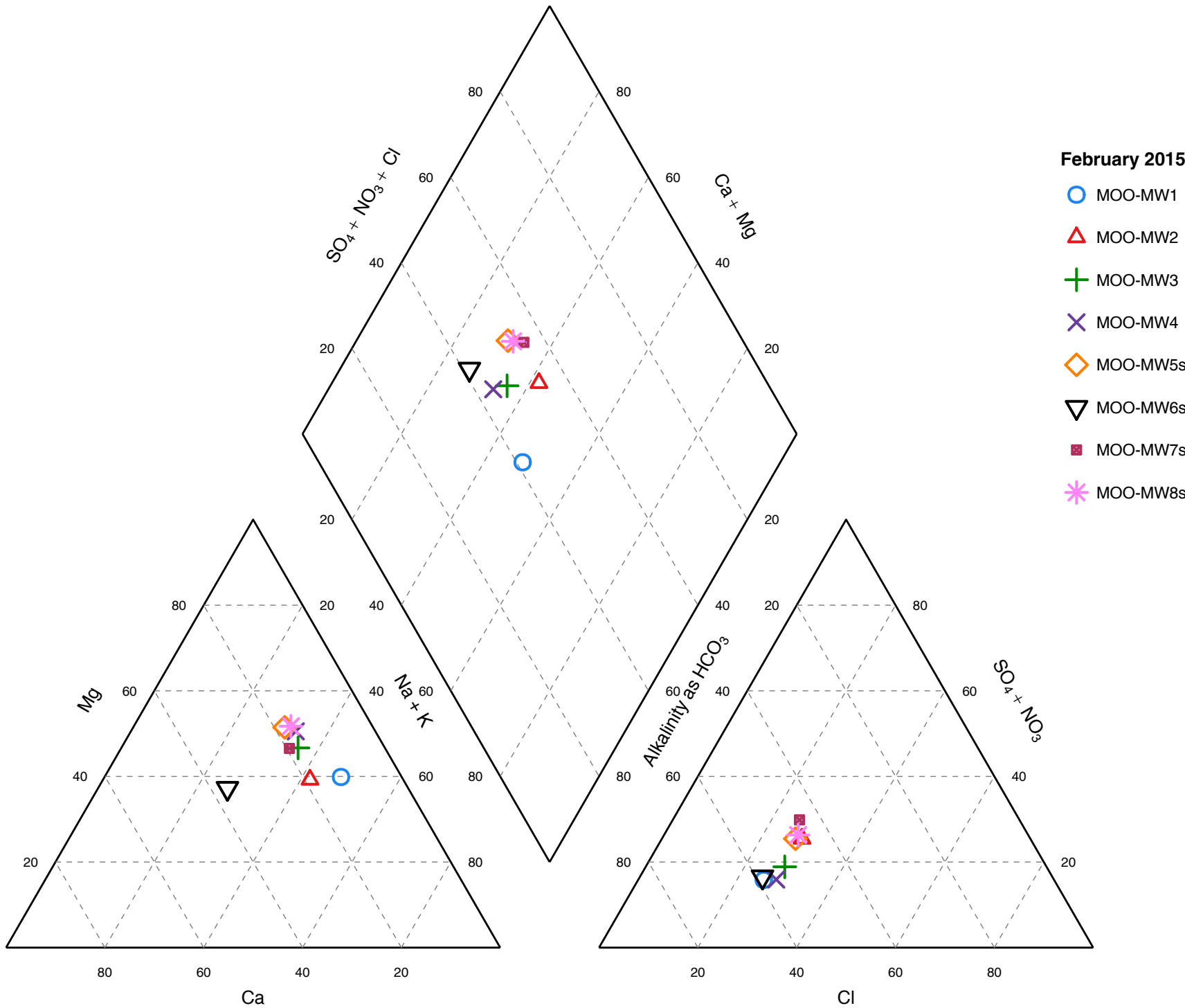

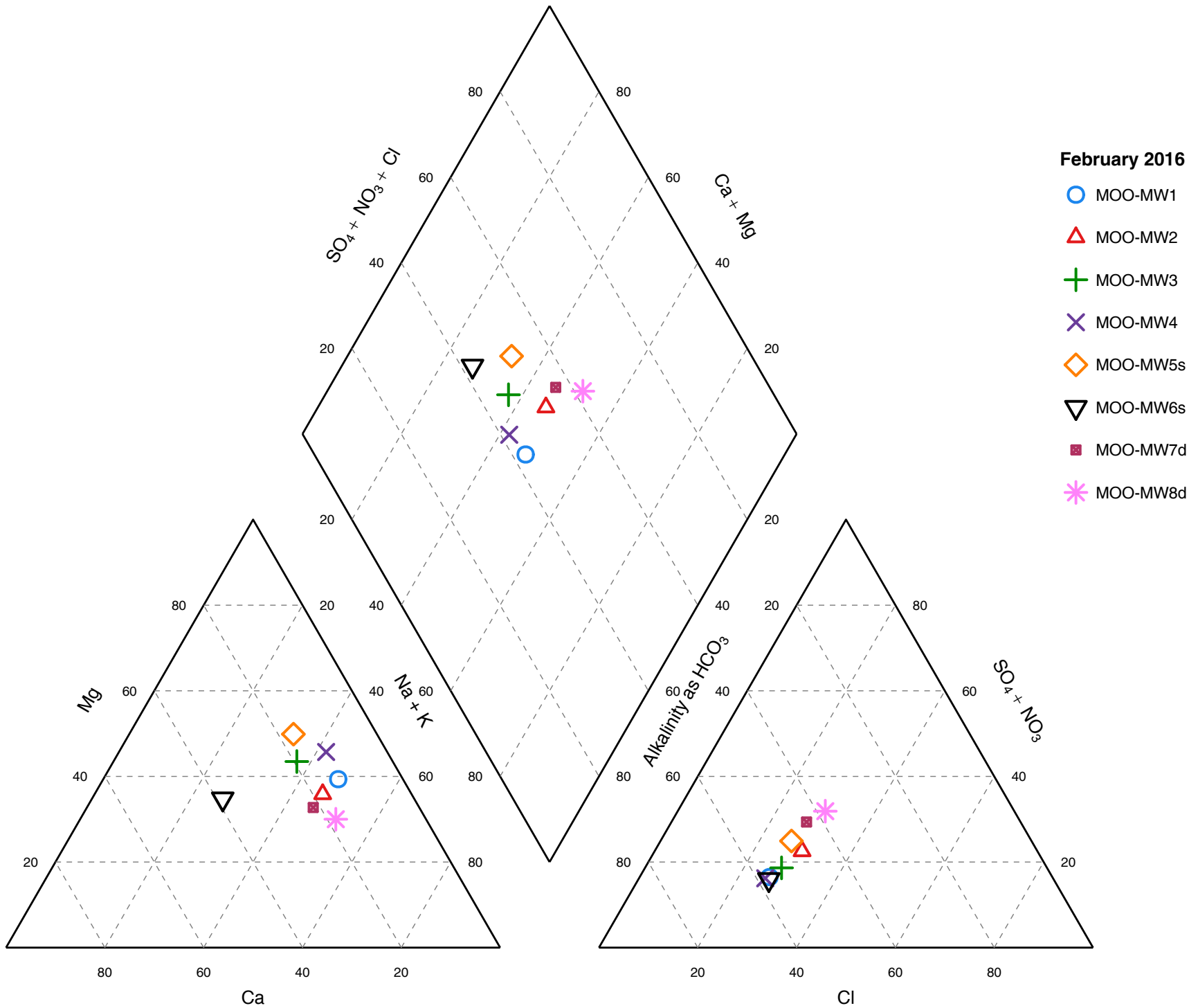

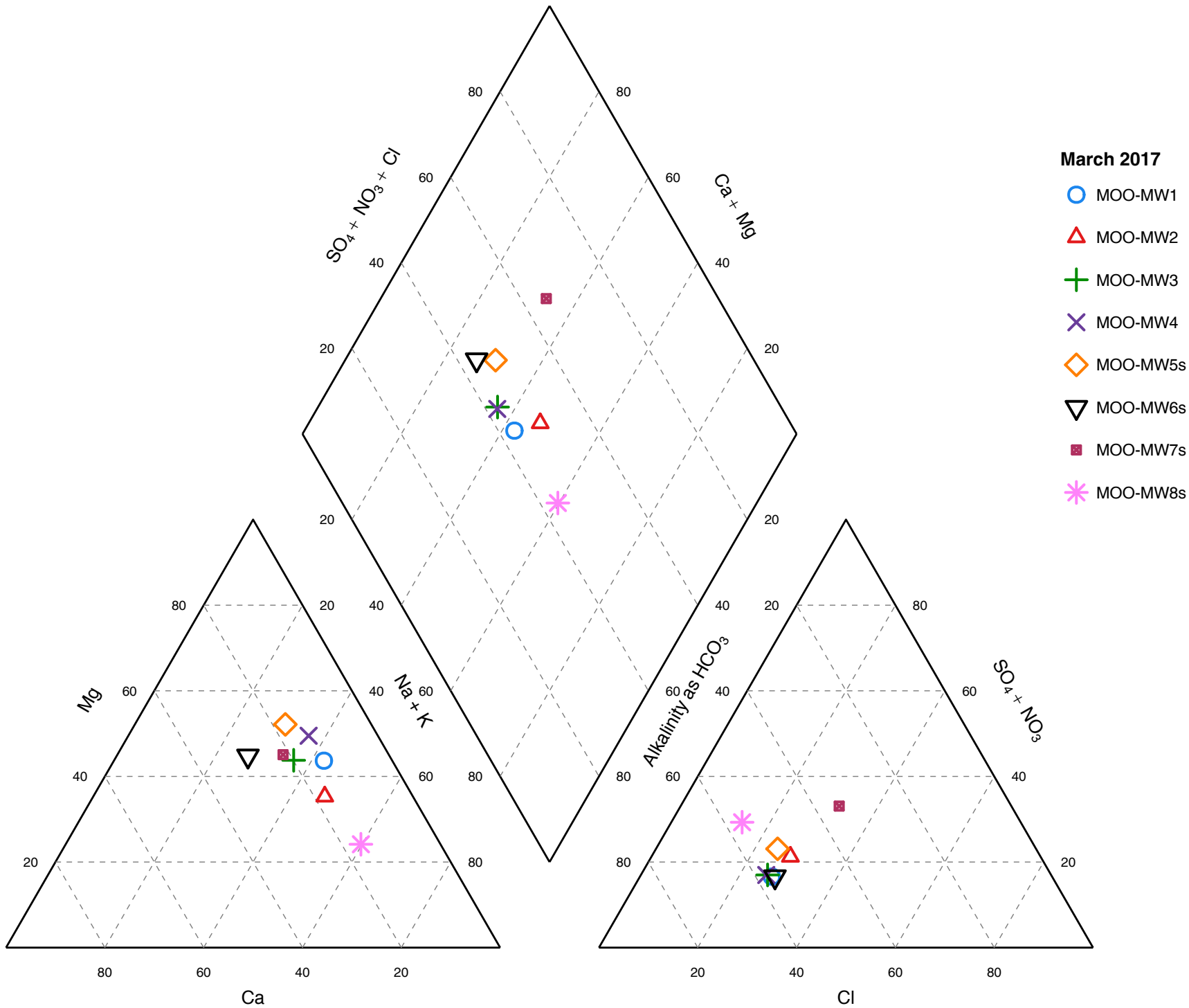

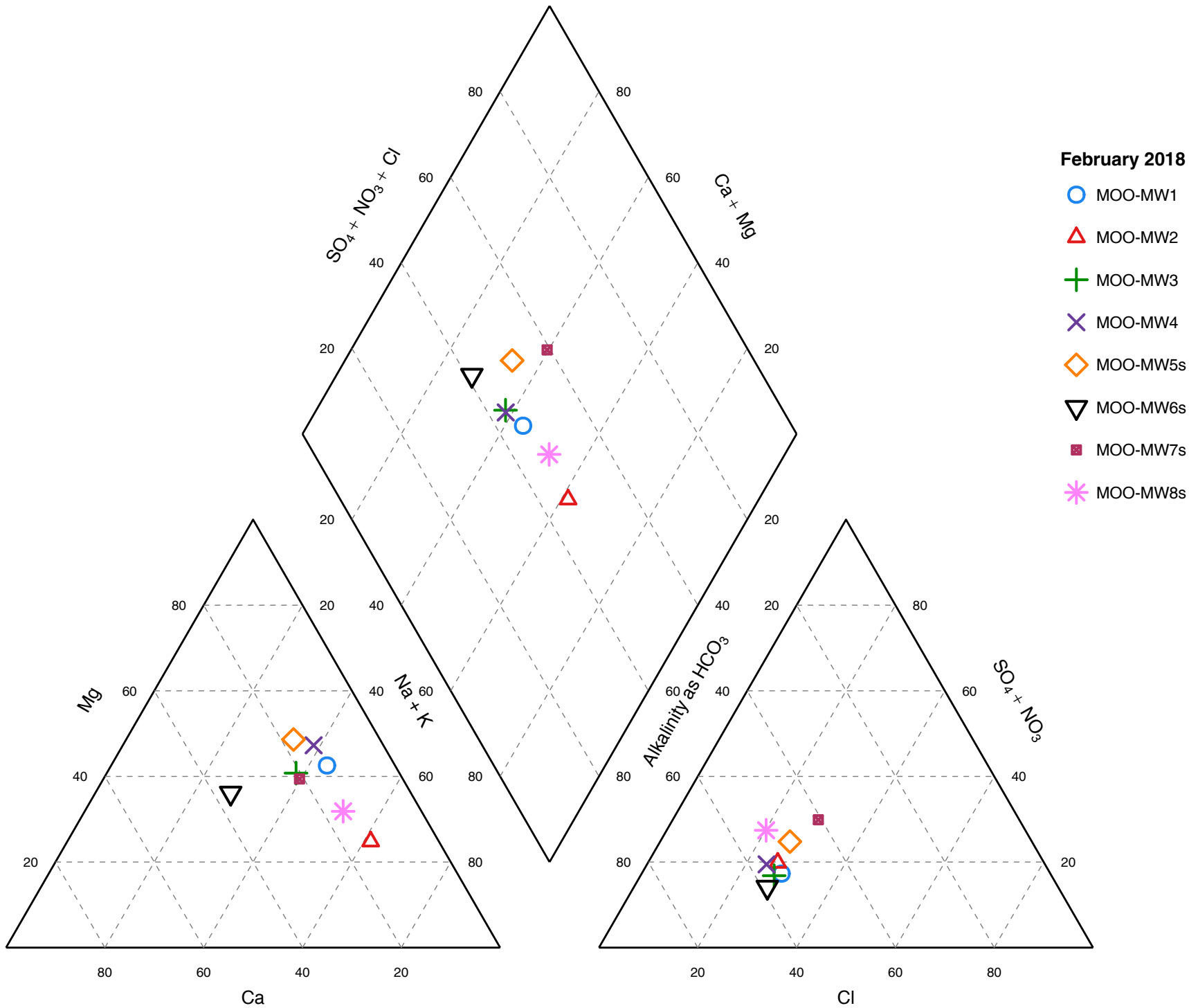

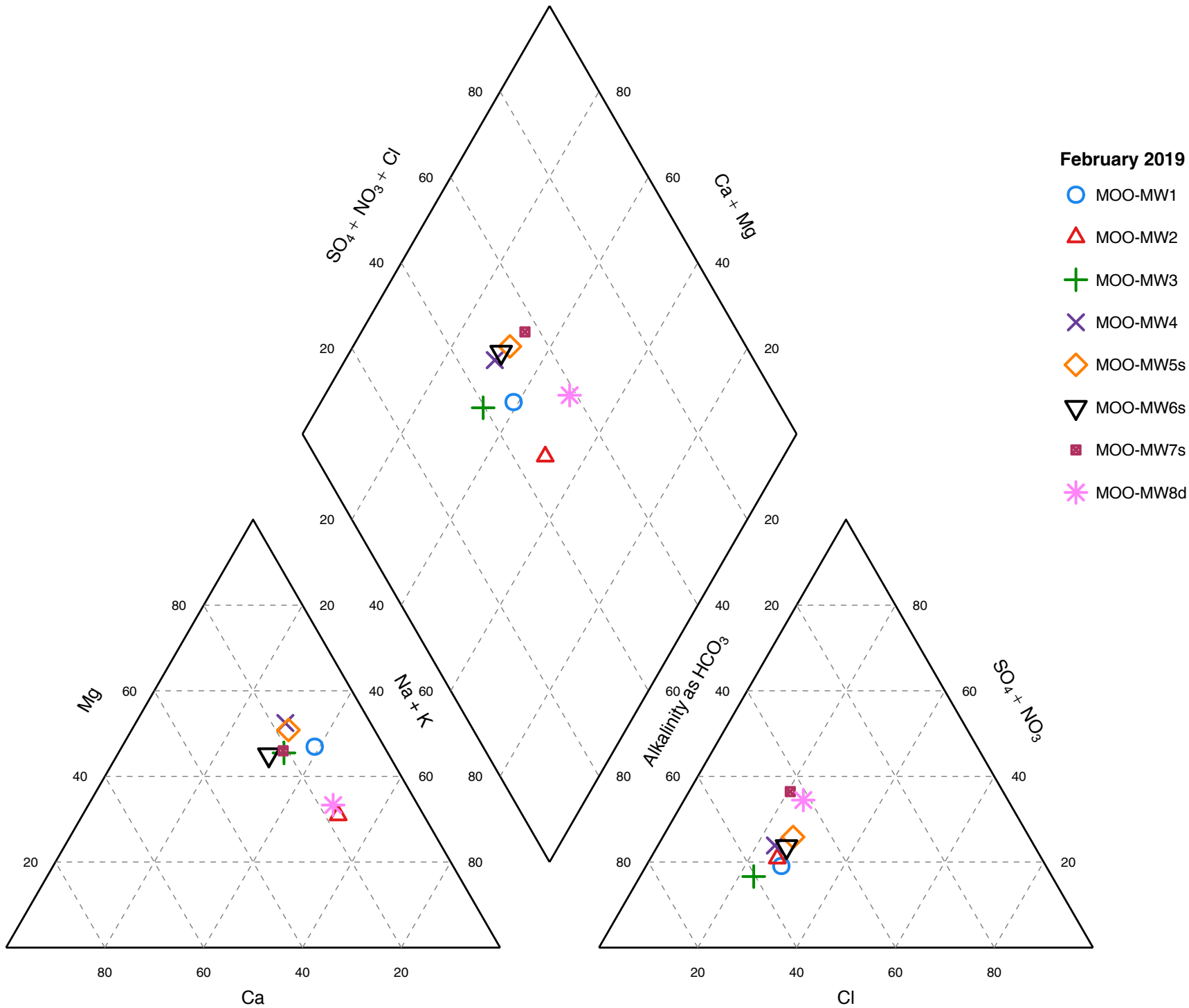

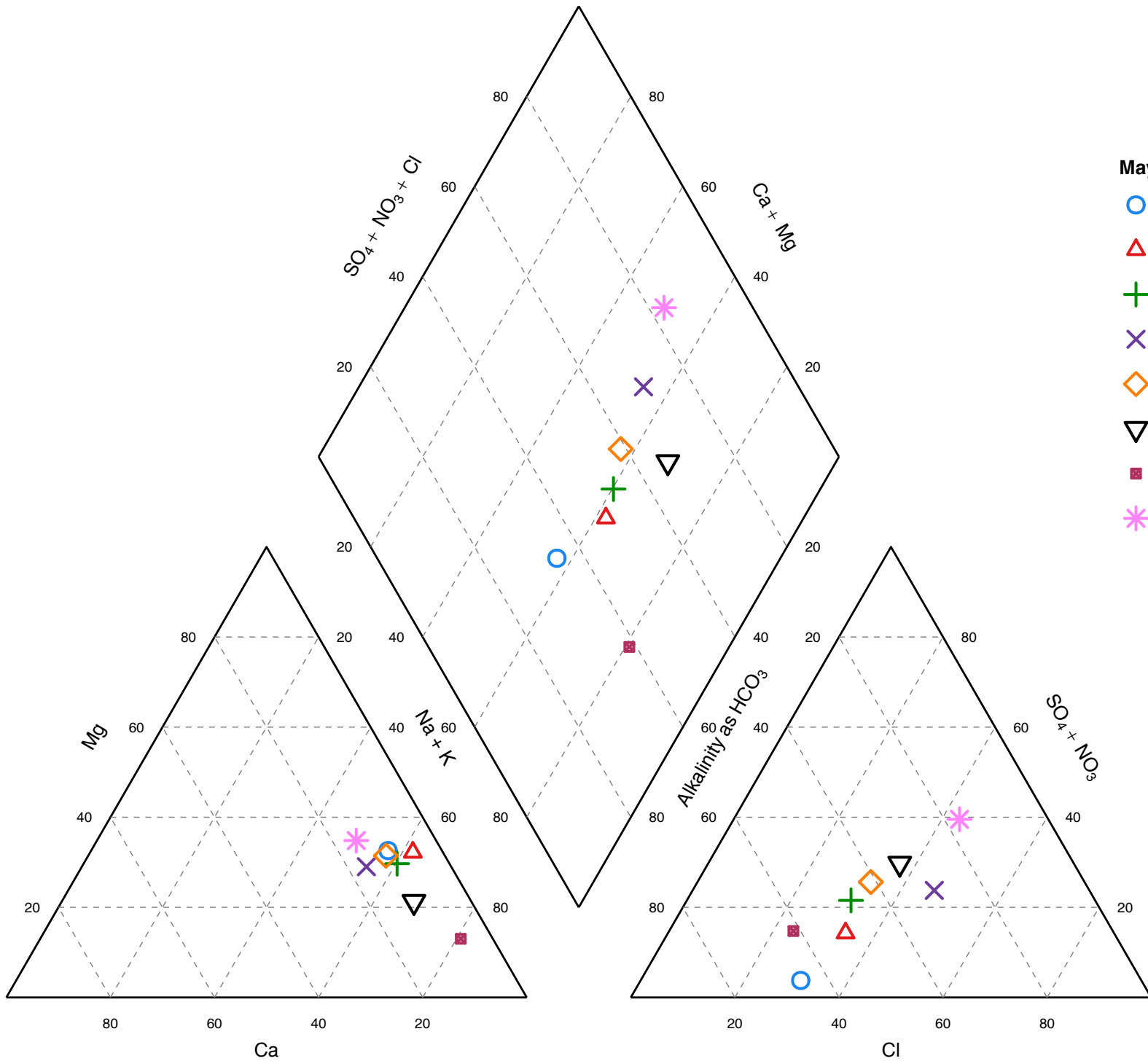

May 2012

- TON-MW1s
- △ TON-MW2s
- + TON-MW3s
- × TON-MW4s
- ◇ TON-MW5s
- ▽ TON-MW6s
- TON-MW7s
- * TON-MW8s

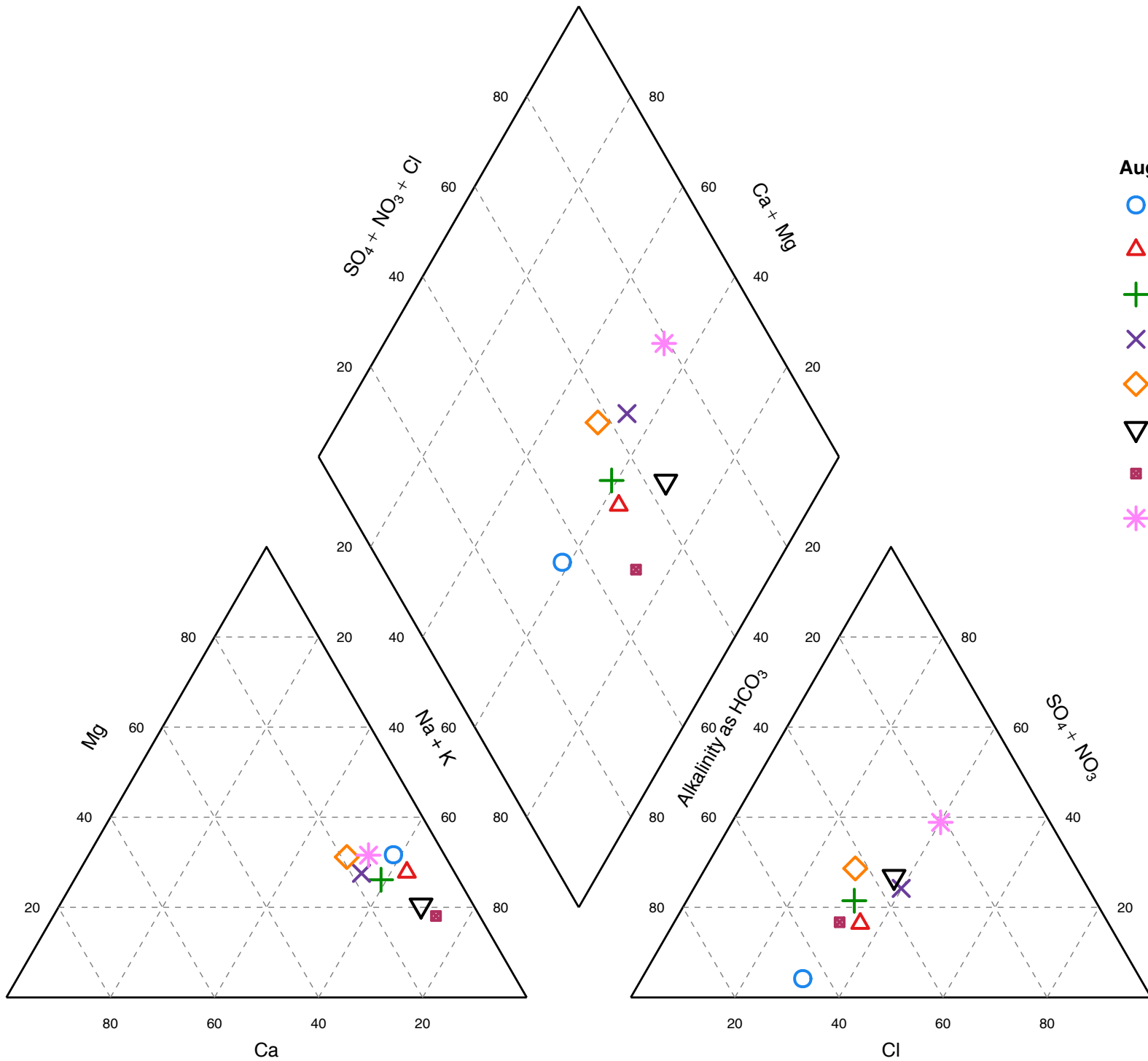

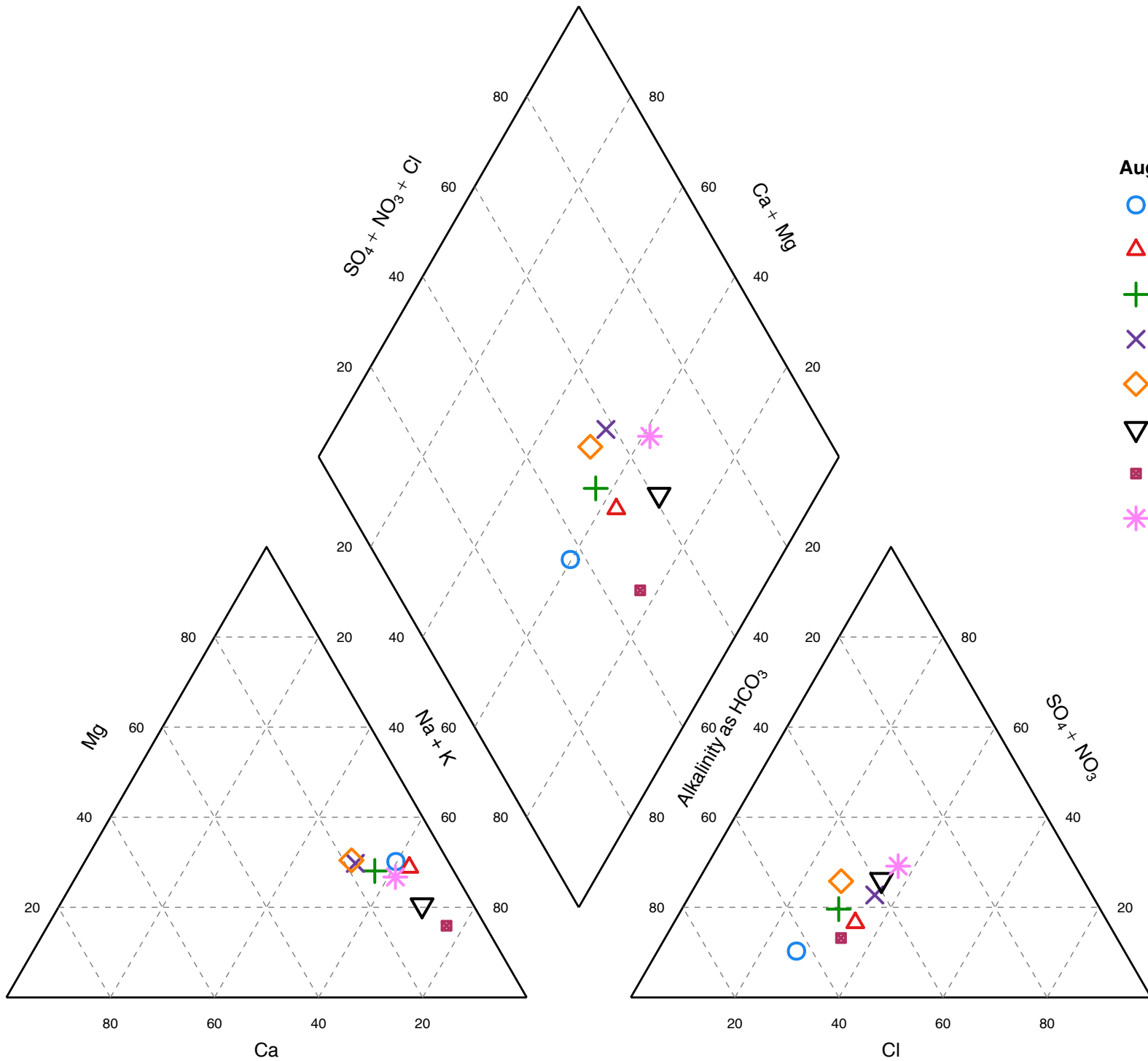

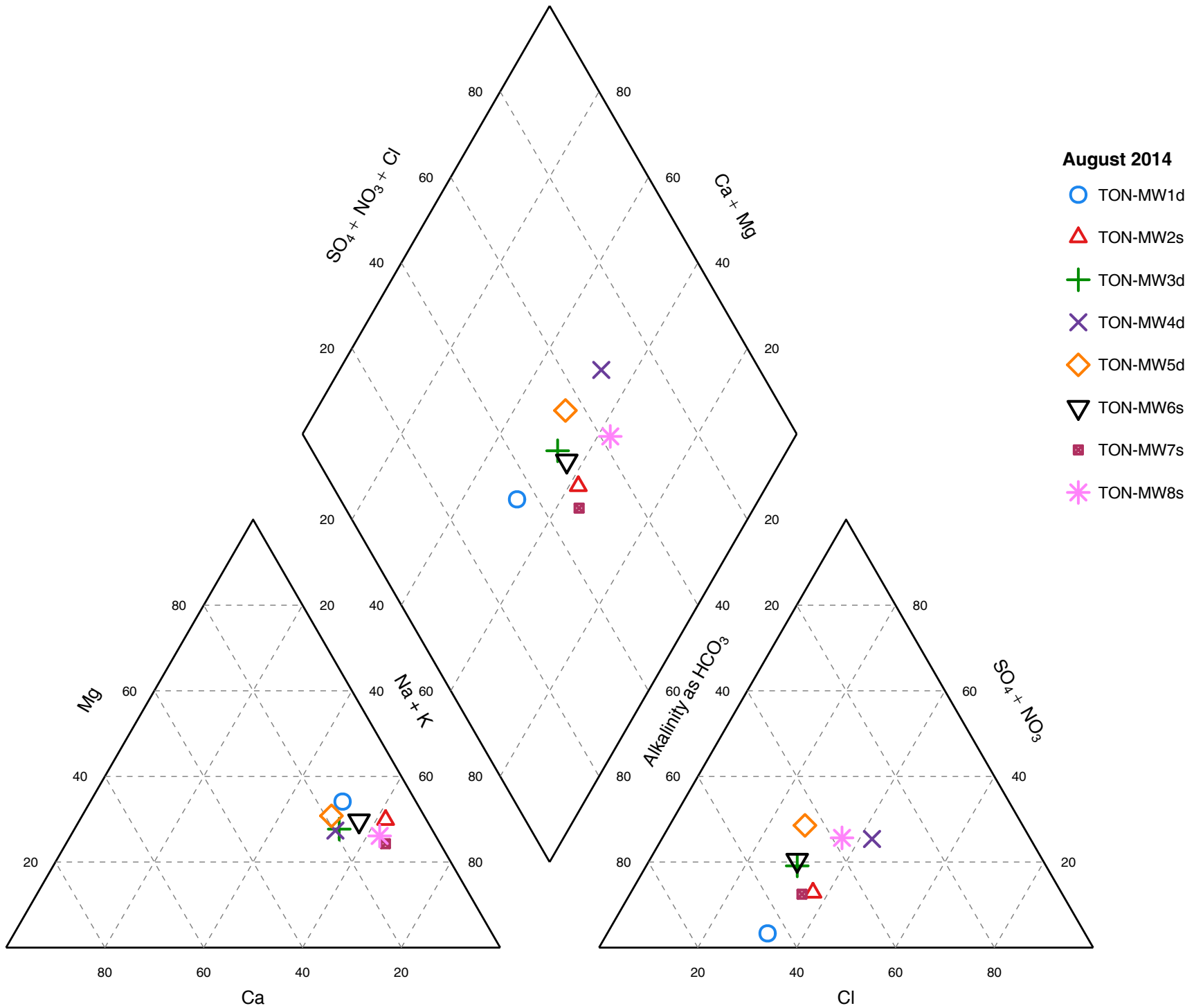

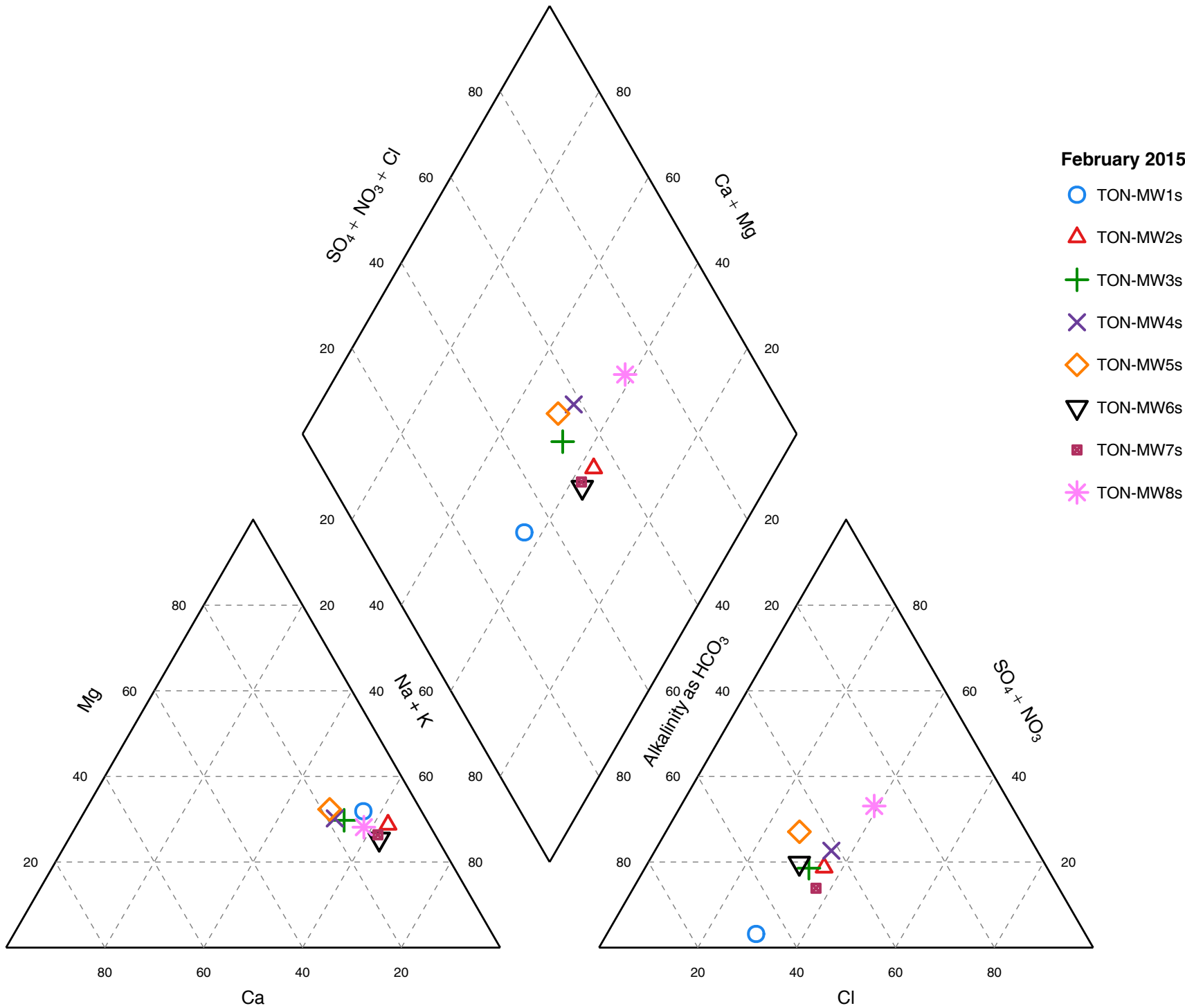

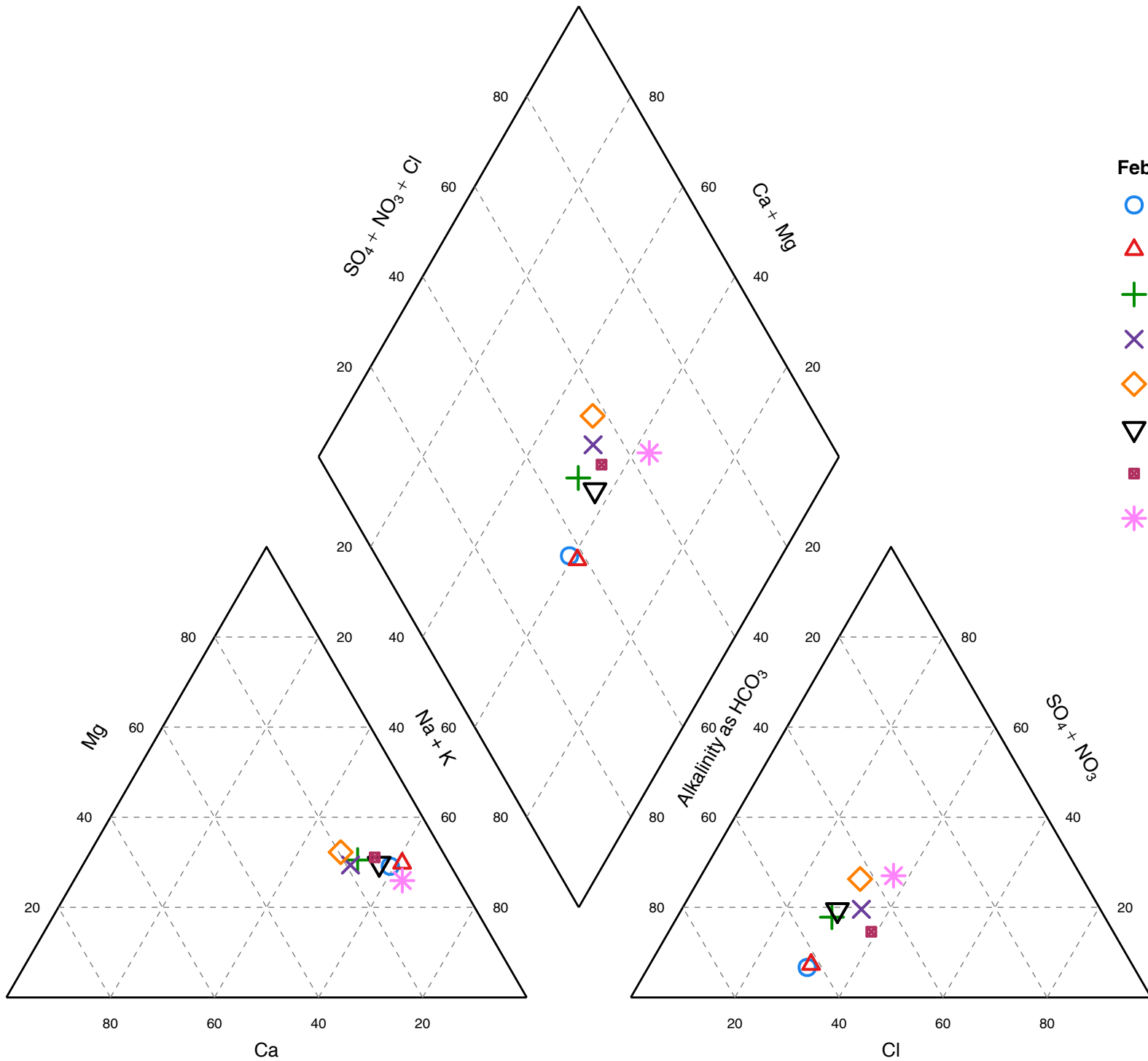

February 2016

- TON-MW1s
- △ TON-MW2s
- + TON-MW3s
- × TON-MW4s
- ◇ TON-MW5s
- ▽ TON-MW6s
- TON-MW7s
- * TON-MW8s

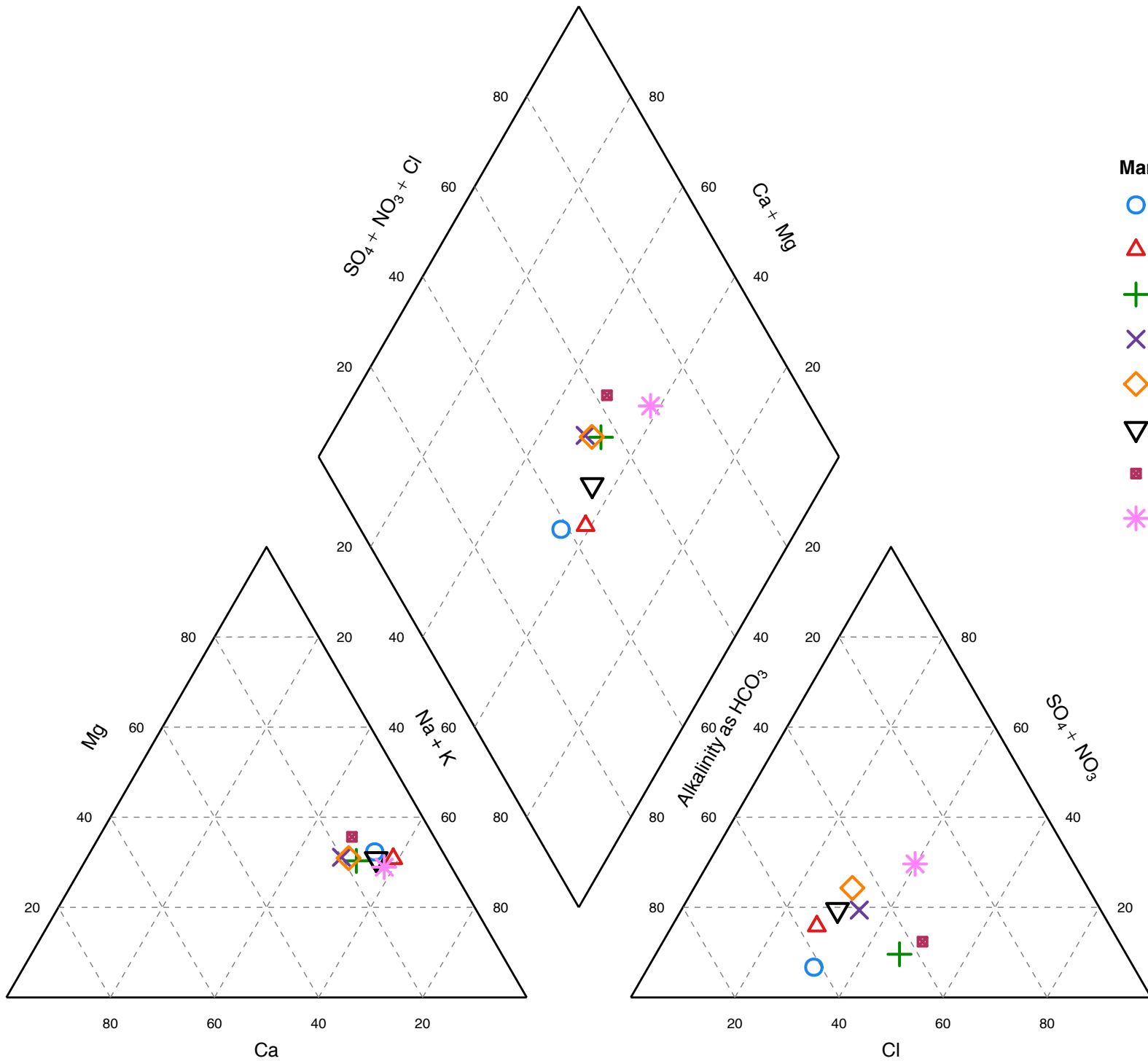

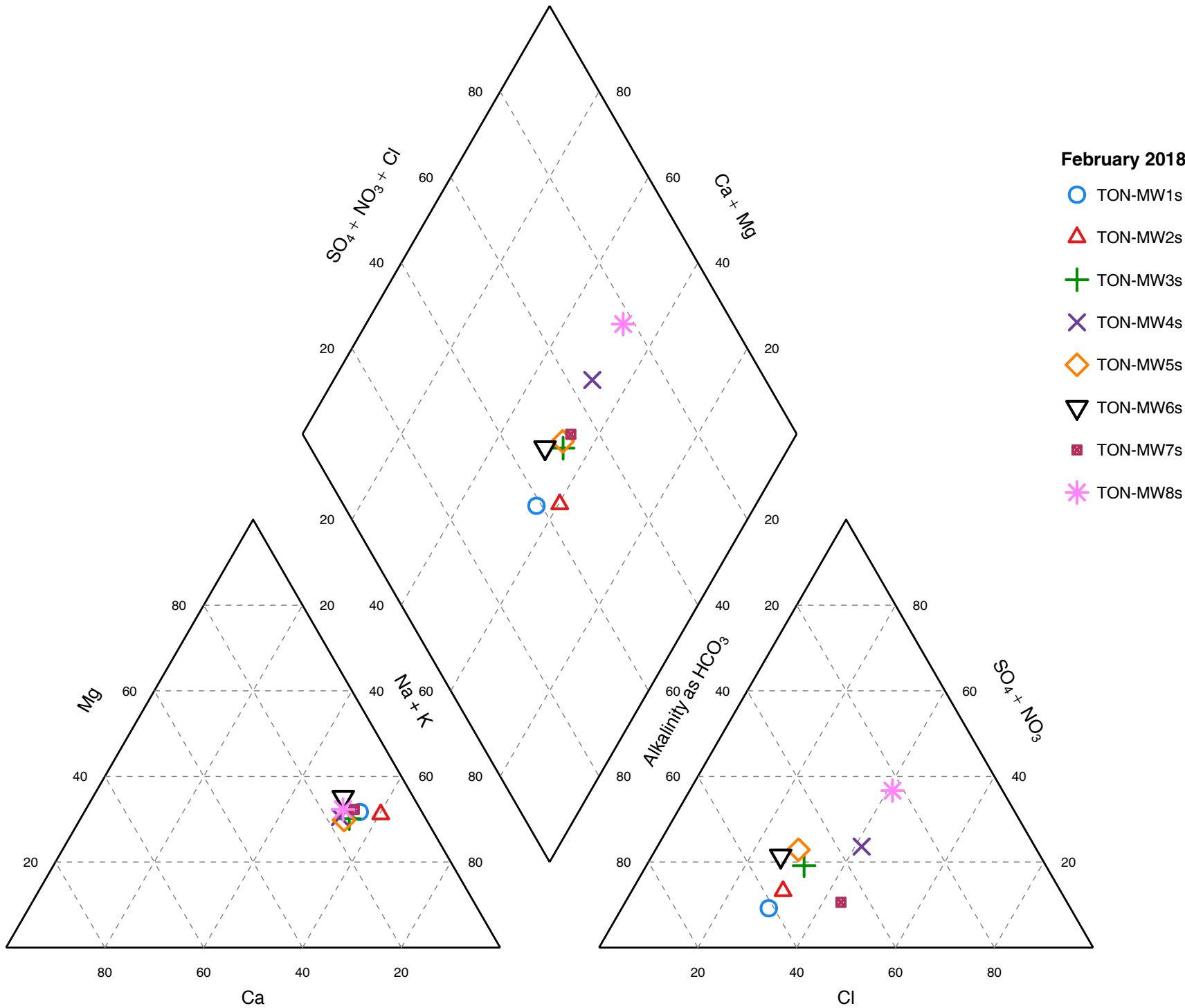

February 2019

* TON-MW8s

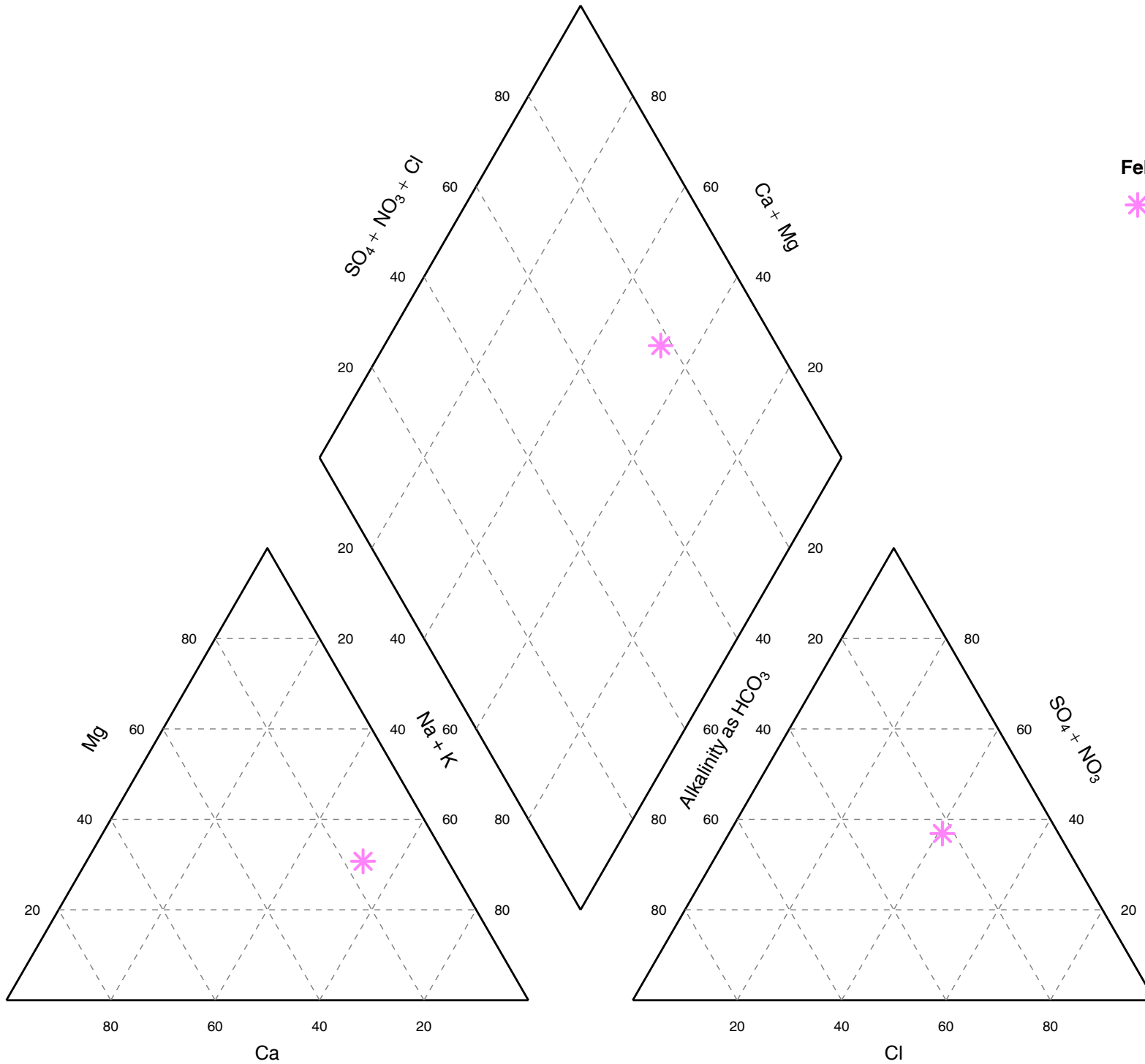

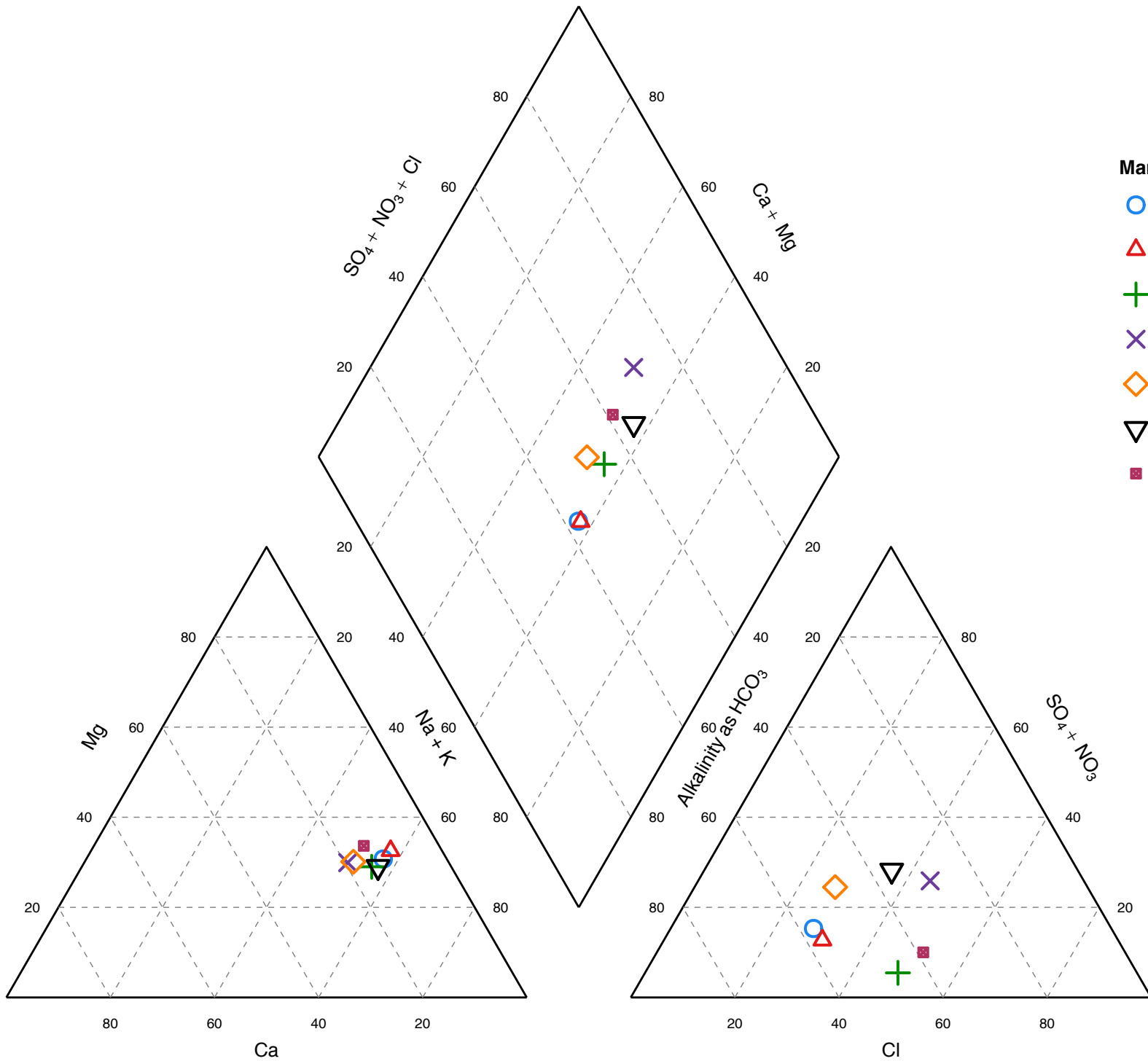

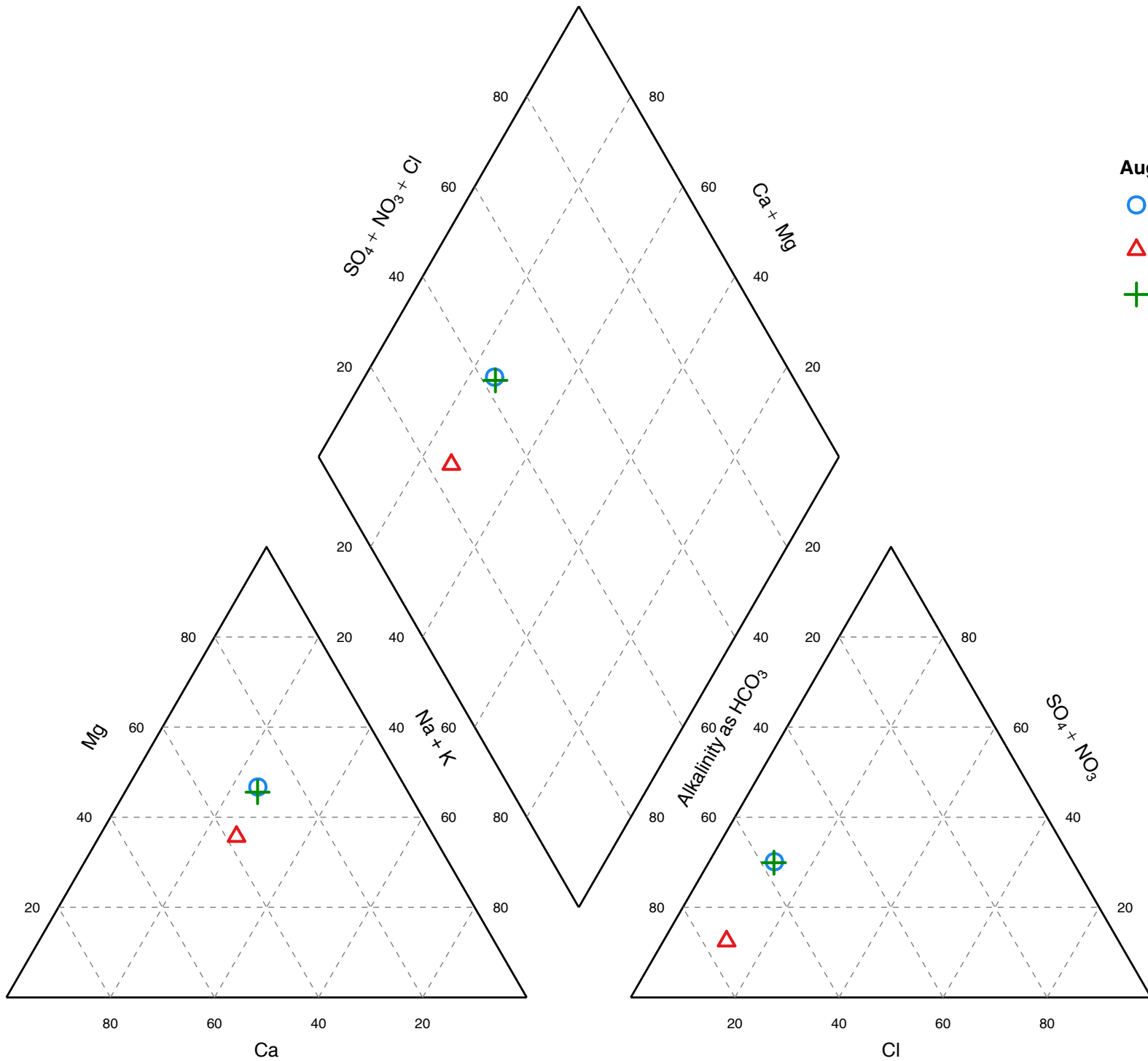

August 2013

○ BRE-MW1s

△ BRE-MW2s

⊕ BRE-MW3s

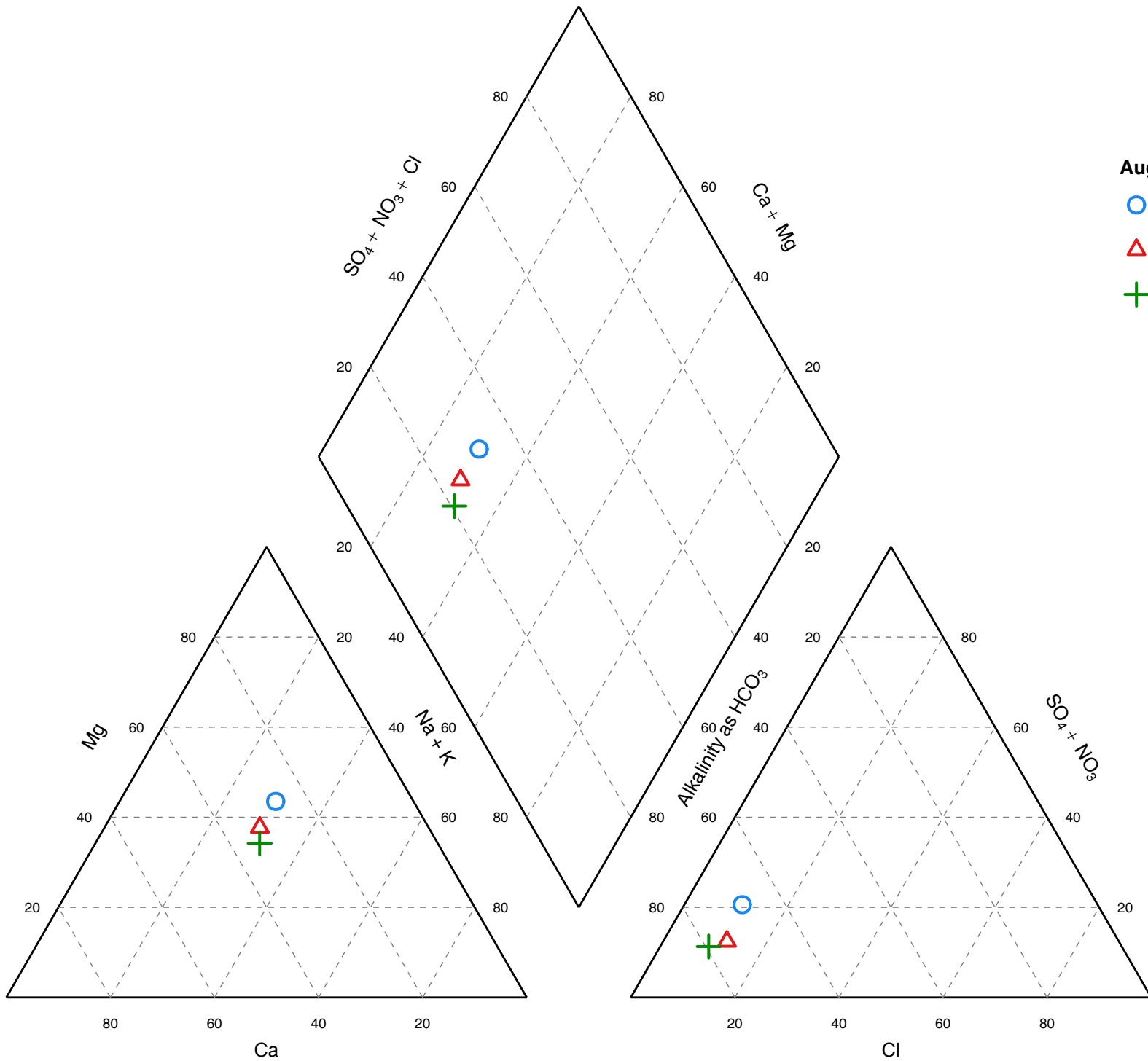

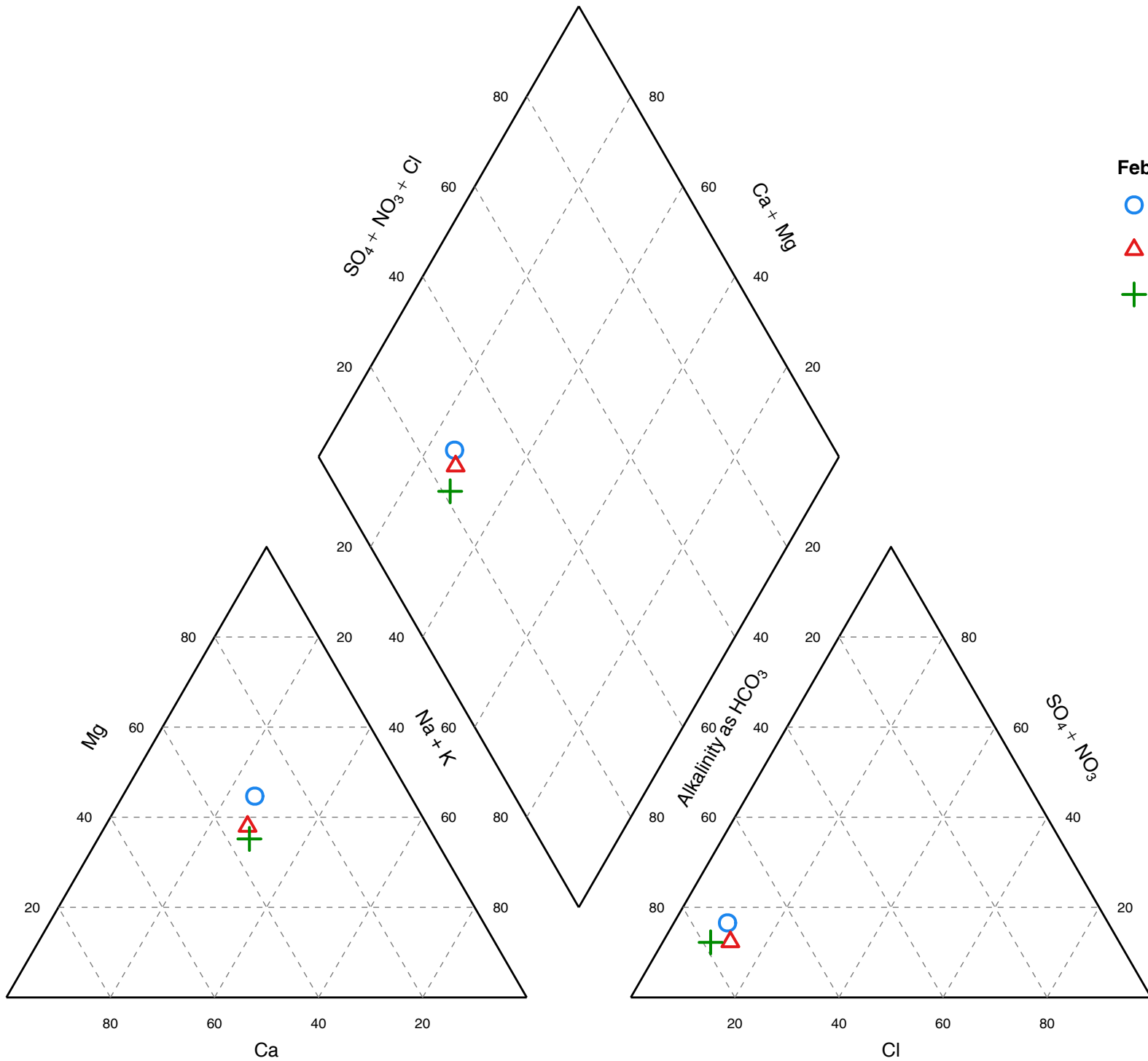

February 2015

○ BRE-MW1d

△ BRE-MW2s

+ BRE-MW3s

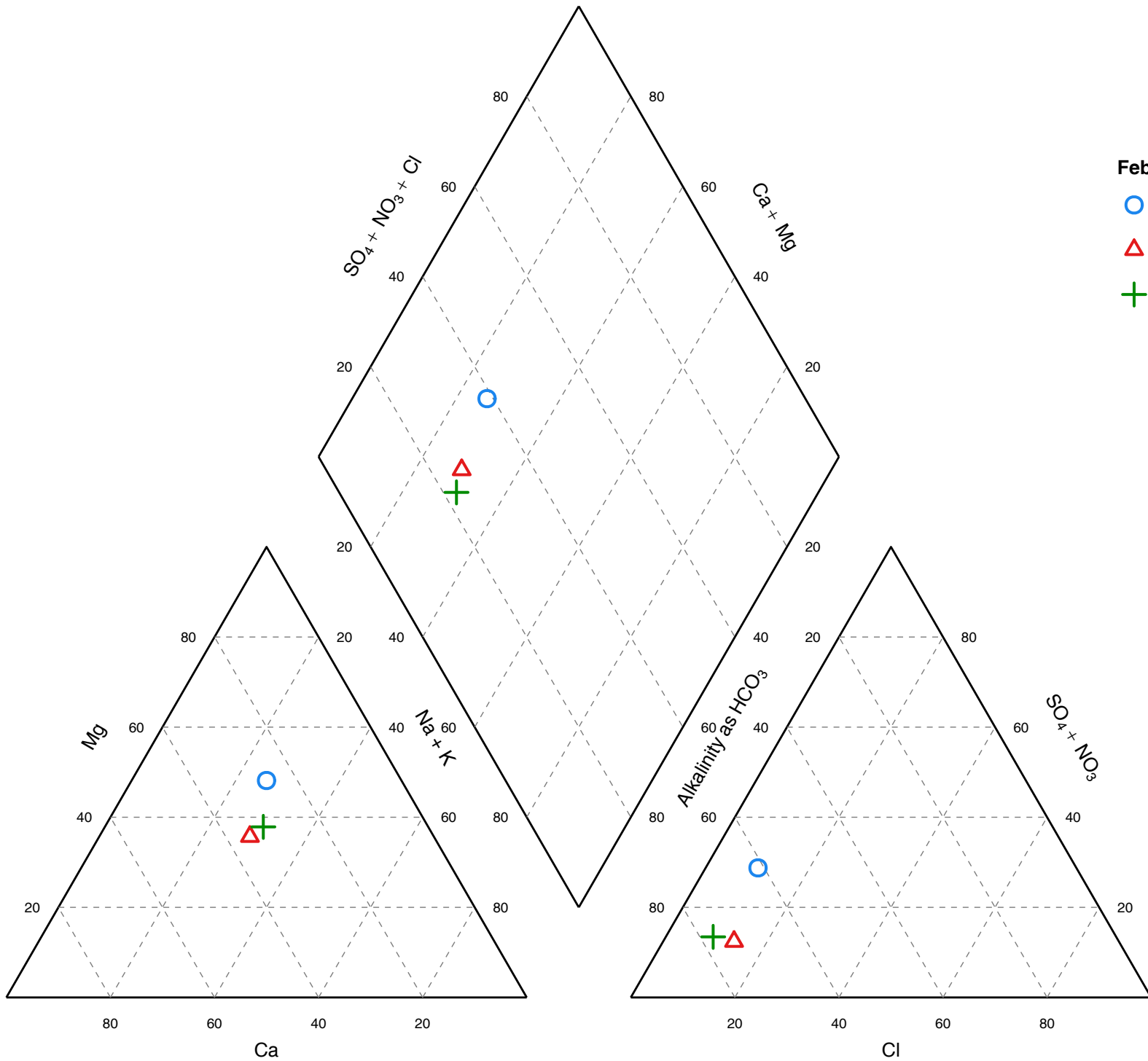

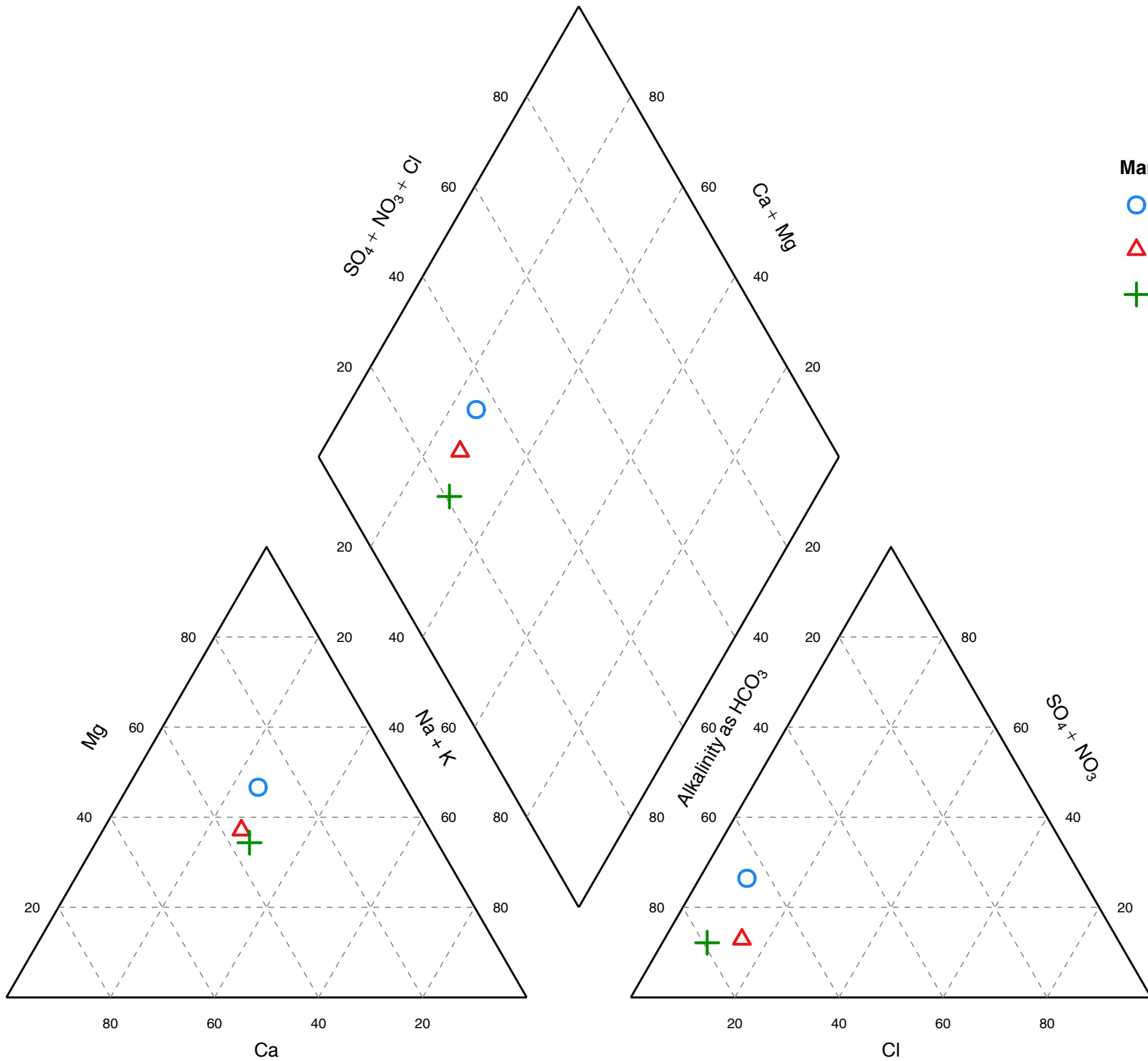

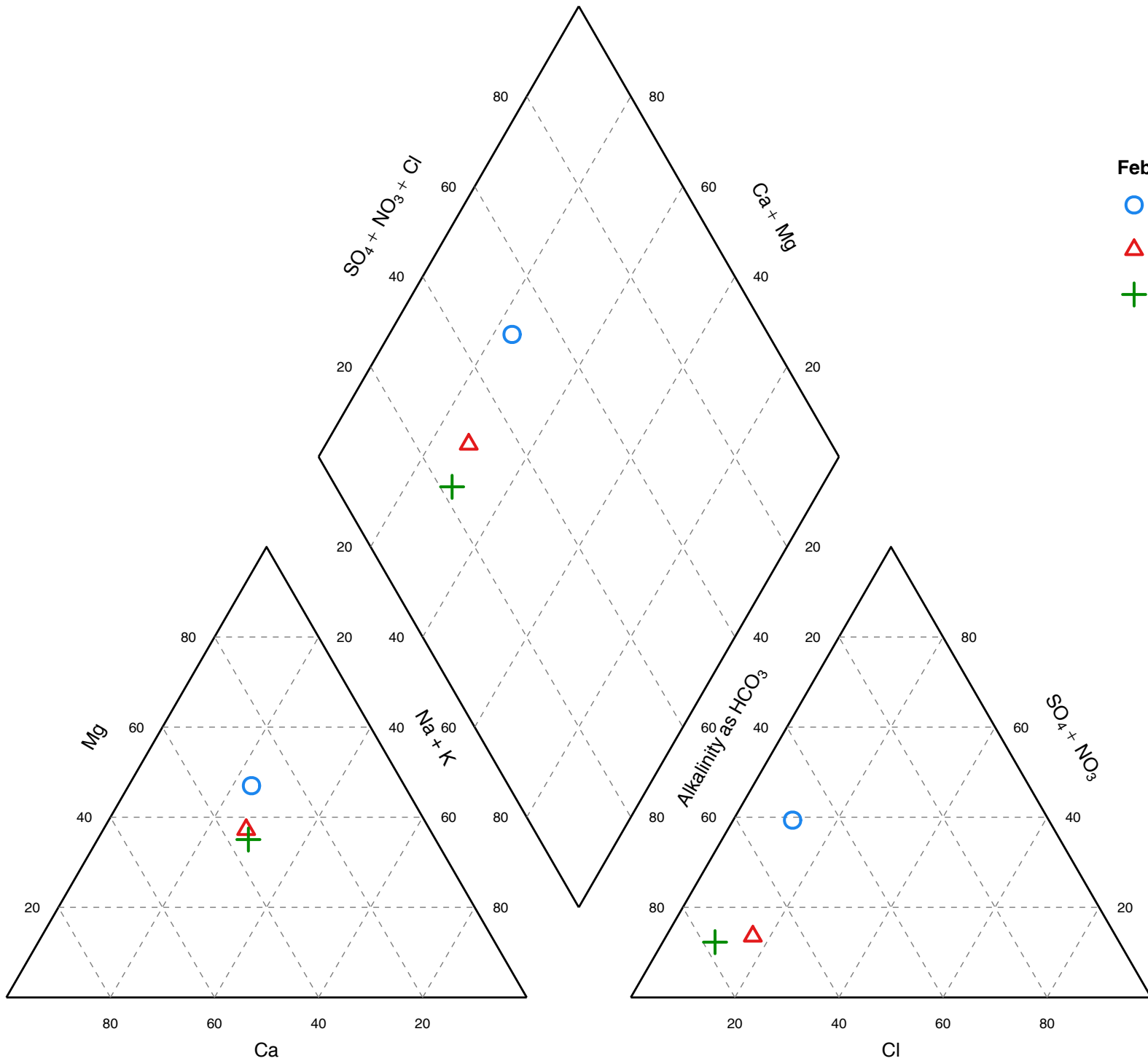

February 2018

○ BRE-MW1s

△ BRE-MW2s

+ BRE-MW3s

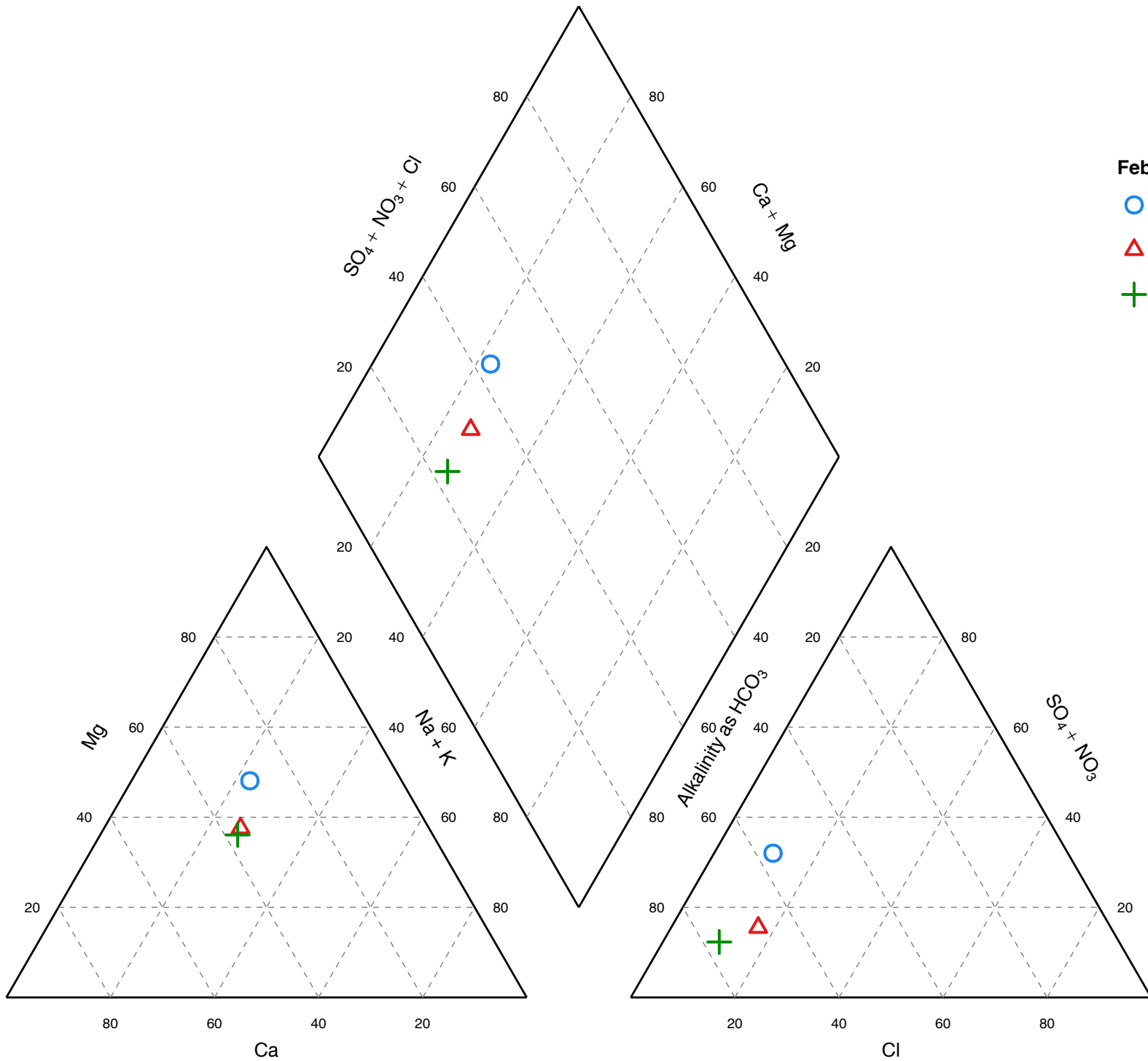

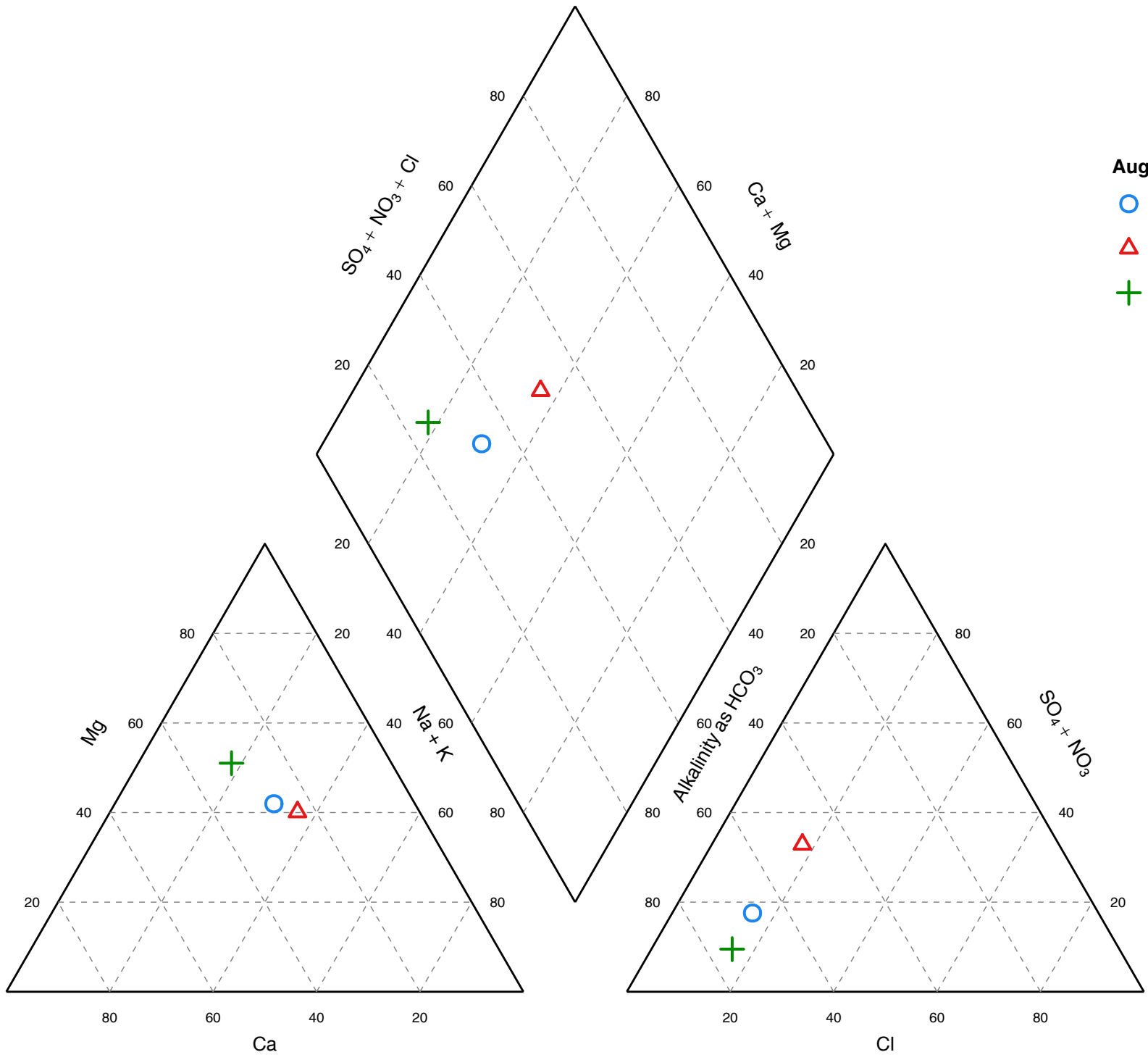

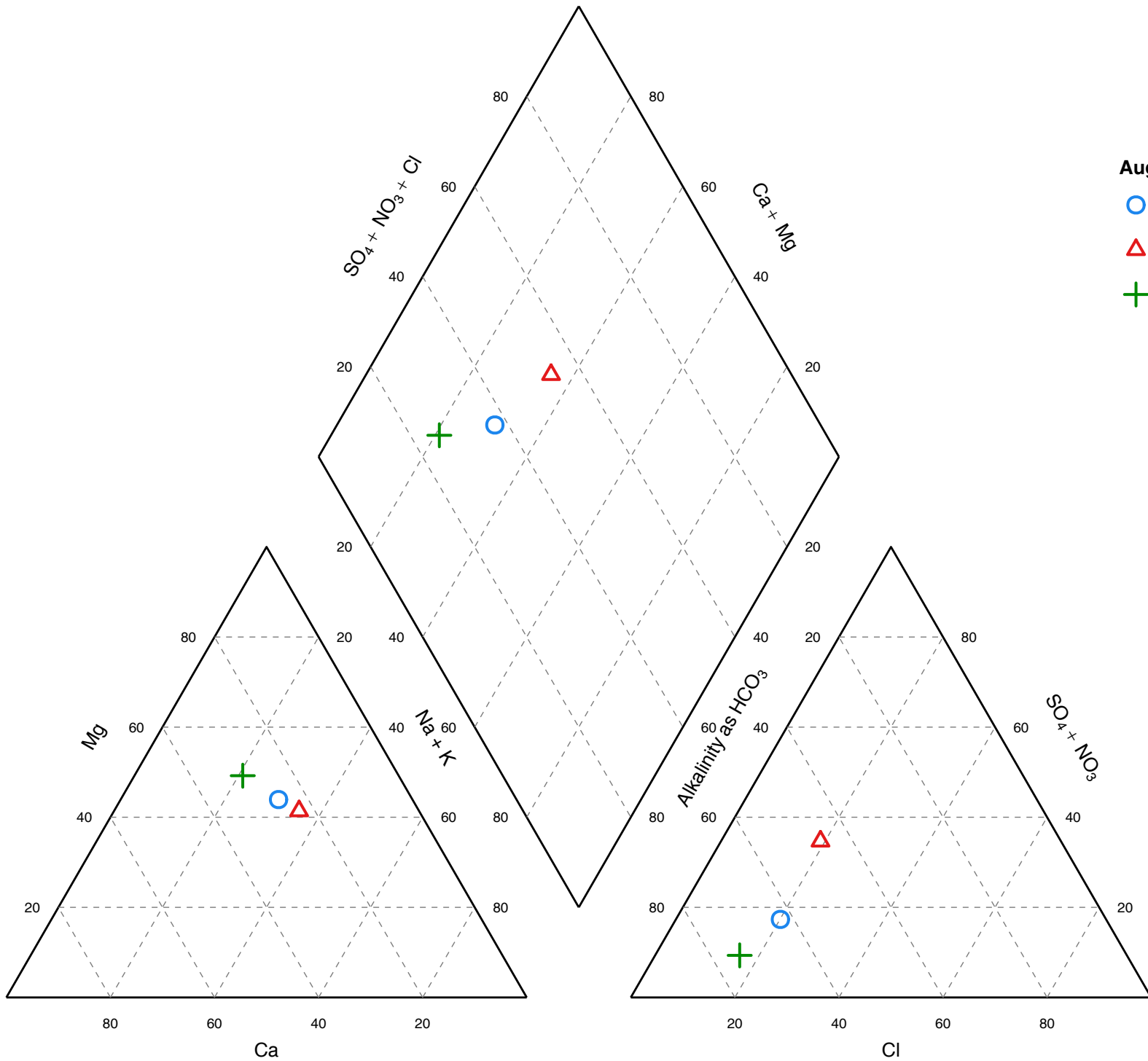

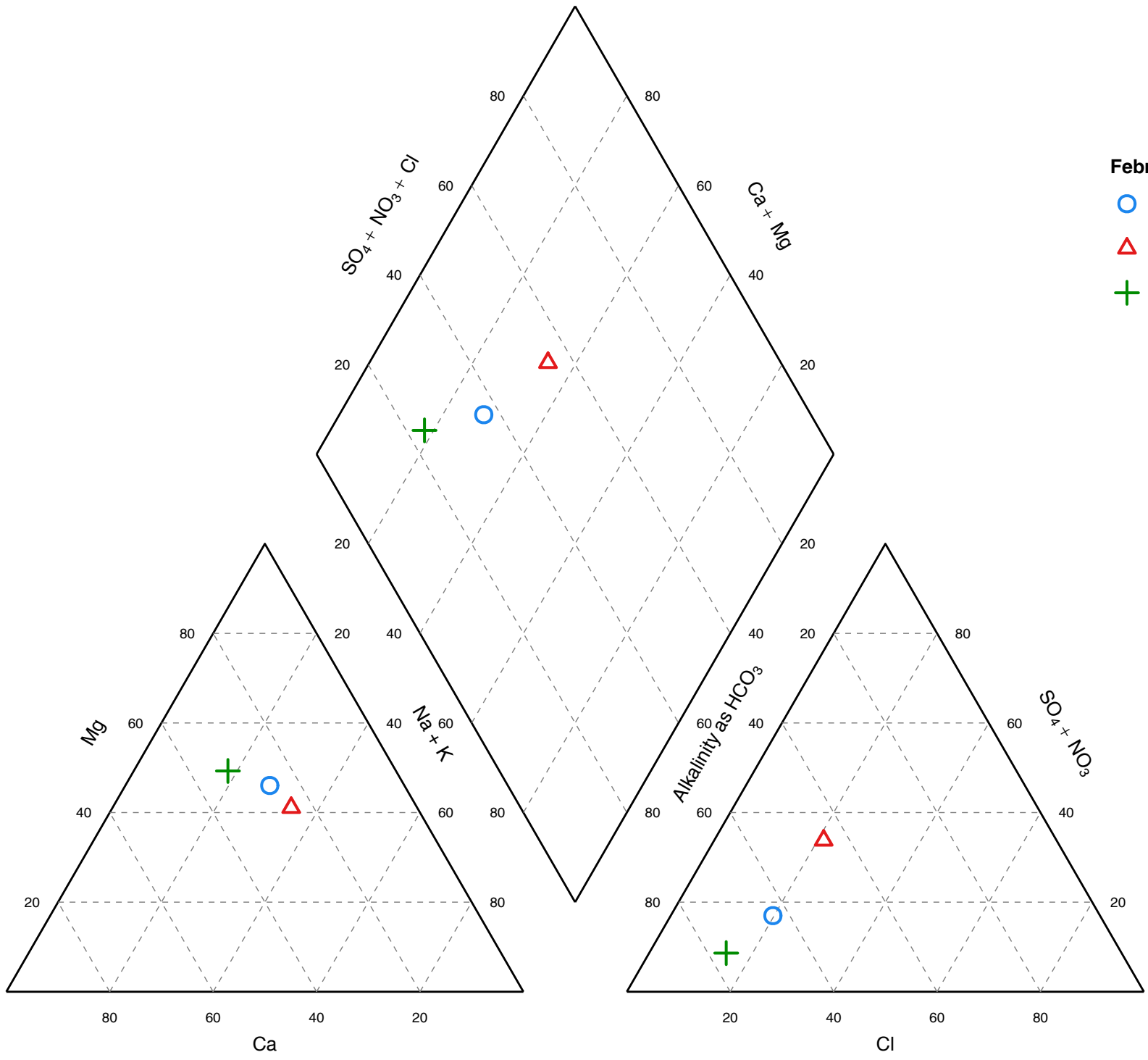

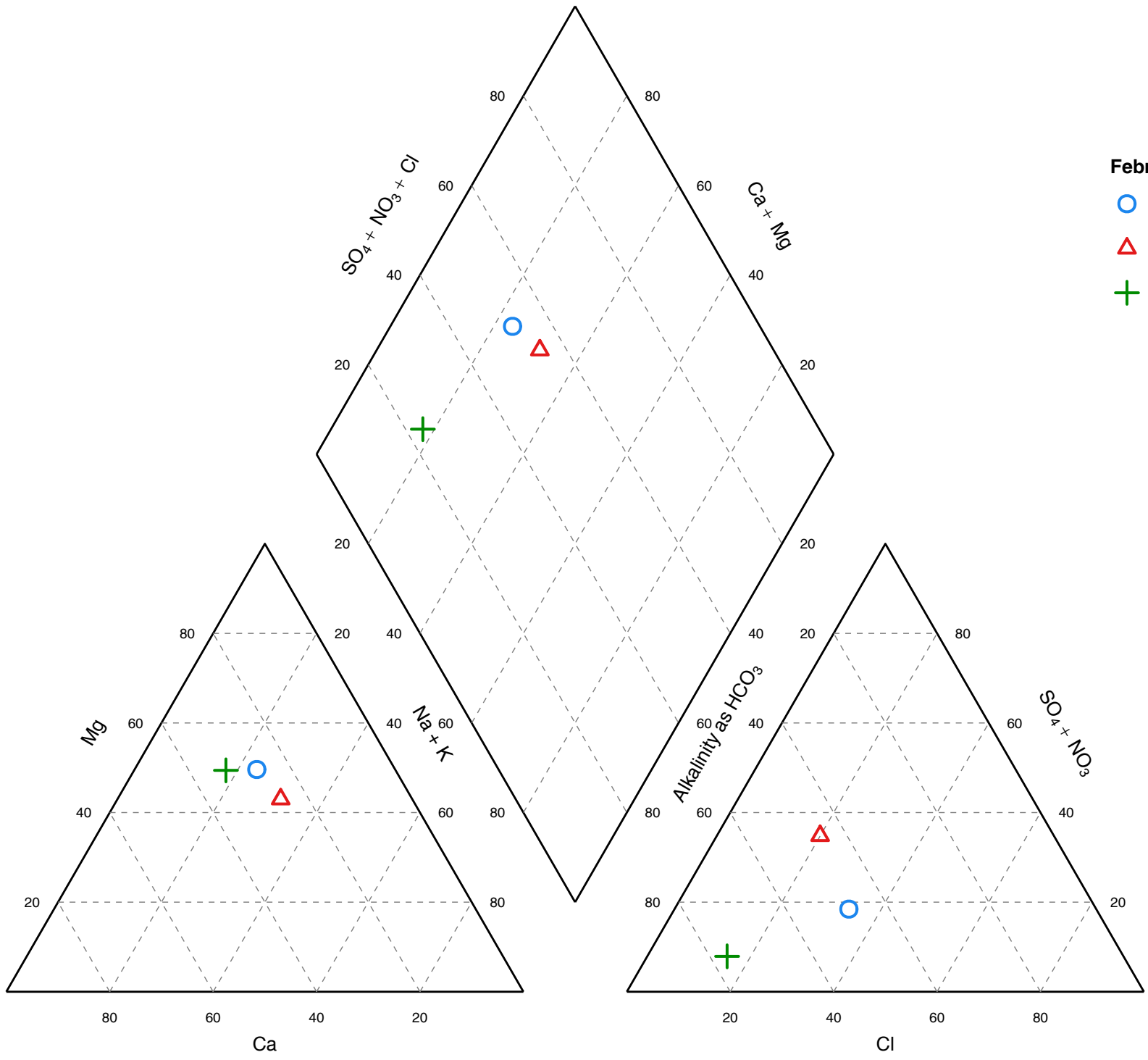

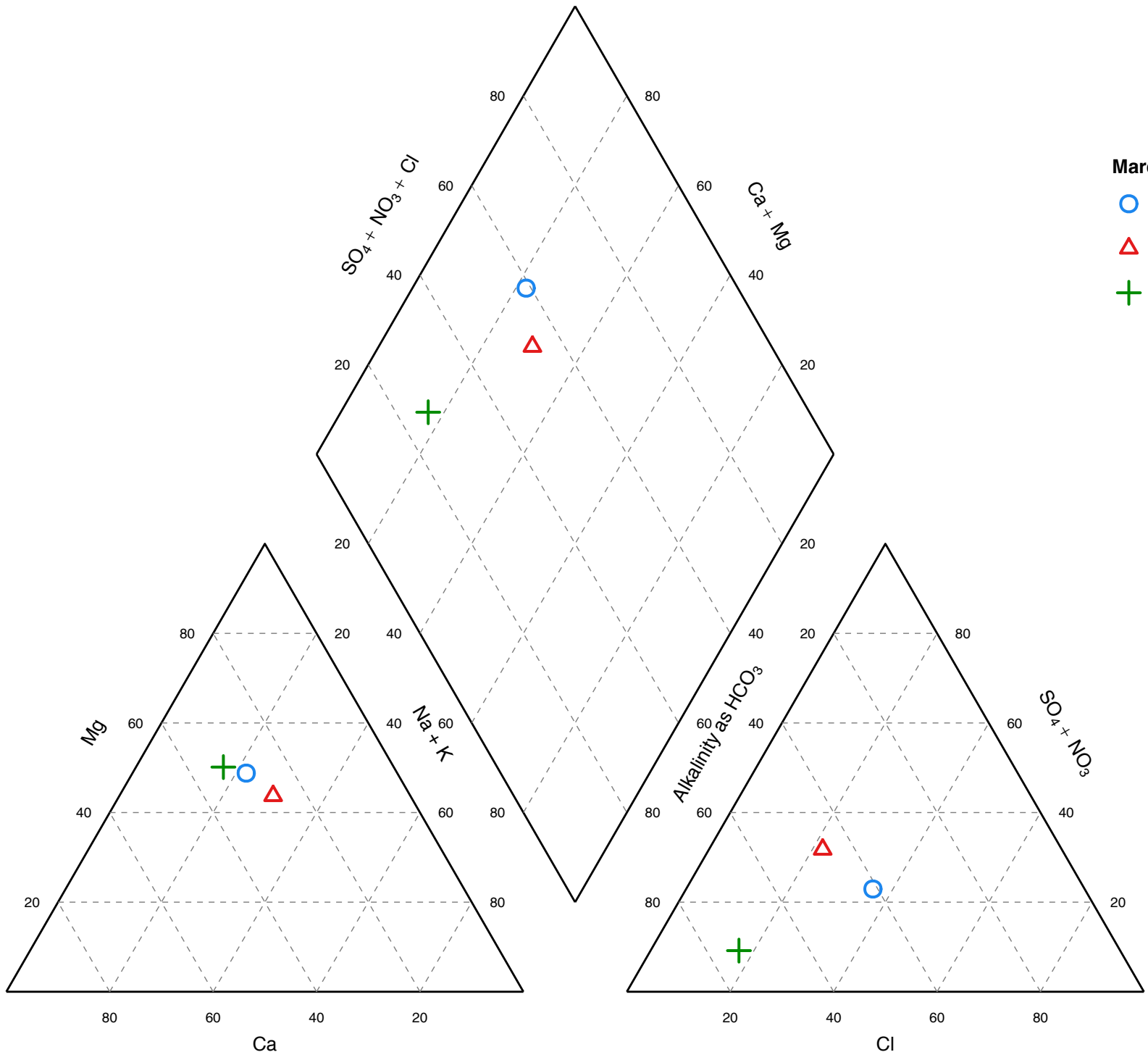

March 2017

○ CRE-MW1s

△ CRE-MW2s

+ CRE-MW3s

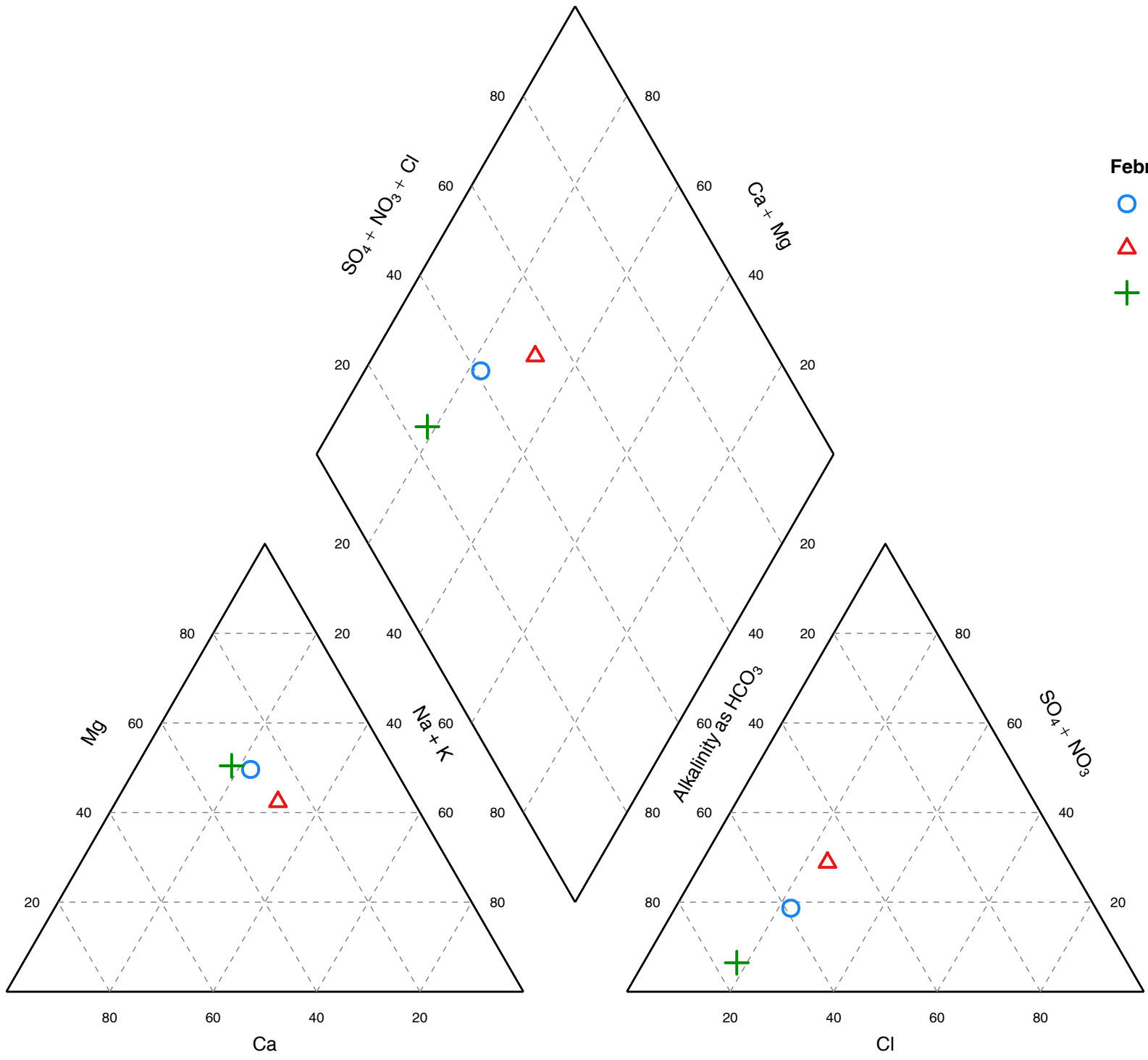

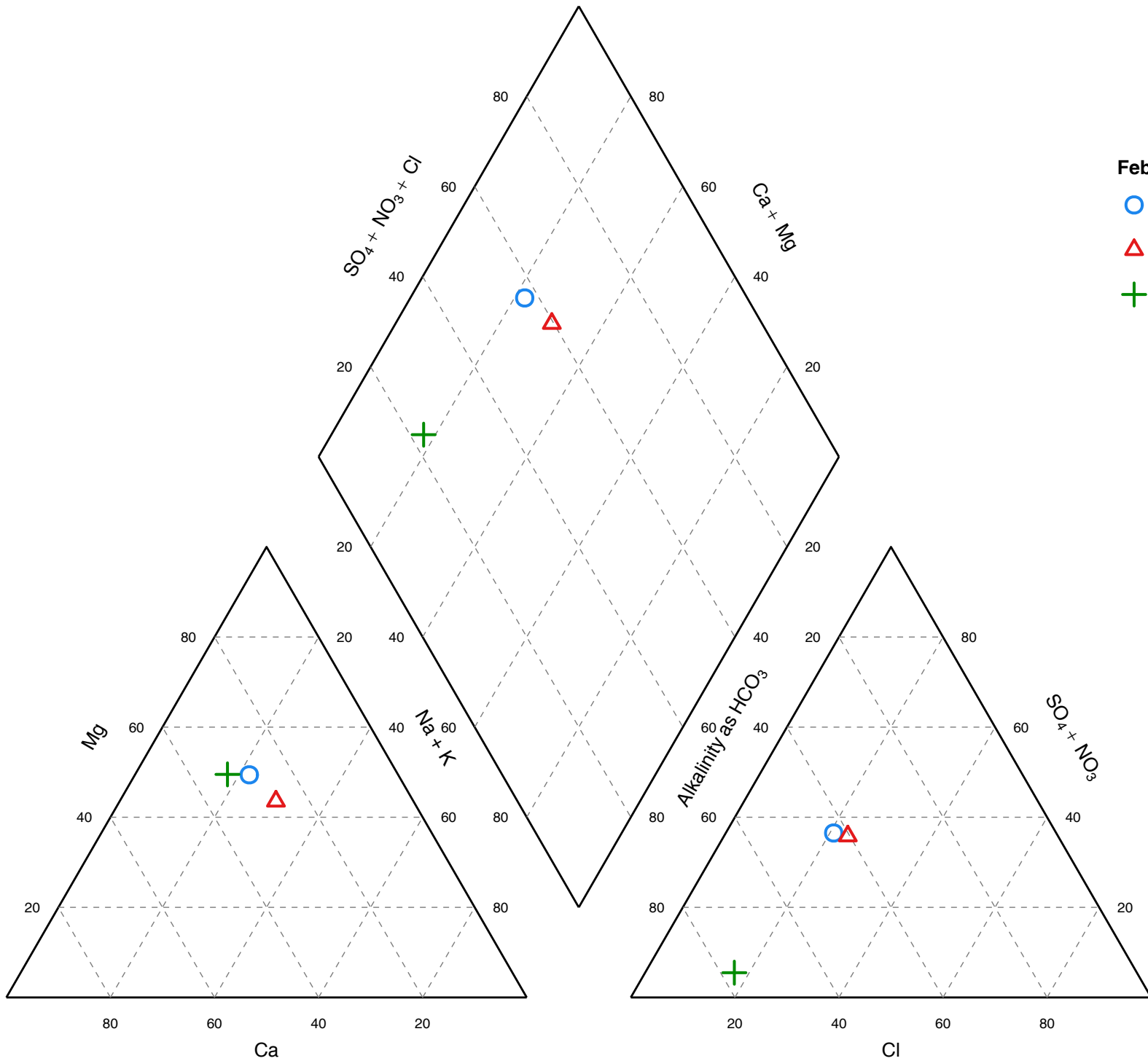

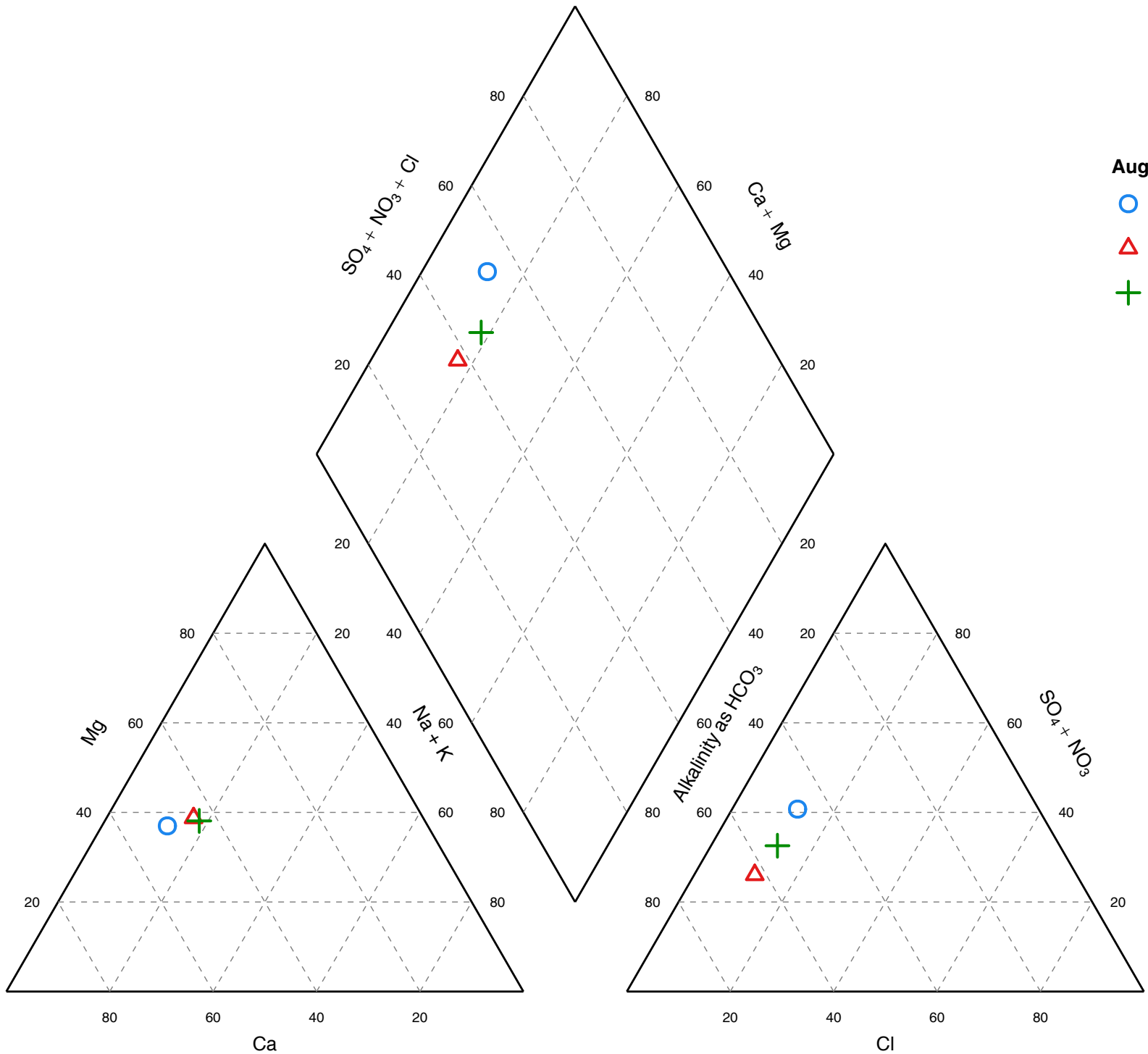

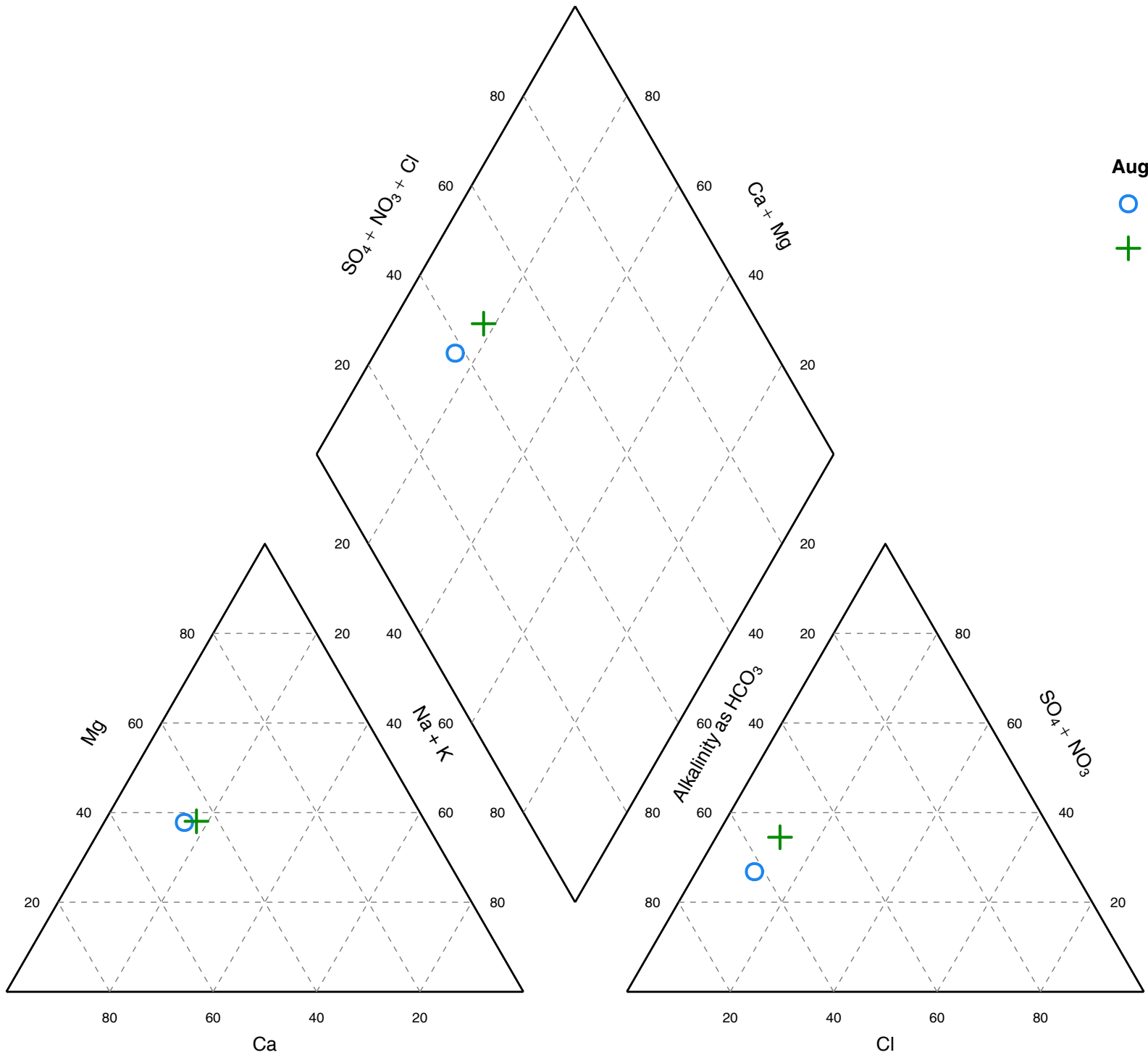

August 2014

○ MTS-MW1

+ MTS-MW3d

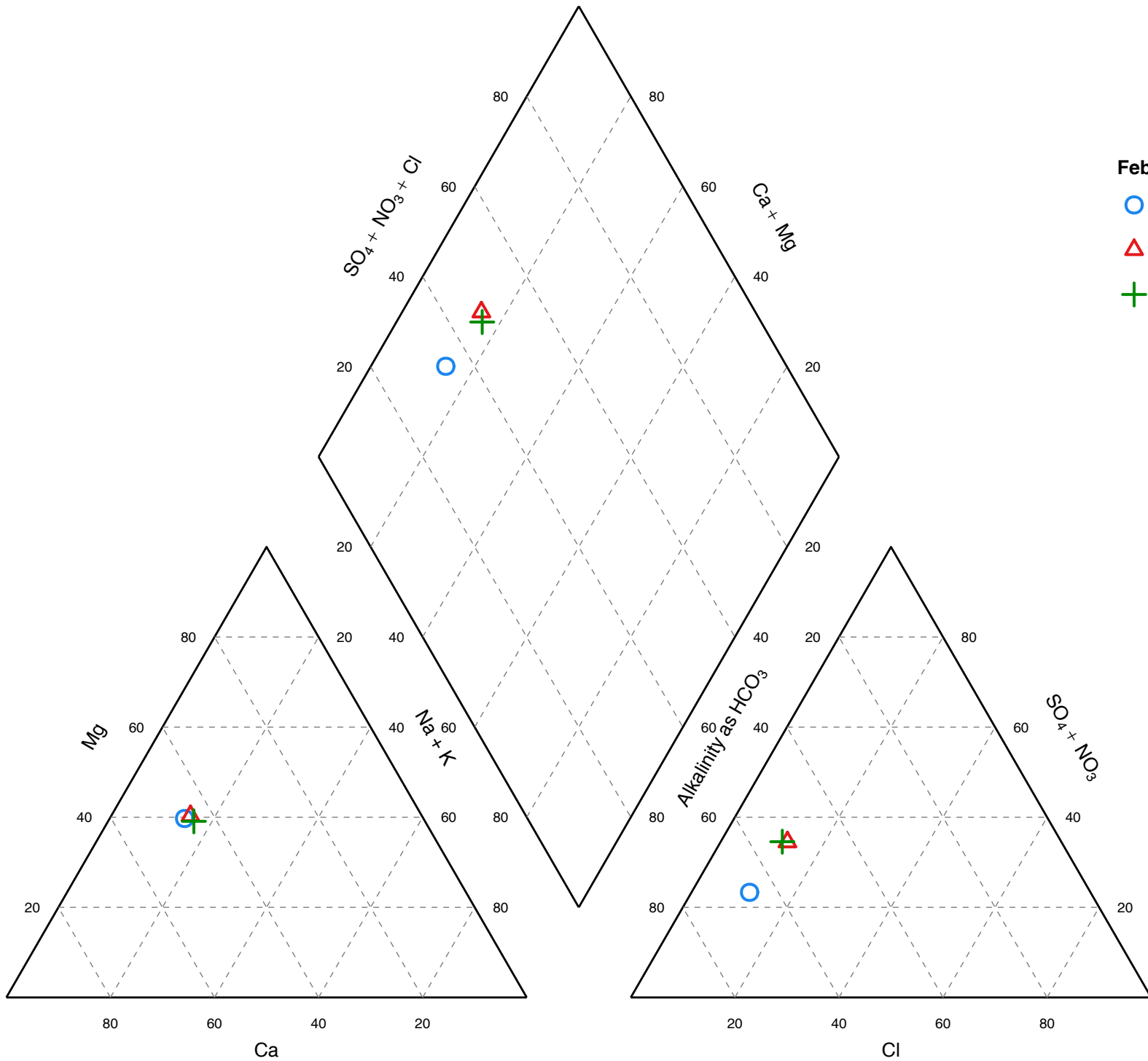

February 2015

- MTS-MW1
- △ MTS-MW2d
- + MTS-MW3d

February 2016

○ MTS-MW1

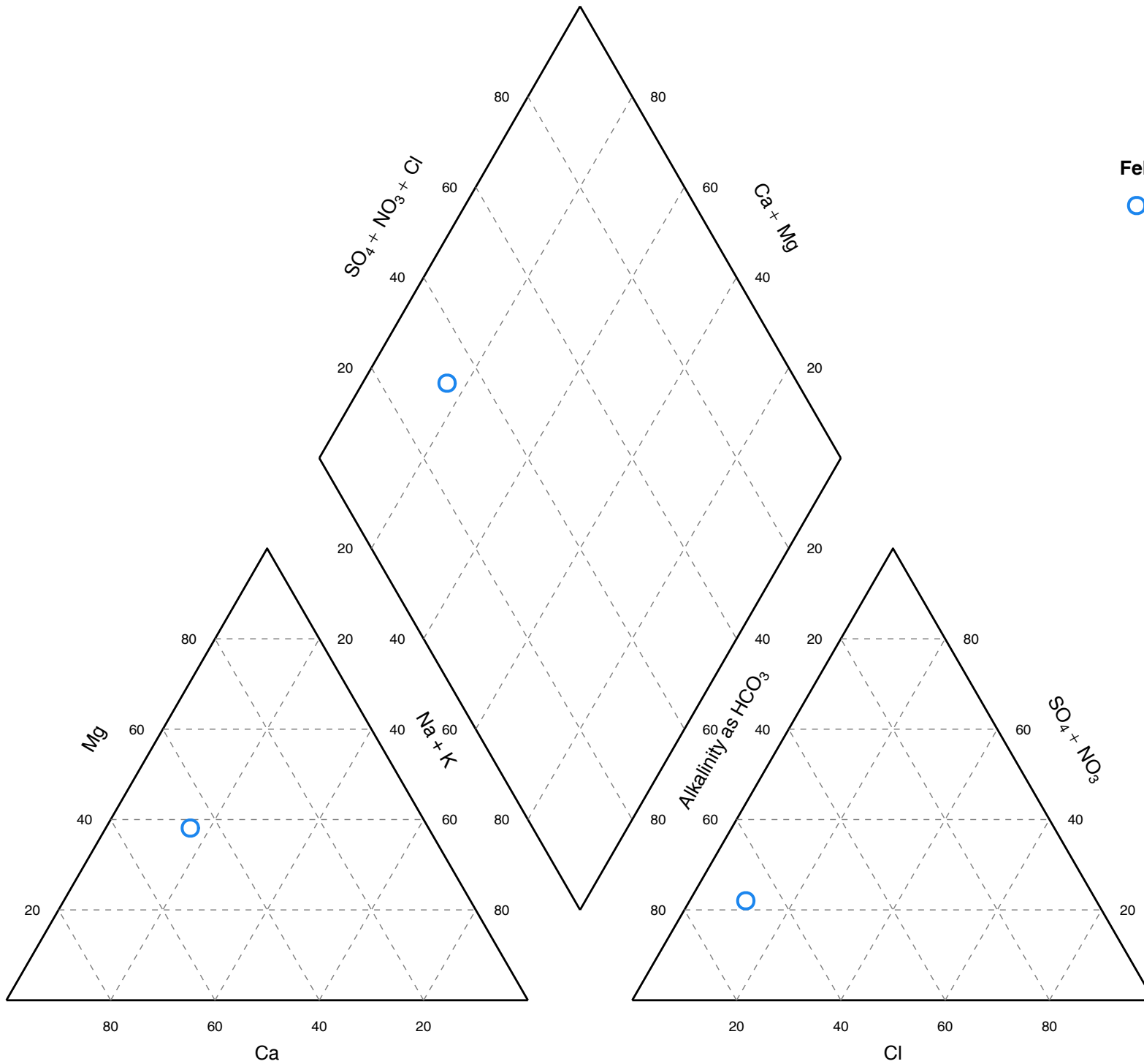

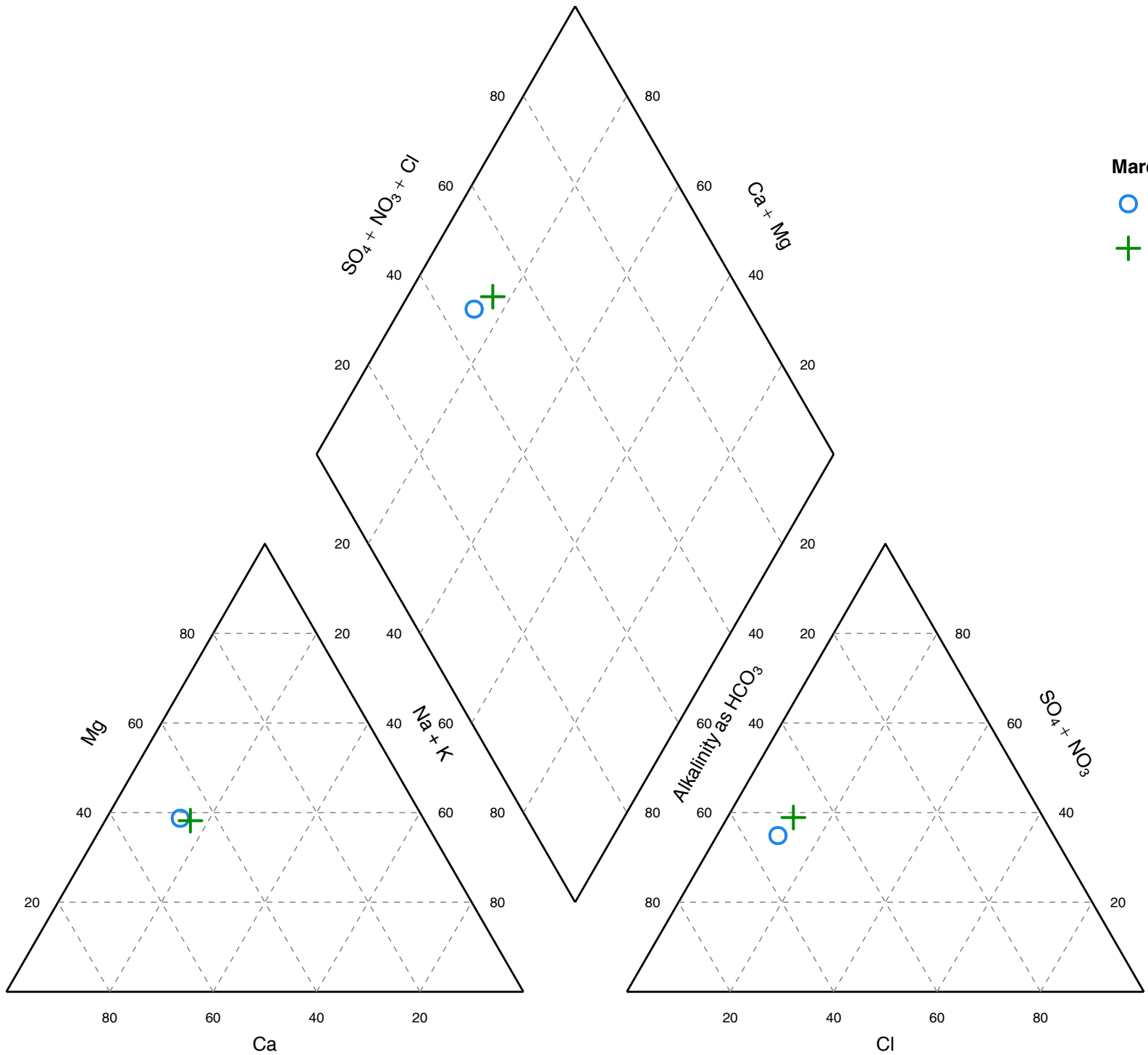

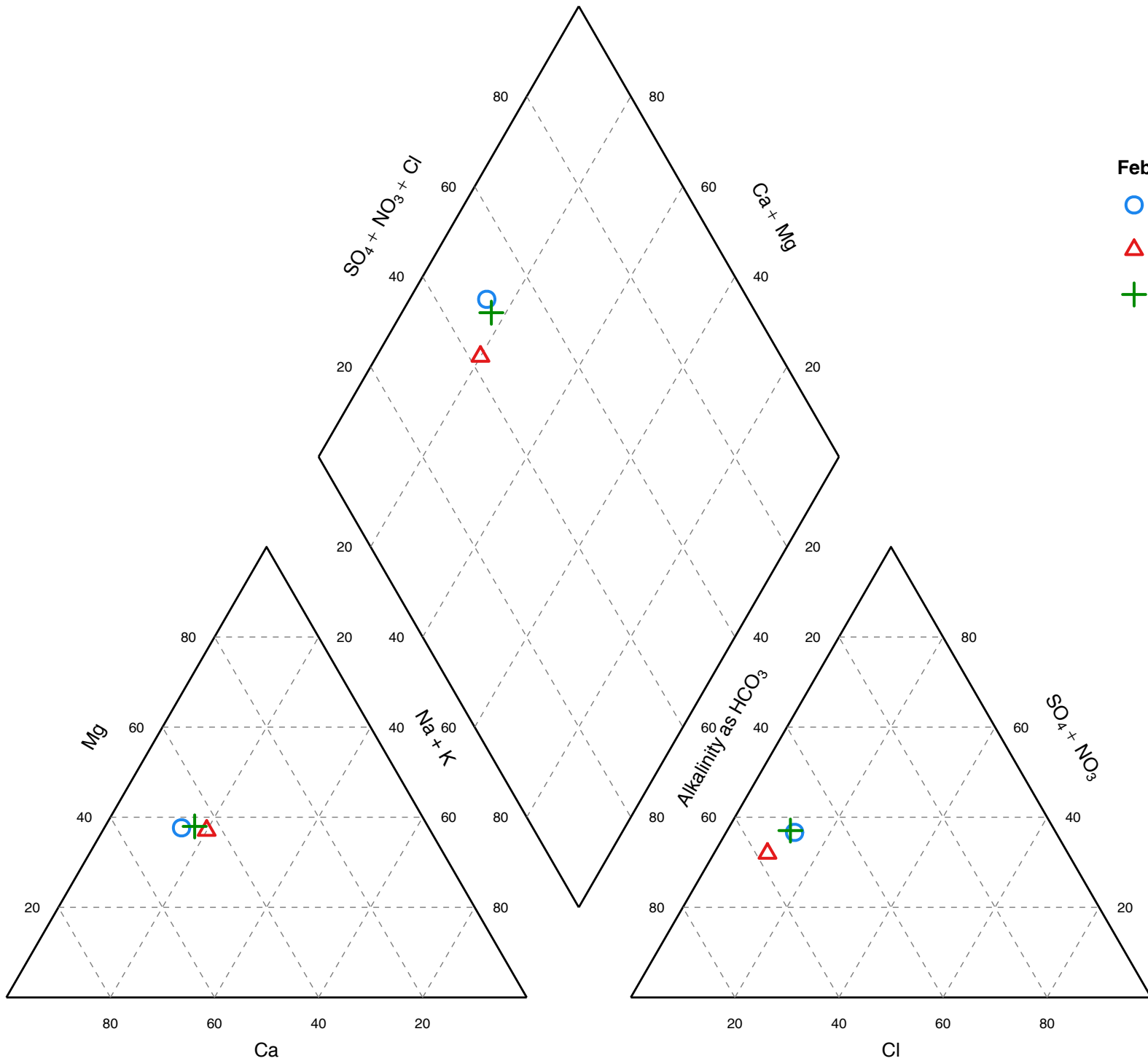

February 2019

○ MTS-MW1

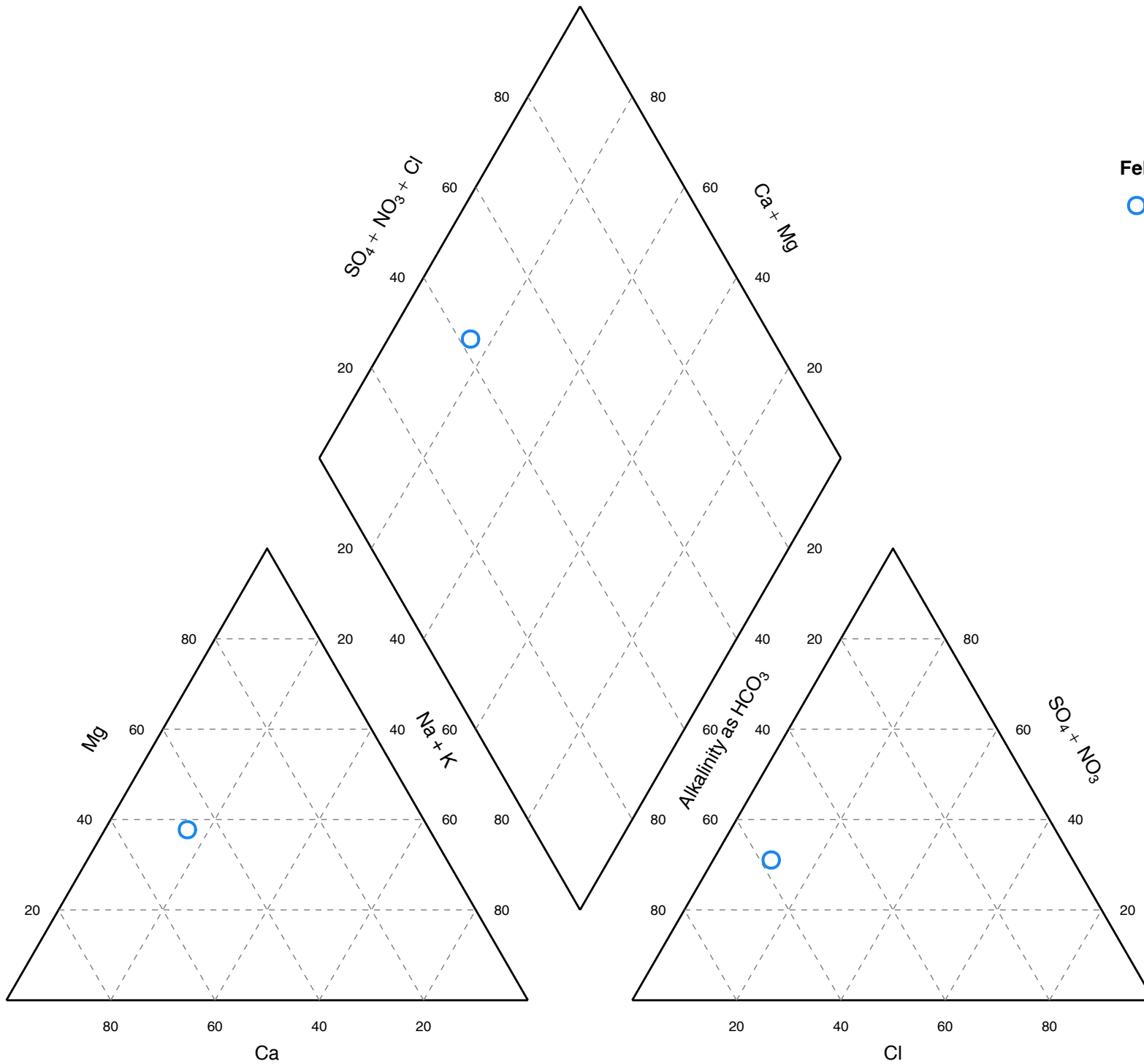

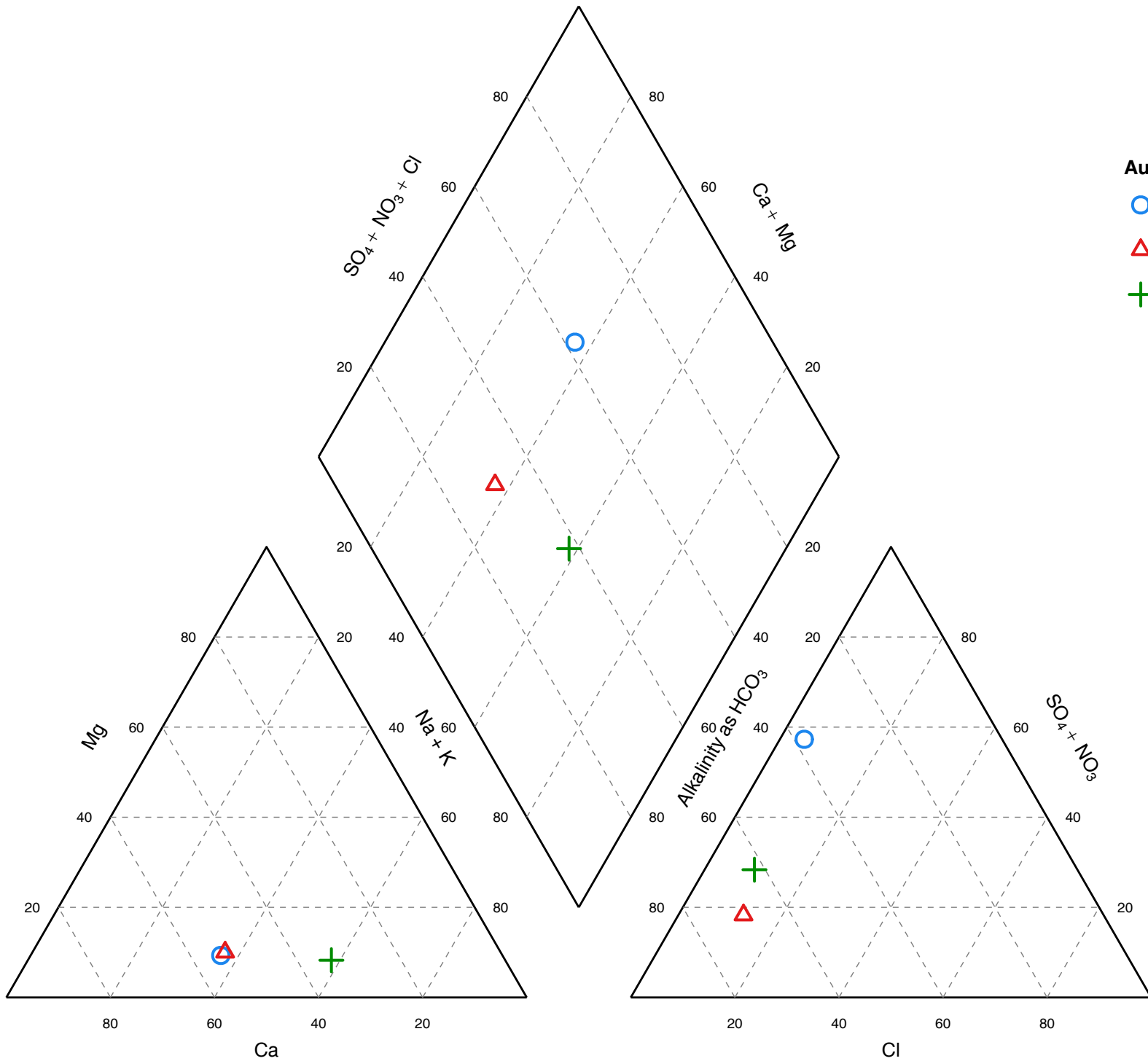

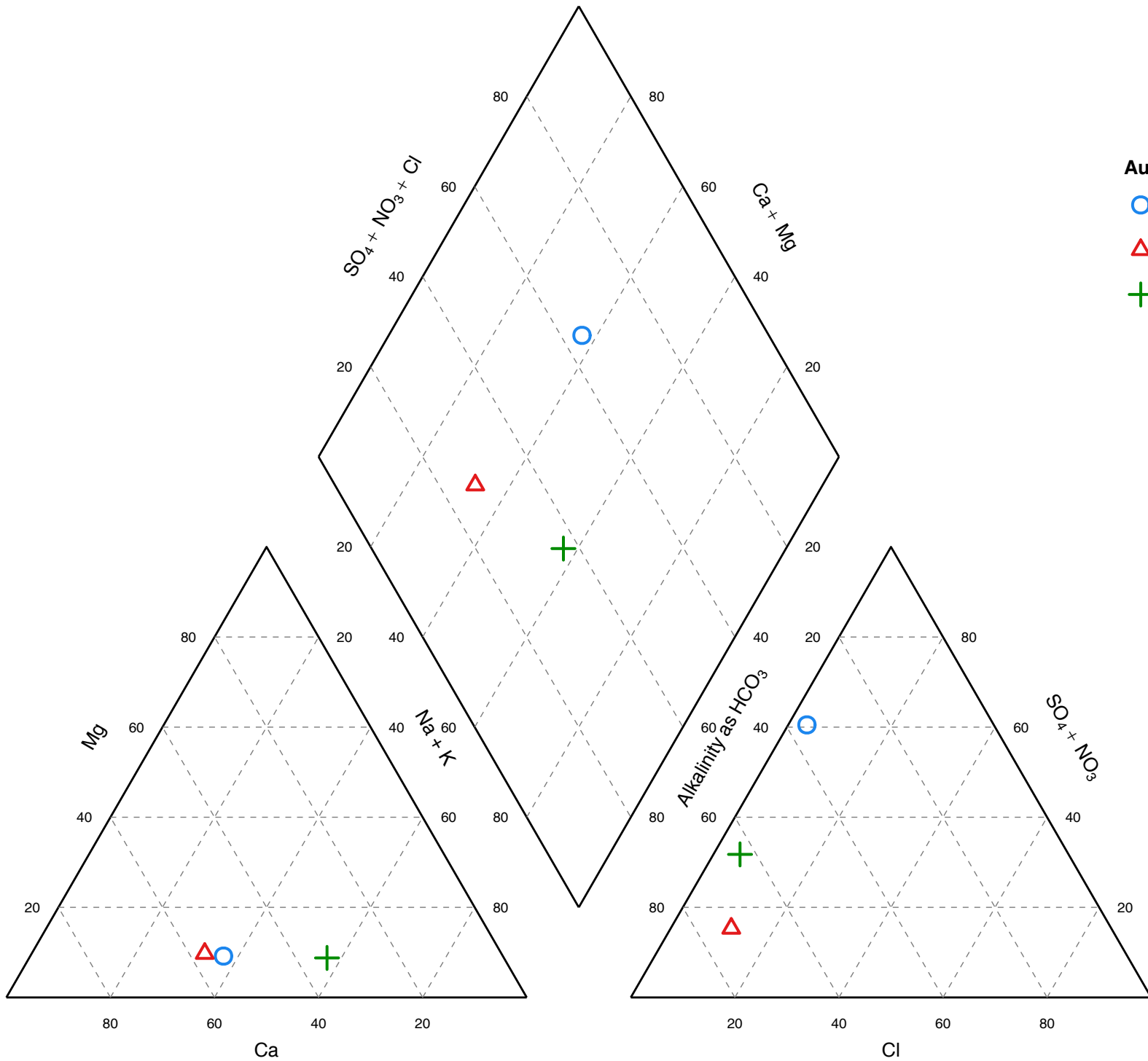

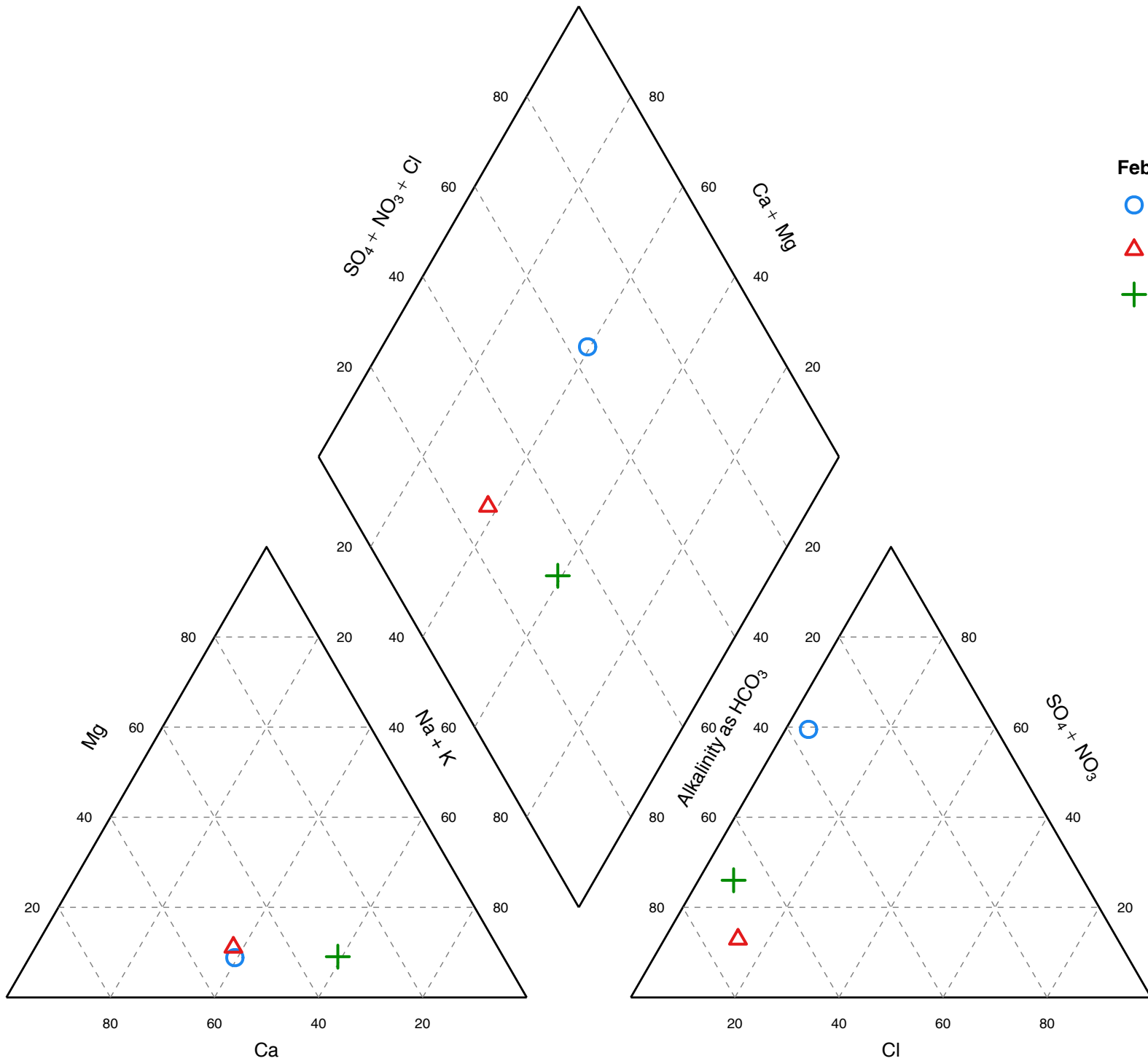

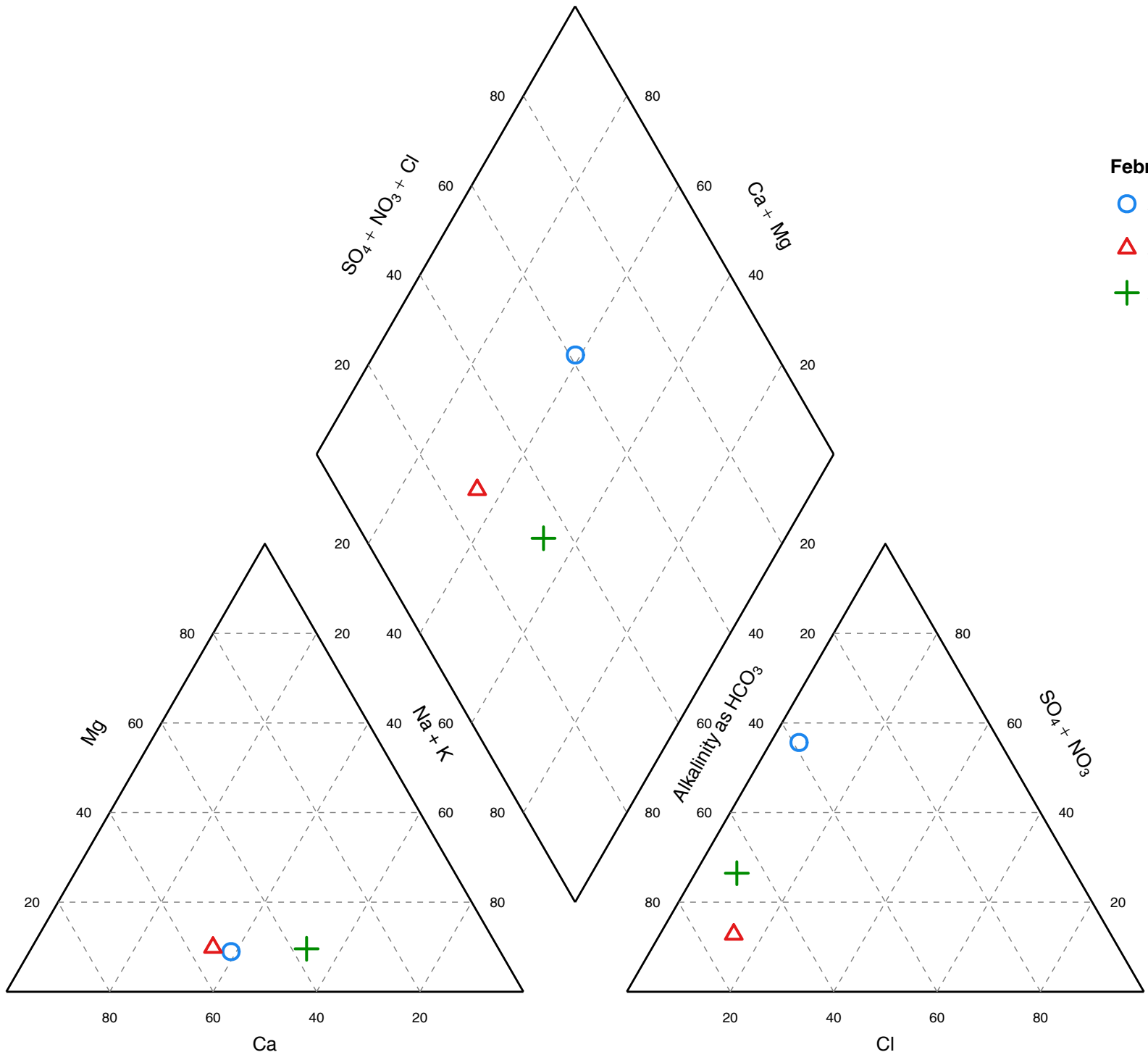

February 2016

- AUK-MW1
- △ AUK-MW2
- + AUK-MW3

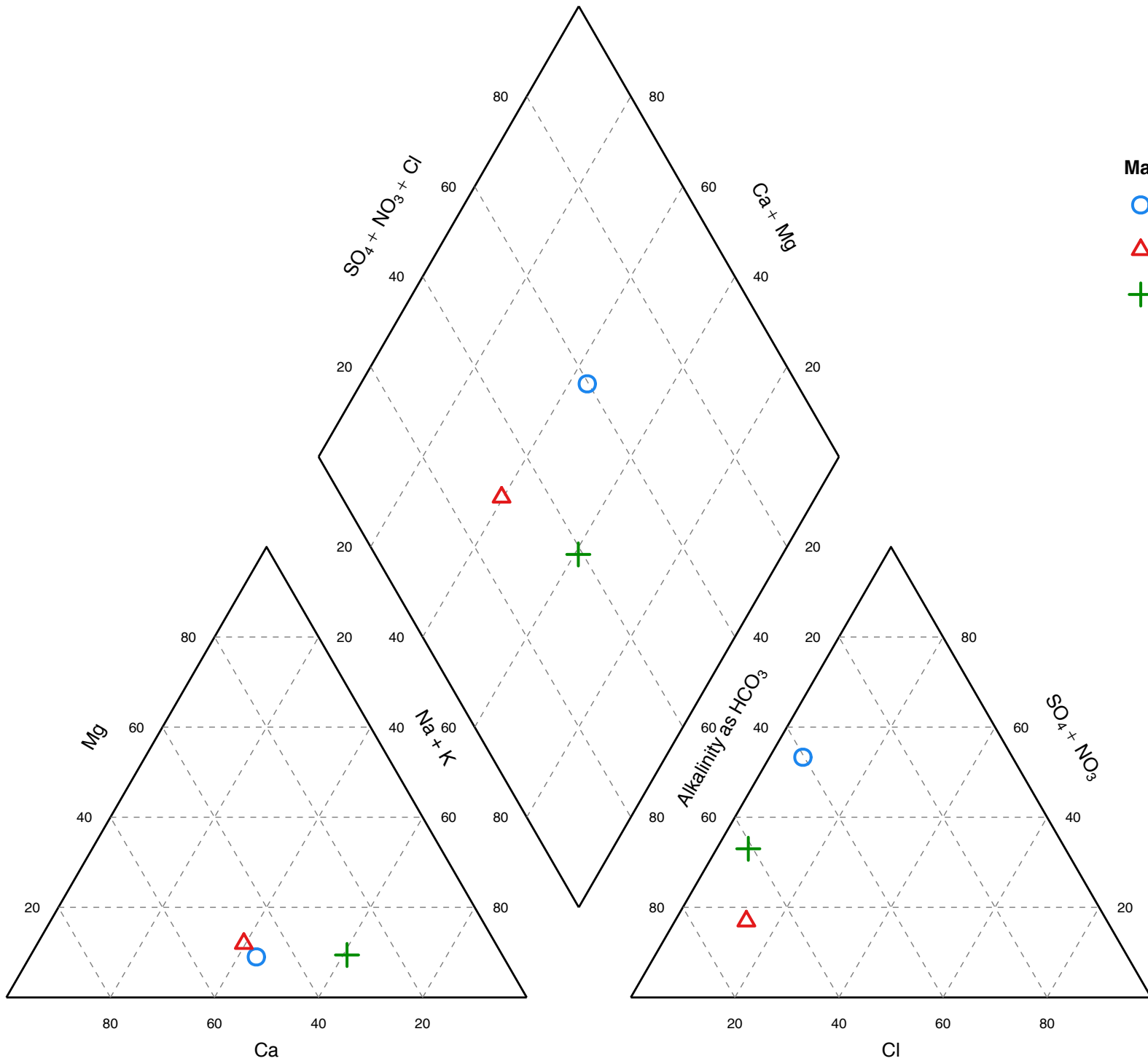

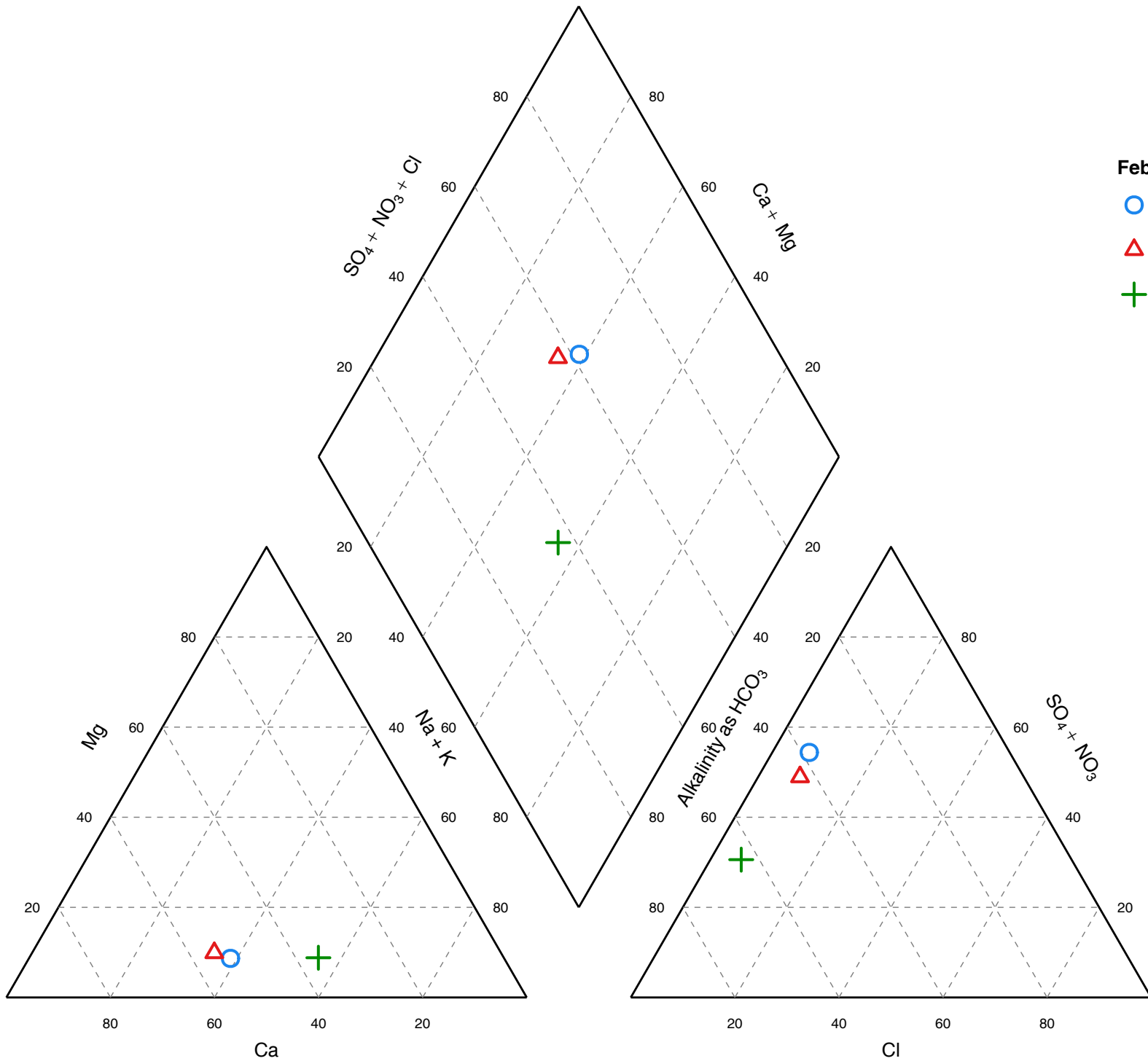

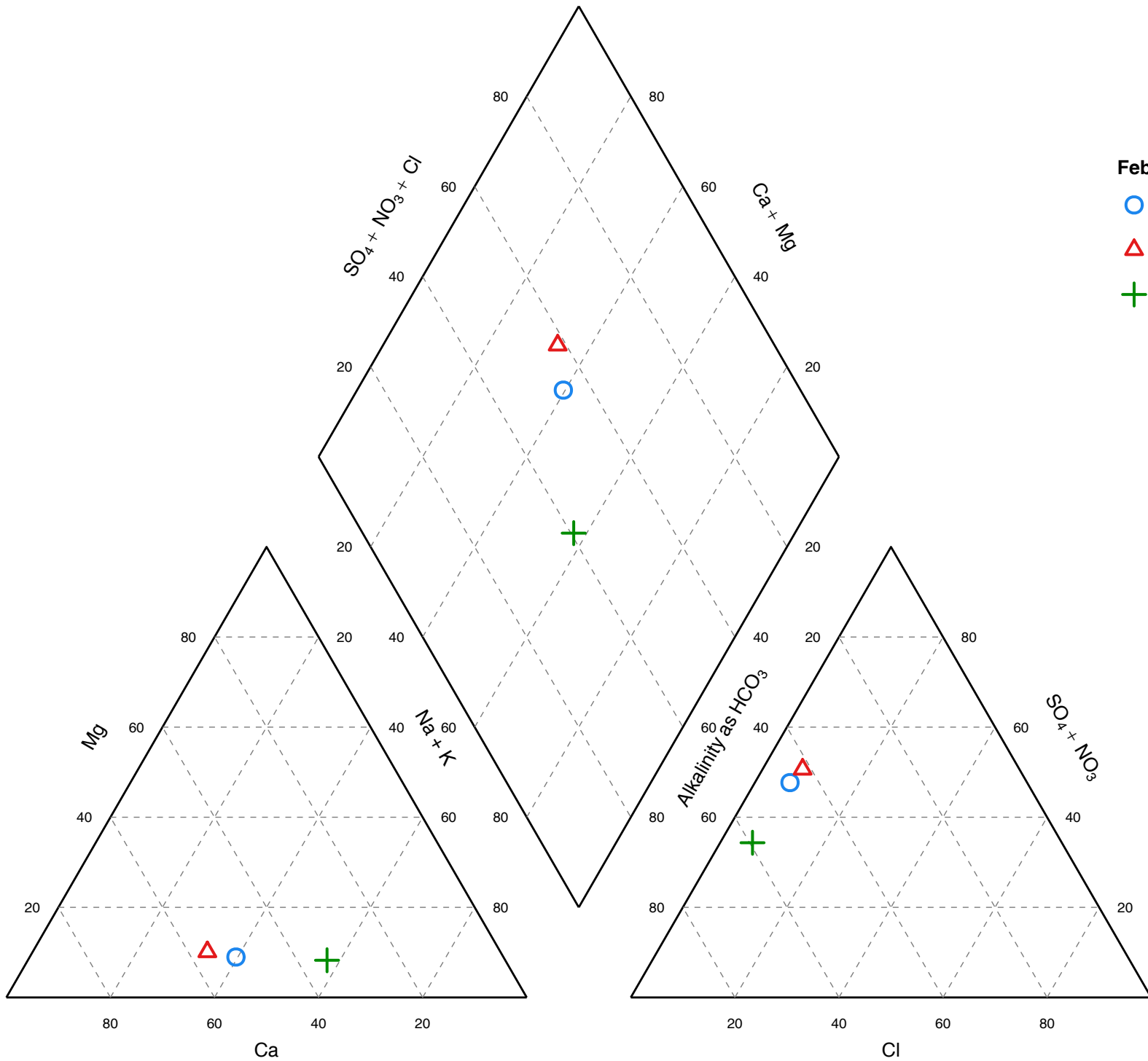

February 2019

○ AUK-MW1

△ AUK-MW2

+ AUK-MW3

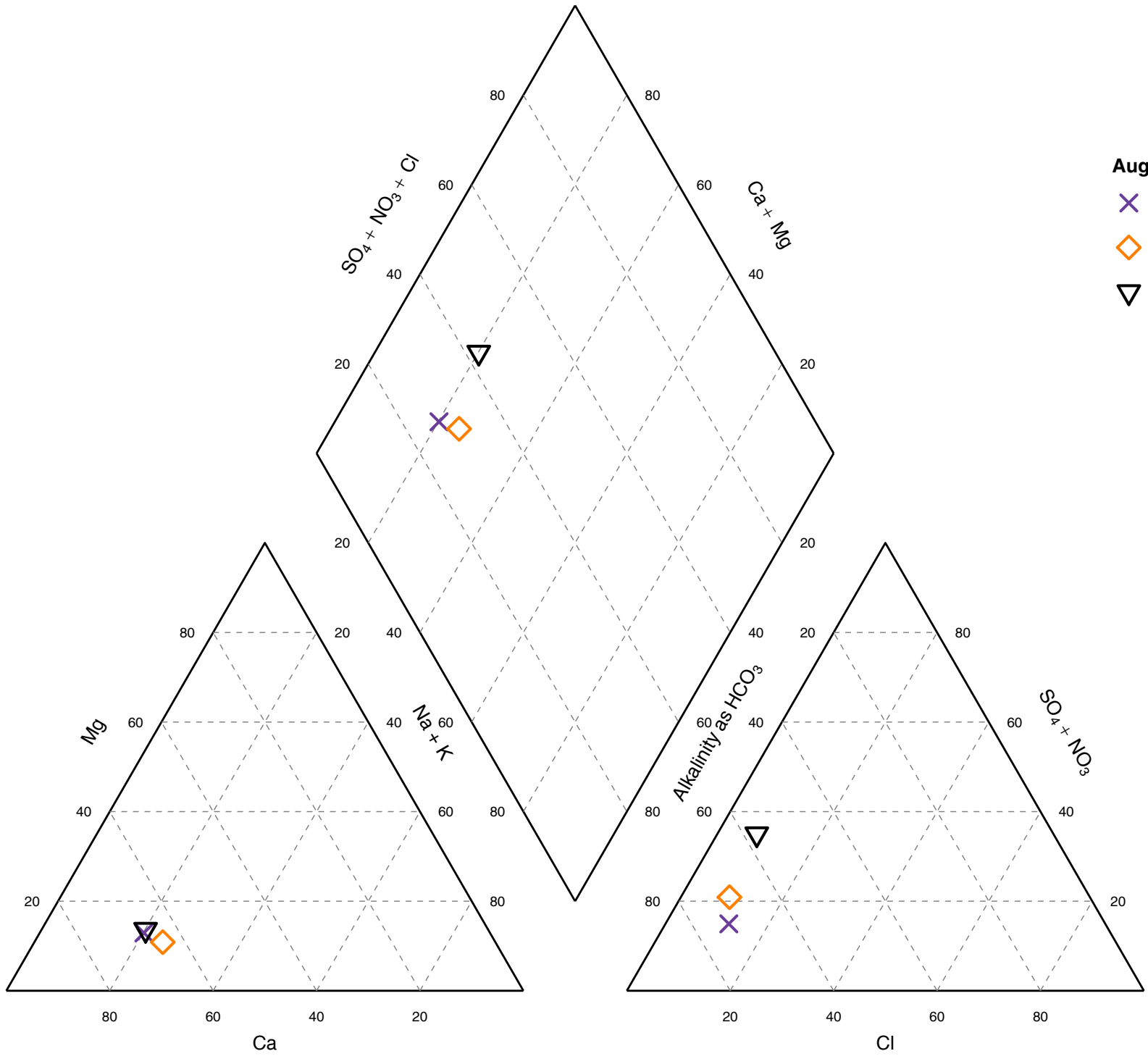

August 2013

✕ DLF-MW4C

◇ DLF-MW5C

▽ DLF-MW6C

August 2014

▽ DLF-MW6B

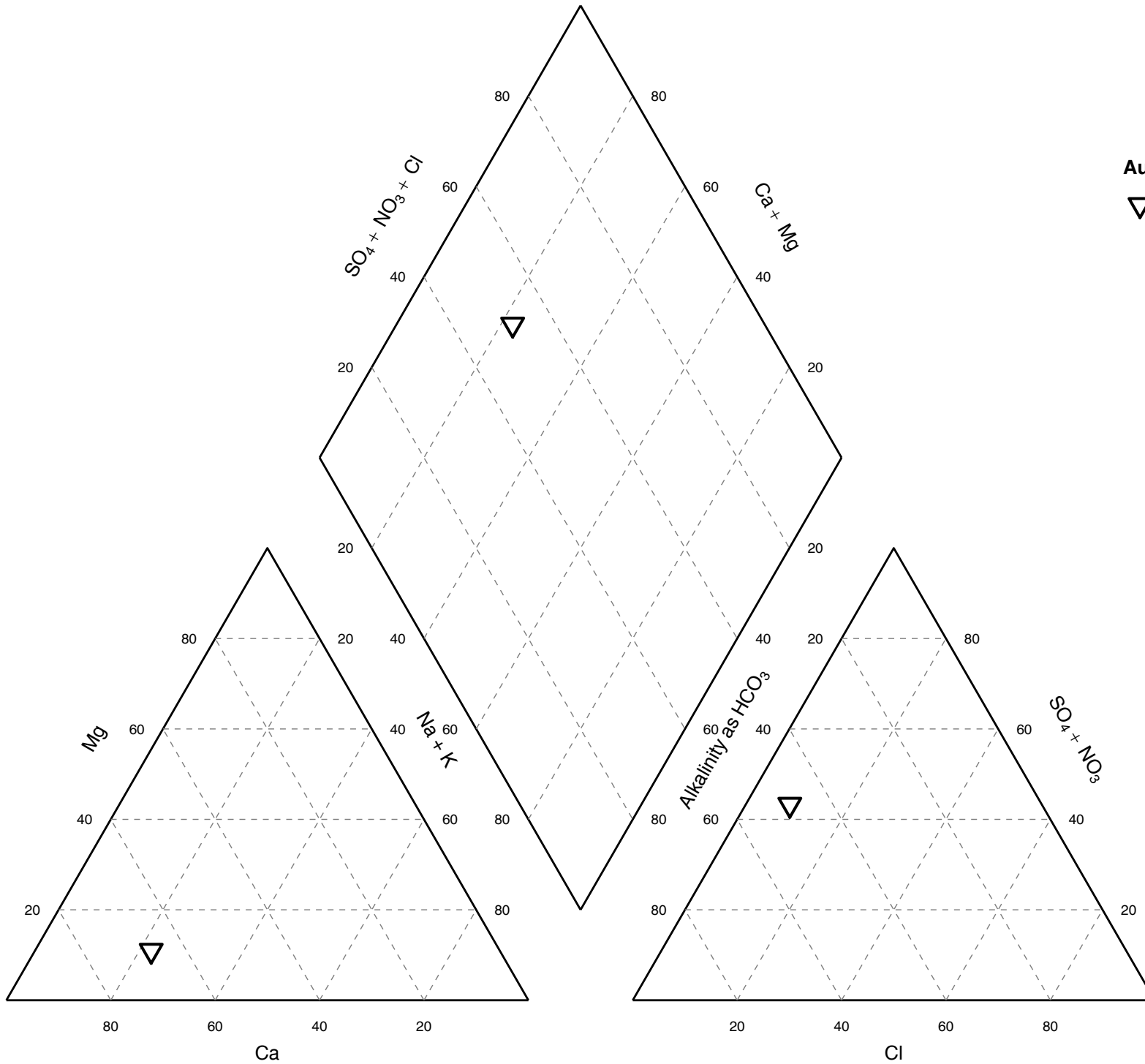

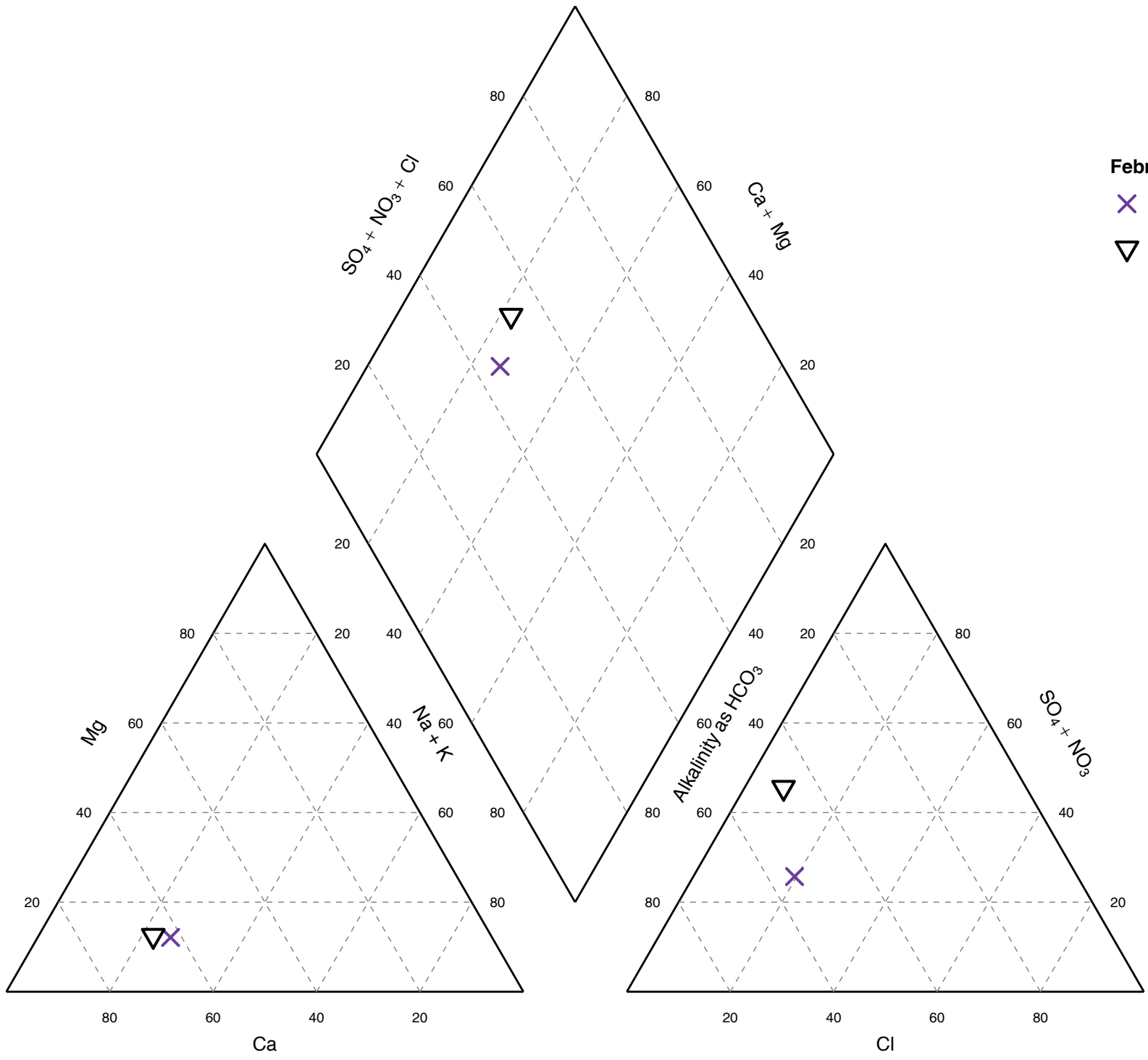

February 2015

X DLF-MW4C

▽ DLF-MW6B

February 2016

▽ DLF-MW6B

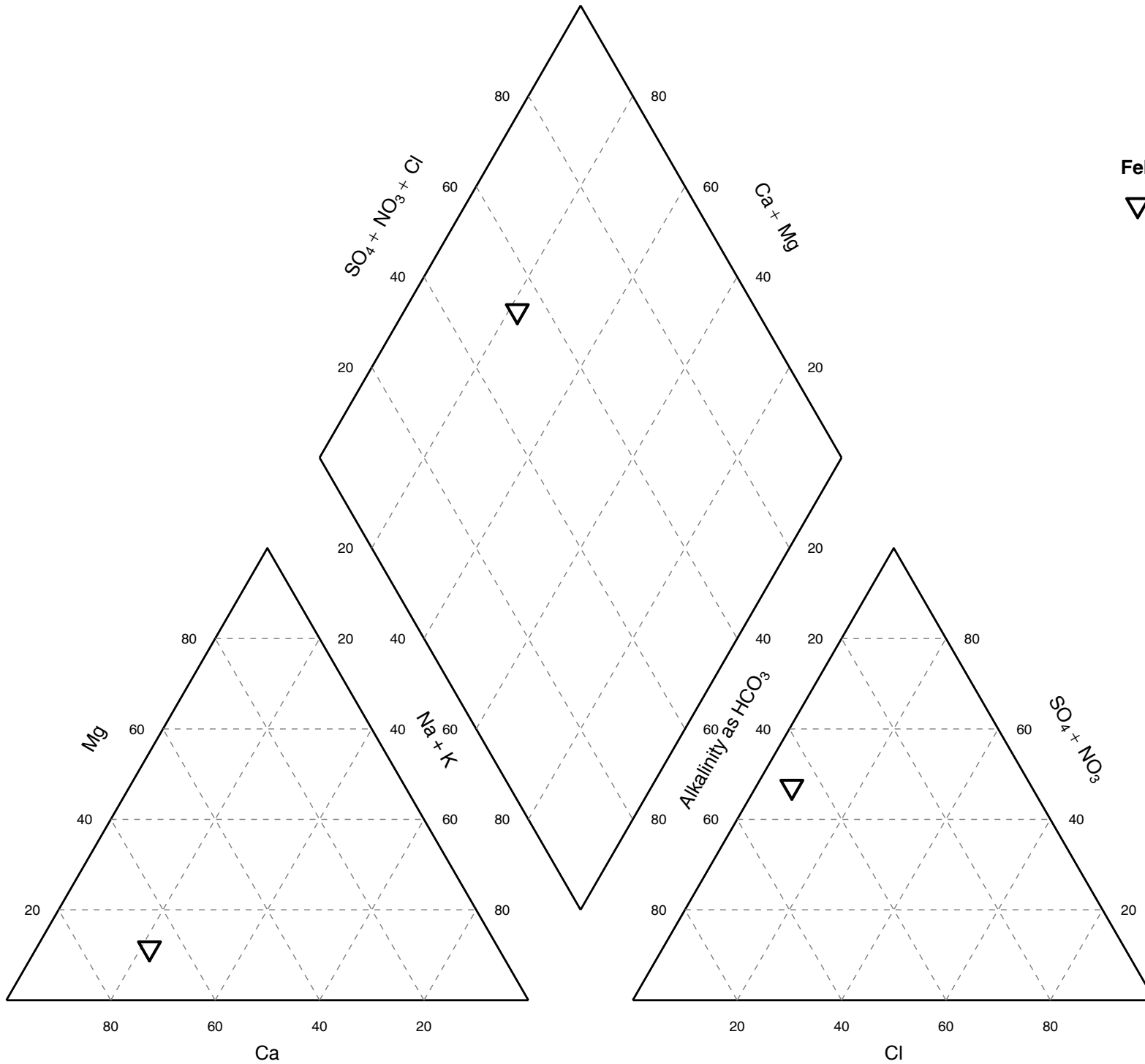

March 2017

▽ DLF-MW6D

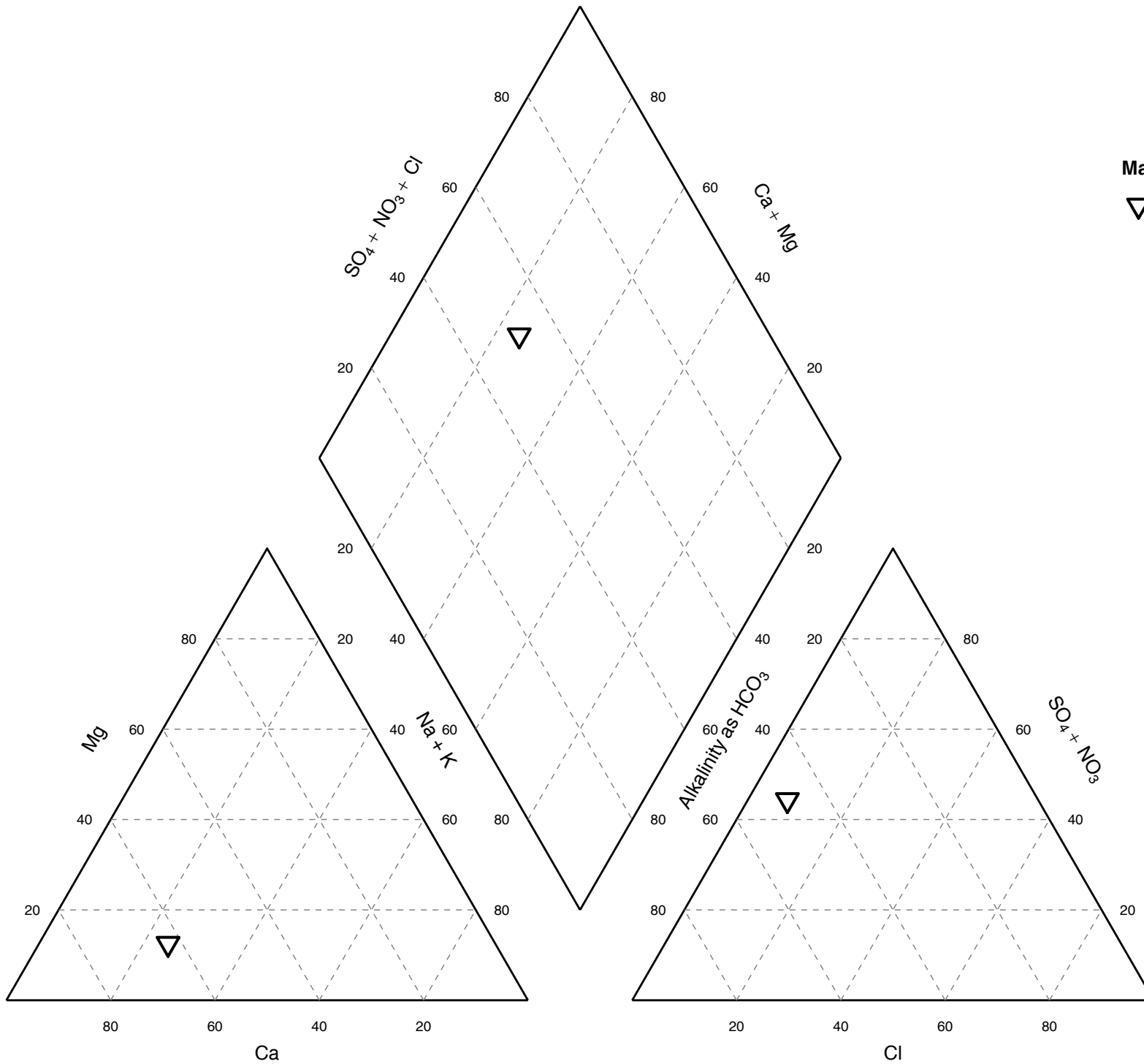

February 2018

▽ DLF-MW6B

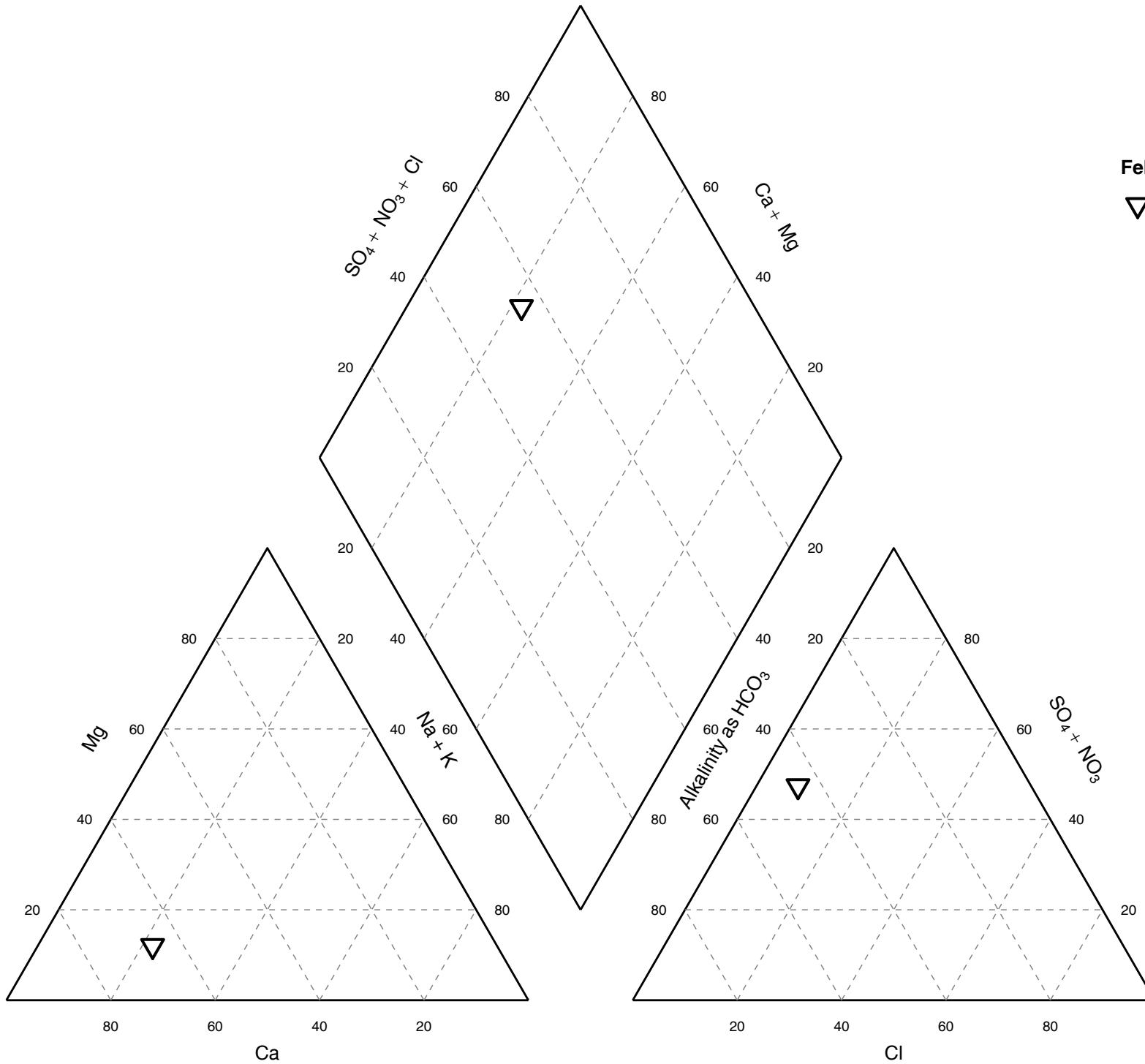

February 2019

▽ DLF-MW6C

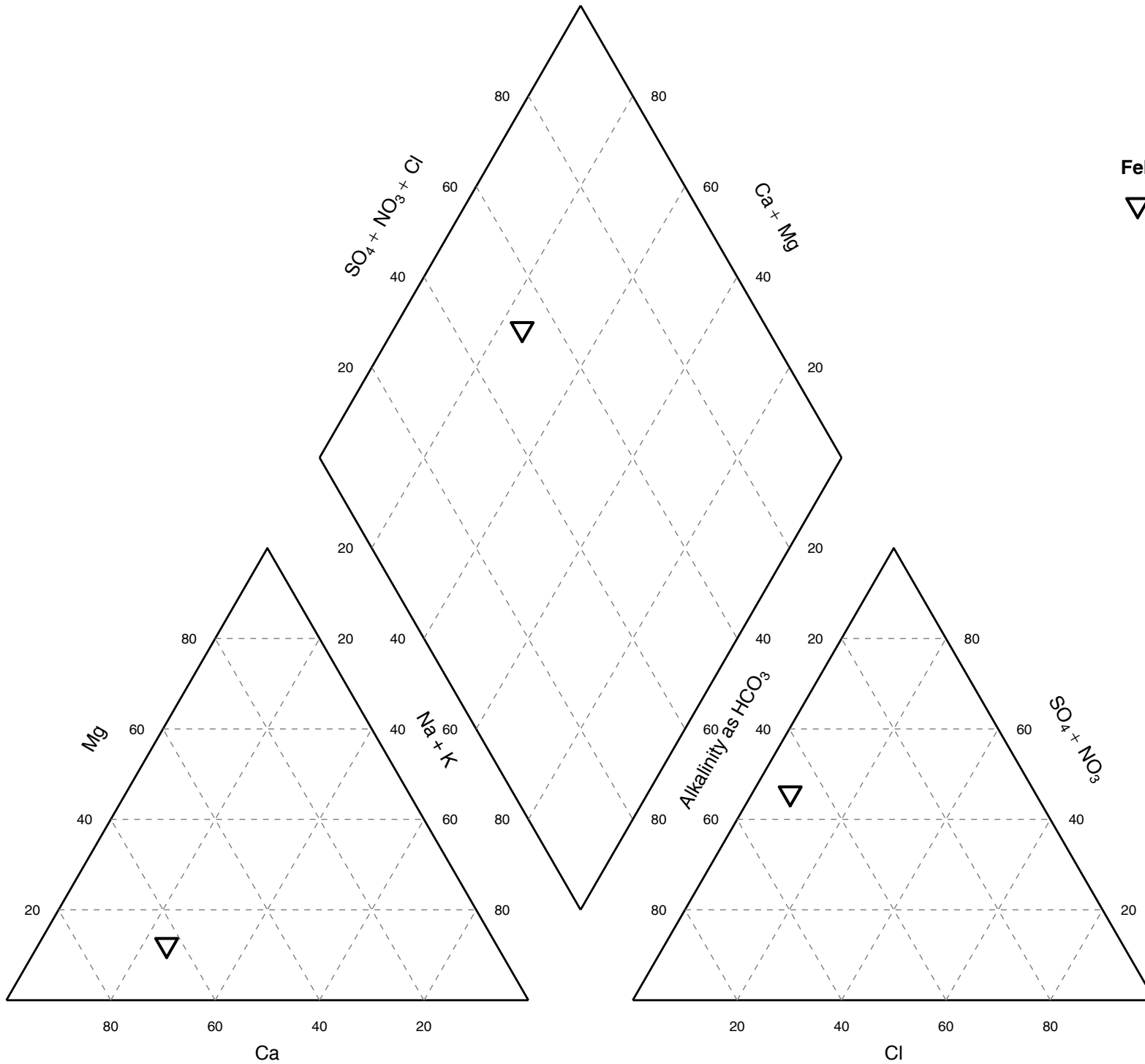

August 2013

△ ELK-MW2B

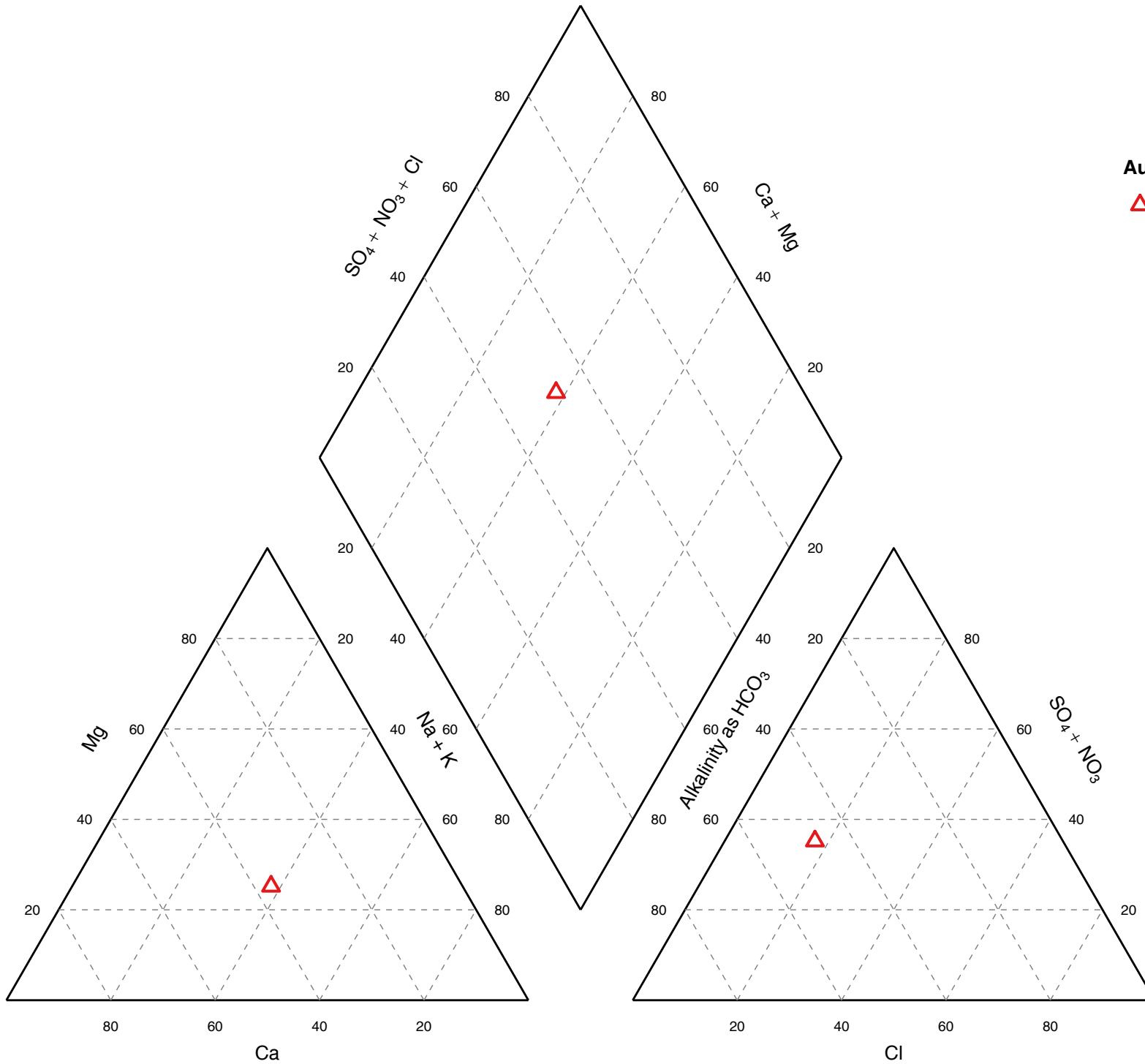

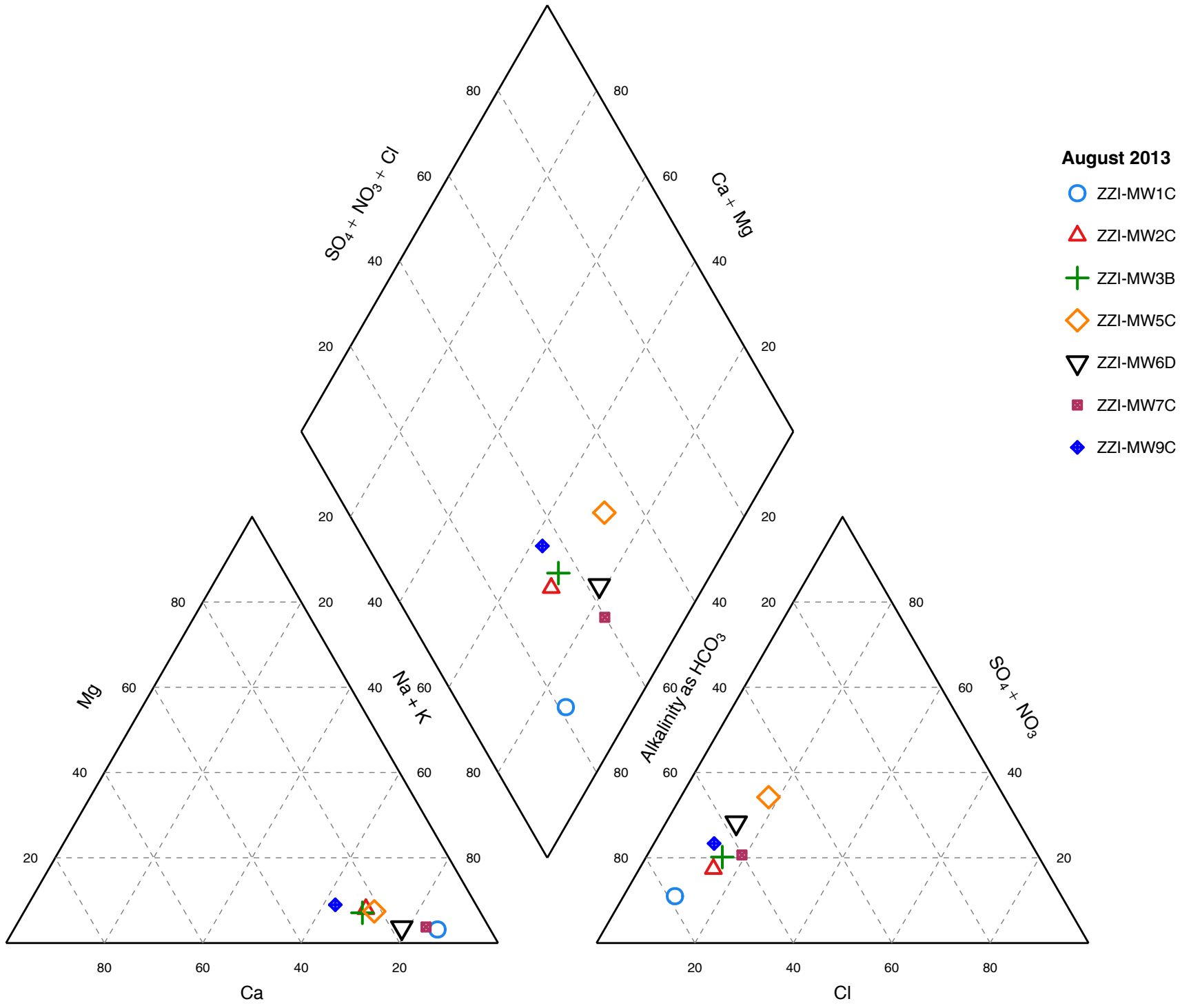

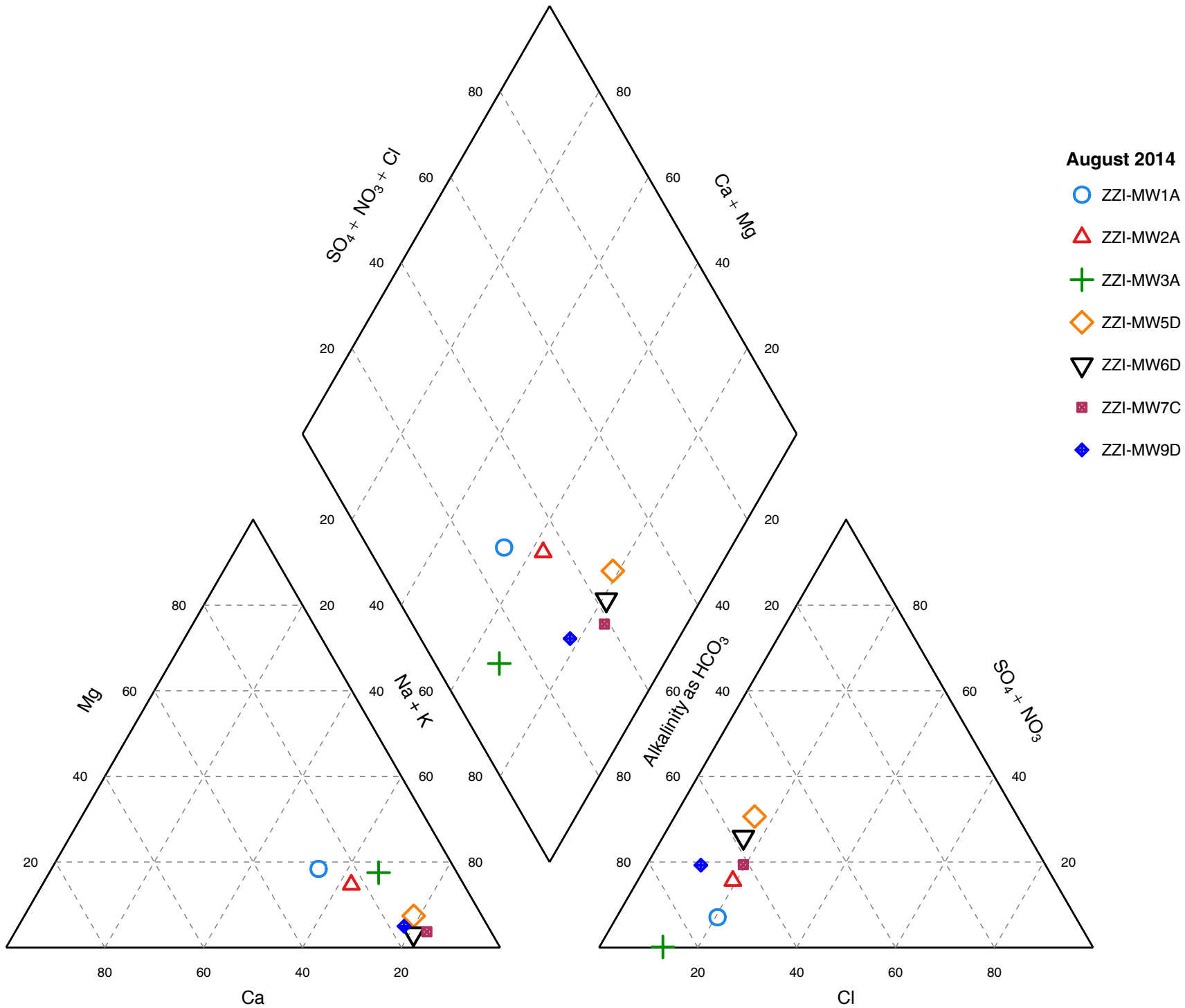

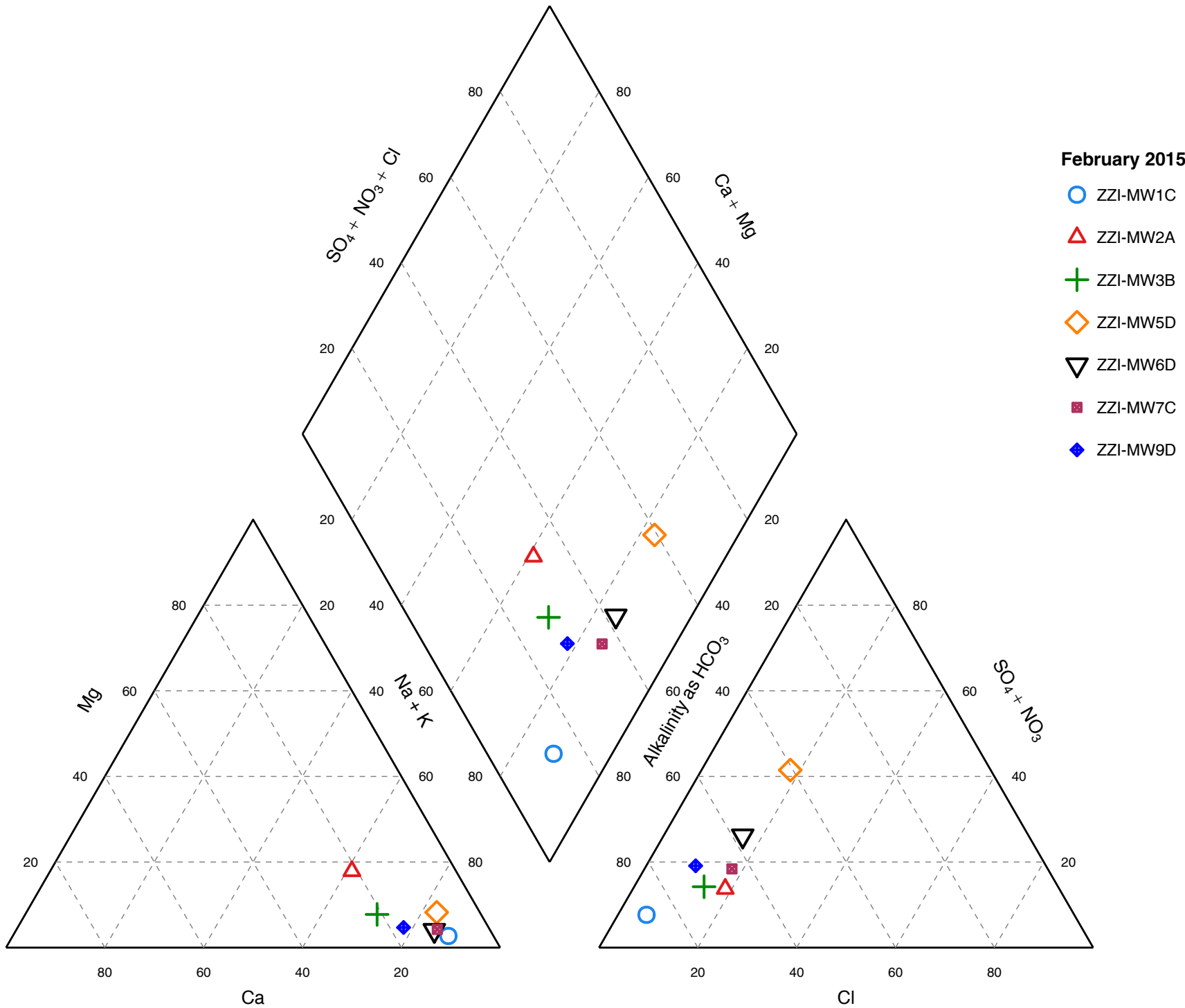

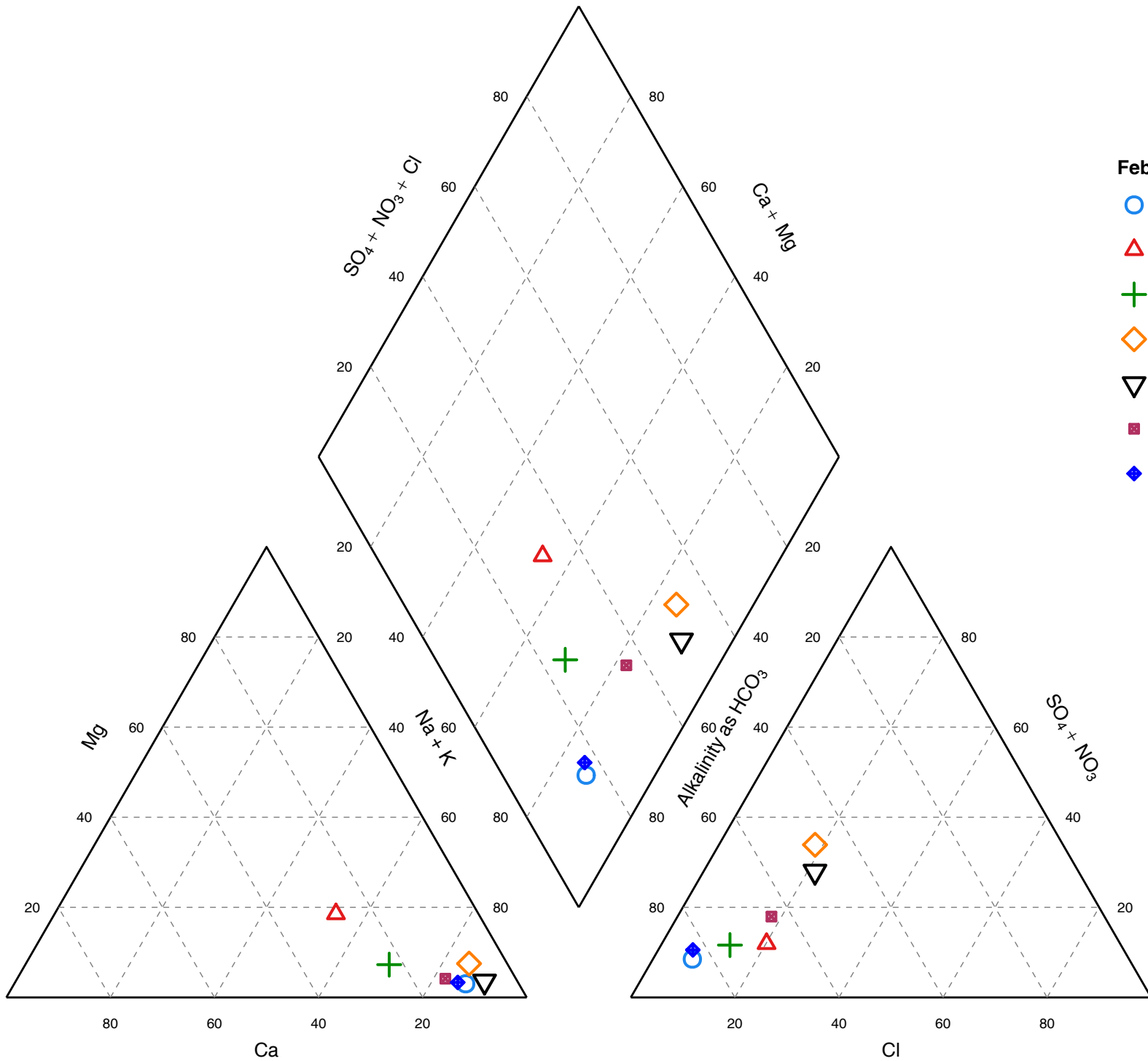

February 2016

- ZZI-MW1C
- △ ZZI-MW2A
- + ZZI-MW3B
- ◇ ZZI-MW5D
- ▽ ZZI-MW6D
- ZZI-MW7C
- ◆ ZZI-MW9D

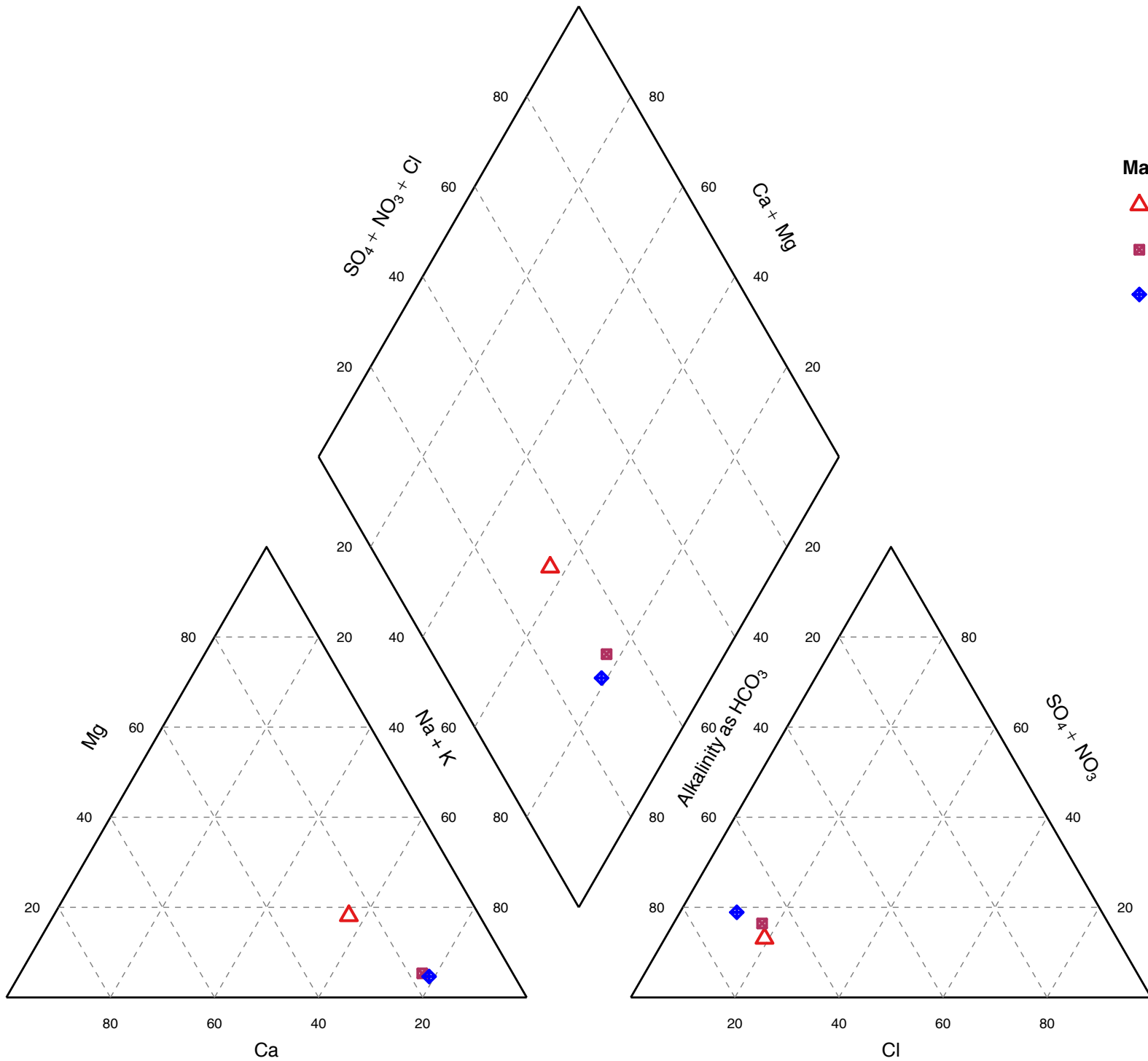

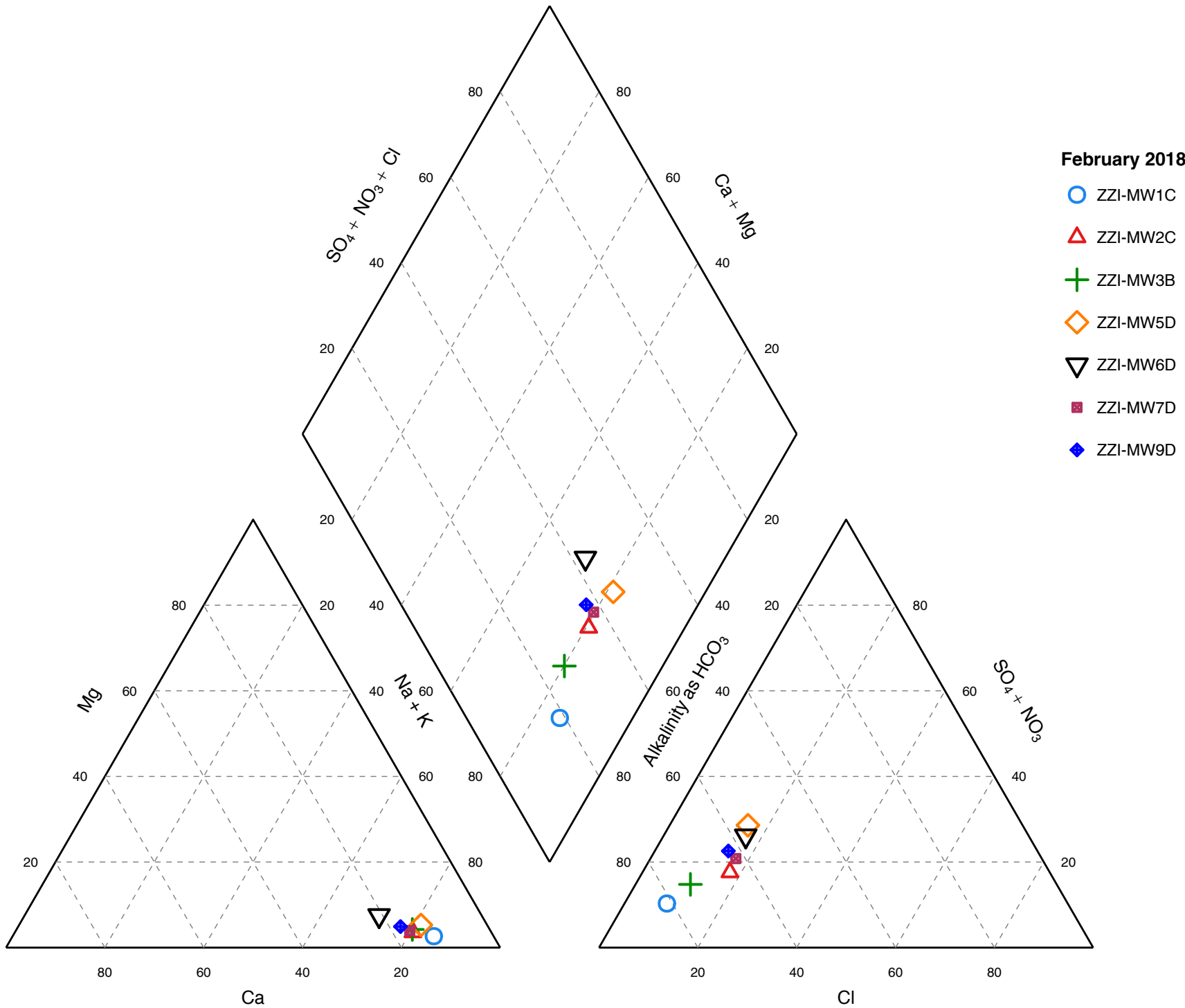

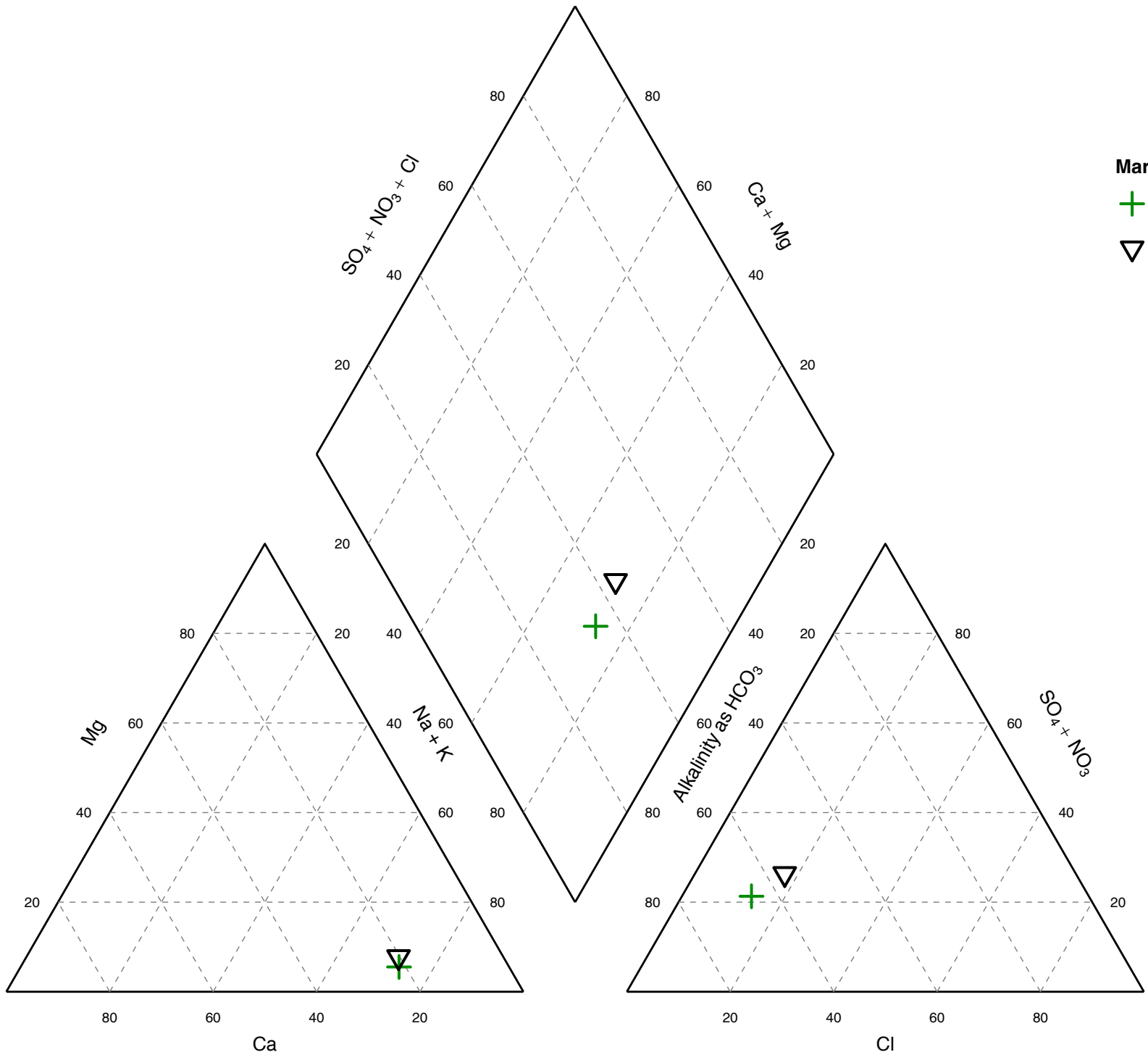

March 2019
 + ZZI-MW3B
 ▽ ZZI-MW6D

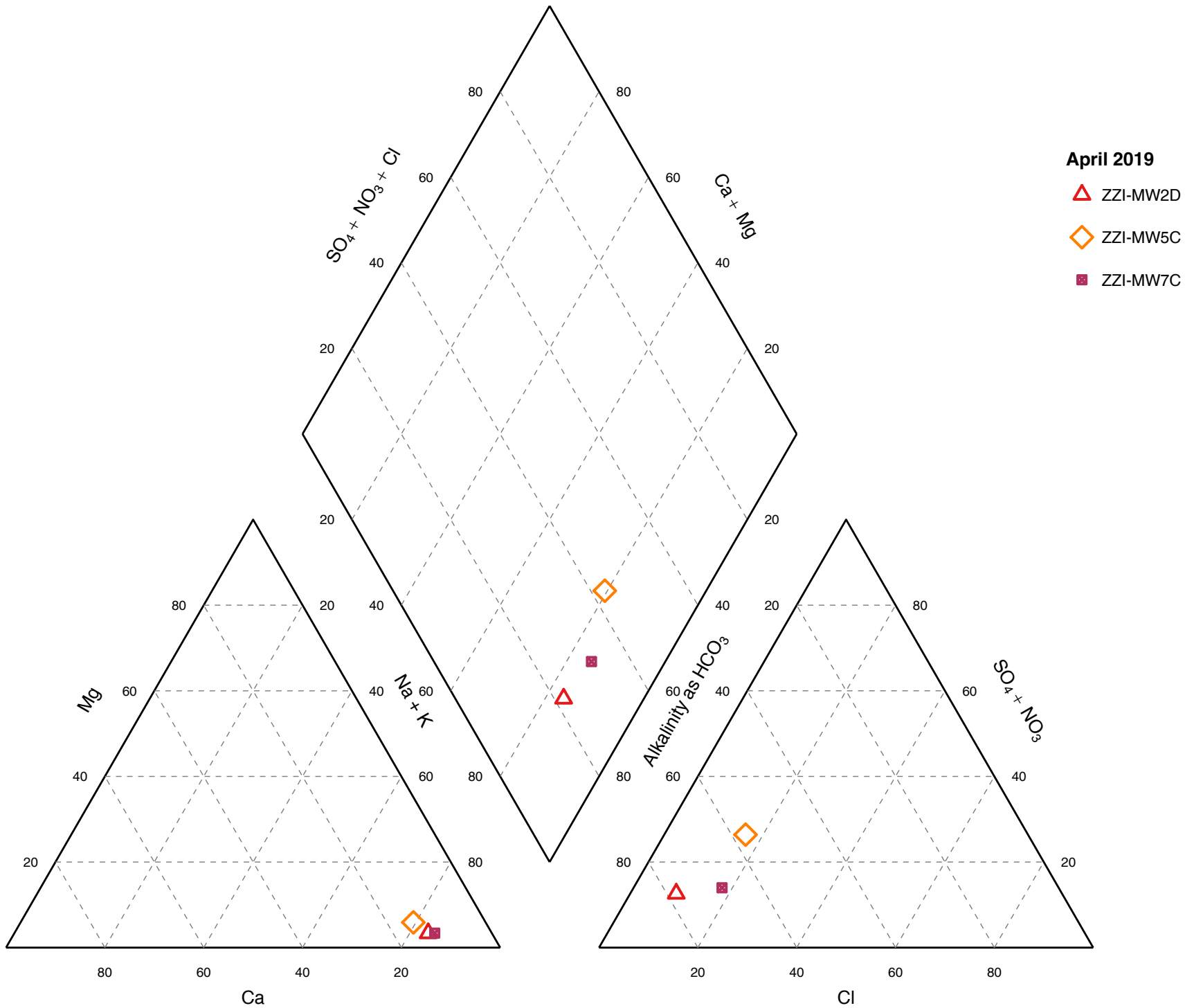

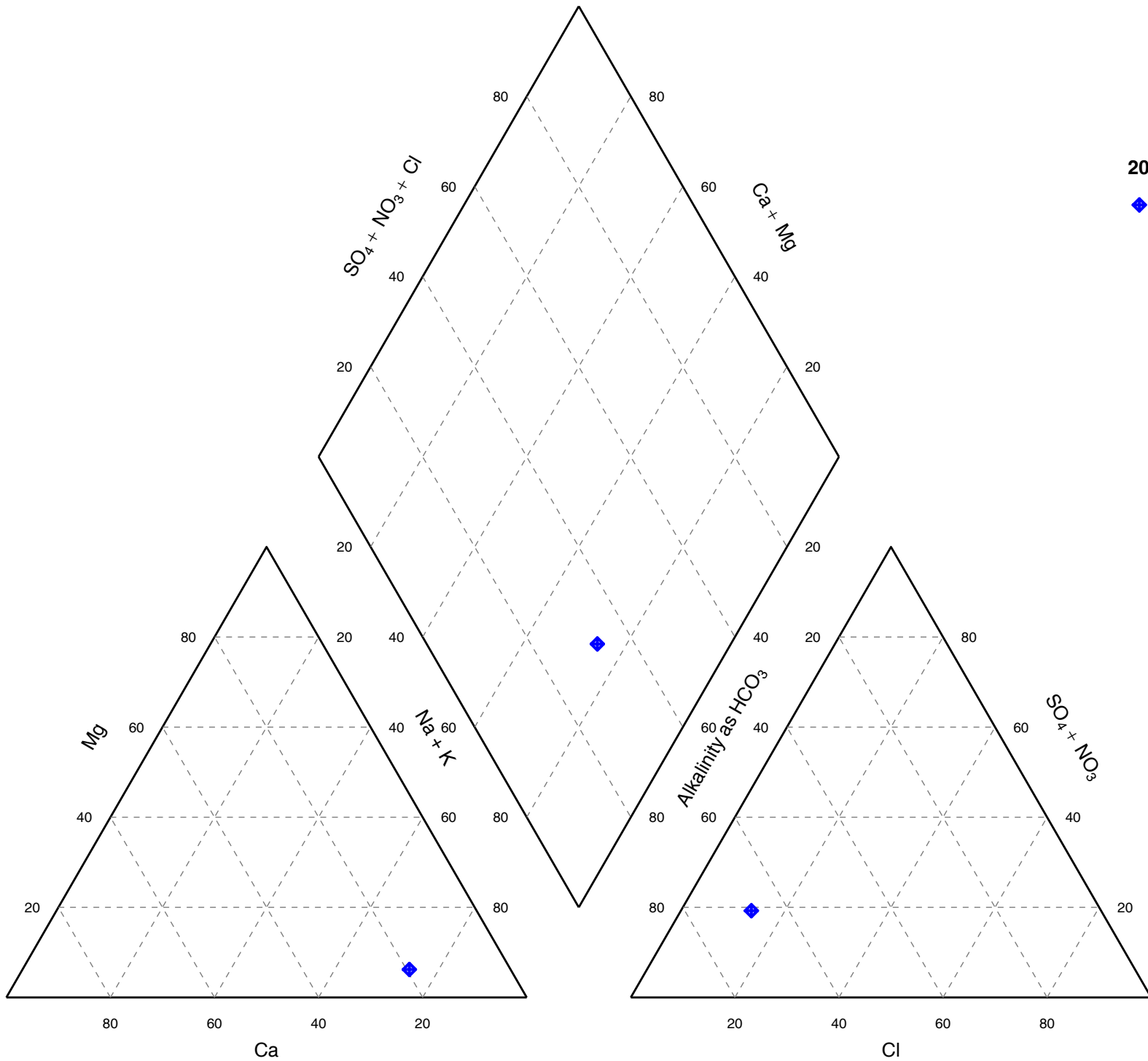

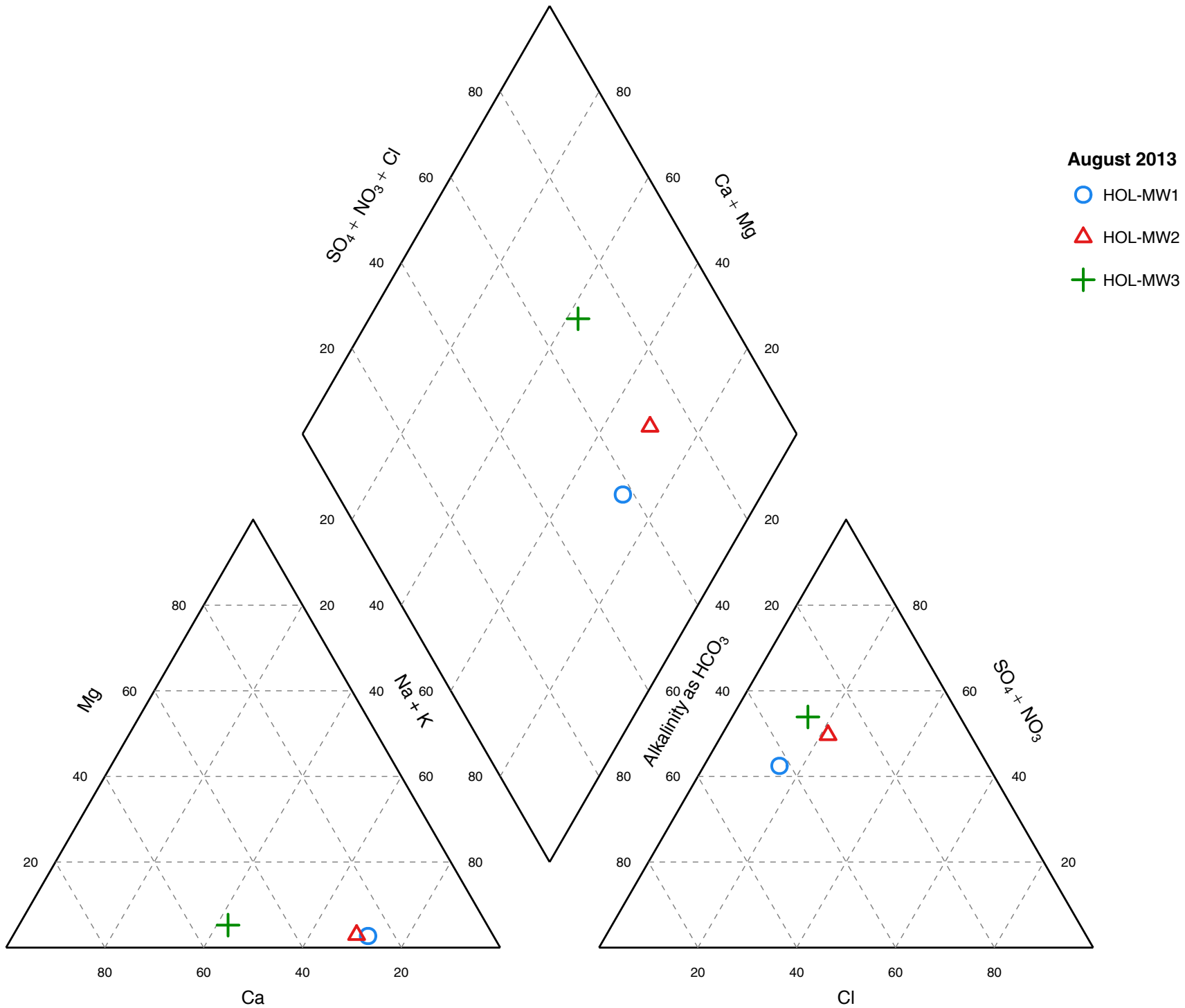

August 2014

HOL-MW1

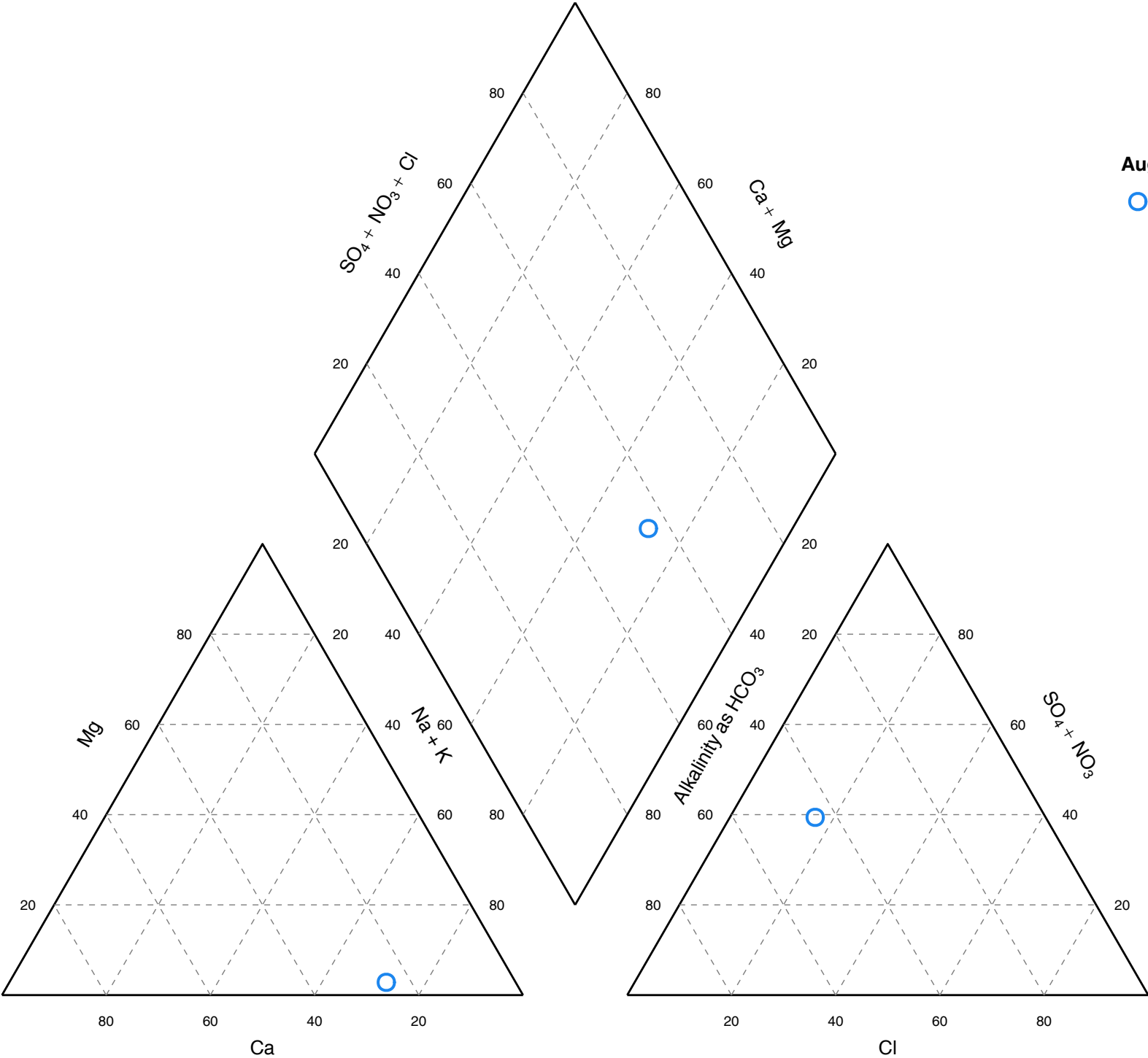

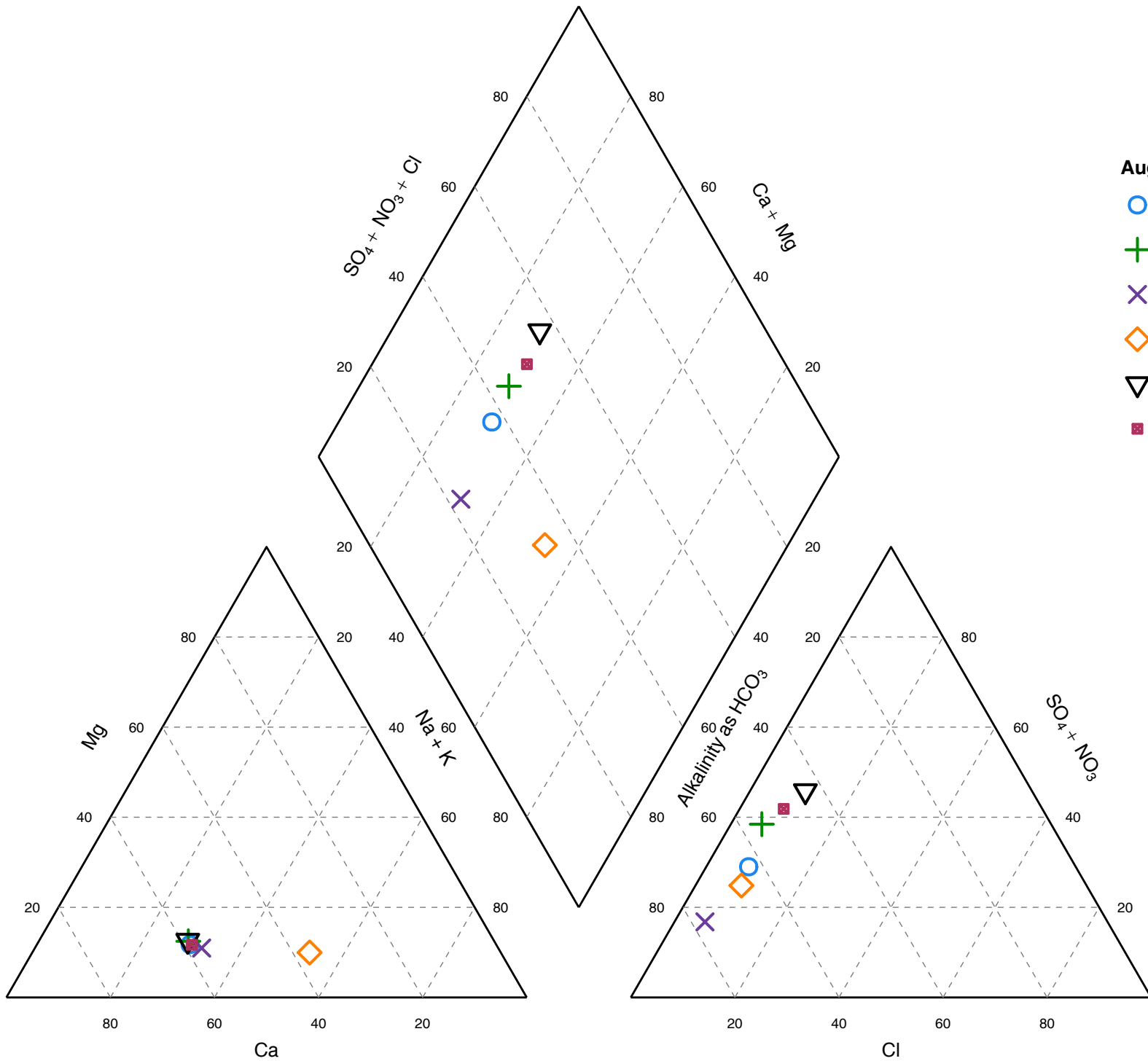

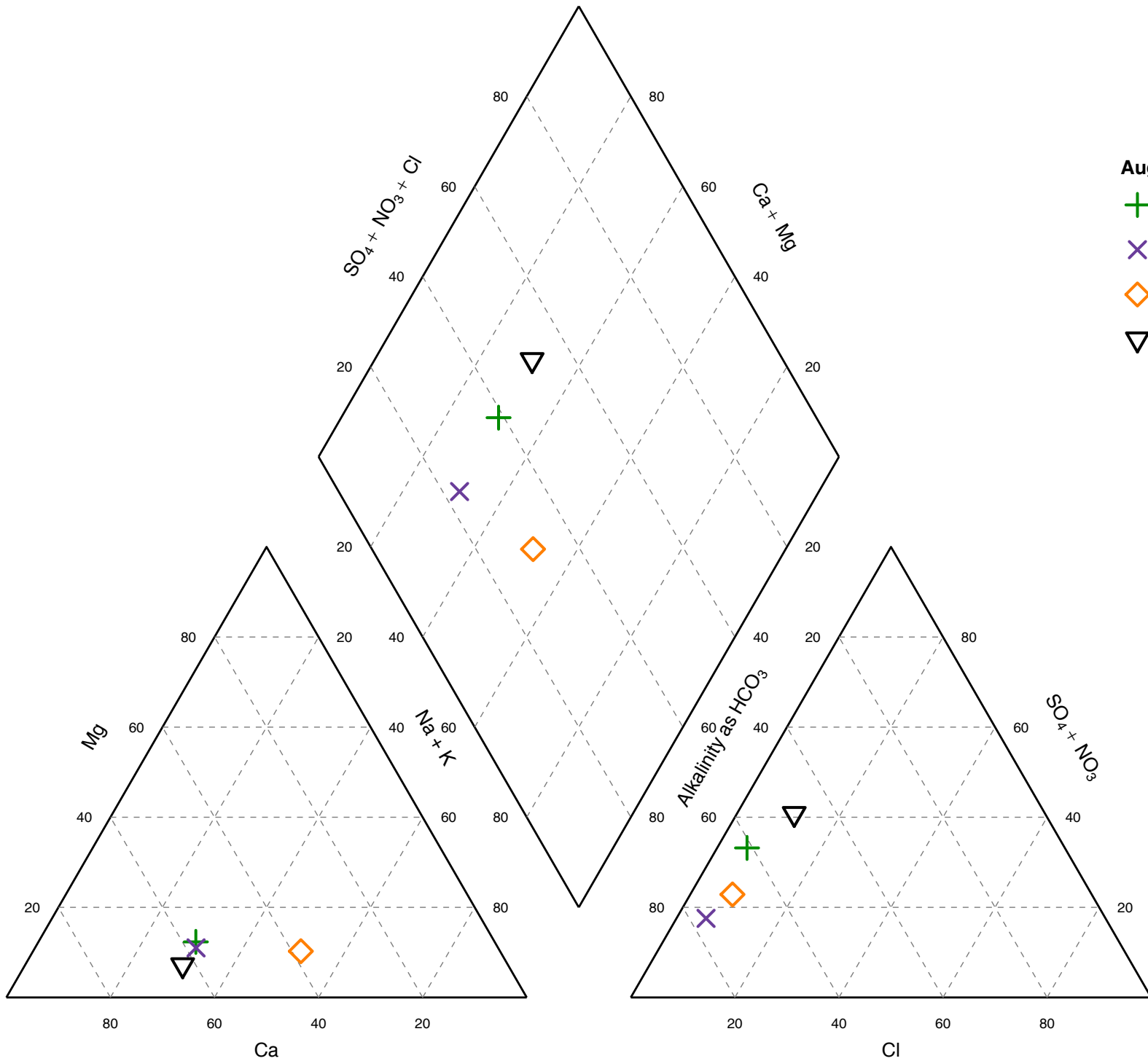

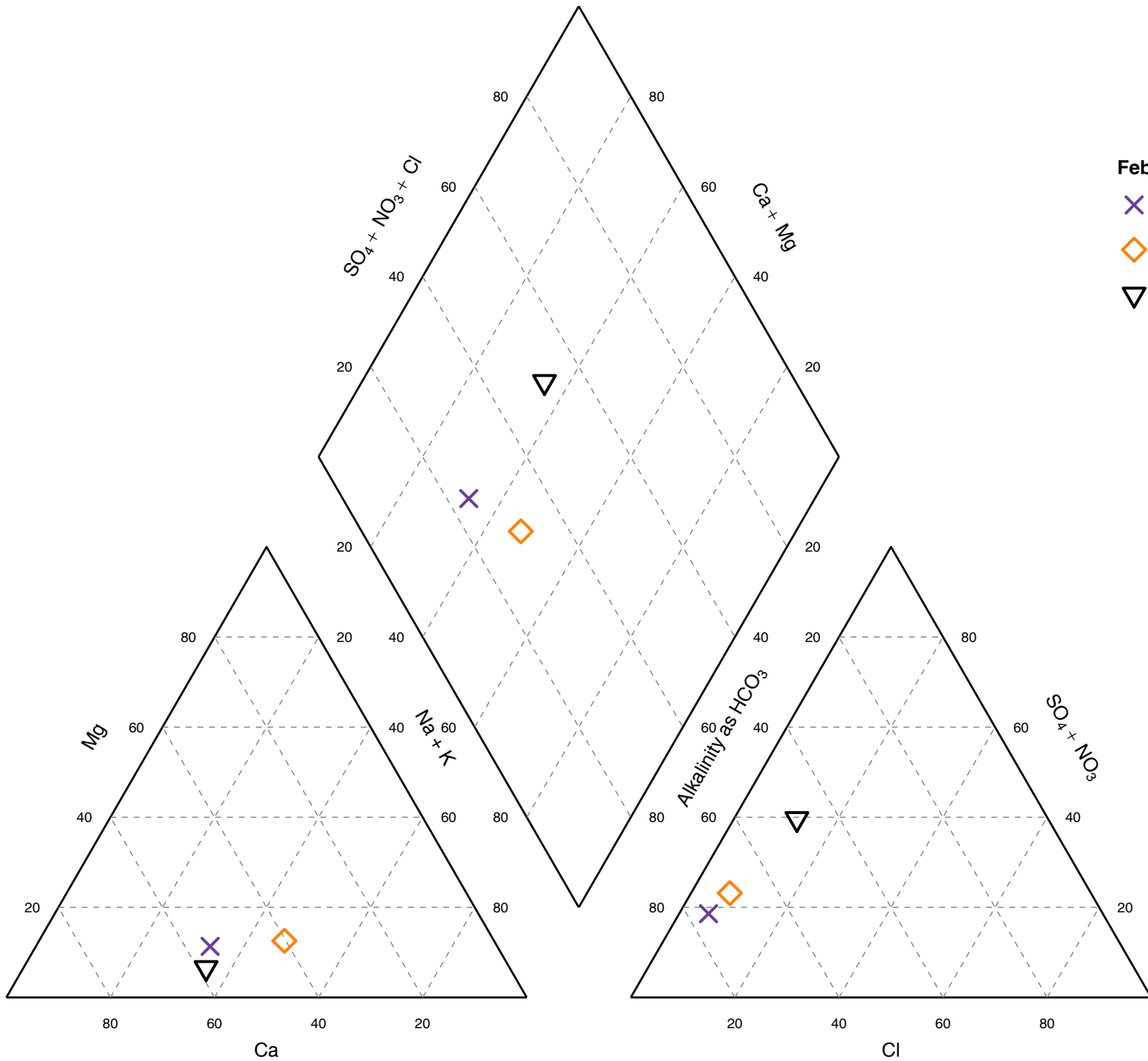

February 2016

▽ JAD-MW6d

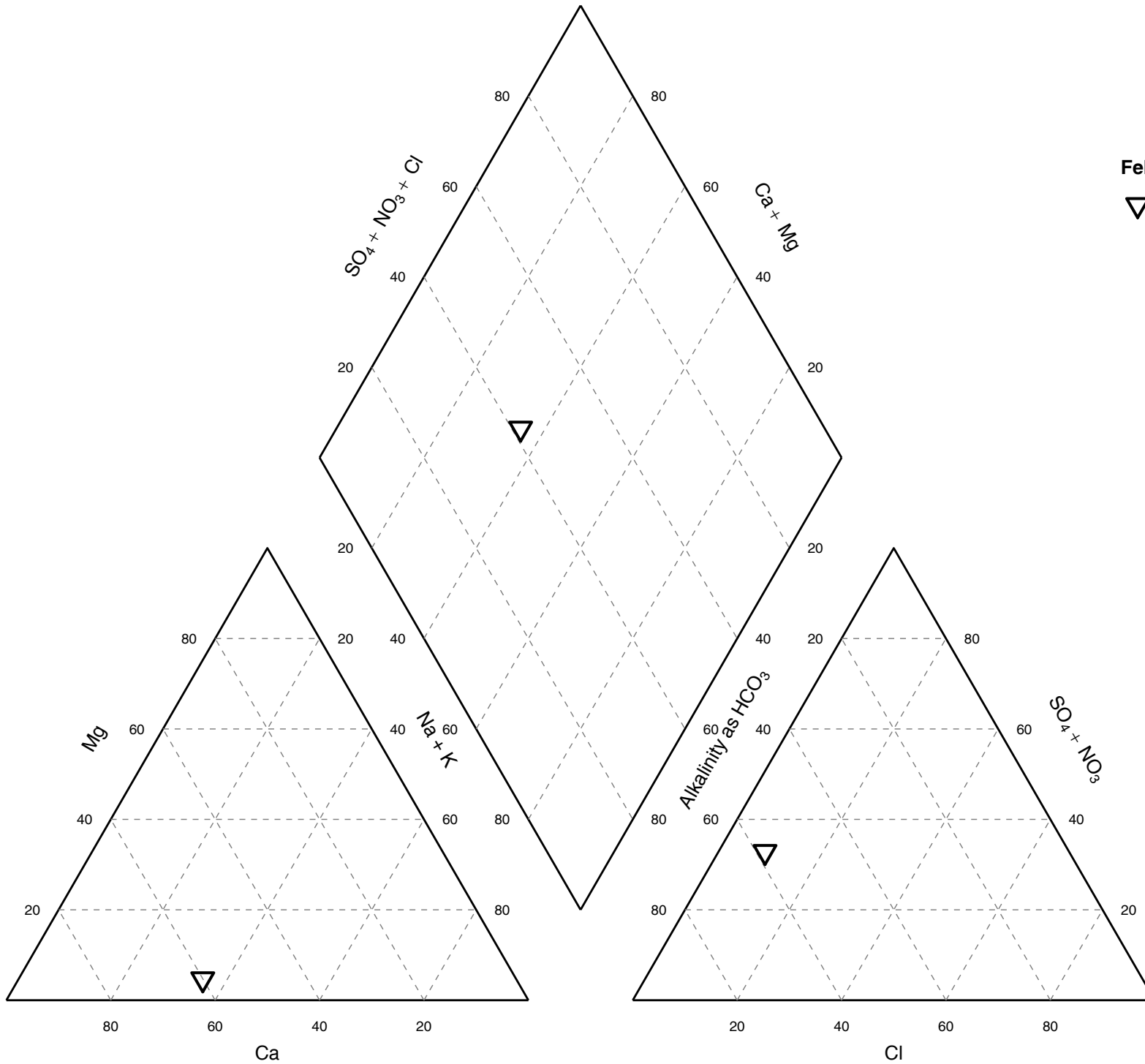

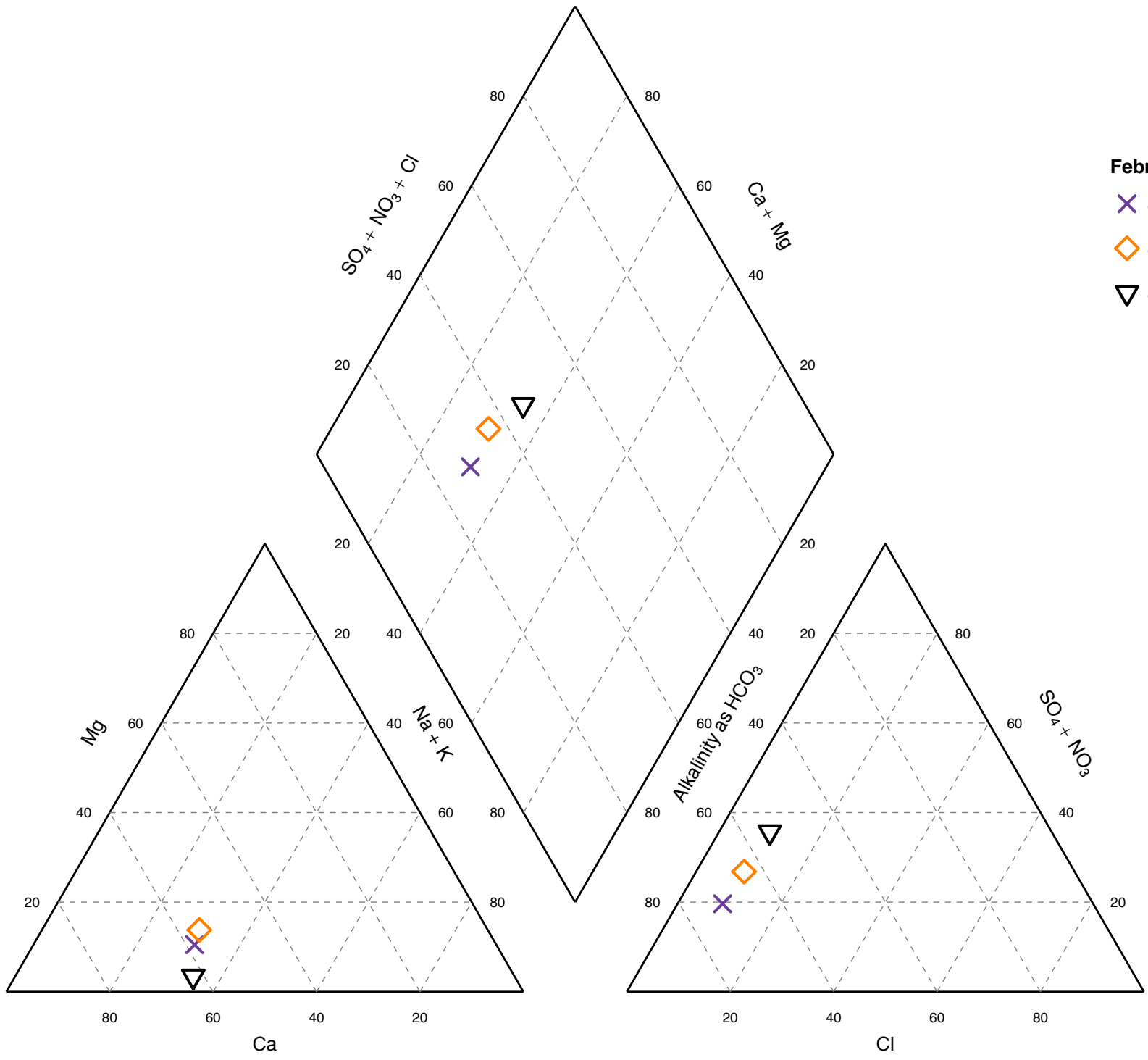

February 2018

✕ JAD-MW4d

◇ JAD-MW5s

▽ JAD-MW6d

March 2019

✕ JAD-MW4d

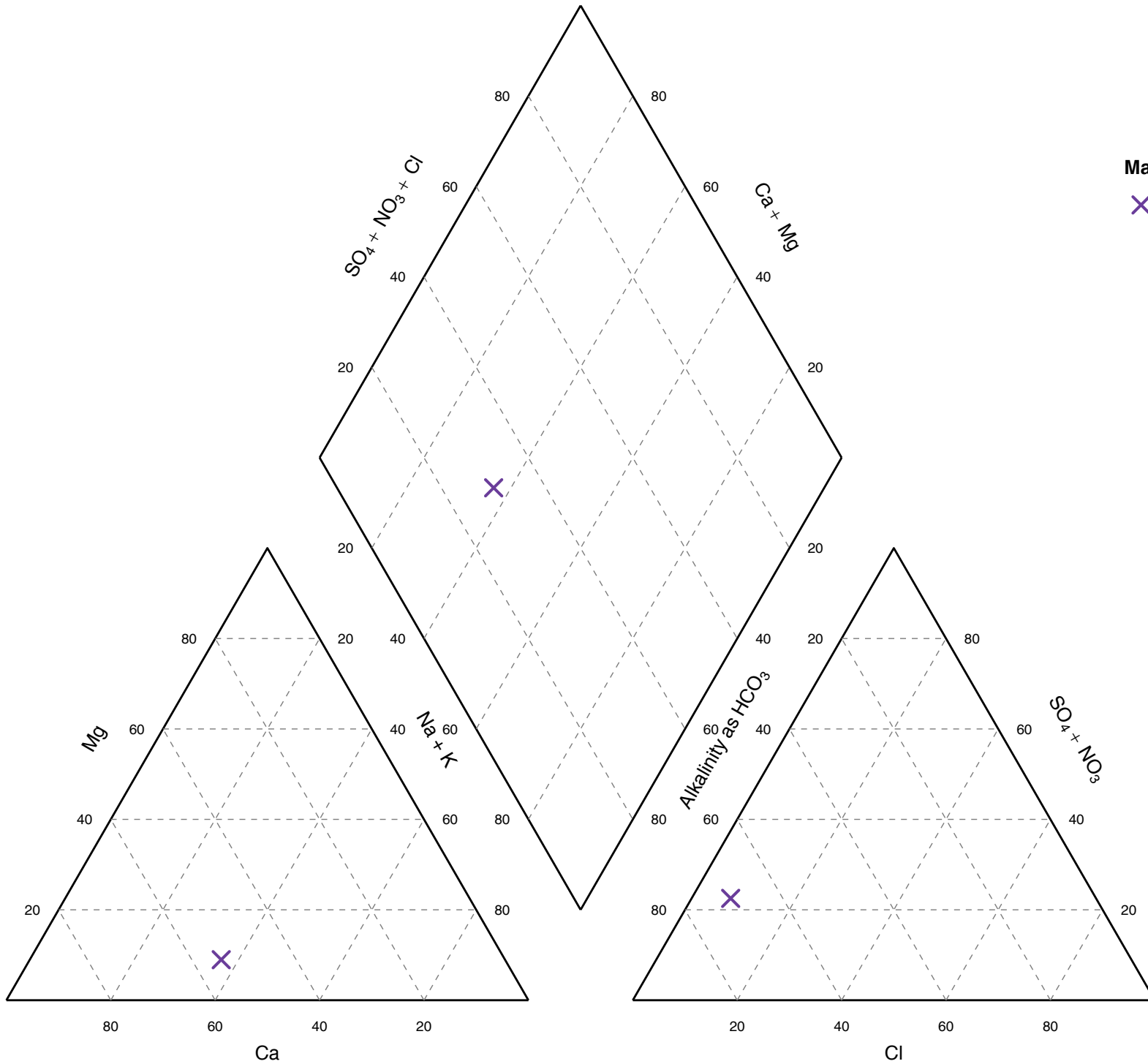

April 2019

▽ JAD-MW6d

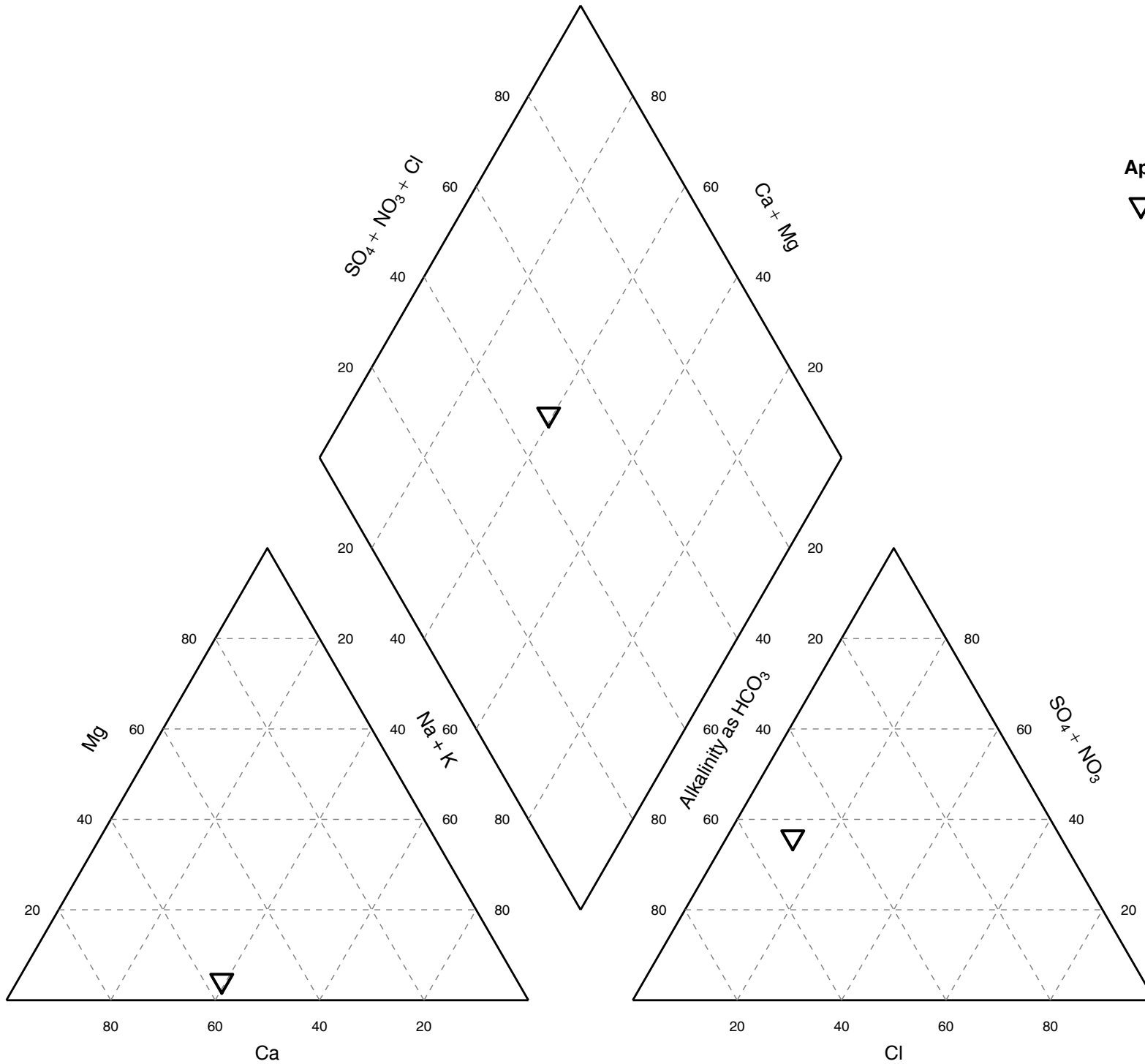

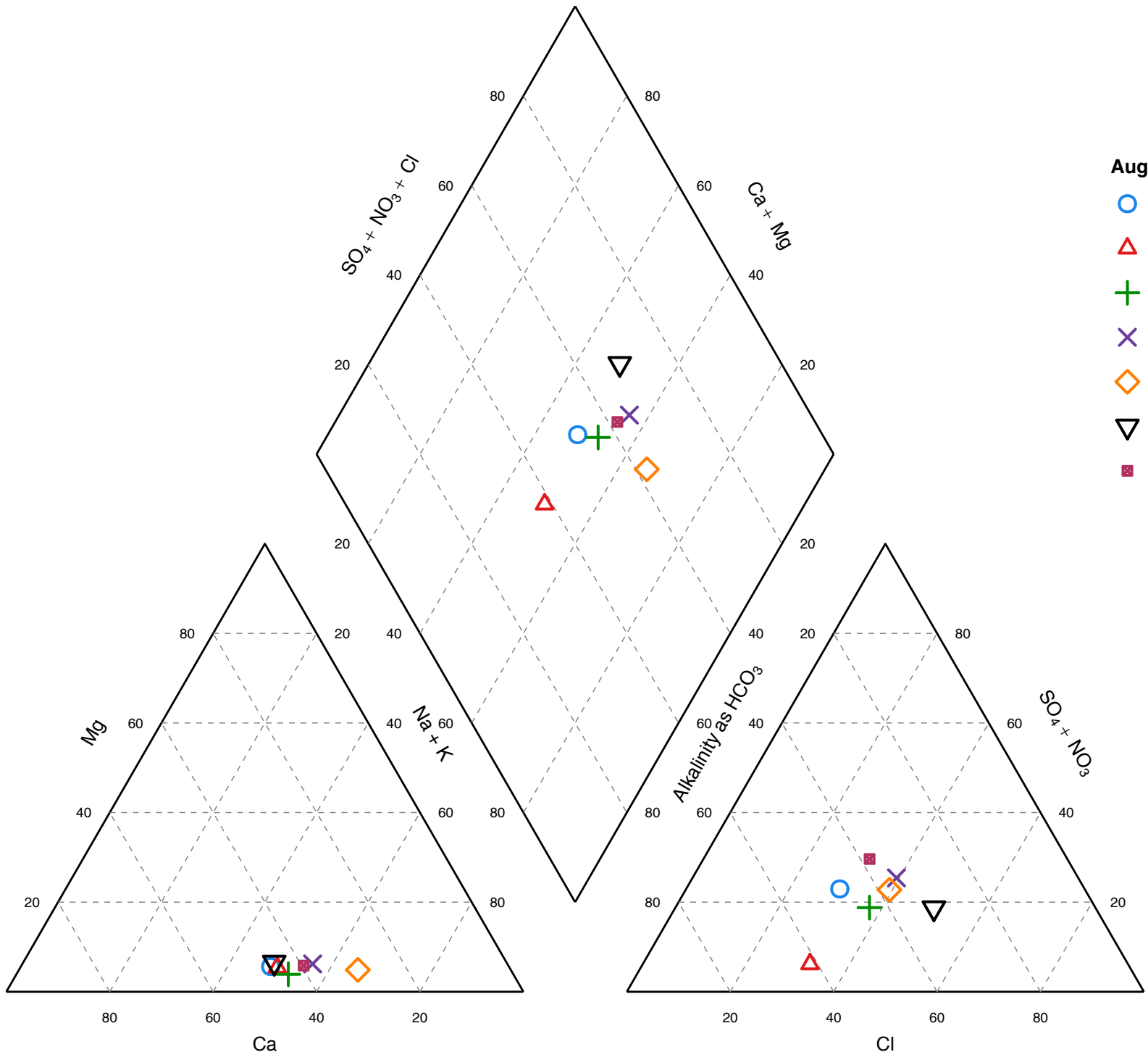

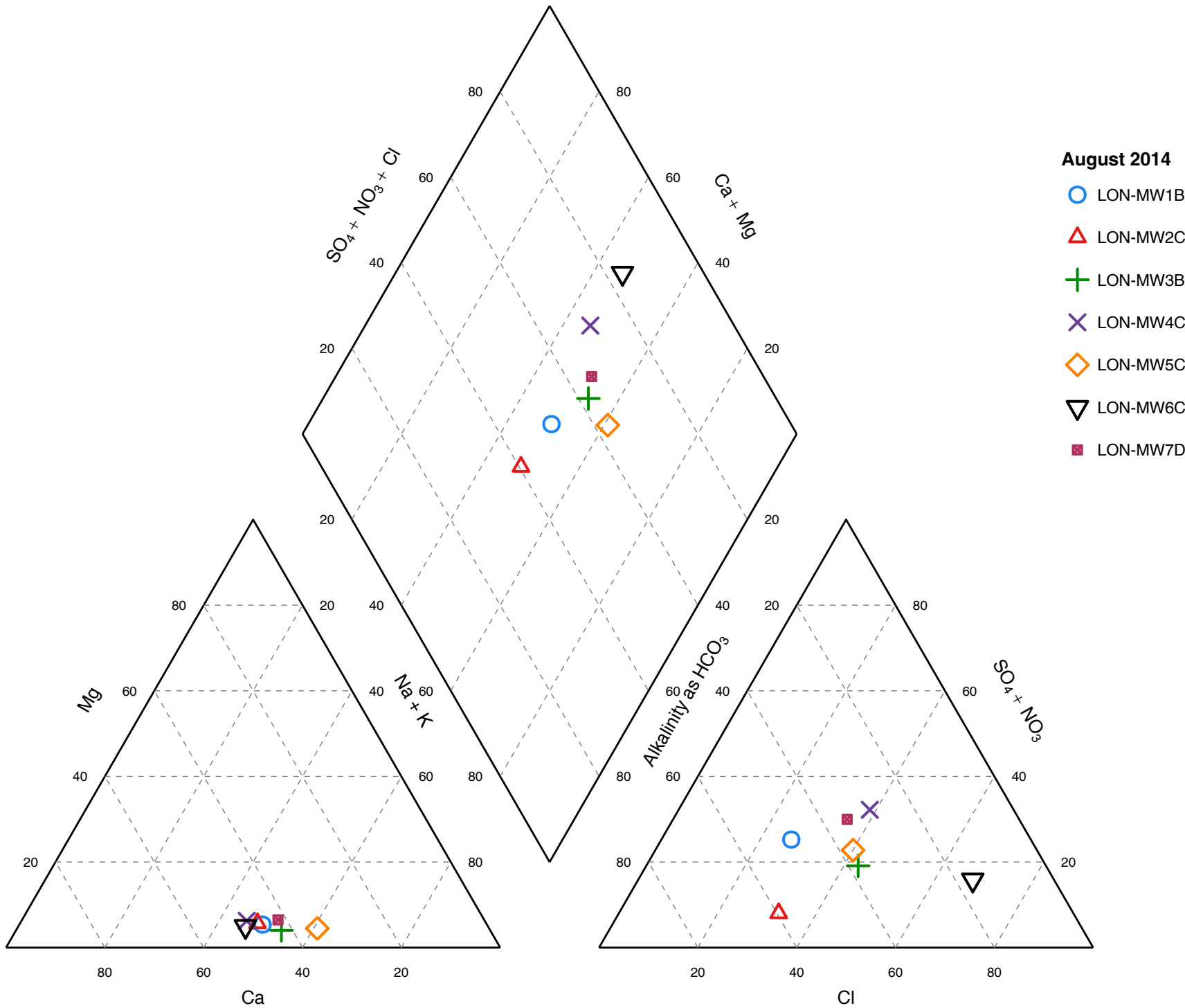

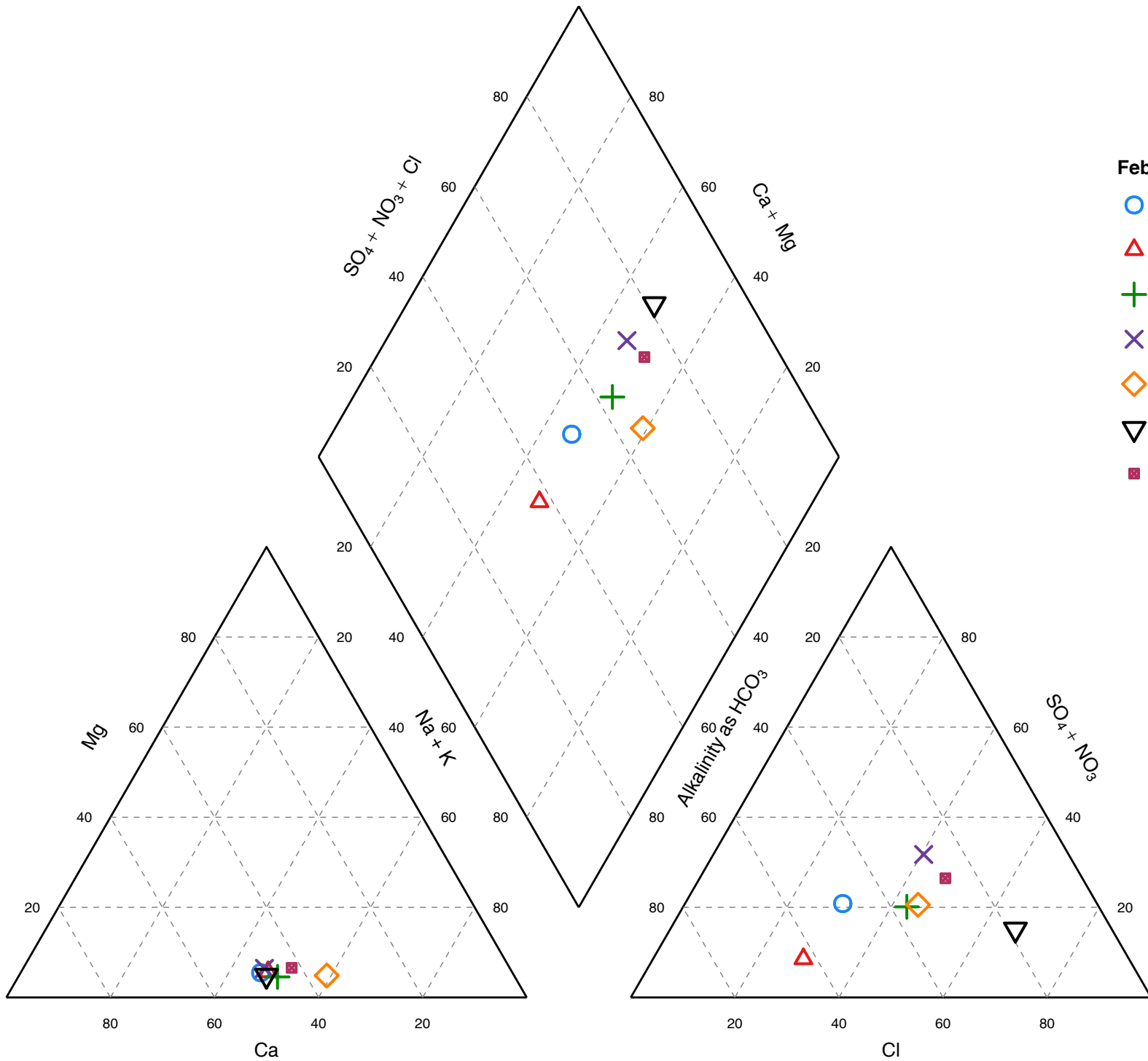

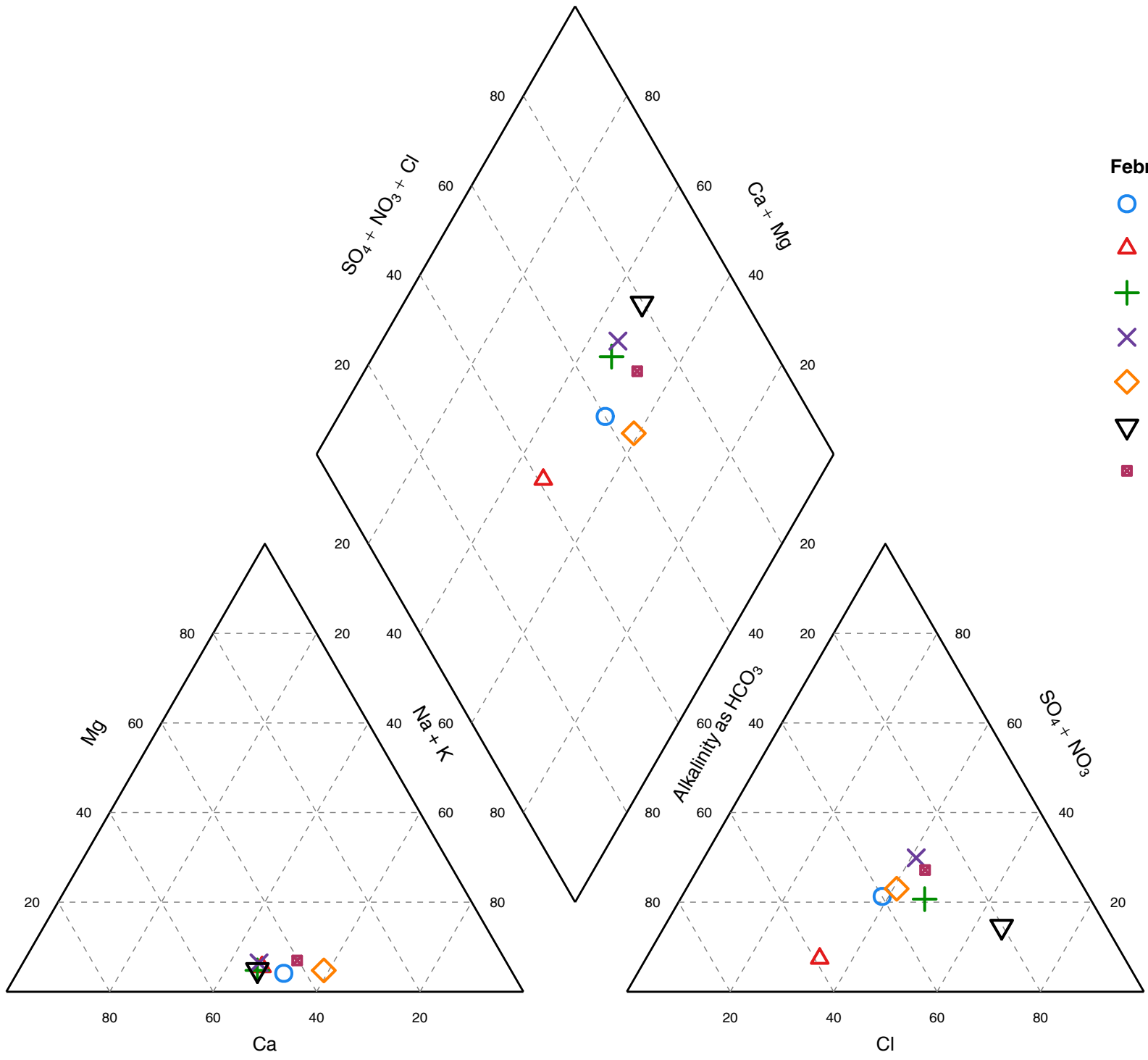

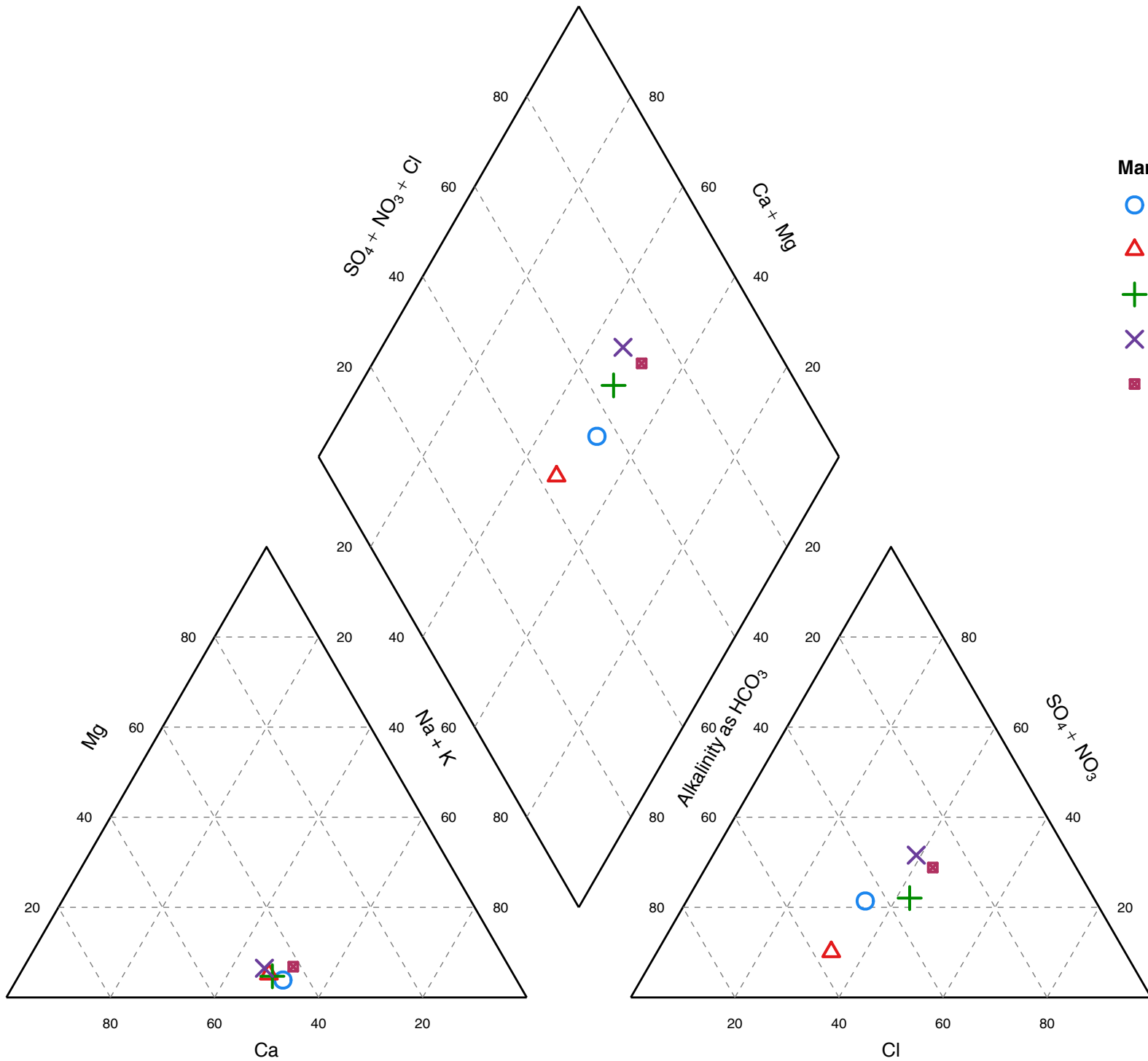

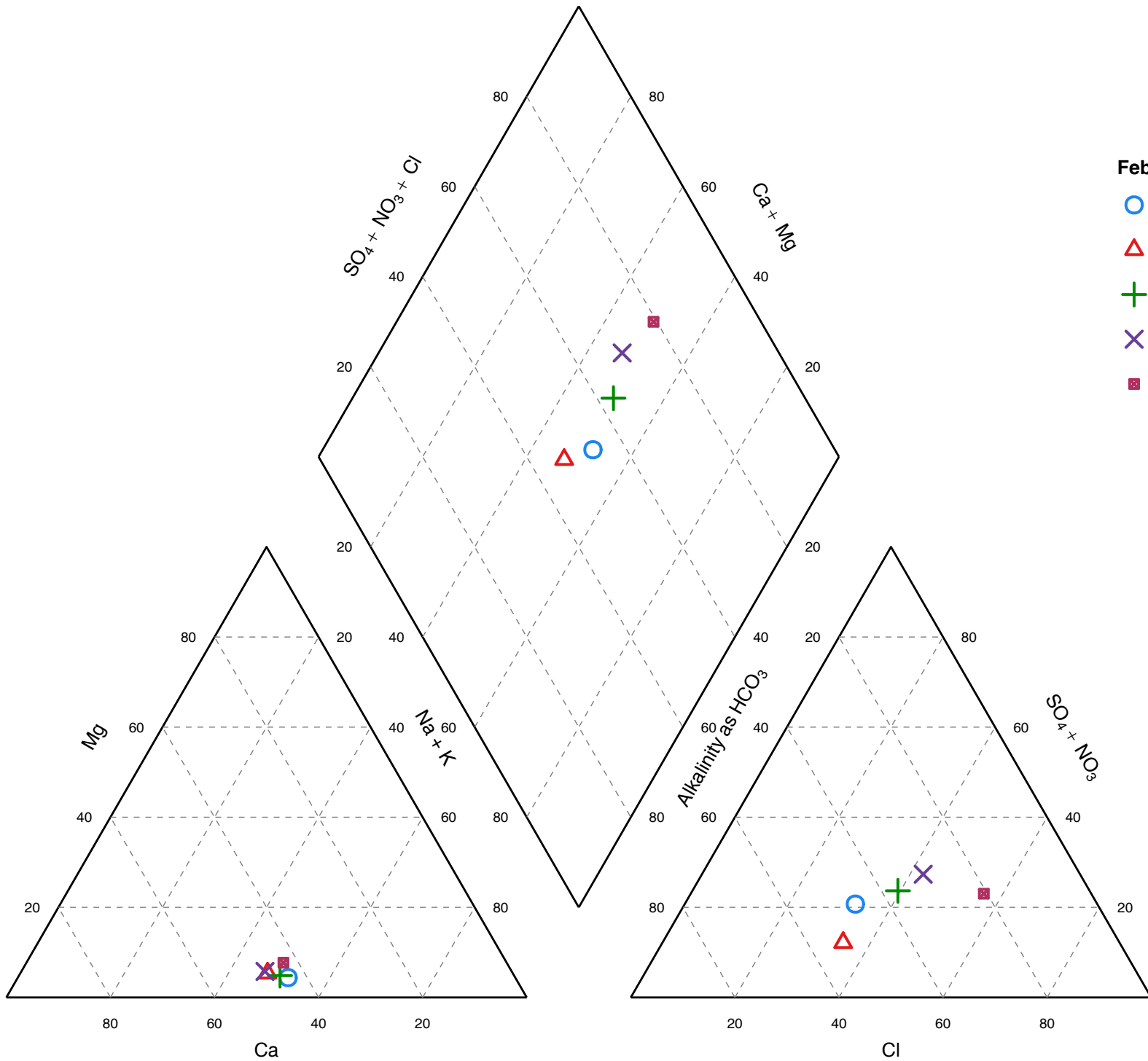

February 2019

✕ LON-MW4C

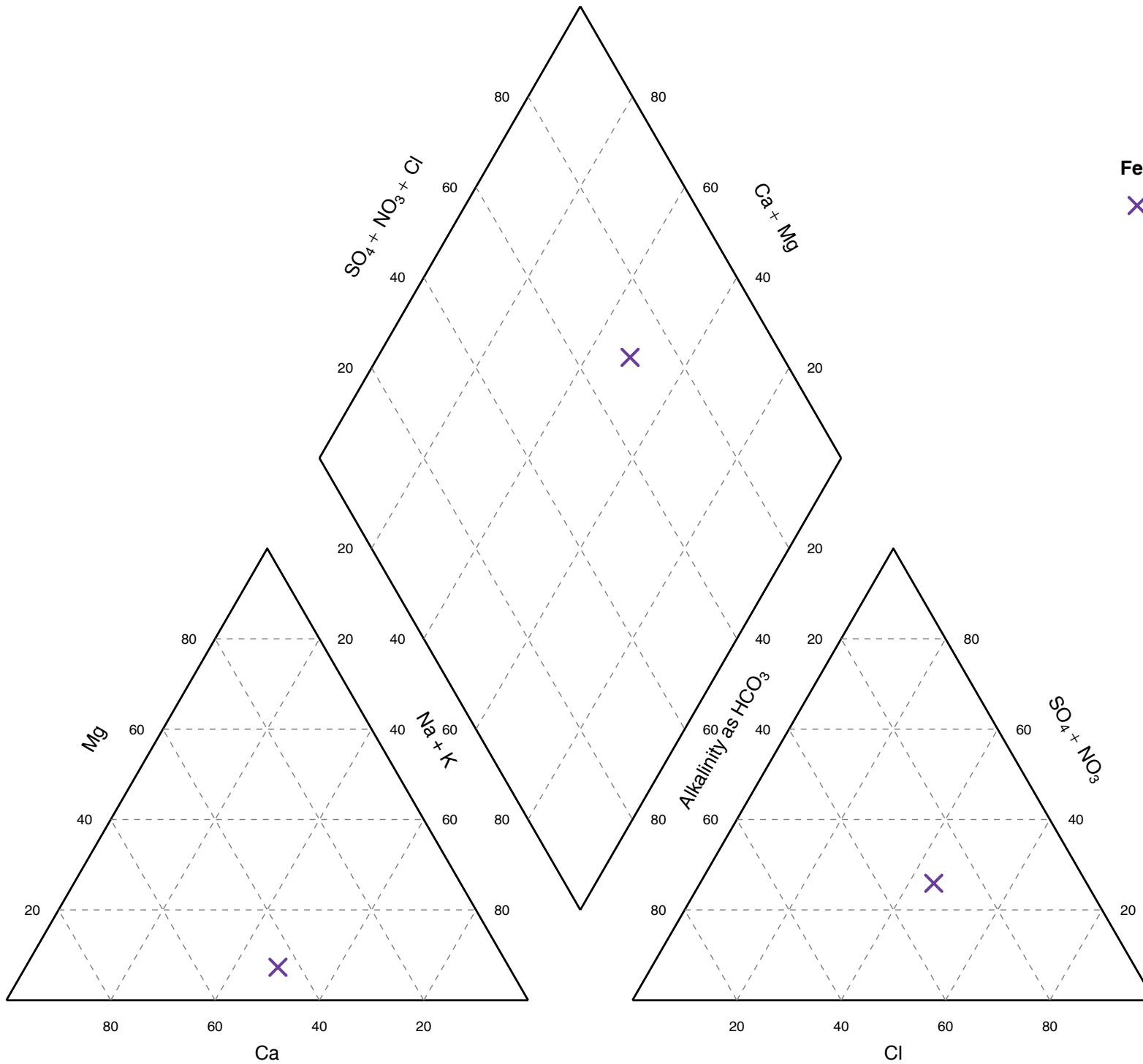

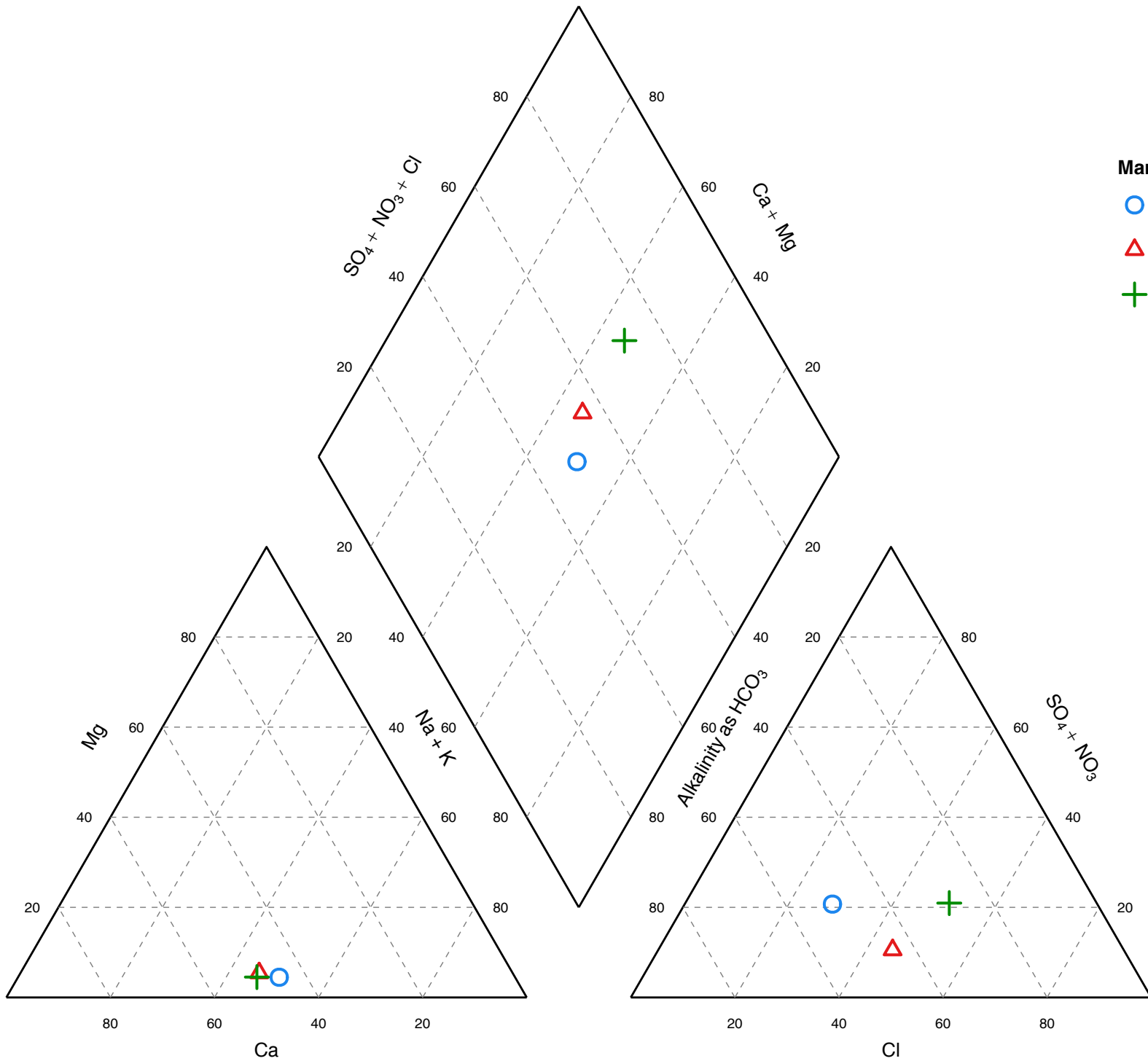

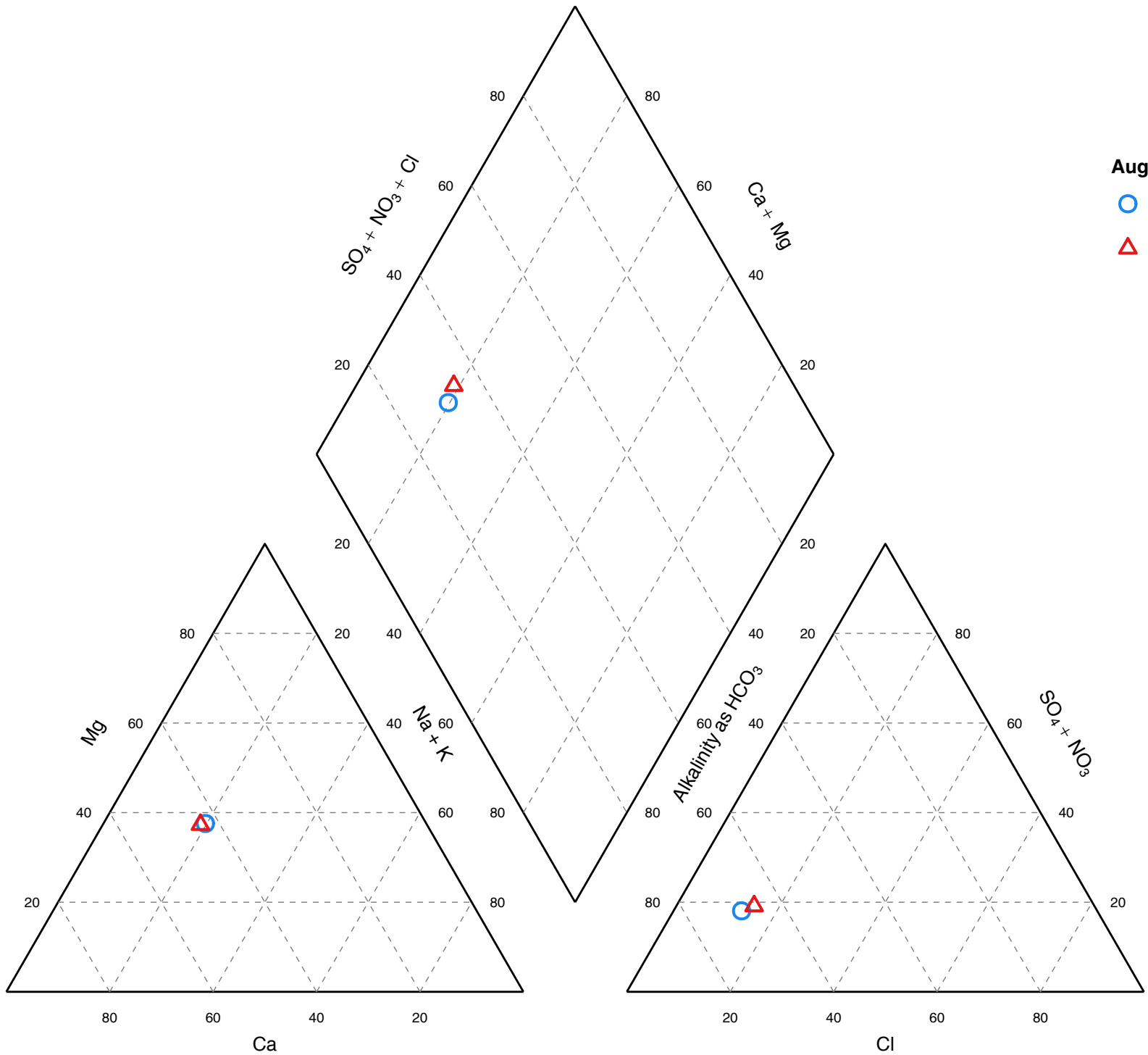

August 2013

○ ADO-MW1s

△ ADO-MW2d

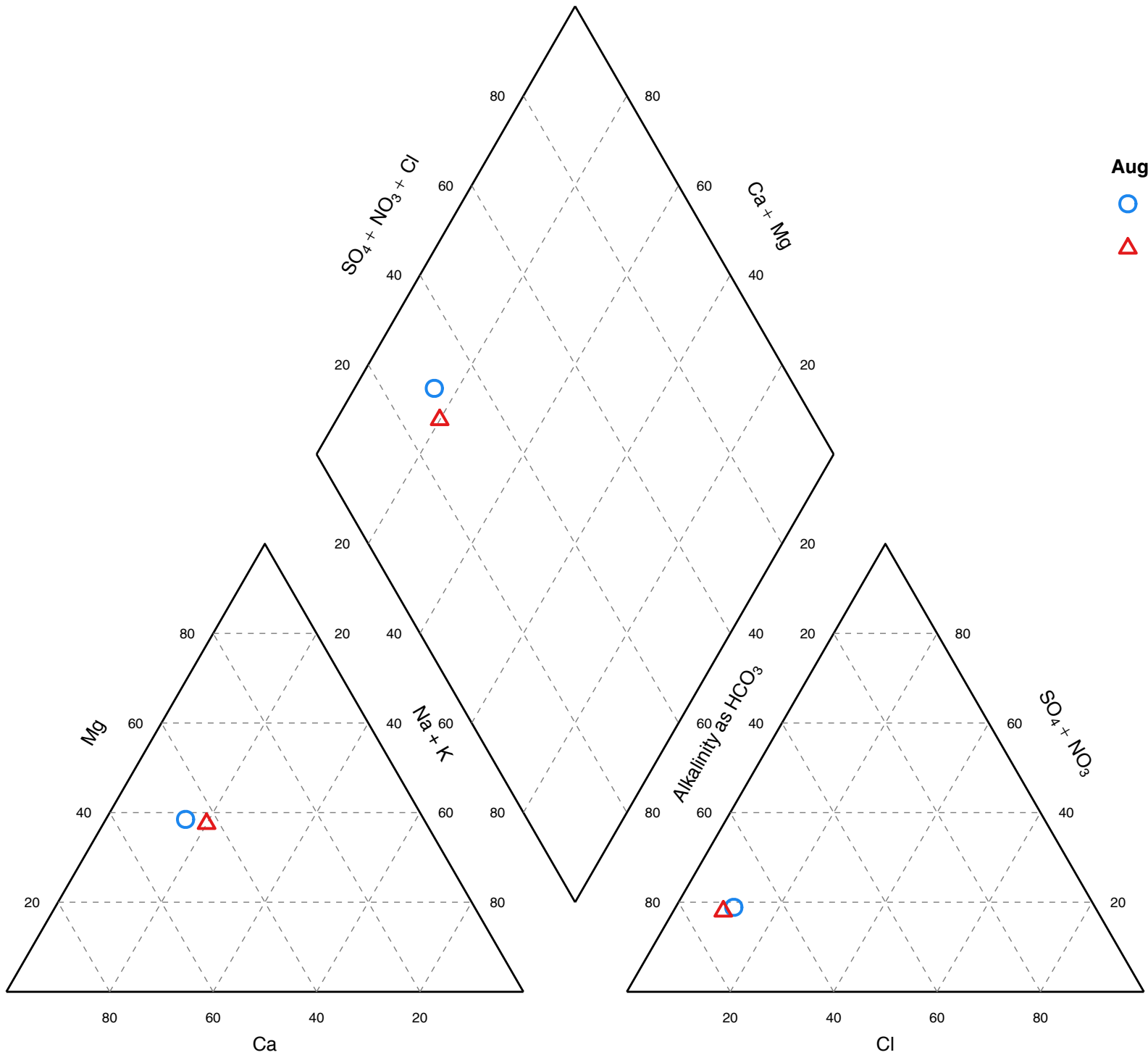

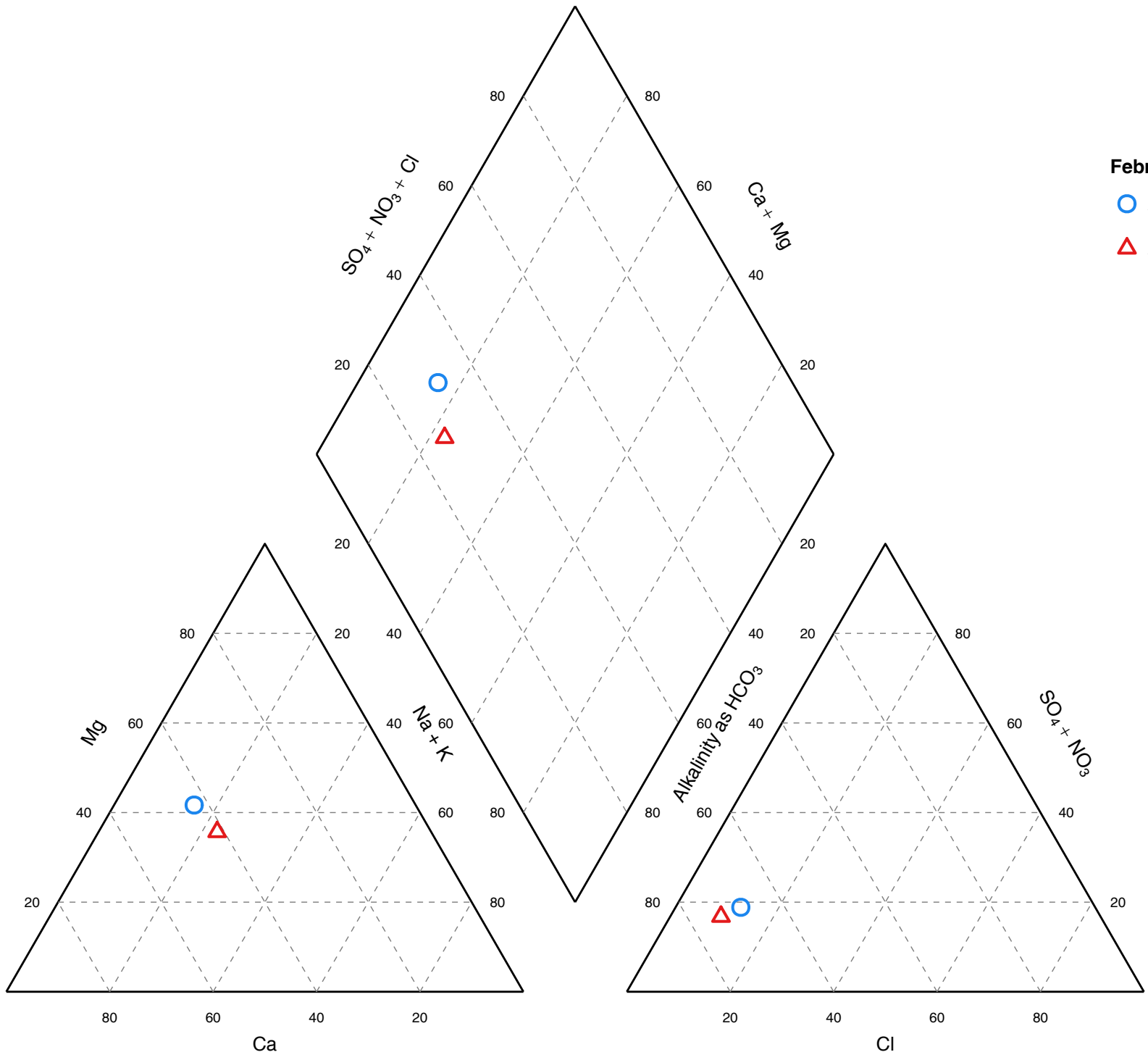

February 2015

- ADO-MW1d
- △ ADO-MW2d

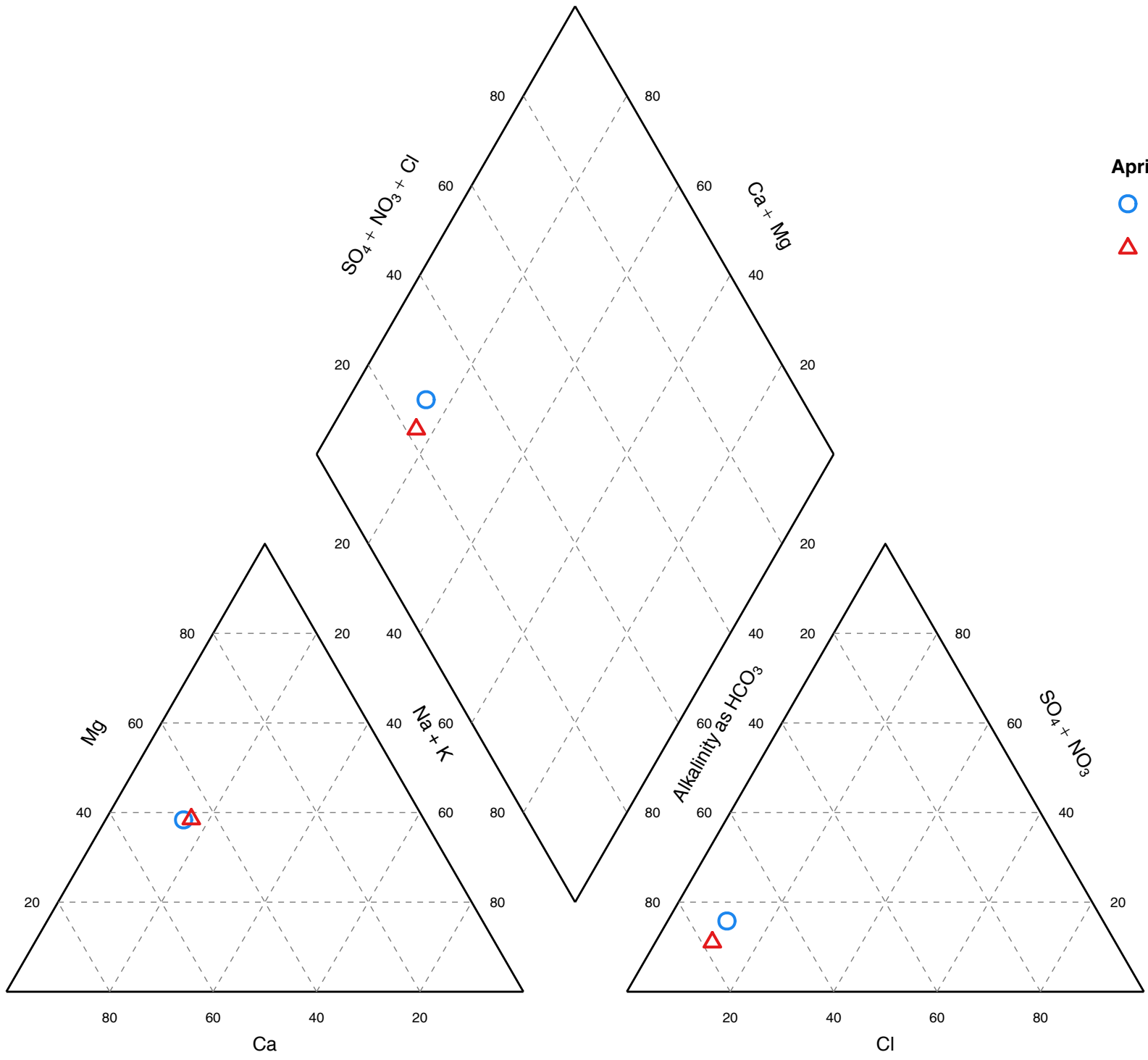

April 2017

○ ADO-MW1d

△ ADO-MW2d

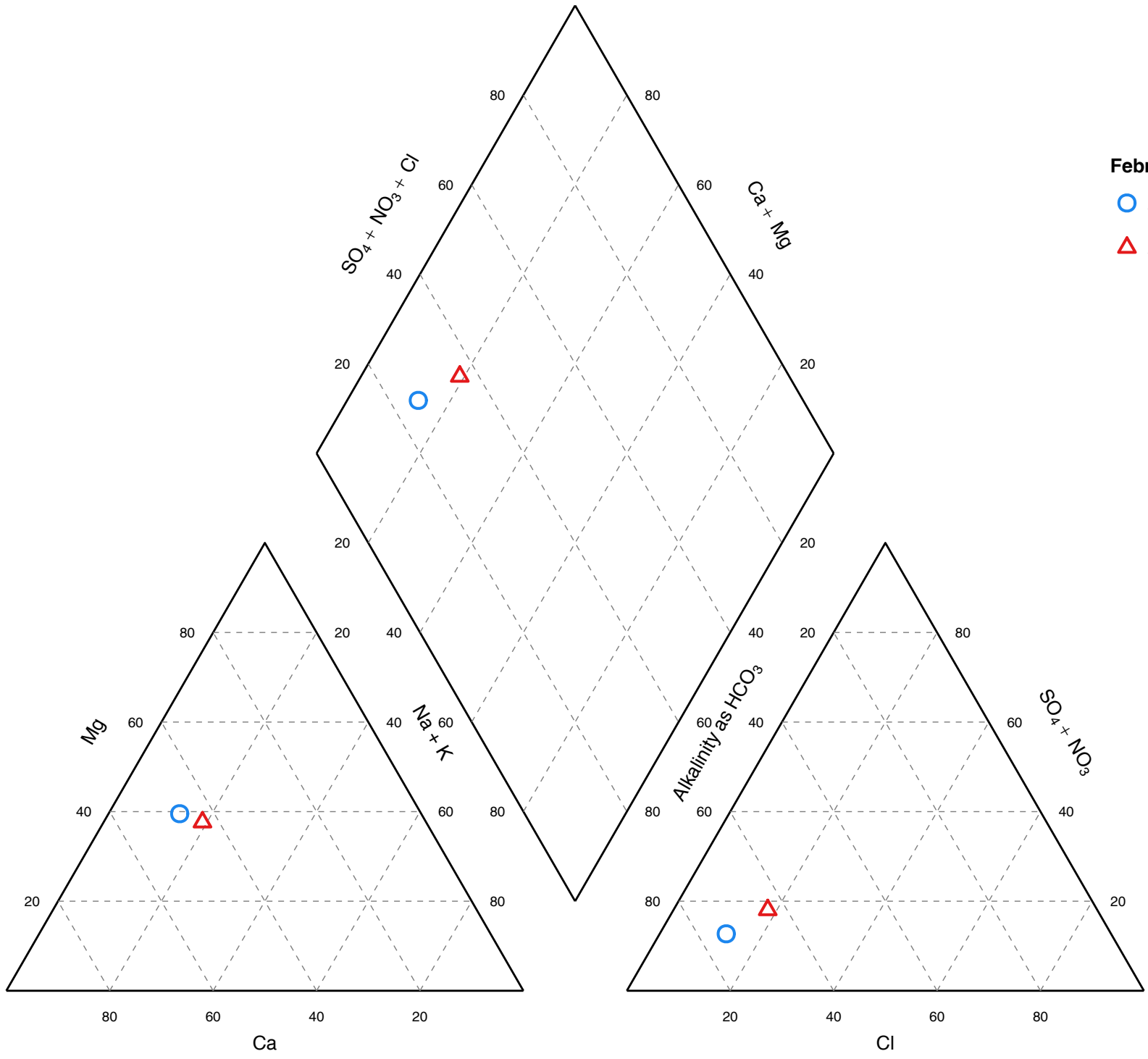

February 2018

- ADO-MW1d
- △ ADO-MW2d

February 2019

△ ADO-MW2d

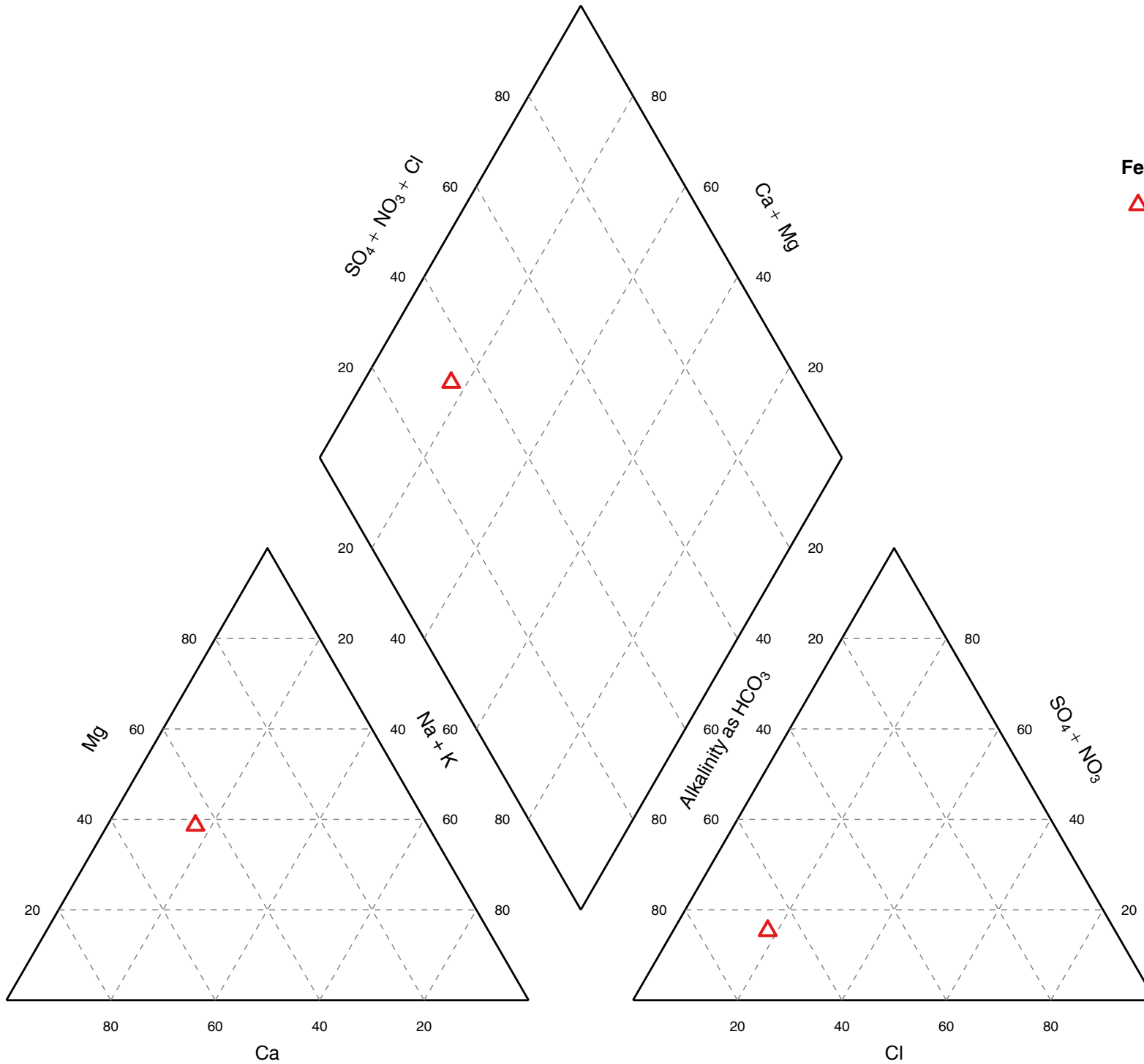

March 2019

○ ADO-MW1d

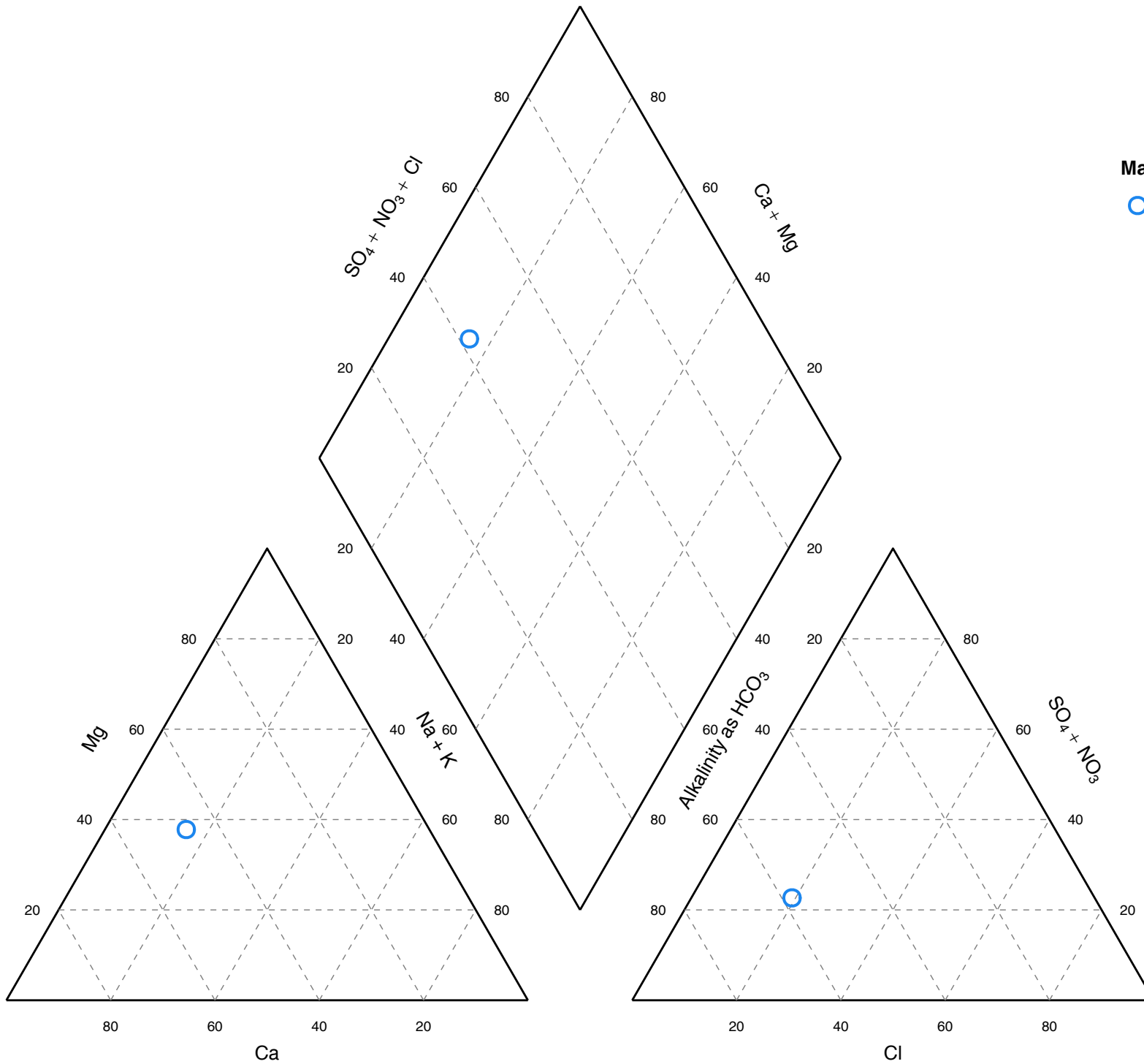

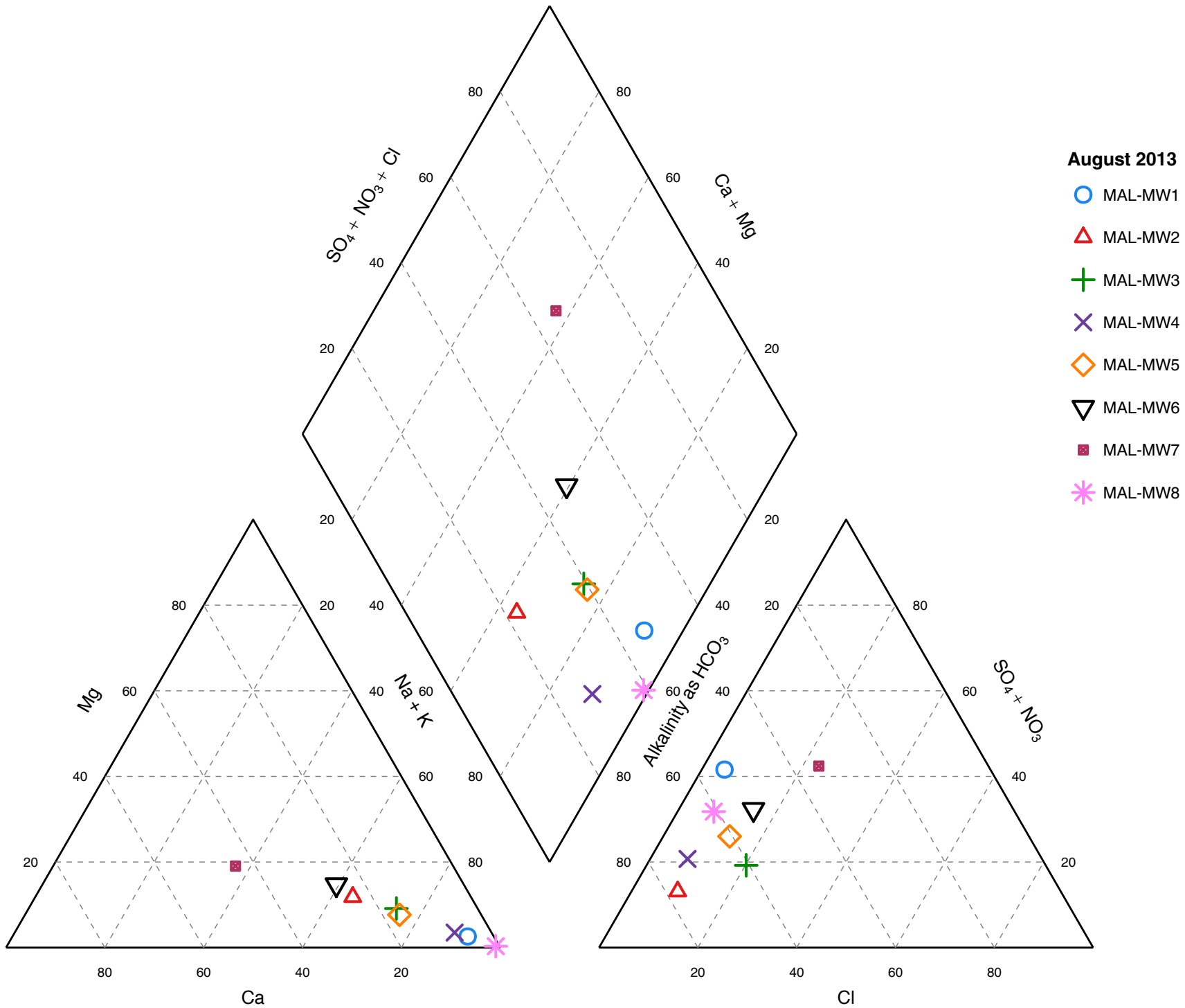

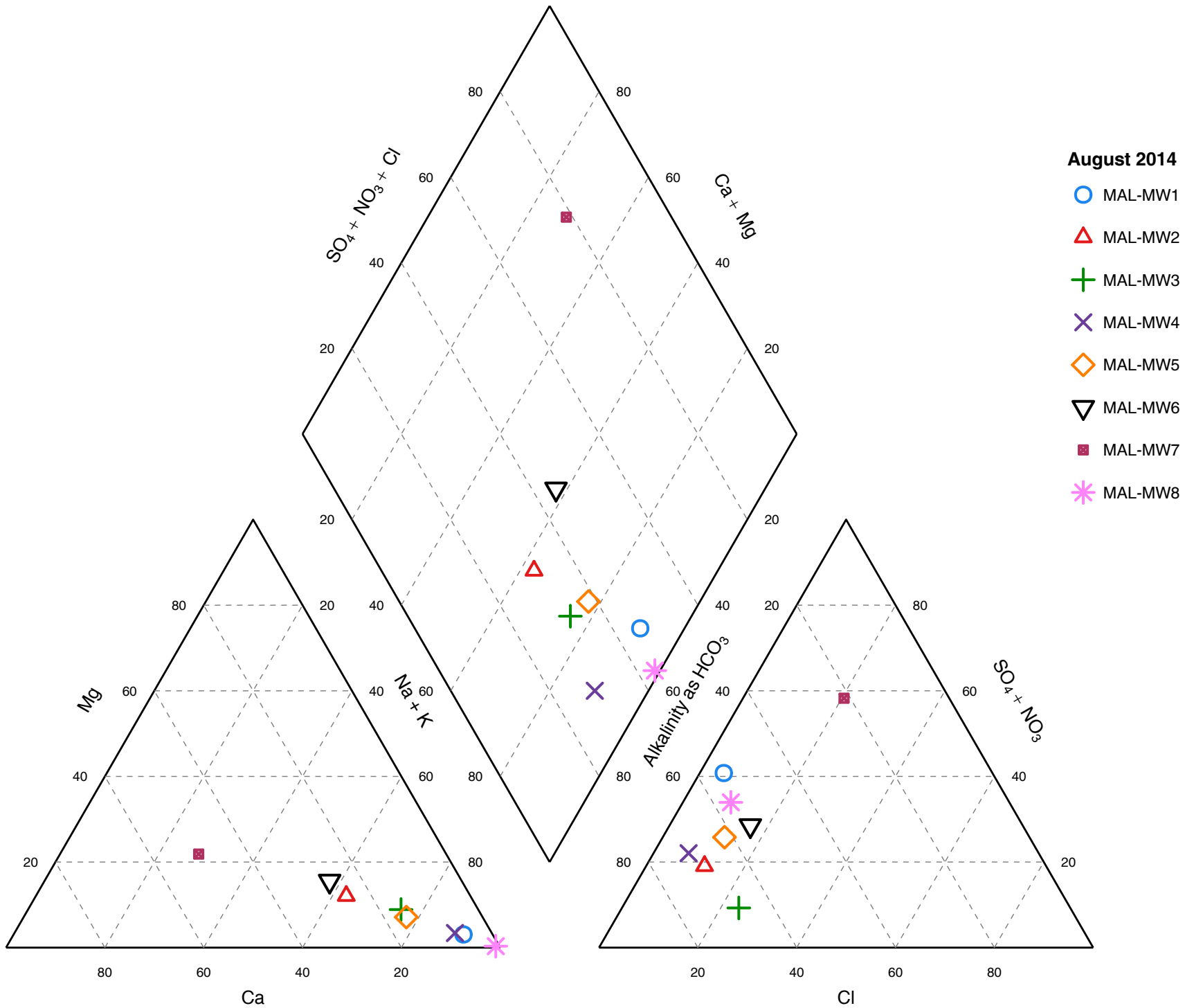

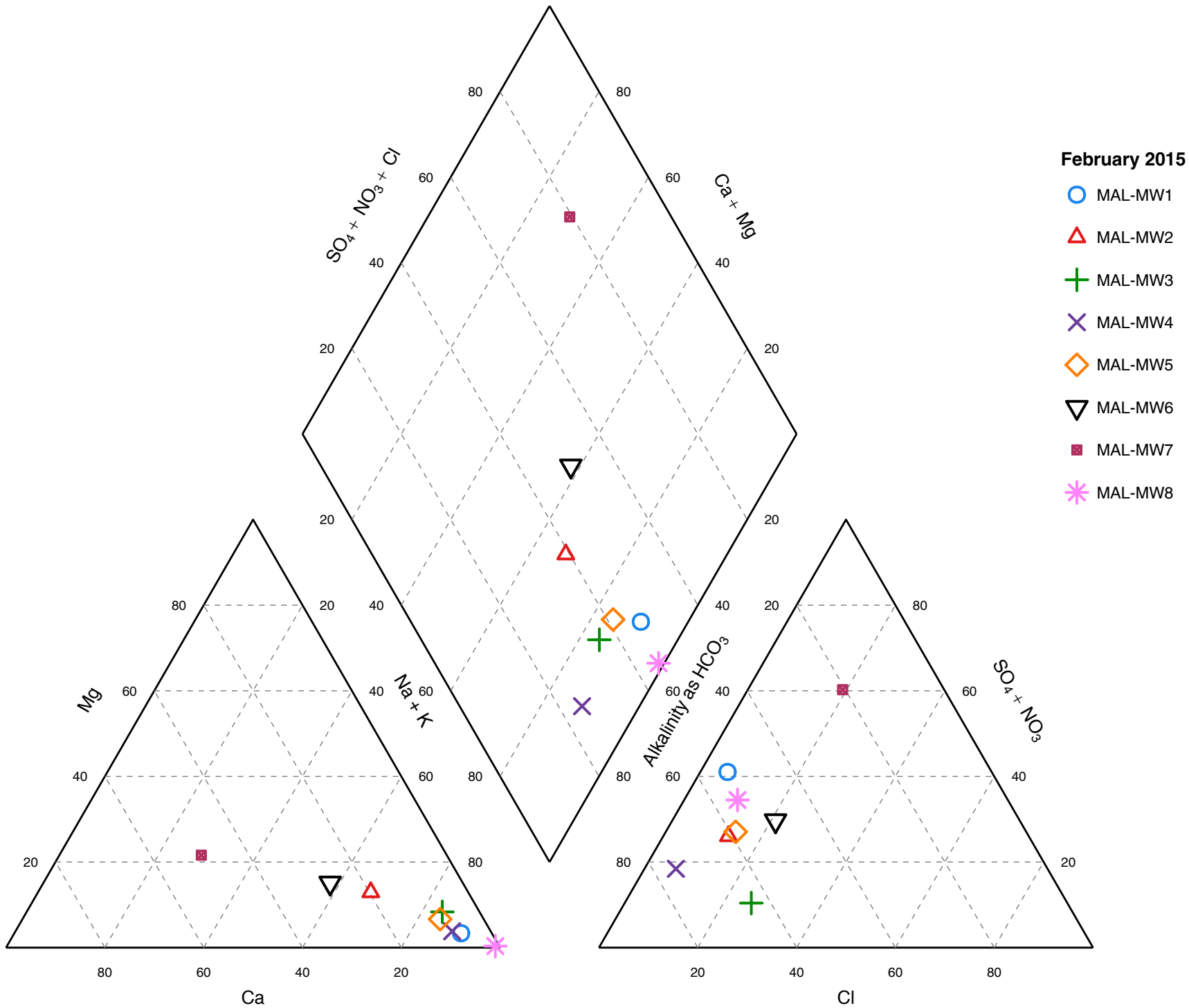

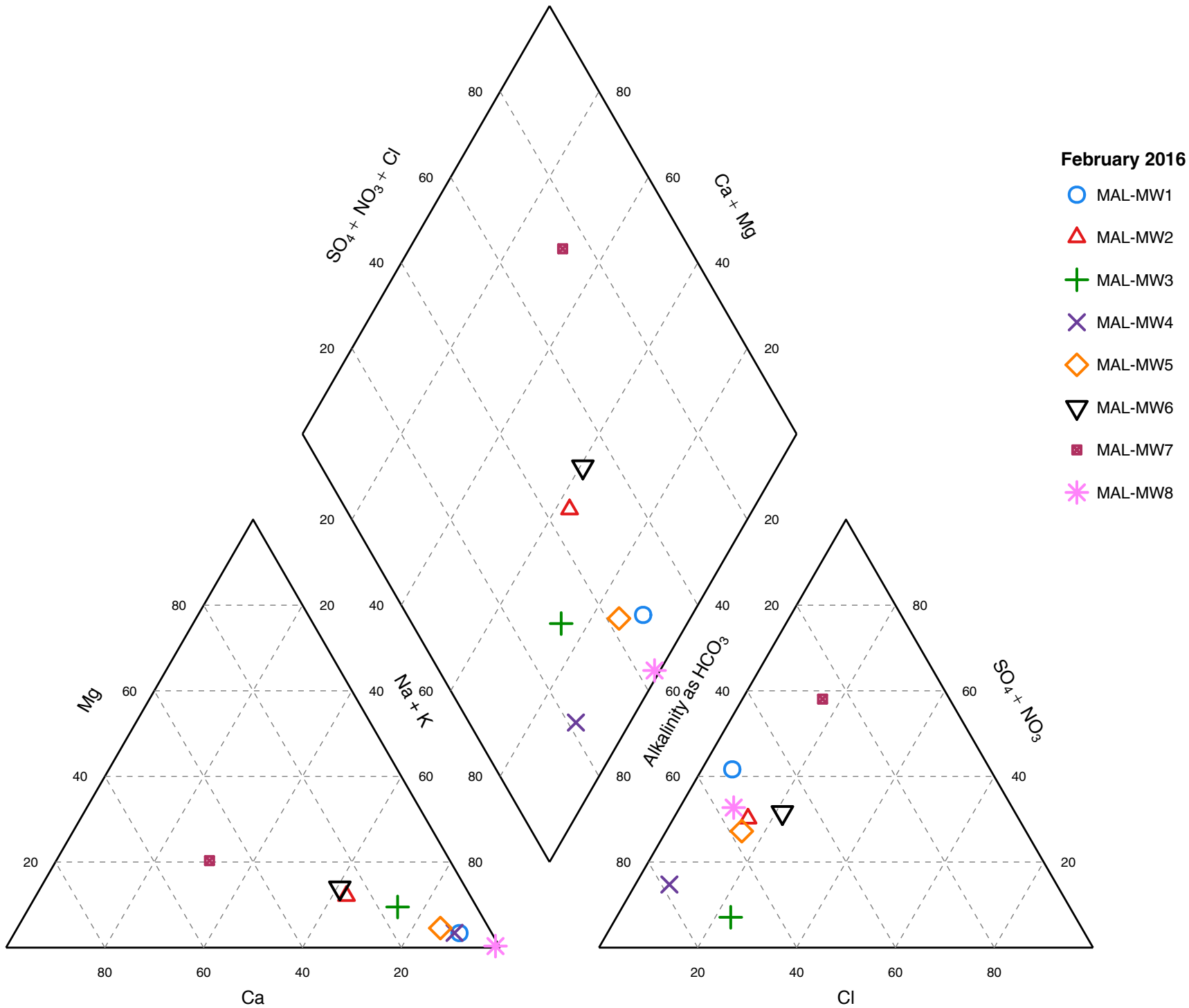

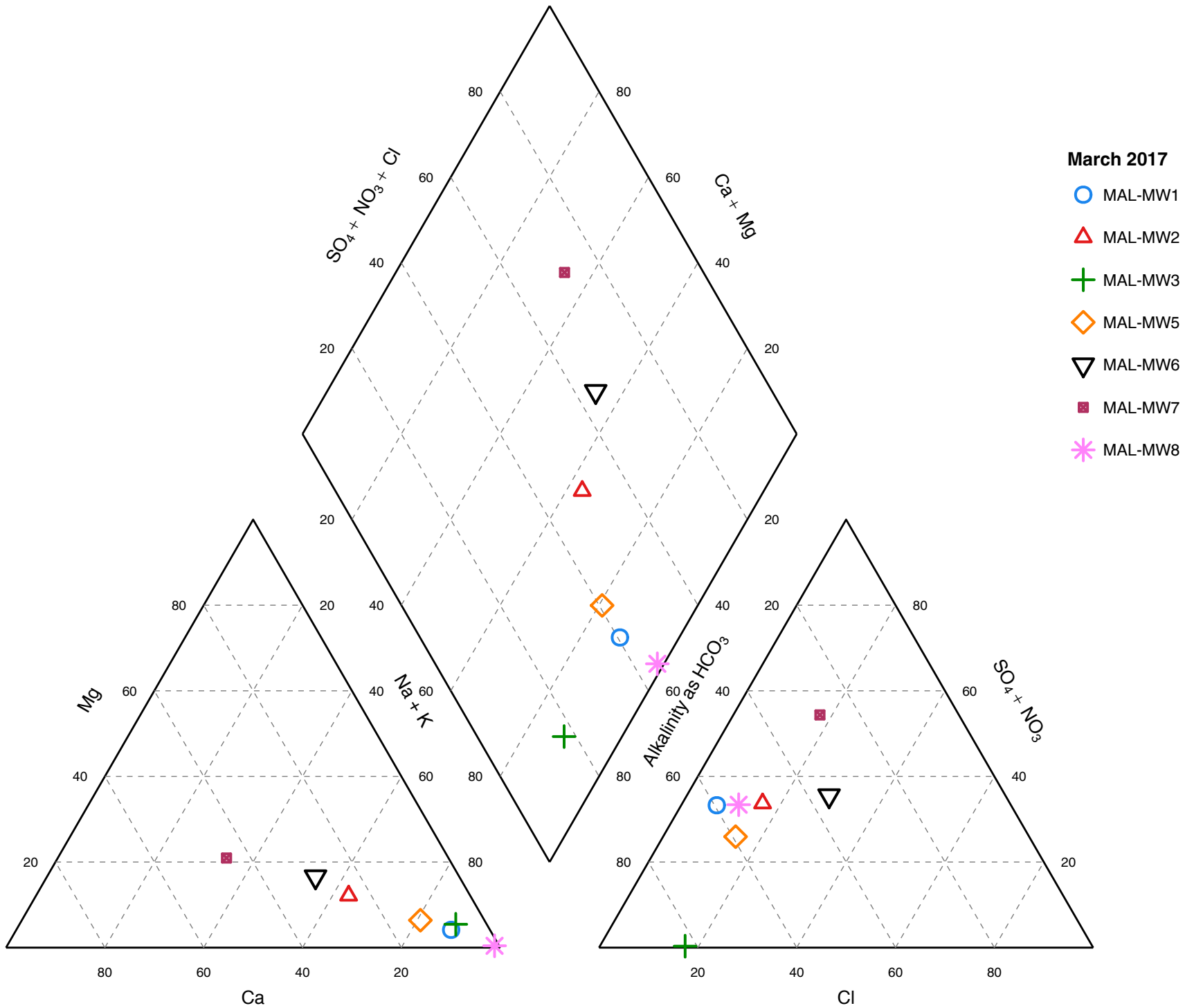

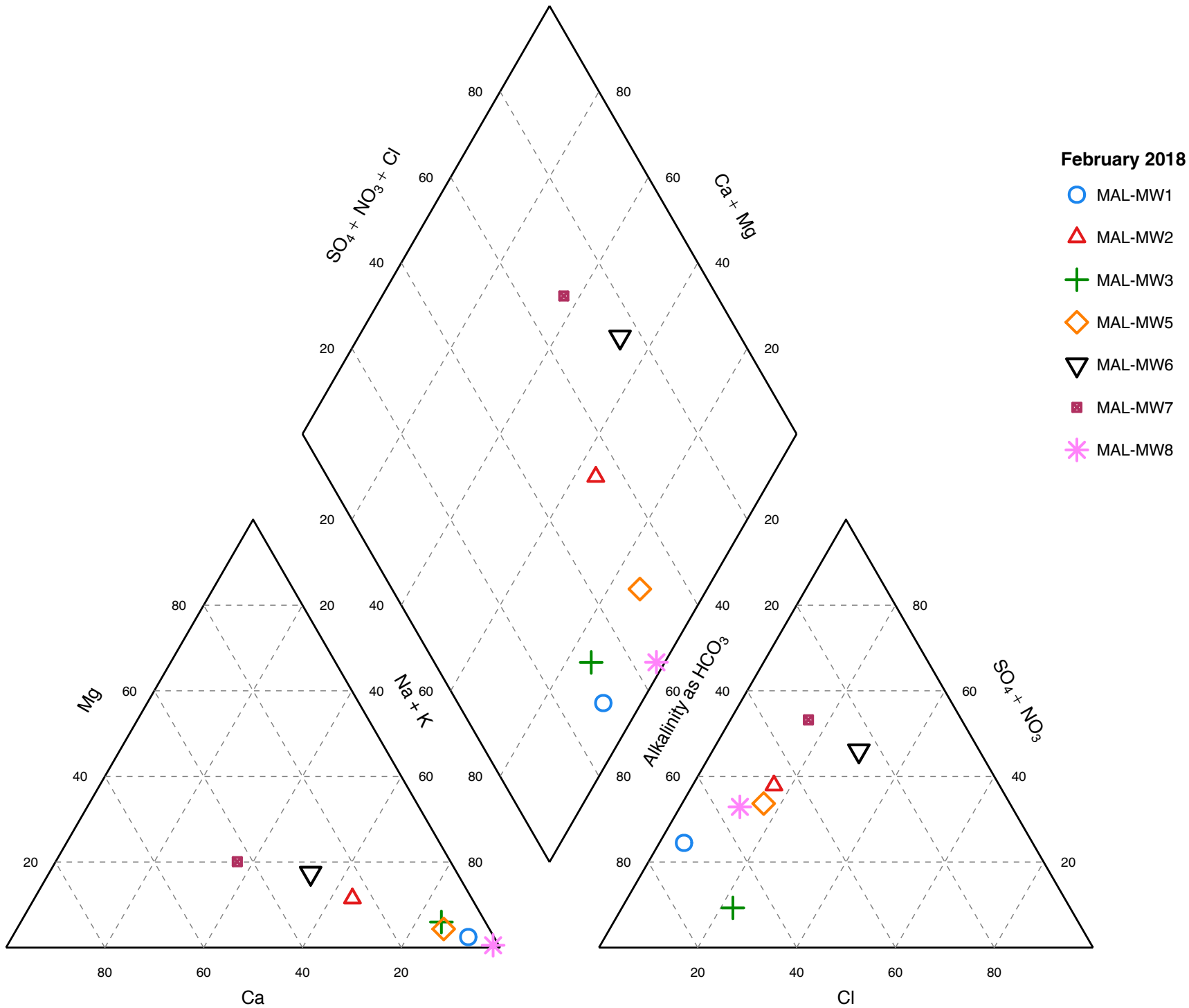

February 2019

* MAL-MW8

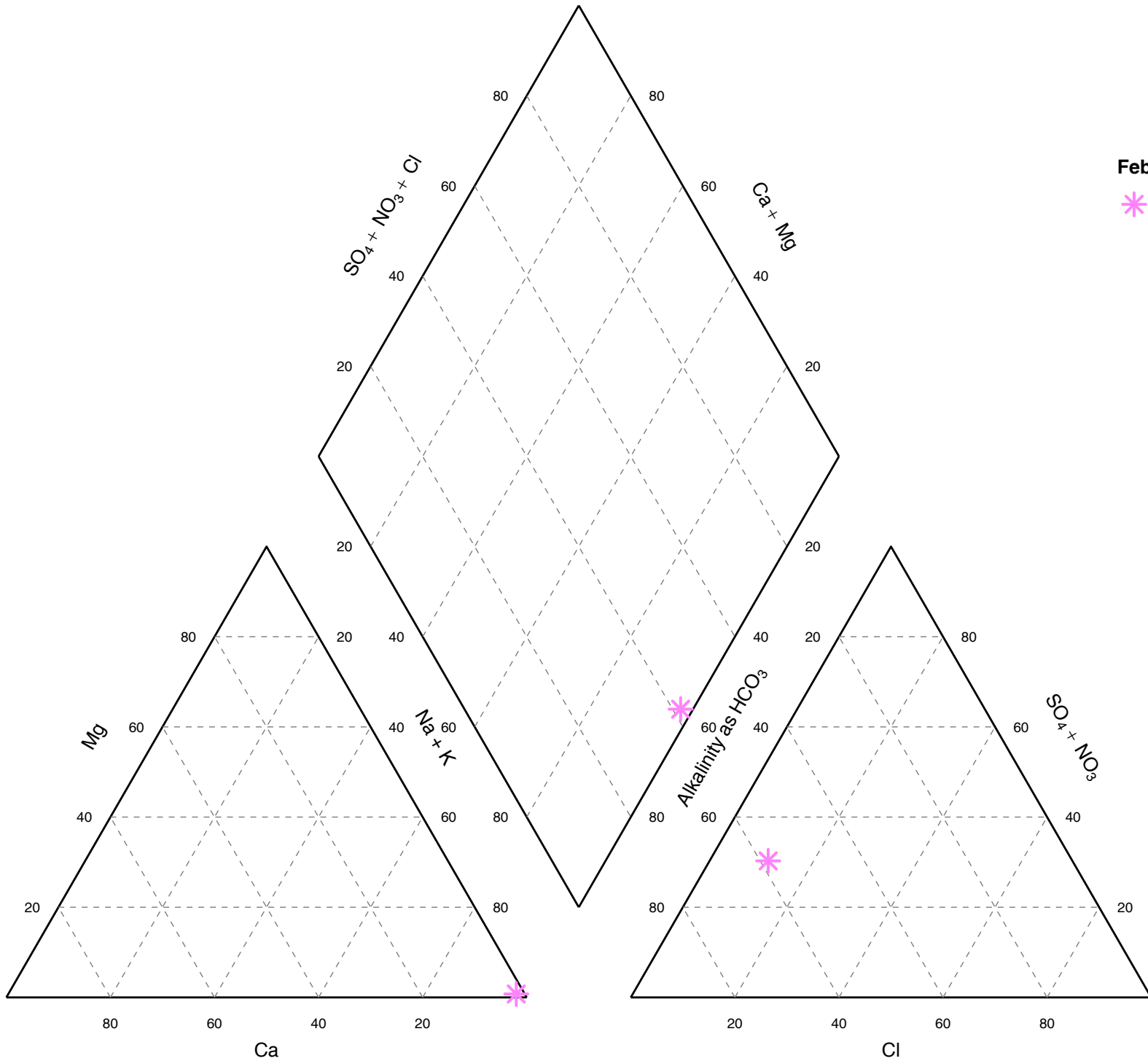

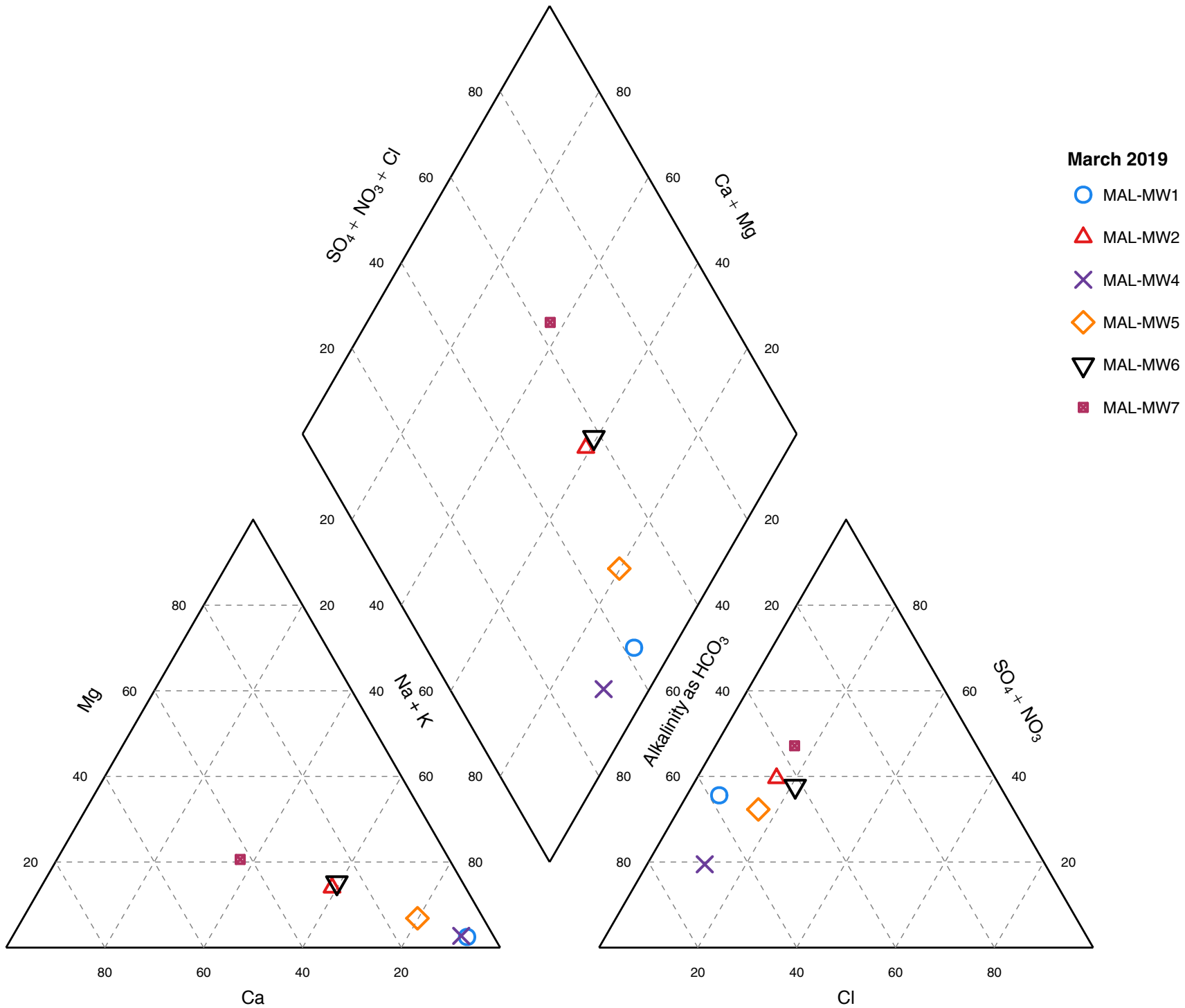

August 2013

● MAP-MW10

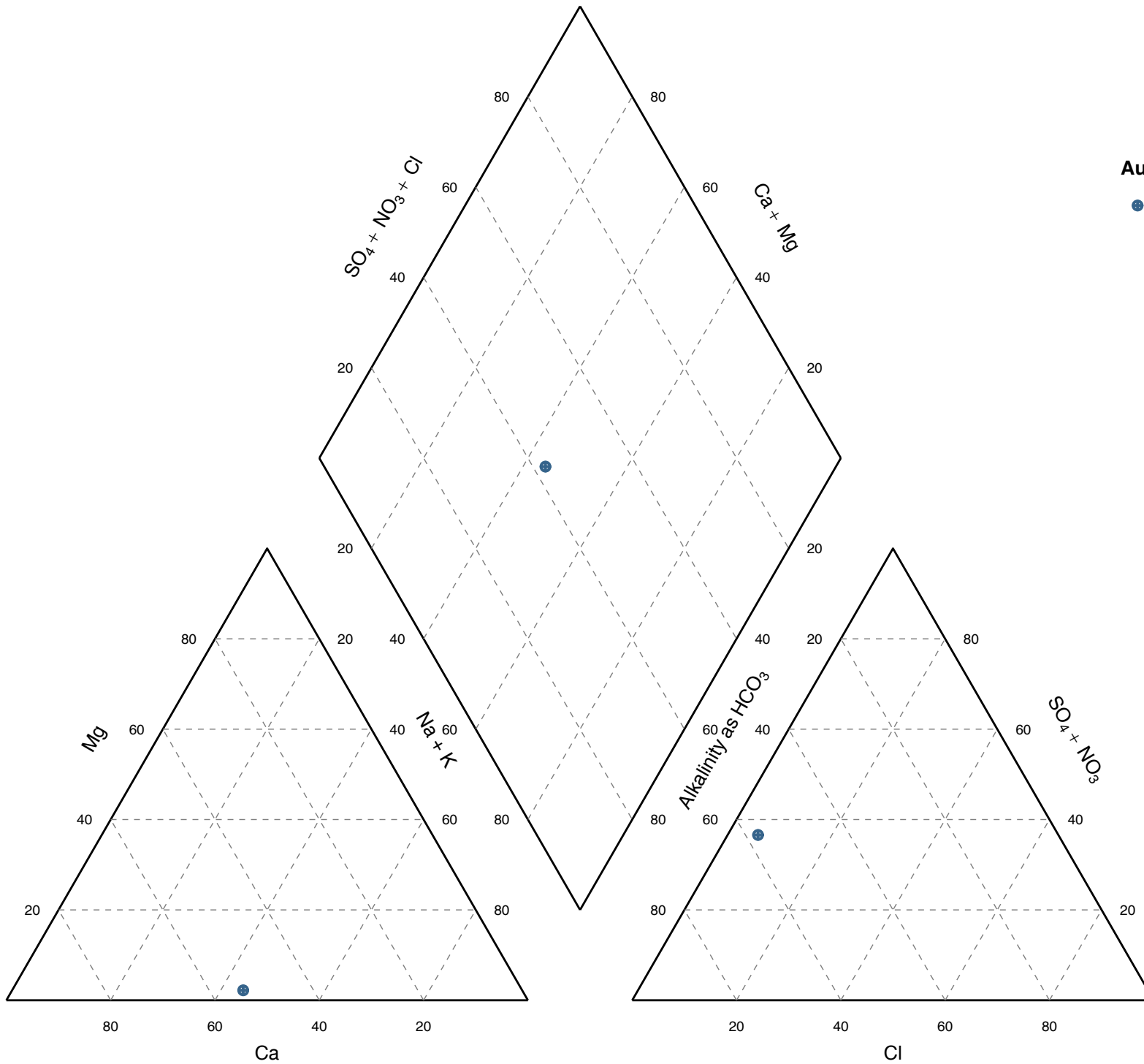

August 2014

● MAP-MW10

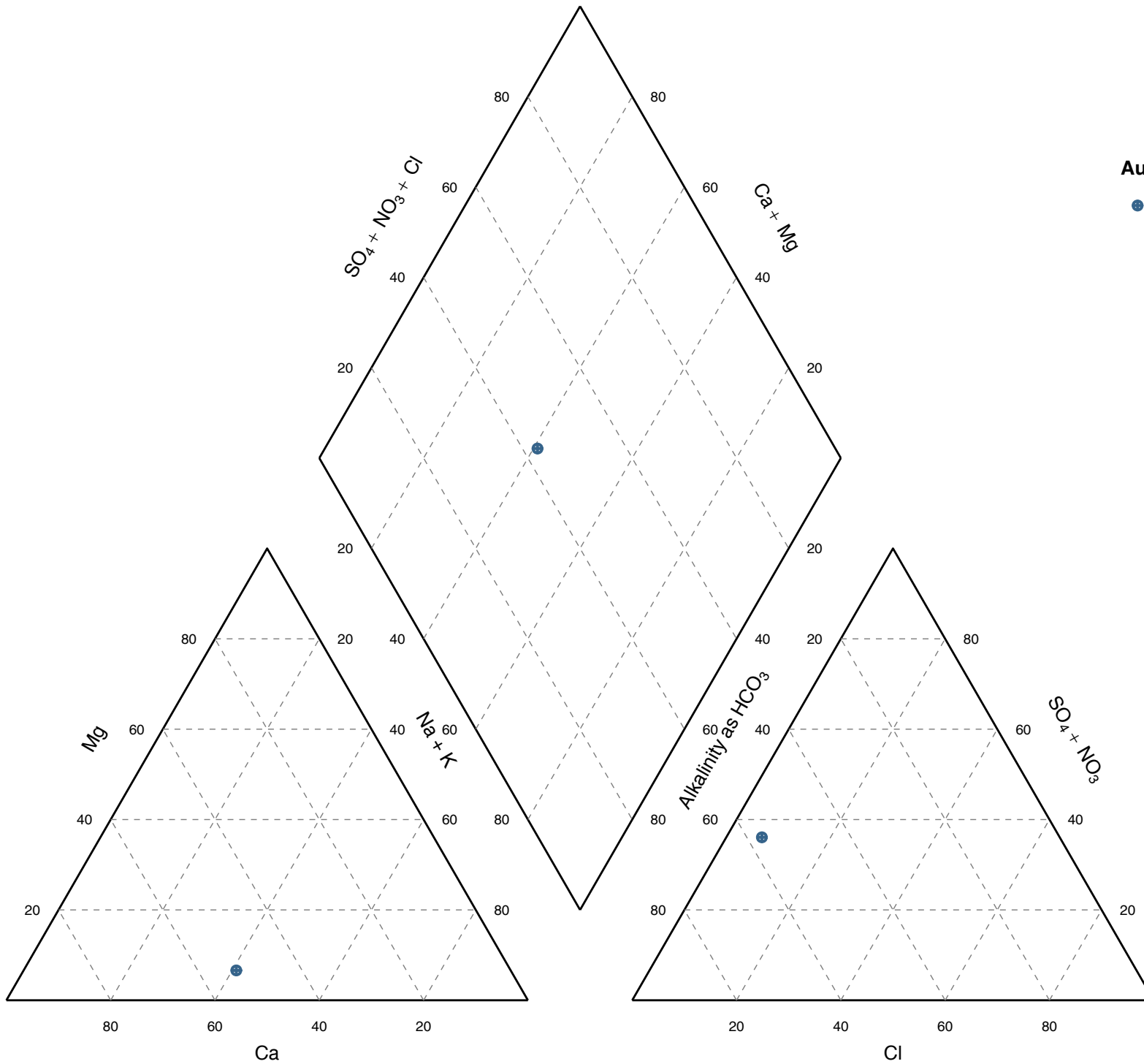

February 2015

● MAP-MW10

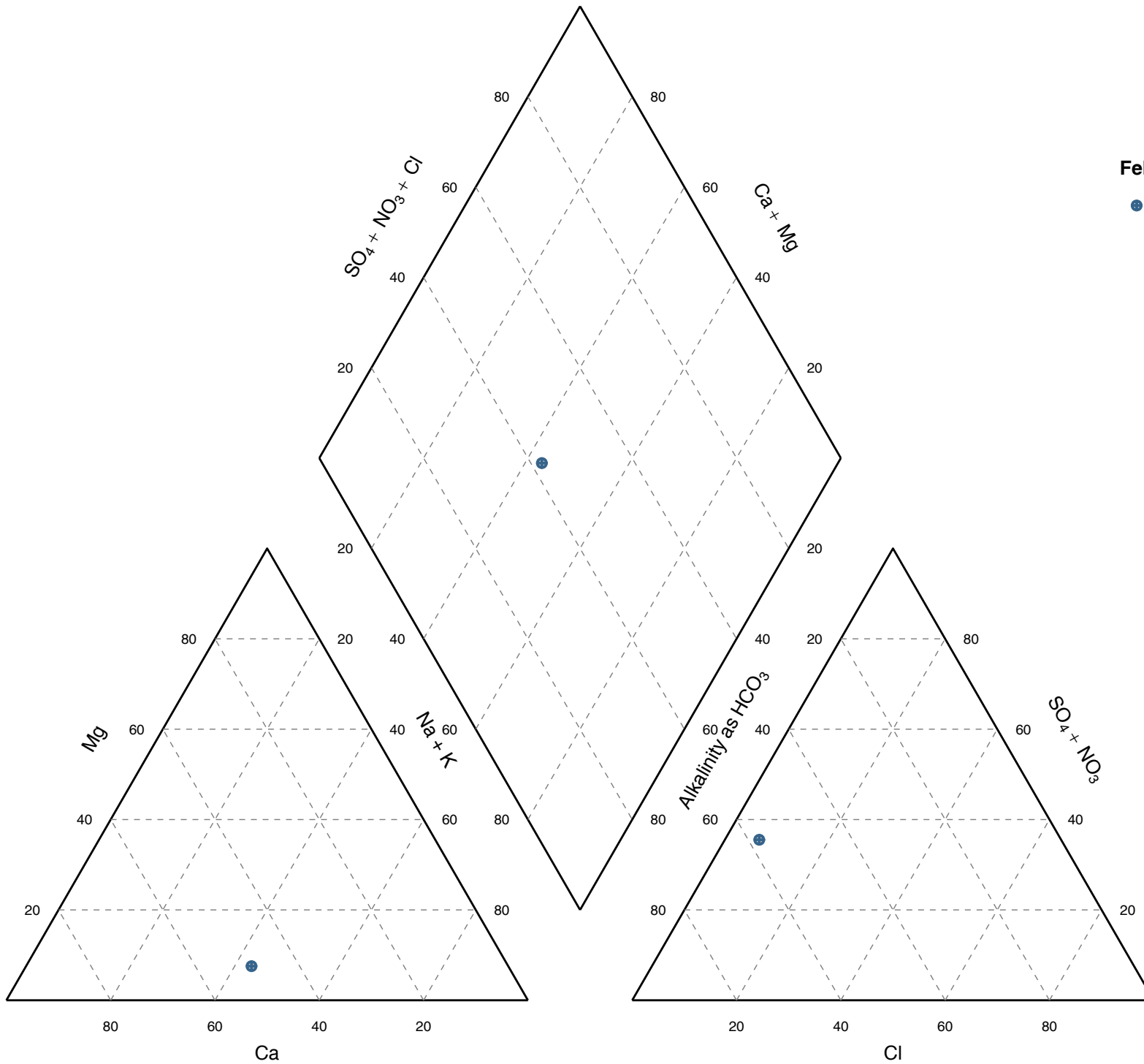

February 2016

● MAP-MW10

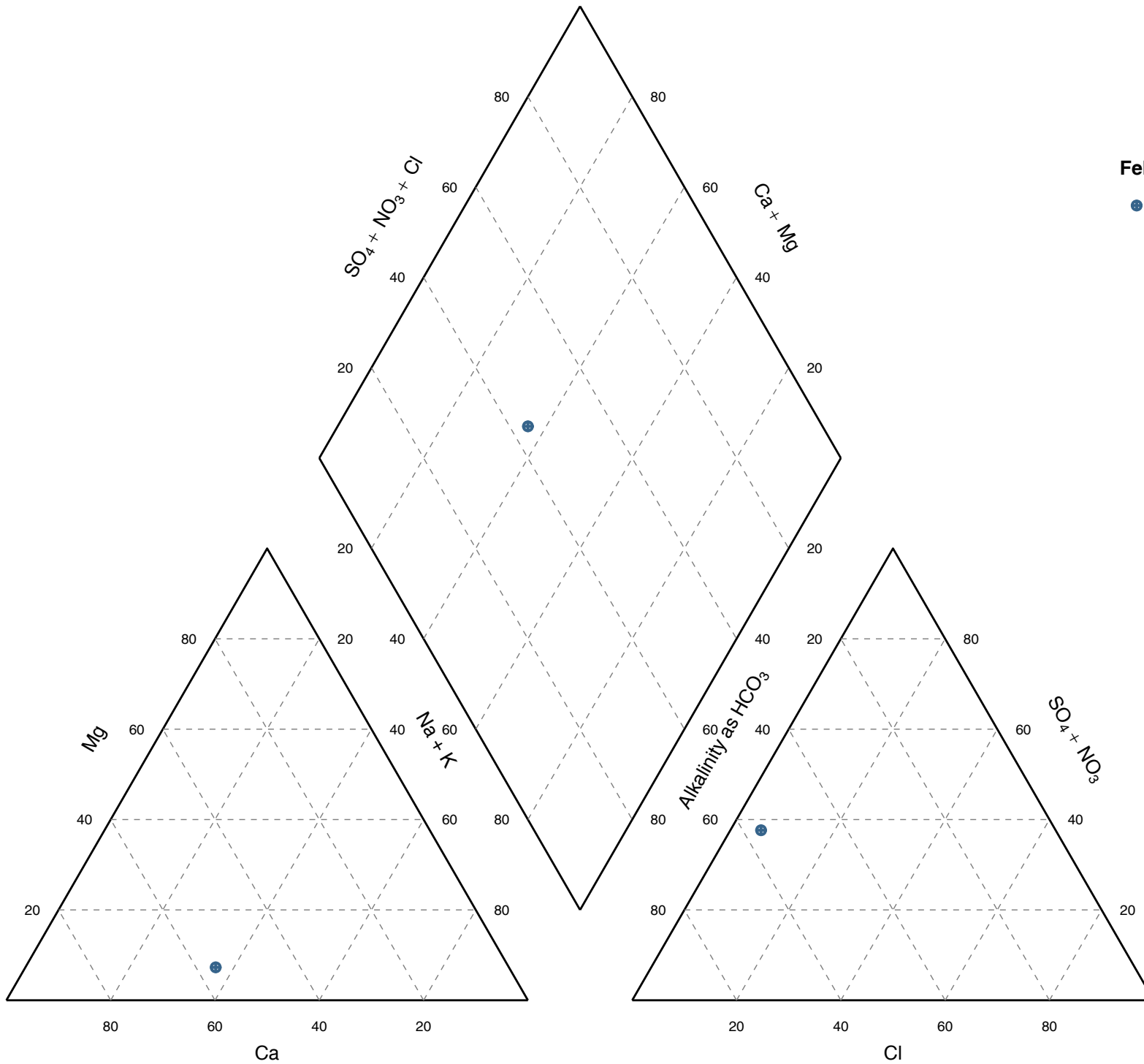

March 2017

● MAP-MW10

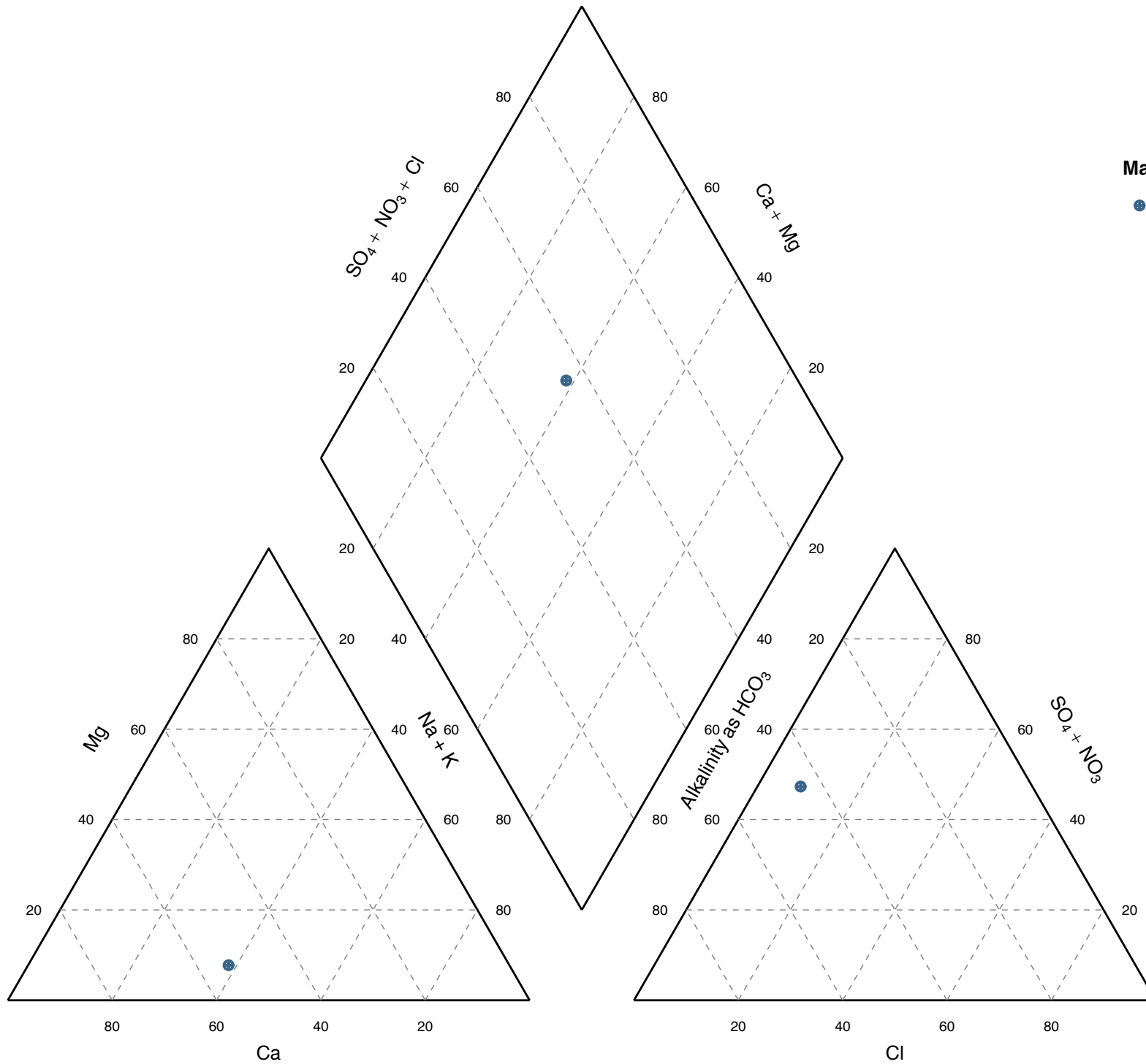

February 2018

● MAP-MW10

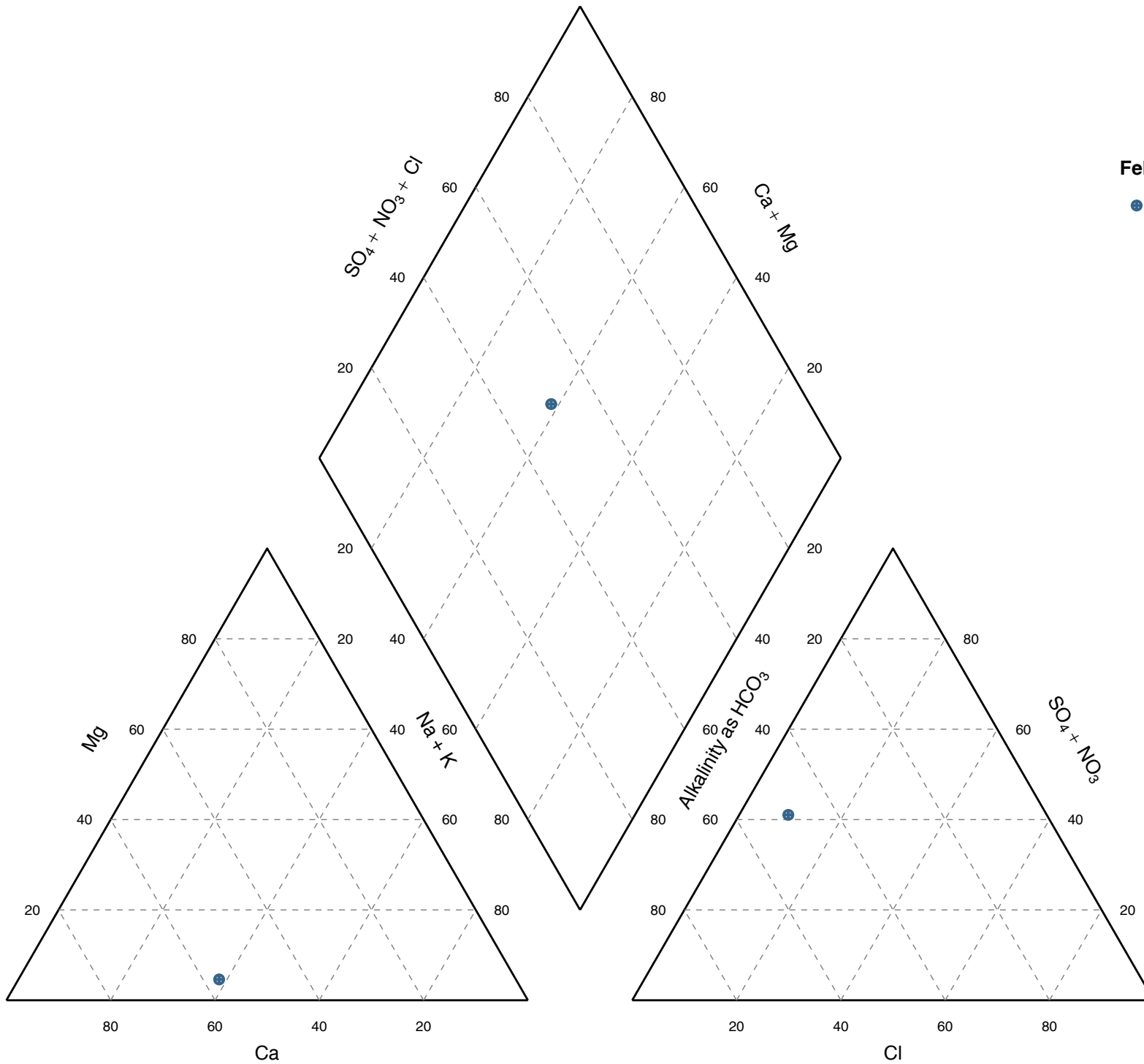

February 2019

● MAP-MW10

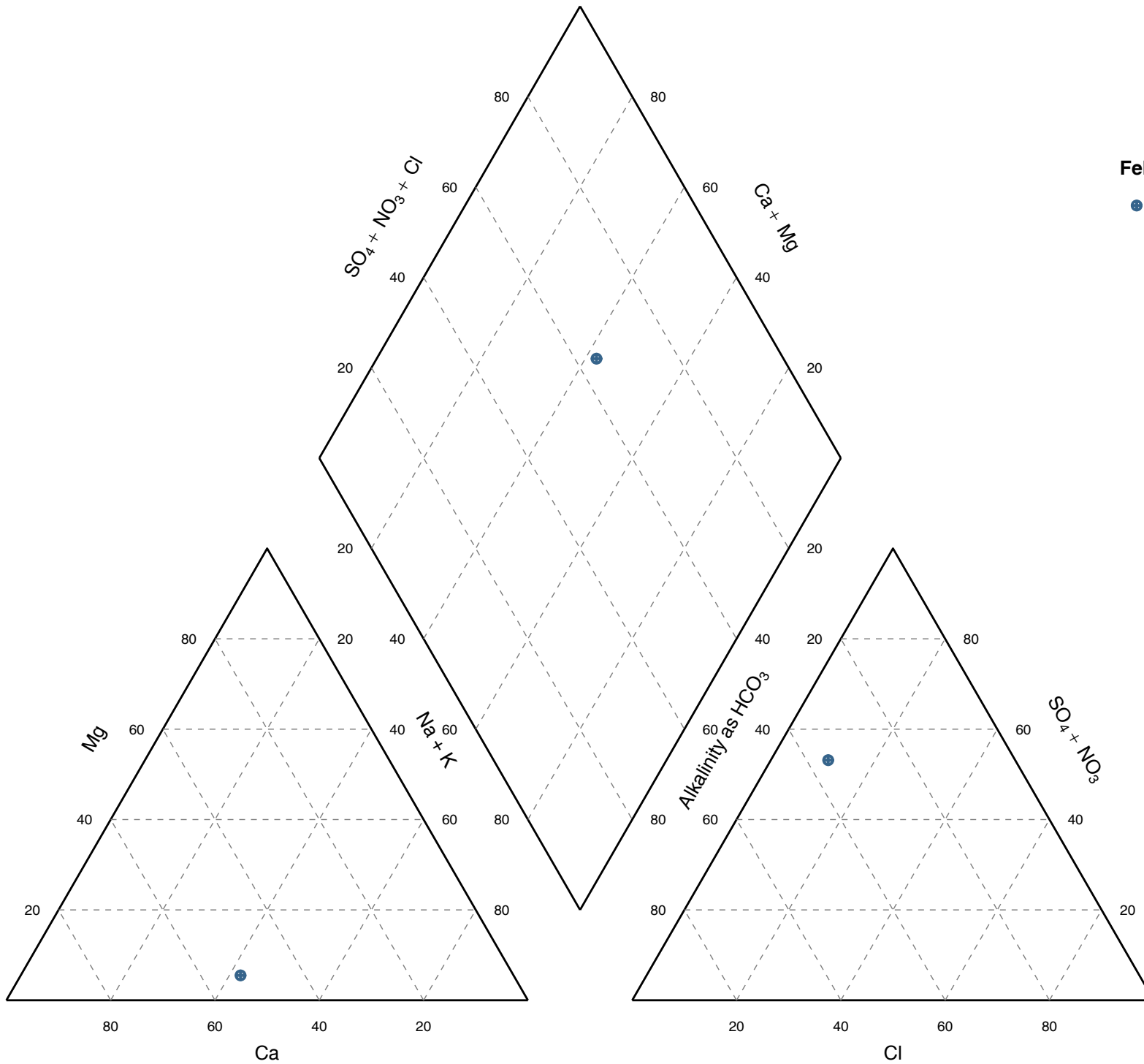

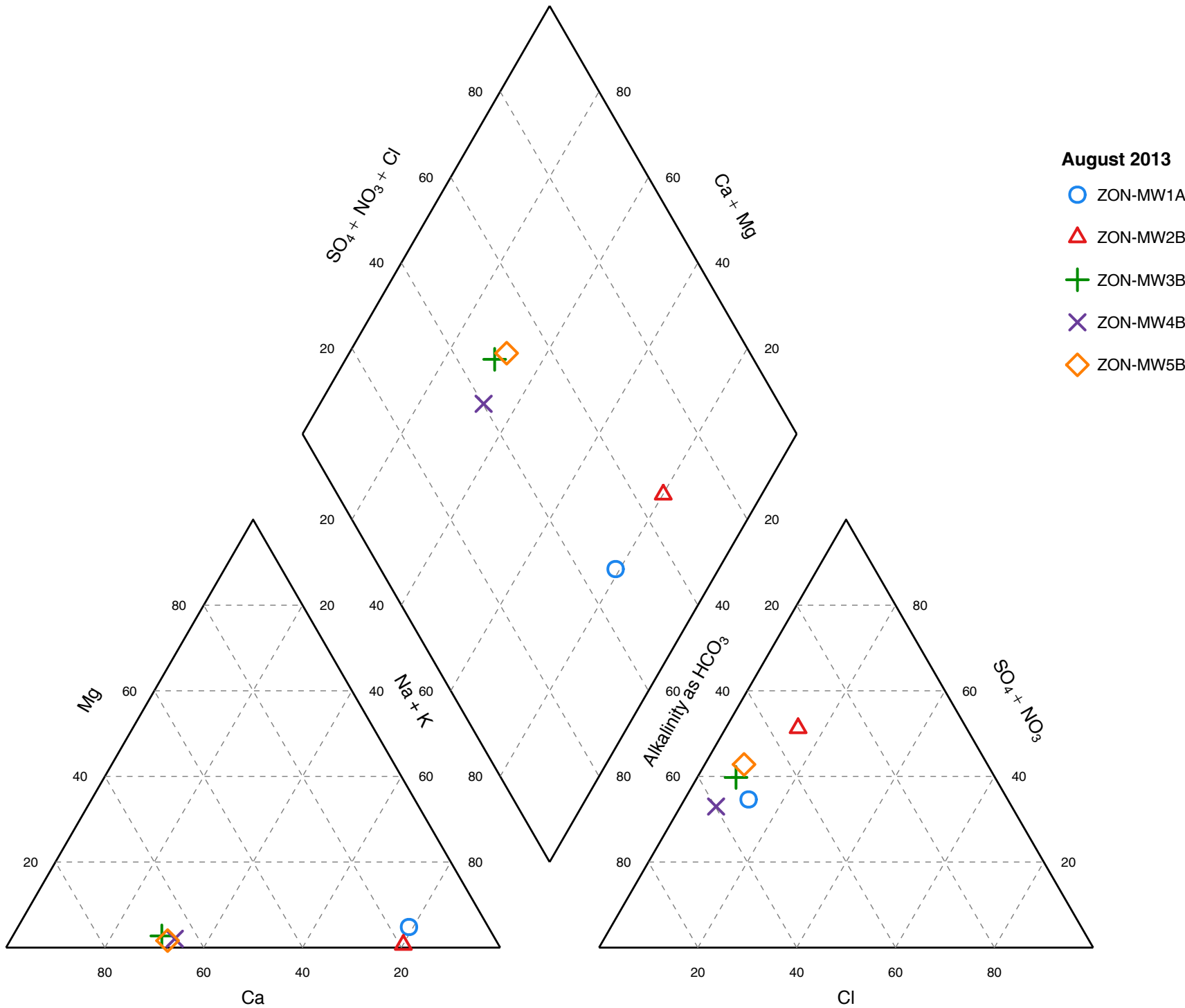

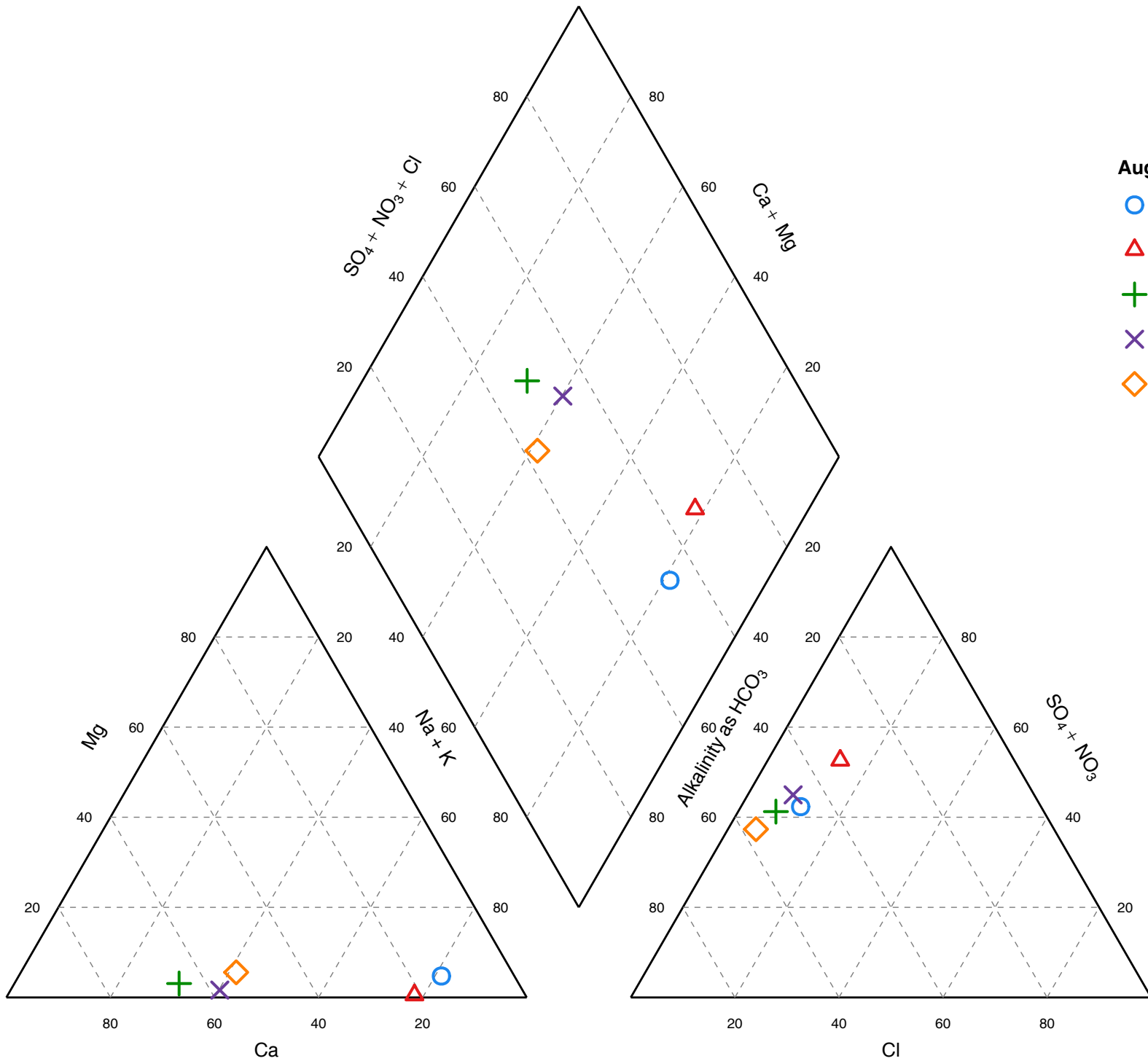

August 2014

- ZON-MW1A
- △ ZON-MW2B
- + ZON-MW3B
- × ZON-MW4B
- ◇ ZON-MW5A

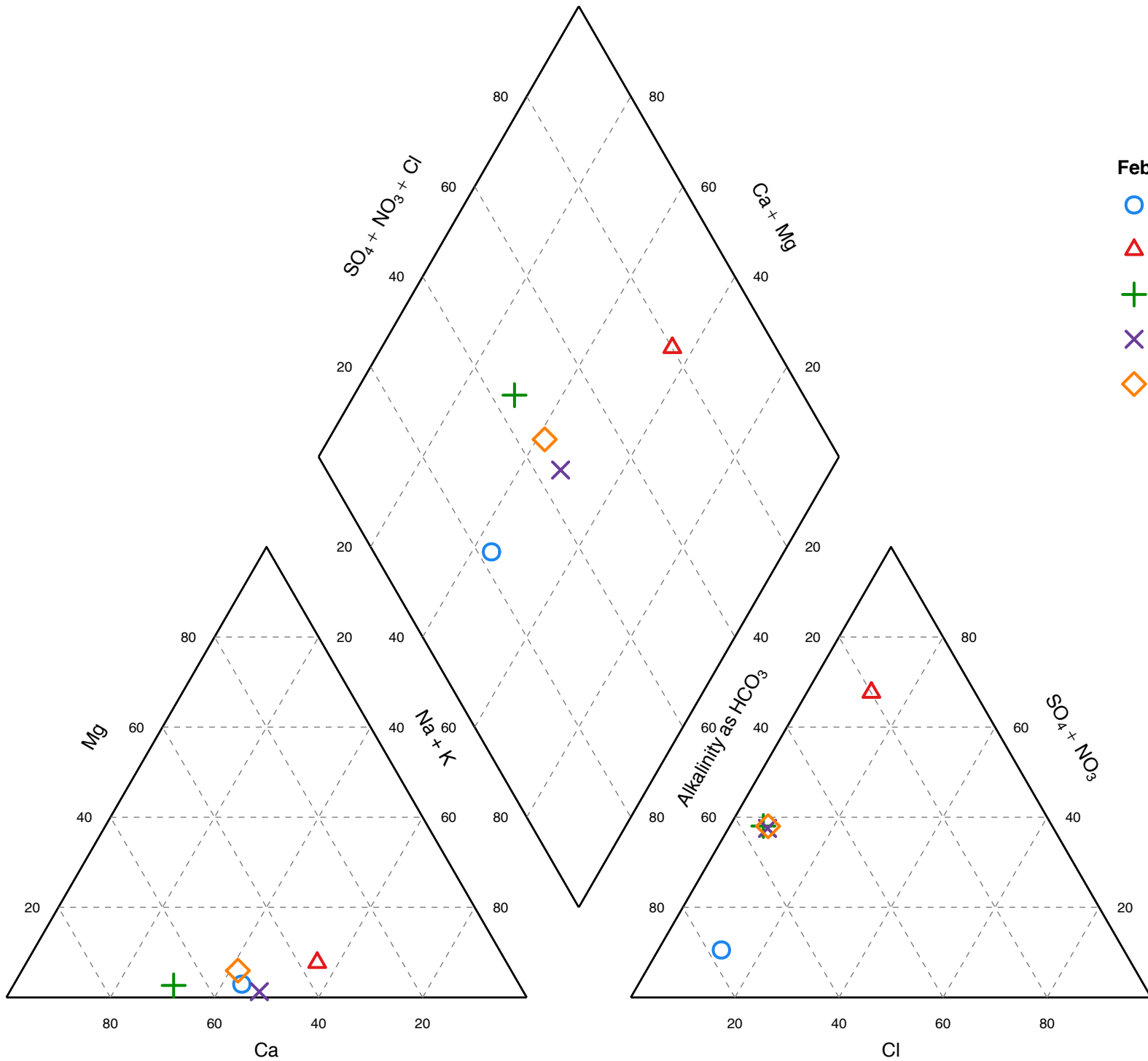

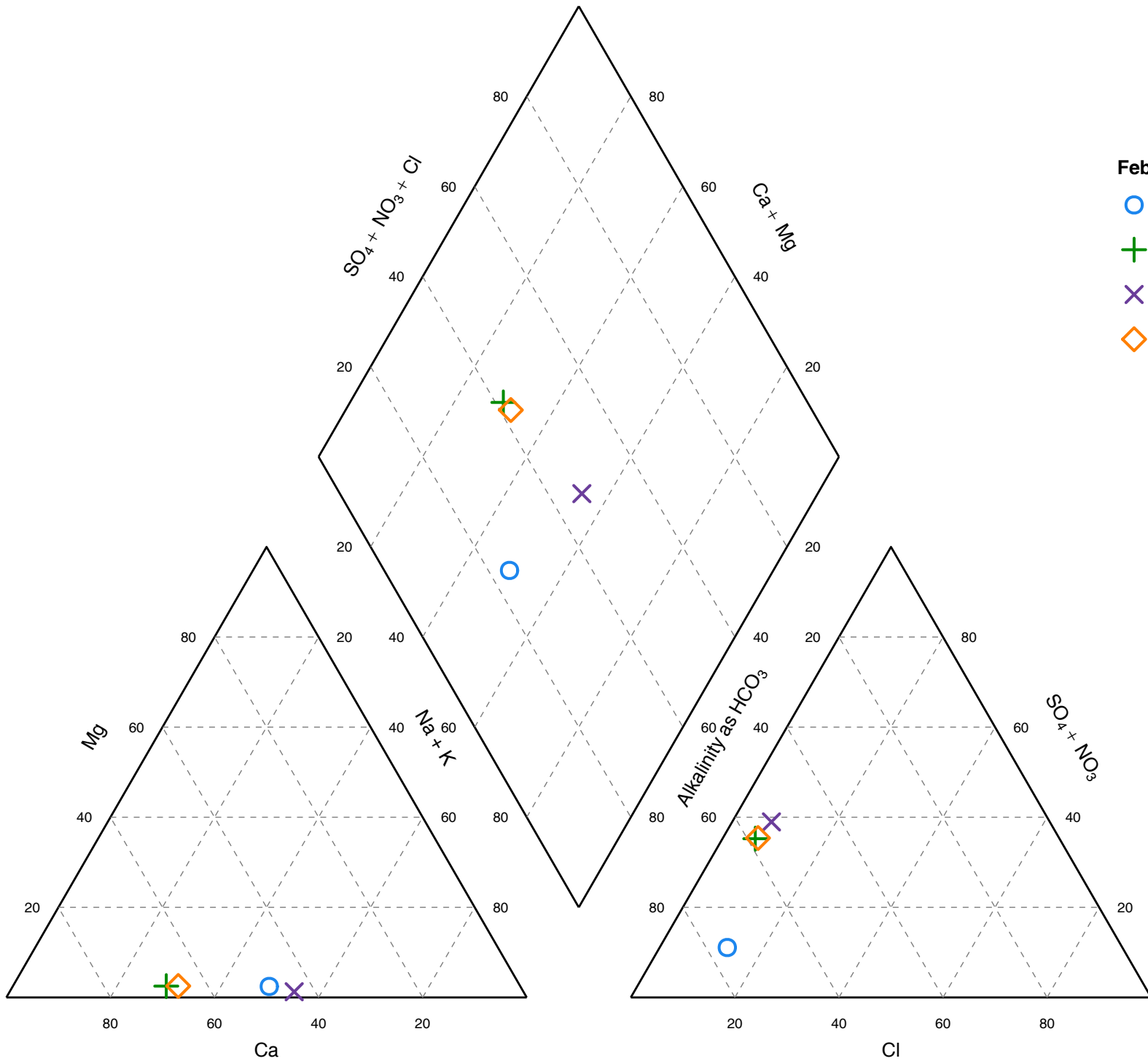

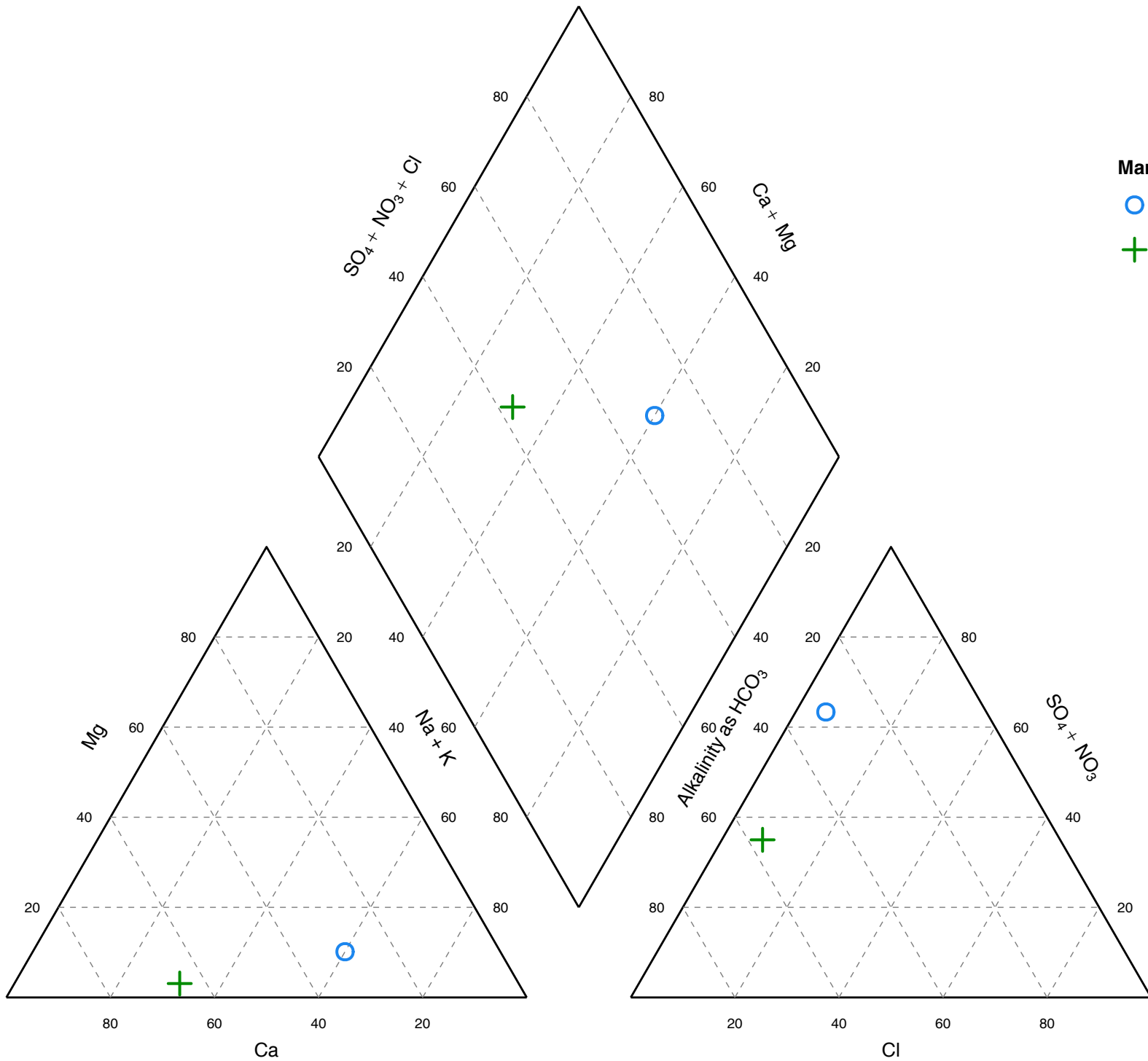

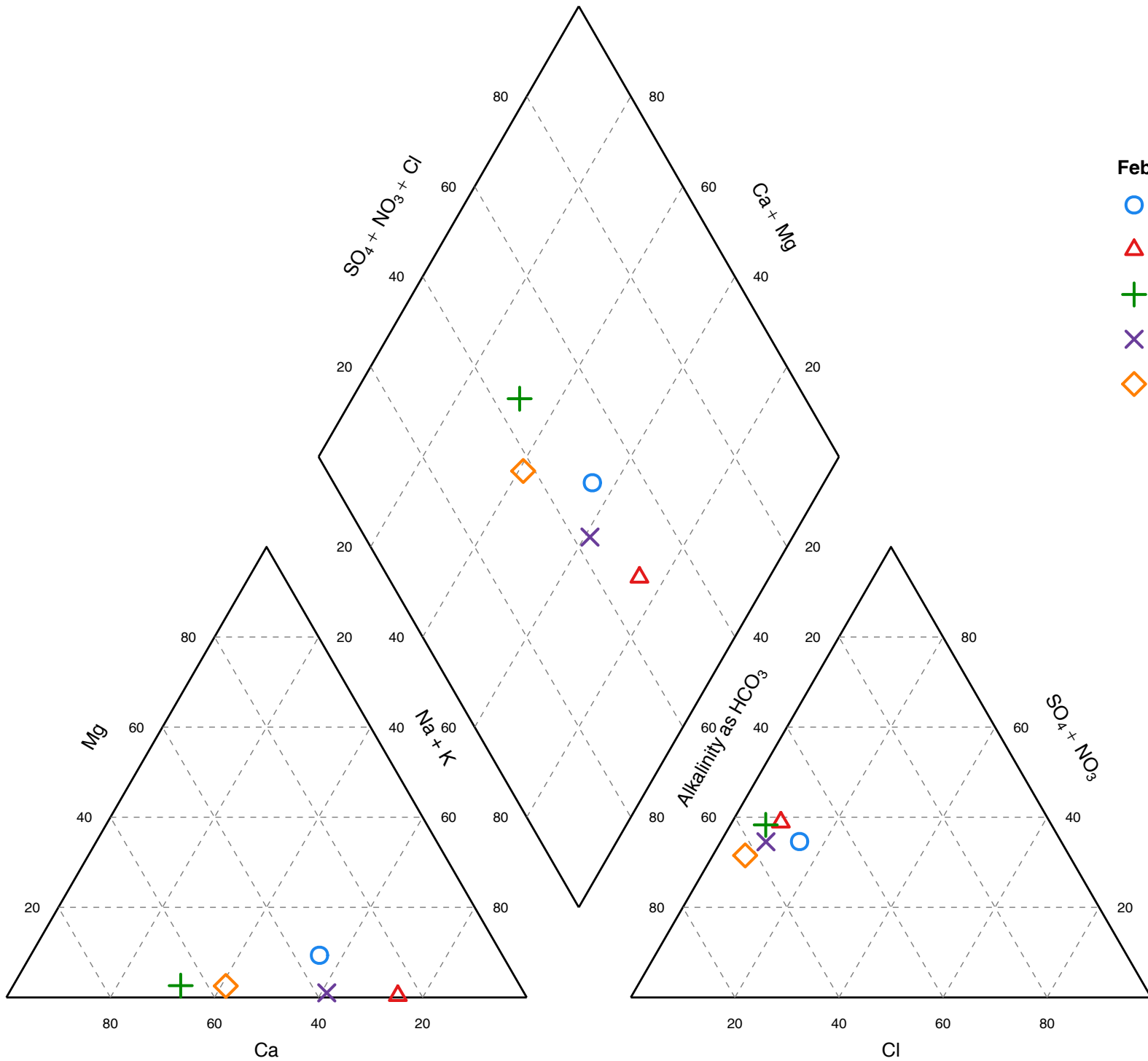

February 2019

△ ZON-MW2B

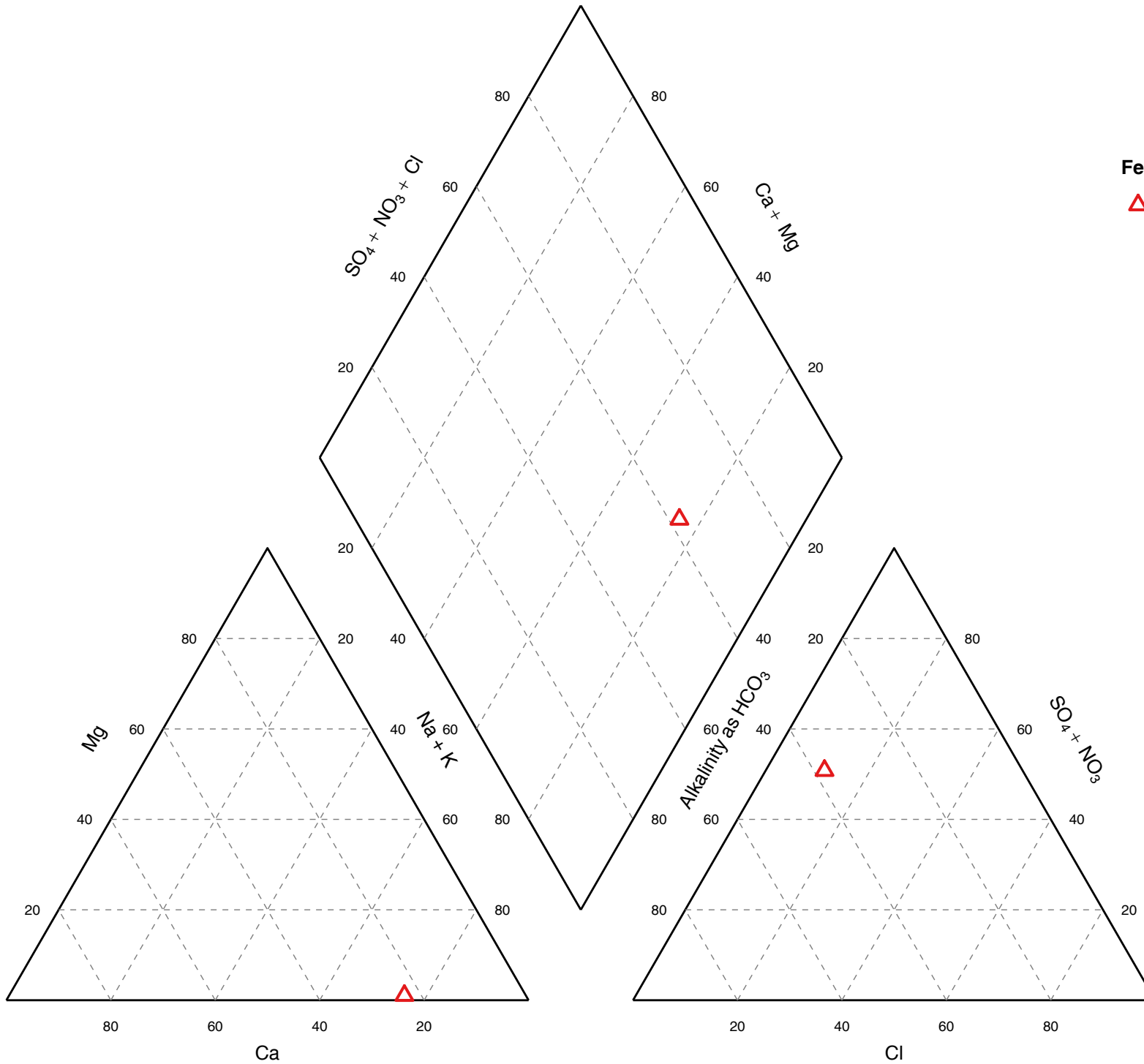

March 2019

+ ZON-MW3B

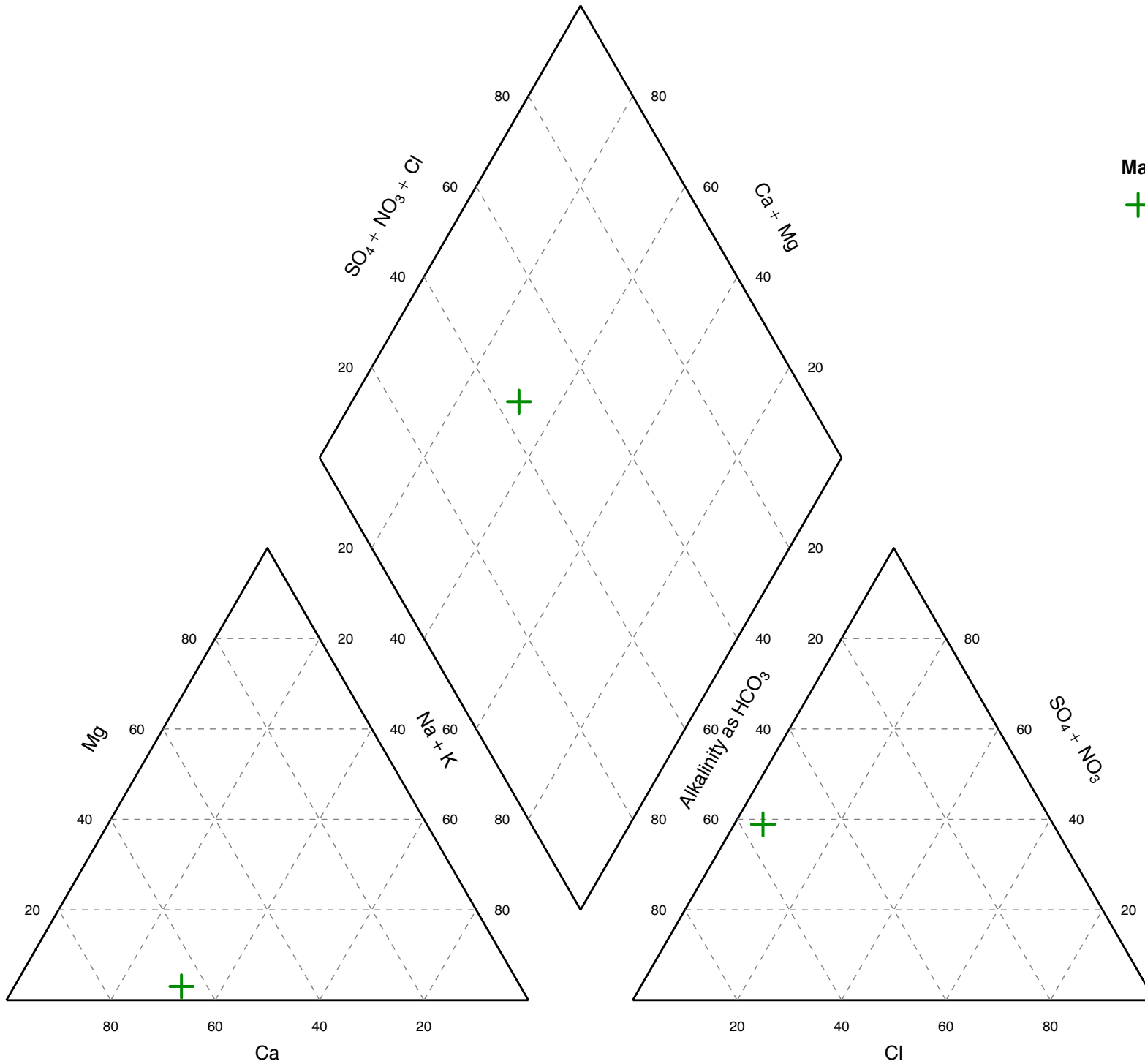

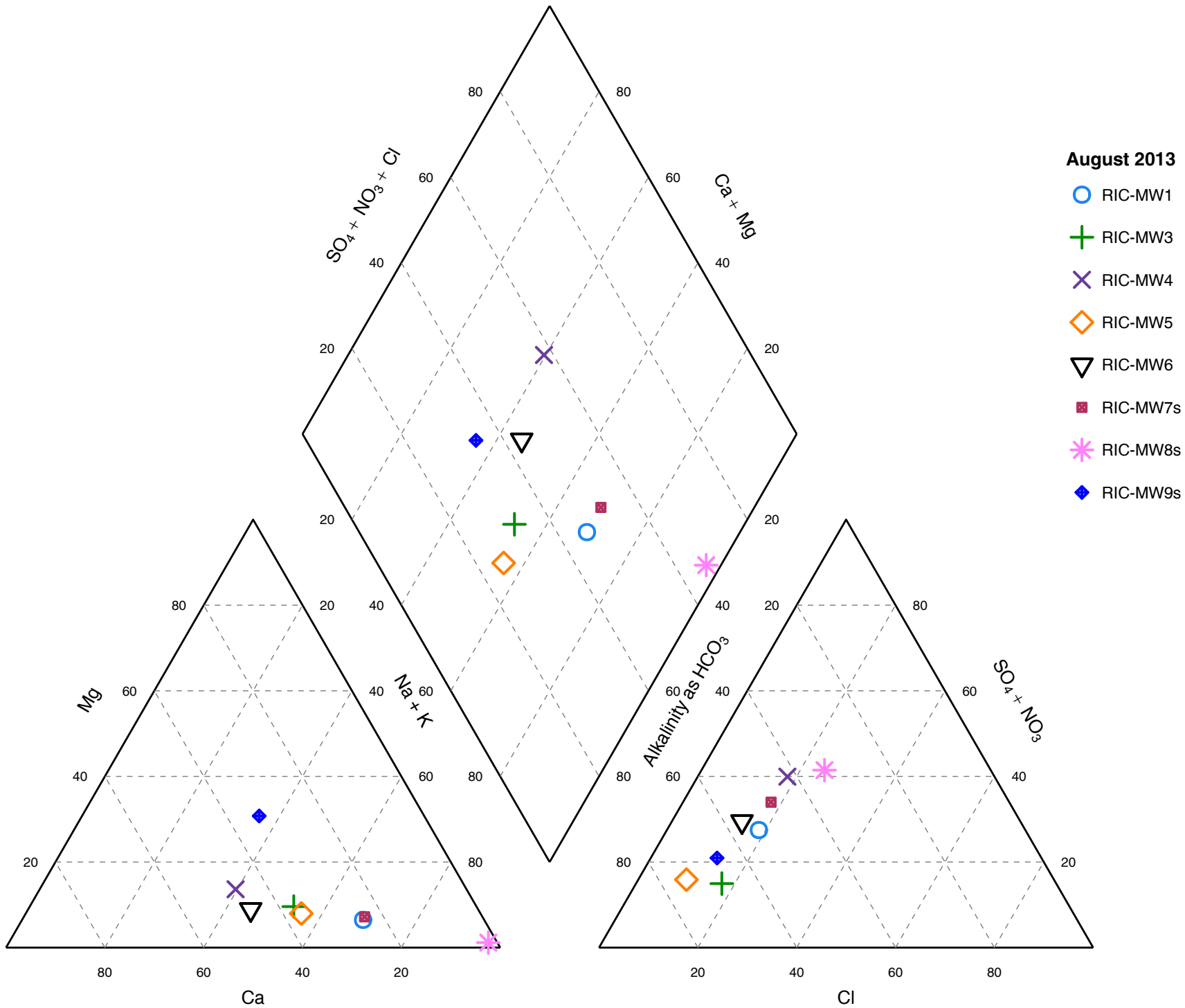

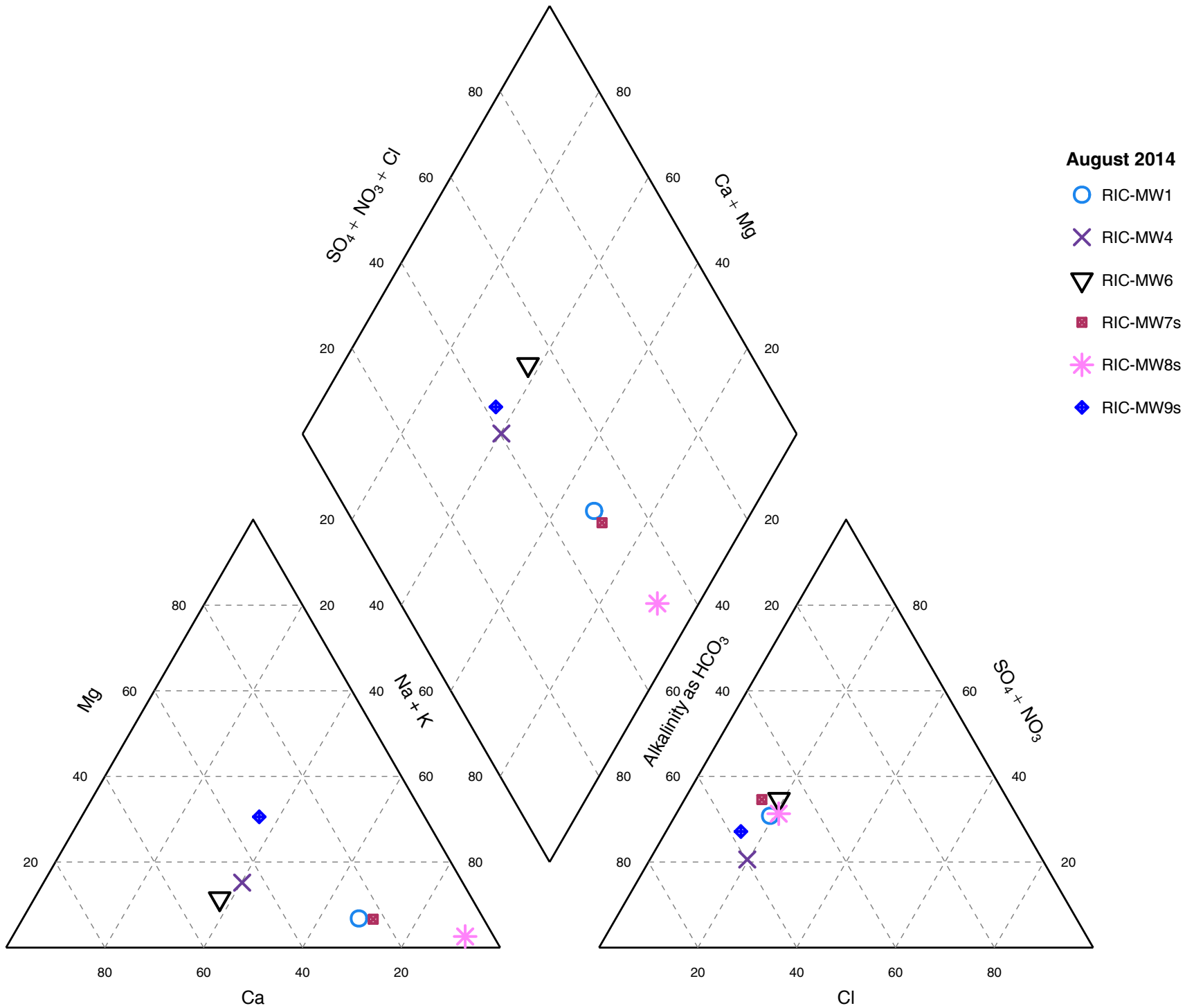

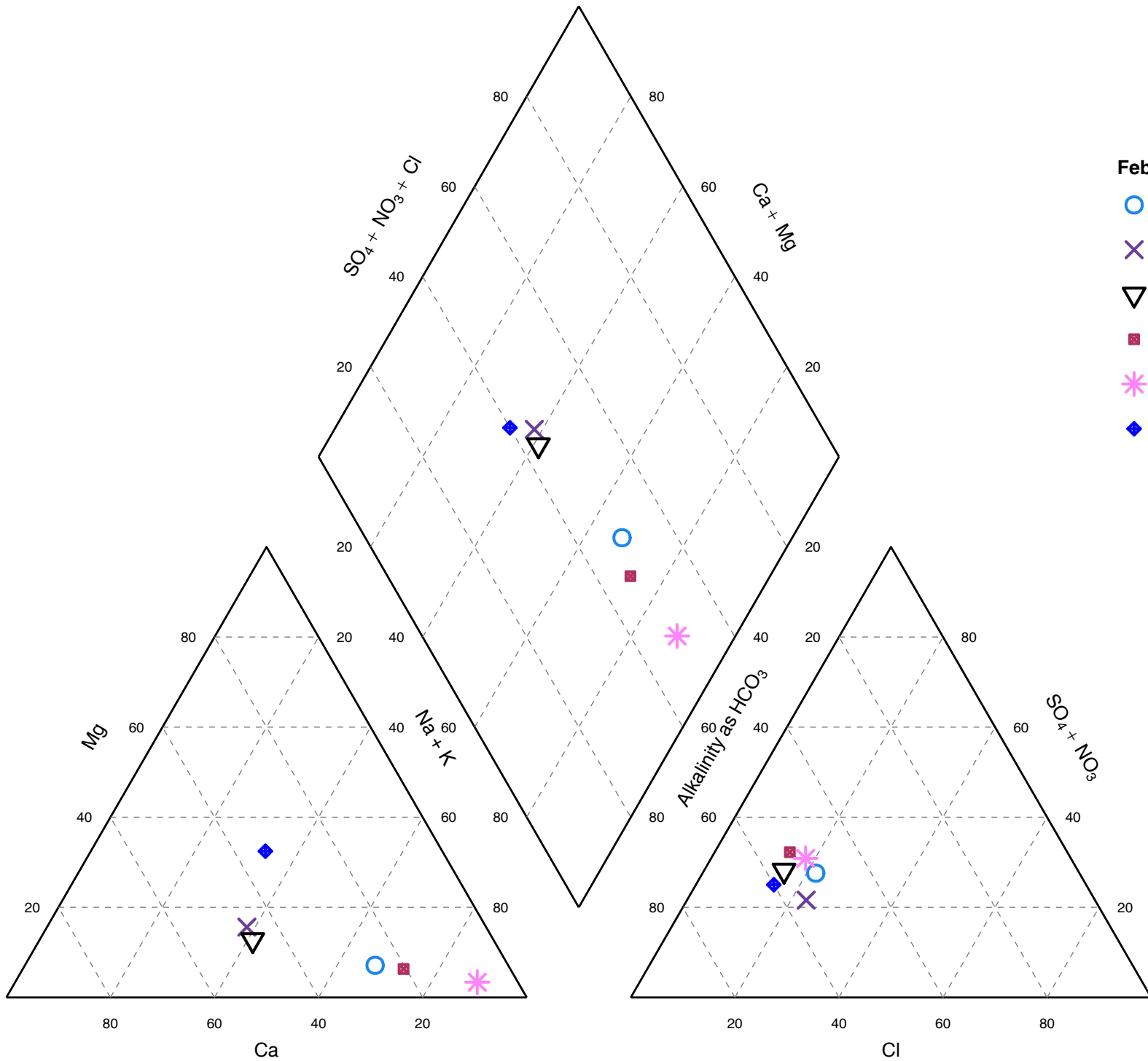

February 2015

- RIC-MW1
- ✕ RIC-MW4
- ▽ RIC-MW6
- RIC-MW7s
- * RIC-MW8s
- ◆ RIC-MW9s

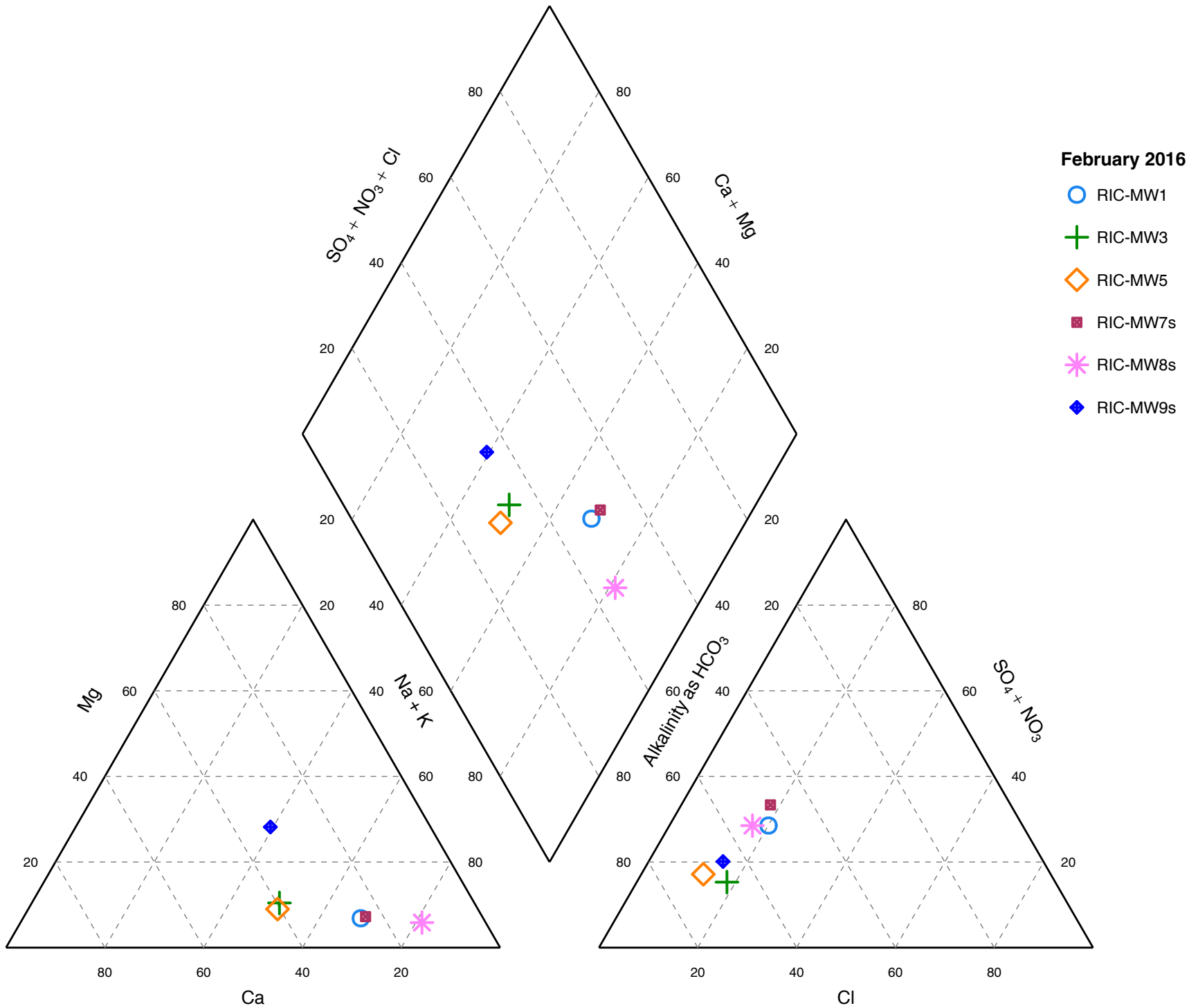

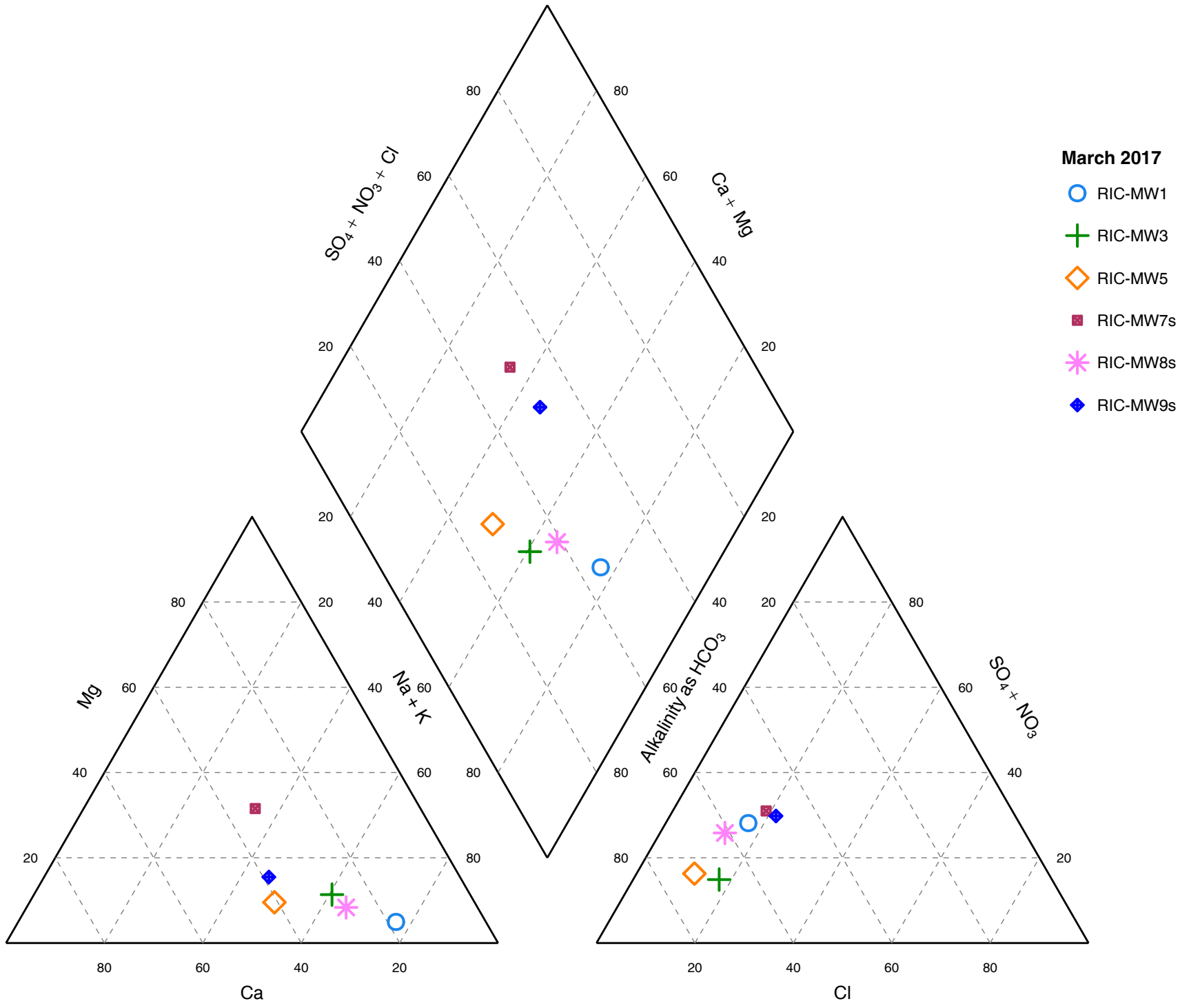

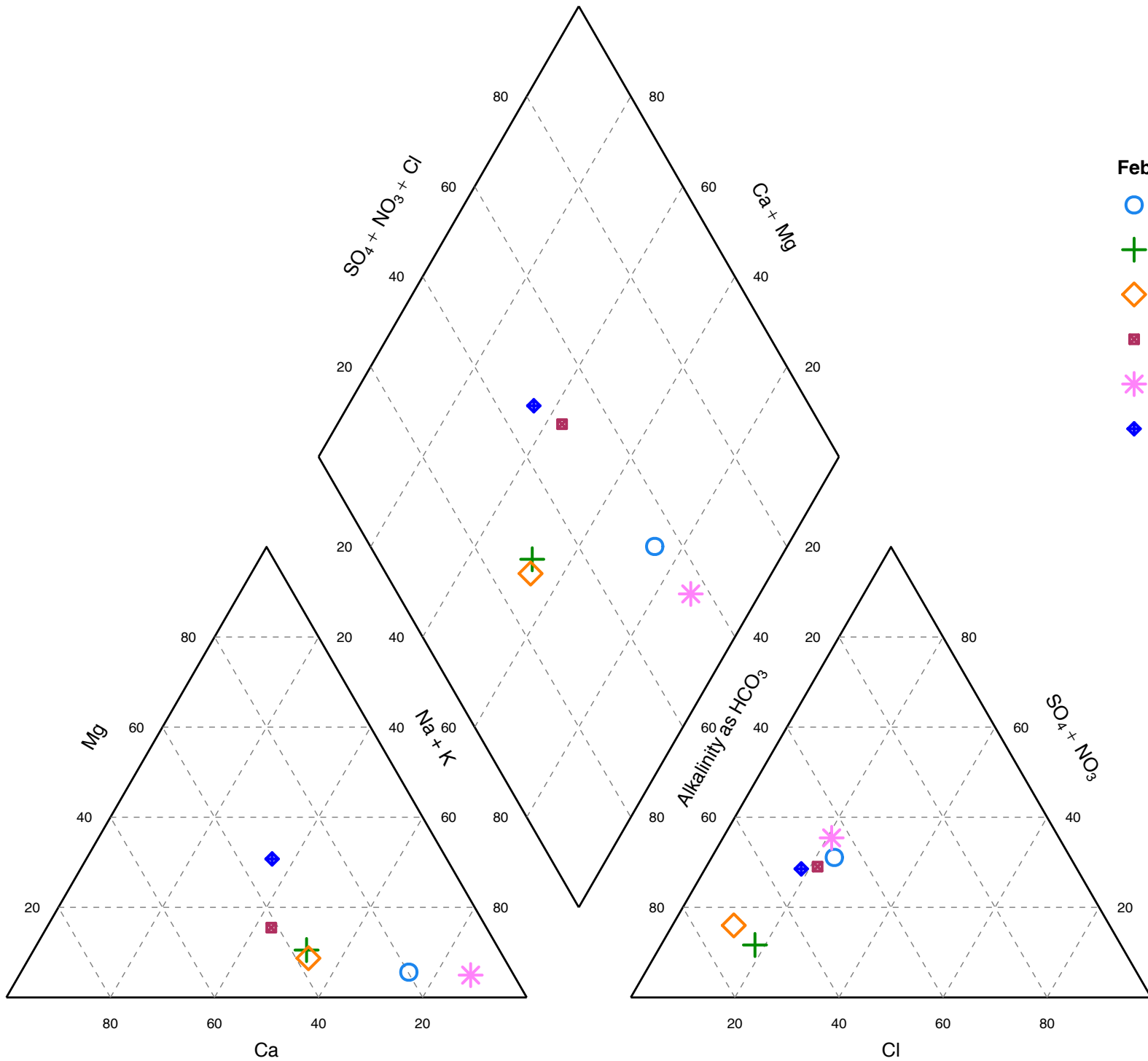

February 2019

◆ RIC-MW9s

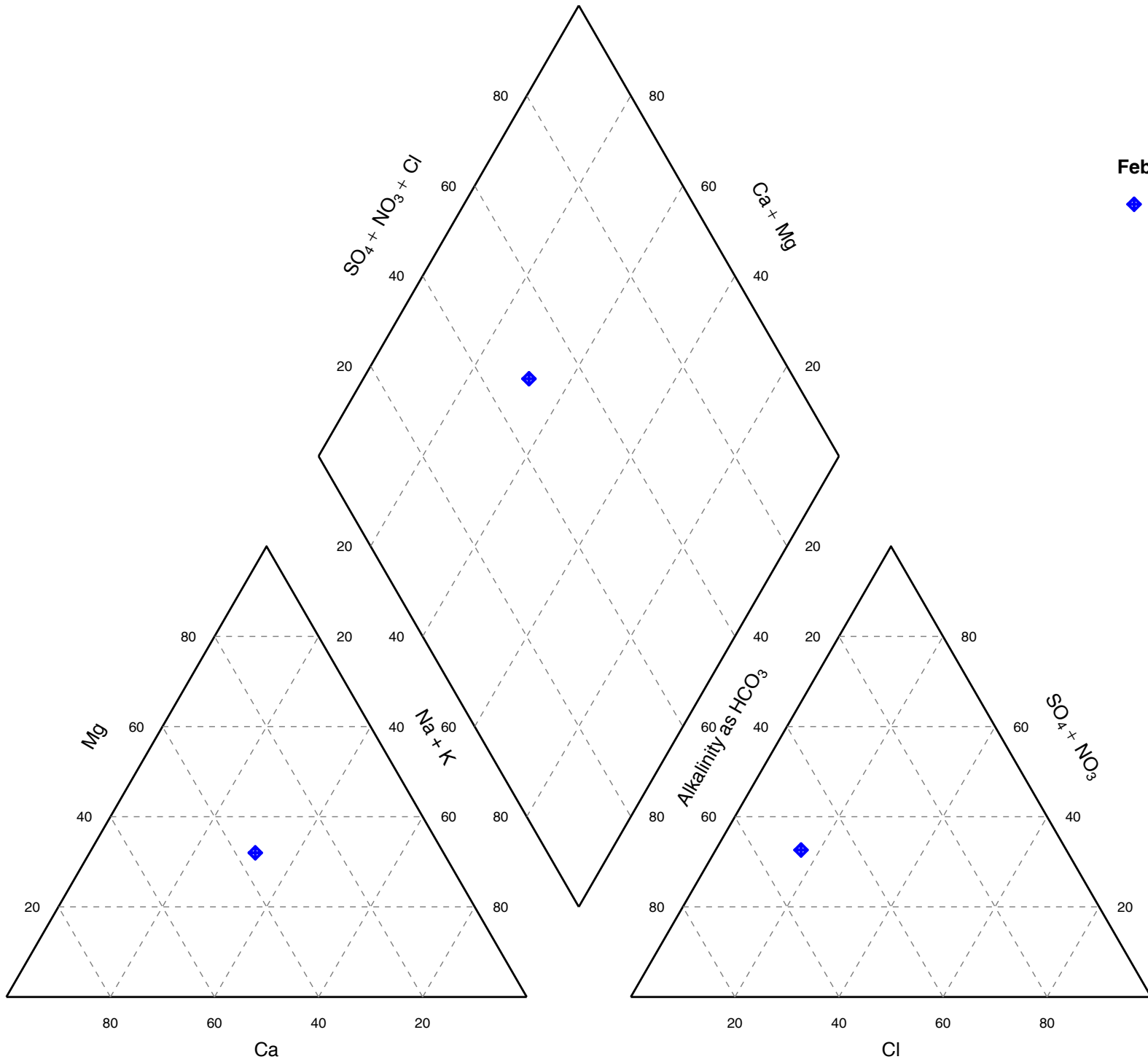

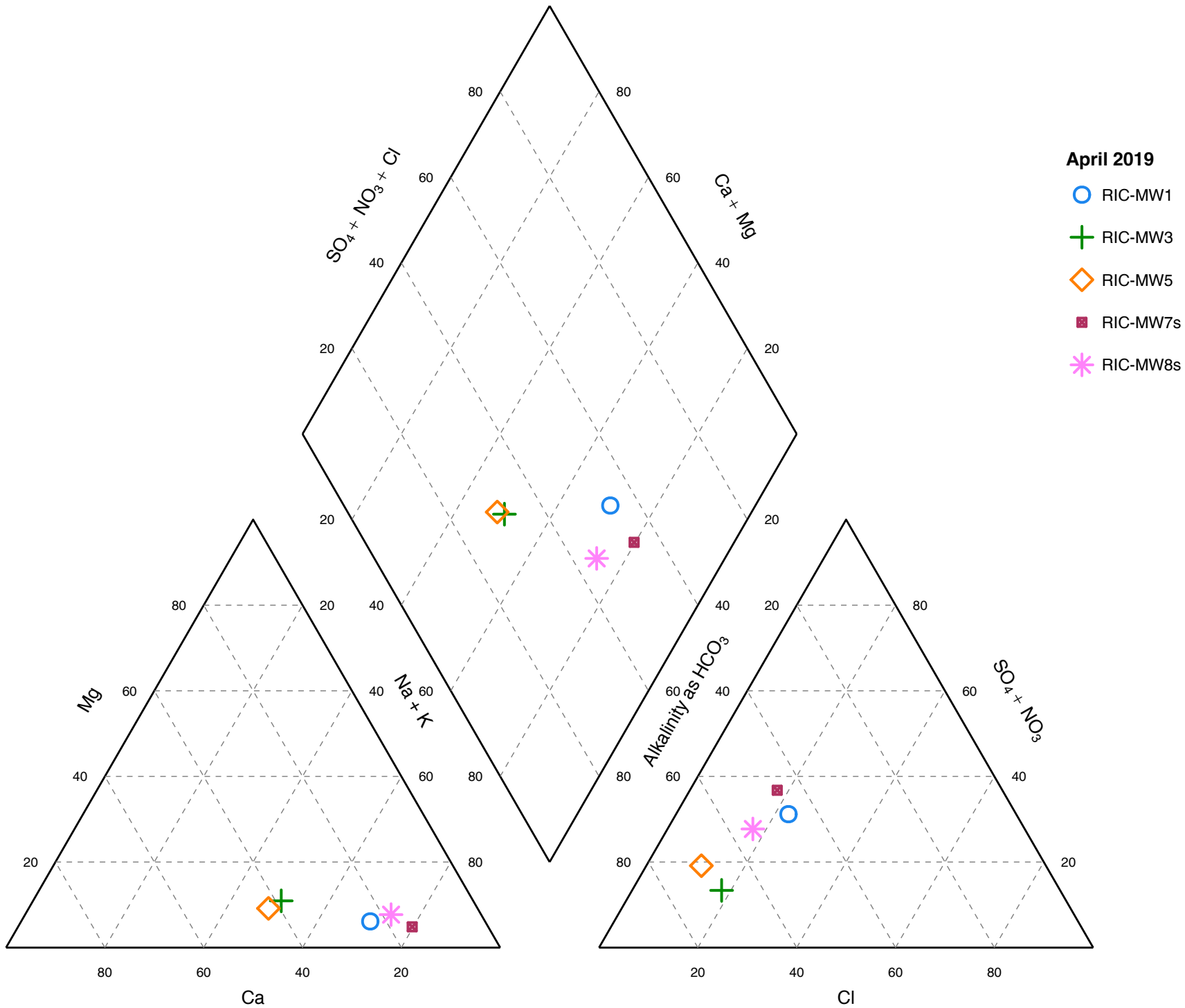

August 2013

+ SIE-MW3

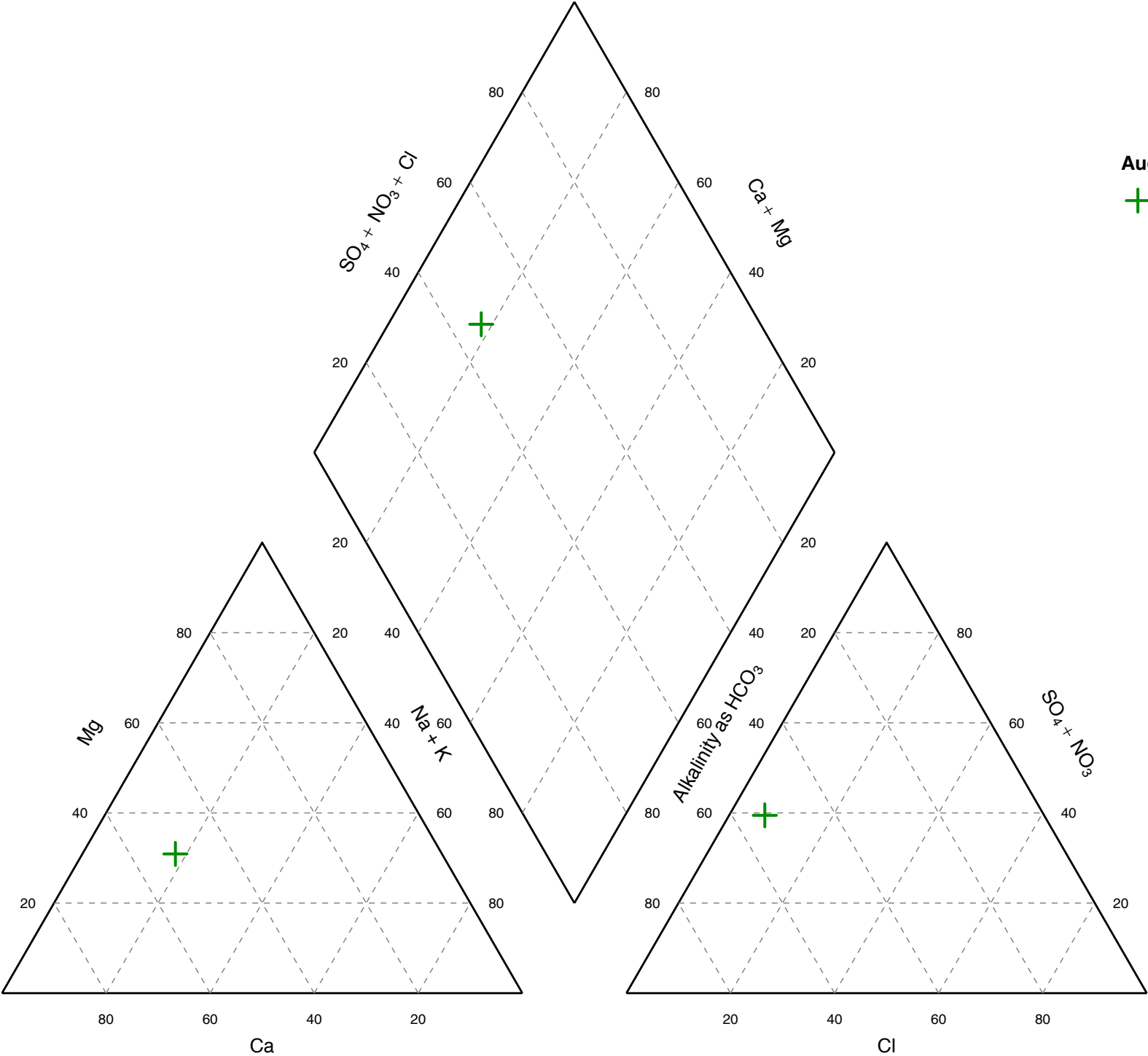

August 2014

○ SIE-MW1

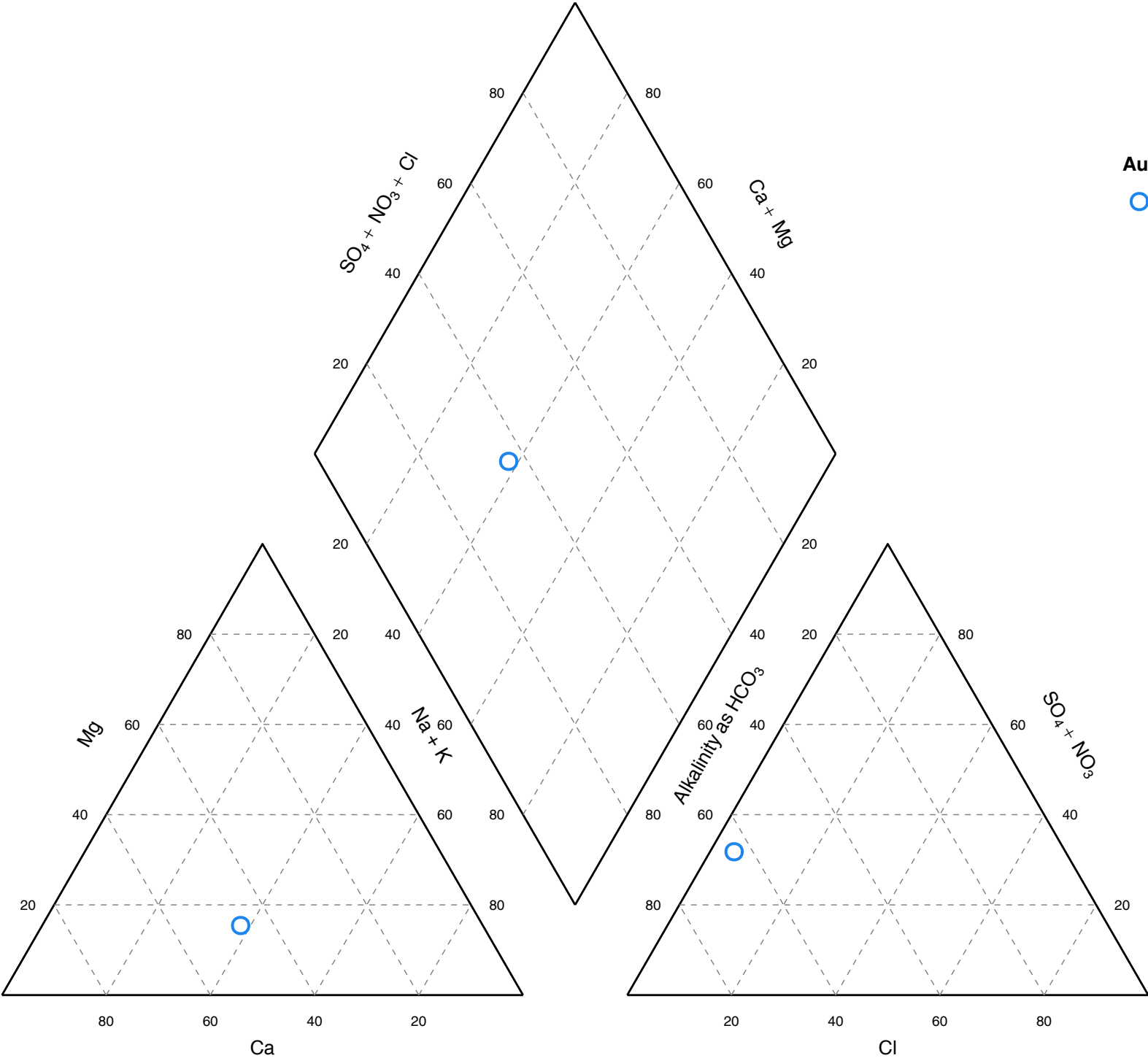

February 2015

○ SIE-MW1

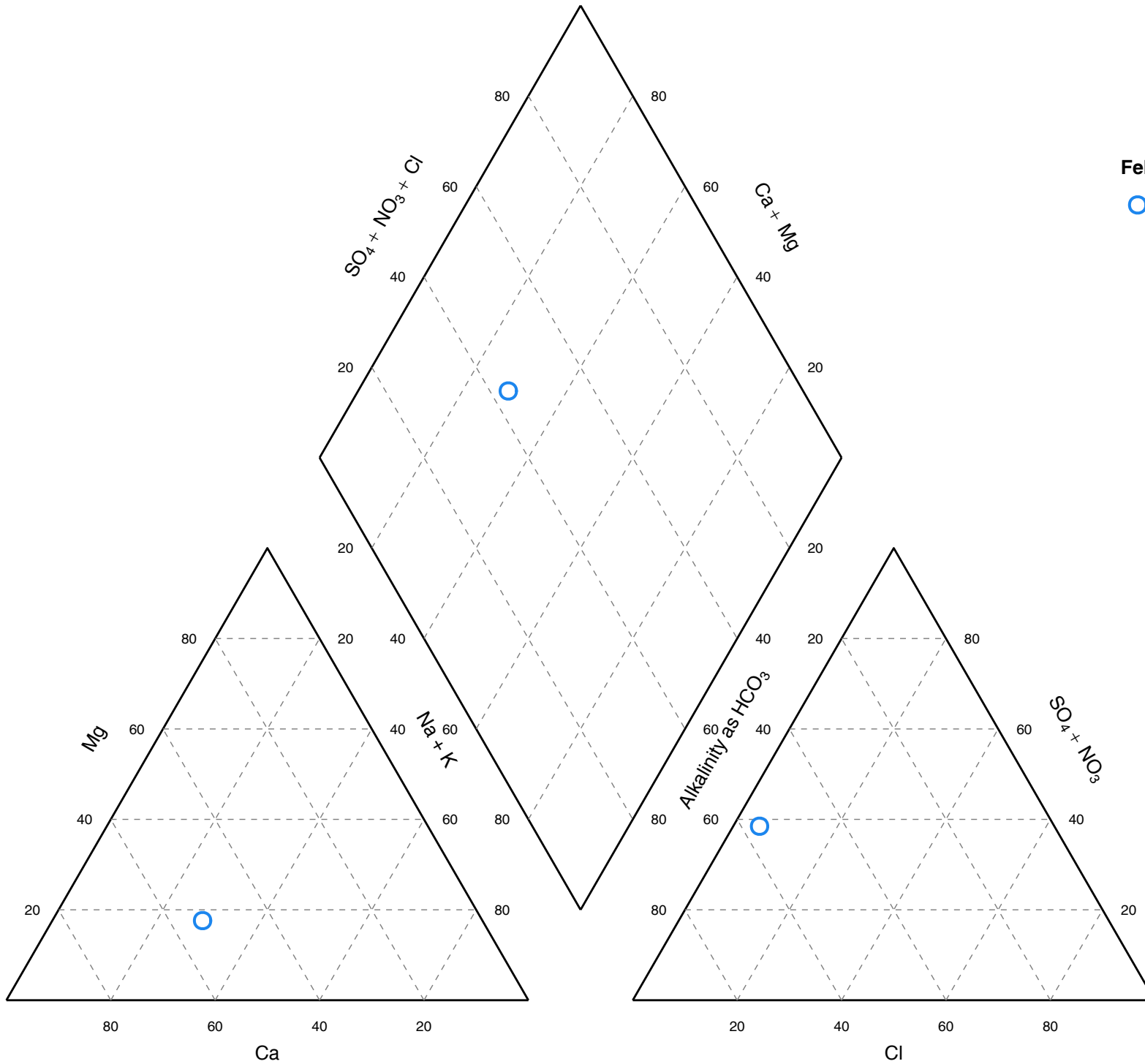

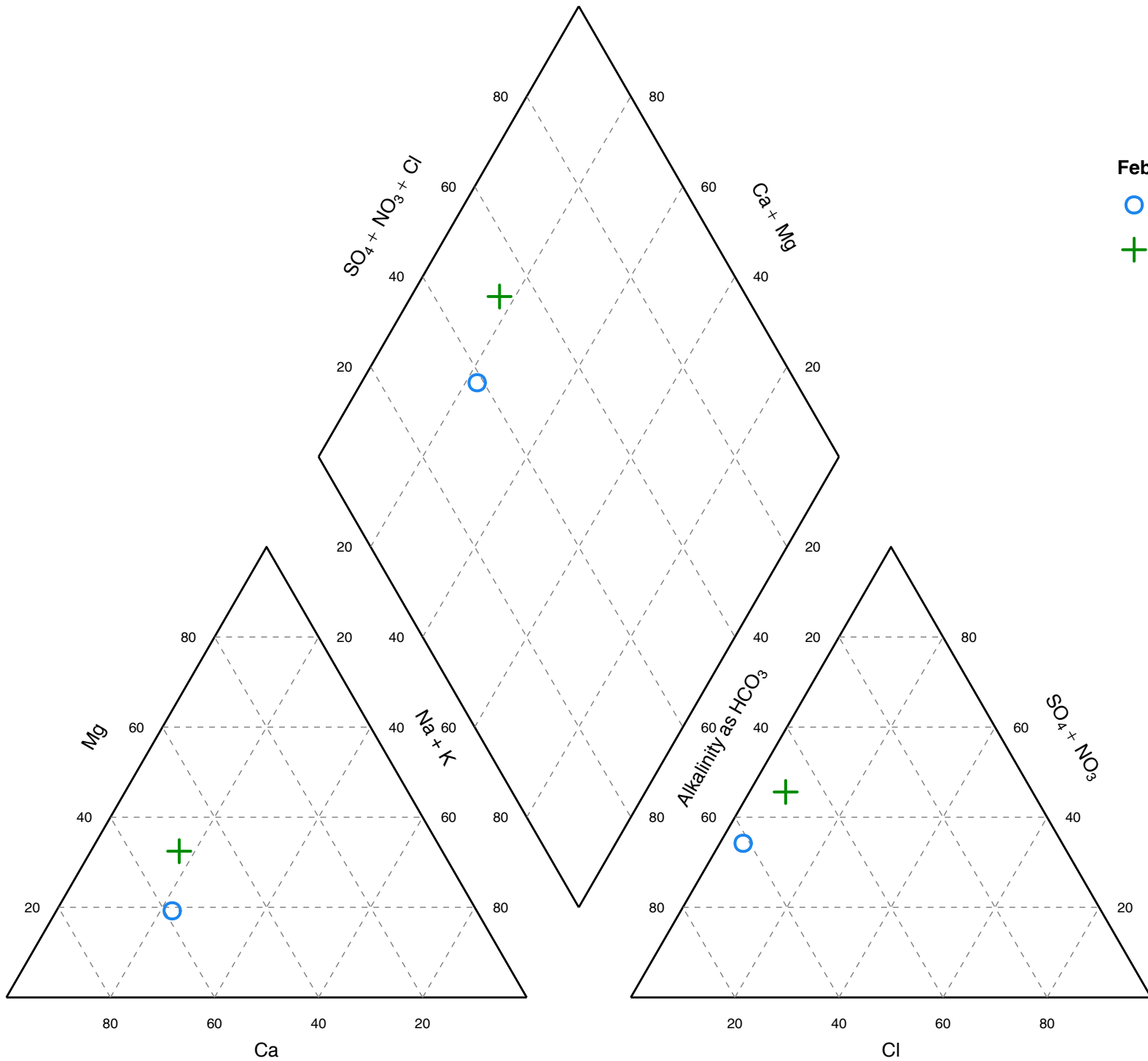

February 2016

○ SIE-MW1

✚ SIE-MW3

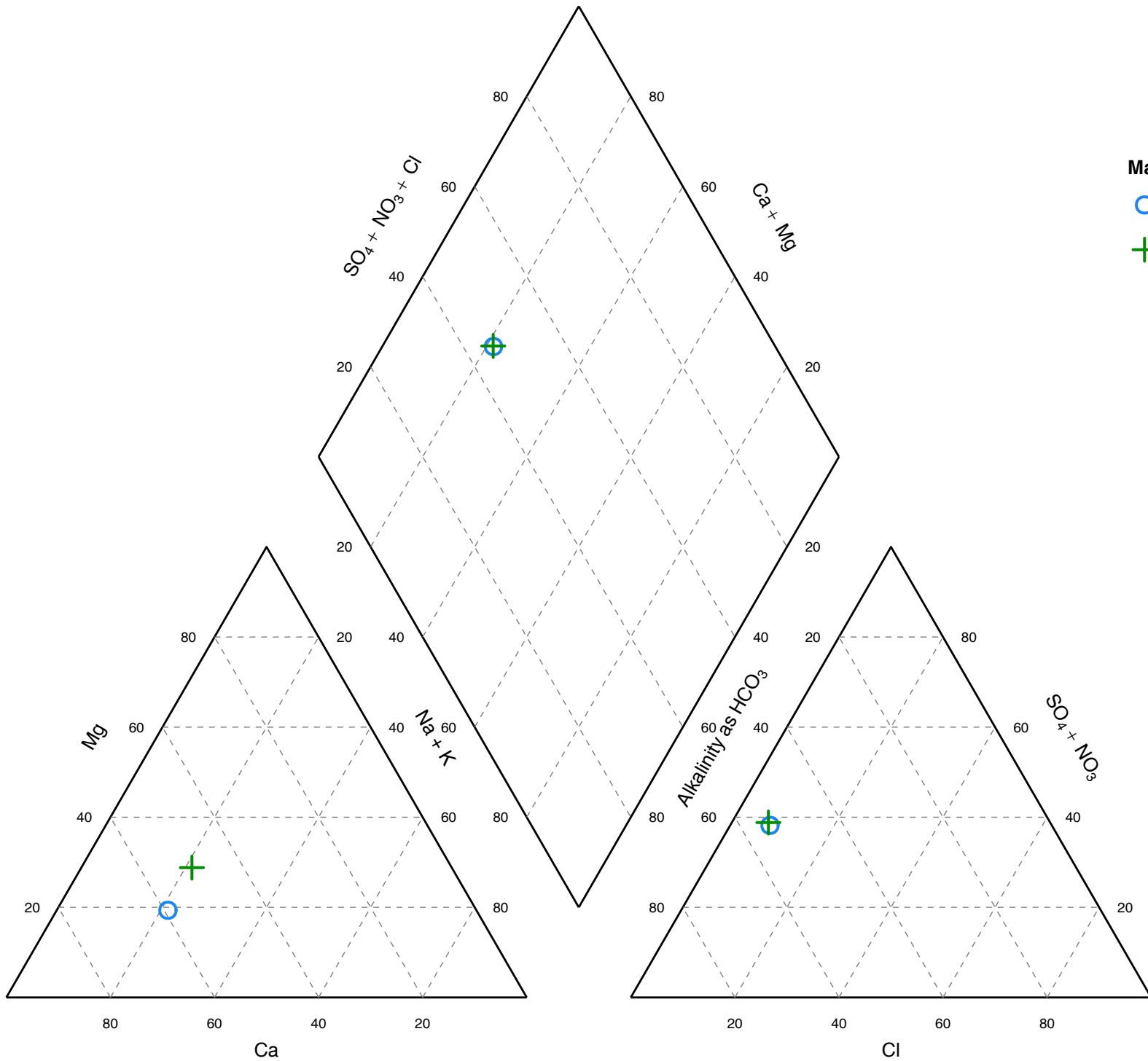

March 2017

○ SIE-MW1

⊕ SIE-MW3

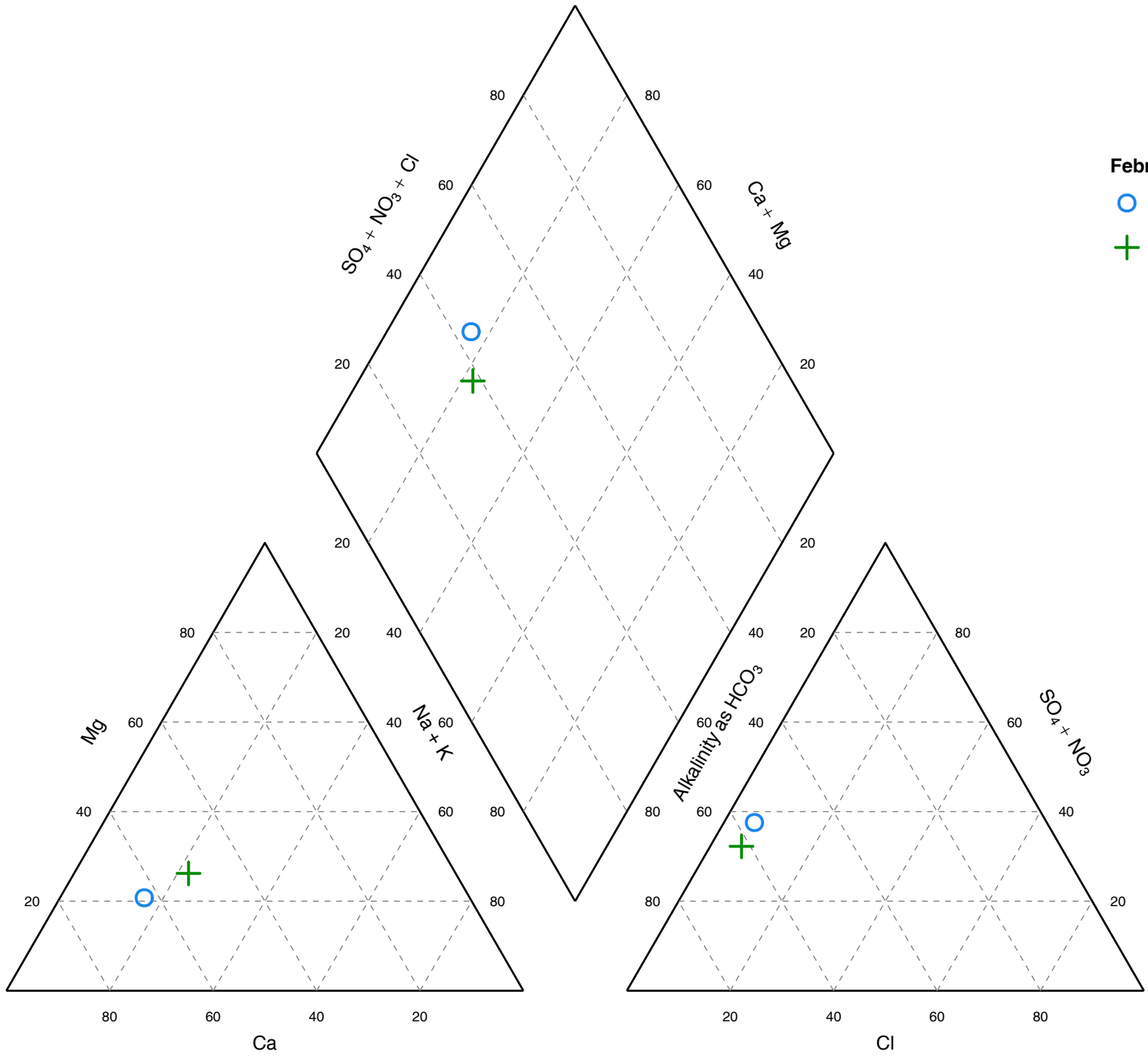

February 2018

○ SIE-MW1

+ SIE-MW3

February 2019

○ SIE-MW1

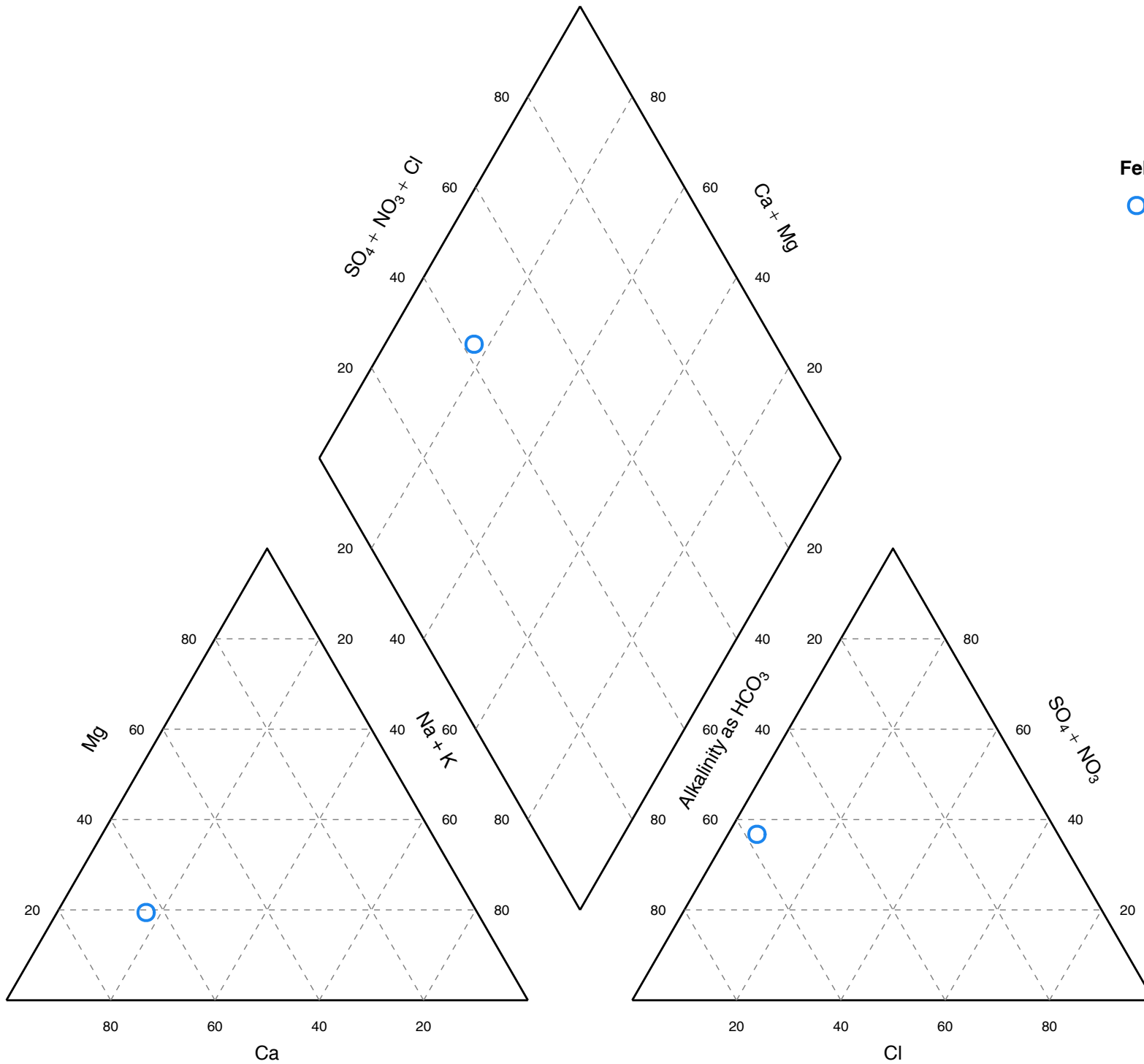

March 2019

+ SIE-MW3

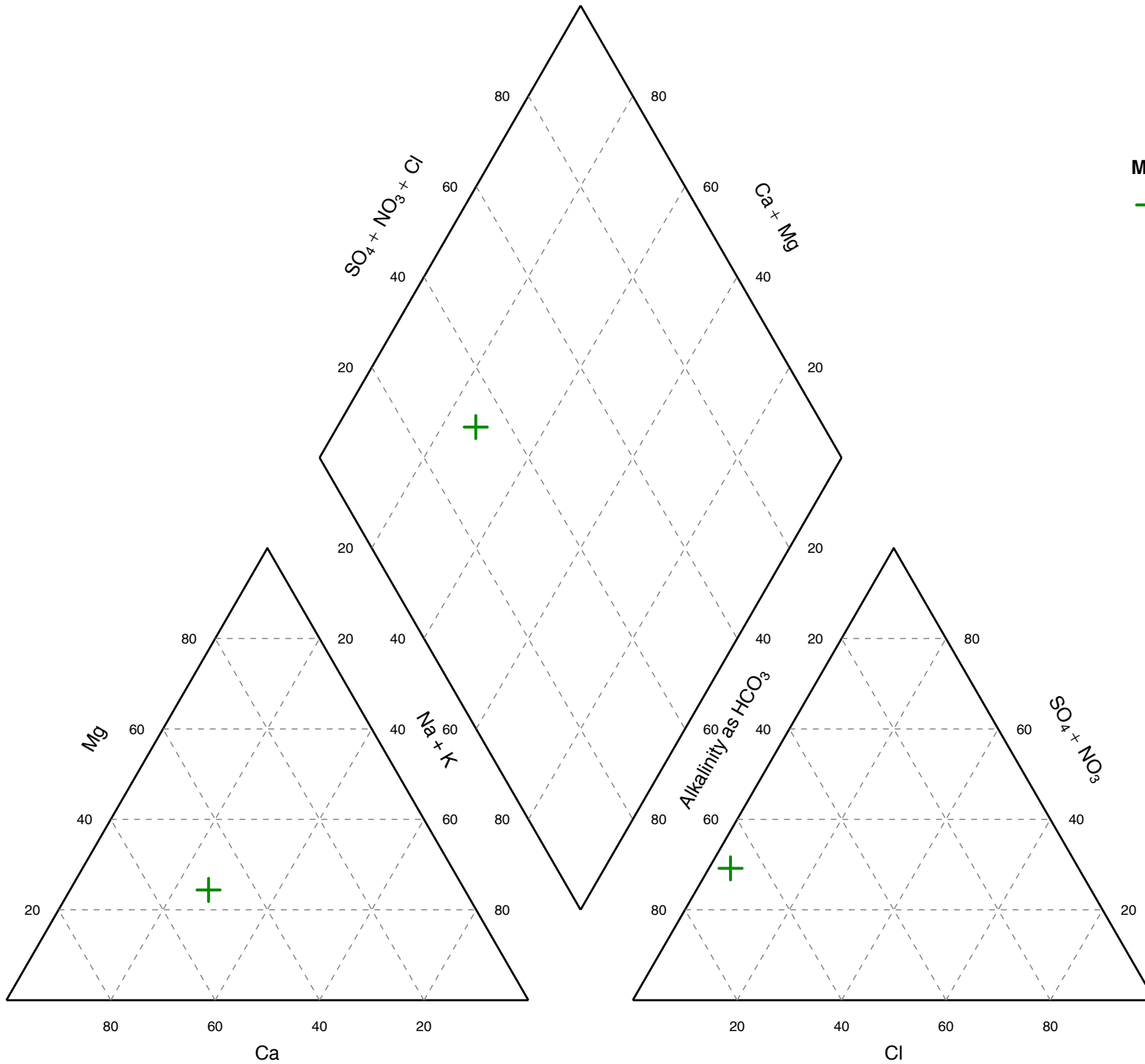

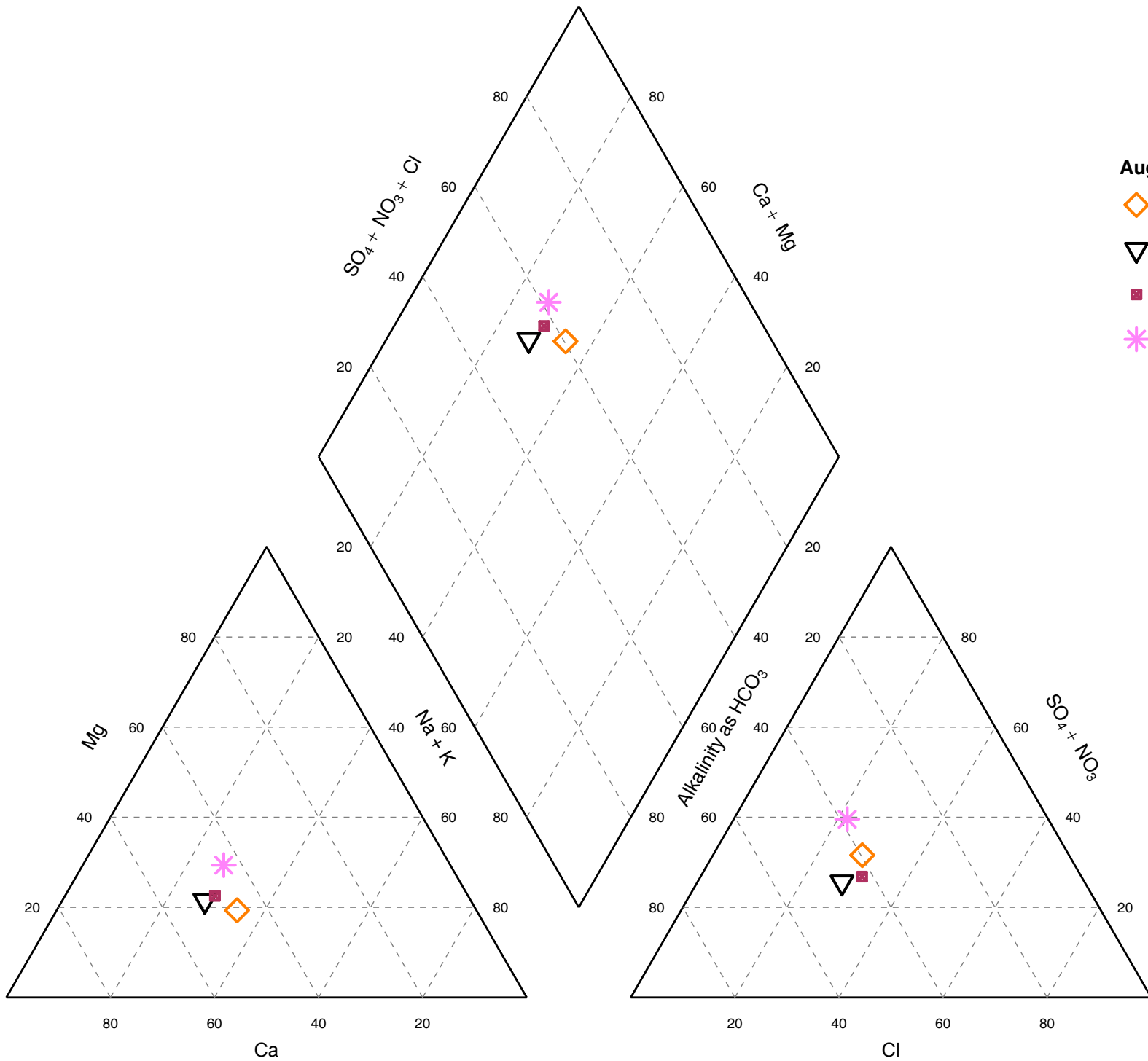

August 2013

- ◇ SO2-MW5s
- ▽ SO2-MW6s
- SO2-MW7d
- * SO2-MW8d

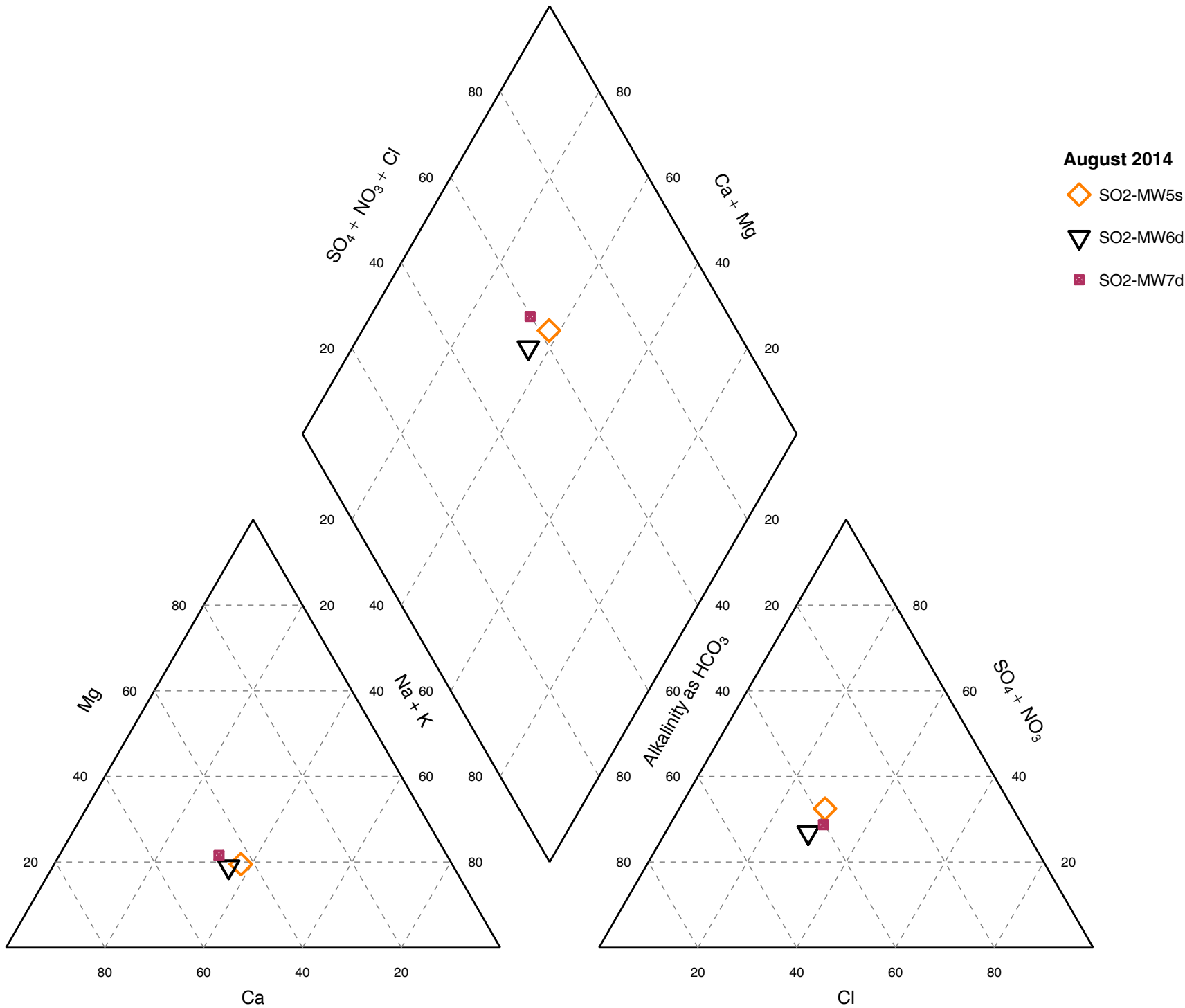

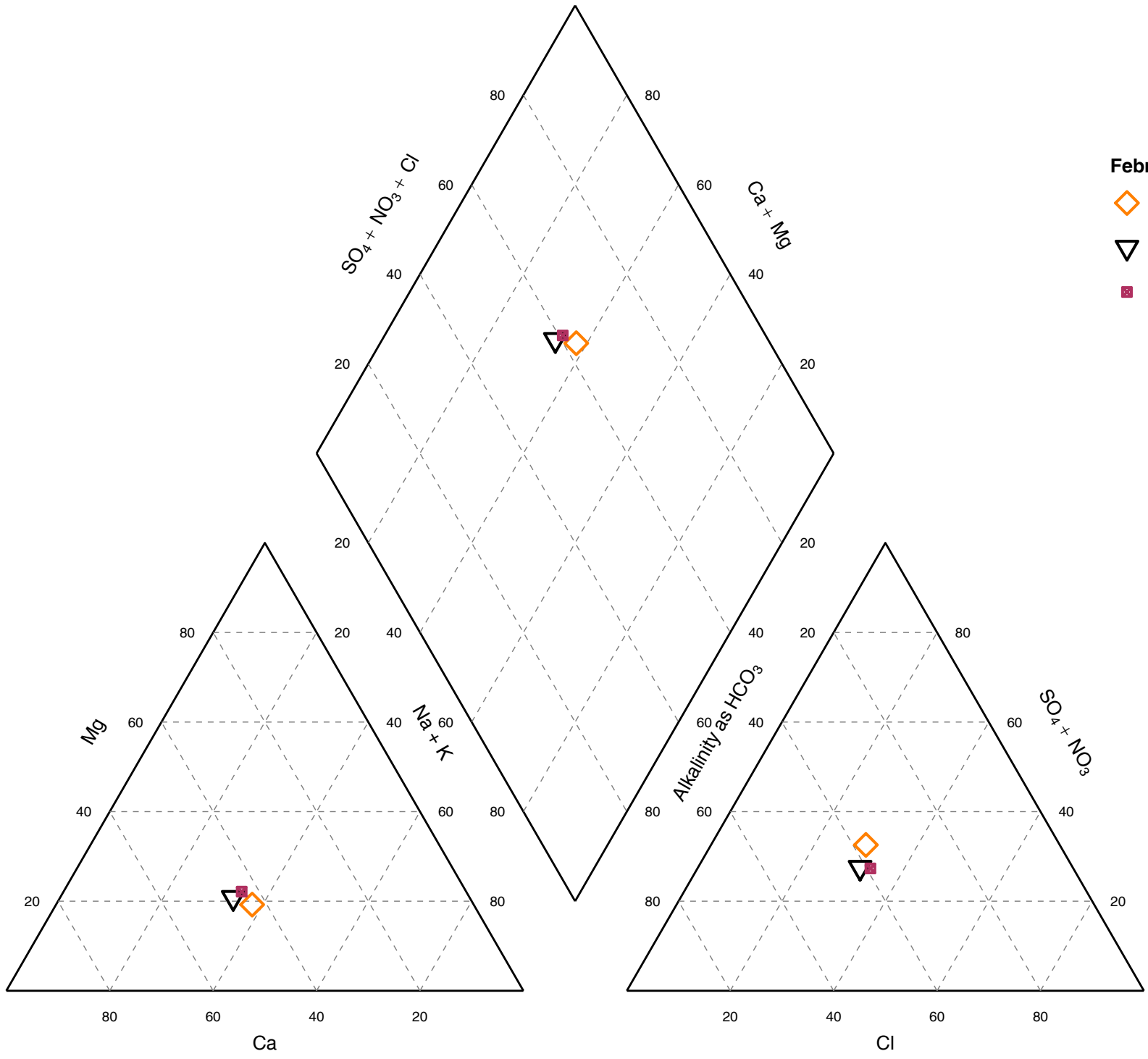

February 2015

- ◇ SO2-MW5s
- ▽ SO2-MW6d
- SO2-MW7d

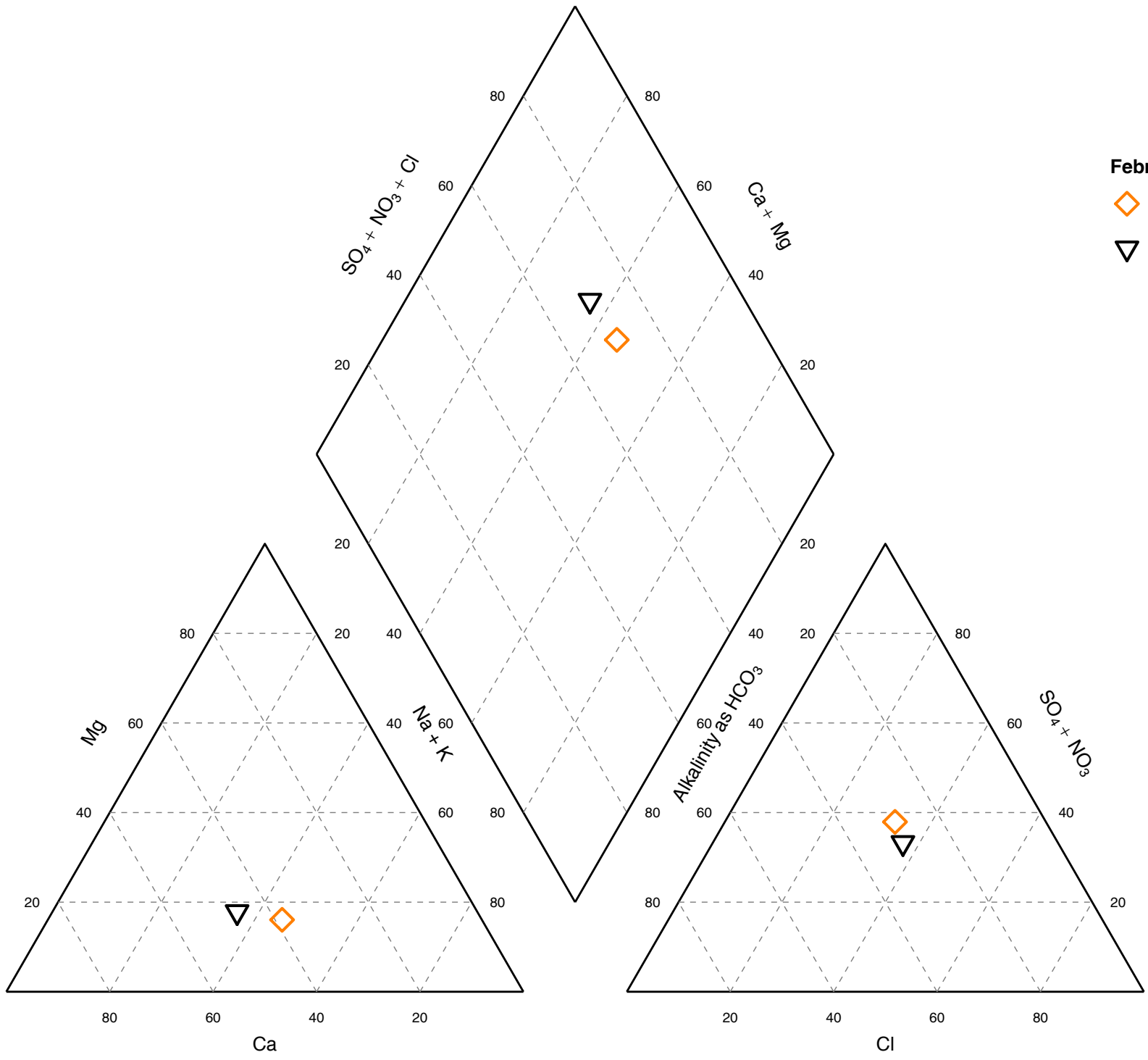

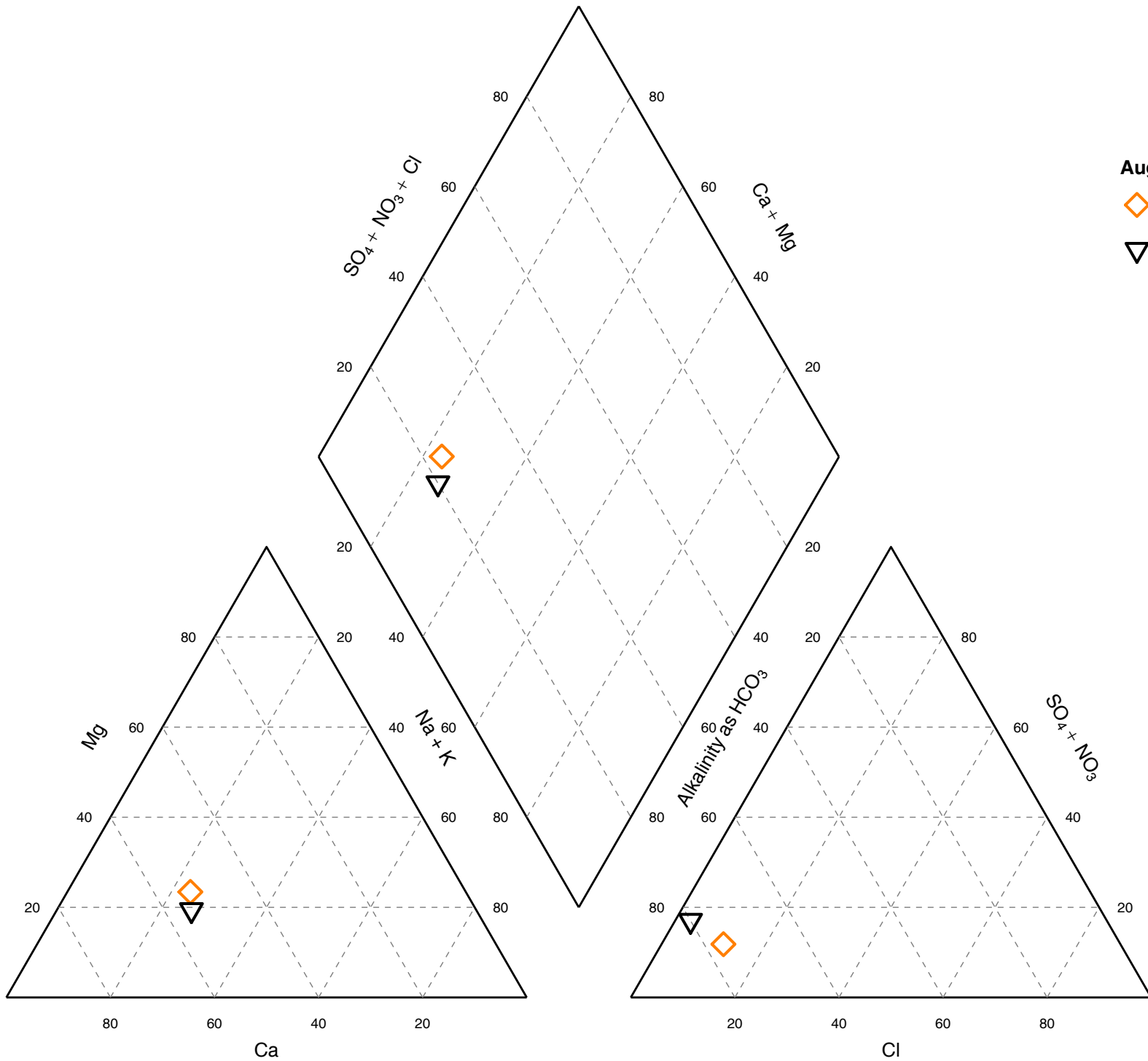

August 2013

◇ SOJ-MW5d

▽ SOJ-MW6d

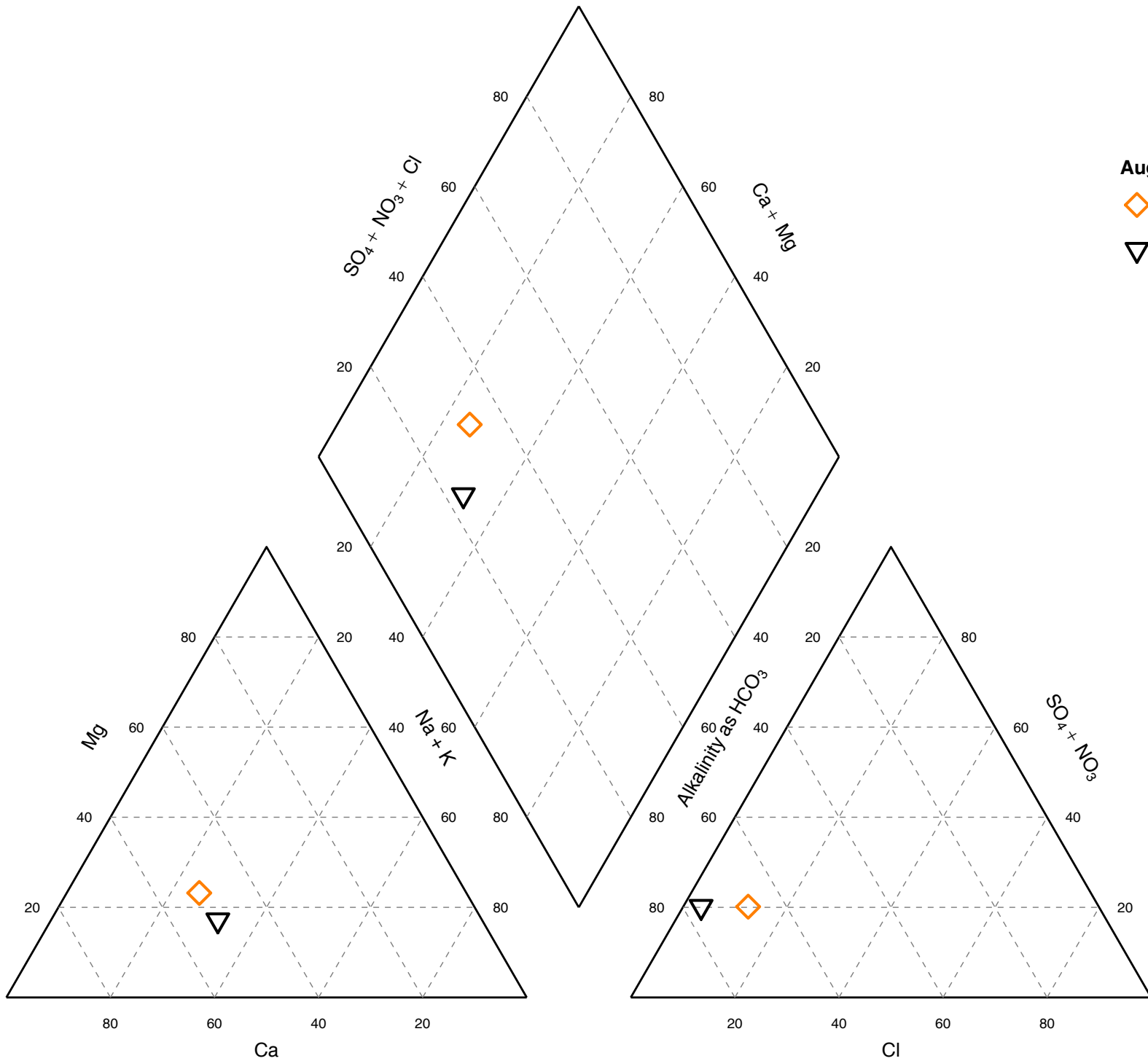

August 2014

◇ SOJ-MW5d

▽ SOJ-MW6d

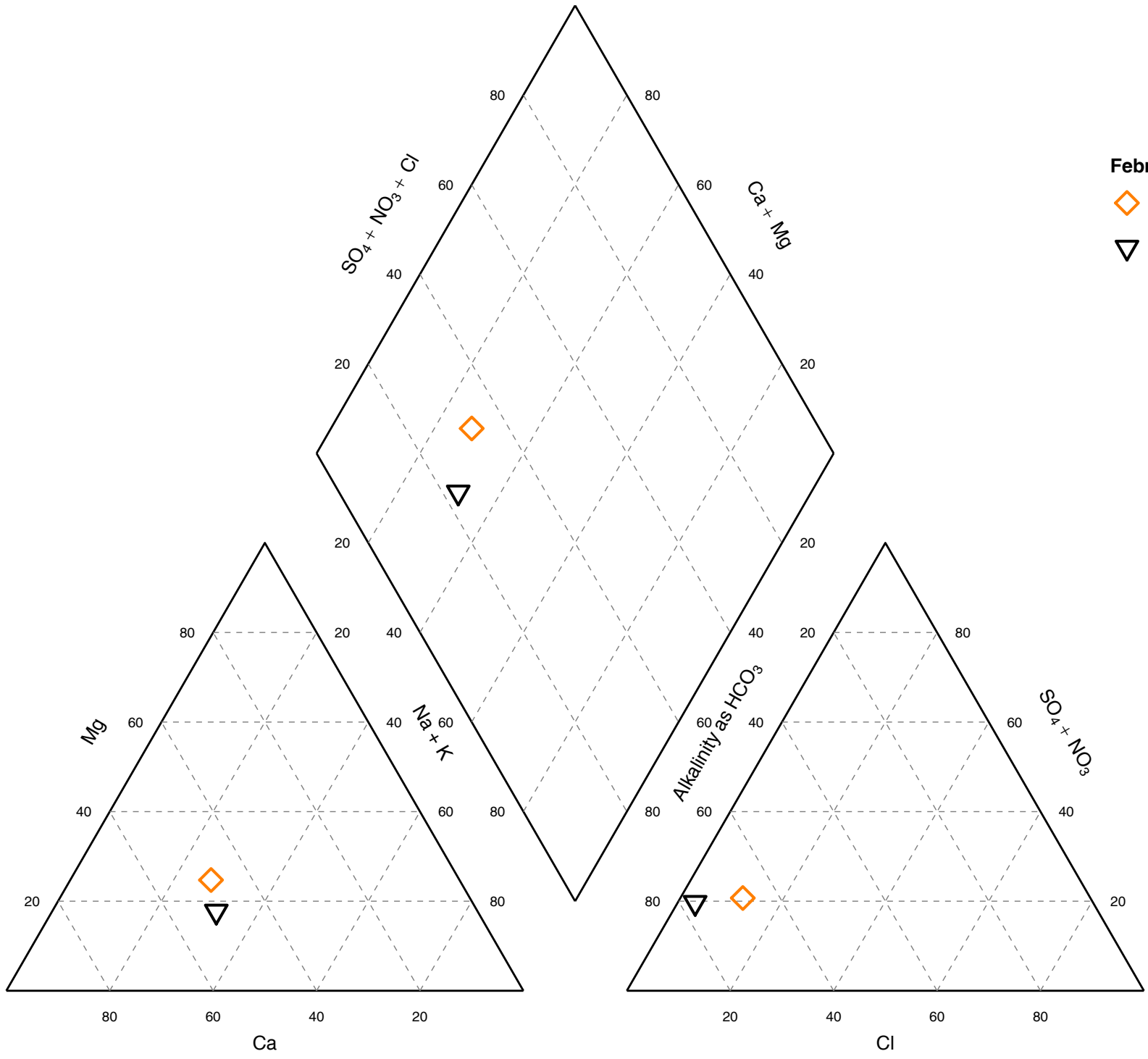

February 2015

◇ SOJ-MW5d

▽ SOJ-MW6d

Attachment A13

Ordinary Least Squares Regression (OLSR) – Total Nitrogen and TDS (2012-2019) including Q1/Q3 and Q2/Q4 Trendlines

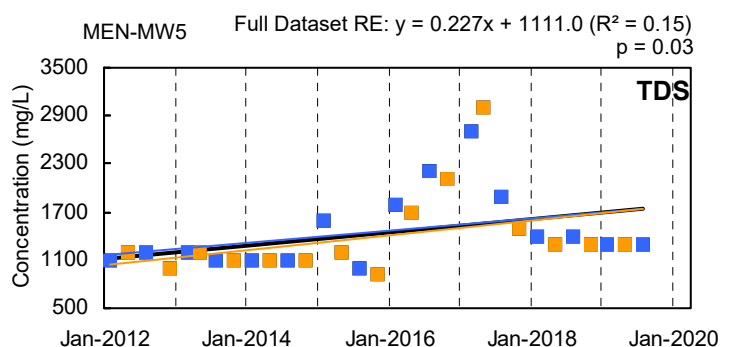
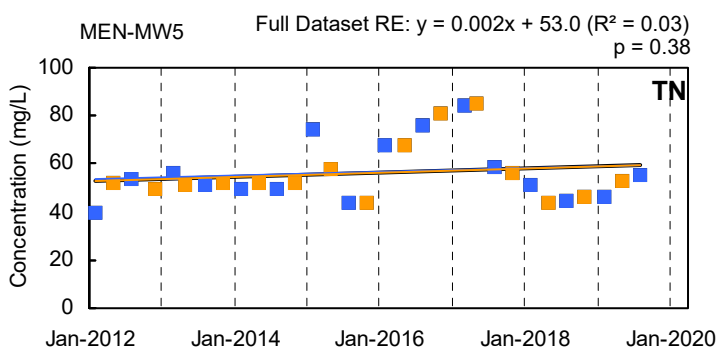
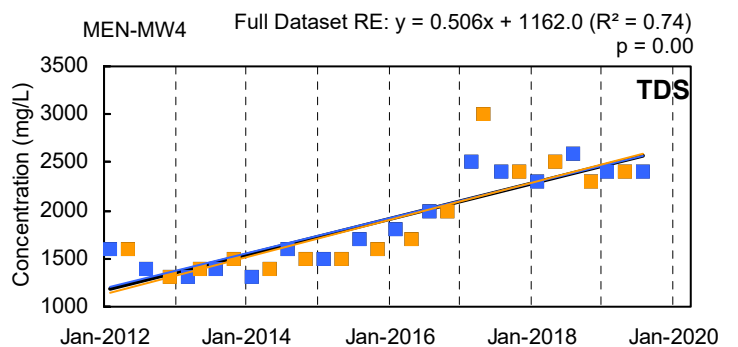
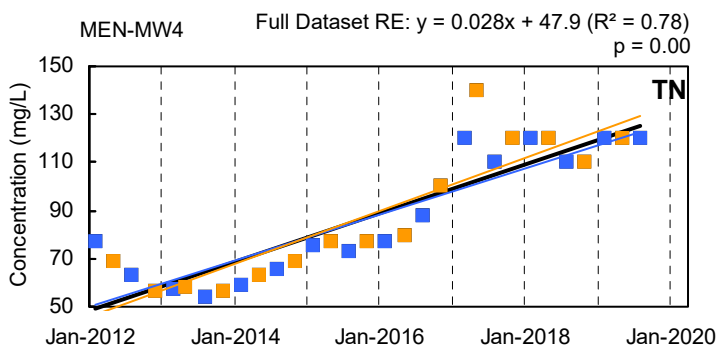
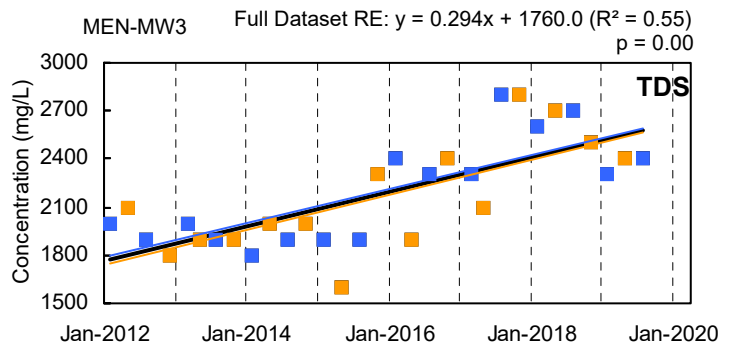
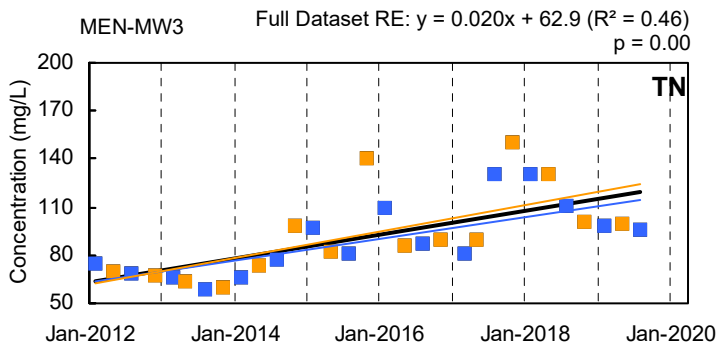
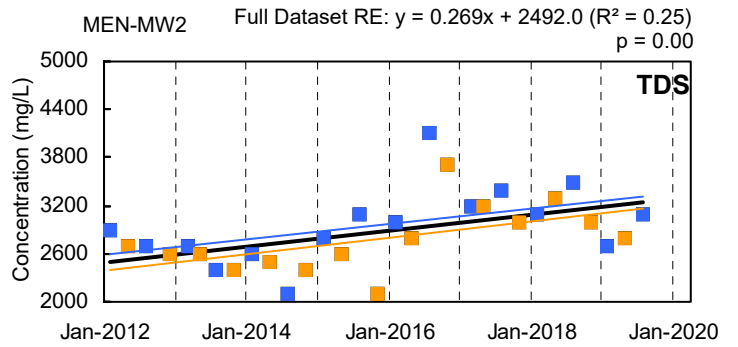
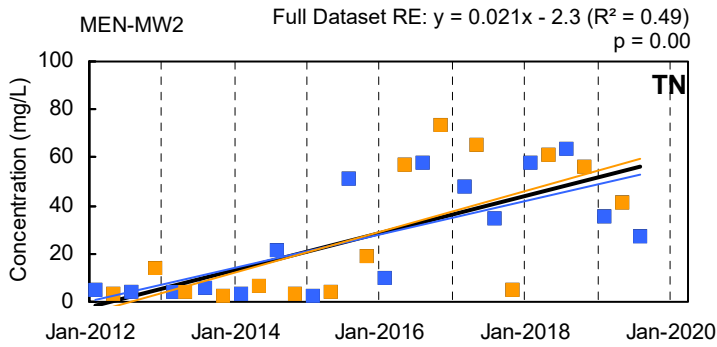
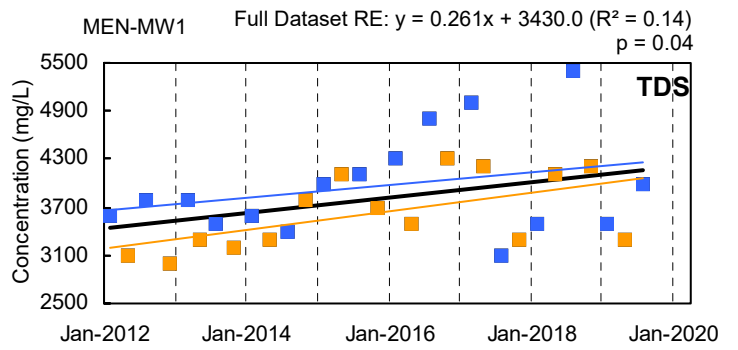
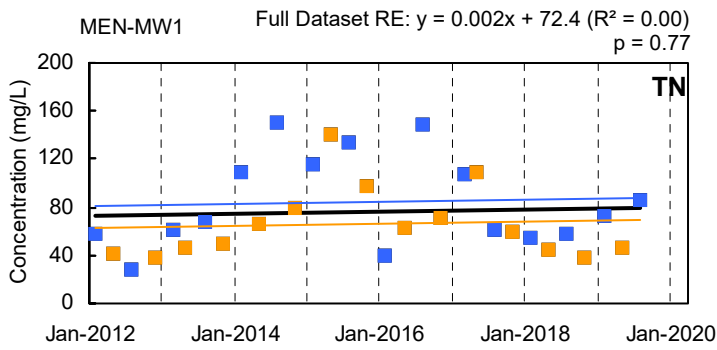

■ Q1/Q3 Result ■ Q2/Q4 Result
— Q1/Q3 Trendline — Q2/Q4 Trendline — Full Dataset Trendline

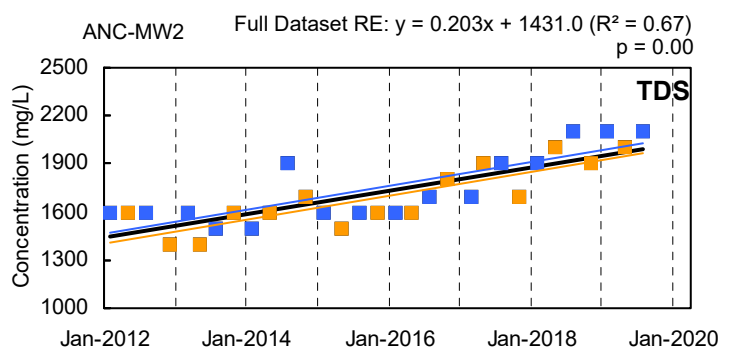
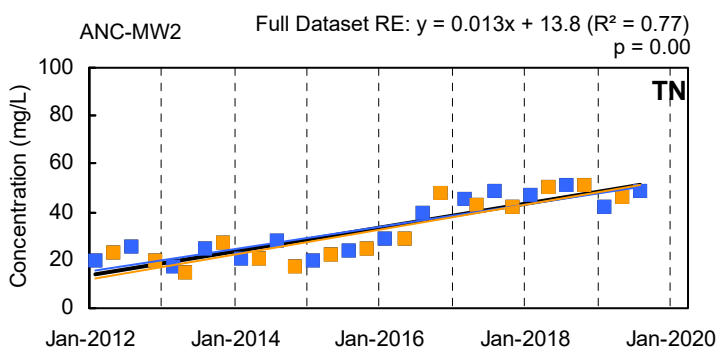
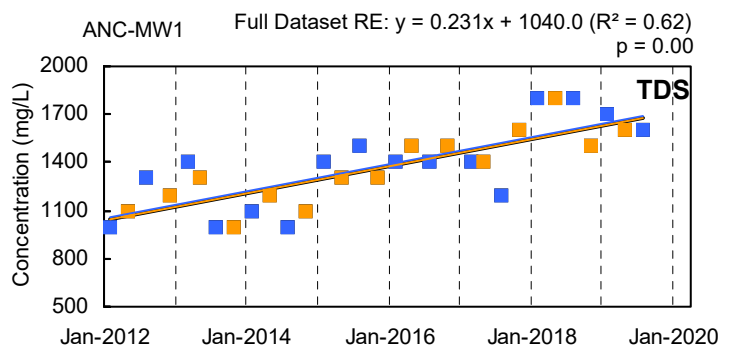
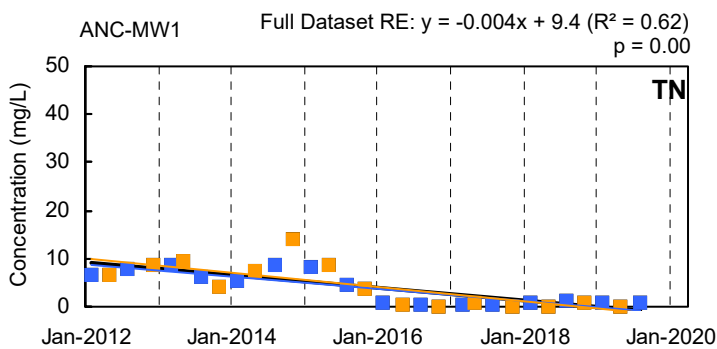
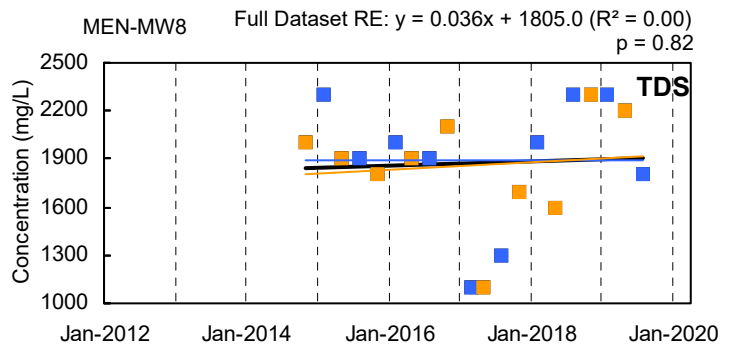
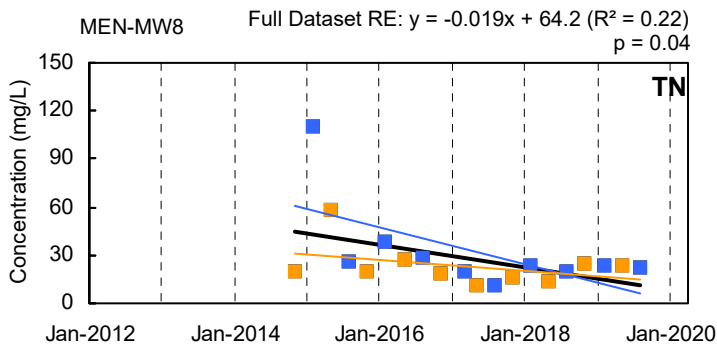
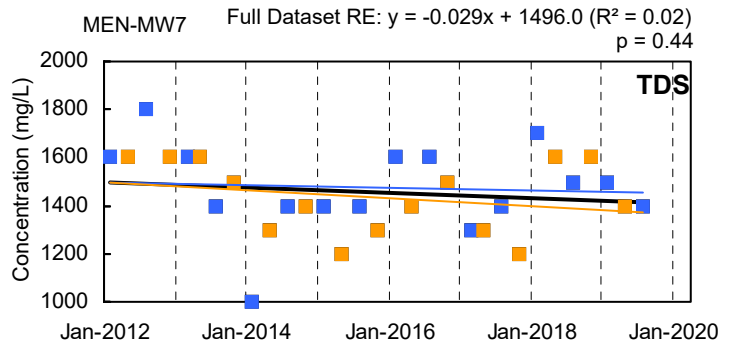
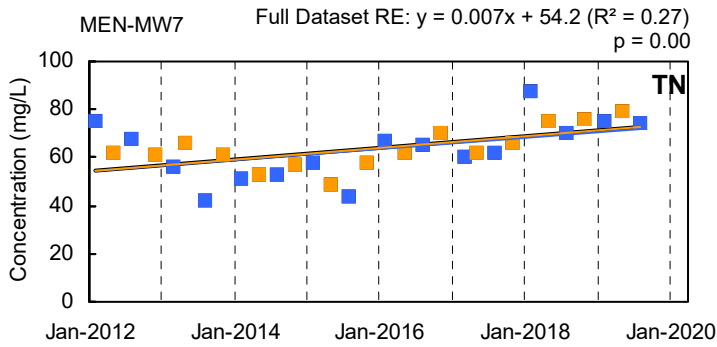
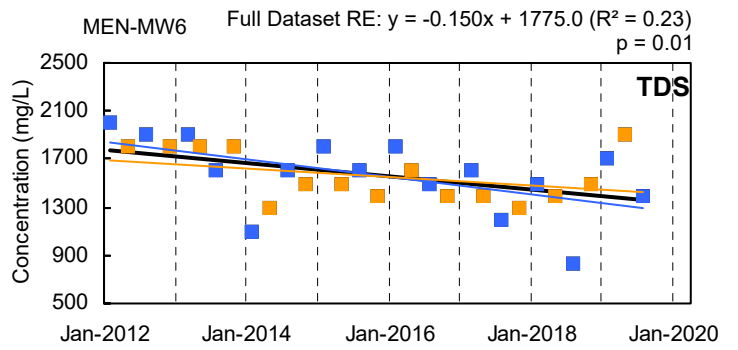
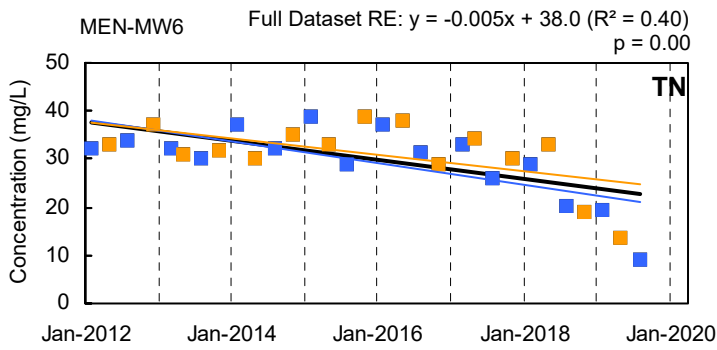

■ Q1/Q3 Result ■ Q2/Q4 Result
— Q1/Q3 Trendline — Q2/Q4 Trendline — Full Dataset Trendline

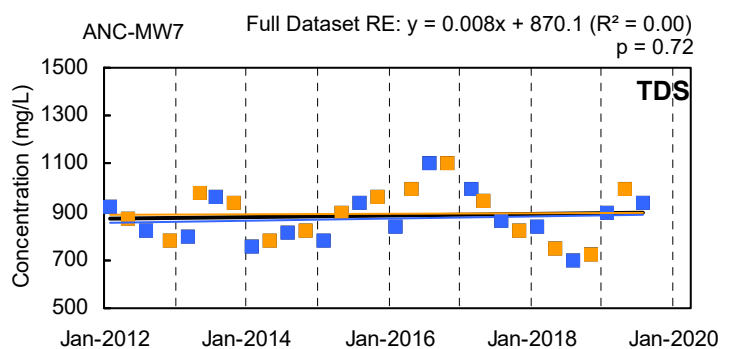
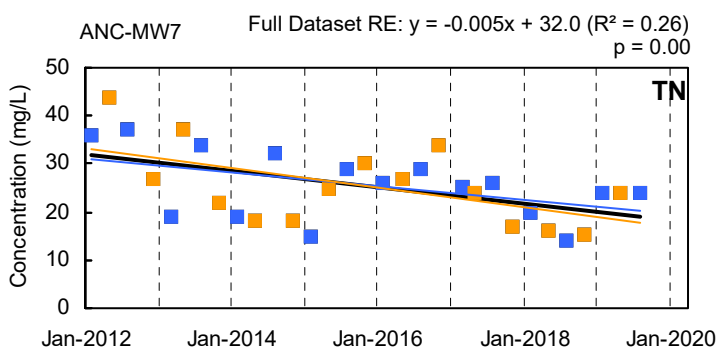
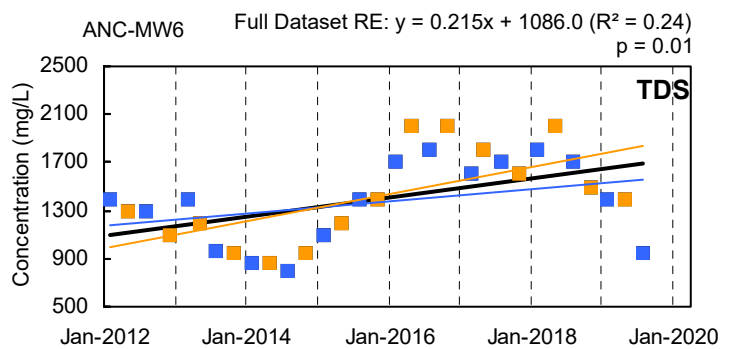
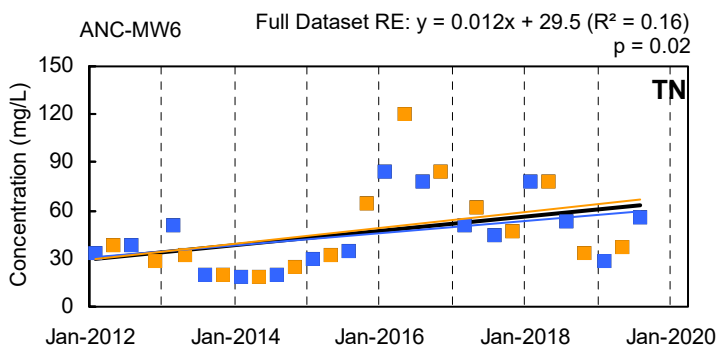
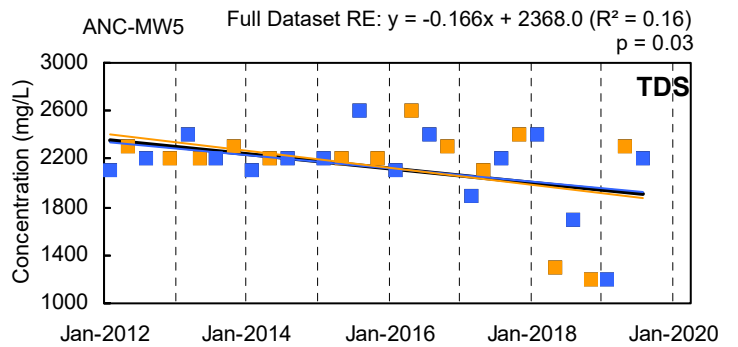
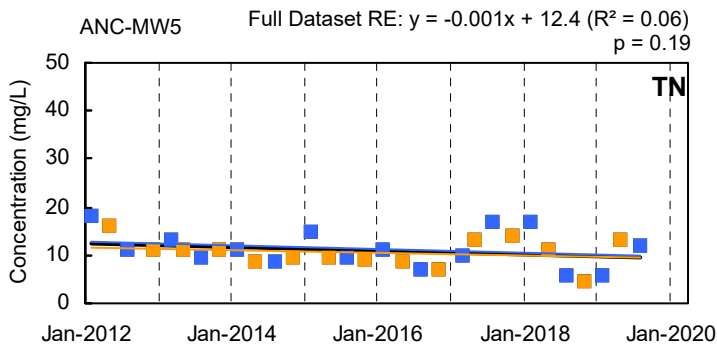
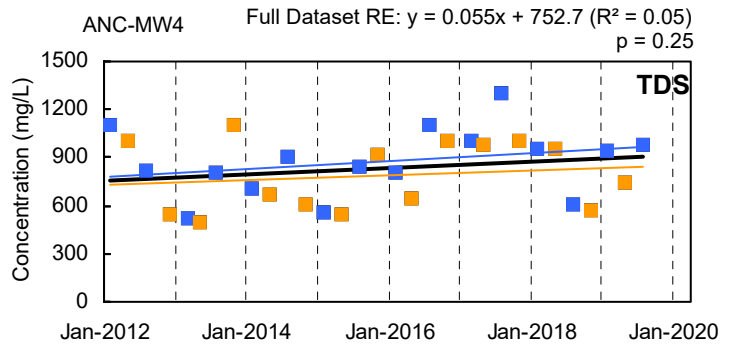
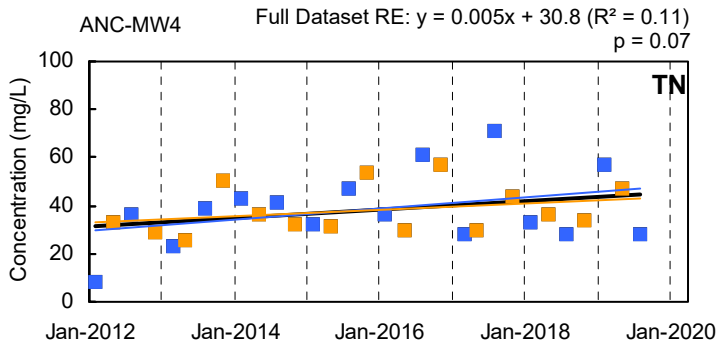
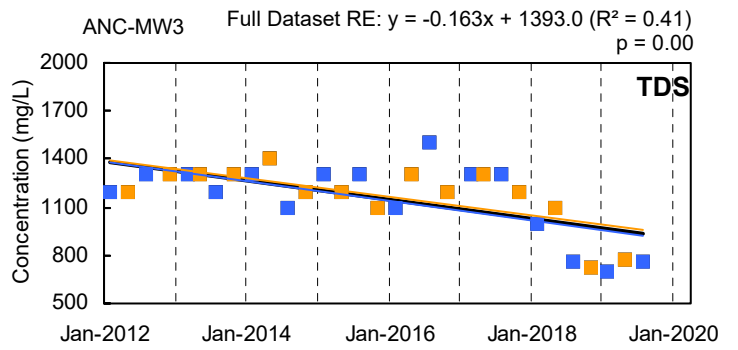
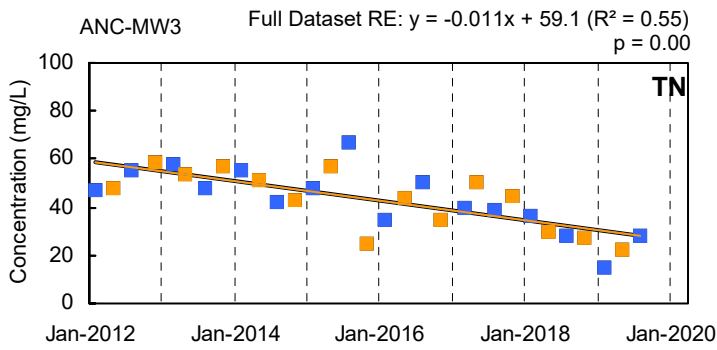

■ Q1/Q3 Result ■ Q2/Q4 Result
— Q1/Q3 Trendline — Q2/Q4 Trendline — Full Dataset Trendline

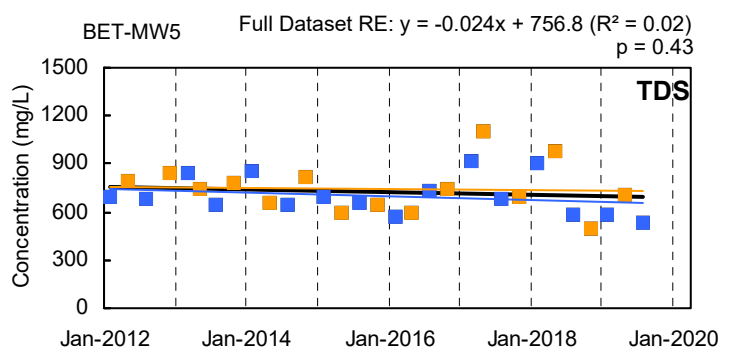
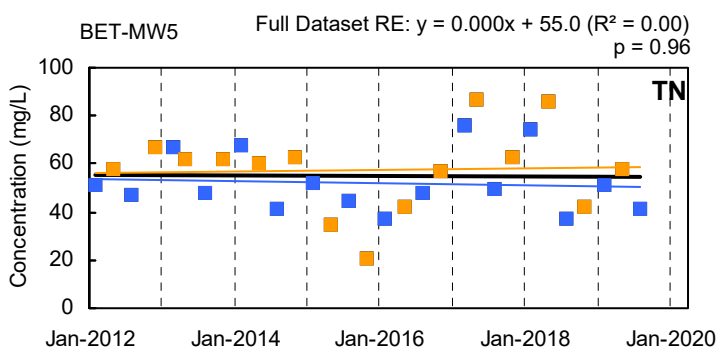
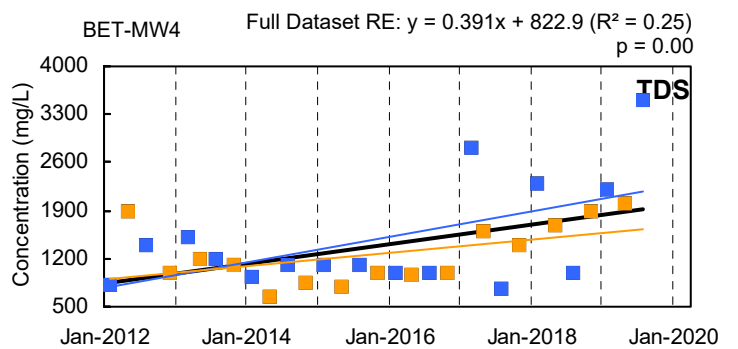
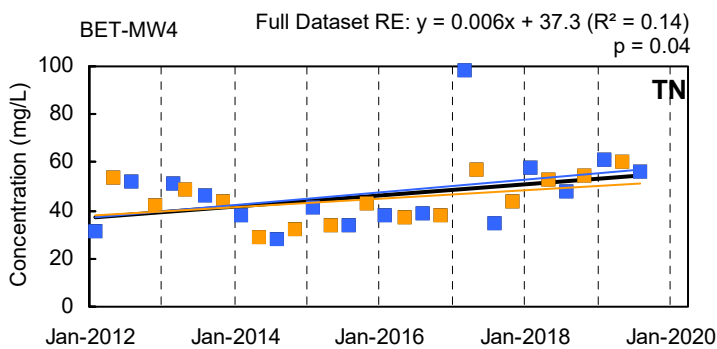
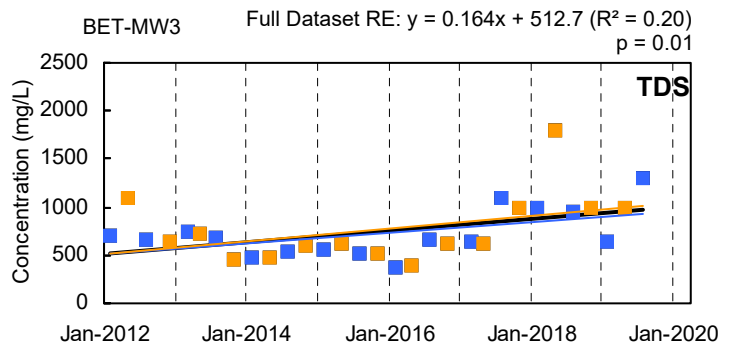
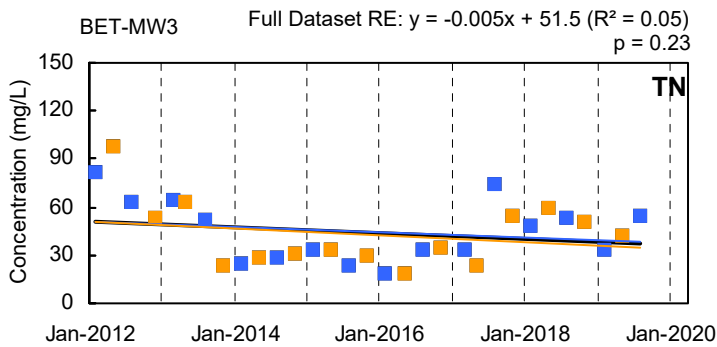
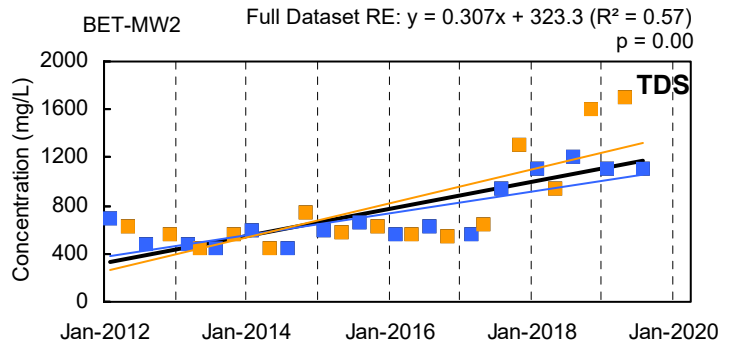
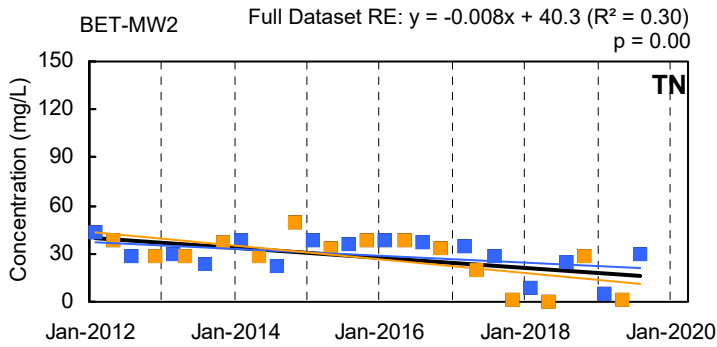
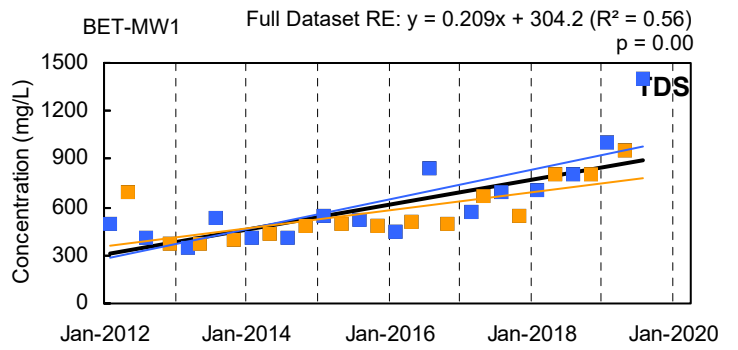
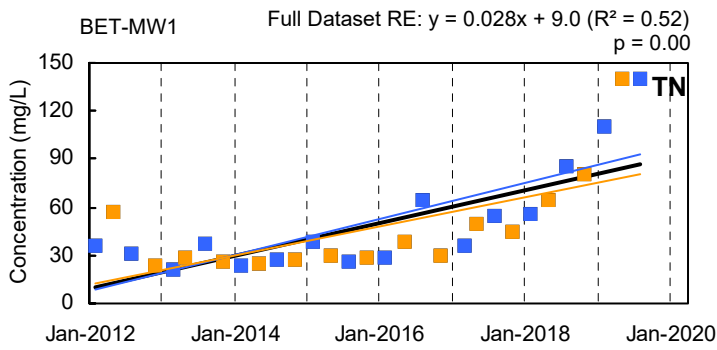

■ Q1/Q3 Result ■ Q2/Q4 Result
— Q1/Q3 Trendline — Q2/Q4 Trendline — Full Dataset Trendline

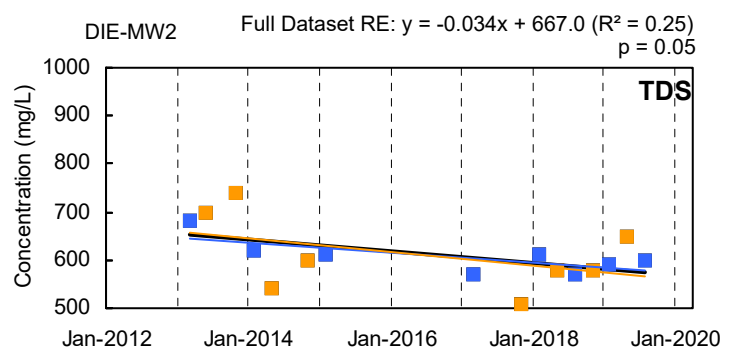
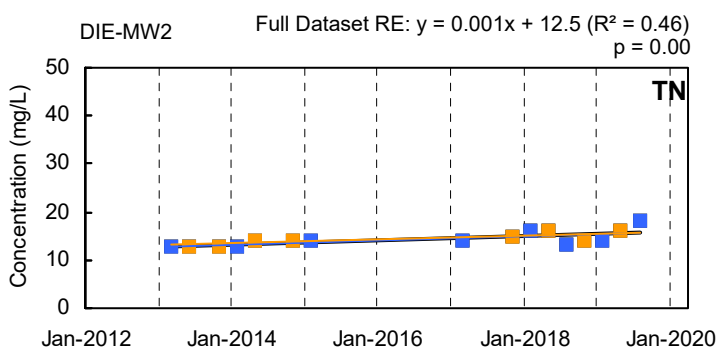
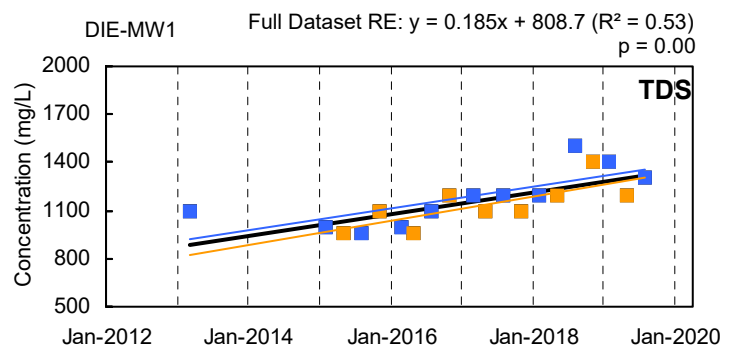
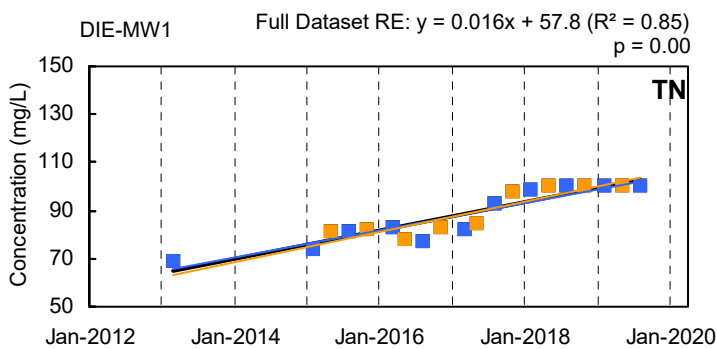
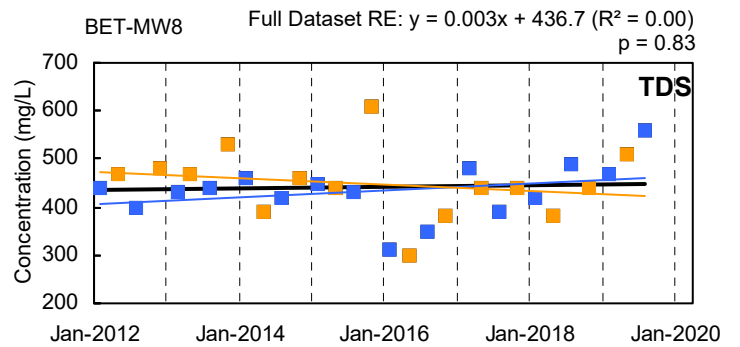
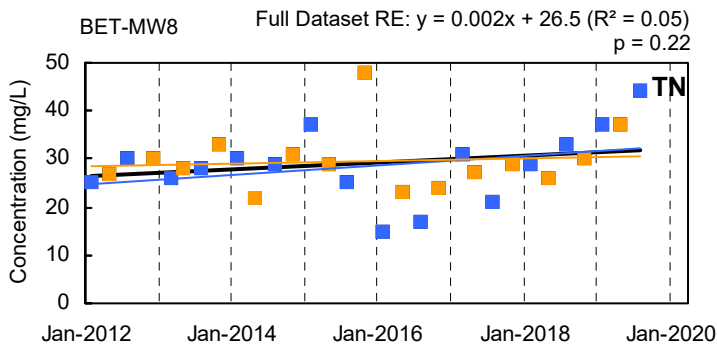
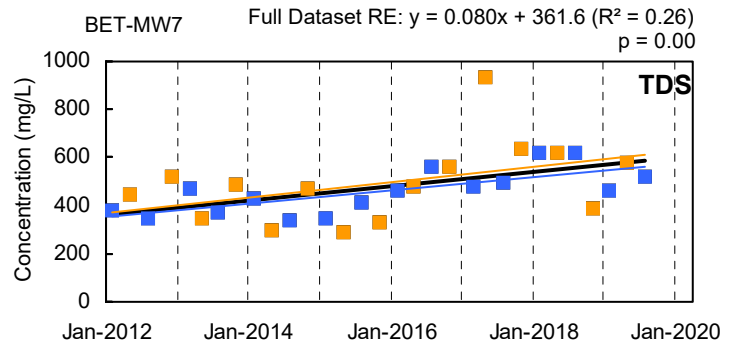
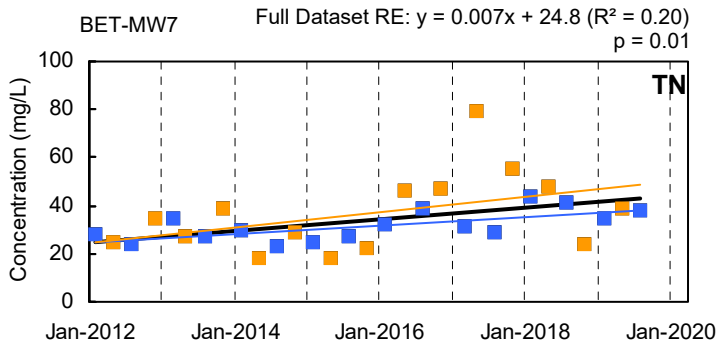
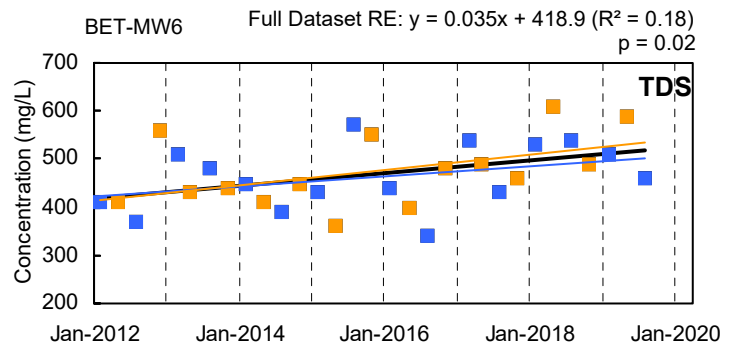
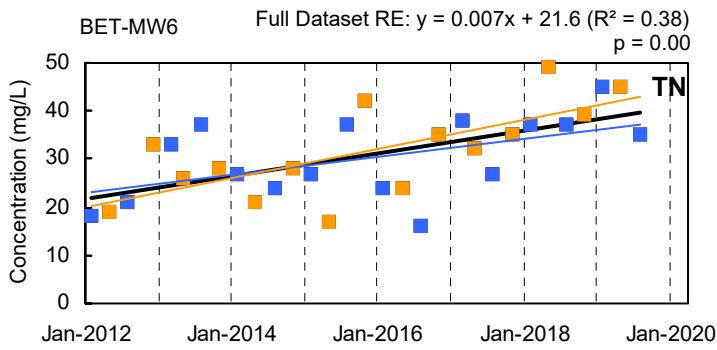

■ Q1/Q3 Result ■ Q2/Q4 Result
— Q1/Q3 Trendline — Q2/Q4 Trendline — Full Dataset Trendline

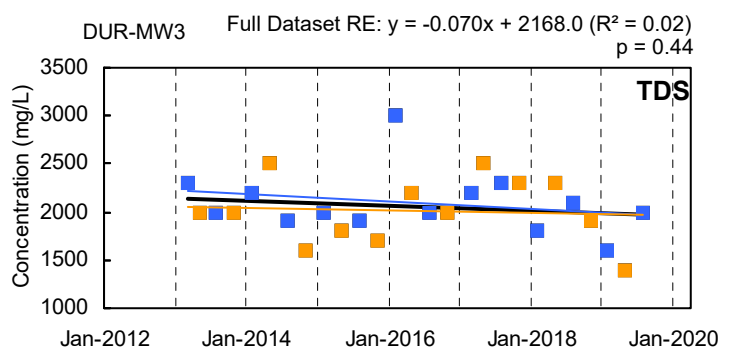
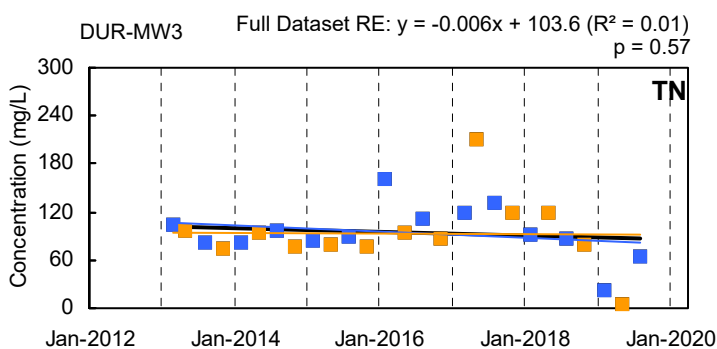
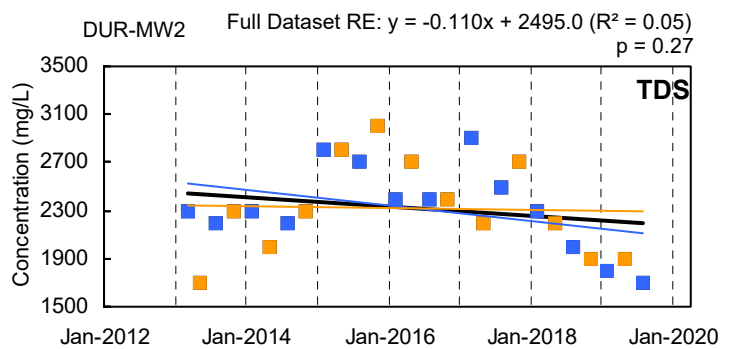
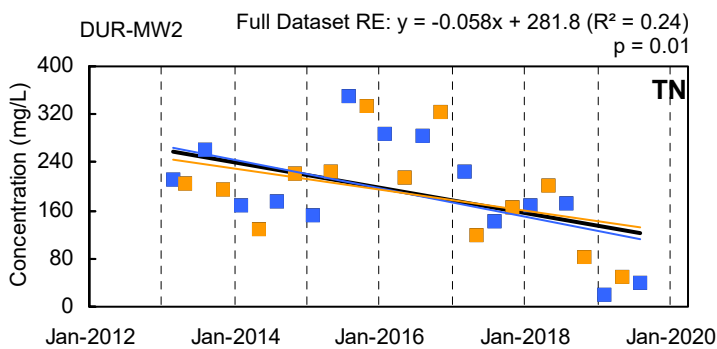
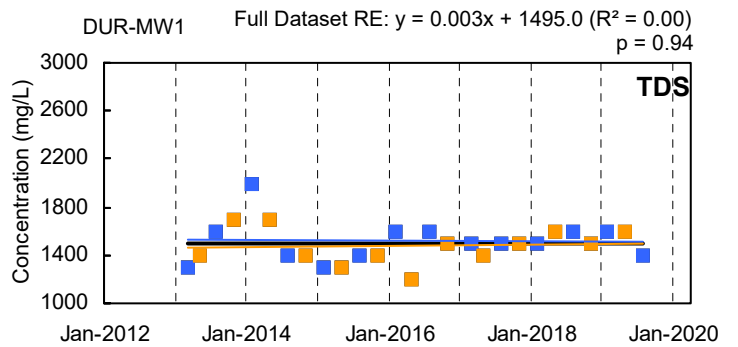
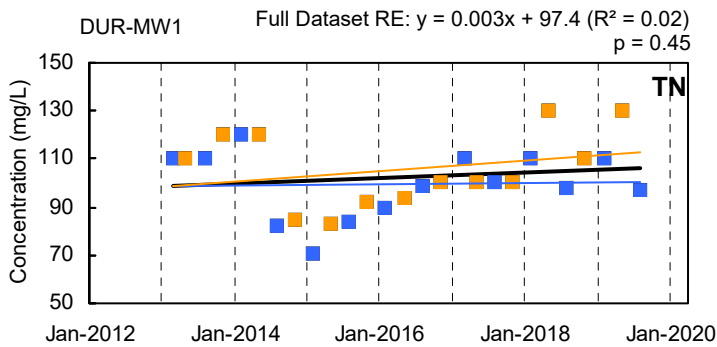
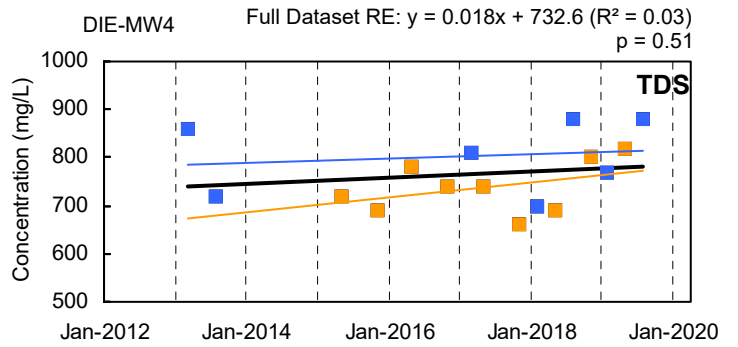
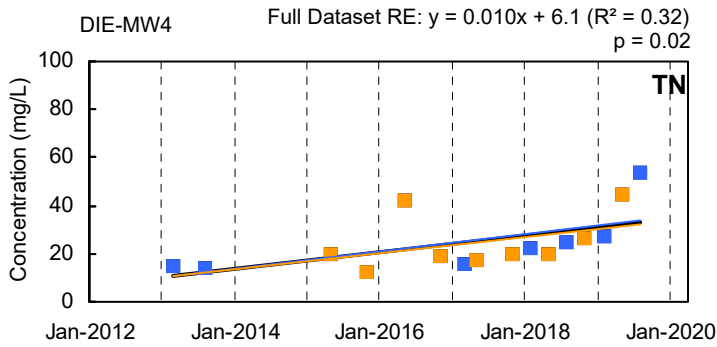
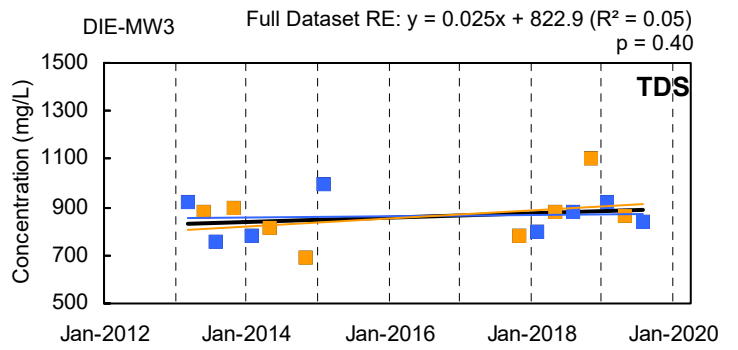
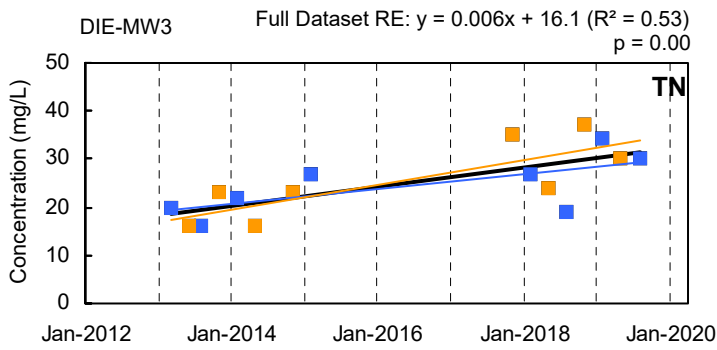

■ Q1/Q3 Result ■ Q2/Q4 Result
— Q1/Q3 Trendline — Q2/Q4 Trendline — Full Dataset Trendline

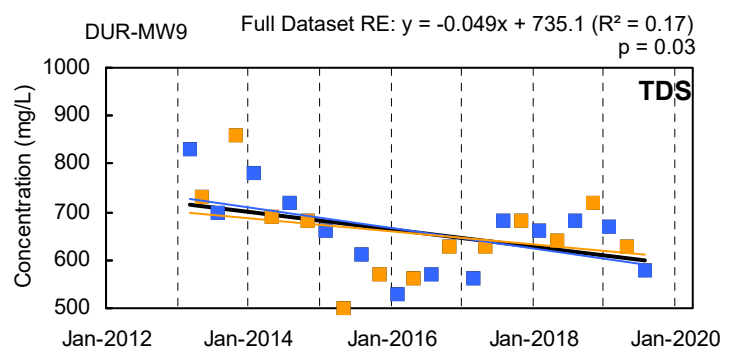
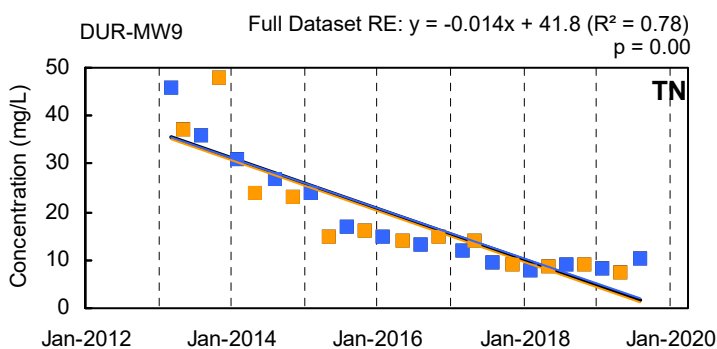
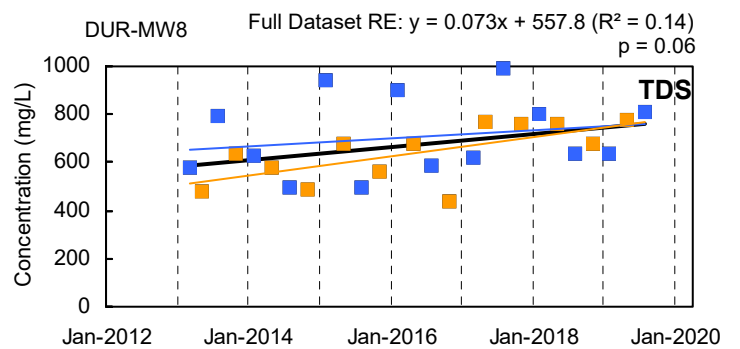
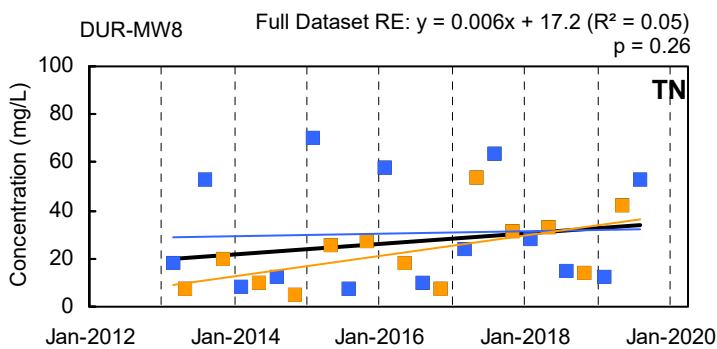
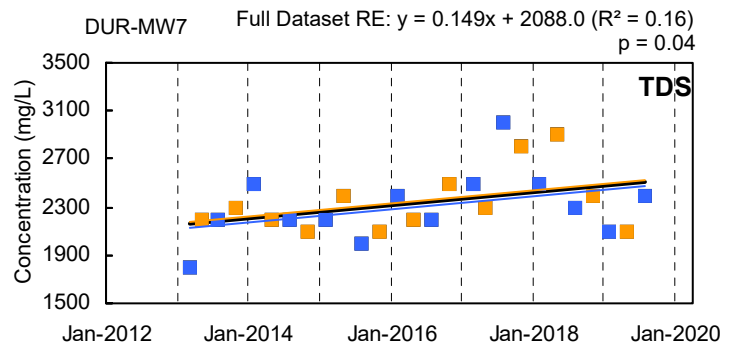
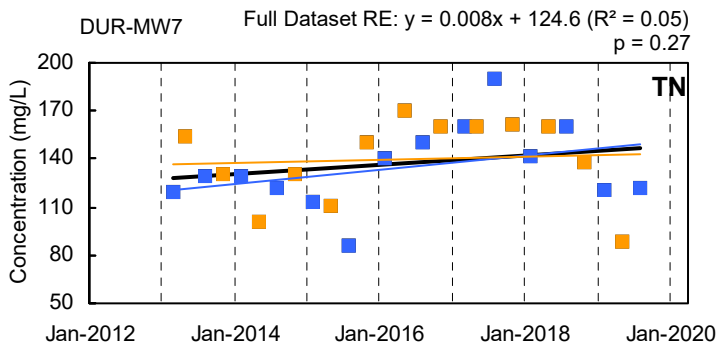
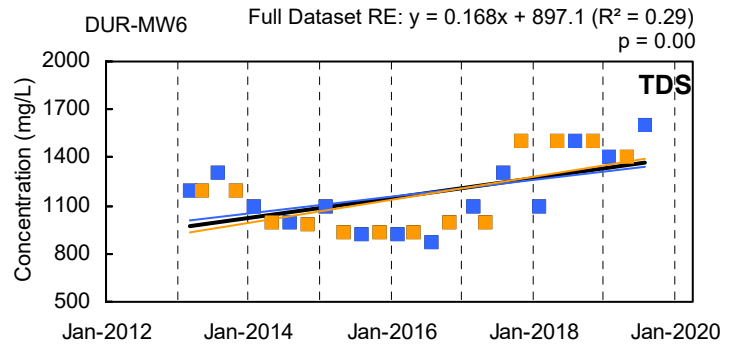
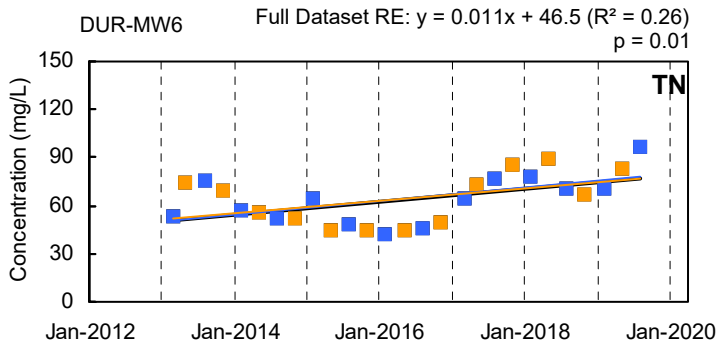
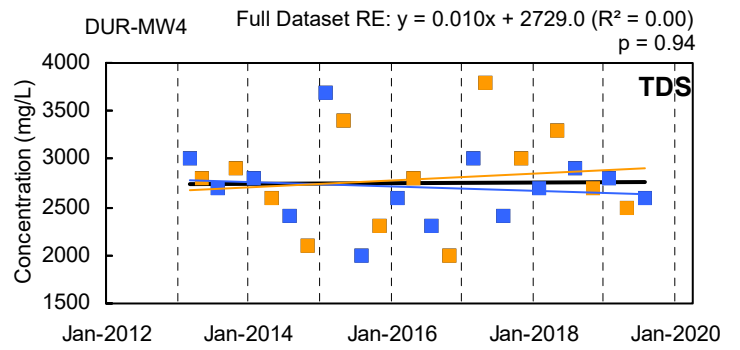
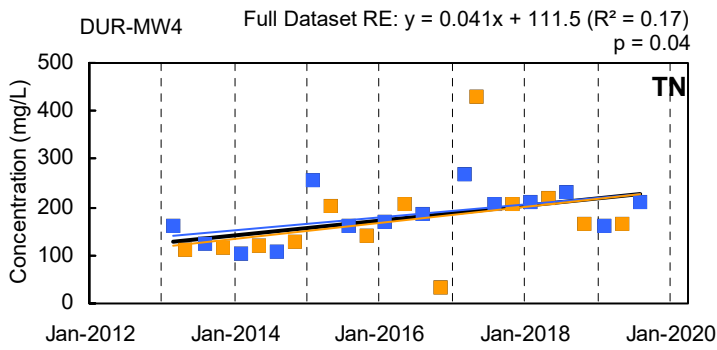

■ Q1/Q3 Result ■ Q2/Q4 Result
— Q1/Q3 Trendline — Q2/Q4 Trendline — Full Dataset Trendline

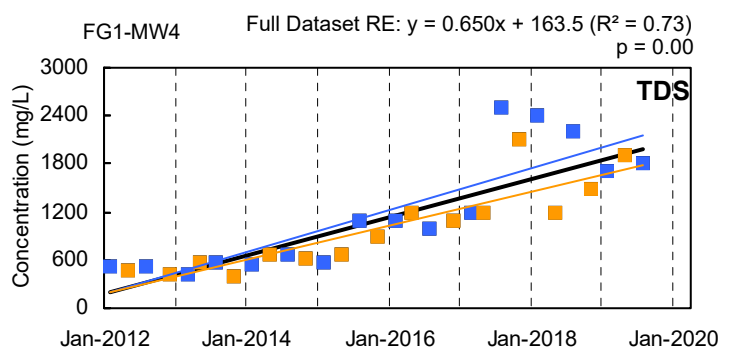
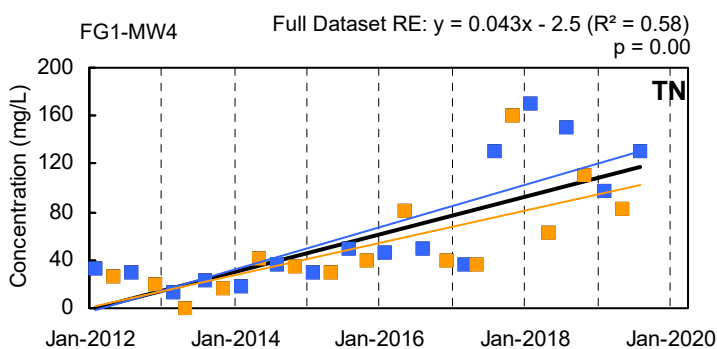
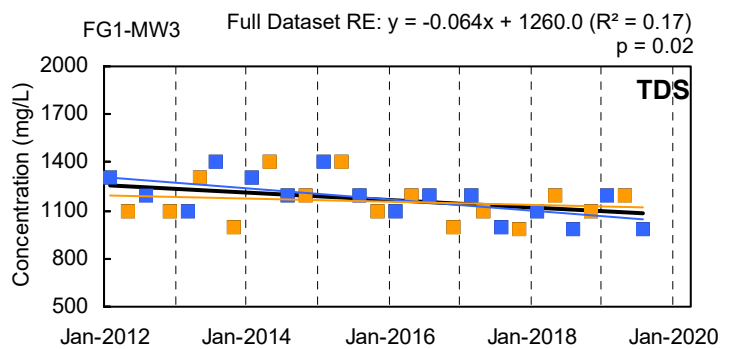
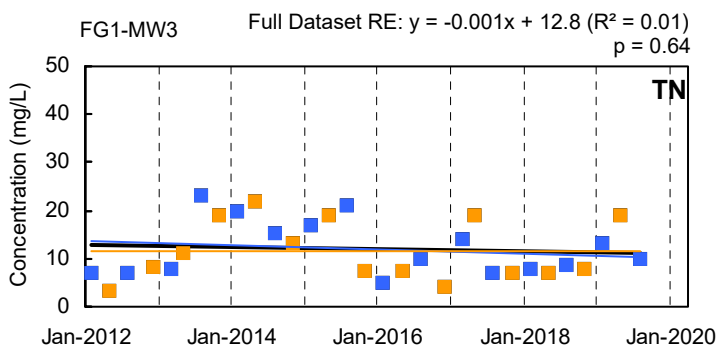
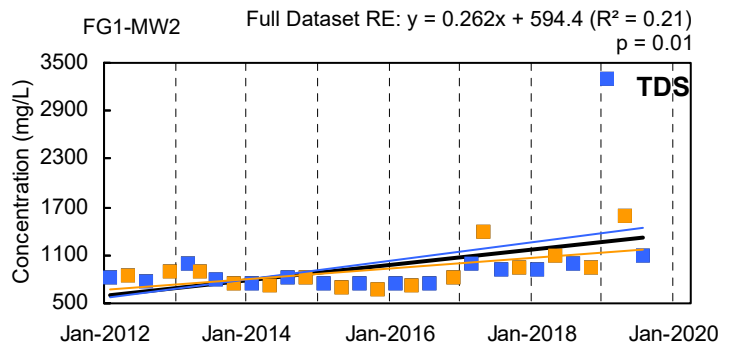
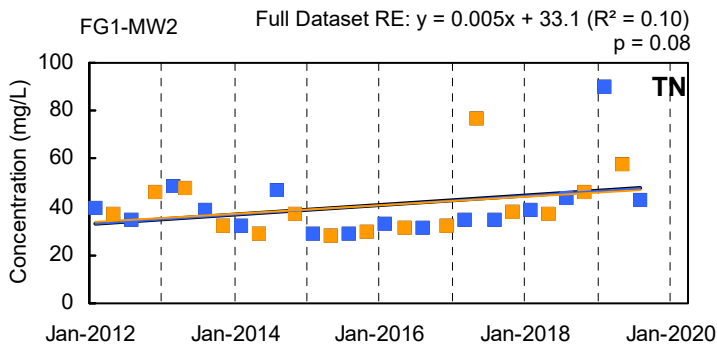
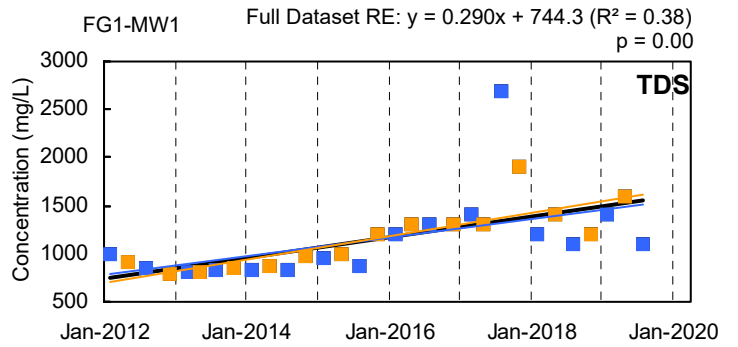
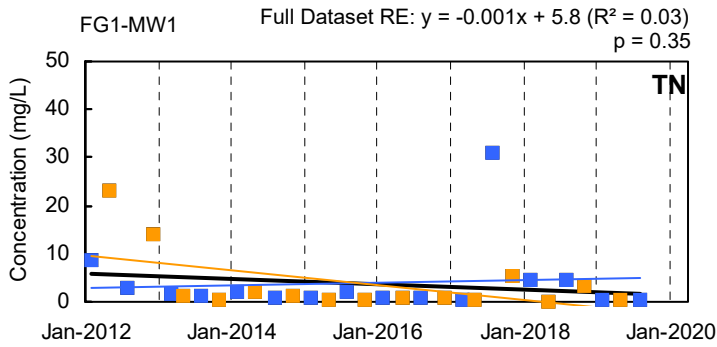
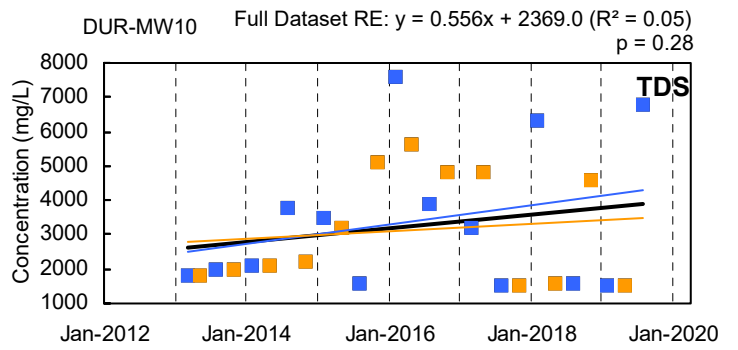
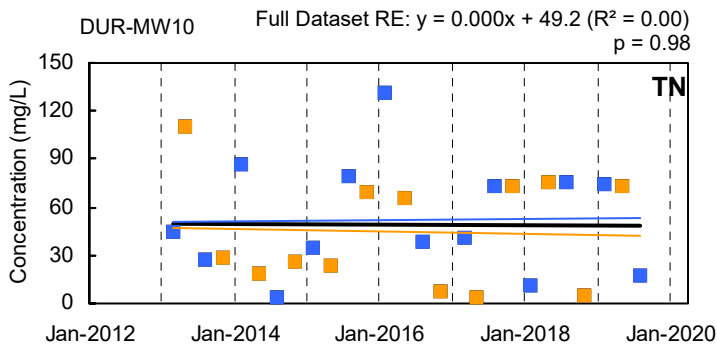

■ Q1/Q3 Result ■ Q2/Q4 Result
— Q1/Q3 Trendline — Q2/Q4 Trendline — Full Dataset Trendline

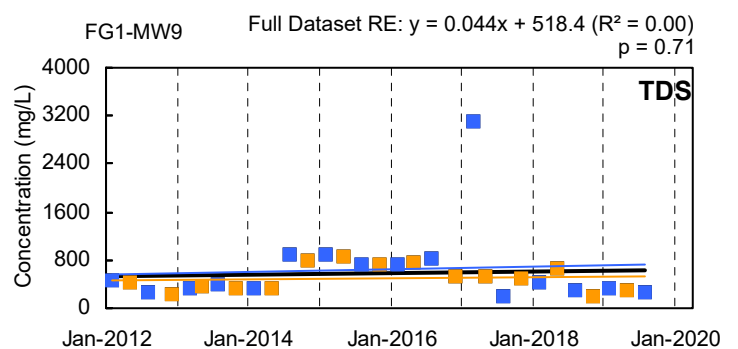
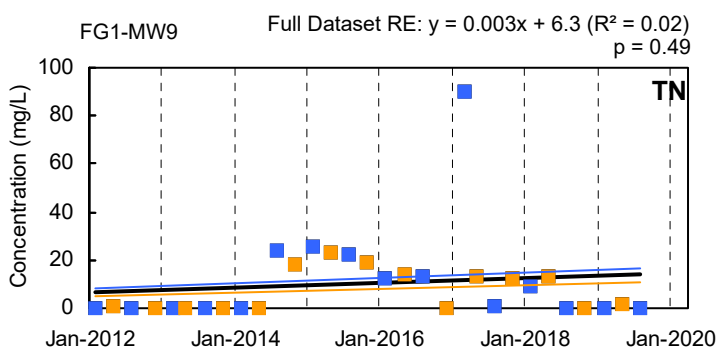
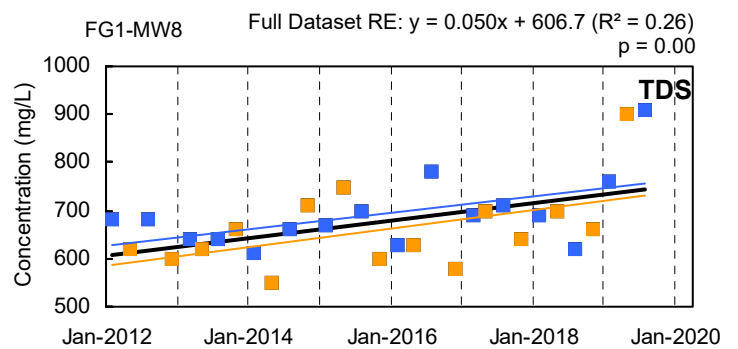
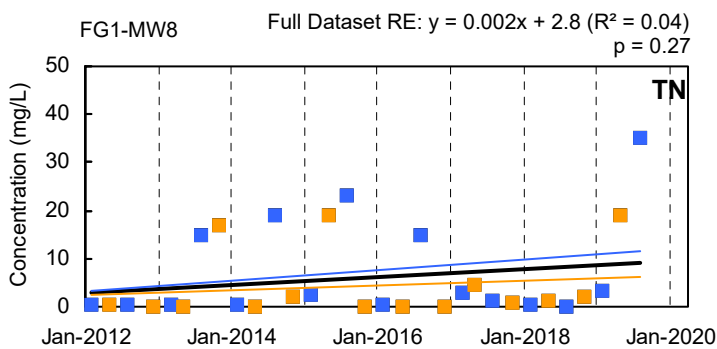
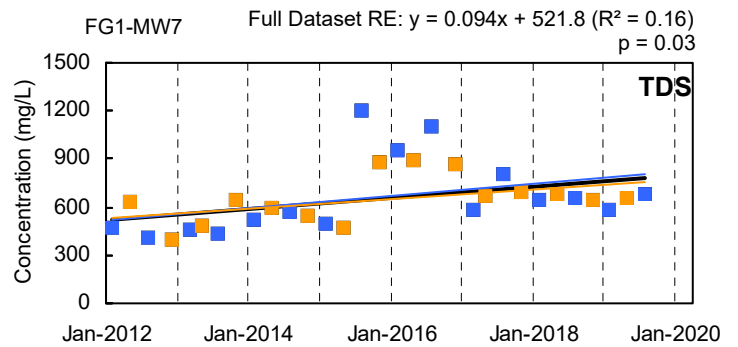
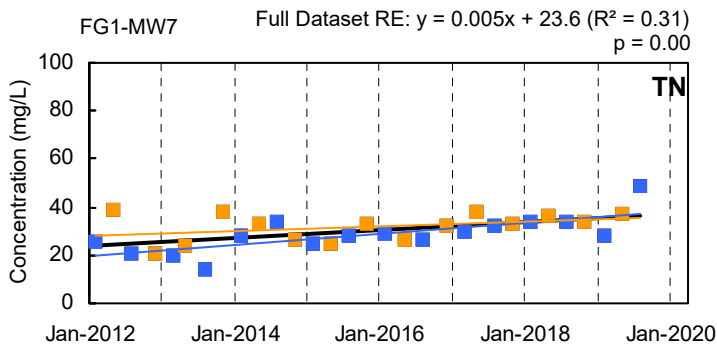
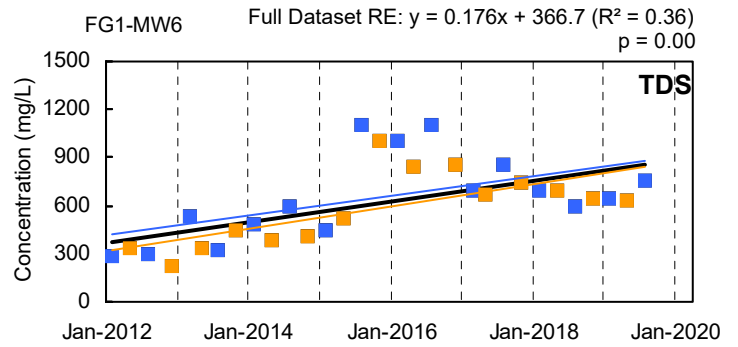
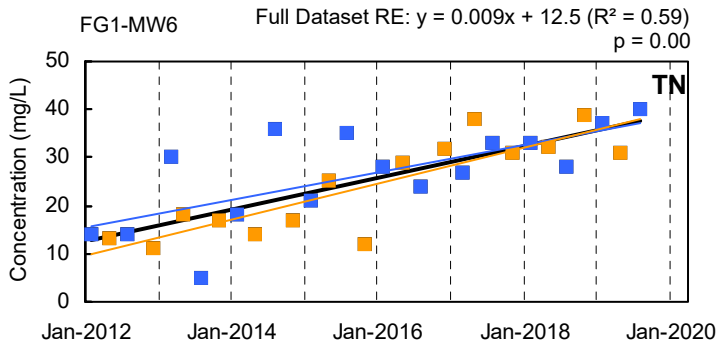
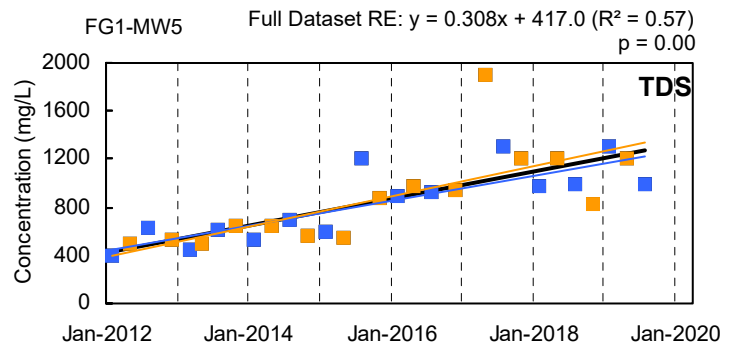
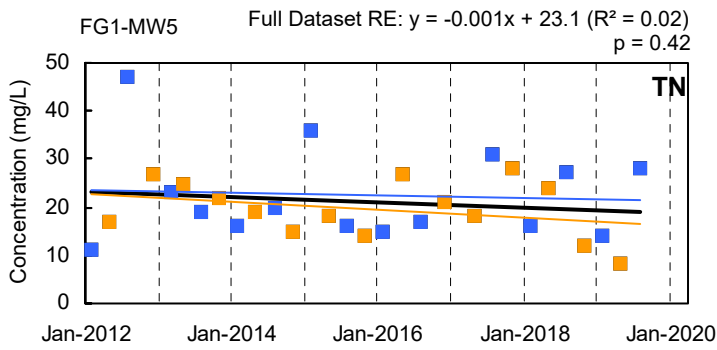

■ Q1/Q3 Result ■ Q2/Q4 Result
— Q1/Q3 Trendline — Q2/Q4 Trendline — Full Dataset Trendline

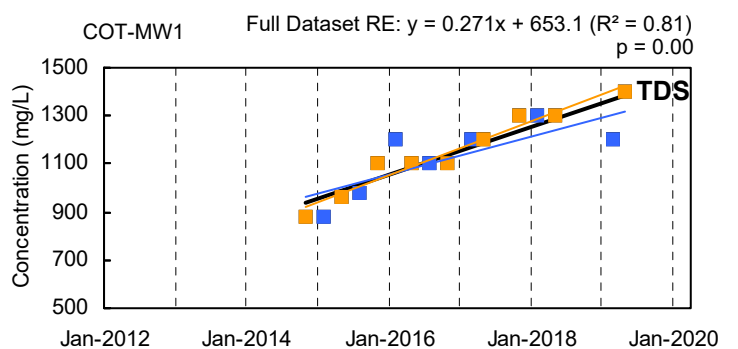
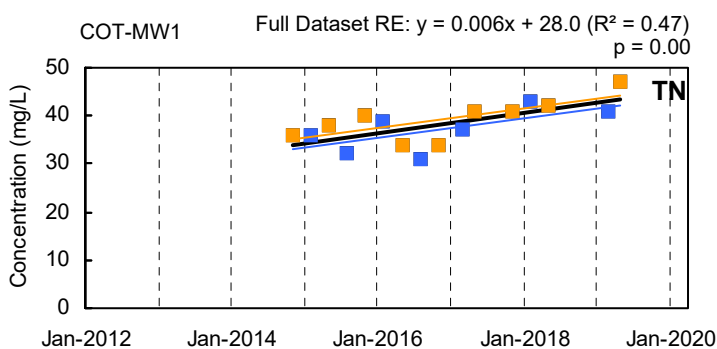
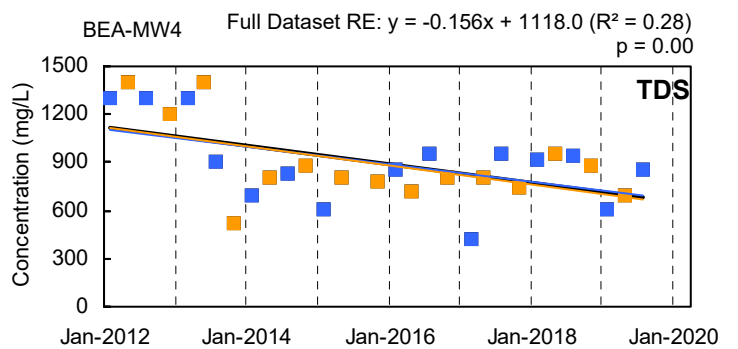
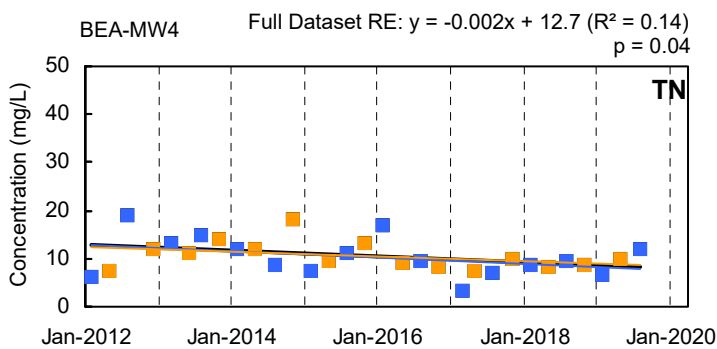
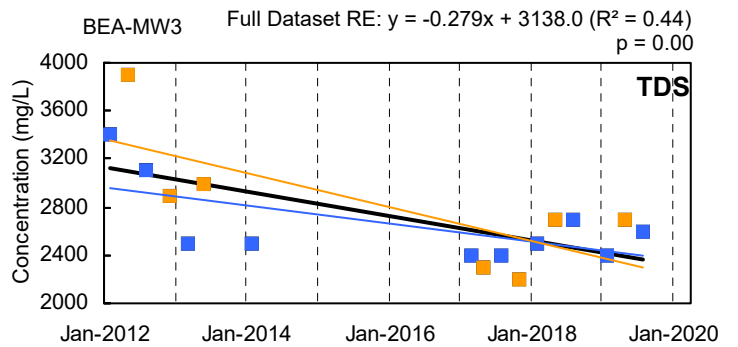
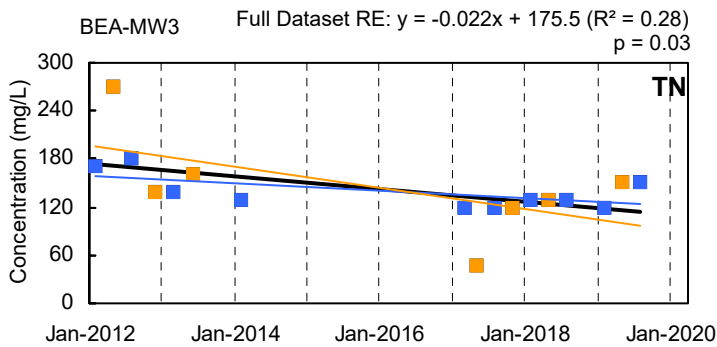
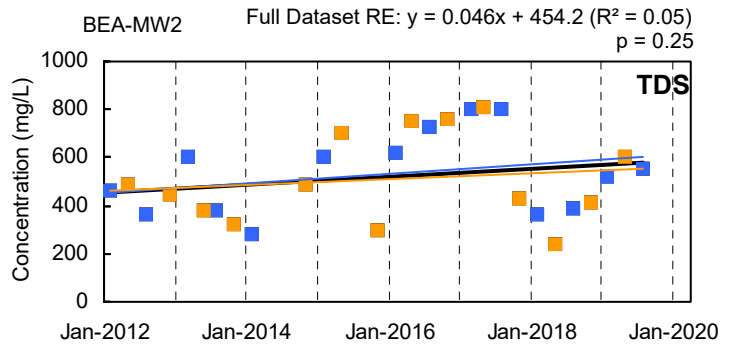
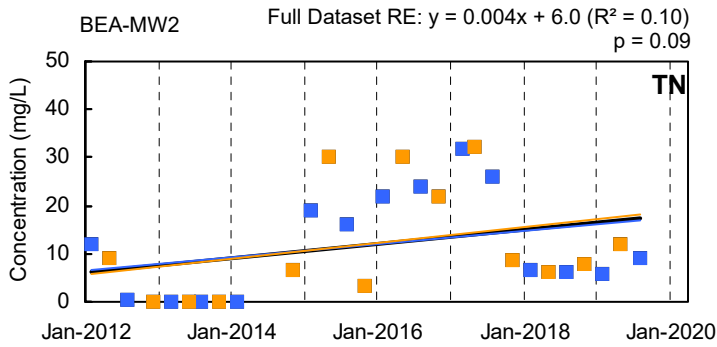
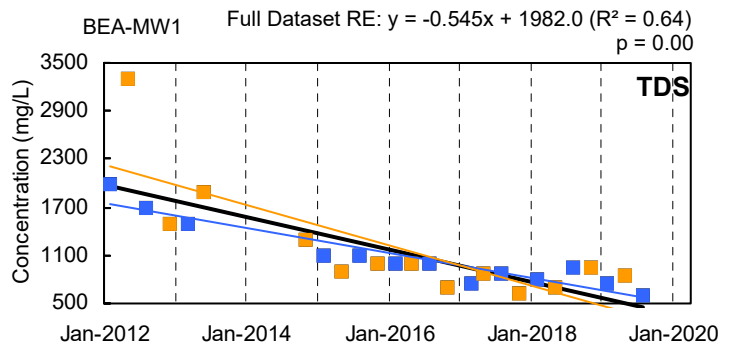
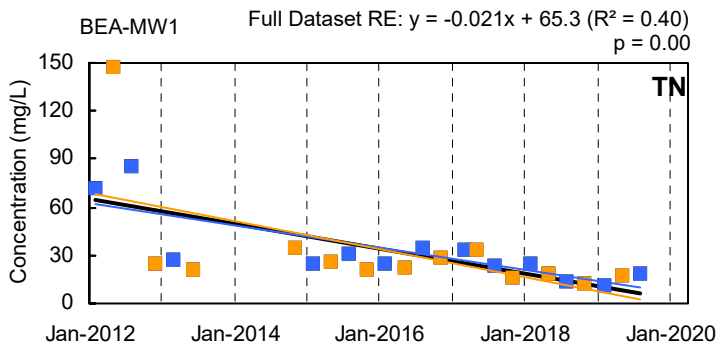

■ Q1/Q3 Result ■ Q2/Q4 Result
— Q1/Q3 Trendline — Q2/Q4 Trendline — Full Dataset Trendline

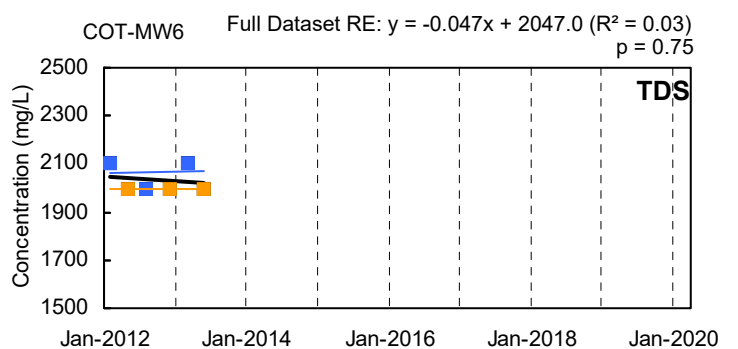
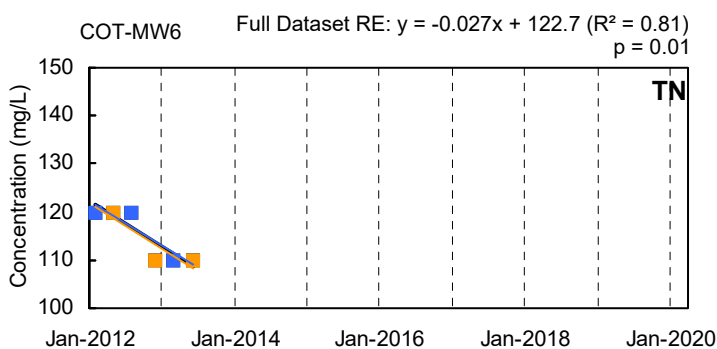
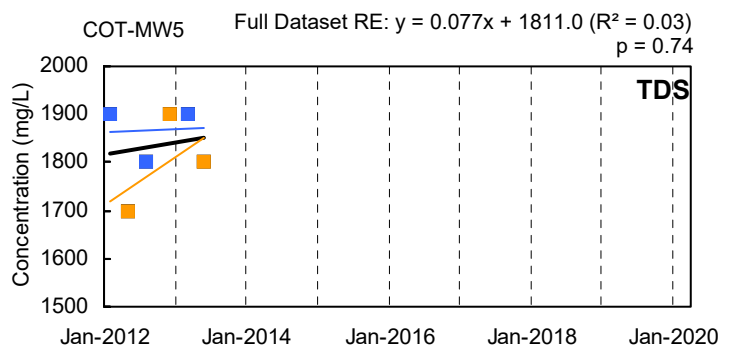
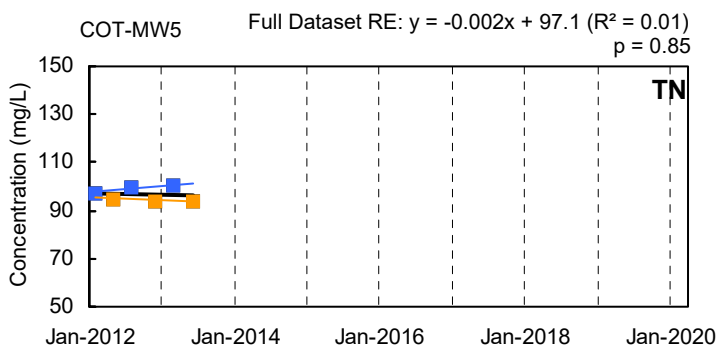
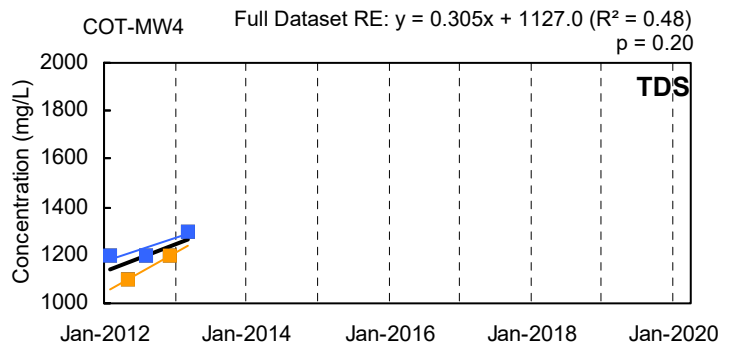
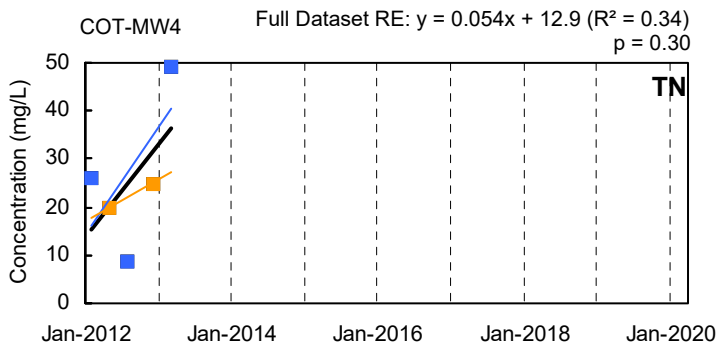
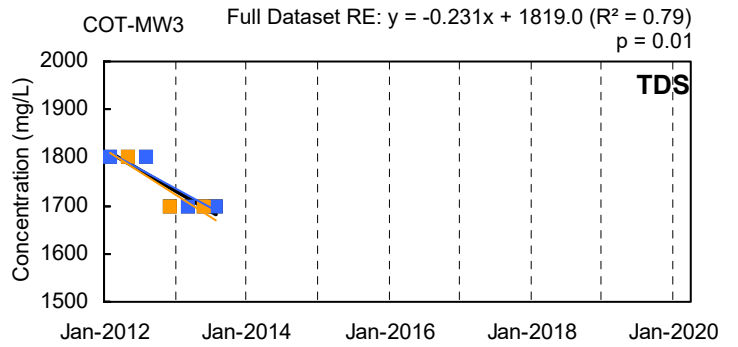
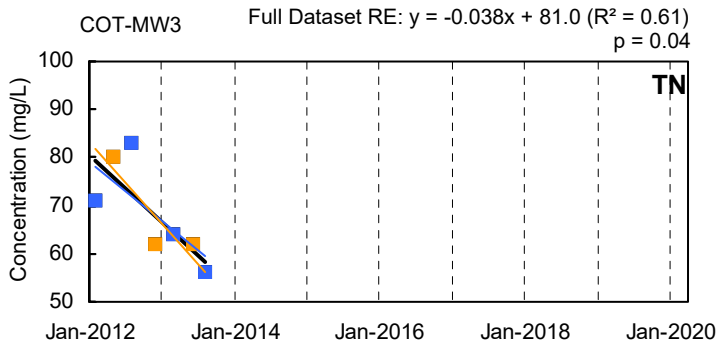
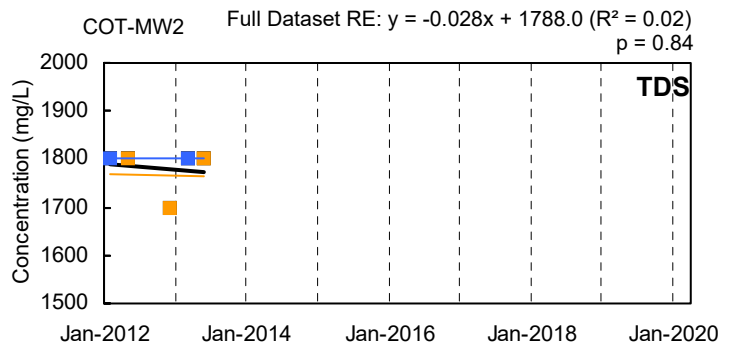
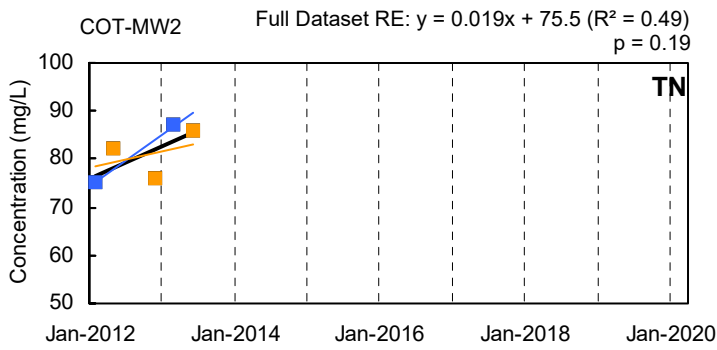

■ Q1/Q3 Result ■ Q2/Q4 Result
— Q1/Q3 Trendline — Q2/Q4 Trendline — Full Dataset Trendline

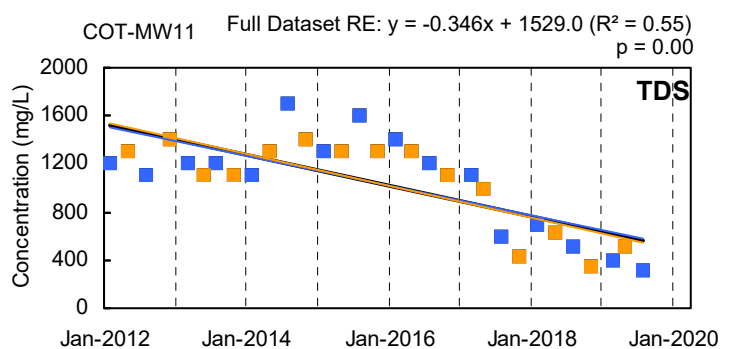
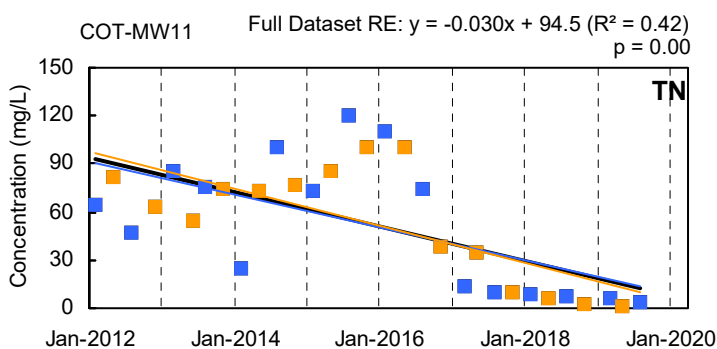
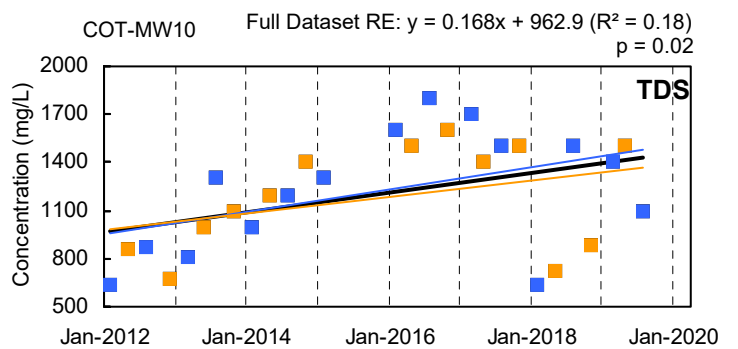
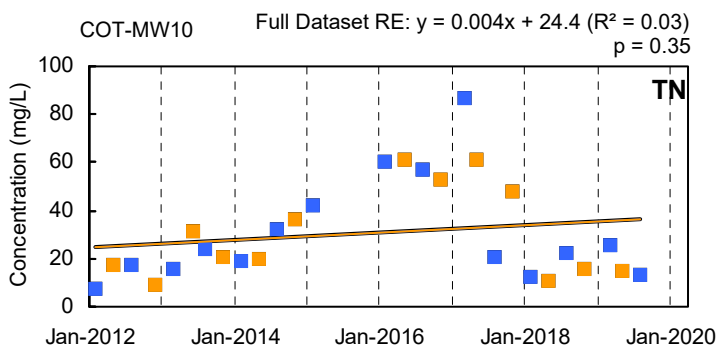
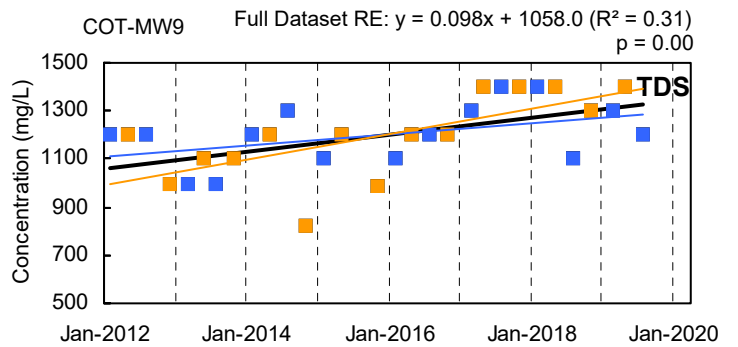
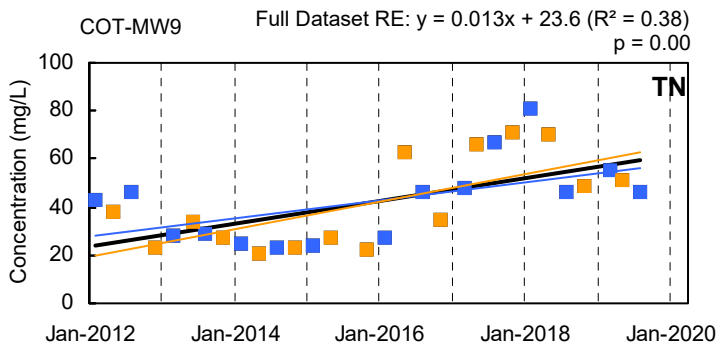
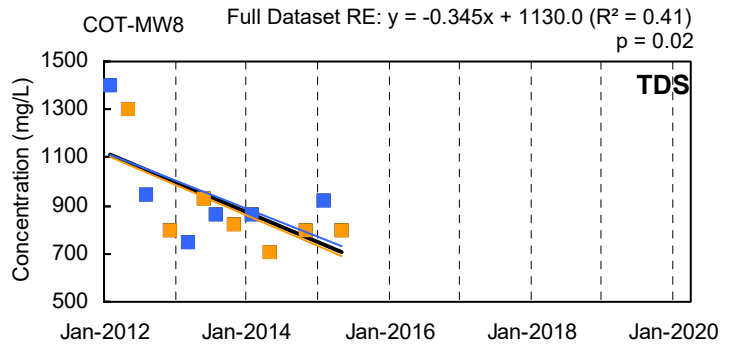
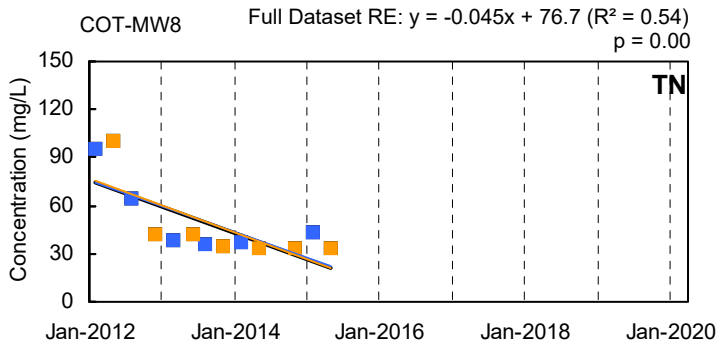
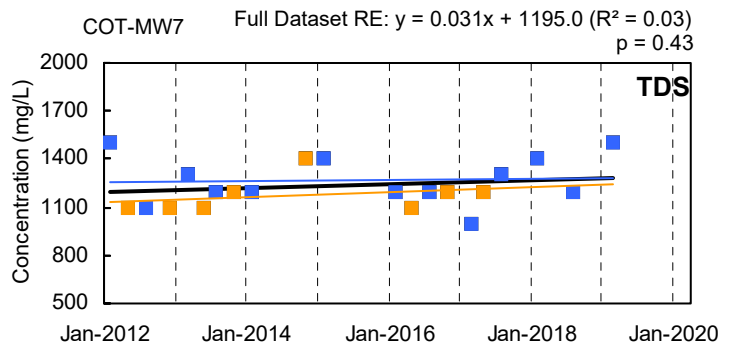
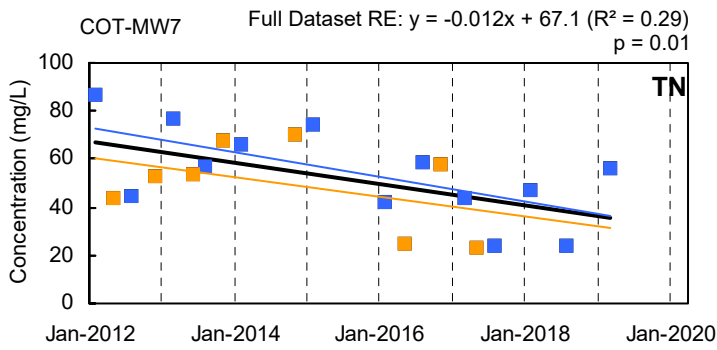

■ Q1/Q3 Result ■ Q2/Q4 Result
— Q1/Q3 Trendline — Q2/Q4 Trendline — Full Dataset Trendline

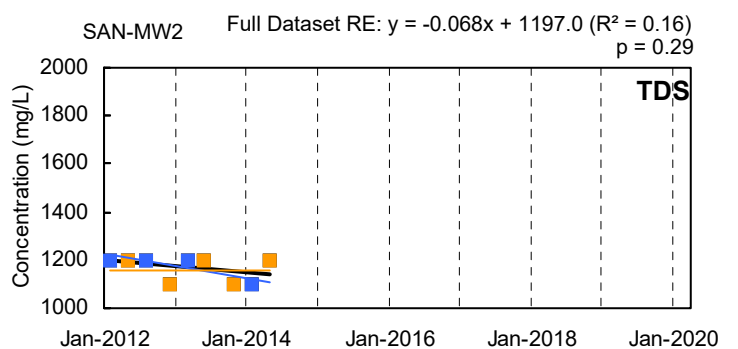
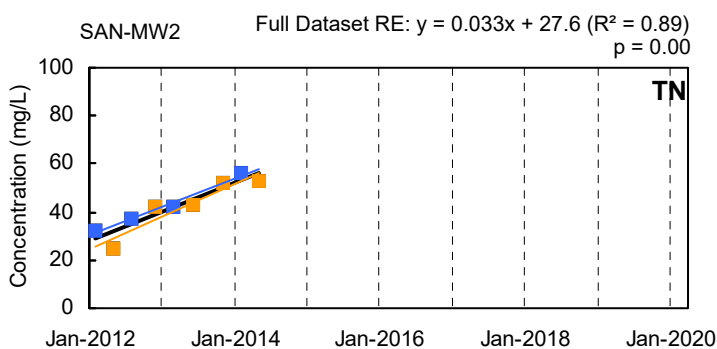
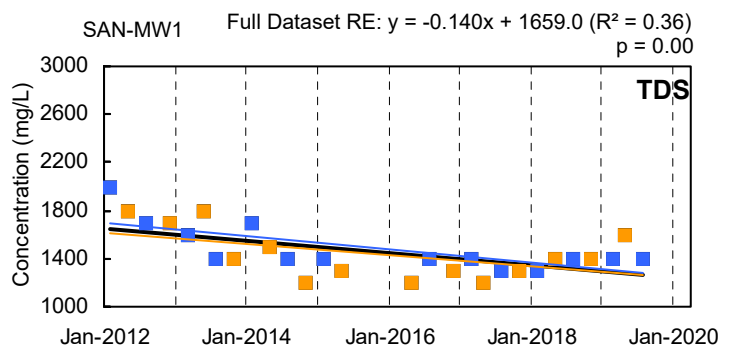
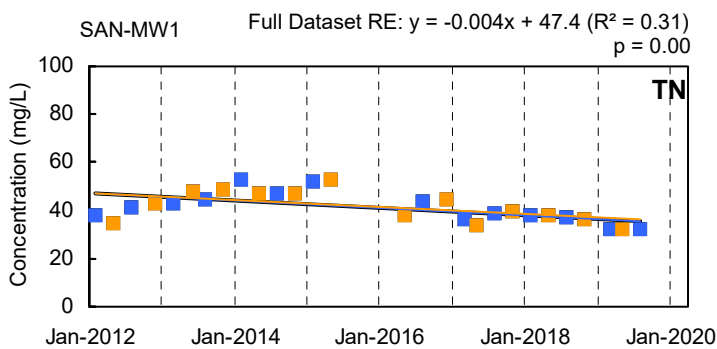
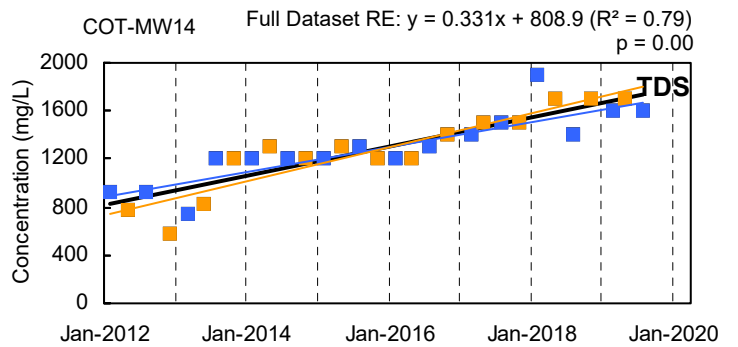
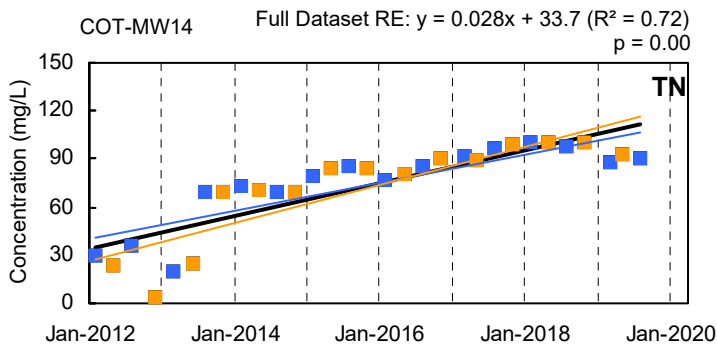
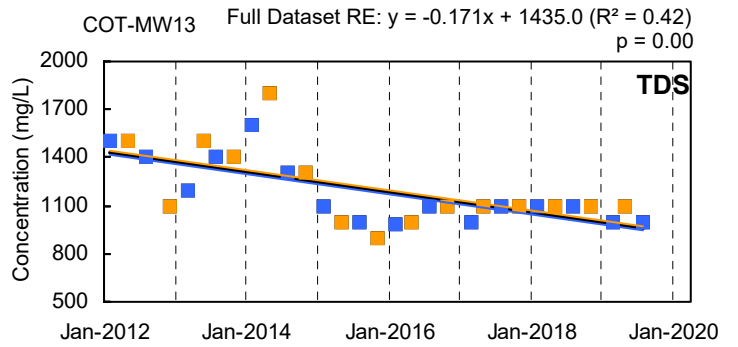
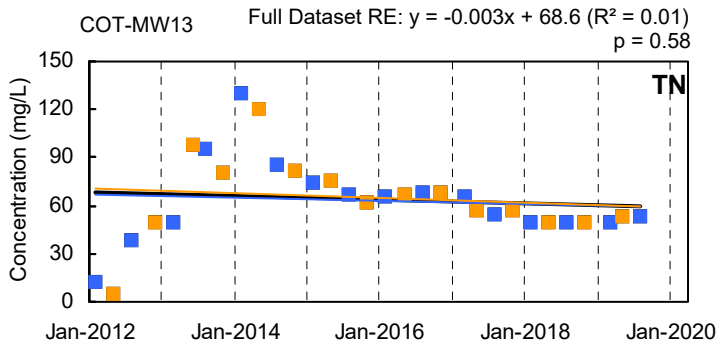
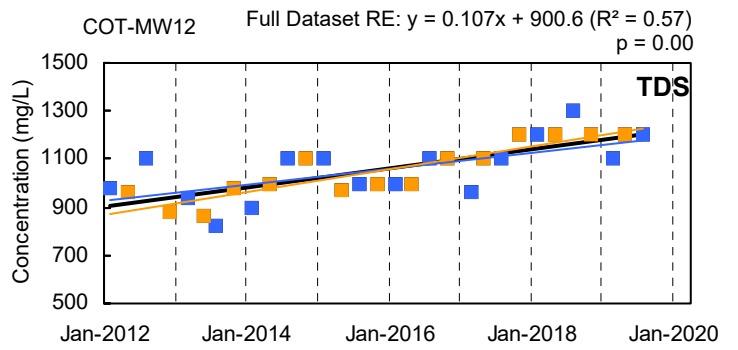
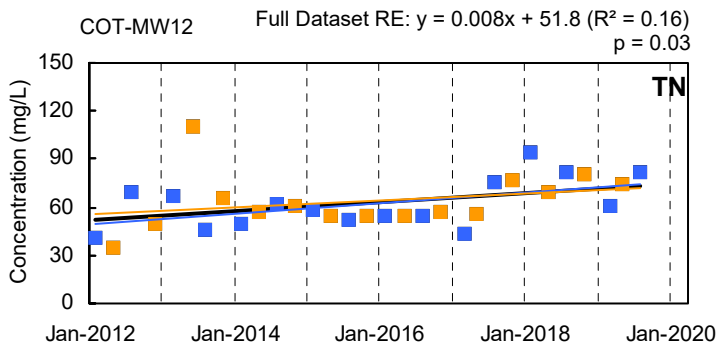

■ Q1/Q3 Result ■ Q2/Q4 Result
— Q1/Q3 Trendline — Q2/Q4 Trendline — Full Dataset Trendline

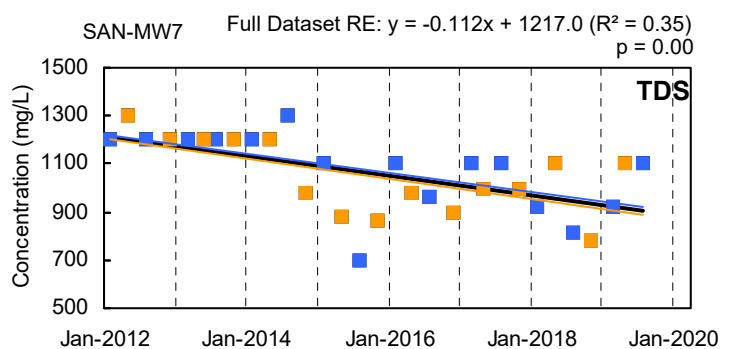
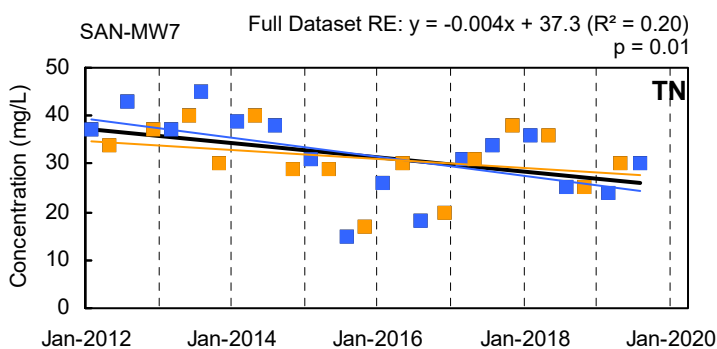
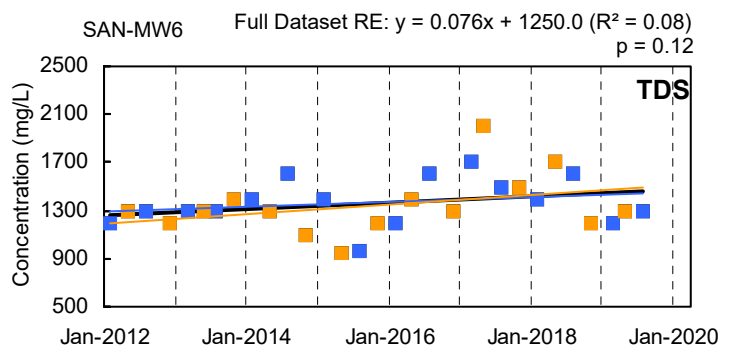
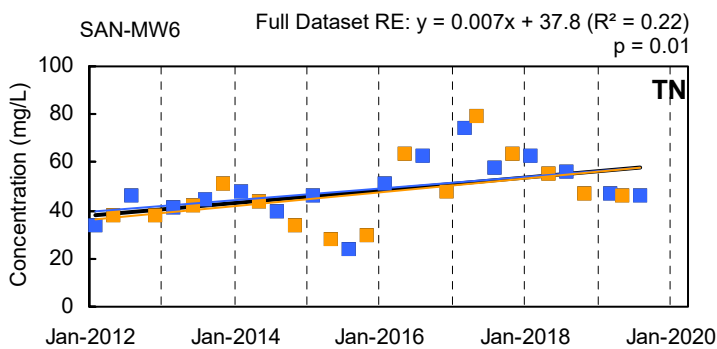
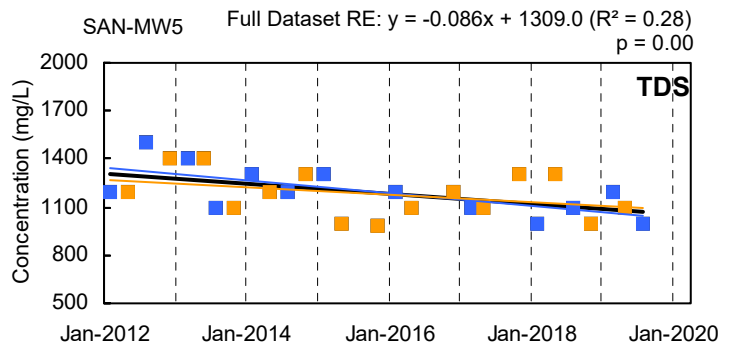
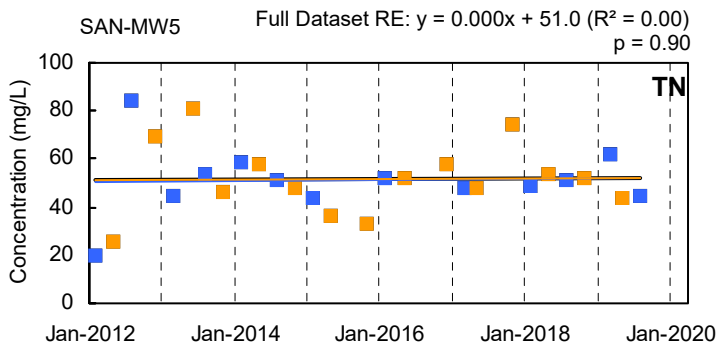
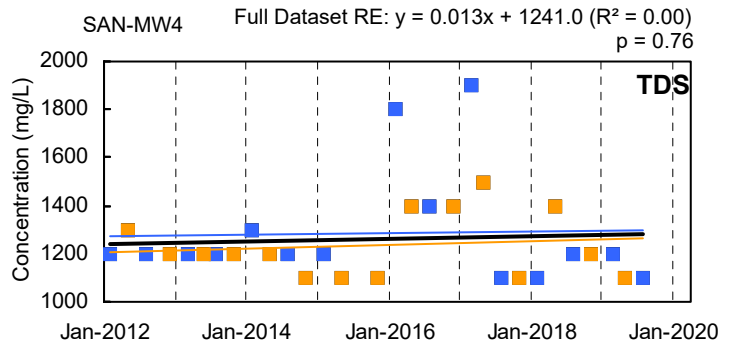
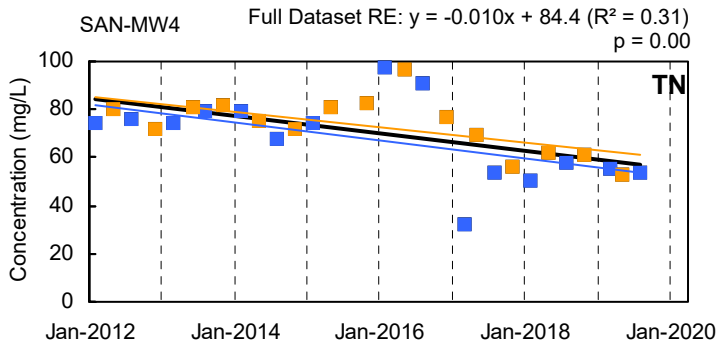
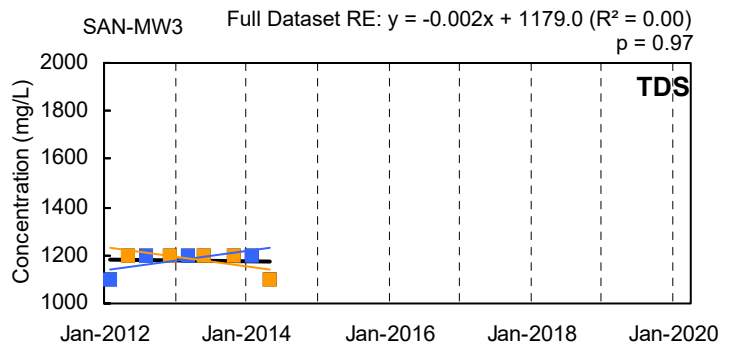
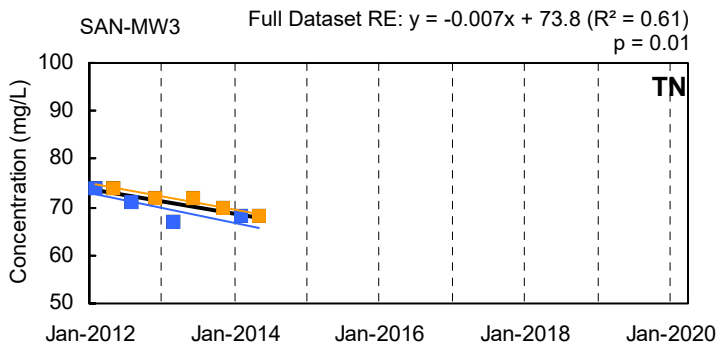

■ Q1/Q3 Result ■ Q2/Q4 Result
— Q1/Q3 Trendline — Q2/Q4 Trendline — Full Dataset Trendline

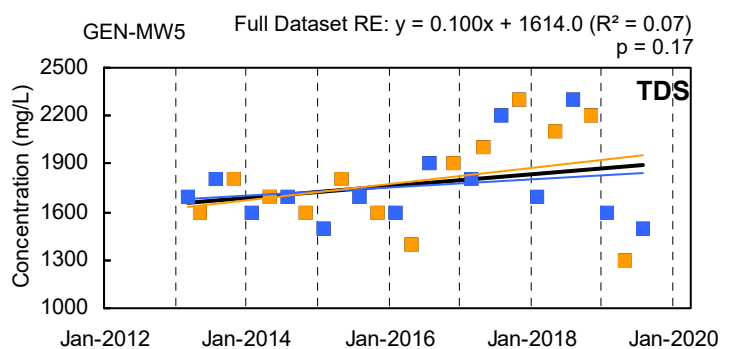
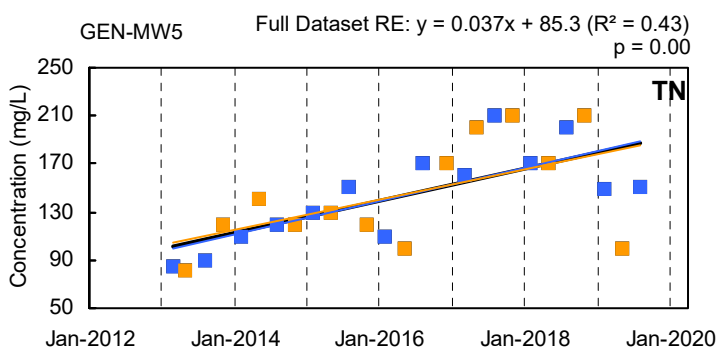
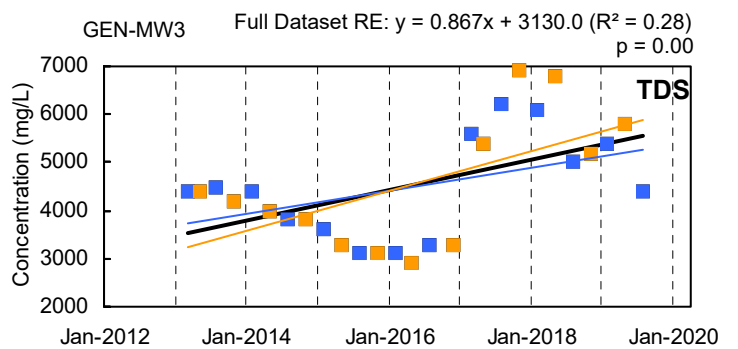
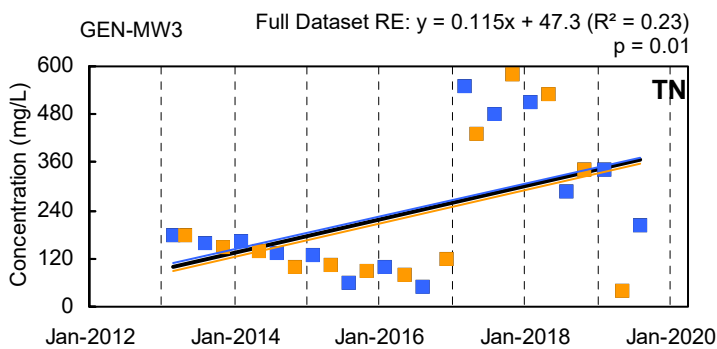
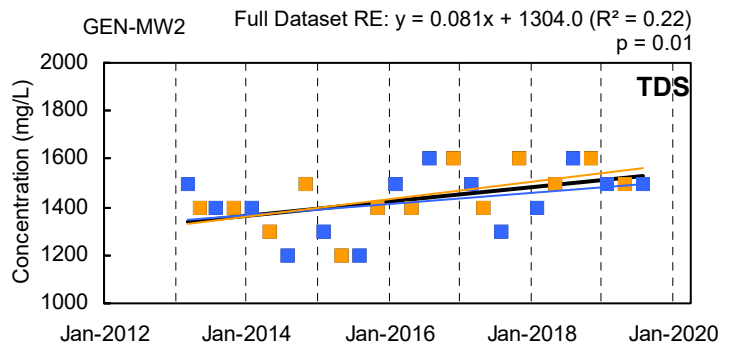
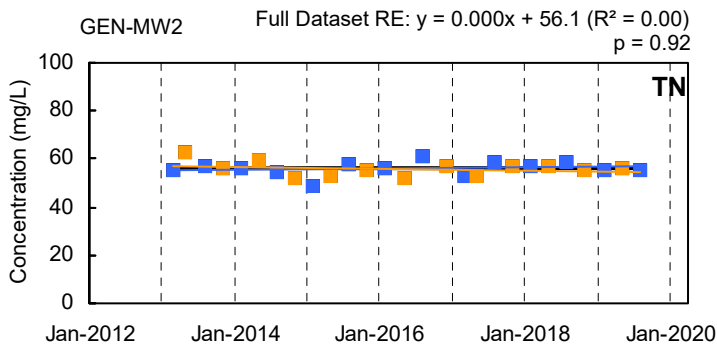
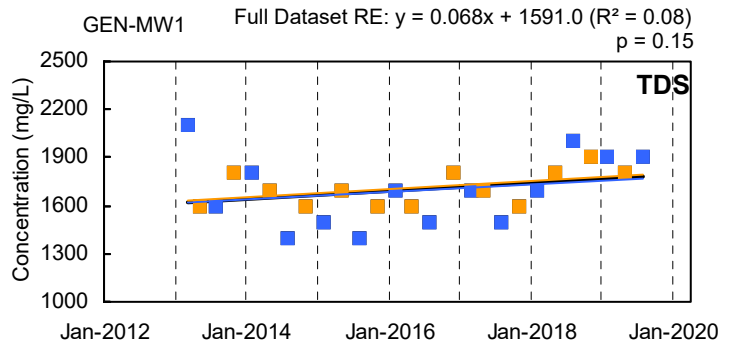
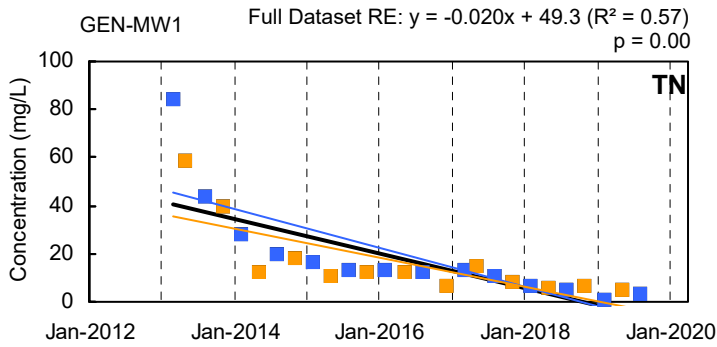
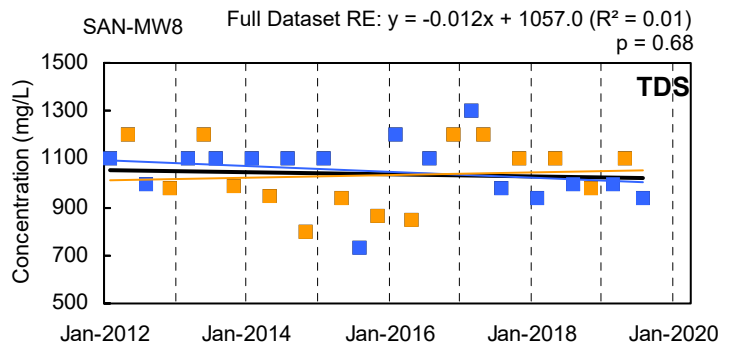
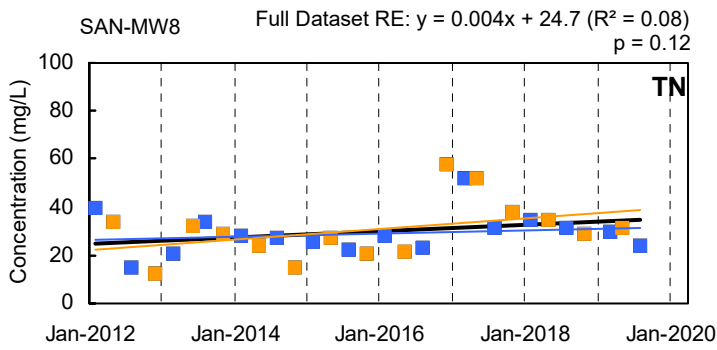

■ Q1/Q3 Result ■ Q2/Q4 Result
— Q1/Q3 Trendline — Q2/Q4 Trendline — Full Dataset Trendline

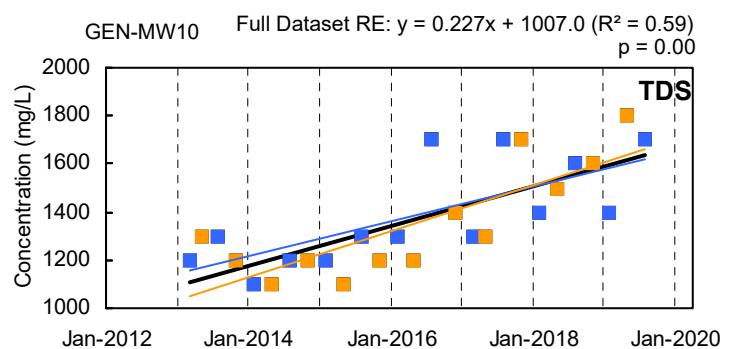
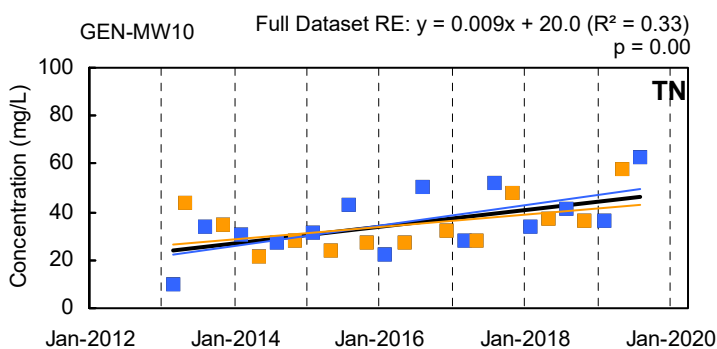
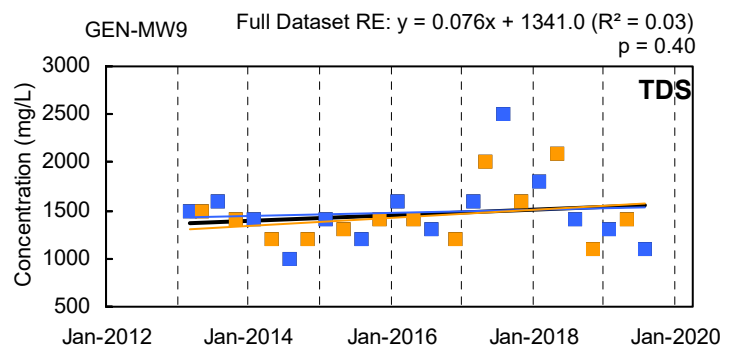
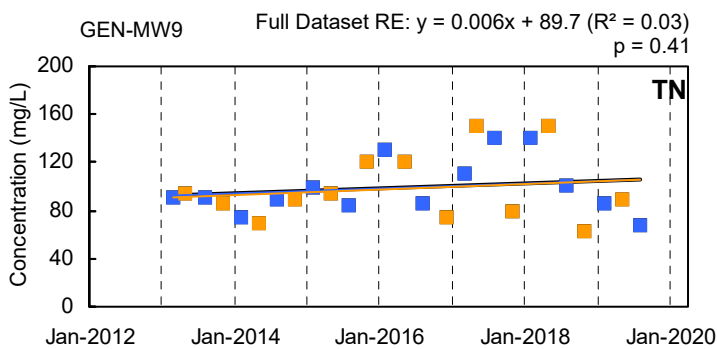
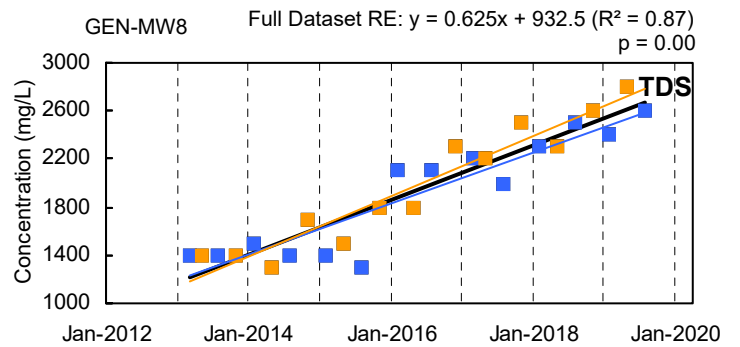
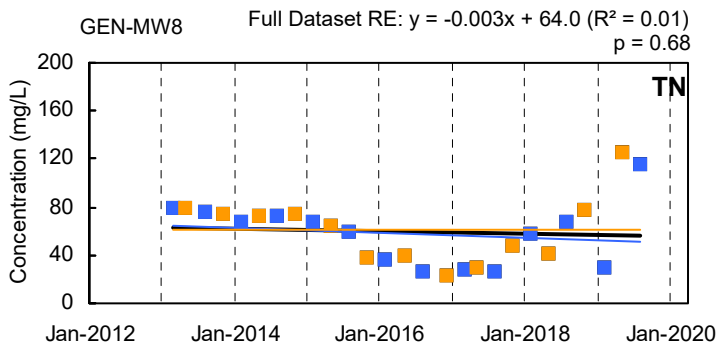
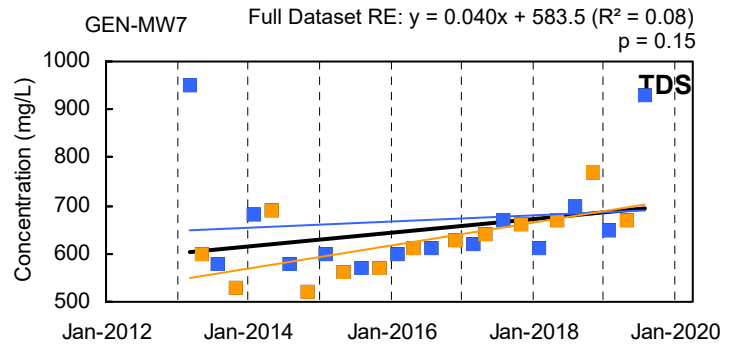
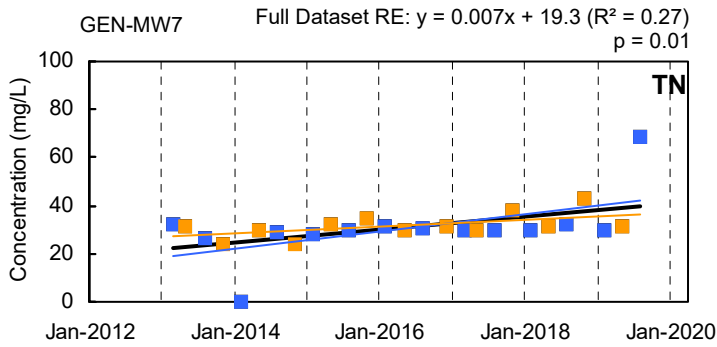
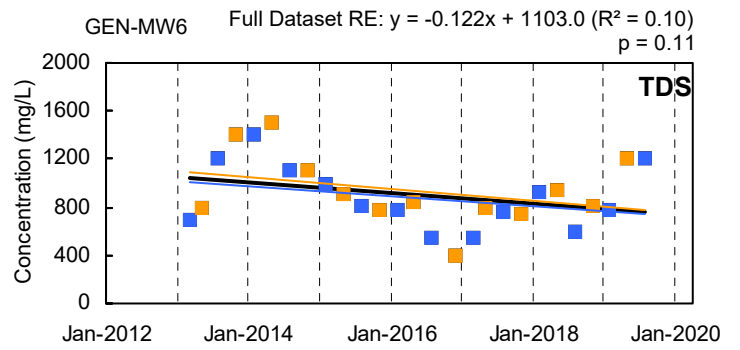
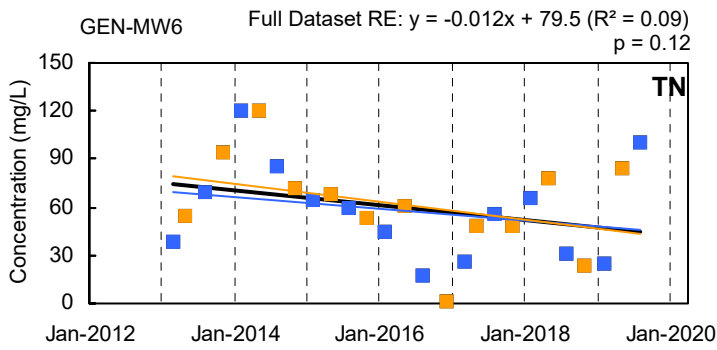

■ Q1/Q3 Result ■ Q2/Q4 Result
— Q1/Q3 Trendline — Q2/Q4 Trendline — Full Dataset Trendline

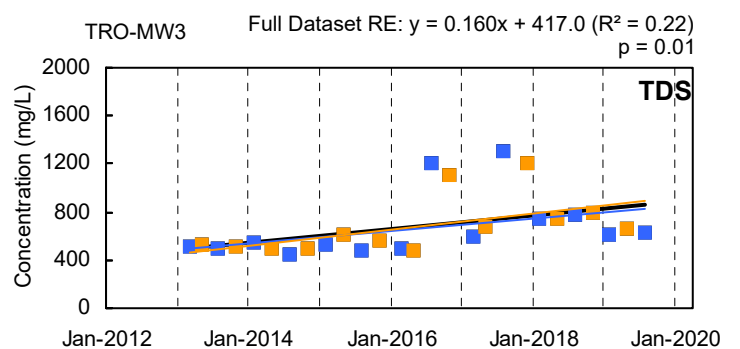
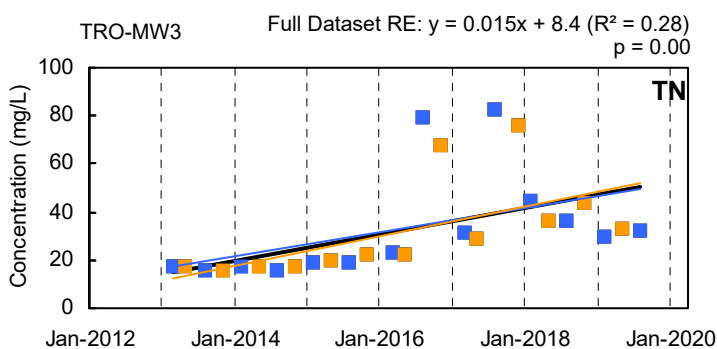
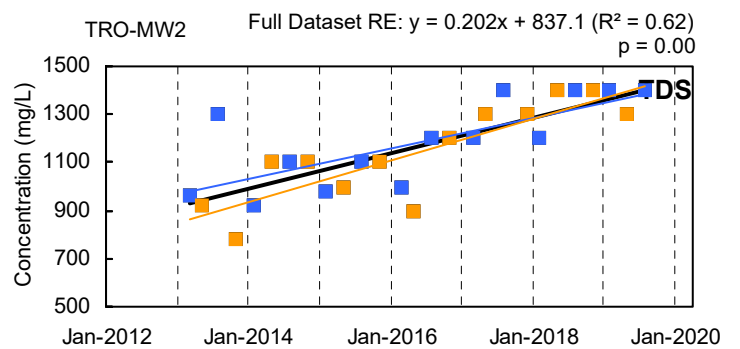
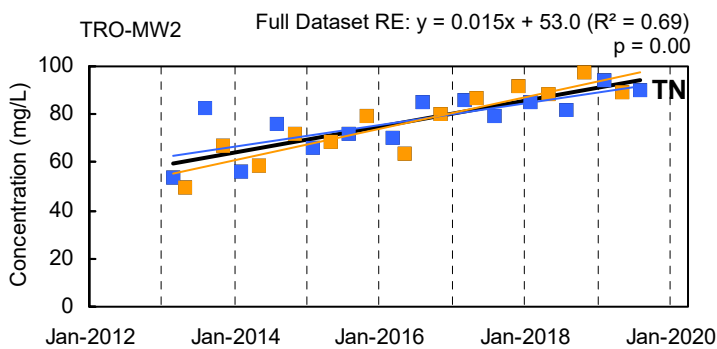
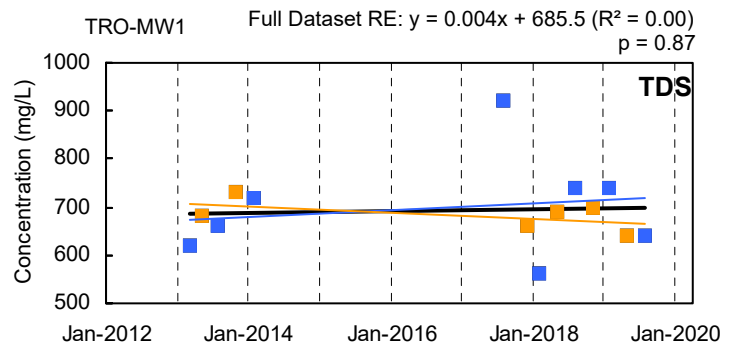
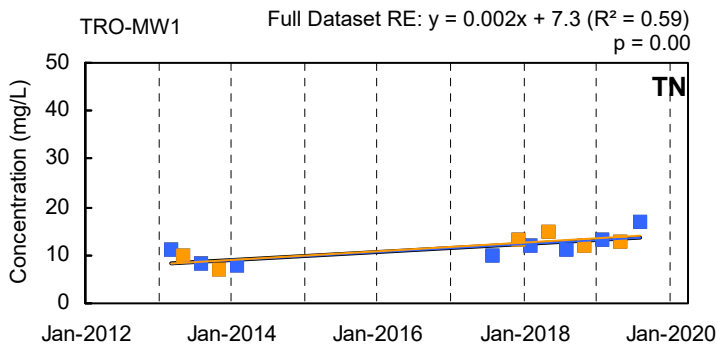
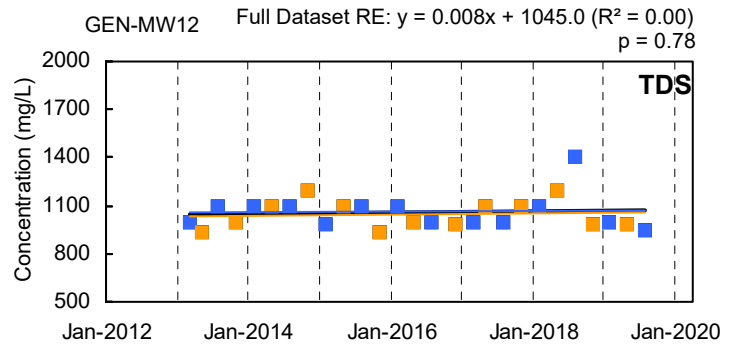
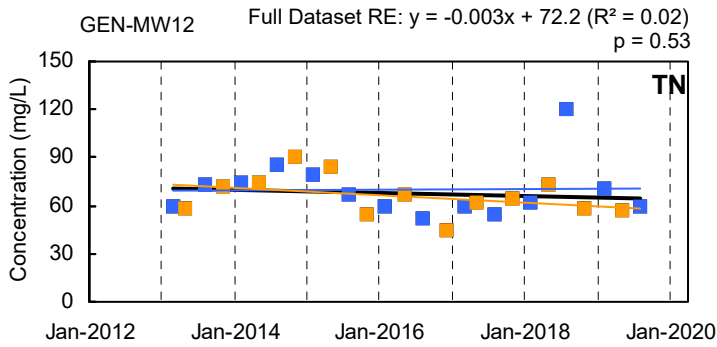
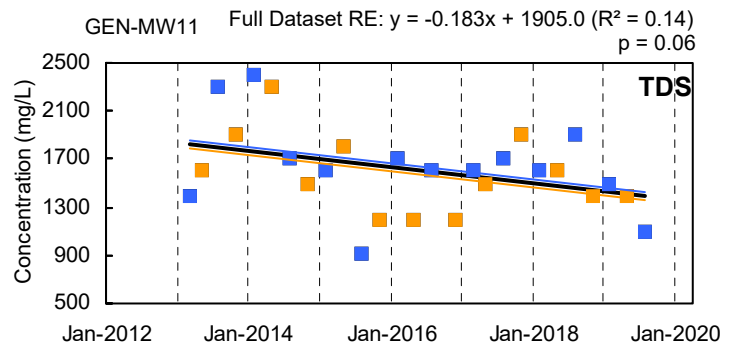
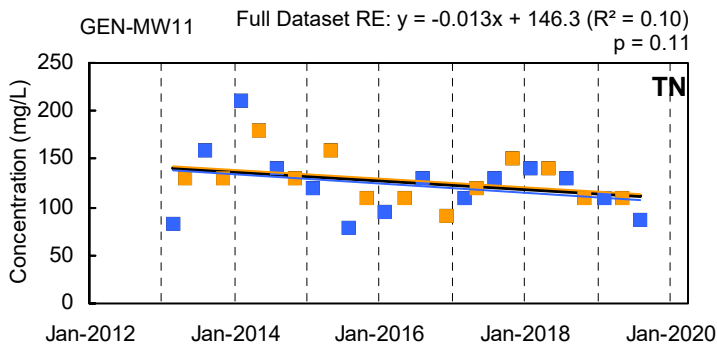

■ Q1/Q3 Result ■ Q2/Q4 Result
— Q1/Q3 Trendline — Q2/Q4 Trendline — Full Dataset Trendline

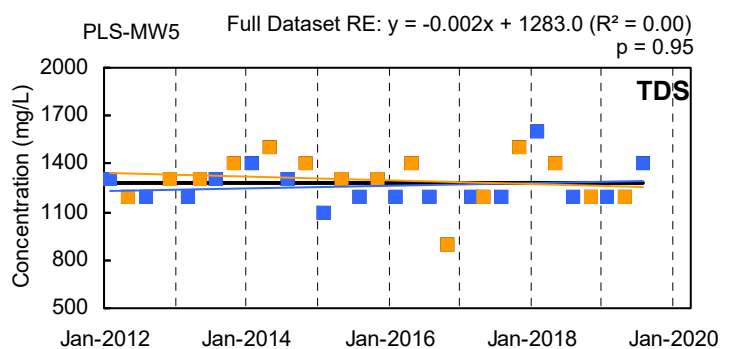
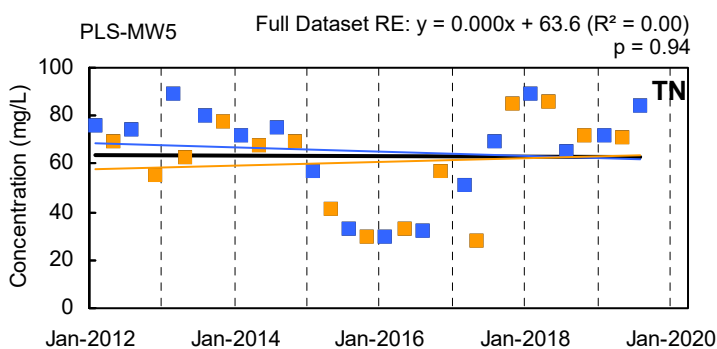
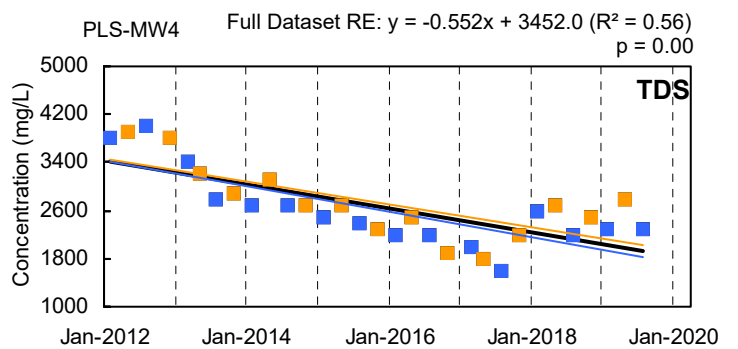
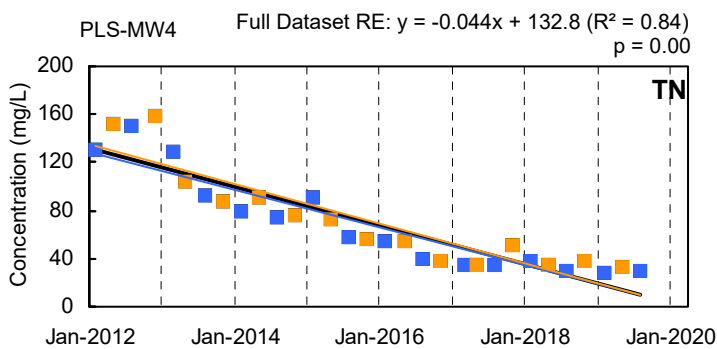
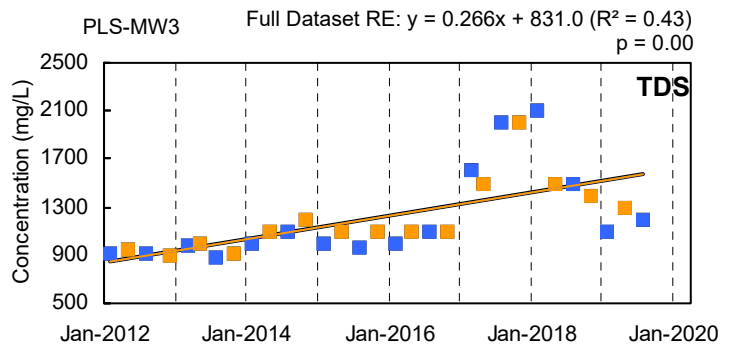
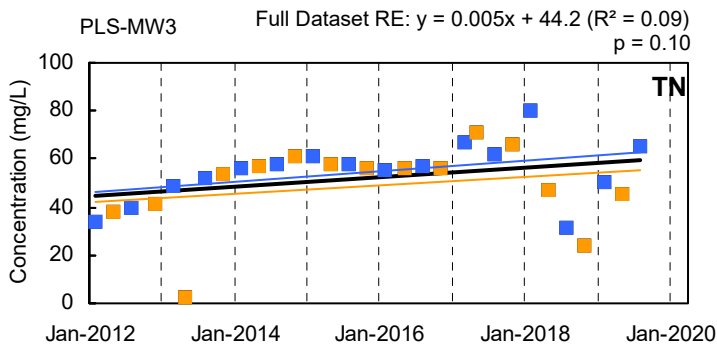
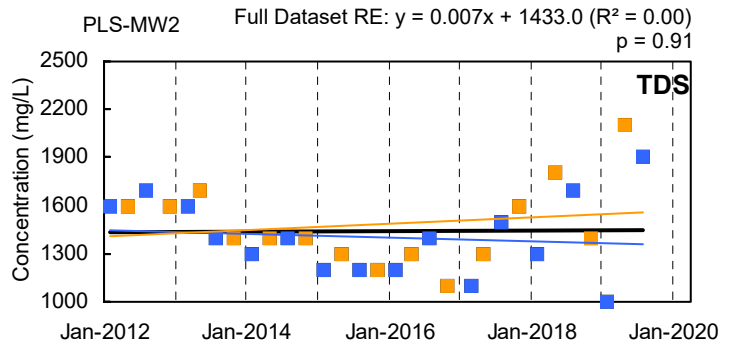
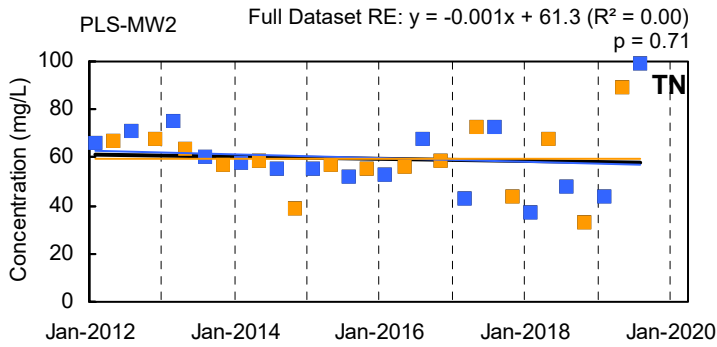
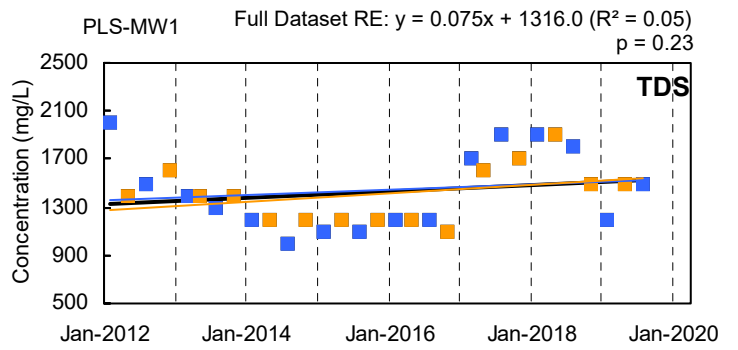
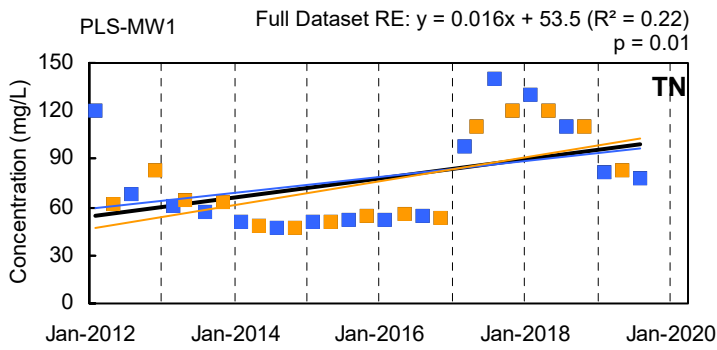

■ Q1/Q3 Result ■ Q2/Q4 Result
— Q1/Q3 Trendline — Q2/Q4 Trendline — Full Dataset Trendline

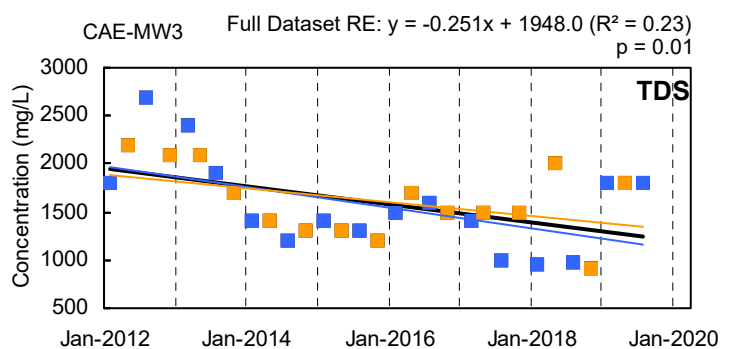
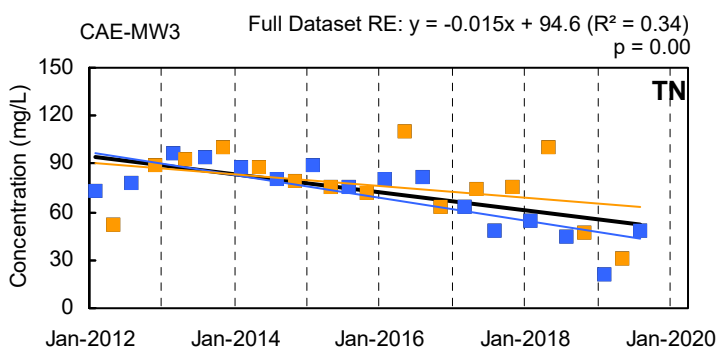
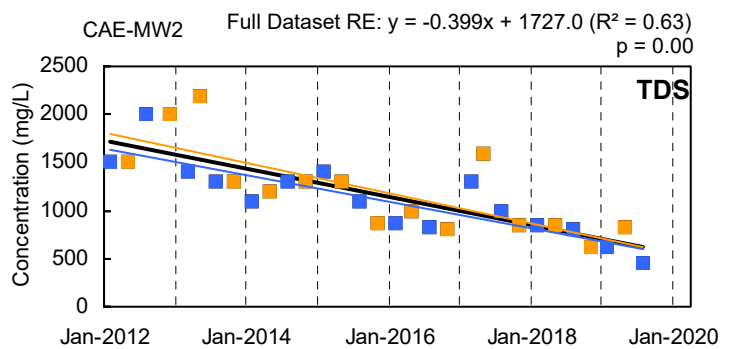
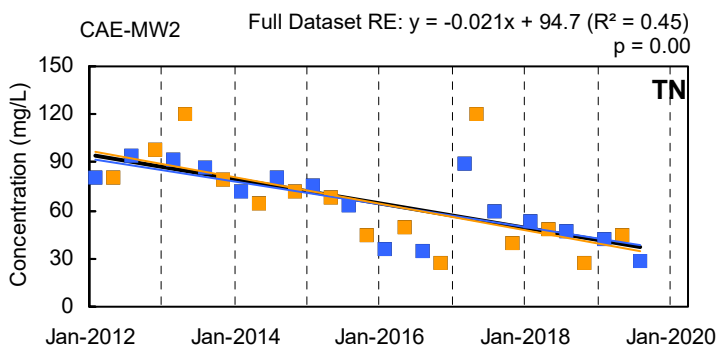
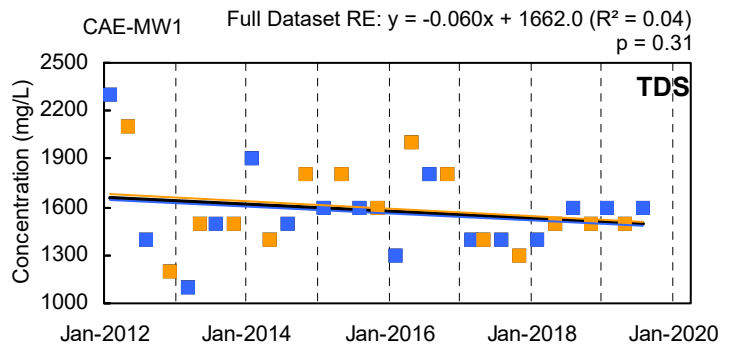
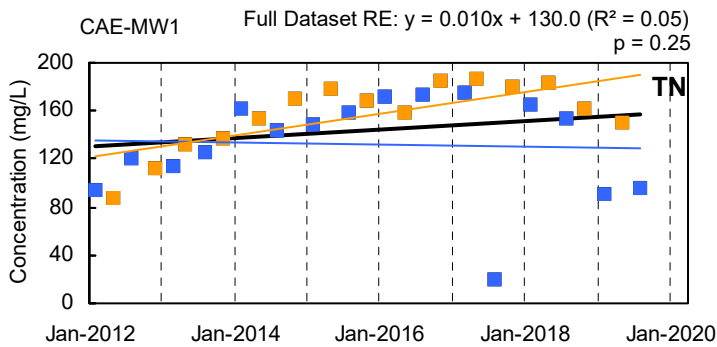
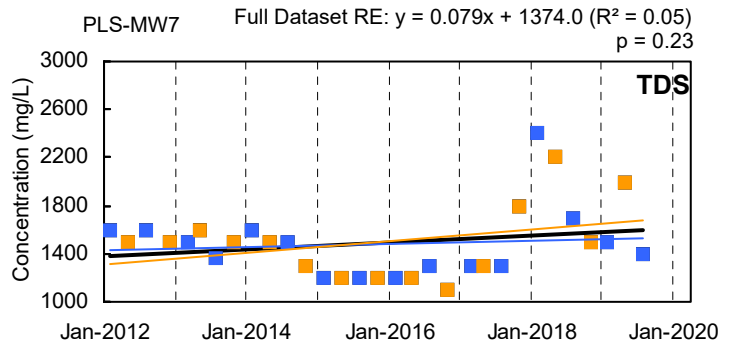
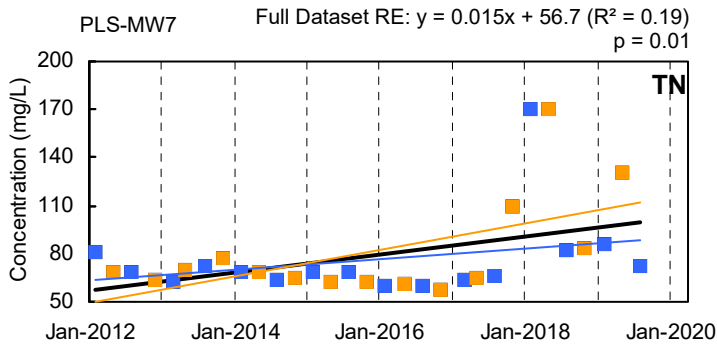
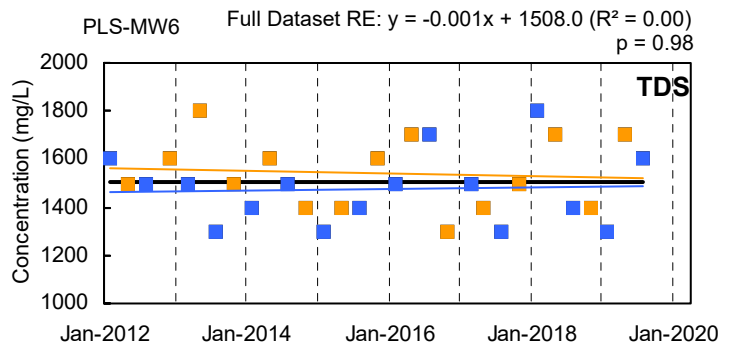
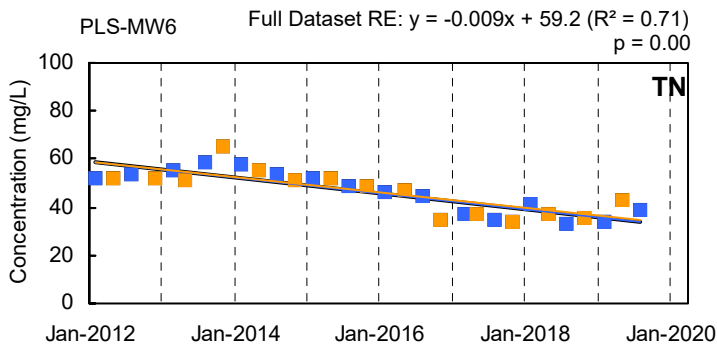

■ Q1/Q3 Result ■ Q2/Q4 Result
— Q1/Q3 Trendline — Q2/Q4 Trendline — Full Dataset Trendline

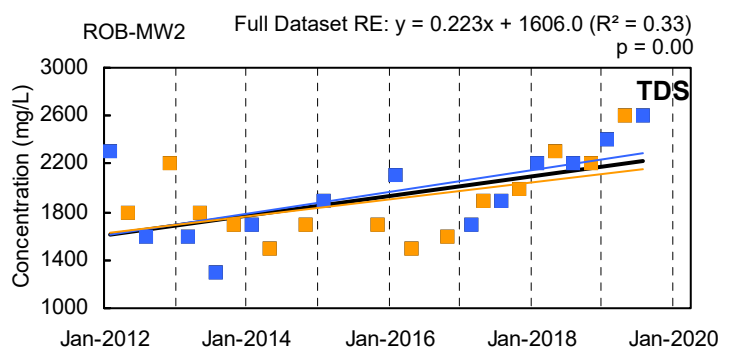
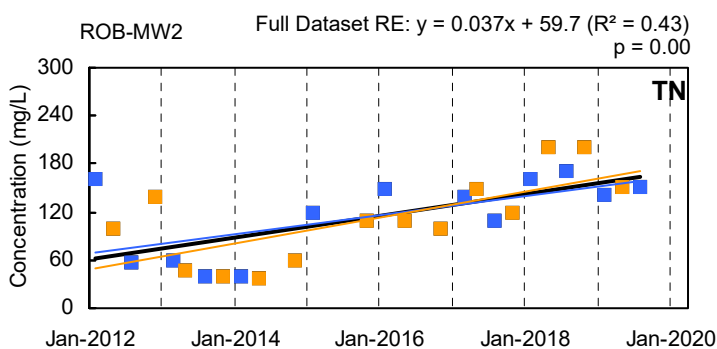
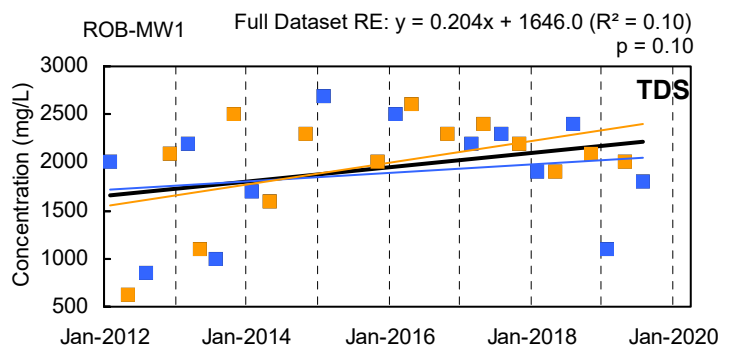
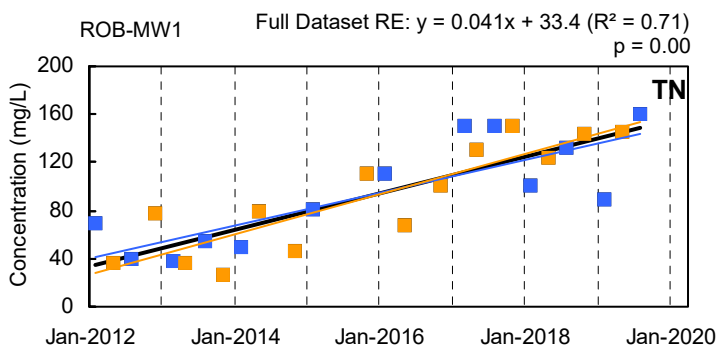
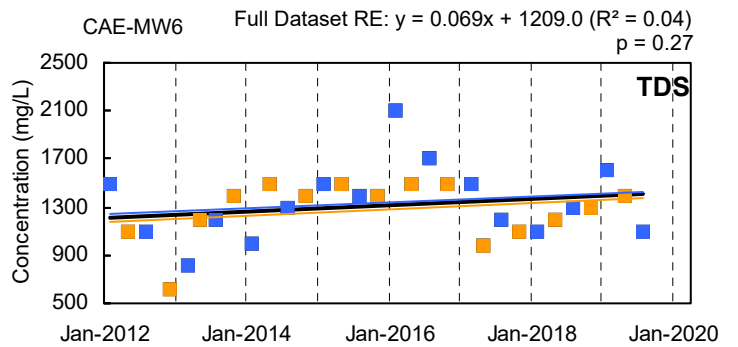
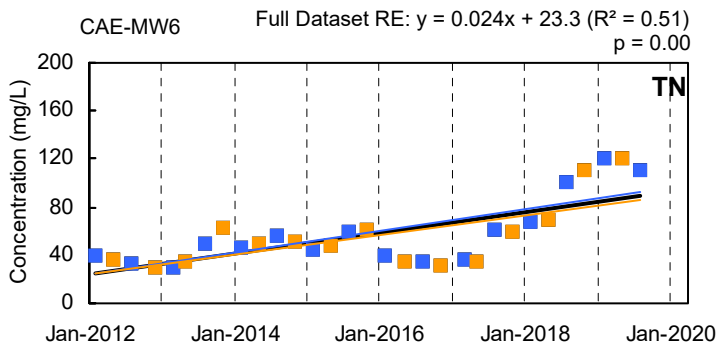
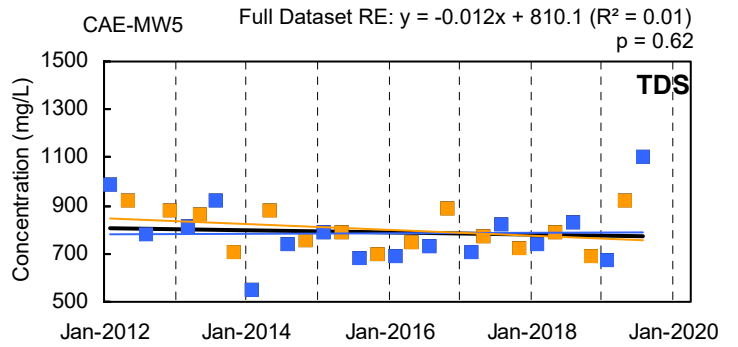
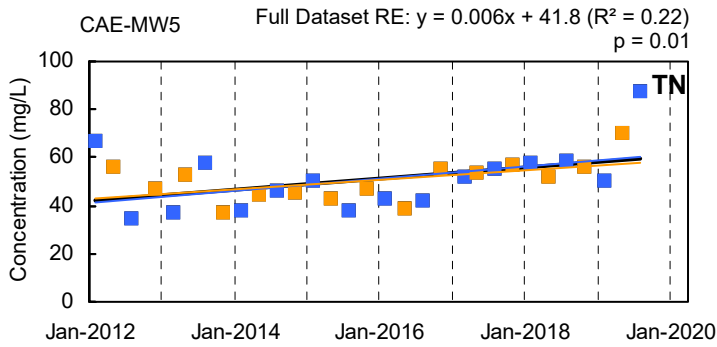
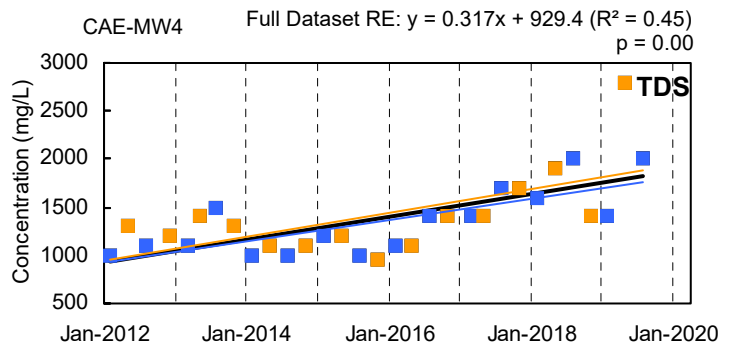
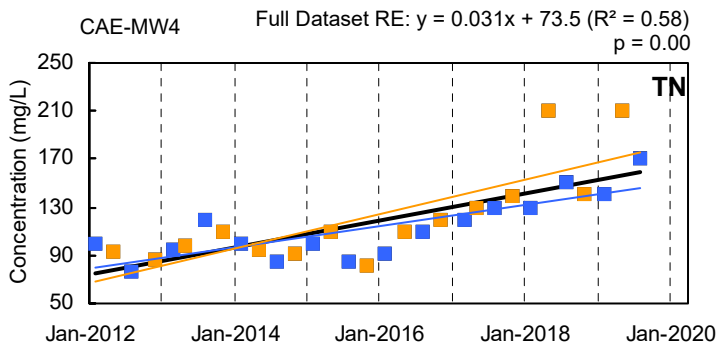

■ Q1/Q3 Result ■ Q2/Q4 Result
— Q1/Q3 Trendline — Q2/Q4 Trendline — Full Dataset Trendline

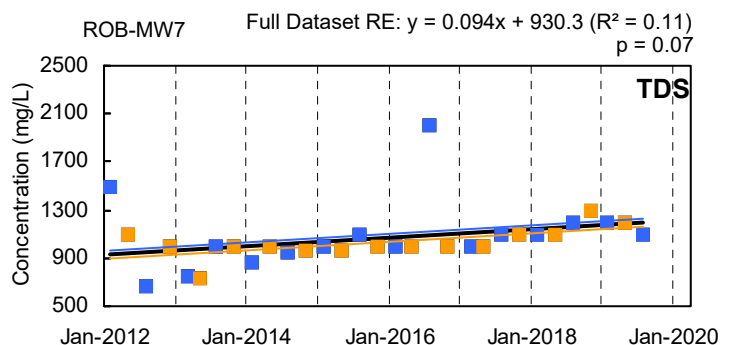
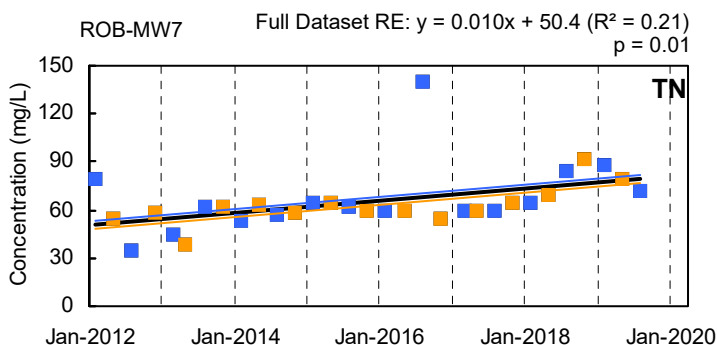
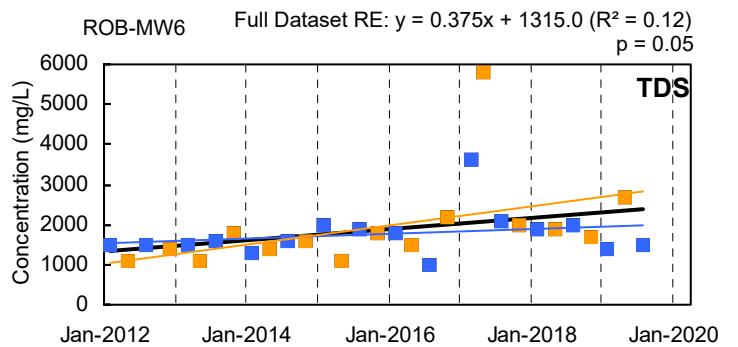
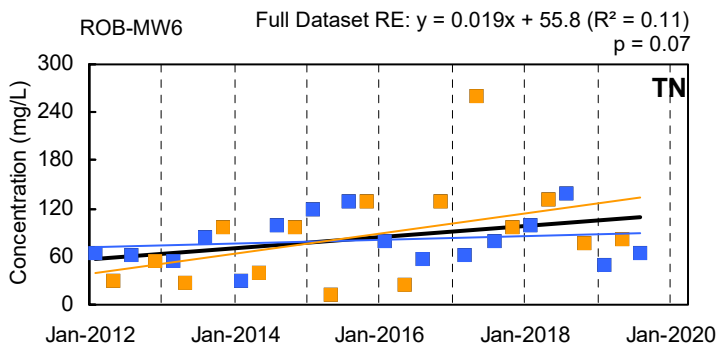
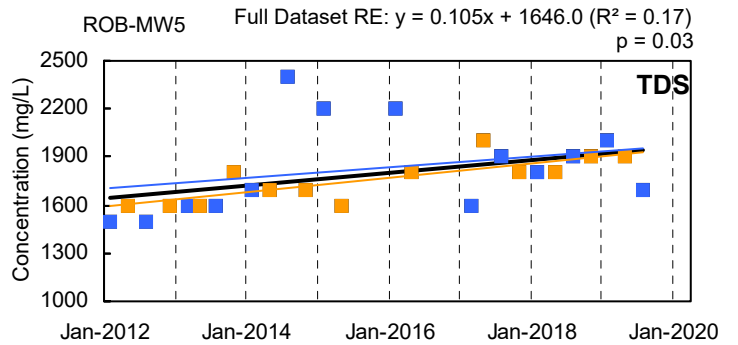
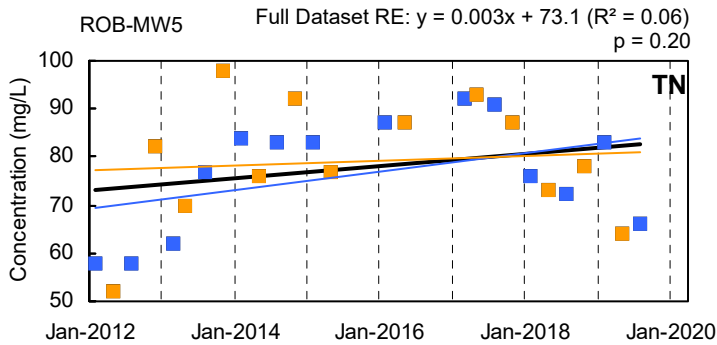
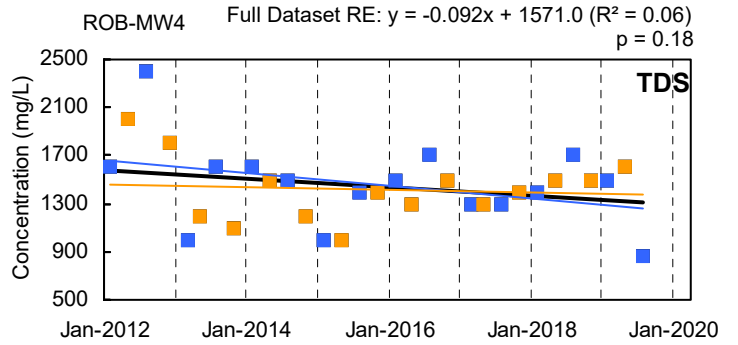
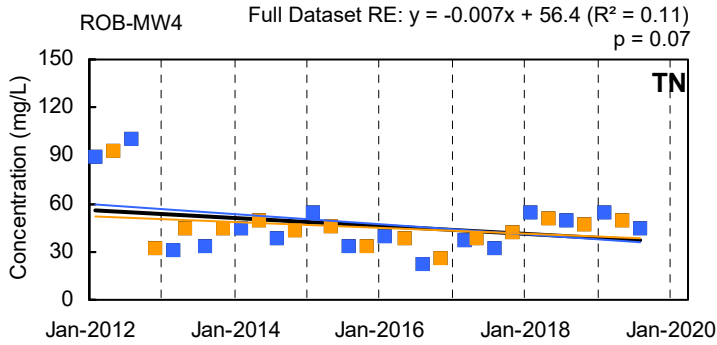
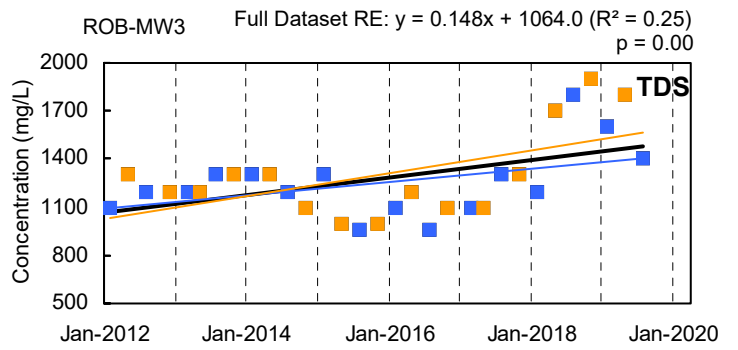
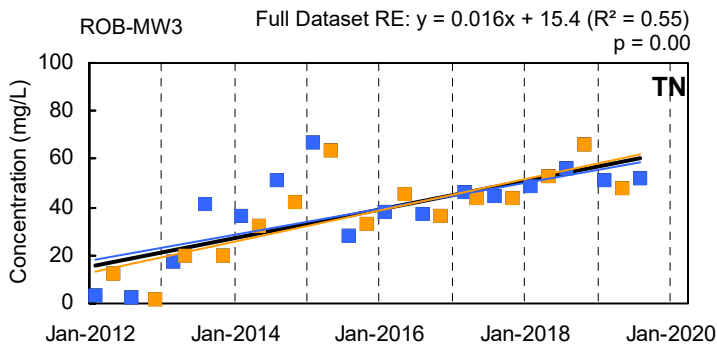

■ Q1/Q3 Result ■ Q2/Q4 Result
— Q1/Q3 Trendline — Q2/Q4 Trendline — Full Dataset Trendline

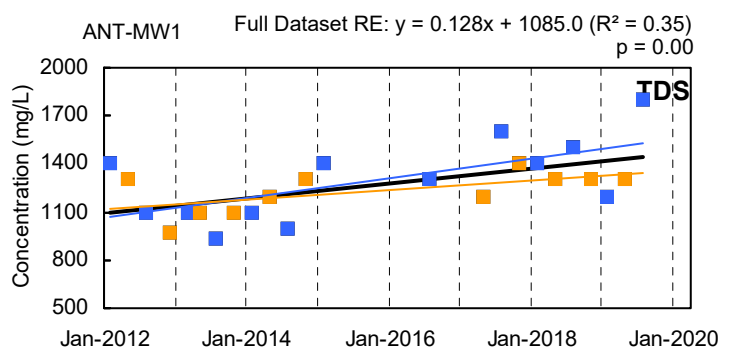
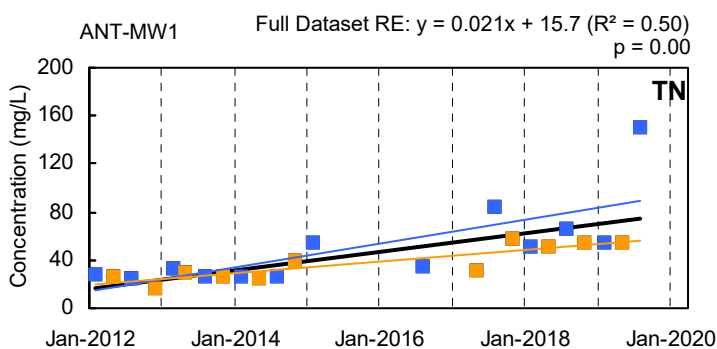
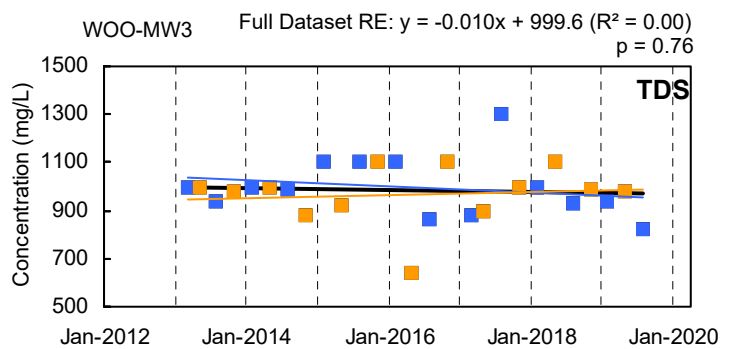
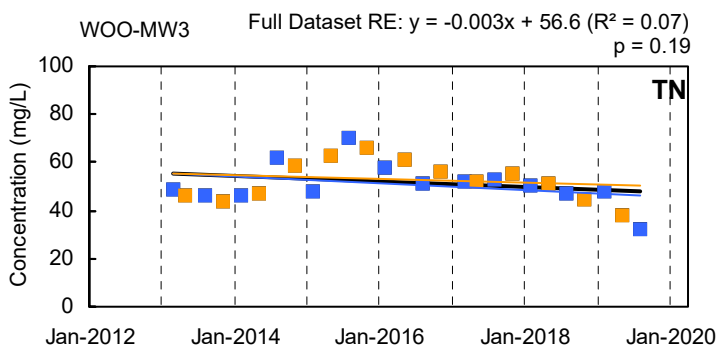
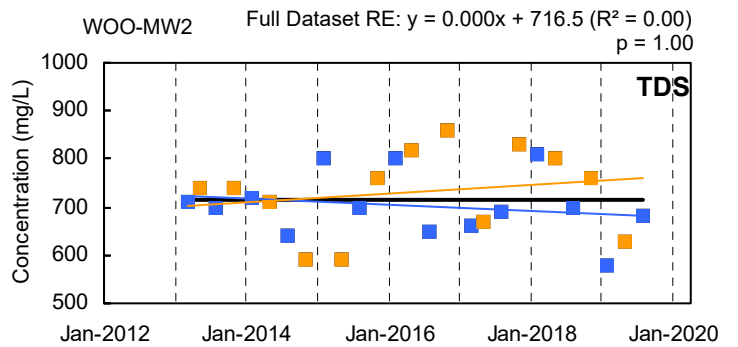
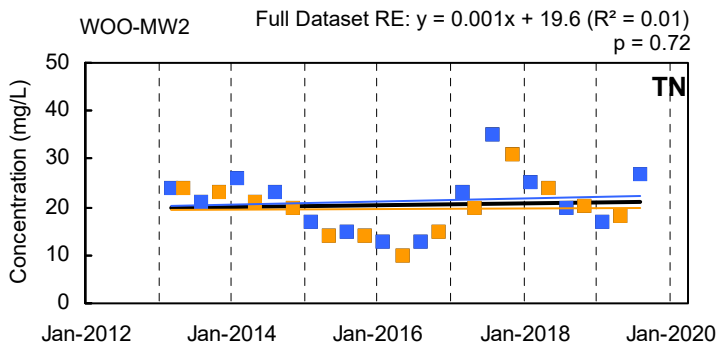
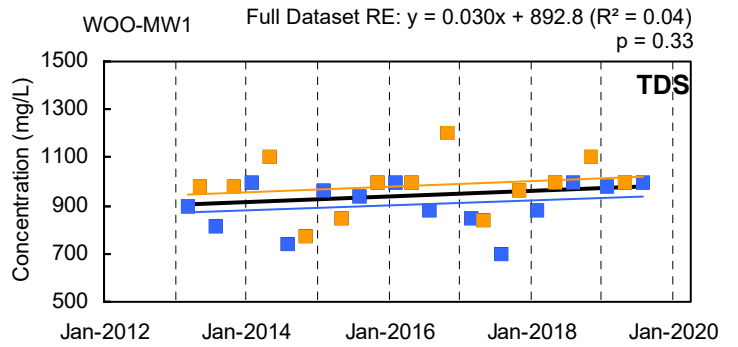
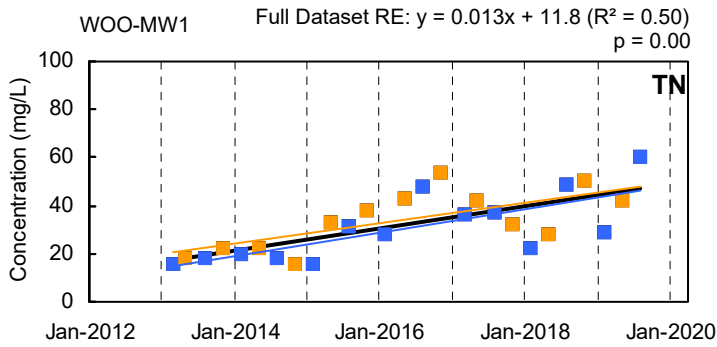
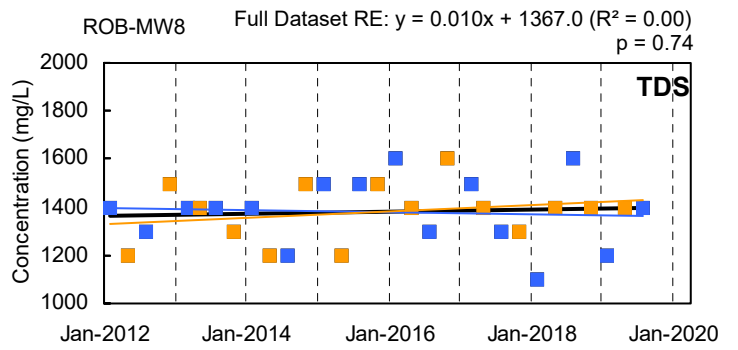
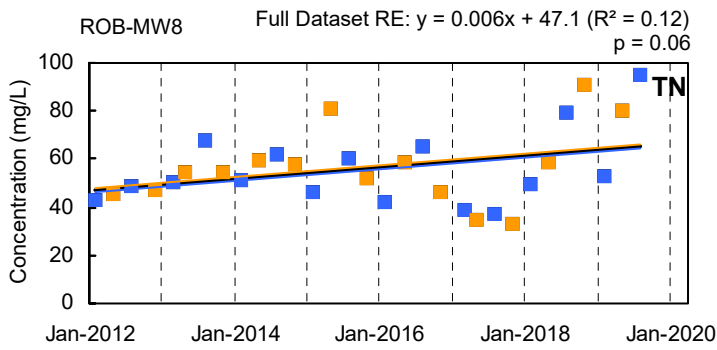

■ Q1/Q3 Result ■ Q2/Q4 Result
— Q1/Q3 Trendline — Q2/Q4 Trendline — Full Dataset Trendline

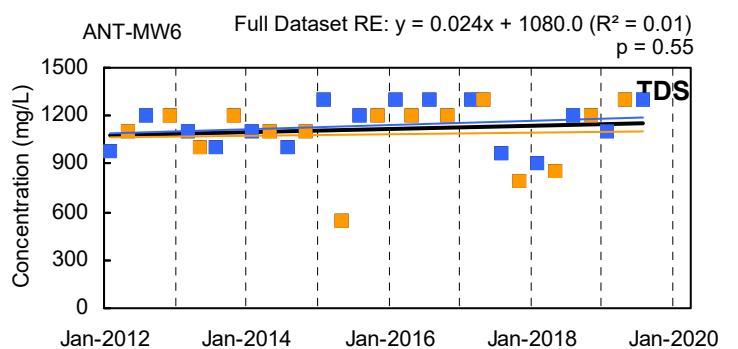
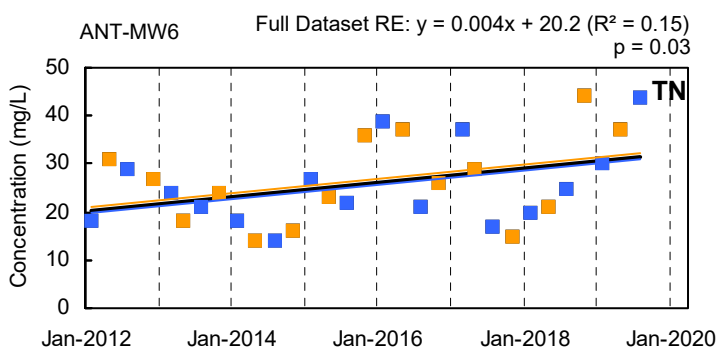
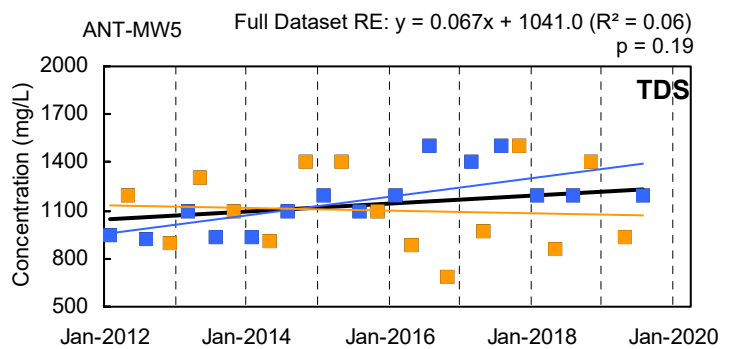
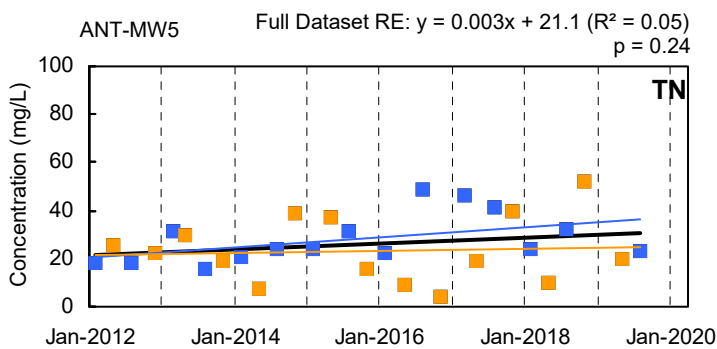
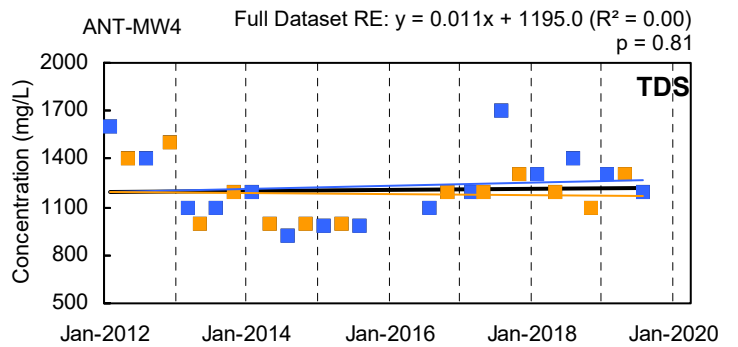
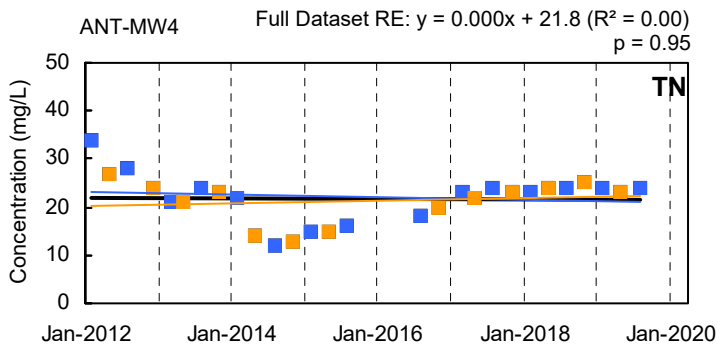
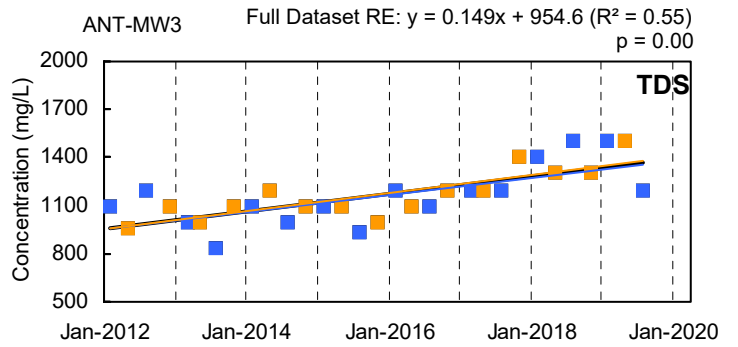
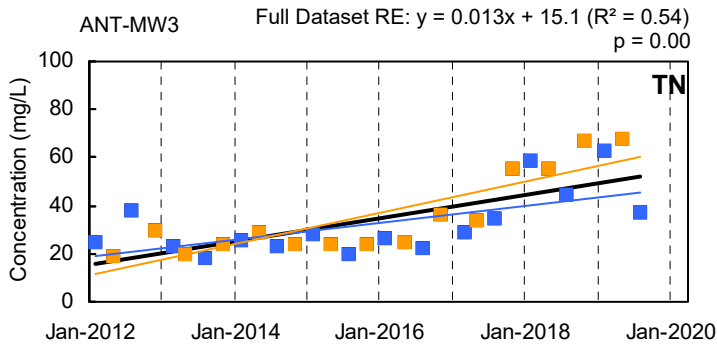
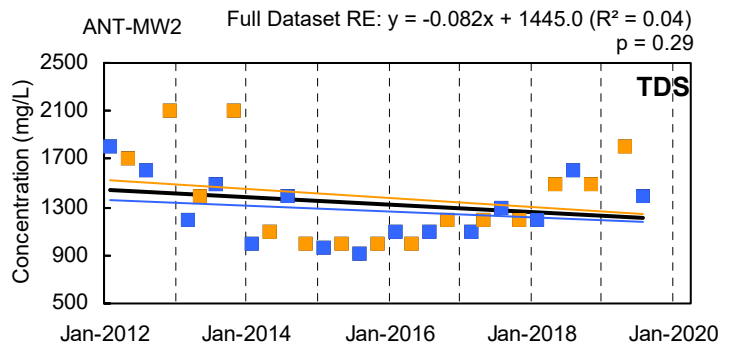
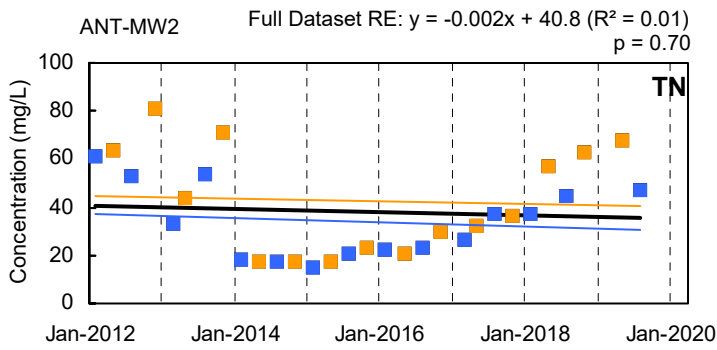

■ Q1/Q3 Result ■ Q2/Q4 Result
— Q1/Q3 Trendline — Q2/Q4 Trendline — Full Dataset Trendline

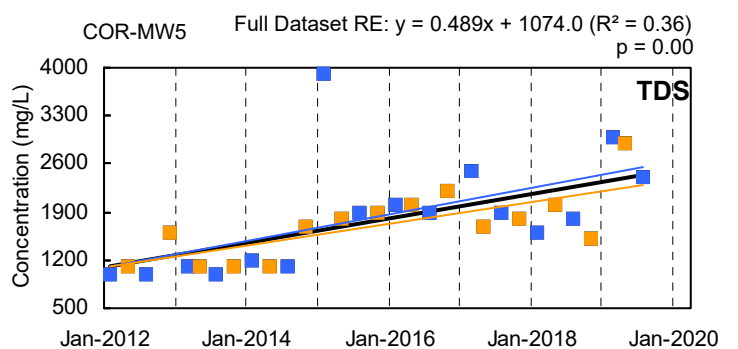
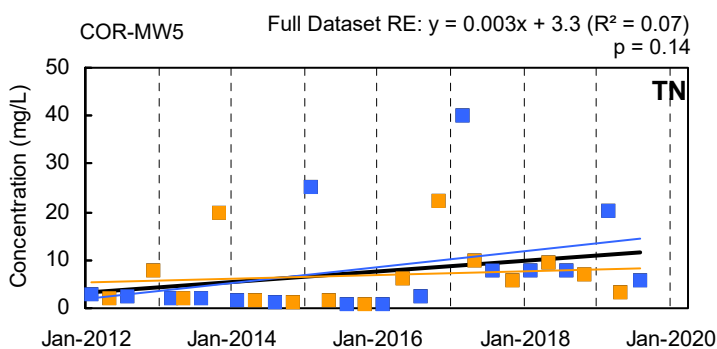
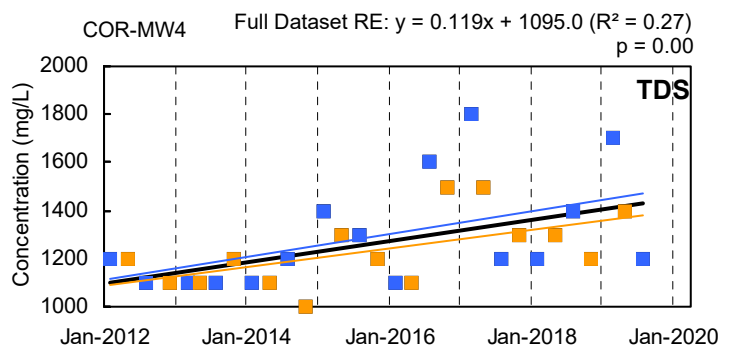
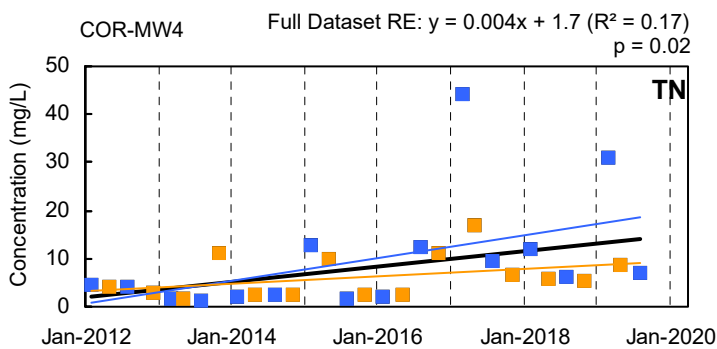
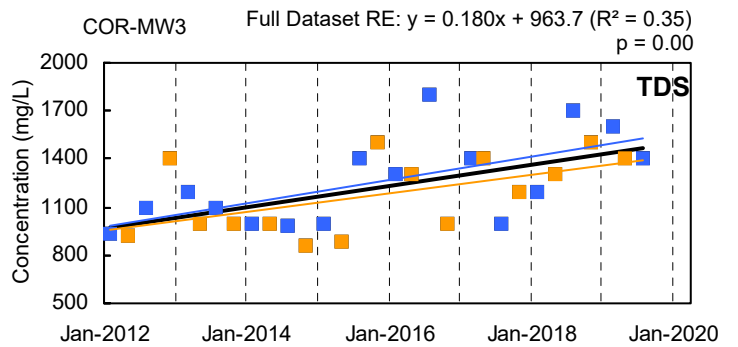
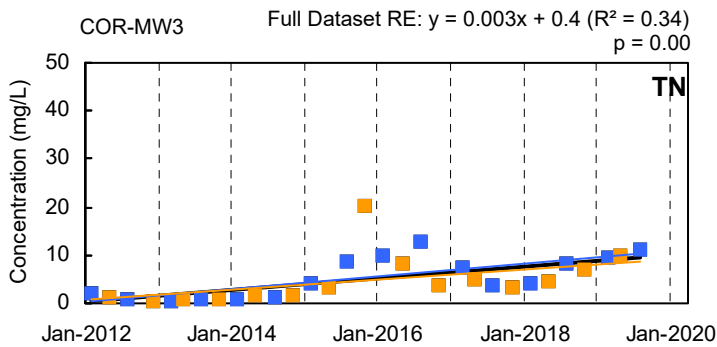
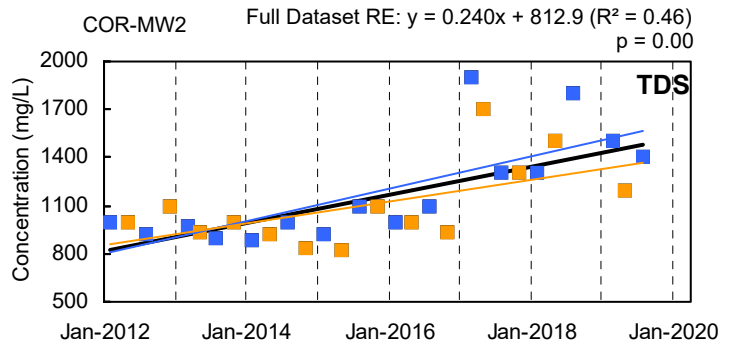
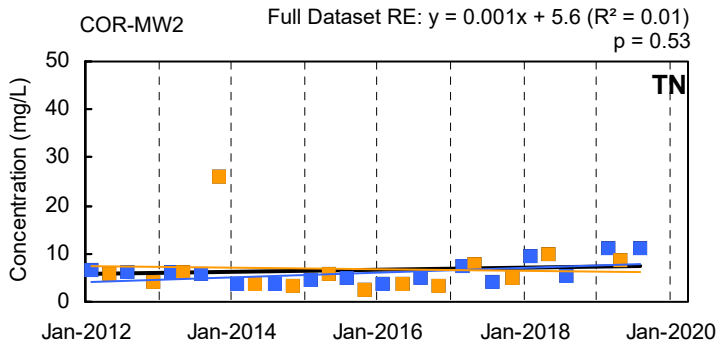
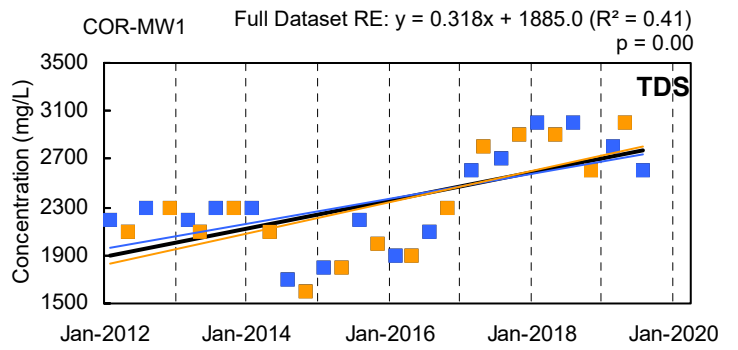
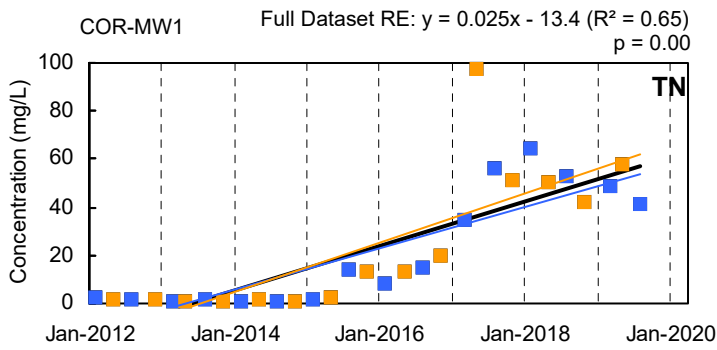

■ Q1/Q3 Result ■ Q2/Q4 Result
— Q1/Q3 Trendline — Q2/Q4 Trendline — Full Dataset Trendline

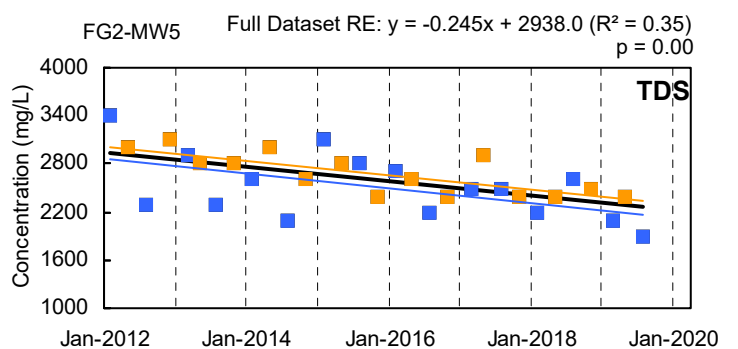
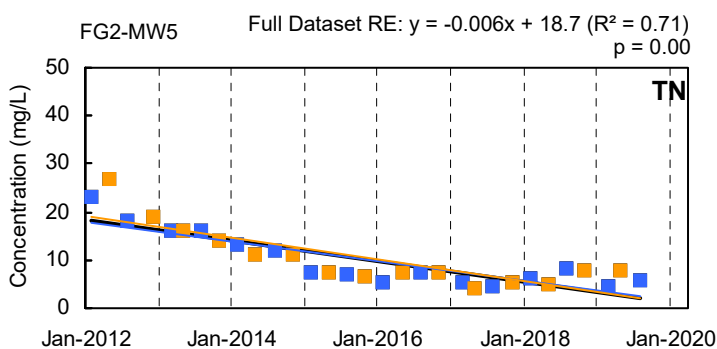
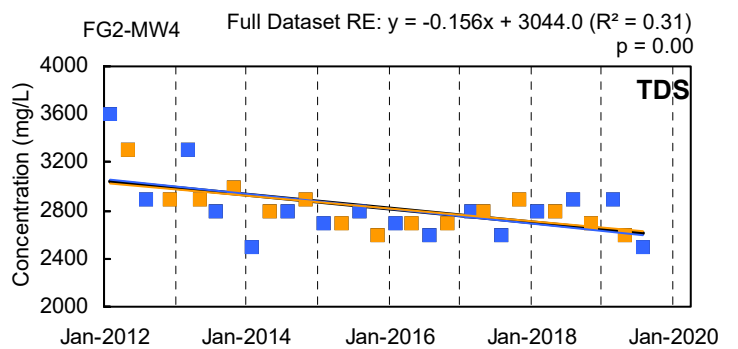
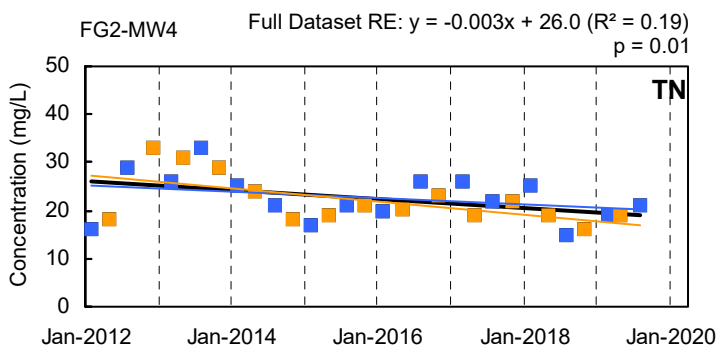
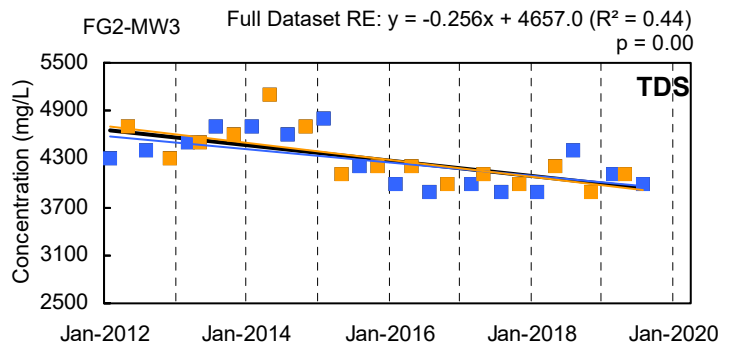
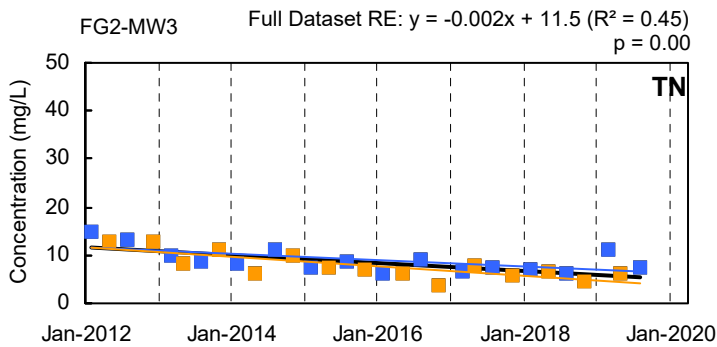
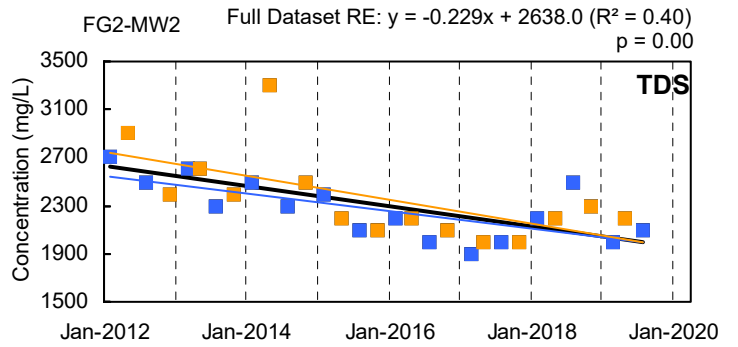
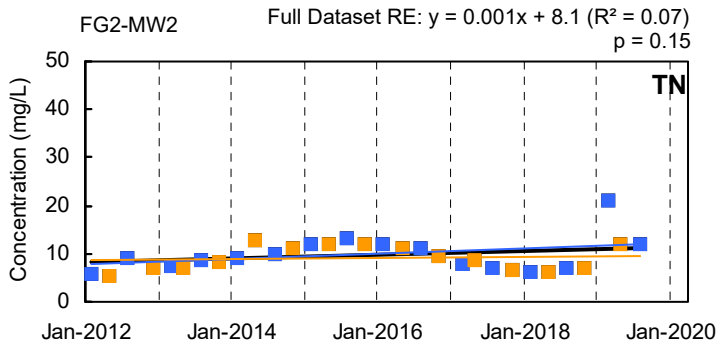
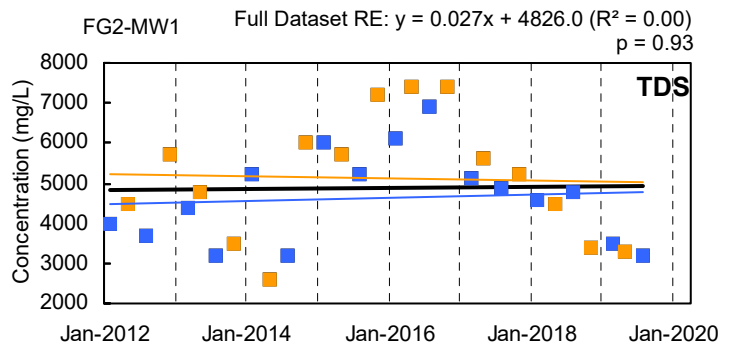
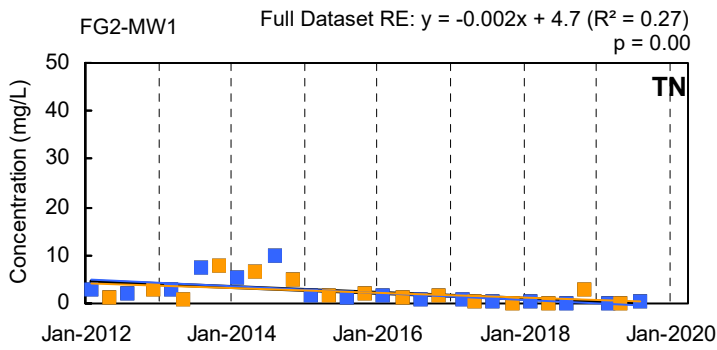

■ Q1/Q3 Result ■ Q2/Q4 Result
— Q1/Q3 Trendline — Q2/Q4 Trendline — Full Dataset Trendline

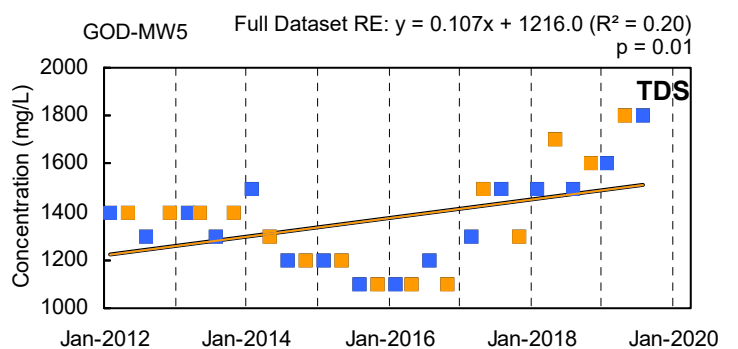
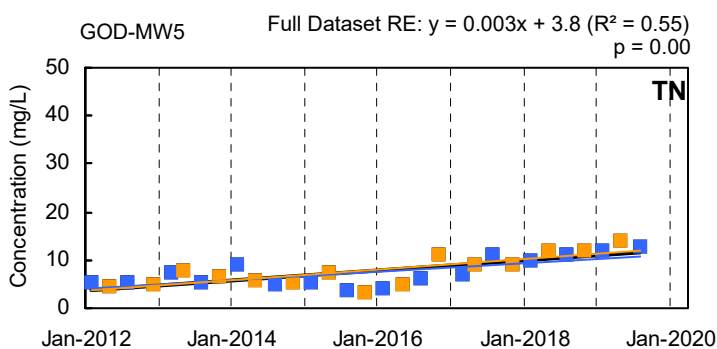
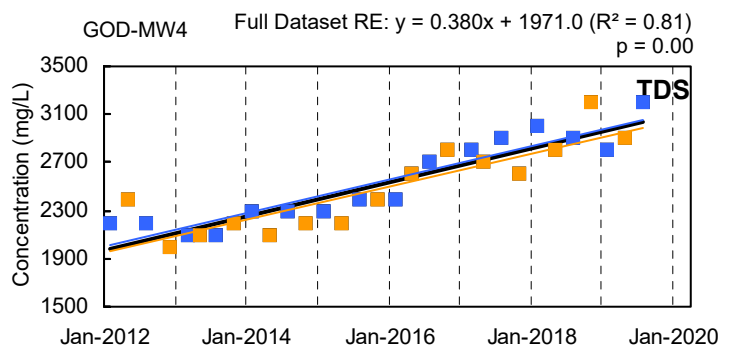
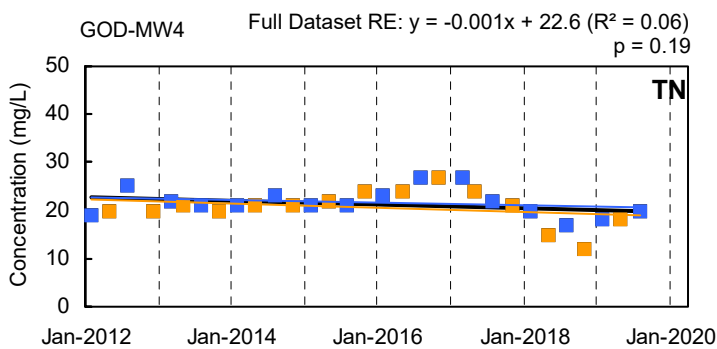
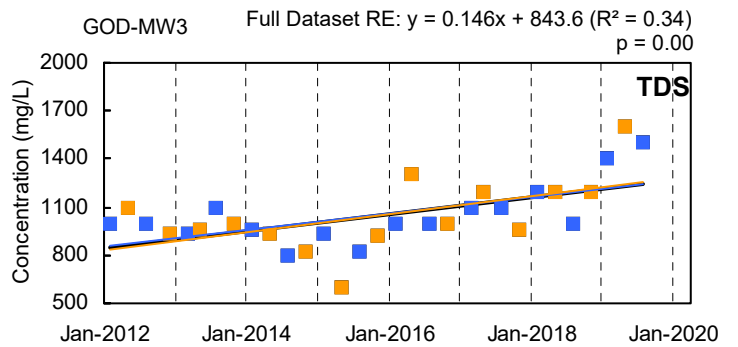
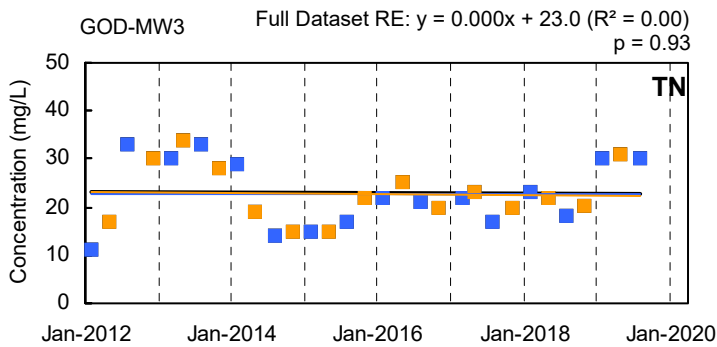
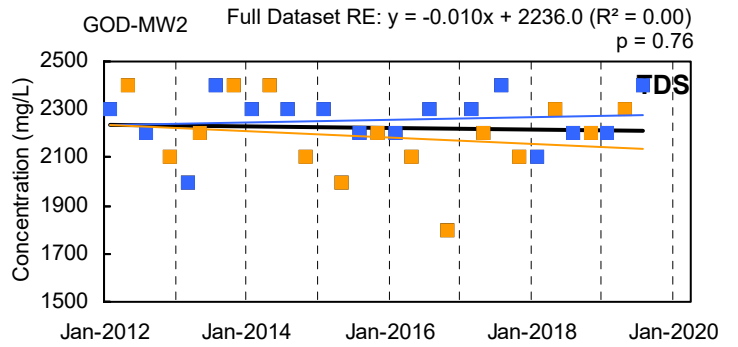
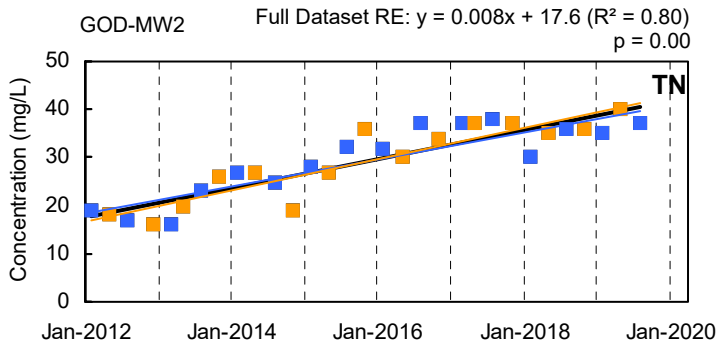
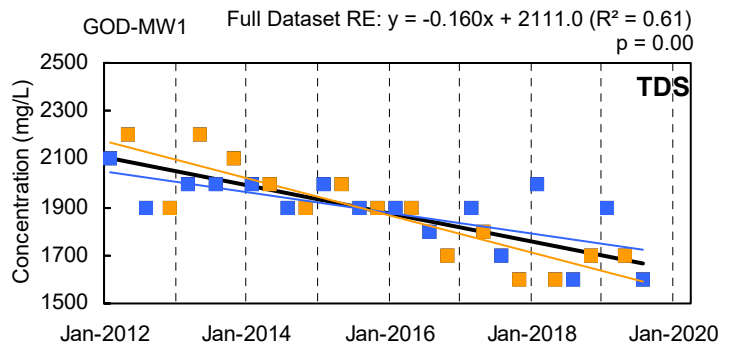
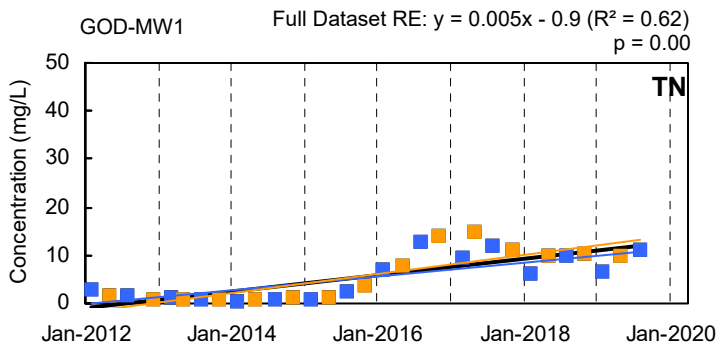

■ Q1/Q3 Result ■ Q2/Q4 Result
— Q1/Q3 Trendline — Q2/Q4 Trendline — Full Dataset Trendline

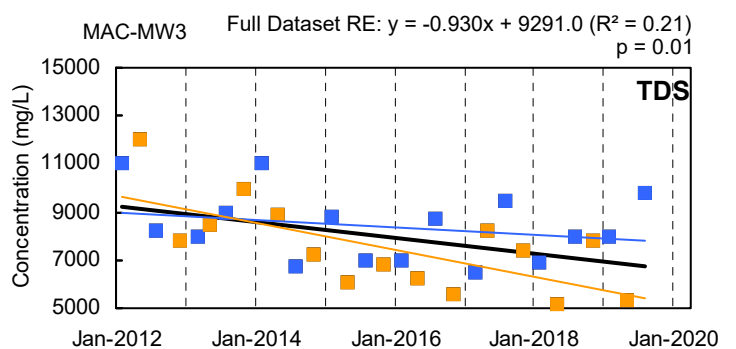
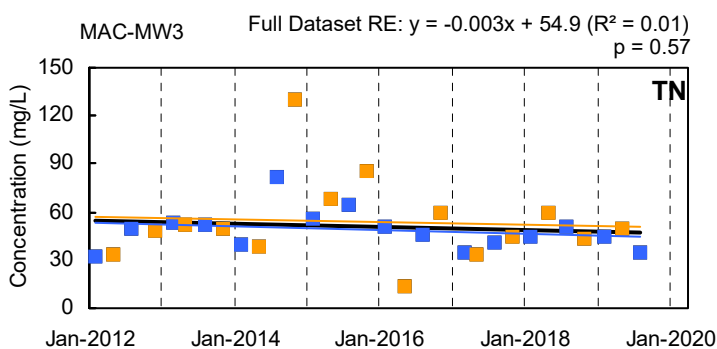
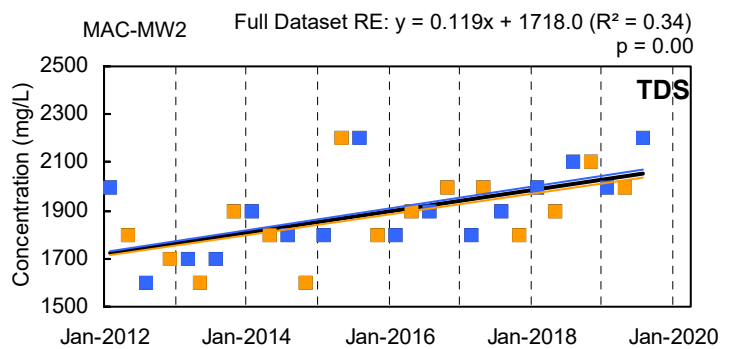
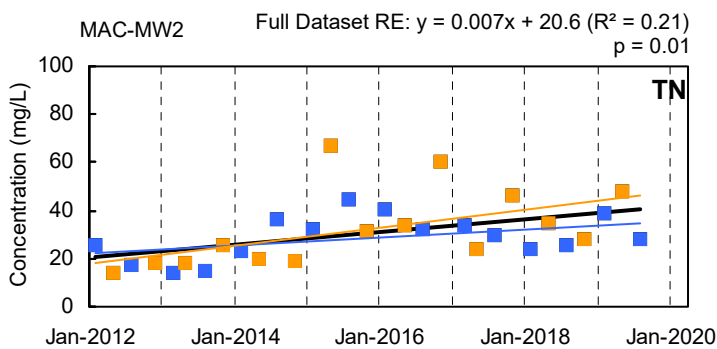
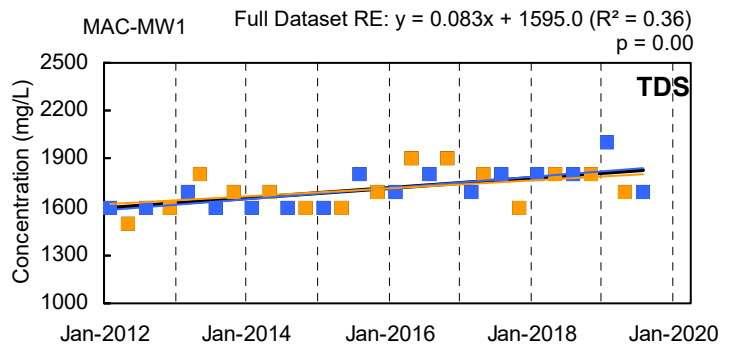
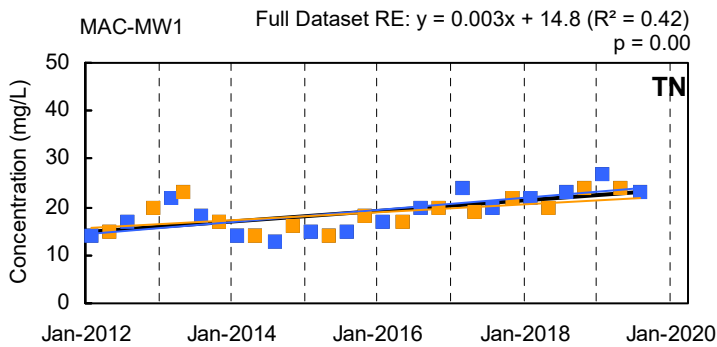
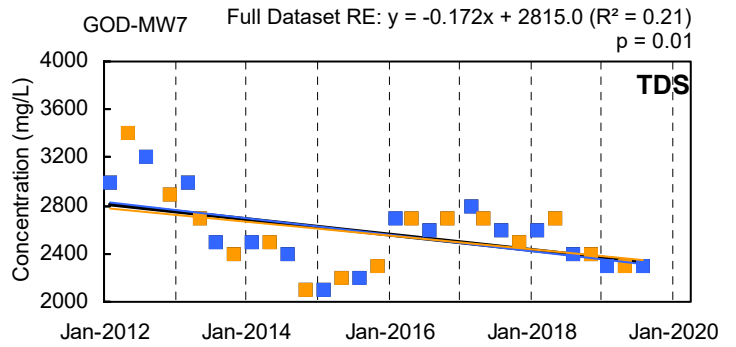
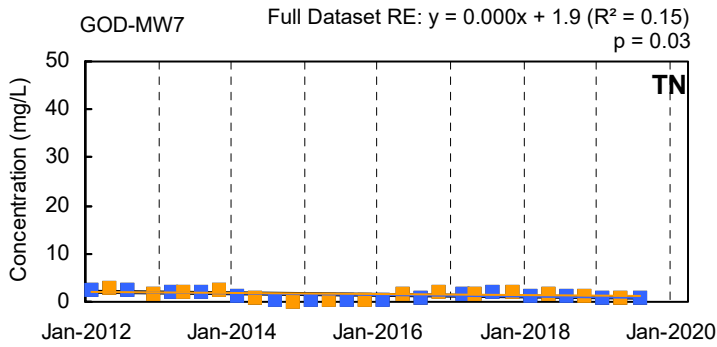
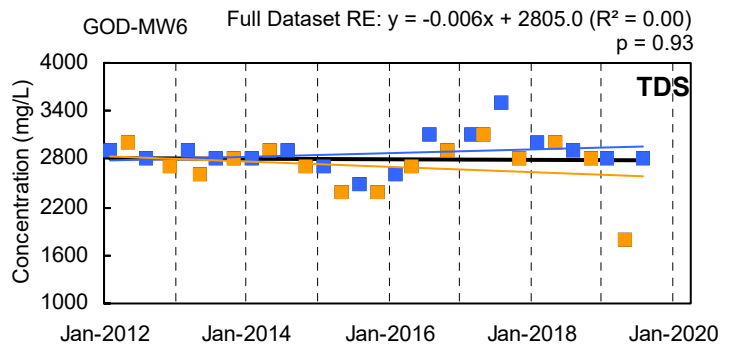
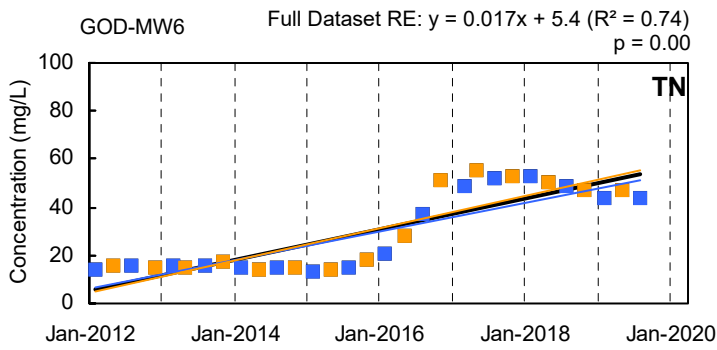

■ Q1/Q3 Result ■ Q2/Q4 Result
— Q1/Q3 Trendline — Q2/Q4 Trendline — Full Dataset Trendline

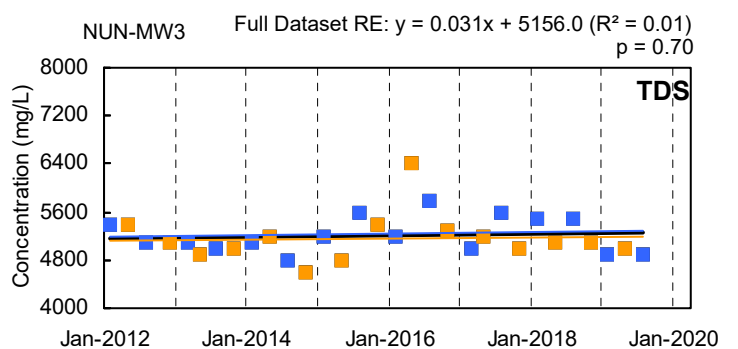
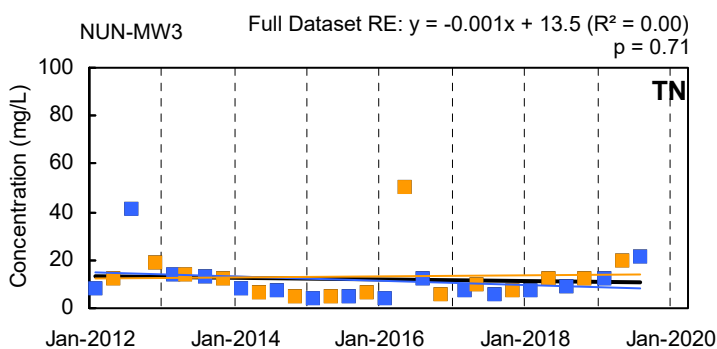
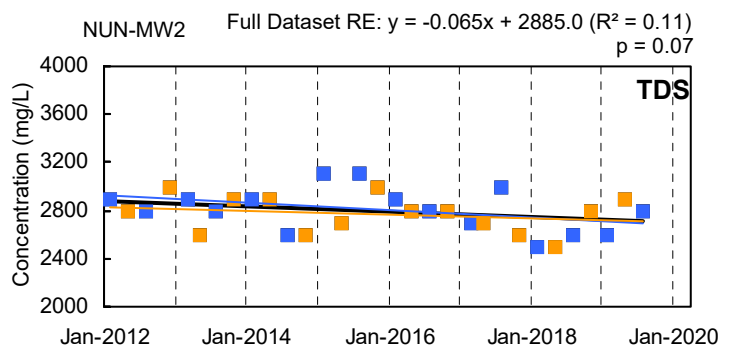
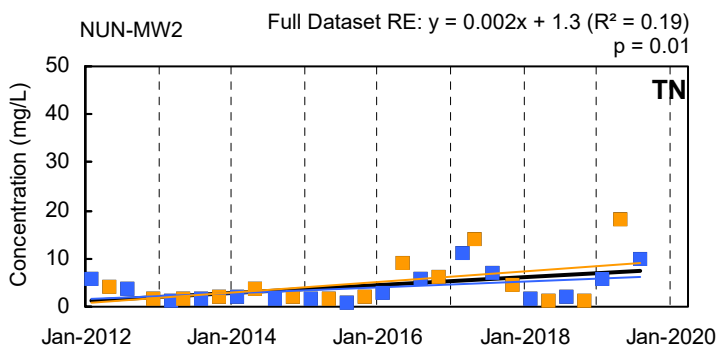
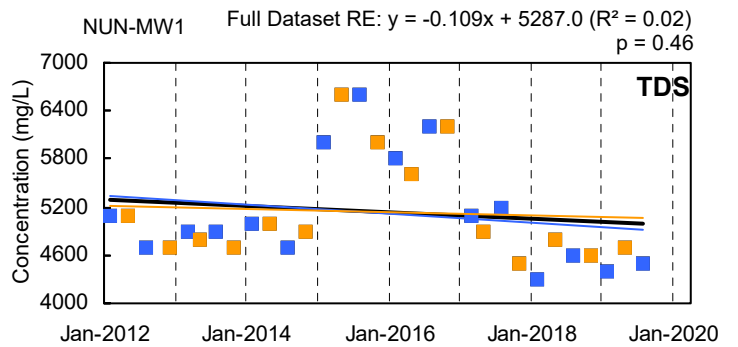
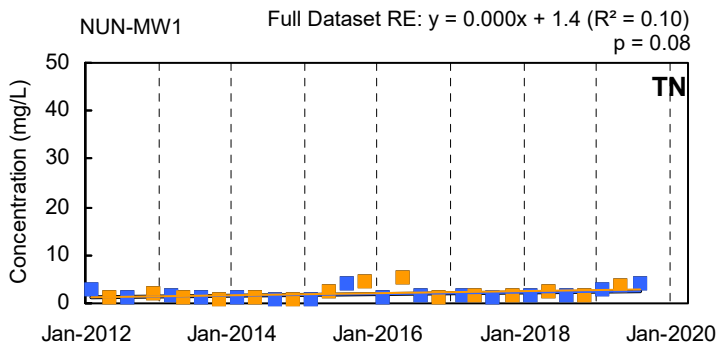
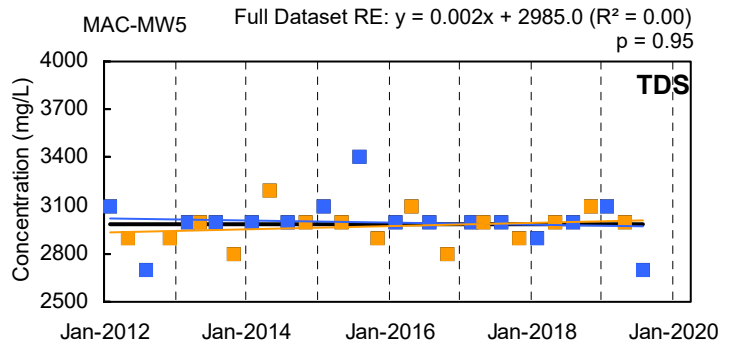
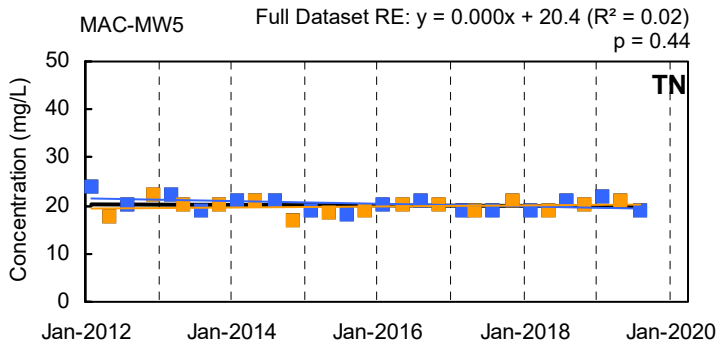
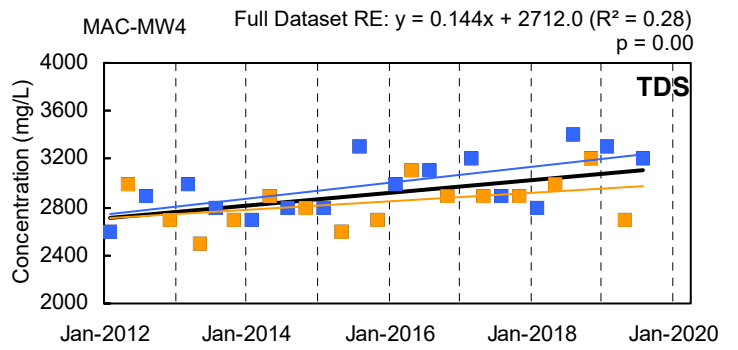
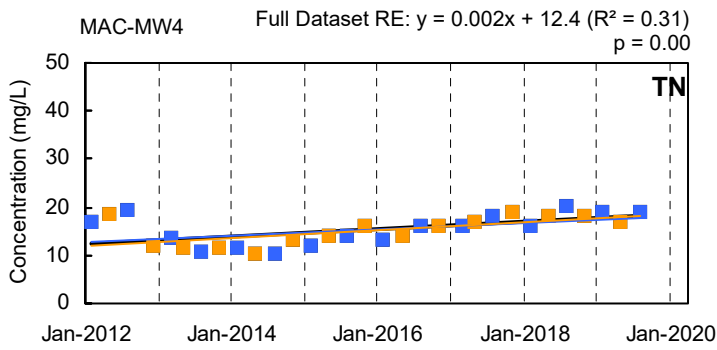

■ Q1/Q3 Result ■ Q2/Q4 Result
— Q1/Q3 Trendline — Q2/Q4 Trendline — Full Dataset Trendline

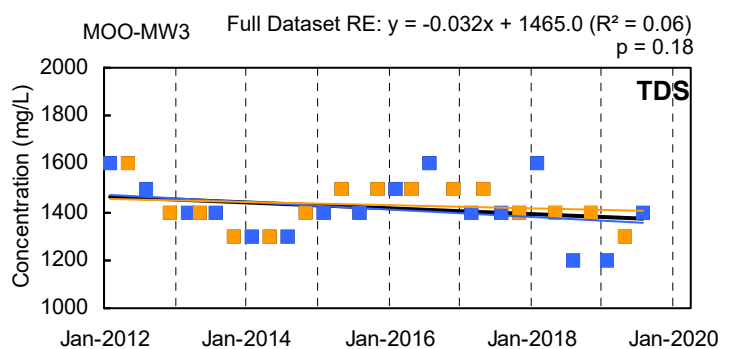
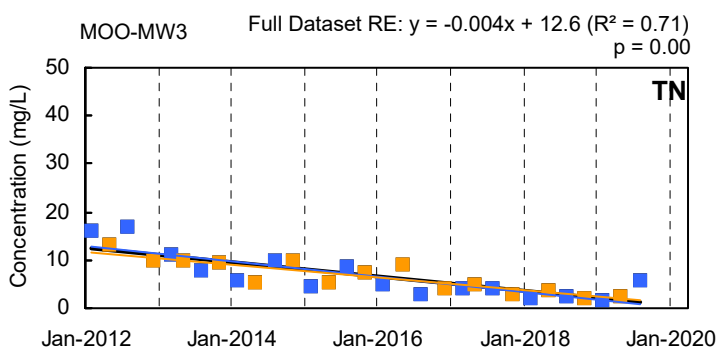
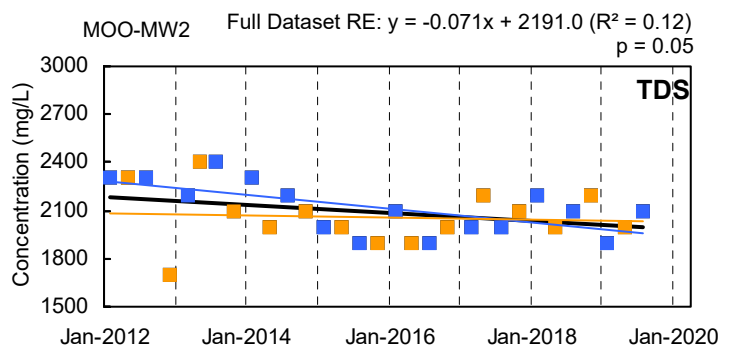
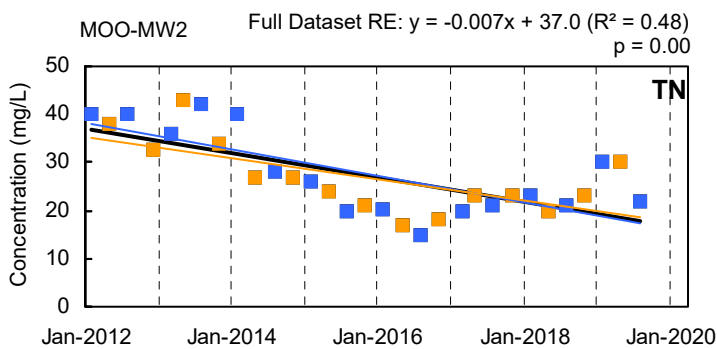
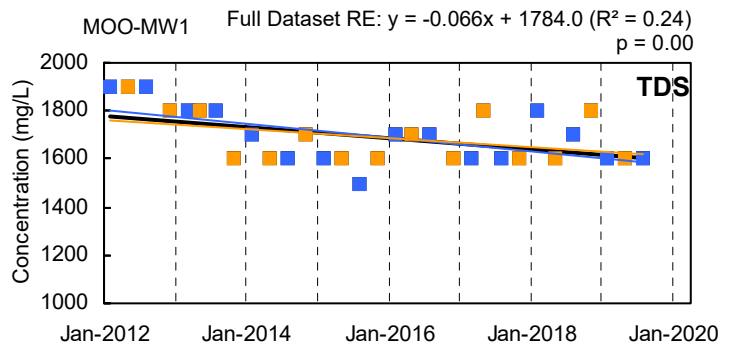
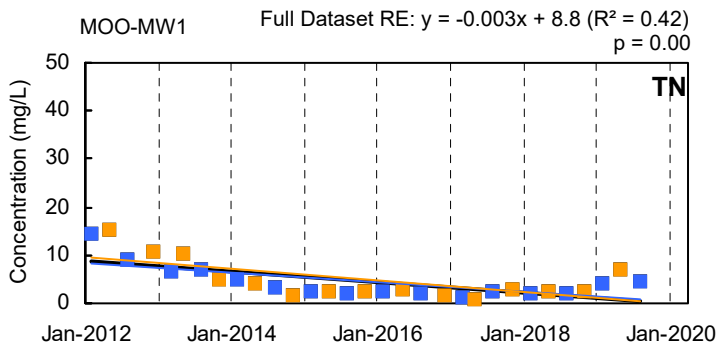
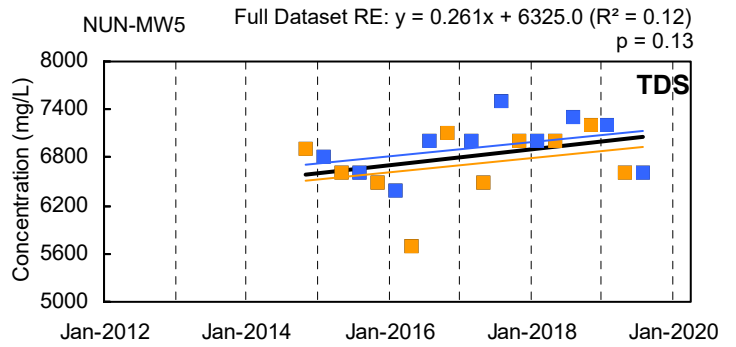
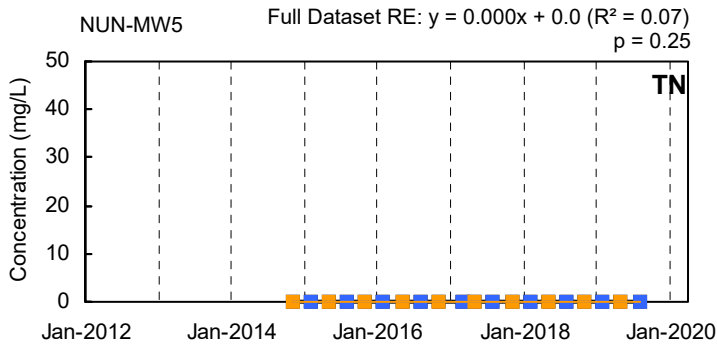
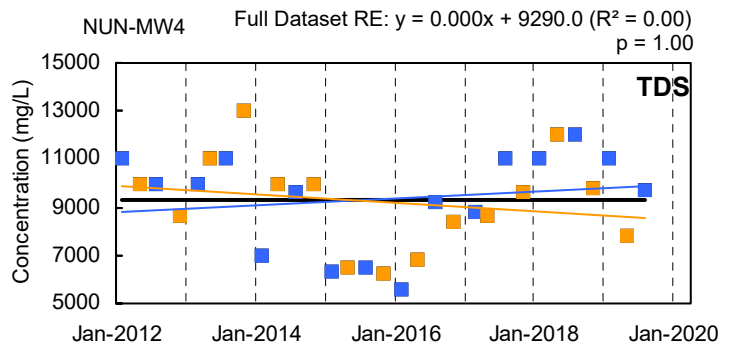
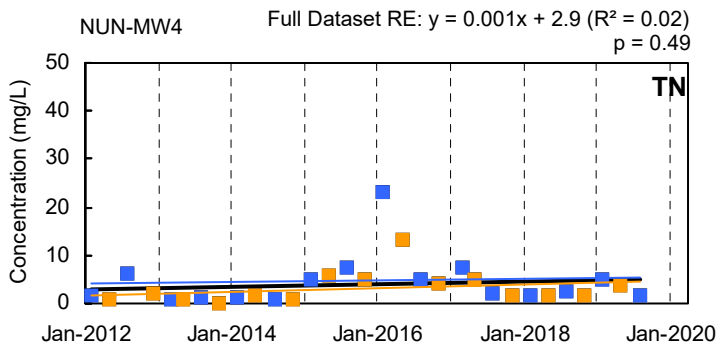

■ Q1/Q3 Result ■ Q2/Q4 Result
— Q1/Q3 Trendline — Q2/Q4 Trendline — Full Dataset Trendline

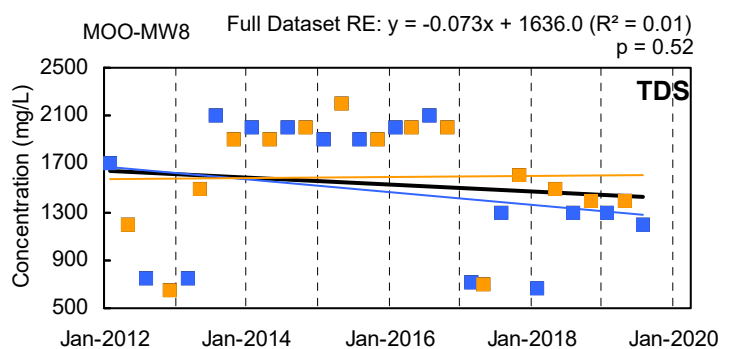
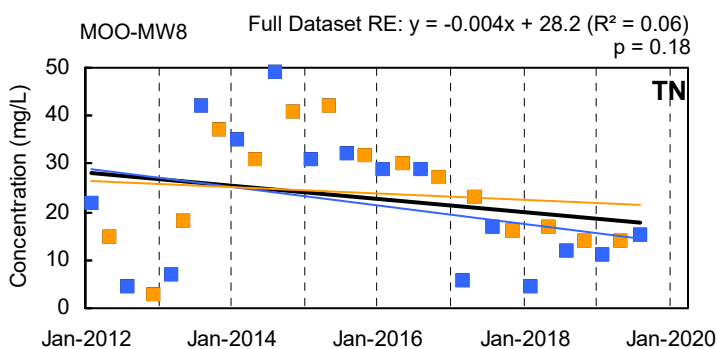
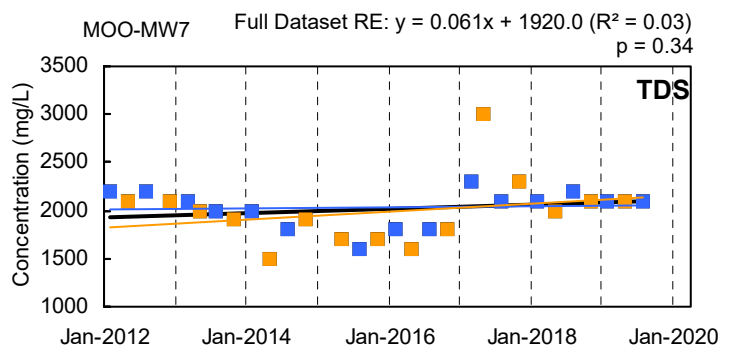
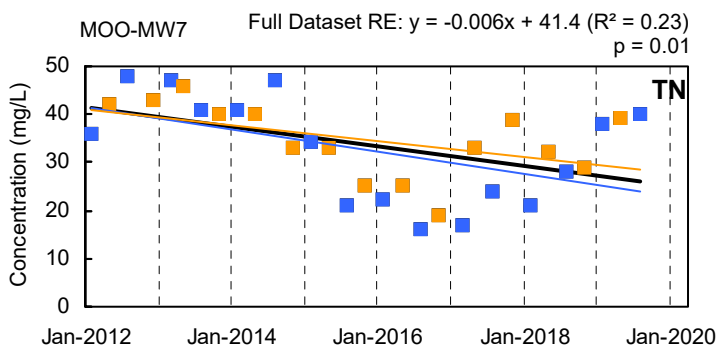
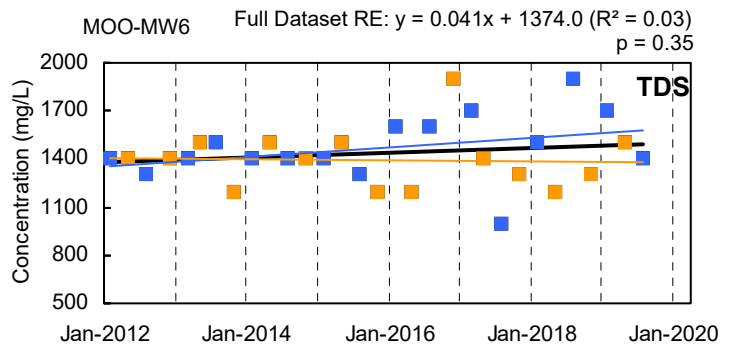
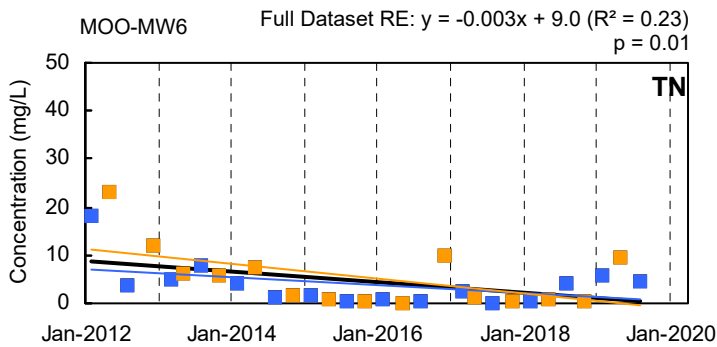
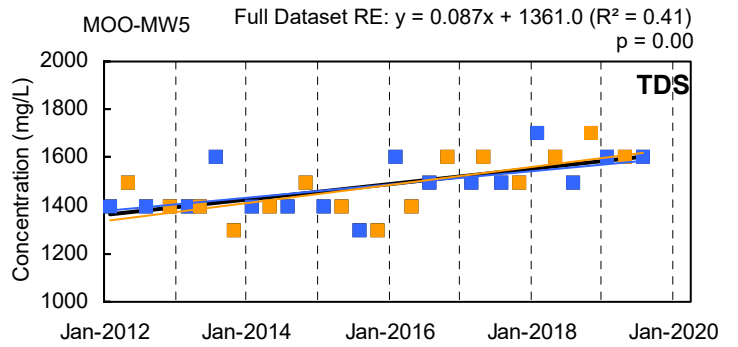
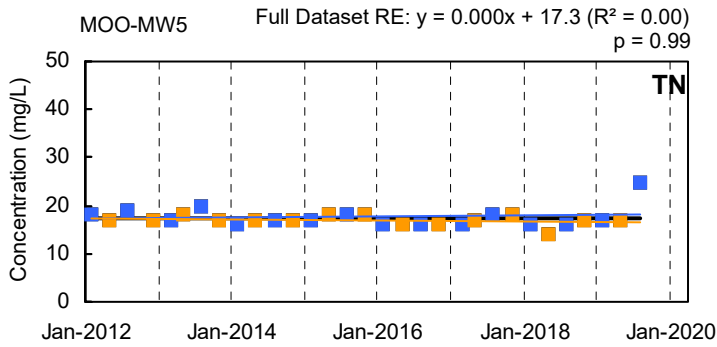
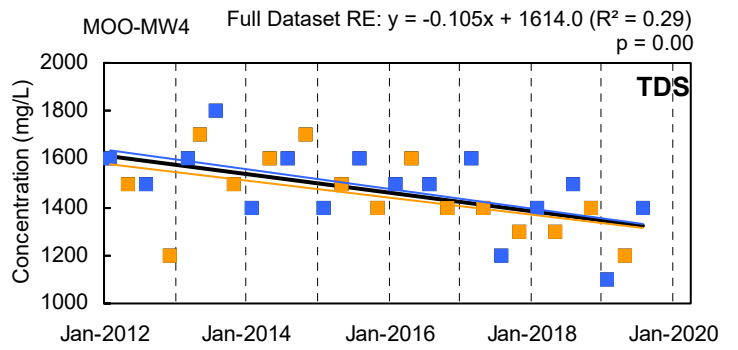
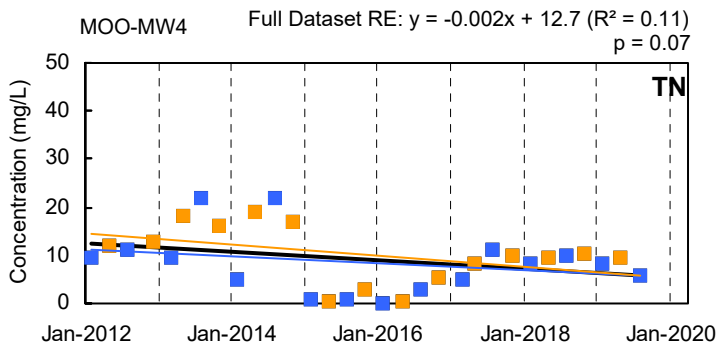

■ Q1/Q3 Result ■ Q2/Q4 Result
— Q1/Q3 Trendline — Q2/Q4 Trendline — Full Dataset Trendline

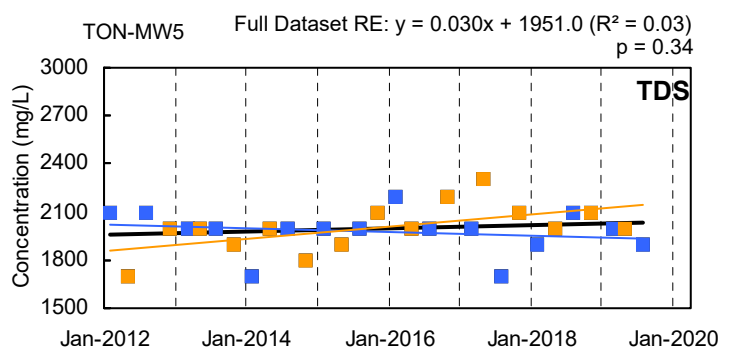
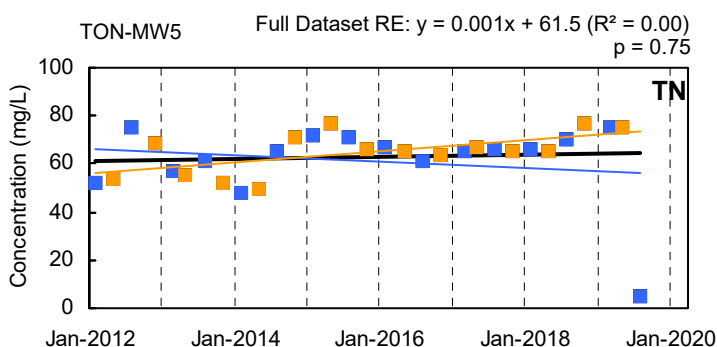
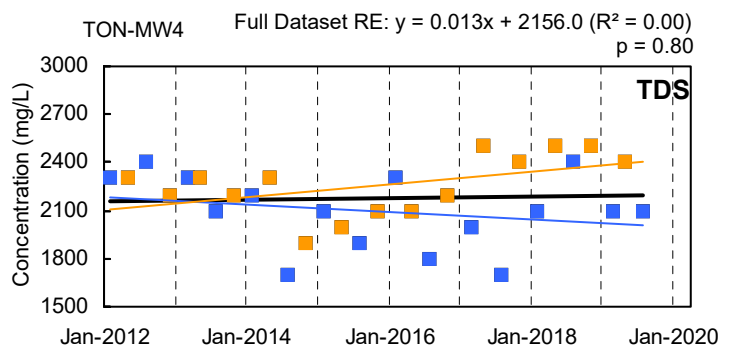
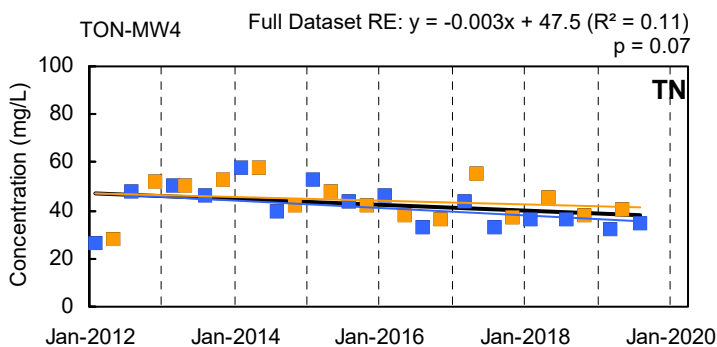
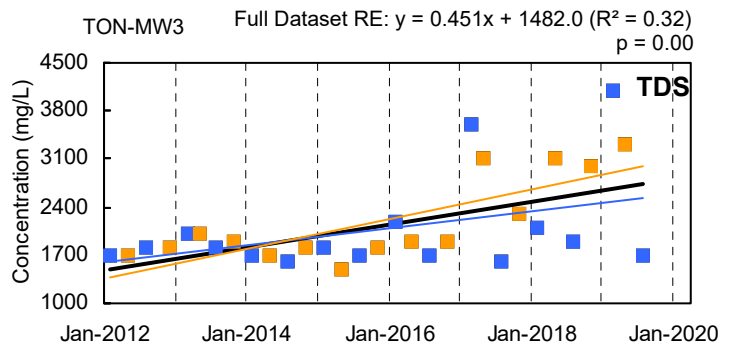
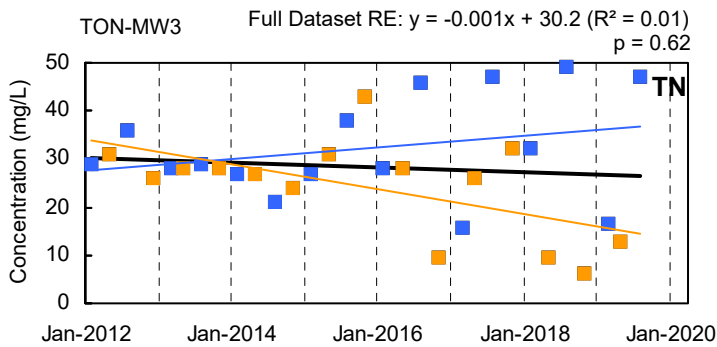
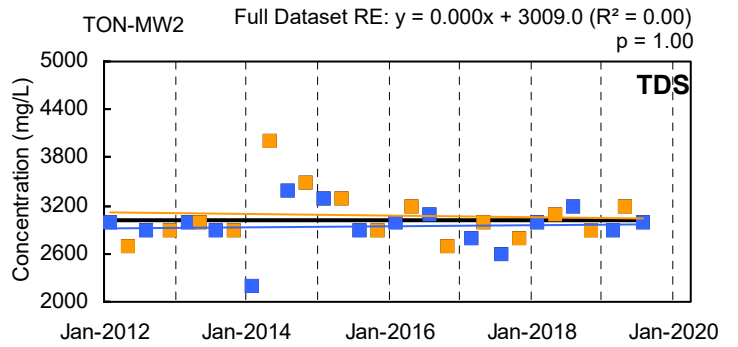
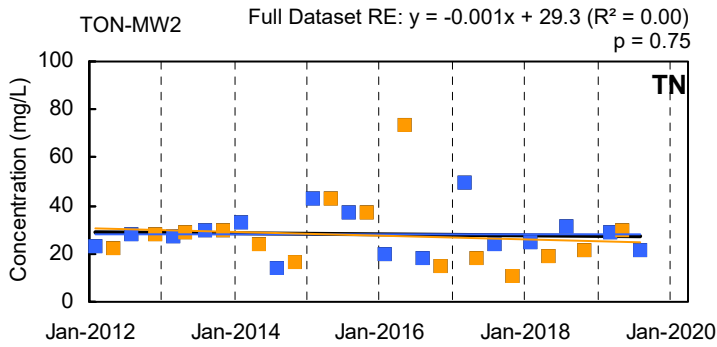
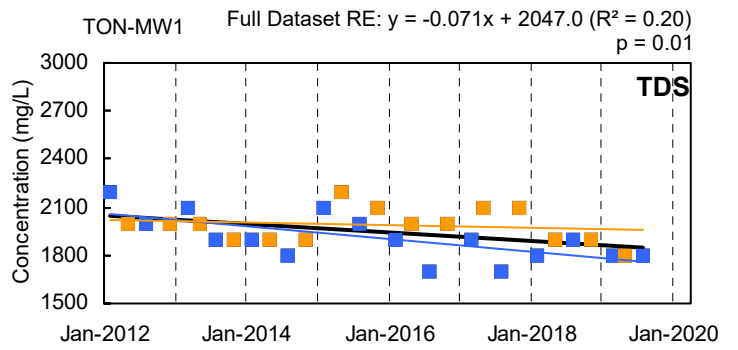
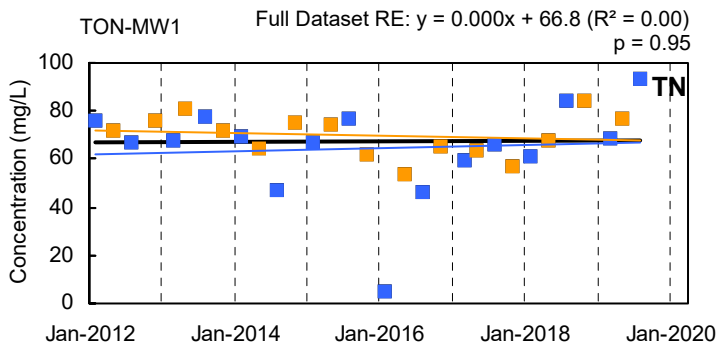

■ Q1/Q3 Result ■ Q2/Q4 Result
— Q1/Q3 Trendline — Q2/Q4 Trendline — Full Dataset Trendline

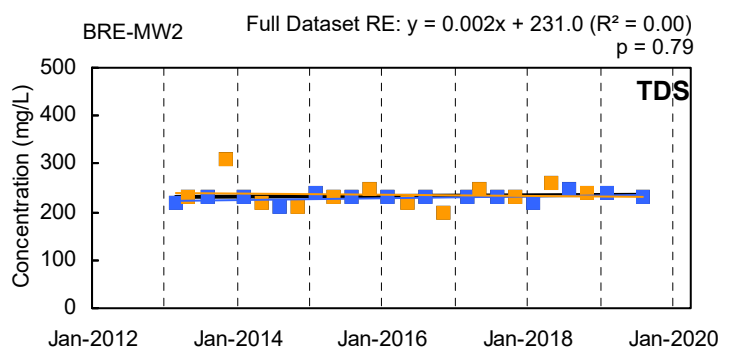
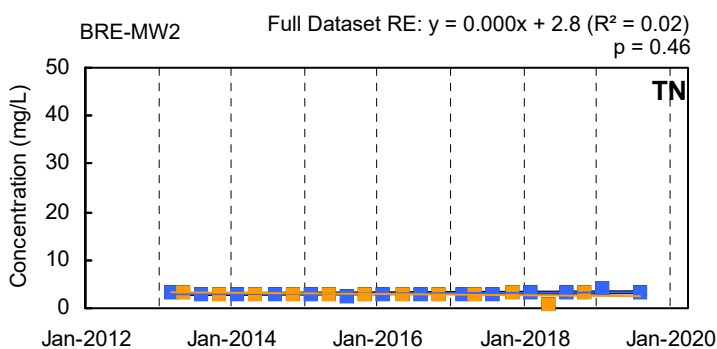
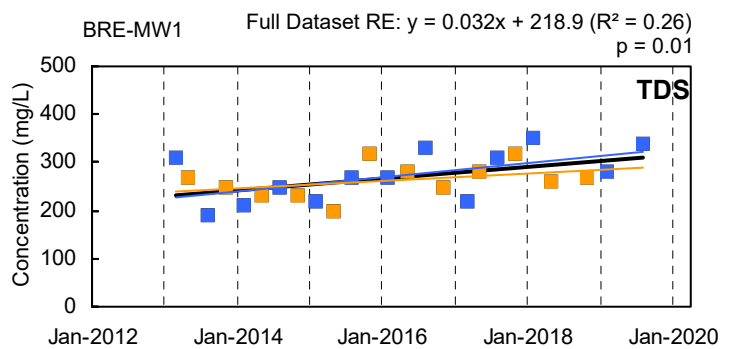
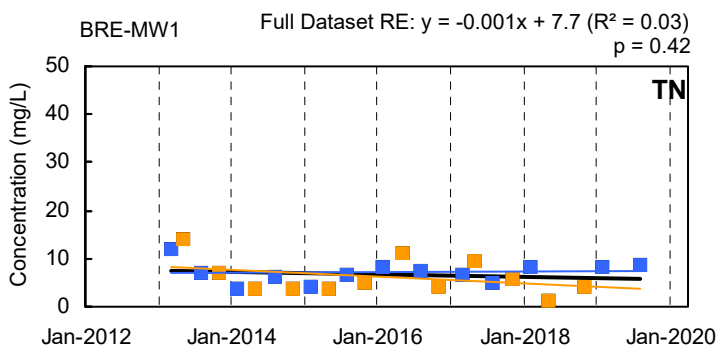
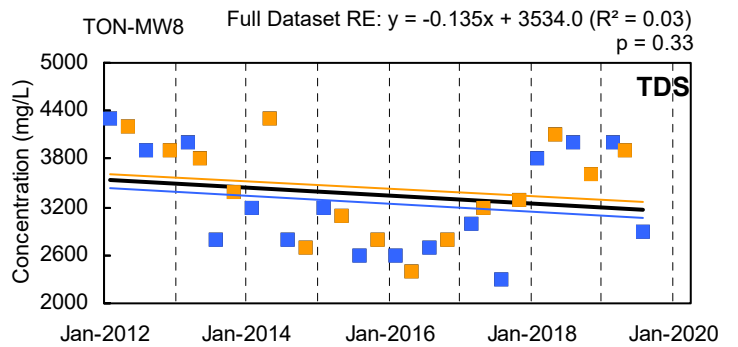
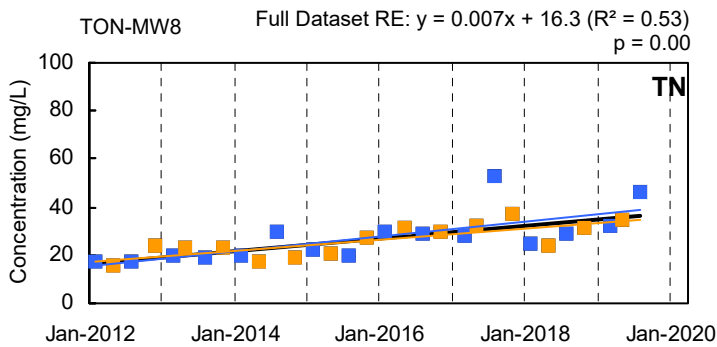
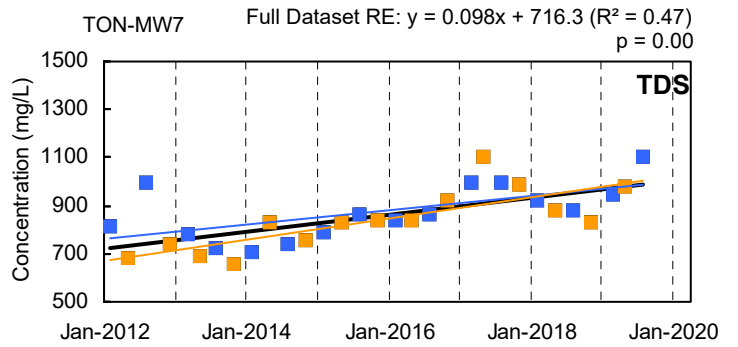
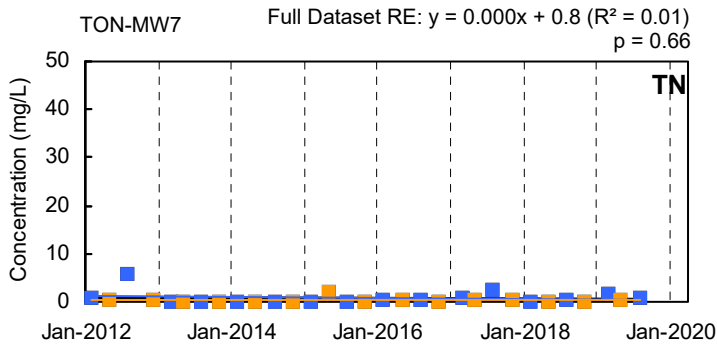
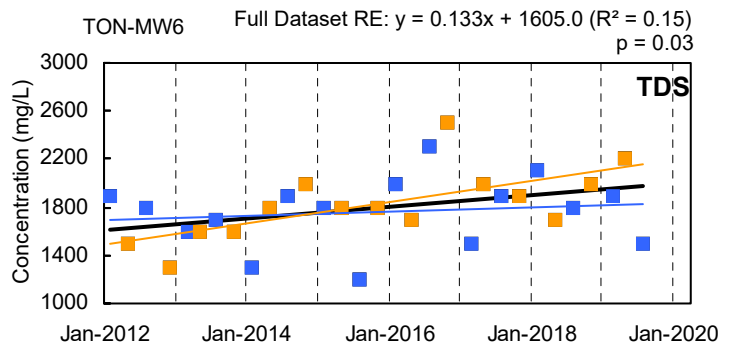
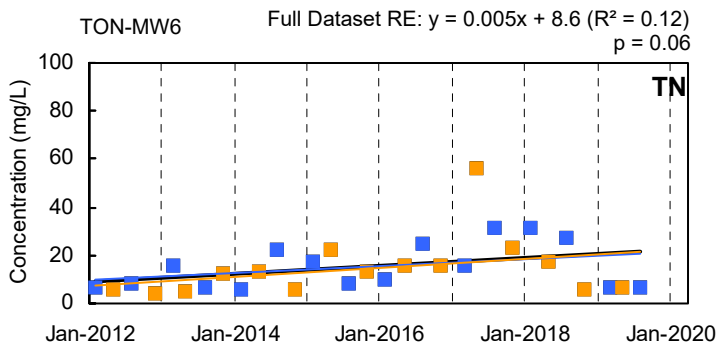

■ Q1/Q3 Result ■ Q2/Q4 Result
— Q1/Q3 Trendline — Q2/Q4 Trendline — Full Dataset Trendline

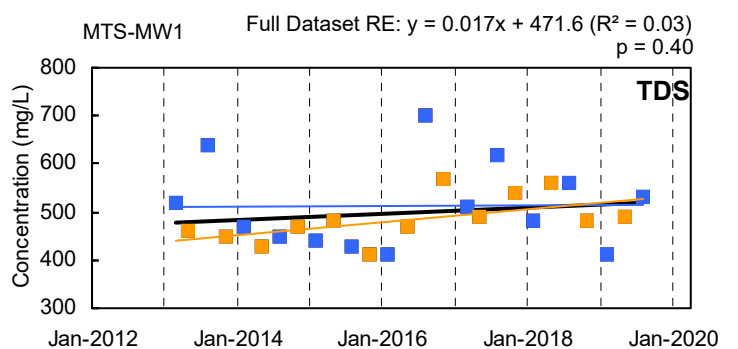
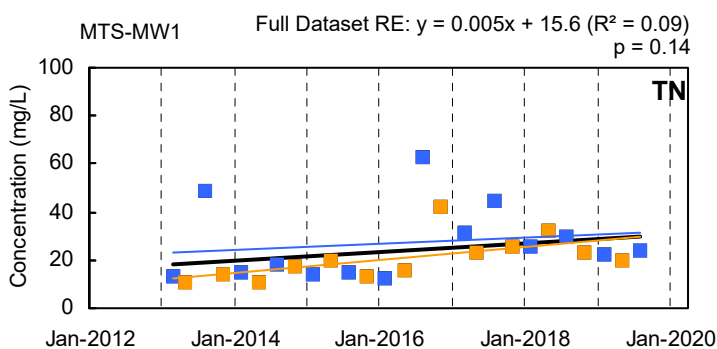
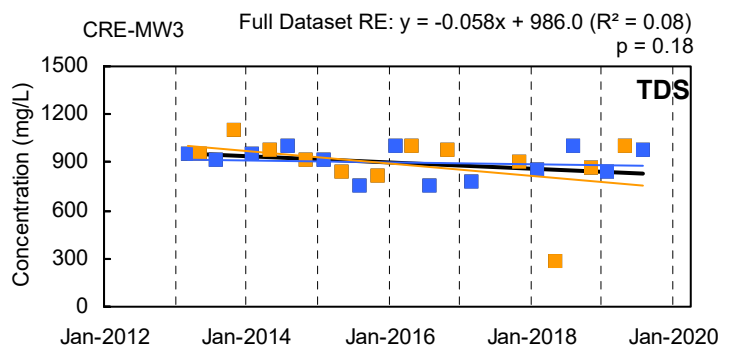
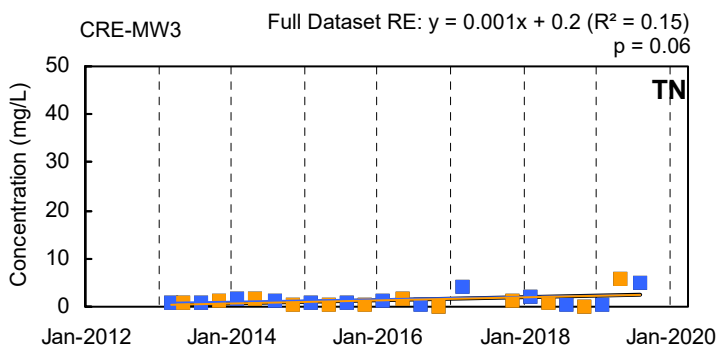
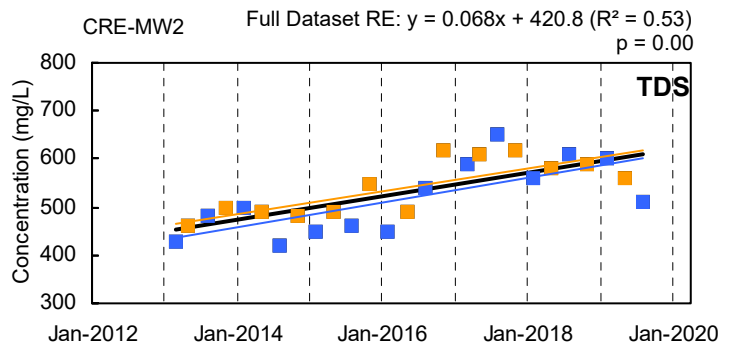
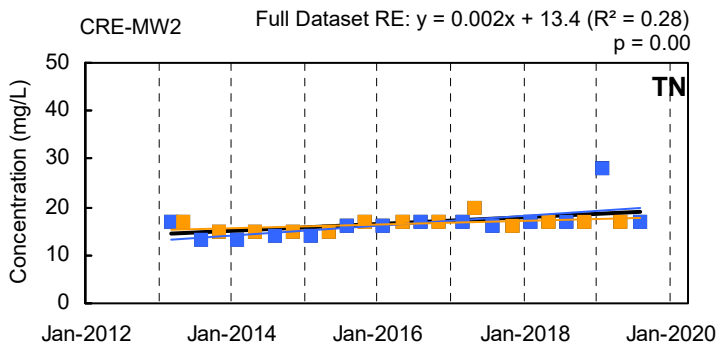
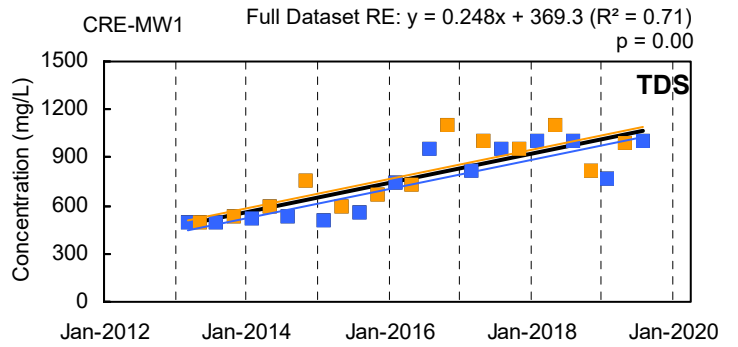
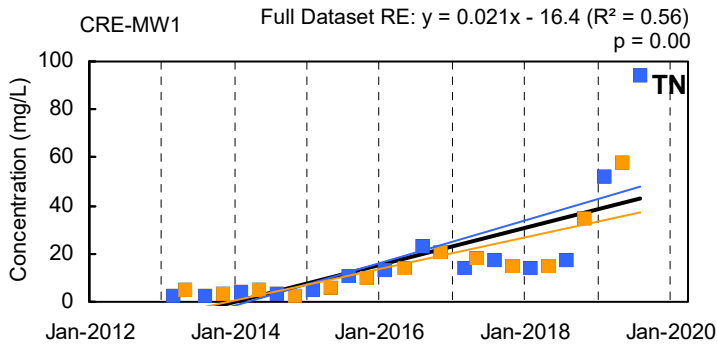
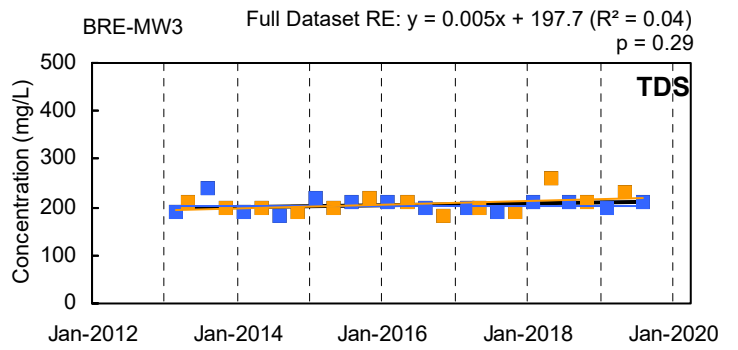
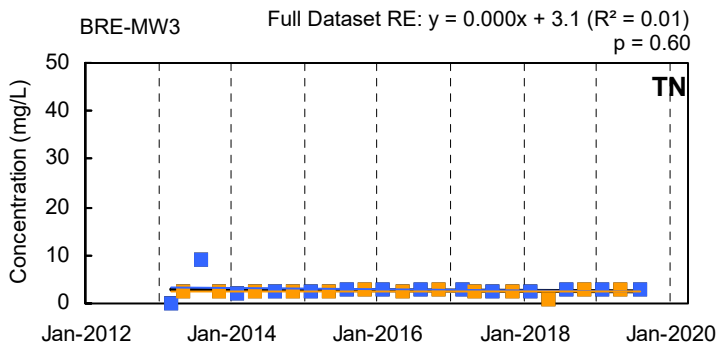

■ Q1/Q3 Result ■ Q2/Q4 Result
— Q1/Q3 Trendline — Q2/Q4 Trendline — Full Dataset Trendline

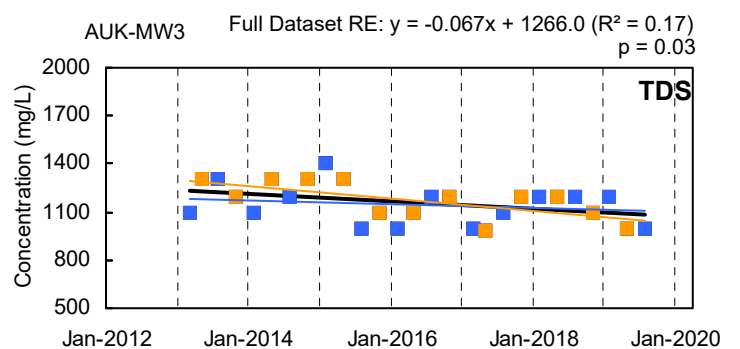
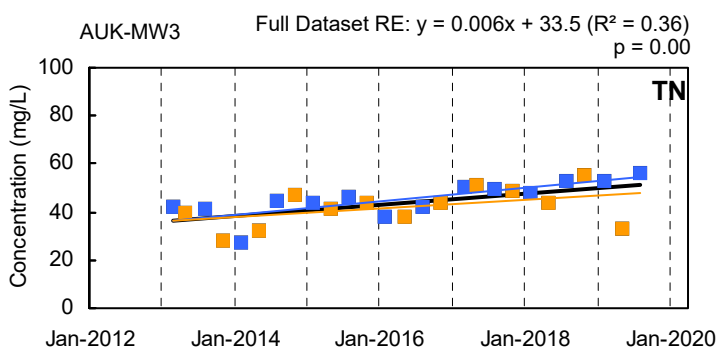
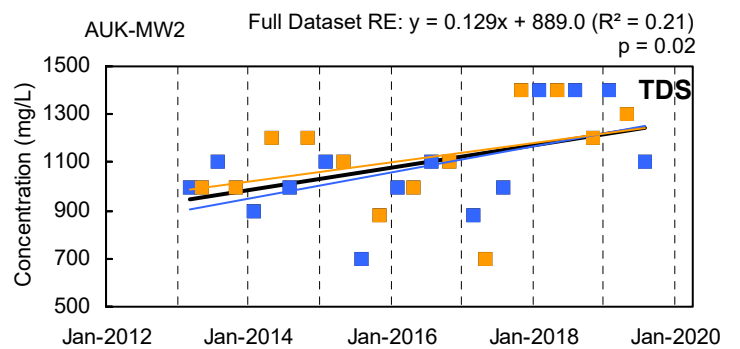
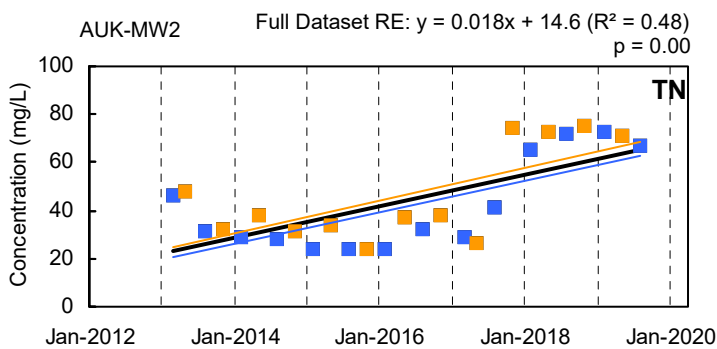
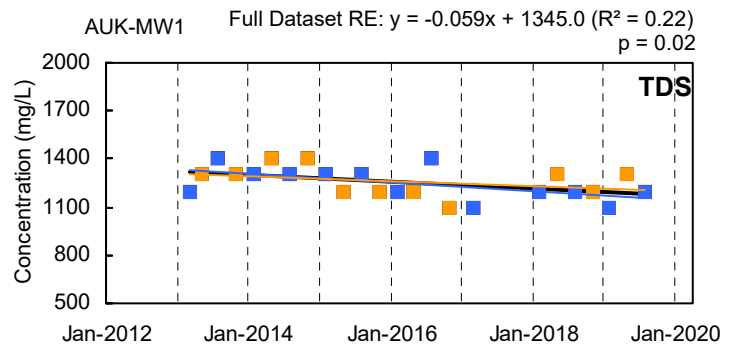
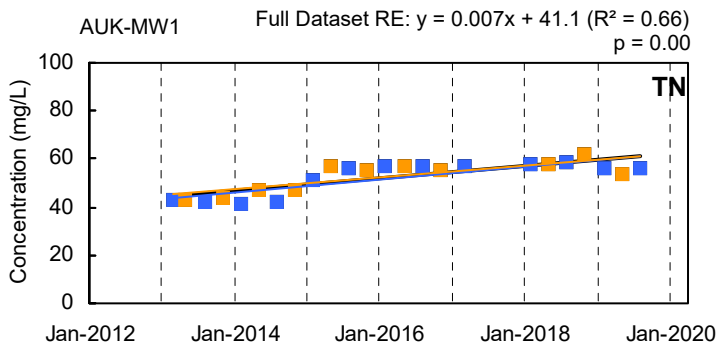
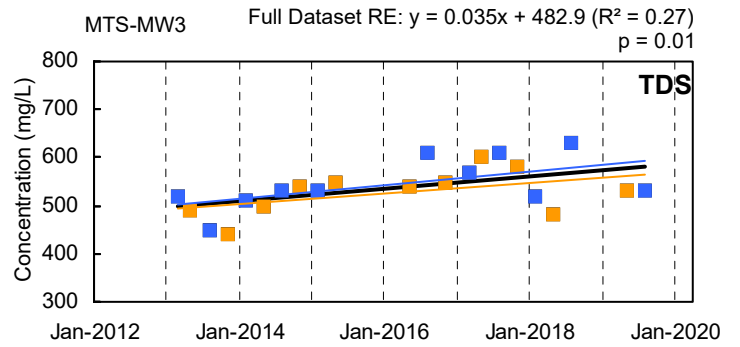
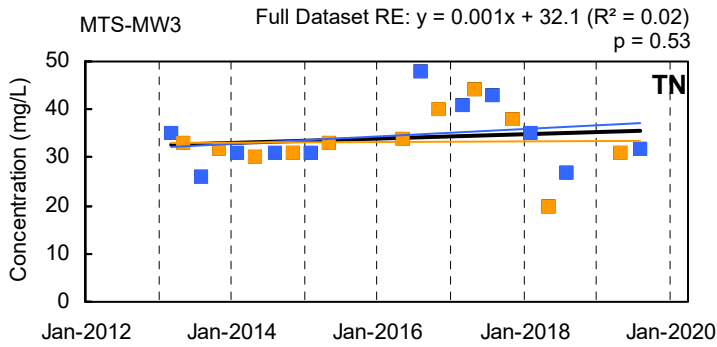
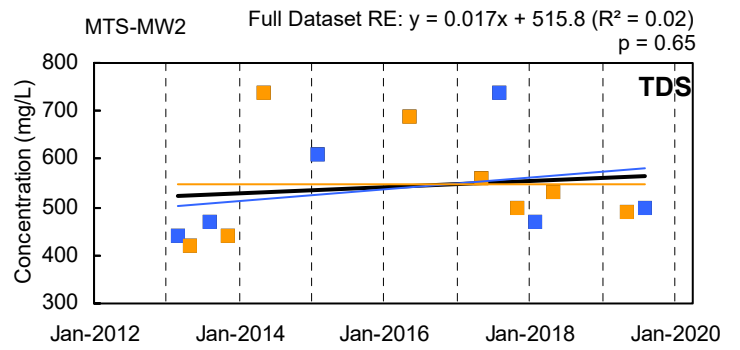
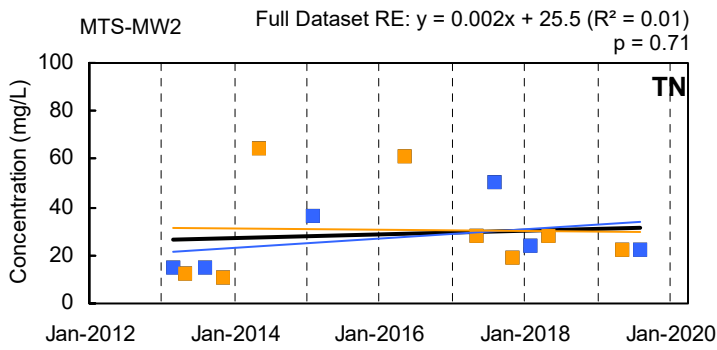

■ Q1/Q3 Result ■ Q2/Q4 Result
— Q1/Q3 Trendline — Q2/Q4 Trendline — Full Dataset Trendline

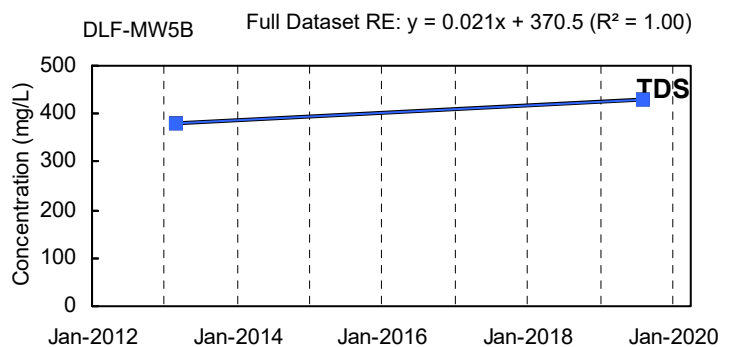
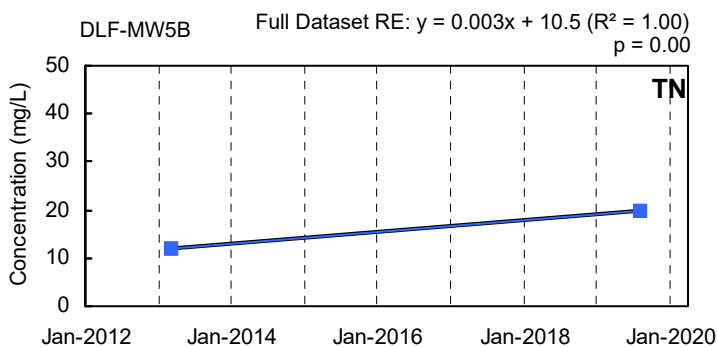
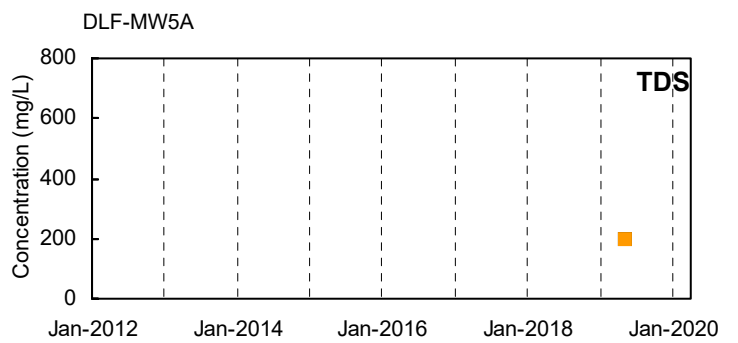
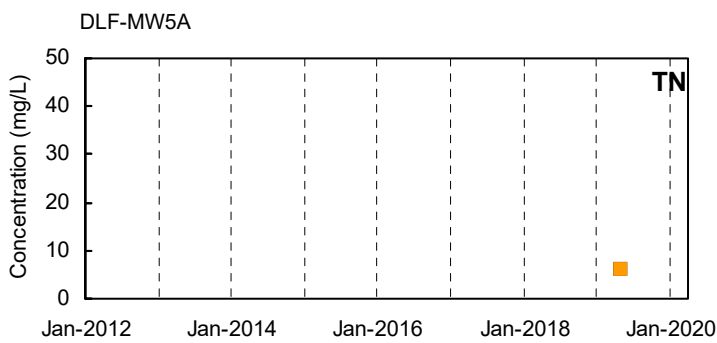
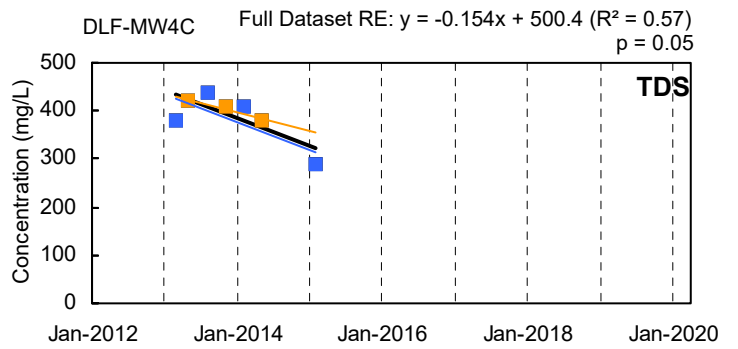
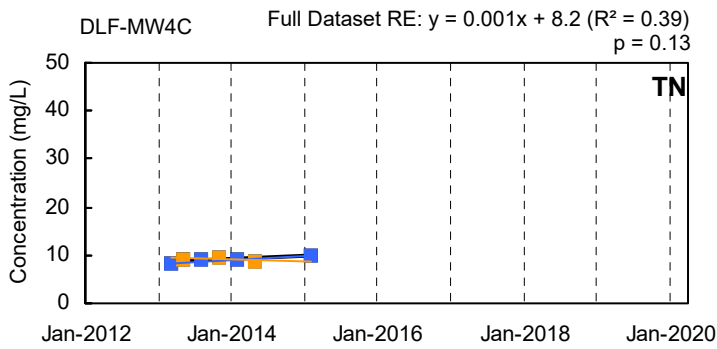
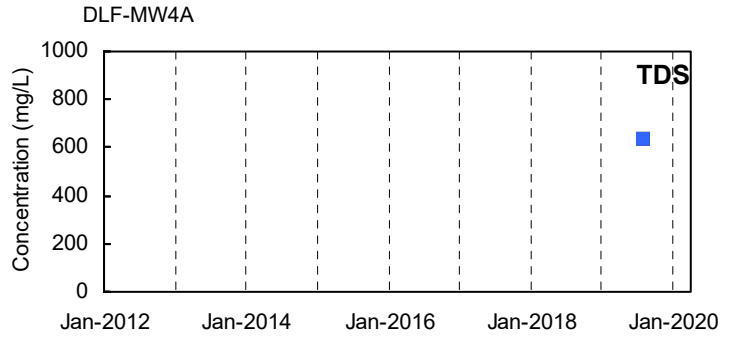
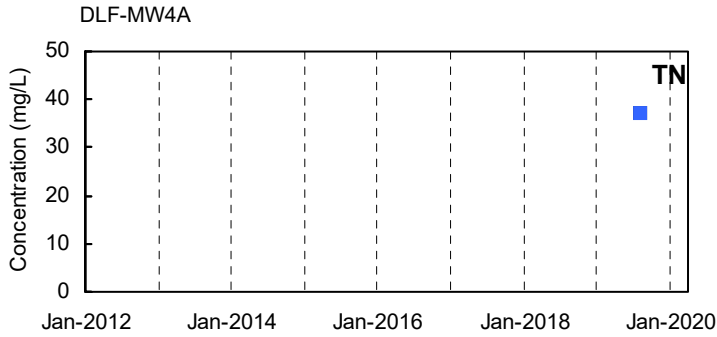
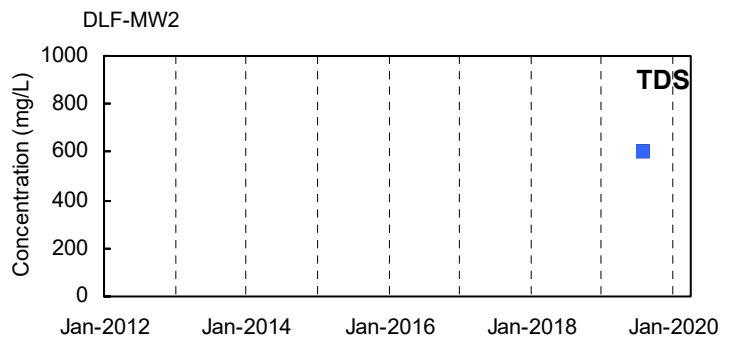
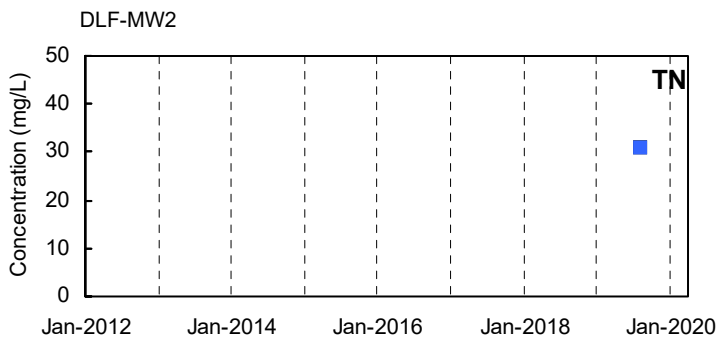

■ Q1/Q3 Result ■ Q2/Q4 Result
— Q1/Q3 Trendline — Q2/Q4 Trendline — Full Dataset Trendline

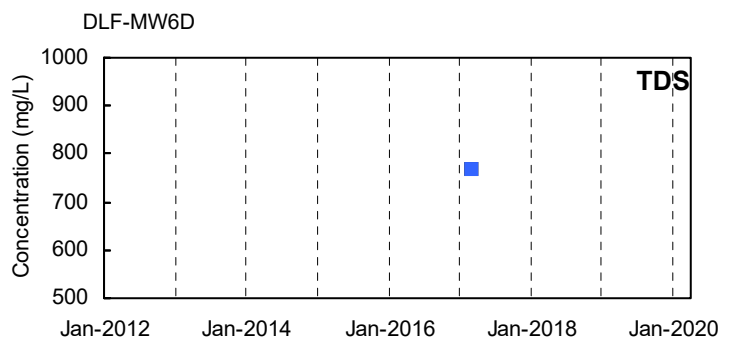
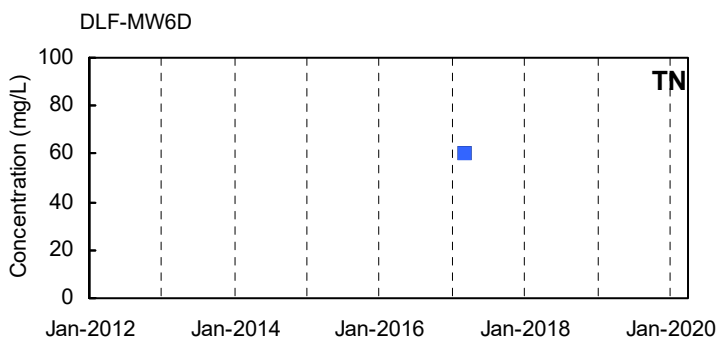
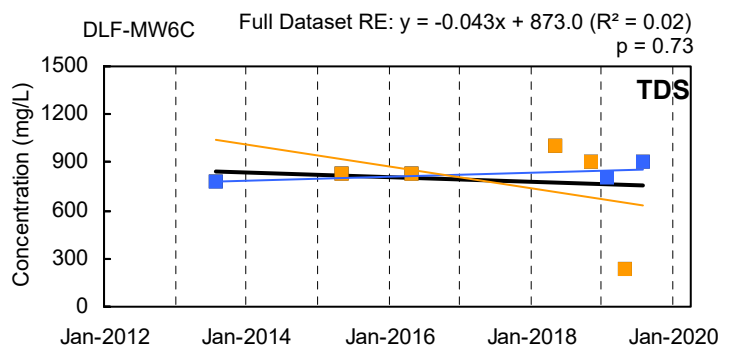
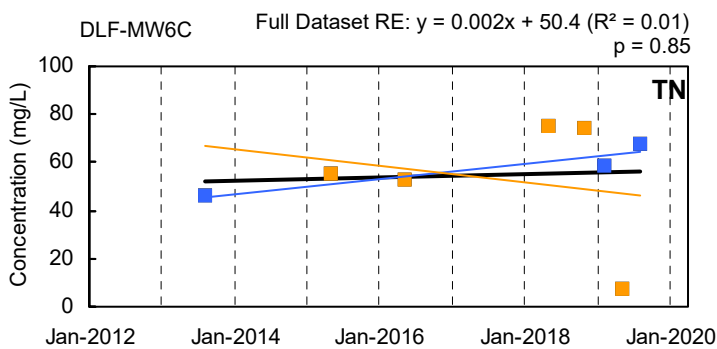
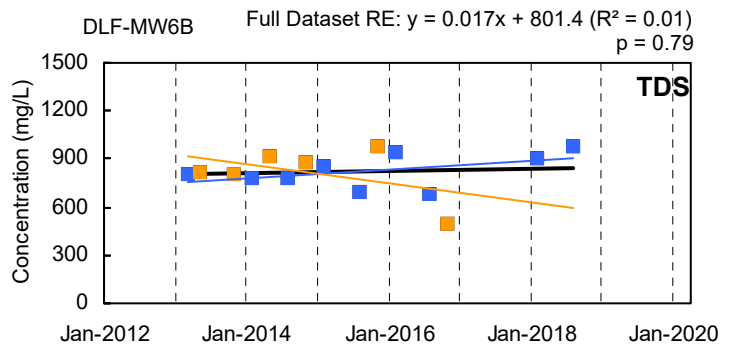
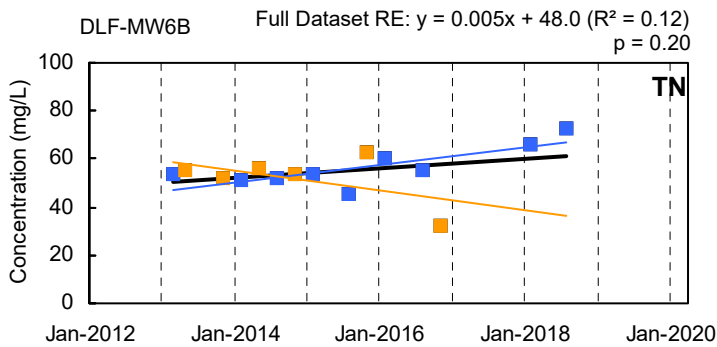
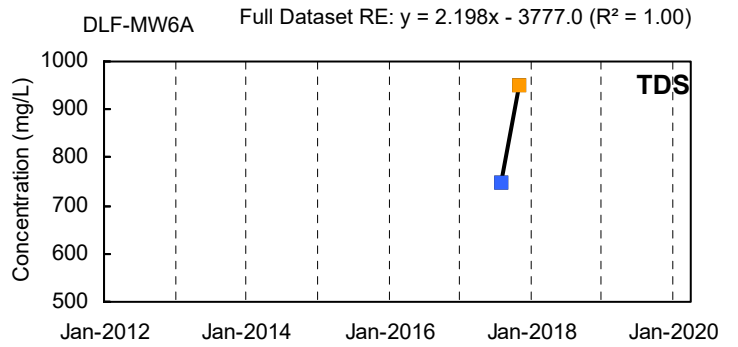
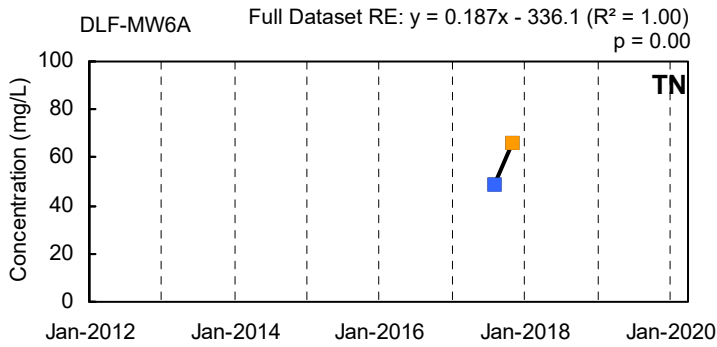
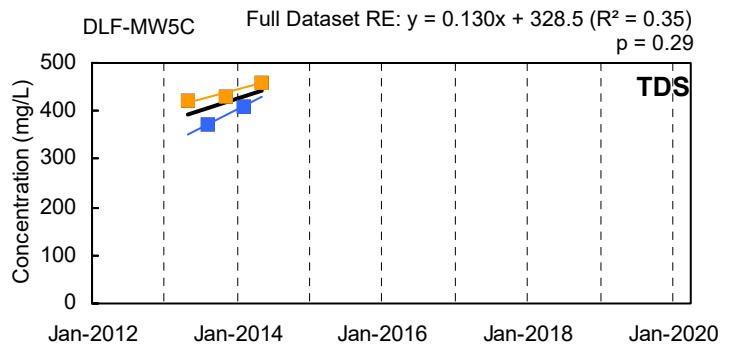
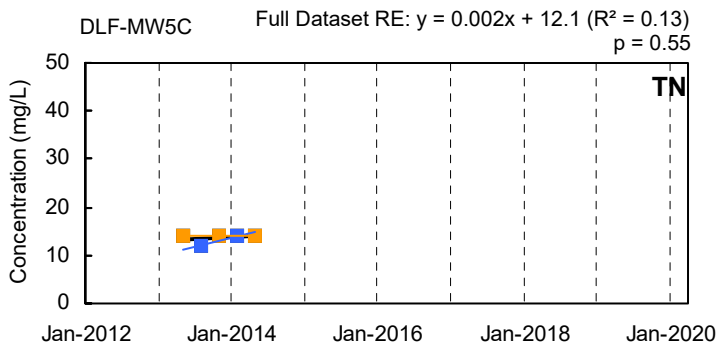

■ Q1/Q3 Result ■ Q2/Q4 Result
— Q1/Q3 Trendline — Q2/Q4 Trendline — Full Dataset Trendline

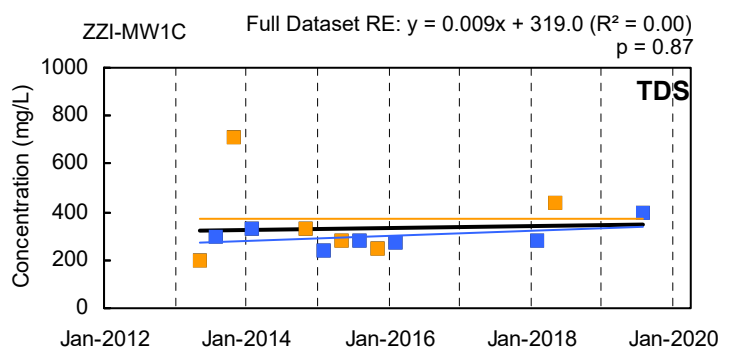
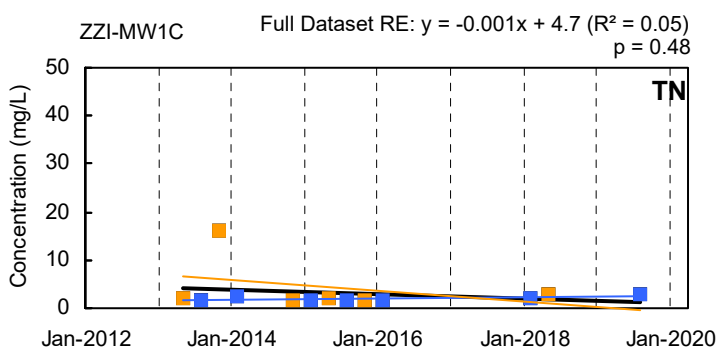
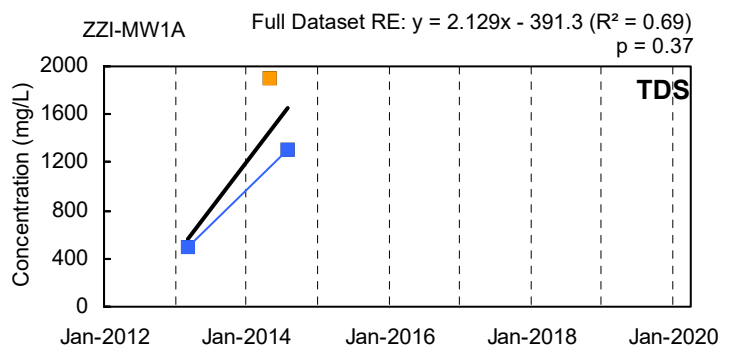
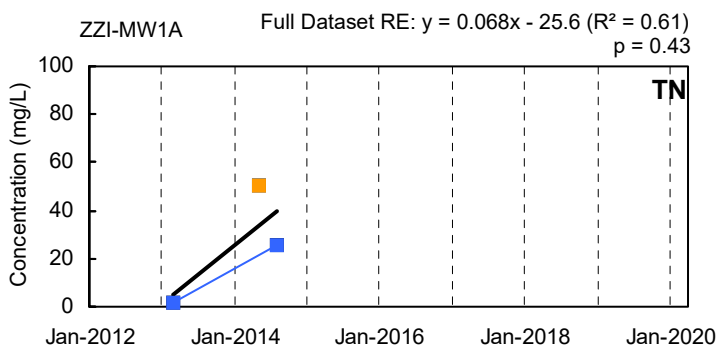
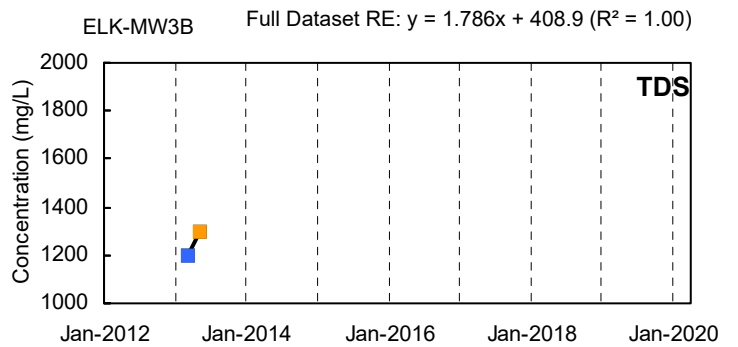
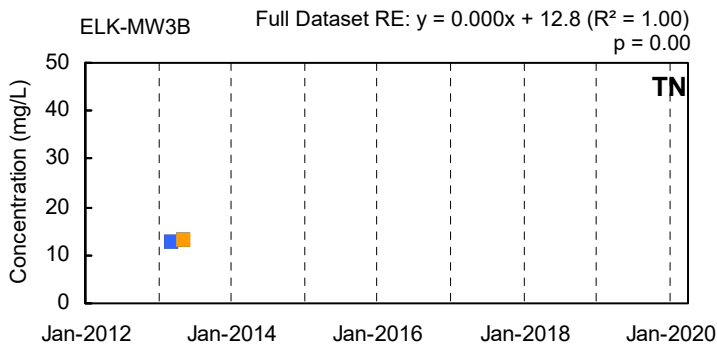
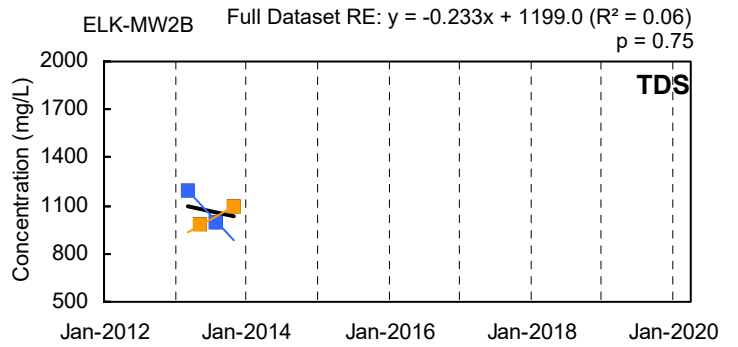
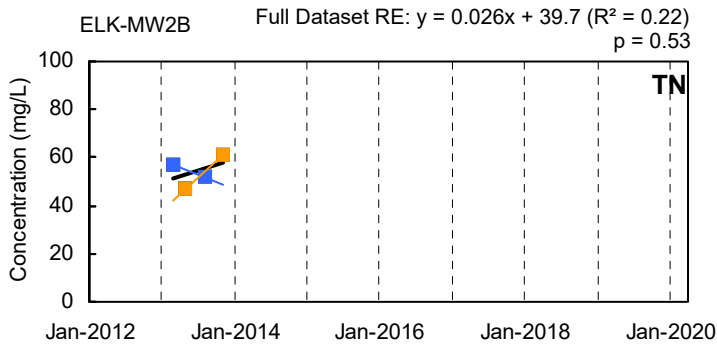
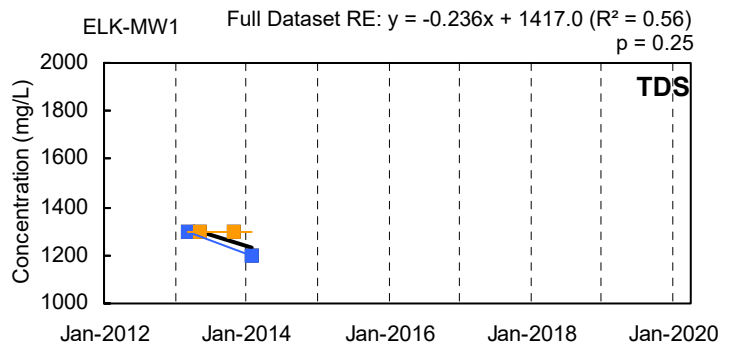
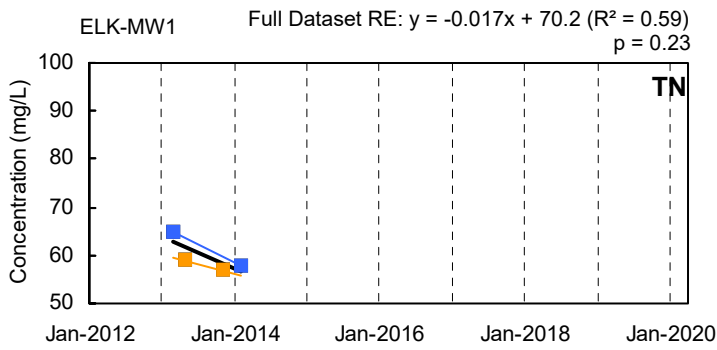

■ Q1/Q3 Result ■ Q2/Q4 Result
— Q1/Q3 Trendline — Q2/Q4 Trendline — Full Dataset Trendline

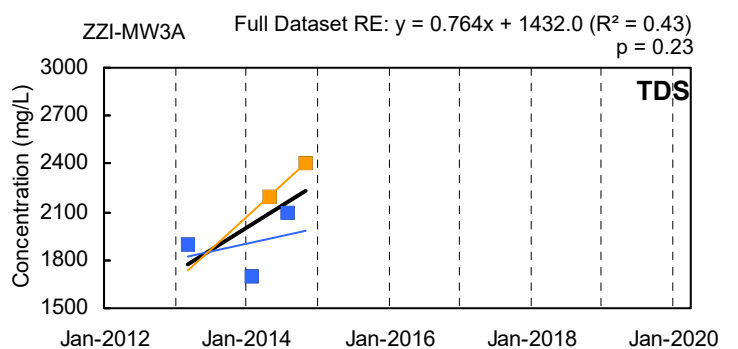
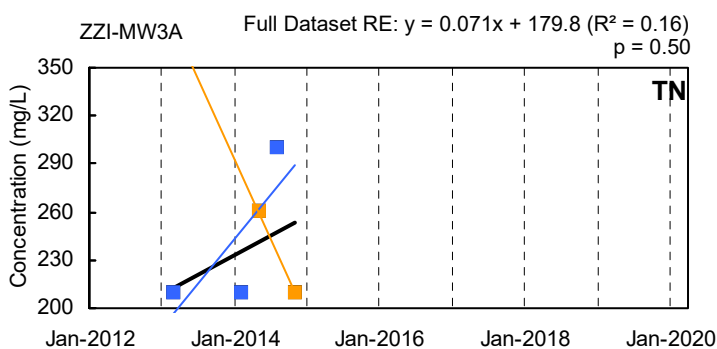
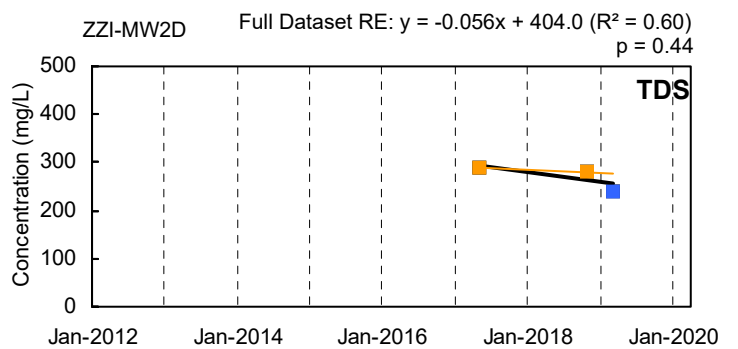
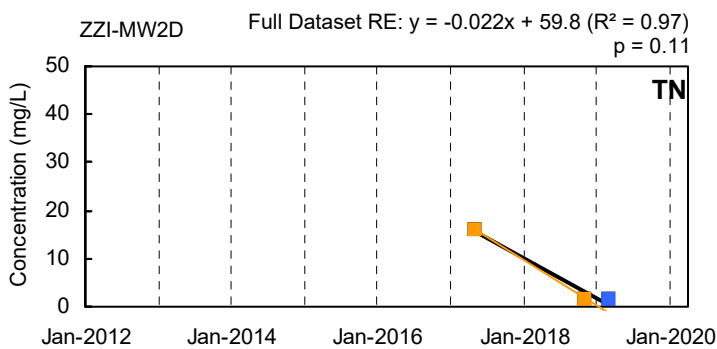
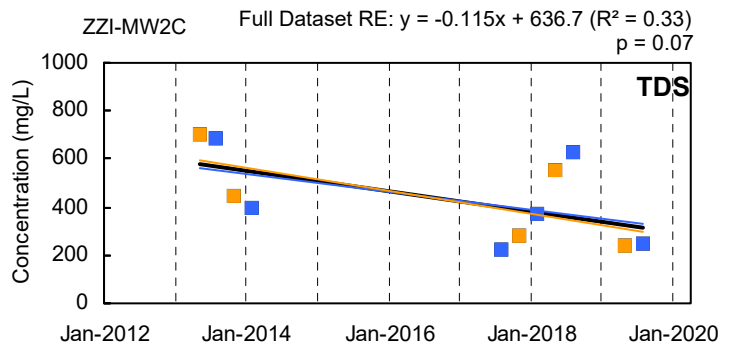
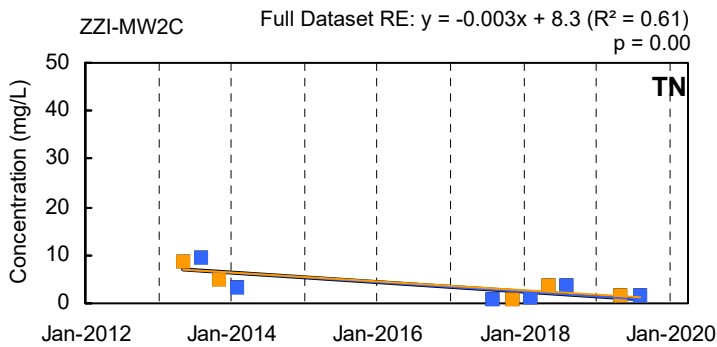
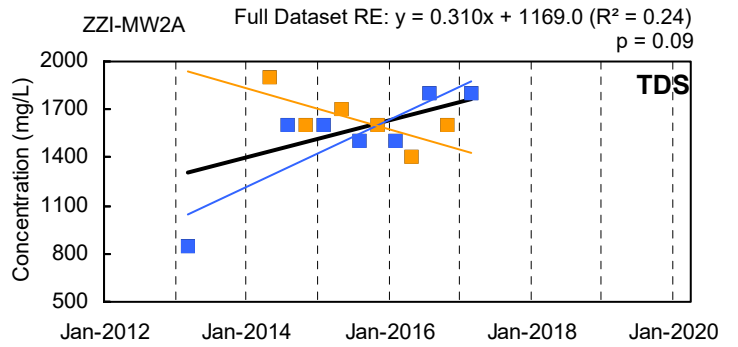
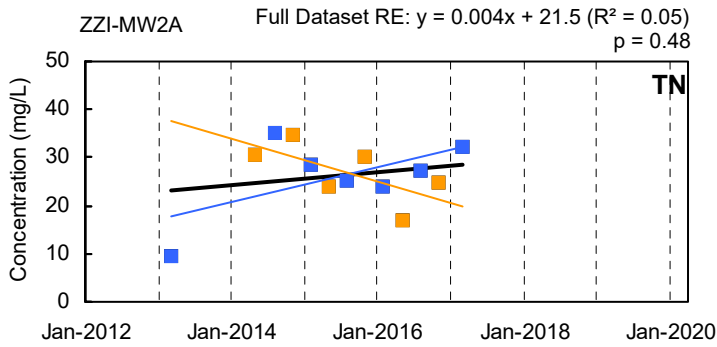
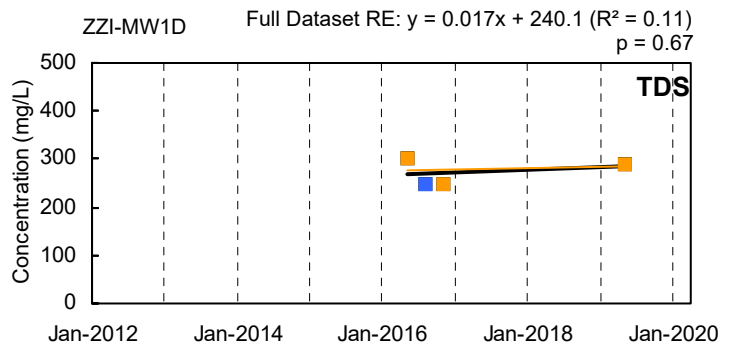
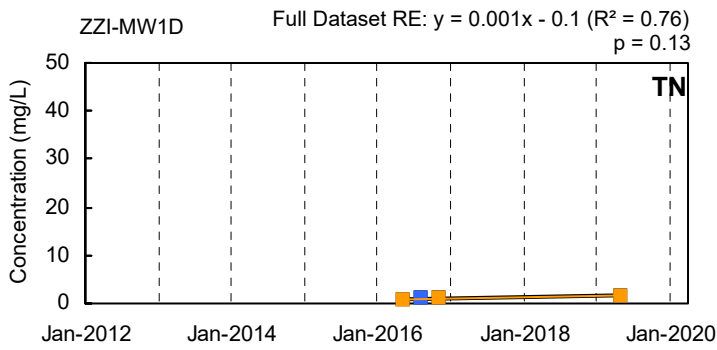

■ Q1/Q3 Result ■ Q2/Q4 Result
— Q1/Q3 Trendline — Q2/Q4 Trendline — Full Dataset Trendline

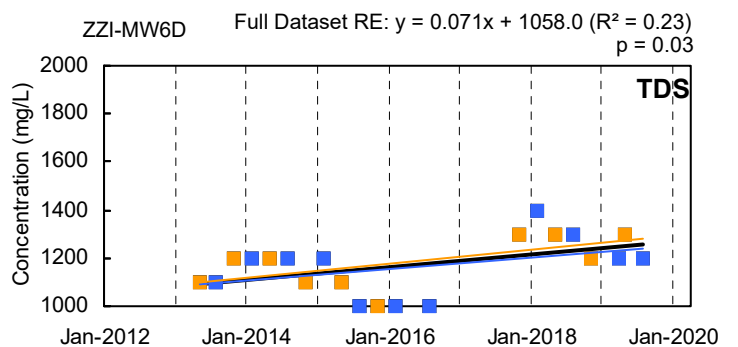
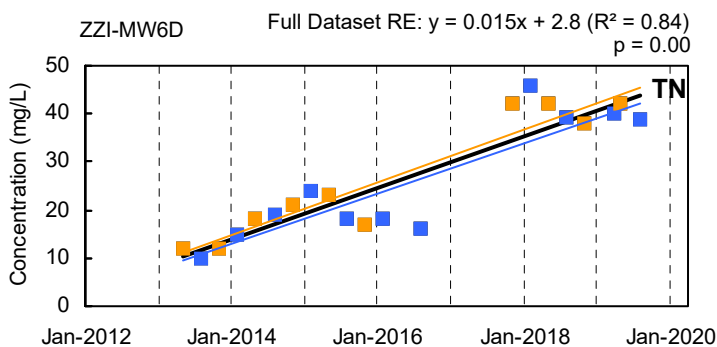
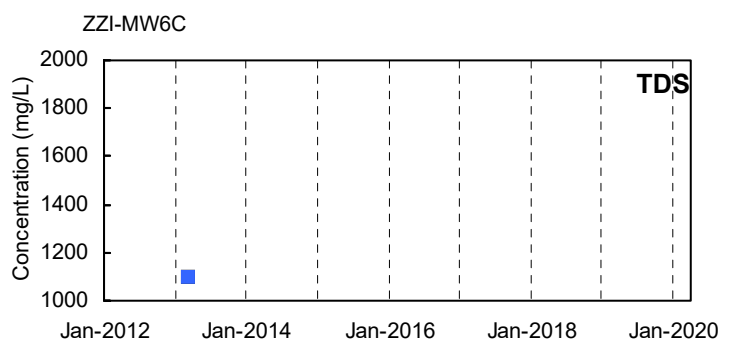
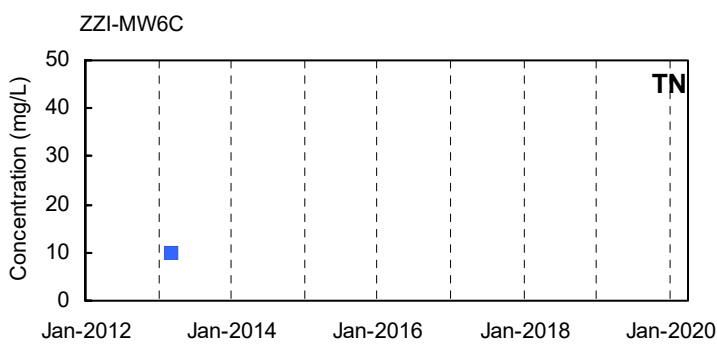
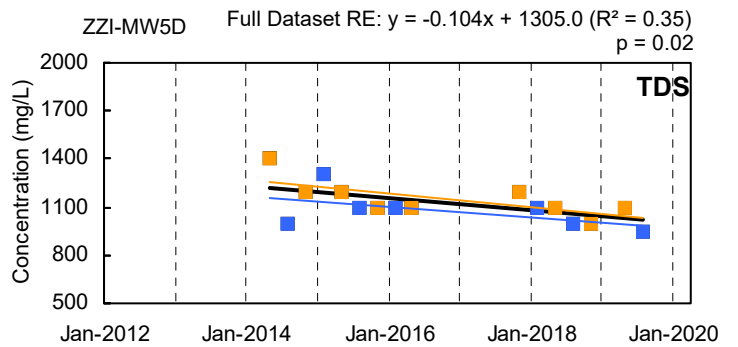
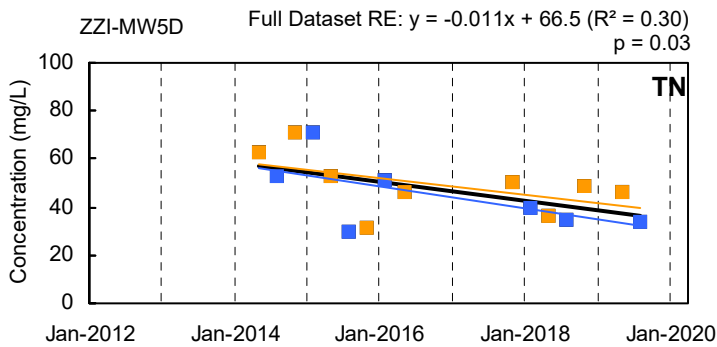
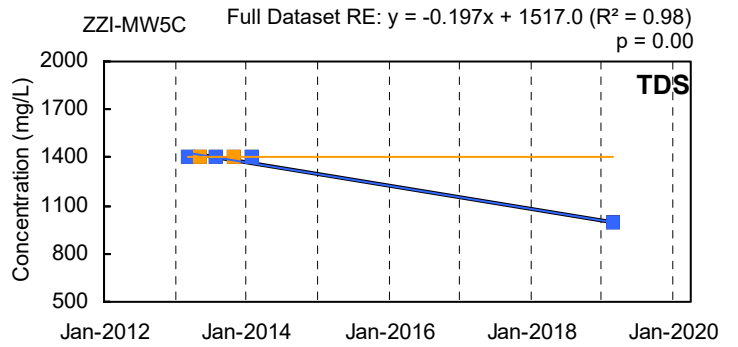
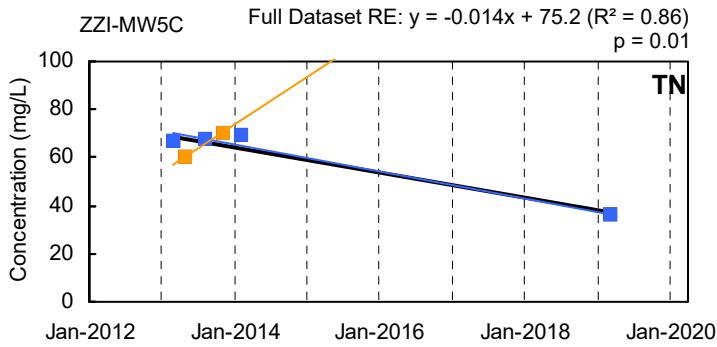
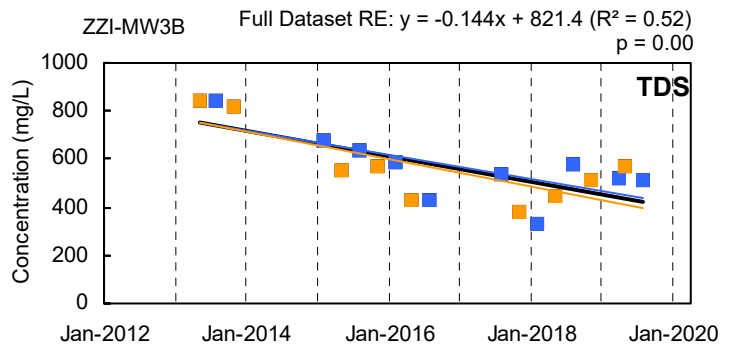
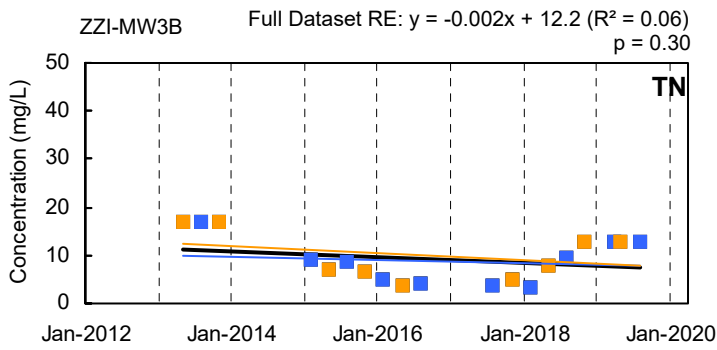

■ Q1/Q3 Result ■ Q2/Q4 Result
— Q1/Q3 Trendline — Q2/Q4 Trendline — Full Dataset Trendline

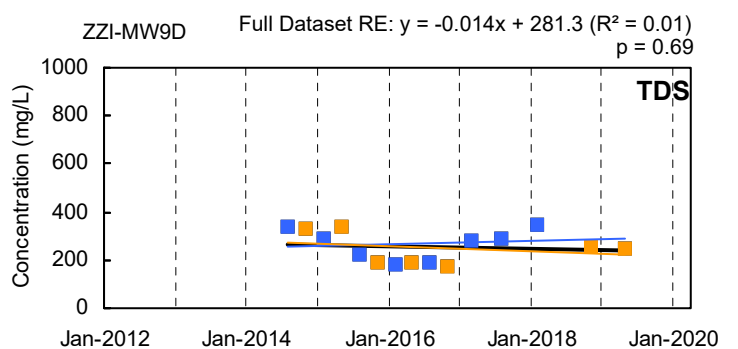
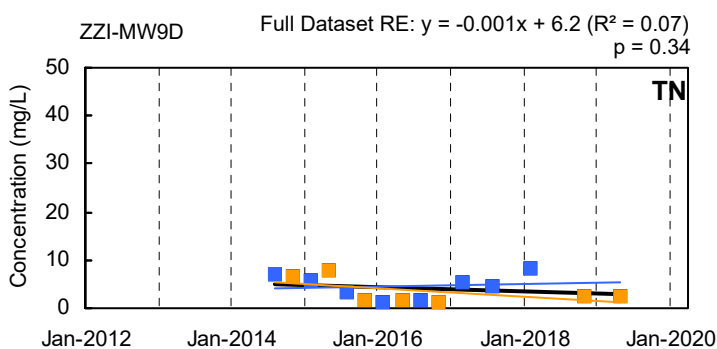
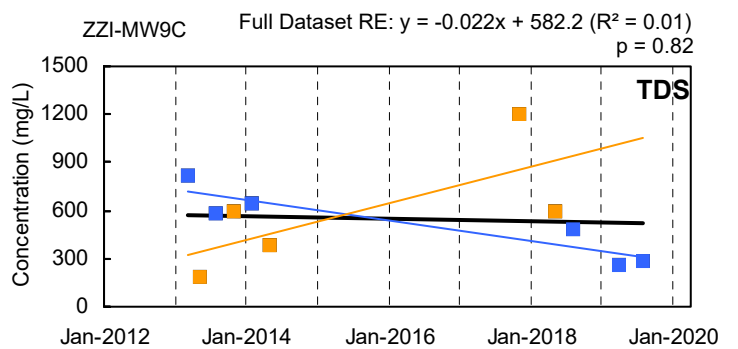
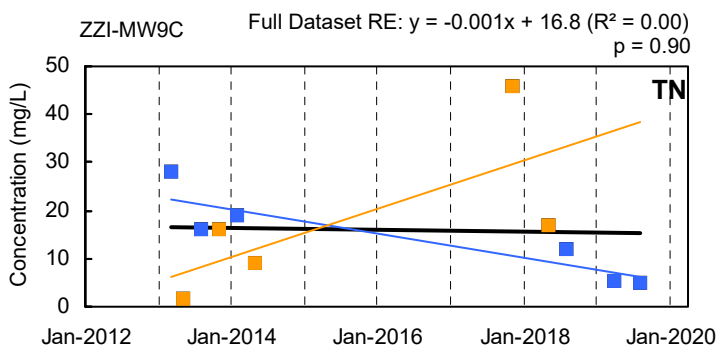
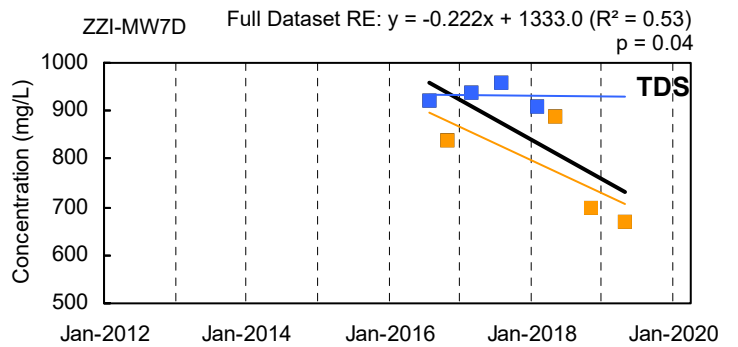
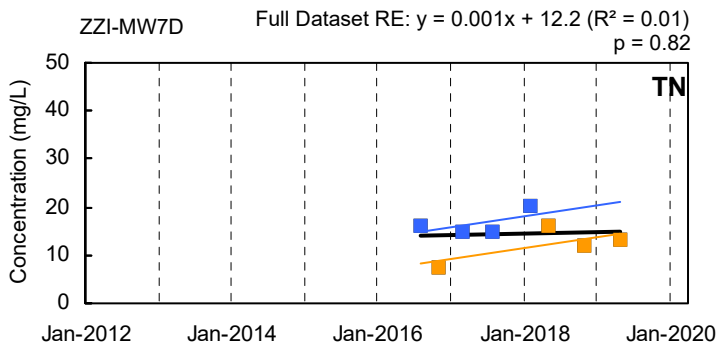
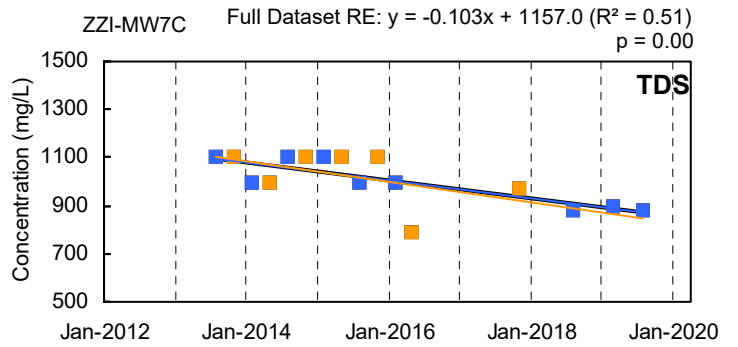
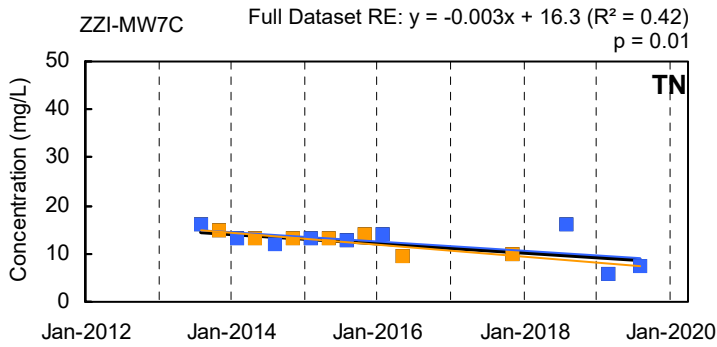
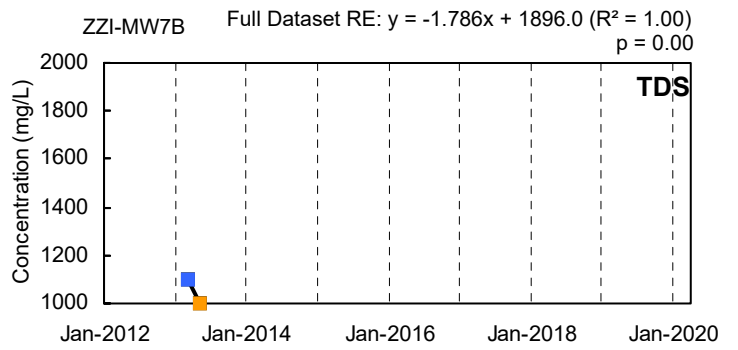
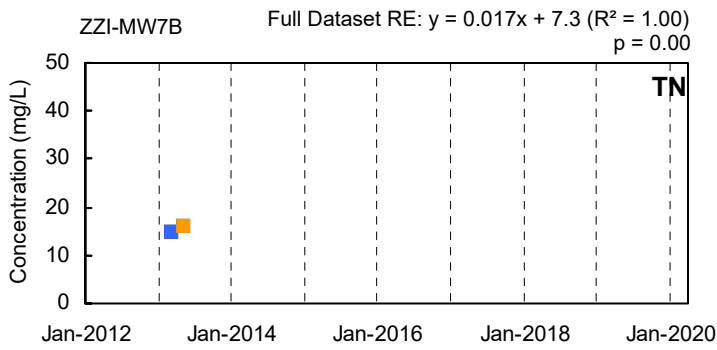

■ Q1/Q3 Result ■ Q2/Q4 Result
— Q1/Q3 Trendline — Q2/Q4 Trendline — Full Dataset Trendline

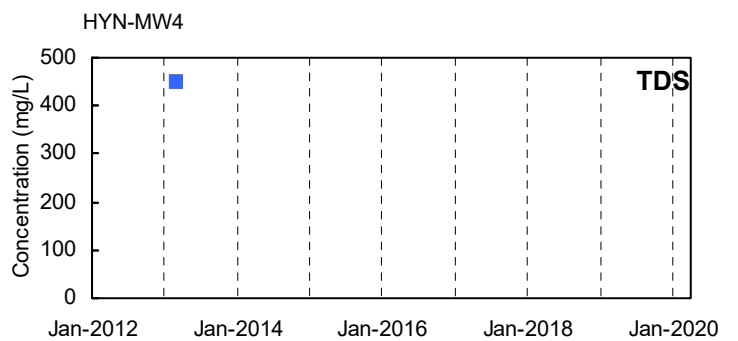
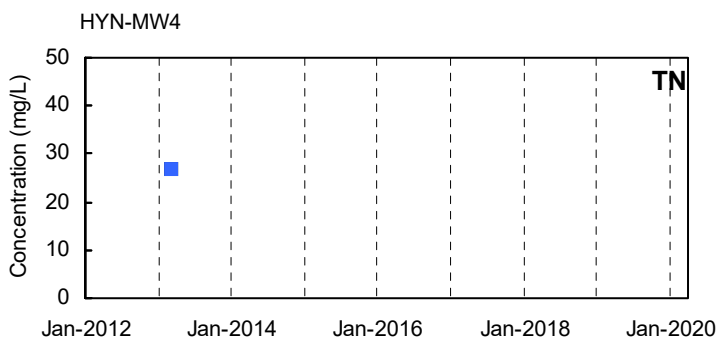
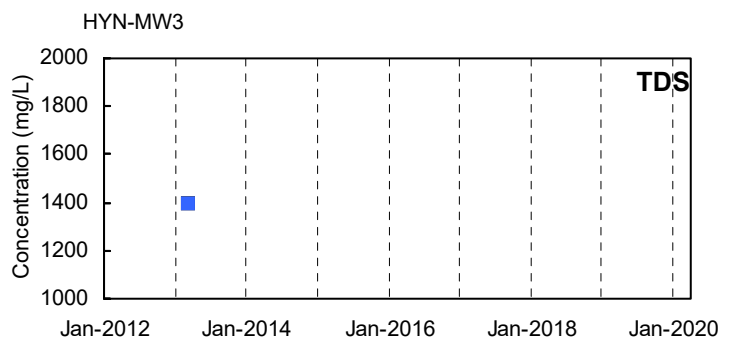
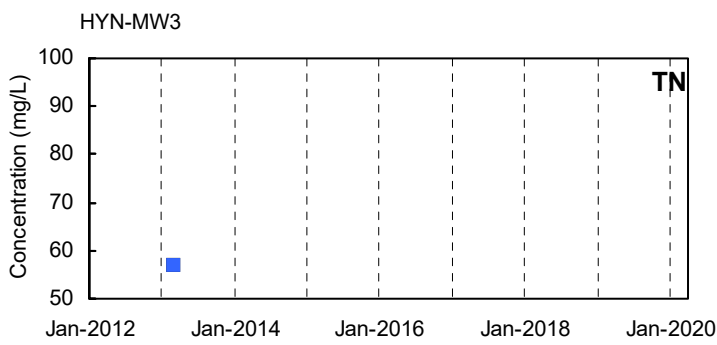
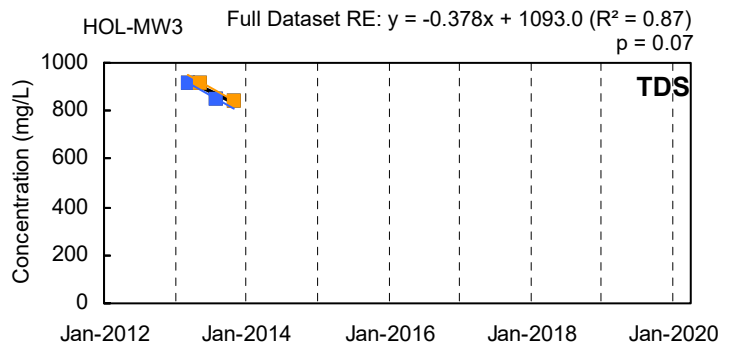
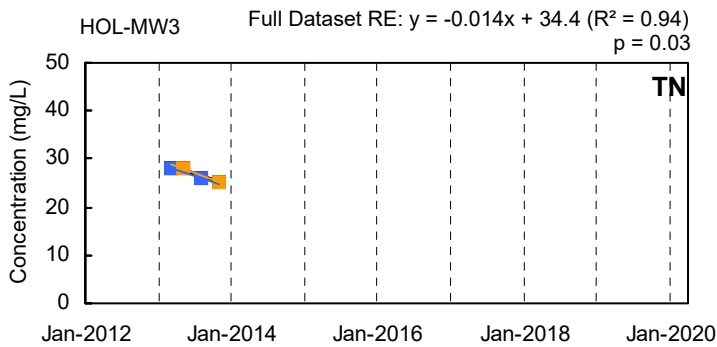
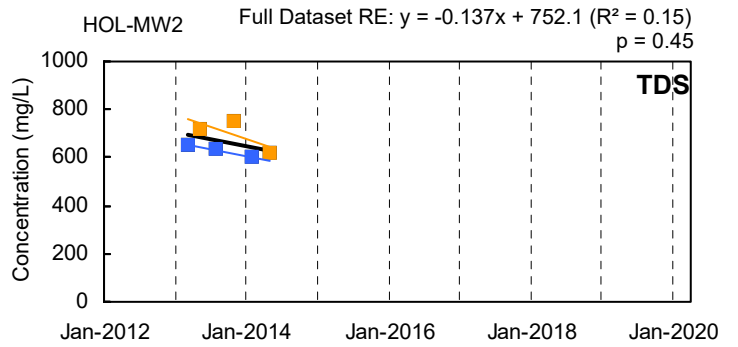
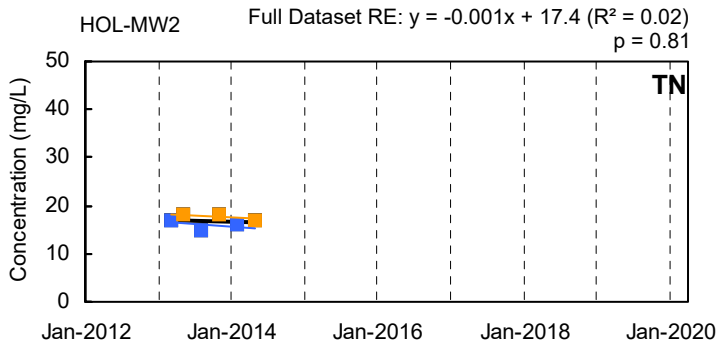
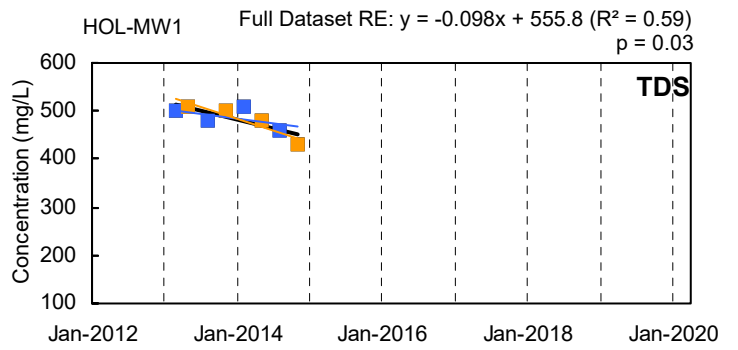
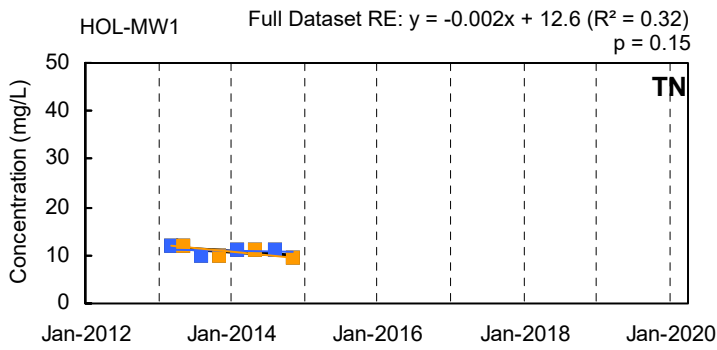

■ Q1/Q3 Result ■ Q2/Q4 Result
— Q1/Q3 Trendline — Q2/Q4 Trendline — Full Dataset Trendline

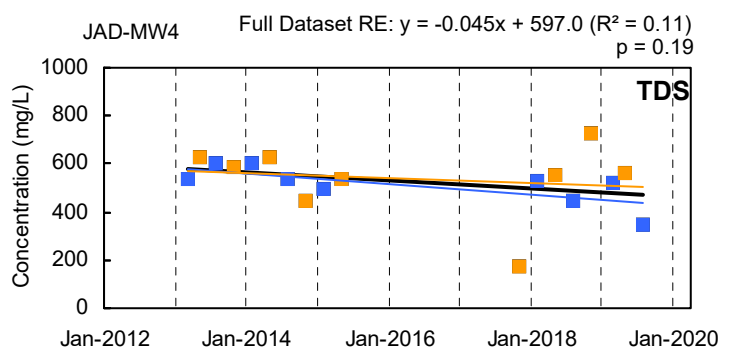
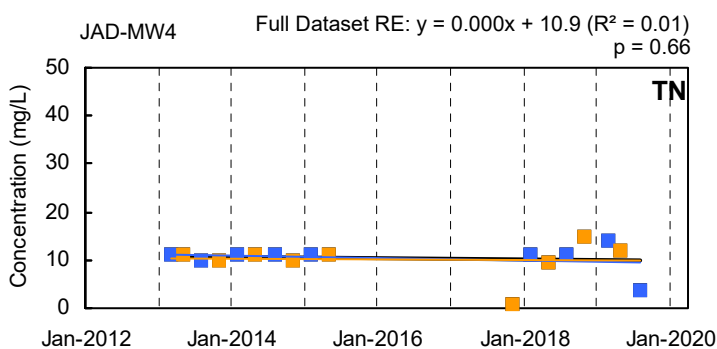
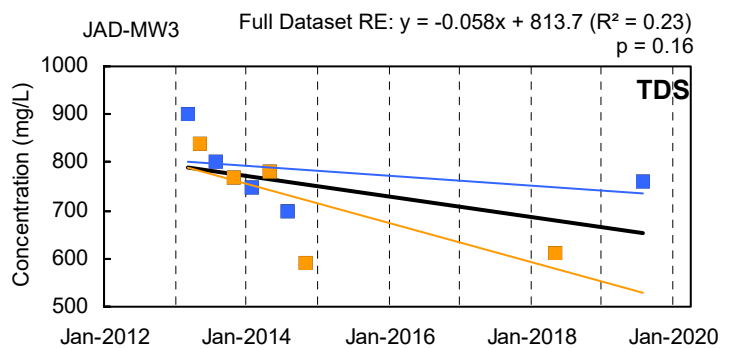
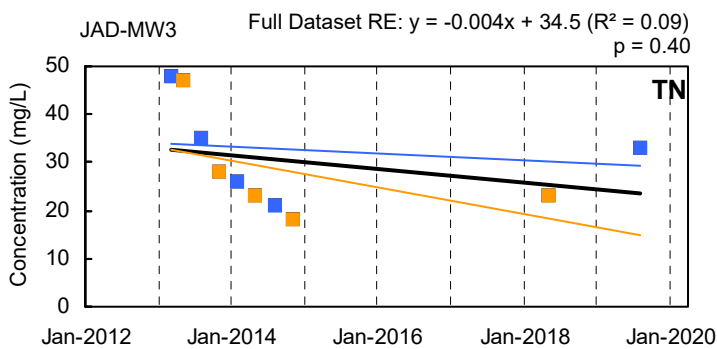
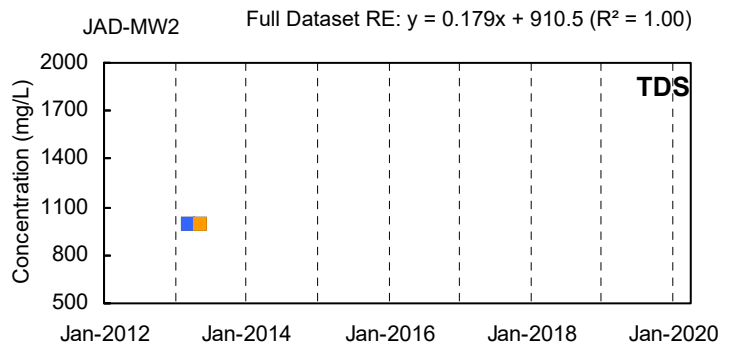
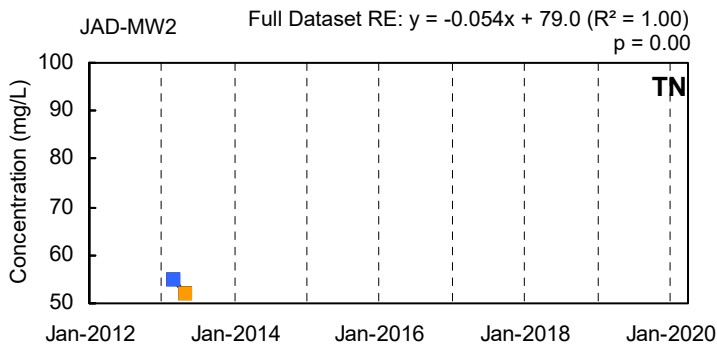
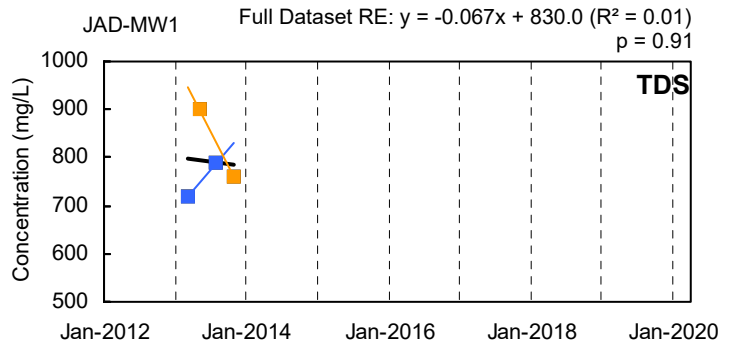
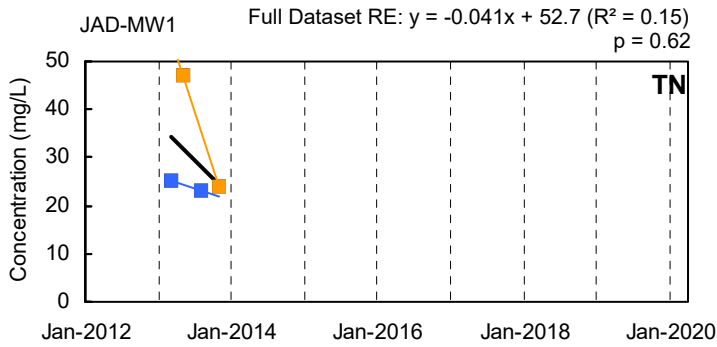
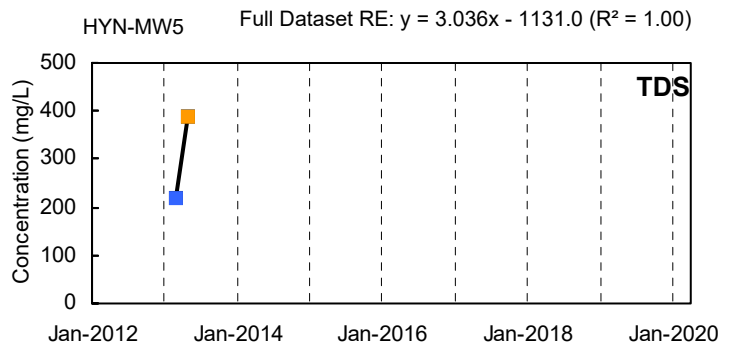
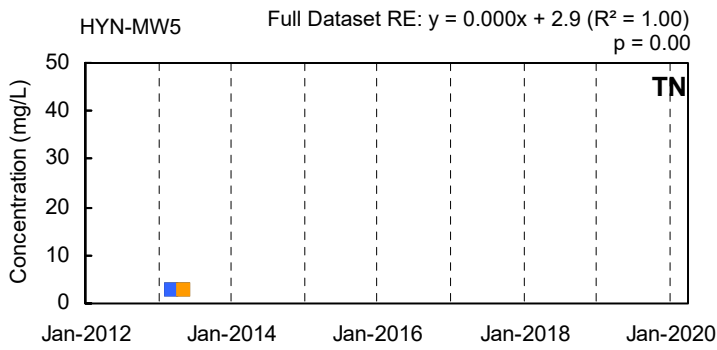

■ Q1/Q3 Result ■ Q2/Q4 Result
— Q1/Q3 Trendline — Q2/Q4 Trendline — Full Dataset Trendline

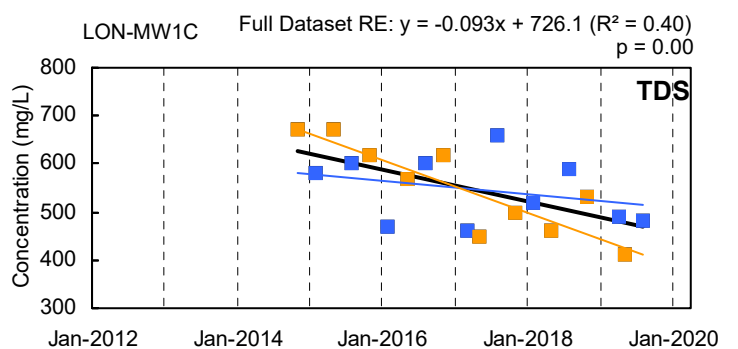
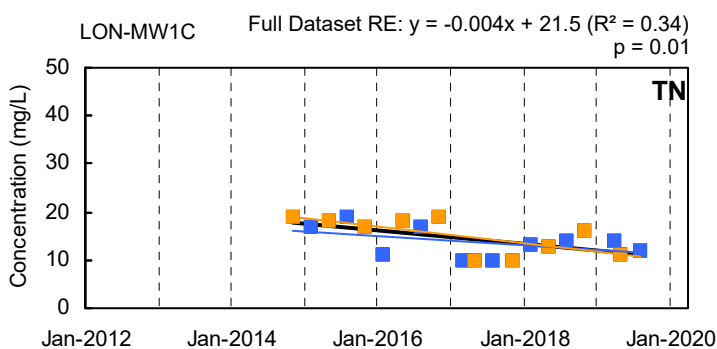
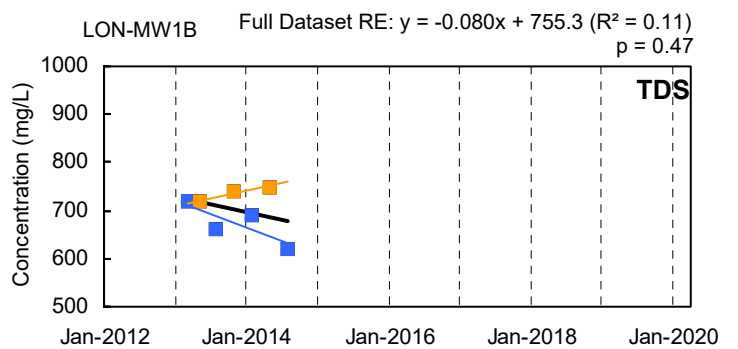
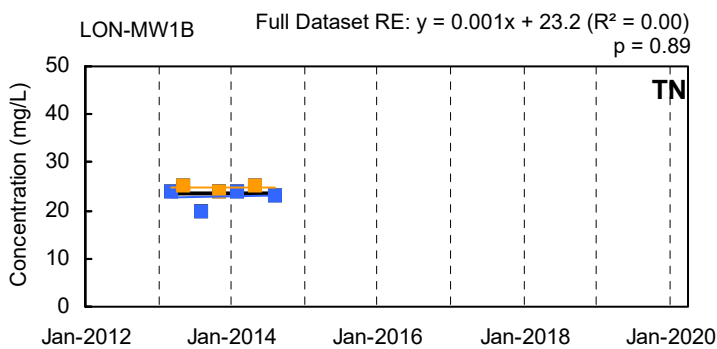
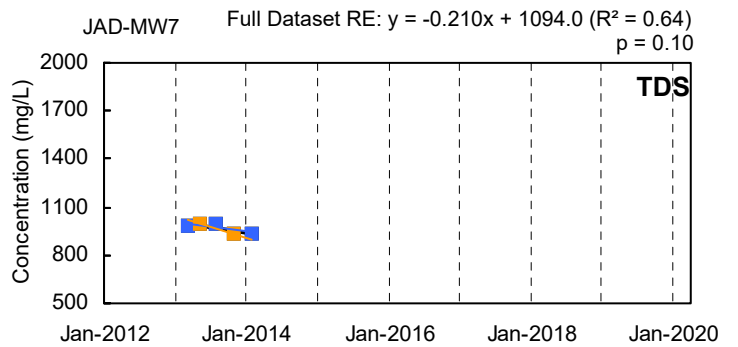
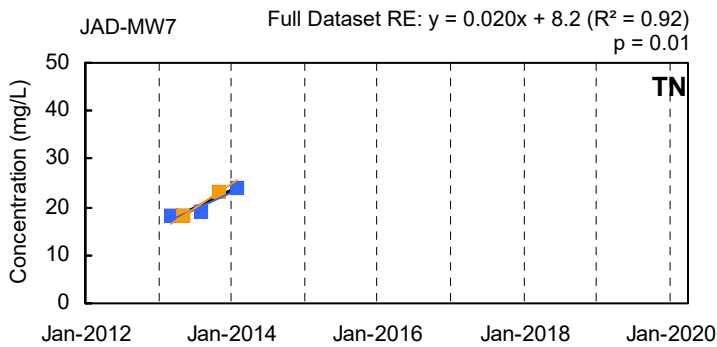
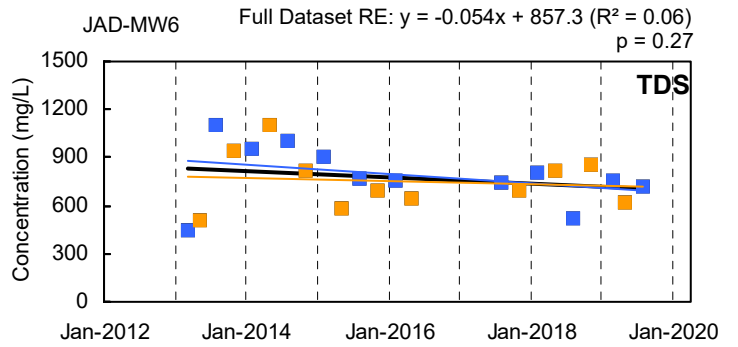
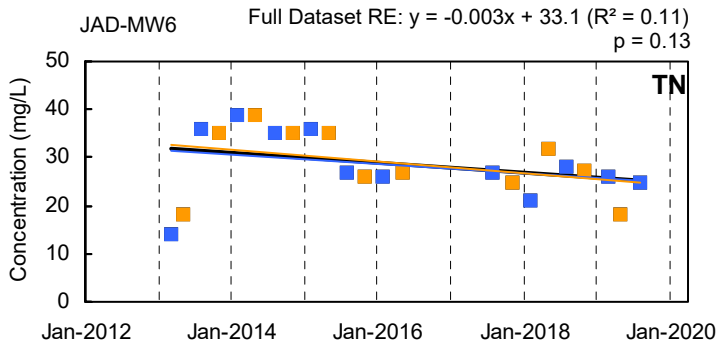
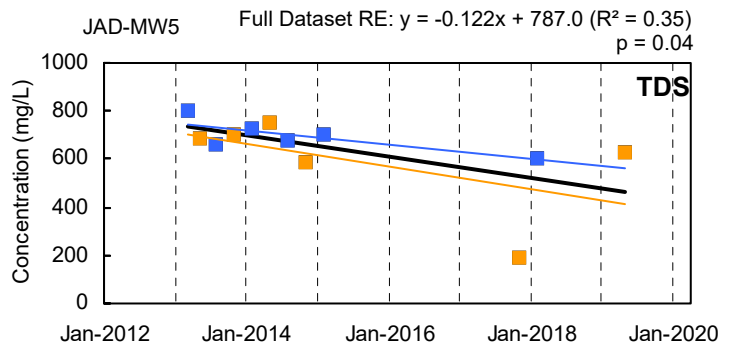
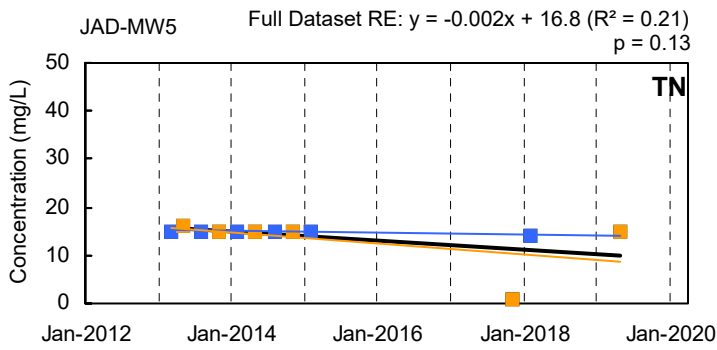

■ Q1/Q3 Result ■ Q2/Q4 Result
— Q1/Q3 Trendline — Q2/Q4 Trendline — Full Dataset Trendline

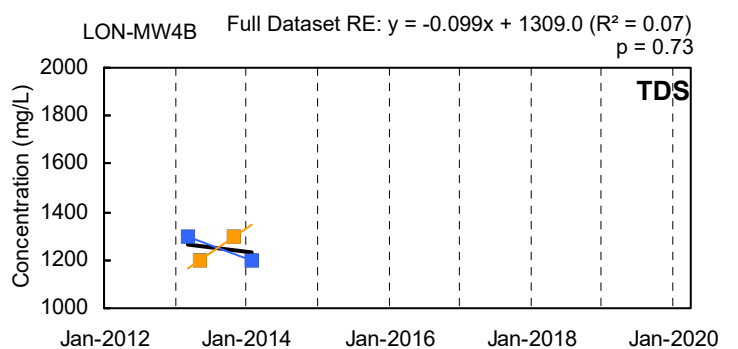
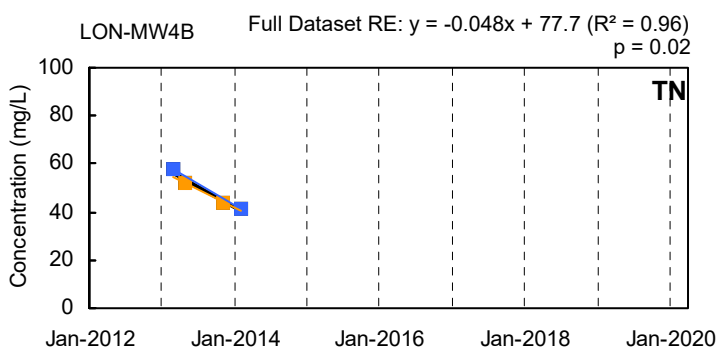
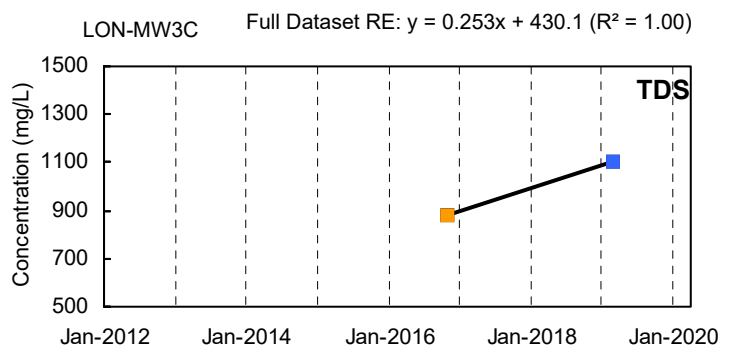
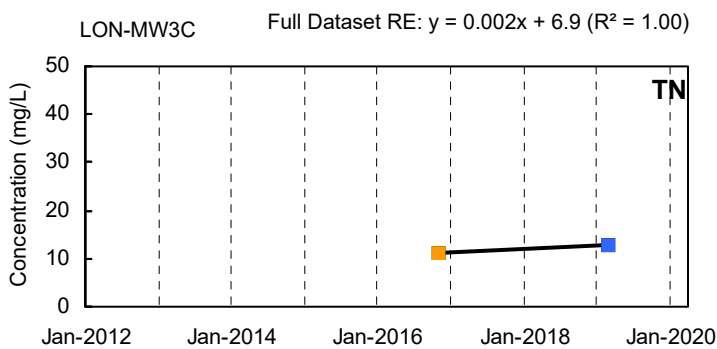
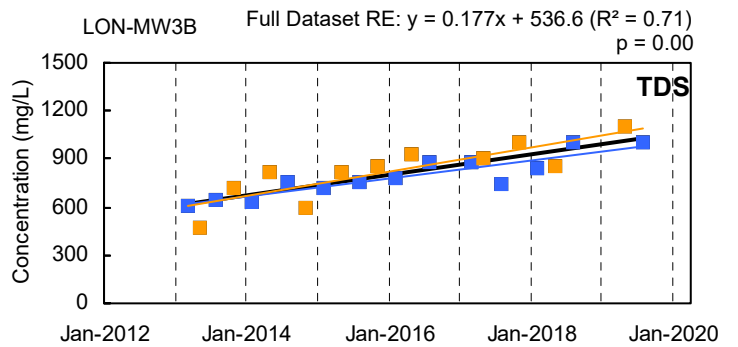
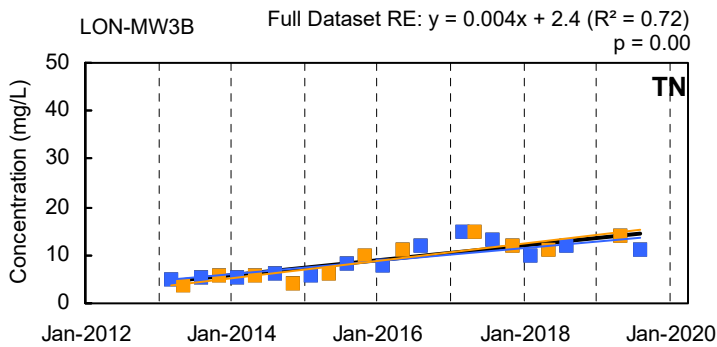
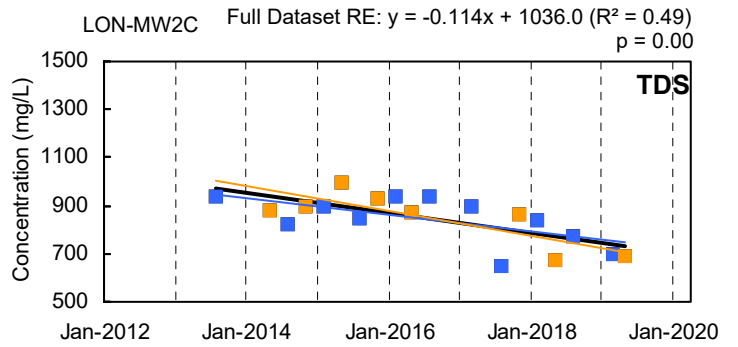
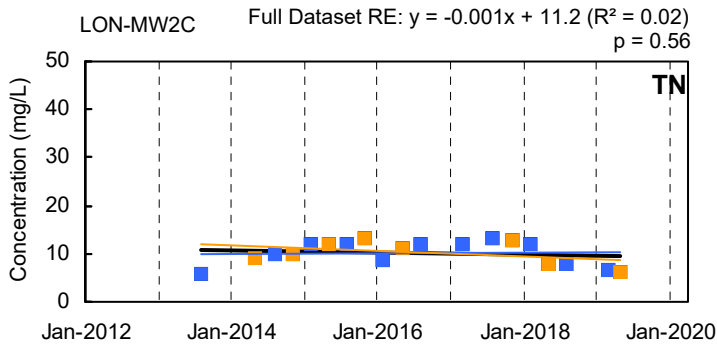
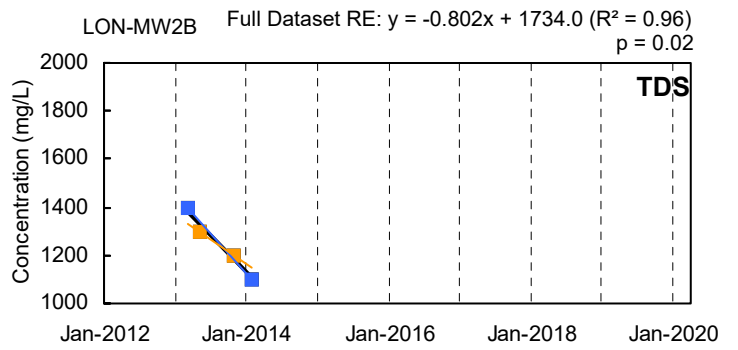
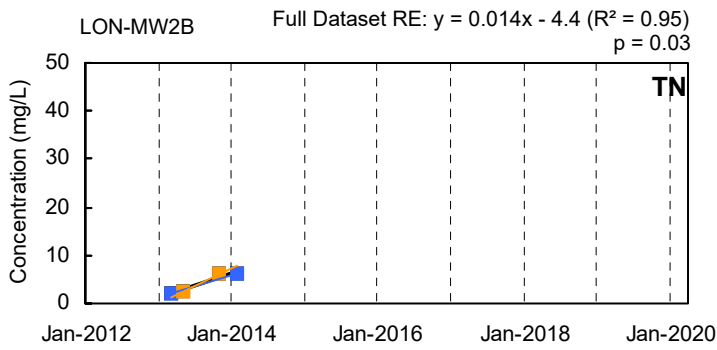

■ Q1/Q3 Result ■ Q2/Q4 Result
— Q1/Q3 Trendline — Q2/Q4 Trendline — Full Dataset Trendline

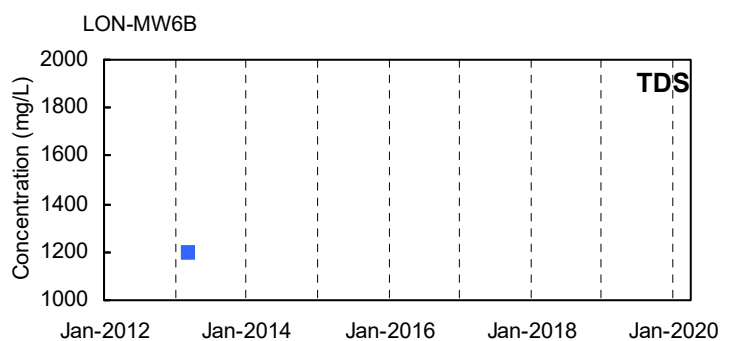
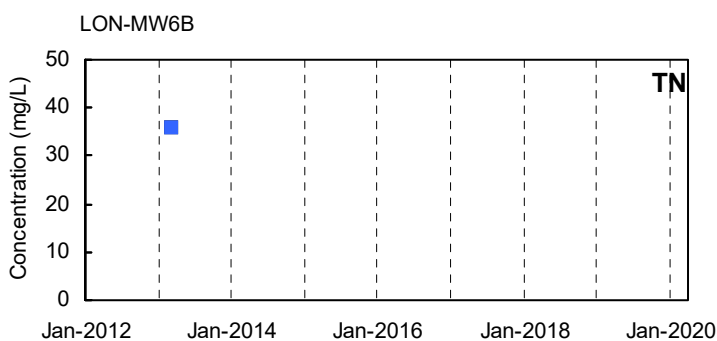
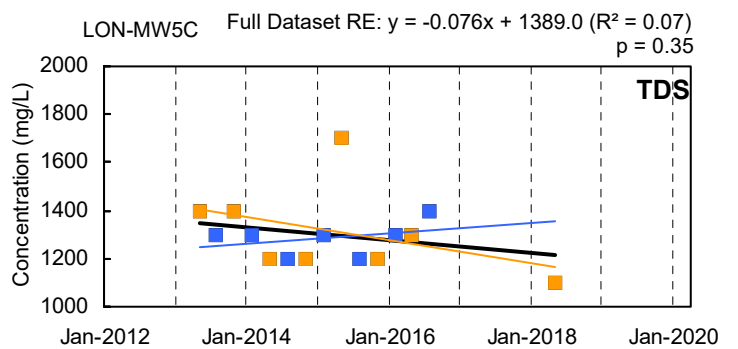
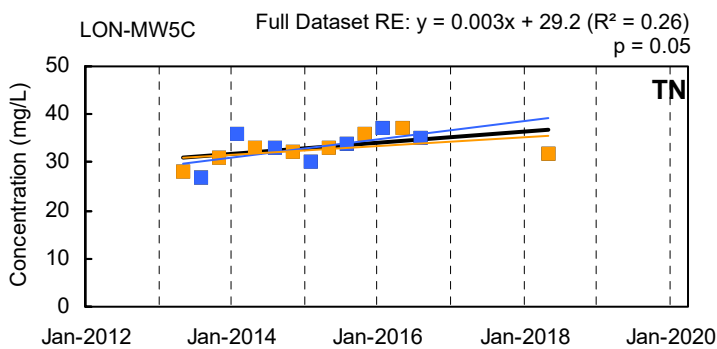
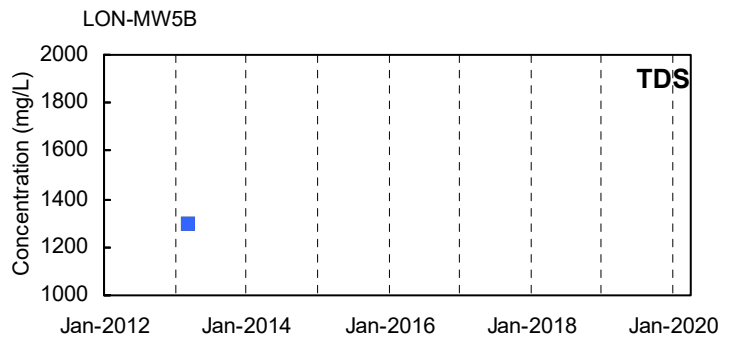
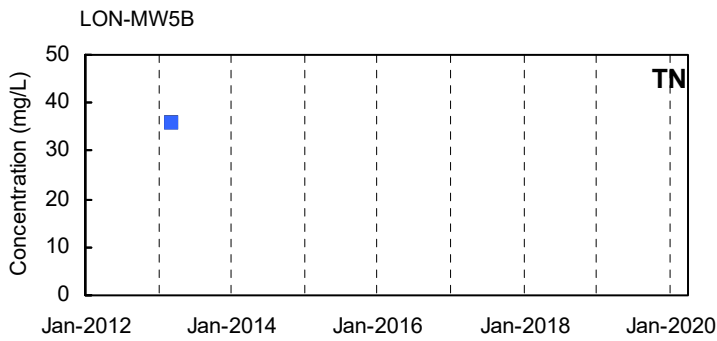
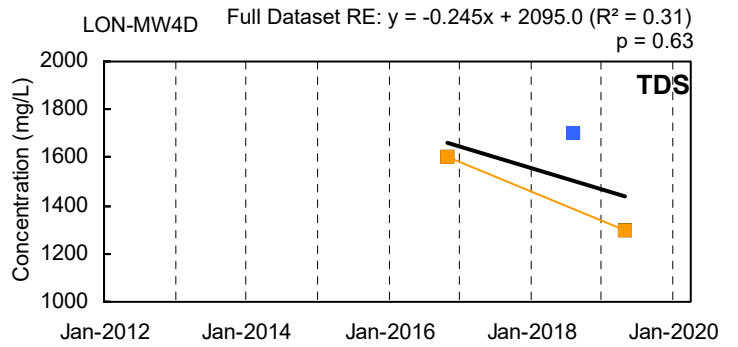
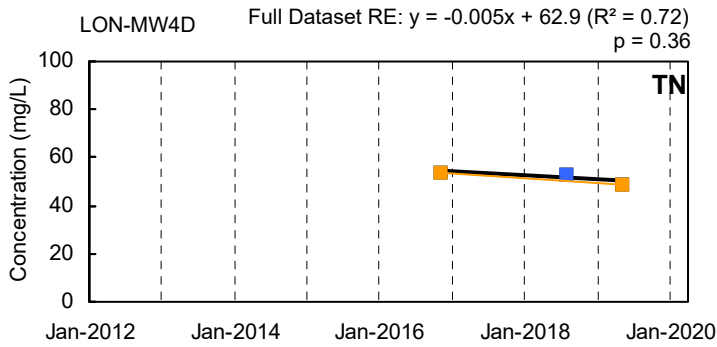
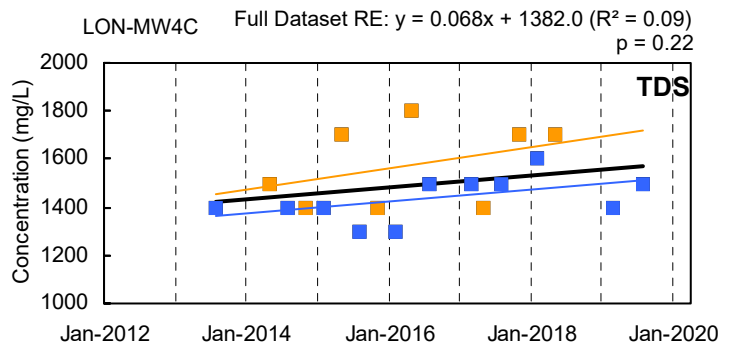
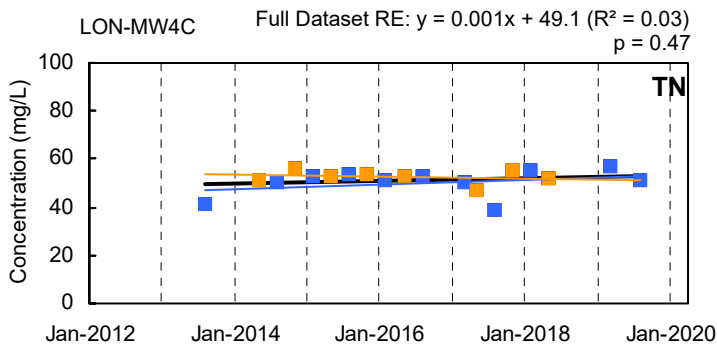

■ Q1/Q3 Result ■ Q2/Q4 Result
— Q1/Q3 Trendline — Q2/Q4 Trendline — Full Dataset Trendline

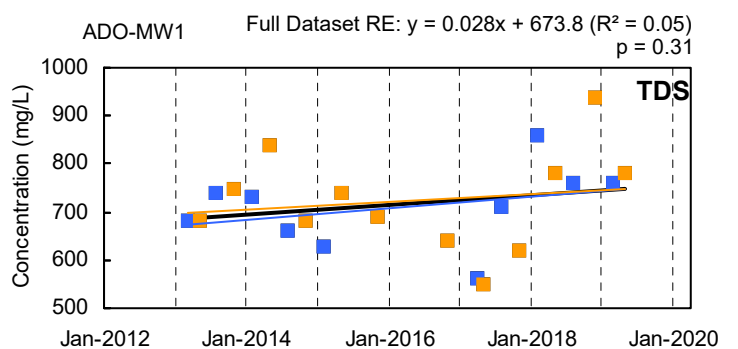
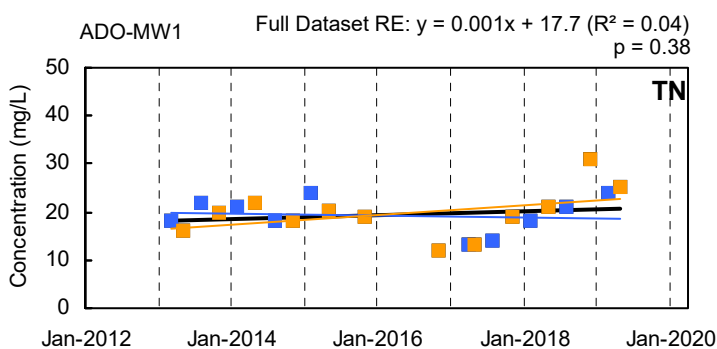
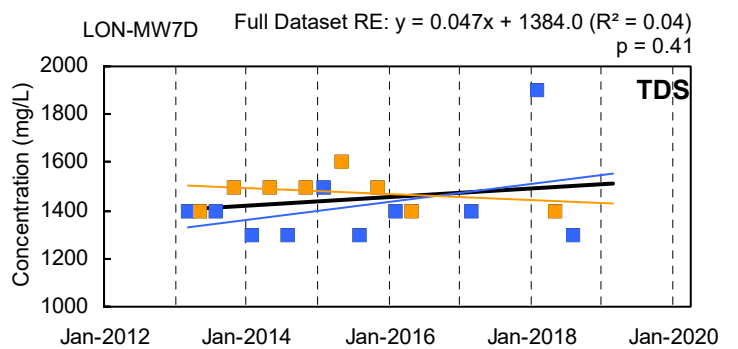
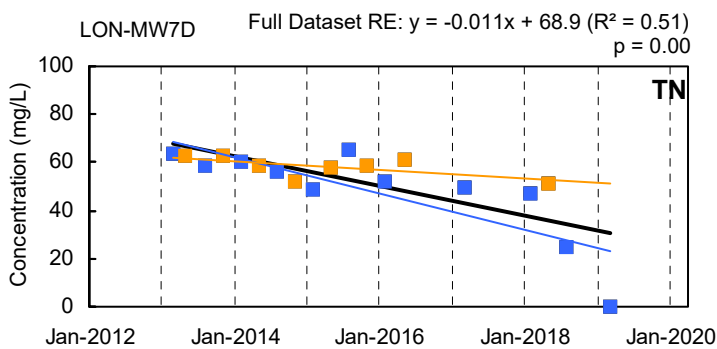
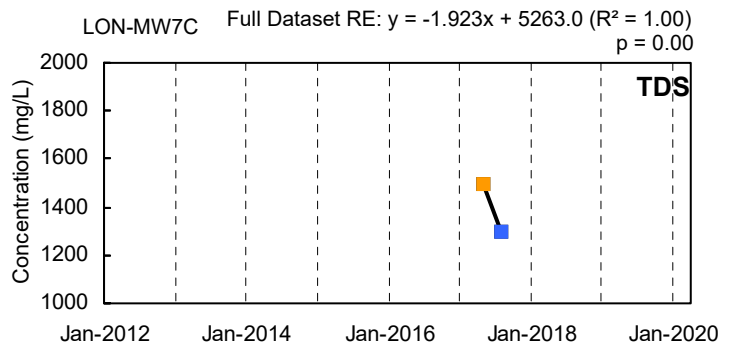
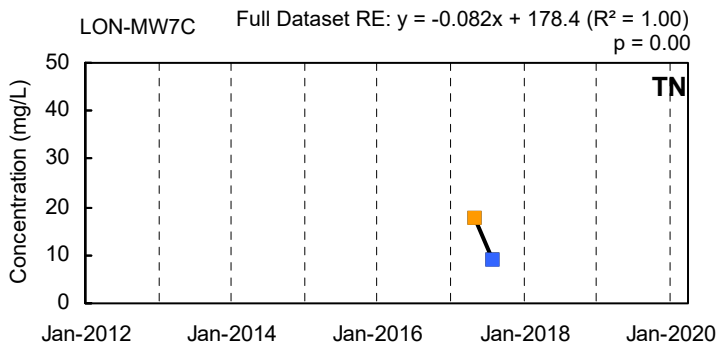
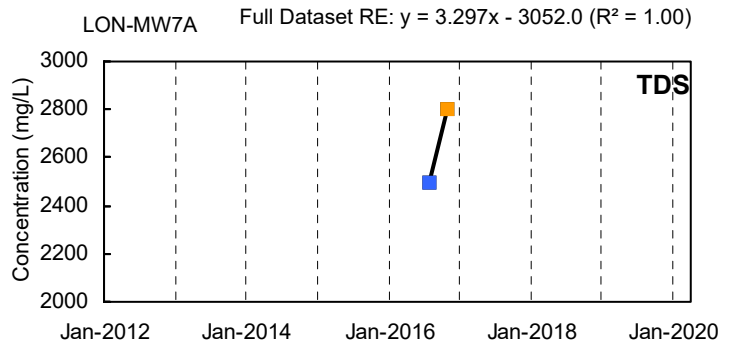
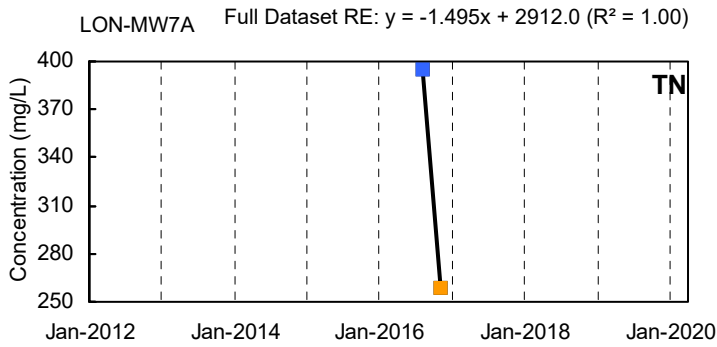
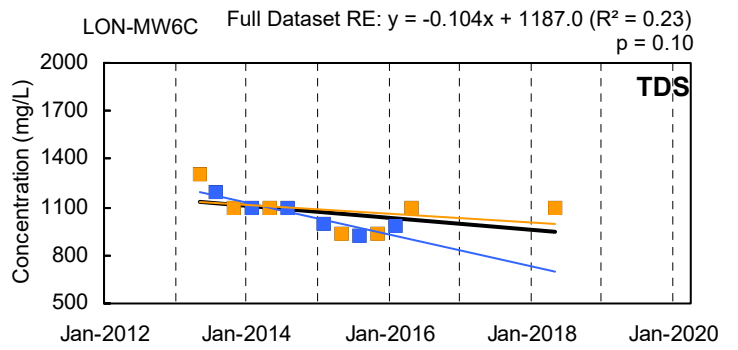
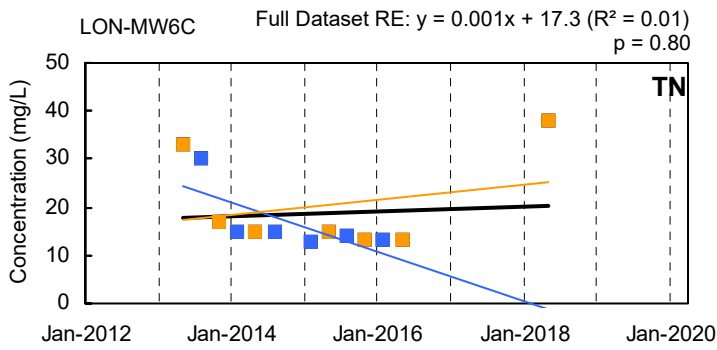

■ Q1/Q3 Result ■ Q2/Q4 Result
— Q1/Q3 Trendline — Q2/Q4 Trendline — Full Dataset Trendline

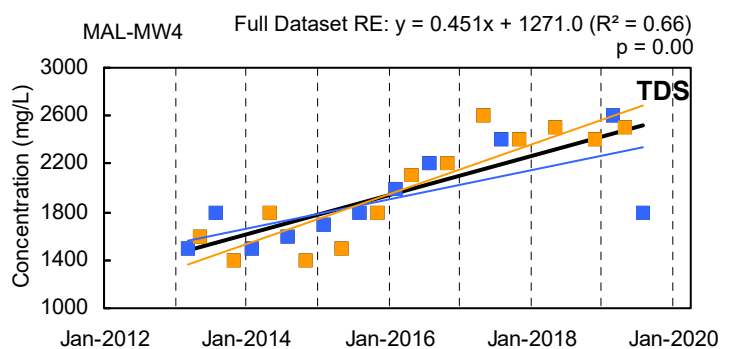
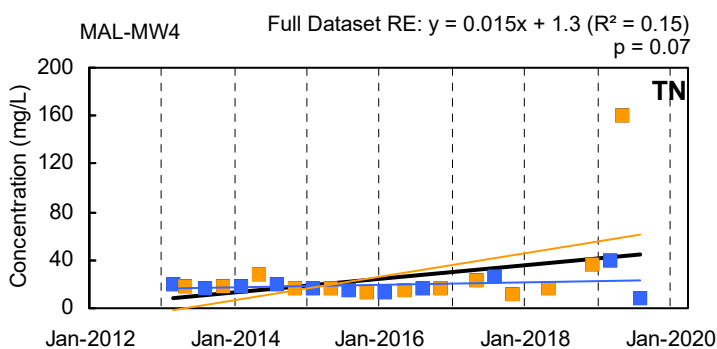
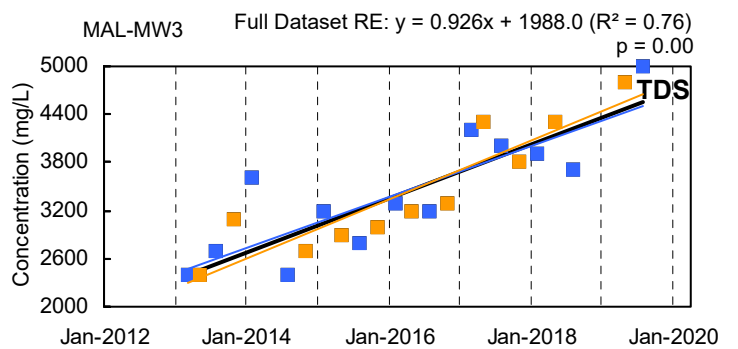
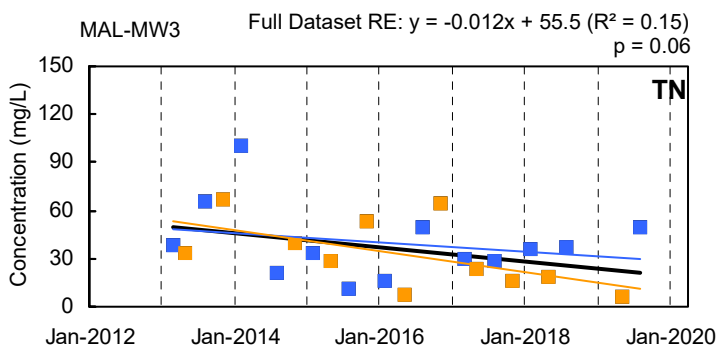
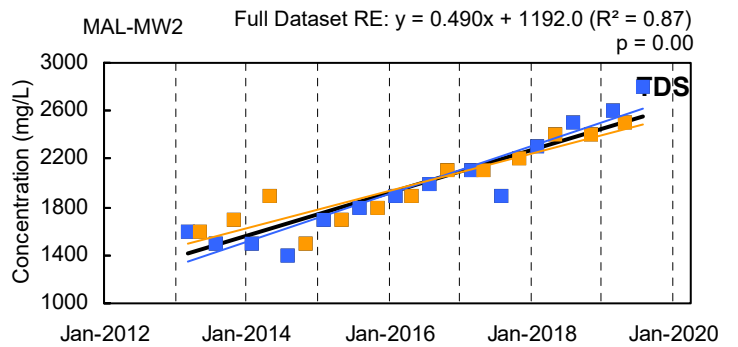
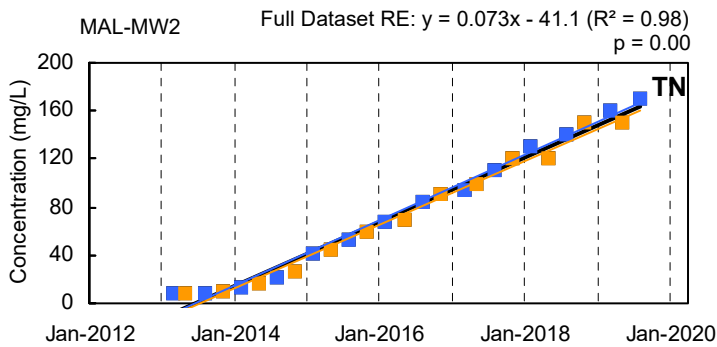
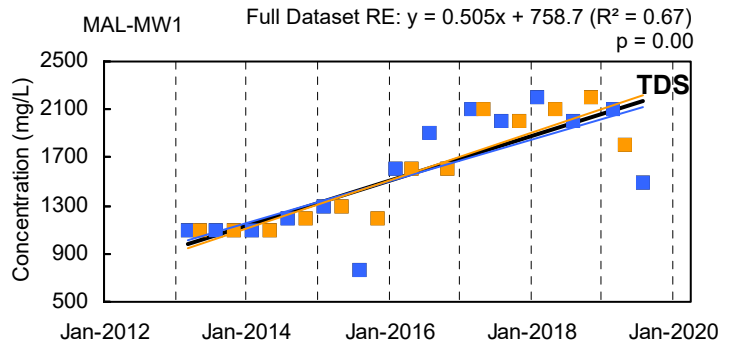
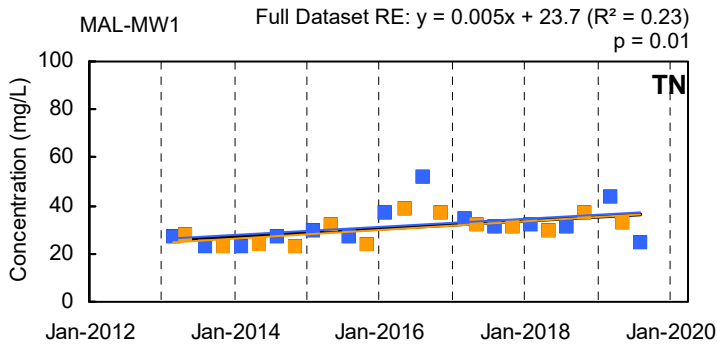
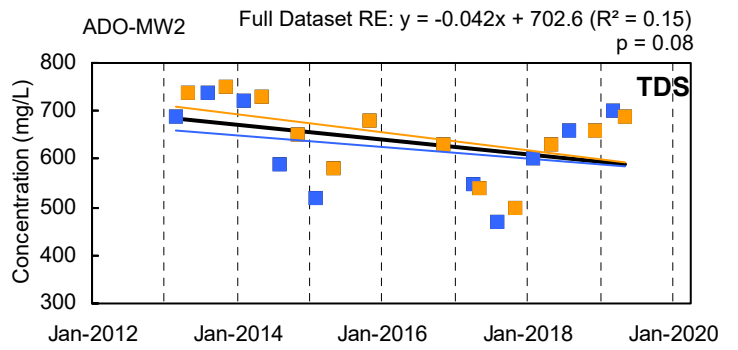
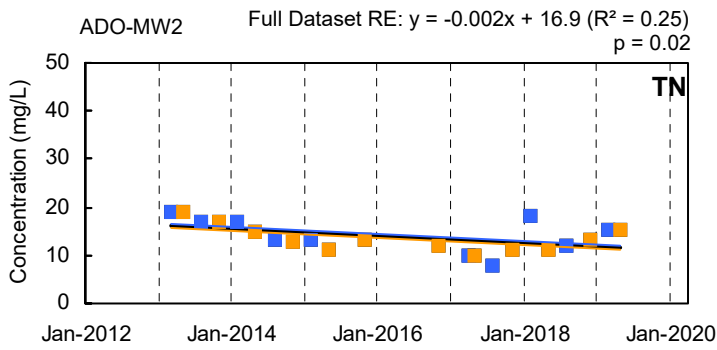

■ Q1/Q3 Result ■ Q2/Q4 Result
— Q1/Q3 Trendline — Q2/Q4 Trendline — Full Dataset Trendline

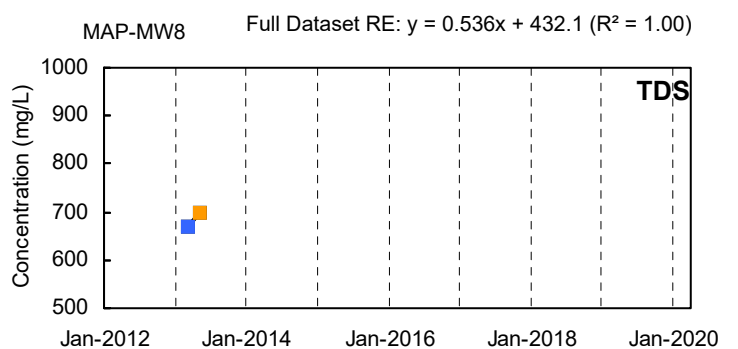
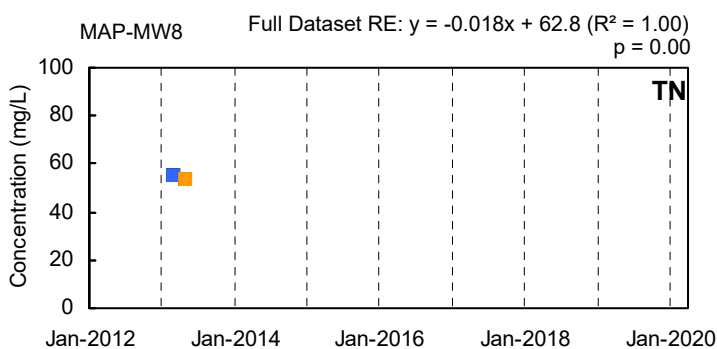
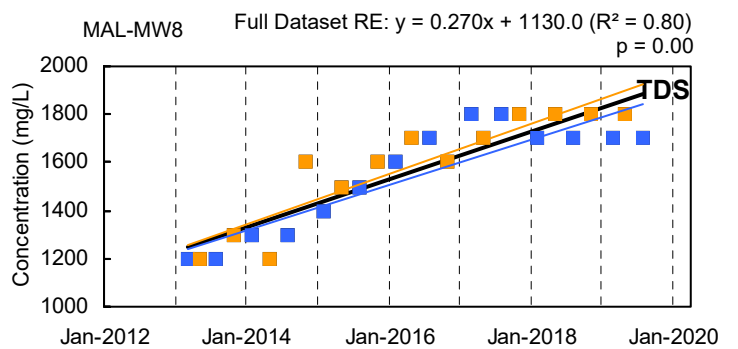
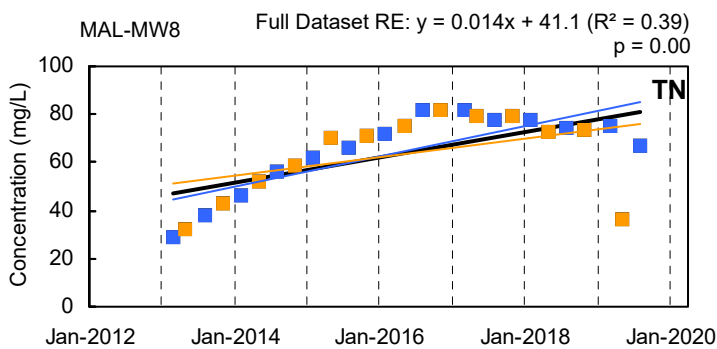
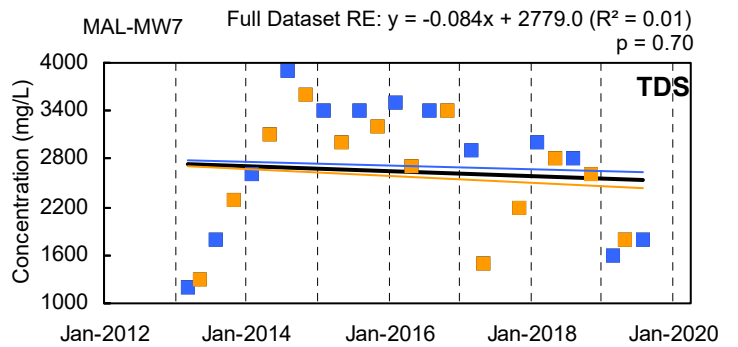
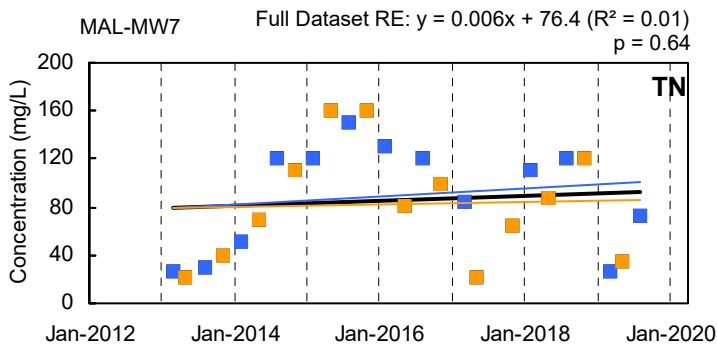
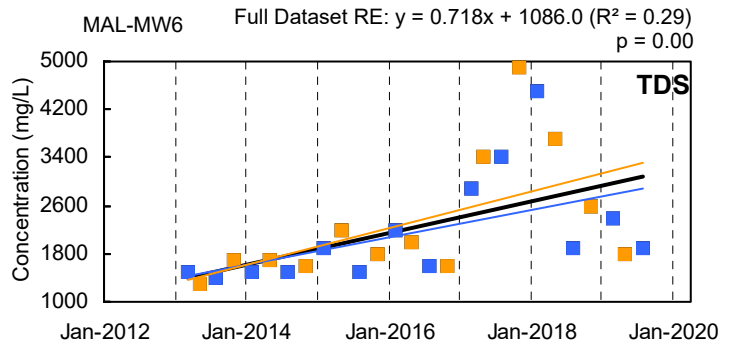
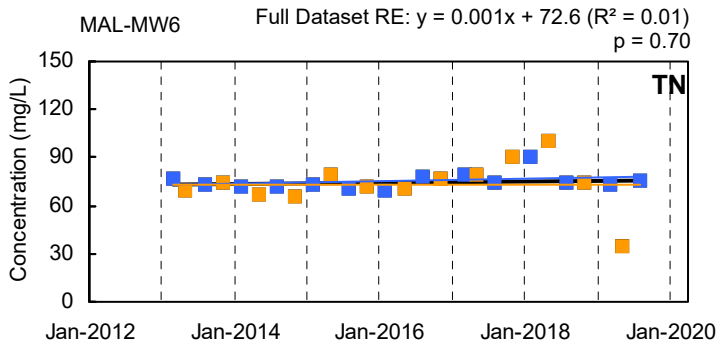
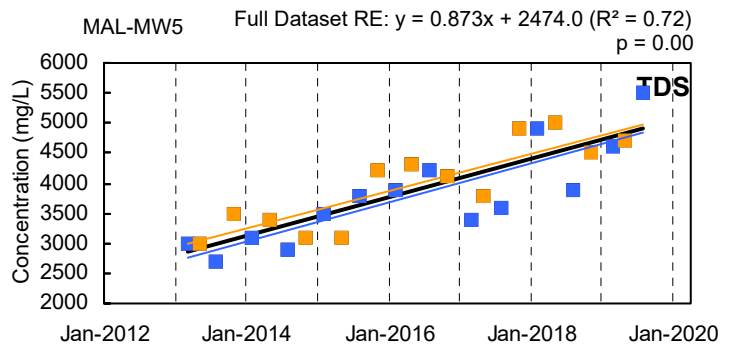
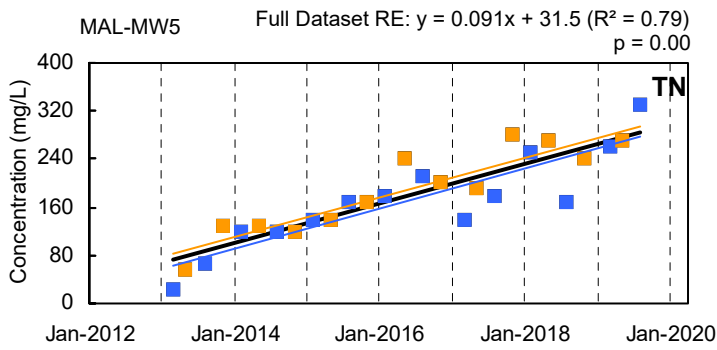

■ Q1/Q3 Result ■ Q2/Q4 Result
— Q1/Q3 Trendline — Q2/Q4 Trendline — Full Dataset Trendline

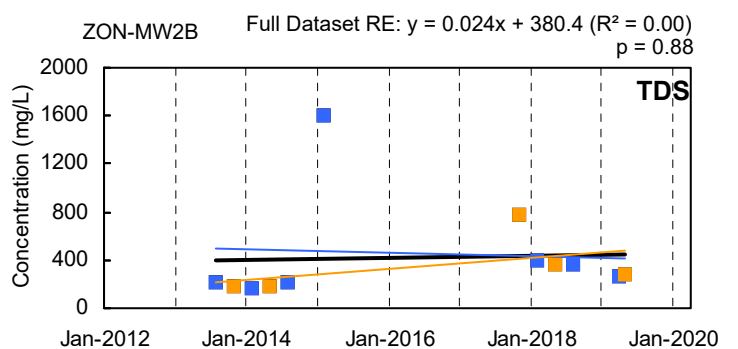
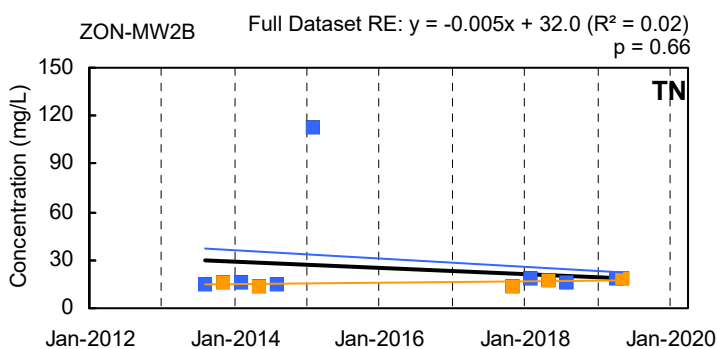
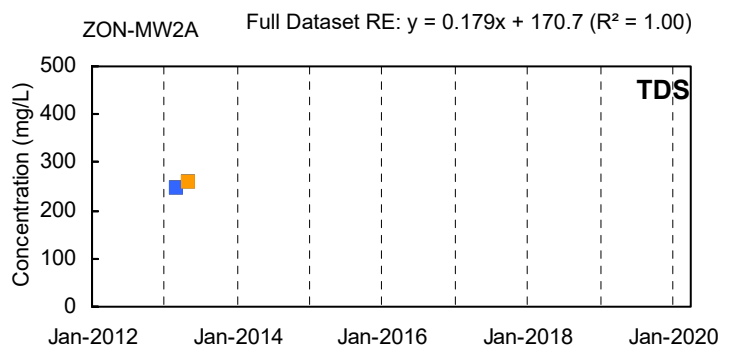
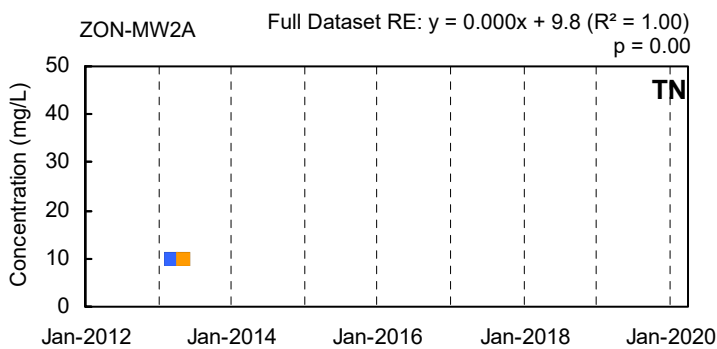
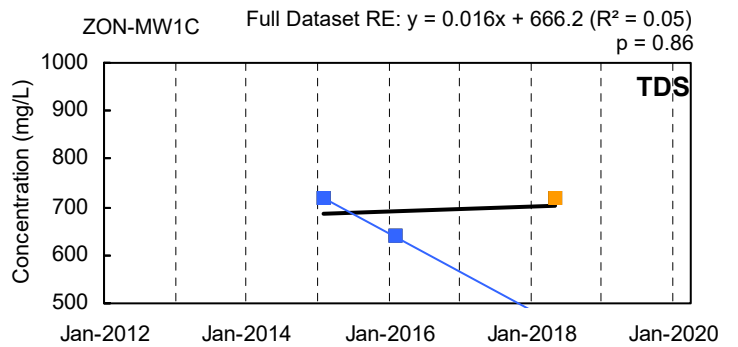
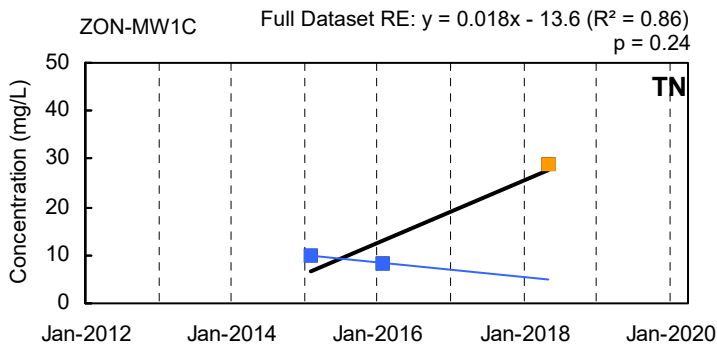
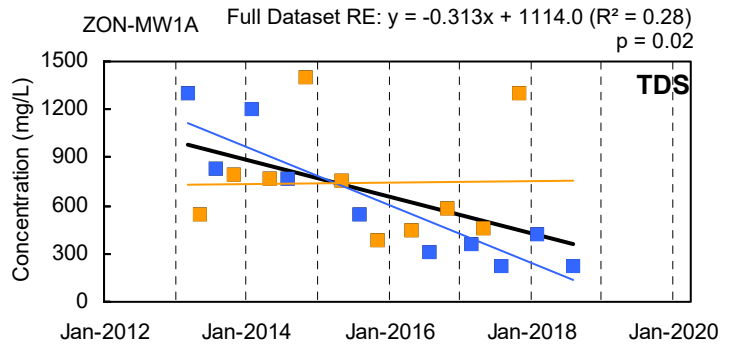
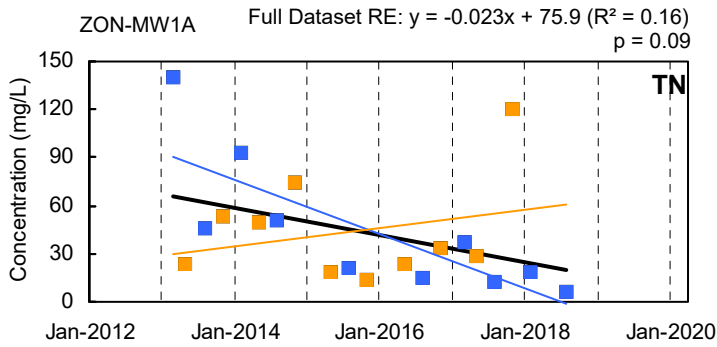
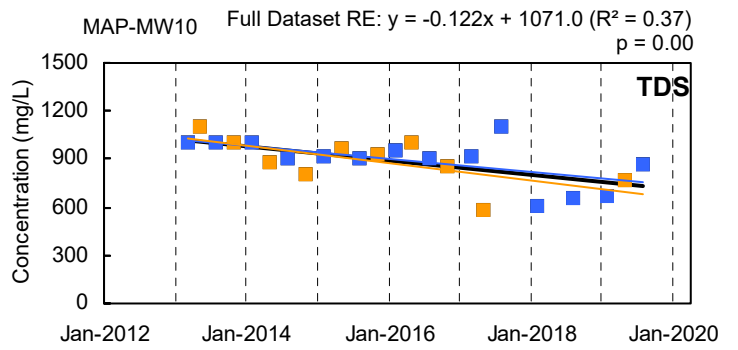
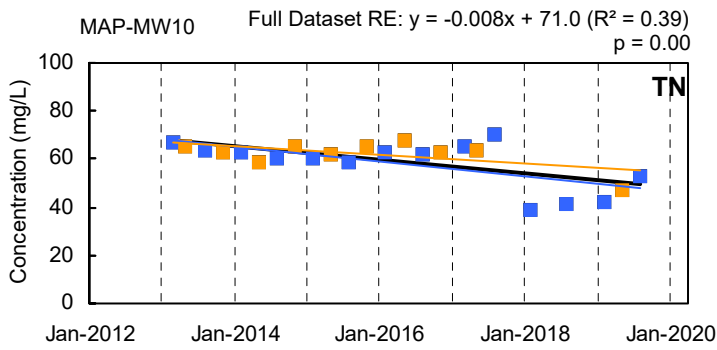

■ Q1/Q3 Result ■ Q2/Q4 Result
— Q1/Q3 Trendline — Q2/Q4 Trendline — Full Dataset Trendline

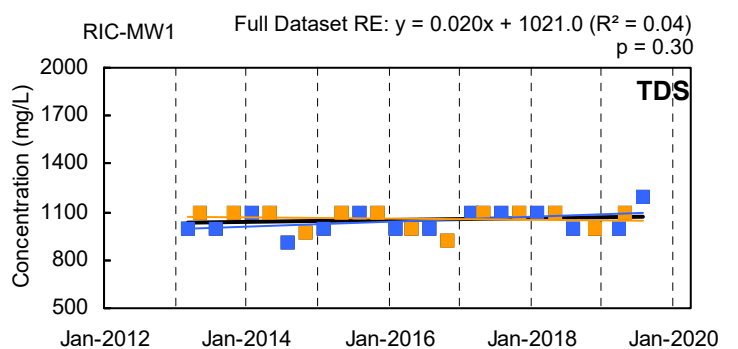
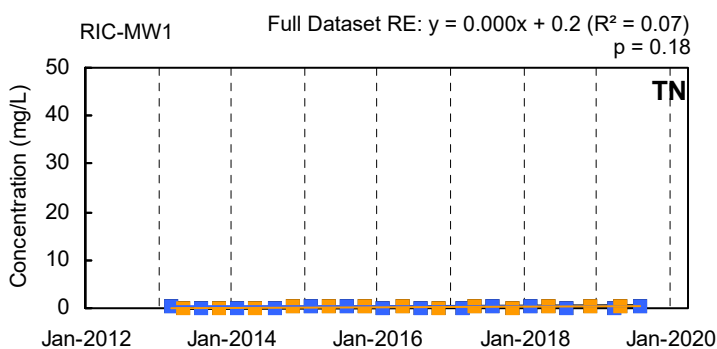
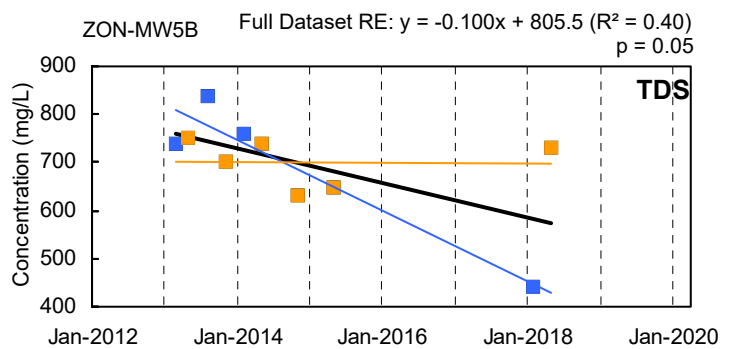
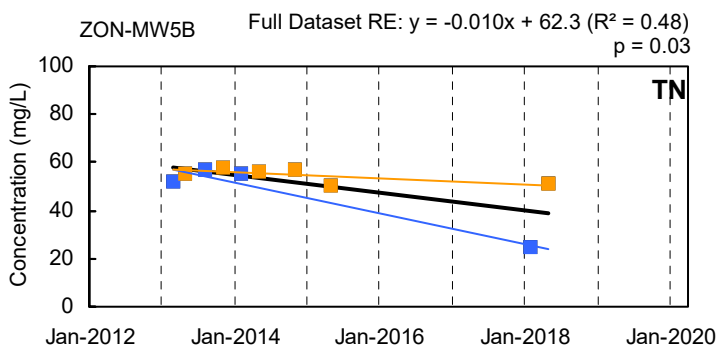
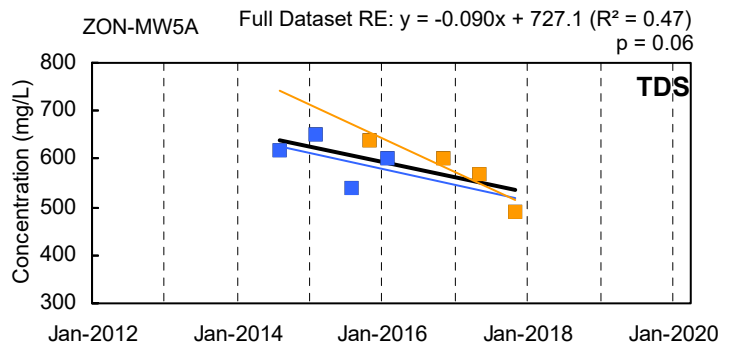
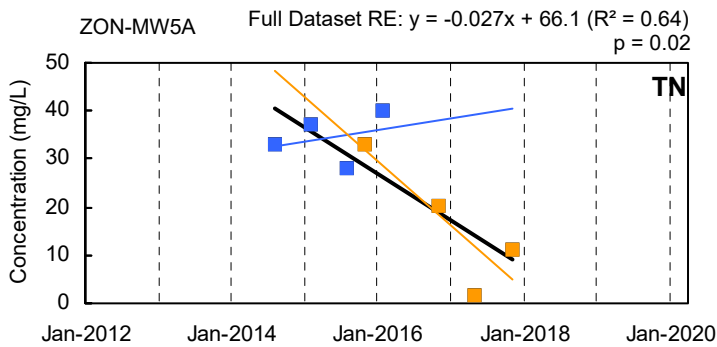
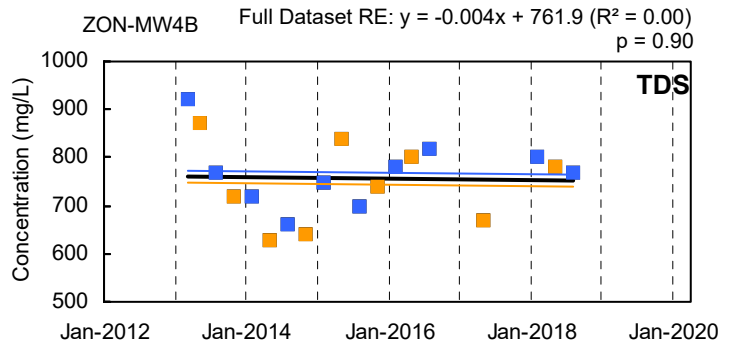
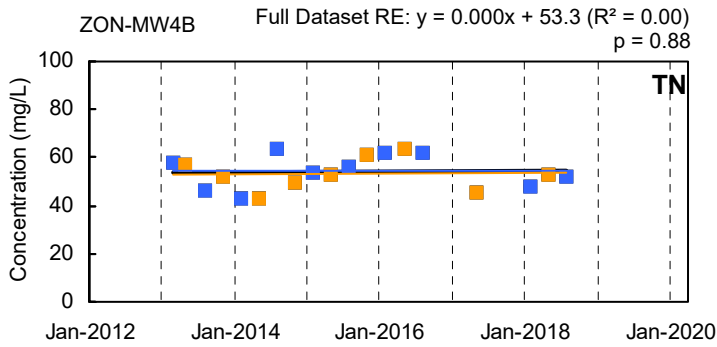
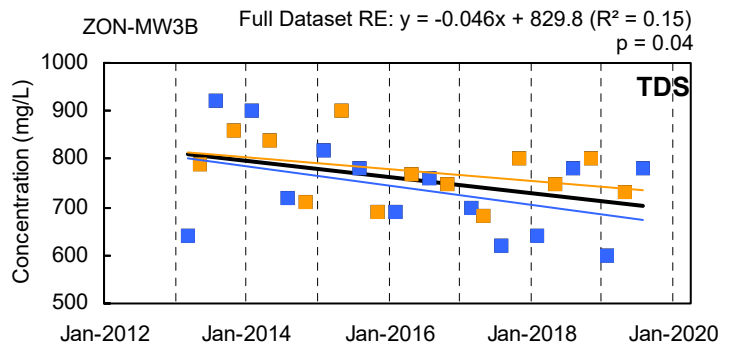
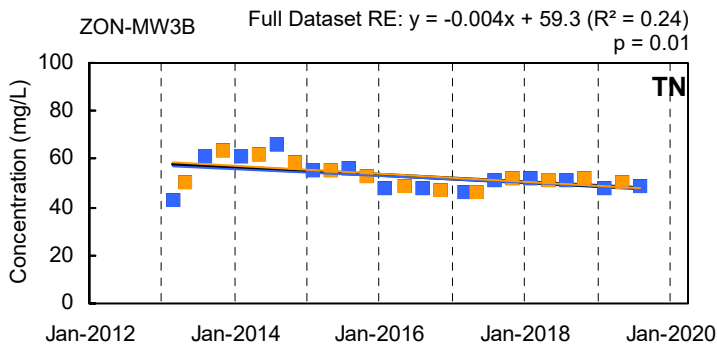

■ Q1/Q3 Result ■ Q2/Q4 Result
— Q1/Q3 Trendline — Q2/Q4 Trendline — Full Dataset Trendline

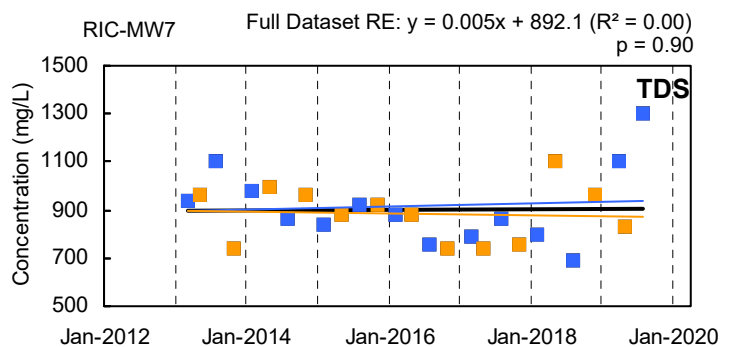
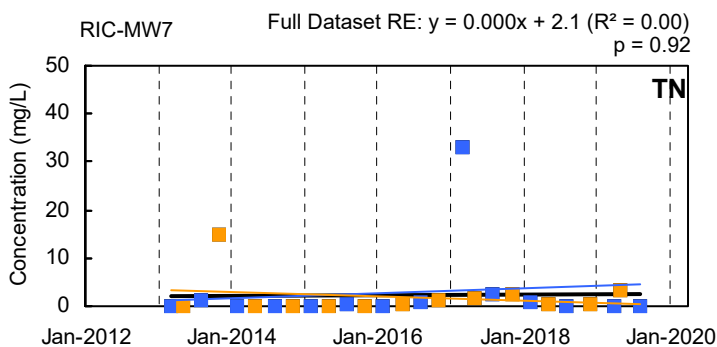
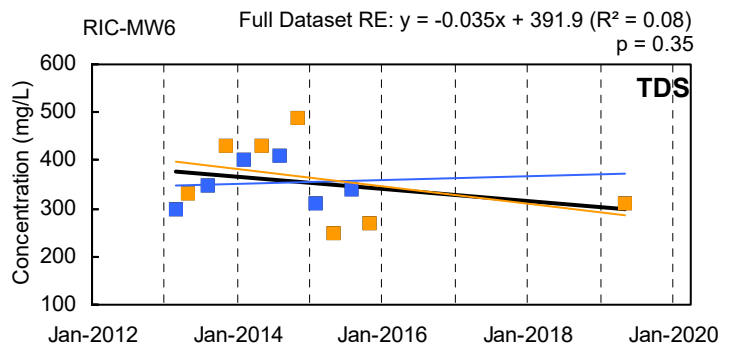
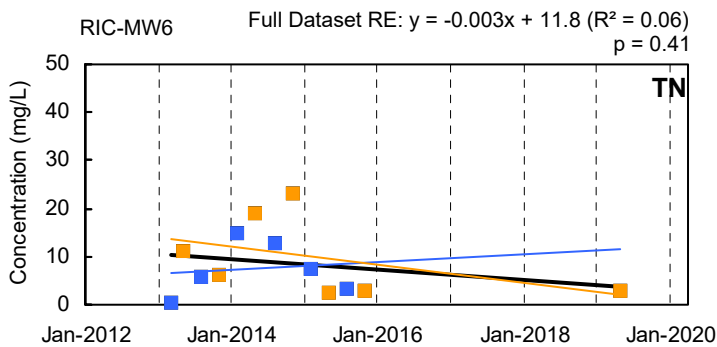
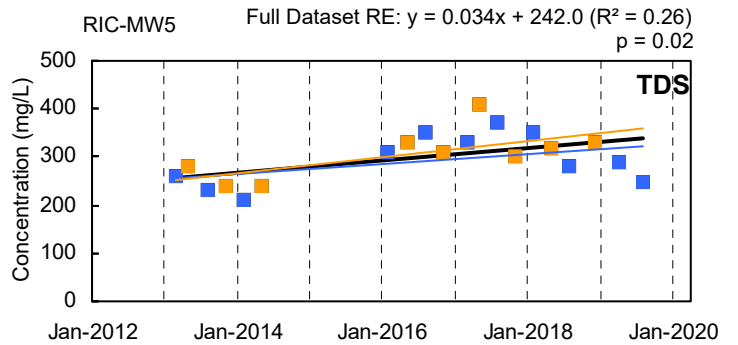
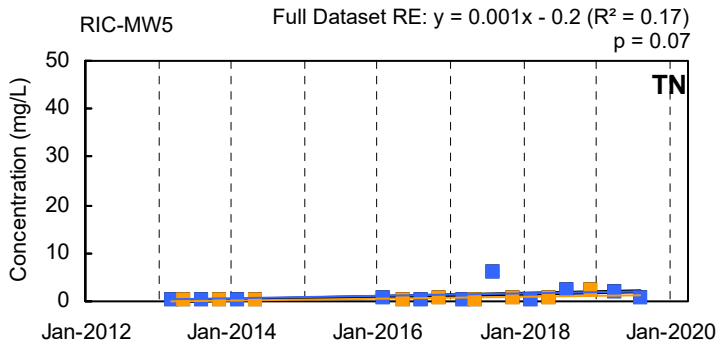
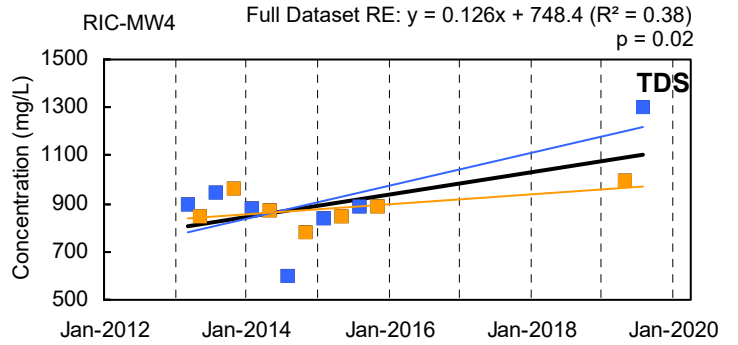
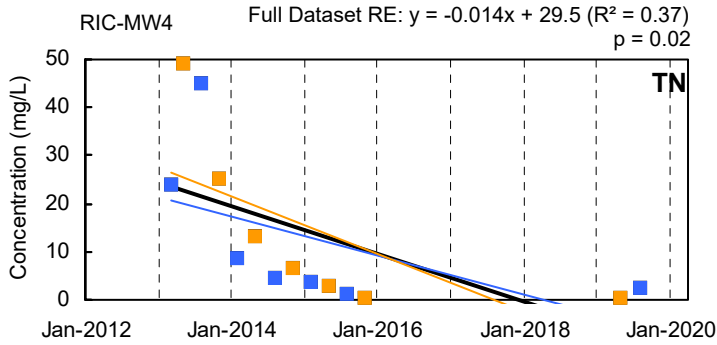
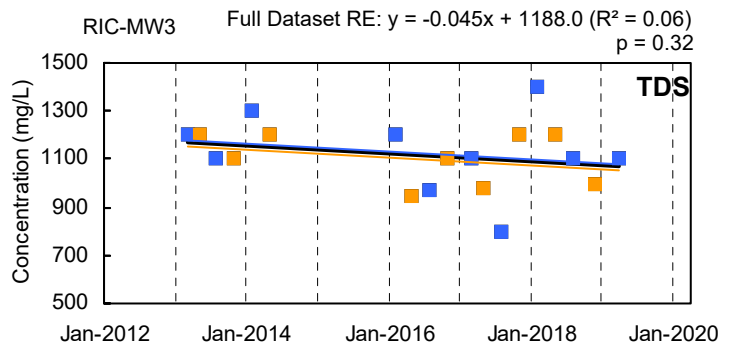
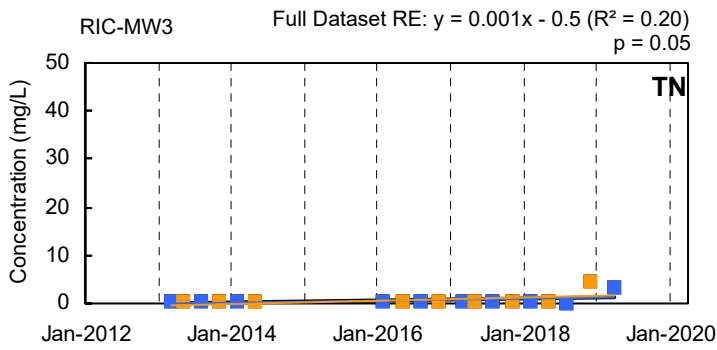

■ Q1/Q3 Result ■ Q2/Q4 Result
— Q1/Q3 Trendline — Q2/Q4 Trendline — Full Dataset Trendline

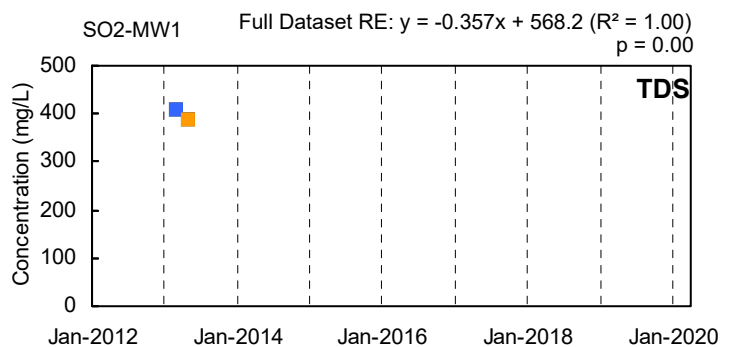
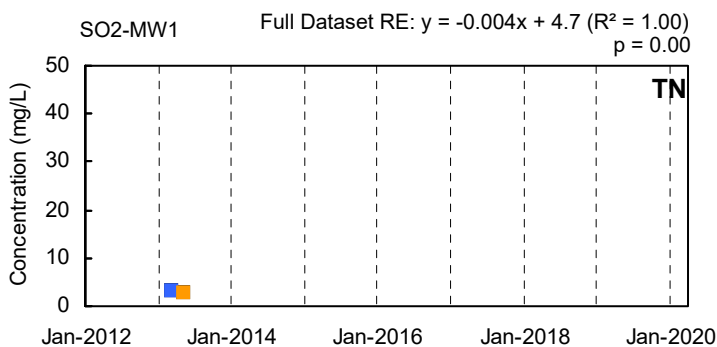
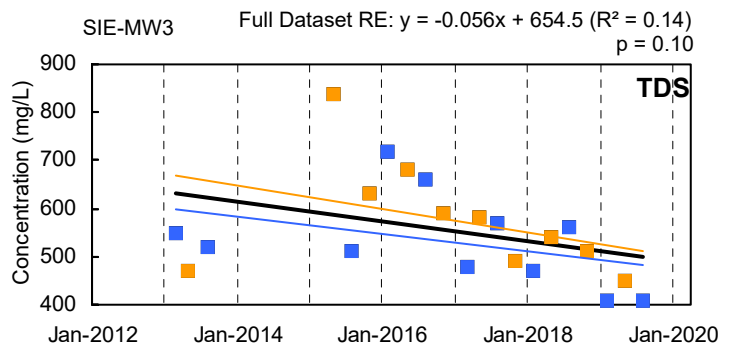
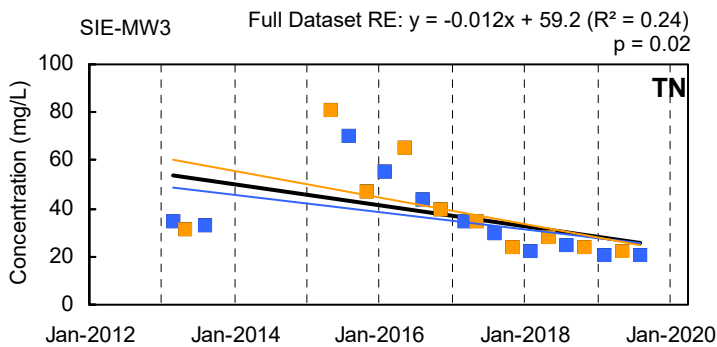
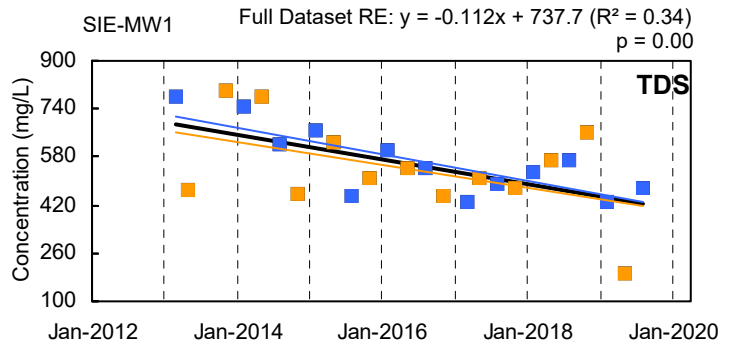
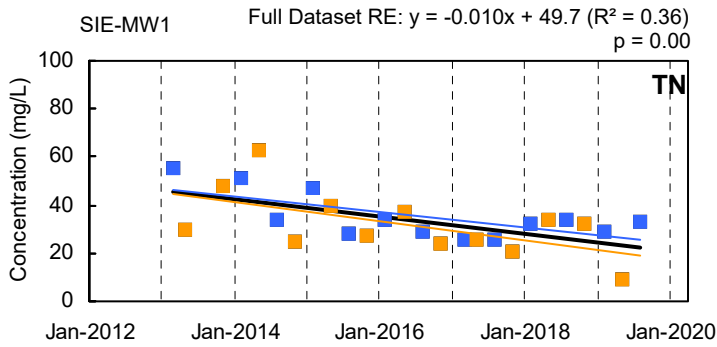
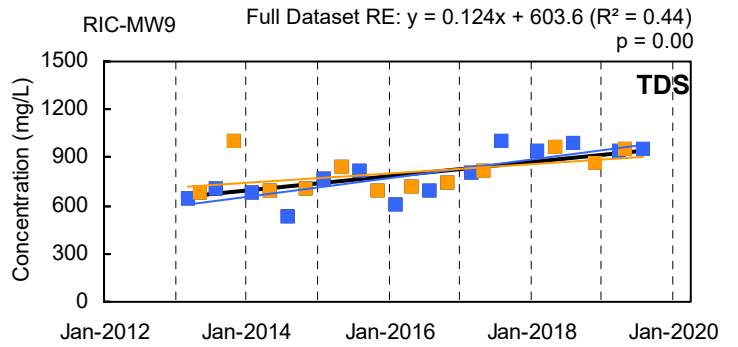
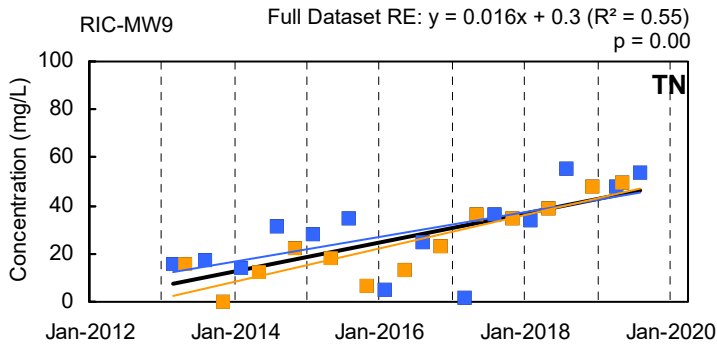
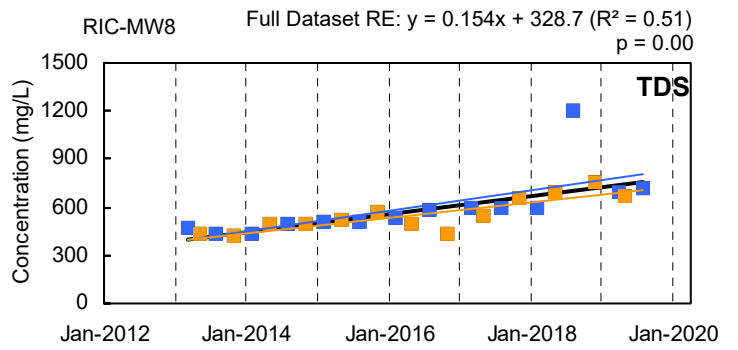
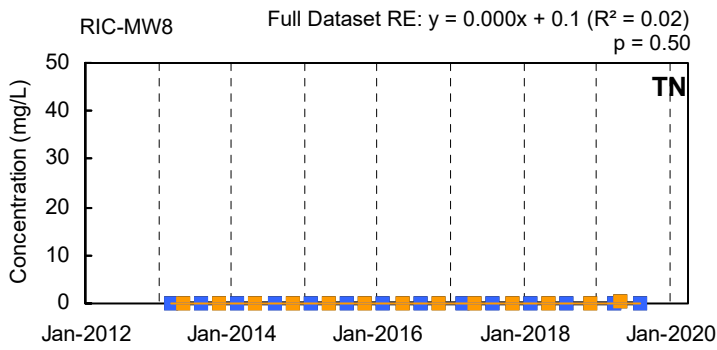

■ Q1/Q3 Result ■ Q2/Q4 Result
— Q1/Q3 Trendline — Q2/Q4 Trendline — Full Dataset Trendline

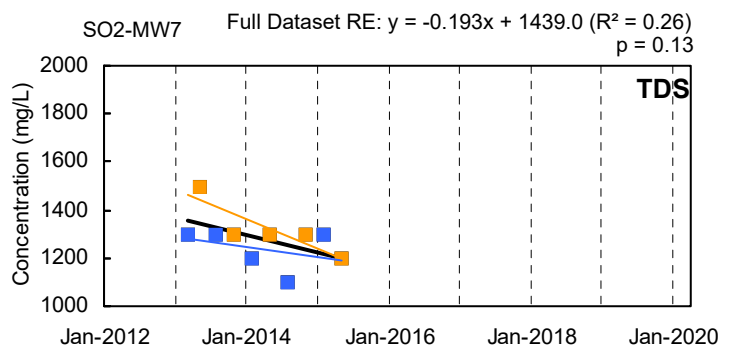
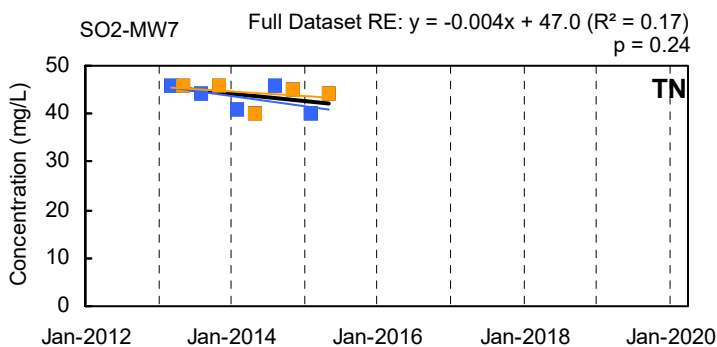
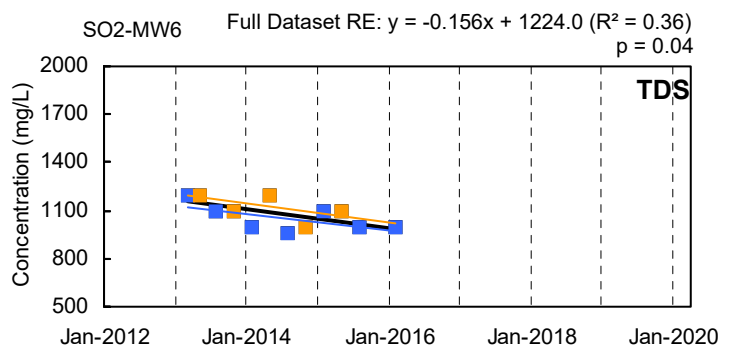
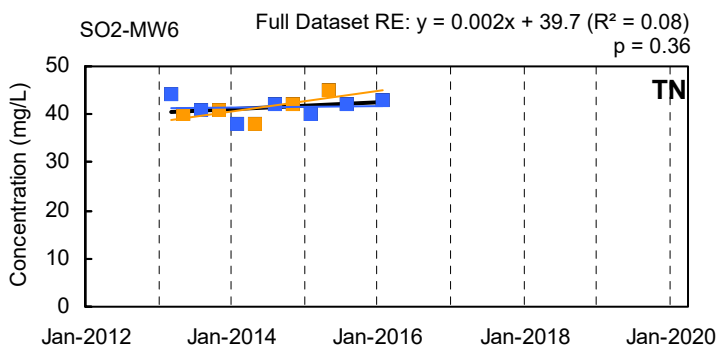
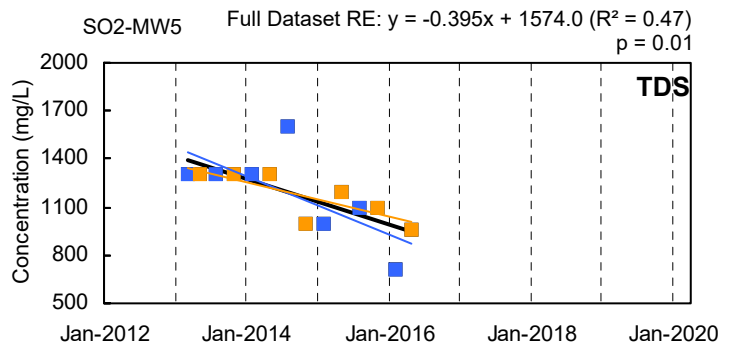
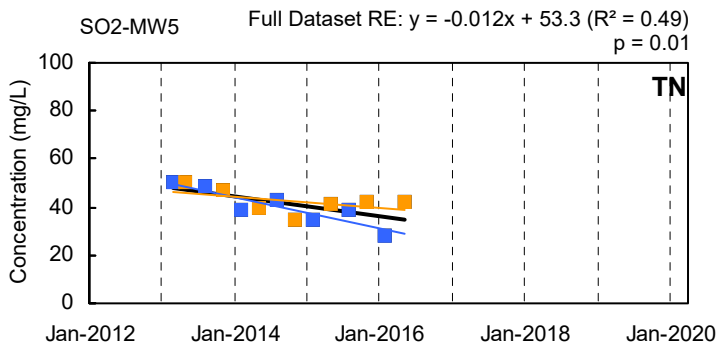
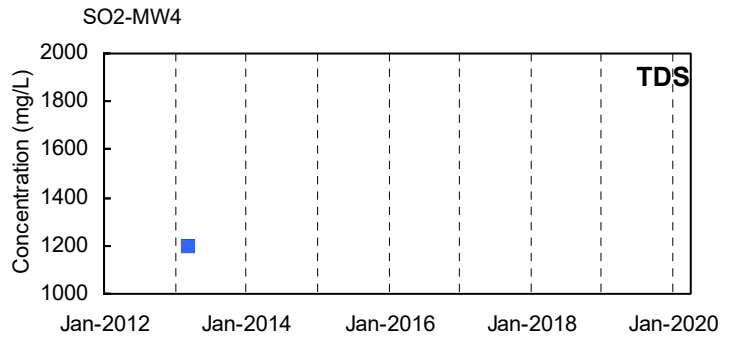
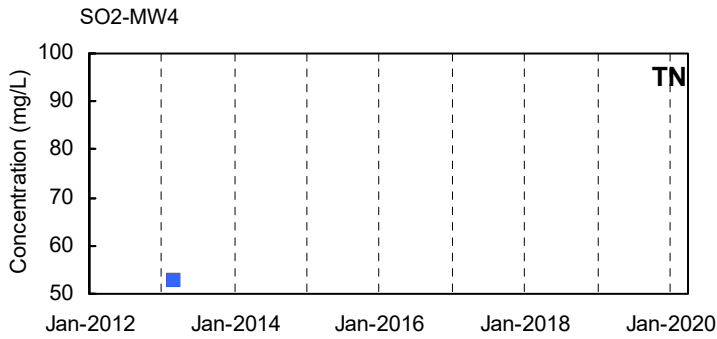
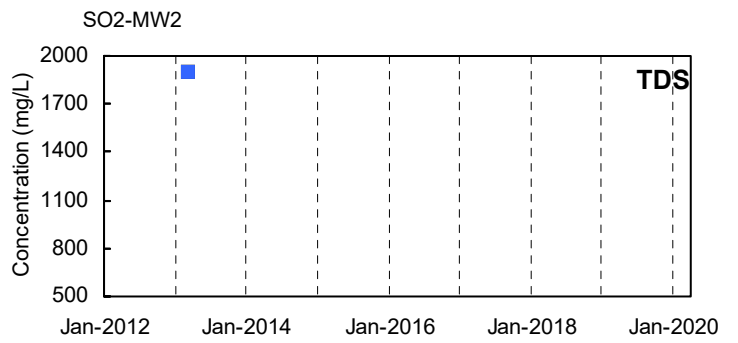
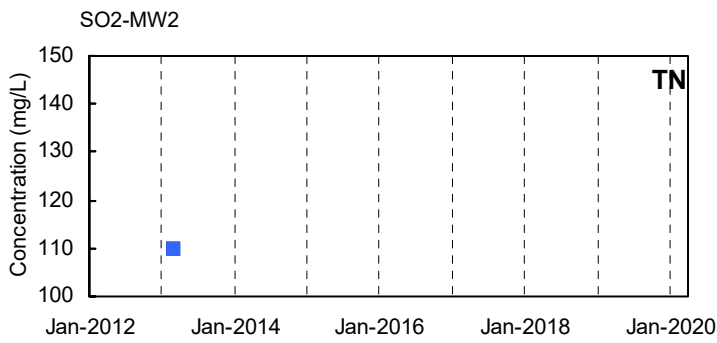

■ Q1/Q3 Result ■ Q2/Q4 Result
— Q1/Q3 Trendline — Q2/Q4 Trendline — Full Dataset Trendline

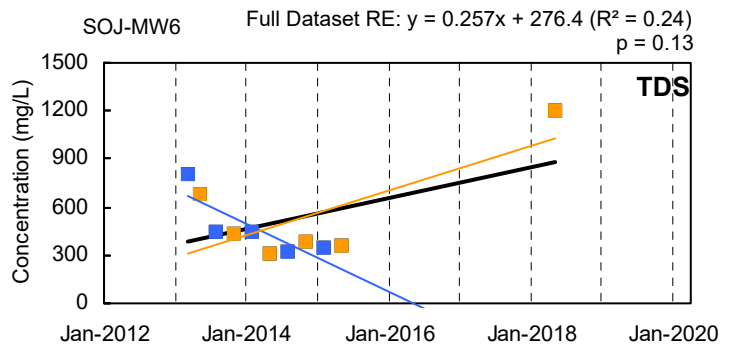
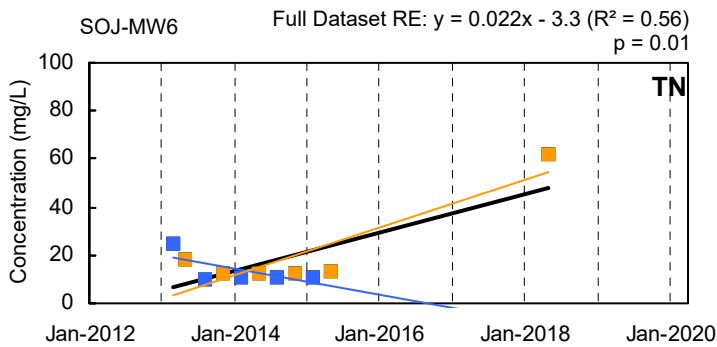
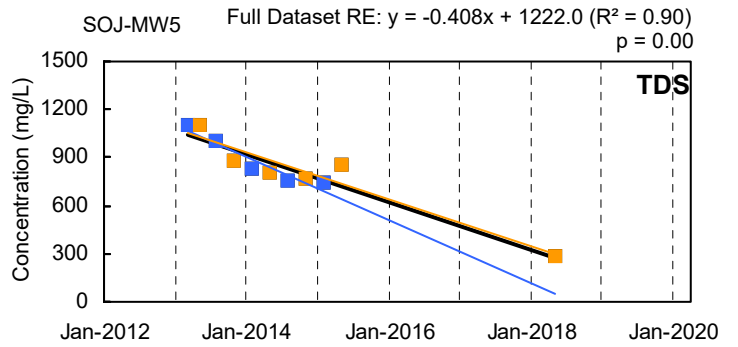
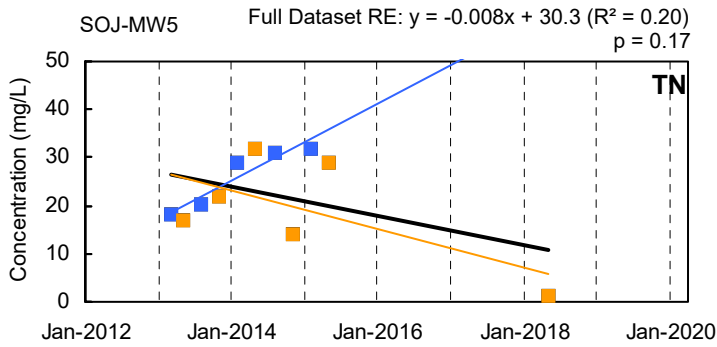
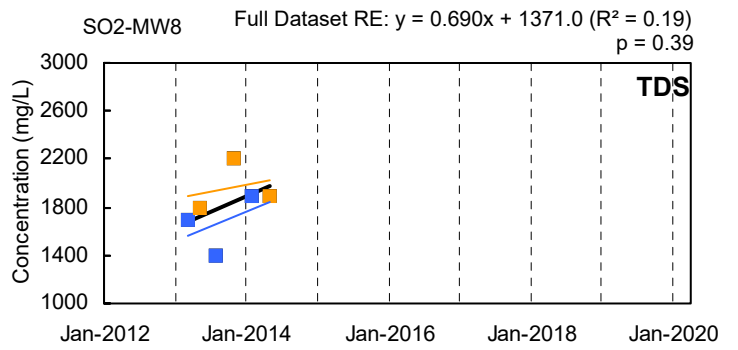
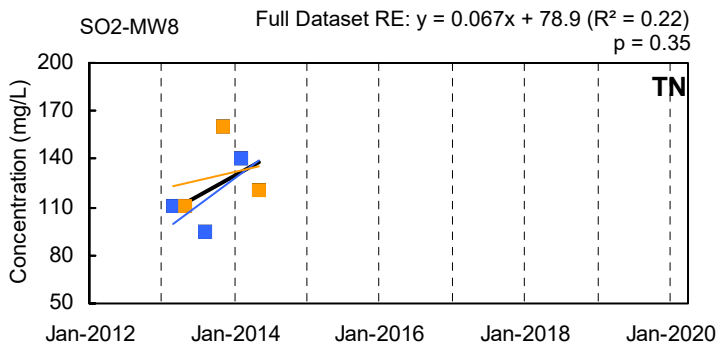

■ Q1/Q3 Result ■ Q2/Q4 Result
— Q1/Q3 Trendline — Q2/Q4 Trendline — Full Dataset Trendline

Attachment A14

Ordinary Least Squares Regression (OLSR) – Total Nitrogen and TDS (2012-2019) including Q1, Q2, Q3, Q4
Trendlines

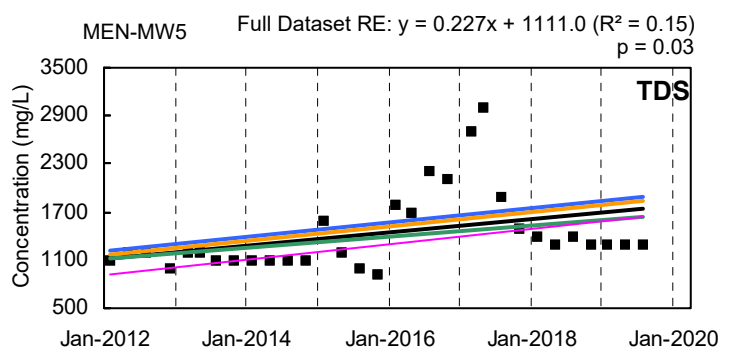
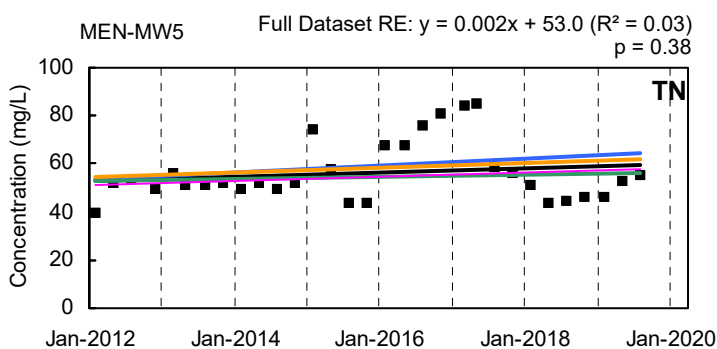
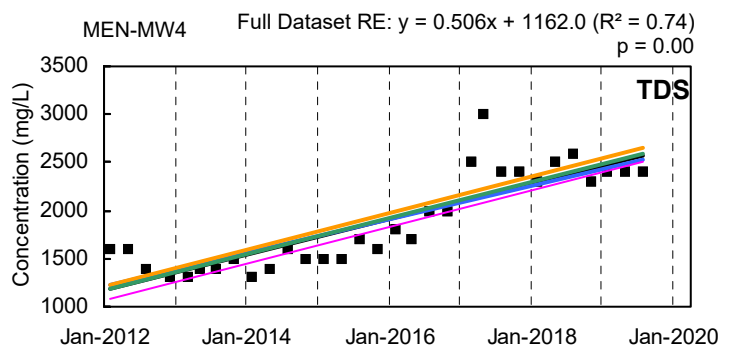
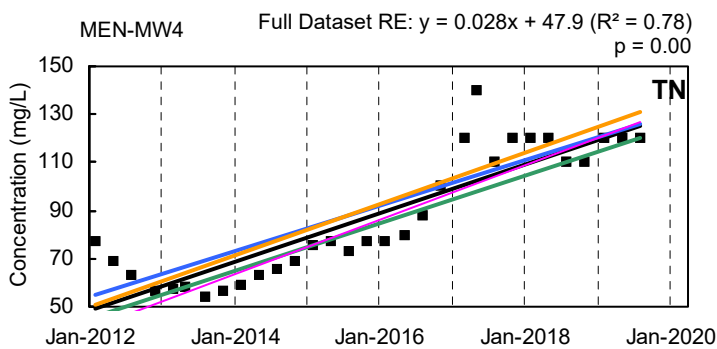
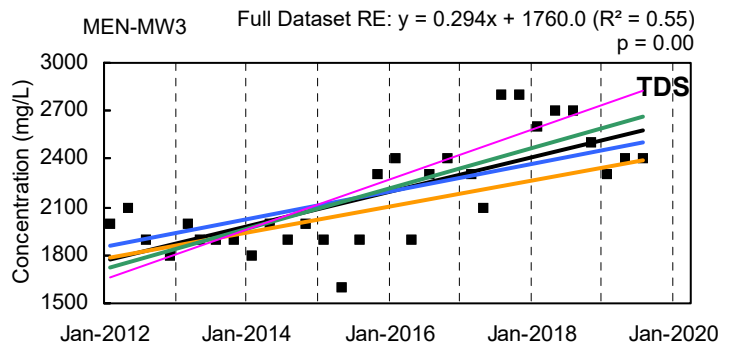
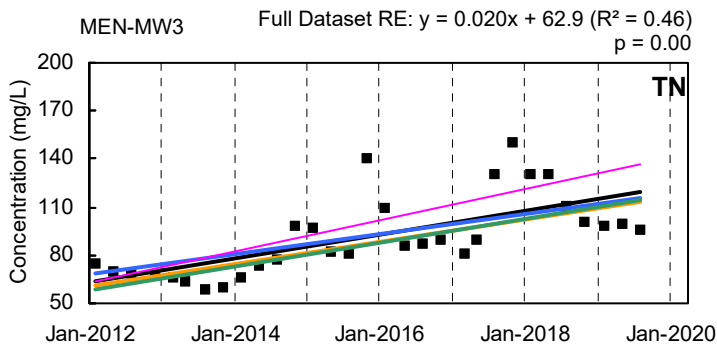
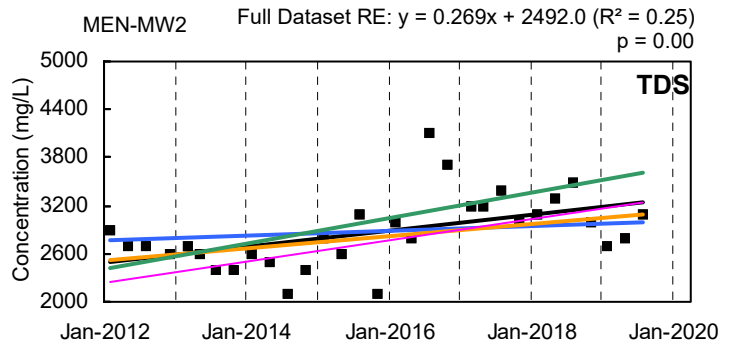
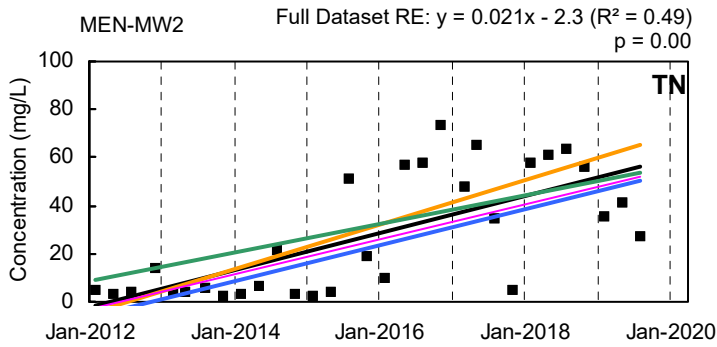
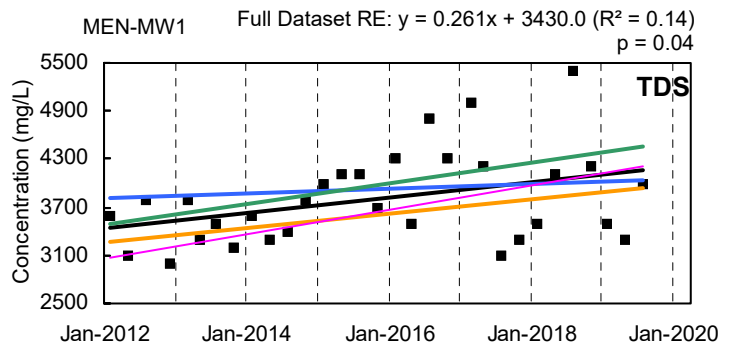
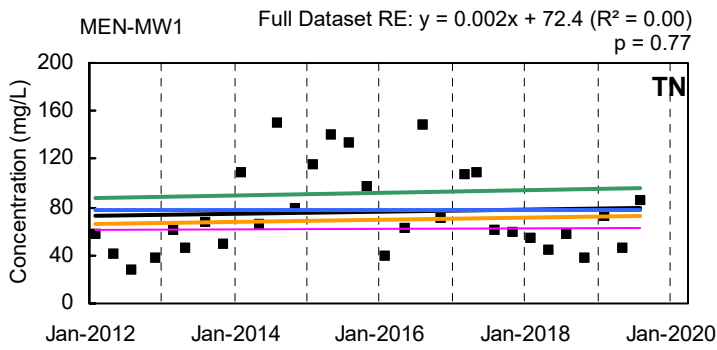

— Q1 Trendline — Q2 Trendline
— Q3 Trendline — Q4 Trendline — Full Dataset Trendline

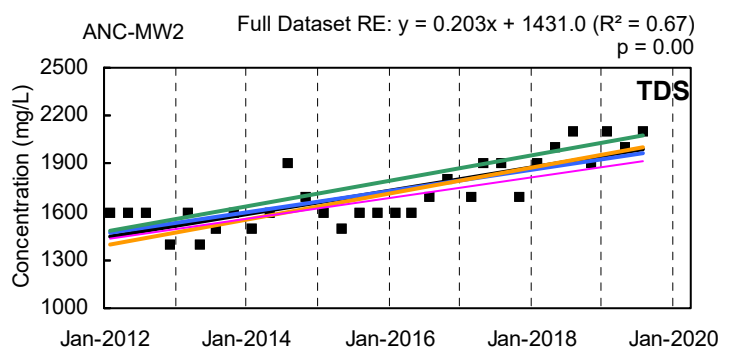
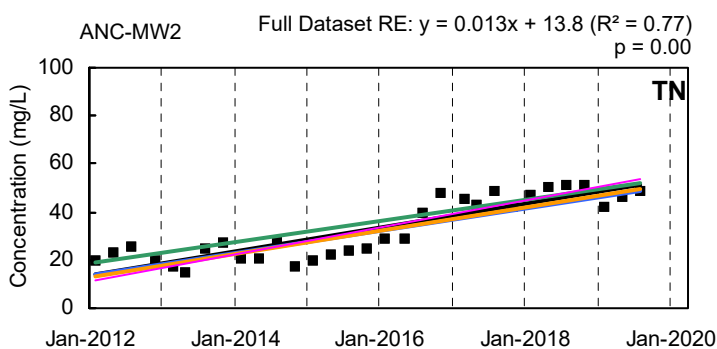
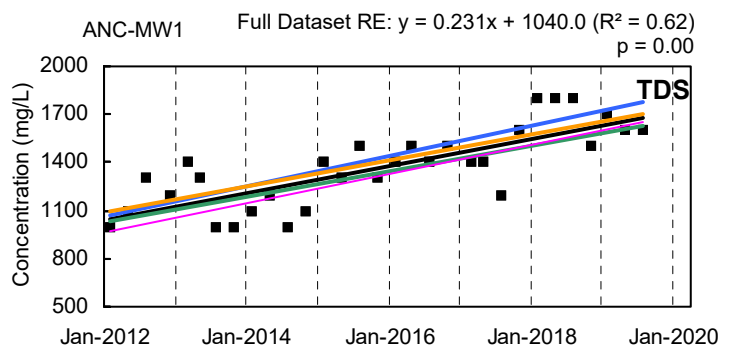
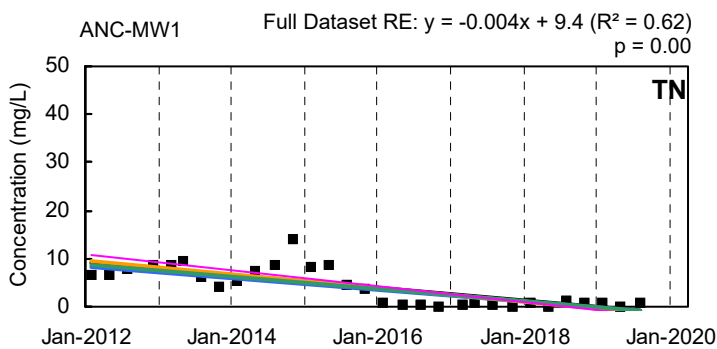
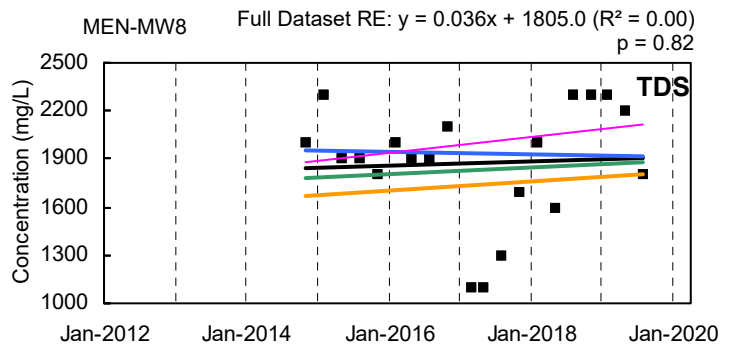
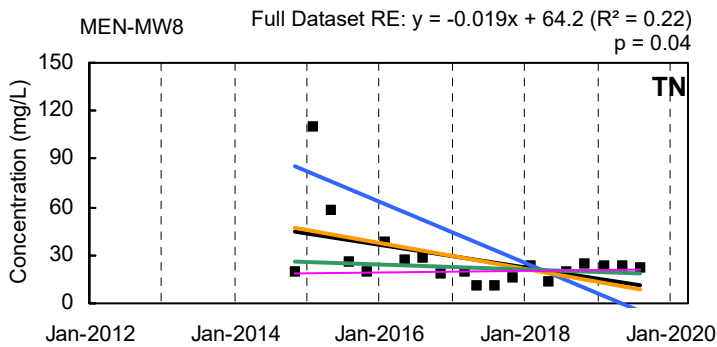
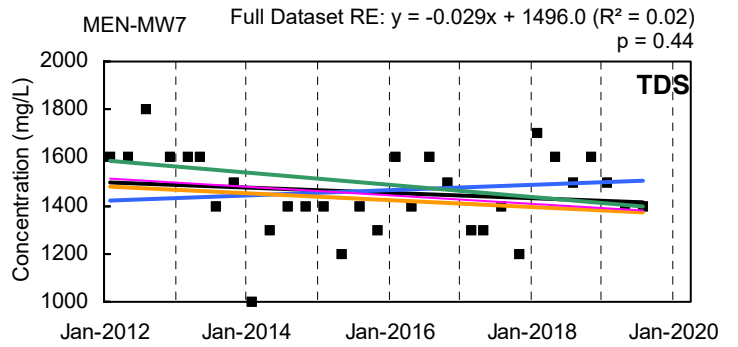
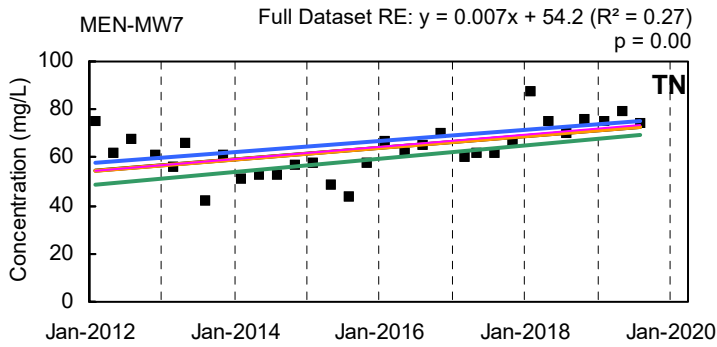
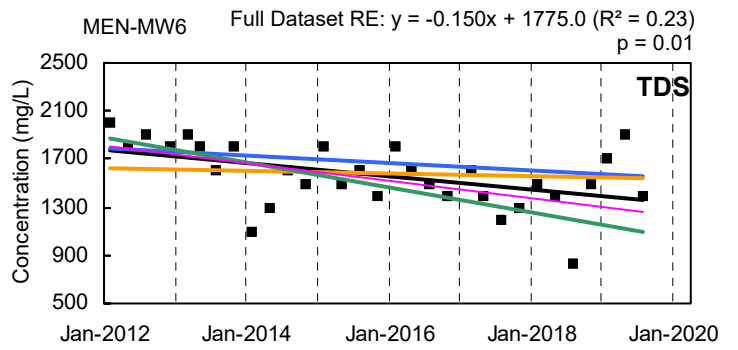
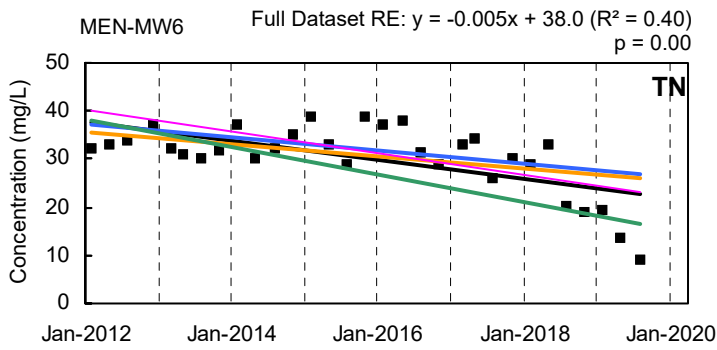

— Q1 Trendline — Q2 Trendline
— Q3 Trendline — Q4 Trendline — Full Dataset Trendline

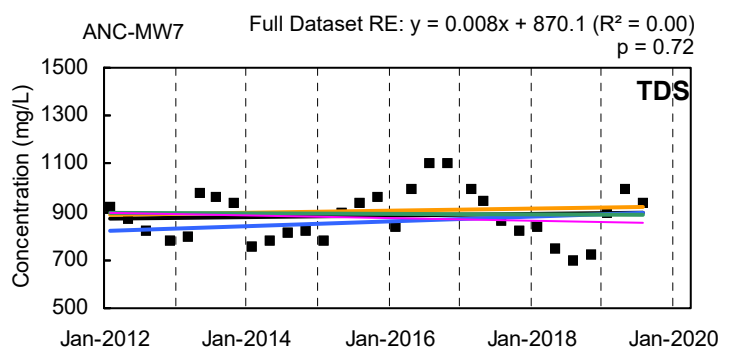
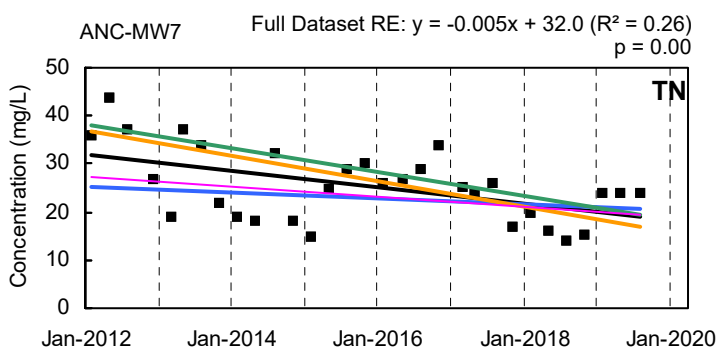
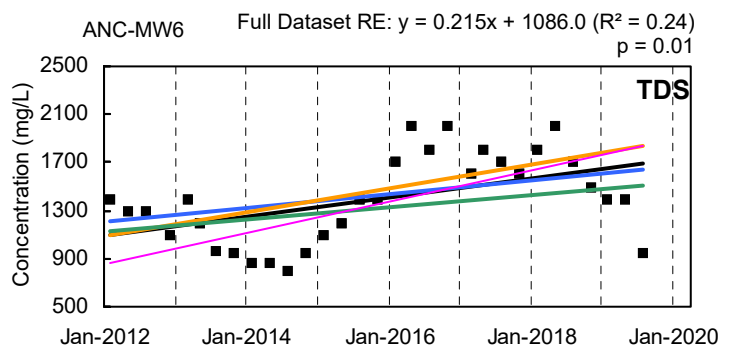
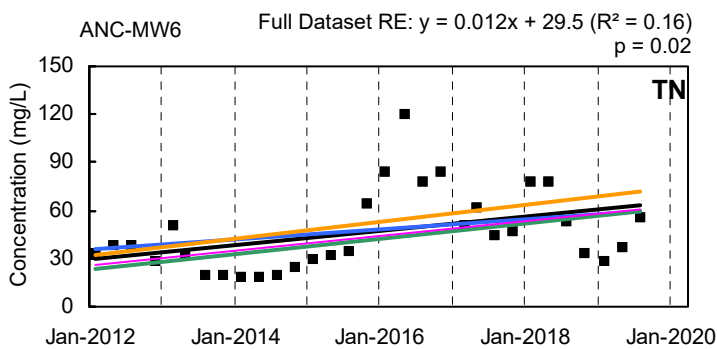
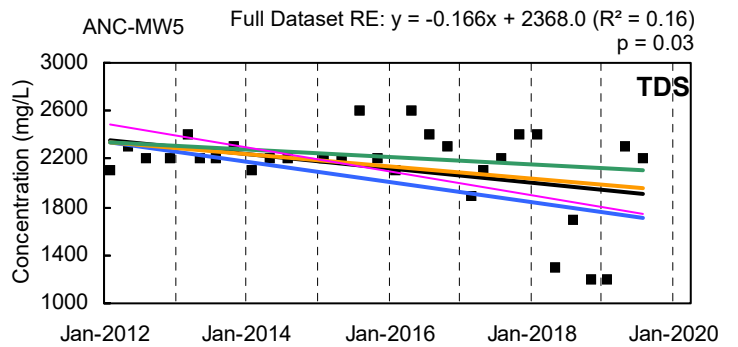
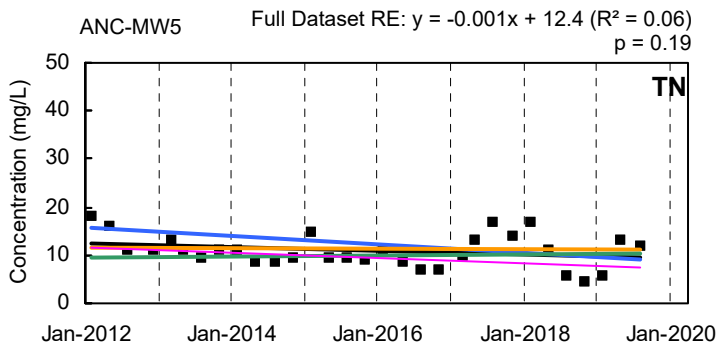
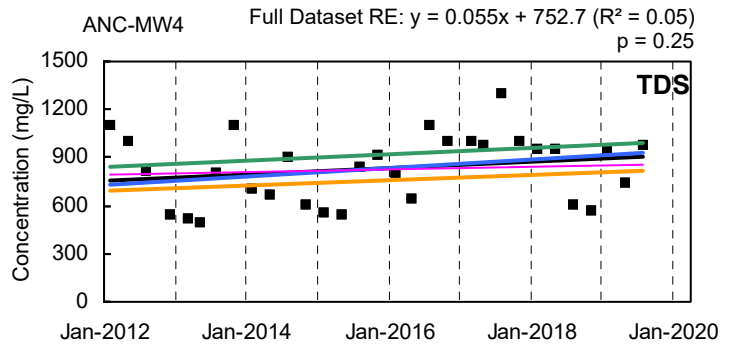
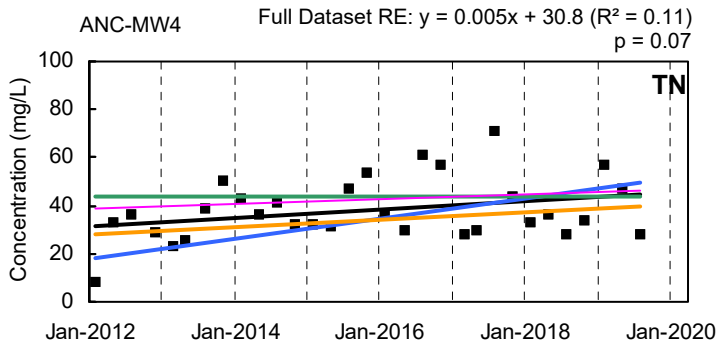
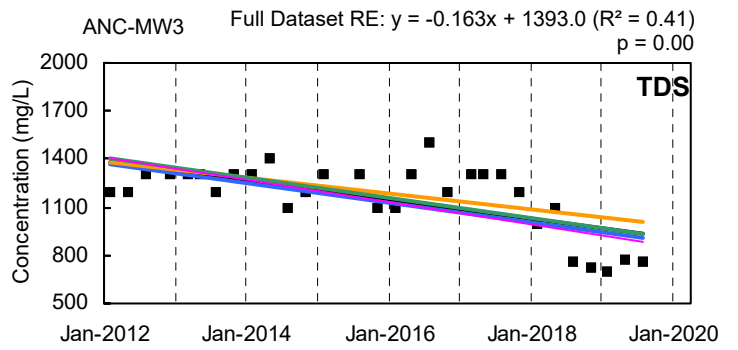
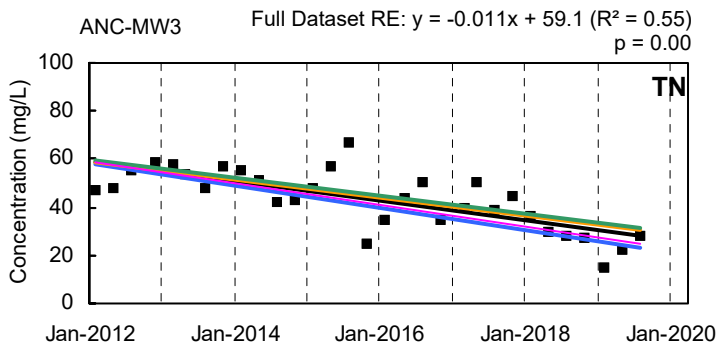

— Q1 Trendline — Q2 Trendline
— Q3 Trendline — Q4 Trendline — Full Dataset Trendline

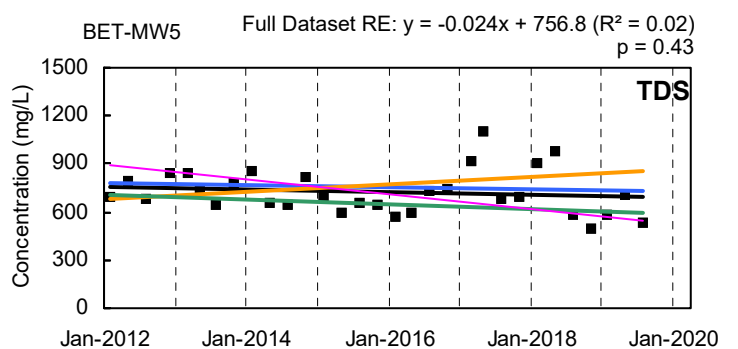
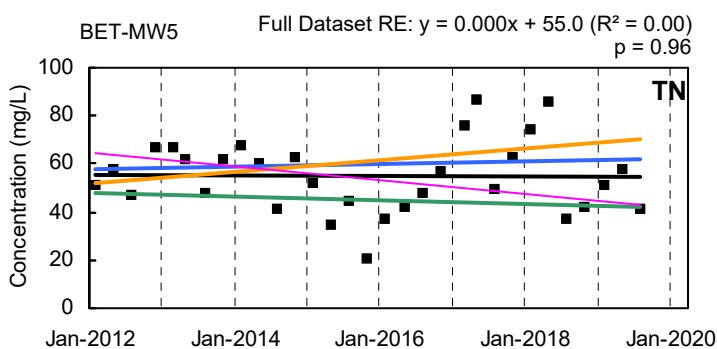
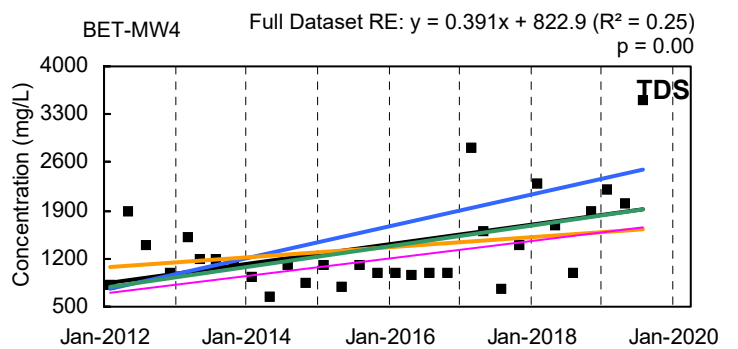
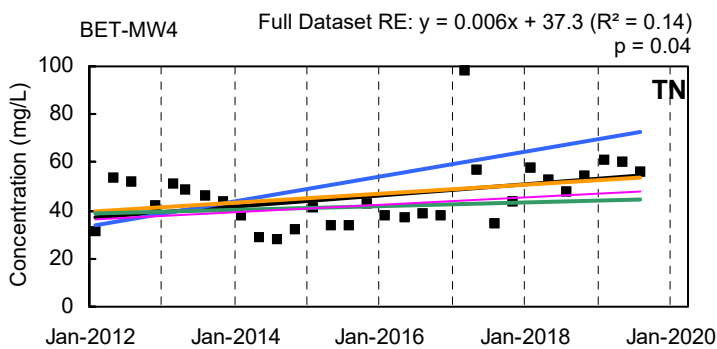
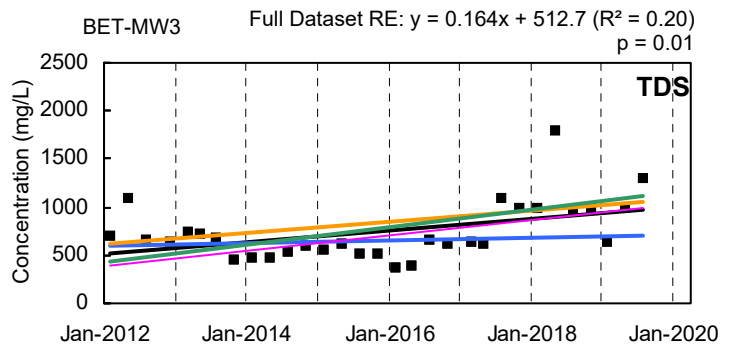
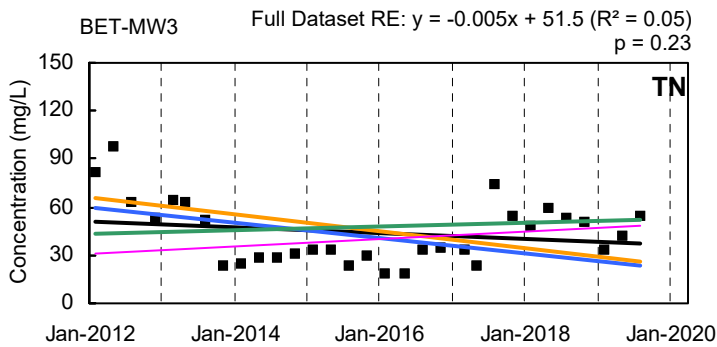
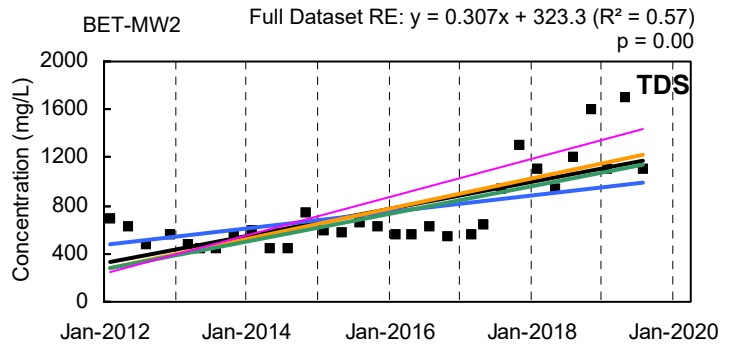
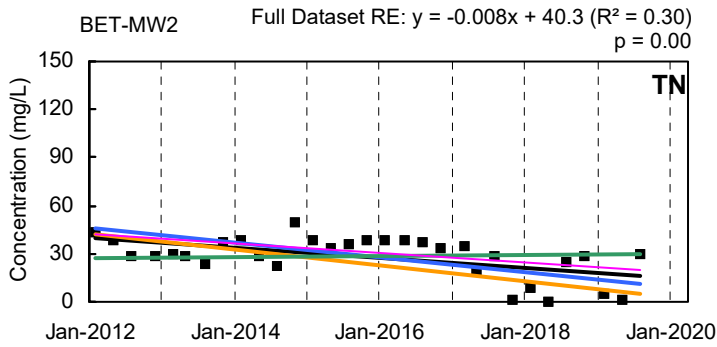
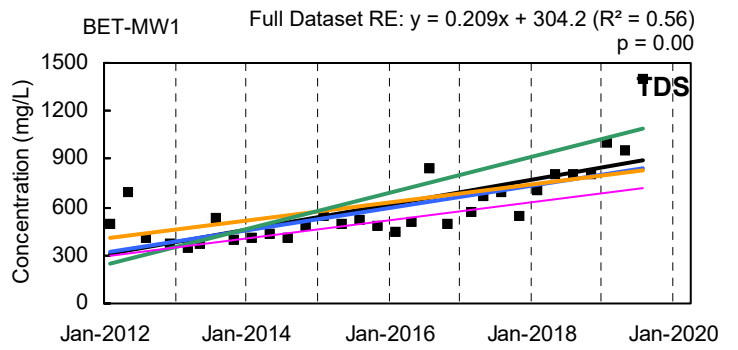
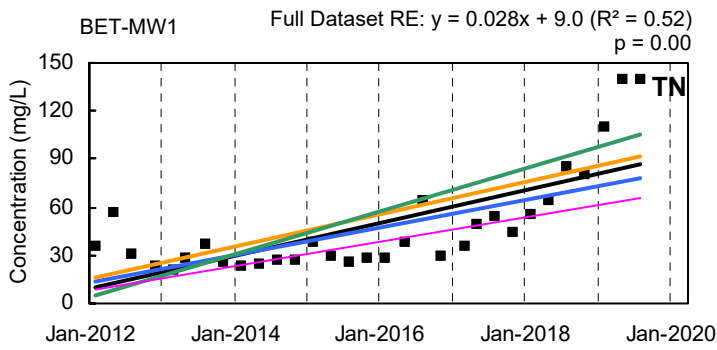

— Q1 Trendline — Q2 Trendline
— Q3 Trendline — Q4 Trendline — Full Dataset Trendline

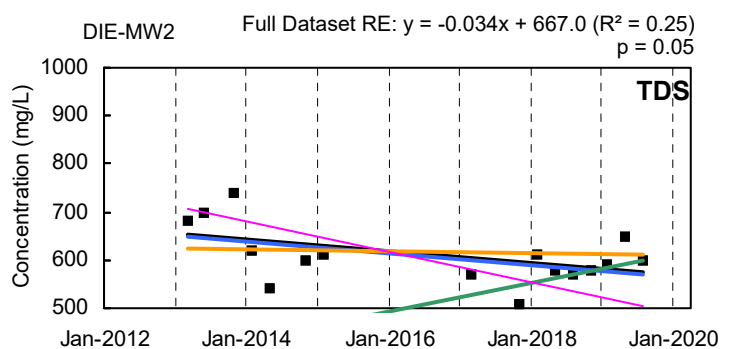
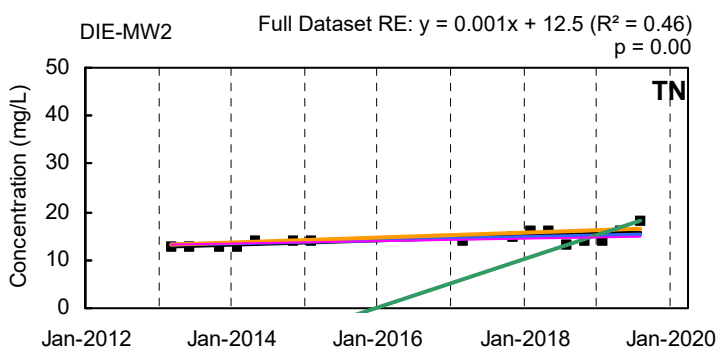
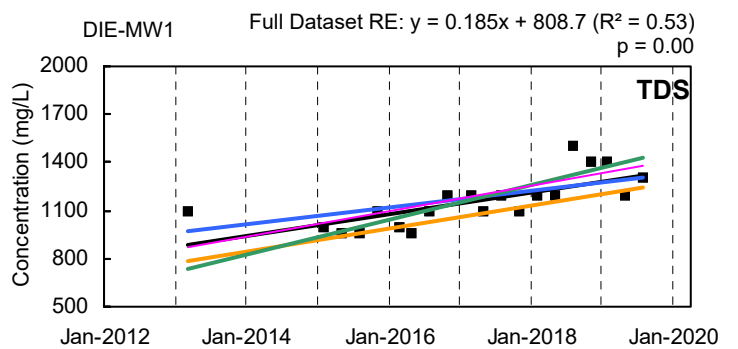
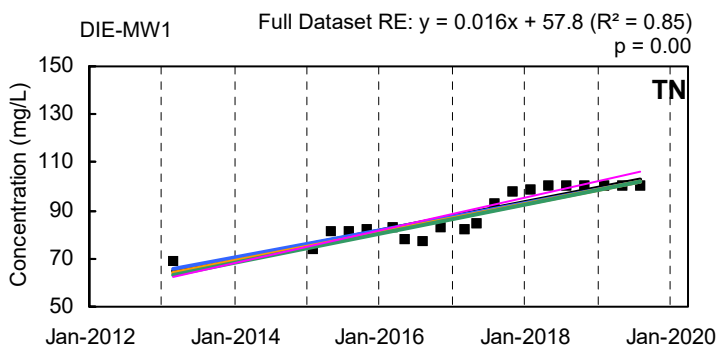
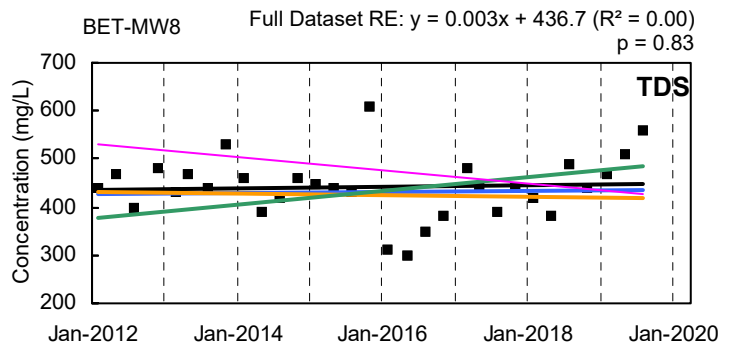
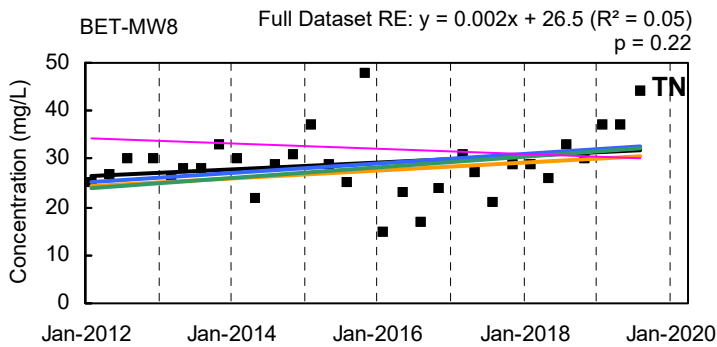
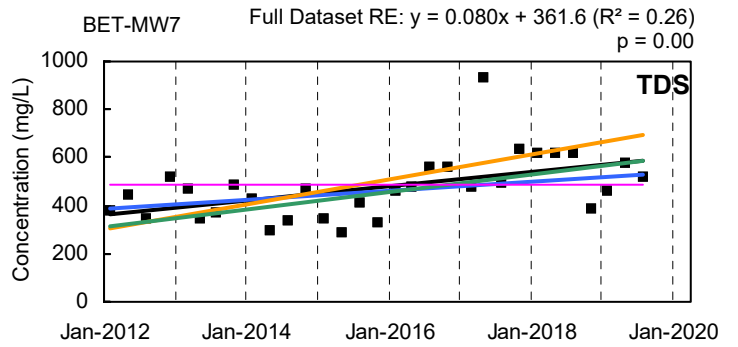
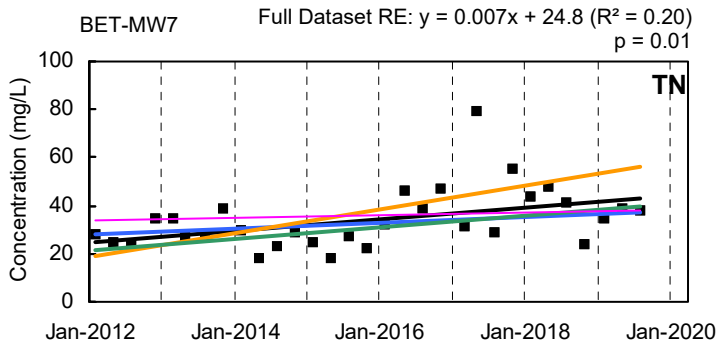
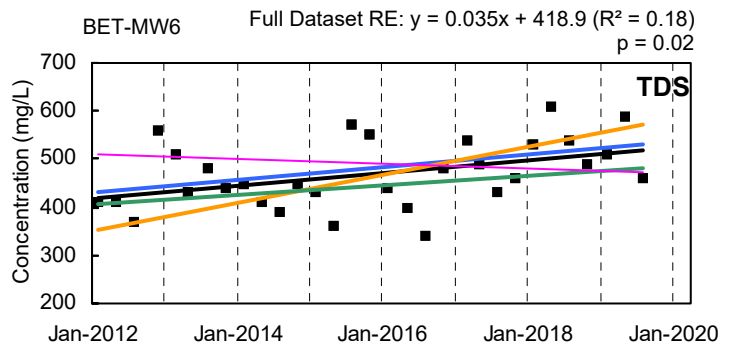
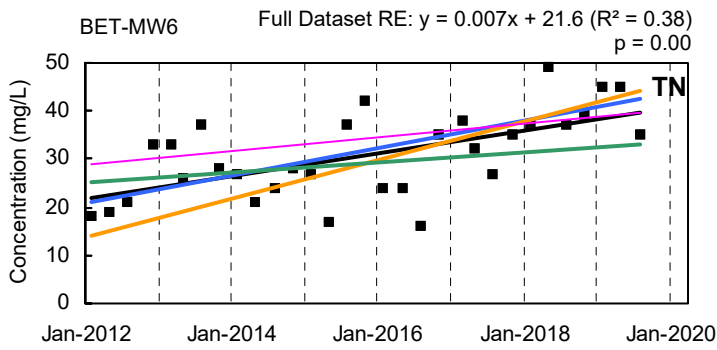

— Q1 Trendline — Q2 Trendline
— Q3 Trendline — Q4 Trendline — Full Dataset Trendline

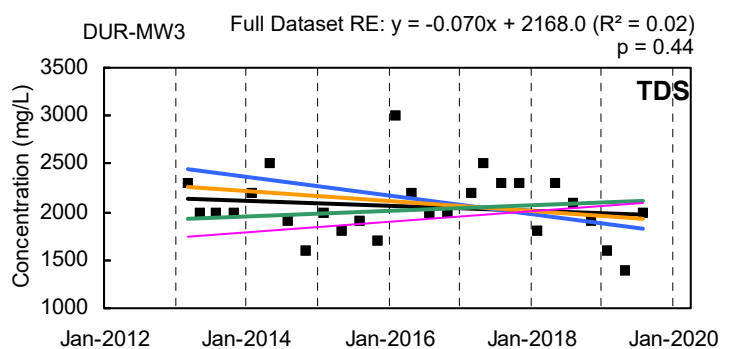
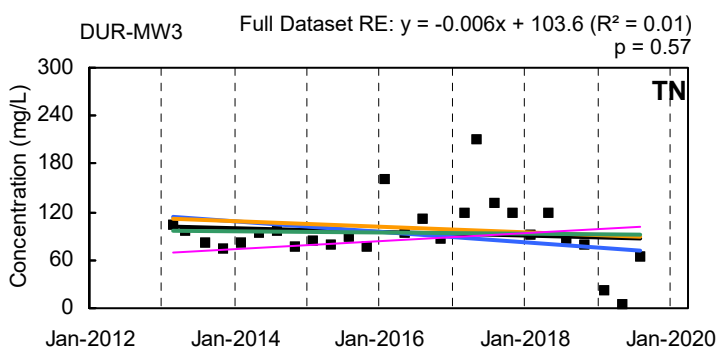
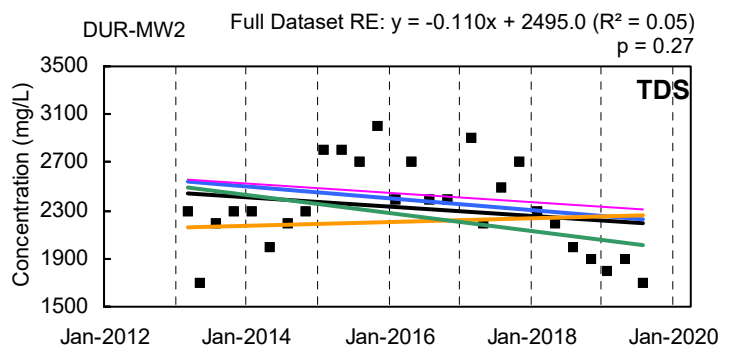
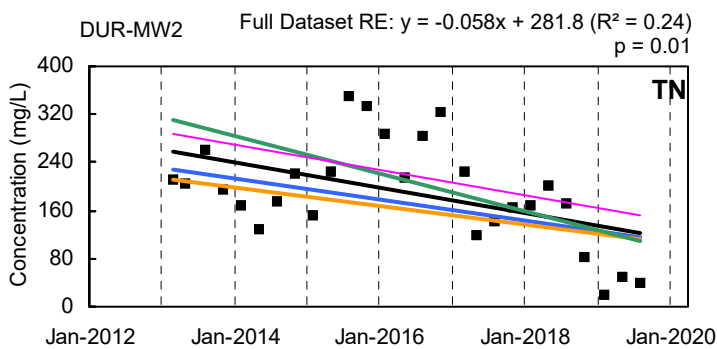
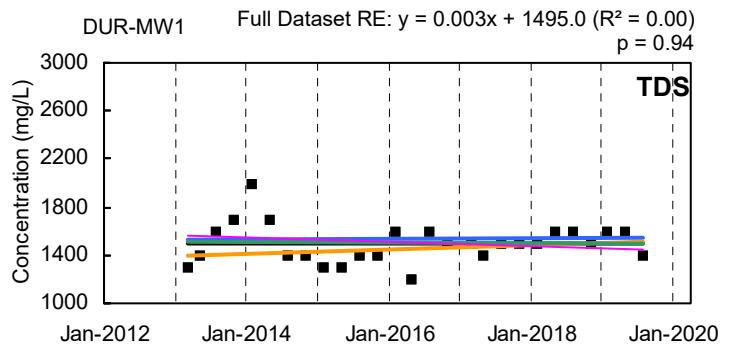
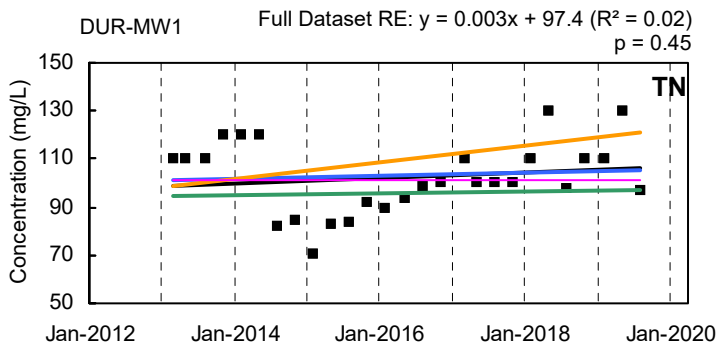
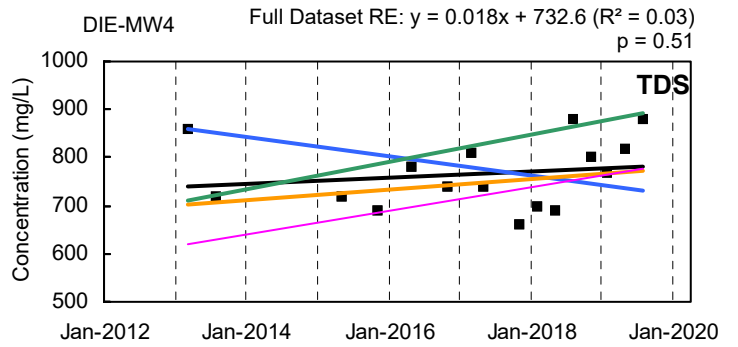
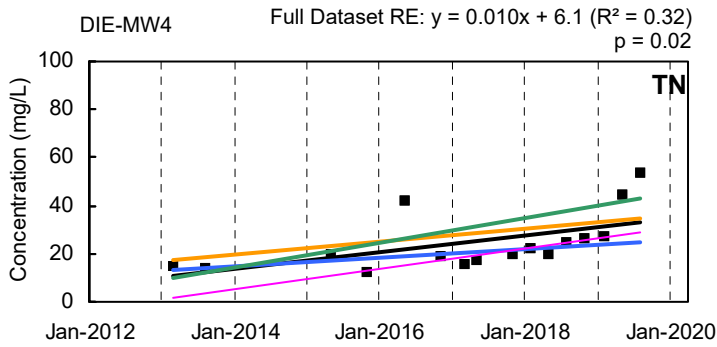
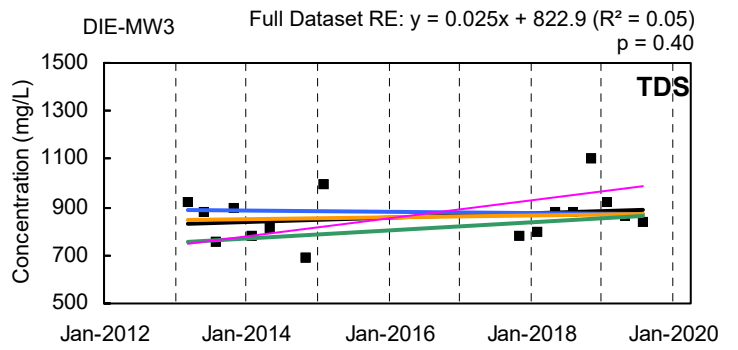
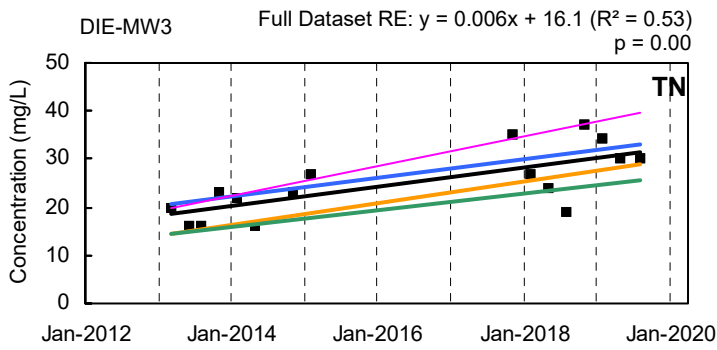

— Q1 Trendline — Q2 Trendline
— Q3 Trendline — Q4 Trendline — Full Dataset Trendline

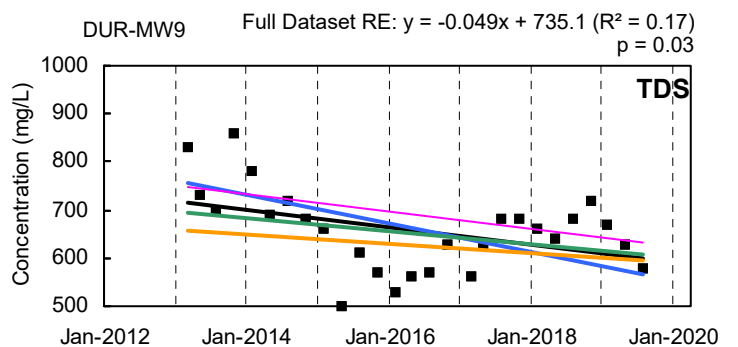
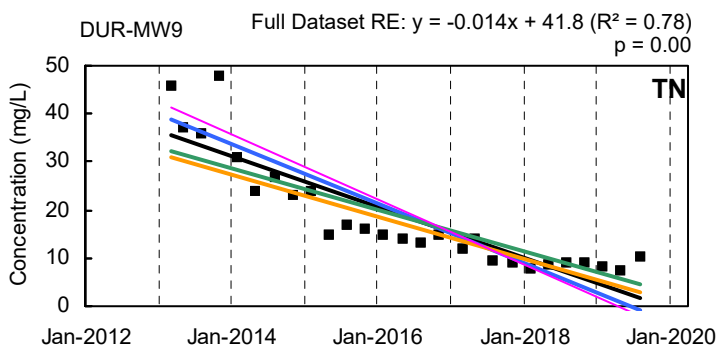
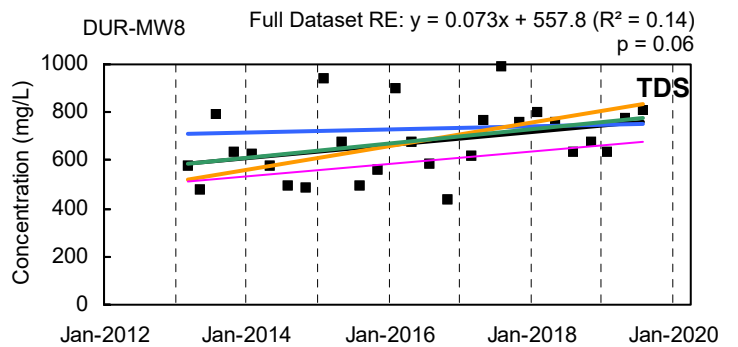
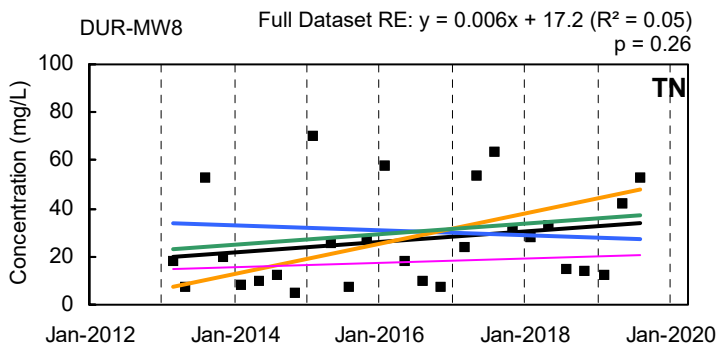
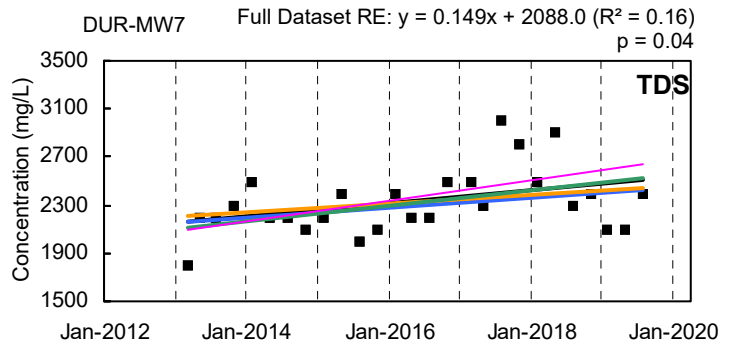
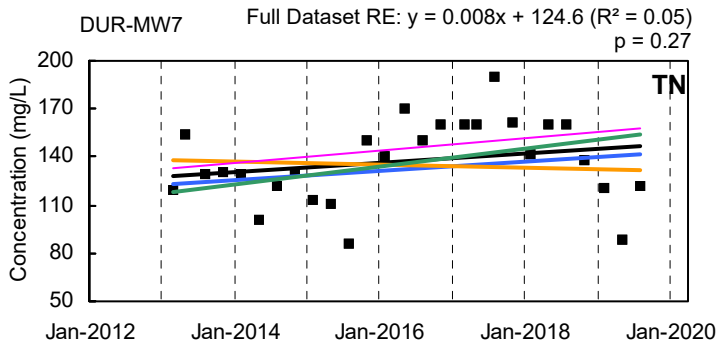
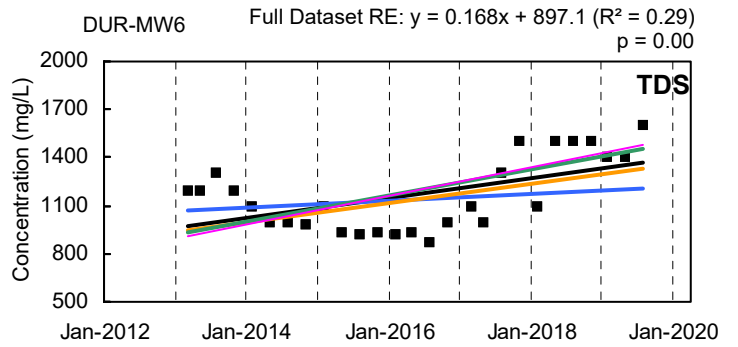
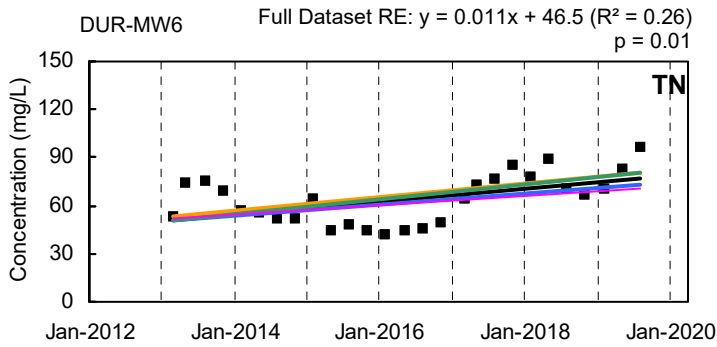
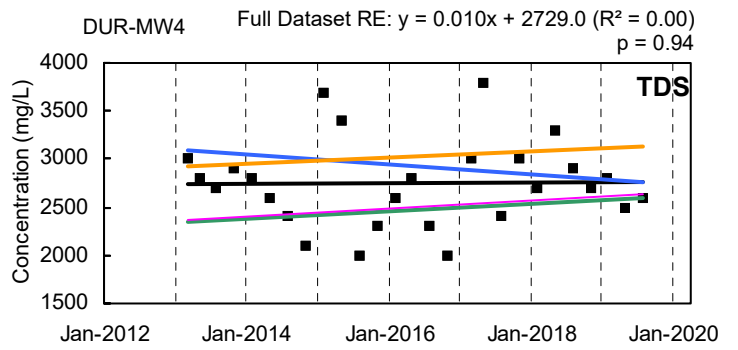
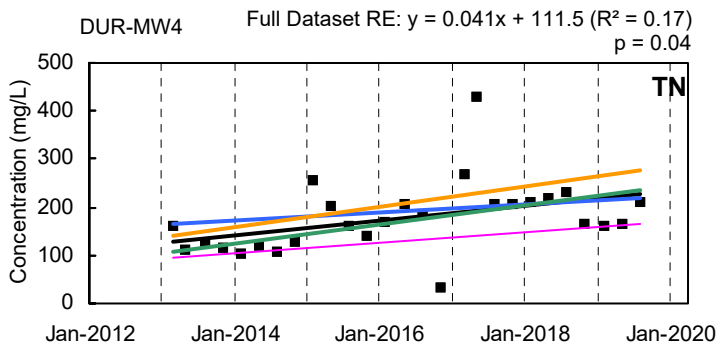

— Q1 Trendline — Q2 Trendline
— Q3 Trendline — Q4 Trendline — Full Dataset Trendline

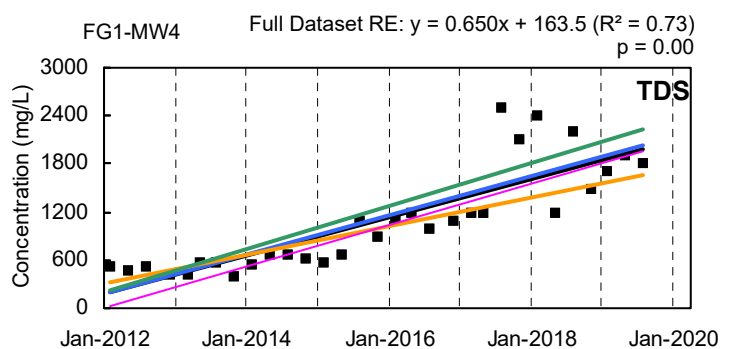
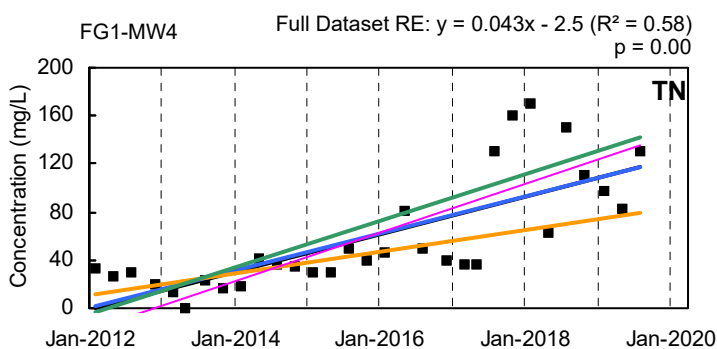
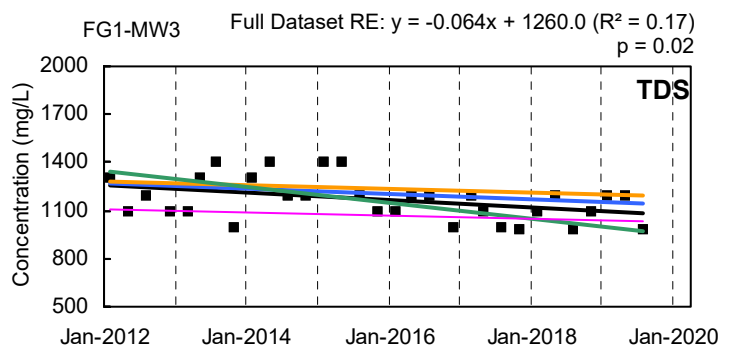
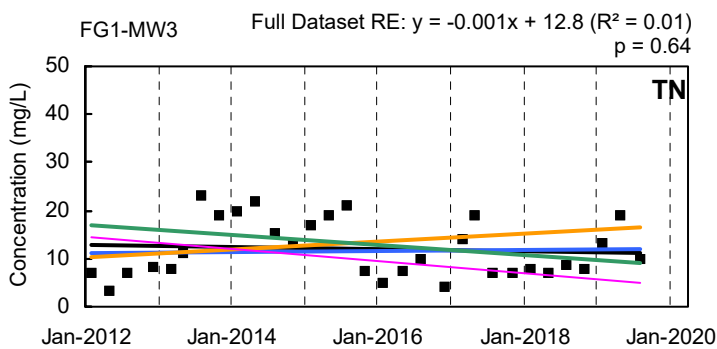
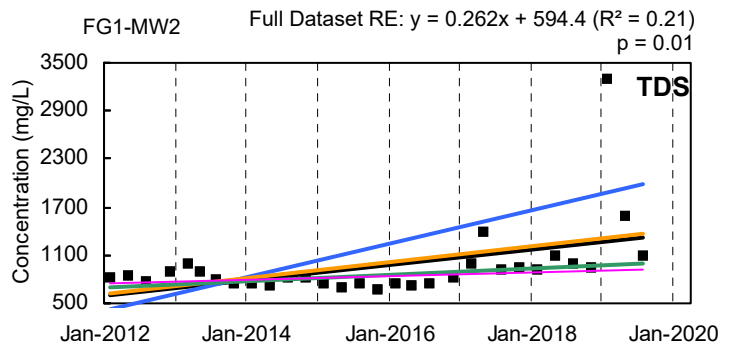
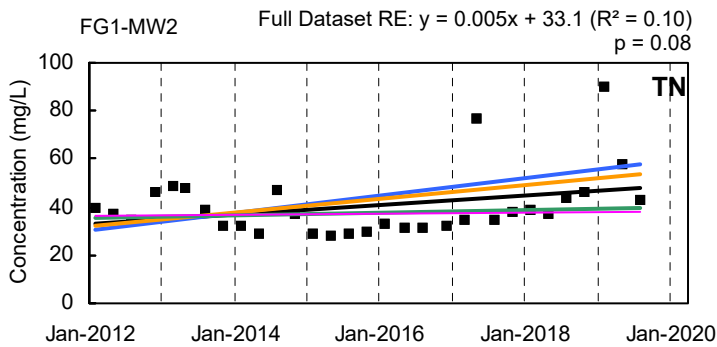
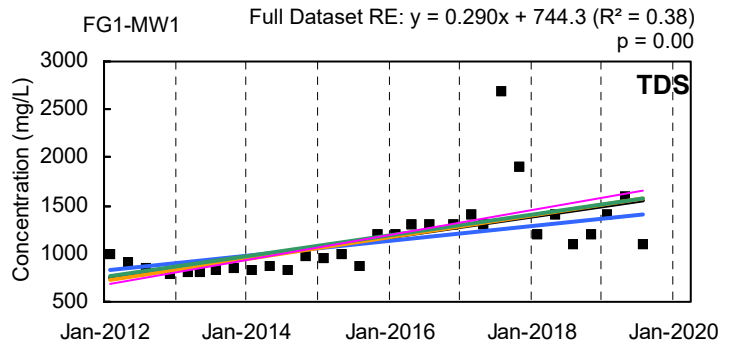
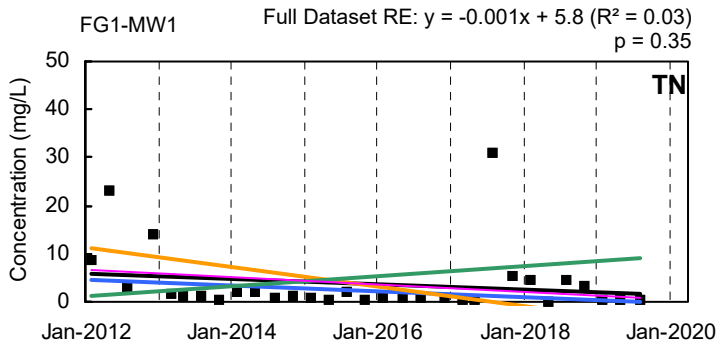
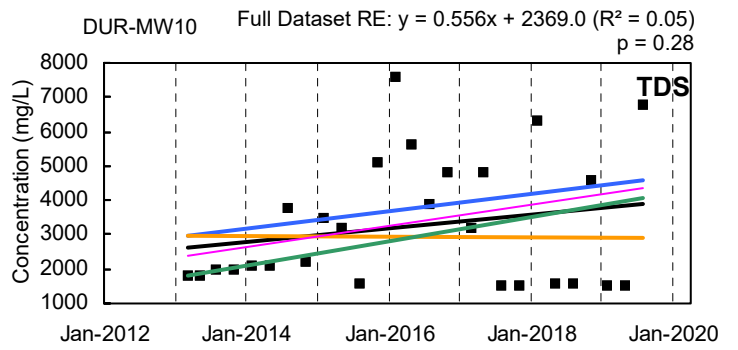
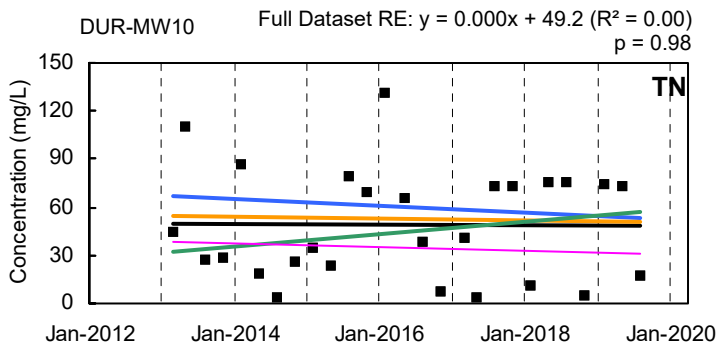

— Q1 Trendline — Q2 Trendline
— Q3 Trendline — Q4 Trendline — Full Dataset Trendline

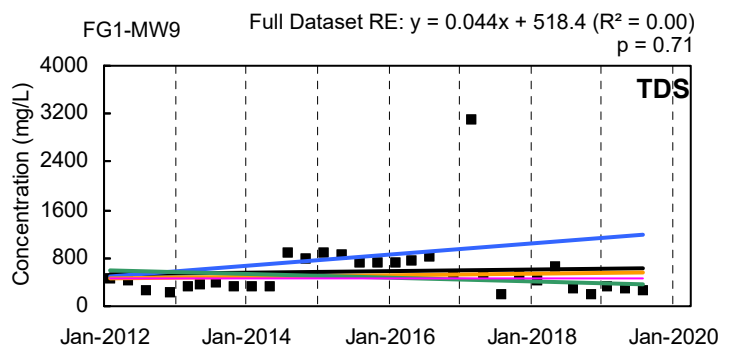
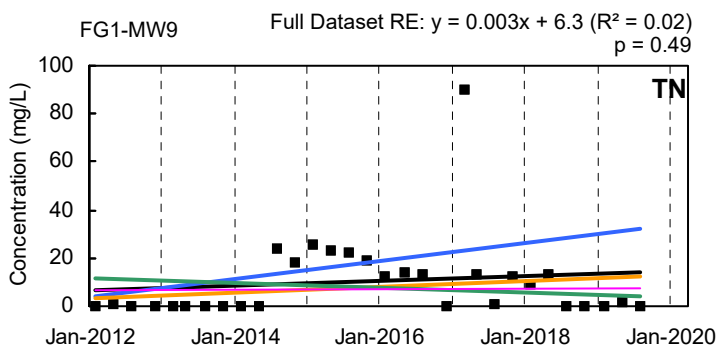
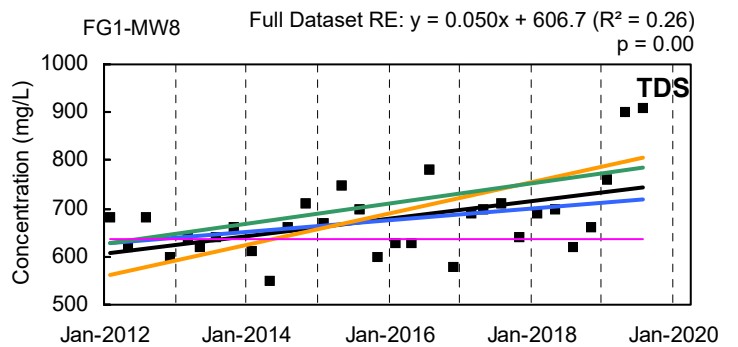
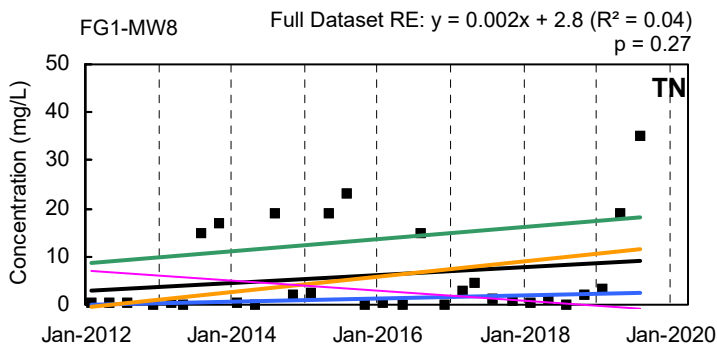
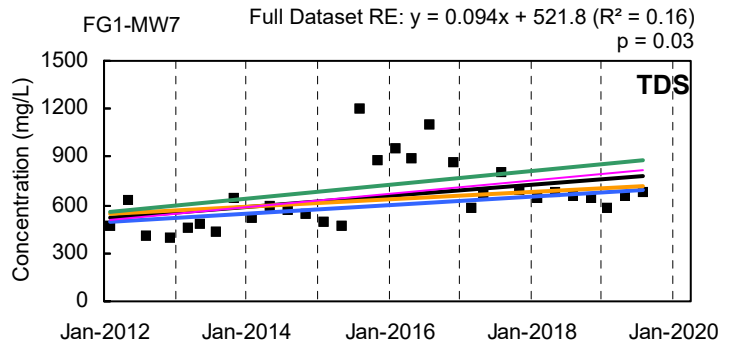
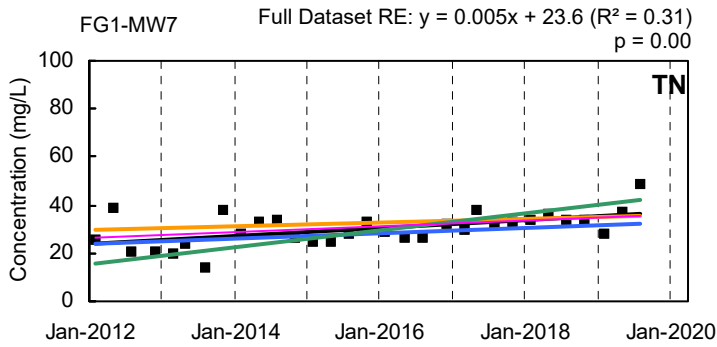
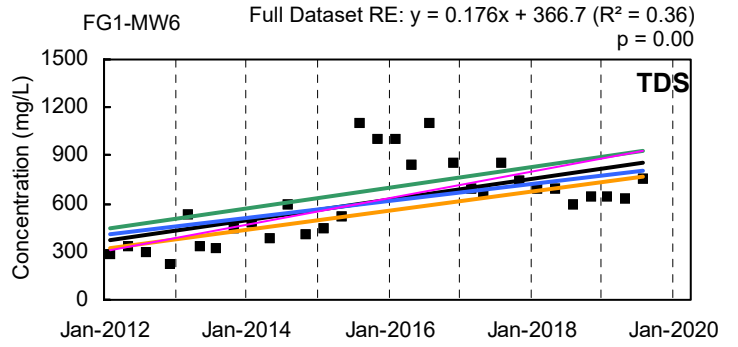
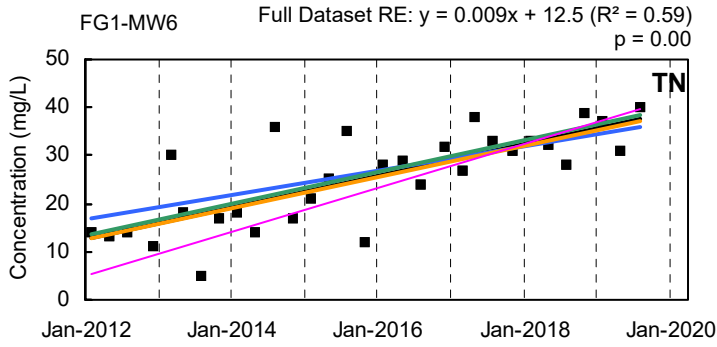
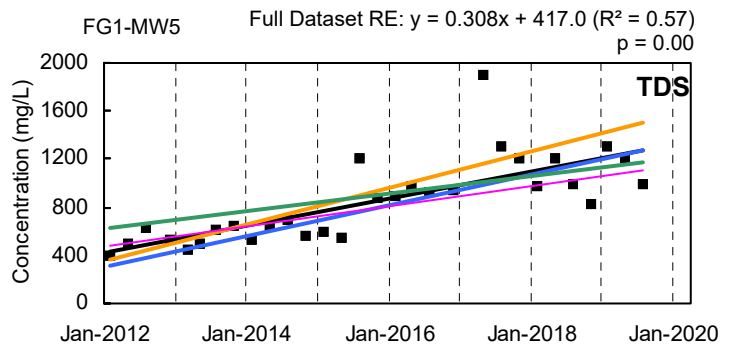
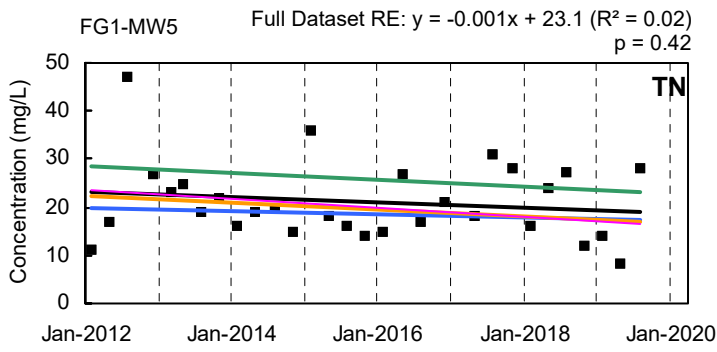

— Q1 Trendline — Q2 Trendline
— Q3 Trendline — Q4 Trendline — Full Dataset Trendline

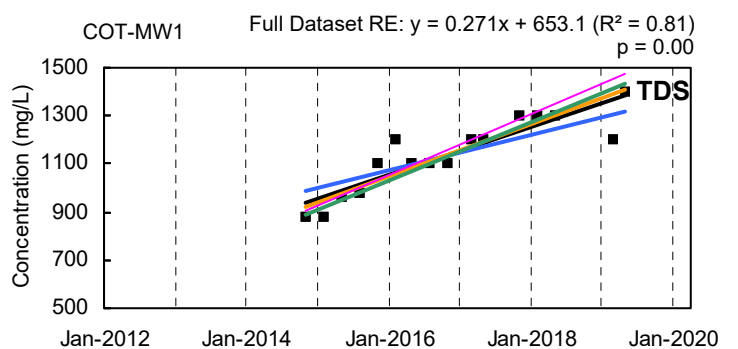
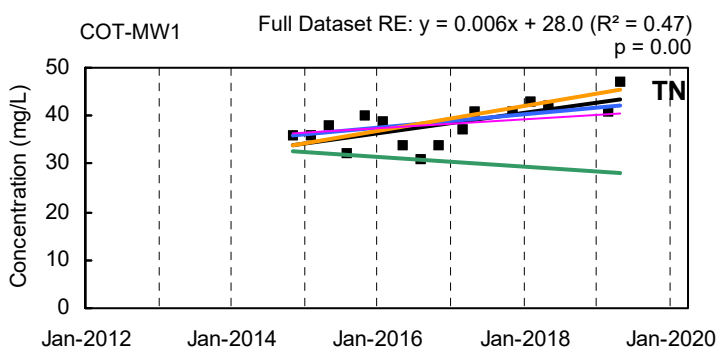
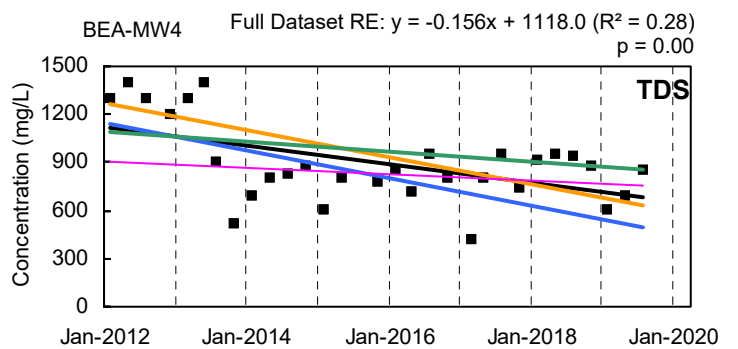
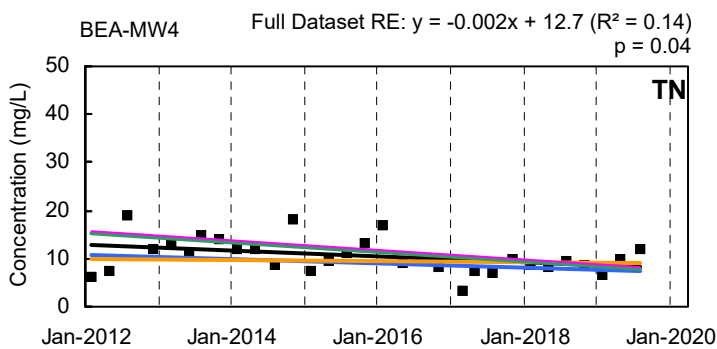
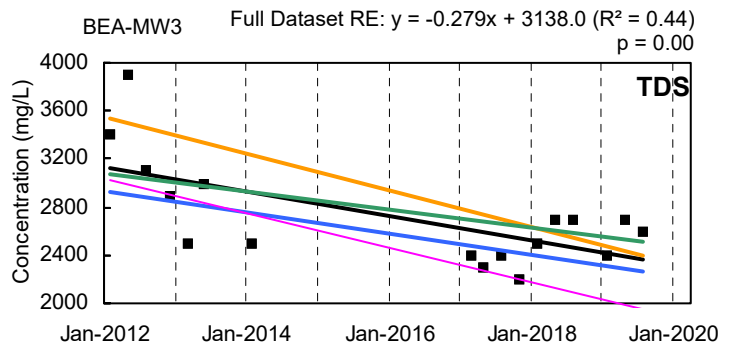
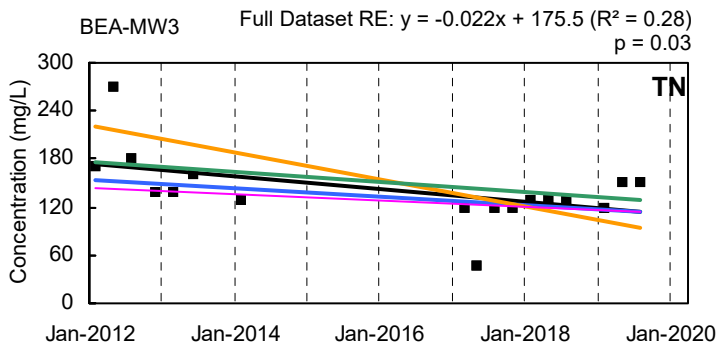
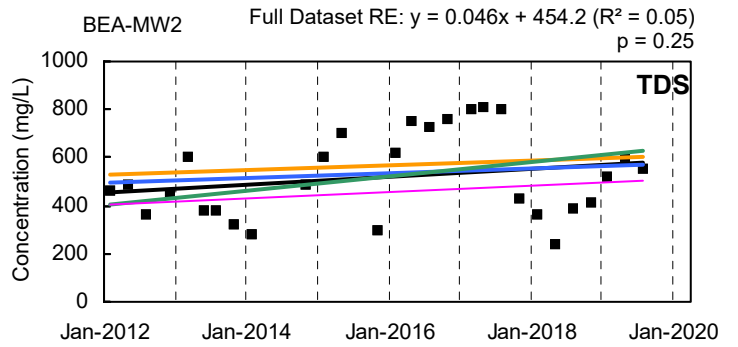
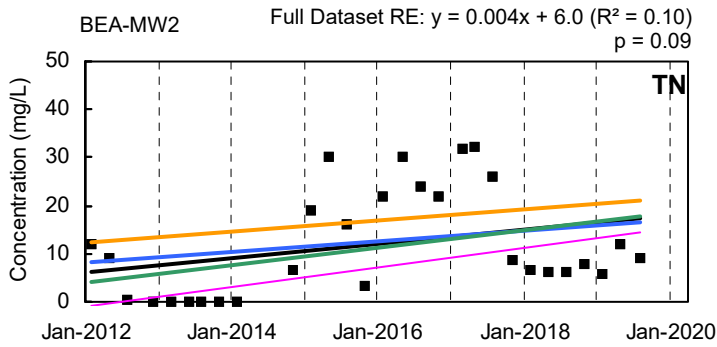
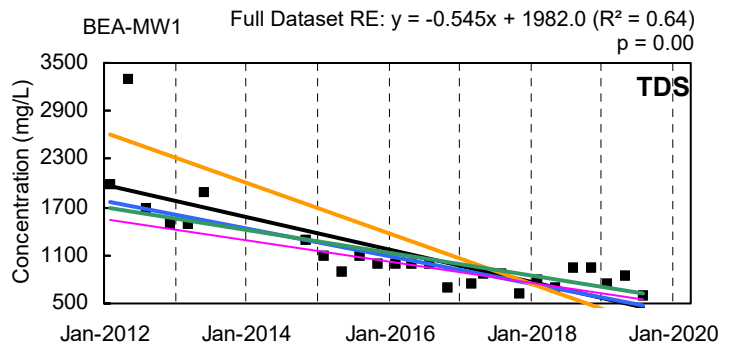
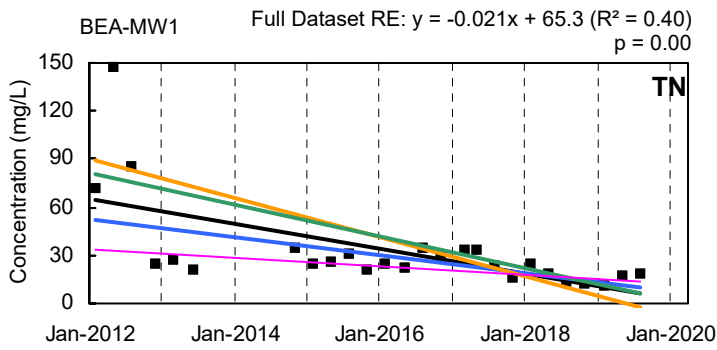

— Q1 Trendline — Q2 Trendline
— Q3 Trendline — Q4 Trendline — Full Dataset Trendline

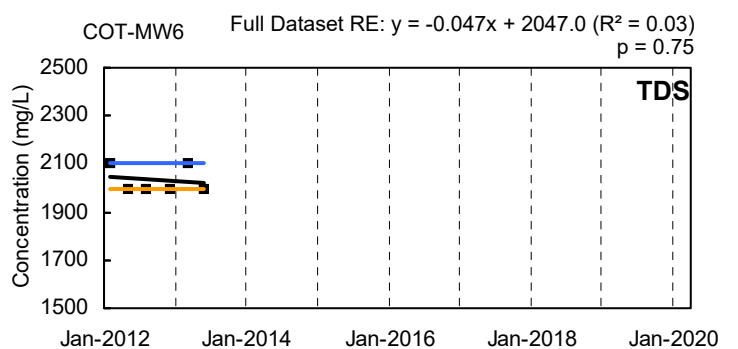
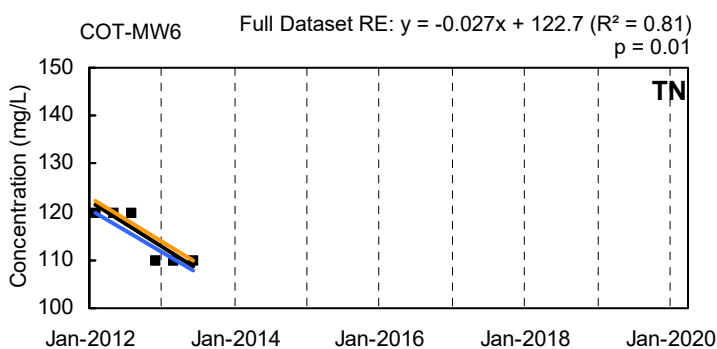
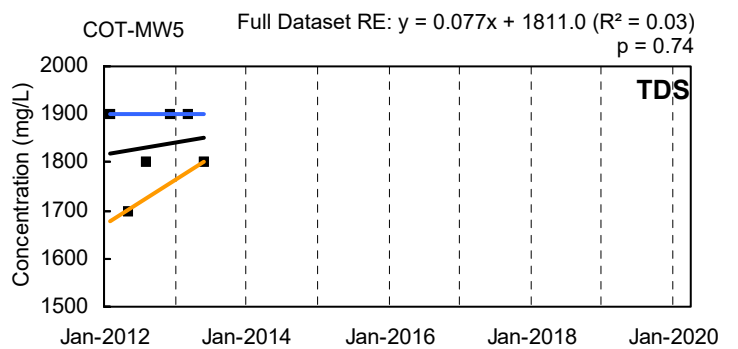
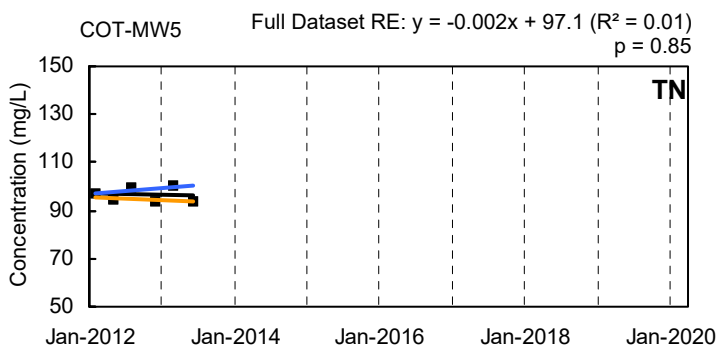
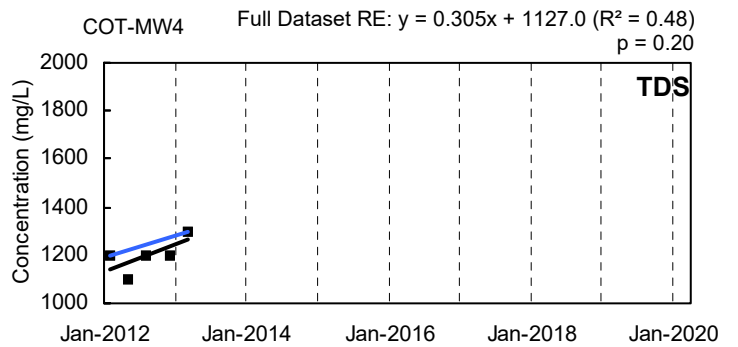
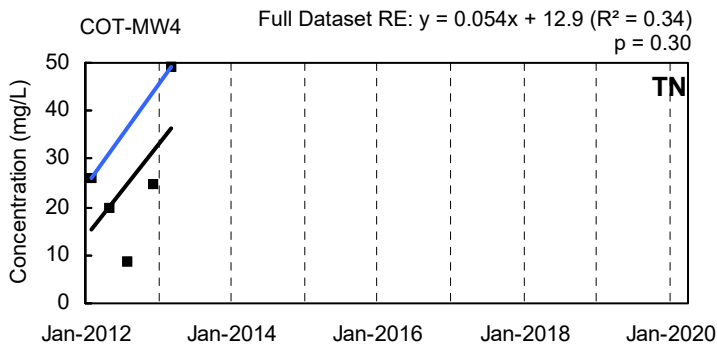
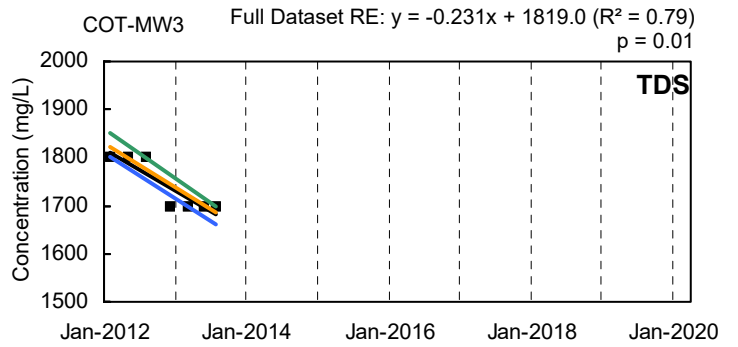
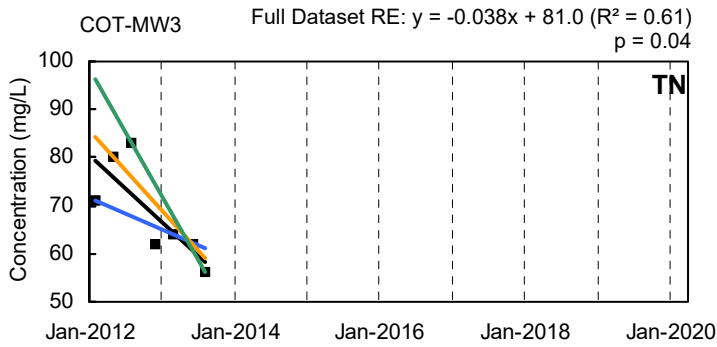
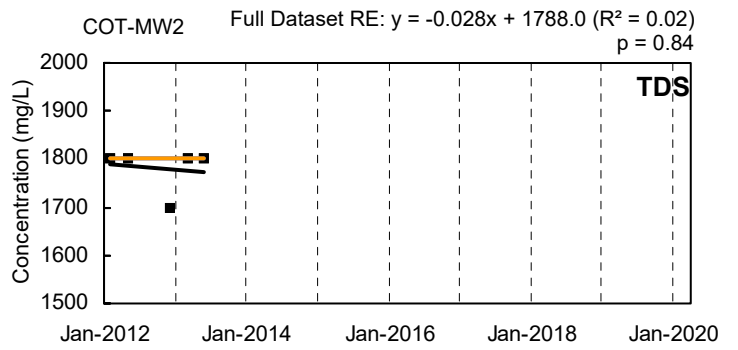
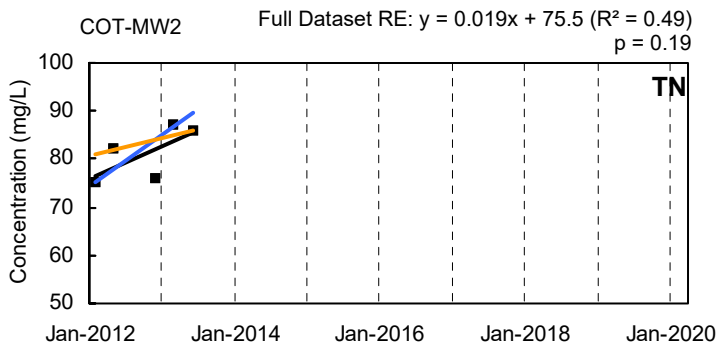

— Q1 Trendline — Q2 Trendline
— Q3 Trendline — Q4 Trendline — Full Dataset Trendline

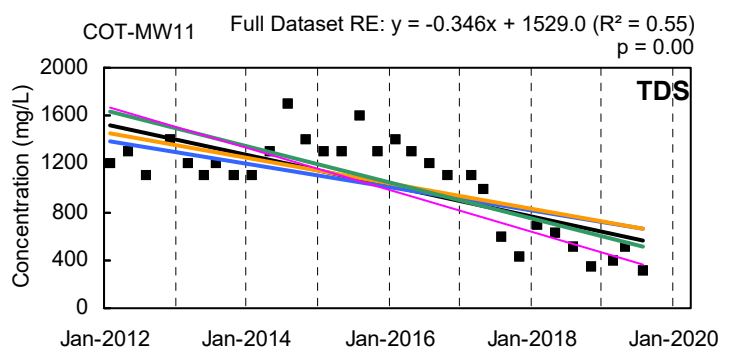
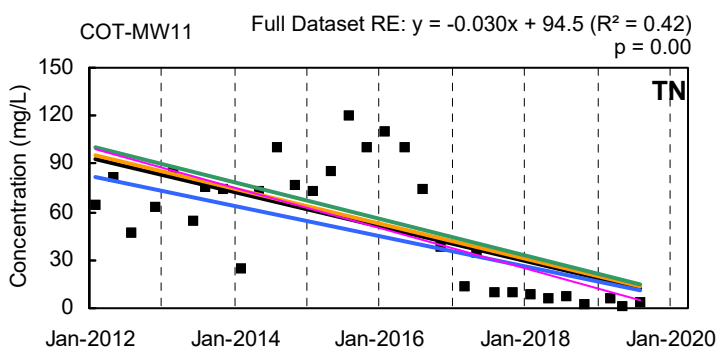
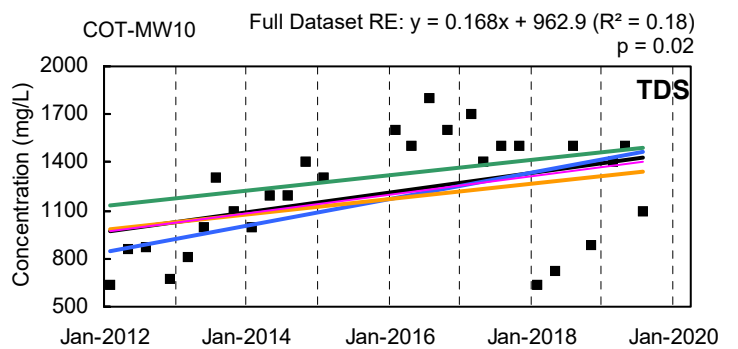
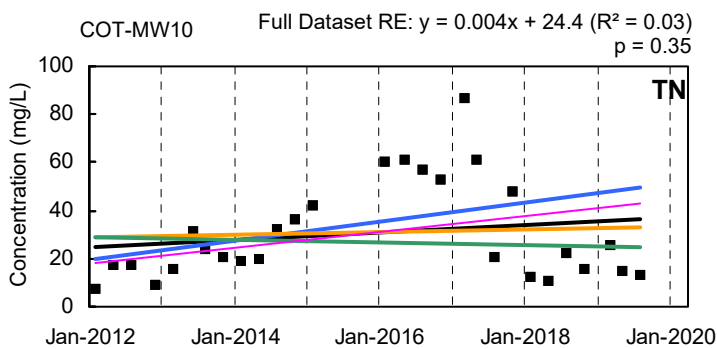
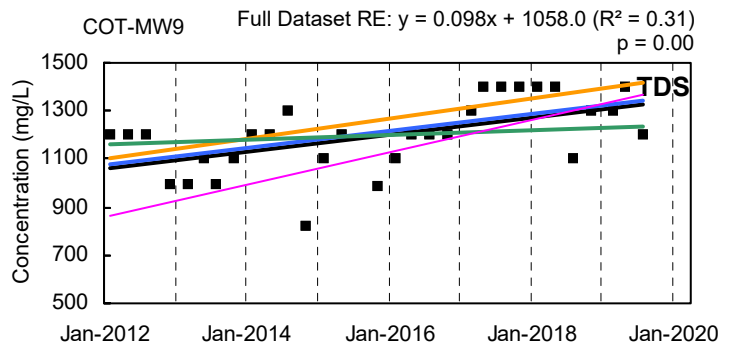
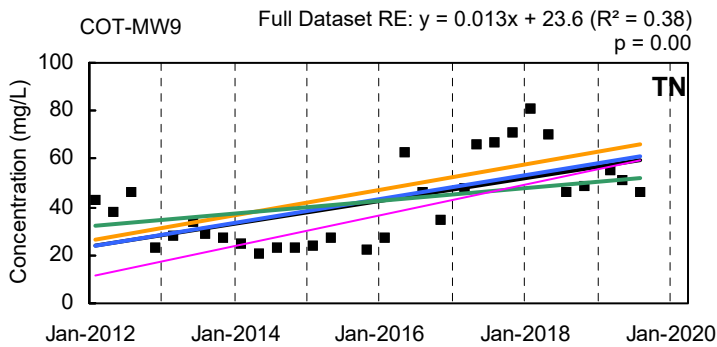
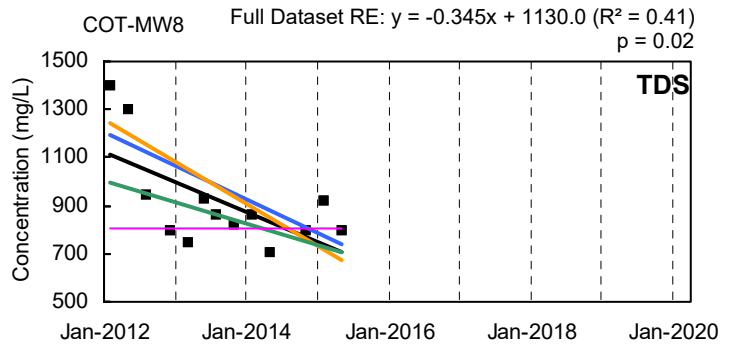
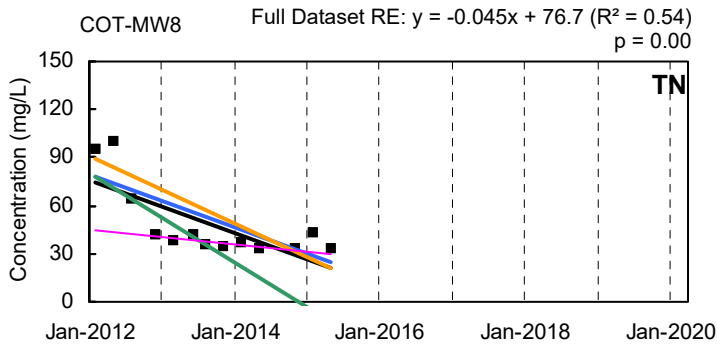
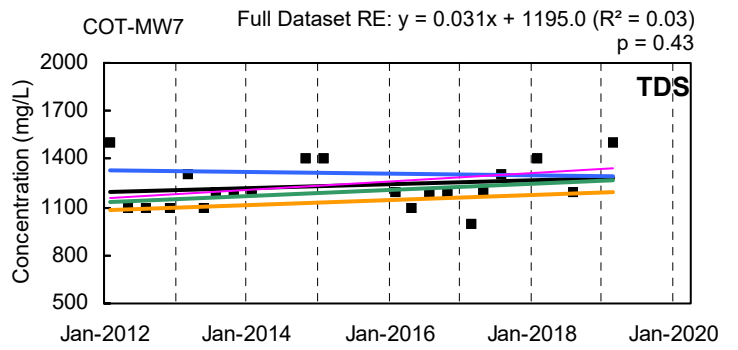
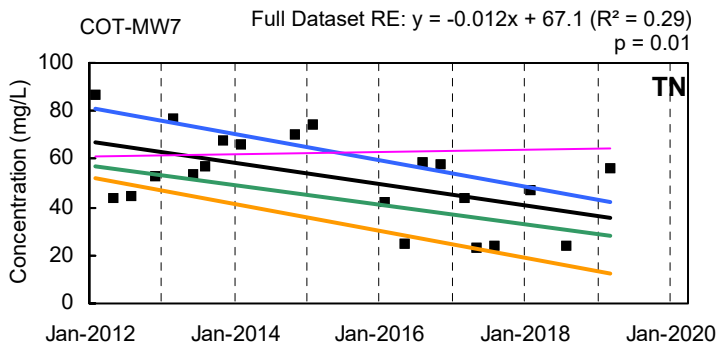

— Q1 Trendline — Q2 Trendline
— Q3 Trendline — Q4 Trendline — Full Dataset Trendline

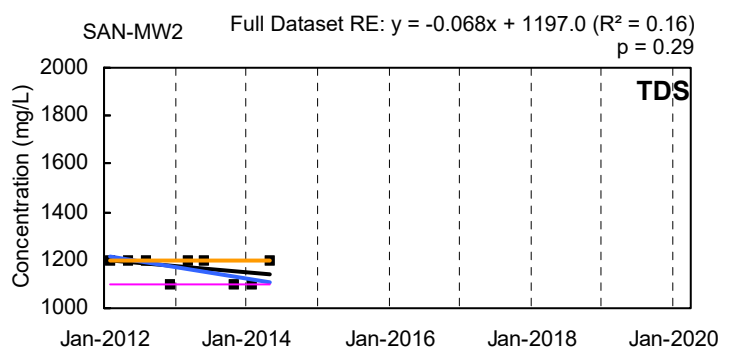
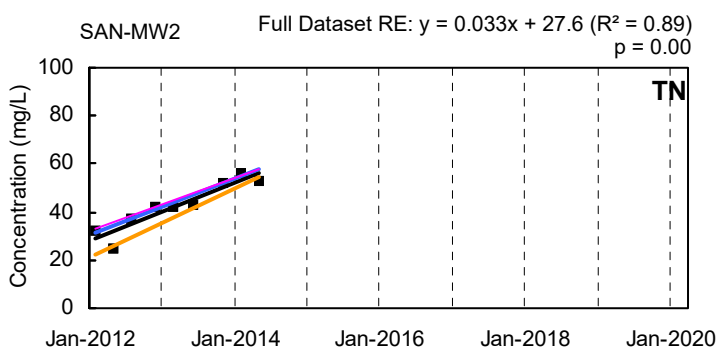
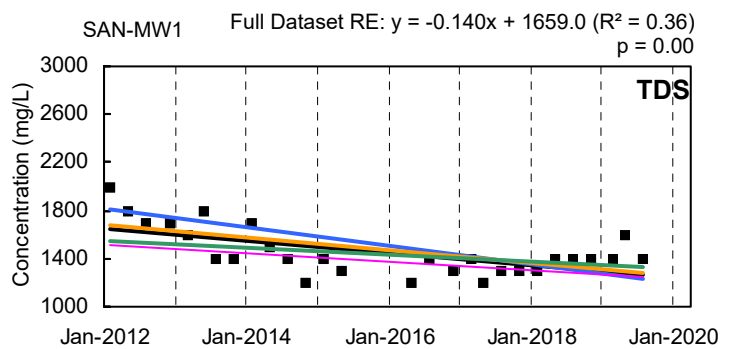
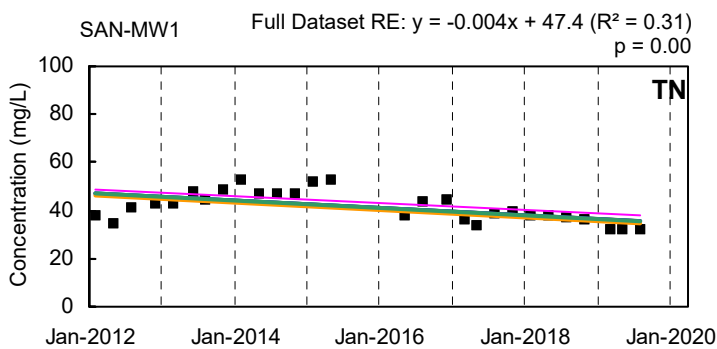
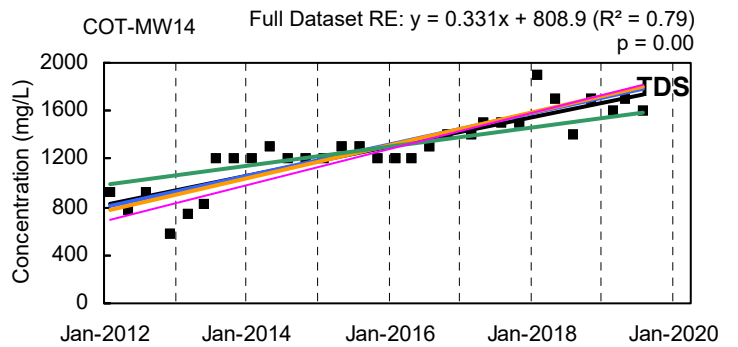
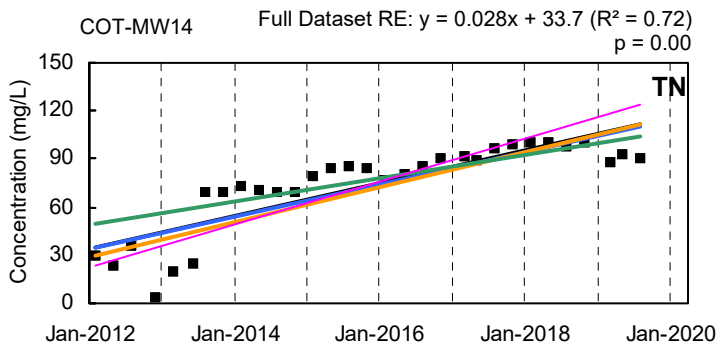
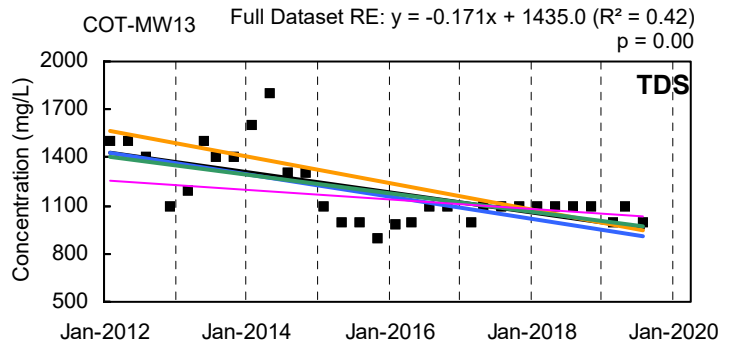
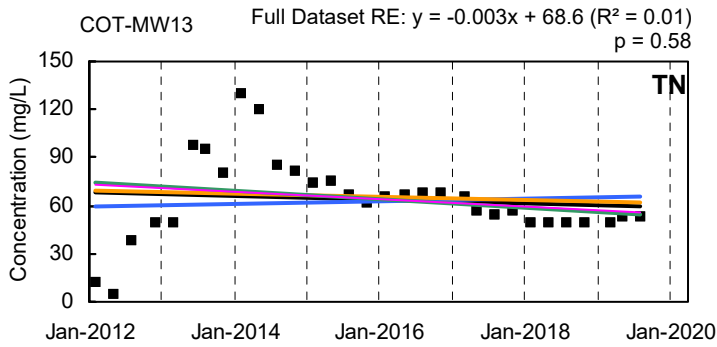
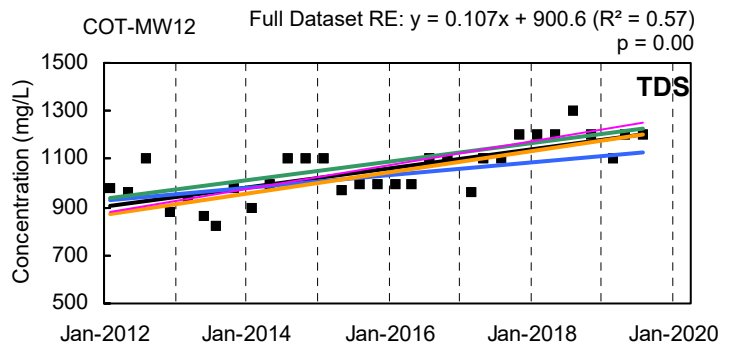
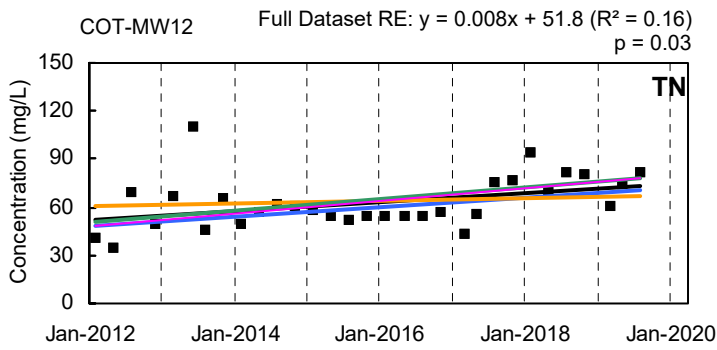

— Q1 Trendline — Q2 Trendline
— Q3 Trendline — Q4 Trendline — Full Dataset Trendline

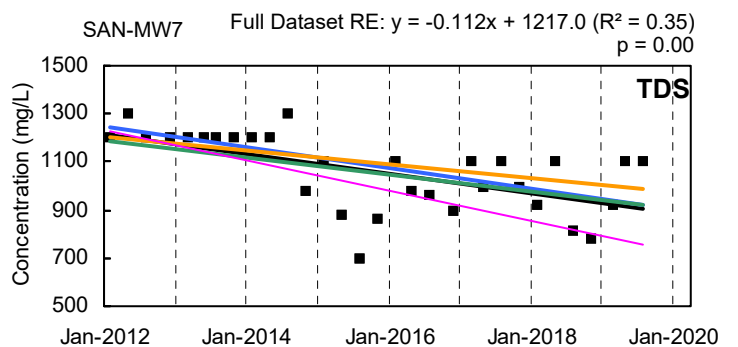
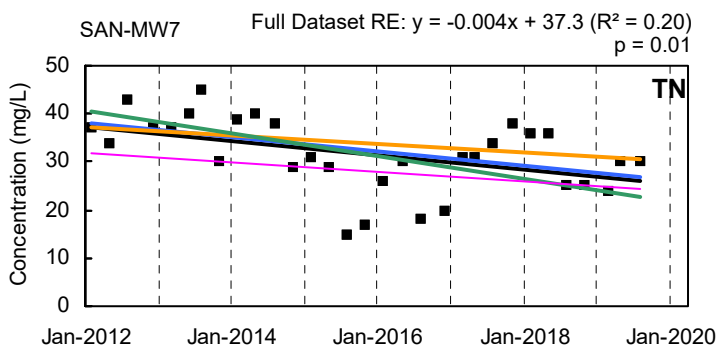
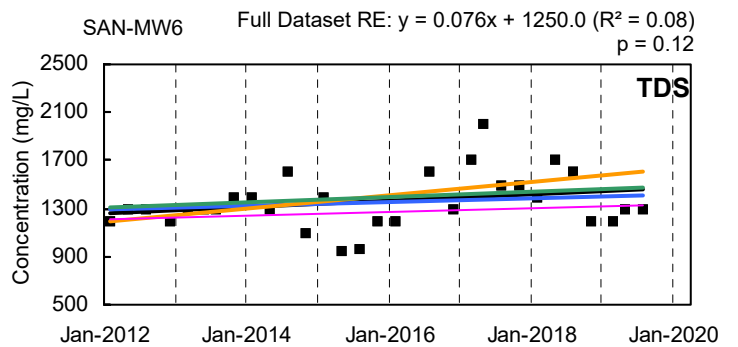
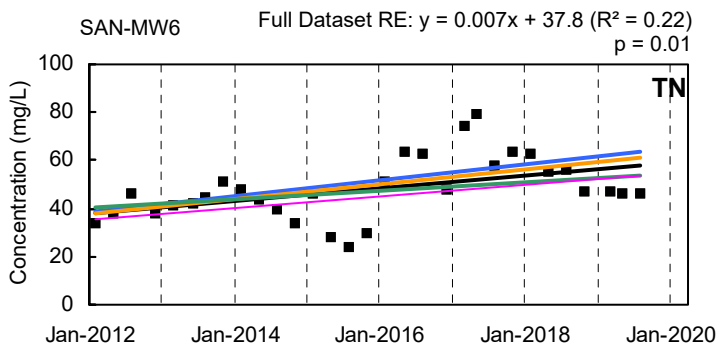
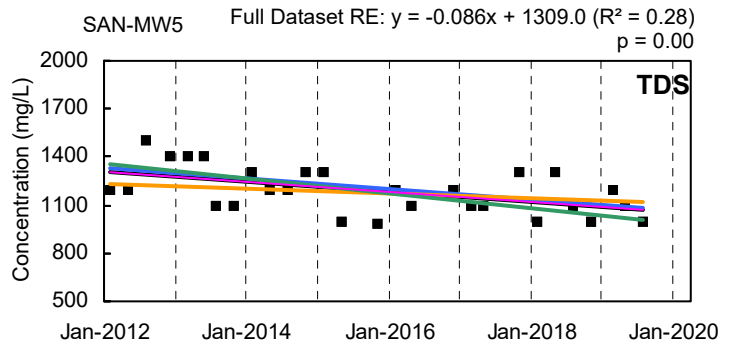
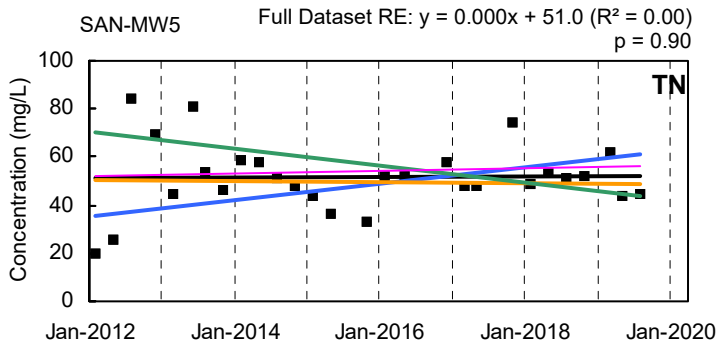
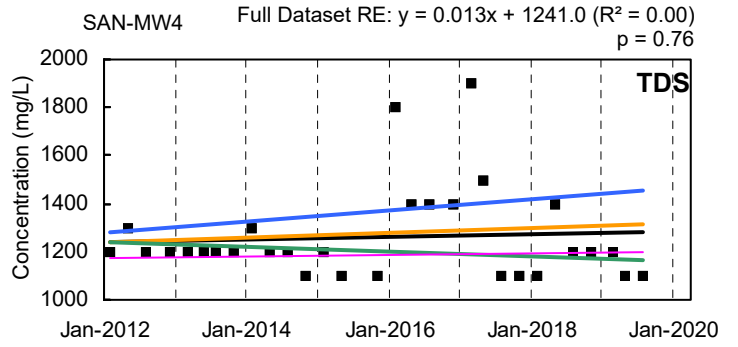
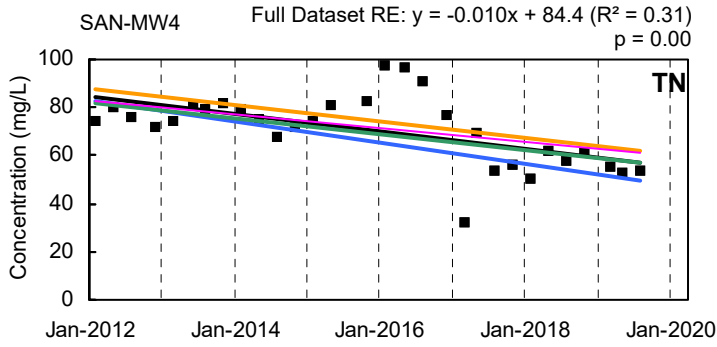
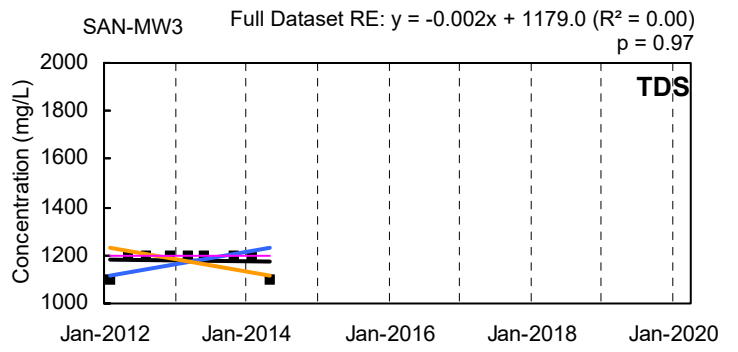
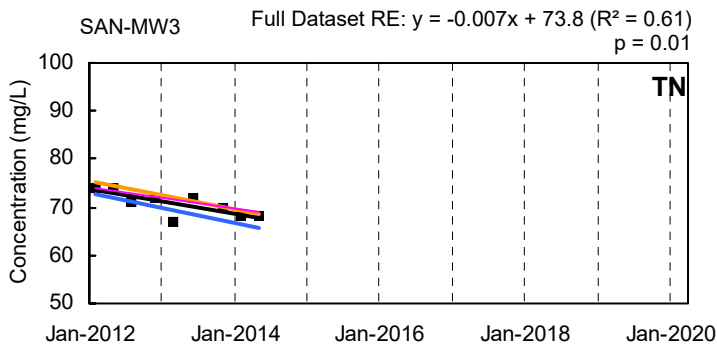

— Q1 Trendline — Q2 Trendline
— Q3 Trendline — Q4 Trendline — Full Dataset Trendline

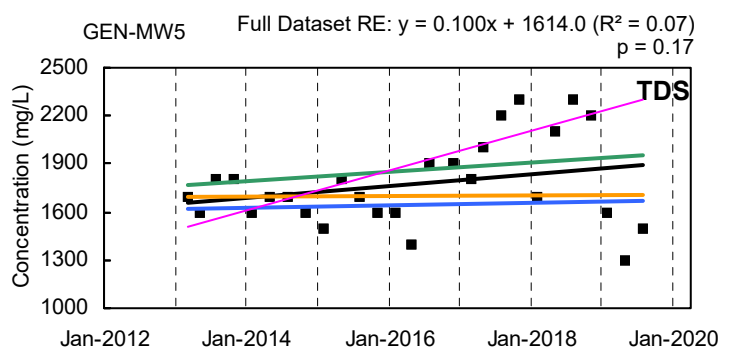
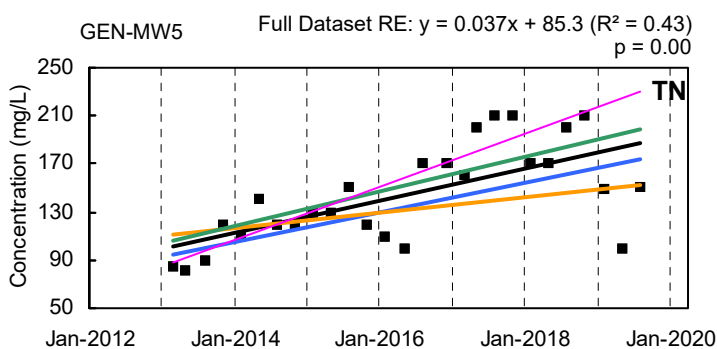
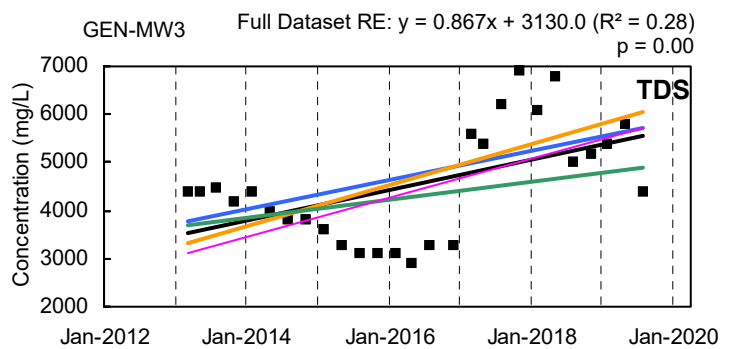
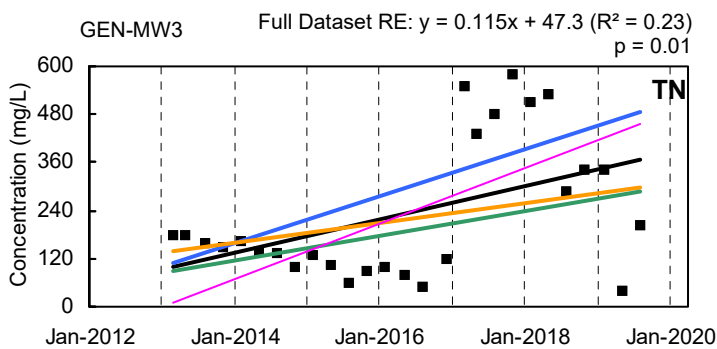
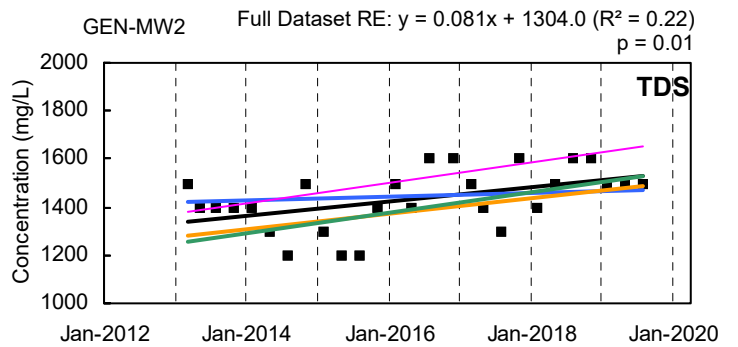
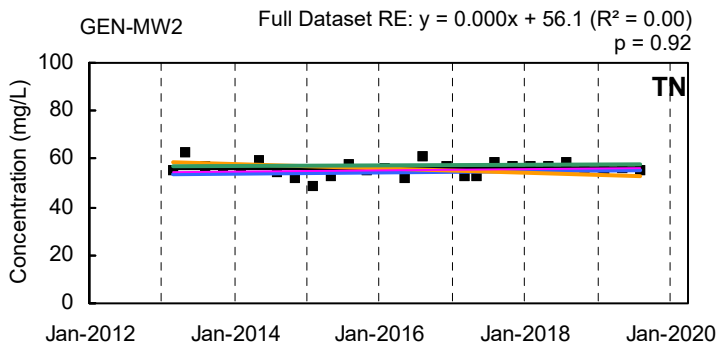
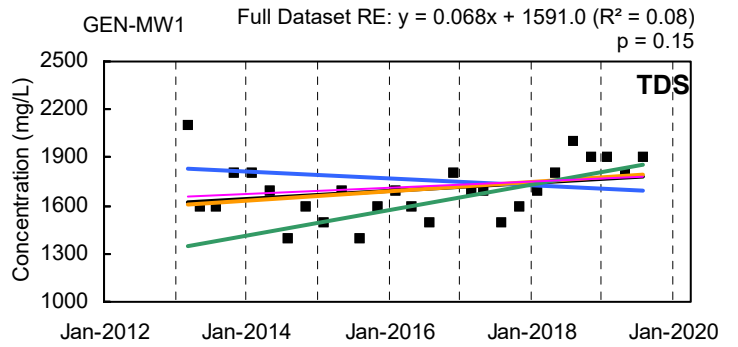
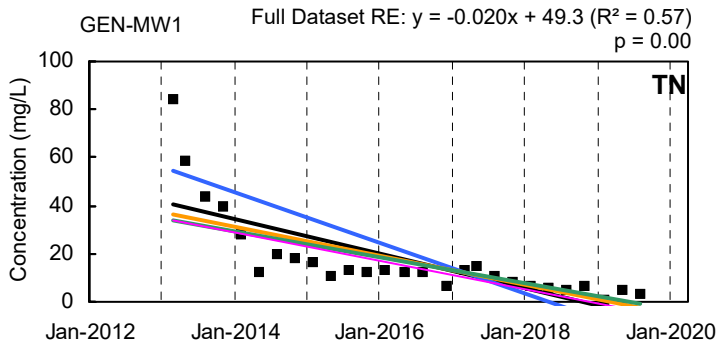
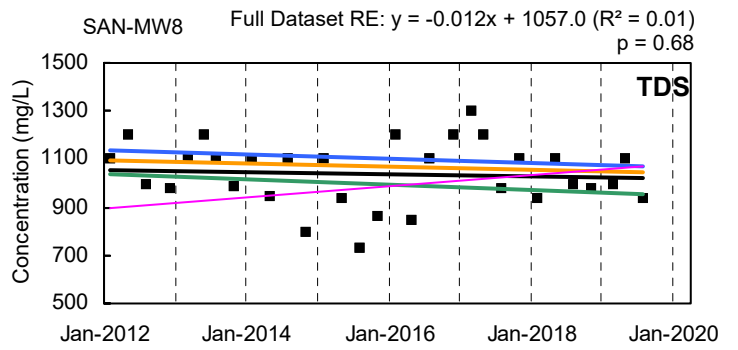
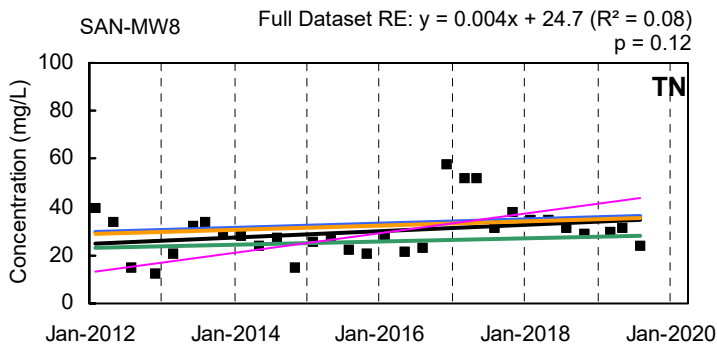

— Q1 Trendline — Q2 Trendline
— Q3 Trendline — Q4 Trendline — Full Dataset Trendline

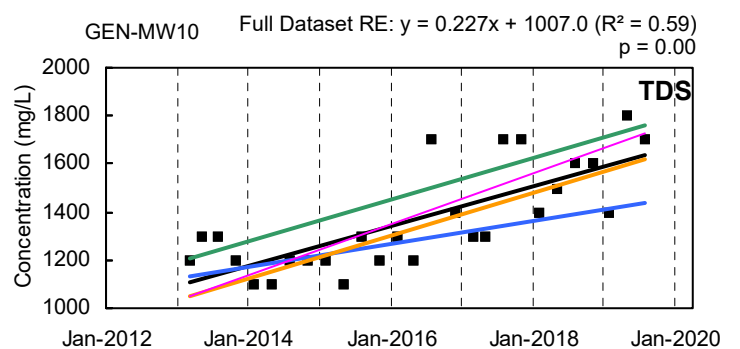
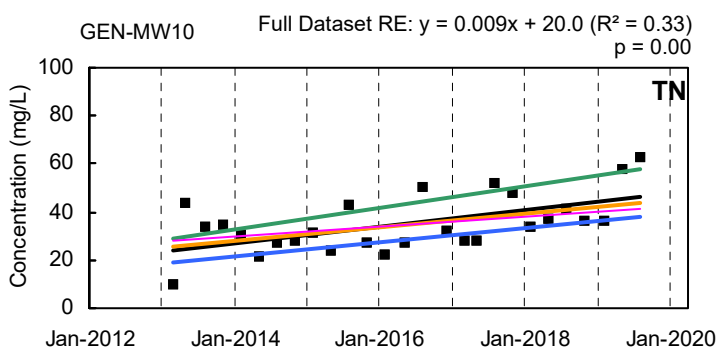
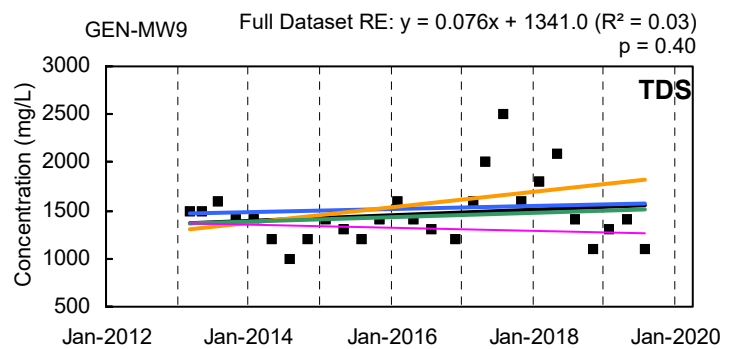
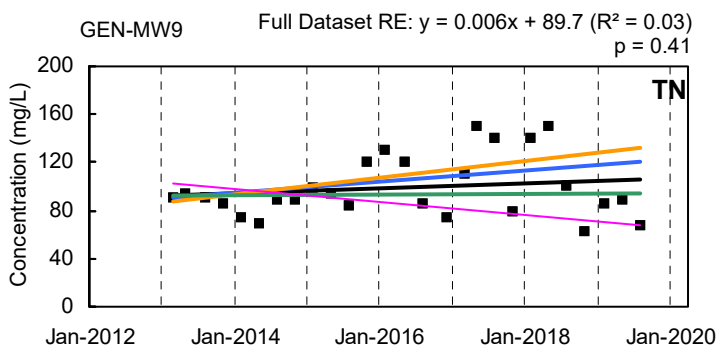
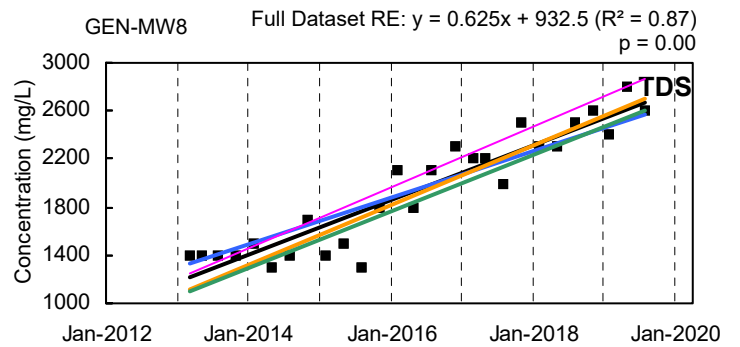
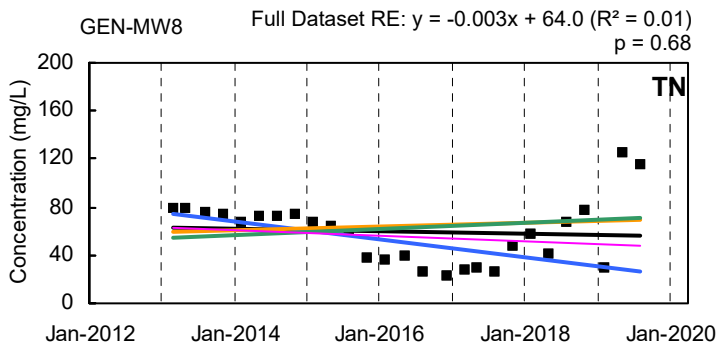
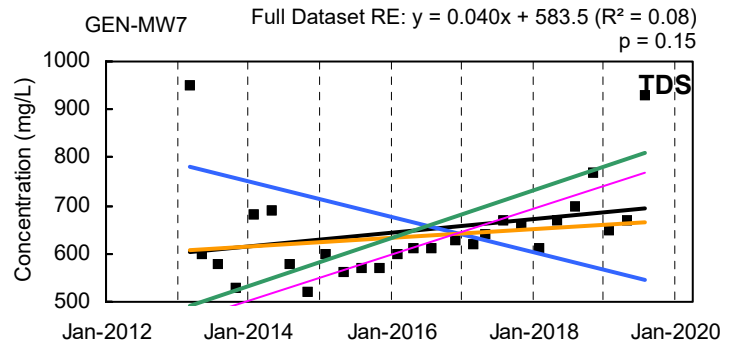
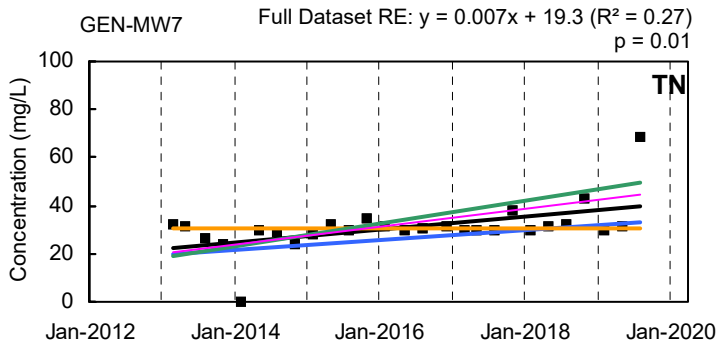
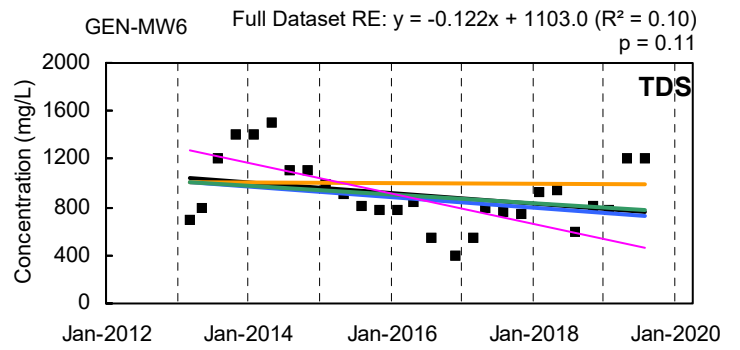
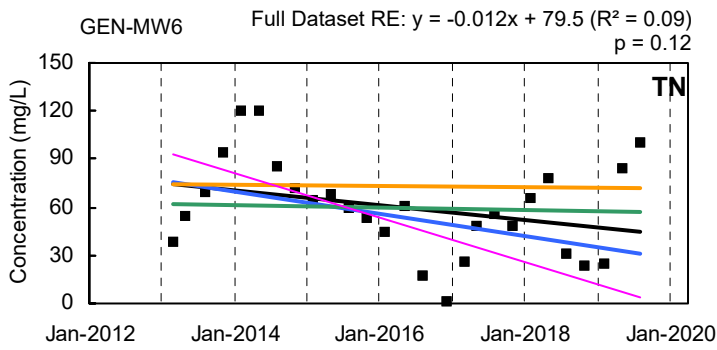

— Q1 Trendline — Q2 Trendline
— Q3 Trendline — Q4 Trendline — Full Dataset Trendline

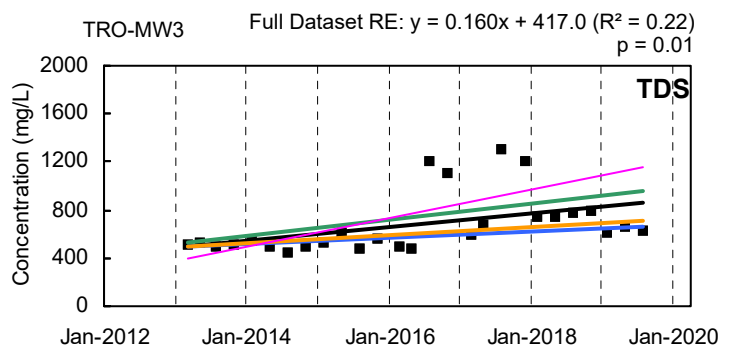
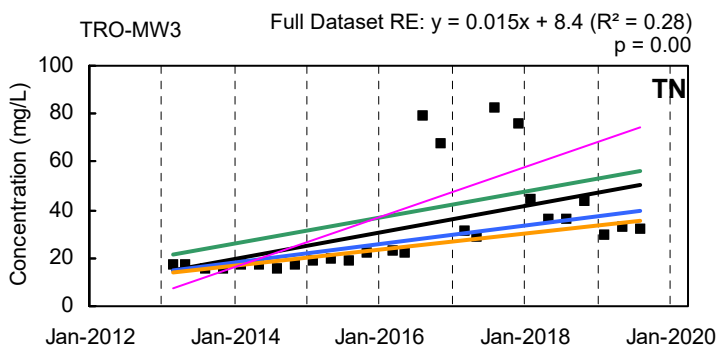
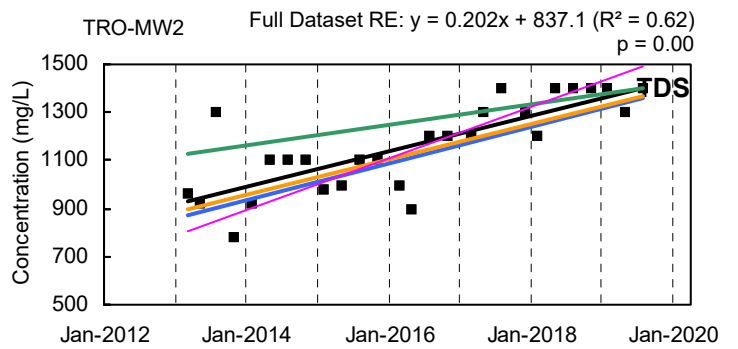
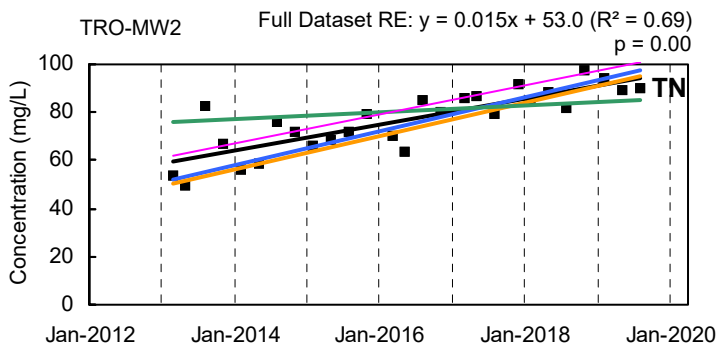
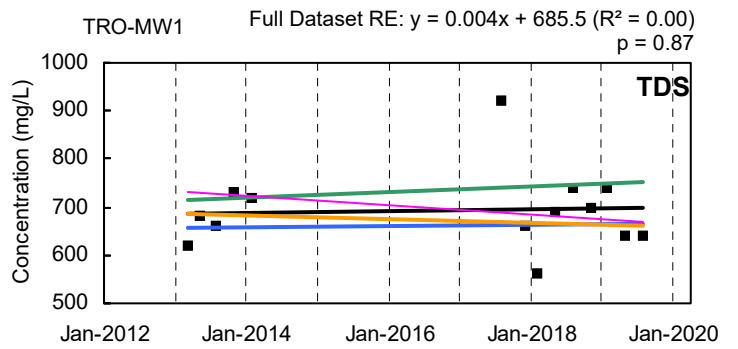
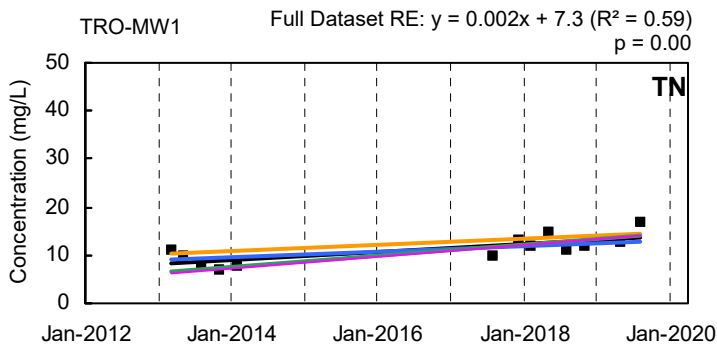
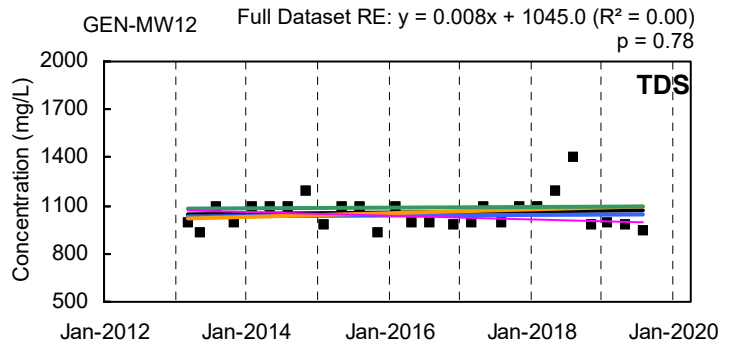
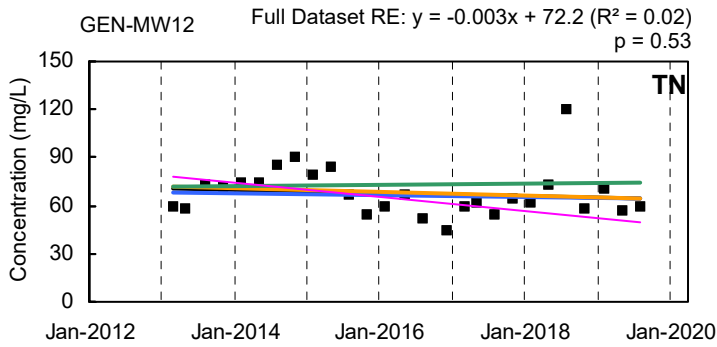
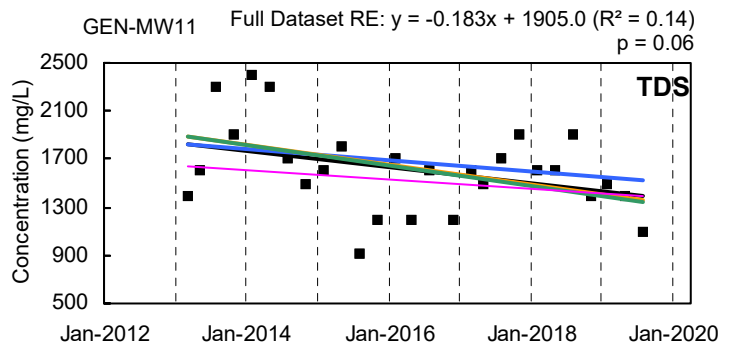
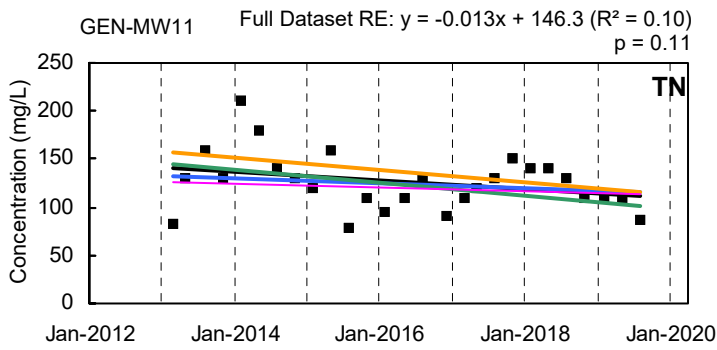

— Q1 Trendline — Q2 Trendline
— Q3 Trendline — Q4 Trendline — Full Dataset Trendline

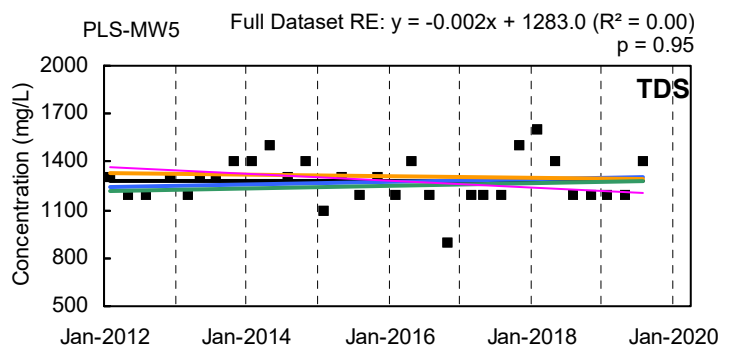
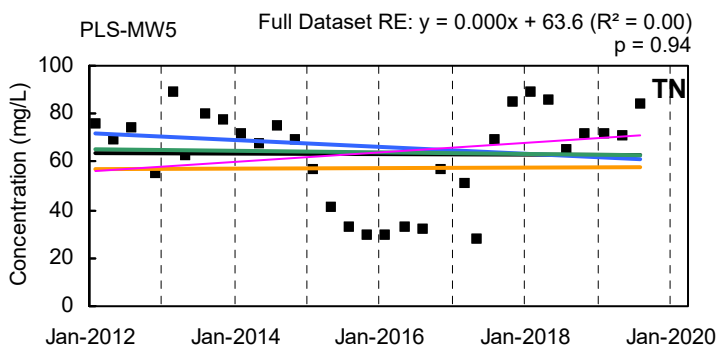
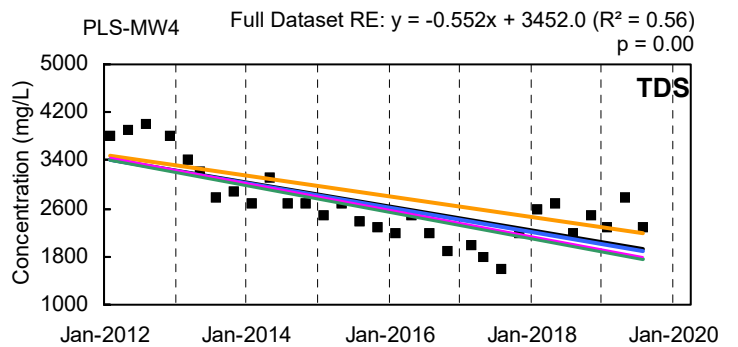
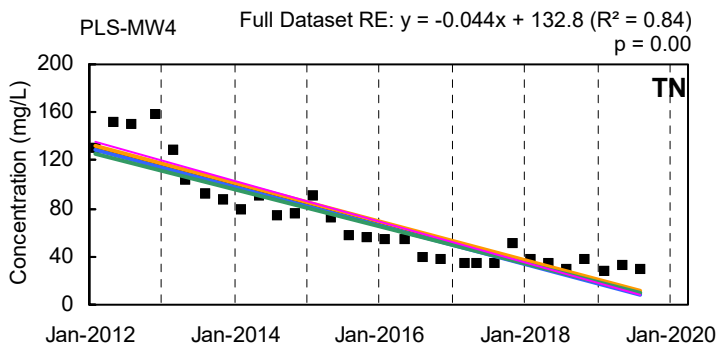
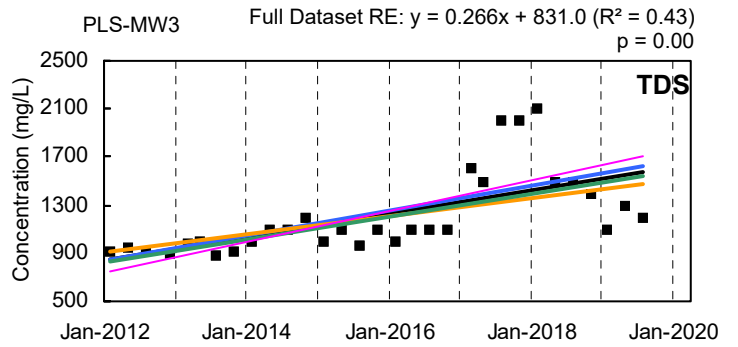
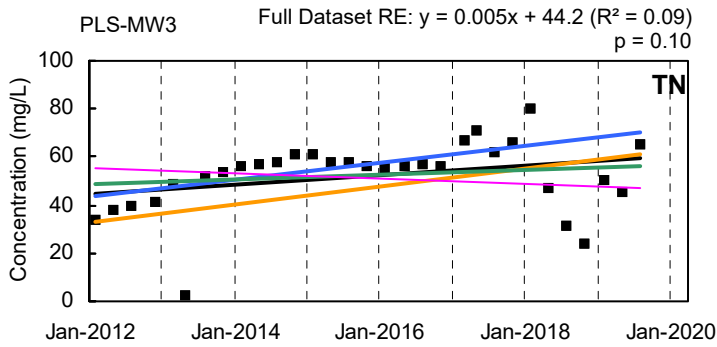
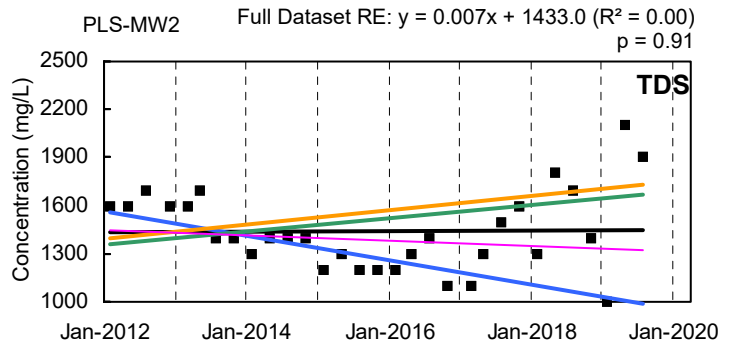
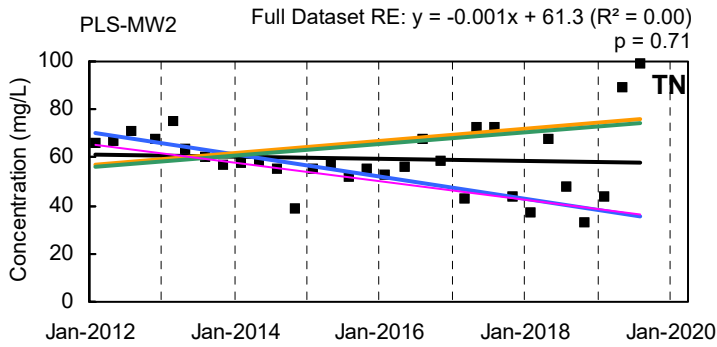
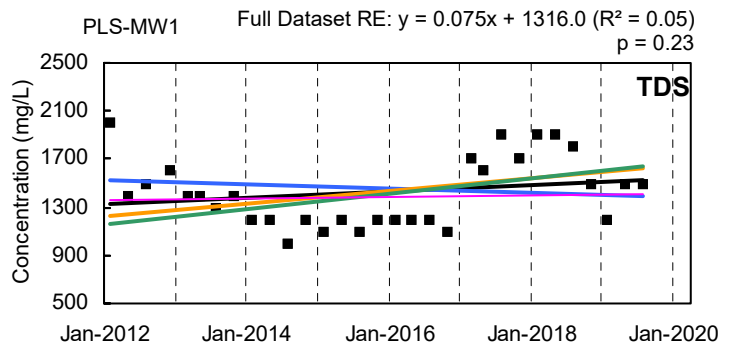
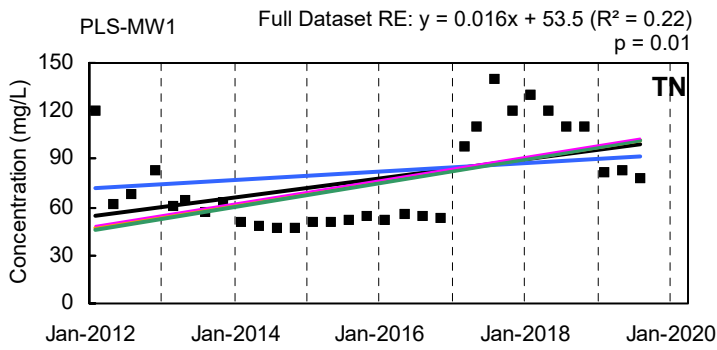

— Q1 Trendline — Q2 Trendline
— Q3 Trendline — Q4 Trendline — Full Dataset Trendline

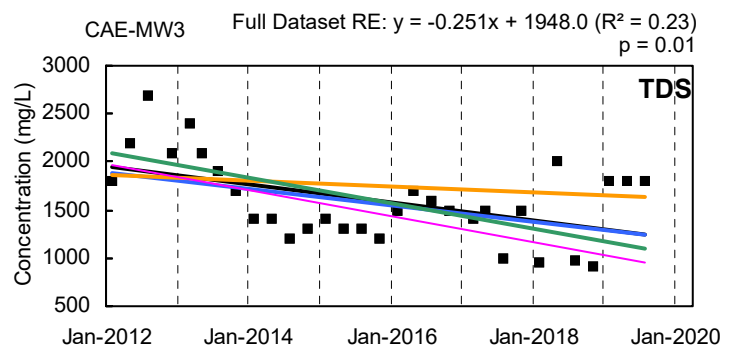
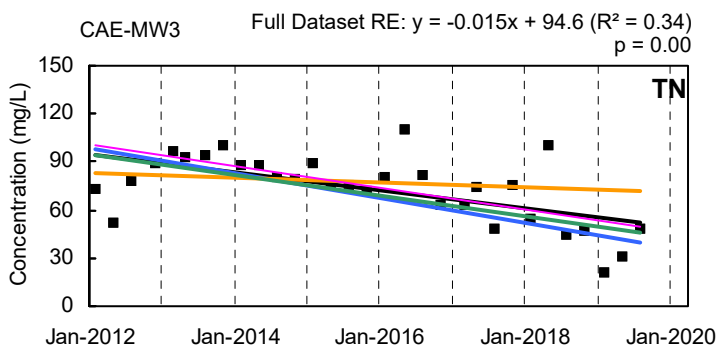
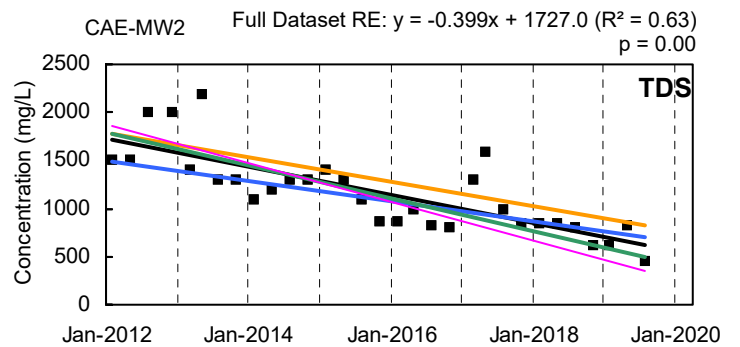
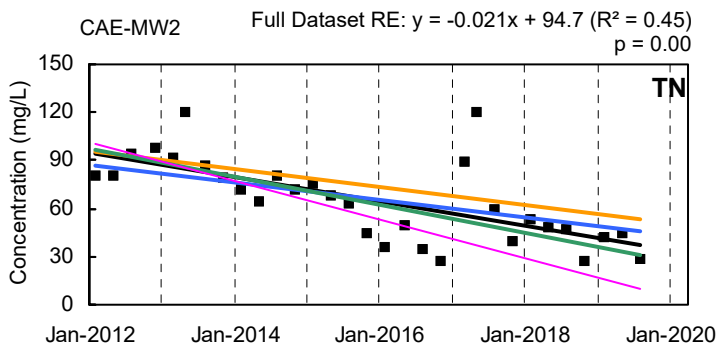
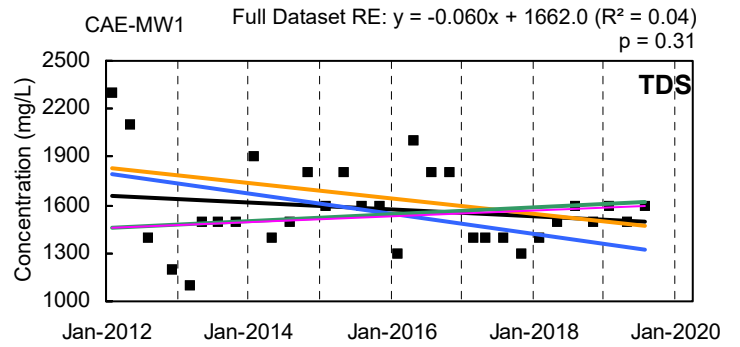
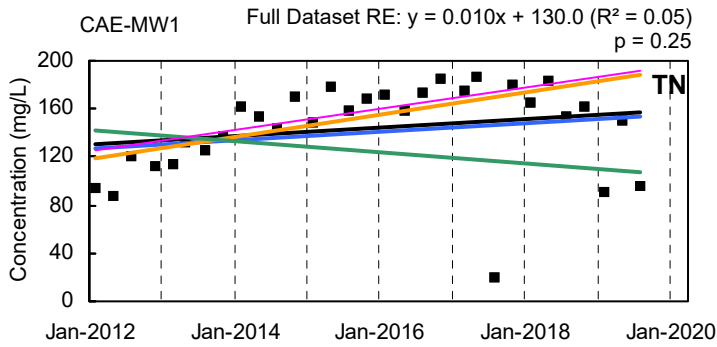
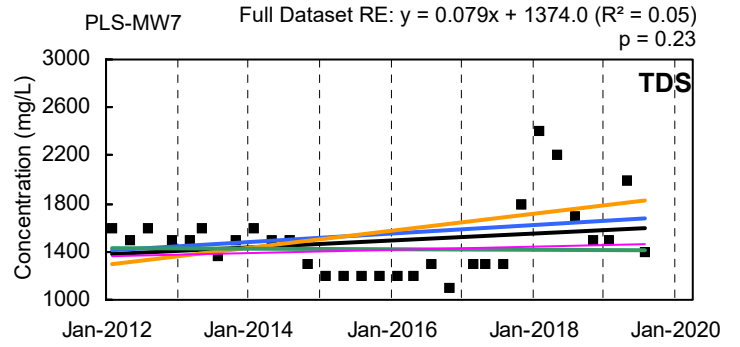
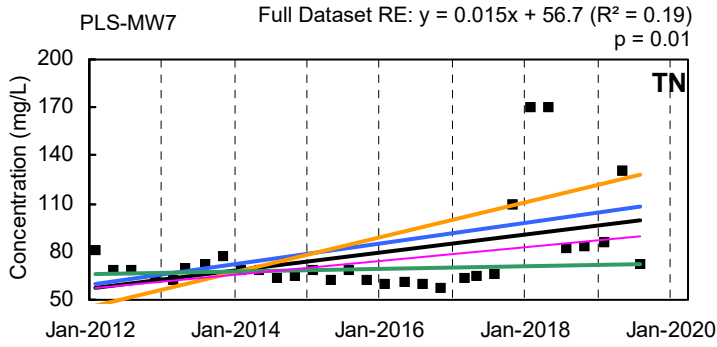
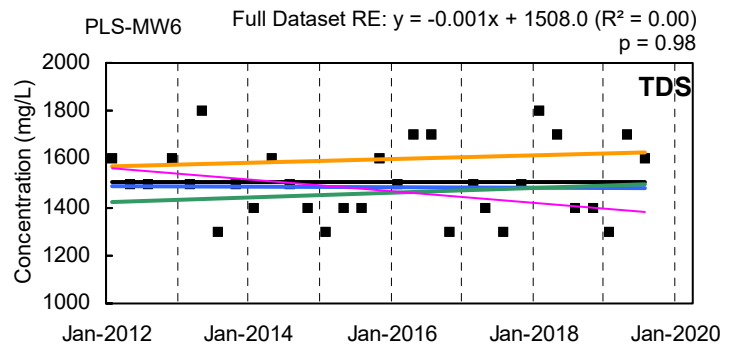
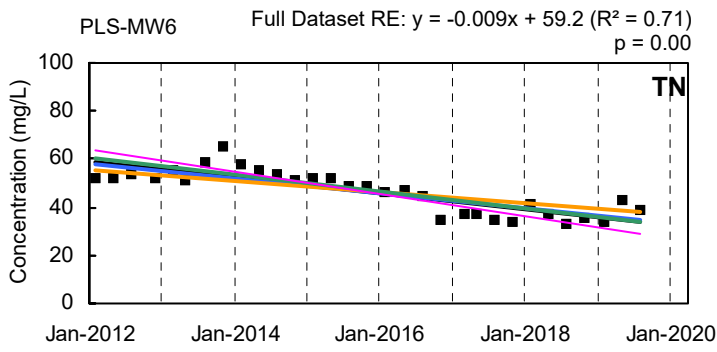

— Q1 Trendline — Q2 Trendline
— Q3 Trendline — Q4 Trendline — Full Dataset Trendline

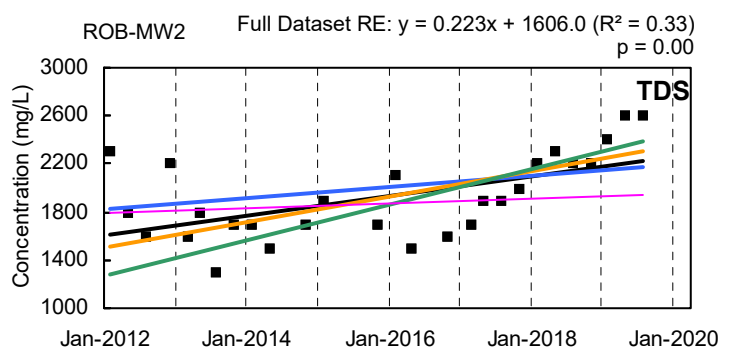
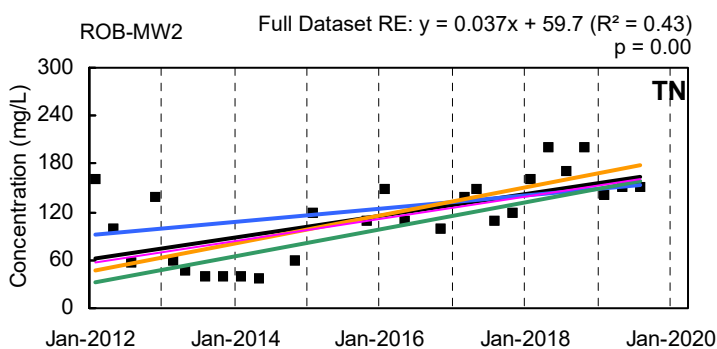
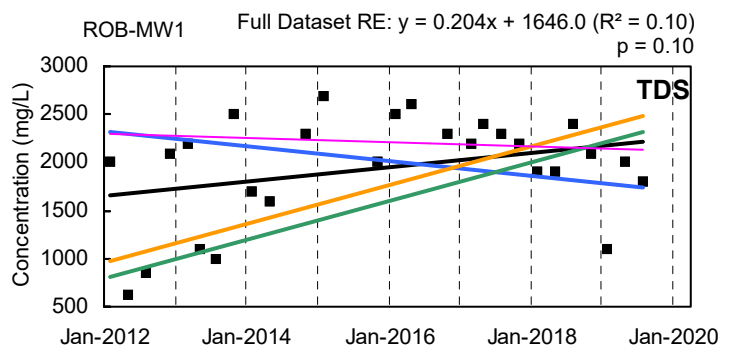
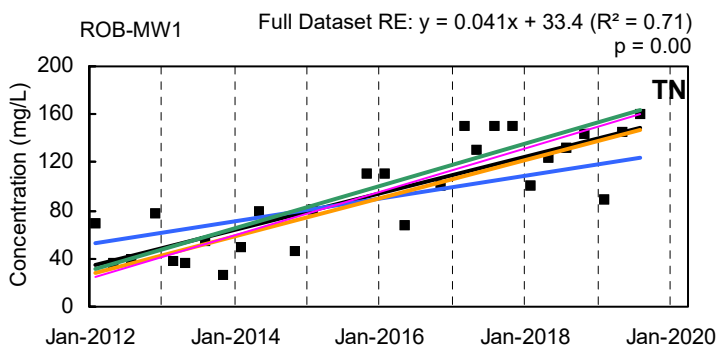
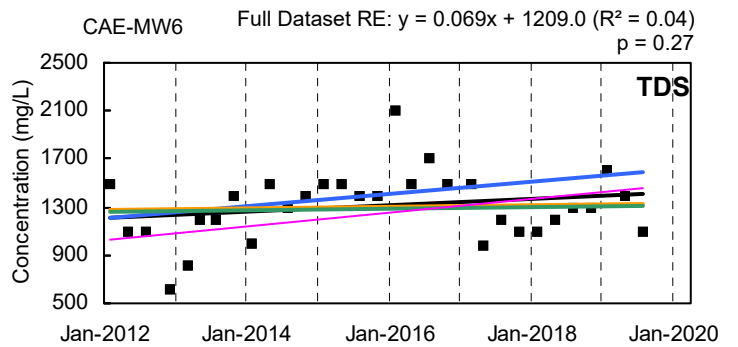
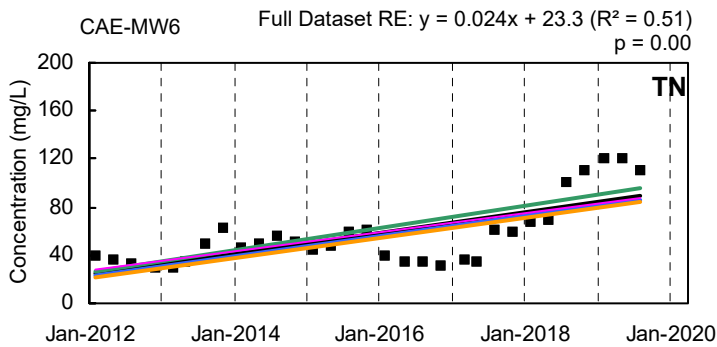
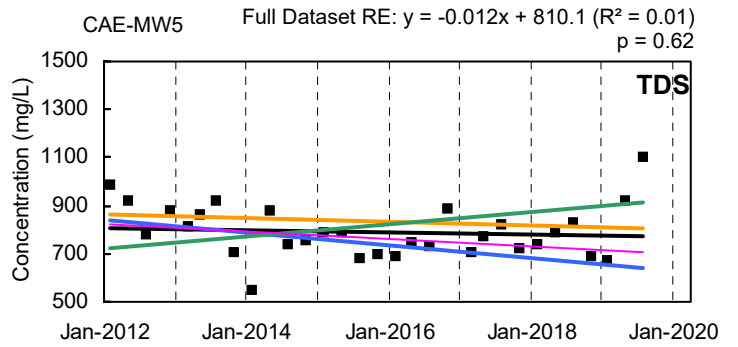
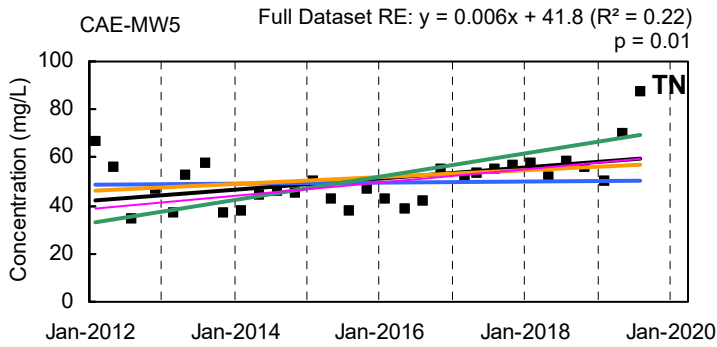
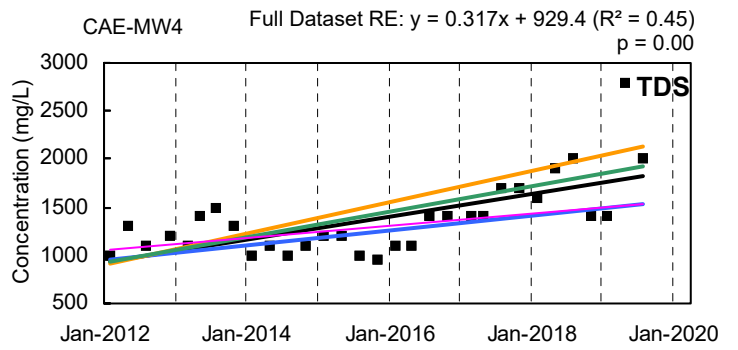
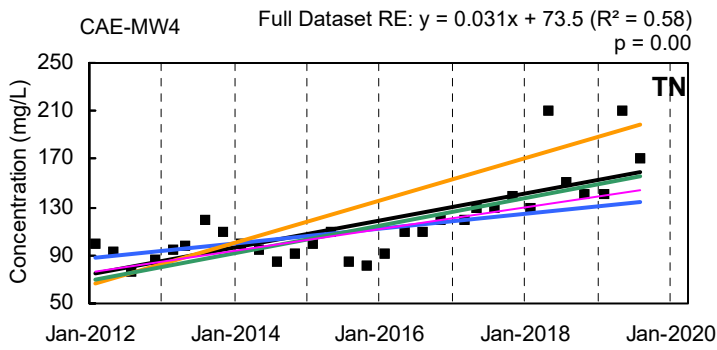

— Q1 Trendline — Q2 Trendline
— Q3 Trendline — Q4 Trendline — Full Dataset Trendline

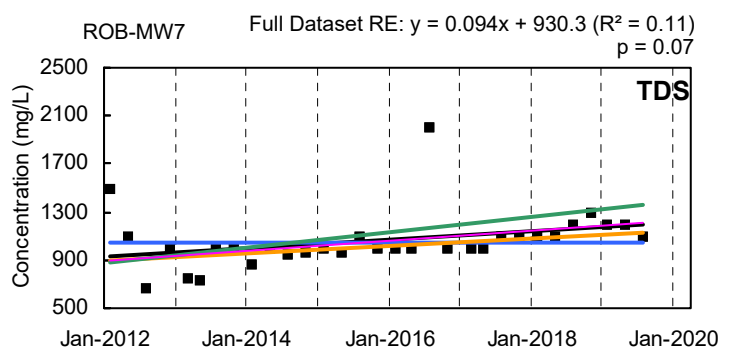
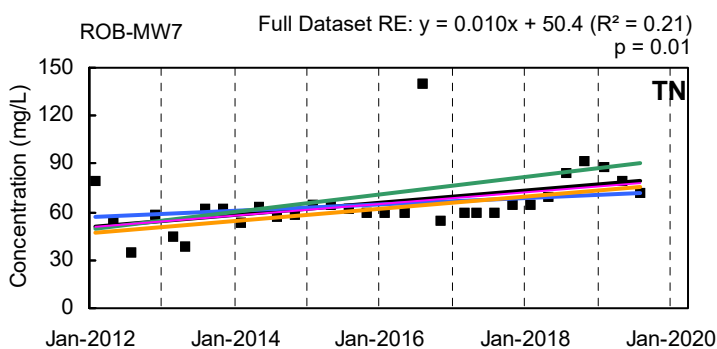
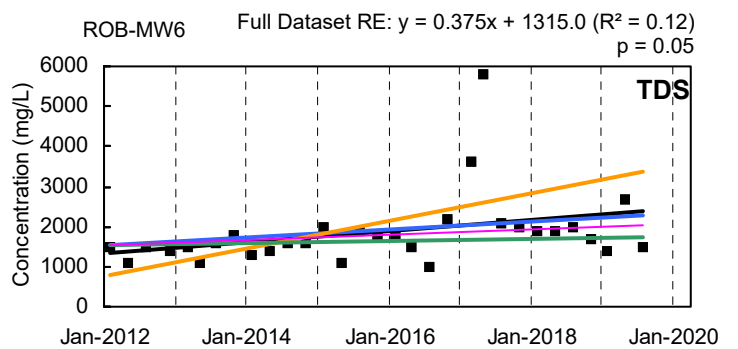
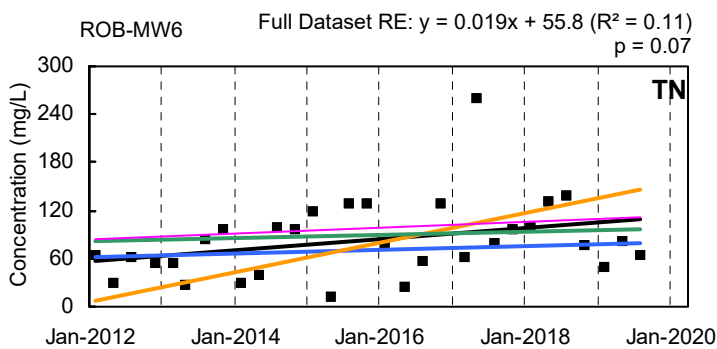
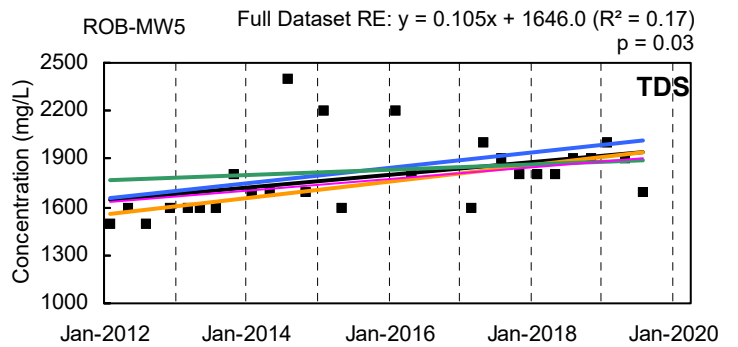
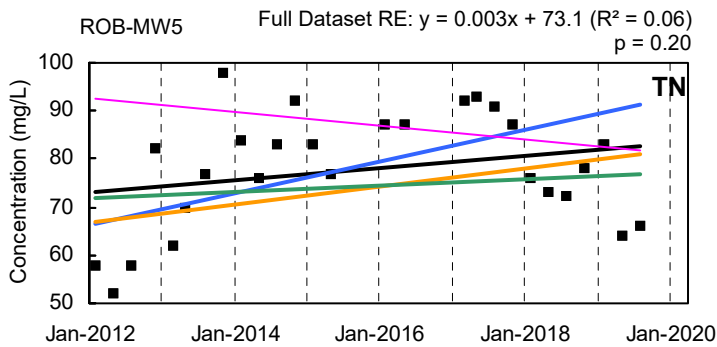
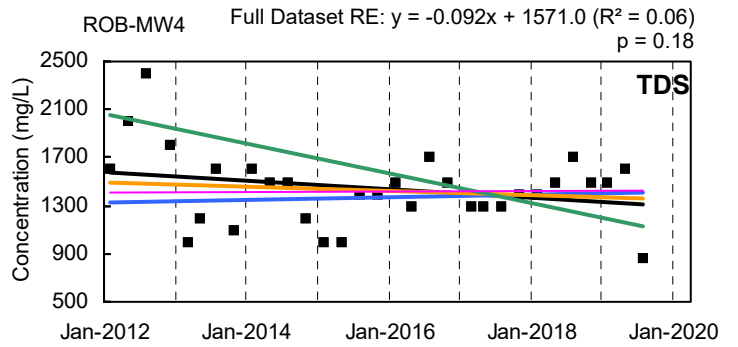
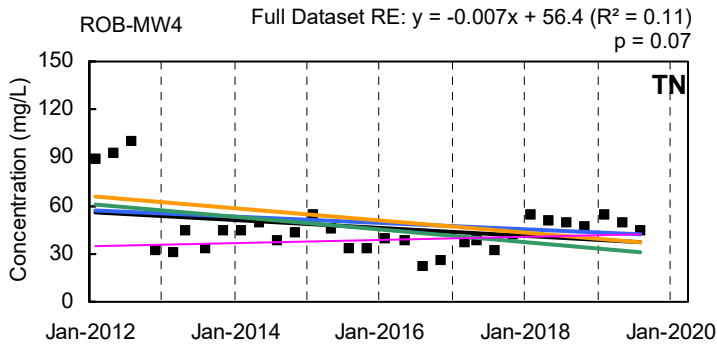
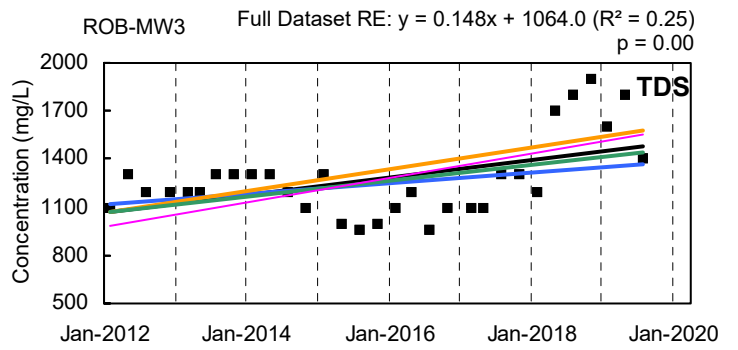
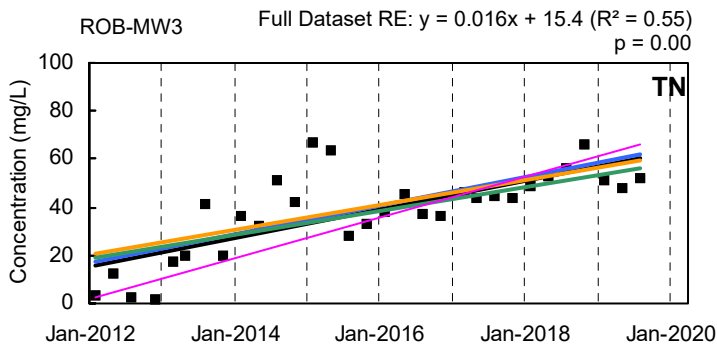

— Q1 Trendline — Q2 Trendline
— Q3 Trendline — Q4 Trendline — Full Dataset Trendline

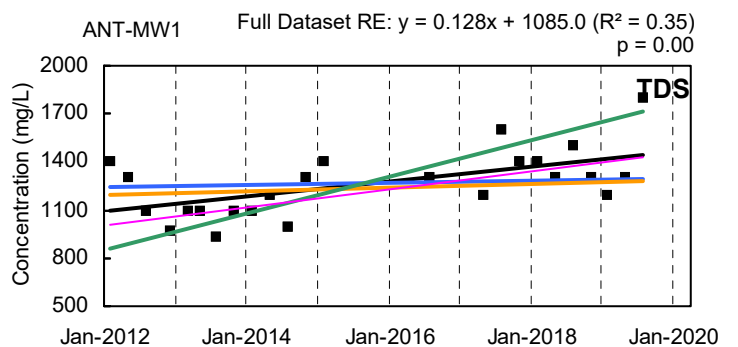
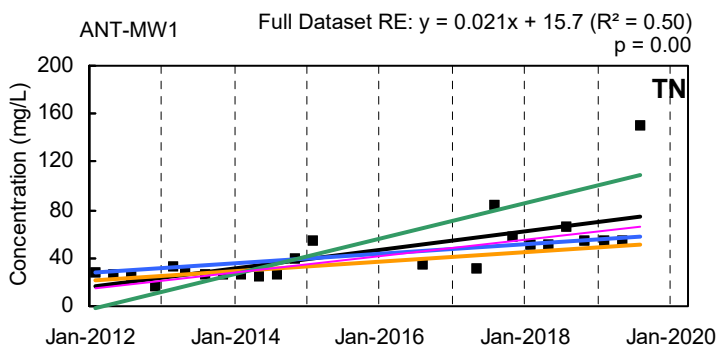
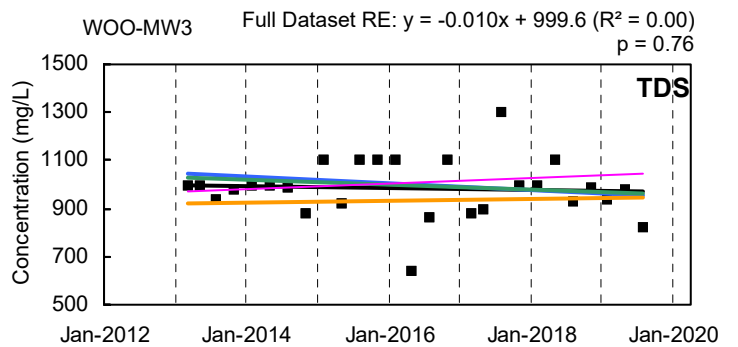
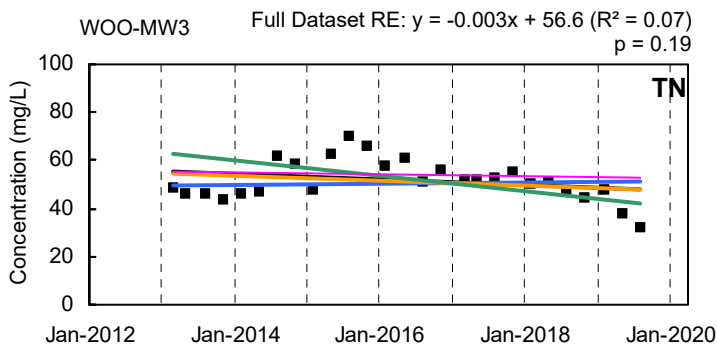
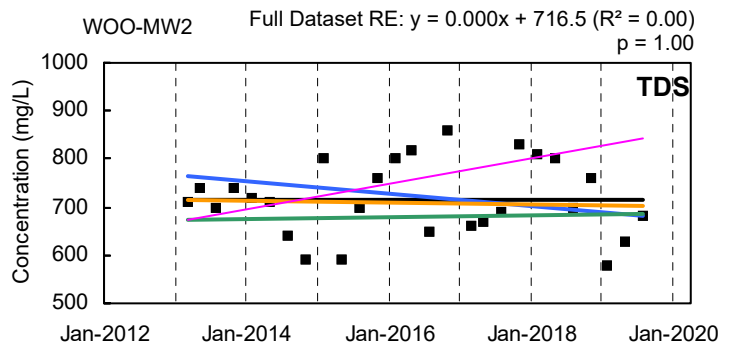
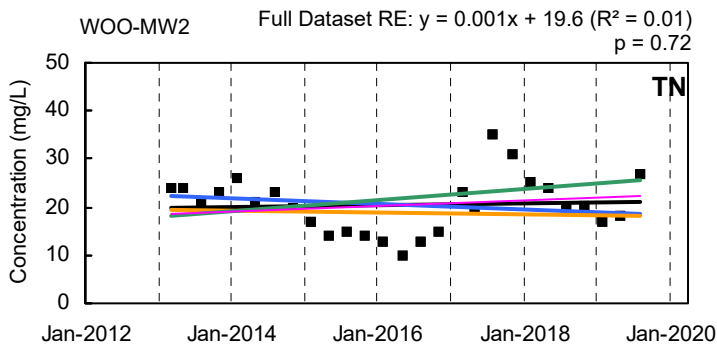
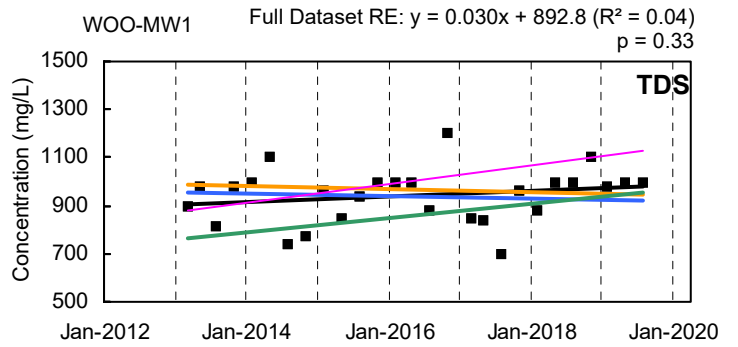
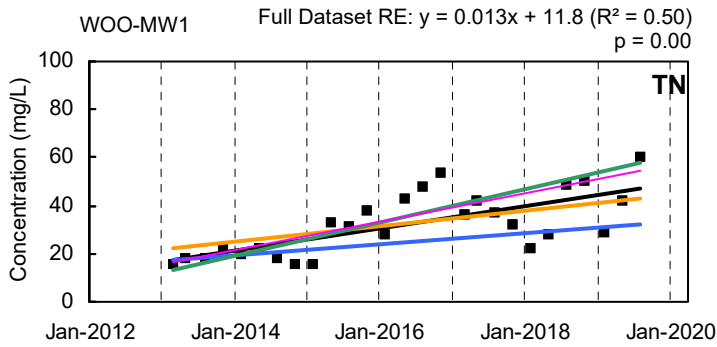
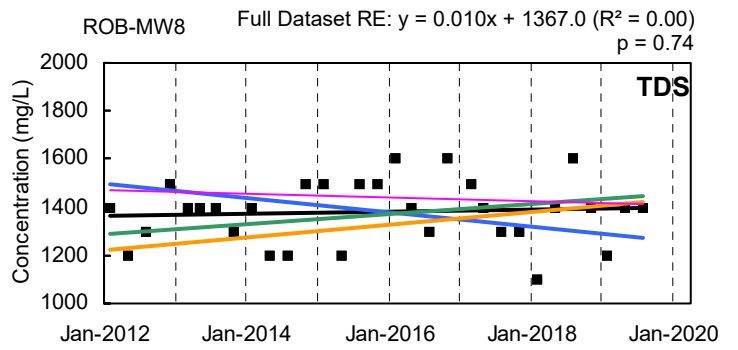
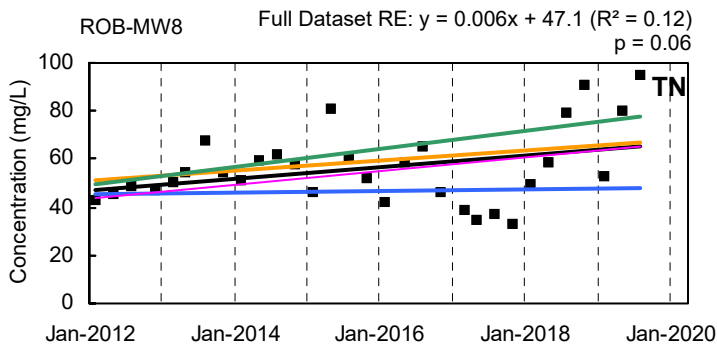

— Q1 Trendline — Q2 Trendline
— Q3 Trendline — Q4 Trendline — Full Dataset Trendline

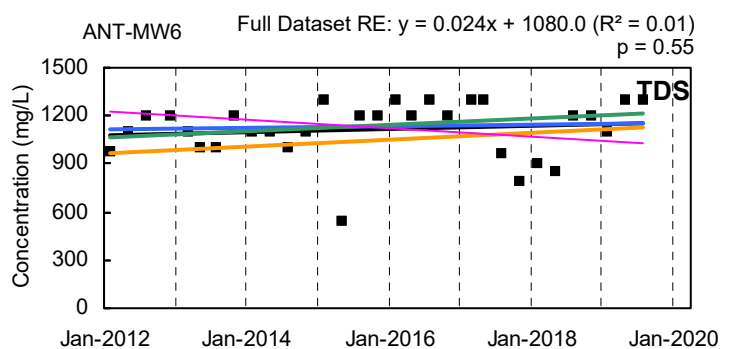
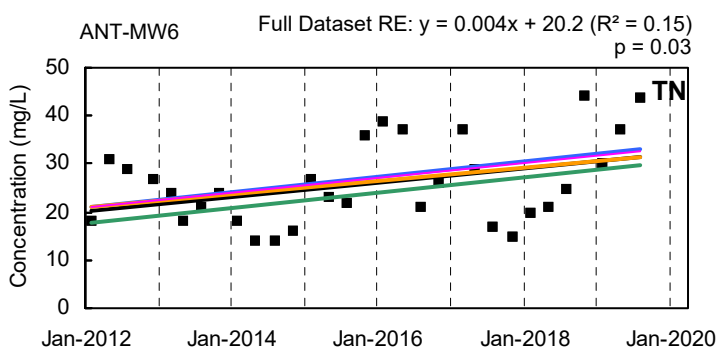
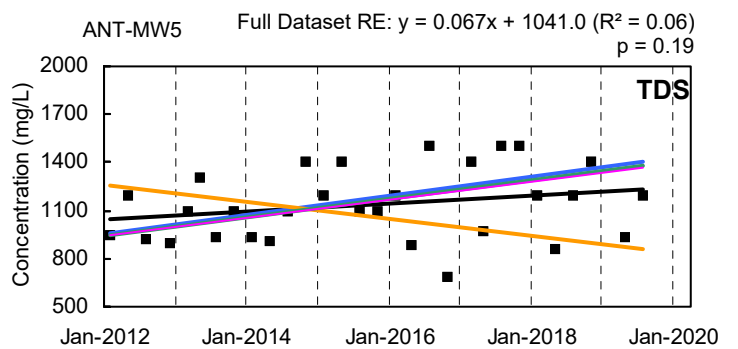
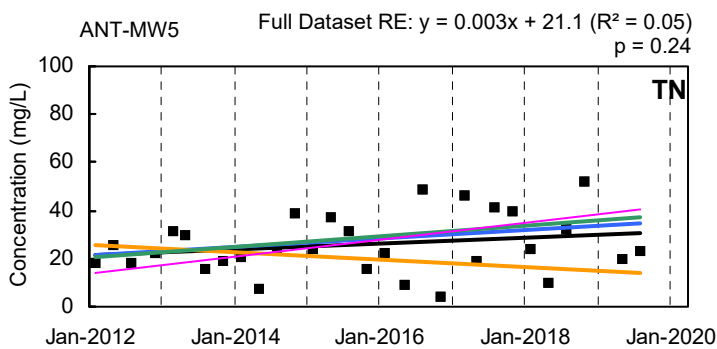
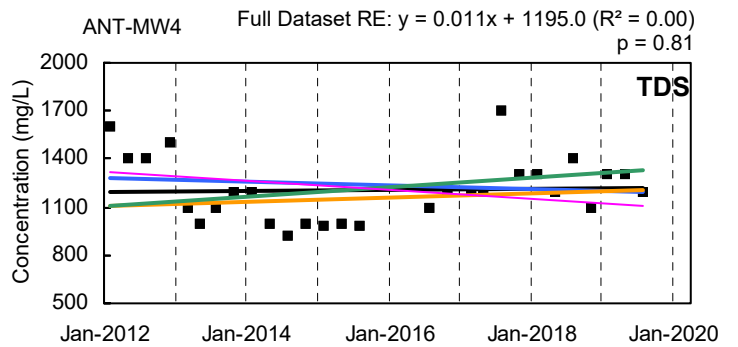
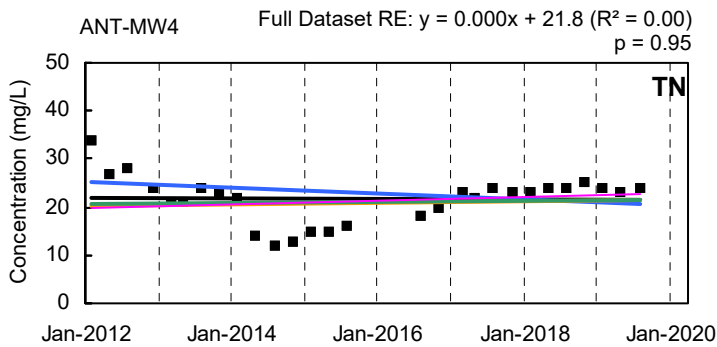
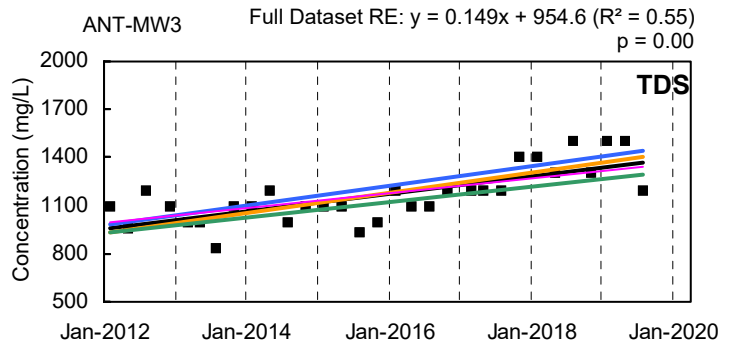
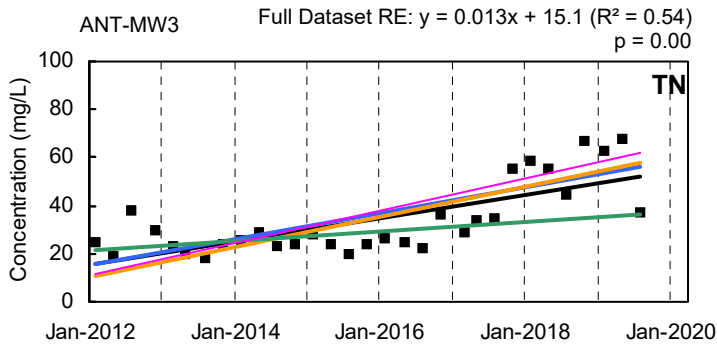
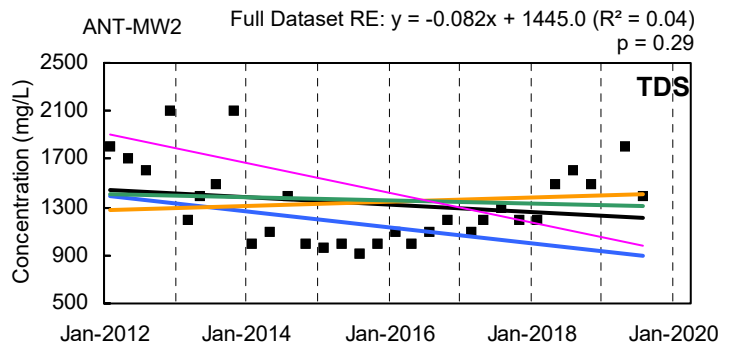
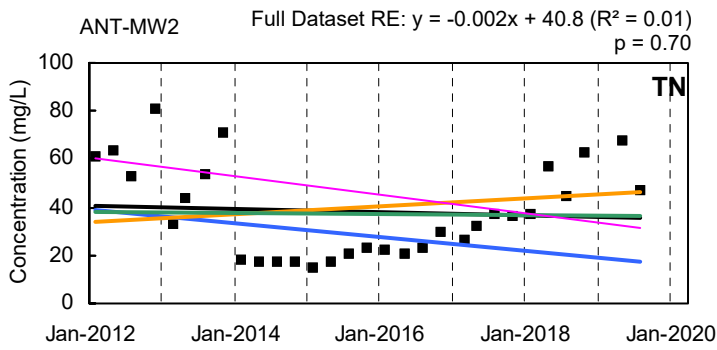

— Q1 Trendline — Q2 Trendline
— Q3 Trendline — Q4 Trendline — Full Dataset Trendline

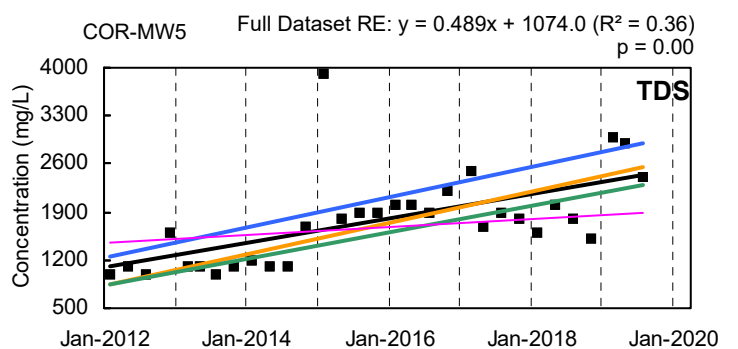
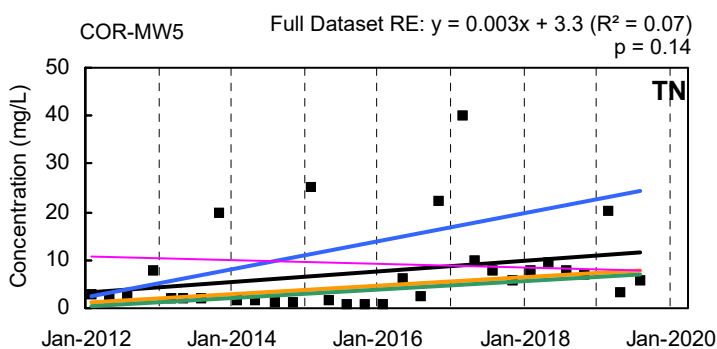
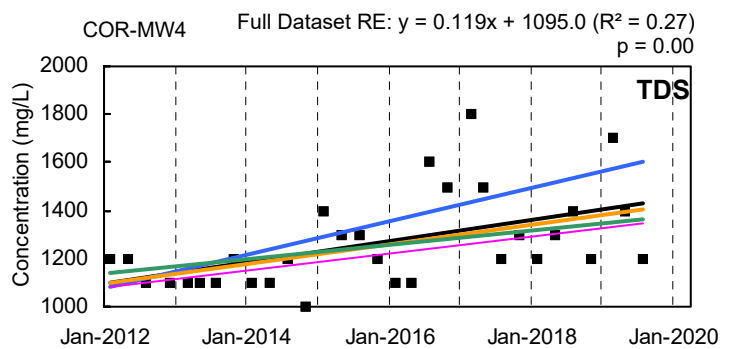
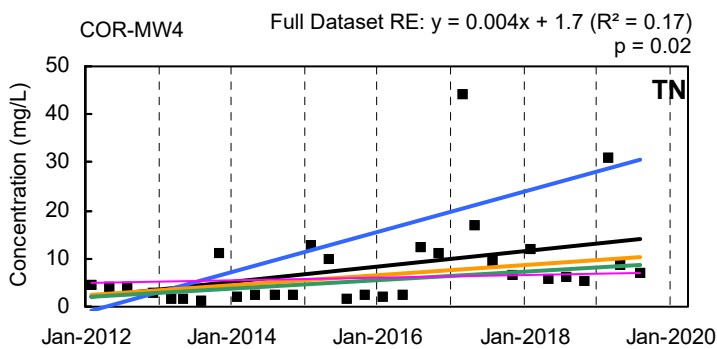
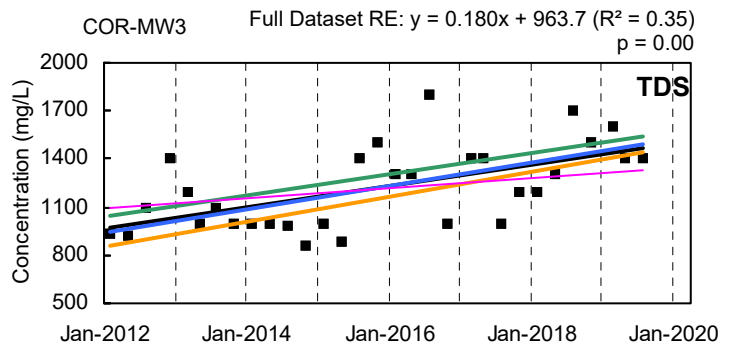
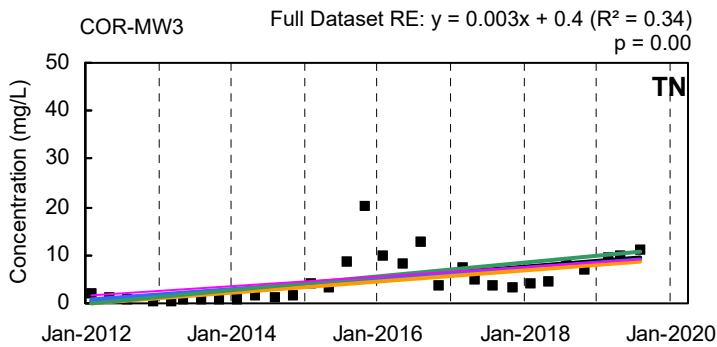
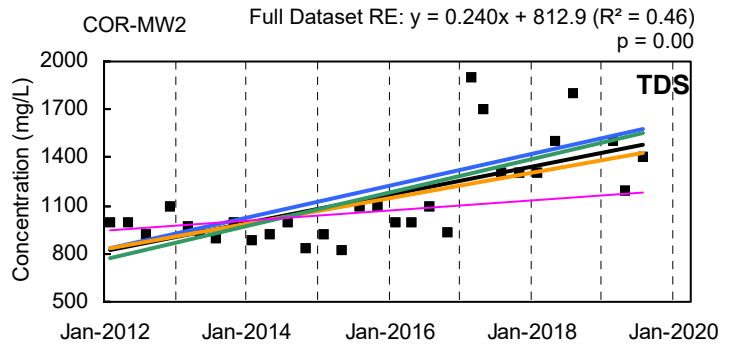
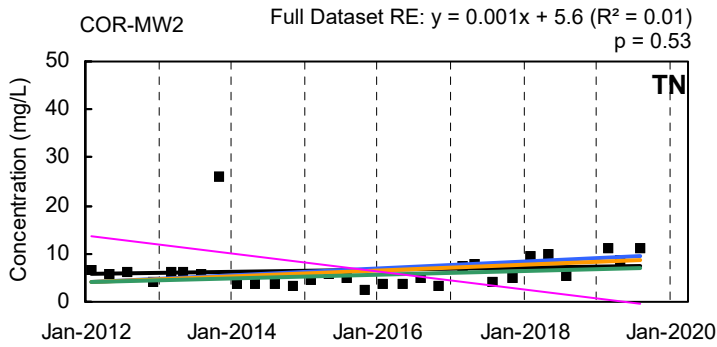
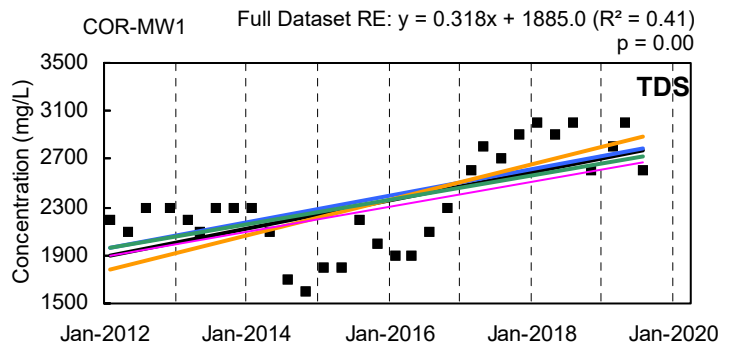
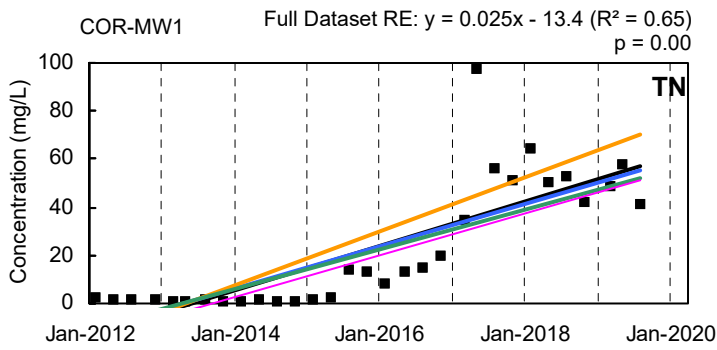

— Q1 Trendline — Q2 Trendline
— Q3 Trendline — Q4 Trendline — Full Dataset Trendline

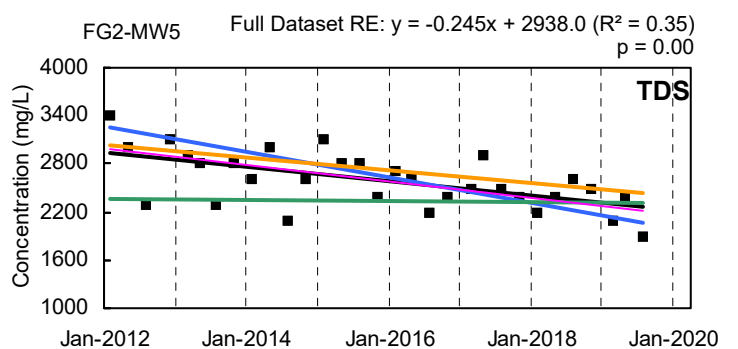
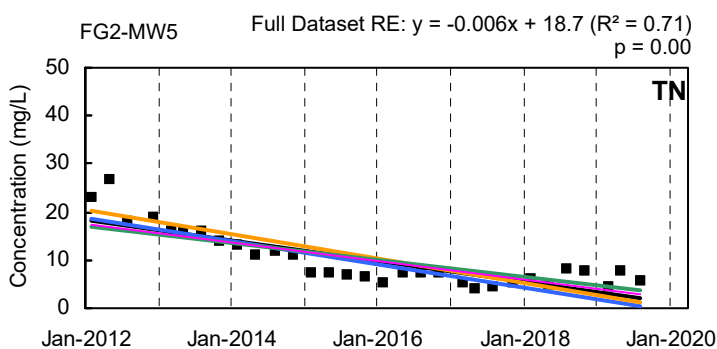
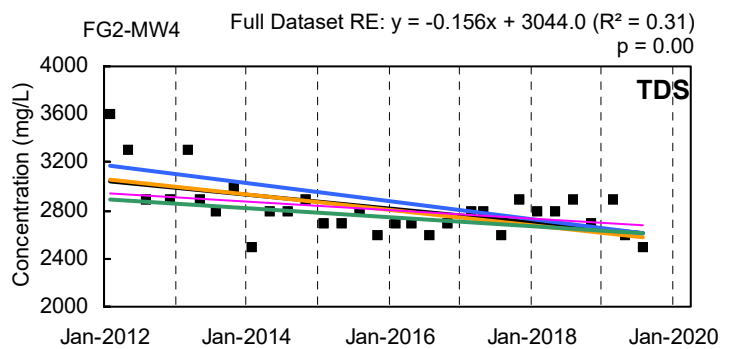
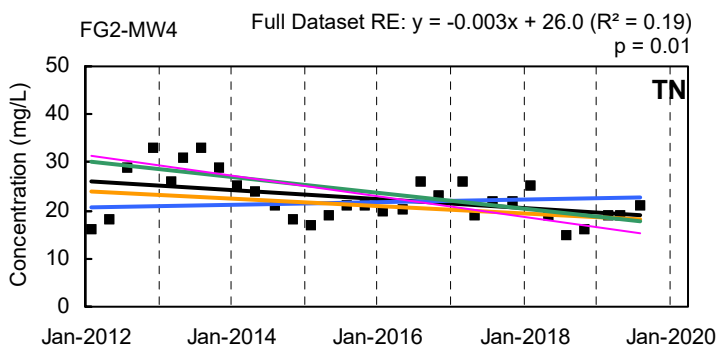
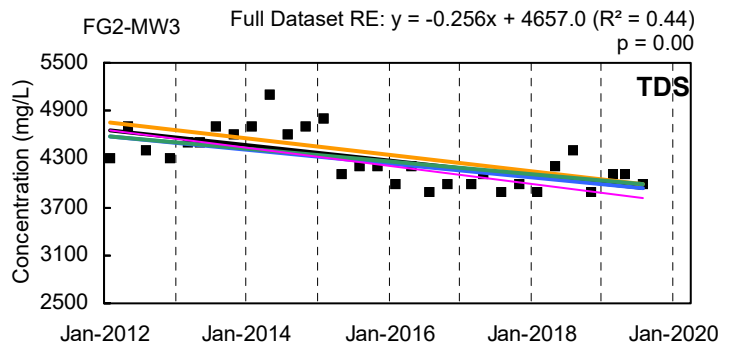
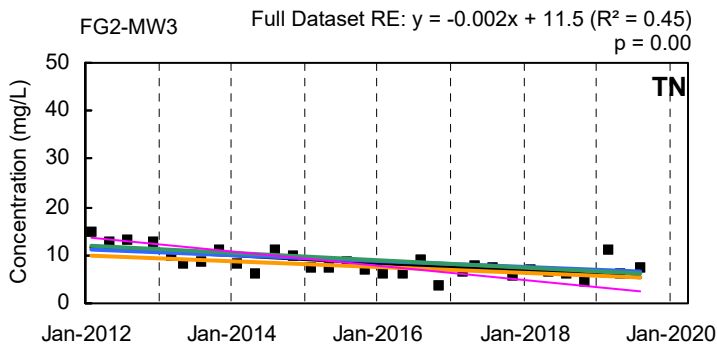
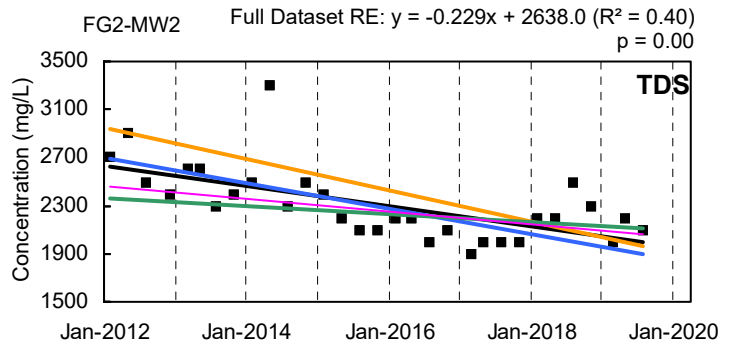
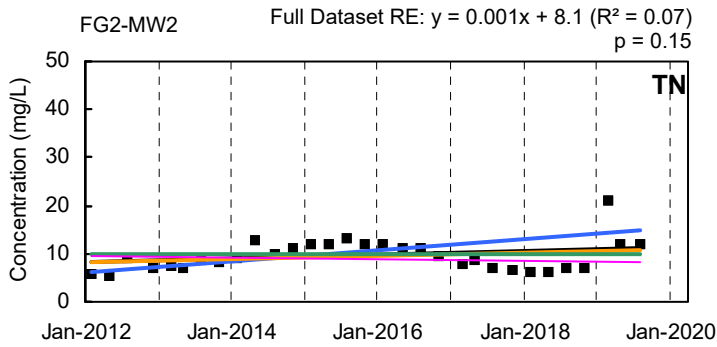
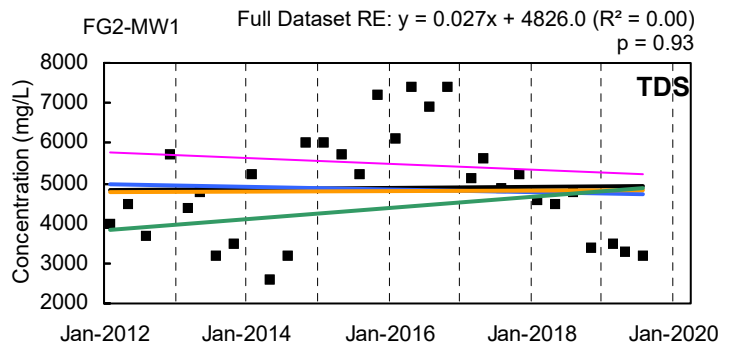
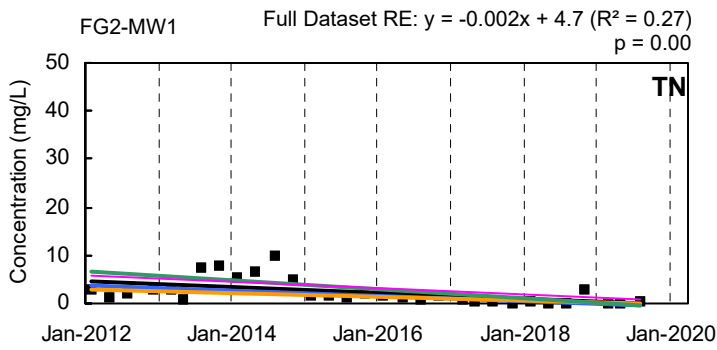

— Q1 Trendline — Q2 Trendline
— Q3 Trendline — Q4 Trendline — Full Dataset Trendline

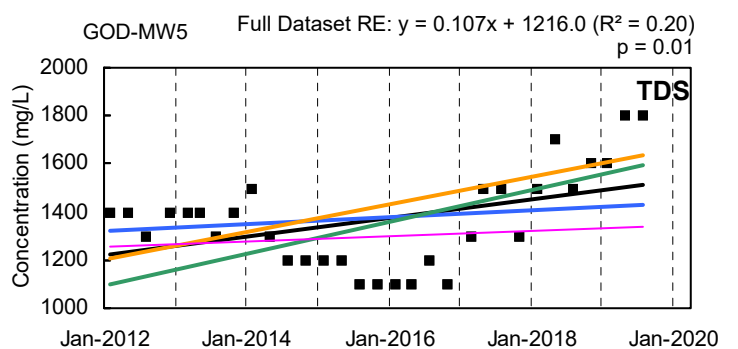
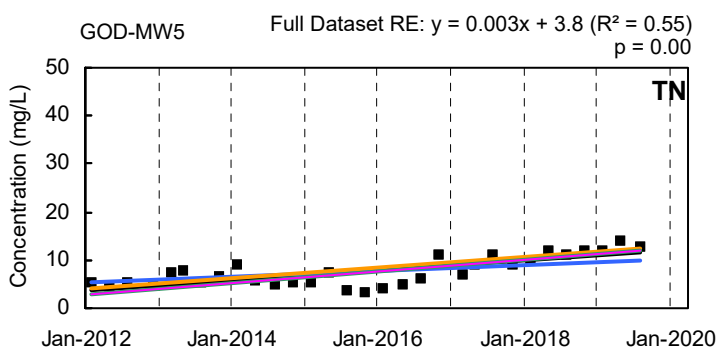
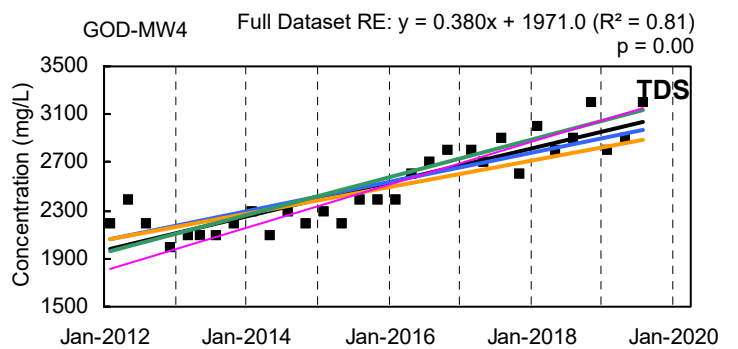
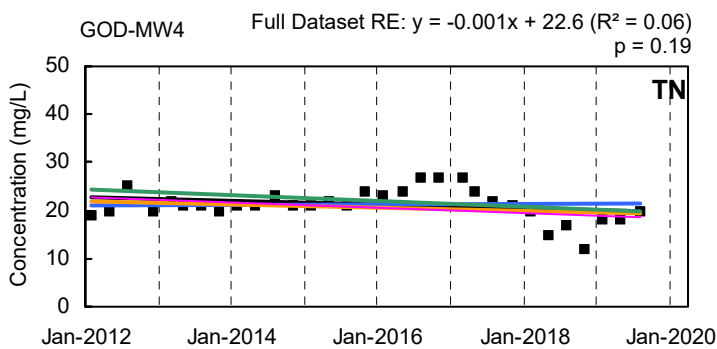
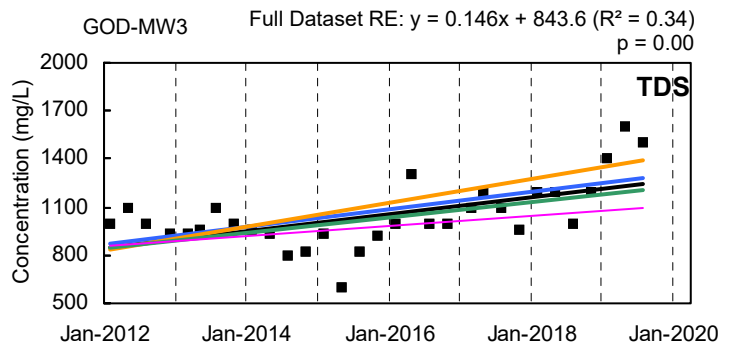
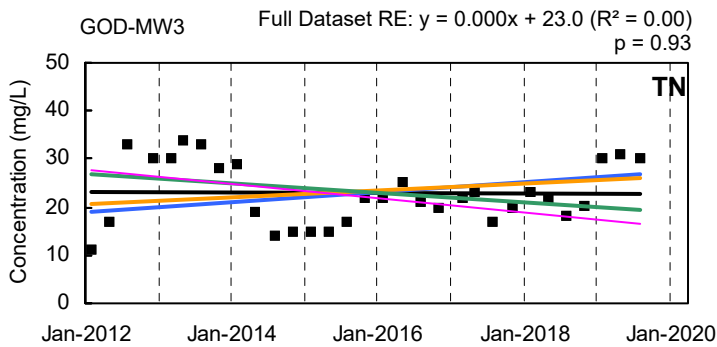
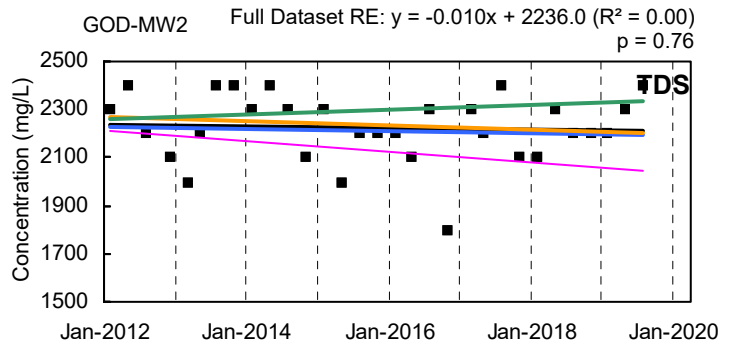
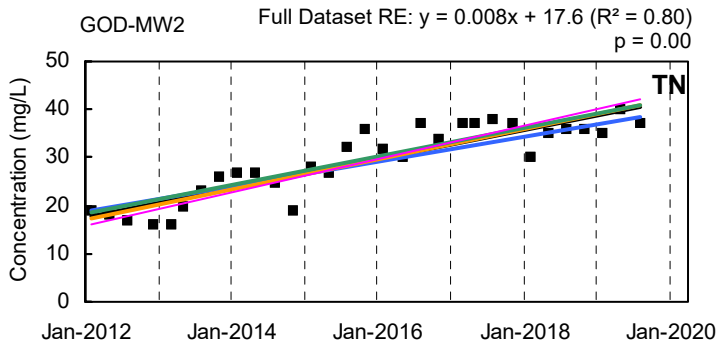
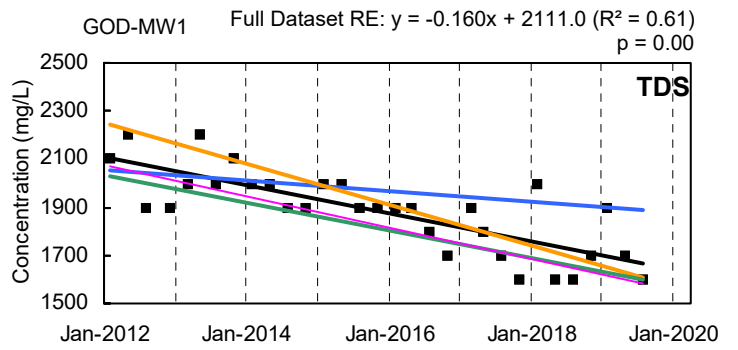
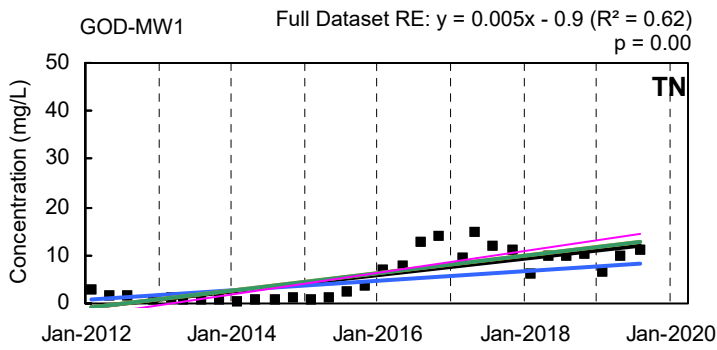

— Q1 Trendline — Q2 Trendline
— Q3 Trendline — Q4 Trendline — Full Dataset Trendline

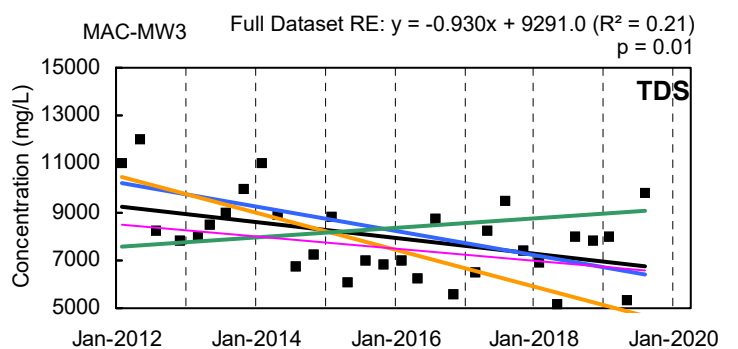
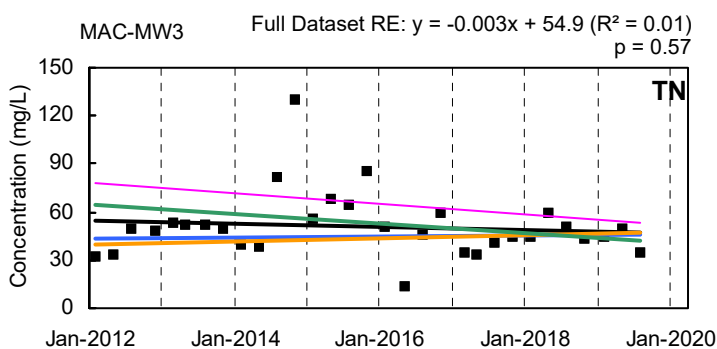
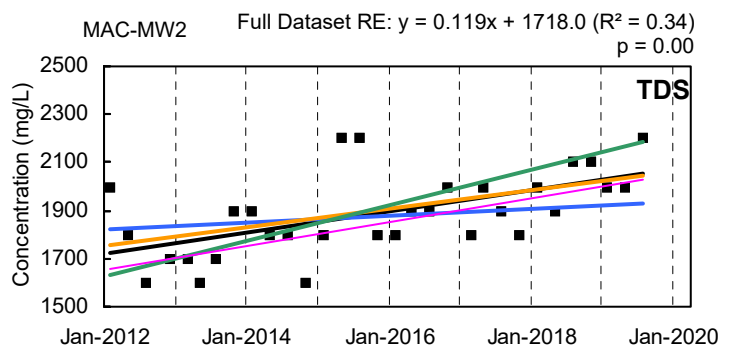
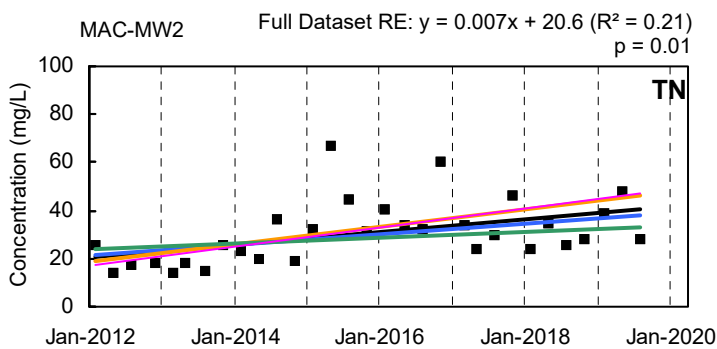
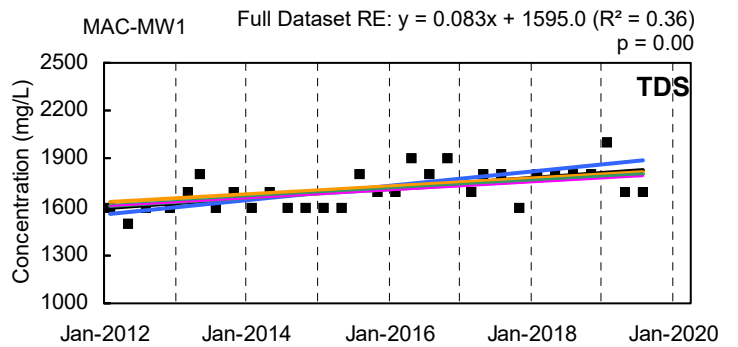
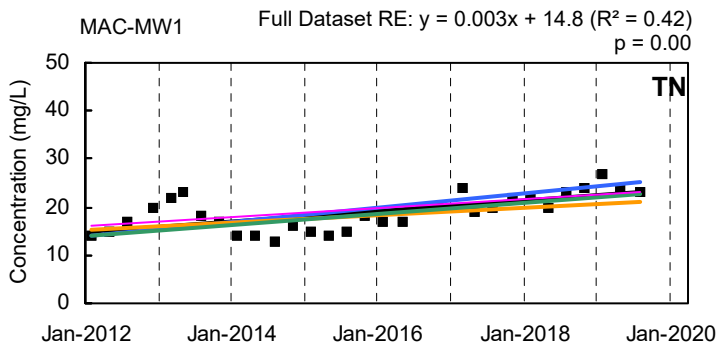
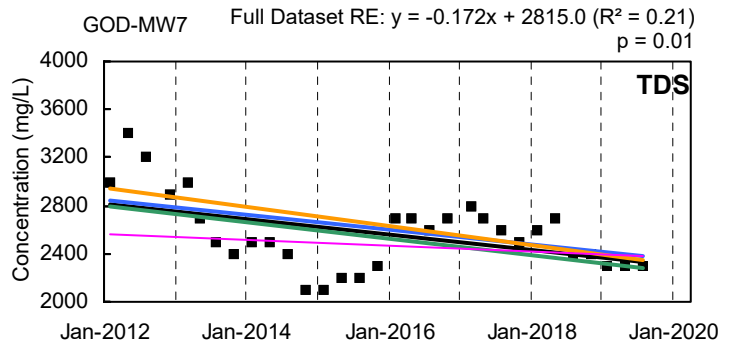
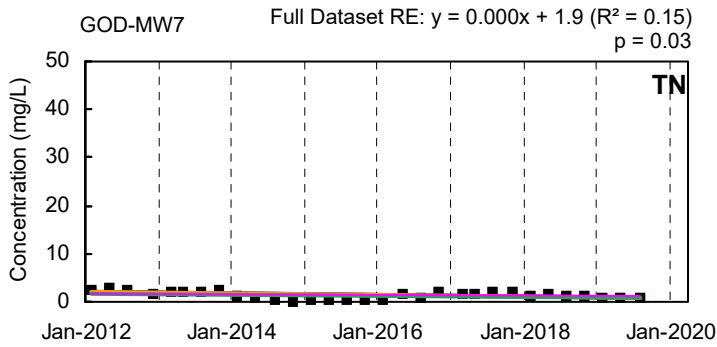
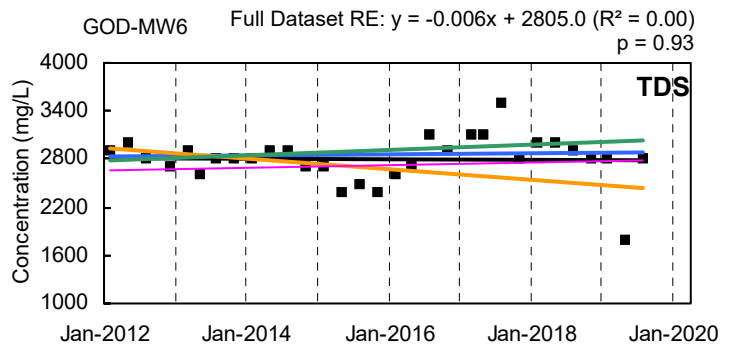
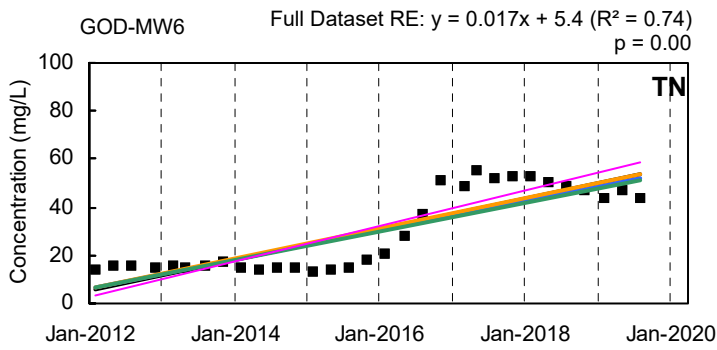

— Q1 Trendline — Q2 Trendline
— Q3 Trendline — Q4 Trendline — Full Dataset Trendline

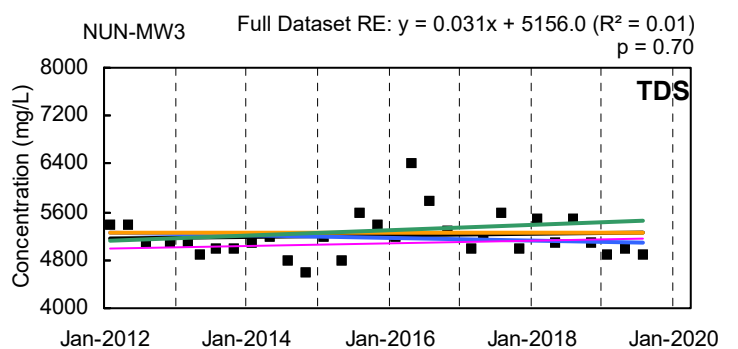
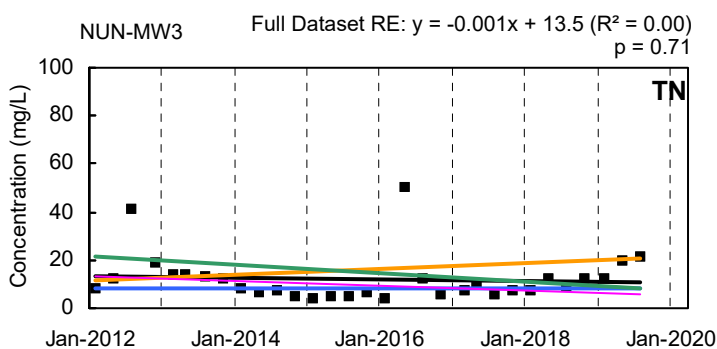
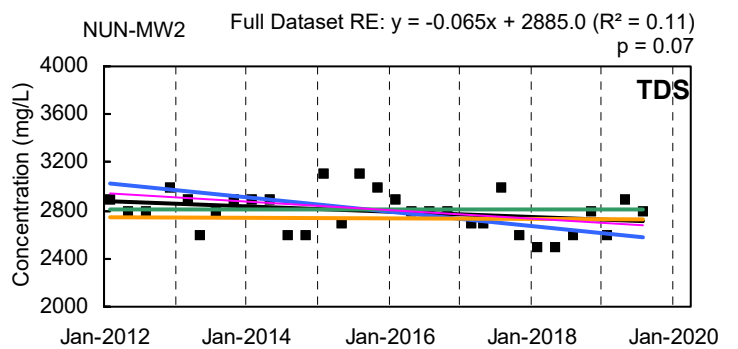
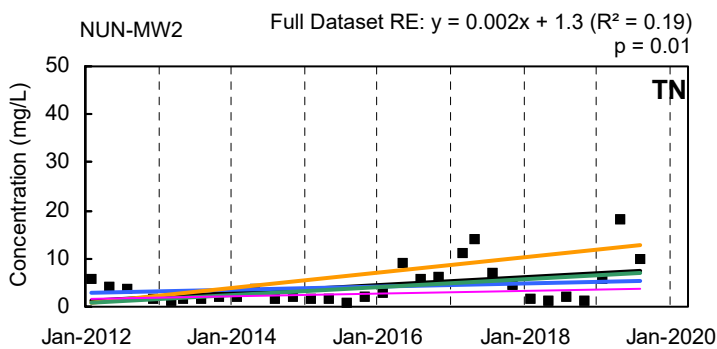
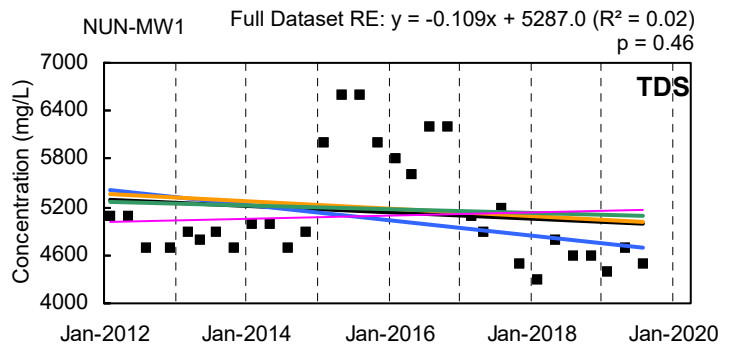
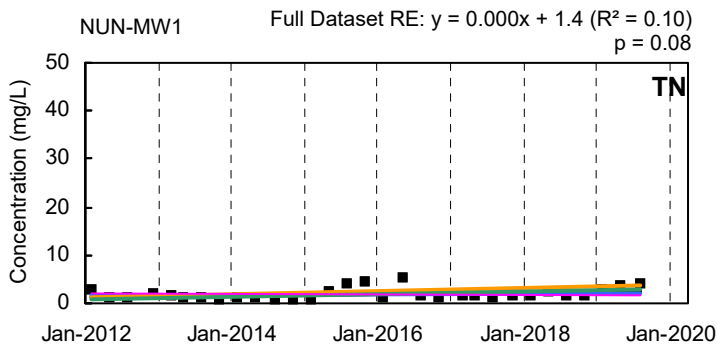
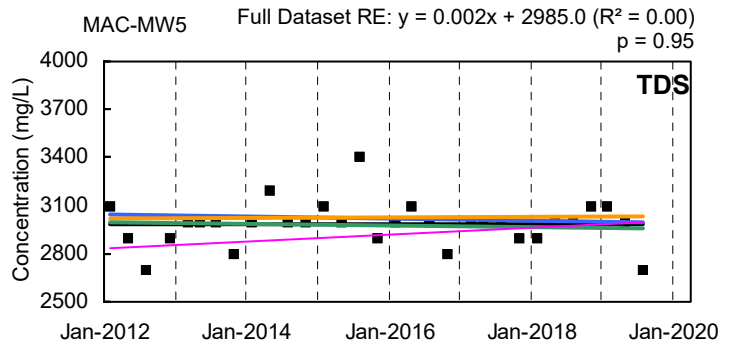
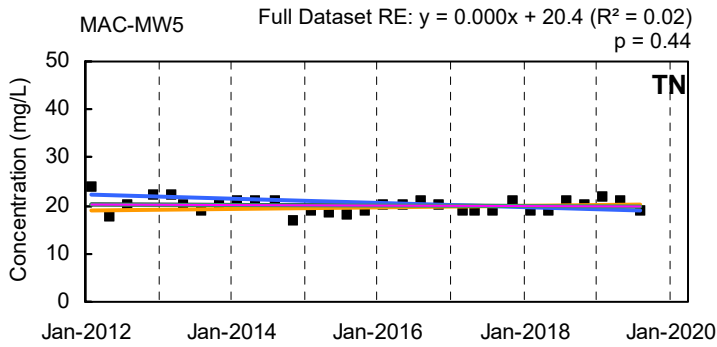
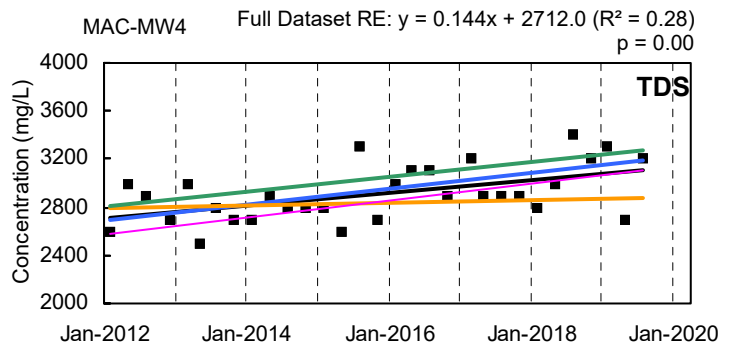
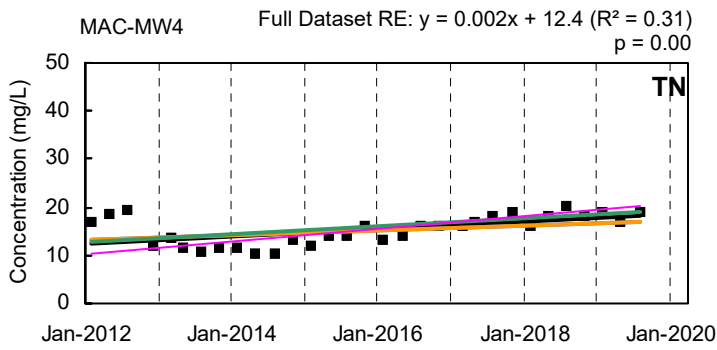

— Q1 Trendline — Q2 Trendline
— Q3 Trendline — Q4 Trendline — Full Dataset Trendline

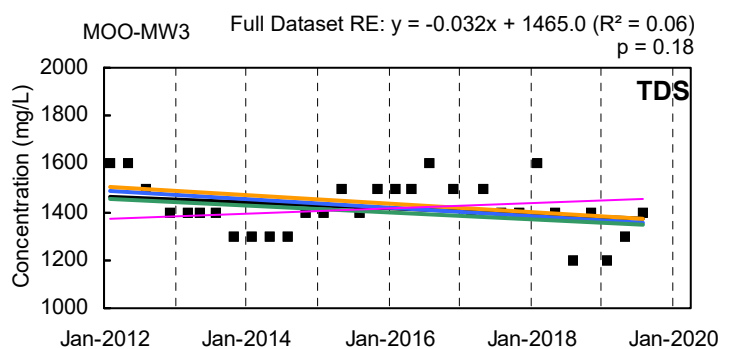
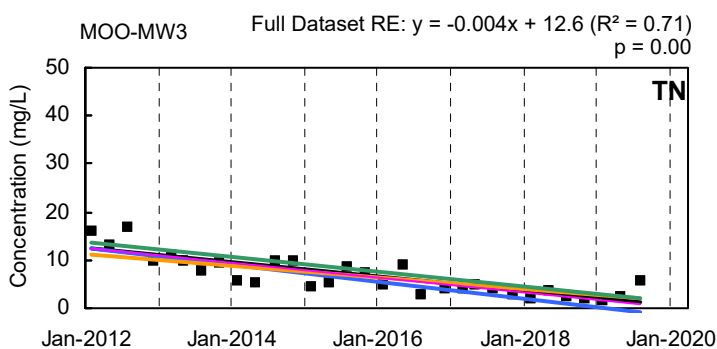
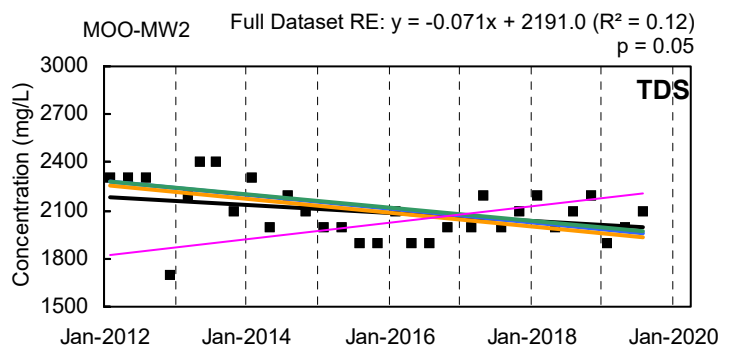
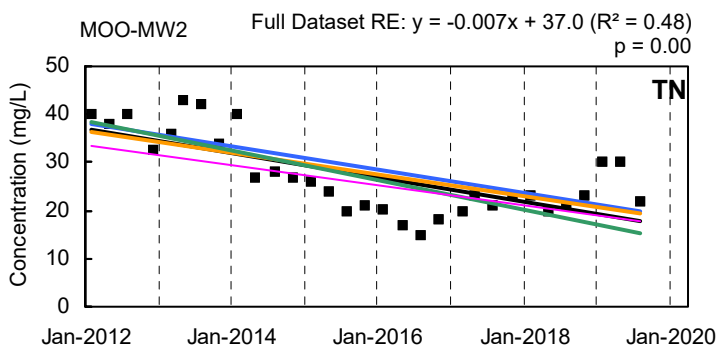
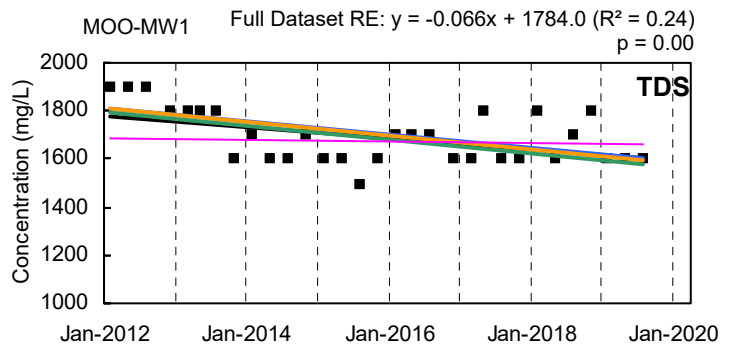
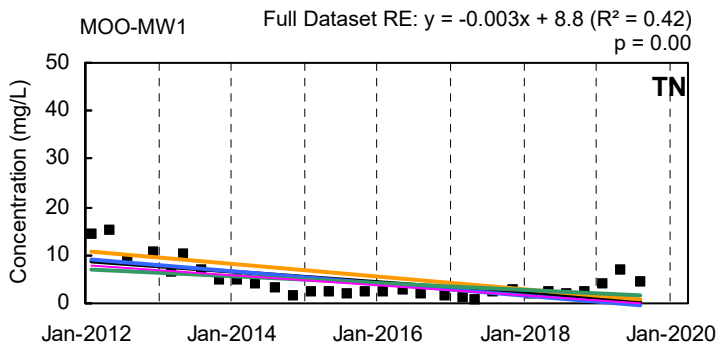
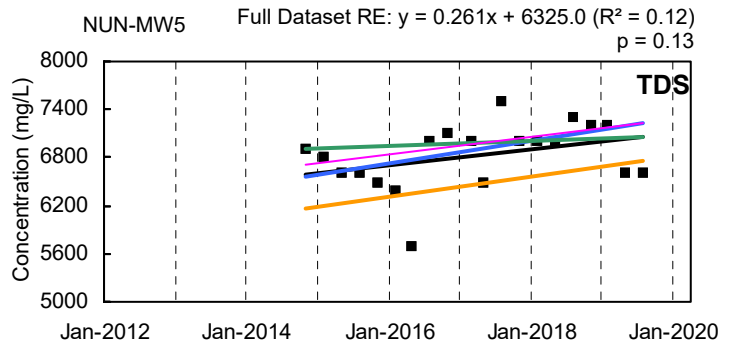
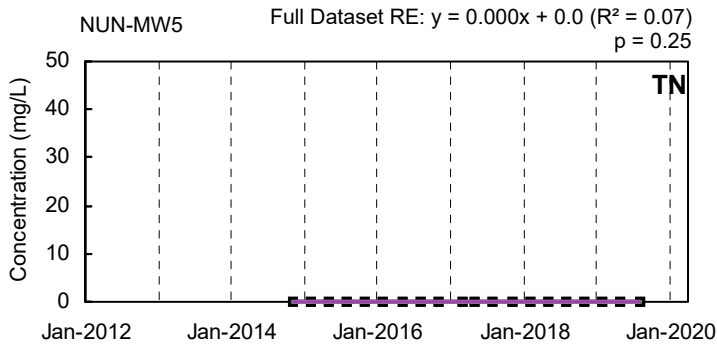
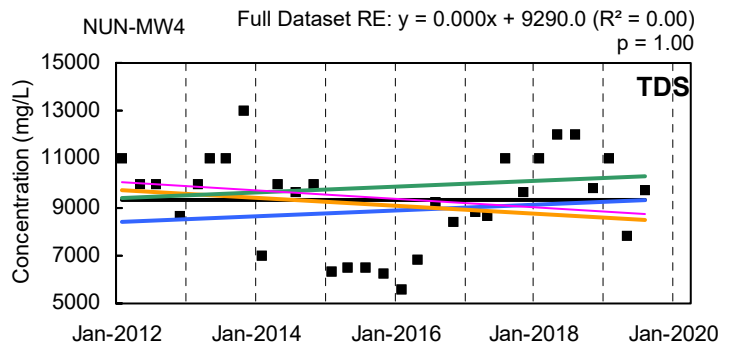
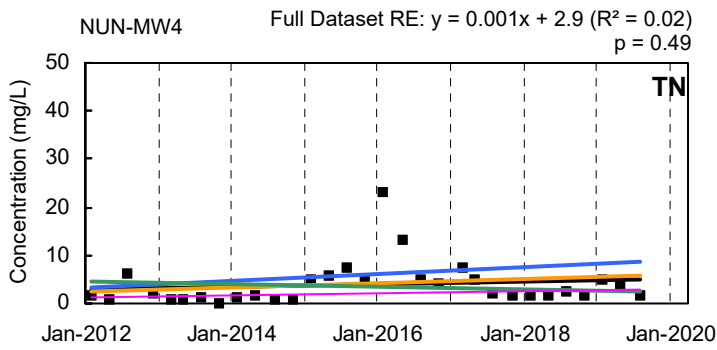

— Q1 Trendline — Q2 Trendline
— Q3 Trendline — Q4 Trendline — Full Dataset Trendline

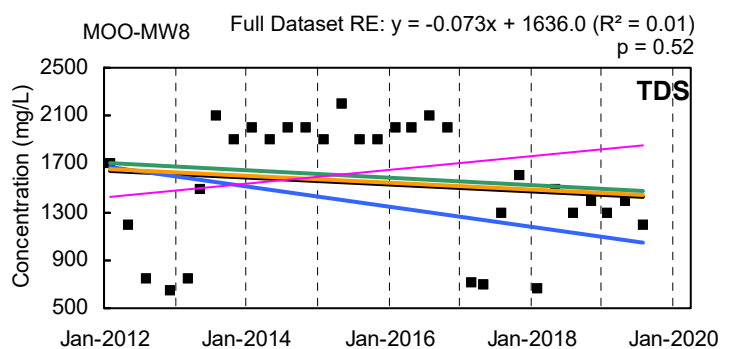
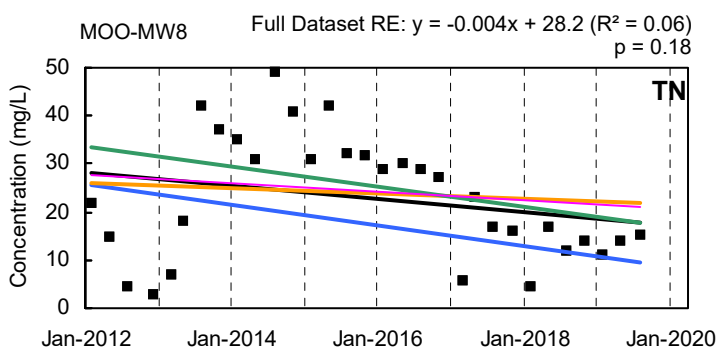
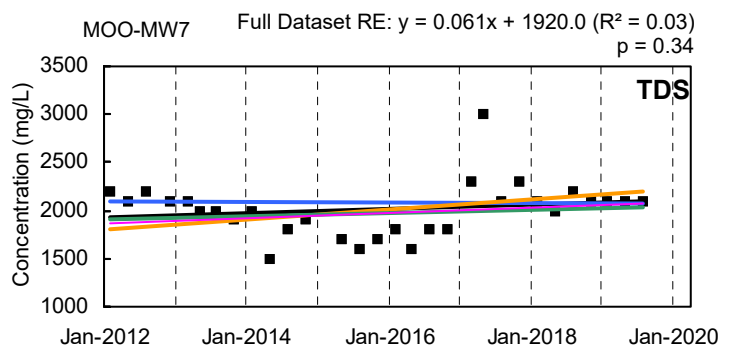
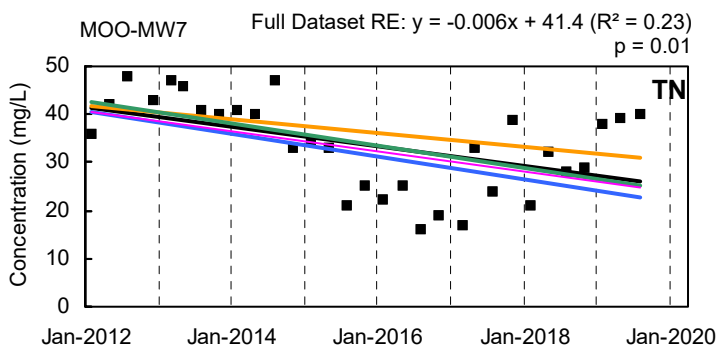
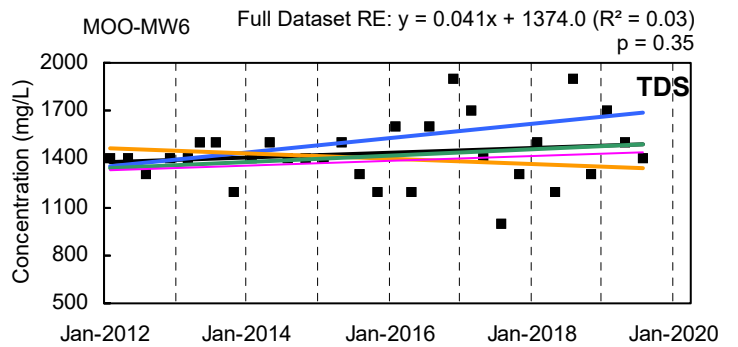
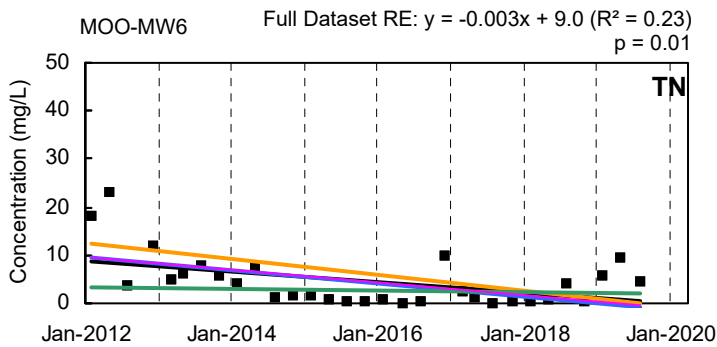
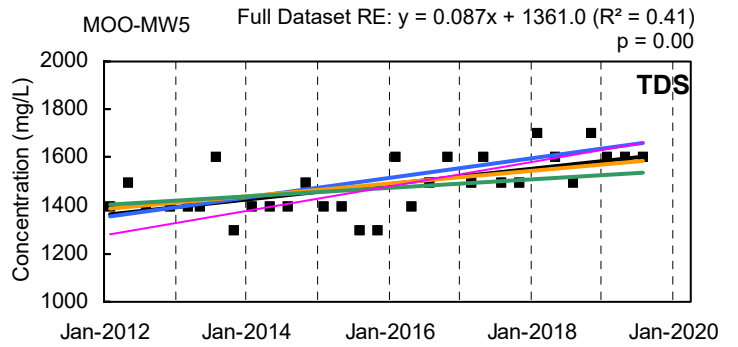
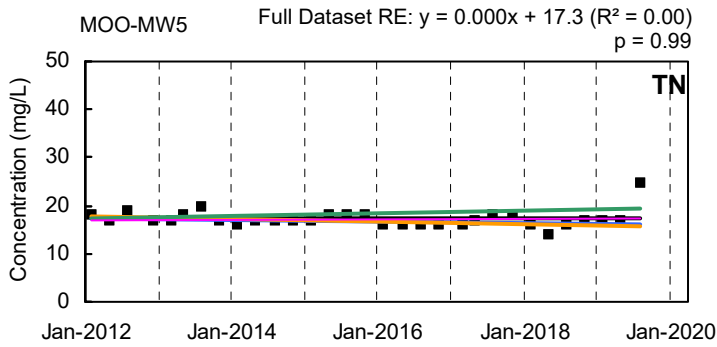
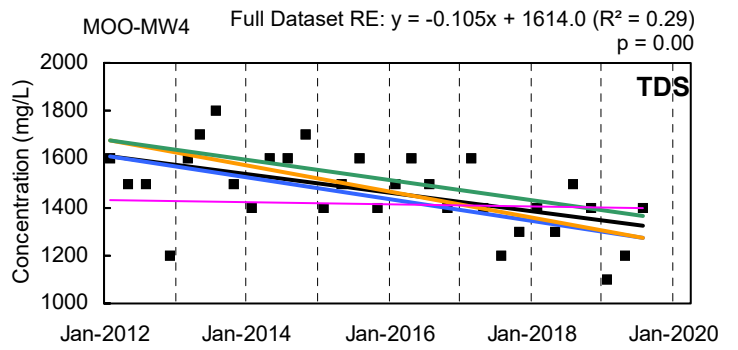
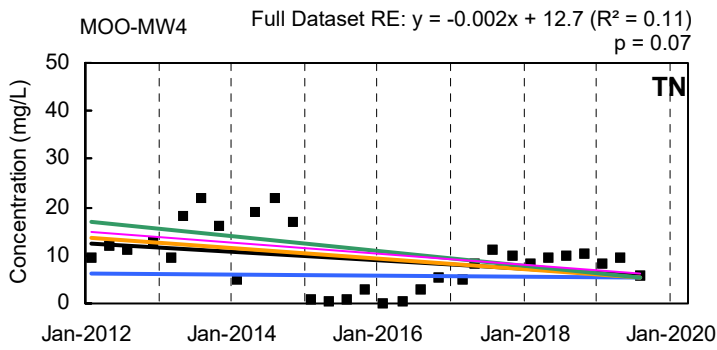

— Q1 Trendline — Q2 Trendline
— Q3 Trendline — Q4 Trendline — Full Dataset Trendline

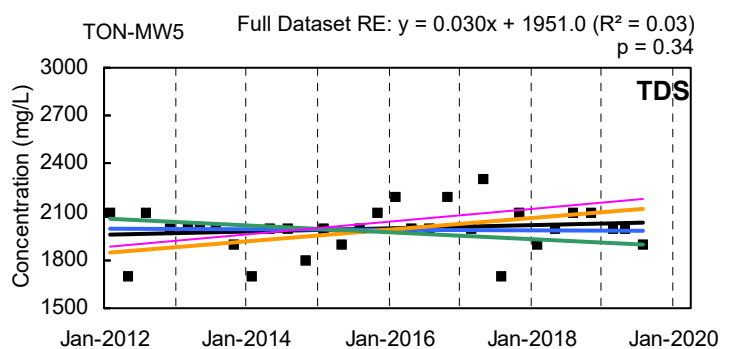
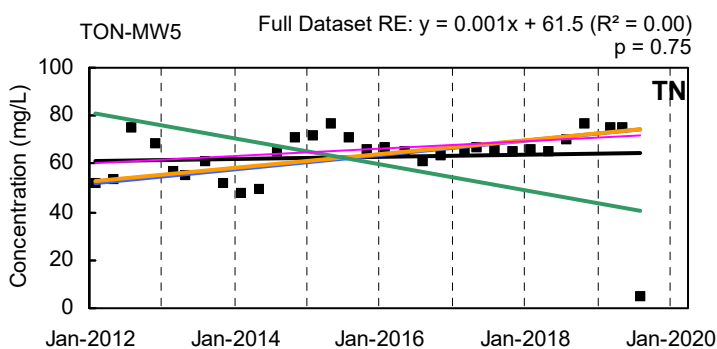
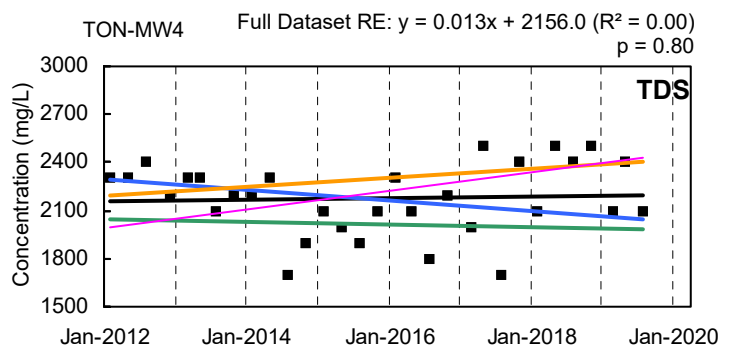
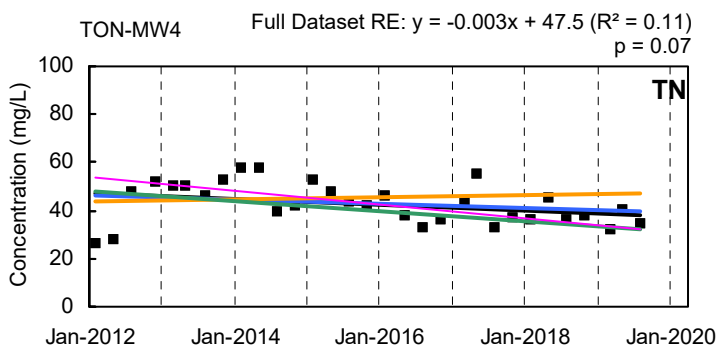
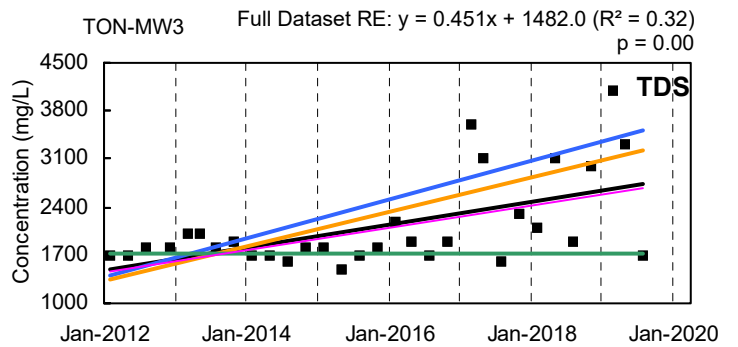
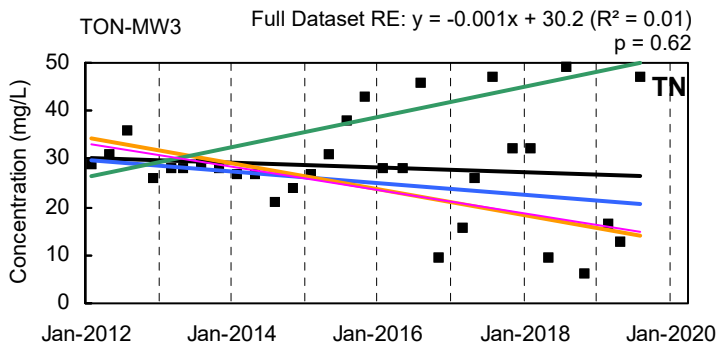
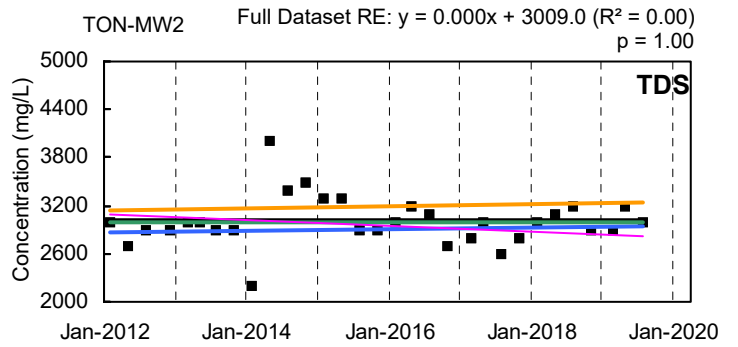
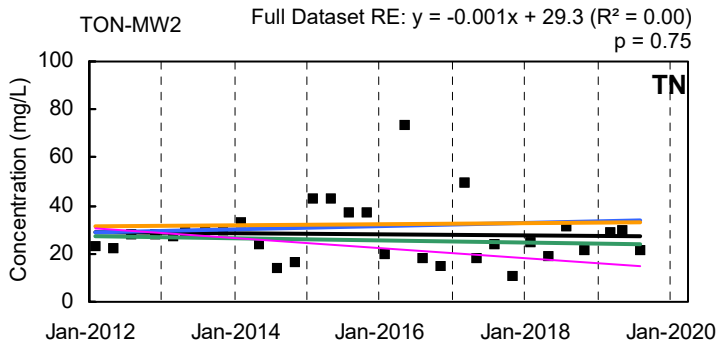
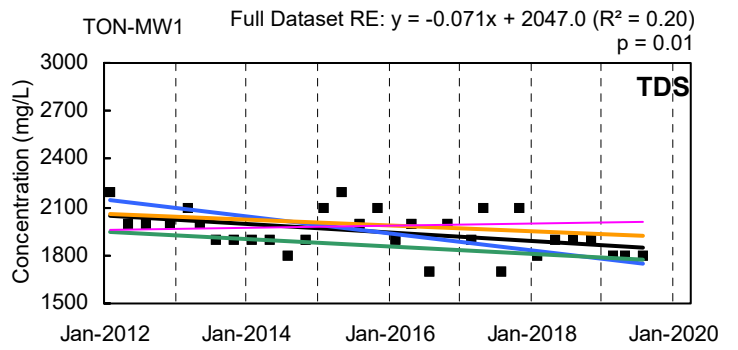
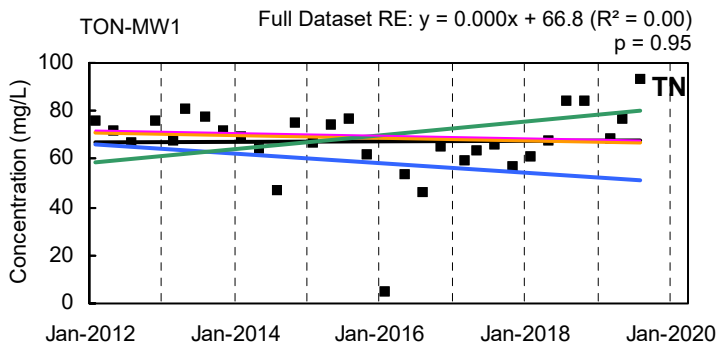

— Q1 Trendline — Q2 Trendline
— Q3 Trendline — Q4 Trendline — Full Dataset Trendline

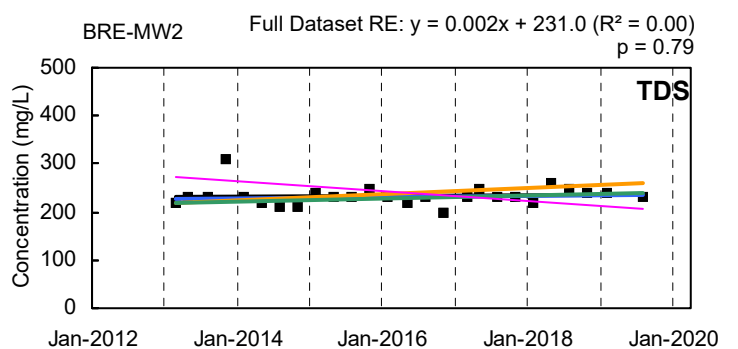
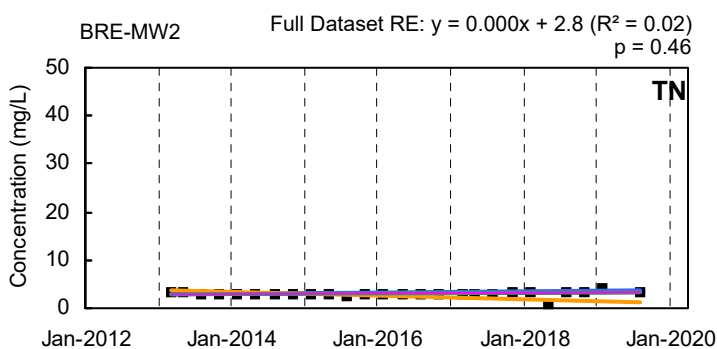
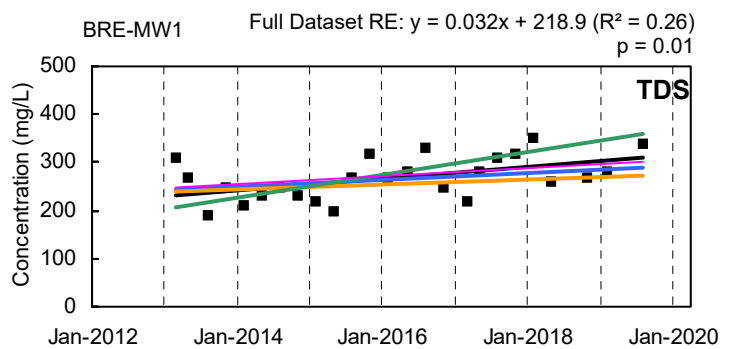
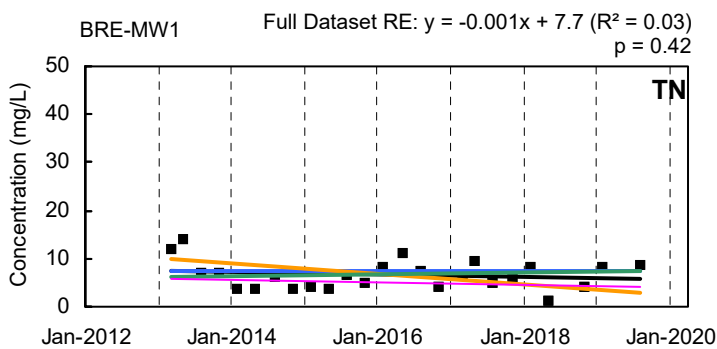
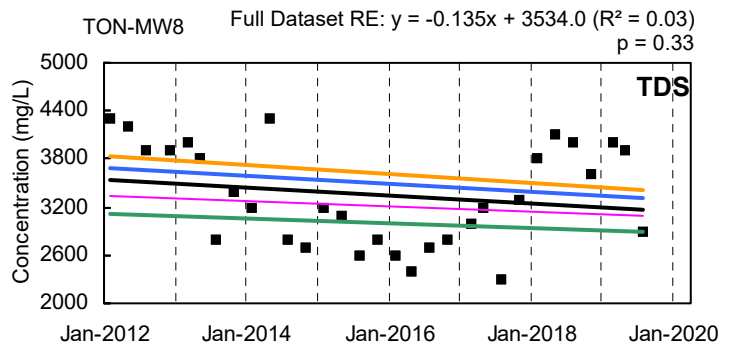
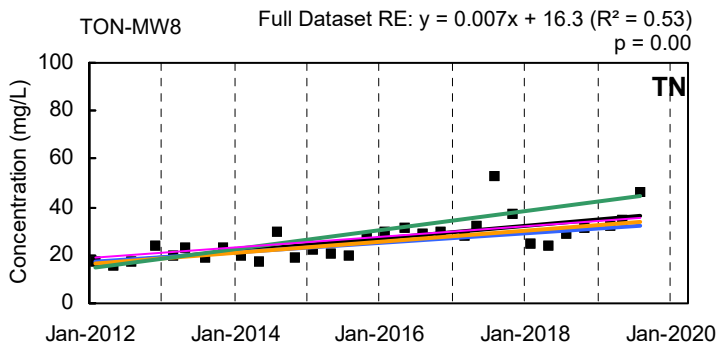
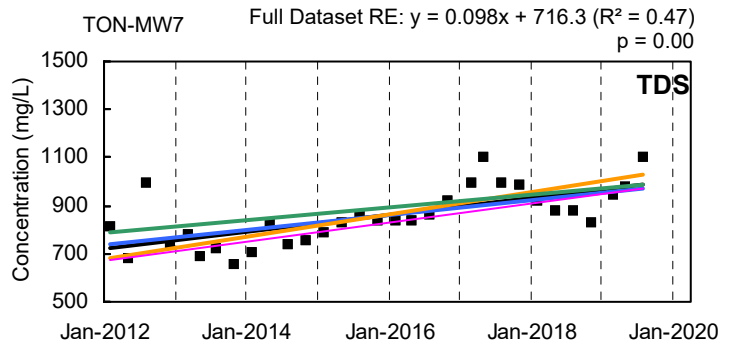
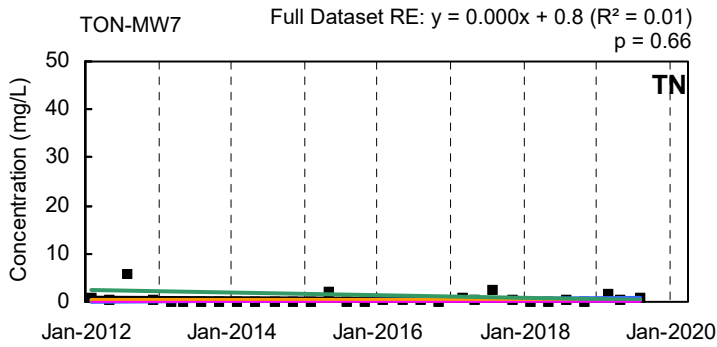
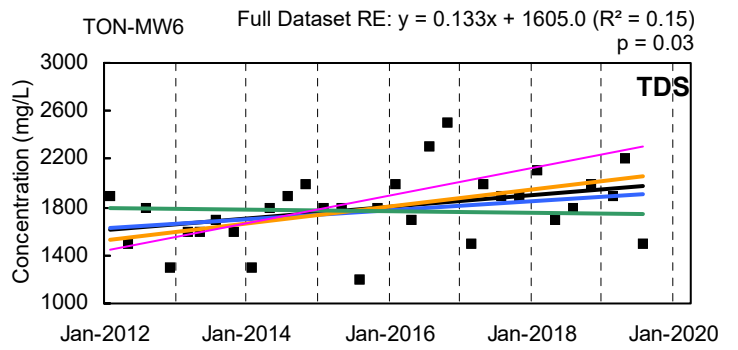
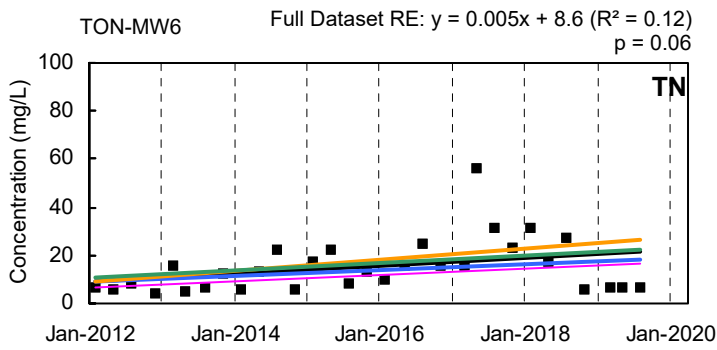

— Q1 Trendline — Q2 Trendline
— Q3 Trendline — Q4 Trendline — Full Dataset Trendline

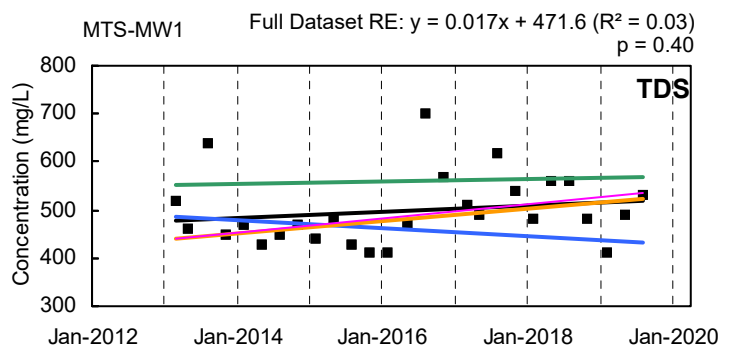
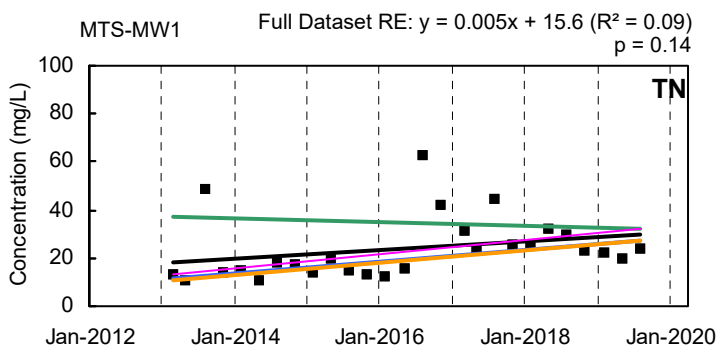
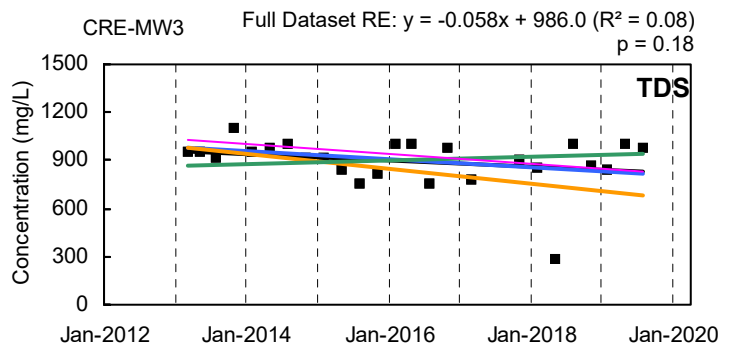
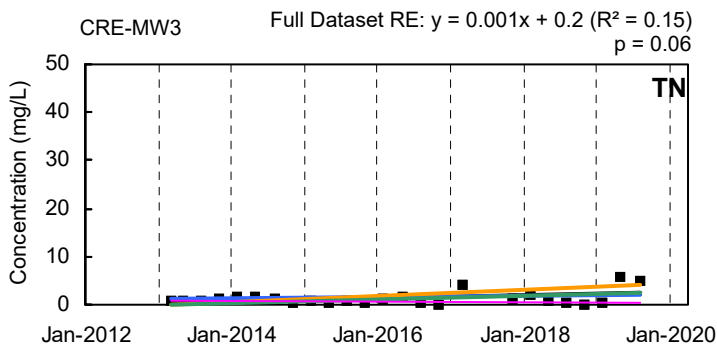
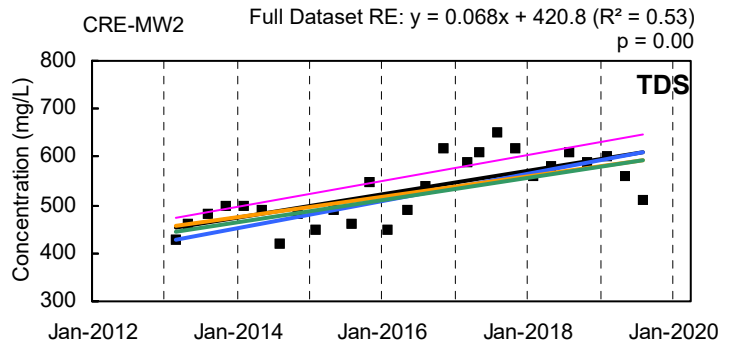
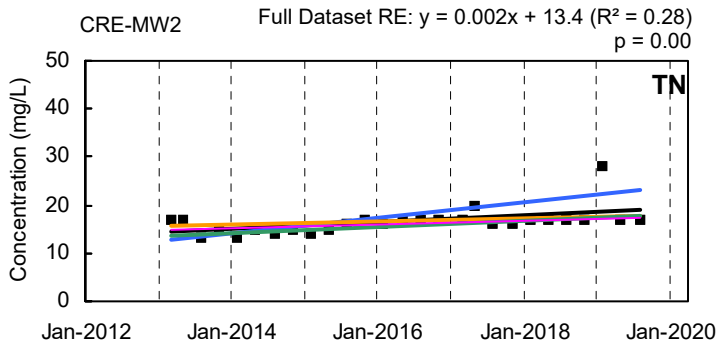
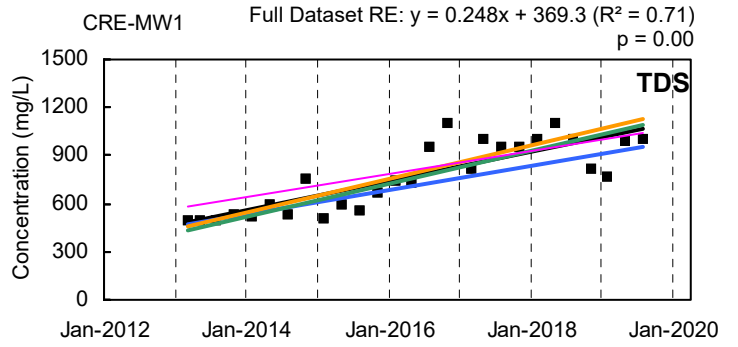
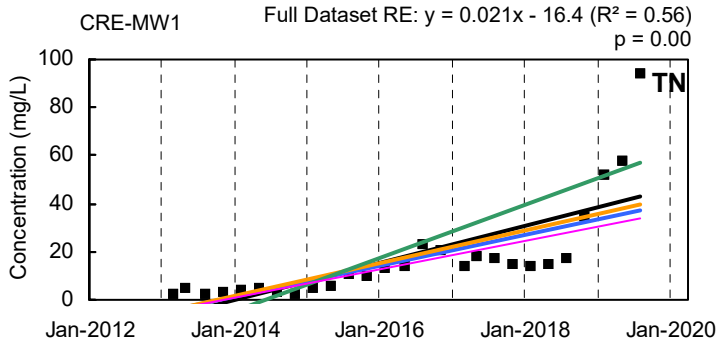
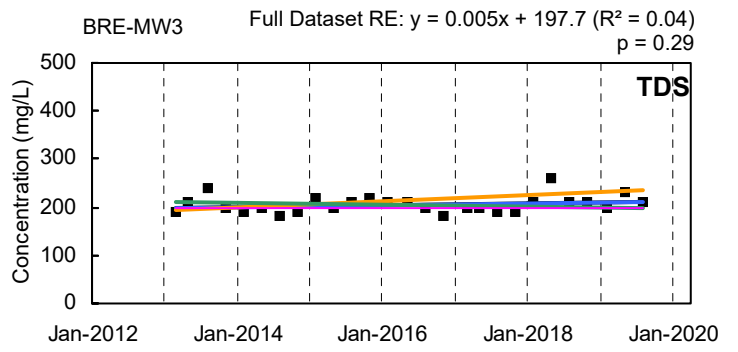
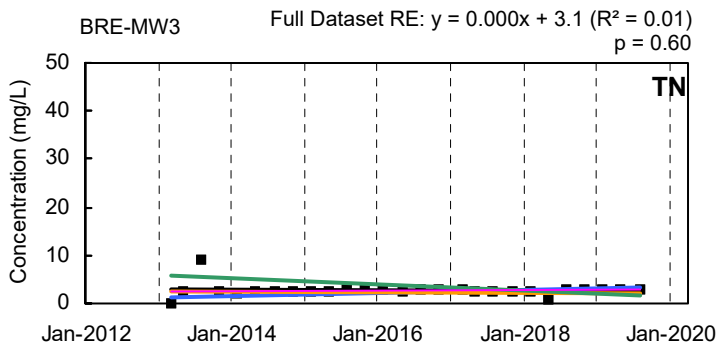

— Q1 Trendline — Q2 Trendline
— Q3 Trendline — Q4 Trendline — Full Dataset Trendline

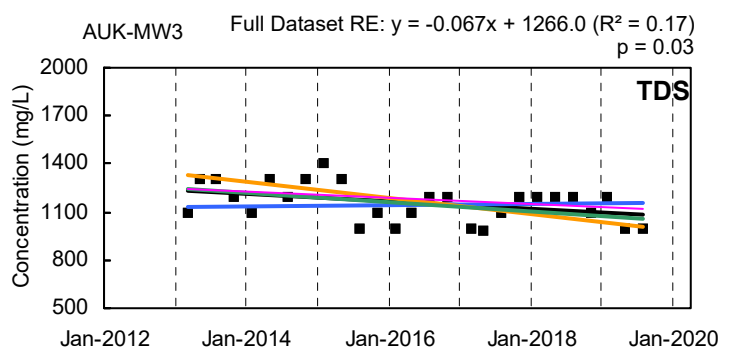
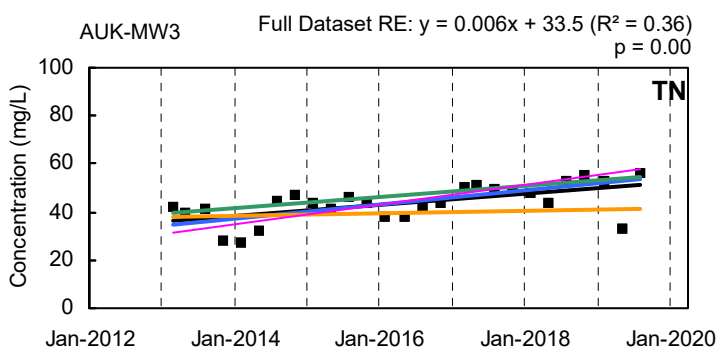
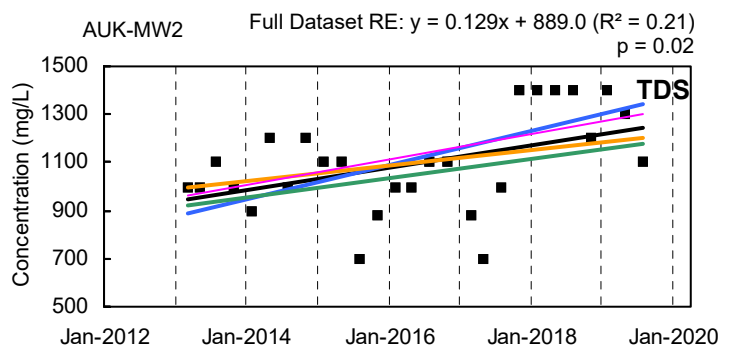
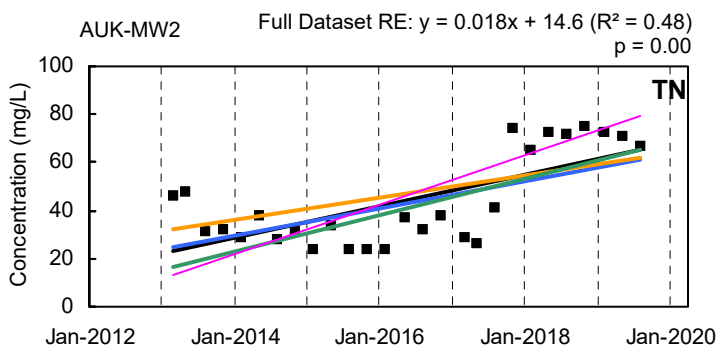
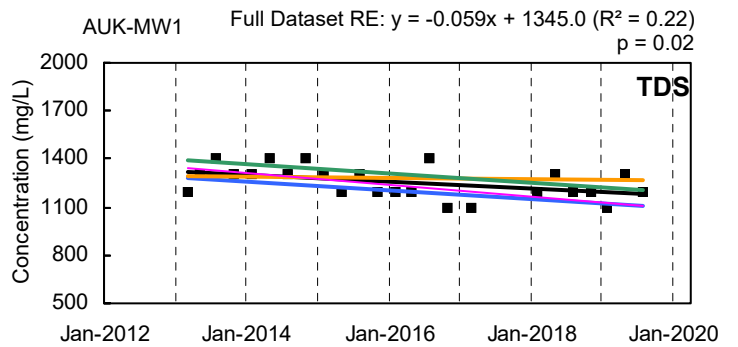
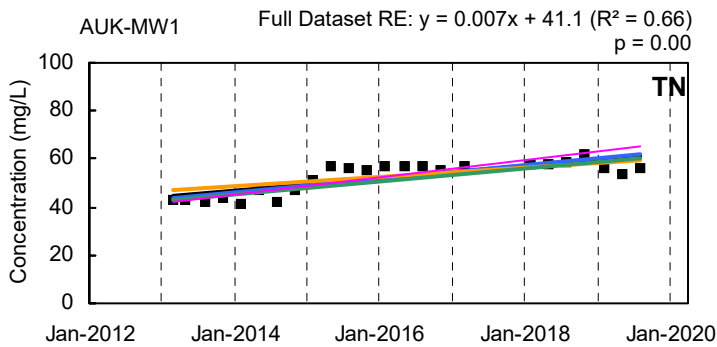
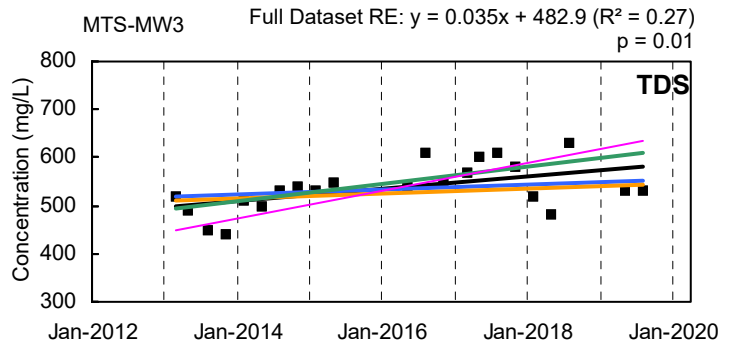
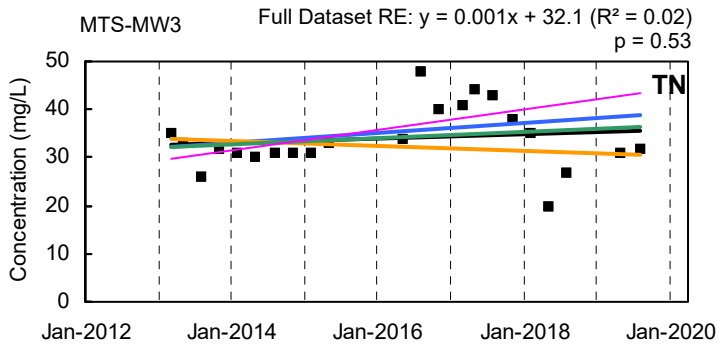
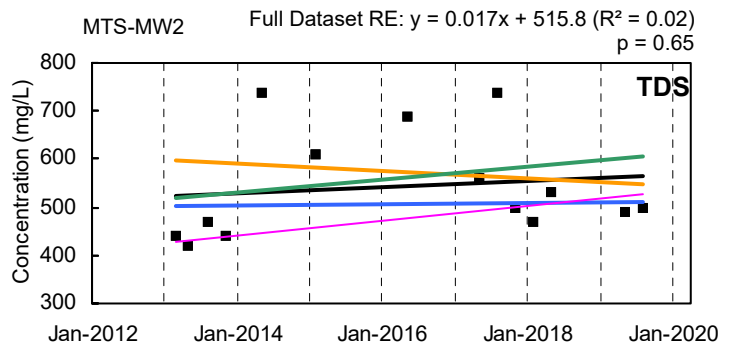
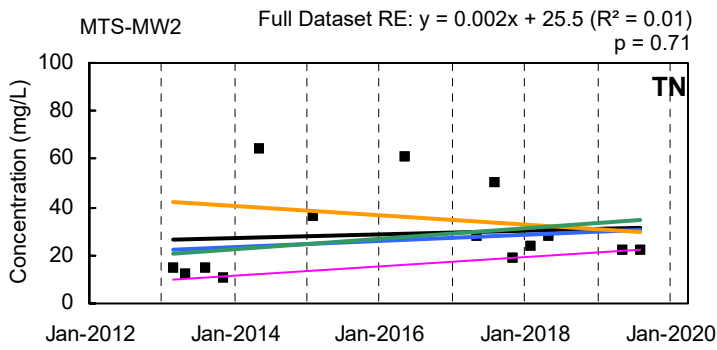

— Q1 Trendline — Q2 Trendline
— Q3 Trendline — Q4 Trendline — Full Dataset Trendline

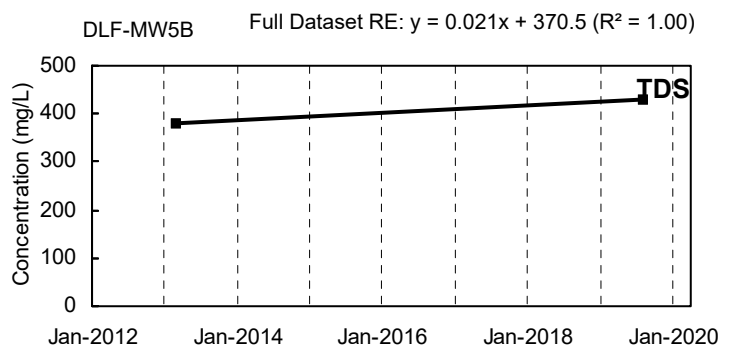
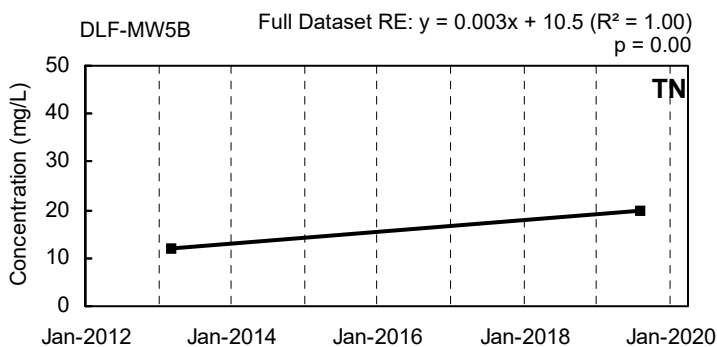
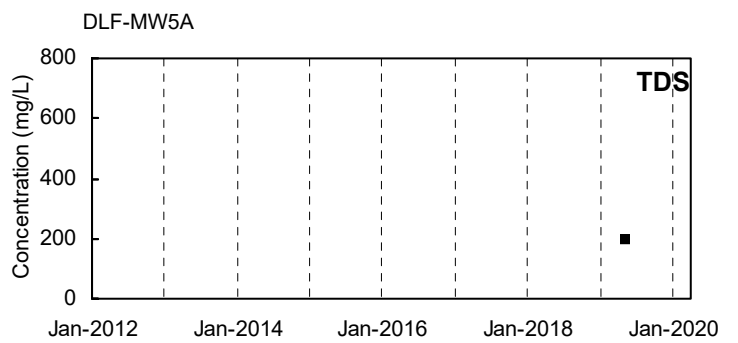
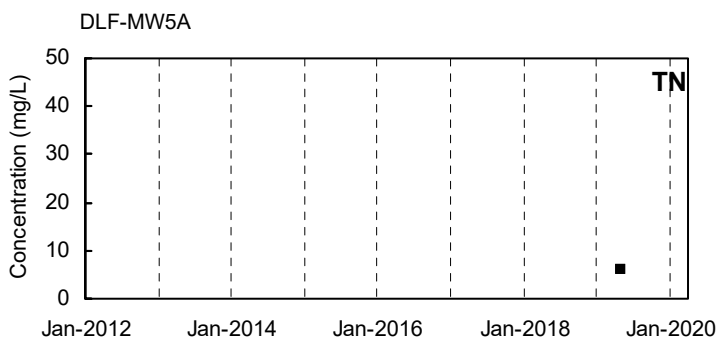
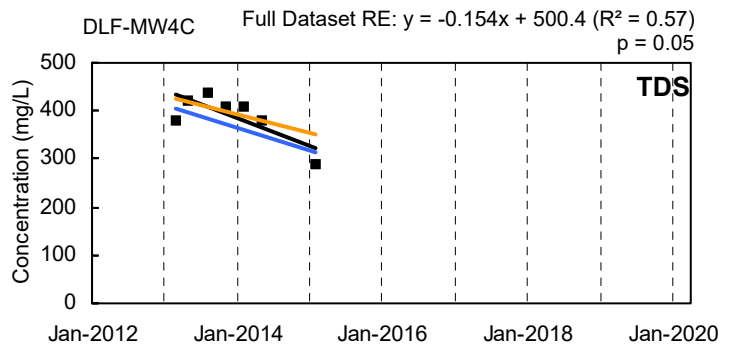
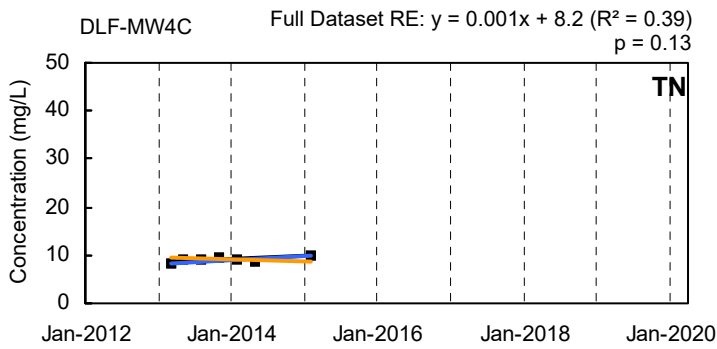
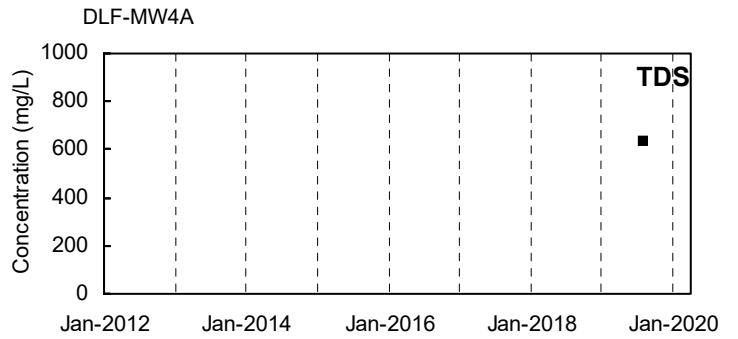
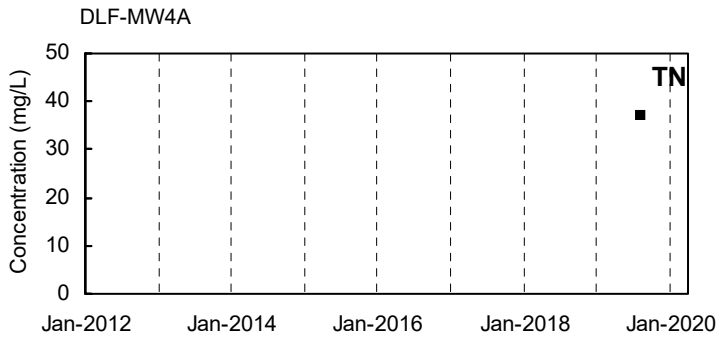
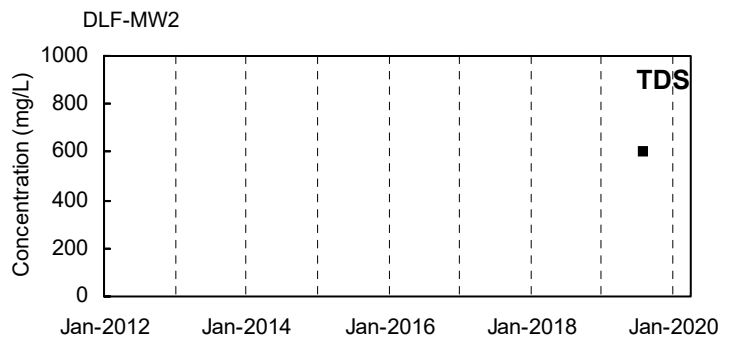
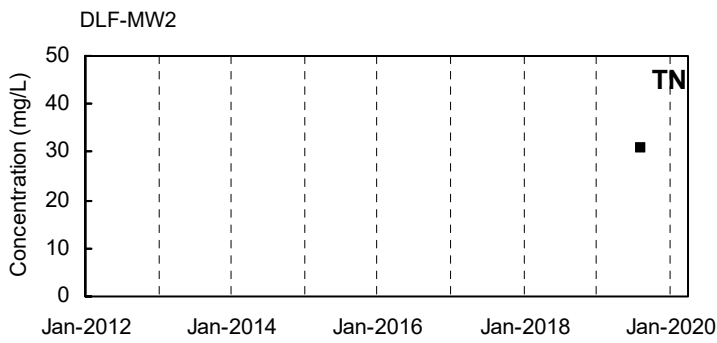

— Q1 Trendline — Q2 Trendline
— Q3 Trendline — Q4 Trendline — Full Dataset Trendline

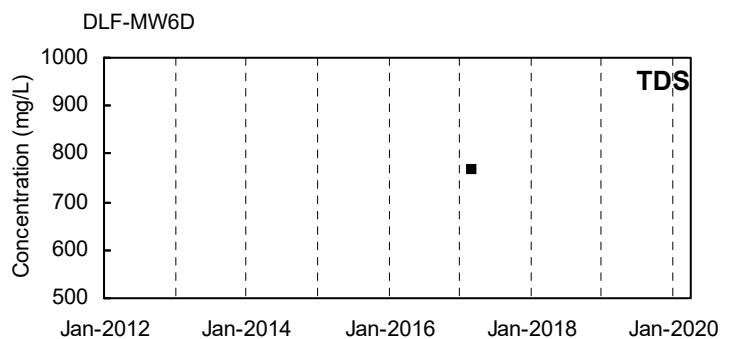
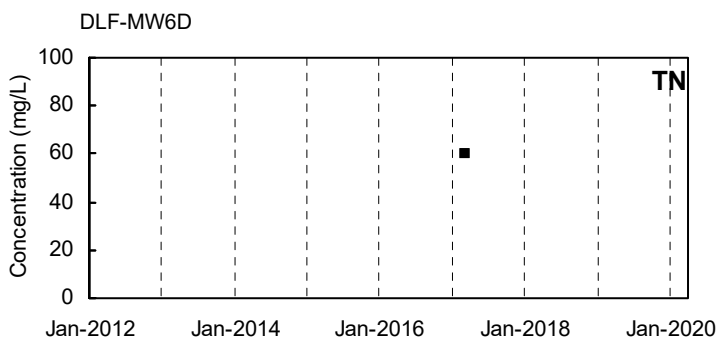
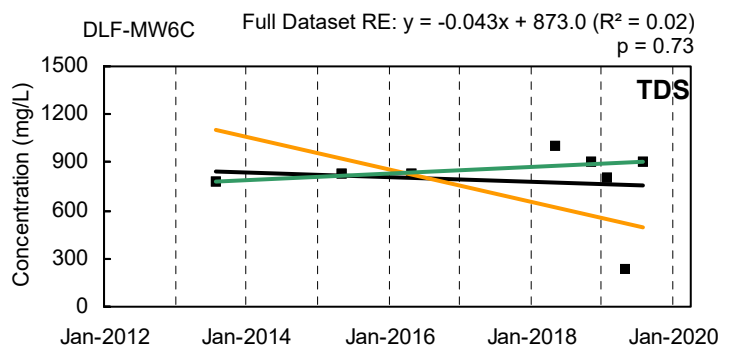
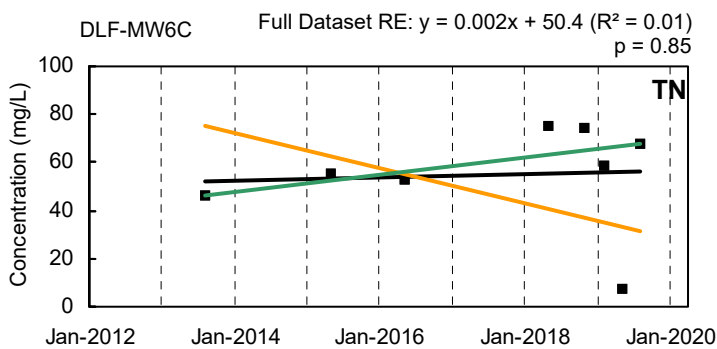
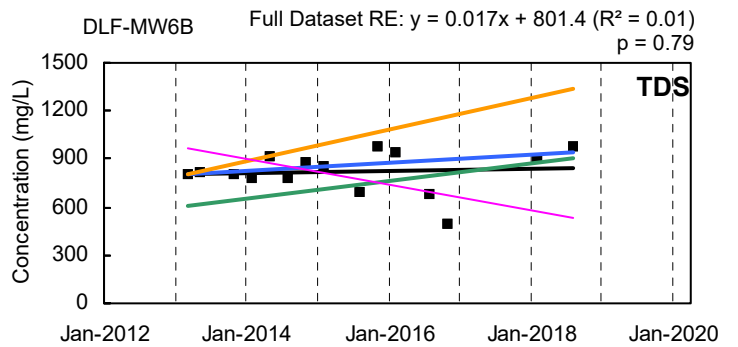
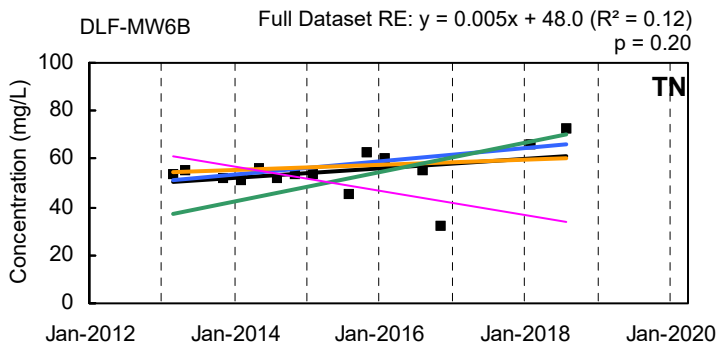
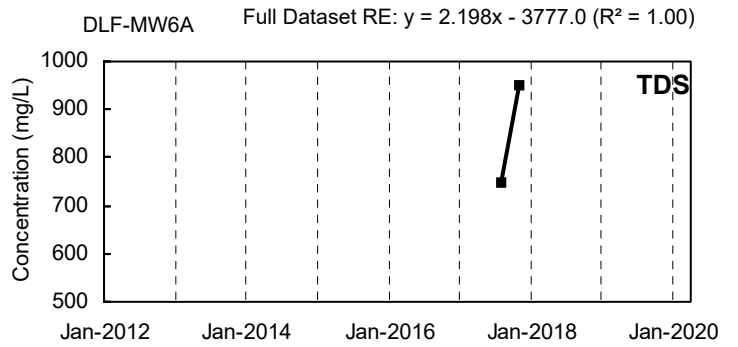
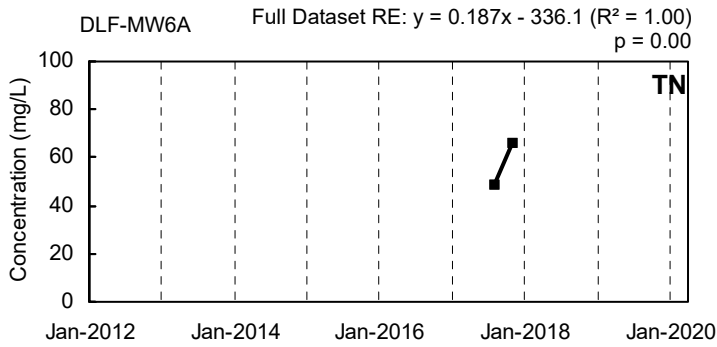
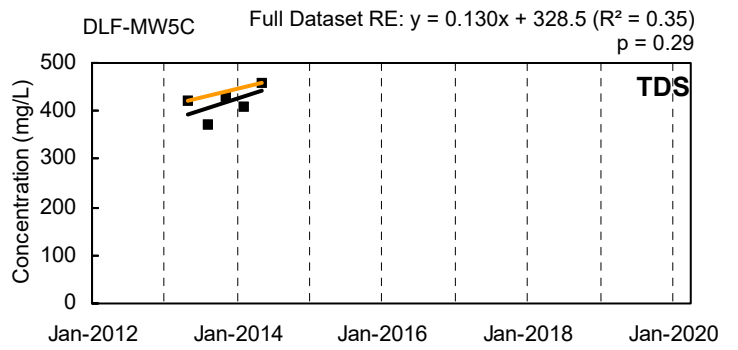
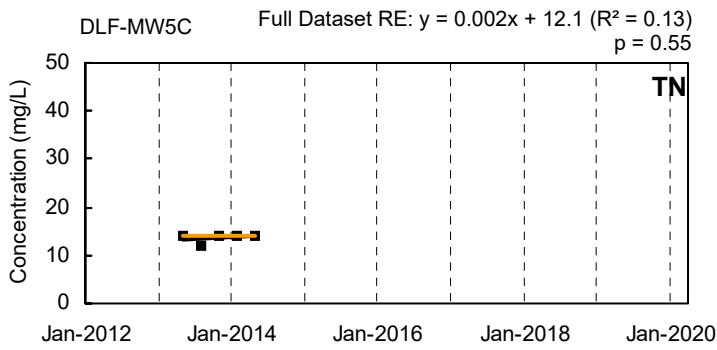

— Q1 Trendline — Q2 Trendline
— Q3 Trendline — Q4 Trendline — Full Dataset Trendline

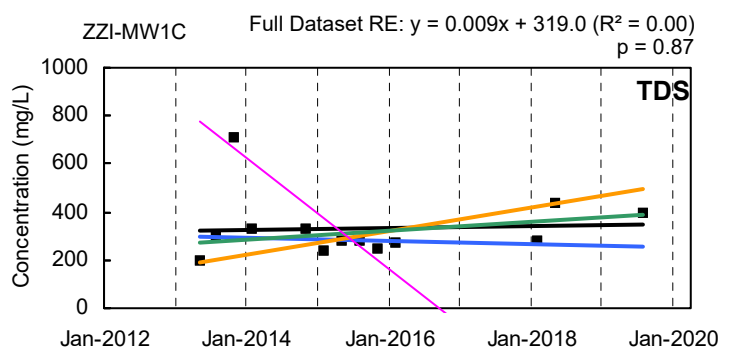
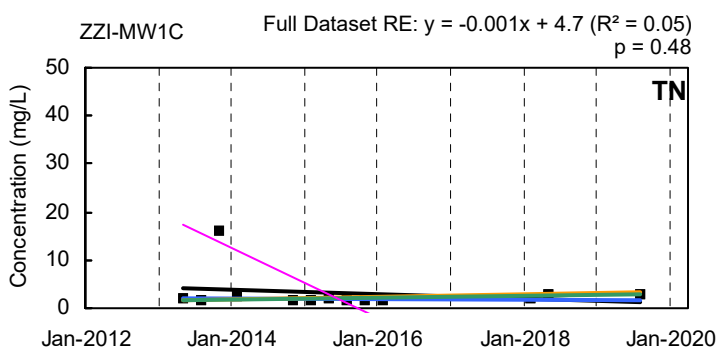
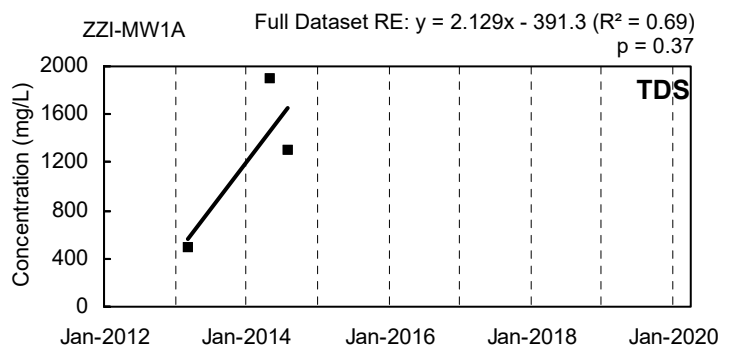
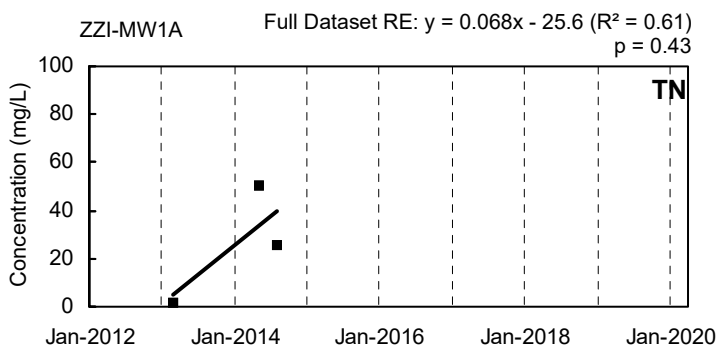
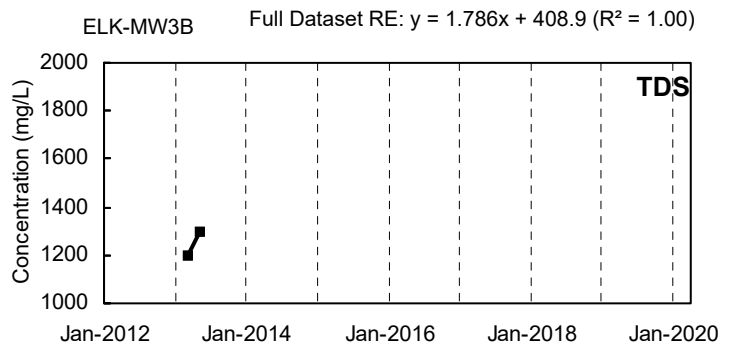
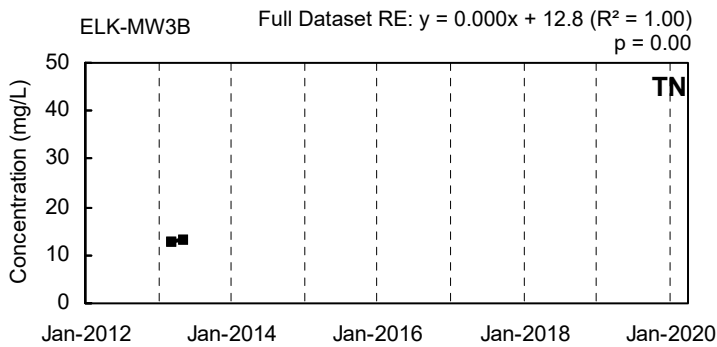
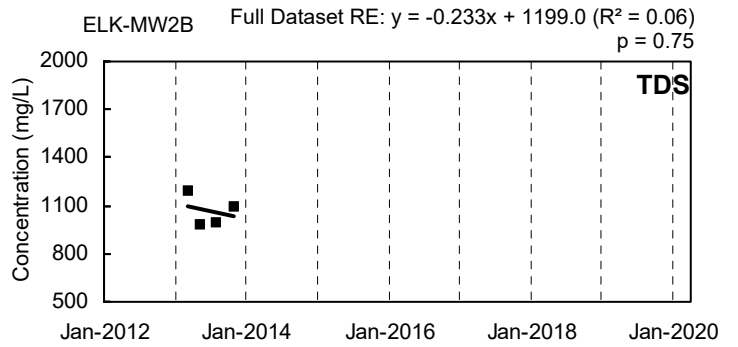
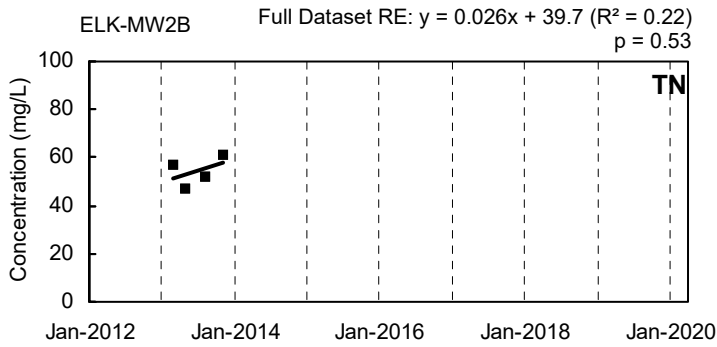
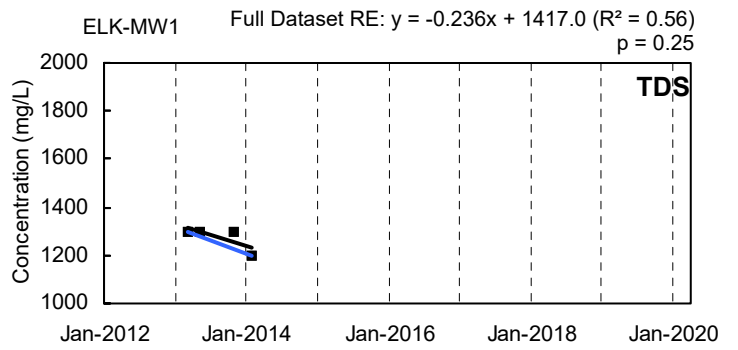
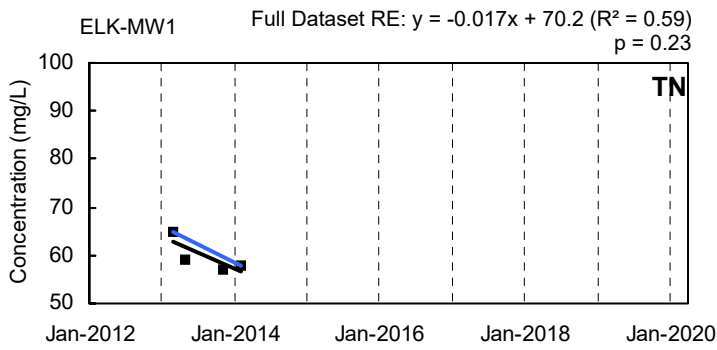

— Q1 Trendline — Q2 Trendline
— Q3 Trendline — Q4 Trendline — Full Dataset Trendline

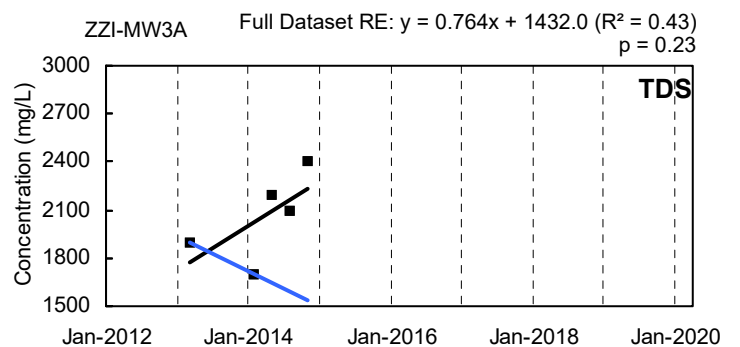
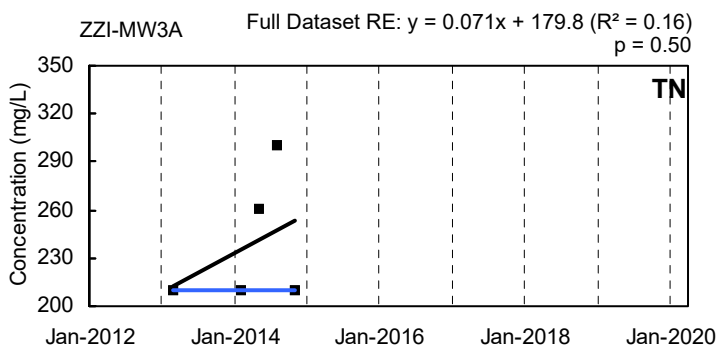
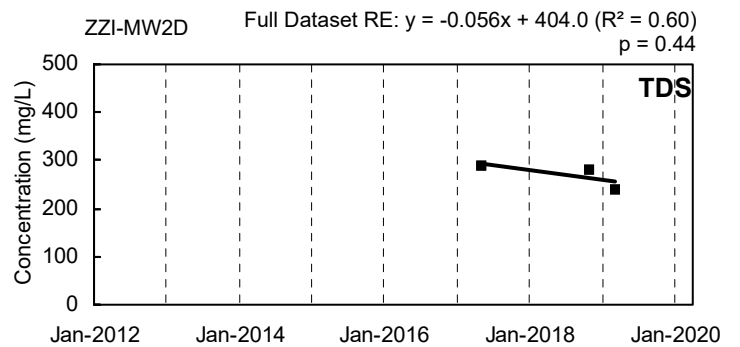
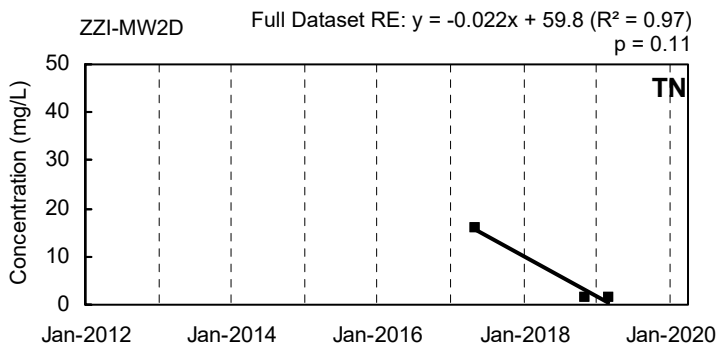
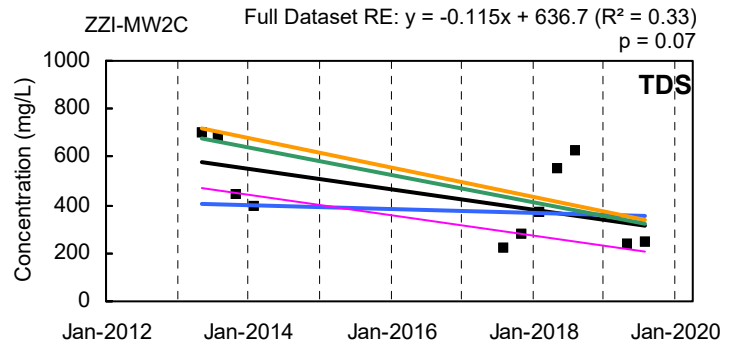
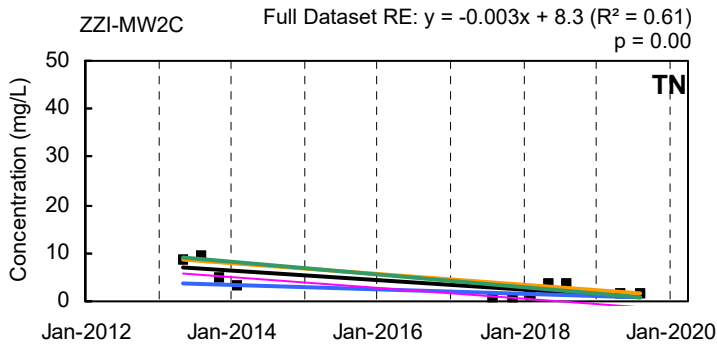
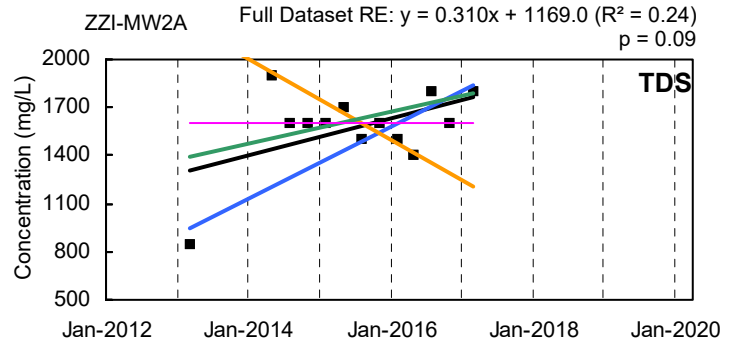
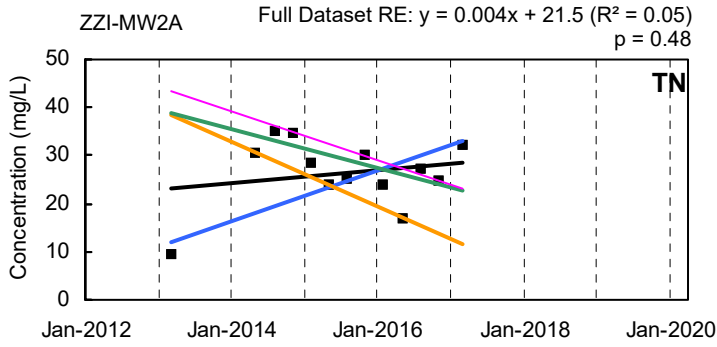
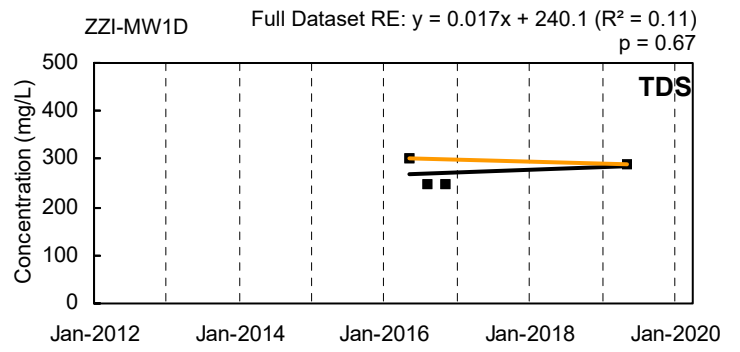
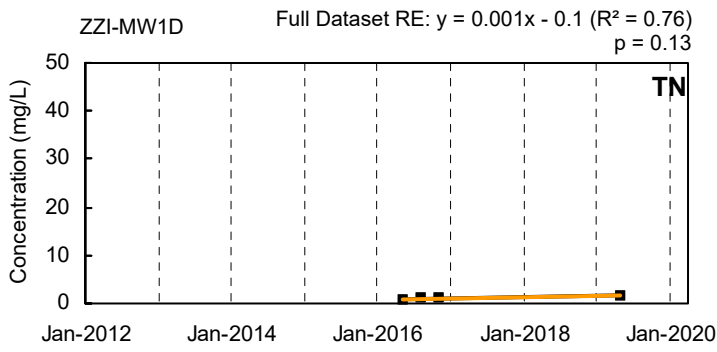

— Q1 Trendline — Q2 Trendline
— Q3 Trendline — Q4 Trendline — Full Dataset Trendline

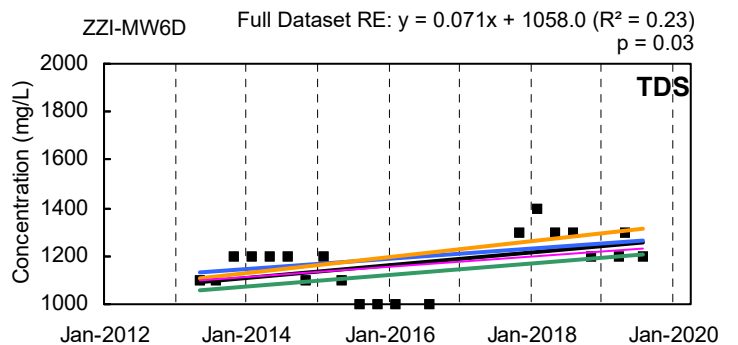
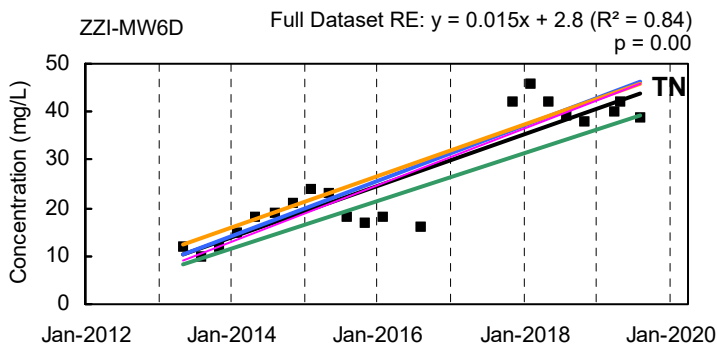
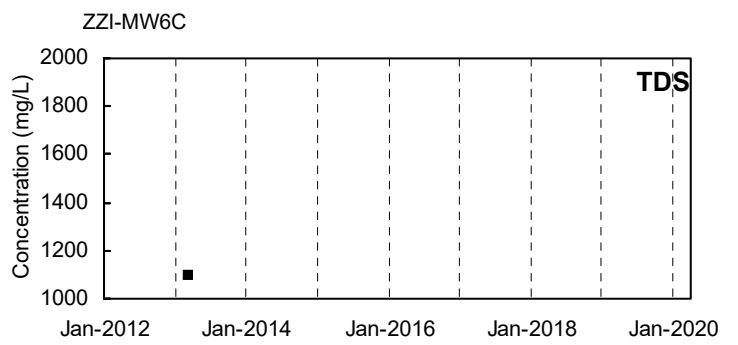
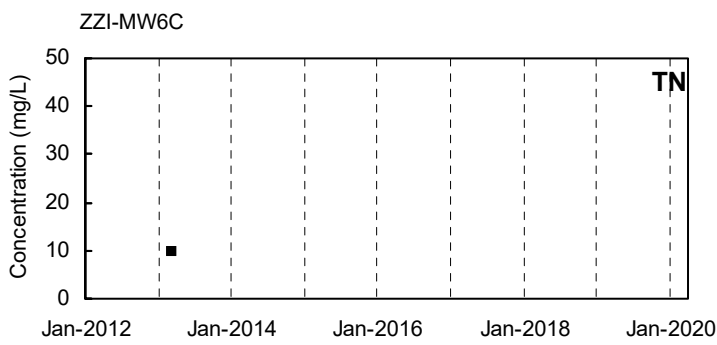
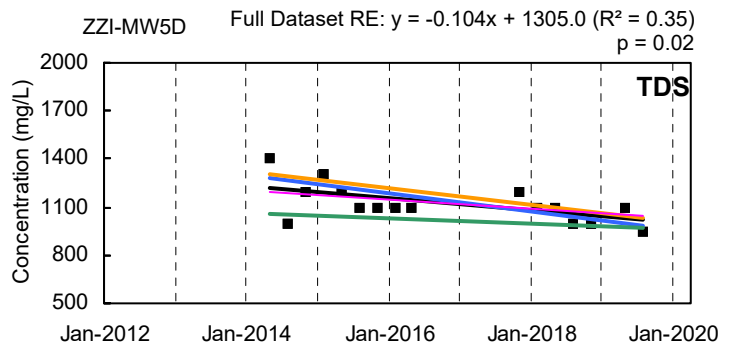
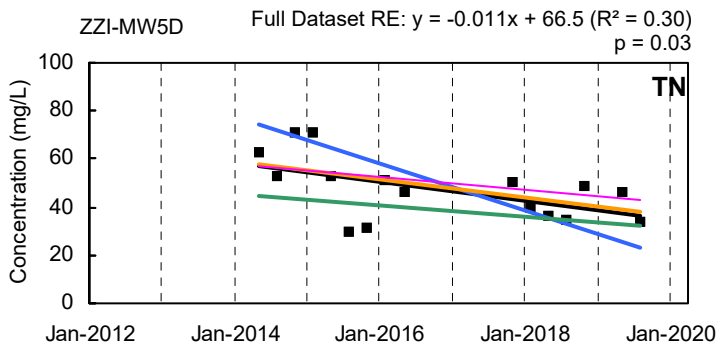
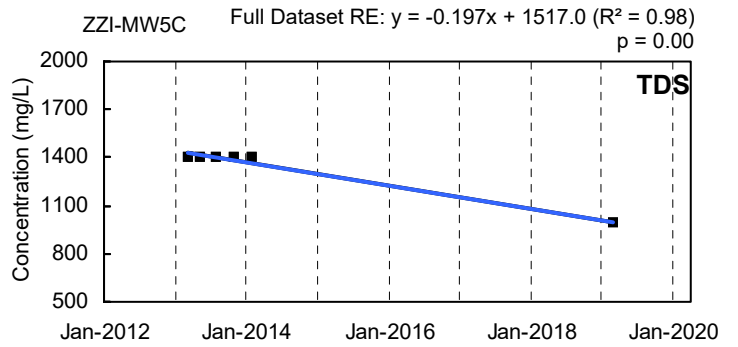
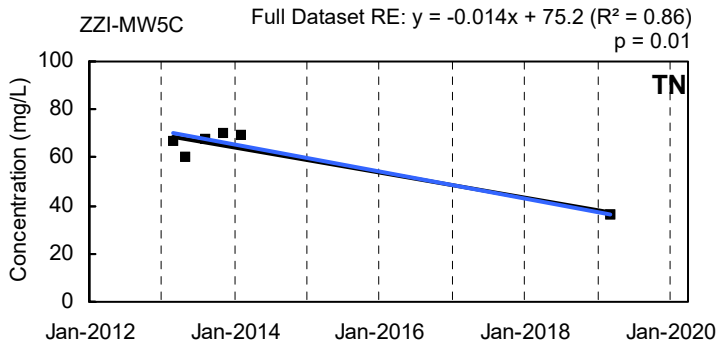
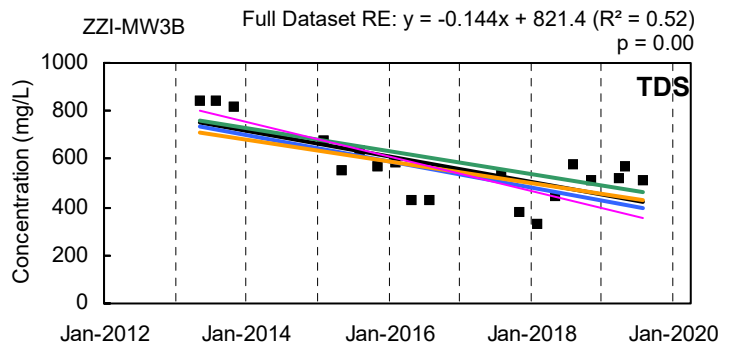
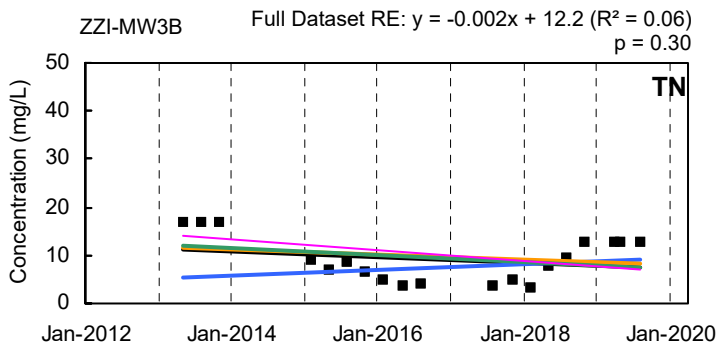

— Q1 Trendline — Q2 Trendline
— Q3 Trendline — Q4 Trendline — Full Dataset Trendline

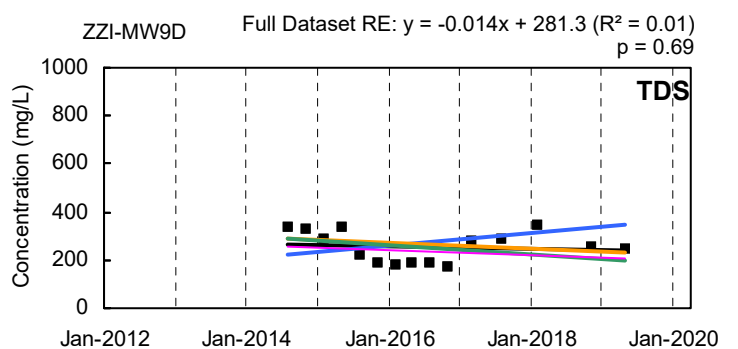
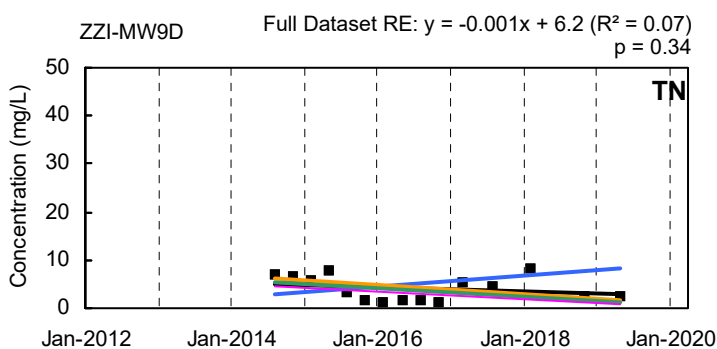
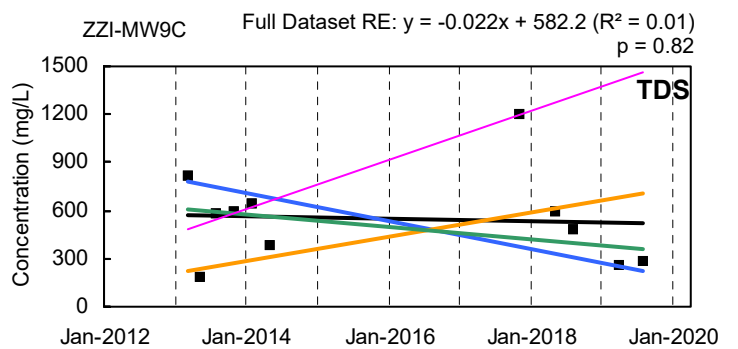
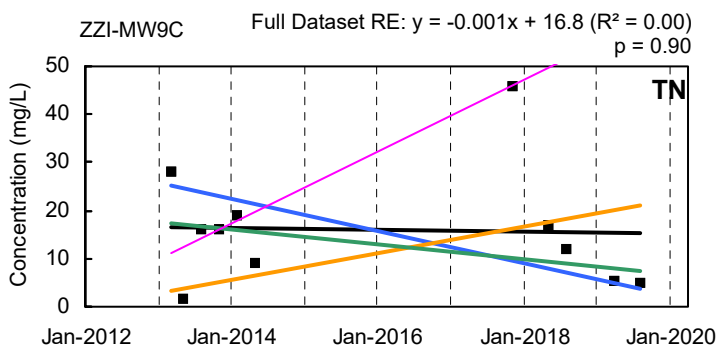
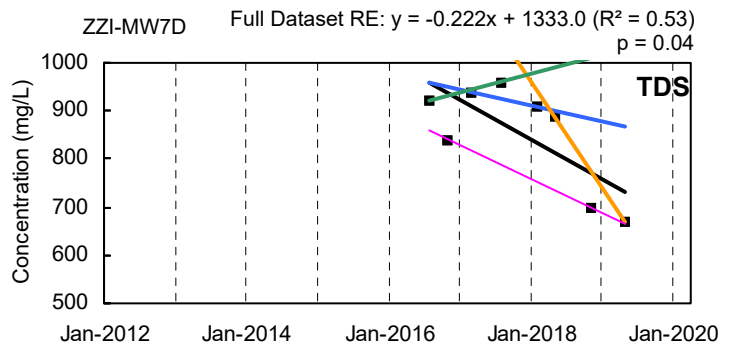
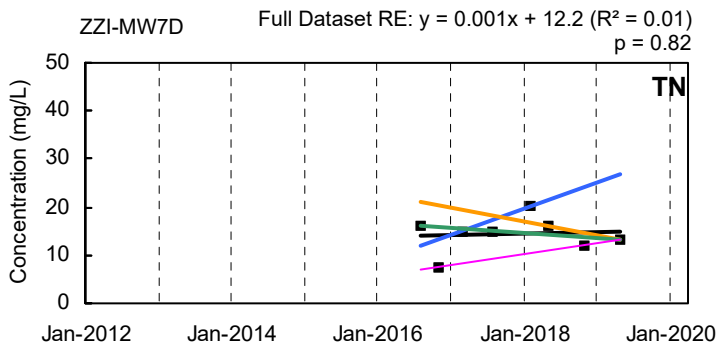
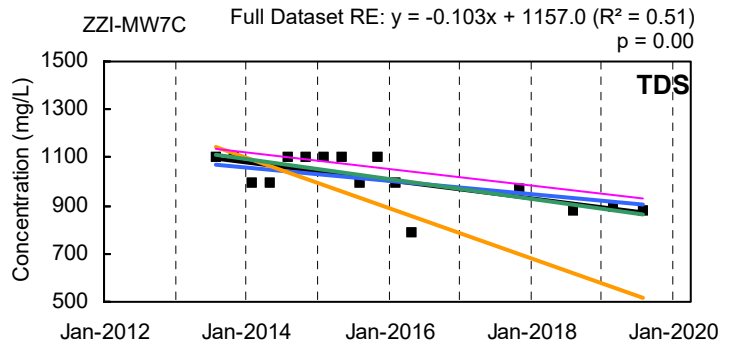
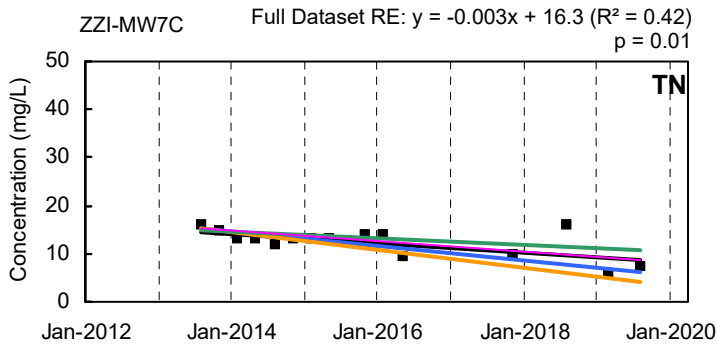
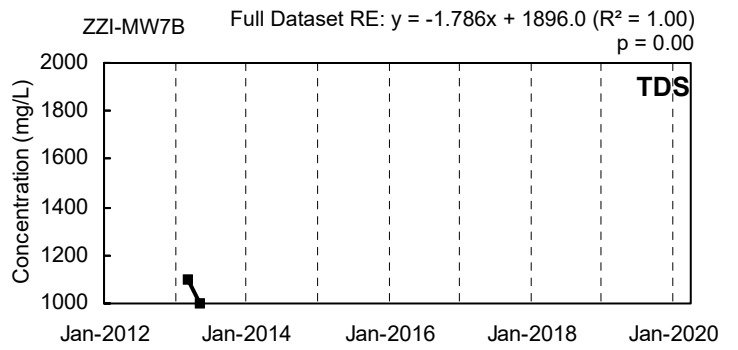
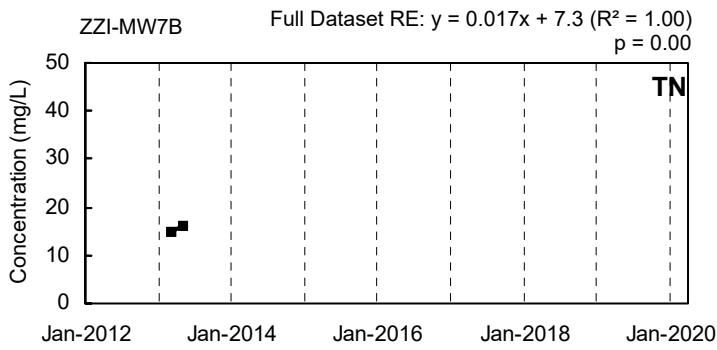

— Q1 Trendline — Q2 Trendline
— Q3 Trendline — Q4 Trendline — Full Dataset Trendline

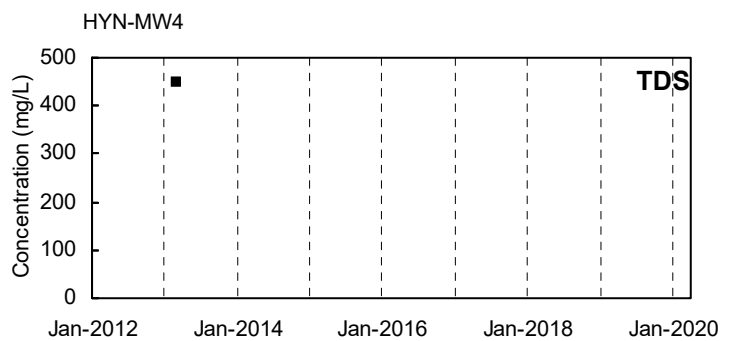
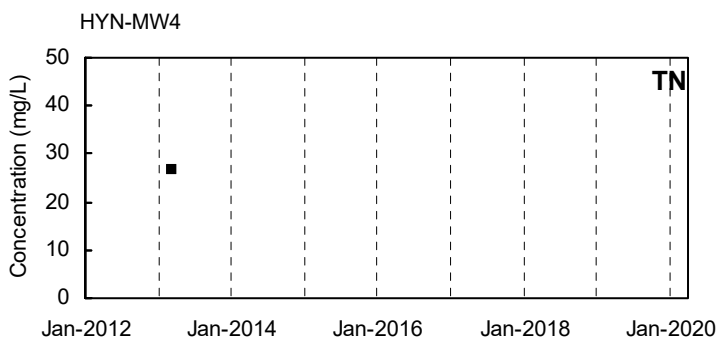
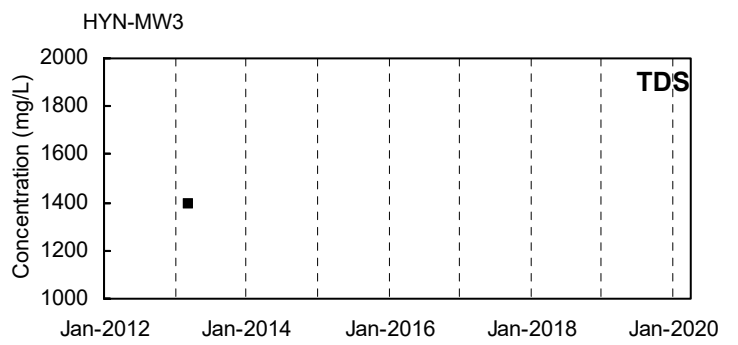
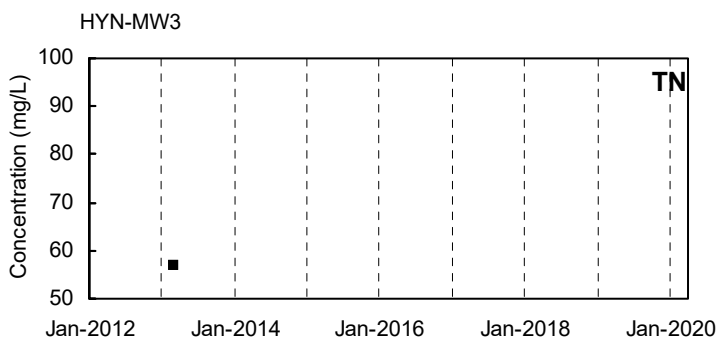
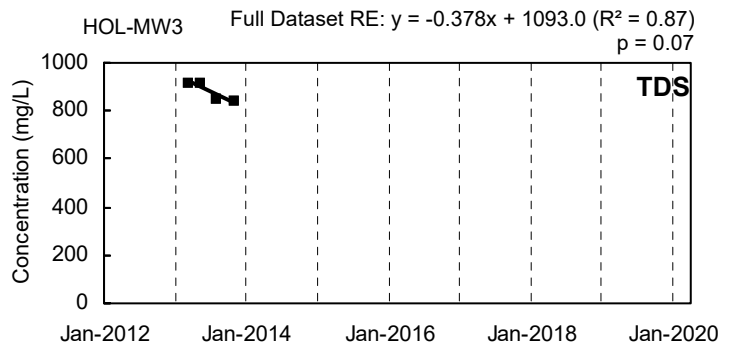
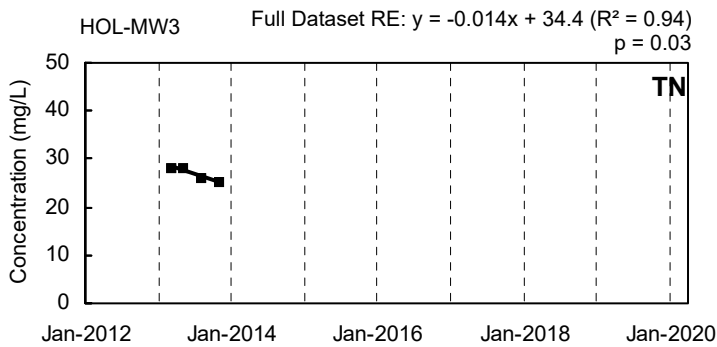
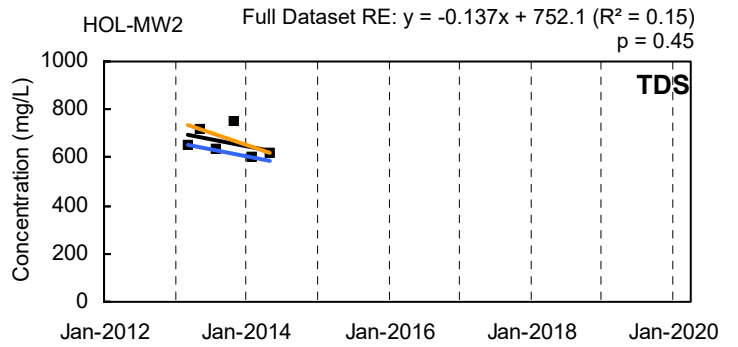
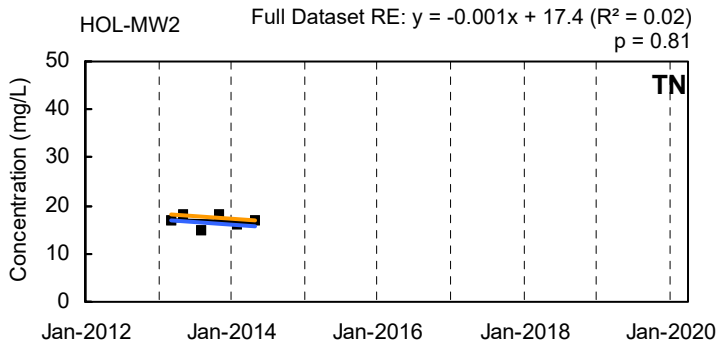
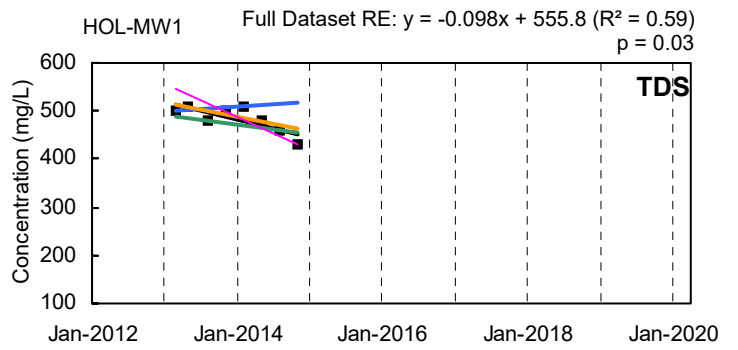
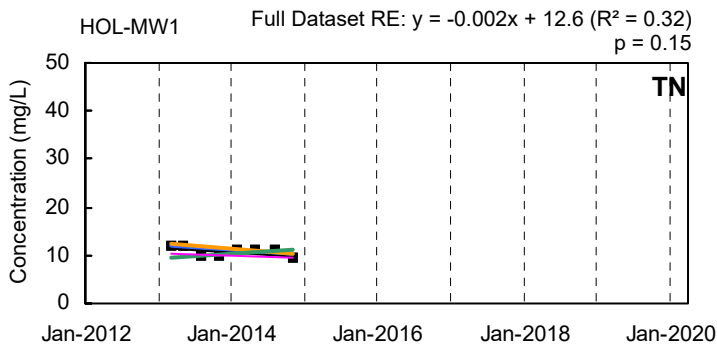

— Q1 Trendline — Q2 Trendline
— Q3 Trendline — Q4 Trendline — Full Dataset Trendline

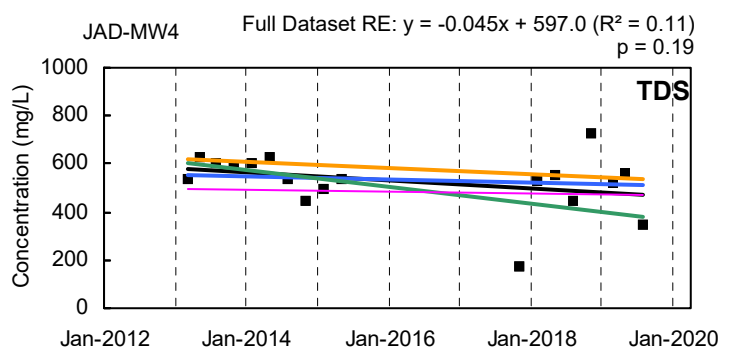
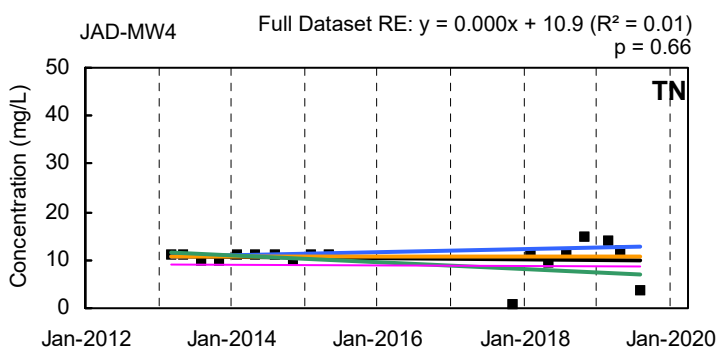
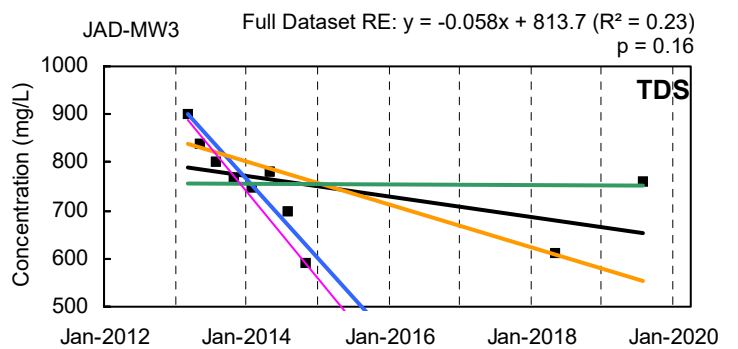
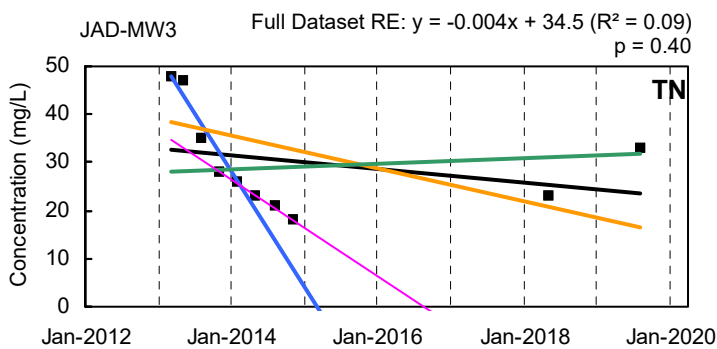
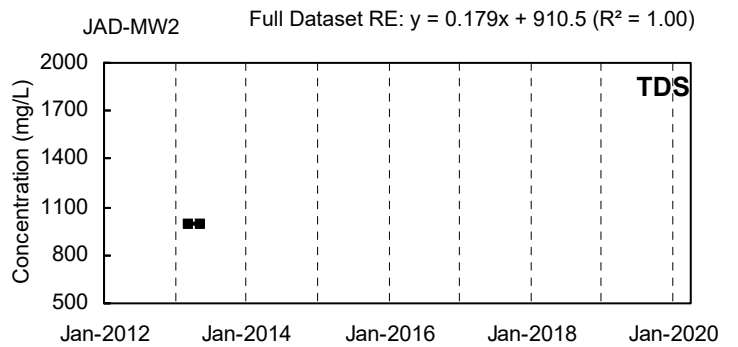
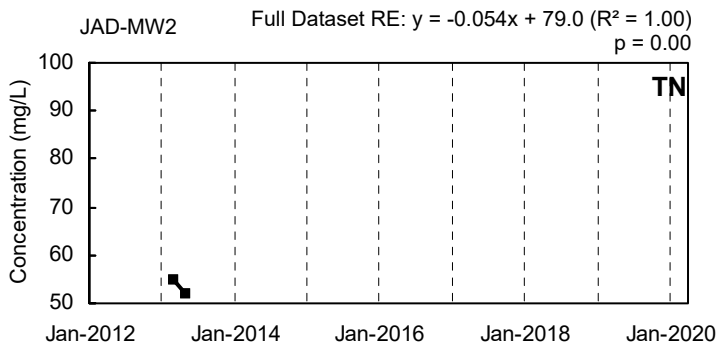
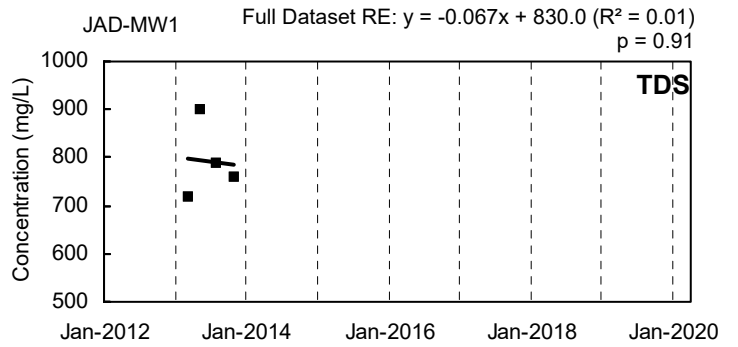
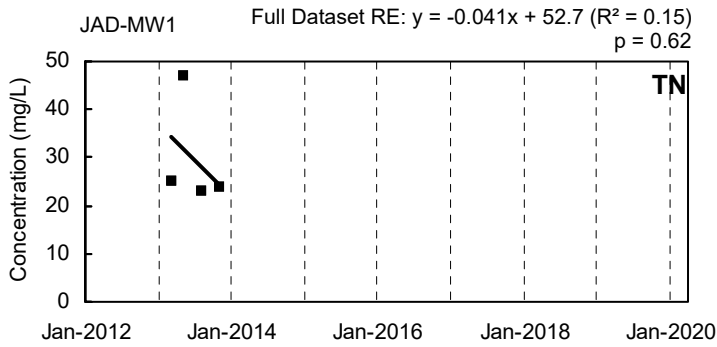
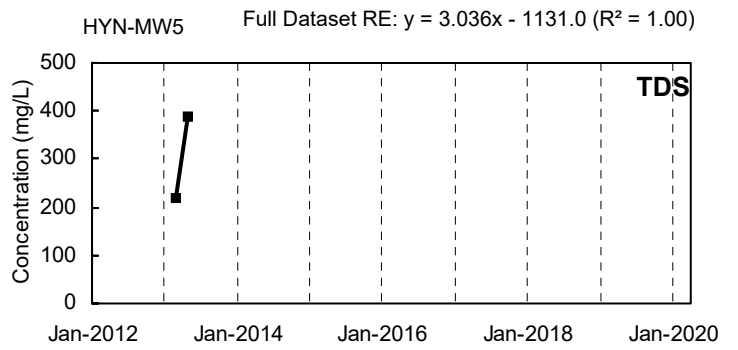
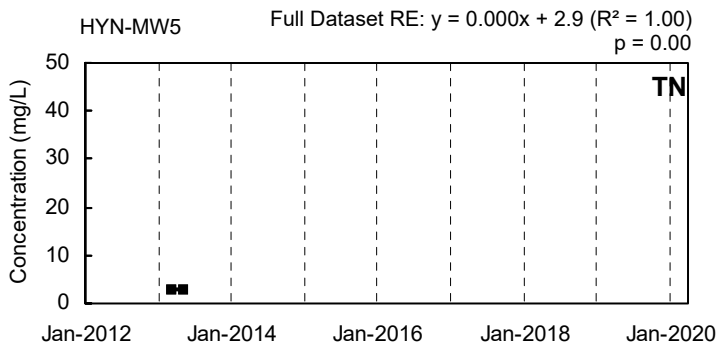

— Q1 Trendline — Q2 Trendline
— Q3 Trendline — Q4 Trendline — Full Dataset Trendline

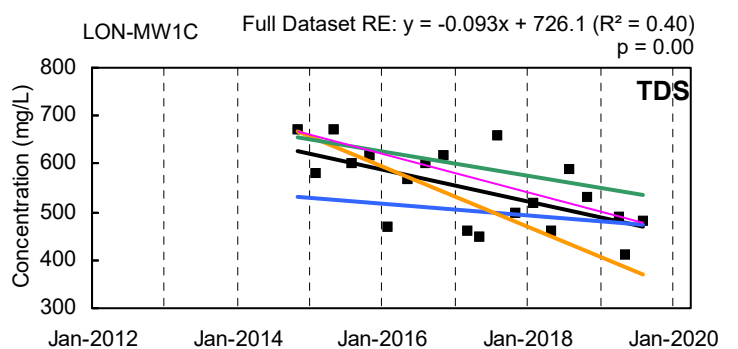
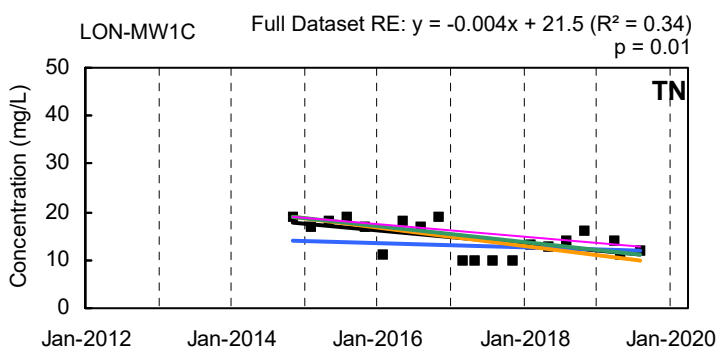
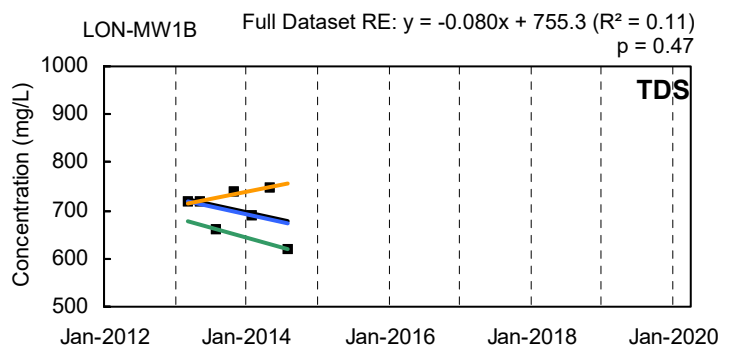
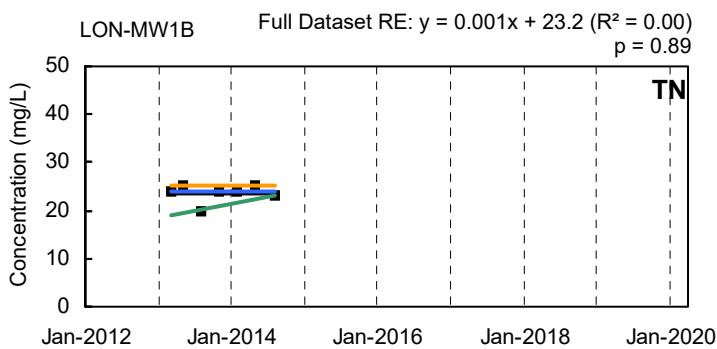
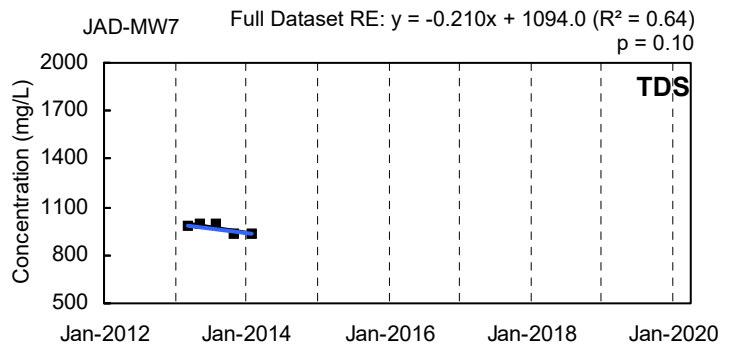
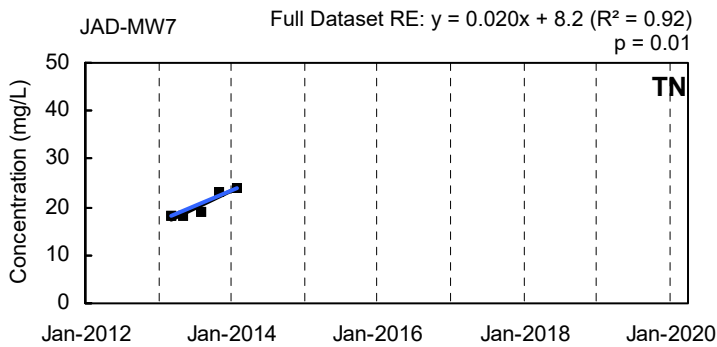
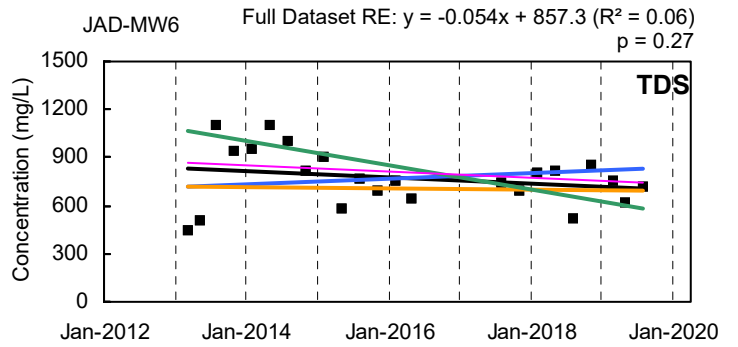
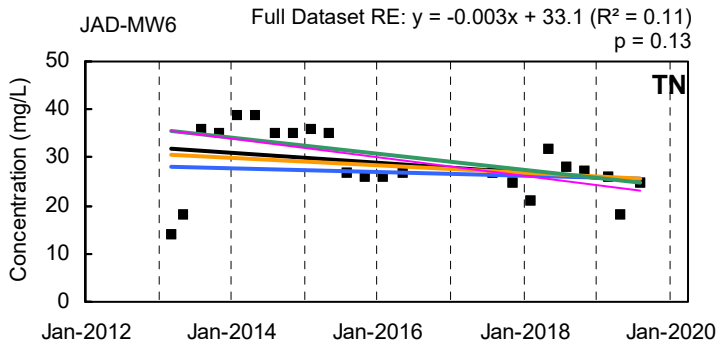
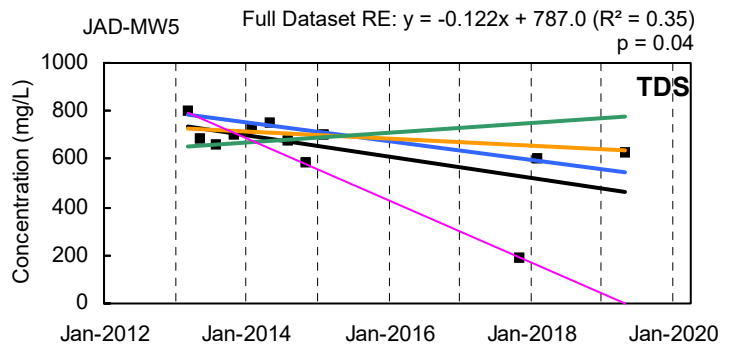
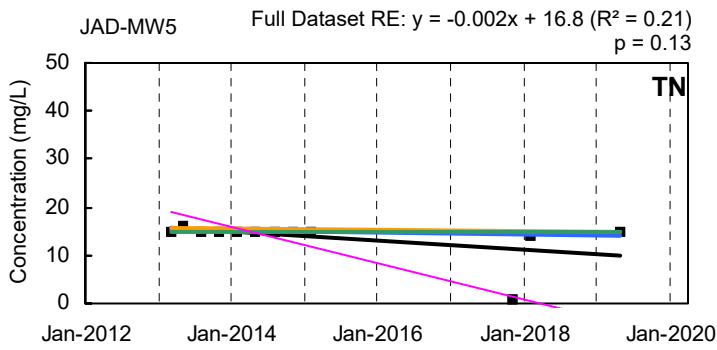

— Q1 Trendline — Q2 Trendline
— Q3 Trendline — Q4 Trendline — Full Dataset Trendline

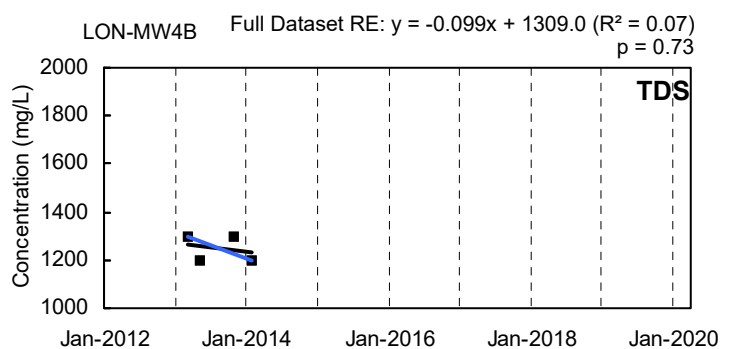
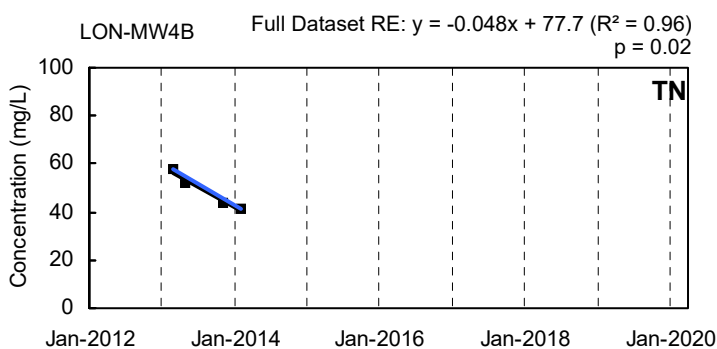
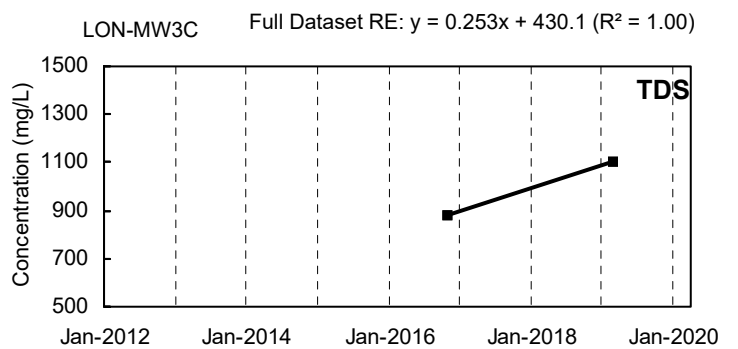
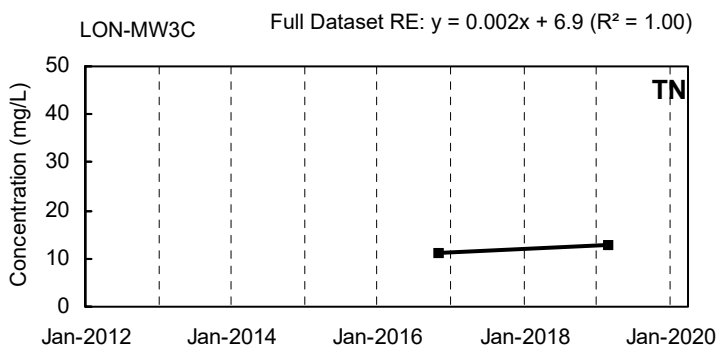
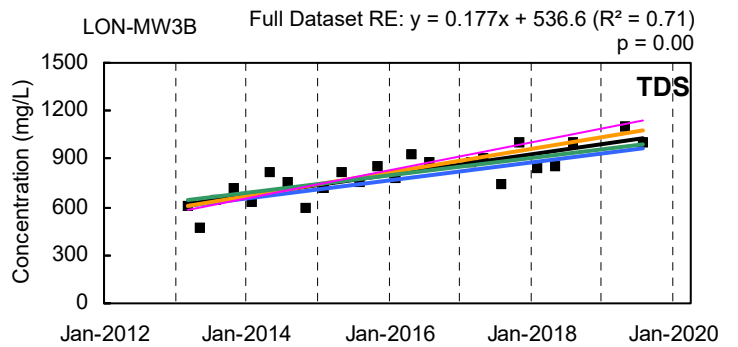
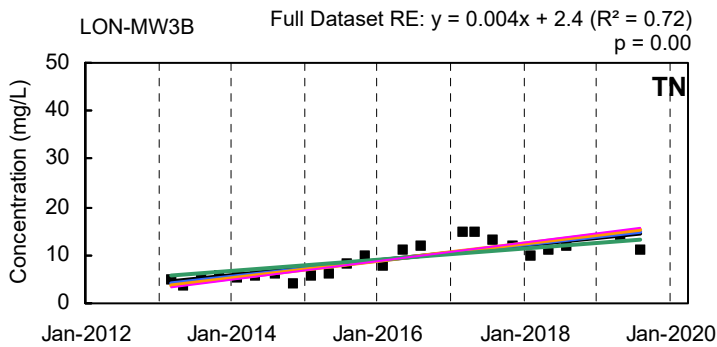
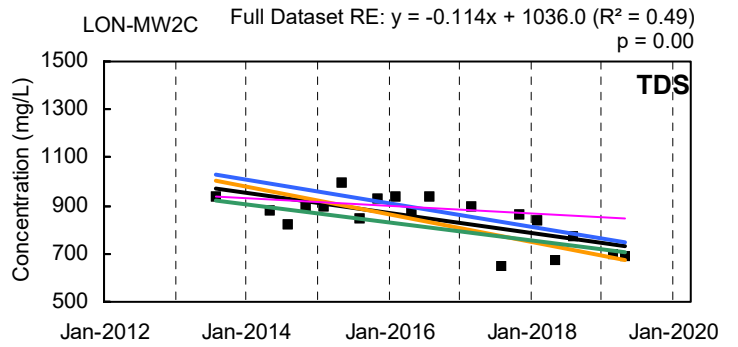
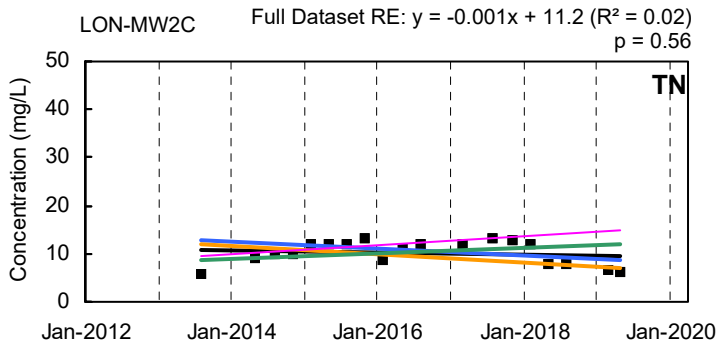
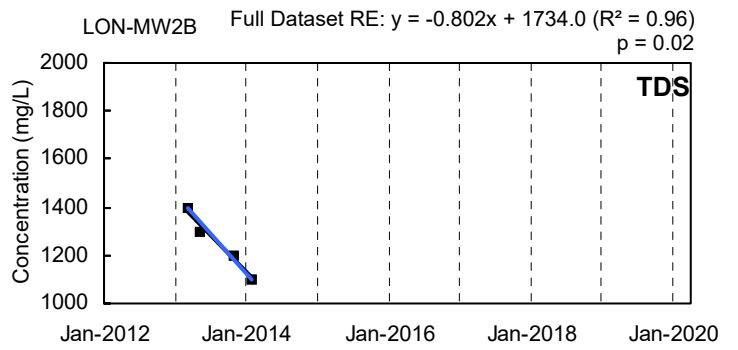
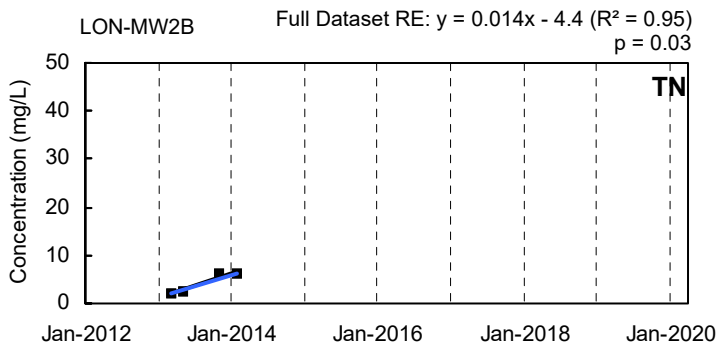

— Q1 Trendline — Q2 Trendline
— Q3 Trendline — Q4 Trendline — Full Dataset Trendline

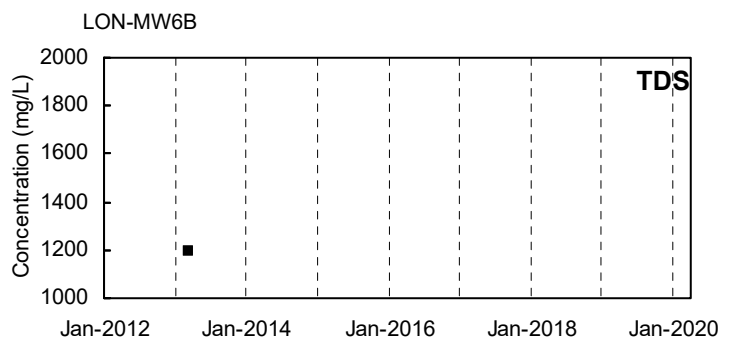
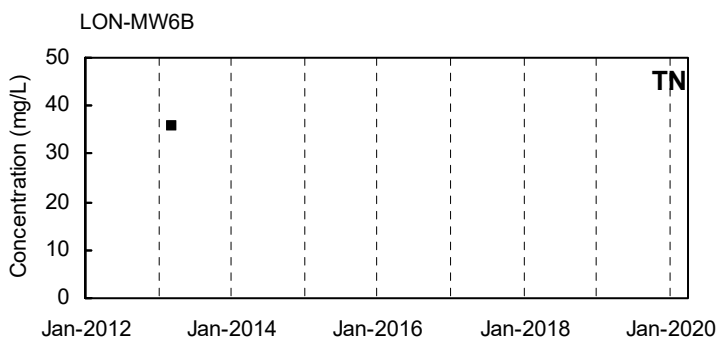
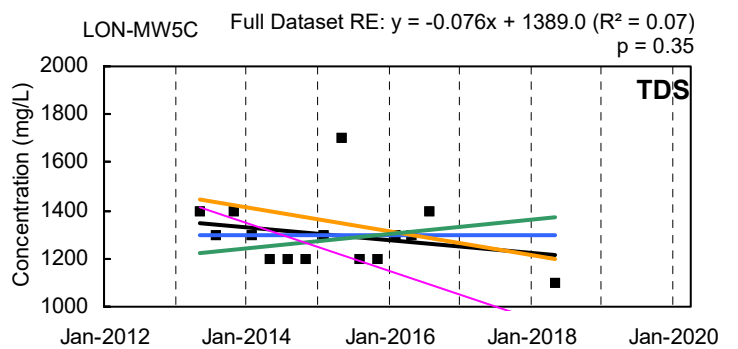
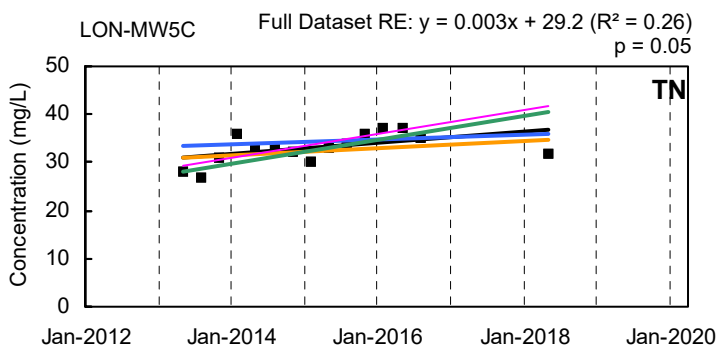
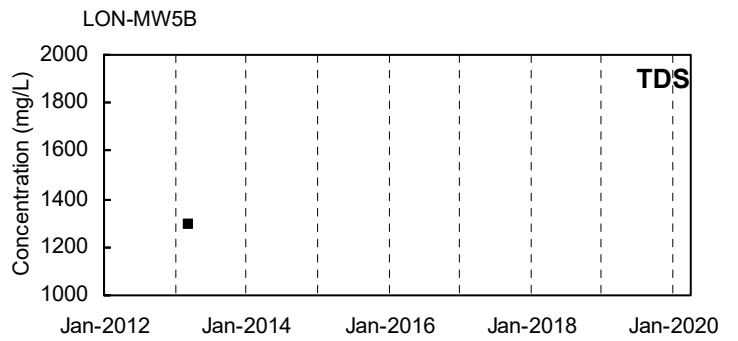
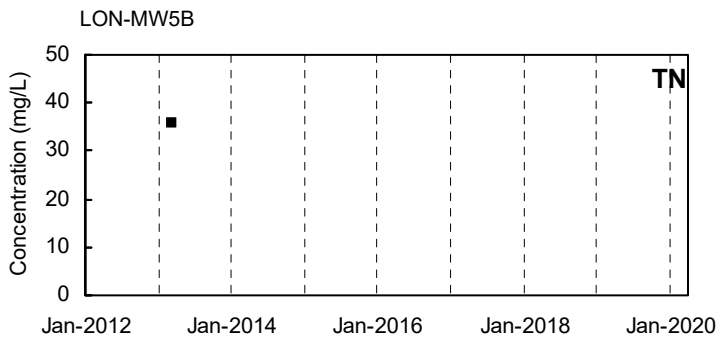
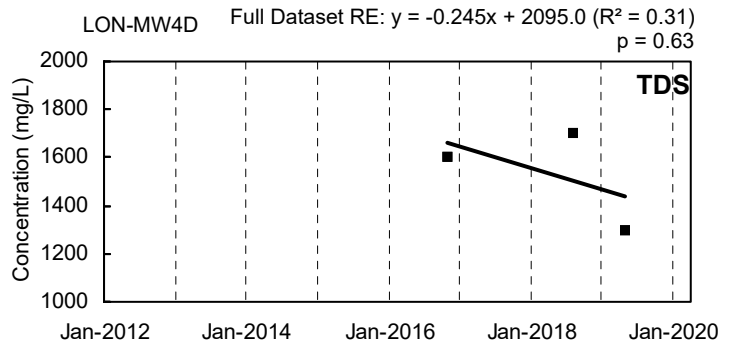
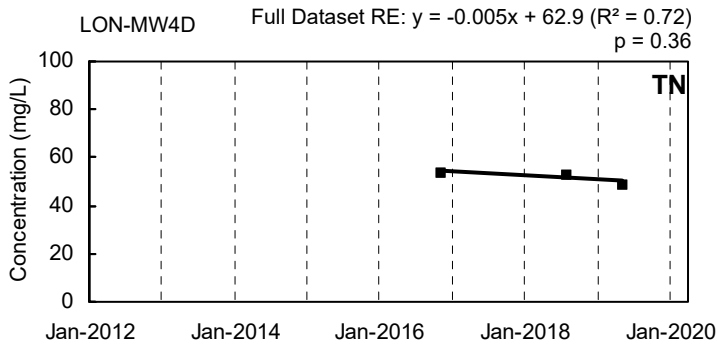
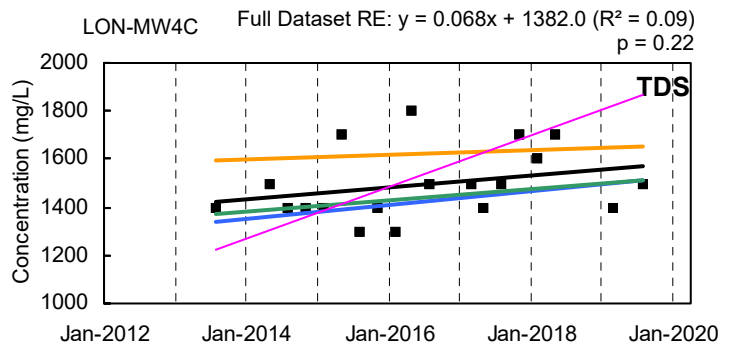
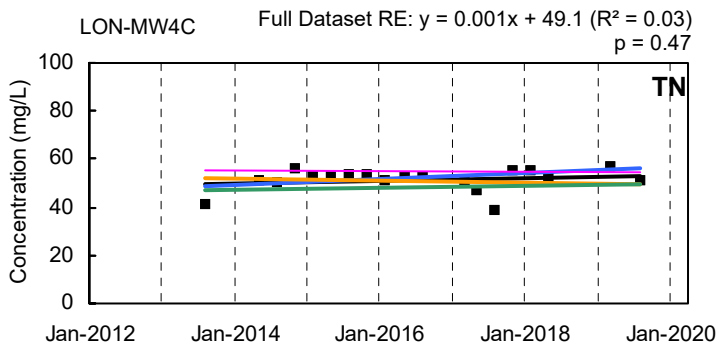

— Q1 Trendline — Q2 Trendline
— Q3 Trendline — Q4 Trendline — Full Dataset Trendline

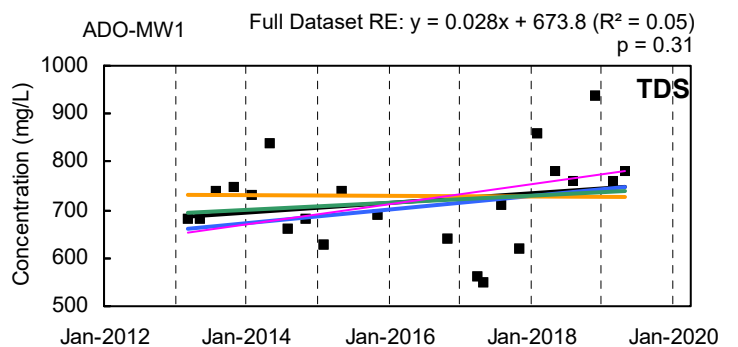
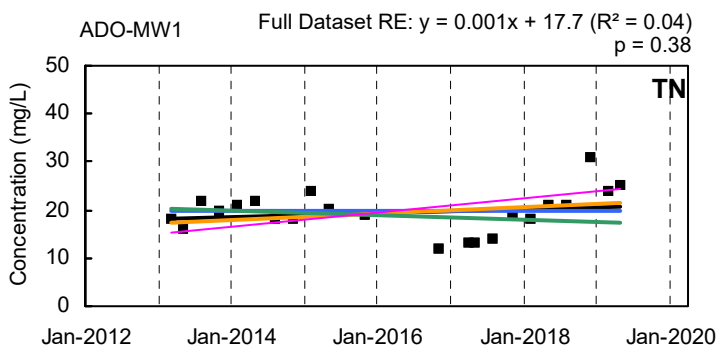
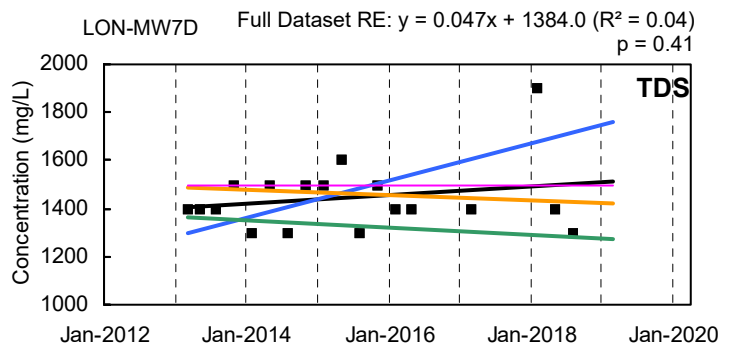
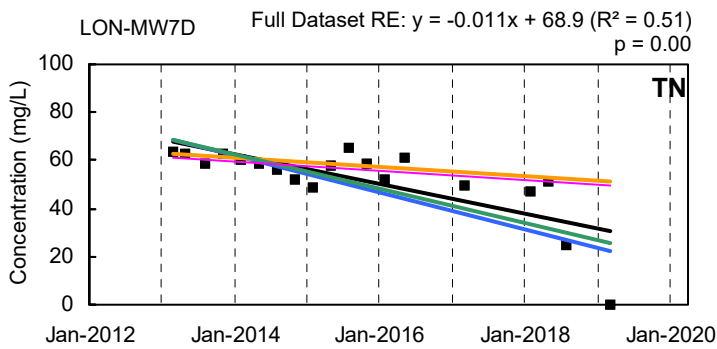
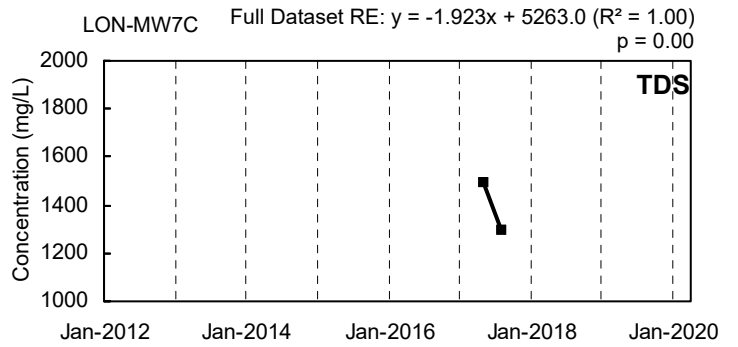
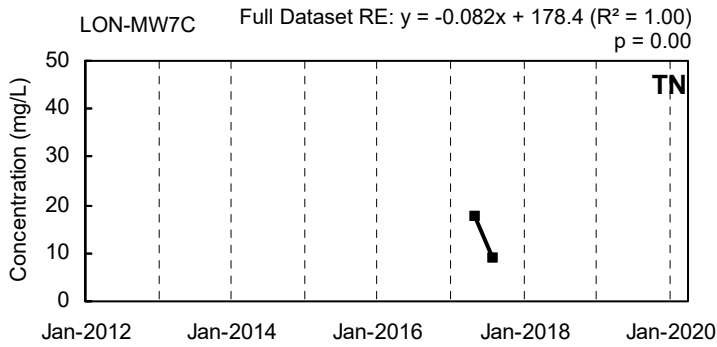
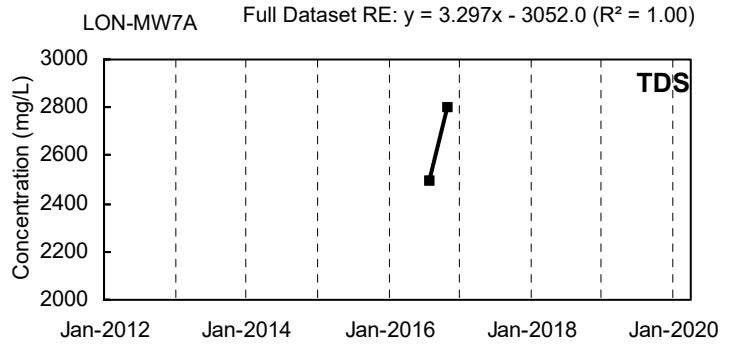
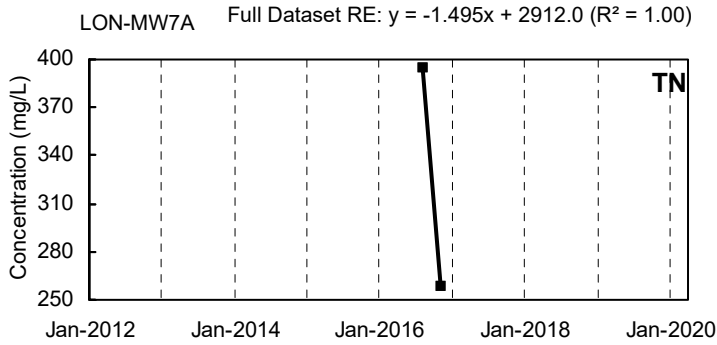
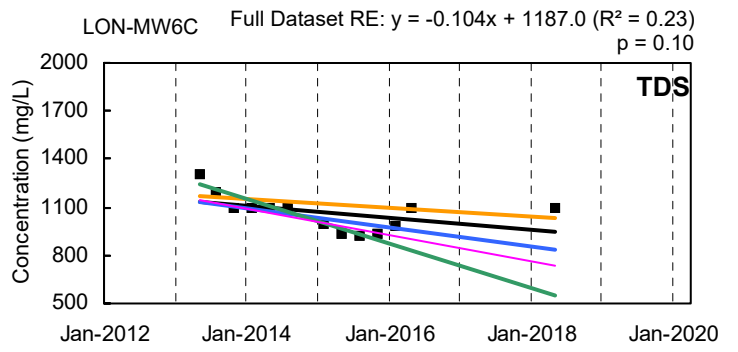
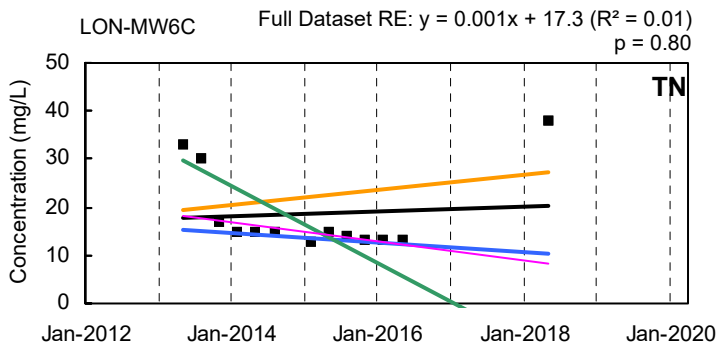

Q1 Trendline Q2 Trendline
 Q3 Trendline Q4 Trendline Full Dataset Trendline

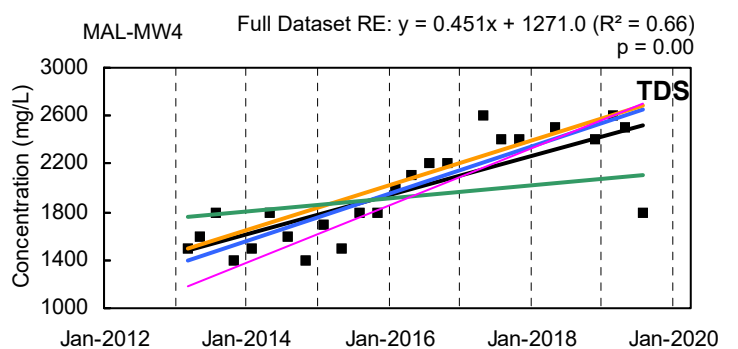
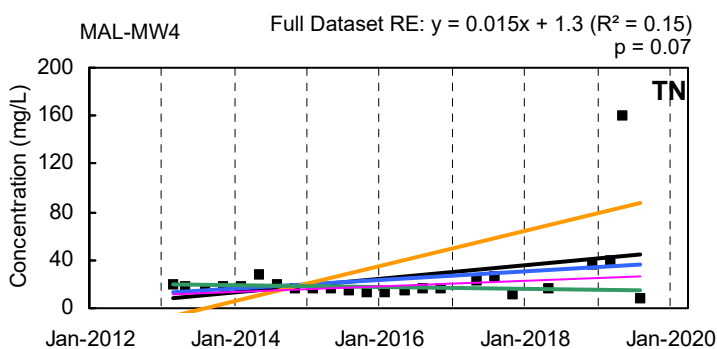
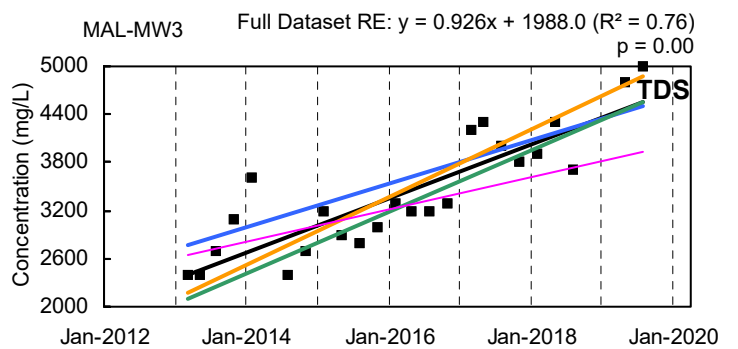
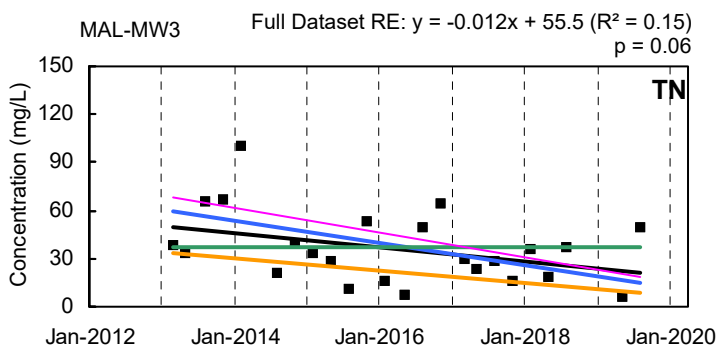
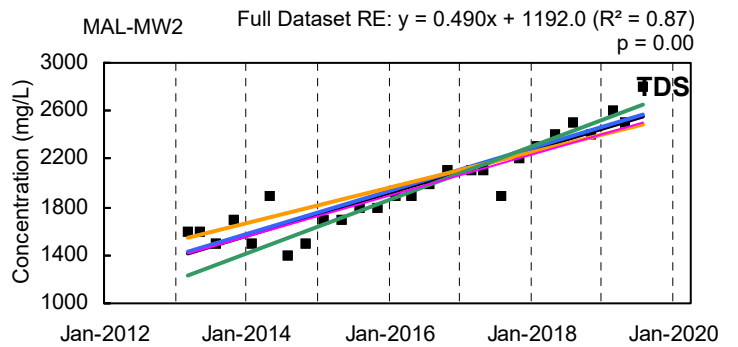
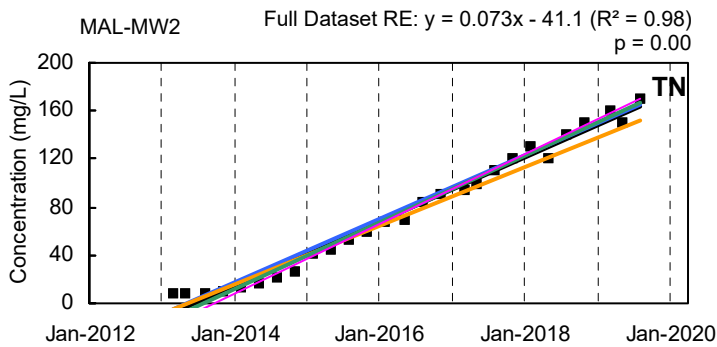
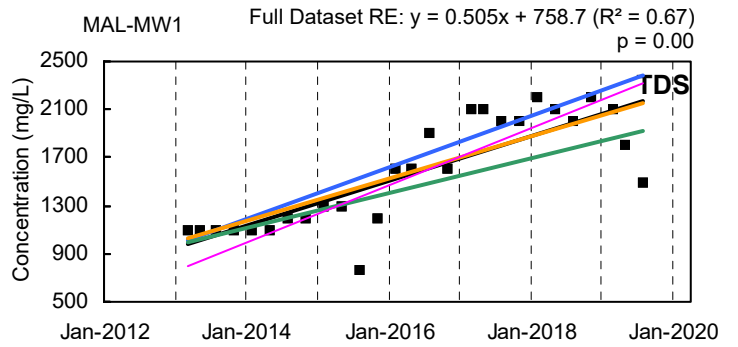
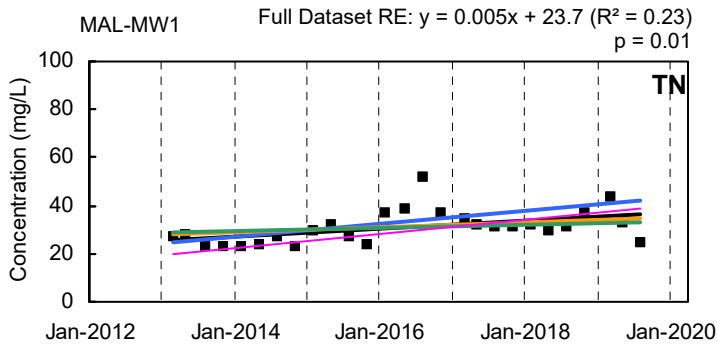
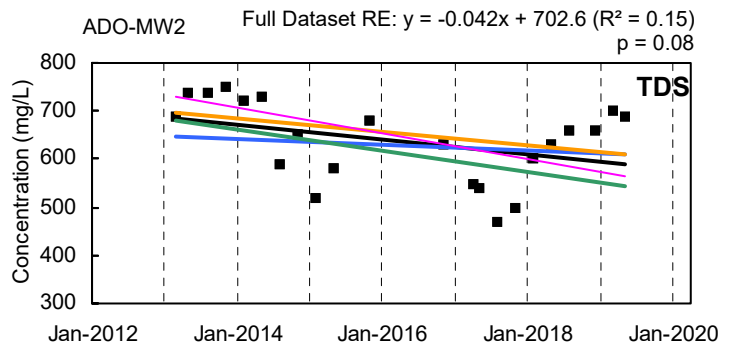
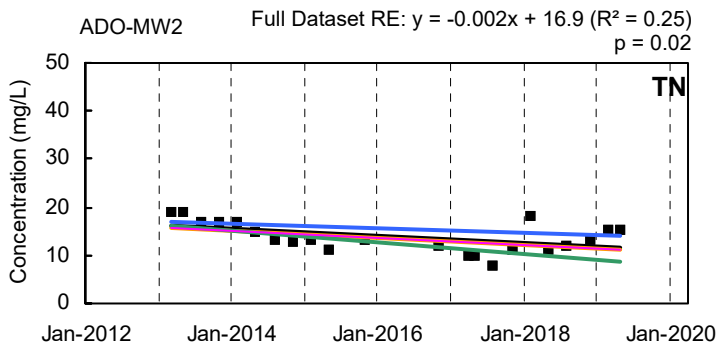

— Q1 Trendline — Q2 Trendline
— Q3 Trendline — Q4 Trendline — Full Dataset Trendline

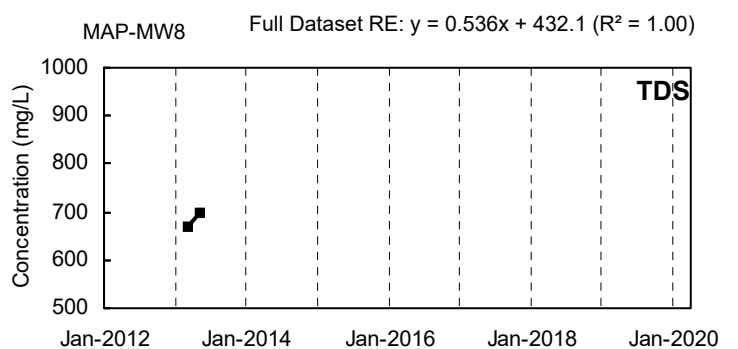
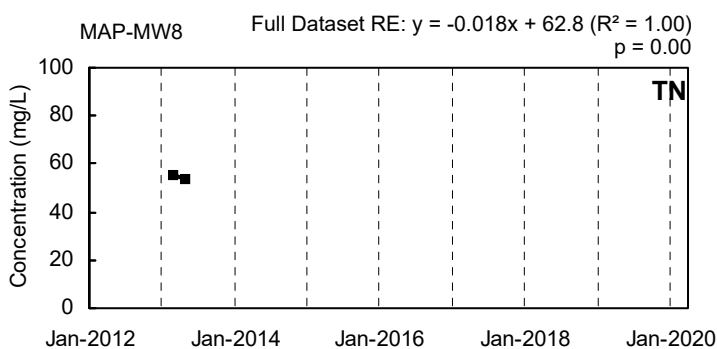
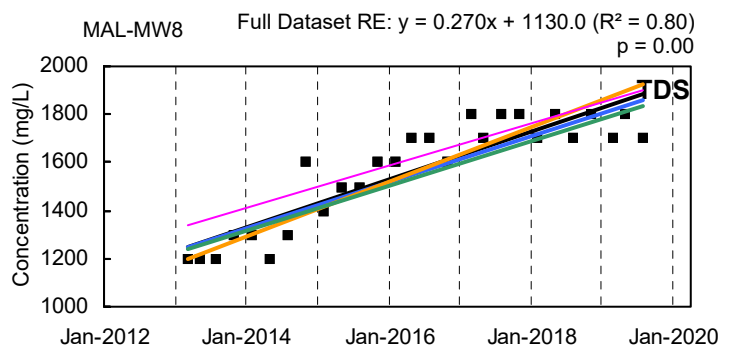
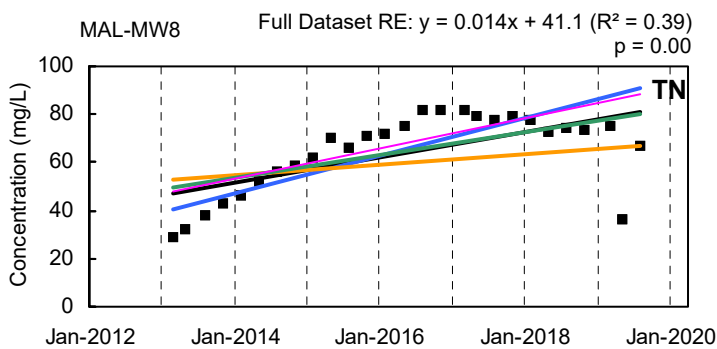
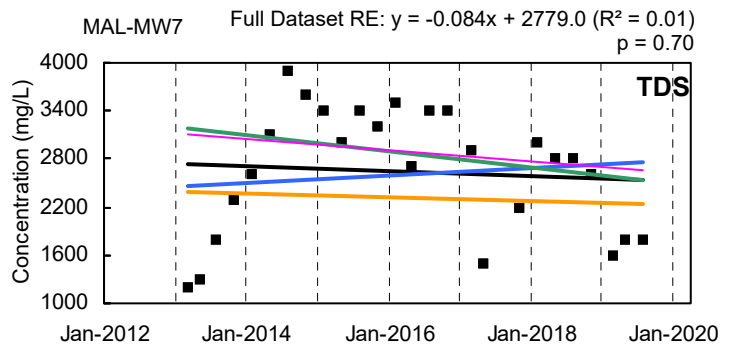
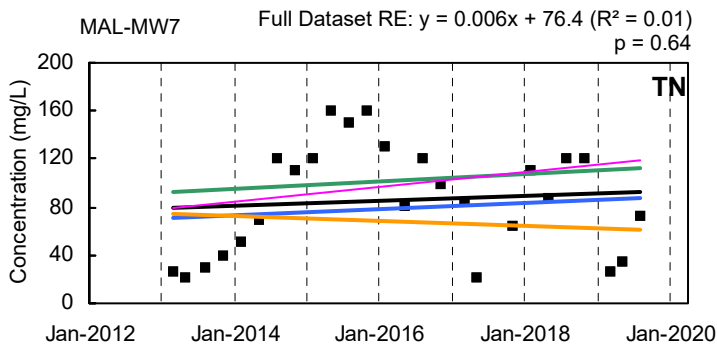
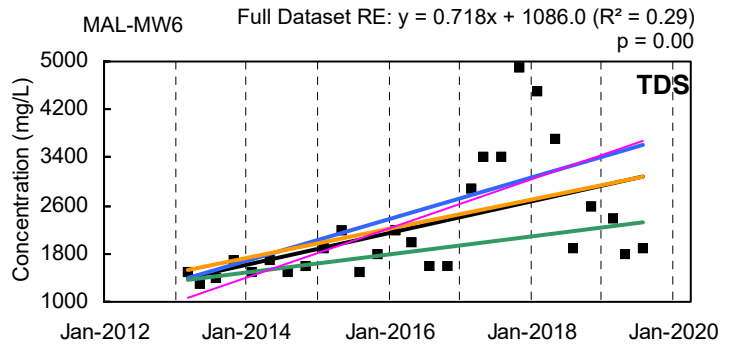
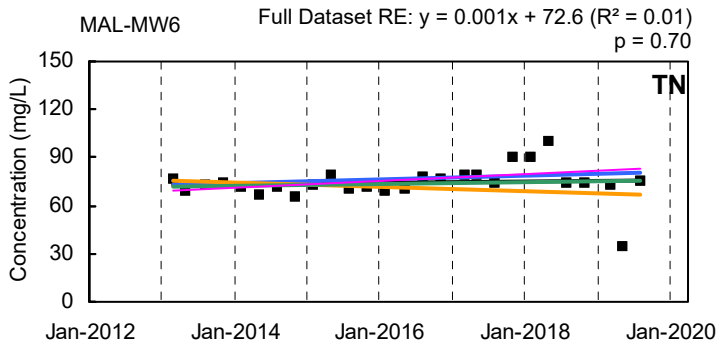
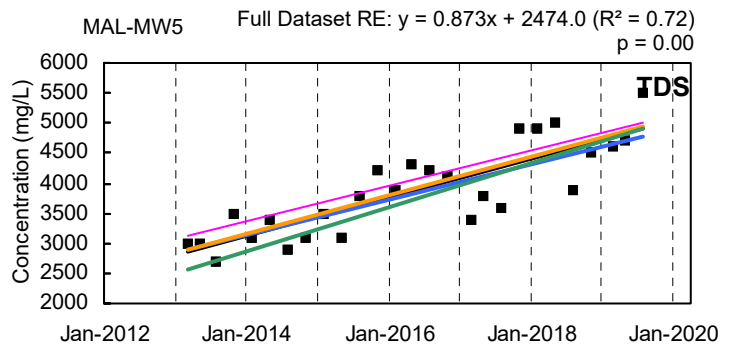
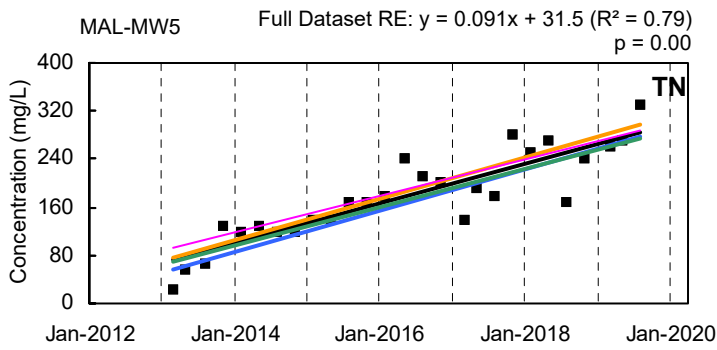

— Q1 Trendline — Q2 Trendline
— Q3 Trendline — Q4 Trendline — Full Dataset Trendline

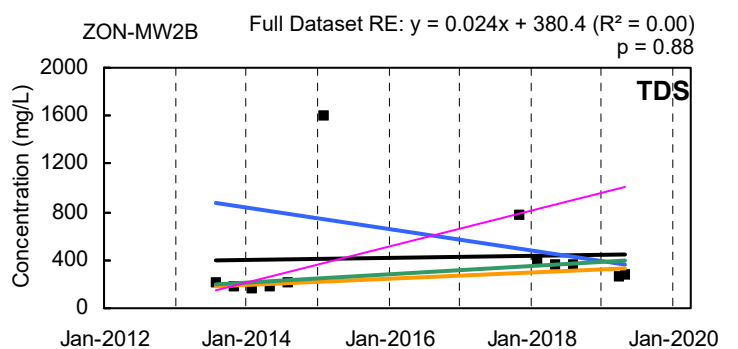
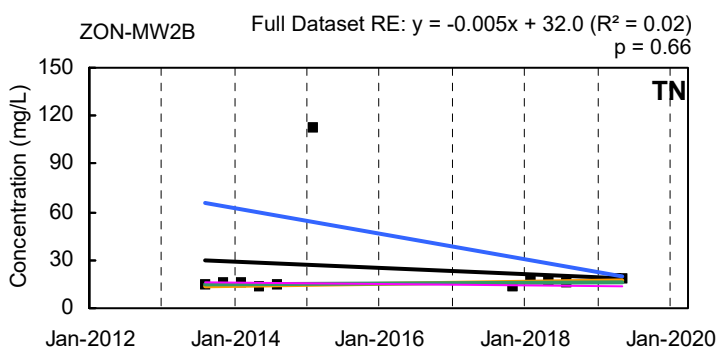
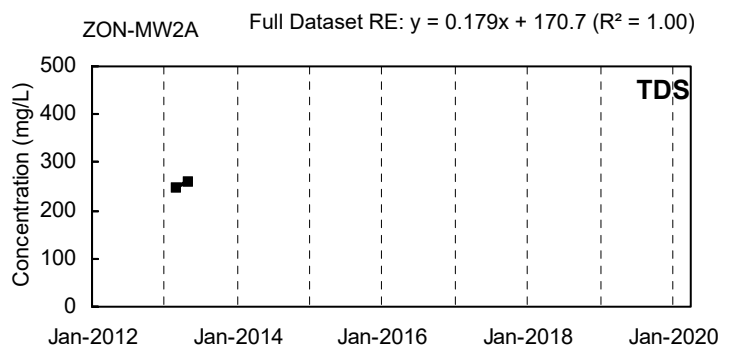
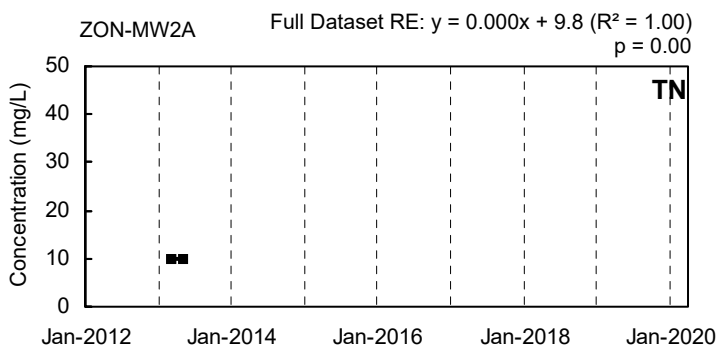
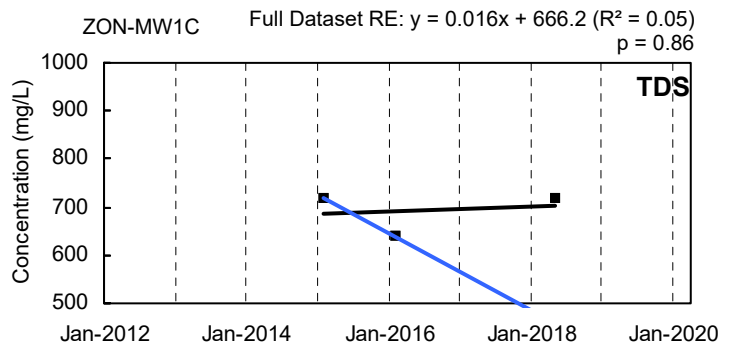
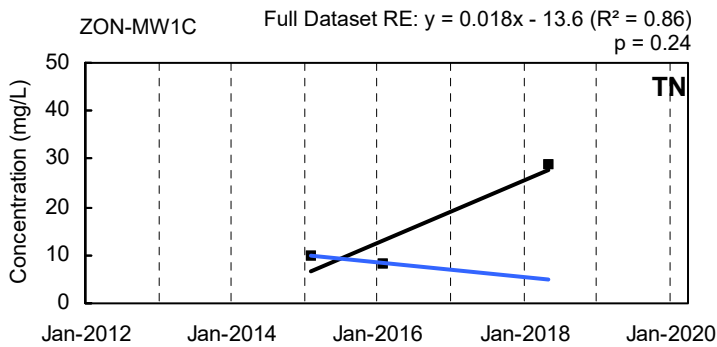
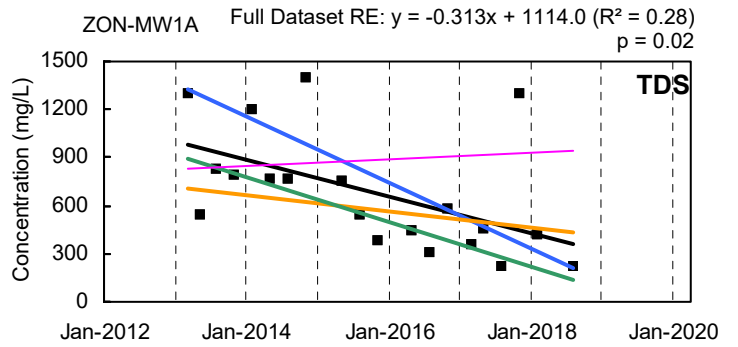
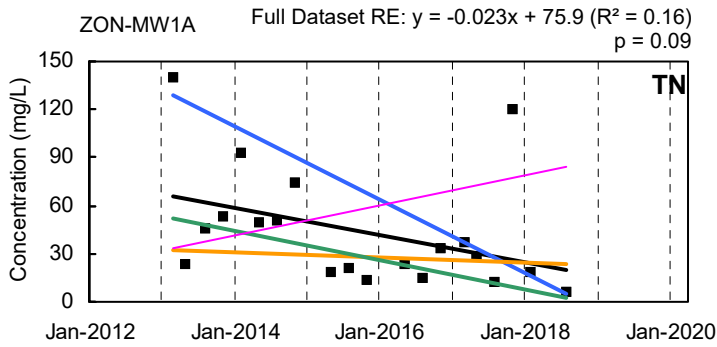
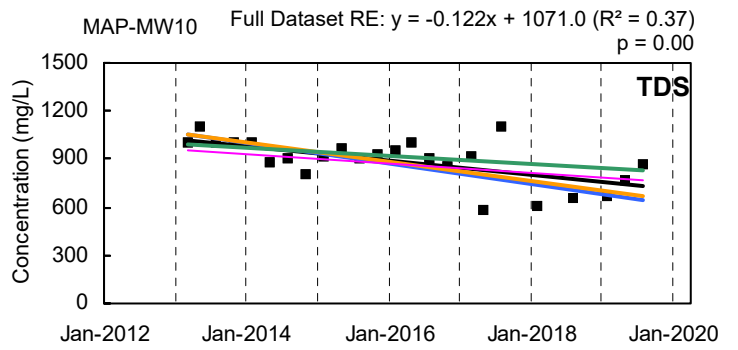
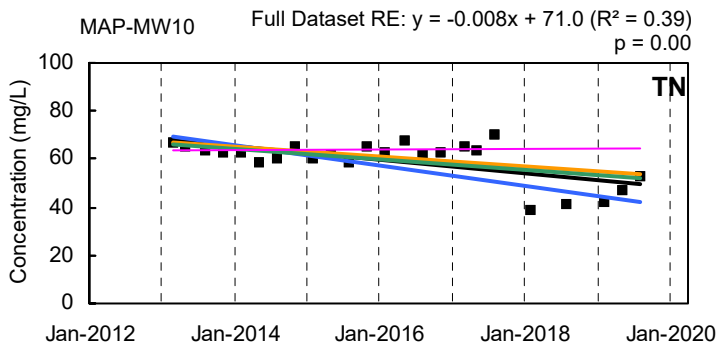

— Q1 Trendline — Q2 Trendline
— Q3 Trendline — Q4 Trendline — Full Dataset Trendline

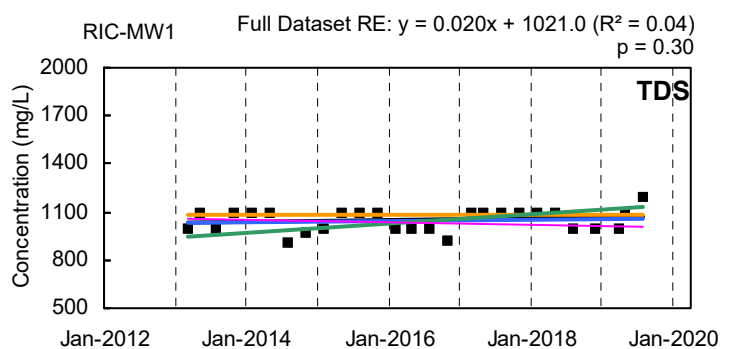
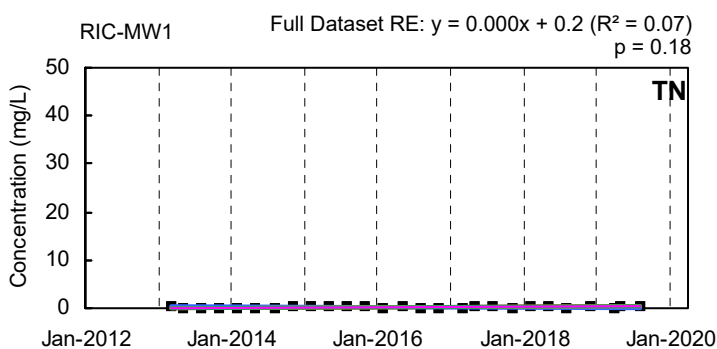
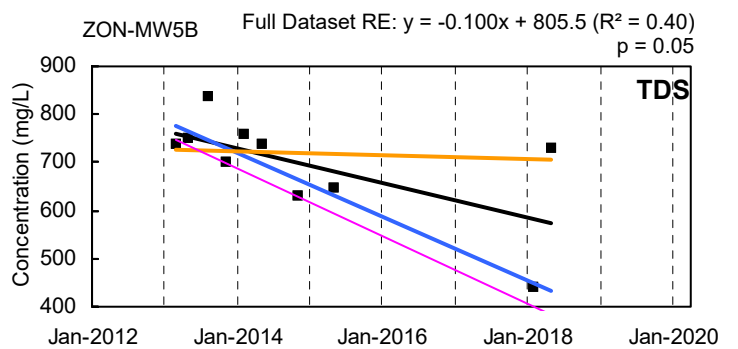
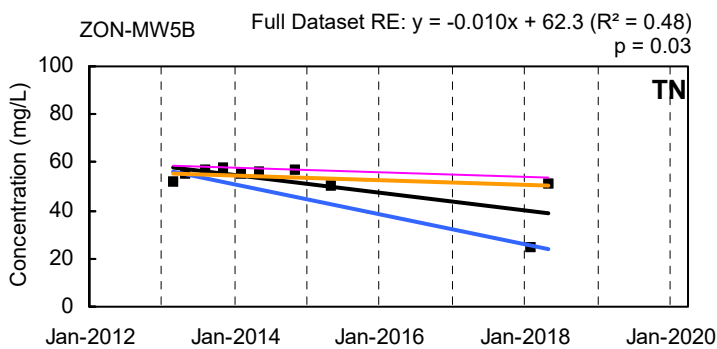
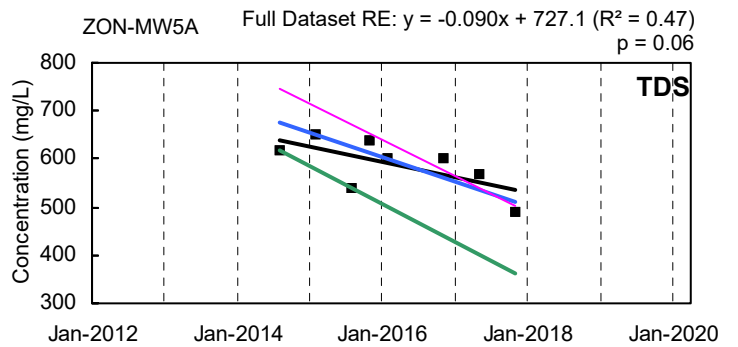
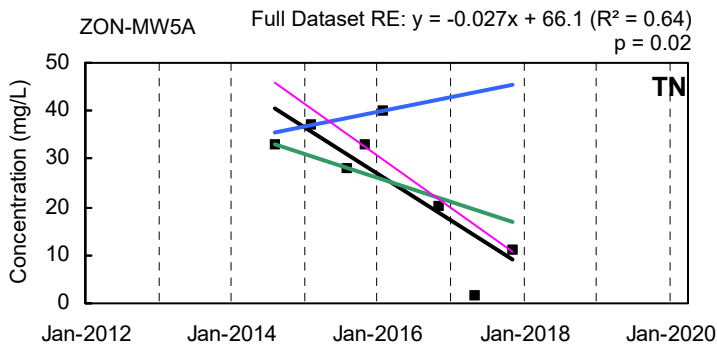
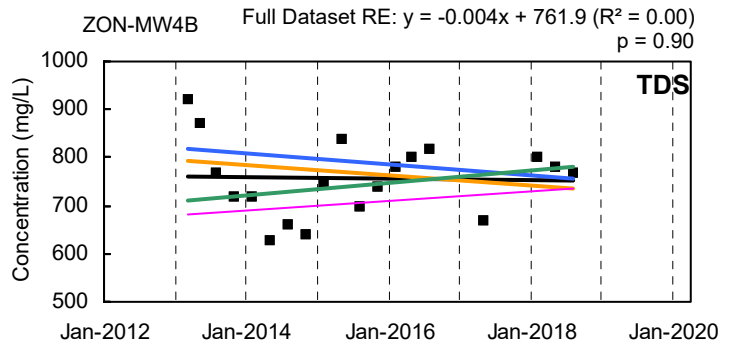
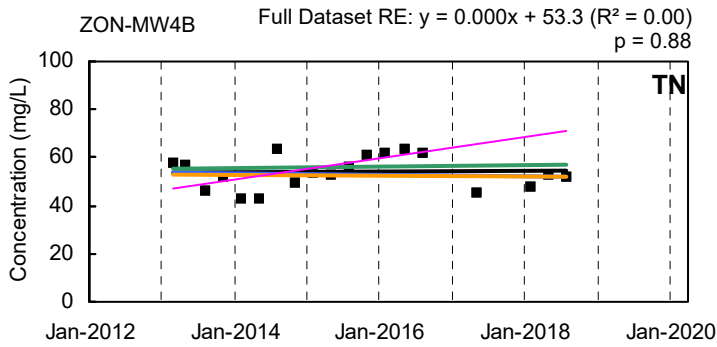
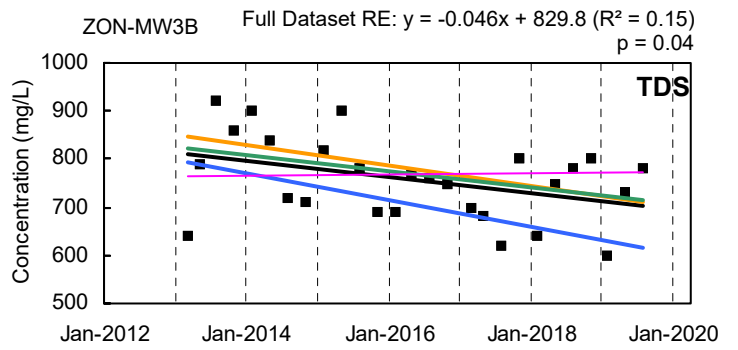
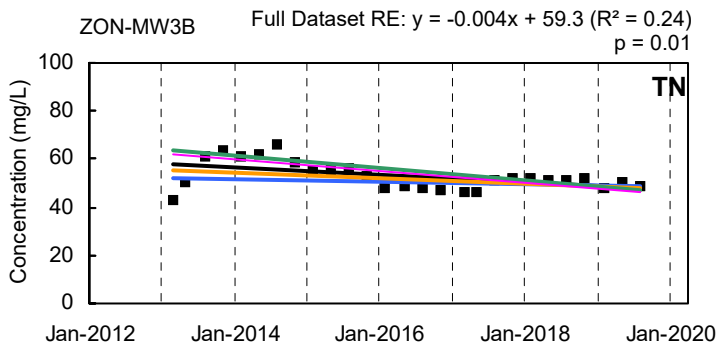

— Q1 Trendline — Q2 Trendline
— Q3 Trendline — Q4 Trendline — Full Dataset Trendline

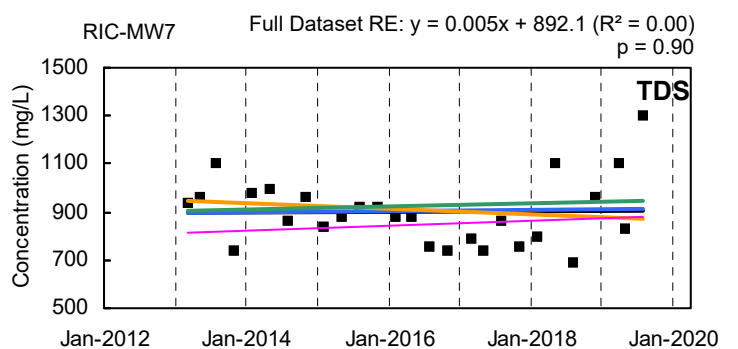
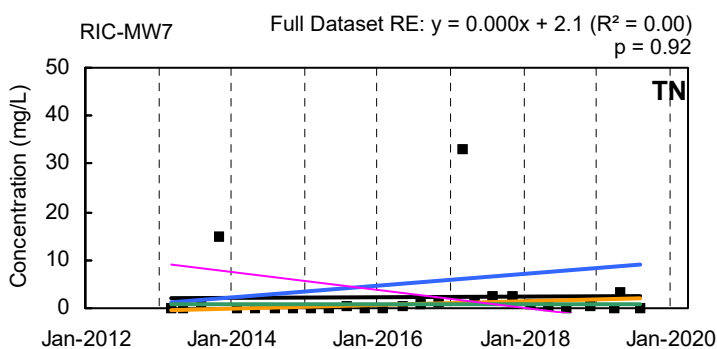
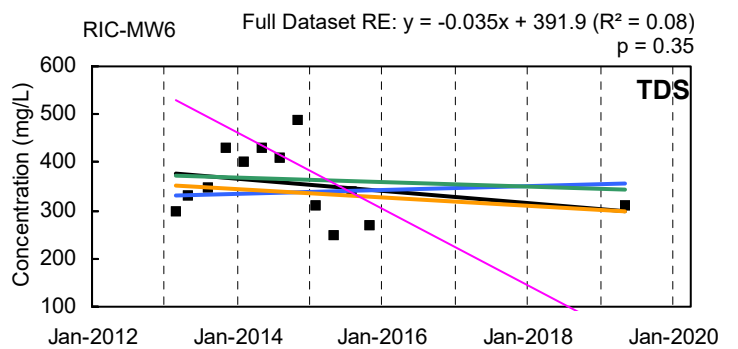
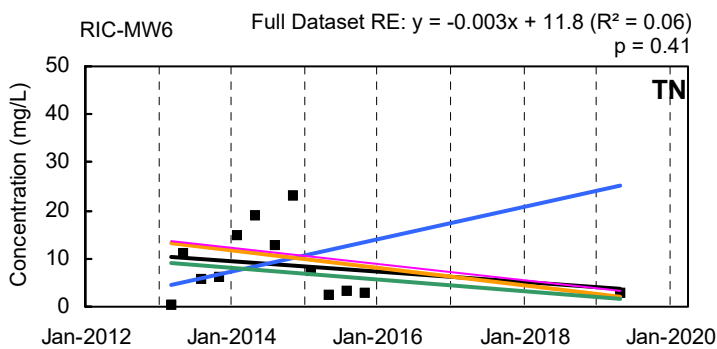
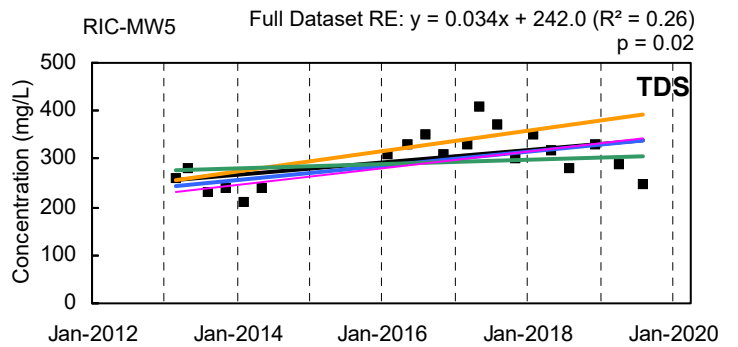
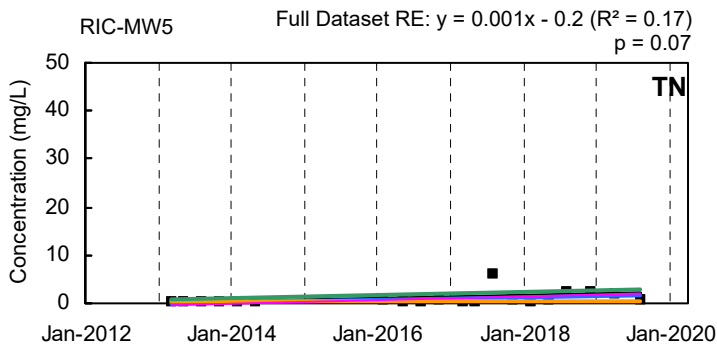
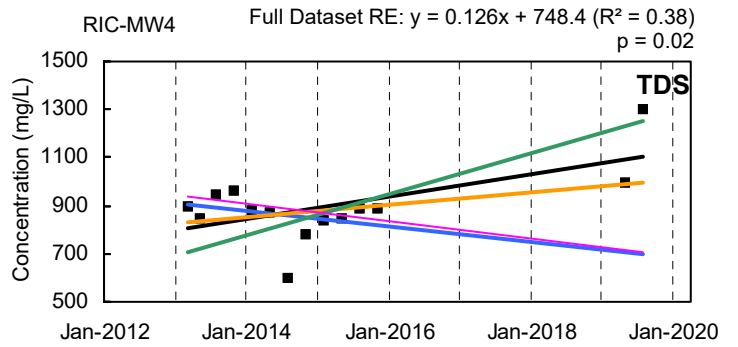
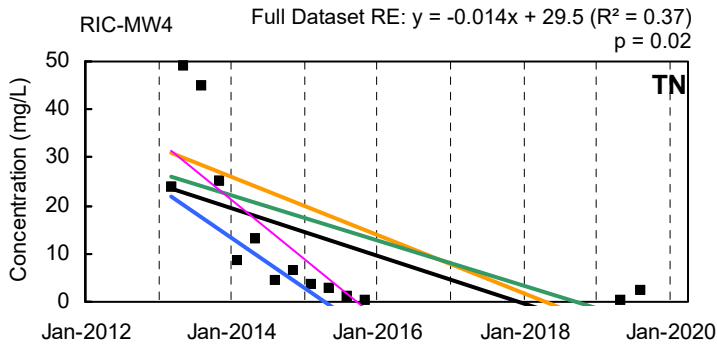
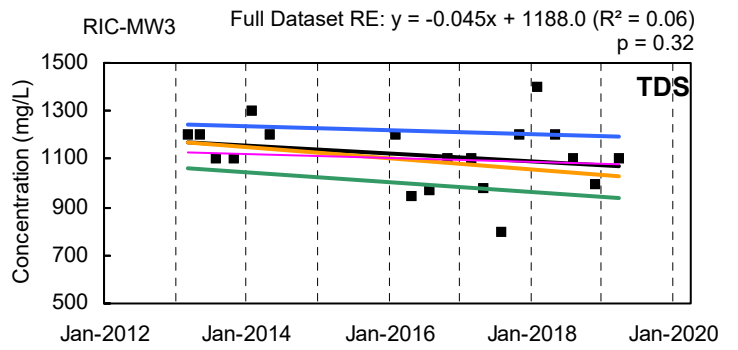
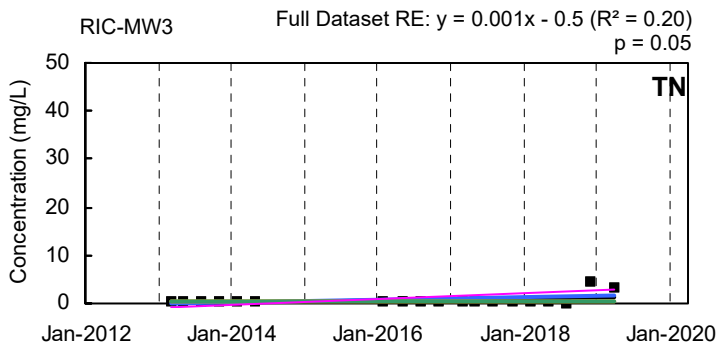

— Q1 Trendline — Q2 Trendline
— Q3 Trendline — Q4 Trendline — Full Dataset Trendline

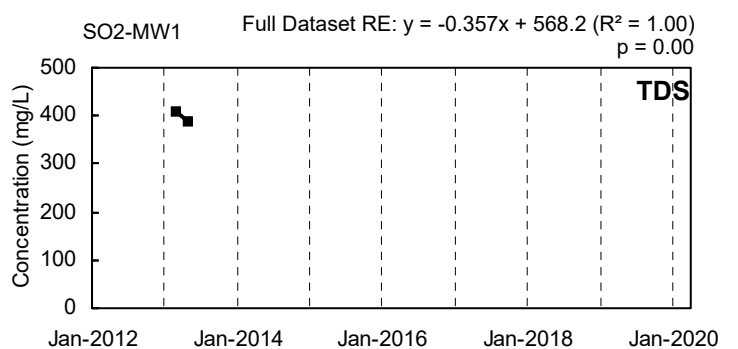
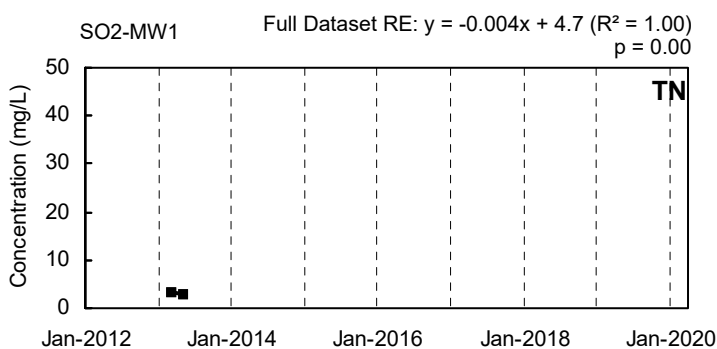
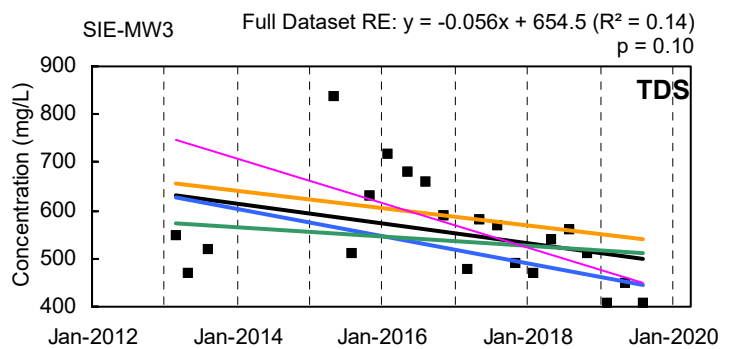
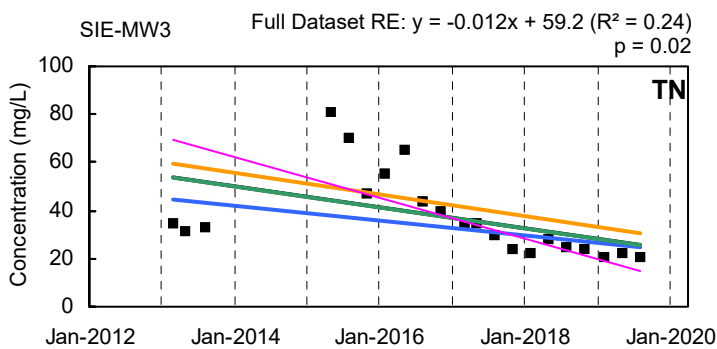
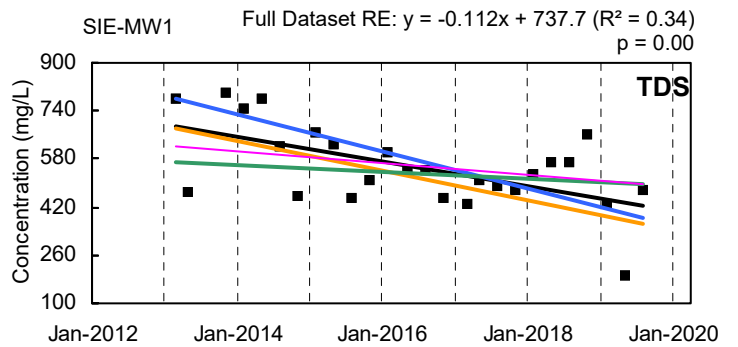
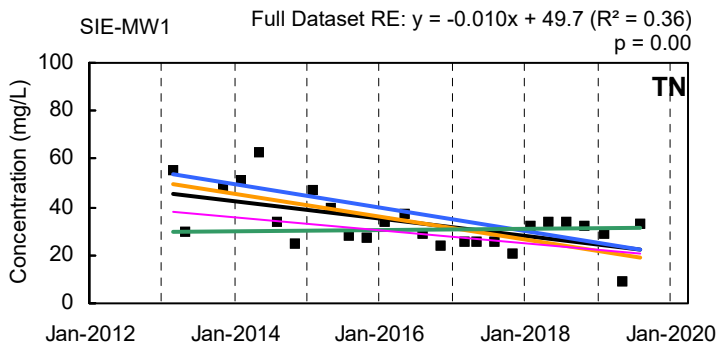
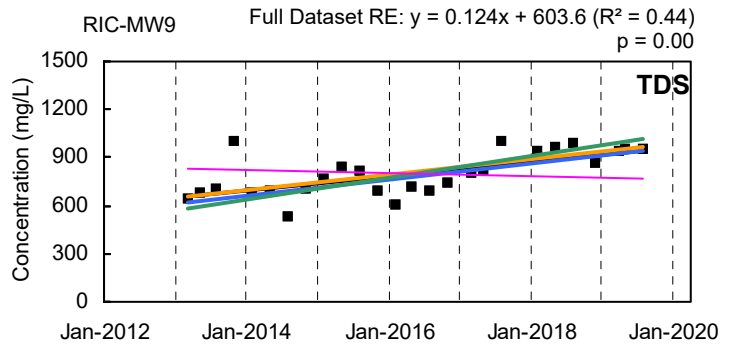
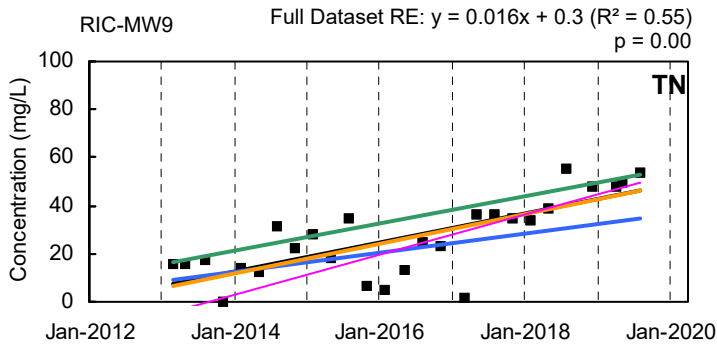
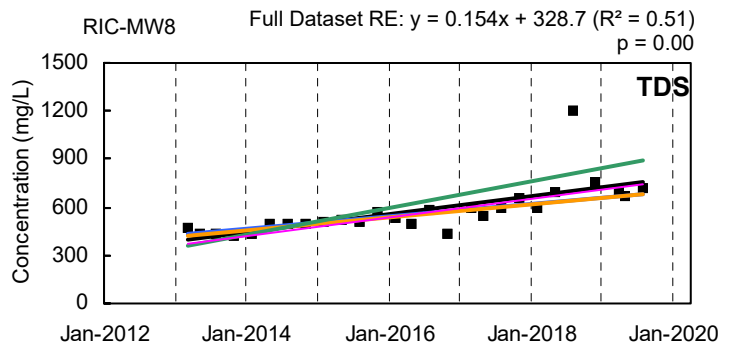
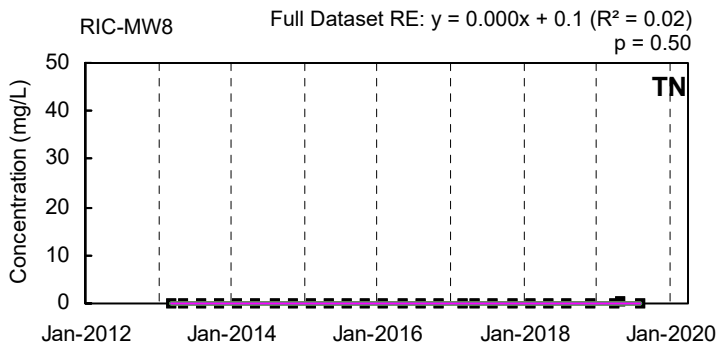

— Q1 Trendline — Q2 Trendline
— Q3 Trendline — Q4 Trendline — Full Dataset Trendline

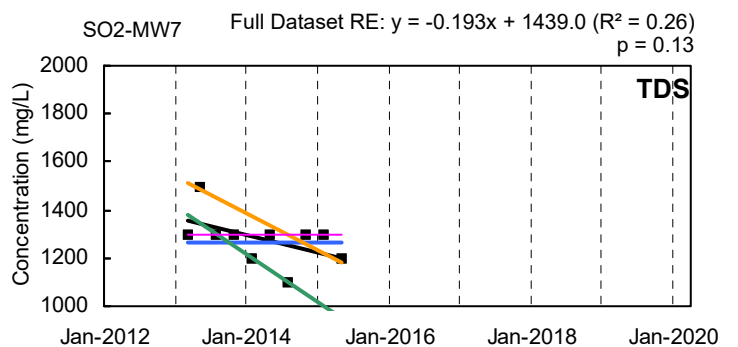
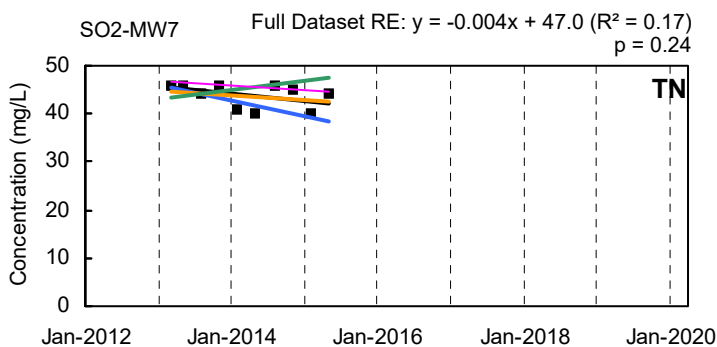
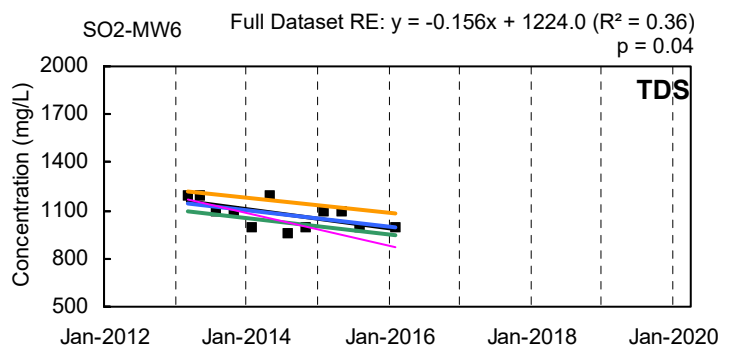
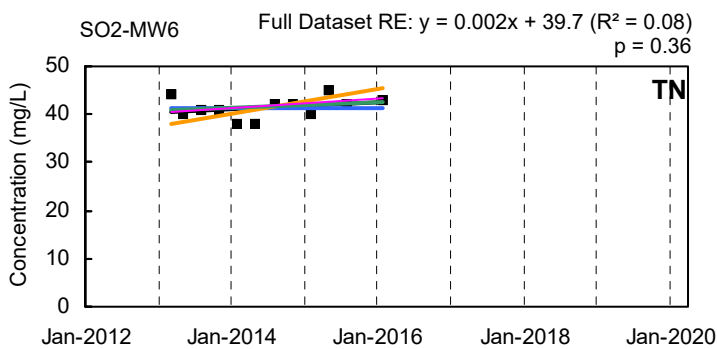
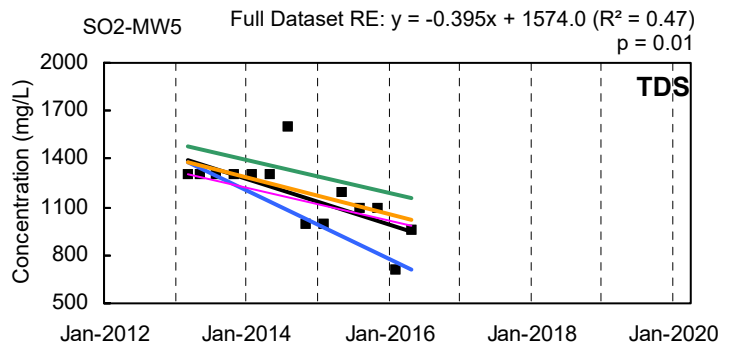
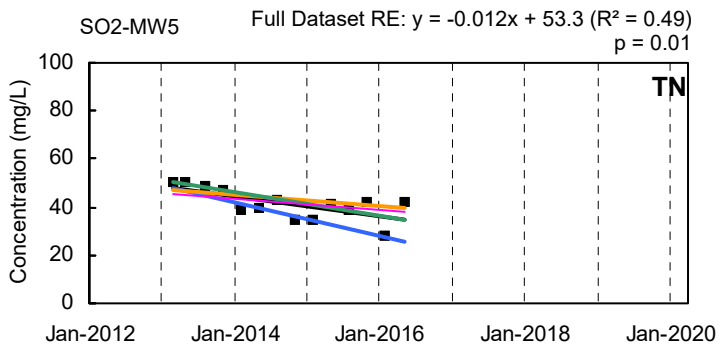
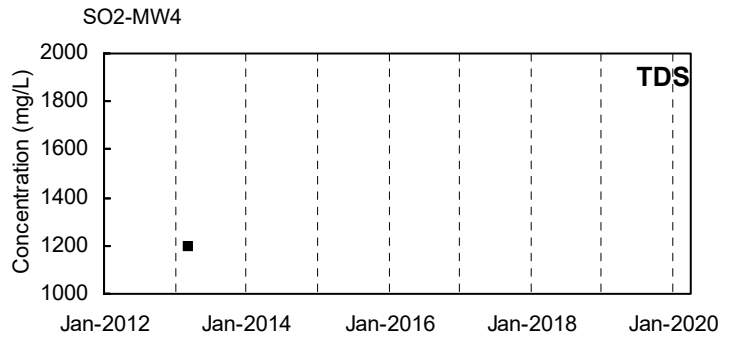
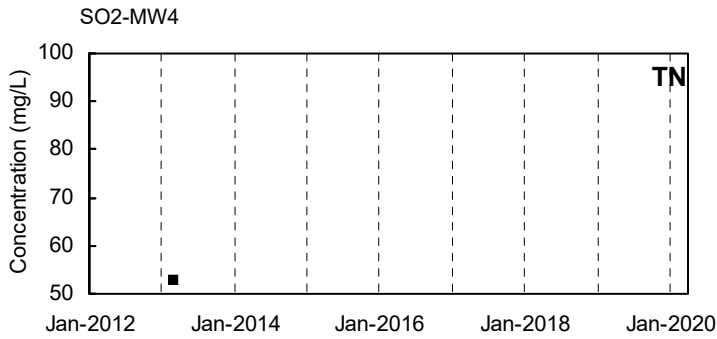
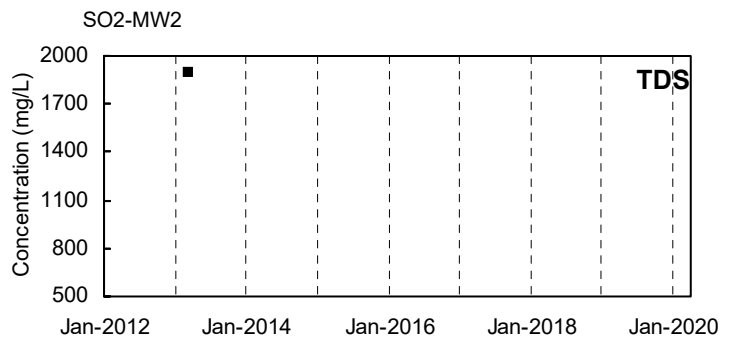
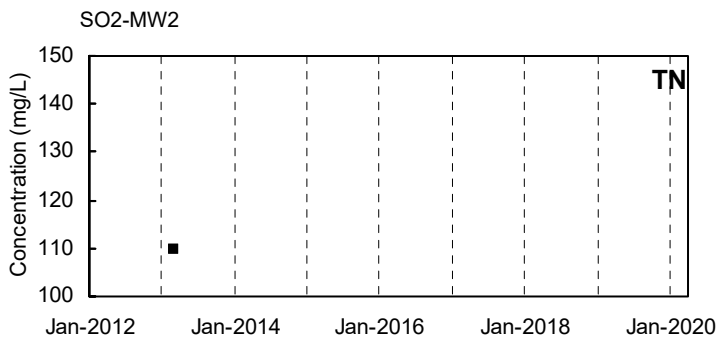

— Q1 Trendline — Q2 Trendline
— Q3 Trendline — Q4 Trendline — Full Dataset Trendline

