

**CALIFORNIA REGIONAL WATER QUALITY CONTROL BOARD
SAN DIEGO REGION**

2375 Northside Drive, Suite.100, San Diego, CA 92108
Phone (619) 516-1990 • Fax (619) 516-1994
<http://www.waterboards.ca.gov/sandiego/>

Clean Water Act Section 401 Water Quality Certification
and Waste Discharge Requirements
for Discharge of Dredged and/or Fill Materials

**PROJECT: Residential Dock Replacement at 17 Blue Anchor Project
Certification Number R9-2018-0138
WDID: 9 000003330**

Reg. Meas. ID: 422923 Place ID: 849342 Party ID: 581502 Person ID: 581505
--

**APPLICANT: Sig Kupka
17 Blue Anchor Cay Road
Coronado, CA 92118**

ACTION:

<input type="checkbox"/> Order for Low Impact Certification	<input type="checkbox"/> Order for Denial of Certification
<input checked="" type="checkbox"/> Order for Technically-conditioned Certification	<input type="checkbox"/> Enrollment in Isolated Waters Order No. 2004-004-DWQ
<input checked="" type="checkbox"/> Enrollment in SWRCB GWDR Order No. 2003-017-DWQ	

PROJECT DESCRIPTION

An application dated June 20, 2018 and revised applications received on August 29, 2018 and October 1, 2018 submitted by and on behalf of, respectively, Mr. Sig Kupka (hereinafter Applicant), for Water Quality Certification pursuant to section 401 of the Clean Water Act (United States Code (USC) Title 33, section 1341) for the proposed Residential Dock Replacement at 17 Blue Anchor Project (Project). The California Regional Water Quality Control Board, San Diego Region (San Diego Water Board) deemed the application to be complete on October 30, 2018. The Applicant proposes to discharge dredged or fill material to waters of the United States and/or State associated with construction activity at the Project site. The Applicant has also applied under the Rivers and Harbors Act section 10 for coverage by Regional General Permit No. 85 (SPL-2015-00366) (USACE File No. SPL-2018-00117-SRR).

The Project is located within the City of Coronado, San Diego County, California at 17 Blue Anchor Cay Road. The Project center reading is located at latitude 32.62129 and longitude -117.13084. The Applicant has paid all required application fees for this Certification in the amount of \$1,500.00. On October 30, 2018, the San Diego Water Board provided public notice of the Project application pursuant to California Code of Regulations, title 23, section 3858 by posting information describing the Project on the San Diego Water Board's web site and providing a period of twenty-one days for public review and comment. No comments were received.

The Applicant proposes to replace the existing U-shaped dock with an L-shaped dock in the same general footprint as the current private dock. The Project proposes to remove 0.024 acre (1,026 square feet) of existing floating dock and gangway and 4 12-inch square concrete piles (4 square feet) and install a new dock system that includes 0.019 acre (812 square feet) of new floating dock and gangway and 3 16-inch square concrete piles (5.3 square feet) in San Diego Bay along 60.2 linear feet of shoreline. Additionally, the associated utilities (electrical service and potable water) will also be replaced. After the Project is implemented, the new dock system will result in an approximate net decrease of 0.005 acre (216 square feet) of overall occupied area in San Diego Bay.

The existing dock system will be disassembled by hand tools from a work boat. The disassembled pieces will be rafted together with rope and floated to a location where the docks can be removed out of the water by either a land-based crane, forklift or waterside barge mounted crane. The removed docks will be hauled off to a landfill or recycling facility by truck, as appropriate.

The new dock system and piles will be manufactured off-site, shipped by truck, and then placed in the water by a land-based crane, forklift, or barge-mounted crane. Piles will be installed through predetermined openings in the dock system. Piles will be jetted in place with a barge-mounted crane and jet pump. A silt curtain will be used to contain any turbidity and floating booms will be deployed to capture any released floating debris during all demolition and construction phases. Divers will recover any non-buoyant debris discharged into coastal waters as soon as possible after loss. All recovered debris will be disposed of properly.

Eelgrass occurs in two patches, totaling approximately 689 square feet, in shallow water on each end of the existing dock. One patch of eelgrass is located a few feet from the northeast corner of the dock. The second patch occurs off the southwestern edge of the dock and occurs between the Project area and the neighboring property's boat dock. It is not anticipated that the beds will be disturbed by the Project due to the use of the same pile locations in relation to the beds and use of a low-impact pile installation method.

Under the terms of this Certification, the Applicant must ensure that the design, operation, and degree of treatment expected to be attained from equipment, facilities, or activities (including construction and post-construction BMPs) will adequately prevent and reduce any effluents which may be discharged. Compliance with the Certification conditions will help ensure that construction and post-construction discharges from the Project will not cause or contribute to exceedances of water quality standards in the *Water Quality Control Plan for the San Diego Basin (9)* (Basin Plan).

Project construction will result in permanent impacts of 0.0187 acre (60.2 linear feet) to San Diego Bay waters of the United States and/or State. The Applicant reports that the Project purpose cannot be practically accomplished in a manner which would avoid or result in less adverse impacts to aquatic resources considering all potential practicable alternatives, such as the potential for alternate available locations, designs, reductions in size, configuration or density. Due to the smaller dock size, compensatory mitigation is not required as the Project will result in an overall increase in the amount of un-shaded bay bottom from the reduction in occupied surface area cover of the new dock system in San Diego Bay.

Construction of the proposed project is anticipated to take approximately two months to complete. Additional Project details are provided in Attachments 2 of this Certification.

TABLE OF CONTENTS

I.	STANDARD CONDITIONS	5
II.	GENERAL CONDITIONS.....	5
III.	CONSTRUCTION BEST MANAGEMENT PRACTICES.....	8
IV.	POST-CONSTRUCTION BEST MANAGEMENT PRACTICES.....	10
V.	PROJECT IMPACTS AND COMPENSATORY MITIGATION	10
VI.	MONITORING AND REPORTING REQUIREMENTS.....	13
VII.	NOTIFICATION REQUIREMENTS	18
VIII.	CALIFORNIA ENVIRONMENTAL QUALITY ACT COMPLIANCE	20
IX.	SAN DIEGO WATER BOARD CONTACT PERSON.....	21
X.	WATER QUALITY CERTIFICATION	21

Attachments:

- 1. Definitions**
- 2. Project Figures and Plans**

The San Diego Water Board has independently reviewed the record of the Project to analyze the extent and nature of proposed Project impacts to the water quality and beneficial uses of waters of the United States and/or State and associated compensatory mitigation required to offset impacts attributed to the Project. In accordance with this Certification, the Applicant may proceed with the Project under the following terms and conditions:

I. STANDARD CONDITIONS

Pursuant to section 3860 of title 23 of the California Code of Regulations, the following three standard conditions apply to all water quality certification actions:

- A. This Certification action is subject to modification or revocation upon administrative or judicial review, including review and amendment pursuant to section 13330 of the Water Code and chapter 28, article 6 (commencing with title 23, section 3867), of the California Code of Regulations.
- B. This Certification action is not intended and shall not be construed to apply to any discharge from any activity involving a hydroelectric facility and requiring a Federal Energy Regulatory Commission (FERC) license or an amendment to a FERC license unless the pertinent Certification application was filed pursuant to California Code of Regulations title 23, section 3855 subdivision (b), and that application specifically identified that a FERC license or amendment to a FERC license for a hydroelectric facility was being sought.
- C. This Certification action is conditioned upon total payment of any fee required under title 23, chapter 28 (commencing with section 3830) of California Code of Regulations and owed by the applicant.

II. GENERAL CONDITIONS

- A. **Term of Certification.** Water Quality Certification No. R9-2018-0138 (Certification) shall expire upon a) the expiration or retraction of the Clean Water Act section 404 (33 USC Title 33, section 1344) permit issued by the U.S. Army Corps of Engineers for this Project, or b) five (5) years from the date of issuance of this Certification, whichever occurs first.
- B. **Duty to Comply.** The Applicant must comply with all conditions and requirements of this Certification. Any Certification noncompliance constitutes a violation of the Water Code and is grounds for enforcement action or Certification termination, revocation and reissuance, or modification.
- C. **General Waste Discharge Requirements.** The requirements of this Certification are enforceable through Water Quality Order No. 2003-0017-DWQ, *Statewide General Waste Discharge Requirements for Discharges of Dredged or Fill Material that have Received State Water Quality Certification* (Water Quality Order No. 2003-0017-DWQ). This provision shall apply irrespective of whether a) the federal permit for which the Certification was obtained is subsequently retracted or is expired, or b) the Certification is expired. Water Quality Order No. 2003-0017-DWQ is accessible at:

http://www.waterboards.ca.gov/water_issues/programs/cwa401/docs/generalorders/go_wdr401regulated_projects.pdf.

- D. Project Conformance with Application.** All water quality protection measures and BMPs described in the application and supplemental information for water quality certification are incorporated by reference into this Certification as if fully stated herein. Notwithstanding any more specific conditions in this Certification, the Applicant shall construct, implement and comply with all water quality protection measures and BMPs described in the application and supplemental information. The conditions within this Certification shall supersede conflicting provisions within the application and supplemental information submitted as part of this Certification action.
- E. Project Conformance with Water Quality Control Plans or Policies.** Notwithstanding any more specific conditions in this Certification, the Project shall be constructed in a manner consistent with the Basin Plan and any other applicable water quality control plans or policies adopted or approved pursuant to the Porter Cologne Water Quality Act (Division 7, commencing with Water Code Section 13000) or section 303 of the Clean Water Act (33 USC section 1313). The Basin Plan is accessible at:
- http://www.waterboards.ca.gov/sandiego/water_issues/programs/basin_plan/index.shtml
- F. Project Modification.** The Applicant must submit any changes to the Project, including Project operation, which would have a significant or material effect on the findings, conclusions, or conditions of this Certification, to the San Diego Water Board for prior review and written approval. If the San Diego Water Board is not notified of a significant change to the Project, it will be considered a violation of this Certification.
- G. Certification Distribution Posting.** During Project construction, the Applicant must maintain a copy of this Certification at the Project site. This Certification must be available at all times to site personnel and agencies. A copy of this Certification shall also be provided to any contractor or subcontractor performing construction work, and the copy shall remain in their possession at the Project site.
- H. Inspection and Entry.** The Applicant must allow the San Diego Water Board or the State Water Resources Control Board, and/or their authorized representative(s) (including an authorized contractor acting as their representative), upon the presentation of credentials and other documents as may be required under law, to:
1. Enter upon the Project or Compensatory Mitigation site(s) premises where a regulated facility or activity is located or conducted, or where records must be kept under the conditions of this Certification;
 2. Have access to and copy, at reasonable times, any records that must be kept under the conditions of this Certification;

3. Inspect, at reasonable times, any facilities, equipment (including monitoring and control equipment), practices, or operations regulated or required under this Certification; and
 4. Sample or monitor, at reasonable times, for the purposes of assuring Certification compliance, or as otherwise authorized by the Clean Water Act or Water Code, any substances or parameters at any location.
- I. **Enforcement Notification.** In the event of any violation or threatened violation of the conditions of this Certification, the violation or threatened violation shall be subject to any remedies, penalties, process or sanctions as provided for under State law. For purposes of section 401(d) of the Clean Water Act, the applicability of any State law authorizing remedies, penalties, process or sanctions for the violation or threatened violation constitutes a limitation necessary to assure compliance with the water quality standards and other pertinent requirements incorporated into this Certification.
- J. **Certification Actions.** This Certification may be modified, revoked and reissued, or terminated for cause including but not limited to the following:
1. Violation of any term or condition of this Certification;
 2. Monitoring results indicate that continued Project activities could violate water quality objectives or impair the beneficial uses of San Diego Bay;
 3. Obtaining this Certification by misrepresentation or failure to disclose fully all relevant facts;
 4. A change in any condition that requires either a temporary or permanent reduction or elimination of the authorized discharge; and
 5. Incorporation of any new or revised water quality standards and implementation plans adopted or approved pursuant to the Porter-Cologne Water Quality Control Act or section 303 of the Clean Water Act.

The filing of a request by the Applicant for modification, revocation and reissuance, or termination, or a notification of planned changes or anticipated noncompliance does not stay any Certification condition.

- K. **Duty to Provide Information.** The Applicant shall furnish to the San Diego Water Board, within a reasonable time, any information which the San Diego Water Board may request to determine whether cause exists for modifying, revoking and reissuing, or terminating this Certification or to determine compliance with this Certification.
- L. **Property Rights.** This Certification does not convey any property rights of any sort, or any exclusive privilege.

- M. **Petitions.** Any person aggrieved by this action of the San Diego Water Board may petition the State Water Resources Control Board (State Water Board) to review the action in accordance with the California Code of Regulations, title 23, sections 3867 and following. The State Water Board must receive the petition by 5:00 p.m., 30 days after the date of this Certification. Copies of the law and regulations applicable to filing petitions may be found on the Internet at: http://www.waterboards.ca.gov/public_notices/petitions/water_quality or will be provided upon request.

III. CONSTRUCTION BEST MANAGEMENT PRACTICES

- A. **Approvals to Commence Construction.** The Applicant shall not commence Project construction until all necessary federal, State, and local approvals are obtained.
- B. **Personnel Education.** Prior to the start of the Project, and annually thereafter, the Applicant must educate all personnel on the requirements in this Certification, pollution prevention measures, spill response measures, and BMP implementation and maintenance measures.
- C. **Spill Containment Materials.** The Applicant must, at all times, maintain appropriate types and sufficient quantities of materials on-site to contain any spill or inadvertent release of materials that may cause a condition of pollution or nuisance if the materials reach waters of the United States and/or State.
- D. **General Construction Storm Water Permit.** Prior to start of Project construction, the Applicant must, as applicable, obtain coverage under, and comply with, the requirements of State Water Resources Control Board Water Quality Order No. 2009-0009-DWQ, the *General Permit for Storm Water Discharges Associated with Construction and Land Disturbance Activity*, (General Construction Storm Water Permit) and any reissuance. If Project construction activities do not require coverage under the General Construction Storm Water Permit, the Applicant must develop and implement a runoff management plan (or equivalent construction BMP plan) to prevent the discharge of sediment and other pollutants during construction activities.
- E. **Waste Management.** The Applicant must properly manage, store, treat, and dispose of wastes in accordance with applicable federal, state, and local laws and regulations. Waste management shall be implemented to avoid or minimize exposure of wastes to precipitation or storm water runoff. The storage, handling, treatment, or disposal of waste shall not create conditions of pollution, contamination or nuisance as defined in Water Code section 13050. Upon Project completion, all Project generated debris, building materials, excess material, waste, and trash shall be removed from the Project site(s) for disposal at an authorized landfill or other disposal site in compliance with federal, state and local laws and regulations.
- F. **Waste Management.** Except for a discharge permitted under this Certification, the dumping, deposition, or discharge of trash, rubbish, unset cement or asphalt, concrete, grout, damaged concrete or asphalt, concrete or asphalt spoils, wash water, organic or earthen material, steel, sawdust or other construction debris waste from Project activities directly into waters of the United States and or State, or adjacent to such

waters in any manner which may permit its being transported into the waters, is prohibited.

- G. **Construction Equipment.** All equipment must be washed prior to transport to the Project site and must be free of sediment, debris, and foreign matter. All equipment used in direct contact with surface water shall be steam cleaned prior to use. All equipment using gas, oil, hydraulic fluid, or other petroleum products shall be inspected for leaks prior to use and shall be monitored for leakage. Stationary equipment (e.g., motors, pumps, generator, etc.) shall be positioned over drip pans or other types of containment.
- H. **Process Water.** Water containing mud, silt, or other pollutants from equipment washing or other activities, must not be discharged to waters of the United States and/or State or placed in locations that may be subjected to storm water runoff flows.
- I. **Hazardous Materials.** Except as authorized by this Certification, substances hazardous to aquatic life including, but not limited to, petroleum products, unused cement/concrete, asphalt, and coating materials, must be prevented from contaminating the soil and/or entering waters of the United States and/or State. BMPs must be implemented to prevent such discharges during each Project activity involving hazardous materials.
- J. **Limits of Disturbance.** The Applicant shall clearly define the limits of Project disturbance to waters of the United States and/or State using highly visible markers such as flag markers, construction fencing, or silt barriers prior to commencement of Project construction activities within those areas.
- K. **Silt Curtain Deployment.** The Applicant shall deploy and maintain a continuous length of silt curtain, fully surrounding active discharge activities, including pile driving, in conformance with the following requirements:
1. The silt curtains must restrict the surface visible turbidity plume or surface debris to the area of construction and dredging and must control and contain the migration of re-suspended sediments or debris at the water surface and at depth;
 2. The bottom of the silt curtains must be weighted with ballast weights or rods affixed to the base of the fabric to resist the natural buoyancy of the silt curtain fabric and lessen its tendency to move in response to currents. Where feasible and applicable, the floating silt curtains must be anchored and deployed from the surface of the water to just above the substrate;
 3. The silt curtain must be monitored for damage, dislocation or gaps and must be immediately repaired where it is no longer continuous or where it has loosened; and
 4. The silt curtain must not be removed until the visible turbidity plume has dissipated and/or surface debris is skimmed and removed.

- L. **On-site Qualified Biologist.** The Applicant shall designate an on-site qualified biologist to monitor Project construction activities within or adjacent to waters of the United States and/or State to ensure compliance with the Certification requirements. The biologist shall be given the authority to stop all work on-site if a violation of this Certification occurs or has the potential to occur. Records, field notes, and/or field logs created by biologist(s) for the purpose of documenting construction activities shall be submitted with the Annual Project Progress Report.
- M. **Protection of Eelgrass Beds.** As required in section V.C. of this certification, a pre-construction eelgrass survey must be completed in accordance with the requirements of the *California Eelgrass Mitigation Policy* (CEMP)¹ by a qualified biologist, prior to initiation of construction activities at the site. If eelgrass is found during the pre-construction survey, the Applicant shall also comply with the following requirements:
1. Prior to construction, the boundaries of adjacent eelgrass beds must be staked with ridged PVC markers or self-centering buoys visible at all tide heights. The PVC markers or self-centering buoys must be protected, replaced, and maintained as needed to ensure that they remain in place and properly stake at the boundaries of the eelgrass beds; and
 2. Any silt curtains must be kept an appropriate distance away from staked eelgrass beds in order to prevent damage to eelgrass beds from curtain drag or movement.
- N. **Beneficial Use Protection.** The Applicant must take all necessary measures to protect the beneficial uses of waters of San Diego Bay. This Certification requires compliance with all applicable requirements of the Basin Plan. If at any time, an unauthorized discharge to surface waters occurs or monitoring indicates that the Project is violating, or threatens to violate, water quality objectives, the associated Project activities shall cease immediately and the San Diego Water Board shall be notified in accordance with Notification Requirement VII.B of this Certification. Associated Project activities may not resume without approval from the San Diego Water Board.

IV. POST-CONSTRUCTION BEST MANAGEMENT PRACTICES

- A. **Post-Construction Discharges.** The Applicant shall not allow post-construction discharges from the Project site to cause or contribute to on-site or off-site erosion or damage to properties or Bay habitats.

V. PROJECT IMPACTS AND COMPENSATORY MITIGATION

- A. **Project Impact Avoidance and Minimization.** The Project must avoid and minimize adverse impacts to waters of the United States and/or State to the maximum extent practicable.

¹ National Oceanic and Atmospheric Administration, National Marine Fisheries, West Coast Region. California Eelgrass Mitigation Policy and Implementing Guidelines, October 2014. An electronic copy can be found at the following web page: http://www.westcoast.fisheries.noaa.gov/publications/habitat/california_eelgrass_mitigation/Final%20CEMP%20October%202014/cemp_oct_2014_final.pdf

B. Project Impacts and Compensatory Mitigation. Unavoidable Project impacts to San Diego Bay must not exceed the type and magnitude of impacts described in the table below. At a minimum, compensatory mitigation required to offset unavoidable temporary and permanent Project impacts to waters of the United States and/or State must be achieved as described in the table below:

	Impacts (acres)	Impacts (linear ft.)	Mitigation for Impacts (acres)	Mitigation Ratio (area mitigated :area impacted)	Mitigation for Impacts (linear ft.)	Mitigation Ratio (linear feet mitigated :linear feet impacted)
Permanent Impacts						
San Diego Bay	0.0001 ^a	a	b	b	b	b
	0.0186 ^c	60.2 ^c	b	b	b	b

- a. Total permanent impacts of 0.0001 acre (5.4 square feet; 4 linear feet) from the fill of waters of the United States and/or State for the installation of 3 new 16-inch square guide piles. The linear-foot impacts of fill attributable to guide pile installations are within the shoreline length described for occupied surface area coverage impacts.
- b. Once implemented, the Project will provide an overall net decrease of approximately 0.005 acre (216 square feet) in overall occupied area and a reduction in the number of piles in San Diego Bay as compared to the previous dock system. Therefore, no compensatory mitigation is required for this Project; however, if eelgrass is impacted, the Applicant will provide compensatory mitigation in accordance with the terms of the California Eelgrass Mitigation Policy.
- c. Total permanent impacts of 0.0186 acre (811.4 square feet; 60.2 linear feet of shoreline) due to occupied surface area coverage of waters of the United States and/or State from placement of a new floating dock and gangway.

C. Eelgrass. A pre-construction eelgrass survey must be completed in accordance with the requirements of the California Eelgrass Mitigation Policy (CEMP; National Marine Fisheries Service 2014)² by a qualified biologist, prior to initiation of construction activities at the site. This survey must include both aerial and density characterization of the beds. If eelgrass is found during the pre-construction survey, a post-construction survey must be performed by a qualified biologist within 30 days following project completion to quantify any unanticipated losses to eelgrass habitat. Impacts must then be determined from a comparison of pre- and post-construction survey results. Impacts to eelgrass, if any, must be mitigated through conformance with the CEMP, which defines the mitigation ratio and other requirements to achieve mitigation for significant eelgrass impacts. If required following the post-construction survey, the CEMP defined mitigation must be developed; submitted and approved by the San Diego Water Board,

² National Oceanic and Atmospheric Administration, National Marine Fisheries, West Coast Region. California Eelgrass Mitigation Policy and Implementing Guidelines, October 2014. An electronic copy can be found at the following web page: http://www.westcoast.fisheries.noaa.gov/publications/habitat/california_eelgrass_mitigation/Final%20CEMP%20October%2014/cemp_oct_2014_final.pdf

U.S. Army Corps of Engineers, and National Marine Fisheries Service; and implemented to offset losses to eelgrass.

- D. Compensatory Mitigation Site Design.** If compensatory mitigation for eelgrass impacts is required, the compensatory mitigation site(s) shall be designed to be self-sustaining once performance standards have been achieved.
- E. Temporary Project Impact Areas.** The Applicant must restore all areas of temporary impacts and all other areas of temporary disturbance which could result in a discharge or a threatened discharge of pollutants to waters of the United States and/or State. Restoration must include grading of disturbed areas to pre-project contours and re-vegetation with native species. The Applicant must implement all necessary BMPs to control erosion and discharge from areas associated with the Project.
- F. Long-Term Management and Maintenance.** If compensatory mitigation for eelgrass impacts is required, the compensatory mitigation site(s) must be managed, protected, and maintained, in perpetuity, in conformance with the long-term management plan and the final ecological success performance standards identified in the Mitigation Plan or Name of Document Containing the Standards. The aquatic habitats, riparian areas, buffers and uplands, as appropriate, that comprise the mitigation site(s) must be protected in perpetuity from land-use and maintenance activities that may threaten water quality or beneficial uses within the mitigation area(s) in a manner consistent with the following requirements:
- a. Any maintenance activities on the mitigation site(s) that do not contribute to the success of the mitigation site(s) and enhancement of beneficial uses and ecological functions and services are prohibited;
 - b. Maintenance activities must be limited to the removal of trash and debris, removal of exotic plant species, replacement of dead native plant species, and remedial measures deemed necessary for the success of the compensatory mitigation project;
 - c. If at any time a catastrophic natural event (e.g., fire, flood) causes damage(s) to the mitigation site(s) or other deficiencies in the compensatory mitigation project, the Applicant must take prompt and appropriate action to repair the damage(s) including replanting the affected area(s) and address any other deficiencies. The San Diego Water Board may require additional monitoring by the Applicant to assess how the compensatory mitigation site(s) or project is responding to a catastrophic natural event.
- G. Timing of Mitigation Site Construction.** If compensatory mitigation for eelgrass impacts is required, the construction of proposed mitigation must be completed no later than 9 months following the earliest time of either the direct impact to eelgrass beds or as directed in accordance with CEMP. Delays in implementing mitigation must be compensated for by an increased mitigation implementation of 10% of the cumulative compensatory mitigation for each month of delay.

H. **Mitigation Site(s) Preservation Mechanism.** If compensatory mitigation for eelgrass impacts is required, the Applicant must provide the San Diego Water Board with a draft preservation mechanism (e.g. deed restriction, conservation easement, etc.) **within 90 days from the dredging completion date** that will protect all mitigation areas and their buffers in perpetuity. The Applicant must submit proof of a completed final preservation mechanism that will protect all mitigation areas and their buffers in perpetuity. The conservation easement, deed restriction, or other legal limitation on the mitigation properties must be adequate to demonstrate that the sites will be maintained without future development or encroachment on the sites which could otherwise reduce the functions and values of the sites for the variety of beneficial uses of waters of the United States and/ or State that it supports. The legal limitation must prohibit, without exception, all residential, commercial, industrial, institutional, and transportation development, and any other infrastructure development that would not maintain or enhance the wetland and streambed functions and values of the sites. The preservation mechanism must clearly prohibit activities that would result in soil disturbance or vegetation removal, other than the removal of non-native vegetation. Other infrastructure development to be prohibited includes, but is not limited to, additional utility lines, maintenance roads, and areas of maintained landscaping for recreation.

VI. MONITORING AND REPORTING REQUIREMENTS

- A. **Representative Monitoring.** Samples and measurements taken for the purpose of monitoring under this Certification shall be representative of the monitored activity.
- B. **Monitoring Reports.** Monitoring results shall be reported to the San Diego Water Board at the intervals specified in section VI of this Certification.
- C. **Monitoring and Reporting Revisions.** The San Diego Water Board may make revisions to the monitoring program at any time during the term of this Certification and may reduce or increase the number of parameters to be monitored, locations monitored, the frequency of monitoring, or the number and size of samples collected.
- D. **Records of Monitoring Information.** Records of monitoring information shall include:
1. The date, exact place, and time of sampling or measurements;
 2. The individual(s) who performed the sampling or measurements;
 3. The date(s) analyses were performed;
 4. The individual(s) who performed the analyses;
 5. The analytical techniques or methods used; and
 6. The results of such analyses.

E. Receiving Water Visual Observation Monitoring. The Applicant must conduct visual observation monitoring of the Project activities in the San Diego Bay prior to, during, and after each period of project construction. The visual observation monitoring documentation must be included in the Receiving Water Visual Observation Monitoring Report(s).

1. **Parameters.** The following parameters shall be visually monitored immediately outside of the construction area:
 - a. No floating particulates, suspended materials, grease, or oil; and
 - b. No significant discoloration of the water surface.
2. **Field Documentation.** All visual observations shall be recorded throughout Project construction activities. In addition to the requirements listed in section VI.D., monitoring field logs shall include, but is not limited to, observations of water quality conditions including sheen, color, odor, floating particulates, condition of silt curtain, surface visible turbidity plume. Logs shall also include observations of sensitive biological resources and weather conditions, such as wind speed/direction and cloud cover.

If photo documentation is used in support of visual observations of water quality conditions, it should be conducted in accordance with guidelines posted at http://www.waterboards.ca.gov/sandiego/water_issues/programs/401_certification/docs/401c/401PhotoDocRB9V713.pdf. In addition, photo documentation should include Global Positioning System (GPS) coordinates for each of the photo points referenced; and,

3. **Response Actions.** If the condition of the silt curtain is observed to be damaged, has become dislocated, or has gaps where a visible turbidity plume is forming outside of the silt curtain at the Project Site, a response action shall be taken immediately to correct the situation. Response actions may include, but are not limited to, work stoppage until silt curtain repair is completed, implementation of operational modifications, work stoppage due to the presence of sensitive species until area is vacated, and/or implementation of additional BMPs (e.g., a second silt curtain). Response actions, if needed, shall be documented in the monitoring field log.

F. Annual Project Progress Reports. The Applicant must submit annual Project Progress Reports until this certification has expired or been terminated. The Project Progress Reports must describe the status of BMP implementation, compensatory mitigation (if required by CEMP), and compliance with all requirements of this Certification to the San Diego Water Board prior to **March 1** of each year following the issuance of this Certification, until the Project has reached completion. The Annual Project Progress Reports must contain compensatory mitigation monitoring information sufficient to demonstrate how the compensatory mitigation project is progressing towards accomplishing its objectives and meeting its performance standards. Annual Project Progress Reports must be submitted even if Project construction has not begun.

The monitoring period for each Annual Project Progress Report shall be January 1st through December 31st of each year. If all Project components are complete, including any compensatory mitigation as required by CEMP, the final Annual Project Progress Report may be submitted with the Final Project Completion Report for the purpose of completing all of the necessary requirements of the permit. Annual Project Progress Reports must include, at a minimum, the following:

1. **Project Status and Compliance Reporting.** The Annual Project Progress Report must include the following Project status and compliance information:
 - a. The following identification numbers included at the end of the header or subject line content: Certification No. R9-2018-0136:849181:lhonma;
 - b. The names, qualifications, and affiliations of the persons contributing to the report;
 - c. The status, progress, and anticipated schedule for completion of Project construction activities including the installation and operational status of best management practices project features for erosion and storm water quality treatment;
 - d. A description of Project construction delays encountered or anticipated that may affect the schedule for construction completion;
 - e. A description of each incident of noncompliance during the annual monitoring period and its cause, the period of the noncompliance including exact dates and times, and if the noncompliance has not been corrected, the anticipated time it is expected to continue; and the steps taken or planned to reduce, eliminate, and prevent reoccurrence of the noncompliance; and
 - f. The pre- and post- construction eelgrass surveys, as applicable, required under section V.C of this Certification, including a description of any additional actions that will be taken by the Applicant to mitigate for impact to eelgrass habitat beyond what is expected.
2. **Receiving Water Visual Observation Monitoring Reporting.** The Applicant shall prepare monitoring reports that contain the results of visual observation monitoring activities for each week of monitoring. The reports must include, at a minimum:
 - a. The names, qualifications, and affiliations of the persons contributing to the report;
 - b. Copies of records, field notes/logs, and/or photo documentation of the visual observations required under section VI.E; and

- c. A summary, evaluation, and interpretation of the visual observations recorded and any response actions taken as required under section VI.E, including interpretations and conclusions as to whether applicable receiving water limitations were attained at the site.

3. **Compensatory Mitigation Monitoring Reporting.** If compensatory mitigation for eelgrass impacts is required, mitigation monitoring information must be submitted as part of the Annual Project Progress Report for a period of not less than five years, sufficient to demonstrate that the compensatory mitigation project has accomplished its objectives and met ecological success performance standards contained in the Mitigation Plan. Monitoring shall be conducted in accordance with the standards of the CEMP. Following Project implementation, the San Diego Water Board may reduce or waive compensatory mitigation monitoring requirements upon a determination that performance standards have been achieved. Conversely, the San Diego Water Board may extend the monitoring period beyond five years upon a determination that the performance standards have not been met or the compensatory mitigation project is not on track to meet them. The Annual Project Progress Report must include the following compensatory mitigation monitoring information:

- a. Names, qualifications, and affiliations of the persons contributing to the report;
- b. An evaluation, interpretation, and tabulation of the parameters being monitored, including the results of the Mitigation Plan monitoring program, and all quantitative and qualitative data collected in the field;
- c. Monitoring data interpretations and conclusions as to how the compensatory mitigation project(s) is progressing towards meeting performance standards and whether the performance standards have been met;
- d. A description of the progress toward implementing a plan to manage the compensatory mitigation project after performance standards have been achieved to ensure the long-term sustainability of the resource in perpetuity, including a discussion of long term financing mechanisms, the party responsible for long term management, and a timetable for future steps;
- e. Qualitative and quantitative comparisons of current mitigation conditions with pre-construction conditions and previous mitigation monitoring results;
- f. As-built drawings of the compensatory mitigation project site(s), no bigger than 11"X17"; and
- g. A survey report documenting boundaries of the compensatory mitigation site(s).

G. Final Project Completion Report. The Applicant must submit a Final Project Completion Report to the San Diego Water Board **within 30 days of completion of the Project**. The final report must include the following information, at a minimum:

1. Date of construction initiation; and
2. Date of construction completion.

H. Reporting Authority. The submittal of information required under this Certification, or in response to a suspected violation of any condition of this Certification, is required pursuant to Water Code section 13267 and 13383. Civil liability may be administratively imposed by the San Diego Water Board for failure to submit information pursuant to Water Code sections 13268 or 13385.

I. Electronic Document Submittal. The Applicant must submit all reports and information required under this Certification in electronic format via e-mail to SanDiego@waterboards.ca.gov. Documents over 50 megabytes will not be accepted via e-mail and must be placed on a disc and delivered to:

California Regional Water Quality Control Board
San Diego Region
Attn: 401 Certification No. R9-2018-0138:849342:lhonma
2375 Northside Drive, Suite 100
San Diego, California 92108

Each electronic document must be submitted as a single file, in Portable Document Format (PDF), and converted to text searchable format using Optical Character Recognition (OCR). All electronic documents must include scanned copies of all signature pages; electronic signatures will not be accepted. Electronic documents submitted to the San Diego Water Board must include the following identification numbers in the header or subject line: Certification No. R9-2018-0138:849342:lhonma.

J. Document Signatory Requirements. All applications, reports, or information submitted to the San Diego Water Board must be signed as follows:

1. For a corporation, by a responsible corporate officer of at least the level of vice president.
2. For a partnership or sole proprietorship, by a general partner or proprietor, respectively.
3. For a municipality, or a state, federal, or other public agency, by either a principal executive officer or ranking elected official.
4. A duly authorized representative may sign applications, reports, or information if:
 - a. The authorization is made in writing by a person described above.

- b. The authorization specifies either an individual or position having responsibility for the overall operation of the regulated activity.
- c. The written authorization is submitted to the San Diego Water Board Executive Officer.

If such authorization is no longer accurate because a different individual or position has responsibility for the overall operation of the Project, a new authorization satisfying the above requirements must be submitted to the San Diego Water Board prior to or together with any reports, information, or applications, to be signed by an authorized representative.

- K. **Document Certification Requirements.** All applications, reports, or information submitted to the San Diego Water Board must be certified as follows:

"I certify under penalty of law that I have personally examined and am familiar with the information submitted in this document and all attachments and that, based on my inquiry of those individuals immediately responsible for obtaining the information, I believe that the information is true, accurate, and complete. I am aware that there are significant penalties for submitting false information, including the possibility of fine and imprisonment."

VII. NOTIFICATION REQUIREMENTS

- A. **Commencement of Construction Notification.** The Applicant must notify the San Diego Water Board in writing at least 5 days prior to the start of initial Project construction ground disturbance.
- B. **Twenty-Four Hour Non-Compliance Reporting.** The Applicant shall report any noncompliance which may endanger health or the environment. Any such information shall be provided orally to the San Diego Water Board within **24 hours** from the time the Applicant becomes aware of the circumstances. A written submission shall also be provided within five days of the time the Applicant becomes aware of the circumstances. The written submission shall contain a description of the noncompliance and its cause; the period of noncompliance, including exact dates and times, and if the noncompliance has not been corrected; the anticipated time it is expected to continue; and steps taken or planned to reduce, eliminate, and prevent recurrence of the noncompliance. The San Diego Water Board, or an authorized representative, may waive the written report on a case-by-case basis if the oral report has been received within 24 hours.
- C. **Caulerpa Taxifolia.** The Applicant must conduct a surveillance-level survey for *Caulerpa taxifolia*, in accordance with the requirements in the National Marine Fisheries Service's *Caulerpa* Control Protocol (version 4), dated February 25, 2008, not more than 90 days before the initiation of construction to determine presence/absence of this species within the immediate vicinity of the project. If *Caulerpa taxifolia* is identified during a survey, or at any other time before, during, or within 120 days following completion of authorized activities, both National Marine Fisheries Service and California Department of Fish and Wildlife must be contacted within 24 hours of first noting the occurrence. In the event *Caulerpa taxifolia* is detected, all disturbing activity

must cease until such time as the infestation has been isolated and treated, or the risk of spread from the disturbing activity is eliminated in accordance with the Caulerpa Control Protocol.

- D. Hazardous Substance Discharge.** Except as provided in Water Code section 13271(b), any person who, without regard to intent or negligence, causes or permits any hazardous substance or sewage to be discharged in or on any waters of the State, shall as soon as (a) that person has knowledge of the discharge, (b) notification is possible, and (c) notification can be provided without substantially impeding cleanup or other emergency measures, immediately notify the County of San Diego, in accordance with California Health and Safety Code section 5411.5 and the California Office of Emergency Services of the discharge in accordance with the spill reporting provision of the State toxic disaster contingency plan adopted pursuant to Government Code Title 2, Division 1, Chapter 7, Article 3.7 (commencing with section 8574.17), and immediately notify the State Water Board or the San Diego Water Board of the discharge. This provision does not require reporting of any discharge of less than a reportable quantity as provided for under subdivisions (f) and (g) of section 13271 of the Water Code unless the Applicant is in violation of a Basin Plan prohibition.
- E. Oil or Petroleum Product Discharge.** Except as provided in Water Code section 13272(b), any person who without regard to intent or negligence, causes or permits any oil or petroleum product to be discharged in or on any waters of the State, or discharged or deposited where it is, or probably will be, discharged in or on any waters of the State, shall, as soon as (a) such person has knowledge of the discharge, (b) notification is possible, and (c) notification can be provided without substantially impeding cleanup or other emergency measures, immediately notify the California Office of Emergency Services of the discharge in accordance with the spill reporting provision of the State oil spill contingency plan adopted pursuant to Government Code Title 2, Division 1, Chapter 7, Article 3.7 (commencing with section 8574.1). This requirement does not require reporting of any discharge of less than 42 gallons unless the discharge is also required to be reported pursuant to Clean Water Act section 311, or the discharge is in violation of a Basin Plan prohibition.
- F. Anticipated Noncompliance.** The Applicant shall give advance notice to the San Diego Water Board of any planned changes in the Project or the Compensatory Mitigation project which may result in noncompliance with Certification conditions or requirements.
- G. Transfers.** This Certification is not transferable in its entirety or in part to any person or organization except after notice to the San Diego Water Board in accordance with the following terms:
- 1. Transfer of Property Ownership:** The Applicant must notify the San Diego Water Board of any change in ownership of the Project area. Notification of change in ownership must include, but not be limited to, a statement that the Applicant has provided the purchaser with a copy of the Section 401 Water Quality Certification and that the purchaser understands and accepts the certification requirements and the obligation to implement them or be subject to liability for failure to do so; the

seller and purchaser must sign and date the notification and provide such notification to the San Diego Water Board **within 10 days of the transfer of ownership.**

2. **Transfer of Mitigation Responsibility:** Any notification of transfer of responsibilities to satisfy the mitigation requirements set forth in this Certification must include a signed statement from an authorized representative of the new party (transferee) demonstrating acceptance and understanding of the responsibility to comply with and fully satisfy the mitigation conditions and agreement that failure to comply with the mitigation conditions and associated requirements may subject the transferee to enforcement by the San Diego Water Board under Water Code section 13385, subdivision (a). Notification of transfer of responsibilities meeting the above conditions must be provided to the San Diego Water Board **within 10 days of the transfer date.**
3. **Transfer of Post-Construction BMP Maintenance Responsibility:** The Applicant assumes responsibility for the inspection and maintenance of all post-construction structural BMPs until such responsibility is legally transferred to another entity. At the time maintenance responsibility for post-construction BMPs is legally transferred the Applicant must submit to the San Diego Water Board a copy of such documentation and must provide the transferee with a copy of a long-term BMP maintenance plan that complies with manufacturer specifications. The Applicant must provide such notification to the San Diego Water Board within **10 days** of the transfer of BMP maintenance responsibility.

Upon properly noticed transfers of responsibility, the transferee assumes responsibility for compliance with this Certification and references in this Certification to the Applicant will be interpreted to refer to the transferee as appropriate. Transfer of responsibility does not necessarily relieve the Applicant of responsibility for compliance with this Certification in the event that a transferee fails to comply.

VIII. CALIFORNIA ENVIRONMENTAL QUALITY ACT COMPLIANCE

- A. The City of Coronado is the Lead Agency under the California Environmental Quality Act (CEQA) (Public Resources Code section 21000, et seq.) section 21067 and CEQA Guidelines (California Code of Regulations, title 14, section 15000 et seq.) section 15367. On February 28, 2018, the Lead Agency determined that the Project was constituent with the CEQA categorical exemption issued for the Coronado Cays 5-year Dock Replacement Project 2013-2018, dated April 12, 2013.³
- B. The San Diego Water Board is a Responsible Agency under CEQA (Public Resources Code section 21069; CEQA Guidelines section 15381). The San Diego Water Board has independently determined that the Project, as proposed, is categorically exempt because the Project consists of reconstruction of existing structures where the new structures will be located on the same site as the structure replaced and will have substantially the same purpose and capacity as the structure replaced.⁴

³ California Code of Regulations, Title 14, section 15302

⁴ 14 CCR section 15302

- C. As a Responsible Agency under CEQA, the San Diego Water Board will file a Notice of Exemption in accordance with CEQA Guidelines section 15062.

IX. SAN DIEGO WATER BOARD CONTACT PERSON

Lisa Honma, Environmental Scientist
Telephone: 619-521-3367
Email: Lisa.Honma@waterboards.ca.gov

X. WATER QUALITY CERTIFICATION

I hereby certify that the proposed discharge from the Residential Dock Replacement at 17 Blue Anchor Project (Certification No. R9-2018-0138) will comply with the applicable provisions of sections 301 ("Effluent Limitations"), 302 ("Water Quality Related Effluent Limitations"), 303 ("Water Quality Standards and Implementation Plans"), 306 ("National Standards of Performance"), and 307 ("Toxic and Pretreatment Effluent Standards") of the Clean Water Act. This discharge is also regulated under State Water Board Order No. 2003-0017-DWQ, "*Statewide General Waste Discharge Requirements for Dredged or Fill Discharges that have Received State Water Quality Certification (General WDRs)*," which requires compliance with all conditions of this Water Quality Certification. Please note that enrollment under Order No. 2003-017-DWQ is conditional and, should new information come to our attention that indicates a water quality problem, the San Diego Water Board may issue individual waste discharge requirements at that time.

Except insofar as may be modified by any preceding conditions, all Certification actions are contingent on (a) the discharge being limited to, and all proposed mitigation being completed in strict compliance with, the applicants' Project description and/or the description in this Certification, and (b) compliance with all applicable requirements of the Basin Plan.

I, David W. Gibson, Executive Officer, do hereby certify the forgoing is a full, true, and correct copy of Certification No. R9-2018-0138 issued on December 13, 2018.

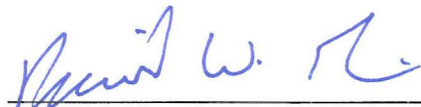

DAVID W. GIBSON
Executive Officer
San Diego Water Board

13 December 2018
Date

ATTACHMENT 1 DEFINITIONS

Activity - when used in reference to a permit means any action, undertaking, or project including, but not limited to, construction, operation, maintenance, repair, modification, and restoration which may result in any discharge to waters of the state.

Buffer - means an upland, wetland, and/or riparian area that protects and/or enhances aquatic resource functions associated with wetlands, rivers, streams, lakes, marine, and estuarine systems from disturbances associated with adjacent land uses.

California Rapid Assessment Method (CRAM) - is a wetland assessment method intended to provide a rapid, scientifically-defensible and repeatable assessment methodology to monitor status and trends in the conditions of wetlands for applications throughout the state. It can also be used to assess the performance of compensatory mitigation projects and restoration projects. CRAM provides an assessment of overall ecological condition in terms of four attributes: landscape context and buffer, hydrology, physical structure and biotic structure. CRAM also includes an assessment of key stressors that may be affecting wetland condition and a "field to PC" data management tool (eCRAM) to ensure consistency and quality of data produced with the method.

Compensatory Mitigation Project - means compensatory mitigation implemented by the Applicant as a requirement of this Certification (i.e., applicant -responsible mitigation), or by a mitigation bank or an in-lieu fee program.

Discharge of dredged material – means any addition of dredged material into, including redeposit of dredged material other than incidental fallback within, the waters of the United States and/or State.

Discharge of fill material – means the addition of fill material into waters of the United States and/or State.

Dredged material – means material that is excavated or dredged from waters of the United States and/or State.

Ecological Success Performance Standards – means observable or measurable physical (including hydrological), chemical, and/or biological attributes that are used to determine if a compensatory mitigation project meets its objectives.

Enhancement – means the manipulation of the physical, chemical, or biological characteristics of an aquatic resource to improve a specific aquatic resource function(s). Enhancement results in the gain of selected aquatic resource function(s) but may also lead to a decline in other aquatic resource function(s). Enhancement does not result in a gain in aquatic resource area.

Establishment – means the manipulation of the physical, chemical, or biological characteristics present to develop an aquatic resource that did not previously exist. Creation results in a gain in aquatic resource area.

Fill material – means any material used for the primary purpose of replacing an aquatic area with dry land or of changing the bottom elevation of a water body.

Isolated wetland – means a wetland with no surface water connection to other aquatic resources.

Mitigation Bank – means a site, or suite of sites, where resources (e.g., wetlands, streams, riparian areas) are restored, established, enhanced, and/or preserved for the purpose of providing mitigation for impacts authorized by this Certification.

Preservation - means the removal of a threat to, or preventing the decline of, aquatic resources by an action in or near those aquatic resources. This term includes activities commonly associated with the protection and maintenance of aquatic resources through the implementation of appropriate legal and physical mechanisms. Preservation does not result in a gain of aquatic resource area or functions.

Re-establishment - means the manipulation of the physical, chemical, or biological characteristics of a site with the goal of returning natural/ historic functions to a former aquatic resource. Re-establishment results in rebuilding a former aquatic resource and results in a gain in aquatic resource area and functions.

Rehabilitation - means the manipulation of the physical, chemical, or biological characteristics of a site with the goal of repairing natural/ historic functions to a degraded aquatic resource. Rehabilitation results in a gain in aquatic resource function, but does not result in a gain in aquatic resource area.

Restoration - means the manipulation of the physical, chemical, or biological characteristics of a site with the goal of returning natural/historic functions to a former or degraded aquatic resource. For the purpose of tracking net gains in aquatic resource area, restoration is divided into two categories: re-establishment and rehabilitation.

Start of Project Construction - For the purpose of this Certification, "start of Project construction" means to engage in a program of on-site construction, including site clearing, grading, dredging, landfilling, changing equipment, substituting equipment, or even moving the location of equipment specifically designed for a stationary source in preparation for the fabrication, erection or installation of the building components of the stationary source within waters of the United States and/or State.

Uplands - means non-wetland areas that lack any field-based indicators of wetlands or other aquatic conditions. Uplands are generally well-drained and occur above (i.e., up-slope) from nearby aquatic areas. Wetlands can, however, be entirely surrounded by uplands. For example, some natural seeps and constructed stock ponds lack aboveground hydrological connection to other aquatic areas. In the watershed context, uplands comprise the landscape matrix in which aquatic areas form. They are the primary sources of sediment, surface runoff, and associated chemicals that are deposited in aquatic areas or transported through them.

Water quality objectives and other appropriate requirements of state law – means the water quality objectives and beneficial uses as specified in the appropriate water quality control plan(s); the applicable provisions of sections 301, 302, 303, 306, and 307 of the Clean Water Act; and any other appropriate requirement of state law.

Waters of the State - means any surface water or groundwater, including saline waters, within the boundaries of the State. [Water Code section 13050, subd. (e)].

Mr. Sig Kupka
Residential Dock Replacement at 17 Blue Anchor Project
Certification No. R9-2018-0138

ATTACHMENT 2
PROJECT FIGURES AND PLANS

Figure 1 – Aerial image showing location of the project site within San Diego Bay

Figure 2 – Eelgrass resources mapped at the project site from MTS (2017)

Existing Dock Demolition Plan, Sheet No. 3

Proposed New Dock Plan-Dimensional Layout, Sheet No. 4

Proposed New Dock Assembly and Sections, Sheet No. 5

Triangle Frame and Side Pile Guide Assemblies, Sheet No. 6

Notch Pile and End Pile Guide Assemblies, Sheet No. 7

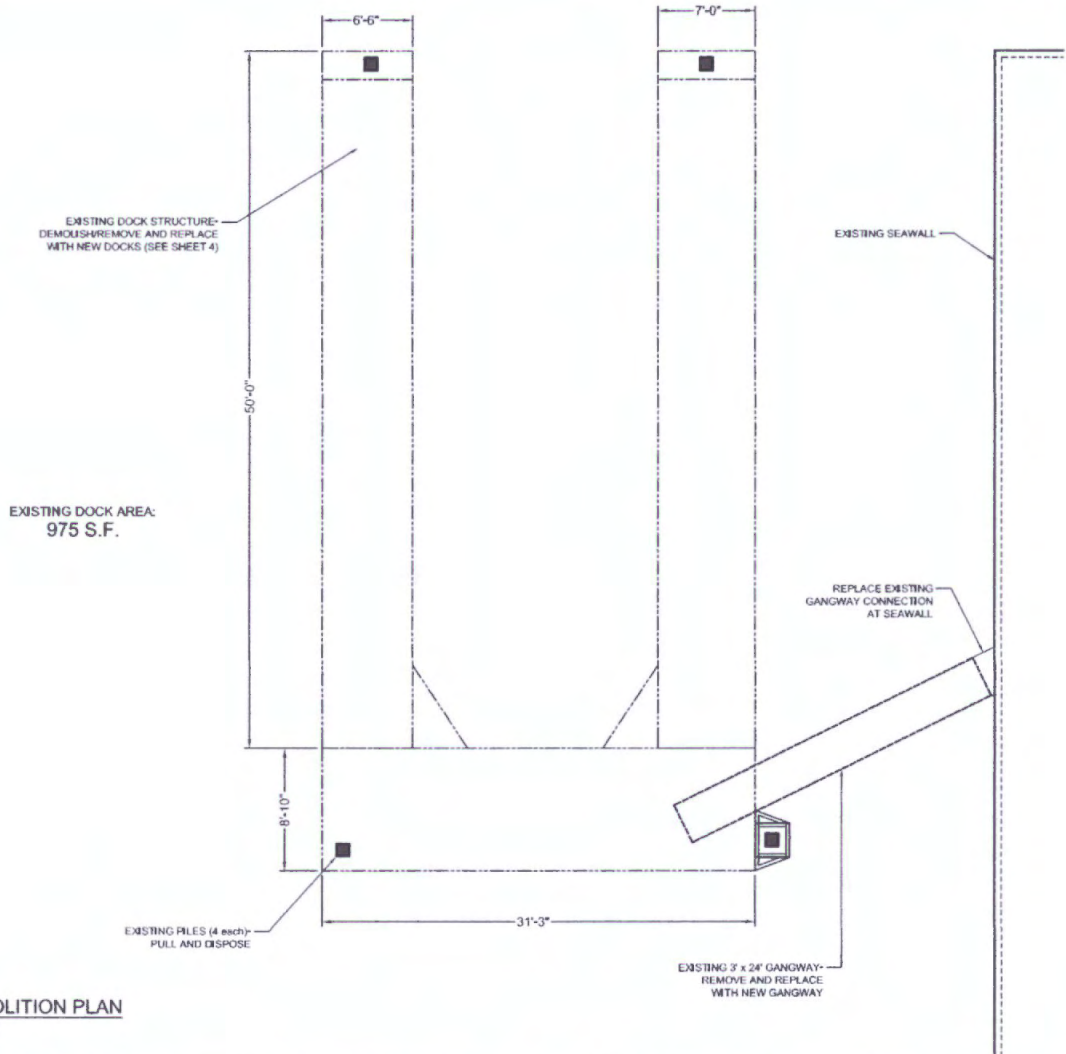

Figure 1. Aerial image showing location of the project site within San Diego Bay. Reference area shown on map was used as part of the project's pre-construction eelgrass survey.



Figure 2. Eelgrass resources mapped at the project site from MTS (2017).

PERMIT DRAWING



EXISTING DOCK- DEMOLITION PLAN
SCALE: 1/4" = 1'-0"

NO.	DATE	DESCRIPTION

Bellingham
MAINE

WE SERVE YOU!
CONCRETE AND PAINT
CONTRACTORS

Southwest Division
CA License #12199
8810 Sundry Lane
Daly City, CA 94020
TEL: (415) 679-2365
FAX: (415) 679-1190

THIS DRAWING CONTAINS PROPRIETARY INFORMATION WHICH IS THE PROPERTY OF BELLINGHAM MARINE INDUSTRIES, INC. AND SHALL NOT BE COPIED, REPRODUCED OR MADE AVAILABLE TO THIRD PARTIES WITHOUT PRIOR WRITTEN PERMISSION FROM BELLINGHAM MARINE INDUSTRIES, INC. UNLESS OTHERWISE INDICATED BY BELLINGHAM MARINE INDUSTRIES, INC.

SITE IMPROVEMENT PLAN			
ACCEPTED BY:	QTY. ENGINEER	R.C.E.	EXP. DATE
ACCEPTED BY:	QTY. ENGINEER	R.C.E.	EXP. DATE

PROJECT NUMBER	16-3-968
ENGINEER / DESIGNER:	G. Burnatyan
PROJECT MANAGER:	R. Mook
CHECKED BY:	

17 BLUE ANCHOR
Coronado, CA
Existing Dock Demolition Plan

SCALE:	AS SHOWN (Sheet Size 24" x 36")
DRAWN BY:	DD
DATE:	2-1-17
SHEET NO.:	3
DRAWING:	DD1

PERMIT DRAWING

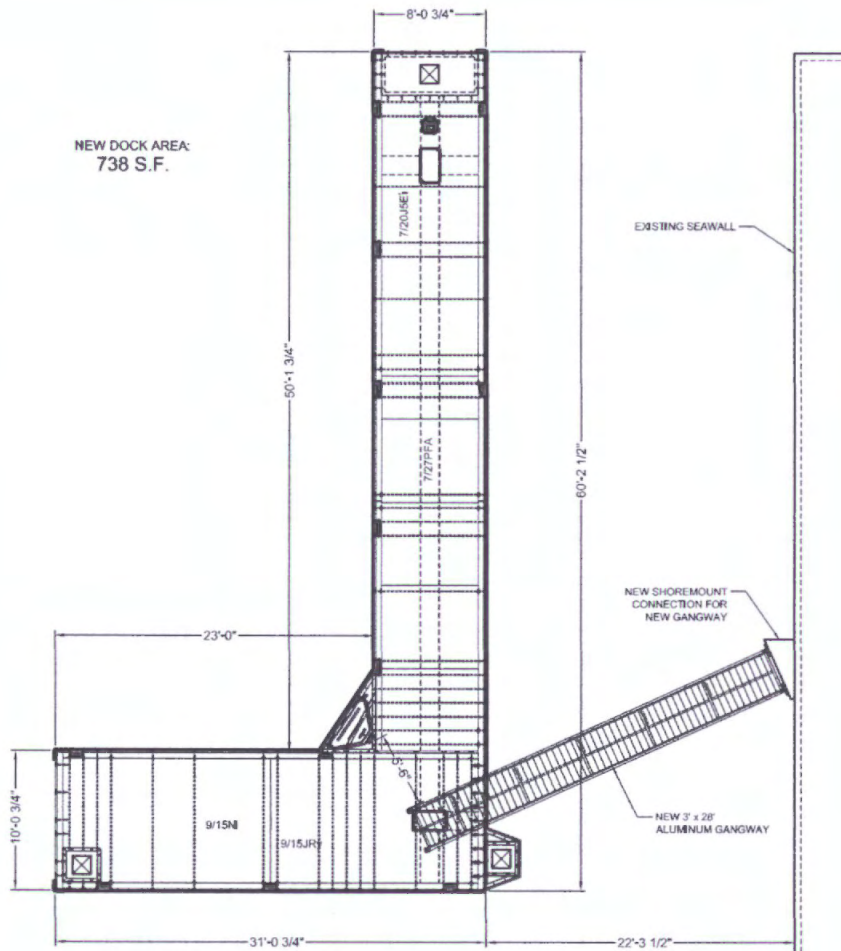

OVERALL DIMENSIONAL PLAN

SCALE: 1/4" = 1'-0"

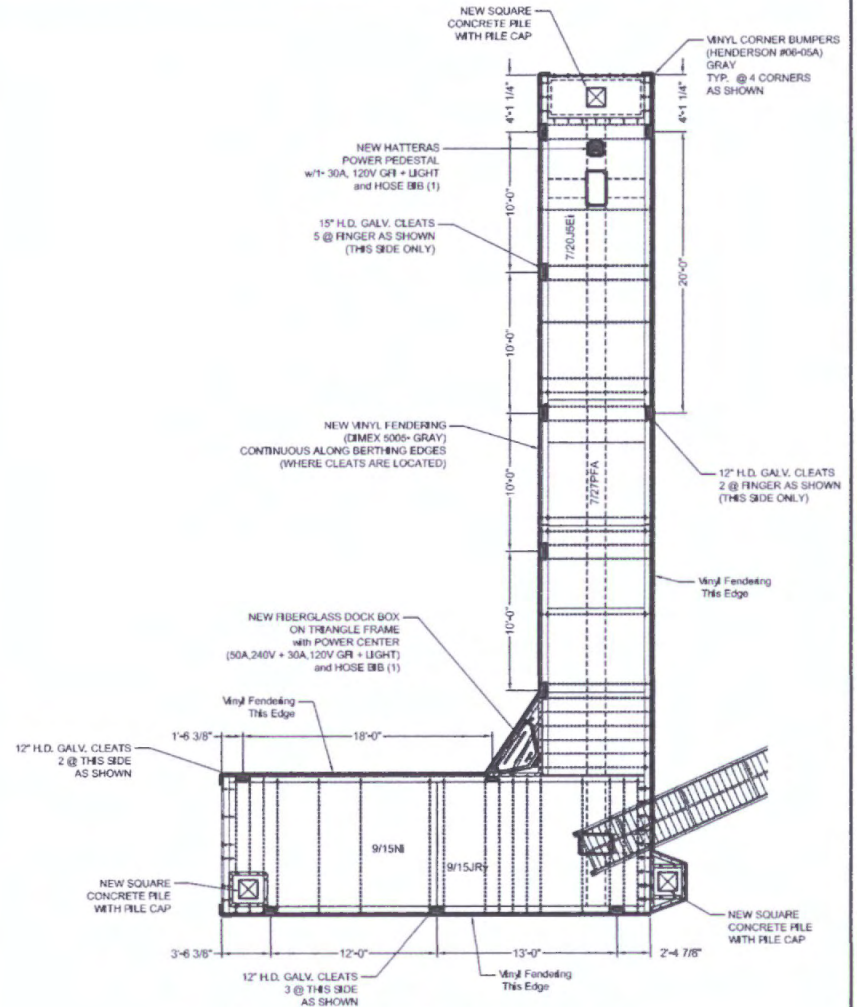

COMPONENT, CLEAT AND NEW PILE PLAN

SCALE: 1/4" = 1'-0"

NO.	DATE	DESCRIPTION	BY

Bellingham MARINE
 1700 S. Highway 101
 Suite 100
 San Marcos, CA 92069
 CA License #12198
 9510 Spaulding Lane
 Dixon, CA 95620
 TEL: (707) 679-3333
 FAX: (707) 679-1760

THIS DRAWING CONTAINS PROPRIETARY INFORMATION WHICH IS THE PROPERTY OF BELLINGHAM MARINE. IT SHALL NOT BE COPIED, REPRODUCED OR MADE AVAILABLE TO THIRD PARTIES WITHOUT PRIOR WRITTEN PERMISSION FROM BELLINGHAM MARINE. UNLESS OTHERWISE INDICATED, UNDECORATED AND © BELLINGHAM MARINE INDUSTRIES, INC.

SITE IMPROVEMENT PLAN			
ACCEPTED BY:			
CITY ENGINEER	R.C.E.	EXP.	DATE
ACCEPTED BY:			
CITY ENGINEER	R.C.E.	EXP.	DATE

PROJECT NUMBER:	16-3-968
ENGINEER / DESIGNER:	C. Burnapyan
PROJECT MANAGER:	R. Mook
CHECKED BY:	

17 BLUE ANCHOR
Coronado, CA
Proposed New Dock Plan- Dimensional Layout

SCALE:	AS SHOWN (Sheet Size 24" x 36")
DRAWN BY:	DD
DATE:	2-1-17
SHEET NO.:	4
DRAWING:	DL1

PERMIT DRAWING

DOCK ASSEMBLY
SCALE: 1/4" = 1'-0"

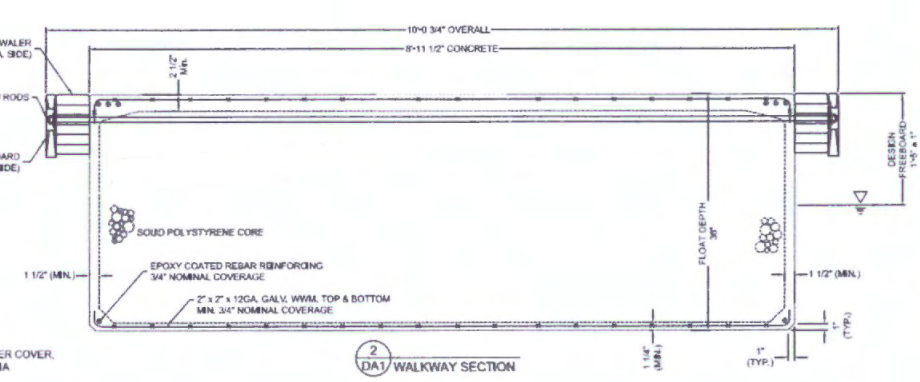
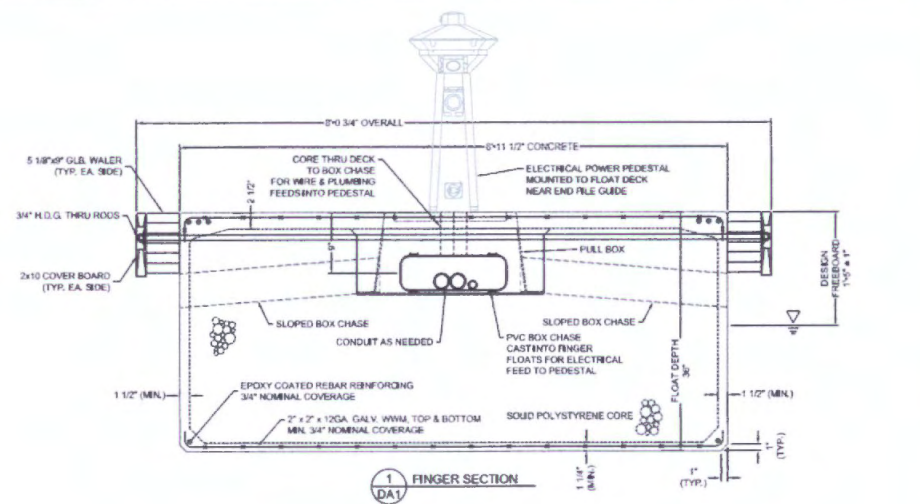
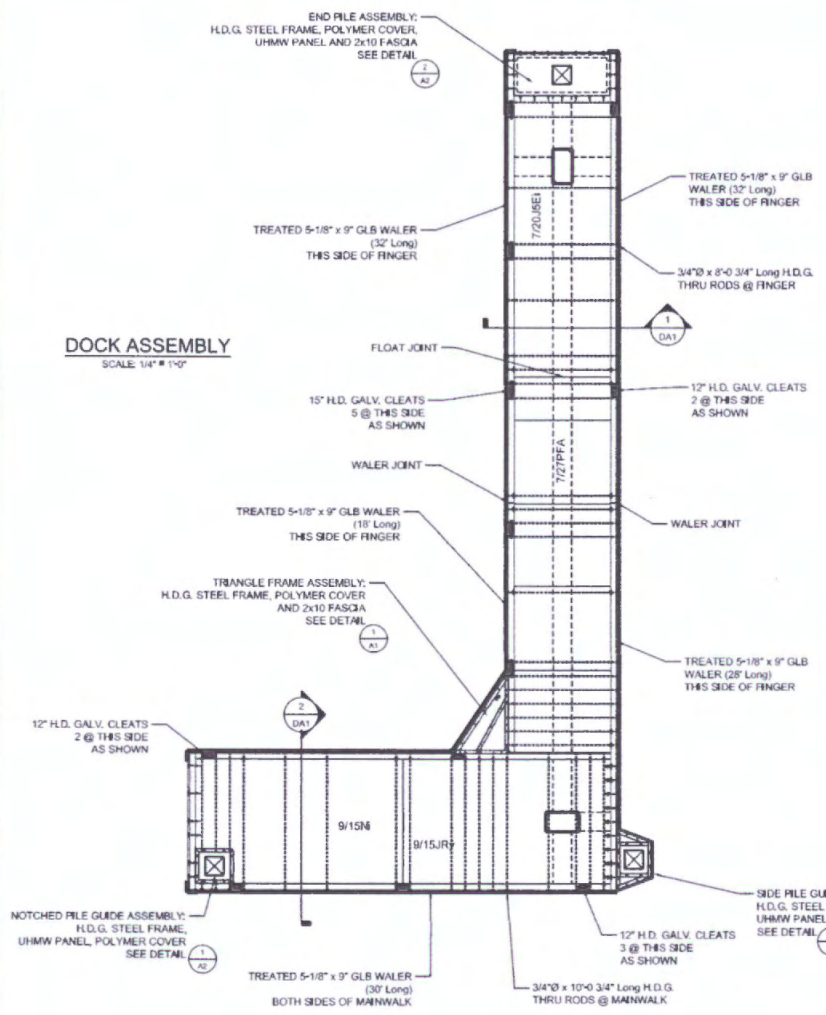

NO.	DATE	DESCRIPTION	BY
REVISIONS			

Bellingham MARINE
 1810 Seabird Lane
 Dana, CA 95620
 TEL: (707) 679-2385
 FAX: (707) 679-1360

THIS DRAWING CONTAINS PROPRIETARY INFORMATION WHICH IS THE PROPERTY OF BELLINGHAM MARINE INDUSTRIES, INC. AND SHALL NOT BE COPIED, REPRODUCED OR MADE AVAILABLE TO THIRD PARTIES WITHOUT THE WRITTEN PERMISSION FROM BELLINGHAM MARINE INDUSTRIES, INC. UNLESS SO INDICATED BY BELLINGHAM MARINE INDUSTRIES, INC.

SITE IMPROVEMENT PLAN			
ACCEPTED BY:	CITY ENGINEER	R.C.E.	EXP. DATE
ACCEPTED BY:	CITY ENGINEER	R.C.E.	EXP. DATE

PROJECT NUMBER	16-3-968
ENGINEER / DESIGNER	G. Burmazyan
PROJECT MANAGER	R. Mick
CHECKED BY:	

17 BLUE ANCHOR
 Coronado, CA
 Proposed New Dock Assembly and Sections

SCALE:	AS SHOWN (Sheet Size 24" x 36")
DRAWN BY:	DD
DATE:	2-1-17
SHEET NO.:	5
DRAWING:	DA1

PERMIT DRAWING

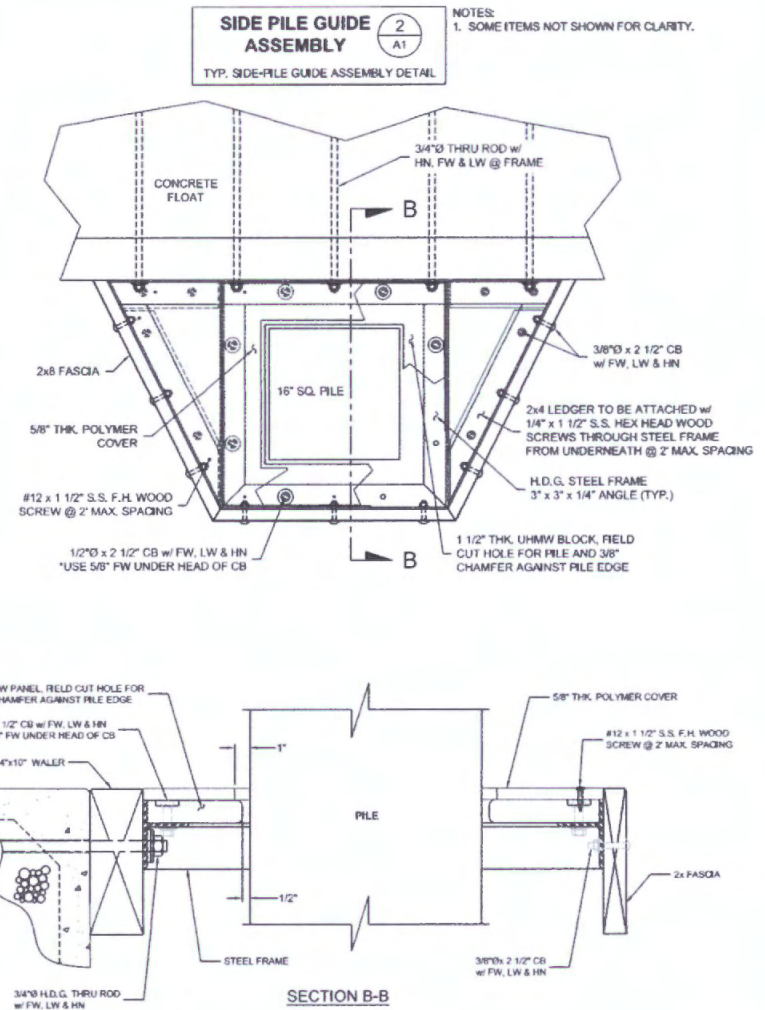
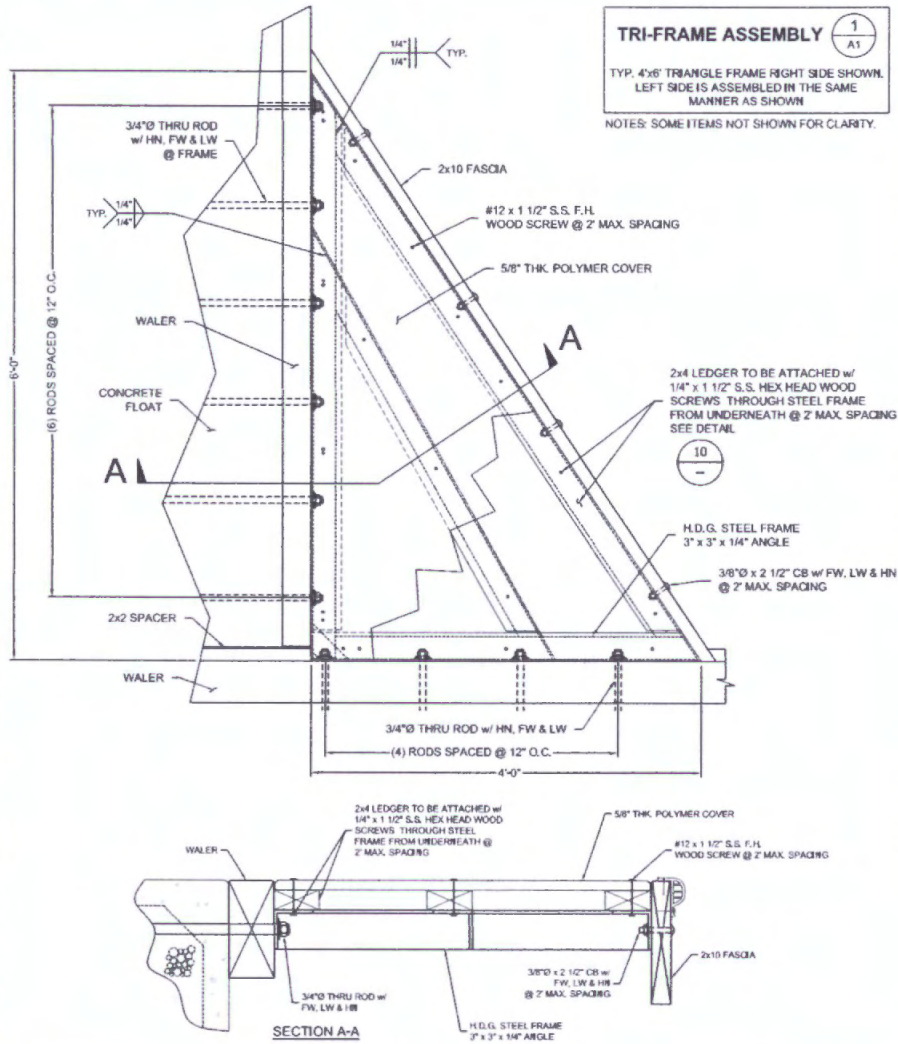

NO.	DATE	DESCRIPTION	BY

Bellingham MARINE

THIS DRAWING CONTAINS PROPRIETARY INFORMATION WHICH IS THE PROPERTY OF BELLINGHAM MARINE INDUSTRIES, INC. AND SHALL NOT BE COPIED, REPRODUCED OR MADE AVAILABLE TO THIRD PARTIES WITHOUT PRIOR WRITTEN PERMISSION FROM BELLINGHAM MARINE INDUSTRIES, INC. UNILKATE, UNILKATE AND BELLINGHAM MARINE INDUSTRIES, INC.

Southwest 0444
CA (Sponsor) #10190
1610 Southway Lane
Oxnard, CA 93020
TEL: (707) 579-2244
FAX: (707) 579-1780

SITE IMPROVEMENT PLAN

ACCEPTED BY: QTY ENGINEER R.C.E. EXP. DATE

ACCEPTED BY: QTY ENGINEER R.C.E. EXP. DATE

PROJECT NUMBER: 16-3-968

ENGINEER / DESIGNER: G. Burnazyan

PROJECT MANAGER: R. Mosk

CHECKED BY:

17 BLUE ANCHOR

Coronado, CA

TRIANGLE FRAME AND SIDE PILE GUIDE ASSEMBLIES

SCALE: AS SHOWN (Sheet Size 24" x 36")

DRAWN BY: DD

DATE: 2-1-17

SHEET NO.: 6

DRAWING: A1

PERMIT DRAWING

1
A2
NOTCHED FLOAT PILE GUIDE ASSEMBLY
TYP. PILE GUIDE ASSEMBLY DETAIL

NOTES. SOME ITEMS NOT SHOWN FOR CLARITY.

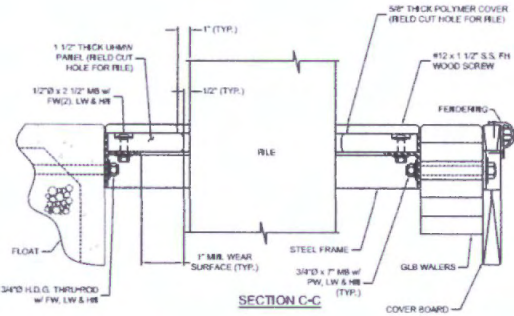
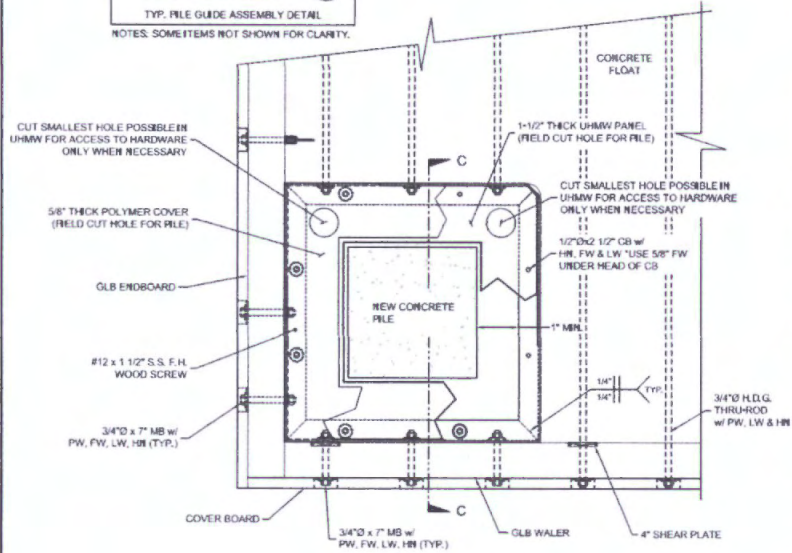

2
A2
ADJUSTABLE PILE END FRAME ASSEMBLY
TYP. PILE END FRAME ASSEMBLY AT PENCERS 635E AND 651E

NOTES:
1. SOME HIDDEN ITEMS MAY NOT BE SHOWN FOR CLARITY.
2. UHMW SHEET CAN BE POSITIONED AT DIFFERENT LOCATIONS WITHIN THE FRAME.
3. INSTALL LEDGERING AT AREAS OF FRAME NOT COVERED BY UHMW SHEET.

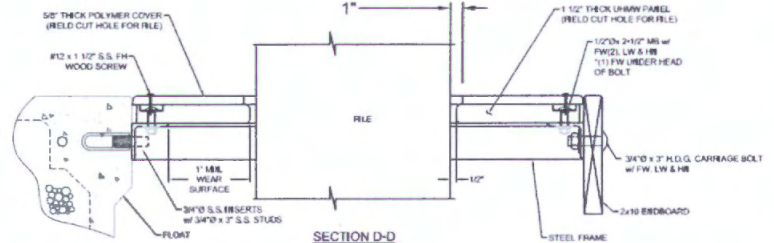
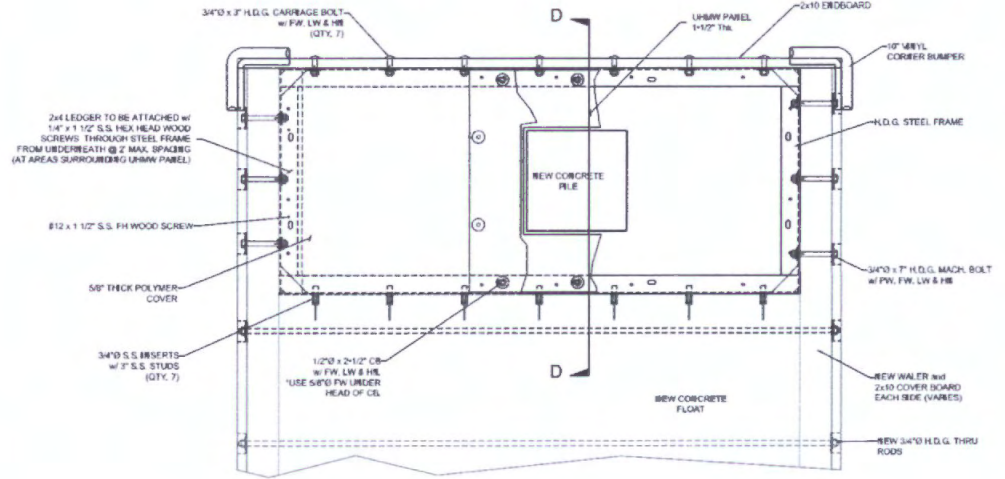

NO.	DATE	DESCRIPTION

Bellingham MARINE
INDUSTRIES, INC.
3000 South Street
Southwest 4400
CA license #121798
8810 Sounding Lane
Bainbridge, CA 95620
TEL: (707) 879-2300
FAX: (707) 879-1100

SITE IMPROVEMENT PLAN

ACCEPTED BY:	QTY ENGINEER	R.C.E.	EXP. DATE
ACCEPTED BY:	QTY ENGINEER	R.C.E.	EXP. DATE

PROJECT NUMBER:
16-3-968

ENGINEER / DESIGNER:
O. Burnatyan

PROJECT MANAGER:
R. Mick

CHECKED BY:

17 BLUE ANCHOR

Coronado, CA

NOTCH PILE AND END PILE GUIDE ASSEMBLIES

SCALE: AS SHOWN
(Sheet Size 24" x 36")

DRAWN BY: DD

DATE: 2-1-17

SHEET NO: 7

DRAWING: A2