

# FINAL REPORT

## REDONDO BEACH GENERATING STATION



### CLEAN WATER ACT SECTION 316(b) IMPINGEMENT MORTALITY AND ENTRAINMENT CHARACTERIZATION STUDY

*Prepared by*

*MBC Applied Environmental Sciences*  
Tenera Environmental, Inc.

*For*



**1100 North Harbor Drive**  
**Redondo Beach, California 90277**

December 19, 2007

**TABLE OF CONTENTS**

<b><u>SECTION</u></b>	<b><u>PAGE</u></b>
<b>1.0 EXECUTIVE SUMMARY .....</b>	<b>1-1</b>
1.1 Entrainment.....	1-1
1.2 Source Water.....	1-2
1.3 Impingement .....	1-3
1.4 Impact Assessment .....	1-4
<b>2.0 INTRODUCTION.....</b>	<b>2-1</b>
2.1 Background and Overview .....	2-1
2.1.1 Section 316(b) of the Clean Water Act.....	2-2
2.1.2 Development of the Study Plan .....	2-4
2.1.3 Study Plan Objectives.....	2-4
2.1.4 Study Plan Approach .....	2-6
2.2 Report Organization.....	2-7
2.3 Contractors and Responsibilities.....	2-7
<b>3.0 DESCRIPTION OF THE GENERATING STATION AND CHARACTERISTICS OF THE SOURCE WATER BODY .....</b>	<b>3-1</b>
3.1 Description of the Generating Station.....	3-1
3.2 Description of the Cooling Water Intake Systems.....	3-1
3.2.1 Plant 2 CWIS .....	3-3
3.2.2 Plant 3 CWIS .....	3-6
3.2.3 Circulating Water Pump Flows.....	3-9
3.3 Environmental Setting .....	3-11
3.3.1 Physical Description .....	3-11
33.1.1 Physical Features .....	3-11
33.1.2 Temperature and Salinity.....	3-13
33.1.3 Tides and Currents.....	3-14
3.3.2 Source Water Definition .....	3-20
33.2.1 Study Requirements and Rationale.....	3-20
33.2.2 Methods for Calculating RBGS Source Water .....	3-21
3.3.3 Biological Resources .....	3-22
33.3.1 Habitat Variation .....	3-23
33.3.2 Nursery Grounds.....	3-24
33.3.3 Fish Diversity.....	3-25
33.3.4 Shellfish Diversity .....	3-26
33.3.5 Protected Species .....	3-26
<b>4.0 COOLING WATER INTAKE STRUCTURE ENTRAINMENT AND SOURCE WATER STUDY</b>	<b>4-1</b>
4.1 Introduction.....	4-1
4.1.1 Discussion of Species to be Analyzed .....	4-1
4.1.1.1 Fish .....	4-2
4.1.1.2 Shellfish.....	4-2

4.1.1.3	Protected Species .....	4-2
4.2	Historical Data .....	4-3
4.2.1	Summary of Historical Data .....	4-3
4.3	Methods .....	4-5
4.3.1	Field Sampling.....	4-5
4.3.1.1	Cooling-Water Intake System Entrainment Sampling.....	4-5
4.3.1.2	Source Water Sampling .....	4-5
4.3.2	Laboratory Analysis.....	4-6
4.3.3	QA/QC Procedures & Data Validation.....	4-6
4.3.4	Data Analysis.....	4-7
4.3.4.1	Entrainment Estimates .....	4-7
4.3.4.2	Demographic Approaches.....	4-8
4.3.4.3	Empirical Transport Model.....	4-11
4.4	Data Summary .....	4-16
4.4.1	Data Summary of Processed Samples.....	4-16
4.5	Results.....	4-17
4.5.1	Cooling Water Intake Structures Entrainment Summary .....	4-17
4.5.1.1	Fishes .....	4-17
4.5.1.2	Invertebrates .....	4-27
4.5.2	Source Water Summary .....	4-30
4.5.2.1	Fishes .....	4-30
4.5.2.2	Target Invertebrates .....	4-34
4.5.3	Results by Species for Cooling Water Intake Structure Entrainment .....	4-35
4.5.3.1	Anchovies (Engraulidae) .....	4-35
4.5.3.2	Silversides (Atherinopsidae).....	4-48
4.5.3.3	Clingfishes ( <i>Gobiesox</i> spp.).....	4-58
4.5.3.4	Sea Basses ( <i>Paralabrax</i> spp.).....	4-65
4.5.3.5	White croaker ( <i>Genyonemus lineatus</i> ).....	4-74
4.5.3.6	Queenfish ( <i>Seriphus politus</i> ) and Unidentified Croakers (Sciaenidae).....	4-85
4.5.3.7	Garibaldi ( <i>Hypsypops rubicundus</i> ) .....	4-99
4.5.3.8	Combtooth blennies ( <i>Hypsoblennius</i> spp.) .....	4-107
4.5.3.9	Labrisomid blennies (Labrisomidae) .....	4-120
4.5.3.10	Kelp Blennies ( <i>Gibbonsia</i> spp.).....	4-127
4.5.3.11	CIQ Goby complex ( <i>Clevelandia</i> , <i>Ilypnus</i> , <i>Quietula</i> ) .....	4-134
4.5.3.12	Blind goby ( <i>Typhlogobius californiensis</i> ) .....	4-145
4.5.3.13	California halibut ( <i>Paralichthys californicus</i> ) .....	4-152
4.5.3.14	California spiny lobster ( <i>Panulirus interruptus</i> ).....	4-165
<b>5.0</b>	<b>IMPINGEMENT STUDY .....</b>	<b>5-1</b>
5.1	Introduction.....	5-1
5.1.1	Discussion of Species to be Analyzed .....	5-1
5.2	Methods .....	5-2
5.2.1	Field Sampling.....	5-2
5.2.2	QA/QC Procedures and Data Validation .....	5-4
5.2.3	Data Analysis.....	5-5
5.2.3.1	Impingement Estimates.....	5-5
5.2.3.2	Impingement Impact Assessment .....	5-5
5.3	Data Summary .....	5-7
5.4	Historical Data .....	5-7

5.4.1	Summary of Historical Data .....	5-7
5.4.2	Relevance to Current Conditions .....	5-9
5.4.3	QA/QC Procedures & Data Validation .....	5-9
5.5	Results .....	5-9
5.5.1	Impingement Summary .....	5-9
5.5.1.1	Comparison with Previous Studies .....	5-25
5.5.2	Fishes by Species .....	5-25
5.5.2.1	Black perch ( <i>Embiotoca jacksoni</i> ) .....	5-26
5.5.2.2	California scorpionfish ( <i>Scorpaena guttata</i> ) .....	5-29
5.5.2.3	Blacksmith ( <i>Chromis punctipinnis</i> ) .....	5-32
5.5.2.4	Rainbow seaperch ( <i>Hypsurus caryi</i> ) .....	5-34
5.5.2.5	Queenfish ( <i>Seriphus politus</i> ) .....	5-37
5.5.2.6	Kelp bass ( <i>Paralabrax clathratus</i> ) .....	5-40
5.5.2.7	Black croaker ( <i>Cheilotrema saturnum</i> ) .....	5-42
5.5.2.8	Rubberlip seaperch ( <i>Rhacochilus toxotes</i> ) .....	5-46
5.5.2.9	Round stingray ( <i>Urobatis halleri</i> ) .....	5-49
5.5.2.10	Rock wrasse ( <i>Halichoeres semicinctus</i> ) .....	5-52
5.5.2.11	Walleye surfperch ( <i>Hyperprosopon argenteum</i> ) .....	5-54
5.5.2.12	Señorita ( <i>Oxyjulis californica</i> ) .....	5-56
5.5.2.13	Northern anchovy ( <i>Engraulis mordax</i> ) .....	5-57
5.5.2.14	Pile perch ( <i>Rhacochilus vacca</i> ) .....	5-58
5.5.2.15	Shiner perch ( <i>Cymatogaster aggregata</i> ) .....	5-61
5.5.2.16	Brown rockfish ( <i>Sebastes auriculatus</i> ) .....	5-63
5.5.2.17	White seaperch ( <i>Phanerodon furcatus</i> ) .....	5-64
5.5.2.18	Barred sand bass ( <i>Paralabrax nebulifer</i> ) .....	5-66
5.5.2.19	Cabezon ( <i>Scorpaenichthys marmoratus</i> ) .....	5-67
5.5.2.20	Vermilion rockfish ( <i>Sebastes miniatus</i> ) .....	5-69
5.5.3	Shellfishes by Species .....	5-71
5.5.3.1	Rock crabs ( <i>Cancer</i> spp.) .....	5-71
5.5.3.2	California spiny lobster ( <i>Panulirus interruptus</i> ) .....	5-81
5.5.3.3	Sheep crab ( <i>Loxorhynchus grandis</i> ) .....	5-83
5.5.3.4	California two-spot octopus ( <i>Octopus</i> spp) .....	5-85
5.5.3.5	Market squid ( <i>Loligo opalescens</i> ) .....	5-87
<b>6.0</b>	<b>IMPACT ASSESSMENT .....</b>	<b>6-1</b>
6.1	Impact Assessment Overview: Data and Approach .....	6-1
6.1.1	CWIS impacts .....	6-2
6.1.2	Review of IM&E Sampling Approach .....	6-3
6.1.3	Approaches for assessment of CWIS impacts .....	6-4
6.1.3.1	Adverse Environmental Impact (AEI) Standard .....	6-5
6.1.4	Relating measured impacts to source populations .....	6-6
6.2	Summary of Entrainment and Impingement Results .....	6-13
6.2.1	All Life Stages of Fishes by Species .....	6-13
6.2.1.1	Taxa Composition .....	6-13
6.2.1.2	Temporal Occurrence .....	6-15
6.2.2	All Life Stages of Shellfishes by Species .....	6-16
6.2.2.1	Taxa Composition .....	6-16
6.2.2.2	Temporal Occurrence .....	6-18
6.2.3	Combined Analysis and Modeling Results for Selected Species .....	6-18
6.3	Assessment of Taxa by Habitat Type .....	6-22

---

6.3.1	Background on Oceanographic Setting and Population Trends .....	6-22
6.3.1.1	Habitat Associations and Fisheries .....	6-24
6.3.2	Bay and Harbor Habitats.....	6-25
6.3.3	Rocky Reef and Kelp Bed Habitats .....	6-27
6.3.4	Coastal Pelagic Habitats .....	6-31
6.3.5	Shelf Habitats.....	6-33
6.3.6	Deep Pelagic Habitats.....	6-40
6.4	Conclusions and Discussion .....	6-40
6.4.1	IM&E Losses Relative to 1977 EPA AEI Criteria .....	6-40
6.4.2	IM&E Losses Relative to Other AEI Criteria.....	6-43
<b>7.0</b>	<b>LITERATURE CITED.....</b>	<b>7-1</b>

**APPENDICES**

Appendix A. Physical Oceanographic Data

Appendix B. Study Procedures

Appendix C. Model Parameterization

Appendix D. Entrainment and Source Water Data

Appendix E. Impingement Data

Appendix F. Master Species Lists

**LIST OF TABLES**

Table 1.4-1. Summary of entrainment and impingement sampling results and model output for common fish and invertebrate species at RBGS Units 5–8 in 2006–07. Model estimates indicate whether the number was based on eggs (E), larvae (L), or both combined (C). Egg entrainment from Units 7&8 only. .... 1-6

Table 3.3-1. Mean velocities (cm/s) in the vicinity of RBGS from Hickey (1992) from October 1985 to February 1986 at Station C1 located at 30 m (100 ft) bottom depth. .... 3-15

Table 3.3-2. ADCP deployment parameters for current meter in the vicinity of RBGS (Station CM5). 3-18

Table 3.3-1. Fish and shellfish species with designated EFH or CDFG special status species entrained and/or impinged at the RBGS in 2006. .... 3-27

Table 4.2-1. Summary of larval fish densities and annual entrainment estimates for Redondo Beach Generating Station in 1979–1980 (from SCE 1983). .... 4-4

Table 4.4-1. Entrainment/source water surveys and number of samples collected from January 2006 through January 2007. .... 4-16

Table 4.5-1. Abundance of larval fishes sampled at RBGS Station H2 (Units 5&6 Entrainment) from January 2006 to December 2006. .... 4-18

Table 4.5-2. Abundance of larval fishes and fish eggs sampled at RBGS Station E4 (Units 7&8) from January 2006 to January 2007. .... 4-19

Table 4.5-3. Calculated total annual entrainment of larval fishes at RBGS Units 5&6 in 2006 based on actual and design (maximum) cooling water intake pump flows. .... 4-21

Table 4.5-4. Calculated total annual entrainment of larval fishes and fish eggs at RBGS Units 7&8 in 2006 based on actual and design (maximum) cooling water intake pump flows. .... 4-22

Table 4.5-5. Abundance of target shellfish larvae sampled at RBGS Station H2 from January 2006 to December 2006. .... 4-27

Table 4.5-6. Abundance of target shellfish larvae sampled at RBGS Entrainment Station E4 from January 2006 and January 2007. .... 4-28

Table 4.5-7. Calculated total annual entrainment of target shellfish larvae at RBGS Units 5&6 based on actual and design (maximum) cooling water intake pump flows from January 2006 to December 2006. .... 4-29

Table 4.5-8. Calculated total annual entrainment of target shellfish larvae at RBGS Units 7&8 based on actual and design (maximum) cooling water intake pump flows from January 2006 to January 2007. .... 4-29

Table 4.5-9. Average concentration of larval fishes in samples collected at the RBGS source water stations in King Harbor and Santa Monica Bay in 2006. .... 4-31

Table 4.5-10. Average concentration of target invertebrate larvae in samples collected at the RBGS source water stations in King Harbor and Santa Monica Bay in 2006. .... 4-34

Table 4.5-11. Annual landings and revenue for northern anchovy in the Los Angeles region based on PacFIN data. .... 4-38

Table 4.5-12. Stage-specific life history parameters for northern anchovy (*Engraulis mordax*) modified from Butler et al. (1993). .... 4-43

Table 4.5-13. Survivorship table for adult northern anchovy (*Engraulis mordax*) from Butler et al. (1993) showing spawners ( $L_x$ ) surviving at the start of age interval and numbers of eggs spawned annually ( $M_x$ ). .... 4-44

Table 4.5-14. Results of *FH* modeling for anchovy eggs and larvae at Units 5&6 based on entrainment estimates calculated using actual and design (maximum) CWIS flows. .... 4-44

Table 4.5-15. Results of *FH* modeling for anchovy eggs and larvae at Units 7&8 based on entrainment estimates calculated using actual and design (maximum) CWIS flows. .... 4-45

Table 4.5-16. Results of AEL modeling for northern anchovy larvae at Units 5&6 based on entrainment estimates calculated using actual and design (maximum) CWIS flows. .... 4-46

Table 4.5-17. Results of AEL modeling for northern anchovy larvae at Units 7&8 based on entrainment estimates calculated using actual and design (maximum) CWIS flows. ....	4-46
Table 4.5-18. ETM data for northern anchovy larvae at Units 5&6. ETM calculations based on actual and design (maximum) cooling water flows and a sampling volume in the nearshore of 396,693,881 m <sup>3</sup> . ....	4-47
Table 4.5-19. ETM data for northern anchovy larvae at Units 7&8. ETM calculations based on actual and design (maximum) cooling water flows and a sampling volume in the nearshore of 396,693,881 m <sup>3</sup> . ....	4-48
Table 4.5-20. Annual landings (number of fish) for jacksmelt and topsmelt in the Southern California region based on RecFIN data. ....	4-53
Table 4.5-21. ETM data for silverside larvae at Units 5&6. ETM calculations based on actual and design (maximum) cooling water flows and a sampling volume in the nearshore of 396,693,881 m <sup>3</sup> . ....	4-57
Table 4.5-22. ETM data for silverside larvae at Units 7&8. ETM calculations based on actual and design (maximum) cooling water flows and a sampling volume in the nearshore of 396,693,881 m <sup>3</sup> . ....	4-57
Table 4.5-23. ETM data for clingfish larvae at Units 5&6. ETM calculations based on actual and design (maximum) cooling water flows and a sampling volume in the nearshore of 396,693,881 m <sup>3</sup> . ....	4-64
Table 4.5-24. ETM data for clingfish larvae at Units 7&8. ETM calculations based on actual and design (maximum) cooling water flows and a sampling volume in the nearshore of 396,693,881 m <sup>3</sup> . ....	4-64
Table 4.5-25. Annual estimated landings for barred sand bass, kelp bass, and spotted sand bass in the Southern California region based on RecFIN data. ....	4-67
Table 4.5-26. ETM data for sea bass larvae at Units 5&6. ETM calculations based on actual and design (maximum) cooling water flows and a sampling volume in the nearshore of 396,693,881 m <sup>3</sup> . ....	4-73
Table 4.5-27. ETM data for sea bass larvae at Units 7&8. ETM calculations based on actual and design (maximum) cooling water flows and a sampling volume in the nearshore of 396,693,881 m <sup>3</sup> . ....	4-74
Table 4.5-28. Annual landings and revenue for white croaker in the Los Angeles region based on PacFIN data. ....	4-76
Table 4.5-29. Results of FH modeling for white croaker eggs based on entrainment estimates calculated using actual and design (maximum) CWIS flows for Units 7&8. ....	4-83
Table 4.5-30. ETM data for white croaker larvae at Units 5&6. ETM calculations based on actual and design (maximum) cooling water flows and a sampling volume in the nearshore of 396,693,881 m <sup>3</sup> . ....	4-84
Table 4.5-31. ETM data for white croaker larvae at Units 7&8. ETM calculations based on actual and design (maximum) cooling water flows and a sampling volume in the nearshore of 396,693,881 m <sup>3</sup> . ....	4-84
Table 4.5-32. Annual landings for queenfish in the Southern California region based on RecFIN data. ....	4-89
Table 4.5-33. ETM data for queenfish larvae at Units 5&6. ETM calculations based on actual and design (maximum) cooling water flows and a sampling volume in the nearshore of 396,693,881 m <sup>3</sup> . ....	4-97
Table 4.5-34. ETM data for queenfish larvae at Units 7&8. ETM calculations based on actual and design (maximum) cooling water flows and a sampling volume in the nearshore of 396,693,881 m <sup>3</sup> . ....	4-97
Table 4.5-35. ETM data for unidentified croaker larvae at Units 5&6. ETM calculations based on actual and design (maximum) cooling water flow and a sampling volume in the nearshore of 396,693,881 m <sup>3</sup> . ....	4-98

Table 4.5-36. <i>ETM</i> data for unidentified croaker larvae at Units 7&8. <i>ETM</i> calculations based on actual and design (maximum) cooling water flow and a sampling volume in the nearshore of 396,693,881 m <sup>3</sup> .....	4-99
Table 4.5-37. <i>ETM</i> data for garibaldi larvae at Units 5&6. <i>ETM</i> calculations based on actual and design (maximum) cooling water flows and a sampling volume in the nearshore of 396,693,881 m <sup>3</sup> .....	4-106
Table 4.5-38. <i>ETM</i> data for garibaldi larvae at Units 7&8. <i>ETM</i> calculations based on actual and design (maximum) cooling water flows and a sampling volume in the nearshore of 396,693,881 m <sup>3</sup> .....	4-106
Table 4.5-39. Survivorship table for adult combtooth blenny from data in Stephens (1969) showing spawners (L <sub>x</sub> ) surviving to the age interval and numbers of eggs spawned annually (M <sub>x</sub> ). .....	4-115
Table 4.5-40. Results of <i>FH</i> modeling for combtooth blenny larvae based on entrainment estimates for Units 5&6 calculated using actual and design (maximum) CWIS flows.....	4-116
Table 4.5-41. Results of <i>FH</i> modeling for combtooth blenny larvae based on entrainment estimates calculated for Units 7&8 using actual and design (maximum) CWIS flows.....	4-116
Table 4.5-42. Results of <i>AEI</i> modeling for combtooth blenny larvae based on entrainment estimates for Units 5&6 calculated using actual and design (maximum) CWIS flows.....	4-117
Table 4.5-43. Results of <i>AEI</i> modeling for combtooth blenny larvae based on entrainment estimates calculated for Units 7&8 using actual and design (maximum) CWIS flows.....	4-117
Table 4.5-44. <i>ETM</i> data for combtooth blenny larvae at Units 5&6. <i>ETM</i> calculations based on actual and design (maximum) cooling water flows and a sampling volume in the nearshore of 396,693,881 m <sup>3</sup> .....	4-119
Table 4.5-45. <i>ETM</i> data for combtooth blenny larvae at Units 7&8. <i>ETM</i> calculations based on actual and design (maximum) cooling water flows and a sampling volume in the nearshore of 396,693,881 m <sup>3</sup> .....	4-119
Table 4.5-46. <i>ETM</i> data for labrisomid blenny larvae at Units 5&6. <i>ETM</i> calculations based on actual and design (maximum) cooling water flows and a sampling volume in the nearshore of 396,693,881 m <sup>3</sup> .....	4-126
Table 4.5-47. <i>ETM</i> data for labrisomid blenny larvae at Units 7&8. <i>ETM</i> calculations based on actual and design (maximum) cooling water flows and a sampling volume in the nearshore of 396,693,881 m <sup>3</sup> .....	4-127
Table 4.5-48. <i>ETM</i> data for kelp blenny larvae at Units 5&6. <i>ETM</i> calculations based on actual and design (maximum) cooling water flows and a sampling volume in the nearshore of 396,693,881 m <sup>3</sup> .....	4-133
Table 4.5-49. <i>ETM</i> data for kelp blenny larvae at Units 7&8. <i>ETM</i> calculations based on actual and design (maximum) cooling water flows and a sampling volume in the nearshore of 396,693,881 m <sup>3</sup> .....	4-134
Table 4.5-50. Total lifetime fecundity estimates for three goby species based on a life table in Brothers (1975).....	4-141
Table 4.5-51. Results of <i>FH</i> modeling for CIQ goby complex larvae based on entrainment estimates at Units 5&6 calculated using actual and design (maximum) CWIS flows.....	4-142
Table 4.5-52. Results of <i>FH</i> modeling for CIQ goby complex larvae based on entrainment estimates at Units 7&8 calculated using actual and design (maximum) CWIS flows.....	4-142
Table 4.5-53. Results of <i>AEI</i> modeling for CIQ goby complex larvae based on entrainment estimates at Units 5&6 calculated using actual and design (maximum) CWIS flows.....	4-143
Table 4.5-54. Results of <i>AEI</i> modeling for CIQ goby complex larvae based on entrainment estimates at Units 7&8 calculated using actual and design (maximum) CWIS flows.....	4-143
Table 4.5-55. <i>ETM</i> data for unidentified goby larvae at Units 5&6. <i>ETM</i> calculations based on actual and design (maximum) cooling water flows and a sampling volume in the nearshore of 735,176,994 m <sup>3</sup> .....	4-144



Table 4.5-56. <i>ETM</i> data for unidentified goby larvae at Units 7&8. <i>ETM</i> calculations based on actual and design (maximum) cooling water flows and a sampling volume in the nearshore of 735,176,994 m <sup>3</sup> .	4-145
Table 4.5-57. <i>ETM</i> data for blind goby larvae at Units 5&6. <i>ETM</i> calculations based on actual and design (maximum) cooling water flows and a sampling volume in the nearshore of 396,693,881 m <sup>3</sup> .	4-151
Table 4.5-58. <i>ETM</i> data for blind goby larvae at Units 7&8. <i>ETM</i> calculations based on actual and design (maximum) cooling water flows and a sampling volume in the nearshore of 396,693,881 m <sup>3</sup> .	4-152
Table 4.5-59. Annual landings for California halibut in the Southern California region based on RecFIN and PacFIN data from 2000–2006.	4-155
Table 4.5-60 Results of <i>FH</i> modeling for California halibut larvae based on Units 5&6 entrainment estimates calculated using actual and design (maximum) CWIS flows.	4-162
Table 4.5-61 Results of <i>FH</i> modeling for California halibut eggs and larvae based on entrainment estimates at Units 7&8 calculated using actual and design (maximum) CWIS flows.	4-163
Table 4.5-62. <i>ETM</i> data for California halibut larvae at Units 5&6. <i>ETM</i> calculations based on actual and design cooling water flows and a sampling volume in the nearshore of 396,693,881 m <sup>3</sup> .	4-164
Table 4.5-63. <i>ETM</i> data for California halibut larvae at Units 7&8. <i>ETM</i> calculations based on actual and design cooling water flows and a sampling volume in the nearshore of 396,693,881 m <sup>3</sup> .	4-164
Table 4.5-64. Annual landings and revenue for California spiny lobster in the Los Angeles region based on PacFIN data.	4-166
Table 4.5-65. <i>ETM</i> data for California spiny lobster larvae at Units 5&6. <i>ETM</i> calculations based on actual and design (maximum) cooling water flows and a sampling volume in the nearshore of 396,693,881 m <sup>3</sup> .	4-171
Table 4.5-66 <i>ETM</i> data for California spiny lobster larvae at Units 7&8. <i>ETM</i> calculations based on actual and design (maximum) cooling water flows and a sampling volume in the nearshore of 396,693,881 m <sup>3</sup> .	4-171
Table 5.4-1. Daily average impingement estimates at the RBGS from October 1978 through September 1980.	5-8
Table 5.5-1. Summary of RBGS Units 5&6 fish impingement from January 2006 through January 2007 based on <b>actual</b> cooling water flow volumes.	5-10
Table 5.5-2. Summary of RBGS Units 5&6 fish impingement from January 2006 through January 2007 based on <b>design</b> (maximum) cooling water flow volumes.	5-10
Table 5.5-3. Summary of RBGS Units 7&8 fish impingement from January 2006 through January 2007 based on <b>actual</b> cooling water flow volumes.	5-12
Table 5.5-4. Summary of RBGS Units 7&8 fish impingement from January 2006 through January 2007 based on <b>actual</b> and <b>design (maximum)</b> cooling water flow volumes.	5-13
Table 5.5-5. Summary of RBGS Units 5&6 invertebrate impingement from January 2006 through January 2007 based on <b>actual</b> cooling water flow volumes. (* denotes shellfish).	5-14
Table 5.5-6. Summary of RBGS Units 5&6 invertebrate impingement from January 2006 through January 2007 based on <b>design (maximum)</b> cooling water flow volumes. (* denotes shellfish).	5-14
Table 5.5-7. Summary of RBGS Units 7&8 invertebrate impingement from January 2006 through January 2007 based on <b>actual</b> cooling water flow volumes. (* denotes shellfish).	5-15
Table 5.5-8. Summary of RBGS Units 7&8 invertebrate impingement from January 2006 through January 2007 based on <b>actual</b> and <b>design (maximum)</b> cooling water flow volumes. (* denotes shellfish).	5-16
Table 5.5-9. Annual landings and revenue for surfperches in the Los Angeles region based on PacFIN data.	5-27
Table 5.5-10. Queenfish life history parameters used in equivalent adult modeling.	5-39
Table 5.5-11. Kelp bass life history parameters used in equivalent adult modeling.	5-41

---

Table 5.5-12. Black croaker life history parameters used in equivalent adult modeling. ....	5-45
Table 5.5-13. Northern anchovy life history parameters used in equivalent adult modeling. ....	5-58
Table 5.5-14. Banded sand bass life history parameters used in equivalent adult modeling. ....	5-67
Table 5.5-15. Annual landings and revenue for cabezon in the Los Angeles region based on PacFIN data. ....	5-69
Table 5.5-16. Annual landings and revenue for vermilion rockfish in the Los Angeles region based on PacFIN data. ....	5-70
Table 5.5-17. Annual landings and revenue for squid in the Los Angeles region based on PacFIN data. ....	5-89
Table 6.1-1. Habitat associations for taxa included in assessment of CWIS effects at the RBGS. Primary habitat in bold, upper case and secondary habitat in lower case. Taxa also designated as to whether they are targeted by a sport (S) or commercial (C) fishery. ....	6-12
Table 6.2-1. Estimated annual entrainment of common fish larvae at RBGS Units 5–8 and fish eggs at RBGS Units 7&8 in 2006–07. ....	6-14
Table 6.2-2. Estimated annual impingement (number and biomass) of common fishes at RBGS Units 5–8 in 2006–07. ....	6-15
Table 6.2-3. Estimated annual entrainment of target shellfish larvae at RBGS Units 5–8 in 2006–07. ....	6-17
Table 6.2-4. Estimated annual impingement of common shellfishes (and other invertebrates) at RBGS Units 5–8 in 2006–07. ....	6-17
Table 6.2-5. Summary of entrainment and impingement sampling results and model output for common fish and invertebrate species at RBGS Units 5–8 in 2006–07. Model estimates indicate whether the number was based on eggs (E), larvae (L), or both combined (C). Egg entrainment from Units 7&8 only. ....	6-20
Table 6.3-1. Percent of fish larvae entrained (abundance and number of taxa) or adults/juvenile fishes impinged (biomass and number of taxa) associated with general habitat types and fisheries. ....	6-24
Table 6.4-1. Fish and shellfish species under NMFS federal management or with CDFG special status entrained and/or impinged at RBGS in 2006. ....	6-42
Table 6.4-2. Summary of positive time series findings for selected fish species in detailed evaluation with respect to oceanographic variables (ENSO, SST, and PDO), fishing effects and the current population trends. ....	6-45

**LIST OF FIGURES**

Figure 3.1-1. Location of the RBGS. .... 3-2

Figure 3.2-1. Location of the RBGS intake and discharge structures. (Metric measurement units not included.) ..... 3-3

Figure 3.2-2. Cross sectional diagram of offshore seawater intake risers. (Metric measurement units not included.) ..... 3-5

Figure 3.2-3. Plant 2 intake structure: plan view and typical cross section. (Metric measurement units not included.) ..... 3-6

Figure 3.2-4. Plant 3 intake structure: plan view and typical cross section. (Metric measurement units not included.) ..... 3-8

Figure 3.2-5. Daily cooling water flow volumes at the RBGS from January 2006 to February 2007. (A) Units 5&6, (B) Units 7&8, and (C) Units 5 through 8. .... 3-10

Figure 3.3-1. Santa Monica Bay geographical features. .... 3-12

Figure 3.3-2. Hourly surface water temperatures at NOAA Station 9410840 at Santa Monica Pier, California from January through December, 2006. .... 3-14

Figure 3.3-3. Schematic showing processes affecting long-period circulation and water properties in the Southern California Bight (from Hickey et al. 2003). .... 3-16

Figure 3.3-4. Selected mean currents in the central Southern California Bight for spring and summer. Measurement depth in meters is given near the tip of each arrow (from Hickey et al. 2003). .... 3-17

Figure 3.3-5. Location of current meter station CM5 that was deployed from January 2006 to January 2007. .... 3-19

Figure 3.3-6. Cumulative current vectors from Station CM in Santa Monica Bay, January 2006–January 2007. .... 3-20

Figure 3.3-7. Locations of the RBGS entrainment and source water sampling stations, and current meter stations within the study grid. .... 3-22

Figure 4.5-1. Mean concentration (# / 1,000 m<sup>3</sup> [264,172 gal]) and standard deviation of all larval fishes collected at the RBGS Station H2 from January 2006 through December 2006. .... 4-24

Figure 4.5-2. Mean concentration (# / 1,000 m<sup>3</sup> [264,172 gal]) and standard deviation of all larval fishes collected at the RBGS Entrainment Station E4 from January 2006 through January 2007. .... 4-25

Figure 4.5-3. Mean concentration (# / 1,000 m<sup>3</sup> [264,172 gal]) and standard deviation of fish eggs collected at the RBGS Entrainment Station E4 from January 2006 through January 2007. .... 4-25

Figure 4.5-4. Mean concentration (#/1.0 m<sup>3</sup> [264 gal]) of all fish larvae at the RBGS Entrainment Station E4 during night (Cycle 3) and day (Cycle 1) sampling. .... 4-26

Figure 4.5-5. Mean concentration (#/1.0 m<sup>3</sup> [264 gal]) of all fish eggs at the RBGS Entrainment Station E4 during night (Cycle 3) and day (Cycle 1) sampling. .... 4-26

Figure 4.5-6. Mean concentration (# / 1,000 m<sup>3</sup> [264,172 gal]) and standard deviation of all larval fishes collected at the RBGS source water stations during 2006. .... 4-33

Figure 4.5-7. Mean concentration (#/1.0 m<sup>3</sup> [264 gal]) of all fish larvae at the RBGS Source Water Stations during night (Cycle 3) and day (Cycle 1) sampling. .... 4-33

Figure 4.5-8. Mean concentration (# / 1,000 m<sup>3</sup> [264,172 gal]) of engraulid larvae collected from King Harbor, 1974-2006. Source: Vantuna Research Group. .... 4-38

Figure 4.5-9. Mean concentration (# / 1,000 m<sup>3</sup> [264,172 gal]) and standard deviation of anchovy larvae collected at RBGS Station H2 from January 2006 through December 2006. .... 4-40

Figure 4.5-10. Mean concentration (# / 1,000 m<sup>3</sup> [264,172 gal]) and standard deviation of anchovy larvae collected at RBGS entrainment Station E4 from January 2006 through January 2007. .... 4-40

Figure 4.5-11. Mean concentration (# / 1,000 m<sup>3</sup> [264,172 gal]) and standard deviation of anchovy larvae collected at RBGS source water stations during 2006. .... 4-41

Figure 4.5-12. Mean concentration (#/1.0 m<sup>3</sup> [264 gal]) of anchovy larvae at entrainment Station E4 during night (Cycle 3) and day (Cycle 1) sampling. .... 4-41

Figure 4.5-13. Length (mm) frequency distribution for larval anchovies collected at entrainment stations in Santa Monica Bay during 2006. ....	4-42
Figure 4.5-14. Silverside fishery and population trends: a) recreational landings, b) King Harbor observational data, and c) Ocean Resource Enhancement Hatchery Program (OREHP) gill net monitoring data. Error bars are $\pm 1$ S.E. ....	4-51
Figure 4.5-15. Mean concentration (# / 1,000 m <sup>3</sup> [264,172 gal]) of silverside ( <i>Atherinopsidae</i> ) larvae collected from King Harbor, 1974-2006. Source: Vantuna Research Group. ....	4-52
Figure 4.5-16. Mean concentration (# / 1,000 m <sup>3</sup> [264,172 gal]) and standard deviation of silverside larvae collected at RBGS entrainment Station H2 from January 2006 through December 2006. ....	4-54
Figure 4.5-17. Mean concentration (# / 1,000 m <sup>3</sup> [264,172 gal]) and standard deviation of silverside larvae collected at RBGS entrainment Station E4 from January 2006 through January 2007. ....	4-54
Figure 4.5-18. Mean concentration (# / 1,000 m <sup>3</sup> [264,172 gal]) and standard deviation of silverside larvae collected at RBGS source water stations during 2006. ....	4-55
Figure 4.5-19. Mean concentration (#/1.0 m <sup>3</sup> [264 gal]) of silverside larvae at entrainment Station E4 during night (Cycle 3) and day (Cycle 1) sampling. ....	4-55
Figure 4.5-20. Length (mm) frequency distribution for larval silversides collected at entrainment stations in Santa Monica Bay during 2006. ....	4-56
Figure 4.5-21. Mean concentration (# / 1,000 m <sup>3</sup> [264,172 gal]) of clingfish ( <i>Gobiesox</i> spp.) larvae collected from King Harbor, 1974-2006. Source: Vantuna Research Group. ....	4-59
Figure 4.5-22. Mean concentration (# / 1,000 m <sup>3</sup> [264,172 gal]) and standard deviation of clingfish larvae collected at RBGS entrainment Station H2 from January 2006 through December 2006. ....	4-60
Figure 4.5-23. Mean concentration (# / 1,000 m <sup>3</sup> [264,172 gal]) and standard deviation of clingfish larvae collected at RBGS entrainment Station E4 from January 2006 through January 2007. ....	4-61
Figure 4.5-24. Mean concentration (# / 1,000 m <sup>3</sup> [264,172 gal]) and standard deviation of clingfish larvae collected at RBGS source water stations during 2006. ....	4-61
Figure 4.5-25. Mean concentration (#/1.0 m <sup>3</sup> [264 gal]) of clingfish larvae at entrainment Station E4 during night (Cycle 3) and day (Cycle 1) sampling. ....	4-62
Figure 4.5-26. Length (mm) frequency distribution for larval clingfishes collected at entrainment stations in Santa Monica Bay during 2006. ....	4-62
Figure 4.5-27. a) Abundance of kelp bass ( <i>Paralabrax clathratus</i> ) and b) barred sand bass ( <i>Paralabrax nebulifer</i> ) measured on diver transects at King Harbor and Palos Verdes from 1974–2006. Source: Vantuna Research Group. ....	4-68
Figure 4.5-28. Mean concentration (# / 1,000 m <sup>3</sup> [264,172 gal]) and standard deviation of sea bass larvae collected at RBGS entrainment Station H2 from January 2006 through December 2006. ....	4-70
Figure 4.5-29. Mean concentration (# / 1,000 m <sup>3</sup> [264,172 gal]) and standard deviation of sea bass larvae collected at RBGS entrainment Station E4 from January 2006 through January 2007. ....	4-70
Figure 4.5-30. Mean concentration (# / 1,000 m <sup>3</sup> [264,172 gal]) and standard deviation of sea bass larvae collected at RBGS source water stations during 2006. ....	4-71
Figure 4.5-31. Mean concentration (#/1.0 m <sup>3</sup> [264 gal]) of sea bass larvae at entrainment Station E4 during night (Cycle 3) and day (Cycle 1) sampling. ....	4-71
Figure 4.5-32. Length (mm) frequency distribution for sea bass larvae collected at entrainment stations in Santa Monica Bay during 2006. ....	4-72
Figure 4.5-33. White croaker fishery and population trends: a) recreational and commercial landings, b) Ocean Resource Enhancement Hatchery Program (OREHP) gill net monitoring data, and c) NPDES trawl programs. Error bars are $\pm 1$ S.E. ....	4-78
Figure 4.5-34. Mean concentration (# / 1,000 m <sup>3</sup> [264,172 gal]) of white croaker larvae collected from King Harbor, 1974-2006. Source: Vantuna Research Group. ....	4-79
Figure 4.5-35. Mean concentration (# / 1,000 m <sup>3</sup> [264,172 gal]) and standard deviation of white croaker larvae collected at RBGS entrainment Station H2 from January 2006 through December 2006. ....	4-80

Figure 4.5-36. Mean concentration (# / 1,000 m <sup>3</sup> [264,172 gal]) and standard deviation of white croaker larvae collected at RBGS entrainment Station E4 from January 2006 through January 2007. ....	4-80
Figure 4.5-37. Mean concentration (# / 1,000 m <sup>3</sup> [264,172 gal]) and standard deviation of white croaker larvae collected at RBGS source water stations during 2006. ....	4-81
Figure 4.5-38. Mean concentration (#/1.0 m <sup>3</sup> [264 gal]) of white croaker larvae at entrainment Station E4 during night (Cycle 3) and day (Cycle 1) sampling. ....	4-81
Figure 4.5-39. Length (mm) frequency distribution for larval white croaker collected at entrainment Station E4. ....	4-82
Figure 4.5-40. Queenfish fishery and population trends: a) recreational and commercial landings, b) Ocean Resource Enhancement Hatchery Program (OREHP) gill net monitoring data, and c) NPDES trawl programs. ....	4-88
Figure 4.5-41. Mean concentration (# / 1,000 m <sup>3</sup> [264,172 gal]) of queenfish and unidentified sciaenid larvae collected from King Harbor, 1974-2006. Source: Vantuna Research Group. ....	4-89
Figure 4.5-42. Mean concentration (# / 1,000 m <sup>3</sup> [264,172 gal]) and standard deviation of queenfish larvae collected at RBGS entrainment Station H2 from January 2006 through December 2006. ....	4-91
Figure 4.5-43. Mean concentration (# / 1,000 m <sup>3</sup> [264,172 gal]) and standard deviation of queenfish larvae collected at RBGS entrainment Station E4 from January 2006 through January 2007. ....	4-91
Figure 4.5-44. Mean concentration (# / 1,000 m <sup>3</sup> [264,172 gal]) and standard deviation of queenfish larvae collected at RBGS source water stations during 2006. ....	4-92
Figure 4.5-45. Mean concentration (# / 1,000 m <sup>3</sup> [264,172 gal]) and standard deviation of unidentified croaker larvae collected at RBGS entrainment Station H2 from January 2006 through December 2006. ....	4-92
Figure 4.5-46. Mean concentration (# / 1,000 m <sup>3</sup> [264,172 gal]) and standard deviation of unidentified croaker larvae collected at RBGS entrainment Station E4 from January 2006 through January 2007. ....	4-93
Figure 4.5-47. Mean concentration (# / 1,000 m <sup>3</sup> [264,172 gal]) and standard deviation of unidentified croaker larvae collected at RBGS source water stations during 2006. ....	4-93
Figure 4.5-48. Mean concentration (#/1.0 m <sup>3</sup> [264 gal]) of queenfish larvae at entrainment Station E4 during night (Cycle 3) and day (Cycle 1) sampling. ....	4-94
Figure 4.5-49. Mean concentration (#/1.0 m <sup>3</sup> [264 gal]) of unidentified croaker larvae at entrainment Station E4 during night (Cycle 3) and day (Cycle 1) sampling. ....	4-94
Figure 4.5-50. Length (mm) frequency distribution for larval queenfish collected at entrainment Station E4. ....	4-95
Figure 4.5-51. Length (mm) frequency distribution for larval unidentified croaker collected at entrainment Station E4. ....	4-95
Figure 4.5-52. Mean concentration (# / 1,000 m <sup>3</sup> [264,172 gal]) of garibaldi larvae collected from King Harbor, 1974-2006. Source: Vantuna Research Group. ....	4-101
Figure 4.5-53. Mean concentration (# / 1,000 m <sup>3</sup> [264,172 gal]) and standard deviation of garibaldi larvae collected at RBGS Station H2 from January 2006 through December 2006. ....	4-102
Figure 4.5-54. Mean concentration (# / 1,000 m <sup>3</sup> [264,172 gal]) and standard deviation of garibaldi larvae collected at RBGS entrainment Station E4 from January 2006 through January 2007. ....	4-102
Figure 4.5-55. Mean concentration (# / 1,000 m <sup>3</sup> [264,172 gal]) and standard deviation of garibaldi larvae collected at RBGS source water stations during 2006. ....	4-103
Figure 4.5-56. Mean concentration (#/1.0 m <sup>3</sup> [264 gal]) of garibaldi larvae at entrainment Station E4 during night (Cycle 3) and day (Cycle 1) sampling. ....	4-103
Figure 4.5-57. Length (mm) frequency distribution for larval garibaldi collected at entrainment stations in Santa Monica Bay during 2006. ....	4-104
Figure 4.5-58. Abundance of combtooth blennies collected per boulder at King Harbor, Redondo Beach, California from 1984–2006 (from Pondella, unpubl. data). ....	4-110

---

Figure 4.5-59. Mean concentration (# / 1,000 m <sup>3</sup> [264,172 gal]) of combtooth blenny ( <i>Hypsoblennius</i> spp.) larvae collected from King Harbor, 1974-2006. Source: Vantuna Research Group.....	4-110
Figure 4.5-60. Mean concentration (# / 1,000 m <sup>3</sup> [264,172 gal]) and standard deviation of combtooth blenny larvae collected at RBGS entrainment Station H2 from January 2006 through December 2006. ....	4-112
Figure 4.5-61. Mean concentration (# / 1,000 m <sup>3</sup> [264,172 gal]) and standard deviation of combtooth blenny larvae collected at RBGS entrainment Station E4 from January 2006 through January 2007. ....	4-112
Figure 4.5-62. Mean concentration (# / 1,000 m <sup>3</sup> [264,172 gal]) and standard deviation of combtooth blenny larvae collected at RBGS source water stations during 2006. ....	4-113
Figure 4.5-63. Mean concentration (#/1.0 m <sup>3</sup> [264 gal]) of combtooth blenny larvae at entrainment Station E4 during night (Cycle 3) and day (Cycle 1) sampling. ....	4-113
Figure 4.5-64. Length (mm) frequency distribution for larval combtooth blennies collected at entrainment stations in Santa Monica Bay during 2006. ....	4-114
Figure 4.5-65. Mean concentration (# / 1,000 m <sup>3</sup> [264,172 gal]) of reef finspot larvae collected from King Harbor, 1974-2006. Source: Vantuna Research Group. ....	4-121
Figure 4.5-66. Mean concentration (# / 1,000 m <sup>3</sup> [264,172 gal]) and standard deviation of labrisomid larvae collected at RBGS entrainment Station H2 from January 2006 through January 2007. ....	4-123
Figure 4.5-67. Mean concentration (# / 1,000 m <sup>3</sup> [264,172 gal]) and standard deviation of labrisomid larvae collected at RBGS entrainment Station E4 from January 2006 through January 2007. ....	4-123
Figure 4.5-68. Mean concentration (# / 1,000 m <sup>3</sup> [264,172 gal]) and standard deviation of labrisomid larvae collected at RBGS source water stations during 2006. ....	4-124
Figure 4.5-69. Mean concentration (#/1.0 m <sup>3</sup> [264 gal]) of labrisomid larvae at entrainment Station E4 during night (Cycle 3) and day (Cycle 1) sampling. ....	4-124
Figure 4.5-70. Length (mm) frequency distribution for larval labrisomid blennies collected at entrainment stations in Santa Monica Bay during 2006. ....	4-125
Figure 4.5-71. Mean concentration (# / 1,000 m <sup>3</sup> [264,172 gal]) of kelp blenny ( <i>Gibbonsia</i> spp.) larvae collected from King Harbor, 1974-2006. Source: Vantuna Research Group.....	4-128
Figure 4.5-72. Mean concentration (# / 1,000 m <sup>3</sup> [264,172 gal]) and standard deviation of kelp blenny larvae collected at RBGS entrainment Station H2 from January through December 2006. ....	4-130
Figure 4.5-73. Mean concentration (# / 1,000 m <sup>3</sup> [264,172 gal]) and standard deviation of kelp blenny larvae collected at RBGS entrainment Station E4 from January 2006 through January 2007. ....	4-130
Figure 4.5-74. Mean concentration (# / 1,000 m <sup>3</sup> [264,172 gal]) and standard deviation of kelp blenny larvae collected at RBGS source water stations during 2006. ....	4-131
Figure 4.5-75. Mean concentration (#/1.0 m <sup>3</sup> [264 gal]) of kelp blenny larvae at entrainment Station E4 during night (Cycle 3) and day (Cycle 1) sampling. ....	4-131
Figure 4.5-76. Length (mm) frequency distribution for kelp blenny larvae collected at entrainment stations in Santa Monica Bay during 2006. ....	4-132
Figure 4.5-77. Mean concentration (# / 1,000 m <sup>3</sup> [264,172 gal]) of Goby type A/C larvae collected from King Harbor, 1974-2006. Source: Vantuna Research Group.....	4-137
Figure 4.5-78. Mean concentration (# / 1,000 m <sup>3</sup> [264,172 gal]) and standard deviation of unidentified CIQ goby larvae collected at RBGS entrainment Station H2 from January through December 2006. ....	4-138
Figure 4.5-79. Mean concentration (# / 1,000 m <sup>3</sup> [264,172 gal]) and standard deviation of unidentified CIQ goby larvae collected at RBGS entrainment Station E4 from January 2006 through January 2007. ....	4-138
Figure 4.5-80. Mean concentration (# / 1,000 m <sup>3</sup> [264,172 gal]) and standard deviation of unidentified CIQ goby larvae collected at RBGS source water stations during 2006. ....	4-139
Figure 4.5-81. Mean concentration (#/1.0 m <sup>3</sup> [264 gal]) of unidentified CIQ goby larvae at entrainment Station E4 during night (Cycle 3) and day (Cycle 1) sampling. ....	4-139

---

Figure 4.5-82. Length (mm) frequency distribution for unidentified CIQ goby larvae collected at entrainment stations in Santa Monica Bay during 2006. ....	4-140
Figure 4.5-83. Mean concentration (# / 1,000 m <sup>3</sup> [264,172 gal]) of blind goby larvae collected from King Harbor, 1974-2006. Source: Vantuna Research Group. ....	4-146
Figure 4.5-84. Mean concentration (# / 1,000 m <sup>3</sup> [264,172 gal]) and standard deviation of blind goby larvae collected at RBGS entrainment Station H2 from January through December 2006. ....	4-148
Figure 4.5-85. Mean concentration (# / 1,000 m <sup>3</sup> [264,172 gal]) and standard deviation of blind goby larvae collected at RBGS entrainment Station E4 from January 2006 through January 2007. ....	4-148
Figure 4.5-86. Mean concentration (# / 1,000 m <sup>3</sup> [264,172 gal]) and standard deviation of blind goby larvae collected at RBGS source water stations during 2006. ....	4-149
Figure 4.5-87. Mean concentration (#/1.0 m <sup>3</sup> [264 gal]) of blind goby larvae at entrainment Station E4 during night (Cycle 3) and day (Cycle 1) sampling. ....	4-149
Figure 4.5-88. Length (mm) frequency distribution for blind goby larvae collected at entrainment stations in Santa Monica Bay during 2006. ....	4-150
Figure 4.5-89. Recreational (1,000s of fish) and commercial (1,000s of lbs) of California halibut ( <i>Paralichthys californicus</i> ) from 1980–2006 (sources: PacFIN and RecFIN databases). ....	4-156
Figure 4.5-90. Mean catch (#fish/station) of California halibut in Santa Monica Bay and the remainder of the Southern California Bight from 1995–2006. Data are from the Ocean Resource Enhancement Hatchery Program (OREHP) gill net monitoring program. ....	4-157
Figure 4.5-91. Mean concentration (# / 1,000 m <sup>3</sup> [264,172 gal]) of California halibut larvae collected from King Harbor, 1974-2006. Source: Vantuna Research Group. ....	4-157
Figure 4.5-92. Mean concentration (# / 1,000 m <sup>3</sup> [264,172 gal]) and standard deviation of California halibut larvae collected at RBGS entrainment Station H2 from January through December 2006. ....	4-159
Figure 4.5-93. Mean concentration (# / 1,000 m <sup>3</sup> [264,172 gal]) and standard deviation of California halibut larvae collected at RBGS entrainment Station E4 from January 2006 through January 2007. ....	4-159
Figure 4.5-94. Mean concentration (# / 1,000 m <sup>3</sup> [264,172 gal]) and standard deviation of California halibut larvae collected at RBGS source water stations during 2006. ....	4-160
Figure 4.5-95. Mean concentration (#/1.0 m <sup>3</sup> [264 gal]) of California halibut larvae at entrainment Station E4 during night (Cycle 3) and day (Cycle 1) sampling. ....	4-160
Figure 4.5-96. Length (mm) frequency distribution for larval California halibut collected at entrainment stations in Santa Monica Bay during 2006. ....	4-161
Figure 4.5-97. Mean concentration (# / 1,000 m <sup>3</sup> [264,172 gal]) and standard deviation of spiny lobster larvae collected at RBGS entrainment Station H2 from January through December 2006. ....	4-168
Figure 4.5-98. Mean concentration (# / 1,000 m <sup>3</sup> [264,172 gal]) and standard deviation of spiny lobster larvae collected at RBGS entrainment Station E4 from January 2006 through January 2007. ....	4-168
Figure 4.5-99. Mean concentration (# / 1,000 m <sup>3</sup> [264,172 gal]) and standard deviation of spiny lobster larvae collected at RBGS source water stations during 2006. ....	4-169
Figure 4.5-100. Mean concentration (#/1.0 m <sup>3</sup> [264 gal]) of spiny lobster larvae at entrainment Station E4 during night (Cycle 3) and day (Cycle 1) sampling. ....	4-169
Figure 5.5-1. Mean concentration (# / 1,000,000 m <sup>3</sup> ) and standard error of fishes collected in RBGS Units 5&6 impingement samples during 2006-2007. ....	5-18
Figure 5.5-2. Mean biomass (kg / 1,000,000 m <sup>3</sup> ) and standard error of fishes collected in RBGS Units 5&6 impingement samples during 2006-2007. ....	5-18
Figure 5.5-3. Mean concentration (# / 1,000,000 m <sup>3</sup> ) and standard error of fishes collected in RBGS Units 7&8 impingement samples during 2006-2007. ....	5-19
Figure 5.5-4. Mean biomass (kg / 1,000,000 m <sup>3</sup> ) and standard error of fishes collected in RBGS Units 7&8 impingement samples during 2006-2007. ....	5-19

Figure 5.5-5. Mean concentration (# / 1,000,000 m <sup>3</sup> ) and standard error of invertebrates collected in RBGS Units 5&6 impingement samples during 2006-2007.....	5-20
Figure 5.5-6. Mean biomass (kg / 1,000,000 m <sup>3</sup> ) and standard error of invertebrates collected in RBGS Units 5&6 impingement samples during 2006-2007.....	5-20
Figure 5.5-7. Mean concentration (# / 1,000,000 m <sup>3</sup> ) and standard error of invertebrates collected in RBGS Units 7&8 impingement samples during 2006-2007.....	5-21
Figure 5.5-8. Mean biomass (kg / 1,000,000 m <sup>3</sup> ) and standard error of invertebrates collected in RBGS Units 7&8 impingement samples during 2006-2007.....	5-21
Figure 5.5-9. Mean concentration (#/1,000,000 m <sup>3</sup> ) of fishes in impingement samples during night (Cycles 3&4) and day (Cycles 1&2) sampling at Units 7&8. ....	5-22
Figure 5.5-10. Mean biomass (kg/1,000,000 m <sup>3</sup> ) of fishes in impingement samples during night (Cycles 3&4) and day (Cycles 1&2) sampling at Units 7&8. ....	5-22
Figure 5.5-11. Mean concentration (#/1,000,000 m <sup>3</sup> ) of invertebrates in impingement samples during night (Cycles 3&4) and day (Cycles 1&2) sampling at Units 5&6. ....	5-23
Figure 5.5-12. Mean biomass (kg/1,000,000 m <sup>3</sup> ) of invertebrates in impingement samples during night (Cycles 3&4) and day (Cycles 1&2) sampling at Units 5&6. ....	5-23
Figure 5.5-13. Mean concentration (#/1,000,000 m <sup>3</sup> ) of invertebrates in impingement samples during night (Cycles 3&4) and day (Cycles 1&2) sampling at Units 7&8. ....	5-24
Figure 5.5-14. Mean biomass (kg/1,000,000 m <sup>3</sup> ) of invertebrates in impingement samples during night (Cycles 3&4) and day (Cycles 1&2) sampling at Units 7&8. ....	5-24
Figure 5.5-15. Abundance of black perch ( <i>Embiotoca jacksoni</i> ) measured during diver transects at King Harbor and Palos Verdes from 1974-2006. Source: Vantuna Research Group. ....	5-28
Figure 5.5-16. Length (mm) frequency distribution for black perch collected in impingement samples.....	5-29
Figure 5.5-17. Length (mm) frequency distribution for California scorpionfish collected in impingement samples. ....	5-31
Figure 5.5-18. Length (mm) frequency distribution for blacksmith collected in impingement samples. ....	5-34
Figure 5.5-19. Abundance of rainbow seaperch ( <i>Hypsurus caryi</i> ) measured during diver transects at King Harbor and Palos Verdes from 1974-2006. Source: Vantuna Research Group. ....	5-36
Figure 5.5-20. Length (mm) frequency distribution for rainbow seaperch collected in impingement samples.....	5-37
Figure 5.5-21. Length (mm) frequency distribution for queenfish collected in impingement samples. ....	5-38
Figure 5.5-22. Distribution of queenfish age classes in RBGS impingement samples.....	5-39
Figure 5.5-23. Length (mm) frequency distribution for kelp bass collected in impingement samples....	5-41
Figure 5.5-24. Distribution of kelp bass age classes in RBGS impingement samples. ....	5-42
Figure 5.5-25. Length (mm) frequency distribution for black croaker collected in impingement samples.....	5-44
Figure 5.5-26. Distribution of black croaker age classes in RBGS impingement samples.....	5-45
Figure 5.5-27. Abundance of rubberlip seaperch ( <i>Rhacochilus toxotes</i> ) measured during diver transects at King Harbor and Palos Verdes from 1974-2006. Source: Vantuna Research Group. ....	5-48
Figure 5.5-28. Length (mm) frequency distribution for rubberlip seaperch collected in impingement samples.....	5-49
Figure 5.5-29. Disc width (mm) frequency distribution for round stingray collected in impingement samples.....	5-51
Figure 5.5-30. Length (mm) frequency distribution for rock wrasse collected in impingement samples.....	5-53
Figure 5.5-31. Abundance of walleye surfperch ( <i>Hyperprosopon argenteum</i> ) measured during diver transects at King Harbor and Palos Verdes from 1974-2006. Source: Vantuna Research Group. ....	5-55
Figure 5.5-32. Abundance of pile perch ( <i>Rhacochilus vacca</i> ) measured during diver transects at King Harbor and Palos Verdes from 1974-2006. Source: Vantuna Research Group. ....	5-60



---

Figure 5.5-33. Abundance of shiner perch ( <i>Cymatogaster aggregata</i> ) measured during diver transects at King Harbor and Palos Verdes from 1974-2006. Source: Vantuna Research Group. ....	5-62
Figure 5.5-34. Abundance of white seaperch ( <i>Phanerodon furcatus</i> ) measured during diver transects at King Harbor and Palos Verdes from 1974-2006. Source: Vantuna Research Group. ....	5-66
Figure 5.5-35. Mean concentration (# / 1,000,000 m <sup>3</sup> ) and standard error of yellow crab collected in impingement samples during 2006-2007. ....	5-76
Figure 5.5-36. Mean biomass (kg / 1,000,000 m <sup>3</sup> ) and standard error of yellow crab collected in impingement samples during 2006-2007. ....	5-76
Figure 5.5-37. Mean concentration (#/1,000,000 m <sup>3</sup> ) of yellow crab in impingement samples during night (Cycles 3&4) and day (Cycles 1&2) sampling at the RBGS. ....	5-77
Figure 5.5-38. Mean biomass (kg/1,000,000 m <sup>3</sup> ) of yellow crab in impingement samples during night (Cycles 3&4) and day (Cycles 1&2) sampling at the RBGS. ....	5-77
Figure 5.5-39. Carapace width (mm) frequency distribution for yellow crab collected in impingement samples. ....	5-78
Figure 5.5-40. Mean concentration (# / 1,000,000 m <sup>3</sup> ) and standard error of Pacific rock crab collected in impingement samples during 2006-2007. ....	5-79
Figure 5.5-41. Mean biomass (kg / 1,000,000 m <sup>3</sup> ) and standard error of Pacific rock crab collected in impingement samples during 2006-2007. ....	5-79
Figure 5.5-42. Mean concentration (#/1,000,000 m <sup>3</sup> ) of Pacific rock crab in impingement samples during night (Cycles 3&4) and day (Cycles 1&2) sampling at the RBGS. ....	5-80
Figure 5.5-43. Mean biomass (kg/1,000,000 m <sup>3</sup> ) of Pacific rock crab in impingement samples during night (Cycles 3&4) and day (Cycles 1&2) sampling at the RBGS. ....	5-80
Figure 5.5-44. Carapace width (mm) frequency distribution for Pacific rock crab collected in impingement samples. ....	5-81
Figure 5.5-45. Carapace length (mm) frequency distribution for California spiny lobster collected in impingement samples. ....	5-82
Figure 5.5-46. Carapace width (mm) frequency distribution for sheep crab collected in impingement samples. ....	5-85
Figure 6.1-1. Distribution and abundance of northern anchovy larvae ( <i>Engraulis mordax</i> ) at permanent stations sampled in the CalCOFI study in the SCB from 1951 through 1998 (from Moser et al. 2001). ....	6-8
Figure 6.1-2. Distribution and abundance of larvae of a) croakers (Family Sciaenidae), b) kelp and sand basses ( <i>Paralabrax</i> spp.), and c) California halibut ( <i>Paralichthys californicus</i> ) across permanent stations in the SCB from 1951 through 1998 (from Moser et al. 2001). ....	6-9
Figure 6.1-3. Marine habitat types in California (from Allen and Pondella [2006b]). ....	6-10
Figure 6.3-1. Sea surface temperature anomalies for Newport Pier, California. Values are ± the long-term average (1925–2006). ....	6-23
Figure 6.3-2. Abundance of combtooth blennies collected per boulder at King Harbor, California from 1984–2006 (from VRG, unpubl. data). ....	6-26
Figure 6.3-3. Average larval density of blennies ( <i>Hypsoblennius</i> spp.) and unidentified gobies (Gobiidae) at King Harbor stations (Series H), Units 7&8 entrainment Station E4, and nearshore source water stations (Series S and O) in 2006. ....	6-27
Figure 6.3-4. Abundance of garibaldi ( <i>Hypsypops rubicundus</i> ) measured during diver transects at King Harbor and Palos Verdes from 1974-2006. (from VRG, unpubl. data). ....	6-29
Figure 6.3-5. Average larval density of selected cryptic fish species in King Harbor, 1984–2006. (from VRG, unpubl. data). ....	6-30
Figure 6.3-6. Recreational (1000's of fish) and commercial (1000's of lbs) catches of California halibut ( <i>Paralichthys californicus</i> ) from 1980-2006 (sources: PacFIN and RecFIN databases)....	6-36

---

Figure 6.3-7. Mean catch (#fish/station) of California halibut in Santa Monica Bay and the remainder of the Southern California Bight from 1995-2006. Data are from the Ocean Resource Enhancement Hatchery Program (OREHP) gill net monitoring program. ....6-37

Figure 6.3-8. Recreational (1000's of fish) and commercial (1000's of lbs) of sanddabs (*Citharichthys* spp.) from 1980-2006 (sources: PacFIN and RecFIN databases). ....6-38

Figure 6.3-9. Commercial catches of rock crab (*Cancer* spp.) in the Los Angeles region, 1981–2006. .6-39

---

---

## LIST OF ABBREVIATIONS AND ACRONYMS

ADCP	acoustic Doppler current profiler
<i>AEL</i>	adult equivalent loss
BMPs	best management practices
BTA	best technology available
CDFG	California Department of Fish and Game
CDS	Comprehensive Demonstration Study
cm	centimeter(s)
cm/s	centimeters per second
CPFV	commercial passenger fishing vessels
CWA	Clean Water Act
CWIS	cooling water intake system
dph	days post hatch
<i>EAM</i>	equivalent adult model
EFH	Essential Fish Habitat
El.	Elevation (relative to mean sea level)
ENSO	El Niño-Southern Oscillation
EPA	United States Environmental Protection Agency
<i>ETM</i>	Empirical Transport Model
<i>FH</i>	fecundity hindcasting
FMP	Fishery Management Plan
ft	feet
ft/s	feet per second
g	grams
gal	gallons
gpm	gallons per minute
HTP	Hyperion Treatment Plant
in	inches
km	kilometers
LADWP	Los Angeles Department of Water and Power
LARWQCB	Los Angeles Regional Water Quality Control Board
lbs	pounds
m	meters
m/s	meters per second
m <sup>3</sup>	cubic meters
mgd	million gallons per day
mi	miles
min	minute(s)
ml	milliliters
MLLW	mean lower low water
mm	millimeters
mm/d	millimeters per day
MSL	mean sea level
mt	metric tons
MW	megawatts
NL	notochord length
NMFS	National Marine Fisheries Service
NOAA	National Oceanic and Atmospheric Administration
PacFIN	Pacific Fisheries Information Network

PDO	Pacific Decadal Oscillation
PE	proportional entrainment
PFMC	Pacific Fisheries Management Council
PIC	Proposal for Information Collection
$P_m$	probability of mortality
ppt	parts per thousand
QA	Quality Assurance
QC	Quality Control
RBGS	Redondo Beach Generating Station
RecFIN	Recreational Fisheries Information Network
RWQCB	Regional Water Quality Control Board
SCB	Southern California Bight
SCCWRP	Southern California Coastal Water Research Project
SL	standard length
SWRCB	State Water Resources Control Board
TL	total length
USFWS	United States Fish and Wildlife Services
VRG	Vantuna Research Group (Occidental College)
YOY	young-of-the-year

## **1.0 EXECUTIVE SUMMARY**

This report presents data from in-plant and offshore field surveys performed for the AES Redondo Beach 316(b) Impingement Mortality and Entrainment Characterization Study. This study was designed and performed to comply with the EPA's Section 316(b) Phase II Final Regulations, which became effective in 2004. Originally the results from the study were to be used in determining impingement mortality and entrainment estimates, evaluating potential fish protection technologies and operational measures, scaling potential restoration projects, and/or evaluating the benefits achieved in reducing IM&E at the AES Redondo Beach Generating Station (RBGS). However, in March 2007, EPA suspended the Phase II regulations and directed administrators to determine compliance with Section 316(b) on a best professional judgment (BPJ) basis.

This report is being submitted to the Los Angeles Regional Water Quality Control Board (LARWQCB) with information that it can use in its decision-making on 316(b) compliance for the RBGS. Prior to the Phase II regulations, 316(b) decisions were based on precedents from case law and on EPA's draft "Guidance for Evaluating the Adverse Impact of Cooling Water Intake Structures on the Aquatic Environment: Section 316(b) P.L. 92-500" (EPA 1977). As Section 316(b) requires that an intake technology employs the 'best technology available' (BTA) for minimizing 'adverse environmental impacts' (AEI), there are two steps in determining compliance:

1. Whether or not an AEI is caused by the operation of the intakes, and if so,
2. What intake structure represents BTA to minimize that impact.

The usual approach for a 316(b) demonstration would include consideration of BTA only if a determination was made that a facility is causing an AEI. The purpose of this report is to assess the potential for AEI from the operation of the RBGS cooling water intake systems (CWISs). The two primary impacts of a once-through CWIS are impingement of juvenile/adult life stages of fishes, shellfishes, and other organisms on screens, and entrainment of smaller organisms, usually larval forms of fishes and shellfishes, and other forms of plankton, into the CWIS. The information in this report will also be used to assist in the renewal of the National Pollutant Discharge Elimination System (NPDES) permit for the RBGS. This report provides a characterization of the fish and invertebrate species subject to entrainment and impingement at the RBGS, information on the current level of IM&E at the RBGS, and a discussion of the level of significance of the IM&E losses.

### **1.1 ENTRAINMENT**

Composition and abundance of ichthyoplankton and shellfish larvae entrained at the RBGS were determined by bi-weekly sampling with plankton nets in the immediate proximity of the Units 7&8 intake structure from January 2006 to January 2007, and monthly sampling from January to December 2006 near the Units 5&6 intake. Units 5&6 were initially determined to be exempt from the entrainment study due to their low operating capacity over the years prior to 2006, but the two units were operated more frequently during 2006 and it was decided that entrainment estimates should be included in the analysis.

Sampling near the intakes of Units 5&6 was done monthly because the station was one of two that were initially sited to characterize source water plankton in King Harbor, and all source water stations were sampled on a monthly basis.

During the study year, Units 5&6 were operated at approximately 23% of the maximum design cooling water flow while Units 7&8 were operated at approximately 19% of the maximum flow. From January 1, 2006 to January 31, 2007, daily cooling water flow averaged 183,857 m<sup>3</sup> per day (48.575 mgd) at Units 5&6 and 475,498 m<sup>3</sup> per day (125.627 mgd) at Units 7&8.

A total of 2,524 entrainable fish larvae from 42 separate taxonomic categories was collected from the 12 entrainment surveys at Units 5&6, and a total of 7,785 entrainable fish larvae from 66 separate taxonomic categories was collected from the 25 entrainment surveys at Units 7&8. The most abundant larval fish taxa in the samples were combtooth blennies, which comprised 42.1% and 29.5% of the total larvae collected from Units 5&6 and 7&8, respectively, followed by unidentified gobies (35.3% and 11.4%, respectively). A total of 47,972 fish eggs from 15 separate taxonomic categories was collected at the Units 7&8 intake. The most abundant taxonomic group of fish eggs in the samples was unidentified eggs, which made up 69.6% of the total eggs collected, followed by anchovy eggs (11.6%). No fish eggs were processed from the samples collected at the Units 5&6 intake. The peak in abundance of all the larval fish combined occurred in August at Units 5&6 and in June at Units 7&8, while the highest concentrations of eggs occurred during May. There were generally more larval fish collected during each survey at night than during the day but less of a diel difference in egg concentrations. Total annual entrainment of fish larvae at Units 5&6 was estimated to be 101,659,379 based on actual cooling water flows and 356,000,276 based on design, or maximum capacity, flows. Total annual entrainment of all fish eggs and larvae at Units 7&8 was estimated to be 2,234,923,515 and 189,537,344, respectively based on actual cooling water flows. Using the design flow volumes, estimates increased to 7,536,186,504 eggs and 744,808,585 larvae.

A total of 35 larval target shellfishes representing 10 taxa was collected from the sampling at the Units 5&6 intake during 12 monthly surveys in 2006, and a total of 460 larval target shellfishes representing 19 taxa was collected at the Units 7&8 intake during 25 bi-weekly surveys in 2006–2007. The most abundant target shellfish larvae in the samples were California spiny lobster, followed by unidentified spider crab megalops (*Majidae* unid.). Total annual entrainment for Units 5&6 was estimated to be 2.8 million target shellfish larvae based on actual flows and 4.8 million based on design flows. Total annual entrainment for Units 7&8 was estimated to be 20.5 million target shellfish larvae based on actual flows. Using the design, or maximum capacity flows, estimates increased to 43.9 million shellfish larvae.

## **1.2 SOURCE WATER**

To determine composition and abundance of the early life stages of fish and shellfish in the King Harbor and Santa Monica Bay source waters for the Units 5&6 and Units 7&8 CWISs, sampling was conducted once monthly on the same day that the entrainment station was sampled. The RBGS source water biological sampling boundaries consisted of the waters within King Harbor, and extended approximately

3,400 m (11,155 ft) upcoast and downcoast from the King Harbor entrance, and approximately 2,400 m (7,875 ft) offshore.

A total of 13,938 fish larvae from 84 separate taxonomic categories was collected from the source water stations during the 12 surveys, including Station H2 in King Harbor that was originally sampled as a source water station but then was used to represent entrainment for those units. The most abundant fish larvae in the samples were unidentified gobies (30.0%) followed by combtooth blennies (22.1%). The highest concentrations of larval fishes occurred during April and the lowest were observed in January and February. As was seen at the entrainment station, there were generally more larval fish collected during night sampling than during day sampling.

A total of 832 larval invertebrates representing 23 taxa was collected from the RBGS source water stations (including Station H2) during 12 monthly surveys in 2006. The most abundant target invertebrate larvae in the samples were California spiny lobster followed by kelp crab megalops (*Pugettia* spp.), which made up 24.7% and 19.1%, respectively, of the total target invertebrate larvae collected. A total of 40 market squid paralarvae was also collected during source water sampling.

### **1.3 IMPINGEMENT**

A total of 10 normal operation surveys were conducted at both Units 5&6 and Units 7&8, and two heat treatment surveys were conducted at Units 7&8, from January 2006 through January 2007. Results from the monthly normal operation surveys were extrapolated based on cooling water flow volumes, and summed with heat treatment results to estimate total annual impingement. At Units 5&6, an estimated 133 fish from three species weighing 27 kg (60 lbs) was estimated to be impinged during the study year based on actual cooling water flow volumes. These three species were round stingray (66 individuals), California clingfish (34 individuals), and bat ray (33 individuals). Additionally, 273 macroinvertebrates from seven species weighing 48 kg (108 lbs) was estimated to be impinged during the study year. The most abundant invertebrates were common salp (80 individuals), yellow crab (41 individuals), and northern kelp crab (41 individuals).

At Units 7&8, an estimated 1,101 fish from 36 species weighing 176 kg (388 lbs) was estimated to be impinged during the study year. The three most abundant species were northern anchovy (271 individuals), bat ray (141 individuals), and black perch (121 individuals). Approximately 29% of fish impingement abundance was recorded during two heat treatments, while the other 71% occurred during normal operations. And additionally, 1,907 macroinvertebrates from at least 17 taxa weighing 410 kg (905 lbs) were estimated to be impinged at Units 7&8 during the study year. The most abundant invertebrates were California two-spot octopus (335 individuals), yellow crab (232 individuals), and blackspotted bay shrimp (201 individuals). Approximately 13% of macroinvertebrate impingement abundance was recorded during two heat treatments, while the other 87% occurred during normal operations.

## 1.4 IMPACT ASSESSMENT

The data collected from the entrainment, source water, and impingement sampling was used to assess the potential for AEI to fish and shellfish populations. The assessment was limited to the taxa that were sufficiently abundant to provide a reasonable assessment of impacts. The list of taxa was reviewed and approved by all stakeholders, including the LARWQCB staff. The most abundant taxa had the greatest frequency of occurrence among surveys and stations. Since the most abundant organisms may not necessarily be those that experience the greatest effects at the population level, the data were also examined to determine if additional taxa should be included in the assessment, such as threatened or endangered taxa. The National Marine Fisheries Service requested that all species managed under the Magnuson-Stevens Fishery Conservation and Management Act be assessed in the impingement section. None of these species were included in the entrainment assessment (beyond those which comprised the most abundant taxa) since they were otherwise scarce in entrainment samples. No species listed as threatened or endangered by the state or federal governments were entrained or impinged at the RBGS during the study, consistent with past results.

The assessment was primarily done by calculating impingement and entrainment estimates based on actual cooling water flow volumes at the RBGS for individual taxa, and then using these results to model the losses to adult and larval source populations using two general modeling approaches and three different models. One approach uses species-specific life history parameters in two different demographic models to estimate the equivalent number of adults lost due to entrainment and impingement: adult equivalent loss (*AEL*) and fecundity hindcasting (*FH*). The number of adult equivalents was calculated for some taxa both entrained and impinged, while fecundity hindcasting was used to estimate the number of adult females whose lifetime reproductive output was lost to entrainment. The demographic estimates from entrainment and impingement were added together to evaluate combined effects of the CWIS. The life history information necessary for the modeling was not available for most species so a combined assessment was only done for northern anchovy. The other modeling approach was only used with the entrainment and source water data. This model (the empirical transport model [*ETM*]) estimates the conditional mortality on a population resulting from entrainment.

The assessment included 32 taxonomic groups or species of fishes and four taxonomic groups of shellfishes (Table 1.4-1). These taxa were categorized into five habitat types that were simplified from a more detailed categorization of habitats by Allen and Pondella (2006b). Taxa that occurred in more than one habitat were assigned to the habitat group that best reflected the primary distribution for each particular taxon. This approach was used because it focused the assessment on the taxa and habitats that were most at risk for potential effects from the RBGS cooling water systems.

Taxa that were associated with habitats that are only affected by the transport of larvae out of their native habitat into nearshore areas where they are susceptible to entrainment are at very low risk of being impacted by the RBGS cooling water systems. These include taxa associated with offshore pelagic habitats and those whose primary distribution is on the continental shelf. Most of the taxa included in the assessment did not have limited habitat associations that would place them at greater potential risk to cooling water system effects. Although a taxon may be limited to a single habitat type, the entire



distribution of the population is also important. For example, while northern anchovy and market squid were assigned to the coastal pelagic habitats, they are distributed across large oceanic areas. Similarly, taxa such as rockfishes that are distributed across broad areas of the shelf are at less risk than shelf species with more limited nearshore distributions.

Table 1.4-1. Summary of entrainment and impingement sampling results and model output for common fish and invertebrate species at RBGS Units 5–8 in 2006–07. Model estimates indicate whether the number was based on eggs (E), larvae (L), or both combined (C). Egg entrainment from Units 7&8 only.

Species	Common Name	Est. Annual Larval Ent. (millions)	Est. Annual Egg Ent. (millions)	ETM $P_m$ (%)	2*FH	AEL	Annual Imping. Estimate	Imping. Weight (kg)	EAM <sup>1</sup>
<b>Fishes</b>									
<i>Hypsoblennius</i> spp.	combtooth blennies	113.73	0	9.77	129,980 <sup>L</sup>	277,362 <sup>L</sup>	-	-	
Gobiidae unid.	CIQ gobies	51.60	0	12.42	93,348 <sup>L</sup>	42,236 <sup>L</sup>	-	-	
<i>Engraulis mordax</i>	northern anchovy	33.20	354.78	0.74	29,174 <sup>C</sup>	59,004 <sup>L</sup>	271	2.41	830
<i>Hypsypops rubicundus</i>	garibaldi	18.81	0.08	8.42			-	-	
<i>Genyonemus lineatus</i>	white croaker	12.63	0.24	0.50	<1 <sup>E</sup>		1	<0.01	
Labrisomidae unid.	labrisomid blennies	11.91	0	11.42			-	-	
<i>Seriphus politus</i> <sup>2</sup>	queenfish	7.60	0	0.12			87	0.93	106
<i>Typhlogobius californiensis</i>	blind goby	5.69	0	9.81			-	-	
Gobiesocidae unid.	clingfishes	5.09	0	17.43			34	0.03	
Atherinopsidae unid. <sup>3</sup>	silversides	2.05	0	3.19			1	0.03	
<i>Gibbonsia</i> spp.	clinid kelpfishes	1.72	0	4.14			-	-	
<i>Paralabrax</i> spp. <sup>4</sup>	sea basses	1.23	0.04	0.26			80	60.51	9
<i>Paralichthys californicus</i>	California halibut	1.06	0.09	0.17	4 <sup>C</sup>		2	0.28	
<i>Myliobatis californica</i>	bat ray	-	-				174	63.40	
<i>Embiotoca jacksoni</i>	black perch	-	-				121	12.78	
<i>Urobatis halleri</i>	round stingray	-	-				74	23.18	
<i>Porichthys notatus</i>	plainfin midshipman	-	-				67	11.87	
<i>Scorpaena guttata</i>	California scorpionfish	-	-				52	5.72	
<i>Hyperprosopon argenteum</i>	walleye surfperch	-	-				42	0.46	
<i>Oxyjulis californica</i>	señorita	0.92	0				41	2.08	
<i>Chromis punctipinnis</i>	blacksmith	-	-				29	2.48	
<i>Cymatogaster aggregata</i>	shiner perch	-	-				26	0.65	
<i>Hypsurus caryi</i>	rainbow seaperch	-	-				25	1.67	

(table continued)

Table 1.4-1 (continued). Summary of entrainment and impingement sampling results and model output for common fish and invertebrate species at RBGS Units 5–8 in 2006–07.

Species	Common Name	Est. Annual Larval Ent. (millions)	Est. Annual Egg Ent. (millions)	ETM $P_m$ (%)	2*FH	AEL	Annual Imping. Estimate	Imping. Weight (kg)	EAM <sup>1</sup>
<b><u>Fishes (cont.)</u></b>									
<i>Cheilotrema saturnum</i>	black croaker	0.26	0				14	1.726	17
<i>Rhacochilus toxotes</i>	rubberlip seaperch	-	-				12	1.32	
<i>Halichoeres semicinctus</i>	rock wrasse	0.16	0				10	1.26	
<i>Rhacochilus vacca</i>	pile perch	-	-				7	1.16	
<i>Sebastes auriculatus</i>	brown rockfish	-	-				6	1.06	
<i>Phanerodon furcatus</i>	white seaperch	-	-				5	0.17	
<b><u>Shellfishes</u></b>									
<i>Panulirus interruptus</i>	Calif. spiny lobster	13.75	-	11.43			208	76.96	
<i>Cancer</i> spp.	cancer (rock) crabs	0.45	-				430	37.11	
<i>O. bimaculatus/bimaculoides</i>	Calif. two-spot octopus						335	45.92	
<i>Loxorhynchus grandis</i>	sheep crab	-	-				178	251.94	

<sup>1</sup>standardized impingement adult equivalent mortality

<sup>2</sup>larval entrainment estimate includes queenfish and unidentified croakers combined

<sup>3</sup>only topsmelt was collected in impingement samples.

<sup>4</sup>only kelp bass and barred sand bass were collected in impingement samples, and only kelp bass was analyzed using the EAM

Although habitat and geographic distribution are important considerations, they all need to be considered relative to the magnitude of effects. At the RBGS the largest entrainment and impingement effects occurred to fish whose primary habitat is the abundant rocky reef (and riprap) habitat of King Harbor and off the Palos Verdes Peninsula. Previous studies of King Harbor have identified it as a source of reef fish larvae that is more productive than surrounding reef areas (Stephens and Pondella 2002). It is important to note that many of the taxa entrained and/or impinged are not targeted by commercial or recreational fishing that would compound any effects of the operation of the cooling water systems on the populations. Based on these criteria the assessment focused on taxa such as northern anchovy, California halibut, and rock crabs, which are also targeted by sport and/or commercial fishing. The magnitude of impacts to these and other taxa were relatively low and not at levels that would represent risk of AEI to the populations.

Although EPA acknowledges it is difficult to determine the magnitude of impact that would result in an AEI, the conclusions of this study were consistent with a recent review on population-level effects on harvested fish stocks (Newbold and Iovanna 2007). The authors modeled the potential effects of entrainment and impingement on populations of 15 fish stocks that are targeted by either commercial and/or recreational fisheries by using empirical data on entrainment and impingement, life history, and stock size. For 12 of the 15 species modeled, the effects of theoretically removing all of the sources of power plant entrainment and impingement were low (less than 2.5%). For the other three species, the effects ranged from 22.3% for striped bass on the Atlantic coast to 79.4% for Atlantic croaker. Their overall conclusions were that population-level effects were negligible for most fish stocks but could be severe for some species with population and harvest characteristics similar to their three examples. Unlike the harvested fishes analyzed by Newbold and Iovanna (2007), the largest effects of entrainment at the RBGS occurred for non-harvested species (such as clingfishes and combtooth blennies) that occur mostly on the rocky reef/riprap habitat that surrounds the cooling water intake structures, and these were still at low levels that would not represent a risk of AEI to the populations. As mentioned previously, King Harbor acts as a source for reef fish larvae and has been demonstrated to be more productive than nearby natural reefs.

## **2.0 INTRODUCTION**

The Redondo Beach Generating Station (RBGS) is a fossil-fueled steam electric power generating station that is owned and operated by AES Redondo Beach, L.L.C. (AES) and is located along the shore of King Harbor in Redondo Beach, California. RBGS currently operates four natural gas units. Cooling water for all four units is withdrawn through three submerged offshore intakes, two in King Harbor and one in Santa Monica Bay near the entrance to King Harbor. Cooling water for two of the units is discharged north of King Harbor into the Santa Monica Bay. The discharge for the other two units is located in King Harbor adjacent to the intake pipe.

Cooling water intake systems (CWISs) are regulated under §316(b) of the federal Clean Water Act (CWA). In July 2004, the U.S. Environmental Protection Agency (EPA) established new regulations for §316(b) applicable to large, existing power plants with daily cooling water volumes in excess of 50 million gallons per day (mgd). Due to the design, location, and operating characteristics of the cooling water systems for RBGS, which combined withdraw a maximum of 891 mgd, the RBGS was subject to these new regulations that required submittal of a comprehensive compliance plan by January 7, 2008. The new regulations were challenged by a coalition of environmental groups and the case was heard by the U.S. Court of Appeals, Second Circuit. The court rendered a decision in January 2007 that remanded multiple key components of the regulations back to the EPA. In March 2007, the EPA issued a memorandum suspending the Phase II regulations and directing that all permits for Phase II facilities implement 316(b) on a case-by-case basis using “best professional judgment” (BPJ). The language of the memorandum was expanded and published in the Federal Register in July 2007 (Vol. 72, 130:37107-37109).

The studies presented in this report were done in partial fulfillment of the requirements of the new regulations. With the suspension of the Phase II regulations, the results of the studies will be used to determine if impingement mortality and entrainment losses pose any significant risk of adverse environmental impact (AEI) to the species and life stages of fish and shellfish entrained and/or impinged. The absence of any significant impacts would be a technically sound basis under BPJ for determining that the cooling water intake structures of the RBGS represent the best technology available (BTA) for minimizing adverse environmental impacts. This would allow any additional requirements to further reduce impingement mortality and/or entrainment to be deferred until issues with the Phase II regulations are resolved by EPA.

### **2.1 BACKGROUND AND OVERVIEW**

On July 9, 2004, the U.S. Environmental Protection Agency published the second phase of new regulations under §316(b) of the CWA. The final Phase II regulations went into effect in September 2004, and applied to existing generating stations (Phase II facilities) with cooling water intake structures that withdraw at least 50 mgd from rivers, streams, lakes, reservoirs, oceans, estuaries, or other waters of the United States. Pursuant to the Phase II regulations, AES submitted the Proposal for Information

Collection (PIC) for RBGS to the Los Angeles Regional Water Quality Control Board (LARWQCB) in September 2005. The PIC included the study plan for the RBGS IM&E Characterization Study.

### **2.1.1 Section 316(b) of the Clean Water Act**

Section 316(b) of the CWA requires that the location, design, construction, and capacity of CWISs reflect BTA to minimize adverse environmental impacts due to the impingement mortality of aquatic organisms (i.e., fish, shellfish, and other forms of aquatic life) on intake structures and the entrainment of eggs and larvae through cooling water systems. The new §316(b) Phase II regulations established performance standards for CWISs of existing power plants that withdraw more than 50 mgd of surface waters and use more than 25% of the withdrawn water for cooling purposes. The regulations required all large existing power plants to reduce impingement mortality by 80–95% and to reduce entrainment of smaller aquatic organisms drawn through the cooling system by 60–90% when compared against a “calculation baseline”. The water body type on which the facility is located, the capacity utilization rate, and the magnitude of the design intake flow relative to the waterbody flow were to be used to determine whether a facility was required to meet the performance standards for only impingement or both impingement and entrainment.

The Phase II regulations provided power plants with five options for meeting the performance standards, but unless a facility could show that it met the standards using the existing intake design or was installing one of the approved EPA technologies for IM&E reduction, it was required to submit information documenting its existing levels of IM&E. These data could be derived from existing data that may have previously been collected at the facility or a similar facility nearby. The data were then required to be submitted in an Impingement Mortality and Entrainment (IM&E) Characterization Study that was one component of the §316(b) Comprehensive Demonstration Study required under the Phase II regulations. The impingement mortality component of the studies was not required if the through-screen intake velocity was less than or equal to 0.5 feet per second (ft/s) (or 15 centimeters [cm] per second). The entrainment characterization component was not required if a facility:

1. Has a capacity utilization rate of less than 15%;
2. Withdraws cooling water from a lake or reservoir, excluding the Great Lakes; or
3. Withdraws less than 5% of the mean annual flow of a freshwater river or stream.

Based on previously collected intake velocity measurements and plant operating characteristics, both the IM&E components of the study were required at the RBGS. However, the entrainment portion of the study was not required at Units 5&6 since Unit 5 had an average capacity utilization rate (2000-2004) of 6.9% and Unit 6 had an average capacity utilization rate of 9.7%. Previous §316(b) demonstration studies were done at RBGS from 1978 through 1980 (SCE 1983). Entrainment samples were collected monthly at Redondo Beach from August 1979 through July 1980 and impingement samples were collected from October 1978 through September 1980. A detailed summary of the historical IM&E studies is provided in Sections 4.4 and 5.4. Due to the time period since the original data were collected a study plan for new IM&E studies was submitted with the PIC to the LARWQCB in September 2005.

The PIC was submitted prior to the publication of the U.S. Court of Appeals decision on the Phase II regulations issued on January 25, 2006. The Court decision was a result of a lawsuit brought against the EPA by several states, environmental groups, and power companies challenging several aspects of EPA's final Phase II regulations. The decision supported the petitioner's contention that EPA exceeded its authority in rejecting closed-cycle cooling as BTA, and selecting instead a range of technologies as BTA that were based on the agency's use of improper cost-benefit analysis. Nevertheless, the Court found that EPA may consider costs to determine what technologies are reasonably available. The Court also criticized the EPA's selection of a suite of technologies as BTA, remanding to the EPA the provision establishing BTA and requiring more justification on the basis for the agency's decision or a new determination of BTA based on appropriate considerations. The Court also remanded to EPA certain provisions in the Phase II regulations that set performance standards to be achieved through compliance measures, and provisions that allowed compliance through the use of restoration measures in lieu of BTA.

The EPA issued a memorandum to its Regional Offices dated March 20, 2007. This memorandum announced that EPA was withdrawing the §316(b) Phase II regulations for existing steam electric generating stations based on the Court decision. The memorandum further directed EPA Regional Offices to implement §316(b) in NPDES permits on a BPJ basis until the issues raised by the Court decision are resolved. EPA is currently considering several alternatives in response to the Court decision and it may be several years before it is resolved either through further litigation and/or Rulemaking.

The information in this report is being submitted to assist in the evaluation of fish protection technologies and operational measures described in the PIC so that when the Phase II regulations are finally resolved, AES Redondo Beach will be in a position to move forward in a timely matter with compliance. This information is also important in evaluating the potential for AEI potentially caused by entrainment and impingement. In support of the approach to compliance, the assessment of the IM&E study focuses on determining if impingement and entrainment losses pose a significant risk of AES to the species and life stages of fish and shellfish entrained and/or impinged. The AEI assessment in this report is based on previous EPA guidance on §316(b) (EPA 1977) and focuses on evaluating the following:

- Potential impacts that could pose a risk to populations of any impinged or entrained species;
- Impacts to the local commercial or recreational fishery; or
- Any impacts to a protected species.

For entrained and juvenile species the analysis will provide estimates of the adult losses for a representative set of commercial and recreational species. For forage species, estimates of the reductions to commercial and recreational species will be made due to the reduction in biomass as a result of impingement and entrainment. Demonstrating no significant risk of AEI would be a technically sound basis to defer requirements for reducing impingement mortality and/or entrainment until issues with the Phase II regulations are resolved. The rationale and approach for the AEI assessment, as well as the results and conclusions of the assessment, are presented in Section 6.0.

### **2.1.2 Development of the Study Plan**

The AES RBGS IM&E Characterization Study Plan was developed in 2005 by MBC Applied Environmental Sciences and Tenera Environmental. The Study Plan was designed to provide the biological information necessary to fulfill all pertinent §316(b) Phase II requirements, and was based on entrainment and impingement studies performed in California in recent years for California Energy Commission relicensing studies (such as those at the AES Huntington Beach, Duke Morro Bay, Duke Moss Landing, and Duke South Bay Power Plants), and §316(b) demonstrations (such as at the PG&E Diablo Canyon and NRG Encina Power Plants). All of these studies were performed with input from technical working groups, comprised of representatives from the project applicants, the California Regional Water Quality Control Board (RWQCB), California Department of Fish and Game (CDFG), National Marine Fisheries Service (NMFS), U.S. Fish and Wildlife Service (USFWS), and consultants.

The Study Plan was submitted to the LARWQCB in September 2005. AES Redondo Beach and its consultants subsequently met with the LARWQCB to review the Study Plan and address comments. Pursuant to comments during the meeting that were included in a letter from the LARWQCB (January 2006) the following changes were made to the Study Plan:

- Fish eggs were to be identified (to the extent practicable) and counted from entrainment samples; and
- Crab megalopae larvae were to be identified (to the extent practicable) and counted from entrainment samples.

### **2.1.3 Study Plan Objectives**

Under the new §316(b) regulations, the IM&E Characterization Study was required to include the following elements (for all applicable components):

1. Taxonomic identifications of all life stages of fish, shellfish, and any species protected under federal, state, or tribal law (including threatened or endangered species) that are in the vicinity of the CWIS and are susceptible to impingement and entrainment;
2. A characterization of all life stages of fish, shellfish, and any species protected under federal, state, or tribal law (including threatened or endangered species) identified in the taxonomic identification noted previously, including a description of the abundance and temporal and spatial characteristics in the vicinity of the CWIS, based on sufficient data to characterize the annual, seasonal, and diel variations in the IM&E; and
3. Documentation of current IM&E of all life stages of fish, shellfish, and any protected species identified previously and an estimate of IM&E to be used as the calculation baseline.

The new §316(b) regulations provided the LARWQCB with considerable latitude in determining the level of detail necessary in meeting these objectives and states that “while the taxonomic identification in item 1 will need to be fairly comprehensive, the quantitative data required in items 2 and 3 may be more focused on species of concern, and/or species for which data are available.” If the CDS is based on a given technology, restoration or site-specific standards, the level of detail in terms of the quantification of the baseline can be tailored to the compliance alternative selected and does not have to address all species



and life stages. Logically it can be based on dominant species and/or commercially or recreationally important species.

The data collected from the study were to be used in developing a characterization of baseline levels of IM&E for the RBGS required under the Phase II regulations. The calculation baseline was defined in the new §316(b) regulations as follows:

*“Calculation baseline means an estimate of impingement mortality and entrainment that would occur at your site assuming that: the cooling water system has been designed as a once-through system; the opening of the cooling water intake structure is located at, and the face of the standard 3/8-inch mesh traveling screen is oriented parallel to, the shoreline near the surface of the source waterbody; and the baseline practices, procedures, and structural configuration are those that your facility would maintain in the absence of any structural or operational controls, including flow or velocity reductions, implemented in whole or in part for the purposes of reducing impingement mortality and entrainment. You may also choose to use the current level of impingement mortality and entrainment as the calculation baseline. The calculation baseline may be estimated using: historical impingement mortality and entrainment data from your facility or another facility with comparable design, operational, and environmental conditions; current biological data collected in the waterbody in the vicinity of your cooling water intake structure; or current impingement mortality and entrainment data collected at your facility. You may request that the calculation baseline be modified to be based on a location of the opening of the cooling water intake structure at a depth other than at or near the surface if you can demonstrate to the Director that the other depth would correspond to a higher baseline level of impingement mortality and/or entrainment.”*

As presented in the PIC, the RBGS cooling water intake structures do not conform to the calculation baseline. Deviations from the calculation baseline are:

- The intakes are located offshore rather than at the shoreline;
- The intakes are submerged rather than at, or near, the surface;
- The intake designs include the use of velocity cap;
- The traveling screen mesh size is 5/8-in at Units 5 through 8.

The new regulations allowed facilities to take credit for deviations from the calculation baseline if it could be demonstrated that these deviations provide reduced levels of IM&E. With the suspension of the Phase II regulations, the same arguments regarding deviations from the calculation baseline would still apply in determining if the current intake design represents the BTA for minimizing AEI.

Another objective of the study was to provide data that can be used in meeting different alternatives for compliance that might be used by AES Redondo Beach. One approach that was the subject of the Court Decision was the use of restoration measures to meet the performance standards for IM&E reduction. To this end, source water data were collected to estimate the sizes of the populations potentially subject to entrainment. The Court Decision rejected the use of restoration, but the source water data will still be important in assessing the impacts of entrainment that would otherwise be limited to few species with

sufficient life history information. The study provides data that could be used to evaluate and estimate the economic value of the environmental benefit of meeting the performance standards. While the Court decision has limited the use of the data in cost-benefit analyses, this aspect is still important in evaluating the potential AEI of IM&E and is one of the approaches used in the assessment presented in Chapter 6.0.

#### **2.1.4 Study Plan Approach**

The IM&E studies at RBGS were designed to examine losses resulting from both impingement of juvenile and adult fish and shellfishes on traveling screens at the intake during normal operations and from entrainment of larval fishes and shellfishes into the cooling water intake system. The sampling methodologies and analysis techniques were designed to collect the data necessary for compliance with the §316(b) Phase II Final Rule and were similar to recent impingement and entrainment studies conducted for the AES Huntington Beach Generating Station (MBC and Tenera 2005), the Duke Energy South Bay Power Plant (Tenera 2004), and the Cabrillo Power I LLC, Encina Power Station (Tenera, in progress). The studies at Huntington Beach were performed as part of the California Energy Commission CEQA process for permitting power plant modernization projects, while the South Bay and Encina projects were for §316(b) compliance. The study plans for these projects were subject to review by state and federal resource agency staff and independent scientists from various academic institutions and environmental organizations.

Impingement sampling has been conducted at the RBGS since the 1970s. The recent NPDES permit for the RBGS requires impingement sampling at least once every two months during heat treatments. The impingement sampling methods used in the IM&E study were somewhat similar to those used in the NPDES monitoring program. However, the 316(b) sampling program included monthly normal operation impingement sampling, with the 24-hour normal operation surveys consisting of four 6-hour cycles to document diel variation in impingement.

The entrainment sampling was designed to reflect the uncertainties surrounding the use of restoration for compliance with the new §316(b) regulations. Since the use of restoration will not be allowed under the Court decision, the entrainment data will be used in baseline calculations of losses that would be required to estimate the commercial and recreational values of adult fish losses. Larval fish and shellfish abundances vary greatly throughout the year and therefore biweekly sampling was used for characterizing entrainment. If the restoration option is still available as a result of further changes to the Phase II regulations or State policy, models of the conditional mortality due to entrainment could be used in designing appropriate restoration projects for offsetting entrainment losses. These models are based on proportional comparisons of entrainment and source water abundances and are theoretically insensitive to seasonal or annual changes in the abundance of entrained species. Therefore, source water sampling occurred monthly which is consistent with the sampling frequency for recently completed studies in southern California.

## **2.2 REPORT ORGANIZATION**

Section 3.0 of this report includes a detailed description of the RBGS and its cooling water intake systems. Cooling water flow volumes withdrawn during the course of the 2006-07 studies are presented and discussed, and these flows were used in calculating estimates of IM&E presented in other sections of the report. Section 3.0 also includes a description of the habitats and marine biological communities in the vicinity of the RBGS. The methods and results from the entrainment and source water sampling programs are presented in Section 4.0, and the methods and results for impingement are presented in Section 5.0. The results from the IM&E sampling are integrated into an impact assessment for the RBGS in Section 6.0. References used in the report are presented in Section 7.0. Appendices to this report include study procedures and detailed summaries of entrainment, source water data, and impingement data.

## **2.3 CONTRACTORS AND RESPONSIBILITIES**

The IM&E Study was designed and performed by MBC Applied Environmental Sciences (Costa Mesa, California) and Tenera Environmental (San Luis Obispo, California). The roles of each of the respective firms were as follows:

- *MBC Applied Environmental Sciences*
  - Study design
  - Field sampling
  - Impingement Mortality data entry and analysis
  - Reporting
- Tenera Environmental
  - Study design
  - Physical oceanographic data collection and analysis
  - Field sampling QA/QC
  - Entrainment laboratory processing
  - Entrainment data entry and analysis
  - Reporting

Each contractor (MBC and Tenera) was responsible for ensuring that all data were verified prior to being entered, and that appropriate QA/QC measures were employed during data collection, entry, and analysis.

### **3.0 DESCRIPTION OF THE GENERATING STATION AND CHARACTERISTICS OF THE SOURCE WATER BODY**

The following section describes the RBGS and the surrounding aquatic environment. A description of the generating station and its cooling water intake systems is presented in Sections 3.1 and 3.2. A description of the physical and biological environments in the vicinity of the RBGS is presented in Section 3.3.

#### **3.1 DESCRIPTION OF THE GENERATING STATION**

RBGS is located in the city of Redondo Beach in Los Angeles County, CA, in the southern part of Santa Monica Bay (Figure 3.1-1). RBGS was designed with eight generating units. However, the units for Plant 1 (Units 1, 2, 3, and 4) are currently retired and have not been in service since 1996. RBGS currently operates four natural gas units (Units 5, 6, 7, and 8). Plant 2 (Units 5&6) and Plant 3 (Units 7&8) utilize once-through cooling water systems with offshore intake and discharge systems. The orientation of the intakes relative to RBGS and King Harbor is shown in Figure 3.2-1. Plants 2 & 3 produce a combined output of 1,310 MW. However, over the past five years the capacity utilization of both plants has been less than 50%, with Plant 2 operating less frequently than Plant 3. The total annual energy generated is approximately 2,987,000 megawatt-hours. From 2000 through 2004, capacity factors at the RBGS were as follows:

- Unit 5 – 6.9%
- Unit 6 – 9.7%
- Unit 7 – 31.4%
- Unit 8 – 25.8%

#### **3.2 DESCRIPTION OF THE COOLING WATER INTAKE SYSTEMS**

Cooling water for Units 5–8 is withdrawn through three submerged offshore intakes, two in King Harbor and one in Santa Monica Bay near the entrance to King Harbor (Figure 3.2-1). All of these structures are located within the nearshore zone. The two onshore screen structures for Plants 2&3 are located approximately 701 m (2,300 ft) northeast from the offshore intakes. Trash racks are installed across the onshore intake structures to prevent large debris from entering the intake bays. Vertical traveling water screens are installed behind the trash racks to strain out smaller debris. Circulating water pumps are located downstream of the traveling water screens to convey screened flow to the condensers. Plant 2 cooling water is discharged north of King Harbor into Santa Monica Bay. The Plant 3 discharge is located in King Harbor adjacent to the intake pipe.

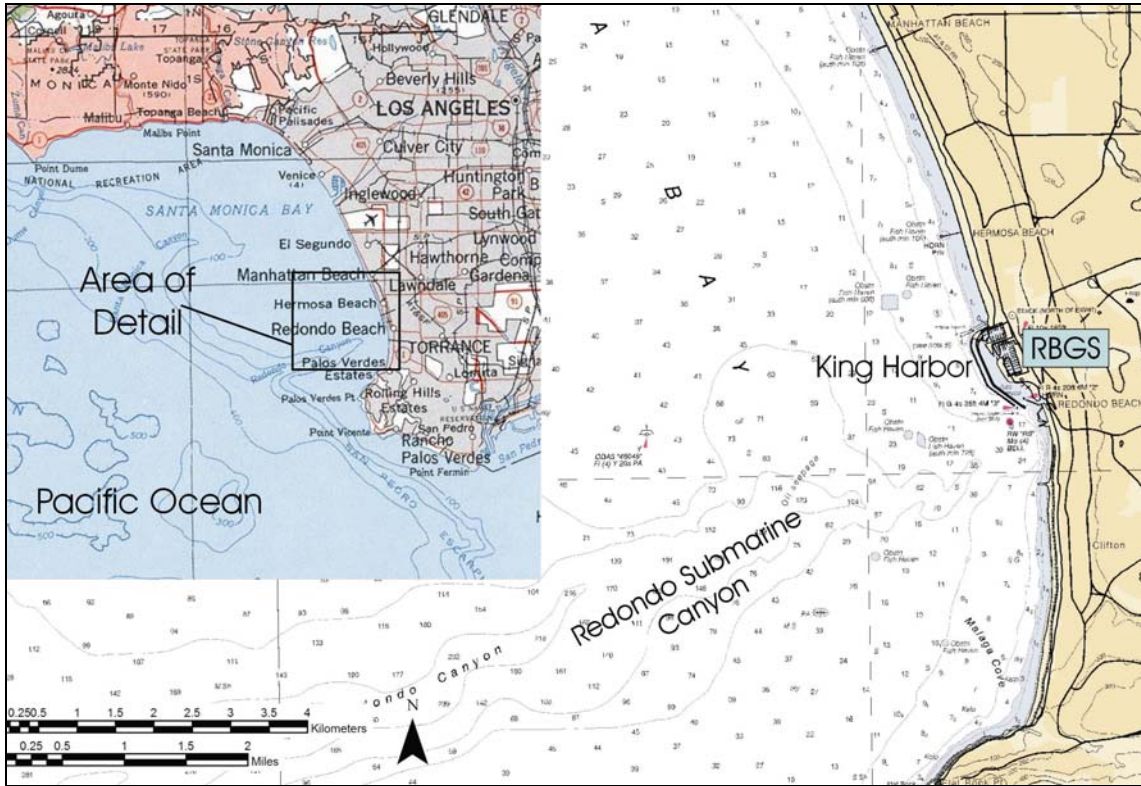

Figure 3.1-1. Location of the RBGS.

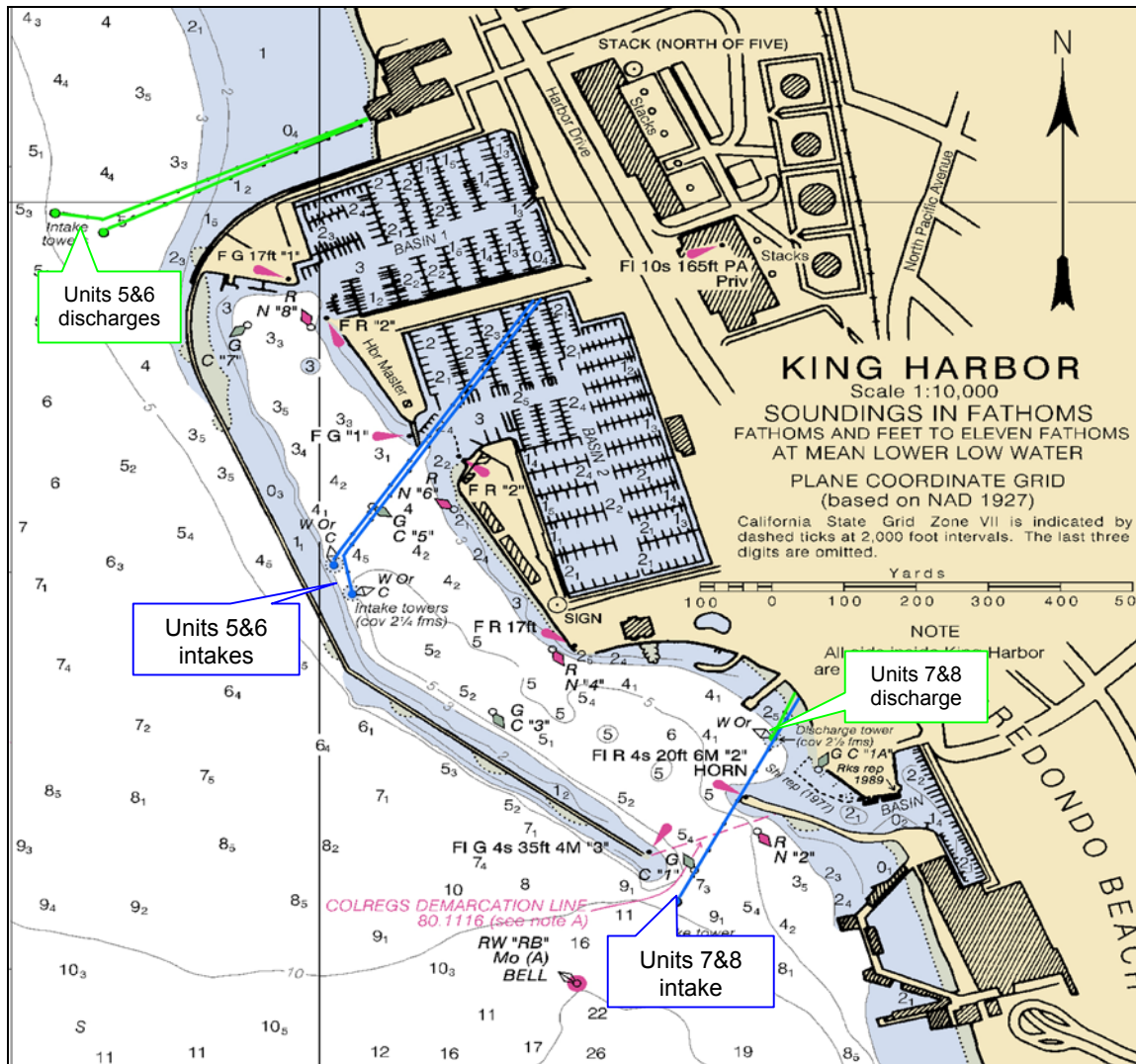

Figure 3.2-1. Location of the RBGS intake and discharge structures. (Metric measurement units not included.)

### 3.2.1 Plant 2 CWIS

Plant 2 has two offshore intake conduits running approximately 692 m (2,270 ft) from King Harbor to the onshore screen structure. Both 3-m (10-ft) diameter intake conduit pipes extend out from the screenhouse to two 5.2 m x 3.5 m (17 ft x 11 ft 4 in) vertical risers that are 10.7 m (35 ft) high (Figure 3.2-2). The top of the risers each have a 7.6 m x 9.4 m (25 ft x 31 ft) concrete velocity cap. The top of the caps are at El. -4.9 m (-16.0 ft) (re: MSL). Vertical fiberglass bars 3.2-cm (1 1/4-in) diameter by 1.2 m (4 ft) long with 35.6-cm (14-in) clear spacing are installed around the perimeter of the velocity cap openings. Units 5&6 can withdraw water through both offshore intake structures. Figure 3-3 provides a cross section view of the Plant 2 velocity caps. Assuming that all the flow for Plant 2 goes through only one velocity cap, results in an

inlet velocity of about 0.27 m/s (0.9 ft/s) and a 1.31 m/s (4.3 ft/s) velocity in the pipe. If the Plant 2 flow is through both offshore intakes, the approach velocity at the cap is 0.15 m/s (0.5 ft/s) with a pipe entrance velocity of 0.64 m/s (2.1 ft/s). The onshore intake structure of Plant 2 has an approach velocity of 0.27 m/s (0.9 ft/s) at the trash racks and traveling water screens under full flow conditions and low water levels.

The RBGS's onshore screenhouse structure for Plant 2 is located approximately 94 m (310 ft) inland from the shoreline. Figure 3.2-3 provides a top view and side view of the CWIS. The circulating water flows in from the offshore conduit through two 2.7 m (8.7 ft) wide, submerged inlet tunnels. These expand into a common forebay on the south side of the pumphouse. The Plant 2 screenhouse has a minimum invert at El -5.8 m (-19.0 ft) upstream of the traveling water screens. At the traveling water screens the invert is at El. -4.9 m (-16.0 ft). Sluice gates are located at the entrance of the bay to control the routing of the cooling water. The common forebay is 15.2 m (50 ft) wide, splitting into four 3.1 m (10.2 ft) wide bays with trash racks installed. The trash racks prevent any large debris from reaching the circulating water pumps that may have entered through the velocity cap. The trash racks are equipped with 9.5-mm x 50.8-mm (3/8 in x 2 in) carbon steel bars with 11.4-cm (4 1/2-in) spacing. Debris accumulated on these racks is cleaned periodically by divers. Vertical traveling water screens are located 4.5 m (14 ft 11 in) upstream from the center line of the circulating water pumps. The four screens are 2.1 m (7 ft) wide with 15.9 mm (5/8 in) square mesh openings and extend from El. -4.9 m (-16.0 ft) to above El. 5.5 m (18.0 ft). Stop logs are provided upstream and downstream of the traveling water screens to allow dewatering of the bay for maintenance. The screens operate automatically when the differential pressure across the screen reaches 30.5 cm (12 in). Each screen is designed to rotate at 3 m/min (10 ft/min). Screen wash water is collected in a sluiceway that conveys debris and fish into a large mesh basket. The screens are cleaned by a front and back spray wash system with a flow of 0.6 m<sup>3</sup>/min (164 gpm) at 70 psig (pounds per square inch gauge). Screen wash water is supplied by two of the three pumps.

Four vertical, mixed-flow circulating water pumps (two per unit) are located downstream from the traveling screens. At Unit 5, two cooling water pumps each provide a maximum of 145.0 m<sup>3</sup> per minute (38,300 gallons per minute [gpm]) of cooling water at full load, and at Unit 6, two cooling water pumps each provide a maximum of 139.1 m<sup>3</sup> per minute (36,750 gpm) of cooling water at full load. The total flow at Units 5 and 6 with all pumps operating is 818,105 m<sup>3</sup> per day (216.1 mgd). The flow from all four pumps is combined into two intake pipes before reaching the condensers. The Plant 2 discharge is located approximately 488 m (1,600 ft) offshore, outside of the King Harbor breakwaters. The two discharge pipes return the circulating water back to Santa Monica Bay.

The cooling water system is heat treated as needed to prevent condenser biofouling. This is done by recirculation of warmed cooling water through the system. The circulated water is maintained at a temperature of 46°C (115°F) for 1 hour and 40 minutes. Each cooling water pipeline is also usually injected with liquid chlorine for 10 minutes per day per shift. Chlorine levels in the discharge water are kept within the limits of the NPDES permit.

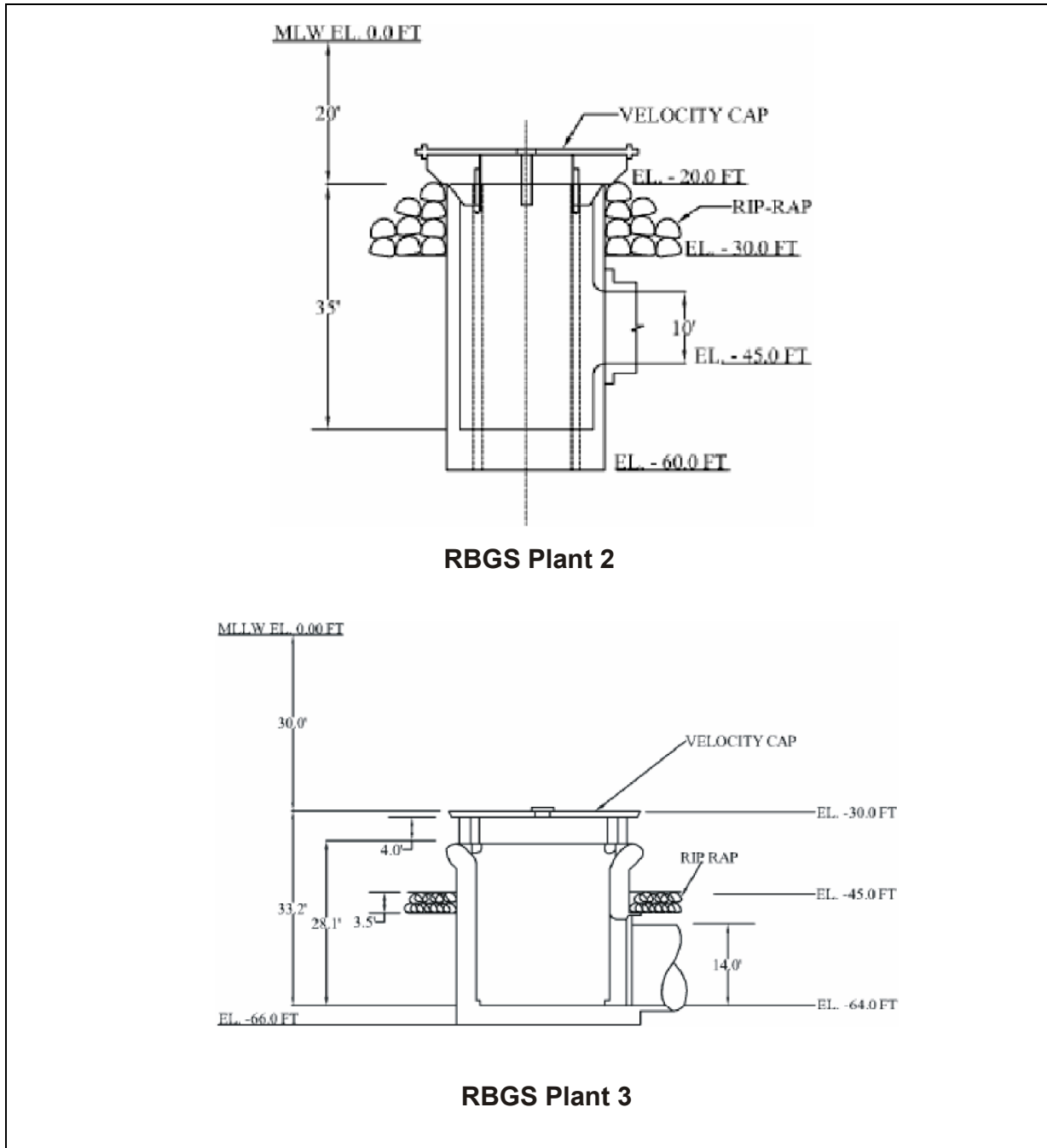

Figure 3.2-2. Cross sectional diagram of offshore seawater intake risers. (Metric measurement units not included.)



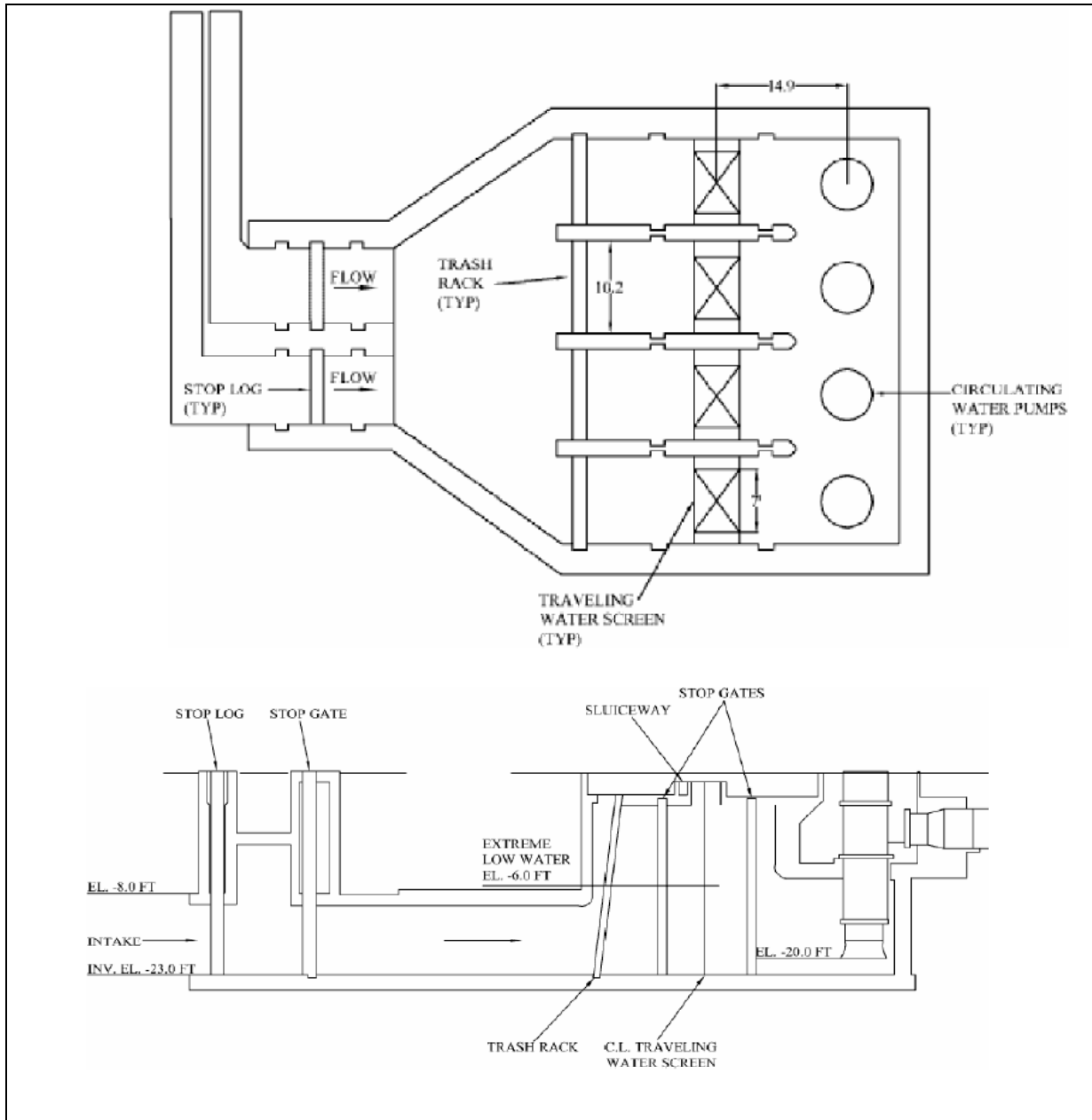

Figure 3.2-3. Plant 2 intake structure: plan view and typical cross section. (Metric measurement units not included.)

### 3.2.2 Plant 3 CWIS

Plant 3 has an offshore intake conduit that runs approximately 1,000 m (3,280 ft) from Santa Monica Bay (between the north and south breakwaters) to the onshore screen structure (Figure 3.2-1). The 4.3 m (14 ft) diameter intake conduit pipe extends out from the screenhouse to a 7.5 m x 7.5 m (24.5 ft x 24.5 ft) vertical riser that is 8.8 m (29 ft) high (Figure 3.2-2). The top of the riser has an 8.3-m x 9.8-m (27 ft-2 in

x 32 ft-2 in) concrete velocity cap. The top of the cap is at El. -9.1 m (-30.0 ft). Vertical fiberglass rods of 19 mm (¾ in) diameter by 1.2 m (4 ft) long with 35.6 cm (14 in) clear spacing are installed around the perimeter of the velocity cap opening.

RBGS's onshore screen structure for Plant 3 is located approximately 649 m (2,130 ft) from the shoreline. A top view and cross sectional view of the CWIS is shown in Figure 3.2-4. The circulating water flows from the offshore conduit into a common screenhouse for both units. The invert at the screenhouse is at El. -7.0 m (-23.0 ft). Two stop log gates are located upstream of two 8.3-m (27 ft-3 in) wide forebays. Each forebay bifurcates into 3.4 m (11 ft-2 in) wide bays where trash racks are installed. The trash racks have 9.5 mm x 50.8-mm (3/8 in x 2 in) carbon steel bars with 11.4 cm (4 ½ in) spacing. Debris accumulated on these racks is cleaned periodically by divers. The invert of the Plant 3 screenhouse is El. -7.0 m (-23.0 ft) at the traveling water screens (i.e. the four traveling screens extend from El. -7.0 m to 4.6 m [-23.0 ft to El. 15.0 ft]). Vertical traveling water screens are located 8.5 m (28 ft) upstream from the centerline of the circulating water pumps. The screens are 3 m (10 ft) wide with 15.9 mm (5/8 in) square mesh openings. Stop logs are provided upstream and downstream of the traveling water screen to allow dewatering of the bay for screen maintenance. The screens operate when the differential water level exceeds 22.9 cm (9 in) across the screen. Each screen is designed to rotate at 3 m/min (10 fpm). Debris collected in the stainless steel mesh baskets are washed along a sluiceway by a front spraywash system with a flow of 2.0 m<sup>3</sup>/min (528 gpm) at 90 psig. Plant 3 has a similar debris collection system as Plant 2. Screenwash water is supplied by two pumps located in the structure rated at 1,750 rpm at 125 hp.

Four vertical, mixed-flow circulating water pumps (two per unit) are located downstream from the traveling screens. Each of the cooling water pumps provides a maximum of 442.8 m<sup>3</sup> per minute (117,000 gpm) of cooling water at full load. The total flow at Units 7&8 with all pumps operating is 2,550,787 m<sup>3</sup> per day (673.9 mgd). After passing through the condensers, warmed water is discharged into a 14-ft internal diameter pipe that runs approximately 45 m (147 ft) offshore in King Harbor. The discharged water exits through a 4.3-m (14.0-ft) diameter vertical riser that is situated in waters approximately 6.4 m (21 ft) deep.

The cooling water system is heat treated as needed to prevent condenser biofouling. This is done by recirculation of warmed cooling water through the system. The circulated water is maintained at a temperature of 46°C (115°F) for 1 hour and 40 minutes. Each cooling water pipeline is also usually injected with liquid chlorine for 10 minutes per day per shift. Chlorine levels in the discharge water are kept within the limits of the NPDES permit.

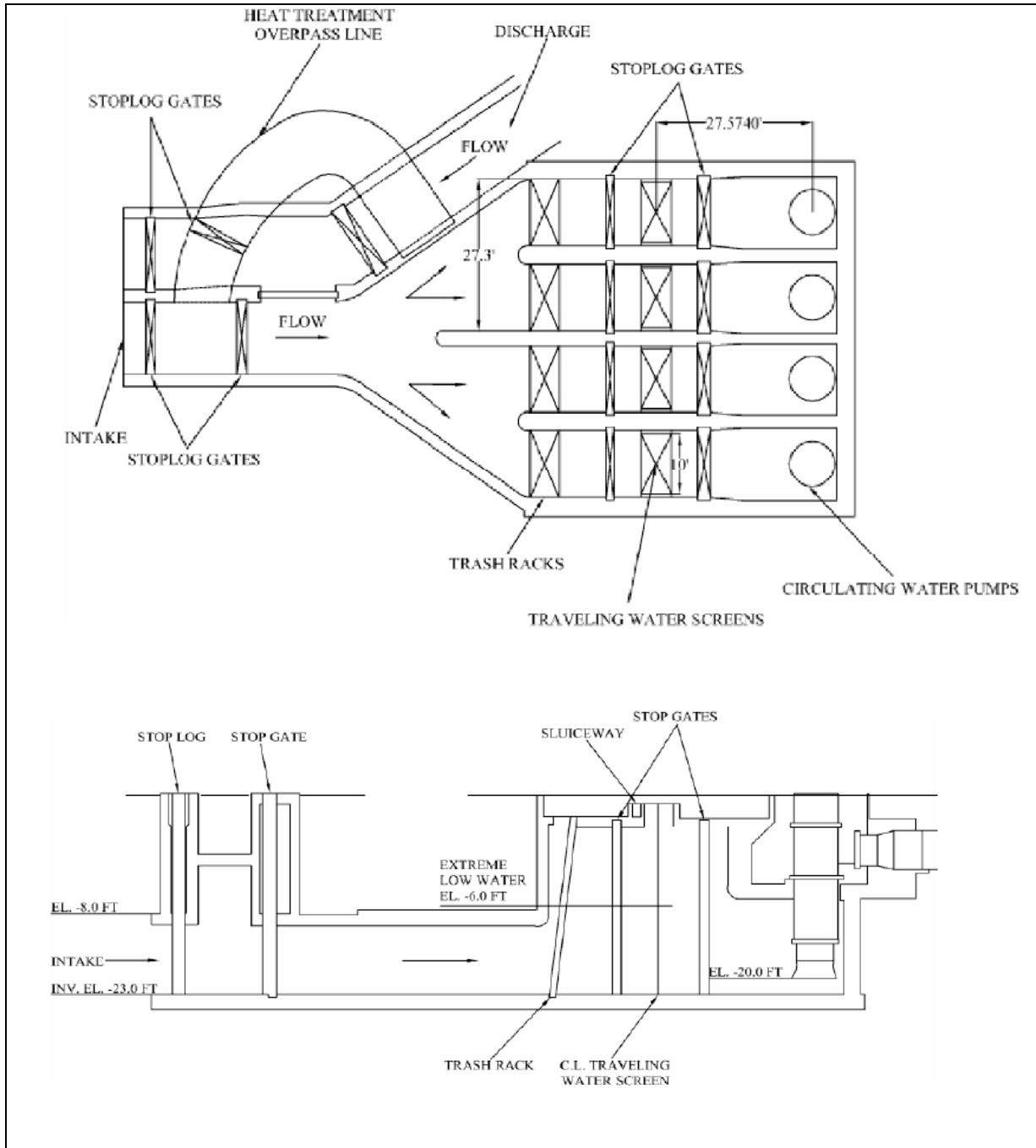

Figure 3.2-4. Plant 3 intake structure: plan view and typical cross section. (Metric measurement units not included.)

### **3.2.3 Circulating Water Pump Flows**

The RBGS CWISs withdraw a maximum of 3,368,892 m<sup>3</sup> per day (890.064 mgd) of cooling water from King Harbor and Santa Monica Bay. Velocities inside the circulating water systems were calculated using design flow of the facility and the water level at El. 0.0 m mean lower low water (MLLW). At Units 5&6, it was assumed that all cooling water flow was directed through only one velocity cap. The horizontal water velocity at the Units 5&6 velocity cap opening was calculated to be 0.27 m/s (0.9 ft/s), and in the intake pipe to be 1.31 m/s (4.3 ft/s). Assuming maximum flow conditions and low water levels, approach velocity at the onshore bar racks and traveling screens at Units 5&6 was estimated at 0.27 m/s (0.9 ft/s). At Units 7&8 (assuming maximum flow), the estimated intake velocity at the velocity opening was 0.98 m/s (3.2 ft/s), and in the pipe was 2.07 m/s (6.8 ft/s). Assuming maximum flow and low water levels, estimated velocity at Units 7&8 approaching the bar racks was 0.27 m/s (0.9 ft/s) and approaching the traveling screens was 0.30 m/s (1.0 ft/s).

Daily cooling water flow volumes at the RBGS during 2006-07 are depicted in Figures 3.2-5a–c. At Units 5&6, cooling water flows varied throughout the year, with extended periods of little or no operation recorded in January, October, November, and December 2006, and January 2007, and consistently higher flows in summer 2006. Units 7&8 operated primarily between April and September 2006, with intermittent flows during other times of the year. From January 1, 2006 to January 31, 2007, daily cooling water flow averaged 183,857 m<sup>3</sup> per day (48.575 mgd) at Units 5&6 and 475,498 m<sup>3</sup> per day (125.627 mgd) at Units 7&8. This was equivalent to approximately 23% of maximum flow at Units 5&6 and 19% of maximum flow at Units 7&8.

(A)

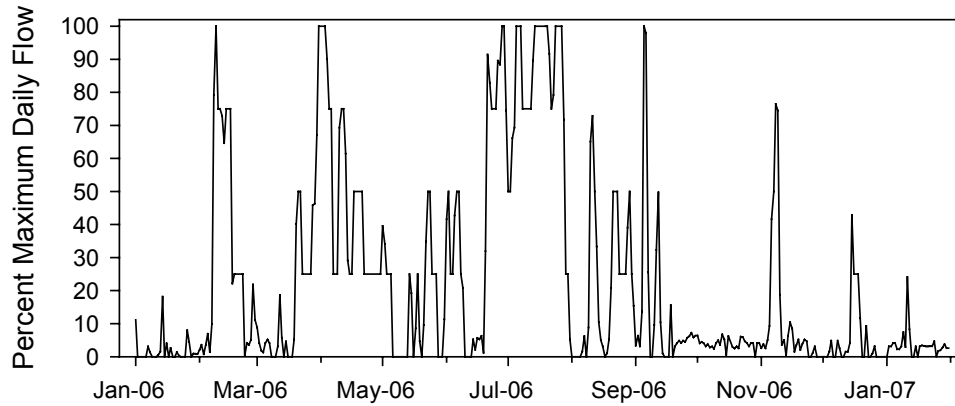

(B)

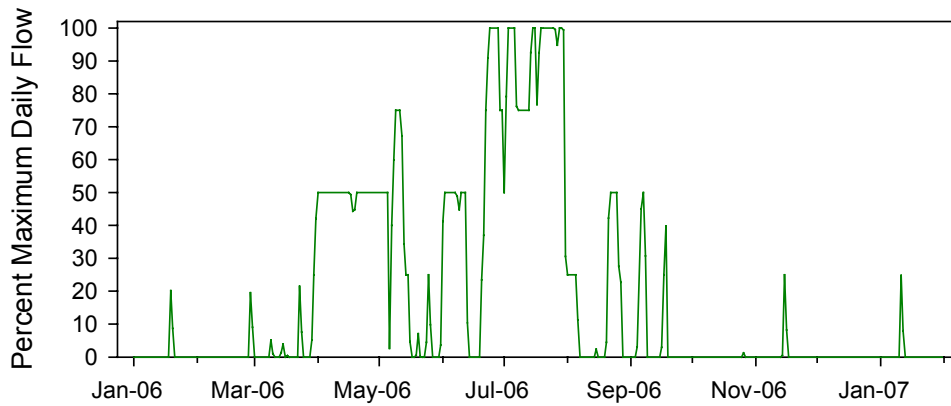

(C)

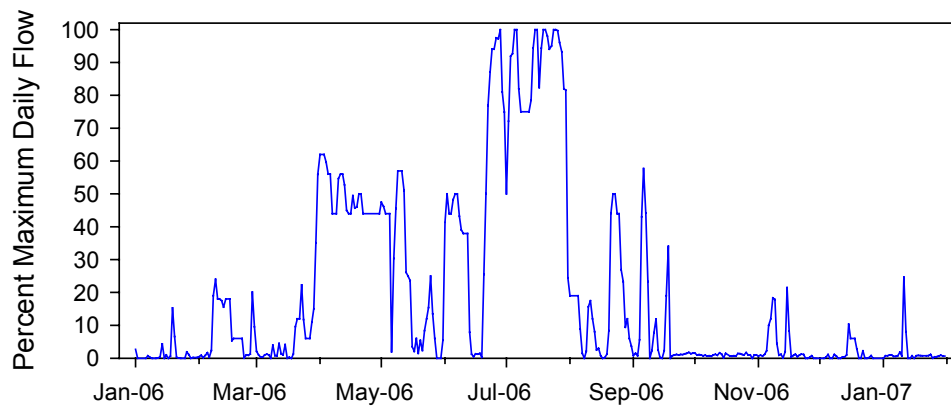

Figure 3.2-5. Daily cooling water flow volumes at the RBGS from January 2006 to February 2007. (A) Units 5&6, (B) Units 7&8, and (C) Units 5 through 8.

### **3.3 ENVIRONMENTAL SETTING**

#### **3.3.1 Physical Description**

Santa Monica Bay is an open embayment approximately 43 km (27 mi) across and delineated by Point Dume, which is located approximately 42 km (26 mi) to the northwest of the RBGS and Palos Verdes Point, which is located approximately 9 km (6 mi) to the south (Figure 3.1-1). The surface area of the Bay is approximately 428 km<sup>2</sup> (266 mi<sup>2</sup>) (MBC 1988). The Bay is characterized by a gently sloping continental shelf which extends seaward to the shelf break at water depths of approximately 80 m (265 ft) (Terry et al. 1956). Natural rocky outcrops are confined to the northern and southern portions of the bay from Point Dume to the Malibu coast area to the north, and the Palos Verdes point area to the south, respectively. Sediments off the RBGS are primarily composed of sand, with lesser amounts of gravel, silt, and clay (MBC 2007).

King Harbor is a shallow, semi-enclosed, man-made harbor. The harbor breakwaters were constructed between 1950 and 1958 (Stephens and Pondella 2002). Subtidal sediments in the harbor and in the nearshore areas are predominantly sand, with lesser amounts of silt and clay (MBC 2007). Prior to the construction of King Harbor, Redondo Canyon was likely a sediment sink. However, the King Harbor breakwater may be impounding sediments that formerly flowed into the canyon (USACE 1986).

##### **3.3.1.1 Physical Features**

There are two submarine canyons in central and southern Santa Monica Bay: Redondo Canyon (off King Harbor, Redondo Beach, California) and Santa Monica Canyon, which is in the central portion of Santa Monica Bay upcoast from the RBGS (Figure 3.3-1). Santa Monica Canyon heads at a depth of about 55 m (180 ft) at a location about 5.6 km (3.5 mi) offshore, and the average gradient along the canyon axis is 3% (Terry et al. 1956). The head of Redondo Canyon is much closer to shore, and the gradient is much steeper at the head (8%). However, the average gradient throughout the rest of the canyon (4%) is similar to that of Santa Monica Canyon.

Wastewater from the City of Los Angeles is discharged into Santa Monica Bay from an ocean discharge that extends 8 km (5 mi) offshore from the Hyperion Treatment Plant (HTP), which is approximately 9 km (6 mi) upcoast from the RBGS. The HTP has a design capacity of 1,703,250 m<sup>3</sup> per day (450 mgd) of secondary-treated effluent. Up until the 1980s, the HTP discharged sludge through another discharge that extends 11 km (7 mi) from shore. That outfall is still in place but not used. A third sewage outfall extends 2 km (1 mi) from shore immediately upcoast from the SGS, but is only used for emergency purposes.

Two other coastal generating stations utilize the bay for cooling water purposes. The El Segundo Generating Station, located approximately 7 km (4 mi) upcoast from the RBGS, operates two cooling water systems with a maximum permitted volume of 2,295,981 m<sup>3</sup> per day (607 mgd). The LADWP SGS, located approximately 8 km (5 mi) upcoast from the RBGS, withdraws up to 1,874,938 m<sup>3</sup> per day (495 mgd) of cooling water from Santa Monica Bay through a single cooling water intake structure. A Chevron refinery also discharges about 22,710 to 26,495 m<sup>3</sup> (6 to 7 mgd) of treated effluent to Santa Monica Bay just downcoast from the SGS.

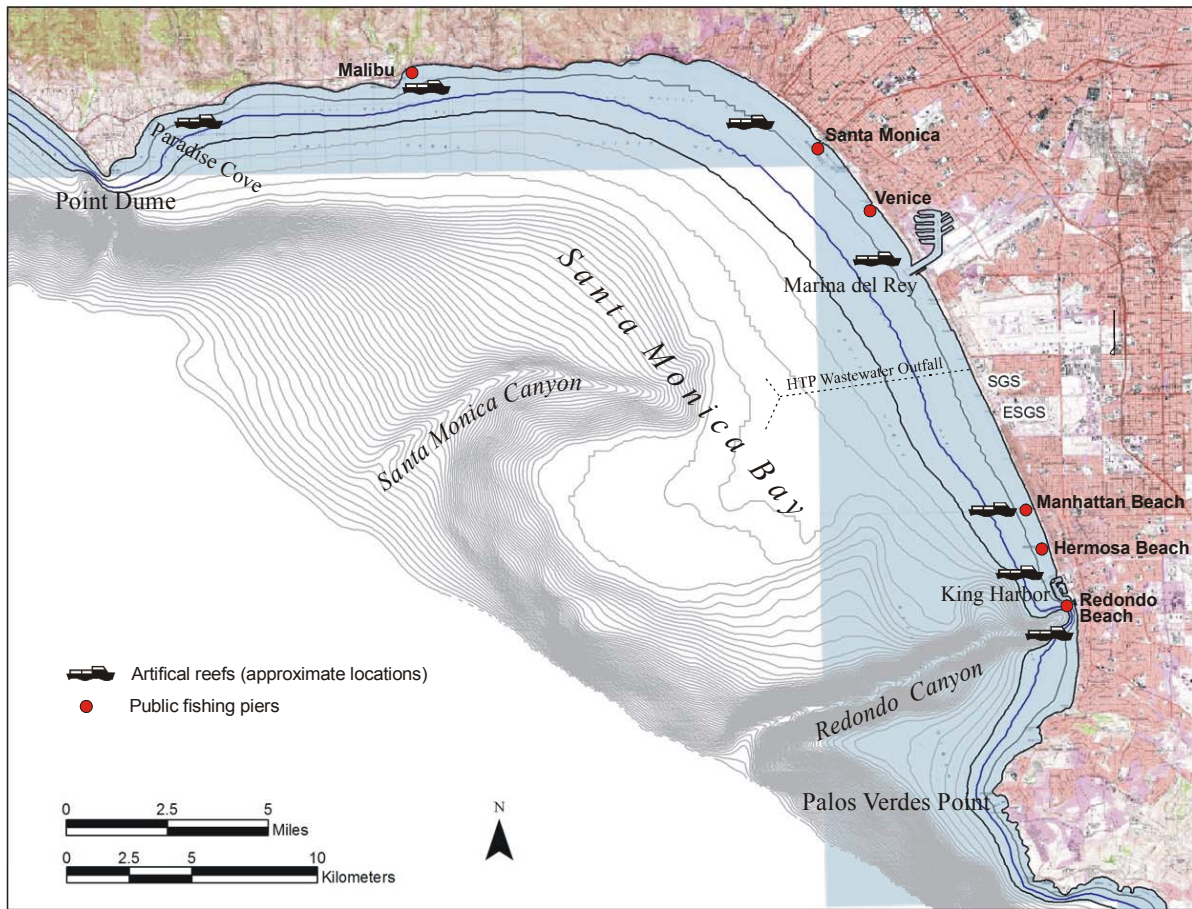

Figure 3.3-1. Santa Monica Bay geographical features.

Two small-vessel harbors serve Santa Monica Bay: Marina del Rey and King Harbor. Fourteen artificial reefs designed to enhance marine life and provide sport fishing opportunities were installed off Malibu, Paradise Cove, Santa Monica, Marina del Rey, Manhattan Beach, Hermosa Beach, and Redondo Beach beginning in 1958; at least nine of these reefs remain (MBC 1993). Public piers are located at Malibu, Santa Monica, Venice, Manhattan Beach, Hermosa Beach, and Redondo Beach.

#### 3.3.1.1.1 Climate and Weather

Southern California lies in a climatic regime defined as Mediterranean, characterized by mild winters and warm, dry summers. In Santa Monica Bay, coolest temperatures generally occur from December through March, with warmest temperatures in August and September (NDBC 2007). Average monthly air temperatures in Santa Monica Bay range from 13 to 15°C (55 to 59°F) from December through March to about 18°C (64°F) in August and September (NDBC 2007). In 2006, monthly average temperatures ranged from 12.6–22.7°C (54.6–72.8°F), while annual minimum and maximum temperatures of 5.0°C

(41.0°F) and 39.9°C (93.0°F) occurred in March and June (National Climatic Data Center Station KLAX). Average annual precipitation in the coastal regions ranges between 25 and 38 cm (10 and 15 in), with most precipitation occurring from October through April.

A subtropical high-pressure system offshore the Southern California Bight (SCB) produces a net weak southerly/onshore flow in the area (Dailey et al. 1993). Wind speeds are usually moderate, and are on the order of 10 km/hr. Wind speeds diminish with proximity to the coast, averaging about one-half the speeds offshore. Coastal winds in southern California are about one-half those found off central and northern California. However, strong winds occasionally accompany the passage of a storm. A diurnal land breeze is typical, particularly during summer, when a thermal low forms over the deserts to the east of the Los Angeles area. On occasion, a high-pressure area develops over the Great Basin, reversing the surface pressure gradient and resulting in strong, dry, gusty offshore winds in the coastal areas. These Santa Ana winds are most common in late summer, but can occur any time of year.

### **3.3.1.2 Temperature and Salinity**

The salinity in the surface waters of the SCB is relatively constant (isohaline). According to Dailey et al. (1993) salinities in the nearshore peak in July at around 33.6 parts per thousand (ppt) and decrease in late winter and early spring to 33.4–33.5 ppt. Tides and temperatures are recorded at the NOAA station (Station ID: 9410840) located on the Santa Monica Pier 11.8 km (7.4 mi) northwest of RBGS (34° 0.5' N, 118° 30.0' W). In 2006, the sea temperatures ranged from a March low of 11.4°C (52.5°F) to 24.3°C (75.7°F) in July and averaged 17.0°C (62.6°F) Figure 3.3-2.

In King Harbor, temperatures are normally slightly higher than in the surrounding Santa Monica Bay since the harbor is more isolated from nearshore currents and surf-induced turbulence (MBC 2006, 2007). However, the volume and temperature of waters discharged from Units 7&8 have a strong influence on the temperature of the receiving waters within King Harbor. In winter and summer, water temperatures within the harbor can be similar to those in the nearshore waters of Santa Monica Bay if Units 7&8 are not operating. Strong thermoclines can develop in summer due to solar insolation and the relatively shallow waters of King Harbor. Salinity is usually between 32.5 and 34.5 ppt in King Harbor, with values increasing with depth (MBC 2006, 2007).



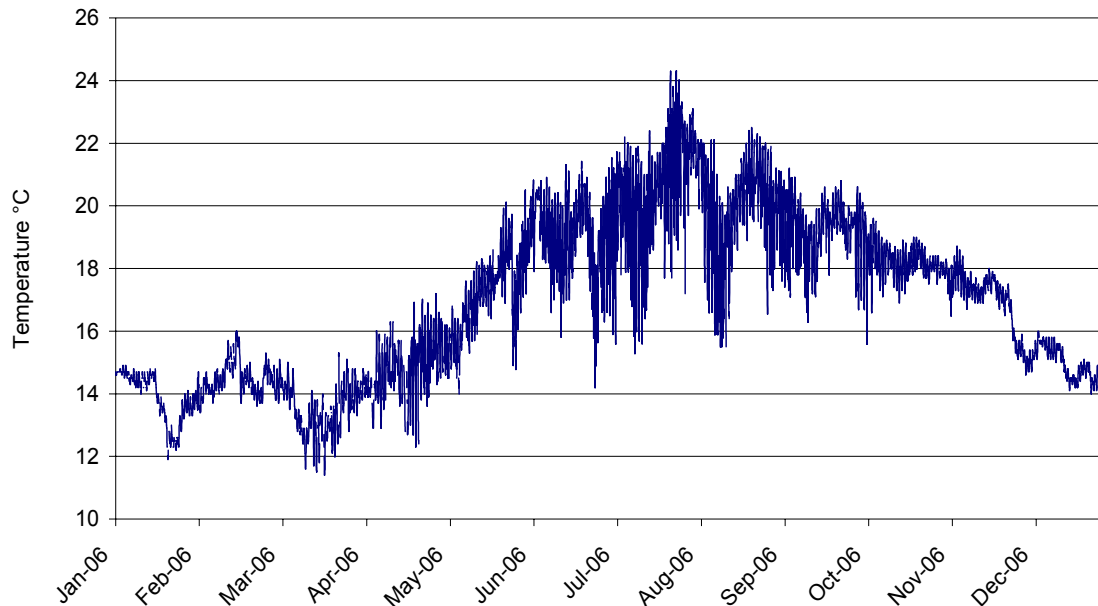

Figure 3.3-2. Hourly surface water temperatures at NOAA Station 9410840 at Santa Monica Pier, California from January through December, 2006.

### 3.3.1.3 Tides and Currents

#### 3.3.1.3.1 Overview

Tides in southern California are classified as mixed, semi-diurnal, with two unequal high tides (high water and higher high water) and two unequal low tides (low water and lower low water) each lunar day (approximately 24.5 hr). From January 2006 through January 2007, water level extremes in Santa Monica Bay ranged from  $-0.622$  m to  $+2.192$  m ( $-2.040$  ft to  $+7.192$  ft) above Mean Lower Low Water (MLLW) (NOS 2007).

Water circulation near RBGS is affected by the presence of the constructed breakwater protecting King Harbor with the inner waters isolated from open coastal circulation and wave-induced turbulence. Water exchange between the harbor and outer coast is driven by a combination of tidally-induced currents and the operation of circulating water pumps from the RBGS.

The prevailing current direction in the shallow, nearshore areas of Santa Monica Bay (SMB) is downcoast (equatorward) suggesting an eddy-type circulation pattern resulting from the upcoast (poleward) currents outside of the bay (Hendricks 1980). This description is supported by more extensive studies by Hickey (1992) that also showed downcoast currents on the shelf within the bay and prevailing upcoast (poleward) currents at the edge of the shelf at the outer boundary of SMB. The circulation pattern within the bay results from the presence of the Southern California Countercurrent in the outer coastal waters of the

Southern California Bight. Hickey et al. (2003) found that subtidal currents in SMB are dominated by relatively long time scales (10–25 days), large alongshore scales, and significant offshore propagation. Large scale remote forcing initially pushes water into the bay as part of a throughflow, later becoming an eddy that produces counterflow in a typically southeastern direction along the SMB shoreline. However, currents shift in relation to upwelling events and other large scale hydrographic processes along the coast (Figure 3.3-3) resulting in flow regimes that differ seasonally (Figure 3.3-4). Current velocities that were measured offshore from the generating station in 2006 are presented in Section 3.4.2—*Source Water Definition*.

Table 3.3-1. Mean velocities (cm/s) in the vicinity of RBGS from Hickey (1992) from October 1985 to February 1986 at Station C1 located at 30 m (100 ft) bottom depth.

Depth (m)	OCT		NOV		DEC		JAN		ALL	
	u*	v	u	v	u	v	u	v	u	v
5	-1.2	-8.8	-1.1	-7.9	-0.3	-1.7	-0.4	-1.3	-0.7	-4.5
10	1.3	-6.4	1.2	-5.2	1.0	-0.9	0.7	-0.5	1.0	-2.9
20	-0.4	-3.2	-0.5	-2.1	0.3	1.9	-0.1	0.6	-0.1	-0.3

\*Note: u=across basin, v=along basin.

Hickey (1992) described the residence time of water within the Santa Monica and San Pedro basins using drifters. She found that the residence time is both spatially and temporally variable as some drifters barely moved at all whereas others nearby moved large distances in the same period. Drifters deployed in January 1990 escaped westward in about a week. In the July, residence times were only 3–5 days for drifters deployed anywhere over Santa Monica Basin. She found that drifters caught up by the Santa Monica canyon eddy escaped the basin in less than one week, and that most of the other drifters that were not cast ashore escaped the Bight in the ~2 week deployment period, roughly half passing north into the Santa Barbara Channel and half passing south of the Channel Islands.

The CROSS oceanographic study deployed current meters in the Santa Monica Basin over bottoms as shallow as 30 m (100 ft) in Santa Monica Bay from October 1985 to February 1986 (Hickey 1992). Monthly mean velocities from three depths at the station closest to RBGS are presented in Table 3.3-1.

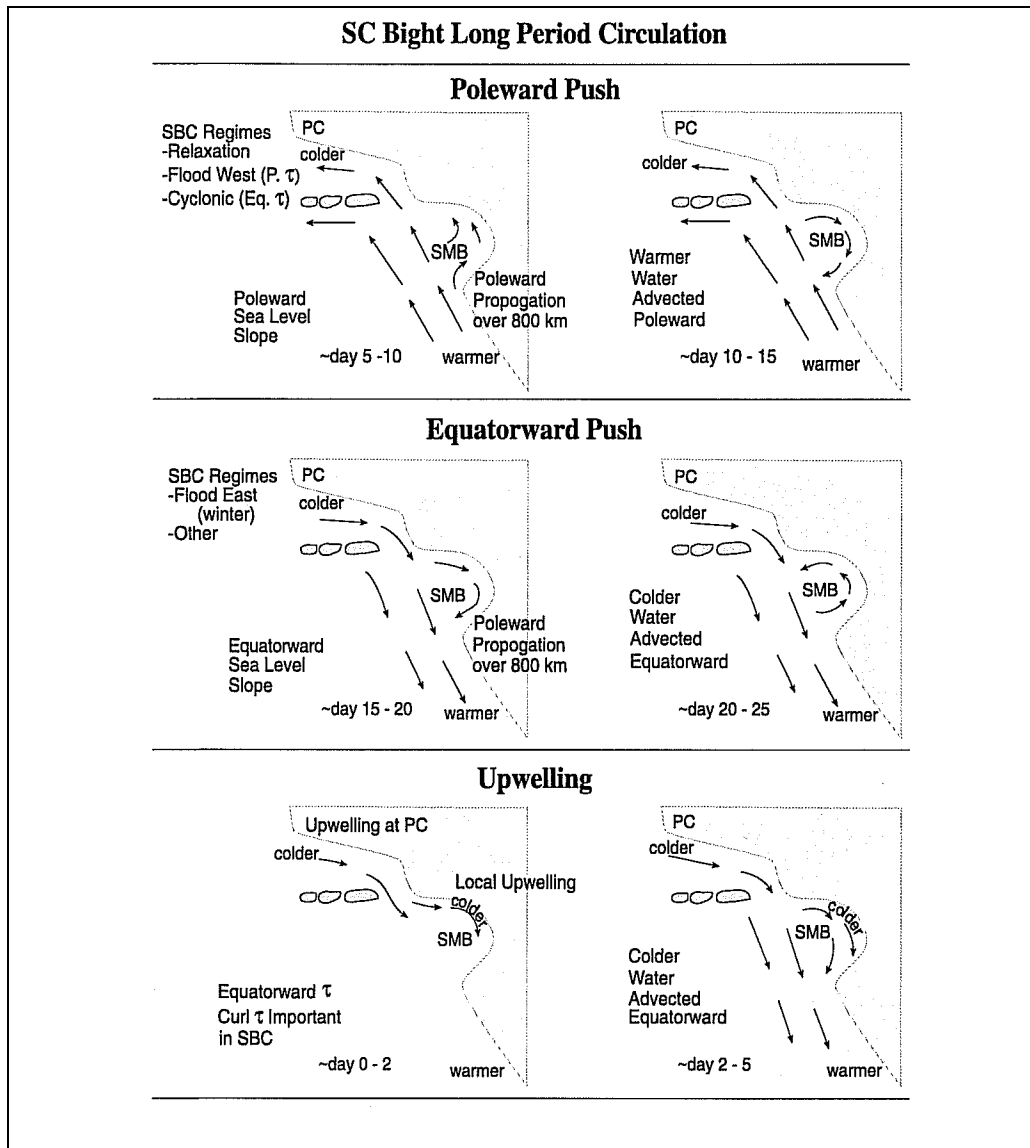

Figure 3.3-3. Schematic showing processes affecting long-period circulation and water properties in the Southern California Bight (from Hickey et al. 2003).

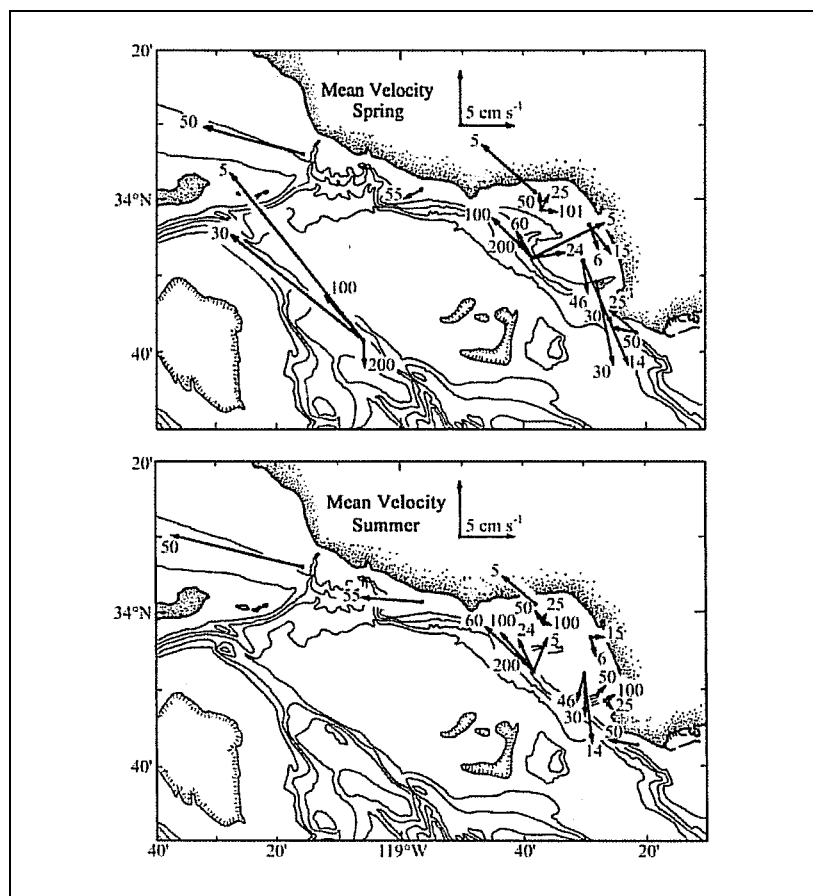

Figure 3.3-4. Selected mean currents in the central Southern California Bight for spring and summer. Measurement depth in meters is given near the tip of each arrow (from Hickey et al. 2003).

### 3.3.1.3.2 2006 ADCP Deployment

Physical oceanographic data were collected from the source water body to describe current regimes that can affect larval transport in the vicinity of the RBGS. A Nortek Aquadopp® acoustic Doppler current profiler (ADCP) was positioned approximately 1.0 km (0.6 mi) from shore at a depth of  $-16.15$  m ( $-53$  ft) MLLW (CM5, Figure 3.3-5). The position of the station was  $33.852542^{\circ}\text{N}$ ,  $-118.410757^{\circ}\text{W}$ . The CM5 station was commissioned on January 10, 2006 and was decommissioned on January 19, 2007. Data were downloaded on February 3, 2006, May 3, 2006, and September 1, 2006. CM5 had an operating frequency of 1 MHz (Table 3.3-2) and collected data at hourly intervals in a usable range that extended from 0.4 m (blinking range, 1.3 ft) from the ADCP to somewhat less than 90% of the distance to the surface. The half-power full beam-width was 2.4 degrees. Other measurement specifications are listed in Table 3.3-2. Water temperature and water depth (pressure) were also measured by the unit. Water temperatures were calibrated over an approximately four-month period from September 2006 to January

2007 using a calibrated Starr-Oddi thermistor. Pressure measurements were adjusted using barometric pressure data measured at the Los Angeles International Airport and corrected for sea level.

Table 3.3-2. ADCP deployment parameters for current meter in the vicinity of RBGS (Station CM5).

Unit	Oper. Freq.	Deploy depth (m)	Cells (#)	Cell size (m)	Max. range (m)	Cell precision (cm/s)	Ping rate	Averaging Interval (s)	Repetition rate (hr)
CM5	1 MHZ	16.15	17	1.0	17.4	0.8	87%	180	1.0

The velocities recorded from near bottom to the near surface were averaged at hourly intervals to estimate water column average east and north velocity vectors. Hourly east and north displacements, calculated by the product of velocity and time, were used to estimate net displacement over the year. The coastline north of the current meter station is oriented to 347.6°T and south of the station the coastline runs almost north to south, and therefore the 12.4° rotation was applied to present current vectors in onshore and alongshore components. The sum of the hourly alongshore components of the current measurement was maximized by applying a rotation of 12.4° at Station CM5. After rotating current velocities and averaging over the water column, the cumulative current vectors were plotted.

Figure 3.3-6 shows the net displacements at the current meter stations from January 2006 to January 2007 relative to the current meter location. During the 13-month measurement period the net displacement of water was to the west (offshore) and slightly to the north (upcoast). During the first six months of 2006 currents moved offshore with a net downcoast movement until mid-summer when flows shifted to predominantly upcoast direction (Figure 3.3-6). Periodic upcoast and downcoast reversals occurred with approximately bi-weekly frequency indicating a tidal component to the shifts.

Current vector frequencies, water temperatures and tidal elevation data from the ADCP unit are presented as monthly plots in Appendix A. Water depths at CM5 varied from a low of 15.5 m (50.9 ft) to a high of 18.3 m (60.0 ft) MLLW and averaged 16.2 m (53.2 ft). Temperature varied from a minimum of 10.2°C (50.4°F) in April 2006 to a maximum of 20.8°C (69.4°F) in July 2006 with an average of 13.4°C (56.1°F).

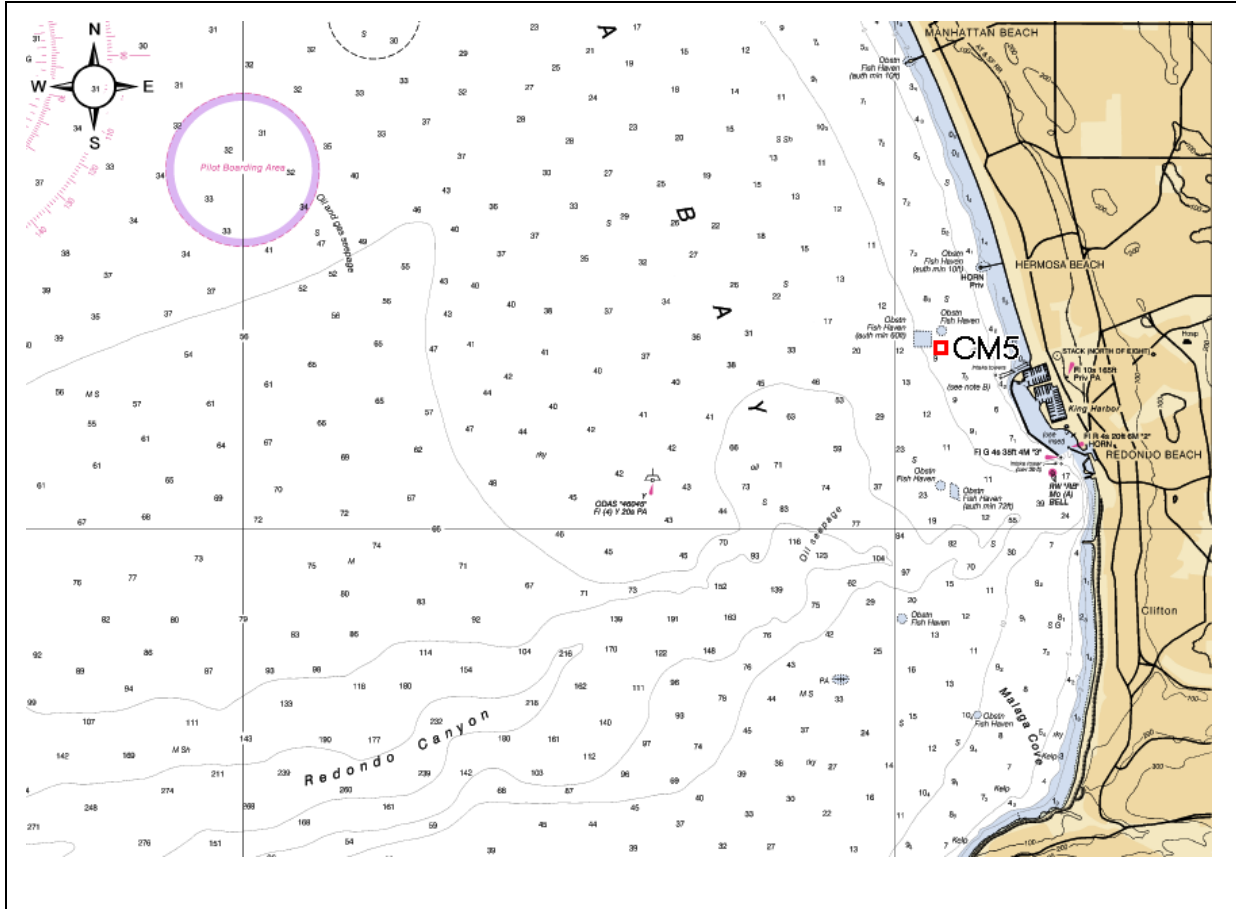

Figure 3.3-5. Location of current meter station CM5 that was deployed from January 2006 to January 2007.

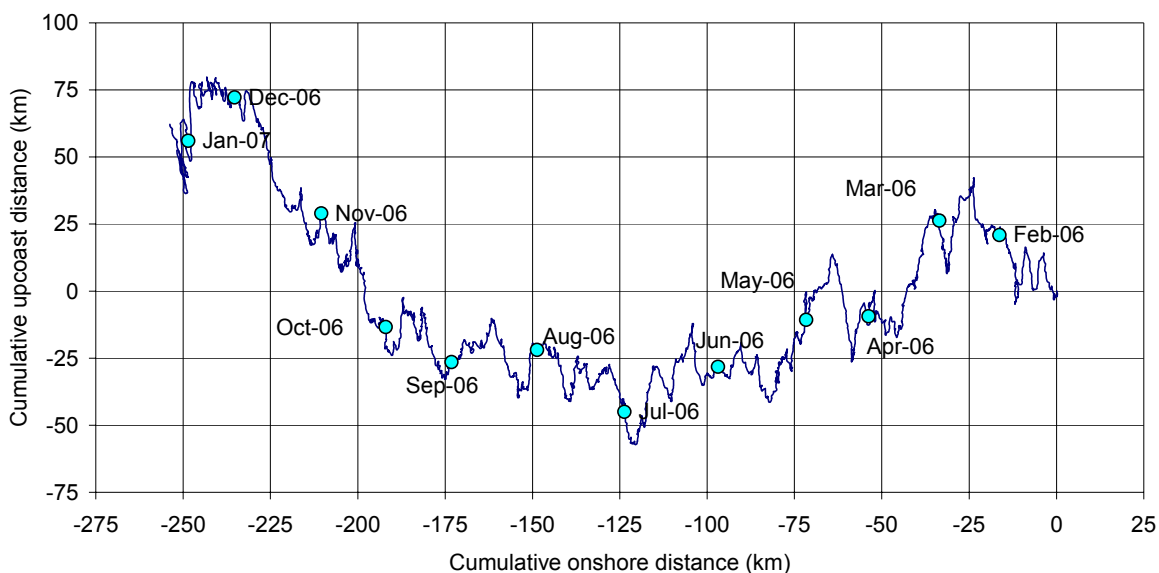

Figure 3.3-6. Cumulative current vectors from Station CM in Santa Monica Bay, January 2006–January 2007.

### 3.3.2 Source Water Definition

The source water study area was designed to 1) characterize the larvae of ichthyoplankton and shellfish larvae potentially entrained by the RBGS cooling water intakes, and 2) be representative of the nearshore habitats in the vicinity of the RBGS intakes.

#### 3.3.2.1 Study Requirements and Rationale

The primary approach for assessing the effects of entrainment by the RBGS requires an estimate of the source water population for each species entrained. The spatial extent of the source water population subject to entrainment is a function of larval duration and circulation of the seawater. Information on larval duration is estimated from data on the length of the larvae collected from the entrainment samples. The volume of the source water in the nearshore area, which is potentially subject to entrainment, is affected by currents that change seasonally and due to weather and sea conditions. The rationale and methods for defining the source water for the RBGS are described in the following sections.

To determine composition and abundance of ichthyoplankton in the source water, sampling was done monthly on the same day that the entrainment station was sampled. The source water sampling design was proposed because of the need to extrapolate densities offshore to determine the appropriate source water area during each survey. Source water was sampled at seven stations located upcoast, downcoast, and offshore from the RBGS intake structure and inside King Harbor (Figure 3.3-7). Offshore stations

(Series O) were targeted at the 25 m (81 ft) MLLW depth contour, and inshore (Series S) stations were at 10 m (33 ft) MLLW. The harbor stations (Series H) averaged approximately 9 m (30 ft).

The spacing of the samples upcoast and downcoast was based on a review of water current data available from the area. Data from Hickey (1992) showed that nearshore alongshelf water currents in Santa Monica Bay averaged 0.15 ft/s (4.5 cm/s) with a monthly maximum average speed of 0.29 ft/s (8.8 cm/s). Based on these water current speeds, the distances that larvae could be transported alongshore during a day ranged from 2.4 to 4.7 mi (3.9 to 7.6 km). The maximum value was used to determine the alongshore extent of the source water sampling stations since the proportional entrainment estimate used in the *ETM* is an estimate of the daily entrainment mortality on the available source water population. The spacing of the stations was also designed for consistency with source water sampling done for the Scattergood and El Segundo Generating Stations further upcoast in Santa Monica Bay. The RBGS stations did not include the stations further offshore that were sampled for the other plants because deeper depths occur closer to shore at King Harbor due to the presence of the Redondo Submarine Canyon (Figure 3.3-7).

### **3.3.2.2 Methods for Calculating RBGS Source Water**

The Redondo Beach source water region was divided into two areas. One was the harbor source water area delineated by a boundary connecting the tips of the King Harbor breakwaters, and the other was the offshore source water represented by the area approximately 3,400 m (11,155 ft) upcoast and downcoast from the King Harbor entrance and offshore approximately 2,400 m (7,785 ft) parallel to the shoreline. The inshore and nearshore X-Y-Z bathymetry (gridded) data were provided by Redondo Beach Harbor Bathymetry from U.S. Army Corps of Engineers (USACE). The 50 m grid cells used for offshore source water area and volume calculations were created from 10-m contour lines from the California Department of Fish and Game GIS (2007a). The California Department of Fish and Game contours were derived from grid files made from 75 original tiled digital elevation models (DEMs) that were mosaiced into one grid and resampled to 200 m. These mosaiced DEMs were produced by Teale Data Center from a contract with the Department of Fish and Game, funded by the Resources Agency. Using ArcInfo 8.1, 10-m contour intervals were created out to 600 m.

All depths (elevations) for determining source water volumes and planimetric surface areas for the Santa Monica Bay were relative to MSL as measured at the tide gauge at Station 9410840, Santa Monica, CA. All themes were re-projected to the Albers Equal Area Projection (tn83m). A coastline theme was created from USGS topographic maps at 1:24,000 in the tn83m projection. All Coastal Maps were georeferenced to the California Digital Raster Graphics (DRGs), 7.5 Minute (O) Series, Albers NAD83.



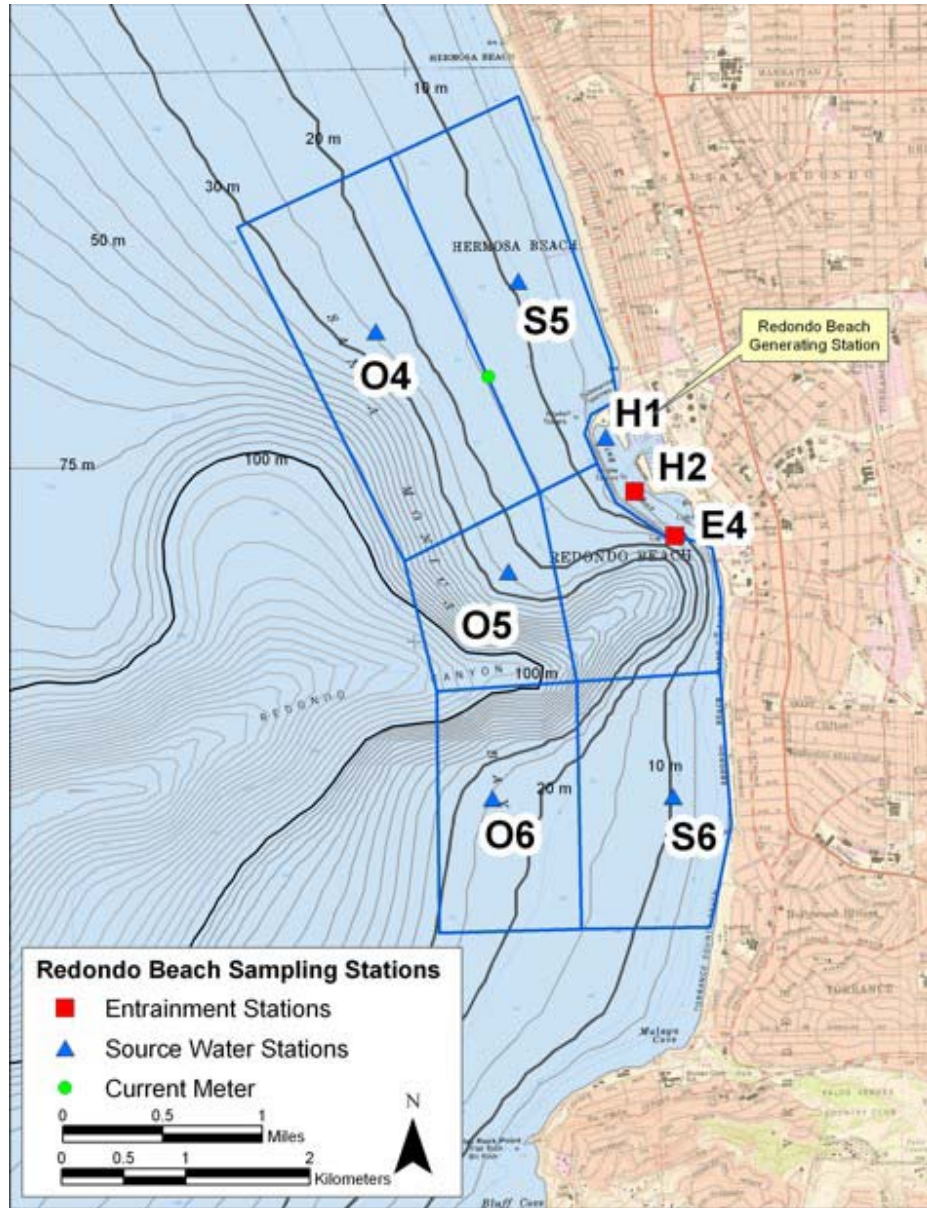

Figure 3.3-7. Locations of the RBGS entrapment and source water sampling stations, and current meter stations within the study grid.

### 3.3.3 Biological Resources

The following sections describe the aquatic biological habitats and communities in the vicinity of the RBGS, including both invertebrate and fish communities. Santa Monica Bay is the submerged portion of the Los Angeles Coastal Plain, and includes several types of marine habitat that support more than 5,000 species of plants and animals (SMBRC 2004). Most marine organisms within Santa Monica Bay and its watershed are temperate species with geographic ranges extending far beyond the immediate area. Most species are members of the San Diegan Province, which extends from Point Conception south to

Magdalena Bay, Baja California Sur (Horn and Allen 1978). Fewer species belong to the Oregonian Province, which ranges from southern Canada to northern Baja California.

### **3.3.3.1 Habitat Variation**

The pelagic habitat of Santa Monica Bay includes the entire water column within the bay, a volume of approximately 6,840 billion gallons (MBC 1993). Organisms found in this habitat include a myriad of planktonic organisms (phytoplankton, zooplankton, and ichthyoplankton) that have little or no swimming ability to resist ocean currents, and nektonic organisms, such as fishes and sharks that are freely mobile in local and oceanic currents. The pelagic habitat also supports large numbers of pinnipeds (including Pacific harbor seal and California sea lion), cetaceans (such as gray whale, bottlenose dolphin, and common dolphin), and birds, including California brown pelican, terns, and gulls (MBC 1988).

Intertidal habitat within the Santa Monica Bay is divided almost equally between sandy and rocky habitats (MBC 1988). Rocky intertidal habitat is comprised of both natural and artificial rocky substrate, such as the breakwaters at Marina del Rey and King Harbor. Natural rocky intertidal substrate occurs along the Malibu coast from Point Dume to Paradise Cove, along occasional patches from Paradise Cove to Big Rock Beach, and south along the Palos Verdes Peninsula.

Giant kelp beds occur on submerged rocky reefs in depths of about 20 to 70 ft. At present, kelp beds are limited to locations on the Palos Verdes Shelf, approximately 6 km (3.7 mi) south of King Harbor, and along Leo Carillo State Beach and the Malibu coast, approximately 30 km (18.6 mi) to the northwest (SMBRC 2004). Current canopy coverage is relatively low compared to historic coverage, but the extent of kelp is considered stable at Palos Verdes. The kelp beds in the Malibu area have increased in recent years, due in part to recent restoration efforts, improved water quality, and favorable oceanic conditions.

Most of the seafloor in the Santa Monica Bay and King Harbor consists of unconsolidated (soft) sediments comprised of sand, silt, and clay. Most of the energy entering this habitat is in the form of detrital fallout and phytoplankton from the pelagic habitat, although detritus from surface runoff and discharged sewage may also be important (MBC 1988). A high proportion of soft-bottom benthos live most of their lives permanently in the sediments and are termed infauna; those which live on the surface of the seafloor are called epifauna. The soft-bottom habitat also supports several species of algae, macrofauna/megafauna (including crabs, snails, sea stars, urchins, and sea cucumbers), and fishes, including California halibut (*Paralichthys californicus*).

Ten brackish wetlands of various sizes and conditions located along Santa Monica Bay contribute larval and adult forms of marsh fish and invertebrates and vegetative organic production. The marshes range from small, seasonally-inundated river mouths (Zuma Beach west of Point Dume) to the larger Ballona Wetlands Complex at Marina del Rey. Historically, the Los Angeles River occasionally emptied into Santa Monica Bay at Ballona Creek instead of at its present-day mouth at Long Beach. The course of the River changed during unusually heavy storms from 1815–1825 and again in 1862 and 1884 (Terry et al. 1956). The area between Ballona Creek and present-day Beverly Hills was often a vast swamp. In 1868, the Ballona Wetlands comprised 8.5 km<sup>2</sup> (2,100 acres). Development of Marina del Rey, the Venice

Canal system, residential and commercial properties, and the channelization of Ballona Creek reduced this area to less than 0.6 km<sup>2</sup> (160 acres) of wetland habitat (MBC 1993).

The wetlands at Ballona Creek, 14 km (8.7 mi) north of King Harbor, support a number of transient fish species but only nine residents (Swift and Frantz 1981). Dominant species include arrow goby (*Clevelandia ios*), mosquitofish (*Gambusia affinis*; a freshwater species), and topsmelt (*Atherinops affinis*). Numerous shorebirds, water fowl, and terrestrial birds are known to occur at Ballona wetlands, Marina del Rey, and Malibu Lagoon (MBC 1988).

There are no major freshwater rivers that empty into the Santa Monica Bay, though there are some smaller streams. Small freshwater marshes occur at Malibu Lagoon and at Ballona Creek (MBC 1988). These marshes are home to numerous insects, amphibians, reptiles, and birds that live among the tules, cattails, and pond weeds (Jaeger and Smith 1966). Fresh water introduced by storm water and urban runoff has attracted increased attention in recent years. Control of pollutants from runoff has proven difficult due to the ubiquitous nature of the sources and current storm water regulations rely on compliance with best management practices instead of clearly defined effluent limits (SMBRC 2004).

Some of the important human uses of the Santa Monica Bay that have directly and indirectly affected its ecology include sport and commercial fishing, industrial uses, and coastal development. Approximately 48% of the Santa Monica Bay's watershed is characterized as developed (SMBRC 2004). Most of the remaining undeveloped area is located in the Santa Monica Mountains National Recreation Area. Commercial fishing was banned throughout most of Santa Monica Bay by the California Department of Fish and Game in 1933 (MBC 1985). Sport fishing is allowed throughout the Santa Monica Bay, and landings are currently operated out of Marina del Rey and King Harbor. Recreational fish are also caught by private boaters, from shore, and from piers. Several artificial reefs were constructed in the Santa Monica Bay beginning in 1958 to enhance marine life and fishing opportunities (MBC 1988).

Industrial uses of the Santa Monica Bay include cooling water supply, transport and refinery of oil/gas products, and waste disposal. Both the Joint Water Pollution Control Plant (JWPCP) and the Hyperion Treatment Plant discharge treated wastewater to the Santa Monica Bay. These facilities achieved full secondary treatment as of 1998 for Hyperion Treatment Plant and late 2002 for JWPCP (SMBRC 2004). Since 1971 there has been a steady decrease of contaminant inputs from these facilities to the Bay. Still, the Santa Monica Bay is listed as a Section 303(d) impaired waterbody largely due to sediment contamination resulting from the historic discharge of wastewater and sludge.

### **3.3.3.2 Nursery Grounds**

It is unknown to what extent Santa Monica Bay serves as a nursery for fish and invertebrate species; however, it can be assumed that the variety of habitat types within the bay are likely used by numerous species for such purposes. On the open coast, recruitment to the mainland shelf occurs year-round, but is greatest from winter to spring (Cross and Allen 1993). The rocky intertidal zone is a turbulent and dynamic environment, and in southern California there are only a handful of fish species considered residents of this habitat, including some sculpins (Cottidae) and pricklebacks (Stichaeidae). Most resident

intertidal fishes lay demersal rather than planktonic eggs, and parental care is relatively high (Horn and Martin 2006). The larvae of most intertidal fishes spend about one to two months in the plankton, but disperse only short distances and tend to stay within the area they were hatched.

Reefs and kelp beds provide habitat for a wide variety of fishes and invertebrates. Most commonly, passive drift carries late larval stages to the vicinity of these habitats where settlement takes place (Cowen 1985). In other species (possibly including chubs and giant kelpfish [*Heterostichus rostratus*]), actively swimming late larval stages may follow gradients in perceptual cues or internal waves to reefs. In still other species, larvae produced on a reef may have behavioral mechanisms to retard drift processes, keeping them in the local area for settlement (Stephens et al. 2006). Pondella et al. (2002) determined densities of adult black perch (*Embiotoca jacksoni*) and pile perch (*Rhacochilus vacca*) remained stable during the period 1974-1998, indicative of a mature reef community. However, during this same time period, density of sub-adults for both species decreased at King Harbor and nearby Rancho Palos Verdes, while density of juveniles was relatively constant. Overall, the authors determined that surfperch production at King Harbor (an artificial reef) was higher than that at Rancho Palos Verdes (a natural reference reef). From 1974-1993, the number of young-of-the-year fish of all species that recruited annually to King Harbor and Palos Verdes was highly correlated with the annual biomass of macrozooplankton in the California Current, and indicator of Bight-wide productivity (Holbrook et al. 1997). Furthermore, the relationships between macrozooplankton biomass and annual recruitment did not differ between surfperches (live-bearers) and fishes that disperse larvae during spawning.

On the soft-bottom substrata of the southern California mainland shelf, Allen (1982) found that 45% of the 40 major fish community members had pelagic eggs and larvae, 18% (all rockfishes) were ovoviviparous with pelagic larvae, 15% had demersal eggs and pelagic larvae (such as combfishes, sculpins, and poachers), 12% were viviparous (bearing live young—all surfperches), and 10% had demersal eggs and larvae (including midshipman and eelpouts). Southern California is located at the edge of the geographic range of many cool- and warm-water fish species, and recruitment of juveniles is episodic and species dependent (Allen 2006). Coastal settlement is more variable than in bays, and interannual variation is probably primarily due to oceanic conditions that affect transport and survival of larvae, along with spawning success and availability of suitable benthic habitat for settling juveniles. In 1989, Allen and Herbinson (1991) surveyed bay, open coast, and protected coastal habitats in southern California with fine-mesh beam trawls. In general, fish densities were higher in bays than on the open coast, densities decreased with increasing depth, and highest densities were recorded in spring (May). On the inner shelf (6 to 15 m, or 20 to 49 ft), speckled sanddab (*Citharichthys stigmaeus*) was the most frequent juvenile fish taxa encountered, but queenfish (*Seriphus politus*) was most abundant.

### **3.3.3.3 Fish Diversity**

From 1991 through 2006, at least 103 distinct fish species were impinged during normal operations and heat treatments at the RBGS (MBC 2007). The most abundant taxa were Pacific sardine (*Sardinops sagax*), blacksmith (*Chromis punctipinnis*), and queenfish. These three species combined accounted for 62% of annual impingement abundance. Nearly 93% of the Pacific sardine were impinged during 1992 and 1993, and their abundance declined dramatically thereafter. An average of about 49 fish species are

impinged annually. In 2005, the most abundant species were shiner perch (*Cymatogaster aggregata*), queenfish, and California scorpionfish (*Scorpaena guttata*).

McGowen (1978) recorded 46 egg types from King Harbor and surrounding waters in 1974 and 1975, although 81 to 87% of those were unidentifiable. In winter, the most abundant larvae were from sculpins and croakers (Sciaenidae), while gobies (Gobiidae) were dominant in spring. In summer, the most abundant larvae were those of combtooth blennies (*Hypsoblennius* spp.), clinid kelpfishes (Clinidae), gobies, and croakers. Highest densities of combtooth blennies, Goby Type A, and snubnose pipefish (formerly *Bryx arctus*, now *Cosmocampus arctus*) larvae occurred at stations furthest in King Harbor, while the percentage of larvae which hatched from pelagic eggs increased with distance from the inner reaches of the harbor. In total, more than 90% of the larval fishes of the surface waters of King Harbor and nearby Santa Monica Bay were found to belong to just five fish families: Blenniidae, Clinidae, Gobiidae, Engraulidae (anchovies), and Sciaenidae.

#### **3.3.3.4 Shellfish Diversity**

In 2005, 27 macroinvertebrate taxa were collected in impingement samples at the RBGS (MBC 2006). The most abundant taxa were unidentified moon jelly (*Aurelia* sp), purple-striped jelly (*Chrysaora colorata*), and red rock shrimp (*Lysmata californica*). Impingement abundance was slightly higher at Units 7&8 (59%) than at Units 5&6 (41%). However, biomass was substantially greater at Units 7&8 (198 kg) than at Units 5&6 (52 kg), due primarily to the higher number of larger individuals of purple-striped jelly, California spiny lobster (*Panulirus interruptus*), and sheep crab (*Loxorhynchus grandis*).

#### **3.3.3.5 Protected Species**

The §316(b) regulations require “...*taxonomic identifications of all life stages of fish, shellfish, and any species protected under Federal, State, or Tribal law (including threatened and endangered species identified pursuant to paragraph (b)(3)(i) of this section, including a description of the abundance and temporal and spatial characteristics in the vicinity of the cooling water intake structure(s), based on sufficient data to characterize annual, seasonal, and diel variations in impingement mortality and entrainment (e.g. related to climate and weather differences, spawning, feeding, and water column migration). These may include historical data that are representative of the current operation of your facility and of biological conditions of the site.*”

On January 30, 2007, representatives from AES Redondo Beach, MBC Applied Environmental Sciences, and Tenera Environmental met with representatives from the LARWQCB, EPA Region IX, State Water Resources Control Board (SWRCB), CDFG, and NMFS to review preliminary data from the RBGS IM&E Characterization Study, and determine the fish and shellfish taxa to be assessed in the RBGS IM&E Characterization Study Report. The meeting was also attended by representatives from Heal the Bay and Santa Monica Baykeeper.

No Federal/State threatened or endangered fish/shellfish species were identified in entrainment and impingement samples at the RBGS (see Sections 4.0 and 5.0). This is consistent with past entrainment and impingement sampling conducted at the RBGS.

At the January 30 meeting, NMFS requested that all species impinged or entrained that have Essential Fish Habitat (EFH) designated under the Magnuson-Stevens Fishery Conservation and Management Act (Magnuson-Stevens Act) be assessed in the RBGS IM&E Report. It was further agreed that for entrainment, additional demographic or ETM calculations would only be performed on these species if they were collected in sufficient numbers in entrainment and source water samples, and if sufficient life history information was available to permit those calculations.

Off southern California, the species with EFH designated are listed in the Coastal Pelagics Fishery Management Plan (FMP) and Pacific Groundfish FMP. The goals of the management plans include, but are not limited to: the promotion of an efficient and profitable fishery, achievement of optimal yield, provision of adequate forage for dependent species, prevention of overfishing, and development of long-term research plans (PFMS 1998; 2006b). There are four fish and one invertebrate species covered under the Coastal Pelagics FMP: northern anchovy, Pacific sardine (*Sardinops sagax*), jack mackerel (*Trachurus symmetricus*), Pacific chub mackerel (*Scomber japonicus*), and market squid (*Loligo opalescens*). There are 89 fish species covered under the Pacific Groundfish FMP, including ratfish (*Hydrolagus colliei*), finescale codling (*Antimora microlepis*), Pacific rattail (*Coryphaenoides acrolepis*), three species of sharks, three skates, six species of roundfish, 62 species of scorpionfishes and thornyheads, and 12 species of flatfishes. For both the Coastal Pelagics and Pacific Groundfish, EFH includes all the waters off southern California offshore to the Exclusive Economic Zone. A list of species covered under the two FMPs that occurred during entrainment and impingement sampling at the RBGS is provided in Table 3.3-1. More information on these species is provided in Sections 4.0 and 5.0.

Table 3.3-1. Fish and shellfish species with designated EFH or CDFG special status species entrained and/or impinged at the RBGS in 2006.

<b>Species</b>	<b>Common Name</b>	<b>Management Group</b>
<i>Engraulis mordax</i>	northern anchovy	Coastal Pelagics
<i>Loligo opalescens</i>	market squid	Coastal Pelagics
<i>Sardinops sagax</i>	Pacific sardine	Coastal Pelagics
<i>Hypsypops rubicundus</i>	garibaldi	CDFG
<i>Leuresthes tenuis</i>	California grunion	CDFG
<i>Citharichthys sordidus</i>	Pacific sanddab	Pacific Groundfish
<i>Merluccius productus</i>	Pacific hake	Pacific Groundfish
<i>Microstomus pacificus</i>	Dover sole	Pacific Groundfish
<i>Parophrys vetulus</i>	English sole	Pacific Groundfish
<i>Platichthys stellatus</i>	starry flounder	Pacific Groundfish
<i>Scorpaena guttata</i>	Calif. scorpionfish	Pacific Groundfish
<i>Scorpaenichthys marmoratus</i>	cabazon	Pacific Groundfish
<i>Sebastes</i> spp	rockfishes	Pacific Groundfish
<i>Sebastes auriculatus</i>	brown rockfish	Pacific Groundfish
<i>Sebastes miniatus</i>	vermilion rockfish	Pacific Groundfish

Some fish and invertebrate species (abalone) in southern California are protected under CDFG regulations although few marine species are listed as either threatened or endangered. Special-status species that could potentially occur in the vicinity of the RBGS and that have planktonic larvae potentially at risk of entrainment include garibaldi (*Hypsypops rubicundus*), tidewater goby (*Eucyclogobius newberryi*), giant sea bass (*Stereolepis gigas*), and California grunion (*Leuresthes tenuis*).

The garibaldi, designated as the California state marine fish, is a bright orange shallow-water species that is relatively common around natural and artificial rock reefs in southern California. Because of its territorial behavior it is an easy target for fishers and could be significantly depleted if not protected. Garibaldi spawn from March through October, and the female deposits demersal adhesive eggs in a nest that may contain up to 190,000 eggs deposited by several females (Fitch and Lavenberg 1975). Larval duration ranges from 18–22 days (mean of 20 days) based on daily incremental marks on otoliths in recently settled individuals (Wellington and Victor 1989). The larvae are susceptible to entrainment, particularly in summer months when spawning is at its peak.

The giant sea bass is a long-lived species that can grow to over 2.1 m (7 ft) in length and weigh over 227 kg (500 lbs) (Love 1996). Giant sea bass were once a relatively common inhabitant of Southern California waters, yet in the 1980s it was facing the threat of local extinction off the California coast due to overfishing. Actions were taken by CDFG, resulting in protection from commercial and sport fishing that went into effect in 1982. Although the larvae are potentially susceptible to entrainment from coastally-sited power plants in southern California, no giant sea bass larvae have been identified from entrainment samples.

The tidewater goby is a fish species endemic to California and is listed as federally endangered. The tidewater goby is threatened by modification and loss of habitat resulting primarily from coastal development. It appears to spend all life stages in lagoons, estuaries, and river mouths (Swift et al. 1989) but may enter marine environments when flushed out of these preferred habitats during storm events. Adults or larvae may not survive for long periods in the marine environment but larval transport over short distances may be a natural mechanism for local dispersal.

California grunion is a special status species not because the population is threatened or endangered, but because their spring-summer spawning activity on southern California beaches puts them at risk of overharvesting, and CDFG actively manages the fishery to ensure sustainability. Spawning occurs only three or four nights following each full or new moon, and then only for 1–3 hours immediately after the high tide, from late February to early September (Love 1996). The female swims onto the beach, digs tail-first into the wet sand, and lays her eggs which are then fertilized by the male. After the eggs hatch, the larvae are carried offshore and can be susceptible to entrainment for approximately 30 days as they develop in the plankton.

## 4.0 COOLING WATER INTAKE STRUCTURE ENTRAINMENT AND SOURCE WATER STUDY

### 4.1 INTRODUCTION

The entrainment study incorporates two design elements: 1) CWIS sampling, and 2) source water sampling. Sampling at the Units 5&6 intakes and 7&8 intakes provided estimates of the total numbers of each larval species entrained through the CWIS depending on pumping capacity. The sampling design was originally not designed to estimate entrainment for Units 5&6, but one of the source water stations in King Harbor was located in the vicinity of the intake so entrainment could also be estimated for the CWIS for those units. The source water populations of fish and shellfish larvae were sampled to estimate proportional entrainment losses for selected species. Abundances of larval fishes and shellfishes vary throughout the year due to changes in composition and the oceanographic environment. The sampling design was consistent with other recently completed entrainment studies conducted for the AES Huntington Beach Generating Station (MBC and Tenera 2005), the Duke Energy South Bay Power Plant (Tenera 2004), and the Cabrillo Power I LLC, Encina Power Station (Tenera, *in preparation*).

The entrainment study was designed to specifically address the following questions:

- What are the species composition and abundance of the larval fishes, fish eggs, crab megalops, and spiny lobster larvae entrained by RBGS?
- What are the local species composition and abundance of the entrainable larval fishes, fish eggs, crab megalops, and spiny lobster larvae in Santa Monica Bay?
- What are the potential impacts of entrainment losses on these populations due to operation of the CWIS?

The following sections explain the entrainment study methods, quality assurance procedures, and study results analyzed on a temporal and spatial basis in relation to power plant operation in 2006.

#### 4.1.1 Discussion of Species to be Analyzed

Planktonic organisms in the source water body that are smaller than the CWIS screening system mesh (5/8 inch) are susceptible to entrainment. These include species that complete their entire life cycle as planktonic forms (holoplankton) and those with only a portion of their life cycle in the plankton as eggs or larvae (meroplankton). This study estimated entrainment effects on meroplanktonic species including all fish eggs and larvae, and the advanced larval stages of several invertebrate species including all crabs, market squid, and California spiny lobster. None of the holoplanktonic forms (such as copepods) were enumerated because these populations are typically widespread, the species have short generation times, and population-level impacts, though small, cannot be accurately estimated. All target taxa in the samples were identified to the lowest practical taxonomic level, but some specimens were combined into broader taxonomic groups because the morphological characteristics of some species are not distinct at smaller stages, descriptions are lacking for some of the larvae (particularly for many of the crab megalops), or



specimens were damaged and could not be positively identified. Although all target taxa specimens were enumerated in the samples, including uncommon species and those with no direct fishery value, detailed impact analysis was only applied to a few of the more abundant species or species-groups, in addition to the specific shellfish taxa (spiny lobsters, market squid) regardless of abundance.

#### **4.1.1.1 Fish**

Many of the marine fishes in the vicinity of the CWIS produce free-floating larvae as an early life stage, a notable exception being the surfperches which bear well-developed live young. Planktonic larval development promotes dispersal of the population but also puts larvae at risk of entrainment. Some groups (e.g., croakers, flatfishes, anchovies) broadcast eggs directly into the water column where they develop in a free-floating state until hatching into the larval form. In this case both eggs and larvae are potentially susceptible to entrainment. For groups that deposit adhesive eggs onto the substrate (e.g., gobies, cottids) or brood eggs internally until larvae are extruded (e.g., rockfishes, pipefishes), only the larvae and not the eggs are potentially at risk of entrainment.

#### **4.1.1.2 Shellfish**

“Shellfish” is a general term to describe crabs, shrimps, lobsters, clams, squids and other invertebrates that are consumed by humans, and it is used to differentiate this group of fishery species from “finfish” which includes bony fishes, sharks and rays. In the present study, crabs, spiny lobster, and market squid were selected as representative of the shellfish species at potential risk of entrainment, some of which have direct fishery value and others that are primarily important only as forage species for higher trophic levels. The inclusion of certain shellfish larvae as target species, and the enumeration of only the later stages such as megalops and phyllosomes, was a compromise between attempting to characterize the abundance of all planktonic organisms entrained into the CWIS (a nearly impossible task) and only a few species with commercial fishery value. In addition, only a few species have complete larval descriptions which makes accurate identifications problematical, and impact analyses based on broad taxonomic groups are subject to a great deal of uncertainty. Nevertheless, by including the megalops stage of all crabs in the sample identifications (e.g. hermit crabs, porcelain crabs, shore crabs) there is some measure of the relative effects of entrainment on source populations of some of the more abundant but lesser-known species that have planktonic larvae.

#### **4.1.1.3 Protected Species**

Some fish and invertebrate species (abalone) in California are protected under California Department of Fish and Game regulations although few marine species are listed as either threatened or endangered. Special status fish species that could occur in the vicinity of the power plant and that have planktonic larvae potentially at risk of entrainment include garibaldi, giant sea bass (*Stereolepis gigas*), tidewater goby (*Eucyclogobius newberryi*), and California grunion (*Leuresthes tenuis*).

## 4.2 HISTORICAL DATA

### 4.2.1 Summary of Historical Data

Daily entrainment rates for the Redondo Beach Generating Station (RBGS) Units 1-8 in 1979–1980 (SCE 1983) were based on density data of plankton collected from the intakes at RBGS. These daily densities were then applied to the daily cooling water volumes for RBGS and used to calculate estimated annual entrainment for certain target species. The sampling program at RBGS focused on obtaining entrainment levels for ‘target species’, which provided representative information regarding the effects of the generating station on the marine community, based upon criteria selected in consultation with the CRWQCB and the California Department of Fish and Game. These ‘key species’ were defined as those with some or all of the following characteristics:

- Importance in community trophic structure (planktivorous, piscivorous, benthic feeders, or as a prey food source),
- Present in the source water body during most of the year, allowing statistical comparisons of the data,
- Potentially subject to entrainment and/or impingement during some or all of their life stages,
- Economic value as a sport or commercial fishery species.

As explained in SCE (1983), the entrainment study design was closely associated with the entrainment of larval fishes to quantify losses to the fishery resource by means of an Impact Assessment Model. Intake stations at the RBGS were sampled over a 10-day period during the middle of each month throughout the year. Results for Units 5&6 were extrapolated to Units 1–4 adjusted for flow volume differences. Daily entrainment estimates for Units 7&8 were developed directly from samples collected at that location. Within the 10-day period there were four 24-hour sampling periods (also referred to as replicate samples) during each monthly sampling survey, with six periods (two day, two night, and two crepuscular) sampled throughout a 24-hour period at offshore intake risers. For each month, mean daily larval entrainment was estimated by multiplying larval concentrations by flow volumes for each station.

Through-plant mortality of entrained larvae for this study was assumed to be 100%, giving a conservative or higher than actual estimate of entrainment effects than suggested from previous studies that indicated a range of mortality rates from 10-70% depending on the target species (SCE 1982a). Fish pump nets were used to sample entrained ichthyoplankton at RBGS within the intake risers using a centrifugal whorl Nielsen Model NCH Fish Pump (SCE 1982b). Samples were filtered through a 333 micron mesh net and preserved in 4% buffered Formalin.

Table 4.2-1 summarizes the entrainment densities of target species recorded over the 12-month study. Annual variations in water flow at RBGS throughout the year were not reported, so daily and annual entrainment levels were calculated using the volume of 320,000 gpm or a flow rate of 20.2 m<sup>3</sup>/sec for Units 1-6 and 467,400 gpm or a flow rate of 29.5 m<sup>3</sup>/sec for Units 7&8. White croaker larvae had the greatest concentrations in the entrainment samples with densities averaging 595 larvae per 1,000 m<sup>3</sup>

(264,000 gal) for Units 1-8, although their densities were considerably lower for Units 1-6 (93 per 1,000 m<sup>3</sup>) than at Units 7&8 (1,097 per 1,000 m<sup>3</sup>). This translated to an annual entrainment mortality of 1.08 billion larvae for white croaker. Entrainment estimates for all other target species combined was 537 million larvae annually.

Other fish larvae were identified and enumerated to provide additional information about the ichthyoplankton community. These taxa included cheekspot goby, kelpfish, blenny, reef finspot, blacksmith, California clingfish, giant kelpfish, unidentified larvae and yolk sac larvae, and other miscellaneous teleosts. In general, these other species ranked 1-10 for Units 1-6 and 3-10 for Units 7-8 in entrainment samples and comprised 38.8% of larval fish collections. Monthly density values for all larvae were highest from March to September and lowest from October to February, with one exception during January in which there was a high abundance of white croaker from Units 7 and 8. Mean monthly density values varied from 169 to 2,281 larvae per 1,000 m<sup>3</sup> at Units 1-6, and 764 to 8,925 larvae per 1,000 m<sup>3</sup> at Units 7 and 8.

Table 4.2-1. Summary of larval fish densities and annual entrainment estimates for Redondo Beach Generating Station in 1979–1980 (from SCE 1983).

	Mean Daily Larval Density (#/1,000 m <sup>3</sup> )	Mean Daily Larval Density (#/1,000 m <sup>3</sup> )	Calculated Annual Entrainment at RBGS (millions)
	Units 1-6	Units 7-8	
<b>316 (b) Target Species</b>			
northern anchovy	6.33	392.73	369.38
white croaker	92.71	1,096.99	1,079.31
queenfish	3.45	169.88	160.24
Pacific butterfish	<0.58	0.78	1.10
kelp bass	0.58	1.96	2.19
barred sand bass	–	0.39	0.37
sargo	<0.58	0.39	0.73
black croaker	<0.58	0.39	0.73
<b>Other Species</b>			
cheekspot goby	358.16	182.44	396.76
reef finspot	270.06	117.31	280.32
kelpfish	198.08	109.46	227.40
blenny	71.40	103.97	141.99
Pisces larvae, unid.	26.49	76.11	87.60
goby	14.40	–	9.13
California clingfish	9.21	–	5.84
Pisces yolk sac larvae	8.64	124.37	121.18
giant kelpfish	7.49	–	4.75
blacksmith	–	83.96	78.11
Other miscellaneous	37.43	262.08	267.55

\* Note: A volume of 1,000 m<sup>3</sup> is equal to 264,000 gallons.

An impact analysis model was developed that calculated a probability of survival of all life stages as a ratio of the size of the offshore population with and without the effect of the generating station intake. Values of percent probability of mortality ( $1-R_c$ ) due to operation of the RBGS indicated that in no species did the maximum effect exceed 1.4%. In most cases the calculated probability was a small fraction of 1% and the impact of all 15 target taxa examined was found to be insignificant. It was concluded that operation of the RBGS did not adversely affect the nearshore fish populations of the Southern California Bight (SCE 1983).

## **4.3 METHODS**

### **4.3.1 Field Sampling**

#### **4.3.1.1 Cooling-Water Intake System Entrainment Sampling**

Composition and abundance of ichthyoplankton and shellfish larvae entrained by RBGS was determined by sampling in the immediate proximity of the Units 7&8 intake (Station E4, Figure 3.3-7) every two weeks from January 2006 through January 2007, and monthly near the Units 5&6 intake (Station H2). During the initial study design and subsequent sampling effort Station H2 was designated a source water station but was located in close proximity to the intakes for Units 5&6 so the data could be used to estimate entrainment for those units if necessary. The position of the sampling stations during each survey was determined using a differential GPS. Sampling was done within 50–100 m (164–328 ft) of the intake structures using a towed bongo frame that sampled the water column from the surface down to approximately 0.15 m (0.5 ft) off the bottom, and back to the surface. The openings on the frame were 60 cm (2 ft) in diameter and the plankton nets were constructed of 333- $\mu$ m Nitex® nylon mesh, and were similar in design to the nets used by the CalCOFI program. Each net was fitted with a Dacron sleeve, a plastic cod-end container to retain the organisms, and a calibrated General Oceanics flowmeter (Model 2030R) to measure of the amount of water filtered. Sampling was conducted four times per 24-hour period—once every six hours.

Two replicate tows were taken with a target sample volume for each net of approximately 20–30 m<sup>3</sup> (5,300 to 8,000 gallons). Only a single replicate tow was taken at the Units 5&6 intake station. The nets were redeployed if the target volume was not collected during the initial tow. At the end of each tow, nets were retrieved and the contents of the net gently rinsed with seawater into the cod-end. Contents were washed down from the outside of the net to avoid the introduction of plankton from the wash-down water. Samples were then carefully transferred to pre-labeled jars with pre-printed internal labels and the two samples preserved separately in 4% buffered formalin-seawater.

#### **4.3.1.2 Source Water Sampling**

The configuration of the source water study area was selected to 1) characterize the larvae of ichthyoplankton and shellfish potentially entrained by the intakes, and 2) represent larval forms present in the nearshore habitats in the vicinity of the intakes.

Source water was sampled at 7 stations located upcoast, downcoast, and offshore from the intake structures and inside King Harbor (Figure 3.3-7). All stations were sampled using a wheeled bongo plankton net using the same oblique towing method as the entrainment sampling. Sampling was conducted once monthly on the same day that the entrainment station was sampled. Samples were processed using the same procedures described for entrainment sampling. During each monthly source water survey, the seven source water stations were sampled four times per 24-hour period—once every six hours. This interval allowed adequate time for one vessel and crew to conduct all source water and entrainment sampling while also partitioning samples into day-night blocks for analysis of diel trends. During each sampling cycle the order in which the stations were sampled was varied to avoid introducing a systematic bias into the data. Detailed stepwise procedures are presented in Appendix B.

#### **4.3.2 Laboratory Analysis**

Samples were returned to the laboratory and transferred from formalin to 70% ethanol after approximately 72 hours. Samples were examined under a dissecting microscope and all fish larvae were removed and placed in labeled vials. Fish eggs were also removed from the entrainment samples for Units 7&8. In addition, the following shellfish larvae were also removed:

- crab megalops
- California spiny lobster phyllosoma
- market squid paralarvae

The samples from the two nets were preserved in separate 400 ml (0.1 gal) jars and processed separately, but the data from the two nets were combined for analysis. If the quantity of material in the two samples was very large then only one of the two samples was processed and analyzed. However, if the quantity of material exceeded 200 ml (6.8 oz), then the sample was split into multiple jars to ensure that the material was properly preserved. In some cases the collection of ctenophores, salps, and other larger planktonic organisms resulted in samples with large volumes of material, but these could be separated from other plankton with little difficulty and were generally not split, depending upon the final volume of the material.

Specimens were enumerated and identified to the lowest practical taxon. A representative sample of up to 50 larvae from each species for each survey (100 during the first two surveys) was measured from the entrainment samples using a dissecting microscope and image analysis system. If fewer than 50 individuals from a species were collected during the survey then all of the larvae from the survey were measured. Total length was measured to an accuracy of at least 0.004 inch (0.1 millimeter).

#### **4.3.3 QA/QC Procedures & Data Validation**

A quality control (QC) program was implemented for the field and laboratory components of the study. Quality control surveys were completed on a quarterly basis to ensure that the field sampling was conducted properly. Prior to the start of the study the field survey procedures were reviewed with all personnel, and all personnel were given printed copies of the procedures.

A more detailed QC program was applied to all laboratory processing. The first ten samples sorted by an individual were resorted by a designated quality control (QC) sorter. A sorter was allowed to miss one target organism if the total number of target organisms in the sample was less than 20. For samples with 20 or more target organisms the sorter was required to maintain a sorting accuracy of 90%. After a sorter completed ten consecutive samples with greater than 90% accuracy, the sorter had one of their next ten samples randomly selected for a QC check. If the sorter failed to achieve an accuracy level of 90% then their next ten samples were resorted by the QC sorter until they met the required level of accuracy. If the sorter maintained the required level of accuracy random QC checks resumed at the level of one sample check per ten sorted.

A similar QC program was conducted for the taxonomists identifying the samples. The first ten samples of fish or invertebrates identified by an individual taxonomist were completely re-identified by a designated QC taxonomist. A total of at least 50 individual fish or invertebrate larvae from at least five taxa must have been present in these first ten samples; if not, additional samples were re-identified until this criterion was met. Taxonomists were required to maintain a 95% identification accuracy level in these first ten samples. After the taxonomist identified ten consecutive samples with greater than 95% accuracy, they had one of their next ten samples checked by a QC taxonomist. If the taxonomist maintained an accuracy level of 95% then they continued to have one of each ten samples checked by a QC taxonomist. If one of the checked samples fell below the minimum accuracy level then ten more consecutive samples were identified by the QC taxonomist until ten consecutive samples met the 95% criterion. Identifications were cross-checked against taxonomic voucher collections maintained by MBC and Tenera Environmental, and specialists were consulted for problem specimens.

#### **4.3.4 Data Analysis**

##### **4.3.4.1 Entrainment Estimates**

Estimates of daily larval entrainment for the sampling period from January 2006 through January 2007 at RBGS were calculated from data collected from Station H2 for the Units 5&6 CWIS and Station E4 for the Units 7&8 CWIS and data on daily cooling water flow from the two pair of units. Estimates of average larval concentration for the day when entrainment samples were collected were extrapolated across the days between surveys to calculate total entrainment during the days when no samples were collected. The total estimated daily entrainment for the survey periods and across the entire year were then summed to obtain separate estimates of total survey and annual entrainment, respectively, for the Units 5&6 and Units 7&8 CWISs. Estimates were calculated using actual cooling water flow during the survey periods and also using the maximum flow capacities, although such capacities are never achieved on a continual basis due to operational constraints. The annual entrainment estimates, in conjunction with demographic data collected from the fisheries literature, were used in modeling CWIS effects using adult equivalent loss (*AEL*) and fecundity hindcasting (*FH*). Data for the same target taxa from sampling of the entrained larvae and potential source populations of larvae were used to calculate estimates of *PE* that were used to estimate the probability of mortality ( $P_m$ ) due to entrainment using the *ETM*. In the RBGS entrainment study, each approach (e.g., *AEL*, *FH*, and *ETM*), as appropriate for each target taxon, was used to assess effects of power plant losses.

As a result of the difference in sampling frequency and sample processing for the Units 5&6 and Units 7&8 entrainment stations the data presented for two intakes are not identical. The fishes and shellfishes selected for detailed analysis were chosen based on the results from the more comprehensive sampling done at Units 7&8 in cooperation with the LARWQCB and resource agency staff. No data on fish eggs are presented for Units 5&6 since eggs were not processed from these samples in accordance with the source water station sample processing protocols. Comparison of day-night differences in entrainment are not presented for the Units 5&6 entrainment station because the fewer number of surveys would not provide the same level of comparison available at Units 7&8 and larval fish behavior wouldn't be expected to differ between the two intakes.

All of the modeling approaches require an estimate of the age of the larvae being entrained. The demographic approaches extrapolate estimates from the average age at entrainment, while the *ETM* requires an estimate of the period of time that the larvae are exposed to entrainment. These estimates were obtained by measuring a representative number of larvae of each of the target taxa from the samples collected from all of the Santa Monica Bay entrainment stations (E1–E4) and using published larval growth rates. Although a large number of larvae may have been collected and measured from entrainment samples, a random sample of 200 from the total measurements was used to calculate the average age at entrainment and total larval duration. The average age at entrainment was calculated by dividing the difference between the size at hatching and the average size of the larvae from entrainment by a larval growth rate obtained from the literature. The period of time that the larvae were exposed to entrainment was calculated by dividing the difference between the size at hatching and the size at the 95<sup>th</sup> percentile by a larval growth rate obtained from the literature. The duration of the egg stage was added to this value for species with planktonic eggs. The 95<sup>th</sup> percentile value was used to eliminate outliers from the calculations. The size at hatching was estimated as follows:

$$\text{Hatch Length} = \text{Median Length} - ((\text{Median Length} - 1^{\text{st}} \text{ Percentile Length})/2).$$

This calculated value was used because of the large variation in size among larvae smaller than the average length and approximates the value of the 25<sup>th</sup> percentile used in other studies as the hatch length. This calculation assumes that the length frequency distribution is skewed towards smaller sized larvae and usually resulted in a value close to the hatch size reported in the literature. The length frequency distributions for several of the fishes did not follow this pattern and the length of the 10<sup>th</sup> percentile of the distribution was used as the hatch length for these taxa to eliminate outlier values.

#### **4.3.4.2 Demographic Approaches**

*AEL* models evolved from impact assessments that compared power plant losses to commercial fisheries harvests and/or estimates of the abundance of adults. In the case of adult fishes impinged by intake screens, the comparison was relatively straightforward. To compare the numbers of impinged sub-adults and juveniles and entrained larval fishes to adults, it was necessary to convert all these losses to adult equivalents. Horst (1975) and Goodyear (1978) provided early examples of the equivalent adult model (*EAM*) to convert numbers of entrained early life stages of fishes to their hypothetical adult equivalency.

Demographic approaches, exemplified by the *EAM*, produce an absolute measure of loss beginning with simple numerical inventories of entrained or impinged individuals and increasing in complexity when the inventory results are extrapolated to estimate numbers of adult fishes or biomass. We used two different but related demographic approaches in assessing entrainment effects at RBGS: *AEL*, which expresses effects as absolute losses of numbers of adults, and *FH*, which estimates the number of adult females at the age of maturity whose reproductive output has been eliminated by entrainment of larvae.

Age-specific survival and fecundity rates are required for *AEL* and *FH*. *AEL* estimates require survivorship estimates from the age at entrainment to adult recruitment: *FH* requires egg and larval survivorship up to the age of entrainment plus estimates of fecundity. Furthermore, to make estimation practical, the affected population is assumed to be stable and stationary, and age-specific survival and fecundity rates are assumed to be constant over time. Each of these approaches provides estimates of adult fish losses, which ideally need to be compared to standing stock estimates of adult fishes.

Species-specific survivorship information (e.g., age-specific mortality) from egg or larvae to adulthood is limited for many of the taxa collected during the study. These rates, when available, were inferred from the literature. The uncertainty associated with published demographic parameters is seldom known and rarely reported, but the likelihood that it is very large needs to be considered when interpreting results from the demographic approaches for estimating entrainment effects. For some well-studied species (e.g., northern anchovy), portions of early mortality schedules and fecundity have been reported. Because the accuracy of the estimated entrainment effects from *AEL* and *FH* will depend on the accuracy of age-specific mortality and fecundity estimates, lack of demographic information may limit the utility of these approaches.

The precursor to the *AEL* and *FH* calculations is an estimate of total annual larval entrainment. Estimates of larval entrainment at RBGS were based on bi-weekly sampling where  $E_T$  is the estimate of total entrainment for the yearlong study period and  $E_i$  is the entrainment estimate for the individual survey periods. Estimates of entrainment for the study period were based on two-stage sampling designs, with days within surveys, and cycles (four six-hour collection periods per day) within days. The within-day sampling was based on a stratified random sampling scheme with four temporal cycles and two replicates per cycle. Estimates of variation for each survey were computed from the four temporal cycles.

There were usually no estimates of variation available for the life history information used in the models. The ratio of the mean to standard deviation (coefficient of variation) was assumed to be 50% for all life history parameters used in the models.

#### *Fecundity Hindcasting (FH)*

The *FH* approach compares larval entrainment losses with adult fecundity to estimate the amount of adult female reproductive output eliminated by entrainment, hindcasting the numbers of females at the age of maturity effectively removed from the reproductively active population. The accuracy of these estimates of effects, as with those of the *AEL* above, is dependent upon accurate estimates of age-specific mortality from the egg and early larval stages to entrainment and accurate estimates of the total lifetime female fecundity. If it can be assumed that the adult population has been stable at some current level of



exploitation and that the male:female ratio is constant and 50:50, then fecundity and mortality are integrated into an estimate of the loss of adults at the age of maturity (age at which 50% of the females are sexually mature) by converting entrained larvae back into females (e.g., hindcasting) and multiplying by two.

A potential advantage of *FH* is that survivorship need only be estimated for a relatively short period of the larval stage (e.g., egg to larval entrainment). The method requires age-specific mortality rates and fecundities to estimate entrainment effects and some knowledge of the abundance of adults to assess the fractional losses these effects represent. This method assumes that the loss of the reproductive potential of a single female at the age of maturity is equivalent to the loss of two adult fish at the age of maturity, assuming a 50:50 male:female ratio.

In the *FH* approach, the total larval entrainment for a species,  $E_T$ , was projected backward from the average age at entrainment to estimate the number of females at the age of maturity that would produce over their lifetime the numbers of larvae seen in the entrainment samples. The estimated number of breeding females at the age of maturity, *FH*, whose fecundity is equal to the total loss of entrained larvae was calculated as follows:

$$FH = \frac{E_T}{TLF \cdot \prod_{j=1}^n S_j} \quad (1)$$

Where:

$E_T$  = total entrainment estimate;

$S_j$  = survival rate from eggs to entrained larvae of the  $j^{\text{th}}$  stage ; and

$TLF$  = average total lifetime fecundity for females, equivalent to the average number of eggs spawned per female over their reproductive years.

The two key input parameters in Equation 1 are total lifetime fecundity  $TLF$  and survival rates  $S_j$  from spawning to the average age at entrainment. The average age at entrainment was estimated from lengths of a representative sample of larvae measured from the entrainment samples. Descriptions of these parameters may not be available for many species and are a possible limitation of the method.  $TLF$  was estimated in these studies using survivorship and fecundity tables that account for changes in fecundity with age. The data used in calculating  $TLF$  are described below for each taxon.

#### *Adult Equivalent Loss (AEL)*

The *AEL* approach uses estimates of the abundance of the entrained or impinged organisms to project the loss of equivalent numbers of adults based on mortality schedules and age-at-recruitment. The primary advantage of this approach is that it translates power plant-induced early life-stage mortality into numbers of adult fishes that are familiar units to resource managers. *AEL* does not require source water estimates of larval abundance in assessing effects. This latter advantage may be offset by the need to gather age-specific mortality rates to predict adult losses and the need for information on the adult population of interest for estimating population-level effects (i.e., fractional losses).

Starting with the number of age class  $j$  larvae entrained  $E_j$ , it is conceptually easy to convert these numbers to an equivalent number of adults lost  $AEL$  at some specified age class from the formula:

$$AEL = \sum_{j=1}^n E_j S_j \quad (2)$$

Where:

$n$  = number of age classes from the average age at entrainment to adult recruitment;

$E_j$  = estimated number of larvae lost in age class  $j$ ; and

$S_j$  = survival probability for the  $j$  th class to adulthood (Goodyear 1978).

Age-specific survival rates from the average age at entrainment to the age at first maturity must be included in this assessment method. The age at first maturity, when 50% of the females are mature, was used in the  $AEL$  extrapolations so the  $FH$  and  $AEL$  models are extrapolated to the same age and can be compared using the equivalency that  $2FH \approx AEL$ . We used a modified form of Equation 2 where the total entrainment was used having an average age  $a$ :

$$AEL = E_T \prod_{j=a}^n S_j \quad (3)$$

Where:

$E_T$  = annual estimate of larvae lost in all age classes.

The average age at entrainment was estimated from lengths of a representative sample of larvae as described above. For some commercial species, natural survival rates are known after the fish recruit into the commercial fishery. For the earlier years of development, this information is not well known for commercial species and may not exist for some non-commercial species.

#### 4.3.4.3 Empirical Transport Model

As an alternative to the demographic models described above, the  $ETM$  was proposed by the USFWS to estimate mortality rates resulting from circulating water withdrawals by power plants (Boreman et al. 1978, and subsequently in Boreman et al. 1981). The  $ETM$  provides an estimate of incremental mortality (a conditional estimate in absence of other mortality, Ricker 1975) caused by RBGS entrainment on local Santa Monica Bay larval populations by using empirical data (plankton samples) rather than relying solely on hydrodynamic and demographic calculations. Consequently,  $ETM$  requires an additional level of field sampling to characterize the abundance and composition of source water larval populations. The fractional loss to the source water population represented by entrainment is provided by estimates of  $PE$  for each survey that can then be expanded to predict regional effects on appropriate adult populations using  $ETM$ , as described below.

Variations of this model have been discussed in MacCall et al. (1983) and have been used to assess impacts at a southern California power plant (Parker and DeMartini 1989). The  $ETM$  has also been used

to assess impacts at the Salem Nuclear Generating Station in Delaware Bay, New Jersey (PSE&G 1993) as well as other power stations along the East Coast. Empirical transport modeling permits the estimation of conditional mortality due to entrainment while accounting for the spatial and temporal variability in distribution and vulnerability of each life stage to power plant withdrawals. The modeling approach described below uses a *PE* approach that is similar to the method described by MacCall et al. (1983) and used by Parker and DeMartini (1989) in their final report to the California Coastal Commission (Murdoch et al. 1989b) for the San Onofre Nuclear Generating Station.

The general equation to estimate *PE* for a day on which entrainment was sampled is:

$$PE_i = \frac{N_{Ei}}{N_{Si}} \quad (4)$$

where :

$N_{Ei}$  = estimated average number of larvae entrained during the day in survey i, calculated as  
(estimated concentration of larvae in the water entrained that day) × (average daily cooling flow volume during the survey period),

$N_{Si}$  = estimated number of larvae in the source water that day in survey i (estimated concentration of larvae in the source water that day) × (source water volume).

The  $PE_i$  value represents the effects of a number of processes operating over a day and is estimated for each survey. When actual cooling water flow was used in calculating entrainment estimates, the  $PE_i$  estimate was calculated using the average daily cooling water flow over each entrainment survey period, an approximate period of two weeks for Units 7&8 and four weeks for Units 5&6. Values were also calculated for design maximum flows for comparative purposes.

If larval entrainment mortality is constant throughout the period and a larva is susceptible to entrainment over  $d$  days, then the proportion of larvae that escape entrainment in survey  $i$  is:

$$(1 - PE)^d,$$

where the larval duration,  $d$ , from hatching to entrainment was calculated as described above.

The surveys in each study period were used to estimate larval mortality ( $P_M$ ) due to entrainment using the following equation

$$P_M = 1 - \sum_{i=1}^{12} f_i (1 - PE_i \cdot P_S)^d, \quad (5)$$

where:

$PE_i$  = estimate of proportional entrainment for the  $i$ th survey,

$P_S$  = estimate of the proportion of the total source water population represented by the sampled population,

$f_i$  = proportion of the total annual source water population present during the  $i$ th survey, and

$d$  = the estimated number of days of larval life.

To establish independent survey estimates, it was assumed that during each survey a new and distinct cohort of larvae was subject to entrainment. Each of the surveys was weighted by  $f_i$  and estimated as the proportion of the total annual source water population present during each  $i^{\text{th}}$  survey period. For the entire year-long study period, the sum of the proportions equals one:

$$f_i = \frac{N_S}{\sum_{i=1}^n N_{Si}} \text{ and } \sum_{i=1}^n f_i = 1. \quad (6)$$

The estimate of the population-wide  $PE$  is the central feature of the  $ETM$  approach (Boreman et al. 1981, MacCall et al. 1983). If a population is stable and stationary, then  $P_M$  also estimates the effects on the fully-recruited adult age classes when uncompensated natural mortality from larva to adult is assumed. As shown in Equations 4 and 5, estimates of  $PE$  are based on larval population estimates within specific volumes of water. While a reasonably accurate estimate of the volume of the cooling water intake flow can be obtained, estimating the volume of the source water is more difficult and will vary depending upon oceanographic conditions and taxa group. The proportion of the sampled source water population to the total source population,  $P_S$ , was estimated based on the alongshore current displacement, calculated over the period of time that the larvae were estimated to be exposed to entrainment. This period of time was estimated using length data from a representative number of larvae (100-200) from the entrainment samples for each taxon. The maximum age was calculated as the upper 95<sup>th</sup> percentile value of the lengths measured from the samples. The maximum age at entrainment was calculated by dividing the difference between the upper 95<sup>th</sup> percentile values of the lengths and the estimated hatch length or 10<sup>th</sup> percentile value of the lengths, depending on the taxa, by an estimated larval growth rate.

The incorporation of  $P_S$  into the  $ETM$  model is typically defined by the ratio of the area or volume of the sampled population to a larger area or volume containing the population of inference (Parker and DeMartini 1989). If an estimate of the larval (or adult) population in the larger area is available, it can also be computed using the estimate of the larval or adult population in the study grid, defined by Ricker (1975) as the proportion of the parental stock. If the distribution in the larger area is assumed to be uniform, then the value of  $P_S$  for the proportion of the population will be the same as the proportion computed using area or volume. The source water for all of the taxa was only assumed to extend out to the offshore edge of the study grid because current data did not include a strong onshore component, presumably due to the presence of the Redondo Canyon. As a result,  $P_S$  was calculated as the ratio:

$$P_S = N_S / N_P, \quad (7)$$

where  $N_S$  is the number of larvae in the sampled population, and  $N_P$  is the number of larvae in the population of inference. The numerator  $N_S$  is the same as estimate,  $N_{S_i}$  (Equation 4), used in the calculation of  $PE$ , as follows:

$$N_{S_i} = \sum_{k=1}^{10} A_{G_k} \cdot \bar{D}_k \cdot \rho_{i,k}, \quad (8)$$

where:

$A_{G_k}$  = area of source water sampling area station  $k$ ;

$\bar{D}_k$  = average depth of the  $k^{\text{th}}$  station; and

$\rho_{i,k}$  = density (per  $\text{m}^3$ ) of larvae in  $k^{\text{th}}$  station during survey  $i$ .

The total alongshore displacement in the  $i^{\text{th}}$  survey, including both upcoast and downcoast movement, was calculated during a period equal to the larval duration before each survey as follows:

$$P_{S_i} = \frac{N_{S_i}}{N_{P_i}} = \frac{N_{S_i}}{\sum_{k=1}^6 \frac{L_{P_i} \cdot N_{G_{ik}}}{L_{G_{ik}}}}. \quad (9)$$

The current data for both estimates were from data collected from the current meter at Station CM5 located in the source water sampling area.

No adjustment for the source water volume of King Harbor was necessary and as a result the estimate of  $PE_i$  used in the calculation of  $P_M$  was modified from Equation 4 as follows:

$$PE_i = \left( \frac{N_{E_i}}{(N_{NS_i} / P_S) + N_{KHS_i}} \right), \quad (10)$$

where

$N_{NS_i}$  = estimated average number of larvae in nearshore source water area, and

$N_{KHS_i}$  = estimated average number of larvae in KingHarbor source water area.

Assumptions associated with the estimation of  $P_M$  include the following:

- The samples at each survey period represent a new and independent cohort of larvae;
- The estimates of larval abundance for each survey represent a proportion of total annual larval production during that survey;
- The conditional probability of entrainment  $PE_i$  is constant within survey periods; and
- Lengths and applied growth rates of larvae accurately estimate larval duration.

The variance calculations associated with  $P_M$  only include the error directly associated with the sampling in the  $PE_i$  and was calculated using the average coefficient of variation from the estimates of  $PE_i$  as follows:

$$Var(P_M) = \sqrt{(CV_{PE} / 100)P_M} .$$

This estimate does not include the error associated with the estimates of  $P_S$ , the larval duration, and source water, entrainment, and outflow volumes. It also does not account for the variance across the days within a survey period.

## 4.4 DATA SUMMARY

### 4.4.1 Data Summary of Processed Samples

Twenty-six entrainment surveys were completed between January 11, 2006 and January 8, 2007 at the Units 7&8 entrainment station and 12 surveys at the source water stations (Table 4.4-1). Sampling efforts alternated between surveys where only entrainment samples were collected at Units 7&8 and surveys where all entrainment and source water samples were collected. A total of 388 and 960 samples were collected from the Units 7&8 entrainment station and Units 5&6 entrainment and source water stations, respectively.

Table 4.4-1. Entrainment/source water surveys and number of samples collected from January 2006 through January 2007.

Survey Number	Date	<u>Units 7&amp;8 Entrainment Samples</u>		<u>Source Water/Units 5&amp;6 Entrainment Samples</u>	
		Number Collected	Number Processed	Number Collected	Number Processed
SMBEA01	1/11/06	16	16	–	–
SMBEA02	1/25/06	16	16	56	56
SMBEA03	2/8/06	16	16	–	–
SMBEA04	2/23/06	16	16	56	56
SMBEA05	no survey <sup>a</sup>	–	–	–	–
SMBEA06	3/22/06	16	16	56	56
SMBEA07	4/13/06	16	16	–	–
SMBEA08	4/19/06	16	16	56	56
SMBEA09	5/3/06	16	16	–	–
SMBEA10	5/17/06	16	16	56	56
SMBEA11	6/1/06	16	16	–	–
SMBEA12	6/14/06	16	16	30 <sup>b</sup>	27
SMBEA13	6/28/06	16	16	–	–
SMBEA14	07/12/06	16	16	56	56
SMBEA15	07/26/06	16	16	–	–
SMBEA16	08/09/06	16	16	56	56
SMBEA17	08/23/06	16	16	–	–
SMBEA18	09/06/06	16	16	–	–
SMBEA19	09/20/06	16	16	56	56
SMBEA20	10/04/06	16	16	–	–
SMBEA21	10/18/06	16	16	56	56
SMBEA22	11/01/06	16	16	–	–
SMBEA23	11/15/06	16	16	56	56
SMBEA24	11/27/06	6 <sup>c</sup>	6	–	–
SMBEA25	12/13/06	16	16	56	56
SMBEA26	01/08/07	16	16	–	–
<b>Total</b>		<b>390</b>	<b>390</b>	<b>646</b>	<b>643</b>

<sup>a</sup> survey cancelled due to adverse sea conditions.

<sup>b</sup> three samples voided due to poor preservation.

<sup>c</sup> some samples could be not collected due to rough sea conditions.

## 4.5 RESULTS

### 4.5.1 Cooling Water Intake Structures Entrainment Summary

#### 4.5.1.1 Fishes

A total of 2,524 entrainable fish larvae from 42 separate taxonomic categories was collected from the 12 entrainment surveys at Units 5&6 (Table 4.5-1 and Appendix D), and a total of 7,785 entrainable fish larvae from 66 separate taxonomic categories was collected from the 25 entrainment surveys at Units 7&8 (Table 4.5-2 and Appendix D). The most abundant larval fish taxa in the samples were combtooth blennies, which comprised 42.1% and 29.5% of the total larvae collected from Stations H2 and E4, respectively, followed by unidentified gobies (35.3% and 11.4%, respectively). A total of 47,972 fish eggs from 15 separate taxonomic categories was collected at the Units 7&8 intake. The most abundant taxonomic group of fish eggs in the samples was unidentified eggs, which made up 69.6% of the total eggs collected, followed by anchovy eggs (11.6%). No fish eggs were processed from the samples collected at the Units 5&6 intake. The peak in abundance of all the larval fish combined occurred in August at Station H2 and June at Station E4 (Figures 4.5-1 and 4.5-2), while the highest concentrations of eggs occurred during May (Figure 4.5-3). There were generally more larval fish collected during each survey at night than during the day (Figure 4.5-4) but less of a diel difference in egg concentrations (Figure 4.5-5). Total annual entrainment of fish larvae at Units 5&6 was estimated to be 101,659,379 based on actual cooling water flows and 356,000,276 based on design, or maximum capacity, flows (Table 4.5-3). Total annual entrainment of all fish eggs and larvae at Units 7&8 was estimated to be 2,234,923,515 and 189,537,344, respectively based on actual cooling water flows (Table 4.5-2). Using the design flow volumes, estimates increased to 7,536,186,504 eggs and 744,808,585 larvae.



Table 4.5-1. Abundance of larval fishes sampled at RBGS Station H2 (Units 5&6 Entrainment) from January 2006 to December 2006.

Taxon	Common Name	Avg. Conc. (per 1,000 m <sup>3</sup> )	Total Count	Percentage of Total	Cumulative Percentage
<b>Larval Fish</b>					
<i>Hypsoblennius</i> spp.	cometooth blennies	498.84	1,036	42.11	42.11
Gobiidae unid.	gobies	420.15	926	35.46	77.57
Labrisomidae unid.	labrisomid blennies	65.48	149	5.53	83.10
Engraulidae unid.	anchovies	35.57	69	3.00	86.10
<i>Hypsypops rubicundus</i>	garibaldi	25.24	55	2.13	88.23
Gobiesocidae unid.	clingfishes	23.21	44	1.96	90.19
unidentified fish, damaged	unidentified damaged fish	17.66	39	1.49	91.68
<i>Typhlogobius californiensis</i>	blind goby	16.91	35	1.43	93.11
<i>Genyonemus lineatus</i>	white croaker	12.60	25	1.06	94.17
<i>Gibbonsia</i> spp.	clinid kelpfishes	11.49	21	0.97	95.14
larvae, unidentified yolksac	unidentified yolksac larvae	8.16	19	0.69	95.83
Sciaenidae unid.	croakers	7.50	16	0.63	96.46
Atherinopsidae unid.	silversides	3.97	9	0.33	96.80
<i>Paralichthys californicus</i>	California halibut	3.58	8	0.30	97.10
<i>Oxyjulis californica</i>	senorita	3.30	7	0.28	97.38
<i>Citharichthys</i> spp.	sanddabs	2.76	5	0.23	97.61
<i>Ruscarius creaseri</i>	roughcheek sculpin	2.40	5	0.20	97.81
<i>Semicossyphus pulcher</i>	California sheephead	2.31	5	0.19	98.01
<i>Menticirrhus undulatus</i>	California corbina	2.27	4	0.19	98.20
<i>Syngnathus</i> spp.	pipefishes	2.25	5	0.19	98.39
<i>Clinocottus</i> spp.	sculpins	2.19	5	0.18	98.57
<i>Rhinogobiops nicholsi</i>	blackeye goby	2.08	4	0.18	98.75
Blenniidae unid.	blennies	1.62	3	0.14	98.89
<i>Pleuronichthys guttulatus</i>	diamond turbot	1.24	3	0.10	98.99
Haemulidae unid.	grunts	1.18	3	0.10	99.09
<i>Artedius</i> spp.	sculpins	0.96	2	0.08	99.17
<i>Icelinus</i> spp.	sculpins	0.95	2	0.08	99.25
Blennioidei unid.	blennies	0.94	2	0.08	99.33
<i>Pleuronichthys</i> spp.	turbots	0.93	2	0.08	99.41
<i>Paralabrax</i> spp.	sea basses	0.91	2	0.08	99.49
Pleuronectidae unid.	righteye flounders	0.78	2	0.07	99.55
Ophidiidae unid.	cusk-eels	0.70	2	0.06	99.61
<i>Seriphus politus</i>	queenfish	0.59	1	0.05	99.66
<i>Xystreureys liolepis</i>	fantail sole	0.53	1	0.04	99.71
<i>Sebastes</i> spp.	rockfishes	0.53	1	0.04	99.75
larval/post-larval fish unid.	larval fishes	0.52	1	0.04	99.79
Chaenopsidae unid.	tube blennies	0.52	1	0.04	99.84
<i>Stenobranchius leucopsarus</i>	northern lampfish	0.50	1	0.04	99.88
Cottidae unid.	sculpins	0.45	1	0.04	99.92
<i>Peprilus simillimus</i>	Pacific butterfish	0.34	1	0.03	99.95
<i>Halichoeres semicinctus</i>	rock wrasse	0.34	1	0.03	99.98
<i>Leptocottus armatus</i>	Pacific staghorn sculpin	0.28	1	0.02	100.00
		<b>1,184.74</b>	<b>2,524</b>		

Table 4.5-2. Abundance of larval fishes and fish eggs sampled at RBGS Station E4 (Units 7&8) from January 2006 to January 2007.

<b>Taxon</b>	<b>Common Name</b>	<b>Avg. Conc. (per 1,000 m<sup>3</sup>)</b>	<b>Total Count</b>	<b>Percentage of Total</b>	<b>Cumulative Percentage</b>
<b>Larval Fish</b>					
<i>Hypsoblennius</i> spp.	combtooth blennies	244.43	2,176	29.54	29.54
Gobiidae unid.	gobies	94.16	820	11.38	40.91
Engraulidae unid.	anchovies	93.12	941	11.25	52.16
<i>Genyonemus lineatus</i>	white croaker	90.02	868	10.88	63.04
<i>Hypsypops rubicundus</i>	garibaldi	64.49	554	7.79	70.84
unidentified fish, damaged	unidentified damaged fish	28.37	273	3.43	74.26
<i>Seriphus politus</i>	queenfish	27.87	324	3.37	77.63
Labrisomidae unid.	labrisomid blennies	20.72	188	2.50	80.13
Sciaenidae unid.	croakers	19.32	209	2.33	82.47
larval/post-larval fish unid.	larval fishes	16.49	175	1.99	84.46
<i>Typhlogobius californiensis</i>	blind goby	15.40	143	1.86	86.32
<i>Gibbonsia</i> spp.	clinid kelpfishes	14.56	122	1.76	88.08
Gobiesocidae unid.	clingfishes	10.62	87	1.28	89.37
Atherinopsidae unid.	silversides	10.30	104	1.24	90.61
<i>Paralabrax</i> spp.	sand bass	7.95	91	0.96	91.57
<i>Ruscarius creaseri</i>	roughcheek sculpin	6.65	64	0.80	92.37
larvae, unidentified yolksac	unidentified yolksac larvae	6.11	58	0.74	93.11
<i>Paralichthys californicus</i>	California halibut	6.07	66	0.73	93.85
<i>Pleuronichthys guttulatus</i>	diamond turbot	4.68	49	0.57	94.41
<i>Sphyræna argentea</i>	Pacific barracuda	3.92	42	0.47	94.88
<i>Citharichthys</i> spp.	sanddabs	3.26	34	0.39	95.28
<i>Parophrys vetulus</i>	English sole	2.79	32	0.34	95.62
<i>Clinocottus</i> spp.	sculpins	2.68	25	0.32	95.94
<i>Oxyjulis californica</i>	senorita	2.67	26	0.32	96.26
<i>Scorpaenichthys marmoratus</i>	cabezon	2.29	18	0.28	96.54
<i>Pleuronichthys</i> spp.	turbots	2.12	23	0.26	96.79
<i>Pleuronichthys verticalis</i>	hornyhead turbot	2.09	22	0.25	97.05
<i>Pleuronichthys ritteri</i>	spotted turbot	1.93	21	0.23	97.28
Pleuronectidae unid.	righteye flounders	1.73	19	0.21	97.49
Ophidiidae unid.	cusk-eels	1.71	18	0.21	97.70
<i>Stenobranchius leucopsarus</i>	northern lampfish	1.58	16	0.19	97.89
<i>Merluccius productus</i>	Pacific hake	1.44	16	0.17	98.06
<i>Syngnathus</i> spp.	pipefishes	1.28	13	0.16	98.22
<i>Rhinogobiops nicholsii</i>	blackeye goby	1.23	11	0.15	98.36
Labridae unid.	wrasses	1.18	13	0.14	98.51
<i>Cheilotrema saturnum</i>	black croaker	1.14	9	0.14	98.64
<i>Sebastes</i> spp.	rockfishes	0.98	10	0.12	98.76
<i>Menticirrhus undulatus</i>	California corbina	0.98	8	0.12	98.88
<i>Oxylebius pictus</i>	painted greenling	0.85	8	0.10	98.98
Scorpaenidae unid.	scorpionfishes	0.65	7	0.08	99.06
<i>Xystreurus liolepis</i>	fantail sole	0.63	7	0.08	99.14
Pleuronectiformes unid.	flatfishes	0.57	5	0.07	99.21

(table continued)

Table 4.5-2. (continued). Abundance of larval fishes and fish eggs sampled at RBGS Station E4 (Units 7&8) from January 2006 to January 2007.

Taxon	Common Name	Avg. Conc. (per 1,000 m <sup>3</sup> )	Total Count	Percentage of Total	Cumulative Percentage
<i>Rimicola</i> spp.	kelp clingfishes	0.52	6	0.06	99.27
<i>Artedius</i> spp.	sculpins	0.48	5	0.06	99.33
<i>Halichoeres semicinctus</i>	rock wrasse	0.45	5	0.05	99.38
Cottidae unid.	sculpins	0.45	5	0.05	99.44
<i>Zaniolepis</i> spp.	combfishes	0.43	4	0.05	99.49
<i>Ophidion scrippsae</i>	basketweave cusk-eel	0.42	5	0.05	99.54
<i>Semicossyphus pulcher</i>	California sheephead	0.41	4	0.05	99.59
<i>Hippoglossina stomata</i>	bigmouth sole	0.35	3	0.04	99.63
<i>Sardinops sagax</i>	Pacific sardine	0.32	3	0.04	99.67
<i>Symphurus stearnsii</i>	California tonguefish	0.31	4	0.04	99.71
Bathymasteridae unid.	ronquils	0.28	3	0.03	99.74
<i>Leuroglossus stilbius</i>	California smoothtongue	0.28	3	0.03	99.78
<i>Medialuna californiensis</i>	halfmoon	0.27	3	0.03	99.81
<i>Lepidogobius lepidus</i>	bay goby	0.27	3	0.03	99.84
<i>Heterostichus rostratus</i>	giant kelpfish	0.20	2	0.02	99.86
Paralichthyidae unid.	sand flounders	0.18	2	0.02	99.89
Pomacentridae unid.	damsel fishes	0.13	1	0.02	99.90
<i>Platichthys stellatus</i>	starry flounder	0.10	1	0.01	99.91
<i>Icelinus</i> spp.	sculpins	0.10	1	0.01	99.93
<i>Gillichthys mirabilis</i>	longjaw mudsucker	0.10	1	0.01	99.94
Chaenopsidae unid.	tube blennies	0.09	1	0.01	99.95
<i>Chitonotus / Icelinus</i>	sculpins	0.09	1	0.01	99.96
<i>Roncador stearnsii</i>	spotfin croaker	0.09	1	0.01	99.97
<i>Chilara taylori</i>	spotted cusk-eel	0.08	1	0.01	99.98
<i>Lythrypnus</i> spp.	gobies	0.07	1	0.01	99.99
<i>Microstomus pacificus</i>	Dover sole	0.07	1	0.01	100.00
		<b>827.59</b>	<b>7,785</b>		
<b>Fish Eggs</b>					
fish eggs unid.	unidentified fish eggs	5,664.24	32,020	69.57	69.57
Engraulidae unid.	anchovy eggs	941.64	5,605	11.57	81.13
Paralichthyidae unid.	sand flounder eggs	442.64	3,390	5.44	86.57
Sciaen. / Paralich. / Labridae	SPL fish eggs	362.99	1,656	4.46	91.03
<i>Pleuronichthys</i> spp.	turbot eggs	320.29	1,951	3.93	94.96
<i>Citharichthys</i> spp.	sanddab eggs	287.77	2,461	3.53	98.50
Sciaenidae unid.	croaker eggs	72.12	528	0.89	99.38
<i>Genyonemus lineatus</i>	white croaker eggs	16.92	153	0.21	99.59
Labridae unid.	wrasse eggs	15.07	69	0.19	99.78
<i>Paralichthys californicus</i>	California halibut eggs	10.25	93	0.13	99.90
<i>Sphyaena argentea</i>	Pacific barracuda eggs	3.49	15	0.04	99.94
Pleuronectidae unid.	righteye flounder eggs	1.97	20	0.02	99.97
<i>Pleuronichthys guttulatus</i>	diamond turbot eggs	1.38	6	0.02	99.99
<i>Paralabrax</i> spp.	sand bass eggs	0.75	3	0.01	99.99
<i>Hypsypops rubicundus</i>	garilbaldi eggs	0.44	2	0.01	100.00
		<b>8,141.96</b>	<b>47,972</b>		

Table 4.5-3. Calculated total annual entrainment of larval fishes at RBGS Units 5&6 in 2006 based on actual and design (maximum) cooling water intake pump flows.

<b>Taxon</b>	<b>Common Name</b>	<b>Annual Entrainment (Actual Flows)</b>	<b>Standard Error</b>	<b>Annual Entrainment (Design Flows)</b>	<b>Standard Error</b>
<b>Larval Fish</b>					
<i>Hypsoblennius</i> spp.	combtooth blennies	47,309,239	1,785,648	147,738,354	3,398,316
Gobiidae unid.	gobies	33,282,431	1,973,855	129,632,951	4,854,363
Labrisomidae unid.	labrisomid blennies	6,229,110	244,994	20,797,565	463,448
Gobiesocidae unid.	clingfishes	2,412,470	153,327	6,372,050	349,866
<i>Hypsypops rubicundus</i>	garibaldi	1,988,681	250,634	7,060,384	540,609
unidentified fish, damaged	unidentified damaged fish	1,573,225	91,759	5,368,353	229,380
<i>Typhlogobius californiensis</i>	blind goby	1,447,499	111,025	4,633,499	263,605
Engraulidae unid.	anchovies	1,312,342	36,638	9,777,970	175,752
<i>Genyonemus lineatus</i>	white croaker	1,093,369	91,707	3,559,616	224,945
larvae, unidentified yolksac	unidentified yolksac larvae	854,299	51,589	2,704,224	90,182
Sciaenidae unid.	croakers	670,537	63,953	2,504,052	165,481
Atherinopsidae unid.	silversides	352,252	43,562	1,087,989	94,878
<i>Gibbonsia</i> spp.	clinid kelpfishes	332,788	31,829	3,442,061	200,313
<i>Menticirrhus undulatus</i>	California corbina	273,227	35,417	749,368	78,196
<i>Syngnathus</i> spp.	pipefishes	204,436	27,567	708,934	64,185
<i>Oxyjulis californica</i>	senorita	202,944	18,794	1,003,540	58,058
Haemulidae unid.	grunts	179,196	27,149	372,548	47,532
Blenniidae unid.	blennies	177,470	37,017	444,574	84,017
<i>Paralichthys californicus</i>	California halibut	175,487	23,609	1,096,896	88,336
<i>Citharichthys</i> spp.	sanddabs	158,676	21,840	759,983	74,447
<i>Clinocottus</i> spp.	sculpins	136,624	19,863	608,048	57,308
<i>Ruscarius creaseri</i>	roughcheek sculpin	120,060	16,369	664,630	51,891
<i>Semicossyphus pulcher</i>	California sheephead	107,628	24,726	793,622	92,533
<i>Artedius</i> spp.	sculpins	100,053	16,984	260,313	37,885
<i>Icelinus</i> spp.	sculpins	96,892	16,091	257,469	34,872
<i>Rhinogobiops nicholsi</i>	blackeye goby	91,168	13,981	591,084	50,284
<i>Paralabrax</i> spp.	sea basses	84,010	20,621	314,005	53,077
Pleuronectidae unid.	righteye flounders	80,385	13,366	211,045	29,489
Ophidiidae unid.	cusk-eels	64,581	15,852	241,386	40,802
larval/post-larval fish unid.	larval fishes	57,183	11,927	143,248	27,071
Chaenopsidae unid.	tube blennies	57,183	11,927	143,248	27,071
<i>Seriphus politus</i>	queenfish	56,179	14,391	163,360	30,872
<i>Stenobranchius leucopsarus</i>	northern lampfish	54,335	11,333	136,112	25,723
Blennioidei unid.	blennies	51,888	10,756	282,732	36,954
<i>Pleuronichthys guttulatus</i>	diamond turbot	51,233	9,510	364,553	38,504
<i>Pleuronichthys</i> spp.	turbots	46,906	10,359	286,795	36,138
<i>Sebastes</i> spp.	rockfishes	42,501	11,606	144,456	27,300
Cottidae unid.	sculpins	36,068	9,849	122,590	23,167
<i>Peprilus simillimus</i>	Pacific butterfish	31,645	7,768	118,279	19,993
<i>Halichoeres semicinctus</i>	rock wrasse	31,645	7,768	118,279	19,993
<i>Leptocottus armatus</i>	Pacific staghorn sculpin	26,051	7,086	74,934	14,421
<i>Xystreurus liolepis</i>	fantail sole	5,482	1,113	145,176	27,436
		<b>101,659,379</b>		<b>356,000,276</b>	

Table 4.5-4. Calculated total annual entrainment of larval fishes and fish eggs at RBGS Units 7&8 in 2006 based on actual and design (maximum) cooling water intake pump flows.

<b>Taxon</b>	<b>Common Name</b>	<b>Annual Entrainment (Actual Flows)</b>	<b>Standard Error</b>	<b>Annual Entrainment (Design Flows)</b>	<b>Standard Error</b>
<b>Larval Fish</b>					
<i>Hypsoblennius</i> spp.	combtooth blennies	66,422,665	4,346,079	215,134,524	12,270,864
Engraulidae unid.	anchovies	31,894,728	1,644,483	85,144,128	3,602,029
Gobiidae unid.	gobies	18,234,242	1,042,001	85,058,614	2,952,706
<i>Hypsypops rubicundus</i>	garibaldi	16,824,709	2,281,497	56,293,706	6,742,370
<i>Genyonemus lineatus</i>	white croaker	11,540,146	510,893	77,987,397	8,153,189
unidentified fish, damaged	unidentified damaged fish	5,928,186	289,669	25,544,115	775,554
Labrisomidae unid.	labrisomid blennies	5,676,402	396,984	18,262,100	1,071,392
<i>Typhlogobius californiensis</i>	blind goby	4,237,710	438,612	13,810,333	1,319,807
<i>Seriphus politus</i>	queenfish	3,745,507	605,288	24,919,399	2,595,482
larval/post-larval fish unid.	larval fishes	3,151,283	291,321	14,787,620	953,435
Sciaenidae unid.	croakers	3,139,095	193,913	17,509,653	854,328
Gobiesocidae unid.	clingfishes	2,677,766	302,561	9,428,166	852,290
Atherinopsidae unid.	silversides	1,704,581	164,738	10,713,659	752,042
<i>Gibbonsia</i> spp.	clinid kelpfishes	1,386,384	148,979	15,074,166	1,328,379
larvae, unidentified yolksac	unidentified yolksac larvae	1,170,185	97,460	5,428,720	314,896
<i>Paralabrax</i> spp.	sand bass	1,152,846	163,596	7,108,505	659,626
<i>Paralichthys californicus</i>	California halibut	875,880	137,016	5,723,042	661,340
<i>Citharichthys</i> spp.	sanddabs	811,680	73,240	2,878,826	209,398
<i>Oxyjulis californica</i>	senorita	723,188	68,004	2,349,929	143,257
<i>Sphyræna argentea</i>	Pacific barracuda	672,241	92,278	3,502,681	306,780
<i>Ruscarius creaseri</i>	roughcheek sculpin	619,711	61,654	7,400,899	660,030
<i>Syngnathus</i> spp.	pipefishes	559,168	52,424	1,140,256	94,799
<i>Pleuronichthys verticalis</i>	hornyhead turbot	544,020	84,107	2,029,879	256,611
Scorpaenidae unid.	scorpionfishes	520,889	121,895	584,411	131,633
<i>Stenobranchius leucopsarus</i>	northern lampfish	436,562	53,868	1,613,315	164,234
<i>Clinocottus</i> spp.	sculpins	396,411	31,695	2,634,889	115,283
<i>Parophrys vetulus</i>	English sole	369,086	88,108	4,028,114	562,736
<i>Rhinogobiops nicholsii</i>	blackeye goby	339,920	35,787	1,041,253	84,129
<i>Pleuronichthys ritteri</i>	spotted turbot	277,750	37,285	1,717,153	142,796
<i>Sebastes</i> spp.	rockfishes	267,001	58,878	931,084	126,335
<i>Cheilotrema saturnum</i>	black croaker	264,056	50,144	1,029,853	140,779
<i>Pleuronichthys</i> spp.	turbots	244,364	25,224	1,934,699	115,923
<i>Pleuronichthys guttulatus</i>	diamond turbot	226,425	32,497	4,242,652	250,943
Ophidiidae unid.	cusks-eels	214,634	29,299	1,532,262	113,153
Pleuronectidae unid.	righteye flounders	206,336	17,972	1,917,126	74,605
<i>Merluccius productus</i>	Pacific hake	146,457	27,644	1,987,199	176,087
<i>Artedius</i> spp.	sculpins	139,818	18,746	387,922	46,092
<i>Symphurus atricaudus</i>	California tonguefish	139,368	35,363	276,280	52,215
Labridae unid.	wrasses	136,605	26,339	1,059,314	119,538
<i>Halichoeres semicinctus</i>	rock wrasse	125,500	19,308	405,770	36,712
Bathymasteridae unid.	ronquils	123,001	22,446	254,487	44,431
<i>Semicossyphus pulcher</i>	California sheephead	111,779	20,727	364,248	65,973

(table continued)

Table 4.5-4 (continued). Calculated total annual entrainment of larval fishes and fish eggs at RBGS Units 7&8 in 2006 based on actual and design (maximum) cooling water intake pump flows.

<b>Taxon</b>	<b>Common Name</b>	<b>Annual Entrainment (Actual Flows)</b>	<b>Standard Error</b>	<b>Annual Entrainment (Design Flows)</b>	<b>Standard Error</b>
<i>Pleuronectiformes</i> unid.	flatfishes	105,964	20,592	478,509	60,041
<i>Lepidogobius lepidus</i>	bay goby	104,664	21,930	211,092	44,124
<i>Oxylebius pictus</i>	painted greenling	98,006	23,783	1,079,116	180,181
<i>Xystreurus liolepis</i>	fantail sole	87,372	33,650	567,637	117,783
<i>Menticirrhus undulatus</i>	California corbina	82,566	16,359	871,702	109,191
Cottidae unid.	sculpins	71,135	11,486	372,117	39,140
<i>Leuroglossus stilbius</i>	California smoothtongue	64,974	13,475	354,231	39,770
<i>Chilara taylori</i>	spotted cusk-eel	64,608	17,940	72,487	19,373
<i>Heterostichus rostratus</i>	giant kelpfish	59,255	13,222	170,916	33,072
<i>Medialuna californiensis</i>	halfmoon	50,737	12,897	239,532	42,252
<i>Rimicola</i> spp.	kelp clingfishes	47,297	19,669	723,084	131,015
<i>Zaniolepis</i> spp.	combfishes	46,877	12,670	295,105	53,076
<i>Ophidion scrippsae</i>	basketweave cusk-eel	41,199	13,107	375,525	62,857
Chaenopsidae unid.	tube blennies	39,427	11,014	81,574	21,802
<i>Chitonotus / Icelinus</i>	sculpins	39,427	11,014	81,574	21,802
<i>Scorpaenichthys marmoratus</i>	cabezon	38,190	21,409	2,294,505	388,839
<i>Icelinus</i> spp.	sculpins	32,142	10,174	65,890	20,836
<i>Sardinops sagax</i>	Pacific sardine	26,967	7,883	287,869	46,847
<i>Platichthys stellatus</i>	starry flounder	10,151	5,156	92,524	24,728
<i>Gillichthys mirabilis</i>	longjaw mudsucker	9,942	5,050	90,618	24,219
Pomacentridae unid.	damsel fishes	9,187	4,148	113,301	30,281
Paralichthyidae unid.	sand flounders	8,908	4,525	164,815	31,150
<i>Microstomus pacificus</i>	Dover sole	7,577	3,438	111,559	22,772
<i>Lythrypnus</i> spp.	gobies	7,238	3,677	65,972	17,632
<i>Hippoglossina stomata</i>	bigmouth sole	5,251	4,093	293,915	61,235
<i>Roncador stearnsii</i>	spotfin croaker	0	0	81,067	21,666
<b>Fish Eggs</b>		<b>189,537,344</b>		<b>744,808,585</b>	
fish eggs unid.	unidentified fish eggs	1,605,529,188	39,444,233	5,254,825,323	84,691,448
Engraulidae unid. (eggs)	anchovy eggs	354,770,573	21,766,832	824,879,641	43,318,474
<i>Pleuronichthys</i> spp. (eggs)	turbot eggs	82,676,023	5,030,408	304,390,420	10,370,972
Paralichthyidae unid. (eggs)	sand flounder eggs	79,188,881	4,876,678	475,904,395	17,148,779
Sciaenidae / Paralich. / Labr.	SPL fish eggs	65,958,572	4,346,946	322,224,186	13,179,525
<i>Citharichthys</i> spp. (eggs)	sanddab eggs	28,594,090	1,479,144	224,909,192	7,464,007
Sciaenidae unid. (eggs)	croaker eggs	11,547,728	546,559	83,387,279	3,532,023
Labridae unid. (eggs)	wrasse eggs	4,579,339	577,820	13,449,734	1,144,095
<i>Pleuronectidae</i> unid. (eggs)	righteye flounder eggs	866,678	147,480	1,736,831	295,350
<i>Pleuronichthys guttulatus</i> (eggs)	diamond turbot eggs	439,751	68,282	1,247,516	154,423
<i>Sphyraena argentea</i> (eggs)	Pacific barracuda eggs	331,730	71,741	3,124,393	487,511
<i>Genyonemus lineatus</i> (eggs)	white croaker eggs	235,529	29,400	16,700,091	624,802
<i>Paralichthys californicus</i> (eggs)	California halibut eggs	89,660	33,174	8,374,606	836,775
<i>Hypsypops rubicundus</i> (eggs)	garibaldi eggs	77,548	31,305	363,558	100,833
<i>Paralabrax</i> spp. (eggs)	sand bass eggs	38,224	11,561	669,339	89,570
		<b>2,234,923,515</b>		<b>7,536,186,504</b>	

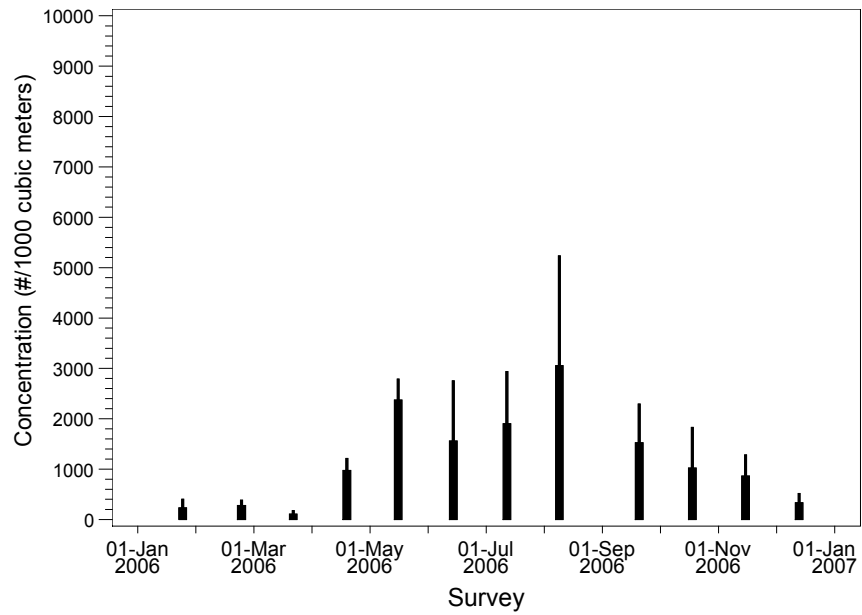

Figure 4.5-1. Mean concentration (# / 1,000 m<sup>3</sup> [264,172 gal]) and standard deviation of all larval fishes collected at the RBGS Station H2 from January 2006 through December 2006.

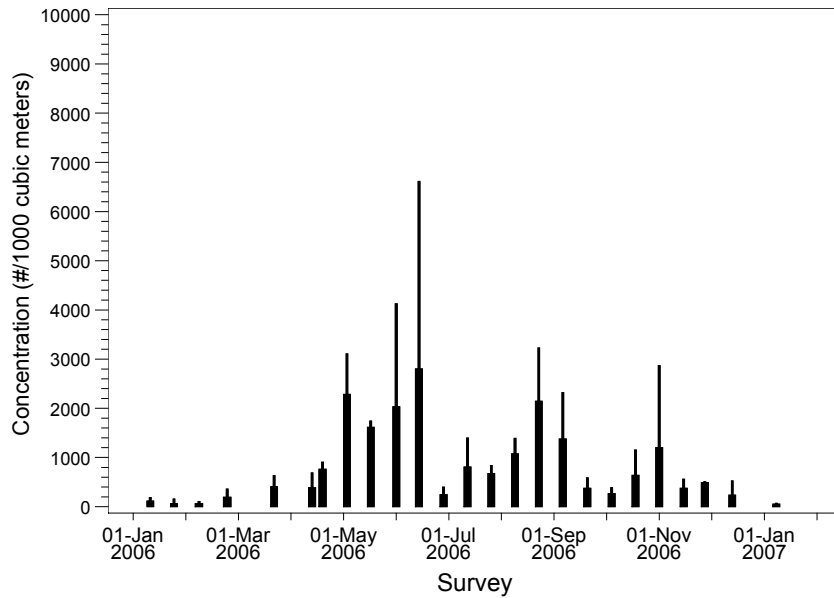

Figure 4.5-2. Mean concentration (# / 1,000 m<sup>3</sup> [264,172 gal]) and standard deviation of all larval fishes collected at the RBGS Entrainment Station E4 from January 2006 through January 2007.

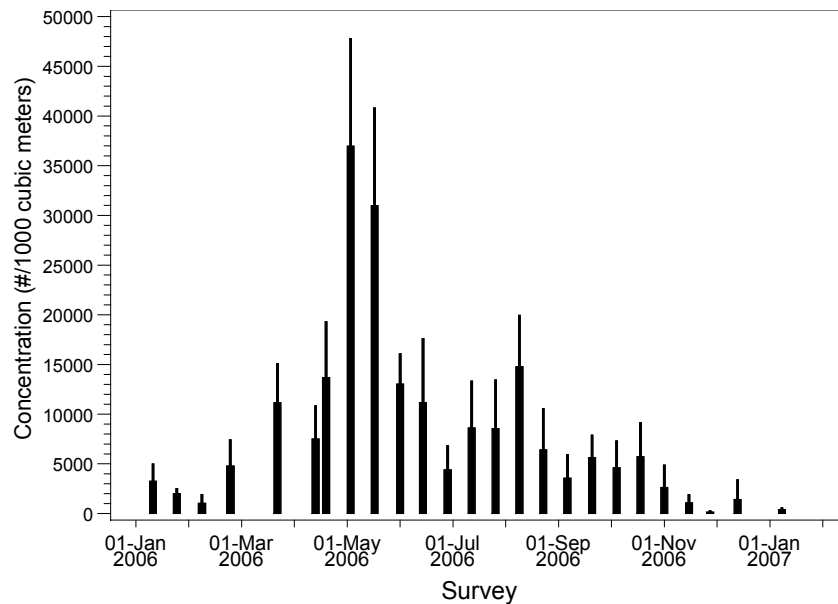

Figure 4.5-3. Mean concentration (# / 1,000 m<sup>3</sup> [264,172 gal]) and standard deviation of fish eggs collected at the RBGS Entrainment Station E4 from January 2006 through January 2007.



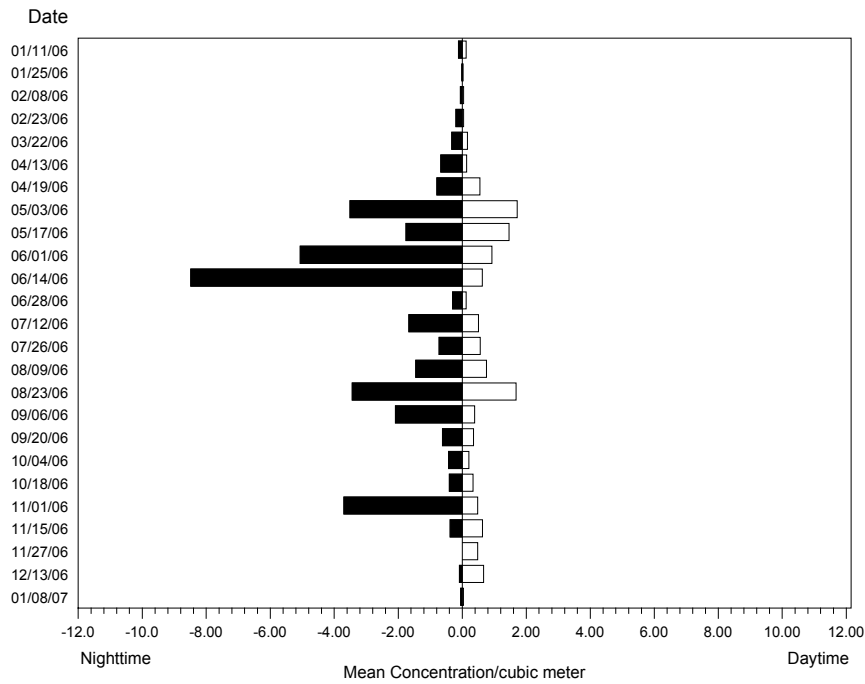

Figure 4.5-4. Mean concentration (#/1.0 m<sup>3</sup> [264 gal]) of all fish larvae at the RBGS Entrainment Station E4 during night (Cycle 3) and day (Cycle 1) sampling.

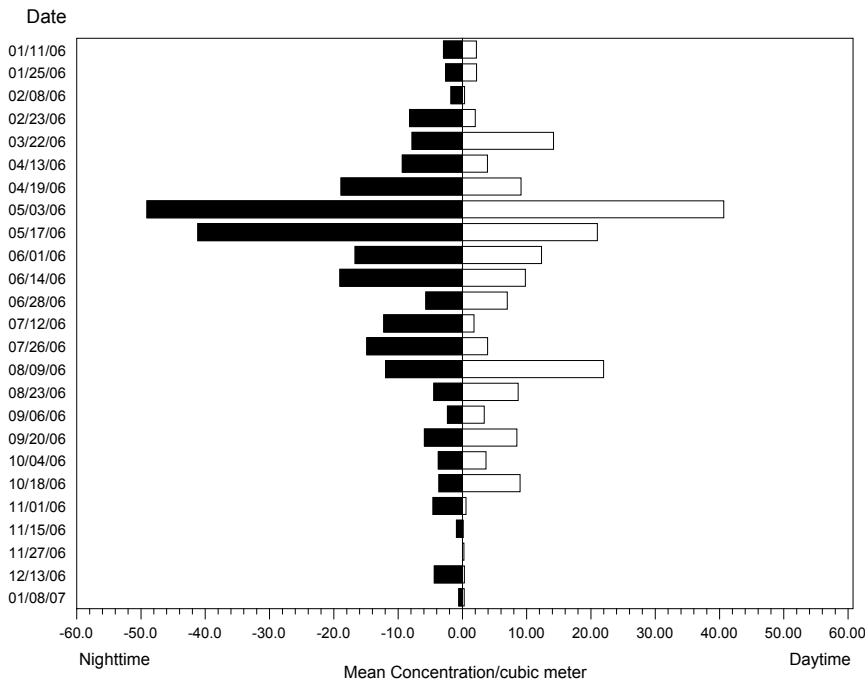

Figure 4.5-5. Mean concentration (#/1.0 m<sup>3</sup> [264 gal]) of all fish eggs at the RBGS Entrainment Station E4 during night (Cycle 3) and day (Cycle 1) sampling.

**4.5.1.2 Invertebrates**

A total of 35 larval target shellfishes representing 10 taxa was collected from Station H2 during 12 monthly surveys in 2006 (Table 4.5-5 and Appendix D), and a total of 460 larval target shellfishes representing 19 taxa was collected from Station E4 during 25 bi-weekly surveys in 2006–2007 (Table 4.5-6 and Appendix D). The most abundant target shellfish larvae in the samples were California spiny lobster, followed by unidentified spider crab megalops (Majidae unid.). Total annual entrainment for Units 5&6 was estimated to be 2.8 million target shellfish larvae based on actual flows and 4.8 million based on design flows (Table 4.5-7). Total annual entrainment for Units 7&8 was estimated to be 20.5 million target shellfish larvae based on actual flows. Using the design, or maximum capacity flows, the estimates at Units 7&8 increased to 43.9 million shellfish larvae (Table 4.5-8).

Table 4.5-5. Abundance of target shellfish larvae sampled at RBGS Station H2 from January 2006 to December 2006.

<b>Taxon</b>	<b>Common Name</b>	<b>Avg. Conc. (per 1,000 m<sup>3</sup>)</b>	<b>Total Count</b>	<b>Percentage of Total</b>	<b>Cumulative Percentage</b>
<i>Panulirus interruptus</i>	Calif. spiny lobster (larval)	8.63	19	53.41	53.41
Majidae unid.	spider crab megalops	2.31	5	14.27	67.68
<i>Pugettia</i> spp.	kelp crabs megalops	1.02	2	6.33	74.01
Paguridae unid.	hermit crab megalops	1.01	2	6.25	80.26
<i>Petrolisthes</i> spp.	porcelain crab megalops	0.80	2	4.97	85.23
Brachyura unid.	unidentified crab megalops	0.57	1	3.50	88.73
<i>Portunus xantusii</i>	Xantus' swimming crab megalops	0.55	1	3.43	92.16
<i>Pinnixa</i> spp.	pea crabs megalops	0.45	1	2.76	94.92
<i>Loligo opalescens</i>	market squid	0.44	1	2.71	97.63
Pinnotheridae	pea crab megalops	0.38	1	2.37	100.00
		<b>16.17</b>	<b>35</b>		

Table 4.5-6. Abundance of target shellfish larvae sampled at RBGS Entrainment Station E4 from January 2006 and January 2007.

<b>Taxon</b>	<b>Common Name</b>	<b>Avg. Conc. (per 1,000 m<sup>3</sup>)</b>	<b>Total Count</b>	<b>Percentage of Total</b>	<b>Cumulative Percentage</b>
<i>Panulirus interruptus</i>	Calif. spiny lobster	19.38	190	39.85	39.85
Majidae unid.	spider crab	5.06	51	10.41	50.26
<i>Pinnixa</i> spp.	pea crabs	3.92	37	8.07	58.33
<i>Pugettia</i> spp.	kelp crabs	3.22	28	6.61	64.95
Grapsidae unid.	shore crab	2.92	21	6.00	70.95
Paguridae unid.	hermit crab	2.76	27	5.68	76.63
<i>Lophopanopeus</i> spp.	black-clawed crab	2.63	26	5.41	82.04
Brachyura unid.	unidentified crab	1.53	12	3.15	85.20
<i>Emerita analoga</i>	mole crabs	1.47	16	3.02	88.21
<i>Cancer</i> spp.	cancer crabs	1.36	13	2.80	91.02
Porcellanidae unid.	porcelain crab	0.79	8	1.63	92.64
unidentified crab	unidentified crab	0.78	7	1.61	94.25
<i>Pachycheles</i> spp.	porcelain crabs	0.74	7	1.53	95.79
<i>Petrolisthes</i> spp.	porcelain crab	0.68	7	1.40	97.18
<i>Portunus xantusii</i>	Xantus' swimming crab	0.56	2	1.15	98.34
<i>Pachycheles rudis</i>	thickclaw porcelain crab	0.28	3	0.58	98.92
Diogenidae	left-handed hermit crabs	0.23	2	0.46	99.38
<i>Loligo opalescens</i>	market squid (paralarvae)	0.19	2	0.40	99.78
<i>Pachycheles pubescens</i>	pubescent porcelain crab	0.11	1	0.22	100.00
		<b>48.62</b>	<b>460</b>		

Table 4.5-7. Calculated total annual entrainment of target shellfish larvae at RBGS Units 5&6 based on actual and design (maximum) cooling water intake pump flows from January 2006 to December 2006.

<b>Taxon</b>	<b>Common Name</b>	<b>Annual Entrainment (Actual Flows)</b>	<b>Standard Error</b>	<b>Annual Entrainment (Design Flows)</b>	<b>Standard Error</b>
<i>Panulirus interruptus</i>	Calif. spiny lobster	1,924,221	190,477	2,421,597	220,843
Majidae unid.	spider crab	418,380	57,797	711,920	75,712
<i>Petrolisthes</i> spp.	porcelain crab	138,308	21,854	245,081	31,125
Pinnotheridae	pea crab	89,679	17,227	105,218	19,884
Paguridae unid.	hermit crab	64,058	12,379	277,984	37,228
<i>Pugettia</i> spp.	kelp crabs	52,653	10,900	390,541	44,753
<i>Loligo opalescens</i>	market squid	41,483	10,626	120,625	22,796
<i>Pinnixa</i> spp.	pea crabs	36,068	9,849	122,590	23,167
<i>Portunus xantusii</i>	Xantus' swimming crab	18,743	6,889	152,267	28,776
Brachyura unid.	unidentified crab	10,648	3,537	233,539	36,036
		<b>2,794,242</b>		<b>4,781,362</b>	

Table 4.5-8. Calculated total annual entrainment of target shellfish larvae at RBGS Units 7&8 based on actual and design (maximum) cooling water intake pump flows from January 2006 to January 2007.

<b>Taxon</b>	<b>Common Name</b>	<b>Annual Entrainment (Actual Flows)</b>	<b>Standard Error</b>	<b>Annual Entrainment (Design Flows)</b>	<b>Standard Error</b>
<i>Panulirus interruptus</i>	Calif. spiny lobster	11,831,612	1,686,256	17,322,709	1,972,362
<i>Pinnixa</i> spp.	pea crabs	1,644,752	241,619	3,415,352	334,254
Majidae unid.	spider crab	1,224,858	115,608	4,634,505	240,394
<i>Lophopanopeus</i> spp.	black-clawed crab	1,132,197	171,829	2,301,711	286,658
<i>Pugettia</i> spp.	kelp crabs	1,003,119	157,334	3,559,368	248,937
Paguridae unid.	hermit crab	696,519	80,379	2,508,374	172,534
<i>Pachycheles</i> spp.	porcelain crabs	472,079	128,981	720,395	153,112
<i>Emerita analoga</i>	mole crabs	463,779	93,246	1,186,401	196,399
<i>Cancer</i> spp.	cancer crabs	448,345	86,516	1,404,660	142,221
Porcellanidae unid.	porcelain crab	366,005	68,172	650,169	92,253
Grapsidae unid.	shore crab	348,849	67,728	2,506,823	255,109
<i>Petrolisthes</i> spp.	porcelain crab	211,722	38,816	434,017	79,494
	unidentified crab	193,987	21,166	676,334	59,429
Brachyura unid.	unidentified crab	192,139	33,192	1,396,736	134,893
<i>Pachycheles rudis</i>	thickclaw porcelain crab	96,299	23,659	309,203	54,142
<i>Loligo opalescens</i>	market squid	60,104	19,025	123,211	38,963
<i>Pachycheles pubescens</i>	pubescent porcelain crab	47,355	12,656	94,828	25,344
Diogenidae	left-handed hermit crabs	26,035	9,240	193,852	37,423
<i>Portunus xantusii</i>	Xantus' swimming crab	2,658	2,072	494,080	108,451
		<b>20,462,413</b>		<b>43,932,727</b>	

## 4.5.2 Source Water Summary

### 4.5.2.1 Fishes

A total of 13,938 fish larvae from 84 separate taxonomic categories was collected from the source water stations during the twelve surveys, including Station H2 in King Harbor that was originally sampled as a source water station but then was used to represent entrainment for those units (Table 4.5-9). The most abundant fish larvae in the samples were unidentified gobies (30.0%) followed by combtooth blennies (22.1%). The greatest concentrations of larval fishes occurred during April and the lowest were observed in January and February (Figure 4.5-5). As was seen at the entrainment station, there were generally more larval fish collected during night sampling than during day sampling (Figure 4.5-6). Data from the entrainment and source water surveys including standardized concentrations of larvae per water volume are presented in Appendix D.

Table 4.5-9. Average concentration of larval fishes in samples collected at the RBGS source water stations in King Harbor and Santa Monica Bay in 2006.

<b>Taxon</b>	<b>Common Name</b>	<b>Avg. Conc. (per 1,000 m<sup>3</sup>)</b>	<b>Total Count</b>	<b>Percentage of Total</b>	<b>Cumulative Percentage</b>
Gobiidae unid.	gobies	296.13	4,240	29.96	29.96
<i>Hypsoblennius</i> spp.	combtooth blennies	218.04	2,381	22.06	52.01
<i>Genyonemus lineatus</i>	white croaker	122.45	1,945	12.39	64.40
Engraulidae unid.	anchovies	118.21	1,842	11.96	76.36
Labrisomidae unid.	labrisomid blennies	25.12	324	2.54	78.90
unidentified larvae, damaged	unid. damaged larvae	22.24	343	2.25	81.15
unidentified larvae, yolksac	unid. yolksac larvae	18.93	277	1.91	83.06
Sciaenidae unid.	croakers	15.27	219	1.54	84.61
<i>Hypsypops rubicundus</i>	garibaldi	13.96	126	1.41	86.02
<i>Parophrys vetulus</i>	English sole	13.86	320	1.40	87.42
<i>Paralichthys californicus</i>	California halibut	12.45	197	1.26	88.68
Gobiesocidae unid.	clingfishes	8.54	110	0.86	89.55
<i>Paralabrax</i> spp.	sand bass	8.31	121	0.84	90.39
<i>Seriphus politus</i>	queenfish	6.68	94	0.68	91.06
<i>Typhlogobius californiensis</i>	blind goby	6.54	85	0.66	91.72
<i>Citharichthys</i> spp.	sanddabs	6.19	89	0.63	92.35
Atherinopsidae unid.	silversides	6.17	81	0.62	92.97
<i>Pleuronichthys guttulatus</i>	diamond turbot	5.36	82	0.54	93.51
<i>Oxyjulis californica</i>	senorita	4.51	61	0.46	93.97
<i>Pleuronichthys ritteri</i>	spotted turbot	4.42	66	0.45	94.42
<i>Stenobranchius leucopsarus</i>	northern lampfish	4.27	100	0.43	94.85
<i>Sebastes</i> spp.	rockfishes	3.94	73	0.40	95.25
<i>Gibbonsia</i> spp.	clinid kelpfishes	3.54	42	0.36	95.61
<i>Pleuronichthys</i> spp.	turbots	3.32	58	0.34	95.94
<i>Pleuronichthys verticalis</i>	hornyhead turbot	3.22	55	0.33	96.27
<i>Chromis punctipinnis</i>	blacksmith	3.03	45	0.31	96.57
Ophidiidae unid.	cusks-eels	2.47	37	0.25	96.82
Haemulidae unid.	grunts	2.44	37	0.25	97.07
<i>Menticirrhus undulatus</i>	California corbina	2.25	31	0.23	97.30
Bathymasteridae unid.	ronquils	2.11	36	0.21	97.51
larval/post-larval fish unid.	larval fishes	2.05	33	0.21	97.72
<i>Rhinogobiops nicholsii</i>	blackeye goby	1.71	31	0.17	97.89
<i>Merluccius productus</i>	Pacific hake	1.64	39	0.17	98.06
<i>Sphyaena argentea</i>	Pacific barracuda	1.64	22	0.17	98.22
Pleuronectidae unid.	righteye flounders	1.38	32	0.14	98.36
<i>Lepidogobius lepidus</i>	bay goby	1.02	20	0.10	98.47
<i>Clinocottus</i> spp.	sculpins	0.90	14	0.09	98.56
Paralichthyidae unid.	sand flounders	0.86	12	0.09	98.64
Bathylagidae unid.	blacksmelt	0.83	25	0.08	98.73
<i>Syngnathus</i> spp.	pipefishes	0.83	12	0.08	98.81
<i>Cheilotrema saturnum</i>	black croaker	0.76	8	0.08	98.89
<i>Semicossyphus pulcher</i>	California sheephead	0.67	10	0.07	98.96
<i>Ruscarius creaseri</i>	roughcheek sculpin	0.65	11	0.07	99.02

(table continued)

Table 4.5-9 (continued). Average concentration of larval fishes in samples collected at the RBGS source water stations in King Harbor and Santa Monica Bay in 2006.

Taxon	Common Name	Avg. Conc. (per 1,000 m <sup>3</sup> )	Total Count	Percentage of Total	Cumulative Percentage
Pleuronectiformes unid.	flatfishes	0.65	12	0.07	99.09
<i>Icelinus</i> spp.	sculpins	0.63	10	0.06	99.15
<i>Symphurus stearnsii</i>	California tonguefish	0.59	8	0.06	99.21
<i>Xystreureys liolepis</i>	fantail sole	0.55	9	0.06	99.27
<i>Leuroglossus stilbius</i>	California smoothtongue	0.50	9	0.05	99.32
<i>Zaniolepis</i> spp.	combfishes	0.44	8	0.04	99.36
<i>Halichoeres semicinctus</i>	rock wrasse	0.41	7	0.04	99.40
<i>Lyopsetta exilis</i>	slender sole	0.40	7	0.04	99.44
<i>Umbrina roncadior</i>	yellowfin croaker	0.38	5	0.04	99.48
<i>Xenistius californiensis</i>	salema	0.33	5	0.03	99.52
<i>Oligocottus / Clinocottus</i>	sculpins	0.33	2	0.03	99.55
<i>Ophidion scrippsae</i>	basketweave cusk-eel	0.31	5	0.03	99.58
Blenniidae unid.	blennies	0.30	4	0.03	99.61
Cottidae unid.	sculpins	0.26	4	0.03	99.64
<i>Sardinops sagax</i>	Pacific sardine	0.23	4	0.02	99.66
<i>Rimicola</i> spp.	kelp clingfishes	0.22	3	0.02	99.68
<i>Peprilus simillimus</i>	Pacific butterfish	0.22	4	0.02	99.71
<i>Hippoglossina stomata</i>	bigmouth sole	0.21	3	0.02	99.73
<i>Artedius</i> spp.	sculpins	0.20	3	0.02	99.75
<i>Triphoturus mexicanus</i>	Mexican lampfish	0.19	3	0.02	99.77
<i>Odontopyxis trispinosa</i>	pygmy poacher	0.18	4	0.02	99.78
<i>Heterostichus rostratus</i>	giant kelpfish	0.17	2	0.02	99.80
Chaenopsidae unid.	tube blennies	0.16	3	0.02	99.82
<i>Medialuna californiensis</i>	halfmoon	0.16	2	0.02	99.83
Pomacentridae unid.	damsel fishes	0.16	2	0.02	99.85
<i>Atractoscion nobilis</i>	white seabass	0.14	2	0.01	99.86
<i>Trachurus symmetricus</i>	jack mackerel	0.14	2	0.01	99.88
Blennioidei unid.	blennies	0.13	2	0.01	99.89
<i>Gillichthys mirabilis</i>	longjaw mudsucker	0.13	2	0.01	99.90
<i>Scorpaenichthys marmoratus</i>	cabezon	0.12	2	0.01	99.92
Labridae unid.	wrasses	0.11	2	0.01	99.93
Clupeiformes unid.	herrings and anchovies	0.08	1	0.01	99.94
<i>Lythrypnus zebra</i>	zebra goby	0.08	1	0.01	99.94
<i>Oxylebius pictus</i>	painted greenling	0.08	1	0.01	99.95
<i>Oligocottus</i> spp.	sculpins	0.07	1	0.01	99.96
<i>Liparis</i> spp.	snailfishes	0.07	1	0.01	99.96
<i>Roncadior stearnsii</i>	spotfin croaker	0.06	1	0.01	99.97
<i>Nannobranchium</i> spp.	lanternfishes	0.06	1	0.01	99.98
<i>Anisotremus davidsonii</i>	sargo	0.05	1	0.01	99.98
<i>Microstomus pacificus</i>	Dover sole	0.05	1	0.00	99.99
Cyclopteridae unid.	snailfishes	0.04	1	0.00	99.99
<i>Leptocottus armatus</i>	Pacific staghorn sculpin	0.04	1	0.00	100.00
Osmeriformes	salmons	0.04	1	0.00	100.00
		<b>988.56</b>	<b>13,938</b>		

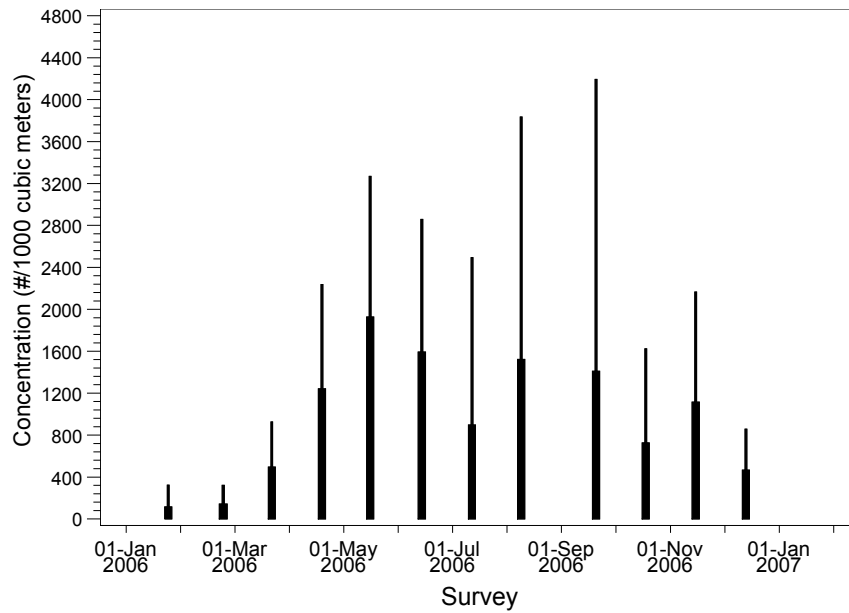

Figure 4.5-6. Mean concentration (# / 1,000 m<sup>3</sup> [264,172 gal]) and standard deviation of all larval fishes collected at the RBGS source water stations during 2006.

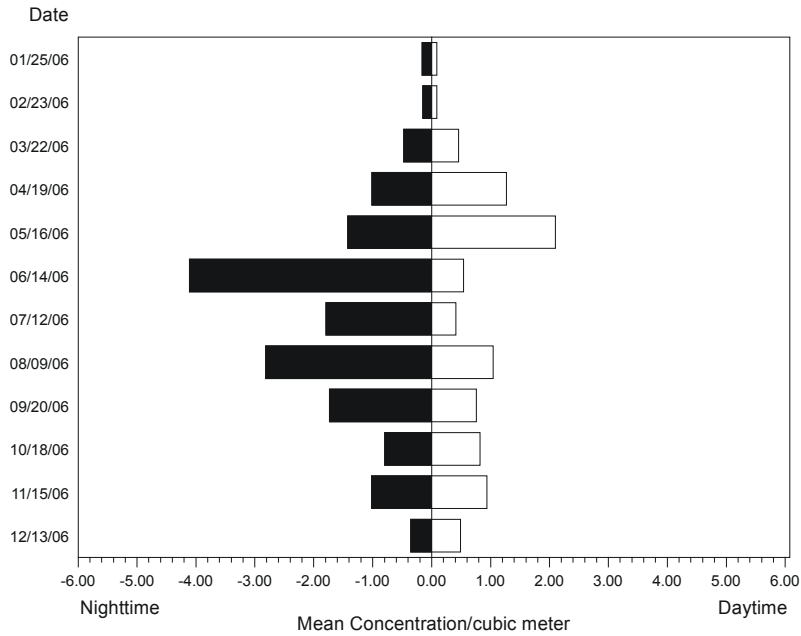

Figure 4.5-7. Mean concentration (#/1.0 m<sup>3</sup> [264 gal]) of all fish larvae at the RBGS Source Water Stations during night (Cycle 3) and day (Cycle 1) sampling.



**4.5.2.2 Target Invertebrates**

A total of 832 larval invertebrates representing 23 taxa was collected from the RBGS source water stations during 12 monthly surveys in 2006 (Table 4.5-6 and Appendix D). The most abundant target invertebrate larvae in the samples were California spiny lobster, followed by kelp crab megalops (*Pugettia* spp.), which made up 24.7% and 19.1%, respectively of the total target invertebrate larvae collected. A total of 40 market squid paralarvae were collected.

Table 4.5-10. Average concentration of target invertebrate larvae in samples collected at the RBGS source water stations in King Harbor and Santa Monica Bay in 2006.

Taxon	Common Name	Avg. Conc. (per 1,000 m <sup>3</sup> )	Total Count	Percentage of Total	Cumulative Percentage
<i>Panulirus interruptus</i>	California spiny lobster (larval)	14.77	204	24.67	24.67
<i>Pugettia</i> spp.	kelp crabs megalops	11.41	149	19.07	43.74
Majidae unid.	spider crab megalops	9.03	125	15.08	58.82
<i>Pinnixa</i> spp.	pea crabs megalops	4.72	74	7.89	66.71
<i>Cancer</i> spp.	cancer crabs megalops	3.35	50	5.59	72.30
<i>Loligo opalescens</i>	market squid	2.96	40	4.94	77.24
<i>Emerita analoga</i>	mole crabs megalops	2.73	41	4.57	81.81
Brachyura unid.	unidentified crab megalops	1.76	20	2.93	84.74
Paguridae unid.	hermit crab megalops	1.51	22	2.52	87.26
unidentified crab	unidentified crab megalops	1.48	26	2.48	89.74
<i>Lophopanopeus</i> spp.	black-clawed crab megalops	1.37	16	2.28	92.02
Grapsidae unid.	shore crab megalops	1.07	13	1.78	93.81
Diogenidae	left-handed hermit crabs megalops	1.01	13	1.69	95.49
<i>Pachycheles</i> spp.	porcelain crabs megalops	0.79	12	1.32	96.82
<i>Petrolisthes</i> spp.	porcelain crab megalops	0.62	9	1.03	97.85
<i>Pinnotheres</i> spp.	pea crab megalops	0.38	5	0.63	98.48
Porcellanidae unid.	porcelain crab megalops	0.26	4	0.44	98.92
<i>Portunus xantusii</i>	Xantus' swimming crab megalops	0.25	3	0.42	99.34
Pinnotheridae	pea crab megalops	0.14	2	0.23	99.57
Anomura unid.	Anomuran crab (megalops)	0.07	1	0.11	99.68
<i>Pachycheles rudis</i>	thickclaw porcelain crab megalops	0.06	1	0.11	99.79
<i>Pachycheles pubescens</i>	pubescent porcelain crab megalops	0.06	1	0.11	99.90
Hippoidea	mole crab megalops	0.06	1	0.10	100.00
		<b>59.86</b>	<b>832</b>		

### 4.5.3 Results by Species for Cooling Water Intake Structure Entrainment

The following fish taxa were selected for detailed evaluation of entrainment effects based on their abundance in the entrainment samples for Units 7&8 or status as a PFMC managed species and were agreed upon with staff from the LARWQCB and other resource agencies. The list of species analyzed comprised nearly 90% of the larvae entrained at RBGS in 2006 (Table 4.5-1). In taxonomic order these are:

- anchovies (*Engraulis mordax* and Engraulidae) + eggs
- silversides (Atherinopsidae)
- clingfishes (*Gobiesox* spp.)
- sea basses (*Paralabrax* spp.)
- white croaker (*Genyonemus lineatus*)
- queenfish (*Seriphus politus*)
- unidentified croakers (Sciaenidae)
- garibaldi (*Hypsypops rubicundus*)
- combtooth blennies (*Hypsoblennius* spp.)
- Labrisomid blennies (mainly *Paraclinus integripinnis*)
- kelp blennies (*Gibbonsia* spp.)
- unidentified gobies (Gobiidae)
- blind goby (*Typhlogobius californiensis*)
- California halibut (*Paralichthys californicus*)

#### 4.5.3.1 Anchovies (Engraulidae)

Three species of anchovy (Family Engraulidae) inhabit nearshore areas of southern California: northern anchovy (*Engraulis mordax*), deepbody anchovy (*Anchoa compressa*) and slough anchovy (*Anchoa delicatissima*). This analysis of entrainment effects on anchovies will concentrate on life history aspects of the northern anchovy because all of the Engraulid larvae collected that were large enough to be positively identified were northern anchovies. Seventy-five percent of the specimens classified in the entrainment samples as Engraulidae were northern anchovy. The remainder were very small specimens still in their recently hatched yolk-sac stage and some that were damaged to an extent that they could not be positively identified to the species level.

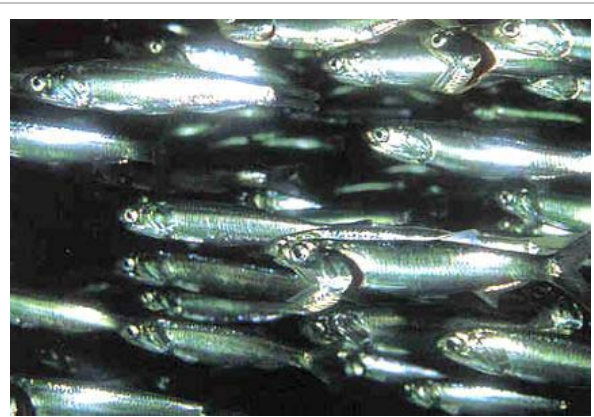

Mark Conlin

Northern anchovy range from Cabo San Lucas, Baja California to Queen Charlotte Island, British Columbia (Miller and Lea 1972), and the Gulf of California (Hammann and Cisneros-Mata 1989). They

are most common from Magdalena Bay, Baja California to San Francisco Bay within 157 km (98 mi) of shore (Hart 1973; MBC 1987). Three genetically distinct subpopulations are recognized for northern anchovy; (1) Northern subpopulation, from northern California to British Columbia; (2) Central subpopulation, from central California to northern Baja California; and (3) Southern subpopulation, off southern Baja California (Emmett et al. 1991).

#### 4.5.3.1.1 Life History and Ecology

The reported depth range of northern anchovy is from the surface to depths of 310 m (1,017 ft) (Davies and Bradley 1972). Juveniles are generally more common inshore and in estuaries. Eggs are elliptical and occur from the surface to depths of about 50 m (164 ft), while larvae are found from the surface to about 75 m (246 m) in epipelagic and nearshore waters (Garrison and Miller 1982). Northern anchovy larvae feed on dinoflagellates, rotifers, and copepods (MBC 1987).

Northern anchovy spawn throughout the year off southern California, with peak spawning between February and May (Brewer 1978) although this may vary annually and geographically. Most spawning takes place within 100 km (62 mi) of shore (MBC 1987). On average, female anchovies off Los Angeles spawn every 7–10 days during peak spawning periods, approximately 20 times per year (Hunter and Macewicz 1980, MBC 1987). Most spawning occurs at night and is completed by dawn (Hunter and Macewicz 1980). Anchovies are all sexually mature by age two, and the fraction of the population that is sexually mature at one year of age can range from 47 to 100% depending on the water temperature during development (Bergen and Jacobsen 2001). Love (1996) reported that they release 2,700–16,000 eggs per batch, with an annual fecundity of up to 130,000 eggs per year in southern California. Parrish et al. (1986) and Butler et al. (1993) stated that the total annual fecundity for one-year old females was 20,000–30,000 eggs, while a five-year old could release up to 320,000 eggs per year.

The northern anchovy egg hatches in two to four days, has a larval phase lasting approximately 70 days, and undergoes transformation into a juvenile at about 35–40 mm (Hart 1973, MBC 1987, Moser 1996). Larvae begin schooling at 11–12 mm (0.4–0.5 in) SL (Hunter and Coyne 1982). Northern anchovy on average reach 102 mm (4 in) in their first year, and 119 mm (4.7 in) in their second (Sakagawa and Kimura 1976). Larval survival is strongly influenced by the availability and density of phytoplankton species (Emmett et al. 1991). Storms and strong upwelling reduce larval food availability, and strong upwelling may transport larvae out of the Southern California Bight (Power 1986). However, strong upwelling may benefit juveniles and adults by increasing food resources. Growth in length is most rapid during the first four months, and growth in weight is most rapid during the first year (Hunter and Macewicz 1980; PFMC 1983). They mature at 78–140 mm (3.1–5.5 in) in length, in their first or second year (Frey 1971, Hunter and Macewicz 1980). Maximum size is about 230 mm (9.1 in) and 60 g (2.1 oz) (Fitch and Lavenberg 1971, Eschmeyer and Herald 1983). Maximum age is about seven years (Hart 1973), though most live less than four years (Fitch and Lavenberg 1971).

Northern anchovy are very important in the trophic ecology of marine food webs. They are random planktonic feeders, filtering plankton as they swim (Fitch and Lavenberg 1971). Juveniles and adults feed

mainly at night on zooplankton, including planktonic crustaceans and fish larvae (Fitch and Lavenberg 1971, Hart 1973, Allen and DeMartini 1983). Numerous fish and marine mammal species feed on northern anchovy. Elegant tern and California brown pelican reproduction is strongly correlated with the annual abundance of this species (Emmett et al. 1991). Thermal tolerance studies show that juveniles and adults avoid temperatures above 25°C (77°F) (Brewer 1974).

#### 4.5.3.1.2 Population Trends and Fishery

Northern anchovy is one of four coastal pelagic fish species managed by the Pacific Fisheries Management Council (PFMC)—the other species include Pacific sardine, Pacific mackerel, and jack mackerel. Northern anchovy in the northeastern Pacific is divided into three subpopulations, or stocks: northern, central, and southern. Since 1978 the PFMC has managed northern anchovy from the central and northern subpopulations. The central subpopulation includes landings from San Francisco to Punta Baja, Baja California.

Three separate commercial fisheries target northern anchovy in California and Mexico waters: 1) the reduction fishery, 2) the live bait fishery, and a 3) non-reduction fishery (Bergen and Jacobson 2001). In the reduction fishery anchovies are converted to meal, oil, and protein supplements while the non-reduction fishery includes fish that are processed for human consumption, for animal food, or frozen for use as fishing bait.

Northern anchovy populations began to increase following the collapse of the Pacific sardine (*Sardinops sagax*) fishery in 1952. Landings remained fairly low throughout the 1950s but increased rapidly in the mid 1960s when reduction of anchovy without associated canning was permitted (Bergen and Jacobson 2001). The demand for this fishery was highly linked to the production and price of fishmeal worldwide (Mason 2004). A drastic decline of 40% in fishmeal prices worldwide during the early 1980s (Durrand 1998) and the decline in anchovy abundance nearly ended anchovy reduction by 1983.

Estimates of the central subpopulation averaged about 359,000 tons from 1963 through 1972, increased to over 1.7 million tons in 1974, and then declined to 359,000 tons in 1978 (Bergen and Jacobsen 2001). Anchovy biomass in 1994 was estimated at 432,000 tons. The stock is thought to be stable, and the size of the anchovy resource is largely dependent on natural influences such as ocean temperatures related to a cold regime in the Pacific Decadal Oscillation (Chavez et al. 2003).

The California commercial fishery for northern anchovy varies substantially by region and year. There have not been any landings of northern anchovy recorded from San Diego County since 1996 when 144,242 kg (318,000 lbs) were landed (PacFIN 2007). In 2004 there were 147,417 kg (325,000 lbs) landed in the Los Angeles area as compared to 2.75 million kg (6.07 million lbs) in the Santa Barbara area, and 3.89 million kg (8.58 million lbs) in the Monterey area for a total value of \$750,000. Annual landings in the Los Angeles region since 2000 have varied from a high of 3.9 million kg (8.6 million lbs) in 2001, to a low of 0.14 million kg (0.3 million lbs) in 2004, with an average of 1.4 million kg (3 million lbs) annually (Table 4.5-11).

Table 4.5-11. Annual landings and revenue for northern anchovy in the Los Angeles region based on PacFIN data.

Year	Landed Weight (kg)	Landed Weight (lbs)	Revenue
2000	1,279,437	2,820,677	\$145,579
2001	3,656,509	8,061,223	\$319,628
2002	1,205,307	2,657,247	\$100,716
2003	327,468	721,944	\$37,750
2004	147,003	324,087	\$35,699
2005	1,979,989	4,365,130	\$185,579
2006	865,971	1,909,139	\$75,104

Concentrations of larval anchovies, as measured in King Harbor as part of the Occidental College – Vantuna Research Group’s long-term studies, peaked in the mid-1970s before declining substantially in 1978 (Figure 4.5-8). Despite subsequent peaks during 1982 and 1987, concentrations have remained below 200 larvae per 1,000 m<sup>3</sup> since the 1970s. This corresponds with data collected in southern California as part of the CalCOFI program, which documented peaks in the density of larval northern anchovy in 1975, 1981 and 1987, and relatively low concentrations in other years; no data were collected in 1982 or 1983 (Moser et al. 2001).

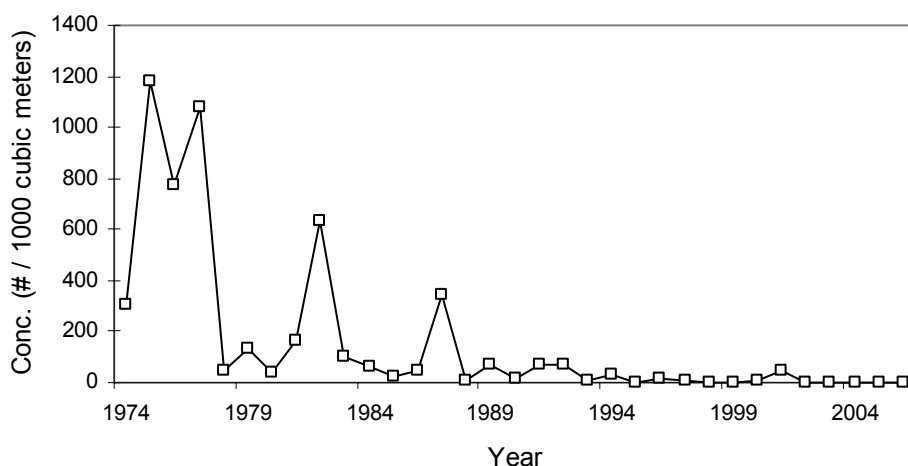

Figure 4.5-8. Mean concentration (# / 1,000 m<sup>3</sup> [264,172 gal]) of engraulid larvae collected from King Harbor, 1974-2006. Source: Vantuna Research Group.

The earlier 316(b) study from RBGS in 1979–1980 (SCE 1983) reported estimates of average concentrations of northern anchovy sampled at the intake stations and found the highest densities from December through March and lowest densities from May through August. Mean daily densities were 393 larvae per 1,000 m<sup>3</sup> (264,172 gal) at Units 7&8. Mean concentrations in 1979–1980 were approximately

three times greater than the concentrations estimated from the 2006 entrainment sampling near the RBGS intake (using actual flow volumes).

A total of 30 inner shelf and 16 bay and harbor stations were sampled during 2003 within the southern California Bight by the Southern California Coastal Water Research Project (SCCWRP) (Allen et al. 2007). Species abundance was 0.25 fish/ station for northern anchovy at bay and harbor stations during 5-10 minute trawls, while this species was not present at inner shelf stations.

#### 4.5.3.1.3 Sampling Results

Engraulid larvae (including northern anchovy) was the fourth most abundant taxon at Station H2 with a mean concentration of 36 larvae per 1,000 m<sup>3</sup> over 12 monthly surveys. It was the third most abundant taxon at Station E4 with a mean concentration of 93 larvae per 1,000 m<sup>3</sup> while engraulid eggs had an average concentration of 942 per 1,000 m<sup>3</sup> (Table 4.5-1). Almost all larvae occurred in May 2006 at both stations (Figures 4.5-9 and 4.5-10). During the period of maximum abundance in May anchovies were present in the entrainment samples at average concentrations ranging from approximately 420 larvae per 1,000 m<sup>3</sup> at Station H2 to 1,400 larvae per 1,000 m<sup>3</sup> at Station E4. They were either absent or only present in very low concentrations in all other months. Monthly source water concentrations followed a similar seasonal pattern with maximum concentrations of about 1,200 per 1,000 m<sup>3</sup> in May 2006 (Figure 4.5-11). Engraulid larvae were more common in the nighttime samples than in daytime samples (Figure 4.5-12). The length frequency distribution of measured northern anchovy larvae was skewed toward the 2.0 mm (0.08 in) and 3.0 mm (0.12 in) size classes with about 70 % of sampled larvae in these classes. Larvae in the 4.0–25.0 mm (0.16–0.99 in) size classes were relatively evenly distributed with about 1–5% of sampled larvae in each size class (Figure 4.5-13). The lengths of the larvae from the entrainment station samples ranged from 1.1–25.1 mm (0.04–0.99 in) with a mean of 5.2 mm (0.20 in) NL.

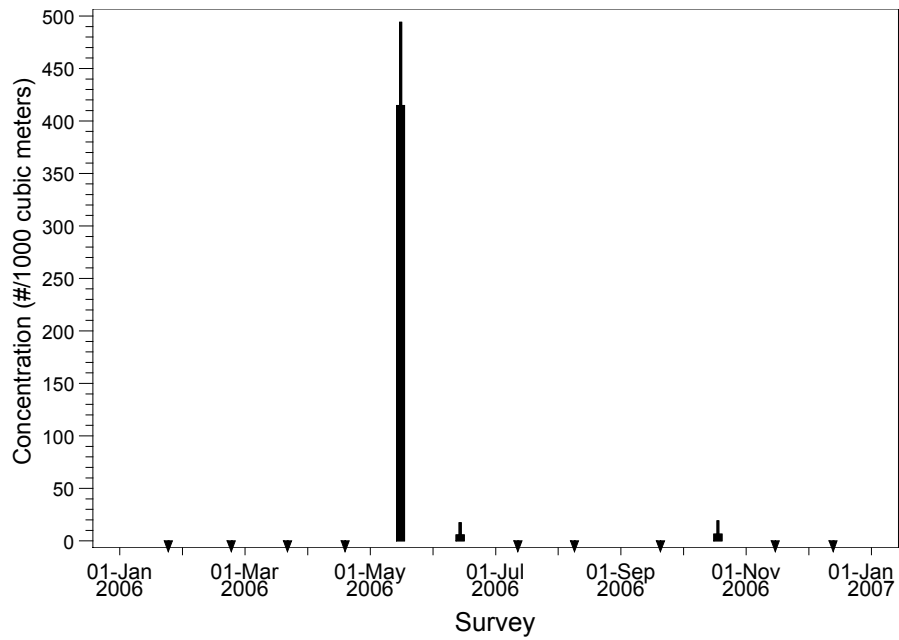

Figure 4.5-9. Mean concentration (# / 1,000 m<sup>3</sup> [264,172 gal]) and standard deviation of anchovy larvae collected at RBGS Station H2 from January 2006 through December 2006.

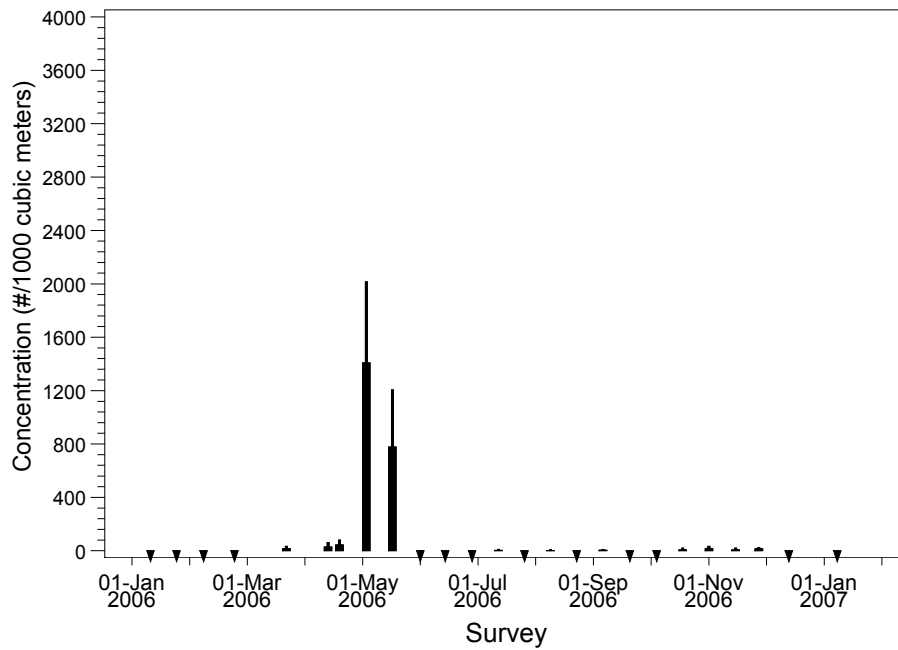

Figure 4.5-10. Mean concentration (# / 1,000 m<sup>3</sup> [264,172 gal]) and standard deviation of anchovy larvae collected at RBGS entrapment Station E4 from January 2006 through January 2007.

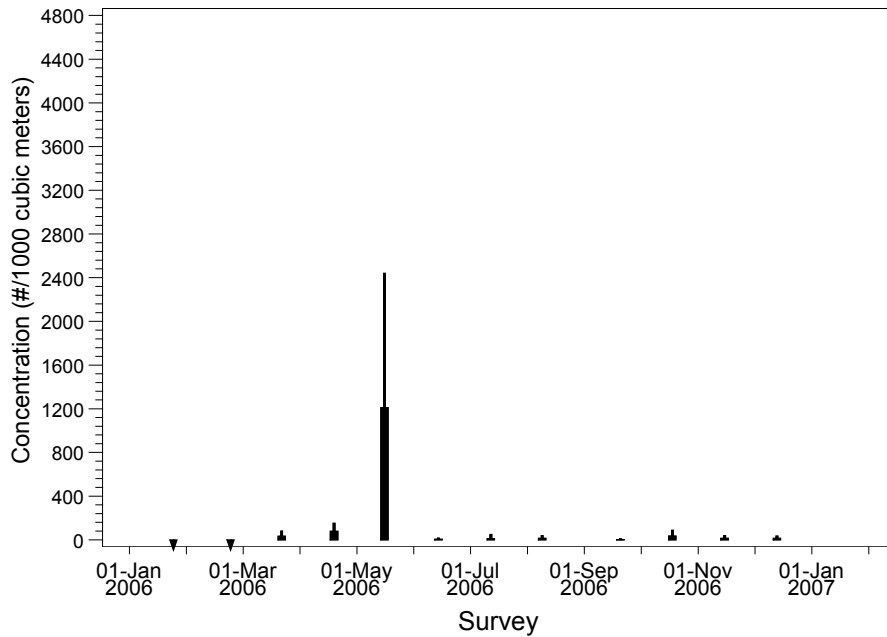

Figure 4.5-11. Mean concentration (# / 1,000 m<sup>3</sup> [264,172 gal]) and standard deviation of anchovy larvae collected at RBGS source water stations during 2006.

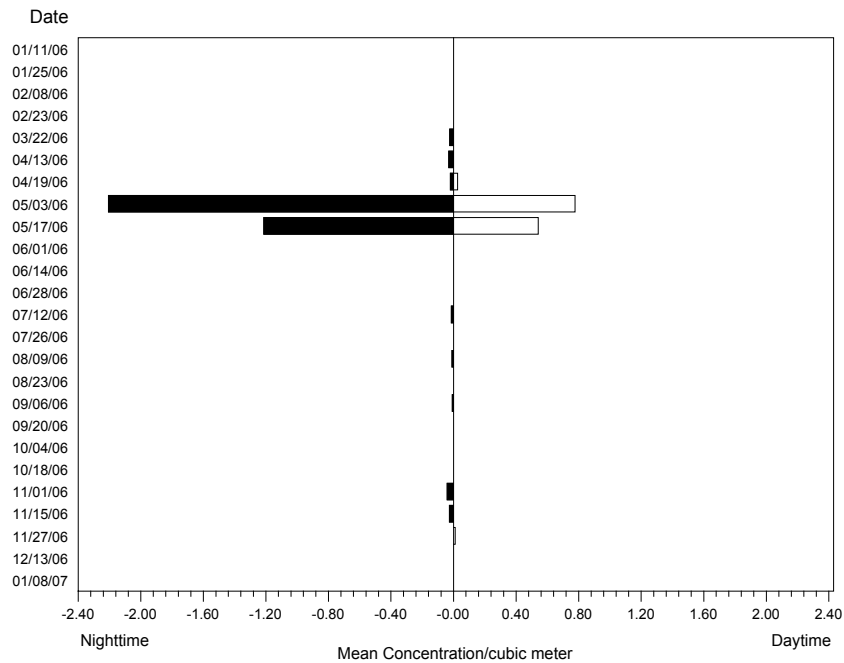

Figure 4.5-12. Mean concentration (#/1.0 m<sup>3</sup> [264 gal]) of anchovy larvae at entrainment Station E4 during night (Cycle 3) and day (Cycle 1) sampling.



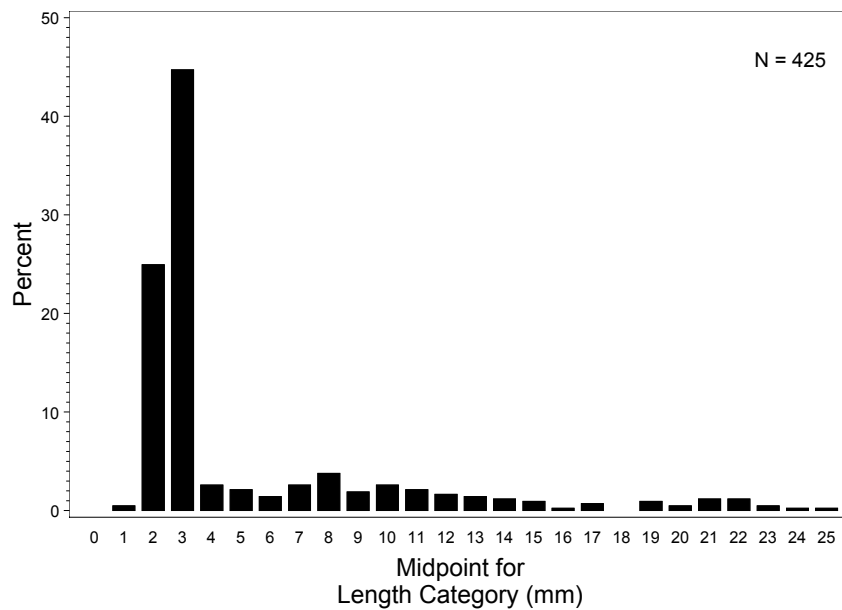

Figure 4.5-13. Length (mm) frequency distribution for larval anchovies collected at entrainment stations in Santa Monica Bay during 2006.

#### 4.5.3.1.4 Modeling Results

The following section presents the results for demographic and empirical transport modeling of entrainment effects on Engraulidae (northern anchovy) larvae. Adult female equivalents were also estimated using *FH* for Engraulidae (northern anchovy) egg entrainment. Total annual entrainment at RBGS Units 5&6 was estimated at 1,312,342 larvae using actual flows (standard error of 36,638) and 9,777,970 using design flows. Annual entrainment of anchovies at Units 7&8 was 354,770,573 eggs (standard error of 21,766,832) and 31,894,728 larvae (standard error of 3,648,747) using measured cooling water flows during the 2006–2007 study period (Table 4.5-2). If the CWIS pumps were run at the design (maximum capacity) flows, annual entrainment estimates at Units 7&8 increased to 824,879,641 eggs (standard error 43,318,474) and 85,144,128 larvae (standard error 3,602,029) (Table 4.5-2). The total duration used in the *ETM* calculations included both the estimated egg duration from the literature and the estimated larval duration to provide an integrated estimate of entrainment effects on northern anchovy.

#### *Fecundity Hindcasting (FH)*

The entrainment estimates for northern anchovy eggs and larvae for the sampling period were used to estimate the number of breeding females at the age of maturity (age at which 50% of the females are sexually mature) needed to produce the estimated number of larvae entrained. Butler et al. (1993)

modeled annual fecundity and egg and larval survivorship for northern anchovy. Their “best” estimate can be derived by fitting the range of mortality estimates from field collections to the assumption of a stable and stationary population age structure. Instantaneous daily mortality estimates from Butler et al. (1993) were converted, over their average stage durations, to finite survivorship rates for each developmental stage (Table 4.5-8). The average age of the eggs in the entrainment samples was calculated to be 1.29 days, the mean of an exponential distribution based on the Z for the egg stage from Butler et al. (1993). Survival to the average age was calculated as 0.74 using the stage survival over 2.9 days. Fish at the mean age of entrainment include yolk sac, early stage and late stage larvae. Therefore, survival estimates for all three stages were combined to obtain a finite survival value of 0.005 up to the mean age at entrainment (7.3 days). The mean age at entrainment was calculated by dividing a larval growth rate of 0.41 millimeters per day (mm/d) (0.02 in/d) into the difference between the mean length (5.1 mm [0.20 in]) and the estimated hatch length of 2.1 mm (0.08 in).

Table 4.5-12. Stage-specific life history parameters for northern anchovy (*Engraulis mordax*) modified from Butler et al. (1993).

Stage	Z <sub>best</sub>	Stage duration (days)	Age (days)	S <sub>best</sub>	CV <sub>best</sub>
Egg	0.231	2.9		0.512	0.142
Yolk-sac larva	0.366	3.6	6.5	0.093	0.240
Early larva	0.286	12	18.5	0.032	0.071
Late larva	0.0719	45	63.5	0.039	0.427
Early juvenile	0.0141	62	125.5	0.417	0.239
Late Juvenile	0.0044	80	205.5	0.703	0.033
Pre-recruit	0.0031	287	492.5	0.411	0.088

Z = instantaneous daily mortality; S = finite survival rate.

The survivorship values in Table 4.5-9 were used to estimate an average annual fecundity of 163,090 eggs produced over a seven-year period using the data presented in Butler et al. (1993).

Table 4.5-13. Survivorship table for adult northern anchovy (*Engraulis mordax*) from Butler et al. (1993) showing spawners ( $L_x$ ) surviving at the start of age interval and numbers of eggs spawned annually ( $M_x$ ).

Age (yr)	$L_x$	$M_x$	$L_x M_x$
1	1,000	22,500	22,500,000
2	468	93,500	43,800,000
3	216	195,000	42,000,000
4	102	280,000	28,600,000
5	48	328,000	15,700,000
6	22	328,000	7,210,000
7	10	328,000	3,280,000
<b>TLF =</b>			<b>163,090</b>

The total lifetime fecundity (TLF) was calculated as the sum of  $L_x M_x$  divided by 1,000.

The estimated numbers of reproductive age adult female northern anchovies whose lifetime reproductive output was entrained through the RBGS CWIS Units 5&6 for 2006 were 16 based on actual flows and 117 based on design flows. For Units 7&8 the numbers increased to 2,930 based on egg entrainment, and 11,641 based on larval entrainment using actual cooling water flows during the period (Table 4.5-14). Using the design flows, the estimates were 6,813 reproductive age adult females lost based on egg entrainment and 31,076 lost based on larval entrainment during the sampling period. The sensitivity analysis, based on the 90% confidence intervals, shows that the variation in our estimates of entrainment had much less of an effect on the variation of the *FH* estimates than the life history parameters used in the model.

Table 4.5-14. Results of *FH* modeling for anchovy eggs and larvae at Units 5&6 based on entrainment estimates calculated using actual and design (maximum) CWIS flows.

Parameter	Estimate	Std. Error	<i>FH</i> Lower Estimate	<i>FH</i> Upper Estimate	<i>FH</i> Range
<b>Actual Flows</b>					
<i>FH</i> Estimate	<b>16</b>	14	4	65	62
Total Entrainment	1,312,342	36,638	15	16	1
<b>Design Flows</b>					
<i>FH</i> Estimate	117	101	28	487	459
Total Entrainment	9,777,970	175,752	114	121	7

The upper and lower estimates are based on a 90% confidence interval of the mean. *FH* estimates were also calculated using the upper and lower confidence estimates from the entrainment estimates.

Table 4.5-15. Results of *FH* modeling for anchovy eggs and larvae at Units 7&8 based on entrainment estimates calculated using actual and design (maximum) CWIS flows.

<b>Parameter</b>	<b>Estimate</b>	<b>Std. Error</b>	<b><i>FH</i> Lower Estimate</b>	<b><i>FH</i> Upper Estimate</b>	<b><i>FH</i> Range</b>
<b><u>Actual Flows</u></b>					
<i>Eggs</i>					
<i>FH</i> Estimate	<b>2,930</b>	2,080	912	9,417	8,506
Total Entrainment	354,770,573	21,766,832	2,634	3,226	591
<i>Larvae</i>					
<i>FH</i> Estimate	<b>11,641</b>	10,099	2,794	48,506	45,712
Total Entrainment	31,894,728	1,644,483	10,654	12,628	1,975
<b><u>Design Flows</u></b>					
<i>Eggs</i>					
<i>FH</i> Estimate	6,813	4,830	2,122	21,871	19,749
Total Entrainment	824,879,641	43,318,474	6,224	7,401	1,177
<i>Larvae</i>					
<i>FH</i> Estimate	31,076	26,945	7,464	129,381	121,916
Total Entrainment	85,144,128	3,602,029	28,914	33,239	4,325

The upper and lower estimates are based on a 90% confidence interval of the mean. *FH* estimates were also calculated using the upper and lower confidence estimates from the entrainment estimates.

*Adult Equivalent Loss (AEL)*

The parameters required for formulation of *AEL* estimates include larval survival from entrainment to settlement and survival from settlement to the age at maturity. Instantaneous daily mortality estimates from Butler et al. (1993) were converted, over their average stage durations, to finite survivorship rates for each developmental stage (Table 4.5-13). The early larval stage survival was adjusted to the mean age at entrainment (7.3 days) and used to calculate a finite survival through age 63.5 d of 0.174 using the daily survival rates for late stage larvae. The other finite survival rates from Butler et al. (1993) were used to estimate the number of adults of age one year, the age of first maturity when 50% of the females are sexually mature. The equivalent number of adult northern anchovies calculated from the number of larvae entrained through the RBGS CWIS for the sampling period was 2,332 for Units 5&6 and 56,672 for Units 7&8 based on actual flows (Tables 4.5-16 and 4.5-17). Estimated losses under design flows increased to 17,374 and 151,287 for the two unit pairs.

Table 4.5-16. Results of AEL modeling for northern anchovy larvae at Units 5&6 based on entrainment estimates calculated using actual and design (maximum) CWIS flows.

<b>Parameter</b>	<b>Estimate</b>	<b>Std. Error</b>	<b>AEL Lower Estimate</b>	<b>AEL Upper Estimate</b>	<b>AEL Range</b>
<b>Actual Flows</b>					
<i>AEL</i> Estimate	<b>2,332</b>	2,698	348	15,642	15,295
Total Entrainment	1,312,342	36,638	2,225	2,439	214
<b>Design Flows</b>					
<i>AEL</i> Estimate	17,374	20,099	2,591	116,511	113,920
Total Entrainment	9,777,970	175,752	16,860	17,888	1,027

The upper and lower estimates are based on a 90% confidence interval of the mean. AEL estimates were also calculated using the upper and lower confidence estimates from the entrainment estimates.

Table 4.5-17. Results of AEL modeling for northern anchovy larvae at Units 7&8 based on entrainment estimates calculated using actual and design (maximum) CWIS flows.

<b>Parameter</b>	<b>Estimate</b>	<b>Std. Error</b>	<b>AEL Lower Estimate</b>	<b>AEL Upper Estimate</b>	<b>AEL Range</b>
<b>Actual Flows</b>					
<i>AEL</i> Estimate	<b>56,672</b>	65,618	8,437	380,677	372,240
Total Entrainment	31,894,728	1,644,483	51,865	61,478	9,613
<b>Design Flows</b>					
<i>AEL</i> Estimate	151,287	175,112	22,536	1,015,604	993,067
Total Entrainment	85,144,128	3,602,029	140,759	161,816	21,057

The upper and lower estimates are based on a 90% confidence interval of the mean. AEL estimates were also calculated using the upper and lower confidence estimates from the entrainment estimates.

*Empirical Transport Model (ETM)*

A larval growth rate of 0.41 mm/d (0.02 in/d) for northern anchovies was estimated from Methot and Kramer (1979) and used with the difference in the lengths between the estimated hatch length and the 95<sup>th</sup> percentiles of the measurements to estimate that the larvae were exposed to entrainment for a period of approximately 33.4 days. The average duration of the planktonic egg stage, 2.9 days, was added to the period for the larvae to estimate a total period of exposure of 36.3 days.

The monthly estimates of *PE* for northern anchovies for 2006 ranged from 0 to 00018 at Units 5&6 (Table 4.5-18) and 0 to 0.00034 at Units 7&8 (Table 4.5-19) using the actual flows. Design flow ETM estimates ranged from 0 to 00051 at Units 5&6 and 0 to 0.00095 at Units 7&8. The largest proportion of the source population was present during the May survey ( $f_i = 0.855$  or 85.5%). The values in the table were used to calculate  $P_M$  estimates of 0.00066 and 0.00680 for Units 5&6 and Units 7&8, respectively, based on actual flows, and 0.00495 and 0.0307 based on the design flows using the alongshore

extrapolated estimate of the total source population. The average alongshore displacement over the period of exposure was 25.91 km (11.0 mi), indicating that larvae from about half of the 60 km (37 mi) coastline of Santa Monica Bay may be subject to entrainment. The small estimate of  $P_M$  is a direct result of the large source population potentially subject to entrainment.

Table 4.5-18. ETM data for northern anchovy larvae at Units 5&6. *ETM* calculations based on actual and design (maximum) cooling water flows and a sampling volume in the nearshore of 396,693,881 m<sup>3</sup>.

Survey Date	Actual Flows		Design Flows		$f_i$
	<i>PE</i> Estimate	<i>PE</i> Std. Err.	<i>PE</i> Estimate	<i>PE</i> Std. Err.	
25-Jan-06	0	0	0	0	0
23-Feb-06	0	0	0	0	0
22-Mar-06	0	0	0	0	0.02483
19-Apr-06	0	0	0	0	0.05117
17-May-06	0.00002	0.00001	0.00016	0.00007	0.85500
14-Jun-06	0.00018	0.00132	0.00051	0.00301	0.00226
12-Jul-06	0	0	0	0	0.00831
9-Aug-06	0	0	0	0	0.01348
20-Sep-06	0	0	0	0	0.00314
18-Oct-06	0	0.00002	0.00009	0.00055	0.01696
15-Nov-06	0	0	0	0	0.01040
13-Dec-06	0	0	0	0	0.01445
<b><math>P_M</math></b>	<b>0.00066</b>	0.00012	<b>0.00495</b>	0.00073	–

Table 4.5-19. ETM data for northern anchovy larvae at Units 7&8. ETM calculations based on actual and design (maximum) cooling water flows and a sampling volume in the nearshore of 396,693,881 m<sup>3</sup>.

Survey Date	Actual Flows		Design Flows		$f_i$
	PE Estimate	PE Std. Err.	PE Estimate	PE Std. Err.	
25-Jan-06	0	0	0	0	0
23-Feb-06	0	0	0	0	0
22-Mar-06	0.00006	0.00021	0.00095	0.00219	0.02483
19-Apr-06	0.00034	0.00073	0.00070	0.00150	0.05117
17-May-06	0.00019	0.00029	0.00092	0.00085	0.85500
14-Jun-06	0	0	0	0	0.00226
12-Jul-06	0.00026	0.00133	0.00031	0.00156	0.00831
9-Aug-06	0.00001	0.00010	0.00016	0.00076	0.01348
20-Sep-06	0	0	0	0	0.00314
18-Oct-06	0	0	0.00029	0.00177	0.01696
15-Nov-06	0.00001	0.00015	0.00050	0.00211	0.01040
13-Dec-06	0	0	0	0	0.01445
$P_M$	<b>0.0068</b>	0.0036	<b>0.0307</b>	0.0113	–

#### 4.5.3.2 Silversides (Atherinopsidae)

Three species of silversides (family Atherinopsidae) occur in California ocean waters and in the vicinity of the RBGS: topsmelt (*Atherinops affinis*), jacksmelt (*Atherinopsis californiensis*), and the California grunion (*Leuresthes tenuis*). Topsmelt are found from Vancouver Island British Columbia, to the Gulf of California, (Miller and Lea 1972), with a disjunct distribution in the northern gulf (Robertson and Allen 2002). Jacksmelt are found in estuaries and coastal marine environments from Yaquina Bay, Oregon to the Gulf of California (Eschmeyer et al. 1983, Robertson and Allen 2002). California grunion are found from San Francisco to Magdalena Bay, Baja California (Miller and Lea 1972) but are most abundant from Point Conception southward (Love 1996).



Jamie Siler

##### 4.5.3.2.1 Life History and Ecology

These schooling fishes are very common in estuaries, kelp beds, and along sandy beaches. Although mostly observed on the surface, topsmelt have been seen to depths of 9 m (30 ft) (Love 1996). Jacksmelt

have been observed at depths of 29 m (95 ft). Grunion are usually seen from just behind the surf line to depths of about 18 m (60 ft).

In a five-year study of fishes in San Diego Bay, topsmelt ranked second in abundance and fifth in biomass, comprising about 23% of the individuals and 9% of the total weight (Allen 1999). Topsmelt were captured in all samples with peak abundances generally occurring in April due to heavy recruitment of young-of-the-year (YOY). Topsmelt occurred in a wide size range over the study and were represented by four age classes. Typically, YOY and juvenile topsmelt primarily occupied the intertidal zone while adult fish also occupied nearshore and midwater channel sub-habitats. Topsmelt and grunion were collected in the 1979-80 impingement study conducted at EPS, comprising 13.7 and 10.8% respectively of total number of fishes collected (SDG&E 1980).

Adult topsmelt mature within 2–3 years to an approximate length of 10–15 cm (4–6 in) and can reach a length of 37 cm (14.5 in). They have a life expectancy of up to eight years (Love 1996). Jacksmelt is the largest member of the three species of the silverside that occur in California with adults reaching a maximum length of 44 cm (17 in) (Miller and Lea 1972). The fish reach maturity after two years at a size range of 18–20 cm (7.0–7.8 in) SL, and can live to a maximum age of nine or ten years (Clark 1929). Grunion reach 19 cm (7.5 in) in length, with a life span of up to four years. They mature at one year old at a length of approximately 12–13 cm (5 in).

The spawning activity of topsmelt corresponds to changes in water temperature (Middaugh et al. 1990). In Newport Bay, topsmelt spawn from February to June peaking in May and June (Love 1996). Females deposit the eggs on marine plants and other floating objects where fertilization occurs (Love 1996). Fecundity is a function of female body size with individuals in the 11–12 cm (4.3–4.7 in) range spawning approximately 200 eggs per season, and fish 16 cm (6.3 in) or greater spawning 1,000 eggs per season (Fronk 1969). The spawning season for jacksmelt is from October through March (Clark 1929), with peak activity from January through March (Allen et al. 1983). Individuals may spawn multiple times during the reproductive season and reproductive females have eggs of various sizes and maturities present in the ovary (Clark 1929). Fecundity has not been well documented but is possibly over 2,000 eggs per female (Emmett et al. 1991). Females lay eggs on marine plants and other floating objects where fertilization by males occurs (Love 1996). The spawning activity of grunion is quite different from the other silversides. Spawning occurs only three or four nights following each full or new moon, and then only for 1–3 hours immediately after the high tide, from late February to early September (peaking late March to early June) (Love 1996). The female swims onto the beach and digs into the wet sand, burying herself up to her pectoral fins or above. The male or males curve around her with vents touching her body, and when the female lays her eggs beneath the sand, males emit sperm, which flows down her body and fertilizes the eggs (Love 1996). Females spawn four to eight times per season at about 15-day intervals, producing 1,000–3,000 eggs. Plankton sampling conducted during an earlier 316(b) study at Scattergood Generating Station (IRC 1981) found that nearly all silverside larvae were collected in surface samples indicating a strong behavioral tendency for these larvae to actively maintain their position in surface strata, possibly through a phototactic response.



#### 4.5.3.2.2 Population Trends and Fishery

Bays, estuaries, and soft bottom sediments in the surf zone are the primary habitats where silversides (jacksmelt, topsmelt, and grunion) are most abundant within southern California (Allen et al. 2006; Allen and Pondella 2006). Topsmelt numbers are much greater in bays compared to semi-protected or exposed coastlines (Allen and Herbinson 1991), whereas jacksmelt form larger and denser schools than topsmelt in nearshore areas (Gregory 2001a). Differential habitat use within bays and estuaries indicate that topsmelt occupy much of the water column both along the shoreline and main channels (Allen et al. 2002; Valle et al. 1999).

Population trends of silversides can be examined to evaluate variability over time. There were no consistent trends for the recreational catch in southern California from 1980-2006 (Figure 4.5-14a). In a King Harbor study time series conducted by the Vantuna Research Group, silversides were combined into one category due to the difficulty of identifying species-level differences in the field. From 1974-2006, two trends emerge. First, the density of silversides was generally higher prior to the regime shift associated with the PDO (Figure 4.5-14b). Secondly, the density of silversides declined from the early 1970s to the early 1990s, then remained fairly constant through 2006. Overall, the density of silversides declined significantly from 1974-2006. In the OREHP time series (Figure 4.5-14c), catch per sampling period from 1995–2006 varied around an average of 10.7 fish/station in Santa Monica Bay and 15.3 fish/station in the rest of the Southern California Bight. The difference between the two time series were high catches of jacksmelt in the April samples at Seal Beach in 1995, 1999, and 2001. Jacksmelt move into this area in the spring to lay their eggs. Overall, since the mid-1990s silversides have been increasing in catch throughout the southern California bight including Santa Monica Bay.

A limited fishery exists for silversides in which they are marketed fresh for human consumption or for bait (Gregory 2001a). The commercial fishery for silversides has been conducted with a variety of gears including gillnets, lampara nets, and round haul nets. Historically, set-lines were used in San Francisco Bay for jacksmelt, and during the 1920s beach nets were used at Newport Beach (Gregory 2001a). Commercial catches of jacksmelt have varied sharply over the past 80 years fluctuating from more than 907,000 kg (2,000,000 lbs) in 1945 to 1,147 kg (2,530 lbs) in 1998 and 1999. Silversides, in general, are an incidental fishery and the large fluctuations in the catch records reflect demand rather than relative abundances.

Grunion are primarily harvested by recreational fishers by hand when these fish spawn on wet sandy beaches during spring and summer. They are also taken incidentally in bait nets and other round haul nets in limited quantities and are used as live bait, although no commercial landings have been reported (Gregory 2001b). In the 1920s, the recreational fishery was showing signs of depletion, and a regulation was passed in 1927 establishing a closed season of three months, April through June. The fishery improved, and in 1947, the closure was shortened to April through May.

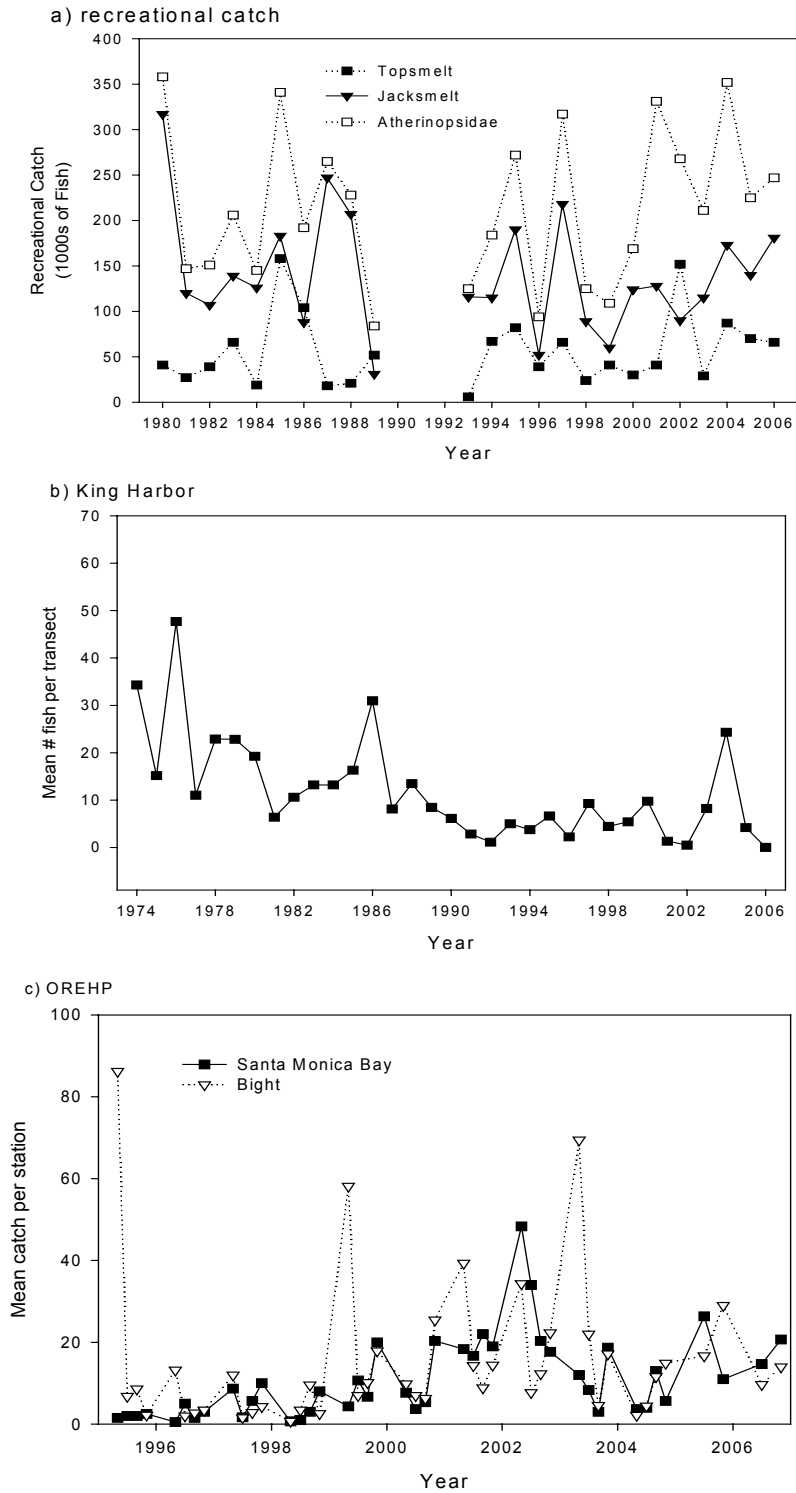

Figure 4.5-14. Silverside fishery and population trends: a) recreational landings, b) King Harbor observational data, and c) Ocean Resource Enhancement Hatchery Program (OREHP) gill net monitoring data. Error bars are  $\pm 1$  S.E.

Concentrations of larval silversides, as measured in King Harbor as part of the Occidental College – Vantuna Research Group’s long-term studies, have fluctuated substantially since 1974 (Figure 4.5-15). Mean densities have ranged between 0.2 and 41 larvae per 1,000 m<sup>3</sup>, with peaks in abundance during 1975, 1977, 1982, 1995–1996, 2000, and 2006.

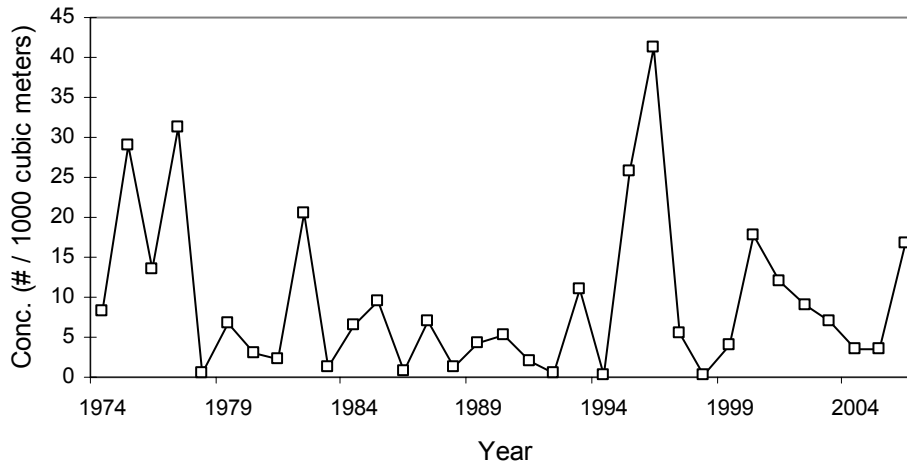

Figure 4.5-15. Mean concentration (# / 1,000 m<sup>3</sup> [264,172 gal]) of silverside (*Atherinopsidae*) larvae collected from King Harbor, 1974-2006. Source: Vantuna Research Group.

Both topsmelt and jacksmelt make up a significant portion of the catch from piers and along shores. Jacksmelt shore landings declined by over 75% in the 1990s compared to the 1980s (Jarvis et al. 2004). Recent catch estimates of jacksmelt by recreational anglers in southern California from 2000 to 2006 ranged from 29,000 to 152,000 fish, with an average of 67,900 fish caught annually (Table 4.5-20). Sport fishery catch estimates for topsmelt in southern California from 2000 to 2006 ranged from 90,000 to 181,000 fish, with an average of 135,900 fish caught annually. A total of 45 kg (100 lbs) of jacksmelt with a revenue of \$75 were landed commercially in the Santa Monica Bay area in 2006, while only 0.9 kg (2 lbs) of topsmelt (probably for live bait) with a revenue of \$20 were landed according to specific CDFG catch block data from the area.

Table 4.5-20. Annual landings (number of fish) for jacksmelt and topsmelt in the Southern California region based on RecFIN data.

<b>Year</b>	<b>Jacksmelt</b>	<b>Topsmelt</b>
2000	124,000	30,000
2001	128,000	41,000
2002	90,000	152,000
2003	115,000	29,000
2004	173,000	87,000
2005	140,000	70,000
2006	181,000	66,000

#### 4.5.3.2.3 Sampling Results

The three species of silversides were grouped together for analysis purposes. Silverside larvae was the eleventh most abundant taxon at entrainment Station H2 with a mean concentration of 4 per 1,000 m<sup>3</sup> (Table 4.5-1) and the twelfth most abundant taxon at entrainment Station E4 with a mean concentration of 10 per 1,000 m<sup>3</sup> over all surveys (Table 4.5-2). The larvae occurred sporadically throughout the year (Figures 4.5-16 and 4.5-17), with a maximum abundances of 70 per 1,000 m<sup>3</sup> in late March 2006 at Station E4. Monthly source water concentrations (Figure 4.5-18) were lower than the entrainment concentrations (ca. average of less than 12 per 1,000 m<sup>3</sup> during spring). Comparing Cycle 1 and Cycle 3 abundances, they were more common in nighttime samples during winter and spring, but were only collected in daytime samples in the summer (Figure 4.5-19). The length frequency distribution of measured silverside larvae was normally distributed with a peak in 8.0 mm size class (Figure 4.5-20). The lengths of the larvae from the entrainment station samples ranged from 4.5–16.0 mm (0.18–0.63 in) with a mean NL of 8.0 mm (0.31 in).

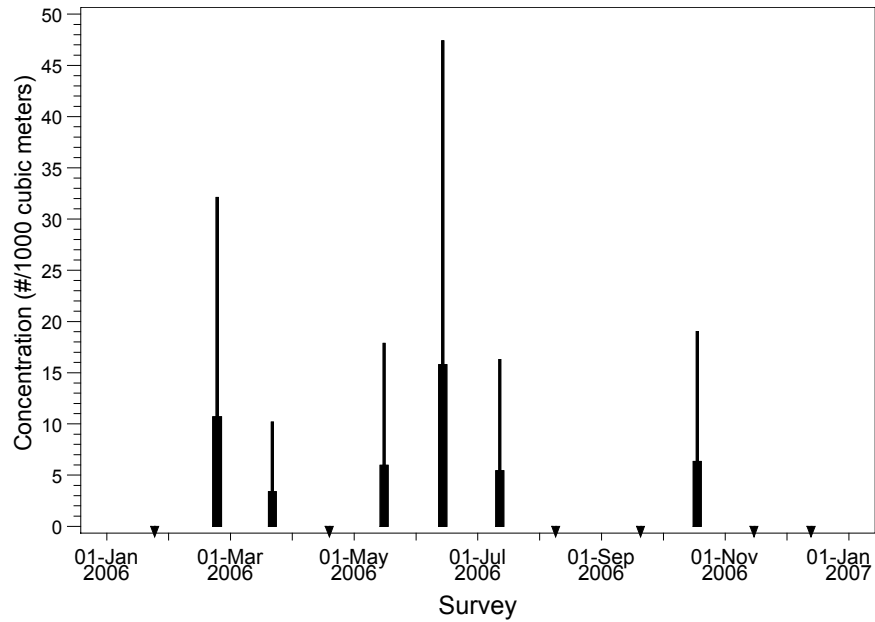

Figure 4.5-16. Mean concentration (# / 1,000 m<sup>3</sup> [264,172 gal]) and standard deviation of silverside larvae collected at RBGS entrapment Station H2 from January 2006 through December 2006.

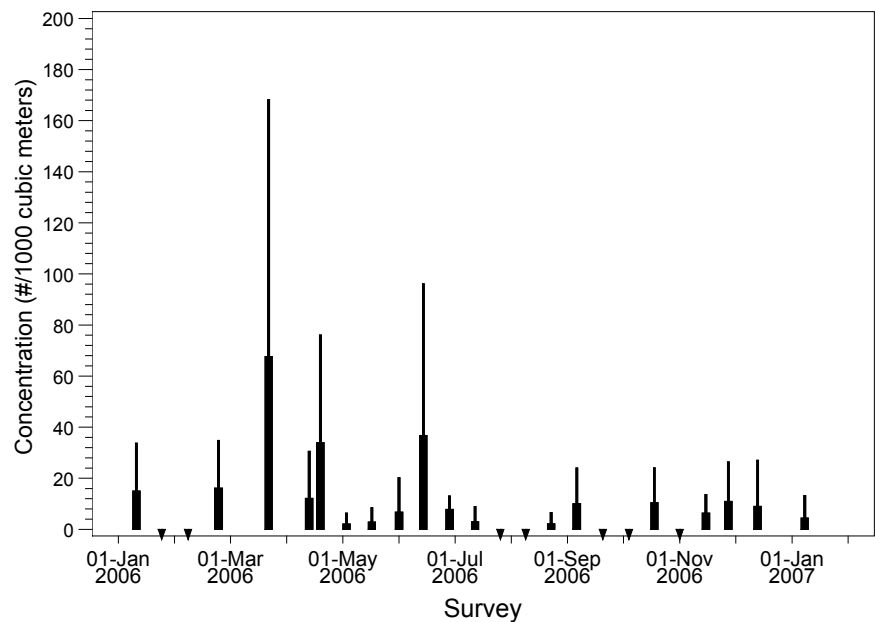

Figure 4.5-17. Mean concentration (# / 1,000 m<sup>3</sup> [264,172 gal]) and standard deviation of silverside larvae collected at RBGS entrapment Station E4 from January 2006 through January 2007.

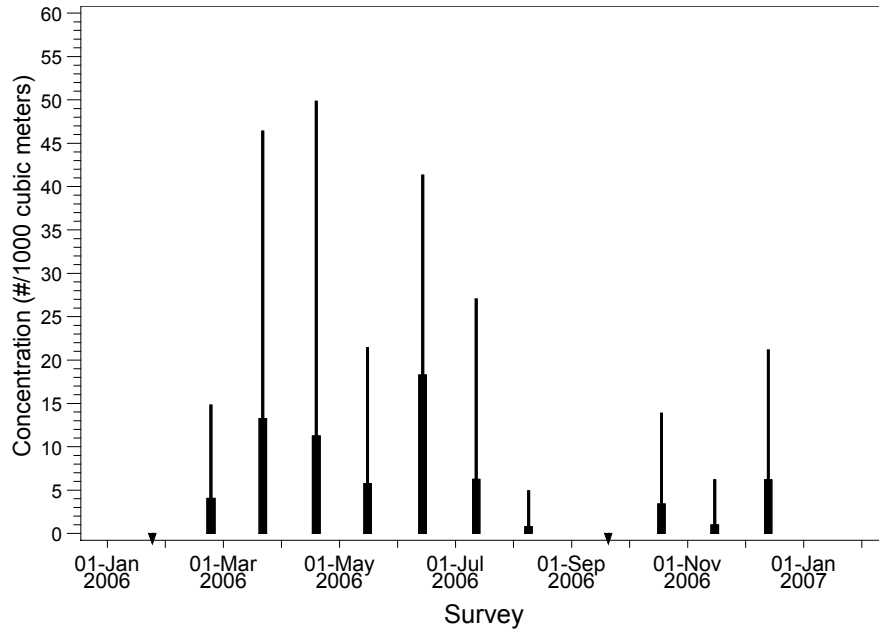

Figure 4.5-18. Mean concentration (# / 1,000 m<sup>3</sup> [264,172 gal]) and standard deviation of silverside larvae collected at RBGS source water stations during 2006.

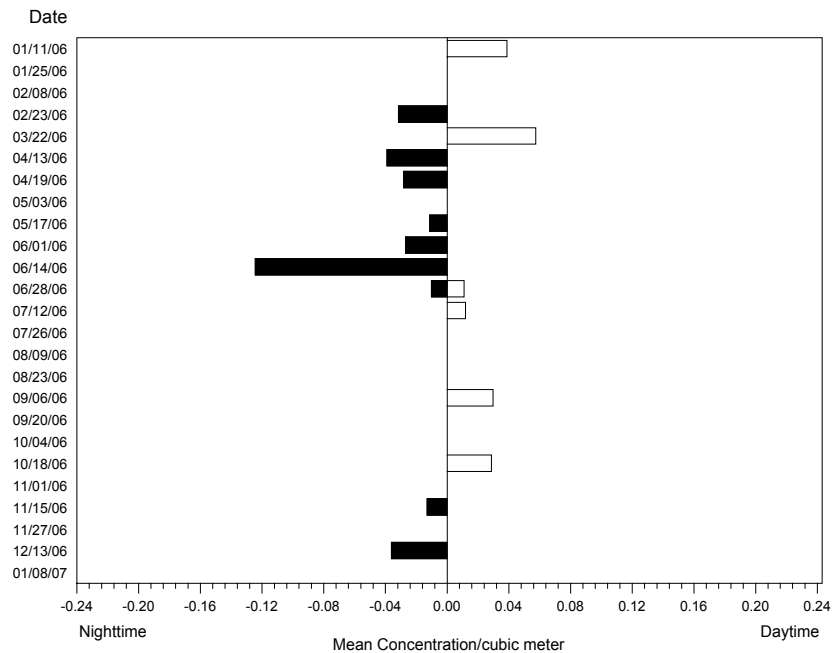

Figure 4.5-19. Mean concentration (#/1.0 m<sup>3</sup> [264 gal]) of silverside larvae at entrainment Station E4 during night (Cycle 3) and day (Cycle 1) sampling.

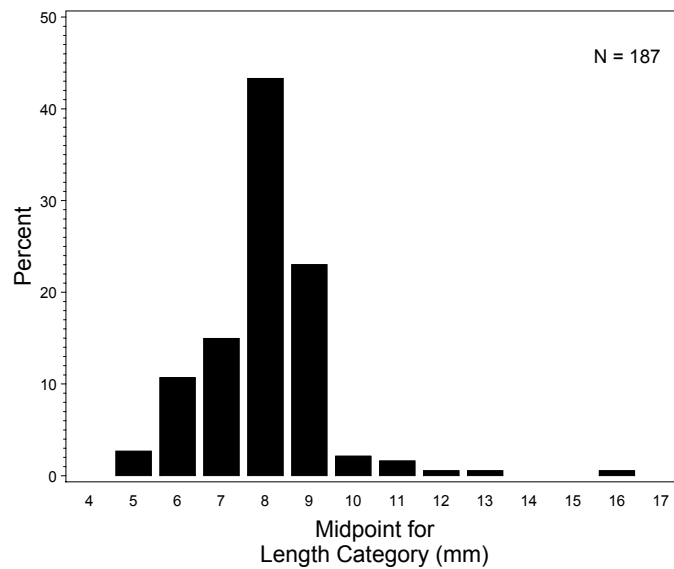

Figure 4.5-20. Length (mm) frequency distribution for larval silversides collected at entrainment stations in Santa Monica Bay during 2006.

#### 4.5.3.2.4 Modeling Results

The following section presents the results of the *ETM* for *Atherinopsidae* complex (silverside) larvae. Although there was information on the early life history for California grunion, there was very little species-specific information available for the other two species, topsmelt and jacksmelt, that were collected in greater abundances during the study. Therefore, CWIS effects were estimated using only the *ETM*. Total annual larval silverside entrainment at RBGS was estimated at 353,252 for Units 5&6 (Table 4.5-3) and 1,704,581 for Units 7&8 (Table 4.5-4) using actual cooling water flows during 2006. If the CWIS pumps were run at the design (maximum capacity) flows, annual entrainment estimates increased to 1,087,989 and 10,713,659 larvae, respectively. No silverside eggs were collected in the entrainment samples at Station E4.

#### *Empirical Transport Model (ETM)*

A larval growth rate of 0.44 mm/d (0.02 in/d) for silversides was estimated from laboratory studies by Middaugh et al. (1990) and used with the difference between the calculated hatch length (6.5 mm [0.25 in]) and the length of the 95<sup>th</sup> percentile of the measurements (10.0 mm [0.39 in]) to estimate that the larvae were exposed to entrainment for a period of approximately 7.9 days.

The monthly estimates of *PE* for silversides for the sampling period ranged from 0 to 0.00864 for Units 5&6 and 0 to 0.01473 for Units 7&8 using the actual flows (Tables 4.5-21 and 4.5-22). The estimates for design flows ranged from 0 to 0.00881 for Units 5&6 and from 0 to 0.05730 for Units 7&8. The largest proportion of the source population was present during the June survey ( $f_i = 0.273$  or 27.3%). The values in the tables were used to calculate  $P_M$  estimates of 0.00597 (0.6%) for Units 5&6 and 0.0259 (2.6%) for

Units 7&8 based on the actual flows and using the alongshore extrapolated estimate of the total source population. The alongshore current data were used to estimate that the total larval source population extended along an average coastal distance of 6.3 km (3.9 mi) based on the number of days that the larvae are potentially exposed to entrainment.

Table 4.5-21. *ETM* data for silverside larvae at Units 5&6. *ETM* calculations based on actual and design (maximum) cooling water flows and a sampling volume in the nearshore of 396,693,881 m<sup>3</sup>.

Survey Date	<u>Actual Flows</u>		<u>Design Flows</u>		<i>f<sub>i</sub></i>
	<i>PE</i> Estimate	<i>PE</i> Std. Err.	<i>PE</i> Estimate	<i>PE</i> Std. Err.	
25-Jan-06	0	0	0	0	0
23-Feb-06	0.00348	0.00316	0.01184	0.00881	0.06934
22-Mar-06	0.00027	0.00027	0.00077	0.0006	0.26079
19-Apr-06	0	0	0	0	0.10289
17-May-06	0.00082	0.00101	0.00618	0.00581	0.05308
14-Jun-06	0.00092	0.00116	0.00268	0.00269	0.27228
12-Jul-06	0.00864	0.01577	0.01013	0.01836	0.01652
9-Aug-06	0	0	0	0	0.00044
20-Sep-06	0	0	0	0	0
18-Oct-06	0.00042	0.00046	0.01111	0.01168	0.02609
15-Nov-06	0	0	0	0	0.02380
13-Dec-06	0	0	0	0	0.17477
<b><i>P<sub>M</sub></i></b>	<b>0.00597</b>	0.00662	<b>0.01966</b>	0.01741	–

Table 4.5-22. *ETM* data for silverside larvae at Units 7&8. *ETM* calculations based on actual and design (maximum) cooling water flows and a sampling volume in the nearshore of 396,693,881 m<sup>3</sup>.

Survey Date	<u>Actual Flows</u>		<u>Design Flows</u>		<i>f<sub>i</sub></i>
	<i>PE</i> Estimate	<i>PE</i> Std. Err.	<i>PE</i> Estimate	<i>PE</i> Std. Err.	
25-Jan-06	0	0	0	0	0
23-Feb-06	0.00076	0.00086	0.05578	0.03471	0.06934
22-Mar-06	0.00325	0.00368	0.04781	0.03132	0.26079
19-Apr-06	0.00894	0.01929	0.01832	0.03952	0.10289
17-May-06	0.00208	0.00255	0.00983	0.00864	0.05308
14-Jun-06	0.00416	0.00469	0.01949	0.01710	0.27228
12-Jul-06	0.01473	0.02678	0.01738	0.03147	0.01652
9-Aug-06	0	0	0	0	0.00044
20-Sep-06	0	0	0	0	0
18-Oct-06	0	0	0.05730	0.04800	0.02609
15-Nov-06	0.00058	0.00141	0.02225	0.02480	0.02380
13-Dec-06	0	0	0.00787	0.01007	0.17477
<b><i>P<sub>M</sub></i></b>	<b>0.0259</b>	0.0328	<b>0.1935</b>	0.2092	–



#### 4.5.3.3 Clingfishes (*Gobiesox* spp.)

Clingfishes in Californian waters are represented by five species: *Gobiesox muscarum*, *G. papillifer*, *G. rhessodon*, *G. maeandricus*, and *G. eugrammus*. The southernmost range of Californian clingfishes is represented by the bearded clingfish, *G. papillifer*, which extends as far south as Panama while the California clingfish, *G. maeandricus*, which is distributed as far north as Alaska, exhibits the northernmost range (Briggs 1955). *Gobiesox rhessodon* is most abundant in southern California waters (Miller and Lea 1972). Their common name is derived from the characteristic fused pelvic fins that form a cup-like suction disk allowing them to adhere to the substrate. *Gobiesox* spp. are not commercially or recreationally fished and as such, there are no fishery data available.



##### 4.5.3.3.1 Life History and Ecology

Clingfishes are found at depths ranging from the intertidal to 82 meters (Eschmeyer and Herald 1983). Most are found among rocks and shell debris, and within stands of eel grass and kelp (Watson 1996). The majority of the adult diet in *G. rhessodon* was found to consist of isopods and amphipods with polychaetes, mollusks and other crustaceans comprising the remainder of food items (Wells 1979).

Males of *G. rhessodon* grow to a larger size than females, with females becoming mature at a length of approximately 25 mm (1 in) SL. Clingfishes produce demersal, adhesive eggs that may be attached to kelp, eelgrass, or the undersides of rocks. Johnson (1970) found that female *G. maeandricus* spawn in May and April with a fecundity of 194–382 eggs per female. The spawning season of *G. rhessodon* in southern California was found to occur from approximately late September through October with an average fecundity of 261 eggs per batch (Wells 1979). Egg diameters of *G. maeandricus* ranged from 1.25–1.90 mm (Johnson 1970) though Allen and Ilg (1983) reported a slightly larger diameter of 1.68–1.92 mm with an average of 1.78 mm. *Gobiesox maeandricus* larvae hatch at 5.6–5.8 mm while *G. rhessodon* larvae hatch at lengths between 3.9 and 4.1 mm (Allen and Ilg 1983). Pre-flexion larvae of *G. eugrammus*, *G. rhessodon*, and *G. maeandricus* are 3.8–6.6 mm (Watson 1996), 3.0–4.5 mm (Allen 1979), and 6.2–7.0 mm (Allen and Ilg 1983), respectively. Transformation of *G. eugrammus* occurs at around 7.4 mm (0.3 in) (Watson 1996) and in *G. maeandricus* at 10.0–13.0 mm (0.4–0.5 in) (Allen and Ilg 1983). Juveniles of *G. eugrammus*, *G. rhessodon*, and *G. maeandricus* range in size from 12.5–21.3 mm, 15.6–19.3 mm (0.6–0.8 in) (Watson 1996), and at least 9.0–13.0 mm (0.4–0.5 in) (Allen and Ilg 1983). Maximum longevity was estimated to be approximately 5 years in *G. rhessodon* based on the examination of otolith growth annuli.

4.5.3.3.2 Population Trends and Fishery

Concentrations of larval clingfishes (*Gobiesox* spp.), as measured in King Harbor as part of the Occidental College – Vantuna Research Group’s long-term studies, have fluctuated substantially since 1974, with substantial peaks between 1978 and 1991 (Figure 4.5-21); concentrations have remained relatively low since a major decline in 1992.

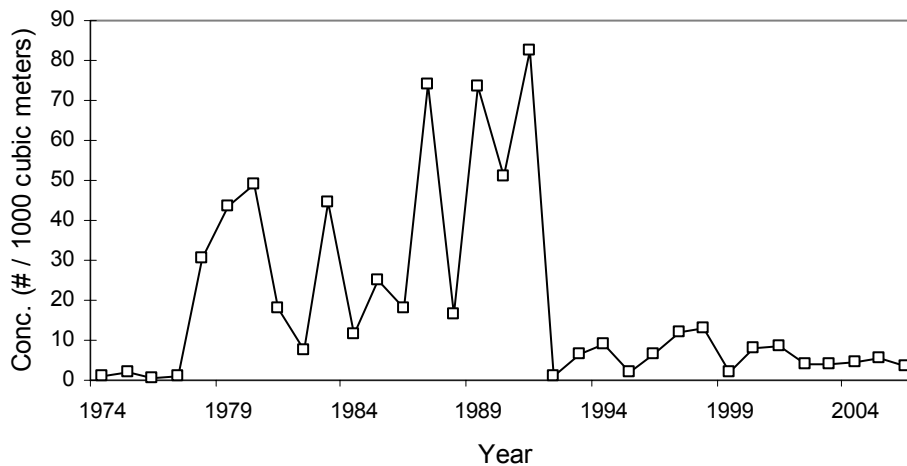

Figure 4.5-21. Mean concentration (# / 1,000 m<sup>3</sup> [264,172 gal]) of clingfish (*Gobiesox* spp.) larvae collected from King Harbor, 1974-2006. Source: Vantuna Research Group.

4.5.3.3.3 Sampling Results

Clingfish larvae was the sixth most abundant taxon at entrainment Station H2 with a mean concentration of 23 per 1,000 m<sup>3</sup> (Table 4.5-1) and the eleventh most abundant taxon at entrainment station E4 with a mean concentration of 11 per 1,000 m<sup>3</sup> over all surveys (Table 4.5-2). The larvae were most abundant in the April–June period and were absent or in low abundance in the fall and winter surveys (Figures 4.5-22 and 4.5-23). Highest average abundances of approximately 190 per 1,000 m<sup>3</sup> occurred in April 2006 at Station H2. Monthly source water concentrations followed a similar seasonal pattern (Figure 4.5-24) but were generally less than half the entrainment concentrations. Average concentrations peaked at about 50 per 1,000 m<sup>3</sup> in late April. Larvae were slightly more abundant in nighttime samples than in daytime samples (Figure 4.5-25). The length frequency distribution of measured clingfish larvae was skewed toward the 3-3.5 mm size classes with over 70% of the measured larvae in this size range (Figure 4.5-26). The lengths of the larvae from the entrainment station samples ranged from 2.3–5.2 mm with a mean of 3.4 mm NL.

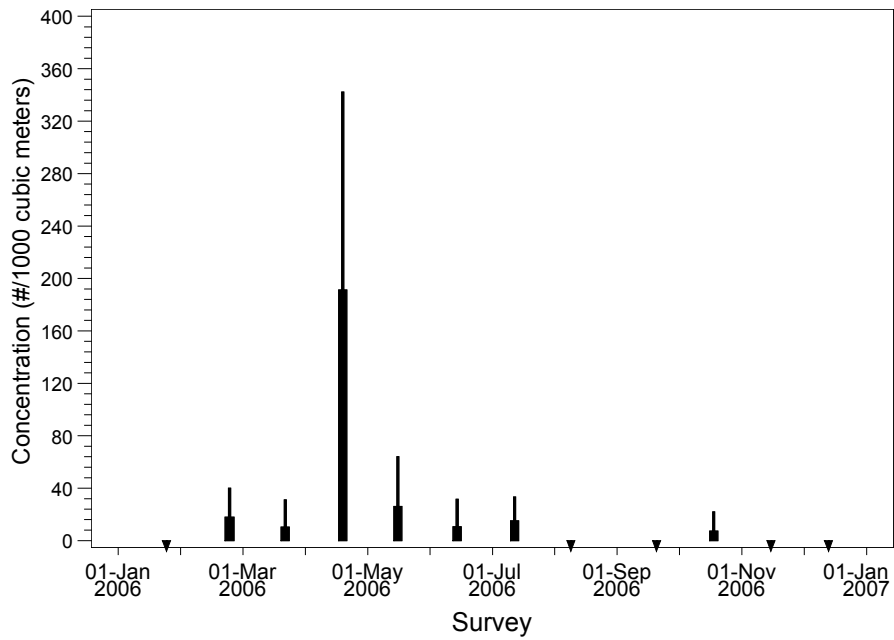

Figure 4.5-22. Mean concentration (# / 1,000 m<sup>3</sup> [264,172 gal]) and standard deviation of clingfish larvae collected at RBGS entrainment Station H2 from January 2006 through December 2006.

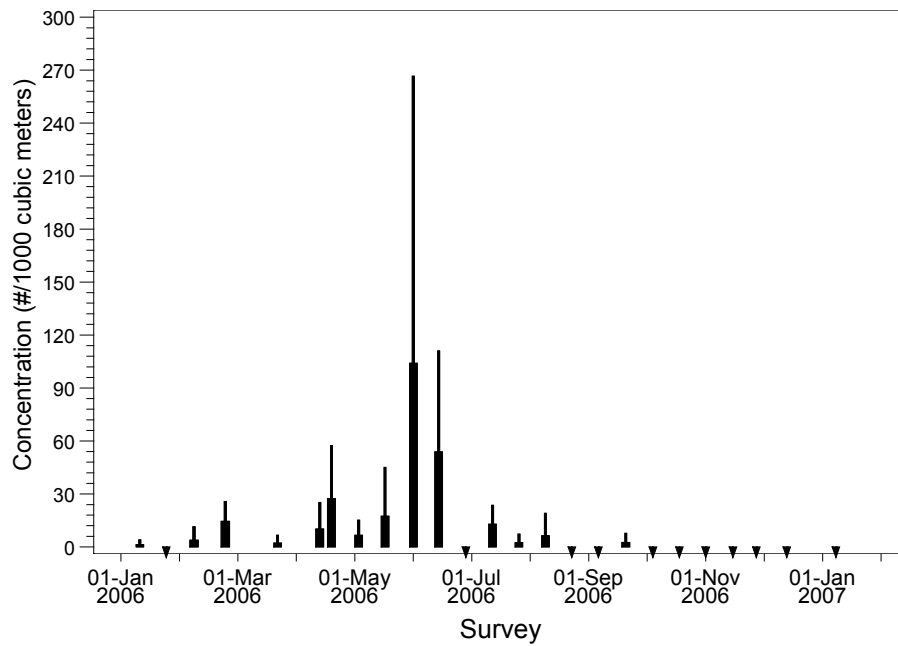

Figure 4.5-23. Mean concentration (# / 1,000 m<sup>3</sup> [264,172 gal]) and standard deviation of clingfish larvae collected at RBGS entrainment Station E4 from January 2006 through January 2007.

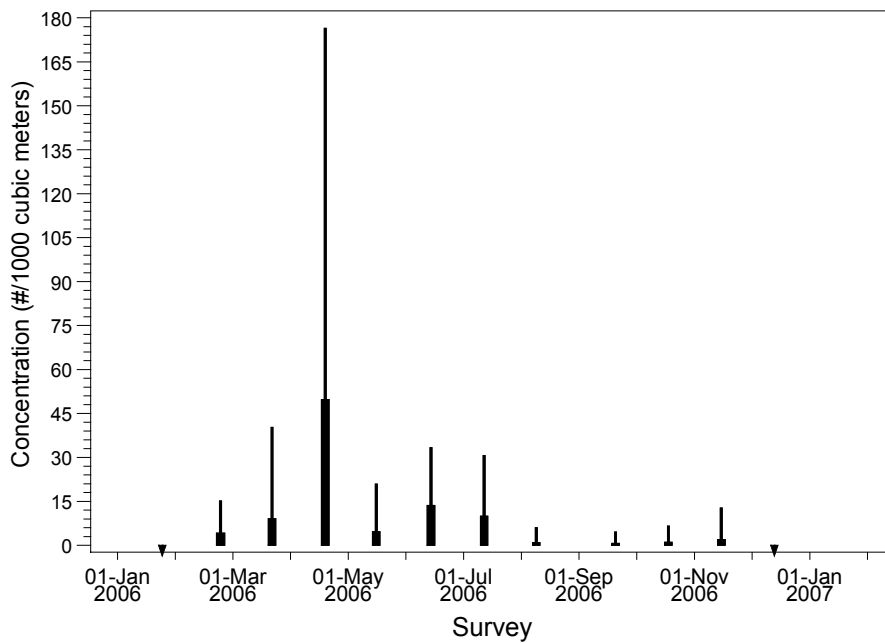

Figure 4.5-24. Mean concentration (# / 1,000 m<sup>3</sup> [264,172 gal]) and standard deviation of clingfish larvae collected at RBGS source water stations during 2006.

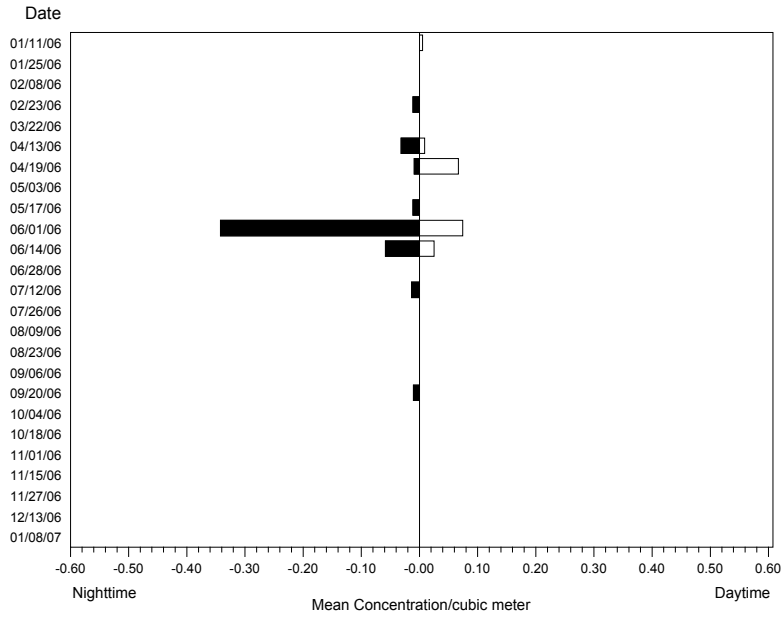

Figure 4.5-25. Mean concentration (#/1.0 m<sup>3</sup> [264 gal]) of clingfish larvae at entrainment Station E4 during night (Cycle 3) and day (Cycle 1) sampling.

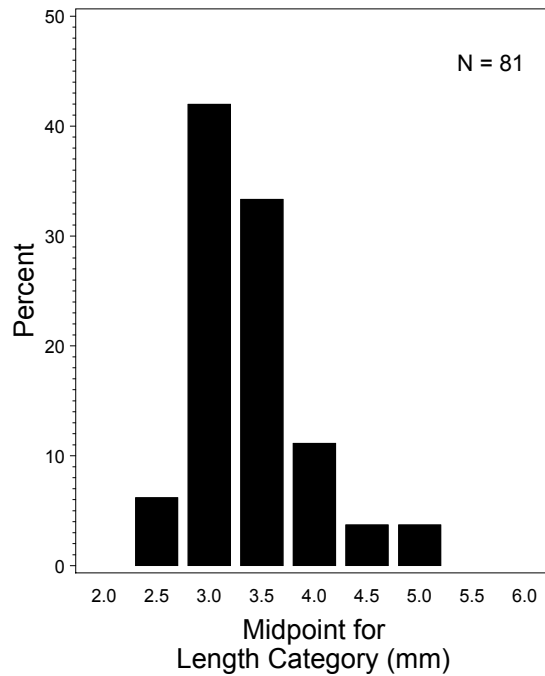

Figure 4.5-26. Length (mm) frequency distribution for larval clingfishes collected at entrainment stations in Santa Monica Bay during 2006.

#### 4.5.3.3.4 Modeling Results

The following section presents the results of the *ETM* for Gobiesocidae complex (clingfish) larvae. There was very little species-specific information available on natural mortality rates of clingfishes at various stages, so CWIS effects were estimated using only the *ETM*. Total annual larval clingfish entrainment at RBGS was estimated at 2,412,470 for Units 5&6 (Table 5.4-3) and 2,677,766 for Units 7&8 (Table 5.4-4) using actual flow data. If the CWIS pumps were run at the design (maximum capacity) flows, annual entrainment estimates increased to 6,372,050 larvae and 9,428,166 larvae for the two unit pairs. No clingfish eggs were identified from the entrainment samples because the eggs are demersal and would not be subject to entrainment.

#### *Empirical Transport Model (ETM)*

A larval growth rate of 0.075 mm/d for clingfishes was estimated from laboratory studies by Allen (1983) and used with the difference between the calculated hatch length (4.9 mm) and the length of the 95<sup>th</sup> percentile of the measurements to estimate that the larvae were exposed to entrainment for a period of approximately 22.8 days.

The monthly estimates of *PE* for clingfishes for the sampling period ranged from 0 to 0.02254 for Units 5&6 (Table 4.5-23) and 0 to 0.01269 for Units 5&6 (Table 4.5-24) using the actual flows. The largest proportion of the source population was present during the June survey ( $f_i = 0.271$  or 27.1%). The values in the tables were used to calculate  $P_M$  estimates of 0.07967 for Units 5&6 and 0.0946 for Units 7&8 based on the actual flows and using the alongshore extrapolated estimate of the total source population. The alongshore current data were used to estimate that the total larval source population extended along an average coastal distance of 16.9 km (10.5 mi) based on the number of days that the larvae are potentially exposed to entrainment.

Table 4.5-23. ETM data for clingfish larvae at Units 5&6. ETM calculations based on actual and design (maximum) cooling water flows and a sampling volume in the nearshore of 396,693,881 m<sup>3</sup>.

Survey Date	Actual Flows		Design Flows		$f_i$
	PE Estimate	PE Std. Err.	PE Estimate	PE Std. Err.	
25-Jan-06	0	0	0	0	0
23-Feb-06	0.0026	0.00608	0.00883	0.01662	0.07526
22-Mar-06	0.01221	0.02795	0.03513	0.06802	0.01867
19-Apr-06	0.01345	0.02341	0.0337	0.05686	0.19746
17-May-06	0.00382	0.00453	0.02876	0.02795	0.08985
14-Jun-06	0.00027	0.00159	0.0008	0.00365	0.27104
12-Jul-06	0.00234	0.0057	0.00274	0.00663	0.16555
9-Aug-06	0	0	0	0	0.11332
20-Sep-06	0	0	0	0	0.06596
18-Oct-06	0.02254	0.03308	0.59676	0.84395	0.00099
15-Nov-06	0	0	0	0	0.00191
13-Dec-06	0	0	0	0	0
<b><math>P_M</math></b>	<b>0.07967</b>	0.07579	<b>0.19108</b>	0.15574	–

Table 4.5-24. ETM data for clingfish larvae at Units 7&8. ETM calculations based on actual and design (maximum) cooling water flows and a sampling volume in the nearshore of 396,693,881 m<sup>3</sup>.

Survey Date	Actual Flows		Design Flows		$f_i$
	PE Estimate	PE Std. Err.	PE Estimate	PE Std. Err.	
25-Jan-06	0	0	0	0	0
23-Feb-06	0.00030	0.00097	0.02233	0.03505	0.07526
22-Mar-06	0.00158	0.00491	0.02330	0.04512	0.01867
19-Apr-06	0.00736	0.01399	0.01508	0.02867	0.19746
17-May-06	0.01269	0.01667	0.05984	0.06026	0.08985
14-Jun-06	0.00271	0.01042	0.01272	0.04004	0.27104
12-Jul-06	0.00618	0.01311	0.00729	0.01543	0.16555
9-Aug-06	0.00060	0.00263	0.00735	0.02184	0.11332
20-Sep-06	0.00021	0.00162	0.00437	0.01577	0.06596
18-Oct-06	0	0	0	0	0.00099
15-Nov-06	0	0	0	0	0.00191
13-Dec-06	0	0	0	0	0
<b><math>P_M</math></b>	<b>0.0946</b>	0.1184	<b>0.2819</b>	0.2630	–

#### 4.5.3.4 Sea Basses (*Paralabrax* spp.)

Three species of basses, family Serranidae, genus *Paralabrax*, occur in California ocean waters: spotted sand bass (*P. maculatofasciatus*), barred sand bass (*P. nebulifer*), and kelp bass (*P. clathratus*). Spotted sand bass are found from Monterey, California to Mazatlan, Mexico, including the Gulf of California (Robertson and Allen 2002); barred sand bass are found from Santa Cruz to Magdalena Bay; and kelp bass are found from the mouth of the Columbia River in Washington to Magdalena Bay, Baja California (Miller and Lea 1972). However, Love (1996)



reports that spotted sand bass are not common north of Newport Bay in southern California and Allen and Hovey (2001a,b) state that barred and kelp bass are rare north of Point Conception.

##### 4.5.3.4.1 Life History and Ecology

The life history of the spotted sand bass is described in Allen et al. (1995). Adults can reach 56 cm (22 in) in length and live to at least 14 years of age. Females mature within the first year and approximately half are mature when they reach 15.5 cm (6 in) long. Males mature are all mature at 3 yrs with about half of the males reaching maturity at 18 cm (7 in). Some individuals within populations are protogynous, changing sex from female to male as they grow. Spawning in California occurs from June through August. Love et al. (1996) analyzed life history parameters for barred sand bass and kelp bass. Adult barred sand bass can reach 65 cm (25.5 in) and live to 24 years of age. Adult kelp bass reach 72 cm (28.5 in) and live to at least 34 years of age. Kelp and barred sand bass reach sexual maturity between 18 and 27 cm (7 to 10.5 in), at about 3–5 years of age. Kelp and barred sand bass form large breeding aggregations in deeper waters and spawn from April through November, peaking in summer months. All three species are multiple spawners (Oda et al. 1993).

In a study of *Paralabrax* fecundity by DeMartini (1987), the number of eggs ranged over a factor of 15 from about 12,000 eggs in a 447 g fish to >185,000 eggs in a 2,625 g fish. The smallest fish, a 148 g sand bass, contained 16,500 eggs. Sample females contained a mean  $\pm$  1 S. E. of  $760 \pm 80$  eggs per gram of ovary and  $70 \pm 12$  eggs per gram of ovary-free body weight. All three species –*P. clathratus*, *P. maculatofasciatus*, and *P. nebulifer*– are capable of daily spawning in season (Oda et al. 1993). However, not all fish captured in the Oda et al. (1993) study demonstrated evidence of daily spawning: 32% of the *P. clathratus* females (n = 84), 20% of the *P. maculatofasciatus* females (n = 79), and 31% of the *P. nebulifer* females (n = 81) showed evidence of spawning on two consecutive days. There was no statistically significant difference in the average size of specimens that exhibited evidence of daily spawning, compared to those that had spawned the day before collection. A standard weight female (ca. 700 g OFW [ovary-free weight] and 300 mm SL) was calculated to average 81,000 eggs per batch. This



estimate of batch fecundity for *Paralabrax* is higher than that reported by DeMartini (1987) and may indicate the variation possible in these species of *Paralabrax*.

Kelp bass are found associated with structure, such as kelp or rocks, from the subtidal zone to depths of 61 m (200ft) (Love 1996). They are typically found in water less than 21 m (70 ft) (Allen and Hovey 2001a). Spotted sand bass are found in back bays and lagoons where there is extensive cover (Love 1996). They have been taken in water as deep as 61 m (200 ft), however they are usually found shallower than 6.1 m (20 ft) (Love 1996). Barred sand bass are found at the sand-rock interface, and are commonly observed at artificial reefs. Barred sand bass have been taken in water as deep as 183 m (600 ft), but are usually found in water shallower than 27 m (90 ft).

#### 4.5.3.4.2 Population Trends and Fishery

Kelp bass and barred sand bass are two of the most important nearshore, recreational species caught within southern California waters (Allen and Hovey 2001a, b). The fishery for these species occurs throughout most of southern California from Ensenada, Baja California to Gaviota in Santa Barbara County including the Channel Islands.

These species have been an important component of both recreational and commercial catches since the early 1900s. The earliest management attempt to conserve these species occurred in 1939 when a limit of 15 fish/day was placed on sport fish catches in California. Since then a number of other regulations have changed including a ban on commercial fishing for these species in California waters and a minimum size limit of 10.5 inches total length in the recreational fishery in 1953, an increase to 12 inches in 1959, and a combined limit of 10 basses in 1979 (Young 1963; Stull et al. 1987).

Records prior to 1975 did not differentiate catches of kelp bass and barred sand bass from other related species including rock bass (*Paralabrax* spp., which also includes the spotted sand bass, *P. maculatofasciatus*). Catches of both kelp and barred sand bass have fluctuated greatly since the early 1960's and are suggested to be influenced by the density of kelp forests (*Macrocystis*) which vary intra-annually (Dotson and Charter 2003). Catch rates for these species were higher during the late 1980s compared to the 1970s while mean lengths were essentially unchanged between those periods (Love et al. 1996). Specific habitat requirements indicates that high adult densities of kelp bass occur within kelp/rock habitat whereas barred sand bass prefer rocky, hard-bottom or sand areas (Stull et al. 1987).

Recent population trends indicate that landings aboard commercial passenger fishing vessels (CPFVs) declined during the 1990s compared to the 1980s (Allen and Hovey 2001a, b). Specific habitat requirements and a high degree of site fidelity with limited movements (Lowe et al. 2003) suggest that these species can be subject to changes in abundance depending on the availability and amount of suitable habitat. Sport fishery catch estimates of spotted sand bass in the southern California region from 2000 to 2006 ranged from 14,000 to 74,000 fish, with an average of 44,000 fish caught annually (Table 4.5-25). Catch estimates of kelp bass in southern California ranged from 157,000 to 587,000 fish from 2000 to 2006, with an average of 351,300 fish caught annually. Barred sand bass catch estimates ranged from

139,000 to 1,130,000 fish caught annually between 2000-2006, with an average of 720,000 fish caught annually (RecFin 2007).

Table 4.5-25. Annual estimated landings for barred sand bass, kelp bass, and spotted sand bass in the Southern California region based on RecFIN data.

<b>Year</b>	<b>Barred Sand bass</b>	<b>Kelp Bass</b>	<b>Spotted Sand bass</b>
2000	1,130,000	587,000	74,000
2001	806,000	385,000	49,000
2002	1,062,000	291,000	52,000
2003	892,000	434,000	62,000
2004	704,000	446,000	14,000
2005	307,000	157,000	38,000
2006	139,000	159,000	19,000

The earlier 316(b) study from RBGS in 1979–1980 (SCE 1983) reported estimates of average concentrations of kelp and barred sand bass sampled at the intake stations and found the highest densities in August and September while they were low or absent throughout the rest of the year. Mean daily densities were 2.35 larvae per 1,000 m<sup>3</sup> (264,172 gal) at Units 7&8 and mean concentrations in 1979–1980 were approximately five times lower than the concentrations estimated from the 2006 entrainment sampling near the RBGS intake (using actual flow volumes).

Fishery-independent data from underwater counts of sea basses at King Harbor and Palos Verdes Point showed that kelp bass populations peaked in the early 1980s and have steadily declined since then (Figure 4.5-27). When barred sand bass increased in the 1990s, apparently as a result of a long-term ocean-warming trend, kelp bass did not show a similar response (Stephens et al. 1984). Both species have declined following the increases through 2002. Ocean temperature regime changes and fishing pressure may have contributed to the declines

A total of 30 inner shelf and 16 bay and harbor stations were sampled during 2003 within the southern California Bight by the Southern California Coastal Water Research Project (SCCWRP) (Allen et al. 2007). Species abundance was 7.4 fish/ station for barred sand bass and 1.1 fish/ station for spotted sand bass at bay and harbor stations during 5–10 minute trawls. These species were not as abundant at inner shelf stations as the abundance was 0.03 and 0 fish/station for barred sand bass and spotted sand bass, respectively.

a) kelp bass

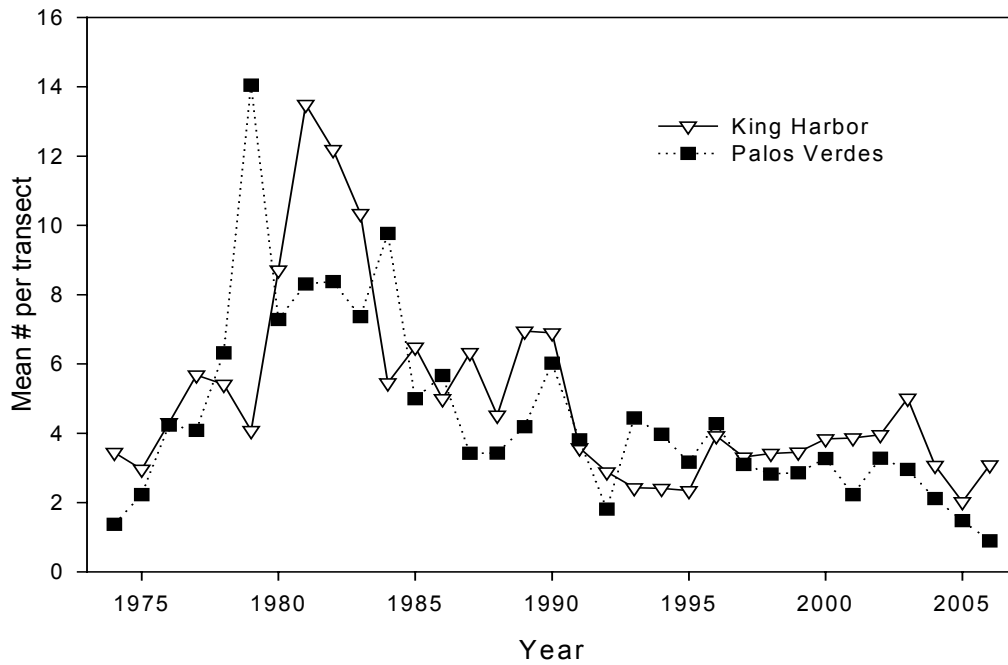

b) barred sand bass

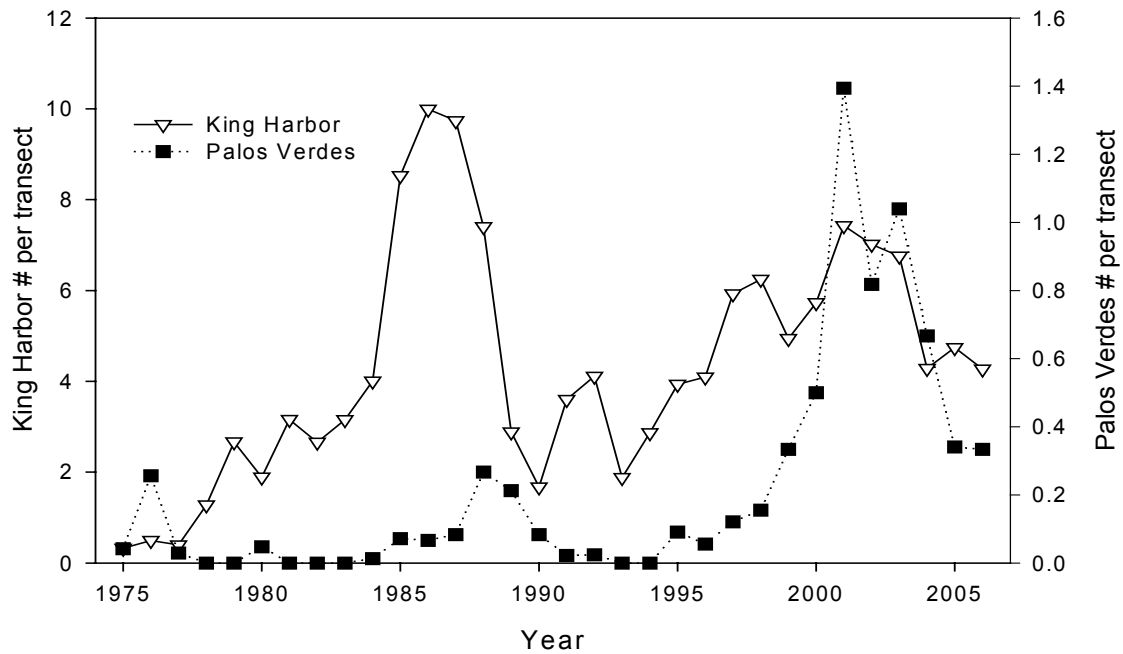

Figure 4.5-27. a) Abundance of kelp bass (*Paralabrax clathratus*) and b) barred sand bass (*Paralabrax nebulifer*) measured on diver transects at King Harbor and Palos Verdes from 1974–2006. Source: Vantuna Research Group.

#### 4.5.3.4.3 Sampling Results

The three species of sea basses were grouped together for analysis purposes. The sea bass larvae complex was very scarce at entrainment Station H2 (less than 1 larva per 1,000 m<sup>3</sup> over all surveys [Table 4.5-1]) and was the thirteenth most abundant taxon at entrainment Station E4 with a mean concentration of 8 larvae per 1,000 m<sup>3</sup> over all surveys (Table 4.5-2). Sea bass larvae had a very narrow range of occurrence at the entrainment stations, mostly in the August–September period (Figures 4.5-28 and 4.5-29) with peak abundances of about 90 per 1,000 m<sup>3</sup> at Station E4. Monthly average source water concentrations followed a similar seasonal pattern but larvae were present in samples starting in April (Figure 4.5-30). Average sea bass concentrations peaked in August at about 45 per 1,000 m<sup>3</sup> in the source water samples. Larvae were collected more frequently at night than in daytime samples (Figure 4.5-31). The length frequency distribution of measured sea bass larvae was skewed toward the lower size classes with a peak in the range of 1.5 – 2.0 mm (Figure 4.5-32). The lengths of the larvae from the entrainment station samples ranged from 0.9 to 2.8 mm with a mean of 1.7 mm NL.

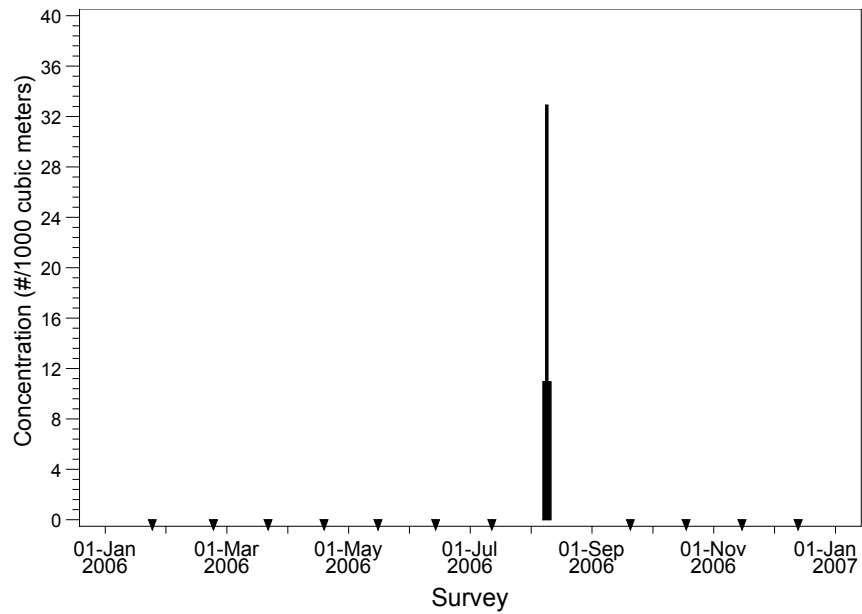

Figure 4.5-28. Mean concentration (# / 1,000 m<sup>3</sup> [264,172 gal]) and standard deviation of sea bass larvae collected at RBGS entrapment Station H2 from January 2006 through December 2006.

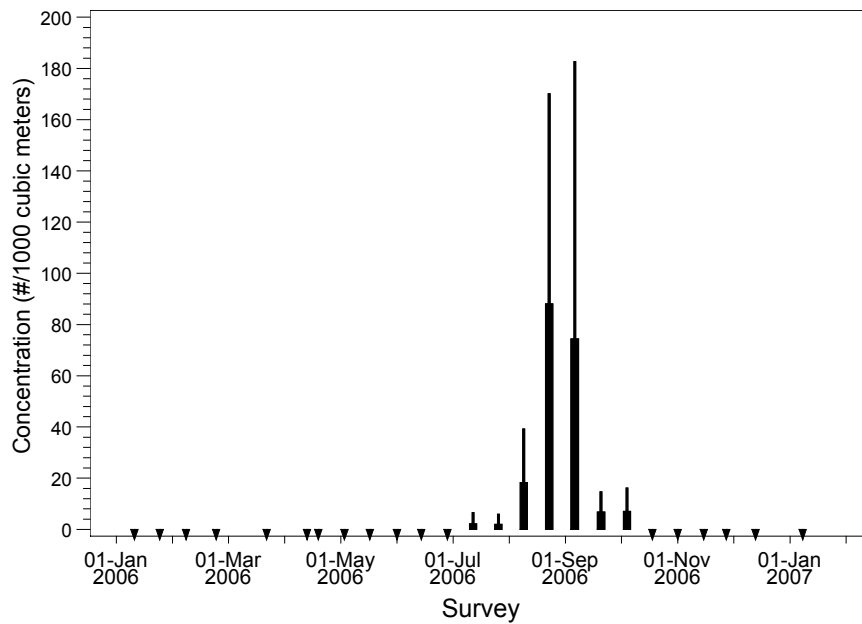

Figure 4.5-29. Mean concentration (# / 1,000 m<sup>3</sup> [264,172 gal]) and standard deviation of sea bass larvae collected at RBGS entrapment Station E4 from January 2006 through January 2007.

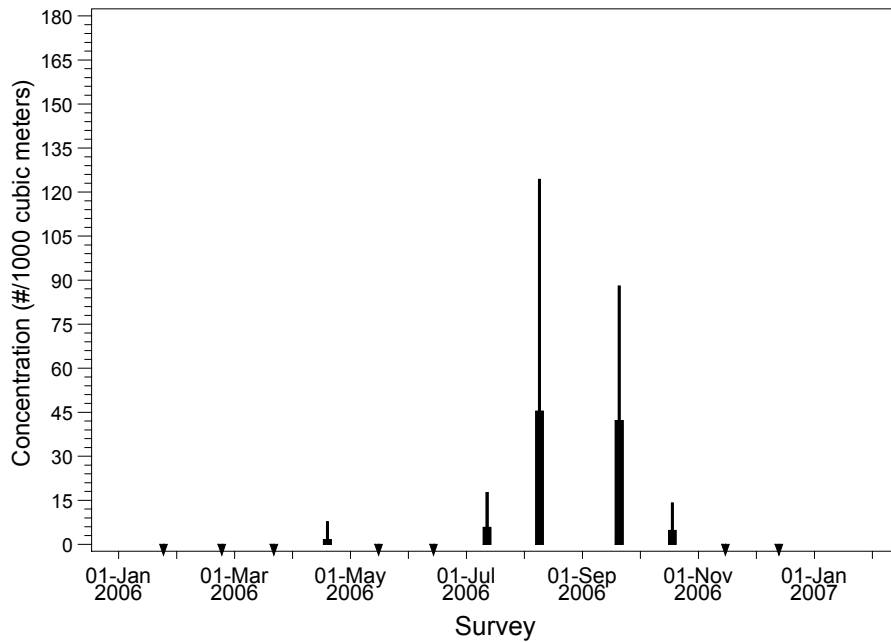

Figure 4.5-30. Mean concentration (# / 1,000 m<sup>3</sup> [264,172 gal]) and standard deviation of sea bass larvae collected at RBGS source water stations during 2006.

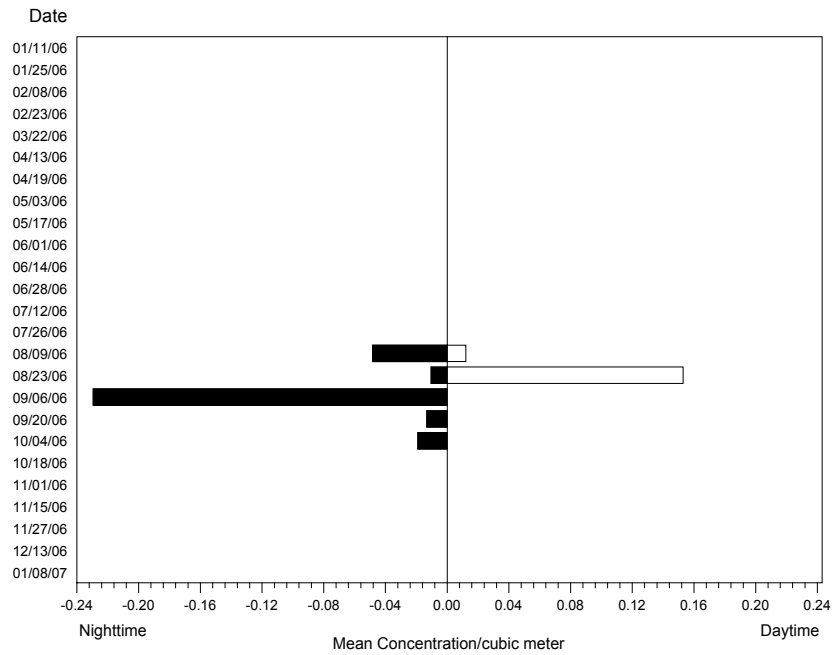

Figure 4.5-31. Mean concentration (#/1.0 m<sup>3</sup> [264 gal]) of sea bass larvae at entrainment Station E4 during night (Cycle 3) and day (Cycle 1) sampling.

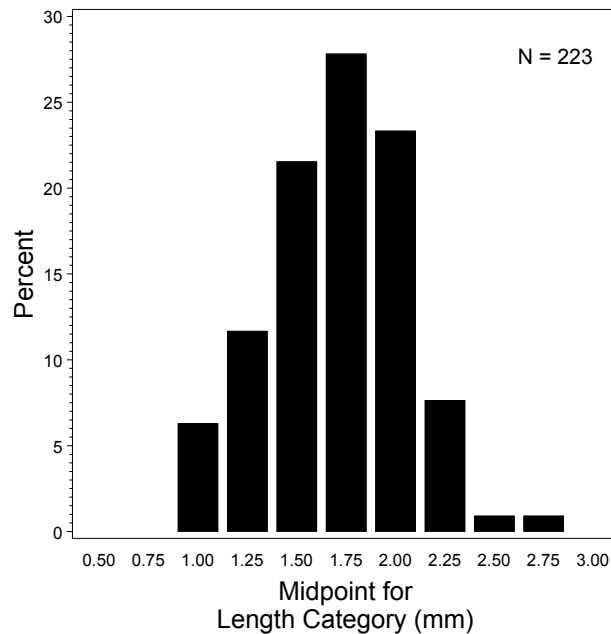

Figure 4.5-32. Length (mm) frequency distribution for sea bass larvae collected at entrainment stations in Santa Monica Bay during 2006.

#### 4.5.3.4.4 Modeling Results

There was very little species-specific information available on the early life history of sea basses. Therefore, circulating water system effects were estimated using only the *ETM* and neither of the demographic models. The total duration used in the *ETM* calculations included both the estimated egg duration from the literature and the estimated larval duration to provide an integrated estimate of entrainment effects on sea basses. The sea bass egg stage is planktonic with a duration estimated at 3 days (Cordes and Allen 1997). Total annual larval sea bass entrainment was estimated at 84,010 larvae at RBGS Units 5&6 (Table 4.5-2) and 1,152,846 larvae and 38,224 eggs at Units 7&8 using actual cooling water flows during the study period (Table 4.5-4). If the CWIS pumps were run at the design (maximum capacity) flows, annual entrainment estimates increased to 314,005 larvae for Units 5&6, and 7,108,505 larvae and 669,339 eggs for Units 7&8.

#### *Empirical Transport Model (ETM)*

A larval growth rate of 0.27 mm/d (0.01 in/d) for sea bass larvae was calculated from data available in Cailliet et al. (2000) and Moser (1996) and used with the difference between the calculated hatch length (1.3 mm [0.05 in]) and the length of the 95<sup>th</sup> percentile of the measurements (2.2 mm [0.09 in]) to estimate that the larvae were exposed to entrainment for a period of approximately 3.2 days. The egg duration of 3 days was added to this value for a total period of exposure of 6.2 days.

August was the only month during which a  $PE$  estimate could be calculated for sea basses at Units 5&6, and this value was 0.0003 (Table 4.5-26). The monthly estimates at Units 7&8 ranged from 0 to 0.00194 using the actual flows and from 0 to 0.00582 using the design flows (Table 4.5-27). The largest proportion of the source population was present during the September survey ( $f_i = 0.4881$  or 48.8%). The values in the tables were used to calculate  $P_M$  estimates of 0.00072 and 0.00190 for the two unit pairs based on actual flows and using the alongshore extrapolated estimate of the total source population. The model calculations only used four estimates of  $PE$ , increasing the uncertainty associated with the estimate for this taxa group. The alongshore current data were used to estimate that the total larval source population extended along an average coastal distance of 4.8 km (3.0 mi) based on the number of days that the larvae are potentially exposed to entrainment.

Table 4.5-26. *ETM* data for sea bass larvae at Units 5&6. *ETM* calculations based on actual and design (maximum) cooling water flows and a sampling volume in the nearshore of 396,693,881 m<sup>3</sup>.

Survey Date	<u>Actual Flows</u>		<u>Design Flows</u>		$f_i$
	$PE$ Estimate	$PE$ Std. Err.	$PE$ Estimate	$PE$ Std. Err.	
25-Jan-06	0	0	0	0	0
23-Feb-06	0	0	0	0	0
22-Mar-06	0	0	0	0	0
19-Apr-06	0	0	0	0	0.01838
17-May-06	0	0	0	0	0
14-Jun-06	0	0	0	0	0
12-Jul-06	0	0	0	0	0.05391
9-Aug-06	0.0003	0.00019	0.00112	0.00051	0.39001
20-Sep-06	0	0	0	0	0.48807
18-Oct-06	0	0	0	0	0.04964
15-Nov-06	0	0	0	0	0
13-Dec-06	0	0	0	0	0
<b><math>P_M</math></b>	<b>0.00072</b>	0.00044	<b>0.00268</b>	0.00120	—



Table 4.5-27. *ETM* data for sea bass larvae at Units 7&8. *ETM* calculations based on actual and design (maximum) cooling water flows and a sampling volume in the nearshore of 396,693,881 m<sup>3</sup>.

Survey Date	Actual Flows		Design Flows		$f_i$
	<i>PE</i> Estimate	<i>PE</i> Std. Err.	<i>PE</i> Estimate	<i>PE</i> Std. Err.	
25-Jan-06	0	0	0	0	0
23-Feb-06	0	0	0	0	0
22-Mar-06	0	0	0	0	0
19-Apr-06	0	0	0	0	0.01838
17-May-06	0	0	0	0	0
14-Jun-06	0	0	0	0	0
12-Jul-06	0.00194	0.00145	0.00229	0.00170	0.05391
9-Aug-06	0.00047	0.00021	0.00582	0.00187	0.39001
20-Sep-06	0.00004	0.00006	0.00080	0.00080	0.48807
18-Oct-06	0	0	0	0	0.04964
15-Nov-06	0	0	0	0	0
13-Dec-06	0	0	0	0	0
<b><math>P_M</math></b>	<b>0.0019</b>	0.0026	<b>0.0169</b>	0.0160	–

#### 4.5.3.5 White croaker (*Genyonemus lineatus*)

White croaker (*Genyonemus lineatus*) range from Magdalena Bay, Baja California (Miller and Lea 1972), north to Barkley Sound, British Columbia (Eschmeyer and Herald 1983). They are one of eight species of croakers (Family Sciaenidae) found off California. The other croakers include: white seabass (*Atractoscion nobilis*), black croaker (*Cheilotrema saturnum*), queenfish (*Seriphus politus*), California corbina (*Menticirrhus undulatus*), spotfin croaker (*Roncador stearnsii*), yellowfin croaker, and shortfin corvina.

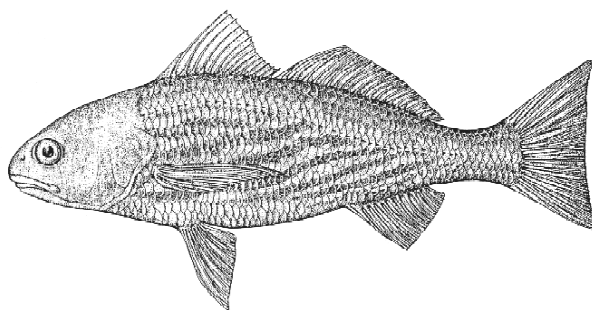

Illustration from NOAA

##### 4.5.3.5.1 Life History and Ecology

The reported depth range of white croaker is from near the surface to depths of 238 m (781 ft) (Love et al. 2005); however, in southern California, Allen, M. (1982) found white croaker over soft bottoms between 10 and 130 m (33 and 427 ft), and it was collected most frequently at 10 m (33 ft). It is nocturnally active, and is considered a benthic searcher that feeds on a wide variety of benthic invertebrate prey. Adults feed

on polychaetes and crustaceans, while juveniles feed during the day in midwater on zooplankton (Allen, M. 1982).

White croakers are oviparous broadcast spawners. They mature between 130 and 190 mm TL, from their first to fourth year; while approximately 50% spawn during their first year (Love et al. 1984). About half of males mature by 140 mm TL, and half of females by 150 mm TL, with all fish mature by 190 mm TL in their third to fourth year (Love et al. 1984). Off Long Beach, white croaker spawn primarily from November through August, with peak spawning occurring from January through March (Love et al. 1984). However, some spawning can occur year-round. Batch fecundities ranged from about 800 eggs in a 155 mm female to about 37,200 eggs in a 260 mm female, with spawning taking place as often as every five days (Love et al. 1984). In their first and second years, females spawn for three months for a total of about 18 times per season. Older fish spawn for about four months and about 24 times per season (Love et al. 1984). Some older fish may spawn for seven months. The nearshore waters from Redondo Beach (Santa Monica Bay) to Laguna Beach are considered an important spawning center for this species (Love et al. 1984). A smaller spawning center occurs off Ventura.

Newly hatched white croaker larvae are 1–2 mm SL and not well developed (Watson 1982). Larvae are principally located within 4 km from shore, and as they develop tend to move shoreward and into the epibenthos (Schlotterbeck and Connally 1982). Murdoch et al. (1989b) estimated a daily larval growth rate of 0.20 mm/day. Maximum reported size is 414 mm (Miller and Lea 1972), with a life span of 12–15 years (Frey 1971, Love et al. 1984). White croakers grow at a fairly constant rate throughout their lives, though females increase in size more rapidly than males from age 1 (Moore 2001). No mortality estimates are available for any of the life stages of this species.

White croaker are primarily nocturnal benthic feeders, though juveniles may feed in the water column during the day (Allen, M. 1982). Important prey items include polychaetes, amphipods, shrimps, and chaetognaths (Allen, M. 1982). In Outer Los Angeles Harbor, Ware (1979) found that important prey items included polychaetes, benthic crustaceans, free-living nematodes, and zooplankton. Younger individuals feed on holoplanktonic crustaceans and polychaete larvae. White croaker may move offshore into deeper water during winter months (Allen and DeMartini 1983); however, this pattern is apparent only south of Redondo Beach (Herbinson et al. 2001).

#### 4.5.3.5.2 Population Trends and Fishery

White croaker is an important constituent of commercial and recreational fisheries in California. Prior to 1980, most commercial catches of white croaker were taken by otter trawl, round haul net (lampara), gill net, and hook and line in southern California, but after 1980 most commercial catches were taken primarily by trawl and hook and line (Love et al. 1984). Also, since then the majority of the commercial fishery shifted to central California near Monterey mainly due to the increased demand for this species from the developing fishery by Southeast Asian refugees (Moore and Wild 2001). Most of the recreational catch still occurs in southern California from piers, breakwaters, and private and sport boats.

Before 1980, state-wide white croaker landings averaged 685,000 lbs annually, exceeding 1 million lbs for several years (Moore and Wild 2001). High landings in 1952 probably occurred due to the collapse of the Pacific sardine fishery. Since 1991, landings averaged 461,000 lbs and steadily declined to an all-time low of 142,500 lbs in 1998. Landings by recreational fishermen aboard CPFVs averaged about 12,000 fish per year from 1990 to 1998, with most of the catch coming from southern California.

Annual commercial landings in the Los Angeles region since 2000 have been variable with an average of 19,707 kg (43,447 lbs) and an average net worth of \$29,384 annually (Table 4.5-28). Sport fishery catch estimates of white croaker in the southern California region from 2000–2006 ranged from 64,000–253,000 fish, with an average of 189,400 fish caught annually (RecFIN 2007).

Table 4.5-28. Annual landings and revenue for white croaker in the Los Angeles region based on PacFIN data.

<b>Year</b>	<b>Landed Weight (kg)</b>	<b>Landed Weight (lbs)</b>	<b>Revenue</b>
2000	40,025	88,240	\$50,688
2001	23,387	51,560	\$36,086
2002	25,880	57,056	\$41,816
2003	21,772	48,000	\$33,837
2004	8,894	19,608	\$14,653
2005	11,182	24,652	\$17,531
2006	6,809	15,011	\$11,079
<b>average</b>	<b>19,707</b>	<b>43,447</b>	<b>\$29,384</b>

The earlier 316(b) study from RBGS in 1979–1980 (SCE 1983) reported estimates of average concentrations of white croaker sampled at the intake stations and found the highest densities from November through April and lowest densities from June through September. Mean daily densities were 1097 larvae per 1,000 m<sup>3</sup> (264,172 gal) at Units 7&8 and mean concentrations in 1979–1980 were approximately ten times greater than the concentrations estimated from the 2006 entrainment sampling near the RBGS intake (using actual flow volumes).

Annual relative abundance of white croaker in impingement samples at southern California power plants showed decreases during the strong El Niño events of 1982-83, 1986-87, and 1997-98 as compared with non- El Niño years (Herbinson et al. 2001). Additionally, the relative abundance of local populations have been influenced by contamination from PCBs and other chlorinated hydrocarbons within bays and has lead to early ovulation, lower batch fecundities, and lower fertilization rates when compared to non-contaminated areas (Cross and Hose 1988).

A total of 30 inner shelf and 16 bay and harbor stations were sampled during 2003 within the southern California Bight by the Southern California Coastal Water Research Project (SCCWRP) (Allen et al. 2007). Species abundance was 0.25 fish/ station for white croaker at bay and harbor stations during 5–10 minute trawls, while this species was not present in the inner shelf station samples.

Recreational and commercial catches of white croaker showed a declining trend from 1980-2006 (Figure 4.5-33a; D. Pondella, pers. communication). However, fishery-independent data from trawls did not indicate a similar trend, suggesting the recreational fishery trend is due to fishing practice changes since 1980. These two data sets were positively correlated with each other, and the commercial catch was correlated with sea surface temperature. In the OREHP monitoring program, the catch per sampling period increased over the sample period (Figure 4.5-33b). The NPDES trawl data suggested a similar pattern (Figure 4.5-33c) with catches of white croaker from 1978–2006 oscillating without a significant trend over the study period. This catch was not correlated with any oceanographic parameters (PDO, SST, or ENSO).

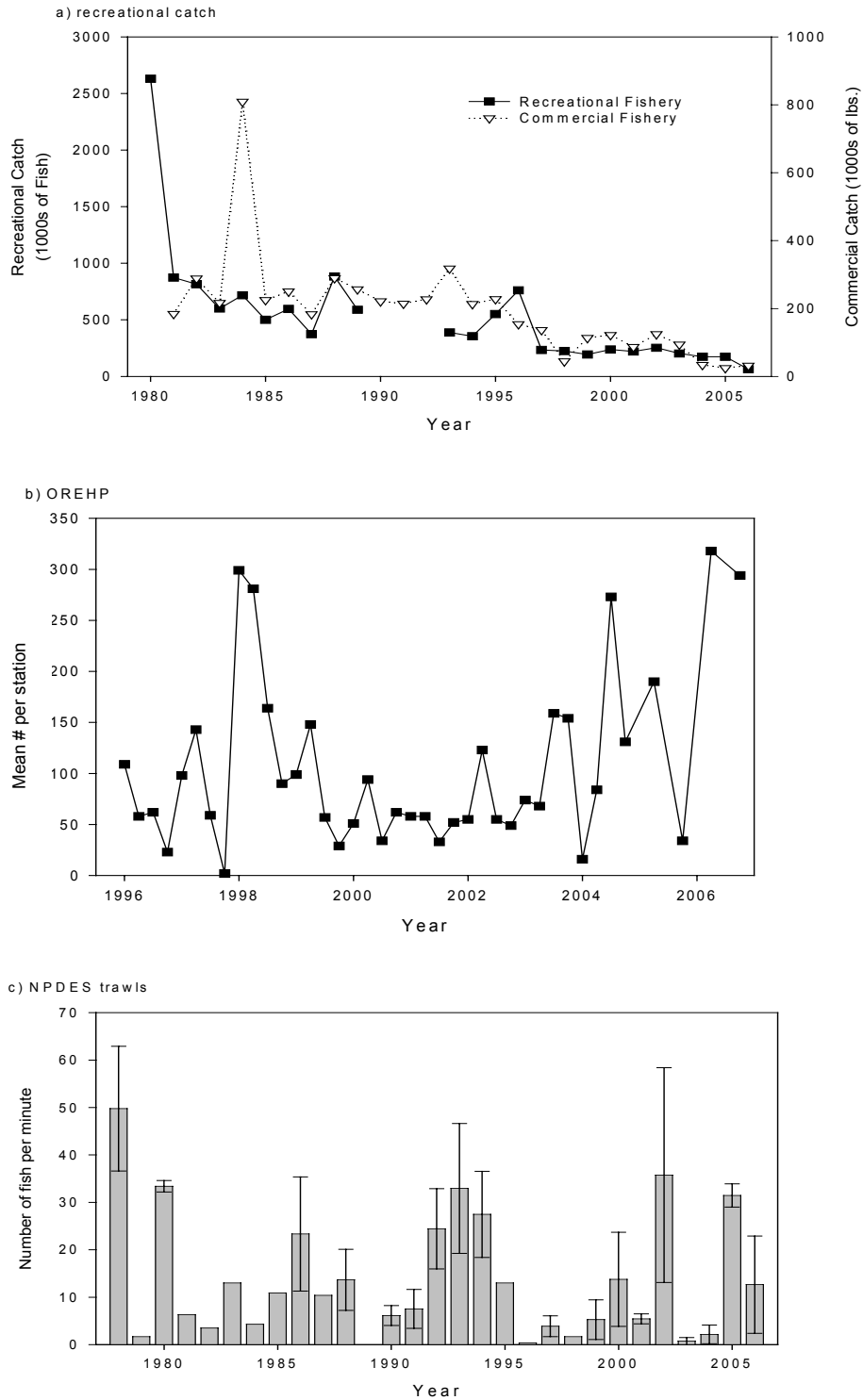

Figure 4.5-33. White croaker fishery and population trends: a) recreational and commercial landings, b) Ocean Resource Enhancement Hatchery Program (OREHP) gill net monitoring data, and c) NPDES trawl programs. Error bars are  $\pm 1$  S.E.

Concentrations of white croaker larvae, as measured in King Harbor as part of the Occidental College – Vantuna Research Group’s long-term studies, were collected in highest numbers prior to the 1983-4 El Niño event (Figure 4.5-34); concentrations have remained relatively low since 1995.

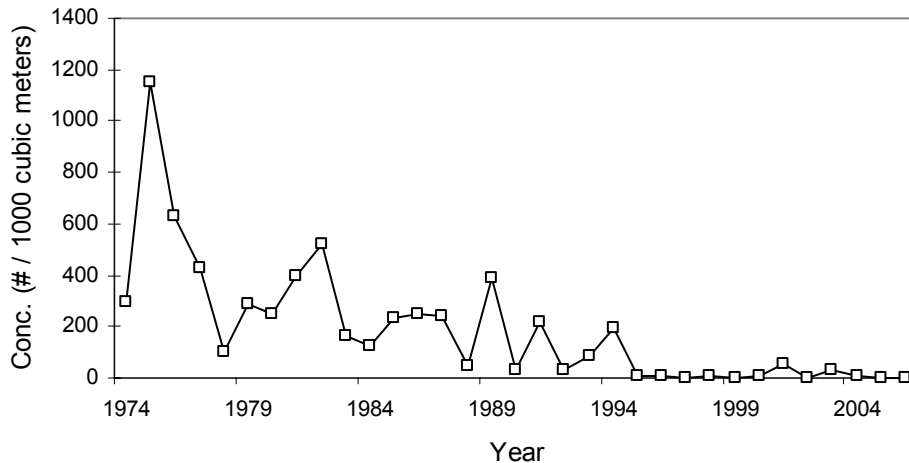

Figure 4.5-34. Mean concentration (# / 1,000 m<sup>3</sup> [264,172 gal]) of white croaker larvae collected from King Harbor, 1974-2006. Source: Vantuna Research Group.

#### 4.5.3.5.3 Sampling Results

White croaker larvae was the eighth most abundant taxon at entrainment Station H2 with a mean concentration of 13 per 1,000 m<sup>3</sup> over all surveys (Table 4.5-1), but was the fourth most abundant taxon at Station E4 with a mean concentration of 90 per 1,000 m<sup>3</sup> over all surveys (Table 4.5-2). White croaker larvae were present sporadically throughout the year at the entrainment stations, with peaks in average abundance in the spring and fall (Figures 4.5-35 and 4.5-36). Average concentrations of white croaker at Station E4 peaked at about 400 larvae per 1,000 m<sup>3</sup> in April and at about 900 larvae per 1,000 m<sup>3</sup> in November. Source water average abundances followed the same seasonal pattern, except that concentrations of larvae were approximately equal in the spring and in the fall. Peak average abundances in April and November were about 500 per 1,000 m<sup>3</sup> (Figure 4.5-37). White croaker larvae were more common in the night samples than in the daytime (Figures 4.5-38). The length frequency plot for entrained white croaker larvae was skewed toward the lower size classes with about 75% of sampled larvae in the 2–3 mm size classes and a decline in frequency of occurrence at larger size classes to 9.0 mm, with a few sampled larvae in the 12.0 and 14.0 mm size classes (Figure 4.5-39). Lengths of measured white croaker ranged from 1.0–14.0 mm NL. The mean length of specimens from the entrainment station samples was 3.0 mm NL for white croaker.

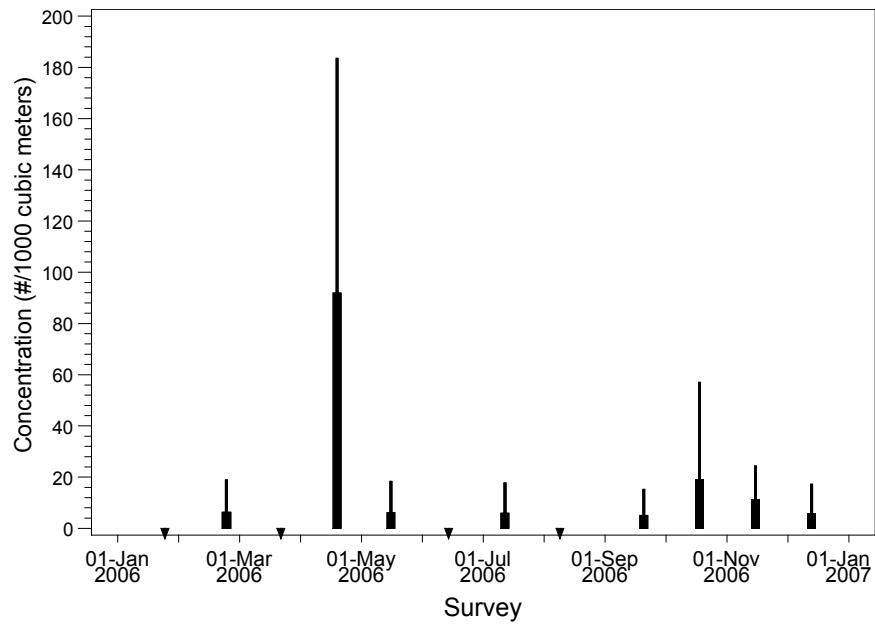

Figure 4.5-35. Mean concentration (# / 1,000 m<sup>3</sup> [264,172 gal]) and standard deviation of white croaker larvae collected at RBGS entrapment Station H2 from January 2006 through December 2006.

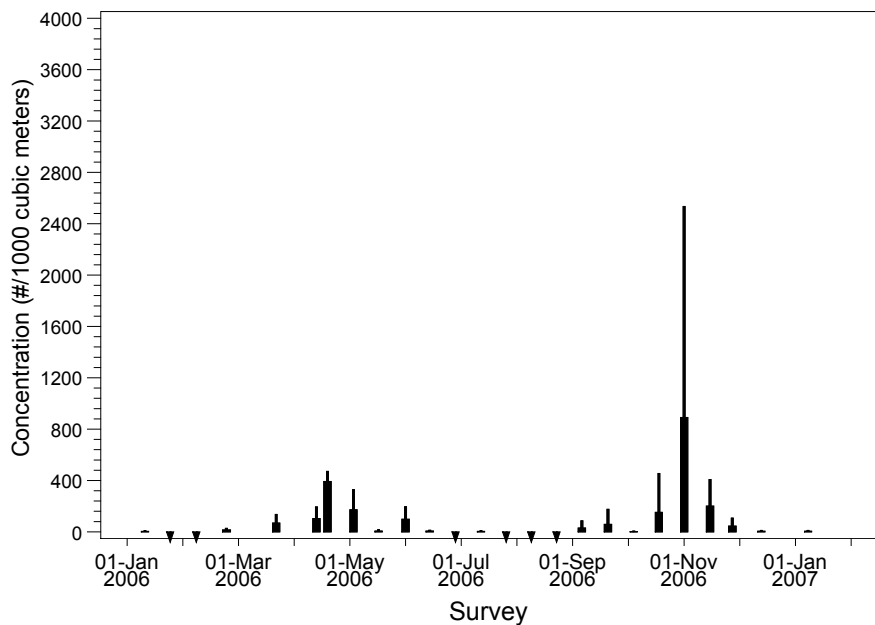

Figure 4.5-36. Mean concentration (# / 1,000 m<sup>3</sup> [264,172 gal]) and standard deviation of white croaker larvae collected at RBGS entrapment Station E4 from January 2006 through January 2007.

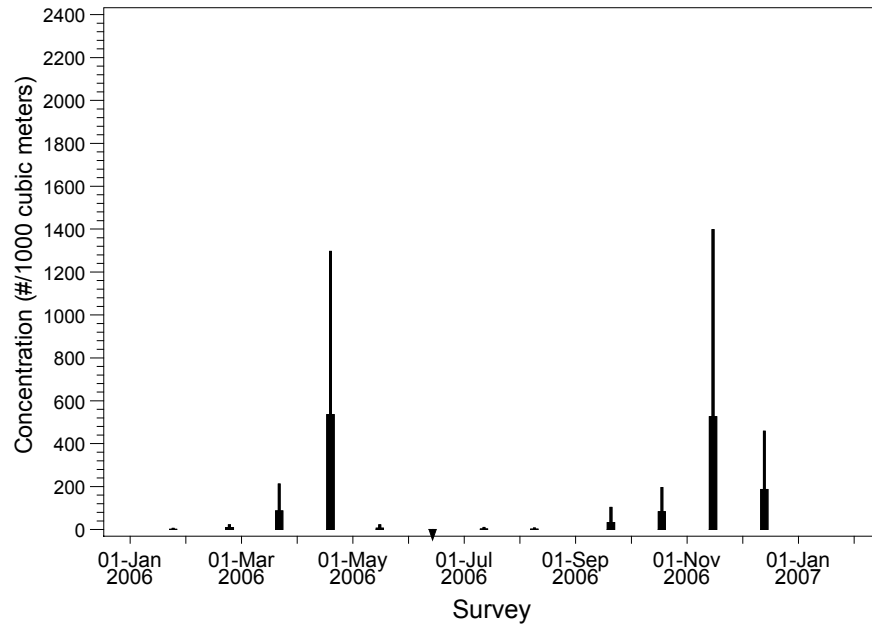

Figure 4.5-37. Mean concentration (# / 1,000 m<sup>3</sup> [264,172 gal]) and standard deviation of white croaker larvae collected at RBGS source water stations during 2006.

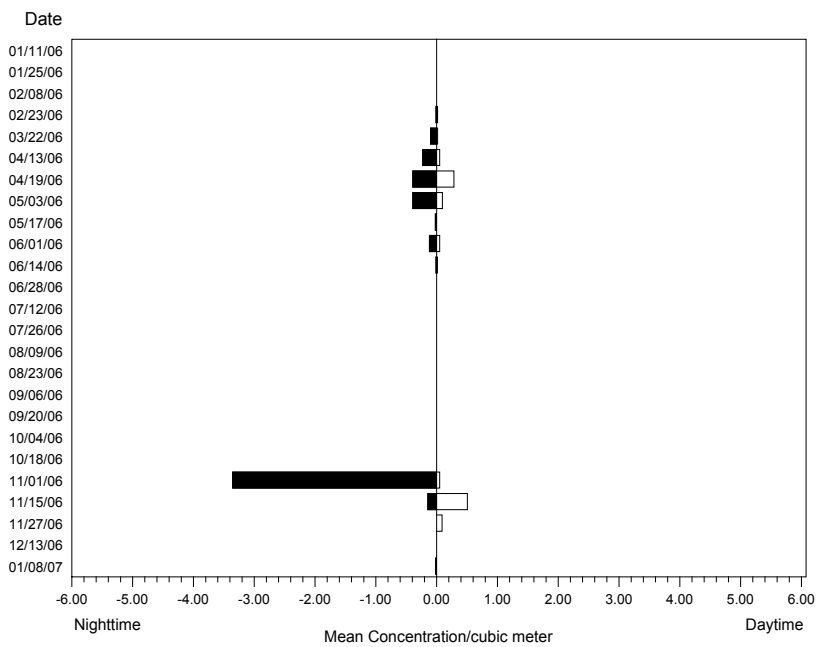

Figure 4.5-38. Mean concentration (#/1.0 m<sup>3</sup> [264 gal]) of white croaker larvae at entrainment Station E4 during night (Cycle 3) and day (Cycle 1) sampling.



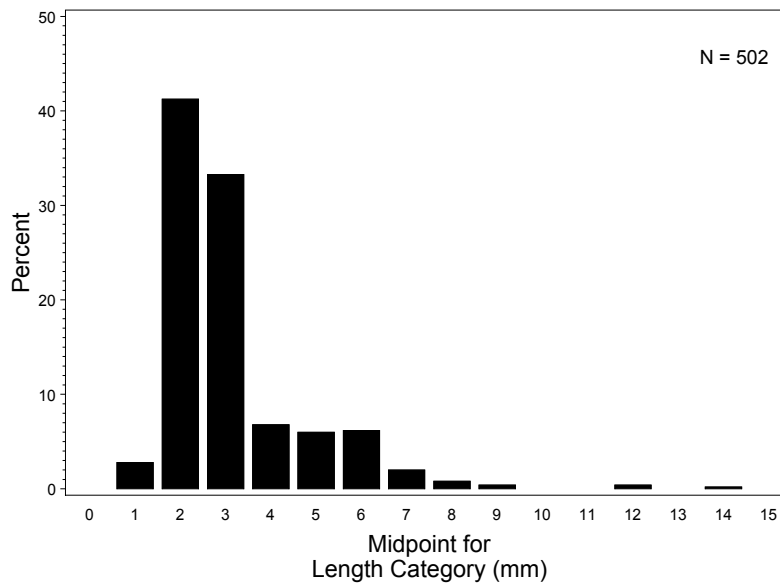

Figure 4.5-39. Length (mm) frequency distribution for larval white croaker collected at entrainment Station E4.

#### 4.5.3.5.4 Modeling Results

The following section presents the results for the empirical transport modeling of entrainment effects on white croaker. No age-specific estimates of survival for larval and later stages of development were available from the literature for white croaker, therefore no estimates of *FH* or *AEL* were calculated, but enough information was available to estimate *FH* based on numbers of eggs entrained. Total annual entrainment was estimated at 1,093,369 white croaker larvae for RBGS Units 5&6 (Table 4.5-3), and 11,540,146 larvae and 235,529 eggs for Units 7&8 using actual cooling water flows during 2006 (Table 4.5-4). If the CWIS pumps were run at the design (maximum capacity) flows, annual entrainment estimates increased to 3,559,616 larvae at Units 5&6, and 77,987,397 larvae and 16,700,091 eggs at Units 7&8. The total duration used in the *ETM* calculations included both the estimated egg duration from the literature and the estimated larval duration to provide an integrated estimate of entrainment effects on white croaker.

#### *Fecundity Hindcasting (FH)*

The annual entrainment estimate for white croaker eggs was used to calculate the number of females of average age and fecundity that would produce in their lifetime the number of eggs entrained. An estimate of egg survival of 0.781 was based on an egg stage duration of 2.17 days and an average age at entrainment of 0.97 days. A total lifetime fecundity of 2,294,250 eggs per female was calculated based on an average number of eggs per batch of 19,000, an average number of 21 batches per year, and an average age in the population of 5.75 years. Life history information presented in Love et al. (1984) is summarized in Section 4.5.3.5.1 *Life History and Ecology*. The estimated numbers of female white

croakers whose lifetime reproductive output was entrained through the RBGS CWIS at Units 7&8 for the 2006 period was estimated as less than one adult using the actual flows and increased to nine adults using the design flow volumes (Table 4.5-29).

Table 4.5-29. Results of *FH* modeling for white croaker eggs based on entrainment estimates calculated using actual and design (maximum) CWIS flows for Units 7&8.

<b>Parameter</b>	<b>Estimate</b>	<b>Std. Error</b>	<b><i>FH</i> Lower Estimate</b>	<b><i>FH</i> Upper Estimate</b>	<b><i>FH</i> Range</b>
<b><u>Actual Flows</u></b>					
<i>FH</i> Estimate	< 1	0	0	0	0
Total Entrainment	235,529	29,400	0	0	0
<b><u>Design Flows</u></b>					
<i>FH</i> Estimate	9	7	3	30	27
Total Entrainment	16,700,091	624,802	9	10	1

The upper and lower estimates are based on a 90% confidence interval of the mean. *FH* estimates were also calculated using the upper and lower confidence estimates from the entrainment estimates.

*Empirical Transport Model (ETM)*

A larval growth rate was derived from data on five species of Sciaenidae (croakers) that were raised in the laboratory by Southwest Fisheries Science Center staff (Moser 1996). These were the black croaker, corbina, spotfin croaker, queenfish, and yellowfin croaker. Hatch lengths and larval length at various numbers of days after birth presented in Moser (1996) were used to calculate an average daily growth rate from hatching through the flexion stage for Sciaenidae. The growth rate calculated from these data was 0.248 mm/d (0.01 in/d). Although the species did not include white croaker this estimate was used for both white croaker and unidentified croakers since the species that were measured all have larvae that are nearly indistinguishable at small sizes (Moser 1996). A random sample of 200 lengths from the 588 measured white croaker larvae were used to calculate a difference between the estimated hatch length (2.0 mm [0.08 in]) and the 95<sup>th</sup> percentiles of the measurements (6.3 mm [0.25 in]) to estimate that white croaker were exposed to entrainment for periods of approximately 17.3 days. The duration of the planktonic egg stage, 2.2 days, was added to the periods for the larvae to estimate a total periods of exposure of 19.5.

The monthly estimates of proportional entrainment (*PE*) for white croaker for 2006 ranged from 0 to 0.00127 using the actual flows for Units 5&6, and from 0 to 0.00327 for Units 7&8 (Table 4.5-30). Using the design flows the maximum monthly *PE* values increased to 0.00630 and 0.00515 (Table 4.5-31). The largest proportion of the source population was present during the April survey ( $f_i = 0.333$  or 33.3%). The values in the tables were used to calculate  $P_M$  estimates of 0.00034 and 0.00470 based on actual flows and using the alongshore extrapolated estimate of the total source population. The period of larval exposure coupled with average current velocities indicates that larvae from alongshore distances of 14.7 km (9.1 mi) may be subject to entrainment. The small estimates of  $P_M$  are a direct result of the large source population potentially subject to entrainment.

Table 4.5-30. *ETM* data for white croaker larvae at Units 5&6. *ETM* calculations based on actual and design (maximum) cooling water flows and a sampling volume in the nearshore of 396,693,881 m<sup>3</sup>.

Survey Date	<u>Actual Flows</u>		<u>Design Flows</u>		$f_i$
	<i>PE</i> Estimate	<i>PE</i> Std. Err.	<i>PE</i> Estimate	<i>PE</i> Std. Err.	
25-Jan-06	0	0	0	0	0.00001
23-Feb-06	0.00016	0.00052	0.00055	0.00144	0.00559
22-Mar-06	0	0	0	0	0.04773
19-Apr-06	0.00004	0.00007	0.0001	0.00016	0.33291
17-May-06	0.00022	0.00033	0.00167	0.00199	0.00405
14-Jun-06	0	0	0	0	0.00032
12-Jul-06	0.00127	0.00541	0.00149	0.0063	0.00129
9-Aug-06	0	0	0	0	0.00070
20-Sep-06	0.00001	0.00005	0.00007	0.00026	0.03116
18-Oct-06	0	0.00002	0.00011	0.0004	0.05289
15-Nov-06	0	0	0.00001	0.00003	0.33268
13-Dec-06	0	0	0.00001	0.00006	0.19066
<b><math>P_M</math></b>	<b>0.00034</b>	0.00120	<b>0.00115</b>	<b>0.00103</b>	–

Table 4.5-31. *ETM* data for white croaker larvae at Units 7&8. *ETM* calculations based on actual and design (maximum) cooling water flows and a sampling volume in the nearshore of 396,693,881 m<sup>3</sup>.

Survey Date	<u>Actual Flows</u>		<u>Design Flows</u>		$f_i$
	<i>PE</i> Estimate	<i>PE</i> Std. Err.	<i>PE</i> Estimate	<i>PE</i> Std. Err.	
25-Jan-06	0	0	0	0	0.00001
23-Feb-06	0.00005	0.00018	0.00384	0.00794	0.00559
22-Mar-06	0.00031	0.00031	0.00453	0.00254	0.04773
19-Apr-06	0.00064	0.00069	0.00130	0.00140	0.33291
17-May-06	0.00109	0.00162	0.00515	0.00576	0.00405
14-Jun-06	0.00327	0.01114	0.01534	0.04182	0.00032
12-Jul-06	0.00188	0.00798	0.00222	0.00938	0.00129
9-Aug-06	0	0	0	0	0.00070
20-Sep-06	0.00012	0.00088	0.00255	0.00950	0.03116
18-Oct-06	0	0	0.00275	0.01007	0.05289
15-Nov-06	0.00002	0.00007	0.00066	0.00132	0.33268
13-Dec-06	0	0	0.00003	0.00012	0.19066
<b><math>P_M</math></b>	<b>0.0047</b>	0.0039	<b>0.0220</b>	0.0185	–

#### 4.5.3.6 Queenfish (*Seriphus politus*) and Unidentified Croakers (Sciaenidae)

Queenfish (*Seriphus politus*) ranges from Vancouver Island, British Columbia to southern Gulf of California (Love et al. 2005). Queenfish is common in southern California, but rare north of Monterey. It is one of eight species of croakers or 'drums' (Family Sciaenidae) found off California. The other croakers include: black croaker, white croaker, California corbina, spotfin croaker, yellowfin croaker, white seabass, and shortfin corvina. This section also includes results on

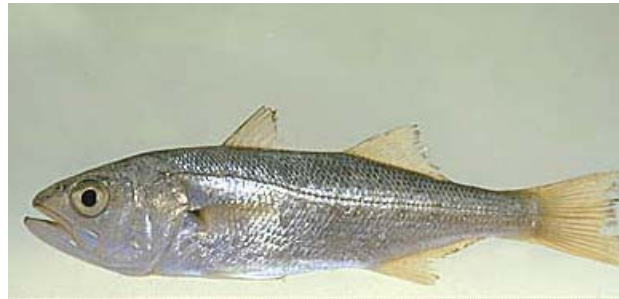

Milton Love

unidentified croakers because queenfish and several other croakers spawn during the summer and their larvae cannot be reliably separated into species at very small sizes. White croaker is not included in this group because they generally spawn earlier in the year and their larvae can be distinguished from other croakers at small sizes. This section only includes life history and other information on queenfish.

##### 4.5.3.6.1 Life History and Ecology

The reported depth range of queenfish is from the surface to depths of about 181 m (594 ft) (Love et al. 2005). In southern California, Allen, L. (1982) found queenfish mainly over soft bottoms at 10–70 m (33–230 ft), with highest abundance occurring at the 10 m stratum. Queenfish form dense, somewhat inactive, schools close to shore during the day, but disperse to feed in midwater after sunset (Hobson and Chess 1976). In a study of queenfish off northern San Diego County, DeMartini et al. (1985) found that adults of both sexes made onshore and offshore migrations, but immature fish generally remained within 2.5 km (1.6 mi) of shore at night. Queenfish are active throughout the night, feeding several meters off the seafloor either in small schools or individually.

Queenfish mature at 10.5–12.7 cm TL (4.1–5.0 in) (DeMartini and Fountain 1981, Love 1996), during their first spring or second summer. Maximum reported size is 30.5 cm (12 in) TL (Miller and Lea 1972). Immature individuals grow at a rate of about 2.5 mm/day, while early adults grow about 1.8 mm/day (Murdoch et al. 1989a). Mortality rate estimates are unavailable for this species.

Queenfish are summer spawners. Goldberg (1976) found queenfish enter spawning condition in April and spawn into August, while DeMartini and Fountain (1981) recorded spawning as early as March. Spawning is asynchronous among females, but there are monthly peaks in intensity during the waxing (first quarter) of the moon (DeMartini and Fountain 1981). They also state that mature queenfish spawn every 7.4 days, on average, regardless of size. Duration of the spawning season is a function of female body size, ranging from three months (April–June) in recruit spawners to six months (March–August) in repeat spawners (>13.5 cm SL, or 5.3 in). Based on the spawning frequency and number of months of spawning, these two groups of spawners can produce about 12 and 24 batches of eggs during their respective spawning seasons (DeMartini and Fountain 1981). DeMartini (1991) noted the relationship

between declines in fecundity, gonadal and somatic condition of queenfish in southern California, and the crash in planktonic production during the 1982–84 El Niño event.

Goldberg (1976) found no sexually mature females less than 14.8 cm (6 in) SL in Santa Monica Bay. This differs from the findings of DeMartini and Fountain (1981) who found sexually mature females at 10.0–10.5 cm (3.9–4.1 in) SL off San Onofre at slightly greater than age-1. Batch fecundities in queenfish off San Onofre ranged from 5,000 eggs in a 10.5 cm (4.1 in) female to about 90,000 eggs in a 25 cm (9.8 in) fish. The average-sized female (14 cm, 42 g) had a potential batch fecundity of 12,000–13,000 eggs. Murdoch et al. (1989a) estimated the average batch fecundity to be 12,700 for queenfish collected over a five-year period. Based on a female spawning frequency of 7.4 days, a 10.5-cm (4.1-in) female that spawns for three months (April–June) can produce about 60,000 eggs per year, while a 25-cm (9.8-in) female that spawns for six months (March through August) can produce nearly 2.3 million eggs per year (DeMartini and Fountain 1981).

Queenfish feed mainly on crustaceans, including amphipods, copepods, and mysids, along with polychaetes and fishes (Quast 1968, Hobson and Chess 1976, Hobson et al. 1981, Feder et al. 1974). They are a forage species that is probably consumed by a wide variety of larger piscivorous fishes such as halibut, kelp bass, Pacific bonito, Pacific mackerel, and sharks as well as sea lions and cormorants.

#### 4.5.3.6.2 Population Trends and Fishery

Queenfish are numerically one of the most abundant species along sandy or muddy bottom habitats in southern California. They dominate much of the surf zone along with other species such as silversides (topsmelt and jacksmelt) and northern anchovy (Allen and Pondella 2006). Large numbers of juveniles typically aggregate near drift algal beds within the surf zone (Allen and DeMartini 1983)

Queenfish are one of the most abundant species sampled in beam trawls, otter trawls, and lampara nets. They were one of the three most abundant species of soft-bottom associated fishes in southern California along with white croaker and northern anchovy during a 1982–1984 study using otter trawls (Love et al. 1986). They were more abundant in shallower water depth strata making up about 47% of the fish sampled from 6.1-12.2 m. Queenfish were also major constituents in beam trawl surveys and made up 50% of catches in exposed coastal sites and 72% of the catch in semi-protected coastal along with white croaker (Allen and Herbinson 1991).

Long term trends from coastal generating power plants indicate that queenfish was the most abundant species impinged at five southern California generating stations from 1977 to 1998, and that they accounted for over 60% of the total fishes impinged (Herbinson et al. 2001). Their abundance was stable during this period, with notable declines occurring during strong El Niño events. Abundance remained relatively high throughout the 20-year study period.

The earlier 316(b) study from RBGS in 1979–1980 (SCE 1983) reported estimates of average concentrations of queenfish sampled at the intake stations and found the highest densities from March through July and lowest densities from September through February. Mean daily densities were 170

larvae per 1,000 m<sup>3</sup> (264,172 gal) at Units 7&8 and mean concentrations in 1979–1980 were approximately six times greater than the concentrations estimated from the 2006 entrainment sampling near the RBGS intake (using actual flow volumes).

A total of 30 inner shelf and 16 bay and harbor stations were sampled during 2003 within the southern California Bight by the Southern California Coastal Water Research Project (SCCWRP) (Allen et al. 2007). Species abundance was 11.6 fish/ station for queenfish at bay and harbor stations during 5-10 minute trawls. This species was scarce at inner shelf stations with a mean abundance of 0.03 fish/station.

Various time-series analyses conducted by the Vantuna Research Group (D. Pondella, pers. comm.) showed that catches of queenfish fluctuated over time. In the recreational fishery, no visible trend was apparent, with catches fluctuating between 38,000 and 292,000 fish per year and an aberrant peak in 2002 (Figure 4.5-40a). The catch data did not reflect any significant response to oceanographic variables (PDO, SST, and ENSO). In the OREHP data set, catch fluctuated appreciably in both Santa Monica Bay and the remainder of the bight (Figure 4.5-40b). These two time series were not correlated with each other. Catch in the bight showed an increasing trend from 1995–2006 while catch in Santa Monica Bay was largely unchanged. April 2002 (67.1 fish/station) was the second highest catch in the OREHP study with the greatest catch in June 2000 (71.6 fish/station). The increasing trend in the NPDES trawl data set since the late 1990s peaked in 2002; however, catch was higher in several previous years (Figure 4.5-40c). Trawl data did not indicate either a positive or negative trend in queenfish population. Queenfish catches were correlated with sea surface temperature and the ENSO index. Queenfish populations appear to respond positively during warm water periods, and as such, catches were consistent over the last two decades and may be increasing.

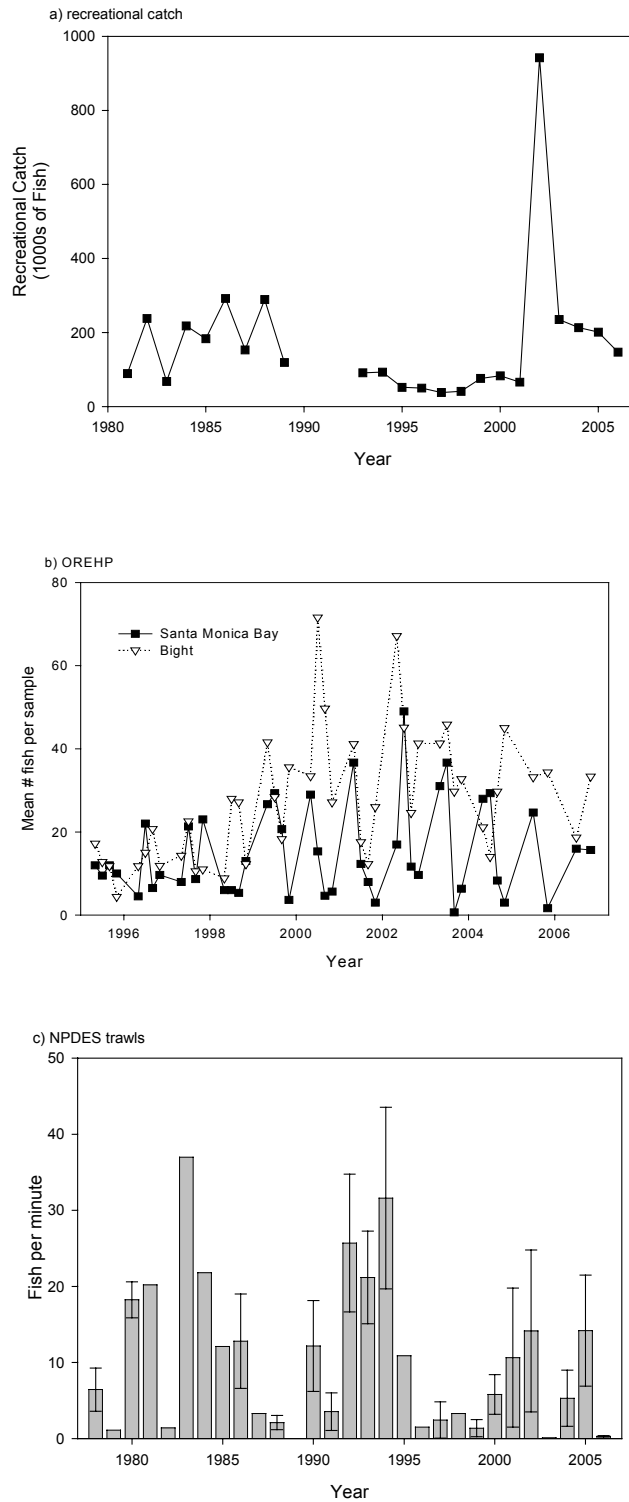

Figure 4.5-40. Queenfish fishery and population trends: a) recreational and commercial landings, b) Ocean Resource Enhancement Hatchery Program (OREHP) gill net monitoring data, and c) NPDES trawl programs.

Concentrations of queenfish larvae, as measured in King Harbor as part of the Occidental College – Vantuna Research Group’s long-term studies, were collected in highest numbers prior to the 1983-4 El Niño event (Figure 4.5-41). Larval sciaenid concentrations peaked in 1976, 1988, and 2001.

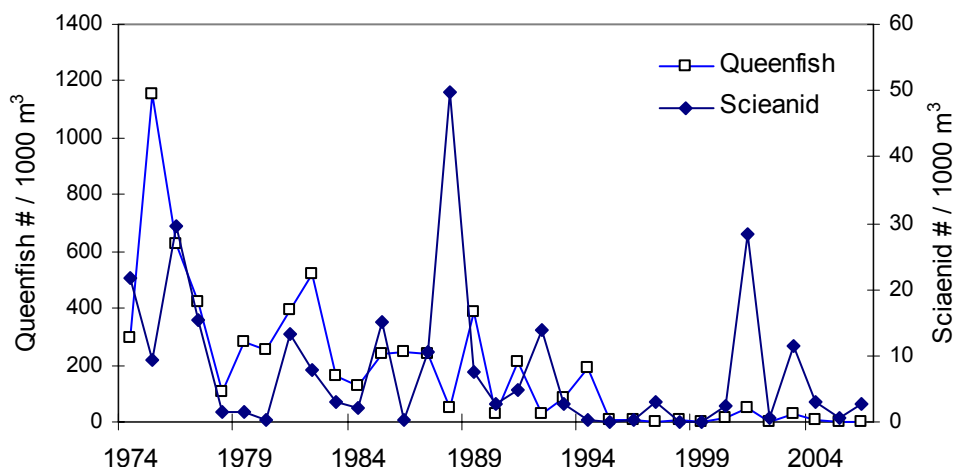

Figure 4.5-41. Mean concentration (# / 1,000 m<sup>3</sup> [264,172 gal]) of queenfish and unidentified sciaenid larvae collected from King Harbor, 1974-2006. Source: Vantuna Research Group.

Although queenfish is not considered a highly desired species compared to other sciaenids, it is caught in fairly substantial numbers by both recreational and commercial fisheries. No specific landings were reported in commercial landing statistics for southern California from 2000–2006 (PacFIN 2007), although they may have been grouped as ‘unspecified croakers’. Recent population trends indicate a decline in shore landings by over 75% in the 1990s compared to the 1980s (Jarvis et al. 2004). Sport fishery catch estimates of queenfish in the southern California region from 2000–2006 ranged from 66,000 to 942,000 fish, with an average of approximately 270,000 fish caught annually (Table 4.5-32).

Table 4.5-32. Annual landings for queenfish in the Southern California region based on RecFIN data.

Year	Estimated Catch
2000	83,000
2001	66,000
2002	942,000
2003	235,000
2004	213,000
2005	201,000
2006	147,000
<b>average</b>	<b>269,571</b>



4.5.3.6.3 Sampling Results

Queenfish larvae were scarce at entrainment Station H2 with a mean concentration of less than 1 per 1,000 m<sup>3</sup> over all surveys (Table 4.5-1), but it was the sixth most abundant taxon at entrainment Station E4 with a mean concentration of 28 per 1,000 m<sup>3</sup> over all surveys (Table 4.5-2). Unidentified croaker (Sciaenidae), which consisted of a combination of newly-hatched queenfish and several other croaker species, had mean concentrations of 8 per 1,000 m<sup>3</sup> at Station H2 and 19 per 1,000 m<sup>3</sup> at Station E4. Queenfish larvae were present in the summer and early fall entrainment surveys (Figures 4.5-42 and 4.5-43), and peaked at about 420 larvae per 1,000 m<sup>3</sup> in September at Station E4. Larvae were present from late May through late September in the source water samples and peaked in June at about 80 per 1,000 m<sup>3</sup> (Figure 4.5-44). Unidentified croaker larvae were abundant in late summer and early fall entrainment samples (Figures 4.5-45 and 4.5-46) but were most abundant in June at the source water stations (Figure 4.5-47). Concentrations of unidentified croaker peaked at approximately 200 larvae per 1,000 m<sup>3</sup> in late August entrainment Station E4 and peaked at about 160 per 1,000 m<sup>3</sup> at the combined source water stations. Queenfish were more common in the night samples than in the daytime samples (Figure 4.5-48) but no trend was observed with unidentified croaker larvae (Figure 4.5-49). The length frequency plot for queenfish showed a unimodal curve with over 90% of sampled larvae smaller than 2.5 mm and about a 1-2% frequency of occurrence at larger size classes up to 6.0 mm (Figure 4.5-50). Lengths ranged from 1.3 mm NL to 6.1 mm NL with a mean length of 2.3 mm NL in the entrainment station samples. Over 93% of the measured unidentified croakers in entrainment samples were smaller than 2.5 mm (Figure 4.5-51) indicating that they were recently hatched and had not developed the pigmentation and other characteristics necessary for positive identification to the species level. Unidentified croaker lengths ranged from 0.8–6.7 mm NL with a mean of 1.6 mm NL.

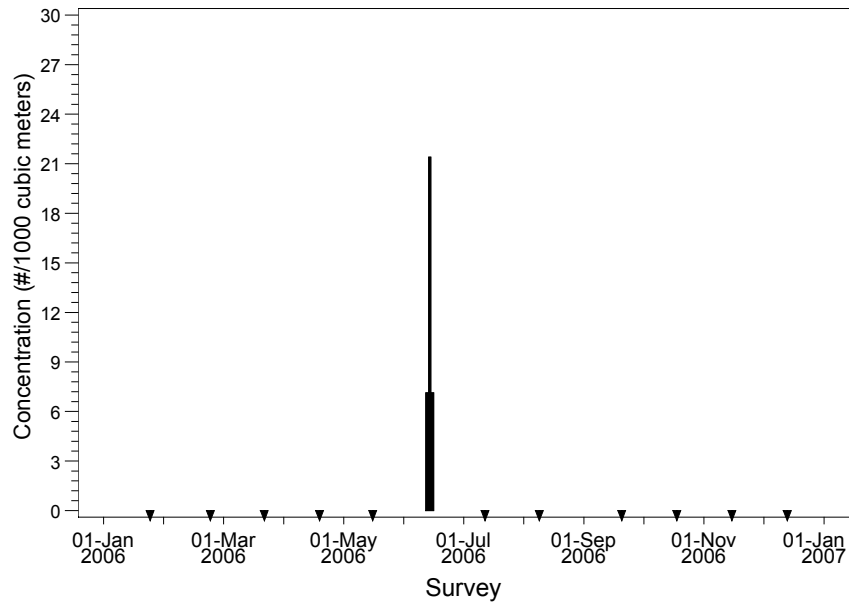

Figure 4.5-42. Mean concentration (# / 1,000 m<sup>3</sup> [264,172 gal]) and standard deviation of queenfish larvae collected at RBGS entrainment Station H2 from January 2006 through December 2006.

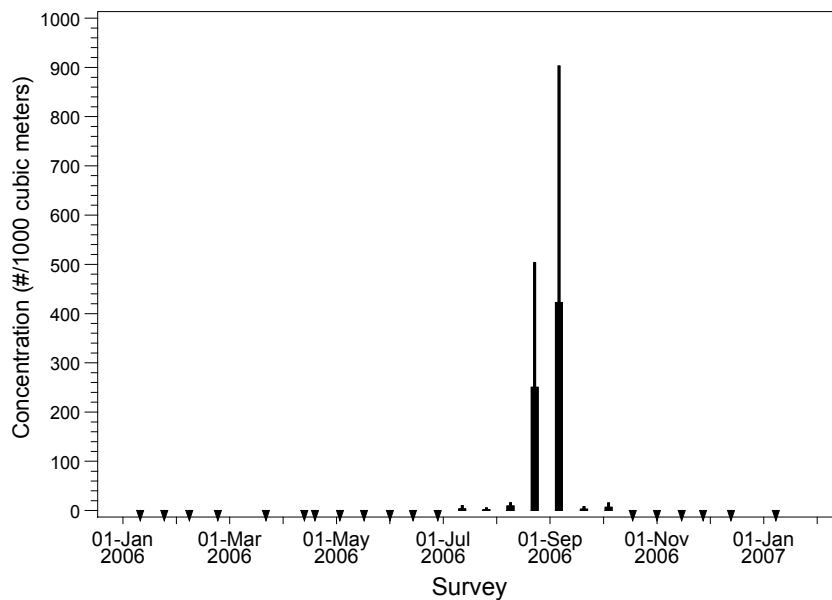

Figure 4.5-43. Mean concentration (# / 1,000 m<sup>3</sup> [264,172 gal]) and standard deviation of queenfish larvae collected at RBGS entrainment Station E4 from January 2006 through January 2007.

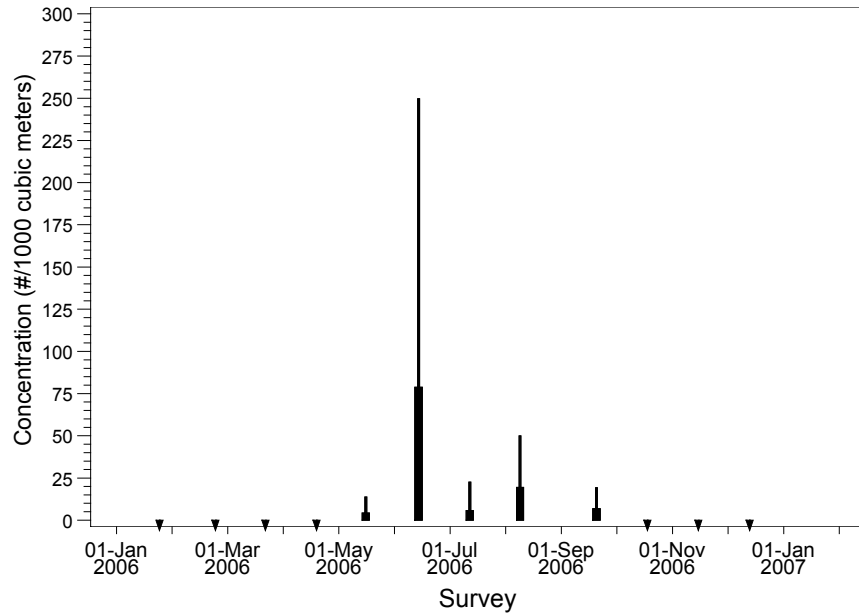

Figure 4.5-44. Mean concentration (# / 1,000 m<sup>3</sup> [264,172 gal]) and standard deviation of queenfish larvae collected at RBGS source water stations during 2006.

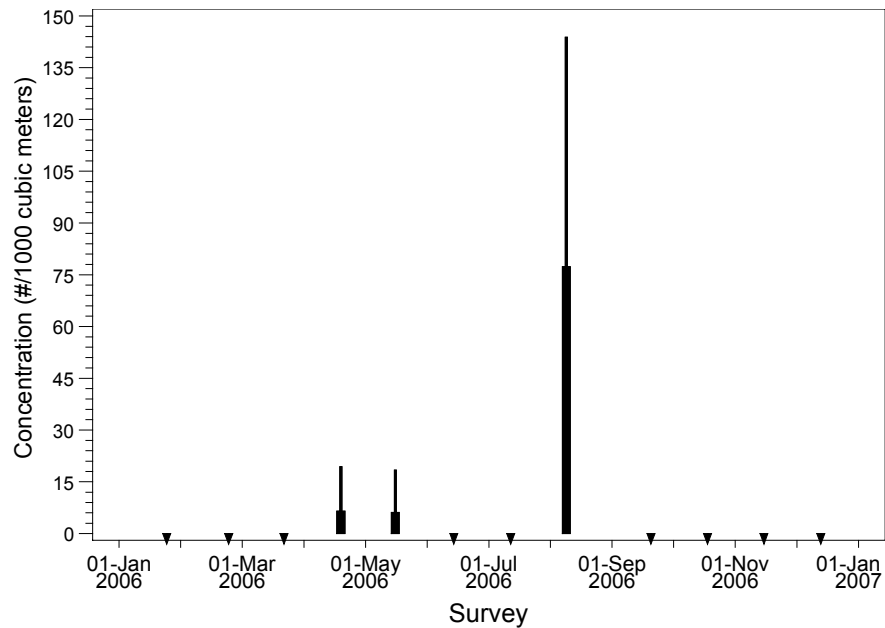

Figure 4.5-45. Mean concentration (# / 1,000 m<sup>3</sup> [264,172 gal]) and standard deviation of unidentified croaker larvae collected at RBGS entrainment Station H2 from January 2006 through December 2006.

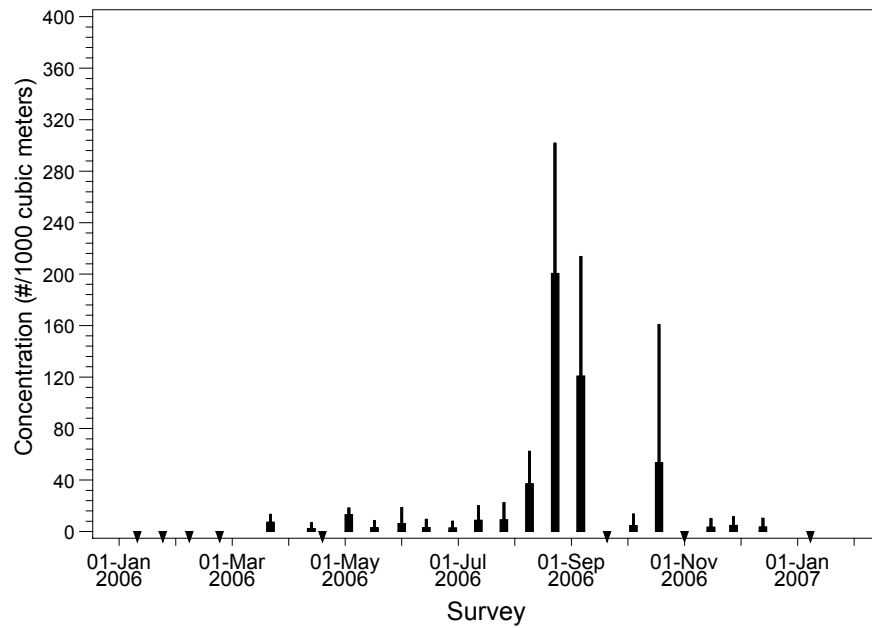

Figure 4.5-46. Mean concentration (# / 1,000 m<sup>3</sup> [264,172 gal]) and standard deviation of unidentified croaker larvae collected at RBGS entrainment Station E4 from January 2006 through January 2007.

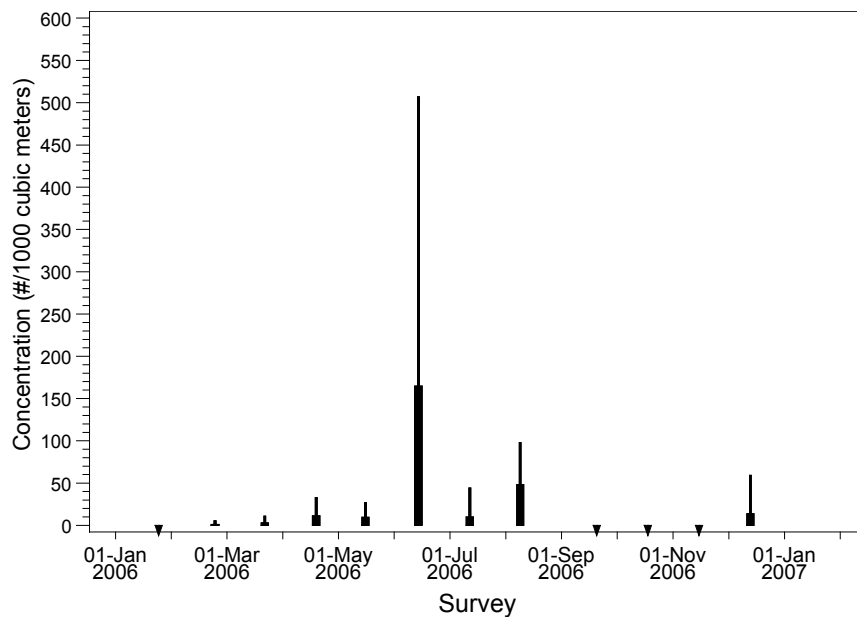

Figure 4.5-47. Mean concentration (# / 1,000 m<sup>3</sup> [264,172 gal]) and standard deviation of unidentified croaker larvae collected at RBGS source water stations during 2006.

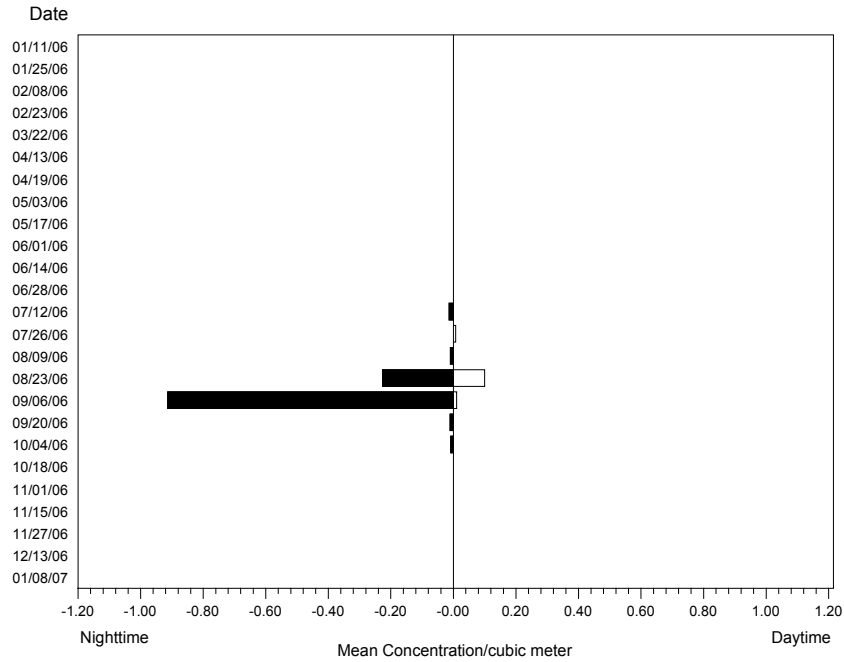

Figure 4.5-48. Mean concentration (#/1.0 m<sup>3</sup> [264 gal]) of queenfish larvae at entrainment Station E4 during night (Cycle 3) and day (Cycle 1) sampling.

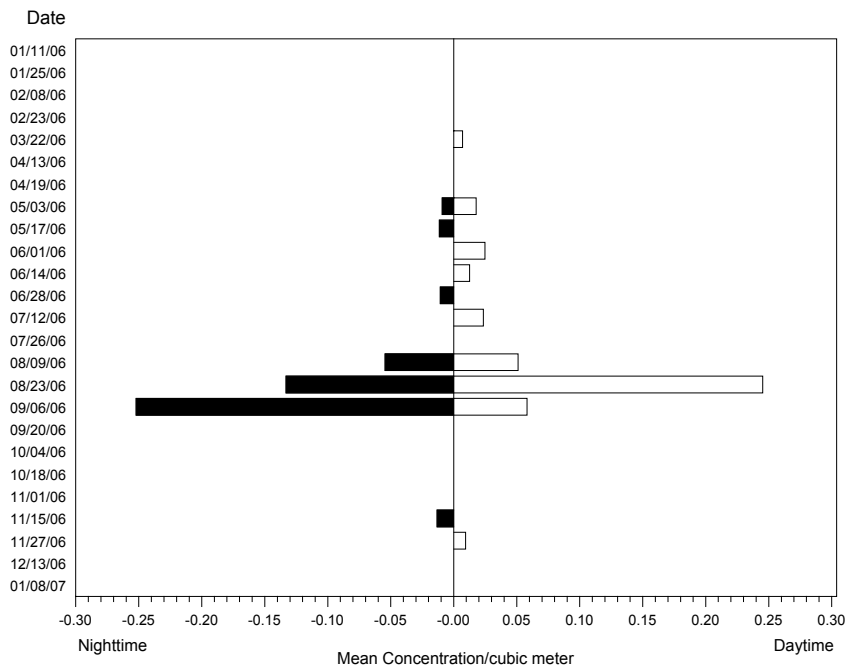

Figure 4.5-49. Mean concentration (#/1.0 m<sup>3</sup> [264 gal]) of unidentified croaker larvae at entrainment Station E4 during night (Cycle 3) and day (Cycle 1) sampling.

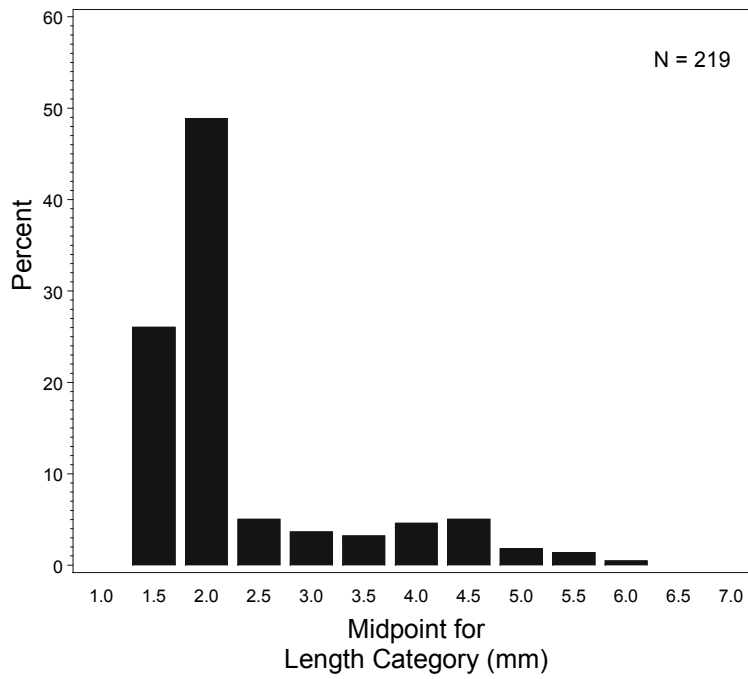

Figure 4.5-50. Length (mm) frequency distribution for larval queenfish collected at entrainment Station E4.

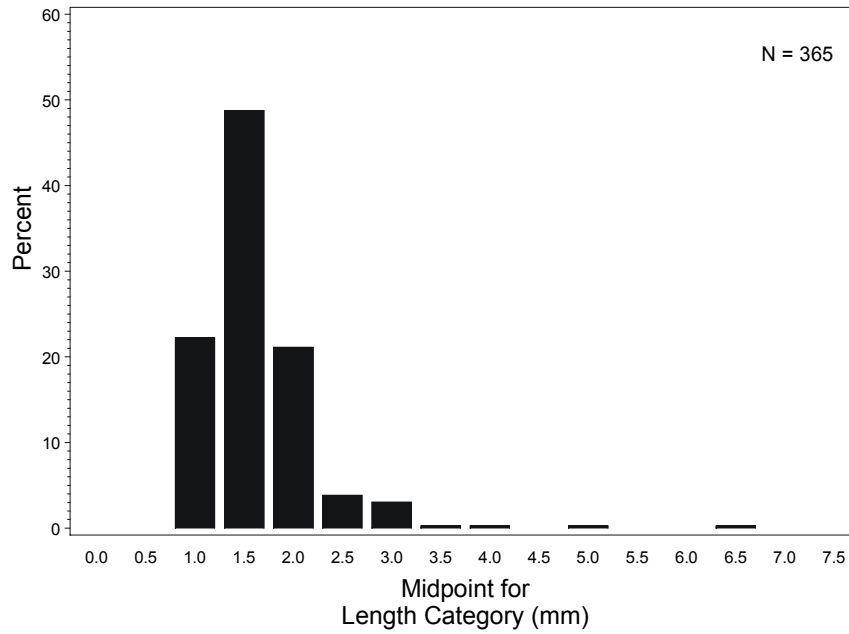

Figure 4.5-51. Length (mm) frequency distribution for larval unidentified croaker collected at entrainment Station E4.

#### 4.5.3.6.4 Modeling Results

The following section presents the results for empirical transport modeling of entrainment effects on queenfish and unidentified croaker larvae. No age-specific estimates of survival for larval and later stages of development were available from the literature for queenfish, and therefore no estimates of *FH* or *AEL* were calculated. Total annual entrainment for queenfish larvae at RBGS Units 5&6 was estimated at 56,179 using actual cooling water flows (Table 5.4-3), while the estimate at Units 7&8 was 3,745,507 (Table 5.4-4). If the CWIS pumps were run at the design (maximum capacity) flows, annual entrainment estimates increased to 163,300 queenfish larvae at Units 5&6 and 24,919,399 at Units 7&8. Entrainment estimates of unidentified croaker larvae were 670,537 and 17,509,653 for the two unit pairs based on actual flows, and 2,504,052 and 3,139,095 based on design flows. The total duration used in the *ETM* calculations included both the egg duration and the larval duration to provide an integrated estimate of entrainment effects.

#### *Empirical Transport Model (ETM)*

A larval growth rate was derived from data on five species of Sciaenidae (croakers) that were raised in the laboratory by Southwest Fisheries Science Center staff (Moser 1996). These were the black croaker, corbina, spotfin croaker, queenfish, and yellowfin croaker. Hatch lengths and larval length at various numbers of days after birth presented in Moser (1996) were used to calculate an average daily growth rate from hatching through the flexion stage for Sciaenidae. The growth rate calculated from these data was 0.248 mm/d (0.01 in/d). A random sample of 200 lengths from the 219 measured queenfish and 365 measured unidentified croaker larvae were used to calculate a difference between the estimated hatch lengths (the 10<sup>th</sup> percentile length for unidentified croakers) and the 95<sup>th</sup> percentiles of the measurements to estimate that white croaker and unidentified croakers were exposed to entrainment for periods of approximately 12.3 and 7.5 days, respectively. The duration of the planktonic egg stage, 2.2 days, was added to the periods for the larvae to estimate a total periods of exposure of 14.5 and 9.7 days, respectively.

The monthly estimate of *PE* for queenfish at Units 5&6 could only be calculated for the month of June and was very low (0.00002) (Table 4.5-33). At Units 7&8 the values ranged from 0 to 0.00059 using actual flows and from 0 to 0.00173 using the design flows (Table 4.5-34). Queenfish larvae were only collected from entrainment Station E4 during three of the paired entrainment-source water surveys, and they were also collected at the source water stations in May and June with the largest proportion of the source population present during the June survey ( $f_i = 0.694$  or 69.4%). The  $P_M$  estimate was 0.0010 based on the actual flows and an estimate of 0.0057 based on the design flows using the alongshore extrapolated estimate of the total source population. The model calculations for Units 7&8 are based on only three estimates of *PE* and the estimates for Units 5&6 are based on a single estimate increasing the uncertainty associated with the estimate for this taxa group. The average alongshore displacement of larvae was 11.8 km (7.3 mi). The small estimates of  $P_M$  are a direct result of the large source population potentially subject to entrainment.

Table 4.5-33. *ETM* data for queenfish larvae at Units 5&6. *ETM* calculations based on actual and design (maximum) cooling water flows and a sampling volume in the nearshore of 396,693,881 m<sup>3</sup>.

Survey Date	<u>Actual Flows</u>		<u>Design Flows</u>		<i>f<sub>i</sub></i>
	<i>PE</i> Estimate	<i>PE</i> Std. Err.	<i>PE</i> Estimate	<i>PE</i> Std. Err.	
25-Jan-06	0	0	0	0	0
23-Feb-06	0	0	0	0	0
22-Mar-06	0	0	0	0	0
19-Apr-06	0	0	0	0	0
17-May-06	0	0	0	0	0.01707
14-Jun-06	0.00002	0.00006	0.00005	0.00014	0.69378
12-Jul-06	0	0	0	0	0.06751
9-Aug-06	0	0	0	0	0.16940
20-Sep-06	0	0	0	0	0.05224
18-Oct-06	0	0	0	0	0
15-Nov-06	0	0	0	0	0
13-Dec-06	0	0	0	0	0
<b><i>P<sub>M</sub></i></b>	<b>0.00018</b>	0.00019	<b>0.00052</b>	0.00043	–

Table 4.5-34. *ETM* data for queenfish larvae at Units 7&8. *ETM* calculations based on actual and design (maximum) cooling water flows and a sampling volume in the nearshore of 396,693,881 m<sup>3</sup>.

Survey Date	<u>Actual Flows</u>		<u>Design Flows</u>		<i>f<sub>i</sub></i>
	<i>PE</i> Estimate	<i>PE</i> Std. Err.	<i>PE</i> Estimate	<i>PE</i> Std. Err.	
25-Jan-06	0	0	0	0	0
23-Feb-06	0	0	0	0	0
22-Mar-06	0	0	0	0	0
19-Apr-06	0	0	0	0	0
17-May-06	0	0	0	0	0.01707
14-Jun-06	0	0	0	0	0.69378
12-Jul-06	0.00059	0.00167	0.00070	0.00196	0.06751
9-Aug-06	0.00014	0.00024	0.00173	0.00276	0.16940
20-Sep-06	0.00005	0.00031	0.00107	0.00331	0.05224
18-Oct-06	0	0	0	0	0
15-Nov-06	0	0	0	0	0
13-Dec-06	0	0	0	0	0
<b><i>P<sub>M</sub></i></b>	<b>0.0010</b>	0.0004	<b>0.0057</b>	0.0019	–



The monthly estimates of  $PE$  for unidentified croakers for 2006 ranged from 0 to 0.00211 at Units 5&6 and 0 to 0.00198 at Units 7&8 using actual flows (Tables 4.5-35 and 4.5-36). Using the design flows the estimates ranged from 0 to 0.00790 at Units 5&6 and from 0 to 0.04419 at Units 7&8. The largest proportion of the source population was present during the June survey ( $f_i = 0.610$  or 61.0%). The values in the tables were used to calculate a  $P_M$  estimate of 0.0025 at Units 7&8 based on actual flows and 0.0268 based on design flows using the alongshore extrapolated estimate of the total source population (Table 4.5-36). The average alongshore displacement was 7.3 km (4.5 mi). The small estimate of  $P_M$  (less than one-half percent) is a direct result of the large source population potentially subject to entrainment.

Table 4.5-35. *ETM* data for unidentified croaker larvae at Units 5&6. *ETM* calculations based on actual and design (maximum) cooling water flow and a sampling volume in the nearshore of 396,693,881 m<sup>3</sup>.

Survey Date	<u>Actual Flows</u>		<u>Design Flows</u>		$f_i$
	$PE$ Estimate	$PE$ Std. Err.	$PE$ Estimate	$PE$ Std. Err.	
25-Jan-06	0	0	0	0	0
23-Feb-06	0	0	0	0	0.00492
22-Mar-06	0	0	0	0	0.00988
19-Apr-06	0.00016	0.00056	0.00041	0.00133	0.04113
17-May-06	0.00021	0.00027	0.00156	0.00157	0.03248
14-Jun-06	0	0	0	0	0.60997
12-Jul-06	0	0	0	0	0.04344
9-Aug-06	0.00211	0.00088	0.0079	0.0028	0.14285
20-Sep-06	0	0	0	0	0
18-Oct-06	0	0	0	0	0.01875
15-Nov-06	0	0	0	0	0.00115
13-Dec-06	0	0	0	0	0.09542
<b><math>P_M</math></b>	<b>0.00303</b>	0.00075	<b>0.01122</b>	0.00237	–

Table 4.5-36. *ETM* data for unidentified croaker larvae at Units 7&8. *ETM* calculations based on actual and design (maximum) cooling water flow and a sampling volume in the nearshore of 396,693,881 m<sup>3</sup>.

Survey Date	Actual Flows		Design Flows		$f_i$
	<i>PE</i> Estimate	<i>PE</i> Std. Err.	<i>PE</i> Estimate	<i>PE</i> Std. Err.	
25-Jan-06	0	0	0	0	0
23-Feb-06	0	0	0	0	0.00492
22-Mar-06	0.00118	0.00087	0.01743	0.00735	0.00988
19-Apr-06	0	0	0	0	0.04113
17-May-06	0.00048	0.00065	0.00228	0.00230	0.03248
14-Jun-06	0.00001	0.00003	0.00006	0.00013	0.60997
12-Jul-06	0.00198	0.00268	0.00234	0.00315	0.04344
9-Aug-06	0.00096	0.00038	0.01180	0.00390	0.14285
20-Sep-06	0	0	0	0	0
18-Oct-06	0	0	0.04419	0.07212	0.01875
15-Nov-06	0.00085	0.00395	0.03267	0.07212	0.00115
13-Dec-06	0	0	0.00081	0.00112	0.09542
$P_M$	<b>0.0025</b>	0.0033	<b>0.0268</b>	0.0321	–

#### 4.5.3.7 Garibaldi (*Hypsypops rubicundus*)

Garibaldi (*Hypsypops rubicundus*) ranges from Monterey Bay, California to southern Baja California and Guadalupe Island (off northern central Baja California) in Mexico, but is not abundant north of Santa Barbara (Fitch and Lavenberg 1975). They are one of two common species of damselfishes (Family Pomacentridae) found off southern California, the other being the blacksmith. Garibaldi is the California state marine fish and is fully protected by law.

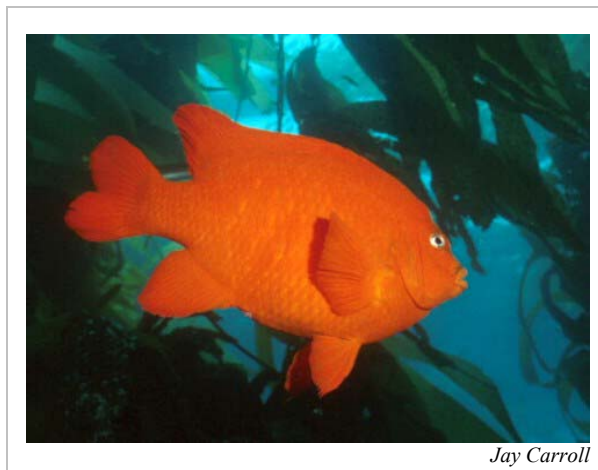

##### 4.5.3.7.1 Life History and Ecology

Garibaldi occurs over rocky bottoms in clear water, often near crevices and small caves, from the intertidal zone (as juveniles) to depths of 29 m (95 ft). They occur on the outer coast, around islands, and in protected bays and harbors (Fitch and Lavenberg 1975), typically as individuals (adults defend a territory all year) but occasionally in loose aggregations. They attain a maximum length up to 38.1 cm TL (15 in) although few are larger than 30.5 cm (12 in). Males are larger than females at a given age (Limbaugh 1964). Males begin to mature at about 3 yr but females may not reproduce until age 5–6 yr.

Garibaldi spawn from March through October (Love 1996), and the female deposits demersal adhesive eggs in a nest that the male has prepared by clearing off all growth except calcareous tubes and filamentous red algae. Males defend algal nests within permanent territories (10–15 m<sup>2</sup> [108–161 ft<sup>2</sup>]) on which females deposit eggs (Clarke 1970). Males that guard nesting areas with sparse algal cover tend to be less likely to court passing females (Sikkel 1995). DeMartini et al. (1994) measured mean batch fecundity at 12,546 eggs with an average of 35 eggs per gram of body weight. Some nests may contain up to 190,000 eggs deposited by several females (Fitch and Lavenberg 1975). Female garibaldi in southern California were estimated to spawn about 24 times during their 144-day spawning season (DeMartini et al. 1994). Females preferentially approach nests with eggs in the early stages of development prior to or in the absence of male courtship and are more likely to spawn in such nests than in empty nests or nests with only eggs in the advanced stages of development (Sikkel 1989). Eggs in the early stages of development are bright yellow and turn gray as development proceeds. Eggs hatch in 12–23 days (Sikkel 1989) depending on temperature. Larvae are primarily neustonic, initially ca. 2.2 mm (0.09 in) in length and attain flexion at ca 3.5 mm (0.14 in) (Moser 1996). Transformation occurs at a length of ca 5–10 mm (0.20–0.39 in) and settlement has been noted to occur at approximately 20 mm (0.79 in) SL. Larval duration ranges from 18–22 days (mean of 20 days) based on daily incremental marks on otoliths in recently settled individuals (Wellington and Victor 1989). High sedimentation and increased turbidity are factors that affect recruitment success of juveniles (Pondella and Stephens 1994), while increasing water temperatures during El Niño years have a negative effect on larval populations because adults may abandon their nests and retreat to deeper, cooler waters (Stephens et al. 1994).

As juveniles garibaldi feed on planktonic crustaceans, such as copepods, amphipods, and isopods (Clarke 1970). As adults they are typically carnivorous feeding on a variety of invertebrates including sponges, sea anemones, bryozoans, worms, crustaceans, clams and mussels, snail eggs, and their own eggs. Field observations and experiments during the mating phase show that brood-guarding males usually cannibalize older clutches if the older eggs are exposed to empty nest space (Sikkel 1994a). Males nearly always cannibalize the entire brood when they receive only a single clutch, and the probability of cannibalism of last clutches increases with brood age (Sikkel 1994b). Garibaldi are only active during the day and shelter in holes in the reef at night (Clarke 1970). Juvenile garibaldi are preyed upon by larger fishes such as kelp bass, and adult garibaldi are preyed upon by sharks, giant sea bass, moray eels, and sea lions.

#### 4.5.3.7.2 Population Trends and Fishery

Long-term trends in population abundance of garibaldi have been extensively studied at a few sites within southern California including King Harbor, Palos Verdes, and along the Channel Islands (Stephens et al. 1984, 1994; Pondella and Stephens 1994; Davis et al. 1997). There were notable increases in fish density from diver transect surveys during the late 1970s to early 1980s with a slight decline by the mid 1980s at Palos Verdes and King Harbor. Since then the population has remained fairly stable and constant at both sites. Garibaldi showed some year-to-year variation at Channel Island sites since 1985, but there were no apparent long-term trends in abundance (Davis et al. 1997; Tenera 2006). Although some individuals may be caught incidentally, there is no legal fishery for garibaldi because it is a protected species.

Concentrations of garibaldi larvae, as measured in King Harbor as part of the Occidental College – Vantuna Research Group’s long-term studies, have fluctuated substantially since 1974 (Figure 4.5-52). This species was absent during the first three years of the study, but appeared in increasing numbers in subsequent years. Highest concentrations were recorded in 1990, 1997, and 2004.

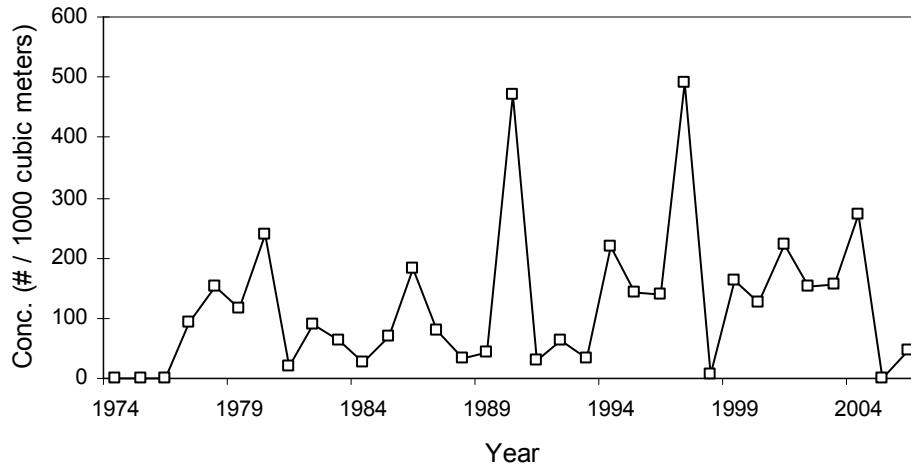

Figure 4.5-52. Mean concentration (# / 1,000 m<sup>3</sup> [264,172 gal]) of garibaldi larvae collected from King Harbor, 1974-2006. Source: Vantuna Research Group.

#### 4.5.3.7.3 Sampling Results

Garibaldi larvae was the fifth most abundant taxon at the entrainment station for Units 5&6 (Station H2) with a mean concentration of 25 larvae per 1,000 m<sup>3</sup> over all surveys (Table 4.5-1). Garibaldi larvae was also the fifth most abundant taxon at the entrainment station for Units 7&8 (Station E4) with a mean concentration of 64 larvae per 1,000 m<sup>3</sup> over all surveys (Table 4.5-2). Garibaldi larvae were present at the entrainment and source water stations from April to August (Figures 4.5-53, 4.5-54 and 4.5-55). Abundance at the entrainment stations was much greater than at the source water stations. Average larval garibaldi concentrations peaked in June at about 150 larvae per 1,000 m<sup>3</sup> at entrainment Station H2, at about 700 larvae per 1,000 m<sup>3</sup> at entrainment Station E4, and at about 65 per 1,000 m<sup>3</sup> at the source water stations. Garibaldi larvae were primarily found in the nighttime samples with a very small percentage collected during daytime sampling (Figures 4.5-56). The length frequency plot for garibaldi showed a relatively normal distribution with the majority of sampled larvae in the 2.5 and 2.75 mm (0.10 and 0.11 in) size classes (Figure 4.5-57). Lengths ranged from 2.1 mm (0.08 in) NL to 3.2 mm (0.13 in) NL with a mean length of 2.6 mm (0.10 in) NL in the entrainment station samples.

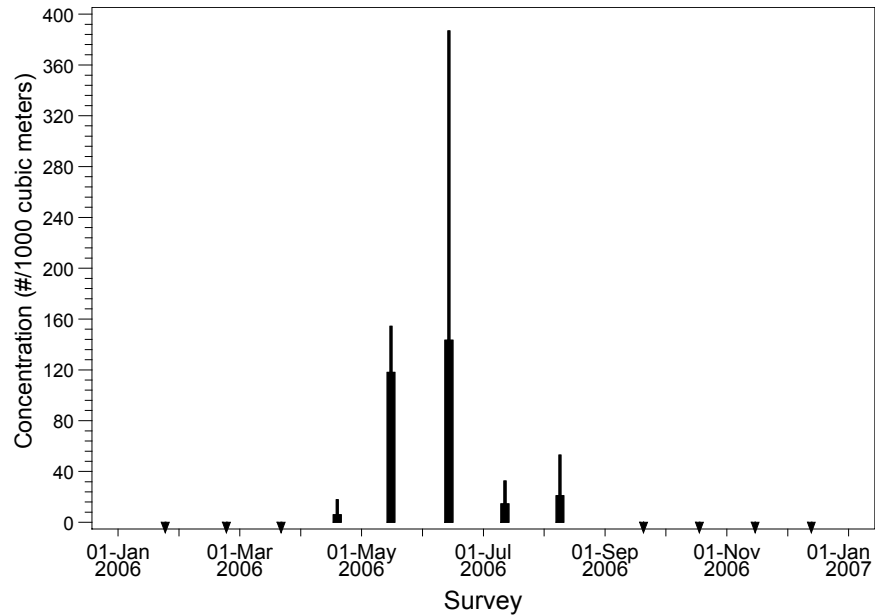

Figure 4.5-53. Mean concentration (# / 1,000 m<sup>3</sup> [264,172 gal]) and standard deviation of garibaldi larvae collected at RBGS Station H2 from January 2006 through December 2006.

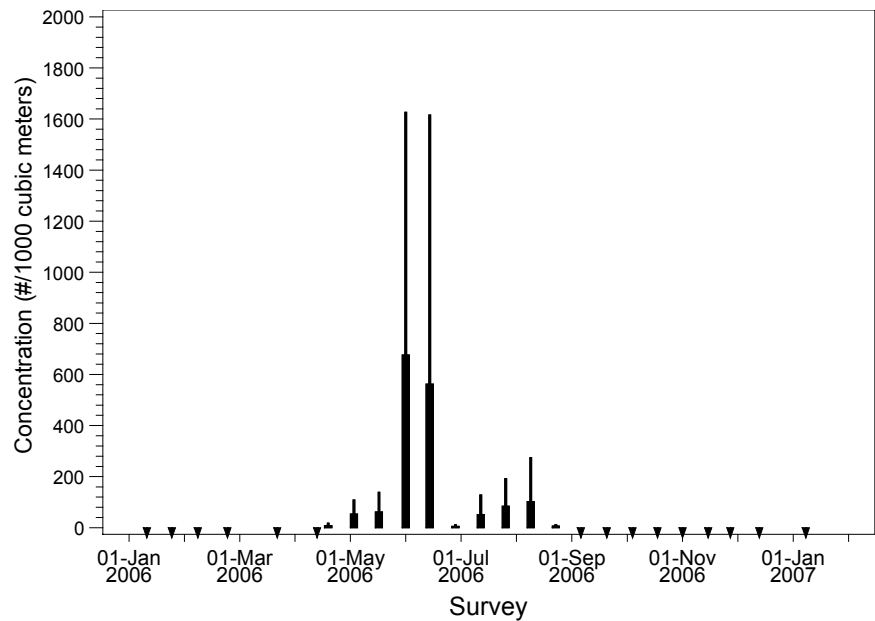

Figure 4.5-54. Mean concentration (# / 1,000 m<sup>3</sup> [264,172 gal]) and standard deviation of garibaldi larvae collected at RBGS entrapment Station E4 from January 2006 through January 2007.

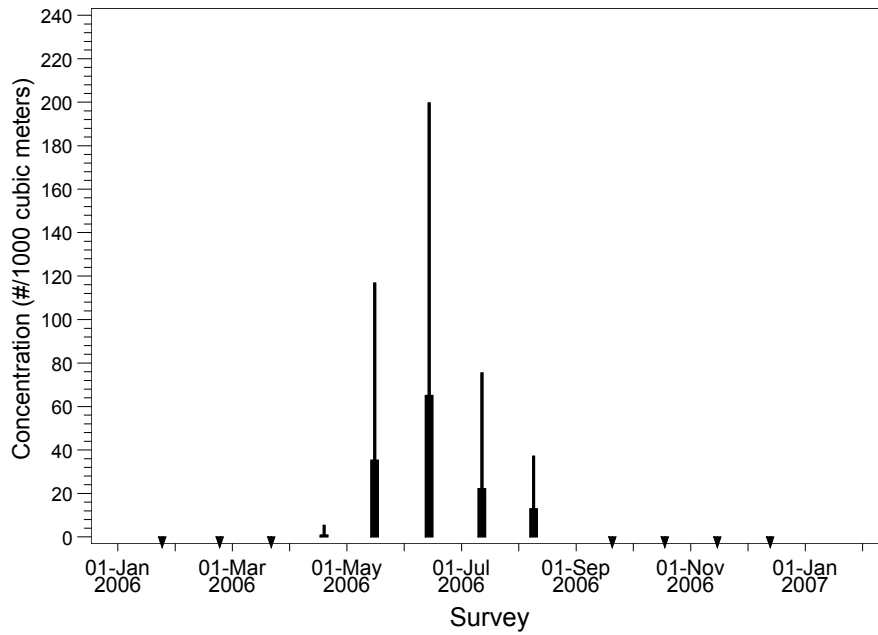

Figure 4.5-55. Mean concentration (# / 1,000 m<sup>3</sup> [264,172 gal]) and standard deviation of garibaldi larvae collected at RBGS source water stations during 2006.

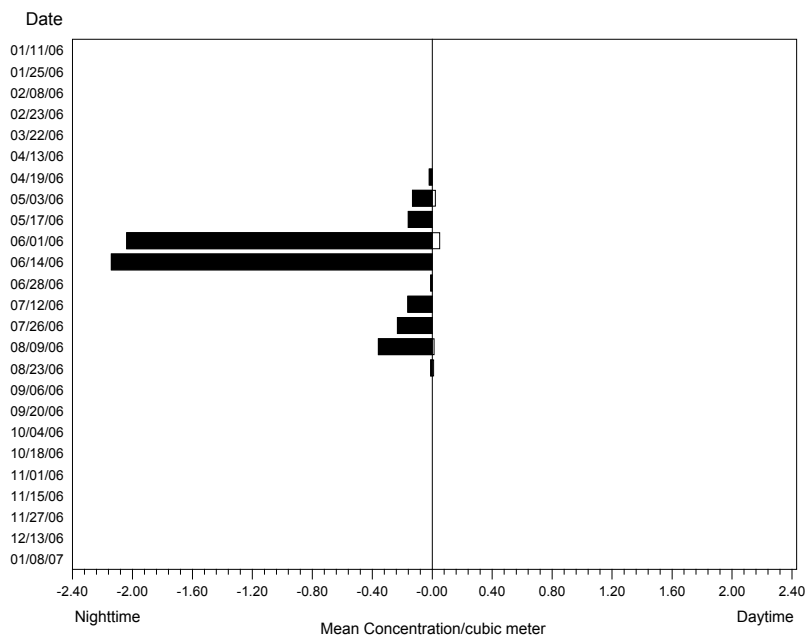

Figure 4.5-56. Mean concentration (#/1.0 m<sup>3</sup> [264 gal]) of garibaldi larvae at entrainment Station E4 during night (Cycle 3) and day (Cycle 1) sampling.

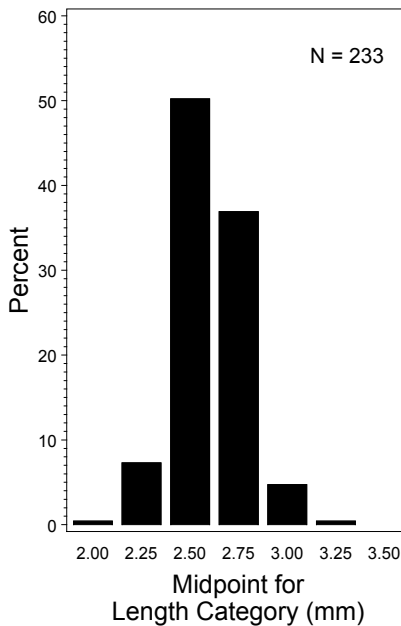

Figure 4.5-57. Length (mm) frequency distribution for larval garibaldi collected at entrainment stations in Santa Monica Bay during 2006.

#### 4.5.3.7.4 Modeling Results

The following section presents the results for the empirical transport modeling of entrainment effects on garibaldi. No age-specific estimates of survival for larval and later stages of development were available from the literature for garibaldi, therefore no estimates of *FH* or *AEL* were calculated. Total annual entrainment at RBGS Units 5&6 was estimated at 1,988,681 larvae using measured cooling water flows during 2006 (Table 4.5-1) and 7,060,384 larvae using design flows (Table 4.5-3). Total annual entrainment at RBGS Units 7&8 was estimated at 77,548 eggs and 16,824,709 larvae using measured cooling water flows during 2006 (Table 4.5-4). If the CWIS pumps were run at the design (maximum capacity) flows, annual entrainment estimates increased to 363,558 eggs and 56,293,706 larvae (Table 4.5-4). The total duration used in the *ETM* calculations included both the estimated egg duration and the estimated larval duration to provide an integrated estimate of entrainment effects on garibaldi.

#### *Empirical Transport Model (ETM)*

A larval growth rate of 0.29 mm/day (0.01 in/day) for garibaldi was estimated from Wellington and Victor (1989) and used with the difference in the lengths of the 25<sup>th</sup> (2.4 mm) and 95<sup>th</sup> percentiles (3.1 mm [0.12 in]) of the measurements to estimate that the larvae were exposed to entrainment for a period of approximately 1.6 days.

Garibaldi larvae were absent from entrainment samples at both stations from September through March. The monthly estimates of proportional entrainment ( $PE$ ) for garibaldi at Units 5&6 ranged from 0 to 0.02120 using actual flows and from 0 to 0.08753 using design flows (Table 4.5-37). The monthly estimates of proportional entrainment ( $PE$ ) for garibaldi at Units 7&8 ranged from 0 to 0.10896 using actual flows and from 0 to 0.23675 using design flows (Table 4.5-38). The largest estimate was calculated for the April survey for actual flow estimates at both intakes, and during the June survey for design flow estimates. The largest proportion of the source population was present during June 2006 ( $f_i = 0.613$  or 61.3%). Garibaldi larvae were present in five of the 12 surveys. The values in the table for Units 5&6 were used to calculate a  $P_M$  estimate of 0.0107 based on actual flows and an estimate of 0.0364 based on design flows during the period. The values in the table for Units 7&8 were used to calculate a  $P_M$  estimate of 0.0736 based on actual flows and an estimate of 0.3180 based on design flows during the period. The period of larval exposure coupled with average current velocities indicates that larvae from alongshore distances of 1.4 km (0.9 mi) may be subject to entrainment.



Table 4.5-37. *ETM* data for garibaldi larvae at Units 5&6. *ETM* calculations based on actual and design (maximum) cooling water flows and a sampling volume in the nearshore of 396,693,881 m<sup>3</sup>.

Survey Date	<u>Actual Flows</u>		<u>Design Flows</u>		<i>f<sub>i</sub></i>
	<i>PE</i> Estimate	<i>PE</i> Std. Err.	<i>PE</i> Estimate	<i>PE</i> Std. Err.	
25-Jan-06	0	0	0	0	0
23-Feb-06	0	0	0	0	0
22-Mar-06	0	0	0	0	0
19-Apr-06	0.02120	0.00762	0.05311	0.01826	0.00725
17-May-06	0.01162	0.00185	0.08753	0.01342	0.08110
14-Jun-06	0.00664	0.00186	0.01932	0.00472	0.61336
12-Jul-06	0.00918	0.00208	0.01077	0.00243	0.08773
9-Aug-06	0.00359	0.00069	0.01340	0.00213	0.21056
20-Sep-06	0	0	0	0	0
18-Oct-06	0	0	0	0	0
15-Nov-06	0	0	0	0	0
13-Dec-06	0	0	0	0	0
<b><i>P<sub>M</sub></i></b>	<b>0.01072</b>	0.01537	<b>0.03644</b>	0.04571	–

Table 4.5-38. *ETM* data for garibaldi larvae at Units 7&8. *ETM* calculations based on actual and design (maximum) cooling water flows and a sampling volume in the nearshore of 396,693,881 m<sup>3</sup>.

Survey Date	<u>Actual Flows</u>		<u>Design Flows</u>		<i>f<sub>i</sub></i>
	<i>PE</i> Estimate	<i>PE</i> Std. Err.	<i>PE</i> Estimate	<i>PE</i> Std. Err.	
25-Jan-06	0	0	0	0	0
23-Feb-06	0	0	0	0	0
22-Mar-06	0	0	0	0	0
19-Apr-06	0.10896	0.03201	0.22336	0.06560	0.00725
17-May-06	0.03504	0.00875	0.16522	0.03018	0.08110
14-Jun-06	0.05050	0.01554	0.23675	0.06014	0.61336
12-Jul-06	0.10058	0.02468	0.11867	0.02900	0.08773
9-Aug-06	0.01656	0.00376	0.20425	0.03396	0.21056
20-Sep-06	0	0	0	0	0
18-Oct-06	0	0	0	0	0
15-Nov-06	0	0	0	0	0
13-Dec-06	0	0	0	0	0
<b><i>P<sub>M</sub></i></b>	<b>0.0736</b>	0.1203	<b>0.3180</b>	0.4212	–

#### 4.5.3.8 Combtooth blennies (*Hypsoblennius* spp.)

Combtooth blennies comprise a large group of subtropical and tropical fishes that inhabit inshore rocky habitats throughout much of the world. The family Blenniidae, the combtooth blennies, contains about 345 species in 53 genera (Nelson 1994, Moser 1996). They derive their common name from the arrangement of closely spaced teeth in their jaws. Three species of the genus *Hypsoblennius* occur in southern California: bay blenny (*H. gentilis*), rockpool blenny (*H. gilberti*), and mussel blenny (*H. jenkinsi*). These species co-occur throughout much of their range although they occupy different habitats. The bay blenny is found along both coasts of Baja California and up the California coast to as far north as Monterey Bay, (Miller and Lea 1972, Robertson and Allen 2002). The rockpool blenny occurs from Magdalena Bay, Baja California to Point Conception, California (Miller and Lea 1972, Stephens et al. 1970). The range of the mussel blenny extends from Morro Bay to Magdalena Bay, Baja California and in the northern Gulf of California (Love et al. 2005).



Gerald Allen

##### 4.5.3.8.1 Life History and Ecology

Combtooth blennies are all relatively small fishes that typically grow to a total length of less than 200 mm (7.9 in) (Moser 1996). Most have blunt heads that are topped with some arrangement of cirri (Moyle and Cech 1988, Moser 1996). Their bodies are generally elongate and without scales. Dorsal fins are often continuous and contain more soft rays than spines (Moyle and Cech 1988). Coloration in the group is quite variable, even among individuals of the same species (Stephens et al. 1970).

The three species of *Hypsoblennius* found in California waters are morphologically similar as early larvae (Moser 1996, Ninos 1984). For this reason most *Hypsoblennius* identified in the EPS 316(b) plankton collections were identified as *Hypsoblennius* spp. Certain morphological features (e.g., preopercular spines) develop at larger sizes and allow taxonomists to identify some larvae to the species level.

Blennies inhabit a variety of hard substrates in the intertidal and shallow subtidal zones of tropical and subtropical marine habitats throughout the world. They may occur to depths of 24 m (80 ft) but are more frequently found in water depths of less than 5 m (15 ft) (Love 1996). Combtooth blennies are common in rocky tidepools, reefs, breakwaters, and on pier pilings. They are also frequently observed on encrusted buoys and boat hulls.

The California blennies have different habitat preferences. The mussel blenny is only found subtidally and inhabits mussel beds, the empty drill cavities of boring clams, barnacle tests, or in crevices among the vermiform snail tubes *Serpulorbis* spp. (Stephens 1969, Stephens et al. 1970). They generally remain

within one meter of their chosen refuge (Stephens et al. 1970). The bay blenny is usually found subtidally but appear to have general habitat requirements and may inhabit a variety of intertidal and subtidal areas (Stephens et al. 1970). They are commonly found in mussel beds and on encrusted floats, buoys, docks, and even fouled boat hulls (Stephens 1969, Stephens et al. 1970). Bay blennies are also typically found in bays as the common name implies and are tolerant of estuarine conditions (Stephens et al. 1970). They are among the first resident fish species to colonize new or disturbed marine habitats such as new breakwaters or mooring floats after the substrate is first colonized by attached invertebrates (Stephens et al. 1970, Moyle and Cech 1988). Rockpool blennies are mainly found along shallow rocky shorelines, along breakwaters, and in shallow kelp forests along the outer coast.

**Summary of combtooth blenny distribution and life history attributes.**

<p><b>Range:</b></p> <ul style="list-style-type: none"> <li>• Bay blenny—Monterey Bay to Gulf of California.</li> <li>• Mussel blenny—Morro Bay to Magdalena Bay Baja California and the northern Gulf of California</li> <li>• Rockpool blenny—Morro Bay to Magdalena Bay Baja California</li> </ul> <p><b>Life History:</b></p> <ul style="list-style-type: none"> <li>• Size: bay blenny to 14.7 cm (5.8 in) TL, mussel blenny to 13 cm (5.1 in), rockpool blenny to 17 cm (6.8 in)</li> <li>• Age at maturity: all species ≈0.5 yr</li> <li>• Life span: bay blenny ≈7 yr, mussel blenny &lt;6 yr, rockpool blenny &gt;8 yr</li> <li>• Fecundity: bay blenny 500–1,500 eggs, mussel blenny 200–2,000 eggs, rockpool blenny 700-1,700 eggs</li> </ul> <p><b>Habitat:</b></p> <ul style="list-style-type: none"> <li>• Bay blenny—soft bottom in bays and estuaries, associated with submerged aquatic vegetation and mussels on mooring buoys; to 24 m (80 ft)</li> <li>• Mussel blenny—empty worm tubes and barnacle tests on pilings, mussel beds, crevices in shallow rock reefs; to 21 m (70 ft)</li> <li>• Rockpool blenny—under rocks, in crevices on shallow rock reefs; to 18 m (60 ft)</li> </ul> <p><b>Fishery:</b> None</p>
---

Female blennies mature quickly and reproduce within the first year, reaching peak reproductive potential in the third year (Stephens 1969). The spawning season typically begins in the spring and may extend into September (Stephens et al. 1970). Blennies are oviparous and lay demersal eggs that are attached to the nest substrate by adhesive pads or filaments (Moser 1996). Males tend the nest and developing eggs. Females spawn 3–4 times over a period of several weeks (Stephens et al. 1970). Males guard the nest aggressively and will often chase the female away; however, several females may occasionally spawn with a single male. The number of eggs a female produces varies proportionately with size (Stephens et al. 1970). The mussel blenny spawns approximately 500 eggs in the first reproductive year and up to 1,500 eggs by the third year (Stephens et al. 1970). Total lifetime fecundity may be up to 7,700 eggs (Stephens 1969).

Larvae are pelagic and average approximately 2.7 mm (0.11 in) in length two days after hatching (Stephens et al. 1970). The planktonic phase for *Hypsoblennius* spp. larvae may last for 3 months (Stephens et al. 1970, Love 1996). Captured larvae released by divers have been observed to use surface water movement and near-surface currents to aid swimming (Ninos 1984). After release the swimming larvae orient to floating algae, bubbles on the surface, or the bottoms of boats or buoys. The size at settlement ranges from 12–14 mm (0.5–0.6 in). After the first year mussel and bay blenny averaged 40

and 45 mm (1.6 and 1.8 in) total length, respectively (Stephens et al. 1970). Bay blenny grow to a slightly larger size and live longer than mussel blenny, reaching a size of 15 cm (5.9 in) and living for 6–7 years (Stephens 1969, Stephens et al. 1970, Miller and Lea 1972). Mussel blennies grow to 13 cm (5.1 in) and have a life span of 3–6 years (Stephens et al. 1970, Miller and Lea 1972). Male and female growth rates are similar.

Juvenile and adult combtooth blennies are omnivores and eat both algae and a variety of invertebrates, including limpets, urchins, and bryozoa (Stephens 1969, Love 1996). They are preyed on by spotted sand bass, kelp bass, giant kelpfish, and cabezon (Stephens et al. 1970).

#### 4.5.3.8.2 Population Trends and Fishery

There is no fishery for combtooth blennies; therefore, there are no records on adult population trends in Santa Monica Bay based on landings data. However, Stephens and Pondella (2002) measured annual larval densities at King Harbor from 1974–1997 and found an overall decline in combtooth blennies from highest densities in the mid 1970s to lowest densities in the mid 1990s. Part of the decline was attributed to a period of warmer water temperatures throughout the region beginning in the late 1970s, but other localized disturbances to nesting habitat from storm damage, breakwater renovation, and channel dredging may have had an effect on larval production.

There were no independent data on goby population abundances from any of the areas within Santa Monica Bay located for this assessment. Long-term data on abundances of combtooth blennies from King Harbor in Redondo Beach were collected from surveys of quarry rock boulders from 1984–2006 (Pondella unpubl. data). An average of 1.62 blennies was collected per boulder each year. At the beginning of the study, they were found in the highest densities (9.57 individuals/boulder) and then declined until 1995 when the density recorded was 0.143/boulder (Figure 4.5-58). Since 1995, the density increased to 1.57 individuals/boulder in 2005. Annual average densities of combtooth blennies in King Harbor were correlated with average annual sea surface temperatures. This is shown in the decline in densities following major El Niño periods in 1983, 1987, 1992–1993, and 1997. The period of warm seawater temperatures resulted in declines in combtooth blenny larvae in King Harbor in the 1990s (Stephens and Pondella 2002; Figure 4.5-59). The correlation between adult density and sea surface temperature suggests that the abundance of this short-lived species was dependent on successful recruitment in response to optimal oceanographic conditions.

The earlier 316(b) study from RBGS in 1979–1980 (SCE 1983) reported estimates of average concentrations of combtooth blennies sampled at the intake stations and found the highest densities from May through September and lowest densities from November through March. Mean daily densities were 104 larvae per 1,000 m<sup>3</sup> (264,172 gal) at Units 7&8 and mean concentrations in 1979–1980 were approximately one and a half times lower than the concentrations estimated from the 2006 entrainment sampling near the RBGS intake (using actual flow volumes).

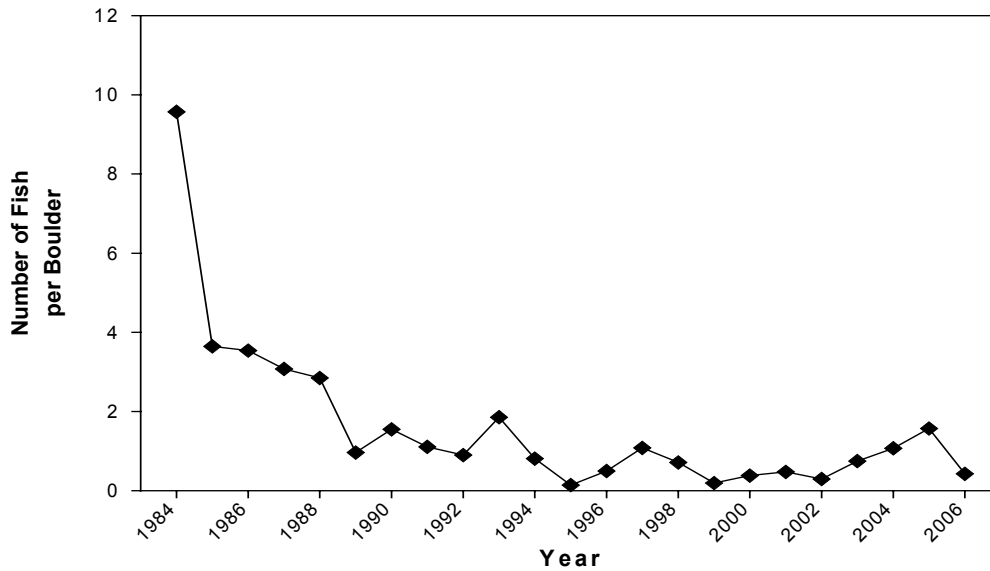

Figure 4.5-58. Abundance of combtooth blennies collected per boulder at King Harbor, Redondo Beach, California from 1984–2006 (from Pondella, unpubl. data).

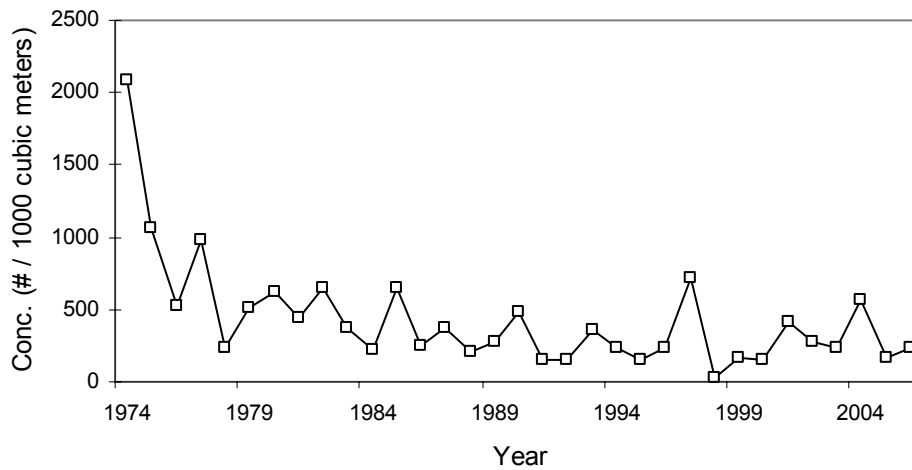

Figure 4.5-59. Mean concentration (# / 1,000 m<sup>3</sup> [264,172 gal]) of combtooth blenny (*Hypsoblennius* spp.) larvae collected from King Harbor, 1974-2006. Source: Vantuna Research Group.

#### 4.5.3.8.3 Sampling Results

Combtooth blenny was the most abundant taxon at both entrainment stations with a mean concentration of 499 larvae per 1,000 m<sup>3</sup> over all surveys at the Units 5&6 entrainment station (H2) (Table 4.5-1) and a mean concentration of 244 larvae per 1,000 m<sup>3</sup> over all surveys at the Units 7&8 entrainment station (E4) (Table 4.5-2). They were present in almost all entrainment surveys throughout the year except for January and February, with peak abundances occurring May through August (Figures 4.5-60 and 4.5-61). Average abundance peaked in May at the Units 5&6 entrainment station at about 1,200 larvae per 1,000 m<sup>3</sup> (Figure 4.5-60) and at about 1,700 larvae per 1,000 m<sup>3</sup> at the Units 7&8 entrainment station (Figure 4.5-61). Source water abundances followed the same seasonal pattern, with a peak in average concentration in June at approximately 800 per 1,000 m<sup>3</sup> (Figure 4.5-62). There were substantially more larvae in the nighttime samples than daytime samples (Figure 4.5-63). The length frequency distribution for larvae was unimodal, with 99% of measured specimens in the 2–3 mm (0.08-0.12 in) NL size classes and a few in the 4-6 mm (0.16-0.24 in) NL and 13 mm NL size classes (Figure 4.5-64). The mean length of specimens from the entrainment station samples was 2.3 mm (0.09 in) NL with a size range from 1.7 to 13.1 mm (0.07 to 0.51 in) NL.

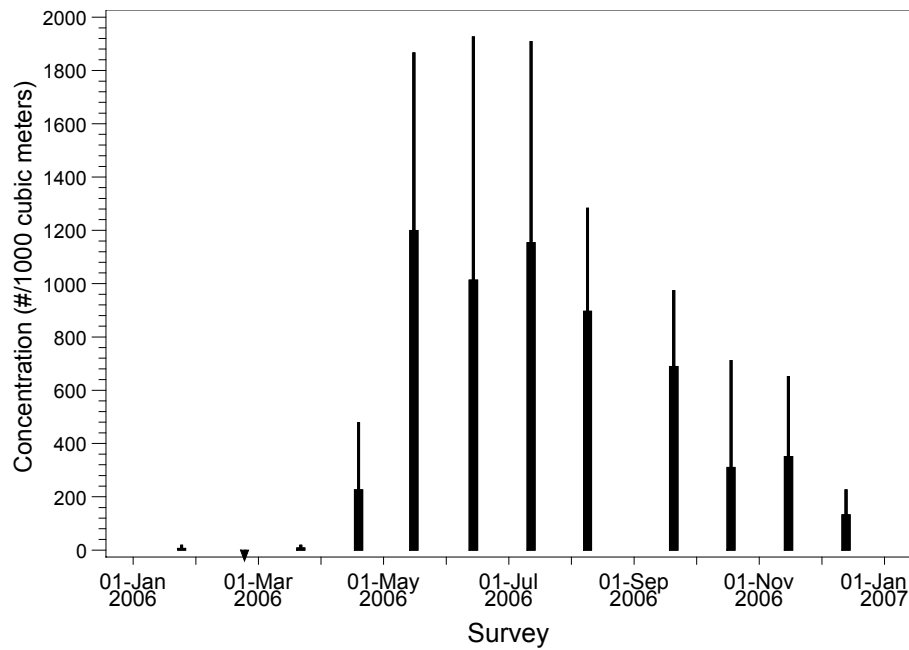

Figure 4.5-60. Mean concentration (# / 1,000 m<sup>3</sup> [264,172 gal]) and standard deviation of combtooth blenny larvae collected at RBGS entrainment Station H2 from January 2006 through December 2006.

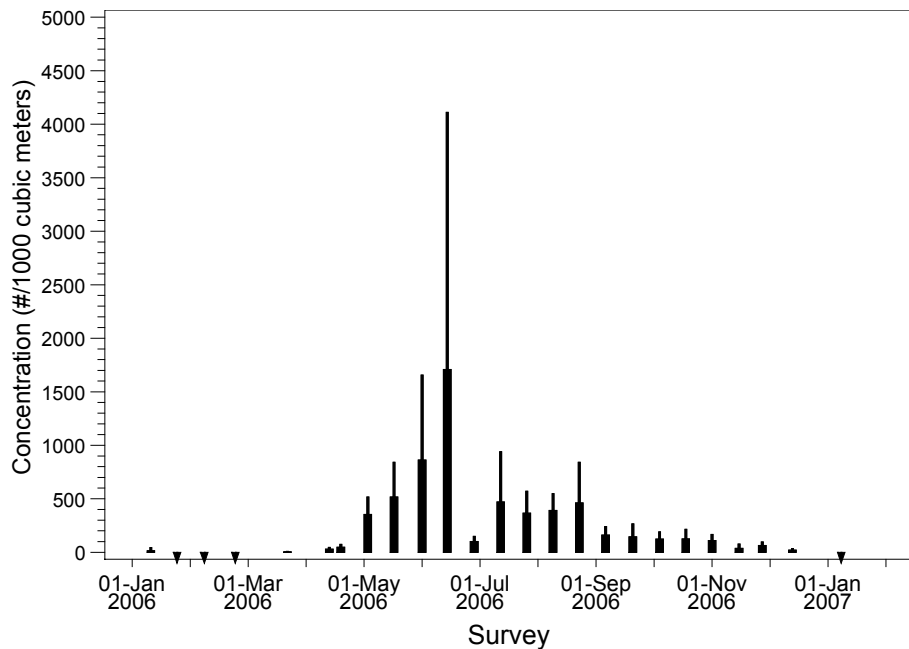

Figure 4.5-61. Mean concentration (# / 1,000 m<sup>3</sup> [264,172 gal]) and standard deviation of combtooth blenny larvae collected at RBGS entrainment Station E4 from January 2006 through January 2007.

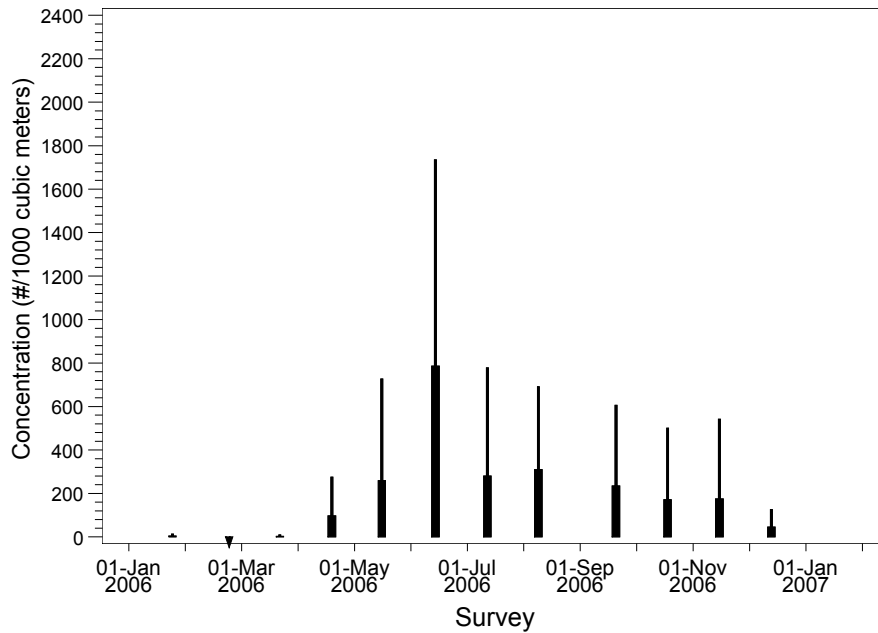

Figure 4.5-62. Mean concentration (# / 1,000 m<sup>3</sup> [264,172 gal]) and standard deviation of combtooth blenny larvae collected at RBGS source water stations during 2006.

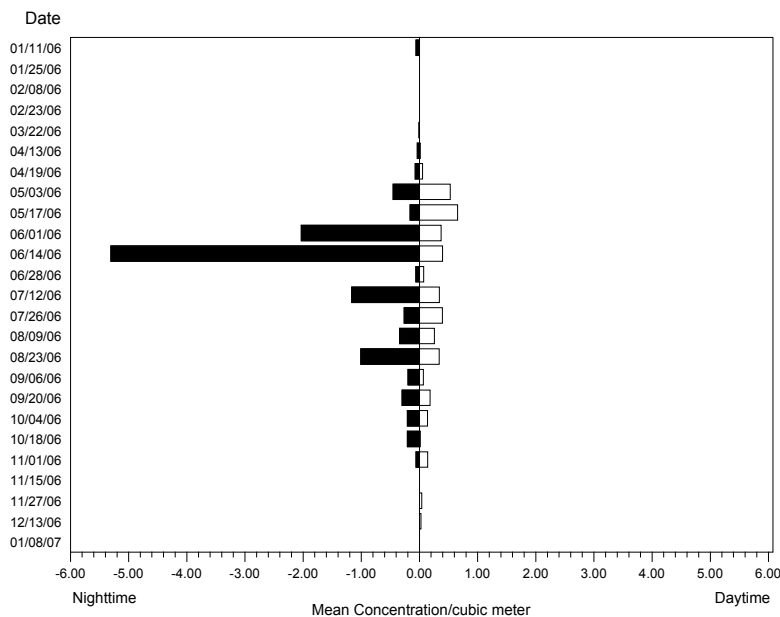

Figure 4.5-63. Mean concentration (#/1.0 m<sup>3</sup> [264 gal]) of combtooth blenny larvae at entrainment Station E4 during night (Cycle 3) and day (Cycle 1) sampling.



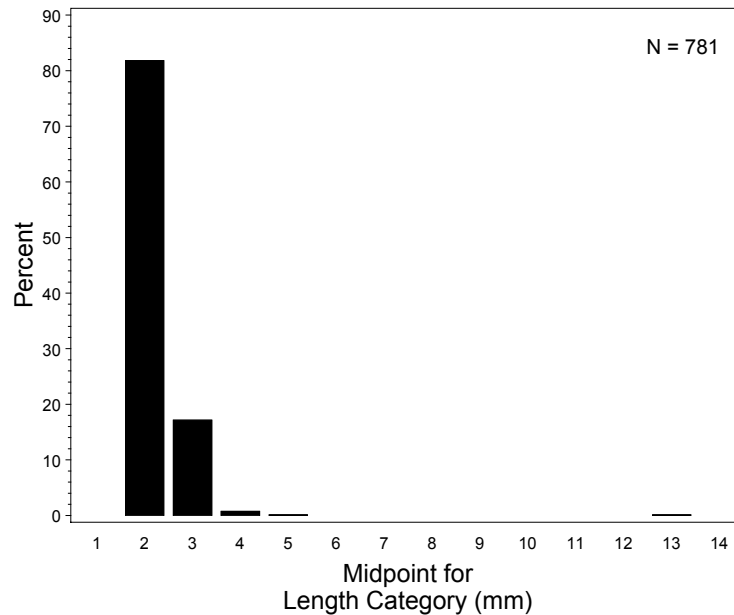

Figure 4.5-64. Length (mm) frequency distribution for larval combtooth blennies collected at entrainment stations in Santa Monica Bay during 2006.

#### 4.5.3.8.4 Modeling Results

The following section presents the results for demographic and empirical transport modeling of CWIS effects on combtooth blennies. There was enough information on the life history of blennies to calculate both *FH* and *AEL* estimates. Larval survival was estimated using data from Stephens (1969) and Stevens and Moser (1982), and larval growth was estimated using information from Stevens and Moser (1982). Total annual entrainment at RBGS Units 5&6 was estimated at 47,309,239 larvae using measured cooling water flows during 2006 and 147,738,354 larvae using design flows (Table 4.5-3). Total annual entrainment of combtooth blenny larvae at RBGS Units 7&8 was estimated at 66,422,665 using actual cooling water flows during 2006 (Table 4.5-4). If the CWIS pumps were run at the design (maximum capacity) flows for Units 7&8, annual entrainment estimates increased to 215,134,524 larvae (Table 4.5-4).

#### *Fecundity Hindcasting (FH)*

The annual entrainment estimates for combtooth blenny larvae were used to estimate the number of females at the age of maturity needed to produce this number of larvae over their lifetimes. No estimates of egg survival for combtooth blenny were available, but because egg masses are attached to the substrate and guarded by the male (Stephens et al. 1970), egg survival is probably high and was conservatively assumed to be 100%. The mean length from a random sample of 200 combtooth blenny larvae was 2.4 mm (0.09 in). A larval growth rate of 0.20 mm/d (0.008 in/d) was derived from data in Stevens and Moser (1982). The mean length of 2.3 mm (0.09 in) and estimated hatch length of 2.1 mm (0.08 in) were used with the growth rate to estimate that the mean age at entrainment was 1.5 days. A daily survival rate

of 0.89 computed from data in Stephens (1969) was used to calculate survival to the average age at entrainment as  $0.89^{1.5} = 0.84$ . A quadratic equation was used to estimate adult survival  $S$  at age in days  $x$  using Figure 17 in Stephens (1969) as follows:

$$S = 8.528 \times 10^{-8} x^2 - 3.918 \times 10^{-4} x + 0.4602 .$$

An adult survivorship table (Table 4.5-39) was constructed using the survival equation based on Stephens (1969) and information about eggs from Stephens (1969; Table 3) on *H. gentilis*, *H. gilberti* and *H. jenkinsi* to estimate a lifetime fecundity of 2,094 eggs.

Table 4.5-39. Survivorship table for adult combtooth blenny from data in Stephens (1969) showing spawners ( $L_x$ ) surviving to the age interval and numbers of eggs spawned annually ( $M_x$ ).

Age (yr)	$L_x$	$M_x$	$L_x M_x$
0.5	1,000	367	366,667
1.5	693	633	438,624
2.5	443	1,067	472,794
3.5	252	1,533	386,465
4.5	119	2,000	237,915
5.5	44	2,500	109,973
6.5	27	3,000	81,415
<b>TLF =</b>			<b>2,094</b>

The estimated numbers of female combtooth blennies at the age of maturity (0.5 years) whose lifetime reproductive output was entrained through the RBGS Units 5&6 CWIS during 2006 was 27,034 based on entrainment estimates calculated using actual cooling water flows and 84,423 adult females using design flows (Table 4.5-40). At Units 7&8, the estimates were 37,956 based on entrainment estimates calculated using actual cooling water flows and 122,935 adult female using the design flows (Table 4.5-41). blennies lost. The sensitivity analysis, based on the 90% confidence intervals, shows that the variation in the estimates of entrainment abundance had much less of an effect on the variation of the  $FH$  estimates than the life history parameters used in the model.

Table 4.5-40. Results of *FH* modeling for combtooth blenny larvae based on entrainment estimates for Units 5&6 calculated using actual and design (maximum) CWIS flows.

Parameter	Estimate	Std. Error	<i>FH</i> Lower Estimate	<i>FH</i> Upper Estimate	<i>FH</i> Range
<b>Actual Flows</b>					
<i>FH</i> Estimate	27,034	23,434	6,496	112,512	106,017
Total Entrainment	47,309,239	1,785,648	25,356	28,713	3,357
<b>Design Flows</b>					
<i>FH</i> Estimate	84,423	73,138	20,302	351,057	330,755
Total Entrainment	147,738,354	3,398,316	81,228	87,617	6,389

The upper and lower estimates are based on a 90% confidence interval of the mean. *FH* estimates were also calculated using the upper and lower confidence estimates from the entrainment estimates.

Table 4.5-41. Results of *FH* modeling for combtooth blenny larvae based on entrainment estimates calculated for Units 7&8 using actual and design (maximum) CWIS flows.

Parameter	Estimate	Std. Error	<i>FH</i> Lower Estimate	<i>FH</i> Upper Estimate	<i>FH</i> Range
<b>Actual Flows</b>					
<i>FH</i> Estimate	37,956	32,965	9,095	158,397	149,301
Total Entrainment	66,422,665	4,346,079	33,871	42,041	8,171
<b>Design Flows</b>					
<i>FH</i> Estimate	122,935	106,695	29,487	512,527	483,040
Total Entrainment	215,134,524	12,270,864	111,400	134,470	23,069

The upper and lower estimates are based on a 90% confidence interval of the mean. *FH* estimates were also calculated using the upper and lower confidence estimates from the entrainment estimates.

#### *Adult Equivalent Loss (AEL)*

The parameters required for formulation of *AEL* include larval survival from entrainment to settlement and survival from settlement to the average age of reproduction for a mature female. Larval survival from entrainment through settlement at 50 days was estimated as  $0.89^{(50-1.5)} = 0.003$  using the same daily survival rate used in formulating *FH*. Juvenile and adult survival was calculated from observed age group abundances in Stephens (1969). Daily survival through the average female age of 2.7 years for the three species was estimated as 0.99 and was used to calculate a finite survival of 0.79.

The equivalent number of adult combtooth blennies calculated from the number of larvae entrained through the RBGS Units 5&6 CWIS for the sampling period was 115,375 based on actual cooling water flows and 360,295 based on design flows during 2006 (Table 4.5-42). At the Units 7&8 CWIS the estimates of equivalent number of adult combtooth blennies was 161,987 based on actual cooling water

flows and 524,656 based on design flows (Table 4.5-43). The results of the sensitivity analysis show that the model estimates were much more sensitive to the error associated with the life history estimates than the entrainment estimates used in the model.

Table 4.5-42. Results of *AEL* modeling for combtooth blenny larvae based on entrainment estimates for Units 5&6 calculated using actual and design (maximum) CWIS flows.

<b>Parameter</b>	<b>Estimate</b>	<b>Std. Error</b>	<b><i>AEL</i> Lower Estimate</b>	<b><i>AEL</i> Upper Estimate</b>	<b><i>AEL</i> Range</b>
<b><u>Actual Flows</u></b>					
<i>AEL</i> Estimate	<b>115,375</b>	141,372	15,372	865,967	850,596
Total Entrainment	47,309,239	1,785,648	108,211	122,538	14,327
<b><u>Design Flows</u></b>					
<i>AEL</i> Estimate	360,295	441,347	48,032	2,702,636	2,654,605
Total Entrainment	147,738,354	3,398,316	346,662	373,928	27,266

The upper and lower estimates are based on a 90% confidence interval of the mean. *AEL* estimates were also calculated using the upper and lower confidence estimates from the entrainment estimates.

Table 4.5-43. Results of *AEL* modeling for combtooth blenny larvae based on entrainment estimates calculated for Units 7&8 using actual and design (maximum) CWIS flows.

<b>Parameter</b>	<b>Estimate</b>	<b>Std. Error</b>	<b><i>AEL</i> Lower Estimate</b>	<b><i>AEL</i> Upper Estimate</b>	<b><i>AEL</i> Range</b>
<b><u>Actual Flows</u></b>					
<i>AEL</i> Estimate	<b>161,987</b>	198,676	21,541	1,218,159	1,196,619
Total Entrainment	66,422,665	4,346,079	144,552	179,423	34,871
<b><u>Design Flows</u></b>					
<i>AEL</i> Estimate	524,656	643,266	69,815	3,942,743	3,872,928
Total Entrainment	215,134,524	12,270,864	475,429	573,883	98,455

The upper and lower estimates are based on a 90% confidence interval of the mean. *AEL* estimates were also calculated using the upper and lower confidence estimates from the entrainment estimates.

*Empirical Transport Model (ETM)*

A sample of 200 lengths from the measured larvae were used to calculate the difference between the estimated hatch length and the 95<sup>th</sup> percentiles (2.8 mm [0.11 in]) of the measurements and a growth rate of 0.20 mm/d (0.008 in/d) was used to estimate that blennies were exposed to entrainment for a period of approximately 3.8 days.

The monthly estimates of *PE* for combtooth blennies for the 2006 period varied among surveys and ranged from 0 to 0.05871 using actual flows and from 0 to 0.13668 using design flows for Units 5&6 (Table 4.5-44). The monthly estimates of *PE* for combtooth blennies for the 2006 period varied among surveys and ranged from 0 to 0.07443 using actual flows and from 0 to 0.8782 using design flows for

Units 7&8 (Table 4.5-45). The largest proportion of the source population was present during the June survey ( $f_i = 0.438$  or 43.8 percent). As the results for the February survey show, there were periods when combtooth blenny larvae were collected at the source water stations but not at the entrainment station (i.e.,  $PE_i=0$  and  $f_i > 0$ ). The values in the table for Units 5&6 were used to calculate a  $P_M$  estimate of 0.0396 based on actual flows and an estimate of 0.1124 based on design flows using only the alongshore extrapolated estimate of the total source population. The values in the table for Units 7&8 were used to calculate a  $P_M$  estimate of 0.0581 based on actual flows and an estimate of 0.2021 based on design flows using only the alongshore extrapolated estimate of the total source population. The relatively short period of larval exposure to entrainment was used to estimate that larvae were transported an average distance alongshore of 3.1 km (1.9 mi).

Table 4.5-44. *ETM* data for combtooth blenny larvae at Units 5&6. *ETM* calculations based on actual and design (maximum) cooling water flows and a sampling volume in the nearshore of 396,693,881 m<sup>3</sup>.

Survey Date	Actual Flows		Design Flows		$f_i$
	<i>PE</i> Estimate	<i>PE</i> Std. Err.	<i>PE</i> Estimate	<i>PE</i> Std. Err.	
25-Jan-06	0.00681	0.02061	0.13668	0.14743	0.00010
23-Feb-06	0	0	0	0	0
22-Mar-06	0.00763	0.00554	0.02196	0.01359	0.00118
19-Apr-06	0.00758	0.00551	0.01899	0.01270	0.02164
17-May-06	0.00860	0.00142	0.06473	0.00841	0.11410
14-Jun-06	0.00401	0.00136	0.01167	0.00346	0.43798
12-Jul-06	0.05871	0.01072	0.06888	0.01251	0.10090
9-Aug-06	0.00786	0.00125	0.02937	0.00388	0.19493
20-Sep-06	0.00558	0.00184	0.04118	0.00973	0.06310
18-Oct-06	0.00209	0.00058	0.05540	0.01465	0.03172
15-Nov-06	0.00562	0.00346	0.04563	0.01754	0.02256
13-Dec-06	0.00229	0.00135	0.05032	0.01942	0.01180
<b><math>P_M</math></b>	<b>0.03960</b>	0.02678	<b>0.11244</b>	0.06528	–

Table 4.5-45. *ETM* data for combtooth blenny larvae at Units 7&8. *ETM* calculations based on actual and design (maximum) cooling water flows and a sampling volume in the nearshore of 396,693,881 m<sup>3</sup>.

Survey Date	Actual Flows		Design Flows		$f_i$
	<i>PE</i> Estimate	<i>PE</i> Std. Err.	<i>PE</i> Estimate	<i>PE</i> Std. Err.	
25-Jan-06	0	0	0	0	0.00010
23-Feb-06	0	0	0	0	0
22-Mar-06	0.00208	0.00197	0.03065	0.01870	0.00118
19-Apr-06	0.00606	0.00253	0.01242	0.00519	0.02164
17-May-06	0.01846	0.00352	0.08703	0.01201	0.11410
14-Jun-06	0.01311	0.00612	0.06147	0.02239	0.43798
12-Jul-06	0.07443	0.01641	0.08782	0.01927	0.10090
9-Aug-06	0.00324	0.00054	0.03991	0.00514	0.19493
20-Sep-06	0.00130	0.00097	0.02684	0.00906	0.06310
18-Oct-06	0	0	0.06985	0.01299	0.03172
15-Nov-06	0.00038	0.00043	0.01476	0.00686	0.02256
13-Dec-06	0	0	0.02462	0.00933	0.01180
<b><math>P_M</math></b>	<b>0.0581</b>	0.0500	<b>0.2021</b>	0.1352	–

#### 4.5.3.9 Labrisomid blennies (Labrisomidae)

The family Labrisomidae is a predominantly tropical family of fishes with three species occurring in southern California: island kelpfish (*Alloclinus holderi*), deepwater blenny (*Cryptotrema corallinum*), and reef finspot (*Paraclinus integripinnis*) (Moser 1996). The reef finspot (pictured) is the most common of the three species along the southern California mainland and is known to occur from Santa Barbara County

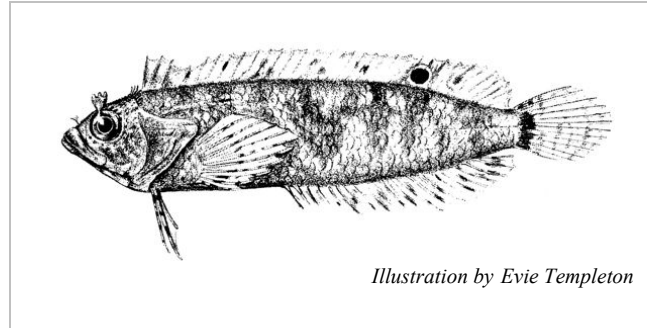

(Love et. al 2005) to southern Baja California (Miller and Lea 1972). Of the larvae identified in entrainment samples as Labrisomidae, most if not all, can be assigned to reef finspot based on the predominance of adults in the study area, but Labrisomidae larvae share certain characteristics that prevent identification of early pre-flexion stages to the species level.

##### 4.5.3.9.1 Life History and Ecology

Reef finspot occurs along the mainland and islands from the intertidal zone to depths of 15 m (50 ft). Their preferred habitat is within rock substrate and particularly in association with macroalgae (Stephens et al. 2006). They are more abundant in shallower nearshore waters (<3 m depths) than the closely related island kelpfish (Allen et al. 1992) and it was noted that cryptic fishes in general appear to make a substantial contribution to the abundance and diversity of fish assemblages inhabiting rock reef environments in southern California. Reef finspot is a primary carnivore on small crustaceans such as isopods and amphipods (Fitch and Lavenberg 1975). They probably serve as prey for larger piscivorous fishes.

Most reef finspots will spawn when they are about one year old. An examination of otoliths from several individuals indicated that fish 5 cm TL (2 in) were in their third year, and that based on a maximum reported length of approximately 60 mm (2.5 in), the maximum age probably does not exceed five (Fitch and Lavenberg 1975). Spawning season is late spring to early fall with a July–September peak (Moser 1996). Females are oviparous and produce clusters of 1.0 mm diameter eggs that are attached to benthic macrophytes with a small bundle of adhesive filaments. There is no information on batch fecundity or developmental times for the eggs and larvae. Larvae attain flexion at a size of approximately 6.7 mm (0.3 in), and late post-flexion larvae are 8.9 mm (0.4 in) (Moser 1996). There are no published data available on larval growth rates or instantaneous mortality rates.

##### 4.5.3.9.2 Population Trends and Fishery

Trends in the southern California population of reef finspot have been identified in two studies, one examining tidepool fish assemblages and the other larval abundances. A study of seasonal and annual changes in tidepool fishes in southern California from 1995 to 2000 found that reef finspot, although relatively rare compared to other species in the assemblage, was more abundant in the warm-water El Niño years than in cooler-water La Niña years (Davis 2000). No clear seasonal trends were evident in the

data for reef finspot, probably due to their patchy abundance among sites. Stephens and Pondella (2002) measured the abundance of larval fishes in King Harbor from 1974–1997 and were able to track annual densities of reef finspot larvae. Highest densities of approximately 300–600 per 1,000 m<sup>3</sup> occurred from 1978–1981, declined precipitously in 1982, increased to intermediate levels in the mid-1980s, and stabilized at average densities of approximately 100 per 1,000 m<sup>3</sup> in the later portion of the study (Figure 4.5-65). The data generally corroborate the findings of Davis (2000) regarding the positive influence of El Niño conditions on the abundance of this species. Annual densities of reef finspot were significantly higher in the King Harbor samples than in bight-wide samples, reflecting the localized distribution of this predominantly nearshore species in shallow rocky habitats and artificial substrates found in harbors. The larvae were also abundant in samples from nearby Marina del Rey, again as a result of habitat availability for the adult spawning population. Because of their small size and cryptic habits there is no fishery for reef finspots.

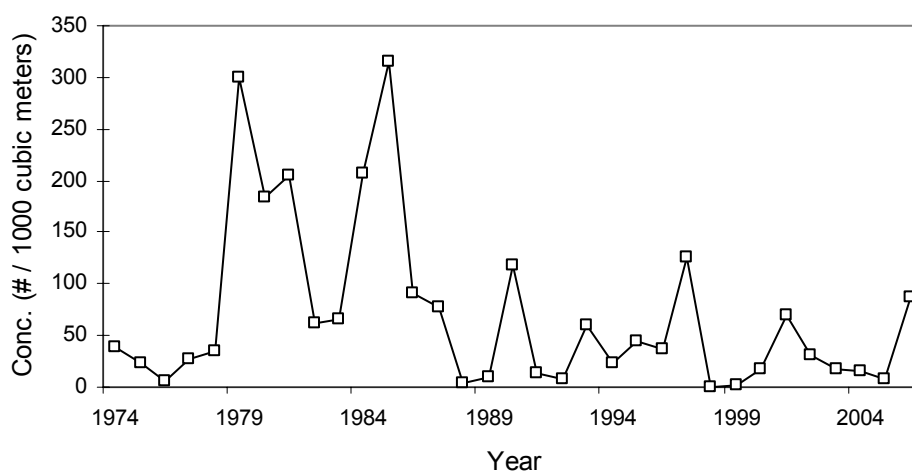

Figure 4.5-65. Mean concentration (# / 1,000 m<sup>3</sup> [264,172 gal]) of reef finspot larvae collected from King Harbor, 1974-2006. Source: Vantuna Research Group.

#### 4.5.3.9.3 Sampling Results

Labrisomid larvae was the third most abundant taxon at the Units 5&6 entrainment station (H2) with a mean concentration of 65 larvae per 1,000 m<sup>3</sup> over all surveys (Table 4.5-1). At Units 7&8, labrisomid larvae was the seventh most abundant taxon at the entrainment station (E4) with a mean concentration of 21 larvae per 1,000 m<sup>3</sup> over all surveys (Table 4.5-2). At the entrainment station (H2) for Units 5&6 they were present in entrainment surveys from May to November, with peak abundances in August (Figure 4.5-66). Even though concentrations were higher at the Units 5&6 entrainment station, they were more consistently abundant at the Units 7&8 entrainment station (E4) with peak abundances occurring June through September (Figure 4.5-67). Average abundance peaked in August at the Units 5&6 entrainment station at about 500 larvae per 1,000 m<sup>3</sup> (Figure 4.5-66), while average abundances peaked in



June at the Units 7&8 entrainment station at about 110 larvae per 1,000 m<sup>3</sup> (Figure 4.5-67). Larvae were present in source water samples from March to December, with a peak in abundances from May through August. Average source water abundances peaked in August at approximately 115 per 1,000 m<sup>3</sup> (Figure 4.5-68). No trend was observed between nighttime samples and daytime samples (Figure 4.5-69). The length frequency range for labrisomids was normally distributed with most sampled larvae between 3-4 mm (0.12-0.16 in) (Figure 4.5-70). The mean length of specimens from the entrainment station samples was 3.9 mm (0.15 in) NL with a size range from 1.8 to 7.6 mm (0.07 to 0.30 in) NL.

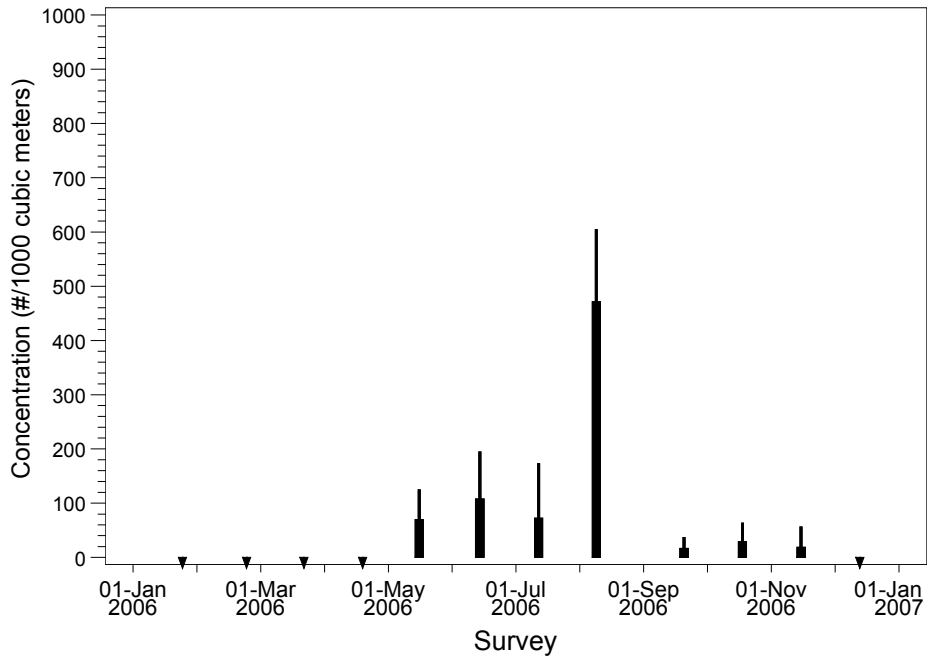

Figure 4.5-66. Mean concentration (# / 1,000 m<sup>3</sup> [264,172 gal]) and standard deviation of labrisomid larvae collected at RBGS entrapment Station H2 from January 2006 through January 2007.

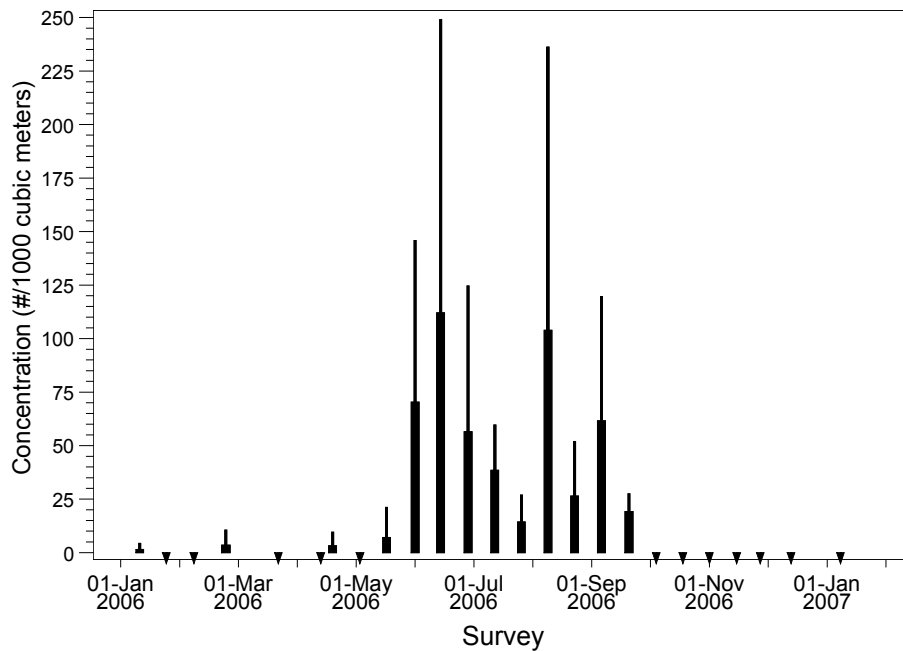

Figure 4.5-67. Mean concentration (# / 1,000 m<sup>3</sup> [264,172 gal]) and standard deviation of labrisomid larvae collected at RBGS entrapment Station E4 from January 2006 through January 2007.

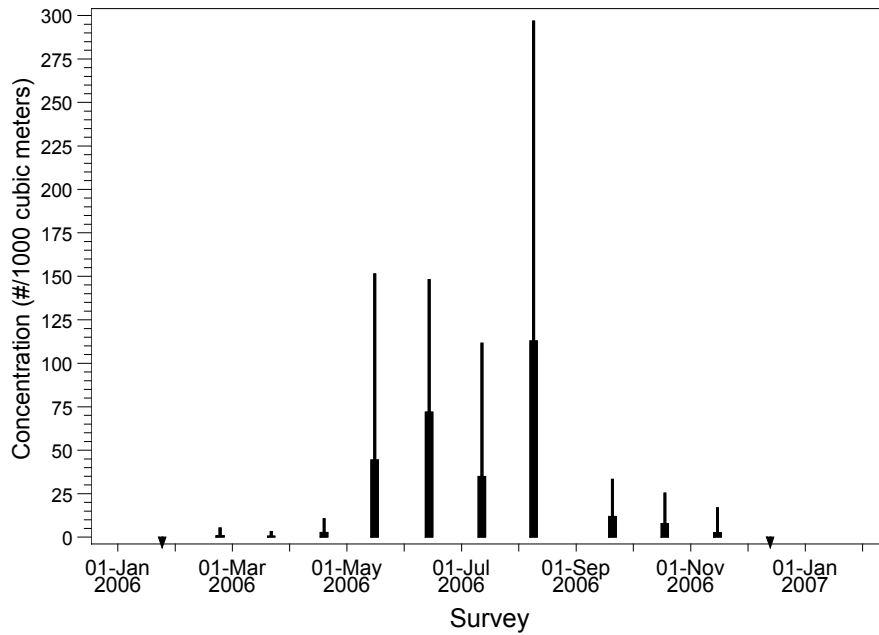

Figure 4.5-68. Mean concentration (# / 1,000 m<sup>3</sup> [264,172 gal]) and standard deviation of labrisomid larvae collected at RBGS source water stations during 2006.

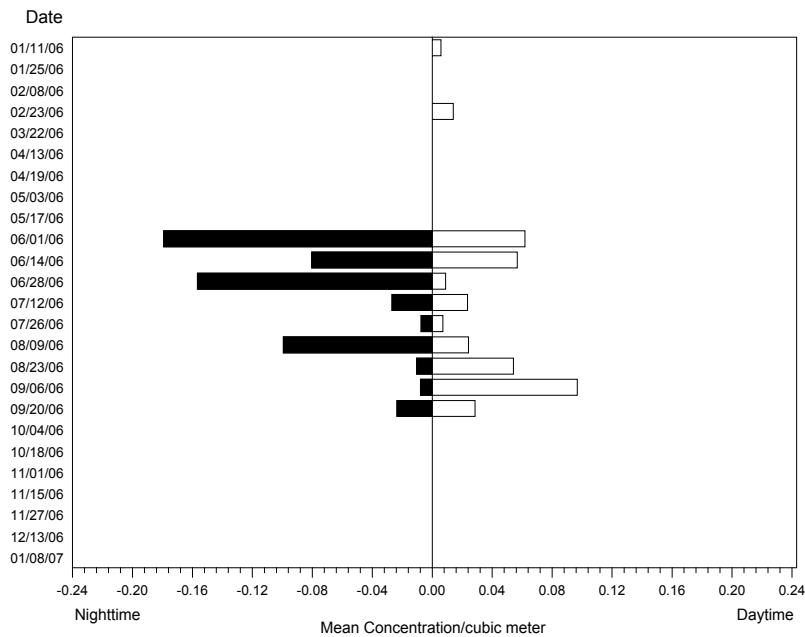

Figure 4.5-69. Mean concentration (#/1.0 m<sup>3</sup> [264 gal]) of labrisomid larvae at entrainment Station E4 during night (Cycle 3) and day (Cycle 1) sampling.

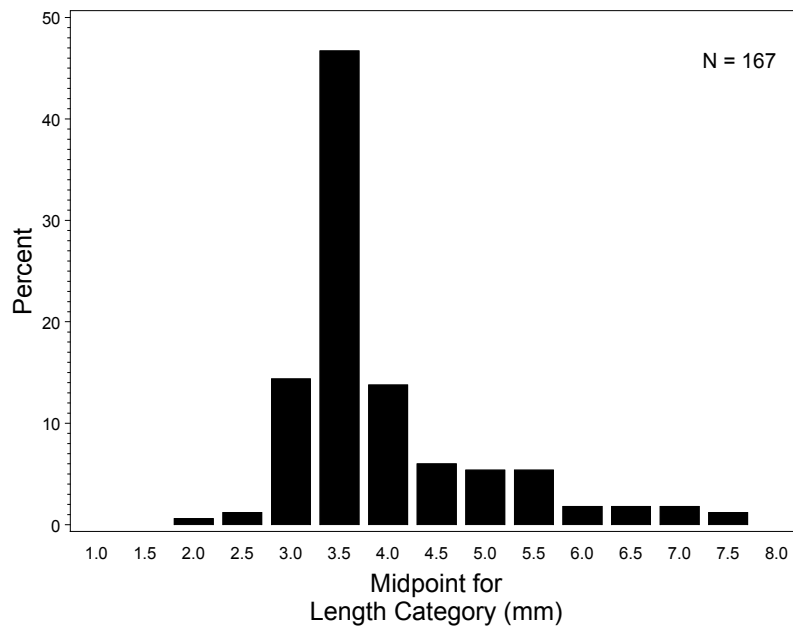

Figure 4.5-70. Length (mm) frequency distribution for larval labrisomid blennies collected at entrainment stations in Santa Monica Bay during 2006.

#### 4.5.3.9.4 Modeling Results

The following section presents the results for the empirical transport modeling of entrainment effects on labrisomid blennies. No age-specific estimates of survival for larval and later stages of development were available from the literature; therefore no estimates of *FH* or *AEL* were calculated. Total annual entrainment at RBGS Units 5&6 was estimated at 6,229,110 larvae (standard error of 244,994) using measured cooling water flows during 2006 and would increase to 20,797,565 larvae (standard error of 463,448) if the CWIS pumps were run at design (maximum) capacity (Table 4.5-3). Total annual entrainment at RBGS Units 7&8 was estimated at 5,676,402 larvae (standard error of 396,984) using measured cooling water flows during 2006 and would increase to 18,262,100 larvae (standard error of 1,071,392) if the CWIS pumps were run at design (maximum) capacity (Table 4.5-4).

#### *Empirical Transport Model (ETM)*

No information on larval growth rates of *Paraclinus integripinnis* or other labrisomid blennies was available in the literature, so information on the larval growth rate of the giant kelpfish (*Heterostichus rostratus*), a co-occurring species in the kelp blenny family, was used to estimate a larval growth rate of 0.25 mm/day (0.01 in/day). This was used with the difference in the lengths of the 95<sup>th</sup> percentiles (3.1 mm [0.12 in]) of the measurements to estimate that the larvae were exposed to entrainment for a period of approximately 1.6 days. Labrisomids do not have planktonic eggs that would require adjustment of the duration of exposure to entrainment.

Labrisomid larvae were mainly present in the entrainment samples from April through November, but occurred in the source water samples during all months except January and December (Tables 4.5-46 and 4.5-47). The monthly estimates of proportional entrainment (*PE*) for labrisomids for Units 5&6 ranged from 0 to 0.07346 using actual flows and from 0 to 0.59676 using design flows (Table 4.5-46). At Units 7&8, the monthly estimates of *PE* ranged from 0 to 0.01009 using actual flows and from 0 to 0.03477 using design flows (Table 4.5-47). The largest estimate for Units 5&6 was calculated for the November survey at Units 5&6, and the July survey at Units 7&8. The largest proportion of the source population was present during August 2006 ( $f_i = 0.337$  or 33.7%). The values in the table for Units 5&6 were used to calculate a  $P_M$  estimate of 0.0714 based on actual flows and an estimate of 0.2156 based on design flows during the period. The values in the table were used to calculate a  $P_M$  estimate of 0.0428 based on actual flows and an estimate of 0.2197 based on design flows during the period. The period of larval exposure coupled with average current velocities indicates that larvae from alongshore distances of 9.3 km (5.8 mi) may be subject to entrainment.

Table 4.5-46. ETM data for labrisomid blenny larvae at Units 5&6. ETM calculations based on actual and design (maximum) cooling water flows and a sampling volume in the nearshore of 396,693,881 m<sup>3</sup>.

Survey Date	Actual Flows		Design Flows		$f_i$
	<i>PE</i> Estimate	<i>PE</i> Std. Err.	<i>PE</i> Estimate	<i>PE</i> Std. Err.	
25-Jan-06	0	0	0	0	0
23-Feb-06	0	0	0	0	0.02142
22-Mar-06	0	0	0	0	0.00324
19-Apr-06	0	0	0	0	0.04513
17-May-06	0.00804	0.00650	0.06056	0.04377	0.03914
14-Jun-06	0.00195	0.00266	0.00567	0.00673	0.28445
12-Jul-06	0.00612	0.01168	0.00718	0.01358	0.13312
9-Aug-06	0.01353	0.00689	0.05057	0.02477	0.33682
20-Sep-06	0.00065	0.00131	0.00480	0.00561	0.07348
18-Oct-06	0.00025	0.00048	0.00666	0.01242	0.06234
15-Nov-06	0.07346	0.16064	0.59676	0.84395	0.00085
13-Dec-06	0	0	0	0	0
<b><math>P_M</math></b>	<b>0.07142</b>	0.05124	<b>0.21561</b>	0.13721	–

Table 4.5-47. ETM data for labrisomid blenny larvae at Units 7&8. ETM calculations based on actual and design (maximum) cooling water flows and a sampling volume in the nearshore of 396,693,881 m<sup>3</sup>.

Survey Date	Actual Flows		Design Flows		$f_i$
	PE Estimate	PE Std. Err.	PE Estimate	PE Std. Err.	
25-Jan-06	0	0	0	0	0
23-Feb-06	0.00035	0.00067	0.02608	0.01757	0.02142
22-Mar-06	0	0	0	0	0.00324
19-Apr-06	0.00132	0.00333	0.00270	0.00682	0.04513
17-May-06	0.00405	0.00594	0.01910	0.01968	0.03914
14-Jun-06	0.00393	0.00732	0.01843	0.02668	0.28445
12-Jul-06	0.01009	0.01379	0.01190	0.01624	0.13312
9-Aug-06	0.00282	0.00314	0.03477	0.02648	0.33682
20-Sep-06	0.00084	0.00093	0.01727	0.01282	0.07348
18-Oct-06	0	0	0	0	0.06234
15-Nov-06	0	0	0	0	0.00085
13-Dec-06	0	0	0	0	0
$P_M$	<b>0.0428</b>	0.0442	<b>0.2197</b>	0.1653	–

#### 4.5.3.10 Kelp Blennies (*Gibbonsia* spp.)

Kelp blennies (Clinidae) of the genus *Gibbonsia* are represented in California waters by three species: *G. montereyensis*, *G. metzi*, and *G. elegans*. The first two species range from British Columbia to central Baja California while *G. elegans* ranges from central California to southern Baja California (Love et al. 2005). All three species are similar in appearance and are differentiated mainly by fin ray counts and the presence or absence of scales on the caudal fin (Miller and Lea 1972).

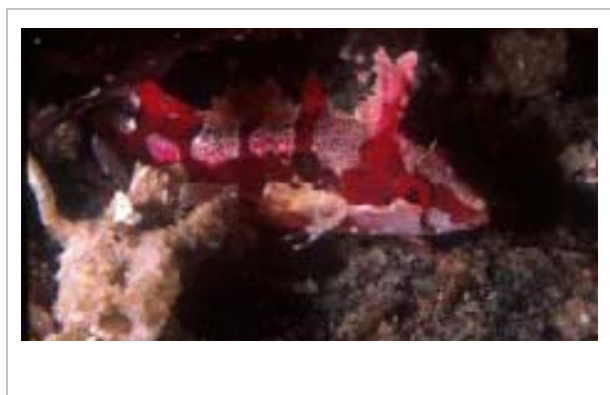

##### 4.5.3.10.1 Life History and Ecology

Kelp blennies are small, cryptic fishes generally found living in nearshore rocky reefs among kelp and seaweeds (Lamb and Edgell, 1986; Moser, 1996) from the intertidal zone to depths of 56 m (185 ft) (Love 1996) but is not common below about 15 m (50 ft) (Fitch and Lavenberg 1975). Kelp blennies are known to spawn year-round (Williams 1954) though exhibit a peak in their spawning between February and April (Watson 1996). Each species of *Gibbonsia* is oviparous (Nelson 1994), spawning demersal eggs which are adhesive and are attached to algal nests (Fitch and Lavenberg 1975, Moser 1996). *Gibbonsia elegans* is reported to have a fecundity of 2,300 eggs/female (Bane and Bane 1971). Kelp blennies first

spawn at 2 years of age and may spawn several times per year (Fitch and Lavenberg 1975). Larval growth was estimated by Stepien (1986) for the closely-related giant kelpfish, *Heterostichus rostratus*, at 0.25 mm/day  $\pm$  0.013. The larval yolk-sac stage ranges in size from 4.6-4.8 mm (0.18-0.19 in), preflexion from 4.6-6.4 mm (0.18-0.25 in), flexion from 6.6-8.0 mm (0.26-0.31 in), and postflexion from 8.4-20.0 mm (0.33-0.79 in) (Watson 1996). Kelp blennies may live to about 7 years (Fitch and Lavenberg 1975). There are no catch data for these species because they are not caught commercially and only captured occasionally for aquarium display.

#### 4.5.3.10.2 Population Trends and Fishery

In King Harbor, concentrations of larval kelp blennies (*Gibbonsia* spp.) have increased substantially since 1990 (Figure 4.5-71). This taxon was collected sporadically and in low concentrations during the first 17 years of the study, but densities increased in the following years. Highest concentrations were recorded in 1994, and from 2001 through 2006.

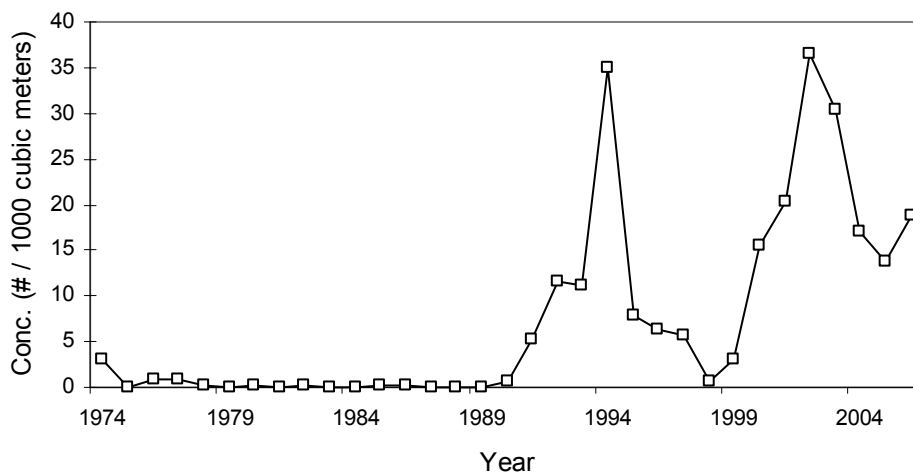

Figure 4.5-71. Mean concentration (# / 1,000 m<sup>3</sup> [264,172 gal]) of kelp blenny (*Gibbonsia* spp.) larvae collected from King Harbor, 1974-2006. Source: Vantuna Research Group.

#### 4.5.3.10.3 Sampling Results

Kelp blenny larvae was the tenth most abundant taxon at both the Units 5&6 and Units 7&8 entrainment stations with mean concentrations over all surveys of 11 and 15 larvae per 1,000 m<sup>3</sup> at Stations H2 and E4, respectively (Tables 4.5-1 and 4.5-2). At the entrainment station for Units 5&6 (H2) they were only present in five of the twelve surveys (Figure 4.5-72), but at the entrainment station for Units 7&8 (E4) they were present in entrainment surveys throughout the year (Figure 4.5-73), with peak abundances at both stations occurring in summer and winter. Average abundance peaked in June at Station E4 at about 60 larvae per 1,000 m<sup>3</sup> and again in December at approximately 120 larvae per 1,000 m<sup>3</sup> (Figure 4.5-73). Source water abundances followed the same seasonal pattern but average abundances were considerably less than observed at the entrainment stations. Source water abundances peaked in June at approximately 5 per 1,000 m<sup>3</sup> and in October at approximately 11 larvae per 1,000 m<sup>3</sup> (Figure 4.5-74). Larvae were more common in the daytime samples than in nighttime samples (Figure 4.5-75). The length frequency range for larvae was normally distributed with a bias toward the smaller size classes. The majority of sampled larvae were between 3-6 mm (0.12-0.24 in) (Figure 4.5-76). The mean length of specimens from the entrainment station samples was 5.6 mm (0.22 in) NL with a size range from 3.4 to 17.1 mm (0.13 to 0.67 in) NL.



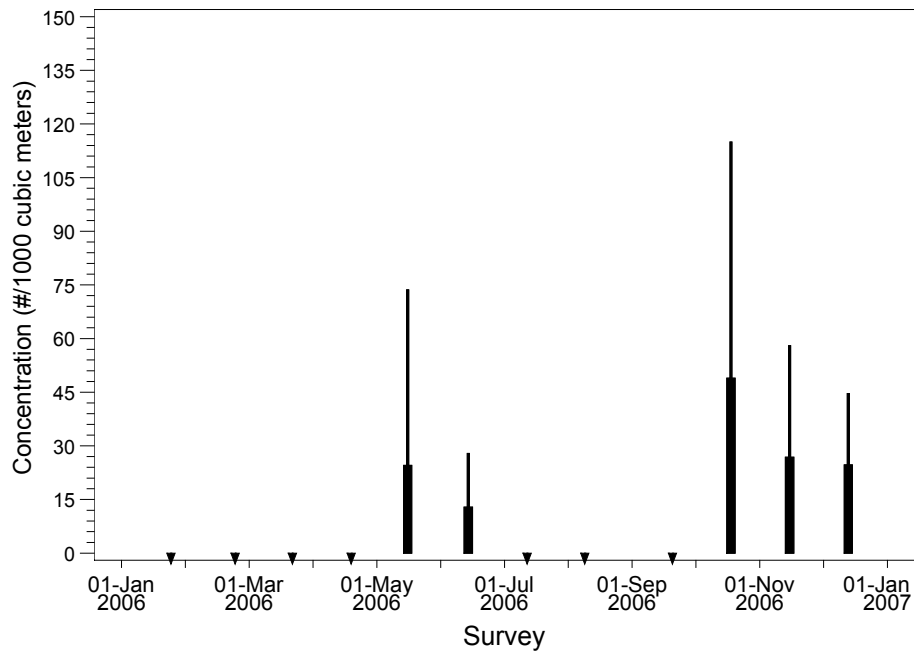

Figure 4.5-72. Mean concentration (# / 1,000 m<sup>3</sup> [264,172 gal]) and standard deviation of kelp blenny larvae collected at RBGS entrapment Station H2 from January through December 2006.

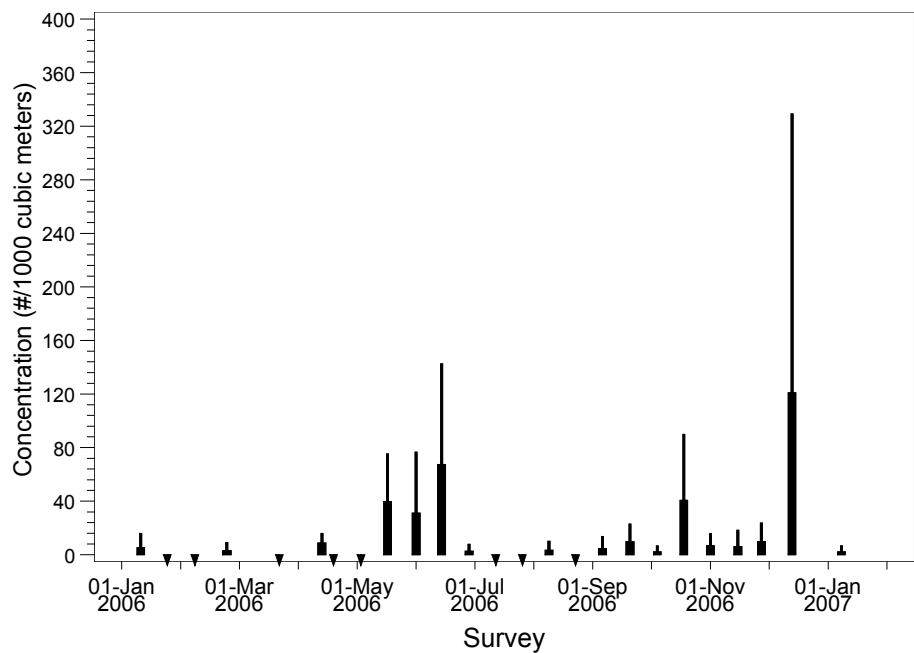

Figure 4.5-73. Mean concentration (# / 1,000 m<sup>3</sup> [264,172 gal]) and standard deviation of kelp blenny larvae collected at RBGS entrapment Station E4 from January 2006 through January 2007.

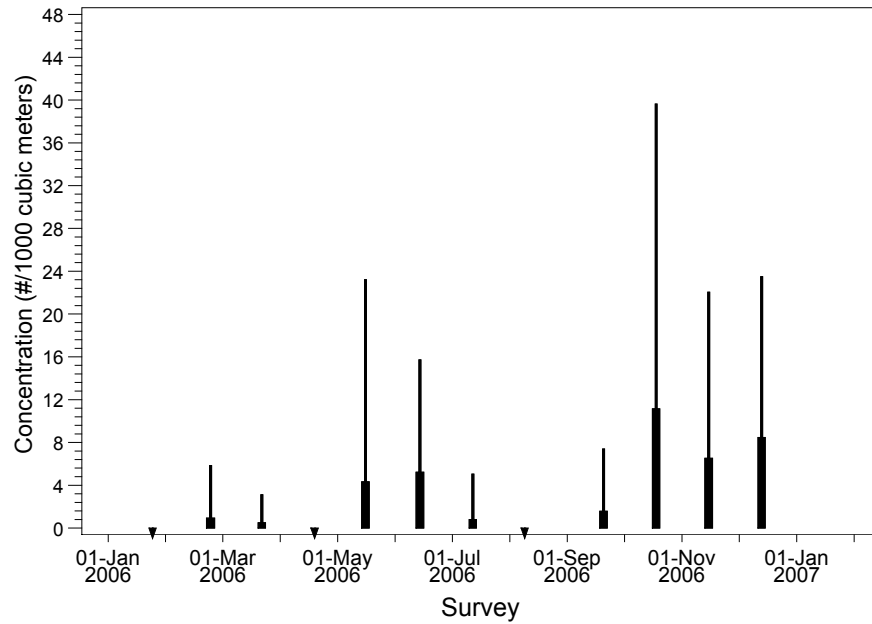

Figure 4.5-74. Mean concentration (# / 1,000 m<sup>3</sup> [264,172 gal]) and standard deviation of kelp blenny larvae collected at RBGS source water stations during 2006.

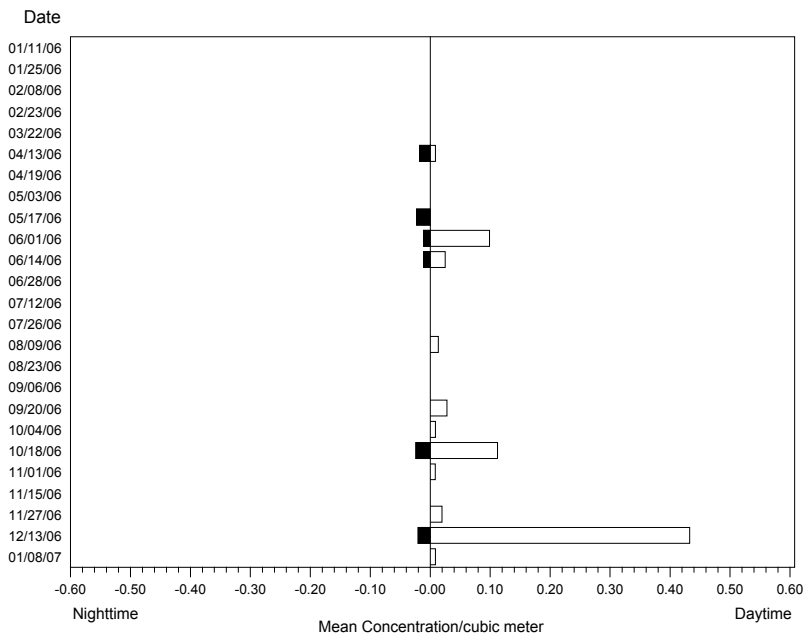

Figure 4.5-75. Mean concentration (#/1.0 m<sup>3</sup> [264 gal]) of kelp blenny larvae at entrainment Station E4 during night (Cycle 3) and day (Cycle 1) sampling.

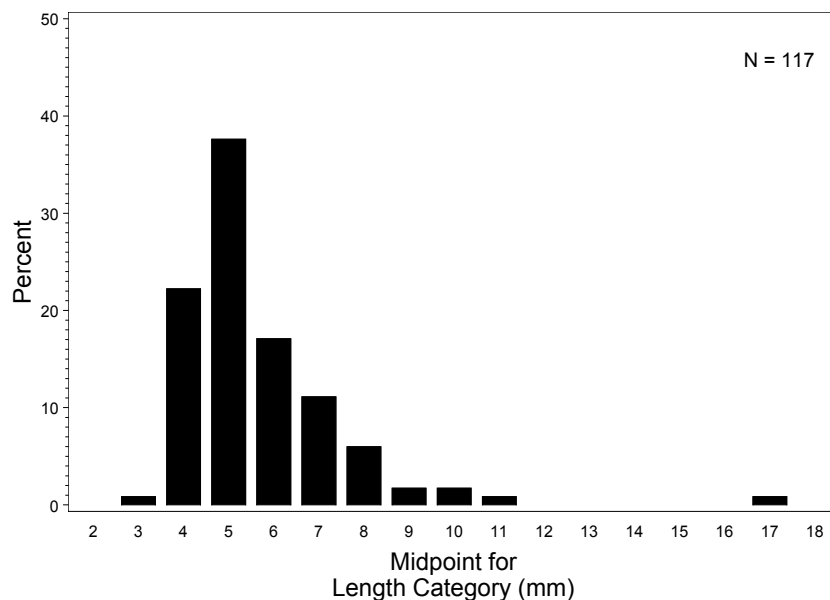

Figure 4.5-76. Length (mm) frequency distribution for kelp blenny larvae collected at entrainment stations in Santa Monica Bay during 2006.

#### 4.5.3.10.4 Modeling Results

The following section presents the results for the empirical transport modeling of entrainment effects on kelp blennies. No age-specific estimates of survival for larval and later stages of development were available from the literature; therefore no estimates of *FH* or *AEL* were calculated. Total annual entrainment at RBGS Units 5&6 was estimated at 332,788 larvae using measured cooling water flows during 2006 and 3,442,061 larvae if the CWIS pumps were run at design (maximum) capacity all year (Table 4.5-3). Total annual entrainment at RBGS Units 7&8 was estimated at 1,386,384 larvae using measured cooling water flows during 2006 and 15,074,166 larvae if the CWIS pumps were run at design (maximum) capacity (Table 4.5-4).

#### *Empirical Transport Model (ETM)*

No information on larval growth rates of *Gibbonsia* was available in the literature, so information on the larval growth rate of the giant kelpfish (*Heterostichus rostratus*), a co-occurring species in the kelp blenny family, was used to estimate a larval growth rate of 0.25 mm/day (0.01 in/day). This was used with the difference in the lengths of the 95<sup>th</sup> percentiles of the measurements to estimate that the larvae were exposed to entrainment for a period of approximately 18.9 days. The duration was not adjusted for a planktonic egg stage because these fishes have demersal eggs that would not be exposed to entrainment.

Kelp blenny larvae were mainly present in the entrainment samples from May through December, but occurred in the source water samples during all months except January and April (Tables 4.5-48 and 4.5-49). At Units 5&6, the monthly estimates of *PE* ranged from 0 to 0.0021 using actual flows and from 0 to 0.0171 using design flows (Table 4.5-48). The largest estimate was calculated for the November survey,

but the largest proportion of the source population was present during December 2006 ( $f_i = 0.494$  or 49.4%). The values in the table were used to calculate a  $P_M$  estimate of 0.0062 based on actual flows and an estimate of 0.0050 based on design flows. At Units 7&8, the monthly estimates of  $PE$  ranged from 0 to 0.01400 using actual flows and from 0 to 0.06603 using the design flows, with the largest estimate for the May survey (Table 4.5-49). The values in the table were used to calculate a  $P_M$  estimate of 0.0352 based on actual flows and an estimate of 0.3059 based on design flows. The period of larval exposure coupled with average current velocities indicates that larvae from alongshore distances of 14.5 km (9.0 mi) may be subject to entrainment.

Table 4.5-48. *ETM* data for kelp blenny larvae at Units 5&6. *ETM* calculations based on actual and design (maximum) cooling water flows and a sampling volume in the nearshore of 396,693,881 m<sup>3</sup>.

Survey Date	Actual Flows		Design Flows		$f_i$
	$PE$ Estimate	$PE$ Std. Err.	$PE$ Estimate	$PE$ Std. Err.	
25-Jan-06	0	0	0	0	0
23-Feb-06	0	0	0	0	0.01664
22-Mar-06	0	0	0	0	0.00023
19-Apr-06	0	0	0	0	0
17-May-06	0.00168	0.00232	0.01268	0.01325	0.10073
14-Jun-06	0.00033	0.00109	0.00097	0.00272	0.16876
12-Jul-06	0	0	0	0	0.00038
9-Aug-06	0	0	0	0	0.01043
20-Sep-06	0	0	0	0	0.04090
18-Oct-06	0.00019	0.00053	0.00502	0.01356	0.14132
15-Nov-06	0.00211	0.00733	0.01714	0.04468	0.02675
13-Dec-06	0.00005	0.00017	0.00110	0.00281	0.49385
<b><math>P_M</math></b>	<b>0.00624</b>	0.00701	<b>0.05502</b>	0.04972	–

Table 4.5-49. *ETM* data for kelp blenny larvae at Units 7&8. *ETM* calculations based on actual and design (maximum) cooling water flows and a sampling volume in the nearshore of 396,693,881 m<sup>3</sup>.

Survey Date	Actual Flows		Design Flows		$f_i$
	PE Estimate	PE Std. Err.	PE Estimate	PE Std. Err.	
25-Jan-06	0	0	0	0	0
23-Feb-06	0.00017	0.00111	0.01264	0.02843	0.01664
22-Mar-06	0	0	0	0	0.00023
19-Apr-06	0	0	0	0	0
17-May-06	0.01400	0.01225	0.06603	0.04982	0.10073
14-Jun-06	0.00339	0.01127	0.01592	0.04356	0.16876
12-Jul-06	0	0	0	0	0.00038
9-Aug-06	0.00174	0.00812	0.02145	0.07212	0.01043
20-Sep-06	0.00073	0.00382	0.01511	0.05001	0.04090
18-Oct-06	0	0	0.01300	0.03345	0.14132
15-Nov-06	0.00032	0.00222	0.01215	0.03945	0.02675
13-Dec-06	0	0	0.01676	0.05563	0.49385
$P_M$	<b>0.0352</b>	0.0189	<b>0.3059</b>	0.3339	–

**4.5.3.11 CIQ Goby complex (*Clevelandia*, *Ilypnus*, *Quietula*)**

Gobies are small, demersal fishes that are found worldwide in shallow tropical to temperate marine environments. Many members of the family are euryhaline and are able to tolerate very low salinities and even freshwater. The family Gobiidae contains approximately 1,875 species in 212 genera (Nelson 1994, Moser 1996). Twenty-one goby species from 16 genera occur from the northern California border to south of Baja California (Moser 1996). In addition to the three species comprising the CIQ complex



Greg Goldsmith, USFWS

(arrow goby *Clevelandia ios* [pictured above], cheekspot goby *Ilypnus gilberti*, and shadow goby *Quietula y-cauda*), there are at least six other common species in southern California: blackeye goby (*Rhinogobiops nicholsii*), yellowfin goby (*Acanthogobius flavimanus*), longjaw mudsucker (*Gillichthys mirabilis*), blind goby, bay goby (*Lepidogobius lepidus*), and bluebanded goby (*Lythrypnus dalli*).

Myomere counts, gut proportions, and pigmentation characteristics can be used to identify most fish larvae to the species level. However, the arrow, cheekspot, and shadow gobies cannot be differentiated with complete confidence at most larval stages (Moser 1996). Therefore, larval gobies collected during entrainment sampling that could not be identified to the species level were grouped into the ‘CIQ’ goby complex (for *Clevelandia*, *Ilypnus* and *Quietula*), or the family level ‘Gobiidae’ if specimens were damaged but could still be recognized as gobiids. Some larger larval specimens with well-preserved pigmentation patterns could be identified to the species level (W. Watson, Southwest Fisheries Science

Center, pers. comm.) but those that were speciated in this study were subsequently combined into the CIQ complex for analysis. The following section presents an overview of the family and life history characteristics of each of the three species.

#### 4.5.3.11.1 Life History and Ecology

All three species have overlapping ranges in southern California and occupy similar habitats. Arrow goby is the most abundant of the three species in bays and estuaries from Tomales Bay to San Diego Bay, including Elkhorn Slough (Cailliet et al. 1977), Anaheim Bay (MacDonald 1975) and Newport Bay (Allen, L. 1982). Arrow and cheekspot gobies were reported as abundant from the Cabrillo Beach area in outer Los Angeles Harbor based on beach seine sampling (Allen et al. 1983). The life history of the arrow goby was reviewed by Emmett et al. (1991) and the comparative ecology and behavior of all three species were studied by Brothers (1975) in Mission Bay.

Arrow goby have the most northerly range of the three species, occurring from Vancouver Island, British Columbia to southern Baja California (Eschmeyer and Herald 1983). The reported northern range limits of both shadow goby (*Quietula y-cauda*) and cheekspot goby (*Ilypnus gilberti*) are in central California with sub-tropical southern ranges that extend well into the Gulf of California (Robertson and Allen 2002). Their physiological tolerances reflect their geographic distributions with arrow goby less tolerant of warmer temperatures compared to cheekspot goby. When exposed to temperatures of 32.1°C (89.8°F) for three days in a laboratory experiment, no arrow gobies survived but 95% of cheekspot goby did survive (Brothers 1975). The species inhabits burrows of ghost shrimps (*Neotrypaea* spp.) and other burrowing invertebrates such as the fat innkeeper worm (*Urechis caupo*), and gobies exposed to warm temperatures on mudflats can seek refuge in their burrows where temperatures can be several degrees cooler than surface temperatures.

#### Summary of CIQ goby distribution and life history attributes.

**Range:** Vancouver Island, British Columbia to Gulf of California

**Life History:**

- Size up to 57 mm (2.1 in) (arrow goby); 64 mm (2.5 in) (cheekspot goby); 70 mm (2.75 in) (shadow goby)
- Age at maturity from 0.7–1.5 yr
- Life span ranges from <3 yr (arrow goby) to 5 yr (shadow goby)
- Spawns year-round in bays and estuaries; demersal, adhesive eggs with fecundity from 225–1,400 eggs per female and multiple spawning of 2–5 times per yr
- Juveniles from 14.0–29.0 mm are < 1 yr old

**Habitat:** Mud and sand substrates of bays and estuaries; commensally in burrows of shrimps and other invertebrates.

**Fishery:** None.

The reproductive biology is similar among the three species in the CIQ complex. Arrow goby typically mature sooner than the other two species, attaining 50% maturity in the population after approximately 8 mo as compared to 16–18 mo for cheekspot and shadow gobies (Brothers 1975). Mature females for all three of these species are oviparous and produce demersal eggs that are elliptical in shape, adhesive, and

attached to a nest substratum at one end (Matarese et al. 1989, Moser 1996). Hatched larvae are planktonic with the duration of the planktonic stage estimated at 60 days for populations in Mission Bay (Brothers 1975). Arrow goby mature more quickly and spawn a greater number of eggs at a younger age than either the cheekspot or shadow gobies. As with most fishes fecundity is dependent on age and size of the female. Fecundity of gobies in Mission Bay ranged from 225–750 eggs per batch for arrow gobies, 225–1,030 eggs for cheekspot, and 340–1,400 for shadow, for a mean value of 615 per batch for the CIQ complex. Mature females for the CIQ complex deposit 2–5 batches of eggs per year.

CIQ complex larvae hatch at a size of 2–3 mm (0.08–0.12 in) (Moser 1996). Data from Brothers (1975) were used to estimate an average growth rate of 0.16 mm/d (0.001 in/d) for the approximately 60-day period from hatching to settlement. Brothers (1975) estimated a 60-day larval mortality of 98.3% for arrow goby larvae, 98.6% for cheekspot, and 99.2% for shadow. These values were used to estimate average daily survival at 0.93 for the three species. Once the larvae transform at a size of approximately 10–15 mm (0.39–0.59 in) SL, depending on the species (Moser 1996), the juveniles settle into the benthic environment. For the Mission Bay populations mortality following settlement was 99% per year for arrow goby, 66–74% for cheekspot goby, and 62–69% for shadow goby. Few arrow gobies exceeded 3 yr of age based on otolith records, whereas cheekspot and shadow gobies commonly lived for 4 yr (Brothers 1975).

Gobies eat a variety of larval, juvenile, and adult crustaceans, mollusks, and insects. Many will also eat small fishes, fish eggs, and fish larvae.

#### 4.5.3.11.2 Population Trends and Fishery

There are no published multi-year studies of post-settlement goby populations in the Santa Monica Bay area, but in a 5-year study of fishes in San Diego Bay from 1994–1999, approximately 75% of the estimated 4.5 million (standing stock) gobies were juveniles (Allen et al. 2002). Seasonal peaks in population abundance generally occurred in summer and fall and were associated with settlement of young-of-the-year although high abundances were also recorded in January and April of some years. Population abundances vary among years and may be correlated to the severity of winter rainfall events and urban runoff that may impact the water quality of seasonal estuaries in southern California. There is no fishery for these goby species because of their small size.

The earlier 316(b) study from RBGS in 1979–1980 (SCE 1983) reported estimates of average concentrations of gobies sampled at the intake stations. Gobies were only collected at Units 1-6, with highest densities from July through November and lowest densities from December through April. Mean daily densities were 260 larvae per 1,000 m<sup>3</sup> (264,172 gal).

In King Harbor, Goby type A/C larvae (the same group of gobies as those in the CIQ complex) were not recorded prior to 1978 (Figure 4.5-65). Concentrations peaked in 1979 at 674 larvae per 1,000 m<sup>3</sup>, then decreased in 1980 and have been below 300 larvae per 1,000 m<sup>3</sup> ever since.

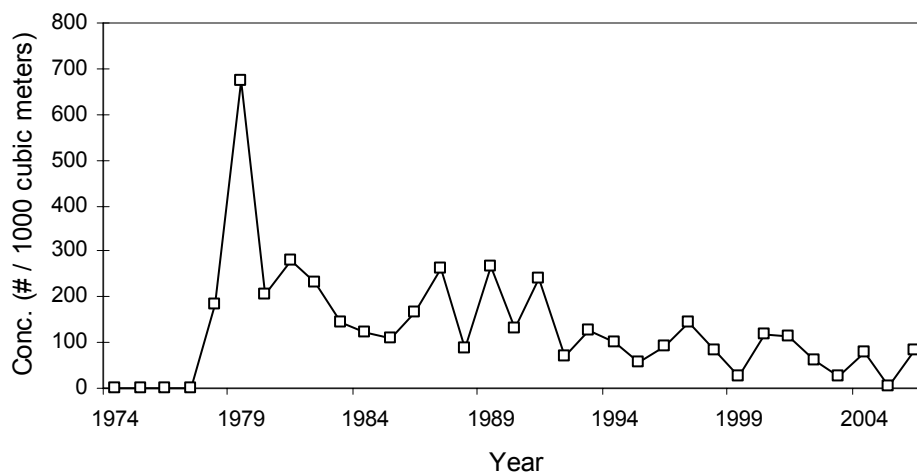

Figure 4.5-77. Mean concentration (# / 1,000 m<sup>3</sup> [264,172 gal]) of Goby type A/C larvae collected from King Harbor, 1974-2006. Source: Vantuna Research Group.

#### 4.5.3.11.3 Sampling Results

CIQ complex goby larvae were the second most abundant taxon at both the Units 5&6 entrainment station (H2) and the Units 7&8 entrainment station (E4) with mean concentrations over all surveys of 420 and 94 per 1,000 m<sup>3</sup>, respectively (Tables 4.5-1 and 4.5-2). They were present in all surveys at both stations with peak abundances from July through November. Peak average abundance at both entrainment stations occurred in late August 2006 at approximately 1,500 larvae per 1,000 m<sup>3</sup> at the Units 5&6 entrainment station (Figure 4.5-78) and 300 larvae per 1,000 m<sup>3</sup> at the Units 7&8 entrainment station (Figure 4.5-79). At the Units 7&8 entrainment station another peak in abundance occurred in November. Gobies were also present at the source water stations during all months of the year with a peak average concentration in September 2006 at approximately 1,000 larvae per 1,000 m<sup>3</sup> (Figure 4.5-80). Comparison of larval concentrations between daytime and nighttime collections showed no apparent trend (Figure 4.5-81). The length-frequency distribution for a representative sample of CIQ goby larvae showed that the majority of the sampled larvae were recently hatched based on the reported hatch size of 2–3 mm (0.08–0.12 in) (Moser 1996). A small proportion of the measured larvae were in the 4–12 mm (0.16–0.47 in) size classes (Figure 4.5-82). The mean length of measured specimens from the entrainment station samples was 3.0 mm (0.12 in) NL with a size range from 1.7 mm (0.07 in) to 15.2 mm (0.60 in) NL.



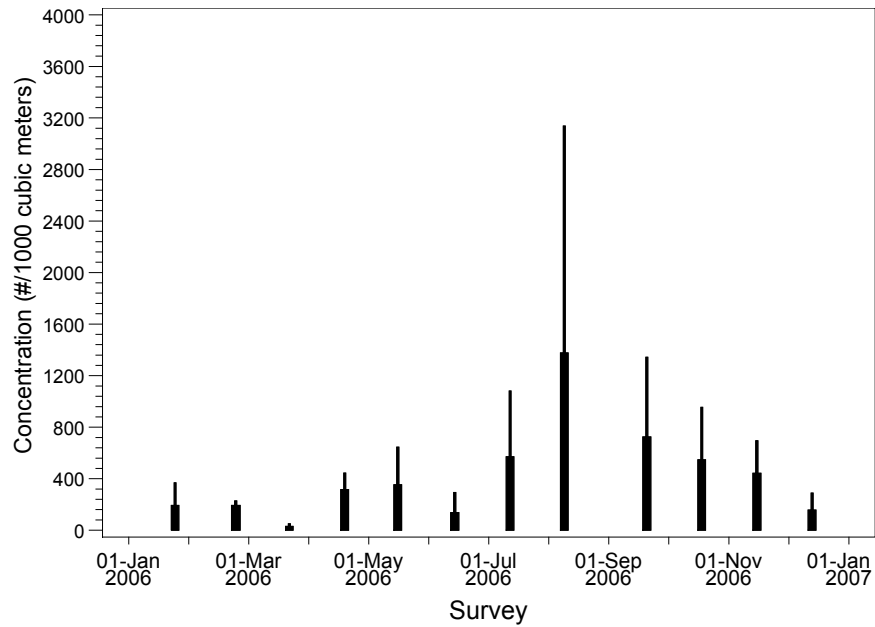

Figure 4.5-78. Mean concentration (# / 1,000 m<sup>3</sup> [264,172 gal]) and standard deviation of unidentified CIQ goby larvae collected at RBGS entrapment Station H2 from January through December 2006.

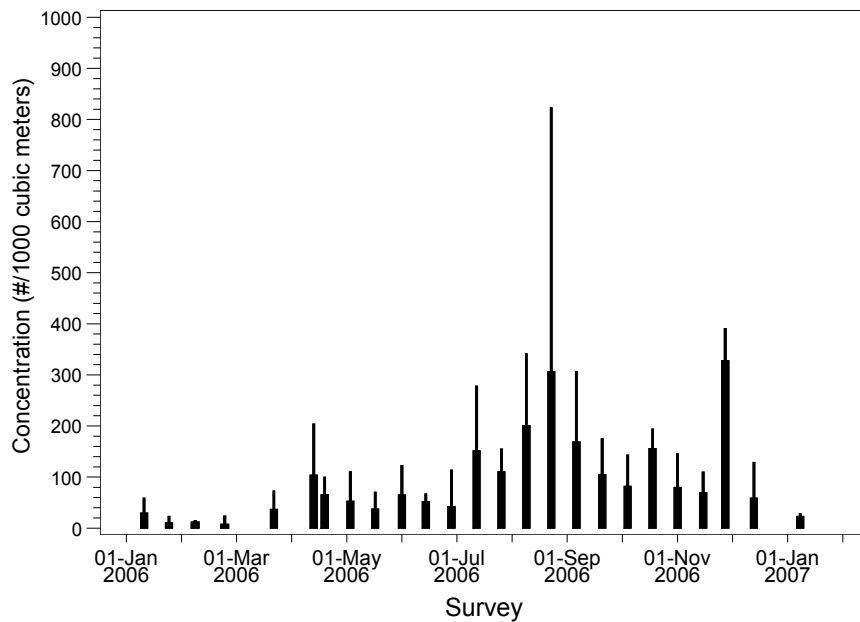

Figure 4.5-79. Mean concentration (# / 1,000 m<sup>3</sup> [264,172 gal]) and standard deviation of unidentified CIQ goby larvae collected at RBGS entrapment Station E4 from January 2006 through January 2007.

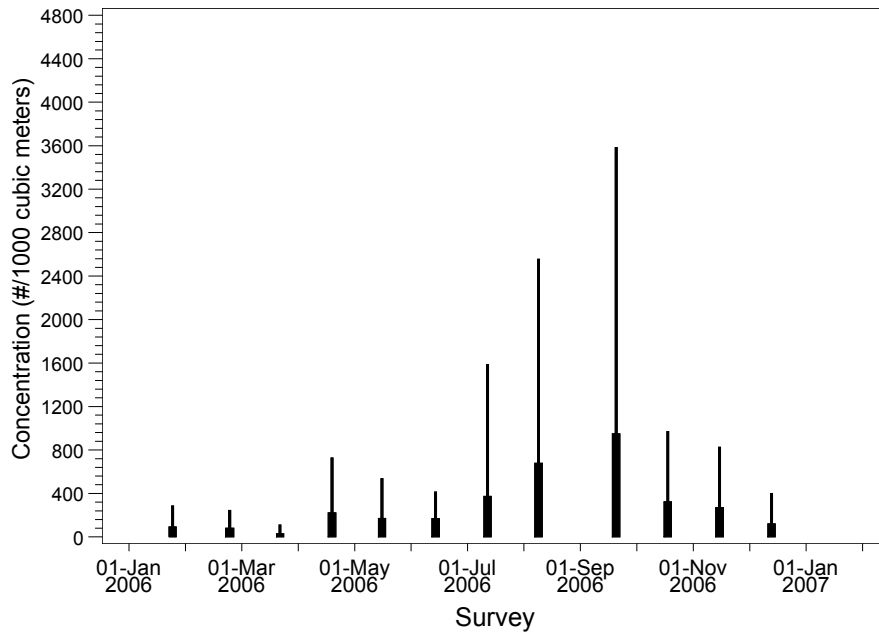

Figure 4.5-80. Mean concentration (# / 1,000 m<sup>3</sup> [264,172 gal]) and standard deviation of unidentified CIQ goby larvae collected at RBGS source water stations during 2006.

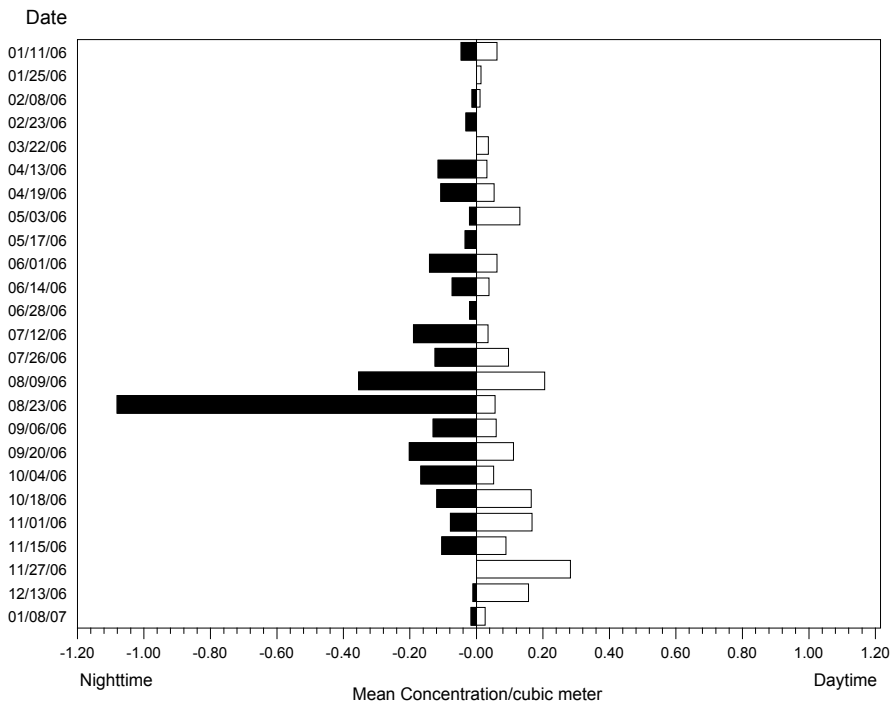

Figure 4.5-81. Mean concentration (#/1.0 m<sup>3</sup> [264 gal]) of unidentified CIQ goby larvae at entrainment Station E4 during night (Cycle 3) and day (Cycle 1) sampling.

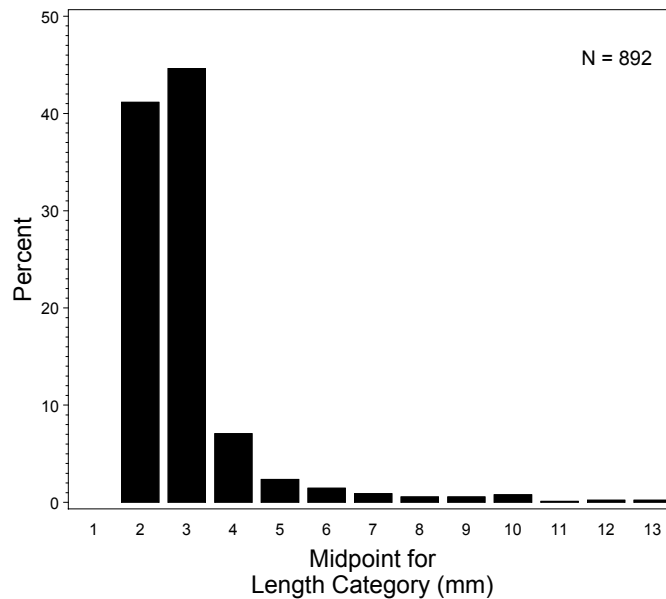

Figure 4.5-82. Length (mm) frequency distribution for unidentified CIQ goby larvae collected at entrainment stations in Santa Monica Bay during 2006.

#### 4.5.3.11.4 Modeling Results

The following section presents the results for demographic and empirical transport modeling of CWIS entrainment effects on CIQ goby populations. A comprehensive comparative study of the three goby species in the CIQ complex by Brothers (1975) from Mission Bay in San Diego County provided the necessary life history information for both the *FH* and *AEL* demographic models. Total annual entrainment of CIQ goby larvae at RBGS Units 5&6 was estimated to be 33,282,431 using actual measured cooling water flows during 2006 and would increase to 129,632,951 larvae if the CWIS pumps were run at design (maximum) capacity (Table 4.5-3). At Units 7&8, total annual entrainment of CIQ goby larvae was estimated to be 18,234,242 using actual measured cooling water flows during 2006 and would increase to 85,058,614 larvae if the CWIS pumps were run at design (maximum) capacity (Table 4.5-4).

#### *Fecundity Hindcasting (FH)*

The annual entrainment estimate for CIQ gobies was used to estimate the number of females at the age of maturity needed to produce the number of larvae entrained during their lifetime. No estimates of egg survival for gobies were available, but because gobies deposit demersal egg masses (Wang 1986) and exhibit parental care, usually provided by the adult male, egg survival is generally high and was conservatively assumed to be 100%. Estimates of larval survival for the three species from Brothers (1975) were used to compute an average daily survival of 0.93. A larval growth rate of 0.16 mm/d (0.006 in/d) was estimated from transformation lengths reported by Brothers (1975) for the three species and an

estimated transformation age of 60 days. The mean length (2.8 mm [0.11 in]) and the estimated hatch length of 2.2 mm (0.09 in) based on the length of the 10<sup>th</sup> percentile from a random sample of 200 of the measured larvae were used with the calculated growth rate to estimate that the mean age at entrainment was 4.1 days. Survival to the average age at entrainment was then estimated as  $0.93^{4.1} = 0.75$ . A survivorship table was constructed using data from Brothers (1975) and was used to estimate a total lifetime fecundity of 1,400 eggs (Table 4.5-50). The age when at 50% of the female population was reproductive averaged 1.67 years.

The estimated numbers of female gobies at the age of maturity whose lifetime reproductive output was entrained through the RBGS Units 5&6 CWIS for 2006 was estimated as 31,769 using actual cooling water flows and 123,738 using design capacity (maximum) flows (Table 4.5-51). At Units 7&8, the estimated numbers of female gobies at the age of maturity whose lifetime reproductive output was for 2006 was estimated as 17,405 using actual cooling water flows and 81,191 using design capacity (maximum) flows (Table 4.5-52). The results of the sensitivity analysis show that the greatest uncertainty associated with the estimated is related to the life history parameters in the model and not the entrainment estimates.

Table 4.5-50. Total lifetime fecundity estimates for three goby species based on a life table in Brothers (1975).

Species	Age	N	% Mature	Fecundity	Spawns	No. Eggs	Eggs per Spawner	TLF
<i>Clevelandia ios</i>	0	500	0					
	1	100	81	450	1.5	54,675	547	
	2	4	100	700	2.0	5,600	56	<b>603</b>
<i>Ilypnus gilberti</i>	0	500	0					
	1	80	10	260	0	0		
	2	51	71	480	1.5	26,071	511	
	3	14	99	720	3.0	29,938	587	
<i>Quietula y-cauda</i>	4	2	100	900	3.0	5,400	106	<b>1,204</b>
	0	500	0					
	1	74	23	410	0	0		
	2	50	87	620	1.5	4,0455	809	
	3	26	99	840	2.5	54,054	1081	
	4	7	100	1,200	3.0	25,200	504	<b>2,394</b>
							<b>Mean</b>	<b>1,400</b>

Table 4.5-51. Results of *FH* modeling for CIQ goby complex larvae based on entrainment estimates at Units 5&6 calculated using actual and design (maximum) CWIS flows.

Parameter	Estimate	Std. Error	<i>FH</i> Lower Estimate	<i>FH</i> Upper Estimate	<i>FH</i> Range
<b>Actual Flows</b>					
<i>FH</i> Estimate	31,769	27,577	7,618	132,481	124,863
Total Entrainment	33,282,431	1,973,855	28,670	34,868	6,199
<b>Design Flows</b>					
<i>FH</i> Estimate	123,738	107,261	29,732	514,972	485,240
Total Entrainment	129,632,95	4,854,363	116,116	131,361	15,245

The upper and lower estimates are based on a 90% confidence interval of the mean. *FH* estimates were also calculated using the upper and lower confidence estimates from the entrainment estimates.

Table 4.5-52. Results of *FH* modeling for CIQ goby complex larvae based on entrainment estimates at Units 7&8 calculated using actual and design (maximum) CWIS flows.

Parameter	Estimate	Std. Error	<i>FH</i> Lower Estimate	<i>FH</i> Upper Estimate	<i>FH</i> Range
<b>Actual Flows</b>					
<i>FH</i> Estimate	17,405	15,106	4,175	72,564	68,390
Total Entrainment	18,234,242	1,042,001	15,769	19,041	3,272
<b>Design Flows</b>					
<i>FH</i> Estimate	81,191	70,370	19,512	337,835	318,323
Total Entrainment	85,058,614	2,952,706	76,555	85,827	9,273

The upper and lower estimates are based on a 90% confidence interval of the mean. *FH* estimates were also calculated using the upper and lower confidence estimates from the entrainment estimates.

*Adult Equivalent Loss (AEL)*

The parameters required for formulation of *AEL* estimates include larval survival from entrainment to settlement and survival from settlement to the average age of reproduction for a mature female. Larval survival from entrainment through settlement was estimated as  $0.93^{60 \cdot 4.1} = 0.02$  using the same daily survival rate used in formulating *FH*. Brothers (1975) estimated that mortality in the first year following settlement was 99% for arrow, 66–74% for cheekspot, and 62–69% for shadow goby. These estimates were used to calculate a daily survival of 0.995 that was used to estimate a finite survival of 0.21 for the first year following settlement. Daily survival through the average female age of 2.21 years from life table data for the three species was estimated as 0.994 and was used to calculate a finite survival over the period of 0.21.

The equivalent number of adult CIQ gobies calculated from the number of larvae entrained through the RBGS Units 5&6 CWIS for 2006 was 27,287 based on an entrainment estimate calculated using actual CWIS flows and 106,280 based on design flows (Table 4.5-53). At Units 7&8, the equivalent number of

adult CIQ gobies for 2006 was 20,487 based on an entrainment estimate calculated using actual CWIS flows and 69,735 based on design flows (Table 4.5-54). The results of the sensitivity analysis show that the greatest uncertainty associated with the estimates is related to the life history parameters in the model and not the entrainment estimates.

Table 4.5-53. Results of *AEL* modeling for CIQ goby complex larvae based on entrainment estimates at Units 5&6 calculated using actual and design (maximum) CWIS flows.

<b>Parameter</b>	<b>Estimate</b>	<b>Std. Error</b>	<b><i>AEL</i> Lower Estimate</b>	<b><i>AEL</i> Upper Estimate</b>	<b><i>AEL</i> Range</b>
<b><u>Actual Flows</u></b>					
<i>AEL</i> Estimate	<b>27,287</b>	30,685	4,291	173,517	169,226
Total Entrainment	33,282,431	1,973,855	24,625	29,949	5,324
<b><u>Design Flows</u></b>					
<i>AEL</i> Estimate	106,280	119,416	16,739	674,791	658,052
Total Entrainment	129,632,95	4,854,363	99,733	112,827	13,094

The upper and lower estimates are based on a 90% confidence interval of the mean. *AEL* estimates were also calculated using the upper and lower confidence estimates from the entrainment estimates.

Table 4.5-54. Results of *AEL* modeling for CIQ goby complex larvae based on entrainment estimates at Units 7&8 calculated using actual and design (maximum) CWIS flows.

<b>Parameter</b>	<b>Estimate</b>	<b>Std. Error</b>	<b><i>AEL</i> Lower Estimate</b>	<b><i>AEL</i> Upper Estimate</b>	<b><i>AEL</i> Range</b>
<b><u>Actual Flows</u></b>					
<i>AEL</i> Estimate	<b>14,949</b>	16,810	2,351	95,046	92,695
Total Entrainment	18,234,242	1,042,001	13,544	16,355	2,811
<b><u>Design Flows</u></b>					
<i>AEL</i> Estimate	69,736	78,349	10,985	442,700	431,715
Total Entrainment	85,058,614	2,952,706	65,753	73,718	7,964

The upper and lower estimates are based on a 90% confidence interval of the mean. *AEL* estimates were also calculated using the upper and lower confidence estimates from the entrainment estimates.

*Empirical Transport Model (ETM)*

The larval duration used to calculate the *ETM* estimates for CIQ gobies was based on the lengths of entrained larvae. The difference between the lengths of the 95<sup>th</sup> percentile (4.7 mm [0.32 in]) and the estimated hatch length of the estimated hatch length of 2.2 mm (0.09 in) based on the length of the 10<sup>th</sup> percentile was used with a growth rate of 0.16 mm/d (0.006 in/d) to estimate that CIQ goby larvae were vulnerable to entrainment for a period of 15.7 days.

CIQ gobies larvae were present in the source water and entrainment samples throughout the year (Tables 4.5-55 and 4.5-56). The monthly estimates of *PE* for Units 5&6 ranged from 0.00068 to 0.03156 using actual flows and from 0.00790 to 0.10727 using design flows. The monthly estimates for Units 7&8 ranged from 0.00019 to 0.01181 using actual flows and from 0.00637 to 0.04705 using design flows. At

Units 5&6 the largest value for the actual flow estimates occurred during the February survey, while the largest estimate occurred during the July survey at Units 7&8. The largest proportion of the source population occurring during August ( $f_i = 0.218$  or 21.8%). The values in the table for Units 5&6 were used to calculate a  $P_M$  estimate of 0.0877 based on actual flows and an estimate of 0.3104 based on design flows (Table 4.5-55). The values in the table for Units 7&8 were used to calculate a  $P_M$  estimate of 0.0365 based on actual flows and an estimate of 0.1980 based on design flows (Table 4.5-56). The estimates for both intakes were based on the alongshore extrapolated estimate of the total source population. The period of larval exposure to entrainment was used to estimate that larvae could have been transported an average distance alongshore over the 12 surveys of 12.5 km (7.8 mi).

Table 4.5-55. *ETM* data for unidentified goby larvae at Units 5&6. *ETM* calculations based on actual and design (maximum) cooling water flows and a sampling volume in the nearshore of 735,176,994 m<sup>3</sup>.

Survey Date	<u>Actual Flows</u>		<u>Design Flows</u>		$f_i$
	<i>PE</i> Estimate	<i>PE</i> Std. Err.	<i>PE</i> Estimate	<i>PE</i> Std. Err.	
25-Jan-06	0.00416	0.00854	0.08346	0.08988	0.01293
23-Feb-06	0.03156	0.04105	0.10727	0.13897	0.01012
22-Mar-06	0.00428	0.00263	0.01232	0.00689	0.02217
19-Apr-06	0.00951	0.00794	0.02381	0.01940	0.04865
17-May-06	0.01000	0.00658	0.07529	0.03947	0.03971
14-Jun-06	0.00186	0.00379	0.00541	0.00865	0.07403
12-Jul-06	0.01433	0.02695	0.01681	0.03148	0.11139
9-Aug-06	0.00940	0.01711	0.03514	0.05169	0.21806
20-Sep-06	0.00296	0.00453	0.02185	0.02189	0.18434
18-Oct-06	0.00068	0.00062	0.01791	0.01562	0.10696
15-Nov-06	0.00481	0.00461	0.03904	0.02546	0.05412
13-Dec-06	0.00036	0.00070	0.00790	0.01033	0.11753
<b><math>P_M</math></b>	<b>0.08770</b>	0.07856	<b>0.31042</b>	0.21734	–

Table 4.5-56. *ETM* data for unidentified goby larvae at Units 7&8. *ETM* calculations based on actual and design (maximum) cooling water flows and a sampling volume in the nearshore of 735,176,994 m<sup>3</sup>.

Survey Date	Actual Flows		Design Flows		$f_i$
	PE Estimate	PE Std. Err.	PE Estimate	PE Std. Err.	
25-Jan-06	0.00028	0.00074	0.01381	0.01701	0.01293
23-Feb-06	0.00019	0.00084	0.01365	0.02465	0.01012
22-Mar-06	0.00320	0.00306	0.04705	0.02917	0.02217
19-Apr-06	0.00749	0.00658	0.01536	0.01349	0.04865
17-May-06	0.00529	0.00382	0.02493	0.01343	0.03971
14-Jun-06	0.00136	0.00130	0.00637	0.00560	0.07403
12-Jul-06	0.01181	0.02178	0.01393	0.02565	0.11139
9-Aug-06	0.00130	0.00184	0.01599	0.01917	0.21806
20-Sep-06	0.00048	0.00075	0.00985	0.00896	0.18434
18-Oct-06	0	0	0.01595	0.00803	0.10696
15-Nov-06	0.00050	0.00065	0.01917	0.01258	0.05412
13-Dec-06	0	0	0.00919	0.01394	0.11753
$P_M$	<b>0.0365</b>	0.0253	<b>0.1980</b>	0.1252	–

#### 4.5.3.12 Blind goby (*Typhlogobius californiensis*)

The blind goby (*Typhlogobius californiensis*) ranges from San Simeon Point, central California (Eschmeyer and Herald 1983) to Magdalena Bay, southern Baja California (Miller and Lea 1972). Gobies are small, demersal fishes that are found worldwide in shallow tropical to temperate marine environments. Many members of the family are euryhaline and are able to tolerate very low salinities and even freshwater. The family Gobiidae contains approximately 1,875 species in 212 genera (Nelson 1994, Moser 1996). Twenty-one goby species from 16 genera occur from the northern California border to south of Baja California (Moser 1996). In addition to the blind goby there are at least eight other common species in southern California: arrow goby (*Clevelandia ios*), shadow goby (*Quietula y-cauda*), cheekspot goby (*Ilypnus gilberti*), blackeye goby (*Rhinogobiops nicholsii*), yellowfin goby (*Acanthogobius flavimanus*), longjaw mudsucker (*Gillichthys mirabilis*), bay goby (*Lepidogobius lepidus*), and bluebanded goby (*Lythrypnus dalli*).



##### 4.5.3.12.1 Life History and Ecology

Blind gobies live mainly in intertidal areas along the coast of southern and central California. As adults, they are found exclusively in rocky areas within burrows that are dug out by the tidepool ghost shrimp



(*Neotrypaea biffari* [formerly *Callinassa affinis*]). The blind goby has an obligate commensal relationship with the tidepool ghost shrimp in that adult blind gobies are always found in the ghost shrimp burrows, but the shrimp may be found without the gobies (McCosker 2006).

The spawning season for blind gobies typically extends from May through July, with peak spawning occurring in June (MacGinitie 1939). Multiple spawnings of 6–8 times per year have been reported for this particular species. Blind gobies form monogamous pairs for life with only one pair occupying a single burrow. They become sexually mature within a year of hatching and fecundity estimates range between 2,500-15,000 eggs per batch depending on the size of fish. Blind gobies are about 3.25 mm in length at hatching. Although very little is known of the early life history for this species, the eyes of newly hatched individuals are normal until the fish reaches the transformation stage. When they settle to a benthic habitat and enter a ghost shrimp burrow, the retina withdraws and tissue slowly grows over their eyes rendering them non-functional for their adult life (Ritter 1893).

#### 4.5.3.12.2 Population Trends and Fishery

In King Harbor, mean blind goby larvae concentrations have varied between 0.6 and 44.0 larvae per 1,000 m<sup>3</sup> since 1974 (Figure 4.5-83). Concentrations peaked in 1986, and then declined to near zero three years later. Since then, larval concentrations increased reaching another peak in 2001, followed by another decline.

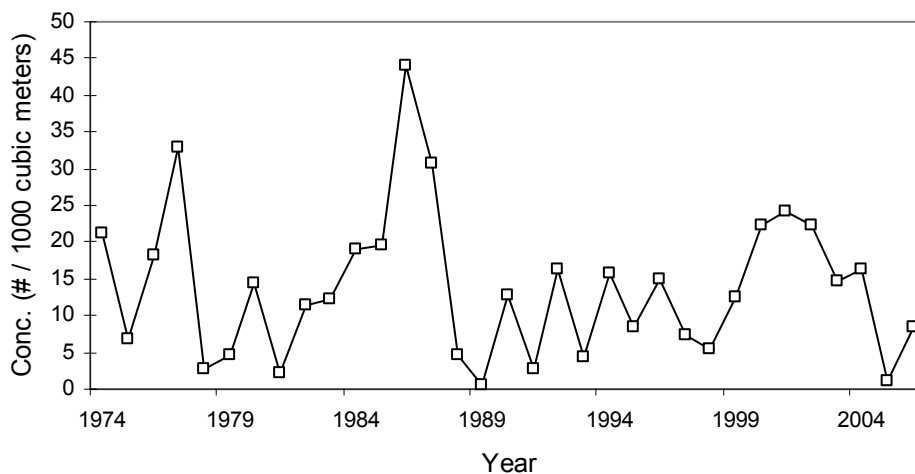

Figure 4.5-83. Mean concentration (# / 1,000 m<sup>3</sup> [264,172 gal]) of blind goby larvae collected from King Harbor, 1974-2006. Source: Vantuna Research Group.

#### 4.5.3.12.3 Sampling Results

Blind goby larvae were the eighth and ninth most abundant taxon at the Units 5&6 (H2) and Units 7&8 (E4) entrainment stations with mean concentrations over all surveys of 17 and 15 per 1,000 m<sup>3</sup>, respectively (Tables 4.5-1 and 4.5-2). They were present in entrainment samples from January to August 2006 and again in December 2006, with increased abundance in April through June (Figures 4.5-84 and 4.5-85). The highest average abundances occurred at the Units 7&8 intake station in June 2006 with over 150 larvae per 1,000 m<sup>3</sup>. Blind gobies were present at the source water stations from March through August with a peak average concentration in May 2006 at 17 larvae per 1,000 m<sup>3</sup> (Figure 4.5-86). Larvae were more common in nighttime samples than in daytime samples (Figure 4.5-87). The length-frequency distribution for blind goby larvae showed a normal distribution with most larvae in the 2.50 and 2.75 mm (0.10 and 0.11 in) size classes (Figure 4.5-88). The mean length of measured specimens from the entrainment station samples was 2.7 mm (0.11 in) NL with a size range from 2.2 mm (0.09 in) to 3.2 mm (0.13 in) NL.

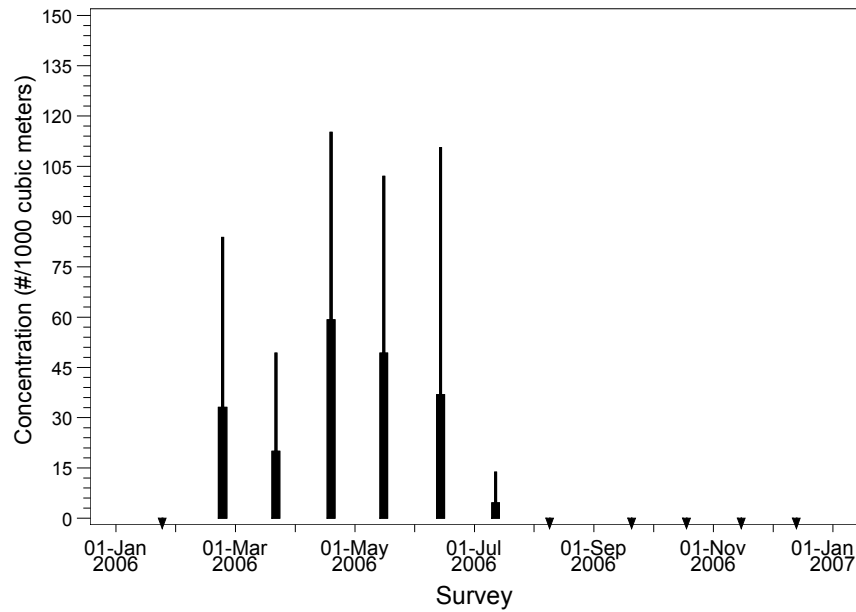

Figure 4.5-84. Mean concentration (# / 1,000 m<sup>3</sup> [264,172 gal]) and standard deviation of blind goby larvae collected at RBGS entrainment Station H2 from January through December 2006.

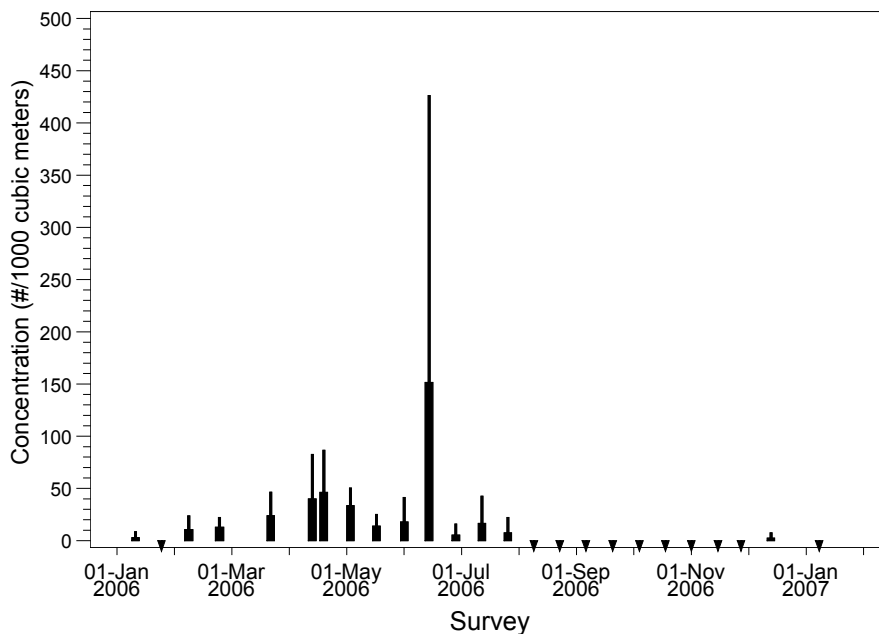

Figure 4.5-85. Mean concentration (# / 1,000 m<sup>3</sup> [264,172 gal]) and standard deviation of blind goby larvae collected at RBGS entrainment Station E4 from January 2006 through January 2007.

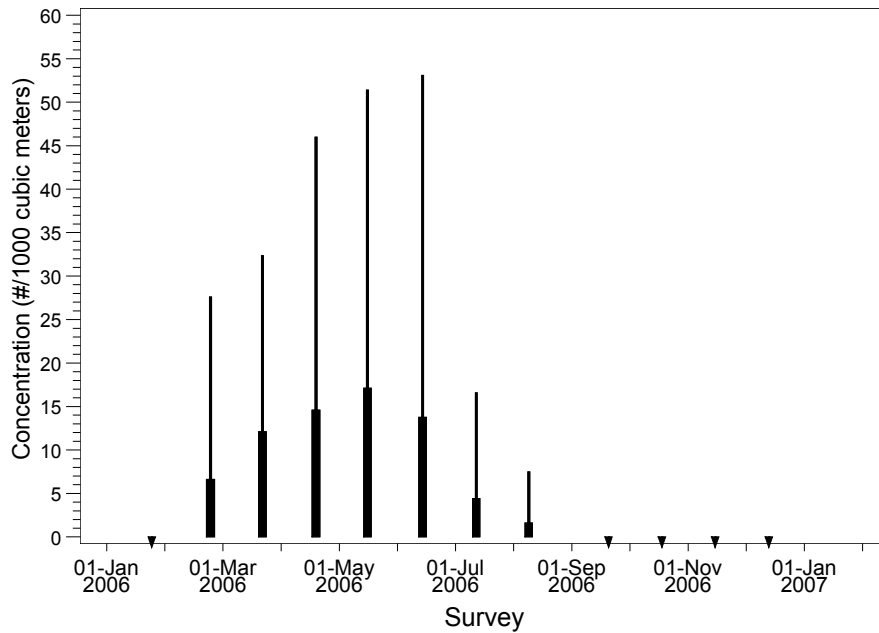

Figure 4.5-86. Mean concentration (# / 1,000 m<sup>3</sup> [264,172 gal]) and standard deviation of blind goby larvae collected at RBGS source water stations during 2006.

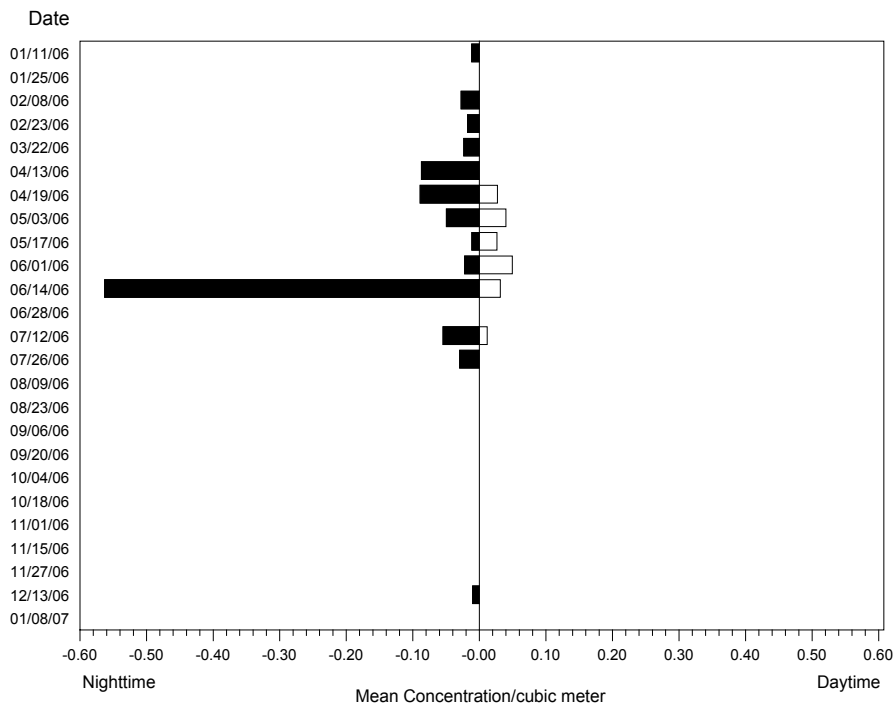

Figure 4.5-87. Mean concentration (#/1.0 m<sup>3</sup> [264 gal]) of blind goby larvae at entrainment Station E4 during night (Cycle 3) and day (Cycle 1) sampling.

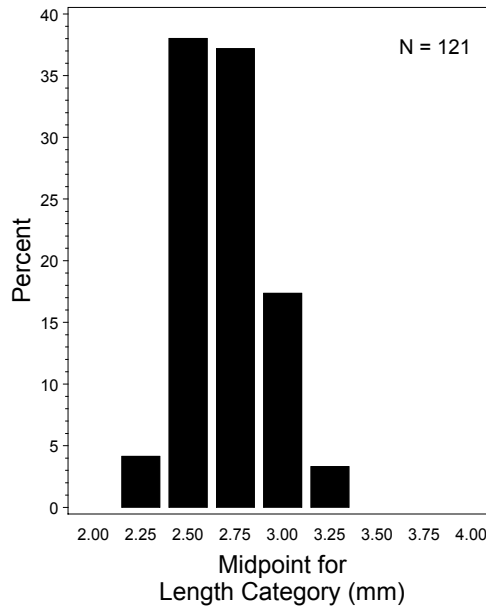

Figure 4.5-88. Length (mm) frequency distribution for blind goby larvae collected at entrainment stations in Santa Monica Bay during 2006.

#### 4.5.3.12.4 Modeling Results

The following section presents the results for the empirical transport modeling of CWIS entrainment effects on blind goby populations. No age-specific estimates of survival for larval and later stages of development were available from the literature; therefore no estimates of *FH* or *AEL* were calculated. Total annual entrainment of blind goby larvae during 2006 at RBGS Units 5&6 was estimated to be 1,447,499 using actual cooling water flows and 4,633,499 if the CWIS pumps were run at design (maximum) capacity (Table 4.5-3). At Units 7&8 larval entrainment during 2006 was estimated to be 4,237,710 using actual cooling water flows and increased to 13,810,333 larvae if the CWIS pumps were run at design (maximum) capacity (Table 4.5-4).

#### *Empirical Transport Model (ETM)*

The blind goby has similar life history parameters and is found in similar habitat as gobies of the CIQ goby complex, thus the growth rate used for the CIQ complex larvae was also used for the blind goby. The larval development of the blind goby is also consistent with that of the CIQ complex. The hatching length range of gobies in the CIQ complex is 2–3 mm (0.08–0.12 in) and blind gobies hatch at 3–3.3 mm (0.12–0.13 in). The sizes at flexion and transformation are also similar for the two groups (Moser 1996). The data were used to estimate a larval growth rate of 0.159 mm/day (0.006 in/d). This was used with the difference in the lengths of the 95<sup>th</sup> percentiles of the measurements to estimate that the larvae were exposed to entrainment for a period of approximately 3.7 days.

Blind goby larvae were mainly present in the entrainment samples from February through July at both entrainment stations, and the source water samples from February through August (Tables Table 4.5-57 and 4.5-58). The monthly estimates of  $PE$  at Units 5&6 ranged from 0 to 0.01729 using actual flows and from 0 to 0.06424 using design flows (Table 4.5-57). The largest estimate was calculated for the April survey, but the largest proportion of the source population was present during June 2006 ( $f_i = 0.40.5$  or 40.5%). At Units 7&8, the monthly estimates ranged from 0 to 0.06093 using actual flows and from 0 to 0.12109 using design flows (Table 4.5-35). The values in the table for Units 5&6 were used to calculate  $P_M$  estimates of 0.0205 based on actual flows and an estimate of 0.0664 based on design flows. At Units 7&8 the  $P_M$  estimates were 0.0776 based on actual flows and 0.2617 based on design flows. The period of larval exposure coupled with average current velocities indicates that larvae from alongshore distances of 2.6 km (1.6 mi) may be subject to entrainment.

Table 4.5-57. *ETM* data for blind goby larvae at Units 5&6. *ETM* calculations based on actual and design (maximum) cooling water flows and a sampling volume in the nearshore of 396,693,881 m<sup>3</sup>.

Survey Date	Actual Flows		Design Flows		$f_i$
	$PE$ Estimate	$PE$ Std. Err.	$PE$ Estimate	$PE$ Std. Err.	
25-Jan-06	0	0	0	0	0
23-Feb-06	0.01729	0.00774	0.05877	0.02103	0.06680
22-Mar-06	0.00284	0.00192	0.00817	0.00443	0.16930
19-Apr-06	0.01014	0.00534	0.02540	0.01274	0.12841
17-May-06	0.00853	0.00286	0.06424	0.01664	0.08837
14-Jun-06	0.00324	0.00235	0.00944	0.00596	0.40511
12-Jul-06	0.00542	0.00217	0.00636	0.00252	0.09686
9-Aug-06	0	0	0	0	0.03596
20-Sep-06	0	0	0	0	0
18-Oct-06	0	0	0	0	0
15-Nov-06	0	0	0	0	0
13-Dec-06	0	0	0	0	0.00919
<b><math>P_M</math></b>	<b>0.02049</b>	0.02799	<b>0.06641</b>	0.07873	–

Table 4.5-58. *ETM* data for blind goby larvae at Units 7&8. *ETM* calculations based on actual and design (maximum) cooling water flows and a sampling volume in the nearshore of 396,693,881 m<sup>3</sup>.

Survey Date	Actual Flows		Design Flows		$f_i$
	PE Estimate	PE Std. Err.	PE Estimate	PE Std. Err.	
25-Jan-06	0	0	0	0	0
23-Feb-06	0.00097	0.00047	0.07130	0.01974	0.06680
22-Mar-06	0.00207	0.00142	0.03046	0.01350	0.16930
19-Apr-06	0.03026	0.01462	0.06204	0.02997	0.12841
17-May-06	0.01202	0.00350	0.05668	0.01294	0.08837
14-Jun-06	0.02583	0.01841	0.12109	0.07388	0.40511
12-Jul-06	0.06093	0.02137	0.07189	0.02512	0.09686
9-Aug-06	0	0	0	0	0.03596
20-Sep-06	0	0	0	0	0
18-Oct-06	0	0	0	0	0
15-Nov-06	0	0	0	0	0
13-Dec-06	0	0	0.10765	0.07212	0.00919
$P_M$	<b>0.0776</b>	0.1034	<b>0.2617</b>	0.2889	–

**4.5.3.13 California halibut (*Paralichthys californicus*)**

California halibut (*Paralichthys californicus*) is an important part of California’s commercial and recreational fisheries (Kramer et al. 2001; Starr et al. 1998). It ranges from northern Washington to southern Baja California and is found from very shallow nearshore waters in bay nursery grounds to depths of at least 281 m (922 ft) (Love et al. 2005; Haaker 1975).



4.5.3.13.1 Life History and Ecology

Juveniles and adults typically occur on sandy sediments at depths less than 30 m (98 ft) but sometimes concentrate near rocks, algae, or Pacific sand dollar (*Dendraster excentricus*) beds (Feder et al. 1974). As with other flatfishes, they frequently lie buried or partially buried in the sediment. Newly settled and juvenile halibut often occur in unvegetated shallow embayments and occasionally on the outer coast, suggesting that bays are an important nursery habitat for this species (Kramer et al. 2001).

California halibut is a broadcast spawner with eggs being fertilized externally. The spawning season is generally thought to extend from February to August with most spawning occurring in May (Frey 1971) although some fall spawning may also occur. The average number of eggs per spawn is 313,000–589,000

with an average reproductive output of approximately 5.5 million eggs per spawning season (Caddell et al. 1990). During spawning season females may release eggs every 7 days and the largest individuals may produce in excess of 50 million eggs per year (Caddell et al. 1990). Captive specimens were observed to spawn at least 13 times per season. Halibut eggs are 0.7–0.8 mm (0.03 in) in diameter (Ahlstrom et al. 1984) and are most abundant in the water column in less than 75 m (246 ft) depths and within 6.5 km (4 mi) from shore (Kramer et al. 2001).

Upon hatching, the larvae (1.6–2.1 mm [0.06–0.08 in] NL [Moser 1996]) are pelagic (Frey 1971), and most abundant between Santa Barbara, California, and Punta Eugenia, Baja California Sur (Ahlstrom and Moser 1975) from January through April and June through August (Moser 1996). California halibut have a pelagic larval stage of 20–29 days (Gadomski et al. 1990). Larval transformation occurs at a length of ca. 7.5–9.4 mm [0.29–0.37 in] SL (Moser 1996) at which time the young fish settle to the bottom, generally in bays but also occasionally in shallow substrates along the open coast (Haugen 1990). Kramer (1991) found that 6–10 mm (0.24–0.39 in) California halibut larvae grew <0.3 mm/day (<0.01 in/d), while larger 70–120 mm (2.76–4.72 in) halibut grew about 1.0 mm/day (0.04 in/d). In a laboratory study, California halibut held at 16°C grew to a length of 11.1 mm ± 2.61 (SD) in 2 mo from an initial hatch length of 1.9 mm (Gadomski et al. 1990). After settling in the bays, the juveniles may remain there for about 2 years until they emigrate to the outer coast. There is a large discrepancy in size and age of maturity between males and females (Love and Brooks 1990). Males mature at sizes ranging between 19 cm (7.4 in) to 32 cm (12.6 in) with 50% maturity at 22.5 cm (8.8 in), while females matured between 36–59 cm (14.2–23.2 in) with 50% maturity occurring at 47 cm (18.5 in). Most males are mature by the first year and all are mature at 3 years, whereas a few females spawn during their second year, half at about 4.5 years, and all are mature by age 7. Males emigrate out of the bays when they mature (i.e. at 20 cm [7.9 in]) but females migrate out as subadults at a length of about 25 cm (9.8 in) (Haugen 1990). Subadults remain nearshore at depths of 6–20 m (20–66 ft) (Clark 1930; Haaker 1975). California halibut may reach 152 cm (59.8 in) and 33 kg (72.7 lb) (Eschmeyer and Herald 1983). Individuals may live as long as 30 years (Frey 1971).

California halibut feed during both day and night, but show a preference for daytime feeding (Haaker 1975). This species is an ambush feeder, typically lying partially buried in the sand until prey approaches. They prey on Pacific sardine, anchovies, squid, and other nektonic nearshore fish species (Kramer et al. 2001). Small halibut in bays eat small crustaceans and become increasingly piscivorous with size. Other similar species of flatfishes such as sand sole and bigmouth sole may compete with California halibut within their range (Haugen 1990). Because of an extensive overlap in diet, habitat, geographic and bathymetric distributions, and probable foraging behavior, the California lizardfish may be the most important potential competitor of medium-sized California halibut (Allen, M. 1982).

#### 4.5.3.13.2 Population Trends and Fishery

The California halibut is an important species to both commercial and recreational fisheries in southern and central California. Halibut are harvested commercially through the use of otter trawls, set gill and trammel nets, and hook and line (Kramer et al. 2001). Trawl or drag nets were first used in the San



Francisco area dating back to 1876. Two vessels towed the original trawl nets, known as paranzella. This method remained fairly standard for the trawl fishery for nearly 50 years until the late 1930s and early 1940s when the otter trawl replaced paranzellas and reduced the need for a second boat (Clark 1935, Scofield 1948). Entangling nets such as trammel nets have been used to catch halibut since the 1880s (Ueber 1988). Historically, most halibut were primarily taken by trammel nets or trawl, although more recently the use of set gill nets in southern California have replaced trawling as the dominant gear type used (Barsky 1990).

Barsky (1990) described the many shifts that have occurred in the geographic center of the commercial California halibut fishery. Most shifts occurred due to shifting abundances in different localities and also because of regulation changes, although environmental influences may have played a role as well. During the earliest years the fishery was centered off the southern California bight and Baja California. Trammel nets were the preferred method for fleets in these areas since the use of trawl nets was prohibited in Los Angeles and San Diego counties beginning in the early 1900s. Gradually the fishery shifted northwards to Ventura and Santa Barbara counties during the 1970s. Prior to 1969 the trawl fishery caught most halibut in these counties, but tighter regulations on the trawl fishery in the early 1970s along with the ease, efficiency, and cost effectiveness of entangling nets paved the way for this method. Exceptions have occurred during El Nino years such as 1983 when halibut landings were greatest in the San Francisco area.

A number of regulation changes have been implemented throughout the history of this fishery in order to assist with restoration efforts for this species. Trawl fishing has been prohibited in state waters (0–3 nautical miles from shore) since 1915, with a few seasonal and area closures since then. Today trawling is permitted in federal waters (3–200 nautical miles from shore) with a minimum mesh size of 4.5 in and is prohibited in state waters with the exception of designated “California halibut trawl grounds” between Point Arguello and Point Mugu with certain mesh size requirements and seasonal closures to protect spawning adults. Similarly, trammel nets were originally prohibited in state waters in 1911, but since then have been subject to various area, depth, mesh size requirements, and seasonal closures throughout the state. A sharp decline in recreational landings during the 1960s lead to regulation changes in 1971 that set a minimum size limit of 56 cm (22 in) for sport caught halibut. A 13-fold decrease in recreational landings from 1948 to 1958 was attributed to the expanding CPFV fleet and no size restrictions, and it appears that a ban on gillnetting in 1994 or any other regulations have had little effect on halibut as recreational catches have remained consistently low since the 1960s (Dotson and Charter 2003). Commercial fishing laws prohibit sale of California halibut less than 56 cm (22 in) total length and the same 56 cm (22 in) size limit also applies to fish caught recreationally.

California halibut have a high commercial and recreational fishery value. The fishery for this species was reviewed in Kramer et al. (2001) and since 1980 the commercial catch has remained relatively constant averaging approximately 0.54 million kg (1.0 million lbs) per year statewide. In southern California the commercial landings for halibut averaged 165,697 kg (365,330 lbs) between 2000 and 2006 landed for an average annual revenue of \$1,370,368 (PacFIN 2007) (Table 4.5-59). In Los Angeles County, in particular, commercial catches have varied from a high of 86393 kg (190,464 lbs) in 2000 to a low of

24,948 kg (55,800 lbs) in 2006. Recreational catch of halibut in the southern California region has varied annually from an estimated 104,000 fish in 2002 to 25,000 in 2004.

Table 4.5-59. Annual landings for California halibut in the Southern California region based on RecFIN and PacFIN data from 2000–2006.

Year	<u>Southern California (All Counties Combined)</u>				<u>Los Angeles County</u>		
	Estimated Recreational Catch	Commercial Landings (lbs)	Commercial Landings (kg)	Value	Commercial Landings (lbs)	Commercial Landings (kg)	Value
2000	103,000	461,216	209,204	\$1,447,476	190,464	86,393	\$632,251
2001	85,000	505,417	229,253	\$1,662,777	124,679	56,553	\$433,402
2002	104,000	483,400	219,267	\$1,695,468	145,065	65,800	\$538,929
2003	87,000	332,273	150,716	\$1,237,440	92,366	41,897	\$383,049
2004	25,000	340,600	154,494	\$1,459,720	112,383	50,976	\$487,091
2005	31,000	214,989	97,517	\$977,340	62,080	28,159	\$296,200
2006	27,000	219,413	99,524	\$1,112,354	55,800	25,310	\$270,768
<b>Average</b>	66,000	365,330	165,711	\$1,370,368	111,834	50,727	\$434,527

A total of 30 inner shelf and 16 bay and harbor stations were sampled during 2003 within the southern California Bight by the Southern California Coastal Water Research Project (SCCWRP) (Allen et al. 2007). Species abundance was 5.9 fish/ station for California halibut at bay and harbor stations during 5-10 minute trawls. This species was not as abundant at inner shelf stations as the abundance was 1.3 fish/station.

This study, along with previous studies conducted in 1993 and 1998 by the SCCWRP, shows that halibut were a dominant component of the biomass in surveys executed in 1993, 1998, and 2003. Since it is an inner shelf species, California halibut are exposed to numerous other impacts that might affect the population. From 1981-2006, commercial catch of California halibut fluctuated between 142,292 kg (315,090 lbs) in 1985 and a low of 14,511 kg (31,991 lbs) in 1994 (Figure 4.5-89) with the catch declining significantly between these years. Neither this decline nor the overall declining trend of commercial catch was correlated with oceanographic variables (SST, PDO, or ENSO). The decline between 1985 and 1994 may best be explained by fishery practices during this period. The white seabass fishery crashed by 1981 (Allen et al. in press) resulting in increased landings of halibut, leopard shark and soupfin shark in the nearshore gill net fishery in southern California as fishers targeted the remaining stocks. This preempted a decline in all of these stocks until the gill net fishery was moved out of state waters in 1994 (Pondella and Allen, in review). Following the 1994 management action, these nearshore stocks rebounded, yet catch of halibut declined again from 1999–2006. The recreational catch has fluctuated over time but the range in recent years is not very different from levels in the early 1980s (Figure 4.5-89).

Commercial and recreational catch data are sometimes difficult to interpret without the backdrop of the effort and other socioeconomic information. From 1995-2006, sampling was performed quarterly using

gill nets at several locations in the SCB (Pondella unpubl. data). The mean catch in Santa Monica Bay for California halibut over the period was 1.28 fish/station and the mean catch in the remainder of the bight was 2.23 fish/station (Figure 4.5-90). This difference was statistically significant. Mean catch in Santa Monica Bay was correlated with mean catch in the remainder of the bight. Although this may indicate that the stock in Santa Monica Bay was under the same constraints as the remainder of the bight from 1995-2006, the increase in mean catch in Santa Monica Bay in 2006 resulted in the highest values recorded during the study. The data show an almost inverse relationship with the trends in recreational and commercial catch over the same period, most noticeably with the increase in catch from 2003 through 2004 that compares with declines in fishery catches.

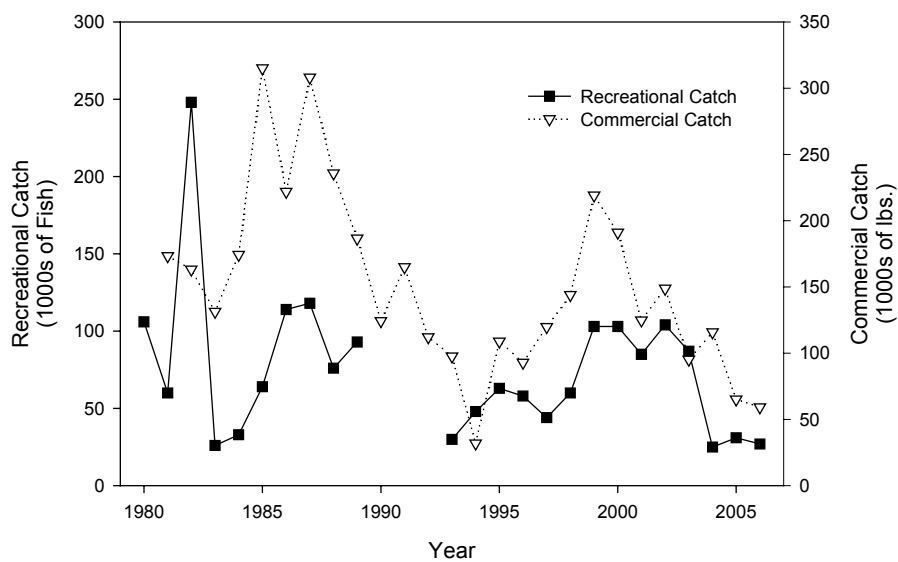

Figure 4.5-89. Recreational (1,000s of fish) and commercial (1,000s of lbs) of California halibut (*Paralichthys californicus*) from 1980–2006 (sources: PacFIN and RecFIN databases).

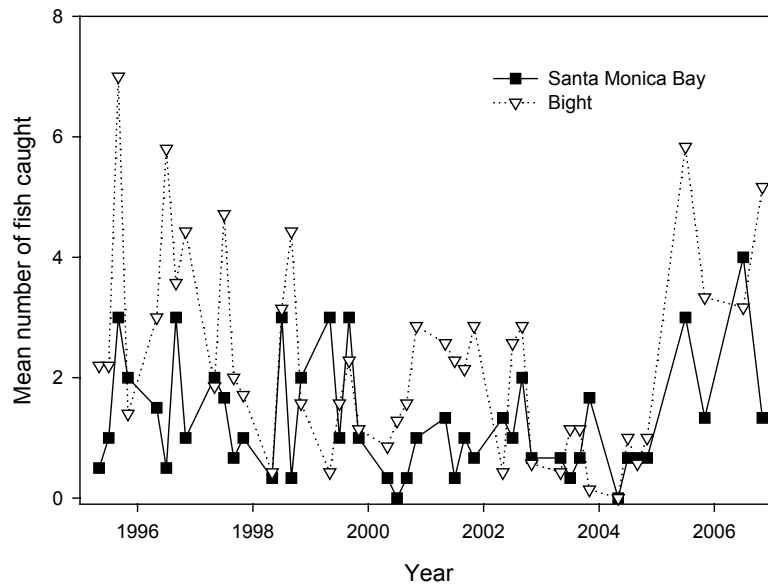

Figure 4.5-90. Mean catch (#fish/station) of California halibut in Santa Monica Bay and the remainder of the Southern California Bight from 1995–2006. Data are from the Ocean Resource Enhancement Hatchery Program (OREHP) gill net monitoring program.

In King Harbor, larval California halibut concentrations have fluctuated substantially since 1974, with highest concentration of 38 larvae per 1,000 m<sup>3</sup> in 1986 and 1987 (Figure 4.5-91). There were large annual spikes in larval concentrations approximately every other year following 1987 until 1995 when concentrations fell below 5 larvae per 1,000 m<sup>3</sup> and have remained at pre-1980 levels ever since.

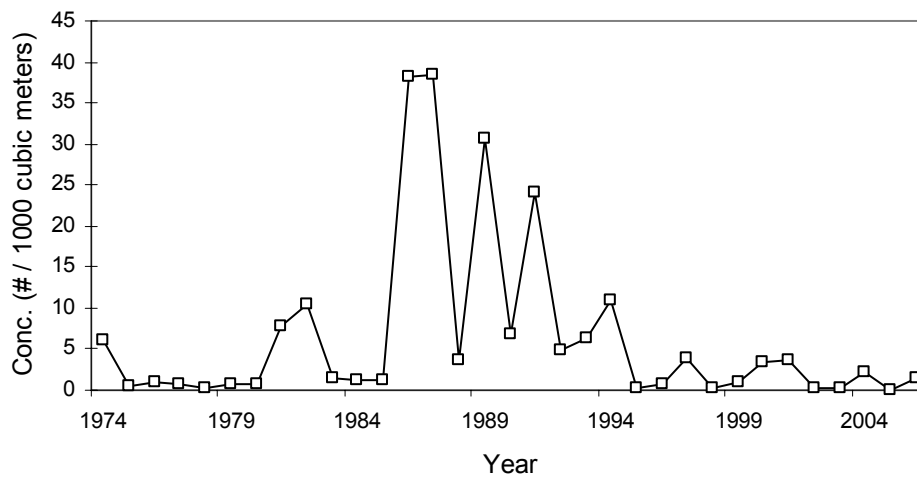

Figure 4.5-91. Mean concentration (# / 1,000 m<sup>3</sup> [264,172 gal]) of California halibut larvae collected from King Harbor, 1974-2006. Source: Vantuna Research Group.

#### 4.5.3.13.3 Sampling Results

Halibut larvae was the eleventh most abundant taxon at the Units 5&6 entrainment station and the fifteenth most abundant taxon at the Units 7&8 entrainment station with mean concentrations over all surveys of 4 and 6 per 1,000 m<sup>3</sup>, respectively (Tables 4.5-1 and 4.5-2). They were collected at the entrainment stations sporadically throughout the year, but much less frequently at the Units 5&6 station, with a slight increase in abundances in the spring and a more pronounced increase in the fall (Figures 4.5-92 and 4.5-93). The highest abundances were measured at the Units 7&8 entrainment station in September 2006 at about 70 larvae per 1,000 m<sup>3</sup>. Halibut larvae were present in all surveys at the source water stations with the highest average abundance occurring in November at approximately 32 larvae per 1,000 m<sup>3</sup> (Figure 4.5-94). No significant trend was observed between daytime and nighttime samples (Figure 4.5-95). The length-frequency distribution for measured halibut larvae showed that the majority of the sampled larvae were recently hatched based on the reported hatch size of ca. 1.8 mm (0.07 in) (Figure 4.5-96; Moser 1996). The mean length of measured specimens from the entrainment station samples was 2.1 mm (0.08 in) NL with a size range from 1.1 mm (0.04 in) to 7.8 mm (0.31 in) NL.

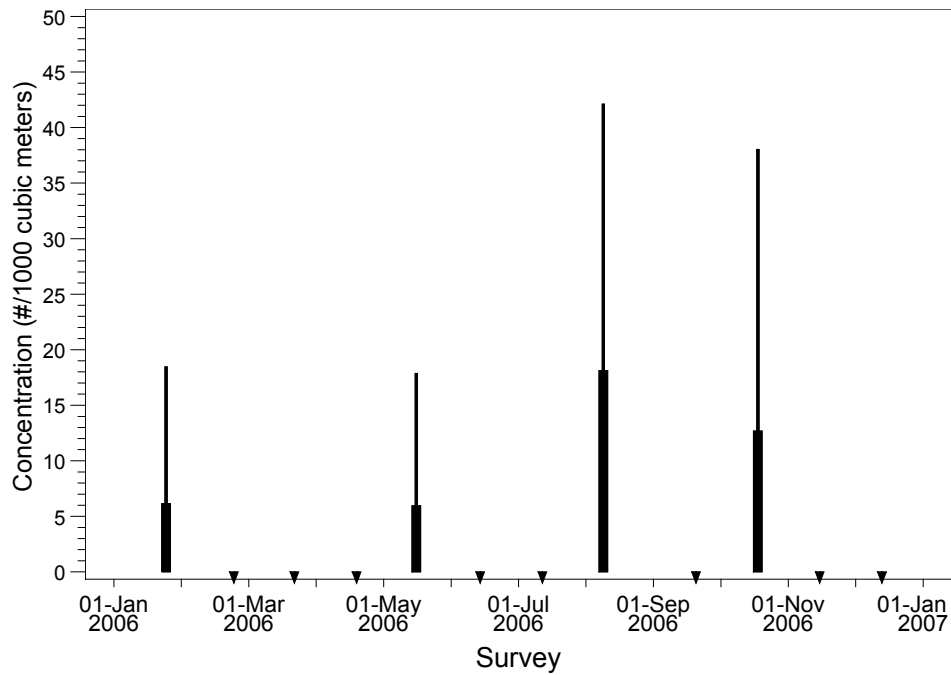

Figure 4.5-92. Mean concentration (# / 1,000 m<sup>3</sup> [264,172 gal]) and standard deviation of California halibut larvae collected at RBGS entrainment Station H2 from January through December 2006.

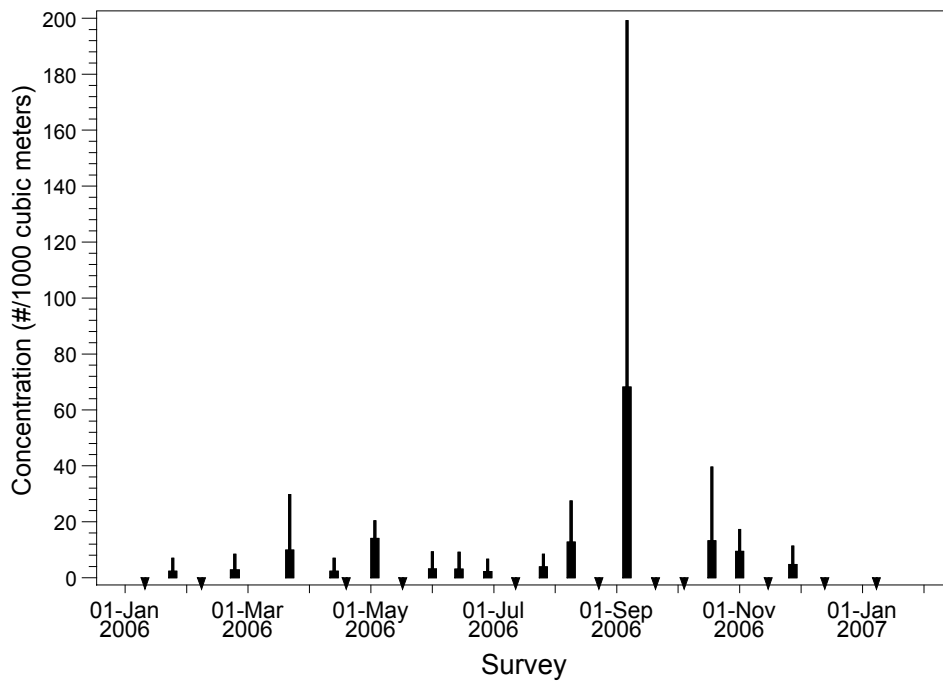

Figure 4.5-93. Mean concentration (# / 1,000 m<sup>3</sup> [264,172 gal]) and standard deviation of California halibut larvae collected at RBGS entrainment Station E4 from January 2006 through January 2007.

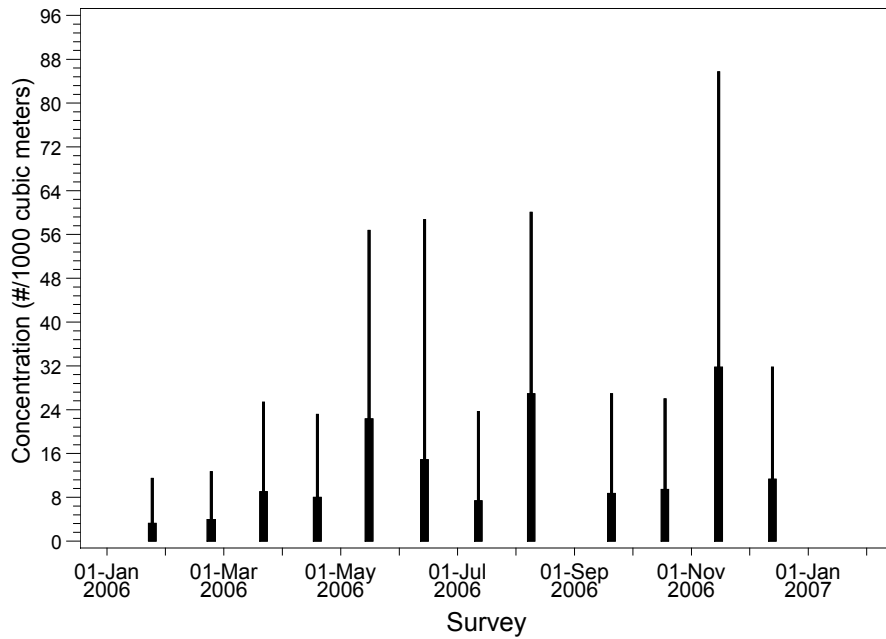

Figure 4.5-94. Mean concentration (# / 1,000 m<sup>3</sup> [264,172 gal]) and standard deviation of California halibut larvae collected at RBGS source water stations during 2006.

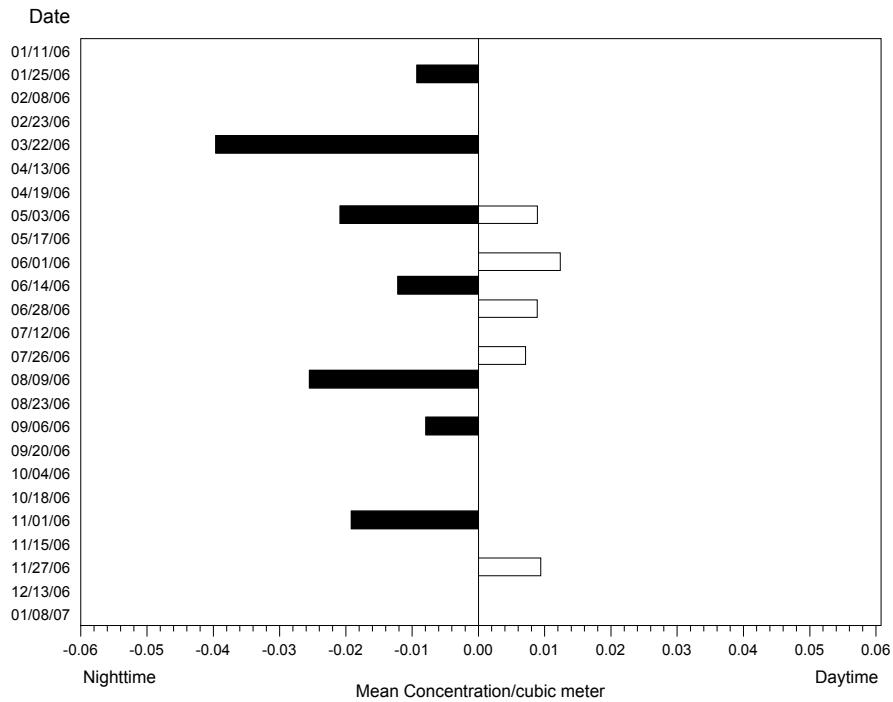

Figure 4.5-95. Mean concentration (#/1.0 m<sup>3</sup> [264 gal]) of California halibut larvae at entrainment Station E4 during night (Cycle 3) and day (Cycle 1) sampling.

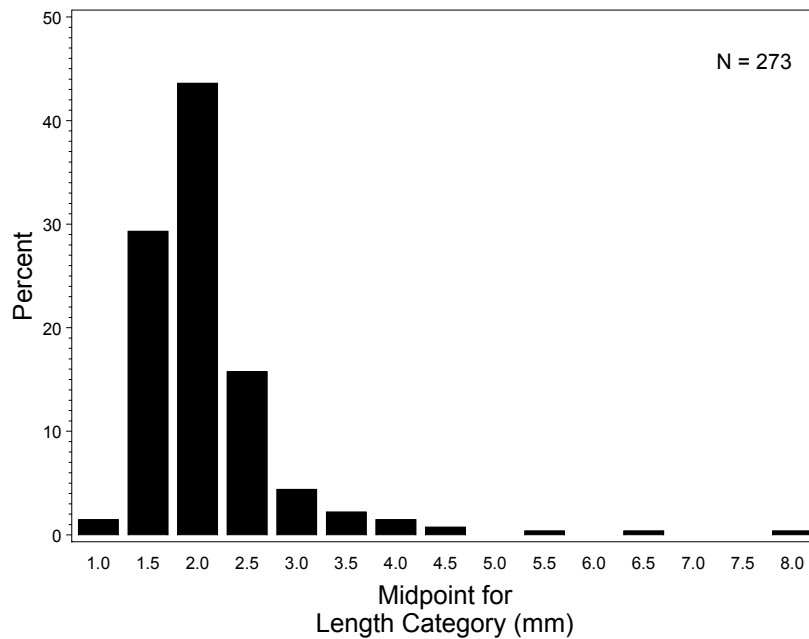

Figure 4.5-96. Length (mm) frequency distribution for larval California halibut collected at entrainment stations in Santa Monica Bay during 2006.

#### 4.5.3.13.4 Modeling Results

The following section presents the results for demographic and empirical transport modeling of CWIS effects on California halibut larvae at Units 5&6 and eggs and larvae at Units 7&8. There was information on California halibut life history that allowed for calculation of an *FH* estimate, but not enough information on late larval and juvenile survival necessary for calculating an estimate of *AEL*. Total annual entrainment of California halibut larvae at RBGS Units 5&6 during 2006 was estimated at 175,487 and 1,096,896 using actual and design capacity (maximum) cooling water flows, respectively (Table 4.5-3). At Units 7&8, total annual entrainment during 2006 of California halibut eggs and larvae at RBGS was estimated at 89,660 and 875,880 using actual cooling water flows (Table 4.5-4). If the Units 7&8 CWIS pumps were run at their design capacity (maximum), annual entrainment estimates increased to 8,374,606 eggs and 5,723,042 larvae (Table 4.5-4). The total duration used in the *ETM* calculations included both the estimated egg duration from the literature and the estimated larval duration to provide an integrated estimate of entrainment effects.

#### *Fecundity Hindcasting (FH)*

The annual entrainment estimates for California halibut larvae at Units 5&6, and eggs and larvae at Units 7&8, were used to estimate the number of females at the age of maturity needed to produce the numbers of eggs and larvae over their lifetimes. An estimate of total egg survival of 0.5 was calculated from laboratory studies by Caddell et al. (1990) for an estimated planktonic duration of 2.19 d (Gadomski et al. 1990, Emmett et al. 1991, and Gadomski and Caddell 1996). Daily larval survival for early stage larvae



up to age 43.3 d was estimated at 0.95 from data in Kramer (1991). The mean length (2.1 mm [0.08 in]) and estimated hatch length of 1.6 mm (0.06 in) were used with a growth rate of 0.19 mm/d (0.01 in/d) calculated from data in (Gadomski and Peterson 1988) to estimate that the larvae were exposed to entrainment for an average period of 2.7 days. The survival to the average age at entrainment was then calculated as  $0.95^{2.7} = 0.89$ . Total lifetime fecundity was estimated at 1,973,371 eggs using data in MacNair et al. (2001). This life history information was used to estimate that the numbers of entrained larvae at Units 5&6 were equivalent to the loss of less than one reproductive age female California halibut using the actual cooling water flows and the loss of one female halibut using the design flows (Table 4.5-60). At Units 7&8, the numbers of entrained eggs and larvae were equivalent to the loss of one reproductive age female California halibut using the actual cooling water flows and the loss of 13 female halibut using the design flows (Table 4.5-61). The results of the sensitivity analysis show that the greatest uncertainty associated with the estimates is the life history parameters and not the entrainment estimates.

Table 4.5-60 Results of *FH* modeling for California halibut larvae based on Units 5&6 entrainment estimates calculated using actual and design (maximum) CWIS flows.

<b>Parameter</b>	<b>Estimate</b>	<b>Std. Error</b>	<b><i>FH</i> Lower Estimate</b>	<b><i>FH</i> Upper Estimate</b>	<b><i>FH</i> Range</b>
<b><u>Actual Flows</u></b>					
<i>FH</i> Estimate	< 1	< 1	< 1	1	1
Total Entrainment	175,487	23,609	< 1	< 1	< 1
<b><u>Design Flows</u></b>					
<i>FH</i> Estimate	1	1	< 1	5	5
Total Entrainment	1,096,896	88,336	1	1	< 1

The upper and lower estimates are based on a 90% confidence interval of the mean. *FH* estimates were also calculated using the upper and lower confidence estimates from the entrainment estimates.

Table 4.5-61 Results of *FH* modeling for California halibut eggs and larvae based on entrainment estimates at Units 7&8 calculated using actual and design (maximum) CWIS flows.

<b>Parameter</b>	<b>Estimate</b>	<b>Std. Error</b>	<b><i>FH</i> Lower Estimate</b>	<b><i>FH</i> Upper Estimate</b>	<b><i>FH</i> Range</b>
<b><u>Actual Flows</u></b>					
<i>Eggs</i>					
<i>FH</i> Estimate	< 1	0	0	0	0
Total Entrainment	89,660	33,174	0	0	0
<i>Larvae</i>					
<i>FH</i> Estimate	1	1	0	4	4
Total Entrainment	875,880	137,016	1	1	1
<b><u>Design Flows</u></b>					
<i>Eggs</i>					
<i>FH</i> Estimate	6	4	2	19	17
Total Entrainment	8,374,606	836,775	5	7	2
<i>Larvae</i>					
<i>FH</i> Estimate	7	6	2	28	26
Total Entrainment	5,723,042	661,340	5	8	2

The upper and lower estimates are based on a 90% confidence interval of the mean. *FH* estimates were also calculated using the upper and lower confidence estimates from the entrainment estimates.

*Empirical Transport Model (ETM)*

The same growth rate used in the *FH* modeling, 0.19 mm/d (0.01 in/d), was used with the estimated length at hatching (1.6 mm [0.06 in]) and length of the 95<sup>th</sup> percentile length (3.5 mm [0.14 in]) of a random sample of 200 of the measured larvae to estimate that the larvae were exposed to entrainment for a maximum period of 10.0 days. The total period of exposure is increased to 12.1 d when the duration of the egg stage is added to the estimate.

At both Units 5&6 and Units 7&8 halibut larvae were only collected during a few of the paired entrainment/source water surveys relative to the source water stations where they were present during all of the surveys. The largest proportion of the source water population was present during the November survey ( $f_i = 0.188$  or 18.8%). The monthly estimates of *PE* for California halibut at Units 5&6 ranged from 0 to 0.00046 using actual flows and from 0 to 0.00672 using design flows (Table 4.5-62). The values in the table were used to calculate a  $P_M$  estimate of 0.0008 based on actual flows and an estimate of 0.0043 based on design flows using the extrapolated alongshore estimate of the total source population. At Units 7&8, the monthly estimates of *PE* ranged from 0 to 0.00019 using actual flows and from 0 to 0.01349 using design flows (Table 4.5-63). The values for Units 7&8 were used to calculate a  $P_M$  estimate of 0.0009 based on actual flows and 0.0138 based on design flows using the extrapolated alongshore estimate of the total source population. The period of larval exposure to entrainment allows larvae to be transported an estimated average distance alongshore of 9.5 km (6.0 mi).

Table 4.5-62. *ETM* data for California halibut larvae at Units 5&6. *ETM* calculations based on actual and design cooling water flows and a sampling volume in the nearshore of 396,693,881 m<sup>3</sup>.

Survey Date	Actual Flows		Design Flows		$f_i$
	<i>PE</i> Estimate	<i>PE</i> Std. Err.	<i>PE</i> Estimate	<i>PE</i> Std. Err.	
25-Jan-06	0.00013	0.00066	0.00255	0.00614	0.01337
23-Feb-06	0	0	0	0	0.02472
22-Mar-06	0	0	0	0	0.05103
19-Apr-06	0	0	0	0	0.06059
17-May-06	0.00007	0.00009	0.00056	0.00055	0.12966
14-Jun-06	0	0	0	0	0.08195
12-Jul-06	0	0	0	0	0.04745
9-Aug-06	0.00028	0.00033	0.00106	0.00099	0.18463
20-Sep-06	0	0	0	0	0.07345
18-Oct-06	0.00005	0.00016	0.00143	0.00415	0.03739
15-Nov-06	0	0	0	0	0.18820
13-Dec-06	0	0	0	0	0.10756
<b><math>P_M</math></b>	<b>0.00080</b>	0.00044	<b>0.00429</b>	0.00189	–

Table 4.5-63. *ETM* data for California halibut larvae at Units 7&8. *ETM* calculations based on actual and design cooling water flows and a sampling volume in the nearshore of 396,693,881 m<sup>3</sup>.

Survey Date	Actual Flows		Design Flows		$f_i$
	<i>PE</i> Estimate	<i>PE</i> Std. Err.	<i>PE</i> Estimate	<i>PE</i> Std. Err.	
25-Jan-06	0.00006	0.00030	0.00301	0.00723	0.01337
23-Feb-06	0.00008	0.00014	0.00555	0.00305	0.02472
22-Mar-06	0.00046	0.00074	0.00672	0.00511	0.05103
19-Apr-06	0	0	0	0	0.06059
17-May-06	0	0	0	0	0.12966
14-Jun-06	0.00011	0.0003	0.00052	0.00098	0.08195
12-Jul-06	0	0	0	0	0.04745
9-Aug-06	0.00019	0.00022	0.00233	0.00204	0.18463
20-Sep-06	0	0	0	0	0.07345
18-Oct-06	0	0	0.00463	0.01349	0.03739
15-Nov-06	0	0	0	0	0.18820
13-Dec-06	0	0	0	0	0.10756
<b><math>P_M</math></b>	<b>0.0009</b>	0.0005	<b>0.0138</b>	0.0056	–

**4.5.3.14 California spiny lobster (*Panulirus interruptus*)**

California spiny lobster ranges from Monterey Bay, California, to Manzanillo, Mexico, and there is also a small population along the northwestern shore of the Gulf of California (MBC 1987). They are the only representative of the spiny lobster family (Palinuridae) in southern California.



*Courtesy of NOAA Central Library Photo Collection*

**4.5.3.14.1 Life History and Ecology**

During their first two years, juveniles inhabit surfgrass beds from the lower intertidal to depths of about 5 m (16 ft). Juveniles and adults are considered benthic, though they have been observed swimming near the surface, and occur from the intertidal zone to about 80 m (262 ft). Preferred habitats include mussel beds, rocky areas, and in kelp beds (Morris et al. 1980, Barsky 2001).

California spiny lobster are oviparous, the sexes are separate, and fertilization is external. With few exceptions, adult females spawn every year. Barsky (2001) reported that mating occurs from November through May, and Wilson (1948) indicated the primary spawning season was from March to August. Mating takes place on rocky bottoms in water depths of 10–30 m (33–98 ft) (Mitchell et al. 1969). Spawning occurs from the Channel Islands off southern California to Magdalena Bay, Baja California, including other offshore islands and banks, such as Cortez and Tanner (MBC 1987). Females move inshore to depths less than 10 m (33 ft) to extrude and fertilize the eggs. At San Clemente Island, females carried between 120,000 eggs (66 mm [2.6 in] carapace length [CL]) and 680,000 eggs (91 mm [3.6 in] CL) (Barsky 2001).

The eggs hatch from March to December. Larvae are pelagic and are found from the surface to depths of 137 m (449 ft), and within 530 km (329 mi) of shore (MBC 1987). Upon hatching, transparent larvae (phyllosoma) go through 12 molts, increasing in size with each subsequent molt. Phyllosoma are infrequently collected in the Southern California Bight (Johnson 1956, MBC 1987). After five to ten months, the phyllosoma transform into the puerulus larval stage, which resembles the adult form but is still transparent. The puerulus actively swims inshore where it settles in shallow water. At La Jolla, puerulus appeared in nearshore waters in late May and occurred there through mid-September (Serfling and Ford 1975). It is hypothesized that the puerulus stage of California spiny lobster lasts approximately two to three months (Serfling and Ford 1975).

A 6.1-mm (0.2-in) CL juvenile specimen goes through 20 molts to reach 45.7 mm (1.8 in) CL at the end of its first year (Barsky 2001). Spiny lobsters molt four times during the second year, and three times during the third year. Mitchell et al. (1969) found adult spiny lobsters (larger than 41 mm [1.6 in] CL) molt once yearly. Both sexes reach maturity at approximately 5 to 6 years at a mean size of 63.5 mm (2.5 in) CL (Barsky 2001). It takes a spiny lobster 7–11 years to reach the legal fishery size of 83 mm (3.3 in) CL. Females grow faster (4.4 mm/yr [0.2 in/yr]) than males (3.7 mm/yr [0.1 in/yr]) (Mitchell et al. 1969).

Males may live up to 30 years, and reach a maximum length of 91 cm TL [35.8 in] and maximum weight of 15.8 kg (34.8 lbs). Females may live up to 17 years, and reach a maximum size of 50 cm TL [19.7 in] and 5.5 kg (12.1 lbs) (MBC 1987).

Lobsters are nocturnal, seeking crevices in which to hide during the day, and moving about the bottom at night (Wilson 1948). *Panulirus* is an omnivorous bottom forager, feeding on snails, mussels, urchins, clams, and fish (Tegner and Levin 1983; Barsky 2001). A large portion of the population makes seasonal migrations stimulated by changes in water temperature, with an offshore migration in winter and an inshore migration in late-spring and early summer (Mitchell et al. 1969; Barsky 2001). By the end of August, berried females and juveniles comprise the bulk of the shallow-water population. Warmer water temperatures shorten the development time of lobster eggs. By late September, the thermocline breaks down and lobsters move to deeper water (10–30 m) where they remain for the winter (MBC 1987).

4.5.3.14.2 Population Trends and Fishery

California spiny lobster have been fished commercially in southern California since the late 1800s (Barsky 2001). They are fished with traps, most of which are constructed of wire mesh. Most traps are fished in shallow rocky areas in waters shallower than 31 m (100 ft) deep. Commercial landings in the Los Angeles area have fluctuated, ranging between 43,084 kg and 62,585 kg (95,000 lbs and 138,000 lbs) per year since 2000 (Table 4.5-64). In 2005, commercial landings of spiny lobster in the Los Angeles area totaled 101,324 kg (223,420 lbs) at a value of \$1,771,864 (CDFG 2006). Commercial landings from Santa Monica Bay area catch blocks in 2006 totaled 18,213 kg (40,152 lbs) at an estimated value of \$372,220 (CDFG 2007b). In 2005, a total of 104 spiny lobster weighing 62.206 kg (137.164 lbs) was impinged at the RBGS (MBC 2006). From 2000 through 2005, annual impingement of California spiny lobster ranged between 104 individuals (2005) and 464 individuals (2000).

Table 4.5-64. Annual landings and revenue for California spiny lobster in the Los Angeles region based on PacFIN data.

<b>Year</b>	<b>Landed Weight (kg)</b>	<b>Landed Weight (lbs)</b>	<b>Revenue</b>
2000	47,879	105,574	\$715,355
2001	49,333	108,779	\$707,831
2002	43,429	95,761	\$653,172
2003	54,654	120,512	\$858,713
2004	62,419	137,634	\$997,151
2005	55,946	123,362	\$977,519
2006	52,902	116,650	\$1,086,553

#### 4.5.3.14.3 Sampling Results

Lobster larvae was the most abundant invertebrate taxon at both the Units 5&6 and Units 7&8 entrainment stations with mean concentrations over all surveys of 9 and 19 per 1,000 m<sup>3</sup>, respectively (Table 4.5-5 and 4.5-6). They were only collected at the Units 5&6 entrainment station during two surveys in July and August (Figure 4.5-97). At the Units 7&8 entrainment station they were collected from late June through mid-September (Figure 4.5-98). The highest average abundance at both entrainment stations occurred in July 2006 at Units 7&8 at about 200 larvae per 1,000 m<sup>3</sup>. Lobster larvae were present in four summer surveys of the source water stations with peak average abundance occurring in July at approximately 140 larvae per 1,000 m<sup>3</sup> (Figure 4.5-99). The majority of lobster larvae was collected during one survey, with an average concentration over four times greater than the other surveys in which they were collected. Lobster larvae were significantly more common in the nighttime samples versus daytime samples, with a small percentage of the larvae collected during the daytime in one survey (Figure 4.5-100).

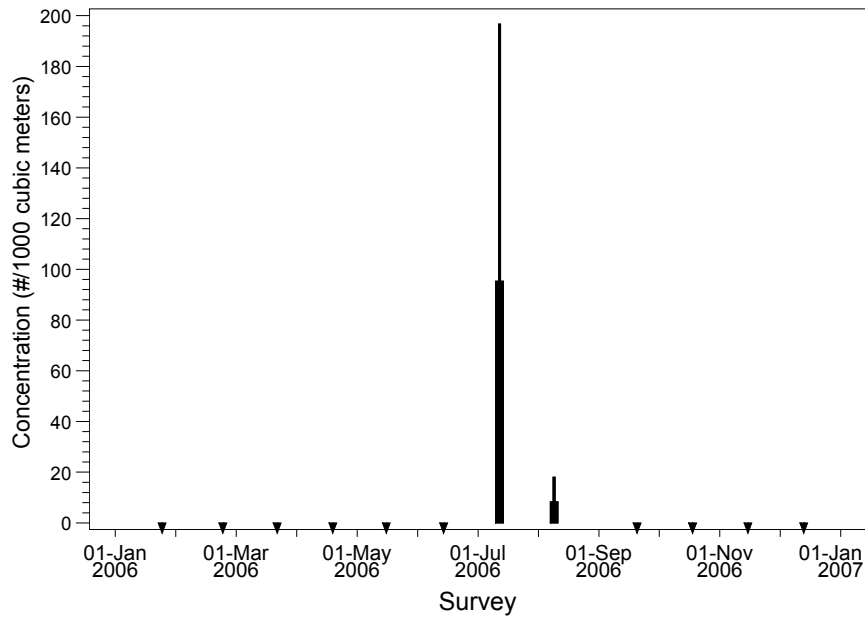

Figure 4.5-97. Mean concentration (# / 1,000 m<sup>3</sup> [264,172 gal]) and standard deviation of spiny lobster larvae collected at RBGS entrainment Station H2 from January through December 2006.

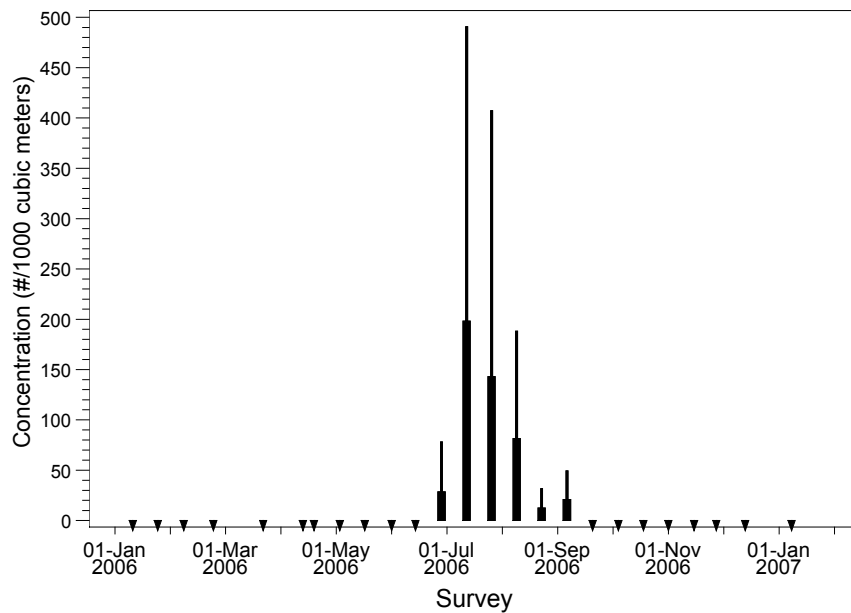

Figure 4.5-98. Mean concentration (# / 1,000 m<sup>3</sup> [264,172 gal]) and standard deviation of spiny lobster larvae collected at RBGS entrainment Station E4 from January 2006 through January 2007.

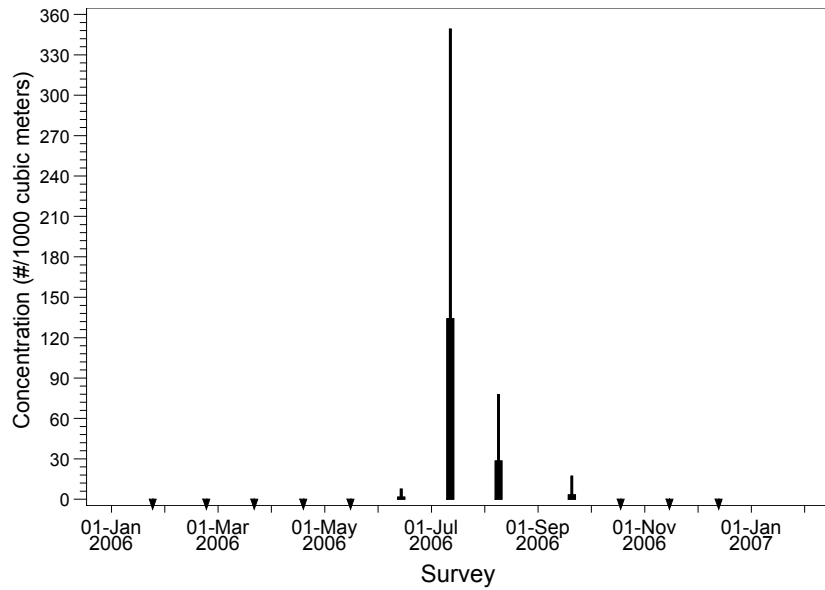

Figure 4.5-99. Mean concentration (# / 1,000 m<sup>3</sup> [264,172 gal]) and standard deviation of spiny lobster larvae collected at RBGS source water stations during 2006.

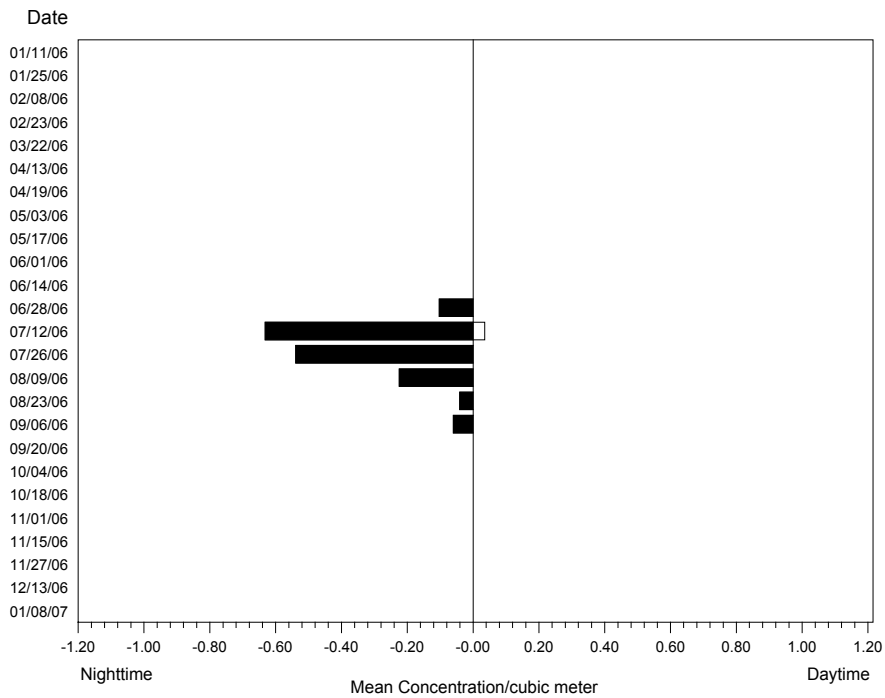

Figure 4.5-100. Mean concentration (#/1.0 m<sup>3</sup> [264 gal]) of spiny lobster larvae at entrapment Station E4 during night (Cycle 3) and day (Cycle 1) sampling.



#### 4.5.3.14.4 Modeling Results

The following section presents the results for the empirical transport modeling of entrainment effects on California spiny lobster. No age-specific estimates of survival for larval and later stages of development were available from the literature; therefore no estimates of *FH* or *AEL* were calculated. Total annual entrainment during 2006 of California spiny lobster larvae at RBGS Units 5&6 was estimated at 1,924,221 using actual cooling water flows and increased to 2,421,597 larvae if the CWIS pumps were run at their design (maximum) capacity (Table 4.5-7). At Units 7&8, total annual entrainment of California spiny lobster larvae was estimated at 11,831,612, using actual cooling water flows and 17,322,709 larvae if the CWIS pumps were run at their design (maximum) capacity (Table 4.5-8). The total duration used in the *ETM* calculations included the estimated larval duration of 7.75 months to provide an integrated estimate of entrainment effects (Serfling and Ford 1975).

#### *Empirical Transport Model (ETM)*

Only two estimates of *PE* for California spiny lobster for 2006 were able to be estimated using the entrainment data from both stations and the source water data (Tables 4.5-65 and 4.5-66). The largest proportion of the source water population present during the July survey ( $f_i = 0.748$  or 74.8%). The  $P_M$  estimates in the tables have a high degree of uncertainty associated with them because they are based on only two estimates of *PE*, but also because of the uncertainty associated with the larval duration used in the calculations. The larval duration assumes that spiny lobster larvae are exposed to entrainment during the entire 7.75 months of their larval development. This literature-derived estimate (Serfling and Ford 1975) greatly increases the estimated effects of entrainment on spiny lobster even though the larvae may not be exposed to entrainment during certain stages of their development. For example, the long larval duration of California spiny lobster larvae was used to estimate that the larvae may be transported into King Harbor from as far as 111.3 km (69 mi) outside of the Bay, even though an average distance alongshore over the 12 surveys of 54.4 km (34 mi) was used in the modeling.

Table 4.5-65. *ETM* data for California spiny lobster larvae at Units 5&6. *ETM* calculations based on actual and design (maximum) cooling water flows and a sampling volume in the nearshore of 396,693,881 m<sup>3</sup>.

Survey Date	Actual Flows		Design Flows		<i>f<sub>i</sub></i>
	<i>PE</i> Estimate	<i>PE</i> Std. Err.	<i>PE</i> Estimate	<i>PE</i> Std. Err.	
25-Jan-06	0	0	0	0	0
23-Feb-06	0	0	0	0	0
22-Mar-06	0	0	0	0	0
19-Apr-06	0	0	0	0	0
17-May-06	0	0	0	0	0
14-Jun-06	0	0	0	0	0.01640
12-Jul-06	0.00009	0.00059	0.00010	0.00069	0.74825
9-Aug-06	0.00001	0.00010	0.00004	0.00032	0.21211
20-Sep-06	0	0	0	0	0.02324
18-Oct-06	0	0	0	0	0
15-Nov-06	0	0	0	0	0
13-Dec-06	0	0	0	0	0
<b><i>P<sub>M</sub></i></b>	<b>0.01587</b>	0.01220	<b>0.01994</b>	0.01442	–

Table 4.5-66 *ETM* data for California spiny lobster larvae at Units 7&8. *ETM* calculations based on actual and design (maximum) cooling water flows and a sampling volume in the nearshore of 396,693,881 m<sup>3</sup>.

Survey Date	Actual Flows		Design Flows		<i>f<sub>i</sub></i>
	<i>PE</i> Estimate	<i>PE</i> Std. Err.	<i>PE</i> Estimate	<i>PE</i> Std. Err.	
25-Jan-06	0	0	0	0	0
23-Feb-06	0	0	0	0	0
22-Mar-06	0	0	0	0	0
19-Apr-06	0	0	0	0	0
17-May-06	0	0	0	0	0
14-Jun-06	0	0	0	0	0.01640
12-Jul-06	0.00057	0.00468	0.00067	0.00549	0.74825
9-Aug-06	0.00010	0.00116	0.00122	0.01027	0.21211
20-Sep-06	0	0	0	0	0.02324
18-Oct-06	0	0	0	0	0
15-Nov-06	0	0	0	0	0
13-Dec-06	0	0	0	0	0
<b><i>P<sub>M</sub></i></b>	<b>0.0985</b>	0.0923	<b>0.1620</b>	0.1386	–

## 5.0 IMPINGEMENT STUDY

### 5.1 INTRODUCTION

The purpose of the impingement study is to determine the extent of potential impacts from the operation of the cooling water systems of the RBGS on fishes and selected invertebrates. Impingement occurs when organisms larger than the traveling screen mesh size (15.9 mm or 5/8 inch) become trapped against the screens, either because they are too fatigued to swim against the intake flow at the screens or they are dead.

There are two facets to the impingement study: *normal operation* sampling and *heat treatment* sampling. Samples collected during normal operations were used to characterize fish loss from the day-to-day operation of the generating station. These samples were collected over a 24-hr period to determine the daily loss from operation of the cooling water system. Samples were also collected during heat treatments, when waters within the CWISs were heated and fishes and invertebrates succumbed to the higher temperatures. Combined, normal operation and heat treatment samples were used to estimate the annual loss of juvenile and adult fishes and shellfishes due to the operation of the cooling water intake systems at the RBGS.

#### 5.1.1 Discussion of Species to be Analyzed

Several types of organisms are susceptible to impingement by the generating station. All fishes and macroinvertebrates were processed (identified, enumerated, and where appropriate, measured) in impingement samples. However, assessment of impingement effects was limited to the most abundant fish taxa that together comprised more than 90% of all juveniles and adults collected in impingement samples at the generating station. Assessment of impingement effects on invertebrates was limited to those that were considered commercially or recreationally important, and were collected in sufficient numbers to warrant analysis.

On January 30, 2007, representatives from AES Redondo Beach, MBC, and Tenera met with representatives from the LARWQCB, EPA Region IX, State Water Resources Control Board (SWRCB), California Department of Fish and Game (CDFG), and National Marine Fisheries Service (NMFS) to review preliminary data from the RBGS IM&E Characterization Study, and determine the fish and shellfish species that would be assessed in the IM&E Report.

No Federal/State threatened or endangered fish/shellfish species were identified in entrainment and impingement samples collected from the RBGS (see Sections 4.0 and 5.0). This is consistent with past entrainment and impingement sampling conducted at the RBGS (SCE 1983; MBC 2007).

At the January 30 meeting, NMFS requested that all species impinged or entrained that have Essential Fish Habitat (EFH) designated under the Magnuson-Stevens Fishery Conservation and Management Act (Magnuson-Stevens Act) be considered for assessment in the RBGS IM&E report. It was agreed that for entrainment, additional demographic or *ETM* calculations would only be performed on these species if

they were collected in sufficient abundance in entrainment and source water samples, and if sufficient life history information was available to permit those calculations. For impingement, it was agreed that only market squid (*Loligo opalescens*) would need additional assessment since impingement estimates are calculated for all species, and no additional modeling was proposed. At a subsequent meeting on May 7, 2007, it was agreed that all species with designated EFH that were impinged would be assessed in the impingement mortality assessments.

Off southern California, the species with designated EFH re listed in the Coastal Pelagics FMP and the Pacific Groundfish FMP. The goals of the management plans include, but are not limited to: the promotion of an efficient and profitable fishery, achievement of optimal yield, provision of adequate forage for dependent species, prevention of overfishing, and development of long-term research plans (PFMC 1998, 2006). There are four fish and one invertebrate species covered under the Coastal Pelagics FMP: northern anchovy (*Engraulis mordax*), Pacific sardine (*Sardinops sagax*), jack mackerel (*Trachurus symmetricus*), Pacific (chub) mackerel (*Scomber japonicus*), and market squid. There are 89 fish species covered under the Pacific Groundfish FMP, including ratfish (*Hydrolagus colliei*), finescale codling (*Antimora microlepis*), Pacific rattail (*Coryphaenoides acrolepis*), three species of sharks, three skate species, six species of roundfish, 62 species of scorpionfishes and thornyheads, and 12 species of flatfishes. For both the Coastal Pelagics and Pacific Groundfish, EFH includes all waters off southern California offshore to the Exclusive Economic Zone.

## **5.2 METHODS**

The following sections provide information on the impingement sample collection and data analysis methods. The impingement sampling provided current estimates of the taxonomic composition, abundance, biomass, seasonality, and diel periodicity of organisms impinged at the RBGS. The sampling program also documented the size, sex, and physical condition of selected fish and shellfish. The abundance and biomass of organisms impinged was used to calculate impingement rates (e.g., the number of organisms impinged per 1,000,000 m<sup>3</sup> [264,200,793 gallons] cooling water flowing into each CWIS).

The RBGS consists of two separate screening facilities: one for Units 5&6 and one for Units 7&8. Each screening facility consists of bar racks, traveling screens, and the circulating water pumps. Seawater drawn into each RBGS unit first enters the in-plant forebay, passes through the bar racks, followed by the traveling screens, and is then pumped to the condensers. All material that was impinged on the traveling screens during the surveys was subsequently rinsed from the screens by a high-pressure wash system into a collection basket. A more complete description of the cooling water systems is presented in Section 3.2.

### **5.2.1 Field Sampling**

Impingement sampling was conducted approximately monthly during normal operations, as well as during all scheduled heat treatments, between January 19, 2006, and January 12, 2007. Normal operation impingement sampling at the RBGS was conducted over one 24-hour period each month at units that had operating circulating water pumps. Before each sampling effort, the traveling screens were rotated and washed clean of all impinged debris and organisms. The sluiceways and collection baskets were also

cleaned before the start of each sampling effort. The operating status of the circulating water pumps was recorded on an hourly basis during the study year. During each survey, the 24-hour sampling period was divided into four 6-hour cycles. Initiation of sample collection occurred as follows: Cycle 1 (approx. 0700-1300 hr), Cycle 2 (approx. 1300-1900 hr), Cycle 3 (approx. 1900-0100 hr), and Cycle 4 (approx. 0100-0700 hr). During this time, the traveling screens were stationary for a period of approximately 5.75 hours and then rotated and washed for 15 minutes. This rinse period allowed the entire screen to be rinsed of all material impinged since the last screen wash cycle. The impinged material was rinsed from the screens into the collection baskets associated with each set of screens.

On some occasions, the screen wash systems were operated (automatically or manually) prior to end of each cycle. The material that was rinsed on these occasions was combined with the material collected at the end of each cycle. All debris and organisms rinsed from each unit was processed separately from other units.

All fishes and macroinvertebrates collected at the end of each cycle were removed from any other impinged debris, identified, enumerated, and weighed. Depending on the number of individuals of a given species present in the sample, one of two specific procedures was used, as described below. Each of these procedures involved the following measurements and observations:

- The appropriate linear measurement for individual fish and shellfish was determined and recorded. These measurements were recorded to the nearest 1 mm (0.04 in). The following standard linear measurements were used for the animal groups indicated:

Fishes - Total body length (TL) for sharks and rays and standard length (SL) for bony fishes.

Crabs - Maximum carapace width (CW).

Shrimps & Lobsters - Carapace length (CL), measured from the anterior margin of carapace between the eyes to the posterior margin of the carapace.

Octopus - Maximum "tentacle" spread (arm span), measured from the tip of one tentacle to the tip of the opposite tentacle.

Squid - Dorsal mantle length (DML), measured from the edge of the mantle to the posterior end of the body.

- The wet body weight of individual fish and shellfish was determined after shaking loose water from the body. Total weight of all individuals combined was determined in the same manner. All weights were recorded to the nearest 1 g (0.035 ounce).
- The qualitative body condition of individual fish and shellfish was determined and recorded, using codes for decomposition and physical damage.
- Determination of sex was made for fishes where such determination could be made by external morphology (such as surfperches, sharks, and rays).
- Shellfishes and other macroinvertebrates were identified to species and their abundance recorded, but they were not measured.

- The amount and type of debris (e.g., *Mytilus* shell fragments, wood fragments, etc.) and any unusual operating conditions in the screen well system were recorded in the “Notes” section of the data sheet. Information on weather was also recorded during each collection.

The following specific procedures were used for processing fishes and shellfishes when the number of individuals per species in the sample or subsample was less than 30:

- For each individual of a given species, the linear measurement, weight, and body condition codes were determined and recorded.

The following specific subsampling procedures were used for fishes and shellfishes when the number of individuals per species was greater than 30:

- The linear measurement, individual weight, and body condition codes for a subsample of 30 individuals were recorded individually on the data sheet. The individuals selected for measurement were selected after spreading out all of the individuals in a sorting container, making sure that they were well mixed and not segregated into size groups. Individuals with missing heads or other major body parts were not measured.
- The linear measurements of up to 200 individuals of each taxon were recorded.
- The total number and total weight of all the remaining individuals combined was determined and recorded separately.

Heat treatment impingement sampling occurred during all heat treatments. Sampling procedures for heat treatment sampling involved rotating and rinsing the traveling screens prior to the start of the procedure. During the heat treatment, the traveling screens were rotated until normal cooling water system operation was resumed and no more dead fish or shellfish were washed off the screens. Sample processing procedures were the same as those for normal operation impingement sampling.

### **5.2.2 QA/QC Procedures and Data Validation**

A QA/QC program was implemented to ensure that all of the organisms were removed from the debris and that the correct identification, enumeration, length, and weight measurements of the organisms were recorded on the data sheets. Random cycles were chosen for QA/QC re-sorting to verify that all the collected organisms were removed from the impinged material. Quality control surveys were done on a quarterly basis during the study. If the count of any individual taxon made during the QA/QC survey varied by more than 5% (or one individual if the total number of individuals was less than 20) from the count recorded by the observer, then the next three sampling cycles for that biologist were checked. The survey procedures were reviewed with all personnel prior to the start of the study and all personnel were given printed copies of the procedures.

### **5.2.3 Data Analysis**

#### **5.2.3.1 Impingement Estimates**

A log with hourly observations of each of the circulating water pumps for the entire study period was obtained from AES Redondo Beach. Impingement rates were calculated using the circulating water flow during each of the cycles of each 24-hour survey. The total time for each cycle was multiplied by the known flow rate of each of the circulating water pumps in operation during each cycle.

The estimated daily impingement rate was used to calculate the monthly and annual impingement. The days between the impingement collections were assigned to a monthly survey period by setting the collection day as the median day within the period and designating the days before and after the collection date to the closest sampling day to create a monthly survey period. The total calculated flow for each survey period was multiplied by the taxon-specific impingement rates for both abundance and biomass. The estimated impingement rate for each monthly survey period was summed to determine the annual normal operation impingement estimates for each taxon based on actual cooling water flow volumes. These were added to impingement totals from heat treatments to estimate total annual impingement. Similar calculations were made based on the design (maximum) flow volumes at each CWIS.

During impingement sampling, all fishes and invertebrates that were retained on the traveling screens were rinsed from the screens, flowed along a water-filled sluiceway, and were deposited into the impingement collection baskets for processing. Data are presented for all impinged taxa, but a subset of species was selected for more detailed analysis. This included fish that together comprised the top 90% or more of the total abundance in impingement samples. In addition, commercially or recreationally important invertebrates that were also impinged were selected for additional analysis. Lastly, NMFS requested all species impinged that have Essential Fish Habitat (EFH) designated under the Magnuson-Stevens Fishery Conservation and Management Act be assessed in the RBGS IM&E Characterization Study Report. This methodology was approved by the LARWQCB, SWRCB, EPA Region IX, NMFS, and CDFG during our May 7, 2007 meeting.

To put the impingement results in context, losses were compared with (1) known population estimates where available, (2) commercial fishing landings for those species harvested commercially, and (3) sport fishing landings for those species targeted by recreational anglers. Commercial landing data were derived from three potential sources: (1) the Pacific Fishery Information Network (PacFIN), which summarized all commercial landings in the Los Angeles Area for the last seven years, (2) CDFG landing reports originating from Los Angeles area ports from 2005, and (3) CDFG catch block data from Santa Monica Bay area catch blocks in 2006. The seven catch blocks included in this analysis included: 680, 701, 702, 703, 720, 721, and 722. Sport fishing landings were derived from the Recreational Fishery Information Network (RecFIN), which included all marine areas in southern California.

#### **5.2.3.2 Impingement Impact Assessment**

For an assessment of the potential impacts on fish stocks from species impinged at the RBGS, annual impingement estimates were used to estimate the number of equivalent adults lost to impingement. These individuals would have lived and been subject to mortality sources other than impingement at the RBGS.

The method of computing equivalent adults is similar to demographic modeling of entrainment mortality estimates. Conversion of impingement totals was limited to few species with sufficient life history information. Such a conversion of numbers of juveniles and adults in impingement samples to number equivalent adults has not been performed in recent impingement studies in California. However, the methods described below are similar to those used by the EPA in developing the §316(b) Phase I and Phase II regulations. Results and discussion of the assessments for both impingement and entrainment are presented in Section 6.0—Impact Assessment.

#### 5.2.3.2.1 Equivalent Adult Model

Ages were assigned to individual recorded lengths for impinged kelp bass, queenfish, northern anchovy, and black croaker using growth curves. Species-specific von Bertalanffy growth parameters, annual (daily) total instantaneous mortality ( $Z$ ), and female length at 50% maturity were collected from available age and growth studies, both published and unpublished, and online databases (such as FishBase [www.fishbase.org] and the CDFG web life history database [www.dfg.ca.gov/mrd/lifehistories/index.html]). For each individual fish the age was estimated using the von Bertalanffy growth model with the appropriate parameters ( $L_{\infty}, k, t_0$ ).

$$L_t = L_{\infty} \left(1 - e^{-k(t-t_0)}\right)$$

Annual (daily) age was calculated as

$$t = t_0 + \frac{\ln\left(1 - \frac{L_t}{L_{\infty}}\right)}{-k}$$

An interval of time  $\Delta t$  was calculated using the difference between the estimated age of impingement  $t$  and the age at 50% maturity  $L_{50\%}$ :

$$\Delta t = \frac{\ln\left(1 - \frac{L_{50\%}}{L_{\infty}}\right) - \ln\left(1 - \frac{L_t}{L_{\infty}}\right)}{-k}$$

Instantaneous mortality ( $Z$ ) for each species was taken from these same age and growth studies (see species-specific analysis for citation), where available, or calculated based on published daily mortality rates. Total annual instantaneous survival was calculated as  $S = e^{-Z}$ . The species-specific age at 50% female maturity was derived using the von Bertalanffy equation using the reported size at 50% maturity. Equivalent adult abundances of the species-specific age at 50% maturity were calculated using a modification of the Equivalent Adult Model (EAM; USEPA 2002):

$$AE = \sum_{i=1}^N S^{(t_{50\%} - t_{est})}$$



where:

$AE$  = number of target age equivalents killed

$N$  = number of individuals impinged

$S$  = total annual instantaneous survival

$t_{50\%}$  = age at female 50% maturity

$t_{est}$  = estimated age of impinged fish

Equivalent adults were summed across all surveys. All calculations were based on measured individuals. The proportion of the total measured to the total impinged was calculated. Total survey-specific equivalent adult estimates were divided by the proportion measured to derive the total adult equivalents taken based on total impinged abundance by survey type. Adult equivalent abundances attributed to heat treatments were not adjusted for flow. Adult equivalents attributed to normal monthly impingement characterization surveys were extrapolated based on cooling water flows as described previously for normal operation estimated abundance. In the instances that not all impinged individuals were measured, the equivalent adult estimate was adjusted based on the ratio of measured individuals to total impinged individuals prior to extrapolation over flow.

### 5.3 DATA SUMMARY

The following sections summarize historical and recent impingement data from the RBGS. A summary of historical impingement data is presented in Section 5.4, while data from the 2006-07 316(b) Impingement Mortality Study is presented in Section 5.5.

### 5.4 HISTORICAL DATA

Impingement sampling was conducted during the 1978–1980 316(b) demonstration (SCE 1983) and from the 1970s through 2005 as required by the RBGS NPDES permit (MBC 2007). These data are summarized to provide information on historical impingement at the RBGS.

#### 5.4.1 Summary of Historical Data

The most abundant species collected during the 1978–1980 316(b) demonstration impingement study were queenfish and shiner perch, which together comprised 71% of impingement abundance at Units 1–8. (Units 1–4 have been retired). The next most abundant taxa were walleye surfperch (*Hyperprosopon argenteum*), northern anchovy, and kelp bass (*Paralabrax clathratus*), which contributed an additional 22% to the impingement abundance.

At Units 1–6, impingement was dominated by queenfish (57%), shiner perch (12%), and walleye surfperch (11%) (Table 5.4-1). Queenfish was collected throughout the two-year study period, though highest abundances were recorded between February and May 1980. Shiner perch was most abundant during heat treatments, and walleye surfperch was most abundant between January and March 1980.

Table 5.4-1. Daily average impingement estimates at the RBGS from October 1978 through September 1980.

Taxa	Common Name	Units 1-6		Units 7&8		Percent of Total
		Normal Ops.	Heat Treatment	Normal Ops.	Heat Treatment	
<i>Seriphus politus</i>	queenfish	75.05	73.68	41.71	25.41	56.6
<i>Cymatogaster aggregata</i>	shiner perch	3.54	28.53	5.28	16.52	14.1
<i>Hyperprosopon argenteum</i>	walleye surfperch	17.26	11.60	5.57	3.90	10.0
<i>Engraulis mordax</i>	northern anchovy	19.42	0.02	9.76	0.05	7.7
<i>Paralabrax clathratus</i>	kelp bass	0.22	0.38	8.39	6.18	4.0
<i>Phanerodon furcatus</i>	white seaperch	2.08	5.53	1.32	2.01	2.9
<i>Peprilus simillimus</i>	Pacific pompano	1.78	2.56	0.04	<0.01	1.1
<i>Genyonemus lineatus</i>	white croaker	0.63	2.93	0.35	0.33	1.1
<i>Embiotoca jacksoni</i>	black perch	0.41	0.52	0.73	1.77	0.9
<i>Cheilotrema saturnum</i>	black croaker	0.28	0.33	0.45	1.28	0.6
<i>Sebastes paucispinis</i>	bocaccio	0.02	0.02	1.15	0.61	0.5
<i>Paralabrax nebulifer</i>	barred sand bass	0.04	0.04	0.47	0.72	0.3
<i>Umbrina roncadore</i>	yellowfin croaker	0.18	0.18	0.14	0.09	0.2
<i>Anisotremus davidsonii</i>	sargo	0.02	0.02	0.01	0.03	<0.1
<i>Roncadore stearnsii</i>	spotfin croaker	-	-	-	0.08	<0.1
<b>Total</b>		<b>120.93</b>	<b>126.34</b>	<b>75.37</b>	<b>58.98</b>	<b>100.0</b>

At Units 7&8, queenfish comprised the major portion of impingement abundance during the two-year study period (Table 5.4-1). Queenfish comprised 35% of total impingement at Units 7&8, and was taken regularly during most months of normal operation collections. The same species that were common at Units 1–6 also occurred at Units 7&8, including shiner perch (11% of abundance), kelp bass (8%), walleye surfperch (5%), and northern anchovy (5%). Shiner perch recorded during normal operations occurred primarily in October and November 1978 and August 1980, with most other individuals observed during heat treatments. Most northern anchovy impinged during normal operations occurred during November 1979 and January 1980. More than 90% of kelp bass impinged at Units 7&8 occurred during October 1978.

During the last fifteen years of heat treatment impingement monitoring at the RBGS (1991–2005), a total of 143,150 fish was estimated to be impinged (MBC 2007). The most abundant fish species impinged were Pacific sardine (29% of total abundance), blacksmith (24%), queenfish (10%), shiner perch (6%), and California scorpionfish (3%). In 2005, the most abundant species were shiner perch (975 individuals), queenfish (289 individuals), California scorpionfish (152 individuals), black perch (135 individuals), and bocaccio (*Sebastes paucispinis*; 105 individuals). A total of 1,143 macroinvertebrates weighing 249.650 kg (550.478 lbs) was also impinged in 2005. The most abundant invertebrates impinged were unidentified moon jelly (*Aurelia* sp), purple-striped jelly (*Chrysaora colorata*), and red rock shrimp (*Lysmata californica*), which together comprised 46% of the abundance and 52% of the biomass.

#### **5.4.2 Relevance to Current Conditions**

The historical impingement data presented in Section 5.4 is relevant for historical comparisons. During the 1978–1980 study, Units 1–4 were still in operation; therefore, impingement was noticeably higher than recent levels. Units 1–4 were retired from service in 1987.

#### **5.4.3 QA/QC Procedures & Data Validation**

The sampling program during the 1978–1980 study was conducted with the approval of the LARWQCB, and detailed procedures and methodologies can be found in SCE (1982a, 1982b, 1983).

During the NPDES impingement surveys (1991–2005), sampling was done in accordance with specifications set forth by the LARWQCB in the NPDES permit for the plant. Specimens of uncertain identity were crosschecked against taxonomic voucher collections maintained by MBC, as well as available taxonomic literature. Occasionally, outside experts were consulted to assist in the identification of species whose identification was difficult. Scales used to measure biomass (spring and electronic) were calibrated every three months.

The following measures were employed to ensure accuracy of all data entered into computer databases and spreadsheets:

- Upon returning from the field, all field data sheets were checked by the Project Manager for completeness and any obvious errors;
- Data were entered into pre-formatted spreadsheets;
- After data were entered, copies of the spreadsheets were checked against the field data sheets;
- Data were submitted annually to the LARWQCB, EPA Region IX, and the CDFG.

### **5.5 RESULTS**

The following sections summarize results from the 2006-07 impingement sampling at the RBGS. The study was designed to provide information necessary to characterize annual, seasonal, and diel variations in impingement mortality as required by the §316(b) Phase II regulations. Annual variation was characterized by comparison to previous impingement studies. Seasonal variation was characterized by analysis of impingement rates during the yearlong study, and diel variation was characterized by analysis of daytime and nighttime impingement collections during 2006-07.

#### **5.5.1 Impingement Summary**

During 2006-2007, normal operation impingement surveys were performed during 10 of 13 months at the RBGS between January 19, 2006 and January 11, 2007, consisting of 10 surveys from each of the two screening facilities. No samples were collected in September, October, and December 2006 due to non-operation (or very limited operation) of the cooling water systems during these months. No heat treatments occurred at Units 5&6 during the study period, while two heat treatments were monitored at Units 7&8. Those heat treatments occurred on April 12 and June 30, 2006.

At Units 5&6, a total of four fishes representing three species weighing 0.819 kg (1.806 lbs) was collected during the ten surveys, while at Units 7&8 a total of 337 fishes representing 36 species weighing 37.376 kg (82.400 lbs) was collected over the same period (Tables 5.5-1 through 5.5-4). The estimated annual total impingement based on actual cooling water flow volumes for Units 5&6 was 133 individuals weighing 27.227 kg (60.036 lbs), while an estimated 1,101 individuals weighing 175.985 kg (388.047 lbs) were impinged at Units 7&8 (Tables 5.5-1 and 5.5-3). Using design (maximum) cooling water flow volumes, the estimated annual impingement was 263 individuals weighing 32.084 kg (70.745 lbs) at Units 5&6 and 2,910 individuals weighing 596.692 kg (1,315.706 lbs) at Units 7&8 (Tables 5.5-2 and 5.5-4). During normal operation surveys at Units 7&8, a total of 22 individuals from 12 fish species weighing 2.993 kg (6.600 lbs) was collected, which, based on cooling water flows, results in an estimated annual impingement of 786 individuals weighing 141.602 kg (312.232 lbs). Two heat treatments at Units 7&8 contributed an additional 315 individuals from 33 fish species weighing 34.383 kg (75.815 lbs).

Table 5.5-1. Summary of RBGS Units 5&6 fish impingement from January 2006 through January 2007 based on **actual** cooling water flow volumes.

Taxa	Common Name	Recorded in Normal Op. Samples		Estimated Annual Impingement		Percent of Total	
		No.	Wt. (kg)	No.	Wt. (kg)	No.	Wt. (kg)
<i>Urobatis halleri</i>	round stingray	2	0.539	66	17.918	49.6	65.8
<i>Gobiesox rhessodon</i>	California clingfish	1	0.001	34	0.034	25.6	0.1
<i>Myliobatis californica</i>	bat ray	1	0.279	33	9.275	24.8	34.1
<b>Totals:</b>		<b>4</b>	<b>0.819</b>	<b>133</b>	<b>27.227</b>	<b>100.0</b>	<b>100.0</b>

Table 5.5-2. Summary of RBGS Units 5&6 fish impingement from January 2006 through January 2007 based on **design** (maximum) cooling water flow volumes.

Taxa	Common Name	Recorded in Normal Op. Samples		Estimated Annual Impingement		Percent of Total	
		No.	Wt. (kg)	No.	Wt. (kg)	No.	Wt. (kg)
<i>Gobiesox rhessodon</i>	California clingfish	1	0.001	146	0.146	55.5	0.5
<i>Urobatis halleri</i>	round stingray	2	0.539	78	21.045	29.7	65.6
<i>Myliobatis californica</i>	bat ray	1	0.279	39	10.893	14.8	34.0
<b>Totals:</b>		<b>4</b>	<b>0.819</b>	<b>263</b>	<b>32.084</b>	<b>100.0</b>	<b>100.0</b>

Based on actual cooling water flows, round stingray (*Urobatis halleri*) was the most abundant fish species impinged at Units 5&6 with an estimated 66 individuals (49.6% of the total) weighing 17.918 kg (39.509 lbs) (65.8% of the total), followed by 34 California clingfish (*Gobiesox rhessodon*) weighing 0.034 kg (0.075 lbs), and 33 bat rays (*Myliobatis californica*) weighing 9.275 kg (20.451 lbs) (34.1% of the

biomass) (Table 5.5-1). When the estimates were calculated using maximum cooling water flows for Units 5&6, the annual estimate increased to 263 individuals with a weight of 32.084 kg (70.745 lbs) (Table 5.5-2). Using actual cooling water flows at Units 7&8, northern anchovy was the most abundant species impinged with an estimated 271 individuals (24.6%) weighing 2.408 kg (5.310 lbs) (1.4%) followed by 141 bat rays weighing 54.124 kg (119.343 lbs) (30.8% of the total biomass), and 121 black perch (*Embiotoca jacksoni*) weighing 12.781 kg (28.182 lbs) (Table 5.5-3). The remaining 33 species were each represented by less than 90 individuals, with eight species represented by a single individual impinged during one of the two heat treatments. When the estimates were calculated using maximum cooling water flows for Units 7&8, the annual estimate increased to 2,910 individuals with a weight of 596.692 kg (1,315.706 lbs) (Table 5.5-4).

Nine macroinvertebrates representing eight species weighing 1.409 kg (3.107 lbs) were collected during normal operation surveys at Units 5&6 (Table 5.5-5). Based on actual cooling water flow volumes these observations resulted in an estimated annual impingement of 273 individuals weighing 48.833 kg (107.677 lbs). When the estimates were calculated using maximum cooling water flows for Units 5&6, the annual estimate increased to 1,085 individuals with a weight of 162.760 kg (358.886 lbs) (Table 5.5-6). Using actual cooling water flows at Units 7&8, 123 individuals representing 16 macroinvertebrate taxa were recorded during normal operation surveys, which results in an estimated 1,658 individuals weighing 388.387 kg (856.393 lbs) impinged during the year (Table 5.5-7). An additional 249 individuals from 12 species weighing 21.828 kg (48.131 lbs) were observed during heat treatments. Based on actual cooling water flow volumes at Units 7&8, an estimated total of 1,907 individuals weighing 410.215 kg (904.524 lbs) was impinged during the study period. When the estimates were calculated using maximum cooling water flows for Units 7&8, the annual estimate increased to 25,209 individuals with a weight of 1,862.944 kg (4,107.792 lbs) (Table 5.5-8).

Common salp (*Thetys vagina*) was the most abundant invertebrate species impinged at Units 5&6 with an estimated 80 individuals (29.3%) weighing 0.400 kg (0.882 lbs) based on actual cooling water flow volumes (Table 5.5-5). The remaining eight species were each represented by a single individual during surveys, but due to variations in cooling water flow volumes, their estimated abundances varied from 41 individuals (northern kelp crab [*Pugettia producta*] and yellow crab [*Cancer anthonyi*]) to 13 individuals each from Pacific rock crab (*Cancer antennarius*), giant-frond-aeolis (*Dendronotus iris*), and unidentified octopus (*Octopus* sp). Three species with high individual weights contributed greater than 95% of the total biomass, including (in descending order) California spiny lobster (*Panulirus interruptus*), yellow crab, and purple-striped jellyfish. Based on actual cooling water flow volumes, California two-spot octopus (*Octopus bimaculatus/bimaculoides*) was the most abundant macroinvertebrate species impinged at Units 7&8 with an estimated 335 individuals (17.6%) weighing 45.915 kg (101.243 lbs) (11.2%), followed by 232 yellow crab weighing 6.365 kg (14.035 lbs) and 201 blackspotted bay shrimp (*Crangon nigromaculata*) weighing 0.335 kg (0.739 lbs) (Table 5.5-7).

Table 5.5-3. Summary of RBGS Units 7&8 fish impingement from January 2006 through January 2007 based on **actual** cooling water flow volumes.

Taxa	Common Name	Recorded in Normal Op. Samples		Estimated Normal Op. Impingement		Recorded in Heat Treatments		Estimated Annual Impingement	
		No.	Wt. (kg)	No.	Wt. (kg)	No.	Wt. (kg)	No.	Wt. (kg)
<i>Engraulis mordax</i>	northern anchovy	5	0.055	269	2.370	2	0.038	271	2.408
<i>Myliobatis californica</i>	bat ray	3	1.012	141	54.124	-	-	141	54.124
<i>Embiotoca jacksoni</i>	black perch	2	0.437	33	8.593	88	4.188	121	12.781
<i>Seriphus politus</i>	queenfish	2	0.012	68	0.343	19	0.585	87	0.928
<i>Porichthys notatus</i>	plainfin midshipman	1	0.177	67	11.867	-	-	67	11.867
<i>Paralabrax nebulifer</i>	barred sand bass	1	0.950	61	58.289	4	0.628	65	58.917
<i>Scorpaena guttata</i>	California scorpionfish	2	0.219	25	2.783	27	2.933	52	5.716
<i>Hyperprosopon argenteum</i>	walleye surfperch	1	0.011	34	0.377	8	0.085	42	0.462
<i>Oxyjulis californica</i>	senorita	1	0.054	34	1.850	7	0.225	41	2.075
<i>Chromis punctipinnis</i>	blacksmith	-	-	-	-	29	2.478	29	2.478
<i>Cymatogaster aggregata</i>	shiner perch	2	0.039	21	0.550	5	0.099	26	0.649
<i>Hypsurus caryi</i>	rainbow seaperch	-	-	-	-	25	1.668	25	1.668
<i>Citharichthys stigmatias</i>	speckled sanddab	1	0.016	20	0.316	-	-	20	0.316
<i>Paralabrax clathratus</i>	kelp bass	-	-	-	-	15	1.594	15	1.594
<i>Cheilotrema saturnum</i>	black croaker	-	-	-	-	14	1.726	14	1.726
<i>Heterostichus rostratus</i>	giant kelpfish	1	0.011	13	0.140	1	0.009	14	0.149
<i>Rhacochilus toxotes</i>	rubberlip seaperch	-	-	-	-	12	1.323	12	1.323
<i>Halichoeres semicinctus</i>	rock wrasse	-	-	-	-	10	1.263	10	1.263
<i>Urobatis halleri</i>	round stingray	-	-	-	-	8	5.262	8	5.262
<i>Rhacochilus vacca</i>	pile perch	-	-	-	-	7	1.160	7	1.160
<i>Sebastes auriculatus</i>	brown rockfish	-	-	-	-	6	1.064	6	1.064
<i>Phanerodon furcatus</i>	white seaperch	-	-	-	-	5	0.167	5	0.167
<i>Brachyistius frenatus</i>	kelp perch	-	-	-	-	4	0.126	4	0.126
<i>Chilara taylori</i>	spotted cusk-eel	-	-	-	-	3	0.130	3	0.130
<i>Artedius lateralis</i>	smoothhead sculpin	-	-	-	-	2	0.015	2	0.015
<i>Heterodontus francisci</i>	horn shark	-	-	-	-	2	2.770	2	2.770
<i>Menticirrhus undulatus</i>	California corbina	-	-	-	-	2	0.407	2	0.407
<i>Paralichthys californicus</i>	California halibut	-	-	-	-	2	0.280	2	0.280
<i>Atherinops affinis</i>	topsmelt	-	-	-	-	1	0.031	1	0.031
<i>Cephaloscyllium ventriosum</i>	swell shark	-	-	-	-	1	3.119	1	3.119
<i>Genyonemus lineatus</i>	white croaker	-	-	-	-	1	0.004	1	0.004
<i>Hypsoblennius gilberti</i>	rockpool blenny	-	-	-	-	1	0.025	1	0.025
<i>Rathbunella alleni</i>	striped ronquil	-	-	-	-	1	0.011	1	0.011
<i>Scorpaenichthys marmoratus</i>	cabezon	-	-	-	-	1	0.824	1	0.824
<i>Sebastes miniatus</i>	vermillion rockfish	-	-	-	-	1	0.009	1	0.009
<i>Xenistius californiensis</i>	salema	-	-	-	-	1	0.137	1	0.137
<b>Totals:</b>		<b>22</b>	<b>2.993</b>	<b>786</b>	<b>141.602</b>	<b>315</b>	<b>34.383</b>	<b>1,101</b>	<b>175.985</b>

Table 5.5-4. Summary of RBGS Units 7&8 fish impingement from January 2006 through January 2007 based on **actual** and **design (maximum)** cooling water flow volumes.

Taxa	Common Name	Recorded in All Samples		Estimated Annual Impingement			
		No.	Wt. (kg)	Actual Flow		Design Flow	
		No.	Wt. (kg)	No.	Wt. (kg)	No.	Wt. (kg)
<i>Engraulis mordax</i>	northern anchovy	7	0.093	271	2.408	693	7.805
<i>Myliobatis californica</i>	bat ray	3	1.012	141	54.124	508	210.063
<i>Seriphus politus</i>	queenfish	21	0.597	87	0.928	306	2.326
<i>Paralabrax nebulifer</i>	barred sand bass	5	1.578	65	58.917	290	272.126
<i>Embiotoca jacksoni</i>	black perch	90	4.625	121	12.781	223	25.612
<i>Scorpaena guttata</i>	California scorpionfish	29	3.152	52	5.716	200	21.88
<i>Cymatogaster aggregata</i>	shiner perch	7	0.138	26	0.649	172	2.83
<i>Porichthys notatus</i>	plainfin midshipman	1	0.177	67	11.867	135	23.871
<i>Heterostichus rostratus</i>	giant kelpfish	2	0.020	14	0.149	88	0.961
<i>Citharichthys stigmaeus</i>	speckled sanddab	1	0.016	20	0.316	48	0.775
<i>Hyperprosopon argenteum</i>	walleye surfperch	9	0.096	42	0.462	47	0.515
<i>Oxyjulis californica</i>	senorita	8	0.279	41	2.075	46	2.335
<i>Chromis punctipinnis</i>	blacksmith	29	2.478	29	2.478	29	2.478
<i>Hypsurus caryi</i>	rainbow seaperch	25	1.668	25	1.668	25	1.668
<i>Paralabrax clathratus</i>	kelp bass	15	1.594	15	1.594	15	1.594
<i>Cheilotrema saturnum</i>	black croaker	14	1.726	14	1.726	14	1.726
<i>Rhacochilus toxotes</i>	rubberlip seaperch	12	1.323	12	1.323	12	1.323
<i>Halichoeres semicinctus</i>	rock wrasse	10	1.263	10	1.263	10	1.263
<i>Urobatis halleri</i>	round stingray	8	5.262	8	5.262	8	5.262
<i>Rhacochilus vacca</i>	pile perch	7	1.160	7	1.160	7	1.160
<i>Sebastes auriculatus</i>	brown rockfish	6	1.064	6	1.064	6	1.064
<i>Phanerodon furcatus</i>	white seaperch	5	0.167	5	0.167	5	0.167
<i>Brachyistius frenatus</i>	kelp perch	4	0.126	4	0.126	4	0.126
<i>Chilara taylori</i>	spotted cusk-eel	3	0.130	3	0.130	3	0.130
<i>Heterodontus francisci</i>	horn shark	2	2.770	2	2.770	2	2.770
<i>Menticirrhus undulatus</i>	California corbina	2	0.407	2	0.407	2	0.407
<i>Paralichthys californicus</i>	California halibut	2	0.280	2	0.280	2	0.280
<i>Artedius lateralis</i>	smoothhead sculpin	2	0.015	2	0.015	2	0.015
<i>Cephaloscyllium ventriosum</i>	swell shark	1	3.119	1	3.119	1	3.119
<i>Scorpaenichthys marmoratus</i>	cabezon	1	0.824	1	0.824	1	0.824
<i>Xenistius californiensis</i>	salema	1	0.137	1	0.137	1	0.137
<i>Atherinops affinis</i>	topsmelt	1	0.031	1	0.031	1	0.031
<i>Hypsoblennius gilberti</i>	rockpool blenny	1	0.025	1	0.025	1	0.025
<i>Rathbunella alleni</i>	stripefin ronquil	1	0.011	1	0.011	1	0.011
<i>Sebastes miniatus</i>	vermilion rockfish	1	0.009	1	0.009	1	0.009
<i>Genyonemus lineatus</i>	white croaker	1	0.004	1	0.004	1	0.004
<b>Totals:</b>		<b>337</b>	<b>37.376</b>	<b>1,101</b>	<b>175.985</b>	<b>2,910</b>	<b>596.692</b>

Table 5.5-5. Summary of RBGS Units 5&6 invertebrate impingement from January 2006 through January 2007 based on **actual** cooling water flow volumes. (\* denotes shellfish).

Taxa	Common Name	Recorded in Normal Op. Samples		Estimated Annual Impingement		Percent of Total	
		No.	Wt. (kg)	No.	Wt. (kg)	No.	Wt. (kg)
<i>Thetys vagina</i>	common salp	2	0.009	80	0.400	29.3	0.8
<i>Cancer anthonyi</i>	yellow crab*	1	0.327	41	13.378	15.0	27.4
<i>Pugettia producta</i>	northern kelp crab*	1	0.005	41	0.205	15.0	0.4
<i>Chrysaora colorata</i>	purple-striped jellyfish	1	0.300	39	11.803	14.3	24.2
<i>Panulirus interruptus</i>	California spiny lobster*	1	0.644	33	21.408	12.1	43.8
<i>Cancer antennarius</i>	Pacific rock crab*	1	0.052	13	0.687	4.8	1.4
<i>Dendronotus iris</i>	giant-frond-aeolis	1	0.007	13	0.093	4.8	0.2
<i>Octopus sp</i>	octopus, unid.*	1	0.065	13	0.859	4.8	1.8
<b>Totals:</b>		<b>9</b>	<b>1.409</b>	<b>273</b>	<b>48.833</b>	<b>100.0</b>	<b>100.0</b>

Table 5.5-6. Summary of RBGS Units 5&6 invertebrate impingement from January 2006 through January 2007 based on **design (maximum)** cooling water flow volumes. (\* denotes shellfish).

Taxa	Common Name	Recorded in Normal Op. Samples		Estimated Annual Impingement		Percent of Total	
		No.	Wt. (kg)	No.	Wt. (kg)	No.	Wt. (kg)
<i>Chrysaora colorata</i>	purple-striped jellyfish	1	0.300	276	82.852	25.4	50.9
<i>Thetys vagina</i>	common salp	2	0.009	259	1.047	23.9	0.6
<i>Cancer anthonyi</i>	yellow crab*	1	0.327	131	42.818	12.1	26.3
<i>Pugettia producta</i>	northern kelp crab*	1	0.005	131	0.655	12.1	0.4
<i>Octopus sp</i>	octopus, unid.*	1	0.065	83	5.37	7.6	3.3
<i>Cancer antennarius</i>	Pacific rock crab*	1	0.052	83	4.296	7.6	2.6
<i>Dendronotus iris</i>	giant-frond-aeolis	1	0.007	83	0.578	7.6	0.4
<i>Panulirus interruptus</i>	California spiny lobster*	1	0.644	39	25.144	3.6	15.4
<b>Totals:</b>		<b>9</b>	<b>1.409</b>	<b>1,085</b>	<b>162.760</b>	<b>100.0</b>	<b>100.0</b>



Table 5.5-7. Summary of RBGS Units 7&8 invertebrate impingement from January 2006 through January 2007 based on **actual** cooling water flow volumes. (\* denotes shellfish).

Taxa	Common Name	Recorded in Normal Op. Samples		Estimated Normal Op. Impingement		Recorded in Heat Treatments		Estimated Annual Impingement	
		No.	Wt. (kg)	No.	Wt. (kg)	No.	Wt. (kg)	No.	Wt. (kg)
<i>O. bimaculatus/bimaculoides</i>	California two-spot octopus*	6	0.919	331	44.949	4	0.966	335	45.915
<i>Cancer anthonyi</i>	yellow crab*	67	0.936	161	5.759	71	0.606	232	6.365
<i>Crangon nigromaculata</i>	blackspotted bay shrimp*	3	0.005	201	0.335	-	-	201	0.335
<i>Loxorhynchus grandis</i>	sheep crab*	9	12.960	177	251.904	1	0.033	178	251.937
<i>Panulirus interruptus</i>	California spiny lobster*	7	2.003	131	38.002	44	17.547	175	55.549
<i>Loligo opalescens</i>	California market squid*	3	0.079	154	4.176	-	-	154	4.176
<i>Cancer antennarius</i>	Pacific rock crab*	10	0.815	122	16.543	13	0.040	135	16.583
<i>Parastichopus parvimensis</i>	warty sea cucumber	2	0.118	81	4.912	7	2.371	88	7.283
<i>Pyromaia tuberculata</i>	tuberculate pear crab*	1	0.002	61	0.123	27	0.037	88	0.160
Cnidaria	sea jelly, unid.	2	0.069	87	4.393	-	-	87	4.393
<i>Lysmata californica</i>	red rock shrimp*	4	0.007	6	0.009	71	0.102	77	0.111
<i>Portunus xantusii</i>	Xantus swimming crab*	5	0.088	62	1.371	2	0.047	64	1.418
<i>Strongylocentrotus purpuratus</i>	purple sea urchin	1	0.001	61	0.061	-	-	61	0.061
<i>Chrysaora colorata</i>	purple-striped jellyfish	1	0.800	20	15.822	-	-	20	15.822
<i>Cancer productus</i>	red rock crab*	1	0.016	2	0.025	4	0.026	6	0.051
<i>Pugettia producta</i>	northern kelp crab*	-	-	-	-	3	0.010	3	0.010
<i>Cancer gracilis</i>	graceful crab*	-	-	-	-	2	0.043	2	0.043
<i>Cancer jordani</i>	hairy rock crab*	1	0.002	1	0.003	-	-	1	0.003
<b>Totals:</b>		<b>123</b>	<b>18.820</b>	<b>1,658</b>	<b>388.387</b>	<b>249</b>	<b>21.828</b>	<b>1,907</b>	<b>410.215</b>

Table 5.5-8. Summary of RBGS Units 7&8 invertebrate impingement from January 2006 through January 2007 based on **actual** and **design (maximum)** cooling water flow volumes. (\* denotes shellfish).

Taxa	Common Name	Estimated Annual Impingement					
		Recorded in All Samples		Actual Flow		Design Flow	
		No.	Wt. (kg)	No.	Wt. (kg)	No.	Wt. (kg)
<i>Cancer anthonyi</i>	yellow crab*	138	1.542	232	6.365	17,030	173.386
<i>Cancer antennarius</i>	Pacific rock crab*	23	0.855	135	16.583	2,110	68.903
<i>Lysmata californica</i>	red rock shrimp*	75	0.109	77	0.111	911	1.482
<i>Loxorhynchus grandis</i>	sheep crab*	10	12.993	178	251.937	903	1297.404
<i>Octopus bimaculatus/bimaculoides</i>	California two-spot octopus*	10	1.885	335	45.915	773	81.252
<i>Portunus xantusii</i>	Xantus swimming crab*	7	0.135	64	1.418	512	7.711
<i>Panulirus interruptus</i>	California spiny lobster*	51	19.550	175	55.549	488	147.327
<i>Crangon nigromaculata</i>	blackspotted bay shrimp*	3	0.005	201	0.335	405	0.674
<i>Loligo opalescens</i>	California market squid*	3	0.079	154	4.176	382	10.118
<i>Parastichopus parvimensis</i>	warty sea cucumber	9	2.489	88	7.283	341	22.801
<i>Pyromaia tuberculata</i>	tuberculate pear crab*	28	0.039	88	0.160	313	0.609
<i>Cancer jordani</i>	hairy rock crab*	1	0.002	1	0.003	302	0.603
<i>Strongylocentrotus purpuratus</i>	purple sea urchin	1	0.001	61	0.061	286	0.286
Cnidaria	sea jelly, unid.	2	0.069	87	4.393	247	9.193
<i>Cancer productus</i>	red rock crab*	5	0.042	6	0.051	153	2.410
<i>Chrysaora colorata</i>	purple-striped jellyfish	1	0.800	20	15.822	48	38.732
<i>Pugettia producta</i>	northern kelp crab*	3	0.010	3	0.010	3	0.010
<i>Cancer gracilis</i>	graceful crab*	2	0.043	2	0.043	2	0.043
<b>Totals:</b>		<b>372</b>	<b>40.648</b>	<b>1,907</b>	<b>410.215</b>	<b>25,209</b>	<b>1,862.944</b>

Figures 5.5-1 through 5.5-8 present the fish impingement density (based on abundance and biomass) during the ten monthly surveys conducted from January 2006 through January 2007. At Units 5&6, fish impingement was only recorded in July and August, with annual peaks in both abundance and biomass recorded in July, due to the unique occurrence of both round stingray and bat ray (Figures 5.5-1 and 5.5-2). Only one fish (California clingfish) was collected at Units 5&6 in August, and it only weighed one gram; therefore, the biomass is barely visible in Figure 5.5-2. Fish impingement abundance at Units 7&8 was highest in spring, with peak rates recorded in April (Figure 5.5-3). Highest impingement biomass was recorded in August, and resulted from the impingement of relatively large individual fishes such as bat ray and barred sand bass (*Paralabrax nebulifer*) (Figure 5.5-4). Invertebrate impingement abundance at Units 5&6 was greatest from February to May, with highest abundance recorded in May (Figure 5.5-5). Invertebrate biomass at Units 5&6 was more variable, with the highest impingement rate recorded in April (Figure 5.5-6). At Units 7&8, invertebrate abundance was the highest during the last two surveys, with peak abundance recorded in November, although invertebrates were consistently recorded during the first eight surveys (Figure 5.5-7). Invertebrate biomass at Units 7&8 was much more variable throughout the year, with a peak in May (Figure 5.5-8).

In general, fish impingement was more consistent during nighttime. All four fish collected at Units 5&6 were recorded after dusk, while night surveys were more consistent at Units 7&8, although the peak

abundance was recorded during the day in April (Figure 5.5-9). Conversely, fish biomass at Units 7&8 was noticeably greater during the night, with the peak biomass recorded in August at night (Figure 5.5-10). Invertebrate abundance at Units 5&6 was generally higher during daytime surveys, while overall highest densities were observed during night surveys in April and May (Figure 5.5-11). Invertebrate biomass at Units 5&6 was more variable than abundance with daytime surveys recording slightly greater abundance than nighttime surveys (Figures 5.5-12). Invertebrate abundance at Units 7&8 was relatively similar, with a slight increase during the night (Figure 5.5-13). Invertebrate biomass exhibited a different pattern than abundance at Units 7&8, with nighttime surveys recording substantially greater biomass than daytime surveys (Figure 5.5-14).

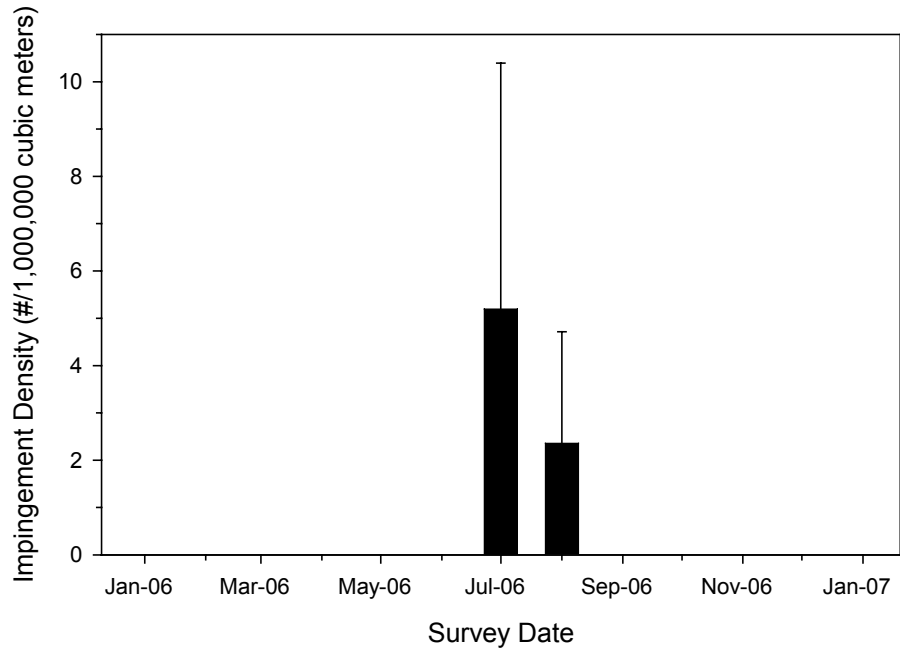

Figure 5.5-1. Mean concentration (# / 1,000,000 m<sup>3</sup>) and standard error of fishes collected in RBGS Units 5&6 impingement samples during 2006-2007.

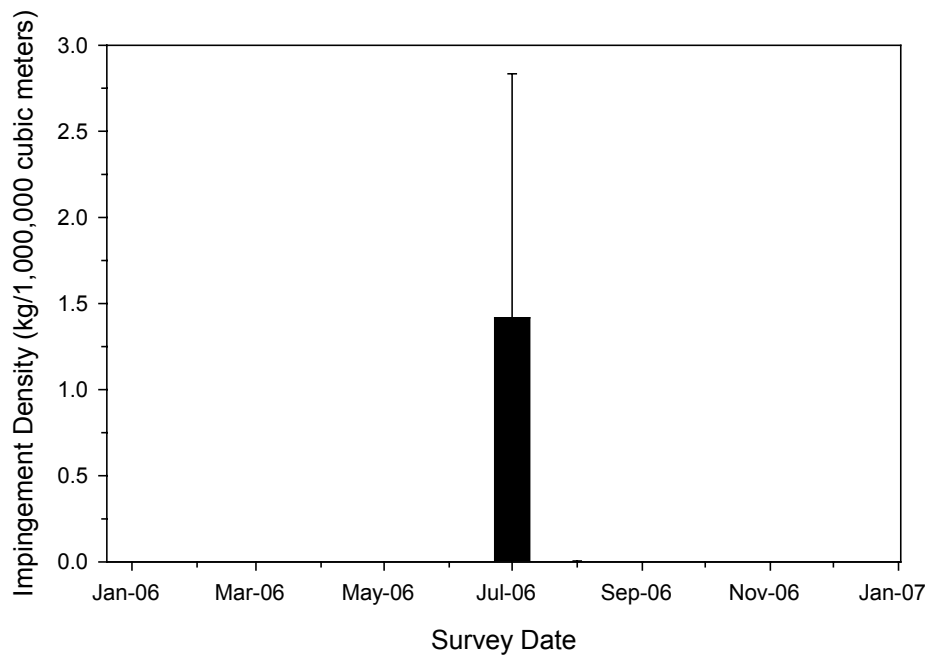

Figure 5.5-2. Mean biomass (kg / 1,000,000 m<sup>3</sup>) and standard error of fishes collected in RBGS Units 5&6 impingement samples during 2006-2007.

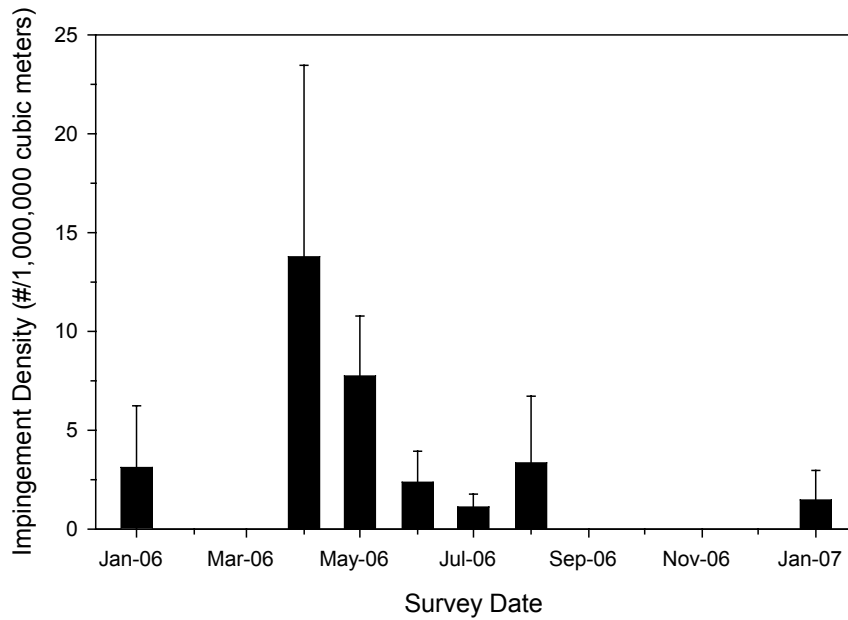

Figure 5.5-3. Mean concentration (# / 1,000,000 m<sup>3</sup>) and standard error of fishes collected in RBGS Units 7&8 impingement samples during 2006-2007.

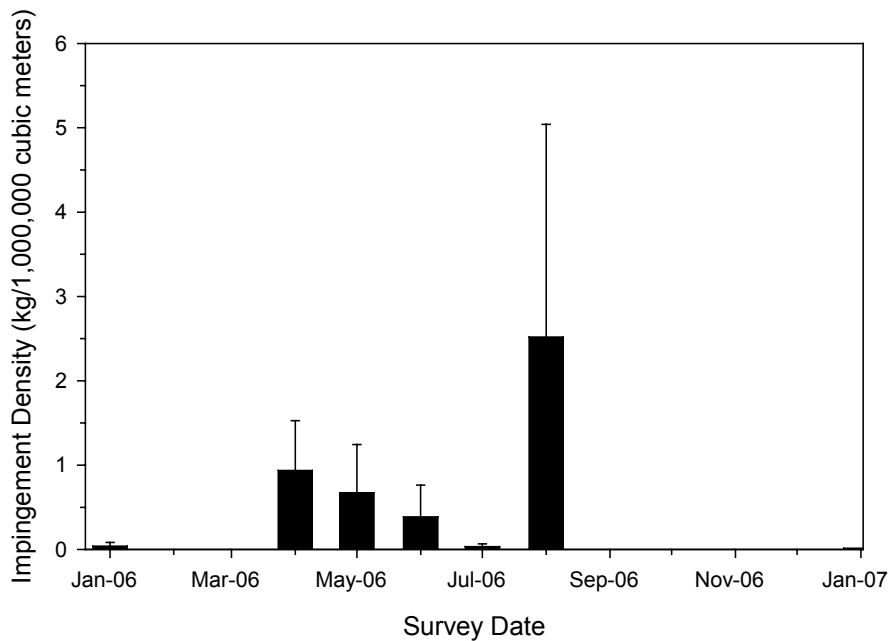

Figure 5.5-4. Mean biomass (kg / 1,000,000 m<sup>3</sup>) and standard error of fishes collected in RBGS Units 7&8 impingement samples during 2006-2007.

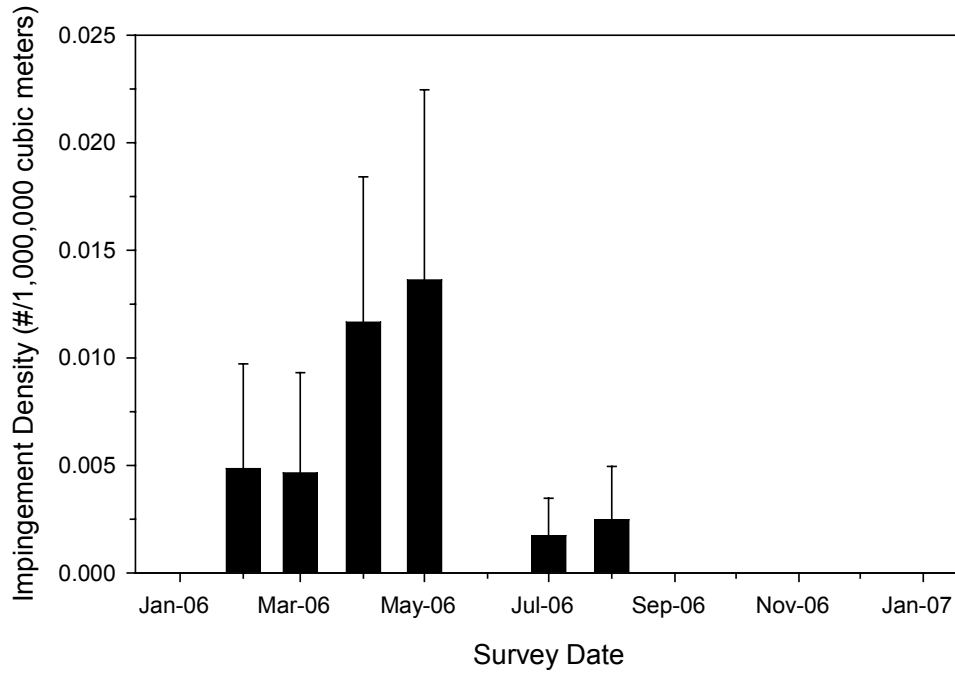

Figure 5.5-5. Mean concentration (# / 1,000,000 m<sup>3</sup>) and standard error of invertebrates collected in RBGS Units 5&6 impingement samples during 2006-2007.

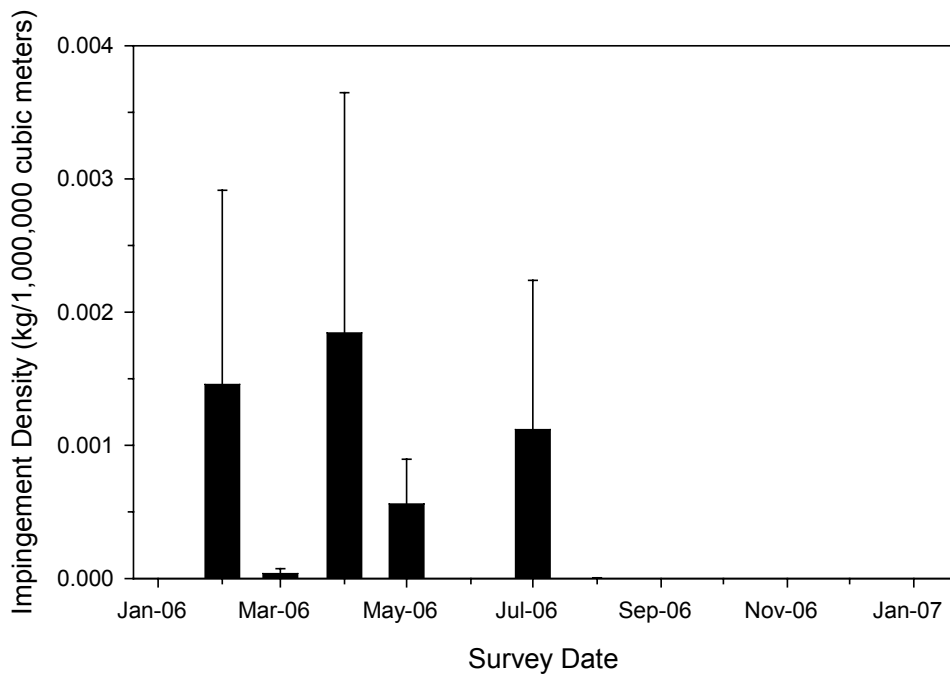

Figure 5.5-6. Mean biomass (kg / 1,000,000 m<sup>3</sup>) and standard error of invertebrates collected in RBGS Units 5&6 impingement samples during 2006-2007.

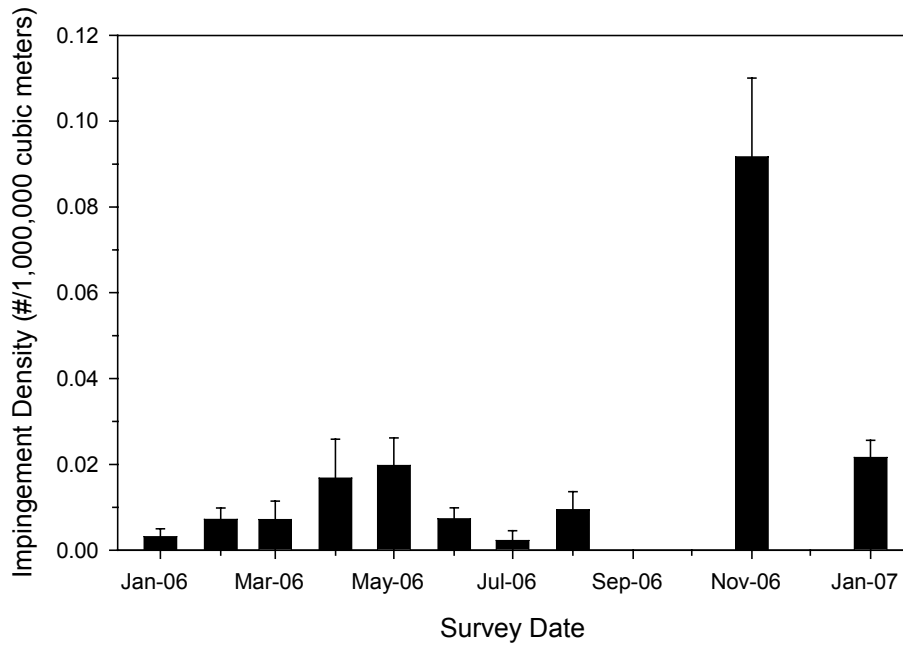

Figure 5.5-7. Mean concentration (# / 1,000,000 m<sup>3</sup>) and standard error of invertebrates collected in RBGS Units 7&8 impingement samples during 2006-2007.

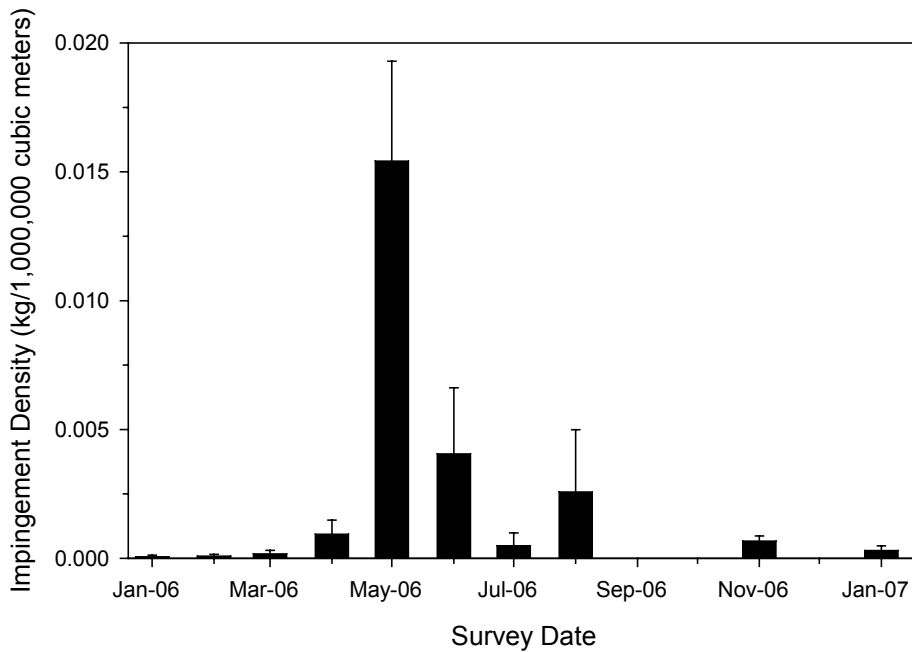

Figure 5.5-8. Mean biomass (kg / 1,000,000 m<sup>3</sup>) and standard error of invertebrates collected in RBGS Units 7&8 impingement samples during 2006-2007.

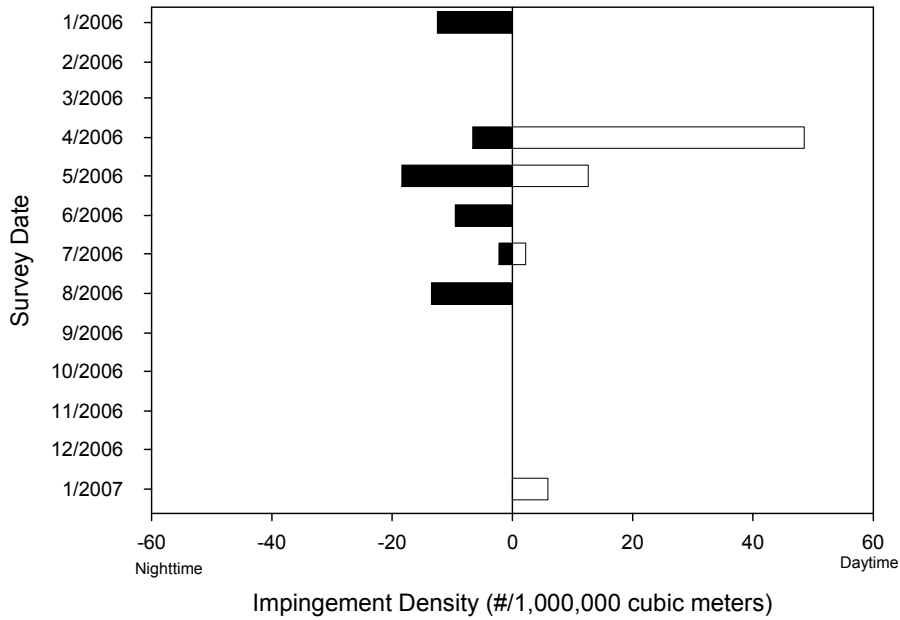

Figure 5.5-9. Mean concentration (#/1,000,000 m<sup>3</sup>) of fishes in impingement samples during night (Cycles 3&4) and day (Cycles 1&2) sampling at Units 7&8.

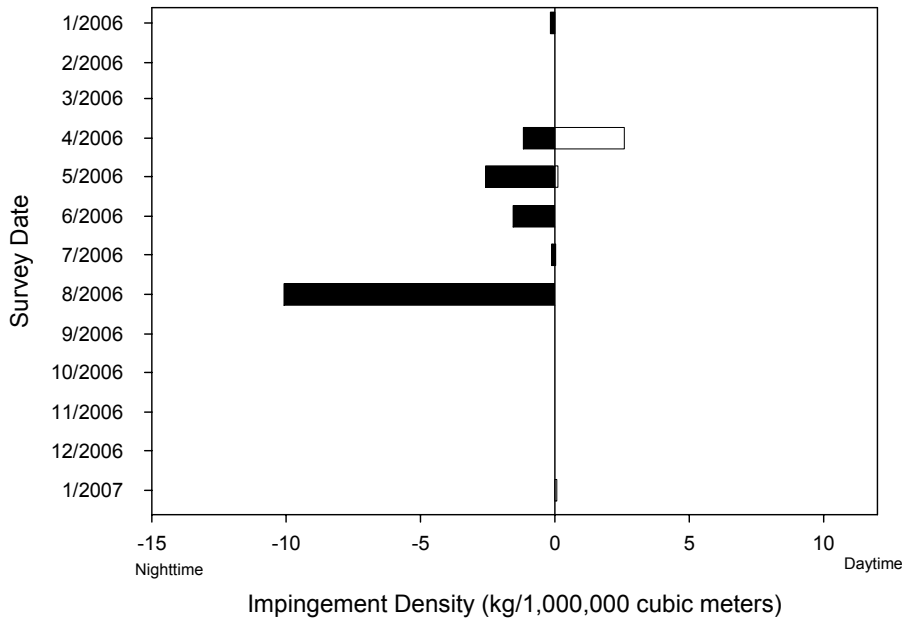

Figure 5.5-10. Mean biomass (kg/1,000,000 m<sup>3</sup>) of fishes in impingement samples during night (Cycles 3&4) and day (Cycles 1&2) sampling at Units 7&8.



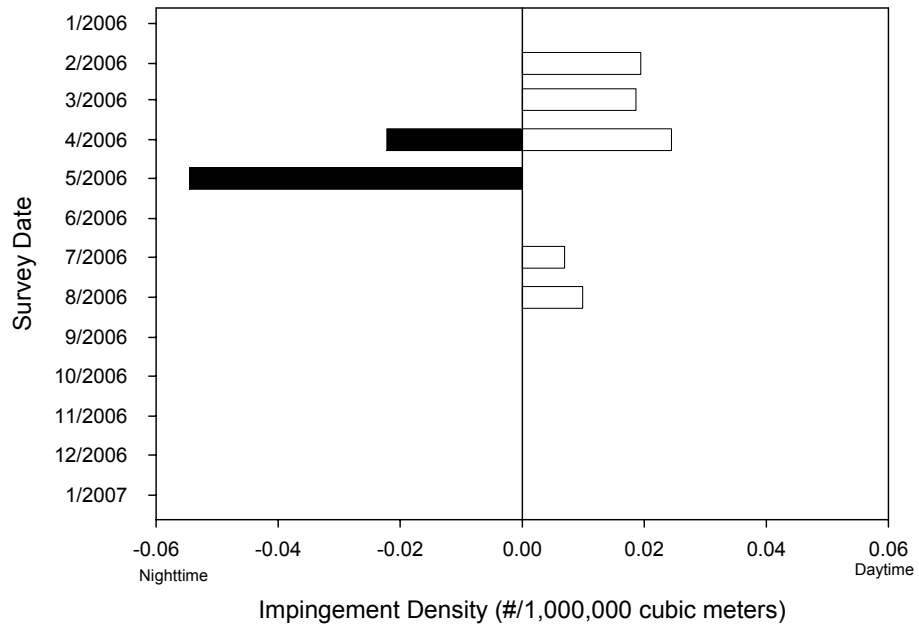

Figure 5.5-11. Mean concentration (#/1,000,000 m<sup>3</sup>) of invertebrates in impingement samples during night (Cycles 3&4) and day (Cycles 1&2) sampling at Units 5&6.

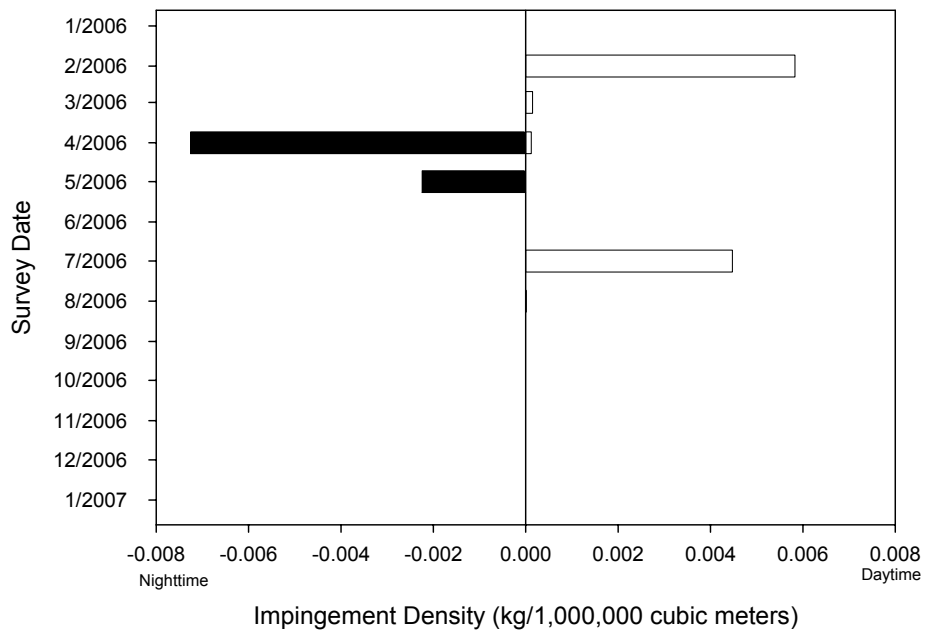

Figure 5.5-12. Mean biomass (kg/1,000,000 m<sup>3</sup>) of invertebrates in impingement samples during night (Cycles 3&4) and day (Cycles 1&2) sampling at Units 5&6.

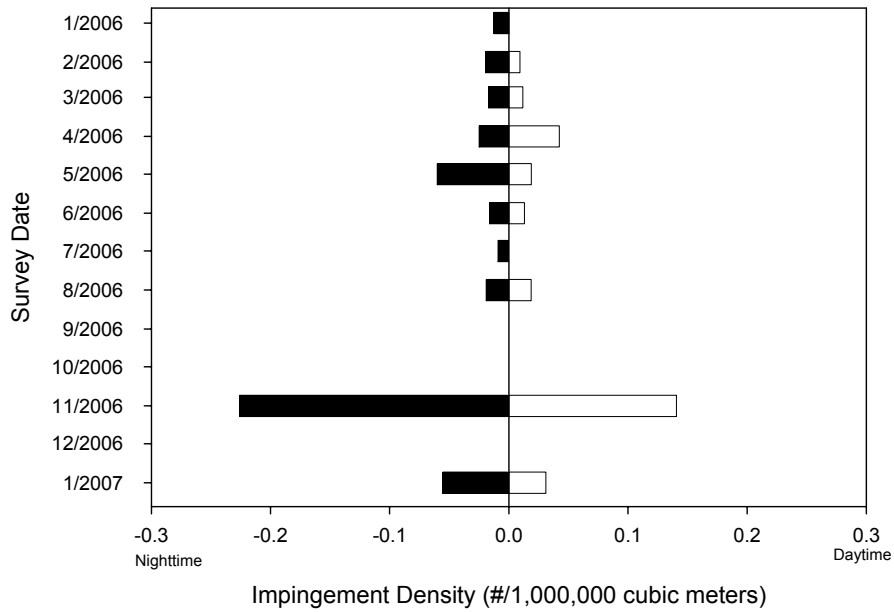

Figure 5.5-13. Mean concentration (#/1,000,000 m<sup>3</sup>) of invertebrates in impingement samples during night (Cycles 3&4) and day (Cycles 1&2) sampling at Units 7&8.

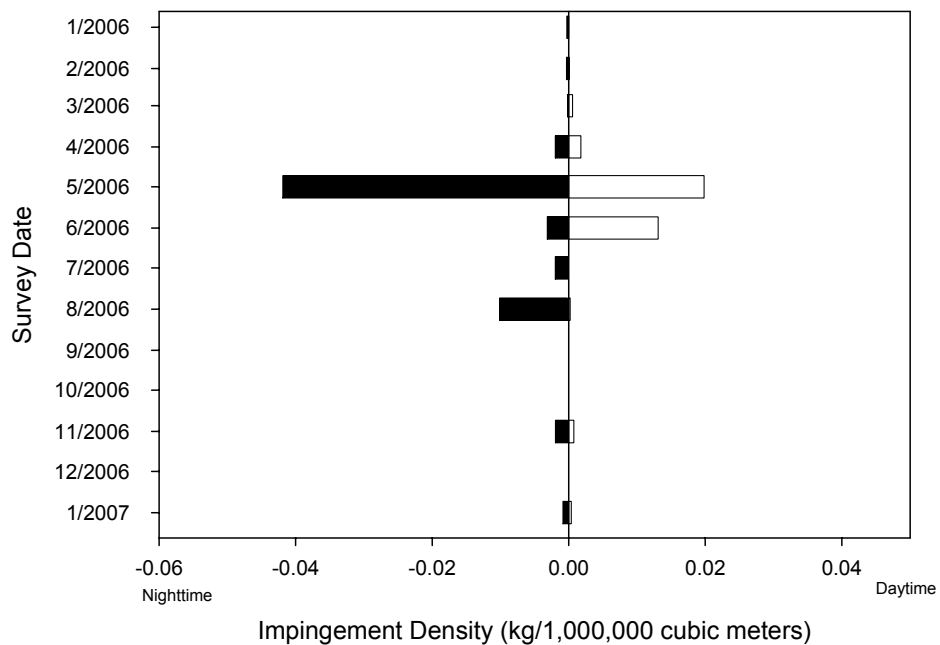

Figure 5.5-14. Mean biomass (kg/1,000,000 m<sup>3</sup>) of invertebrates in impingement samples during night (Cycles 3&4) and day (Cycles 1&2) sampling at Units 7&8.

### **5.5.1.1 Comparison with Previous Studies**

The annual fish impingement estimate for 2006-07 based on actual cooling water flow volumes (<1 fish per day at Units 5&6 and 3 fish per day at Units 7&8) is substantially lower than the impingement estimates recorded from 1978-80 by SCE (1983) (247 fish per day at Units 1-6 and 134 fish per day at Units 7&8). This is likely due to large changes in plant operations, including the retirement of Units 1-4, and reduced operations of Units 5-8.

Since 1991, annual estimated impingement at the RBGS based on actual cooling water flow volumes has ranged between 1,134 fishes (2003) and 46,086 fishes (1992) (MBC 2007). However, since 1994 impingement has never exceeded 10,000 fish per year, and during the last three years has ranged between 1,000 and 3,000 fishes. Therefore, results in 2006-07 are consistent with recent trends. In 2005, a total of 2,392 fishes from 49 species was estimated to be impinged at the RBGS. The most abundant species were shiner perch (975 individuals), queenfish (289 individuals), California scorpionfish (152 individuals), and black perch (135 individuals) (MBC 2006).

### **5.5.2 Fishes by Species**

Eighteen fish species were impinged in sufficient numbers to warrant further analysis. These taxa included (with sampled abundance in parentheses):

- black perch (90 individuals)
- California scorpionfish (29 individuals)
- blacksmith (29 individuals)
- rainbow seaperch (25 individuals)
- queenfish (21 individuals)
- kelp bass (15 individuals)
- black croaker (14 individuals)
- rubberlip seaperch (12 individuals)
- round stingray (10 individuals)
- rock wrasse (10 individuals)
- walleye surfperch (9 individuals)
- señorita (8 individuals)
- northern anchovy (7 individuals)
- pile perch (7 individuals)
- shiner perch (6 individuals)
- brown rockfish (6 individuals)
- white seaperch (5 individuals)
- barred sand bass (5 individuals)

Combined, these 18 species represented 90.6% of the sampled impingement abundance. Two additional species were requested to be analyzed in further detail due their inclusion in the Pacific Groundfish Fishery Management Plan: cabezon and vermilion rockfish (one individual each).

### 5.5.2.1 Black perch (*Embiotoca jacksoni*)

Black perch (*Embiotoca jacksoni*) ranges from Point Abreojos, Baja California, Mexico to Fort Bragg, California in depths from 0 to 50 m (0 to 164 ft) (Miller and Lea 1972; Allen 1982). Nineteen species of perch are common to the nearshore waters of southern California, with 10 of these species commonly observed in central and southern California (Miller and Lea 1972; Allen and Pondella 2006). Allen and Pondella (2006) included black perch in their southern California shallow rock sand group. Black perch has been frequently observed in impingement sampling throughout southern California since 1990, albeit in greatly reduced abundances in comparison to more abundant perch species, such as walleye surfperch (*Hyperprosopon argenteum*) (MBC unpubl. data).

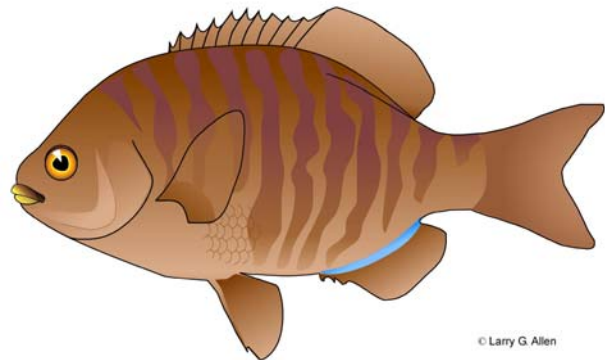

#### 5.5.2.1.1 Life History and Ecology

Quast (1968a) included black perch in his Zone II classification as a bottom microcarnivore, typically patrolling the areas of coralline red algae. Stephens et al. (2006) further confirmed this habitat affinity, noting a stronger presence in the southern portion of the Southern California Bight. Within this zone, Quast (1968b) reported their primary prey items reflect this habitat preference, with the principle composition including polychaete worms, amphipods, and spider crabs. Allen (1982) determined gammaridean amphipods and reptantian decapods comprised the majority of prey items, though polychaetes were also important. Black perch ranked higher in abundance along the mainland (14<sup>th</sup>) than at Santa Catalina Island (30<sup>th</sup>) in fish assemblages sampled by gillnet from 1996 to 1998, indicating preference for the mainland, which may be attributed to the greater overall frequency of the rocky-reef, sandy-bottom ecotone they prefer (Pondella and Allen 2000; Allen and Pondella 2006). Along the Los Angeles Federal Breakwater, black perch represented nearly 12% of all fishes, or the second most abundant species observed (Froeschke et al. 2005).

Like all surfperches, black perch is viviparous, producing free-swimming, fully developed young. Young surfperches are larger than the typical 9.5-mm (3/8-in) screen mesh at most generating stations, preventing their entrainment and transport throughout the cooling water system. Froeschke et al. (in press) reported that black perch exhibit a general 1:1 sex ratio, with a peak spawning period in southern California from July through October. These authors noted that gestating females were capable of carrying between 4 and 17 embryos, with larger females carrying more embryos.

Froeschke et al. (in press) reported black perch to reach a maximum age of seven years old, with the predominance of individuals less than five years old. The authors noted that, as with most fish, growth was fastest during the early part of their life, with maximum growth between ages 0 and 2 before slowing.

5.5.2.1.2 Population Trends and Fishery

Surfperch commercial landings, overall, steadily declined from the peak in 1982, with some research indicating the decline may partially be attributable to increased water temperature that dominated the northeast Pacific Ocean throughout much of the 1980s and 1990s (Fritzsche and Collier 2001). The NMFS Los Angeles Times recreational fishing database recorded an annual mean landing of 50 black perch from all landings ranging from Paradise Cove on the northwestern edge of the Santa Monica Bay south to San Diego, California over the period 1991–2003 (NMFS 2007). Due to the random nature of the recreational fishing data, no real population trends can be determined for black perch. Total statewide recreational landings of “surfperches” were 489,000 fish in 1999, with most of the catch in central and northern California (Fritzsche and Collier 2001). Commercial landings in the Los Angeles area have fluctuated between about 136 and 1,361 kg (300 and 3,000 lbs) per year since 2000 (Table 5.5-9). In 2005, “surfperch” landings in the Los Angeles area totaled 21.3 kg (47 lbs) at a value of \$86 (CDFG 2006). Commercial landings of “surfperches” reported from catch blocks in the Santa Monica Bay area totaled 117.0 kg (258 lbs) in 2006, at an estimated value of \$1,092 (CDFG 2007b).

Table 5.5-9. Annual landings and revenue for surfperches in the Los Angeles region based on PacFIN data.

<b>Year</b>	<b>Landed Weight in kg (lbs)</b>	<b>Revenue</b>
2000	1,278 (2,817)	\$3,085
2001	239 (526)	\$1,315
2002	972 (2,143)	\$6,455
2003	414 (913)	\$1,743
2004	164 (362)	\$689
2005	161 (354)	\$403
2006	497 (1,095)	\$2,624

During 1978-80, an estimated 0.93 black perch were impinged daily at Units 1-6, and 2.5 black perch were impinged daily at Units 7&8 (SCE 1983). From 2003 through 2005, estimated annual impingement of black perch ranged from 39 individuals (2003) to 135 individuals (2005) (MBC 2007). Since 1991, 3,789 black perch were estimated to have been impinged at the RBGS, an average of about 253 individuals per year.

In King Harbor, densities of adult and juvenile black perch remained relatively constant between 1974 and 1998, indicating the harbor essentially acts as a mature artificial reef (Pondella et al. 2002). Results since 1998 indicate a slight increase in King Harbor, while numbers at Palos Verdes, a nearby natural reef, remained relatively constant (Figure 5.5-15). The density of sub-adults at King Harbor, however, declined since 1974, suggesting an increase in mortality at the end of the first year. Results from King Harbor corresponded to those from nearby Palos Verdes. The authors determined that surfperch production in King Harbor has been higher than at Palos Verdes.

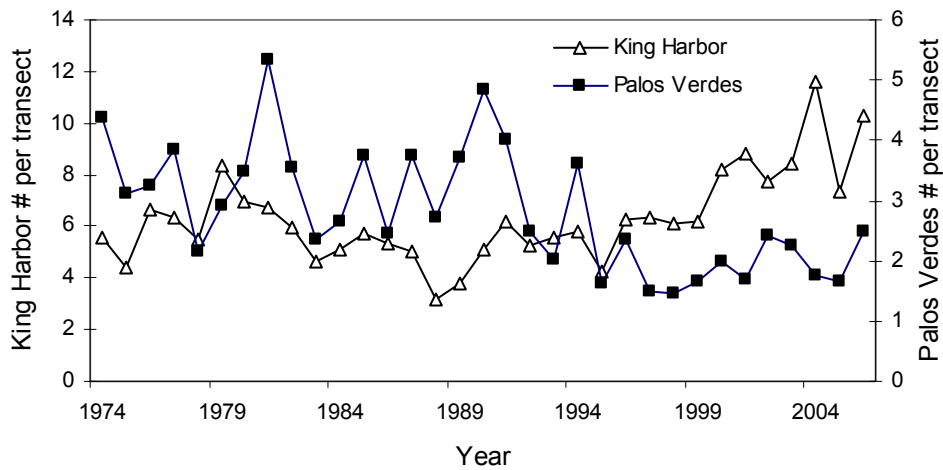

Figure 5.5-15. Abundance of black perch (*Embiotoca jacksoni*) measured during diver transects at King Harbor and Palos Verdes from 1974-2006. Source: Vantuna Research Group.

#### 5.5.2.1.3 Sampling Results

An estimated 121 black perch weighing 54.124 kg (119.343 lbs) were impinged at RBGS based on actual cooling water flow volumes, with all individuals attributed to Units 7&8, and most impinged during heat treatments (Table 5.5-3). Length frequency analysis of 89 individuals indicated a mean length of 101 mm SL ranging from 60 to 221 mm SL in a bimodal distribution with peaks at 90 and 130 mm SL (Figure 5.5-16), or approximately one to two years old (Froeschke et al. in press). The sex was determined for 52 individuals, of which 62% were female, 37% male and less than 2% were juvenile. All of the individuals were dead when collected, of which 98% were collected during two heat treatments (Table 5.5-3).

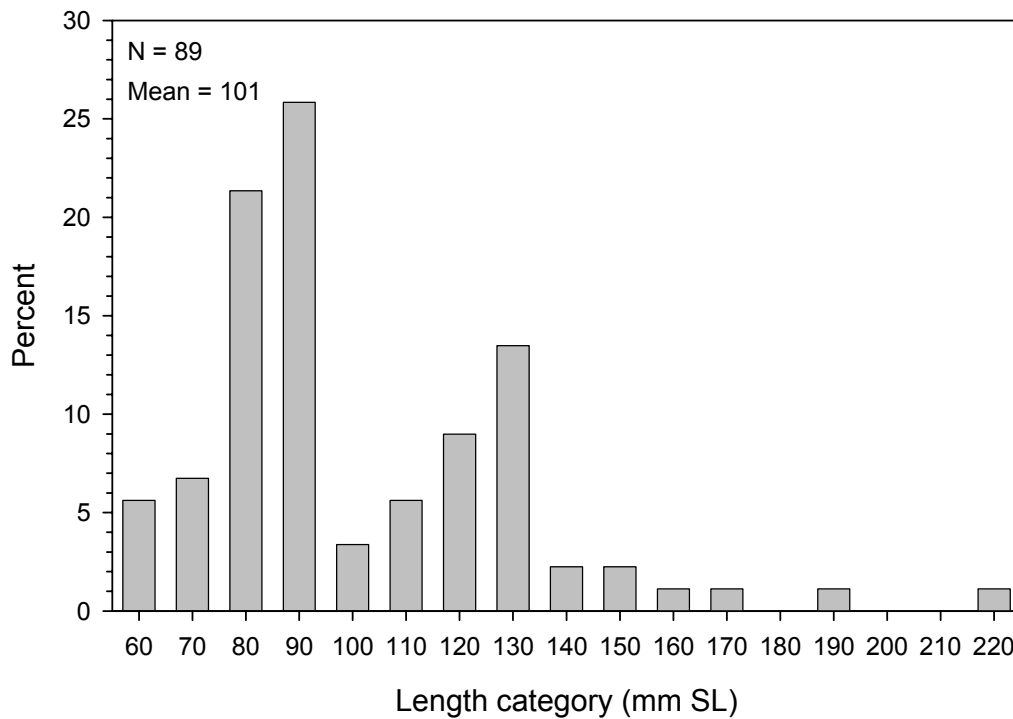
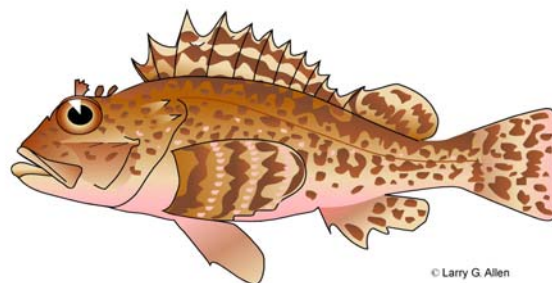

Figure 5.5-16. Length (mm) frequency distribution for black perch collected in impingement samples.

**5.5.2.2 California scorpionfish (*Scorpaena guttata*)**

California scorpionfish (*Scorpaena guttata*) ranges from Uncle Sam Bank, Baja California, Mexico to Santa Cruz, California in depths from the surf zone to 183 m (Miller and Lea 1972; Love et al. 2005). Allen and Pondella (2006) included California scorpionfish in their northern kelp and southern mid depth reef species group. California scorpionfish have been commonly observed during impingement sampling throughout southern California (MBC unpubl. data).



**5.5.2.2.1 Life History and Ecology**

Love et al. (1987) reported California scorpionfish were often found lodged in crevices of the reef, while they were noted to seasonally aggregate over sand and muddy bottoms. Within the reef community, California scorpionfish typically occur as a Zone I bottom mesocarnivore, primarily hunting fish and

macroinvertebrates near the base of a kelp/rock reef (Quast 1968a). Exhibiting a generally southern distribution within the Southern California Bight, California scorpionfish catch rates were lowest near Santa Barbara, California before increasing with distance southward before peaking near San Diego, California as well as around the Santa Catalina, San Clemente, and Coronado Islands, based on California Department of Fish and Game records (Love et al. 1987). Furthermore, these authors reported high spawning site fidelity for California scorpionfish, with all 17 of the 17 tag recoveries off Dago Bank (Horseshoe Kelp) being initially tagged and released there. They further note that few individuals were found on the bank year round, rather dense aggregations forming in late spring and summer.

California scorpionfish generally mature near 180 mm total length, or two years of age, with peak gonosomatic indices for both sexes from June through August (Love et al. 1987). The authors further hypothesized that California scorpionfish aggregate at “traditional” spawning sites and engage in polygamous spawning. Characterization of the dispersal patterns of the planktonic stages has been difficult with few collected during long-term monitoring programs, namely offshore surveys by CalCOFI and within King Harbor, Redondo Beach, California (Love et al. 1987). The lack of larvae within King Harbor was further puzzling due to the relatively high abundance of young-of-the-year and 1-year-old individuals within the harbor.

Love et al. (1987) reported males and females to grow at significantly different rates, with females attaining greater size and age (443 mm TL, 21 years old). Females were observed to grow at a faster rate through their first seven years before leveling off, while males grew at a more consistent rate throughout their life, with a slight reduction in the last five years (Love et al. 1987).

#### 5.5.2.2.2 Population Trends and Fishery

At the time, Love et al. (1987), reporting on data from April 1975 to December 1978, noted that California scorpionfish constituted a minor portion of the commercial passenger fishing vessel catch, ranking 15th or comprising about 1.5% of all individuals taken. Analysis of long-term trends in the NMFS Los Angeles Times recreational fishing database recorded an annual mean landing of 36,767 individuals from all landings ranging from Paradise Cove on the northwestern edge of the Santa Monica Bay south to San Diego, California over the period 1959 – 2003 (NMFS 2007). Notably, the mean annual landings from 1987 to 2003 (93,890) increased nearly 45-fold over the annual average for 1959 to 1986 (2,085). Commercial landings indicate a slightly different trend, with relatively high landings recorded, albeit with high interannual variation, before 1979, followed by notably reduced landings overall from 1980 to 1999 (Love 2001). The author further noted that fishery-independent data suggested substantial short term fluctuations in the local populations. In 2005, California scorpionfish landings in the Los Angeles area totaled 4,439 kg (9,789 lbs) at a value of \$27,888 (CDFG 2006). Commercial landings of California scorpionfish reported from catch blocks in the Santa Monica Bay area totaled 33.6 kg (74 lbs) in 2006, at an estimated value of \$206 (CDFG 2007b).

Scorpionfish were not analyzed in detail in the 1978-1980 316(b) demonstration (SCE 1983). From 2003 through 2005, estimated annual impingement of scorpionfish ranged from 128 individuals (2003) to 152



individuals (2005) (MBC 2007). Since 1991, 4,284 California scorpionfish were estimated to have been impinged at the RBGS, an average of about 286 individuals per year.

#### 5.5.2.2.3 Sampling Results

An estimated 52 California scorpionfish weighing 5.716 kg (12.604 lbs) were impinged at RBGS based on actual cooling water flow volumes (Table 5.5-3). All individuals were recorded from Units 7&8 in a nearly 50:50 split between normal operation and heat treatments. Length frequency analysis of 29 measured individuals indicated a mean length of 133 mm SL ranging from 82 to 266 mm SL. The distribution of lengths was highly variable with an overall peak abundance in the 110-mm SL size class (Figure 5.5-17) or approximately Age Class I (Love et al. 1987). The condition of 27 individuals was assessed upon collection with 63% alive and 37% dead.

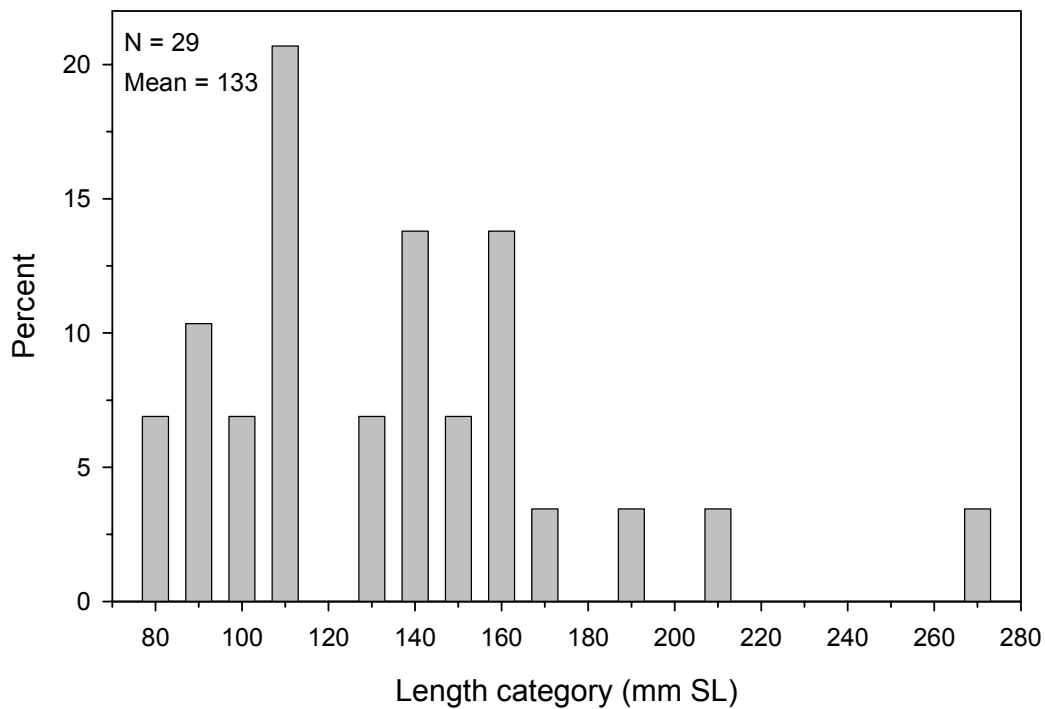
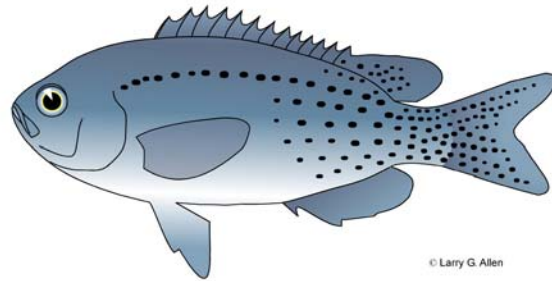

Figure 5.5-17. Length (mm) frequency distribution for California scorpionfish collected in impingement samples.

### 5.5.2.3 Blacksmith (*Chromis punctipinnis*)

Blacksmith (*Chromis punctipinnis*) range from Point San Pablo, Baja California, Mexico to Monterey, California in depths from the surface to 46 m (Miller and Lea 1972). It is one of only two species of the family Pomacentridae common to southern California, the other being garibaldi. Both species were included in the southern kelp reef species assemblage described by Allen and Pondella (2006). Blacksmith have been frequently observed in impingement sampling throughout southern California since 1990 (MBC unpubl. data).



#### 5.5.2.3.1 Life History and Ecology

Limbaugh (1964) reported blacksmith to frequently occur over high-relief rocky reefs, with or without kelp. Quast (1968c) reported similar findings, with densities increasing among more southward stations in San Diego, California and into Mexican waters as compared with more northerly stations, such as Gaviota, California, with densities increasing seasonally with the onset of reproductive activities. Quast (1968a) included blacksmith in his Zone III classification for their common occurrence within the open water areas of the kelp bed, typically below the area occupied by topsmelt. Within this zone, blacksmith commonly prey on small “microscopic” prey items such as various planktonic organisms, such as copepods, mysids, and crustacean eggs (Limbaugh 1964; Quast 1968b). Hobson and Chess (1976) reported blacksmith primarily hunt during daylight hours, before retreating to the caves and crevices of the reef at night. Blacksmith ranked higher in abundance at Santa Catalina Island (20<sup>th</sup>) than along the mainland (35<sup>th</sup>) in fish assemblages sampled by gillnet from 1996 to 1998, indicating slight preference for the island, which may be attributed to the greater overall frequency of rocky reef habitat (Pondella and Allen 2000). Along the Los Angeles Federal Breakwall, blacksmith numerically dominated the overall assemblage, accounting for nearly 57% of all fishes, many of which were recently recruited juveniles (Froeschke et al. 2005).

Blacksmith lay eggs in closely guarded nests created by the males, often in holes or caves throughout the reef (Limbaugh 1964). This author described the courtship as aggressive, with the male frequently biting and harassing the female as he led her to his nest. Once the eggs are laid, the female is chased off while the male continues to guard the nest; otherwise the eggs are subject to predation from nearby reef fishes. Pelagic larvae are typically observed from mid-summer to early fall. Juvenile blacksmith were frequently observed in large schools, typically from August through October (Limbaugh 1964; Froeschke and Allen 2006).

Little information is available in the primary literature regarding age and growth of blacksmith (Cailliet et al. 2001). Limbaugh (1964) suggested blacksmith mature at 140 mm, or approximately 2 years old.

#### 5.5.2.3.2 Population Trends and Fishery

Blacksmith are not the subject of any targeted fishery, commercial or recreational, although they do occur as bycatch in both. They are commonly taken by pier fishermen as well as recreational anglers fishing adjacent to rocky reefs. The NMFS Los Angeles Times recreational fishing database recorded an annual mean landing of 2,182 blacksmith from all landings ranging from Paradise Cove on the northwestern edge of the Santa Monica Bay south to San Diego, California over the period 1991-2003 (NMFS 2007). Due to the random nature of the recreational fishing data, no real population trends can be determined for blacksmith. In 2005, blacksmith landings in the Los Angeles area totaled 25.8 kg (57 lbs) at a value of \$32 (CDFG 2006). There were no commercial landings of blacksmith reported from catch blocks in the Santa Monica Bay area in 2006 (CDFG 2007b).

Blacksmith were not analyzed in detail in the 1978-1980 316(b) demonstration (SCE 1983). From 2003 through 2005, estimated annual impingement of blacksmith ranged from 86 individuals (2003) to 139 individuals (2004) (MBC 2007). Since 1991, 33,706 blacksmith were estimated to have been impinged at the RBGS, an average of about 2,247 individuals per year. However, more than 81% of the individuals impinged were recorded from 1991 through 1993. Since 1999, annual impingement has ranged from 54 to 459 individuals per year.

#### 5.5.2.3.3 Sampling Results

Twenty-nine blacksmith weighing 2.478 kg (5.464 lbs) were impinged exclusively during heat treatments at Units 7&8 (Table 5.5-3). Analysis of these 29 individuals recorded lengths ranging from 84 to 165 mm SL with a mean length of 141 mm SL. The length frequency distribution indicated a modal distribution peaking at 150 mm SL (Figure 5.5-18) or approximately 2 years old (Limbaugh 1964). All individuals examined were dead.

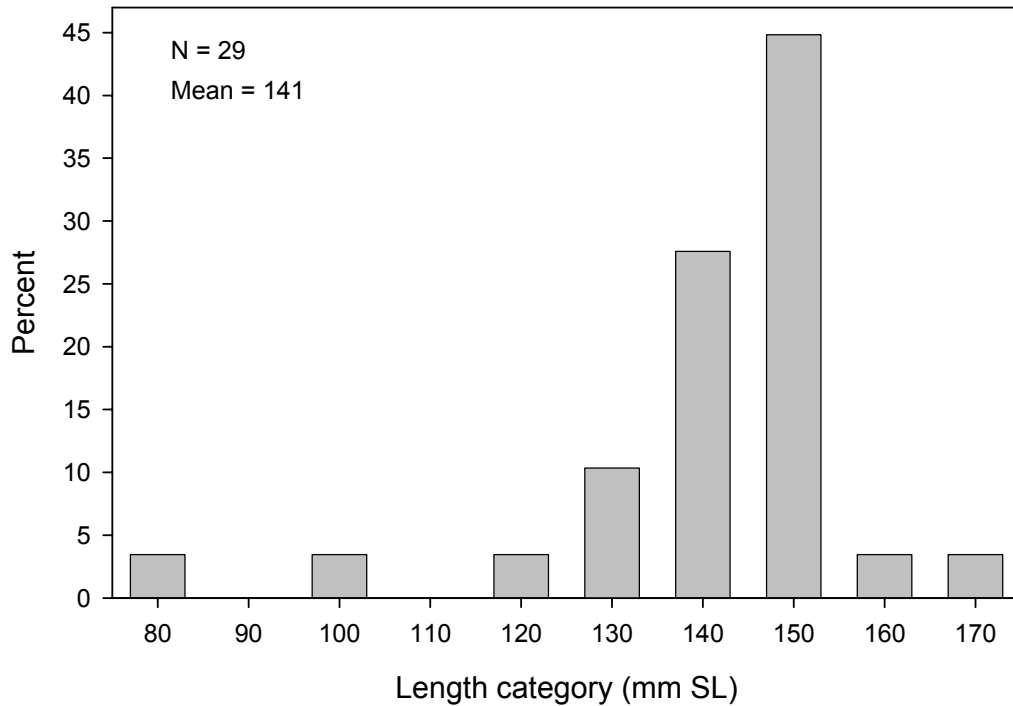
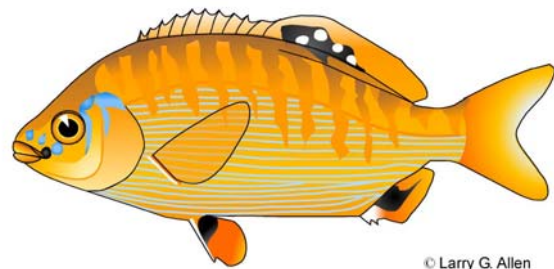

Figure 5.5-18. Length (mm) frequency distribution for blacksmith collected in impingement samples.

#### 5.5.2.4 Rainbow seaperch (*Hypsurus caryi*)

Rainbow seaperch (*Hypsurus caryi*) is a member of the family Embiotocidae, or surfperches. As the name suggests, rainbow seaperch is a colorful species, with orange and blue horizontal stripes on the body, orange bars on the back and blue streaks and blotches on the head (Eschmeyer et al. 1983; Love 1996). Rainbows range from Cape Mendocino in northern California to northern Baja California, Mexico in depths to 40 m (131 ft). Rainbow seaperch are rocky substrate associates, often found at the edges of kelp beds and occasionally over sandy bottoms, but not in surf. Rainbows may be found as single individuals or in small schools, and seasonally will form large schools. In King Harbor, Redondo Beach, California, rainbow seaperch have been noted to come into shallow depths during winter and spring (Love 1996). Rainbow seaperch may grow up to 30 cm (1 ft) in length.



© Larry G. Allen

5.5.2.4.1 Life History and Ecology

Courtship in rainbow seaperch occurs in fall over shallow sandy bottoms with some drift algae (Love 1996). Like all surfperches, rainbow seaperch are viviparous with the young being highly developed and able to swim free at birth (Love 1996; Fritzsche and Collier 2001). Female rainbows are mature at about 13 cm (5 in) and produce 5 to 22 young per season (Love 1996). The young are about 5 cm (2 in) long at birth, and may be found among algae in shallow areas. Rainbow seaperch are benthic feeders that pick amphipods, isopods and other crustaceans as well as snails and brittle stars from the sea floor.

5.5.2.4.2 Population Trends and Fishery

Rainbow seaperch are occasionally caught by recreational anglers from boats and piers or from rocky shores, and are more commonly taken in northern and central California than in southern California (Eschmeyer et al. 1983; Love 1996). Annual "surfperch" landings for southern California for 2000-2006 are presented in Table 5.5-5. A small commercial fishery takes about 180 kg (400 lbs) per year (Love 1996). Commercial landings do not differentiate rainbow seaperch from most other surfperch species, so current size of the fishery is difficult to determine. In 2005, "surfperch" landings in the Los Angeles area totaled 21.3 kg (47 lbs) at a value of \$86 (CDFG 2006). Commercial landings of "surfperches" reported from catch blocks in the Santa Monica Bay area totaled 117.0 kg (258 lbs) in 2006, at an estimated value of \$1,092 (CDFG 2007b).

Rainbow seaperch were not analyzed in detail in the 1978-1980 316(b) demonstration (SCE 1983). From 2003 through 2005, estimated annual impingement of rainbow seaperch ranged from 17 individuals (2003) to 69 individuals (2004) (MBC 2007). Since 1991, 1,059 rainbow seaperch were estimated to have been impinged at the RBGS, an average of about 71 individuals per year. Fishery-independent counts of rainbow seaperch from King Harbor indicate densities decreased following the 1983-4 El Niño, while densities at Palos Verdes peaked during the ten years following that event (Figure 5.5-19).

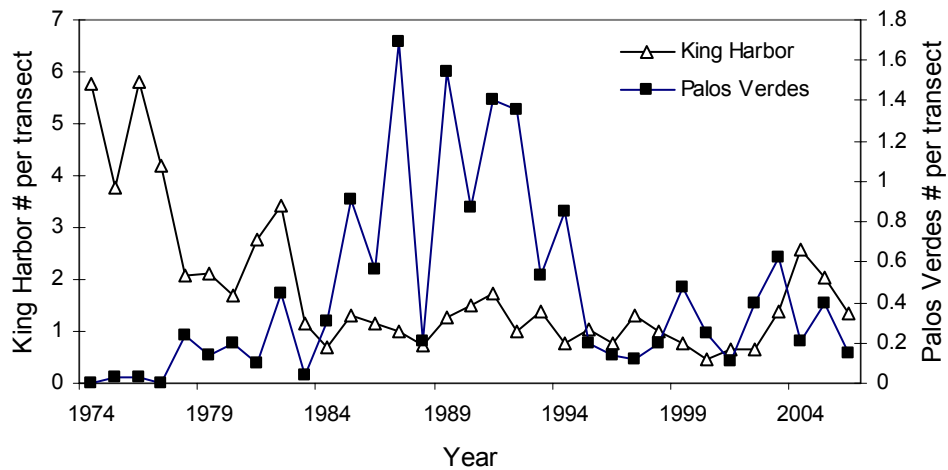

Figure 5.5-19. Abundance of rainbow seaperch (*Hypsurus caryi*) measured during diver transects at King Harbor and Palos Verdes from 1974-2006. Source: Vantuna Research Group.

#### 5.5.2.4.3 Sampling Results

Occurring exclusively during heat treatments at Units 7&8, 25 rainbow seaperch weighing 1.668 kg (3.678 lbs) were impinged (Table 5.5-3). Lengths of these 25 individuals ranged from 50 to 186 mm SL with a mean length of 124 mm SL. Distribution analysis of these lengths was trimodal with peaks at 70, 120, and 160 mm SL (Figure 5.5-20). These three peaks, in the absence of published age at length information, suggests three age classes (I, II, III). The sexual distribution of these individuals was split 50:50 between females and males, with all individuals dead upon collection.

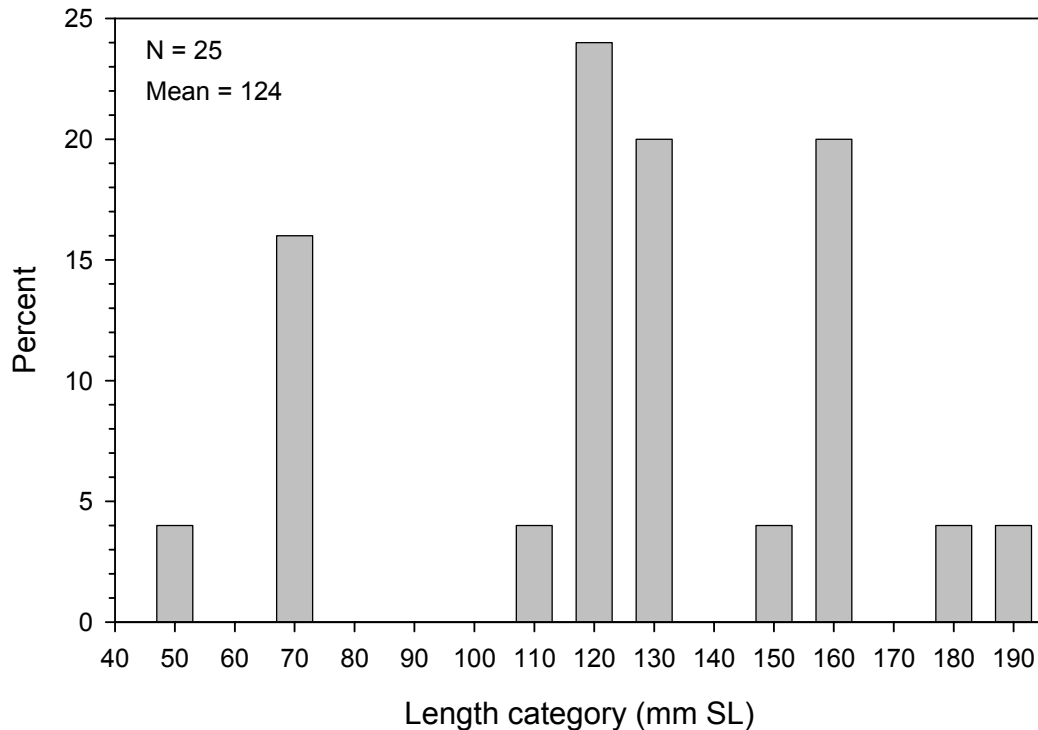

Figure 5.5-20. Length (mm) frequency distribution for rainbow seaperch collected in impingement samples.

### 5.5.2.5 Queenfish (*Seriphus politus*)

Information on the life history and ecology of queenfish is presented in Section 4.5.3.6.

#### 5.5.2.5.1 Population Trends and Fishery

Queenfish was the most abundant sciaenid impinged at five generating stations in southern California from 1977 to 1998, and accounted for over 60% of the total fishes impinged (Herbinson et al. 2001). Annual abundance fluctuated from year to year, with notable declines during the strong El Niño events of 1982-83, 1986-87, and 1997-98. However, abundance remained relatively high throughout the over 20-year study period.

Queenfish was the most abundant fish species in the 1978-1980 316(b) demonstration, with impingement averaging about 149 individuals per day at Units 1-6 and 67 individuals per day at Units 7&8 (SCE 1983). From 2003 through 2005, estimated annual impingement of queenfish ranged from 18 individuals (2004) to 311 individuals (2003) (MBC 2007). Since 1991, 14,939 queenfish were estimated to have been impinged at the RBGS, an average of about 996 individuals per year. Impingement of this species has been cyclical, with annual peaks recorded in 1991, 1997, and 2001.

5.5.2.5.2 Sampling Results

During the yearlong study, an estimated 87 queenfish weighing 0.928 kg (2.046 lbs) were impinged at RBGS Units 7&8 based on actual cooling water flow volumes with the majority attributed to normal operation (Table 5.5-3). Length frequency analysis of the 21 individuals measured indicates a mean length of 120 mm SL, with lengths ranging from 68 to 161 mm SL. Distribution was bimodal with peaks at 80 and 130 mm SL (Figure 5.5-21), which correspond to young of the year and Age Class II individuals (MBC and VRG unpubl. data). All individuals collected were dead, with 90% observed during heat treatments (Table 5.5-3).

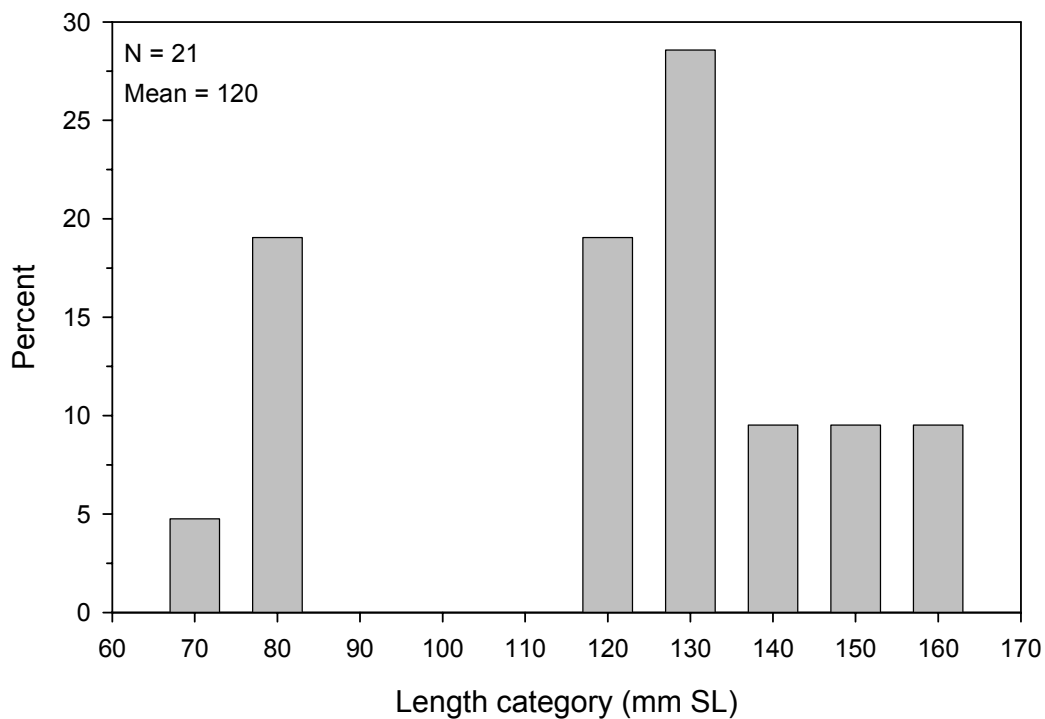

Figure 5.5-21. Length (mm) frequency distribution for queenfish collected in impingement samples.



5.5.2.5.3 Modeling Results

Queenfish life history parameters are presented in Table 5.5-10. Unpublished research by MBC and the Occidental College Vantuna Research Group (VRG) provided all of the applicable adult life history parameters which indicate the age at 50% maturity is 1.77 years. Age class frequency analysis indicated the majority of individuals collected were less than 3.3 years old (Figure 5.5-22). A total of 106 adult equivalents were taken over the year based on actual cooling water flow volumes. Of these, 38 were directly attributable to heat treatments while an estimated 68 were impinged during normal operation of the cooling water system calculated using actual flow volumes. Recalculating the adult equivalent estimates using design (maximum) flow volumes resulted in a total loss of 210 adult equivalents.

Table 5.5-10. Queenfish life history parameters used in equivalent adult modeling.

Total Adult Mortality (Z)	Survival (S)	von Bertalanffy growth parameters*			Age at 50% Maturity	Length at 50% Maturity
		$L_{inf}$	k	$t_0$		
0.3512	0.703843	176 mm TL	0.302	-1.234	1.76642	105 mm TL

\* Data from MBC and VRG unpublished data

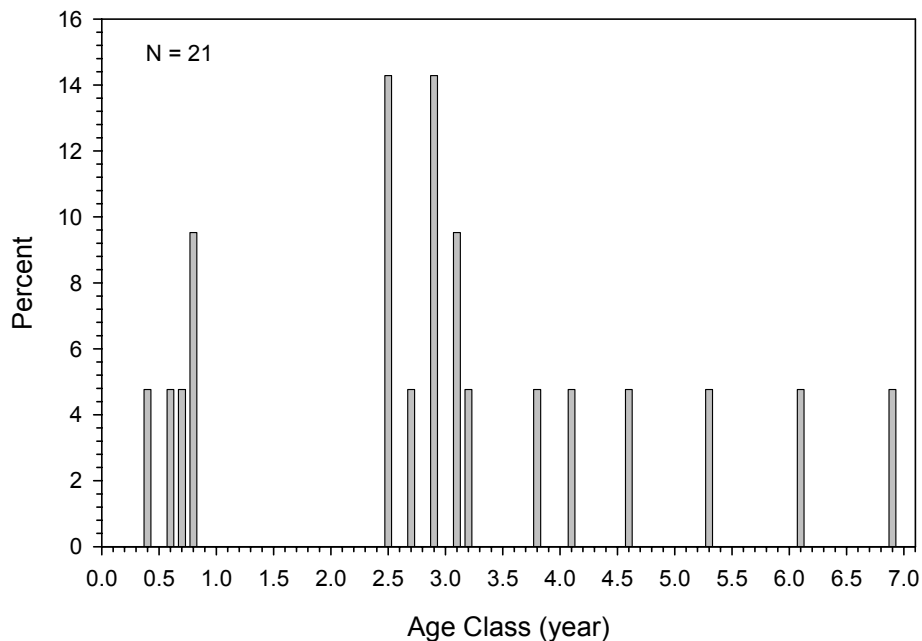
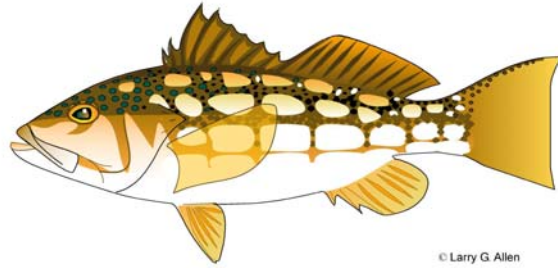

Figure 5.5-22. Distribution of queenfish age classes in RBGS impingement samples.

### 5.5.2.6 Kelp bass (*Paralabrax clathratus*)

Information on the life history and ecology of kelp bass is presented in Section 4.5.3.4.



#### 5.5.2.6.1 Population Trends and Fishery

Kelp bass was the fifth most abundant fish species in the 1978-1980 316(b) demonstration, with impingement averaging less than one individual per day at Units 1-6 and 15 individuals per day at Units 7&8 (SCE 1983). From 2003 through 2005, estimated annual impingement of kelp bass ranged from 22 individuals (2005) to 145 individuals (2004) (MBC 2007). Since 1991, 3,993 kelp bass were estimated to have been impinged at the RBGS, an average of about 266 individuals per year. However, nearly 50% of the 15-year total was impinged between 1991 and 1993. Between 1974 and 1998, densities of adult kelp bass in King Harbor were relatively constant, with a peak in the early 1980s (Pondella et al. 2002). Densities were significantly higher in King Harbor (mean of 3.6 individuals/100 m<sup>2</sup>) than at a nearby reference reef at Palos Verdes (mean of 2.9 individuals/100 m<sup>2</sup>).

#### 5.5.2.6.2 Sampling Results

All kelp bass, 15 individuals weighing 1.594 kg (3.515 lbs), were impinged during heat treatments at Units 7&8 in 2006 (Table 5.5-3). All 15 individuals were measured with lengths ranging from 131 to 208 mm SL and a mean length of 160 mm SL. The distribution was variable with a peak in the 170-mm SL size class (Figure 5.5-23). Sixty percent of the individuals were collected alive while the remaining 40% were dead.

#### 5.5.2.6.3 Modeling Results

Kelp bass life history parameters are presented in Table 5.5-11. All life history parameters other than total instantaneous annual mortality (*Z*) were taken from Love et al. (1996). No estimates for *Z* were available in the literature, so the estimate was taken from CDFG web life history database. Age class frequency analysis indicated the majority of individuals collected was less than 2.6 years old (Figure 5.5-24). A total of nine adult equivalents was taken over the year based on actual cooling water flow, all during heat treatments.

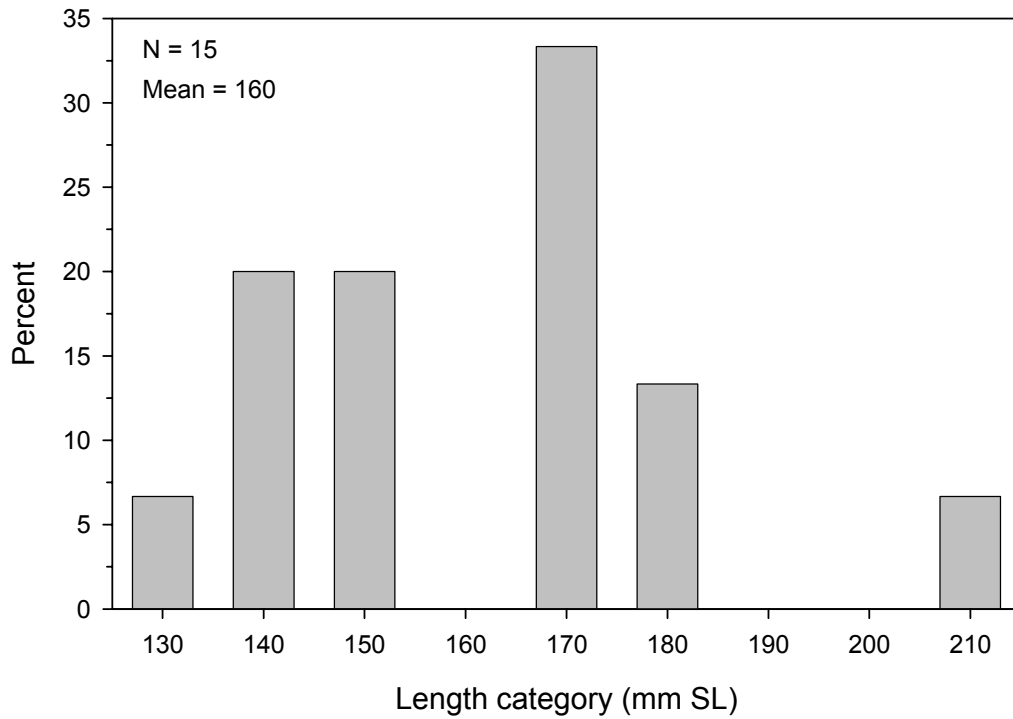

Figure 5.5-23. Length (mm) frequency distribution for kelp bass collected in impingement samples.

Table 5.5-11. Kelp bass life history parameters used in equivalent adult modeling.

Total Adult Mortality (Z)*	Survival (S)	von Bertalanffy growth parameters**			Age at 50% Maturity	Length at 50% Maturity**
		$L_{inf}$	k	$t_0$		
0.544	0.580422	698 mm TL	0.06	-3.5	3.02067	226 mm TL

\*[www.dfg.ca.gov/mrd/lifehistories/index.html](http://www.dfg.ca.gov/mrd/lifehistories/index.html)

\*\* Love et al. 1996

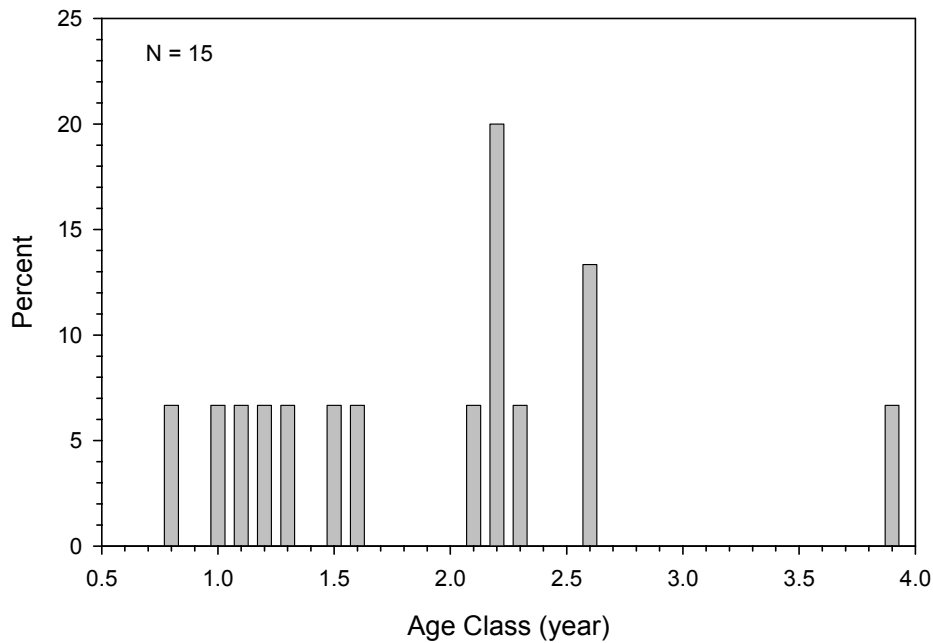
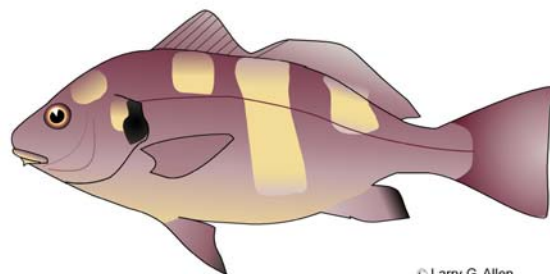

Figure 5.5-24. Distribution of kelp bass age classes in RBGS impingement samples.

### 5.5.2.7 Black croaker (*Cheilotrema saturnum*)

Black croaker (*Cheilotrema saturnum*) is a member of the drums and croakers family (Sciaenidae) and ranges from Point Conception, California to central Baja California (including the Gulf of California) in depths from 3 to 50 m (Limbaugh 1961; Miller and Lea 1972). Seven species of croaker, in addition to black croaker, are common to the Southern California Bight (SCB), including white croaker, queenfish, yellowfin croaker, white seabass, California



© Larry G. Allen

corbina, spotfin croaker, and shortfin corvina (Miller and Lea 1972). Two other species (orangemouth corvina and bairdiella) are currently believed to be restricted to the Salton Sea, California within the SCB.

#### 5.5.2.7.1 Life History and Ecology

Black croaker is common to open-coast, shallow rocky reefs and kelp beds (Limbaugh 1961; Allen 1985) with large adults occupying shelters within the reef structure and smaller individuals typically occurring above the sand substrate in and around the reef (Limbaugh 1961). Nocturnal in nature, aggregations have

been observed migrating away from the reef to feed and reproduce at night, while remaining relatively sessile within the reef area during the day (Limbaugh 1961). Limbaugh (1961) observed aggregations of adults concentrated near the 7-m isobath, but as deep as 50 m. He noted that individuals were more abundant in the shallower portion of their depth distribution.

Black croaker is an oviparous broadcast spawner with pelagic eggs and larvae (Moser 1996). Greater than 50% of both males and females are reproductively mature by 150 mm standard length (SL) or approximately one year of age (Miller et al. in prep b). Spawning is most prevalent in the late spring to summer months, with a peak in June and July based on histological examination (Goldberg 1981) and seasonal gonosomatic index (GSI) analysis (Miller et al. in prep a). Late-stage larvae have been collected as early as July (Miller et al. in prep a), with regular collections from August through October (Limbaugh 1961, Moser 1996). Spawning populations were found to be statistically skewed towards males at a ratio of 1.22:1 (male:female), with each sex represented in all size and age classes (Miller et al., in prep a).

Moser (1996) reported newly hatched black croaker larvae to be 1.5 mm notochord length (NL). Flexion occurs at approximately 5.6 mm NL and transformation occurs at standard lengths in excess of 11 mm (Moser 1996). Black croaker grows rapidly during the first six years, attaining an average length of 200 mm SL before growth rates slow (Miller et al. in prep a). Black croaker reportedly grows to 380 mm SL (Miller and Lea 1972) and 22 years old with no significant differences in the growth rates between males and females (Miller et al. in prep a). The strongest recruitment year within the last decade occurred in 1997, which corresponded to the highest sea surface temperature in the same time period (Miller et al. in prep a). The estimated annual survivorship rate for black croaker is 0.85 (0.15 mortality) (Miller et al. in prep a).

Gut contents of adults indicate their diet consists primarily of demersal crustaceans such as crabs, shrimp, and amphipods (Limbaugh 1961). Recent anecdotal observations of one adult black croaker gut contents included two blackeye gobies (*Rhinogobiops nicholsii*) (Miller, personal observation). Nearshore gillnet sampling from Newport Beach to Santa Barbara, California, including Santa Catalina Island, indicated the largest sustaining population to occur near the Palos Verdes Peninsula, California (Miller et al. in prep a). Pondella and Allen (2000) also noted higher population densities occurred at mainland sites compared to Santa Catalina Island sites. However, the individuals collected at the island sites were larger on average than those encountered along the mainland (Miller et al. in prep a). Black croaker is commonly found in association with sargo (*Anisotremus davidsonii*) and salema (*Xenistius californiensis*), with the juveniles of both species displaying similar body coloration to those of young black croaker (Limbaugh 1961).

#### 5.5.2.7.2 Population Trends and Fishery

Historically, black croaker has been the third most abundant croaker species among impingement samples at southern California coastal generating stations since 1976, surpassed only by white croaker and queenfish (Herbinson et al. 2001). Long-term trends in impingement observations indicate an overall declining abundance, with a minor upturn in 1997. Currently, no commercial fisheries target black croaker, and only incidental catches occur in the recreational fishery.

Black croaker was the tenth most abundant fish species in the 1978-1980 316(b) demonstration, with impingement averaging less than one individual per day at Units 1-6 and about two individuals per day at Units 7&8 (SCE 1983). From 2003 through 2005, estimated annual impingement of black croaker ranged from 12 individuals (2003) to 40 individuals (2004) (MBC 2007). Since 1991, 2,411 black croaker were estimated to have been impinged at the RBGS, an average of about 161 individuals per year.

#### 5.5.2.7.3 Sampling Results

Fourteen black croaker weighing 1.726 kg (3.806 lbs) were impinged exclusively during heat treatments at Units 7&8 (Table 5.5-3). These individuals ranged in length from 119 to 200 mm SL with a mean length of 170 mm SL. Length frequency analysis noted a highly variable distribution with peaks at 150, 170, and 200 mm SL (Figure 5.5-25) or Age Classes IV and V (Miller, unpubl. data). Seventy-five percent of these individuals were dead with the remaining 25% collected alive.

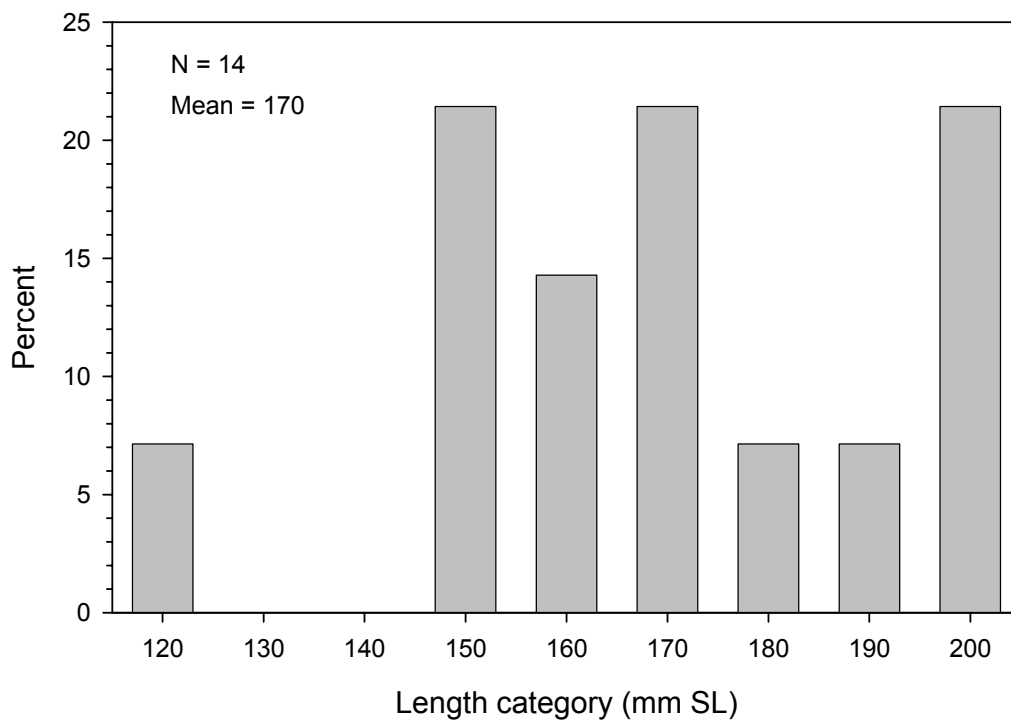

Figure 5.5-25. Length (mm) frequency distribution for black croaker collected in impingement samples.

5.5.2.7.4 Modeling Results

Black croaker life history parameters are presented in Table 5.5-12. All life history parameters were taken from Miller et al. (in review). Age class frequency analysis indicated the majority of individuals collected ranged from 0.5 to 4.1 years old (Figure 5.5-26). A total of 17 adult equivalents were taken over the year based on actual cooling water flow, all during heat treatments.

Table 5.5-12. Black croaker life history parameters used in equivalent adult modeling.

Total Adult Mortality (Z)*	Survival (S)	von Bertalanffy growth parameters*			Age at 50% Maturity	Length at 50% Maturity*
		$L_{inf}$	k	$t_0$		
0.17	0.843664817	238 mm SL	0.31	-1.78	1.42946	150 mm SL

\*Miller et al. (in review)

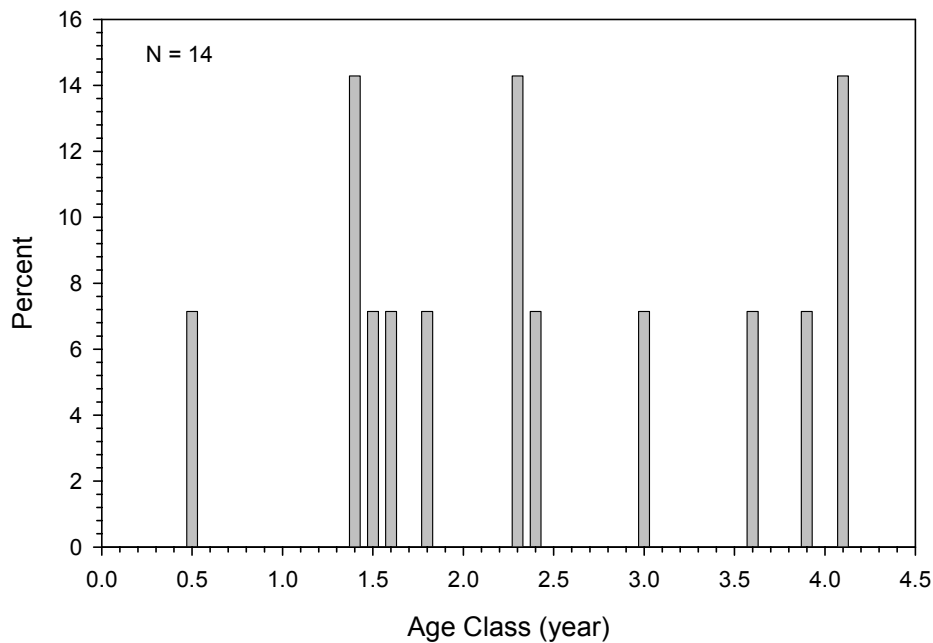
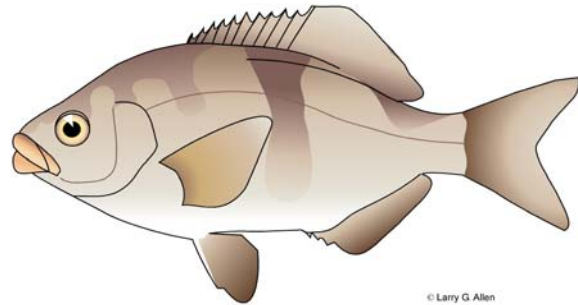

Figure 5.5-26. Distribution of black croaker age classes in RBGS impingement samples.

### 5.5.2.8 Rubberlip seaperch (*Rhacochilus toxotes*)

Rubberlip seaperch (*Rhacochilus toxotes*) is the largest member of the surfperch family (Embiotocidae), with individuals reaching up to 47 cm (18.5 in) total length (Eschmeyer et al. 1983; Fritzsche and Hassler 1989; Love 1996; Fritzsche and Collier 2001). Rubberlips derive their name from their very thick white or pale pink lips that distinguish them from other surfperches. The body color of most individuals is silvery-green fading to brassy below, while others have black, blue, or



purplish tints on the dorsal surfaces (Eschmeyer et al. 1983; Fritzsche and Hassler 1989). Adults have one or two dusky bars along the sides, while young up to 15 cm (6 in) are pinkish with a dark bar mid-side. Rubberlip seaperch ranges from Mendocino County, northern California to central Baja California, including Guadalupe Island, but is most common south of central California (Eschmeyer et al. 1983; Fritzsche and Hassler 1989; Love 1996; Fritzsche and Collier 2001).

#### 5.5.2.8.1 Life History and Ecology

Rubberlips are often found in schools of 50 to 100 individuals and are abundant near hard structures such as rocky reefs, in kelp beds, around piers and underwater structures, and occasionally in quiet backwaters. While known to occur at depths from the shallow subtidal to 46 m (150 ft), they more commonly are found at between 3 and 30 m (10 to 98 ft). Adults typically occur near bottom or mid-water near the lower kelp canopy, while the young utilize the kelp understory or areas with thick cover for concealment (Fritzsche and Hassler 1989; Love 1996). Rubberlip seaperch feed both diurnally and nocturnally, and may occur slightly more frequently at night (Fritzsche and Hassler 1989).

Rubberlip surfperch have a lifespan of seven to ten years (Fritzsche and Hassler 1989). Little is known about the life history of the species. Individuals appear to be at almost 9 cm (>3.5 in) when born, about 33 cm (13 in) at 4 years, 42 cm (16.5 in) at 8 years, and 43 cm (17 in) at 9 years (Fitch and Lavenberg 1971; Love 1996). Age of sexual maturity is not known (Fritzsche and Collier 2001). Mating probably occurs in late summer or fall with males darkening and leaving the protection of their normal habitat to hang head down in the mid water column away from the protection of the kelp canopy (Love 1996). During courtship single males have been observed escorting multiple females but breeding behavior has not been noted. Spawning in southern California occurs late spring to early summer (Fitch and Lavenberg 1971; Fritzsche and Collier 2001). Like all surfperches, rubberlip seaperch are viviparous, with the young being highly developed at birth. Brood size in rubberlips has not been studied, but an eight-year-old female collected at Redondo Beach was reported with 21 nearly mature embryos (Fitch and Lavenberg 1971).

Rubberlip seaperch are considered an “oral winnower”, using their flexible lips to suction thin-shelled invertebrates from rocks (Love 1996; Fritzsche and Hassler 1989). The fish are then able to sort the small invertebrates from debris in their mouths, expelling the debris and swallowing the prey. Diet of the perch is almost exclusively crustaceans such as shrimp, amphipods, and small crabs, but small mollusks and



algae are also occasionally taken. Young pile perch are vulnerable to larger fish such as kelp bass, while adults are preyed on by larger predators including electric rays, sharks, large basses, pinnipeds and cormorants (Fritzsche and Hassler 1989; Love 1996).

#### 5.5.2.8.2 Population Trends and Fishery

Rubberlip seaperch is an important recreational species in California (Fitch and Lavenberg 1971; Fritzsche and Hassler 1989; Love 1996; Fritzsche and Collier 2001). Many are taken from piers, jetties, and small skiffs near kelp beds or by spear by divers. In California, recreational anglers caught an average of 19,000 rubberlips between 1993 and 2000, ranging from 13,000 in 1993 to 44,000 in 1997 (Fritzsche and Collier 2001). Recreational "surfperch" landings for southern California for 2000-2006 are presented in Table 5.5-5.

No recent estimates of the rubberlip seaperch population size are available (Fritzsche and Collier 2001). Rubberlips support a small commercial fishery in California, caught by seine or hook and line (Love 1996; Fritzsche and Collier 2001). In 2005, "surfperch" landings in the Los Angeles area totaled 21.3 kg (47 lbs) at a value of \$86 (CDFG 2006). Commercial landings differentiate rubberlip seaperch from other surfperch species, but in 2006, the Santa Monica Bay catch blocks indicated that no rubberlip seaperch were taken commercially during the year (CDFG 2007b).

Rubberlip seaperch was not analyzed during the 1978-1980 316(b) demonstration (SCE 1983). From 2003 through 2005, estimated annual impingement of rubberlip seaperch ranged from 1 individual (2003) to 43 individuals (2005) (MBC 2007). Since 1991, 542 rubberlip seaperch were estimated to have been impinged at the RBGS, an average of about 36 individuals per year. Fishery-independent counts of rubberlip seaperch from King Harbor and Palos Verdes fluctuated from 1974 through 2005, though highest numbers at both locations were recorded in 2006 (Figure 5.5-27).

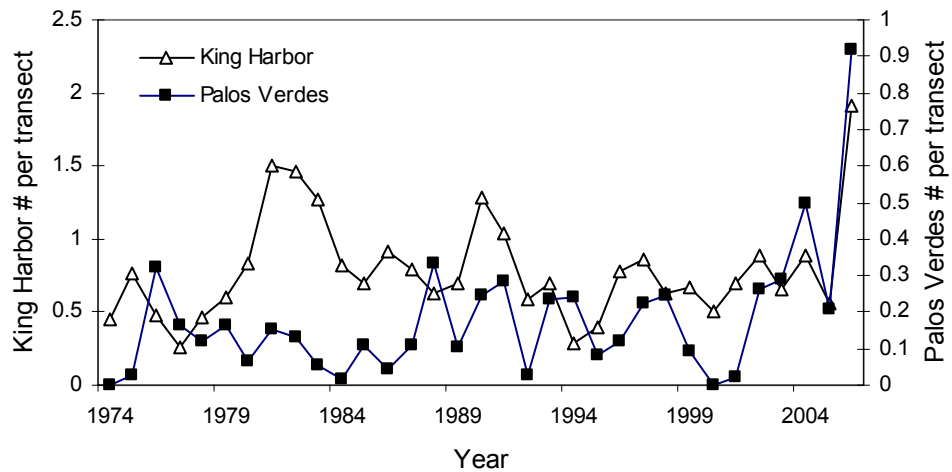

Figure 5.5-27. Abundance of rubberlip seaperch (*Rhacochilus toxotes*) measured during diver transects at King Harbor and Palos Verdes from 1974-2006. Source: Vantuna Research Group.

#### 5.5.2.8.3 Sampling Results

A total of 12 rubberlip seaperch weighing 1.323 kg (2.917 lbs) was impinged during heat treatments at Units 7&8 (Table 5.5-3). No other individuals were observed. These individuals ranged in length from 78 to 228 mm SL with a mean length of 147 mm SL. Most individuals were in the 150- and 170-mm SL size classes (Figure 5.5-28), indicating all individuals were likely less than four years old. The sex was determined for nine individuals, of which 56% were female and 44% were male. All individuals were dead upon collection.

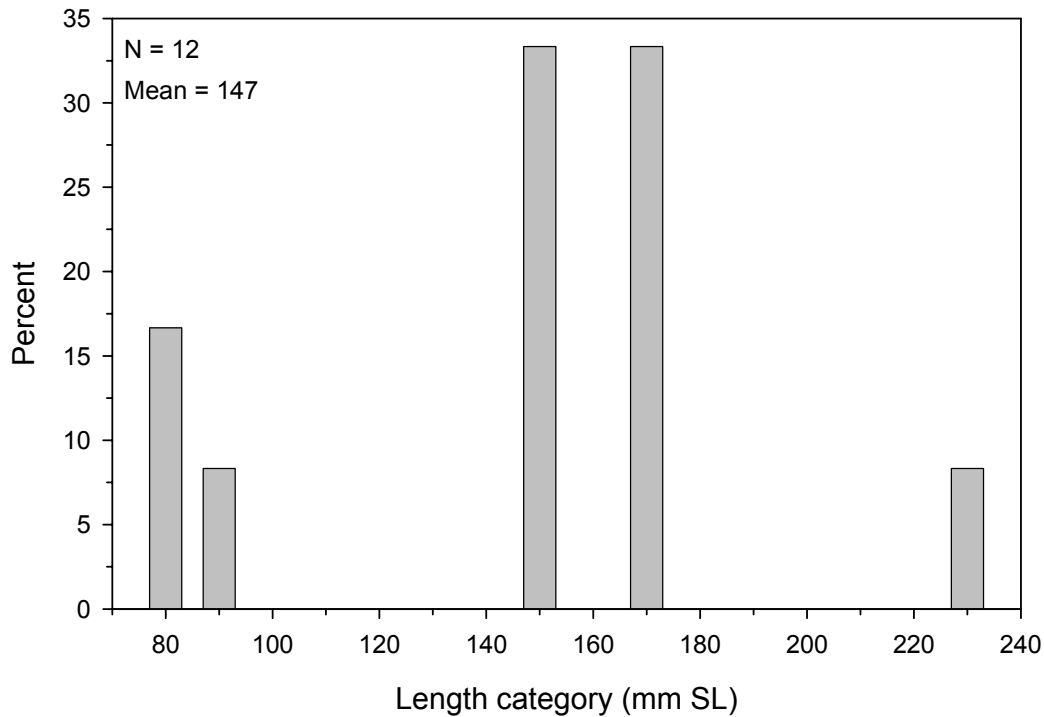

Figure 5.5-28. Length (mm) frequency distribution for rubberlip seaperch collected in impingement samples.

### 5.5.2.9 Round stingray (*Urobatis halleri*)

The round stingray (*Urobatis halleri*), is the most common stingray found off the California coast. It has a restricted habitat ranging from Eureka, northern California to Panama. It is most commonly found in shallow, coastal water bodies (Love 1996; Zorzi et al. 2001). Round stingrays are the single species belonging to the family Urolophidae, which is one of eight families in the order Myliobatiformes. Rays in this order are all warm-water organisms found close to shore (Bond 1996).



#### 5.5.2.9.1 Life History and Ecology

The habitat distribution of the round stingray is fairly limited for this benthic species. They can be found off beaches and in protected bays and channels, where they inhabit soft, loose sand or muddy bottoms.

They are commonly found in shallow coastal areas at depths of 1 to 30 m (3 to 98 ft), more commonly in waters less than 15 m (49 ft) deep. Mature females are more common further offshore, usually occurring in waters 12 to 18 m (39 to 59 ft) deep, whereas males prefer waters less than 12 m (39 ft) deep. Adults are not commonly found in very shallow waters in the winter months (Love 1996; Zorzi et al. 2001).

Round stingrays bear live young, with a gestation period of approximately three months (Babel 1967). In June, females move to shallow, inshore waters just for the time required to breed with males. They return to these same waters to spawn in August and September. A female can produce up to eight young per litter with an average of three per litter. Individuals measure about 100 mm (3.9 in) in length at birth (Love 1996).

There is not much information on age and growth for the round stingray; lack of suitable otoliths or scales makes it difficult to determine. They can reach a maximum length of 558 mm (22 in), and are considered mature at 254 to 266 mm (10.0 to 10.5 in) in length. At birth the young remain in water shallower than about 4 m (13 ft) until they reach approximately 152 to 177 mm (6 to 7 in) in length (Love 1996). The round stingray uses its stinging spine in defense against its predators. Due to the shallow nature of their coastal habitat, they often incidentally sting beach goers that wade in these shallow waters (Love 1996; Zorzi et al. 2001). Stingrays exhibit a seasonal spine-shedding period during fall where the old spine is shed and a new spine is regenerated. They can also regenerate a spine that is lost during other times of years (Johansson et al. 2004).

Due to the limited habitat where round stingrays can be found, their food source is also limited. Smaller stingrays will feed on invertebrates such as worms, shrimps, crabs, and amphipods. Larger stingrays primarily feed on clams (Love 1996).

#### 5.5.2.9.2 Population Trends and Fishery

Round stingrays are incidentally caught from pier and shore anglers. There is currently not a market for this species in California. In 2005, “stingray” landings in the Los Angeles area totaled 649 kg (1,430 lbs) at a value of \$292 (CDFG 2006). All of the landings were reported in the spring and summer (April–August 2005). There were no commercial landings of “stingray” reported from catch blocks in Santa Monica Bay in 2006 (CDFG 2007b).

Round stingray was not analyzed during the 1978-1980 316(b) demonstration (SCE 1983). From 2003 through 2005, estimated annual impingement of round stingray ranged from 2 individuals (2004) to 55 individuals (2005) (MBC 2007). Since 1991, 657 round stingrays were estimated to have been impinged at the RBGS, an average of about 44 individuals per year. Highest impingement occurred in 2001 with 101 individuals.

#### 5.5.2.9.3 Sampling Results

An estimated total of 74 round stingray weighing 23,180 kg (51,112 lbs) were impinged over the year at RBGS based on actual cooling water flow volumes, with 66 attributed to Units 5&6 with a weight of

17.918 kg (39.509 lbs) and an additional eight individuals weighing 5.262 kg (11.603 lbs) recorded during heat treatments at Units 7&8 (Tables 5.5-1 and 5.5-3). The individuals impinged during normal operations at Units 5&6 occurred in July. Length frequency analysis of 10 measured individuals indicated a mean disc width (DW) of 204 mm. Individuals ranged in size from 155 mm DW to 247 mm DW in a bimodal distribution peaking at 170 mm and 210 mm DW (Figure 5.5-29), or approximately 3 years old and in excess of 7 years old, respectively (Babel 1967). Sex was determined for 10 individuals, of which 80% were female and 20% were male. Of the 10 individuals that were evaluated for condition factor, 80% were alive and 20% were dead.

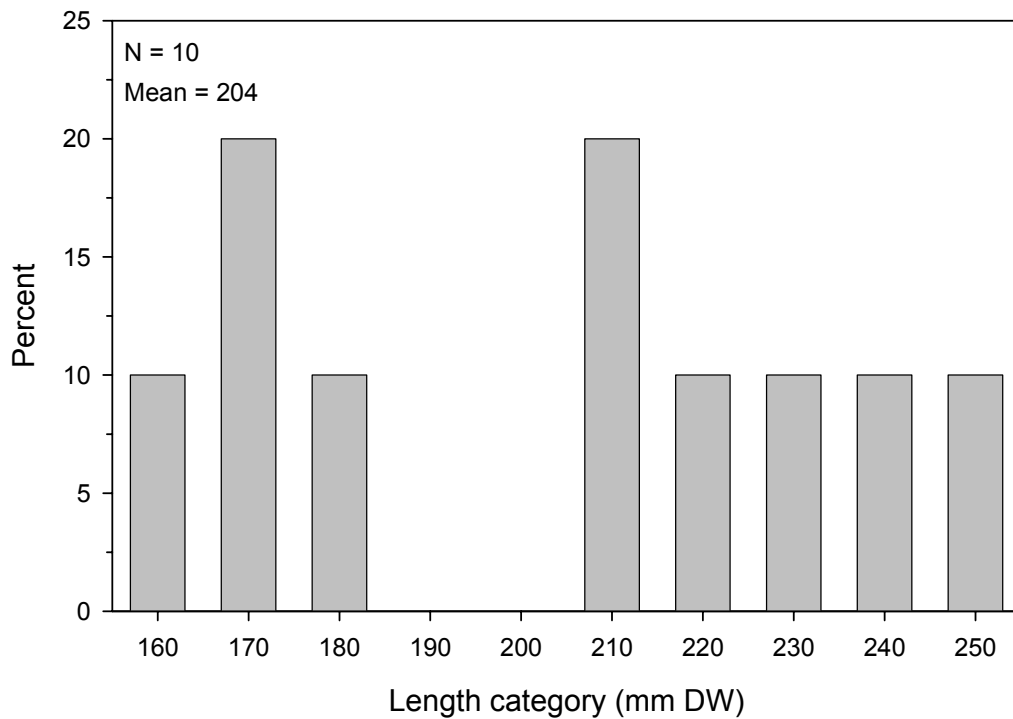
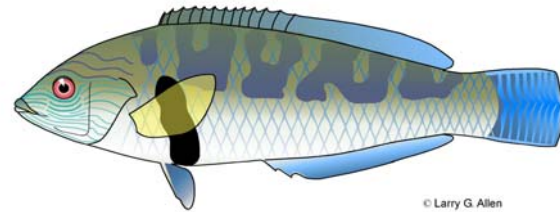
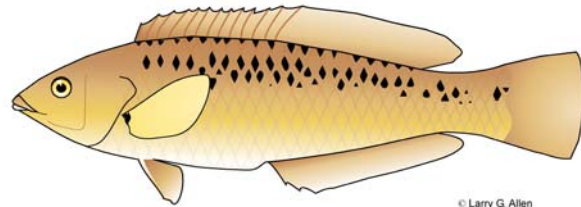

Figure 5.5-29. Disc width (mm) frequency distribution for round stingray collected in impingement samples.

**5.5.2.10 Rock wrasse (*Halichoeres semicinctus*)**

Rock wrasse (*Halichoeres semicinctus*) ranges from the Gulf of California, Baja California, Mexico to Point Conception, California in depths from the surface to 24 m (Miller and Lea 1972). Allen and Pondella (2006) included rock wrasse in their Baja kelp reef species group. Rock wrasse has been infrequently observed in low abundances during impingement sampling, principally occurring at Redondo Beach and Scattergood Generating Stations in Santa Monica Bay (MBC unpubl. data).



**5.5.2.10.1 Life History and Ecology**

Fitch and Lavenberg (1975) reported rock wrasse to occupy rocky habitat near kelp beds. Rock wrasse exhibited similar relative abundances in gillnet collections at Santa Catalina Island and along the mainland from Ventura to Newport Beach, California (Pondella and Allen 2000).

Rock wrasse have been identified as a protogynous hermaphrodite, similar to other wrasses such as California sheephead (*Semicossyphus pulcher*), meaning most individuals undergo a post-maturational sex change from female to male, based on environmental cues such as size and density of males (Fitch and Lavenberg 1975; Warner 1984). Most spawning events observed by Adreani and Allen (in press) consisted of paired individuals, with a single male spawning with multiple females. Occasionally, a smaller, “sneaker” male would join the spawning rush at the last moment and release milt in with the pelagic eggs.

Little information regarding the age and growth of rock wrasse has been reported in the primary literature (Cailliet et al. 2000). Fitch and Lavenberg (1975) reported a 356-mm individual was nine years old based on otolith examination.

**5.5.2.10.2 Population Trends and Fishery**

No fishery or population data was reported by NMFS for rock wrasse. Fitch and Lavenberg (1975) reported that an estimated 2,400 individuals are taken by sportfishers each year, with an additional 100 taken as bycatch by commercial net fisheries. These authors further indicate that while rock wrasse may be of lesser desirability as a food fish, they are sought out for the aquarium trade due to their bright coloration. There were no Los Angeles area landings of rock wrasse reported in 2005 (CDFG 2006). A total of 3.6 kg (8 lbs) were reported from catch blocks in Santa Monica Bay in 2006 at an estimated value of \$80 (CDFG 2007b).

Rock wrasse was not analyzed during the 1978-1980 316(b) demonstration (SCE 1983). From 2003 through 2005, estimated annual impingement of rock wrasse ranged from 3 individuals (2003 and 2005) to 4 individuals (2004) (MBC 2007). Since 1991, 249 rock wrasse were estimated to have been impinged at the RBGS, an average of about 17 individuals per year. Highest impingement occurred in 1991 with 53 individuals.

### 5.5.2.10.3 Sampling Results

Ten rock wrasse weighing 1.263 kg (2.785 lbs) were collected during heat treatments at RBGS Units 7&8 (Table 5.5-3). No other individuals were observed during the study period. These ten individuals ranged in length from 156 to 226 mm SL with a mean of 177 mm SL. Peak abundance was recorded in the 160-mm SL size class (Figure 5.5-30). Seventy percent of the observed individuals were dead upon collection while the remaining 30% were alive.

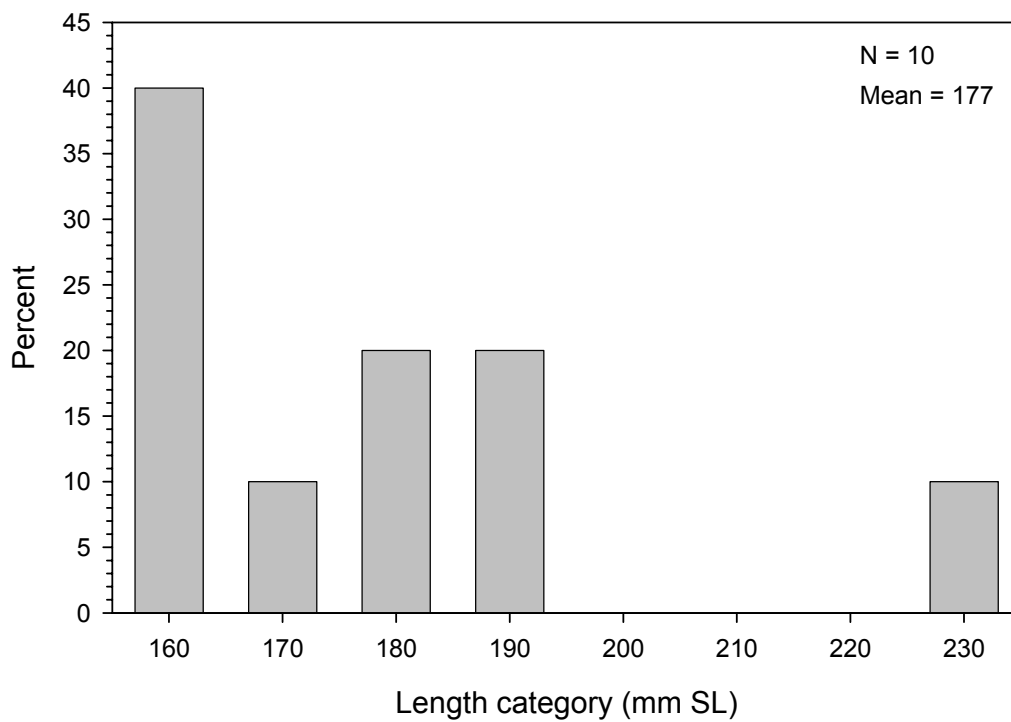
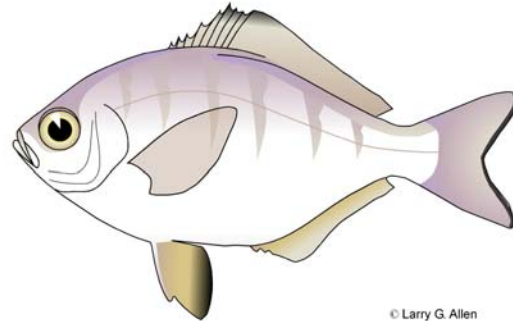

Figure 5.5-30. Length (mm) frequency distribution for rock wrasse collected in impingement samples.

#### 5.5.2.11 Walleye surfperch (*Hyperprosopon argenteum*)

Walleye surfperch (*Hyperprosopon argenteum*) is a member of the Family Embiotocidae, the surfperches (Eschmeyer et al. 1983; Fritzsche and Collier 2001). Fish of this family are perch-like, compressed laterally with an elliptical shape and forked tail. Most species occurring off California are found in beaches, rocky reefs, and kelp beds. Surfperches are characterized by their reproduction, internal fertilization and vivipary, bearing live young.



Defining characteristics of the walleye surfperch include silver to bluish coloration, black tipped pelvic fins, and large eyes (Miller and Lea 1972; Eschmeyer et al. 1983; Fritzsche and Collier 2001). The range of the walleyes extends south of Vancouver Island, British Columbia to Punta San Rosarito, central Baja California, Mexico; though they are most abundant in southern California (Love et al. 2005).

##### 5.5.2.11.1 Life History and Ecology

Walleye surfperches inhabit the shallow waters to depths of 18 m (60 ft), often along the surf zone of sandy beaches, among piers, and within kelp beds. This species is often encountered in schools. Walleye surfperches can grow up to 30 cm (12 in) (Miller and Lea 1972; Eschmeyer et al. 1983). Their fastest growth rate occurs during the first year then decreases consistently over time following sexual maturity (Anderson and Bryan 1970; Eckmayer 1979; DeMartini et al. 1983). Female surfperches achieve sexual maturation at as small as 9.5 cm (3.7 in), within a year after birth, and begin mating in the fall or winter (DeMartini et al. 1983; Fritzsche and Collier 2001). Larger, older females generally become pregnant sooner than younger females and produce numerous fully developed young. After internal fertilization occurs, gestation lasts five to six months with young released in late spring to early summer (DeMartini et al. 1983). The peak of release is late April to early May (DeMartini et al. 1983). On average, females birth five to twelve young at about 3.8 cm (1.5 in) in length, with number of young dependent on the size of the female (Fritzsche and Collier 2001). These surfperches generally forage along the bottom feeding on polychaetes, mollusks, isopods, and small crustaceans such as sand crabs (Eschmeyer et al. 1983; Fritzsche and Collier 2001).

##### 5.5.2.11.2 Population Trends and Fishery

The commercial fishery for surfperches in general has been variable with a relatively low demand for fresh surfperch (Fritzsche and Collier 2001). Until 1987, the California Department of Fish and Game did not have a separate market for surfperches. In 1999, the total catch for all surfperches was 68,039 kg (49,000 lbs) (Fritzsche and Collier 2001). The recreational fishery, on the other hand, brings in high landings of surfperch. Surfperches overall are popular sport fishery species. Walleyes, specifically, numbered 164,000 in the 1993 catch, with pier, shore, and jetty landings comprising 90% of the catch



(Fritzsche and Collier 2001). Currently, sport take is calculated to average 112,000 fish annually, and no restriction on catches of walleye surfperch has been set (Fritzsche and Collier 2001). However, the total walleye population is unknown, thus the effects of fishing on the population is unknown (Fritzsche and Collier 2001).

Walleye surfperch was the third most abundant species analyzed during the 1978-1980 316(b) demonstration, with an estimated daily impingement of about 28 individuals at Units 1-6 and 9 individuals at Units 7&8 (SCE 1983). From 2003 through 2005, estimated annual impingement of walleye surfperch ranged from 2 individuals (2003) to 29 individuals (2005) (MBC 2007). Since 1991, 351 walleye surfperch were estimated to have been impinged at the RBGS, an average of about 23 individuals per year. Highest impingement occurred in 1991 and 1992 with 58 and 54 individuals, respectively. Walleye surfperch has not been abundant during diver transects in King Harbor since the transition from the cold water regime in the 1970s, but it is still occasionally observed (Figure 5.5-31).

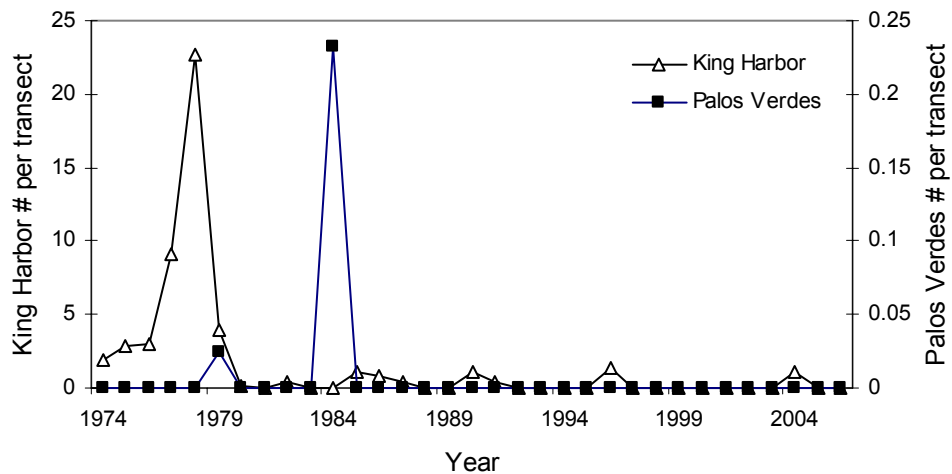

Figure 5.5-31. Abundance of walleye surfperch (*Hyperprosopon argenteum*) measured during diver transects at King Harbor and Palos Verdes from 1974-2006. Source: Vantuna Research Group.

### 5.5.2.11.3 Sampling Results

During the study, an estimated 42 walleye surfperch weighing 0.462 kg (1.019 lbs) were impinged based on actual cooling water flow volumes (Table 5.5-3). All individuals were recorded at Units 7&8 with all but eight attributed to normal operation. Length frequency analysis of the nine measured individuals indicated a mean length of 72 mm SL ranging from 69 to 80 mm SL. Of these nine, seven were in the 70-mm SL size class and all nine were collected alive.

#### 5.5.2.12 Señorita (*Oxyjulis californica*)

Señorita (*Oxyjulis californica*) are relatively small members of the wrasse (Labridae) family found from Salt Point in northern California to south-central Baja California, Mexico (Fitch and Lavenberg 1975; Eschmeyer et al. 1983; Love 1996). During cool water periods, the range contracts and individuals are found mainly south of Point Conception (Love 1996). Señorita is a cigar-shaped fish with large scales and buckteeth that protrude from their mouths. Color is usually dusky yellow, but orangish, brownish and even pinkish individuals have been observed (Fitch and Lavenberg 1975; Eschmeyer et al. 1983; Love 1996). All have a large dark or black spot on the base of the tail.

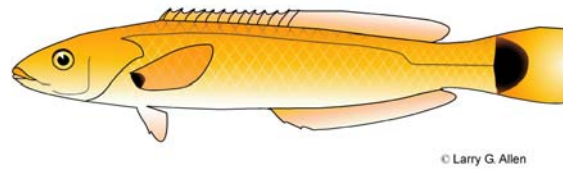

##### 5.5.2.12.1 Life History and Ecology

While juveniles have been observed intertidally, adults are known to occur to depths of at least 98 m (320 ft), but are most common at depths less than 23 m (75 ft). Señorita are usually found mid-water, associated with kelp and algae over rocky reefs where they may occur in small loose schools, pairs, or singly. Young tend to stay closer to the cover of kelp than the adults.

Señorita are diurnal, active during the day and sleep buried in sand at night (Eschmeyer et al. 1983; Love 1996). Shortly after sunset, señorita search out coarse sand where they quickly burrow into the bottom and orient themselves with their heads protruding. Just before sunrise they wakeup, shake free of the bottom and comb sand grains from their gills (Love 1996). The habit of burying themselves is also used as a defense if disturbed (Eschmeyer et al. 1983).

Señorita live about seven years and grow to 30 cm (11.7 in), reaching 7 cm (3 in) at one year and 22 cm (8.5 in) at four years (Fitch and Lavenberg 1975; Eschmeyer et al. 1983; Love 1996). Señorita become mature at one year, but unlike other local wrasses does not change sex as they grow. Señorita are oviparous (broadcast spawners), but number of eggs produced or whether individuals spawn more than once a year is unknown (Fitch and Lavenberg 1975; Moser 1996). Spawning takes place from April through August, and both eggs and larvae are planktonic. Planktonic larvae are often found within 240 km (150 mi) of the shore and are known to occur as far as 480 km (300 mi) offshore (Love 1996). Young-of-the-year are found in nearshore waters from June through November.

Young señorita eat plankton while older fish pick hydroids, bryozoans, worms, mollusks, amphipods and other crustaceans off kelp (Fitch and Lavenberg 1975; Love 1996). On occasion, señorita have been observed acting as cleaners, picking external parasites off larger fish, but this does not appear to be a regular activity for the species. Señorita are vulnerable to larger fish such as bass, as well as pinnipeds and cormorants.

5.5.2.12.2 Population Trends and Fishery

Señorita are occasionally taken from piers and boats, but are not generally desirable to anglers (Fitch and Lavenberg 1975; Love 1996). The small mouths and protruding teeth make señorita excellent bait stealers and they are usually considered a nuisance by recreational fishers. There is currently no commercial food market for señorita, but they are occasionally taken in other fisheries. There is a small aquarium trade fishery. There were 4.5 kg (10 lbs) of señorita landed in Los Angeles area landings in 2005 at an estimated value of \$100 (CDFG 2006). Commercial landings for señorita from Santa Monica Bay catch blocks in 2006 totaled 4.5 kg (10 lbs) with a value of \$50 (CDFG 2007b).

Señorita was not analyzed during the 1978-1980 316(b) demonstration (SCE 1983). From 2003 through 2005, estimated annual impingement of señorita ranged from 5 individuals (2003) to 25 individuals (2005) (MBC 2007). Since 1991, 847 señorita were estimated to have been impinged at the RBGS, an average of about 56 individuals per year. Highest impingement occurred in 1991 (205 individuals) and 1997 (128 individuals).

5.5.2.12.3 Sampling Results

An estimated 41 señorita weighing 2.075 kg (4.575 lbs) were impinged from January 2006 to January 2007 at the RBGS based on actual cooling water flow volumes (Table 5.5-3). Normal operation of Units 7&8 accounted for 83% of the impingement (during July 2006) with the remainder impinged during heat treatments. Length frequency analysis of the eight measured individuals indicated a mean length of 132 mm SL with sizes ranging from 96 to 162 mm SL. Four of the eight individuals were in the 140-mm SL size class. Six of the eight individuals observed were dead while the remaining two were alive, with the majority of observations occurring during heat treatments.

**5.5.2.13 Northern anchovy (*Engraulis mordax*)**

Information on the life history and ecology of northern anchovy is presented in Section 4.5.3.1.

5.5.2.13.1 Population Trends and Fishery

Northern anchovy was the fourth most abundant species analyzed during the 1978-1980 316(b) demonstration, with impingement averaging about 19 fish per day at Units 1-6 and 10 fish per day at Units 7&8 (SCE 1983). From 2003 through 2005, estimated annual impingement of northern anchovy ranged from 0 individuals (2003) to 255 individuals (2004) (MBC 2007). Since 1991, 3,171 northern anchovy were estimated to have been impinged at the RBGS, an average of about 211 individuals per year. Highest impingement occurred in 2001 (839 individuals) and 1992 (800 individuals).

5.5.2.13.2 Sampling Results

The most abundant species impinged at the RBGS was northern anchovy with an estimated 271 individuals weighing 2.408 kg (5.310 lbs) based on actual cooling water flow volumes, with all occurring at Units 7&8 primarily during normal operation (Table 5.5-3). Length frequency analysis of the seven

measured individuals indicated a mean length of 113 mm SL ranging from 100 to 128 mm SL, with three individuals in the 100 mm SL size class. These same seven individuals were examined for disposition with 14% collected alive and 86% dead.

5.5.2.13.3 Modeling Results

Northern anchovy life history parameters are presented in Table 5.5-13. von Bertalanffy parameters were derived from data presented for San Pedro Channel, California in Parrish et al. (1985). Annual survival estimates were calculated based on daily mortality rates (0.997902) summarized in Butler et al. (1993). Age and size at 50% maturity, 0.986614 years and 96 mm SL, respectively, were taken from Hunter and Macewicz (1980). The seven northern anchovies measured over the year ranged in size from 100 to 128 mm SL, with all but two an estimated 5 years old or less. Over the survey year approximately 830 adult equivalent northern anchovies were impinged during the actual operation of the cooling water intake systems. Of these, 815 individuals were impinged during normal operation of the systems with an additional 15 individuals impinged during heat treatments. Recalculation of these values based on design (maximum) cooling water flow volumes amounted to 1,915 equivalent adults.

Table 5.5-13. Northern anchovy life history parameters used in equivalent adult modeling.

Total Adult Mortality (Z)*	Survival (S)	von Bertalanffy growth parameters**			Age at 50% Maturity	Length at 50% Maturity***
		L <sub>inf</sub>	k	t <sub>0</sub>		
0.997902	0.464636	135.7 mm SL	0.784	-0.58	0.987	96 mm SL

\*Calculated from Butler et al. (1993)

\*\* Calculated from Parrish et al. (1985)

\*\*\* Hunter and Macewicz (1980)

**5.5.2.14 Pile perch (*Rhacochilus vacca*)**

Pile perch (*Rhacochilus vacca*) is a relatively large (to 44 cm, 17.5 in) member of California’s nearshore surfperch (Embiotocidae) community (Eschmeyer et al. 1983; Fritzsche and Hassler 1989; Love 1996; Fritzsche and Collier 2001). Pile perch is found from southeastern Alaska to north-central Baja California, including Guadalupe Island, but occurs more commonly south of British Columbia.

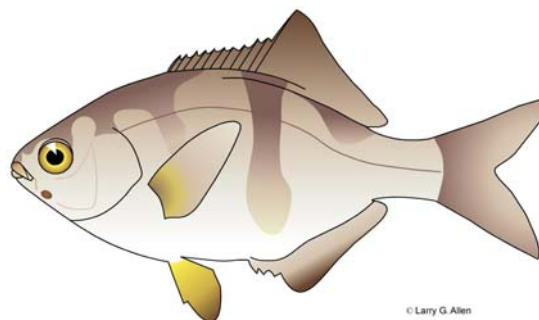

5.5.2.14.1 Life History and Ecology

Typically an inshore species, pile perch are common in rocky areas, in kelp beds, and around piers and underwater structures, from the shallow subtidal to about 46 m (150 ft) where they are active during the day. Pile perch are blackish, gray, or brownish above and silvery below with a dark bar mid-body and a

distinctive dorsal fin with the first soft rays longer than the others, giving the fin a peaked shape. In the field, pile perch may be observed singly, in small schools or larger aggregations. They prefer cooler water and at Redondo Beach in southern California the species is known to move into shallow depths (4 to 5 m, 13 to 16 ft) in winter and spring and more offshore (8 m or 26 ft) when water temperatures rise in summer and fall (Fritzsche and Hassler 1989; Love 1996).

Individuals may live up to ten years, becoming sexually mature during their second year at about 18 cm (7 in) (Fritzsche and Hassler 1989; Love 1996; Fritzsche and Collier 2001). In fall, breeding males become very dark, almost black, with black spots on their snouts (Eschmeyer et al. 1983; Love 1996). Courtship involves males darkening and leaving the protection of their normal habitat to hang head down in the mid water column (Love 1996). Aggression among males during courtship has been observed and single males have been seen escorting multiple females. Mating occurs when a pair of pile perch swimming in the same direction turns on their sides or backs and briefly brings their urogenital openings into contact (Fritzsche and Hassler 1989). Spawning in southern California pile perch begins in April (Love 1996). Like all surfperches, pile perch are viviparous, with the young being highly developed at birth. Brood size in pile perch is correlated to size, weight, and age of the female (Fritzsche and Hassler 1989). At the age of first reproduction females produce 11.7 offspring on average, while older individuals (7 to 10 years) may produce broods of up to 60 young. The birth of the perch in late spring and early summer coincides with maximum kelp and algae cover available to the small perch for protection.

Pile perch have strong, well-developed teeth that allow them to feed on hard-shelled animals (Fritzsche and Hassler 1989; Love 1996; Fritzsche and Collier 2001). In the laboratory they have been observed to feed on whole mussels up to 2.5 cm (1 in) long, and even newborns are known to eat small clams and mussels. In the field, pile perch feed on a wide variety of hard-bodied animals such as brittle stars, crabs, snails, clams, and mussels. Young pile perch are vulnerable to larger fish such as kelp bass, while adults are preyed on by larger predators including electric rays, sharks, large basses, pinnipeds and cormorants (Fritzsche and Hassler 1989; Love 1996).

#### 5.5.2.14.2 Population Trends and Fishery

Pile perch are an important recreational species along the west coast of the United States (Fritzsche and Hassler 1989; Love 1996; Fritzsche and Collier 2001). Pile perch may be caught year-round, and in California, an average of 16,000 perch were caught annually between 1993 and 1999 (Fritzsche and Collier 2001). Many are taken from piers, jetties, beaches, and boats or by spear by divers (Fritzsche and Hassler 1989; Love 1996; Fritzsche and Collier 2001).

Pile perch support a small commercial fishery in Del Mar, California and Papalote Bay in Baja California, but otherwise do not contribute noticeably to commercial landings in California (Fritzsche and Collier 2001). Because commercial landings do not differentiate most surfperch species, current size of the fishery and population estimates are difficult to determine, however it is estimated that the fishery averages about 90 kg (200 lbs) per year (Love 1996). In 2005, pile perch landings in the Los Angeles Area totaled 12.7 kg (28 lbs) at an estimated value of \$28 (CDFG 2006). In 2006, the Santa Monica Bay

catch blocks of unspecified surfperch (which may include pile perch) totaled 117 kg (258 lbs) at a value of \$1,092 (CDFG 2007b).

Pile perch was not analyzed during the 1978-1980 316(b) demonstration (SCE 1983). From 2003 through 2005, estimated annual impingement of pile perch ranged from 0 individuals (2005) to 49 individuals (2004) (MBC 2007). Since 1991, 1,539 pile perch were estimated to have been impinged at the RBGS, an average of about 103 individuals per year. Highest impingement occurred in 1992 (274 individuals) and 1997 (258 individuals).

In King Harbor, densities of adult and juvenile pile perch remained relatively constant between 1974 and 1998, indicating the harbor essentially acts as a mature artificial reef (Pondella et al. 2002). The density of sub-adults at King Harbor, however, declined since 1974, suggesting an increase in mortality at the end of the first year. Results from King Harbor corresponded to those from nearby Palos Verdes, a natural reef. The authors determined that surfperch production in King Harbor has been higher than at Palos Verdes (Figure 5.5-32).

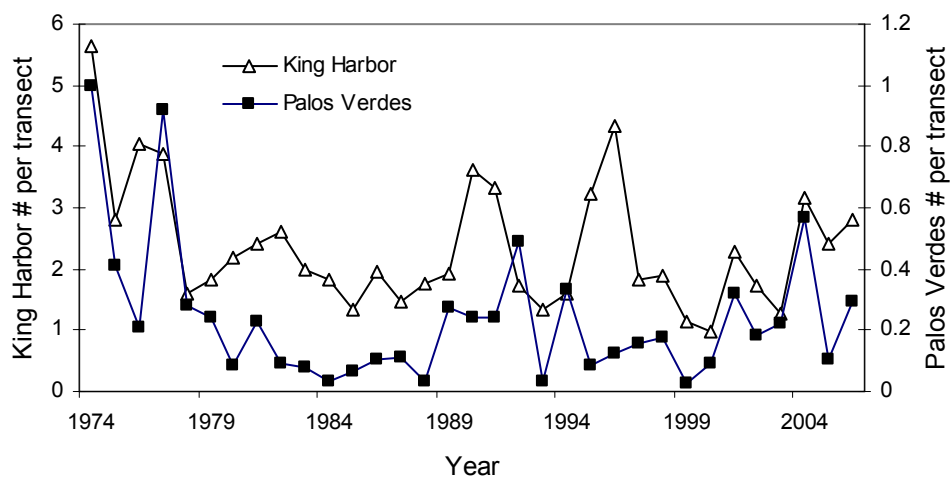

Figure 5.5-32. Abundance of pile perch (*Rhacochilus vacca*) measured during diver transects at King Harbor and Palos Verdes from 1974-2006. Source: Vantuna Research Group.

#### 5.5.2.14.3 Sampling Results

Seven pile perch weighing 1.160 kg (2.558 lbs) were impinged during heat treatments at Units 7&8 (Table 5.5-3). These seven individuals ranged in length from 78 to 228 mm SL, with a mean length of 166 mm SL. Two individuals were in the 190-mm SL size class, while the remaining size classes were each represented by one individual. Sex was determined for six individuals with 67% male and 33% female. All seven individuals observed during the heat treatments were dead.

**5.5.2.15 Shiner perch (*Cymatogaster aggregata*)**

Shiner perch (*Cymatogaster aggregata*) ranges from San Quintin Bay, Baja California, to Port Wrangell, Alaska (Miller and Lea 1972). There are 19 species of Pacific nearshore surfperches (Family Embiotocidae) that occur off southern California (Miller and Lea 1972). Most inhabit nearshore waters, bays, and estuaries, though some are found further offshore.



**5.5.2.15.1 Life History and Ecology**

Shiner perch occurs primarily in shallow-water marine, bay, and estuarine habitats (Emmett et al.

1991), and is demersal on sandy and muddy bottoms. On the southern California shelf, shiner perch are found at depths to 90 m (295 ft), and Allen (1982) reported most occur at about 70 m (230 ft). It has been reported to depths of 146 m (480 ft) (Miller and Lea 1972). Juveniles and adults occur in oligohaline to euryhaline waters, and even occasionally in fresh water. This species forms schools or aggregations during the day (Fitch and Lavenberg 1975), but solitary individuals are found on the bottom at night. Important prey items for this species off southern California include calanoid copepods and chaetognaths (Allen 1982). It is a predominantly diurnal visual plankton picker, but larger individuals may engage in nocturnal epibenthic searching (Allen 1982). Shiner perch, along with white croaker, formed Allen's (1982) "nearshore schoolers" recurrent group; the two species occur commonly off southern California even though shiner perch is considered a cold-temperate, outer-shelf species, while white croaker is a temperate, inner-shelf species.

Eggs of the shiner perch are fertilized internally, and females give birth to live young. Mating occurs primarily in the spring and summer in California (Bane and Robinson 1970). The reproductive capacity of this species is directly related to female size; smaller females produce as few as 5 young, while larger females can produce over 20 young (Wilson and Millemann 1969). Shiner perch have no larval stage. At birth, fully developed young are about 34 to 78 mm in length (Wilson and Millemann 1969; Hart 1973). Shiner perch live for about eight years and reach about 180 mm in length (Miller and Lea 1972; Hart 1973).

**5.5.2.15.2 Population Trends and Fishery**

This species is not commercially important, but some shiner perch are landed for bait and human consumption (Emmett et al. 1991). Shiner perch are fished recreationally, especially from piers and in bays and estuaries. Total statewide recreational landings of "surfperches" were 489,000 fish in 1999, with most of the catch in central and northern California (Fritzsche and Collier 2001). Commercial landings in the Los Angeles area have fluctuated between about 136 and 1,361 kg (300 and 3,000 lbs) per year since 2000 (Table 5.5-5). In 2005, "surfperch" landings in the Los Angeles area totaled 21.3 kg (47 lbs) at a value of \$86 (CDFG 2006). Commercial landings of "surfperches" reported from catch blocks in the

Santa Monica Bay area totaled 117.0 kg (258 lbs) in 2006, at an estimated value of \$1,092 (CDFG 2007b). Numbers of shiner perch in southern California waters declined after the mid-1970s, and this is likely related to warming ocean temperature, decreased zooplankton biomass, and reduced upwelling (Stull and Tang 1996; Beck and Herbinson 2003; Allen et al. 2003). This was particularly evident at King Harbor, but there was a peak in observed abundance at Palos Verdes in 1994 (Figure 5.5-33). Still, abundance at both King Harbor and Palos Verdes has been very low since then. Shiner perch was the second most abundant species analyzed during the 1978-1980 316(b) demonstration, with an estimated daily impingement of about 32 individuals at Units 1-6 and 22 individuals at Units 7&8 (SCE 1983). From 2003 through 2005, estimated annual impingement of shiner perch ranged from 35 individuals (2004) to 975 individuals (2005) (MBC 2007). Since 1991, 8,312 shiner perch were estimated to have been impinged at the RBGS, an average of about 554 individuals per year. Highest impingement occurred in 1991 and 1992 with 1,343 and 1,094 individuals, respectively.

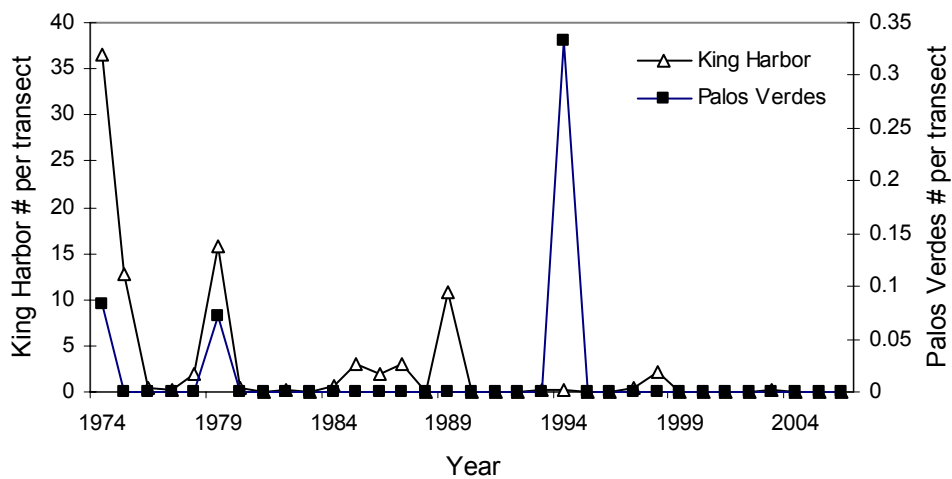

Figure 5.5-33. Abundance of shiner perch (*Cymatogaster aggregata*) measured during diver transects at King Harbor and Palos Verdes from 1974-2006. Source: Vantuna Research Group.

### 5.5.2.15.3 Sampling Results

An estimated 26 shiner perch weighing 0.649 kg (1.431 lbs) were impinged at Units 7&8 based on actual cooling water flow volumes (Table 5.5-3). Nineteen percent were impinged during heat treatments while the remaining 81% were attributed to normal operations. Seven individuals were measured spanning a length range from 55 to 103 mm SL, with a mean length of 85 mm SL. Greater than 40% of these individuals were in the 100-mm SL size class or approximately three years old (Anderson and Bryan 1970).



#### 5.5.2.16 Brown rockfish (*Sebastes auriculatus*)

Brown rockfish (*Sebastes auriculatus*) ranges from Prince William Sound, Alaska to Bahia San Hipolito, Baja California, Mexico in depths ranging from shallow nearshore waters to 135 m (Love et al. 2002). Allen and Pondella (2006) included brown rockfish in their kelp reef species group. Brown rockfish have been commonly observed in low abundances during impingement sampling at southern California coastal generating stations (MBC unpubl. data).

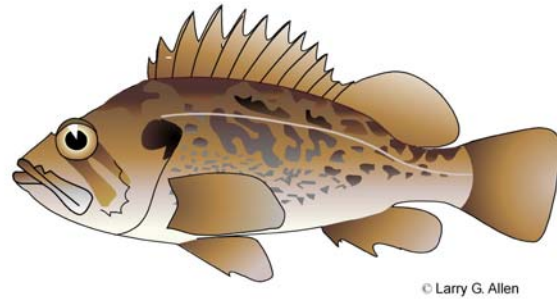

##### 5.5.2.16.1 Life History and Ecology

Brown rockfish exhibit age (developmental) stage specific habitat preferences. Love et al. (2002) report that pelagic juveniles maintain within the water column for 2.5 to 3 months before settling out in shallow water, where they will stay for the next several years, before gradually moving deeper with age. Rocky outcroppings, in both shallow and deeper waters, provide the most desirable habitat for brown rockfish (Love et al. 2002). These authors further noted that extensive subadult migrations from shallow bays to outer coastal waters have been recorded, some covering up to 50 km in distance.

Female rockfish undergo internal fertilization before producing pelagic larvae. Within southern California, Love et al. (2002) reported brown rockfish matured at a smaller size than their more northerly counterparts, with all groups reaching 50% maturity between 240 and 310 mm. They further reported that a female produces up to 339,000 eggs per season, with the principle spawning season from January through August in southern California.

Brown rockfish have been aged to 34 years, with a 190-mm individual averaging 3 years of age, a 240- to 310-mm individual being between 4 and 5 years old, and a 380-mm individual being approximately 10 years old (Love et al. 2002). Love et al. (2002) noted that female brown rockfish reached a greater maximum size than males, with both sexes maturing at about the same age and length.

##### 5.5.2.16.2 Population Trends and Fishery

Historically, brown rockfish, along with all *Sebastes* species have been regularly targeted by both commercial and recreational anglers (Love et al. 2002). Commonly taken by the commercial live-fish fishery, the commercial and recreational landings of brown rockfish have declined in recent years (Ashcraft and Heisdorf 2001), due to reduced stocks, as with all Eastern Pacific rockfishes, as well as more recent fishery regulations implementing seasonal closures in addition to depth and gear restrictions. There were no reported commercial landings of brown rockfish in the Los Angeles area in the PacFIN database since 2000. In 2005, brown rockfish landings in the Los Angeles area totaled 13.6 kg (30 lbs) at a value of \$68 (CDFG 2006). Commercial landings of “nearshore rockfishes” reported from catch blocks

in the Santa Monica Bay area totaled 105.5 kg (233 lbs) in 2006, at an estimated value of \$523 (CDFG 2007b).

Brown rockfish was not analyzed during the 1978-1980 316(b) demonstration (SCE 1983). From 2003 through 2005, estimated annual impingement of brown rockfish ranged from 0 individuals (2004) to 31 individuals (2005) (MBC 2007). Since 1991, 94 brown rockfish were estimated to have been impinged at the RBGS, an average of about 6 individuals per year. Highest impingement occurred in 2005 (31 individuals).

#### 5.5.2.16.3 Sampling Results

Six brown rockfish weighing 1.064 kg (2.346 lbs) were impinged during heat treatments at Units 7&8 (Table 5.5-3). No other individuals were observed. Their lengths ranged from 161 to 196 mm SL with a mean length of 177 mm. Two of the six individuals were included in the 170-mm SL size class, or approximately two years old (Love et al. 2002). The remaining individuals were dispersed amongst four unique size classes. All individuals were collected alive.

#### 5.5.2.17 White seaperch (*Phanerodon furcatus*)

White seaperch (*Phanerodon furcatus*) ranges from Bahia San Carlos, Baja California, Mexico to Vancouver Island, British Columbia, Canada ranging in depths from the surfzone to 70 m (Miller and Lea 1972; Love et al. 2005). Allen and Pondella (2006) included white seaperch in their southern shallow rock sand species group. White seaperch have been commonly observed in low abundances during impingement sampling at southern California coastal generating stations (MBC unpubl. data).

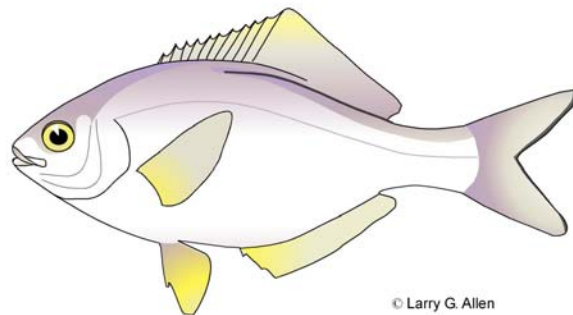

#### 5.5.2.17.1 Life History and Ecology

Feder et al. (1974) noted that white seaperch tend to form loose schools in open water around the reef along the rock-sand interface. Helvey and Dorn (1981) reported white seaperch to be common around offshore cooling water structures in southern California, especially in fall and summer.

Like all surfperch, white seaperch perch are viviparous, producing free-swimming, fully developed young. The young are larger than the typical 9.5-mm (3/8-in) screen mesh at most coastal generating stations, preventing their entrainment and transport throughout the cooling water system. Feder et al. (1974) reported that young were observed in September.

Age and growth in white seaperch have been studied in two disjoint populations, one in Humboldt Bay, California and one in Anaheim Bay, California (Anderson and Bryan 1970; Eckmayer 1979). Both studies recorded individuals up to seven years old, with the northern population attaining a greater size (214 mm SL) than the southern individuals (195 mm SL), based on growth model estimations. Both populations exhibited the greatest growth over the first two years before markedly slowing.

#### 5.5.2.17.2 Population Trends and Fishery

Surfperch commercial landings, overall, steadily declined from the peak in 1982, with some research indicating the decline may partially be attributable to increased water temperature that dominated the northeast Pacific Ocean throughout much of the 1980s and 1990s (Fritzsche and Collier 2001). Fishery dependent data on white seaperch, specifically, is limited, as they are of minimal importance as a commercial or recreational fishery, often taken as bycatch. Their preference for small prey items limits their recreational importance, with the bulk of surfperch landings recorded being attributed to some of the remaining species.

Total statewide recreational landings of “surfperches” were 489,000 fish in 1999, with most of the catch in central and northern California (Fritzsche and Collier 2001). Commercial landings in the Los Angeles area have fluctuated between about 136 and 1,361 kg (300 and 3,000 lbs) per year since 2000 (Table 5.5-5). In 2005, “surfperch” landings in the Los Angeles area totaled 21.3 kg (47 lbs) at a value of \$86 (CDFG 2006). Commercial landings of “surfperches” reported from catch blocks in the Santa Monica Bay area totaled 117.0 kg (258 lbs) in 2006, at an estimated value of \$1,092 (CDFG 2007b).

White seaperch was the sixth most abundant species analyzed during the 1978-1980 316(b) demonstration (SCE 1983). Average daily impingement during that study was about 8 individuals at Units 1-6 and 3 individuals at Units 7&8. From 2003 through 2005, estimated annual impingement of white seaperch ranged from 5 individuals (2004) to 23 individuals (2005) (MBC 2007). Since 1991, 867 white seaperch were estimated to have been impinged at the RBGS, an average of about 58 individuals per year. Highest impingement occurred in 2002 (221 individuals). Fishery-independent data from King Harbor and Palos Verdes recorded declining abundance from the 1970s through the 1990s; less than one fish per transect was recorded at King Harbor from 1991 through 2001 (Figure 5.5-34). However, since 2001 abundance has increased.

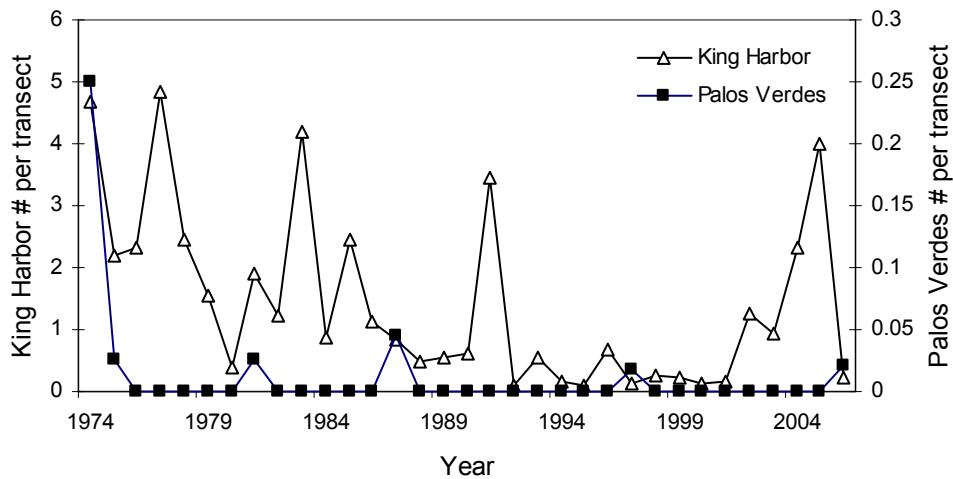

Figure 5.5-34. Abundance of white seaperch (*Phanerodon furcatus*) measured during diver transects at King Harbor and Palos Verdes from 1974-2006. Source: Vantuna Research Group.

#### 5.5.2.17.3 Sampling Results

Five white seaperch weighing 0.167 kg (0.368 lbs) were impinged during heat treatments at Units 7&8 (Table 5.5-3). No other individuals were observed during the study period. Lengths of these five individuals ranged from 64 to 143 mm SL, with a mean length of 99 mm SL. Two individuals were each in the 70- and 140-mm SL size classes, with the final individual in the 60-mm SL size class. Of the five individuals collected, four were dead and one was mutilated while the sex of two males was determined. The sex was not determined on the remaining three individuals.

#### 5.5.2.18 Barred sand bass (*Paralabrax nebulifer*)

Information on the life history and ecology of barred sand bass is presented in Section 4.5.3.4.

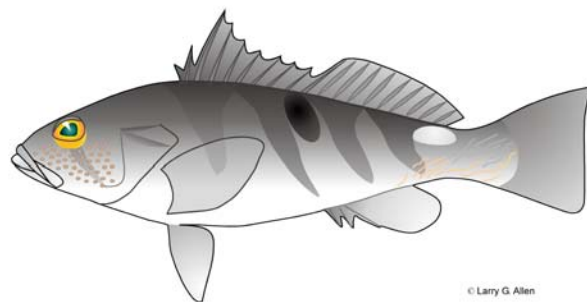

##### 5.5.2.18.1 Population Trends and Fishery

Barred sand bass was the twelfth most abundant species analyzed during the 1978-1980 316(b) demonstration (SCE 1983). Average daily impingement during that study was less than one individual at Units 1-6 and about one individual at Units 7&8. From 2003 through 2005, estimated annual impingement of barred sand bass ranged from 21 individuals (2003 and 2005) to 52 individuals (2004) (MBC 2007). Since 1991, 1,999 barred sand bass were estimated to have been impinged at the RBGS, an average of about 133 individuals per year. Highest impingement occurred in 1991 (258 individuals).

5.5.2.18.2 Sampling Results

An estimated 65 barred sand bass weighing 58.917 kg (129.912 lbs) was impinged at the RBGS based on actual cooling water flow volumes (Table 5.5-3). All of the individuals were attributed to Units 7&8, with all but four recorded during normal operations. Length frequency analysis of the five individuals indicated a mean length of 217 mm SL with two individuals in the 210-mm SL size class, which corresponds to Age Class II fish (Love et al. 1996). Three of the five fish examined were dead, while the remaining two were alive.

5.5.2.18.3 Modeling Results

Barred sand bass life history parameters are presented in Table 5.5-14. All life history parameters other than total instantaneous annual mortality (Z) were taken from Love et al. (1996). No estimates for Z were available in the literature for barred sand bass, so the estimate for kelp bass, a close congener, was taken from CDFG web life history database. EAM estimates were based on the lengths of five impinged individuals with estimated ages ranging from 1.1 to 10.8 years, although all but one were less than 3.6 years old. A total of 4,238 adult equivalents were taken over the year based on actual cooling water flow. Of these, four were directly attributable to heat treatments while an estimated 4,234 were contributed by normal operation of the cooling water system calculated over actual flow rates. Recalculating the actual flow estimates to plant design flow equated to a total loss of 19,723 adult equivalents.

Table 5.5-14. Barred sand bass life history parameters used in equivalent adult modeling.

Total Adult Mortality (Z)*	Survival (S)	von Bertalanffy growth parameters**			Age at 50% Maturity	Length at 50% Maturity**
		L <sub>inf</sub>	k	t <sub>0</sub>		
0.544	0.580422	662 mm TL	0.08	-2.63	2.968667	239 mm TL

\* [www.dfg.ca.gov/mrd/lifehistories/index.html](http://www.dfg.ca.gov/mrd/lifehistories/index.html) for *P. clathratus*

\*\* Love et al. 1996

**5.5.2.19 Cabezon (*Scorpaenichthys marmoratus*)**

Cabezon (*Scorpaenichthys marmoratus*) belong to the family Cottidae, the sculpins. This scaleless species exhibits brown, red, or green coloration interspersed with intense dark and light mottling, often with reddish adult males and greenish adult females (Eschmeyer et al. 1983; Love 1996; Miller and Lea 1982).

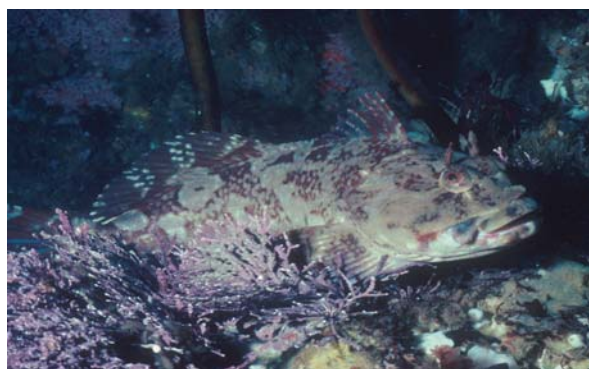

Jay Carroll

5.5.2.19.1 Life History and Ecology

Cabezon can be found from Sitka, Alaska to central Baja California, Mexico, but are most abundant from Washington to southern California. Cabezon

inhabit depths from the intertidal zone to 76 m (250 ft). Cabezon are solitary, hard bottom dwellers, but can occasionally be found around rocky reefs, structures (oil platforms, wrecks), and in the kelp canopy (Love 1996; Wilson-Vandenberg and Hardy 2001). The largest cabezon was recorded at 99 cm (39 in) (Eschmeyer et al. 1983).

Cabezon sexual maturity has limited information and show differences in size and age at maturity variable by latitude (Wilson-Vandenberg and Hardy 2001). In general, females reach maturity between 3 to 5 years of age (Love 1996). However, all females are mature by age-4 with lengths between 47 cm (19 in) and 59 cm (23 in) (Wilson-Vandenberg and Hardy 2001). Cabezon fecundity can reach counts of up to 152,000 eggs in a female of 76 cm (30 in). These sculpin are oviparous, with the female spawning the eggs into an intertidal nest that is guarded by the male. Off California, spawning occurs from late October to April with a peak in January (Love 1996). Once the larvae hatch, they become pelagic and spend three to four months feeding on zooplankton (Wilson-Vandenberg and Hardy 2001). Upon reaching about 4 cm (1.5 in) in length, juvenile cabezon become demersal and appear in shallow water habitats from April to June. Cabezon diets differ amongst juveniles and adults. Juveniles prey primarily on amphipods and smaller crustaceans such as shrimp and crabs, while adults have a diet composed of crabs, fish, small lobsters, mollusks, and fish eggs (Love 1996; Wilson-Vandenberg and Hardy 2001).

#### 5.5.2.19.2 Population Trends and Fishery

The cabezon commercial fishery had been recorded as a small but consistent market until the late 1990s when the live-fish market began (Love 1996; Wilson-Vandenberg and Hardy 2001). In 1998, commercial landings reached over 169,190 kg (373,000 lbs) using primarily trap and hook-and-line gear. Sampled catches from 1995-1998 suggested the majority of the catch was comprised of immature fish. Due to concerns of overfishing, NMFS implemented a Nearshore Fishery Management Plan in 1999 to prevent cabezon and other nearshore fish from becoming endangered. In 2004, the commercial fishery landed 49,313 kg (108,716 lbs), and showed successful adherence to the Total Available Catch for the years 2002, 2003, and 2004 (CDFG 2006). Cabezon is covered under the Pacific Groundfish FMP.

Commercial landings in the Los Angeles area have fluctuated between about 50 and 700 kg (100 and 1,500 lbs) per year since 2000 (Table 5.5-15). In 2005, cabezon landings in the Los Angeles area totaled 331.1 kg (730 lbs) at a value of \$1,300 (CDFG 2006). Commercial landings of cabezon reported from catch blocks in the Santa Monica Bay area totaled 20.2 kg (45 lbs) in 2006, at an estimated value of \$263 (CDFG 2007b).

Cabezon was not analyzed during the 1978-1980 316(b) demonstration (SCE 1983). From 2003 through 2005, estimated annual impingement of cabezon ranged from 3 individuals (2004 and 2005) to 5 individuals (2003) (MBC 2007). Since 1991, 435 cabezon were estimated to have been impinged at the RBGS, an average of about 29 individuals per year. Highest impingement occurred in 2000 (179 individuals).

Table 5.5-15. Annual landings and revenue for cabezon in the Los Angeles region based on PacFIN data.

Year	Landed Weight in kg (lbs)	Revenue
2000	141 (311)	\$960
2001	678 (1,494)	\$6,457
2002	87 (191)	\$564
2003	52 (114)	\$278
2004	96 (211)	\$1,017
2005	312 (687)	\$2,585
2006	268 (592)	\$2,046

5.5.2.19.3 Sampling Results

One cabezon weighing 0.824 kg (1.817 lbs) was impinged during a heat treatment at Units 7&8 (Table 5.5-3). No other individuals were observed. This individual measured 285 mm SL and was collected dead.

**5.5.2.20 Vermilion rockfish (*Sebastes miniatus*)**

Vermilion rockfish (*Sebastes miniatus*) belong to the family Scorpaenidae. True to its common name, the vermilion rockfish coloration varies from bright red to dark dusky red and mottled with gray along the sides (Eschmeyer et al. 1983; Love et al. 2002). The species ranges from Prince William Sound, Alaska to central Baja California, Mexico, but are most abundant from northern California to northern Baja California. Vermilion rockfish inhabit depths from the subtidal zone to 436 m (1,440 ft).



5.5.2.20.1 Life History and Ecology

Most adults are found between 50 m to 100 m (165 to 495 ft), while juveniles tend to be more subtidal (Love 1996, Love et al. 2002; Miller and Lea 1982). Adult vermilion rockfish generally aggregate in high relief areas, and can occasionally be found along the bottom of oil platforms or live solitarily in shallow-water caves (Love et al. 2002). Juvenile rockfish, however, are solitary and tend to inhabit sand patches between structures or near rocky substrata (Love et al. 2002). The largest length recorded for vermilion rockfish is 76 cm (30 in) (Eschmeyer et al. 1983; Love et al. 2002).

Vermilion rockfish differ in size and age at maturity (Love et al. 2002). Some females have been recoded as mature at the length of 31 cm (12 in) at four years. However, all females are mature by 47 cm (19 in) and nine years. Recorded fecundity shows a range of 63,000 eggs in a female of 32 cm (12.5 in) to 2,600,000 eggs in a female of 55 cm (21.5 in) (VenTresca 2001). Vermilion rockfish have been recorded

displaying courtship behavior, wherein females undergo internal fertilization. Release of larvae with lengths of about 4.3 mm (0.2 in) occurs from July to March in southern California. When released, larvae are generally found in pelagic waters and settle in May near protective structures in shallower waters until they progressively move to deeper depths (VenTresca 2001; Love et al. 2002). Vermilion rockfish prey primarily on fish and benthic organisms including northern anchovies, lanternfish, squid, crabs, and octopi, but have been recorded feeding on salps, shrimp, copepods, and polychaetes.

5.5.2.20.2 Population Trends and Fishery

Historically, the commercial and recreational fishery has viewed vermilion rockfish as a highly prized market species. However due to its inclusion of a general market category of “rockfish, Group Red”, historical data on catch abundances are unreliable previous to 1994, when “Rockfish, vermilion” became a printed market category (VenTresca 2001). During the late 1990s, annual landings of vermilion rockfish declined when the NMFS implemented a Nearshore Fishery Management Plan in 1999 in an attempt to rebuild the nearshore fish population. As of 2004, recreational fishery landings (167,000 kg [368,172 lbs]) remained higher than commercial landings (5,000 kg [11,024 lbs]) (MacCall 2005). The current recreational fishery often takes vermilion rockfish by hook-and-line anglers along California and is composed mostly of juvenile fishes (VenTresca 2001; Love et al. 2002). Vermilion rockfish is covered under the Pacific Groundfish FMP.

Commercial landings in the Los Angeles area were only recorded in 2000 in the PacFIN database (Table 5.5-16). In 2005, vermilion rockfish landings in the Los Angeles area totaled 1,671.6 kg (3,686 lbs) at a value of \$3,686 (CDFG 2006). Commercial landings of vermilion rockfish reported from catch blocks in the Santa Monica Bay area totaled 191.2 kg (422 lbs) in 2006, at an estimated value of \$913 (CDFG 2007b).

Table 5.5-16. Annual landings and revenue for vermilion rockfish in the Los Angeles region based on PacFIN data.

<b>Year</b>	<b>Landed Weight in kg (lbs)</b>	<b>Revenue</b>
2000	78 (172)	\$367
2001	-	-
2002	-	-
2003	-	-
2004	-	-
2005	-	-
2006	-	-

Vermilion rockfish was not analyzed during the 1978-1980 316(b) demonstration (SCE 1983). From 2003 through 2005, only one individual was impinged at the RBGS (2005) (MBC 2007). Since 1991, only three vermilion were estimated to have been impinged at the RBGS.



#### 5.5.2.20.3 Sampling Results

One vermilion rockfish weighing 0.009 kg (0.020 lbs) was impinged during a heat treatment at Units 7&8 (Table 5.5-3). No other individuals were observed. This individual measured 66 mm SL, representing young-of-the-year, and was collected alive.

### 5.5.3 Shellfishes by Species

Six shellfish species were impinged in sufficient numbers to warrant further analysis. These taxa included (with sampled abundance in parentheses):

- yellow crab (128 individuals)
- California spiny lobster (52 individuals)
- Pacific rock crab (24 individuals)
- sheep crab (10 individuals)
- Calif. two-spot octopus (10 individuals)

One additional species was requested to be analyzed in further detail due its inclusion in the Coastal Pelagics Fishery Management Plan: market squid (three individuals).

#### 5.5.3.1 Rock crabs (*Cancer* spp.)

Crabs of the genus *Cancer* are widely distributed in the coastal waters of the west coast of North America. They occur in intertidal and shallow subtidal habitats on both rock and sand substrate. Of the nine species known to occur in the northeast Pacific, four species contribute to economically significant fisheries. Dungeness crab (*Cancer magister*) has the highest economic value among these, and three species of rock crabs (yellow crab [*C. anthonyi*], Pacific (brown) rock crab [*C. antennarius*], and red rock crab [*C. productus*]) comprise the remainder of the catches.



Dan Dugan

These three species of rock crab, including hairy rock crab, the smaller slender crab (*C. gracilis*), and bigtooth rock crab (*C. amphioetus*) may all be found in the vicinity of the RBGS. All but Dungeness crab and bigtooth rock crab occurred in impingement samples at the RBGS in 2006. Yellow crab and Pacific rock crab occurred in sufficient numbers to warrant analysis.

##### 5.5.3.1.1 Life History and Ecology

All species of *Cancer* crabs share certain fundamental life history traits. Eggs are extruded from the ovaries through an oviduct and are carried in a sponge-like mass beneath the abdominal flap of the adult

female. After a development period of several weeks, the eggs hatch and a pre-zoea larva emerges, beginning the planktonic life history phase. As in all crustaceans, growth progresses through a series of molts. The planktonic larvae advance through six stages of successive increases in size: five zoea (not including the brief pre-zoea stage) and one megalopal. After several weeks as planktonic larvae, the crabs metamorphose into the first crab stage (first instar) and settle out to begin their benthic life history phase. Maturity is generally attained within one to two years. Mature females mate while in the soft shell molt condition and extrude fertilized eggs onto the abdominal pleopods. Females generally produce one or two batches per year, typically in winter.

The main determinant of brood size and reproductive output in brachyuran crabs is body size, and the range of egg production in *Cancer* crabs generally reflects this relationship (Hines 1991). Yellow crab produce on average 2.21 million eggs per brood. The next largest species collected in impingement sampling, red rock crab, produces 877,000 eggs per brood. Brown rock crab females seem to be an exception to this relationship because they are, on average, smaller than the red rock crab, yet produce an average of 1.2 million eggs per batch. Slender crab is one of the smallest of the five species living near RBGS and their average egg production per brood is 454,000. Female *Cancer* crabs typically produce a single batch per year, generally in the winter; however, due to occasional multiple spawnings, the average number of batches per year may be greater than one (Carroll 1982; Hines 1991).

Cancrid crabs function as both scavengers and predators in the marine environment. Prey varies as a function of age and size of the individual but benthic invertebrates such as clams, worms, and snails comprise the majority of prey species. Claw morphology of each species is adapted to the types of preferred prey. For example, the heavier crusher claws of the brown rock crab and yellow crab facilitate the breaking of gastropod shells whereas the tapered dactyls of the slender crab are used to probe in soft sediments for worms and other soft-bodied prey. Winn (1985) documented the occurrence of cannibalism among rock crabs, particularly adults on juveniles. However, since juveniles generally inhabited shallower areas than adults, effects on the younger cohorts were diminished.

During their planktonic existence, crab larvae can become widely distributed in nearshore waters. In a study in Monterey Bay, Graham (1989) found that slender crab stage 1 zoeae were very abundant close to shore (within 6 km or 3.7 mi) during March and August. Later stage larvae, including megalopae, were found further from shore during all times of the year. This offshore larval distribution, compared to the nearshore distribution of Pacific (brown) rock crab larvae found off Diablo Canyon Power Plant, probably reflects the fact that adult slender crabs are widely distributed in coastal shelf areas, further offshore than brown rock crabs. The megalops larvae and juvenile crabs are frequently found crawling unharmed on and under the bells, and even in the stomachs, of larger jellyfishes, especially purple-striped jelly (*Chrysaora colorata*) (Morris et al. 1980).

Juvenile rock crabs are an important prey item for a variety of fishes and invertebrates. In southern California, this includes barred sand bass (*Paralabrax nebulifer*), shovelnose guitarfish (*Rhinobatos productus*), and the sand star (*Astropecten verrilli*) (Roberts et al. 1984; VanBlaricom 1979).

Each species in the genus has characteristic differences in distribution, preferred habitat, growth rates, and demographic parameters. For example, brown rock crab is a relatively large species (carapace width >200 mm) that lives primarily on sand and mud substrates in estuarine and coastal shelf areas. Slender crab is a smaller species (carapace width >130 mm) associated with mixed rock-sand substrates in shallow outer coast habitats. These types of differences imply that specific information on life history parameters cannot readily be generalized among *Cancer* species. The following sections describe the life history and ecology of the two most abundant rock crabs collected in impingement samples in 2006.

#### *5.5.3.1.1.1 Yellow crab*

Yellow crab ranges from Humboldt Bay, California to Bahia Magdalena, Baja California. It occurs in rocky areas of bays and estuaries, the low intertidal zone, and subtidally to depths of 132 m (291 ft), but is most commonly found in depths between 18 to 55 m (59 to 180 ft) (Morris et al. 1980; Carroll and Winn 1989; Jensen 1995). Within this range their distribution is almost exclusively associated with sand substrata (Winn 1985; Carroll and Winn 1989). The species is most abundant on the expanses of open, sandy substrata that characterize much of the Southern California Bight. It is, however, also commonly encountered near the rock-sand interface of natural and artificial reefs in the region (Morris et al. 1980; Carroll and Winn 1989). In the northern parts of their range, where rocky benthic substrata predominate, their distribution appears to be confined more to bays, sloughs, and estuaries (Jensen 1995). They are the most abundant rock crab species harvested in southern California, often composing 70 to 95% of the total crab catch in the region (Carroll and Winn 1989). During diver surveys of yellow rock crab populations in Santa Monica Bay it was noted that the species was never seen during daylight hours in the vicinity of traps, but were often abundant in the traps the next morning (R. Hardy, CDFG, pers. comm.). These observations suggest that yellow rock crab are nocturnally active in shallow water and remain buried and inactive during daylight hours.

Anderson and Ford (1976) described the growth of yellow crab under laboratory conditions. Total larval development times from hatching through the megalops stage were 33 days and 45 days at 22°C and 18°C, respectively. The total time spent in the megalops stage averaged 8 days at 22°C and 12 days at 18°C. Yellow crab can live at least 5 years and attain a carapace width of 170 mm (6.7 in) after 16 crab instars (molts).

#### *5.5.3.1.1.2 Pacific (brown) rock crab*

Pacific rock crab (or brown rock crab) ranges between Queen Charlotte Sound, British Columbia, and Isla de Todos Santos, Baja California (Jensen 1995), although the range of peak abundance extends from San Francisco Bay to coastal areas south of the U.S.-Mexico border (Carroll and Winn 1989). They occur from the lower intertidal zone to depths exceeding 100 m (328 ft) but are typically found near the rock-sand interface in depths of less than 55 m (180 ft) (Carroll and Winn 1989). Juvenile brown rock crab inhabiting the intertidal zone survive exposure to the air during low tide by sheltering themselves under rocks and algae (Ricketts et al. 1985). This species is a scavenger and active predator.

Mating occurs after females molt and are still soft-shelled, and ovigerous females are most common from November to January, but may be found year-round (Morris et al. 1980; Carroll 1982). Adult crabs are sexually dimorphic, with males attaining a larger size and growing larger more robust chelae (claws). Male crabs grow to a size of 178 mm (7 in) maximum carapace width while females reach 148 mm (5.8 in) (Jensen 1995). The life span of brown rock crab is estimated to be five to six years (Carroll 1982). The size of a female's egg mass is variable and can contain from 410,000 to 2.79 million eggs (Carroll and Winn 1989). Development of the eggs and subsequent hatching takes seven to eight weeks at temperatures of 10° to 18° C (50° to 64° F) (Anderson and Ford 1976; Carroll 1982). Carapace width increases in the brown rock crab range from 7 to 26% per molt, while increases in body weight of 50 to 70% have been measured (Carroll 1982). The sexes undergo a molt to maturity (50% maturity value of population using Somerton [1980] method) from between 60 and 80 mm CW (2.4 and 3.1 in) (Carroll 1982). Brown rock crabs are estimated to go through 10 to 12 molts before reaching sexual maturity (Parker 2001).

Brown rock crab eggs require a development time of approximately seven to eight weeks from extrusion to hatching (Carroll 1982). Larval development in the brown rock crab was described by Roesijadi (1976). Eggs hatch into pre-zoea larvae that molt to first stage zoea in less than 1 hour. Average larval development time (from hatching through completion of the fifth stage) was 36 days at 13.8°C. Although some crabs molted to the megalops stage, none molted to the first crab instar stage, so the actual duration of the megalops stage is unknown. Based on predicted megalops duration of approximately 12 days measured for the closely related yellow crab, the estimated length of time from hatching to settling for brown rock crab is approximately 48 days. Brown rock crabs mature at an age of about 18 months post-settlement with a size of approximately 60 mm CW (2.4 in) and a weight of 73 g (0.161 lbs) (Carroll 1982). Faster growth rates may occur in highly productive environments such as on the supporting members of offshore oil platforms and females may become reproductive in less than one year post-settlement (D. Dugan, pers. comm.). Brown rock crabs can probably live to a maximum age of about six years. Size at recruitment to the fishery is approximately 125 mm CW (4.9 in), at an age of four years for males and four and one-half years for females.

#### 5.5.3.1.2 Population Trends and Fishery

Rock crabs are fished along the entire California coast with crab pots, though some landings are reported from set gill nets and trawls as well (CDFG 2004). Three species are harvested commercially in southern California: brown rock crab, red rock crab, and yellow crab. There is no commercial fishery for the slender crab or hairy rock crab. The rock crab fishery is most important in southern California (from Morro Bay south), which produces a majority of the landings, and of lesser importance in northern areas of California where a fishery for the more desirable Dungeness crab takes place. Most rock crabs are landed alive for retail sale by fresh fish markets. The commercial harvest has been difficult to assess on a species-by-species basis because the fishery statistics are combined into the general "rock crab" category. From 1991 through 1999 state-wide rock crab landings (including claws) averaged 1.2 million lbs per year (Parker 2001).

Regulations currently specify a minimum harvest size of 4.25-in carapace width. A small recreational fishery for rock crabs also exists, with a 4.0-in minimum carapace width and a personal bag limit of 35 crabs per day. Crabs are collected by divers or shore pickers with hoop nets and crab traps. Commercial landings of rock crabs in 2006 in Santa Monica Bay catch blocks totaled 21,328 kg (47,020 lbs) at a value of \$75,574 (CDFG 2007b). In 2005, Los Angeles area landings (between Dana Point and Santa Monica) for unspecified rock crabs totaled 45,100 kg (99,446 lbs) at a value of \$134,622, while landings for red rock crab totaled 325 kg (716 lbs) at a value of \$1,184 (CDFG 2006).

Invertebrates were not analyzed during the 1978-1980 316(b) demonstration (SCE 1983). In 2005, a total of 118 rock crabs were impinged at the RBGS, including 77 Pacific rock crab, 22 slender crab, and 19 yellow crab (MBC 2006). All but 75 Pacific rock crab were impinged at Units 7&8. In 2004, a total of 224 Pacific rock crab, 211 yellow crab, 18 slender crab, and 1 red rock crab were impinged at the RBGS; all were impinged during heat treatments at Units 7&8 (MBC 2005). In 2003, 717 Pacific rock crab and 87 yellow crab were impinged at the RBGS; all were recorded at Units 7&8 (MBC 2004).

#### 5.5.3.1.3 Sampling Results

An estimated 273 yellow crab were collected at RBGS at Units 5&6 and 7&8 based on actual cooling water flow volumes (Tables 5.5-5 and 5.5-7). At Units 5&6, an estimated 41 individuals weighing 13.378 kg (29.498 lbs) were impinged during normal operation. Normal operation at Units 7&8 impinged an estimated 161 individuals weighing 5.759 kg (12.699 lbs), with an additional 71 individuals weighing 0.606 kg (1.336 lbs) impinged during heat treatments. Normal operation surveys at Units 7&8 in November 2006 and January 2007 recorded peak impingement rates for both abundance and biomass (Figures 5.5-35 and 5.5-36). Analysis of the diel variation indicated greater proportions of individuals (abundance and biomass) were impinged during nighttime surveys (Figures 5.5-37 and 5.5-38). Between the two screenwells, a total of 138 individuals were measured over a range of 20 to 122 mm CW with a mean of 37 mm CW. Length frequency analysis indicates a modal distribution with a peak at 30 mm CW (Figure 5.5-39).

An estimated total of 148 Pacific rock crab weighing 17.270 kg (38.080 lbs) was impinged at the RBGS based on actual cooling water flow volumes (Tables 5.5-5 and 5.5-7). Normal operation impingement at Units 5&6 contributed an estimated 13 individuals weighing 0.687 kg (1.515 lbs) (Table 5.5-5). At Units 7&8, normal operation accounted for an estimated 122 individuals weighing 16.534 kg (36.457 lbs) while heat treatments impinged 13 individuals weighing 0.040 kg (0.088 lbs) for a unit total of 135 individuals at 16.583 kg (36.566 lbs). Abundance during normal operation peaked in November (Figure 5.5-40) while impinged biomass peaked in June (Figure 5.5-41). Impingement peaked during daytime for both abundance and biomass (Figures 5.5-42 and 5.5-43). The carapace width for 24 individuals was recorded with a mean of 41 mm CW and a ranged from 21 to 134 mm CW. Length frequency analysis suggested a modal distribution peaking at 30 mm CW (Figure 5.5-44).

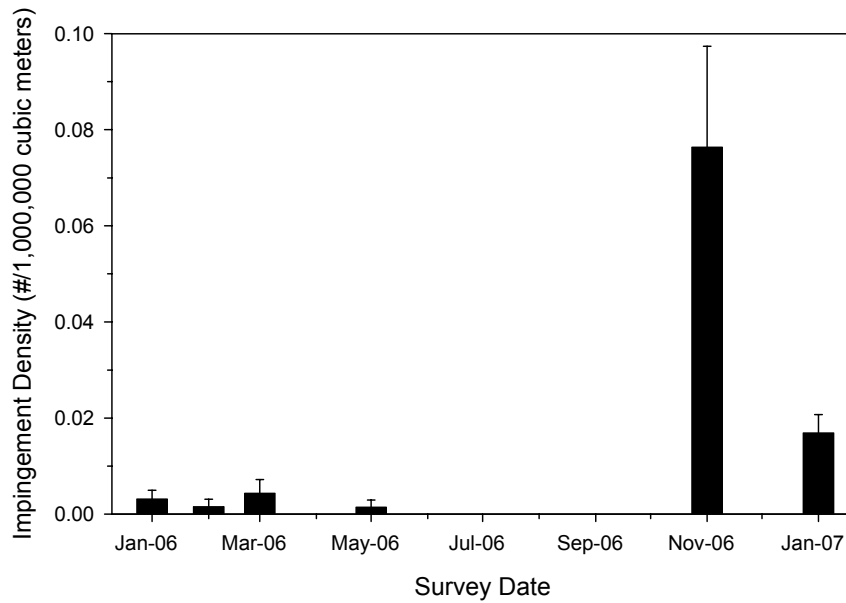

Figure 5.5-35. Mean concentration (# / 1,000,000 m<sup>3</sup>) and standard error of yellow crab collected in impingement samples during 2006-2007.

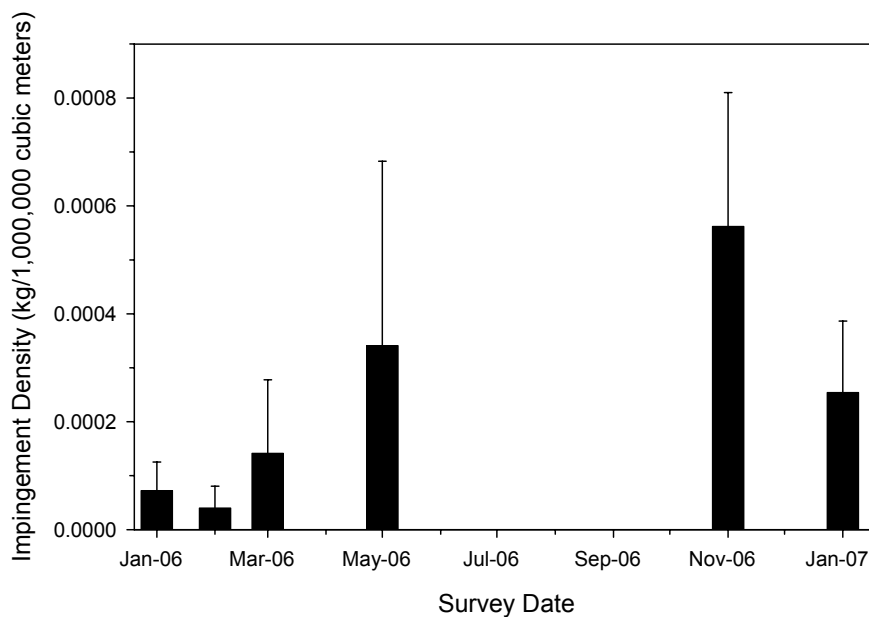

Figure 5.5-36. Mean biomass (kg / 1,000,000 m<sup>3</sup>) and standard error of yellow crab collected in impingement samples during 2006-2007.

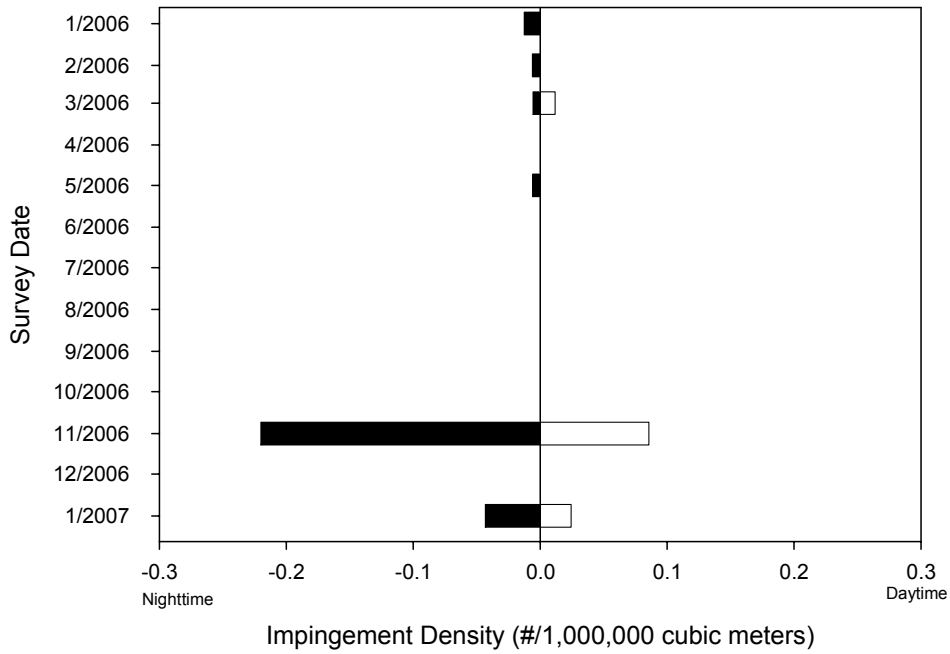

Figure 5.5-37. Mean concentration (#/1,000,000 m<sup>3</sup>) of yellow crab in impingement samples during night (Cycles 3&4) and day (Cycles 1&2) sampling at the RBGS

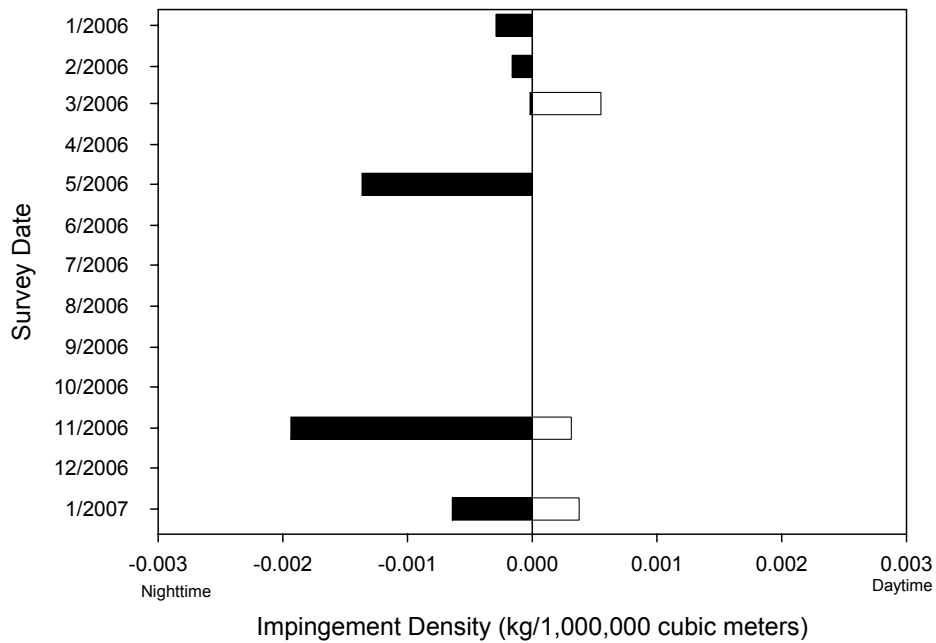

Figure 5.5-38. Mean biomass (kg/1,000,000 m<sup>3</sup>) of yellow crab in impingement samples during night (Cycles 3&4) and day (Cycles 1&2) sampling at the RBGS.

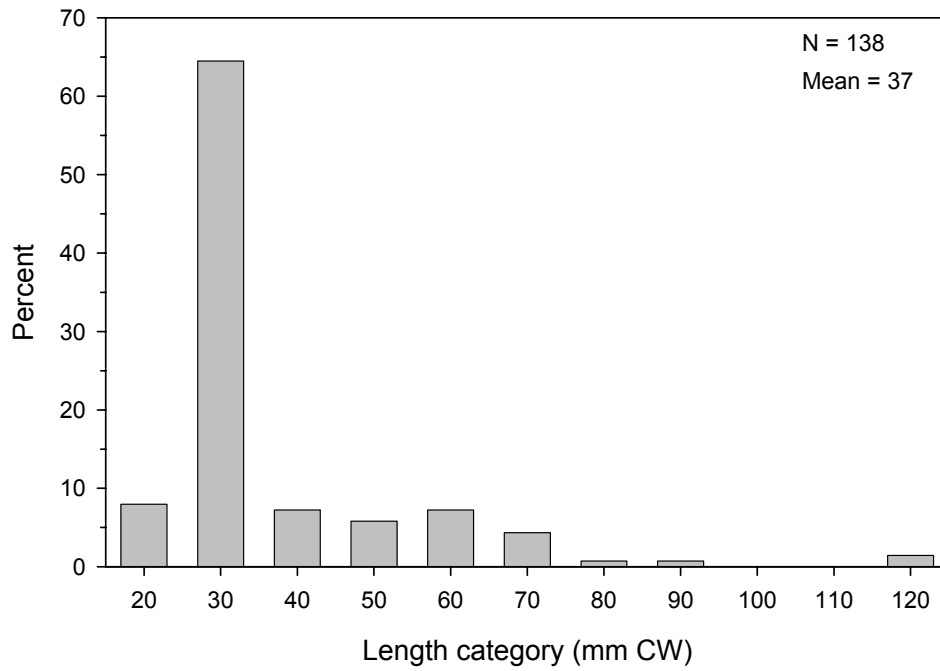

Figure 5.5-39. Carapace width (mm) frequency distribution for yellow crab collected in impingement samples.



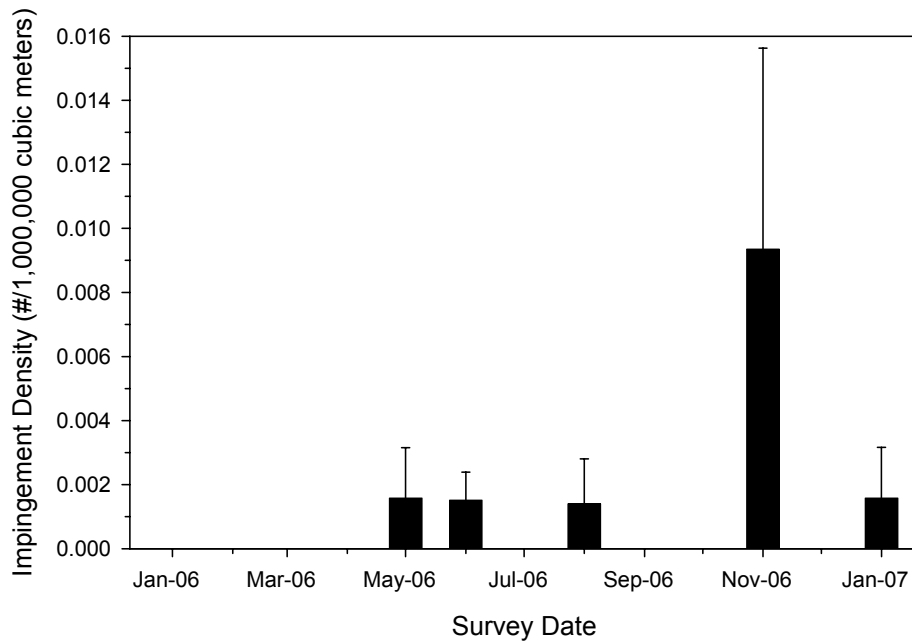

Figure 5.5-40. Mean concentration (# / 1,000,000 m<sup>3</sup>) and standard error of Pacific rock crab collected in impingement samples during 2006-2007.

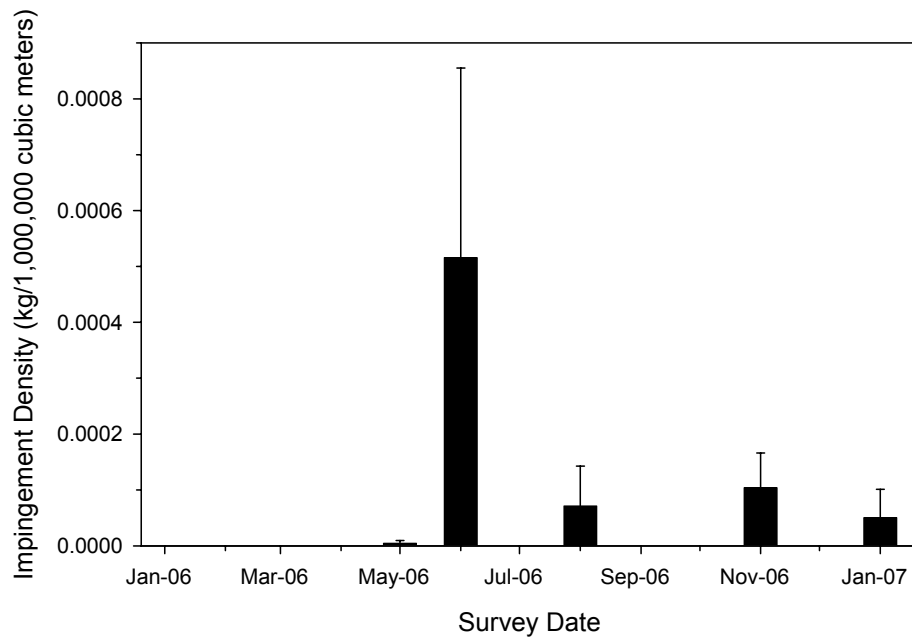

Figure 5.5-41. Mean biomass (kg / 1,000,000 m<sup>3</sup>) and standard error of Pacific rock crab collected in impingement samples during 2006-2007.

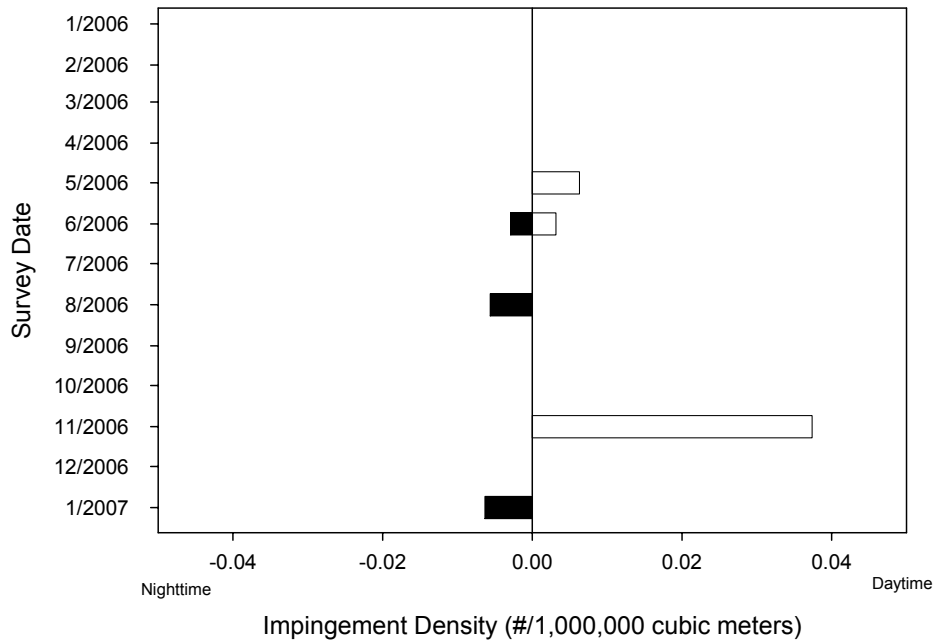

Figure 5.5-42. Mean concentration (#/1,000,000 m<sup>3</sup>) of Pacific rock crab in impingement samples during night (Cycles 3&4) and day (Cycles 1&2) sampling at the RBGS.

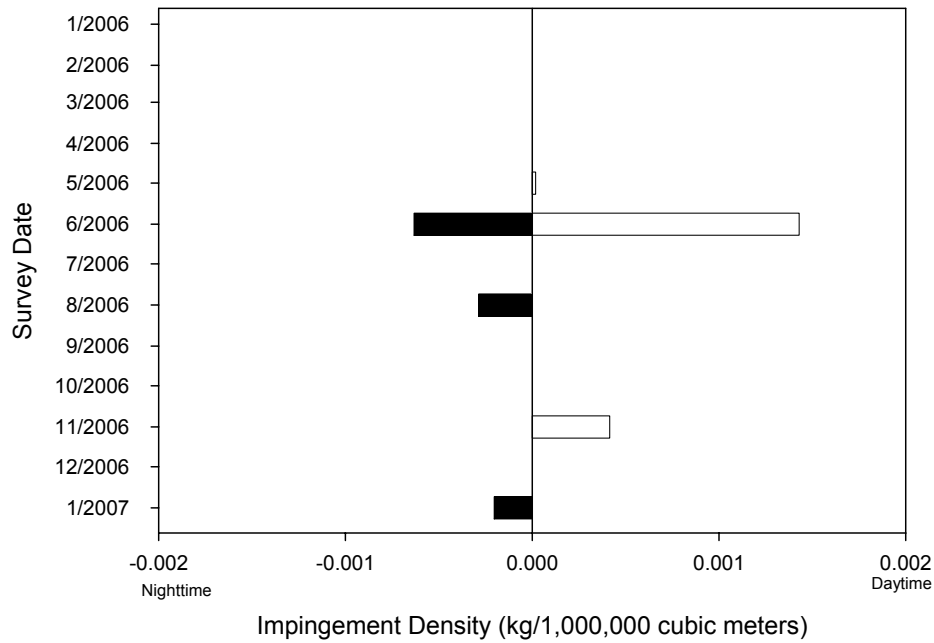

Figure 5.5-43. Mean biomass (kg/1,000,000 m<sup>3</sup>) of Pacific rock crab in impingement samples during night (Cycles 3&4) and day (Cycles 1&2) sampling at the RBGS.

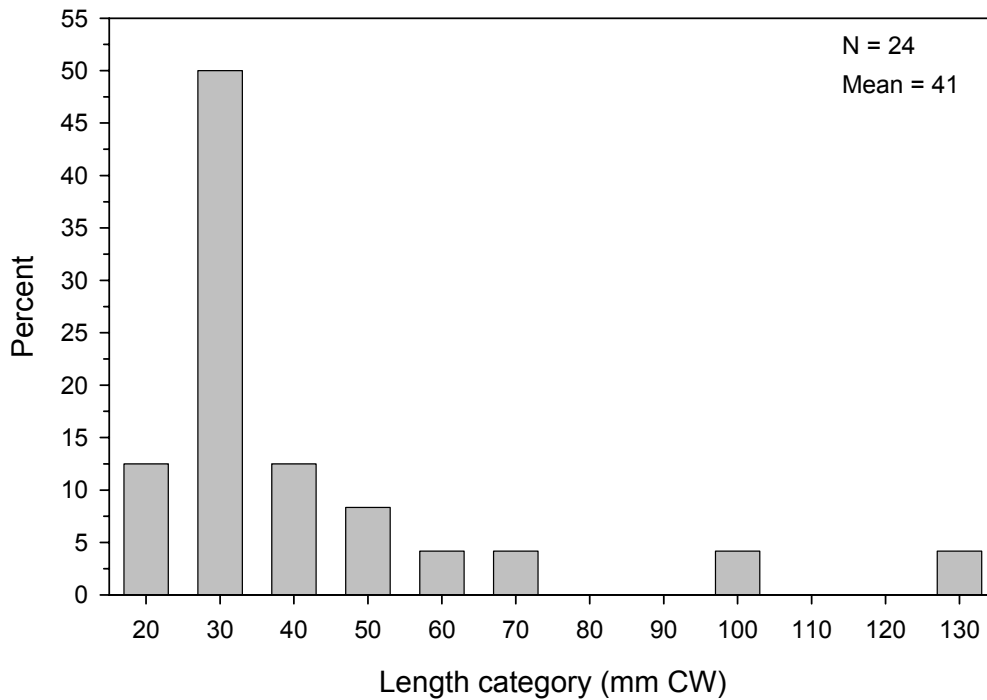

Figure 5.5-44. Carapace width (mm) frequency distribution for Pacific rock crab collected in impingement samples.

### 5.5.3.2 California spiny lobster (*Panulirus interruptus*)

Information on the life history and ecology of California spiny lobster is presented in Section 4.5.3.14.

#### 5.5.3.2.1 Population Trends and Fishery

Invertebrates were not analyzed during the 1978-1980 316(b) demonstration (SCE 1983). In 2005, a total of 80 California spiny lobster were impinged at the RBGS; all were recorded at Units 7&8 (MBC 2006). Of the 80 impinged, 58 occurred during four heat treatments, and 22 were estimated to be impinged during normal operations. In 2004, a total of 1,056 California spiny lobster were impinged at the RBGS; all were recorded at Units 7&8 (MBC 2005). Of the 1,056 impinged, 99 occurred during two heat treatments, and 957 were estimated to be impinged during normal operations. In 2003, a total of 329 California spiny lobster were impinged at the RBGS; all were recorded at Units 7&8 (MBC 2004). Of the 329 impinged, 83 occurred during two heat treatments, and 246 were estimated to be impinged during normal operations.

5.5.3.2.2 Sampling Results

An estimated total of 208 California spiny lobster were impinged at the RBGS during the yearlong study based on actual cooling water flow volumes (Tables 5.5-5 and 5.5-7). An estimated 33 individuals weighing 21.408 kg (47.205 lbs) were impinged during normal operations at Units 5&6 (Table 5.5-5). At Units 7&8, an estimated 131 lobsters weighing 38.002 kg (83.794 lbs) were impinged during normal operations while heat treatments contributed an additional 44 individuals weighing 17.547 kg (38.691 lbs) (Table 5.5-7). During normal operations, lobsters were impingement from May through July 2006. Fifty-two individuals were measured with carapace lengths ranging from 50 to 159 mm CL with a mean of 80 mm CL. Peak abundance was in the 70-mm CL size class (Figure 5.5-45). Of the 52 measured individuals, 11 were female and 41 were male with all but three individuals collected alive.

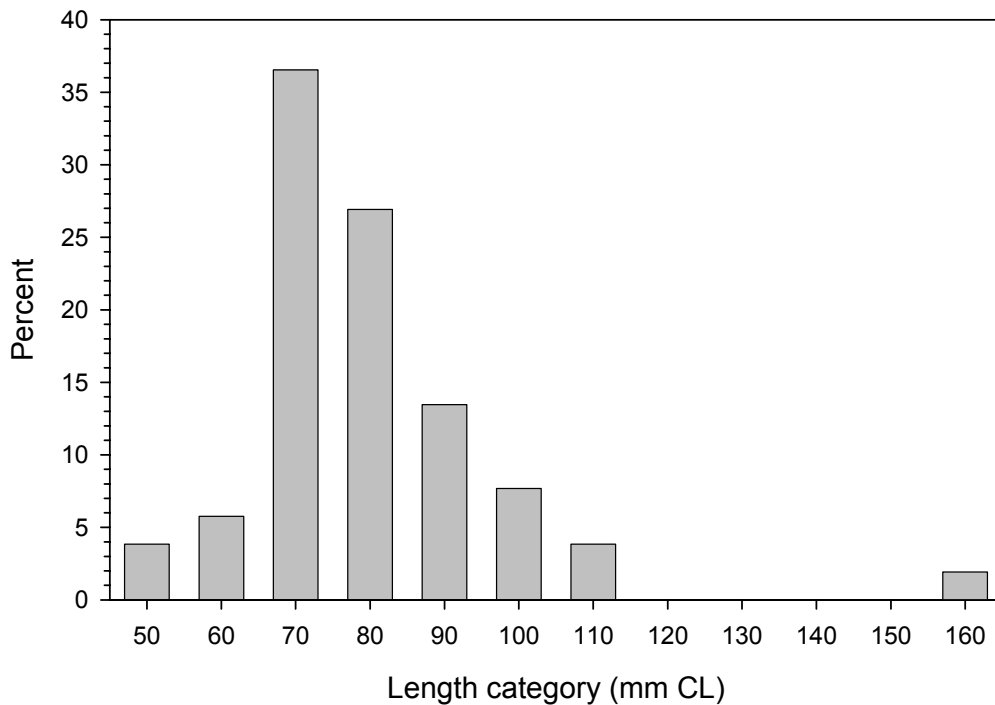

Figure 5.5-45. Carapace length (mm) frequency distribution for California spiny lobster collected in impingement samples.

### 5.5.3.3 Sheep crab (*Loxorhynchus grandis*)

Sheep crab (*Loxorhynchus grandis*) is the largest member of the spider crab family (Majidae) in California (Culver and Kuris 2001). Sheep crab range from Cordell Bank, Marin Co., California to Cape Thurloe, Baja California, and are most abundant off southern California. Another species in the same genus, masking crab (*Loxorhynchus crispatus*), occurs from Redding Rock, California to Isla Natividad, Baja California (Morris et al. 1980).



#### 5.5.3.3.1 Life History and Ecology

These crabs are occasionally found intertidally, but are more characteristically found subtidally to depths of about 125 m (410 ft) (Morris et al. 1980; Culver and Kuris 2001). Carapace length in mature crabs may reach 173 mm (6.8 in) in females and 244 mm (9.6 in) in males. Size alone does not indicate maturity, which is ascertained by the relative width of the abdomen in females and by the length and morphology of the claw in males. Longevity of the sheep crab is unknown, but many mature adults appear to be at least four years old. Studies suggest that sheep crab stop molting upon maturity (terminal molt), after which the crabs can no longer grow in size nor regenerate limbs (Culver and Kuris 2001).

Berried (egg bearing) female sheep crabs can be found throughout the year, with peaks in abundance in spring through late summer (Morris et al. 1980; Hobday and Rumsey 1999; Culver and Kuris 2001). Males over-winter in deep water, and in early spring, both sexes migrate onshore. During spring and summer, the crabs demonstrate an aggregate mating phenomena with females, mostly gravid, found in piles on the seafloor. Large adult males display competitive behavior on the perimeter of the aggregations and the formation of obstetrical pairs (back-to-back mating) occurs (Culver and Kuris 2001). Adult females store sperm, allowing for multiple broods in the absence of males. Brood sizes range from 125,000 to 500,000 eggs, and probably increase with size of the female. Little is known of the duration the females carry the eggs, or how long the larval forms are in the plankton. Brooding eggs have been observed year-round, but seasonal recruitment has also been noted, suggesting variable transport of larvae before recruitment. At La Jolla, however, juvenile abundances were found to peak between March and May, approximately three to six months after possible spawning events (Hobday and Rumsey 1999). Sheep crab larvae undergo metamorphic development with the first post-embryonic phase as a zoea and the last post-embryonic phase, before settlement, as a megalops.

Juvenile sheep crabs disguise themselves with living barnacles, algae, sponges and encrusting material to blend in with their background and avoid predation (Morris et al. 1980; Culver and Kuris 2001). Young crabs are preyed upon by cabezon, California sheephead, octopus, rays and sharks. Adult sheep crabs probably have few predators. As individuals grow, they lose the instinct to decorate and conceal themselves, and adults are often observed on open sandy bottoms. Sheep crabs are carnivores and

scavengers, and have been observed in captivity feeding on dead fish, clams and mussels, sea stars, octopuses and kelp.

#### 5.5.3.3.2 Population Trends and Fishery

The population size of the sheep crab is unknown, but large populations have been reported off Los Angeles and San Diego (Culver and Kuris 2001). In Santa Barbara, the crab had been a bycatch of the nearshore gillnet fishery for years with no indication of a decline in the population. The sheep crab fishery was developed in 1984 in Santa Barbara in an attempt to provide value to the sheep crab bycatch. The fishery expanded following the development of a market for claws, and by 1988, 48,811 kg (107,609 lbs) of live sheep crab and 175,035 kg (385,886 lbs) of claws (75% sheep crab and 25% rock crab) were landed. The claw market was primarily a gillnet fishery since removing the animal from the net and taking the claws usually killed them. In 1990, California banned use of gillnets in shallow water. Following the phase-out of gillnets landings of claws were reduced to about 2,268 kg (5,000 lbs) per year, while live crab take by trap has remained consistent at about 34,020 kg (75,000 lbs) per year. Both males and females are taken for the live, whole body fishery, while only large adult males are utilized for the claw fishery. Abundance of the species appears stable; however an overall decrease in crab size has been reported, likely due to pressure on large males for both the whole body and claw market. The market for sheep crab remains relatively low; however landings may increase if new markets are expanded. Commercial landings of sheep crab in Santa Monica Bay catch blocks in 2006 totaled 4,178 kg (9,211 lbs) at a value of \$10,113.36 (CDFG 2007b).

Invertebrates were not analyzed during the 1978-1980 316(b) demonstration (SCE 1983). In 2005, 50 sheep crab were impinged at the RBGS (MBC 2006). Six individuals were recorded during four heat treatments at Units 7&8, and the other 44 were estimated to be impinged during normal operations at Units 7&8. In 2004, 71 sheep crab were impinged at the RBGS; three were recorded during two heat treatments at Units 7&8 and the remaining 68 occurred during normal operations at Units 7&8 (MBC 2005). In 2003, six sheep crab were impinged during two heat treatments and 21 individuals were estimated to be impinged during normal operations; all individuals were recorded at Units 7&8 (MBC 2004).

#### 5.5.3.3.3 Sampling Results

An estimated 178 sheep crab weighing 251.937 kg (555.521 lbs) were impinged at Units 7&8 based on actual cooling water flow volumes, with all but one individual weighing 0.033 kg (0.073 lbs) attributed to normal operations (Table 5.5-7). During normal operations sampling, six were collected in May, two in June, and one in August 2006. No individuals were recorded at Units 5&6. Ten sheep crab were measured within a range of 38 to 172 mm CW and a mean carapace width of 123 mm. Length frequency analysis indicates peak abundance in the 130-mm CW size class (Figure 5.5-46). Seventy percent of these individuals were male while the remaining 30% were female. Furthermore, 80% of these individuals were collected alive while the remaining 20% were dead upon collection.

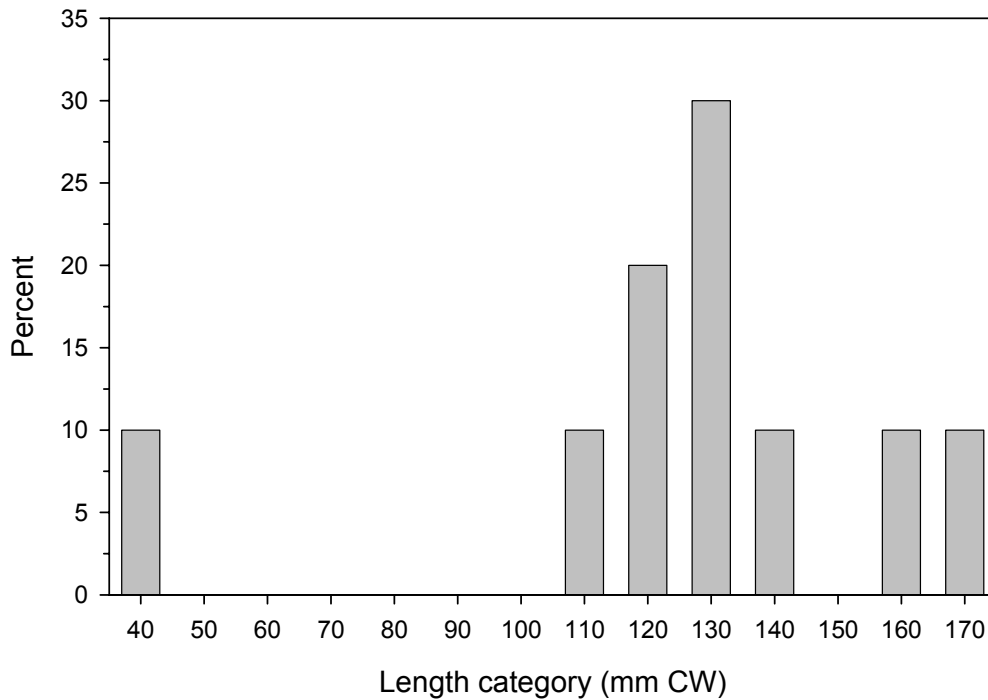

Figure 5.5-46. Carapace width (mm) frequency distribution for sheep crab collected in impingement samples.

**5.5.3.4 California two-spot octopus (*Octopus spp*)**

There are two similar octopus species that occur in southern California: *Octopus bimaculatus* and *O. bimaculoides*. Both are referred to as the two-spotted octopus since they are difficult to distinguish, and for more than 60 years were thought to represent a single species (Morris et al. 1980). *O. bimaculoides* ranges from San Simeon, California, to Bahia San Quintin, Baja California, and is found in a variety of habitats to depths of 20 m (66 ft) (Lang and Hochberg 1997). The sibling species, *O. bimaculatus*, has a similar geographic distribution, occurring from Santa Barbara, California, south to Punta Eugenia, Baja California, and in some locations within the Gulf of California. It also occurs in slightly deeper depths (to 50 m or 164 ft) (Morris et al. 1980; Lang and Hochberg 1997).



#### 5.5.3.4.1 Life History and Ecology

Both octopus species occur in a variety of habitats, including mudflats, intertidal zones, reefs, crevices, and kelp beds. *O. bimaculoides* females lay their eggs under rocks from late winter to early summer, and brood them continuously for two to four months (Morris et al. 1980). Females lay between 200 and 800 eggs, depending on female size and condition (Lang and Hochberg 1997). The young remain on the bottom after hatching, and often move toward the intertidal. Adults feed on mollusks, crustaceans, and fishes. In the rocky intertidal zone, *O. bimaculoides* drills and feeds principally on limpets (*Collisella* and *Notoacmea*), snails (*Tegula* spp.), Pacific littleneck (*Protothaca staminea*), and hermit crabs (*Pagurus* spp.) (Morris et al. 1980). They also feed on mussels (*Mytilus* spp.) and the Pacific calico scallop (*Argopecten ventricosus*) (Lang and Hochberg 1997).

*O. bimaculatus* spawns throughout most of the year, though there is a distinct seasonal peak from April through July (Lang and Hochberg 1997). Hatching takes place in a relatively short time-frame since there is an inverse relationship between development time and water temperature (Ambrose 1981). Ambrose (1981) also reported an average clutch size of about 20,000 eggs for a female weighing about 260 g (0.573 lbs). After hatching, young octopuses are planktonic for several months, and then settle to the bottom (Lang and Hochberg 1997). Juvenile *O. bimaculatus* feed on small crustaceans, while adults consume a wide variety of motile benthic invertebrates.

#### 5.5.3.4.2 Population Trends and Fishery

Most California landings of octopus result from incidental catches in other fisheries (Lang and Hochberg 1997). In 2005, commercial landings of octopus in the Los Angeles area totaled 182.7 kg (403 lbs) at a value of \$558 (CDFG 2006). Commercial landings from Santa Monica Bay area catch blocks in 2006 totaled 10.9 kg (24 lbs) at an estimated value of \$10 (CDFG 2007b). Invertebrates were not analyzed during the 1978-1980 316(b) demonstration (SCE 1983). In 2005, one two-spot octopus was impinged at Units 5&6 and 35 were impinged at Units 7&8 (MBC 2006). Most occurred during heat treatments at Units 7&8. In 2004, 188 octopus were impinged at the RBGS; 187 individuals were recorded in normal operations at Units 7&8 (MBC 2005). In 2003, 43 two-spot octopus were impinged at the RBGS, with 32 estimated in normal operations and 11 during two heat treatments (MBC 2004).

#### 5.5.3.4.3 Sampling Results

An estimated 335 California two-spot octopus weighing 45.915 kg (101.243 lbs) were impinged at Units 7&8 based on actual cooling water flow volumes, with all but four attributed to normal operation of the cooling water system (Table 5.5-7). None was recorded at Units 5&6. The maximum arm span of six of these individuals was measured, with values ranging from 210 to 570 mm with a mean of 423 mm. The distribution of these measurements was highly variable with two individuals in 450-mm size class, while the remaining individuals were scattered among five unique size classes. The final disposition of seven individuals was recorded with 71% dead and 29% alive.



**5.5.3.5 Market squid (*Loligo opalescens*)**

Market squid (*Loligo opalescens*) range from offshore British Columbia to Bahia Asuncion, Baja California, including Guadalupe Island off Baja California (Morris et al. 1980; MBC 1987). However, they are found in highest numbers between Monterey and San Diego, California, and are only found north of Puget Sound during or following El Niño events. The distribution of this species is classified as ‘Transitional Endemic’ since market squid are limited to the California Current and the eastern portion of the Northeast Pacific Transition Zone. Market squid are managed under the Coastal Pelagic Species Fishery Management Plan (PFMC 1998).

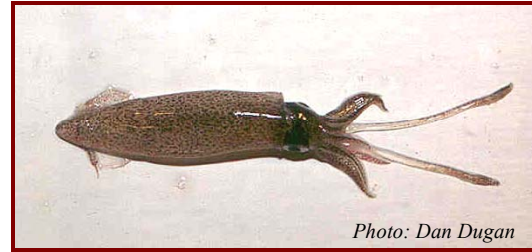

**5.5.3.5.1 Life History and Ecology**

Eggs of the market squid are benthic, while juveniles and adults are considered pelagic (Fields 1965). They are actually found over the continental shelf from the surface to depths of at least 800 m (2,625 ft) (PFMC 1998). Recksiek and Kashiwada (1979) found larvae in much higher concentrations near bottom than in the water column. Mature squid form large spawning aggregations in nearshore waters, and in southern California, these usually occur from November through August (Fields 1965).

During copulation, a male holds the female from below, and a bundle of spermatophores is subsequently transferred from the mantle cavity of the male to a position near the female’s oviduct (Hurley 1977). In southern California, squid spawn primarily in winter (December to March), though spawning has also been recorded in July (Morris et al. 1980). Fields (1965) suggested nighttime spawning in market squid; however, recent observations suggest this species spawns exclusively during daytime (Forsythe et al. 2004). Market squid are terminal spawners, spawning once then dying.

Age at reproduction is 24 to 28 weeks (Yang et al. 1986). Egg capsules are usually deposited on sandy substrate, often at the edges of canyons or rocky outcroppings (McGowan 1954). Egg deposition occurs between depths of 5 and 55 m (16 and 180 ft), and is most common between 20 and 35 m (66 and 115 ft) (PFMC 1998). Each egg capsule contains 180 to 300 eggs (Morris et al. 1980). Egg development is dependent on water temperature; eggs hatch at 19 to 25 days at 17°C (63°F), 27 to 30 days at 15°C (59°F), and 30 to 35 days at 14°C (57°F) (Yang et al. 1986). Females produce 20 to 30 egg capsules, and each capsule is individually attached to the substrate (PFMC 1998). Fields (1965) reported four females depositing 17,000 eggs in 85 capsules in one evening, equivalent to about 21 capsules and 4,250 eggs per squid. Recksiek and Frey (1978) reported a fecundity of 4,000 to 9,000 eggs per female (MBC 1987). Macewicz et al. (2004) report an average fecundity of 3,844 oocytes based on an average female length of 129 mm (5.1 in) dorsal mantle length (DML).

Young squid hatch within three to five weeks after the capsule is deposited (McGowan 1954; Fields 1965). Newly hatched squid (paralarvae) resemble miniature adults and are about 2.5 to 3.0 mm (0.1 in)

in length. After hatching, young *Loligo* swim upward toward the light, bringing them to the sea surface (Fields 1965).

Butler et al. (1999) determined growth averages about 0.6 mm (0.02 in) DML per day, and maximum ages in 1998 were 238 days for females and 243 days for males. Yang et al. (1986) recorded a maximum life span of 235 and 248 days for two laboratory-reared populations. Yang et al. (1986), Butler et al. (1999), and Jackson (1998) determined that Fields (1965) and Spratt (1979) underestimated growth and overestimated longevity—squid were initially reported to live as long as three years. Growth increases exponentially during the first two months, and then slows to logarithmically thereafter (Yang et al. 1986). Schooling behavior has been observed in squid as small as 15 mm (0.6 in) DML (Yang et al. 1986).

Squid hatched in early summer will grow rapidly during the summer growing season when nutrients from increased upwelling cause plankton blooms. As spawning continues from June through September, newly hatched squid have less time available in the growing season, which can slow the growth rate (Spratt 1979). Adults measure up to 305 mm (12 in) total length and weigh between 56 and 84 g (0.123 and 0.185 lbs) (Vojtkovich 1998), with spawning males normally being larger than females. Males reach 19 cm DML (7.5 in), a maximum weight of about 130 g (0.287 lbs), and have larger heads and thicker arms than females (PFMC 1998). Females reach about 17 cm DML (6.7 in) and a maximum weight of 90 g (0.198 lbs).

Planktonic invertebrates are the primary food source of young squid (Spratt 1979). Squid feed mostly on crustaceans, and to a lesser degree fishes, cephalopods, gastropods, and polychaetes (Karpov and Cailliet 1979). The diet of market squid changes with water depth and location, but does not differ much among size classes or between sexes (Karpov and Cailliet 1979). Squid captured in deeper water feed more frequently on euphausiids and copepods, whereas squid captured near the surface feed predominantly on euphausiids, as well as cephalopods, fish, mysids, and megalops larvae. In spawning schools, 75% of stomachs examined had remains of market squid (Fields 1965).

Cailliet et al. (1979) determined affinities of multiple species with market squid. In Monterey Bay, the species with the highest affinities with market squid were northern anchovy, Pacific electric ray (*Torpedo californica*), Scyphomedusae (jellies), plainfin midshipman (*Porichthys notatus*), Pacific sanddab (*Citharichthys stigmaeus*), and white croaker.

#### 5.5.3.5.2 Population Trends and Fishery

Large-scale fluctuations are characteristic of the squid stock, due primarily to its short life span and from the influence of wide variations in oceanographic conditions (NMFS 1999). However, the short life history of this species allows for squid to recover after natural population declines as soon as ocean conditions improve. The best information indicates squid have a high natural mortality rate (approaching 100% per year) and that the adult population is composed almost entirely of new recruits (PFMC 1998). In 1997, California passed Assembly Bill AB 364, which not only initiated closures and established a fishery permit fee, but designated funds from the permits to be used for squid research and management.

The California fishery for market squid began in Monterey Bay in the late-1800s (Vojkovich 1998). It expanded into southern California only after the 1950s, and prior to 1987, catches in southern California rarely exceeded 20,000,000 kg (44,100,000 lbs). After that, landings increased four-fold until the fishery collapsed in 1998, and California squid fishers sought federal disaster assistance (Zeidberg et al. 2004). In California, most squid marketed for human consumption is frozen, but smaller amounts are canned or sold fresh (PFMC 1998). Squid are also sold live and frozen for bait. Los Angeles area commercial landings have varied substantially since 2000, ranging between 7.7 and 44.8 million kg (16.9 and 98.8 million pounds) annually (PacFIN 2007), with both the total catch and market value increasing substantially the last four years (Table 5.5-17). Los Angeles area landings in 2005 totaled 31,559,678 kg (69,573,734 lbs) at an estimated value of \$18,511,585 (CDFG 2006). Landings in Santa Monica Bay area catch blocks in 2006 totaled 307,773 kg (678,512 lbs) at an estimated value of \$169,920 (CDFG 2007b).

Table 5.5-17. Annual landings and revenue for squid in the Los Angeles region based on PacFIN data.

<b>Year</b>	<b>Landed Weight in kg (lbs)</b>	<b>Revenue</b>
2000	44,831,189 (98,854,319)	\$11,360,252
2001	39,163,504 (86,355,527)	\$8,491,578
2002	28,155,199 (62,082,214)	\$6,430,766
2003	7,703,122 (16,985,383)	\$4,424,230
2004	10,501,964 (23,156,830)	\$4,845,324
2005	31,808,088 (70,136,834)	\$18,664,223
2006	37,053,145 (81,702,193)	\$20,370,612

Invertebrates were not analyzed during the 1978-1980 316(b) demonstration (SCE 1983). In 2005, two market squid were impinged during heat treatments at the RBGS, both at Units 7&8 during heat treatments (MBC 2006). A total of 351 market squid were impinged in 2004, all during normal operations at Units 7&8 (MBC 2005). Only one market squid was impinged in 2003 during a heat treatment at Units 7&8 (MBC 204).

#### 5.5.3.5.3 Sampling Results

At Units 7&8, an estimated 154 California market squid weighing 4.176 kg (9.208 lbs) were impinged during normal operation based on actual cooling water flow volumes (Table 5.5-7). Three individuals were collected during normal operations sampling: one individual was collected in March and the other two were collected in April 2006. No individuals were collected during heat treatments or at Units 5&6. Mantle length measurements from three individuals were 108, 119, and 130 mm. All three individuals were collected dead.

## 6.0 IMPACT ASSESSMENT

### 6.1 IMPACT ASSESSMENT OVERVIEW: DATA AND APPROACH

Section 316(b) of the Clean Water Act regulates cooling water intake systems at electrical generating facilities, and requires that the location, design, construction, and capacity of cooling water intake structures reflect BTA for minimizing adverse environmental impact (AEI). In 2004, the U.S. EPA published 316(b) Phase II regulations for existing power plants, which established performance standards for reducing entrainment by 60–90% and impingement mortality by 80–95%. However, the Phase II rule was suspended by EPA in 2007. On May 20, 2007, EPA transmitted a memorandum to regional administrators informing them that the Phase II rule should be considered suspended, and that “*all permits for Phase II facilities should include conditions under Section 316(b) of the Clean Water Act developed on a Best Professional Judgment basis. See 40 CFR 401.14.*” As written, the Clean Water Act does not specify required CWIS technologies or methods by which EPA must make its determinations under Section 316(b).

Prior to the publication of the Phase II rule in 2004, regulators relied on EPA’s (1977) draft guidelines for evaluating adverse impacts of cooling water intake structures to determine compliance with Section 316(b). At the RBGS, the previous 316(b) demonstration (SCE 1983) evaluated entrainment and impingement impacts using several methods, including:

1. Evaluation of IM&E losses relative to known source populations;
2. Estimation of the probability of avoiding IM&E during a five-year period; and
3. Assigning a relative level of impact for each taxa analyzed.

Separate analyses were done for the Units 1–6 and Units 7–8 CWISs. The projected effect of switching to alternative intake technologies on the levels of impact was also assessed as part of the intake technology evaluation.

Under the previous 316(b) evaluation, impacts were classified as ‘significant’ or ‘insignificant’. An insignificant impact was one in which the IM&E losses would have no effect on nearshore population dynamics, and long-term population observations would not reveal significant differences in abundance or distribution of the affected organisms. A significant impact was one in which the IM&E losses caused a discernible statistical effect on population abundance and/or distribution that could lead to ecological or economic impacts. The ultimate conclusion of the previous RBGS 316(b) demonstration was that there were no significant adverse impacts on nearshore fish populations in the Southern California Bight from the operation of the RBGS, and the velocity-capped configuration of the intakes represented BTA for minimizing AEI.

Since the new Phase II regulations were based on performance standards for reducing entrainment and impingement and did not explicitly rely on determining whether existing levels represented an AEI, EPA determined the “*...performance standards reflect the best technology available for minimizing adverse*

*environmental impacts determined on a national categorical basis.”* Although AEI was not intended to be used in assessing compliance under the new regulations, the potential for AEI was still considered in determining the types of plants and water body where the new performance standards would apply. Plants with low capacity factors and low cooling water volumes were considered to be BTA since their cooling systems had a low potential for adverse environmental impacts.

In its 1977 draft guidance document, EPA indicated “*Adverse aquatic environmental impacts occur whenever there will be entrainment or impingement damage as a result of the operation of a specific cooling water intake structure. The critical question is the magnitude of any adverse impact.*” EPA also clarified in the guidance document: “*Regulatory agencies should clearly recognize that some level of intake damage can be acceptable if that damage represents a minimization of environmental impact.*”

In the 2006 IM&E study, entrainment and impingement losses were measured by collecting samples within the RBGS (IM) and in the vicinity of the Units 5&6 and Units 7&8 intakes (E). The purpose of this impact assessment is to put the measured losses into context, and to evaluate the potential for AEI due to the CWISs.

### **6.1.1 CWIS impacts**

There are three general types of effects associated with cooling water intake structures: (1) thermal effects, (2) impingement effects, and (3) entrainment effects. Thermal effects are regulated under Section 316(a) of the Clean Water Act and the *Water Quality Control Plan for Control of Temperature in the Coastal and Interstate Waters and Enclosed Bays of California (California Thermal Plan)*. The NPDES permit issued by the LARWQCB for the RBGS indicates that the generating station continues to operate in compliance with the Thermal Plan. Entrainment occurs when organisms are drawn into a cooling water intake structure and subsequently pass through the RBGS. Organisms large enough to become trapped on the traveling screens are impinged.

In discussing the potential effects of the RBGS CWISs on fish and shellfish populations, the life histories of the species in the community need to be considered. First, several fish species in the nearshore coastal areas around RBGS have early life stages that are not susceptible to entrainment. Live-bearers, such as surfperches and some sharks and rays, produce young that are fully developed and too large to be entrained. Secondly, for fishes with entrainable life stages, the period of time that they are vulnerable to entrainment may be relatively short. As the study results for RBGS show, many species are only vulnerable to entrainment for a few days when they are newly hatched since their swimming ability increases rapidly with age and development. With increased age many species begin searching for adult habitat, usually on the bottom, where they are less susceptible to entrainment through the elevated intake risers. Some fishes, such as blennies, gobies and topsmelt, have demersal eggs that are not subject to entrainment. From the standpoint of impingement effects, one of the most abundant groups of species in protected bays and estuaries, gobies, are generally not susceptible to impingement after transformation to the juvenile life stage because they are bottom-dwelling species that typically do not move up into the water column. This is also true of many flatfishes which are bottom-dwellers and also, generally, strong swimmers. Even fish species that swim in the water column are generally not susceptible to impingement

effects as they mature because they are able to swim against the slow approach velocity of the cooling water inflow.

### **6.1.2 Review of IM&E Sampling Approach**

The Phase II 316(b) regulations required that IM&E studies include “*Documentation of current impingement mortality and entrainment of all life stages of fish, shellfish, and any protected species identified previously and an estimate of impingement mortality and entrainment to be used as the calculation baseline.*” For the purposes of this study the term ‘shellfish’ was interpreted as including commercially and recreationally important species of crustaceans (crabs, lobsters, shrimp, etc.) and mollusks (squid and octopus) that are harvested on a regular basis from the coastal areas surrounding the RBGS. This definition does not include organisms such as clams, mussels, or other crustaceans and mollusks that may only be harvested occasionally by recreational fishers, although the entrainment processing was expanded, at the request of the LARWQCB staff, to include all crab megalops stage larvae, and the impingement sampling quantified all organisms regardless of fishery status. This definition was used because ‘shellfish’ could also be considered as including all species of shelled invertebrates, including zooplankton, and clarification of the term was not provided in the regulations.

The Rule’s entrainment performance standard focuses on addressing impacts to fish and shellfish rather than lower trophic levels such as phyto- and zooplankton. EPA recognized the low vulnerability of phyto- and zooplankton in its 1977 draft 316(b) guidance (EPA 1977). There are several reasons why there is a low potential for impacts to phyto- and zooplankton and why it made sense for the EPA to focus on effects on fish and shellfish. The reasons include the following:

- The extremely short generation times; on the order of a few hours to a few days for phytoplankton and a few days to a few weeks for zooplankton;
- Both phyto- and zooplankton have the capability to reproduce continually depending on environmental conditions; and
- The most abundant phyto- and zooplankton species along the California coast have populations that span the entire Pacific, or in some cases, all of the world’s oceans. For example, *Acartia tonsa*, one of the common copepod species found in the nearshore areas of California is distributed along the Atlantic and Pacific coasts of North and South America and the Indian Ocean.

Relative to the large abundances of phyto- and zooplankton, larval fishes make up a minute fraction of the total numbers of organisms present in seawater. The EPA has correctly focused on potential impacts on fishes and shellfishes because they are more susceptible to entrainment effects for the following reasons:

- They have much shorter spawning seasons relative to phyto- and zooplankton. In many species, spawning occurs only once during the year;
- Unlike phyto- and zooplankton that may be distributed over large oceanic areas, most fishes are restricted to the narrow shelf along the coast and in some cases have specific habitat requirements that further restrict their distribution; and

- Unlike many phyto- and zooplankton, there is a greater likelihood of mortality due to entrainment in larval fishes, since many lower trophic level organisms are not soft bodied as is the case for finfish and are better able to tolerate passage through the cooling water system.

The impingement and entrainment sampling at RBGS was therefore focused on fishes and shellfishes as required in the new 316(b) Phase II regulations. All of the fishes and shellfishes collected during the impingement sampling were counted and identified, while fish larvae, megalops stages of crabs, phyllosome larvae of spiny lobster, and squid larvae were identified and counted from the entrainment samples at the Units 5&6 and Units 7&8 intakes, and fish eggs were also processed from the samples at Units 7&8. The new 316(b) Phase II regulations provide latitude for focusing on the set of species that can be accurately quantified and that will provide the necessary detail to support development of other aspects of the CDS, and therefore, allows for negotiating an acceptable compromise between the regulating agency and the discharger. The target group of organisms that were included in the entrainment sample processing was finalized at a January 12, 2006 LARWQCB meeting.

The specific taxa (species or group of species) that were included in the assessment are limited to those that were sufficiently abundant to provide reasonable assessment of impacts. For the purposes of this assessment, the taxa analyzed were limited to the most abundant taxa that together comprised 90–95% of all larvae entrained and/or juveniles and adults impinged by the generating station. The most abundant taxa were used in the assessment because they provide the most robust and reliable estimates for assessing the effects of the RBGS cooling water systems. Since the most abundant organisms may not necessarily be the organisms that experience the greatest effects on the population level, the data were also carefully examined to determine if additional taxa should be included in the assessment. For example, this might include commercially or recreationally important taxa, taxa with limited habitats, and any threatened or endangered fish or shellfish species. No listed species were entrained or impinged at the RBGS during the study and no additional taxa beyond those selected based on sampling abundance were included in the assessment.

Results for individual taxa from the impingement and entrainment sampling were combined, where possible, to evaluate the total effects of the CWISs. This was done by extrapolating the numbers of adult and juvenile fishes impinged to the same age used in the adult equivalent loss (*AEL*) and fecundity hindcasting (*FH*) models for the entrainment data. The age used in the *AEL* and *FH* modeling was the age of first maturity where approximately 50% of the females in the population are reproductive. Unfortunately, the life history information necessary for the modeling is unavailable for most species so combined assessments were only possible for northern anchovy, queenfish, black croaker, and kelp bass.

### **6.1.3 Approaches for assessment of CWIS impacts**

Due to the suspension of the 316(b) Phase II rule, state and federal permit writers have been directed to implement Section 316(b) on a case-by-case basis using “best professional judgment”. In the case of the RBGS, the permit applicant is obligated to provide the LARWQCB with the “best information reasonably available” to assist it in fulfilling its decision-making responsibility. To make Section 316(b) decisions, permit writers have relied on precedent from other cases and on the USEPA (1977) informal draft

*“Guidance for Evaluating the Adverse Impact of Cooling Water Intake Structures on the Aquatic Environment: Section 316(b) P.L. 92-500”.*

As is clear from the statute, the permit writer must consider two basic issues in making a finding that an intake technology employs BTA for minimizing AEI:

1. Whether or not an AEI is caused by the intakes and, if so,
2. What intake technologies represent BTA to minimize that impact.

The usual approach for a 316(b) demonstration would be to consider the question of BTA only if a determination has been made that a facility is causing an AEI.

### **6.1.3.1 Adverse Environmental Impact (AEI) Standard**

Since there are no regulations defining AEI, permit decisions must be based on the EPA’s AEI interpretations provided in guidance documents issued since the 1970s. In those documents, the EPA has indicated that assessment of AEI should be based on an evaluation of population level effects, not just losses of individual organisms. In its 1975 Draft BTA Guidelines, the EPA stated that “[a]dverse environmental impacts occur when the ecological function of the organism(s) of concern is impaired or reduced to a level which precludes maintenance of existing populations...”. Additionally, in the 1976 Development Document, released in conjunction with the EPA’s previous Section 316(b) rules, the EPA said that “[t]he major impacts related to cooling water use are those affecting the aquatic ecosystems. Serious concerns are with population effects that...may interfere with the maintenance or establishment of optimum yields to sport or commercial fish and shellfish, decrease populations of endangered organisms, and seriously disrupt sensitive ecosystems.”

USEPA (1977) draft guidelines acknowledge that the determination of the extent of AEI when it is occurring is difficult to assess. They state that “Adverse aquatic environmental impacts occur whenever there will be entrainment or impingement damage as a result of the operation of a specific cooling water intake structure. The critical question is the magnitude of any adverse impact. The exact point at which adverse aquatic impact occurs at any given plant site or water body segment is highly speculative and can only be estimated on a case-by-case basis...”

Due to the obvious difficulties with determining the extent of AEI, the document (USEPA 1977) provides some general guidelines. These involve determining the “relative biological value of the source water body zone of influence for selected species and determining the potential for damage by the intake structure” based on the following considerations of the value of a given area to a particular species:

- principal spawning (breeding) ground;
- migratory pathways;
- nursery or feeding areas;
- numbers of individuals present; and
- other functions critical during the life history.



Following this general approach provided by USEPA (1977), additional criteria can be evaluated that are specific to the marine environment around RBGS and directly applicable to the present 316(b) study:

- population distribution (pelagic, subtidal, nearshore subtidal & intertidal);
- range, density, and dispersion of population;
- population center (source or sink);
- magnitude of effects;
- long-term abundance trends (e.g., fishery catch data);
- long-term environmental trends (climatological or oceanographic); and
- life history strategies (e.g., longevity and fecundity).

By assessing the relative value of each of these criteria for a particular taxon, we can better assess the extent of the impact that the loss of these animals has on the local environment and the populations at large.

#### **6.1.4 Relating measured impacts to source populations**

The potential magnitude of the losses due to entrainment and impingement depend on many factors including:

- Characteristics of the source water body – currents, potential larval sources;
- Vulnerability based on distribution (sink/source), habitat preference, and life history attributes of spawning populations;
- Lack of entrainment impacts to species, such as surfperches and elasmobranches, with no planktonic phase;
- Lack of impingement impacts to fishes and invertebrates with limited mobility;
- Rates of decrease for non-IM&E fishes due to other causes and comparing those to species subject to IM&E.

The criteria used to evaluate the potential for AEI need to be placed into a larger context using the characteristics of the source water and the biological community. This assessment focuses on a set of species that were collected during the study in adequate abundances to provide reasonable confidence in the estimates of entrainment and impingement effects. These species were also selected to be broad enough to include representatives from the different habitats and species groups present in the source water. As previously discussed (Section 6.1.1), not all of the fishes and shellfishes in the source water are subject to entrainment or impingement, and only a few species occur in high abundance in both entrainment and impingement samples. These differences in the vulnerability to entrainment and impingement occur due to different life histories of the species, and the differences in habitat preferences and behavior that may occur at different life stages. This assessment focuses on the distribution of the species and their habitats to determine which species are at greatest risk. An example of a high-risk

species would be a rare or endangered species with a distribution that was limited to the shallow sandy shoreline areas of Santa Monica Bay, or the semi-enclosed area of King Harbor.

Data on water current flow and direction collected during the study and the size distributions of entrained larvae were used to estimate the spatial extent of the effective source populations of larvae for modeling entrainment effects. The larval durations for the species analyzed for this report, with the exception of northern anchovy, indicated that the source populations for the larvae were largely limited to the vicinity of Santa Monica Bay and King Harbor, in particular. The source population for northern anchovy for the modeling was limited to the bay, but the larval duration and corresponding current data indicated that the source population extended beyond the bay. These data were consistent with results from CalCOFI showing that northern anchovy larvae are distributed throughout the Southern California Bight (SCB) with peak abundances in the outer shelf areas (Figure 6.1-1) (Moser et al. 2001). In the outer shelf beyond the boundaries of Santa Monica Bay larvae are transported by the predominant upcoast (poleward) California Countercurrent (Hickey 1992). The presence of the California Countercurrent in the outer coastal waters of the SCB results in an eddy-type circulation pattern within Santa Monica Bay (Hickey et al. 2003). Hickey (1992) described the residence time of water within the Santa Monica and San Pedro basins using drifters. Drifters deployed in January 1990 in Santa Monica Bay escaped westward in about a week and most of the other drifters, which were not cast ashore, escaped the SCB in the ~2 week deployment period, roughly half passing north into the Santa Barbara Channel and half passing south of the Channel Islands. The estimates of larval duration and the prevailing oceanographic conditions indicate that Santa Monica Bay is a logical focus for examining the potential effects of entrainment and impingement.

The focus of the assessment should be on species with adult populations in the nearshore areas of Santa Monica Bay that are directly affected by entrainment and impingement at the RBGS CWIS. The location of the RBGS Units 7&8 intake at the entrance to King Harbor results in a higher probability of larval entrainment for species such as garibaldi and combtooth blennies that are associated with constructed breakwater and piling habitats. However, other nearshore fishes such as croakers, sea basses, and California halibut largely occur as adults in nearshore areas and CalCOFI data show their larvae have similar distributions (Figure 6.1-2). Therefore several criteria (distribution, range, density, dispersion of population, and population center) can be used to focus the assessment on species with adult and larval distributions that would place them at greatest risk to entrainment and impingement effects.

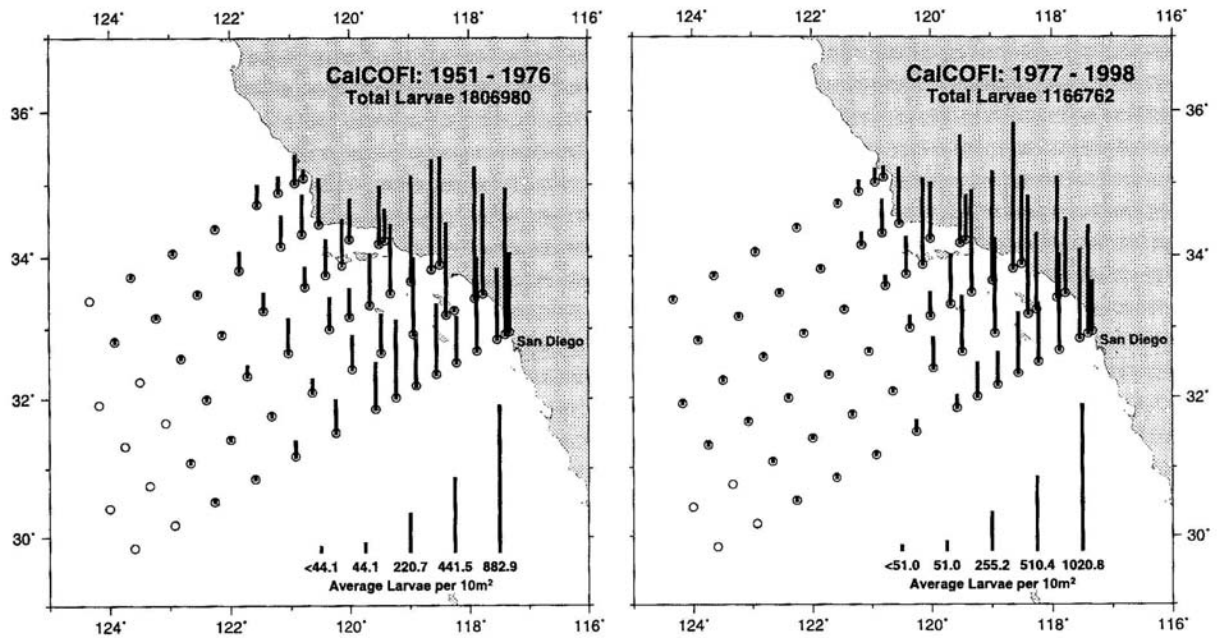
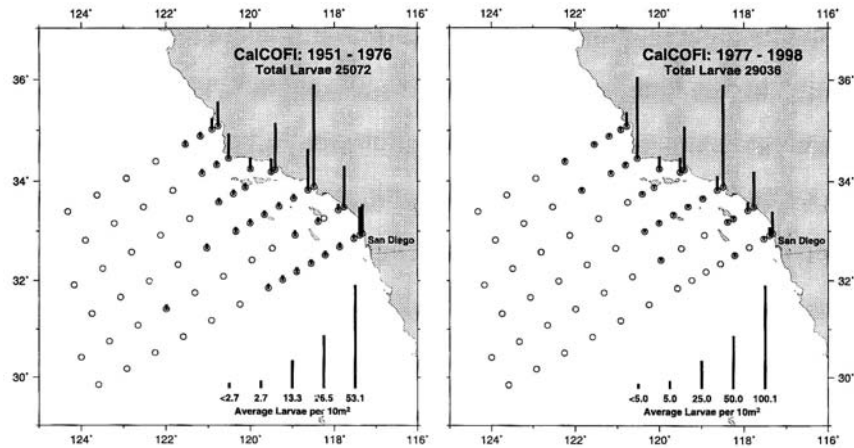
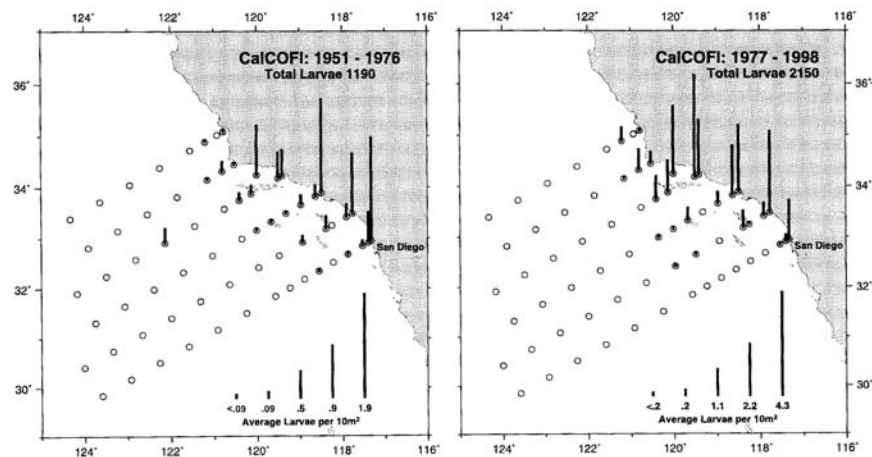

Figure 6.1-1. Distribution and abundance of northern anchovy larvae (*Engraulis mordax*) at permanent stations sampled in the CalCOFI study in the SCB from 1951 through 1998 (from Moser et al. 2001).

a) croakers



b) kelp and sand basses



c) California halibut

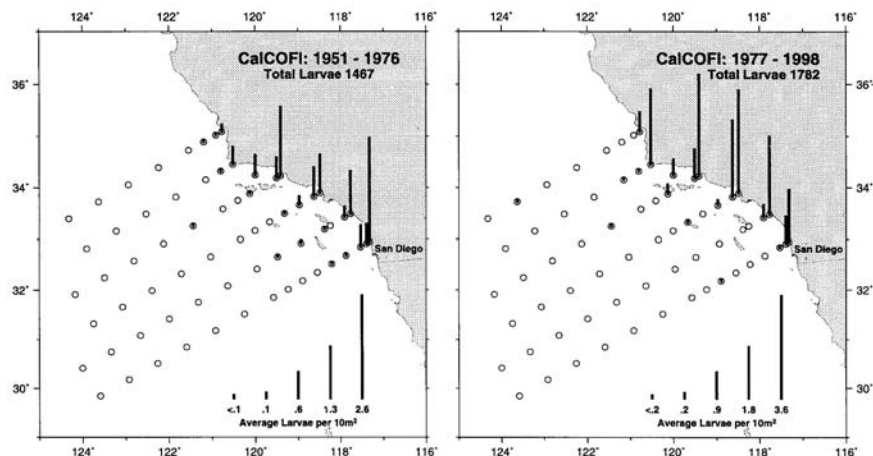

Figure 6.1-2. Distribution and abundance of larvae of a) croakers (Family Sciaenidae), b) kelp and sand basses (*Paralabrax* spp.), and c) California halibut (*Paralichthys californicus*) across permanent stations in the SCB from 1951 through 1998 (from Moser et al. 2001).

These criteria relate directly to the habitats associated with the fishes and shellfishes potentially affected by entrainment and impingement. This approach to classification has been taken in recent studies of marine fishes of California (Horn and Allen 1978; Allen 1985; Allen and Pondella 2006b) and will be used to organize the discussion of taxa included in this assessment. We have simplified the more detailed categorization of habitats used by Allen and Pondella (2006b), which included several habitats used to define deeper offshore areas (Figure 6.1-3). These deeper offshore habitat types can be combined for the purposes of our assessment since the taxa associated with those habitats are generally not at risk of entrainment and impingement and were collected in very low numbers. The habitats defined by Allen and Pondella (2006b) have been simplified for this assessment to the following habitat types:

- bays, harbors, and estuaries;
- subtidal and intertidal rocky reefs and kelp beds;
- coastal pelagic;
- continental shelf and slope; and
- deep pelagic including deep bank and rocky reefs.

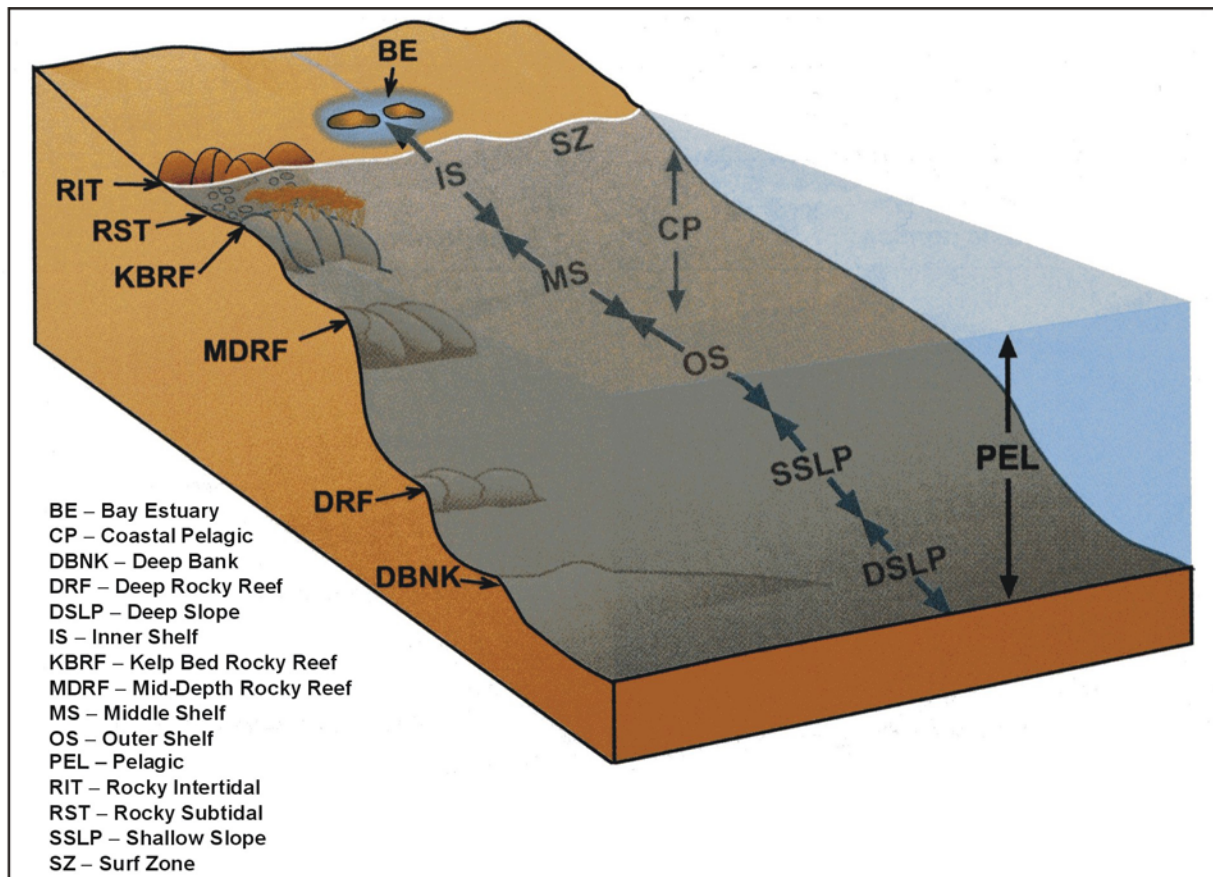

Figure 6.1-3. Marine habitat types in California (from Allen and Pondella [2006b]).

The taxa included in this assessment were categorized into these habitat types (Table 6.1-1). Taxa that occurred in more than one habitat were included in the habitat group that best reflected the primary distribution for the taxa and if a primary habitat could not be identified, it was categorized into the habitat where they are at greatest risk to the effects of entrainment and impingement. For example, kelp and sand basses occur in both bay and harbor, and rocky reef/kelp habitats but are more commonly associated with rocky reef/kelp habitats, the habitat that also places them at greater risk to power plant effects from RBGS. This raises an important point in regards to impact assessment. Taxa that occupy several different habitats will be less at risk from power plant impacts, especially if at least one of the habitats is not directly affected by entrainment and impingement.

This approach to assessing AEI is consistent with recent trends in fisheries management toward using ecosystem-based management approaches (Larkin 1996; Link 2002; Mangel and Levin 2005). This approach recognizes that fishing stocks can only be managed effectively if the sustainability and health of habitats and other components of the ecosystem are also considered. An ecosystem-based approach also addresses other human activities in addition to fishing and the environmental factors that affect an ecosystem, the response of the ecosystem, and the outcomes in terms of benefits and impacts on humans. In this context it will help identify the habitats most at risk to CWIS effects and help identify a broader context for the effects relative to the entire ecosystem. If restoration were used as a tool to compensate for the effects of RBGS, the approach would help identify the habitats most in need of restoration.

Table 6.1-1. Habitat associations for taxa included in assessment of CWIS effects at the RBGS. Primary habitat in bold, upper case and secondary habitat in lower case. Taxa also designated as to whether they are targeted by a sport (S) or commercial (C) fishery.

Scientific name	Common name	Fishery		Habitats		
		S-Sport C-Comm.	bays, harbors	reefs, kelp beds	coastal pelagic	shelf
Atherinopsidae	silversides	S, C	x		<b>X</b>	
<i>Cheilotrema saturnum</i>	black croaker	S		<b>X</b>	x	
<i>Chromis punctipinnis</i>	blacksmith	S		<b>X</b>		
<i>Cymatogaster aggregata</i>	shiner perch	S	<b>X</b>	x		
<i>Embiotoca jacksoni</i>	black perch		x	<b>X</b>		
<i>Engraulis mordax</i>	northern anchovy	C			<b>X</b>	
<i>Genyonemus lineatus</i>	white croaker	S, C	x		<b>X</b>	x
<i>Gibbonsia</i> spp.	kelpfishes		x	<b>X</b>		
Gobiidae	CIQ goby complex		<b>X</b>			
<i>Gobiesox</i> spp.	clingfishes			<b>X</b>		
<i>Halichoeres semicinctus</i>	rock wrasse			<b>X</b>		
<i>Hyperprosopon argenteum</i>	walleye surfperch		x		<b>X</b>	
<i>Hypsoblennius</i> spp.	combtooth blennies		<b>X</b>	x		
<i>Hypsypops rubicundus</i>	garibaldi		x	<b>X</b>		
<i>Hypsurus caryi</i>	rainbow seaperch			<b>X</b>		
<i>Myliobatis californica</i>	bat ray		<b>X</b>	x		
<i>Oxyjulis californica</i>	señorita			<b>X</b>		
<i>Paralabrax</i> spp.	sea basses	S	x	<b>X</b>		
<i>Paraclinus integripinnis</i>	reef finspot		x	<b>X</b>		
<i>Paralichthys californicus</i>	California halibut	S	x			<b>X</b>
<i>Phanerodon furcatus</i>	white seaperch	S	<b>X</b>	x		x
<i>Rhacochilus toxotes</i>	rubberlip seaperch	S		<b>X</b>		x
<i>Rhacochilus vacca</i>	pile perch	S		<b>X</b>		
Sciaenidae	croakers	S, C			<b>X</b>	x
<i>Scorpaena guttulata</i>	California scorpionfish	S		<b>X</b>		x
<i>Sebastes auriculatus</i>	brown rockfish	S, C		x		<b>X</b>
<i>Seriphus politus</i>	queenfish	S			<b>X</b>	x
<i>Typhlogobius californiensis</i>	blind goby			<b>X</b>		
<i>Urobatis halleri</i>	round stingray		<b>X</b>			x
<i>Cancer</i> spp.	Cancer (rock) crabs	S, C	x	x		<b>X</b>
<i>Loligo opalescens</i>	market squid	C			<b>X</b>	
<i>Loxorhynchus grandis</i>	sheep crab	C		<b>X</b>		x
<i>Octopus bimac./bimac.</i>	two-spot octopus	C	x	<b>X</b>		
<i>Panulirus interruptus</i>	California spiny lobster	S, C		<b>X</b>		

## **6.2 SUMMARY OF ENTRAINMENT AND IMPINGEMENT RESULTS**

The following section summarizes the combined results of the entrainment and impingement studies at RBGS Units 5–8 to provide an overview of annual impacts to marine life that are directly attributable to operation of the generating station. Earlier sections of the report provide greater detail and explanation of the results on individual species, and the information in this section provides an overview of the major results. In addition, for those species such as queenfish that were affected by both entrainment of eggs and larvae and impingement of juveniles and adults, the data are summarized together for all life stages. In order to compare predicted effects of IM&E on such species, calculated losses are standardized to a common age-class that represents fishes at the age of maturity for that species. In later sections, the information on calculated losses is compared to long-term population trends and then discussed in terms of potential adverse environmental impacts to King Harbor and Santa Monica Bay.

### **6.2.1 All Life Stages of Fishes by Species**

#### **6.2.1.1 Taxa Composition**

Data from biweekly entrainment surveys conducted at RBGS in 2006 were used to estimate that 291.2 million fish larvae were entrained through the Units 5–8 CWIS using actual cooling water flow volumes (Table 6.2-1). There were 2.23 billion fish eggs entrained through the Units 7&8 CWIS, but eggs were not enumerated for Units 5&6 so estimates could be calculated. Approximately 39% of the total larvae entrained were combtooth blennies, 18% were CIQ gobies, 11% were northern anchovies, 6% were garibaldi, and 4% were white croaker. Larvae of approximately 73 fish taxa were represented in the collections. The most abundant taxonomic groups of fish eggs in the samples were unidentified eggs (72%), followed by anchovy eggs (16%), turbot eggs (4%) and sand flounder eggs (4%). Eggs of approximately 15 taxa were represented in the collections. A complete listing of all of the taxonomic categories identified during the study is presented in Appendix F.

Impingement was the combined result of flows from normal operations at both Units 5&6 and Units 7&8, as well as from two heat treatment procedures performed at Units 7&8 to remove fouling organisms from the cooling water system. An estimated total of 1,234 fishes (including sharks and rays) with a biomass of 203 kg (448 lbs) was impinged at both RBGS intakes during the one-year study (Tables 5.5-1 and 5.5-2). Most (89%) of the impingement of fishes in 2006 occurred as a result of the operation and maintenance of RBGS Units 7&8. The two heat treatments at those units accounted for 29% of fish abundance and 20% of the fish biomass. The top three species impinged by weight (bat ray, barred sand bass, and round stingray) accounted for about 72% of the annual impingement biomass (Table 6.2-2). In terms of numbers, northern anchovy was the most abundantly impinged species at the RBGS (estimated at 271 individuals per year), followed by bat ray (174 individuals) and black perch (121 individuals).



Table 6.2-1. Estimated annual entrainment of common fish larvae at RBGS Units 5–8 and fish eggs at RBGS Units 7&8 in 2006–07.

	Common Name	Actual Flows	% Comp.	Cumulative %
<b><u>Fish Larvae</u></b>				
1	combtooth blennies	113,731,903	39.06	39.06
2	gobies	51,516,673	17.69	56.75
3	anchovies	33,207,070	11.40	68.15
4	garibaldi	18,813,390	6.46	74.61
5	white croaker	12,633,515	4.34	78.95
6	labrisomid blennies	11,905,512	4.09	83.04
7	unidentified damaged fish	7,501,411	2.58	85.62
8	blind goby	5,685,209	1.95	87.57
9	clingfishes	5,090,236	1.75	89.32
10	croakers	3,809,632	1.31	90.63
11	queenfish	3,801,686	1.31	91.94
12	larval fishes	3,208,466	1.10	93.04
	<i>61 other taxa</i>	20,292,018	6.97	100.00
		<b>291,196,721</b>	<b>100.00</b>	
<b><u>Fish Eggs</u></b>				
1	unidentified fish eggs	1,605,529,188	71.84	71.84
2	anchovy eggs	354,770,573	15.87	87.71
3	turbot eggs	82,676,023	3.70	91.41
4	sand flounder eggs	79,188,881	3.54	94.95
5	SPL fish eggs	65,958,572	2.95	97.90
6	sanddab eggs	28,594,090	1.28	99.18
	<i>9 other taxa</i>	18,206,187	0.81	100.00
		<b>2,234,923,515</b>	<b>100.00</b>	

Table 6.2-2. Estimated annual impingement (number and biomass) of common fishes at RBGS Units 5–8 in 2006–07.

	<b>Common Name</b>	<b>Estimated Number</b>	<b>% Total Number</b>	<b>Estimated Biomass (kg)</b>	<b>% Total Biomass</b>
1	northern anchovy	271	21.96	2.408	1.18
2	bat ray	174	14.10	63.399	31.20
3	black perch	121	9.81	12.781	6.29
4	queenfish	87	7.05	0.928	0.46
5	round stingray	74	6.00	23.180	11.41
6	plainfin midshipman	67	5.43	11.867	5.84
7	barred sand bass	65	5.27	58.917	28.99
8	California scorpionfish	52	4.21	5.716	2.81
9	walleye surfperch	42	3.40	0.462	0.23
10	señorita	41	3.32	2.075	1.02
11	California clingfish	34	2.76	0.034	0.02
12	blacksmith	29	2.35	2.478	1.22
13	shiner perch	26	2.11	0.649	0.32
14	rainbow seaperch	25	2.03	1.668	0.82
15	speckled sanddab	20	1.62	0.316	0.16
16	kelp bass	15	1.22	1.594	0.78
17	black croaker	14	1.13	1.726	0.85
	<i>20 other species</i>	77	6.24	13.014	6.40
		<b>1,234</b>	<b>100.00</b>	<b>203.212</b>	<b>100.00</b>

### 6.2.1.2 Temporal Occurrence

There were two main peaks in abundance of larval fishes—June and August (Figures 4.5-1 and 4.5-2), while the highest concentrations of eggs occurred during May (Figure 4.5-3). Although high concentrations of larvae typically occur during spring upwelling periods in high productivity coastal waters, some species also had spawning peaks in other months. For example, sea bass larvae occurred mainly in August-September whereas white croaker had two spawning peaks—one in April and another in November. Larvae and eggs were generally more abundant in samples collected at night than those collected during the day. For the larvae, some of the increased nighttime densities may have resulted from more efficient capture rates of the nets at night compared to daylight hours.

Fish impingement rates were a function of both plant operating capacity and abundance of fishes in the source water. Normal operation impingement abundance at Units 7&8 peaked in April and May (Figure 5.5-3), although most of the impingement was attributable to heat treatments in April and June 2006. Biomass at Units 7&8 was highest in August, resulting from the impingement of relatively larger species (i.e., barred sand bass and bat ray) (Figure 5.5-4). Only four fish were collected at Units 5&6 during surveys in July and August (Figure 5.5-1).

## 6.2.2 All Life Stages of Shellfishes by Species

### 6.2.2.1 Taxa Composition

Entrainment of invertebrate larvae was focused only on “shellfish” which by definition were crabs, spiny lobster, and market squid. The vast majority of entrained invertebrate larvae and holoplanktonic species (species whose entire life cycle is spent in the plankton) were not enumerated because of the impracticality of sorting and identifying them—many have no published guides to their identification—as well as their typically high densities and widespread distribution. The target list of shellfish also included several species with some type of fishery value. A total of 495 larval invertebrates representing 21 taxa was collected from the RBGS entrainment stations during surveys in 2006 and early 2007 (Tables 4.5-5 and 4.5-6). Total annual entrainment at RBGS was estimated to be 23.3 million target invertebrate larvae, and California spiny lobster was the most abundant target invertebrate larvae in the samples with an estimated annual entrainment of 13.8 million larvae (Table 6.2-3). The only other common species with commercial fishery importance was cancer (rock) crab megalops with an estimated 448,345 larvae entrained annually.

For this assessment, impingement data were divided into shellfish (crabs, lobster, shrimps, octopus and market squid) and other (non-edible) macroinvertebrates. Sheep crab, California spiny lobster, and California two-spot octopus comprised 89% of the impinged shellfish biomass. A total of 15 species of shellfishes was used to estimate a total annual impingement of 419 kg (924 lbs) with 60% contributed by sheep crab (Table 6.2-4). A total of 1,651 shellfishes with a biomass of 383 kg (844 lbs) was impinged at Units 7&8, and accounted for 92% of the total abundance and 91% of the total biomass impinged.

The most abundant macroinvertebrates were warty sea cucumber (*Parastichopus parvimensis*), unidentifiable sea jellies (Cnidaria), and common salp (*Thetys vagina*). Only six non-shellfish macroinvertebrate taxa were impinged at the RBGS with an estimated annual impingement of 388 individuals weighing 40 kg (88 lbs) (Table 6.2-4). At Units 5&6, a total of 132 macroinvertebrates with a biomass of 12 kg (27 lbs) was impinged (Table 5.5-5). The only macroinvertebrates impinged at Units 5&6 were common salp, purple-striped jellyfish (*Chrysaora colorata*), and giant-frond aeolis (*Dendronotus iris*). At Units 7&8, a total of 256 macroinvertebrates with a biomass of 28 kg (61 lbs) was impinged. The only species with any commercial fishery value were the warty sea cucumber, with an estimated annual impingement of 7 kg (16 lbs), and purple sea urchin (*Strongylocentrotus purpuratus*), with estimated annual impingement of 61 g (0.1 lbs).

Table 6.2-3. Estimated annual entrainment of target shellfish larvae at RBGS Units 5–8 in 2006–07.

	Common Name	Actual Flows	% Comp.	Cumulative %
<b>Shellfish Larvae</b>				
1	California spiny lobster	13,755,833	59.15	59.15
2	pea crabs megalops	1,644,752	7.07	66.22
3	spider crab megalops	1,643,238	7.07	73.29
4	black-clawed crab megalops	1,132,197	4.87	78.16
5	kelp crabs megalops	1,055,772	4.54	82.70
6	hermit crab megalops	760,577	3.27	85.97
7	porcelain crabs megalops	472,079	2.03	88.00
8	mole crabs megalops	463,779	1.99	89.99
9	cancer crabs megalops	448,345	1.93	91.92
10	porcelain crab megalops	366,005	1.57	93.49
	<i>11 other taxa</i>	1,514,078	6.51	100.00
		<b>23,256,655</b>	<b>100.00</b>	

Table 6.2-4. Estimated annual impingement of common shellfishes (and other invertebrates) at RBGS Units 5–8 in 2006–07.

	Common Name	Estimated Number	% Total Number	Estimated Biomass (kg)	% Total Biomass
<b>Shellfishes</b>					
1	Calif. two-spot octopus	335	18.69	45.915	10.95
2	yellow crab	273	15.23	19.743	4.71
3	California spiny lobster	208	11.61	76.957	18.36
4	blackspotted bay shrimp	201	11.22	0.335	0.08
5	sheep crab	178	9.93	251.937	60.10
6	California market squid	154	8.59	4.176	1.00
7	Pacific rock crab	148	8.26	17.270	4.12
8	tuberculate pear crab	88	4.91	0.160	0.04
9	red rock shrimp	77	4.30	0.111	0.03
10	Xantus swimming crab	64	3.57	1.418	0.34
	<i>5 other taxa</i>	66	3.68	1.171	0.28
		<b>1,792</b>	<b>100.00</b>	<b>419.193</b>	<b>100.00</b>
<b>Other Invertebrates</b>					
1	warty sea cucumber	88	22.68	7.283	18.27
2	sea jelly, unid.	87	22.42	4.393	11.02
3	common salp	80	20.62	0.400	1.00
4	purple sea urchin	61	15.72	0.061	0.15
5	purple-striped jellyfish	59	15.21	27.625	69.31
6	giant-frond-aeolis	13	3.35	0.093	0.23
		<b>388</b>	<b>100.00</b>	<b>39.855</b>	<b>100.00</b>

### 6.2.2.2 Temporal Occurrence

Spiny lobster larvae was the most abundant group of target shellfish with any commercial significance, and these were mainly present during July and August. They were present in entrainment samples in June and September and absent during all other months. Target shellfish larvae for all other taxa were highly variable among surveys, typically with one or two of the monthly surveys with high abundances and few or none present during other surveys.

Impingement abundance of shellfish and macroinvertebrates at Units 5&6 was highest from February through May 2006, while at Units 7&8 it was highest in November 2006 (Figures 5.5-5 and 5.5-7). Invertebrate biomass at Units 5&6 was highest in February and April, while at Units 7&8 it peaked in May 2006 (Figures 5.5-6 and 5.5-8). Only nine invertebrates were collected at Units 5&6 during the study. At Units 7&8 a total of 123 invertebrates were collected during monthly normal operations sampling and an additional 249 invertebrates were collected during heat treatments.

### 6.2.3 Combined Analysis and Modeling Results for Selected Species

Annual impacts for all IM&E species that were subjected to detailed analysis are based on actual 2006 flow rates for Units 5–8 (Table 6.2-5). The criteria for detailed treatment was either a species that ranked high in IM&E abundance, or one that was of significant fishery importance even if it did not have overall high abundances. Fourteen fish species (or taxa groups of similar species) and one shellfish species were modeled for entrainment effects, and an additional eighteen fish species and three shellfish species were evaluated for impingement effects. Up to three modeling approaches (*AEL*, *FH*, and *ETM*) were used to approximate population-level effects of entrainment, but the *FH* or *AEL* models were dependent on detailed life history information and could only be applied to five of the fourteen taxa. Because the *ETM* approach was based on proportional entrainment between intake and source water larval densities, and sufficient early life history data were available, it could be applied to all fourteen larval taxa. Of the 14 taxa subjected to additional entrainment modeling, six were not impinged during the study: combtooth blennies, CIQ gobies, garibaldi, labrisomid blennies, blind goby, and clinid kelpfishes. Conversely, more than a dozen taxa that were impinged were not collected in entrainment samples, nine of which were surfperches and rays that bear live young that are capable of swimming. Another modeling approach, *EAM*, which is equivalent to the *AEL* model used for entrainment, was used to convert numbers of individuals impinged to equivalent adults, the same ages modeled for entrainment. Modeling of impingement totals was limited to species with sufficient life history information, and thus could only be performed for four species.

In terms of estimated annual numbers of adult fishes impacted, combtooth blenny was the species group most affected, with approximately 130,000–277,000 adult equivalents lost annually due to the entrainment of larvae, based on the *FH* and *AEL* modeling results, respectively. No juveniles/adults were impinged, thus *EAM* was not calculated for this species group. The *ETM* calculations provided an estimated larval mortality due to entrainment ( $P_M$ ) of 9.77%.

Enough life history information was available to calculate each demographic model from entrainment and impingement estimates for northern anchovy. Approximately 29,000–59,000 adult equivalents were lost annually due to the entrainment of eggs and larvae. Impingement losses were minor in comparison, with an estimated 830 equivalent adults lost due to the impingement of juveniles and adults. The *ETM* calculations provided an estimated larval mortality due to entrainment ( $P_M$ ) of 0.74%.

Equivalent adult losses of gobiid larvae ranged from approximately 42,000–93,000 fish using the *AEL* and *FH* models. No juveniles/adults were impinged, thus *EAM* was not calculated for this species group. The *ETM* calculations provided an estimated larval mortality due to entrainment ( $P_M$ ) of 12.42% during the sampling period.

Impingement was relatively low for all species, but three species in particular—northern anchovy, bat ray, and black perch—were impinged in the greatest numbers over the study year. Of these three species, only northern anchovy possessed sufficient life history information to calculate equivalent adult mortality. As discussed previously, impingement losses equated to 830 equivalent adults. Bat ray and black perch are live-bearers, and thus are not subject to entrainment.

Table 6.2-5. Summary of entrainment and impingement sampling results and model output for common fish and invertebrate species at RBGS Units 5–8 in 2006–07. Model estimates indicate whether the number was based on eggs (E), larvae (L), or both combined (C). Egg entrainment from Units 7&8 only.

Species	Common Name	Est. Annual Larval Ent. (millions)	Est. Annual Egg Ent. (millions)	ETM $P_m$ (%)	2*FH	AEL	Annual Imping. Estimate	Imping. Weight (kg)	EAM <sup>1</sup>
<b>Fishes</b>									
<i>Hypsoblennius</i> spp.	combtooth blennies	113.73	0	9.77	129,980 <sup>L</sup>	277,362 <sup>L</sup>	-	-	
Gobiidae unid.	CIQ gobies	51.60	0	12.42	93,348 <sup>L</sup>	42,236 <sup>L</sup>	-	-	
<i>Engraulis mordax</i>	northern anchovy	33.20	354.78	0.74	29,174 <sup>C</sup>	59,004 <sup>L</sup>	271	2.41	830
<i>Hypsypops rubicundus</i>	garibaldi	18.81	0.08	8.42			-	-	
<i>Genyonemus lineatus</i>	white croaker	12.63	0.24	0.50	<1 <sup>E</sup>		1	<0.01	
Labrisomidae unid.	labrisomid blennies	11.91	0	11.42			-	-	
<i>Seriphus politus</i> <sup>2</sup>	queenfish	7.60	0	0.12			87	0.93	106
<i>Typhlogobius californiensis</i>	blind goby	5.69	0	9.81			-	-	
Gobiesocidae unid.	clingfishes	5.09	0	17.43			34	0.03	
Atherinopsidae unid. <sup>3</sup>	silversides	2.05	0	3.19			1	0.03	
<i>Gibbonsia</i> spp.	clinid kelpfishes	1.72	0	4.14			-	-	
<i>Paralabrax</i> spp. <sup>4</sup>	sea basses	1.23	0.04	0.26			80	60.51	9
<i>Paralichthys californicus</i>	California halibut	1.06	0.09	0.17	4 <sup>C</sup>		2	0.28	
<i>Myliobatis californica</i>	bat ray	-	-				174	63.40	
<i>Embiotoca jacksoni</i>	black perch	-	-				121	12.78	
<i>Urobatis halleri</i>	round stingray	-	-				74	23.18	
<i>Porichthys notatus</i>	plainfin midshipman	-	-				67	11.87	
<i>Scorpaena guttata</i>	California scorpionfish	-	-				52	5.72	
<i>Hyperprosopon argenteum</i>	walleye surfperch	-	-				42	0.46	
<i>Oxyjulis californica</i>	señorita	0.92	0				41	2.08	
<i>Chromis punctipinnis</i>	blacksmith	-	-				29	2.48	
<i>Cymatogaster aggregata</i>	shiner perch	-	-				26	0.65	
<i>Hypsurus caryi</i>	rainbow seaperch	-	-				25	1.67	

(table continued)

Table 6.2-5 (continued). Summary of entrainment and impingement sampling results and model output for common fish and invertebrate species at RBGS Units 5–8 in 2006–07.

Species	Common Name	Est. Annual Larval Ent. (millions)	Est. Annual Egg Ent. (millions)	ETM $P_m$ (%)	2*FH	AEL	Annual Imping. Estimate	Imping. Weight (kg)	EAM <sup>1</sup>
<b><u>Fishes (cont.)</u></b>									
<i>Cheilotrema saturnum</i>	black croaker	0.26	0				14	1.726	17
<i>Rhacochilus toxotes</i>	rubberlip seaperch	-	-				12	1.32	
<i>Halichoeres semicinctus</i>	rock wrasse	0.16	0				10	1.26	
<i>Rhacochilus vacca</i>	pile perch	-	-				7	1.16	
<i>Sebastes auriculatus</i>	brown rockfish	-	-				6	1.06	
<i>Phanerodon furcatus</i>	white seaperch	-	-				5	0.17	
<b><u>Shellfishes</u></b>									
<i>Panulirus interruptus</i>	Calif. spiny lobster	13.75	-	11.43			208	76.96	
<i>Cancer</i> spp.	cancer (rock) crabs	0.45	-				430	37.11	
<i>O. bimaculatus/bimaculoides</i>	Calif. two-spot octopus						335	45.92	
<i>Loxorhynchus grandis</i>	sheep crab	-	-				178	251.94	

<sup>1</sup>standardized impingement adult equivalent mortality

<sup>2</sup>larval entrainment estimate includes queenfish and unidentified croakers combined

<sup>3</sup>only topsmelt was collected in impingement samples.

<sup>4</sup>only kelp bass and barred sand bass were collected in impingement samples, and only kelp bass was analyzed using the EAM



### **6.3 ASSESSMENT OF TAXA BY HABITAT TYPE**

The following sections present assessments for taxa from the five habitat types simplified from Allen and Pondella (2006b). A general discussion of the habitat and the potential risk to the habitat due to RBGS operation will be followed by discussion of the specific impacts to the fishes and shellfishes included in the assessment for each habitat type (Table 6.1-1).

#### **6.3.1 Background on Oceanographic Setting and Population Trends**

Water temperatures and current patterns have a significant effect on marine faunal composition. Understanding the nature of the variability in these physical factors is essential for explaining long-term population trends for many marine species. The SCB is the transition zone between the cool-temperate Oregonian fauna to the north and the warm-temperate San Diegan fauna to the south. This transition results from the geology and oceanic current structure of the region. The source of cold water is the California Current, the eastern branch of the North Pacific Gyre. The strength of the California Current varies on many time frames. On a multi-decadal scale it oscillates between a warm and cold phase referred to as the Pacific Decadal Oscillation (PDO). During the warm phase the PDO is relatively weaker than average, while during the cold phase it is stronger than average. This multi-decadal oscillation has had a significant effect on the SCB and the most pertinent debate concerns when it will switch back to a cold phase (Bograd et al. 2000; Durazo et al. 2001; Lluch-Belda et al. 2001). During the cold phase, the bight is colder than average and dominated by the Oregonian fauna. The opposite is the case for the warm phase; the bight is warmer than average and dominated by the San Diegan fauna. There have been three transitions in the PDO over the last century. The most recent oscillation of the PDO caused a regime shift starting in the late 1970s that was completed by the end of the 1982–1984 El Niño, the largest El Niño recorded at that time (Stephens et al. 1984; Holbrook et al. 1997). The 1982–1984 El Niño effectively extirpated the Oregonian fauna from the nearshore environment of Santa Monica Bay.

The strength of the PDO varies annually and the most important phenomenon with respect to this variation is the El Niño-Southern Oscillation (ENSO). This oscillation consists of two components, El Niño and La Niña periods. El Niño causes the California Current to weaken and move offshore as warm subtropical water moves into the SCB. The rebound from this event is the shift to La Niña, which in effect is manifested as a strengthening of the California Current and generally cooler water in the SCB. Either phase of an ENSO generally lasts one to two years, depending upon its strength, and is particularly important for understanding fish dynamics in the SCB for a variety of reasons. First, in the El Niño phase, the bight is warmed and mobile warm-water fishes and invertebrates immigrate or recruit into the region (Lea and Rosenblatt 2000; Pondella and Allen 2001). Cold water forms migrate out of the region, moving into deeper (cooler) water or are extirpated. During the La Niña phase, the SCB usually, but not always, is cooler than normal, and there is an increase in cold temperate (Oregonian fauna) organisms through the same processes. Highly mobile organisms will immigrate or emigrate from the bight during these periods; and on smaller spatial scales, less mobile organisms may exhibit offshore versus onshore movements. However, the resident fauna tends not to be altered on such short time frames when compared to the magnitude of the PDO.

In the decade prior to this study there were three major events that affected the California Current System that need to be explained in order to understand the oceanographic setting of this study period. The first was the 1997–98 El Niño, the strongest recorded event of its kind. This was followed by a series of four cold water years (1999–2002) including the strongest La Niña on record (Schwing et al. 2000; Goericke et al. 2005). The possible return to the cold water phase of the PDO did not occur since 2003–2004 was described as a ‘normal’ year (Goericke et al. 2004). This ‘normal’ year turned out to be the beginning of an extended warm phase that has persisted through 2006 (Peterson et al. 2006, Figure 6.3-1). Thus, the oceanographic context for this study can best be described as a warm phase of the PDO that has persisted for three years, preceded by four unusually cool years.

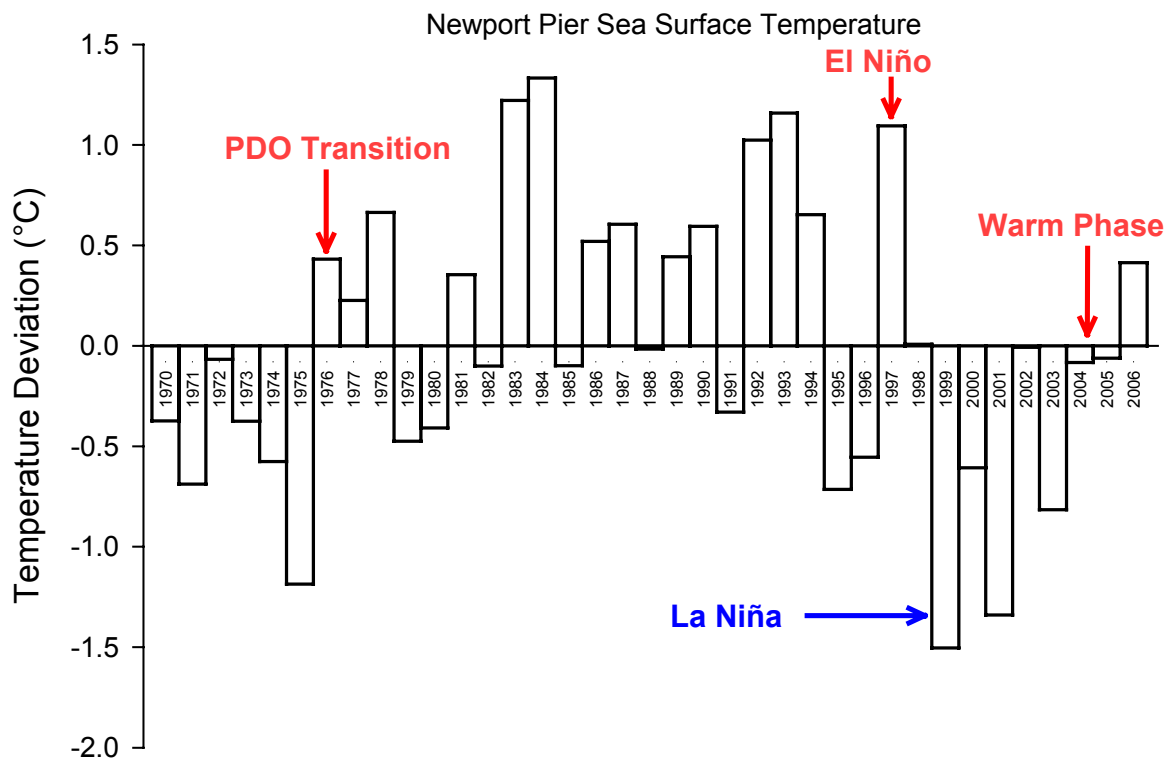

Figure 6.3-1. Sea surface temperature anomalies for Newport Pier, California. Values are  $\pm$  the long-term average (1925–2006).

To determine the current population status of fishes and invertebrates in the SCB requires placing this data into an appropriate long-term context. From an oceanographic standpoint, the influences that were associated with change over time are the PDO, the ENSO, and the associated ocean temperature changes. These oceanographic metrics are interconnected with each other and have effects in the SCB on varying time scales. In order to understand the responses of organisms in the SCB to these various environmental metrics, it is important to realize the general trends for the region (Brooks et al. 2002) and that each taxon may have a unique response to these metrics based upon its life history characteristics and evolution.

In addition, to the real-time responses these organisms have to oceanographic parameters, anthropogenic influences also have significant effects. Currently, the most extensively studied anthropogenic effects are

related to overfishing and the various management actions associated with fishing. In the SCB, all of the top-level predators (with the exception of marine mammals) were overfished during the last seven decades (Ripley 1946; Love et al. 1998; Allen et al. in press; Pondella and Allen in review). The effects of fisheries were also species-specific, as the effort, type of fishery, and associated management actions vary case by case. Some fishes were reserved for recreational anglers (e.g., kelp bass, barred sand bass) as they were historically overfished by commercial fishers (Young 1963); others were primarily commercial species (e.g., anchovies); while others were/are caught by both fisheries (e.g., California halibut). Fishery data may or may not reflect actual population trends due to socioeconomic considerations such as market value, effort, management actions, etc. Fishery-independent monitoring programs produce the best population time series metrics and also allow non-commercial species to be evaluated.

**6.3.1.1 Habitat Associations and Fisheries**

Entrained larvae were categorized in terms of the habitat types typically utilized by juveniles and adults, and the type of fishery, if any, that each taxon supports. This was done using the fishes and shellfishes from entrainment and impingement at Units 7&8 because it represented a greater abundance and higher diversity of species than Units 5&6. Most larval taxa were typically associated with the types of habitats in close proximity to the intake: bay/harbor and rocky reef/kelp bed. Species primarily associated with the bay/harbor habitat (e.g., gobies and blennies) had the greatest number of individuals entrained (47.8%) even though there were fewer taxa (13.4%) than other habitat types (Table 6.3-1). Sport fishery species accounted for approximately 14.5% of the total number of larvae entrained and commercial fishery species accounted for 31.0%, while species with no direct fishery value comprised the majority (67.4%) of the larvae entrained. (Note that some species such as white croaker were classified as both a sport and commercial fishery species). For impinged species the majority of the biomass was from species not targeted by sport or commercial fisheries. However, 51.4% of the impinged species were targeted by sportfishers.

Table 6.3-1. Percent of fish larvae entrained (abundance and number of taxa) or adults/juvenile fishes impinged (biomass and number of taxa) associated with general habitat types and fisheries.

<b>Attributes</b>	<b>Entrained % abundance</b>	<b>Entrained % # taxa</b>	<b>Impinged % biomass</b>	<b>Impinged % # taxa</b>
<u>Habitat Association</u>				
bays, harbors	47.79	13.43	43.01	10.81
coastal pelagic	29.45	11.94	1.89	13.51
continental shelf	2.68	31.34	9.87	24.32
rocky reef, kelp	19.79	37.31	45.28	51.35
deep pelagic	0.28	2.99	0.00	0.00
<u>Fishery</u>				
sport	14.53	32.84	40.33	51.35
commercial	30.95	28.36	1.89	16.22
none	67.37	53.73	59.27	45.95

Note: Species may have more than one associated fishery.

Since impingement affects juvenile and adult stages of fishes and shellfishes, there are greater percentages of species associated with the types of habitats in close proximity to the intake than found from the entrainment data (Table 6.3-1). No species from deep pelagic habitats were collected in impingement samples, and by far the greatest abundance of fishes was associated rocky reef/kelp bed and bay/harbor habitats most at risk to impingement. The percentage is much greater than found among the fishes in the entrainment samples since the larvae from these other habitats can be transported into the vicinity of King Harbor where they are subject to entrainment.

### **6.3.2 Bay and Harbor Habitats**

The bay and harbor habitat type includes bays, harbors and estuaries that are either entirely marine and largely influenced by tidal movement of seawater, or estuarine areas where freshwater input results in lower salinity seawater in some areas. Bays and harbors in Santa Monica Bay include Marina del Rey and King Harbor. Characteristic fishes from these habitats include deepbody anchovy (*Anchoa compressa*), bay pipefish (*Syngnathus leptorhynchus*), bay blenny, round stingray, and diamond turbot (Allen and Pondella 2006b). Estuarine areas in Santa Monica Bay include Malibu Lagoon and Ballona Wetlands. Characteristic fishes from this habitat include slough anchovy (*Anchoa delicatissima*), barred pipefish (*Syngnathus auliscus*), longjaw mudsucker (*Gillichthys mirabilis*), and shadow and arrow goby (Allen and Pondella 2006b). Several species of fishes collected during the entrainment and impingement sampling had some dependency on bay and harbor habitats during at least some stage of their life (Table 6.1-1). Several of the abundant impinged species were associated with bay and harbor habitats, including bat ray and round stingray. Combined impingement of both, however, was less than 90 kg (198 lbs). Two taxa, CIQ gobies and combtooth blennies, were among the most abundantly entrained larvae. While CIQ gobies are almost totally confined to soft substrates of bays, two species of combtooth blennies common to harbors, the rockpool blenny (*Hypsoblennius gilberti*) and mussel blenny (*Hypsoblennius jenkinsi*), also inhabit shallow intertidal and subtidal rocky reef habitats.

Annual entrainment of blenny and goby larvae at Units 5–8 was estimated to be 113.7 and 51.6 million larvae, respectively, based on actual flow volumes (Table 6.2-7). No eggs from either group of fishes were entrained because both deposit adhesive eggs that are not vulnerable to entrainment. The entrainment and source water data on larval concentrations were used to estimate that 9.8% of the larval blennies and 12.4% and larval gobies in the source waters were lost due to entrainment (Table 6.2-7). The entrainment losses were also used to estimate that the larvae entrained would have resulted in 130,000–277,000 adult blennies and 42,000–93,000 adult gobies based on actual flow volumes.

Since adult gobies and blennies occur in benthic habitats and rarely swim into the water column, they were generally not susceptible to impingement unless they colonized the boulder habitat surrounding the intake riser. Only one rockpool blenny (from a heat treatment at Units 7&8) was impinged during the study. The rockpool blenny has a broader distribution, including nearshore rocky habitat, than the other two blenny species.

Blennies utilize submerged artificial substrates (such as pier pilings, dock floats, and breakwater boulders) and their associated fouling communities for shelter and spawning habitat. King Harbor is a

constructed harbor that supports a relatively large, local population of blennies, and this explains why their larvae were the most abundantly entrained fish larvae. Long-term data on abundances of combtooth blennies from King Harbor were collected from surveys of quarry rock boulders from 1984–2006 (VRG, unpubl. data). An average of 1.62 blennies was collected per boulder each year. At the beginning of the study they were found in the highest densities (9.57 individuals/boulder) and then declined until 1995 when the density was 0.143/boulder (Figure 6.3-2). Since 1995, the density increased to 1.57 individuals/boulder in 2005. Annual average densities of combtooth blennies in King Harbor was found to be correlated with average annual sea surface temperatures ( $R = 0.492$ ,  $P = 0.017$ ). This is shown in the decline in densities following major El Niño periods in 1983, 1987, 1992–1993, and 1997.

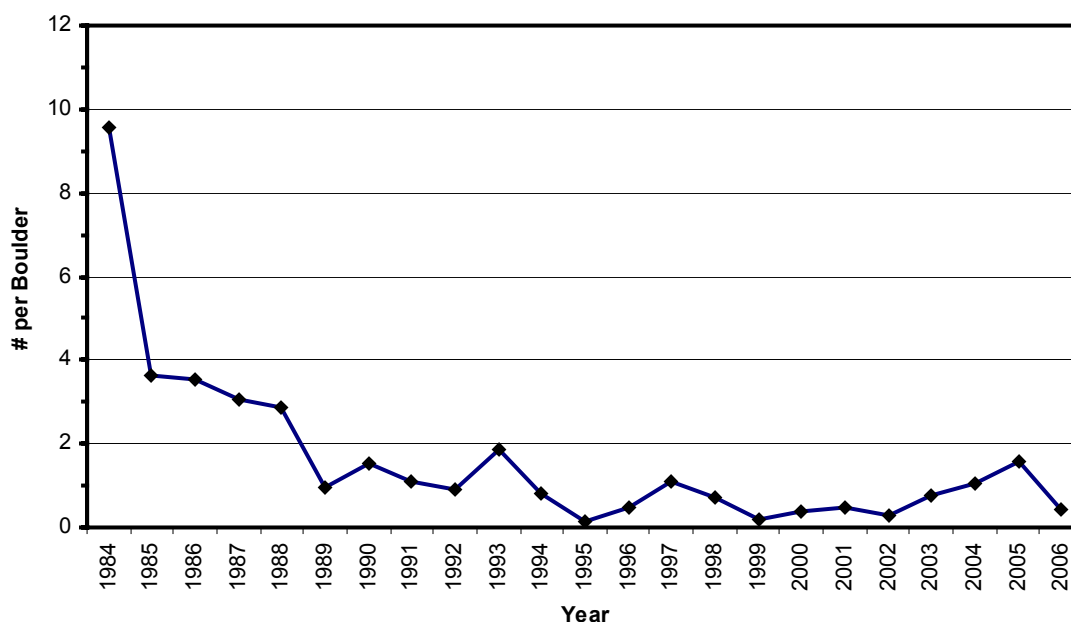

Figure 6.3-2. Abundance of combtooth blennies collected per boulder at King Harbor, California from 1984–2006 (from VRG, unpubl. data).

Despite a long-term decline in the adult population and declines in combtooth blenny larvae in King Harbor in the 1990s (Stephens and Pondella 2002), the average entrainment density of blennies in 2006 at Stations H2 and E4 (372 per 1,000 m<sup>3</sup>) was nearly four times greater than the densities measured in the 1979–1980 316(b) study (104 per 1,000 m<sup>3</sup>). Most blenny larvae that were sampled in 2006, and presumably during the earlier study also, were recently hatched based on their size frequency distribution. They reached peak densities during summer months and would be most vulnerable to entrainment on strong ebb tides when outgoing currents carried them toward the intake near the harbor entrance. A comparison of densities among stations demonstrates that there was a decreasing gradient of larval abundance from the inner King Harbor stations out into the nearshore source waters (Figure 6.3-3). Densities at the entrainment station were intermediate, on average. Although the *ETM* calculations were

used to estimate that entrainment mortality may affect as much as 10% of the source water population of larvae, this is comprised almost entirely of larvae spawned in King Harbor and then transported offshore. Highly variable larval production among years, short generation times, and a correlation in adult density with sea surface temperature are evidence that the recruitment success of blennies is dependent on optimal oceanographic conditions and has no apparent relationship to entrainment mortality.

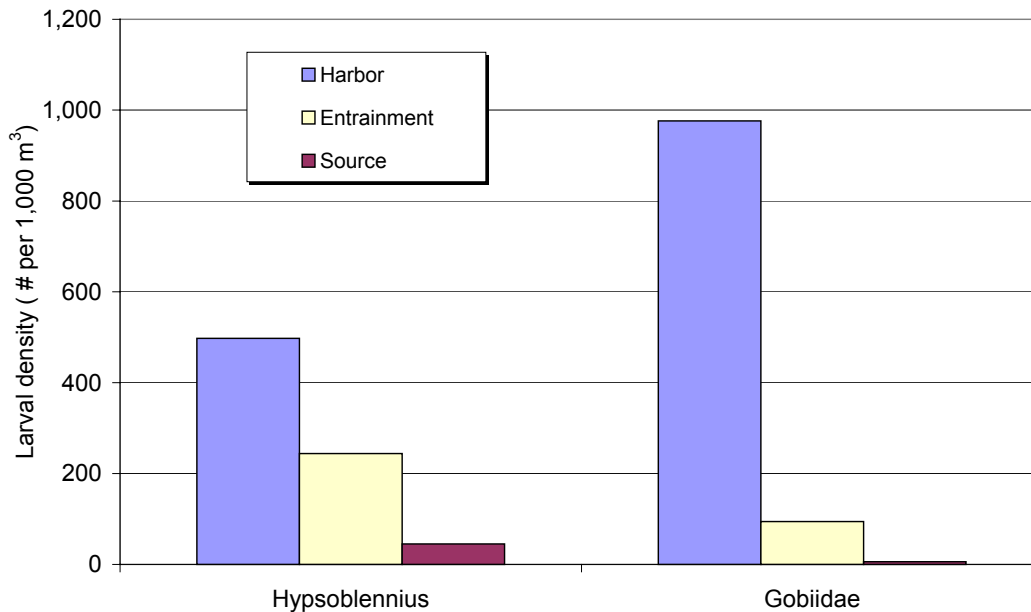

Figure 6.3-3. Average larval density of blennies (*Hypsoblennius* spp.) and unidentified gobies (Gobiidae) at King Harbor stations (Series H), Units 7&8 entrainment Station E4, and nearshore source water stations (Series S and O) in 2006.

Although CIQ complex (arrow, cheekspot and shadow goby) larvae were the second most abundant larval form entrained and also had the second highest estimated entrainment effects based on the *ETM* modeling (12.4%), there is very little risk to these populations for the same reasons explained previously for combtooth blennies. The majority of larvae entrained by the plant originated in the more protected back areas of King Harbor as evidenced by the decreasing onshore-offshore gradient of densities (Figure 6.3-3) and the higher densities measured at Station E4. Once the larvae are transported out into the coastal waters of Santa Monica Bay they are effectively lost to the population since there is only a small likelihood that they would be transported back into their predominant adult habitat, which would also include not only King Harbor but also areas such as Ballona Wetlands and Marina del Rey approximately 14 km (8.7 mi) upcoast.

### 6.3.3 Rocky Reef and Kelp Bed Habitats

Physical structure and food resources are essential factors in promoting fish abundance and diversity. Shallow rocky reefs and giant kelp (*Macrocystis pyrifera*) forests often associated with them provide both

structure and food supply. In the Santa Monica Bay region, the greatest area of these habitats occurs near headlands in the vicinity of Palos Verdes Point and the coastline of Malibu and Point Dume. Artificial structures such as harbor breakwaters at King Harbor and Marina del Rey, and emplaced artificial fishing reefs within Santa Monica Bay are also significant resources for fishes associated with these habitats. Common species in these assemblages include kelp bass, barred sand bass, black perch, opaleye (*Girella nigricans*), halfmoon (*Medialuna californiensis*), California sheephead (*Semicossyphus pulcher*), señorita, garibaldi, zebraperch (*Hermosilla azurea*), and salema (Stephens et al. 2006b). Although the presence and extent of giant kelp affects the abundance of some reef fishes, many other factors can also affect their distributions, and it is not unusual to find many of the species characteristic of kelp bed habitats in other shallow water locations. Common species of fishes and target invertebrates that are typically associated with rocky reef habitats that were entrained or impinged at RBGS included the garibaldi, labrisomid blennies, blind goby, clingfishes (Gobiesocidae), clinid kelpfishes (*Gibbonsia* spp.), and sea basses (including kelp bass, [*Paralabrax clathratus*], and barred sand bass, [*P. nebulifer*]), and California spiny lobster (*Panulirus interruptus*) (Table 6.1-1). Impacts to representative species from this habitat are briefly discussed.

Garibaldi is common in nearshore areas in southern California and is associated with artificial substrates in bays and harbors, as well as natural rock reefs along the mainland and islands. For the purposes of this assessment, the rocky reef habitat was considered its primary habitat. Of the larval species entrained within this habitat category, garibaldi had the greatest estimated numbers for fishes, and spiny lobster had the greatest number for target invertebrates. No age-specific estimates of survival for larval and later stages of development were available from the literature for garibaldi; therefore only *ETM* estimates could be calculated for this species. Approximately 18.8 million garibaldi larvae were entrained at RBGS in 2006 which equated to approximately 8% of the estimated source water population. No juvenile/adult garibaldi were impinged in 2006; only eight individuals were estimated to be impinged at the RBGS since 1991 (MBC 2006). Adult females deposit their eggs in discrete nests on rock surfaces. When the eggs hatch the larvae are immediately susceptible to entrainment before they develop a strong ability to swim. As a protected species under CDFG fishery regulations, there is no allowable take of juvenile or adult garibaldi in California without a permit. Therefore, it has no direct commercial or recreational fishery value. Perhaps its most notable intrinsic value to humans, and the main reason for its protected status, is its striking bright orange color that makes it a popular subject for underwater photography and observation by divers, coupled with its territorial behavior and susceptibility to spearfishing. Garibaldi can normally be seen in spring and summer in shallow rocky areas around harbors and marinas as they guard nesting territories.

Long term abundance of garibaldi at both King Harbor and nearby Palos Verdes has shown a remarkably stable population over the past 25 years (Figure 6.3-4). Similar stability in local populations has been documented at the Channel Islands by the National Park Service Kelp Forest Monitoring Program. Despite interannual changes in oceanographic conditions and variability in recruitment strength, it appears that populations of garibaldi are linked to the availability of habitat in which they can establish nesting territories. Strong recruitment from 1975 through 1977 established a large population, and from 1978 through 1980, adults were relatively crowded on reefs, straining normal territorial limits (Stephens

et al. 1994). A decline in garibaldi at King Harbor began in winter 1980 for unknown reasons, and again in the late 1980s when the breakwater (the main habitat of garibaldi) was severely damaged by storm waves, and the subsequent rebuilding and dredging took place. No nests were observed in King Harbor during those years. If the proportional mortality from entrainment at RBGS had a long-term effect, it would be reflected as a decline in the adult population, particularly since the species is unfished. However, because other areas in the SCB show similar long-term stability in the population, the additional mortality due to RBGS does not represent any risk of adverse environmental impacts.

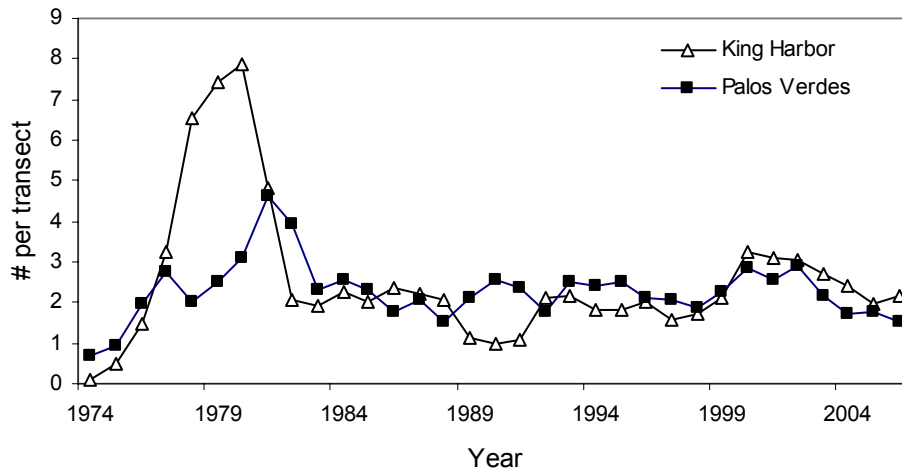

Figure 6.3-4. Abundance of garibaldi (*Hypsypops rubicundus*) measured during diver transects at King Harbor and Palos Verdes from 1974-2006. (from VRG, unpubl. data).

Four species of small cryptic fish species characteristic of rocky reefs were entrained in numbers that resulted in  $P_M$  values ranging from 4.1 to 17.4%. These included blind goby, reef finspot (Labrisomid blennies), clinid kelpfishes, and clingfishes. These fishes are rarely seen by casual observers because they are small and well-hidden among algae and boulders, but they can be common in suitable habitats. As with many small species they are generally short-lived, and their populations can fluctuate substantially over time as evidenced by long-term data collected in King Harbor (Figure 6.3-5).



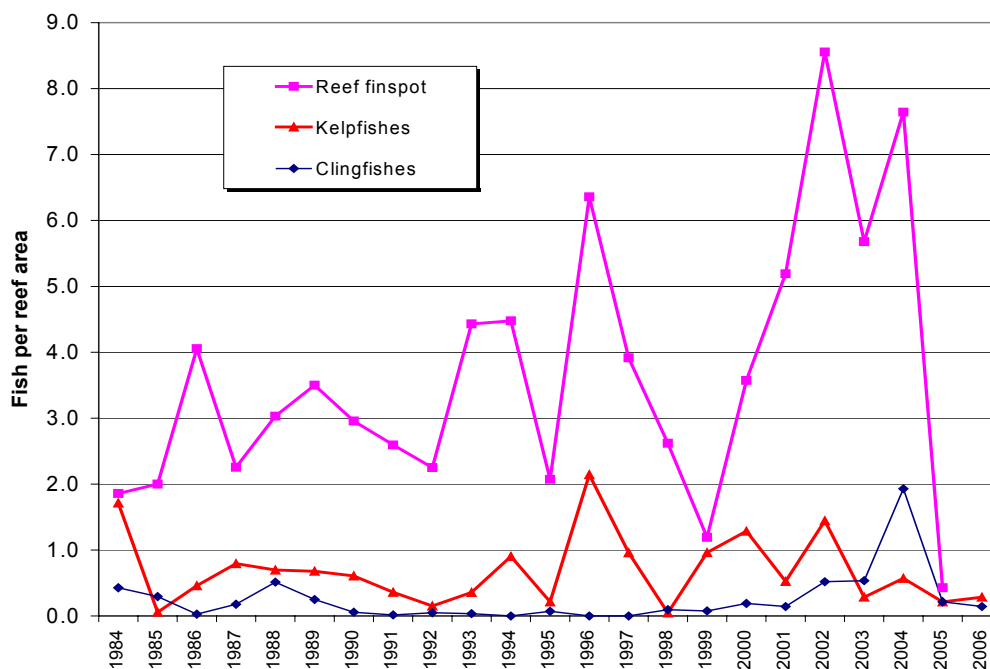

Figure 6.3-5. Average larval density of selected cryptic fish species in King Harbor, 1984–2006. (from VRG, unpubl. data).

These fishes have demersal, adhesive eggs, and most of the larvae entrained were probably spawned within King Harbor or nearby on constructed breakwater or piling habitat. The lack of any long-term declines in abundance for these species coupled with highly variable interannual densities indicate that their populations are more sensitive to environmental factors than additional sources of larval mortality from entrainment by RBGS.

California spiny lobster was one of the shellfish larvae selected for analysis because of its importance in commercial and sport fisheries in southern California, and the fact that it is a common macroinvertebrate in rocky reef and kelp bed habitats. Estimated annual entrainment was 13.8 million phyllosome larvae. No age-specific estimates of survival for larval and later stages of development were available from the literature; therefore only *ETM* estimates could be calculated for this species. Approximately 11% of the spiny lobster population in the vicinity of RBGS is lost due to entrainment. California spiny lobster was the third most abundant shellfish species impinged with an estimated 208 individuals weighing 77 kg (170 lbs) (Table 6.2-5). Spiny lobster also contributed second most to biomass. It was impinged during normal operations primarily from May through July 2006. The mean carapace length (CL) of 46 impinged lobsters was 80 mm (3.2 in), slightly smaller than the approximate legal minimum fishery size limit (83 mm) and an approximate age of 7–11 years old.

Because of its proximity to the King Harbor breakwater, the RBGS intakes affect some of the species associated with rocky reef habitat. Stephens and Pondella (2002) concluded that the breakwater represents a mature artificial reef that contributes to the reef fish larval pool of the SCB, acting as a source of larvae for other reef areas. The nearest natural rock reefs begin approximately 4 km (5 mi) south of King Harbor and extend for a distance of approximately 20 km (12.4 mi) around the margin of the Palos Verdes peninsula. Although the approximately 2.5 km (1.5 mi) of shallow breakwater habitat at King Harbor provides a locally diverse assemblage with some potential for enhancing bight-wide populations, the more extensive reach of contiguous nearshore habitat around Palos Verdes must have a proportionally larger influence as a larval source. Most of the larvae entrained at RBGS likely originated in the immediate vicinity of King Harbor, based on a gradient analysis of larval densities (Figure 6.3-3). Adult densities of some reef-associated species such as garibaldi and kelp bass are very similar between King Harbor and Palos Verdes (VRG, unpublished data) and track closely in their long-term trends (Figures 4.5-20 and 6.3-4). Densities of these species, as well as for barred sand bass, have often been higher within King Harbor than at Palos Verdes. The combined evidence suggests that the low levels of IM&E from RBGS do not significantly affect fish and shellfish populations associated with natural rock reefs and kelp beds in Santa Monica Bay.

The annual losses due to entrainment and impingement of species associated with rock reefs and kelp habitats were low in comparison to the fishery take for these species. Sport fishery catch estimates of kelp bass in southern California ranged from 157,000 to 587,000 fish in 2000–2006, with an average of 351,300 fish caught annually. Barred sand bass catch estimates ranged from 139,000 to 1,130,000 fish caught annually between 2000-2006, with an average of 720,000 fish (RecFin 2007). Assuming that entrainment losses translate directly to losses of recreational catch, the annual losses from both entrainment ( $P_M = 0.26$ ) and impingement (80 fish) of both species at RBGS in 2006 was very low. It is important to keep in mind that kelp and sand basses occur in other bay/harbor and reef habitats that are not subject to CWIS effects. Although spiny lobster had the second greatest macroinvertebrate impingement biomass (77 kg [170 lbs]), impingement was still very low (<0.5%) relative to the landings of this species in the Santa Monica Bay area. Commercial landings of California spiny lobster in the Los Angeles area totaled 101,324 kg (223,420 lbs) in 2005 (CDFG 2006). Commercial landings from Santa Monica Bay area catch blocks in 2006 totaled 18,213 kg (40,152 lbs) at an estimated value of \$372,220 (CDFG 2007b).

#### **6.3.4 Coastal Pelagic Habitats**

The most extensive type of nearshore habitat in Santa Monica Bay is the coastal pelagic habitat, which in the expanded definition used for this assessment, also includes the surfzone habitat. Most of the shallow water areas of Santa Monica Bay include sandy bottom with relatively few hard bottom relief features. Several of the species entrained or impinged at RBGS are characteristic of the coastal pelagic zone. These included northern anchovy, white croaker, queenfish, and silversides (primarily topsmelt and jacksmelt) (Table 6.1-1). Some of these species, such as northern anchovy and white croaker, can be considered habitat generalists because they are also found in bays and a variety of other shallow water locations (Allen and Pondella 2006b). Juveniles of most of these species also tend to be abundant in the shallower

depths of the habitat range as demonstrated by the small size distributions collected from impingement data.

The estimated annual loss of northern anchovy due to operation of the RBGS Units 5–8 CWIS included 33.2 million larvae and at least 355 million anchovy eggs (Table 6.2-1). Probability of mortality ( $P_M$ ) estimates for this species were 0.7%. Northern anchovy was the most abundant species impinged in 2006–7, and was collected only at Units 7&8, and primarily during normal operations impingement sampling. Annual impingement of northern anchovy was estimated as 271 individuals with a combined weight of 2.4 kg (5.3 lbs) (Table 6.2-2). The study conducted in King Harbor suggests that large-scale oceanographic phenomena, and not localized perturbations such as intake effects, are responsible for the population-wide changes seen in northern anchovy (Stephens and Pondella 2002). Northern anchovy are an indicator organism for the PDO in the California Current System (Chavez et al. 2003; Norton and Mason 2005; Horn and Stephens 2006). Scale deposition of this species in the anoxic Santa Barbara Basin is one tool that has been used in reconstructing the phases of the PDO over the past 2,000 years (Baumgartner et al. 1992; Finney et al. 2002). Northern anchovy dominates during the cold water phase, while Pacific sardine is dominant during the warm water phase. The commercial catch of northern anchovy follows this pattern and by 1983 the catch of northern anchovy had basically disappeared in California (Mason 2004). The faunal switch associated with the PDO at the end of the 1970s was really completed in the Southern California Bight with the 1982–84 El Niño (Stephens et al. 1984; Holbrook et al. 1997), the largest El Niño recorded at that time. During the strong La Niña years (1999-2002) there was resurgence in catch of this stock. However, a return in catch of northern anchovy and a corresponding stock increase in Southern California will undoubtedly be delayed until the next cold phase of the PDO.

Another nearshore pelagic taxon characteristic of the coastal pelagic habitat is silversides, a family represented by topsmelt, jacksmelt and California grunion. Relatively few larvae of this taxon were entrained or impinged with annual entrainment estimated at 2.1 million larvae per year, and a total of one topsmelt impinged with a biomass of 31 g (0.068 lbs). Topsmelt and jacksmelt deposit their eggs on submerged aquatic vegetation or shallow structures in bays and harbors, so larval entrainment would be expected to be low on the open coast in the vicinity of the RBGS intakes. Their widespread occurrence in the coastal pelagic habitat in southern California explains their presence in the impingement samples, and the numbers impinged annually are a small fraction of the population in Santa Monica Bay.

White croaker and queenfish are two common members of the croaker family that are found in Santa Monica Bay in the nearshore sand bottom habitat—queenfish as a pelagic species and white croaker as a bottom-associated species. White croaker was the fifth most abundant larval taxon entrained at RBGS (Table 6.2-1), but there was only a single fish impinged (Table 6.2-7). As summarized in Section 4.5.3.5, recreational and commercial catches of white croaker declined from 1980–2006; however, fishery-independent data indicate a stable or increasing trend. Queenfish was the eleventh most abundant taxon with 4 million larvae entrained and it was the fourth most abundant species impinged with 87 individuals collected, mostly during normal operations, at a biomass of 0.9 kg (2 lbs). Neither the catch nor long-term nearshore monitoring data indicated a discernible pattern; however, catches were correlated with sea

surface temperature and the ENSO index (see Section 4.5.3.6). Other species of croakers, such as California corbina, were entrained or impinged in comparatively low numbers.

Walleye surfperch is a member of the live-bearing surfperch family, and as such it is not susceptible to entrainment, only impingement. Walleye surfperch was the ninth most abundant species with an estimated annual impingement of 42 individuals weighing 0.5 kg (1.0 lbs). Like most other members of the surfperch family, individuals are strong swimmers adapted to living in swift currents and wave-swept nearshore areas. Approximately 23 walleye surfperch were impinged annually at the RBGS.

One of the target invertebrates selected for analysis was the market squid because of its wide distribution and commercial fishery importance. Large-scale fluctuations are characteristic of the squid stock, due primarily to its short life span and the influence of variations in oceanographic conditions (NMFS 1999). Los Angeles area commercial landings ranged between 7.7 and 44.8 million kg (16.9 and 98.8 million pounds) annually from 2000–2006 with both the total catch and market value increasing substantially during the last two years (PacFIN 2007). Landings in Santa Monica Bay area catch blocks in 2006 totaled 307,773 kg (678,512 lbs). Based on the two specimens captured in entrainment samples, the annual entrainment estimate for squid paralarvae (hatchlings) was approximately 102,000 individuals. There was not enough information available on natural mortality rates to project adult equivalents from this number of larvae, but the total impingement was estimated as approximately 154 adults weighing 4.2 kg (22.3 lbs) annually. This is very small compared to the annual take from the commercial fishery, which has grown over recent years to be one of the largest fisheries in California.

In summary, the coastal pelagic habitat is extensive within the SCB, and most of the common fish species that are part of this assemblage are wide-ranging. Most have a directed commercial or sport fishery and their populations are generally sensitive to large-scale oceanographic influences. Given the wide distributions of most of the component species, including distributions in other habitats where they are not as susceptible to CWIS effects, there is no indication that the facility adversely impacts their populations.

### **6.3.5 Shelf Habitats**

Shelf habitats include several different habitats from Allen and Pondella (2006b) including inner, middle, and outer shelves (depths to 200 m), and shallow slope (200–500 m) habitats. The abundance, biomass, and other population attributes of the fish assemblages in these habitats increase from the inner to outer shelf (Allen 2006). Allen attributed this gradient to the increased variability in ocean conditions on the inner shelf due to runoff, pollution, and several other potential factors. A variety of flatfishes and other species dominates the fish assemblages on the soft mud and sandy bottoms in these habitats. Fishes characteristic of the inner and middle shelf include California halibut, bay goby (*Lepidogobius lepidus*), California tonguefish (*Symphurus atricaudus*), bigmouth sole (*Hippoglossina stomata*), hornyhead turbot (*Pleuronichthys verticalis*), and California skate (*Raja inornata*) (Allen and Pondella 2006b). Fishes characteristic of the outer shelf and slope include plainfin midshipman, Pacific sanddab (*Citharichthys sordidus*), pink seaperch (*Zalembius rosaceus*), curlfin turbot (*Pleuronichthys decurrens*), Dover sole

(*Microstomus pacificus*), longspine thornyhead (*Sebastolobus altivelis*), and California grenadier (*Nezumia stelgidolepis*) (Allen and Pondella 2006b).

The fishes and shellfishes from these habitats support a variety of commercially and recreationally important species, including rock and Dungeness crab (*Cancer magister*) fisheries. The fish species caught by commercial fisheries in these habitats are broadly categorized as groundfish and are jointly managed by the California Department of Fish and Game (CDFG), and the Pacific Fishery Management Council (PFMC) and NOAA Fisheries. Two periods of rapid growth in groundfish landings have been identified (Mason 2004). The first period was during the early 1940s when demand due to World War II led to increased landings with Dover sole as the most abundant component of the catch. The second period of increase occurred in the 1970s leading to the largest groundfish landing on record in the late 1970s and early 1980s with rockfishes, Dover sole, and sablefish (*Anoplopoma fimbria*) being the largest components of the catch. Through the 1990s there was a general decline in landings. Mason (2004) identified market demand, variability in ocean conditions, and effects of exploitation as the three primary factors contributing to the changes in groundfish landings.

Soft-bottom habitats in southern California have been widely studied by several research organizations. Extensive sampling of the Southern California Bight (SCB) by the Southern California Coastal Water Research Project (SCCWRP) was conducted in 1994, 1998, and 2003 using a stratified random sampling design that primarily targeted the inner and middle shelf habitats (Allen et al. 1998, 2002, 2007). During the survey in 1994, 87 species of fish were collected with flatfish dominating the catch. Pacific sanddab, Dover sole, and hornyhead turbot had the highest percentage occurrence; Pacific sanddab, plainfin midshipman, and slender sole (*Eopsetta exilis*) were the most abundant; and California halibut, Pacific sanddab, and white croaker comprised the largest percentage of the total biomass in the survey. A more extensive survey in 1998 that included harbor areas collected 143 species with Pacific sanddab and California lizardfish (*Synodus lucioceps*) having the highest percentage occurrence; white croaker, Pacific sanddab, California lizardfish, and queenfish were the most abundant species; and white croaker, Pacific sanddab, California halibut, longfin sanddab (*Citharichthys xanthostigma*), and queenfish comprised the largest percentage of the biomass. The 2003 survey was expanded to include the continental slope and collected 142 species with Dover sole and Pacific sanddab having the highest frequency of occurrence; Pacific sanddab, speckled sanddab (*Citharichthys stigmaeus*), slender sole, and yellowchin sculpin (*Icelinus quadriseriatus*) had the greatest abundance; and Pacific sanddab, slender sole, California halibut, queenfish, Dover sole, English sole (*Parophrys vetulus*), and round stingray comprised the largest percentage of the total biomass.

Despite the similarities in the dominant species among the three surveys there were significant changes in response to the prevailing ocean climate during each of the surveys (1994-warm regime; 1998-El Niño; and 2003-cold regime) (Allen et al. 2007). These differences occurred as species shifted their depth distributions in response to changes in ocean temperatures. This was consistent with Allen's (2006) observation that fish assemblages on the shelf varied by depth more than by regions within southern California. Overall, mean fish abundance and species richness per haul increased with fish abundance in 2003 during the cold regime to levels about two times greater than in any of the previous surveys. The

results showed the importance of considering oceanic regime in any assessment of demersal fish communities to avoid confusing natural changes with the effects of a CWIS or other anthropogenic impact. The overall conclusions from SCWRRP's bight-wide surveys were that fish assemblages in southern California were healthy.

While the shelf species are treated in this assessment as an assemblage, it is apparent that impacts from entrainment and impingement would have the greatest potential impacts on fishes that are distributed on the inner shelf. In the assessment of shelf taxa from RBGS this would include only California halibut. As pointed out by Allen (2006) the fishes that occur on the inner shelf closer to the shoreline are more subject to highly variable ocean conditions caused by runoff, pollution, etc. This would also make them more susceptible to CWIS effects. Fishes that are more broadly distributed across the shelf, such as sanddabs, would be less subject to these sources of variation.

The estimated effects of entrainment and impingement on the fishes from shelf habitats were all low relative to species from other habitat types that occur in the vicinity of the RBGS. California halibut was the eighteenth highest taxa entrained, with an estimated 1.0 million larvae entrained (Tables 4.5-1 and 4.5-2). These levels of entrainment are low relative to the estimate of total average lifetime fecundity of 2.0 million eggs (estimated from data in MacNair et al. [1991]) and estimates of annual fecundity for the largest females of up to 6.5 million eggs (Caddell et al. 1990). The entrainment estimates for California halibut eggs and larvae represent the loss of fewer than four adult halibut. The estimated mortality due to entrainment was 0.17%. Similar numbers of larval sanddabs were estimated to be entrained (0.97 million larvae), although the entrainment estimate for sanddab eggs was higher (28.6million eggs for Units 7&8).

From 1981-2006, commercial catch of California halibut fluctuated between 142,292 kg (315,090 lbs) in 1985 and a low of 14,511 kg (31,991 lbs) in 1994 (Figure 6.3-6) with the catch declining significantly between these years ( $R=0.521$ ,  $p=0.006$ ). Neither this decline nor the overall pattern of commercial catch was correlated with oceanographic variables (SST, PDO, or ENSO). The decline between 1985 and 1994 may best be explained by fishery practices during this period. The white seabass fishery crashed by 1981 (Allen et al. in press) resulting in increased landings of halibut, leopard shark and soupfin in the nearshore gill net fishery in southern California as fishers targeted the remaining stocks. This pre-empted a decline in all of these stocks until the gill net fishery was moved out of state waters in 1994 (Pondella and Allen, in review). Following the 1994 management action, these nearshore stocks rebounded, yet catch of halibut declined again from 1999–2006. The recreational catch has fluctuated over time but the range in recent years is not very different from levels in the early 1980s (Figure 6.3-6).

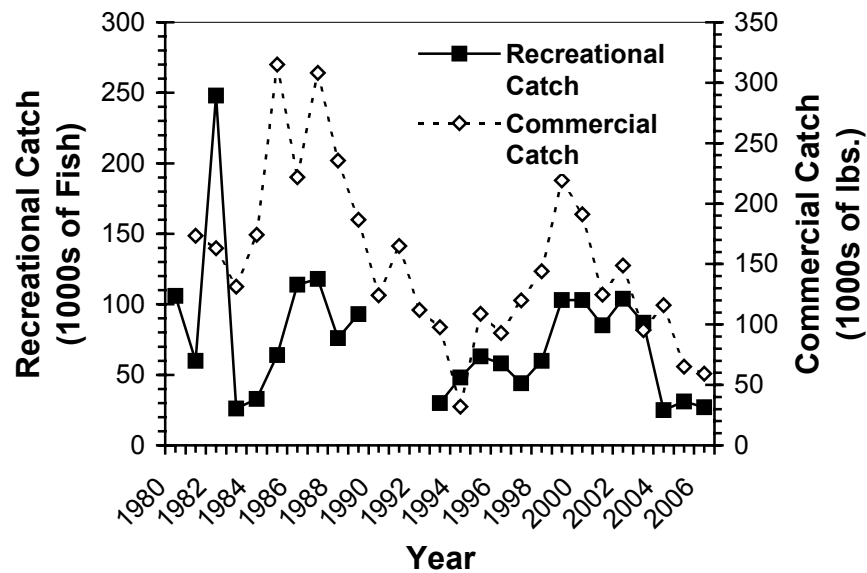

Figure 6.3-6. Recreational (1000's of fish) and commercial (1000's of lbs) catches of California halibut (*Paralichthys californicus*) from 1980-2006 (sources: PacFIN and RecFIN databases).

Commercial and recreational catch data are sometimes difficult to interpret without the backdrop of the effort and other socioeconomic information. From 1995-2006 sampling was done quarterly using gill nets at several locations in the SCB (Pondella unpubl. data). The mean catch in Santa Monica Bay for California halibut over the period was 1.28 fish/station and the mean catch in the remainder of the bight was 2.23 fish/station (Figure 6.3-7). This difference was statistically significant (ANOVA  $F_{1,86} = 10.52$ ,  $p = 0.0017$ ). Mean catch in Santa Monica Bay was correlated with mean catch in the remainder of the SCB ( $R = 0.349$ ,  $p = 0.02$ ). Although this may indicate that the stock in Santa Monica Bay was under the same constraints as the remainder of the bight from 1995-2006, the increase in mean catch in Santa Monica Bay in 2006 resulted in the highest values recorded during the study. The data show an almost inverse relationship with the trends in recreational and commercial catch over the same period, most noticeably with the increase in catch from 2003 through 2004 that compares with declines in fishery catches.

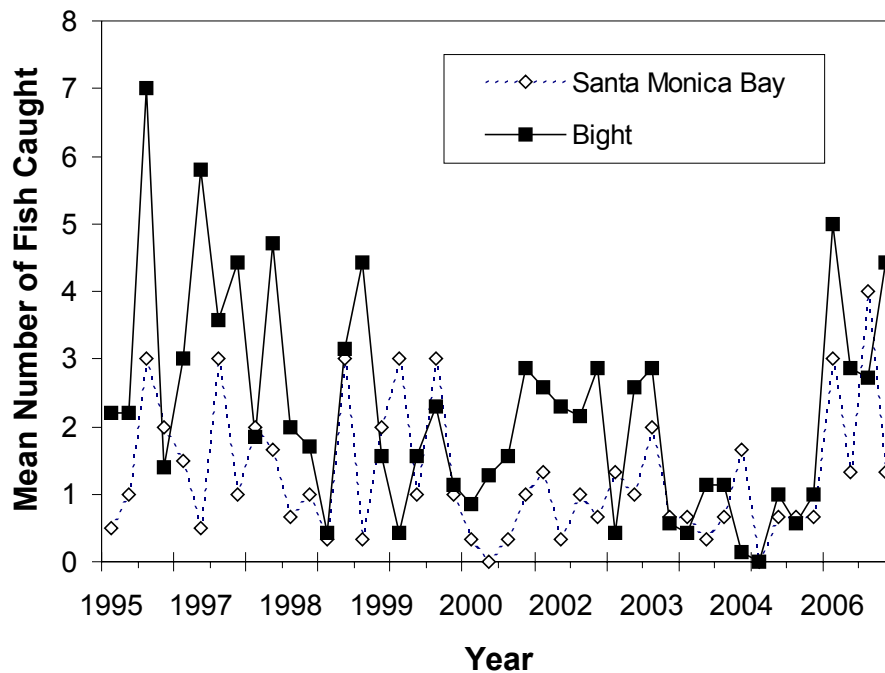

Figure 6.3-7. Mean catch (#fish/station) of California halibut in Santa Monica Bay and the remainder of the Southern California Bight from 1995-2006. Data are from the Ocean Resource Enhancement Hatchery Program (OREHP) gill net monitoring program.

Although it is difficult to determine the status of California halibut populations in Santa Monica Bay the low levels of entrainment and impingement from the RBGS represent very little risk to the healthy population indicated by results from the SCCWRP and OHREP studies.

The broad distribution of sanddabs and the low estimates of entrainment and impingement mortality indicate very little risk of AEI due to the CWISs of the RBGS. The health of the sanddab population is documented by independent studies done by SCCWRP and CalCOFI which are supported by data on commercial and recreational catch. The patterns of fluctuation over time of the catch from both fisheries were similar ( $R = 0.665$ ,  $P = 0.001$ ). The recreational catch fluctuated from between 13,000 and 154,000 fish per year; yet this catch did not change significantly over time (Figure 6.3-10,  $R=0.238$ ,  $p=0.261$ ). The commercial take varied between 129 and 6,346 kg (284 and 13,991 lbs) per year and increased significantly in recent years ( $R=0.468$ ,  $P=0.018$ ) (Figure 6.3-8). The increase in the sport and commercial catch in recent years indicate that the population of sanddabs in the SCB is healthy and there is no risk to the population from the low levels of entrainment and impingement losses from the RBGS.



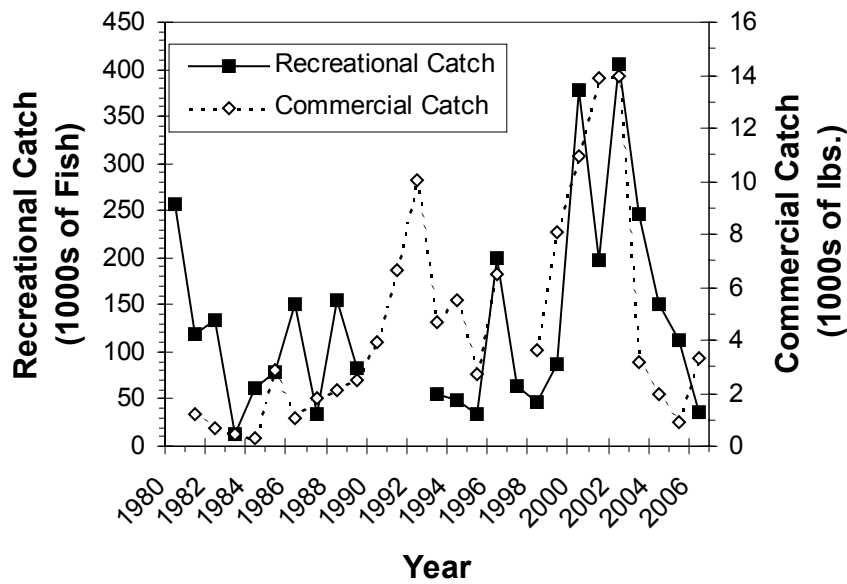

Figure 6.3-8. Recreational (1000’s of fish) and commercial (1000’s of lbs) of sanddabs (*Citharichthys* spp.) from 1980-2006 (sources: PacFIN and RecFIN databases).

Annual impingement of shelf species was highest for plainfin midshipman (67 individuals) and brown rockfish (*Sebastes auriculatus*), with an estimated annual impingement of 6 individuals weighing 1 kg (2 lbs). These and the other shelf species comprised only a small portion of the abundance and biomass collected during impingement samples (Tables 5.5-1 and 5.5-3). Impingement of shelf species was probably low relative to other habitat types because these fishes are largely bottom dwellers and generally do not occur in the water column where the intakes are located. Many shelf species utilize inshore areas during earlier developmental stages. An example is brown rockfish, which is most common at depths of about 120 m (396 ft), but pelagic juveniles settle in shallow water in spring at depths of about 36 m (120 ft) (Love et al. 2002). Densities of cancer (rock) crab megalops were too low to analyze, but impingement of rock crabs (*Cancer* spp.) totaled 9% (37 kg [82 lbs]) of the total shellfish impingement biomass. The majority of the impinged cancer crabs were from two species, Pacific rock crab and yellow crab, which are both targets of commercially and recreational fishing. As summarized in Section 5.5.3.1, commercial landings of rock crabs in Santa Monica Bay in 2006 totaled 21,328 kg (47,020 lbs); therefore, annual impingement was equivalent to about 0.2% of the local commercial landings.

Although the low levels of entrainment and estimated entrainment mortality for California halibut indicate very low potential for AEI due to RBGS intake effects (Table 6.2-7), it is also a species likely to be affected since it is primarily distributed on the inner shelf and is also targeted by commercial and recreational fisheries. Although it is difficult to determine the status of California halibut populations in

Santa Monica Bay the low levels of entrainment and impingement from the RBGS represent very little risk to the healthy population indicated by results from the SCCWRP and OHREP studies.

Rock crabs of the genus *Cancer* are widely distributed on shelf habitats, but are also common on rock reefs (*C. antennarius*) and bays (*C. anthonyi*). Although the Dungeness crab (*C. magister*) is a highly managed species and is the most desirable from a fishery standpoint, it occurs mostly north of Point Conception and does not contribute significantly to the crab fishery in southern California. Most of the commercial catches in the SCB are comprised of yellow crab, red rock crab, and Pacific rock crab. Long-term trends in the fishery for this species complex in the Los Angeles region showed a peak in the early 1980s followed by a decline to a stable, but low, catch rate (Figure 6.3-9). These species have a high fecundity and are widely distributed throughout the region. It is unlikely that entrainment or impingement at the RBGS would have any significant effect on their local populations.

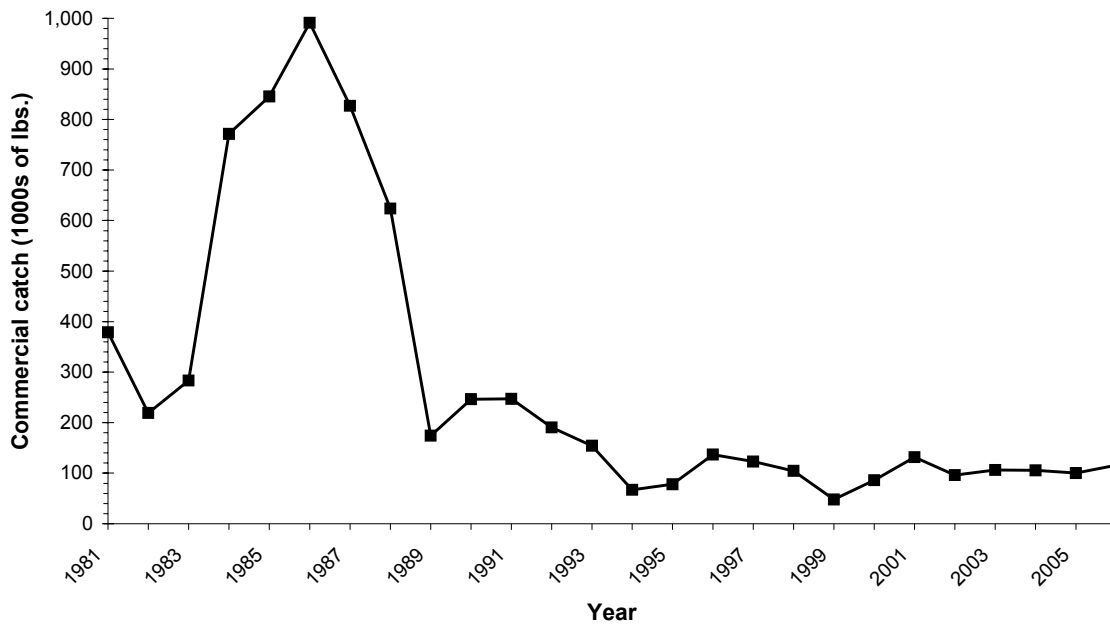

Figure 6.3-9. Commercial catches of rock crab (*Cancer* spp.) in the Los Angeles region, 1981–2006.

### 6.3.6 Deep Pelagic Habitats

Deep pelagic habitats include several different habitats described by Allen and Pondella (2006b) including deep slope, deep bank, and deep rocky reef habitats. This category also includes open ocean pelagic habitats. Some of these habitats are extremely productive and the fishes inhabiting these areas are the basis of large commercial fisheries. The fisheries in the areas outside the three-mile limit of California state waters are federally managed by the PFMC. Fishes characteristic of the deep shelf, bank and slope habitats include Pacific hake (*Merluccius productus*), splitnose rockfish (*Sebastes diploproa*), rex sole (*Glyptocephalus zachirus*), sablefish, blackgill rockfish (*S. melanostomus*), and shortspine thornyhead (*Sebastolobus alascanus*). Several different species of rockfishes dominate the fish assemblages on the deep reef, shelf and canyon habitats including bocaccio (*Sebastes paucispinis*), chilipepper (*S. goodei*), and greenspotted (*S. chlorostichus*), greenstriped (*S. elongatus*), rosethorn (*S. helvomaculatus*), and pinkrose (*S. simulator*) rockfishes. Fishes characteristic of open ocean pelagic habitats include swordfish (*Xiphias gladius*), striped marlin (*Tetrapturus audax*), several species of shark, albacore (*Thunnus alalunga*), and bluefin (*T. thynnus*), bigeye (*T. obesus*), and yellowfin tuna (*T. albacares*). Although the fishes characteristic of these habitats occasionally occur closer to shore their primary habitats are offshore in open water or at deep ocean depths.

Fishes from these habitats are not at risk due to entrainment or impingement by the RBGS CWIS. No fishes or shellfishes characteristic of this habitat type were collected during impingement sampling. The larvae from these habitats are subject to entrainment, but once the larvae are transported into nearshore areas the likelihood of them maturing to adults is probably very low due to the unique adaptations many of these species have to life in deep water habitats not found close to shore. Two species from these habitats were collected during entrainment sampling—northern lampfish and California smoothtongue (*Leuroglossus stilbius*)—and accounted for only a small fraction of the total entrainment. Northern lampfish is found to depths of 2,900 m (9,500 ft) and California smoothtongue occurs to depths of 690 m (2,264 ft) (Eschmeyer et al. 1983; Neighbors and Wilson 2006). These species also occur in midwater where the larvae are subject to onshore currents that could potentially result in transport into Santa Monica Bay where they are subject to entrainment (Neighbors and Wilson 2006). The primary distribution for these species is the outer coastal waters where the larvae are in higher abundances; therefore, they were not included in this assessment.

## 6.4 CONCLUSIONS AND DISCUSSION

### 6.4.1 IM&E Losses Relative to 1977 EPA AEI Criteria

EPA (1977) provided some general guidelines to determine the “relative biological value of the source water body zone of influence for selected species and the potential for damage by the intake structure” based on the following considerations of the value of a given area to a particular species:

- principal spawning (breeding) ground;
- nursery or feeding areas;

- migratory pathways;
- numbers of individuals present; and
- other functions critical during the life history.

The area in which the RBGS intake structures are located is adjacent to a productive artificial reef (King Harbor breakwater) and man-made structures that provide habitat for a wide variety of fishes and invertebrates characteristic of several habitat types in southern California, as defined by Allen and Pondella (2006b). In regards to the AEI criteria, the habitats are not unique as a spawning area for these particular fishes because they are widespread in southern California. Examples of unique spawning areas for certain species would be embayments with submerged aquatic vegetation (e.g. for silversides), intertidal sand beaches (e.g. for California grunion), or intertidal boulder fields (e.g. plainfin midshipmen). Spotfin croaker are known to form spawning aggregations in the nearshore coastal pelagic zone in summer, but the lack of any high density pulses of larvae in the RBGS entrainment samples indicates that the vicinity of the RBGS intakes is not an important area for such aggregations.

Concerning specific nursery areas for young-of-the-year (YOY) fishes, these would mostly include bay habitats (e.g. for California halibut, gobies, etc.) although nearshore areas with accumulations of drift algae or surfgrass on the bottom can also attract many species of juvenile fishes (Allen and Pondella 2006b). In the present study impingement totals were relatively low and small individuals comprised the bulk of the impingement total, including black perch and rock crabs. This indicates that the intake locations in shallow water may have a disproportionate effect on juveniles of some species due to the midwater intake opening and weaker swimming abilities of these taxa compared with the adults.

The issue in the EPA guidelines of fish migratory pathways relative to intake location primarily concerns anadromous fishes and situations with power plant intakes located on or near rivers that may function as narrow migratory corridors for certain species. Because the RBGS intakes are located in a man-made harbor and near the open ocean, this issue is not of concern for any of the species that were impinged. In addition, almost all of the impinged species are year-round residents and not highly migratory although some species, such as California halibut, may exhibit some seasonal onshore-offshore movements.

The other points of concern relative to intake location and fish distribution are numbers of individuals present and other functions critical during the life history (i.e., high concentrations of individuals present in the area for reasons other than spawning, recruitment, or migration). This may include a circumstance where, for example, prevailing currents or the proximity to certain bathymetric features attracts prey items for a predatory species and thus results in high concentrations of a species that may subsequently be at risk of impingement. Data collected during this study suggests that there are no species that are especially vulnerable to impingement or entrainment due to their behavior at any stage in their life history. This includes all common species as well as any special-status species designated for protection under state or federal statutes.

No federal/state threatened or endangered fish/shellfish species were identified in entrainment and impingement samples collected from RBGS. This is consistent with past entrainment and impingement

sampling conducted at RBGS. Off southern California, species managed under the Magnuson-Stevens Fishery Conservation and Management Act are listed in the Coastal Pelagics Fishery Management Plan (FMP) and the Pacific Groundfish FMP. EFH includes all waters off southern California offshore to the Exclusive Economic Zone. A list of species covered under the two FMPs that occurred in entrainment and/or impingement samples at the RBGS is provided in Table 6.4-1. More information on some of these species is presented in Sections 4.0 and 5.0.

Table 6.4-1. Fish and shellfish species under NMFS federal management or with CDFG special status entrained and/or impinged at RBGS in 2006.

<b>Species</b>	<b>Common Name</b>	<b>Management Group</b>	<b>Estimated No. Larvae (based on Entrainment Samples)</b>	<b>Juveniles/Adults (based on Impingement Samples)*</b>
<i>Engraulis mordax</i>	northern anchovy	Coastal Pelagics	33,207,070	271
<i>Hypsypops rubicundus</i>	garibaldi	CDFG	18,813,390	–
<i>Parophrys vetulus</i>	English sole	Pacific Groundfish	369,086	–
<i>Sebastes</i> spp.	rockfishes	Pacific Groundfish	309,502	–
<i>Merluccius productus</i>	Pacific hake	Pacific Groundfish	146,457	–
<i>Loligo opalescens</i>	market squid	Coastal Pelagics	101,587	154
<i>S. marmoratus</i>	cabezon	Pacific Groundfish	38,190	1
<i>Sardinops sagax</i>	Pacific sardine	Coastal Pelagics	26,967	–
<i>Platichthys stellatus</i>	starry flounder	Pacific Groundfish	10,151	–
<i>Microstomus pacificus</i>	Dover sole	Pacific Groundfish	7,577	–
<i>Citharichthys sordidus</i>	Pacific sanddab	Pacific Groundfish	2,816	–
<i>Scorpaena guttata</i>	California scorpionfish	Pacific Groundfish	–	52
<i>Sebastes auriculatus</i>	brown rockfish	Pacific Groundfish	–	6
<i>Sebastes miniatus</i>	vermilion rockfish	Pacific Groundfish	–	1

\* Includes estimated numbers from normal operations impingement, and actual numbers from heat treatment surveys.

#### **6.4.2 IM&E Losses Relative to Other AEI Criteria**

Additional criteria that were evaluated because they were specific to the marine environment around RBGS included:

- distribution (pelagic, subtidal, nearshore subtidal & intertidal);
- range, density, and dispersion of population;
- population center (source or sink);
- magnitude of effects;
- long-term abundance trends (e.g., fishery catch data);
- long-term environmental trends (climatological or oceanographic); and
- life history strategies (e.g., longevity and fecundity).

These criteria were used in assessing the effects of individual taxa and to place the estimated effects into a larger context using the characteristics of the source water and the biological community. The separation of the taxa on the basis of habitat allowed the assessment to focus on the groups most at risk due to entrainment and impingement. Taxa with larvae that are transported out of their native habitat into nearshore areas where they are subject to entrainment are less at risk than taxa that occur in the vicinity of the intake where all life stages are vulnerable to both entrainment and impingement. Also, taxa that occur in several different habitats will be less at risk than taxa that only occur in habitats directly affected by the RBGS intakes. Most of the taxa included in the assessment did not have limited habitat associations that would place them at greater risk to entrainment. Finally, the entire distribution of the population is also important, especially for species that may be more limited to shallow nearshore areas where they are not only subject to CWIS effects from RBGS and other facilities, but other impacts associated with nearshore coastal environments, such as habitat alteration, pollution, and so on. As a result, fishes such as northern anchovy that are distributed across large coastal areas will be less at risk than species with more limited nearshore distributions.

Based on the above criteria, the largest potential impacts should occur to gobies and blennies which both primarily occur in protected bay and harbor habitats, had the highest estimated entrainment mortality, and most of the larvae probably originated within King Harbor. Stephens and Pondella (2002) noted that the King Harbor breakwater “represents a mature artificial reef and contributes to the reef fish larval pool of the bight, acting as a source rather than a sink”. Therefore, although the RBGS undoubtedly reduces the larval export of gobies and blennies due to its location at the entrance to the harbor, there should be less effect on the populations within King Harbor, which seems to be supported by the limited data available on the adult populations.

The criteria of distribution, range, habitat, and population center all need to be considered relative to the magnitude of the effects. The potential for entrainment effects at power plants like RBGS with intakes adjacent to the open coast are less than power plants that draw cooling water from more enclosed water bodies, although a moderate proportion of the larvae entrained at RBGS appeared to have been spawned

from within King Harbor. The fish populations potentially affected by entrainment from open coast facilities are typically distributed across hundreds of miles of coastline and are connected by coastal currents that help distribute larvae into areas that may have reduced abundances. As a result, there should be little potential for impacts due to once-through cooling on the open coast. It is also important that several of the most abundant fishes are not targeted by commercial or recreational fishing that would compound any effects of the CWISs on the populations. However, the assessment also examined effects on fishes such as queenfish, sand and kelp basses, and California halibut, which are also targeted by sport or commercial fishing. The magnitude of the impacts to these and the other taxa were all relatively low and not at levels that would represent a risk of AEI to the populations.

Fish impingement has been routinely measured for decades at several coastal power plants in southern California, and these data are reported annually as part of their NPDES receiving water monitoring studies. The same core group of fish species continues to be impinged at these power plants, and there is no detectable effect from the operation of the cooling water systems. For example, at the Huntington Beach Generating Station (Orange County, California) three fish species (queenfish, white croaker, and northern anchovy) have comprised over 80% of the long-term impingement abundance from 1979 to 2005 (MBC 2006a). At RBGS ten fish species have accounted for 83% of the impingement abundance from 1991 through 2005 (MBC 2006b). As expected, the relative abundance of these species fluctuated over time, but they continue to thrive in the study area. Furthermore, for species that are harvested commercially, such as northern anchovy, the biomass of fishes that are impinged is orders of magnitude below the reported commercial landings from the Los Angeles area.

The same is true for species that are targeted by recreational fishing. From the mid-1940s to the early 1970s, the sportfish catch per unit effort in Santa Monica Bay more than doubled despite the fact that three generating stations commenced operation during that time period (MBC 1985). Analysis of this trend revealed that fish abundance was highly correlated with water temperature and transparency. Similar correlations have been recorded in recent years by many researchers, suggesting regional climatic events play a much larger role in the fluctuations of fish populations than any effects due to impingement or entrainment.

For the species in the detailed evaluation nearly every type of effect over time was found (Table 6.4-3). Anchovies disappeared from the commercial fishery after the regime shift and were essentially absent during the last two decades. Any time series data that extends to before or during this regime shift has evidence of this change. For example, kelp bass increased in density from the early 1970s to the early 1980s and then declined through 2006. Its fishery has suffered a similar decline. Other fisheries were declining (California halibut and white croaker) while catch in the fishery independent monitoring programs found them to be either increasing or stable over time. Fisheries that were not declining (queenfish and barred sand bass) had some type of positive correlation with ENSO and/or SST, while the declining fisheries did not. This indicates that the fishing effects may be masking the natural variation for these taxa.

After the faunal shift (i.e., post 1982–1984 El Niño), fishes that would be negatively affected by warming conditions were essentially extirpated from the nearshore environment of Santa Monica Bay. Other than

the taxa that appear to be affected by commercial and recreational fishing pressure, the remaining species are stable over time. This period was marked by general low fish productivity (Brooks et al. 2002) until the La Niña of 1999 and the following four-year cool water period. At this point, the catch or density of these stocks appeared to either increase or remain stable through 2006.

Table 6.4-2. Summary of positive time series findings for selected fish species in detailed evaluation with respect to oceanographic variables (ENSO, SST, and PDO), fishing effects and the current population trends.

<b>Taxon</b>	<b>ENSO</b>	<b>SST</b>	<b>PDO</b>	<b>Fishing Effects</b>	<b>Current Population Trend</b>
Anchovies			Yes	Historic	stable
Silversides			Yes		increasing
Kelp bass			Yes	Yes, declining	declining
Barred sand bass		Yes (-)			increasing
Spotted sand bass				Yes, declining	declining
White croaker				Yes, declining	increasing
Queenfish	Yes (+)	Yes (+)		Yes, stable	stable
Combtooth blennies		Yes (+)	Yes		stable
California halibut				Yes, declining	stable

The conclusion that the levels of entrainment and impingement at RBGS are not resulting in any AEI to fish or shellfish populations in Santa Monica Bay is consistent with a recent review on population-level effects on harvested fish stocks (Newbold and Iovanna 2007). The authors modeled the potential effects of entrainment and impingement on populations of 15 fish stocks that are targeted by either commercial or recreational fisheries using empirical data on entrainment and impingement, life history, and stock size. For 12 of the 15 species, the effects of removing all of the sources of power plant entrainment and impingement were very low (less than 2.5%). For the other three species, the effects ranged from 22.3% for striped bass on the Atlantic coast to 79.4% for Atlantic croaker. Their overall conclusions were that population-level effects were negligible for most fish stocks but could be severe for a few. They attributed the absence of large effects for most species to compensatory effects that are probably acting on the populations at some level. If there is strong density dependence acting on these populations during the life stages from the period when they are vulnerable to entrainment as larvae through the age of maturity, then they concluded that there should be very little potential for population-level effects due to entrainment and impingement.

Unlike the harvested fishes analyzed by Newbold and Iovanna (2007), the largest effects of entrainment at RBGS were for two non-harvested fishes that also occur in semi-protected waters. They did conclude that significant effects could occur in some species. For example, they estimated the impacts for Atlantic croaker at over 43% largely due to high rates of entrainment mortality. These levels are much higher than any of the levels estimated from the RBGS. The mortality rates from entrainment for West Coast species of fishes are typically much lower and closer in value to the levels that Newbold and Iovanna concluded represented little risk to the populations. This includes the species entrained in highest numbers at the



RBGS. As discussed earlier, King Harbor acts as a source for reef fish larvae and has been demonstrated to be more productive than nearby natural reefs (Stephens and Pondella 2002)..

## 7.0 LITERATURE CITED

- Adreani, M. S. and L. G. Allen. In press. Reproductive behavior and mating system of the temperate wrasse, *Halichoeres semicinctus*. J. Fish. Biol.
- Ahlstrom, E. H. and H. G. Moser. 1975. Distributional atlas of fish larvae in the California Current region: flatfishes, 1955 through 1960. CalCOFI Atlas No. 23. 207 p.
- Ahlstrom, E. H., K. Amaoka, D. A. Hensley, H. G. Moser, and B. Y. Sumida. 1984. Pleuronectiformes: development. Pp. 640–670 In H. G. Moser, W. J. Richards, D. M. Cohen, M. P. Fahay, A. W. Kendall, Jr., and S. L. Richardson, eds. Ontogeny and systematics of fishes. Amer. Soc. Ichthyol. and Herpetol., Spec. Publ. No. 1. 760 p.
- Allen, L. G. 1979. Larval development of *Gobiesox rhesodon* (Gobiesocidae) with notes on the larva of *Rimicola muscarum*. Fish. Bull. 77: 300–304.
- Allen, L. G. 1982. Seasonal abundance, composition, and productivity of the littoral fish assemblage in upper Newport Bay, California. Fish. Bull. 80:769–790.
- Allen, L. G. 1983. Larval development of the northern clingfish, *Gobiesox maendricus*. Copeia 1983(2):551–554.
- Allen, L. G. 1985. A habitat analysis of the nearshore marine fishes from southern California. Bull. So. Calif. Acad. Sci. 84(3):133–155.
- Allen, L. G. 1999. Fisheries Inventory and Utilization of San Diego Bay, San Diego, California. Final Report: Sampling Period July 1994 to April 1999. Prepared for U.S. Navy and the San Diego Unified Port District.
- Allen, L.G. and E. E. DeMartini. 1983. Temporal and spatial patterns of nearshore distribution and abundance of the pelagic fishes off San Onofre-Oceanside, California. Fish. Bull. 81(3):569–586.
- Allen, L. G. and J. M. Ilg. 1983. Larval development of the northern clingfish, *Gobiesox maeandricus*. Copeia. 1983 (2): 551–554.
- Allen, L. G. and T. E. Hovey. 2001a. Barred sand bass. Pp. 224–225 in W. S. Leet, C. M. Dewees, R. Klingbeil, and E. J. Larson, eds. California's Living Marine Resources: A Status Report. Univ. Calif. Press. 592 p.
- Allen, L. G. and T. E. Hovey. 2001b. Kelp Bass. Pp. 222–223 in W. S. Leet, C. M. Dewees, R. Klingbeil, and E. J. Larson, eds. California's Living Marine Resources: A Status Report. Univ. Calif. Press. 592 p.

- Allen, L. G. and D. J. Pondella II. 2006a. Surf zone, coastal pelagic zone, and harbors. Pp. 149–166 *in* The ecology of marine fishes: California and adjacent waters. L. G. Allen, D. J. Pondella II, and M. H. Horn, eds., Univ. Calif. Press., Los Angeles, CA. 660 p.
- Allen, L. G. and D. J. Pondella II. 2006b. Ecological classification. Pp. 81–113 *in* The ecology of marine fishes: California and adjacent waters. L. G. Allen, D. J. Pondella II, and M. H. Horn, eds., Univ. Calif. Press., Los Angeles, CA. 660 p.
- Allen, L. G., A. M. Findlay, and C. M. Phalen. 2002. Structure and standing stock of the fish assemblages of San Diego Bay, California from 1994 to 1999. *Bull. So. Calif. Acad. Sci.* 101:49–85.
- Allen, L. G., L. S. Bouvier, and R. E. Jensen. 1992. Abundance, diversity, and seasonality of cryptic fishes and their contribution to a temperate reef assemblage off Santa Catalina Island, California. *Bull. So. Calif. Acad. Sci.* 91(2):55–69.
- Allen, L. G., M. H. Horn, F. A. Edmands II, and C. Usui. 1983. Structure and seasonal dynamics of the fish assemblage in the Cabrillo Beach area of Los Angeles Harbor, California. *Bull. So. Cal. Acad. Sci.* 82(2):47–70.
- Allen, L. G., M. M. Yoklavich, G. M. Cailliet, and M. H. Horn. 2006. Bays and estuaries. Pp. 119–148 *in* The ecology of marine fishes: California and adjacent waters. L. G. Allen, D. J. Pondella II, and M. H. Horn, eds., Univ. Calif. Press., Los Angeles, CA. 660 p.
- Allen, L. G., Pondella, D. J., II and M. A. Shane. (In press). Documenting the return of a fishery: distribution and abundance of juvenile white seabass (*Atractoscion nobilis*) in the shallow nearshore waters of the Southern California Bight, 1995-2005. Fisheries Research.
- Allen, L. G., T. E. Hovey, M. S. Love, and J. T. W. Smith. 1995. The life history of the spotted sand bass (*Paralabrax maculatofasciatus*) within the southern California Bight. *CalCOFI Rep.* 36:193–203.
- Allen, L. G., D. J. Pondella II, and M. A. Shane. In Press. Documenting the return of a fishery: distribution and abundance of juvenile white seabass (*Atractoscion nobilis*) in the shallow nearshore waters of the Southern California Bight, 1995–2005. *Fish. Res.*
- Allen, M. J. 1982. Functional structure of soft-bottom fish communities of the southern California shelf. Ph.D. dissertation, Univ. Calif., San Diego, La Jolla, CA. 577 p.
- Allen, M. J. 2006. Continental shelf and upper slope. Pp. 167–202 *in* The ecology of marine fishes: California and adjacent waters. L. G. Allen, D. J. Pondella II, and M. H. Horn, eds., Univ. Calif. Press., Los Angeles, CA. 660 p.
- Allen, M. J. and K. T. Herbinson. 1990. Settlement of juvenile California halibut, *Paralichthys californicus*, along the coasts of Los Angeles, Orange, and San Diego Counties in 1989. *CalCOFI Rep.* 31:84–96.

- Allen, M. J. and K. T. Herbinson. 1991. Beam trawl survey of bay and nearshore fishes of the soft-bottom habitat of Southern California in 1989. *CalCOFI Rep.* 32:112–127.
- Allen, M. J., S. L. Moore, K. C. Schiff, S. B. Weisberg, D. Diener, J. K. Stull, A. Groce, J. Mubarak, C. L. Tang, and R. Gartman. 1998. Southern California Bight 1994 Pilot Project: V. Demersal fishes and megabenthic invertebrates. *So. Calif. Coast. Water Res. Proj.*, Westminster, CA. 324 p.
- Allen, M. J., T. Mikel, D. Cadien, J. E. Kalman, E. T. Jarvis, K. C. Schiff, D. W. Diehl, S. L. Moore, S. Walther, G. Deets, C. Cash, S. Watts, D. J. Pondella II, V. Raco-Rands, C. Thomas, R. Gartman, L. Sabin, W. Power, A. K. Groce, and J. L. Armstrong. 2007. Southern California Bight 2003 Regional Monitoring Program: IV. Demersal Fishes and Megabenthic Invertebrates. Southern California Coastal Water Research Project. Costa Mesa, CA.
- Allen, M. J., R. W. Smith, E. T. Jarvis, V. Raco-Rands, B. Bernstein, and K. Herbinson. 2003. Temporal trends in southern California nearshore fish populations relative to environmental influences. Paper presented at the So. Calif. Acad. Sci., California State University Northridge, 9 May 2003.
- Ambrose, R. F. 1981. Observations on the embryonic development and early post-embryonic development of *Octopus bimaculatus*. *Veliger* 24:139-146.
- Anderson, R. D. and C. F. Bryan. 1970. Age and growth of three surfperches (Embiotocidae) from Humboldt Bay, California. *Trans. Amer. Fish. Soc.* 3:475–482.
- Anderson, W. R. and R. F. Ford. 1976. Early development, growth and survival of the yellow crab *Cancer anthonyi* Rathbun (Decapoda, Brachyura) in the laboratory. *Aquaculture* 7: 276–279.
- Ashcraft, S. E. and M. Heisdorf. 2001. Brown Rockfish. Pp. 170–172 in W. S. Leet, C. M. Dewees, R. Klingbeil, and E. J. Larson, eds. *California's Living Marine Resources: A Status Report*. Univ. Calif. Press. 592 p.
- Babel, J. S. 1967. Reproduction, life history, and ecology of the round stingray, *Urolophus halleri* Cooper. *Bull.* 137. Calif. Dept. Fish and Game, Sacramento, CA. 62 p.
- Bane, G. W., and Bane, A. W. 1971. Bay fishes of northern California. Mariscos Publications, Hampton Bays, N. Y. 143 p.
- Bane, G. W. and M. Robinson. 1970. Studies on the shiner perch, *Cymatogaster aggregata* Gibbons, in upper Newport Bay, California. *Wassmann J. Biol.* 28(2):259-268.
- Barlow, G. W. 1963. Species structure of the gobiid fish *Gillichthys mirabilis* from coastal sloughs of the eastern Pacific. *Pac. Sci.* 17(1):47-72.
- Barsky, K. C. 1990. History of the commercial California halibut fishery. Pp. 217–227 In C. W. Haugen, ed. *The California halibut, Paralichthys californicus*, resource and fisheries. Calif. Dept. Fish and Game, Fish Bull. 174.

- Barsky, K.C. 2001. California spiny lobster. Pp. 98–100 in W. S. Leet, C. M. Dewees, R. Klingbeil, and E. J. Larson, eds. California's Living Marine Resources: A Status Report. Univ. Calif. Press. 592 p.
- Baumgartner, T. R., A. Soutar, and V. Ferreira-Bartrina. 1992. Reconstruction of the history of Pacific sardine and northern anchovy populations of the past two millennia from sediments of the Santa Barbara Basin, California. CalCOFI Rep. 33:24–40.
- Beck, D. S. and K. T. Herbinson. 2003. Declines in abundance of three nearshore surfperches off Huntington Beach, California, 1971–2001. So. Calif. Acad. Sci., California State University Northridge, 9 May 2003.
- Bergen, D. R. and L. D. Jacobsen. 2001. Northern anchovy. Pp. 303–305 in W. S. Leet, C. M. Dewees, R. Klingbeil, and E. J. Larson, eds. California's Living Marine Resources: A Status Report. Univ. Calif. Press. 592 p.
- Bograd, S. J., P. M. DiGiacomo, R. Durazo, T. L. Hayward, K. D. Hyrenbach, R. J. Lynn, A. W. Mantyla, F. B. Schwing, W. J. Sydeman, T. B., B. Lavaniegos, and C. S. Moore. 2000. The state of the California Current, 1999-2000: forward to a new regime? CalCOFI Rep. 41:26–52.
- Bond, C. E. 1996. Biology of Fishes. Saunders College Publishing, San Diego, CA. 105 p.
- Boreman, J., C. P. Goodyear, and S. W. Christensen. 1978. An empirical transport model for evaluating entrainment of aquatic organism by power plants. U.S. Fish Wildl. Ser. FWS/OBS–78/90, Ann Arbor, MI.
- Boreman, J., C. P. Goodyear, and S. W. Christensen. 1981. An empirical methodology for estimating entrainment losses at power plants sited on estuaries. Trans. Am. Fish. Soc. 110:253–260.
- Brewer, G. 1974. Thermal tolerance and toxicity studies. Pp. 21-43 in: Soule, D.F. and M. Oguri (Eds.). Part 3: Marine studies of San Pedro Bay, California. Allan Hancock Found., Univ. So. Calif., Los Angeles, CA. 86 p.
- Brewer, G.D. 1978. Reproduction and spawning of northern anchovy, *Engraulis mordax*, in San Pedro Bay, CA. Calif. Fish and Game 64(3):175–184.
- Briggs, J. C. 1955. "A Monograph of the Clingfishes (order Xenopterygii)." Stanford Ichthyological Bulletin 6:1–224.
- Brooks, A. J., R. J. Schmitt, and S. J. Holbrook. 2002. Declines in regional fish populations: have species responded similarly to environmental change? Mar. Freshwater Res. 53:189–198.
- Brothers, E. B. 1975. The comparative ecology and behavior of three sympatric California gobies. Ph.D. Dissertation, Univ. Calif. San Diego. 370 p.
- Butler, J., D. Fuller, and M. Yaremko. 1999. Age and growth of market squid (*Loligo opalescens*) off California during 1998. CalCOFI Rep. 40:191–195.

- Butler, J. L., P. E. Smith, and N. C. H. Lo. 1993. The effect of natural variability of life-history parameters on anchovy and sardine population growth. *CalCOFI Rep.* 37:152–159.
- Caddell, S. M., D. M. Gadomski, and L. R. Abbott. 1990. Induced spawning of the California halibut, *Paralichthys californicus*, under artificial and natural conditions. *Calif. Dept Fish Game, Fish Bull.* 174:175–197.
- Cailliet, G. M., B. Antrim, D. Ambrose, S. Pace, and M. Stevenson. 1977. Species composition, abundance and ecological studies of fishes, larval fishes, and zooplankton in Elkhorn Slough. Pp. 216-386 *in*: J. Nybakken, G. Cailliet, and W. Broenkow (eds.). *Ecological and hydrographic studies of Elkhorn Slough, Moss Landing Harbor and nearshore coastal waters, July 1974 to June 1976.* Moss Landing Marine Lab., Moss Landing, CA.
- Cailliet, G. M., E. J. Burton, J. M. Cope, L. A. Kerr, R. J. Larson, R. N. Lea, D. VenTresca, and E. Knaggs. 2000. Biological characteristics of nearshore fishes of California. Submitted to the Pacific States Marine Fisheries Commission. <http://www.dfg.ca.gov/mrd/lifehistories/index.html#summary>
- Cailliet, G. M., K. A. Karpov, and D. A. Ambrose. 1979. Pelagic assemblages as determined from purse seine and large midwater trawl catches in Monterey Bay and their affinities with the market squid, *Loligo opalescens*. *CalCOFI Rep.* 20:21–30.
- California Department of Fish and Game (CDFG). 2006. Final California commercial landings for 2005. <http://www.dfg.ca.gov/mrd/landings05.html>.
- California Department of Fish and Game (CDFG). 2007a. CDFG Geographic Information System, 2000 data. [http://www.dfg.ca.gov/itbweb/gis/mr\\_bathy.htm](http://www.dfg.ca.gov/itbweb/gis/mr_bathy.htm).
- California Department of Fish and Game (CDFG). 2007b. 2006 Catch Block Data. Received from CDFG Marine Fisheries Statistical Unit, Los Alamitos, CA. Feb. 2007.
- Carroll, J. C. 1982. Seasonal abundance, size composition, and growth of rock crab, *Cancer antennarius*, off central California. *J. Crustacean Biol.* 2(4):549–561.
- Carroll, J. C., and R. N. Winn. 1989. Species profiles: life histories and environmental requirements of coastal fishes and invertebrates (Pacific Southwest): brown rock crab, red rock crab, and yellow crab. U.S. Fish and Wildlife Service, Biology Report 82(11.117). 16 p.
- Chavez, F. P., J. Ryan, S. E. Lluch-Cota, and M. Niquen. 2003. From anchovies to sardines and back: multidecadal change in the Pacific Ocean. *Science* 299:217–221.
- Clark, F. N. 1929. The life history of the California jacksmelt, *Atherinopsis californiensis*. *Calif. Div. Fish Game, Fish Bull.* 16. 22 p.
- Clark, F. N. and J. B. Phillips. 1952. The northern anchovy (*Engraulis mordax*) in the California fishery. *Calif. Dept. Fish and Game, Fish Bull.* 38(2):189-208.
- Clark, G. H. 1930. California halibut. *Calif. Dept. Fish Game, Fish Bull.* 16:315–317.

- Clark, G. H. 1935. San Francisco Trawl Fishery. Calif. Dept. Fish Game, Fish Bull. 21:22–37.
- Clarke, T. A. 1970. Territorial behavior and population dynamics of a pomacentrid fish, the garibaldi, *Hypsypops rubicunda*. Ecol. Mongr. 40:189–212.
- Cordes, J. F. and L. G. Allen. 1997. Estimates of age, growth and settlement from otoliths of young-of-the-year kelp bass (*Paralabrax clathratus*). Bull. So. Calif. Acad. Sci. 96(2):43–60.
- Cowen, R. K. 1985. Large-scale pattern of recruitment in the labrid, *Semicossyphus pulcher*: causes and implications. J. Mar. Res. 43:719-742.
- Cross, J. N. and J. E. Hose. 1988. Evidence for impaired reproduction in white croaker (*Genyonemus lineatus*) from contaminated areas off southern California. Mar. Env. Res. 24:185–188.
- Cross, J. N. and L. G. Allen. 1993. Fishes. Ch. 9 *in*: Dailey, M.D., D.J. Reish, and J.W. Anderson (eds.). Ecology of the Southern California Bight: A synthesis and interpretation. Univ. Calif. Press, Los Angeles, CA. 926 p.
- Culver, C. S. and A. M. Kuris. 2001. Sheep Crab. Pp. 115–117 *in* W. S. Leet, C. M. Dewees, R. Klingbeil, and E. J. Larson, eds. California’s Living Marine Resources: A Status Report. Univ. Calif. Press. 592 p.
- Dailey, M. D., J. W. Anderson, D. J. Reish, and D. S. Gorsline. 1993. The Southern California Bight: Background and setting. Ch. 1 *in* Dailey, M.D., D.J Reish, and J.W. Anderson, eds. Ecology of the Southern California Bight: A synthesis and interpretation. Univ. Calif. Press, Los Angeles, CA. 926 p.
- Daugherty, A. E., F. E. Felin, and J. MacGregor. 1955. Age and length composition of the northern anchovy catch off the coast of California in 1952-53 and 1953-54. Calif. Dept. Fish and Game, Fish Bull. 101:36-66.
- Davies, I. E. and R. P. Bradley. 1972. Deep observations of anchovy and blue sharks from Deepstar 2000. Fish. Bull.. 70:510–511.
- Davis, G. E., D. J. Kushner, J. M. Mondragon, J. E. Mondragon, D. Lerma, and D. V. Richards. 1997. Kelp Forest Monitoring Handbook. Volume 1: Sampling Protocol Channel Islands National Park. National Park Service. Ventura, California.
- Davis, J. L. D. 2000. Changes in a tidepool fish assemblage on two scales of environmental variation: seasonal and El Nino southern oscillation. Limnology and Oceanography 45(6):1368–1379.
- Dawson, M. N, K. D. Louie, M. Barlow, D. K. Jacobs, and C. C. Swift. 2002. Comparative phylogeography of sympatric sister species, *Clevelandia ios* and *Eucyclogobius newberryi* (Teleostei, Gobiidae), across the California Transition Zone. Mol. Ecol. 11:1065-1075.
- DeMartini, E. E. 1987. Tests of ovary subsampling options and preliminary estimates of batch fecundity for two *Paralabrax* species. CalCOFI Rep. 28:168–170.

- DeMartini, E. E. 1991. Annual variations in fecundity, egg size, and the gonadal and somatic conditions of queenfish *Seriphus politus* (Sciaenidae). Fish. Bull. 89(1):9–18.
- DeMartini, E. E. and R. K. Fountain. 1981. Ovarian cycling frequency and batch fecundity in the queenfish, *Seriphus politus*: attributes representative of serial spawning fishes. Fish. Bull. 79(3):547–560.
- DeMartini, E. E., L. G. Allen, R. K. Fountain, and D. Roberts. 1985. Diel and depth variations in the sex-specific abundance, size composition, and food habits of queenfish, *Seriphus politus* (Sciaenidae). Fish. Bull. 83(2):171–185.
- DeMartini, E. E., A. M. Barnett, T. D. Johnson and R. F. Ambrose. 1994. Growth and production estimates for biomass-dominant fishes on a southern California artificial reef. Bull. Mar. Sci. 55(2–3):484–500.
- DeMartini, E. E., T. O. Moore and K. M. Plummer, 1983. Reproductive and growth dynamics of *Hyperprosopon argenteum* (Embiotocidae) near San Diego, California. Env. Biol. Fish. 8(1):29–38.
- Dotson, R. C. and R. L. Charter. 2003. Trends in the southern California sport fishery. CalCOFI Rep. 44:94–106.
- Durazo, R., T. R. Baumgartner, S. J. Bograd, C. A. Collins, S. de la Campa, J. Garcia, G. Gaxiola-Castro, A. Huyer, K. D. Hyrenbach, D. Loya, R. J. Lynn, F. B. Schwing, R. L. Smith, W. J. Sydeman, and P. Wheeler. 2001. The state of the California Current, 2000–2001: A third straight La Niña year. CalCOFI Rep. 42:27–60.
- Durrand, M. H. 1998. Fishmeal price behaviour: global dynamics and short-term changes. Pp. 465–480 in Global versus local changes in upwelling systems. M. H. Durrand, P. Cury, R. Mendelsohn, C. Roy, A. Bakun, D. Pauly, eds. Editions de l'Orstom.
- Eckmayer, W. J. 1979. Age and growth of four surfperches (Embiotocidae) from the outer harbor of Anaheim Bay, California. Calif. Dept. Fish and Game, Fish Bull. 65:265–272.
- Emmett, R. L., S. L. Stone, S. A. Hinton, and M. E. Monaco. 1991. Distribution and abundance of fishes and invertebrates in west coast estuaries, Vol. II. Species life history summaries. ELMR Rep. No. 8. NOAA/NOS Strategic Environmental Assessments Division, Rockville, MD. 329 p.
- Environmental Protection Agency (EPA). 1977. Draft Guidance for Evaluating the Adverse Impact of Cooling Water Intake Structures on the Aquatic Environment: Section 316(b) P.L. 92-500.
- Erisman, B. E. and L. G. Allen, 2005. Color Patterns and Associated Behaviors in the Kelp Bass, *Paralabrax clathratus* (Teleostei: Serranidae). Bull. So. Calif. Acad. Sci. 104(2): 45–62.
- Erisman, B. E. and L. G. Allen. 2006. Reproductive behaviour of a temperate serranid fish, *Paralabrax clathratus* (Girard), from Santa Catalina Island, California, U.S.A. J. Fish. Bio. 68:157–184.



- Eschmeyer, W. N., E. S. Herald, and H. Hammann. 1983. A Field Guide to Pacific Coast Fishes of North America. Houghton Mifflin, New York, NY. 336 p.
- Feder, H. M., C. H. Turner, and C. Limbaugh. 1974. Observations on fishes associated with kelp beds in southern California. Calif. Dept. Fish and Game, Fish Bull. 160. 138 p.
- Fields, W. G. 1965. The structure, development, food relations, reproduction, and life history of the squid *Loligo opalescens* Berry. Calif. Dept. of Fish and Game, Fish Bull. 131.
- Finney, B. P., I. Gregory-Evans, M. S. V., Douglas, and J. P. Smol. 2002. Fisheries productivity in the northeastern Pacific Ocean over the past 2,200 years. Nature 416:729–733.
- Fitch, J. E. and R. J. Lavenberg. 1971. Tidepool and nearshore fishes of California. Univ. Calif. Press, Berkeley, CA. 156 p.
- Fitch, J. E. and R. J. Lavenberg. 1975. Marine food and game fishes of California. Univ. Calif. Press, Berkeley, CA. 179 p.
- Forsythe, J., N. Kangas, and R. T. Hanlon. 2004. Does the California market squid (*Loligo opalescens*) spawn naturally during the day or at night? A note on the successful use of ROVs to obtain basic fisheries biology data. Fish. Bull. 102(2):389–392.
- Frey, H. W., ed. 1971. California's living marine resources and their utilization. Calif. Dept. Fish and Game. 148 p.
- Fritzsche, R. A., and T. J. Hassler. 1989. Species Profiles: Life histories and environmental requirements of coastal fish and invertebrates (Pacific southwest). Pile perch, striped seaperch, and rubberlip seaperch. U.S. Fish and Wildlife Service Biological Rpt. 82(11.103). U.S. Army Corps of Engineers, TR EL-82-4. 15 p.
- Fritzsche, R. A. and P. Collier. 2001. Surfperches. Pp. 236–240 in W. S. Leet, C. M. Dewees, R. Klingbeil, and E. J. Larson, eds. California's Living Marine Resources: A Status Report. Univ. Calif. Press. 592 p.
- Froeschke, J. T., L. G. Allen, and D. J. Pondella. 2005. The reef fish assemblage of the outer Los Angeles Federal Breakwater, 2002-2003. Bull. So. Calif. Acad. Sci. 104:63–74.
- Froeschke, J. T., L. G. Allen, D. J. Pondella. In press. Life history and courtship behavior of black perch (*Embiotoca jacksoni*, Teleostomi: Embiotocidae) from southern California. Pacific Sci.
- Fronk, R. H. 1969. Biology of *Atherinops affinis* Hubbs in Newport Bay. M.S. Thesis, Univ. of Calif., Irvine. 106 p.
- Gadomski, D. M. and S. M. Caddell. 1996. Effects of temperature on the development and survival of eggs of four coastal California fishes. Fish. Bull. 94:41–48.

- Gadomski, D. M., and J. H. Petersen. 1988. Effects of food deprivation on the larvae of two flatfishes. *Marine Ecological Progress Series*. 44:103–111.
- Gadomski, D. M., S. M. Caddell, L. R. Abbot, and T. C. Caro. 1990. Growth and development of larval and juvenile California halibut *Paralichthys californicus*, reared in the laboratory. *Calif. Dept. Fish Game, Fish. Bull.* 174:85–98.
- Garrison, K. J. and B. S. Miller. 1982. A review of the early life history of Puget Sound fishes. *Fish. Res. Inst., Univ. Wash. Seattle, WA. FRI-UW-8216.* 729 p.
- Goericke, R., E. Venrick, A. Mantyla, S. J. Bograd, F. B. Schwing, A. Huyer, R. L. Smith, P. A. Wheeler, R. Hooff, W. T. Peterson, F. Chavez, C. Collins, B. Marinovic, N. Lo, G. Gaxiola-Castro, R. Durazo, K. D. Hyrenbach, and W. J. Sydeman. 2005. The state of the California Current, 2004-2005: still cool? *CalCOFI Rep.* 46:32–71.
- Goldberg, S. R. 1976. Seasonal spawning cycles of the sciaenid fishes *Genyonemus lineatus* and *Seriplus politus*. *Fish. Bull.* 74(4):983–984.
- Goldberg, S. R. 1981. Seasonal spawning cycle of the black croaker, *Cheilotrema saturnum* (Sciaenidae). *Fish. Bull.* 79(3):561–562.
- Goodyear, C. P. 1978. Entrainment impact estimates using the equivalent adult approach. United States Fish and Wildlife Service, FWS/OBS–78/65, Ann Arbor, MI.
- Graham, W. M. 1989. The influence of hydrography on the larval dynamics and recruitment of five Cancer crab species in northern Monterey Bay. M.S. Thesis, University of California, Santa Cruz. 170 p.
- Gregory, P. A. 2001a. Silversides. Pp. 243–245 in W. S. Leet, C. M. Dewees, R. Klingbeil, and E. J. Larson, eds. *California's Living Marine Resources: A Status Report*. Univ. Calif. Press. 592 p.
- Gregory, P. A. 2001b. Grunion. Pp. 246–247 in W. S. Leet, C. M. Dewees, R. Klingbeil, and E. J. Larson, eds. *California's Living Marine Resources: A Status Report*. Univ. Calif. Press. 592 p.
- Haaker, P. L. 1975. The biology of the California halibut, *Paralichthys californicus* (Ayres), in Anaheim Bay, California. Pp. 137–151 In E.D. Lane and C.W. Hill, eds. *The marine resources of Anaheim Bay*. Calif. Dept. Fish and Game, Fish Bull. 165.
- Hammann, M. G., and M. A. Cisneros-Mata. 1989. Range extension and commercial captures of the northern anchovy, *Engraulis mordax* Girard, in the Gulf of California, Mexico. *Calif. Fish Game* 75:49–53.
- Hart, J. L. 1973. Pacific fishes of Canada. *Fish. Res. Board Can., Bull.* 180. 740 p.
- Hastings, P. A. 1989. Protogynous hermaphroditism in *Paralabrax maculatofasciatus* (Pisces: Serranidae). *Copeia* 1989:184–188.

- Haugen, C. W. (ed.) 1990. The California Halibut, *Paralichthys californicus*, Resource and Fisheries. Calif. Dept. Fish Game, Fish Bull. 174. 475 p.
- Helvey, M. and P. Dorn. 1981. The fish population associated with an offshore water intake structure. Bull. So. Calif. Acad. Sci. 80:23–31.
- Hendricks, T. J. 1980. Currents in the Los Angeles area. Pp. 243–256 in Coastal Water Research Project Biennial Report 1979-1980. So. Calif. Coast. Water Res. Proj., Long Beach, CA. 363 p.
- Herbison, K. T., M. J. Allen, and S. L. Moore. 2001. Historical trends in nearshore croaker (Family Sciaenidae) populations in southern California from 1977 through 1998. Pp. 253–264 in S. B. Weisberg and D. Hallock, eds. Southern California Coastal Water Research Project Annual Report 1999-2000, So. Calif. Coast. Water Res. Proj., Westminster, CA.
- Hickey, B. M. 1993. Physical oceanography. Pp. 19–70 in Ecology of the Southern California Bight. M. D. Dailey, D. J. Reish, and J. W. Anderson (eds.). Univ. Calif. Press, Berkeley, CA. 926 p.
- Hickey, B. M., E. L. Dobbins, and S. E. Allen. 2003. Local and remote forcing of currents and temperature in the central Southern California bight. J. Geophysical Res. 108:C3 (26)1–26.
- Hickey, B. M. 1992. Circulation over the Santa Monica-San Pedro basin and shelf. Prog. Oceanog. 30:37–115.
- Hines, A. H. 1991. Fecundity and reproductive output in nine species of *Cancer* crabs (Crustacea, Brachyura, Cancridae). Can. J. Fish. and Aquatic Sci. 48:267–275.
- Hobday, A. J. and S. M. Rumsey. 1999. Population dynamics of the sheep crab *Loxorhynchus grandis* (Majidae) Stimpson 1857 at La Jolla California. Scripps Inst. Oceanog. La Jolla, California. 32 p.
- Hobson, E. S. and J. R. Chess. 1976. Trophic interactions among fishes and zooplankters near shore at Santa Catalina Island, California. Fish. Bull. 74(3):567–598.
- Hobson, E. S., W. N. McFarland, and J. R. Chess. 1981. Crepuscular and nocturnal activities of Californian nearshore fishes, with consideration of their scotopic visual pigments and the photic environment. Fish. Bull. 79(1):1–17.
- Holbrook, S. J., R. J. Schmitt, and J. S. Stephens, Jr. 1997. Changes in an assemblage of temperate reef fishes associated with a climate shift. Ecol. Appl. 7(4):1,299–1,310.
- Horn, M. H. and J. S. Stephens, Jr. 2006. Climate change and overexploitation. Pp. 621–635 in The ecology of marine fishes: California and adjacent waters. L. G. Allen, D. J. Pondella II, and M. H. Horn, eds., Univ. Calif. Press., Los Angeles, CA. 660 p.
- Horn, M. H., and L. G. Allen. 1978. A distributional analysis of California coastal marine fishes. J. Biogeography. 5:23–42.

- Horn, M. H. and K. L. M. Martin. 2006. Rocky intertidal zone. Pp. 205–226 in *The ecology of marine fishes: California and adjacent waters*. L. G. Allen, D. J. Pondella II, and M. H. Horn, eds., Univ. Calif. Press., Los Angeles, CA. 660 p.
- Horst, T. J. 1975. The assessment of impact due to entrainment of ichthyoplankton. Pp. 107–118 In S. B. Saila, ed., *Fisheries and Energy Production: A symposium*. Lexington Books, D.C. Heath and Company, Lexington, MA.
- Hovey, C. B., L. G. Allen, and T. E. Hovey. 2002. The reproductive pattern of barred sand bass (*Paralabrax nebulifer*) from southern California. *CalCOFI Rep.* 43:174-181.
- Hunter, J. R. and B. J. Macewicz. 1980. Sexual maturity, batch fecundity, spawning frequency, and temporal pattern of spawning for the northern anchovy, *Engraulis mordax*, during the 1979 spawning season. *CalCOFI Rep.* 21:139–149.
- Hunter, J. R. and K. M. Coyne. 1982. The onset of schooling in northern anchovy larvae, *Engraulis mordax*. *CalCOFI Rep.* 23:246–251.
- Hurley, A. C. 1977. Mating behavior of the squid *Loligo opalescens*. *Mar. Behav. Physiol.* 1977(4):195–203.
- Intersea Research Corporation (IRC). 1981. SGS Cooling Water Intake Study: 316(b) Demonstration Program. Prepared for the Los Angeles Dept. Water and Power, Los Angeles, CA. Nov. 1981.
- Jackson, G. D. 1998. Research into the life history of *Loligo opalescens*: where to from here? *CalCOFI Rep.* 39:101–107.
- Jaeger, E. C. and A. C. Smith. 1966. Introduction to the natural history of southern California. Univ. Calif. Press, Berkeley, CA. 104 p.
- Jarvis, E. T., M. J. Allen, and R. W. Smith. 2004. Comparison of recreational fish catch trends to environment-species relationships and fishery-independent data in the southern California bight, 1980–2000. *CalCOFI Rep.* 45:167–179.
- Jensen, G. C. 1995. Pacific coast crabs and shrimps. *Sea Challengers*, Monterey, CA. 87 p.
- Johansson, P. K. E., T. G. Douglass, and C. G. Lowe. 2004. Caudal spine replacement and histogenesis in the round stingray, *Urobatis halleri*. *Bull. So. Calif. Acad. Sci.* 103(3)115–124.
- Johnson, C. R. 1970. Notes on the intertidal life history of the northern clingfish, *Gobiesox maeandricus* (Gerard). *Amer. Midland Nat.* 83 (2): 625–627.
- Johnson, M. W. 1956. The larval development of the California spiny lobster, *Panulirus interruptus*, (Randall), with notes on *Panulirus gracilis* Streets. *Proc. Calif. Acad. Sci. Fourth Series* 29(1):1–19.

- Jordan, D. S. and B. W. Evermann. 1896. The fishes of Middle and North America: A descriptive catalogue of the species of fish-like vertebrates found in the waters of North America.
- Karpov, K. A. and G. M. Cailliet. 1979. Prey composition of the market squid, *Loligo opalescens* Berry, in relation to depth and location of capture, size of squid, and sex of spawning squid. CalCOFI Rep. 20:51–57.
- Kramer, S. H. 1991. Growth, mortality, and movements of juvenile California halibut *Paralichthys californicus* in shallow coastal and bay habitats of San Diego County, California. Fish. Bull. 89(2):195–207.
- Kramer, S. H., J. S. Sunada, and S. P. Wertz. 2001. California halibut. Pp. 195–197 in W. S. Leet, C. M. Dewees, R. Klingbeil, and E. J. Larson, eds. California's Living Marine Resources: A Status Report. Univ. Calif. Press. 592 p.
- Lamb, A., and Edgell, P. 1986. Coastal Fishes of the Pacific Northwest. Harbour Publishing Co. Ltd., Canada. 224 p.
- Lang, M. A and F. G. Hochberg, eds. 1997. Proceedings of the Workshop on the Fishery and Market Potential of Octopus in California. Univ. So. Calif., Catalina Mar. Sci. Center, 31 Aug. – 8 Sep. 1989. Smith. Inst., Wash. D.C. 191 p.
- Larkin, P. A. 1996. Concepts and issues in marine ecosystem management. Rev. in Fish Biol. and Fisheries 6:139–164.
- Lea, R. N. and R. H. Rosenblatt. 2000. Observations on fishes associated with the 1997-98 El Niño off California. CalCOFI Rep. 41:117–129.
- Limbaugh, C. 1961. Life-history and ecological notes on the black croaker. Calif. Dept. Fish and Game, Fish Bull. 47:163-174.
- Limbaugh, C. 1964. Notes on the life history of two Californian pomacentrids: garibaldi, *Hypsypops rubicundus* (Girard), and blacksmith, *Chromis punctipinnis* (Cooper). Pac. Sci. 28:41–50.
- Link, J. S. 2002. Ecological considerations in fisheries management: when does it matter? Fisheries 27(4):10–17.
- Lluch-Belda, D. R. M. Laurs, D. B. Lluch-Cota and S. E. Lluch-Cota. 2001. Long-term trends of interannual variability in the California Current System. CalCOFI Rep. 42:129–144.
- Love, M. 1996. Probably more than you want to know about the fishes of the Pacific Coast. Really Big Press, Santa Barbara, CA. 381 p.
- Love, M. S. 2001. California scorpionfish. Pp. 160–161 in W. S. Leet, C. M. Dewees, R. Klingbeil, and E. J. Larson, eds. California's Living Marine Resources: A Status Report. Univ. Calif. Press. 592 p.

- Love, M. S. and A. Brooks. 1990. Size and age at first maturity of the California halibut, *Paralichthys californicus*, in the southern California Bight. Pp. 167–174 in C. W. Haugen, ed. The California halibut, *Paralichthys californicus*, resource and fisheries. Calif. Dept. of Fish Game, Fish Bull. 174.
- Love, M. S., G. E. McGowen, W. Westphal, R. J. Lavenberg, and L. Martin. 1984. Aspects of the life history and fishery of the white croaker, *Genyonemus lineatus* (Sciaenidae) off California. Fish. Bull. 82(1):179–198.
- Love, M. S., J. S. Stephens Jr., P. A. Morris, M. M. Singer, M. Sandhu, and T. C. Sciarrotta. 1986. Inshore soft substrata fishes in the southern California Bight: an overview. CalCOFI Rep. 27:84–104.
- Love, M. S., B. Axell, P. Morris, R. Collins, and A. Brooks. 1987. Life history and fishery of the California scorpionfish, *Scorpaena guttata*, within the Southern California Bight. Fish. Bull. 85:99–116.
- Love, M. S., A. Brooks, and J. R. R. Ally. 1996. An analysis of commercial passenger fishing vessel fisheries for kelp bass and barred sand bass in the southern California Bight. Calif. Dept. Fish and Game, Fish Bull. 82(3):105–121.
- Love, M. S., D. Busatto, J. Stephens and P. A. Gregory, 1996. Aspects of the life histories of the kelp bass, *Paralabrax clathratus*, and barred sand bass, *P. nebulifer*, from the southern California Bight. Fish. Bull. 94:472–481.
- Love M, S, J. E. Caselle, and W. Van Buskirk. 1998. A severe decline in the commercial passenger fishing vessel rockfish (*Sebastes* spp.) catch in the southern California bight, 1980-1996. CalCOFI Rep. 39:180–195.
- Love, M. S., M. Yoklavich, and L. Thorsteinson. 2002. The Rockfishes of the Northeast Pacific. Univ. Calif. Press, Berkley, CA. 405 p.
- Love, M. S., C. W. Mecklenburg, T. A. Mecklenburg, and L. K. Thorsteinson. 2005. Resource Inventory of Marine and Estuarine Fishes of the West Coast and Alaska: A Checklist of North Pacific and Arctic Ocean Species from Baja California to the Alaska–Yukon Border. U. S. Department of the Interior, U. S. Geological Survey, Biological Resources Division, Seattle, Washington, 98104, OCS Study MMS 2005-030 and USGS/NBII 2005-001.
- Lowe, C. G., D. T. Topping, D. P. Cartamil, and Y. P. Papastamatiou. 2003. Movement patterns, home range, and habitat utilization of adult kelp bass *Paralabrax clathratus* in a temperate no-take marine reserve. Mar. Ecol. Progr. Ser. 256:205–216.
- MacCall, A.D., 2005. Assessment of Vermilion Rockfish in Southern and Northern California, August 2005. NOAA NMFS Southwest Fisheries Science Center. 128 p.
- MacCall, A. D., K. R. Parker, R. Leithiser, and B. Jessee. 1983. Power plant impact assessment: A simple fishery production model approach. Fish. Bull. 81(3):613–619.

- MacDonald, C. K. 1975. Notes on the family Gobiidae from Anaheim Bay. pp. 117–121 In E. D. Lane and C. W. Hill (eds.). The marine resources of Anaheim Bay. Calif. Dept. Fish and Game, Fish Bull. 165.
- Macewicz, B. J., J. R. Hunter, N. C. H. Lo, and E. L. LaCasella. 2004. Fecundity, egg deposition, and mortality of market squid (*Loligo opalescens*). Fish. Bull. U.S. 102(2):306–327.
- MacGinitie, G. E. 1939. The natural history of the blind goby, *Typhlogobius californiensis*, Steindachner. The Amer. Midland Natu. 21(2):489–505.
- MacNair, L. S., M. L. Domeier, and C. S. Y. Chun. 2001. Age, growth, and mortality of California halibut, *Paralichthys californicus*, along southern and central California. Fish. Bull. 99(4):588–600.
- Mangel, M. and P. S. Levin. 2005. Regime, phase and paradigm shifts: making community ecology the basic science for fisheries. Phil. Trans. Royal Soc. B. 360:95–105.
- Mason, J. E. 2004 Historical patterns from 74 years of commercial landings from California waters. CalCOFI Rep. 45:180–190.
- Matarese, A. C., A. W. Kendall Jr., D. M. Blood, and B. M. Vintner. 1989. Laboratory guide to early life history stages of northeast Pacific fishes. NOAA Technical Report NMFS 80, 652 p.
- MBC Applied Environmental Sciences (MBC). 1985. Santa Monica Bay: Sport Fishing Revitalization Study (In Response to Assembly Bill No. 2642, Ch. 1525, Stat. 1984). Prepared for Calif. Dept. Fish and Game. Dec. 1985.
- MBC Applied Environmental Sciences (MBC). 1987. Ecology of important fisheries species offshore California. OCS Study 86-0093. Prepared for Minerals Management Service, Pacific OCS Region. 251 p.
- MBC Applied Environmental Sciences (MBC). 1988. The State of Santa Monica Bay: Part I. Assessment of conditions and pollution impacts. Prepared for the So. Calif. Assoc. Gov. Oct. 1988.
- MBC Applied Environmental Sciences (MBC). 1993. Santa Monica Bay Characterization Study, 1993. Prepared for the Santa Monica Bay Rest. Proj. April 1993.
- MBC Applied Environmental Sciences (MBC). 2003. National pollutant discharge elimination system 2003 receiving water monitoring report. El Segundo and Scattergood Generating Stations, Los Angeles County, California. Prepared for Los Angeles Dept. Water and Power and El Segundo Power L.L.C. 63 p., plus appendices.
- MBC Applied Environmental Sciences (MBC). 2004. National Pollutant Discharge Elimination System 2003 receiving water monitoring report, AES Redondo Beach L.L.C. Generating Station, Los Angeles County, California. Prepared for AES Redondo Beach L.L.C. 63 p. plus appendices.

- MBC Applied Environmental Sciences (MBC). 2005. National Pollutant Discharge Elimination System 2004 receiving water monitoring report, AES Redondo Beach L.L.C. Generating Station, Los Angeles County, California. Prepared for AES Redondo Beach L.L.C. 62 p. plus appendices.
- MBC Applied Environmental Sciences (MBC). 2006. National Pollutant Discharge Elimination System 2005 receiving water monitoring report, AES Redondo Beach L.L.C. Generating Station, Los Angeles County, California. Prepared for AES Redondo Beach L.L.C. 70 p. plus appendices.
- MBC Applied Environmental Sciences (MBC). 2007. National Pollutant Discharge Elimination System 2006 receiving water monitoring report, AES Redondo Beach L.L.C. Generating Station, Los Angeles County, California. Prepared for AES Redondo Beach L.L.C. 73 p. plus appendices.
- MBC Applied Environmental Sciences (MBC) and Tenera Environmental. 2005. AES Huntington Beach Generating Station Entrainment and Impingement Study Final Report. Prepared for AES Huntington Beach L.L.C. and California Energy Commission, Sacramento, California. April 2005.
- McCosker, J. E. 2006. Symbiotic relationships. Pp. 554–563 *in* The ecology of marine fishes: California and adjacent waters. L. G. Allen, D. J. Pondella II, and M. H. Horn, eds., Univ. Calif. Press., Los Angeles, CA. 660 p.
- McGowan, J. A. 1954. Observations on the sexual behavior and spawning of the squid, *Loligo opalescens*, at La Jolla, California. Calif. Dept. Fish and Game, Fish Bull. 40(1):47–54.
- McGowen, G. 1978. Effects of thermal effluent from Southern California Edison's Redondo Beach Steam Generating Plant on the warm temperate fish fauna of King Harbor Marina. Ichthyoplankton study report for Phase III. Occidental College, Los Angeles, CA. Submitted to So. Calif. Edison Co. 78-RD-47. Aug. 1978. 65 p. plus appendices.
- Methot, R. D., Jr. and D. Kramer. 1979. Growth of the northern anchovy, *Engraulis mordax*, larvae in the sea. Fish. Bull. 77:413–420.
- Middaugh, D. P., M. J. Hemmer, J. M. Shenker, and T. Takita. 1990. Laboratory culture of jacksmelt, *Atherinopsis californiensis*, and topsmelt, *Atherinops affinis* (Pisces: Atherinidae), with a description of larvae. Calif. Dept. Fish and Game, Fish Bull. 76(1):4–13.
- Miller, D. J. and R. N. Lea. 1972. Guide to the coastal marine fishes of California. California Fish Bulletin No. 157. 249 p.
- Miller, E. F. and L. G. Allen. 2006. Observations on the mating behavior of captive spotted sand bass (*Paralabrax maculatofasciatus*). Bull. So. Calif. Acad. Sci. 105(1):17–29.
- Miller, E. F., D. J. Pondella, and L. G. Allen. In prep. a. Aspects of the life history of black croaker, *Cheilotrema saturnum*, within the Southern California Bight.
- Miller, E.F., D.J. Pondella, and L. G. Allen. In prep. b. Distribution and reproduction of two commons southern California sciaenids, spotfin croaker (*Roncador stearnsii*) and California corbina (*Menticirrhus undulatus*).



- Mitchell, C. T., C. H. Turner, and A. R. Strachan. 1969. Observations on the biology and behavior of the California spiny lobster, *Panulirus interruptus* (Randall). Calif. Dept. Fish and Game, Fish Bull. 55(2):121–131.
- Moore, S. L. 2001. Age and growth of white croaker (*Genyonemus lineatus*) off Palos Verdes and Dana Point, California. Pp. 154–163 in SCCWRP Annual Report 1999-2000. So. Calif. Coastal Water Res. Project, Westminster, CA. March 2001. 308 p.
- Moore, S. L. and P. W. Wild. 2001. White croaker. Pp. 234–235 in W. S. Leet, C. M. Dewees, R. Klingbeil, and E. J. Larson, eds. California's Living Marine Resources: A Status Report. Univ. Calif. Press. 592 p.
- Morris, R. H., D. P. Abbott, and E. C. Haderlie. 1980. Intertidal invertebrates of California. Stanford Univ. Press, Stanford, CA. 690 p.
- Moser, H.G., ed. 1996. The early stages of fishes in the California Current Region. CalCOFI Atlas No. 33. Allen Press, Inc., Lawrence, KS. 1,505 p.
- Moser, H. G., R. L. Charter, W. Watson, D. A. Ambrose, K. T. Hill, P. E. Smith, J. L. Butler, E. M. Sandknop, and S. R. Charter. 2001. The CalCOFI ichthyoplankton time series: potential contributions to the management of rocky-shore fishes. CalCOFI Rep. 42: 112–128.
- Moyle, P. B. and Cech. 1988. Fishes: An Introduction to Ichthyology. Department of Wildlife and Fisheries Biology, Univ. Calif. Davis. Prentice Hall, Englewood Cliffs, NJ.
- Murdoch, W. W., B. J. Mechalas, and R. C. Fay. 1989a. Technical Report to the California Coastal Commission. D. Adult-Equivalent Loss. 33 p.
- Murdoch, W. W., B. J. Mechalas, and R.C. Fay. 1989b. Technical Report to the California Coastal Commission. N. Integration of local repressions and increases in fish stocks with inplant losses.
- Murdoch, W.W., R. C. Fay, and B. J. Mechalas. 1989c. Final Report of the Marine Review Committee to the California Coastal Commission, MRC Doc. No. 89-02, 346 p.
- National Data Buoy Center (NDBC). 2007. Web site: <http://www.ndbc.noaa.gov/>. Accessed 27 March 2007. Data Buoy 46025 located just offshore Santa Monica Bay.
- National Marine Fisheries Service (NMFS). 1999. Our living oceans. Report on the status of the U.S. living marine resources, 1999. U.S. Dept. Commerce, NOAA Tech. Memo. NMFS-F/SPO-41. 301 p.
- National Marine Fisheries Service (NMFS). 2007. Recreational sport fisheries data for southern California. <http://swfscdata.nmfs.noaa.gov/latimes/>
- National Marine Fisheries Service – Southwest Fisheries Science Center (NMFS – SWFSC). 2007. Website: <http://swfsc.noaa.gov/textblock.aspx?Division=FRD&id=929&ParentMenuId=100>. Accessed 12 Feb. 2007.

- National Ocean Service (NOS). 2007. Web site: <http://co-ops.nos.noaa.gov/>. Accessed 27 March 2007. Water level data for Santa Monica tide gauge.
- Neighbors, M. A. and R. R. Wilson, Jr. 2006. Deep sea. Pp. 342–383 *in* The ecology of marine fishes: California and adjacent waters. L. G. Allen, D. J. Pondella II, and M. H. Horn, eds., Univ. Calif. Press., Los Angeles, CA. 660 p.
- Nelson, J. S. 1994. Fishes of the World, 3rd Ed. John Wiley and Sons, Inc., New York. 600 p.
- Newbold, S. C. and R. Iovanna. 2007. Population level impacts of cooling water withdrawals on harvested fish stocks. Environ. Sci. Technol. 41:2,108–2,114.
- Ninos, M. 1984. Settlement and metamorphosis in *Hypsoblennius* (Pisces, Blenniidae). Ph.D Thesis, Univ. of So. Calif. 86 p.
- Norton, J. G. and J. E. Mason. 2004. Locally and remotely forced environmental influences on California commercial harvest of fish and invertebrate landings. CalCOFI Rep. 45:136–145.
- Norton, J. G. and J. E. Mason. 2005. Relationship of California sardine (*Sardinops sagax*) abundance to climate-scale ecological changes in the California Current system. CalCOFI Rep. 46:83–92.
- Oda, D. L., R. J. Lavenberg, and J. M. Rounds. 1993. Reproductive biology of three California species of *Paralabrax* (Pisces: Serranidae). CalCOFI Rep. 34:122–132.
- PacFIN. 2007. Pacific Coast Fisheries Information Network. <http://www.psmfc.org/pacfin/data.html>.
- Pacific Fishery Management Council. 1983. Northern anchovy management plan incorporating the final supplementary EIS/OPIR/IRFA. Pac. Fish. Mgmt. Council, Portland, OR.
- Pacific Fishery Management Council. 1998. Coastal Pelagic Species Fishery Management Plan. Amendment 8 to the Northern Anchovy Fishery Management Plan. Dec. 1998. 40 p. plus appendices.
- Pacific Fishery Management Council. 2006. Pacific Coast Groundfish Fishery Management Plan: For the California, Oregon, and Washington Groundfish Fishery as Amended through Amendment 19 (including Amendment 16-4). Nov. 2006. 167 p. plus appendices.
- Parker, D. 2001. Rock crabs. Pp. 112-114 *in* W. S. Leet, C. M. Dewees, R. Klingbeil, and E. J. Larson, eds. California's Living Marine Resources: A Status Report. Univ. Calif. Press. 592 p.
- Parker, K. R., and E. E. DeMartini. 1989. Chapter D: Adult-equivalent loss. Technical Report to the California Coastal Commission. Prepared by Marine Review Committee, Inc., 56 p.
- Parrish, R. H., C. H. Nelson, and A. Bakun. 1986. Transport mechanisms and reproductive success of fishes in the California Current. Biol. Oceanog. 1(2):175–203.

- Pearcy, W. G. and S. S. Myers. 1974. Larval fishes of Yaquina Bay, Oregon: A nursery ground for marine fishes? *Fishery Bulletin* 72(1):201-213.
- Peterson W. T., R. Emmett, R. Goericke, E. Venrick, A. Mantyla, S. J. Bograd, F. B. Schwing, R. Hewitt, N. Lo, W. Watson, J. Barlow, M. Lowry, S. Ralston, K. A. Forney, B. E. Lavaniegos, W. J. Sydeman, D. Hyrenbach, R. W. Bradley, P. Warzybok, F. Chavez, K. Hunter, S. Benson, M. I. Weise, and J. Harvey. 2006. The state of the California Current, 2005-2006: warm in the north, cool in the south. *CalCOFI Rep.* 47:30-74.
- Pondella, D. J., II and L. G. Allen. Can we save the big fish? In review, *Marine Biology*.
- Pondella, D. J., II, and J. S. Stephens, Jr. 1994. Factors affecting the abundance of juvenile fish species on a temperate artificial reef. *Bulletin of Marine Science.* 55(2):1,216-1,223.
- Pondella, D. J., II, and L. G. Allen. 2000. The nearshore fish assemblage of Santa Catalina Island. *In* D.R. Browne, K.L. Mitchell and H.W. Chaney, eds. *The Proceedings of the Fifth California Islands Symposium*, Santa Barbara Museum of Natural History, Santa Barbara, California: 394-400.
- Pondella D. J., II, J. S. Stephens, Jr., and M. T. Craig. 2002. Fish production of a temperate artificial reef based on the density of embiotocids (Teleostei: Perciformes). *ICES J. Mar. Sci.* 59:S88-S93.
- Power, J. H. 1986. A model of the drift of northern anchovy, *Engraulis mordax* larvae in the California Current. *Fish. Bull.* 78(4):855-876.
- Public Service Electric and Gas Company (PSE&G). 1993. Appendix I—Modeling. Permit No. NJ0005622. Prepared by Lawler, Matusky, and Skelly Engineers, Pearl River, NY. Comments on NJPDES Draft, 82 p.
- Quast, J. C. 1968a. Fish fauna of the rocky inshore zone. *in* W. J. North and C. L. Hubbs, eds. *Utilization of Kelp-Bed Resources in Southern California.* Calif. Dept. Fish and Game, Fish Bull. 139. 264 p.
- Quast, J. C. 1968b. Observations on the food of the kelp-bed fishes. *Calif. Dept. Fish and Game, Fish Bull.* 139:109-142. 55 p. plus appendices.
- Quast, J. C. 1968c. Estimates of the populations and the standing crop of fishes. *in* W. J. North and C. L. Hubbs, eds. *Utilization of Kelp-Bed Resources in Southern California.* Calif. Dept. Fish and Game, Fish Bull. 139. 264 p.
- Quast, J. C. 1968d. Observations on the food and biology of the kelp bass, *Paralabrax clathratus*, with notes on its sport fishery at San Diego, California. *Calif. Dept. Fish and Game, Fish Bull.* 139:81-108.
- RecFIN. 2007. Recreational Fisheries Information Network. <http://www.psmfc.org/recfin/data.htm>.
- Recksiek, C. W. and J. Kashiwada. 1979. Distribution of larval squid, *Loligo opalescens*, in various nearshore locations. *CalCOFI Rep.* 20:31-34.

- Ricker, W. E. 1975. Computation and interpretation of biological statistics of fish populations. Fish. Res. Board Can. Bull. 91, 382 p.
- Ricketts, E. F., J. Calvin, J. W. Hedgepeth, and D. W. Phillips. 1985. Between Pacific tides. Fifth Ed. Stanford Univ. Press, Stanford, California. 652 p.
- Ripley W. E. 1946. The soupfin shark and the fishery. Calif. Dept. Fish and Game, Fish Bulletin 64:7–38.
- Ritter, W. E. 1893. On the eyes, the integumentary sense papillae, and the integument of the San Diego blind fish (*Typhlogobius californiensis* Steindachner). Bull. Harvard Mus. Comp. Zool. 24(3):51–102.
- Roberts, D. A., E. E. DeMartini, and K. M. Plummer. 1984. The feeding habits of juvenile – small adult barred sand bass (*Paralabrax nebulifer*) in nearshore waters off northern San Diego County. CalCOFI Rep. 25:105–111.
- Robertson, D. R. and G. R. Allen. 2002. Shorefishes of the tropical eastern Pacific: an information system. Smithsonian Tropical Research Institution, Balboa, Panamá.
- Roesijadi, G. 1976. Descriptions of the prezoae of *Cancer magister* Dana and *Cancer productus* Randall and the larval stages of *Cancer antennarius* Stimpson (Decapoda, Brachyura). Crustaceana 31:275–295.
- Sadovy, Y. and M. L. Domier. 2005. Perplexing problems of sexual patterns in the fish genus *Paralabrax* (Serranidae, Serraninae). J. Zoo. 267:121–133.
- Sakagawa, G. T. and M. Kimura. 1976. Growth of laboratory-reared northern anchovy, *Engraulis mordax*, from southern California. Fish. Bull. 74(2):271–279.
- San Diego Gas and Electric (SDG&E). 1980. Encina Power Plant cooling water intake system demonstration. Prepared for California Regional Water Quality Control Board, San Diego Region.
- Santa Monica Bay Restoration Commission (SMBRC). 2004. State of the Bay 2004: Progress and Challenges. 45 p.
- Schlotterbeck, R. E. and D. W. Connally. 1982. Vertical stratification of three nearshore southern California larval fishes (*Engraulis mordax*, *Genyonemus lineatus*, and *Seriphus politus*). Fish. Bull. 80(4):895–902.
- Schwing, F. B., C. S. Moore, S. Ralston and K. M. Sakuma. 2000. Record coastal upwelling in the California Current in 1999. CalCOFI Rep. 41:148–160.
- Scofield, W. L. 1948. Trawling gear in California. Calif. Dept. Fish Game, Fish Bull. 72:60 p.
- Serfling, S. A. and R. F. Ford. 1975. Ecological studies of the puerulus larval stage of the California spiny lobster, *Panulirus interruptus*. Fish. Bull. 73(2):360-377.

- Sikkel, P. C. 1989. Egg presence and developmental stage influence spawning-site choice by female garibaldi. *Animal Behaviour* 38(3):447–456.
- Sikkel, P. C. 1994a. Filial cannibalism in a paternal-caring marine fish: The influence of egg developmental stage and position in the nest. *Animal Behaviour*. 47(5)1,149–1,158.
- Sikkel, P. C. 1994b. Why female garibaldi prefer males with young eggs: A test of the parental investment hypothesis. *Ethology, Ecology & Evolution*. 6(2):191–211.
- Sikkel, P. C. 1995. Effects of nest quality on male courtship and female spawning-site choice in an algal-nesting damselfish. *Bull. Mar. Sci.* 57(3):682–689.
- Smith, P. E. 1972. The increase in spawning biomass of northern anchovy, *Engraulis mordax*. *Fish. Bull.* 70:849–874.
- Somerton, D. A. 1980. A computer technique for estimating the size of sexual maturity in crabs. *Canad. J. Fish. Aquat. Sci.* 37:1,480-1,494.
- Southern California Edison Company (SCE). 1982a. 316(b) Demonstration Technical Appendix: Impact assessment model and Bight-wide plankton investigations. Southern California Edison Company Research and Development Series: 82-RD-93. 30 p. plus appendices.
- Southern California Edison Company (SCE). 1982b. Marine ichthyoplankton entrainment studies. August 1979-September 1980. Ormond Beach, Redondo Beach Units and 7 & 8, and San Onofre Nuclear Generating Station Unit 1. Volume II- Analysis and interpretation. Prepared by MBC Applied Environmental Sciences. Southern California Edison Company Research and Development Series: 82-RD-12. 62 pp.
- Southern California Edison Company (SCE). 1983. Redondo Beach Generating Station 316(b) Demonstration. Prepared for California Regional Water Quality Control Board, Los Angeles Region. Jan. 1983. 46 p. plus appendices.
- Spratt, J. D. 1979. Age and growth of the market squid, *Loligo opalescens* Berry, from statoliths. *CalCOFI Rep.* 20:58–64.
- Starr, R. M., K. A. Johnson, E. A. Laman, and G. M. Cailliet. 1998. Fishery resources of the Monterey Bay National Marine Sanctuary. Publ. No. T-042. California Sea Grant College System, Univ. Calif., La Jolla, CA. 102 p.
- Stephens, J. S. Jr. 1969. Growth, longevity, and the effect of size on the biology of certain Blennioid fishes. Final Report. National Science Foundation GB 5940. 83 p.
- Stephens, J. S., Jr. and D. Pondella II. 2002. Larval productivity of a mature artificial reef: the ichthyoplankton of King Harbor, California, 1974–1997. *ICES J. Mar. Sci.* 59:S51–S58.

- Stephens, J. S. Jr., R. K. Johnson, G. S. Key and J. E. McCosker. 1970. The comparative ecology of three sympatric species of California blennies of the genus *Hypsoblennius* Gill (Teleostomi, Blenniidae). Ecol. Monogr. 40(2):213–233.
- Stephens, J. S. Jr., P. A. Morris, K. E. Zerba, and M. Love. 1984. Factors affecting fish diversity on a temperate reef II: the fish assemblage of Palos Verdes Point, 1974–1981. *Envir. Biol. Fishes*, 11:259-275.
- Stephens, J. S., Jr., P. A. Morris, D. J. Pondella, T. A. Koonce, and G. A. Jordan. 1994. Overview of the dynamics of an urban artificial reef fish assemblage at King Harbor, California, USA, 1974-1991: A recruitment driven system. *Bull. Mar. Sci.* 55(2):1,224–1,239.
- Stephens, J. S., R. J. Larson, and D. J. Pondella. 2006. Rocky reefs and kelp beds. Pp. 227–252 in *The ecology of marine fishes: California and adjacent waters*. L. G. Allen, D. J. Pondella II, and M. H. Horn, eds., Univ. Calif. Press., Los Angeles, CA. 660 p.
- Stepien, C. A. 1986. Life history and larval development of the giant kelpfish, *Heterostichus rostratus* Girard, 1854. *Fish. Bull.* 84 (4): 809–826.
- Stevens, E. G. and H. G. Moser. 1982. Observations on the early life history of the mussel blenny, *Hypsoblennius jenkinsi*, and the bay blenny, *Hypsoblennius gentilis*, from specimens reared in the laboratory. *CalCOFI Rep.* 23:269–275.
- Stull, J. K., K. A. Dryden, and P. A. Gregory. 1987. A historical review of fisheries statistics and environmental and societal influences off the Palos Verdes Peninsula, California. *CalCOFI Rep.* 28:135–154.
- Stull, J. K. and C. Tang. 1996. Demersal fish trawls off Palos Verdes, Southern California, 1973-1993. *CalCOFI Rep.* 37:211–264.
- Swift, C. C. and G. D. Frantz. 1981. Estuarine fish communities of Ballona. Pp. F-1 to F-31 in R.W. Schreiber, ed. *The biota of the Ballona Region, Los Angeles County*. Los Angeles Co. Mus. Nat. Hist. Los Angeles, CA.
- Swift, C. C., J. L. Nelson, C. Maslow, and T. Stein. 1989. Biology and distribution of the tidewater goby, *Eucyclogobius newberryi* (Pisces: Gobiidae) in California. *Contributions in Science*, 404:1–19.
- Tegner, M. J. and L. A. Levin. 1983. Spiny lobsters and sea urchins: Analysis of a predator-prey interaction. *J. Exp. Mar. Biol. Ecol.* 73:125–150.
- Tenera Environmental. 2004. SBPP Cooling Water System Effects on San Diego Bay, Volume II: Compliance with Section 316(b) of the Clean Water Act for the South Bay Power Plant. Prepared for Duke Energy South Bay.
- Tenera Environmental. 2006. Compilation and analysis of CIAP nearshore survey data. Calif. Dept Fish Game. <http://www.dfg.ca.gov/mrd/fir/sss.html#crane>.

- Tenera Environmental. *In Prep.* EPS Cooling Water System Entrainment and Impingement of Marine Organisms: Effects on the Biological Resources of Agua Hedionda Lagoon and the Nearshore Ocean Environment. Prepared for NRG Cabrillo Encina Power Station.
- Terry, R. D., S. A. Keesling, and E. Uchupi. 1956. Submarine geology of Santa Monica Bay, California. Report to Hyperion Engineers, Inc., Geol. Dept., Univ. So. Calif., Los Angeles, CA. 177 p.
- U.S. Army Corps of Engineers (USACE). 1986. Southern California Coastal Processes Data Summary. Coast of California Storm and Tidal Waves Study, Rep. CCSTWS 86-1. Feb. 1986. 572 p.
- Ueber, E. 1988. The traditional central California setnet fishery. *Mar. Fish. Rev.* 50(2):40–48.
- Valle, C. F., J. W. O'Brien, and K. B. Wiese. 1999. Differential habitat use by California halibut, *Paralichthys californicus*, barred sand bass, *Paralabrax nebulifer*, and other juvenile fishes in Alamitos Bay, California. *Fish. Bull.* 97(3):646–660.
- VanBlaricom, G. R. 1979. Experimental analyses of structural regulation in a marine sand community exposed to oceanic swell. *Ecol. Monogr.*, Vol. 52(3), pp. 283–305.
- VenTresca, D. A. 2001. Vermilion Rockfish. Pp. 189-190 in W. S. Leet, C. M. Dewees, R. Klingbeil, and E. J. Larson, eds. California's Living Marine Resources: A Status Report. Univ. Calif. Press. 592 p.
- Vojkovich, M. 1998. The California fishery for market squid (*Loligo opalescens*). *CalCOFI Rep.* 39:55–60.
- Wang, J. C. S. 1986. Fishes of the Sacramento-San Joaquin Estuary and Adjacent Waters, California: a Guide to the Early Life Histories. Interagency Ecological Study Program for the Sacramento-San Joaquin Estuary, Technical Report 9.
- Ware, R. R. 1979. The food habits of the white croaker *Genyonemus lineatus* and an infaunal analysis near areas of waste discharge in Outer Los Angeles Harbor. Thesis, Calif. State Univ. Long Beach. August 1979. 163 p.
- Warner, R. R. 1984. Mating behavior and hermaphroditism in coral reef fishes. *American Scientist* 72:128–136.
- Watson, W. 1982. Development of eggs and larvae of the white croaker, *Genyonemus lineatus* Ayres (Pisces: Sciaenidae) off the southern California coast. *Fish. Bull.* 80(3):403–417.
- Watson, W. 1996. Gobiesocidae: Clingfishes. Pp. 597-603 *In* The Early Stages of Fishes in the California Current System (H. G. Moser, Ed.), Vol. 33. Allen Press, Inc, La Jolla, California.
- Wellington, G. M. and B. C. Victor. 1989. Planktonic duration of one hundred species of Pacific and Atlantic damselfishes (Pomacentridae). *Mar. Biol.* 101:557–567.

- Wells, A. W. 1979. Notes on the life history of the California clingfish, *Gobiesox rhesodon* (Gobiesociformes, Gobiesocidae). California Dept. Fish and Game, Fish Bull. 65: 106–110.
- Williams, G. C. 1954. Differential vertical distribution of the sexes in *Gibbonsia elegans* with remarks on two nominal subspecies of this fish. Copeia. 4: 267–273.
- Wilson, D. C. and R. E. Millemann. 1969. Relationships of female age and size embryo number and size in the shiner perch, *Cymatogaster aggregata*. J. Fish. Res. Board Can. 267:2,339–2,344.
- Wilson, R. C. 1948. A review of the southern California spiny lobster fishery. Calif. Dept. Fish and Game, Fish Bull. 34(2):71–80.
- Wilson-Vandenberg, D. and R. Hardy, 2001. Cabezon. Pp. 156–159 in W. S. Leet, C. M. Dewees, R. Klingbeil, and E. J. Larson, eds. California's Living Marine Resources: A Status Report. Univ. Calif. Press. 592 p.
- Winn, R. N. 1985. Comparative ecology of three cancrid crab species (*Cancer anthonyi*, *C. antennarius*, *C. productus*) in marine subtidal habitats in southern California. Ph.D. Dissertation, Univ. So. Calif. 235 p.
- Yang, W. T., R. F. Hixon, P. E. Turk, M. E. Krejci, W. H. Hulet, and R. T. Hanlon. 1986. Growth, behavior, and sexual maturation of the market squid, *Loligo opalescens*, cultured through the life cycle. Fish. Bull. 84(4):771–798.
- Young, P. H. 1963. The kelp bass (*Paralabrax clathratus*) and its fishery, 1947–1958. Calif Dept. Fish and Game, Fish. Bull. 122. 67 p.
- Zeidberg, L. D., W. Hamner, K. Moorehead, and E. Kristof. 2004. Egg masses of *Loligo opalescens* (Cephalopoda: Myopida) in Monterey Bay, California following the El Niño event of 1997-1998. Bull. Mar. Sci. 74(1):129–141.
- Zorzi, G. D., L. K. Martin, and J. Ugoretz. 2001. Skates and rays. Pp. 257–261 in W. S. Leet, C. M. Dewees, R. Klingbeil, and E. J. Larson, eds. California's Living Marine Resources: A Status Report. Univ. Calif. Press. 592 p.



*Redondo Beach Generating Station*

## **Appendix A**

---

# **Physical Oceanographic Data**

A1. Source Water Currents

A2. Source Water Temperatures from ADCP Instruments



## Appendix A1 Source Water Currents

Physical oceanographic data were collected from the source water body to describe current regimes that can affect larval transport in the vicinity of the RBGS. A Nortek Aquadopp® acoustic Doppler current profiler (ADCP) was positioned approximately 1.0 km (0.6 mi) from shore at a depth of –16.15 m (–52.99 ft) MLLW (CM5, Figures A1-1 to A1-4). The latitudes and longitudes of the station was 33.852542°N, -118.410757°W. The CM 5 station was commissioned on January 10, 2006 and was decommissioned on January 19, 2007. Data was downloaded on February 3, 2006, May 3, 2006, and September 1, 2006. CM 5 had an operating frequency of 1 MHz and collected data at hourly intervals in a usable range that extended from 0.4 m (blanking range, 1.3 ft) from the ADCP to somewhat less than 90% of the distance to the surface. The half-power full beam-width was 2.4 degrees. Other measurement specifications are listed in Table A1-1. Water temperature and water depth (pressure) were also measured monthly (Table A2-1, Figures A2-1 to A2-8). Water temperatures were calibrated over an approximately four-month period from September 2006 to January 2007 using a calibrated Starr-Oddi thermistor. Pressure measurements were adjusted using barometric pressure data measured at the Los Angeles International Airport and corrected for sea level.

Table A1-1. ADCP deployment parameters for current meter in the vicinity of RBGS (Stations CM 5).

Unit	Oper. Freq.	Deploy depth (m)	Cells (#)	Cell size (m)	Max. range (m)	Cell precision (cm/s)	Ping rate	Averaging Interval (s)	Repetition rate (hr)
CM 5	1 MHZ	16.15	17	1.0	17.4	0.8	87%	180	1.0

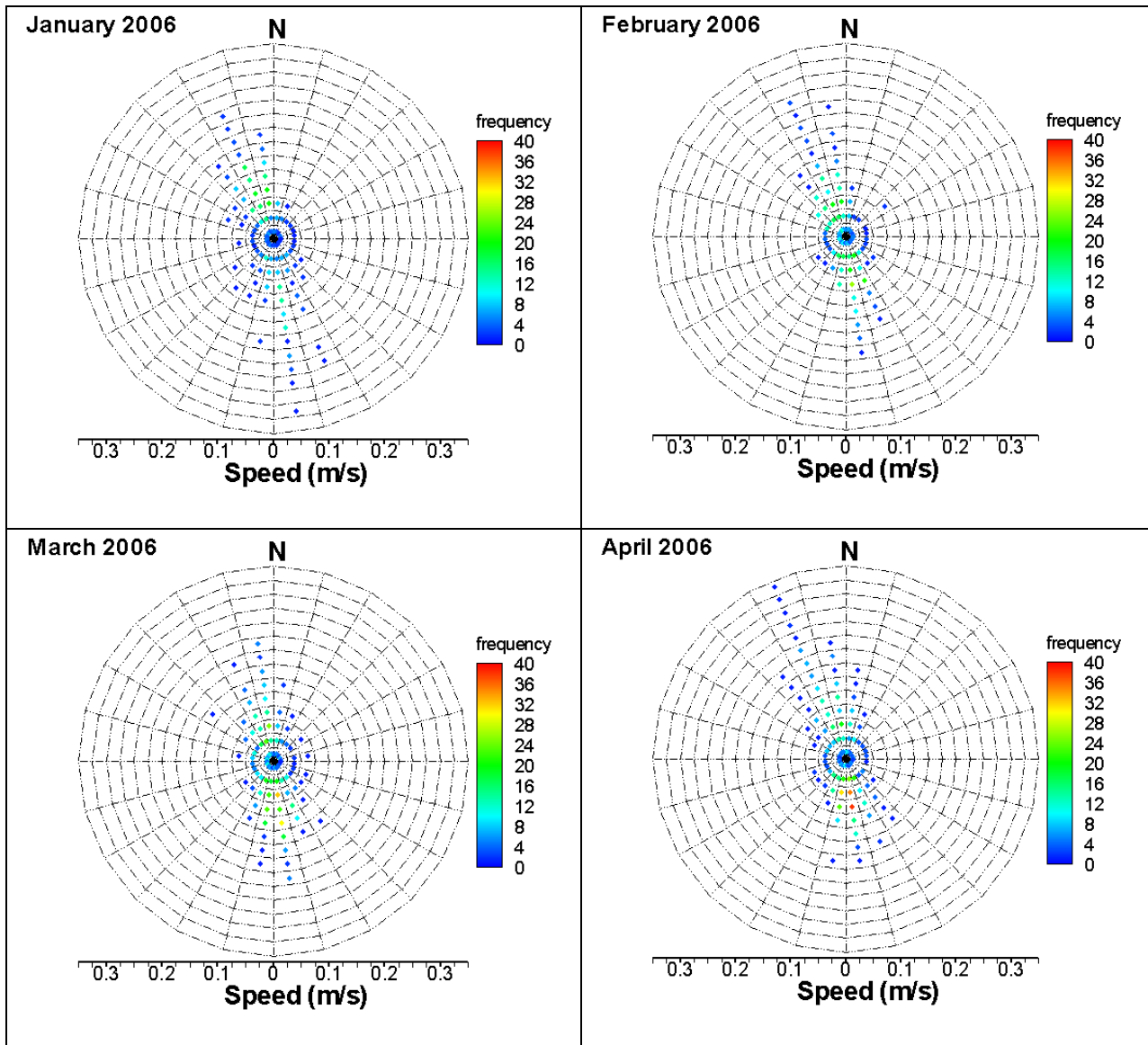

**Figure A1-1.** Hourly estimates of water column speed and direction at location CM 5, January – April 2006. Frequency is number of hourly observations.

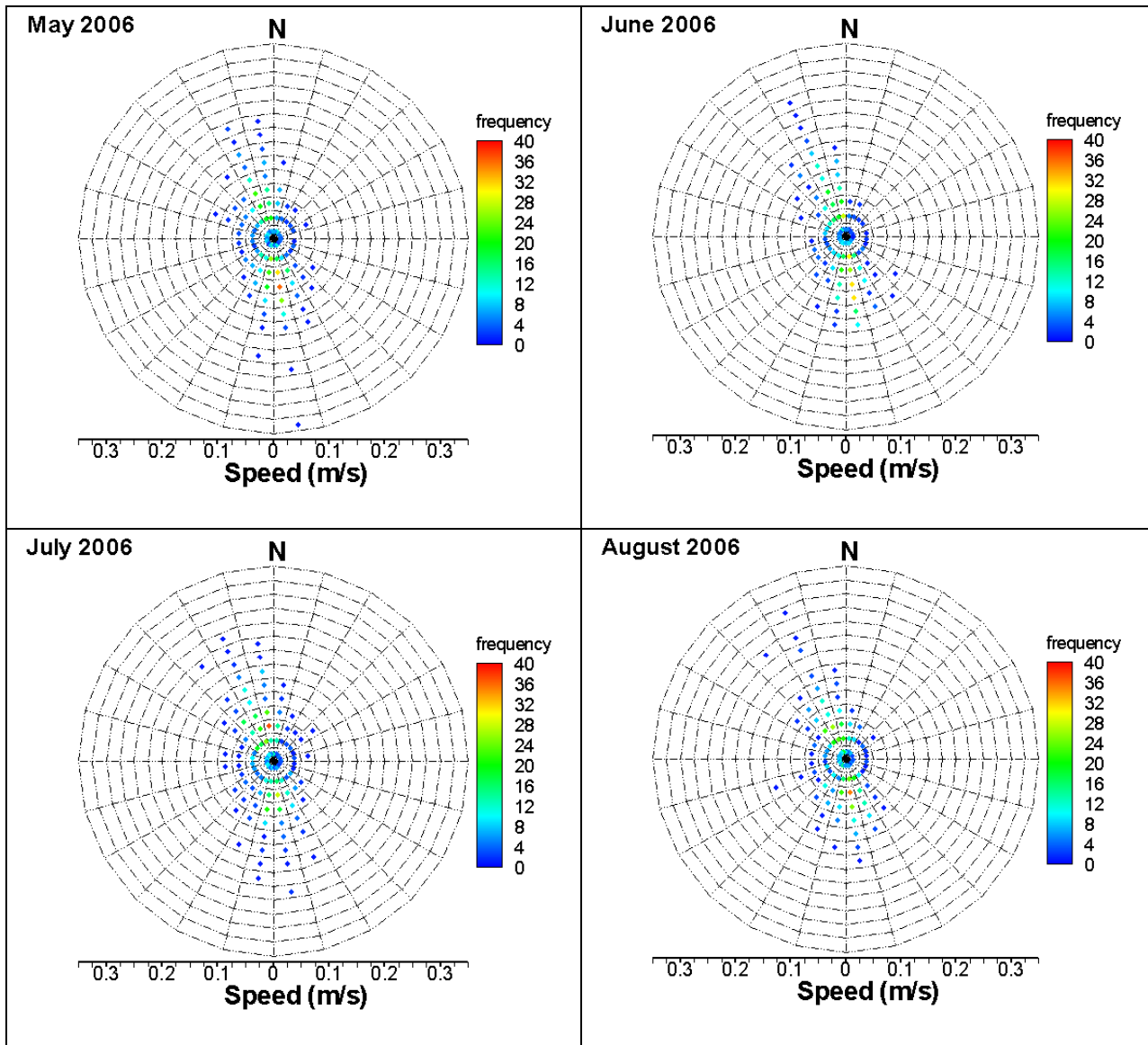

**Figure A1-2.** Hourly estimates of water column speed and direction at location CM 5, May – August 2006. Frequency is number of hourly observations.

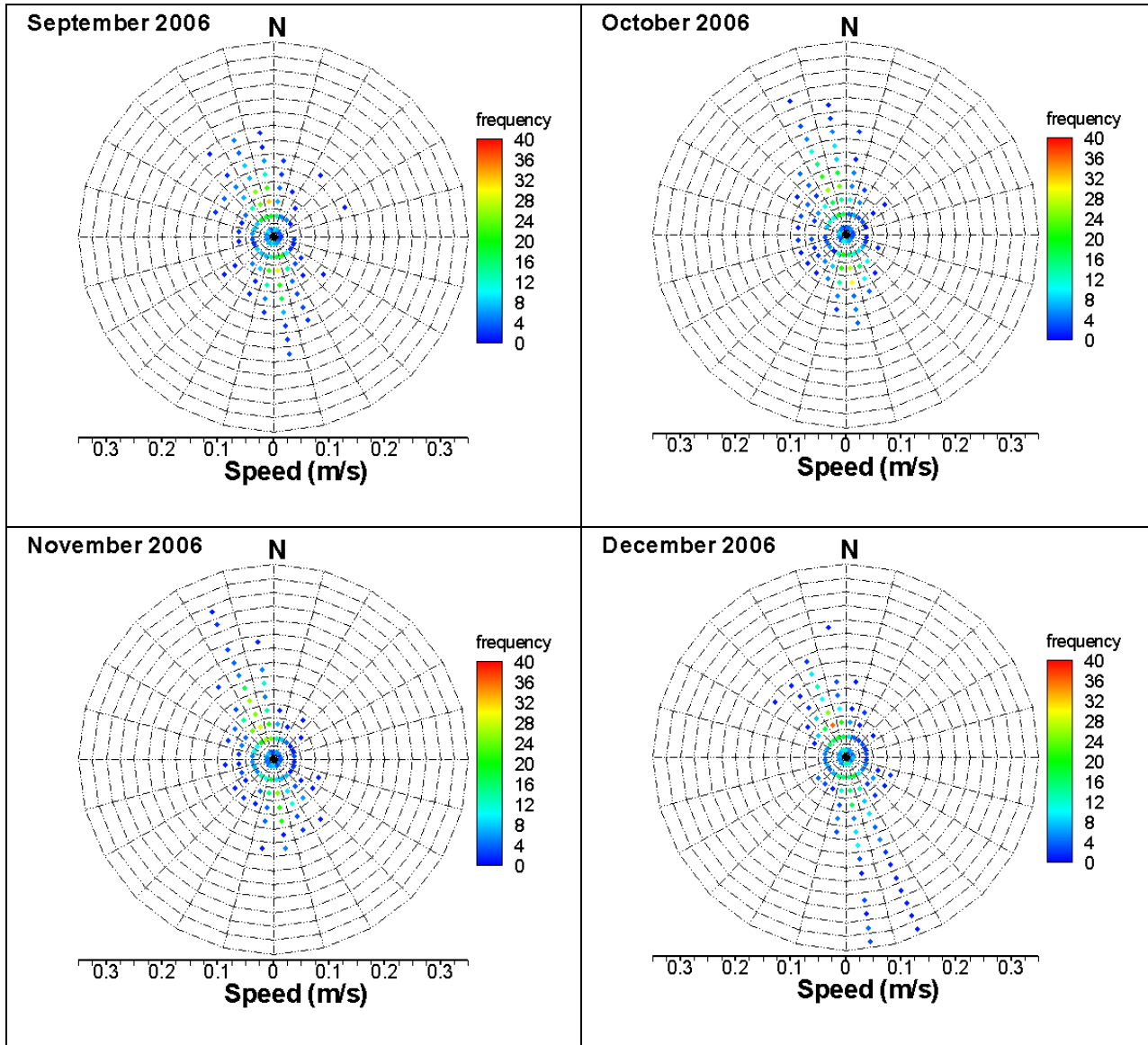

**Figure A1-3.** Hourly estimates of water column speed and direction at location CM 5, September – December 2006. Frequency is number of hourly observations.

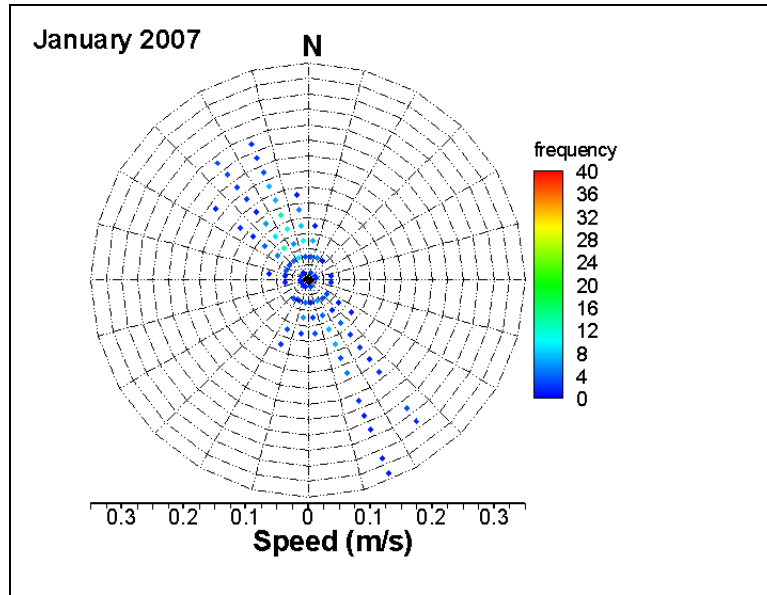

**Figure A1-4.** Hourly estimates of water column speed and direction at location CM 5, January 2007. Frequency is number of hourly observations.

**Appendix A2**  
**Source Water Temperatures from ADCP Instruments**



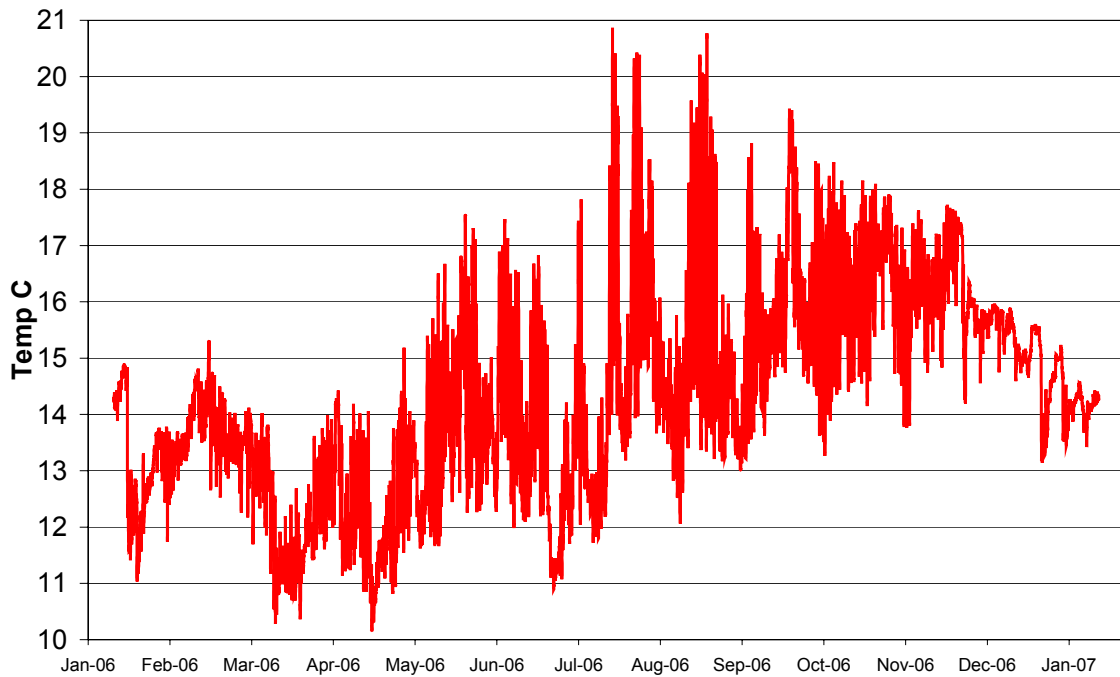

Figure A2-1. Yearly temperature from January 2006 to January 2007 at CM5.

Table A2-1. Monthly and yearly mean temperatures recorded from January 2006 through January 2007 at CM5.

Month	Mean	Standard Dev	Max	Min
January	13.14	0.97	14.88	11.06
February	13.70	0.51	15.29	12.28
March	12.18	0.96	14.12	10.29
April	12.21	0.98	15.18	10.17
May	13.66	1.28	17.53	11.65
June	13.50	1.44	17.47	10.89
July	14.46	2.05	20.84	11.73
August	15.02	1.60	20.70	12.09
September	15.45	1.40	19.40	13.02
October	16.11	1.08	18.49	13.29
November	16.26	0.83	17.88	13.77
December	15.31	0.63	16.36	13.14
January 07	14.31	0.39	15.21	13.42
<b>Total Year</b>	<b>14.28</b>	<b>1.78</b>	<b>20.84</b>	<b>10.17</b>

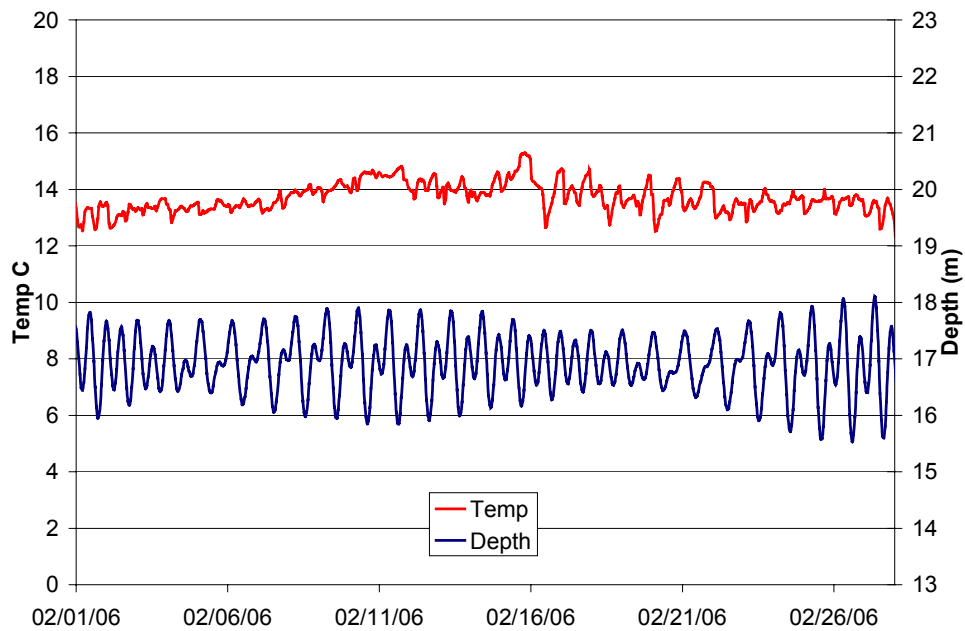
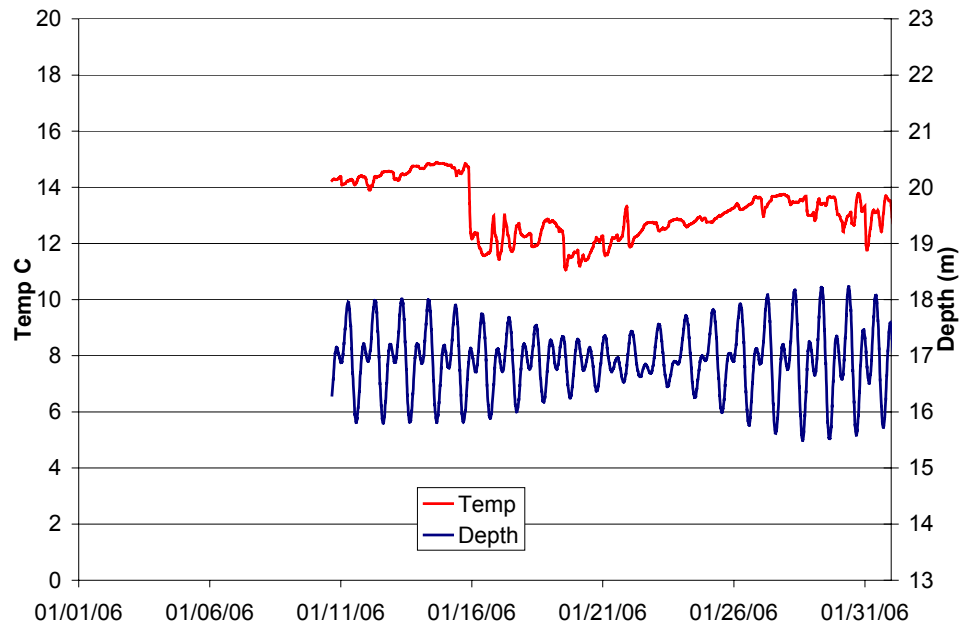
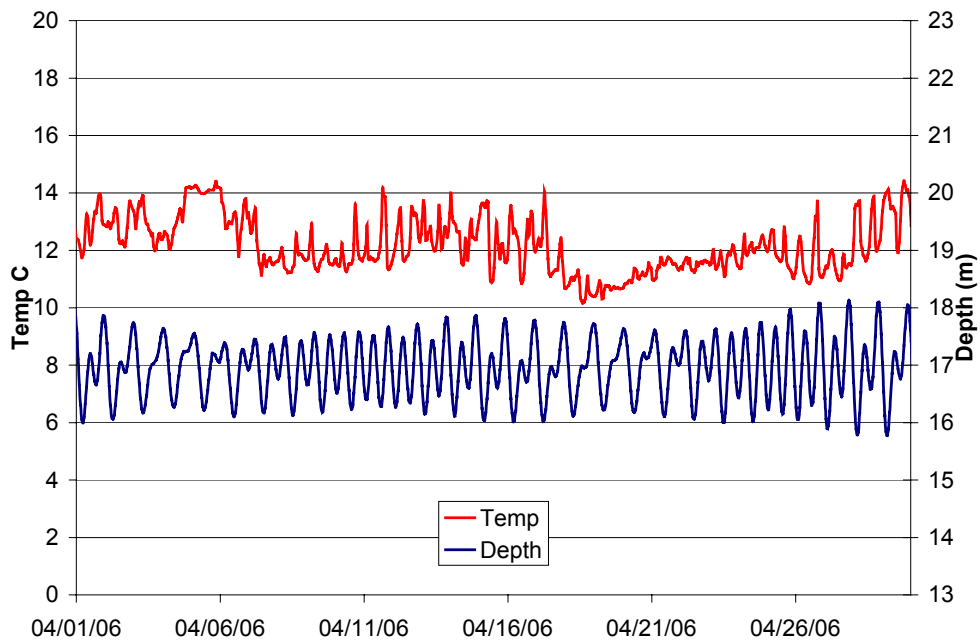
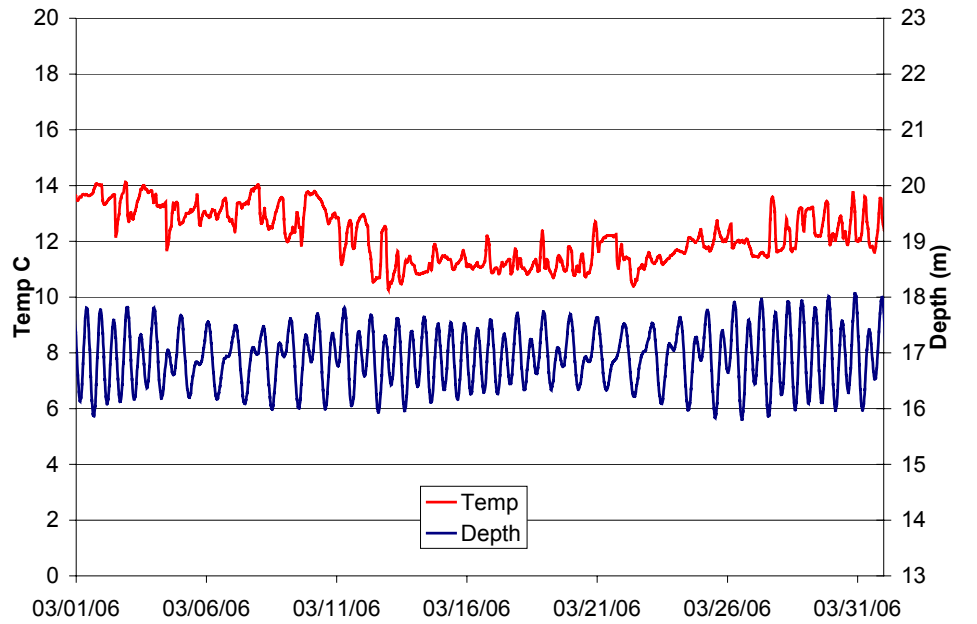
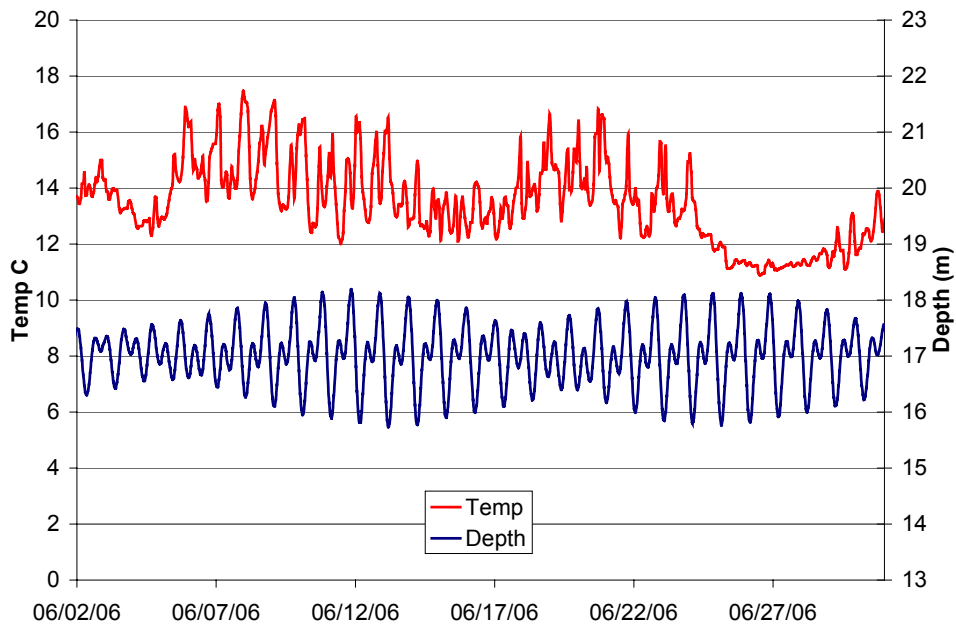
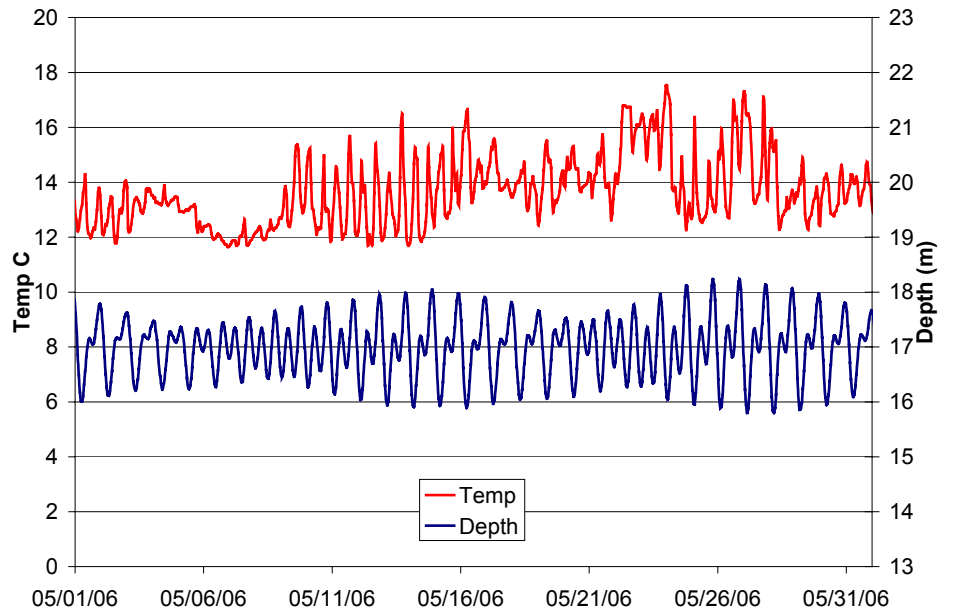

Figure A2-2. Near-bottom temperature and tidal depth from January (top) to February (bottom), 2006 at CM 5.



**Figure A2-3.** Near-bottom temperature and tidal depth from March (top) to April (bottom), 2006 at CM 5.



**Figure A2-4.** Near-bottom temperature and tidal depth from May (top) to June (bottom), 2006 at CM 5.

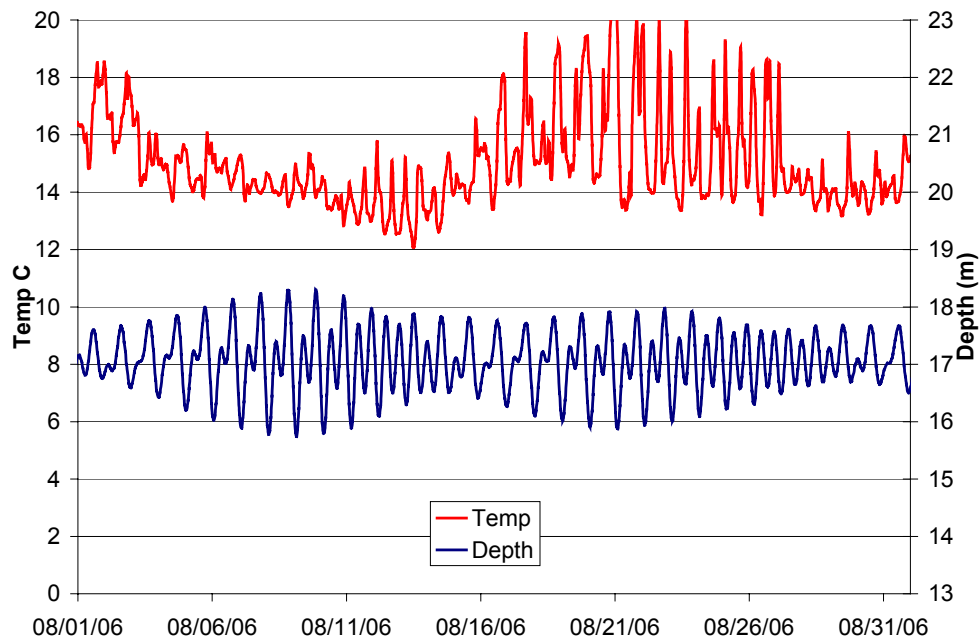
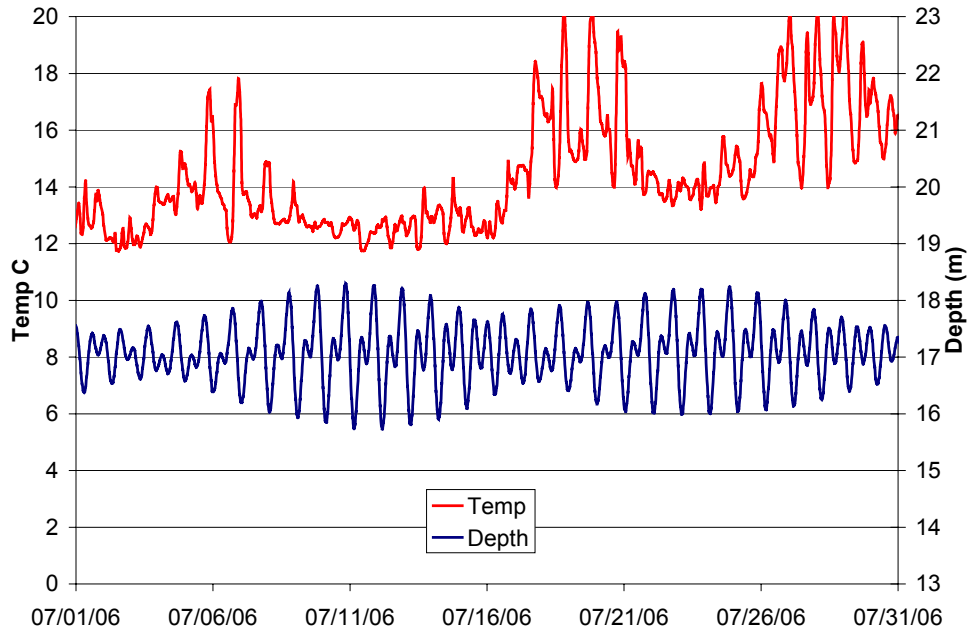
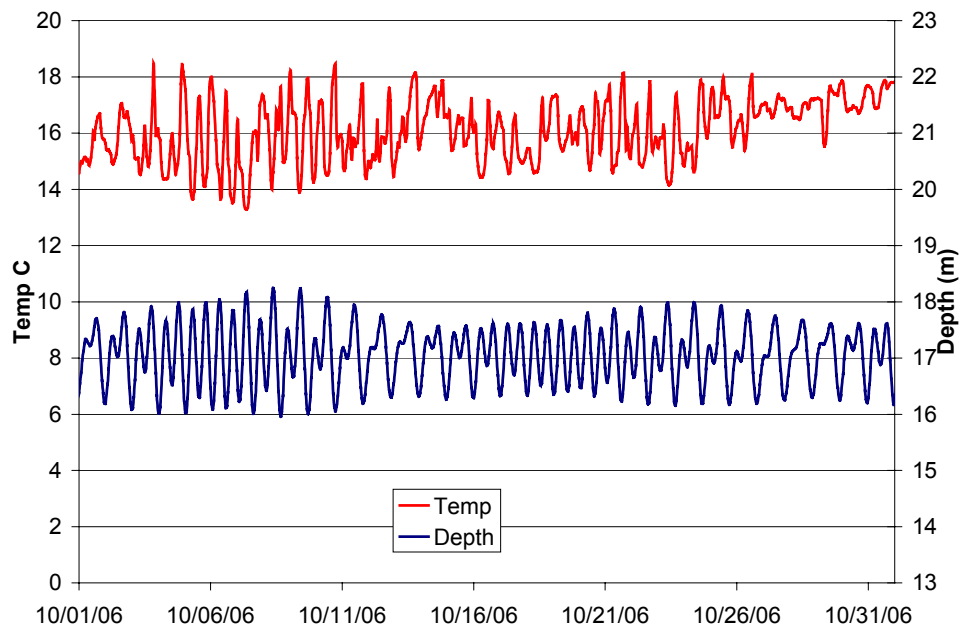
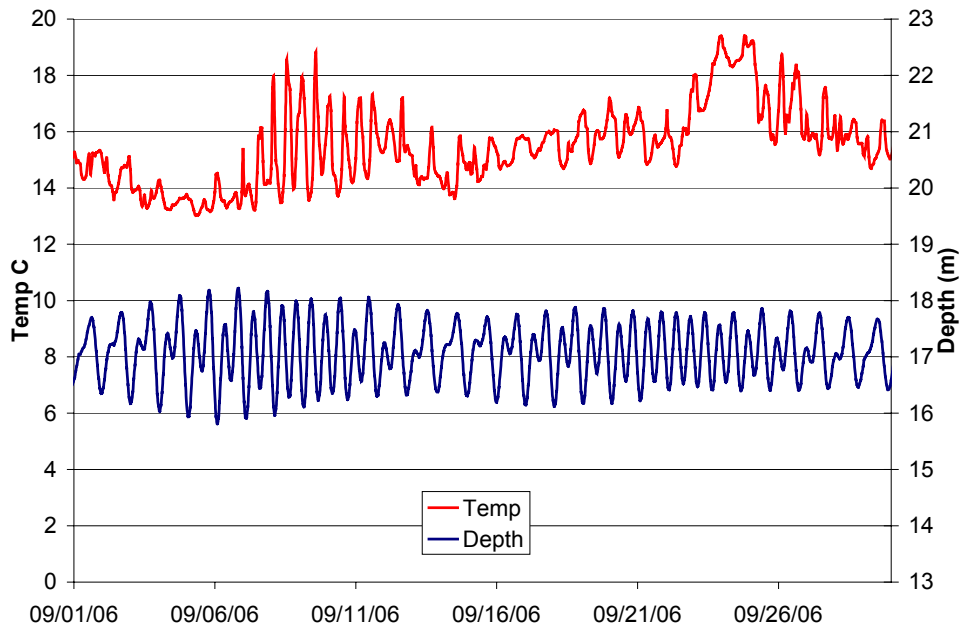

Figure A2-5. Near-bottom temperature and tidal depth from July (top) to August (bottom), 2006 at CM 5.



**Figure A2-6.** Near-bottom temperature and tidal depth from September (top) to October (bottom), 2006 at CM 5.

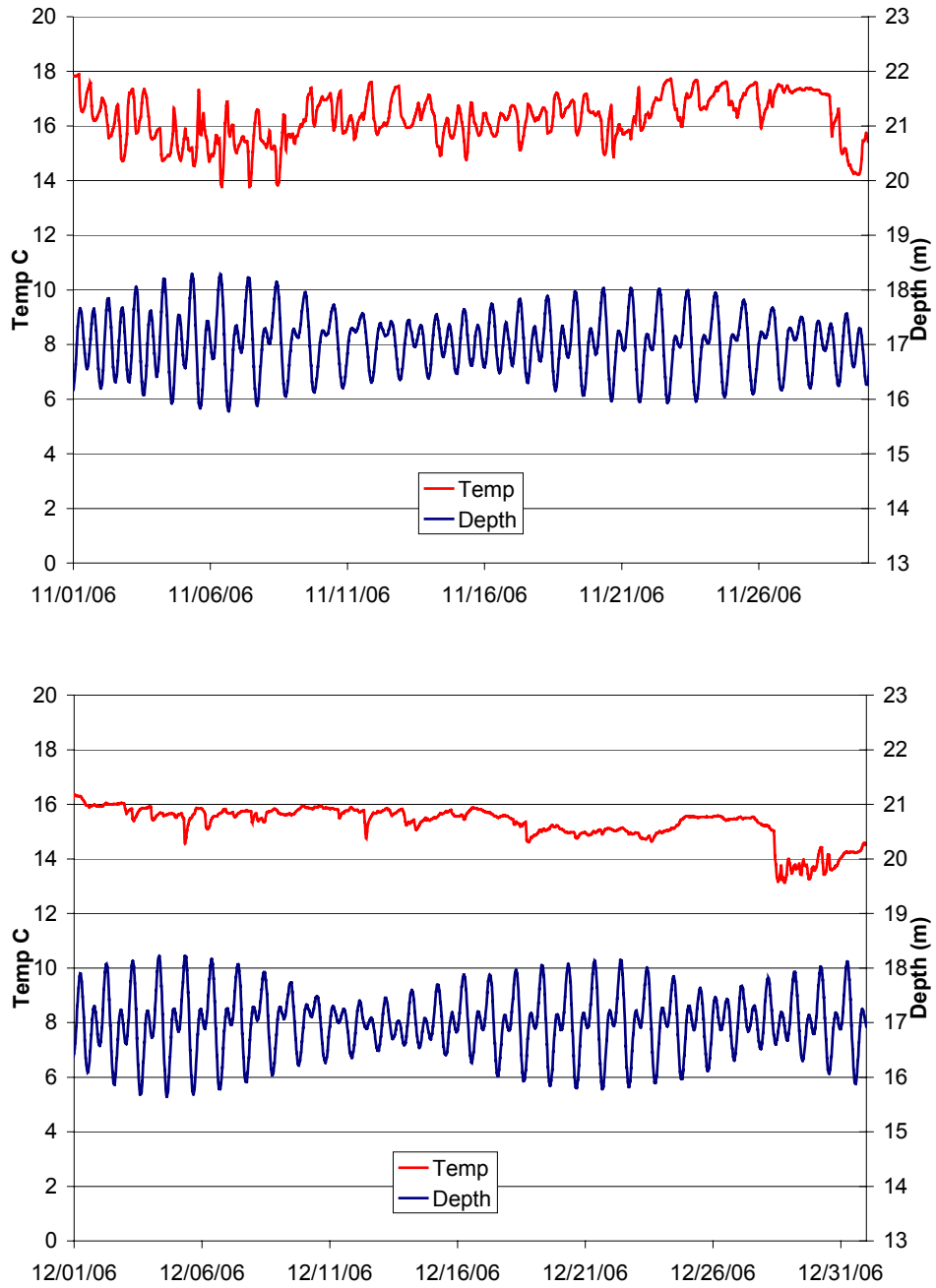

Figure A2-7. Near-bottom temperature and tidal depth from November (top) to December (bottom), 2006 at CM 5.

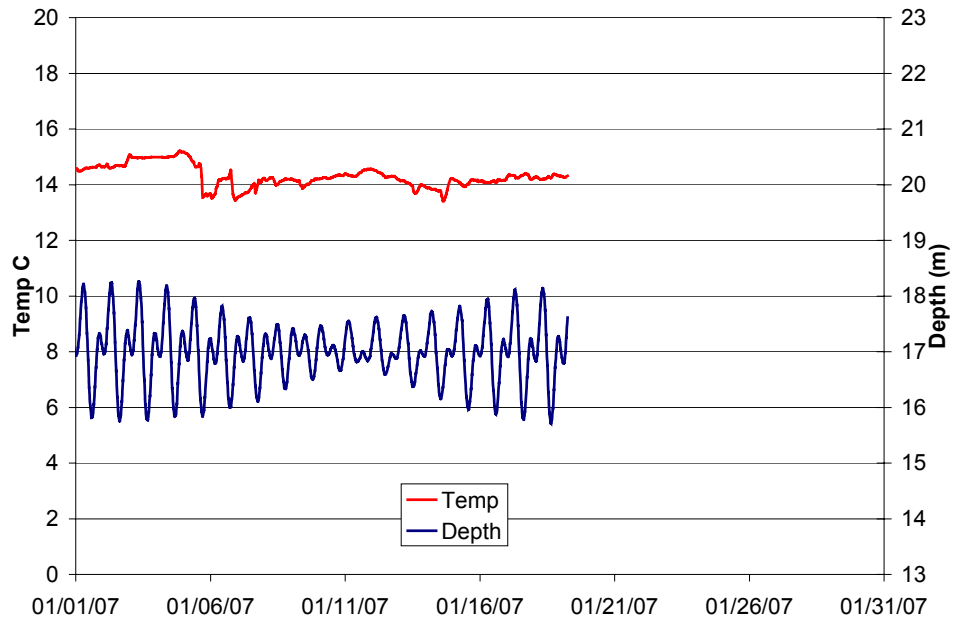

Figure A2-8. Near-bottom temperature and tidal depth from January 2007 at CM 5.



*Redondo Beach Generating Station*

## **Appendix B**

---

# **Field Sampling and Sample Processing Procedures**

- B1. Entrainment Field Sampling
- B2. Entrainment Sample Sorting
- B3. Entrainment Sample Identification
- B4. Impingement Field Sampling

**APPENDIX B1: PROCEDURE FOR COLLECTING PLANKTON SAMPLES  
FOR ENTRAINMENT STUDIES**

1.0 PURPOSE

The purpose of this document is to define the steps and equipment necessary to accurately collect plankton samples using a wheeled bongo frame near the Redondo Beach Generating Station (RBGS).

2.0 RESPONSIBILITIES

2.1 Task/Field leader:

- Notify the station of the proposed sampling dates.
- Schedule and coordinate sampling surveys and notifying the U.S. Coast Guard prior to sampling.
- Verify that all investigating biologists conducting the sampling have read and understand these procedures.
- Verify that procedures have been followed during sample collection and that the sampling has been conducted safely.
- Verify that information on data sheets have been reviewed and properly recorded.

2.2 Investigating biologist:

- Conduct sampling using the following procedures.

3.0 RBGS CONTACT INFORMATION

<b>Name</b>	<b>Cell/Outside Line</b>	<b>E-mail Information</b>
RaNae Loveland	(310) 318-7418 (310) 995-5925	ranae.Loveland@aes.com

4.0 PROCEDURES

4.1 Mobilization

- a. Notify plant personnel of the dates of field sampling prior to the sampling day.
- b. Ensure there are enough jars, labels, and preservative (formalin) for the sample collection. Print the required number of blank field data sheets on waterproof paper.
- c. Inspect the wheeled bongo frame, nets and codends for any damage. If damaged, repairs must be made before sampling begins. Ensure that the flowmeters have been calibrated within the past 90 days and that they are operational. Attach a flowmeter in approximately the center of each frame mouth.
- d. Ensure that all additional equipment (Table B1-1) is in good operating condition. Make repairs if necessary.

4.2 Sample Collection

- a. Samples will be collected every six hours in a 24-hr period (four cycles) according to the schedule developed by the Task Leader. A survey team consists of at least a boat driver and two investigating biologists to conduct the sampling.

- b. Locate the station using the latitude/longitude coordinates. Determine the water depth with the fathometer and record the water depth on the field data sheet.
- c. Ensure that the winch line and a weight (15-20 lb salmon ball) are securely attached to the center of the bongo frame. Ensure that the nets, codends and flowmeters are securely attached. The nets should be 333- $\mu$ m mesh.
- d. Record each flowmeter's serial number on the field data sheet (Attachment B1-1). Record the number from the flowmeter counter spins on the field data sheet prior to lowering the frame into the water. Record the start time (local time) on the field data sheet.
- e. Using the measured marks on the winch cable, lower the frame and nets through the water column until the wheels on the sides of the frame are on the bottom. When the cable starts to slack, the boat is motored forward and the cable is retrieved trying to maintain a 45-degree tow angle. When the frame reaches the surface, carefully pull it into the boat. Verify that the nets have not picked up any sediment from the bottom. If there is any sediment in the nets or codends, discard both samples by detaching the codends and rinsing the nets of collected material and then reattach the codends. Repeat the sample collection at that station.
- f. Check that the number of spins on each flowmeter counter to verify that the target volume of 15-20 m<sup>3</sup> has been collected (number of spins should be about 2,000). If the target volume has not been met with one tow, subsequent tows will be performed at the station until the target volume has been collected.
- g. If the correct volume has been collected record the end number of spins from each flowmeter on the field data sheet. Subtract the initial number of spins from the end number and record the total on the field data sheet. If the integrity of either or both flowmeter readings is questionable (e.g., seaweed wrapped around the propellers), discard both samples by detaching the codends and rinsing the nets of collected material and then reattach the codends. Repeat the sample collection at that station.
- h. Record the end time (local time) on the field data sheet.
- i. Beginning at the top of the net, rinse the collected material down into the codend. Since the wash water is not filtered and may contain plankton, rinse the net from the outside ensuring that unfiltered water does not contaminate the sample. Inspect the net to ensure that it has been thoroughly rinsed. Samples will then be carefully transferred to pre-labeled jars with preprinted internal labels. The sample from each net will be placed in separate labeled jars.
- j. Detach the codend from net #1 and rinse the sample from the codend into a labeled sample jar using a squirt bottle containing seawater. Then, using a graduated cylinder or other measuring device, add enough formalin to make a 10%-formalin seawater solution. Rinse and inspect the codend of net #1 before reattaching to the net. Follow the same procedure for net #2. Sample preservation should be completed soon after collection.
- k. If the collected material will fill over ½ of the sample jar, split the sample into at least two labeled jars so that there is enough ethanol for proper preservation.
- l. Ensure that the sample jar contains both an inner label and an exterior label.
- m. The following is an explanation of the coding for the field datasheet survey and station numbers and jar labels:
  1. Each survey number on the data sheet consists of a series of 5 letters followed by 2 numbers (SMBEA##). The first three letters are "SMB" refers to Santa Monica Bay, and the "EA" refers to entrainment abundance. The two numbers refer to the survey number with the first survey being 01. The survey number increases by one for each new 24-hour sampling effort.
  2. The station designation consists of a letter-number-letter-number combination. This letter/numbering system was set up for all three Santa Monica Bay generating stations (Scattergood, El Segundo, and Redondo Beach). The first letter refers to the station being an Outer, Mid, Shore, Harbor, or Entrainment station (see map in Attachment B1-2). The first

number refers to the number of the station that links to the station letter. The numbers for each of the stations listed above are as follows:

<b>Station letter</b>	<b>Station number</b>
<u>O</u> uter	1-5
<u>M</u> id	1-3
<u>S</u> hore	1-7
<u>H</u> arbor	1-2
<u>E</u> ntrainment	1-4

3. Entrainment Station E1 is located near Scattergood’s intake structure, E2 and E3 are at El Segundo, and E4 is at Redondo Beach.
  4. The second letter designates the replicate, either “A” or “B”. The source water stations only have one sample so always use the letter “A”. There are two samples collected at the entrainment location so the letters “A” and “B” will be used to separate these two replicates. The second number designates the net number, either “1” or “2.” For example, O3A1 means that the sample was collected from Station O3, Sample A, and Net 1.
  5. The date of sampling will correspond to the actual start date of each sample. At the start of a new day (midnight), use a new field data sheet.
- n. Deliver the samples to the laboratory at the completion of the sampling effort.

#### 4.3 Sample Voiding in the Field

- a. Samples should be voided if any of the following occurs: 1) possible flowmeter obstruction due to kelp or other debris on the propeller, 2) obviously malfunctioning or damaged flowmeters; 3) damaged (torn) nets found after a sample is collected; 4) large quantities of sediment in the net that were collected when the wheeled bongo frame was on the bottom; 5) gear failure which prevents completion of any tows/hauls; 6) an incident or situation which may prevent reliable data collection; 7) an incident or situation which may jeopardize the safety of sampling personnel.
- b. If a hole or tear is found in the net mesh, mark the damaged area and either repair or replace the net. Discard both samples and repeat the sample collection. Record this on the data sheet.
- c. The number of flowmeter spins from the paired bongo nets needs to be checked in the field to confirm that the measured volumes were similar.

**Table B1-1.** Equipment List.

1. Wheeled bongo net frame, attached 333/335 micron mesh nets, codends, and calibrated flowmeters (include at least 1 back up net and flowmeter)
2. Winch (davits) and line for net deployment and retrieval
3. Stock solution of formalin
4. Squeeze bottles
5. Labeled jars for sample storage
6. Data sheets, pencils, permanent markers, and labels
7. Wash-down pump
8. Watch
9. Fathometer
10. GPS

**Redondo Beach Generating Station  
IM&E Characterization Study**

**Appendix B1: Entrainment Field Sampling Procedure**

**Santa Monica Bay Entrainment Abundance Field Data Sheet - El Segundo (ESGS), Redondo Beach (RBGS), & Scattergood (SGS)**

Sheet #: \_\_\_\_\_ Date: \_\_\_\_\_ Mesh: 0.335 mm Flowmeter 1: \_\_\_\_\_ Conversion 1: \_\_\_\_\_  
 Survey #: S M B E A Crew: \_\_\_\_\_ Net Dia.: 0.60 m Flowmeter 2: \_\_\_\_\_ Conversion 2: \_\_\_\_\_

Station (A#A#)	Flowmeter Start	Flowmeter End	Total Flow	Volume (cu. m)	Sample Number	Cycle (1-4)	Temp (°C)	Salinity (ppt)	Tide (E, F, HS, LS)	Station Depth (ft)	Start Time (PST)	End Time (PST)	Total (min)
1													
2													
1													
2													
1													
2													
1													
2													
1													
2													
1													
2													
1													
2													
1													
2													
Survey: <u>SMBEA##</u> (Santa Monica Bay Entrainment Abundance) Date: <u>MM/DD/YY</u> Station: <u>A#A#</u> A# (Station Designation - Outer 1-5, Mid 1-3, Harbor 1-2, Shore 1-7 or Entrainment 1-2) A (Replicate A or B - Only Entrainment samples have two replicates) # (Net 1 or 2) Tide: <u>Ebb, Flood, High Slack (HS), or Low Slack (LS)</u>							NOTES: _____ _____ _____						

Reviewed By / Date: \_\_\_\_\_ Entered By / Date: \_\_\_\_\_ Copied By / Date: \_\_\_\_\_

**Attachment B1-1.** Example field datasheet for Santa Monica Bay station sampling.

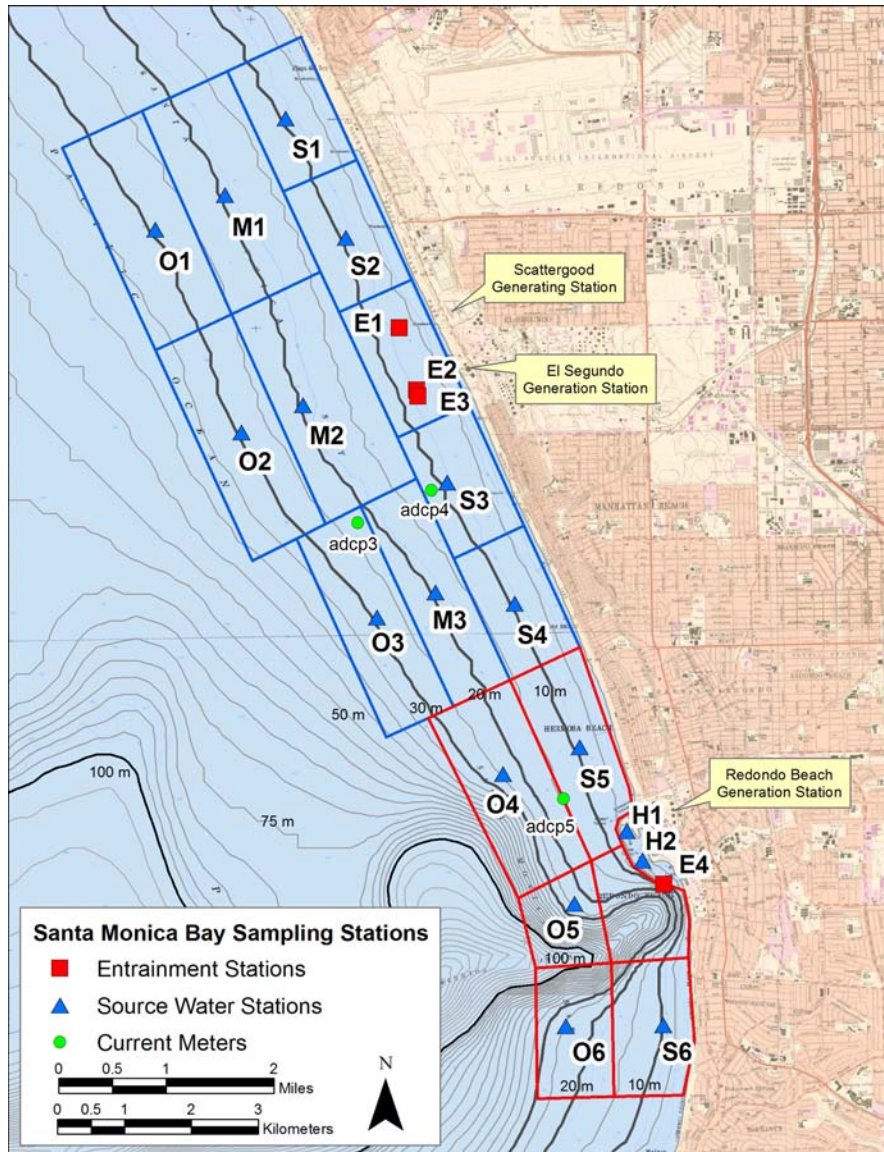

Attachment B1-2. Map of Santa Monica Bay stations.

## APPENDIX B2: PROCEDURE FOR SORTING PLANKTON SAMPLES IN THE LABORATORY

### 1.0 PURPOSE

The purpose of this procedure is to define the steps for sorting target organisms from plankton samples collected at Redondo Beach Power Plant, and to describe the Quality Control Program (QC) used to monitor the sorting accuracy of individual sorters.

### 2.0 RESPONSIBILITIES

- Laboratory Supervisor is responsible for assuring that plankton sample sorting is in accordance with written procedures.
- The Quality Control Supervisor is responsible for implementing the Quality Control Program, which monitors sorting accuracy in accordance with written procedures.
- Investigating biologists are responsible for sorting samples in accordance with written procedures.

### 3.0 INSTRUCTIONS

#### 3.1 Sorting Procedures

##### 3.1.1 Sample Processing

- a. Ensure that the proper equipment necessary for sample processing is available (Table B2-1).
- b. Samples that were originally fixed in formaldehyde after collection must be transferred to 70% ethanol before laboratory processing. This is done outside to lessen the exposure to formaldehyde fumes. Only qualified personnel who have read and signed the information about the hazards of working with formaldehyde may transfer samples.
  1. A funnel with the appropriate mesh size attached to its bottom opening is placed into a jar or can. The mesh must not be larger than that used during sample collection. Place the jar and funnel in a tray so the sample can be retrieved if spillage occurs.
  2. Pour the sample carefully into the canning funnel. The sample jar and jar lid are rinsed with water, directing the water and organisms into the funnel. Rinse the sample with water to flush the formaldehyde from the sample.
  3. Rinse the sample into a labeled jar with 70% ethanol from a squeeze bottle. Make certain that the jar has both an inner label and a jar top label. Additional ethanol is added to the sample jar to cover the sample.
  4. The waste formaldehyde and rinse water is then discarded into the appropriate hazardous waste container.
- c. Consult the sorting schedule posted in the processing laboratory to determine sorting priorities.
- d. Sign out the sample in the Laboratory Tracking MS Excel file and the Laboratory Sample Tracking Sheet (Attachment B2-1) by writing your initials under the 'sorter' column. Transcribe information from the sample label into the Sorter's Log Book (Attachment B2-2) and into the sorter's notebook (each sorter has separate log sheets and a notebook for this purpose).



- e. Take two clean canning funnels with attached mesh netting, one labeled 'sorted' and the other labeled 'unsorted'. The mesh size should be no larger than that used to collect the samples.
- f. Place the 'unsorted' canning funnel over the 'used alcohol' bottle and funnel, which is located in a dish so samples can be retrieved if a spill occurs. Pour the sample into the canning funnel. The canning funnel will contain the material to be sorted, while the ethanol will drain into the 'used alcohol' bottle.
- g. Using 70% ethanol or 70% used alcohol in a squeeze bottle, rinse any remaining sample from the sample jar, the jar lid and inner sample label into the canning funnel containing the unsorted sample.
- h. Place the 'unsorted' funnel containing the sample and the empty 'sorted' funnel into individual glass bowls in a tray. Make sure the sample is covered with water so it will not dehydrate during processing.
- i. Using forceps, transfer a small amount of the sample from the 'unsorted' funnel to the sorting tray. Add enough water to cover the sample. Distribute the sample in the sorting tray.
- j. Place the sorting tray on the base of the dissecting microscope. Adjust the magnification so that the field of view is slightly larger than the width of an individual marked grid.
- k. Arrange the light source to provide adequate illumination.
- l. Carefully scan the entire sorting tray using the grids for orientation. Remove the target organism with forceps and place them either into a shell vial containing 70% ethanol or into a small dish containing water. Count the organisms as they are removed. A list of what target organisms and when to pull them is posted in the lab.
- m. Log the number of organisms removed from the sample in the sorter notebook.
- n. Scan the tray a second time. If target organisms are found on the second pass, repeat a third time. Continue this process until a scan does not produce any additional target organisms.
- o. Once sorted, pour the sorted sample into the 'sorted' funnel and rinse with a small amount of water. Take a second aliquot from the 'unsorted' funnel as described above. Repeat the above steps until the entire sample has been sorted.
- p. If the sorter thinks there will be more than 500 fish eggs in a sample then the sample may be "sub sampled" for eggs. When "sub sampling" the sample should be processed first for fish larvae and selected invertebrate larvae. When ready to "sub sample" put the sorted sample back in the original sample jar and fill the jar with 70% ethanol up to the lip of the jar. Jar size varies, but they will typically be 500 ml (if sizes varies there will be a posting in the lab). A 'sub sample' should be 10 percent of the sample volume so the sorter will use the aliquot transfer pipette with the 10 ml attachment and take 5 aliquots. The sample should be stirred up in order to get a fair amount of sample in the aliquot. Once the aliquot is processed for fish eggs it may be returned to the original sample jar with the rest of the sorted sample. Make sure it is noted in the logbook and record the total volume of the sample and the volume of the sub sample. There will be an extra data sheet in the laboratory tracking sheets and a column in the MS Excel tracking sheets to record the sub sample information. On top of the sample jar put a white dot with survey number, sample number, sorters initials, sub sample date, and "SS".
- q. When the sorting has been completed, the sorted organisms should be placed into a shell vial containing 70% ethanol. Fill the shell vial completely with clean 70% ethanol then place cotton into the top end of the vial to keep the organisms inside. Place the vial into a labeled snap cap containing 70% ethanol. Make sure the shell vial and cotton are completely covered with 70% ethanol.

- r. Label each jar lid with the appropriate colored dot label. Prepare a waterproof inner label for the jar containing the shell vial. Both labels should contain the following information:
  - 1. Survey number
  - 2. Collection date
  - 3. Station, cycle and sample number
  - 4. Collection start time
  - 5. Jar number (if more than one jar)
  - 6. Sorter's initials
  - 7. Number of organisms in shell vial
- s. The total number of sorted organisms and the total time required to process the sample is recorded in the sorter's notebook.
- t. Put the sorted sample back into the original sample jar. Used alcohol may be used to fill sample jar to at least  $\frac{3}{4}$  full. Rinse any remaining sample from the funnel into the jar using a squirt bottle containing ethanol. Make sure the inner waterproof label is in the sample jar. Thoroughly clean the funnels of all remaining sample.
- u. If a sample must be stored before completion:
  - 1. Put the sorted portion of the sample back into the original sample jar. Rinse any remaining material from the funnel into the jar using a squirt bottle containing ethanol. Make sure that the sample is adequately covered with ethanol.
  - 2. Put the unsorted sample into a second jar. Rinse any sample from the 'unsorted' funnel into the jar using a squirt bottle containing ethanol. Using a dot label, label the jar lid with the sample identification information, sorter's initials, and the word "unsorted". Make an additional inner label with the sample identification information and marked 'unsorted'. Place the label inside the jar with the 'unsorted' sample. Make certain that the 'unsorted' sample is adequately covered with ethanol.
  - 3. The sorted and unsorted portion of the sample should be stored until sorting can continue.

3.1.2 Once the sample is completed, place an appropriately colored dot label on the jar top with the sorter's initials and date of sorting. Return the jar to the box from which it was originally removed.

- a. Transcribe the information recorded in the sorter's notebook to the computer on the Laboratory Tracking Sheets and the Quality Control log and on the Laboratory Sample Tracking Sheet (Attachment B2-1), and to the Sorter's Log (Attachment B3-2).

### 3.2 Sorting Quality Control Program

#### 3.2.1 QC Sorting Criteria

- a. The first ten samples that are sorted by an individual are completely resorted by a designated QC sorter. A sorter is allowed to miss one target organism when the original sorted count is 1–19. For original counts above 20 a sorter must maintain a sorting accuracy of 90%.
- b. After the sorter has passed 10 consecutive sorts, the program is switched to a '1 sample in 10' QC program for that sorter. After the sorter has completed another 10 samples, one sample is randomly selected by the designated QC sorter for a QC resort.
- c. If the sorter maintains the 90% accuracy sorting rate for this sample, then the sorter continues in the '1 sample in 10' QC mode.

- d. If a sample does not meet the 90% accuracy rate their subsequent samples will be resorted until 10 consecutive samples meet the criteria.

3.2.2 QC Resorting

- a. Sorting procedures used during the QC resort are the same as the sorting procedures described in Section 3.1.
- b. All fish and selected invertebrate larvae that were missed by the sorter are removed during the QC resort.
- c. For the QC process, a larval fish is defined as having a head plus at least 50% of the body. Any parts without a head and/or less than 50% of the body will be considered fragments and will not be counted against the original sorter as a missed fish. However, it is important for each sorter to remove all fish and fragments from each sample that is sorted and correctly record them as # fish / # fragments in the sorter's notebook and on the tracking sheet.
- d. Any vials of fish larvae or selected invertebrate larvae generated from the resort are labeled with an orange dot label, and labeled as described in the sorting procedures with the addition of "QC" added to the label.
- e. An orange dot label should also be placed on the top of the jar of the sample that was resorted and labeled with the QC person's initials, survey number, sample number, and date the resort was completed.
- f. The vials are stored in the appropriate location.

3.3 Waste Disposal

- 3.3.1 No formaldehyde or water contaminated with formaldehyde should be disposed of into the sewage system. Dispose of any water contaminated with this chemical in the designated waste water container to be disposed of at a local hazardous materials waste depository.

4.0 RECORDS

- 4.1 All data sheets are later reviewed by the Lab Manager or designated staff.
- 4.2 Original data sheets are permanently stored.

**Table B2-1.** Equipment List

1. Tray or dish
2. Bowls
3. Sample jars
4. Two canning funnels with attached plankton mesh netting, labeled with mesh size, and labeled 'sorted' and 'unsorted'
5. Squeeze bottle containing 70 percent ethanol (denatured)
6. Squeeze bottle containing fresh water
7. Sorting tray or petri dish marked with a sorting grid
8. Dissecting microscope with light source
9. Glass shell vials and cotton
10. Jar/vials with lids
11. Forceps
12. Waterproof labels
13. Dot labels
14. Sorter's notebook
15. Plankton splitter



### Santa Monica Bay Power Plants-Sorter's Log (SMBEA)

Name: \_\_\_\_\_

Sample Information					Sort Information								Quality Control					
Survey Number	Station	Cycle	Sample	Collection Time	Date Sorted	Sort Time			# of Fish	# of Fish Eggs	# of Megs	Lobster/ Squid	QC'ed By	QC'ed Date	QC Fish	Fish P / F	QC Other *	Other P / F
						SGS	ESGS	RBGS										

\*specify which (fish eggs(E), megs(M), lobster(L), or squid(S))

## APPENDIX B3: PROCEDURES FOR THE IDENTIFICATION OF LARVAL FISHES and TARGET INVERTEBRATES

### 1.0 PURPOSE

The purpose of these procedures is to define the steps for identifying planktonic organisms, and to describe the Quality Control (QC) Program used to monitor the accuracy of each individual's identification performance.

### 2.0 RESPONSIBILITIES

- The Lead Taxonomist is responsible for assuring that plankton identifications are performed in accordance with written procedures and for implementing the Quality Control Program.
- Investigating biologists are responsible for plankton identifications and for monitoring accuracy in accordance with written procedures.

### 3.0 INSTRUCTIONS

#### 3.1 Identification procedures for larval fishes, *Cancer* spp. crab and *Panulirus* lobsters.

- a. Ensure that the proper equipment necessary for the identification of target organisms is available (Table B3-1).
- b. The fish and target invertebrates from each sample are kept in separate containers and processed following this procedure in essentially the same manner.
- c. The container of target organisms to be identified is carefully emptied into a dish. The dish is placed on the microscope stage and the lighting adjusted to provide adequate illumination.
- d. Each target organism is identified to the lowest taxonomic classification possible. The total number of each taxon is recorded on the Entrainment /Source Water Plankton Tow Lab Data Sheet (Attachment B3-1).
- e. All individuals of each identified taxon of larvae from a sample should be put into a shell vial containing 100% ethanol. Each vial should contain a label with the taxon name and sample number. Cotton should be pushed into the upper end of the vial to keep the label and organisms enclosed.
- f. Mutilated larvae (partial organisms that are missing body parts and are unable to be identified) are placed in a separate labeled vial. Whole larvae that are unidentified, are placed in a separate labeled vial.
- g. All vials containing target organisms from an individual sample should be put into a labeled jar containing enough ethanol to cover the vials. The jar should contain both an inside label and a label attached to the outside of the lid denoting the sample number, date and time collected, and identifier's initials. Tighten the jar lid to prevent evaporation of the preservative. Samples with many different fish taxa may require more than one labeled jar.
- h. On the Laboratory Sample Tracking Sheet, record the identifier's initials and date sample was logged in. The identifier's log will contain the total number of larvae identified and the date identified. If more than one day was needed to complete the identification, record the date the sample identification was completed.
- i. Place the jar into the appropriate box containing identified samples.

- j. Dispose of any liquids containing ethanol into the appropriate waste container.

### 3.2 Identification Quality Control (QC) Program

#### 3.2.1 Fishes

- a. The first ten samples of larval fishes that are identified by an individual identifying biologist will be completely re-identified by a designated identification QC biologist. A total of at least 50 individuals from at least 5 taxa (50/5 criteria) must be present in these first ten samples. If the first 10 consecutive samples do not pass the 50/5 criteria, additional samples must be re-identified until this criteria is met.
- b. The identifying biologist must maintain a 95% identification accuracy level in these first 10 samples. For all samples, if a sample contains between 1–19 larvae, one larvae can be misidentified and the sample will not fail the QC check.
- c. If the identifying biologist identifies a larval fish to a certain family or genus and subsequently the identification QC biologist is able to refine the identification to a lower taxonomic level, this will not be considered a misidentification pertaining to the 95% identification accuracy level. A misidentification will be one in which the identifying biologist identifies the fish as belonging to a certain family, genus or species, and then the identification QC biologist determines that the initial identification was incorrect and changes the identification to a different family, genus or species or changes it to a higher taxonomic group.
- d. After the identifying biologist has passed 10 consecutive samples, the program is switched to a “1 sample in 10” QC program. After the identifying biologist has completed another 10 samples, one sample is randomly selected by the designated identification QC biologist for a QC review.
- e. If this sample maintains the 95% accuracy level as determined by the identification QC biologist, then the identifying biologist continues in the “1 sample in 10” QC mode. If a sample does not meet the 95% accuracy level, their subsequent samples will be re-identified until 10 consecutive samples meet this level of accuracy.
- f. Any misidentified fish found by the identification QC biologist, will be placed into the appropriate labeled vial for that sample. This information will be recorded on the Fish Identification Data Sheet.

#### 3.2.2 *Cancer* spp. and *Panulirus* spp.

- a. The first ten samples identified by an individual identifying biologist will be completely re-identified by a designated identification QC biologist.
- b. The identifying biologist must maintain a 95% accuracy level in these first 10 samples. For all samples, if a sample contains between 1-19 larvae, one larvae can be misidentified and the sample will not fail the QC check.
- c. After the identifying biologist has passed 10 consecutive samples, the program is switched to a “1 sample in 10” QC program. After the identifying biologist has completed another 10 samples, one sample is randomly selected by the designated identification QC biologist for a QC review.
- d. If this sample maintains the 95% accuracy level as determined by the identification QC biologist, then the identifying biologist continues in the “1 sample in 10” QC mode.
- e. If an identifier’s sample does not meet the 95% accuracy level, their subsequent samples will be re-identified until 10 consecutive samples meet this level.



- f. Any misidentified larva found by the identification QC biologist, will be placed into the appropriate labeled vial for that sample and recorded on the appropriate laboratory identification data sheet.

### 3.3 Larval Fish Measuring

#### 3.3.1 Larval Fish Measuring Procedure

- a. Turn on the computer, camera, and light source at the measuring station.
- b. Consult the measuring schedule near the measuring station to determine measuring priorities and retrieve the binder containing the appropriate data sheets.
- c. Locate the box containing the fish to be measured and place it in a easily accessible area close to the measuring station.
- d. Open the Optimas Image Analysis or ImageJ software by clicking with the mouse on the appropriate software icon.
- e. Open the Larval Fish Measuring macro in Optimas, or the FishMeasure2 macro in ImageJ and follow the macros' directions.
- f. Select the jar of fish to be measured and consult the jar label. Compare data on the jar label with the inner label and the data sheet for this sample. Consult an identifier regarding discrepancies between labels.
- g. Enter the data queried for by the macro including the last five digits of the serial number, the measurer's initials, the data sheet sequence number and the species code.
- h. Open the jar and remove the vials for the target taxa to be measured as per the posted list. Place the vials in a rack designed to allow the vials to maintain an upright posture so as to reduce spillage.
- i. Select the first vial to be measured. Remove the cotton and the label. Compare the label with the data sheet for confirmation.
- j. Empty the vial into a shallow dish. Remove any fish that have adhered to the vial, cotton, the label, or any tools used in the transferring process and place the fish in the dish. Add alcohol to the dish if necessary to prevent desiccation.
- k. If the number of larval fish in the vial exceeds what can be reasonably measured on a single image capture, transfer some of the fish to another glass dish and immerse them in alcohol.
- l. Place the dish on the stage of the microscope. Arrange the fish so that all fish appear on the screen. Adjust the zoom, focus, and lighting for the best possible image. If this is the first group of larval fish being measured, or if the magnification has been changed, it is necessary to re-calibrate. Place the micrometer on the stage of the microscope and re-calibrate by drawing a line from one of the micrometers millimeter marks to another, noting the distance between the two marks, and entering that value when queried. Replace the dish containing the larval fish to be measured.
- m. Measure larval fish by drawing a line from the pre-maxillary to the end of the notochord, being careful to follow the contours of the fish. If the fish is too damaged to find either the pre-maxillary or to estimate the path taken by the notochord, do not measure, and proceed to the next larval fish. If the line does not adequately approximate the larval fish's length it must be re-measured.
- n. Note the program's display of the measurement, check that it seems reasonable. If it does not seem reasonable, it may be necessary to re-calibrate and re-measure. If the

problem persists, contact an identifier. Make note of any problems in measuring and post near the measuring station.

- o. The macro will store the measurement in separate data files along with the necessary sample information.
- p. Repeat the above steps for all fish in the dish.
- q. When all larval fish in the dish have been measured, fill the vial that originally contained the fish with alcohol and transfer the measured fish to the vial.
- r. If the larval fish from this vial have been segregated into two or more groups, place another group into the dish, being careful to submerge them in alcohol, and measure as above. Do not measure more than fifty larval fish of any one taxon from each survey.

#### 4.0 RECORDS

- 4.1 All data sheets are later reviewed by the Lab Manager or designated staff.
- 4.1 Original data sheets are permanently stored.

**Table B3-1.** Equipment List

1. Dissecting microscope, with camera attachment connected to computer equipped with Optimas 6.2 or ImageJ if measuring larvae
2. Light source
3. Micrometer
4. Sorting tray or petri dish
5. Squeeze bottle containing 70% ethanol (denatured)
6. Glass shell vials
7. Holder for shell vials
8. Jar containing target organisms to be identified
9. Cotton
10. Forceps
11. Waterproof labels
12. Dot labels
13. Data sheets
14. Identifier's log sheet
15. Taxonomic references

Redondo Beach Generating Station  
IM&E Characterization Study

Appendix B3: Entrainment Sample Identification Procedure

SANTA MONICA BAY (ESGS), (RBGS) and (SGS) - Lab Data Sheet

Sheet:

Survey: \_\_\_\_\_ Date: \_\_\_\_\_ Start Time: \_\_\_\_\_ Cycle: \_\_\_\_\_ Station: \_\_\_\_\_

Species Code	Taxon	Count	QC Resort Additional Count	Total Count	Stage	Entrain-able	Comments
<b>NOTES:</b>			<b>Total:</b>				

	<u>ID'ed By / Date</u>	<u>ID QC By / Date</u>	<u>QC Resort By / Date</u>	<u>Entered By / Date</u>
Fish	_____	_____	_____	_____
Eggs	_____	_____	_____	_____
Inverts	_____	_____	_____	_____

Attachment B3-1. Entrainment /Source Water Plankton Tow Lab Data Sheet

## APPENDIX B4: IMPINGEMENT FIELD SAMPLING PROCEDURES

### 1.0 PURPOSE

The purpose of this document is to identify the procedures and equipment necessary to accurately collect and process impingement samples at the Redondo Beach Generating Station (RBGS).

### 2.0 RESPONSIBILITIES

#### 2.1 Task/Field leader:

- Contact plant to obtain clearance for personnel that will be conducting the sampling.
- Verify that all investigating biologists conducting the sampling have read and understand these procedures.
- Verify that procedures have been followed during sample collection and that the sampling has been conducted safely.

#### 2.2 Investigating biologist:

- Conduct sampling using the following procedures.

### 3.0 RBGS CONTACT INFORMATION

<b>Name</b>	<b>Cell/Offsite Number</b>	<b>E-mail Information</b>
RaNae Loveland	(310) 318-7418	ranae.loveland@aes.com
RaNae Loveland	(310) 995-5925	
Emergency Number Control	(310) 318-7503	Units 7&8 control room

### 4.0 PROCEDURES

Impingement sampling will only be undertaken when there is water passing through the traveling screens (TS) of Units 5&6 or Units 7&8. If only one pump is in operation, proceed with sample collection using the following procedures. The bar rack area does not require daily cleaning, thus no collections will be conducted from this area. Each normal operation impingement survey consists of an initial cleaning period followed by four 6-hr sampling cycles. Table B4-1 presents the proposed schedule for each survey.

#### 4.1 Mobilization

- a. Notify plant personnel of the dates, times, and names of the biologists that will be onsite during each survey. All personnel will require a photo identification (driver's license, passport, etc.) to obtain access to the plant site.
- b. The equipment listed in Table B4-2 is required for sampling and should be checked before leaving for the plant. Verify that any scales used for the sampling have been calibrated within the previous three months.

#### 4.2 Traveling Screen Sample Collection

- a. Impingement sampling procedures will be the same at all units. The TS will be rinsed and cleaned every 6 hours during the 24-hr period. Material from the traveling screens is diverted into sump collection areas. Figure B4-1 shows the Unit 5&6 collection basket, while the Units 7&8 collection basket is shown in Figure B4-2.

- b. Make sure that the collection basket has been emptied prior to the survey. If there is any debris in it, contact an operator to have them remove the basket using a crane so that it can be emptied.
- c. The initial screenwash is for cleaning purposes only; do not process any materials from the sump after the cleaning rinse. The time at the end of the initial TS rinse is the beginning of Cycle 1. Record this on the appropriate datasheet.
- d. The mesh in the collection basket has a larger mesh than the mesh of the TS. Secure a mesh net/vexar basket (with mesh of the same size or smaller than the TS mesh) inside of the metal basket so that impinged materials can easily be removed. If the debris load is too heavy for the mesh net/vexar basket or it is damaged and materials accumulate in the metal basket, make sure an operator is available to use a crane to pull the metal basket out for sample collection.
- e. Have plant personnel activate the TS wash system thirty minutes prior to the end of each cycle so that all impinged material is rinsed from the screens into the collection basket.
- f. Remove all impinged fish and invertebrates from the impinged debris.
- g. Replace the mesh net/vexar basket in the rectangular sump before initiation of the screenwash for the next cycle.
- h. All collected impinged material will be processed using the procedures in following section.

**4.3 Sample Processing**

- a. Remove all fishes and invertebrates from the impinged debris. Record the volume of the debris (gallons) on the datasheet. Also record the composition and percentage of the debris.
- b. All fishes, crabs, shrimps and prawns, and cephalopod mollusks are identified, counted, measured (see measurement criteria below), and weighed. This information is recorded on the appropriate datasheet. All other invertebrates are identified and recorded as present by entering a “P” in the count box.

<b>Organism Group</b>	<b>Length Measuring Criteria</b>
Fishes	Total body length for sharks, disc width for skates and rays and standard lengths for bony fishes
Crabs	Maximum carapace width
Spiny lobster and Shrimps	Carapace length, measured from the anterior margin of carapace between the eyes to the posterior margin of the carapace
Octopus	Maximum “arm” spread, measured from the tip of one tentacle to the tip of the opposite tentacle
Squid	Dorsal mantle length, measured from the edge of the mantle to the posterior end of the body

- c. Record all organism names on the appropriate datasheet, using their scientific names whenever possible. The taxa codes are recorded after the datasheets are returned to the office.
- d. Make certain of all identifications before recording the name on the datasheets. If an organism cannot be positively identified it should be saved. The voucher specimen should be placed in a plastic bag with a waterproof label indicating the location, cycle, date, time, and the initials of the collector. If personnel on the next cycle can positively identify the organism record the organism’s name on the datasheet. If positive identification cannot be made the organism is returned to the laboratory for identification.
- e. If a large number (more than 30) of any individual countable species is collected during a cycle, individually measure and weigh 30 randomly selected individuals of this species and then count

and measure the remaining individuals and record this information on a separate line on the datasheet. For example: if 198 deepbody anchovies were collected, randomly select 30 individuals and record on the first row *Anchoa compressa*, count = 1, Length = standard length (the distance from the tip of the snout to the posterior vertical margin of the hypural plate) to the nearest mm, weight = weight to nearest gram, sex = “-“ (if the sex cannot be determined without dissection, record a “-“), and condition = alive (A), dead (D), or mutilated (M). Continue this procedure for the other 29 randomly chosen deepbody anchovies. Then batch weigh the remaining individual. If all of the individuals are alive, put an “A” in the Cond. box. If some are dead and some mutilated, use additional rows to fill in the appropriate information in the corresponding row(s).

- f. Determine the sex of the countable organisms to the extent possible without dissection. Assign the letter M to refer to males, F for females, J for juveniles, G for gravid. Put a “-“ if the sex cannot be determined without dissection.
- g. Record the condition of each countable organisms: A for alive; D for dead; M for mutilated. If an individual is mutilated, do not measure the length. If there are more than 30 non-mutilated individuals, the mutilated individual(s) can be weighed with the batch weight of the additional individuals. If there are less than 30 non-mutilated individuals, record the weight of the mutilated individual(s) but not their lengths.
- h. Record any anomalies or other notes (encountered in each cycle) in the notes section on the datasheet.
- i. At the end of each cycle verify that: a) the sampling procedures have been followed correctly, b) the data has been recorded correctly and legibly, and then c) sign and date the “Reviewed by/Date” section at the bottom of the datasheet.
- j. Put all dead animals and discarded debris in trash dumpsters. Make sure to double bag the material as collection of the trash may not occur for several days.
- k. Quality control (QC) checks will be performed on at least a quarterly basis to verify all organisms are being removed from the debris and that the correct identification, enumeration, length and weight measurements of the organisms are being recorded on the datasheet. The QC team will randomly choose the actual impingement cycles that will be checked and will resort the debris for any missed organisms. All organisms will then be identified, remeasured and reweighed by the QC team to ensure that the data is being recorded correctly. If a sampling team fails a QC check, they will be retrained on fish identification and sample collection. QC checks will be performed on the sampling team until they pass the QC requirements. The QC checks will be fully documented and reported to the Project Manager.

#### 4.4 General

- a. All information recorded on the datasheets must be written legibly with a pencil.
- b. Keep information separate for each cycle
- c. The survey number will be determined based on the month corresponding to that survey (eg., month 1 = survey 1). Make sure the correct survey number is recorded.
- d. Make certain that the unit #s and cycle numbers are correct on the datasheet you are using. Record the date and time for the start and end of each screen wash (generally 15 to 20 minutes) and cycle duration times (generally 6 hours). Each 24-hr survey is divided into 4 six-hour cycles.
- e. Record the names of all personnel present during each cycle.
- f. Use military time (0000 – 2400) to record every cycle collected. Record all times as local time (Pacific Standard Time or Pacific Daylight Time).

- g. During each screen wash, verify that the screens are operating properly (the screens should be moving and the water should be spraying). Check with the operator to find out how many circulating water pumps are operating.
- h. If a survey cannot be completed or is cancelled, make a note on the appropriate data sheet explaining the reason for the cancellation. Write the survey number that corresponds to that week, date and sign the datasheet.
- i. At the end of each screen wash, record the relevant meteorological data.
- j. If the traveling screens trip before the 6-hour cycle is over, collect all material and process it as part of the upcoming cycle. If possible, have the screen wash system run at the scheduled times.

#### 4.5 Heat Treatments

During heat treatments follow the same procedures as during normal impingement sampling. Use a separate data sheet for each species collected. A single data sheet can be used for several species if low numbers of these species are collected.

If an extremely large amount of material is collected in the sump basket, sub-sampling of the most abundant fishes/shellfishes should occur to minimize the time taken to process the sample. Sub-sampling procedures are as follows:

- a. Remove the less abundant fishes/shellfishes from the impinged material; and record as individuals on the datasheets.
- b. Collect a sub-sample (for example, two 3-gallon sub-samples) from the pile of impinged material. Make sure to randomly sample the pile by collecting organisms from different areas of the pile. Discard the remaining material and record the volume discarded on the data sheets.
- c. The number and weight of the organisms collected from each sub-sample should not be recorded with the other data. Record the sub-sample data on a separate datasheet. Make certain that record of the organisms from the sub-samples can be linked back to the quantity of material discarded and not sampled.



**Table B4-1.** Target schedule for 24-hour impingement sampling effort (schedule assumes that at least one circulating water pump is in operation). Based on 30 minutes for complete rotation of travel screens at each unit.

<b>Time</b>	<b>Units 5/6</b>	<b>Units 7/8</b>
8:00	Rinse and Clean	
8:30	Start Cycle 1	
9:00		Rinse and Clean
9:30		Start Cycle 1
10:00		
10:30		
11:00		
11:30		
12:00		
12:30		
13:00		
13:30		
14:00	Rinse Cycle 1	
14:30	Start Cycle 2	
15:00	Process Cycle 1	Rinse Cycle 1
15:30		Start Cycle 2
16:00		Process Cycle 1
16:30		
17:00		
17:30		
18:00		
18:30		
19:00		
19:30		
20:00	Rinse Cycle 2	
20:30	Start Cycle 3	
21:00	Process Cycle 2	Rinse Cycle 2
21:30		Start Cycle 3
22:00		Process Cycle 2
22:30		
23:00		
23:30		
0:00		
0:30		
1:00		
1:30		
2:00	Rinse Cycle 3	
2:30	Start Cycle 4	
3:00	Process Cycle 3	Rinse Cycle 3
3:30		Start Cycle 4
4:00		Process Cycle 3
4:30		
5:00		
5:30		
6:00		
6:30		
7:00		
7:30		
8:00	Rinse Cycle 4	
8:30	Process Cycle 4	
9:00		Rinse Cycle 4
9:30		Process Cycle 4
10:00		
10:30		
11:00		

Note: Schedule is separated into 30-minute increments to show activities associated with each cleaning and collection cycle at the two sets of traveling screens.

**Table B4-2.** Equipment List.

1. Datasheets printed on waterproof paper
2. Pencils
3. Scales (Electronic and spring)
4. Measuring boards
5. Fish and invertebrate identification keys
6. Buckets and plastic totes
7. Floodlights and extension cords
8. Calipers
9. Calculator
10. Hardhats
11. Safety Glasses
12. Rubber/latex gloves
13. Clipboard

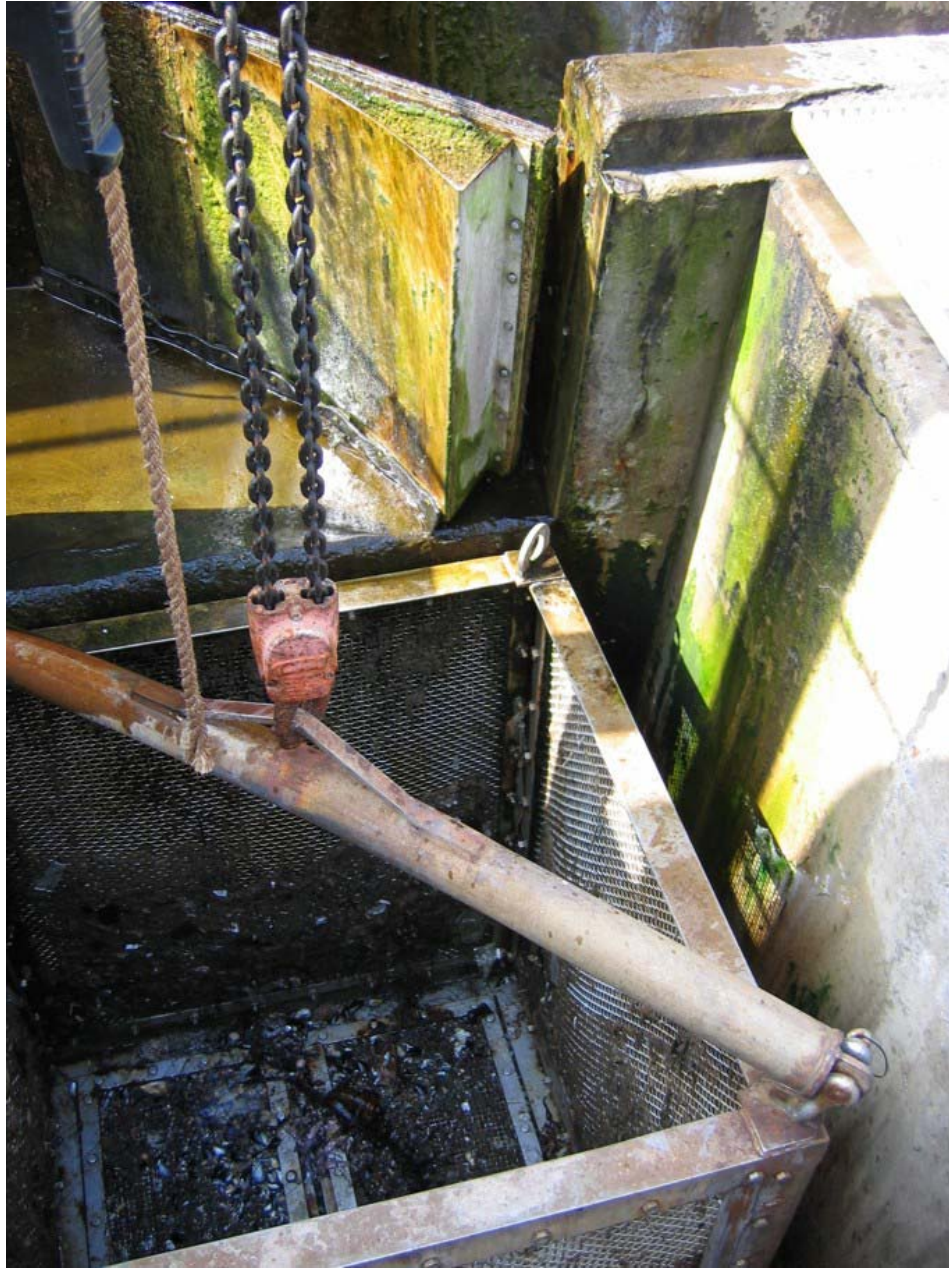

**Figure B4-1.** Unit 5&6 traveling screen collection basket.



**Figure B4-2.** One of the Unit 7&8 collection baskets.

*Redondo Beach Generating Station*

## **Appendix C**

---

### **Model Parameterization**

- C1. Estimating Total Entrainment
- C2. Estimating Proportional Entrainment  
and the *ETM* Calculations
- C3. Demographic Model Calculations

## Appendix C1 Estimating Total Entrainment

The following section describes calculations used for assessing entrainment effects at the Redondo Beach Generating Station (RBGS). The equations are presented in a general form that is applicable to sample designs that may have differing numbers of stations, sampling periods, or replicates. The RBGS entrainment study will sample only one station. While the summation signs over stations are presented in the equations they will be summing over an  $n$  of one in the actual calculations and therefore will drop out of the formulas.

A general form can be written for summing entrainment over stations at an intake or entrainment site using cycles within a day and days within time periods. Let

- $i = \text{period } (i = 1, \dots, N);$
- $j = \text{day within period } (j = 1, \dots, N_i);$
- $k = \text{cycle within day } (k = 1, \dots, N_{ij});$
- $l = \text{station } (l = 1, \dots, N_{ijk});$
- $m = \text{volume at station within cycle } (m = 1, \dots, N_{ijkl}).$

The total larval entrainment at an intake source can be expressed as

$$E_T = \sum_{i=1}^N \sum_{j=1}^{N_i} \sum_{k=1}^{N_{ij}} \sum_{l=1}^{N_{ijk}} \rho_{ijkl} V_{ijkl} \tag{A1}$$

where

$\rho_{ijkl}$  = density of larvae at the  $l$ th station within the  $k$ th cycle on the  $j$ th day in the  $i$ th time period;

$V_{ijkl}$  = volume of water passing the at the  $l$ th station within the  $k$ th cycle on the  $j$ th day in the  $i$ th time period.

This summation assumes that stations represent the total intake volume of the power plant. It also assumes that the larval density in the volume of water passing a station is constant over time and space over any cycle. An estimate of the total larval entrainment can be made by taking  $n_{ijkl}$  samples of the  $N_{ijkl}$  volumes passing a station as

$$\hat{E}_T = \sum_{i=1}^N \sum_{j=1}^{N_i} \sum_{k=1}^{N_{ij}} \sum_{l=1}^{N_{ijk}} \frac{V_{ijkl}}{n_{ijkl}} \sum_{m=1}^{n_{ijkl}} \rho_{ijklm} \quad (\text{A2})$$

If we also assume that entrainment volume is constant and the same at all stations then

$$\hat{E}_T = \sum_{i=1}^N V_{ijkl} \sum_{j=1}^{N_i} \sum_{k=1}^{N_{ij}} \sum_{l=1}^{N_{ijk}} \frac{1}{n_{ijkl}} \sum_{m=1}^{n_{ijkl}} \rho_{ijklm} \quad (\text{A3})$$

Strata will be defined as the stations and cycles with constant  $N_{ij}$  and  $N_{ijk}$ . In addition, we sample  $n_i$  days of the  $N_i$  possible during a period so that

$$\begin{aligned} \hat{E}_T &= \sum_{i=1}^N N_i N_{ij} N_{ijk} V_{ijkl} \frac{1}{n_i} \sum_{j=1}^{N_i} \sum_{k=1}^{N_{ij}} \sum_{l=1}^{N_{ijk}} \left( \frac{1}{N_{ij} N_{ijk} n_{ijkl}} \right) \sum_{m=1}^{n_{ijkl}} \rho_{ijklm} \\ &= \sum_{i=1}^N V_i \frac{1}{n_i} \sum_{j=1}^{N_i} \sum_{k=1}^{N_{ij}} \sum_{l=1}^{N_{ijk}} \left( \frac{1}{N_{ij} N_{ijk} n_{ijkl}} \right) \sum_{m=1}^{n_{ijkl}} \rho_{ijklm} \end{aligned} \quad (\text{A4})$$

where

$$V_i = \sum_{j=1}^{N_i} \sum_{l=1}^{N_{ij}} \sum_{k=1}^{N_{ijk}} V_{ijkl}$$

If only one day per period is sampled Equation A4 can be expressed as

$$\begin{aligned} \hat{E}_T &= \sum_{i=1}^N V_i \sum_{k=1}^{N_{ij}} \sum_{l=1}^{N_{ijk}} \left( \frac{1}{N_{ij} N_{ijk} n_{ijkl}} \right) \sum_{m=1}^{n_{ijkl}} \rho_{ijklm} \\ &= \sum_{i=1}^N V_i \sum_{k=1}^{N_{ij}} \sum_{l=1}^{N_{ijk}} \left( \frac{1}{N_{ij} N_{ijk}} \right) \hat{\rho}_{ijkl} \end{aligned} \quad (\text{A5})$$

with estimated variance

$$\widehat{Var}(\hat{E}_T) = \sum_{i=1}^N V_i^2 \sum_{k=1}^{N_{ij}} \sum_{l=1}^{N_{ijk}} \left( \frac{1}{N_{ij} N_{ijk}} \right)^2 \left( 1 - \frac{n_{ijkl}}{N_{ijkl}} \right) \frac{\widehat{Var}(\rho_{ijkl})}{n_{ijkl}} \quad (\text{A6})$$

where

$$\widehat{Var}(\rho_{ijkl}) = \frac{\sum_{m=1}^{n_{ijkl}} (\rho_{ijklm} - \widehat{\rho}_{ijkl})^2}{(n_{ijkl} - 1)};$$

$$\widehat{\rho}_{ijkl} = \frac{\sum_{m=1}^{n_{ijkl}} \rho_{ijklm}}{n_{ijkl}}.$$

Estimates of  $E_T$  based on Equation A5 will be used in *FH* and *AEL* calculations to estimate annual effects of entrainment on fishes and invertebrates. Equation A6 will underestimate the true variance because it does not include within-period variance. In practice, we ignore the finite population correction,  $\left(1 - \frac{n_{ijkl}}{N_{ijkl}}\right)$  because  $N_{ijkl}$  is large. Estimators similar to Equation A5 and Equation A6 are used for calculating survey period estimates of intake and source populations for use in ETM calculations.



## Appendix C2

### Estimating Proportional Entrainment and the ETM Calculations

The empirical transport model (*ETM*) is used to estimate the total mortality probability for larvae from power plant entrainment. The estimate is based on periodic estimates of the probability of entrainment mortality based on daily samples. In the following calculations we assume all larvae entrained die. Generally, sampling takes place over the course of a year so that larval mortality of various species is estimated.

The daily probability of entrainment can be defined as

$$PE_i = \frac{\text{abundance of entrained larvae}_i}{\text{abundance of larvae in source population}_i}$$

= probability of entrainment in *i*th time period (*i* = 1, ..., *N*).

In turn, the daily probability can be estimated and expressed as

$$PE_i = \frac{\widehat{E}_i}{\widehat{R}_i} \tag{B1}$$

where

$\widehat{E}_i$  = estimated abundance of larvae entrained in the *i*th time period (*i* = 1, ..., *N*);

$\widehat{R}_i$  = estimated abundance of larvae at risk of entrainment from the source population in the *i*th time period (*i* = 1, ..., *N*).

### Estimating Daily Entrainment

The estimate of total Redondo Beach Generating Station (RBGS) entrainment on day *j* in period *i* can be expressed from equation (A4) as

$$\begin{aligned}\widehat{E}_{ij} &= \sum_{k=1}^4 \sum_{l=1}^1 V_{ijkl} \frac{1}{3} \sum_{m=1}^3 \rho_{ijklm} \\ &= V_{ij} \sum_{k=1}^4 \sum_{l=1}^1 \left( \frac{1}{12} \right) \sum_{m=1}^3 \rho_{ijklm}\end{aligned}\quad (B2)$$

with associated variance

$$Var\left(\widehat{E}_{ij} \mid E_{ij}\right) = V_{ij}^2 \sum_{k=1}^4 \sum_{l=1}^1 \left( \frac{1}{12} \right)^2 \left( 1 - \frac{3}{N_{ijkl}} \right) S_{\rho_{ijkl}}^2 \quad (B3)$$

which can be estimated by

$$\widehat{Var}\left(\widehat{E}_{ij}\right) = V_{ij}^2 \sum_{k=1}^4 \sum_{l=1}^1 \left( \frac{1}{12} \right)^2 \left( 1 - \frac{3}{N_{ijkl}} \right) S_{\rho_{ijkl}}^2. \quad (B4)$$

The finite population correction [i.e.,  $\left( 1 - \frac{3}{N_{ijkl}} \right)$ ] can be ignored because  $N_{ijkl}$  is exceedingly large. Only one day is sampled per period. The period estimated entrainment and variance are

$$\widehat{E}_i = V_i \sum_{k=1}^4 \sum_{l=1}^1 \left( \frac{1}{12} \right) \sum_{m=1}^3 \rho_{ijklm} \quad (B5)$$

$$\widehat{Var}\left(\widehat{E}_i\right) = V_i^2 \sum_{k=1}^4 \sum_{l=1}^1 \left( \frac{1}{12} \right)^2 S_{\rho_{ijkl}}^2. \quad (B6)$$

## Estimating Numbers of Larvae at Risk

With the defined and agreed-upon sources of Santa Monica Bay (S) larvae, the daily abundance of larvae at risk can be estimated by

$$\widehat{R}_{ij} = V_S \cdot \widehat{\rho}_{S_{ij}} \quad (B7)$$

where  $V_S$  denotes daily exchanged and static volumes at Santa Monica Bay (S), and  $\widehat{\rho}$  denotes an estimate of average density in each respective source water bodies. The variance of Expression B7 can be written as

$$Var\left(\widehat{R}_{ij} \mid R_{ij}\right) = V_S^2 \cdot Var\left(\widehat{\rho}_{S_{ij}} \mid \bar{\rho}_{S_{ij}}\right) \quad (B8)$$

The individual variances within Formula B8 describe temporal-spatial variance in density within the source population during the day of sampling. Seven source water locations are sampled in Santa Monica Bay. Ideally, tow samples would be collected randomly through time and space

during a sampling day over a potential source population. However, practical limitations due to sampling a large area required a directed and fixed time and location sampling scheme. Our source water estimates of population and variance are made for each period using only one day, i.e.  $\widehat{R}_i = \widehat{R}_{ij}$  and  $\widehat{Var}(\widehat{R}_i) = Var(\widehat{R}_{ij} | R_{ij})$ .

## Period Entrainment and ETM Calculations

By dividing estimated period entrainment (B5) by the corresponding source population (B7) an estimate of entrainment mortality can be written as

$$\widehat{PE}_i = \frac{\widehat{E}_i}{\widehat{R}_i} \quad (B9)$$

### Variance for the Estimate of $PE_i$

The variance for the period estimate of  $\widehat{PE}_i$  can be expressed as

$$Var(\widehat{PE}_i | PE_i) = Var\left(\frac{\widehat{E}_i}{\widehat{R}_i} \middle| E_i, R_i\right).$$

Assuming zero covariance between the entrainment and source and using the delta method (Seber 1982), the variance of an estimator formed from a quotient (like  $\widehat{PE}_i$ ) can be effectively approximated by

$$Var\left(\frac{A}{B}\right) \approx Var(A) \left(\frac{\partial \left[\frac{A}{B}\right]}{\partial A}\right)^2 + Var(B) \left(\frac{\partial \left[\frac{A}{B}\right]}{\partial B}\right)^2.$$

The delta method approximation of  $Var(\widehat{PE}_i)$  is shown as

$$Var(\widehat{PE}_i) = Var\left(\frac{\widehat{E}_i}{V_s \cdot \widehat{\rho}_{s_i}}\right)$$

where by the Delta method can be approximated by

$$\widehat{Var}(\widehat{PE}_i) \approx \widehat{Var}(\widehat{E}_i) \left( \frac{1}{V_S \cdot \widehat{\rho}_{S_i}} \right)^2 + \widehat{Var}(V_S \cdot \widehat{\rho}_{S_i}) \left( \frac{-\widehat{E}_i}{V_S \cdot (\widehat{\rho}_{S_i})^2} \right)^2 \quad (B10)$$

and is equivalent to

$$= PE_i^2 \left[ CV(\widehat{E}_i)^2 + CV(V_S \cdot \widehat{\rho}_{S_i})^2 \right]$$

where

$$\widehat{R}_i = V_S \cdot \widehat{\rho}_{S_{ij}} \quad \text{and}$$

$$CV(\widehat{\theta}|\theta) = \frac{\widehat{Var}(\widehat{\theta}|\theta)}{\widehat{\theta}^2}.$$

Regardless of whether the species has a single spawning period per year or multiple overlapping spawnings the estimate of total larval entrainment mortality can be expressed by

$$\widehat{P}_M = 1 - \sum_{i=1}^N \widehat{f}_i (1 - \widehat{PE}_i)^q \quad (B11)$$

where

$q$  = number of days of larval life, and

$\widehat{f}_i$  = estimated annual fraction of total larvae hatched during the  $i$ th survey period.

Formula (B11) is based on the total probability law where

$$P(A) = \sum_{i=1}^N P(A|B_i) \cdot P(B_i).$$

In the above example, the event A is larval survival and event B is hatching with  $P(B)$

estimated by  $\widehat{f}_i$  where

$$\widehat{f}_i = \frac{\widehat{E}_i}{E_T},$$

where  $\widehat{E}_i$  = estimated entrainment for the  $i$ th survey period. Then based on the Delta method

$$\begin{aligned}\widehat{Var}(\widehat{f}_i) &= \widehat{Var}\left[\frac{\widehat{E}_i}{\widehat{E}_T}\right] \\ &= \widehat{Var}\left[\frac{\widehat{E}_i}{\widehat{E}_i + \sum_{j \neq i}^N \widehat{E}_j}\right] \\ &= \widehat{f}_i^2 (1 - \widehat{f}_i)^2 \left[ \frac{\widehat{Var}(\widehat{E}_i)}{\widehat{E}_i^2} + \frac{\widehat{Var}(\widehat{E}_T)}{\widehat{E}_T^2} \right].\end{aligned}$$

The estimates of  $PE_i$  and  $f_i$  and their respective variance estimates can be combined in an estimate of the variance for  $\widehat{P}_M$  following the Delta method (Seber 1982) for variance and covariance as follows:

$$\begin{aligned}\widehat{Var}(\widehat{P}_M) &= \widehat{Var}\left(1 - \sum_{i=1}^N \widehat{f}_i (1 - \widehat{PE}_i)^q\right) \\ &= \widehat{Var}\left(\sum_{i=1}^N \widehat{f}_i (1 - \widehat{PE}_i)^q\right) \\ &= \sum_{i=1}^N \left[ \widehat{Var}(\widehat{f}_i) (1 - \widehat{PE}_i)^{2q} \right] \\ &\quad + \sum_{i=1}^N \left[ \widehat{Var}(\widehat{PE}_i) (\widehat{f}_i q (1 - \widehat{PE}_i)^{q-1})^2 \right] \\ &\quad + 2 \sum_{i=1}^N \sum_{j>i}^N \text{cov}(\widehat{f}_i, \widehat{f}_j) (1 - \widehat{PE}_j)^q (1 - \widehat{PE}_i)^q \quad \text{where} \\ \text{cov}(\widehat{f}_i, \widehat{f}_j) &= \left(\frac{1}{\widehat{E}_T}\right)^2 \left[ \widehat{f}_i \widehat{f}_j \widehat{Var}\left(\sum_{g \neq i, j}^N \widehat{E}_g\right) + \widehat{f}_i (1 - \widehat{f}_j) \widehat{E}_i + \widehat{f}_j (1 - \widehat{f}_i) \widehat{E}_j \right].\end{aligned}$$

## Appendix C3 Demographic Model Calculations

### Fecundity Hindcasting (*FH*)

The estimated total larval entrainment for a species ( $\widehat{E}_T$ ) was used to estimate the number of breeding females needed to produce the number of larvae entrained. The estimated number of breeding females ( $\widehat{FH}$ ) whose fecundity was equal to the estimated total loss of entrained larvae is calculated as follows:

$$\widehat{FH} = \frac{\widehat{E}_T}{\widehat{TLF} \cdot \prod_{i=1}^n S_i} \quad (C1)$$

where

- $n$  = number of larval stages vulnerable to entrainment,
- $\widehat{E}_T$  = estimated total entrainment,
- $S_i$  = survival rate from eggs to larvae of the  $i$ th stage, and
- $\widehat{TLF}$  = estimated total life time fecundity for females, equivalent to the average number of eggs spawned per female over their reproductive years.

Equation C1 is based on the simplified case of a single synchronized spawning by a species. For species with overlapping or continuous spawning, larval abundance would have to be specified by week and age class (i.e.,  $\widehat{E}_{ij}$ ). However, we used the mean size of all larvae entrained to estimate a representative age of larvae, and then estimated a survival rate to this representative age. Two input parameters in Equation C1 that may not be available for many species, and thus may limit the method, are lifetime fecundity ( $TLF$ ) and survival rates ( $S_i$ ) from spawning to entrainment.

In practice, survival was estimated by either one or several age classes, depending on the data source, to the estimated age at entrainment. The expected total lifetime fecundity  $E(TLF)$  was

approximated by modeling a linear survivorship for a female once she reached the age of maturity, and using a constant number of eggs produced per year.

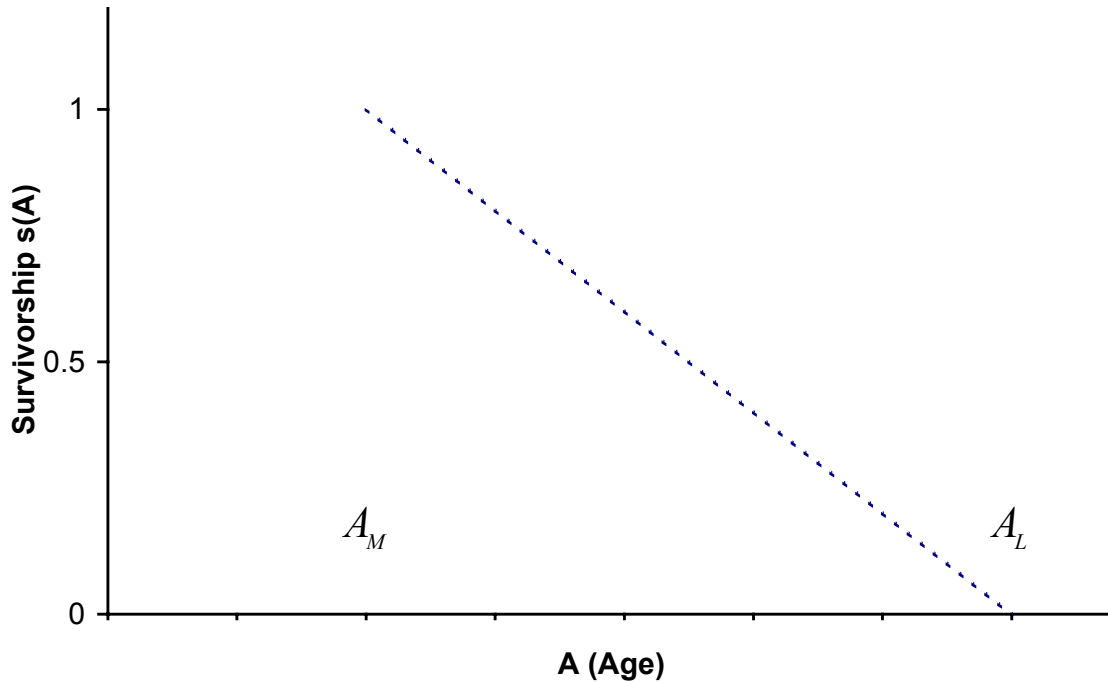

The number of eggs produced per year was approximated as the average number of eggs per year. Thus

$$\begin{aligned} \widehat{TLF} &= \int_{A_M}^{A_L} F(A)s(A) dA \\ &= \bar{F} \int_{A_M}^{A_L} \frac{A_L - A}{A_L - A_M} dA \\ &= \bar{F} \left( \frac{A_L - A_M}{2} \right) \end{aligned}$$

where

$s(A)$  = survivorship of a female;

$F(A)$  = eggs produced;

$A_M$  = age of maturity; and

$A_L$  = age at death.

In other words,

$$\begin{aligned}
 \widehat{TLF} &= \text{Estimated Total Lifetime Fecundity} \\
 &= \text{Average eggs/year} \cdot \text{Average number of years of reproductive life} \\
 &= \text{Average eggs/year} \cdot \left( \frac{\text{Longevity} - \text{Age at maturation}}{2} \right).
 \end{aligned}
 \tag{C2}$$

The expected length of reproductive life was approximated as the midpoint between the times of maturation and longevity. The approximation of linear survivorship between these events implies uniform survival. For exploited species such as northern anchovy and sardine, the expected number of years of reproductive life may be much less than predicted using this assumption.

Simulation, comparing exponential survival, shows that the calculation of  $\widehat{TLF}$  will be negatively biased for species with short reproductive lifespans, and positively biased for those with longer durations.

The variance of  $\widehat{FH}$  was approximated by the Delta method (Seber 1982):

$$\widehat{Var}(\widehat{FH}) = (\widehat{FH})^2 \left[ CV^2(\widehat{E}_T) + \sum_{j=1}^n CV^2(\widehat{S}_j) + CV^2(\widehat{F}) + \left( \frac{\widehat{Var}(A_L) + \widehat{Var}(A_M)}{(A_L - A_m)^2} \right) \right]$$

where

$CV(\widehat{E}_T)$  = CV of estimated entrainment (estimated by  $CV(\widehat{I})$  when available),

$CV(\widehat{S}_j)$  = CV of estimated survival of eggs and larvae up to entrainment,

$CV(\widehat{F})$  = CV of estimated average annual fecundity,

$A_M$  = age at maturation, and

$A_L$  = age at maturity.

The behavior of the estimator for  $FH$  appears log-linear, suggesting that an approximate confidence interval can be based on the assumptions that  $\ln(\widehat{FH})$  is normally distributed and uses the pivotal quantity

$$Z = \frac{\ln \widehat{FH} - \ln FH}{\sqrt{\frac{\widehat{Var}(\widehat{FH})}{\widehat{FH}^2}}}.$$



A 90% confidence interval for  $FH$  was estimated by solving for  $FH$  and setting  $Z$  equal to  $\pm 1.645$ , i.e.

$$\widehat{FH} \cdot e^{-1.645 \sqrt{\frac{\widehat{Var}(FH)}{\widehat{FH}^2}}} \text{ to } \widehat{FH} \cdot e^{+1.645 \sqrt{\frac{\widehat{Var}(FH)}{\widehat{FH}^2}}}$$

## Adult Equivalent Loss (AEL)

The *AEL* approach uses estimates of the abundance of entrained or impinged organisms to forecast the loss of equivalent numbers of adults. Starting with the number of age class  $j$  larvae entrained ( $\widehat{E}_j$ ), it is conceptually easy to convert these numbers to an equivalent number of adults lost ( $\widehat{AEL}$ ) at some specified age class from the formula:

$$\widehat{AEL} = \sum_{j=1}^n \widehat{E}_j \widehat{S}_j \tag{C3}$$

where

$n$  = number of age classes,

$\widehat{E}_j$  = estimated number of larvae lost in age class  $j$ , and

$\widehat{S}_j$  = survival rate for the  $j$ th age class to adulthood (Goodyear 1978).

Age-specific survival rates from larval stage to recruitment into the fishery (through juvenile and early adult stages) must be included in this assessment method. For some commercial species, survival rates are known for adults in the fishery; but for most species, age-specific larval survivorship has not been well described.

When age-specific survival rates from larval stage to recruitment into the fishery were available, *AEL* was calculated using survival from a representative age of the entrained larvae at RBGS. This age was calculated by dividing the average larval length at entrainment (minus hatch length) by a literature-based growth rate. Age-specific survivorship for any interval of time ( $t$ ) was then calculated following the formula (Ricker 1975)

$$\frac{N_t}{N_0} = e^{-Zt}$$

where

$N_t$  = number of animals in the population at time  $t$ ,  
 $N_0$  = number of animals in the population at time  $t = 0$ ,  
 $\frac{N_t}{N_0} = S$  (finite survivorship to time  $t$ ),  
 $e = 2.71828\dots$ (base of the natural log), and  
 $Z$  = instantaneous mortality rate.

Survivorship to recruitment, to an adult age, was apportioned into several age stages, and  $AEL$  was calculated using the total entrainment as

$$\widehat{AEL} = \hat{E}_T \prod_{j=1}^n \hat{S}_j \quad (C4)$$

where

$n$  = number of age classes from entrainment to recruitment and  
 $\hat{S}_j$  = survival rate from the beginning to end of the  $j$ th age class.

The variance of  $\widehat{AEL}$  can be estimated using a Taylor series approximation (Delta method of Seber 1982) as

$$\widehat{Var}(\widehat{AEL}) = \widehat{AEL}^2 \left( CV^2(\hat{E}_T) + \sum_{j=1}^n CV^2(\hat{S}_j) \right). \quad (C5)$$

An alternative analysis would be to compare  $\widehat{AEL}$  with the size of the adult population of interest or with fishery harvest data. This method converts numbers of adult losses into fractional loss of the population of interest (e.g., stock assessment). However, information describing adult stocks is limited for many species, and independent field estimates of survival from time of entrainment to adulthood are not available for some species. For some species where such information is unavailable, we can estimate this parameter by assuming a stationary population where an adult female must produce two adults (i.e., one male and one female). Overall survival ( $S_T$ ) can then be estimated from total lifetime fecundity ( $TLF$ ) by the quantity

$$\hat{S}_T = \frac{2}{TLF} = \hat{S}_{egg} \cdot \hat{S}_{larvae} \cdot \hat{S}_{adult},$$

which leads to

$$\hat{S}_{adult} = \frac{2}{\widehat{TLF} \cdot \hat{S}_{egg} \cdot \hat{S}_{larvae}}. \quad (C6)$$

Substituting Equation 11 into the overall form of the *AEL* equation where

$$\widehat{AEL} = \hat{E}_T \cdot \hat{S}_{adult} \tag{C7}$$

yields

$$\widehat{AEL} = \frac{2(\hat{E}_T)}{\hat{S}_{egg} \cdot \hat{S}_{larva} \cdot \widehat{TLF}}$$

where

$$\widehat{AEL} \equiv 2\widehat{FH} . \tag{C8}$$

Without independent adult survival rates and assuming a 50:50 sex ratio,  $\widehat{AEL}$  and  $\widehat{FH}$  are deterministically related according to Equation 13, with an associated standard error of  $\widehat{SE}(\widehat{AEL}) = 2\widehat{SE}(\widehat{FH})$ . Equation 13 should be aligned so that the average female age is also the age of recruitment used in computing  $\widehat{AEL}$ . This alignment is accomplished by solving the simple exponential survival equation (Ricker 1975)

$$N_t = N_0 \cdot e^{-Z(t-t_0)}$$

by substituting numbers of either equivalent adults or hindcast females, their associated ages, and mortality rates into the equation where,

- $N_t$  = number of adults at time  $t$ ,
- $N_0$  = number of adults at time  $t_0$ ,
- $Z$  = instantaneous rate of natural mortality, and
- $t$  = age of hindcast animals ( $FH$ ) or extrapolated age of animals ( $AEL$ ).

This allows for the alignment of ages in either direction such that  $2FH \equiv AEL$  since they are either hindcast or extrapolated to the same age.

The estimates of mortality calculated from the *AEL* and *FH* approaches can be compared for the same time periods for taxa where independent estimates are available for (1) survival from entrainment to recruitment into the fishery and (2) entrainment back to hatching. These comparisons serve as a method of cross-validation for the demographic approaches to impact assessment.

## Literature Cited

- Goodyear, C. P. 1978. Entrainment impact estimates using the equivalent adult approach. United States Fish and Wildlife Service, FWS/OBS-78/65, Ann Arbor, MI.
- Ricker, W. E. 1975. Computation and interpretation of biological statistics of fish populations. Fishery Research Board of Canada Bulletin 91. 382 pp.
- Seber, G. A. F. 1982. The Estimation of Animal Abundance and Related Parameters. McMillan. London. 654 p.

*Redondo Beach Generating Station*

## **Appendix D**

---

### **Entrainment Data**

Appendix D. Data by Survey and Station

Redondo Beach Generating Station  
Entrainment Study - Fish and Invertebrate Abundances

Survey: SMBEA02  
Start Date: 1/25/2006  
Stations: H2 (UNITS 5&6 INTAKE)

Taxon	Common Name	Count	Mean Concentration (#/1,000m <sup>3</sup> )
<b>Fishes</b>			
Gobiidae unid.	gobies	29	192.88
<i>Rhinogobiops nicholsi</i>	blackeye goby	2	12.52
<i>Clinocottus analis</i>	wooly sculpin	1	7.11
<i>Hypsoblennius</i> spp.	combtooth blennies	1	6.15
<i>Paralichthys californicus</i>	California halibut	1	6.15
<i>Ruscarius creaseri</i>	roughcheek sculpin	1	6.15
		<b>Total Fishes: 35</b>	
<b>Target Invertebrates</b>			
No Invertebrates			

Redondo Beach Generating Station  
Entrainment Study - Fish and Invertebrate Abundances

Survey: SMBEA04  
Start Date: 2/23/2006  
Stations: H2 (UNITS 5&6 INTAKE)

Taxon	Common Name	Count	Mean Concentration (#/1,000m <sup>3</sup> )
<b>Fishes</b>			
Gobiidae unid.	gobies	33	193.42
<i>Typhlogobius californiensis</i>	blind goby	6	33.06
<i>Gobiesox</i> spp.	clingfishes	3	17.91
<i>Atherinopsis californiensis</i>	jacksmelt	2	10.70
Cottidae unid.	sculpins	1	5.35
<i>Genyonemus lineatus</i>	white croaker	1	6.31
<i>Ruscarius creaseri</i>	roughcheek sculpin	1	5.35
<i>Sebastes</i> spp.	rockfishes	1	6.31
		<b>Total Fishes: 48</b>	
<b>Target Invertebrates</b>			
Pinnixa spp. (megalops)	pea crabs megalops	1	5.35
		<b>Total Target Invertebrates: 1</b>	

Redondo Beach Generating Station  
 Entrainment Study - Fish and Invertebrate Abundances

Survey: SMBEA06  
 Start Date: 3/22/2006  
 Stations: H2 (UNITS 5&6 INTAKE)

Taxon	Common Name	Count	Mean Concentration (#/1,000m <sup>3</sup> )
<b>Fishes</b>			
Gobiidae unid.	gobies	7	29.99
<i>Typhlogobius californiensis</i>	blind goby	4	19.96
<i>Clinocottus analis</i>	wooly sculpin	2	6.78
<i>Gobiesox</i> spp.	clingfishes	2	10.34
<i>Hypsoblennius</i> spp.	combtooth blennies	2	8.56
larval fish - damaged	unidentified larval fishes	2	8.03
<i>Artedius lateralis</i>	smoothhead sculpin	1	3.39
Atherinopsidae unid.	silversides	1	3.39
<i>Icelinus</i> spp.	sculpins	1	5.17
<i>Leptocottus armatus</i>	Pacific staghorn sculpin	1	3.39
Pleuronectidae unid.	righteye flounders	1	3.39
<i>Ruscarius creaseri</i>	roughcheek sculpin	1	5.17
		<b>Total Fishes: 25</b>	
<b>Target Invertebrates</b>			
No Invertebrates			

Redondo Beach Generating Station  
 Entrainment Study - Fish and Invertebrate Abundances

Survey: SMBEA08  
 Start Date: 4/19/2006  
 Stations: H2 (UNITS 5&6 INTAKE)

Taxon	Common Name	Count	Mean Concentration (#/1,000m <sup>3</sup> )
<b>Fishes</b>			
Gobiidae unid.	gobies	49	315.82
<i>Hypsoblennius</i> spp.	combtooth blennies	35	226.30
<i>Gobiesox</i> spp.	clingfishes	29	191.24
<i>Genyonemus lineatus</i>	white croaker	15	91.85
<i>Typhlogobius californiensis</i>	blind goby	9	59.19
Blenniidae unid.	blennies	3	19.41
<i>Artedius</i> spp.	sculpins	1	8.09
Chaenopsidae unid.	tube blennies	1	6.25
<i>Citharichthys stigmaeus</i>	speckled sanddab	1	8.09
<i>Clinocottus analis</i>	wooly sculpin	1	6.25
<i>Hypsypops rubicundus</i>	garibaldi	1	5.94
<i>Icelinus</i> spp.	sculpins	1	6.25
larval/post-larval fish unid.	larval fishes	1	6.25
Pleuronectidae unid.	righteye flounders	1	5.94
<i>Rhinogobiops nicholsi</i>	blackeye goby	1	6.25
Sciaenidae unid.	croakers	1	6.47
<i>Stenobranchius leucopsarus</i>	northern lampfish	1	5.94
		<b>Total Fishes: 151</b>	
<b>Target Invertebrates</b>			
Paguridae unid. (megalops)	hermit crab megalops	1	6.47
		<b>Total Target Invertebrates: 1</b>	



Redondo Beach Generating Station  
 Entrainment Study - Fish and Invertebrate Abundances

Survey: SMBEA10  
 Start Date: 5/16/2006  
 Stations: H2 (UNITS 5&6 INTAKE)

Taxon	Common Name	Count	Mean Concentration (#/1,000m <sup>3</sup> )
<b>Fishes</b>			
<i>Hypsoblennius</i> spp.	combtooth blennies	194	1,199.23
Gobiidae unid.	gobies	56	353.88
<i>Engraulis mordax</i>	northern anchovy	48	297.02
Engraulidae unid.	anchovies	19	117.72
<i>Hypsypops rubicundus</i>	garibaldi	19	118.11
Labrisomidae unid.	labrisomid blennies	11	69.81
<i>Typhlogobius californiensis</i>	blind goby	8	49.30
larval fish fragment	unidentified larval fishes	5	30.46
<i>Gibbonsia</i> spp.	clinid kelpfishes	4	24.55
<i>Gobiesox</i> spp.	clingfishes	4	26.07
larval fish - damaged	unidentified larval fishes	3	18.98
<i>Oxyjulis californica</i>	senorita	2	12.09
<i>Ruscarius creaseri</i>	roughcheek sculpin	2	12.08
Atherinopsidae unid.	silversides	1	5.96
<i>Citharichthys stigmaeus</i>	speckled sanddab	1	5.96
<i>Clinocottus analis</i>	wooly sculpin	1	6.13
<i>Genyonemus lineatus</i>	white croaker	1	6.13
<i>Paralichthys californicus</i>	California halibut	1	5.96
<i>Rhinogobiops nicholsi</i>	blackeye goby	1	6.14
Sciaenidae unid.	croakers	1	6.13
		<b>Total Fishes: 382</b>	
<b>Target Invertebrates</b>			
No Invertebrates			

Redondo Beach Generating Station  
 Entrainment Study - Fish and Invertebrate Abundances

Survey: SMBEA12  
 Start Date: 6/14/2006  
 Stations: H2 (UNITS 5&6 INTAKE)

Taxon	Common Name	Count	Mean Concentration (#/1,000m <sup>3</sup> )
<b>Fishes</b>			
<i>Hypsoblennius</i> spp.	combtooth blennies	182	1,013.15
<i>Hypsypops rubicundus</i>	garibaldi	27	143.28
Gobiidae unid.	gobies	21	136.98
Labrisomidae unid.	labrisomid blennies	19	107.72
larval fish - damaged	unidentified larval fishes	7	40.03
<i>Typhlogobius californiensis</i>	blind goby	7	36.86
<i>Gibbonsia</i> spp.	clinid kelpfishes	2	12.87
<i>Gobiesox</i> spp.	clingfishes	2	10.53
<i>Oxyjulis californica</i>	senorita	2	10.90
<i>Atherinops affinis</i>	topsmelt	1	5.27
Atherinopsidae unid.	silversides	1	5.27
<i>Citharichthys stigmaeus</i>	speckled sanddab	1	7.13
Engraulidae unid.	anchovies	1	5.73
larvae, unidentified yolksac	unidentified yolksac larvae	1	5.73
Larval fish fragment	unidentified larval fishes	1	5.73
<i>Leuresthes tenuis</i>	California grunion	1	5.27
<i>Seriphus politus</i>	queenfish	1	7.13
		<b>Total Fishes: 277</b>	
<b>Target Invertebrates</b>			
<i>Loligo opalescens</i>	market squid	1	5.27
		<b>Total Target Invertebrates: 1</b>	

Redondo Beach Generating Station  
 Entrainment Study - Fish and Invertebrate Abundances

Survey: SMBEA14  
 Start Date: 7/12/2006  
 Stations: H2 (UNITS 5&6 INTAKE)

Taxon	Common Name	Count	Mean Concentration (#/1,000m <sup>3</sup> )
<b>Fishes</b>			
<i>Hypsoblennius</i> spp.	combtooth blennies	209	1,153.74
Gobiidae unid.	gobies	109	570.52
Labrisomidae unid.	labrisomid blennies	15	72.37
<i>Gobiesox</i> spp.	clingfishes	3	15.10
<i>Hypsypops rubicundus</i>	garibaldi	3	14.62
larval fish - damaged	unidentified larval fishes	3	15.10
larval fish fragment	unidentified larval fishes	3	14.62
larvae, unidentified yolksac	unidentified yolksac larvae	2	11.87
<i>Atherinops affinis</i>	topsmelt	1	5.43
<i>Genyonemus lineatus</i>	white croaker	1	5.91
Haemulidae unid.	grunts	1	5.94
<i>Menticirrhus undulatus</i>	California corbina	1	5.43
<i>Syngnathus</i> spp.	pipefishes	1	5.43
<i>Typhlogobius californiensis</i>	blind goby	1	4.59
		<b>Total Fishes: 353</b>	
<b>Target Invertebrates</b>			
<i>Panulirus interruptus</i> (phyllosome)	California spiny lobster (larval)	17	95.27
Majidae unid. (megalops)	spider crab megalops	4	20.88
<i>Petrolisthes</i> spp. (megalops)	porcelain crab megalops	1	5.43
Pinnotheridae (megalops)	pea crab megalops	1	4.59
		<b>Total Target Invertebrates: 23</b>	

Redondo Beach Generating Station  
Entrainment Study - Fish and Invertebrate Abundances

Survey: SMBEA16  
Start Date: 8/9/2006  
Stations: H2 (UNITS 5&6 INTAKE)

Taxon	Common Name	Count	Mean Concentration (#/1,000m <sup>3</sup> )
<b>Fishes</b>			
Gobiidae unid.	gobies	316	1,376.34
<i>Hypsoblennius</i> spp.	combtooth blennies	179	896.20
Labrisomidae unid.	labrisomid blennies	93	471.49
larvae, unidentified yolksac	unidentified yolksac larvae	14	70.22
Sciaenidae unid.	croakers	14	77.37
larval fish - damaged	unidentified larval fishes	6	24.87
<i>Hypsypops rubicundus</i>	garibaldi	5	20.99
<i>Paralichthys californicus</i>	California halibut	4	18.13
larval fish fragment	unidentified larval fishes	3	12.48
<i>Menticirrhus undulatus</i>	California corbina	3	21.82
Haemulidae unid.	grunts	2	8.26
Ophidiidae unid.	cusks-eels	2	8.43
<i>Paralabrax</i> spp.	sea basses	2	10.97
<i>Syngnathus</i> spp.	pipefishes	2	8.43
Blennioidei unid.	blennies	1	4.13
<i>Halichoeres semicinctus</i>	rock wrasse	1	4.13
<i>Oxyjulis californica</i>	senorita	1	4.13
<i>Peprilus simillimus</i>	Pacific butterfish	1	4.13
<i>Pleuronichthys guttulatus</i>	diamond turbot	1	4.21
<i>Pleuronichthys</i> spp.	turbots	1	5.48
		<b>Total Fishes: 651</b>	
<b>Target Invertebrates</b>			
<i>Panulirus interruptus</i> (phyllosome)	California spiny lobster (larval)	2	8.34
<i>Pugettia</i> spp. (megalops)	kelp crabs megalops	1	5.48
<i>Petrolisthes</i> spp. (megalops)	porcelain crab megalops	1	4.21
		<b>Total Target Invertebrates: 4</b>	

Redondo Beach Generating Station  
 Entrainment Study - Fish and Invertebrate Abundances

Survey: SMBEA19  
 Start Date: 9/20/2006  
 Stations: H2 (UNITS 5&6 INTAKE)

Taxon	Common Name	Count	Mean Concentration (#/1,000m <sup>3</sup> )
<b>Fishes</b>			
Gobiidae unid.	gobies	125	724.68
<i>Hypsoblennius spp.</i>	combtooth blennies	112	689.08
<i>Semicossyphus pulcher</i>	California sheephead	5	27.71
larval fish - damaged	unidentified larval fishes	4	29.80
Labrisomidae unid.	labrisomid blennies	3	16.66
larvae, unidentified yolksac	unidentified yolksac larvae	2	10.13
<i>Oxyjulis californica</i>	senorita	2	12.52
<i>Genyonemus lineatus</i>	white croaker	1	5.07
<i>Syngnathus spp.</i>	pipefishes	1	7.45
		<b>Total Fishes: 255</b>	
<b>Target Invertebrates</b>			
No Invertebrates			

Redondo Beach Generating Station  
Entrainment Study - Fish and Invertebrate Abundances

Survey: SMBEA21  
Start Date: 10/18/2006  
Stations: H2 (UNITS 5&6 INTAKE)

Taxon	Common Name	Count	Mean Concentration (#/1,000m <sup>3</sup> )
<b>Fishes</b>			
Gobiidae unid.	gobies	82	546.93
<i>Hypsoblennius</i> spp.	combtooth blennies	45	310.32
<i>Gibbonsia</i> spp.	clinid kelpfishes	7	48.94
Labrisomidae unid.	labrisomid blennies	5	28.99
<i>Genyonemus lineatus</i>	white croaker	3	19.01
<i>Paralichthys californicus</i>	California halibut	2	12.67
<i>Atherinopsis californiensis</i>	jacksmelt	1	6.34
<i>Citharichthys sordidus</i>	Pacific sanddab	1	6.00
<i>Citharichthys stigmaeus</i>	speckled sanddab	1	6.00
Engraulidae unid.	anchovies	1	6.34
<i>Gobiesox</i> spp.	clingfishes	1	7.32
<i>Pleuronichthys guttulatus</i>	diamond turbot	1	5.67
<i>Pleuronichthys</i> spp.	turbots	1	5.67
<i>Syngnathus</i> spp.	pipefishes	1	5.67
<i>Xystreurus liolepis</i>	fantail sole	1	6.34
		<b>Total Fishes: 153</b>	
<b>Target Invertebrates</b>			
Paguridae unid. (megalops)	hermit crab megalops	1	5.67
		<b>Total Target Invertebrates: 1</b>	

Redondo Beach Generating Station  
Entrainment Study - Fish and Invertebrate Abundances

Survey: SMBEA23  
Start Date: 11/15/2006  
Stations: H2 (UNITS 5&6 INTAKE)

Taxon	Common Name	Count	Mean Concentration (#/1,000m <sup>3</sup> )
<b>Fishes</b>			
Gobiidae unid.	gobies	73	443.01
<i>Hypsoblennius</i> spp.	combtooth blennies	56	350.91
<i>Gibbonsia</i> spp.	clinid kelpfishes	4	26.85
Labrisomidae unid.	labrisomid blennies	3	18.74
<i>Genyonemus lineatus</i>	white croaker	2	11.22
Blennioidei unid.	blennies	1	7.18
<i>Pleuronichthys guttulatus</i>	diamond turbot	1	4.98
		<b>Total Fishes: 140</b>	
<b>Target Invertebrates</b>			
Portunus xantusii (megalops)	Xantus' swimming crab megalops	1	6.65
		<b>Total Target Invertebrates: 1</b>	

Redondo Beach Generating Station  
 Entrainment Study - Fish and Invertebrate Abundances

Survey: SMBEA25  
 Start Date: 12/13/2006  
 Stations: H2 (UNITS 5&6 INTAKE)

Taxon	Common Name	Count	Mean Concentration (#/1,000m <sup>3</sup> )
<b>Fishes</b>			
Gobiidae unid.	gobies	26	157.38
<i>Hypsoblennius</i> spp.	combtooth blennies	21	132.47
<i>Gibbonsia</i> spp.	clinid kelpfishes	4	24.69
larval fish fragment	unidentified larval fishes	2	11.82
<i>Genyonemus lineatus</i>	white croaker	1	5.74
		<b>Total Fishes: 54</b>	
<b>Target Invertebrates</b>			
Brachyura unid. (megalops)	unidentified crab megalops	1	6.80
Majidae unid. (megalops)	spider crab megalops	1	6.80
<i>Pugettia</i> spp. (megalops)	kelp crabs megalops	1	6.80
		<b>Total Target Invertebrates: 3</b>	

Redondo Beach Generating Station  
Entrainment Study - Fish and Invertebrate Abundances

Survey: SMBEA01  
Start Date: 1/11/2006  
Stations: E4 (UNITS 7&8 INTAKE)

Taxon	Common Name	Count	Mean Concentration (#/1,000m <sup>3</sup> )
<b>Fishes</b>			
Gobiidae unid.	gobies	16	29.59
<i>Ruscarius creaseri</i>	roughcheek sculpin	7	19.22
<i>Hypsoblennius</i> spp.	combtooth blennies	5	14.87
<i>Atherinopsis californiensis</i>	jacksmelt	7	10.97
<i>Pleuronichthys guttulatus</i>	diamond turbot	2	5.77
<i>Zaniolepis frenata</i>	shortspine combfish	2	5.64
<i>Gibbonsia</i> spp.	clinid kelpfishes	2	5.29
<i>Scorpaenichthys marmoratus</i>	cabezon	2	5.29
<i>Typhlogobius californiensis</i>	blind goby	1	2.86
<i>Genyonemus lineatus</i>	white croaker	1	2.77
Atherinopsidae unid.	silversides	1	2.65
Cottidae unid.	sculpins	1	2.65
Labrisomidae unid.	labrisomid blennies	1	1.45
<i>Atherinops affinis</i>	topsmelt	1	1.36
<i>Clinocottus analis</i>	wooly sculpin	1	1.36
<i>Clinocottus</i> spp.	sculpins	1	1.36
<i>Gobiesox</i> spp.	clingfishes	1	1.36
		<b>Total Fishes: 52</b>	
<b>Eggs</b>			
<i>Citharichthys</i> spp. (eggs)	sanddab eggs	1,212	2,916.42
<i>Paralichthys californicus</i> (eggs)	California halibut eggs	51	133.79
<i>Genyonemus lineatus</i> (eggs)	white croaker eggs	40	100.31
<i>Pleuronichthys</i> spp. (eggs)	turbot eggs	40	85.91
fish eggs unid.	unidentified fish eggs	6	16.74
Paralichthyidae unid. (eggs)	sand flounder eggs	2	2.71
		<b>Total Eggs: 1,351</b>	
<b>Target Invertebrates</b>			
<i>Hemigrapsus</i> spp. (megalops)	shore crab megalops	2	5.77
		<b>Total Target Invertebrates: 2</b>	



Redondo Beach Generating Station  
Entrainment Study - Fish and Invertebrate Abundances

Survey: SMBEA02  
Start Date: 1/25/2006  
Stations: E4 (UNITS 7&8 INTAKE)

Taxon	Common Name	Count	Mean Concentration (#/1,000m <sup>3</sup> )
<b>Fishes</b>			
<i>Scorpaenichthys marmoratus</i>	cabezon	10	33.75
<i>Pleuronichthys guttulatus</i>	diamond turbot	3	10.45
Gobiidae unid.	gobies	3	10.22
<i>Ruscarius creaseri</i>	roughcheek sculpin	1	3.40
<i>Zaniolepis latipinnis</i>	longspine combfish	1	2.42
<i>Paralichthys californicus</i>	California halibut	1	2.32
		<b>Total Fishes: 19</b>	
<b>Eggs</b>			
<i>Citharichthys</i> spp. (eggs)	sanddab eggs	318	863.49
<i>Paralichthyidae</i> unid. (eggs)	sand flounder eggs	247	768.90
<i>Pleuronichthys</i> spp. (eggs)	turbot eggs	40	121.22
<i>Genyonemus lineatus</i> (eggs)	white croaker eggs	42	113.33
fish eggs unid.	unidentified fish eggs	31	84.87
<i>Paralichthys californicus</i> (eggs)	California halibut eggs	17	51.61
Engraulidae unid. (eggs)	anchovy eggs	1	2.59
		<b>Total Eggs: 696</b>	
<b>Target Invertebrates</b>			
<i>Cancer gracilis</i> (megalops)	slender crab megalops	1	3.34
		<b>Total Target Invertebrates: 1</b>	

Redondo Beach Generating Station  
Entrainment Study - Fish and Invertebrate Abundances

Survey: SMBEA02  
Start Date: 1/25/2006  
Stations: H1-H2

Taxon	Common Name	Count	Mean Concentration (#/1,000m <sup>3</sup> )
<b>Fishes</b>			
Gobiidae unid.	gobies	93	321.04
<i>Hypsoblennius</i> spp.	combt tooth blennies	4	13.43
<i>Rhinogobiops nicholsi</i>	blackeye goby	3	9.54
<i>Clinocottus analis</i>	wooly sculpin	1	3.56
<i>Citharichthys stigmaeus</i>	speckled sanddab	1	3.50
<i>Genyonemus lineatus</i>	white croaker	1	3.28
<i>Pleuronichthys</i> spp.	turbots	1	3.28
<i>Paralichthys californicus</i>	California halibut	1	3.08
<i>Ruscarius creaseri</i>	roughcheek sculpin	1	3.08
		<b>Total Fishes: 106</b>	
<b>Target Invertebrates</b>			
No Invertebrates			

Redondo Beach Generating Station  
 Entrainment Study - Fish and Invertebrate Abundances

Survey: SMBEA02  
 Start Date: 1/25/2006  
 Stations: O4-O6, S5-S6

Taxon	Common Name	Count	Mean Concentration (#/1,000m <sup>3</sup> )
<b>Fishes</b>			
<i>Pleuronichthys verticalis</i>	hornyhead turbot	3	3.32
<i>Paralichthys californicus</i>	California halibut	3	3.31
<i>Sebastes</i> spp.	rockfishes	3	3.30
<i>Heterostichus rostratus</i>	giant kelpfish	1	1.35
<i>Citharichthys stigmaeus</i>	speckled sanddab	1	1.29
<i>Rhinogobiops nicholsi</i>	blackeye goby	1	1.02
<i>Clinocottus analis</i>	wooly sculpin	1	1.00
Pleuronectiformes unid.	flatfishes	1	0.90
larval fish - damaged	unidentified larval fishes	1	0.86
		<b>Total Fishes: 15</b>	
<b>Target Invertebrates</b>			
<i>Pugettia</i> spp. (megalops)	kelp crabs megalops	4	4.34
unidentified crab (megalops)	unidentified crab megalops	3	3.07
<i>Cancer antennarius</i> (megalops)	brown rock crab megalops	1	1.33
<i>Pinnixa</i> spp. (megalops)	pea crabs megalops	1	1.33
<i>Cancer gracilis</i> (megalops)	slender crab megalops	1	0.96
		<b>Total Target Invertebrates: 10</b>	

Redondo Beach Generating Station  
 Entrainment Study - Fish and Invertebrate Abundances

Survey: SMBEA03  
 Start Date: 2/8/2006  
 Stations: E4 (UNITS 7&8 INTAKE)

Taxon	Common Name	Count	Mean Concentration (#/1,000m <sup>3</sup> )
<b>Fishes</b>			
<i>Ruscarius creaseri</i>	roughcheek sculpin	6	21.58
Gobiidae unid.	gobies	4	12.20
<i>Clinocottus analis</i>	wooly sculpin	4	11.41
<i>Typhlogobius californiensis</i>	blind goby	3	10.54
<i>Gobiesox</i> spp.	clingfishes	1	3.81
<i>Artedius lateralis</i>	smoothhead sculpin	1	2.67
		<b>Total Fishes: 19</b>	
<b>Eggs</b>			
Paralichthyidae unid. (eggs)	sand flounder eggs	192	630.74
<i>Citharichthys</i> spp. (eggs)	sanddab eggs	107	351.91
<i>Genyonemus lineatus</i> (eggs)	white croaker eggs	12	37.11
<i>Pleuronichthys</i> spp. (eggs)	turbot eggs	4	13.76
Engraulidae unid. (eggs)	anchovy eggs	1	3.29
fish eggs unid.	unidentified fish eggs	1	2.67
		<b>Total Eggs: 317</b>	
<b>Target Invertebrates</b>			
Grapsidae unid. (megalops)	shore crab megalops	1	3.29
		<b>Total Target Invertebrates: 1</b>	

Redondo Beach Generating Station  
Entrainment Study - Fish and Invertebrate Abundances

Survey: SMBEA04  
Start Date: 2/23/2006  
Stations: E4 (UNITS 7&8 INTAKE)

Taxon	Common Name	Count	Mean Concentration (#/1,000m <sup>3</sup> )
<b>Fishes</b>			
<i>Ruscarius creaseri</i>	roughcheek sculpin	22	59.52
<i>Scorpaenichthys marmoratus</i>	cabezon	6	18.26
<i>Atherinopsis californiensis</i>	jacksmelt	6	16.14
<i>Oxylebius pictus</i>	painted greenling	5	14.78
<i>Gobiesox</i> spp.	clingfishes	5	14.51
<i>Genyonemus lineatus</i>	white croaker	5	14.20
<i>Typhlogobius californiensis</i>	blind goby	5	12.85
<i>Merluccius productus</i>	Pacific hake	4	10.39
Gobiidae unid.	gobies	3	7.88
<i>Clinocottus analis</i>	wooly sculpin	2	6.12
Labrisomidae unid.	labrisomid blennies	1	3.51
<i>Gibbonsia</i> spp.	clinid kelpfishes	1	3.04
<i>Pleuronichthys guttulatus</i>	diamond turbot	1	2.82
<i>Pleuronichthys verticalis</i>	hornyhead turbot	1	2.82
<i>Paralichthys californicus</i>	California halibut	1	2.80
<i>Parophrys vetulus</i>	English sole	1	2.51
<i>Rhinogobiops nicholsi</i>	blackeye goby	1	2.25
		<b>Total Fishes: 70</b>	
<b>Eggs</b>			
Paralichthyidae unid. (eggs)	sand flounder eggs	1,463	3,997.30
<i>Citharichthys</i> spp. (eggs)	sanddab eggs	86	237.52
fish eggs unid.	unidentified fish eggs	70	189.09
<i>Genyonemus lineatus</i> (eggs)	white croaker eggs	58	170.01
<i>Pleuronichthys</i> spp. (eggs)	turbot eggs	33	92.61
<i>Paralichthys californicus</i> (eggs)	California halibut eggs	25	70.75
Engraulidae unid. (eggs)	anchovy eggs	10	27.55
		<b>Total Eggs: 1,745</b>	
<b>Target Invertebrates</b>			
<i>Emerita analoga</i> (megalops)	mole crabs megalops	2	4.49
<i>Pugettia</i> spp. (megalops)	kelp crabs megalops	1	3.51
<i>Pachycheles</i> spp. (megalops)	porcelain crabs megalops	1	3.04
Majidae unid. (megalops)	spider crab megalops	1	2.25
<i>Pinnixa</i> spp. (megalops)	pea crabs megalops	1	2.25
		<b>Total Target Invertebrates: 6</b>	

Redondo Beach Generating Station  
 Entrainment Study - Fish and Invertebrate Abundances

Survey: SMBEA04  
 Start Date: 2/23/2006  
 Stations: H1-H2

Taxon	Common Name	Count	Mean Concentration (#/1,000m <sup>3</sup> )
<b>Fishes</b>			
Gobiidae unid.	gobies	92	281.76
<i>Typhlogobius californiensis</i>	blind goby	7	19.50
<i>Sebastes</i> spp.	rockfishes	5	15.48
<i>Gobiesox</i> spp.	clingfishes	5	14.59
<i>Genyonemus lineatus</i>	white croaker	2	6.12
<i>Atherinopsis californiensis</i>	jacksmelt	2	5.35
<i>Ruscarius creaseri</i>	roughcheek sculpin	2	5.34
<i>Atherinops affinis</i>	topsmelt	1	3.42
<i>Rhinogobiops nicholsi</i>	blackeye goby	1	3.42
<i>Citharichthys stigmaeus</i>	speckled sanddab	1	2.97
<i>Parophrys vetulus</i>	English sole	1	2.97
Cottidae unid.	sculpins	1	2.68
		<b>Total Fishes: 120</b>	
<b>Target Invertebrates</b>			
<i>Pinnixa</i> spp. (megalops)	pea crabs megalops	1	2.68
		<b>Total Target Invertebrates: 1</b>	

Redondo Beach Generating Station  
Entrainment Study - Fish and Invertebrate Abundances

Survey: SMBEA04  
Start Date: 2/23/2006  
Stations: O4-O6, S5-S6

Taxon	Common Name	Count	Mean Concentration (#/1,000m <sup>3</sup> )
<b>Fishes</b>			
<i>Pleuronichthys guttulatus</i>	diamond turbot	9	10.52
<i>Genyonemus lineatus</i>	white croaker	10	10.27
<i>Paralichthys californicus</i>	California halibut	6	5.52
<i>Parophrys vetulus</i>	English sole	5	4.88
<i>Sebastes</i> spp.	rockfishes	4	3.67
<i>Syngnathus</i> spp.	pipefishes	2	2.57
<i>Atherinopsis californiensis</i>	jacksmelt	2	2.16
<i>Stenobranchius leucopsarus</i>	northern lampfish	2	2.07
Sciaenidae unid.	croakers	2	1.65
Cottidae unid.	sculpins	1	1.51
<i>Typhlogobius californiensis</i>	blind goby	2	1.48
<i>Gibbonsia</i> spp.	clinid kelpfishes	1	1.30
<i>Oxylebius pictus</i>	painted greenling	1	1.30
<i>Scorpaenichthys marmoratus</i>	cabezon	1	1.26
Labrisomidae unid.	labrisomid blennies	1	1.17
<i>Icelinus</i> spp.	sculpins	1	0.92
<i>Merluccius productus</i>	Pacific hake	1	0.81
larval fish - damaged	unidentified larval fishes	1	0.65
Paralichthyidae unid.	sand flounders	1	0.65
		<b>Total Fishes: 53</b>	
<b>Target Invertebrates</b>			
<i>Pinnixa</i> spp. (megalops)	pea crabs megalops	4	3.88
<i>Pugettia</i> spp. (megalops)	kelp crabs megalops	2	1.62
<i>Hemigrapsus nudus</i> (megalops)	purple shore crab megalops	1	1.21
<i>Cancer gracilis</i> (megalops)	slender crab megalops	1	1.17
<i>Pachycheles</i> spp. (megalops)	porcelain crabs megalops	1	0.65
		<b>Total Target Invertebrates: 9</b>	

Redondo Beach Generating Station  
Entrainment Study - Fish and Invertebrate Abundances

Survey: SMBEA06  
Start Date: 3/22/2006  
Stations: E4 (UNITS 7&8 INTAKE)

Taxon	Common Name	Count	Mean Concentration (#/1,000m <sup>3</sup> )
<b>Fishes</b>			
<i>Genyonemus lineatus</i>	white croaker	33	67.91
<i>Parophrys vetulus</i>	English sole	28	59.59
Gobiidae unid.	gobies	18	36.67
Atherinopsidae unid.	silversides	17	33.30
<i>Atherinopsis californiensis</i>	jacksmelt	14	28.90
<i>Ruscarius creaseri</i>	roughcheek sculpin	13	25.37
<i>Typhlogobius californiensis</i>	blind goby	12	23.82
<i>Merluccius productus</i>	Pacific hake	11	21.70
Pleuronectidae unid.	righteye flounders	8	15.31
<i>Engraulis mordax</i>	northern anchovy	7	14.92
<i>Stenobranchius leucopsarus</i>	northern lampfish	6	12.72
<i>Rimicola</i> spp.	kelp clingfishes	5	10.28
<i>Paralichthys californicus</i>	California halibut	5	9.90
<i>Clinocottus analis</i>	wooly sculpin	4	8.07
Sciaenidae unid.	croakers	4	7.25
<i>Pleuronichthys verticalis</i>	hornyhead turbot	2	4.45
<i>Leuroglossus stilbius</i>	California smoothtongue	2	4.23
<i>Pleuronichthys guttulatus</i>	diamond turbot	2	4.23
<i>Hypsoblennius</i> spp.	combtooth blennies	2	3.83
<i>Leuresthes tenuis</i>	California grunion	2	3.60
<i>Sebastes</i> spp.	rockfishes	1	2.22
<i>Gobiesox</i> spp.	clingfishes	1	2.20
<i>Oxylebius pictus</i>	painted greenling	1	2.01
larval/post-larval fish unid.	larval fishes	1	1.84
<i>Microstomus pacificus</i>	Dover sole	1	1.82
<i>Atherinops affinis</i>	topsmelt	1	1.80
<i>Pleuronichthys</i> spp.	turbots	1	1.80
larval fish - damaged	unidentified larval fishes	1	1.75
		<b>Total Fishes: 203</b>	
<b>Eggs</b>			
fish eggs unid.	unidentified fish eggs	4,586	8,764.49
<i>Pleuronichthys</i> spp. (eggs)	turbot eggs	401	780.28
Sciaenidae unid. (eggs)	croaker eggs	261	504.78
Paralichthyidae unid. (eggs)	sand flounder eggs	232	446.16
<i>Citharichthys</i> spp. (eggs)	sanddab eggs	204	387.98
Engraulidae unid. (eggs)	anchovy eggs	134	265.93
		<b>Total Eggs: 5,818</b>	
<b>Target Invertebrates</b>			
Majidae unid. (megalops)	spider crab megalops	6	12.88
Paguridae unid. (megalops)	hermit crab megalops	3	5.79
<i>Cancer gracilis</i> (megalops)	slender crab megalops	2	4.04
<i>Cancer productus</i> (megalops)	red rock crab megalops	2	3.71
<i>Pinnixa</i> spp. (megalops)	pea crabs megalops	1	2.22
<i>Pachycheles rudis</i> (megalops)	thickclaw porcelain crab	1	2.20
unidentified crab (megalops)	unidentified crab megalops	1	1.84
		<b>Total Target Invertebrates: 16</b>	

Redondo Beach Generating Station  
Entrainment Study - Fish and Invertebrate Abundances

Survey: SMBEA06  
Start Date: 3/22/2006  
Stations: H1-H2

Taxon	Common Name	Count	Mean Concentration (#/1,000m <sup>3</sup> )
<b>Fishes</b>			
Gobiidae unid.	gobies	47	90.94
<i>Parophrys vetulus</i>	English sole	14	33.29
<i>Gobiesox</i> spp.	clingfishes	16	31.79
<i>Typhlogobius californiensis</i>	blind goby	14	27.94
<i>Genyonemus lineatus</i>	white croaker	4	7.47
<i>Hypsoblennius</i> spp.	combtooth blennies	3	6.61
larval fish - damaged	unidentified larval fishes	3	6.55
<i>Clinocottus analis</i>	wooly sculpin	3	5.12
<i>Rhinogobiops nicholsi</i>	blackeye goby	2	3.46
<i>Icelinus</i> spp.	sculpins	1	2.59
<i>Ruscarius creaseri</i>	roughcheek sculpin	1	2.59
<i>Engraulis mordax</i>	northern anchovy	1	2.33
Pleuronectiformes unid.	flatfishes	1	2.33
<i>Sebastes</i> spp.	rockfishes	1	2.33
<i>Citharichthys stigmaeus</i>	speckled sanddab	1	1.73
<i>Gibbonsia</i> spp.	clinid kelpfishes	1	1.73
<i>Artedius lateralis</i>	smoothhead sculpin	1	1.70
Atherinopsidae unid.	silversides	1	1.70
<i>Leptocottus armatus</i>	Pacific staghorn sculpin	1	1.70
Pleuronectidae unid.	righteye flounders	1	1.70
<i>Atherinopsis californiensis</i>	jacksmelt	1	1.68
		<b>Total Fishes: 118</b>	
<b>Target Invertebrates</b>			
unidentified crab (megalops)	unidentified crab megalops	2	4.65
Paguridae unid. (megalops)	hermit crab megalops	1	2.33
<i>Loligo opalescens</i>	market squid	1	1.73
		<b>Total Target Invertebrates: 4</b>	



Redondo Beach Generating Station  
Entrainment Study - Fish and Invertebrate Abundances

Survey: SMBEA06  
Start Date: 3/22/2006  
Stations: O4-O6, S5-S6

Taxon	Common Name	Count	Mean Concentration (#/1,000m <sup>3</sup> )
<b>Fishes</b>			
<i>Parophrys vetulus</i>	English sole	249	159.64
<i>Genyonemus lineatus</i>	white croaker	180	118.06
<i>Stenobranchius leucopsarus</i>	northern lampfish	83	52.47
<i>Engraulis mordax</i>	northern anchovy	69	42.78
larval fish fragment	unidentified larval fishes	41	23.51
<i>Sebastes</i> spp.	rockfishes	36	22.41
<i>Merluccius productus</i>	Pacific hake	30	17.96
Pleuronectidae unid.	righteye flounders	25	16.21
<i>Paralichthys californicus</i>	California halibut	19	12.66
larval fish - damaged	unidentified larval fishes	19	11.88
<i>Atherinopsis californiensis</i>	jacksnelt	13	11.05
<i>Pleuronichthys verticalis</i>	hornyhead turbot	14	9.60
<i>Pleuronichthys</i> spp.	turbots	14	8.72
Bathylagidae unid.	blacksmelt	16	7.65
<i>Lepidogobius lepidus</i>	bay goby	11	7.17
<i>Pleuronichthys guttulatus</i>	diamond turbot	10	6.91
<i>Rhinogobiops nicholsi</i>	blackeye goby	11	6.76
Atherinopsidae unid.	silversides	7	6.15
<i>Typhlogobius californiensis</i>	blind goby	9	5.77
larvae, unidentified yolksac	unidentified yolksac larvae	8	5.50
<i>Citharichthys stigmaeus</i>	speckled sanddab	8	4.46
Sciaenidae unid.	croakers	5	4.08
Engraulidae unid.	anchovies	5	3.39
Bathymasteridae unid.	ronquils	5	3.33
Gobiidae unid.	gobies	5	3.27
<i>Bathylagus ochotensis</i>	popeye blacksmelt	6	3.12
Pleuronectiformes unid.	flatfishes	4	2.62
<i>Citharichthys</i> spp.	sanddabs	3	2.16
<i>Ruscarius creaseri</i>	roughcheek sculpin	3	1.91
<i>Zaniolepis frenata</i>	shortspine combfish	3	1.84
Chaenopsidae unid.	tube blennies	2	1.47
<i>Leuroglossus stilbius</i>	California smoothtongue	2	1.45
<i>Pleuronichthys ritteri</i>	spotted turbot	2	1.45
<i>Hypsoblennius</i> spp.	combtooth blennies	2	1.35
<i>Odontopyxis trispinosa</i>	pygmy poacher	2	1.12
<i>Citharichthys sordidus</i>	Pacific sanddab	2	1.08
<i>Microstomus pacificus</i>	Dover sole	1	0.82
Cyclopteridae unid.	snailfishes	1	0.74
Labrisomidae unid.	labrisomid blennies	1	0.74
<i>Icelinus quadriseriatus</i>	yellowchin sculpin	1	0.73
<i>Sebastes paucispinis</i>	bocaccio	1	0.73
larval/post-larval fish unid.	larval fishes	1	0.69
Osmeriformes	salmons	1	0.68

(continued)

Redondo Beach Generating Station  
 Entrainment Study - Fish and Invertebrate Abundances

Survey: SMBEA06  
 Start Date: 3/22/2006  
 Stations: O4-O6, S5-S6 (continued)

Taxon	Common Name	Count	Mean Concentration (#/1,000m <sup>3</sup> )
<b>Fishes (continued)</b>			
<i>Scorpaenichthys marmoratus</i>	cabezon	1	0.68
Oligocottus / Clinocottus	sculpins	1	0.63
<i>Lyopsetta exilis</i>	slender sole	1	0.42
		<b>Total Fishes: 933</b>	
<b>Target Invertebrates</b>			
unidentified crab (megalops)	unidentified crab megalops	21	13.50
Majidae unid. (megalops)	spider crab megalops	8	5.81
<i>Pugettia</i> spp. (megalops)	kelp crabs megalops	7	5.18
<i>Cancer gracilis</i> (megalops)	slender crab megalops	7	4.49
<i>Emerita analoga</i> (megalops)	mole crabs megalops	5	3.87
Paguridae unid. (megalops)	hermit crab megalops	3	2.20
Diogenidae (megalops)	left-handed hermit crabs	2	1.55
<i>Pachycheles pubescens</i> (megalops)	pubescent porcelain crab	1	0.93
<i>Pachycheles rudis</i> (megalops)	thickclaw porcelain crab	1	0.93
<i>Pinnixa</i> spp. (megalops)	pea crabs megalops	1	0.82
<i>Pinnotheres</i> spp. (megalops)	pea crab megalops	1	0.64
		<b>Total Target Invertebrates: 57</b>	

Redondo Beach Generating Station  
Entrainment Study - Fish and Invertebrate Abundances

Survey: SMBEA07  
Start Date: 4/13/2006  
Stations: E4 (UNITS 7&8 INTAKE)

Taxon	Common Name	Count	Mean Concentration (#/1,000m <sup>3</sup> )
<b>Fishes</b>			
<i>Genyonemus lineatus</i>	white croaker	44	103.93
Gobiidae unid.	gobies	42	103.69
<i>Typhlogobius californiensis</i>	blind goby	17	40.01
<i>Hypsoblennius</i> spp.	combtooth blennies	12	29.37
<i>Engraulis mordax</i>	northern anchovy	11	25.85
<i>Gobiesox</i> spp.	clingfishes	4	10.15
<i>Atherinops affinis</i>	topsmelt	4	9.76
<i>Ruscarius creaseri</i>	roughcheek sculpin	4	9.66
<i>Gibbonsia</i> spp.	clinid kelpfishes	4	8.70
Pleuronectidae unid.	righteye flounders	2	4.97
<i>Pleuronichthys verticalis</i>	hornyhead turbot	2	4.96
<i>Stenobranchius leucopsarus</i>	northern lampfish	2	4.88
<i>Parophrys vetulus</i>	English sole	2	4.63
<i>Lepidogobius lepidus</i>	bay goby	2	4.09
<i>Leuroglossus stilbius</i>	California smoothtongue	1	2.65
<i>Atherinopsis californiensis</i>	jacksmelt	1	2.32
<i>Paralichthys californicus</i>	California halibut	1	2.32
<i>Pleuronichthys</i> spp.	turbots	1	2.31
Sciaenidae unid.	croakers	1	2.31
Engraulidae unid.	anchovies	1	2.23
<i>Heterostichus rostratus</i>	giant kelpfish	1	2.23
<i>Artedius lateralis</i>	smoothhead sculpin	1	2.20
<i>Clinocottus analis</i>	wooly sculpin	1	2.20
<i>Pleuronichthys ritteri</i>	spotted turbot	1	2.04
		<b>Total Fishes: 162</b>	
<b>Eggs</b>			
fish eggs unid.	unidentified fish eggs	2,360	5,696.32
Engraulidae unid. (eggs)	anchovy eggs	293	691.68
Paralichthyidae unid. (eggs)	sand flounder eggs	236	570.23
<i>Pleuronichthys</i> spp. (eggs)	turbot eggs	114	274.50
<i>Citharichthys</i> spp. (eggs)	sanddab eggs	62	143.22
Sciaenidae unid. (eggs)	croaker eggs	36	85.52
Pleuronectidae unid. (eggs)	righteye flounder eggs	19	46.97
		<b>Total Eggs: 3,120</b>	
<b>Target Invertebrates</b>			
<i>Pinnixa</i> spp. (megalops)	pea crabs megalops	4	9.42
Majidae unid. (megalops)	spider crab megalops	4	9.01
<i>Pachycheles rudis</i> (megalops)	thickclaw porcelain crab	2	4.88
<i>Pugettia</i> spp. (megalops)	kelp crabs megalops	2	4.63
<i>Pachycheles pubescens</i> (megalops)	pubescent porcelain crab	1	2.65
Porcellanidae unid. (megalops)	porcelain crab megalops	1	2.65
<i>Emerita analoga</i> (megalops)	mole crabs megalops	1	2.23
Paguridae unid. (megalops)	hermit crab megalops	1	2.23
		<b>Total Target Invertebrates: 16</b>	

Redondo Beach Generating Station  
Entrainment Study - Fish and Invertebrate Abundances

Survey: SMBEA08  
Start Date: 4/19/2006  
Stations: E4 (UNITS 7&8 INTAKE)

Taxon	Common Name	Count	Mean Concentration (#/1,000m <sup>3</sup> )
<b>Fishes</b>			
<i>Genyonemus lineatus</i>	white croaker	135	392.16
Gobiidae unid.	gobies	24	65.27
<i>Hypsoblennius</i> spp.	combtooth blennies	17	47.42
<i>Typhlogobius californiensis</i>	blind goby	16	46.30
<i>Engraulis mordax</i>	northern anchovy	12	37.72
<i>Atherinopsis californiensis</i>	jacksmelt	12	31.67
<i>Gobiesox</i> spp.	clingfishes	9	27.41
larval fish - damaged	unidentified larval fishes	5	13.87
larval fish fragment	unidentified larval fishes	4	12.88
<i>Stenobranchius leucopsarus</i>	northern lampfish	4	11.90
<i>Rhinogobiops nicholsi</i>	blackeye goby	3	9.29
<i>Clinocottus analis</i>	wooly sculpin	3	9.03
<i>Hypsypops rubicundus</i>	garibaldi	3	8.00
larvae, unidentified yolksac	unidentified yolksac larvae	2	7.08
Engraulidae unid.	anchovies	2	6.36
<i>Artedius lateralis</i>	smoothhead sculpin	2	5.12
<i>Ruscarius creaseri</i>	roughcheek sculpin	2	4.79
<i>Merluccius productus</i>	Pacific hake	1	3.89
Pleuronectiformes unid.	flatfishes	1	3.89
<i>Citharichthys stigmaeus</i>	speckled sanddab	1	3.51
Labrisomidae unid.	labrisomid blennies	1	3.18
<i>Parophrys vetulus</i>	English sole	1	2.93
<i>Icelinus</i> spp.	sculpins	1	2.58
<i>Lepidogobius lepidus</i>	bay goby	1	2.55
<i>Atherinops affinis</i>	topsmelt	1	2.24
		<b>Total Fishes: 263</b>	
<b>Eggs</b>			
fish eggs unid.	unidentified fish eggs	3,221	9,144.56
Engraulidae unid. (eggs)	anchovy eggs	1,213	3,290.41
Paralichthyidae unid. (eggs)	sand flounder eggs	205	559.72
<i>Pleuronichthys</i> spp. (eggs)	turbot eggs	145	395.94
<i>Citharichthys</i> spp. (eggs)	sanddab eggs	101	278.52
Sciaenidae unid. (eggs)	croaker eggs	3	10.97
<i>Genyonemus lineatus</i> (eggs)	white croaker eggs	1	2.24
Pleuronectidae unid. (eggs)	righteye flounder eggs	1	2.24
		<b>Total Eggs: 4,890</b>	
<b>Target Invertebrates</b>			
Majidae unid. (megalops)	spider crab megalops	13	34.23
<i>Pinnixa</i> spp. (megalops)	pea crabs megalops	10	23.68
<i>Emerita analoga</i> (megalops)	mole crabs megalops	9	20.20
<i>Petrolisthes</i> spp. (megalops)	porcelain crab megalops	7	16.99
unidentified crab (megalops)	unidentified crab megalops	3	8.30
Paguridae unid. (megalops)	hermit crab megalops	3	7.41
<i>Loligo opalescens</i>	market squid	2	4.82

(continued)

Redondo Beach Generating Station  
Entrainment Study - Fish and Invertebrate Abundances

Survey: SMBEA08  
Start Date: 4/19/2006  
Stations: E4 (UNITS 7&8 INTAKE) (continued)

Taxon	Common Name	Count	Mean Concentration (#/1,000m <sup>3</sup> )
<b>Target Invertebrates (continued)</b>			
Porcellanidae unid. (megalops)	porcelain crab megalops	2	4.82
Grapsidae unid. (megalops)	shore crab megalops	1	2.93
		<b>Total Target Invertebrates: 50</b>	

Redondo Beach Generating Station  
Entrainment Study - Fish and Invertebrate Abundances

Survey: SMBEA08  
Start Date: 4/19/2006  
Stations: H1-H2

Taxon	Common Name	Count	Mean Concentration (#/1,000m <sup>3</sup> )
<b>Fishes</b>			
Gobiidae unid.	gobies	261	774.10
<i>Hypsoblennius</i> spp.	combtooth blennies	96	295.46
<i>Gobiesox</i> spp.	clingfishes	56	171.13
<i>Genyonemus lineatus</i>	white croaker	20	60.74
<i>Typhlogobius californiensis</i>	blind goby	15	47.72
<i>Atherinops affinis</i>	topsmelt	11	31.05
larval fish fragment	unidentified larval fishes	10	28.64
Blenniidae unid.	blennies	3	9.70
<i>Rhinogobiops nicholsi</i>	blackeye goby	3	9.23
<i>Engraulis mordax</i>	northern anchovy	3	8.82
larval/post-larval fish unid.	larval fishes	3	8.81
<i>Atherinopsis californiensis</i>	jacksmelt	2	5.87
<i>Artedius</i> spp.	sculpins	1	4.05
<i>Citharichthys stigmaeus</i>	speckled sanddab	1	4.05
Sciaenidae unid.	croakers	1	3.23
Chaenopsidae unid.	tube blennies	1	3.13
<i>Clinocottus analis</i>	wooly sculpin	1	3.13
<i>Icelinus</i> spp.	sculpins	1	3.13
<i>Hypsypops rubicundus</i>	garibaldi	1	2.97
Pleuronectidae unid.	righteye flounders	1	2.97
<i>Stenobranchius leucopsarus</i>	northern lampfish	1	2.97
Gobiesocidae unid.	clingfishes	1	2.96
larval fish - damaged	unidentified larval fishes	1	2.78
<i>Sebastes</i> spp.	rockfishes	1	2.78
		<b>Total Fishes: 495</b>	
<b>Target Invertebrates</b>			
Paguridae unid. (megalops)	hermit crab megalops	1	3.23
Grapsidae unid. (megalops)	shore crab megalops	1	2.90
		<b>Total Target Invertebrates: 2</b>	

Redondo Beach Generating Station  
Entrainment Study - Fish and Invertebrate Abundances

Survey: SMBEA08  
Start Date: 4/19/2006  
Stations: O4-O6, S5-S6

Taxon	Common Name	Count	Mean Concentration (#/1,000m <sup>3</sup> )
<b>Fishes</b>			
<i>Genyonemus lineatus</i>	white croaker	701	725.19
<i>Engraulis mordax</i>	northern anchovy	88	92.79
<i>Parophrys vetulus</i>	English sole	48	50.42
larvae, unidentified yolksac	unidentified yolksac larvae	34	38.76
Bathymasteridae unid.	ronquils	30	30.70
larval fish fragment	unidentified larval fishes	31	30.63
<i>Hypsoblennius</i> spp.	combtooth blennies	15	17.31
<i>Pleuronichthys verticalis</i>	hornyhead turbot	15	15.74
Sciaenidae unid.	croakers	14	14.62
Engraulidae unid.	anchovies	11	13.83
<i>Stenobranchius leucopsarus</i>	northern lampfish	10	11.20
<i>Paralichthys californicus</i>	California halibut	12	11.19
larval/post-larval fish unid.	larval fishes	12	11.14
<i>Merluccius productus</i>	Pacific hake	8	8.73
<i>Pleuronichthys</i> spp.	turbots	8	8.03
<i>Leuroglossus stilbius</i>	California smoothtongue	7	7.01
<i>Lyopsetta exilis</i>	slender sole	6	6.36
Labrisomidae unid.	labrisomid blennies	3	3.77
<i>Icelinus quadriseriatus</i>	yellowchin sculpin	3	3.49
<i>Zaniolepis frenata</i>	shortspine combfish	3	3.23
<i>Citharichthys</i> spp.	sanddabs	3	3.11
<i>Pleuronichthys guttulatus</i>	diamond turbot	3	3.09
<i>Sebastes</i> spp.	rockfishes	3	2.96
<i>Lepidogobius lepidus</i>	bay goby	3	2.88
<i>Paralabrax</i> spp.	sea basses	2	2.30
<i>Bathylagus ochotensis</i>	popeye blacksmelt	2	2.22
Gobiidae unid.	gobies	1	1.61
<i>Citharichthys stigmaeus</i>	speckled sanddab	1	1.35
<i>Citharichthys sordidus</i>	Pacific sanddab	1	1.33
<i>Typhlogobius californiensis</i>	blind goby	1	1.33
Blenniidae unid.	blennies	1	1.23
Paralichthyidae unid.	sand flounders	1	1.23
<i>Gobiesox</i> spp.	clingfishes	1	1.20
larval fish - damaged	unidentified larval fishes	1	1.19
<i>Ruscarius creaseri</i>	roughcheek sculpin	1	1.19
<i>Zaniolepis latipinnis</i>	longspine combfish	1	1.19
<i>Odontopyxis trispinosa</i>	pygmy poacher	1	1.12
<i>Oligocottus</i> spp.	sculpins	1	1.12
<i>Peprilus simillimus</i>	Pacific butterfish	1	1.12
<i>Artedius lateralis</i>	smoothhead sculpin	1	1.04
Atherinopsidae unid.	silversides	1	0.99
Pleuronectiformes unid.	flatfishes	1	0.98
<i>Xystreurus liolepis</i>	fantail sole	1	0.84

(continued)

Redondo Beach Generating Station  
 Entrainment Study - Fish and Invertebrate Abundances

Survey: SMBEA08  
 Start Date: 4/19/2006  
 Stations: O4-O6, S5-S6 (continued)

Taxon	Common Name	Count	Mean Concentration (#/1,000m <sup>3</sup> )
<b>Fishes (continued)</b>			
<i>Rhinogobiops nicholsi</i>	blackeye goby	1	0.77
		<b>Total Fishes: 1,093</b>	
<b>Target Invertebrates</b>			
<i>Pugettia</i> spp. (megalops)	kelp crabs megalops	46	48.89
<i>Loligo opalescens</i>	market squid	42	42.70
Majidae unid. (megalops)	spider crab megalops	29	30.47
<i>Emerita analoga</i> (megalops)	mole crabs megalops	29	27.53
<i>Pinnixa</i> spp. (megalops)	pea crabs megalops	22	21.71
<i>Petrolisthes</i> spp. (megalops)	porcelain crab megalops	7	6.84
unidentified crab (megalops)	unidentified crab megalops	5	6.52
Paguridae unid. (megalops)	hermit crab megalops	6	6.40
Porcellanidae unid. (megalops)	porcelain crab megalops	6	5.49
Diogenidae (megalops)	left-handed hermit crabs	4	4.47
<i>Cancer anthonyi</i> (megalops)	yellow crab megalops	4	3.83
<i>Lophopanopeus</i> spp. (megalops)	black-clawed crab megalops	3	3.51
<i>Cancer antennarius</i> (megalops)	brown rock crab megalops	3	3.08
Grapsidae unid. (megalops)	shore crab megalops	2	1.60
Brachyura unid. (megalops)	unidentified crab megalops	1	1.19
<i>Pinnotheres</i> spp. (megalops)	pea crab megalops	1	1.19
<i>Cancer gracilis</i> (megalops)	slender crab megalops	1	1.04
		<b>Total Target Invertebrates: 211</b>	

Redondo Beach Generating Station  
Entrainment Study - Fish and Invertebrate Abundances

Survey: SMBEA09  
Start Date: 5/3/2006  
Stations: E4 (UNITS 7&8 INTAKE)

Taxon	Common Name	Count	Mean Concentration (#/1,000m <sup>3</sup> )
<b>Fishes</b>			
Engraulidae unid.	anchovies	567	1,322.07
<i>Hypsoblennius</i> spp.	combtooth blennies	153	354.52
<i>Genyonemus lineatus</i>	white croaker	73	171.51
<i>Engraulis mordax</i>	northern anchovy	40	85.86
<i>Hypsypops rubicundus</i>	garibaldi	22	53.50
Gobiidae unid.	gobies	23	52.87
<i>Typhlogobius californiensis</i>	blind goby	14	33.46
larval fish fragment	unidentified larval fishes	15	31.99
<i>Citharichthys stigmaeus</i>	speckled sanddab	9	20.06
<i>Sebastes</i> spp.	rockfishes	6	14.91
<i>Paralichthys californicus</i>	California halibut	6	14.06
Sciaenidae unid.	croakers	6	13.04
<i>Citharichthys</i> spp.	sanddabs	5	11.69
<i>Ruscarius creaseri</i>	roughcheek sculpin	4	9.55
<i>Oxyjulis californica</i>	senorita	4	9.18
<i>Pleuronichthys guttulatus</i>	diamond turbot	3	7.37
Bathymasteridae unid.	ronquils	3	7.12
<i>Stenobranchius leucopsarus</i>	northern lampfish	3	6.84
<i>Gobiesox</i> spp.	clingfishes	3	6.61
larval fish - damaged	unidentified larval fishes	3	6.48
<i>Clinocottus analis</i>	wooly sculpin	2	4.87
<i>Rhinogobius nicholsi</i>	blackeye goby	2	4.72
larvae, unidentified yolksac	unidentified yolksac larvae	2	4.58
<i>Oxylebius pictus</i>	painted greenling	2	4.56
<i>Pleuronichthys</i> spp.	turbots	2	4.35
Cottidae unid.	sculpins	2	4.12
<i>Pleuronichthys verticalis</i>	hornyhead turbot	1	2.61
<i>Zaniolepis</i> spp.	combfishes	1	2.61
Chaenopsidae unid.	tube blennies	1	2.28
Chitonotus / Icelinus	sculpins	1	2.28
<i>Pleuronichthys ritteri</i>	spotted turbot	1	2.23
Labridae unid.	wrasses	1	2.19
<i>Artedius lateralis</i>	smoothhead sculpin	1	2.13
Atherinopsidae unid.	silversides	1	2.13
larval/post-larval fish unid.	larval fishes	1	2.13
Pleuronectiformes unid.	flatfishes	1	1.99
<i>Semicossyphus pulcher</i>	California sheephead	1	1.99
		<b>Total Fishes: 985</b>	
<b>Eggs</b>			
fish eggs unid.	unidentified fish eggs	3,885	18,200.36
Engraulidae unid. (eggs)	anchovy eggs	3,306	15,544.79
Paralichthyidae unid. (eggs)	sand flounder eggs	305	1,359.85
<i>Pleuronichthys</i> spp. (eggs)	turbot eggs	232	1,098.68
<i>Citharichthys</i> spp. (eggs)	sanddab eggs	79	365.67

(continued)



Redondo Beach Generating Station  
 Entrainment Study - Fish and Invertebrate Abundances

Survey: SMBEA09  
 Start Date: 5/3/2006  
 Stations: E4 (UNITS 7&8 INTAKE) (continued)

Taxon	Common Name	Count	Mean Concentration (#/1,000m <sup>3</sup> )
<b>Eggs (continued)</b>			
Sciaenidae unid. (eggs)	croaker eggs	64	290.33
Sciaen. / Paralich. / Labridae (eggs)	fish eggs	19	97.80
Labridae unid. (eggs)	wrasse eggs	2	10.29
		<b>Total Eggs: 7,892</b>	
<b>Target Invertebrates</b>			
<i>Pinnixa</i> spp. (megalops)	pea crabs megalops	6	15.00
<i>Emerita analoga</i> (megalops)	mole crabs megalops	4	9.78
<i>Cancer antennarius</i> (megalops)	brown rock crab megalops	1	2.28
		<b>Total Target Invertebrates: 11</b>	

Redondo Beach Generating Station  
Entrainment Study - Fish and Invertebrate Abundances

Survey: SMBEA10  
Start Date: 5/16/2006  
Stations: E4 (UNITS 7&8 INTAKE)

Taxon	Common Name	Count	Mean Concentration (#/1,000m <sup>3</sup> )
<b>Fishes</b>			
<i>Hypsoblennius</i> spp.	combtooth blennies	178	516.45
<i>Engraulis mordax</i>	northern anchovy	147	404.50
Engraulidae unid.	anchovies	136	372.96
larval fish fragment	unidentified larval fishes	23	71.24
<i>Hypsypops rubicundus</i>	garibaldi	23	61.46
<i>Gibbonsia</i> spp.	clinid kelpfishes	15	39.70
Gobiidae unid.	gobies	14	37.54
larvae, unidentified yolksac	unidentified yolksac larvae	8	23.93
<i>Gobiesox</i> spp.	clingfishes	6	17.38
<i>Clinocottus analis</i>	wooly sculpin	5	14.73
<i>Typhlogobius californiensis</i>	blind goby	5	13.94
<i>Ruscarius creaseri</i>	roughcheek sculpin	3	8.73
Labrisomidae unid.	labrisomid blennies	3	7.05
<i>Genyonemus lineatus</i>	white croaker	2	5.67
larval fish - damaged	unidentified larval fishes	1	3.40
<i>Cheilotrema saturnum</i>	black croaker	1	2.95
<i>Citharichthys stigmaeus</i>	speckled sanddab	1	2.87
Sciaenidae unid.	croakers	1	2.87
Atherinopsidae unid.	silversides	1	2.84
Pleuronectiformes unid.	flatfishes	1	2.84
		<b>Total Fishes: 574</b>	
<b>Eggs</b>			
fish eggs unid.	unidentified fish eggs	4,404	24,582.13
Engraulidae unid. (eggs)	anchovy eggs	619	3,560.65
<i>Pleuronichthys</i> spp. (eggs)	turbot eggs	182	1,033.90
Sciaen. / Paralich. / Labridae (eggs)	fish eggs	152	917.82
<i>Paralichthyidae</i> unid. (eggs)	sand flounder eggs	85	448.85
<i>Citharichthys</i> spp. (eggs)	sanddab eggs	54	307.77
Sciaenidae unid. (eggs)	croaker eggs	24	126.11
<i>Pleuronichthys guttulatus</i> (eggs)	diamond turbot eggs	1	4.42
		<b>Total Eggs: 5,521</b>	
<b>Target Invertebrates</b>			
unidentified crab (megalops)	unidentified crab megalops	2	5.45
<i>Pinnixa</i> spp. (megalops)	pea crabs megalops	1	2.84
		<b>Total Target Invertebrates: 3</b>	

Redondo Beach Generating Station  
Entrainment Study - Fish and Invertebrate Abundances

Survey: SMBEA10  
Start Date: 5/16/2006  
Stations: H1-H2

Taxon	Common Name	Count	Mean Concentration (#/1,000m <sup>3</sup> )
<b>Fishes</b>			
<i>Hypsoblennius</i> spp.	cometooth blennies	249	771.48
Gobiidae unid.	gobies	186	590.18
<i>Engraulis mordax</i>	northern anchovy	81	250.27
Labrisomidae unid.	labrisomid blennies	49	152.65
Engraulidae unid.	anchovies	47	144.83
<i>Hypsypops rubicundus</i>	garibaldi	37	113.27
<i>Typhlogobius californiensis</i>	blind goby	17	52.88
<i>Gobiesox</i> spp.	clingfishes	5	16.30
larval fish - damaged	unidentified larval fishes	5	16.02
larvae, unidentified yolksac	unidentified yolksac larvae	5	15.24
larval fish fragment	unidentified larval fishes	5	15.23
<i>Gibbonsia</i> spp.	clinid kelpfishes	5	15.12
Atherinopsidae unid.	silversides	3	9.51
<i>Oxyjulis californica</i>	senorita	3	9.45
<i>Paralichthys californicus</i>	California halibut	2	6.38
<i>Rhinogobiops nicholsi</i>	blackeye goby	2	6.10
<i>Ruscarius creaseri</i>	roughcheek sculpin	2	6.04
Bathymasteridae unid.	ronquils	1	3.40
<i>Pleuronichthys</i> spp.	turbots	1	3.40
<i>Icelinus</i> spp.	sculpins	1	3.27
<i>Seriphus politus</i>	queenfish	1	3.27
<i>Clinocottus analis</i>	wooly sculpin	1	3.06
<i>Genyonemus lineatus</i>	white croaker	1	3.06
Sciaenidae unid.	croakers	1	3.06
<i>Citharichthys stigmaeus</i>	speckled sanddab	1	2.98
		<b>Total Fishes: 711</b>	
<b>Target Invertebrates</b>			
No Invertebrates			

Redondo Beach Generating Station  
Entrainment Study - Fish and Invertebrate Abundances

Survey: SMBEA10  
Start Date: 5/16/2006  
Stations: O4-O6, S5-S6

Taxon	Common Name	Count	Mean Concentration (#/1,000m <sup>3</sup> )
<b>Fishes</b>			
<i>Engraulis mordax</i>	northern anchovy	915	985.22
Engraulidae unid.	anchovies	504	552.82
larval fish fragment	unidentified larval fishes	76	83.74
<i>Hypsoblennius</i> spp.	combtooth blennies	48	52.49
<i>Paralichthys californicus</i>	California halibut	26	28.67
Sciaenidae unid.	croakers	12	12.16
larvae, unidentified yolksac	unidentified yolksac larvae	9	10.23
<i>Pleuronichthys verticalis</i>	hornyhead turbot	8	9.00
<i>Genyonemus lineatus</i>	white croaker	7	7.50
<i>Pleuronichthys</i> spp.	turbots	7	6.42
<i>Rhinogobiops nicholsi</i>	blackeye goby	6	6.27
<i>Seriphus politus</i>	queenfish	4	4.71
<i>Cheilotrema saturnum</i>	black croaker	4	4.65
<i>Citharichthys stigmaeus</i>	speckled sanddab	4	4.40
Atherinopsidae unid.	silversides	5	4.23
<i>Hypsypops rubicundus</i>	garibaldi	4	4.16
<i>Parophrys vetulus</i>	English sole	3	3.47
<i>Citharichthys sordidus</i>	Pacific sanddab	3	3.09
<i>Typhlogobius californiensis</i>	blind goby	3	2.81
<i>Oxyjulis californica</i>	senorita	2	2.53
<i>Trachurus symmetricus</i>	jack mackerel	2	2.32
<i>Citharichthys</i> spp.	sanddabs	2	2.19
Gobiidae unid.	gobies	2	2.17
larval fish - damaged	unidentified larval fishes	2	2.03
unidentified fish, damaged	unidentified damaged fish	1	1.41
<i>Lepidogobius lepidus</i>	bay goby	1	1.27
<i>Semicossyphus pulcher</i>	California sheephead	1	1.18
<i>Hypsoblennius jenkinsi</i>	mussel blenny	1	1.15
<i>Ruscarius creaseri</i>	roughcheek sculpin	1	1.07
<i>Zaniolepis frenata</i>	shortspine combfish	1	1.07
Pleuronectiformes unid.	flatfishes	1	1.03
<i>Bathylagus ochotensis</i>	popeye blacksmelt	1	1.02
Labrisomidae unid.	labrisomid blennies	1	1.02
Pleuronectidae unid.	righteye flounders	1	1.02
<i>Sebastes</i> spp.	rockfishes	1	1.02
<i>Peprilus simillimus</i>	Pacific butterfish	1	0.69
		<b>Total Fishes: 1,670</b>	
<b>Target Invertebrates</b>			
<i>Pinnixa</i> spp. (megalops)	pea crabs megalops	13	14.13
<i>Cancer anthonyi</i> (megalops)	yellow crab megalops	3	3.33
Majidae unid. (megalops)	spider crab megalops	2	2.31
<i>Loligo opalescens</i>	market squid	2	2.05
unidentified crab (megalops)	unidentified crab megalops	1	1.03

(continued)

Redondo Beach Generating Station  
 Entrainment Study - Fish and Invertebrate Abundances

Survey: SMBEA10  
 Start Date: 5/16/2006  
 Stations: O4-O6, S5-S6 (continued)

Taxon	Common Name	Count	Mean Concentration (#/1,000m <sup>3</sup> )
<b>Target Invertebrates (continued)</b>			
Hippoidea (megalops)	mole crab megalops	1	0.89
Paguridae unid. (megalops)	hermit crab megalops	1	0.76
<i>Emerita analoga</i> (megalops)	mole crabs megalops	1	0.69
<b>Total Target Invertebrates:</b>		<b>24</b>	

Redondo Beach Generating Station  
Entrainment Study - Fish and Invertebrate Abundances

Survey: SMBEA11  
Start Date: 6/1/2006  
Stations: E4 (UNITS 7&8 INTAKE)

Taxon	Common Name	Count	Mean Concentration (#/1,000m <sup>3</sup> )
<b>Fishes</b>			
<i>Hypsoblennius</i> spp.	combtooth blennies	267	862.43
<i>Hypsypops rubicundus</i>	garibaldi	216	676.32
<i>Gobiesox</i> spp.	clingfishes	29	104.11
<i>Genyonemus lineatus</i>	white croaker	29	98.29
Labrisomidae unid.	labrisomid blennies	22	70.29
Gobiidae unid.	gobies	20	64.82
larval fish - damaged	unidentified larval fishes	15	44.28
<i>Gibbonsia</i> spp.	clinid kelpfishes	10	31.03
<i>Typhlogobius californiensis</i>	blind goby	6	17.90
<i>Cheilotrema saturnum</i>	black croaker	4	12.38
larval fish fragment	unidentified larval fishes	2	7.10
<i>Rhinogobiops nicholsi</i>	blackeye goby	2	7.09
Sciaenidae unid.	croakers	2	6.17
<i>Atherinops affinis</i>	topsmelt	1	3.98
larvae, unidentified yolksac	unidentified yolksac larvae	1	3.98
<i>Citharichthys stigmaeus</i>	speckled sanddab	1	3.55
unidentified fish, damaged	unidentified damaged fish	1	3.47
<i>Citharichthys</i> spp.	sanddabs	1	3.28
larval/post-larval fish unid.	larval fishes	1	3.28
<i>Paralichthys californicus</i>	California halibut	1	3.09
<i>Stenobranchius leucopsarus</i>	northern lampfish	1	3.09
<i>Leuresthes tenuis</i>	California grunion	1	2.77
		<b>Total Fishes: 633</b>	
<b>Eggs</b>			
fish eggs unid.	unidentified fish eggs	1,831	11,785.44
<i>Pleuronichthys</i> spp. (eggs)	turbot eggs	57	377.37
Paralichthyidae unid. (eggs)	sand flounder eggs	49	319.69
Sciaen. / Paralich. / Labridae (eggs)	fish eggs	35	215.49
<i>Citharichthys</i> spp. (eggs)	sanddab eggs	33	209.24
Sciaenidae unid. (eggs)	croaker eggs	15	100.27
<i>Pleuronichthys guttulatus</i> (eggs)	diamond turbot eggs	4	24.69
		<b>Total Eggs: 2,024</b>	
<b>Target Invertebrates</b>			
<i>Pinnixa</i> spp. (megalops)	pea crabs megalops	2	5.85
Paguridae unid. (megalops)	hermit crab megalops	2	5.53
unidentified crab (megalops)	unidentified crab megalops	1	3.98
		<b>Total Target Invertebrates: 5</b>	

Redondo Beach Generating Station  
Entrainment Study - Fish and Invertebrate Abundances

Survey: SMBEA12  
Start Date: 6/14/2006  
Stations: E4 (UNITS 7&8 INTAKE)

Taxon	Common Name	Count	Mean Concentration (#/1,000m <sup>3</sup> )
<b>Fishes</b>			
<i>Hypsoblennius</i> spp.	combtooth blennies	579	1,709.19
<i>Hypsypops rubicundus</i>	garibaldi	195	562.42
<i>Typhlogobius californiensis</i>	blind goby	52	151.52
Labrisomidae unid.	labrisomid blennies	39	112.07
<i>Gibbonsia</i> spp.	clinid kelpfishes	23	67.40
<i>Gobiesox</i> spp.	clingfishes	19	53.81
Gobiidae unid.	gobies	17	51.71
<i>Leuresthes tenuis</i>	California grunion	7	19.82
<i>Oxyjulis californica</i>	senorita	5	15.29
larval fish - damaged	unidentified larval fishes	5	14.62
Atherinopsidae unid.	silversides	4	11.46
larvae, unidentified yolksac	unidentified yolksac larvae	3	8.26
<i>Genyonemus lineatus</i>	white croaker	2	5.89
<i>Atherinops affinis</i>	topsmelt	2	5.49
Sciaenidae unid.	croakers	1	3.14
<i>Paralichthys californicus</i>	California halibut	1	3.04
larval fish fragment	unidentified larval fishes	1	2.84
<i>Heterostichus rostratus</i>	giant kelpfish	1	2.75
<i>Syngnathus</i> spp.	pipefishes	1	2.75
		<b>Total Fishes: 957</b>	
<b>Eggs</b>			
fish eggs unid.	unidentified fish eggs	1,479	8,496.49
Sciaen. / Paralich. / Labridae (eggs)	fish eggs	310	1,803.17
<i>Pleuronichthys</i> spp. (eggs)	turbot eggs	63	359.25
<i>Citharichthys</i> spp. (eggs)	sanddab eggs	49	275.77
Paralichthyidae unid. (eggs)	sand flounder eggs	39	221.16
<i>Hypsypops rubicundus</i> (eggs)	garibaldi eggs	2	10.95
Labridae unid. (eggs)	wrasse eggs	2	7.45
Engraulidae unid. (eggs)	anchovy eggs	1	5.61
		<b>Total Eggs: 1,945</b>	
<b>Target Invertebrates</b>			
<i>Lophopanopeus</i> spp. (megalops)	black-clawed crab megalops	7	20.11
Paguridae unid. (megalops)	hermit crab megalops	3	9.12
Diogenidae (megalops)	left-handed hermit crabs	1	3.04
Grapsidae unid. (megalops)	shore crab megalops	1	3.04
Porcellanidae unid. (megalops)	porcelain crab megalops	1	2.75
		<b>Total Target Invertebrates: 13</b>	

Redondo Beach Generating Station  
Entrainment Study - Fish and Invertebrate Abundances

Survey: SMBEA12  
Start Date: 6/14/2006  
Stations: H1-H2

Taxon	Common Name	Count	Mean Concentration (#/1,000m <sup>3</sup> )
<b>Fishes</b>			
<i>Hypsoblennius</i> spp.	combtooth blennies	422	1,194.86
Gobiidae unid.	gobies	99	281.31
Labrisomidae unid.	labrisomid blennies	42	114.08
<i>Hypsypops rubicundus</i>	garibaldi	36	97.61
larval fish - damaged	unidentified larval fishes	11	29.59
<i>Gobiesox</i> spp.	clingfishes	9	23.79
<i>Typhlogobius californiensis</i>	blind goby	8	21.15
<i>Atherinops affinis</i>	topsmelt	6	14.93
<i>Gibbonsia</i> spp.	clinid kelpfishes	3	9.15
<i>Oxyjulis californica</i>	senorita	3	7.52
Engraulidae unid.	anchovies	2	6.35
<i>Citharichthys stigmaeus</i>	speckled sanddab	2	6.28
<i>Seriphus politus</i>	queenfish	2	6.28
Atherinopsidae unid.	silversides	2	6.03
larvae, unidentified yolksac	unidentified yolksac larvae	2	5.58
Sciaenidae unid.	croakers	2	5.43
<i>Cheilotrema saturnum</i>	black croaker	1	3.48
Oligocottus / Clinocottus	sculpins	1	3.48
larval fish fragment	unidentified larval fishes	1	2.87
<i>Sphyrna argentea</i>	Pacific barracuda	1	2.72
<i>Leuresthes tenuis</i>	California grunion	1	2.63
		<b>Total Fishes: 656</b>	
<b>Target Invertebrates</b>			
Brachyura unid. (megalops)	unidentified crab megalops	1	3.48
<i>Loligo opalescens</i>	market squid	1	2.63
		<b>Total Target Invertebrates: 2</b>	



Redondo Beach Generating Station  
Entrainment Study - Fish and Invertebrate Abundances

Survey: SMBEA12  
Start Date: 6/14/2006  
Stations: O4-O6, S5-S6

Taxon	Common Name	Count	Mean Concentration (#/1,000m <sup>3</sup> )
<b>Fishes</b>			
Sciaenidae unid.	croakers	94	377.39
<i>Hypsoblennius</i> spp.	combtooth blennies	63	240.44
<i>Seriphus politus</i>	queenfish	46	175.23
larval fish - damaged	unidentified larval fishes	21	83.95
<i>Citharichthys stigmaeus</i>	speckled sanddab	18	72.91
larvae, unidentified yolksac	unidentified yolksac larvae	13	59.92
<i>Paralichthys californicus</i>	California halibut	9	34.69
<i>Sphyræna argentea</i>	Pacific barracuda	8	32.03
<i>Hypsypops rubicundus</i>	garibaldi	5	21.78
Gobiidae unid.	gobies	5	19.98
<i>Pleuronichthys verticalis</i>	hornyhead turbot	5	18.35
Labrisomidae unid.	labrisomid blennies	4	15.68
<i>Oxyjulis californica</i>	senorita	3	11.76
<i>Pleuronichthys</i> spp.	turbots	3	11.25
<i>Umbrina roncadior</i>	yellowfin croaker	2	8.44
<i>Citharichthys sordidus</i>	Pacific sanddab	2	8.43
<i>Atractoscion nobilis</i>	white seabass	2	7.84
<i>Pleuronichthys ritteri</i>	spotted turbot	2	7.55
<i>Leuresthes tenuis</i>	California grunion	2	7.54
<i>Rhinogobiops nicholsi</i>	blackeye goby	1	3.92
<i>Typhlogobius californiensis</i>	blind goby	1	3.92
<i>Cheilotrema saturnum</i>	black croaker	1	3.71
Engraulidae unid.	anchovies	1	3.71
Pleuronectidae unid.	righteye flounders	1	3.71
<i>Pleuronichthys guttulatus</i>	diamond turbot	1	3.71
Atherinopsidae unid.	silversides	1	3.63
Pleuronectiformes unid.	flatfishes	1	3.63
<i>Roncadior stearnsi</i>	spotfin croaker	1	3.63
larval/post-larval fish unid.	larval fishes	1	3.62
<i>Peprilus simillimus</i>	Pacific butterfish	1	3.62
		<b>Total Fishes: 318</b>	
<b>Target Invertebrates</b>			
Majidae unid. (megalops)	spider crab megalops	8	29.29
Paguridae unid. (megalops)	hermit crab megalops	6	21.82
<i>Cancer anthonyi</i> (megalops)	yellow crab megalops	4	14.65
<i>Pugettia</i> spp. (megalops)	kelp crabs megalops	3	11.03
<i>Lophopanopeus</i> spp. (megalops)	black-clawed crab megalops	1	7.47
Brachyura unid. (megalops)	unidentified crab megalops	2	7.41
<i>Pinnixa</i> spp. (megalops)	pea crabs megalops	2	7.23
<i>Panulirus interruptus</i> (phyllosome)	California spiny lobster	1	3.71
Diogenidae (megalops)	left-handed hermit crabs	1	3.63
<i>Loligo opalescens</i>	market squid	1	3.63
		<b>Total Target Invertebrates: 29</b>	

Redondo Beach Generating Station  
Entrainment Study - Fish and Invertebrate Abundances

Survey: SMBEA13  
Start Date: 6/28/2006  
Stations: E4 (UNITS 7&8 INTAKE)

Taxon	Common Name	Count	Mean Concentration (#/1,000m <sup>3</sup> )
<b>Fishes</b>			
<i>Hypsoblennius</i> spp.	combtooth blennies	39	100.67
Labrisomidae unid.	labrisomid blennies	22	56.49
Gobiidae unid.	gobies	16	42.23
larval fish - damaged	unidentified larval fishes	3	8.06
<i>Syngnathus</i> spp.	pipefishes	3	7.86
Atherinopsidae unid.	silversides	3	7.81
<i>Hypsypops rubicundus</i>	garibaldi	2	5.35
<i>Typhlogobius californiensis</i>	blind goby	2	5.30
<i>Pleuronichthys verticalis</i>	hornyhead turbot	1	2.73
Sciaenidae unid.	croakers	1	2.66
<i>Gibbonsia</i> spp.	clinid kelpfishes	1	2.60
larval fish fragment	unidentified larval fishes	1	2.52
<i>Paralichthys californicus</i>	California halibut	1	2.21
		<b>Total Fishes: 95</b>	
<b>Eggs</b>			
fish eggs unid.	unidentified fish eggs	673	3,455.59
Paralichthyidae unid. (eggs)	sand flounder eggs	86	434.34
<i>Pleuronichthys</i> spp. (eggs)	turbot eggs	64	338.69
<i>Citharichthys</i> spp. (eggs)	sanddab eggs	22	116.08
Engraulidae unid. (eggs)	anchovy eggs	5	25.49
Sciaenidae unid. (eggs)	croaker eggs	3	15.83
<i>Pleuronichthys guttulatus</i> (eggs)	diamond turbot eggs	1	5.46
		<b>Total Eggs: 854</b>	
<b>Target Invertebrates</b>			
<i>Panulirus interruptus</i> (phyllosome)	California spiny lobster	11	28.41
<i>Lophopanopeus</i> spp. (megalops)	black-clawed crab megalops	6	15.79
<i>Pachycheles</i> spp. (megalops)	porcelain crabs megalops	6	15.58
Paguridae unid. (megalops)	hermit crab megalops	3	7.79
Grapsidae unid. (megalops)	shore crab megalops	3	7.69
Porcellanidae unid. (megalops)	porcelain crab megalops	3	7.69
Majidae unid. (megalops)	spider crab megalops	1	2.56
<i>Pugettia</i> spp. (megalops)	kelp crabs megalops	1	2.56
		<b>Total Target Invertebrates: 34</b>	

Redondo Beach Generating Station  
Entrainment Study - Fish and Invertebrate Abundances

Survey: SMBEA14  
Start Date: 7/12/2006  
Stations: E4 (UNITS 7&8 INTAKE)

Taxon	Common Name	Count	Mean Concentration (#/1,000m <sup>3</sup> )
<b>Fishes</b>			
<i>Hypsoblennius</i> spp.	combtooth blennies	147	471.21
Gobiidae unid.	gobies	49	151.45
<i>Hypsypops rubicundus</i>	garibaldi	16	51.59
Labrisomidae unid.	labrisomid blennies	15	38.45
larval fish - damaged	unidentified larval fishes	9	26.24
<i>Typhlogobius californiensis</i>	blind goby	5	16.63
<i>Gobiesox</i> spp.	clingfishes	5	12.86
Sciaenidae unid.	croakers	3	8.70
larvae, unidentified yolksac	unidentified yolksac larvae	2	5.52
<i>Engraulis mordax</i>	northern anchovy	1	3.35
<i>Pleuronichthys verticalis</i>	hornyhead turbot	1	3.35
<i>Seriphus politus</i>	queenfish	1	3.35
<i>Cheilotrema saturnum</i>	black croaker	1	2.98
<i>Leuresthes tenuis</i>	California grunion	1	2.98
<i>Pleuronichthys ritteri</i>	spotted turbot	1	2.90
<i>Genyonemus lineatus</i>	white croaker	1	2.82
<i>Paralabrax</i> spp.	sea basses	1	2.18
		<b>Total Fishes: 259</b>	
<b>Eggs</b>			
fish eggs unid.	unidentified fish eggs	1,241	7,588.54
<i>Pleuronichthys</i> spp. (eggs)	turbot eggs	63	422.19
Paralichthyidae unid. (eggs)	sand flounder eggs	45	274.65
Sciaen. / Paralich. / Labridae (eggs)	fish eggs	26	148.37
<i>Citharichthys</i> spp. (eggs)	sanddab eggs	10	63.27
Labridae unid. (eggs)	wrasse eggs	10	61.75
Engraulidae unid. (eggs)	anchovy eggs	10	57.80
Sciaenidae unid. (eggs)	croaker eggs	1	4.24
		<b>Total Eggs: 1,406</b>	
<b>Target Invertebrates</b>			
<i>Panulirus interruptus</i> (phyllosome)	California spiny lobster	61	198.17
<i>Pinnixa</i> spp. (megalops)	pea crabs megalops	8	26.87
<i>Pugettia</i> spp. (megalops)	kelp crabs megalops	9	26.67
<i>Cancer anthonyi</i> (megalops)	yellow crab megalops	3	10.21
Majidae unid. (megalops)	spider crab megalops	3	10.21
Paguridae unid. (megalops)	hermit crab megalops	2	5.52
Brachyura unid. (megalops)	unidentified crab megalops	1	3.43
<i>Lophopanopeus</i> spp. (megalops)	black-clawed crab megalops	1	3.35
		<b>Total Target Invertebrates: 88</b>	

Redondo Beach Generating Station  
Entrainment Study - Fish and Invertebrate Abundances

Survey: SMBEA14  
Start Date: 7/12/2006  
Stations: H1-H2

Taxon	Common Name	Count	Mean Concentration (#/1,000m <sup>3</sup> )
<b>Fishes</b>			
Gobiidae unid.	gobies	424	1,299.06
<i>Hypsoblennius</i> spp.	combtooth blennies	297	856.65
Labrisomidae unid.	labrisomid blennies	39	109.63
<i>Hypsypops rubicundus</i>	garibaldi	15	42.97
<i>Gobiesox</i> spp.	clingfishes	8	22.46
larval fish - damaged	unidentified larval fishes	7	19.77
larval fish fragment	unidentified larval fishes	5	13.42
Atherinopsidae unid.	silversides	3	9.86
<i>Atherinops affinis</i>	topsmelt	3	9.32
larvae, unidentified yolksac	unidentified yolksac larvae	3	9.20
<i>Typhlogobius californiensis</i>	blind goby	3	8.90
Haemulidae unid.	grunts	1	2.97
<i>Genyonemus lineatus</i>	white croaker	1	2.96
<i>Gibbonsia</i> spp.	clinid kelpfishes	1	2.81
<i>Oxyjulis californica</i>	senorita	1	2.81
<i>Menticirrhus undulatus</i>	California corbina	1	2.71
<i>Syngnathus</i> spp.	pipefishes	1	2.71
		<b>Total Fishes: 813</b>	
<b>Target Invertebrates</b>			
<i>Panulirus interruptus</i> (phyllosome)	California spiny lobster	21	59.62
Grapsidae unid. (megalops)	shore crab megalops	5	16.51
Majidae unid. (megalops)	spider crab megalops	4	10.44
<i>Pugettia</i> spp. (megalops)	kelp crabs megalops	1	3.26
<i>Petrolisthes</i> spp. (megalops)	porcelain crab megalops	1	2.71
Pinnotheridae (megalops)	pea crab megalops	1	2.30
		<b>Total Target Invertebrates: 33</b>	

Redondo Beach Generating Station  
Entrainment Study - Fish and Invertebrate Abundances

Survey: SMBEA14  
Start Date: 7/12/2006  
Stations: O4-O6, S5-S6

Taxon	Common Name	Count	Mean Concentration (#/1,000m <sup>3</sup> )
<b>Fishes</b>			
<i>Hypsoblennius</i> spp.	combtooth blennies	47	49.31
larvae, unidentified yolksac	unidentified yolksac larvae	46	48.46
Haemulidae unid.	grunts	21	22.95
<i>Menticirrhus undulatus</i>	California corbina	18	21.85
<i>Engraulis mordax</i>	northern anchovy	18	15.08
Sciaenidae unid.	croakers	13	14.03
<i>Hypsypops rubicundus</i>	garibaldi	11	13.88
<i>Pleuronichthys</i> spp.	turbots	12	12.60
<i>Pleuronichthys ritteri</i>	spotted turbot	9	10.38
<i>Paralichthys californicus</i>	California halibut	11	10.31
<i>Paralabrax</i> spp.	sea basses	7	8.07
<i>Seriphus politus</i>	queenfish	10	7.96
Labrisomidae unid.	labrisomid blennies	5	5.04
larval fish - damaged	unidentified larval fishes	4	5.04
<i>Gobiesox</i> spp.	clingfishes	4	4.98
<i>Pleuronichthys verticalis</i>	hornyhead turbot	4	4.34
Gobiidae unid.	gobies	4	3.51
larval fish fragment	unidentified larval fishes	3	3.35
larval/post-larval fish unid.	larval fishes	3	3.35
<i>Xystreurus liolepis</i>	fantail sole	3	2.66
Pomacentridae unid.	damsel fishes	2	2.61
<i>Typhlogobius californiensis</i>	blind goby	3	2.61
Ophidiidae unid.	cusk-eels	2	2.26
<i>Cheilotrema saturnum</i>	black croaker	2	2.12
<i>Genyonemus lineatus</i>	white croaker	2	2.12
<i>Xenistius californiensis</i>	salema	1	1.23
<i>Syngnathus</i> spp.	pipefishes	1	1.10
Atherinopsidae unid.	silversides	1	1.07
<i>Nannobranchium</i> spp.	lanternfishes	1	1.07
<i>Icelinus</i> spp.	sculpins	1	1.05
<i>Odontopyxis trispinosa</i>	pygmy poacher	1	0.77
<i>Oxyjulis californica</i>	senorita	1	0.64
<i>Sardinops sagax</i>	Pacific sardine	1	0.64
<i>Sphyrnaea argentea</i>	Pacific barracuda	1	0.64
		<b>Total Fishes: 273</b>	
<b>Target Invertebrates</b>			
<i>Panulirus interruptus</i> (phyllosome)	California spiny lobster	163	163.89
Majidae unid. (megalops)	spider crab megalops	52	50.90
<i>Pinnixa</i> spp. (megalops)	pea crabs megalops	54	48.48
<i>Pugettia</i> spp. (megalops)	kelp crabs megalops	38	41.22
<i>Loligo opalescens</i>	market squid	19	19.95
<i>Cancer anthonyi</i> (megalops)	yellow crab megalops	16	14.23
<i>Pachycheles</i> spp. (megalops)	porcelain crabs megalops	11	10.78

(continued)

Redondo Beach Generating Station  
 Entrainment Study - Fish and Invertebrate Abundances

Survey: SMBEA14  
 Start Date: 7/12/2006  
 Stations: O4-O6, S5-S6 (continued)

Taxon	Common Name	Count	Mean Concentration (#/1,000m <sup>3</sup> )
<b>Target Invertebrates (continued)</b>			
<i>Lophopanopeus</i> spp. (megalops)	black-clawed crab megalops	11	10.31
Brachyura unid. (megalops)	unidentified crab megalops	7	7.30
Pinnotheridae (megalops)	pea crab megalops	4	4.26
<i>Cancer antennarius</i> (megalops)	brown rock crab megalops	5	4.03
Paguridae unid. (megalops)	hermit crab megalops	3	2.61
<i>Pinnotheres</i> spp. (megalops)	pea crab megalops	2	2.27
<i>Petrolisthes</i> spp. (megalops)	porcelain crab megalops	2	2.16
Porcellanidae unid. (megalops)	porcelain crab megalops	1	1.23
Grapsidae unid. (megalops)	shore crab megalops	1	1.12
Diogenidae (megalops)	left-handed hermit crabs	1	1.11
<i>Portunus xantusii</i> (megalops)	Xantus' swimming crab	1	1.10
<b>Total Target Invertebrates:</b>		<b>391</b>	

Redondo Beach Generating Station  
Entrainment Study - Fish and Invertebrate Abundances

Survey: SMBEA15  
Start Date: 7/26/2006  
Stations: E4 (UNITS 7&8 INTAKE)

Taxon	Common Name	Count	Mean Concentration (#/1,000m <sup>3</sup> )
<b>Fishes</b>			
<i>Hypsoblennius</i> spp.	combtooth blennies	173	365.51
Gobiidae unid.	gobies	55	110.35
<i>Hypsypops rubicundus</i>	garibaldi	43	84.50
Scorpaenidae unid.	scorpionfishes	7	16.34
Labrisomidae unid.	labrisomid blennies	7	14.34
<i>Oxyjulis californica</i>	senorita	5	11.43
larval fish fragment	unidentified larval fishes	5	10.95
Sciaenidae unid.	croakers	4	9.12
larvae, unidentified yolksac	unidentified yolksac larvae	4	8.48
<i>Syngnathus</i> spp.	pipefishes	4	7.99
<i>Typhlogobius californiensis</i>	blind goby	4	7.40
<i>Symphurus atricauda</i>	California tonguefish	2	3.90
<i>Paralichthys californicus</i>	California halibut	2	3.88
<i>Gobiesox</i> spp.	clingfishes	1	2.43
Ophidiidae unid.	cusk-eels	1	2.34
<i>Chilara taylori</i>	spotted cusk-eel	1	2.03
larval/post-larval fish unid.	larval fishes	1	2.03
<i>Rhinogobiops nicholsi</i>	blackeye goby	1	2.03
<i>Halichoeres semicinctus</i>	rock wrasse	1	1.97
<i>Paralabrax</i> spp.	sea basses	1	1.97
<i>Semicossyphus pulcher</i>	California sheephead	1	1.85
<i>Seriphus politus</i>	queenfish	1	1.78
		<b>Total Fishes: 324</b>	
<b>Eggs</b>			
fish eggs unid.	unidentified fish eggs	1,841	7,488.37
Sciaen. / Paralich. / Labridae (eggs)	fish eggs	168	673.20
<i>Pleuronichthys</i> spp. (eggs)	turbot eggs	59	232.64
Paralichthyidae unid. (eggs)	sand flounder eggs	16	77.39
Labridae unid. (eggs)	wrasse eggs	11	53.07
<i>Citharichthys</i> spp. (eggs)	sanddab eggs	9	34.97
Engraulidae unid. (eggs)	anchovy eggs	1	3.70
		<b>Total Eggs: 2,105</b>	
<b>Target Invertebrates</b>			
<i>Panulirus interruptus</i> (phyllosome)	California spiny lobster	74	142.95
<i>Lophopanopeus</i> spp. (megalops)	black-clawed crab megalops	5	9.43
Majidae unid. (megalops)	spider crab megalops	1	2.03
<i>Cancer antennarius</i> (megalops)	brown rock crab megalops	1	1.85
Brachyura unid. (megalops)	unidentified crab megalops	1	1.78
		<b>Total Target Invertebrates: 82</b>	

Redondo Beach Generating Station  
Entrainment Study - Fish and Invertebrate Abundances

Survey: SMBEA16  
Start Date: 8/9/2006  
Stations: E4 (UNITS 7&8 INTAKE)

Taxon	Common Name	Count	Mean Concentration (#/1,000m <sup>3</sup> )
<b>Fishes</b>			
<i>Hypsoblennius</i> spp.	combtooth blennies	119	390.07
Gobiidae unid.	gobies	64	200.67
Labrisomidae unid.	labrisomid blennies	34	103.86
<i>Hypsypops rubicundus</i>	garibaldi	31	102.45
larvae, unidentified yolksac	unidentified yolksac larvae	12	39.97
Sciaenidae unid.	croakers	12	37.04
larval fish fragment	unidentified larval fishes	12	36.21
larval fish - damaged	unidentified larval fishes	7	23.51
<i>Menticirrhus undulatus</i>	California corbina	7	21.84
<i>Paralabrax</i> spp.	sea basses	7	18.29
<i>Oxyjulis californica</i>	senorita	5	14.77
<i>Paralichthys californicus</i>	California halibut	4	12.73
<i>Cheilotrema saturnum</i>	black croaker	3	10.28
Ophidiidae unid.	cusk-eels	3	9.71
<i>Seriphus politus</i>	queenfish	3	9.31
<i>Pleuronichthys</i> spp.	turbots	3	9.14
<i>Gobiesox</i> spp.	clingfishes	2	6.35
<i>Semicossyphus pulcher</i>	California sheephead	2	6.35
<i>Sardinops sagax</i>	Pacific sardine	1	3.96
<i>Gibbonsia</i> spp.	clinid kelpfishes	1	3.36
<i>Pleuronichthys ritteri</i>	spotted turbot	1	3.36
Pomacentridae unid.	damsel fishes	1	3.17
Engraulidae unid.	anchovies	1	2.42
larval/post-larval fish unid.	larval fishes	1	2.42
<i>Sphyrna argentea</i>	Pacific barracuda	1	2.42
		<b>Total Fishes: 337</b>	
<b>Eggs</b>			
fish eggs unid.	unidentified fish eggs	1,904	12,865.99
Sciaen. / Paralich. / Labridae (eggs)	fish eggs	226	1,545.35
<i>Pleuronichthys</i> spp. (eggs)	turbot eggs	36	240.00
<i>Sphyrna argentea</i> (eggs)	Pacific barracuda eggs	9	58.94
<i>Citharichthys</i> spp. (eggs)	sanddab eggs	6	39.68
Labridae unid. (eggs)	wrasse eggs	3	19.18
Paralichthyidae unid. (eggs)	sand flounder eggs	2	12.79
<i>Paralabrax</i> spp. (eggs)	sea bass eggs	1	4.99
		<b>Total Eggs: 2,187</b>	
<b>Target Invertebrates</b>			
<i>Panulirus interruptus</i> (phyllosome)	California spiny lobster	28	81.48
<i>Lophopanopeus</i> spp. (megalops)	black-clawed crab megalops	1	2.42
Majidae unid. (megalops)	spider crab megalops	1	2.42
<i>Pinnixa</i> spp. (megalops)	pea crabs megalops	1	2.42
		<b>Total Target Invertebrates: 31</b>	



Redondo Beach Generating Station  
Entrainment Study - Fish and Invertebrate Abundances

Survey: SMBEA16  
Start Date: 8/9/2006  
Stations: H1-H2

Taxon	Common Name	Count	Mean Concentration (#/1,000m <sup>3</sup> )
<b>Fishes</b>			
Gobiidae unid.	gobies	955	2,341.88
<i>Hypsoblennius</i> spp.	combtooth blennies	320	809.85
Labrisomidae unid.	labrisomid blennies	141	360.51
larvae, unidentified yolksac	unidentified yolksac larvae	26	66.99
Sciaenidae unid.	croakers	20	55.12
Ophidiidae unid.	cusk-eels	11	28.87
larval fish - damaged	unidentified larval fishes	8	17.42
<i>Menticirrhus undulatus</i>	California corbina	4	13.25
<i>Paralabrax</i> spp.	sea basses	5	12.41
larval fish fragment	unidentified larval fishes	5	11.32
<i>Hypsypops rubicundus</i>	garibaldi	5	10.49
<i>Oxyjulis californica</i>	senorita	4	9.39
<i>Paralichthys californicus</i>	California halibut	4	9.06
larval/post-larval fish unid.	larval fishes	3	8.69
<i>Halichoeres semicinctus</i>	rock wrasse	3	6.56
<i>Syngnathus</i> spp.	pipefishes	2	4.21
Haemulidae unid.	grunts	2	4.13
Atherinopsidae unid.	silversides	1	2.74
<i>Genyonemus lineatus</i>	white croaker	1	2.74
<i>Pleuronichthys</i> spp.	turbots	1	2.74
<i>Sphyræna argentea</i>	Pacific barracuda	1	2.74
Labridae unid.	wrasses	1	2.25
<i>Seriphus politus</i>	queenfish	1	2.25
<i>Pleuronichthys guttulatus</i>	diamond turbot	1	2.11
Blennioidei unid.	blennies	1	2.07
<i>Peprilus simillimus</i>	Pacific butterfish	1	2.07
		<b>Total Fishes: 1,527</b>	
<b>Target Invertebrates</b>			
<i>Panulirus interruptus</i> (phyllosome)	California spiny lobster	2	4.17
<i>Pugettia</i> spp. (megalops)	kelp crabs megalops	1	2.74
Majidae unid. (megalops)	spider crab megalops	1	2.25
<i>Petrolisthes</i> spp. (megalops)	porcelain crab megalops	1	2.11
		<b>Total Target Invertebrates: 5</b>	

Redondo Beach Generating Station  
Entrainment Study - Fish and Invertebrate Abundances

Survey: SMBEA16  
Start Date: 8/9/2006  
Stations: O4-O6, S5-S6

Taxon	Common Name	Count	Mean Concentration (#/1,000m <sup>3</sup> )
<b>Fishes</b>			
larvae, unidentified yolksac	unidentified yolksac larvae	100	118.27
<i>Hypsoblennius</i> spp.	combtooth blennies	89	100.33
<i>Paralabrax</i> spp.	sea basses	49	58.50
Sciaenidae unid.	croakers	39	45.41
<i>Paralichthys californicus</i>	California halibut	29	34.03
<i>Seriphus politus</i>	queenfish	22	26.34
Ophidiidae unid.	cusk-eels	19	21.50
<i>Engraulis mordax</i>	northern anchovy	18	19.53
<i>Pleuronichthys ritteri</i>	spotted turbot	14	15.50
<i>Hypsypops rubicundus</i>	garibaldi	12	13.86
Labrisomidae unid.	labrisomid blennies	11	13.74
<i>Oxyjulis californica</i>	senorita	12	13.59
Haemulidae unid.	grunts	11	12.79
<i>Sphyræna argentea</i>	Pacific barracuda	11	12.32
Gobiidae unid.	gobies	10	11.34
larval/post-larval fish unid.	larval fishes	10	11.11
larval fish fragment	unidentified larval fishes	8	10.56
<i>Hypsoblennius jenkinsi</i>	mussel blenny	10	9.60
<i>Menticirrhus undulatus</i>	California corbina	8	9.58
<i>Symphurus atricauda</i>	California tonguefish	7	8.47
<i>Pleuronichthys</i> spp.	turbots	4	4.43
<i>Xenistius californiensis</i>	salema	4	4.34
<i>Halichoeres semicinctus</i>	rock wrasse	4	4.21
<i>Ophidion scrippsae</i>	basketweave cusk-eel	4	4.17
<i>Umbrina roncadore</i>	yellowfin croaker	3	3.88
<i>Semicossyphus pulcher</i>	California sheephead	3	3.50
<i>Xystreurus liolepis</i>	fantail sole	3	3.20
Paralichthyidae unid.	sand flounders	2	2.77
larval fish - damaged	unidentified larval fishes	2	2.53
<i>Typhlogobius californiensis</i>	blind goby	2	2.24
<i>Gobiesox</i> spp.	clingfishes	1	1.33
Pleuronectidae unid.	righteye flounders	1	1.23
<i>Citharichthys stigmaeus</i>	speckled sanddab	1	1.18
<i>Liparis</i> spp.	snailfishes	1	1.11
<i>Pleuronichthys verticalis</i>	hornyhead turbot	1	1.05
<i>Chromis punctipinnis</i>	blacksmith	1	1.04
<i>Hippoglossina stomata</i>	bigmouth sole	1	1.04
<i>Triphoturus mexicanus</i>	Mexican lampfish	1	1.00
<i>Anisotremus davidsonii</i>	sargo	1	0.88
<i>Genyonemus lineatus</i>	white croaker	1	0.88
<i>Syngnathus</i> spp.	pipefishes	1	0.88
<i>Sardinops sagax</i>	Pacific sardine	1	0.87
		<b>Total Fishes: 532</b>	

(continued)

Redondo Beach Generating Station  
 Entrainment Study - Fish and Invertebrate Abundances

Survey: SMBEA16  
 Start Date: 8/9/2006  
 Stations: O4-O6, S5-S6 (continued)

Taxon	Common Name	Count	Mean Concentration (#/1,000m <sup>3</sup> )
<b>Target Invertebrates</b>			
<i>Panulirus interruptus</i> (phyllosome)	California spiny lobster	32	38.09
<i>Pugettia</i> spp. (megalops)	kelp crabs megalops	35	36.44
Majidae unid. (megalops)	spider crab megalops	24	26.50
<i>Pinnixa</i> spp. (megalops)	pea crabs megalops	9	8.67
Brachyura unid. (megalops)	unidentified crab megalops	5	4.98
Diogenidae (megalops)	left-handed hermit crabs	3	3.27
Grapsidae unid. (megalops)	shore crab megalops	2	2.20
<i>Pinnotheres</i> spp. (megalops)	pea crab megalops	1	1.35
<i>Portunus xantusii</i> (megalops)	Xantus' swimming crab	1	1.23
<i>Lophopanopeus</i> spp. (megalops)	black-clawed crab megalops	1	1.18
<i>Cancer anthonyi</i> (megalops)	yellow crab megalops	1	1.11
Paguridae unid. (megalops)	hermit crab megalops	1	0.88
<i>Emerita analoga</i> (megalops)	mole crabs megalops	1	0.87
<b>Total Target Invertebrates:</b>		<b>116</b>	

Redondo Beach Generating Station  
Entrainment Study - Fish and Invertebrate Abundances

Survey: SMBEA17  
Start Date: 8/23/2006  
Stations: E4 (UNITS 7&8 INTAKE)

Taxon	Common Name	Count	Mean Concentration (#/1,000m <sup>3</sup> )
<b>Fishes</b>			
<i>Hypsoblennius</i> spp.	combtooth blennies	194	461.62
larval/post-larval fish unid.	larval fishes	166	392.24
Gobiidae unid.	gobies	121	306.67
<i>Seriphus politus</i>	queenfish	107	250.58
larval fish fragment	unidentified larval fishes	97	225.38
Sciaenidae unid.	croakers	87	200.46
<i>Paralabrax</i> spp.	sea basses	39	88.12
<i>Sphyræna argentea</i>	Pacific barracuda	34	79.55
Labrisomidae unid.	labrisomid blennies	12	26.46
<i>Pleuronichthys verticalis</i>	hornyhead turbot	11	25.13
larval fish - damaged	unidentified larval fishes	9	21.64
<i>Xystreurys liolepis</i>	fantail sole	5	11.54
<i>Halichoeres semicinctus</i>	rock wrasse	3	7.11
<i>Citharichthys stigmatæus</i>	speckled sanddab	3	6.96
<i>Citharichthys</i> spp.	sanddabs	3	6.89
<i>Hypsypops rubicundus</i>	garibaldi	3	6.73
<i>Medialuna californiensis</i>	halfmoon	3	6.70
<i>Syngnathus</i> spp.	pipefishes	2	4.80
<i>Pleuronichthys ritteri</i>	spotted turbot	2	4.57
<i>Menticirrhus undulatus</i>	California corbina	1	2.54
Pleuronectidae unid.	righteye flounders	1	2.54
<i>Pleuronichthys</i> spp.	turbots	1	2.32
Atherinopsidae unid.	silversides	1	2.19
<i>Sardinops sagax</i>	Pacific sardine	1	2.04
		<b>Total Fishes: 906</b>	
<b>Eggs</b>			
fish eggs unid.	unidentified fish eggs	1,057	4,943.60
Sciaen. / Paralich. / Labridae (eggs)	fish eggs	219	951.60
<i>Pleuronichthys</i> spp. (eggs)	turbot eggs	79	380.78
<i>Citharichthys</i> spp. (eggs)	sanddab eggs	12	59.06
Paralichthyidae unid. (eggs)	sand flounder eggs	8	38.43
Labridae unid. (eggs)	wrasse eggs	7	31.34
<i>Sphyræna argentea</i> (eggs)	Pacific barracuda eggs	3	13.50
		<b>Total Eggs: 1,385</b>	
<b>Target Invertebrates</b>			
<i>Lophopanopeus</i> spp. (megalops)	black-clawed crab megalops	5	12.86
<i>Panulirus interruptus</i> (phyllosome)	California spiny lobster	5	12.42
Majidae unid. (megalops)	spider crab megalops	2	5.19
Grapsidae unid. (megalops)	shore crab megalops	2	5.08
		<b>Total Target Invertebrates: 14</b>	

Redondo Beach Generating Station  
Entrainment Study - Fish and Invertebrate Abundances

Survey: SMBEA18  
Start Date: 9/6/2006  
Stations: E4 (UNITS 7&8 INTAKE)

Taxon	Common Name	Count	Mean Concentration (#/1,000m <sup>3</sup> )
<b>Fishes</b>			
<i>Seriphus politus</i>	queenfish	208	422.59
Gobiidae unid.	gobies	76	168.59
<i>Hypsoblennius</i> spp.	combtooth blennies	72	160.63
Sciaenidae unid.	croakers	59	120.70
<i>Paralabrax</i> spp.	sea basses	38	74.40
<i>Paralichthys californicus</i>	California halibut	32	68.14
Labrisomidae unid.	labrisomid blennies	25	61.60
larvae, unidentified yolksac	unidentified yolksac larvae	19	38.77
<i>Genyonemus lineatus</i>	white croaker	14	28.69
Ophidiidae unid.	cusk-eels	13	28.53
Labridae unid.	wrasses	11	25.16
larval fish fragment	unidentified larval fishes	9	22.35
<i>Pleuronichthys</i> spp.	turbots	9	18.69
<i>Pleuronichthys guttulatus</i>	diamond turbot	8	17.18
<i>Pleuronichthys ritteri</i>	spotted turbot	8	16.18
<i>Sphyrna argentea</i>	Pacific barracuda	7	15.99
larval fish - damaged	unidentified larval fishes	5	11.08
<i>Ophidion scrippsae</i>	basketweave cusk-eel	5	10.50
<i>Leuresthes tenuis</i>	California grunion	4	10.02
<i>Oxyjulis californica</i>	senorita	5	9.66
larval/post-larval fish unid.	larval fishes	4	8.28
Pleuronectidae unid.	righteye flounders	3	5.81
<i>Citharichthys stigmaeus</i>	speckled sanddab	3	5.53
<i>Gibbonsia</i> spp.	clinid kelpfishes	2	4.54
<i>Engraulis mordax</i>	northern anchovy	2	4.25
<i>Pleuronichthys verticalis</i>	hornyhead turbot	2	3.97
<i>Symphurus atricauda</i>	California tonguefish	2	3.82
<i>Platichthys stellatus</i>	starry flounder	1	2.59
<i>Gillichthys mirabilis</i>	longjaw mudsucker	1	2.53
<i>Halichoeres semicinctus</i>	rock wrasse	1	2.27
Paralichthyidae unid.	sand flounders	1	2.27
<i>Rhinogobiops nicholsi</i>	blackeye goby	1	1.98
<i>Lythrypnus</i> spp.	gobies	1	1.84
		<b>Total Fishes: 651</b>	
<b>Eggs</b>			
fish eggs unid.	unidentified fish eggs	485	2,249.74
Sciaen. / Paralich. / Labridae (eggs)	fish eggs	152	767.51
<i>Pleuronichthys</i> spp. (eggs)	turbot eggs	68	313.29
Paralichthyidae unid. (eggs)	sand flounder eggs	26	123.02
Labridae unid. (eggs)	wrasse eggs	18	80.92
<i>Sphyrna argentea</i> (eggs)	Pacific barracuda eggs	3	14.93
<i>Citharichthys</i> spp. (eggs)	sanddab eggs	2	9.84
Engraulidae unid. (eggs)	anchovy eggs	1	3.92
		<b>Total Eggs: 755</b>	

(continued)

Redondo Beach Generating Station  
 Entrainment Study - Fish and Invertebrate Abundances

Survey: SMBEA18  
 Start Date: 9/6/2006  
 Stations: E4 (UNITS 7&8 INTAKE) (continued)

Taxon	Common Name	Count	Mean Concentration (#/1,000m <sup>3</sup> )
<b>Target Invertebrates</b>			
<i>Panulirus interruptus</i> (phyllosome)	California spiny lobster	11	21.00
Majidae unid. (megalops)	spider crab megalops	10	19.45
<i>Pugettia</i> spp. (megalops)	kelp crabs megalops	4	8.23
Brachyura unid. (megalops)	unidentified crab megalops	3	5.96
Grapsidae unid. (megalops)	shore crab megalops	1	5.23
<i>Pinnixa</i> spp. (megalops)	pea crabs megalops	1	2.61
Paguridae unid. (megalops)	hermit crab megalops	1	1.98
<i>Lophopanopeus</i> spp. (megalops)	black-clawed crab megalops	1	1.84
Porcellanidae unid. (megalops)	porcelain crab megalops	1	1.84
<b>Total Target Invertebrates:</b>		<b>33</b>	

Redondo Beach Generating Station  
Entrainment Study - Fish and Invertebrate Abundances

Survey: SMBEA19  
Start Date: 9/20/2006  
Stations: E4 (UNITS 7&8 INTAKE)

Taxon	Common Name	Count	Mean Concentration (#/1,000m <sup>3</sup> )
<b>Fishes</b>			
<i>Hypsoblennius</i> spp.	combtooth blennies	45	143.89
Gobiidae unid.	gobies	33	104.67
<i>Genyonemus lineatus</i>	white croaker	17	58.52
Labrisomidae unid.	labrisomid blennies	6	19.22
<i>Gibbonsia</i> spp.	clinid kelpfishes	3	9.66
<i>Paralabrax</i> spp.	sea basses	2	6.80
<i>Syngnathus</i> spp.	pipefishes	2	6.59
<i>Oxyjulis californica</i>	senorita	2	6.48
larval fish fragment	unidentified larval fishes	1	3.50
Pleuronectidae unid.	righteye flounders	1	3.50
larvae, unidentified yolksac	unidentified yolksac larvae	1	3.29
<i>Gobiesox</i> spp.	clingfishes	1	2.60
<i>Pleuronichthys ritteri</i>	spotted turbot	1	2.60
<i>Rimicola</i> spp.	kelp clingfishes	1	2.60
<i>Seriphus politus</i>	queenfish	1	2.60
		<b>Total Fishes: 117</b>	
<b>Eggs</b>			
fish eggs unid.	unidentified fish eggs	672	4,304.99
Sciaen. / Paralich. / Labridae (eggs)	fish eggs	119	744.32
<i>Pleuronichthys</i> spp. (eggs)	turbot eggs	47	300.84
<i>Citharichthys</i> spp. (eggs)	sanddab eggs	16	107.43
Labridae unid. (eggs)	wrasse eggs	14	101.27
Paralichthyidae unid. (eggs)	sand flounder eggs	7	46.63
<i>Paralabrax</i> spp. (eggs)	sea bass eggs	2	13.73
Sciaenidae unid. (eggs)	croaker eggs	2	13.69
		<b>Total Eggs: 879</b>	
<b>Target Invertebrates</b>			
Paguridae unid. (megalops)	hermit crab megalops	2	5.19
Diogenidae (megalops)	left-handed hermit crabs	1	2.60
		<b>Total Target Invertebrates: 3</b>	

Redondo Beach Generating Station  
 Entrainment Study - Fish and Invertebrate Abundances

Survey: SMBEA19  
 Start Date: 9/20/2006  
 Stations: H1-H2

Taxon	Common Name	Count	Mean Concentration (#/1,000m <sup>3</sup> )
<b>Fishes</b>			
Gobiidae unid.	gobies	1,198	3,291.87
<i>Hypsoblennius</i> spp.	combtooth blennies	241	742.55
<i>Oxyjulis californica</i>	senorita	12	40.41
Labrisomidae unid.	labrisomid blennies	12	35.02
larval fish - damaged	unidentified larval fishes	4	14.90
<i>Semicossyphus pulcher</i>	California sheephead	5	13.86
<i>Syngnathus</i> spp.	pipefishes	3	10.90
larvae, unidentified yolksac	unidentified yolksac larvae	3	8.08
<i>Pleuronichthys guttulatus</i>	diamond turbot	2	6.60
<i>Genyonemus lineatus</i>	white croaker	2	5.55
larval fish fragment	unidentified larval fishes	2	4.91
<i>Seriphus politus</i>	queenfish	1	3.59
<i>Symphurus atricauda</i>	California tonguefish	1	3.59
<i>Paralabrax</i> spp.	sea basses	1	3.01
<i>Gibbonsia</i> spp.	clinid kelpfishes	1	2.45
		<b>Total Fishes: 1,488</b>	
<b>Target Invertebrates</b>			
No Invertebrates			



Redondo Beach Generating Station  
Entrainment Study - Fish and Invertebrate Abundances

Survey: SMBEA19  
Start Date: 9/20/2006  
Stations: O4-O6, S5-S6

Taxon	Common Name	Count	Mean Concentration (#/1,000m <sup>3</sup> )
<b>Fishes</b>			
<i>Paralabrax</i> spp.	sea basses	51	57.82
<i>Genyonemus lineatus</i>	white croaker	37	42.84
<i>Chromis punctipinnis</i>	blacksmith	33	38.18
<i>Hypsoblennius</i> spp.	combtooth blennies	26	29.26
<i>Oxyjulis californica</i>	senorita	20	23.87
larvae, unidentified yolksac	unidentified yolksac larvae	17	19.88
<i>Paralichthys californicus</i>	California halibut	11	12.20
Gobiidae unid.	gobies	8	9.97
<i>Seriphus politus</i>	queenfish	7	8.12
<i>Citharichthys stigmaeus</i>	speckled sanddab	6	7.65
<i>Pleuronichthys ritteri</i>	spotted turbot	6	7.33
larval fish fragment	unidentified larval fishes	6	6.85
<i>Pleuronichthys guttulatus</i>	diamond turbot	6	6.64
<i>Pleuronichthys verticalis</i>	hornyhead turbot	4	4.52
Engraulidae unid.	anchovies	3	3.43
Labrisomidae unid.	labrisomid blennies	2	2.64
larval fish - damaged	unidentified larval fishes	2	2.35
Ophidiidae unid.	cusk-eels	2	2.29
<i>Hypsoblennius jenkinsi</i>	mussel blenny	2	2.14
<i>Heterostichus rostratus</i>	giant kelpfish	1	1.47
<i>Gibbonsia</i> spp.	clinid kelpfishes	1	1.22
Paralichthyidae unid.	sand flounders	1	1.22
<i>Pleuronichthys</i> spp.	turbots	1	1.19
Haemulidae unid.	grunts	1	1.11
Pleuronectiformes unid.	flatfishes	1	1.09
<i>Citharichthys sordidus</i>	Pacific sanddab	1	1.05
<i>Gobiesox</i> spp.	clingfishes	1	1.01
Labridae unid.	wrasses	1	1.01
<i>Semicossyphus pulcher</i>	California sheephead	1	1.01
		<b>Total Fishes: 259</b>	
<b>Target Invertebrates</b>			
<i>Emerita analoga</i> (megalops)	mole crabs megalops	5	6.39
<i>Panulirus interruptus</i> (phyllosome)	California spiny lobster	4	4.58
<i>Pugettia</i> spp. (megalops)	kelp crabs megalops	3	3.57
Majidae unid. (megalops)	spider crab megalops	3	3.52
<i>Lophopanopeus</i> spp. (megalops)	black-clawed crab megalops	2	2.59
<i>Pinnixa</i> spp. (megalops)	pea crabs megalops	1	1.31
Grapsidae unid. (megalops)	shore crab megalops	1	1.28
<i>Cancer antennarius</i> (megalops)	brown rock crab megalops	1	1.24
Diogenidae (megalops)	left-handed hermit crabs	1	1.12
Paguridae unid. (megalops)	hermit crab megalops	1	1.12
Brachyura unid. (megalops)	unidentified crab megalops	1	0.96
		<b>Total Target Invertebrates: 23</b>	

Redondo Beach Generating Station  
Entrainment Study - Fish and Invertebrate Abundances

Survey: SMBEA20  
Start Date: 10/4/2006  
Stations: E4 (UNITS 7&8 INTAKE)

Taxon	Common Name	Count	Mean Concentration (#/1,000m <sup>3</sup> )
<b>Fishes</b>			
<i>Hypsoblennius</i> spp.	combtooth blennies	55	122.72
Gobiidae unid.	gobies	36	81.92
<i>Paralabrax</i> spp.	sea basses	3	7.03
larval fish fragment	unidentified larval fishes	3	6.93
larvae, unidentified yolksac	unidentified yolksac larvae	3	6.69
<i>Seriphus politus</i>	queenfish	3	6.66
Sciaenidae unid.	croakers	2	4.53
<i>Pleuronichthys guttulatus</i>	diamond turbot	2	4.53
larval fish - damaged	unidentified larval fishes	2	4.25
<i>Pleuronichthys ritteri</i>	spotted turbot	1	2.28
<i>Pleuronichthys</i> spp.	turbots	1	2.28
<i>Sebastes</i> spp.	rockfishes	1	2.28
<i>Genyonemus lineatus</i>	white croaker	1	2.27
Labridae unid.	wrasses	1	2.27
Ophidiidae unid.	cusk-eels	1	2.27
Pleuronectiformes unid.	flatfishes	1	2.27
<i>Roncador stearnsi</i>	spotfin croaker	1	2.27
<i>Gibbonsia</i> spp.	clinid kelpfishes	1	2.17
<i>Citharichthys stigmaeus</i>	speckled sanddab	1	2.11
		<b>Total Fishes: 119</b>	
<b>Eggs</b>			
fish eggs unid.	unidentified fish eggs	810	3,469.74
Sciaen. / Paralich. / Labridae (eggs)	fish eggs	102	429.79
<i>Pleuronichthys</i> spp. (eggs)	turbot eggs	82	354.89
Paralichthyidae unid. (eggs)	sand flounder eggs	43	203.04
<i>Citharichthys</i> spp. (eggs)	sanddab eggs	31	135.83
Sciaenidae unid. (eggs)	croaker eggs	2	9.33
Labridae unid. (eggs)	wrasse eggs	1	4.58
		<b>Total Eggs: 1,071</b>	
<b>Target Invertebrates</b>			
<i>Hemigrapsus oregonensis</i> (megs.)	yellow shore crab megalops	2	4.54
Grapsidae unid. (megalops)	shore crab megalops	2	4.38
Majidae unid. (megalops)	spider crab megalops	1	2.38
Paguridae unid. (megalops)	hermit crab megalops	1	2.27
		<b>Total Target Invertebrates: 6</b>	

Redondo Beach Generating Station  
Entrainment Study - Fish and Invertebrate Abundances

Survey: SMBEA21  
Start Date: 10/18/2006  
Stations: E4 (UNITS 7&8 INTAKE)

Taxon	Common Name	Count	Mean Concentration (#/1,000m <sup>3</sup> )
<b>Fishes</b>			
Gobiidae unid.	gobies	55	156.02
<i>Genyonemus lineatus</i>	white croaker	70	151.85
<i>Hypsoblennius</i> spp.	combtooth blennies	43	125.31
Sciaenidae unid.	croakers	23	53.62
<i>Gibbonsia</i> spp.	clinid kelpfishes	12	40.64
larval fish fragment	unidentified larval fishes	11	28.29
<i>Paralichthys californicus</i>	California halibut	6	13.19
Atherinopsidae unid.	silversides	3	10.47
<i>Pleuronichthys guttulatus</i>	diamond turbot	4	9.98
larval fish - damaged	unidentified larval fishes	4	9.41
<i>Pleuronichthys ritteri</i>	spotted turbot	3	6.68
<i>Engraulis mordax</i>	northern anchovy	3	6.51
<i>Xystreurus liolepis</i>	fantail sole	2	4.34
Pleuronectiformes unid.	flatfishes	1	3.30
<i>Rhinogobiops nicholsi</i>	blackeye goby	1	3.30
<i>Sebastes</i> spp.	rockfishes	1	2.98
<i>Hippoglossina stomata</i>	bigmouth sole	1	2.56
Paralichthyidae unid.	sand flounders	1	2.34
<i>Citharichthys sordidus</i>	Pacific sanddab	1	2.17
<i>Citharichthys stigmaeus</i>	speckled sanddab	1	2.17
larvae, unidentified yolk sac	unidentified yolk sac larvae	1	2.17
<i>Pleuronichthys verticalis</i>	hornyhead turbot	1	2.17
		<b>Total Fishes: 248</b>	
<b>Eggs</b>			
fish eggs unid.	unidentified fish eggs	646	4,174.16
Sciaen. / Paralich. / Labridae (eggs)	fish eggs	125	762.52
<i>Pleuronichthys</i> spp. (eggs)	turbot eggs	55	344.83
<i>Citharichthys</i> spp. (eggs)	sanddab eggs	31	203.04
Paralichthyidae unid. (eggs)	sand flounder eggs	26	147.49
Engraulidae unid. (eggs)	anchovy eggs	6	39.65
Sciaenidae unid. (eggs)	croaker eggs	5	31.75
Labridae unid. (eggs)	wrasse eggs	1	6.80
		<b>Total Eggs: 895</b>	
<b>Target Invertebrates</b>			
Grapsidae unid. (megalops)	shore crab megalops	1	3.43
Paguridae unid. (megalops)	hermit crab megalops	1	3.43
Majidae unid. (megalops)	spider crab megalops	1	3.30
Brachyura unid. (megalops)	unidentified crab megalops	1	2.17
		<b>Total Target Invertebrates: 4</b>	

Redondo Beach Generating Station  
Entrainment Study - Fish and Invertebrate Abundances

Survey: SMBEA21  
Start Date: 10/18/2006  
Stations: H1-H2

Taxon	Common Name	Count	Mean Concentration (#/1,000m <sup>3</sup> )
<b>Fishes</b>			
Gobiidae unid.	gobies	368	1,116.41
<i>Hypsoblennius</i> spp.	combtooth blennies	182	551.03
<i>Gibbonsia</i> spp.	clinid kelpfishes	9	30.61
Labrisomidae unid.	labrisomid blennies	6	17.56
<i>Genyonemus lineatus</i>	white croaker	4	12.24
<i>Paralichthys californicus</i>	California halibut	2	6.34
<i>Atherinopsis californiensis</i>	jacksmelt	2	6.23
Atherinopsidae unid.	silversides	2	5.64
<i>Gillichthys mirabilis</i>	longjaw mudsucker	2	5.64
<i>Pleuronichthys guttulatus</i>	diamond turbot	2	5.57
<i>Gobiesox</i> spp.	clingfishes	1	3.66
Engraulidae unid.	anchovies	1	3.17
<i>Xystreurus liolepis</i>	fantail sole	1	3.17
<i>Clinocottus analis</i>	wooly sculpin	1	3.06
<i>Citharichthys sordidus</i>	Pacific sanddab	1	3.00
<i>Citharichthys stigmaeus</i>	speckled sanddab	1	3.00
<i>Pleuronichthys</i> spp.	turbots	1	2.83
<i>Syngnathus</i> spp.	pipefishes	1	2.83
		<b>Total Fishes: 587</b>	
<b>Target Invertebrates</b>			
Majidae unid. (megalops)	spider crab megalops	2	6.14
Grapsidae unid. (megalops)	shore crab megalops	1	3.06
Paguridae unid. (megalops)	hermit crab megalops	1	2.83
		<b>Total Target Invertebrates: 4</b>	

Redondo Beach Generating Station  
Entrainment Study - Fish and Invertebrate Abundances

Survey: SMBEA21  
Start Date: 10/18/2006  
Stations: O4-O6, S5-S6

Taxon	Common Name	Count	Mean Concentration (#/1,000m <sup>3</sup> )
<b>Fishes</b>			
<i>Genyonemus lineatus</i>	white croaker	102	111.14
Engraulidae unid.	anchovies	39	44.96
<i>Hypsoblennius</i> spp.	combtooth blennies	16	18.55
<i>Pleuronichthys guttulatus</i>	diamond turbot	12	14.00
<i>Citharichthys stigmaeus</i>	speckled sanddab	10	11.84
<i>Chromis punctipinnis</i>	blacksmith	11	11.72
<i>Paralichthys californicus</i>	California halibut	9	10.66
<i>Pleuronichthys ritteri</i>	spotted turbot	7	7.99
<i>Paralabrax</i> spp.	sea basses	6	6.66
larval fish - damaged	unidentified larval fishes	6	6.48
Paralichthyidae unid.	sand flounders	5	6.08
Gobiidae unid.	gobies	5	6.06
larval fish fragment	unidentified larval fishes	4	4.62
Labrisomidae unid.	labrisomid blennies	4	4.09
<i>Rimicola</i> spp.	kelp clingfishes	3	3.76
larvae, unidentified yolksac	unidentified yolksac larvae	3	3.43
<i>Gibbonsia</i> spp.	clinid kelpfishes	3	3.35
<i>Pleuronichthys</i> spp.	turbots	3	3.23
Ophidiidae unid.	cusk-eels	2	2.69
<i>Medialuna californiensis</i>	halfmoon	2	2.64
<i>Hippoglossina stomata</i>	bigmouth sole	2	2.41
<i>Engraulis mordax</i>	northern anchovy	2	2.32
<i>Triphoturus mexicanus</i>	Mexican lampfish	2	2.12
Haemulidae unid.	grunts	1	1.34
<i>Xystreurus liolepis</i>	fantail sole	1	1.25
Pleuronectidae unid.	righteye flounders	1	1.14
<i>Citharichthys sordidus</i>	Pacific sanddab	1	1.06
<i>Citharichthys</i> spp.	sanddabs	1	1.06
Pleuronectiformes unid.	flatfishes	1	1.04
Cottidae unid.	sculpins	1	1.01
<i>Clinocottus analis</i>	wooly sculpin	1	0.98
<i>Hypsoblennius jenkinsi</i>	mussel blenny	1	0.98
<i>Ophidion scrippsae</i>	basketweave cusk-eel	1	0.98
		<b>Total Fishes: 268</b>	
<b>Target Invertebrates</b>			
Majidae unid. (megalops)	spider crab megalops	8	8.52
Brachyura unid. (megalops)	unidentified crab megalops	2	2.22
Paguridae unid. (megalops)	hermit crab megalops	2	2.16
Grapsidae unid. (megalops)	shore crab megalops	2	2.10
<i>Pugettia</i> spp. (megalops)	kelp crabs megalops	1	0.98
		<b>Total Target Invertebrates: 15</b>	

Redondo Beach Generating Station  
Entrainment Study - Fish and Invertebrate Abundances

Survey: SMBEA22  
Start Date: 11/1/2006  
Stations: E4 (UNITS 7&8 INTAKE)

Taxon	Common Name	Count	Mean Concentration (#/1,000m <sup>3</sup> )
<b>Fishes</b>			
<i>Genyonemus lineatus</i>	white croaker	365	891.33
<i>Hypsoblennius</i> spp.	combtooth blennies	49	110.11
Gobiidae unid.	gobies	35	79.84
<i>Pleuronichthys guttulatus</i>	diamond turbot	23	51.57
<i>Engraulis mordax</i>	northern anchovy	7	16.31
<i>Paralichthys californicus</i>	California halibut	4	9.40
<i>Pleuronichthys</i> spp.	turbots	4	9.03
<i>Gibbonsia</i> spp.	clinid kelpfishes	3	6.78
<i>Citharichthys stigmaeus</i>	speckled sanddab	2	5.03
Pleuronectidae unid.	righteye flounders	2	4.57
larval fish fragment	unidentified larval fishes	2	4.50
<i>Citharichthys sordidus</i>	Pacific sanddab	1	2.52
<i>Pleuronichthys ritteri</i>	spotted turbot	1	2.40
<i>Syngnathus</i> spp.	pipefishes	1	2.09
<i>Sardinops sagax</i>	Pacific sardine	1	2.06
<i>Sebastes</i> spp.	rockfishes	1	2.06
		<b>Total Fishes: 501</b>	
<b>Eggs</b>			
fish eggs unid.	unidentified fish eggs	441	2,007.14
<i>Pleuronichthys</i> spp. (eggs)	turbot eggs	67	311.09
Paralichthyidae unid. (eggs)	sand flounder eggs	41	193.59
Sciaenidae unid. (eggs)	croaker eggs	14	64.35
<i>Citharichthys</i> spp. (eggs)	sanddab eggs	10	44.00
		<b>Total Eggs: 573</b>	
<b>Target Invertebrates</b>			
Paguridae unid. (megalops)	hermit crab megalops	4	9.65
Majidae unid. (megalops)	spider crab megalops	2	4.76
<i>Pinnixa</i> spp. (megalops)	pea crabs megalops	1	2.44
		<b>Total Target Invertebrates: 7</b>	

Redondo Beach Generating Station  
Entrainment Study - Fish and Invertebrate Abundances

Survey: SMBEA23  
Start Date: 11/15/2006  
Stations: E4 (UNITS 7&8 INTAKE)

Taxon	Common Name	Count	Mean Concentration (#/1,000m <sup>3</sup> )
<b>Fishes</b>			
<i>Genyonemus lineatus</i>	white croaker	64	200.24
Gobiidae unid.	gobies	22	69.70
<i>Hypsoblennius</i> spp.	combtooth blennies	12	36.37
larval fish - damaged	unidentified larval fishes	5	16.34
<i>Engraulis mordax</i>	northern anchovy	2	6.56
Pleuronectidae unid.	righteye flounders	2	6.42
<i>Gibbonsia</i> spp.	clinid kelpfishes	2	6.10
<i>Hippoglossina stomata</i>	bigmouth sole	2	6.10
Sciaenidae unid.	croakers	1	3.30
Atherinopsidae unid.	silversides	1	3.26
<i>Citharichthys sordidus</i>	Pacific sanddab	1	3.17
<i>Clinocottus analis</i>	wooly sculpin	1	3.12
<i>Pleuronichthys</i> spp.	turbots	1	3.12
<i>Atherinops affinis</i>	topsmelt	1	3.09
<i>Pleuronichthys guttulatus</i>	diamond turbot	1	3.01
<i>Pleuronichthys ritteri</i>	spotted turbot	1	3.01
larval fish fragment	unidentified larval fishes	1	2.85
		<b>Total Fishes: 120</b>	
<b>Eggs</b>			
fish eggs unid.	unidentified fish eggs	113	683.06
Sciaenidae unid. (eggs)	croaker eggs	27	158.51
Paralichthyidae unid. (eggs)	sand flounder eggs	18	106.27
<i>Pleuronichthys</i> spp. (eggs)	turbot eggs	16	95.90
<i>Citharichthys</i> spp. (eggs)	sanddab eggs	4	23.35
Sciaen. / Paralich. / Labridae (eggs)	fish eggs	2	13.67
		<b>Total Eggs: 180</b>	
<b>Target Invertebrates</b>			
Brachyura unid. (megalops)	unidentified crab megalops	3	9.40
Majidae unid. (megalops)	spider crab megalops	3	9.35
<i>Cancer antennarius</i> (megalops)	brown rock crab megalops	1	3.30
<i>Cancer anthonyi</i> (megalops)	yellow crab megalops	1	3.26
Paguridae unid. (megalops)	hermit crab megalops	1	3.09
<i>Portunus xantusii</i> (megalops)	Xantus' swimming crab	1	3.09
		<b>Total Target Invertebrates: 10</b>	

Redondo Beach Generating Station  
 Entrainment Study - Fish and Invertebrate Abundances

Survey: SMBEA23  
 Start Date: 11/15/2006  
 Stations: H1-H2

Taxon	Common Name	Count	Mean Concentration (#/1,000m <sup>3</sup> )
<b>Fishes</b>			
Gobiidae unid.	gobies	320	941.35
<i>Hypsoblennius</i> spp.	combtooth blennies	180	579.41
<i>Gibbonsia</i> spp.	clinid kelpfishes	6	19.52
larval fish - damaged	unidentified larval fishes	3	9.64
Labrisomidae unid.	labrisomid blennies	3	9.37
<i>Gobiesox</i> spp.	clingfishes	2	7.09
<i>Genyonemus lineatus</i>	white croaker	2	5.61
Blennioidei unid.	blennies	1	3.59
<i>Clinocottus analis</i>	wooly sculpin	1	2.84
larvae, unidentified yolksac	unidentified yolksac larvae	1	2.84
<i>Pleuronichthys guttulatus</i>	diamond turbot	1	2.49
		<b>Total Fishes: 520</b>	
<b>Target Invertebrates</b>			
<i>Portunus xantusii</i> (megalops)	Xantus' swimming crab	1	3.32
Paguridae unid. (megalops)	hermit crab megalops	1	2.55
		<b>Total Target Invertebrates: 2</b>	



Redondo Beach Generating Station  
Entrainment Study - Fish and Invertebrate Abundances

Survey: SMBEA23  
Start Date: 11/15/2006  
Stations: O4-O6, S5-S6

Taxon	Common Name	Count	Mean Concentration (#/1,000m <sup>3</sup> )
<b>Fishes</b>			
<i>Genyonemus lineatus</i>	white croaker	632	734.13
<i>Paralichthys californicus</i>	California halibut	37	44.49
<i>Pleuronichthys guttulatus</i>	diamond turbot	26	30.06
<i>Pleuronichthys ritteri</i>	spotted turbot	19	21.37
<i>Sebastes</i> spp.	rockfishes	15	20.76
<i>Engraulis mordax</i>	northern anchovy	17	18.64
<i>Hypsoblennius</i> spp.	combtooth blennies	10	12.45
<i>Citharichthys stigmaeus</i>	speckled sanddab	9	10.49
larval fish - damaged	unidentified larval fishes	6	7.48
larvae, unidentified yolksac	unidentified yolksac larvae	6	7.09
<i>Lepidogobius lepidus</i>	bay goby	2	2.59
larval fish fragment	unidentified larval fishes	2	2.55
Paralichthyidae unid.	sand flounders	2	2.49
<i>Citharichthys sordidus</i>	Pacific sanddab	2	2.23
<i>Atherinopsis californiensis</i>	jacksmelt	1	1.38
<i>Clinocottus analis</i>	wooly sculpin	1	1.32
<i>Gibbonsia</i> spp.	clinid kelpfishes	1	1.31
<i>Lythrypnus zebra</i>	zebra goby	1	1.31
Pleuronectiformes unid.	flatfishes	1	1.25
Gobiidae unid.	gobies	1	1.22
<i>Syngnathus</i> spp.	pipefishes	1	1.18
<i>Pleuronichthys verticalis</i>	hornyhead turbot	1	0.96
		<b>Total Fishes: 793</b>	
<b>Target Invertebrates</b>			
<i>Pugettia</i> spp. (megalops)	kelp crabs megalops	13	15.76
Majidae unid. (megalops)	spider crab megalops	11	12.99
<i>Cancer antennarius</i> (megalops)	brown rock crab megalops	9	10.08
<i>Cancer anthonyi</i> (megalops)	yellow crab megalops	2	2.78
Diogenidae (megalops)	left-handed hermit crabs	2	2.38
Brachyura unid. (megalops)	unidentified crab megalops	1	1.18
<i>Pachycheles</i> spp. (megalops)	porcelain crabs megalops	1	1.06
Paguridae unid. (megalops)	hermit crab megalops	1	0.92
		<b>Total Target Invertebrates: 40</b>	

Redondo Beach Generating Station  
 Entrainment Study - Fish and Invertebrate Abundances

Survey: SMBEA24  
 Start Date: 11/27/2006  
 Stations: E4 (UNITS 7&8 INTAKE)

Taxon	Common Name	Count	Mean Concentration (#/1,000m <sup>3</sup> )
<b>Fishes</b>			
Gobiidae unid.	gobies	45	327.67
<i>Hypsoblennius</i> spp.	combtooth blennies	8	63.84
<i>Genyonemus lineatus</i>	white croaker	9	44.78
Atherinopsidae unid.	silversides	1	10.95
<i>Engraulis mordax</i>	northern anchovy	1	10.95
<i>Gibbonsia</i> spp.	clinid kelpfishes	2	9.82
Engraulidae unid.	anchovies	1	5.11
<i>Clinocottus</i> spp.	sculpins	1	4.70
larval fish - damaged	unidentified larval fishes	1	4.70
<i>Paralichthys californicus</i>	California halibut	1	4.70
Sciaenidae unid.	croakers	1	4.70
		<b>Total Fishes: 71</b>	
<b>Eggs</b>			
fish eggs unid.	unidentified fish eggs	9	89.34
<i>Pleuronichthys</i> spp. (eggs)	turbot eggs	1	20.42
Sciaenidae unid. (eggs)	croaker eggs	2	19.81
<i>Citharichthys</i> spp. (eggs)	sanddab eggs	1	10.11
		<b>Total Eggs: 13</b>	
<b>Target Invertebrates</b>			
Grapsidae unid. (megalops)	shore crab megalops	2	21.90
Brachyura unid. (megalops)	unidentified crab megalops	1	10.95
<i>Portunus xantusii</i> (megalops)	Xantus' swimming crab	1	10.95
		<b>Total Target Invertebrates: 4</b>	

Redondo Beach Generating Station  
 Entrainment Study - Fish and Invertebrate Abundances

Survey: SMBEA25  
 Start Date: 12/13/2006  
 Stations: E4 (UNITS 7&8 INTAKE)

Taxon	Common Name	Count	Mean Concentration (#/1,000m <sup>3</sup> )
<b>Fishes</b>			
<i>Gibbonsia</i> spp.	clinid kelpfishes	39	121.02
Gobiidae unid.	gobies	18	58.64
<i>Hypsoblennius</i> spp.	combtooth blennies	7	20.76
larval fish fragment	unidentified larval fishes	4	12.92
Atherinopsidae unid.	silversides	3	9.01
<i>Genyonemus lineatus</i>	white croaker	1	3.96
Sciaenidae unid.	croakers	1	3.40
larval fish - damaged	unidentified larval fishes	1	3.35
<i>Typhlogobius californiensis</i>	blind goby	1	2.51
		<b>Total Fishes: 75</b>	
<b>Eggs</b>			
fish eggs unid.	unidentified fish eggs	167	967.37
Sciaenidae unid. (eggs)	croaker eggs	63	344.21
Paralichthyidae unid. (eggs)	sand flounder eggs	12	62.08
<i>Pleuronichthys</i> spp. (eggs)	turbot eggs	3	18.14
Engraulidae unid. (eggs)	anchovy eggs	4	17.88
<i>Citharichthys</i> spp. (eggs)	sanddab eggs	1	5.52
		<b>Total Eggs: 250</b>	
<b>Target Invertebrates</b>			
<i>Pugettia</i> spp. (megalops)	kelp crabs megalops	11	34.79
Majidae unid. (megalops)	spider crab megalops	2	6.47
Brachyura unid. (megalops)	unidentified crab megalops	1	2.51
<i>Pinnixa</i> spp. (megalops)	pea crabs megalops	1	2.51
		<b>Total Target Invertebrates: 15</b>	

Redondo Beach Generating Station  
 Entrainment Study - Fish and Invertebrate Abundances

Survey: SMBEA25  
 Start Date: 12/13/2006  
 Stations: H1-H2

Taxon	Common Name	Count	Mean Concentration (#/1,000m <sup>3</sup> )
<b>Fishes</b>			
Gobiidae unid.	gobies	137	385.47
<i>Hypsoblennius</i> spp.	combtooth blennies	54	149.54
<i>Gibbonsia</i> spp.	clinid kelpfishes	7	20.46
larval fish fragment	unidentified larval fishes	5	12.24
larval fish - damaged	unidentified larval fishes	3	8.64
<i>Genyonemus lineatus</i>	white croaker	1	2.87
<i>Clinocottus analis</i>	wooly sculpin	1	2.80
Cottidae unid.	sculpins	1	2.05
		<b>Total Fishes: 209</b>	
<b>Target Invertebrates</b>			
Majidae unid. (megalops)	spider crab megalops	3	9.23
Brachyura unid. (megalops)	unidentified crab megalops	1	3.40
<i>Pugettia</i> spp. (megalops)	kelp crabs megalops	1	3.40
		<b>Total Target Invertebrates: 5</b>	

Redondo Beach Generating Station  
Entrainment Study - Fish and Invertebrate Abundances

Survey: SMBEA25  
Start Date: 12/13/2006  
Stations: O4-O6, S5-S6

Taxon	Common Name	Count	Mean Concentration (#/1,000m <sup>3</sup> )
<b>Fishes</b>			
<i>Genyonemus lineatus</i>	white croaker	234	259.91
larval fish fragment	unidentified larval fishes	24	26.71
Sciaenidae unid.	croakers	16	19.20
<i>Engraulis mordax</i>	northern anchovy	15	16.78
<i>Paralichthys californicus</i>	California halibut	16	15.82
Gobiidae unid.	gobies	19	14.28
<i>Pleuronichthys guttulatus</i>	diamond turbot	9	10.99
Atherinopsidae unid.	silversides	7	8.67
<i>Pleuronichthys ritteri</i>	spotted turbot	7	8.01
<i>Stenobranchius leucopsarus</i>	northern lampfish	4	4.80
larval fish - damaged	unidentified larval fishes	4	4.75
<i>Hypsoblennius</i> spp.	combtooth blennies	3	4.10
<i>Gibbonsia</i> spp.	clinid kelpfishes	3	3.67
<i>Lepidogobius lepidus</i>	bay goby	3	3.25
<i>Sebastes</i> spp.	rockfishes	3	3.09
<i>Pleuronichthys</i> spp.	turbots	2	2.83
<i>Clinocottus analis</i>	wooly sculpin	2	2.36
<i>Sardinops sagax</i>	Pacific sardine	2	2.29
Engraulidae unid.	anchovies	2	1.94
Clupeiformes unid.	herrings and anchovies	1	1.35
<i>Citharichthys sordidus</i>	Pacific sanddab	1	1.28
Ophidiidae unid.	cusk-eels	1	1.28
larvae, unidentified yolksac	unidentified yolksac larvae	1	0.97
<i>Icelinus quadriseriatus</i>	yellowchin sculpin	1	0.88
Pleuronectidae unid.	righteye flounders	1	0.64
		<b>Total Fishes: 381</b>	
<b>Target Invertebrates</b>			
<i>Pugettia</i> spp. (megalops)	kelp crabs megalops	57	64.64
Majidae unid. (megalops)	spider crab megalops	18	19.85
Brachyura unid. (megalops)	unidentified crab megalops	5	5.91
<i>Cancer anthonyi</i> (megalops)	yellow crab megalops	4	4.46
Diogenidae (megalops)	left-handed hermit crabs	2	3.05
<i>Pinnixa</i> spp. (megalops)	pea crabs megalops	2	2.55
Grapsidae unid. (megalops)	shore crab megalops	1	1.27
Paguridae unid. (megalops)	hermit crab megalops	1	1.04
Anomura unid. (megalops)		1	0.97
		<b>Total Target Invertebrates: 91</b>	

Redondo Beach Generating Station  
 Entrainment Study - Fish and Invertebrate Abundances

Survey: SMBEA26  
 Start Date: 1/8/2007  
 Stations: E4 (UNITS 7&8 INTAKE)

Taxon	Common Name	Count	Mean Concentration (#/1,000m <sup>3</sup> )
<b>Fishes</b>			
Gobiidae unid.	gobies	11	23.13
larval fish fragment	unidentified larval fishes	5	10.28
Cottidae unid.	sculpins	2	4.46
<i>Atherinopsis californiensis</i>	jacksmelt	2	4.41
<i>Ruscarius creaseri</i>	roughcheek sculpin	2	4.41
<i>Genyonemus lineatus</i>	white croaker	2	3.80
<i>Gibbonsia</i> spp.	clinid kelpfishes	1	2.18
		<b>Total Fishes: 25</b>	
<b>Eggs</b>			
fish eggs unid.	unidentified fish eggs	87	355.29
Sciaenidae unid. (eggs)	croaker eggs	6	23.34
Paralichthyidae unid. (eggs)	sand flounder eggs	5	21.05
<i>Citharichthys</i> spp. (eggs)	sanddab eggs	1	4.62
Sciaen. / Paralich. / Labridae (eggs)	fish eggs	1	4.26
		<b>Total Eggs: 100</b>	
<b>Target Invertebrates</b>			
Grapsidae unid. (megalops)	shore crab megalops	3	5.70
Brachyura unid. (megalops)	unidentified crab megalops	1	2.13
<i>Cancer antennarius</i> (megalops)	brown rock crab megalops	1	2.06
		<b>Total Target Invertebrates: 5</b>	

*Redondo Beach Generating Station*

## **Appendix E**

---

### **Impingement Data**

E1. Normal Operation Impingement Data

E2. Heat Treatment Impingement Data

**Redondo Beach Generating Station – Normal Operation Impingement Data**

**Survey:** 1  
**Date:** January 19-20, 2006

Fish	Taxon	Common Name	Survey Totals	
			Abundance	Biomass (kg)
Units 5&6	No Sample (No pumps operating)			
Units 7&8	<i>Engraulis mordax</i>	northern anchovy	1	0.020
	<i>Seriphus politus</i>	queenfish	1	0.007
			<b>2</b>	<b>0.027</b>

**Shellfish**

Units 5&6	No Sample (No pumps operating)			
Units 7&8	<i>Cancer anthonyi</i>	yellow crab	2	0.046
			<b>2</b>	<b>0.046</b>



**Redondo Beach Generating Station – Normal Operation Impingement Data**

**Survey:** 2  
**Date:** February 27-28, 2006

Fish	Taxon	Common Name	Survey Totals	
			Abundance	Biomass (kg)

Units 5&6	No Fish			
-----------	---------	--	--	--

Units 7&8	No Fish			
-----------	---------	--	--	--

**Shellfish**

Units 5&6	<i>Cancer antennarius</i>	Pacific rock crab	1	0.006
			<b>1</b>	<b>0.006</b>

Units 7&8	<i>Cancer anthonyi</i>	yellow crab	1	0.026
	<i>Cancer productus</i>	red rock crab	1	0.016
	<i>Portunus xantusii</i>	Xantus swimming crab	2	0.016
			<b>4</b>	<b>0.058</b>

**Other Macroinvertebrates**

Units 5&6	<i>Chrysaora colorata</i>	purple-striped jellyfish	1	0.300
			<b>1</b>	<b>0.300</b>

**Redondo Beach Generating Station – Normal Operation Impingement Data**

**Survey:** 3  
**Date:** March 23-24, 2006

Fish	Taxon	Common Name	Survey Totals	
			Abundance	Biomass (kg)
Units 5&6	No Fish			
Units 7&8	No Fish			

**Shellfish**

Units 5&6	No Shellfish			
Units 7&8	<i>Cancer anthonyi</i>	yellow crab	3	0.096
	<i>Loligo opalescens</i>	California market squid	1	0.024
			<b>4</b>	<b>0.120</b>

**Other Macroinvertebrates**

Units 5&6	<i>Thetys vagina</i>	common salp	1	0.008
			<b>1</b>	<b>0.008</b>
Units 7&8	Cnidaria	sea jelly, unid.	1	0.005
			<b>1</b>	<b>0.005</b>

Redondo Beach Generating Station – Normal Operation Impingement Data

Survey: 4  
Date: April 24-25, 2006

Fish	Taxon	Common Name	Survey Totals	
			Abundance	Biomass (kg)
Units 5&6	No Fish			
Units 7&8	<i>Engraulis mordax</i>	northern anchovy	4	0.035
	<i>Myliobatis californica</i>	bat ray	1	0.267
	<i>Porichthys notatus</i>	plainfin midshipman	1	0.177
	<i>Seriphus politus</i>	queenfish	1	0.005
			<b>7</b>	<b>0.484</b>
<b>Shellfish</b>				
Units 5&6	<i>Cancer anthonyi</i>	yellow crab	1	0.327
	<i>Pugettia producta</i>	northern kelp crab	1	0.005
			<b>2</b>	<b>0.332</b>
Units 7&8	<i>Crangon nigromaculata</i>	blackspotted bay shrimp	3	0.005
	<i>Loligo opalescens</i>	California market squid	2	0.055
	<i>Octopus bimaculatus/bimaculoides</i>	California two-spot octopus	3	0.386
			<b>8</b>	<b>0.446</b>
<b>Other Macroinvertebrates</b>				
Units 7&8	Cnidaria	sea jelly, unid.	1	0.064
			<b>1</b>	<b>0.064</b>

Redondo Beach Generating Station – Normal Operation Impingement Data

Survey: 5  
Date: May 25-26, 2006

Fish	Taxon	Common Name	Survey Totals	
			Abundance	Biomass (kg)
Units 5&6	No Fish			
Units 7&8	<i>Embiotoca jacksoni</i>	black perch	1	0.007
	<i>Heterostichus rostratus</i>	giant kelpfish	1	0.011
	<i>Myliobatis californica</i>	bat ray	1	0.195
	<i>Scorpaena guttata</i>	California scorpionfish	2	0.219
			<b>5</b>	<b>0.432</b>
<b>Shellfish</b>				
Units 5&6	<i>Cancer antennarius</i>	Pacific rock crab	1	0.052
	<i>Octopus sp.</i>	octopus, unid.	1	0.065
			<b>2</b>	<b>0.117</b>
Units 7&8	<i>Cancer antennarius</i>	Pacific rock crab	1	0.003
	<i>Cancer anthonyi</i>	yellow crab	1	0.234
	<i>Loxorhynchus grandis</i>	sheep crab	6	8.86
	<i>Panulirus interruptus</i>	California spiny lobster	3	0.947
	<i>Portunus xantusii</i>	Xantus swimming crab	2	0.052
			<b>13</b>	<b>10.096</b>
<b>Other Macroinvertebrates</b>				
Units 5&6	<i>Dendronotus iris</i>	giant-frond-aeolis	1	0.007
			<b>1</b>	<b>0.007</b>

Redondo Beach Generating Station – Normal Operation Impingement Data

Survey: 6  
Date: June 8-9, 2006

Fish	Taxon	Common Name	Survey Totals	
			Abundance	Biomass (kg)
Units 5&6	No Fish			
Units 7&8	<i>Citharichthys stigmaeus</i>	speckled sanddab	1	0.016
	<i>Cymatogaster aggregata</i>	shiner perch	1	0.027
	<i>Embiotoca jacksoni</i>	black perch	1	0.430
			<b>3</b>	<b>0.473</b>

Shellfish

Units 5&6	No Shellfish			
Units 7&8	<i>Cancer antennarius</i>	Pacific rock crab	2	0.670
	<i>Loxorhynchus grandis</i>	sheep crab	2	2.700
	<i>Panulirus interruptus</i>	California spiny lobster	3	0.705
			<b>7</b>	<b>4.075</b>

Other Macroinvertebrates

Units 7&8	<i>Chrysaora colorata</i>	purple-striped jellyfish	1	0.800
	<i>Parastichopus parvimensis</i>	warty sea cucumber	1	0.056
			<b>2</b>	<b>0.856</b>

Redondo Beach Generating Station – Normal Operation Impingement Data

Survey: 7  
Date: July 10-11, 2006

Fish	Taxon	Common Name	Survey Totals	
			Abundance	Biomass (kg)
Units 5&6	<i>Myliobatis californica</i>	bat ray	1	0.279
	<i>Urobatis halleri</i>	round stingray	2	0.539
			<b>3</b>	<b>0.818</b>
Units 7&8	<i>Hyperprosopon argenteum</i>	walleye surfperch	1	0.011
	<i>Oxyjulis californica</i>	senorita	1	0.054
			<b>2</b>	<b>0.065</b>
<b>Shellfish</b>				
Units 5&6	<i>Panulirus interruptus</i>	California spiny lobster	1	0.644
			<b>1</b>	<b>0.644</b>
Units 7&8	<i>Octopus bimaculatus/bimaculoides</i>	California two-spot octopus	2	0.503
	<i>Panulirus interruptus</i>	California spiny lobster	1	0.351
	<i>Portunus xantusii</i>	Xantus swimming crab	1	0.020
			<b>4</b>	<b>0.874</b>

**Redondo Beach Generating Station – Normal Operation Impingement Data**

**Survey:** 8 (Units 7&8 only)  
**Date:** August 2-3, 2006

Fish	Taxon	Common Name	Survey Totals	
			Abundance	Biomass (kg)
Units 7&8	<i>Myliobatis californica</i>	bat ray	1	0.550
	<i>Paralabrax nebulifer</i>	barred sand bass	1	0.950
			<b>2</b>	<b>1.500</b>

**Shellfish**

Units 7&8	<i>Cancer antennarius</i>	Pacific rock crab	1	0.051
	<i>Loxorhynchus grandis</i>	sheep crab	1	1.400
	<i>Octopus bimaculatus/bimaculoides</i>	California two-spot octopus	1	0.030
	<i>Pyromaia tuberculata</i>	tuberculate pear crab	1	0.002
			<b>4</b>	<b>1.483</b>

**Other Macroinvertebrates**

Units 7&8	<i>Parastichopus parvimensis</i>	warty sea cucumber	1	0.062
	<i>Strongylocentrotus purpuratus</i>	purple sea urchin	1	0.001
			<b>2</b>	<b>0.063</b>

**Redondo Beach Generating Station – Normal Operation Impingement Data**

**Survey:** 8 (Units 5&6 only)  
**Date:** August 22-23, 2006

Fish	Taxon	Common Name	Survey Totals	
			Abundance	Biomass (kg)
Units 5&6	<i>Gobiesox rhesodon</i>	California clingfish	1	0.001
			<b>1</b>	<b>0.001</b>

**Shellfish**

Units 5&6 No Shellfish

**Other Macroinvertebrates**

Units 5&6	<i>Thetys vagina</i>	common salp	1	0.001
			<b>1</b>	<b>0.001</b>



**Redondo Beach Generating Station – Normal Operation Impingement Data**

---

**Survey:** 9  
**Date:** September, 2006

<b>Fish</b>	<b>Taxon</b>	<b>Common Name</b>	<b>Survey Totals</b>	
			<b>Abundance</b>	<b>Biomass (kg)</b>

---

Units 5&6	No Sample (No pumps operating)			
-----------	--------------------------------	--	--	--

Units 7&8	No Sample (No pumps operating)			
-----------	--------------------------------	--	--	--

**Shellfish**

---

Units 5&6	No Sample (No pumps operating)			
-----------	--------------------------------	--	--	--

Units 7&8	No Sample (No pumps operating)			
-----------	--------------------------------	--	--	--

**Redondo Beach Generating Station – Normal Operation Impingement Data**

---

**Survey:** 10  
**Date:** October, 2006

<b>Fish</b>	<b>Taxon</b>	<b>Common Name</b>	<b>Survey Totals</b>	
			<b>Abundance</b>	<b>Biomass (kg)</b>

---

Units 5&6	No Sample (No pumps operating)			
-----------	--------------------------------	--	--	--

Units 7&8	No Sample (No pumps operating)			
-----------	--------------------------------	--	--	--

**Shellfish**

---

Units 5&6	No Sample (No pumps operating)			
-----------	--------------------------------	--	--	--

Units 7&8	No Sample (No pumps operating)			
-----------	--------------------------------	--	--	--

**Redondo Beach Generating Station – Normal Operation Impingement Data**

**Survey:** 11  
**Date:** November 15-16, 2006

<b>Fish</b>	<b>Taxon</b>	<b>Common Name</b>	<b>Survey Totals</b>	
			<b>Abundance</b>	<b>Biomass (kg)</b>
Units 5&6	No Fish			
Units 7&8	No Fish			
<b>Shellfish</b>				
Units 5&6	No Shellfish			
Units 7&8	<i>Cancer antennarius</i>	Pacific rock crab	5	0.059
	<i>Cancer anthonyi</i>	yellow crab	49	0.369
	<i>Cancer jordani</i>	hairy rock crab	1	0.002
	<i>Lysmata californica</i>	red rock shrimp	2	0.003
			<b>57</b>	<b>0.433</b>

**Redondo Beach Generating Station – Normal Operation Impingement Data**

---

**Survey:** 12  
**Date:** December, 2006

<b>Fish</b>	<b>Taxon</b>	<b>Common Name</b>	<b>Survey Totals</b>	
			<b>Abundance</b>	<b>Biomass (kg)</b>

---

Units 5&6	No Sample (No pumps operating)			
-----------	--------------------------------	--	--	--

Units 7&8	No Sample (No pumps operating)			
-----------	--------------------------------	--	--	--

**Shellfish**

---

Units 5&6	No Sample (No pumps operating)			
-----------	--------------------------------	--	--	--

Units 7&8	No Sample (No pumps operating)			
-----------	--------------------------------	--	--	--

**Redondo Beach Generating Station – Normal Operation Impingement Data**

Survey: 13  
 Date: January 11-12, 2007

Fish	Taxon	Common Name	Survey Totals	
			Abundance	Biomass (kg)
Units 5&6	No Fish			
Units 7&8	<i>Cymatogaster aggregata</i>	shiner perch	1	0.012
			<b>1</b>	<b>0.012</b>

**Shellfish**

Units 5&6	No Shellfish			
Units 7&8	<i>Cancer antennarius</i>	Pacific rock crab	1	0.032
	<i>Cancer anthonyi</i>	yellow crab	11	0.165
	<i>Lysmata californica</i>	red rock shrimp	2	0.004
			<b>14</b>	<b>0.201</b>

Redondo Beach Generating Station – Heat Treatment Impingement Data

Date: April 12, 2006 Units 7&8

Fish	Taxon	Common Name	Survey Totals	
			Abundance	Biomass (kg)
Units 7&8	<i>Atherinops affinis</i>	topsmelt	1	0.031
	<i>Brachyistius frenatus</i>	kelp perch	4	0.126
	<i>Cephaloscyllium ventriosum</i>	swell shark	1	3.119
	<i>Chilara taylori</i>	spotted cusk-eel	1	0.034
	<i>Chromis punctipinnis</i>	blacksmith	4	0.204
	<i>Cymatogaster aggregata</i>	shiner perch	2	0.051
	<i>Embiotoca jacksoni</i>	black perch	38	2.874
	<i>Engraulis mordax</i>	northern anchovy	2	0.038
	<i>Heterodontus francisci</i>	horn shark	2	2.770
	<i>Hypsoblennius gilberti</i>	rockpool blenny	1	0.025
	<i>Hypsurus caryi</i>	rainbow seaperch	17	1.423
	<i>Menticirrhus undulatus</i>	California corbina	1	0.007
	<i>Oxyjulis californica</i>	senorita	4	0.119
	<i>Paralabrax clathratus</i>	kelp bass	6	0.504
	<i>Paralabrax nebulifer</i>	barred sand bass	3	0.403
	<i>Paralichthys californicus</i>	California halibut	1	0.049
	<i>Rhacochilus toxotes</i>	rubberlip seaperch	8	0.939
	<i>Rhacochilus vacca</i>	pile perch	3	0.458
	<i>Scorpaena guttata</i>	California scorpionfish	14	1.763
	<i>Sebastes auriculatus</i>	brown rockfish	2	0.381
<i>Seriphus politus</i>	queenfish	3	0.023	
<i>Urobatis halleri</i>	round stingray	2	1.802	
			<b>120</b>	<b>17.143</b>
<b>Shellfish</b>				
	<i>Cancer antennarius</i>	Pacific rock crab	1	0.003
	<i>Cancer anthonyi</i>	yellow crab	11	0.397
	<i>Cancer gracilis</i>	graceful crab	1	0.040
	<i>Cancer productus</i>	red rock crab	1	0.020
	<i>Loxorhynchus grandis</i>	sheep crab	1	0.033
	<i>Lysmata californica</i>	red rock shrimp	13	0.029
	<i>Octopus bimaculatus/bimaculoides</i>	California two-spot octopus	1	0.379
	<i>Panulirus interruptus</i>	California spiny lobster	12	4.764
	<i>Portunus xantusii</i>	Xantus swimming crab	2	0.047
	<i>Pugettia producta</i>	northern kelp crab	3	0.010
			<b>46</b>	<b>5.722</b>

Redondo Beach Generating Station – Heat Treatment Impingement Data

Date: April 12, 2006 (Cont.) Units 7&8

Other Macroinvertebrates	Taxon	Common Name	Survey Totals	
			Abundance	Biomass (kg)
Units 7&8	<i>Parastichopus parvimensis</i>	warty sea cucumber	1	0.154
			<b>1</b>	<b>0.154</b>

Redondo Beach Generating Station – Heat Treatment Impingement Data

Date: June 30, 2006 Units 7&8

Fish	Taxon	Common Name	Survey Totals		
			Abundance	Biomass (kg)	
Units 7&8	<i>Artedius lateralis</i>	smoothhead sculpin	2	0.015	
	<i>Cheilotrema saturnum</i>	black croaker	14	1.726	
	<i>Chilara taylori</i>	spotted cusk-eel	2	0.096	
	<i>Chromis punctipinnis</i>	blacksmith	25	2.274	
	<i>Cymatogaster aggregata</i>	shiner perch	3	0.048	
	<i>Embiotoca jacksoni</i>	black perch	50	1.314	
	<i>Genyonemus lineatus</i>	white croaker	1	0.004	
	<i>Halichoeres semicinctus</i>	rock wrasse	10	1.263	
	<i>Heterostichus rostratus</i>	giant kelpfish	1	0.009	
	<i>Hyperprosopon argenteum</i>	walleye surfperch	8	0.085	
	<i>Hypsurus caryi</i>	rainbow seaperch	8	0.245	
	<i>Menticirrhus undulatus</i>	California corbina	1	0.400	
	<i>Oxyjulis californica</i>	senorita	3	0.106	
	<i>Paralabrax clathratus</i>	kelp bass	9	1.090	
	<i>Paralabrax nebulifer</i>	barred sand bass	1	0.225	
	<i>Paralichthys californicus</i>	California halibut	1	0.231	
	<i>Phanerodon furcatus</i>	white seaperch	5	0.167	
	<i>Rathbunella alleni</i>	stripefin ronquil	1	0.011	
	<i>Rhacochilus toxotes</i>	rubberlip seaperch	4	0.384	
	<i>Rhacochilus vacca</i>	pile perch	4	0.702	
	<i>Scorpaena guttata</i>	California scorpionfish	13	1.170	
	<i>Scorpaenichthys marmoratus</i>	cabezon	1	0.824	
	<i>Sebastes auriculatus</i>	brown rockfish	4	0.683	
	<i>Sebastes miniatus</i>	vermillion rockfish	1	0.009	
	<i>Seriphus politus</i>	queenfish	16	0.562	
	<i>Urobatis halleri</i>	round stingray	6	3.460	
	<i>Xenistius californiensis</i>	salema	1	0.137	
				<b>195</b>	<b>17.240</b>



Redondo Beach Generating Station – Heat Treatment Impingement Data

Date: June 30, 2006 (Cont.) Units 7&8

Shellfish	Taxon	Common Name	Survey Totals	
			Abundance	Biomass (kg)
Units 7&8	<i>Cancer antennarius</i>	Pacific rock crab	12	0.037
	<i>Cancer anthonyi</i>	yellow crab	60	0.209
	<i>Cancer gracilis</i>	graceful crab	1	0.003
	<i>Cancer productus</i>	red rock crab	3	0.006
	<i>Lysmata californica</i>	red rock shrimp	58	0.073
	<i>Octopus bimaculatus/bimaculoides</i>	California two-spot octopus	3	0.587
	<i>Panulirus interruptus</i>	California spiny lobster	32	12.783
	<i>Pyromaia tuberculata</i>	tuberculate pear crab	27	0.037
			<b>196</b>	<b>13.735</b>

Other Macroinvertebrates

	<i>Parastichopus parvimensis</i>	warty sea cucumber	6	2.217
			<b>6</b>	<b>2.217</b>

*Redondo Beach Generating Station*

## **Appendix F**

---

### **Master Species List**

F1. Entrainment Master Species List

F2. Impingement Master Species List –  
Invertebrates

F3. Impingement Master Species List - Fishes

## Appendix F1

### Master Species List of organisms identified in the entrainment samples.

Taxa Name	Taxon	Common Name
<b>Cephalopoda</b>	<i>Loligo opalescens</i>	market squid
<b>Decapoda</b>	unidentified crab (megalops)	unid. crab megalops
<b>Palinuridae</b>	<i>Panulirus interruptus</i> (phyllosome)	California spiny lobster (larval)
<b>Anomura</b>	Anomura unid. (megalops)	crustaceans
<b>Paguridae</b>	Paguridae unid. (megalops)	hermit crab megalops
<b>Porcellanidae</b>	<i>Pachycheles pubescens</i> (megalops)	pubescent porcelain crab megalops
	<i>Pachycheles rudis</i> (megalops)	thickclaw porcelain crab megalops
	<i>Pachycheles</i> spp. (megalops)	porcelain crabs megalops
	<i>Petrolisthes</i> spp. (megalops)	porcelain crab megalops
	Porcellanidae unid. (megalops)	porcelain crab megalops
<b>Hippoidea</b>	Hippoidea (megalops)	mole crab megalops
<b>Hippidae</b>	<i>Emerita analoga</i> (megalops)	mole crabs megalops
<b>Diogenidae</b>	Diogenidae (megalops)	left-handed hermit crabs megalops
<b>Brachyura</b>	Brachyura unid. (megalops)	unidentified crab megalops
<b>Majidae</b>	<i>Pugettia</i> spp. (megalops)	kelp crabs megalops
<b>Canceridae</b>	<i>Cancer antennarius</i> (megalops)	brown rock crab megalops
	<i>Cancer anthonyi</i> (megalops)	yellow crab megalops
	<i>Cancer gracilis</i> (megalops)	slender crab megalops
	<i>Cancer productus</i> (megalops)	red rock crab megalops
<b>Portunidae</b>	<i>Portunus xantusii</i> (megalops)	Xantus' swimming crab megalops
<b>Xanthidae</b>	<i>Lophopanopeus</i> spp. (megalops)	black-clawed crab megalops
<b>Pinnotheridae</b>	<i>Pinnixa</i> spp. (megalops)	pea crabs megalops
	<i>Pinnotheres</i> spp. (megalops)	pea crab megalops
	Pinnotheridae (megalops)	pea crab megalops
<b>Grapsidae</b>	Grapsidae unid. (megalops)	shore crab megalops
	<i>Hemigrapsus nudus</i> (megalops)	purple shore crab megalops
	<i>Hemigrapsus oregonensis</i> (megalops)	yellow shore crab megalops
	<i>Hemigrapsus</i> spp. (megalops)	shore crab megalops
<b>Osteichthys</b>	fish eggs unid.	unidentified fish eggs
	larvae, unidentified yolksac	unidentified yolksac larvae
	larval fish - damaged	unidentified larval fishes
	larval fish fragment	unidentified larval fishes
	larval/post-larval fish unid.	larval fishes
<b>Acanthopterygii</b>	Sciaenidae / Paralichthyidae / Labridae	fish eggs
<b>Clupeiformes</b>	Clupeiformes unid.	herrings and anchovies
<b>Clupeidae</b>	<i>Sardinops sagax</i>	Pacific sardine
<b>Engraulidae</b>	Engraulidae unid.	anchovies
	Engraulidae unid. (eggs)	anchovy eggs

(table continued)

Appendix F1 (continued). Master Species List of organisms identified in the entrainment samples.

Taxa Name	Taxon	Common Name
<b>Engraulidae</b>	<i>Engraulis mordax</i>	northern anchovy
<b>Bathylagidae</b>	Bathylagidae unid.	blacksmelt
	<i>Bathylagus ochotensis</i>	popeye blacksmelt
	<i>Leuroglossus stilbius</i>	California smoothtongue
<b>Myctophidae</b>	<i>Stenobranchius leucopsarus</i>	northern lampfish
	<i>Triphoturus mexicanus</i>	Mexican lampfish
<b>Gobiesocidae</b>	Gobiesocidae unid.	clingfishes
	<i>Gobiesox</i> spp.	clingfishes
	<i>Rimicola</i> spp.	kelp clingfishes
<b>Merlucciidae</b>	<i>Merluccius productus</i>	Pacific hake
<b>Ophidiidae</b>	<i>Chilara taylori</i>	spotted cusk-eel
	Ophidiidae unid.	cusk-eels
	<i>Ophidion scrippsae</i>	basketweave cusk-eel
<b>Atherinopsidae</b>	<i>Atherinops affinis</i>	topsmelt
	Atherinopsidae unid.	silversides
	<i>Atherinopsis californiensis</i>	jacksmelt
	<i>Leuresthes tenuis</i>	California grunion
<b>Syngnathidae</b>	<i>Syngnathus</i> spp.	pipefishes
<b>Scorpaenidae</b>	Scorpaenidae unid.	scorpionfishes
	<i>Sebastes paucispinis</i>	bocaccio
	<i>Sebastes</i> spp.	rockfishes
<b>Hexagrammidae</b>	<i>Oxylebius pictus</i>	painted greenling
	<i>Zaniolepis frenata</i>	shortspine combfish
	<i>Zaniolepis latipinnis</i>	longspine combfish
	<i>Zaniolepis</i> spp.	combfishes
<b>Cottidae</b>	<i>Artedius lateralis</i>	smoothhead sculpin
	<i>Artedius</i> spp.	sculpins
	Chitonotus / Icelinus	sculpins
	<i>Clinocottus analis</i>	wooly sculpin
	<i>Clinocottus</i> spp.	sculpins
	Cottidae unid.	sculpins
	<i>Icelinus quadriseriatus</i>	yellowchin sculpin
	<i>Icelinus</i> spp.	sculpins
	<i>Leptocottus armatus</i>	Pacific staghorn sculpin
	Oligocottus / Clinocottus	sculpins
	<i>Oligocottus</i> spp.	sculpins
	<i>Ruscarius creaseri</i>	roughcheek sculpin
	<i>Scorpaenichthys marmoratus</i>	cabezon
<b>Agonidae</b>	<i>Odontopyxis trispinosa</i>	pygmy poacher
<b>Liparidae</b>	Cyclopteridae unid.	snailfishes
	<i>Liparis</i> spp.	snailfishes
<b>Serranidae</b>	<i>Paralabrax</i> spp.	sand bass

(table continued)

Appendix F1 (continued). Master Species List of organisms identified in the entrainment samples.

Taxa Name	Taxon	Common Name
<b>Serranidae</b>	<i>Paralabrax</i> spp. (eggs)	sand bass eggs
<b>Carangidae</b>	<i>Trachurus symmetricus</i>	jack mackerel
<b>Haemulidae</b>	<i>Anisotremus davidsonii</i>	sargo
	Haemulidae unid.	grunts
	<i>Xenistius californiensis</i>	salema
<b>Sciaenidae</b>	<i>Atractoscion nobilis</i>	white seabass
	<i>Cheilotrema saturnum</i>	black croaker
	<i>Genyonemus lineatus</i>	white croaker
	<i>Genyonemus lineatus</i> (eggs)	white croaker eggs
	<i>Menticirrhus undulatus</i>	California corbina
	<i>Roncador stearnsii</i>	spotfin croaker
	Sciaenidae unid.	croakers
	Sciaenidae unid. (eggs)	croaker eggs
	<i>Seriphus politus</i>	queenfish
	<i>Umbrina roncador</i>	yellowfin croaker
<b>Kyphosidae</b>	<i>Medialuna californiensis</i>	halfmoon
<b>Pomacentridae</b>	<i>Chromis punctipinnis</i>	blacksmith
	<i>Hypsypops rubicundus</i>	garibaldi
	<i>Hypsypops rubicundus</i> (eggs)	garibaldi eggs
	Pomacentridae unid.	damselfishes
<b>Sphyraenidae</b>	<i>Sphyraena argentea</i>	Pacific barracuda
	<i>Sphyraena argentea</i> (eggs)	Pacific barracuda eggs
<b>Labridae</b>	<i>Halichoeres semicinctus</i>	rock wrasse
	Labridae unid.	wrasses
	Labridae unid. (eggs)	wrasse eggs
	<i>Oxyjulis californica</i>	senorita
	<i>Semicossyphus pulcher</i>	California sheephead
<b>Bathymasteridae</b>	Bathymasteridae unid.	ronquils
<b>Blenniidae</b>	Blenniidae unid.	blennies
	<i>Hypsoblennius jenkinsi</i>	mussel blenny
	<i>Hypsoblennius</i> spp.	combtooth blennies
<b>Clinidae</b>	Blennioidei unid.	blennies
	Gibbonsia spp.	clinid kelpfishes
	<i>Heterostichus rostratus</i>	giant kelpfish
<b>Chaenopsidae</b>	Chaenopsidae unid.	tube blennies
<b>Labrisomidae</b>	Labrisomidae unid.	labrisomid blennies
<b>Gobiidae</b>	<i>Gillichthys mirabilis</i>	longjaw mudsucker
	Gobiidae unid.	gobies
	<i>Lepidogobius lepidus</i>	bay goby
	<i>Lythrypnus</i> spp.	gobies
	<i>Lythrypnus zebra</i>	zebra goby
	<i>Rhinogobiops nicholsii</i>	blackeye goby

(table continued)

Appendix F1 (continued). Master Species List of organisms identified in the entrainment samples.

Taxa Name	Taxon	Common Name
<b>Gobiidae</b>	<i>Typhlogobius californiensis</i>	blind goby
<b>Stromateidae</b>	<i>Peprilus simillimus</i>	Pacific butterfish
<b>Pleuronectiformes</b>	Pleuronectiformes unid.	flatfishes
<b>Pleuronectidae</b>	<i>Lyopsetta exilis</i>	slender sole
	<i>Microstomus pacificus</i>	Dover sole
	<i>Parophrys vetulus</i>	English sole
	<i>Platichthys stellatus</i>	starry flounder
	Pleuronectidae unid.	righteye flounders
	Pleuronectidae unid. (eggs)	righteye flounder eggs
	<i>Pleuronichthys guttulatus</i>	diamond turbot
	<i>Pleuronichthys guttulatus</i> (eggs)	diamond turbot eggs
	<i>Pleuronichthys ritteri</i>	spotted turbot
	<i>Pleuronichthys</i> spp.	turbots
	<i>Pleuronichthys</i> spp. (eggs)	turbot eggs
	<i>Pleuronichthys verticalis</i>	hornyhead turbot
<b>Paralichthyidae</b>	<i>Citharichthys sordidus</i>	Pacific sanddab
	<i>Citharichthys</i> spp.	sanddabs
	<i>Citharichthys</i> spp. (eggs)	sanddab eggs
	<i>Citharichthys stigmaeus</i>	speckled sanddab
	<i>Hippoglossina stomata</i>	bigmouth sole
	Paralichthyidae unid.	sand flounders
	Paralichthyidae unid. (eggs)	sand flounder eggs
	<i>Paralichthys californicus</i>	California halibut
	<i>Paralichthys californicus</i> (eggs)	California halibut eggs
	<i>Xystreurys liolepis</i>	fantail sole
<b>Cynoglossidae</b>	<i>Symphurus atricaudus</i>	California tonguefish

## Appendix F2

### Master Species List of invertebrates identified in the impingement samples.

Family	Taxon	Common Name
<b>Cnidaria</b>	Cnidaria	sea jelly, unid.
<b>Pelagiidae</b>	<i>Chrysaora colorata</i>	purple-striped jellyfish
<b>Dendronotidae</b>	<i>Dendronotus iris</i>	giant-frond-aeolis
<b>Loliginidae</b>	<i>Loligo opalescens</i>	California market squid
<b>Octopodidae</b>	<i>Octopus bimaculatus/bimaculoides</i> <i>Octopus sp.</i>	California two-spot octopus octopus, unid.
<b>Hippolytidae</b>	<i>Lysmata californica</i>	red rock shrimp
<b>Crangonidae</b>	<i>Crangon nigromaculata</i>	blackspotted bay shrimp
<b>Palinuridae</b>	<i>Panulirus interruptus</i>	California spiny lobster
<b>Majidae</b>	<i>Loxorhynchus grandis</i> <i>Pyromaia tuberculata</i>	sheep crab tuberculate pear crab
<b>Epialtidae</b>	<i>Pugettia producta</i>	northern kelp crab
<b>Cancridae</b>	<i>Cancer anthonyi</i> <i>Cancer antennarius</i> <i>Cancer gracilis</i> <i>Cancer jordani</i> <i>Cancer productus</i>	yellow crab Pacific rock crab slender crab (also graceful crab) hairy rock crab red rock crab
<b>Portunidae</b>	<i>Portunus xantusii</i>	Xantus swimming crab
<b>Strongylocentrotidae</b>	<i>Strongylocentrotus purpuratus</i>	purple sea urchin
<b>Stichopodidae</b>	<i>Parastichopus parvimensis</i>	warty sea cucumber
<b>Salpidae</b>	<i>Thetys vagina</i>	common salp

## Appendix F3

### Master Species List of fishes identified in the impingement samples.

Family	Taxon	Common Name
<b>Chondrichthyes</b>		cartilaginous fishes
<b>Heterodontidae</b>	<i>Heterodontus francisci</i>	horn shark
<b>Schylorhinidae</b>	<i>Cephaloscyllium ventriosum</i>	swell shark
<b>Urolophidae</b>	<i>Urobatis halleri</i>	round stingray
<b>Myliobatidae</b>	<i>Myliobatis californica</i>	bat ray
<b>Actinopterygii</b>		ray-finned fishes
<b>Engraulidae</b>	<i>Engraulis mordax</i>	northern anchovy
<b>Ophididae</b>	<i>Chilara taylori</i>	spotted cusk-eel
<b>Batrachoididae</b>	<i>Porichthys notatus</i>	plainfin midshipman
<b>Atherinopsidae</b>	<i>Atherinops affinis</i>	topsmelt
<b>Scorpaenidae</b>	<i>Scorpaena guttata</i>	California scorpionfish
	<i>Sebastes auriculatus</i>	brown rockfish
	<i>Sebastes miniatus</i>	vermilion rockfish
<b>Cottidae</b>	<i>Artedius lateralis</i>	smoothhead sculpin
	<i>Scorpaenichthys marmoratus</i>	cabezon
<b>Serranidae</b>	<i>Paralabrax clathratus</i>	kelp bass
	<i>Paralabrax nebulifer</i>	barred sand bass
<b>Haemulidae</b>	<i>Xenistius californiensis</i>	salema
<b>Sciaenidae</b>	<i>Cheilotrema saturnum</i>	black croaker
	<i>Genyonemus lineatus</i>	white croaker
	<i>Menticirrhus undulatus</i>	California corbina
	<i>Seriphus politus</i>	queenfish
<b>Embiotocidae</b>	<i>Brachyistius frenatus</i>	kelp perch
	<i>Cymatogaster aggregata</i>	shiner perch
	<i>Embiotoca jacksoni</i>	black perch
	<i>Hyperprosopon argenteum</i>	walleye surfperch
	<i>Hypsurus caryi</i>	rainbow seaperch
	<i>Phanerodon furcatus</i>	white seaperch
	<i>Rhacochilus toxotes</i>	rubberlip seaperch
	<i>Rhacochilus vacca</i>	pile perch
<b>Pomacentridae</b>	<i>Chromis punctipinnis</i>	blacksmith
<b>Labridae</b>	<i>Halichoeres semicinctus</i>	rock wrasse
	<i>Oxyjulis californica</i>	señorita
<b>Bathymasteridae</b>	<i>Rathbunella alleni</i>	stripefin ronquil
<b>Clinidae</b>	<i>Heterostichus rostratus</i>	giant kelpfish
<b>Blennidae</b>	<i>Hypsoblennius gilberti</i>	rockpool blenny

(table continued)



---

(Continued)

<b>Family</b>	<b>Taxon</b>	<b>Common Name</b>
<b>Actinopterygii</b>		ray-finned fishes
<b>Gobiesocidae</b>	<i>Gobiesox rhesodon</i>	California clingfish
<b>Paralichthyidae</b>	<i>Citharichthys stigmaeus</i>	speckled sanddab
	<i>Paralichthys californicus</i>	California halibut

---