

**SEDIMENT CHEMISTRY, TOXICITY, AND BENTHIC  
COMMUNITY CONDITIONS IN SELECTED  
WATER BODIES OF THE LOS ANGELES REGION**

**FINAL REPORT**

**California State Water Resources Control Board  
Division of Water Quality  
Bay Protection and Toxic Cleanup Program**

**California Regional Water Quality Control Board  
Los Angeles Region**

**California Department of Fish and Game  
Marine Pollution Studies Laboratory**

**University of California, Santa Cruz  
Institute of Marine Sciences**

**San Jose State University  
Moss Landing Marine Laboratories**

**August 1998**

SEDIMENT CHEMISTRY, TOXICITY, AND BENTHIC COMMUNITY CONDITIONS IN  
SELECTED WATER BODIES OF THE LOS ANGELES REGION

FINAL REPORT

CALIFORNIA STATE WATER RESOURCES CONTROL BOARD  
DIVISION OF WATER QUALITY  
BAY PROTECTION AND TOXIC CLEANUP PROGRAM

CALIFORNIA DEPARTMENT OF FISH AND GAME  
MARINE POLLUTION STUDIES LABORATORY

UNIVERSITY OF CALIFORNIA, SANTA CRUZ  
INSTITUTE OF MARINE SCIENCES

SAN JOSE STATE UNIVERSITY  
MOSS LANDING MARINE LABORATORIES

AUGUST 1998

## AUTHORS

Brian Anderson, John Hunt, Bryn Phillips, John Newman, and Ron Tjeerdema  
University of California, Santa Cruz

Craig J. Wilson, Gita Kapahi, and Richard A. Sapudar  
State Water Resources Control Board

Mark Stephenson and Max Puckett  
California Department of Fish and Game

Russell Fairey and James Oakden  
San Jose State University Foundation/Moss Landing Marine Laboratories

Michael Lyons and Shirley Birosik  
Regional Water Quality Control Board  
Los Angeles Region

## EXECUTIVE SUMMARY

### *Study Objectives*

The Bay Protection and Toxic Cleanup Program (BPTCP) was established by the California State Legislature in 1989 with four major goals:

- 1) To provide protection of present and future beneficial uses of the bay and estuarine waters of California;
- 2) To identify and characterize toxic hot spots
- 3) To plan for toxic hot spot cleanup or other remedial or mitigation actions; and
- 4) To develop prevention and control strategies for toxic pollutants that will prevent creation of new toxic hot spots or the perpetuation of existing ones within the bays and estuaries of the State.

These goals are being addressed through activities in each of the coastal Water Quality Control Board Regions, including the Los Angeles Region (Region 4). As part of the legislative mandate, the BPTCP has implemented regional monitoring studies to identify toxic hot spots. The assessment strategy has generally relied upon application of various components of the Sediment Quality Triad in a weight-of-evidence approach to hot spot determination (Chapman et al., 1987). In 1992, the Los Angeles Regional Water Quality Control Board (LARWQCB), in cooperation with the State Water Resources Control Board (SWRCB), began BPTCP sediment monitoring in the Los Angeles Region. Initial monitoring activities were conducted in the Los Angeles and Long Beach Harbor areas as part of a three-year cooperative agreement between the National Oceanic and Atmospheric Administration (NOAA) and the SWRCB. The NOAA/SWRCB studies were designed to investigate sediment conditions in Southern California bays and estuaries (Fairey et al., 1995; Anderson et al., 1997). In addition to results from this cooperative agreement study, this report contains results of subsequent LARWQCB/BPTCP investigations conducted throughout the Los Angeles Region.

Studies were performed in inner and outer Los Angeles and Long Beach Harbors, Palos Verdes, Shoreline Marina, Los Alamitos Bay, King Harbor, Marina Del Rey, Ballona Creek, Channel Islands Harbor, Ventura Harbor, Port Hueneme, Malibu Lagoon, Mugu Lagoon, Santa Clara and Ventura River Estuaries, Colorado Lagoon/Simm's Pond, and McGrath Lake in the Los Angeles region.

The objectives of the study were as follows:

Characterize the magnitude and relative spatial distribution of pollution-associated bioeffects in the above-listed water bodies.

Determine relationships between concentrations and mixtures of sediment-associated chemicals and the occurrence and severity of bioeffects.

Distinguish more severely impacted sediments from less severely impacted sediments.

Use a weight-of-evidence approach based on the Sediment Quality Triad to categorize stations for future work.

## Major Findings

Through a cooperative agreement this study achieved the combined program objectives of the Los Angeles Regional Water Quality Control Board, the State Water Resources Control Board's Bay Protection and Toxic Cleanup Program, and the National Oceanic and Atmospheric Administration's Status and Trends Program. Using a weight-of-evidence approach based on the Sediment Quality Triad, measures of chemical pollution, toxicity, benthic community structure, and bioaccumulation were completed on 267 samples collected from 138 stations. Stations in Industrial Harbors, Marinas, and Lagoons were sampled over a five year period to determine relative degradation in selected water bodies in the Los Angeles Region. When combined with measures of other sediment characteristics such as grain size, TOC, unionized ammonia, and hydrogen sulfide, these measures were useful for determining the relative level of pollution and biological impacts at a wide range of stations.

Degree of chemical contamination was assessed using two sets of sediment quality guidelines: the ERL/ERM guidelines developed by NOAA (Long et al., 1995), and the TEL/PEL guidelines developed for the State of Florida (MacDonald, 1996). In addition, non-guideline chemicals were compared to the BPTCP database to compare relative concentrations with those measured statewide. Copper, mercury, zinc, TBT, total chlordane, total PCBs, and high molecular weight PAHs were found to be the chemicals or chemical groups of greatest concern at the Industrial Harbor stations. Copper, lead, mercury, zinc, total chlordane, and total PCBs were found to be the chemicals or chemical groups of greatest concern at the Marina stations. PCBs, and a number of pesticides, including chlordane, dieldrin, endosulfan, and DDT, were the chemicals of greatest concern in the Lagoon stations.

Of the 192 Industrial Harbor stations where toxicity was assessed, 29 % showed significant toxicity to amphipods. Toxicity was highest in the inner Industrial Harbor sediment samples. Pore water samples demonstrated higher toxicity than sediment samples; 79% of the Industrial Harbor stations were toxic to abalone embryos exposed to sediment pore water. Of the 35 Marina stations tested for amphipod toxicity, sediment samples were toxic to amphipods at 31% of the stations. Of the 33 Lagoon station sediment samples tested, 58% were significantly toxic.

Many of the chemicals that correlated with toxicity also exceeded the sediment quality guideline values. Amphipod survival in Industrial Harbor stations was negatively correlated with a number of chemicals or chemical groups, including copper, mercury, nickel, lead, zinc, chlordane, total PCBs, low and high molecular weight, and total PAHs, the ERM Quotient, and the number of ERM Exceedances in the samples. In addition amphipod survival in the Industrial Harbor samples was negatively correlated with sediment grain size and TOC. Because chemicals bind to TOC and fine-grained sediments, it is not possible without further study to separate bioeffects due to these binding phases from those due to pollutants. Abalone development in Industrial Harbor pore water samples was negatively correlated with tin, total chlordane, two PCB congeners, the ERM Quotient value, and the number of ERM Exceedances in these samples. Amphipod survival in Marina sediments was negatively correlated primarily with metals (As, Cu, Pb, Hg, Ni, and zinc), as well as TBT. Amphipod survival in these samples was also negatively correlated with the PEL Quotient, the number of ERM Exceedances, and percent clay

in the samples. Amphipod survival in Lagoon sediment samples was negatively correlated with metals (Cu, Hg, Ag, Zn), pesticides such as chlordane, DDT, and dieldrin, and a number of PCB congeners and PAH compounds. In addition, amphipod survival in Lagoons was negatively correlated with the ERM Quotient and the number of ERM Exceedances in these samples.

Of the 102 Industrial Harbor stations where benthic community structure was characterized, 13% were considered to be degraded. The Relative Benthic Index (RBI), derived to characterize benthic community structure, was negatively correlated with a number of metals, pesticides, PCBs and PAHs. In addition, the RBI was negatively correlated with sediment TOC, the ERM Quotient, and the number of ERM Exceedances. Multivariate and univariate correlations between toxicity test results and benthic community metrics indicated that amphipod survival in toxicity tests was positively correlated with the total number of crustacean individuals and species at these stations. Abalone development in toxicity tests was positively correlated with the number of mollusc individual and species. Only one of 22 Marina samples had significantly degraded benthic community structure ( $RBI \leq 0.30$ ). Benthic community structure at the Marina stations was negatively correlated with metals, pesticides, PCBs, grain size, TOC, and the ERM Quotient and number of ERM Exceedances. All 6 of the Lagoon samples assessed in Mugu Lagoon had degraded benthos.

Bioaccumulation measured in field collected fish and laboratory exposed bivalves (*Macoma nasuta*) indicated that field collected fish in the West Basin and Cabrillo Beach Pier areas of Los Angeles Harbor contained DDT and PCB tissue concentrations that exceeded EPA screening values (U.S. EPA, 1990; U.S. EPA, 1995a). Bivalves exposed to sediments from the Cabrillo Beach Pier area accumulated significantly higher concentrations of DDT and PCBs than clams exposed to control sediment. Fish collected from one station in Mugu Lagoon also had elevated levels of PCBs compared to EPA screening values.

The results of these studies were consolidated into weight-of-evidence categorization tables. Stations were grouped based on chemical and ecotoxicological results into 9 possible categories that considered the magnitude of contamination by chemicals of concern, occurrence of toxicity using multiple toxicity test protocols, benthic community degradation, and in some cases, tissue bioaccumulation. Specific thresholds were established for each measure, beyond which stations were considered to have elevated chemistry, significant toxicity, degraded benthic community structure, or elevated tissue concentrations.

The Industrial Harbor stations that met all the criteria for Category 1 were located in the Consolidated Slip area. Samples from these stations had elevated chemistry, recurrent toxicity, and degraded benthic community structure. A majority of the Industrial Harbor stations met the criteria for Categories 5 or 6. These were stations with either, elevated chemistry and mixed results from biological measures (Cat. 5), or with measured biological impact but chemistry values below thresholds or not measured (Cat. 6).

The majority of Marina stations met the criteria for Categories 5 and 6. Some stations in Marina Del Rey had sediments with elevated chemistry; these stations were also significantly toxic to amphipods. The RBI at some of these stations was relatively low, but did not exceed the threshold for significant benthic community degradation.

The majority of Lagoon stations also met the criteria for Categories 5 and 6. Stations in Colorado Lagoon, Ballona Creek, and McGrath Lake had elevated chemistry and were significantly toxic to amphipods, but benthic community structure was not characterized at these stations. Stations in Mugu Lagoon all met the criteria for Category 6. Individual pesticides exceeded some guideline values in Mugu Lagoon, and amphipod survival was variable. Benthic community structure was degraded at all of the 6 Mugu Lagoon stations analyzed.

Results of these analyses will be combined with existing knowledge of chemicals of concern, biological effects, and site characteristics from previous studies to aid in development of hot spot cleanup plans. In addition, these investigations provide an initial step for identification of reference sites to be used in future monitoring studies.

## ACKNOWLEDGMENTS

This study was conducted with the assistance of a number of colleagues from the Marine Pollution Studies Laboratory and its facilities at Granite Canyon, Moss Landing, and Santa Cruz, California. The authors would like to specifically acknowledge the following people for their efforts in the successful completion of the investigations described in this report.

### University of California, Santa Cruz, Staff Conducting Toxicity Testing at Granite Canyon

Steve Clark, Matt Englund, Michelle Hester, Hilary McNulty, Patty Nicely, Steve Osborne, Witold Piekarski, Kelita Smith, Shirley Tudor, Lisa Weetman, Michelle White

### University of California, Santa Cruz, Trace Organics Laboratory

Jonathan Becker, Gloria J. Blondina, James Derbin, Linda Hannigan, Deborah Holstad, Dana Longo, Raina Scott, Katharine Semsar, Thomas Shyka, Matthew Stoetling, Else Gladish-Wilson, Laura Zirelli

### California Department of Fish and Game, Trace Metal and Sample Collection Laboratory

Jon Goetzl, Gary Ichikawa, Jim Kanihan, Kim Paulson, Mark Pranger

### San Jose State University, Sample Collection and Data Management

Ross Clark, James Downing, Michelle Jacobi, Eric Johnson, Brenda Konar, Stewart Lamerdin, Eli Landrau, Cassandra Roberts

### Moss Landing Marine Laboratories (SJSU), Organic Carbon and Grain Size Analysis

Bill Chevlier, Steve Fitzwater, Craig Hunter, Pat Iampietro, Sean McDermott, Michelle White

### Moss Landing Marine Laboratories (SJSU), Benthic Community Analysis

Carrie Bretz, Diane Carney, Jim Oakden, John Oliver, Pete Slattery

We would especially like to thank Michelle White and Patty Nicely for assistance with preparing this report, specifically for their skills with mapping, data compilation, and statistical analysis. In addition, the authors would like to thank Dr. Edward Long for invaluable contributions to the design and implementation of this study, data interpretation, and technical review.

This study was funded by the State Water Resources Control Board and Los Angeles Regional Water Quality Control Board through the Bay Protection and Toxic Cleanup Program, and the National Oceanic and Atmospheric Administration through NOAA's Bioassessment Branch and the National Status and Trends Program.



# TABLE OF CONTENTS

<b>AUTHORS.....</b>	<b>I</b>
<b>EXECUTIVE SUMMARY.....</b>	<b>II</b>
STUDY OBJECTIVES .....	II
<i>Major Findings</i> .....	iii
<b>ACKNOWLEDGMENTS.....</b>	<b>VI</b>
<b>TABLE OF CONTENTS.....</b>	<b>VII</b>
<b>LIST OF FIGURES.....</b>	<b>X</b>
<b>LIST OF TABLES.....</b>	<b>XIII</b>
<b>LIST OF ABBREVIATIONS.....</b>	<b>XV</b>
<b>LIST OF APPENDICES.....</b>	<b>XVII</b>
<b>INTRODUCTION .....</b>	<b>1</b>
PURPOSE.....	1
PROGRAMMATIC BACKGROUND AND NEEDS .....	2
STUDY AREA .....	3
<i>Industrial Harbors</i> .....	5
<i>Marinas</i> .....	7
<i>Lagoons and River Mouths</i> .....	12
<b>METHODS.....</b>	<b>15</b>
SAMPLE SITE SELECTION.....	15
SAMPLING METHODS.....	16
<i>Summary of Methods</i> .....	16
<i>Cleaning Procedures</i> .....	16
<i>Sediment Sample Collection</i> .....	26
<i>Analysis of Contaminants in Fish Tissue</i> .....	28
<i>Transport of Samples</i> .....	30
<i>Homogenization and Aliquoting of Samples</i> .....	30
<i>Procedures for the Extraction of Pore Water</i> .....	30
<i>Subsurface Water Collection</i> .....	32
<i>Collection of Intact Sediment Cores for Sediment-Water Interface Tests</i> .....	32
<i>Sample Chain of Records &amp; Custody</i> .....	32
<i>Authorization/Instructions to Process Samples</i> .....	33
TRACE METALS ANALYSIS OF SEDIMENTS .....	33
<i>Analytes and Detection Limits</i> .....	33
<i>Sediment Digestion Procedures</i> .....	34
<i>Tissue Digestion Procedures</i> .....	34
<i>Atomic Absorption Methods</i> .....	34
<i>Acid Volatile Sulfide and Simultaneously Extracted Metals – AVS-SEM</i> .....	34
TRACE ORGANIC ANALYSIS OF SEDIMENTS (PCBS, PESTICIDES, AND PAHS) .....	35
<i>Analytes and Detection Limits</i> .....	35
<i>Summary of Methods</i> .....	38
<i>Sediment Extraction</i> .....	39
<i>Tissue Extraction</i> .....	39

<i>Organic Analysis</i> .....	39
TOTAL ORGANIC CARBON ANALYSIS OF SEDIMENTS.....	40
<i>Summary of Methods</i> .....	40
GRAIN SIZE ANALYSIS OF SEDIMENTS.....	41
<i>Sample Splitting and Preparation</i> .....	41
<i>Wet Sieve Analysis (separation of coarse and fine fraction)</i> .....	41
<i>Dry Sieve Analysis (coarse fraction)</i> .....	42
<i>Hydrometer Analysis (Fine Fraction)</i> .....	42
<i>Analytical Procedures</i> .....	42
TOXICITY TESTING.....	42
<i>Summary of Methods</i> .....	42
<i>Sediment Samples</i> .....	43
<i>Pore Water Samples</i> .....	44
<i>Subsurface Water Samples</i> .....	44
<i>Measurement of Ammonia and Hydrogen Sulfide</i> .....	44
<i>Marine (Rhepoxynius abronius) and Estuarine (Eohaustorius estuarius) Amphipod Survival Tests</i> .....	45
<i>Abalone (Haliotis rufescens) Embryo-Larval Development Test</i> .....	46
<i>Bay Mussel (Mytilus spp.) Embryo-Larval Development Test</i> .....	46
<i>Polychaete Worm (Neanthes arenaceodentata) Survival and Growth Test</i> .....	47
<i>Purple Sea Urchin (Strongylocentrotus purpuratus) Embryo-Larval Development Test</i> .....	48
<i>Purple Sea Urchin (Strongylocentrotus purpuratus) Embryo-Larval Development Test Exposed at the Sediment-Water Interface</i> .....	49
<i>Sea Urchin (Strongylocentrotus purpuratus) Fertilization Test</i> .....	49
<i>Test Acceptability and Evaluation</i> .....	50
BENTHIC COMMUNITY ANALYSIS.....	50
BIOACCUMULATION.....	51
<i>28-day Clam (Macoma balthica) Bioaccumulation Test</i> .....	51
<b>DATA ANALYSIS</b> .....	<b>51</b>
COMPARISON OF CHEMISTRY WITH SEDIMENT QUALITY GUIDELINE VALUES.....	51
NON-GUIDELINE CHEMICALS.....	53
ERM AND PEL QUOTIENTS.....	53
STATISTICAL ANALYSIS OF TOXICITY TEST DATA.....	56
RELATIVE BENTHIC INDEX.....	57
<i>Number of Species</i> .....	58
<i>Number of Individuals</i> .....	58
<i>Indicator Species</i> .....	59
<i>Negative Indicator Species</i> .....	59
<i>Positive Indicator Species</i> .....	60
<i>Calculation of RBI</i> .....	60
<i>Use of RBI</i> .....	61
<i>Multivariate and Univariate Techniques for Comparison of Chemistry and Toxicity Data</i> .....	62
STRATEGY FOR CATEGORIZATION OF STATIONS BASED ON AVAILABLE MONITORING DATA.....	63
QUALITY ASSURANCE/QUALITY CONTROL.....	66
<i>Summary of Methods</i> .....	66
<b>RESULTS/DISCUSSION</b> .....	<b>68</b>
INDUSTRIAL HARBORS.....	68
<i>Chemistry Data</i> .....	68
<i>Toxicity Testing Data</i> .....	72
<i>Benthic Community Analysis</i> .....	74
<i>Bioaccumulation Analysis</i> .....	76
<i>Industrial Harbor Station Categorization</i> .....	78
MARINAS.....	80
<i>Chemistry Data</i> .....	80

<i>Toxicity Testing Data</i> .....	81
<i>Benthic Community Analysis</i> .....	82
<i>Marina Station Categorization</i> .....	82
<b>LAGOONS</b> .....	83
<i>Chemistry Data</i> .....	83
<i>Toxicity Testing Data</i> .....	84
<i>Benthic Community Analysis</i> .....	84
<i>Bioaccumulation Analysis</i> .....	85
<i>Lagoon Station Categorization</i> .....	85
<b>STUDY LIMITATIONS</b> .....	86
<b>CONCLUSIONS</b> .....	87
<b>REFERENCES</b> .....	90

## LIST OF FIGURES

FIGURE 1. LOS ANGELES REGION STUDY AREA .....	4
FIGURE 2A-C. OUTER LOS ANGELES AND LONG BEACH HARBOR (A), PORT HUENEME (B), AND PALOS VERDES (C) SAMPLING STATIONS. ....	18
FIGURE 3A-B. INNER LOS ANGELES AND LONG BEACH HARBOR (A) AND CONSOLIDATED SLIP (B) SAMPLING STATIONS. ....	19
FIGURE 4A-B. SHORELINE MARINA (A) AND LOS ALAMITOS BAY (B) SAMPLING STATIONS.....	20
FIGURE 5A-B. KING HARBOR (A) AND MARINA DEL REY (B) SAMPLING STATIONS. ....	21
FIGURE 6A-B. VENTURA HARBOR (A) AND CHANNEL ISLANDS HARBOR (B) SAMPLING STATIONS. ....	22
FIGURE 7. MUGU LAGOON SAMPLING STATIONS .....	23
FIGURE 8A-C. MCGRATH LAKE (A), BALLONA CREEK (B), AND COLORADO LAGOON (C) SAMPLING STATIONS.....	24
FIGURE 9A-C. VENTURA RIVER ESTUARY (A), SANTA CLARA RIVER ESTUARY (B), AND MALIBU LAGOON (C) SAMPLING STATIONS. ....	25
FIGURE 10. NUMBER OF INDUSTRIAL HARBOR STATION SAMPLES EXCEEDING EITHER THE ERL OR ERM SEDIMENT QUALITY GUIDELINES. ....	172
FIGURE 11A-C. DISTRIBUTION OF SEDIMENT SAMPLES IN OUTER LOS ANGELES AND LONG BEACH HARBOR (A), PORT HUENEME (B), AND PALOS VERDES (C) EXCEEDING THE ERM FOR COPPER. ....	173
FIGURE 12A-B. DISTRIBUTION OF SEDIMENT SAMPLES IN INNER LOS ANGELES AND LONG BEACH HARBOR (A), AND CONSOLIDATED SLIP (B) EXCEEDING THE ERM FOR COPPER. ....	174
FIGURE 13A-C. DISTRIBUTION OF SEDIMENT SAMPLES IN OUTER LOS ANGELES AND LONG BEACH HARBOR (A), PORT HUENEME (B), AND PALOS VERDES (C) EXCEEDING THE ERM FOR TOTAL CHLORDANE.....	175
FIGURE 14A-B. DISTRIBUTION OF SEDIMENT SAMPLES IN INNER LOS ANGELES AND LONG BEACH HARBOR (A), AND CONSOLIDATED SLIP (B) EXCEEDING THE ERM FOR TOTAL CHLORDANE.....	176
FIGURE 15A-C. DISTRIBUTION OF SEDIMENT SAMPLES IN OUTER LOS ANGELES AND LONG BEACH HARBOR (A), PORT HUENEME (B), AND PALOS VERDES (C) EXCEEDING THE ERM FOR TOTAL PCB.....	177
FIGURE 16A-B. DISTRIBUTION OF SEDIMENT SAMPLES IN INNER LOS ANGELES AND LONG BEACH HARBOR (A), AND CONSOLIDATED SLIP (B) EXCEEDING THE ERM FOR TOTAL PCB. ....	178
FIGURE 17A-C. DISTRIBUTION OF SEDIMENT SAMPLES IN OUTER LOS ANGELES AND LONG BEACH HARBOR (A), PORT HUENEME (B), AND PALOS VERDES (C) EXCEEDING THE ERM FOR HIGH MOLECULAR WEIGHT PAH. ....	179
FIGURE 18A-B. DISTRIBUTION OF SEDIMENT SAMPLES IN INNER LOS ANGELES AND LONG BEACH HARBOR (A), AND CONSOLIDATED SLIP (B) EXCEEDING THE ERM FOR HIGH MOLECULAR WEIGHT PAH. ....	180
FIGURE 19A-C. ERM QUOTIENT VALUES AT OUTER LOS ANGELES AND LONG BEACH HARBOR (A), PORT HUENEME (B), AND PALOS VERDES (C) SAMPLING STATIONS. ....	181
FIGURE 20A-B. ERM QUOTIENT VALUES AT INNER LOS ANGELES AND LONG BEACH HARBOR (A), AND CONSOLIDATED SLIP (B) SAMPLING STATIONS. ....	182
FIGURE 21A-C. TOXICITY OF SEDIMENT SAMPLES IN OUTER LOS ANGELES AND LONG BEACH HARBOR (A), PORT HUENEME (B), AND PALOS VERDES (C). ....	183
FIGURE 22A-B. TOXICITY OF SEDIMENT SAMPLES IN INNER LOS ANGELES AND LONG BEACH HARBOR (A), AND CONSOLIDATED SLIP (B). ....	184
FIGURE 23A-C. TOXICITY OF POREWATER SAMPLES IN OUTER LOS ANGELES AND LONG BEACH HARBOR (A), PORT HUENEME (B), AND PALOS VERDES (C). ....	185
FIGURE 24A-B. TOXICITY OF POREWATER SAMPLES IN INNER LOS ANGELES AND LONG BEACH HARBOR (A), AND CONSOLIDATED SLIP (B). ....	186
FIGURE 25. AMPHIPOD SURVIVAL AT INDUSTRIAL HARBOR STATIONS RELATIVE TO TOTAL CHLORDANE CONCENTRATIONS. ....	187
FIGURE 26. AMPHIPOD SURVIVAL AT INDUSTRIAL HARBOR STATIONS RELATIVE TO ERMQ AND NUMBER OF ERM EXCEEDANCES. ....	188
FIGURE 27. RELATIONSHIP BETWEEN ABALONE DEVELOPMENT IN 50% POREWATER AT INDUSTRIAL HARBOR STATIONS RELATIVE TO ERMQ AND NUMBER OF ERM EXCEEDANCES.....	189
FIGURE 28A-C. DISTRIBUTION OF STATIONS IN OUTER LOS ANGELES AND LONG BEACH HARBOR (A), PORT HUENEME (B), AND PALOS VERDES (C) DEMONSTRATING BENTHIC COMMUNITY STRUCTURE.....	190
FIGURE 29A-B. DISTRIBUTION OF STATIONS IN INNER LOS ANGELES AND LONG BEACH HARBOR (A), AND CONSOLIDATED SLIP (B) DEMONSTRATING BENTHIC COMMUNITY STRUCTURE.....	191

FIGURE 30. RELATIVE BENTHIC INDEX AT INDUSTRIAL HARBOR STATIONS IN RELATION TO ERMQ AND NUMBER OF ERM EXCEEDANCES.....	192
FIGURE 31. NUMBER OF MARINA STATION SAMPLES EXCEEDING EITHER THE ERL OR ERM SEDIMENT QUALITY GUIDELINES.....	193
FIGURE 32A-B. DISTRIBUTION OF SEDIMENT SAMPLES IN SHORELINE MARINA (A), AND LOS ALAMITOS BAY (B), EXCEEDING THE ERM FOR COPPER. ....	194
FIGURE 33A-B. DISTRIBUTION OF SEDIMENT SAMPLES IN KING HARBOR (A), AND MARINA DEL REY (B) EXCEEDING THE ERM FOR COPPER. ....	195
FIGURE 34. DISTRIBUTION OF SEDIMENT SAMPLES IN CHANNEL ISLANDS HARBOR EXCEEDING THE ERM FOR COPPER. ....	196
FIGURE 35A-B. DISTRIBUTION OF SEDIMENT SAMPLES IN SHORELINE MARINA (A), AND LOS ALAMITOS BAY (B), EXCEEDING THE ERM FOR ZINC. ....	197
FIGURE 36A-B. DISTRIBUTION OF SEDIMENT SAMPLES IN KING HARBOR (A), AND MARINA DEL REY (B) EXCEEDING THE ERM FOR COPPER. ....	198
FIGURE 37. DISTRIBUTION OF SEDIMENT SAMPLES IN CHANNEL ISLANDS HARBOR EXCEEDING THE ERM FOR ZINC. ....	199
FIGURE 38A-B. DISTRIBUTION OF SEDIMENT SAMPLES IN SHORELINE MARINA (A), AND LOS ALAMITOS BAY (B), EXCEEDING THE ERM FOR TOTAL CHLORDANE. ....	200
FIGURE 39A-B. DISTRIBUTION OF SEDIMENT SAMPLES IN KING HARBOR (A), AND MARINA DEL REY (B) EXCEEDING THE ERM FOR TOTAL CHLORDANE. ....	201
FIGURE 40. DISTRIBUTION OF SEDIMENT SAMPLES IN CHANNEL ISLANDS HARBOR EXCEEDING THE ERM FOR TOTAL CHLORDANE. ....	202
FIGURE 41A-B. DISTRIBUTION OF SEDIMENT SAMPLES IN SHORELINE MARINA (A), AND LOS ALAMITOS BAY (B), EXCEEDING THE ERM FOR TOTAL PCB.....	203
FIGURE 42A-B. DISTRIBUTION OF SEDIMENT SAMPLES IN KING HARBOR (A), AND MARINA DEL REY (B) EXCEEDING THE ERM FOR TOTAL PCB.....	204
FIGURE 43. DISTRIBUTION OF SEDIMENT SAMPLES IN CHANNEL ISLANDS HARBOR EXCEEDING THE ERM FOR TOTAL PCB.....	205
FIGURE 44A-B. ERM QUOTIENT VALUES AT SHORELINE MARINA (A), AND LOS ALAMITOS BAY (B).....	206
FIGURE 45A-B. ERM QUOTIENT VALUES KING HARBOR (A), AND MARINA DEL REY (B).....	207
FIGURE 46. ERM QUOTIENT VALUES AT CHANNEL ISLANDS HARBOR STATIONS.....	208
FIGURE 47A-B. TOXICITY OF SEDIMENT SAMPLES AT SHORELINE MARINA (A), AND LOS ALAMITOS BAY (B).....	209
FIGURE 48A-B. TOXICITY OF SEDIMENT SAMPLES AT KING HARBOR (A), AND MARINA DEL REY (B).....	210
FIGURE 49A-B. TOXICITY OF SEDIMENT SAMPLES AT VENTURA HARBOR (A), AND CHANNEL ISLANDS HARBOR (B). ....	211
FIGURE 50. AMPHIPOD SURVIVAL AT MARINA STATIONS IN RELATION TO COPPER AND TBT CONCENTRATIONS... 12	212
FIGURE 51A-B. DISTRIBUTION OF STATIONS IN SHORELINE MARINA (A), AND LOS ALAMITOS BAY (B), DEMONSTRATING BENTHIC COMMUNITY STRUCTURE.....	213
FIGURE 52A-B. DISTRIBUTION OF STATIONS IN KING HARBOR (A), AND MARINA DEL REY (B), DEMONSTRATING BENTHIC COMMUNITY STRUCTURE.....	214
FIGURE 53A-B. DISTRIBUTION OF STATIONS IN VENTURA HARBOR (A), AND CHANNEL ISLANDS HARBOR (B), DEMONSTRATING BENTHIC COMMUNITY STRUCTURE.....	215
FIGURE 54. NUMBER OF LAGOON STATION SAMPLES EXCEEDING EITHER THE ERL OR ERM SEDIMENT QUALITY GUIDELINES.....	216
FIGURE 55. DISTRIBUTION OF SEDIMENT SAMPLES IN MUGU LAGOON EXCEEDING THE ERM FOR ZINC.....	217
FIGURE 56A-C. DISTRIBUTION OF SEDIMENT SAMPLES IN McGRATH LAKE (A), BALLONA CREEK (B), AND COLORADO LAGOON/SIMS POND (C) EXCEEDING THE ERM FOR ZINC.....	218
FIGURE 57. DISTRIBUTION OF SEDIMENT SAMPLES IN MUGU LAGOON EXCEEDING THE ERM FOR TOTAL CHLORDANE.....	219
FIGURE 58A-C. DISTRIBUTION OF SEDIMENT SAMPLES IN McGRATH LAKE (A), BALLONA CREEK (B), AND COLORADO LAGOON/SIMS POND (C) EXCEEDING THE ERM FOR TOTAL CHLORDANE.....	220
FIGURE 59. DISTRIBUTION OF SEDIMENT SAMPLES IN MUGU LAGOON EXCEEDING THE ERM FOR DIELDRIN.....	221
FIGURE 60A-C. DISTRIBUTION OF SEDIMENT SAMPLES IN McGRATH LAKE (A), BALLONA CREEK (B), AND COLORADO LAGOON/SIMS POND (C) EXCEEDING THE ERM FOR DIELDRIN.....	222
FIGURE 61. DISTRIBUTION OF SEDIMENT SAMPLES IN MUGU LAGOON EXCEEDING THE ERM FOR TOTAL PCB. ....	223

FIGURE 62A-C. DISTRIBUTION OF SEDIMENT SAMPLES IN MCGRATH LAKE (A), BALLONA CREEK (B), AND COLORADO LAGOON/SIMS POND (C) EXCEEDING THE ERM FOR TOTAL PCB..... 224

FIGURE 63. ERM QUOTIENT VALUES AT MUGU LAGOON STATIONS..... 225

FIGURE 64A-C. ERM QUOTIENT VALUES AT MCGRATH LAKE (A), BALLONA CREEK (B), AND COLORADO LAGOON/SIMS POND (C). ..... 226

FIGURE 65. TOXICITY OF SEDIMENT SAMPLES AT MUGU LAGOON STATIONS..... 227

FIGURE 66A-C. TOXICITY OF SEDIMENT SAMPLES AT MCGRATH LAKE (A), BALLONA CREEK (B), AND COLORADO LAGOON/SIMS POND (C). ..... 228

FIGURE 67A-C. TOXICITY OF SEDIMENT SAMPLES AT VENTURA RIVER ESTUARY (A), SANTA CLARA RIVER ESTUARY (B), AND MALIBU LAGOON (C)..... 229

FIGURE 68. AMPHIPOD SURVIVAL IN RELATION TO DIELDRIN CONCENTRATIONS AT LAGOON STATIONS. .... 230

FIGURE 69. AMPHIPOD SURVIVAL RELATIVE TO ERM QUOTIENT AND ERM EXCEEDANCES AT LAGOON STATIONS. .... 231

FIGURE 70. DISTRIBUTION OF STATIONS IN MUGU LAGOON DEMONSTRATING BENTHIC COMMUNITY STRUCTURE.232

## LIST OF TABLES

TABLE 1. DESCRIPTIONS OF SAMPLES COLLECTED AS PART OF BPTCP/NOAA MONITORING IN THE LOS ANGELES REGION.....	17
TABLE 2. DRY WEIGHT TRACE METAL MINIMUM DETECTION LIMITS (MDL).....	33
TABLE 3: DRY WEIGHT MINIMUM DETECTION LIMITS OF CHLORINATED PESTICIDES.....	35
TABLE 4. DRY WEIGHT DETECTION LIMITS OF NIST PCB CONGENERS.....	36
TABLE 5. DRY WEIGHT MINIMUM DETECTION LIMITS FOR ADDITIONAL PCB CONGENERS. ....	37
TABLE 6: DRY WEIGHT MINIMUM DETECTION LIMITS OF CHLORINATED TECHNICAL GRADE MIXTURES .....	37
TABLE 7: DRY WEIGHT MINIMUM DETECTION LIMITS OF POLYAROMATIC HYDROCARBONS IN TISSUE .....	38
TABLE 8. DRY WEIGHT MINIMUM DETECTION LIMITS OF ORGANOMETALLIC COMPOUNDS .....	38
TABLE 9. COMPARISON OF SEDIMENT SCREENING LEVELS DEVELOPED BY NOAA AND THE STATE OF FLORIDA.....	54
TABLE 10. CONCENTRATIONS OF NON-GUIDELINE CHEMICALS RELATIVE TO THE BPTCP DATABASE.....	55
TABLE 11. MINIMUM SIGNIFICANT DIFFERENCE (MSD) VALUES CALCULATED FOR SELECTED TOXICITY TESTS. ....	57
TABLE 12. ERM AND PEL QUOTIENTS AND NUMBER OF SEDIMENT QUALITY GUIDELINE EXCEEDANCES AT INDUSTRIAL HARBOR STATIONS.....	103
TABLE 13. SURVIVAL OF AMPHIPODS <i>RHEPOXYNIUS ABRONIUS</i> (RA) OR <i>EOHAUSTORIUS ESTUARIUS</i> (EE) IN INDUSTRIAL HARBOR STATION SEDIMENTS.....	108
TABLE 14A. DEVELOPMENT OF ABALONE EMBRYOS ( <i>HALIOTIS RUFESCENS</i> ) IN INDUSTRIAL HARBOR STATION PORE WATERS (100% CONCENTRATION).....	115
TABLE 14B. DEVELOPMENT OF ABALONE EMBRYOS ( <i>HALIOTIS RUFESCENS</i> ) IN INDUSTRIAL HARBOR STATION PORE WATERS (50% CONCENTRATION).....	120
TABLE 14C. DEVELOPMENT OF ABALONE EMBRYOS ( <i>HALIOTIS RUFESCENS</i> ) IN INDUSTRIAL HARBOR STATION PORE WATERS (25% CONCENTRATION).....	125
TABLE 15. SPEARMAN RANK CORRELATION COEFFICIENTS FOR SELECTED CHEMICALS SIGNIFICANTLY CORRELATED WITH AMPHIPOD SURVIVAL AT INDUSTRIAL HARBOR STATIONS.....	130
TABLE 16. SPEARMAN RANK CORRELATION COEFFICIENTS FOR SELECTED CHEMICALS SIGNIFICANTLY CORRELATED WITH ABALONE DEVELOPMENT IN 25% PORE WATER AT INDUSTRIAL HARBOR STATIONS. ....	131
TABLE 17. RELATIVE BENTHIC INDEX VALUES FOR INDUSTRIAL HARBOR STATIONS.....	132
TABLE 18. SPEARMAN RANK CORRELATION COEFFICIENTS FOR SELECTED CHEMICALS SIGNIFICANTLY NEGATIVELY CORRELATED WITH BENTHIC COMMUNITY STRUCTURE (AS RELATIVE BENTHIC INDEX) AT INDUSTRIAL HARBOR STATIONS.....	137
TABLE 19A. RESULTS OF PRINCIPAL COMPONENTS ANALYSIS (PCA) OF AMPHIPOD SURVIVAL IN TOXICITY TESTS, BENTHIC COMMUNITY STRUCTURE METRICS, AND CHEMICALS MEASURED IN INDUSTRIAL HARBOR SEDIMENTS.....	138
TABLE 19B. RESULTS OF PRINCIPAL COMPONENTS ANALYSIS (PCA) OF ABALONE DEVELOPMENT IN TOXICITY TESTS, BENTHIC COMMUNITY STRUCTURE METRICS, AND CHEMICALS MEASURED IN INDUSTRIAL HARBOR SEDIMENTS.....	139
TABLE 20. SPEARMAN RANK CORRELATION COEFFICIENTS FOR AMPHIPOD SURVIVAL OR ABALONE EMBRYO DEVELOPMENT IN LABORATORY TOXICITY TESTS SIGNIFICANTLY CORRELATED WITH BENTHIC COMMUNITY STRUCTURE METRICS MEASURED AT INDUSTRIAL HARBOR STATIONS.....	140
TABLE 21A. RESULTS OF TOTAL DDT AND TOTAL PCB TISSUE ANALYSES OF FISH COLLECTED AT SELECTED INDUSTRIAL HARBOR STATIONS .....	141
TABLE 21B. RESULTS OF TISSUE ANALYSES OF <i>MACOMA NASUTA</i> BIOACCUMULATION TESTS USING SELECTED INDUSTRIAL HARBOR SEDIMENTS.....	142
TABLE 22. CATEGORIZATION OF LOS ANGELES REGION INDUSTRIAL HARBOR STATIONS BASED ON CHEMISTRY, TOXICITY AND BENTHIC COMMUNITY ANALYSIS.....	143
TABLE 23. ERM AND PEL QUOTIENTS AND NUMBER OF SEDIMENT QUALITY GUIDELINE EXCEEDANCES AT MARINA STATIONS.....	154
TABLE 24. SURVIVAL OF AMPHIPODS <i>RHEPOXYNIUS ABRONIUS</i> (RA) OR <i>EOHAUSTORIUS ESTUARIUS</i> (EE) IN MARINA STATION SEDIMENTS.....	155
TABLE 25. SPEARMAN RANK CORRELATION COEFFICIENTS FOR SELECTED CHEMICALS SIGNIFICANTLY CORRELATED WITH AMPHIPOD SURVIVAL AT MARINA STATIONS. ....	157

TABLE 26. SPEARMAN RANK CORRELATION COEFFICIENTS FOR SELECTED CHEMICALS SIGNIFICANTLY CORRELATED WITH SEA URCHIN DEVELOPMENT AT THE SEDIMENT-WATER INTERFACE AT MARINA STATIONS.....	158
TABLE 27. RELATIVE BENTHIC INDEX VALUES FOR MARINA STATIONS.....	159
TABLE 28. SPEARMAN RANK CORRELATION COEFFICIENTS FOR SELECTED CHEMICALS SIGNIFICANTLY CORRELATED WITH BENTHIC COMMUNITY STRUCTURE (AS RELATIVE BENTHIC INDEX = BI) AT MARINA STATIONS.....	160
TABLE 29. CATEGORIZATION OF LOS ANGELES REGION MARINA STATIONS BASED ON CHEMISTRY, TOXICITY AND BENTHIC ANALYSIS. ....	161
TABLE 30. ERM AND PEL QUOTIENTS AND NUMBER OF SEDIMENT QUALITY GUIDELINE EXCEEDANCES AT LAGOON STATIONS.. ....	163
TABLE 31. SURVIVAL OF AMPHIPODS <i>RHEPOXYNIUS ABRONIUS</i> (RA) OR <i>EOHAUSTORIUS ESTUARIUS</i> (EE) IN MARINA STATION SEDIMENTS. ....	164
TABLE 32. SPEARMAN RANK CORRELATION COEFFICIENTS FOR SELECTED CHEMICALS SIGNIFICANTLY CORRELATED WITH AMPHIPOD SURVIVAL AT LAGOON STATIONS. ....	166
TABLE 33. RELATIVE BENTHIC INDEX VALUES FOR LAGOON STATIONS.....	167
TABLE 34. RESULTS OF TISSUE ANALYSES OF FISH COLLECTED FROM MUGU LAGOON.....	168
TABLE 35. CATEGORIZATION OF LOS ANGELES REGION LAGOON STATIONS BASED ON CHEMISTRY, TOXICITY AND BENTHIC ANALYSIS. ....	169



## LIST OF ABBREVIATIONS

AA	Atomic Absorption
ASTM	American Society for Testing Materials
BPTCP	Bay Protection and Toxic Cleanup Program
CDF	Cumulative Distribution Frequencies
CDFG	California Department of Fish and Game
CH	Chlorinated Hydrocarbon
COC	Chain of Custody
COR	Chain of Records
EDTA	Ethylenediaminetetraacetic Acid
EMAP	Environmental Monitoring and Assessment Program
EPA	U.S. Environmental Protection Agency
ERL	Effects Range Low
ERM	Effects Range Median
ERMQ	Effects Range Median Quotient (Mean)
EqP	Equilibrium Partitioning Coefficient
FAAS	Flame Atomic Absorption Spectroscopy
GC/ECD	Gas Chromatograph Electron Capture Detection
GFAAS	Graphite Furnace Atomic Absorption Spectroscopy
HCl	Hydrochloric Acid
HDPE	High-density Polyethylene
HMW PAH	High Molecular Weight Polynuclear Aromatic Hydrocarbons
HNO <sub>3</sub>	Nitric Acid
HPLC/SEC	High Performance Liquid Chromatography Size Exclusion
H <sub>2</sub> S	Hydrogen Sulfide
IDORG	Identification and Organizational Number
KCL	Potassium Chloride
LARWQCB	Los Angeles Regional Water Quality Control Board
LC <sub>50</sub>	Lethal Concentration (to 50 percent of test organisms)
LMW PAH	Low Molecular Weight Polynuclear Aromatic Hydrocarbons
MDL	Method Detection Limit
MDS	Multi-Dimensional Scaling
MLML	Moss Landing Marine Laboratories
MPSL	Marine Pollution Studies Laboratory
NH <sub>3</sub>	Ammonia
NOAA	National Oceanic and Atmospheric Administration
NOEC	No Observed Effect Concentration
NS&T	National Status and Trends Program
PAH	Polynuclear Aromatic Hydrocarbons
PCB	Polychlorinated Biphenyl
PEL	Probable Effects Level
PELQ	Probable Effects Level Quotient (Mean)

## LIST OF ABBREVIATIONS cont.

PPE	Porous Polyethylene
PPT	Parts Per Thousand
PVC	Polyvinyl Chloride
QA	Quality Assurance
QAPP	Quality Assurance Project Plan
QC	Quality Control
REF	Reference
RWQCB	Regional Water Quality Control Board
SEM-AVS	Simultaneously Extracted Metals-Acid Volatile Sulfide
SJSUF	San Jose State University Foundation
SCCWRP	Southern Calif. Coastal Waters Research Project
SPARC	Scientific Planning and Review Committee
SQC	Sediment Quality Criteria
SWRCB	State Water Resources Control Board
T	Temperature
TBT	Tributyltin
TFE	Tefzel Teflon
TEL	Threshold Effects Level
TIE	Toxicity Identification Evaluation
TOC	Total Organic Carbon
TOF	Trace Organics Facility
UCSC	University of California Santa Cruz
USEPA	U.S. Environmental Protection Agency
WCS	Whole core squeezing

### Units

1 part per thousand (ppt) = 1 mg/g

1 part per million (ppm) = 1 mg/kg, 1 µg/g sed

1 part per billion (ppb) = 1 µg/kg, 1 ng/g sed

## LIST OF APPENDICES

- Appendix A: Data Base Description
- Appendix B: Sampling Data
- Appendix C: Analytical Chemistry Data
  - Section 1: Trace Metal Concentrations
  - Section 2: Trace Metal Concentrations in Porewater
  - Section 3: Acid Volatile Sulfides and Simultaneous Extracted Metals Concentrations
  - Section 4: Pesticide Concentrations
  - Section 5: PCB and Arochlor Concentrations
  - Section 6: PAH Concentrations
  - Section 7: Chemistry Summations and Quotients
  - Section 8: Bivalve and Fish Tissue Chemistry
- Appendix D: Sediment Grain Size and Total Organic Carbon Analyses
- Appendix E: Toxicity Test Data
  - Section 1: *Rhepoxynius abronius* Survival in Sediment
  - Section 2: *Eohaustorius estuarius* Survival in Sediment
  - Section 3: *Haliotis rufescens* Larval Shell Development in Subsurface Water
  - Section 4: *Haliotis rufescens* Larval Shell Development in Porewater
  - Section 5: *Strongylocentrotus purpuratus* Fertilization in Porewater
  - Section 6: *Strongylocentrotus purpuratus* Development in Porewater
  - Section 7: *Strongylocentrotus purpuratus* Development in Intact Sediment Cores
  - Section 8: *Mytilus* Larval Shell Development in Subsurface Water
  - Section 9: *Mytilus* Larval Shell Development in Porewater
  - Section 10: *Neanthes arenaceodentata* Survival in Sediment
  - Section 11: *Neanthes arenaceodentata* Weight Change in Sediment
- Appendix F: Benthic Community Data

## INTRODUCTION

In 1989, the California State legislature established the Bay Protection and Toxic Cleanup Program (BPTCP). One of the primary activities of the BPTCP is monitoring and assessment of sediments in selected California bays and estuaries. The assessment strategy has generally relied upon application of various components of the Sediment Quality Triad in a weight-of-evidence approach to hot spot determination (Chapman et al., 1987).

In 1992, the Los Angeles Regional Water Quality Control Board (LARWQCB), in cooperation with the State Water Resources Control Board (SWRCB), began BPTCP sediment monitoring in the Los Angeles Region. Initial monitoring activities were conducted in the Los Angeles and Long Beach Harbor areas as part of a three-year cooperative agreement between the National Oceanic and Atmospheric Administration (NOAA) and the SWRCB. The NOAA/SWRCB studies were designed to investigate sediment conditions in Southern California bays and estuaries (Fairey et al., 1995; Anderson et al., 1996). In addition to results of the first year of this cooperative agreement, this report contains results of subsequent LARWQCB/BPTCP investigations conducted throughout the Los Angeles Region.

### *Purpose*

Studies were performed in inner and outer Los Angeles and Long Beach Harbors, Palos Verdes, Shoreline Marina, Los Alamitos Bay, King Harbor, Marina Del Rey, Ballona Creek, Channel Islands Harbor, Ventura Harbor, Port Hueneme, Malibu Lagoon, Mugu Lagoon, Santa Clara and Ventura River Estuaries, Colorado Lagoon/Simm's Pond, and McGrath Lake in the Los Angeles region.

The objectives of the study were as follows:

- 1.) Characterize the magnitude and relative spatial distribution of pollution-associated bioeffects in the above-listed water bodies.
- 2.) Determine relationships between concentrations and mixtures of sediment-associated chemicals and the occurrence and severity of bioeffects.
- 3.) Distinguish more severely impacted sediments from less severely impacted sediments.
- 4.) Use a weight-of-evidence approach based on the Sediment Quality Triad to categorize stations for future work.

Results of these analyses are intended to be combined with existing knowledge of chemicals of concern, biological effects, and site characteristics to aid in development of

hot spot cleanup plans. In addition, these investigations provide an initial step for identification of reference sites to be used in future monitoring studies.

A Proposed Regional Toxic Hot Spot Cleanup Plan was published by the LARWQCB in December 1997. Conclusions presented in this document were partly based on results of initial BPTCP studies (LARWQCB, 1997). Much of the data collected as part of the BPTCP had not been reported at the time this document was produced. Consequently, the Cleanup Plan may be revised using results from more recent BPTCP studies presented in this report. In particular, in future versions of the Plan there is an expectation that (1) other sites may be identified as candidate toxic hot spots; (2) potential toxic hot spots will be addressed; (3) cleanup levels may be added to the Cleanup Plan; (4) site rankings may change as new information becomes available. The proposed Regional Toxic Hot Spot Cleanup Plan will be revised and presented to the Regional Water Quality Control Board during late 1998 or early 1999.

### ***Programmatic Background And Needs***

This study was implemented through the Bay Protection and Toxic Cleanup Program (BPTCP). Studies were designed, managed, and coordinated by the LARWQCB, and by the SWRCB's Bays and Estuaries Unit as a cooperative effort with the California Department of Fish and Game's (CDFG) Marine Pollution Studies Laboratory. Initial studies in the LA/Long Beach Harbor area were conducted in cooperation with NOAA's Bioeffects Assessment Branch, and funding in these studies was provided by the SWRCB and NOAA's Coastal Ocean Program.

Although the State Water Board and NOAA have common programmatic needs, they are not identical. NOAA is mandated by Congress to conduct a program of research and monitoring on marine pollution. Much of this research is being conducted through the National Status and Trends (NS&T) Program and the Coastal Ocean Program. The NS&T Program performs regional intensive studies of the magnitude and extent of chemical-associated bioeffects in selected coastal embayments and estuaries. The areas chosen for these regional studies are those in which the pollutant concentrations indicate the greatest potential for biological effects. These biological studies augment the regular chemical monitoring activities of the Program, and provide a means of estimating the toxicity associated with measured concentrations of sediment pollutants.

The California Water Code, Division 7, Chapter 5.6, Section 13390, mandates the SWRCB and the LARWQCB to provide the maximum protection of existing and future beneficial uses of bays and estuarine waters and to plan for remedial actions at those identified toxic hot spots where the beneficial uses are being threatened by toxic pollutants. The BPTCP has four major goals: (1) provide protection of present and future beneficial uses of the bay and estuarine waters of California; (2) identify and characterize toxic hot spots; (3) plan for toxic hot spot cleanup or other remedial or mitigation actions; (4) develop prevention and control strategies for toxic pollutants that will prevent creation

of new toxic hot spots or the perpetuation of existing ones within the bays and estuaries of the State.

Field and laboratory work was accomplished under interagency agreement with, and under the direction of, the CDFG. Sample collection, sample processing, and data management were performed by staff of the San Jose State University Foundation at Moss Landing Marine Laboratories (MLML). MLML staff also performed total organic carbon (TOC) and grain size analyses, as well as benthic community analyses. Toxicity testing was conducted by the University of California at Santa Cruz (UCSC) staff at the CDFG toxicity testing laboratory at Granite Canyon, Monterey County. Trace metals analyses were performed by CDFG personnel at the trace metal analytical facility at MLML. Synthetic organic pesticides, polycyclic aromatic hydrocarbons (PAHs), and polychlorinated biphenyls (PCBs) were analyzed at the UCSC trace organics analytical facility at Long Marine Laboratory in Santa Cruz.

### *Study Area*

The Los Angeles Region encompasses all coastal drainages flowing to the Pacific Ocean between Rincon Point on the coast of western Ventura County, and the eastern Los Angeles County Line, south to the Orange County Line, as well as drainages of the five coastal islands (Anacapa, San Nicolas, Santa Barbara, Santa Catalina, and Santa Cruz). In addition, the region includes all coastal waters within three miles of the continental and coastal island coastlines.

The enclosed bays, estuaries and coastal waters included in this study are shown in Figure 1. The region contains two large deepwater harbors (Los Angeles and Long Beach Harbors) and one smaller deepwater harbor (Port Hueneme). There are small craft marinas within the harbors, as well as tank farms, naval facilities, fish processing plants, boatyards, and container terminals. Several small craft marinas also occur along the coast (Shoreline Marina, Los Alamitos Bay, Marina del Rey, King Harbor, Channel Islands Harbor, and Ventura Harbor).

Several large, primarily concrete-lined rivers lead to tidal prisms influenced by marine waters (eg., Los Angeles River, San Gabriel River). These seasonal rivers drain large urban areas composed primarily of impermeable surfaces. In addition, several of these tidal prisms receive a considerable amount of freshwater throughout the year from publicly-owned treatment plants. Lagoons are located at the mouths of other rivers and creeks draining relatively undeveloped areas (eg., Mugu Lagoon, Malibu Lagoon, Ventura and Santa Clara River estuaries). There are also a few isolated coastal fresh or brackish water bodies receiving runoff from agricultural or residential areas (eg., McGrath Lake, Colorado Lagoon, Sim's Pond).

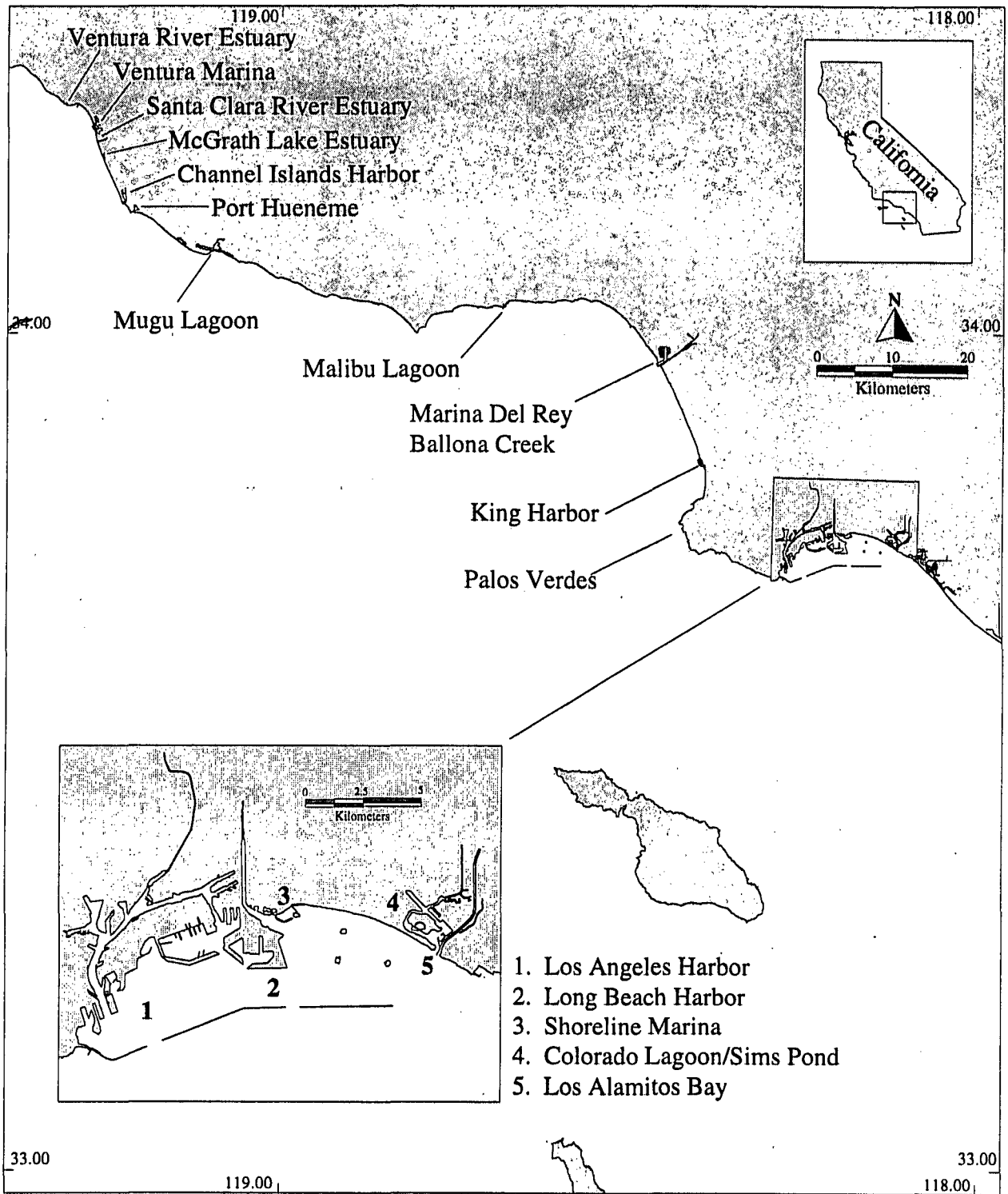


Figure 1. Los Angeles Region Study Area.

## **Industrial Harbors**

### Los Angeles and Long Beach Harbors

The Los Angeles and Long Beach Harbors are located in the southeastern portion of the Los Angeles basin. Along the northern portion of San Pedro Bay is a natural embayment formed by a westerly extension of the coastline that contains both harbors, with the Palos Verdes hills the dominant onshore feature. Offshore, a generally low topographic ridge is associated with the eastern flank of the Palos Verdes uplift and adjacent Palos Verdes fault zone, and extends northwest across the San Pedro shelf nearly to the breakwater of the Los Angeles Harbor.

The port and harbor have been modified over the course of more than one hundred years to include construction of breakwaters, landfills, slips and wharves, along with channelization of drainages, dredging of navigation channels, and reclamation of marshland. The inner harbor includes the Main Channel, the East and West Basins, and the East Channel Basin. The outer harbor is the basin area located between Terminal Island and the San Pedro and Middle Breakwaters. Both harbors are considered to be one oceanographic unit, and have a common breakwater across the mouth of San Pedro Bay. The inner harbors are of estuarine character with regards to aquatic life, while the outer harbors reflect the conditions of the coastal marine waters of the Southern California Bight. Ecological preserves in the area include Point Fermin Marine Life Refuge and Seal Beach National Wildlife Refuge (Port of Los Angeles, 1992).

Beneficial uses for outer Los Angeles and Long Beach Harbors listed by the LARWQCB include contact and non-contact water recreation, Navigation, sport fishing, shellfish harvesting, marine habitat, and preservation of rare and endangered species. Beneficial uses for inner Los Angeles and Long Beach Harbors listed by the LARWQCB include contact and non-contact water recreation, navigation, sport fishing, shellfish harvesting, marine habitat, industrial service supply, and rare and endangered species habitat.

Circulation in the outer harbors results from tidal currents, with the general influx through Angels and Queens Gates, the two vessel traffic openings, and outflux at the east end of Long Beach Harbor. Studies have indicated the existence of a large clockwise eddy, or circular current extending east from the Los Angeles Main Channel to the Navy Mole, and another counter clockwise eddy at a depth of 20 feet. These and other minor eddy currents are considered to be partly responsible for relatively good quality water in the outer harbor (Port of Los Angeles, 1992).

Inner harbor circulation fluctuates with tidal flow, with less mixing than in the outer harbor. These patterns result in the greatest flushing rates due to tides occurring at the harbor entrances, Angels Gate, Queens Gate, and east of Freeman Island. The lowest flushing rates are in the Cerritos Channel, Middle Harbor, and Main Channel (Port of Los Angeles, 1992).



Under the influence of the strong currents and rocky habitat of the outer harbor, aquatic life resembles that of the nearby coast, with the inner harbor having biota such as that generally found in bays and estuaries. The inner harbor has a mostly soft bottom character, and supports the expected assortment of infaunal worms, molluscs, and crustacea, epifaunal starfish and sea urchins, and bottom dwelling fish such as halibut. Species common to the hard substrate of the outer harbor, which include the rocky riprap areas, are the blacksmith, kelp bass, señorita, and various surfperches. Both pelagic and epibenthic-demersal fish are common in both the inner and outer harbors, and include anchovy, white croaker, sardine, and queenfish (Port of Los Angeles, 1992).

In general, the outer harbor areas have a greater species diversity and lower density than inner harbor areas, with inner harbor species being more abundant than those in the outer harbor. The changes to the physical environment in the harbor areas have altered the makeup of the biological communities present, with water quality conditions in the inner harbor improving over the last ten years (Port of Los Angeles, 1992). There is currently an extensive stand of giant kelp (*Macrocystis pyrifera*) along both sides of the San Pedro Breakwater, with large brown algae (*Sargassum muticum*) and ribbon kelp (*Egrecia menziesii*) also represented. Kelp is an important source of primary production in these waters, and provides both food and habitat for nearshore fish and invertebrates.

The major surface drainages in the area include the Los Angeles River, which flows in a channel and drains parts of the San Fernando Valley into eastern San Pedro Bay at Long Beach. The Dominguez Channel drains the intensely urbanized area west of the Los Angeles River into the Consolidated Slip of the Los Angeles inner harbor, carrying with it mostly urban runoff and nonprocess industrial waste discharges. A major source of both freshwater and waste in the outer harbor is secondary effluent from the Terminal Island Treatment Plant (Port of Los Angeles, 1992). Waste discharges to the inner harbor area of Los Angeles Harbor consist of contact and non-contact industrial cooling waste water, stormwater runoff, fuel spills and oil spills from marine vessel traffic or docking facilities, and drainage from several industrial sites. Several areas of the Los Angeles/Long Beach Harbor complex have been put on the U.S. EPA 303(d) list of impaired water bodies by the LARWQCB: the Dominguez Channel Estuary was listed because beneficial uses are not supported for aquatic life due to sediment pollution and benthic community impairment; Consolidated Slip was listed because beneficial uses are not supported for aquatic life due to sediment pollution and toxicity, benthic community impairment, and bioaccumulation; Southwest Slip was listed due to sediment toxicity; and the Cabrillo Pier area was listed because beneficial uses are not supported for aquatic life due to sediment pollution, sediment toxicity, and bioaccumulation of organic chemicals in fish and shellfish tissues.

Sediment studies conducted in the inner and outer LA and Long Beach Harbors include ongoing monitoring of chemistry and benthic community structure at the Terminal Island Sewage Treatment Plant. Sediment chemistry is monitored by the Ports of Los Angeles and Long Beach as part of channel deepening projects, maintenance dredging, and construction of new facilities. In addition to these monitoring programs, the State Mussel

Watch Program conducts routine bioaccumulation monitoring studies at selected stations in the LA and Long Beach Harbors.

### Port Hueneme

Port Hueneme is a medium-sized deepwater harbor located in Ventura County, north of Mugu Lagoon. The total size of the harbor is 121 acres. Part of it was operated by a U.S. Navy Construction Battalion, which is now closed, while the rest of the harbor serves as a commercial port operated by the Oxnard Harbor District. The construction of a majority of the harbor was completed in 1975. The commercial side generally serves ocean-going cargo vessels and oil supply boats; the latter serves the oil platforms in the Santa Barbara Channel. The LARWQCB listed the harbor's beneficial uses as process water supply, contact and noncontact water recreation, navigation, marine habitat, and commercial fishing. Two endangered bird species may use the harbor, the California brown pelican and the California least tern.

Sediment core samples analyzed in 1985 as part of a proposed dredge project indicated relatively low levels of metals, with pesticides below the analytical detection limits (LARWQCB, 1995). Few other sources of information exist on water quality in the port outside of work conducted by the State Mussel Watch (SMW). Recent PAH analyses of transplanted mussels conducted by the SMW program have indicated high levels on both the commercial and Navy sides of the harbor. In addition, this study detected elevated zinc and PCBs on the commercial and Navy sides of the port, respectively. A 1988 SMW TBT study revealed elevated levels of TBT in oyster and mussel tissue, moderately high water column levels, and low mortality with some chambering or stunting. In terms of pollutant concentrations and their effects, this harbor is the least well studied in the Los Angeles Region (LARWQCB, 1995). Port Hueneme has been put on the U.S. EPA 303(d) list of impaired water bodies by the LARWQCB because beneficial uses are not supported for aquatic life due to sediment pollution and toxicity.

### **Marinas**

#### Shoreline Marina

Shoreline Marina was constructed in the late 1970s near the entrance of Queensway Bay, just east of the Port of Long Beach. The marina is primarily a small craft harbor. It also serves as a fish nursery and bird foraging area.

Limited sediment quality data are available from Regional Board sediment sampling in 1988, and a State Board report on TBT pollution. Regional Board sediment sampling indicated levels of lead and zinc were somewhat elevated (up to 91 and 130 ppm, respectively). This is likely a reflection of the proximity of the marina to the mouth of the Los Angeles River which drains into Queensway Bay. The State Board report indicated elevated water levels of TBT (up to 150 PPT), but only trace amounts of TBT were in the sediment. DBT and MBT, however, were found at high levels in the sediment. There are a

large number of recreational craft berthed in the marina and leaching of their antifouling paints are the likely source of the TBT.

The beneficial uses of the marina are: noncontact water recreation, preservation of rare and endangered species, and marine habitat. The toxic hot spot status of Shoreline Marina is currently unknown due to scarcity of available data. The marina is not listed separately in the Water Quality Assessment and may be considered part of Queensway Bay.

### Alamitos Bay

Alamitos Bay is composed of a variety of subareas: the Marine Stadium, a recreation facility built in 1932 and used for boating, water skiing, and jet skiing; Long Beach Marina, which contains five smaller basins for recreational craft and a boatyard; a variety of public and private berths; and the Bay proper which includes several small canals, a bathing beach, and several popular clamming areas. The Bay and marina serve as a fish nursery and bird foraging area. Additional beneficial uses identified by the LARWQCB include contact and noncontact water recreation, commercial and sportfishing for fish and shellfish, and habitat for rare and endangered species. The total acreage of Alamitos Bay is 285 acres.

The Bay receives nonpoint source runoff from a number of storm drains in addition to leaching of boat paint (LARWQCB, 1995). The Bay receives flow via the Marine Stadium, from Los Cerritos Channel, and a flood control structure that drains a large portion of the adjacent cities of east Long Beach, Lakewood, and Bellflower.

A limited amount of recent contamination data is available for the Bay. State Mussel Watch stations sampled in the mid-1980s revealed slightly elevated levels of zinc, cadmium, TBT, and PCBs. A 1986 statewide study found moderately elevated levels of TBT in the water column (as high as 93 ppt) as well as moderately elevated levels in the sediment (up to 540 ppb; LARWQCB, 1995). Regional Board sediment sampling conducted in 1988 found moderately elevated levels of lead and zinc (up to 59 and 110 ppm, respectively) in the Long Beach Marina portion of the Bay (LARWQCB, 1995).

The Los Cerritos Channel tidal prism starts at Anaheim Road and connects with Alamitos Bay through the Marine Stadium; the wetland connects to the Channel a short distance from the lower end of the Channel. The wetlands, and portion of the channel near the wetlands, is an overwintering site for a great diversity of birds (up to 50 species) despite its small size. An endangered bird species, the Belding's Savannah Sparrow, may nest there and an area adjacent to the wetlands is a historic least tern colony site. One small marina is located in the channel that is also used by rowing teams and is a popular fishing area.

State Mussel Watch stations surveyed in the mid-1980s in Los Cerritos Channel showed somewhat elevated levels of chlordane and PCBs, and sediment analyses from dredging projects indicated moderately elevated levels of arsenic, chromium, copper, and zinc (LARWQCB, 1995). The Los Cerritos Channel has been put on the U.S. EPA 303(d) list

of impaired water bodies by the LARWQCB due to elevated ammonia, sediment contamination, and elevated coliform levels.

### King Harbor

King Harbor is located in southern Santa Monica Bay in the city of Redondo Beach. Construction of the harbor initially began in 1937; however, an effective breakwater was not built until the 1950s and inner harbor areas were not developed into their current basin formation until the 1960s. It is primarily a small craft harbor approximately 90 acres in size.

The harbor is utilized by a diverse array of marine flora and fauna and is also a resting and feeding habitat for many species of marine birds. A generating station located near the harbor both takes in and discharges water at the harbor, thus providing some cycling within the waterbody. The harbor's location at the mouth of the Redondo Submarine Canyon creates upwelling of nutrient-rich water into the harbor during the summer. The beneficial uses of the harbor listed by the LARWQCB include industrial service supply, noncontact water recreation, commercial and sportfishing, protection of rare and endangered species, and marine habitat.

As part of biennial surveys conducted by the Southern California Edison-Redondo Beach Generating Station (SCE), data on sediment chemistry (metals Cr, Cu, Ni, and Zn), benthic community structure, and bioaccumulation are collected. Most of the SCE monitoring stations are concentrated in what might be considered the "outer harbor" where the discharge occurs. Sediment chemistry concentrations were relatively low in 1990. Tissue concentrations of these metals were also quite low with the exception of slightly elevated zinc levels. Infaunal and nekton communities were found to be undegraded (LARWQCB, 1995).

LARWQCB sediment sampling conducted in 1988 in Basins 1 and 2 found moderately elevated copper and zinc levels. SMW sampling conducted in 1987 found elevated levels of both copper and zinc (172 and 682 ppm, respectively) at a station located near the boatyard in Basin 1. Low levels of organic chemical compounds were found in the 1987 SMW survey.

The surface water microlayer was sampled and analyzed by Southern California Coastal Water Research Project (SCCWRP) in 1986, and low concentrations of most metals were found in both the dissolved and particulate fractions of the samples. Both copper and zinc, however, were found at over 1 ppm in the dissolved fraction. DDE was found at 26 ppb, along with moderately elevated levels of PAHs (dominated by high molecular weight PAHs, indicating combustion as the major source). Results of a microlayer toxicity test indicated about one-third of the larval kelp bass experienced mortality in the sample and about 50% showed various abnormalities. The toxicity and abnormalities, however, did not appear to be linked to any measured pollutant concentration (Cross et al., 1987).

In a 1988 TBT study conducted by Fish and Game, moderate oyster mortality was discovered in oysters transplanted into Basin 1; those that survived showed stunted shell growth (LARWQCB, 1995). TBT water levels ranged from moderate to high (up to 140 ppt). Oyster tissue levels (420 ppb) were an order of magnitude lower than the mussel tissue levels (6.2 ppm).

### Marina Del Rey

Marina Del Rey harbor was created in the early 1960s from part of Ballona Wetlands. The present Mother's Beach in Basin D was created on the site of the former Lake Los Angeles. Flushing and circulation in the 354-acre harbor tends to be poor. The harbor is considered a fish nursery and a likely least tern foraging site for the Venice Beach nesting colony. The harbor contains many species common to shallow-water embayments (Soule et al., 1997). The beneficial uses of most of the harbor include contact and noncontact water recreation, commercial fishing, preservation of rare and endangered species, marine habitat, and shellfish harvesting.

Several storm drains lead into the back basins, and a large flood control channel, Ballona Creek, drains near the harbor mouth. Approximately 6000 pleasure craft are berthed in the harbor at any one time, the majority of which are scraped or sanded while in the water to remove fouling organisms and renew bottom paint. One large and one small boatyard are located in the harbor. The former Ballona wetland was apparently the site of occasional dumping and some of the effects of this practice may still persist. The former Dow Chemical plant site may also be leaching some contaminants into the Venice Canals that drain into the entrance channel.

A considerable number of studies have been conducted in the harbor, mainly by the SMW program, and Dr. Dorothy Soule, who is associated with USC. The latest report on harbor monitoring (1997) indicates some increased PCB inputs may be occurring, possibly from release of historic polluted soil from construction sites during storms (Soule et al., 1997). Earlier investigations into sediment contamination suggested that Ballona Creek is a major source of pollutants to the harbor; however, the heaviest pollution within the marina proper was in the back basins. Metals pollution was increasing, and some pesticide concentrations were also increasing. Studies conducted in 1987 included investigation of sediment toxicity (Soule et al., 1997). No acute toxicity was found but there was some indication of chronic toxicity. Parts of the marina water column were found to be highly polluted with TBT. Levels of sediment pollutants were correlated with benthic impacts (Soule et al., 1997). There are likely a variety of sources of pollutants in Marina Del Rey including storm drains and anti-fouling paints. SMW results show a gradient in pollution with concentrations increasing towards the back of the marina. Both Cu and Zn concentrations tend to be high in the back basins (LARWQCB, 1995). A SWRCB-CDFG TBT study conducted in 1988 found high levels of TBT in oysters and mussels, high levels in the water column particularly in the back basins, and high mortality or stunting of growth in transplanted oysters (LARWQCB, 1995). Marina Del Rey has been put on the U.S. EPA 303(d) list of

impaired water bodies by the LARWQCB due to sediment pollution and toxicity, and bioaccumulation of chemicals in shellfish tissue.

#### Ventura Marina:

Ventura Marina is a small craft harbor located between the mouths of the Ventura and Santa Clara Rivers. It is home to numerous small boats and two boatyards. The "Ventura Keys" area of the marina is a residential area situated along three canals. The marina is surrounded by agricultural land and a large unlined ditch drains into the Keys area. Since the marina is between the mouths of two rivers which discharge large sediment loads from their relatively undeveloped watersheds, the marina has a constant problem with sedimentation in the entrance.

The marina's beneficial uses are: industrial service supply, navigation, contact and noncontact water recreation, commercial and sportfishing, marine habitat, wildlife habitat, and shellfish harvesting. The Keys beneficial uses are the same with the exception of shellfish harvesting and industrial service supply.

The Ventura Harbor complex includes approximately 50 acres of open water area and approximately 70 acres of mooring areas. Approximately 1500 craft, including 10 sport fishing and 73 commercial fishing vessels, are moored in Ventura Harbor. A commercial fish processing facility, offshore oil drilling support facility and headquarters for the Channel Islands National Park are based at Ventura Harbor. Two boat launching ramps for public use are provided in the harbor.

Ventura Harbor has been put on the U.S. EPA 303(d) list of impaired water bodies by the LARWQCB due to elevated coliform concentrations.

#### Channel Islands Harbor

Channel Islands Harbor is a recreational boating marina located south of the Santa Clara River. Beneficial uses of the harbor include contact and noncontact water recreation, navigation, commercial and sportfishing, and marine habitat, and industrial service supply. Adjacent land uses include urban developments and agriculture land. The inlet canal to the Southern California Edison Ormond Beach power plant is located at the north end of the harbor.

SMW surveys from the early and mid-1980s revealed low to intermediate levels of metals and organic chemical compounds (LARWQCB, 1995). One exception occurred in 1986 when transplanted mussels accumulated 2 ppm of total DDT. Sediment sampling for metals conducted by Regional Board staff in 1988 revealed slightly to moderately elevated levels (LARWQCB, 1995). A 1986 State Board-CDFG study of TBT contamination in harbors revealed elevated levels of TBT in the water column and moderately elevated levels in the sediment (LARWQCB, 1995).

## **Lagoons and River Mouths**

### Malibu Lagoon

Malibu Lagoon is a coastal wetland located on the northern end of Santa Monica Bay. Total acreage of estuarine open water, tidal channels and wetlands is estimated to be 29 acres. Owned by the California Department of Parks and Recreation, the lagoon is operated as a state park for wildlife habitat and passive recreation. Like most coastal wetlands, the lagoon provides habitat for several threatened or endangered bird species, as well as spawning and nursery ground habitat for marine and estuarine vertebrate and invertebrate species. Freshwater flow into the lagoon is dominated by Malibu Creek and treated wastewater discharges. Malibu Creek is considered to be the southernmost range of the endangered steelhead trout. The watershed area is approximately 109 square miles (CERES, 1998). In addition to Malibu Creek, inputs include runoff from residential development of Malibu Colony, a golf course, the Pacific Coast Highway, and commercial developments to the north. Malibu Lagoon has been put on the U.S. EPA 303(d) list of impaired water bodies by the LARWQCB due to bioaccumulation of chemicals in shellfish tissue, degraded benthic community, elevated coliforms, and excessive fresh water.

### Mugu Lagoon

Mugu Lagoon is a 1500-acre coastal lagoon located approximately 40 miles north of Santa Monica Bay. This lagoon is one of the few remaining salt marshes in southern California along the Pacific Flyway. The peregrine falcon, least tern, light-footed clapper rail, and brown pelican are examples of threatened and endangered species that are supported by habitats within Mugu Lagoon. In addition to providing one of the few remaining habitats on the mainland for harbor seals to pup, Mugu Lagoon is a nursery ground for many marine fish and mammals.

Mugu Lagoon is the receiving water body for the Calleguas Creek watershed as well as the agricultural fields of the Oxnard plain. The lagoon borders on an Area of Special Biological Significance and supports a great diversity of wildlife. The Point Mugu Naval Air Base is also located in the immediate vicinity of the lagoon. Calleguas Creek and its major tributaries (Revolon Slough, Conejo Creek, Arroyo Creek, Arroyo Santa Rosa, and Arroyo Simi) drain an area of 343 square miles in southern Ventura County and a small portion of western Los Angeles County. Due to high erosion rates in the watershed and considerable channelization of Calleguas Creek, sedimentation rates are high enough in the watershed that the lagoon could be filled with sediment within 50 years (LARWQCB, 1997).

The Eastern Arm of the lagoon is somewhat removed from the rest of the lagoon and tends to receive water from and drain directly into the lagoon mouth. The water tends to be marine in character the majority of time. The western arm has slower water flow and has the most widespread freshwater influence during wet weather, receiving water from

several drains. The Main lagoon is affected primarily by Calleguas Creek, which carries a considerable amount of water during storms, although this flow is generally funneled into a channel that flows to the lagoon mouth.

Previous monitoring of Mugu Lagoon has identified the following problems: (1) impaired reproduction in the light-footed clapper rail due to elevated levels of DDT and PCBs; (2) fish and shell fish tissue levels which exceeded the National Academy of Sciences guidelines for several pesticides; (3) possible exceedances of U.S. EPA water quality criteria for several metals (nickel, copper, and zinc); (4) possible impacts to sediment and water quality, as well as aquatic community health, from operations at the Naval Air Base. Several banned pesticides continue to be found in high concentrations in the lagoon's sediments and biota (LARWQCB, 1997). Mugu Lagoon has been put on the U.S. EPA 303(d) list of impaired water bodies by the LARWQCB due to sediment pollution, bioaccumulation of chemicals in shellfish tissue, impaired bird reproduction, and excessive sediment. The Calleguas Creek Estuary has been listed due to sediment pollution, water column toxicity, and excessive nitrates, ammonia, and turbidity.

#### McGrath Lake

McGrath Lake is a 40-acre lake within McGrath State Beach and is owned by the California State Parks and Recreation Department. The area is managed for low intensity uses such as hiking and nature observation. Adjacent uses include oil-related facilities to the north and a power plant to the south. To the east are park land and agricultural fields. A public beach is immediately adjacent to the west end of the lake. There is no ocean outlet to the lake but waves occasionally overwash the beach berm. Water is pumped from the lake to the ocean throughout most of the year to maintain a lower lake level and avoid flooding of upstream agriculture fields. In addition, the Lake is breeched intermittently at the southern edge during the wet season to prevent flooding of adjacent agriculture fields. Water sources to the lake include fresh and seawater groundwater seepage, and irrigation water runoff. McGrath Lake was included in the LARWQCB 1996 list of 303(d) impaired water bodies due to sediment pollution (elevated pesticides) and toxicity. The site was polluted in 1993 when a ruptured pipeline released nearly 80,000 gallons of crude oil into an agricultural ditch that drains into the lake. The McGrath Lake Trustee Council currently is developing a management plan for remediation and restoration of the lake habitat and beneficial uses.

#### Ventura River Estuary

Ventura River Estuary lies directly to the west of the city of Ventura and is owned by the city and the California Department of Parks and Recreation. The estuary comprises approximately 10 acres. The total area of the Ventura River watershed is 226 square miles. The site is crossed by Highway 101, a city street, Southern Pacific Railroad tracks, and oil and gas pipelines. In addition to the river and its tributaries, inputs into the estuary include urban and agricultural runoff. Adjacent land uses include the Ventura County Fairgrounds, the city of Ventura, and agricultural lands to the northwest. There is



also an RV park and State Park to the west of the estuary. The estuary is normally subject to tidal influence but in low flow periods a beach berm restricts tidal flow for short periods of time. The LARWQCB listed this site as an impaired water body under Section 303 (d) due to eutrophication and elevated levels of DDT in fish and shellfish tissue.

### Colorado Lagoon

Colorado Lagoon is a 13-acre saltwater influenced man-made water body created by dredging a mudflat. The lagoon is connected by a tidegate to Alamitos Bay through the Marine Stadium. The gate is left open during the winter and is closed at times during the summer to retain enough water in the Lagoon for swimming, which is allowed in the west arm of the Lagoon. Nonpoint source runoff enters the Lagoon from six storm drains. The Lagoon was once a popular clamming site and apparently still supports a considerable number of cherrystone clams. Additional beneficial uses listed by the LARWQCB include contact and noncontact water recreation, commercial and sportfishing, habitat for rare and endangered species, and marine habitat.

SMW data from the mid-1980s and tissue sampling of clams and mussels conducted by the Long Beach Health Department indicated lead levels were as high as 15.8 ppm in resident clams, presumably from street runoff. Resident mussels collected in 1985 contained 19 ppm lead while mussels transplanted into the Lagoon during 1986 accumulated 18 ppm lead. No other metals were elevated. Total chlordane and DDT were initially high but by 1986 had dropped (~300 ppb for each; LARWQCB, 1995). Colorado Lagoon has been put on the U.S. EPA 303(d) list of impaired water bodies by the LARWQCB due to sediment pollution and toxicity, and bioaccumulation of chemicals in shellfish tissue.

## METHODS

Sampling for the Los Angeles Region Bay Protection and Toxic Cleanup Program was conducted in 20 separate sampling periods (called Legs) conducted over a five year period from July 30, 1992 through August 22, 1997 (Table 1). In general, the BPTCP monitoring strategy was designed to proceed in two phases with an initial screening phase followed by confirmation studies. Screening studies typically consisted of some component(s) of the Sediment Quality Triad (Toxicity, Chemistry, and/or Benthic Analyses after Chapman et al., 1987), and confirmation studies were designed to include all components of the Triad, as warranted. Confirmation studies also included bioaccumulation studies at particular stations where the chemicals of concern warranted these analyses. The initial Legs of the Los Angeles Region monitoring (Legs 1-4) were conducted as a cooperative monitoring study between the BPTCP and the NOAA Status and Trends program, as described above. Several of the Los Angeles Region sampling Legs consisted solely of toxicity monitoring at reference sites in Los Angeles and Long Beach Harbors for comparison to toxicity of San Diego Bay sediments (eg., Legs 19, 20, 22, and 23). Later Legs combined screening surveys in water bodies not recently monitored, confirmation studies at stations previously demonstrating toxicity or high chemistry, and in some cases, surveys to locate appropriate reference sites for inclusion in reference envelope determinations (as discussed below).

### *Sample Site Selection*

The Magellan Global Positioning System and reference photographs were used to precisely locate sampling stations. In general, individual sampling locations consisted of three field replicates, referred to as stations, with each station located approximately 100 to 200 meters apart at the points of a triangle centered over the site. In some cases, more detailed information on spatial distributions of chemical pollution and toxicity were required for individual stations. In this case, additional field replicates were sampled around one of the points of the triangle. These were located 50 meters apart.

More intensive sampling was conducted in the Consolidated Slip area in order to determine both the horizontal and vertical extent of chemical contamination and associated toxicity. Thus, in addition to multiple field replicates at several stations in this area, samples were also collected at deeper sediment depths in addition to the 2 cm surficial samples collected at the majority of BPTCP sampling sites. The collection methods for these deeper samples are described in the following section.

In some cases, particularly in later sampling Legs, no field replication was included in the sampling design. In this report, unless otherwise stated, all stations are treated separately for discussion of spatial distribution of chemical pollution and bioeffects. Areal extent of pollution and bioeffects around a particular site are inferred from field replicate data only when sufficient information is available.

The sampling sites were selected to provide a broad representation of conditions and general trends throughout the study area resulting from various pollution sources. Only areas having relatively fine-grained (greater than 30 percent fines) sediments were sampled. Potential reference sites were interspersed in the inner and outer industrial harbors, marinas, and lagoons. Stations sampled in the Industrial Harbors, Marinas, and Lagoons are shown in Figures 2-9.

## ***Sampling Methods***

### **Summary of Methods**

This section describes specific techniques used for collecting and processing samples. Because collection of sediments influences the results of all subsequent laboratory and data analyses, it is important that samples be collected in a consistent and conventionally acceptable manner. Field and laboratory technicians were trained to conduct a wide variety of activities using the accepted procedures of EMAP (Weisberg, 1990), NS&T (NOAA, 1991), and ASTM (1992) to ensure comparability in sample collection among crews and across geographic areas.

### **Cleaning Procedures**

All sampling equipment (i.e., containers, container liners, scoops, water collection bottles) was made from non-contaminating materials and was precleaned and packaged protectively prior to entering the field. Sample collection gear and samples were handled only by personnel wearing non-contaminating polyethylene gloves. All sample collection equipment (excluding the sediment sampler) was cleaned by using the following sequential process: two-day soak and wash in Micro detergent, three tap-water rinses, three deionized water rinses, a three-day soak in 10% HCl, three ASTM Type II Milli-Q water rinses, air dry, three petroleum ether rinses, and air dry.

All cleaning after the Micro detergent step was performed in a positive pressure "clean" room to prevent airborne contaminants from contacting sample collection equipment. Air supplied to the clean room was filtered.

The sediment sampler was cleaned prior to entering the field, and between sampling stations, using the following steps: a vigorous Micro detergent wash and scrub, a seawater rinse, a 10% HCl rinse, and a methanol rinse. The sediment sampler was scrubbed with seawater between successive deployments at the same station to remove adhering sediments from contact surfaces possibly originating below the sampled layer. Sample storage containers were cleaned in accordance with the type of analysis to be performed upon its contents. All containers were cleaned in a positive pressure "clean" room with filtered air to prevent airborne contaminants from contacting sample storage containers.

Plastic containers (HDPE or TFE) for trace metal analysis media (sediment, archive

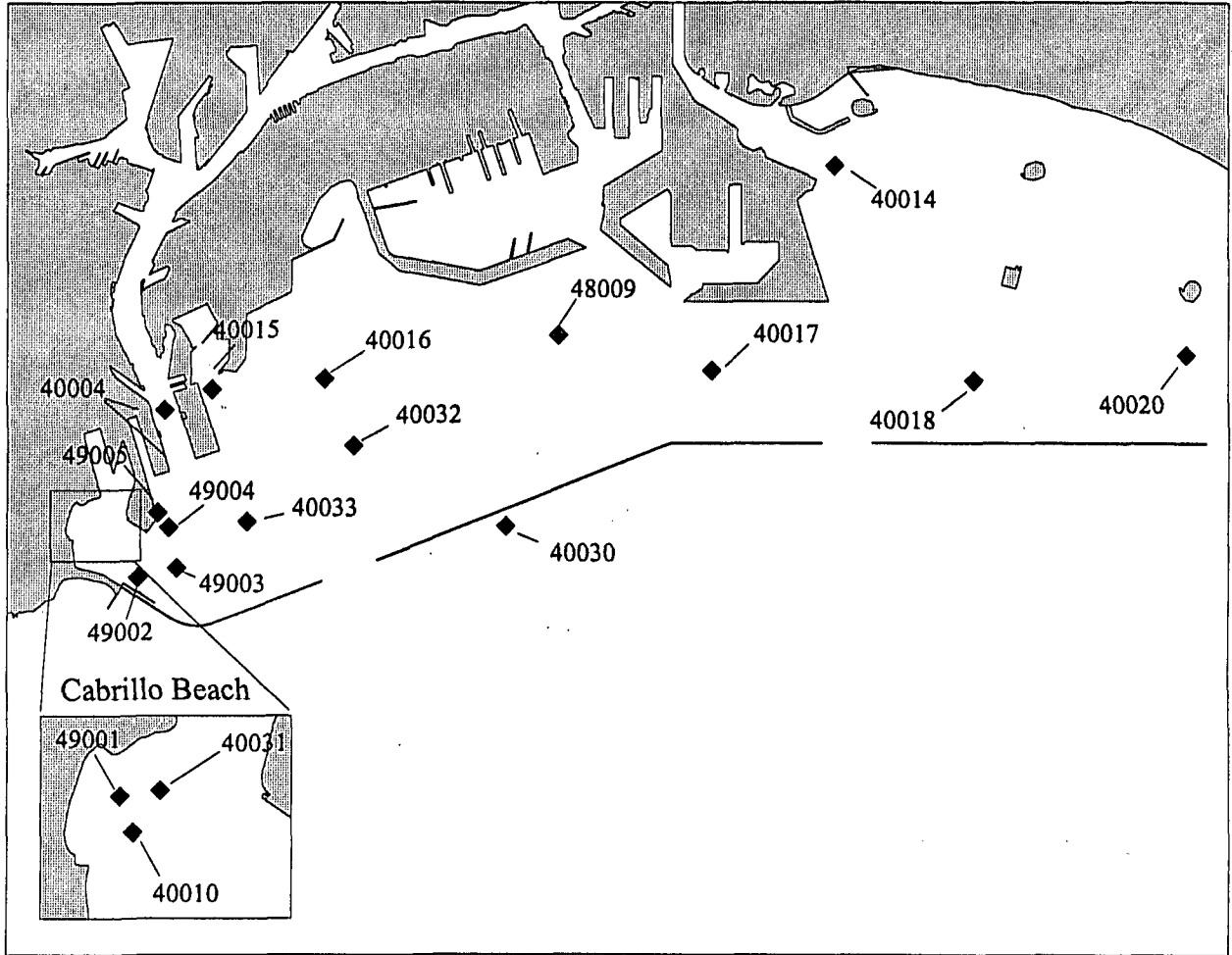
sediment, pore water) were cleaned by: a two-day Micro detergent soak, three tap-water rinses, three deionized water rinses, a three-day soak in 10% HCl or HNO<sub>3</sub>, three Type II Milli-Q water rinses, and air dried.

Glass containers for total organic carbon, grain size or synthetic organic analysis media (sediment, archive sediment, pore water, and subsurface water) and additional teflon sheeting cap-liners were cleaned by: a two-day Micro detergent soak, three tap-water rinses, three deionized water rinses, a three-day soak in 10% HCl or HNO<sub>3</sub>, three Type II Milli-Q water rinses, air dry, three petroleum ether rinses, and air dry.

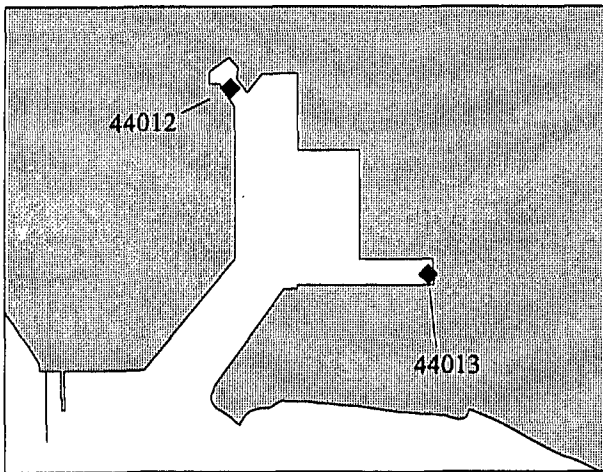
Table 1. Descriptions of samples collected as part of BPTCP/NOAA monitoring in the Los Angeles Region.

Sampling Leg	Sampling Date	Sampling Locations and Descriptions
1	7/30/92	LA and Long Beach Harbors and vicinity screening
2	8/19/92	LA and Long Beach Harbors and vicinity screening
3	9/10/92	LA and Long Beach Harbors and vicinity screening
4	9/15/92	LA and Long Beach Harbors and vicinity screening
11	1/15/93	Northern LA County sites screening
13	2/10/93	Ventura River Lagoon screening
18	5/7/93	LA Harbor screening
19	5/28/93	LA Harbor Reference stations for San Diego Bay study
20	6/18/93	LA Harbor Reference stations for San Diego Bay study
22	8/3-5/93	LA Harbor Reference stations for San Diego Bay study
23	8/17-19/93	LA Harbor Reference stations for San Diego Bay study
25	2/3/94	LA and Long Beach Harbors and vicinity confirmation
26	2/14/94	LA and Long Beach Harbors and vicinity confirmation
30	4/18/94	LA Harbor confirmation, Mugu Lagoon, McGrath Lake screening
32	5/22/94	LA Harbor Reference stations for San Diego Bay study
45	6/24/96	LA Harbor confirmation, Mugu Lagoon, McGrath Lake confirmation Port Hueneme, Shoreline Marina, Marina Del Rey Screening
46	7/22/96	Consolidated Slip confirmation and areal extent
48	2/10/97	LA, Long Beach Harbor and marina reference stations survey #1. Marina Del Rey, Shoreline Marina, King Harbor, Mugu Lagoon confirmation
53	5/12/97	LA, Long Beach Harbor and marina reference stations survey #2. Cabrillo Pier confirmation and bioaccumulation study.
54	8/22/97	Kaiser Pier screening

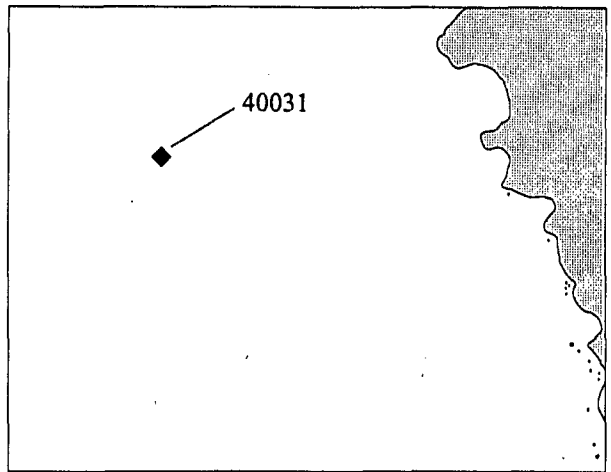
Outer Los Angeles/Long Beach Harbor Stations



Port Hueneme

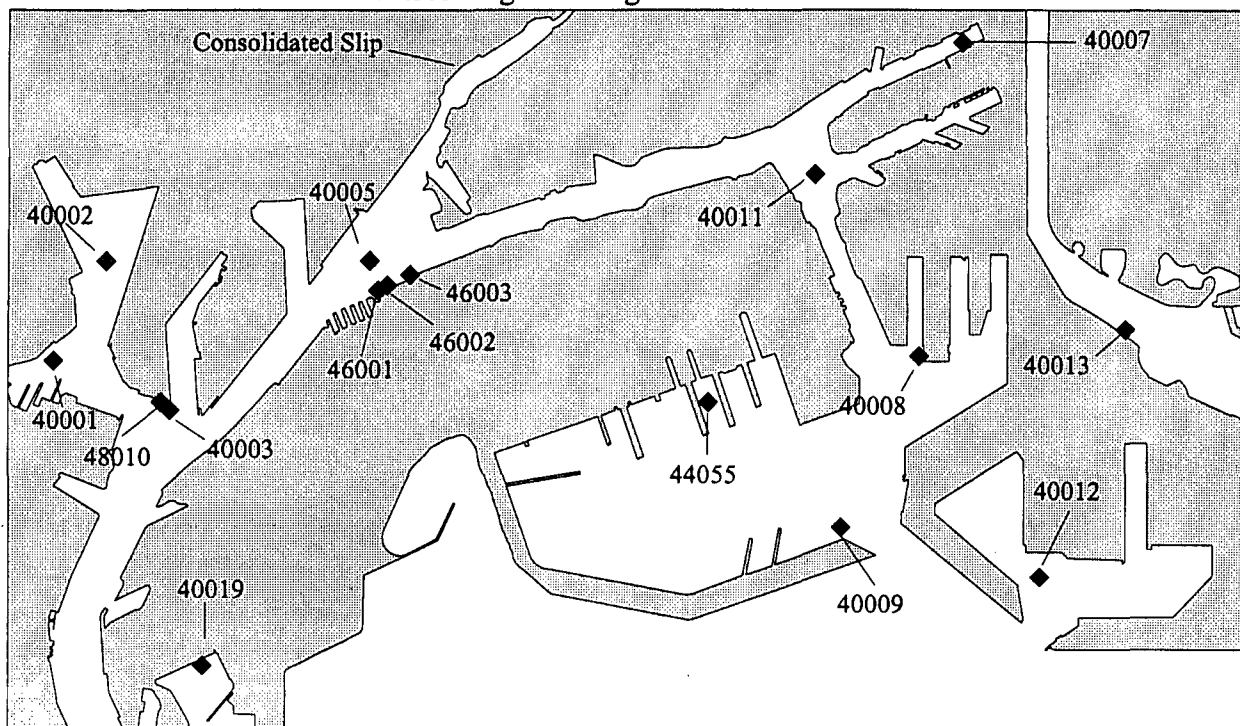


Palos Verdes

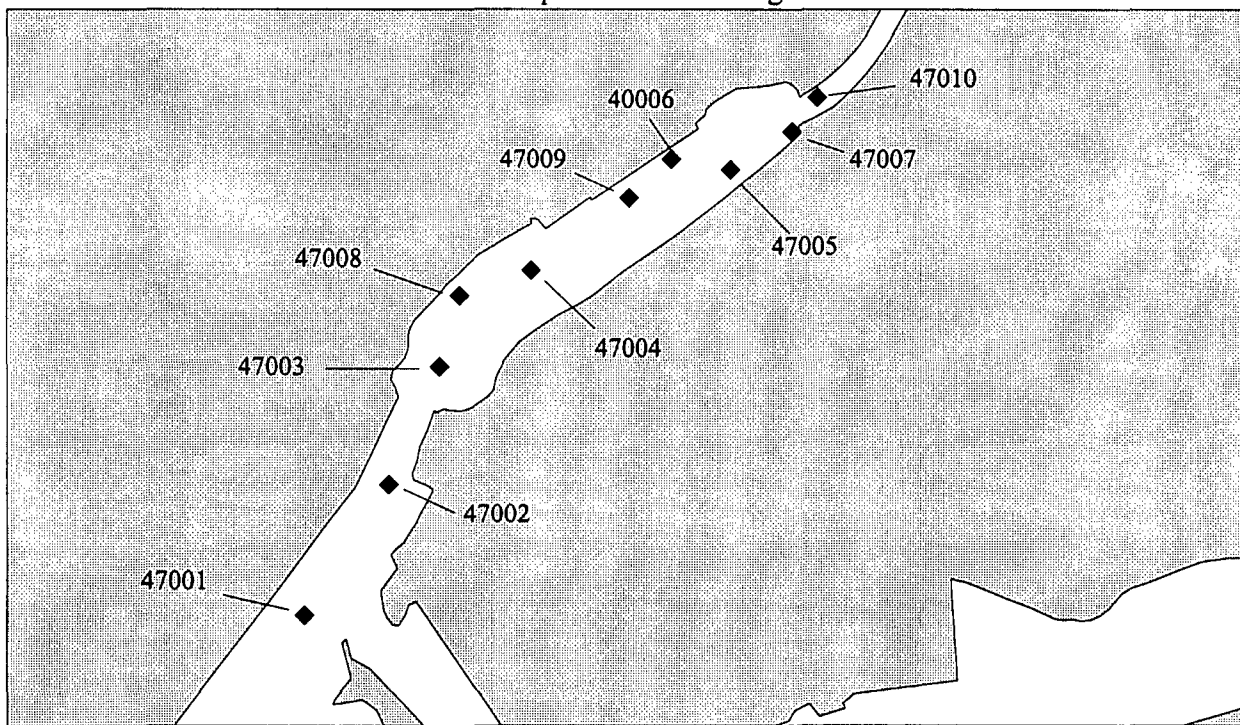


Figures 2a, 2b, and 2c. Outer Los Angeles and Long Beach Harbor (a), Port Hueneme (b), and Palos Verdes (c) Sampling Stations.

### Inner Los Angeles/Long Beach Harbor Stations

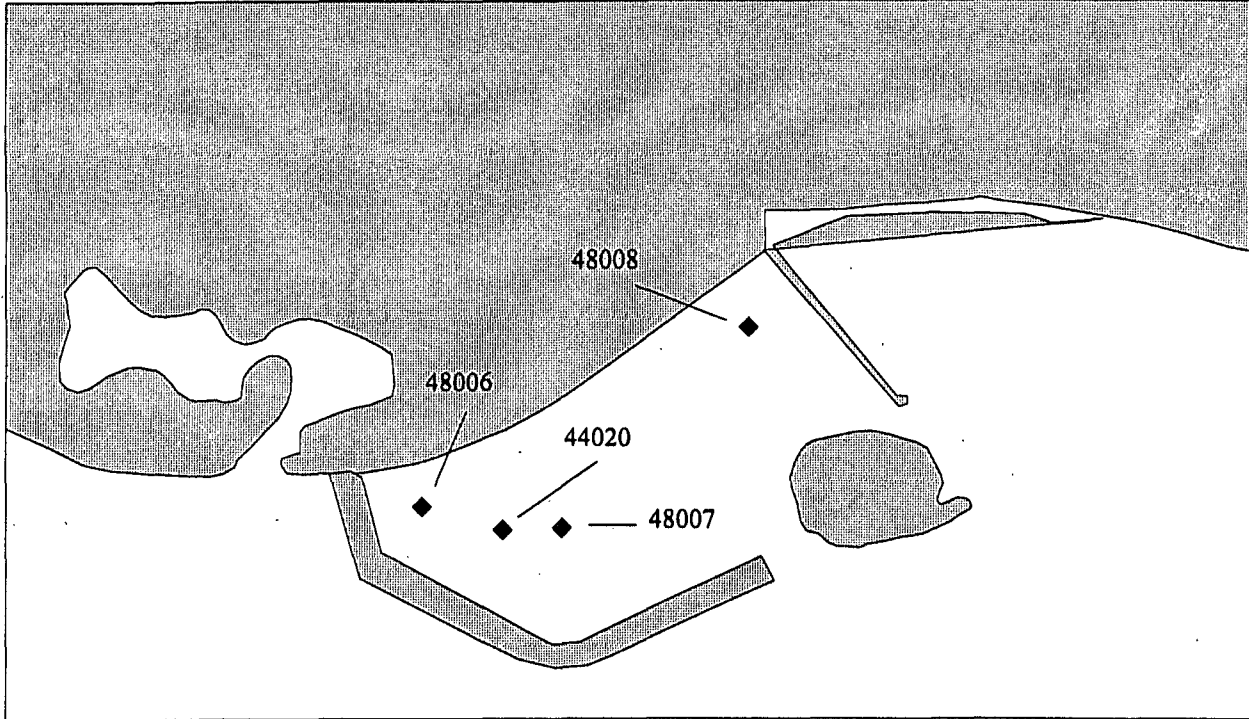


### Consolidated Slip of Inner Los Angeles Harbor

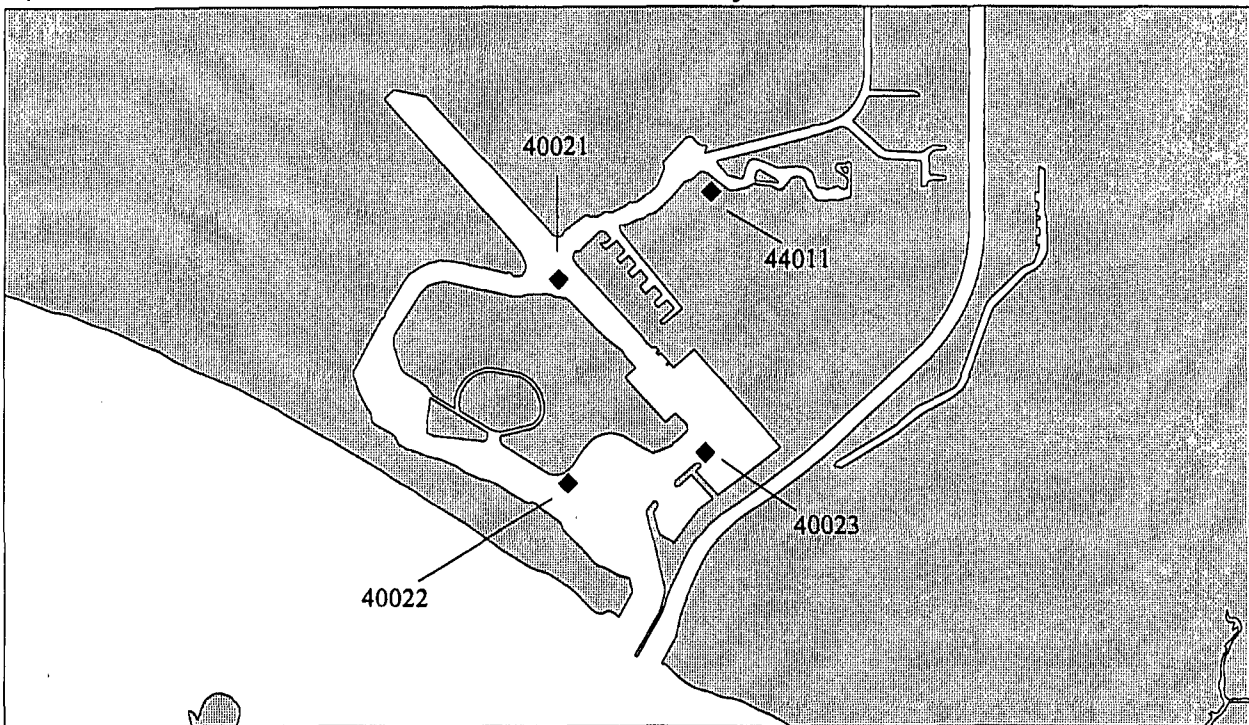


Figures 3a and 3b. Inner Los Angeles and Long Beach Harbor (a) and Consolidated Slip (b) Sampling Stations.

Shoreline Marina

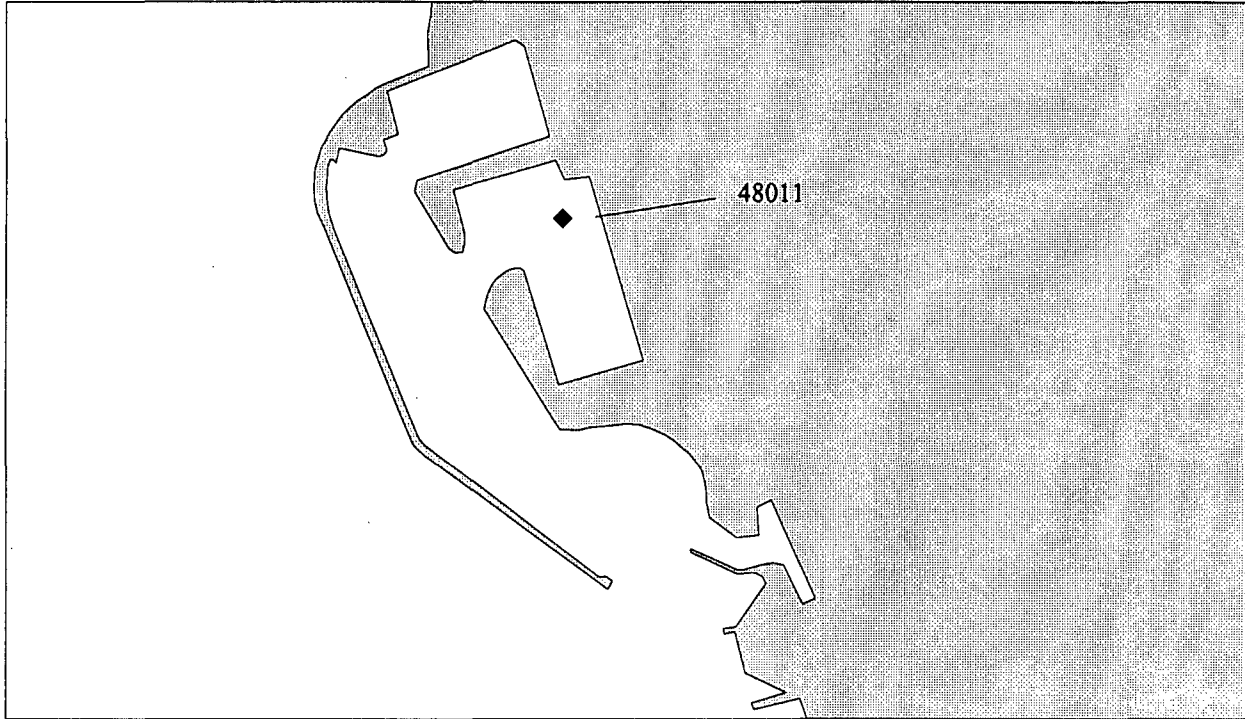


Los Alamitos Bay

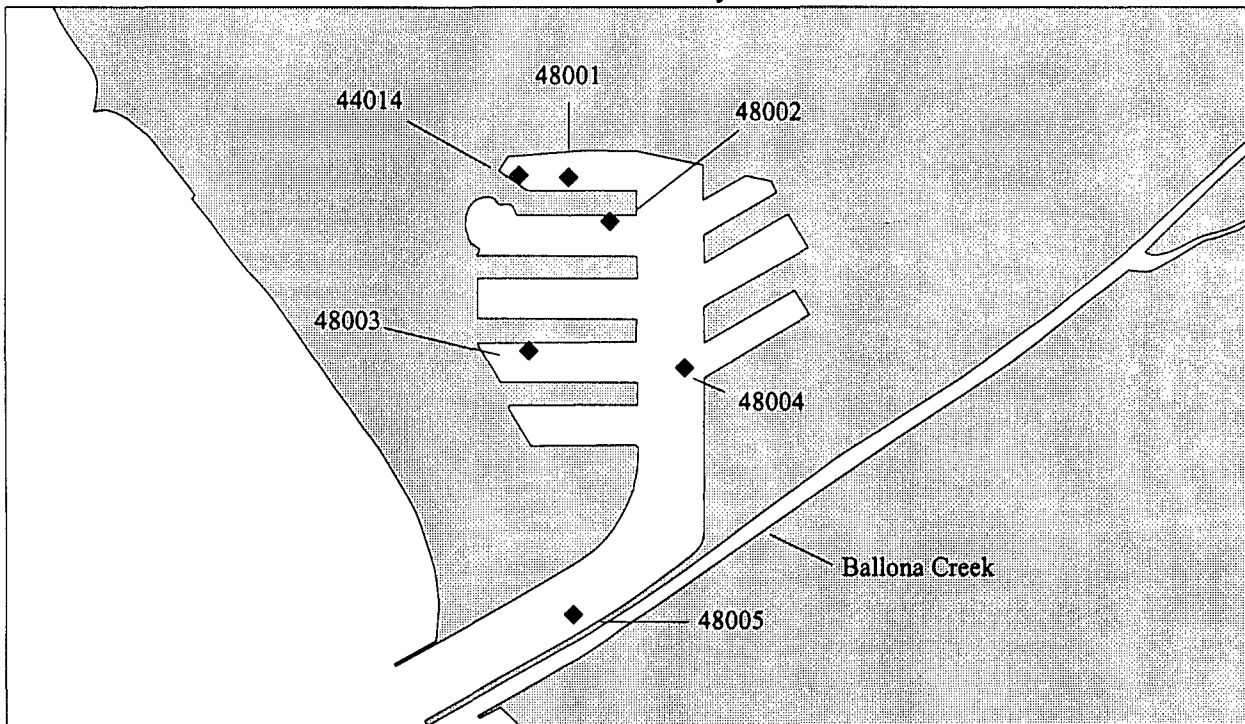


Figures 4a and 4b. Shoreline Marina (a) and Los Alamitos Bay (b) Sampling Stations.

King Harbor



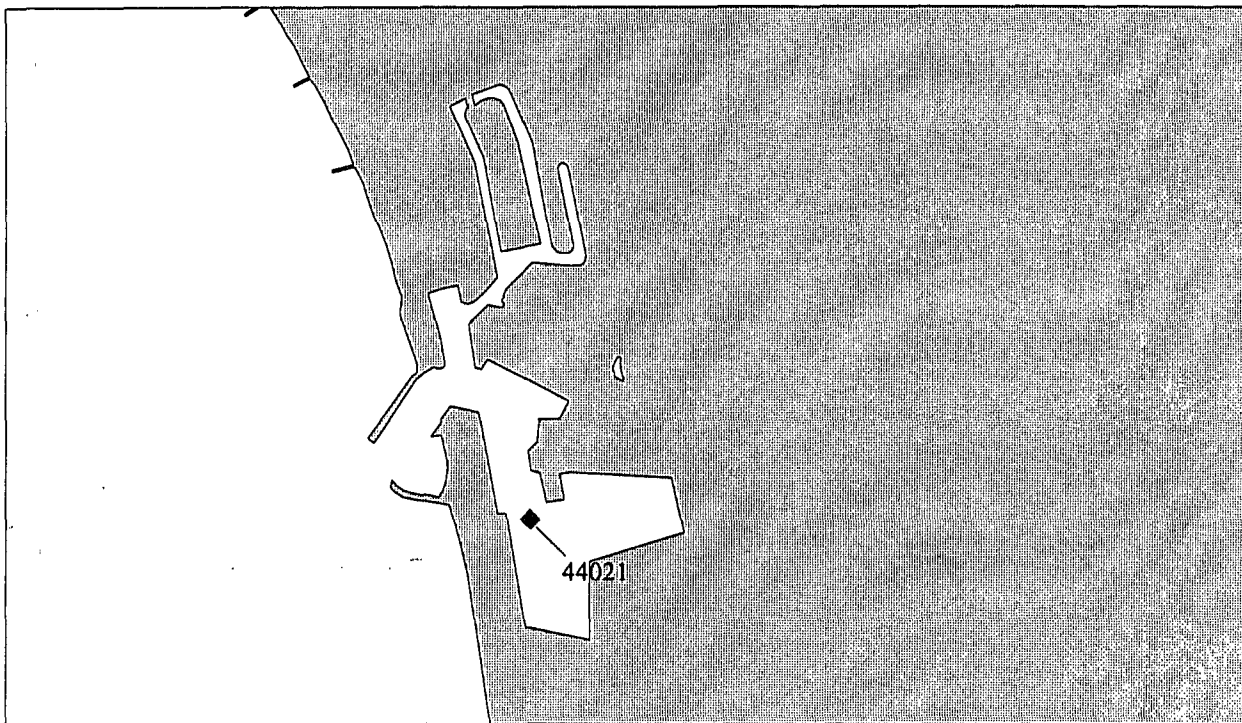
Marina Del Rey



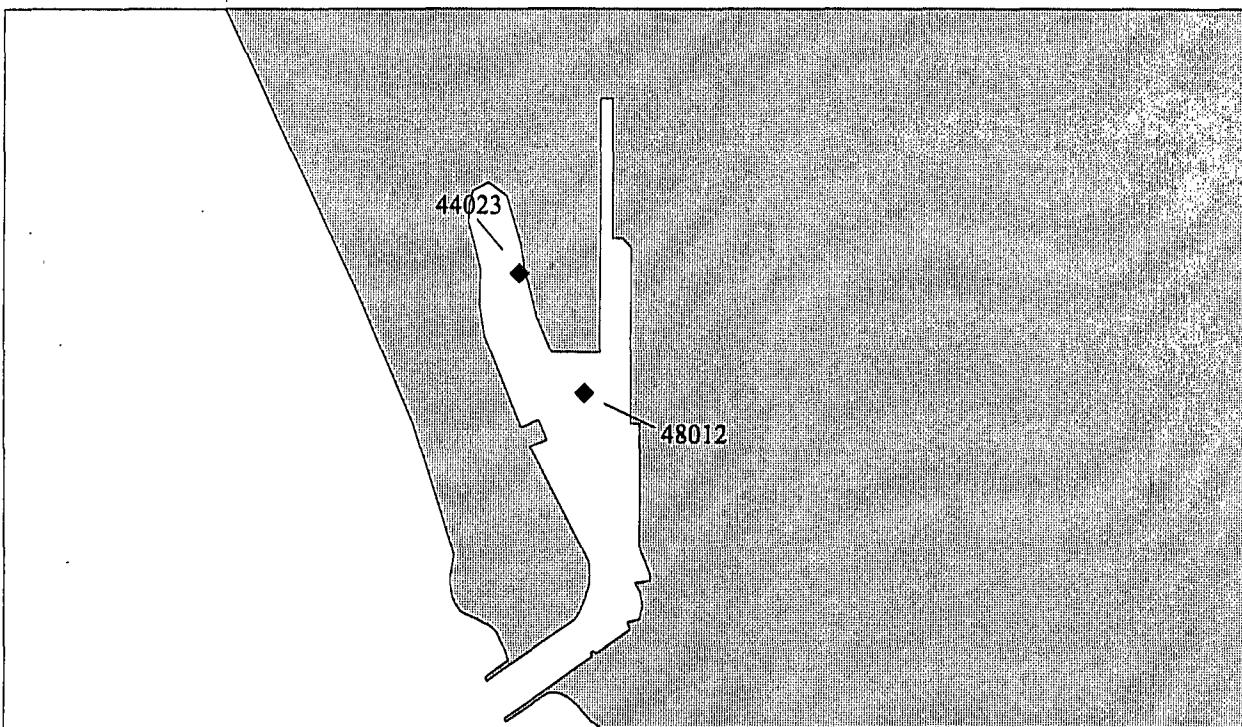
Figures 5a and 5b. King Harbor (a) and Marina Del Rey (b) Sampling Stations.



Ventura Marina



Channel Islands Harbor



Figures 6a and 6b. Ventura Marina (a) and Channel Islands Harbor (b) Sampling Stations.

# Mugu Lagoon

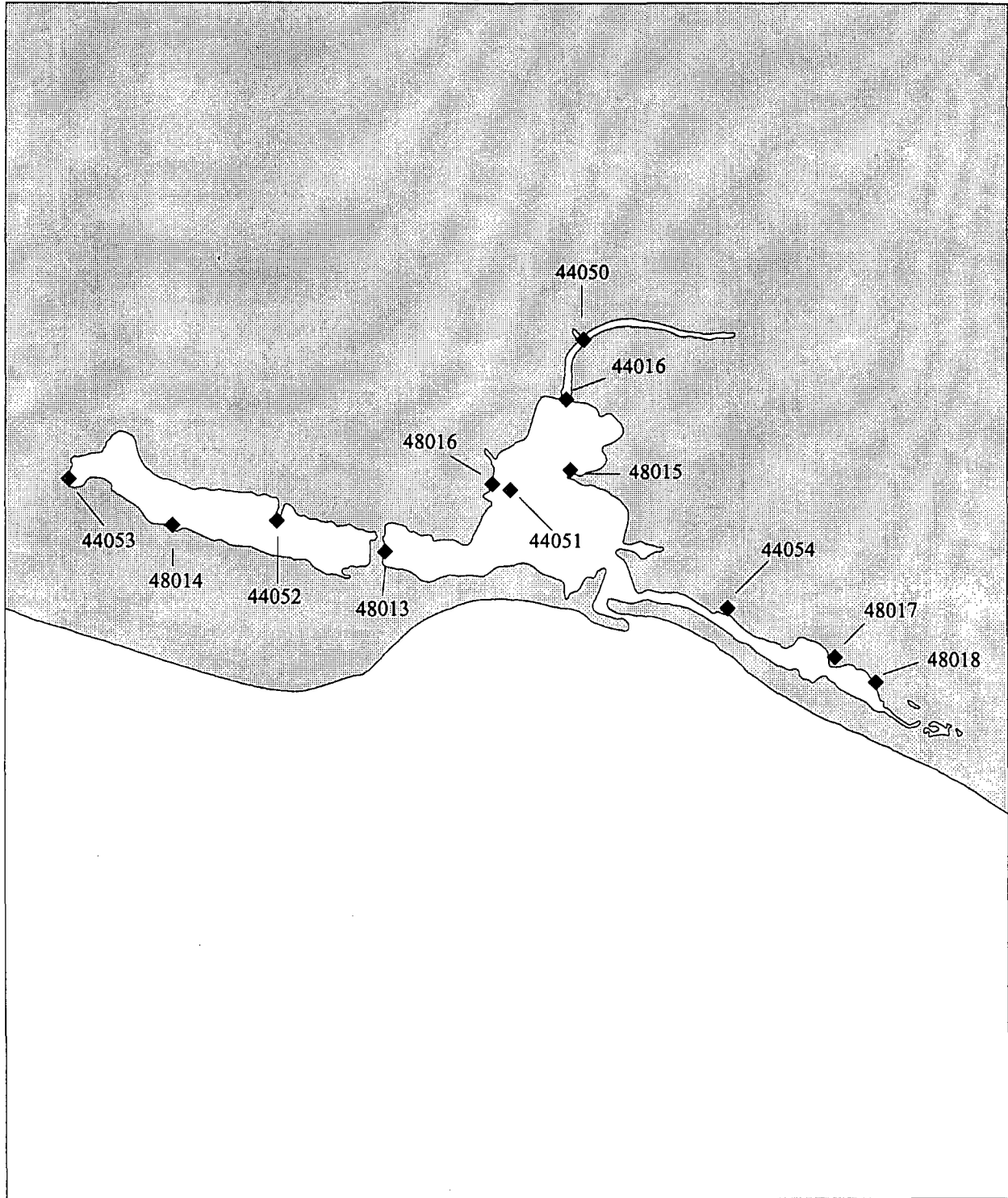
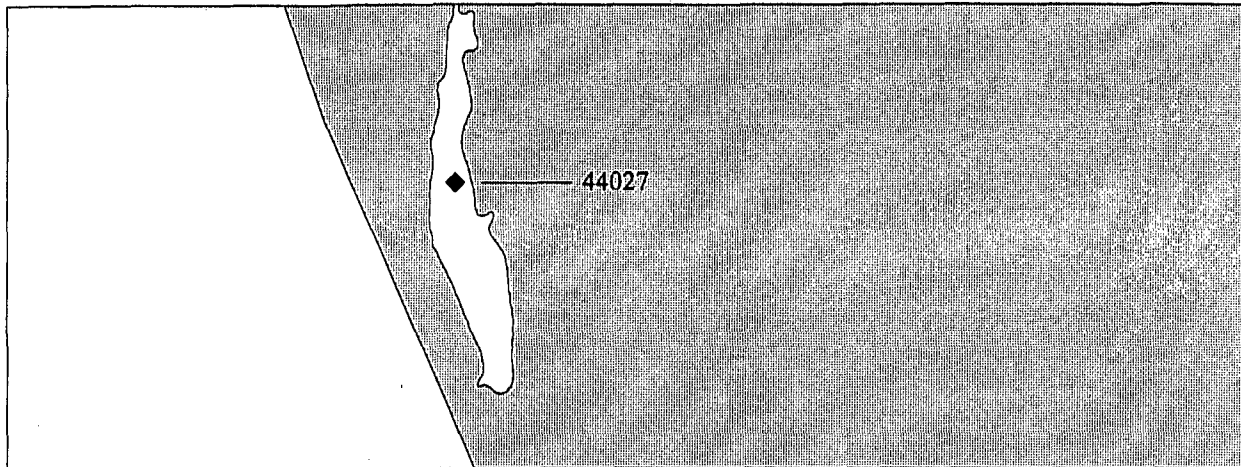
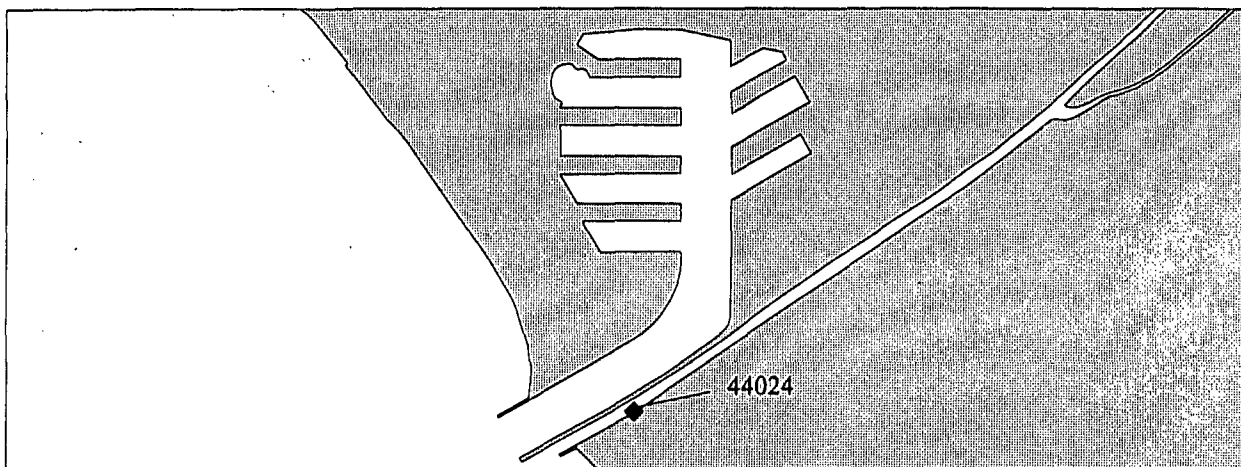


Figure 7. Mugu Lagoon Sampling Stations.

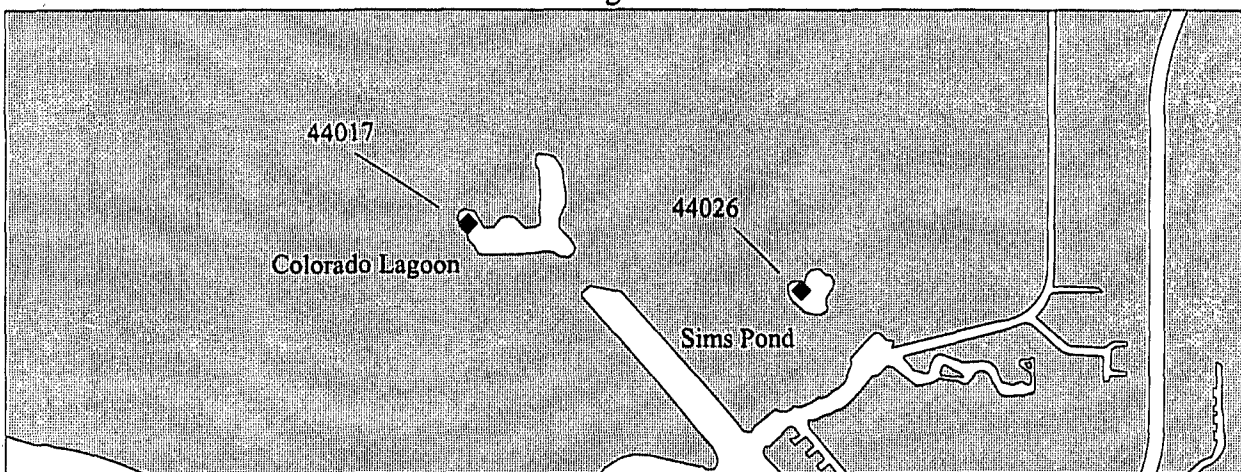
McGrath Lake



Ballona Creek

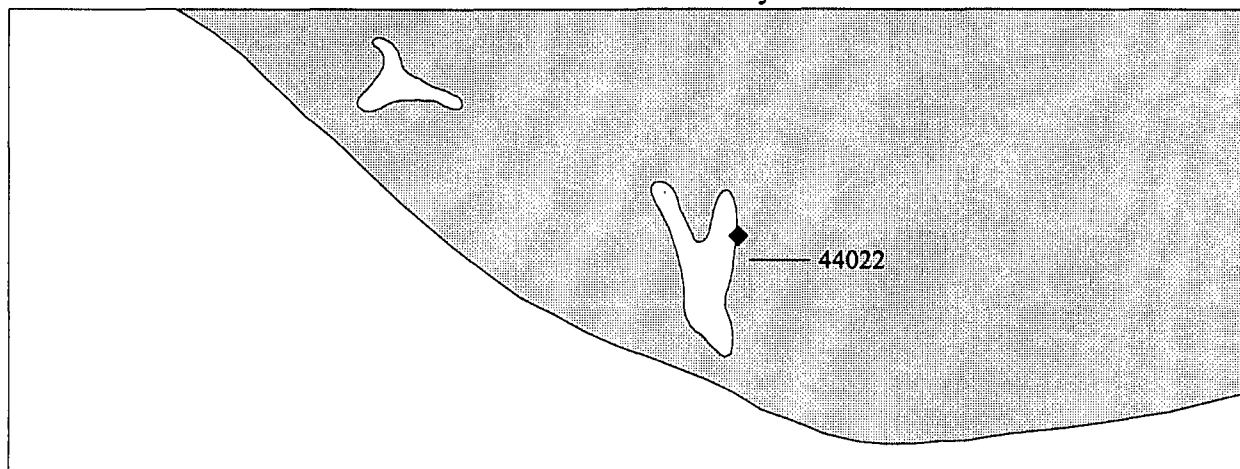


Colorado Lagoon/Sims Pond

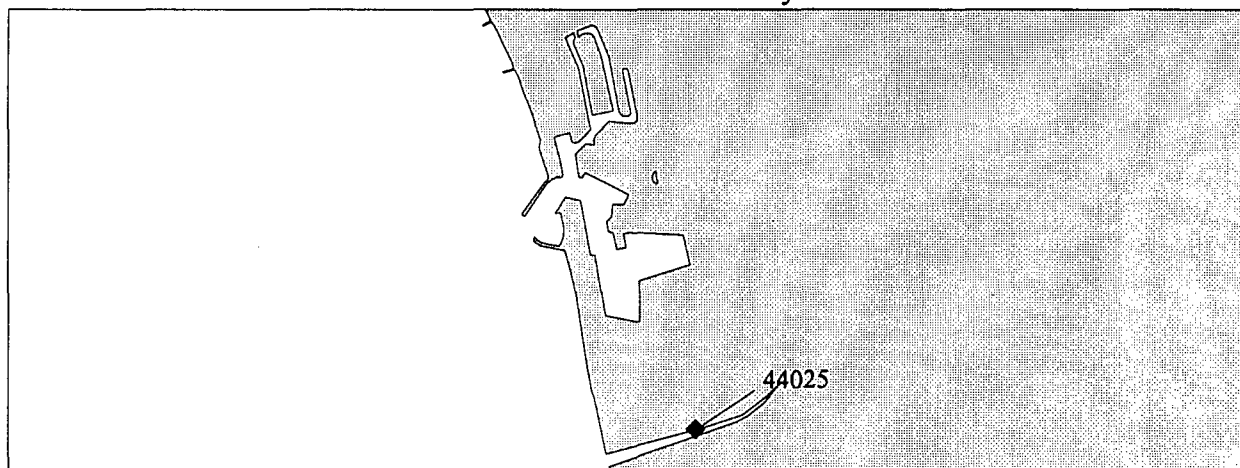


Figures 8a, 8b, and 8c. McGrath Lake (a), Ballona Creek (b), and Colorado Lagoon/Sims Pond (c) Sampling Stations.

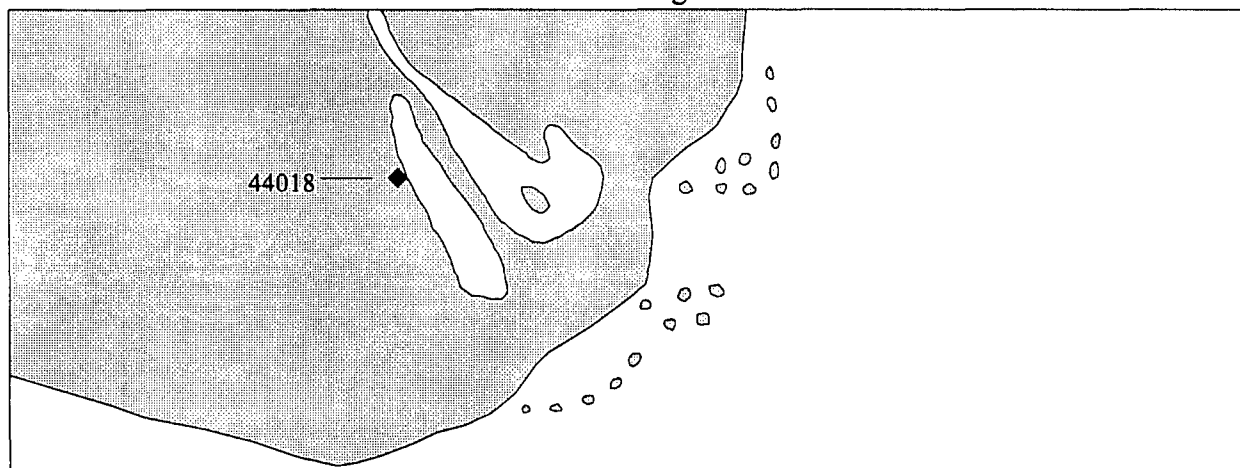
Ventura River Estuary



Santa Clara River Estuary



Malibu Lagoon



Figures 9a, 9b, and 9c. Ventura River Estuary (a), Santa Clara River Estuary (b), and Malibu Lagoon (c) Sampling Stations.

## Sediment Sample Collection

All sampling locations (latitude & longitude), whether altered in the field or predetermined, were verified using a Magellan NAV 5000 Global Positioning System receiver, and recorded in the field logbook.

The primary method of sediment collection was by use of a 0.1m<sup>2</sup> Young-modified Van Veen grab aboard a sampling vessel. Modifications include a non-contaminating Kynar coating which covered the grab's sample box and jaws. After the filled grab sampler was secured on the boat gunnel, the sediment sample was inspected carefully. The following acceptability criteria were met prior to taking sediment samples:

1. Sampler was not over-filled (i.e., the sediment surface was not pressed against the top of the sampler).
2. Overlying water was present, indicating minimal leakage.
3. Overlying water was not excessively turbid, indicating minimal sample disturbance.
4. Sediment surface was relatively flat, indicating minimal sample disturbance.
5. Sediment sample was not washed out due to an obstruction in the sampler jaws.
6. Desired penetration depth was achieved (i.e., 10 cm).
7. Sample was muddy (approx. >30% fines), not sandy or gravelly.
8. Sample did not include excessive shell, organic or man-made debris.

If a sample did not meet all the above criteria, it was rejected, dumped into the bay, and the sampler was re-deployed until a sufficient amount of material was obtained.

It was critical that sample contamination be avoided during sample collection. All sampling equipment (i.e., siphon hoses, scoops, containers) was made of non-contaminating material and was cleaned appropriately before use. Samples were not touched with un-gloved fingers. In addition, potential airborne contamination (e.g., from engine exhaust, cigarette smoke) was avoided. Before sub-samples from the grab sampler were taken, the overlying water was removed by slightly opening the sampler, being careful to minimize disturbance or loss of fine-grained surficial sediment. Once overlying water was removed, the top 2 cm of surficial sediment was sub-sampled from the grab. Subsamples were taken using a precleaned flat bottom scoop. This device allowed a relatively large sub-sample to be taken from a consistent depth. When subsampling surficial sediments, unrepresentative material (e.g., large stones or vegetative material) was removed from the sample in the field. Small rocks and other small foreign material remained in the sample. Determination of overall sample quality was determined by the chief scientist in the field. Such removals were noted on the field data sheet. For the sediment sample, the top 2 cm was removed from the grab and placed in a pre-labeled polycarbonate container. Between grabs or cores, the sediment sample in the container

was covered with a teflon sheet, and the container covered with a lid and kept cool. When a sufficient amount of sediment was collected, the sample was covered with a teflon sheet assuring no air bubbles. A second, larger teflon sheet was placed over the top of the container to ensure an air tight seal, and nitrogen was vented into the container to purge it of oxygen.

If water depth did not permit boat entrance to a site (e.g. <1 meter), divers sampled that site using sediment cores (diver cores). Cores consisted of a 10 cm diameter polycarbonate tube, 30 cm in length, including plastic end caps to aid in transport. Divers entered a study site from one end and sampled in one direction, so as to not disturb the sediment with feet or fins. Cores were taken to a depth of at least 15 centimeters. Sediment was extruded out of the top end of the core to the prescribed depth of 2-cm, removed with a polycarbonate spatula and deposited into a cleaned polycarbonate tub. Additional samples were taken with the same seawater rinsed core tube until the required total sample volume was attained. Diver core samples were treated the same as grab samples, with teflon sheets covering the sample and nitrogen purging. All sample acceptability criteria were met as with the grab sampler.

As discussed above, more intensive sampling was conducted in the Consolidated Slip/Dominguez Channel tidal prism area of inner Los Angeles Harbor in order to investigate the horizontal and vertical distribution of chemical pollution and associated bioeffects in this area. The horizontal distribution of pollution and toxicity was determined by collecting multiple field replicates at several stations along a gradient leading from Henry Ford Bridge and out Dominguez Channel. Samples were collected along two transects, each having four sample locations. The first transect was located in the upper channel and ran from Dominguez Channel to the east end of Consolidated Slip. The second transect was located in the mid to west end of end of Consolidated Slip leading to the east end of East Basin. Both transects were located based on past monitoring data to define the east and west boundaries of sediment pollution in Consolidated Slip.

In order to determine the vertical distribution of pollution and bioeffects, samples at several stations were collected at multiple depths. In addition to the surficial samples collected at the top 2 cm, samples were collected at three additional depths: surface (top 30 cm), Depth 2 (from 30 cm to 90 cm), and Depth 3 (from 90 cm to 150 cm). In most cases, a hard clay layer below 90 cm prevented collection of the third sample depth.

Samples for the vertical distribution study were collected with a gravity coring device deployed from a boat. The corer was lined with a 7-cm diameter polybutyrate liner, which was changed between samples. Once collected, core samples were cut with a stainless steel saw into the three sections, the end of each sediment core adjacent to the saw cut was discarded, and samples were aliquoted as described above.

Replicate benthic samples (n=3) were obtained at predetermined sites from separate deployments of the Van Veen sampler. The three replicates were positioned according to

the BPTCP sampling protocol (e.g., located by previously assigned lat/long coordinates). The coring device was 10 cm in diameter and 14 cm in height, enclosing a 0.0075-m<sup>2</sup> area. Corers were placed into sediment with minimum disruption of the surface sediments, capturing essentially all surface-active fauna as well as species living deeper in the sediment. Corers were pushed about 12 cm into the sediment and retrieved by digging along one side, removing the corer and placing the intact sediment core into a pvc screening device. Sediment cores were carefully sieved through a 0.5-mm screen and residues (e.g., organisms and remaining sediments) were rinsed into pre-labeled storage bags and preserved with a 10% formalin solution. After 3 to 4 days, samples were rinsed and transferred into 70% isopropyl alcohol and stored for future taxonomy and enumeration.

### **Analysis of Contaminants in Fish Tissue**

Fish species targeted for collection were selected and prioritized based on relative abundance of species of interest; species behavior (eg., feeding behavior); and habitat range; frequency of consumption by anglers; likelihood of contaminant accumulation based on tissue lipid content. Composite tissue samples were necessary to maximize the number of stations and fish species on which chemical analysis could be performed. The number of fish required to complete a composite was five for larger fish and fifteen for smaller fish. Fish species collected and number of fish needed to complete a composite were as follows:

1. White Croaker (*Genyonemus lineatus*) (5 per composite)
2. White Surfperch (*Phanerdon furcatus*) (5 per composite)
3. Shiner Surfperch (*Cymatogaster aggregata*) (15 per composite)
4. Topsmelt (*Atherinopsis affinis*) (15 per composite)

Fish were collected from Point Mugu Lagoon October 5, 1992, using a 50' beach seine. Size of topsmelt ranged from 16.5-22 cm (total length) and 10-12.4 cm for shiner surfperch. Fish were collected from Los Angeles Harbor May 14-15, 1997, using a 25' otter trawl. Size of white croaker ranged from 20-28 cm (total length) and 14-19 cm for white surfperch. Collected samples were wrapped in chemically cleaned Teflon® sheeting, to prevent trace metal and trace organic contamination, and frozen for transportation to the laboratory. Dissections and muscle tissue sample preparations were performed using non-contaminating methods in a clean room environment (Stephenson et al., 1994). Equal weight samples were taken from each fish using Teflon® forceps to provide a composite total of approximately 125 grams. All composites were homogenized and homogenate splits were taken for each chemical analysis.

Muscle tissue (i.e., fillets) of white croaker were analyzed with skin on, while topsmelt and perch were analyzed whole body (i.e., head, guts, tail removed). The decision to analyze tissue fillets or whole body was based on the manner in which the particular fish was most commonly cooked and eaten.

All sample composites were analyzed for PAHs, PCB congeners, pesticides, percent moisture and percent lipid. A more detailed description of these methods can be found in the California State Mussel Watch Program Ten Year Data Summary Report (1988) and the California Bay Protection and Toxic Cleanup Program Quality Assurance Project Plan (Stephenson et al., 1994).

The U.S. EPA document used to design the study, *Guidance For Assessing Chemical Contaminant Data For Use In Fish Advisories-Volume 1-Fish Sampling and Analysis* (U.S. EPA, 1995a), was also used to develop the contaminant screening values used in this study. In developing the screening values (SVs) for a number of noncarcinogenic and carcinogenic compounds, risk-based dose response variables were used. These variables were used in the following equations to calculate the SVs used in this study:

$$\begin{aligned} \text{For Noncarcinogens: } SV &= (RfD * BW)/CR \\ \text{For Carcinogens: } SV &= [(RL/SF)*BW]/CR \end{aligned}$$

where SV = Screening Value ( $\mu\text{g/g}$ )  
RfD = Oral reference dose ( $\mu\text{g/g/d}$ )  
RL = Maximum acceptable risk level (dimensionless)  
SF = Oral slope factor ( $\mu\text{g/g/d}^{-1}$ )  
BW = Body Weight (kg)  
CR = Consumption rate of tissue(g/d)

Body weight (BW), consumption rate (CR) and risk level (RL) have been held constant for all calculations in this document. Body weight was chosen at 70 kg, which is the mean body weight for the average male adult population (U.S. EPA, 1990). Consumption rate was chosen at 6.5 grams per day (one meal a month), which is the estimate of the average consumption of fish and shellfish from marine, estuarine and fresh waters by the general adult population (U.S. EPA, 1990). The risk level (RL) was chosen at  $10^{-5}$  as recommended by the EPA Office of Water for the calculation of screening values. In simple terms, this means that if a person weighing 70 kg consumed 6.5 grams of fish per day with the same concentration of contaminant, for 70 years, the increased risk would be at most one additional cancer death per 100,000 persons. Values used for oral RfD and SF were those suggested for use by the EPA (U.S. EPA, 1993). Screening values could not be calculated for all chemicals analyzed in this study since reliable information on the toxicity or carcinogenic potency of chemicals is not available for all analytes. RfD and SF information that has been developed to date is available in the EPA's Integrated Risk Information System (IRIS, 1992). This system is continuously updated, as information becomes available, so calculations of screening values for additional chemicals may be possible in the future. Calculated screening values and comparative screening values from other selected sources are presented in Tables 21 and 34.



The screening values calculated from the constants selected above are used to help identify potential chemicals of concern and should not be treated as health risk thresholds. Comparisons of sample tissue levels with screening values are meant to provide guidance to further investigations of contaminant levels in southern California fish tissues. They should not be construed as regulatory action levels or be used as definitive answers to questions concerning the safety of fish consumption. Health risk concerns will be reviewed and, if necessary, warnings issued, by the California Office of Environmental Health Hazard Assessment (OEHHA).

### **Transport of Samples**

Six-liter polycarbonate sample containers for chemistry and toxicity and benthic cores were packed in ice chests with enough ice to keep them cool for 48 hours. Each container was sealed in precleaned, large plastic bags closed with a cable tie to prevent contact with other samples or ice or water. Ice chests were driven back to the laboratory by the sampling crew or flown by air freight within 24 hours of collection.

### **Homogenization and Aliquoting of Samples**

Samples remained in ice chests (on ice, in double-wrapped plastic bags) until the containers were brought back to the laboratory for homogenization. All sample identification information (station numbers, etc.) was recorded on Chain of Custody (COC) and Chain of Record (COR) forms prior to homogenizing and aliquoting. A single container was placed on plastic sheeting while also remaining in original plastic bags. The sample was stirred with a polycarbonate stirring rod until mud appeared homogeneous.

All prelabeled jars were filled using a clean Teflon or polycarbonate scoop and stored in freezer/refrigerator (according to media/analysis) until analysis. The sediment sample was aliquoted into appropriate containers for trace metal analysis, organic analysis, pore water extraction, and bioassay testing. Samples were placed in boxes sorted by analysis type and leg number. Sample containers for sediment bioassays were placed in a refrigerator (4°C) while sample containers for sediment chemistry (metals, organics, TOC and grain size) were stored in a freezer (-20°C).

### **Procedures for the Extraction of Pore Water**

#### Whole Core Squeezing

In sampling Legs 1 through 23 (Table 1) pore water was extracted from refrigerated (4°C) sediment samples using the whole core squeezing (WCS) method developed by Bender et al. (1987). This method employed mechanical force to squeeze pore water from interstitial spaces. The squeezing technique was a modification of the original Bender design, with some adaptations made based on the work of Carr et al. (1989) and Carr and

Chapman (1991). This WCS method was developed for laboratory or field use in conjunction with standard coring techniques.

The major features of the squeezer consisted of an aluminum support framework, 10-cm i.d. acrylic core tubes with sampling ports, a pressure regulated pneumatic ram with air supply valves, and pH and oxygen electrodes placed in-line with sample effluent. Trace metal contamination was avoided by ensuring that all sample containers, filters and WCS surfaces in contact with the sample were plastics (acrylic, PVC, and TFE) and cleaned with Micro, 10% HCl, Type II Milli-Q® brand water and methanol.

One to two liters of homogenized sediment sample were placed in the squeezer tube for pore water extractions. The tubes were placed in the support framework and pressure was applied to the top piston by adjusting the air supply to the pneumatic ram. An initial air pressure of ~20 psi was sufficient to maintain a steady flow of sample effluent through the top piston, and at no time during squeezing did air pressure exceed 200 psi.

A porous pre-filter (PPE or TFE) was inserted in the top of the piston and used to screen large (> 70 microns) sediment particles. Further filtration was accomplished with disposable TFE filters of 5 microns and 0.45 microns in-line with sample effluent. To compensate for filter clogging and sediment compaction during the course of squeezing, effluent flow was maintained by fine adjustment of the pressure regulator on the air supply to increase the air pressure to the ram.

Sample effluent of the required volume was collected in TFE containers under refrigeration. Pore water was then subsampled in the volumes and specific containers required for archiving and chemical or toxicological analysis. Samples to be analyzed for trace metals were acidified to an approximate pH of 2-3 to minimize oxidation of the metal and adsorption to sample container walls. Other subsamples were either refrigerated or frozen as required under normal holding time criteria for each specific analysis.

Upon completion of a sediment squeezing run, all squeezer surfaces in contact with sample were thoroughly cleaned to minimize metal or organic cross-contamination between samples. Blanks of Type II Milli-Q® brand water were substituted for sample and squeezed prior to and after the core tubes used for sample extractions. This squeezer blank was used as a quality control step to test for possible contaminations. Pore water samples were frozen until needed for testing.

#### Centrifugation Extraction

In sampling Legs 25 through 54 (Table 1), pore water was extracted using centrifugation. All procedures for the centrifugation extraction of pore water were performed using trace metal and trace organic clean techniques. Operations were performed in a positive pressure clean room with filtered air to prevent airborne contamination.

All sample containers or sampling equipment in contact with sediment or porewater received a scrub and 2 day soak in MICRO® detergent, followed by triple fresh and deionized water rinses. Equipment was then immersed in 10% HCl for 3 days, triple rinsed in MILLI-Q® Type II water, air dried, and triple rinsed with petroleum ether.

Samples were stored on ice at 4°C prior to centrifugation. Pre-cleaned Teflon scoops were used to transfer sediment from sample containers to centrifuge jars. High speed one-liter polycarbonate centrifuge jars were used for extraction of pore water. Samples were spun at 2500 G for 30 minutes at 4°C in a Beckman J-6B refrigerated centrifuge.

Porewater was transferred from each centrifuge jar into final sample containers (250 pre-cleaned borosilicate glass jars) using pre-cleaned polyethylene siphons. While decanting, care was used to avoid floating debris, fauna, shell fragments or other solid material. After transfer into final sample containers, porewater was immediately refrigerated at 4°C. Samples were refrigerated, not frozen, and testing was initiated within 24 hours of extraction of the final samples.

### **Subsurface Water Collection**

Subsurface water was collected at selected stations to assess site water toxicity. A polyethylene water sample bottle was attached to the frame of the Van Veen grab sampler and a stopper was pulled as the jaws of the grab closed for a sediment sample. The water sample was consequently collected approximately 0.5 meters above the sediment surface. Subsurface water samples were transferred to acid and solvent rinsed 1 liter amber bottles and held in the dark at 4°C until testing.

### **Collection of Intact Sediment Cores for Sediment-Water Interface Tests**

Intact sediment cores were sampled directly from the Van-Veen grab sampler at selected stations for later sediment-water interface toxicity tests. Cores were 7.5 cm in diameter polycarbonate tubes sampled to a depth of 5 cm. Cores were removed from the sampler by sealing the bottom of the core with polyethylene-gloved hands, and quickly sealing first the bottom, then the top with polyethylene caps. The bottom caps were then wrapped with parafilm™ to prevent leakage, stored upright in an ice chest, and transported to the toxicity testing laboratory via overnight courier. Intact cores were refrigerated in the dark until used in toxicity tests. Sediment-water interface test methods are described below.

### **Sample Chain of Records & Custody**

Chain-of-records documents were maintained for each station. Each form was a record of all sub-samples taken from each sample. IDORG (a unique identification number for only that sample), DFG station numbers and station names, leg number (sample

collection trip batch number), and date collected were included on each sheet. A Chain-of-Custody form accompanies every sample so that each person releasing or receiving a subsample signs and dates the form.

**Authorization/Instructions to Process Samples**

Standardized forms entitled "Authorization/Instructions to Process Samples" accompanied the receipt of any samples by any participating laboratory. These forms were completed by DFG personnel, or its authorized designee, and were signed and accepted by both the DFG authorized staff and the staff accepting samples on behalf of the particular laboratory. The forms contain all pertinent information necessary for the laboratory to process the samples, such as the exact type and number of tests to run, number of laboratory replicates, dilutions, exact eligible cost, deliverable products (including hard and soft copy specifications and formats), filenames for soft copy files, expected date of submission of deliverable products to DFG, and other information specific to the lab/analyses being performed.

**Trace Metals Analysis of Sediments**

Trace metal analyses were conducted at the California Department of Fish and Game's (CDFG) Trace Metals Facility at Moss Landing, CA. Table 2 indicates the trace metals analyzed and lists method detection limits for sediments. These methods were modifications of those described by Evans and Hanson (1993) as well as those developed by the CDFG (California Department of Fish and Game, 1990). Samples were selected for chemical analyses by SWRCB staff based on results from toxicity tests.

**Analytes and Detection Limits**

Table 2. Dry Weight Trace Metal Minimum Detection Limits (MDL). \*\*\*Note that all tissue MDLs are reported in dry weight units because wet weight MDLs are based on percent moisture of the sample.

Analytes	MDL	MDL	MDL
	µg/g dry	µg/g dry	µg/L
	Sediment	Tissue	Water
Silver	0.002	0.01	0.001
Aluminum	1	1	NA
Arsenic	0.1	0.25	0.1
Cadmium	0.002	0.01	0.002
Copper	0.003	0.1	0.04
Chromium	0.02	0.1	0.05
Iron	0.1	0.1	0.1
Mercury	0.03	0.03	NA
Manganese	0.05	0.05	NA

Nickel	0.1	0.1	0.1
Lead	0.03	0.1	0.01
Antimony	0.1	0.1	NA
Tin	0.02	0.02	NA
Selenium	0.1	0.1	NA
Zinc	0.05	0.05	0.02

### **Sediment Digestion Procedures**

One gram aliquot of sediment was placed in a pre-weighed Teflon vessel, and one ml concentrated 4:1 nitric:perchloric acid mixture was added. The vessel was capped and heated in a vented oven at 130°C for four hours. Three mL hydrofluoric acid was added to the vessel, recapped and returned to oven overnight. Twenty mL of 2.5% boric acid were added to vessel and placed in oven for an additional 8 hours. Weights of vessel and solution were recorded, and solution transferred to 30-mL polyethylene bottles.

### **Tissue Digestion Procedures**

A three gram aliquot of tissue was placed in a pre-weighed Teflon vessel, and three mls of concentrated 4:1 nitric:perchloric acid mixture was added. Samples then were capped and heated on hot plates for five hours. Caps were tightened and heated in a vented oven at 130°C for four hours. Samples were allowed to cool and 15 mls of Type II water was added to the vessels. The solution was then quantitatively transferred to a pre weighed 30 ml polyethylene (HDPE) bottle and taken up to a final weight of 20 g with Type II water.

### **Atomic Absorption Methods**

Samples were analyzed by furnace AA on a Perkin-Elmer Zeeman 3030 Atomic Absorption Spectrophotometer, with an AS60 auto sampler, or a flame AA Perkin Elmer Model 2280. Samples, blanks, matrix modifiers, and standards were prepared using clean techniques inside a clean laboratory. ASTM Type II water and ultra clean chemicals were used for all standard preparations. All elements were analyzed with platforms for stabilization of temperatures. Matrix modifiers were used when components of the matrix interferes with adsorption. The matrix modifier was used for Sn, Sb and Pb. Continuing calibration check standards (CLC) were analyzed with each furnace sheet, and calibration curves were run with three concentrations after every 10 samples. Blanks and standard reference materials, MESS1, PACS, BCSS1 or 1646 were analyzed with each set of samples for sediments.

### **Acid Volatile Sulfide and Simultaneously Extracted Metals – AVS-SEM**

This procedure determines the concentration of acid volatile sulfide (AVS) and the concentrations of selected metals that are solubilized during the acidification process (simultaneously extracted metal, SEM). The AVS/SEM procedure followed methods

described by Allen et al. (1993). AVS in the samples was first converted to hydrogen sulfide by acidification with hydrochloric acid at room temperature. The hydrogen sulfide was purged from the samples and trapped in an aqueous solution of sodium hydroxide. Sulfide concentrations were then determined spectrophotometrically by reaction with amine sulfuric acid and ferric chloride reagents to form methylene blue. The SEM are selected metals liberated from the sediment during the acidification. The concentrations of these metals were measured in the remaining acid after filtration of the sample.

### *Trace Organic Analysis of Sediments (PCBs, Pesticides, and PAHs)*

#### **Analytes and Detection Limits**

Analytical sets of 12 samples were scheduled such that extraction and analysis occurred within a 40-day window. The methods employed by the UCSC-TOF were modifications of those described by Sloan et al. (1993). Tables 3-8 indicate the pesticides, PCBs, and PAHs currently analyzed and list method detection limits for sediments on a dry weight basis.

Table 3: Dry Weight Minimum Detection Limits of Chlorinated Pesticides

Analytes †	Database Abbreviation	MDL ng/g dry Sediment	MDL ng/g dry Tissue	MDL ng/L Water
<b>Fraction #1 Analytes †</b>				
Aldrin	ALDRIN	0.5	1.0	2.0
alpha-Chlordene	ACDEN	0.5	1.0	1.0
gamma-Chlordene	GCDEN	0.5	1.0	1.0
o,p'-DDE	OPDDE	1.0	3.0	1.0
o,p'-DDT	OPDDT	1.0	4.0	2.0
Heptachlor	HEPTACHLOR	0.5	1.0	2.0
Hexachlorobenzene	HCB	0.2	1.0	1.0
Mirex	MIREX	0.5	1.0	1.0
<b>Fraction #1 &amp; #2 Analytes †,‡</b>				
p,p'-DDE	PPDDE	1.0	1.0	0.5
p,p'-DDT	PPDDT	1.0	4.0	2.0
p,p'-DDMU	PPDDMU	2.0	5.0	5.0
trans-Nonachlor	TNONA	0.5	1.0	1.0
<b>Fraction #2 Analytes ‡</b>				
cis-Chlordane	CCHLOR	0.5	1.0	1.0
trans-Chlordane	TCHLOR	0.5	1.0	1.0
Chlorpyrifos	CLPYR	1.0	4.0	4.0
Dacthal	DACTH	0.2	2.0	2.0
o,p'-DDD	OPDDD	1.0	5.0	5.0
p,p'-DDD	PPDDD	0.4	3.0	3.0
p,p'-DDMS	PPDDMS	3.0	20	20
p,p'-Dichlorobenzophenone	DICLB	3.0	25	25
Methoxychlor	METHOXY	1.5	15	15
Dieldrin	DIELDRIN	0.5	1.0	1.0

Endosulfan I	ENDO_I	0.5	1.0	1.0
Endosulfan II	ENDO_II	1.0	3.0	3.0
Endosulfan sulfate	ESO4	2.0	5.0	5.0
Endrin	ENDRIN	2.0	6.0	6.0
Ethion	ETHION	2.0	NA	NA
alpha-HCH	HCHA	0.2	1.0	1.0
beta-HCH	HCHB	1.0	3.0	3.0
gamma-HCH	HCHG	0.2	0.8	1.0
delta-HCH	HCHD	0.5	2.0	2.0
Heptachlor Epoxide	HE	0.5	1.0	1.0
cis-Nonachlor	CNONA	0.5	1.0	1.0
Oxadiazon	OXAD	6	NA	NA
Oxychlorodane	OCDAN	0.5	0.2	1.0

† The quantitation surrogate is PCB 103. ‡ The quantitation surrogate is d8-p,p'-DDD

Table 4. Dry Weight Detection Limits of NIST PCB Congeners.

Analytes †	Database Abbreviation	MDL ng/g dry sediment	MDL ng/g dry tissue	MDL ng/L water
2,4'-dichlorobiphenyl	PCB08	0.5	1.0	1.0
2,2',5'-trichlorobiphenyl	PCB18	0.5	1.0	1.0
2,4,4'-trichlorobiphenyl	PCB28	0.5	1.0	1.0
2,2',3,5'-tetrachlorobiphenyl	PCB44	0.5	1.0	1.0
2,2',5,5'-tetrachlorobiphenyl	PCB52	0.5	1.0	1.0
2,3',4,4'-tetrachlorobiphenyl	PCB66	0.5	1.0	1.0
2,2',3,4,5'-pentachlorobiphenyl	PCB87	0.5	1.0	1.0
2,2',4,5,5'-pentachlorobiphenyl	PCB101	0.5	1.0	1.0
2,3,3',4,4'-pentachlorobiphenyl	PCB105	0.5	1.0	1.0
2,3',4,4',5-pentachlorobiphenyl	PCB118	0.5	1.0	1.0
2,2',3,3',4,4'-hexachlorobiphenyl	PCB128	0.5	1.0	1.0
2,2',3,4,4',5'-hexachlorobiphenyl	PCB138	0.5	1.0	1.0
2,2',4,4',5,5'-hexachlorobiphenyl	PCB153	0.5	1.0	1.0
2,2',3,3',4,4',5-heptachlorobiphenyl	PCB170	0.5	1.0	1.0
2,2',3,4,4',5,5'-heptachlorobiphenyl	PCB180	0.5	1.0	1.0
2,2',3,4',5,5',6-heptachlorobiphenyl	PCB187	0.5	1.0	1.0
2,2',3,3',4,4',5,6-octachlorobiphenyl	PCB195	0.5	1.0	1.0
2,2',3,3',4,4',5,5',6-nonachlorobiphenyl	PCB206	0.5	1.0	1.0
2,2',3,3',4,4',5,5',6,6'-decachlorobiphenyl	PCB209	0.5	1.0	1.0

† PCB 103 is the surrogate used for PCBs with 1 - 6 chlorines per molecule. PCB 207 is used for all others.

Table 5. Dry Weight Minimum Detection Limits for additional PCB congeners.

Analytes †	Database Abbreviation	MDL ng/g dry sediment	MDL ng/g dry tissue	MDL ng/L water
2,3-dichlorobiphenyl	PCB5	0.5	1.0	1.0
4,4'-dichlorobiphenyl	PCB15	0.5	1.0	1.0
2,3',6-trichlorobiphenyl	PCB27	0.5	1.0	1.0
2,4,5-trichlorobiphenyl	PCB29	0.5	1.0	1.0
2,4',4-trichlorobiphenyl	PCB31	0.5	1.0	1.0
2,2',4,5'-tetrachlorobiphenyl	PCB49	0.5	1.0	1.0
2,3',4',5-tetrachlorobiphenyl	PCB70	0.5	1.0	1.0
2,4,4',5-tetrachlorobiphenyl	PCB74	0.5	1.0	1.0
2,2',3,5',6-pentachlorobiphenyl	PCB95	0.5	1.0	1.0
2,2',3',4,5-pentachlorobiphenyl	PCB97	0.5	1.0	1.0
2,2',4,4',5-pentachlorobiphenyl	PCB99	0.5	1.0	1.0
2,3,3',4',6-pentachlorobiphenyl	PCB110	0.5	1.0	1.0
2,2',3,3',4,6'-hexachlorobiphenyl	PCB132	0.5	1.0	1.0
2,2',3,4,4',5-hexachlorobiphenyl	PCB137	0.5	1.0	1.0
2,2',3,4',5',6-hexachlorobiphenyl	PCB149	0.5	1.0	1.0
2,2',3,5,5',6-hexachlorobiphenyl	PCB151	0.5	1.0	1.0
2,3,3',4,4',5-hexachlorobiphenyl	PCB156	0.5	1.0	1.0
2,3,3',4,4',5'-hexachlorobiphenyl	PCB157	0.5	1.0	1.0
2,3,3',4,4',6-hexachlorobiphenyl	PCB158	0.5	1.0	1.0
2,2',3,3',4,5,6'-heptachlorobiphenyl	PCB174	0.5	1.0	1.0
2,2',3,3',4',5,6-hexachlorobiphenyl	PCB177	0.5	1.0	1.0
2,2',3,4,4',5,6-heptachlorobiphenyl	PCB183	0.5	1.0	1.0
2,3,3',4,4',5,5'-heptachlorobiphenyl	PCB189	0.5	1.0	1.0
2,2',3,3',4,4',5,5'-octachlorobiphenyl	PCB194	0.5	1.0	1.0
2,2',3,3',4,4',5,6,6'-octachlorobiphenyl	PCB201	0.5	1.0	1.0
2,2',3,4,4',5,5',6-octachlorobiphenyl	PCB203	0.5	1.0	1.0

† PCB 103 is the surrogate used for PCBs with 1 - 6 chlorines per molecule. PCB 207 is used for all others.

Table 6: Dry Weight Minimum Detection Limits of Chlorinated Technical Grade Mixtures

Analytes †	Database Abbreviation	MDL ng/g dry Sediment	MDL ng/g dry Tissue	MDL ng/L Water
Toxaphene ‡	TOXAPH	50	100	100
Polychlorinated Biphenyl Aroclor 1248	ARO1248	5	100	100
Polychlorinated Biphenyl Aroclor 1254	ARO1254	5	50	50
Polychlorinated Biphenyl Aroclor 1260	ARO1260	5	50	50
Polychlorinated Terphenyl Aroclor 5460†	ARO5460	10	100	100

† The quantitation surrogate is PCB 207. ‡ The quantitation surrogate is d8-p,p'-DDD



Table 7: Dry Weight Minimum Detection Limits of Polyaromatic Hydrocarbons in Tissue

Analytes †	Database Abbreviation	MDL ng/g dry Sediment	MDL ng/g dry Tissue	MDL ng/L Water
Naphthalene	NPH	5	10	30
2-Methylnaphthalene	MNP2	5	10	30
1-Methylnaphthalene	MNP1	5	10	30
Biphenyl	BPH	5	10	30
2,6-Dimethylnaphthalene	DMN	5	10	30
Acenaphthylene	ACY	5	10	30
Acenaphthene	ACE	5	10	30
2,3,5-Trimethylnaphthalene	TMN	5	10	30
Fluorene	FLU	5	10	30
Dibenzothiophene	DBT	5	10	30
Phenanthrene	PHN	5	10	30
Anthracene	ANT	5	10	30
1-Methylphenanthrene	MPH1	5	10	30
Fluoranthene	FLA	5	10	30
Pyrene	PYR	5	10	30
Benz[a]anthracene	BAA	5	10	30
Chrysene	CHR	5	10	30
Tryphenylene	TRY	5	10	30
Benzo[b]fluoranthene	BBF	5	10	30
Benzo[k]fluoranthene	BKF	5	10	30
Benzo[e]pyrene	BEP	5	10	30
Benzo[a]pyrene	BAP	5	10	30
Perylene	PER	5	10	30
Indeno[1,2,3-cd]pyrene	IND	5	15	45
Dibenz[a,h]anthracene	DBA	5	15	45
Benzo[ghi]perylene	BGP	5	15	45
Coronene	COR	5	15	45

† See QA report for surrogate assignments.

Table 8. Dry Weight Minimum Detection Limits of Organometallic Compounds

Analytes †	Database Abbreviation	MDL ng/g dry Sediment	MDL ng/g dry Tissue	MDL ng/L Water
Tributyltin	TBT	13	20	1

### Summary of Methods

Analytical sets of 12 samples were scheduled such that extraction and analysis would occur within a 40-day window. Methods employed by UCSC-TOF were modifications of those described by Sloan et al. (1993). Tables 3-8 indicate the pesticides, PCBs, and PAHs currently analyzed, and list method detection limits for sediments and tissues on a dry weight basis.

## **Sediment Extraction**

Samples were removed from the freezer and allowed to thaw. A 10-gram sample of sediment was removed for chemical analysis and an independent 10-gram aliquot was removed for dry weight determinations. The dry weight sample was placed into a pre-weighed aluminum pan and dried at 110°C for 24 hours. The dried sample was reweighed to determine the sample's percent moisture. The analytical sample was extracted 3 times with methylene chloride in a 250-mL amber Boston round bottle on a modified rock tumbler. Prior to rolling, sodium sulfate, copper, and extraction surrogates were added to the bottle. Sodium sulfate dehydrates the sample allowing for efficient sediment extraction. Copper, which was activated with hydrochloric acid, complexes free sulfur in the sediment. After combining the three extraction aliquots, the extract was divided into two portions, one for chlorinated hydrocarbon (CH) analysis and the other for polycyclic aromatic hydrocarbon (PAH) analysis.

## **Tissue Extraction**

Samples were removed from the freezer and allowed to thaw. A 5-gram sample of tissue was removed for chemical analysis and an independent 5-gram aliquot was removed for dry weight determinations. The dry weight sample was placed into a pre-weighed aluminum pan and dried at 110°C for 24 hours. The dried sample was reweighed to determine the sample's percent moisture. The analytical sample was extracted twice with methylene chloride using a Tekmar Tissumizer. Prior to extraction, sodium sulfate and extraction surrogates were added to the sample and methylene chloride.

The two extraction aliquots were combined and brought to 100 mL. A 25-mL aliquot was decanted through a Whatmann 12.5 cm #1 filter paper into a pre-weighed 50 mL flask for lipid weight determination. The filter was rinsed with ~15 mL of methylene chloride and the remaining solvent was removed by vacuum-rotary evaporation. The residue was dried for 2 hours at 110°C and the flask was re-weighed. The change in weight was taken as the total methylene chloride extractable mass. This weight then was used to calculate the samples "percent lipid".

## **Organic Analysis**

The CH portion was eluted through a silica/alumina column, separating the analytes into two fractions. Fraction 1 (F1) was eluted with 1% methylene chloride in pentane and contained > 90% of p,p'-DDE and < 10% of p,p'-DDT. Fraction 2 (F2) analytes were eluted with 100% methylene chloride. The two fractions were exchanged into hexane and concentrated to 500 µL using a combination of rotary evaporation, controlled boiling on tube heaters, and dry nitrogen blow downs.

F1 and F2 fractions were analyzed on Hewlett-Packard 5890 Series gas chromatographs utilizing capillary columns and electron capture detection (GC/ECD). A single 2 µl

splitless injection was directed onto two 60 m x 0.25 mm i.d. columns of different polarity (DB-17 & DB-5; J&W Scientific) using a glass Y-splitter to provide a two dimensional confirmation of each analyte. Analytes were quantified using internal standard methodologies. The extract's PAH portion was eluted through a silica/alumina column with methylene chloride. It then underwent additional cleanup using size-exclusion high performance liquid chromatography (HPLC/SEC). The collected PAH fraction was exchanged into hexane and concentrated to 250  $\mu$ L in the same manner as the CH fractions.

### ***Total Organic Carbon Analysis of Sediments***

#### **Summary of Methods**

Samples were received in the frozen state and allowed to thaw at room temperature. Source samples were gently stirred and sub-samples removed with a stainless steel spatula and placed in labeled 20 ml polyethylene scintillation vials. Approximately 5 grams equivalent dry weight of the wet sample was sub-sampled.

Sub-samples were treated with two, 5 ml additions of 0.5 N, reagent grade HCl to remove inorganic carbon ( $\text{CO}_3^{2-}$ ), agitated, and centrifuged to a clear supernate. Some samples were retreated with HCl to remove residual inorganic carbon. The evolution of gas during HCl treatment indicates the direct presence of inorganic carbon ( $\text{CO}_3^{2-}$ ). After HCl treatment and decanting, samples were washed with approximately 15 ml of deionized-distilled water, agitated, centrifuged to a clear supernate, and decanted. Two sample washings were required to remove weight determination and analysis interferences.

Prepared samples were placed in a 60°C convection oven and allowed to completely dry (approx. 48 hrs). Visual inspection of the dried sample before homogenization ensured complete removal of carbonate containing materials, (shell fragments). Two 61 mm (1/4") stainless steel solid balls were added to the dried sample, capped and agitated in a commercial ball jar mill for three minutes to homogenize the dried sample.

A modification of the high temperature combustion method, utilizing a Wheatstone bridge current differential was used (Control Equipment Co., No. 440 Elemental Analyzer) to determine carbon and nitrogen concentrations. The manufacturer's suggested procedures were followed. The methods are comparable to the validation study of USEPA method MARPCPN I. Two to three aliquots of 5-10 mg of dried prepared sub-sample were used to determine carbon and nitrogen weight percent values. Calibration of the instrument was with known standards using Acetanilide or L-Cystine. Detection limits were 0.2  $\mu$ g/mg, carbon and 0.01  $\mu$ g/mg nitrogen dry weight.

The above methods and protocols are modifications based on several published papers, reference procedures and analytical experimentation experience (Franson, 1981; Froelich, 1980; Hedges and Stern, 1983; MARPCPN I, 1992).

Quality control was assessed by the analysis of National Research Council of Canada Marine Sediment Reference Material, and BCSS-1 at the beginning and end of each sample analysis set (20-30 individual machine analyses). All analyzed values were within suggested criteria of  $\pm 0.09\%$  carbon (2.19% Average). Nitrogen is not reported on the standard data report, but was accepted at  $\pm 0.008\%$  nitrogen (0.195% Average) from the EPA study. Quality assurance was monitored by re-calibration of the instrument every twenty samples and by the analysis of a standard as an unknown and comparing known theoretical percentages with resultant analyzed percentages. Acceptable limits of standard unknowns is less than  $\pm 2\%$ . Sample variance was assessed by duplicate or triplicate sample analysis, variance (standard deviation/mean) was always less than 7%.

### ***Grain Size Analysis of Sediments***

#### **Sample Splitting and Preparation**

The procedure used combined wet and dry sieve techniques to determine particle size of sediment samples. Methods follow those of Folk (1974). Samples were thawed and thoroughly homogenized by stirring with a spatula. Spatulas were rinsed of all adhering sediment between samples. Size of the subsample for analysis was determined by the sand/silt ratio of the sample. During splitting, the sand/silt ratio was estimated and an appropriate sample weight was calculated. Subsamples were placed in clean, pre-weighed beakers. Debris was removed and any adhering sediment was washed into the beaker.

#### **Wet Sieve Analysis (separation of coarse and fine fraction)**

Beakers were placed in a drying oven and sediments were dried at less than 55°C until completely dry (approximately three days). Beakers were removed from drying oven and allowed to equilibrate to room temperature for a least a half-hour. Each beaker and its contents were weighed to the nearest .01 g. This weight minus the empty beaker weight was the total sample weight. Sediments in beakers were disaggregated using 100 ml of a dispersant solution in water (such as 50g Calgon/L water) and the sample was stirred until completely mixed and all lumps disappear. The amount and concentration of dispersant used was recorded on the data sheet for each sample. Sample beakers were placed in an ultrasonic cleaner for 15 minutes for disaggregation. Sediment dispersant slurry was poured into a 63  $\mu\text{m}$  (ASTM #230, 4 phi) stainless steel or brass sieve in a large glass funnel suspended over a 1L hydrometer cylinder by a ring stand. All fine sediments were washed through the sieve with water. Fine sediments were captured in a 1L hydrometer cylinder. Coarse sediments remaining in sieve were collected and returned to the original sample beaker for quantification.

### **Dry Sieve Analysis (coarse fraction)**

The coarse fraction was placed into a preweighed beaker, dried at 55-65°C, allowed to acclimate, and then weighed to 0.01 g. This weight, minus the empty beaker weight, was the coarse fraction weight. The coarse fraction was poured into the top sieve of a stack of ASTM sieves having the following sizes: No. 10 (2.0 mm), 18 (1.0 mm), 45 (0.354 mm), 60 (0.25 mm), 80 (0.177 mm), 120 (0.125 mm), and 170 (0.088 mm). The stack was placed on a mechanical shaker and shaken at medium intensity for 15 minutes. After shaking, each sieve was inverted onto a large piece of paper and tapped 5 times to free stuck particles. The sieve fractions were added cumulatively to a weighing dish, and the cumulative weight after each addition determined to 0.01g. The sample was returned to its original beaker, and saved until sample computations were completed and checked for errors.

### **Hydrometer Analysis (Fine Fraction)**

Hydrometers used for the analysis were precalibrated using the techniques of Lewis (1984). A reference cylinder was filled with water and 100 ml of dispersant solution. Prior to the analysis, a hydrometer reading was taken for Cc, the composite correction for temperature, dispersing agent, and the meniscus.

For each of the sample cylinders, the volume was raised to 1000 ml using tap water. The hydrometer number was recorded, the temperature was noted, and the sample added and stirred for 1 minute. Hydrometer readings were taken at 1 minute, 3 minutes, 10 minutes, 30 minutes, 90 minutes, 4.5 hours and 24 hours. If the water temperature had changed by greater than 2°C then hydrometer corrections were remeasured. The colloidal weight was determined by subtracting the other fractions from the total weight.

### **Analytical Procedures**

Fractional weights and percentages for various particle size fractions were calculated. If only wet sieve analysis was used, weight of fine fraction was computed by subtracting coarse fraction from total sample weight, and percent fine composition was calculated using fine fraction and total sample weights. If dry sieve was employed as well, fractional weights and percentages for the sieve were calculated using custom software on a Macintosh computer. Calibration factors were stored in the computer.

### ***Toxicity Testing***

### **Summary of Methods**

All toxicity tests were conducted at the California Department of Fish and Game's Marine Pollution Studies Laboratory (MPSL) at Granite Canyon. Toxicity tests were conducted

by personnel from the Institute of Marine Sciences, University of California, Santa Cruz. As stated above, this report discusses data collected in 20 sampling Legs over a 5-year period. A number of different toxicity tests were employed during this period. All samples analyzed for toxicity were tested with the 10-day amphipod survival protocol using either *Rhepoxynius abronius* or *Eohaustorius estuarius*. *Rhepoxynius* was used in the majority of the earlier (Screening) Legs while *Eohaustorius* was used in later confirmation Legs. *Eohaustorius* was used in later Legs because it is less susceptible to fine grain sediments and unionized ammonia (EPA, 1994), two sediment characteristics which often confound interpretation of toxicity test results.

In addition to the 10-d solid phase amphipod test, all stations in Legs 1 through 4 were screened for pore water toxicity using the red abalone (*Haliotis rufescens*) 48-h embryo-larval development protocol. Pore water toxicity was also assessed in later Legs (1-23, and 45) using the purple sea urchin (*Strongylocentrotus purpuratus*) embryo-larval development protocol.

A number of other solid-phase and pore water toxicity test protocols were used in this study. In some cases these tests were included as part of ongoing protocol evaluations conducted as part of the Bay Protection and Toxic Cleanup Program. These included the 20-d solid phase growth and survival protocol using the polychaete worm *Neanthes arenaceodentata*, the 96-h solid phase sediment water interface protocol using purple sea urchin embryo development, and the 20-minute purple sea urchin fertilization protocol using pore water. In a few cases the bivalve embryo-larval development protocol using the Bay mussel *Mytilus galloprovincialis* was used to assess pore water or subsurface site water toxicity, because the salinity of the samples was too low to use sea urchin or abalone embryos. The specific methods for all of the species and protocols tested are described in more detail below.

### **Sediment Samples**

Bedded sediment samples were transported to MPSL from the sample-processing laboratory at Moss Landing in ice chests at 4°C. Transport time was one hour. Samples were held at 4°C, and all tests were initiated within 14 days of sample collection, unless otherwise noted in the Quality Assurance Appendix. All sediment samples were handled according to procedures described in ASTM (1992) and BPTCP Quality Assurance Project Plan (QAPP, 1993). Samples were removed from refrigeration the day before the test, and loaded into test containers. Water quality was measured at the beginning and end of all tests. At these times pH, temperature, salinity, and dissolved oxygen were measured in overlying water from all samples to verify that water quality criteria were within the limits defined for each test protocol. Total ammonia concentrations were also measured at these times. Samples of overlying and interstitial water for hydrogen sulfide measurement were taken at the beginning and end of each toxicity test. Interstitial water measurements were taken from Leg 30 on, prior to that only overlying water

measurements were taken. Hydrogen sulfide samples were preserved with zinc acetate and stored in the dark until time of measurement.

### **Pore Water Samples**

Once at MPSL, frozen porewater samples (squeeze extracted porewater, Legs 1-23) were stored in the dark at -12°C until required for testing. Experiments performed by the U.S. National Biological Survey have shown no effects of freezing porewater upon the results of toxicity tests (Carr et al., 1995). Unfrozen pore water samples (centrifuge extracted porewater, Legs 25-54) were stored in the dark, at 4°C. All porewater samples were equilibrated to test temperature (15°C) on the day of a test, and pH, temperature, salinity, and dissolved oxygen were measured in all samples to verify water quality criteria were within the limits defined for the test protocol. Total ammonia and sulfide concentrations were also measured. Pore water samples with salinities outside specified ranges for each protocol were adjusted to within the acceptable range. Salinities were increased by the addition of hypersaline brine, 60 to 80‰, drawn from partially frozen seawater. Dilution water consisted of Granite Canyon seawater (32 to 34‰). Water quality parameters were measured at the beginning and end of each test.

### **Subsurface Water Samples**

Abalone, mussel and urchin embryo-larval development tests were performed on selected subsurface water column samples (described above). Toxicity tests were initiated within 14 days of the sample collection date. Water quality parameters, including ammonia and sulfide concentrations, were measured in one replicate test container from each sample in the overlying water as described above. Measurements were taken at the beginning and end of all tests.

### **Measurement of Ammonia and Hydrogen Sulfide**

Total ammonia concentrations were measured using an Orion Model 95-12 Ammonia Electrode. The concentration of unionized ammonia was derived from the concentration of total ammonia using the following equation (from Whitfield 1974, 1978):

$$[\text{NH}_3] = [\text{total ammonia}] \times ((1 + \text{antilog}(\text{pK}_a^\circ - \text{pH}))^{-1}),$$

where  $\text{pK}_a^\circ$  is the stoichiometric acidic hydrolysis constant for the test temperature and salinity. Values for  $\text{pK}_a^\circ$  were experimentally derived by Khoo et al. (1977). The method detection limit for total ammonia was 0.1 mg/L.

Total sulfide concentrations were measured using an Orion Model 94-16 Silver/Sulfide Electrode, except that samples tested after February, 1994, were measured on a spectrophotometer using a colorimetric method (Phillips et al., 1997). The concentration

of hydrogen sulfide was derived from the concentration of total sulfide by using the following equation (ASCE, 1989):

$$[\text{H}_2\text{S}] = [\text{S}^{2-}] \times (1 - ((1 + \text{antilog}(\text{pK}_a^\circ - \text{pH}))^{-1})),$$

where temperature and salinity dependent  $\text{pK}_a^\circ$  values were taken from Savenko (1977). The method detection limit for total sulfide was 0.1 mg/L for the electrode method, and 0.01 mg/L for the colorimetric method. Values and corresponding detection limits for unionized ammonia and hydrogen sulfide were an order of magnitude lower than those for total ammonia and total sulfide, respectively. Care was taken with all sulfide and ammonia samples to minimize volatilization by keeping water quality sample containers capped tightly until analysis.

### **Marine (*Rhepoxynius abronius*) and Estuarine (*Eohaustorius estuarius*) Amphipod Survival Tests**

Solid-phase sediment sample toxicity was assessed using the 10-day amphipod survival toxicity test protocols outlined in EPA 1994. All *Eohaustorius* and *Rhepoxynius* were obtained from Northwestern Aquatic Sciences in Yaquina Bay, Oregon. Animals were separated into groups of approximately 100 and placed in polyethylene boxes containing Yaquina Bay collection site sediment, then shipped on ice via overnight courier. Upon arrival at Granite Canyon, the *Eohaustorius* were acclimated to 20‰ (T=15°C), and *Rhepoxynius* were acclimated to 28‰ (T=15°C). Once acclimated, the animals were held for an additional 48-hours prior to addition to the test containers. Upon arrival at Granite Canyon, the amphipods were acclimated slowly (<2‰ per day) to 28‰ seawater (T=20°C). Once acclimated, the animals were held for an additional 48 hours prior to inoculation into the test containers.

Test containers were one liter glass beakers or jars containing 2 cm of sediment and filled to the 700-ml line with control seawater adjusted to the appropriate salinity using spring water or distilled well water. Test sediments were not sieved for indigenous organisms prior to testing although at the conclusion of the test, the presence of any predators was noted and recorded on the data sheet. Test sediment and overlying water were allowed to equilibrate for 24 hours, after which 20 amphipods were placed in each beaker along with control seawater to fill test containers to the one-liter line. Test chambers were aerated gently and illuminated continuously at ambient laboratory light levels.

Five laboratory replicates of each sample were tested for ten days. A negative sediment control consisting of five lab replicates of Yaquina Bay home sediment for *Eohaustorius* and *Rhepoxynius* was included with each sediment test. After ten days, the sediments were sieved through a 0.5-mm Nitex screen to recover the test animals, and the number of survivors was recorded for each replicate.



Positive control reference tests were conducted concurrently with each sediment test using cadmium chloride as a reference toxicant. For these tests, amphipod survival was recorded in three replicates of four cadmium concentrations after a 96-hour water-only exposure. A negative seawater control consisting of one-micron-filtered Granite Canyon seawater, diluted to the appropriate salinity was compared to all cadmium concentrations.

Amphipod survival for each replicate was calculated as:

$$\frac{(\text{Number of surviving amphipods}) \times 100}{(\text{Initial number of amphipods})}$$

### **Abalone (*Haliotis rufescens*) Embryo-Larval Development Test**

The red abalone (*Haliotis rufescens*) embryo-larval development test was conducted on some pore water and subsurface water samples. Details of the test protocol are given in EPA (1995). A brief description of the method follows.

Adult male and female abalone were induced to spawn separately using a dilute solution of hydrogen peroxide in seawater. Fertilized eggs were distributed to the test containers within one hour of fertilization. Test containers were polyethylene-capped, seawater leached, 20-ml glass scintillation vials containing 10 ml of sample. Each test container was inoculated with 100 embryos (10/mL). Samples that were tested at multiple concentrations were diluted with one-micron-filtered Granite Canyon seawater. Laboratory controls were included with each set of samples tested. Controls include a dilution water control consisting of Granite Canyon seawater, and a brine control with all samples that require brine adjustment. Tests were conducted at ambient seawater salinity (33±2‰). A 48-h positive control reference test was conducted concurrently with each pore water test using a dilution series of zinc sulfate as a reference toxicant.

After a 48-h exposure period, developing larvae were fixed in 5% buffered formalin. All larvae in each container were examined using an inverted light microscope at 100x to determine the proportion of veliger larvae with normal shells, as described in EPA (1995). Percent normal development was calculated as:

$$\frac{\text{Number of normally developed larvae counted} \times 100}{\text{Total number of larvae counted}}$$

### **Bay Mussel (*Mytilus* spp.) Embryo-Larval Development Test**

The bay mussel (*Mytilus* spp.) embryo-larval development test was conducted on some low salinity pore water and subsurface water samples because this protocol is more tolerant than abalone and sea urchin embryos to lower salinities. Details of the test protocol are given in EPA (1995). A brief description of the method follows.

Adult male and female mussels were induced to spawn separately using temperature shock by raising the ambient temperature by 10°C. Fertilized eggs were distributed to the test containers within four hours of fertilization. Test containers were polyethylene-capped, seawater leached, 20-ml glass scintillation vials containing 10 mLs of sample. Each test container was inoculated with 150 to 300 embryos (15-30/mL) consistent among replicates and treatments within a test set. Samples that were tested at multiple concentrations were diluted with one-micron-filtered Granite Canyon seawater. Laboratory controls were included with each set of samples tested. Controls include a dilution water control consisting of Granite Canyon seawater, a brine control with all samples that require brine adjustment. Tests were conducted at 28±2‰. A 48-h positive control reference test was conducted concurrently with each test using a dilution series of cadmium chloride as a reference toxicant.

After a 48-h exposure period, developing larvae were fixed in 5% buffered formalin. All larvae in each container were examined using an inverted light microscope at 100x to determine the proportion of normal live prossidoconch larvae, as described in EPA (1995). Percent normal live larvae was calculated as:

$$\frac{\text{Number of normal larvae} \times 100}{\text{Initial embryo density}}$$

#### **Polychaete Worm (*Neanthes arenaceodentata*) Survival and Growth Test**

The *Neanthes* test followed procedures described in Puget Sound Protocols (1992). Emergent juvenile *Neanthes arenaceodentata* (2-3 weeks old) were obtained from Dr. Donald Reish of California State University, Long Beach. Worms were shipped in seawater in plastic bags at ambient temperature via overnight courier. Upon arrival at MPSL, worms were allowed to acclimate gradually to 28‰ salinity (<2‰ per day, T=15°C). Once acclimated, the worms were maintained at least 48 hours, and no longer than 10 days, before the start of the test.

Test containers were one-liter glass beakers or jars containing 2 cm of sediment and filled to the 700-ml line with seawater adjusted to 28‰ using spring water or distilled well water. Test sediments were not sieved for indigenous organisms prior to testing, but the presence of any predators was noted and recorded on the data sheet at the conclusion of the test. Test sediment and overlying water were allowed to equilibrate for 24 hours, after which 5 worms were placed in each beaker along with 28‰ seawater to fill test containers to the one-liter line. Test chambers were aerated gently and illuminated continuously at ambient laboratory light levels. Worms were fed TetraMin® every 2 days, and overlying water was renewed every 3 days. Water quality parameters were measured at the time of renewals.

After 20 days, samples were sieved through a 0.5-mm Nitex screen, and the number of surviving worms recorded. Surviving worms from each replicate were wrapped in an

piece of pre-weighed aluminum foil, and placed in a drying oven until reaching a constant weight. Each foil packet was then weighed to the nearest 0.1 mg. Worm survival and mean weight/worm for each replicate was calculated as follows:

$$\text{Percent worm survival} = \frac{(\text{Number of surviving worms})}{(\text{Initial number of worms})} \times 100$$

$$\text{Mean weight per worm} = \frac{(\text{Total weight} - \text{foil weight})}{(\text{Number of surviving worms})} \times 100$$

### **Purple Sea Urchin (*Strongylocentrotus purpuratus*) Embryo-Larval Development Test**

The sea urchin (*Strongylocentrotus purpuratus*) larval development test was conducted on some pore water and solid phase sediment-water interface samples. Details of the test protocol are given in EPA (1995). A brief description of the method follows.

Sea urchins were collected from the Monterey County coast near Granite Canyon, and held at MPSL at ambient seawater temperature and salinity (33±2‰) until testing. Adult sea urchins were held in complete darkness to preserve gonadal condition. On the day of a test, urchins were induced to spawn in air by injection with 0.5M KCl. Eggs and sperm collected from the urchins were mixed in seawater at a 500 to 1 sperm to egg ratio, and embryos were distributed to test containers within 1 hour of fertilization. Test containers were polyethylene-capped, seawater leached, 20-ml glass scintillation vials containing 10 mLs of sample. Each test container was inoculated with approximately 250 embryos (25/ml). All pore water samples were tested at three concentrations: 100, 50 and 25% pore water, each having three replicates. Pore water samples were diluted with one-micron-filtered Granite Canyon seawater. Laboratory controls were included with each set of samples tested. Controls include a dilution water control consisting of Granite Canyon seawater, and a brine control with all samples that require brine adjustment. Tests were conducted at ambient seawater salinity (33±2‰). A 96-hour positive control reference test was conducted concurrently with each pore water test using a dilution series of copper chloride as a reference toxicant.

After a 96-hour exposure, larvae were fixed in 5% buffered formalin. Approximately 100 larvae in each container were examined under an inverted light microscope at 100x to determine the proportion of normally developed larvae as described in EPA (1995). Visual clues used to identify embryos as normal included development of skeletal rods (spicules) that extend beyond half the length of the larvae and normal development of a three-part gut. Embryos demonstrating retarded development were considered abnormal. Percent normal development was calculated as:

$$\frac{\text{Number of normally developed larvae counted}}{\text{Total number of larvae counted}} \times 100$$

### **Purple Sea Urchin (*Strongylocentrotus purpuratus*) Embryo-Larval Development Test Exposed at the Sediment-Water Interface**

In some cases solid-phase sediment toxicity was assessed using the purple sea urchin (*Strongylocentrotus purpuratus*) embryo/larval development test. In this case, sea urchin embryos were exposed to intact (un-homogenized) sediment cores at the sediment-water interface. Intact sediment cores were collected directly from the Van Veen grab sampler. Details of the test protocol are given in the MPLS Standard Operating Procedure, which follows the EPA methods manual (1995). A brief description of the method follows.

Sediment-water interface test containers consisted of a polycarbonate tube with a 25- $\mu$ m screened bottom placed so that the screen was within 1 cm of the surface of an intact sediment core (Anderson et al., 1996). Seawater at ambient salinity was poured into the core tube and allowed to equilibrate for 24 hours before the start of the test. After inserting the screen tube into the equilibrated cores, each tube was inoculated with approximately 250 embryos obtained using the methods described above. A negative laboratory control consisted of the Yaquina Bay home sediment used in all amphipod tests. Tests were conducted at ambient seawater salinity  $\pm$  2‰. Ambient salinity at Granite Canyon is usually 32 to 34‰. A positive control reference test was conducted concurrently with the test using a dilution series of copper chloride as a reference toxicant.

After an exposure period of 96 hours, larvae were fixed in 5% buffered formalin. One hundred larvae in each container were examined under an inverted light microscope at 100x to determine the proportion of normally developed larvae as described in EPA (1995). Percent normal development was calculated as:

$$\frac{\text{Number of normally developed larvae counted} \times 100}{\text{Total number of larvae counted}}$$

### **Sea Urchin (*Strongylocentrotus purpuratus*) Fertilization Test**

The sea urchin (*Strongylocentrotus purpuratus*) fertilization test was conducted on pore water samples. Details of the test protocol are described in Dinnel et al. (1987). Sea urchins were from the same stock described for the sea urchin larval development test. On the day of a test, urchins were induced to spawn in air by injection with 0.5M KCl. Sperm were exposed in test containers for sixty minutes before approximately 1000 eggs were added. After twenty minutes of fertilization, the test was fixed in a 5% buffered formalin solution. A constant sperm to egg ratio of 500 to 1 was used in all tests. This ratio maintained fertilization in the 70-90% range required by the test protocol. Fertilization was determined by the presence or absence of a fertilization membrane. Test containers were polyethylene-capped, seawater leached, 20-ml glass scintillation vials containing 5 mls of pore water. Pore water samples were diluted with one micron-filtered Granite Canyon seawater. Laboratory controls were included with each set of samples

tested. Controls included a dilution water control consisting of Granite Canyon seawater, a brine control with all samples that require brine adjustment. Tests were conducted at ambient seawater salinity (33±2 ppt). A positive control reference test (1 hour sperm exposure) was conducted concurrently with each pore water test using a dilution series of copper chloride as a reference toxicant. All eggs in each container were examined under an inverted light microscope at 100x, and counted as either fertilized or unfertilized. Percent fertilization was calculated as:

$$\frac{\text{Number of fertilized eggs}}{\text{Number of eggs observed}} \times 100$$

### **Test Acceptability and Evaluation**

Quality Assurance/Quality Control (QA/QC) guidelines for the toxicity tests used in the BPTCP project are summarized in the BPTCP Quality Assurance Project Plan (*Stephenson et al.*, 1994). Test acceptability criteria from published protocols were evaluated for all tests. Quality assurance checklists were compiled that noted compliance for all tests with each of these criteria. Evaluation codes were assigned to each deviation from QA/QC guidelines, and can be summarized as follows:

- 3: sample has minor exceedances of QA criteria that are unlikely to affect assessments.
- 4: sample meets or exceeds control criteria requirements.
- 5: data has exceedances, but are generally usable for most assessments and reporting purposes.
- 6: sample has major exceedances of control criteria requirements and the data is not usable for most assessments and reporting purposes.

It is recommended that if assessments are made that are especially sensitive or critical, the QA evaluations be consulted before using the data. Test data judged to be unacceptable are not reported, and samples from unacceptable tests are retested if necessary.

### ***Benthic Community Analysis***

Each catalogued sample was processed individually in the laboratory to obtain an accurate assessment of species diversity and abundance. All macroinvertebrates were sorted from residues under a dissecting microscope, identified to lowest possible taxon, and counted. Laboratory processing of benthic cores consists of both rough and fine sorting. Initial sorting separates animals into large taxonomic groups such as polychaetes, crustaceans, mollusks and other (e.g., phoronids). Bound laboratory logbooks were maintained and used to record number of samples processed by each technician, as well as results of any sample resorts, if necessary. Sorters were required to sign and date a Milestone Progress Checksheet for each replicate sample processed. Specimens of similar taxonomic groups were placed in vials and labeled internally and

externally with project, date collected, site/station information, and IDORG. In-house senior taxonomists and outside specialists processed and verified the accuracy of species identification and enumeration. An archived voucher specimen collection was established at this time.

### ***Bioaccumulation***

#### **28-day Clam (*Macoma balthica*) Bioaccumulation Test**

The 28-day bioaccumulation test with *Macoma nauta* was conducted according to EPA/Army Corps of Engineers Inland Testing Manual (EPA/ACOE, 1994). Clams were obtained from Brezina and Associates (Dillon Beach, CA). Clams arrived via overnight courier on day 0 of the test. Test containers consisted of 5L polyethylene trays with 2.5L of sediment. Sediment was loaded into test containers, and allowed to equilibrate for 24 hours before clams were added. Fifteen clams were placed in 3 replicate containers and flow-through seawater was started at a rate of 120 mL per minute. After 28 days, sediment was screened and discarded. Surviving clams were placed in clean, flow-through seawater to depurate for 24 hours. After depuration, clams were blotted dry, weighed, and frozen for tissue analysis at -12°C.

A negative control consisting of Yaquina Bay amphipod home sediment from Nwas or *Macoma* collection site sediment was used. Three replicates of clams were depurated for 24 hours at the initiation of the test to obtain baseline tissue concentrations.

### **DATA ANALYSIS**

#### ***Comparison of Chemistry with Sediment Quality Guideline Values***

Bioavailability is the key to understanding the relationship between sediment chemistry and biological impacts. However, using TIEs, bioaccumulation analyses, or other specialized methods to evaluate bioavailability was not possible on the large number of samples evaluated in BPTCP studies to date. In order to assess large numbers of samples for their potential to impact biological resources, we compared sediment chemical concentrations to published guideline values derived from studies of approximately one thousand samples collected nationwide. These studies have used empirical observation of large data sets containing matching chemistry and biology data to provide guidance for evaluating the probability that measured contaminant concentrations may contribute to observed biological effects (MacDonald, 1996; Long et al., 1995). While the reported guideline values were derived from sediments containing mixtures of chemicals, they were calculated individually for each chemical. Their application may be confounded in sediments where biological responses are affected by synergistic or antagonistic interactions among multiple compounds, by unmeasured or unidentified compounds, or by unconsidered physical factors.

The National Status and Trends Program has evaluated chemical and toxicological evidence from a number of laboratory, field, and modeling studies to establish ranges of chemical concentrations which are rarely, sometimes, or usually associated with toxicity. Evaluation of available data (Long et al., 1995) has resulted in the identification of three concentration ranges for selected chemical compounds:

- 1) Minimal Effects Range: The range in concentrations over which toxic effects are rarely observed.
- 2) Possible Effects Range: The range in concentrations over which toxic effects are occasionally observed.
- 3) Probable Effects Range: The range in concentrations over which toxic effects are frequently or always observed.

Two different methods were used to determine these chemical ranges. One method developed by NOAA (Long et al., 1995) used chemical data which were associated with toxic response. These data were used to determine the lower 10th percentile of ranked data where chemical concentration was associated with an effect (Effects Range- Low, or ERL). Chemical concentrations below the ERL are not expected to have an effect. The Effects Range- Median (ERM) reflects the 50th percentile of ranked data and represents the level above which effects are expected to occur. Effects are occasionally expected to occur when chemical concentrations fall between the ERL and ERM.

The screening concentrations described by MacDonald (1996) also identify three ranges of chemical concentrations associated with toxic biological response but use an alternate method. The ranges are identified as PEL (Probable Effects Level), and TEL (Threshold Effects Level). TELs were derived by taking the geometric mean of the 50th percentile of the "No Effects" data and the 15th percentile of the "Effects" data. The PEL values were derived by taking the geometric mean of the 85th percentile of the "No Effects" data and the 50th percentile of the "Effects" data. The ERL, ERM, TEL, and PEL values are provided in Table 9.

Although different data sets and percentiles were used in these two approaches to derive chemical screening concentrations, they are in close agreement, usually within a factor of 2. Values reported for both methods are given in Table 1. Neither of these methods is advocated over the other in this report. Both are used in conjunction with biological measures in the following analysis to establish a weight-of-evidence approach to hotspot identification.

It should be noted that the degree of confidence that MacDonald (1996) and Long et al. (1995) had in their respective numerical guidelines varied considerably among the different chemical substances. For example, both had little confidence in the values for nickel, mercury, DDTs, dieldrin, and endrin. Swartz et al. (1994), reported an effect concentration for amphipods exposed to Total DDT in sediment based on laboratory

dose-response experiments and correlations with field data. This effect concentration is used instead of the ERM for total DDT in this report. This value is 100 µg total DDT per gram of organic carbon.

### ***Non-Guideline Chemicals***

To evaluate chemicals for which no ERM or PEL guidelines have been calculated, concentrations of specific chemicals were compared to the range of chemical concentrations in the BPTCP database. This database contains concentrations of approximately 120 analytes measured in sediments collected in the majority of California's bays, estuaries, lagoons and near coastal areas. The following information was described for each chemical: the Median Detection Limit (MDL), the number of samples analyzed, the number of samples above the MDL, the highest value in the dataset, and the 90<sup>th</sup> and 95<sup>th</sup> percentile thresholds for each chemical. In this report, chemicals for which no sediment quality guideline values have been published were compared to the 90<sup>th</sup> and 95<sup>th</sup> percentile thresholds, and to the range of concentration measured throughout the state for comparison (Table 10).

### ***ERM and PEL Quotients***

Sediment Quality Guideline quotients (SQGQ) were calculated to allow a simple comparison between observed chemical concentrations and guideline values developed for that chemical using a nationwide data base. To derive these quotients for a given sample, the concentration of each chemical was divided by its respective SQG value to get a quotient. Quotient values greater than 1 indicated that the chemical in that sample exceeded its guideline value, and was likely to be associated with biological effects, based on comparisons to the large data sets from which the guidelines were derived.

In screening samples for potential effects of chemical mixtures, the quotient values for 16 chemicals were averaged to get a mean SQG quotient. In this report, sample chemical concentrations were compared primarily to ERM values, where possible, and mean ERMQ values were generally used as summary quotients for chemical mixtures. This mean value was calculated somewhat differently from mean ERMQ values presented by Long et al. (1998), as is discussed below in the section on the use of threshold values. The chemicals used to derive this mean value were: Antimony, Cadmium, Chromium, Copper, Lead, Mercury, Silver, Zinc, Total DDT (using the DDT value of Swartz, et al., 1994), Total Chlordane, Dieldrin, Endrin, Total PCBs, low molecular weight (LMW) PAHs, and high molecular weight (HMW) PAHs. In cases where concentrations of these chemicals were below the analytical method detection limit (MDL), a value of one-half the MDL was used in the derivation of the mean ERMQ. The use of mean ERMQ values was designed to assist with screening samples in which multiple compounds contributed to the overall level of chemical pollution, and was intended for use in conjunction with the standard chemical-specific method discussed above. Although synergistic effects are possible with the different contaminants, this is not implied by the use of mean SQGQs. Quotients are presented as a method for comparing relative degree of contamination at these stations to aid management efforts.



Table 9. Comparison of sediment screening levels developed by NOAA and the state of Florida

SUBSTANCE	State of Florida (1)		NOAA (2,3)	
	TEL	PEL	ERL	ERM
Total PCB (ug/kg- dry weight)	21.550	188.79	22.70	180.0
PAH (ug/kg- dry weight)				
Acenaphthene	6.710	88.90	16.00	500.0
Acenaphthylene	5.870	127.89	44.00	640.0
Anthracene	46.850	245.00	85.30	1100.0
Fluorene	21.170	144.35	19.00	540.0
2-methylnaphthalene	20.210	201.28	70.00	670.0
Naphthalene	34.570	390.64	160.00	2100.0
Phenanthrene	86.680	543.53	240.00	1500.0
Total LMW-PAHs	311.700	1442.00	552.00	3160.0
Benz(a)anthracene	74.830	692.53	261.00	1600.0
Benzo(a)pyrene	88.810	763.22	430.00	1600.0
Chrysene	107.710	845.98	384.00	2800.0
Dibenz(a,h)anthracene	6.220	134.61	63.40	260.0
Fluoranthene	112.820	1493.54	600.00	5100.0
Pyrene	152.660	1397.60	665.00	2600.0
Total HMW-PAHs	655.340	6676.14	1700.00	9600.0
Total PAHs	1684.060	16770.54	4022.00	44792.0
Pesticides (ug/kg- dry weight)				
p,p'DDE	2.070	374.17	2.20	27.0
p,p'DDT	1.190	4.77		
Total DDT	3.890	51.70	1.58	100.0/g o.c.
Lindane	0.320	0.99		
Chlordane	2.260	4.79	2.00	6.0
Dieldrin	0.715	4.30		8.0
Endrin				45.0
Metals (mg/kg- dry weight)				
Arsenic	7.240	41.60	8.20	70.0
Antimony			2.00	25.0
Cadmium	0.676	4.21	1.20	9.6
Chromium	52.300	160.40	81.00	370.0
Copper	18.700	108.20	34.00	270.0
Lead	30.240	112.18	46.70	218.0
Mercury	0.130	0.70	0.15	0.7
Nickel	15.900	42.80	20.90	51.6
Silver	0.733	1.77	1.00	3.7
Zinc	124.000	271.00	150.00	410.0

(1) D.D. MacDonald, 1994

(2) Long et al., 1995

(3) Long and Morgan, 1990

Table 10. Concentrations of non-guideline chemicals relative to the BPTCP database.

Chemical Name	BPTCP Code	MDL	# Anal.	# Above MDL	Highest Value	90th % Threshold	95th % Threshold	ERM
Aluminum	ALUMINUM	1	603	603	165,000	83,000	101,000	n/a
Antimony	ANTIMONY	0.1	603	603	52.8	3.35	5.35	25
Arsenic	ARSENIC	0.1	544	544	1140	21.2	26	70
Cadmium	CADMIUM	0.002	603	603	27.9	1.76	2.67	9.6
Chromium	CHROMIUM	0.02	603	603	860	212	250	370
Copper	COPPER	0.003	603	603	7,800	300	400	270
Iron	IRON	0.1	603	603	336,300	55,300	59,900	n/a
Lead	LEAD	0.03	603	603	2100	120	171	218
Manganese	MANGANESE	0.05	603	603	1190	630	682	n/a
Mercury	MERCURY	0.03	603	603	9.14	0.969	1.54	0.7
Nickel	NICKEL	0.1	550	550	167	88	109	51.6
Silver	SILVER	0.002	603	603	35.7	1.58	2.22	3.7
Selenium	SELENIUM	0.1	544	386	35.7	1.09	1.9	n/a
Tin	TIN	0.02	603	603	92.9	9.03	12	n/a
Zinc	ZINC	0.05	603	603	6,000	490	630	410
Aldrin	ALDRIN	0.5	621	22	8.2	4.7	8.2	n/a
Chloropyrifos	CLPYR	1	444	130	78	28	44.4	n/a
Total Chlordane	TTL_CHLR	3	612	403	246	44.57	69.5	6
Dacthal	DACTH	0.2	465	59	25.2	7.51	19	n/a
Total DDT	TTL_DDT	5.4	621	507	3,569	235.5	471.9	46.1, 100/OC
p',p'Dichlorobenz	DICLB	3	465	46	63.3	30.6	35.2	n/a
Dieldrin	DIELDRIN	0.5	618	210	62.6	11.7	16.8	8
Endosulfan I	ENDO_I	0.5	606	17	19.6	13.4	19.6	n/a
Endosulfan II	ENDO_II	1	606	59	59.8	10.4	13.8	n/a
Endosulfan Sulf.	ESO4	2	606	40	163	21	45.6	n/a
Endrin	ENDRIN	2	618	15	21.8	16.4	21.8	45
Ethion	ETHION	2	69	4	36.4	36.4	36.4	n/a
alpha-HCH	HCHA	0.2	465	14	292	26.1	292	n/a
beta-HCH	HCHB	1	465	6	56.8	56.8	56.8	n/a
g-HCH (Lindane)	HCHG	0.2	618	43	8.4	2.82	8.24	0.99 (PEL)
delta-HCH	HCHD	0.5	465	11	99.4	14.4	99.4	n/a
Heptachlor	HEPTACHLR	0.5	621	58	15.8	4.5	7.3	n/a
Heptachlor Epxid	HE	0.5	618	27	17.8	2.5	3.1	n/a
Hexachlorobenz.	HCB	0.2	621	174	59.7	3.63	7.07	n/a
Methoxychlor	METHOXY	1.5	606	60	131	55.3	78.6	n/a
Mirex	MIREX	0.5	620	25	103	2.6	3.74	n/a
Oxadiazon	OXAD	6	465	12	114	45.8	114	n/a
Oxychlordane	OCDAN	0.5	465	37	30.3	10.7	12.3	n/a
Toxaphene	TOXAPH	50	609	10	3,200	3,200	15,700	n/a
Tributyltin	TBT	0.003	555	555	6.21	0.422	0.724	n/a
Total PCB	TTL_PCB	9	684	628	19,901	497	865	180

Table 10 cont. Concentrations of non-guideline chemicals relative to the BPTCP database.

Chemical Name	BPTCP Code	MDL	# Anal.	# Above MDL	Highest Value	90th % Threshold	95th % Threshold	ERM
Low MI Wt PAHs	LMW_PAH	60	624	473	92,097	2,585	4,253	3,160
High MIWt PAHs	HMW_PAH	60	628	606	225,740	15,727	24,473	9,600
Total PAHs	TTL_PAH	60	628	628	227,801	17,107	27,485	44,792
Total Org Carbon	TOC	n/a	686	686	26.8	3	4.01	n/a
ERM Sum Quot.	ERMQ	n/a	548	n/a	4.37	1.11	1.4	n/a
PEL Sum Quot.	PELQ	n/a	553	n/a	7.8	1.52	1.95	n/a

### *Statistical Analysis of Toxicity Test Data*

Samples were defined as toxic if the following two criteria were met: 1) there was a significant difference ( $p < 0.05$ ) in mean organism response (e.g., percent survival) between a sample and the control as determined using a separate-variance t-test, and 2) mean organism response in the toxicity test, as a percent of the control, was less than the threshold based on the 90<sup>th</sup> percentile Minimum Significant Difference (MSD) value, as a percent of the laboratory control value.

Statistical significance in t-tests is determined by dividing an expression of the difference between sample and control by an expression of the variance among replicates. We used a "separate variance" t-test that adjusted the degrees of freedom to account for variance heterogeneity among samples. If the difference between sample and control is large relative to the variance among replicates, then the difference is determined to be significant. In many cases, however, low between-replicate variance will cause a comparison to be considered significant, even though the magnitude of the difference can be small. These samples were identified as "significantly toxic" in this report in order to acknowledge the statistical difference, although it is recognized that the magnitude of toxicity in some cases may not have been biologically meaningful. A second tier of "significant toxicity" was considered in order to identify those samples where the toxic response was considered to be more biologically meaningful. This involved a second comparison to the Minimum Significant Difference value specific to each toxicity test protocol. The magnitude of difference that can be identified as significant is termed the Minimum Significant Difference (MSD), which is dependent on the selected alpha level, the level of between-replicate variation, and the number of replicates specific to the experiment. With the number of replicates and alpha level held constant, the MSD varies with the degree of between-replicate variation. The "detectable difference" inherent to the toxicity test protocol can be determined by identifying the magnitude of difference that can be detected by the protocol 90% of the time (Schimmel et al., 1994; Thursby and Schlekat, 1993). This is equivalent to setting the level of statistical power at 0.90 for these comparisons. This is accomplished by determining the MSD for each t-test conducted, ranking them in ascending order, and identifying the 90th percentile MSD, the MSD that is larger than or equal to 90% of the MSD values generated.

Thursby et al. (1997) identify a value of 80% of the control as the detectable difference for the *Ampelisca* test, and similar values have been derived for BPTCP test data. Current BPTCP detectable difference (90th percentile MSD) values are listed in Table 11. In the maps and tables presented in this report, samples that were significantly different relative to the control value using a t-test are indicated with either a single asterisk (\*) in the toxicity tables, or grey-shaded circles in the maps. Samples that were significantly different from the control value using a t-test and the MSD value are indicated with either a "T" (= Toxic) in the toxicity tables, or black circles in the maps.

Table 11. Minimum Significant Difference (MSD) values calculated for selected toxicity tests.

Species	Name	MSD	% of control	N
Ee	Eohaustorius	25	75	385
Hr	Haliotis (5 reps)	10	90	131
Hr	Haliotis (3 reps)	36	64	336
Hr	Haliotis (all reps)	32	68	467
Me	Mytilus	20	80	223
Na Sv	Neanthes Sv	36	64	335
Na Wt	Neanthes Wt	56	44	335
Ra	Rhepoxynius	23	77	720
Sp Dev	Urchin Dev (5 reps)	22	78	309
Sp Dev	Urchin Dev (3 reps)	45	55	630
Sp Dev	Urchin Dev (all)	40	60	939
Sp Fert	Urchin Fert	12	88	79
Sp SWI	Urchin SWI	41	59	109

### *Relative Benthic Index*

Benthic samples were sieved, sorted and the number of individuals of each species in each replicate core were identified. A number of summary statistics were calculated for each station, including summaries of total fauna, number of species, and the 4 major phyla (Polychaetes, Crustaceans, Molluscs, and Echinoderms).

The Relative Benthic Index (RBI) used in this study utilizes the above summarized fauna information in a refined version of the benthic index presented in the San Diego and Southern California Bays and Estuaries BPTCP reports (Fairey et al., 1996; Anderson et al., 1997; Fairey et al., In Press). It is based on toxicology and natural history considerations concerning responses of marine benthic communities to anthropogenic and natural disturbances. The community patterns used in the index include number of species (all taxa, only molluscs, and only crustaceans); and the number of individuals of crustaceans, the number of individuals of selected species that are indicators of relatively disturbed benthic habitats, and the number of individuals of selected species that are

indicators of relatively undisturbed benthic habitats. The RBI is developed for particular areas by selecting different indicator species. It does not require the presence of uncontaminated reference stations, and does not refer to data beyond that collected in each study. Often the evaluation of community degradation depends on comparisons to uncontaminated reference sites which are difficult to locate and vary for reasons that are unknown and unrelated to contamination.

In addition to review through discussions with other benthic ecologists (B. Thompson, R. Swartz, M. Bergen) involved in ecotoxicological research, the RBI presented here has undergone peer-review by the Scientific Planning and Review Committee (SPARC) convened by the BPTCP for review of all project activities (SWRCB, 1997). Modifications to the RBI suggested by the SPARC reviewers were incorporated into the index presented here.

### **Number of Species**

The number of species often decreases with severe disturbances (Oliver et al., 1977, 1980; Lenihan and Oliver, 1995) and is the best indicator of biodiversity, particularly when species are sampled in relation to habitat area (Hurlbert, 1971; Jumars, 1975, 1976; Abel and Walters, 1979). Therefore, the first community parameter in the RBI is the total number of species found in a standard sample of habitat area. Among the more numerous large taxonomic groups, crustaceans are generally more sensitive to environmental contaminants and other anthropogenic disturbances than most other components of the infauna, particularly polychaetes (Pearson and Rosenberg, 1978; Reish et al., 1980; Thistle, 1981; Swartz et al., 1986; Stull et al., 1986; Oliver et al., 1977; Lenihan and Oliver, 1995; Lenihan et al., 1995). Speciose and numerically abundant crustacean faunas on the Pacific coast of the United States are generally only found in uncontaminated environments (Barnard, 1963), making the number of crustacean species an important indicator of overall environmental health. To a lesser degree, the number of mollusk species also increase with decreasing environmental stress (Stull et al., 1986; Swartz et al., 1986; Oliver et al., 1977), and are thus also included in the RBI. Polychaetes, crustaceans, and molluscs are the three dominate groups of benthic macro-invertebrates from many nearshore communities (Oliver et al., 1980), but unlike the crustaceans and molluscs many of the most opportunistic or weedy species are polychaete (Grassle and Grassle, 1974; McCall, 1977; Oliver et al., 1977; Pearson and Rosenberg, 1978; Reish et al., 1980; Sanders et al., 1980; Santos and Simon, 1980; Thistle, 1981; Rhoads et al., 1982; Lenihan and Oliver, 1995). As a result, the number of polychaete species was not used in the RBI, because they do not indicate as clearly either a relatively disturbed habitat or a relatively undisturbed habitat.

### **Number of Individuals**

An increase in the number of crustacean individuals is also indicative of relatively healthy environments (Stull et al., 1986; Swartz et al., 1986; Oliver et al., 1977; Lenihan and Oliver, 1995), although sometimes one or two crustacean species can be abundant in

disturbed habitats (Vetter, 1995; Okey, 1997), but less so than for other major taxonomic groups, particularly polychaete worms (Pearson and Rosenberg, 1978; Grassle and Grassle, 1974; Oliver et al., 1977). Therefore, the number of individuals of crustaceans is also used in the RBI, but not the number of individuals in any other major taxonomic group.

### **Indicator Species**

Even more than the number of species or the number of crustacean individuals, the population sizes of selected indicator species are strongly associated with benthic habitats that are relatively disturbed or undisturbed (Grassle and Grassle, 1974; Oliver et al., 1977; Davis and Spies, 1980; Westin, 1990; Lenihan and Oliver, 1995; Okey, 1997). Therefore, five species were used in the RBI as indicators of either highly disturbed or undisturbed benthic communities and habitats. The number and identity of indicator species can change from one regional study site to another. Selection of indicator species was based on known responses to anthropogenic and other disturbances (Grassle and Grassle, 1974; McCall, 1977; Oliver et al., 1977; Pearson and Rosenberg, 1978; Davis and Spies, 1980; Sanders et al., 1980; Santos and Simon, 1980; Thistle, 1981; Lenihan and Oliver, 1995; Okey, 1997) and related natural history such as life history traits (Grassle and Grassle, 1974; Oliver et al., 1977; Rhoads et al., 1978; Rhoads and Boyer, 1982; Lenihan and Oliver, 1995) and abundance patterns along environmental gradients and among the study stations (Oliver et al., 1980; Stull et al., 1986; Swartz et al., 1986; Weston, 1990). The 2 negative indicator species are highly opportunistic annelids which thrive in disturbed, polluted, or marginal environments, and are generally not found in less disturbed communities. The 3 positive indicator species are generally not found in polluted habitats and are characteristic of regions where anthropogenic and other severe disturbances do not play major roles in structuring communities. Each indicator species is discussed below:

### **Negative Indicator Species**

#### *Capitella capitata*

The *Capitella* species complex is a cosmopolitan group which lives in a wide range of conditions: fouled or low oxygen, high organic matter and fine sediments. They are abundant around outfalls discharging biological wastes, and have a rapid (1 to 2 month) life cycle. *Capitella* are capable of surviving for days with little or no oxygen, and are often considered the best example of a "weedy", opportunistic species (Grassle and Grassle, 1974, 1976; Oliver et al., 1977; McCall, 1977; Pearson and Rosenberg, 1978; Lenihan and Oliver, 1995; Okey, 1995 and many others).

#### Oligochaetes

Oligochaetes are a poorly known group typically found in peripheral/disturbed habitats such as under decaying algae on beaches, and in fouled or low oxygen muds of back

bays, estuaries, and harbors (Brinkhurst and Simmons, 1968; Pearson and Rosenberg, 1978; Brinkhurst and Cook, 1980). They often occur in large masses devoid of other macrofauna. In SF Bay they may comprise 100% of the fauna where there is gross pollution (i.e., large amounts of organic material from sewage). If oxygen levels are sufficient, and there is little toxic waste and high bacterial levels, oligochaete densities become extremely high (Smith and Carlton, 1975; Brinkhurst and Simmons, 1968). They are well known indicators of relatively degraded freshwater ecosystems (Brinkhurst and Simmons, 1968; Pearson and Rosenberg, 1978; Brinkhurst and Cook, 1980).

### **Positive Indicator Species**

#### *Heterophoxus*

*Heterophoxus* is a fossorial phoxocephalid amphipod which requires well-oxygenated, clean sediment (Slattery, 1985). They are shallow burrowers which occur in the top 1 cm of sand. They are major predators on small soft-bodied infauna (Oliver et al., 1982; Oliver and Slattery, 1985a). Phoxocephalids, such as the similar *Rhepoxynius* spp., are considered highly sensitive to sediment contaminants, and are commonly used in sediment bioassays (Swartz et al., 1979, 1984; Oakden et al., 1984a,b; Lenihan et al., 1995).

#### *Monoculodes*

*Monoculodes* is a fossorial oedocerotid amphipod which requires well-oxygenated, clean sediment (Oliver et al., 1980). They are shallow burrowers which occur at the sand surface/water interface. *Monoculodes* are carnivorous and therefore are probably active and sensitive to sediment surface quality (Mills, 1962; Bousfield, 1970; Bousfield, 1996). They can also colonize relatively small open patches in sandy habitats (Oliver et al., 1977) and have been selected as sensitive species to use in bioassays (Lenihan et al., 1995).

#### *Tellina*

The bivalve mollusc *Tellina* lives in clean, well-oxygenated sands of shallow water (Oliver et al., 1980). Species in Southern California attain great enough densities to be a major component of the shallow water, benthic infaunal community (Barnard, 1963). They are not known to be early colonists in disturbed sedimentary habitats (Oliver et al., 1977).

### **Calculation of RBI**

Previous versions of the Benthic Index have used individual impact thresholds for determination of degree of negative impact to Total Fauna and Number of Crustacean Species (Fairey et al., 1996). While these thresholds have been useful, the necessarily arbitrary nature of the selection process introduced potential artifacts for stations whose

values for Total Fauna, Total Molluscs and Total Crustacea approached the threshold value. To address this problem, calculation of the Relative Benthic Index was revised to be based on percentages of the total range. The final threshold value for determination of impacted versus non-impacted sites was based on the overall Relative Benthic Index and selected using best professional judgment. Justification for this critical threshold value of the RBI is discussed below.

For total fauna, number of mollusk species and number of crustacean species, the maximum and minimum values in these parameters over all the stations were determined. For each station, the total number of species, total mollusk species, and total number of crustacean species were then converted to the percentage of the total range for these parameters. The number of crustacean individuals at each station is similarly converted to a percentage of the total range, and is added to the total fauna, mollusk, and crustacean species numbers. The community numbers thus represent four-sixth of the Relative Benthic Index for each station.

For the positive and negative indicator indices, the final index was weighted towards presence and absence of key indicator species, with abundance of each species given additional incremental weight. Accordingly, the abundance of each indicator species was transformed using a double square-root transformation to compress the range of values. For each species, the transformed abundance was converted to a percentage of the total range. The transformed values of the negative indicator species were summed and subtracted from the sum of the values for the positive indicator species.

The overall Relative Benthic Index was calculated by summing the values of the Total Fauna, Total Molluscs, Crustacean Species, and Indicator Species, and standardizing it to the total range. This resulted in a range in values from 0.00 (Most Impacted) to 1.00 (Least Impacted).

### **Use of RBI**

It is not possible to compare directly RBI values between different regions. The high and low ranges of values vary based on the extreme values within each data set. In addition, different indicator species are often used between regions. What the RBI does provide is the relative "health" of each of the stations in a given data set compared to the other stations in the same data set.

The RBI does not indicate causality. While a low RBI value could be the result of chemical toxicity, it also could be the result of other types of anthropogenic disturbance, such as dredging, or could result from a variety of natural disturbances, such as freshwater runoff, temperature stratification, or storm impacts.

It is not possible to test the RBI to determine significance levels or confidence levels, or to statistically determine what ranking indicates significant impact. However, since a degree of arbitrariness is incorporated into all determinations of significance, whether



statistical or intuitive, this should not be considered a significant drawback. For this study, the threshold for significantly impacted benthic community structure was set at a Relative Benthic Index less than or equal to 0.30. Several factors were considered in deriving this threshold: the stations below the threshold have few overall species, few crustacean species, presence of negative indicator species, and absence of positive indicator species. While it is recognized that this threshold is somewhat arbitrary, it was selected based on the best professional judgement of the benthic ecologists who performed the analyses to be conservative. Stations having an RBI  $\leq 0.30$  would be considered to be significantly degraded by most naturalists familiar with southern California's bays and estuaries. The RBI is not intended as a sole indicator of biological impact. For the purposes of this report, it should only be used in combination with chemistry and toxicity test data to provide a "weight-of-evidence" for determination of the most impacted stations.

#### ***Multivariate and Univariate Techniques for Comparison of Chemistry and Toxicity Data***

While the main objective of this study was to identify stations of concern, the data were also evaluated to investigate whether certain individual chemicals were found to be associated with biological impacts. These preliminary evaluations were made using Principal Components Analysis (a multivariate technique) and Correlation analysis (a univariate technique). Identification of chemicals that were associated with toxicity does not demonstrate cause and effect, but it allows the development of hypotheses concerning the chemical causes of biological impacts. Causes of toxicity can later be investigated with TIEs and other more extensive toxicological methods.

#### **Principle Components Analysis**

Because many chemicals tend to co-vary in sediments, Principal Components Analysis (PCA) was used to investigate relationships between chemistry, toxicity, and benthic indicators prior to conducting simple correlation analyses. The PCA was treated as exploratory in nature; therefore, data were not screened for sample size, normality, linearity, outliers or multicollinearity.

Principal components were extracted using SYSTAT statistics software (v. 7.0.1 for Windows; SPSS, 1997). The analysis was run with a correlation matrix and varimax rotation, and included any factors which accounted for greater than 10% of the total variance. A component loading cutoff value of 0.40 was used in selecting variables for inclusion into factors, based on suggestions by Tabachnick and Fidell (1996) that a cut-off of at least 0.32 be used, and that component loadings of greater than 0.45 are considered fair or better.

#### **Correlation Analysis**

In order to examine associations between levels of pollutants in sediments and the response observed in toxicity tests, Spearman rank correlation coefficients (Rho) were calculated using Systat 7.0 software. Since the response of the control groups for each toxicity test was both acceptable and consistent, the sediment toxicity test data were not

normalized to control results. Rho values, corrected for ties, were determined for each toxicity test and each pollutant or pollutant class, and these Rho values were compared to tables at the appropriate n value to determine the level of statistical significance associated with the observed correlation.

### ***Strategy for Categorization of Stations Based on Available Monitoring Data***

One goal of this study was to identify those sites considered to be of primary concern in terms of chemical pollution and potential impacts on beneficial uses identified through biological measures. By comparing the relative degree of chemical pollution with different measures of toxic effect, and combining these data with information on benthic community degradation, a weight-of-evidence approach may be employed to identify the most impacted sites.

It is recognized that any conclusions based on interpretation of these data should be considered preliminary because of the limited nature of the data set. As with any study of this scope, it is difficult to identify all variables that may be associated with biological responses at a particular location. For example, our characterization of organic chemical contamination is constrained by the limited number of contaminants measured (Appendix B). Samples often contained un-identified organic compounds that were not further characterized due to the limited scope of the study; these could have contributed to the toxicity of the samples. In addition, no measures of interstitial water chemical concentrations were conducted for substances other than ammonia and hydrogen sulfide. Therefore, our ability to characterize bioavailability of the bulk-phase chemicals is limited to TOC normalization. In addition, a limited number of measures of Acid Volatile Sulfides and associated metals (AVS-SEM) were made, which limits our ability to predict bioavailability and toxicity of metals. Conclusions regarding benthic community degradation was limited by the lack of *in situ* sediment dissolved oxygen levels.

Because of these limitations, characterization of the most impacted stations must rely, to a certain extent, on a qualitative interpretation of the data. To accomplish this, individual stations were evaluated based on a Triad of measures (*sensu* Chapman et al., 1987): chemical pollution, benthic community structure, and toxicity to various species.

Using this available data, stations were categorized based on chemical concentrations, the severity of biological impacts, and the completeness of sample characterization. The conceptual framework for categorizing stations is provided in the listing below. In order to categorize stations, it was necessary to define terms such as "elevated chemistry" or "sample toxicity" for a large number of samples. To be consistent, thresholds were established for this purpose. Those thresholds are defined below in the description of the first category. Toxicity thresholds were based on the t-test plus detectable difference criteria (MSD). Benthic community degradation was defined as a Relative Benthic Index  $\leq 0.30$ , based on the best professional judgement of the ecologists who developed the

index. Elevated chemistry was defined as 6 or more chemicals exceeding ERM guidelines, a ERMQ above 0.5, or one or more chemicals at concentrations high enough to likely be associated with biological effects, based on best professional judgement. The ERMQ value of 0.5 was based on an evaluation by Long et al. (in press) that indicated at least 50% of samples in a nationwide evaluation exhibited toxicity when this value was exceeded. The BPTCP has calculated ERMQ values using a different suite of chemicals than that used by Long et al. (in press). The primary differences are that Long et al. (in press) used a number of individual PAHs and the DDT ERM, whereas the BPTCP used only the summary low and high molecular weight PAHs (2 values) and the sediment effect value reported by Swartz et al. (1994) as the DDT value. When the ERMQ values, as calculated by the BPTCP, were compared with amphipod toxicity in the statewide database, 62% of the samples with ERMQs greater than 0.5 were found to be toxic to amphipods.

These chemistry, toxicity, and benthic community threshold values were derived to allow a consistent interpretation of data from samples throughout the Region and state. It is important to note that while these threshold values were selected based on the best available information and best professional judgement of the authors, they are by nature discretionary. Chemical bioavailability varies from sample to sample, and the exact definitions of toxicity and benthic degradation depend on factors not easily analyzed in a large number of samples. Further data collection and analysis may result in the determination of different threshold values and different definitions for biological impacts. The thresholds and station characterizations used here are not intended to be absolute. They are intended to aid in the screening of data collected from a large number of locations, in order to support management decisions. In some cases additional studies may be undertaken to further evaluate the sites of concern identified in this Region-wide assessment. As more data become available through additional studies, more accurate site-specific characterizations of sediment quality may result.

The sites were categorized as follows based on the combination of measurements:

Category 1:

Stations with elevated chemistry\*, recurrent toxicity, and degraded benthos.

Category 2:

Stations with elevated chemistry, one (of one) toxicity hit, and degraded benthos. (Only one sample tested and significant toxicity indicated.)

Category 3:

Stations with elevated tissue chemical concentrations.

Stations where muscle or whole body tissue residues in resident, non-migratory organisms exceed levels established by the FDA or NAS for protection of human health or wildlife. Organisms may be either deployed or collected from resident populations. (FDA and NAS values are given in SWRCB FED on Guidance for THS Cleanup Plans)

Category 4:

Stations with elevated chemistry and biological impacts measured by either toxicity or benthos:

Stations with elevated chemistry, degraded benthos, and  
No available toxicity data.

Stations with elevated chemistry, recurrent toxicity and  
No available benthics data.

Stations with elevated chemistry, toxicity in a single sample and  
No available benthics data. (Only one toxicity sample tested.)

Category 5:

Stations with elevated chemistry and mixed results from biological indicators.

Stations with elevated chemistry, degraded benthos, and  
multiple toxicity tests with some toxic and some non-toxic.

Stations with elevated chemistry, degraded benthos, and  
toxicity data indicating samples were non-toxic.

Stations with elevated chemistry, recurrent toxicity and  
data indicating non-degraded benthos.

Stations with elevated chemistry, toxicity in a single sample and  
data indicating non-degraded benthos. (Only one toxicity sample tested.)

Stations with elevated chemistry, data indicating non-degraded benthos and multiple  
toxicity tests with some toxic and some non-toxic.

Category 6

Stations with measured biological impact but chemistry values below thresholds or not  
measured.

Stations with recurrent toxicity, and degraded benthos, but no chemistry data available.

Stations with recurrent toxicity, and degraded benthos,  
and elevated NH<sub>3</sub> or H<sub>2</sub>S\*\* but no other elevated chemistry.

Stations with recurrent toxicity, and degraded benthos,  
but existing chemistry data indicates five or fewer chemicals measured at elevated  
concentrations.

Stations with a single indicator of biological effect (either recurrent toxicity or degraded benthos), but existing chemistry data indicates five or fewer chemicals measured at elevated concentrations.

Stations with a single toxic sample, but existing chemistry data has no chemicals measured at elevated concentrations.

#### Category 7

Stations with elevated chemistry but biological measures below thresholds.

#### Category 8

Stations with chemistry, toxicity, and benthic degradation below thresholds, or not measured.

#### Category 9--Reference Stations

These should be selected using best professional judgment of available information, including grain size, salinity, chemistry, benthic ecology, and toxicity data, as well as station location relative to pollutant sources. The parameter to be compared to reference (e.g., toxicity) should not be the primary measure used in reference site selection.

Prioritization within these major categories should be determined by the actual data values, such as 20% survival would rank above 55% survival, etc. Best professional judgment will be necessary to balance chemical versus biological data values.

\*Elevated Chemistry could be indicated by:

- 1) Guideline mean quotient value above 0.5, indicating a mixture of pollutants, or
- 2) At least 6 guideline exceedences, or an individual chemical at very high concentrations, such as many times the guideline value, or in the highest 10th percentile for all samples in the Region (or State).

\*\*Elevated concentrations of  $\text{NH}_3$  or  $\text{H}_2\text{S}$  thought to have resulted from human activity may be considered equivalent to elevated concentrations of other anthropogenic chemicals for prioritization purposes, based on best professional judgement. In cases where  $\text{NH}_3$  and  $\text{H}_2\text{S}$  are thought to result from natural processes, high concentrations may be considered as interferences in toxicity or benthic assessments.

Chemistry, toxicity, benthic community data, bioaccumulation or other data from previous studies may be considered as part of the categorization described above.

### ***Quality Assurance/Quality Control***

#### **Summary of Methods**

Summaries of quality assurance and quality control procedures are described under separate cover in the Bay Protection and Toxic Cleanup Program Quality Assurance

Project Plan (Stephenson et al., 1994). This document describes procedures within the program which ensure data quality and integrity. In addition, individual laboratories prepare quality assurance evaluations of each discrete set of samples analyzed and authorized by task order. These documents were submitted to the California Department of Fish and Game for review, then forwarded to the State Water Resources Control Board for further review.

## RESULTS/DISCUSSION

This report consolidates ecotoxicological analyses from 267 sediment samples collected from 138 stations. Due to differences in toxicant sources, physical environments, and beneficial uses, the results and discussion of data collected in the Los Angeles Region are divided into three sections, one for each of the three key waterbody types: Industrial Harbors (Los Angeles and Long Beach Harbors, Palos Verdes, Port Hueneme), Marinas (Shoreline Marina, Los Alamitos Bay, King Harbor, Marina Del Rey, Ballona Creek, Channel Islands Harbor, Ventura Harbor), and Lagoons (Malibu Lagoon, Mugu Lagoon, Colorado Lagoon/Simm's Pond, Santa Clara and Ventura River estuaries, and McGrath Lake). The specific Industrial Harbor, Marina, and Lagoon stations are shown in the sampling stations maps shown in the methods section of the report (Figures 2-9). The remaining figures and tables presenting results of chemical and biological monitoring at these stations are provided at the end of the report and in the Appendices.

### *Industrial Harbors*

#### **Chemistry Data**

##### Data Relative to Quality Assurance Criteria

All trace metal analyses met all quality assurance criteria as described by Stephenson et al. (1994). Many trace organic analyses had minor deviations from QA criteria, as indicated by "-5" QA codes (Appendix C). Most of these deviations involved blank responses outside of control chart guidelines, in which case the chemical concentrations measured were corrected based on blank response prior to reporting. If critical management decisions must be based on data for which a "-5" code is assigned in Appendix C, the reader is advised to consult the data QA reports on file at the SWRCB.

##### Primary Chemicals of Concern

A summary of chemicals at the Industrial Harbor stations that exceeded the ERM/ERL guideline values is presented in Figure 10. Five trace metals were found in relatively high concentrations with copper, mercury, and zinc most often exceeding the chemical guideline values. Copper exceedances of ERM values occurred at Inner Fish Harbor in Long Beach Harbor (Station No.s 40019.1, 40019.2 and 40019.3), and at Cabrillo Beach Pier, Consolidated Slip, and the Kaiser International Berth No. 49 in Los Angeles Harbor (Station No.s 40010.0, 47005.0, and 49004.0, respectively; Figure 11 a-c and Figure 12a-b). Mercury concentrations greater than the ERM value were measured at Southwest Slip (40001.2) and Consolidated Slip (40006.1, 47005) in Los Angeles Harbor, and at Inner Fish Harbor (40019.1, 40019.2, and 40019.3) Long Beach Harbor Channel 2 (40007.2) and Long Beach Inner Harbor Channel 3 (40011.3; Appendix C). Elevated zinc concentrations (>ERM) were measured in several Consolidated Slip samples in Los Angeles Harbor (Appendix C), and Inner Fish Harbor in Long Beach Harbor.

In addition to the metals discussed above, tributyltin (TBT) concentrations were elevated in some of the Industrial Harbor sediments relative to the BPTCP database (Appendix C). TBT concentrations in sediment from the East Turning Basin (40005) and Inner Fish Harbor (40019.1, 40019.2, and 40019.3) were greater than the 95<sup>th</sup> percentile threshold for the statewide BPTCP database. The second highest TBT concentration in the statewide BPTCP database was measured in sediment from Consolidated Slip (40006.2). In addition, concentrations of TBT from Port Hueneme sediment (44013) were elevated relative to those collected throughout the state, exceeding the 90<sup>th</sup> percentile threshold. Selenium concentrations in sediments from several Industrial Harbor stations were also elevated relative to those measured throughout the state. Sediments from Long Beach outer harbor (40033), Inner Fish Harbor (40019.1-40019.3), and Terminal Island STP (40016) all exceeded the 90<sup>th</sup> percentile threshold from the BPTCP database. Sediment from Lower Main Channel (40024.2 and 40024.3) contained selenium concentrations that were twice the 95<sup>th</sup> percentile threshold from the BPTCP database.

Several pesticides exceeded the chemical guideline values. As in previous BPTCP monitoring studies (Fairey et al., 1996; Anderson et al., 1997; Hunt et al., 1998) total chlordane was one of the pesticides most commonly measured at elevated concentrations (Figure 10). Total chlordane is the summation of the major constituents of technical grade chlordane and its metabolites (in this case cis- and trans-Chlordane, Oxychlordane, and cis- and trans-Nonachlor; Appendix C), and comprise a group of nonsystemic stomach and contact insecticides which until the mid 1970's had been used extensively in home and agricultural applications. Although the use of this compound was discontinued in this country due to its widespread occurrence, biomagnification through the foodchain, and persistence in non-target systems, chlordane continues to occur in aquatic ecosystems. Due to their limited water solubility, chlordane compounds tend to bind to organic carbon and settle out of the water column, accumulating in sediments (Wilcok et al., 1993). Elevated chlordane was found at the East Turning Basin (Station No. 40005.1), Inner Queensway Bay (40013.1 and 40013.2), Los Cerritos Channel (44011.0), and at Long Beach Outer Harbor (40018.3; Figure 13). High total chlordane concentrations were also found at several Consolidated Slip stations (Figure 14); the total chlordane concentration at one station (Station No. 47004.0) was 41 times the ERM value.

Total DDT ( $\Sigma$  of ortho and para DDE, DDD, and DDT) exceeding the sediment effect concentration (= 100  $\mu\text{g}$  Total DDT / gram of organic carbon; Swartz et al., 1994) was found only at the Palos Verdes off shore stations (No.s 40031.1, 40031.2, and 40031.3, Appendix C). DDT and its metabolites are a class of relatively water insoluble organochlorine compounds which also tend to bind to organic particulates and thus accumulate in the sediments. Concentrations of these compounds have generally declined in aquatic ecosystems since they were banned for most insecticide applications in 1972, although concentrations of some DDT metabolites have increased. Like chlordane and dieldrin, it is persistent in sediments and may be of significant environmental concern at higher



concentrations (Hoke et al., 1994; Swartz et al., 1994). Elevated concentrations of total DDT have been found off the Palos Verdes Peninsula in previous studies (MacDonald, 1994). Elevated dieldrin concentrations were measured in sediments from several stations in Consolidated Slip (No.s 47002.0, 47003.0, 47009.0; Appendix C).

In addition to the pesticides listed above, endosulfan concentrations were elevated in sediment from Kaiser International Berth 49 (49004) relative to the 90<sup>th</sup> percentile threshold from the BPTCP database. The chlorpyrifos concentration in sediment from Consolidated Slip (47009) exceeded the 90<sup>th</sup> percentile threshold for the BPTCP database (Appendix C).

Total PCB concentrations (the sum of 18 congeners) were the chemical compounds that most commonly exceeded the chemical guideline values (Figure 10). PCBs are base-neutral compounds that are formed by direct chlorination of biphenyl. There are 209 numerically designated individual compounds, called congeners (*e.g.*, PCB #101), based on the possible chlorine substitution patterns. Mixtures of various PCB congeners have been manufactured in the U.S. since 1929 (Phillips, 1987) and are used commercially under the trade name Aroclor. Each PCB mixture has a number designation (*e.g.*, Aroclor 1254) with the last two numbers indicating the percentage of chlorine in the mixture. PCB mixtures were used extensively in the U.S. prior to 1979 for industrial applications which required fluids with thermal stability, fire and oxidation resistance and solubility in organic compounds (Hodges, 1977). PCBs have proven to be extremely persistent in the environment and have demonstrated a variety of adverse carcinogenic and non-carcinogenic effects (U.S. EPA, 1993c). These substances are highly lipophilic and have a high potential to accumulate in the tissues of aquatic organisms and can represent a significant human health hazard (Moore and Walker, 1991).

High concentrations of total PCBs were measured in sediment samples from throughout the Los Angeles and Long Beach Harbor area (Figure 15). Elevated PCB concentrations were found in Southwest Slip (Station No. 40001), Lower Main Channel (40004), East Turning Basin (40005), Inner Fish Harbor (40019), Hugo Neuproler #1 and #2 (46001, 46002), Kaiser International Berth 49 (49004), San Pedro Bay Outer Harbor (48009), Long Beach Harbor Channel 2 (40007), and Palos Verdes (40031). The highest total PCB concentrations measured in the Industrial Harbor samples were from Consolidated Slip (Figure 16). Concentrations above the ERM value were found throughout this area; sediment concentrations of PCBs were 5x, 11x, 8x, and 9x the ERM value at Consolidated Slip stations 47001, 47002, 47003, and 47005, respectively.

Polycyclic aromatic hydrocarbons (PAHs) are base-neutral organic compounds that are components of crude and refined petroleum products and a product of incomplete combustion of hydrocarbons. These compounds are common components of contaminated sediments and are toxic to infaunal invertebrates (Eisler, 1987; Neff, 1979; Neff and Anderson, 1981), in particular amphipods (Swartz et al., 1995). Due to their similar modes of toxicity, individual PAHs are combined into low and high molecular weight groups. Elevated concentrations of low molecular weight PAHs were found in

Southwest Slip (40001), and extremely high concentrations were found at Kaiser International Berth 49 (29x the ERM, Station No. 49004); these are due to onshore coal loading facilities at this site. High molecular weight PAHs were found in Southwest Slip (40001, 40006), Consolidated Slip (47002, 47004, 47009), and Kaiser International Berth 49 (5x the ERM, Station No. 49004). Total PAH concentrations were also 3x above the ERM value at Kaiser International Berth 49 (Figures 17 and 18).

### Chemical Mixtures

As discussed earlier, the majority of sediments contain mixtures of chemicals. In this report, The ERM guidelines developed by Long et al. (1995) and the PEL guidelines developed by McDonald (1996) were used to calculate average ERM Quotients (ERMQ) and PEL Quotients (PELQ). These quotient values do not imply synergism, additivity, or antagonism between chemicals, but instead are used here to indicate the relative degree of pollution due to chemical mixtures. In a recent evaluation of the average ERM and PEL guideline values using chemistry and toxicological data collected throughout the coastal United States, Long et al. (1998) determined that when the average ERMQ exceeded 1.00, the probability of significant amphipod toxicity occurring in these samples was 71%. When the average PELQ exceeded 1.00, the probability of significant toxicity occurring was 56%. In addition, these authors found that when samples contained 11 or more ERM exceedances or 21 or more PEL exceedances, the percentage of significantly toxic samples was 85% and 100%, respectively. As discussed earlier (p 66), for the purposes of this report, stations are considered to have elevated chemistry if the ERMQ is  $\geq 0.5$ , if there are more than 6 or more individual guideline exceedances, or if individual chemicals are considered to be elevated relative to the BPTCP database. In the BPTCP database, when the ERMQ exceeded 0.5, the percentage of samples that were significantly toxic to amphipods was 62%. For mapping purposes, the ERMQ is divided into 4 categories:  $ERMQ < 0.1$ ;  $ERMQ \geq 0.1 < 0.5$ ;  $ERMQ \geq 0.5 < 1.0$ ; and  $ERMQ \geq 1.0$ . For the following discussion, stations that had the greatest pollution by chemical mixtures are highlighted. These are stations with ERMQ values  $\geq 1.0$ . Although both ERMQs and PELQs are provided in the Appendix, data maps in this report emphasize chemical concentrations relative to the ERM values. This does not advocate one set of guideline values over another, but was necessary to simplify data presentation.

Except for the Kaiser International Berth 49 station (Station No. 49004), the majority of Industrial Harbor stations which had ERMQ values greater than 1.00 were located in the Consolidated Slip area (Table 12; Figure 19 a-b, Figure 20a-b). The relatively high ERMQ from the Consolidated Slip sample 47004 was driven to a large extent by total chlordane which was 41 times the ERM value, and by Total PCBs. The high ERMQ at the Kaiser International Berth 49 station was driven to a large extent by Low Molecular Weight PAHs which were 29 times the ERM for this chemical group. Two samples had more than 11 ERM exceedances, one was the Kaiser Int. Berth 49 station (49004), the other was a deep sediment sample (90-150 cm) from Consolidated Slip (47004; ERMQ Table 12).

## Toxicity Testing Data

### Data Relative to Quality Assurance Criteria

All toxicity test data were evaluated for acceptability using the quality assurance guidelines presented in the BPTCP Quality Assurance Project Plan (Stephenson et al., 1994). Most of the data reported here met test acceptability standards for each protocol. Departures from acceptability standards are summarized in Appendix E. Almost all of these were departures in water quality parameters such as dissolved oxygen and were considered to be of minimal concern in terms of data quality. These are coded "-3" in Appendix E. Some of the samples tested with the amphipods *Rhepoxynius abronius* and *Eohaustorius estuarius* also had deviations from the salinity criteria. In the case of *Rhepoxynius*, these were generally samples with final overlying water salinities that were greater than 2‰ from the Granite Canyon seawater control salinity; this usually resulted in salinities of 32‰. In the case of *Eohaustorius*, the final salinities were 24‰, which exceeded the salinity criteria for this protocol by more than 2‰. These salinities are within the tolerance range for these species and are listed in Appendix E. One sample from Port Hueneme (Station No. 44012, IDORG 612) had a final interstitial water salinity of 37‰. It is not clear whether this value is high enough to affect the test results. Results of the sea urchin fertilization and embryo development tests used to assess this sample should be considered with caution.

Several sediment-water interface samples tested with sea urchin development in Leg 48 had low dissolved oxygen values at the end of the exposure (IDORGs 1700, 1703, 1704, 1706-1708; Appendix E). It is not clear whether these values are low enough to affect development of sea urchin larvae. Results of these tests are coded "-5" and should be considered with caution.

Sea urchin fertilization tests were conducted on a number of pore water samples from the Los Angeles Region. Many of these samples were retested because of poor response in brine controls. Bay et al. (1993) discussed commonly observed problems with using the *Strongylocentrotus purpuratus* fertilization test in samples requiring salinity adjustment with hypersaline brine; these include poor control response. Through numerous repeated tests, we were able to achieve acceptable brine control results for all but one sample. However, an additional control treatment to account for the effects of frozen sample storage in Teflon bottles was included in tests from later sampling legs. These additional controls, which were not specified in the BPTCP QAPP, indicated that toxicity using this protocol may be associated with frozen sample storage in Teflon bottles. Because all samples for the fertilization tests were stored frozen in Teflon bottles, we have no assurance that the data from any of these tests is truly indicative of sample toxicity. Any observed toxicity may be wholly or partially due to storage effects. For this reason, all samples were retested with the sea urchin development test. The sea urchin development test was unaffected by these storage artifacts, as indicated by response in frozen storage bottle controls. While sea urchin fertilization data are included in the appendix of this

report, we do not have confidence in their validity because of possible false positives related to sample storage, and these data were not used in the site characterizations or comparisons with chemical concentrations.

The majority of the stations monitored during this project were tested with the amphipod 10-d survival protocol using either *Rhepoxynius abronius* or *Eohaustorius estuarius*, or with abalone development in pore water. The following section therefore emphasizes the results of these toxicity test protocols. Because the other toxicity test protocols were not used consistently, the results from these tests are provided in the Appendices.

Twenty-eight percent (55/192) of the Industrial Harbor station sediments were significantly toxic to amphipods (Table 13). Amphipod survival in the outer Los Angeles and Long Beach Harbor stations was variable but generally higher than the Inner Harbor stations (Figures 21 and 22). Inner Harbor samples that were consistently toxic to amphipods were in Consolidated Slip (47001 – 47010), Southwest Slip (40001), and Southeast Basin (40012). The majority of samples from Consolidated Slip were toxic to amphipods. Both surficial and deeper sediments at this site were toxic, although in many cases surface sediments were more toxic than deeper sediments (Table 13). Although the Palos Verdes offshore station (40031) had elevated concentrations of PCBs and DDT metabolites, none of these samples were significantly toxic to amphipods in these acute exposures.

Considerably more samples were significantly toxic to abalone larvae exposed to sediment pore water. In the Industrial Harbor stations, 79% (61/77) of the samples were toxic to abalone embryo-larval development (Table 14). Many of these samples had unionized ammonia concentrations above the effect threshold for this protocol (Appendix E). In situations where pore water unionized ammonia concentrations were greater than 0.06 mg/L, it is useful to assess toxicity at lower pore water concentrations. In these cases, if toxicity persists in 50 and 25% pore water but ammonia and hydrogen sulfide concentrations are less than the effect threshold, then the toxicity in these samples may be ascribed to other chemical constituents or factors. It should be noted that even in situations where the ammonia threshold is exceeded, other chemicals may be responsible for toxicity. In these situations, TIEs are useful for resolving the confounding effects of ammonia.

Statistical correlations between solid phase and pore water toxicity and bulk-phase chemical concentrations were examined using Spearman Rank Correlations. For these analyses the results of toxicity tests with the two amphipod species *Rhepoxynius abronius* and *Eohaustorius estuarius* were combined. Correlations between sediment chemistry and amphipod survival in the Industrial Harbor stations indicated significant negative correlations with several metals (eg., arsenic, cadmium, copper, mercury, zinc; Table 15). There were also significant negative correlations between amphipod survival and total chlordane (Figure 25), several PCB congeners, total PCBs, and a number of PAH compounds. Amphipod survival was negatively correlated with sediment grain size and TOC. Chemicals often co-vary with TOC and grain size because both organic carbon and

fine-grained sediments bind trace metal and organic chemical compounds. Without additional studies, it is difficult to separate the effects of these sediment characteristics from those of the chemicals bound to them.

Amphipod survival was also significantly correlated with the ERMQ and the Total Number of ERM Exceedances (Table 15; Figure 26). As discussed earlier, correlations are not used to imply a causal relationship between chemistry and toxicity. These analyses are useful, however, to develop hypotheses between chemicals of concern and observed bioeffects. These may be addressed through TIE and other toxicological investigations.

Toxicity to abalone embryos exposed to sediment pore water was negatively correlated with tin, total chlordane, two PCB congeners, the ERMQ, and the total number of ERM Exceedances (Table 16; Figure 27).

### **Benthic Community Analysis**

#### Data Relative to Quality Assurance Criteria

All benthic community analyses followed the quality control procedures described in the Methods section of this report and in the BPTCP QAPP (Stephenson et al., 1994). All resulting data met the quality assurance criteria described in Stephenson et al. (1994).

As discussed earlier, characterizations of benthic community structure were consolidated into a single Relative Benthic Index (RBI) value for each sample. The RBI is a single number that incorporates measures of the Total Number of Fauna, Total Number of Crustacean Species and Individuals, and the relative numbers of Positive and Negative Indicator Species. Thresholds for degraded, transitional, and undegraded benthos were established based on the best professional judgement of the benthic ecologists who performed the analyses. While this was necessary for categorization purposes, it should be noted that the thresholds are somewhat arbitrary. The threshold for degraded benthos was set at a RBI value of 0.30. Samples having index values greater than 0.30 were classified as transitional, even though it is recognized that there is a large difference in benthic community structure between those stations with a RBI of 0.31, and those with a RBI of 0.60. It should also be noted that a number of factors influence benthic community structure, including salinity, temperature, sedimentation rates, and dissolved oxygen levels. These need to be considered on a station-by-station basis when classifying particular sites. Other limitations on the benthic community data are discussed at the end of this report. As with the other toxicological data used in this report, the RBI values should always be used in conjunction with chemical and toxicity test results in a weight-of-evidence approach. More concern should be placed on stations with elevated chemistry, high toxicity and lower RBI values, even if the RBI values are greater than the threshold for degraded benthos.

Benthic community structure was assessed at 102 of the Industrial Harbor stations; approximately 13% of these stations had degraded benthos ( $RBI \leq 0.30$ ). Outer harbor samples having degraded benthos were in Lower Main Channel (40004), the Cabrillo Beach Pier area (40010) and Long Beach Outer Harbor (44018; Figure 28a). In addition, one of the field replicates assessed off Palos Verdes (40031.2) had degraded benthos (Table 17; Figure 28c). Several of the samples with the lowest RBI values were in Consolidated Slip (Table 17; Figure 29b). Although the remaining samples from Consolidated Slip where benthos were assessed were classified as transitional, many had relatively lower RBI values. None of the remaining inner harbor stations were classified as degraded, although the majority were considered to have transitional benthos (Figure 29a). Samples from Inner Fish Harbor (40019), outer Queensway Bay (40014), and West Basin Entrance (40009) had relatively low RBI values but were classified as transitional (Table 17; Figure 29).

Benthic community structure, as represented by the relative RBI, was negatively correlated with a number of chemicals measured in Industrial Harbor sediments. Spearman Rank Correlations indicated significant negative correlations between the RBI values and several metals (eg., arsenic, cadmium, copper and zinc; Table 18). In addition, there were significant negative correlations between the RBI and a number of pesticides, particularly total chlordane, several PAH compounds and PCB congeners, and sediment TOC. There were also significant negative correlations between the RBI and the ERM Quotient and number of ERM exceedances in the Industrial harbor samples (Table 18; Figure 30).

Principal Components Analyses (PCA) were conducted to investigate co-variance between measured chemicals in the Industrial Harbor sediment samples, toxicity test results, and benthic community structure metrics. The PCA were conducted on two subsets of the data: first by analyzing all of the data with the abalone toxicity test data excluded, then with the abalone data included. Results of the first PCA with the abalone data confirmed the results of the previous Spearman Rank Correlations by showing that amphipod survival in the toxicity tests and the Relative Benthic Index were both negatively correlated with a number of chemicals (Table 19a; note: variables with opposite signs in Table 19 are negatively correlated). In addition, the PCA showed a significant positive correlation between higher amphipod survival and a higher Relative Benthic Index. These results were further investigated with Spearman Rank Correlations comparing amphipod survival in toxicity tests with benthic community metrics. These analyses showed significant positive correlations between amphipod survival in the toxicity tests, the total number of crustacean species measured in samples from these stations, and the total number of species measured in these stations (Table 20).

Results of the second PCA that included sediment chemistry, abalone toxicity test data, and benthic community data indicated that development of abalone embryos in sediment pore water was negatively correlated with a number of solid phase chemicals, including pore water unionized ammonia, two metals, a number of pesticides, Total PCBs, and the ERM Quotient (Table 19b). In addition, the PCA showed significant positive

correlations between abalone development in toxicity tests, the mean number of mollusc individual species and individuals, and the total number of species measured at the Industrial Harbor stations. Spearman Rank Correlations confirmed that abalone development was positively correlated with a number of benthic community metrics (Table 20).

These results imply that the laboratory toxicity tests were indicative of benthic impacts at Industrial Harbor stations. Increased survival of amphipods was correlated with a greater number of crustacean species at these stations, and increased abalone development was correlated with greater numbers of mollusc species. The results of the laboratory toxicity tests should not be considered to be predictive of ecological change on a station-by-station basis because these are acute toxicity tests and may not reflect chronic impacts at individual stations. In addition, as discussed earlier, benthic community structure is influenced by environmental factors unrelated to chemical pollution. However, when used in conjunction with chemical analyses and measurements of benthic community structure, they suggest that observed ecological degradation may be associated with sediment pollution detected by chemical analyses and laboratory toxicity tests.

### **Bioaccumulation Analysis**

Because of elevated concentrations of DDT and PCBs in fish collected from selected stations in the Los Angeles and Long Beach Harbor area, a health advisory against consumption of edible non-migratory organisms was issued for the Cabrillo Beach Pier area of outer Los Angeles Harbor (OEHHA, 1991). To determine whether fish from this area continue to accumulate high concentrations of these and other compounds, two species of fish (*Genyonemus lineatus*, *Phanerodon furcatus*) collected from the outer harbor area were analyzed for metals and organic chemical compounds using the methods described above. Fish tissue concentrations were compared to US EPA screening values and National Academy of Science (NAS) guideline values. A quotient value was calculated for selected chemicals of concern by dividing the measured tissue concentration by the US EPA screening value (note: this should not be confused with the ERM and PEL quotient values discussed earlier). This quotient value indicates the magnitude of the screening value exceedance.

In order to determine whether chemicals in sediment at these stations were bioavailable to infaunal organisms, a 28-d bioaccumulation test was conducted with the clam *Macoma nasuta* using the methods described above. Three laboratory replicates from each station were compared to replicates of control sediment, in this case the Yaquina Bay home sediment used in the amphipod tests. Concentrations of chemicals in the clam tissues were compared using t-tests. Chemical concentrations in the clams were also compared to those in the fish to determine whether there appeared to be any qualitative trends between bioaccumulation in bivalves exposed to sediment in the laboratory and field collected fish from the same stations. Concentrations of chemicals in the sediments were also measured in conjunction with these experiments.

### Fish Tissues

Results indicate that concentrations of DDT and PCBs in fish tissues continue to be elevated at Cabrillo Beach and the Long Beach Outer Harbor (Table 21a). Total DDT and Total PCBs in white croaker exceeded EPA screening values at all stations analyzed. Concentrations of these compounds were highest in fish collected from the Cabrillo Beach Pier Central station (Station No. 49002); Total DDT (TTL DDT) and Total PCBs (TTL PCBs) at this station were 16 times and 68 times the EPA screening values, respectively. The high TTL DDT concentrations in these fish were dominated by higher proportions of P'P' DDE, and to a lesser extent P'P' DDD (Appendix C).

Concentrations in white surfperch were considerably lower in all samples. This could be due to several factors including differences in the lipid concentrations in the fish. The mean percent lipid concentrations in white croaker and white surfperch were 13.7% and 11.9%, respectively. While this may have influenced uptake of these highly lipophilic compounds, the proportionately large differences in concentrations of TTL DDT and TTL PCBs between species suggests this is not the only explanation. Differences in feeding behavior, metabolic rates for biotransformation, and proximity to the sediments may also have played a role in tissue bioaccumulation in these species. Only concentrations of PCBs exceeded the EPA screening value in white surfperch tissues.

### Macoma Tissues

As with the fish tissue analyses, results of the *Macoma* laboratory bioaccumulation experiments indicated that Total DDT and PCB concentrations were elevated in bivalves exposed to sediments from these stations (Station No.s 40009, 49002, 49003; Table 21b). Concentrations of Total DDT were significantly higher in clams exposed to West Basin and all Cabrillo Beach Pier sediments when compared to control clams exposed to Yaquina Bay home sediment (t-tests;  $p < 0.05$ ). Concentrations of TTL DDT were elevated in clams exposed to West Basin Entrance sediments (Station No. 40009); these were approximately 4 times the concentrations measured in the control clams. The trends in TTL DDT and TTL PCBs in the *Macoma* experiments were similar to those observed in the fish tissue analyzed from these stations. Cabrillo Beach Pier Central (Station No. 49002) had the highest concentration of TTL DDT in fish tissue, and the highest concentration in *Macoma* exposed to sediment from this station.

TTL PCB concentrations in *Macoma* were also statistically higher in these sediments, particularly in those from West Basin sediments (Table 21b). The West Basin Entrance clams also accumulated several PAH compounds (Appendix C). Although TTL PCBs in the clams exposed to Cabrillo Beach Pier Central station sediments were elevated, they were not significantly different than controls because of higher between-replicate variability.

Sediments collected synoptically from the Cabrillo Beach Pier stations had measurable concentrations of DDT and PCBs, but the levels did not exceed the sediment effect value



reported by Swartz et al. (1994) values for these compounds (Appendix C). While it is difficult to determine the relationship between fish tissue and sediment concentrations of DDT and PCBs at these stations, the bioaccumulation experiments demonstrate that sediment-bound DDT and PCBs are bioavailable to infaunal species, and that laboratory exposed animals may accumulate PCBs to levels exceeding EPA screening levels. Previous exposures of *Macoma nasuta* to sediments contaminated with DDT have demonstrated that 28 days is probably not sufficient for DDT to accumulate to equilibrium levels (Lee et al., 1994). These authors suggest that at least 42 days is necessary to reach steady state. Therefore, the concentrations of DDT measured in clams in these experiments were probably lower than steady-state. It is likely that resident infauna from these stations have higher concentrations of these compounds. This is particularly true for species that ingest sediment. Infaunal prey species are a likely source of these compounds to resident fish. It should be recognized that these fish species are mobile and forage over relatively large areas. Therefore, it is impossible to ascribe concentrations of DDT and PCBs in sediments at these stations to those in fish collected in the vicinity. Future studies should assess concentrations of these compounds in likely prey species (eg., infaunal crustacean species), and measure these chemicals in non-migratory fish species. This information, combined with laboratory experiments designed to investigate DDT and PCBs in sediments with food web relationships would clarify the link between sediment concentrations and fish tissue levels.

### **Industrial Harbor Station Categorization**

As discussed earlier, all Industrial Harbor stations were categorized based on a weight-of-evidence approach. Using various combinations of chemical analyses, toxicity tests, benthic community characterizations, and in some cases bioaccumulation studies, stations were placed in one of 9 categories. Categorization is intended as an aid to further decision making by Regional Board staff regarding site dispositions.

In this study, stations are grouped by station number for categorization purposes. In some cases, stations were visited several times and various chemical and toxicological measures were made on different occasions. For clarity, the following station categorizations group individual stations based on a worst-case basis. Therefore, if a particular station had elevated chemistry and biological impacts on one sampling date but not on another, the station was categorized based on the worst-case characteristics. The additional information from preceding or subsequent sampling at that station were included in the same category for comparison, even though these data might not meet the criteria for that category. It is assumed that reviewers will take this apparent temporal or spatial variability into consideration in the decision making process.

All Industrial Harbor stations are categorized in Table 22. The structure for this table is similar to that of the Marina and Lagoon station categorization tables presented later. This table presents a synthesis of relevant weight-of-evidence information including: Station Number and Name, Sample (IDORG) Number, the ERM Quotient value, selected chemicals exceeding the ERM values and the magnitude of the ERM Exceedance, TOC

and Grain Size, all relevant toxicity test results, and the Relative Benthic Index value. In addition, Table 22 includes bioaccumulation results for stations where this was measured.

Station No. 40006.1 in Consolidated Slip met all of the criteria for Category 1. Surface samples from this station contained a number of chemicals exceeding sediment quality guideline values or were elevated relative to the BPTCP database. Significant toxicity to amphipods was measured in 3 of 4 field replicates, and benthic community structure was degraded in the one sample in which it was quantified. Several other stations in the Consolidated Slip area met the criteria for Category 2 (Station No.s 47002, 47003, 47009 and 47010). These were samples where toxicity was detected on the only occasion it was measured. The Category 2 chemistry data presented in Table 22 is for Consolidated Slip surface samples only; in many cases deeper samples measured at selected stations at this site were more contaminated than surface samples (Appendix C). The remaining stations from Consolidated Slip met the criteria for Category 6. These were stations that had elevated chemistry and were usually toxic to amphipods. Many of these stations did not exceed the threshold for classification as degraded benthos, even though most had relatively lower Relative Benthic Index values.

Because Consolidated Slip was identified by the Los Angeles Regional Board as a site of concern, the vertical and horizontal extent of chemical pollution and toxicity was estimated by a separate study where both were measured at various depths, and along a gradient extending west from the Dominguez Channel. The results indicated that significant pollution was measured at most stations in Consolidated Slip and that in some cases deeper samples were more polluted than surface samples (Table 12; Figure 20b). The majority of these samples were significantly toxic to amphipods; toxicity was sometimes greater in the surface samples (Table 13; Figure 22b). In addition, several of these stations had degraded benthos, and the rest were categorized as having transitional benthos. The aerial extent of chemical pollution and toxicity was estimated for the site by considering the stations with elevated chemistry and toxicity and estimating the surface area covered by these stations. Surface area was estimated using the MapInfo™ GPS mapping program. This assumed that toxicity and chemistry was consistent between the stations and to the edge of the channel. The area significantly polluted and toxic was estimated to be 0.080 square miles. Although it is recognized that this is a preliminary estimate and that more sampling would be required to account for spatial heterogeneity, most of this site appears to be polluted and toxic to at least 90cm depth. The few samples where deeper samples were analyzed indicate that chemical pollution extends deeper at this site.

A majority of the Industrial Harbor stations met criteria for either Categories 5 or 6 (Table 22). Some stations at Cabrillo Beach Pier exhibited elevated tissue concentrations in field-collected fish and laboratory exposed bivalves, and were placed in Category 3 (Table 22). Based on sediment chemistry, toxicity test results, and benthic community structure, these stations also met the Category 6 criteria.

One station off shore of Palos Verdes (40031.2) had high concentrations of p'p DDE, and elevated concentrations of Total DDT and PCBs relative to sediment quality guidelines, although the ERM quotient value at this station was lower than the threshold necessary to categorize a site as having elevated chemistry (ie., ERMQ = 0.5). This station also had degraded benthic community structure at two of the three sub-field replicates monitored. However, amphipod survival at this station was generally high. It is possible that this analysis is limited by the use of a relatively short-term toxicity test. Swartz et al. (1985, 1986) suggest that the absence of acute toxicity does not demonstrate the absence of benthic degradation. Because the other Sediment Quality Triad elements suggest that chronic effects may be associated with elevated concentrations of DDT and PCB compounds, this is a situation where further investigation using a chronic toxicity test (incorporating measures of amphipod growth, survival and fecundity) is warranted.

Some Industrial Harbor stations were categorized as potential reference stations (Category 9; Table 22). These were located in Fish Harbor (40015.3), East Basin (40008.1), Terminal Island (40016.1), and the Turning Basin (48010.0). Although most of these stations had relatively low chemical concentrations, all but one had at least one exceedance of a guideline value. In addition, although benthic community structure was not degraded or transitional at these stations, the Relative Benthic Index values were somewhat low at several of these stations. One goal of this study was to use reference site data to assess biological impacts at polluted stations. There were not a sufficient number of reference sites identified in this study to allow for calculation of reference envelope tolerance limits. Hunt et al. (1998) suggested that a minimum of 20 reference samples was necessary to provide statistical confidence in calculation of reference envelope tolerance limits. To identify more reference sites additional monitoring would be required. By definition, reference sites require low chemical concentrations and undegraded benthic community structure (SWRCB, 1997). Several of the stations listed under Category 8 (Table 22) had low chemical concentrations but benthic structure was not characterized. Because these stations had high amphipod survival as well, they may serve as appropriate reference sites for future monitoring studies. Undegraded benthic community structure at these sites will need to be verified before they can be used for this purpose.

## ***Marinas***

### **Chemistry Data**

#### **Primary Chemicals of Concern**

A summary of chemicals at the Marina stations that exceeded the sediment quality guideline values is presented in Figure 31. Although the chemicals most often exceeding sediment quality guideline values were similar at the Industrial Harbor and Marina stations, the relative proportion of chemicals exceeding guidelines differed between the two waterbody types. The relative proportion of stations with metal concentrations above the ERM guidelines was greater in the Marina stations (Figures 32-37). Copper, mercury

and zinc exceedances of ERM values were all found in Marina Del Rey (Station No.s 44014, 48001, 48002, 48003, and 48006; Figure 33b and 36b).

In addition to the metals discussed above, tributyltin (TBT) concentrations in sediment from one station in Marina Del Rey (44014) were greater than the 90<sup>th</sup> percentile threshold for the statewide BPTCP database. Selenium concentrations in Marina Del Rey (44014) and Shoreline Marina (48007) also exceeded the 90<sup>th</sup> percentile threshold from the statewide BPTCP database.

While elevated pesticide concentrations were not widely detected in most Marina stations, a relative high proportion of Marina stations exceeded the ERM values for total chlordane. Total chlordane concentrations above the ERM value were measured at the entrance of Alamitos Bay (40022, and 40023), at two stations in Shoreline Marina (44020 and 48008), and throughout Marina Del Rey (44014, and Stations 48001 through 48006; Figures 38-39).

A majority of the Marina Station samples exceeded the ERL value for total PCBs and a large proportion of sediments had concentrations above the ERM for total PCBs. Station samples with the highest PCB concentrations were in Shoreline Marina (44020, 48006; Figure 41a-b), Marina Del Rey (44014, 48003, 48005), and King Harbor (48011; Figure 42 a-b). While elevated concentrations of PAHs were found at many Industrial Harbor stations, few samples in the Marinas had concentrations of these chemicals above the guideline values.

A number of samples from Marina Del Rey (48001 – 48005, and 44014) had elevated chemistry relative to ERM Quotient values or the number of guideline exceedances (Table 23, Figures 44-46). Two samples from Shoreline Marina (44020 and 48006) had elevated chemistry based on ERMQ values.

### **Toxicity Testing Data**

Of the 35 Marina samples tested with the amphipod 10-d survival protocol, 31% were significantly toxic (Table 24). As with the Industrial Harbor stations, toxicity was greater in inner station sediments. This was particularly evident in Los Alamitos Bay (Figure 47b), and Marina Del Rey (Figure 48b). Additional toxicity tests were used occasionally to provide additional information for assessing Marina sediment toxicity. Results of these tests are presented in Appendix E.

In contrast to the Industrial Harbor toxicity data where amphipod survival was negatively correlated with metals, pesticides, PAHs and PCBs, Spearman Rank Correlations indicated that in the Marina stations, amphipod survival was negatively correlated primarily with metals (eg., arsenic, copper, lead, mercury, and zinc), tributyltin, and the number of ERM exceedances at these stations (Table 25; Figure 50). In addition, amphipod survival at the Marina stations was negatively correlated with percent clay in the sediment. Toxicity of some of the Marina samples was also assessed by exposing sea

urchin embryos to intact sediment cores at the sediment-water interface (Appendix E). Seventeen percent (2/12) of these samples were significantly toxic. Spearman Rank correlations were used to examine associations between chemistry and embryo-larval development for those samples analyzed for chemistry. The results indicate that sea urchin development was negatively correlated with several chemicals in the Marina samples including three pesticides, a number of PCB congeners, as well as unionized ammonia and hydrogen sulfide in the samples (Table 26).

### **Benthic Community Analysis**

Only 1 of the 22 Marina stations was classified as having degraded benthic community structure (Table 27); this station was in Shoreline Marina (Station No. 48007; Figure 51a). A number of stations in Shoreline Marina (48006, 48020; Figure 51a) and Marina Del Rey (44014, 48003; Figure 52b) were classified as transitional but had relatively low RBI values. Stations closer to the mouth of Marina Del Rey had undegraded benthos. Limitations on benthic community analyses are discussed at the end of this report. Benthic community structure (ie., the RBI) at the Marina stations was negatively correlated with a number of metals (eg., antimony, chromium, copper, lead, mercury, silver, and zinc), several pesticides (chlordanes, DDT metabolites, and dieldrin), and several PCBs. The RBI was also negatively correlated with the ERM Quotient, the number of ERM exceedances in the samples (Table 28), and with sediment grain size and TOC.

### **Marina Station Categorization**

The majority of Marina stations met the criteria for Categories 5 and 6 (Table 29). Significant chemical pollution and toxicity to amphipods was measured at several stations in Marina del Rey. The Relative Benthic Index at those Marina Del Rey stations where benthics were analyzed (48001.0-48003.) indicated transitional benthic community structure, although the RBI values at these stations were relatively low (Table 29).

Shoreline Marina (Station No. 44020.0) had elevated chemistry in all samples assessed, and recurrent toxicity to amphipods (toxic in 3 of 5 samples). Benthic community structure was not analyzed at this station. The one station in Shoreline Marina where benthic community structure was characterized indicated degraded benthos (48007; Table 29), although this sample was not toxic and only Nickel was elevated relative to the guideline values.

Few Marina stations were categorized as potential reference stations (Category 9; Table 29). These were located in Alamitos Bay. Although most of these stations had relatively low chemical concentrations, two had elevated concentrations of Chlordane. In addition, benthic community structure was not measured at these stations. Because designation as a reference site for the BPTCP requires undegraded benthic community structure coupled with low chemistry (Hunt et al., 1998), benthic community structure at these stations would have to be measured prior to their designation as reference sites. One station in

Channel Islands Harbor (48012) was placed in Category 6 due to low amphipod survival. Because this station had relatively undegraded benthos and few chemicals at elevated concentrations it might also serve as a potential reference site.

## *Lagoons*

### **Chemistry Data**

#### Primary Chemicals of Concern

A summary of chemicals at the Lagoon stations that exceeded the sediment quality guideline values is presented in Figure 54. The list of the primary chemicals of concern at the Lagoon stations was similar to those found in the Marina and Industrial Harbor stations, but the relative proportions of the various chemical compounds was different in the Lagoon sediment samples, reflecting the different pollutant inputs to these waterbodies.

Unlike the Marina and Industrial Harbor stations, few metals exceeded the ERM guideline values. Exceedances of the ERM for zinc were found in samples from Ballona Creek and one sample from Colorado Lagoon (Figures 55 and 56). In addition, the selenium concentration at one sample in Mugu Lagoon (48017) exceeded the 90<sup>th</sup> percentile threshold derived from the statewide BPTCP database.

There was a greater relative proportion of Lagoon samples having ERM exceedances of pesticides than were found in the Industrial Harbor or Marina stations. Stations with ERM exceedances for total chlordane were found in Colorado Lagoon (Station No. 44017 was greater than 21x the ERM for total chlordane), and Ballona Creek (44024 was 18x the ERM for total chlordane). Total chlordane in McGrath Lake sediments were measured from 25 to 39x the ERM value. High chlordane concentrations were also measured in several Mugu Lagoon samples (Figure 57 and 58). Relative to the ERM guidelines, elevated concentrations of several pesticides were found in McGrath Lake sediments including total DDT, and Dieldrin (Station No. 44027; Figure 60). High Dieldrin concentrations were also found in Ballona Creek (44024) and Colorado Lagoon (44017). Sediments from some of these sites also contained elevated concentrations of total PCBs (Figures 61-62).

In addition to pesticides for which sediment quality guideline values have been derived, several stations had elevated concentrations of pesticides for which no guideline values exist. Toxaphene and endosulfan concentrations were elevated in McGrath Lake (44027); toxaphene was greater than the 90<sup>th</sup> percentile threshold derived from the statewide BPTCP database, and the endosulfan concentration in McGrath Lake sediment was 3 times the 95<sup>th</sup> percentile threshold. This was the second highest endosulfan concentration measured in sediments as part of the Bay Protection Program. In addition to these pesticides, elevated chlorpyrifos concentrations were found in Ballona Creek

(44024; 2x the 95<sup>th</sup> percentile threshold of the BPTCP database) and Mugu Lagoon (48015; > the 90<sup>th</sup> percentile threshold of the BPTCP database).

One sample from McGrath Lake (44027) had the second highest average ERM Quotient value measured in the Los Angeles region (Table 30; Figures 63-64). This was due to elevated concentrations of a number of pesticides. Total chlordane in sediment from this station was 39 times the ERM value, total DDT was 3 times the effect concentration reported by Swartz et al. (1994), and Dieldrin was 3 times the ERM value. Sediment chemistry at this station was measured twice, once in January 1993 (IDORG = 627), then again in June 1996 (IDORG = 1628). Concentrations of these pesticides increased in sediment at this station between the first and second sampling (Table 30). The ERMQ in one sample from Colorado Lagoon (44017) had an ERMQ of 2.27 (Table 30). This was due to elevated concentrations of total chlordane (21 x the ERM value), and Dieldrin (3x the ERM value). In addition to these stations, several samples from Ballona Creek (Station number 44024), had an ERMQ greater than 1.00. The relatively high ERMQ from Ballona Creek was primarily due to elevated total chlordane (18x the ERM value), Dieldrin (3x the ERM value), and total PCBs (2x the ERM value).

### **Toxicity Testing Data**

Fifty-eight percent (19/33) of Lagoon station sediments were significantly toxic to amphipods. This was a greater proportion of toxic samples than was found in the Industrial Harbor and Marina station sediments (Table 31). A majority of the stations monitored in Mugu Lagoon (Figure 65), and all of the stations in Ballona Creek were toxic to amphipods (Figure 66b). Stations in McGrath Lake that were toxic to the amphipod *Rhepoxynius abronius* were not toxic to *Eohaustorius abronius* when tested at a later date (Table 31; Figure 66a). None of the sediments from the Ventura or Santa Clara River Estuaries, or from Malibu Lagoon were significantly toxic to amphipods or any of the other protocols used (Figure 67; Appendix E).

Spearman Rank correlations indicated that amphipod survival in the Lagoon samples was weakly correlated with several metals (eg., antimony, copper, mercury, silver, zinc, and tin) and a number of PCB congeners (Table 32). There were more significant negative correlations with pesticides measured in the Lagoon stations, particularly total chlordane and dieldrin (Figure 68). There were also significant negative correlations with a number of PAHs, the ERM Quotient and the number of ERM exceedances calculated for these stations (Table 32; Figure 69).

### **Benthic Community Analysis**

The only Lagoon stations where benthic community structure was analyzed were in Mugu Lagoon (48013.0-48018.0), all of these were classified as degraded (Table 33; Figure 70). Two of the stations in Mugu Lagoon had essentially no benthic infaunal

organisms present (48014, 48017). Limitations on benthic community analyses are discussed at the end of this report.

### **Bioaccumulation Analysis**

Mugu Lagoon is an ecologically important estuary which receives runoff from the Calleguas Creek watershed, adjacent agriculture lands, and the Naval Air Station at Point Mugu. Previous studies have indicated elevated concentrations of several pesticides in fish from this water body. In this study, concentrations of chemicals were measured in two species (*Cymatogaster aggregata* and *Atherinops affinis*) collected at the confluence of Calleguas Creek and Mugu Lagoon to assess current conditions in resident fish species.

Of the chemicals measured in fish collected from Mugu Lagoon, DDT and PCBs were significantly elevated relative to EPA screening values (Table 34). Total PCBs measured in shiner surfperch were almost twice the EPA screening value at Station No. 44106. Concentrations were greater in the surfperch than topsmelt. This was partly due to higher lipid levels, which were twice as high in the surfperch as those measured in the topsmelt. In addition, as discussed above, differences in tissue concentrations may also have been related to differences in feeding behavior and metabolic biotransformation rates. Although the station where these fish were collected is where Calleguas Creek enters Mugu Lagoon, a site that receives sediment-bound DDT from this watershed, the highest tissue concentration of Total DDT in the surfperch was less than one half the EPA screening value. Sediment chemistry was not analyzed at this station. However, Total DDT measured in Station 48015, the central Mugu Lagoon station closest to station 44106, had a Total DDT concentration approximately one half the toxic concentration reported by Swartz et al. (1994).

### **Lagoon Station Categorization**

The majority of Lagoon stations met the criteria for Categories 4 and 6 (Table 35). Although stations in Colorado Lagoon (44017), Ballona Creek (44024), and McGrath Lake (44027) had elevated chemistry and were toxic to amphipods, benthic community structure was not characterized at these stations. Colorado Lagoon is polluted by a number of chemicals and has a relatively high ERM Quotient, due in large part to high total chlordane concentrations. Ballona Creek is also polluted by a number of pesticides and exhibited recurrent toxicity to amphipods. Because these sites are highly modified urban environments and probably subject to extreme temperature and/or salinity conditions, it is difficult to determine whether additional benthic characterization would be useful. McGrath Lake sediments act as a sink to adjacent agricultural inputs and therefore contain elevated concentrations of a number of pesticides. This site exhibited recurrent, though variable, toxicity to amphipods. Further characterization of benthic community structure at this site would be useful to determine whether ecological impacts are associated with chemical contaminants.



Stations in Mugu Lagoon all met the criteria for Category 6. Chemical and biological results at these sites were variable. Although individual pesticides sometimes exceeded guideline values, the ERM quotients at these stations were generally low (Table 35). Amphipod survival was lowest at the Mugu Lagoon Entrance (44054), Mugu/Oxnard Ditch (44053), and Central Mugu Lagoon (48015), though survival throughout the Lagoon was variable. Benthic community structure was significantly degraded at all stations where it was characterized. In addition, concentrations of PCBs were elevated in fish caught at the confluence of Calleguas Creek and Mugu Lagoon (44016). As discussed above relative to results at the Palos Verdes stations, this analysis may be limited by the use of relatively acute toxicity test protocols. Analysis of Mugu Lagoon stations with a chronic toxicity test assessing amphipod survival, growth, and fecundity could help confirm whether the observed benthic community degradation at this site is associated with pollution.

## STUDY LIMITATIONS

As discussed previously, this data set was limited by lack of information useful for evaluating the bioavailability of sediment-associated chemicals. There were limited measurements of interstitial water chemical concentrations, and sediment Acid-Volatile Sulfides or Simultaneously Extracted Metals (AVS-SEM). The lack of *in situ* measures of dissolved oxygen concentrations limited conclusions regarding effects of anoxia on benthic community structure. Additional unmeasured factors that may have influenced benthic community structure included seasonal variations in salinity, temperature, freshwater flow, and sedimentation rates. These factors need to be considered by resource managers when considering the effects of chemical pollutants on ecological metrics. In addition, the toxicity tests used in these surveys were generally short-term acute toxicity tests. In situations where stations were dominated by high concentrations of chemicals considered to exhibit chronic toxicity, conclusions based on acute toxicity tests should be treated cautiously.

Because of these limitations, characterization of the most impacted stations must rely, to a certain extent, on a qualitative interpretation of the data. To accomplish this, individual stations were evaluated based on a Triad of measures (*sensu* Chapman et al., 1987): chemical pollution, benthic community structure, and toxicity to various species.

Stations were categorized based on this information, and the completeness of sample characterization. In order to categorize stations, it was necessary to define terms such as "elevated chemistry" or "sample toxicity" for a large number of samples. To be consistent, thresholds were established for this purpose, and these are described above. The chemistry, toxicity, and benthic community threshold values were derived to allow a consistent interpretation of data from samples throughout the Region and state. It is important to note that while these threshold values were selected based on the best available information and best professional judgement of the authors, they are by nature arbitrary. Chemical bioavailability varies from sample to sample, and the exact definitions of toxicity and benthic degradation depend on factors not easily analyzed in a

large number of samples. Further data collection and analysis may result in the determination of different threshold values and different definitions for biological impacts. The thresholds and station characterizations used here are not intended to be absolute. They are intended to aid in the screening of data collected from a large number of locations, in order to support management decisions. In some cases additional studies may be undertaken to further evaluate the sites of concern identified in this Region-wide assessment. As more data become available through additional studies, more accurate site-specific characterizations of sediment quality may result.

It should also be noted that this research provides limited information on spatial extent or temporal variability of chemical pollution and ecotoxicological effect at these sites. These topics should be emphasized in future investigations.

## CONCLUSIONS

1. Through a cooperative agreement this study achieved the combined program objectives of the State Water Resources Control Board's Bay Protection and Toxic Cleanup Program, and the National Oceanic and Atmospheric Administration's Status and Trends Program.
2. Using a weight-of-evidence approach based on the Sediment Quality Triad, measures of chemical pollution, toxicity, benthic community structure, and bioaccumulation were completed at Industrial Harbor, Marina, and Lagoon stations over a five year period to determine relative degradation in selected water bodies in the Los Angeles Region. When combined with measures of other sediment characteristics such as grain size, TOC, unionized ammonia, and hydrogen sulfide, these measures were useful for determining the relative level of pollution and biological impacts at a wide range of stations.
3. Degree of chemical contamination was assessed using two sets of sediment quality guidelines: the ERL/ERM guidelines developed by NOAA (Long et al., 1995), and the TEL/PEL guidelines developed for the State of Florida (MacDonald, 1996). In addition, non-guideline chemicals were compared to the BPTCP database to compare relative concentrations with those measured statewide. Copper, mercury, zinc, TBT, total chlordane, total PCBs, and high molecular weight PAHs were found to be the chemicals or chemical groups of greatest concern at the Industrial Harbor stations. Copper, lead, mercury, zinc, total chlordane, and total PCBs were found to be the chemicals or chemical groups of greatest concern at the Marina stations. PCBs, and a number of pesticides, including chlordane, dieldrin, endosulfan, and DDT, were the chemicals of greatest concern in the Lagoon stations.
4. Of the 192 Industrial Harbor stations where toxicity was assessed, 29 % showed significant toxicity to amphipods. Toxicity was highest in the inner Industrial Harbor sediment samples. Pore water samples demonstrated higher toxicity than sediment samples; 79% of the Industrial Harbor stations were toxic to abalone embryos exposed to sediment pore water. Of the 35 Marina stations tested for amphipod toxicity, sediment

samples were toxic to amphipods at 31% of the stations. Of the 33 Lagoon station sediment samples tested, 58% were significantly toxic.

5. Many of the chemicals that correlated with toxicity also exceeded sediment quality guideline values. Amphipod survival in Industrial Harbor stations was negatively correlated with a number of chemicals or chemical groups, including copper, mercury, nickel, lead, zinc, chlordane, total PCBs, low and high molecular weight, and total PAHs, the ERM Quotient, and the number of ERM Exceedances in the samples. In addition amphipod survival in the Industrial Harbor samples was negatively correlated with sediment grain size and TOC. Because chemicals bind to TOC and fine-grained sediments, it is not possible without further study to separate bioeffects due to these binding phases from those due to pollutants. Abalone development in Industrial Harbor pore water samples was negatively correlated with tin, total chlordane, two PCB congeners, the ERM Quotient value, and the number of ERM Exceedances in these samples. Amphipod survival in Marina sediments was negatively correlated primarily with metals (As, Cu, Pb, Hg, Ni, and zinc), as well as TBT. Amphipod survival in these samples was also negatively correlated with the PEL Quotient, the number of ERM Exceedances, and percent clay in the samples. Amphipod survival in Lagoon sediment samples was negatively correlated with metals (Cu, Hg, Ag, Zn), pesticides such as chlordane, DDT, and dieldrin, and a number of PCB congeners and PAH compounds. In addition, amphipod survival in Lagoons was negatively correlated with the ERM Quotient and the number of ERM Exceedances in these samples.

6. Of the 102 Industrial Harbor stations where benthic community structure was characterized, 13% were considered to be degraded. The Relative Benthic Index (RBI) was negatively correlated with a number of metals, pesticides, PCBs and PAHs. In addition, the RBI was negatively correlated with sediment TOC, the ERM Quotient, and the number of ERM Exceedances. Multivariate and univariate correlations between toxicity test results and benthic community metrics indicated that amphipod survival in toxicity tests was positively correlated with the total number of crustacean individuals and species at these stations. Abalone development in toxicity tests was positively correlated with the number of mollusc individual and species. Only one of 22 Marina samples had significantly degraded benthic community structure ( $RBI \leq 0.30$ ), although several stations had lower RBI values. Benthic community structure at the Marina stations was negatively correlated with metals, pesticides, PCBs, grain size, TOC, and the ERM Quotient and number of ERM Exceedances. All 6 of the Lagoon samples assessed in Mugu Lagoon had degraded benthos.

7. Bioaccumulation measured in field collected fish and laboratory exposed bivalves (*Macoma nasuta*) indicated that field collected fish in the West Basin and Cabrillo Beach Pier areas of Los Angeles Harbor contained DDT and PCB tissue concentrations that exceeded EPA screening values. Bivalves exposed to sediments from the Cabrillo Beach Pier area accumulated significantly higher concentrations of DDT and PCBs than clams exposed to control sediment. Fish collected from one station in Mugu Lagoon also had elevated levels of PCBs.

8. The results of these studies were consolidated into weight-of-evidence categorization tables. Stations were grouped based on chemical and ecotoxicological results into 9 possible categories that considered the magnitude of contamination by chemicals of concern, occurrence of toxicity using multiple toxicity test protocols, benthic community degradation, and in some cases, tissue bioaccumulation. Specific thresholds were established for each measure, beyond which stations were considered to have elevated chemistry, significant toxicity, degraded benthic community structure, or elevated tissue concentrations.

Stations in the Consolidated Slip area were the Industrial Harbor stations that met all the criteria for Category 1. Samples from these stations had elevated chemistry, recurrent toxicity, and degraded benthic community structure. A majority of the Industrial Harbor stations met the criteria for Categories 5 or 6. These were stations with either, elevated chemistry and mixed results from biological measures (Cat. 5), or with measured biological impact but chemistry values below thresholds or not measured (Cat. 6).

The majority of Marina stations met the criteria for Categories 5 and 6. Some stations in Marina Del Rey had sediments with elevated chemistry; these stations were also significantly toxic to amphipods. The RBI at some of these stations was relatively low, but did not exceed the threshold for significant benthic community degradation.

The majority of Lagoon stations also met the criteria for Categories 5 and 6. Stations in Colorado Lagoon, Ballona Creek, and McGrath Lake had elevated chemistry and were significantly toxic to amphipods, but benthic community structure was not characterized at these stations. Stations in Mugu Lagoon all met the criteria for Category 6. Individual pesticides exceeded some guideline values in Mugu Lagoon, and amphipod survival was variable. Benthic community structure was degraded at all of the 6 Mugu Lagoon stations analyzed.

## REFERENCES

- Abbott, R. 1974 (2<sup>nd</sup> ed.). *American Seashells*. New York: Van Nostrand Reinhold. 663 pp.
- Allen, H.E., G. Fu, B. Deng. 1993. Analysis of acid volatile sulfide (AVS) and simultaneously extracted metals (SEM) for the estimation of potential toxicity in aquatic sediments. *Environ. Toxicol. Chem.* 12: 1441-1453.
- Abele, L.G. and K. Walters. 1979. Marine benthic diversity: a critique and alternate explanation. *Journal Biogeography* 6: 115-126.
- American Society for Testing and Materials. 1992. Standard guide for collection, storage, characterization, and manipulation of sediments for toxicological testing. Guide No. E 1392-90. Vol. 11.04, 1139-1153. Philadelphia, PA.
- American Society for Testing and Materials. 1993. Standard guide for conducting sediment toxicity tests with freshwater invertebrates. Guide No. E 1387-93. Vol. 11.04, 1173-1199. Philadelphia, PA.
- Anderson, B.S., J.W. Hunt, M.M. Hester and B.M. Phillips. 1996. Assessment of sediment toxicity at the sediment-water interface. In: G.K. Ostrander (ed.) *Techniques in Aquatic Toxicology*. Lewis Publishers, Ann Arbor, MI.
- Anderson, B.S., J. Hunt, S. Tudor, J. Newman, R. Tjeerdema, R. Fairey, J. Oakden, C. Bretz, C.J. Wilson, F. LaCaro, G. Kapahi, M. Stephenson, M. Puckett, J. Anderson, K.R. Long, T. Fleming, K. Summers. 1997. Chemistry, toxicity and benthic community conditions in sediments of selected southern California bays and estuaries. Final Report, California State Water Resources Control Board.
- Baker, J.H. 1975. Distribution, ecology, and life histories of selected Cypridinacea (Myodocopida, Ostracoda) from the Southern California mainland shelf. PhD Thesis U. Houston.
- Barnard, J. 1963. Relationship of benthic Amphipoda to invertebrate communities of inshore sublittoral sands of southern California. *Pacific Naturalist*. 3: 437-467.
- Bay, S., R. Burgess, and D. Greenstein. 1993. Status and applications in the Echinoid (Phylum Echinodermata) toxicity test methods. In: W.G. Landis, J.S. Hughes and M.A. Lewis, eds. *Environmental Toxicology and Risk Assessment*. ASTM, STP 1179, Philadelphia, PA.
- Becker, D.S. and T.C. Ginn. 1995. Effects of storage time on toxicity of sediments from Puget Sound, Washington. *Environ. Toxicol. Chem.* 14:829-835.

Bender, M., W. Martin, J. Hess, F. Sayles, L. Ball, and C. Lambert. 1987. A whole core squeezer for interfacial pore water sampling. *Limnology and Oceanography*. 32(6): 1214-1255.

Bousfield, E. 1970. Adaptive radiation in sand-burrowing crustaceans. *Chesapeake Science* 11 (3): 143-154.

Bousfield, E. 1996. The amphipod family Oedicerotida on the Pacific Coast of North America. Part 1. The *Monoculodes* and *Synchelidium* generic complexes: systematics and distributional ecology.

Brinkhurst, R.O. and M.L. Simmons. 1968. The aquatic Oligochaeta of the San Francisco Bay system. *California Fish and Game* 54: 180-194.

Brinkhurst, R.O. and D.G. Cook. 1980. Aquatic oligochaete biology. Plenum Press, New York, 529p.

Burgess, R.M., K.A. Schweitzer, R.A. McKinney, and D.K. Phelps. 1993. Contaminated marine sediments: water column and interstitial toxic effects. *Environ. Toxicol. Chem.* 12: 127-138.

California Department of Fish and Game. 1990. Water Pollution Control Laboratory Standard Operating Procedure for Determination of Arsenic in Biological Tissue, Sediment, and Water.

California Department of Fish and Game. 1990. Water Pollution Control Laboratory Standard Operating Procedure for Determination of Selenium in Biological Tissue, Sediment, and Water.

California Environmental Resources Evaluation System (CERES). 1998. Southern California Wetlands Inventory. Website address:  
[http://ceres.ca.gov/wetlands/geo\\_info/so\\_cal.html](http://ceres.ca.gov/wetlands/geo_info/so_cal.html)

California State Mussel Watch Program. 1988. Ten Year Data Summary 1977-1987. Water Quality Monitoring Report No. 87-3. Division of Water Quality. State Water Resources Control Board.

California State Water Resources Control Board. 1997. Scientific Planning and Review Committee: Recommendations on the Bay Protection and Toxic Cleanup Program Monitoring Activities. SWRCB, Sacramento, CA.

Carr, R.S., J. Williams and C.T. Fragata. 1989. Development and Evaluation of a Novel Marine Sediment Pore Water Toxicity Test with the Polychaete *Dinophilus gyrociliatus*. *Environ. Toxicol. Chem.* 8: 533-543.

- Carr, R.S., and D.C. Chapman. 1992. Comparison of Solid-phase and Pore-water Approaches for Assessing the Quality of Marine and Estuarine Sediments. *Chem. Ecol.* 7: 19-30.
- Carr, R.S., and D.C. Chapman. 1995. Comparison of Methods for Conducting Marine and Estuarine Sediment Porewater Toxicity Tests - Extraction, Storage, and Handling Techniques. *Arch. Environ. Contam. Toxicol.* 28: 69-77.
- Chapman, P.M., R.N. Dexter, and E.R. Long. 1987. Synoptic measurements of sediment contamination, toxicity, and infaunal community composition (the Sediment quality Triad) in San Francisco Bay. *Marine Ecology Progress Series.* 37: 75-96.
- Connell, J.H. 1978. Diversity in tropical rain forests and coral reefs. *Science* 199: 1302-1310.
- Cross, J.N., Hardy, J.T., Hose, J.E., Hershelman, G.P., Antrim, L.D., Gossett, R.W., Crecelius, E.A. 1987. Contaminant concentrations and toxicity of sea-surface microlayer near Los Angeles, California. *Mar. Environ. Res.* 23: 307-323.
- Davis, P.H. and R.B. Spies. 1980. Infaunal benthos of a natural petroleum seep: study of community structure. *Marine Biology* 59: 31-41.
- Diaz, R.J. 1992. Ecosystem assessment using estuarine and marine benthic community structure. In: G.A. Burton (ed): *Sediment Toxicity Assessment*. Lewis Publishers, Boca Raton, FL. 67-85.
- Dillon, T.M., D.W. Moore, and A.B. Gibson. 1993. Development of a chronic sublethal bioassay for evaluating contaminated sediment with the marine polychaete worm *Nereis (Neanthes) arenaceodentata*. *Environ. Toxicol. Chem.* 12: 589-605.
- Dinnel, P.A., J.M. Link, and Q.J. Stober. 1987. Improved methodology for a sea urchin sperm cell bioassay for marine waters. *Arch. Environ. Contam. Toxicol.* 16: 23-32.
- Evans, D. and P. Hanson. 1993. Analytical methods for trace elements in sediments by atomic absorption spectrophotometry. In *Sampling and Analytical Methods of the National Status and Trends Program National Benthic Surveillance and Mussel Watch Project 1984-1992*, vol. 3. Lauenstein, G. and A. Cantillo (eds.). NOAA Tech. Mem. NOS ORCA 71. 53-81.
- Fairey, R. 1992. Sampling and analysis of trace metals in sediment interstitial waters. American Geophysical Union. Fall Meeting, 042A-06.

Fairey, R., C. Bretz, S. Lamerdin, J. Hunt, B. Anderson, S. Tudor, C. Wilson, F. LaCaro, M. Stephenson, H. Puckett, E. Long. 1996. Chemistry, toxicity and benthic community conditions in sediment of the San Diego Bay region. Final Report, California State Water Resources Control Board.

Fairey, R., Roberts, C., Jacobi, M., Lamerdin, S, Clark, R., Downing, J., Long, E., Hunt, J., Anderson, B, Newman, J., Stephenson, M., Wilson, C.J. In Press. Patterns of sediment toxicity and chemistry in the San Diego Bay region. Environ. Toxicol. and Chem.

Fenwick, G. 1984. Life history and population biology of the giant ostracod *Leuroleberis zealandica* (Baird, 1850, Myodocopida). J. Exp. Mar. Biol. Ecol. 77(3): 255-390.

Folk, R. 1974. Petrology of Sedimentary Rocks. Hemphill Publ. Co., Austin, TX. 182pp.

Franson, M. A. (Ed). 1981. 505 Organic carbon (total) p. 471-475. In: Standard Methods For the Examination of Water and Wastewater. 15th ed. Am. Public Health Ass.

Froelich, P.M. 1980. Analysis of Organic Carbon in Marine Sediments. Limnology and Oceanography. 25: 564-572.

Giesy, J.P. and R.A. Hoke. 1990. Freshwater Sediment Quality Criteria: Toxicity Bioassessment. Pp. 265-348 in Sediments: Chemistry and Toxicity of In-Place Pollutants. R. Baudo, J. Giesy, and H. Muntau, eds. Lewis Publishers. Michigan.

Grassle, J.F. and J.P. Grassle. 1974. Opportunistic life histories and genetic systems in marine benthic polychaetes. Journal of Marine Research. 32(2): 253-283.

Grassle, J.P. and J.F. Grassle. 1976. Sibling species in the marine pollution indicator *Capitella* (Polychaeta). Science 192: 567-569.

Hedges, J.I. and Stern J.H. 1983. Carbon and Nitrogen Determination of Carbonate Containing Solids. Limnology and Oceanography. 29: 658-663.

Hoke, R.A., G.T. Ankley, A.M. Cotter, T. Goldenstein, P.A. Kosian, G.L. Phipps, F.M. VanderMeiden. 1994. Evaluation of equilibrium partitioning theory for predicting acute toxicity of field-collected sediments contaminated with DDE, DDE and DDD to the amphipod *Hyalella azteca*. Environ. Toxicol. Chem. 13: 157-166.

Hunt, J.W., Anderson, B.S., Tudor, S., Phillips, B.M., Newman, J., Stephenson, M., Puckett, H.M., Fairey, R., Smith, R.W., and Taberski, K. 1998. Evaluation of sediment toxicity tests and reference sites in San Francisco Bay. Final Report. San Francisco Regional Water Quality Control Board, Oakland, California.



- Hurlbert, S.N. 1971. The non-concept of species diversity: a critique and alternate parameters. *Ecology*. 52: 577-586.
- IRIS (Integrated Risk Information System). 1992. U.S. Environmental Protection Agency, Duluth, MN.
- Jumars, P.A. 1975. Environmental grain and polychaete species diversity in a bathyal benthic community. *Marine Biology* 30: 253-266.
- Jumars, P.A. 1976. Deep-sea species diversity: does it have a characteristic scale? *Journal of Marine Research*. 34: 217-246.
- Kennish, M.J. 1991. *Ecology of Estuaries: Anthropogenic Effects*. CRC Press, Boca Raton, FL 494 pp.
- Khoo, K.H., C.H. Culberson, and R.G. Bates. 1977. Thermodynamics of dissociation of ammonium ion in seawater from 5° to 40°C. *J. Solution Chem.* 6: 281-290.
- Klaus, A.D., J.S. Oliver and R.G. Kvitek. 1990. The effects of gray whale, walrus, and ice gouging disturbance on benthic communities in the Bering Sea and Chukchi Sea, Alaska. *National Geographic research* 6(4): 470-484.
- Knezovich, J.P., D.J. Steichen, J.A. Jelinski, and S.L. Anderson. 1996. Sulfide Tolerance of Four Marine Species Used to Evaluate Sediment and Pore Water Toxicity. *Bull. Environ. Contam. Toxicol.* 57: 450-457.
- Lange, G.J., R.E. Cranston, D.H. Hydes, and D. Boust. 1992. Extraction of Pore Water from Marine Sediments: A Review of Possible Artifacts with Pertinent Examples from the North Atlantic. *Mar. Geol.* 109: 53-76.
- Lee, H.L., Lincoff, A., Boese, B.L., Cole, F., Ferraro, S.P., Lamberson, J.O., Ozretich, R.J., Randall, R.C., Rukavina, K.R., Schults, D.W., Sercu, K.A., Specht, D.T., Swartz, R.C., and Young, D.R. 1994. Ecological risk assessment of the marine sediments at the United Heckathorn superfund site. Final Report. U.S. EPA ERL-Narrangansett. ERL-N:N269.
- Lenihan, H. S. and J.S. Oliver. 1995. Anthropogenic and natural disturbances to marine benthic communities in Antarctica. *Ecological Applications* 5(2): 311-326.
- Lenihan, H.L., K.A. Kiest, K.E. Conlan, P.N. Slattery, B.H. Konar and J.S. Oliver. 1995. Patterns of survival and behavior in Antarctic benthic invertebrates exposed to contaminated sediments: field and laboratory bioassay experiments. *Journal of Experimental Marine Biology and Ecology*. 192: 233-255.

- Levin, L. 1981. Dispersion, feeding behavior and competition in two spionid polychaetes. *J. Mar. Res.* 39: 99-117.
- Levin, L.A. 1983. Drift tube studies of Bay-ocean water exchange and implications for larval dispersal. *Estuaries* 6(4): 364-371.
- Lewis, D.W. 1984 *Practical Sedimentology*. Hutchinson Ross Publishing Co., 230pp.
- Light, W. 1980. Invertebrates of the San Francisco Bay estuary system: Spionidae, Polychaeta, Annelida.
- Long, E.R., M.F. Buchman, S.M. Bay, R.J. Breteler, R.S. Carr, P.M. Chapman, J.E. Hose, A.L. Lissner, J. Scott, and D.A. Wolfe. 1990. Comparative evaluation of five toxicity tests with sediments from San Francisco Bay and Tomales Bay, California. *Environ. Contam. and Toxicol.* 9: 1193-1214.
- Long, E.R. M.F. Buchman. 1989. The potential for biological effects of sediment-sorbed contaminants tested in the National Status and Trends Program. NOAA Technical Memorandum NOS OMA 45.
- Long, E.R. and L.G. Morgan. 1990. The potential for biological effects of sediment-sorbed contaminants tested in the National Status and Trends Program. NOAA Technical Memorandum NOS OMA 62. National Oceanic and Atmospheric Administration, Seattle, WA.  
86 pp.
- Long, E.R., D.A. Wolfe, R.S. Carr, K.J. Scott, G.B. Thursby, H.L. Windom, R. Lee, F.D. Calder, G.M. Sloane, and T. Seal. 1994. Magnitude and extent of sediment toxicity in Tampa Bay, Florida. National Oceanic and Atmospheric Administration. NOAA Technical Memorandum NOS ORCA 78.
- Long, E.R., D.L. MacDonald, S.L. Smith and F.D. Calder. 1995. Incidence of Adverse Biological Effects Within Ranges of Chemical Concentration in Marine and Estuarine Sediments. *Environmental Management*. 19 (1): 81-97.
- Long, E.R., Field, L.J., and D.D. MacDonald. 1998. Predicting toxicity in marine sediments with numerical sediment quality guidelines. *Environ. Toxicol. and Chem.* 17(4): 714-727.
- Long, E.R., and D.D. MacDonald. In press. Recommended uses of empirically-derived, sediment quality guidelines for marine and estuarine ecosystems. *Human and Ecolog. Risk Assess.*

Los Angeles Regional Water Quality Control Board, Region (4). 1995. Water Quality Control Plan- Los Angeles Region. Basin Plan for the Coastal Watersheds of Los Angeles and Ventura Counties. LARWQCB, Monterey Park, CA.

Los Angeles Regional Water Quality Control Board, Region (4). 1997. BPTCP Proposed Regional Toxic Hot Spot Cleanup Plan. LARWQCB, Monterey Park, CA.

Los Angeles Regional Water Quality Control Board, Region (4). 1996. Calleguas Creek Watershed. LARWQCB, Monterey Park, CA.

MARPCPN I. 1992. The analysis of carbon and nitrogen from sediments and the particulate fraction of water from estuarine/coastal systems using elemental analysis. Method MARPCPN I. University of Maryland System for environmental and Estuarine Studies, Chesapeake Biological Laboratory. Revision 1.1. Environmental Monitoring Systems Laboratory, Office of Research and Development, U.S. Environmental Protection Agency.

MacDonald, D.D. 1992. Development of an integrated approach to the assessment of sediment quality in Florida. Prepared for the Florida Department of Environmental Regulation. MacDonald Environmental Services, Ltd. Ladysmith, British Columbia. 114 pp.

MacDonald, D.D. 1994. Approach to the Assessment of Sediment Quality in Florida Coastal Waters. Volume 1 - Development and Evaluation of Sediment Quality Assessment Guidelines. Prepared for the Florida Department of Environmental Regulation. MacDonald Environmental Services, Ltd. Ladysmith, British Columbia. 126 pp.

MacDonald, D.D. 1994. Approach to the Assessment of Sediment Quality in Florida Coastal Waters. Volume 2 - Application of the Sediment Quality Assessment Guidelines. Prepared for the Florida Department of Environmental Regulation. MacDonald Environmental Services, Ltd. Ladysmith, British Columbia. 52 pp.

MacDonald, D.D., R.S. Carr, F.D. Calder and E.R. Long. In Press. Development and Evaluation of Sediment Quality Guidelines for Florida Coastal Waters. Ecotoxicology

Maurer, D. 1967. Mode of feeding and diet, and synthesis of studies on marine pelecypods from Tomales Bay, California. *Veliger* 10(1): 72-76.

McCall, P.L. 1977. Community patterns and adaptive strategies of the infaunal benthos of Long Island Sound. *Journal of Marine Research* 35: 221-226.

Menzies, R. 1962. The marine isopod fauna of Bahia de San Quintin, Baja California, Mexico. *Pac. Natur.* 3: 337-348.

- Mills, E. 1962. Amphipod crustaceans of the Pacific coast of Canada. I. Family Oedicerotidae. Nat. Hist. Papers, Nat. Mus. Canada 15: 1-21.
- Mills, E. 1967. Biology of an ampeliscid amphipod crustacean sibling species pair. J. Fish. Res. Bd. Canada. 24: 305-355.
- Neff, J. M. 1979. Polycyclic Aromatic Hydrocarbons in the Aquatic Environment: sources, fates and biological effects. Applied Science Publishers, London, 262 pp.
- Neff, J. M. and J. W. Anderson. 1981. Response of Marine Animals to Petroleum and Specific Petroleum Hydrocarbons. Applied Science Publishers, London, 177 pp.
- Oakden, J.M., J.S. Oliver and A.R. Flegal. 1984a. Behavioral responses of phoxocephalid amphipods to organic enrichment and trace metals in sediment. Marine Ecology Progress Series. 14: 253-257.
- Oakden, J.M., J.S. Oliver and A.R. Flegal. 1984b. EDTA chelation and zinc antagonism with cadmium in sediments: effects on behavior and mortality of two infaunal amphipods. Marine Biology. 84: 125-130.
- Okey, T.A. 1997. Sediment flushing observations, earthquake slumping, and benthic community changes in Monterey Canyon head. Continental Shelf Research. 17: 877-897.
- Oliver, J.S., P.N. Slattery, L.W. Hulberg and J.W. Nybakken 1977. Patterns of succession in benthic infaunal communities following dredging and dredged material disposal in Monterey Bay. Dredged Material Research Program, U.S. Army Engineers Waterways Experiment Station, Technical Report 0-77-27, Vicksburg, Mississippi.
- Oliver, J.S., P.N. Slattery, L.W. Hulberg and J.W. Nybakken. 1980. Relationships between wave disturbance and zonation of benthic invertebrate communities along a subtidal high energy beach in Monterey Bay, California. Fishery Bulletin. 78: 437-454.
- Oliver, J.S., J.M. Oakden and P.N. Slattery. 1982. Phoxocephalid amphipod crustaceans as predators on larvae and juveniles in marine soft bottom communities. Marine Ecology Progress Series. 7: 179-184.
- Oliver, J.S., P.N. Slattery, M.A. Silberstein and E.F. O'Connor. 1983. A comparison of gray whale, *Eschrichtius robustus*, feeding in the Bering Sea and Baja California. Fishery Bulletin. 81: 513-522.
- Oliver, J.S., P.N. Slattery, M.A. Silberstein and E.F. O'Connor. 1984. Gray whale feeding on dense ampeliscid amphipod communities near Bamfield, British Columbia. Canadian Journal of Zoology. 62: 41-49.

- Oliver, J.S. and P.N. Slattery. 1985a. Effects of crustacean predators on species composition and population structure of soft-bodied infauna from McMurdo Sound, Antarctica. *Ophelia*. 24: 155-175.
- Oliver, J.S. and P.N. Slattery. 1985b. Destruction and opportunity on the sea floor: effects of gray whale feeding. *Ecology*. 66(6): 1966-1975.
- Pearson, T.H. and R. Rosenberg. 1978. Macrobenthic succession in relation to organic enrichment and pollution of the marine environment. *Oceanogr. Mar. Biol. Annu. Rev.* 16: 229-311.
- Peeling, T.J. 1974. A proximate biological survey of San Diego Bay, California. Naval Undersea Center. Report number: NUC TP 389.
- Phillips B.M., B.S. Anderson and J.W. Hunt. 1997. Measurement and distribution of interstitial and overlying water ammonia and hydrogen sulfide in sediment toxicity tests. *Mar. Environ. Res.* 44: 117-126.
- Port of Los Angeles. 1992. Los Angeles/Long Beach Harbors Improvement EIR/EIS. Port of Los Angeles and the U.S. Army Corps of Engineers. Los Angeles, CA.
- PSEP. 1991. Interim final recommended guidelines for conducting laboratory bioassays on Puget Sound sediments. U.S. Environmental Protection Agency, Region 10, Office of Puget Sound, Seattle, WA.
- Reid, G. and A. Reid. 1969. Feeding processes of members of the genus *Macoma* (Mollusca: Bivalvia). *Can. J. Zool.* 47: 649-657.
- Reish, D. and J. Barnard. 1960. Field toxicity tests in marine waters utilizing the polychaetous annelid *Capitella capitata* (Fabricius). *Pac. Natur.* 1: 1-12.
- Reish, D.J., D.F. Soule and J.D. Soule. 1980. The benthic biological conditions of Los Angeles-Long Beach Harbours: results of 28 years of investigations and monitoring. *Helgolander Meeresunters.* 34: 193-205.
- Rhoads, D.C., P.L. McCall, and Y.Y. Yingst. 1978. Disturbance and production on the estuarine seafloor. *American Scientist.* 66: 577-586.
- Rhoads, D.C. and L.F. Boyer. 1982. The effects of marine benthos on the physical properties of sediment: a successional perspective. In *Animal-Sediment Relations: The Biogenic Alteration of Sediments*, ed. P.L. McCall and M.J.S. Tevesz, pp. 3-43. Plenum Press, New York.
- Sanders, H.L., J.F. Grassle, G.R. Hampson, L.S. Morse, S. Garner-Price and C.C. Jones. 1980. Anatomy of an oil spill: long-term effects from the grounding of the barge Florida off West Falmouth, Massachusetts. *Journal of Marine Research.* 38: 265-380.

- Santos, S.L. and J.L. Simon. 1980. Response of soft-bottom benthos to annual catastrophic disturbance in a south Florida estuary. *Marine Ecology Progress Series*. 3: 347-355.
- Savenko, V.S. 1977. Marine chemistry: the dissociation of hydrogen sulfide in seawater. *Oceanology*. 16:347-350
- Schimmel, S.C., B.D. Melzian, D.E. Campbell, C.J. Strobel, S.J. Benyi, J.S. Rosen, H.W. Buffum, and N.I. Rubinstein. 1994. Statistical Summary EMAP-Estuaries Virginian Province - 1991. EPA /620/R-94/005.
- Schultz, G. 1969. How to know the marine isopod crustaceans. W. C. Brown Co.
- Schuster, S. 1987. Alternative reproductive behaviors: three discrete male morphs in *Paracerceis sculpta*, an intertidal isopod from the northern Gulf of California. *J. Crust. Biol.* 7: 318-327.
- Slattery, P. 1980. Ecology and life histories of dominant infaunal crustaceans inhabiting the subtidal high energy beach at Moss Landing, California. MS. Thesis, San Jose State University.
- Slattery, P.N. 1985. Life histories of infaunal amphipods from subtidal sands of Monterey Bay, California. *Journal of Crustacean Biology*. 5: 635-649.
- Sloan, C.A., N.G. Adams, R.W. Pearce, D.W. Brown, and S.L. Chan. 1993. Northwest Fisheries Science Center Organic Analytical Procedures. In *Sampling and Analytical Methods of The National Status and Trends Program National Benthic Surveillance and Mussel Watch Projects 1984-1992 - Volume VI Comprehensive descriptions of the trace organic analytical methods*. G.G. Lauenstein and A.Y. Cantillo (Eds). NOAA Technical Memorandum NOS ORCA 71, p 53-97.
- Smith, R. and J. Carlton (eds). 1975 (3rd ed). *Light's manual: Intertidal invertebrates of the central California coast*. UC Press. 716p.
- Soule, D.F., Oguri, M., and Pieper, R.E. 1997. The marine environment of Marina Del rey, July 1995-June 1996. A report to the Department of Beaches and Harbors, County of Los Angeles. Harbors Environmental Projects, University of Southern California, Los Angeles, CA.
- SPSS, Inc. 1997. SYSTAT Statistical Program, Version 7.0. Chicago, IL USA.
- State Water Resources Control Board. 1990. Evaluation of the AET Approach for Assessing Contamination of Marine Sediments in California. Division of Water Quality. Report No. 90-3 WQ. Sacramento, CA.

- State Water Resources Control Board. 1993. Staff Report: Status of the Bay Protection and Toxic Cleanup Program. Division of Water Quality. Sacramento, CA.
- Stephenson, M., M. Puckett, N. Morgan, and M. Reid. 1994. Bay Protection and Toxic Cleanup Program: Quality Assurance Project Plan. Bay Protection and Toxic Cleanup Program, State Water Resources Control Board, Sacramento, CA.
- Stull, J.K., Haydock, C.I., Smith, R.W. and D.E. Montagne. 1986. Long-term changes in the benthic community on the coastal shelf off Palos Verdes, southern California. *Marine Biology*. 91: 539-551.
- Swartz, R.C., W.A. DeBen and F.A. Cole. 1979. A bioassay for the toxicity of sediment to marine macrobenthos. *Water Pollution Control Federation*. 51: 944-950.
- Swartz, R.C., D.W. Shults, G.R. Ditworth and W.A. DeBen. 1984. Toxicity of sewage sludge to *Rhepoxnius abronius*, a marine amphipod. *Archives of Environmental Contamination and Toxicity*. 13: 207-216.
- Swartz, R.C., W.A. DeBen, J.K.P. Jones, J.O. Lamberson and F.A. Cole. 1985. Phoxocephalid amphipod bioassay for marine sediment toxicity. In, *Aquatic toxicity and hazard assessment, Seventh Symposium: ASTM STP 854*, eds, R.D. Cradwell, R. Purdy and R.C. Bahner, American Society for Testing and Materials, Philadelphia, pp. 284-307.
- Swartz, R.C., Cole, F.A., Shults, D.W. and W.A. Deben. 1986. Ecological changes in the southern California bight near a large sewage outfall; benthic conditions 1980-1983. *Marine Ecology Progress Series*. 31: 1-13.
- Swartz, R.C., F.A. Cole, J.O. Lamberson, S.P. Ferraro, D.W. Schults, D.W. Schults, W.A. Deben, H. Lee II, R.J. Ozretich. 1994. Sediment toxicity, contamination and amphipod abundance at a DDT- and Dieldrin-contaminated site in San Francisco Bay. *Environ. Toxicol. Chem.* 13: 949-962.
- Tabachnick, B.G. and L.S. Fidell. 1996. *Using Multivariate Statistics*. Harper Collins College Publishers. New York, NY USA. 880 pp.
- Tang, A., J.G. Kalocai, S. Santos, B. Jamil, J. Stewart. 1997. Sensitivity of blue mussel and purple sea urchin larvae to ammonia. Poster, Society of Environmental Toxicology and Chemistry, 18<sup>th</sup> Annual Meeting, San Francisco.
- Thistle, D. 1981. Natural physical disturbances and communities of marine soft bottoms. *Marine Ecology Progress Series*. 6: 223-228.

Thursby, G.B. and C.E. Schlekat. 1993. Statistical analysis of 10-day solid phase toxicity data for amphipods. Abstract, 14th Annual Meeting, Society of Environmental Toxicology and Chemistry.

Thursby, G.B., J. Heltshe, K.J. Scott. 1997. Revised approach to toxicity test acceptability criteria using a statistical performance assessment. *Environ. Toxicol. Chem.* 16: 1322-1329.

U.S. Environmental Protection Agency. 1988. Briefing Report to the EPA Science Advisory Board: The Apparent Effects Threshold Approach. Puget Sound Estuary Program. U.S. Environmental Protection Agency, Region 10. Seattle, Washington.

U.S. Environmental Protection Agency. 1989. Report of the Sediment Criteria Subcommittee: Evaluation of the Apparent Effects Threshold (AET) Approach for Assessing Sediment Quality. Office of the Administrator. Science Advisory Board. Washington, D.C.

U.S. Environmental Protection Agency. 1990. Exposure Factors Handbook. Office of Health and Environmental Assessment, Washington, DC. EPA-600/8-89-043.

U.S. Environmental Protection Agency/ U.S. Army Corps of Engineers. 1991. Evaluation of Dredged Material Proposed for Ocean Disposal: Testing Manual. EPA – 503/8-91/001. February 1991.

U.S. Environmental Protection Agency. 1993a. Workshop Report on Developmental Neurotoxic Effects Associated with Exposure to PCBs. September 14-15, 1992. Research Triangle Park, NC. Risk Assessment Forum. Washington D.C.

U.S. Environmental Protection Agency. 1993b. Methods for measuring the acute toxicity of effluents and receiving waters to freshwater and marine organisms. Office of Research and Development. EPA/600/4-90/027F. August 1993.

U.S. Environmental Protection Agency. 1994. Methods for Assessing the Toxicity of Sediment-associated Contaminants with Estuarine and Marine Amphipods. Office of Research and Development. EPA 600-R-94-025. June 1994.

U.S. Environmental Protection Agency. 1995a. Guidance for Assessing Chemical Contaminant Data For Use In Fish Advisories- Volume 1 Fish Sampling and Analysis 2nd Edition. Office of Water. EPA 823-R-95-007. September 1995.

U.S. Environmental Protection Agency. 1995b. Short-term methods for estimating the chronic toxicity of effluents and receiving waters to west coast marine and estuarine organisms. Office of Research and Development. EPA/600/R-95/136. August 1995.



VanBlaricom, G.R. 1982. Experimental analysis of structural regulation in a marine sand community exposed to oceanic swell. *Ecological Monographs*. 52: 283-305.

Vetter, E.W. 1995. Detritus-based patches of high secondary production in the nearshore benthos. *Marine Ecology Progress Series*. 120: 251-262.

Weston, D.P. 1990. Quantitative examination of macro-benthic community changes along an organic enrichment gradient. *Marine Ecology Progress Series*. 61: 233-244.

Whitfield, M. 1974. The hydrolysis of ammonium ions in sea water - a theoretical approach. *J. Mar. Biol. Ass. U.K.* 54: 565-580.

Whitfield, M. 1978. The hydrolysis of ammonium ions in sea water - experimental confirmation of predicted constants at one atmosphere pressure. *J. Mar. Biol. Ass. U.K.* 58: 781-787.

Wilcock, R.J., T.J. Smith, R.D. Primore, S.F. Thrush, V. Cumming, J.E. Hewitt. 1993. Bioaccumulation and elimination of chlordane by selected intertidal benthic fauna. *Environ. Toxicol. Chem.* 12: 733-742.

Table 12. ERM and PEL Quotients and Number of Sediment Quality Guideline Exceedances at Industrial Harbor Stations. Stations are ranked in descending order by ERM Quotient.

STANUM	STATION	IDORG	LEG	ERMQ	PELQ	ERM EXCDS	PEL EXCDS
47004.0	Consolidated Slip - 200E - Depth 2	1657	46	4.38	6.30	15	27
47004.0	Consolidated Slip - 200E - Surface	1656	46	1.29	1.86	6	17
49004.0	Kaiser Intl.- Berth 49	1793	54	2.70	5.71	17	19
40006.1	Consolidated Slip - Rep 1	1050	25	1.95	2.66	7	14
40006.1	Consolidated Slip - Rep 2	1051	25	1.65	2.28	7	16
40006.1	Consolidated Slip - Rep 3	1052	25	1.47	2.05	8	19
40006.1	Consolidated Slip	16	1	1.27	1.76	6	13
47002.0	Consolidated Slip - 200 - Surface	1650	46	1.92	2.45	8	15
47002.0	Consolidated Slip - 200 - Depth 2	1651	46	1.57	2.06	4	10
47009.0	Consolidated Slip - 200G - Surface	1664	46	1.66	2.23	8	17
47003.0	Consolidated Slip - 200B - Surface	1653	46	1.63	2.14	6	12
47008.0	Consolidated Slip - Storm Drain	1663	46	1.61	2.12	6	12
47001.0	Consolidated Slip - 198 - Surface	1647	46	1.43	1.88	5	8
47001.0	Consolidated Slip - 198 - Depth 2	1648	46	1.42	1.95	5	12
40006.2	Consolidated Slip	17	1	1.29	1.77	5	18
47007.0	Consolidated Slip - End - Surface	1662	46	1.01	1.32	4	5
40019.3	Inner Fish Harbor	57	2	0.91	1.27	7	14
47010.0	Dominguez - H. Ford Bridge - Surface	1665	46	0.80	1.10	3	5
40019.2	Inner Fish Harbor	56	2	0.66	0.90	5	6
40019.1	Inner Fish Harbor	55	2	0.62	0.89	4	12
40007.2	Long Beach Harbor - Channel 2	20	3	0.59	0.81	4	14
40011.3	Inner Harbor - Channel 3	33	3	0.57	0.69	3	3
40001.3	Southwest Slip	3	1	0.56	0.84	10	16
44012.0	Port Hueneme - Wharf B	1626	45	0.54	0.79	7	15
40031.1	Palos Verdes - Swartz 6	76	3	0.52	0.67	3	5
40001.2	Southwest Slip - Rep 1	1062	25	0.52	0.75	5	12
40001.2	Southwest Slip - Rep 2	1063	25	0.50	0.72	5	13
40001.2	Southwest Slip	2	1	0.42	0.56	4	9
40001.2	Southwest Slip - Rep 3	1064	25	0.32	0.44	1	4
40013.1	Inner Queensway Bay - Rep 3	1058	25	0.52	0.73	1	2
40013.1	Inner Queensway Bay	37	3	0.38	0.54	1	2
40013.1	Inner Queensway Bay - Rep 2	1057	25	0.31	0.43	1	1
40013.1	Inner Queensway Bay - Rep 1	1056	25	0.28	0.41	1	1
40014.2	Outer Queensway Bay	41	3	0.49	0.67	2	2
40014.3	Outer Queensway Bay	42	3	0.48	0.64	2	1
40031.3	Palos Verdes - Swartz 6	78	3	0.47	0.58	3	3
40013.2	Inner Queensway Bay	38	3	0.44	0.63	1	3
40031.2	Palos Verdes (Swartz 6) - Rep 2	1039	25	0.43	0.57	3	5
40031.2	Palos Verdes (Swartz 6) - Rep 3	1004	23	0.39	0.52	2	4

Table 12 cont. ERM and PEL Quotients and Number of Sediment Quality Guideline Exceedances at Industrial Harbor Stations. Stations are ranked in descending order by ERMQ.

STANUM	STATION	IDORG	LEG	ERMQ	PELQ	ERM EXCDS	PEL EXCDS
40031.2	Palos Verdes (Swartz 6) - Rep 1	1038	25	0.38	0.49	3	4
40031.2	Palos Verdes (Swartz 6)	77	3	0.37	0.49	3	4
40031.2	Palos Verdes (Swartz 6) - Rep 2	1003	23	0.36	0.49	3	4
40031.2	Palos Verdes (Swartz 6) - Rep 1	1002	23	0.32	0.44	2	3
40031.2	Palos Verdes (Swartz 6) - Rep 3	1040	25	0.30	0.41	3	4
40031.2	Palos V.(Swartz 6) - Rep 4 Blind	1005	23	0.29	0.42	1	0
40031.2	Palos Verdes (Swartz 6) - Rep 1	1189	30	NA	NA	NA	NA
40031.2	Palos Verdes (Swartz 6) - Rep 2	1190	30	NA	NA	NA	NA
40031.2	Palos Verdes (Swartz 6) - Rep 3	1191	30	NA	NA	NA	NA
40005.1	East Basin - Turning Basin	13	1	0.41	0.54	3	3
48009.0	San Pedro Bay Outer Harbor	1694	48	0.39	0.52	2	1
40001.1	Southwest Slip	1	1	0.38	0.51	1	13
40004.2	Lower Main Channel	11	1	0.37	0.55	1	2
40004.2	Lower Main Channel - Rep 3	832	20	0.24	0.35	1	0
40004.2	Lower Main Channel - Rep 2	831	20	0.21	0.29	1	0
40004.2	Lower Main Channel - Rep 1	830	20	0.20	0.28	1	0
40004.2	Lower Main Channel	789	18	NA	NA	NA	NA
40010.1	Off Cabrillo Beach - Rep 2	1069	26	0.36	0.60	2	2
40010.1	Off Cabrillo Beach - Rep 3	1070	26	0.34	0.57	2	2
40010.1	Off Cabrillo Beach - Rep 1	1068	26	0.33	0.55	1	2
40010.1	Off Cabrillo Beach - Rep 1	1006	23	0.31	0.47	1	2
40010.1	Off Cabrillo Beach	28	2	0.28	0.44	1	1
40010.1	Off Cabrillo Beach	136	4	0.26	0.37	1	1
40010.1	Off Cabrillo Beach	810	19	NA	NA	NA	NA
40010.1	Off Cabrillo Beach	1331	32	NA	NA	NA	NA
49005.0	Kaiser Intl.- Berth 48	1794	54	0.34	0.63	1	5
40004.3	Lower Main Channel	12	1	0.34	0.48	2	3
44013.0	Port Hueneme - Wharf #1	1627	45	0.34	0.55	1	12
40010.3	Off Cabrillo Beach - Rep 2	1075	26	0.33	0.53	1	2
40010.3	Off Cabrillo Beach - Rep 1	1074	26	0.32	0.50	1	1
40010.3	Off Cabrillo Beach - Rep 3	1008	23	0.30	0.47	1	2
40010.3	Off Cabrillo Beach	30	2	0.28	0.43	1	1
40010.3	Off Cabrillo Beach - Rep 3	1076	26	0.26	0.43	1	1
40010.3	Off Cabrillo Beach	138	4	NA	NA	NA	NA
40010.3	Off Cabrillo Beach	1333	32	NA	NA	NA	NA
40011.1	Inner Harbor - Channel 3	31	3	0.33	0.43	1	1
40010.2	Off Cabrillo Beach - Rep 1	1071	26	0.32	0.51	1	2
40010.2	Off Cabrillo Beach - Rep 2	1072	26	0.30	0.48	1	1
40010.2	Off Cabrillo Beach - Rep 2	1007	23	0.30	0.44	1	0

Table 12 cont. ERM and PEL Quotients and Number of Sediment Quality Guideline Exceedances at Industrial Harbor Stations. Stations are ranked in descending order by ERMQ.

STANUM	STATION	IDORG	LEG	ERMQ	PELQ	ERM EXCDS	PEL EXCDS
40010.2	Off Cabrillo Beach - Rep 3	1073	26	0.27	0.44	1	1
40010.2	Off Cabrillo Beach	29	2	0.26	0.38	1	0
40010.2	Off Cabrillo Beach	137	4	NA	NA	NA	NA
40010.2	Off Cabrillo Beach	1332	32	NA	NA	NA	NA
40011.2	Inner Harbor - Channel 3	32	3	0.30	0.45	1	2
44011.0	Los Cerritos Channel Tidal P - Rep3	1079	26	0.30	0.41	1	1
44011.0	Los Cerritos Channel Tidal P - Rep1	1077	26	0.29	0.39	1	1
44011.0	Los Cerritos Channel Tidal P - Rep2	1078	26	0.27	0.37	1	2
44011.0	Los Cerritos Channel Tidal P	611	11	NA	NA	NA	NA
40033.1	Outer Harbor - Pola 10	82	1	0.28	0.40	1	4
40018.3	Long Beach Outer Harbor - 18 - Rep 2	1042	25	0.27	0.37	2	1
40018.3	Long Beach Outer Harbor - 18 - Rep 3	886	22	0.26	0.35	2	1
40018.3	Long Beach Outer Harbor - 18 - Rep 2	885	22	0.25	0.35	1	1
40018.3	Long Beach Outer Harbor - 18 - Rep 1	884	22	0.23	0.32	1	1
40018.3	Long Beach Outer Harbor - 18 - Rep1	1041	25	0.22	0.31	1	1
40018.3	Long Beach Outer Harbor - 18	1695	48	0.25	0.37	2	1
40018.3	Long Beach Outer Harbor - 18 - Rep3	1043	25	0.21	0.30	1	1
40018.3	Long Beach Outer Harbor - 18	54	3	0.21	0.28	1	0
40018.3	Long Beach Outer Harbor - 18 - Rep 1	1192	30	NA	NA	NA	NA
40018.3	Long Beach Outer Harbor - 18 - Rep 2	1193	30	NA	NA	NA	NA
40018.3	Long Beach Outer Harbor - 18 - Rep 3	1194	30	NA	NA	NA	NA
40018.3	Long Beach Outer Harbor - 18	1334	32	NA	NA	NA	NA
40018.3	Long Beach Outer Harbor - 18	1770	53	NA	NA	0	0
40012.0	Southeast Basin	1632	45	0.25	0.33	1	1
40020.2	Long Beach Outer Harbor - 20	1696	48	0.23	0.31	2	1
40012.1	Southeast Basin - Rep 1	1047	25	0.23	0.30	1	1
40012.1	Southeast Basin - Rep 2	1048	25	0.21	0.28	1	0
40012.1	Southeast Basin	34	2	0.20	0.27	1	0
40012.1	Southeast Basin - Rep 3	1049	25	0.18	0.23	1	0
40012.1	Southeast Basin	812	19	NA	NA	NA	NA
40008.1	East Basin - Pier C	22	2	0.23	0.30	1	0
48010.0	Turning Basin	1697	48	0.22	0.31	1	0
40017.3	Long Beach Channel - Rep 2	1060	25	0.21	0.29	1	0
40017.3	Long Beach Channel - Rep 1	1059	25	0.19	0.26	1	0
40017.3	Long Beach Channel - Rep 3	1061	25	0.17	0.22	1	0
40017.3	Long Beach Channel	51	3	0.16	0.21	1	0
40002.2	West Basin - Pier 143	5	1	0.21	0.29	1	0
40016.3	Terminal Island Stp	48	2	0.20	0.26	1	1
40012.2	Southeast Basin	35	2	0.20	0.26	1	1

Table 12 cont. ERM and PEL Quotients and Number of Sediment Quality Guideline Exceedances at Industrial Harbor Stations. Stations are ranked in descending order by ERMQ.

STANUM	STATION	IDORG	LEG	ERMQ	PELQ	ERM EXCDS	PEL EXCDS
40009.0	West Basin Entrance	1699	48	0.20	0.25	0	0
40009.1	West Basin Entrance - Ref 1	834	20	0.18	0.24	1	0
40009.1	West Basin Entrance - Ref 3	836	20	0.18	0.24	0	0
40009.1	West Basin Entrance - Ref 2	835	20	0.17	0.23	1	0
40009.1	West Basin Entrance	25	2	0.16	0.19	0	0
40008.3	East Basin - Pier C	24	2	0.18	0.23	0	0
40015.1	Fish Harbor Entrance	43	2	0.18	0.23	1	0
40016.1	Terminal Island Stp	46	2	0.18	0.23	1	1
40015.3	Fish Harbor Entrance	45	2	0.17	0.22	1	0
40003.1	Turning Basin - Pier 151	7	1	0.17	0.23	1	1
40020.3	Long Beach Outer Harbor - 20	60	3	0.16	0.23	1	0
40009.3	West Basin Entrance	27	2	0.15	0.20	0	0
40020.2	Long Beach Outer Harbor - 20	59	3	0.15	0.21	1	0
40015.1	Fish Harbor Entrance	1698	48	0.15	0.21	1	0
40020.1	Long Beach Outer Harbor - 20	58	3	0.14	0.19	1	0
40032.3	San Pedro Bay - POLA 19	105	2	0.14	0.17	1	0
40032.3	San Pedro Bay - POLA 19	81	1	0.11	0.14	1	0
40015.2	Fish Harbor Entrance	44	2	0.13	0.18	1	0
40003.2	Turning Basin, Pier 151 - Rep 3	1055	25	0.13	0.18	0	0
40003.2	Turning Basin, Pier 151 - Rep 2	1054	25	0.11	0.14	0	0
40003.2	Turning Basin, Pier 151	8	1	0.11	0.15	0	0
40003.2	Turning Basin, Pier 151 - Rep 1	1053	25	0.11	0.13	0	0
40016.2	Terminal Island Stp	47	2	0.13	0.16	0	0
40030.1	San Pedro Breakwater	73	2	0.11	0.13	1	0
40030.2	San Pedro Breakwater	74	2	0.11	0.13	1	0
40032.1	San Pedro Bay - POLA 19	103	2	0.10	0.16	1	0
40032.2	San Pedro Bay - POLA 19	104	2	0.10	0.13	1	0
40002.1	West Basin - Pier 143	4	1	NA	NA	NA	NA
40002.3	West Basin - Pier 143	6	1	NA	NA	NA	NA
40003.3	Turning Basin - Pier 151	9	1	NA	NA	NA	NA
40004.1	Lower Main Channel	10	1	NA	NA	NA	NA
40005.2	East Basin - Turning Basin	14	1	NA	NA	NA	NA
40005.3	East Basin - Turning Basin	15	1	NA	NA	NA	NA
40006.3	Consolidated Slip	18	1	NA	NA	NA	NA
40032.1	San Pedro Bay - POLA 19	79	1	NA	NA	NA	NA
40032.2	San Pedro Bay - POLA 19	80	1	NA	NA	NA	NA
40033.2	Outer Harbor - POLA 10	83	1	NA	NA	NA	NA
40033.3	Outer Harbor - POLA 10	84	1	NA	NA	NA	NA

Table 12 cont. ERM and PEL Quotients and Number of Sediment Quality Guideline Exceedances at Industrial Harbor Stations. Stations are ranked in descending order by ERMQ.

STANUM	STATION	IDORG	LEG	ERMQ	PELQ	ERM EXCDS	PEL EXCDS
40008.2	East Basin - Pier C	23	2	NA	NA	NA	NA
40009.2	West Basin Entrance	26	2	NA	NA	NA	NA
40012.3	Southeast Basin	36	2	NA	NA	NA	NA
40030.3	San Pedro Breakwater	75	2	NA	NA	1	0
40007.1	Long Beach Harbor - Channel 2	19	3	NA	NA	NA	NA
40007.3	Long Beach Harbor - Channel 2	21	3	NA	NA	NA	NA
40013.3	Inner Queensway Bay	39	3	NA	NA	NA	NA
40014.1	Outer Queensway Bay	40	3	NA	NA	NA	NA
40017.1	Long Beach Channel	49	3	NA	NA	NA	NA
40017.2	Long Beach Channel	50	3	NA	NA	NA	NA
40018.1	Long Beach Outer Harbor - 18	52	3	NA	NA	NA	NA
40018.2	Long Beach Outer Harbor - 18	53	3	NA	NA	NA	NA
44012.0	Port Hueneme - Wharf B	612	11	NA	NA	NA	NA
44013.0	Port Hueneme - Wharf #1	613	11	NA	NA	NA	NA
40009.1	West Basin Entrance	790	18	NA	NA	NA	NA
40013.1	Inner Queensway Bay	791	18	NA	NA	NA	NA
40015.3	Fish Harbor Entrance	792	18	NA	NA	NA	NA
40016.2	Terminal Island Stp	793	18	NA	NA	NA	NA
40017.3	Long Beach Channel	811	19	NA	NA	NA	NA
44055.0	L.B. Naval Station - Pier 3 - Rep 1	1198	30	NA	NA	NA	NA
44055.0	L.B. Naval Station - Pier 3 - Rep 2	1199	30	NA	NA	NA	NA
44055.0	L.B. Naval Station - Pier 3 - Rep 3	1200	30	NA	NA	NA	NA
46001.0	Hugo Neuproler - #1	1623	45	NA	NA	1	1
46002.0	Hugo Neuproler - #2	1624	45	NA	NA	1	1
46003.0	Hugo Neuproler - #3	1625	45	NA	NA	0	0
47003.0	Consolidated Slip - 200B - Depth 2	1654	46	NA	NA	7	10
47005.0	Consolidated Slip - 200T - Surface	1659	46	NA	NA	10	11
47005.0	Consolidated Slip - 200T - Depth 2	1660	46	NA	NA	9	9
47005.0	Consolidated Slip - 200T - Depth 3	1661	46	NA	NA	5	9
48009.0	San Pedro Bay Outer Harbor	1769	53	NA	NA	0	0
40020.2	Long Beach Outer Harbor - 20	1771	53	NA	NA	0	0
48010.0	Turning Basin	1772	53	NA	NA	0	0
40015.1	Fish Harbor Entrance	1773	53	NA	NA	0	0
40009.0	West Basin Entrance	1774	53	NA	NA	0	0
49001.0	Cabrillo Beach Pier - West	1778	53	NA	NA	1	1
49002.0	Cabrillo Beach Pier - Central	1779	53	NA	NA	1	0
49003.0	Cabrillo Beach Pier - East	1780	53	NA	NA	1	0

Table 13. Survival of Amphipods *Rhepoxynius abronius* (RA) or *Eohaustorius estuarius* (EE) in Industrial Harbor Station Sediments. MN and SD = mean survival and standard deviation. \* = significantly toxic using a t-test. ns = not significant. T = toxic using a t-test and relative to the MSD value for these protocols. NT = Not Toxic. NA = Not Analyzed.

STANUM	STATION	IDORG	LEG	RA MN	RA SD	RA t-test	RA MSD	EE MN	EE SD	EE t-test	EE MSD
47004.0	Consolidated Slip - 200E - Depth 2	1657	46	NA	NA	NA	NA	33.00	23.00	*	T
47004.0	Consolidated Slip - 200E - Surface	1656	46	NA	NA	NA	NA	40.00	27.00	*	T
49004.0	Kaiser Intl. - Berth 49	1793	54	NA	NA	NA	NA	84.00	5.00	*	NT
40006.1	Consolidated Slip - Rep 1	1050	25	62.00	21.68	*	T	NA	NA	NA	NA
40006.1	Consolidated Slip - Rep 2	1051	25	65.00	9.35	*	T	NA	NA	NA	NA
40006.1	Consolidated Slip - Rep 3	1052	25	80.00	11.18	*	NT	NA	NA	NA	NA
40006.1	Consolidated Slip	16	1	58.00	17.20	*	T	NA	NA	NA	NA
47002.0	Consolidated Slip - 200 - Surface	1650	46	NA	NA	NA	NA	54.00	7.00	*	T
47002.0	Consolidated Slip - 200 - Depth 2	1651	46	NA	NA	NA	NA	86.00	4.00	*	NT
47009.0	Consolidated Slip - 200g - Surface	1664	46	NA	NA	NA	NA	50.00	20.00	*	T
47003.0	Consolidated Slip - 200b - Surface	1653	46	NA	NA	NA	NA	70.00	7.00	*	T
47008.0	Consolidated Slip - Storm Drain	1663	46	NA	NA	NA	NA	52.00	21.00	*	T
47001.0	Consolidated Slip - 198 - Surface	1647	46	NA	NA	NA	NA	61.00	19.00	*	T
47001.0	Consolidated Slip - 198 - Depth 2	1648	46	NA	NA	NA	NA	64.00	13.00	*	T
40006.2	Consolidated Slip	17	1	59.00	16.40	*	T	NA	NA	NA	NA
47007.0	Consolidated Slip - End - Surface	1662	46	NA	NA	NA	NA	65.00	15.00	*	T
40019.3	Inner Fish Harbor	57	2	54.00	21.00	*	T	NA	NA	NA	NA
47010.0	Dominguez - H. Ford Bridge - Surface	1665	46	NA	NA	NA	NA	61.00	21.00	*	T
40019.2	Inner Fish Harbor	56	2	73.00	4.50	*	NT	NA	NA	NA	NA
40019.1	Inner Fish Harbor	55	2	83.00	18.90	ns	NT	NA	NA	NA	NA
40007.2	Long Beach Harbor - Channel 2	20	3	88.00	11.50	ns	NT	NA	NA	NA	NA
40011.3	Inner Harbor - Channel 3	33	3	82.00	2.50	*	NT	NA	NA	NA	NA
40001.3	Southwest Slip	3	1	71.00	13.40	*	NT	NA	NA	NA	NA
44012.0	Port Hueneme - Wharf B	1626	45	NA	NA	NA	NA	98.00	4.00	ns	NT

Table 13 continued. Survival of Amphipods *Rhepoxynius abronius* (RA) or *Eohaustorius estuarius* (EE) in Industrial Harbor Station Sediments. MN and SD = mean survival and standard deviation. \* = significantly toxic using a t-test. ns = not significant. T = toxic using a t-test and relative to the MSD value for these protocols. NT = Not Toxic. NA = Not Analyzed.

STANUM	STATION	IDORG	LEG	RA MN	RA SD	RA t-test	RA MSD	EE MN	EE SD	EE t-test	EE MSD
40031.1	Palos Verdes - Swartz 6	76	3	86.00	7.40	ns	NT	NA	NA	NA	NA
40001.2	Southwest Slip - Rep 1	1062	25	69.00	12.45	*	T	NA	NA	NA	NA
40001.2	Southwest Slip - Rep 2	1063	25	72.00	7.58	*	T	NA	NA	NA	NA
40001.2	Southwest Slip	2	1	51.00	17.80	*	T	NA	NA	NA	NA
40001.2	Southwest Slip - Rep 3	1064	25	58.00	15.25	*	T	NA	NA	NA	NA
40013.1	Inner Queensway Bay - Rep 3	1058	25	71.00	11.40	*	T	NA	NA	NA	NA
40013.1	Inner Queensway Bay	37	3	83.00	13.00	ns	NT	NA	NA	NA	NA
40013.1	Inner Queensway Bay - Rep 2	1057	25	76.00	9.62	*	NT	NA	NA	NA	NA
40013.1	Inner Queensway Bay - Rep 1	1056	25	83.00	8.37	*	NT	NA	NA	NA	NA
40014.2	Outer Queensway Bay	41	3	80.00	14.60	*	NT	NA	NA	NA	NA
40014.3	Outer Queensway Bay	42	3	64.00	36.30	ns	NT	NA	NA	NA	NA
40031.3	Palos Verdes - Swartz 6	78	3	96.00	2.20	ns	NT	NA	NA	NA	NA
40013.2	Inner Queensway Bay	38	3	84.00	6.50	*	NT	NA	NA	NA	NA
40031.2	Palos Verdes (Swartz 6) - Rep 2	1039	25	87.00	8.37	*	NT	NA	NA	NA	NA
40031.2	Palos Verdes (Swartz 6) - Rep 3	1004	23	89.00	10.00	ns	NT	NA	NA	NA	NA
40031.2	Palos Verdes (Swartz 6) - Rep 1	1038	25	70.00	11.73	*	T	NA	NA	NA	NA
40031.2	Palos Verdes (Swartz 6)	77	3	93.00	7.60	ns	NT	NA	NA	NA	NA
40031.2	Palos Verdes (Swartz 6) - Rep 2	1003	23	91.00	7.00	ns	NT	NA	NA	NA	NA
40031.2	Palos Verdes (Swartz 6) - Rep 1	1002	23	97.00	4.00	ns	NT	NA	NA	NA	NA
40031.2	Palos Verdes (Swartz 6) - Rep 3	1040	25	85.00	14.58	ns	NT	NA	NA	NA	NA
40031.2	Palos V.(Swartz 6) - Rep 4 Blind	1005	23	91.00	11.00	ns	NT	NA	NA	NA	NA
40031.2	Palos Verdes (Swartz 6) - Rep 1	1189	30	86.00	12.94	ns	NT	NA	NA	NA	NA
40031.2	Palos Verdes (Swartz 6) - Rep 2	1190	30	86.00	6.52	*	NT	NA	NA	NA	NA
40031.2	Palos Verdes (Swartz 6) - Rep 3	1191	30	91.00	11.94	ns	NT	NA	NA	NA	NA
40005.1	East Basin - Turning Basin	13	1	74.00	11.90	*	NT	NA	NA	NA	NA
48009.0	San Pedro Bay Outer Harbor	1694	48	NA	NA	NA	NA	96.00	4.00	ns	NT
40001.1	Southwest Slip	1	1	65.00	28.90	*	NT	NA	NA	NA	NA



Table 13 continued. Survival of Amphipods *Rhepoxynius abronius* (RA) or *Eohaustorius estuarius* (EE) in Industrial Harbor Station Sediments. MN and SD = mean survival and standard deviation. \* = significantly toxic using a t-test. ns = not significant. T = toxic using a t-test and relative to the MSD value for these protocols. NT = Not Toxic. NA = Not Analyzed.

STANUM	STATION	IDORG	LEG	RA MN	RA SD	RA t-test	RA MSD	EE MN	EE SD	EE t-test	EE MSD
40004.2	Lower Main Channel	11	1	80.00	7.90	*	NT	NA	NA	NA	NA
40004.2	Lower Main Channel - Rep 3	832	20	93.00	8.00	ns	NT	NA	NA	NA	NA
40004.2	Lower Main Channel - Rep 2	831	20	91.00	12.00	ns	NT	NA	NA	NA	NA
40004.2	Lower Main Channel - Rep 1	830	20	91.00	4.00	ns	NT	NA	NA	NA	NA
40004.2	Lower Main Channel	789	18	68.00	18.20	*	T	NA	NA	NA	NA
40010.1	Off Cabrillo Beach - Rep 2	1069	26	48.00	11.51	*	T	NA	NA	NA	NA
40010.1	Off Cabrillo Beach - Rep 3	1070	26	46.00	16.36	*	T	NA	NA	NA	NA
40010.1	Off Cabrillo Beach - Rep 1	1068	26	80.00	16.96	*	NT	NA	NA	NA	NA
40010.1	Off Cabrillo Beach - Rep 1	1006	23	68.00	10.00	*	NT	NA	NA	NA	NA
40010.1	Off Cabrillo Beach	28	2	92.00	7.60	ns	NT	NA	NA	NA	NA
40010.1	Off Cabrillo Beach	136	4	89.00	14.30	ns	NT	NA	NA	NA	NA
40010.1	Off Cabrillo Beach	810	19	58.00	11.00	*	T	NA	NA	NA	NA
40010.1	Off Cabrillo Beach	1331	32	92.00	2.74	ns	NT	NA	NA	NA	NA
49005.0	Kaiser Intl. - Berth 48	1794	54	NA	NA	NA	NA	96.00	4.00	ns	NT
40004.3	Lower Main Channel	12	1	81.00	9.60	*	NT	NA	NA	NA	NA
44013.0	Port Hueneme - Wharf #1	1627	45	NA	NA	NA	NA	99.00	2.00	ns	NT
40010.3	Off Cabrillo Beach - Rep 2	1075	26	64.00	15.57	*	T	NA	NA	NA	NA
40010.3	Off Cabrillo Beach - Rep 1	1074	26	60.00	14.14	*	T	NA	NA	NA	NA
40010.3	Off Cabrillo Beach - Rep 3	1008	23	69.00	10.00	*	NT	NA	NA	NA	NA
40010.3	Off Cabrillo Beach	30	2	91.00	9.60	ns	NT	NA	NA	NA	NA
40010.3	Off Cabrillo Beach - Rep 3	1076	26	48.00	18.91	*	T	NA	NA	NA	NA
40010.3	Off Cabrillo Beach	138	4	84.00	5.50	*	NT	NA	NA	NA	NA
40010.3	Off Cabrillo Beach	1333	32	91.00	5.48	ns	NT	NA	NA	NA	NA
40011.1	Inner Harbor - Channel 3	31	3	85.00	6.90	ns	NT	NA	NA	NA	NA
40010.2	Off Cabrillo Beach - Rep 1	1071	26	78.00	13.04	*	NT	NA	NA	NA	NA
40010.2	Off Cabrillo Beach - Rep 2	1072	26	63.00	14.83	*	T	NA	NA	NA	NA
40010.2	Off Cabrillo Beach - Rep 2	1007	23	90.00	7.00	ns	NT	NA	NA	NA	NA
40010.2	Off Cabrillo Beach - Rep 3	1073	26	72.00	14.83	*	NT	NA	NA	NA	NA

Table 13 continued. Survival of Amphipods *Rhepoxynius abronius* (RA) or *Eohaustorius estuarius* (EE) in Industrial Harbor Station Sediments. MN and SD = mean survival and standard deviation. \* = significantly toxic using a t-test. ns = not significant. T = toxic using a t-test and relative to the MSD value for these protocols. NT = Not Toxic. NA = Not Analyzed.

STANUM	STATION	IDORG	LEG	RA MN	RA SD	RA t-test	RA MSD	EE MN	EE SD	EE t-test	EE MSD
40010.2	Off Cabrillo Beach	29	2	88.00	9.10	ns	NT	NA	NA	NA	NA
40010.2	Off Cabrillo Beach	137	4	89.00	5.50	ns	NT	NA	NA	NA	NA
40010.2	Off Cabrillo Beach	1332	32	82.50	10.41	*	NT	NA	NA	NA	NA
40011.2	Inner Harbor - Channel 3	32	3	84.00	5.30	ns	NT	NA	NA	NA	NA
44011.0	Los Cerritos Channel Tidal P - Rep 3	1079	26	62.00	17.54	*	T	NA	NA	NA	NA
44011.0	Los Cerritos Channel Tidal P - Rep 1	1077	26	66.00	14.75	*	NT	NA	NA	NA	NA
44011.0	Los Cerritos Channel Tidal P - Rep 2	1078	26	62.00	18.23	*	T	NA	NA	NA	NA
44011.0	Los Cerritos Channel Tidal P	611	11	65.00	19.40	*	T	NA	NA	NA	NA
40033.1	Outer Harbor - POLA 10	82	1	71.00	20.40	*	NT	NA	NA	NA	NA
40018.3	Long Beach Outer Harbor - 18 - Rep 2	1042	25	70.00	10.61	*	T	NA	NA	NA	NA
40018.3	Long Beach Outer Harbor - 18 - Rep 3	886	22	89.00	4.00	*	NT	NA	NA	NA	NA
40018.3	Long Beach Outer Harbor - 18 - Rep 2	885	22	91.00	5.00	ns	NT	NA	NA	NA	NA
40018.3	Long Beach Outer Harbor - 18 - Rep 1	884	22	93.00	7.00	ns	NT	NA	NA	NA	NA
40018.3	Long Beach Outer Harbor - 18 - Rep 1	1041	25	56.00	15.97	*	T	NA	NA	NA	NA
40018.3	Long Beach Outer Harbor - 18	1695	48	NA	NA	NA	NA	75.00	23.00	ns	NT
40018.3	Long Beach Outer Harbor - 18 - Rep 3	1043	25	72.00	13.04	*	T	NA	NA	NA	NA
40018.3	Long Beach Outer Harbor - 18	54	3	93.00	4.50	ns	NT	NA	NA	NA	NA
40018.3	Long Beach Outer Harbor - 18 - Rep 1	1192	30	88.00	7.58	*	NT	NA	NA	NA	NA
40018.3	Long Beach Outer Harbor - 18 - Rep 2	1193	30	89.00	5.48	*	NT	NA	NA	NA	NA
40018.3	Long Beach Outer Harbor - 18 - Rep 3	1194	30	81.00	12.45	*	NT	NA	NA	NA	NA
40018.3	Long Beach Outer Harbor - 18	1334	32	90.00	10.00	ns	NT	NA	NA	NA	NA
40018.3	Long Beach Outer Harbor - 18	1770	53	NA	NA	NA	NA	59.00	30.00	*	T
40012.0	Southeast Basin	1632	45	NA	NA	NA	NA	99.00	2.00	ns	NT
40020.2	Long Beach Outer Harbor - 20	1696	48	NA	NA	NA	NA	81.00	15.00	*	NT
40012.1	Southeast Basin - Rep1	1047	25	39.00	15.17	*	T	NA	NA	NA	NA
40012.1	Southeast Basin - Rep2	1048	25	51.00	15.17	*	T	NA	NA	NA	NA
40012.1	Southeast Basin	34	2	77.00	14.00	*	NT	NA	NA	NA	NA
40012.1	Southeast Basin - Rep3	1049	25	66.00	4.18	*	T	NA	NA	NA	NA

Table 13 continued. Survival of Amphipods *Rhepoxynius abronius* (RA) or *Eohaustorius estuarius* (EE) in Industrial Harbor Station Sediments. MN and SD = mean survival and standard deviation. \* = significantly toxic using a t-test. ns = not significant. T = toxic using a t-test and relative to the MSD value for these protocols. NT = Not Toxic. NA = Not Analyzed.

STANUM	STATION	IDORG	LEG	RA MN	RA SD	RA t-test	RA MSD	EE MN	EE SD	EE t-test	EE MSD
40012.1	Southeast Basin	812	19	34.00	21.00	*	T	NA	NA	NA	NA
40008.1	East Basin - Pier C	22	2	80.00	16.20	ns	NT	NA	NA	NA	NA
48010.0	Turning Basin	1697	48	NA	NA	NA	NA	95.00	5.00	ns	NT
40017.3	Long Beach Channel - Rep 2	1060	25	47.00	17.89	*	T	NA	NA	NA	NA
40017.3	Long Beach Channel - Rep 1	1059	25	71.00	10.84	*	T	NA	NA	NA	NA
40017.3	Long Beach Channel - Rep 3	1061	25	61.00	8.22	*	T	NA	NA	NA	NA
40017.3	Long Beach Channel	51	3	88.00	8.40	ns	NT	NA	NA	NA	NA
40002.2	West Basin- Pier 143	5	1	78.00	13.00	*	NT	NA	NA	NA	NA
40016.3	Terminal Island Stp	48	2	80.00	12.70	*	NT	NA	NA	NA	NA
40012.2	Southeast Basin	35	2	78.00	13.50	*	NT	NA	NA	NA	NA
40009.0	West Basin Entrance	1699	48	NA	NA	NA	NA	86.00	7.00	*	NT
40009.1	West Basin Entrance - Ref 1	834	20	97.00	4.00	ns	NT	NA	NA	NA	NA
40009.1	West Basin Entrance - Ref 3	836	20	91.00	7.00	ns	NT	NA	NA	NA	NA
40009.1	West Basin Entrance - Ref 2	835	20	86.00	10.00	ns	NT	NA	NA	NA	NA
40009.1	West Basin Entrance	25	2	88.00	5.70	ns	NT	NA	NA	NA	NA
40008.3	East Basin - Pier C	24	2	76.00	8.90	*	NT	NA	NA	NA	NA
40015.1	Fish Harbor Entrance	43	2	83.00	5.00	*	NT	NA	NA	NA	NA
40016.1	Terminal Island Stp	46	2	72.00	5.70	*	NT	NA	NA	NA	NA
40015.3	Fish Harbor Entrance	45	2	92.00	7.60	ns	NT	NA	NA	NA	NA
40003.1	Turning Basin - Pier 151	7	1	64.00	16.40	*	NT	NA	NA	NA	NA
40020.3	Long Beach Outer Harbor - 20	60	3	84.00	9.60	*	NT	NA	NA	NA	NA
40009.3	West Basin Entrance	27	2	87.00	5.70	ns	NT	NA	NA	NA	NA
40020.2	Long Beach Outer Harbor - 20	59	3	92.00	11.00	ns	NT	NA	NA	NA	NA
40015.1	Fish Harbor Entrance	1698	48	NA	NA	NA	NA	89.00	10.00	ns	NT
40020.1	Long Beach Outer Harbor - 20	58	3	83.00	7.60	*	NT	NA	NA	NA	NA
40032.3	San Pedro Bay - POLA 19	105	2	86.00	15.20	ns	NT	NA	NA	NA	NA
40032.3	San Pedro Bay - POLA 19	81	1	93.00	2.70	ns	NT	NA	NA	NA	NA
40015.2	Fish Harbor Entrance	44	2	83.00	7.60	*	NT	NA	NA	NA	NA

Table 13 continued. Survival of Amphipods *Rhepoxynius abronius* (RA) or *Eohaustorius estuarius* (EE) in Industrial Harbor Station Sediments. MN and SD = mean survival and standard deviation. \* = significantly toxic using a t-test. ns = not significant. T = toxic using a t-test and relative to the MSD value for these protocols. NT = Not Toxic. NA = Not Analyzed.

STANUM	STATION	IDORG	LEG	RA MN	RA SD	RA t-test	RA MSD	EE MN	EE SD	EE t-test	EE MSD
40003.2	Turning Basin, Pier 151 - Rep 3	1055	25	82.00	12.55	*	NT	NA	NA	NA	NA
40003.2	Turning Basin, Pier 151 - Rep 2	1054	25	91.00	6.52	ns	NT	NA	NA	NA	NA
40003.2	Turning Basin, Pier 151	8	1	63.00	29.90	*	NT	NA	NA	NA	NA
40003.2	Turning Basin, Pier 151 - Rep 1	1053	25	85.00	10.00	*	NT	NA	NA	NA	NA
40016.2	Terminal Island Stp	47	2	88.00	8.40	ns	NT	NA	NA	NA	NA
40030.1	San Pedro Breakwater	73	2	90.00	3.50	ns	NT	NA	NA	NA	NA
40030.2	San Pedro Breakwater	74	2	94.00	6.50	ns	NT	NA	NA	NA	NA
40032.1	San Pedro Bay - POLA 19	103	2	94.00	5.50	ns	NT	NA	NA	NA	NA
40032.2	San Pedro Bay - POLA 19	104	2	94.00	5.50	ns	NT	NA	NA	NA	NA
40002.1	West Basin - Pier 143	4	1	75.00	13.90	*	NT	NA	NA	NA	NA
40002.3	West Basin - Pier 143	6	1	74.00	10.80	*	NT	NA	NA	NA	NA
40003.3	Turning Basin - Pier 151	9	1	81.00	9.60	*	NT	NA	NA	NA	NA
40004.1	Lower Main Channel	10	1	78.00	6.70	*	NT	NA	NA	NA	NA
40005.2	East Basin - Turning Basin	14	1	73.00	7.60	*	NT	NA	NA	NA	NA
40005.3	East Basin - Turning Basin	15	1	79.00	15.60	ns	NT	NA	NA	NA	NA
40006.3	Consolidated Slip	18	1	67.00	11.50	*	NT	NA	NA	NA	NA
40032.1	San Pedro Bay - POLA 19	79	1	86.00	4.20	*	NT	NA	NA	NA	NA
40032.2	San Pedro Bay - POLA 19	80	1	85.00	9.40	ns	NT	NA	NA	NA	NA
40033.2	Outer Harbor - POLA 10	83	1	70.00	21.80	*	NT	NA	NA	NA	NA
40033.3	Outer Harbor - POLA 10	84	1	65.00	17.30	*	NT	NA	NA	NA	NA
40008.2	East Basin - Pier C	23	2	78.00	11.50	*	NT	NA	NA	NA	NA
40009.2	West Basin Entrance	26	2	81.00	2.20	*	NT	NA	NA	NA	NA
40012.3	Southeast Basin	36	2	69.00	16.40	*	NT	NA	NA	NA	NA
40030.3	San Pedro Breakwater	75	2	95.00	6.10	ns	NT	NA	NA	NA	NA
40007.1	Long Beach Harbor - Channel 2	19	3	82.00	10.40	*	NT	NA	NA	NA	NA
40007.3	Long Beach Harbor - Channel 2	21	3	78.00	14.40	*	NT	NA	NA	NA	NA
40013.3	Inner Queensway Bay	39	3	81.00	10.80	*	NT	NA	NA	NA	NA
40014.1	Outer Queensway Bay	40	3	78.00	10.40	*	NT	NA	NA	NA	NA

Table 13 continued. Survival of Amphipods *Rhepoxynius abronius* (RA) or *Eohaustorius estuarius* (EE) in Industrial Harbor Station Sediments. MN and SD = mean survival and standard deviation. \* = significantly toxic using a t-test. ns = not significant. T = toxic w/ t-test & MSD. NT = Not Toxic; NA = Not Analyz.

STANUM	STATION	IDORG	LEG	RA MN	RA SD	RA t-test	RA MSD	EE MN	EE SD	EE t-test	EE MSD
40017.1	Long Beach Channel	49	3	76.00	11.40	*	NT	NA	NA	NA	NA
40017.2	Long Beach Channel	50	3	82.00	9.70	*	NT	NA	NA	NA	NA
40018.1	Long Beach Outer Harbor - 18	52	3	67.00	14.40	*	T	NA	NA	NA	NA
40018.2	Long Beach Outer Harbor - 18	53	3	79.00	11.40	*	NT	NA	NA	NA	NA
44012.0	Port Hueneme - Wharf B	612	11	70.00	15.40	*	T	NA	NA	NA	NA
44013.0	Port Hueneme - Wharf #1	613	11	73.00	11.50	*	T	NA	NA	NA	NA
40009.1	West Basin Entrance	790	18	60.00	18.40	*	T	NA	NA	NA	NA
40013.1	Inner Queensway Bay	791	18	50.00	19.00	*	T	NA	NA	NA	NA
40015.3	Fish Harbor Entrance	792	18	75.00	21.50	ns	NT	NA	NA	NA	NA
40016.2	Terminal Island Stp	793	18	63.00	28.00	*	T	NA	NA	NA	NA
40017.3	Long Beach Channel	811	19	54.00	26.30	*	T	NA	NA	NA	NA
44055.0	L.B. Naval Station - Pier 3 - Rep 1	1198	30	77.00	13.51	*	NT	NA	NA	NA	NA
44055.0	L.B. Naval Station - Pier 3 - Rep 2	1199	30	86.00	6.52	*	NT	NA	NA	NA	NA
44055.0	L.B. Naval Station - Pier 3 - Rep 3	1200	30	82.00	2.74	*	NT	NA	NA	NA	NA
46001.0	Hugo Neuproler - #1	1623	45	NA	NA	NA	NA	95.00	6.00	ns	NT
46002.0	Hugo Neuproler - #2	1624	45	NA	NA	NA	NA	98.00	3.00	ns	NT
46003.0	Hugo Neuproler - #3	1625	45	NA	NA	NA	NA	92.00	6.00	*	NT
47003.0	Consolidated Slip - 200B - Depth 2	1654	46	NA	NA	NA	NA	8.00	12.00	*	T
47005.0	Consolidated Slip - 200T - Surface	1659	46	NA	NA	NA	NA	0.00	0.00	*	T
47005.0	Consolidated Slip - 200T - Depth 2	1660	46	NA	NA	NA	NA	18.00	40.00	*	T
47005.0	Consolidated Slip - 200T - Depth 3	1661	46	NA	NA	NA	NA	13.00	29.00	*	T
48009.0	San Pedro Bay Outer Harbor	1769	53	NA	NA	NA	NA	85.00	10.00	*	NT
40020.2	Long Beach Outer Harbor - 20	1771	53	NA	NA	NA	NA	85.00	13.00	*	NT
48010.0	Turning Basin	1772	53	NA	NA	NA	NA	69.00	43.00	ns	NT
40015.1	Fish Harbor Entrance	1773	53	NA	NA	NA	NA	72.00	19.00	*	T
40009.0	West Basin Entrance	1774	53	NA	NA	NA	NA	74.00	12.00	*	NT
49001.0	Cabrillo Beach Pier - West	1778	53	NA	NA	NA	NA	NA	NA	NA	NA
49002.0	Cabrillo Beach Pier - Central	1779	53	NA	NA	NA	NA	NA	NA	NA	NA
49003.0	Cabrillo Beach Pier - East	1780	53	NA	NA	NA	NA	NA	NA	NA	NA

Table 14a. Development of abalone embryos (*Haliotis rufescens*) in Industrial Harbor station pore waters (100% concentration). HRP 100 MN = Mean percent normal development of *Haliotis rufescens* in 100% pore water. SD = Standard Deviation. \* = Significantly Toxic using a t-test. T= Toxic using a t-test and relative to the MSD criteria for this protocol. NT = Not toxic. NA = Not Analyzed.

STANUM	STATION	IDORG	LEG	HRP 100 MN	HRP 100 SD	HRP 100 t-test	HRP 100 MSD
47004.0	Consolidated Slip - 200E - Depth 2	1657	46	NA	NA	NA	NA
47004.0	Consolidated Slip - 200E - Surface	1656	46	NA	NA	NA	NA
49004.0	Kaiser Intl.- Berth 49	1793	54	NA	NA	NA	NA
40006.1	Consolidated Slip - Rep 1	1050	25	NA	NA	NA	NA
40006.1	Consolidated Slip - Rep 2	1051	25	NA	NA	NA	NA
40006.1	Consolidated Slip - Rep 3	1052	25	NA	NA	NA	NA
40006.1	Consolidated Slip	16	1	0.00	0.00	*	T
47002.0	Consolidated Slip - 200 - Surface	1650	46	NA	NA	NA	NA
47002.0	Consolidated Slip - 200 - Depth 2	1651	46	NA	NA	NA	NA
47009.0	Consolidated Slip - 200G - Surface	1664	46	NA	NA	NA	NA
47003.0	Consolidated Slip - 200B - Surface	1653	46	NA	NA	NA	NA
47008.0	Consolidated Slip - Storm Drain	1663	46	NA	NA	NA	NA
47001.0	Consolidated Slip - 198 - Surface	1647	46	NA	NA	NA	NA
47001.0	Consolidated Slip - 198 - Depth 2	1648	46	NA	NA	NA	NA
40006.2	Consolidated Slip	17	1	0.00	0.00	*	T
47007.0	Consolidated Slip - End - Surface	1662	46	NA	NA	NA	NA
40019.3	Inner Fish Harbor	57	2	0.00	0.00	*	T
47010.0	Dominguez - H. Ford Bridge - Surface	1665	46	NA	NA	NA	NA
40019.2	Inner Fish Harbor	56	2	88.60	6.10	ns	NT
40019.1	Inner Fish Harbor	55	2	0.00	0.00	*	T
40007.2	Long Beach Harbor - Channel 2	20	3	0.00	0.00	*	T
40011.3	Inner Harbor - Channel 3	33	3	0.00	0.00	*	T
40001.3	Southwest Slip	3	1	0.70	0.60	*	T
44012.0	Port Hueneme - Wharf B	1626	45	NA	NA	NA	NA
40031.1	Palos Verdes - Swartz 6	76	3	0.00	0.00	*	T
40001.2	Southwest Slip - Rep 1	1062	25	NA	NA	NA	NA
40001.2	Southwest Slip - Rep 2	1063	25	NA	NA	NA	NA
40001.2	Southwest Slip	2	1	81.40	7.90	*	NT
40001.2	Southwest Slip - Rep 3	1064	25	NA	NA	NA	NA
40013.1	Inner Queensway Bay - Rep 3	1058	25	NA	NA	NA	NA
40013.1	Inner Queensway Bay	37	3	0.00	0.00	*	T
40013.1	Inner Queensway Bay - Rep 2	1057	25	NA	NA	NA	NA
40013.1	Inner Queensway Bay - Rep 1	1056	25	NA	NA	NA	NA
40014.2	Outer Queensway Bay	41	3	0.00	0.00	*	T
40014.3	Outer Queensway Bay	42	3	0.00	0.00	*	T
40031.3	Palos Verdes - Swartz 6	78	3	55.60	26.70	*	NT
40013.2	Inner Queensway Bay	38	3	0.00	0.00	*	T
40031.2	Palos Verdes (Swartz 6) - Rep 2	1039	25	NA	NA	NA	NA
40031.2	Palos Verdes (Swartz 6) - Rep 3	1004	23	NA	NA	NA	NA

Table 14a continued. Development of abalone embryos (*Haliotis rufescens*) in Industrial Harbor station pore waters (100% concentration). HRP 100 MN = Mean percent normal development of *Haliotis rufescens* in 100% pore water. SD = Standard Deviation. \* = Significantly Toxic using a t-test. T= Toxic using a t-test and relative to the MSD criteria for this protocol. NT = Not toxic. NA = Not Analyzed.

STANUM	STATION	IDORG	LEG	HRP 100 MN	HRP 100 SD	HRP 100 t-test	HRP 100 MSD
40031.2	Palos Verdes (Swartz 6) - Rep 1	1038	25	NA	NA	NA	NA
40031.2	Palos Verdes (Swartz 6)	77	3	0.00	0.00	*	T
40031.2	Palos Verdes (Swartz 6) - Rep 2	1003	23	NA	NA	NA	NA
40031.2	Palos Verdes (Swartz 6) - Rep 1	1002	23	NA	NA	NA	NA
40031.2	Palos Verdes (Swartz 6) - Rep 3	1040	25	NA	NA	NA	NA
40031.2	Palos V.(Swartz 6) - Rep 4 Blind	1005	23	NA	NA	NA	NA
40031.2	Palos Verdes (Swartz 6) - Rep 1	1189	30	NA	NA	NA	NA
40031.2	Palos Verdes (Swartz 6) - Rep 2	1190	30	NA	NA	NA	NA
40031.2	Palos Verdes (Swartz 6) - Rep 3	1191	30	NA	NA	NA	NA
40005.1	East Basin - Turning Basin	13	1	0.00	0.00	*	T
48009.0	San Pedro Bay Outer Harbor	1694	48	NA	NA	NA	NA
40001.1	Southwest Slip	1	1	72.30	15.90	ns	NT
40004.2	Lower Main Channel	11	1	69.10	29.80	ns	NT
40004.2	Lower Main Channel - Rep 3	832	20	NA	NA	NA	NA
40004.2	Lower Main Channel - Rep 2	831	20	NA	NA	NA	NA
40004.2	Lower Main Channel - Rep 1	830	20	NA	NA	NA	NA
40004.2	Lower Main Channel	789	18	NA	NA	NA	NA
40010.1	Off Cabrillo Beach - Rep 2	1069	26	NA	NA	NA	NA
40010.1	Off Cabrillo Beach - Rep 3	1070	26	NA	NA	NA	NA
40010.1	Off Cabrillo Beach - Rep 1	1068	26	NA	NA	NA	NA
40010.1	Off Cabrillo Beach - Rep 1	1006	23	NA	NA	NA	NA
40010.1	Off Cabrillo Beach	28	2	92.70	3.40	ns	NT
40010.1	Off Cabrillo Beach	136	4	1.70	2.90	*	T
40010.1	Off Cabrillo Beach	810	19	NA	NA	NA	NA
40010.1	Off Cabrillo Beach	1331	32	NA	NA	NA	NA
49005.0	Kaiser Intl.- Berth 48	1794	54	NA	NA	NA	NA
40004.3	Lower Main Channel	12	1	78.70	28.20	ns	NT
44013.0	Port Hueneme - Wharf #1	1627	45	NA	NA	NA	NA
40010.3	Off Cabrillo Beach - Rep 2	1075	26	NA	NA	NA	NA
40010.3	Off Cabrillo Beach - Rep 1	1074	26	NA	NA	NA	NA
40010.3	Off Cabrillo Beach - Rep 3	1008	23	NA	NA	NA	NA
40010.3	Off Cabrillo Beach	30	2	95.60	2.40	ns	NT
40010.3	Off Cabrillo Beach - Rep 3	1076	26	NA	NA	NA	NA
40010.3	Off Cabrillo Beach	138	4	0.00	0.00	*	T
40010.3	Off Cabrillo Beach	1333	32	NA	NA	NA	NA
40011.1	Inner Harbor - Channel 3	31	3	0.00	0.00	*	T
40010.2	Off Cabrillo Beach - Rep 1	1071	26	NA	NA	NA	NA
40010.2	Off Cabrillo Beach - Rep 2	1072	26	NA	NA	NA	NA
40010.2	Off Cabrillo Beach - Rep 2	1007	23	NA	NA	NA	NA
40010.2	Off Cabrillo Beach - Rep 3	1073	26	NA	NA	NA	NA

Table 14a continued. Development of abalone embryos (*Haliotis rufescens*) in Industrial Harbor station pore waters (100% concentration). HRP 100 MN = Mean percent normal development of *Haliotis rufescens* in 100% pore water. SD = Standard Deviation. \* = Significantly Toxic using a t-test. T= Toxic using a t-test and relative to the MSD criteria for this protocol. NT = Not toxic. NA = Not Analyzed.

STANUM	STATION	IDORG	LEG	HRP 100 MN	HRP 100 SD	HRP 100 t-test	HRP 100 MSD
40010.2	Off Cabrillo Beach	29	2	93.80	1.80	ns	NT
40010.2	Off Cabrillo Beach	137	4	0.00	0.00	*	T
40010.2	Off Cabrillo Beach	1332	32	NA	NA	NA	NA
40011.2	Inner Harbor - Channel 3	32	3	0.00	0.00	*	T
44011.0	Los Cerritos Channel Tidal P - Rep3	1079	26	NA	NA	NA	NA
44011.0	Los Cerritos Channel Tidal P - Rep1	1077	26	NA	NA	NA	NA
44011.0	Los Cerritos Channel Tidal P - Rep2	1078	26	NA	NA	NA	NA
44011.0	Los Cerritos Channel Tidal P	611	11	NA	NA	NA	NA
40033.1	Outer Harbor - POLA 10	82	1	0.70	1.30	*	T
40018.3	Long Beach Outer Harbor - 18 - Rep2	1042	25	NA	NA	NA	NA
40018.3	Long Beach Outer Harbor - 18 - Rep 3	886	22	NA	NA	NA	NA
40018.3	Long Beach Outer Harbor - 18 - Rep 2	885	22	NA	NA	NA	NA
40018.3	Long Beach Outer Harbor - 18 - Rep 1	884	22	NA	NA	NA	NA
40018.3	Long Beach Outer Harbor - 18 - Rep1	1041	25	NA	NA	NA	NA
40018.3	Long Beach Outer Harbor - 18	1695	48	NA	NA	NA	NA
40018.3	Long Beach Outer Harbor - 18 - Rep3	1043	25	NA	NA	NA	NA
40018.3	Long Beach Outer Harbor - 18	54	3	92.30	4.40	ns	NT
40018.3	Long Beach Outer Harbor - 18 - Rep 1	1192	30	NA	NA	NA	NA
40018.3	Long Beach Outer Harbor - 18 - Rep 2	1193	30	NA	NA	NA	NA
40018.3	Long Beach Outer Harbor - 18 - Rep 3	1194	30	NA	NA	NA	NA
40018.3	Long Beach Outer Harbor - 18	1334	32	NA	NA	NA	NA
40018.3	Long Beach Outer Harbor - 18	1770	53	NA	NA	NA	NA
40012.0	Southeast Basin	1632	45	NA	NA	NA	NA
40020.2	Long Beach Outer Harbor- 20	1696	48	NA	NA	NA	NA
40012.1	Southeast Basin - Rep1	1047	25	NA	NA	NA	NA
40012.1	Southeast Basin - Rep2	1048	25	NA	NA	NA	NA
40012.1	Southeast Basin	34	2	23.50	37.40	*	T
40012.1	Southeast Basin - Rep3	1049	25	NA	NA	NA	NA
40012.1	Southeast Basin	812	19	NA	NA	NA	NA
40008.1	East Basin - Pier C	22	2	93.10	1.30	ns	NT
48010.0	Turning Basin	1697	48	NA	NA	NA	NA
40017.3	Long Beach Channel - Rep 2	1060	25	NA	NA	NA	NA
40017.3	Long Beach Channel - Rep 1	1059	25	NA	NA	NA	NA
40017.3	Long Beach Channel - Rep 3	1061	25	NA	NA	NA	NA
40017.3	Long Beach Channel	51	3	50.70	7.50	*	T
40002.2	West Basin - Pier 143	5	1	0.00	0.00	*	T
40016.3	Terminal Island Stp	48	2	94.50	1.40	ns	NT
40012.2	Southeast Basin	35	2	94.30	2.20	ns	NT
40009.0	West Basin Entrance	1699	48	NA	NA	NA	NA



Table 14a continued. Development of abalone embryos (*Haliotis rufescens*) in Industrial Harbor station pore waters (100% concentration). HRP 100 MN = Mean percent normal development of *Haliotis rufescens* in 100% pore water. SD = Standard Deviation. \* = Significantly Toxic using a t-test. T= Toxic using a t-test and relative to the MSD criteria for this protocol. NT = Not toxic. NA = Not Analyzed.

STANUM	STATION	IDORG	LEG	HRP 100 MN	HRP 100 SD	HRP 100 t-test	HRP 100 MSD
40009.1	West Basin Entrance - Ref 1	834	20	NA	NA	NA	NA
40009.1	West Basin Entrance - Ref 3	836	20	NA	NA	NA	NA
40009.1	West Basin Entrance - Ref 2	835	20	NA	NA	NA	NA
40009.1	West Basin Entrance	25	2	1.10	1.10	*	T
40008.3	East Basin - Pier C	24	2	0.00	0.00	*	T
40015.1	Fish Harbor Entrance	43	2	51.30	24.00	*	T
40016.1	Terminal Island Stp	46	2	91.60	2.50	*	NT
40015.3	Fish Harbor Entrance	45	2	9.80	9.50	*	T
40003.1	Turning Basin - Pier 151	7	1	0.00	0.00	*	T
40020.3	Long Beach Outer Harbor - 20	60	3	24.20	18.30	*	T
40009.3	West Basin Entrance	27	2	0.00	0.00	*	T
40020.2	Long Beach Outer Harbor - 20	59	3	0.00	0.00	*	T
40015.1	Fish Harbor Entrance	1698	48	NA	NA	NA	NA
40020.1	Long Beach Outer Harbor - 20	58	3	0.00	0.00	*	T
40032.3	San Pedro Bay - POLA 19	105	2	0.00	0.00	*	T
40032.3	San Pedro Bay - POLA 19	81	1	0.00	0.00	*	T
40015.2	Fish Harbor Entrance	44	2	34.90	21.30	*	T
40003.2	Turning Basin, Pier 151 - Rep 3	1055	25	NA	NA	NA	NA
40003.2	Turning Basin, Pier 151 - Rep 2	1054	25	NA	NA	NA	NA
40003.2	Turning Basin, Pier 151	8	1	1.50	2.60	*	T
40003.2	Turning Basin, Pier 151 - Rep 1	1053	25	NA	NA	NA	NA
40016.2	Terminal Island Stp	47	2	71.20	27.10	ns	NT
40030.1	San Pedro Breakwater	73	2	0.00	0.00	*	T
40030.2	San Pedro Breakwater	74	2	0.00	0.00	*	T
40032.1	San Pedro Bay - POLA 19	103	2	0.00	0.00	*	T
40032.2	San Pedro Bay - POLA 19	104	2	0.00	0.00	*	T
40002.1	West Basin - Pier 143	4	1	0.00	0.00	*	T
40002.3	West Basin - Pier 143	6	1	0.00	0.00	*	T
40003.3	Turning Basin - Pier 151	9	1	23.30	38.70	*	T
40004.1	Lower Main Channel	10	1	26.20	33.50	*	T
40005.2	East Basin - Turning Basin	14	1	0.70	1.30	*	T
40005.3	East Basin - Turning Basin	15	1	0.00	0.00	*	T
40006.3	Consolidated Slip	18	1	0.00	0.00	*	T
40032.1	San Pedro Bay - POLA 19	79	1	65.70	23.90	ns	NT
40032.2	San Pedro Bay - POLA 19	80	1	30.70	53.10	ns	NT
40033.2	Outer Harbor - POLA 10	83	1	8.80	10.20	*	T
40033.3	Outer Harbor - POLA 10	84	1	3.30	5.70	*	T
40008.2	East Basin - Pier C	23	2	2.80	2.50	*	T
40009.2	West Basin Entrance	26	2	0.00	0.00	*	T

Table 14a continued. Development of abalone embryos (*Haliotis rufescens*) in Industrial Harbor station pore waters (100% concentration). HRP 100 MN = Mean percent normal development of *Haliotis rufescens* in 100% pore water. SD = Standard Deviation. \* = Significantly Toxic using a t-test. T= Toxic using a t-test and relative to the MSD criteria for this protocol. NT = Not toxic. NA = Not Analyzed.

STANUM	STATION	IDORG	LEG	HRP	HRP	HRP	HRP
				100 MN	100 SD	100 t-test	100 MSD
40012.3	Southeast Basin	36	2	7.50	12.20	*	T
40030.3	San Pedro Breakwater	75	2	0.00	0.00	*	T
40007.1	Long Beach Harbor - Channel 2	19	3	0.00	0.00	*	T
40007.3	Long Beach Harbor - Channel 2	21	3	0.00	0.00	*	T
40013.3	Inner Queensway Bay	39	3	5.50	7.70	*	T
40014.1	Outer Queensway Bay	40	3	0.00	0.00	*	T
40017.1	Long Beach Channel	49	3	0.00	0.00	*	T
40017.2	Long Beach Channel	50	3	20.60	8.90	*	T
40018.1	Long Beach Outer Harbor - 18	52	3	0.00	0.00	*	T
40018.2	Long Beach Outer Harbor - 18	53	3	0.00	0.00	*	T
44012.0	Port Hueneme - Wharf B	612	11	NA	NA	NA	NA
44013.0	Port Hueneme - Wharf #1	613	11	NA	NA	NA	NA
40009.1	West Basin Entrance	790	18	NA	NA	NA	NA
40013.1	Inner Queensway Bay	791	18	NA	NA	NA	NA
40015.3	Fish Harbor Entrance	792	18	NA	NA	NA	NA
40016.2	Terminal Island Stp	793	18	NA	NA	NA	NA
40017.3	Long Beach Channel	811	19	NA	NA	NA	NA
44055.0	L.B. Naval Station - Pier 3 - Rep 1	1198	30	NA	NA	NA	NA
44055.0	L.B. Naval Station - Pier 3 - Rep 2	1199	30	NA	NA	NA	NA
44055.0	L.B. Naval Station - Pier 3 - Rep 3	1200	30	NA	NA	NA	NA
46001.0	Hugo Neuproler - #1	1623	45	NA	NA	NA	NA
46002.0	Hugo Neuproler - #2	1624	45	NA	NA	NA	NA
46003.0	Hugo Neuproler - #3	1625	45	NA	NA	NA	NA
47003.0	Consolidated Slip - 200B - Depth 2	1654	46	NA	NA	NA	NA
47005.0	Consolidated Slip - 200T - Surface	1659	46	NA	NA	NA	NA
47005.0	Consolidated Slip - 200T - Depth 2	1660	46	NA	NA	NA	NA
47005.0	Consolidated Slip - 200T - Depth 3	1661	46	NA	NA	NA	NA
48009.0	San Pedro Bay Outer Harbor	1769	53	NA	NA	NA	NA
40020.2	Long Beach Outer Harbor - 20	1771	53	NA	NA	NA	NA
48010.0	Turning Basin	1772	53	NA	NA	NA	NA
40015.1	Fish Harbor Entrance	1773	53	NA	NA	NA	NA
40009.0	West Basin Entrance	1774	53	NA	NA	NA	NA
49001.0	Cabrillo Beach Pier - West	1778	53	NA	NA	NA	NA
49002.0	Cabrillo Beach Pier - Central	1779	53	NA	NA	NA	NA
49003.0	Cabrillo Beach Pier - East	1780	53	NA	NA	NA	NA

Table 14b. Development of abalone embryos (*Haliotis rufescens*) in Industrial Harbor station pore waters (50% concentration). HRP 50 MN = Mean percent normal development of *Haliotis rufescens* in 50% pore water. SD = Standard Deviation. \* = Significantly Toxic using a t-test. T= Toxic using a t-test and relative to the MSD criteria for this protocol. NT = Not toxic. NA = Not Analyzed.

STANUM	STATION	IDORG	LEG	HRP 50 MN	HRP 50 SD	HRP 50 t-test	HRP 50 MSD
47004.0	Consolidated Slip - 200E - Depth 2	1657	46	NA	NA	NA	NA
47004.0	Consolidated Slip - 200E - Surface	1656	46	NA	NA	NA	NA
49004.0	Kaiser Intl. - Berth 49	1793	54	NA	NA	NA	NA
40006.1	Consolidated Slip - Rep 1	1050	25	NA	NA	NA	NA
40006.1	Consolidated Slip - Rep 2	1051	25	NA	NA	NA	NA
40006.1	Consolidated Slip - Rep 3	1052	25	NA	NA	NA	NA
40006.1	Consolidated Slip	16	1	90.30	4.50	ns	NT
47002.0	Consolidated Slip - 200 - Surface	1650	46	NA	NA	NA	NA
47002.0	Consolidated Slip - 200 - Depth 2	1651	46	NA	NA	NA	NA
47009.0	Consolidated Slip - 200G - Surface	1664	46	NA	NA	NA	NA
47003.0	Consolidated Slip - 200B - Surface	1653	46	NA	NA	NA	NA
47008.0	Consolidated Slip - Storm Drain	1663	46	NA	NA	NA	NA
47001.0	Consolidated Slip - 198 - Surface	1647	46	NA	NA	NA	NA
47001.0	Consolidated Slip - 198 - Depth 2	1648	46	NA	NA	NA	NA
40006.2	Consolidated Slip	17	1	0.00	0.00	*	T
47007.0	Consolidated Slip - End - Surface	1662	46	NA	NA	NA	NA
40019.3	Inner Fish Harbor	57	2	0.00	0.00	*	T
47010.0	Dominguez - H. Ford Bridge - Surface	1665	46	NA	NA	NA	NA
40019.2	Inner Fish Harbor	56	2	95.80	1.60	ns	NT
40019.1	Inner Fish Harbor	55	2	0.00	0.00	*	T
40007.2	Long Beach Harbor - Channel 2	20	3	0.40	0.70	*	T
40011.3	Inner Harbor - Channel 3	33	3	0.00	0.00	*	T
40001.3	Southwest Slip	3	1	40.70	24.20	*	T
44012.0	Port Hueneme - Wharf B	1626	45	NA	NA	NA	NA
40031.1	Palos Verdes - Swartz 6	76	3	88.10	3.20	ns	NT
40001.2	Southwest Slip - Rep 1	1062	25	NA	NA	NA	NA
40001.2	Southwest Slip - Rep 2	1063	25	NA	NA	NA	NA
40001.2	Southwest Slip	2	1	86.60	8.40	ns	NT
40001.2	Southwest Slip - Rep 3	1064	25	NA	NA	NA	NA
40013.1	Inner Queensway Bay - Rep 3	1058	25	NA	NA	NA	NA
40013.1	Inner Queensway Bay	37	3	89.40	0.80	ns	NT
40013.1	Inner Queensway Bay - Rep 2	1057	25	NA	NA	NA	NA
40013.1	Inner Queensway Bay - Rep 1	1056	25	NA	NA	NA	NA
40014.2	Outer Queensway Bay	41	3	0.00	0.00	*	T
40014.3	Outer Queensway Bay	42	3	90.40	5.10	ns	NT
40031.3	Palos Verdes - Swartz 6	78	3	72.00	1.70	*	T
40013.2	Inner Queensway Bay	38	3	87.10	2.10	*	NT
40031.2	Palos Verdes (Swartz 6) - Rep 2	1039	25	NA	NA	NA	NA
40031.2	Palos Verdes (Swartz 6) - Rep 3	1004	23	NA	NA	NA	NA

Table 14b continued. Development of abalone embryos (*Haliotis rufescens*) in Industrial Harbor station pore waters (50% concentration). HRP 50 MN = Mean percent normal development of *Haliotis rufescens* in 50% pore water. SD = Standard Deviation. \* = Significantly Toxic using a t-test. T= Toxic using a t-test and relative to the MSD criteria for this protocol. NT = Not toxic. NA = Not Analyzed.

STANUM	STATION	IDORG	LEG	HRP 50 MN	HRP 50 SD	HRP 50 t-test	HRP 50 MSD
40031.2	Palos Verdes (Swartz 6) - Rep 1	1038	25	NA	NA	NA	NA
40031.2	Palos Verdes (Swartz 6)	77	3	90.30	3.80	ns	NT
40031.2	Palos Verdes (Swartz 6) - Rep 2	1003	23	NA	NA	NA	NA
40031.2	Palos Verdes (Swartz 6) - Rep 1	1002	23	NA	NA	NA	NA
40031.2	Palos Verdes (Swartz 6) - Rep 3	1040	25	NA	NA	NA	NA
40031.2	Palos V.(Swartz 6) - Rep 4 Blind	1005	23	NA	NA	NA	NA
40031.2	Palos Verdes (Swartz 6) - Rep 1	1189	30	NA	NA	NA	NA
40031.2	Palos Verdes (Swartz 6) - Rep 2	1190	30	NA	NA	NA	NA
40031.2	Palos Verdes (Swartz 6) - Rep 3	1191	30	NA	NA	NA	NA
40005.1	East Basin - Turning Basin	13	1	41.90	42.10	ns	NT
48009.0	San Pedro Bay Outer Harbor	1694	48	NA	NA	NA	NA
40001.1	Southwest Slip	1	1	92.50	2.90	ns	NT
40004.2	Lower Main Channel	11	1	94.60	0.90	ns	NT
40004.2	Lower Main Channel - Rep 3	832	20	NA	NA	NA	NA
40004.2	Lower Main Channel - Rep 2	831	20	NA	NA	NA	NA
40004.2	Lower Main Channel - Rep 1	830	20	NA	NA	NA	NA
40004.2	Lower Main Channel	789	18	NA	NA	NA	NA
40010.1	Off Cabrillo Beach - Rep 2	1069	26	NA	NA	NA	NA
40010.1	Off Cabrillo Beach - Rep 3	1070	26	NA	NA	NA	NA
40010.1	Off Cabrillo Beach - Rep 1	1068	26	NA	NA	NA	NA
40010.1	Off Cabrillo Beach - Rep 1	1006	23	NA	NA	NA	NA
40010.1	Off Cabrillo Beach	28	2	96.40	1.20	ns	NT
40010.1	Off Cabrillo Beach	136	4	2.20	0.90	*	T
40010.1	Off Cabrillo Beach	810	19	NA	NA	NA	NA
40010.1	Off Cabrillo Beach	1331	32	NA	NA	NA	NA
49005.0	Kaiser Intl. - Berth 48	1794	54	NA	NA	NA	NA
40004.3	Lower Main Channel	12	1	91.30	2.90	ns	NT
44013.0	Port Hueneme - Wharf #1	1627	45	NA	NA	NA	NA
40010.3	Off Cabrillo Beach - Rep 2	1075	26	NA	NA	NA	NA
40010.3	Off Cabrillo Beach - Rep 1	1074	26	NA	NA	NA	NA
40010.3	Off Cabrillo Beach - Rep 3	1008	23	NA	NA	NA	NA
40010.3	Off Cabrillo Beach	30	2	93.00	0.70	ns	NT
40010.3	Off Cabrillo Beach - Rep 3	1076	26	NA	NA	NA	NA
40010.3	Off Cabrillo Beach	138	4	7.10	3.50	*	T
40010.3	Off Cabrillo Beach	1333	32	NA	NA	NA	NA
40011.1	Inner Harbor - Channel 3	31	3	75.10	12.00	ns	NT
40010.2	Off Cabrillo Beach - Rep 1	1071	26	NA	NA	NA	NA
40010.2	Off Cabrillo Beach - Rep 2	1072	26	NA	NA	NA	NA
40010.2	Off Cabrillo Beach - Rep 2	1007	23	NA	NA	NA	NA

Table 14b continued. Development of abalone embryos (*Haliotis rufescens*) in Industrial Harbor station pore waters (50% concentration). HRP 50 MN = Mean percent normal development of *Haliotis rufescens* in 50% pore water. SD = Standard Deviation. \* = Significantly Toxic using a t-test. T= Toxic using a t-test and relative to the MSD criteria for this protocol. NT = Not toxic. NA = Not Analyzed.

STANUM	STATION	IDORG	LEG	HRP 50 MN	HRP 50 SD	HRP 50 t-test	HRP 50 MSD
40010.2	Off Cabrillo Beach - Rep 3	1073	26	NA	NA	NA	NA
40010.2	Off Cabrillo Beach	29	2	96.70	2.90	ns	NT
40010.2	Off Cabrillo Beach	137	4	1.00	1.80	*	T
40010.2	Off Cabrillo Beach	1332	32	NA	NA	NA	NA
40011.2	Inner Harbor - Channel 3	32	3	0.00	0.00	*	T
44011.0	Los Cerritos Channel Tidal P - Rep3	1079	26	NA	NA	NA	NA
44011.0	Los Cerritos Channel Tidal P - Rep1	1077	26	NA	NA	NA	NA
44011.0	Los Cerritos Channel Tidal P - Rep2	1078	26	NA	NA	NA	NA
44011.0	Los Cerritos Channel Tidal P	611	11	NA	NA	NA	NA
40033.1	Outer Harbor - POLA 10	82	1	0.00	0.00	*	T
40018.3	Long Beach Outer Harbor - 18 - Rep2	1042	25	NA	NA	NA	NA
40018.3	Long Beach Outer Harbor - 18 - Rep 3	886	22	NA	NA	NA	NA
40018.3	Long Beach Outer Harbor - 18 - Rep 2	885	22	NA	NA	NA	NA
40018.3	Long Beach Outer Harbor - 18 - Rep 1	884	22	NA	NA	NA	NA
40018.3	Long Beach Outer Harbor - 18 - Rep1	1041	25	NA	NA	NA	NA
40018.3	Long Beach Outer Harbor - 18	1695	48	NA	NA	NA	NA
40018.3	Long Beach Outer Harbor - 18 - Rep3	1043	25	NA	NA	NA	NA
40018.3	Long Beach Outer Harbor - 18	54	3	91.40	2.50	ns	NT
40018.3	Long Beach Outer Harbor - 18 - Rep 1	1192	30	NA	NA	NA	NA
40018.3	Long Beach Outer Harbor - 18 - Rep 2	1193	30	NA	NA	NA	NA
40018.3	Long Beach Outer Harbor - 18 - Rep 3	1194	30	NA	NA	NA	NA
40018.3	Long Beach Outer Harbor - 18	1334	32	NA	NA	NA	NA
40018.3	Long Beach Outer Harbor - 18	1770	53	NA	NA	NA	NA
40012.0	Southeast Basin	1632	45	NA	NA	NA	NA
40020.2	Long Beach Outer Harbor - 20	1696	48	NA	NA	NA	NA
40012.1	Southeast Basin - Rep 1	1047	25	NA	NA	NA	NA
40012.1	Southeast Basin - Rep 2	1048	25	NA	NA	NA	NA
40012.1	Southeast Basin	34	2	94.20	4.60	ns	NT
40012.1	Southeast Basin - Rep 3	1049	25	NA	NA	NA	NA
40012.1	Southeast Basin	812	19	NA	NA	NA	NA
40008.1	East Basin - Pier C	22	2	0.30	0.50	*	T
48010.0	Turning Basin	1697	48	NA	NA	NA	NA
40017.3	Long Beach Channel - Rep 2	1060	25	NA	NA	NA	NA
40017.3	Long Beach Channel - Rep 1	1059	25	NA	NA	NA	NA
40017.3	Long Beach Channel - Rep 3	1061	25	NA	NA	NA	NA
40017.3	Long Beach Channel	51	3	90.20	1.40	ns	NT
40002.2	West Basin - Pier 143	5	1	0.00	0.00	*	T
40016.3	Terminal Island Stp	48	2	96.60	0.50	ns	NT
40012.2	Southeast Basin	35	2	96.80	0.60	ns	NT

Table 14b continued. Development of abalone embryos (*Haliotis rufescens*) in Industrial Harbor station pore waters (50% concentration). HRP 50 MN = Mean percent normal development of *Haliotis rufescens* in 50% pore water. SD = Standard Deviation. \* = Significantly Toxic using a t-test. T= Toxic using a t-test and relative to the MSD criteria for this protocol. NT = Not toxic. NA = Not Analyzed.

STANUM	STATION	IDORG	LEG	HRP 50 MN	HRP 50 SD	HRP 50 t-test	HRP 50 MSD
40009.0	West Basin Entrance	1699	48	NA	NA	NA	NA
40009.1	West Basin Entrance - Ref 1	834	20	NA	NA	NA	NA
40009.1	West Basin Entrance - Ref 3	836	20	NA	NA	NA	NA
40009.1	West Basin Entrance - Ref 2	835	20	NA	NA	NA	NA
40009.1	West Basin Entrance	25	2	95.30	1.60	ns	NT
40008.3	East Basin - Pier C	24	2	93.20	3.70	ns	NT
40015.1	Fish Harbor Entrance	43	2	97.90	2.20	ns	NT
40016.1	Terminal Island Stp	46	2	97.70	1.40	ns	NT
40015.3	Fish Harbor Entrance	45	2	95.80	0.80	ns	NT
40003.1	Turning Basin - Pier 151	7	1	63.20	24.10	ns	NT
40020.3	Long Beach Outer Harbor - 20	60	3	88.70	0.60	ns	NT
40009.3	West Basin Entrance	27	2	96.80	0.60	ns	NT
40020.2	Long Beach Outer Harbor - 20	59	3	14.60	4.10	*	T
40015.1	Fish Harbor Entrance	1698	48	NA	NA	NA	NA
40020.1	Long Beach Outer Harbor - 20	58	3	6.30	11.00	*	T
40032.3	San Pedro Bay - POLA 19	105	2	0.00	0.00	*	T
40032.3	San Pedro Bay - POLA 19	81	1	15.00	7.80	*	T
40015.2	Fish Harbor Entrance	44	2	95.90	0.30	ns	NT
40003.2	Turning Basin, Pier 151 - Rep 3	1055	25	NA	NA	NA	NA
40003.2	Turning Basin, Pier 151 - Rep 2	1054	25	NA	NA	NA	NA
40003.2	Turning Basin, Pier 151	8	1	97.90	1.40	ns	NT
40003.2	Turning Basin, Pier 151 - Rep 1	1053	25	NA	NA	NA	NA
40016.2	Terminal Island Stp	47	2	96.90	0.90	ns	NT
40030.1	San Pedro Breakwater	73	2	0.00	0.00	*	T
40030.2	San Pedro Breakwater	74	2	48.50	14.00	*	T
40032.1	San Pedro Bay - POLA 19	103	2	11.00	17.20	*	T
40032.2	San Pedro Bay - POLA 19	104	2	16.30	23.80	*	T
40002.1	West Basin - Pier 143	4	1	1.40	1.20	*	T
40002.3	West Basin - Pier 143	6	1	0.00	0.00	*	T
40003.3	Turning Basin - Pier 151	9	1	93.40	5.20	ns	NT
40004.1	Lower Main Channel	10	1	93.30	0.70	ns	NT
40005.2	East Basin - Turning Basin	14	1	88.60	4.60	ns	NT
40005.3	East Basin - Turning Basin	15	1	54.00	9.40	*	T
40006.3	Consolidated Slip	18	1	0.70	1.20	*	T
40032.1	San Pedro Bay - POLA 19	79	1	89.90	4.50	ns	NT
40032.2	San Pedro Bay - POLA 19	80	1	19.90	34.50	*	T
40033.2	Outer Harbor - POLA 10	83	1	86.50	10.80	ns	NT
40033.3	Outer Harbor - POLA 10	84	1	93.60	5.60	ns	NT
40008.2	East Basin - Pier C	23	2	95.20	2.80	ns	NT

Table 14b continued. Development of abalone embryos (*Haliotis rufescens*) in Industrial Harbor station pore waters (50% concentration). HRP 50 MN = Mean percent normal development of *Haliotis rufescens* in 50% pore water. SD = Standard Deviation. \* = Significantly Toxic using a t-test. T= Toxic using a t-test and relative to the MSD criteria for this protocol. NT = Not toxic. NA = Not Analyzed.

STANUM	STATION	IDORG	LEG	HRP 50 MN	HRP 50 SD	HRP 50 t-test	HRP 50 MSD
40009.2	West Basin Entrance	26	2	95.70	2.50	ns	NT
40012.3	Southeast Basin	36	2	62.50	50.40	ns	NT
40030.3	San Pedro Breakwater	75	2	59.50	25.30	ns	NT
40007.1	Long Beach Harbor - Channel 2	19	3	91.60	4.10	ns	NT
40007.3	Long Beach Harbor - Channel 2	21	3	0.40	0.60	*	T
40013.3	Inner Queensway Bay	39	3	90.00	3.20	ns	NT
40014.1	Outer Queensway Bay	40	3	92.50	5.20	ns	NT
40017.1	Long Beach Channel	49	3	72.20	8.60	*	T
40017.2	Long Beach Channel	50	3	86.80	7.60	ns	NT
40018.1	Long Beach Outer Harbor - 18	52	3	86.90	10.40	ns	NT
40018.2	Long Beach Outer Harbor - 18	53	3	1.10	1.90	*	T
44012.0	Port Hueneme - Wharf B	612	11	NA	NA	NA	NA
44013.0	Port Hueneme - Wharf #1	613	11	NA	NA	NA	NA
40009.1	West Basin Entrance	790	18	NA	NA	NA	NA
40013.1	Inner Queensway Bay	791	18	NA	NA	NA	NA
40015.3	Fish Harbor Entrance	792	18	NA	NA	NA	NA
40016.2	Terminal Island Stp	793	18	NA	NA	NA	NA
40017.3	Long Beach Channel	811	19	NA	NA	NA	NA
44055.0	L.B. Naval Station - Pier 3 - Rep 1	1198	30	NA	NA	NA	NA
44055.0	L.B. Naval Station - Pier 3 - Rep 2	1199	30	NA	NA	NA	NA
44055.0	L.B. Naval Station - Pier 3 - Rep 3	1200	30	NA	NA	NA	NA
46001.0	Hugo Neuproler - #1	1623	45	NA	NA	NA	NA
46002.0	Hugo Neuproler - #2	1624	45	NA	NA	NA	NA
46003.0	Hugo Neuproler - #3	1625	45	NA	NA	NA	NA
47003.0	Consolidated Slip -200B - Depth 2	1654	46	NA	NA	NA	NA
47005.0	Consolidated Slip -200T - Surface	1659	46	NA	NA	NA	NA
47005.0	Consolidated Slip -200T - Depth 2	1660	46	NA	NA	NA	NA
47005.0	Consolidated Slip -200T - Depth 3	1661	46	NA	NA	NA	NA
48009.0	San Pedro Bay Outer Harbor	1769	53	NA	NA	NA	NA
40020.2	Long Beach Outer Harbor - 20	1771	53	NA	NA	NA	NA
48010.0	Turning Basin	1772	53	NA	NA	NA	NA
40015.1	Fish Harbor Entrance	1773	53	NA	NA	NA	NA
40009.0	West Basin Entrance	1774	53	NA	NA	NA	NA
49001.0	Cabrillo Beach Pier - West	1778	53	NA	NA	NA	NA
49002.0	Cabrillo Beach Pier - Central	1779	53	NA	NA	NA	NA
49003.0	Cabrillo Beach Pier - East	1780	53	NA	NA	NA	NA

Table 14c. Development of abalone embryos (*Haliotis rufescens*) in Industrial Harbor station pore waters (25% concentration). HRP 25 MN = Mean percent normal development of *Haliotis rufescens* in 25% pore water. SD = Standard Deviation. \* = Significantly Toxic using a t-test. T= Toxic using a t-test and relative to the MSD criteria for this protocol. NT = Not toxic. NA = Not Analyzed.

STANUM	STATION	IDORG	LEG	HRP 25 MN	HRP 25 SD	HRP 25 t-test	HRP 25 MSD
47004.0	Consolidated Slip – 200E - Depth 2	1657	46	NA	NA	NA	NA
47004.0	Consolidated Slip – 200E - Surface	1656	46	NA	NA	NA	NA
49004.0	Kaiser Intl.- Berth 49	1793	54	NA	NA	NA	NA
40006.1	Consolidated Slip - Rep 1	1050	25	NA	NA	NA	NA
40006.1	Consolidated Slip - Rep 2	1051	25	NA	NA	NA	NA
40006.1	Consolidated Slip - Rep 3	1052	25	NA	NA	NA	NA
40006.1	Consolidated Slip	16	1	92.90	3.10	ns	NT
47002.0	Consolidated Slip – 200 - Surface	1650	46	NA	NA	NA	NA
47002.0	Consolidated Slip – 200 - Depth 2	1651	46	NA	NA	NA	NA
47009.0	Consolidated Slip – 200G - Surface	1664	46	NA	NA	NA	NA
47003.0	Consolidated Slip – 200B - Surface	1653	46	NA	NA	NA	NA
47008.0	Consolidated Slip – Storm Drain	1663	46	NA	NA	NA	NA
47001.0	Consolidated Slip – 198 - Surface	1647	46	NA	NA	NA	NA
47001.0	Consolidated Slip – 198 - Depth 2	1648	46	NA	NA	NA	NA
40006.2	Consolidated Slip	17	1	0.40	0.70	*	T
47007.0	Consolidated Slip – End - Surface	1662	46	NA	NA	NA	NA
40019.3	Inner Fish Harbor	57	2	93.00	3.20	ns	NT
47010.0	Dominguez - H. Ford Bridge - Surface	1665	46	NA	NA	NA	NA
40019.2	Inner Fish Harbor	56	2	95.80	0.50	ns	NT
40019.1	Inner Fish Harbor	55	2	0.00	0.00	*	T
40007.2	Long Beach Harbor - Channel 2	20	3	36.60	20.50	*	T
40011.3	Inner Harbor - Channel 3	33	3	62.20	30.60	ns	NT
40001.3	Southwest Slip	3	1	76.50	7.90	*	T
44012.0	Port Hueneme - Wharf B	1626	45	NA	NA	NA	NA
40031.1	Palos Verdes - Swartz 6	76	3	88.60	2.60	ns	NT
40001.2	Southwest Slip - Rep 1	1062	25	NA	NA	NA	NA
40001.2	Southwest Slip - Rep 2	1063	25	NA	NA	NA	NA
40001.2	Southwest Slip	2	1	72.80	18.90	ns	NT
40001.2	Southwest Slip - Rep 3	1064	25	NA	NA	NA	NA
40013.1	Inner Queensway Bay - Rep 3	1058	25	NA	NA	NA	NA
40013.1	Inner Queensway Bay	37	3	90.80	1.50	ns	NT
40013.1	Inner Queensway Bay - Rep 2	1057	25	NA	NA	NA	NA
40013.1	Inner Queensway Bay- Rep 1	1056	25	NA	NA	NA	NA
40014.2	Outer Queensway Bay	41	3	90.80	4.00	ns	NT
40014.3	Outer Queensway Bay	42	3	89.20	3.80	ns	NT
40031.3	Palos Verdes - Swartz 6	78	3	88.20	0.90	*	NT
40013.2	Inner Queensway Bay	38	3	88.40	1.20	ns	NT
40031.2	Palos Verdes (Swartz 6) - Rep 2	1039	25	NA	NA	NA	NA
40031.2	Palos Verdes (Swartz 6) - Rep 3	1004	23	NA	NA	NA	NA
40031.2	Palos Verdes (Swartz 6) - Rep 1	1038	25	NA	NA	NA	NA



Table 14c continued. Development of abalone embryos (*Haliotis rufescens*) in Industrial Harbor station pore waters (25% concentration). HRP 25 MN = Mean percent normal development of *Haliotis rufescens* in 25% pore water. SD = Standard Deviation. \* = Significantly Toxic using a t-test. T= Toxic using a t-test and relative to the MSD criteria for this protocol. NT = Not toxic. NA = Not Analyzed.

STANUM	STATION	IDORG	LEG	HRP 25 MN	HRP 25 SD	HRP 25 t-test	HRP 25 MSD
40031.2	Palos Verdes (Swartz 6)	77	3	92.00	2.70	ns	NT
40031.2	Palos Verdes (Swartz 6) - Rep 2	1003	23	NA	NA	NA	NA
40031.2	Palos Verdes (Swartz 6) - Rep 1	1002	23	NA	NA	NA	NA
40031.2	Palos Verdes (Swartz 6) - Rep 3	1040	25	NA	NA	NA	NA
40031.2	Palos V.(Swartz 6) - Rep 4 Blind	1005	23	NA	NA	NA	NA
40031.2	Palos Verdes (Swartz 6) - Rep 1	1189	30	NA	NA	NA	NA
40031.2	Palos Verdes (Swartz 6) - Rep 2	1190	30	NA	NA	NA	NA
40031.2	Palos Verdes (Swartz 6) - Rep 3	1191	30	NA	NA	NA	NA
40005.1	East Basin - Turning Basin	13	1	97.50	2.70	ns	NT
48009.0	San Pedro Bay Outer Harbor	1694	48	NA	NA	NA	NA
40001.1	Southwest Slip	1	1	92.80	3.90	ns	NT
40004.2	Lower Main Channel	11	1	95.20	3.10	ns	NT
40004.2	Lower Main Channel - Rep 3	832	20	NA	NA	NA	NA
40004.2	Lower Main Channel - Rep 2	831	20	NA	NA	NA	NA
40004.2	Lower Main Channel - Rep 1	830	20	NA	NA	NA	NA
40004.2	Lower Main Channel	789	18	NA	NA	NA	NA
40010.1	Off Cabrillo Beach - Rep 2	1069	26	NA	NA	NA	NA
40010.1	Off Cabrillo Beach - Rep 3	1070	26	NA	NA	NA	NA
40010.1	Off Cabrillo Beach - Rep 1	1068	26	NA	NA	NA	NA
40010.1	Off Cabrillo Beach - Rep 1	1006	23	NA	NA	NA	NA
40010.1	Off Cabrillo Beach	28	2	96.90	2.20	ns	NT
40010.1	Off Cabrillo Beach	136	4	52.90	31.90	ns	NT
40010.1	Off Cabrillo Beach	810	19	NA	NA	NA	NA
40010.1	Off Cabrillo Beach	1331	32	NA	NA	NA	NA
49005.0	Kaiser Intl. - Berth 48	1794	54	NA	NA	NA	NA
40004.3	Lower Main Channel	12	1	96.90	1.20	ns	NT
44013.0	Port Hueneme - Wharf #1	1627	45	NA	NA	NA	NA
40010.3	Off Cabrillo Beach - Rep 2	1075	26	NA	NA	NA	NA
40010.3	Off Cabrillo Beach - Rep 1	1074	26	NA	NA	NA	NA
40010.3	Off Cabrillo Beach - Rep 3	1008	23	NA	NA	NA	NA
40010.3	Off Cabrillo Beach	30	2	92.40	8.20	ns	NT
40010.3	Off Cabrillo Beach - Rep 3	1076	26	NA	NA	NA	NA
40010.3	Off Cabrillo Beach	138	4	50.10	19.20	*	T
40010.3	Off Cabrillo Beach	1333	32	NA	NA	NA	NA
40011.1	Inner Harbor - Channel 3	31	3	90.00	1.70	ns	NT
40010.2	Off Cabrillo Beach - Rep 1	1071	26	NA	NA	NA	NA
40010.2	Off Cabrillo Beach - Rep 2	1072	26	NA	NA	NA	NA
40010.2	Off Cabrillo Beach - Rep 2	1007	23	NA	NA	NA	NA
40010.2	Off Cabrillo Beach - Rep 3	1073	26	NA	NA	NA	NA
40010.2	Off Cabrillo Beach	29	2	96.10	1.50	ns	NT

Table 14c continued. Development of abalone embryos (*Haliotis rufescens*) in Industrial Harbor station pore waters (25% concentration). HRP 25 MN = Mean percent normal development of *Haliotis rufescens* in 25% pore water. SD = Standard Deviation. \* = Significantly Toxic using a t-test. T= Toxic using a t-test and relative to the MSD criteria for this protocol. NT = Not toxic. NA = Not Analyzed.

STANUM	STATION	IDORG	LEG	HRP 25 MN	HRP 25 SD	HRP 25 t-test	HRP 25 MSD
40010.2	Off Cabrillo Beach	137	4	47.60	7.10	*	T
40010.2	Off Cabrillo Beach	1332	32	NA	NA	NA	NA
40011.2	Inner Harbor - Channel 3	32	3	87.60	3.60	ns	NT
44011.0	Los Cerritos Chnl Tidal P - Rep3	1079	26	NA	NA	NA	NA
44011.0	Los Cerritos Chnl Tidal P - Rep1	1077	26	NA	NA	NA	NA
44011.0	Los Cerritos Chnl Tidal P - Rep2	1078	26	NA	NA	NA	NA
44011.0	Los Cerritos Chnl Tidal P	611	11	NA	NA	NA	NA
40033.1	Outer Harbor- Pola 10	82	1	25.50	20.90	*	T
40018.3	Long Beach Outer Harbor - 18 - Rep 2	1042	25	NA	NA	NA	NA
40018.3	Long Beach Outer Harbor - 18 - Rep 3	886	22	NA	NA	NA	NA
40018.3	Long Beach Outer Harbor - 18 - Rep 2	885	22	NA	NA	NA	NA
40018.3	Long Beach Outer Harbor - 18 - Rep 1	884	22	NA	NA	NA	NA
40018.3	Long Beach Outer Harbor - 18 - Rep	1041	25	NA	NA	NA	NA
40018.3	Long Beach Outer Harbor - 18	1695	48	NA	NA	NA	NA
40018.3	Long Beach Outer Harbor - 18 - Rep	1043	25	NA	NA	NA	NA
40018.3	Long Beach Outer Harbor - 18	54	3	93.30	2.30	ns	NT
40018.3	Long Beach Outer Harbor - 18 - Rep 1	1192	30	NA	NA	NA	NA
40018.3	Long Beach Outer Harbor - 18 - Rep 2	1193	30	NA	NA	NA	NA
40018.3	Long Beach Outer Harbor - 18 - Rep 3	1194	30	NA	NA	NA	NA
40018.3	Long Beach Outer Harbor - 18	1334	32	NA	NA	NA	NA
40018.3	Long Beach Outer Harbor - 18	1770	53	NA	NA	NA	NA
40012.0	Southeast Basin	1632	45	NA	NA	NA	NA
40020.2	Long Beach Outer Harbor - 20	1696	48	NA	NA	NA	NA
40012.1	Southeast Basin - Rep1	1047	25	NA	NA	NA	NA
40012.1	Southeast Basin - Rep2	1048	25	NA	NA	NA	NA
40012.1	Southeast Basin	34	2	95.80	2.60	ns	NT
40012.1	Southeast Basin - Rep3	1049	25	NA	NA	NA	NA
40012.1	Southeast Basin	812	19	NA	NA	NA	NA
40008.1	East Basin - Pier C	22	2	94.70	3.10	ns	NT
48010.0	Turning Basin	1697	48	NA	NA	NA	NA
40017.3	Long Beach Channel - Rep 2	1060	25	NA	NA	NA	NA
40017.3	Long Beach Channel - Rep 1	1059	25	NA	NA	NA	NA
40017.3	Long Beach Channel - Rep 3	1061	25	NA	NA	NA	NA
40017.3	Long Beach Channel	51	3	91.70	2.10	ns	NT
40002.2	West Basin - Pier 143	5	1	28.90	27.60	*	T
40016.3	Terminal Island Stp	48	2	95.80	2.70	ns	NT
40012.2	Southeast Basin	35	2	97.50	0.80	ns	NT
40009.0	West Basin Entrance	1699	48	NA	NA	NA	NA
40009.1	West Basin Entrance - Ref 1	834	20	NA	NA	NA	NA
40009.1	West Basin Entrance - Ref 3	836	20	NA	NA	NA	NA

Table 14c continued. Development of abalone embryos (*Haliotis rufescens*) in Industrial Harbor station pore waters (25% concentration). HRP 25 MN = Mean percent normal development of *Haliotis rufescens* in 25% pore water. SD = Standard Deviation. \* = Significantly Toxic using a t-test. T= Toxic using a t-test and relative to the MSD criteria for this protocol. NT = Not toxic. NA = Not Analyzed.

STANUM	STATION	IDORG	LEG	HRP 25 MN	HRP 25 SD	HRP 25 t-test	HRP 25 MSD
40009.1	West Basin Entrance - Ref 2	835	20	NA	NA	NA	NA
40009.1	West Basin Entrance	25	2	95.20	1.10	ns	NT
40008.3	East Basin - Pier C	24	2	92.80	3.00	ns	NT
40015.1	Fish Harbor Entrance	43	2	95.70	1.50	ns	NT
40016.1	Terminal Island Stp	46	2	97.10	1.70	ns	NT
40015.3	Fish Harbor Entrance	45	2	97.70	1.40	ns	NT
40003.1	Turning Basin - Pier 151	7	1	88.30	8.80	ns	NT
40020.3	Long Beach Outer Harbor - 20	60	3	91.10	3.00	ns	NT
40009.3	West Basin Entrance	27	2	94.70	3.00	ns	NT
40020.2	Long Beach Outer Harbor - 20	59	3	90.60	2.20	ns	NT
40015.1	Fish Harbor Entrance	1698	48	NA	NA	NA	NA
40020.1	Long Beach Outer Harbor - 20	58	3	64.30	47.60	ns	NT
40032.3	San Pedro Bay - POLA 19	105	2	60.60	31.70	ns	NT
40032.3	San Pedro Bay - POLA 19	81	1	91.60	5.00	ns	NT
40015.2	Fish Harbor Entrance	44	2	98.20	1.00	ns	NT
40003.2	Turning Basin, Pier 151 - Rep 3	1055	25	NA	NA	NA	NA
40003.2	Turning Basin, Pier 151 - Rep 2	1054	25	NA	NA	NA	NA
40003.2	Turning Basin, Pier 151	8	1	95.80	2.00	ns	NT
40003.2	Turning Basin, Pier 151 - Rep 1	1053	25	NA	NA	NA	NA
40016.2	Terminal Island Stp	47	2	96.50	1.50	ns	NT
40030.1	San Pedro Breakwater	73	2	35.50	6.50	*	T
40030.2	San Pedro Breakwater	74	2	90.00	5.60	ns	NT
40032.1	San Pedro Bay - POLA 19	103	2	90.10	8.10	ns	NT
40032.2	San Pedro Bay - POLA 19	104	2	9.60	5.60	*	T
40002.1	West Basin - Pier 143	4	1	87.70	1.80	*	NT
40002.3	West Basin - Pier 143	6	1	65.20	23.00	ns	NT
40003.3	Turning Basin - Pier 151	9	1	92.20	6.30	ns	NT
40004.1	Lower Main Channel	10	1	93.70	1.20	ns	NT
40005.2	East Basin- Turning Basin	14	1	94.00	3.70	ns	NT
40005.3	East Basin- Turning Basin	15	1	77.90	10.40	ns	NT
40006.3	Consolidated Slip	18	1	44.80	38.00	*	T
40032.1	San Pedro Bay - POLA 19	79	1	97.90	2.70	ns	NT
40032.2	San Pedro Bay - POLA 19	80	1	83.80	8.20	ns	NT
40033.2	Outer Harbor - POLA 10	83	1	96.90	2.90	ns	NT
40033.3	Outer Harbor - POLA 10	84	1	90.60	5.10	ns	NT
40008.2	East Basin - Pier C	23	2	97.60	0.70	ns	NT
40009.2	West Basin Entrance	26	2	94.90	1.90	ns	NT
40012.3	Southeast Basin	36	2	93.70	1.20	ns	NT
40030.3	San Pedro Breakwater	75	2	94.70	1.30	ns	NT

Table 14c continued. Development of abalone embryos (*Haliotis rufescens*) in Industrial Harbor station pore waters (25% concentration). HRP 25 MN = Mean percent normal development of *Haliotis rufescens* in 25% pore water. SD = Standard Deviation. \* = Significantly Toxic using a t-test. T= Toxic using a t-test and relative to the MSD criteria for this protocol. NT = Not toxic. NA = Not Analyzed.

STANUM	STATION	IDORG	LEG	HRP 25 MN	HRP 25 SD	HRP 25 t-test	HRP 25 MSD
40007.1	Long Beach Harbor - Channel 2	19	3	90.70	2.60	ns	NT
40007.3	Long Beach Harbor - Channel 2	21	3	88.20	5.10	ns	NT
40013.3	Inner Queensway Bay	39	3	92.20	2.80	ns	NT
40014.1	Outer Queensway Bay	40	3	86.90	1.40	*	NT
40017.1	Long Beach Channel	49	3	93.70	0.30	ns	NT
40017.2	Long Beach Channel	50	3	91.60	2.00	ns	NT
40018.1	Long Beach Outer Harbor - 18	52	3	90.00	5.30	ns	NT
40018.2	Long Beach Outer Harbor - 18	53	3	94.20	1.80	ns	NT
44012.0	Port Hueneme - Wharf B	612	11	NA	NA	NA	NA
44013.0	Port Hueneme - Wharf #1	613	11	NA	NA	NA	NA
40009.1	West Basin Entrance	790	18	NA	NA	NA	NA
40013.1	Inner Queensway Bay	791	18	NA	NA	NA	NA
40015.3	Fish Harbor Entrance	792	18	NA	NA	NA	NA
40016.2	Terminal Island Stp	793	18	NA	NA	NA	NA
40017.3	Long Beach Channel	811	19	NA	NA	NA	NA
44055.0	L.B. Naval Station - Pier 3 - Rep 1	1198	30	NA	NA	NA	NA
44055.0	L.B. Naval Station - Pier 3 - Rep 2	1199	30	NA	NA	NA	NA
44055.0	L.B. Naval Station - Pier 3 - Rep 3	1200	30	NA	NA	NA	NA
46001.0	Hugo Neuproler - #1	1623	45	NA	NA	NA	NA
46002.0	Hugo Neuproler - #2	1624	45	NA	NA	NA	NA
46003.0	Hugo Neuproler - #3	1625	45	NA	NA	NA	NA
47003.0	Consolidated Slip - 200B - Depth 2	1654	46	NA	NA	NA	NA
47005.0	Consolidated Slip - 200T - Surface	1659	46	NA	NA	NA	NA
47005.0	Consolidated Slip - 200T - Depth 2	1660	46	NA	NA	NA	NA
47005.0	Consolidated Slip - 200T - Depth 3	1661	46	NA	NA	NA	NA
48009.0	San Pedro Bay Outer Harbor	1769	53	NA	NA	NA	NA
40020.2	Long Beach Outer Harbor - 20	1771	53	NA	NA	NA	NA
48010.0	Turning Basin	1772	53	NA	NA	NA	NA
40015.1	Fish Harbor Entrance	1773	53	NA	NA	NA	NA
40009.0	West Basin Entrance	1774	53	NA	NA	NA	NA
49001.0	Cabrillo Beach Pier - West	1778	53	NA	NA	NA	NA
49002.0	Cabrillo Beach Pier - Central	1779	53	NA	NA	NA	NA
49003.0	Cabrillo Beach Pier - East	1780	53	NA	NA	NA	NA

Table 15. Spearman Rank Correlation Coefficients for selected chemicals significantly correlated with amphipod survival at Industrial Harbor stations. \* indicates significance at  $p \leq 0.05$ ; \*\* indicates significance at  $p \leq 0.01$ ; \*\*\* indicates significance at  $p \leq 0.001$ ; N = 126.

Chemical	Spearman rho	Significance
<b>Metals</b>		
Arsenic	-0.410	***
Cadmium	-0.360	***
Copper	-0.463	***
Lead	-0.455	***
Mercury	-0.388	***
Nickel	-0.489	***
Zinc	-0.546	***
<b>Pesticides</b>		
Total Chlordane	-0.403	***
<b>PCBs</b>		
PCB 5	-0.573	***
PCB 31	-0.644	***
Total PCBs	-0.274	**
<b>PAHs</b>		
Benz(a)anthracene	-0.346	***
Benzo(a)pyrene	-0.446	***
Benzo[e]pyrene	-0.401	***
Coronene	-0.720	***
Dibenz[a,h]anthracene	-0.427	***
1-Methylnaphthalene	-0.455	***
2-Methylnaphthalene	-0.424	***
Naphthalene	-0.417	***
LMW PAH	-0.341	***
HMW PAH	-0.411	***
Total PAH	-0.399	***
Fines	-0.350	***
TOC	-0.369	***
ERM Quotient	-0.353	***
# ERM Exceedances	-0.291	***

Table 16. Spearman Rank Correlation Coefficients for selected chemicals significantly correlated with abalone development in 25% pore water at Industrial Harbor stations. \* indicates significance at  $p \leq 0.05$ ; \*\* indicates significance at  $p \leq 0.01$ ; \*\*\* indicates significance at  $p \leq 0.001$ ; N = 54.

Chemical	Spearman rho	Significance
Metals		
Tin	-0.306	*
Pesticides		
Total Chlordane	-0.354	**
PCBs		
PCB 8	-0.267	*
PCB187	-0.265	*
ERM Quotient*	-0.229	*
# ERM Exceedances*	-0.400	**

\*correlations with 50% pore water concentration data

Table 17. Relative Benthic Index values for Industrial Harbor stations. Station categories were D = Degraded (RBI $\leq$ 0.30); T = Transitional (RBI $>$ 0.31 $\leq$ 0.60); U = Undegraded (RBI  $>$ 0.61). NA = Not Analyzed.

STANUM	STATION	IDORG	LEG	Benthic Index	Category
47004.0	Consolidated Slip - 200E - Depth 2	1657	46	NA	NA
47004.0	Consolidated Slip - 200E - Surface	1656	46	0.34	T
49004.0	Kaiser Intl.- Berth 49	1793	54	0.58	T
40006.1	Consolidated Slip - Rep 1	1050	25	NA	NA
40006.1	Consolidated Slip - Rep 2	1051	25	NA	NA
40006.1	Consolidated Slip - Rep 3	1052	25	NA	NA
40006.1	Consolidated Slip	16	1	0.29	D
47002.0	Consolidated Slip - 200 - Surface	1650	46	0.25	D
47002.0	Consolidated Slip - 200 - Depth 2	1651	46	NA	NA
47009.0	Consolidated Slip - 200G - Surface	1664	46	0.24	D
47003.0	Consolidated Slip - 200B - Surface	1653	46	0.3	D
47008.0	Consolidated Slip - Storm Drain	1663	46	0.4	T
47001.0	Consolidated Slip - 198 - Surface	1647	46	0.39	T
47001.0	Consolidated Slip - 198 - Depth 2	1648	46	NA	NA
40006.2	Consolidated Slip	17	1	0.38	T
47007.0	Consolidated Slip - End - Surface	1662	46	0.46	T
40019.3	Inner Fish Harbor	57	2	0.35	T
47010.0	Dominguez - H. Ford Bridge - Surface	1665	46	0.21	D
40019.2	Inner Fish Harbor	56	2	0.38	T
40019.1	Inner Fish Harbor	55	2	0.36	T
40007.2	Long Beach Harbor - Channel 2	20	3	0.53	T
40011.3	Inner Harbor - Channel 3	33	3	0.7	U
40001.3	Southwest Slip	3	1	0.57	T
44012.0	Port Hueneme - Wharf B	1626	45	NA	NA
40031.1	Palos Verdes - Swartz 6	76	3	0.63	U
40001.2	Southwest Slip - Rep 1	1062	25	NA	NA
40001.2	Southwest Slip - Rep 2	1063	25	NA	NA
40001.2	Southwest Slip	2	1	0.50	T
40001.2	Southwest Slip - Rep 3	1064	25	NA	NA
40013.1	Inner Queensway Bay - Rep 3	1058	25	NA	NA
40013.1	Inner Queensway Bay	37	3	0.47	T
40013.1	Inner Queensway Bay - Rep 2	1057	25	NA	NA
40013.1	Inner Queensway Bay - Rep 1	1056	25	NA	NA
40014.2	Outer Queensway Bay	41	3	0.41	T
40014.3	Outer Queensway Bay	42	3	0.41	T
40031.3	Palos Verdes - Swartz 6	78	3	1	U
40013.2	Inner Queensway Bay	38	3	0.47	T
40031.2	Palos Verdes (Swartz 6) - Rep 2	1039	25	NA	NA
40031.2	Palos Verdes (Swartz 6) - Rep 3	1004	23	0.28	D
40031.2	Palos Verdes (Swartz 6) - Rep 1	1038	25	NA	NA
40031.2	Palos Verdes (Swartz 6)	77	3	0.77	U
40031.2	Palos Verdes (Swartz 6) - Rep 2	1003	23	0.44	T
40031.2	Palos Verdes (Swartz 6) - Rep 1	1002	23	0.28	D

Table 17 continued. Relative Benthic Index values for Industrial Harbor stations. Station categories were D = Degraded (RBI $\leq$ 0.30); T = Transitional (RBI $>$ 0.31 $\leq$ 0.60); U = Undegraded (RBI  $>$ 0.61). NA = Not Analyzed.

STANUM	STATION	IDORG	LEG	Benthic Index	Category
40031.2	Palos Verdes (Swartz 6) - Rep 3	1040	25	NA	NA
40031.2	Palos V.(Swartz 6) - Rep 4 Blind	1005	23	NA	NA
40031.2	Palos Verdes (Swartz 6) - Rep 1	1189	30	NA	NA
40031.2	Palos Verdes (Swartz 6) - Rep 2	1190	30	NA	NA
40031.2	Palos Verdes (Swartz 6) - Rep 3	1191	30	NA	NA
40005.1	East Basin - Turning Basin	13	1	0.42	T
48009.0	San Pedro Bay Outer Harbor	1694	48	0.7	U
40001.1	Southwest Slip	1	1	0.47	T
40004.2	Lower Main Channel	11	1	0.57	T
40004.2	Lower Main Channel - Rep 3	832	20	0.30	D
40004.2	Lower Main Channel - Rep 2	831	20	0.25	D
40004.2	Lower Main Channel - Rep 1	830	20	0.40	T
40004.2	Lower Main Channel	789	18	NA	NA
40010.1	Off Cabrillo Beach - Rep 2	1069	26	NA	NA
40010.1	Off Cabrillo Beach - Rep 3	1070	26	NA	NA
40010.1	Off Cabrillo Beach - Rep 1	1068	26	NA	NA
40010.1	Off Cabrillo Beach - Rep 1	1006	23	0.34	T
40010.1	Off Cabrillo Beach	28	2	0.67	U
40010.1	Off Cabrillo Beach	136	4	NA	NA
40010.1	Off Cabrillo Beach	810	19	NA	NA
40010.1	Off Cabrillo Beach	1331	32	NA	NA
49005.0	Kaiser Intl.- Berth 48	1794	54	0.65	U
40004.3	Lower Main Channel	12	1	0.54	T
44013.0	Port Hueneme - Wharf #1	1627	45	NA	NA
40010.3	Off Cabrillo Beach - Rep 2	1075	26	NA	NA
40010.3	Off Cabrillo Beach - Rep 1	1074	26	NA	NA
40010.3	Off Cabrillo Beach - Rep 3	1008	23	0.43	T
40010.3	Off Cabrillo Beach	30	2	1.00	U
40010.3	Off Cabrillo Beach - Rep 3	1076	26	NA	NA
40010.3	Off Cabrillo Beach	138	4	NA	NA
40010.3	Off Cabrillo Beach	1333	32	NA	NA
40011.1	Inner Harbor - Channel 3	31	3	0.63	U
40010.2	Off Cabrillo Beach - Rep 1	1071	26	NA	NA
40010.2	Off Cabrillo Beach - Rep 2	1072	26	NA	NA
40010.2	Off Cabrillo Beach - Rep 2	1007	23	0.27	D
40010.2	Off Cabrillo Beach - Rep 3	1073	26	NA	NA
40010.2	Off Cabrillo Beach	29	2	0.75	U
40010.2	Off Cabrillo Beach	137	4	NA	NA
40010.2	Off Cabrillo Beach	1332	32	NA	NA



Table 17 continued. Relative Benthic Index values for Industrial Harbor stations. Station categories were D = Degraded ( $RBI \leq 0.30$ ); T = Transitional ( $RBI > 0.31 \leq 0.60$ ); U = Undegraded ( $RBI > 0.61$ ). NA = Not Analyzed.

STANUM	STATION	IDORG	LEG	Benthic Index	Category
40011.2	Inner Harbor - Channel 3	32	3	0.53	T
44011.0	Los Cerritos Channel Tidal P - Rep3	1079	26	NA	NA
44011.0	Los Cerritos Channel Tidal P - Rep1	1077	26	NA	NA
44011.0	Los Cerritos Channel Tidal P - Rep2	1078	26	NA	NA
44011.0	Los Cerritos Channel Tidal P	611	11	NA	NA
40033.1	Outer Harbor - POLA 10	82	1	0.72	U
40018.3	Long Beach Outer Harbor - 18 - Rep 2	1042	25	NA	NA
40018.3	Long Beach Outer Harbor - 18 - Rep 3	886	22	0.23	D
40018.3	Long Beach Outer Harbor - 18 - Rep 2	885	22	0.31	T
40018.3	Long Beach Outer Harbor - 18 - Rep 1	884	22	0.23	D
40018.3	Long Beach Outer Harbor - 18 - Rep 1	1041	25	NA	NA
40018.3	Long Beach Outer Harbor - 18	1695	48	0.58	T
40018.3	Long Beach Outer Harbor - 18 - Rep 3	1043	25	NA	NA
40018.3	Long Beach Outer Harbor - 18	54	3	0.52	T
40018.3	Long Beach Outer Harbor - 18 - Rep 1	1192	30	NA	NA
40018.3	Long Beach Outer Harbor - 18 - Rep 2	1193	30	NA	NA
40018.3	Long Beach Outer Harbor - 18 - Rep 3	1194	30	NA	NA
40018.3	Long Beach Outer Harbor - 18	1334	32	NA	NA
40018.3	Long Beach Outer Harbor - 18	1770	53	NA	NA
40012.0	Southeast Basin	1632	45	0.56	T
40020.2	Long Beach Outer Harbor - 20	1696	48	0.81	U
40012.1	Southeast Basin - Rep1	1047	25	NA	NA
40012.1	Southeast Basin - Rep2	1048	25	NA	NA
40012.1	Southeast Basin	34	2	0.61	U
40012.1	Southeast Basin - Rep3	1049	25	NA	NA
40012.1	Southeast Basin	812	19	NA	NA
40008.1	East Basin - Pier C	22	2	0.61	T
48010.0	Turning Basin	1697	48	0.69	U
40017.3	Long Beach Channel - Rep 2	1060	25	NA	NA
40017.3	Long Beach Channel - Rep 1	1059	25	NA	NA
40017.3	Long Beach Channel - Rep 3	1061	25	NA	NA
40017.3	Long Beach Channel	51	3	0.68	U
40002.2	West Basin - Pier 143	5	1	0.50	T
40016.3	Terminal Island Stp	48	2	0.68	U
40012.2	Southeast Basin	35	2	0.5	T
40009.0	West Basin Entrance	1699	48	0.57	T
40009.1	West Basin Entrance - Ref 1	834	20	0.46	T
40009.1	West Basin Entrance - Ref 3	836	20	0.32	T
40009.1	West Basin Entrance - Ref 2	835	20	0.38	T
40009.1	West Basin Entrance	25	2	0.53	T
40008.3	East Basin - Pier C	24	2	0.62	U
40015.1	Fish Harbor Entrance	43	2	0.66	U
40016.1	Terminal Island Stp	46	2	0.76	U

Table 17 continued. Relative Benthic Index values for Industrial Harbor stations. Station categories were D = Degraded ( $RBI \leq 0.30$ ); T = Transitional ( $RBI > 0.31 \leq 0.60$ ); U = Undegraded ( $RBI > 0.61$ ). NA = Not Analyzed.

STANUM	STATION	IDORG	LEG	Benthic Index	Category
40015.3	Fish Harbor Entrance	45	2	0.79	U
40003.1	Turning Basin - Pier 151	7	1	0.66	U
40020.3	Long Beach Outer Harbor - 20	60	3	0.6	T
40009.3	West Basin Entrance	27	2	0.60	T
40020.2	Long Beach Outer Harbor - 20	59	3	0.83	U
40015.1	Fish Harbor Entrance	1698	48	0.78	U
40020.1	Long Beach Outer Harbor - 20	58	3	0.63	U
40032.3	San Pedro Bay - POLA 19	105	2	NA	NA
40032.3	San Pedro Bay - POLA 19	81	1	0.84	U
40015.2	Fish Harbor Entrance	44	2	0.68	U
40003.2	Turning Basin, Pier 151 - Rep 3	1055	25	NA	NA
40003.2	Turning Basin, Pier 151 - Rep 2	1054	25	NA	NA
40003.2	Turning Basin, Pier 151	8	1	0.50	T
40003.2	Turning Basin, Pier 151 - Rep 1	1053	25	NA	NA
40016.2	Terminal Island Stp	47	2	0.75	U
40030.1	San Pedro Breakwater	73	2	NA	NA
40030.2	San Pedro Breakwater	74	2	NA	NA
40032.1	San Pedro Bay - POLA 19	103	2	NA	NA
40032.2	San Pedro Bay - POLA 19	104	2	NA	NA
40002.1	West Basin - Pier 143	4	1	0.48	T
40002.3	West Basin - Pier 143	6	1	0.48	T
40003.3	Turning Basin - Pier 151	9	1	0.54	T
40004.1	Lower Main Channel	10	1	0.69	U
40005.2	East Basin- Turning Basin	14	1	0.47	T
40005.3	East Basin- Turning Basin	15	1	0.46	T
40006.3	Consolidated Slip	18	1	0.30	D
40032.1	San Pedro Bay - POLA 19	79	1	0.79	U
40032.2	San Pedro Bay - POLA 19	80	1	0.92	U
40033.2	Outer Harbor - POLA 10	83	1	0.62	U
40033.3	Outer Harbor - POLA 10	84	1	0.57	T
40008.2	East Basin - Pier C	23	2	0.52	T
40009.2	West Basin Entrance	26	2	0.71	U
40012.3	Southeast Basin	36	2	0.68	U
40030.3	San Pedro Breakwater	75	2	NA	NA
40007.1	Long Beach Harbor - Channel 2	19	3	0.52	T
40007.3	Long Beach Harbor - Channel 2	21	3	0.52	T
40013.3	Inner Queensway Bay	39	3	0.46	T
40014.1	Outer Queensway Bay	40	3	0.42	T
40017.1	Long Beach Channel	49	3	0.52	T
40017.2	Long Beach Channel	50	3	0.55	T

Table 17 continued. Relative Benthic Index values for Industrial Harbor stations. Station categories were D = Degraded (RBI $\leq$ 0.30); T = Transitional (RBI $>$ 0.31 $\leq$ 0.60); U = Undegraded (RBI $>$ 0.61). NA = Not Analyzed.

STANUM	STATION	IDORG	LEG	Benthic Index	Category
40018.1	Long Beach Outer Harbor - 18	52	3	0.51	T
40018.2	Long Beach Outer Harbor - 18	53	3	0.50	T
44012.0	Port Hueneme - Wharf B	612	11	NA	NA
44013.0	Port Hueneme - Wharf #1	613	11	NA	NA
40009.1	West Basin Entrance	790	18	NA	NA
40013.1	Inner Queensway Bay	791	18	NA	NA
40015.3	Fish Harbor Entrance	792	18	NA	NA
40016.2	Terminal Island Stp	793	18	NA	NA
40017.3	Long Beach Channel	811	19	NA	NA
44055.0	L.B. Naval Station - Pier 3 - Rep 1	1198	30	NA	NA
44055.0	L.B. Naval Station - Pier 3 - Rep 2	1199	30	NA	NA
44055.0	L.B. Naval Station - Pier 3 - Rep 3	1200	30	NA	NA
46001.0	Hugo Neuproler - #1	1623	45	NA	NA
46002.0	Hugo Neuproler - #2	1624	45	NA	NA
46003.0	Hugo Neuproler - #3	1625	45	NA	NA
47003.0	Consolidated Slip - 200B - Depth 2	1654	46	NA	NA
47005.0	Consolidated Slip - 200T - Surface	1659	46	0.54	T
47005.0	Consolidated Slip - 200T - Depth 2	1660	46	NA	NA
47005.0	Consolidated Slip - 200T - Depth 3	1661	46	NA	NA
48009.0	San Pedro Bay Outer Harbor	1769	53	NA	NA
40020.2	Long Beach Outer Harbor - 20	1771	53	NA	NA
48010.0	Turning Basin	1772	53	NA	NA
40015.1	Fish Harbor Entrance	1773	53	NA	NA
40009.0	West Basin Entrance	1774	53	NA	NA
49001.0	Cabrillo Beach Pier - West	1778	53	NA	NA
49002.0	Cabrillo Beach Pier - Central	1779	53	NA	NA
49003.0	Cabrillo Beach Pier - East	1780	53	NA	NA

Table 18. Spearman Rank Correlation Coefficients for selected chemicals significantly negatively correlated with Benthic Community Structure (as Relative Benthic Index) at Industrial Harbor stations. \* indicates significance at  $p \leq 0.05$ ; \*\* indicates significance at  $p \leq 0.01$ ; \*\*\* indicates significance at  $p \leq 0.001$ ; N = 68 or 80 depending on chemical.

Chemical	Spearman rho	Sig.	Chemical	Spearman rho	Sig.
<u>Metals</u>			<u>Pesticides</u>		
Antimony	-0.304	**	Aldrin	-0.252	*
Arsenic	-0.392	***	Cis Chlordane	-0.357	***
Cadmium	-0.462	***	Trans Chlordane	-0.335	*
Chromium	-0.305	**	OP DDD	-0.392	***
Copper	-0.402	***	PP DDD	-0.462	***
Lead	-0.440	***	Total DDT	-0.312	**
Mercury	-0.219	*	Heptachlor	-0.414	***
Silver	-0.304	**	Trans Nonachlor	-0.404	***
Zinc	-0.414	***	Total Chlordane	-0.533	***
<u>PAHs</u>			<u>PCBs</u>		
Anthracene	-0.354	***	PCB 28	-0.449	***
Benzo(a)pyrene	-0.360	***	PCB 52	-0.549	***
Benzo[e]pyrene	-0.355	***	PCB 66	-0.470	***
Dibenz[a,h]anthracene	-0.388	***	PCB 101	-0.472	***
Fluoranthene	-0.397	***	PCB 138	-0.452	***
1-Methylnaphthalene	-0.344	***	PCB 153	-0.462	***
2-Methylnaphthalene	-0.377	***	PCB 187	-0.477	***
1-Methylphenanthrene	-0.497	***	Total PCBs	-0.464	***
LMW PAH	-0.390	***			
HMW PAH	-0.436	***			
Total PAH	-0.428	***			
<u>Organotins</u>			<u>Other</u>		
Tributyltin	-0.547	***	TOC	-0.555	***
			ERM Quotient	-0.443	***
			# ERM Exceedances	-0.316	**

Table 19a. Results of Principal Components Analysis (PCA) of amphipod survival in toxicity tests, benthic community structure metrics, and chemicals measured in Industrial Harbor sediments. Significantly correlated variables are indicated in 12 point bold type.

	Rotated Loadings			
	1	2	3	4
Amphipod Survival	<b>-0.675</b>	0.005	0.117	-0.318
No. of Gammarid Amph. Species	0.127	<b>0.869</b>	-0.076	0.077
No. of Gammarid Amph. Individ.s	-0.098	<b>0.648</b>	0.018	-0.184
No. of Other Crustacean Individ.s	-0.099	<b>0.898</b>	0.150	0.023
Mean No. of Crustacean Individ.s	0.099	<b>0.903</b>	-0.047	0.072
Tot. No. of Crustacean Species	-0.215	<b>0.658</b>	0.137	-0.301
Mean No. of Echinoderm Individ.s	-0.151	0.015	<b>0.695</b>	-0.221
Mean No. of Mollusc Individ.s	-0.175	-0.022	0.079	<b>-0.547</b>
Mean No. of Mollusc Species	-0.333	-0.029	-0.051	<b>-0.550</b>
Mean No. of Individuals	0.332	<b>0.788</b>	-0.173	-0.022
Total No. of Species	-0.079	0.308	-0.202	<b>-0.511</b>
Relative Benthic Index	<b>-0.472</b>	0.173	0.013	-0.290
ANTIMONY	<b>0.721</b>	0.154	-0.087	0.357
CADMIUM	<b>0.687</b>	0.223	0.163	0.051
COPPER	0.366	0.009	0.151	<b>0.738</b>
IRON	0.102	-0.099	<b>-0.473</b>	<b>0.686</b>
LEAD	<b>0.821</b>	-0.005	0.029	0.288
MANGANESE	-0.163	-0.117	<b>-0.684</b>	0.202
MERCURY	0.102	-0.095	0.129	<b>0.667</b>
ZINC	<b>0.747</b>	0.005	0.010	<b>0.474</b>
ALDRIN	<b>0.574</b>	-0.097	0.204	-0.083
CisChlordane	<b>0.798</b>	0.072	0.013	0.009
Total DDT	0.053	0.003	0.924	-0.192
DIELDRIN	<b>0.894</b>	0.070	-0.054	-0.076
METHOXY	<b>0.798</b>	-0.116	-0.020	-0.062
Total Chlordane	<b>0.942</b>	0.138	-0.017	-0.022
Total PCB	<b>0.786</b>	-0.044	0.167	0.073
HMW PAH	<b>0.694</b>	-0.011	-0.015	0.434
FINES	0.135	-0.015	-0.066	<b>0.594</b>
TOC	<b>0.751</b>	0.101	0.316	0.300
ERMQ	<b>0.930</b>	0.060	0.149	0.195
ERMEXCDS	<b>0.759</b>	-0.034	0.251	0.325
PELEXCDS	<b>0.750</b>	-0.115	0.222	0.383
% of total variance explained	26.89	10.317	11.549	11.352

Table 19b. Results of Principal Components Analysis (PCA) of Abalone Development in toxicity tests, Benthic Community Structure Metrics, and Chemicals measured in Industrial Harbor sediments. Significantly correlated variables are indicated in 12 point bold type.

	Rotated Loadings				
	1	2	3	4	5
Mean amphipod survival	-0.284	0.205	-0.417	-0.416	-0.293
Mean ab dev. (100% PW)	0.380	-0.027	-0.341	-0.183	-0.393
Mean ab dev. (50% PW)	-0.032	0.037	-0.138	0.025	<b>-0.697</b>
Mean ab dev. (25% PW)	-0.029	-0.031	-0.122	-0.161	<b>-0.642</b>
Unionized ammonia	0.038	-0.100	0.201	0.283	<b>0.721</b>
Mean No. of Gammarid Individ.s	0.017	-0.097	-0.938	0.074	-0.041
No. of Other Crustacean Individ.s	-0.054	0.141	-0.893	-0.058	-0.097
Tot. No. of Crustacean Individ.s	-0.010	-0.008	-0.960	0.026	-0.065
Mean No. of Echinoderm Individ.s	-0.227	<b>0.824</b>	-0.001	-0.134	-0.144
Mean No. of Echinoderm Sp.	-0.102	<b>0.816</b>	0.036	-0.186	-0.289
Mean No. of Mollusc Individ.s	-0.255	0.124	0.244	0.181	<b>-0.566</b>
Mean No. of Mollusc Sp.	-0.287	0.048	0.132	-0.129	<b>-0.534</b>
Mean No. of Polychaete Sp.	-0.036	-0.082	-0.034	<b>-0.489</b>	<b>-0.510</b>
Mean No. of Individuals	0.083	-0.206	-0.804	-0.192	-0.318
Total No. of Species	-0.168	0.064	-0.257	-0.429	<b>-0.619</b>
Relative Benthic Index	-0.318	0.203	-0.488	<b>-0.473</b>	-0.326
ALUMINUM	-0.319	<b>-0.638</b>	0.052	-0.302	-0.077
ANTIMONY	0.609	0.013	0.296	<b>0.567</b>	0.284
CADMIUM	0.240	0.443	-0.281	<b>0.738</b>	0.131
COPPER	0.596	0.169	-0.012	0.196	0.590
MANGANESE	0.312	<b>-0.536</b>	0.357	-0.280	-0.046
MERCURY	0.501	0.127	0.144	0.007	<b>0.465</b>
ZINC	0.555	0.061	0.031	<b>0.677</b>	0.391
TTL_DDT	-0.210	0.950	-0.039	0.010	-0.054
DIELDRIN	-0.003	-0.079	-0.154	<b>0.874</b>	-0.027
TOXAPH	0.014	0.048	0.108	<b>0.896</b>	-0.024
TBT	0.163	0.087	0.084	<b>0.579</b>	0.421
TTL_CHLR	0.011	0.020	0.108	<b>0.965</b>	0.065
TTL_PCB	0.341	0.478	0.117	<b>0.546</b>	<b>0.508</b>
HMW_PAH	0.444	0.014	0.159	0.201	<b>0.496</b>
FINES	0.760	0.011	-0.135	0.277	-0.038
TOC	0.399	0.251	-0.043	<b>0.686</b>	0.259
ERMQ	0.356	0.326	0.138	<b>0.743</b>	0.393
ERMEXCDS	0.318	0.345	0.178	0.359	<b>0.511</b>
PELEXCDS	0.378	0.243	0.224	<b>0.455</b>	<b>0.527</b>
% of Total Var explained	15.235	14.037	11.149	18.742	13.902

Table 20. Spearman Rank Correlation Coefficients for amphipod survival or abalone embryo development in laboratory toxicity tests significantly correlated with Benthic Community Structure metrics measured at Industrial Harbor stations. \* indicates significance at  $p \leq 0.05$ ; \*\* indicates significance at  $p \leq 0.01$ ; \*\*\* indicates significance at  $p \leq 0.001$ ; N = 80 (amphipods) or 47 (abalone).

Benthic Community Metric		
Correlated. with Amphipod Survival	Spearman rho	Significance
Total Number of Cystacean Species	0.373	***
Total Number of Species	0.367	***
Benthic Index	0.276	**
Benthic Community Metric		
Correlated with Abalone Development	Spearman rho	Significance
Total Number of Mollusc Individuals	0.280	*
Total Number of Mollusc Species	0.363	**
Total Number of Individuals	0.490	**
Total Number of Species	0.290	*

Table 21a. Results of total DDT and Total PCB tissue analyses of fish collected at selected Industrial Harbor stations (ng/g wet weight concentrations).

Station Number	Station Name	IDORG	Fish Species	LEG	TTL DDT (ng/g)	TTL DDT Quot.	TTL PCB (ng/g)	TTL PCB Quot.	EPA Excds	% Lipid
40020.2	Long Bch Out. Harb. 20	1781.0	Croaker	53	1096.7	3.7	465.2	46.5	2	9.8
49001.0	Cabr. Bch Pier- West	1782.0	Croaker	53	406.3	1.4	170.2	17.0	2	16.2
49002.0	Cabr. Bch Pier- Cent.	1783.0	Croaker	53	4984.8	16.6	686.6	68.7	2	14.5
49003.0	Cabr. Bch Pier- East	1784.0	Croaker	53	1839.2	6.1	407.3	40.7	2	14.3
49001.0	Cabr. Bch Pier- West	1785.0	Surfperch	53	51.2	0.2	40.1	4.0	1	14.2
49002.0	Cabr. Bch Pier- Cent.	1786.0	Surfperch	53	68.5	0.2	37.9	3.8	1	9.6
49003.0	Cabr. Bch Pier- East	1787.0	Surfperch	53	76.7	0.3	53.5	5.4	1	11.9
NAS	Wildlife Guideline (whole fish)				50		500			
USEPA	Screening Value (edible portion)				300		10			



Table 21b. Results of tissue analyses of *Macoma nasuta* bioaccumulation tests using selected Industrial Harbor sediments. Tissue concentrations are shown for those compounds that were elevated relative to the US EPA screening values (Total DDT and Total PCBs only; as ng/g wet weight concentrations). \* = significantly elevated concentrations, NS = not significant, NA = not analyzed.

Station Number	Station Name	IDORG	Tissue TYPE	TTL DDT	Sig.	TTL PCB	Sig.	TTL DDT Quot.	TTL PCB Quot.	EPA Exceedances
40009.0	West Basin Entrance - 1	1774.1	Macoma	15.49	*	16.526	*	0.052	1.6526	2
40009.0	West Basin Entrance - 2	1774.2	Macoma	11.02	*	11.088	*	0.037	1.1088	1
40009.0	West Basin Entrance - 3	1774.3	Macoma	18.86	*	17.598	*	0.063	1.7598	2
49001.0	Cabrillo Beach Pr - West - 1	1778.1	Macoma	9.59	NA	6.072	NA	0.032	0.6072	0
49002.0	Cabrillo Beach Pr - Center - 1	1779.1	Macoma	11.96	*	5.530	NS	0.040	0.5530	0
49002.0	Cabrillo Beach Pr - Center - 2	1779.2	Macoma	18.74	*	8.406	NS	0.062	0.8406	0
49002.0	Cabrillo Beach Pr - Center - 3	1779.3	Macoma	18.16	*	15.338	NS	0.061	1.5338	1
49003.0	Cabrillo Beach Pr - East - 1	1780.1	Macoma	9.10	*	4.546	*	0.030	0.4546	0
49003.0	Cabrillo Beach Pr - East - 2	1780.2	Macoma	13.43	*	5.272	*	0.045	0.5272	0
49003.0	Cabrillo Beach Pr - East - 3	1780.3	Macoma	10.64	*	5.536	*	0.035	0.5536	0
	GC - Home Control - 1	1806.1	Macoma	2.21		3.624			0.3624	0
	GC - Home Control - 2	1806.2	Macoma	2.18		4.370			0.4370	0
	GC - Home Control - 3	1806.3	Macoma	2.14		3.902			0.3902	0
	GC - Initial Before Exp - 1	1805.1	Macoma	2.31		3.600			0.3600	0
	GC - Initial Before Exp - 2	1805.2	Macoma	2.07		3.886			0.3886	0
	GC - Initial Before Exp - 3	1805.3	Macoma	2.15		3.716			0.3716	0
NAS	Wildlife Guideline (whole fish)			50		500				
USEPA	Screening Val. (edible portion)			300		10				

\* = significant relative to home sediment control using a separate variance t-test at  $p \leq 0.05$  (n=3);

Table 22. Categorization of Los Angeles Region Industrial Harbor stations based on chemistry, toxicity and benthic community analysis. Shading indicates significant toxicity or benthic degradation. na = Not Analyzed; N = [ammonia] > than threshold effect value; S = [sulfide] > than threshold effect value; PW = Pore Water; SWI = Sediment-Water Interface.

Station Number	Station Name	IDOrg	ERMQ	Selected Chemicals and factors by which they exceed ERM values	% TOC	% Fines	Amphipod % NH <sub>3</sub> Surv. H <sub>2</sub> S	Larval Development - Ab or Urch.				Urch SWI	Benthic Index			
								100% NH <sub>3</sub> PW	50% NH <sub>3</sub> PW	25% NH <sub>3</sub> PW						
<b>Category 1 - Stations with elevated chemistry, recurrent toxicity and degraded benthos</b>																
40006.1	Consolidated Slip	16	1.273	p'p,DDE (13)	4.6	90.9	58	0	90	93	na	0.29				
40006.1	Consolidated Slip- R1	1050	1.949	TTL Chlordane (18)	4.3	93.6	62	na	na	na	na	na				
40006.1	Consolidated Slip- R2	1051	1.654	TTL PCB (3), Zn, Hg (1)	4.3	94.0	65	na	na	na	na	na				
40006.1	Consolidated Slip- R3	1052	1.473	HMWPAH (1)	4.5	94.6	80	na	na	na	na	na				
<b>Category 2 - Stations with elevated chemistry, one (of one) toxicity hit and degraded benthos.</b>																
47002.0	Consolidated Slip- 200- Surface	1650	1.917	p'p,DDE (7), TTL Chl. (8), HMWPAH (1)	4.1	80.7	54	na	na	na	na	0.25				
47002.0	Consolidated Slip- 200- Depth 2	1651	1.567	TTL. PCB (11), Dieldrin (1), Zn (1)	2.1	70.2	86	na	na	na	na	na				
47003.0	Consolidated Slip- 200B- Surface	1653	1.629	p'p,DDE (6), TTL Chl. (9),	3.4	62.6	70	na	na	na	na	0.30				
47003.0	Consolidated Slip- 200B- Depth 2	1654	na	TTL PCB (8), Dieldrin (1), DBA (1)	3.6	80.6	8	na	na	na	na	na				
47009.0	Consolidated Slip- 200G- Surface	1664	1.659	p'p,DDE (10), TTL Chl. (11), HMWPAH (1) TTL PCB (2), Dieldrin, Zn (1), Chlorpyr (90th)	4.9	92.8	50	na	na	na	na	0.24				
47010.0	Dominguez- H. Ford Bridge- Surf.	1665	0.801	p'p,DDE (4), TTL Chl. (11), TTL PCB (2)	3.5	99.5	61	N	na	na	na	0.21				
<b>Category 4 - Elevated Chemistry, one measure of Biological Impact (no data for second biological indicator)</b>																
44012.0	Port Hueneme- Wharf B	612	na	TTL PCB (2), ANT (1), BAA (1), BAP (1)	1.4	78.0	70	0	na	na	na	na				
44012.0	Port Hueneme- Wharf B	1626	0.536	CHR (1), DBA (1), HMWPAH (2)	1.3	38.1	98	0	S	na	na	na				
<b>Category 5 - Stations with elevated chemistry and mixed results from biological indicators</b>																
40001.2	Southwest Slip	2	0.420	Hg (1), p'p,DDE (3),	1.4	71.7	51	81	N	87	N	73	na	0.50		
40001.2	Southwest Slip- R1	1062	0.518	TTL PCB (1), BAP (1), DBA (1)	1.3	62.6	69	na	na	na	na	na	na			
40001.2	Southwest Slip- R2	1063	0.496	HMWPAH (2)	1.3	63.5	72	na	na	na	na	na	na			
40001.2	Southwest Slip- R3	1064	0.324		0.8	46.4	58	na	na	na	na	na	na			
40006.2	Consolidated Slip	17	1.289	Zn (1), TTL Chl. (4), p'p,DDE (10) TTL PCB (3), TBT (>95th)	4.3	92.9	59	N	0	N	0	N	0	N	na	0.38

Table 22 continued. Categorization of Los Angeles Region Industrial Harbor stations based on chemistry, toxicity and benthic community analysis. Shading indicates significant toxicity or benthic degradation. na = Not Analyzed; N = [ammonia] > than threshold effect value; S = [sulfide] > than threshold effect value; PW = Pore Water; SWI = Sediment-Water Interface.

Station Number	Station Name	IDOrg	ERMQ	Selected Chemicals and factors by which they exceed ERM values	% TOC	% Fines	Amphipod % NH <sub>3</sub> Surv. H <sub>2</sub> S	Larval Development - Ab or Urch.				Urch SWI	Benthic Index		
								100% NH <sub>3</sub> PW	50% NH <sub>3</sub> H <sub>2</sub> S	25% NH <sub>3</sub> PW	25% NH <sub>3</sub> H <sub>2</sub> S				
<b>Category 5 - Stations with elevated chemistry and mixed results from biological indicators</b>															
40013.1	Inner Queensway Bay	37	0.383	TTL Chlordane (4), p'p,DDE (1)	2.0	94.6	83	0	N	89	N	91	na	0.47	
40013.1	Inner Queensway Bay	791	na		1.4	76.0	50	95		93		90	na	na	
40013.1	Inner Queensway Bay- R1	1056	0.282		0.3	20.5	83	na		na		na	na	na	
40013.1	Inner Queensway Bay- R2	1057	0.308		1.1	21.5	76	na		na		na	na	na	
40013.1	Inner Queensway Bay- R3	1058	0.515		2.0	38.3	71	na		na		na	na	na	
40019.3	Inner Fish Harbor	57	0.914	Cu (2), Hg (3), Zn (1), p'p,DDE (9) TBT (>95th)	3.0	91.1	54	0	N	0	N	93	N	na	0.35
47001.0	Consolidated Slip- 198- Surface	1647	1.429	TTL Chl. (9), p'p,DDE (7)	3.2	84.2	61	na		na		na	na	0.39	
47001.0	Consolidated Slip- 198- Depth 2	1648	1.424	TTL PCB (5), DBA (1)	2.1	72.6	64	na		na		na	na	na	
47004.0	Consolidated Slip- 200E- Surface	1656	1.289	Zn (1), TTL Chl. (9), p'p,DDE (7)	4.3	68.3	40	na		na		na	na	0.34	
47004.0	Consolidated Slip- 200E- Depth 2	1657	4.377	TTL PCB (2), DBA (2), HMWPAH (1)	4.4	86.1	33	na	N	na		na	na	na	
47005.0	Consolidated Slip- 200T- Surface	1659	na	Cr (1), Cu (2), Pb (2), Hg (4), Zn (1)	6.4	78.5	0	na		na		na	na	0.54	
47005.0	Consolidated Slip- 200T- Depth 2	1660	na	p'p,DDE (5), TTL PCB (8)	5.2	76.9	18	na	N	na		na	na	na	
47005.0	Consolidated Slip- 200T- Depth 3	1661	na	BAP (1), DBA (1) TBT (>95th)	6.9	87.2	13	na	N	na		na	na	na	
47008.0	Consolidated Slip- Storm Drain	1663	1.608	Cd(1), TTL Chl (9), p'pDDE (6), TTL PCB (5)	4.0	75.4	52	na		na		na	na	0.40	
<b>Category 6 - Stations with measured biological impact but chemistry values below thresholds or not measured.</b>															
40002.1	West Basin- Pier 143	4	na		1.5	54.0	75	0	N	1		88	na	0.48	
40002.2	West Basin- Pier 143	5	0.212	p'p,DDE (1)	0.9	75.5	78	0	N	0	N	29	na	0.50	
40003.1	Turning Basin- Pier 151	7	0.168	p'p,DDE (1)	0.7	37.5	64	0	N	63	N	88	na	0.66	
40003.3	Turning Basin- Pier 151	9	na		0.8	32.0	81	23	N	93	N	92	na	0.54	

Table 22 continued. Categorization of Los Angeles Region Industrial Harbor stations based on chemistry, toxicity and benthic community analysis. Shading indicates significant toxicity or benthic degradation. na = Not Analyzed; N = [ammonia] > than threshold effect value; S = [sulfide] > than threshold effect value; PW = Pore Water; SWI = Sediment-Water Interface.

Station Number	Station Name	IDOrg	ERMQ	Selected Chemicals and factors by which they exceed ERM values	% TOC	% Fines	Amphipod % NH <sub>3</sub> Surv. H <sub>2</sub> S	Larval Development - Ab or Urch.				Urch SWI	Benthic Index	
								100% NH <sub>3</sub> PW	50% NH <sub>3</sub> H <sub>2</sub> S	25% NH <sub>3</sub> PW	25% NH <sub>3</sub> H <sub>2</sub> S			
Category 6 - Stations with measured biological impact but chemistry values below thresholds or not measured.														
40004.1	Lower Main Channel	10	na		1.3	44.0	78	26	N	93	N	94	na	0.69
40004.2	Lower Main Channel	11	0.368	p'p,DDE (10)	3.4	88.7	80	69	N	95	N	95	na	0.57
40004.2	Lower Main Channel	789	na		0.7	81.0	68	97		96		90	na	na
40004.2	Lower Main Channel- R1	830	0.195		1.6	36.1	91	0	N	0		0	na	0.40
40004.2	Lower Main Channel- R2	831	0.209		1.2	37.0	91	0		0		41	na	0.25
40004.2	Lower Main Channel- R3	832	0.242		2.1	54.4	93	0		13		63	na	0.30
40005.2	East Basin- Turning Basin	14	na		0.6	71.0	73	1	N	89		94	na	0.47
40005.3	East Basin- Turning Basin	15	na		0.6	77.0	79	0	N	54	N	78	na	0.46
40006.3	Consolidated Slip	18	na		4.4	78.0	67	0	N	1		45	na	0.30
40007.1	Long Beach Harbor- Channel 2	19	na		1.2	75.0	82	0		92		91	na	0.52
40007.3	Long Beach Harbor- Channel 2	21	na		0.7	77.0	78	0		0		88	na	0.52
40008.2	East Basin- Pier C	23	na		0.5	63.0	78	3	N	95		98	na	0.52
40008.3	East Basin- Pier C	24	0.182	p'p,DDE (1)	0.8	70.9	76	0	N	93		93	na	0.62
40009.2	West Basin Entrance	26	na		0.4	73.0	81	0	N	96		95	na	0.71
40009.1	West Basin Entrance	25	0.160	p'p,DDE (1)	0.4	57.0	88	1		95		95	na	0.53
40009.1	West Basin Entrance	790	na		0.8	77.0	60	99		81		88	na	na
40009.1	West Basin Entrance- R1	834	0.184		0.8	71.8	97	0	N	14		79	na	0.46
40009.1	West Basin Entrance- R2	835	0.173		0.7	70.9	86	0		15		89	na	0.38
40009.1	West Basin Entrance- R3	836	0.181		1.0	66.3	91	55	N	76		88	na	0.32
40009.3	West Basin Entrance	27	0.154		0.4	83.0	87	0	N	97		95	na	0.60

Table 22 continued. Categorization of Los Angeles Region Industrial Harbor stations based on chemistry, toxicity and benthic community analysis. Shading indicates significant toxicity or benthic degradation. na = Not Analyzed; N = [ammonia] > than threshold effect value; S = [sulfide] > than threshold effect value; PW = Pore Water; SWI = Sediment-Water Interface.

Station Number	Station Name	IDOrg	ERMQ	Selected Chemicals and factors by which they exceed ERM values	% TOC	% Fines	Amphipod % NH <sub>3</sub> Surv. H <sub>2</sub> S	Larval Development - Ab or Urch.						Urch SWI	Benthic Index
								100% NH <sub>3</sub> PW	50% NH <sub>3</sub> H <sub>2</sub> S	25% NH <sub>3</sub> PW	25% NH <sub>3</sub> H <sub>2</sub> S	100% NH <sub>3</sub> H <sub>2</sub> S	50% NH <sub>3</sub> H <sub>2</sub> S		
Category 6 - Stations with measured biological impact but chemistry values below thresholds or not measured.															
40010.1	Off Cabrillo Beach	28	0.282	Cu (1), p'p,DDE (9)	2.9	93.0	92	93		96		97	na	0.67	
40010.1	Off Cabrillo Beach	136	0.260		2.3	88.1	89	2		2		53	na	na	
40010.1	Off Cabrillo Beach	810	na		2.7	92.6	58	0	N	93		na	na	na	
40010.1	Off Cabrillo Beach- 1	1006	0.305		2.8	95.7	68	46		96		96	na	0.34	
40010.1	Off Cabrillo Beach- 1	1068	0.332		2.5	91.9	80	na		na		na	na	na	
40010.1	Off Cabrillo Beach- 2	1069	0.363		2.6	95.2	48	na		na		na	na	na	
40010.1	Off Cabrillo Beach- 3	1070	0.344		2.6	91.1	46	na		na		na	na	na	
40010.1	Off Cabrillo Beach	1331	na		2.9	96.3	92	na		na		na	na	na	
40010.2	Off Cabrillo Beach	29	0.260		p'p,DDE (6)	2.5	76.3	88	94		97		96	na	0.75
40010.2	Off Cabrillo Beach	137	na	1.3		72.0	89	0		1		48	na	na	
40010.2	Off Cabrillo Beach- R2	1007	0.299	2.3		69.9	90	5		31		38	na	0.27	
40010.2	Off Cabrillo Beach- R1	1071	0.318	2.3		82.7	78	na		na		na	na	na	
40010.2	Off Cabrillo Beach- R2	1072	0.304	2.1		71.8	63	na		na		na	na	na	
40010.2	Off Cabrillo Beach- R3	1073	0.272	2.2		77.9	72	na		na		na	na	na	
40010.2	Off Cabrillo Beach	1332	na	2.9		95.0	83	na		na		na	na	na	
40010.3	Off Cabrillo Beach	30	0.282	p'p,DDE (6)	1.1	90.0	91	96		93		92	na	1.00	
40010.3	Off Cabrillo Beach	138	na		1.3	95.0	84	0		7		50	na	na	
40010.3	Off Cabrillo Beach- R3	1008	0.301		2.0	92.8	69	95		96		64	na	0.43	
40010.3	Off Cabrillo Beach- R1	1074	0.319		2.2	89.5	60	na		na		na	na	na	
40010.3	Off Cabrillo Beach- R2	1075	0.329		2.3	95.3	64	na		na		na	na	0.68	
40010.3	Off Cabrillo Beach- R3	1076	0.258		2.0	90.3	48	na		na		na	na	na	
40010.3	Off Cabrillo Beach	1333	na		2.9	97.4	91	na		na		na	na	na	
40011.1	Inner Harbor- Channel 3	31	0.326	p'p,DDE (2)	1.0	87.0	85	0		75		90	na	0.63	
40011.2	Inner Harbor- Channel 3	32	0.304	p'p,DDE (2)	2.1	89.0	84	0		0		88	na	0.53	

Table 22 continued. Categorization of Los Angeles Region Industrial Harbor stations based on chemistry, toxicity and benthic community analysis. Shading indicates significant toxicity or benthic degradation. na = Not Analyzed; N = [ammonia] > than threshold effect value; S = [sulfide] > than threshold effect value; PW = Pore Water; SWI = Sediment-Water Interface.

Station Number	Station Name	IDOrg	ERMQ	Selected Chemicals and factors by which they exceed ERM values	% TOC	% Fines	Amphipod		Larval Development - Ab or Urch.				Urch SWI	Benthic Index
							% NH <sub>3</sub> Surv.	H <sub>2</sub> S	100% NH <sub>3</sub> PW	50% NH <sub>3</sub> H <sub>2</sub> S	25% NH <sub>3</sub> PW	H <sub>2</sub> S		
Category 6 - Stations with measured biological impact but chemistry values below thresholds or not measured.														
40012.1	Southeast Basin	34	0.197	p'p,DDE (2)	1.5	82.3	77	24	94	96	na	0.61		
40012.1	Southeast Basin	812	na		1.6	83.8	34	52	95	na	na	na		
40012.1	Southeast Basin- R1	1047	0.231		1.5	84.4	39	na	na	na	na	na		
40012.1	Southeast Basin- R2	1048	0.211		1.3	78.6	51	na	na	na	na	na		
40012.1	Southeast Basin- R3	1049	0.176		1.0	70.8	66	na	na	na	na	na		
40012.1	Southeast Basin	1632	0.249		1.6	81.1	99	0	S	na	na	0.56		
40012.3	Southeast Basin	36	na		0.7	79.0	69	8	N	63	94	na	0.68	
40013.3	Inner Queensway Bay	39	na		1.7	91.0	81	6	N	90	92	na	0.46	
40014.1	Outer Queensway Bay	40	na		0.9	89.0	78	0	N	93	N	87	na	0.42
40015.1	Fish Harbor Entrance	43	0.178	p'p,DDE (2)	0.9	63.1	83	51	N	98	96	na	0.66	
40015.1	Fish Harbor Entrance	1698	0.146		0.4	43.3	89	na	na	na	na	na	0.78	
40015.1	Fish Harbor Entrance	1773	na		na	na	72	na	na	na	na	96	na	
40015.2	Fish Harbor Entrance	44	0.134	p'p,DDE (2)	0.6	37.0	83	35	N	96	N	98	na	0.68
40016.2	Terminal Island STP	47	0.126		0.5	68.0	88	71	N	97	97	na	0.75	
40016.2	Terminal Island STP	793	na		1.0	86.0	63	89	86	87	na	na		
40017.1	Long Beach Channel	49	na		0.8	80.0	76	0	72	94	na	0.52		
40017.2	Long Beach Channel	50	na		1.3	81.0	82	21	87	92	na	0.55		
40017.3	Long Beach Channel	51	0.164	p'p,DDE (4)	1.4	83.5	88	51	N	90	92	na	0.68	
40017.3	Long Beach Channel	811	na		1.0	74.0	54	0	0	na	na	na	na	
40017.3	Long Beach Channel - R1	1059	0.190		1.4	87.5	71	na	na	na	na	na	na	
40017.3	Long Beach Channel - R2	1060	0.214		1.4	87.6	47	na	na	na	na	na	na	
40017.3	Long Beach Channel - R3	1061	0.168		1.4	75.9	61	na	na	na	na	na	na	

Table 22 continued. Categorization of Los Angeles Region Industrial Harbor stations based on chemistry, toxicity and benthic community analysis. Shading indicates significant toxicity or benthic degradation. na = Not Analyzed; N = [ammonia] > than threshold effect value; S = [sulfide] > than threshold effect value; PW = Pore Water; SWI = Sediment-Water Interface.

Station Number	Station Name	IDOrg	ERMQ	Selected Chemicals and factors by which they exceed ERM values	% TOC	% Fines	Amphipod		Larval Development - Ab or Urch.						Urch SWI	Benthic Index
							% NH <sub>3</sub> Surv.	H <sub>2</sub> S	100% NH <sub>3</sub> PW	H <sub>2</sub> S	50% NH <sub>3</sub> PW	H <sub>2</sub> S	25% NH <sub>3</sub> PW	H <sub>2</sub> S		
<b>Category 6 - Stations with measured biological impact but chemistry values below thresholds or not measured.</b>																
40018.1	Long Beach Outer Harbor 18	52	na		0.6	71.0	67		0		87		90	na	0.51	
40018.2	Long Beach Outer Harbor 18	53	na		0.8	77.0	79		0		1		94	na	0.50	
40018.3	Long Beach Outer Harbor 18	54	0.208	p'p,DDE (3), TTL Chlordane (1)	1.4	79.1	93		92	N	91		93	na	0.52	
40018.3	Long Beach Outer Harbor 18- R1	884	0.233		1.3	75.1	93		0		91		89	na	0.23	
40018.3	Long Beach Outer Harbor 18- R2	885	0.253		1.5	79.9	91		0		91		94	na	0.31	
40018.3	Long Beach Outer Harbor 18- R3	886	0.255		1.3	76.5	89		0		34		81	na	0.23	
40018.3	Long Beach Outer Harbor 18- R1	1041	0.218		1.4	71.9	56		na		na		na	na	na	
40018.3	Long Beach Outer Harbor 18- R2	1042	0.266		1.3	79.1	70		na		na		na	na	0.30	
40018.3	Long Beach Outer Harbor 18- R3	1043	0.211		1.1	71.4	72		na		na		na	na	na	
40018.3	Long Beach Outer Harbor 18- R1	1192	na		1.5	84.6	88		na		na		na	na	na	
40018.3	Long Beach Outer Harbor 18- R2	1193	na		1.5	88.1	89		na		na		na	na	na	
40018.3	Long Beach Outer Harbor 18- R3	1194	na		1.4	82.9	81		na		na		na	na	na	
40018.3	Long Beach Outer Harbor 18	1334	na		1.3	78.0	90		na		na		na	na	na	
40018.3	Long Beach Outer Harbor 18	1695	0.253		1.2	79.9	75		na		na		na	97	0.58	
40018.3	Long Beach Outer Harbor 18	1770	na		na	na	59		na		na		na	96	na	
40020.1	Long Beach Outer Harbor 20	58	0.141	p'p,DDE (1)	0.5	57.0	83		0		6		64	na	0.63	
40020.2	Long Beach Outer Harbor 20	59	0.150	p'p,DDE (2), TTL Chlordane (1)	1.1	64.7	92		0		15		91	na	0.83	
40020.2	Long Beach Outer Harbor 20	1696	0.232		1.0	81.2	81		na		na		na	95	0.81	
40020.3	Long Beach Outer Harbor 20	60	0.164	p'p,DDE (2)	0.9	69.6	84		24		89		91	na	0.60	
40030.1	San Pedro Breakwater	73	0.112	p'p,DDE (3)	0.3	82.0	90		0	N	0		36	na	na	
40030.2	San Pedro Breakwater	74	0.108	p'p,DDE (3)	0.3	29.0	94		0	N	49		90	na	na	

Table 22 continued. Categorization of Los Angeles Region Industrial Harbor stations based on chemistry, toxicity and benthic community analysis. Shading indicates significant toxicity or benthic degradation. na = Not Analyzed; N = [ammonia] > than threshold effect value; S = [sulfide] > than threshold effect value; PW = Pore Water; SWI = Sediment-Water Interface.

Station Number	Station Name	IDOrg	ERMQ	Selected Chemicals and factors by which they exceed ERM values	% TOC	% Fines	Amphipod % NH <sub>3</sub> Surv. H <sub>2</sub> S	Larval Development - Ab or Urch.				Urch SWI	Benthic Index	
								100% NH <sub>3</sub> PW	50% NH <sub>3</sub> H <sub>2</sub> S	25% NH <sub>3</sub> PW	H <sub>2</sub> S			
<b>Category 6 - Stations with measured biological impact but chemistry values below thresholds or not measured.</b>														
40030.3	San Pedro Breakwater	75	na	p'p,DDE (3)	0.8	20.3	95	0	N	60	N	95	na	na
40031.2	Palos Verdes- Swartz 6	77	0.366	p'pDDE (112), TTL DDT (1), TTL PCBs (1)	2.8	62.9	93	0		90		92	na	0.77
40031.2	Palos Verdes- Swartz 6- R1	1002	0.318		2.9	60.3	97	0		2		93	na	0.28
40031.2	Palos Verdes- Swartz 6- R2	1003	0.362		2.8	54.5	91	0		0		93	na	0.44
40031.2	Palos Verdes- Swartz 6- R3	1004	0.385		2.8	54.3	89	86		97		97	na	0.28
40031.2	Palos Verdes- Swartz 6- BLIND	1005	0.285		2.5	69.8	91	27		0		12	na	na
40031.2	Palos Verdes- Swartz 6- R1	1038	0.376		1.9	55.1	70	na		na		na	na	na
40031.2	Palos Verdes- Swartz 6- R2	1039	0.425		2.0	60.3	87	na		na		na	na	na
40031.2	Palos Verdes- Swartz 6- R3	1040	0.302		2.0	41.7	85	na		na		na	na	na
40031.2	Palos Verdes- Swartz 6- R1	1189	na		2.6	58.6	86	na		na		na	na	na
40031.2	Palos Verdes- Swartz 6- R2	1190	na		2.6	57.8	86	na		na		na	na	na
40031.2	Palos Verdes- Swartz 6- R3	1191	na		2.8	61.8	91	na		na		na	na	na
40031.3	Palos Verdes- Swartz 6	78	0.470	p'p,DDE (81), TTL DDT (3), TTL PCB (1)	0.7	51.8	96	56		72		88	na	1.00
40032.1	San Pedro Bay- POLA 19	79	na	p'p,DDE (2)	na	na	86	66	N	90	N	98	na	0.79
40032.1	San Pedro Bay- POLA 19	103	0.104		0.4	26.0	94	0	N	11	N	90	na	na
40032.2	San Pedro Bay- POLA 19	80	na	p'p,DDE (2)	1.8	15.0	85	31	N	20	N	84	na	0.92
40032.2	San Pedro Bay- POLA 19	104	0.099		0.3	40.0	94	0	N	16	N	10	na	na
40032.3	San Pedro Bay- POLA 19	81	0.112	p'p,DDE (5)	0.5	18.1	93	0	N	15	N	92	na	0.84
40032.3	San Pedro Bay- POLA 19	105	0.137		0.3	40.0	86	0	N	0	N	61	na	na
40033.1	Outer Harbor- POLA 10	82	0.278	p'p,DDE (16)	1.2	87.4	71	1	N	0	N	26	na	0.72
40033.2	Outer Harbor- POLA 10	83	na		0.6	92.0	70	9	N	87	N	97	na	0.62
40033.3	Outer Harbor- POLA 10	84	na		1.6	94.0	65	3	N	94	N	91	na	0.57



Table 22 continued. Categorization of Los Angeles Region Industrial Harbor stations based on chemistry, toxicity and benthic community analysis. Shading indicates significant toxicity or benthic degradation. na = Not Analyzed; N = [ammonia] > than threshold effect value; S = [sulfide] > than threshold effect value; PW = Pore Water; SWI = Sediment-Water Interface.

Station Number	Station Name	IDOrg	ERMQ	Selected Chemicals and factors by which they exceed ERM values	% TOC	% Fines	Amphipod % NH <sub>3</sub> Surv. H <sub>2</sub> S	Larval Development - Ab or Urch.				Urch SWI	Benthic Index	
								100% NH <sub>3</sub> PW	50% NH <sub>3</sub> PW	25% NH <sub>3</sub> PW	H <sub>2</sub> S			
<b>Category 6 - Stations with measured biological impact but chemistry values below thresholds or not measured.</b>														
44011.0	Los Cerritos Channel Tidal P	611	na	Total Chlordane (1)	4.6	50.0	65	na	na	na	na	na	na	
44011.0	Los Cerritos Channel Tidal P- R1	1077	0.291	TBT (>90th)	1.0	62.7	66	na	na	na	na	na	na	
44011.0	Los Cerritos Channel Tidal P- R2	1078	0.272		1.0	64.4	62	na	na	na	na	na	na	
44011.0	Los Cerritos Channel Tidal P- R3	1079	0.301		0.9	56.9	62	na	na	na	na	na	na	
44013.0	Port Hueneme- Wharf 1	613	na	HMWPAH (1)	0.5	52.0	73	0	na	na	na	na	na	
44013.0	Port Hueneme- Wharf 1	1627	0.335		1.3	62.6	99	0	NS	na	na	na	na	
46001.0	Hugo Neuproler- 1	1623	na	TTL PCB (2)	1.5	70.3	95	40	NS	na	na	na	na	
46002.0	Hugo Neuproler- 2	1624	na	TTL PCB (2)	1.5	67.8	98	63	S	na	na	na	na	
46003.0	Hugo Neuproler- 3	1625	na		1.4	52.9	92	44	S	na	na	na	na	
<b>Category 7 - Stations with elevated chemistry but biological measures below thresholds.</b>														
40001.3	Southwest Slip	3	0.559	ANT, BAA, CHR (1), BAP,DBA (2) p'p,DDE (3), TTL PCB (1), HMWPAH (1), LMWPAH (2)	2.0	80.5	71	1	N	41	N	77	na	0.57
40007.2	Long Beach Harbor- Channel 2	20	0.585	Hg (1), DBA (1), p'p,DDE (3), TTL PCB (1)	1.6	79.8	88	0		0		37	na	0.53
40011.3	Inner Harbor- Channel 3	33	0.572	Hg (4), p'p,DDE (2)	1.5	88.4	82	0		0		62	na	0.70
40019.1	Inner Fish Harbor	55	0.624	Cu (1), p'p,DDE (7), Hg, TPCB (2), TBT (>95th)	2.5	78.1	83	0	N	0	N	0	na	0.36
40019.2	Inner Fish Harbor	56	0.664	Cu (1), Hg (2), p'p,DDE (7 TTL PCB (2), TBT (>95th)	2.3	76.6	73	89	N	96		96	na	0.38
40031.1	Palos Verdes- Swartz 6	76	0.520	p'p,DDE (84), TTL DDT (3), TTL PCB (1)	0.9	63.0	86	0		88		89	na	0.63
49004.0	Kaiser International- Berth 49	1793	2.695	Cu (1), TTL PCB (1), TTL PAH (3) p'p,DDE (2), HMWPAH (5), LMWPAH (29), Endosulf (>90th)	26.8	40.9	84	na		na		na	na	0.58
49005.0	Kaiser International- Berth 48	1794	0.343	p'p,DDE (8)	2.9	96.4	96	na		na		na	na	0.65

Table 22 continued. Categorization of Los Angeles Region Industrial Harbor stations based on chemistry, toxicity and benthic community analysis. Shading indicates significant toxicity or benthic degradation. na = Not Analyzed; N = [ammonia] > than threshold effect value; S = [sulfide] > than threshold effect value; PW = Pore Water; SWI = Sediment-Water Interface.

Station Number	Station Name	IDOrg	ERMQ	Selected Chemicals and factors by which they exceed ERM values	% TOC	% Fines	Amphipod		Larval Development - Ab or Urch.						Urch SWI	Benthic Index
							% NH <sub>3</sub> Surv.	H <sub>2</sub> S	100% NH <sub>3</sub> PW	NH <sub>3</sub> H <sub>2</sub> S	50% NH <sub>3</sub> PW	NH <sub>3</sub> H <sub>2</sub> S	25% NH <sub>3</sub> PW	NH <sub>3</sub> H <sub>2</sub> S		
<b>Category 8 - Stations with chemistry, toxicity and benthic degradation below thresholds, or not measured.</b>																
40001.1	Southwest Slip	1	0.382	p'p,DDE (3)	1.6	70.1	65		72	N	93	N	93		na	0.47
40002.3	West Basin- Pier 143	6	na		0.9	60.0	74		0	N	0	N	65	N	na	0.48
40003.2	Turning Basin- Pier 151	8	0.105		0.6	23.8	63		2	N	98	N	96		na	0.50
40003.2	Turning Basin- Pier 152- R1	1053	0.105		0.3	16.3	85		na		na		na		na	na
40003.2	Turning Basin- Pier 152- R2	1054	0.112		0.3	15.7	91		na		na		na		na	na
40003.2	Turning Basin- Pier 152- R3	1055	0.133		1.1	20.6	82		na		na		na		na	na
40004.3	Lower Main Channel	12	0.336	p'p,DDE (8), TTL PCB (1)	0.9	82.0	81		79	N	91	N	97		na	0.54
40005.1	East Basin- Turning Basin	13	0.410	p'p,DDE (3), TTL PCB (1), TTL Chlr. (1) TBT (>95th)	2.0	51.6	74		0	N	42		98		na	0.42
40009.0	West Basin Entrance	1699	0.195		0.7	75.3	86		na		na		na		97	0.57
40009.0	West Basin Entrance	1774	na		na	na	74		na		na		na		93	na
40012.2	Southeast Basin	35	0.198	p'p,DDE (2)	1.5	87.6	78		94		97		98		na	0.50
40013.2	Inner Queensway Bay	38	0.441	TTL Chlordane (3)	1.5	90.0	84		0	N	87	N	88		na	0.47
40014.2	Outer Queensway Bay	41	0.491	p'p,DDE (1), TTL Chlordane (3)	2.8	96.6	80		0	N	0	N	91	N	na	0.41
40014.3	Outer Queensway Bay	42	0.475	p'p,DDE (1), TTL Chlordane (3)	2.3	94.4	64		0	N	90	N	89		na	0.41
40020.0	Long Beach Outer Harbor 20	1771	na		na	na	85		na		na		na		89	na

Table 22 continued. Categorization of Los Angeles Region Industrial Harbor stations based on chemistry, toxicity and benthic community analysis. Shading indicates significant toxicity or benthic degradation. na = Not Analyzed; N = [ammonia] > than threshold effect value; S = [sulfide] > than threshold effect value; PW = Pore Water; SWI = Sediment-Water Interface.

Station Number	Station Name	IDOrg	ERMQ	Selected Chemicals and factors by which they exceed ERM values	% TOC	% Fines	Amphipod		Larval Development - Ab or Urch.						Urch SWI	Benthic Index
							% NH <sub>3</sub> Surv.	H <sub>2</sub> S	100% NH <sub>3</sub> PW	H <sub>2</sub> S	50% NH <sub>3</sub> PW	H <sub>2</sub> S	25% NH <sub>3</sub> PW	H <sub>2</sub> S		
<b>Category 8 - Stations with chemistry, toxicity and benthic degradation below thresholds, or not measured</b>																
44055.0	L.B. Naval Station Pier 3- R1	1198	na		2.3	96.8	77		na	na	na	na	na	na	na	
44055.0	L.B. Naval Station Pier 3- R2	1199	na		1.2	85.0	86		na	na	na	na	na	na	na	
44055.0	L.B. Naval Station Pier 3- R3	1200	na		2.2	86.3	82		na	na	na	na	na	na	na	
48009.0	San Pedro Bay- Outer Harbor	1694	0.391	p'p,DDE (1), TTL Chlordane (3)	0.4	75.9	96		na	na	na	na	na	95	0.70	
48009.0	San Pedro Bay- Outer Harbor	1769	na		na	na	85		na	na	na	na	na	63	na	
49001.0	Cabrillo Beach Pier- West	1778	na		2.3	81.6	na		na	na	na	na	na	na	na	
49002.0	Cabrillo Beach Pier- Central	1779	na		1.4	100	na		na	na	na	na	na	na	na	
49003.0	Cabrillo Beach Pier- East	1780	na		1.4	100	na		na	na	na	na	na	na	na	
<b>Category 9 - Reference stations.</b>																
40015.3	Fish Harbor Entrance	45	0.173		0.8	29.4	92		10	N	96	98	na	na	0.79	
40015.3	Fish Harbor Entrance	792	na		0.6	61.0	75		91		83	89	na	na	na	
40008.1	East Basin- Pier C	22	0.228	p'p,DDE (1)	0.6	88.0	80		0	N	93	95	na	na	0.61	
40016.3	Terminal Island STP	48	0.204	p'p,DDE (3)	0.6	91.0	80		95	N	97	96	na	na	0.68	
40016.1	Terminal Island STP	46	0.175	p'p,DDE (4)	0.7	75.0	72		92		98	97	na	na	0.76	
48010.0	Turning Basin	1697	0.216	TTL PCB (1)	0.3	30.8	95		na	na	na	na	na	72	0.69	
48010.0	Turning Basin	1772	na		na	na	69		na	na	na	na	na	87	na	

Table 22 continued. Categorization of Los Angeles Region Industrial Harbor stations based on tissue chemistry analysis of field collected fish and laboratory exposed bivalves. Shading indicates chemical concentrations in *Macoma* which were significantly elevated relative to control values. Quotient value are derived from ratio of measured concentrations to US EPA screening values for Total DDT and PCBs (refer to Table 21).

Station Number	Station Name	IDOrg	Tissue Type	DDT Total	DDT Quotient	PCB Total	PCB Quotient	EPA Exceedances
<b>Category 3 - Stations where field collected or laboratory exposed animals had elevated tissue concentrations</b>								
40009.0	West Basin Entrance- R1	1774.1	Macoma	15.49		16.526		
40009.0	West Basin Entrance- R2	1774.2	Macoma	11.02		11.088		
40009.0	West Basin Entrance- R3	1774.3	Macoma	18.86		17.598		
40020.2	Long Beach Outer Harbor 20	1781.0	Croaker	1096.7	3.7	465.2	46.5	2
49001.0	Cabrillo Beach Pier- West	1778.1	Macoma	9.59		6.072		
49001.0	Cabrillo Beach Pier- West	1782.0	Croaker	406.3	1.4	170.2	17	2
49001.0	Cabrillo Beach Pier- West	1785.0	Surfperch	51.2	0.2	40.1	4	1
49002.0	Cabrillo Beach Pier- Central- R1	1779.1	Macoma	11.96		5.53		
49002.0	Cabrillo Beach Pier- Central- R2	1779.2	Macoma	18.74		8.406		
49002.0	Cabrillo Beach Pier- Central- R3	1779.3	Macoma	18.16		15.338		
49002.0	Cabrillo Beach Pier- Central	1783.0	Croaker	4984.8	16.6	686.6	68.7	2
49002.0	Cabrillo Beach Pier- Central	1786.0	Surfperch	68.5	0.2	37.9	3.8	1
49003.0	Cabrillo Beach Pier- East- R1	1780.1	Macoma	9.1		4.546		
49003.0	Cabrillo Beach Pier- East- R2	1780.2	Macoma	13.43		5.272		
49003.0	Cabrillo Beach Pier- East- R3	1780.3	Macoma	10.64		5.536		
49003.0	Cabrillo Beach Pier- East	1784.0	Croaker	1839.2	6.1	407.3	40.7	2
49003.0	Cabrillo Beach Pier- East	1787.0	Surfperch	76.7	0.3	53.5	5.4	1

Table 23. ERM and PEL Quotients and Number of Sediment Quality Guideline Exceedances at Marina stations. Stations are ranked in descending order by ERM Quotient.

STANUM	STATION	IDORG	LEG	ERMQ	PELQ	ERM EXCDS	PEL EXCDS
48005.0	Marina Del Rey - C1 (X1)	1690	48	1.14	1.64	3	6
44014.0	Marina Del Rey - Rep 2	1081	26	1.09	1.59	7	7
44014.0	Marina Del Rey	614	11	0.92	1.42	8	7
44014.0	Marina Del Rey	1630	45	0.81	1.20	5	7
44014.0	Marina Del Rey - Rep 1	1080	26	0.84	1.25	6	7
44014.0	Marina Del Rey - Rep 3	1082	26	0.72	1.10	5	5
44020.0	Shoreline Marina - Rep 3	1067	25	0.89	1.20	3	6
44020.0	Shoreline Marina	1631	45	0.80	1.13	3	5
44020.0	Shoreline Marina - Rep 1	1065	25	0.73	1.03	3	6
44020.0	Shoreline Marina - Rep 2	1066	25	0.81	1.10	3	6
44020.0	Shoreline Marina	620	11	0.63	0.89	3	5
48006.0	Shoreline Marina - A1 (X1)	1691	48	1.03	1.40	5	5
48003.0	Marina Del Rey - B1 (X1)	1688	48	0.81	1.26	6	7
48001.0	Marina Del Rey - A1 (X1)	1686	48	0.65	0.95	6	6
48004.0	Marina Del Rey - B2 (X2)	1689	48	0.53	0.78	1	3
48002.0	Marina Del Rey - A2 (X2)	1687	48	0.52	0.81	3	3
44023.0	Channel Islands Harbor	623	11	0.41	0.64	3	4
40023.1	Alamitos Bay - Long Beach Marina	1701	48	0.40	0.54	2	2
40023.1	Alamitos Bay - Long Beach	67	4	NA	NA	NA	NA
40023.1	Alamitos Bay - Long Beach Marina	1776	53	NA	NA	0	0
48007.0	Shoreline Marina - B1 (X1)	1692	48	0.38	0.54	2	4
48008.0	Shoreline Marina - C1 (X1)	1693	48	0.31	0.46	1	1
48011.0	King Harbor	1700	48	0.30	0.42	2	1
40022.2	Alamitos Bay - Entrance	65	4	0.25	0.36	2	1
40022.1	Alamitos Bay - Entrance	64	4	0.24	0.33	2	1
40022.3	Alamitos Bay - Entrance	66	4	NA	NA	NA	NA
40021.3	Alamitos Bay - Marine Stadium	63	4	0.18	0.26	0	0
48012.0	Channel Island Harbor - Front	1702	48	0.14	0.23	1	1
40021.1	Alamitos Bay - Marine Stadium	61	4	NA	NA	NA	NA
40021.2	Alamitos Bay - Marine Stadium	62	4	NA	NA	NA	NA
40023.2	Alamitos Bay - Long Beach	68	4	NA	NA	NA	NA
40023.3	Alamitos Bay - Long Beach	69	4	NA	NA	0	0
44021.0	Ventura Marina	621	11	NA	NA	NA	NA
44023.0	Channel Islands Harbor - Rep 1	1207	30	NA	NA	NA	NA
44023.0	Channel Islands Harbor - Rep 2	1208	30	NA	NA	NA	NA
44023.0	Channel Islands Harbor - Rep 3	1209	30	NA	NA	NA	NA
48011.0	King Harbor	1775	53	NA	NA	0	0
48012.0	Channel Island Harbor - Front	1777	53	NA	NA	0	0

Table 24. Survival of Amphipods *Rhepoxynius abronius* (RA) or *Eohaustorius estuarius* (EE) in Marina Station Sediments. MN and SD = mean survival and standard deviation. \* = significantly toxic using a t-test. ns = not significant. T = toxic using a t-test and relative to the MSD value for these protocols. NT = Not Toxic. NA = Not Analyzed.

STANUM	STATION	IDORG	LEG	RA MN	RA SD	RA t-test	RA MSD	EE MN	EE SD	EE t-test	EE MSD
48005.0	Marina Del Rey - C1 (X1)	1690	48	NA	NA	NA	NA	77.00	3.00	*	NT
44014.0	Marina Del Rey -Rep 2	1081	26	42.00	16.43	*	T	NA	NA	NA	NA
44014.0	Marina Del Rey	614	11	53.00	11.00	*	T	NA	NA	NA	NA
44014.0	Marina Del Rey	1630	45	NA	NA	NA	NA	92.00	13.00	ns	NT
44014.0	Marina Del Rey -Rep 1	1080	26	32.00	14.40	*	T	NA	NA	NA	NA
44014.0	Marina Del Rey -Rep 3	1082	26	35.00	18.03	*	T	NA	NA	NA	NA
44020.0	Shoreline Marina - Rep 3	1067	25	73.00	12.04	*	NT	NA	NA	NA	NA
44020.0	Shoreline Marina	1631	45	NA	NA	NA	NA	90.00	8.00	*	NT
44020.0	Shoreline Marina - Rep 1	1065	25	32.00	27.97	*	T	NA	NA	NA	NA
44020.0	Shoreline Marina - Rep 2	1066	25	59.00	22.75	*	T	NA	NA	NA	NA
44020.0	Shoreline Marina	620	11	28.00	9.10	*	T	NA	NA	NA	NA
48006.0	Shoreline Marina - A1 (X1)	1691	48	NA	NA	NA	NA	80.00	0.00	*	NT
48003.0	Marina Del Rey - B1 (X1)	1688	48	NA	NA	NA	NA	51.00	27.00	*	T
48001.0	Marina Del Rey - A1 (X1)	1686	48	NA	NA	NA	NA	49.00	29.00	*	T
48004.0	Marina Del Rey - B2 (X2)	1689	48	NA	NA	NA	NA	89.00	7.00	*	NT
48002.0	Marina Del Rey - A2 (X2)	1687	48	NA	NA	NA	NA	65.00	6.00	*	T
44023.0	Channel Islands Harbor	623	11	48.00	13.50	*	T	NA	NA	NA	NA
40023.1	Alamitos Bay - Long Beach Marina	1701	48	NA	NA	NA	NA	81.00	10.00	*	NT
40023.1	Alamitos Bay - Long Beach	67	4	81.00	18.20	ns	NT	NA	NA	NA	NA
40023.1	Alamitos Bay - Long Beach Marina	1776	53	NA	NA	NA	NA	75.00	14.00	*	NT
48007.0	Shoreline Marina - B1 (X1)	1692	48	NA	NA	NA	NA	71.00	35.00	ns	NT
48008.0	Shoreline Marina - C1 (X1)	1693	48	NA	NA	NA	NA	91.00	7.00	ns	NT
48011.0	King Harbor	1700	48	NA	NA	NA	NA	77.00	30.00	ns	NT
40022.2	Alamitos Bay - Entrance	65	4	92.00	7.60	ns	NT	NA	NA	NA	NA
40022.1	Alamitos Bay - Entrance	64	4	92.00	2.70	ns	NT	NA	NA	NA	NA
40022.3	Alamitos Bay - Entrance	66	4	81.00	7.40	*	NT	NA	NA	NA	NA
40021.3	Alamitos Bay - Marine Stadium	63	4	71.00	12.90	*	NT	NA	NA	NA	NA

Table 24 continued. Survival of Amphipods *Rhepoxynius abronius* (RA) or *Eohaustorius estuarius* (EE) in Marina Station Sediments. MN and SD = mean survival and standard deviation. \* = significantly toxic using a t-test. ns = not significant. T = toxic using a t-test and relative to the MSD value for these protocols. NT = Not Toxic. NA = Not Analyzed.

STANUM	STATION	IDORG	LEG	RA MN	RA SD	RA t-test	RA MSD	EE MN	EE SD	EE t-test	EE MSD
48012.0	Channel Island Harbor - Front	1702	48	NA	NA	NA	NA	79.00	10.00	*	NT
40021.1	Alamitos Bay - Marine Stadium	61	4	75.00	11.70	*	NT	NA	NA	NA	NA
40021.2	Alamitos Bay - Marine Stadium	62	4	77.00	16.00	*	NT	NA	NA	NA	NA
40023.2	Alamitos Bay - Long Beach	68	4	79.00	12.90	*	NT	NA	NA	NA	NA
40023.3	Alamitos Bay - Long Beach	69	4	91.00	10.20	ns	NT	NA	NA	NA	NA
44021.0	Ventura Marina	621	11	67.00	8.40	*	T	NA	NA	NA	NA
44023.0	Channel Islands Harbor - Rep 1	1207	30	80.00	11.73	*	NT	NA	NA	NA	NA
44023.0	Channel Islands Harbor - Rep 2	1208	30	78.00	10.95	*	NT	NA	NA	NA	NA
44023.0	Channel Islands Harbor - Rep 3	1209	30	82.00	5.70	*	NT	NA	NA	NA	NA
48011.0	King Harbor	1775	53	NA	NA	NA	NA	26.00	34.00	*	T
48012.0	Channel Island Harbor - Front	1777	53	NA	NA	NA	NA	58.00	35.00	*	T

Table 25. Spearman Rank Correlation Coefficients for selected chemicals significantly correlated with amphipod survival at Marina stations. \* indicates significance at  $p \leq 0.05$ ; \*\* indicates significance at  $p \leq 0.01$ ; \*\*\* indicates significance at  $p \leq 0.001$ ; N = 13, 25, or 28 depending on chemical.

Chemical	Spearman rho	Significance
Arsenic	-0.517	**
Copper	-0.510	**
Lead	-0.490	**
Mercury	-0.421	**
Nickel	-0.408	**
Zinc	-0.539	**
Tributyltin	-0.594	**
Fines	-0.246	NS
Clay	-0.542	*
TOC	-0.209	NS
ERM Quotient	-0.320	NS
PEL Quotient	-0.350	*
# ERM Exceedances	-0.321	*



Table 26. Spearman Rank Correlation Coefficients for selected chemicals significantly correlated with sea urchin development at the sediment-water interface at Marina stations.

\* indicates significance at  $p \leq 0.05$ ; \*\* indicates significance at  $p \leq 0.01$ ; \*\*\* indicates significance at  $p \leq 0.001$ ; N = 11 or 14 depending on chemical.

Chemical	Spearman rho	Significance
<b>Pesticides</b>		
OP DDT	-0.642	*
Endosulfan	-0.600	*
Mirex	-0.580	*
<b>PCBs</b>		
PCB 138	-0.555	*
PCB 153	-0.627	*
PCB 157	-0.549	*
PCB 170	-0.682	*
PCB 177	-0.582	*
PCB 180	-0.591	*
PCB 183	-0.691	*
PCB 187	-0.545	*
PCB 194	-0.609	*
PCB 201	-0.629	*
PCB 206	-0.664	*
Ammonia	-0.749	**
Hydrogen Sulfide	-0.517	*
Fines	-0.246	NS
Clay	-0.542	NS
TOC	-0.209	NS
ERM Quotient	-0.320	NS
# ERM Exceedances	-0.321	NS

Table 27. Relative Benthic Index values for Marina stations. Station categories were D = Degraded (RBI $\leq$ 0.30); T = Transitional (RBI $>$ 0.31 $\leq$ 0.60); U = Undegraded (RBI  $>$ 0.61). NA = Not Analyzed.

STANUM	STATION	IDORG	LEG	Benthic Index	Category
48005.0	Marina Del Rey- C1 (X1)	1690	48	0.66	U
44014.0	Marina Del Rey-Rep 2	1081	26	NA	NA
44014.0	Marina Del Rey	614	11	NA	NA
44014.0	Marina Del Rey	1630	45	0.34	T
44014.0	Marina Del Rey-Rep 1	1080	26	NA	NA
44014.0	Marina Del Rey-Rep 3	1082	26	NA	NA
44020.0	Shoreline Marina- Rep 3	1067	25	NA	NA
44020.0	Shoreline Marina	1631	45	0.38	T
44020.0	Shoreline Marina- Rep 1	1065	25	NA	NA
44020.0	Shoreline Marina- Rep 2	1066	25	NA	NA
44020.0	Shoreline Marina	620	11	NA	NA
48006.0	Shoreline Marina- A1 (X1)	1691	48	0.34	T
48003.0	Marina Del Rey- B1 (X1)	1688	48	0.43	T
48001.0	Marina Del Rey- A1 (X1)	1686	48	0.43	T
48004.0	Marina Del Rey- B2 (X2)	1689	48	0.62	U
48002.0	Marina Del Rey- A2 (X2)	1687	48	0.49	T
44023.0	Channel Islands Harbor	623	11	NA	NA
40023.1	Alamitos Bay-Long Beach Marina	1701	48	0.66	U
40023.1	Alamitos Bay- Long Beach	67	4	0.80	U
40023.1	Alamitos Bay-Long Beach Marina	1776	53	NA	NA
48007.0	Shoreline Marina- B1 (X1)	1692	48	0.26	D
48008.0	Shoreline Marina- C1 (X1)	1693	48	0.51	T
48011.0	King Harbor	1700	48	0.64	U
40022.2	Alamitos Bay- Entrance	65	4	0.73	U
40022.1	Alamitos Bay- Entrance	64	4	0.70	U
40022.3	Alamitos Bay- Entrance	66	4	0.70	U
40021.3	Alamitos Bay- Marine Stadium	63	4	0.62	U
48012.0	Channel Is. Harbor- Front	1702	48	0.75	U
40021.1	Alamitos Bay- Marine Stadium	61	4	0.58	T
40021.2	Alamitos Bay- Marine Stadium	62	4	0.39	T
40023.2	Alamitos Bay- Long Beach	68	4	0.53	T
40023.3	Alamitos Bay- Long Beach	69	4	0.58	T
44021.0	Ventura Marina	621	11	NA	NA
44023.0	Channel Islands Harbor-Rep 1	1207	30	NA	NA
44023.0	Channel Islands Harbor-Rep 2	1208	30	NA	NA
44023.0	Channel Islands Harbor-Rep 3	1209	30	NA	NA
48011.0	King Harbor	1775	53	NA	NA
48012.0	Channel Is. Harbor- Front	1777	53	NA	NA

Table 28. Spearman Rank Correlation Coefficients for selected chemicals significantly Correlated with Benthic Community Structure (as Relative Benthic Index = BI) at Marina stations. \* indicates significance at  $p \leq 0.05$ ; \*\* indicates significance at  $p \leq 0.01$ ; \*\*\* indicates significance at  $p \leq 0.001$ ; N = 16.

Chemical	Spearman rho	Significance
<b>Metals</b>		
Antimony	-0.743	***
Chromium	-0.720	**
Copper	-0.774	***
Lead	-0.723	**
Mercury	-0.543	*
Silver	-0.446	*
Zinc	-0.752	***
<b>Pesticides</b>		
Trans Chlordane	-0.500	*
PP DDMU	-0.675	**
Dieldrin	-0.525	*
Cis Nonachlor	-0.473	*
Tributyltin	-0.711	**
<b>PCBs</b>		
PCB 44	-0.527	*
PCB 52	-0.538	*
PCB 66	-0.569	*
PCB 101	-0.532	*
PCB 118	-0.549	*
PCB 187	-0.429	*
PCB 195	-0.671	**
PCB 209	-0.629	**
Total PCBs	-0.512	*
Fines	-0.641	**
TOC	-0.664	**
ERMQ	-0.586	**
ERM Exceedances	-0.528	*

Table 29. Categorization of Los Angeles Region Marina stations based on chemistry, toxicity and benthic analysis. Shading indicates significant toxicity or benthic degradation. Shading indicates significant toxicity or benthic degradation. PW = Pore Water, SWI = Sediment-Water Interface.

Station Number	Station Name	IDOrg	ERMQ	Selected chemicals and factors by which the exceed ERM values	% TOC	% Fines	Amphipod		Abalone Development						Urchin Dev.		Urchin NH <sub>3</sub> SWI	Benthic Index
							% NH <sub>3</sub> Surv	H <sub>2</sub> S	100% NH <sub>3</sub> PW	H <sub>2</sub> S	50% NH <sub>3</sub> PW	H <sub>2</sub> S	25% NH <sub>3</sub> PW	H <sub>2</sub> S	100% NH <sub>3</sub> PW	NH <sub>3</sub> H <sub>2</sub> S		
Category 5 - Stations with elevated chemistry and mixed results from biological indicators																		
44014.0	Marina Del Rey	614	0.920	p'p DDE (2)	1.10	93	53	na	na	na	na	na	na	na	na	na	na	na
44014.0	Marina Del Rey- R1	1080	0.843	TTL Chlor (4)	2.51	95	32	na	na	na	na	na	na	na	na	na	na	na
44014.0	Marina Del Rey- R2	1081	1.086	TTL PCBs (2)	2.42	85	42	na	na	na	na	na	na	na	na	na	na	na
44014.0	Marina Del Rey- R3	1082	0.720	Zn, Hg, Pb (1)	2.46	98	35	na	na	na	na	na	na	na	na	na	na	na
44014.0	Marina Del Rey	1630	0.811	Cu (2), TBT (>90th)	2.08	88	92	na	na	na	na	na	na	88	na	na	na	na
44020.0	Shoreline Marina	620	0.628	TTL Chlor (8)	1.10	91	28	na	1	na	na	na	na	87	na	na	na	na
44020.0	Shoreline Marina- R1	1065	0.733	p'p DDE (2)	2.93	62	32	na	na	na	na	na	na	na	na	na	na	na
44020.0	Shoreline Marina- R2	1066	0.805	TTL PCBs (2)	2.86	100	59	na	na	na	na	na	na	na	na	na	na	na
44020.0	Shoreline Marina- R3	1067	0.894		2.85	100	73	na	na	na	na	na	na	na	na	na	na	na
44020.0	Shoreline Marina	1631	0.803		3.40	99	90	na	na	na	na	na	0	NS	na	na	na	na
48001.0	Marina Del Rey - A1 (X1)	1686	0.651	Cu, Hg, Ni, Zn (1) p'pDDE (1), TTL Chlr (2)	1.76	100	49	na	na	na	na	na	na	na	na	91	na	0.43
48002.0	Marina Del Rey - A2 (X2)	1687	0.522	Cu, Zn (1), TTL Chlor (2)	1.42	100	65	na	na	na	na	na	na	na	na	38	na	0.49
48003.0	Marina Del Rey - B1 (X1)	1688	0.805	Cu, Ni, Zn (1), Hg (2) TTL Chlr(2), TTL PCBs (1)	2.26	100	51	na	na	na	na	na	na	na	na	78	na	0.43
Category 6 - Stations with measured biological impact but chemistry values below thresholds or not																		
40021.1	Alamitos Bay- Mar. Stadium	61	na		0.60	53	75	na	0	na	15	na	97	na	na	na	na	na
40021.2	Alamitos Bay- Mar. Stadium	62	na		1.00	79	77	na	0	N	3	na	91	na	na	na	na	na
40023.1	Alamitos Bay- Long Beach	67	na		0.70	58	81	na	0	na	2	na	97	na	na	na	na	na
40023.1	Alamitos Bay- Long Beach	1701	0.395	TTL Chlor. (2)	1.70	78	81	na	na	na	na	na	na	na	na	na	na	na
40023.1	Alamitos Bay- LB Marina	1776	na	p'pDDE (1)			75	na	na	na	na	na	na	na	na	na	na	na
40023.2	Alamitos Bay- Long Beach	68	na		0.80	53	79	na	0	N	0	N	61	na	na	na	na	na
40023.3	Alamitos Bay- Long Beach	69	na		0.70	32	91	na	0	N	0	na	81	na	na	na	na	na

Table 29 continued. Categorization of Los Angeles Region Marina stations based on chemistry, toxicity and benthic analysis. Shading indicates significant toxicity or benthic degradation. Shading indicates significant toxicity or benthic degradation. PW = Pore Water, SWI = Sediment-Water Interface.

Station Number	Station Name	IDOrg	ERMQ	Selected chemicals and factors by which the exceed ERM values		% TOC	% Fines	Amphipod % NH <sub>3</sub> Surv H <sub>2</sub> S		Abalone Development 100% NH <sub>3</sub> PW H <sub>2</sub> S 50% NH <sub>3</sub> PW H <sub>2</sub> S 25% NH <sub>3</sub> PW H <sub>2</sub> S				Urchin Dev. 100% NH <sub>3</sub> PW H <sub>2</sub> S		Urchin NH <sub>3</sub> SWI H <sub>2</sub> S		Benthic Index	
<b>Category 6 - Stations with measured biological impact but chemistry values below thresholds or not</b>																			
44021.0	Ventura Marina	621	na			0.77	97	67	17	na	na	na	na	14	na	na	na	na	
44023.0	Channel Islands Harbor	623	0.410	p'pDDE (2), Ag (1)		0.70	70	48	na	na	na	na	na	1	na	na	na	na	
44023.0	Channel Islands Harbor- R1	1207	na			1.45	82	80	na	na	na	na	na	na	na	na	na	na	
44023.0	Channel Islands Harbor- R2	1208	na			1.47	88	78	na	na	na	na	na	na	na	na	na	na	
44023.0	Channel Islands Harbor- R3	1209	na			0.78	60	82	na	na	na	na	na	na	na	na	na	na	
48007.0	Shoreline Marina B1 (X1)	1692	0.375	Ni (1)		2.86	100	71	na	na	na	na	na	na	98			0.26	
48011.0	King Harbor	1700	0.297	p'pDDE (2), TTL PCBs (1)		1.05	50	77	na	na	na	na	na	na	66			0.64	
48011.0	King Harbor	1775	na			na	na	26	na	na	na	na	na	na	3	N		na	
48012.0	Channel Islands Harbor- Front	1702	0.142	p'pDDE (1)		0.81	83	79	na	na	na	na	na	na	92			0.75	
48012.0	Channel Islands Harbor- Front	1777	na					58	na	na	na	na	na	na	70	N		na	
<b>Category 7 - Stations with elevated chemistry, but biological measures below thresholds</b>																			
48004.0	Marina Del Rey - B2 (X1)	1689	0.527	TTL Chl (3)		1.48	88	89	na	na	na	na	na	na	90			0.62	
48005.0	Marina Del Rey - C1 (X1)	1690	1.135	p'pDDE, TPCBs(1) TTL Chlor. (11)		2.93	88	77	na	na	na	na	na	na	57	N		0.66	
48006.0	Shoreline Marina A1 (X1)	1691	1.034	Zn, p'pDDE (1) TTL Chl (7), TTL PCB(3)		2.56	100	80	na	na	na	na	na	na	86			0.34	
<b>Category 8 - Stations with elevated chemistry, toxicity, and benthic degradation below thresholds</b>																			
48008.0	Shoreline Marina C1 (X1)	1693	0.311			0.96	93	91	na	na	na	na	na	na	96			0.51	
<b>Category 9 - Reference stations</b>																			
40021.3	Alamitos Bay- Mar. Stadium	63	0.182			1.00	39	71	0	N	8	96	na	na	na	na	na	na	
40022.1	Alamitos Bay- Entrance	64	0.244	TTL Chl, p'p DDE (1)		1.10	77	92	0		54	97	na	na	na	na	na	na	
40022.2	Alamitos Bay- Entrance	65	0.252	TTL Chl, p'p DDE (1)		0.90	91	92	0		0	46	na	na	na	na	na	na	
40022.3	Alamitos Bay- Entrance	66	na			0.90	90	81	0	N	7	66	na	na	na	na	na	na	

Table 30. ERM and PEL Quotients and Number of Sediment Quality Guideline Exceedances at Lagoon stations. Stations are ranked in descending order by ERM Quotient.

STANUM	STATION	IDORG	LEG	ERMQ	PELQ	ERM EXCDS	PEL EXCDS
44027.0	McGrath Lake Estuary	1628	45	2.92	4.01	3	4
44027.0	McGrath Lake Estuary	627	11	2.20	3.03	4	5
44027.0	McGrath Lake Estuary - Rep 1	1210	30	NA	NA	NA	NA
44027.0	McGrath Lake Estuary - Rep 2	1211	30	NA	NA	NA	NA
44027.0	McGrath Lake Estuary - Rep 3	1212	30	NA	NA	NA	NA
44017.0	Colorado Lagoon	617	11	2.27	3.38	8	14
44024.0	Ballona Creek	624	11	1.80	2.68	4	9
44024.0	Ballona Creek - Rep 3	1085	26	1.61	2.30	5	8
44024.0	Ballona Creek - Rep 1	1083	26	1.33	1.92	5	6
44024.0	Ballona Creek - Rep 2	1084	26	1.17	1.68	6	8
48017.0	East Mugu Lagoon - C1 (X1)	1707	48	0.31	0.43	2	3
48015.0	Central Mugu Lagoon - B1 (X4)	1705	48	0.28	0.40	2	2
48016.0	Central Mugu Lagoon - B2 (X3)	1706	48	0.25	0.36	2	2
48018.0	East Mugu Lagoon - C2 (X2)	1708	48	0.22	0.34	2	2
48014.0	West Mugu Lagoon - A2 (X3)	1704	48	0.14	0.21	1	2
48013.0	West Mugu Lagoon - A1 (X2)	1703	48	0.12	0.17	1	1
44054.0	Mugu/Entrance - Rep 1	1629	45	0.07	0.10	1	0
44054.0	Mugu/Entrance - Rep 1	1213	30	NA	NA	NA	NA
44054.0	Mugu/Entrance - Rep 2	1214	30	NA	NA	NA	NA
44054.0	Mugu/Entrance - Rep 3	1215	30	NA	NA	NA	NA
44054.0	Mugu/Entrance	655	11	NA	NA	NA	NA
44016.0	Mugu Lagoon	616	11	NA	NA	NA	NA
44018.0	Malibu Lagoon	618	11	NA	NA	NA	NA
44026.0	Sim's Pond	626	11	NA	NA	NA	NA
44050.0	Callegus/Oxnard Ditch #3	651	11	NA	NA	NA	NA
44051.0	Mugu/Main Lagoon	652	11	NA	NA	NA	NA
44052.0	Mugu/Western Arm	653	11	NA	NA	NA	NA
44053.0	Mugu/Oxnard Ditch #1	654	11	NA	NA	NA	NA
44053.0	Mugu/Oxnard Ditch #1 - Rep 1	1216	30	NA	NA	NA	NA
44053.0	Mugu/Oxnard Ditch #1 - Rep 2	1217	30	NA	NA	NA	NA
44053.0	Mugu/Oxnard Ditch #1 - Rep 3	1218	30	NA	NA	NA	NA
44022.0	Ventura River Estuary	622	13	NA	NA	NA	NA
44025.0	Santa Clara River Estuary	625	13	NA	NA	NA	NA

Table 31. Survival of Amphipods *Rhepoxynius abronius* (RA) or *Eohaustorius estuarius* (EE) in Marina Station Sediments. MN and SD = mean survival and standard deviation. \* = significantly toxic using a t-test. ns = not significant. T = toxic using a t-test and relative to the MSD value for these protocols. NT = Not Toxic. NA = Not Analyzed.

STANUM	STATION	IDORG	LEG	RA MN	RA SD	RA t-test	RA MSD	EE MN	EE SD	EE t-test	EE MSD
44027.0	Mcgrath Lake Estuary	1628	45	NA	NA	NA	NA	81.00	9.00	*	NT
44027.0	Mcgrath Lake Estuary	627	11	16.00	11.90	*	T	NA	NA	NA	NA
44027.0	Mcgrath Lake Estuary-Rep 1	1210	30	72.00	13.51	*	NT	NA	NA	NA	NA
44027.0	Mcgrath Lake Estuary-Rep 2	1211	30	75.00	21.79	ns	NT	NA	NA	NA	NA
44027.0	Mcgrath Lake Estuary-Rep 3	1212	30	62.00	15.65	*	T	NA	NA	NA	NA
44017.0	Colorado Lagoon	617	11	NA	NA	NA	NA	5.00	8.70	*	T
44024.0	Ballona Creek	624	11	49.00	12.40	*	T	NA	NA	NA	NA
44024.0	Ballona Creek Rep3	1085	26	42.00	11.51	*	T	NA	NA	NA	NA
44024.0	Ballona Creek-Rep 1	1083	26	54.00	14.75	*	T	NA	NA	NA	NA
44024.0	Ballona Creek-Rep 2	1084	26	60.00	16.83	*	T	NA	NA	NA	NA
48017.0	East Mugu Lagoon- C1 (X1)	1707	48	NA	NA	NA	NA	78.00	9.00	*	NT
48015.0	Central Mugu Lagoon- B1 (X4)	1705	48	NA	NA	NA	NA	17.00	13.00	*	T
48016.0	Central Mugu Lagoon- B2 (X3)	1706	48	NA	NA	NA	NA	85.00	8.00	*	NT
48018.0	East Mugu Lagoon- C2 (X2)	1708	48	NA	NA	NA	NA	84.00	4.00	*	NT
48014.0	West Mugu Lagoon- A2 (X3)	1704	48	NA	NA	NA	NA	89.00	7.00	*	NT
48013.0	West Mugu Lagoon- A1 (X2)	1703	48	NA	NA	NA	NA	87.00	10.00	*	NT
44054.0	Mugu/Entrance-Rep 1	1629	45	NA	NA	NA	NA	99.00	2.00	ns	NT
44054.0	Mugu/Entrance-Rep 1	1213	30	51.00	5.48	*	T	NA	NA	NA	NA
44054.0	Mugu/Entrance-Rep 2	1214	30	69.00	6.52	*	T	NA	NA	NA	NA
44054.0	Mugu/Entrance-Rep 3	1215	30	78.00	9.08	*	NT	NA	NA	NA	NA
44054.0	Mugu/Entrance	655	11	14.00	17.80	*	T	NA	NA	NA	NA
44016.0	Mugu Lagoon	616	11	NA	NA	NA	NA	66.00	11.40	*	T
44018.0	Malibu Lagoon	618	11	NA	NA	NA	NA	87.00	9.10	*	NT
44026.0	Sim's Pond	626	11	NA	NA	NA	NA	91.00	12.40	ns	NT

Table 31 continued. Survival of Amphipods *Rhepoxynius abronius* (RA) or *Eohaustorius estuarius* (EE) in Marina Station Sediments. MN and SD = mean survival and standard deviation. \* = significantly toxic using a t-test. ns = not significant. T = toxic using a t-test and relative to the MSD value for these protocols. NT = Not Toxic. NA = Not Analyzed.

STANUM	STATION	IDORG	LEG	RA MN	RA SD	RA t-test	RA MSD	EE MN	EE SD	EE t-test	EE MSD
44050.0	Callegus/Oxnard Ditch #3	651	11	NA	NA	NA	NA	71.00	6.50	*	T
44051.0	Mugu/Main Lagoon	652	11	68.00	16.00	*	T	NA	NA	NA	NA
44052.0	Mugu/Western Arm	653	11	64.00	9.60	*	T	NA	NA	NA	NA
44053.0	Mugu/Oxnard Ditch #1	654	11	35.00	15.00	*	T	NA	NA	NA	NA
44053.0	Mugu/Oxnard Ditch #1 - Rep 1	1216	30	61.00	14.32	*	T	NA	NA	NA	NA
44053.0	Mugu/Oxnard Ditch #1 - Rep 2	1217	30	61.00	18.17	*	T	NA	NA	NA	NA
44053.0	Mugu/Oxnard Ditch #1 - Rep 3	1218	30	47.00	13.04	*	T	NA	NA	NA	NA
44022.0	Ventura River Estuary	622	13	NA	NA	NA	NA	97.00	2.70	*	NT
44025.0	Santa Clara River Estuary	625	13	NA	NA	NA	NA	99.00	2.20	ns	NT



Table 32. Spearman Rank Correlation Coefficients for selected chemicals significantly correlated with amphipod survival at Lagoon stations. \* indicates significance at  $p \leq 0.05$ ; \*\* indicates significance at  $p \leq 0.01$ ; \*\*\* indicates significance at  $p \leq 0.001$ ; N = 12 or 14 depending on chemical.

Chemical	Spearman rho	Significance
<b>Metals</b>		
Antimony	-0.543	*
Copper	-0.574	*
Mercury	-0.552	*
Silver	-0.495	*
Zinc	-0.673	*
Tin	-0.745	**
<b>Pesticides</b>		
Total Chlordane	-0.780	***
Total DDT	-0.490	*
Dieldrin	-0.833	***
<b>PCBs</b>		
PCB18	-0.487	*
PCB52	-0.482	*
PCB66	-0.474	*
PCB105	-0.501	*
PCB138	-0.490	*
<b>PAHs</b>		
Benzo(a)pyrene	-0.735	**
Benzo(e)pyrene	-0.767	**
Chrysene	-0.732	**
Fluoranthene	-0.697	**
1-Methylphenanthrene	-0.794	***
Phenanthrene	-0.771	***
LMW PAH	-0.692	**
HMW PAH	-0.670	**
Total PAHs	-0.675	**
Fines	-0.345	NS
TOC	-0.420	NS
ERM Quotient	-0.763	**
# ERM Exceedances	-0.783	***

Table 33. Relative Benthic Index values for Lagoon stations. Station categories were D = Degraded (RBI $\leq$ 0.30); T = Transitional (RBI $>$ 0.31 $\leq$ 0.60); U = Undegraded (RBI  $>$ 0.61). NA = Not Analyzed.

STANUM	STATION	IDORG	LEG	Benthic Index	Category
44027.0	McGrath Lake Estuary	1628	45	NA	NA
44027.0	McGrath Lake Estuary	627	11	NA	NA
44027.0	McGrath Lake Estuary - Rep 1	1210	30	NA	NA
44027.0	McGrath Lake Estuary - Rep 2	1211	30	NA	NA
44027.0	McGrath Lake Estuary - Rep 3	1212	30	NA	NA
44017.0	Colorado Lagoon	617	11	NA	NA
44024.0	Ballona Creek	624	11	NA	NA
44024.0	Ballona Creek - Rep3	1085	26	NA	NA
44024.0	Ballona Creek - Rep 1	1083	26	NA	NA
44024.0	Ballona Creek - Rep 2	1084	26	NA	NA
48017.0	East Mugu Lagoon - C1 (X1)	1707	48	0.01	D
48015.0	Central Mugu Lagoon - B1 (X4)	1705	48	0.14	D
48016.0	Central Mugu Lagoon - B2 (X3)	1706	48	0.03	D
48018.0	East Mugu Lagoon - C2 (X2)	1708	48	0.03	D
48014.0	West Mugu Lagoon - A2 (X3)	1704	48	0	D
48013.0	West Mugu Lagoon - A1 (X2)	1703	48	0.13	D
44054.0	Mugu/Entrance - Rep 1	1629	45	NA	NA
44054.0	Mugu/Entrance - Rep 1	1213	30	NA	NA
44054.0	Mugu/Entrance - Rep 2	1214	30	NA	NA
44054.0	Mugu/Entrance - Rep 3	1215	30	NA	NA
44054.0	Mugu/Entrance	655	11	NA	NA
44016.0	Mugu Lagoon	616	11	NA	NA
44018.0	Malibu Lagoon	618	11	NA	NA
44026.0	Sim's Pond	626	11	NA	NA
44050.0	Callegus/Oxnard Ditch #3	651	11	NA	NA
44051.0	Mugu/Main Lagoon	652	11	NA	NA
44052.0	Mugu/Western Arm	653	11	NA	NA
44053.0	Mugu/Oxnard Ditch #1	654	11	NA	NA
44053.0	Mugu/Oxnard Ditch #1 - Rep 1	1216	30	NA	NA
44053.0	Mugu/Oxnard Ditch #1 - Rep 2	1217	30	NA	NA
44053.0	Mugu/Oxnard Ditch #1 - Rep 3	1218	30	NA	NA
44022.0	Ventura River Estuary	622	13	NA	NA
44025.0	Santa Clara River Estuary	625	13	NA	NA

Table 34. Results of tissue analyses of fish collected from Mugu Lagoon. Tissue concentrations are shown for those chemicals that were elevated relative to the US EPA screening values (Total DDT and Total PCBs only, as ng/g wet weight).

Station Number	Station Name	IDORG	Fish Species	TTL DDT (ng/g)	TTL DDT Quot.	TTL PCB (ng/g)	TTL PCB Quot.	EPA Exceeds	% Lipid
44016.0	Mugu Lagoon	283	Topsmelt	15.98	0.053	5.024	0.502	0	0.52
44016.0	Mugu Lagoon	284	Shiner Surfperch	133.53	0.445	17.126	1.713	1	1.08
NAS	Wildlife Guideline (whole fish)			50		500			
USEPA	Screening Value (edible portion)			300		10			

Table 35. Categorization of Los Angeles Region Lagoon stations based on chemistry, toxicity and benthic analysis. Shading indicates significant toxicity or benthic degradation. NA = Not Analyzed; N = ammonia concentrations greater than threshold effect value; PW = Pore Water; SSW = Subsurface Water; SWI = Sediment-Water Interface.

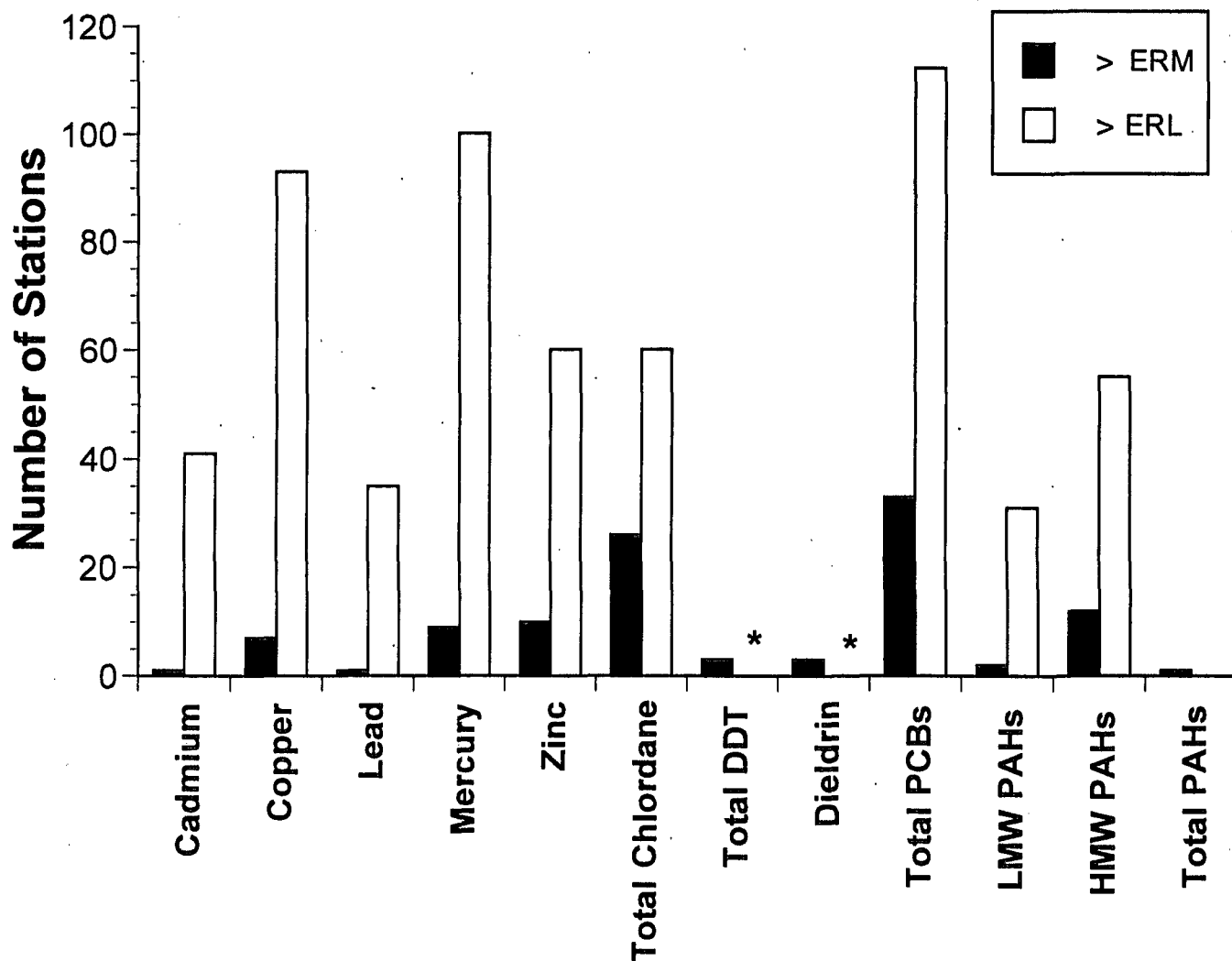
Station Number	Station Name	IDOrg	ERMQ	Selected chemicals and factors by which the exceed ERM values	% TOC	% Fines	Amphipod		Urch. Dev		Ab. Dev		Mussel Dev		Urchin		Benthic Index
							% NH <sub>3</sub> Surv	H <sub>2</sub> S	100% NH <sub>3</sub> PW	H <sub>2</sub> S	100% NH <sub>3</sub> PW	H <sub>2</sub> S	100% NH <sub>3</sub> PW	H <sub>2</sub> S	SSW	H <sub>2</sub> S	
<b>Category 4 - Stations with elevated chemistry and biological impacts measured by either toxicity or benthos.</b>																	
44017.0	Colorado Lagoon	617	2.271	TTL PCB (1), TTL Chlr (22) Dieldrin (3), p'pDDE (3) Pb, Zn (2), Phen (1)	1.90	30	5		na		na	0	N	77		na	na
44024.0	Ballona Creek	624	1.799	TTL Chlor (18)	3.00	65	49	N	0	N	na	na		59		na	na
44024.0	Ballona Creek- R1	1083	1.327	p'pDDE (4)	5.06	52	54		na		na	na		na		na	na
44024.0	Ballona Creek- R2	1084	1.169	TTL DDT, Dieldrin (3)	5.30	66	60		na		na	na		na		na	na
44024.0	Ballona Creek- R3	1085	1.607	Chlorpyr (>95th)	5.67	74	42		na		na	na		na		na	na
44027.0	McGrath Lake Estuary	627	2.196	TTL Chlor (25)	1.00	97	16		na		na	4	N	73		na	na
44027.0	McGrath Lake Estuary- R1	1210	na	p'p DDE (57)	0.81	20	72		na		na	na		na		na	na
44027.0	McGrath Lake Estuary- R2	1211	na	Dieldrin, TTL DDT (3)	0.54	12	75		na		na	na		na		na	na
44027.0	McGrath Lake Estuary- R3	1212	na	Toxaphen. (>90th)	1.81	51	62		na		na	na		na		na	na
44027.0	McGrath Lake Estuary	1628	2.916	Endosulf. (95th)	2.46	90	81		90		na	na		na		na	na
<b>Category 6 - Stations with measured biological impact but chemistry values below thresholds or not measured.</b>																	
44016.0	Mugu Lagoon	616	na		0.73	64	66		na		na	100		74		na	na
44018.0	Malibu Laboon	618	na		0.93	98	87		na		na	100		42		na	na
44026.0	Sim's Pond	626	na		2.40	83	91		na		na	47	N	72		na	na
44050.0	Callegus/Oxnard Ditch 3	651	na		0.45	63	71		na		na	na		na		na	na
44051.0	Mugu- Main Lagoon	652	na		0.76	92	68		75		12	na		na		na	na
44052.0	Mugu- Western Arm	653	na		0.66	99	64		10		na	na		na		na	na

Table 35 continued. Categorization of Los Angeles Region Lagoon stations based on chemistry, toxicity and benthic analysis. Shading indicates significant toxicity or benthic degradation. NA = Not Analyzed; N = ammonia concentrations greater than threshold effect value; PW = Pore Water; SSW = Subsurface Water; SWI = Sediment-Water Interface.

Station Number	Station Name	IDOrg	ERMQ	Selected chemicals and factors by which the exceed ERM values	% TOC	% Fines	Amphipod		Urch. Dev		Ab. Dev		Mussel Dev		Urchin		Benthic Index
							% NH <sub>3</sub> Surv	H <sub>2</sub> S	100% NH <sub>3</sub> PW	H <sub>2</sub> S	100% NH <sub>3</sub> PW	H <sub>2</sub> S	100% NH <sub>3</sub> PW	H <sub>2</sub> S	SSW	H <sub>2</sub> S	
Category 6 - Stations with measured biological impact but chemistry values below thresholds or not measured.																	
44053.0	Mugu/Oxnard Ditch 1	654	na		1.10	91	35		0		na	na	na	na	na	na	na
44053.0	Mugu/Oxnard Ditch 1- R1	1216	na		2.79	84	61		na		na	na	na	na	na	na	na
44053.0	Mugu/Oxnard Ditch 1- R2	1217	na		2.96	85	61		na		na	na	na	na	na	na	na
44053.0	Mugu/Oxnard Ditch 1- R3	1218	na		2.71	93	47		na		na	na	na	na	na	na	na
44054.0	Mugu- Entrance	655	na		0.70	80	14	N	0	N	na	na	na	na	na	na	na
44054.0	Mugu- Entrance- R1	1213	na		0.76	45	51		na		na	na	na	na	na	na	na
44054.0	Mugu- Entrance- R2	1214	na		0.38	21	69		na		na	na	na	na	na	na	na
44054.0	Mugu- Entrance- R3	1215	na		0.33	21	78		na		na	na	na	na	na	na	na
44054.0	Mugu- Entrance- R1	1629	0.068	p/p DDE (1)	0.50	19	99		0	NS	na	na	na	na	na	na	na
48013.0	West Mugu Lagoon- A1 (X2)	1703	0.120	p/p DDE (1)	0.65	38	87		na		na	na	na	na	97		0.13
48014.0	West Mugu Lagoon- A2 (X2)	1704	0.142	p/p DDE (2)	0.91	37	89		na		na	na	na	na	82		0.00
48015.0	Central Mugu Lagoon- B1 (X4)	1705	0.280	TTL Chlr (2), p/pDDE (5) Chlorpyr: (90th)	0.56	82	17		na		na	na	na	na	98		0.14
48016.0	Central Mugu Lagoon- B2 (X3)	1706	0.252	TTL Chlr (2), p/pDDE (4)	1.16	77	85		na		na	na	na	na	89		0.03
48017.0	East Mugu Lagoon- C1 (X1)	1707	0.307	TTL Chlr (2), p/pDDE (6)	1.74	100	78		na		na	na	na	na	13		0.01
48018.0	East Mugu Lagoon- C2 (X2)	1708	0.221	TTL Chlr (1), p/pDDE (5)	1.10	61	84		na		na	na	na	na	22	N	0.03
Category 9 - Reference Stations																	
44022.0	Ventura River Estuary	622	na		1.80	83	97		na		na	100	100	na	na	na	na
44025.0	Santa Clara River Estuary	625	na		0.05	79	99		na		na	100	100	na	na	na	na

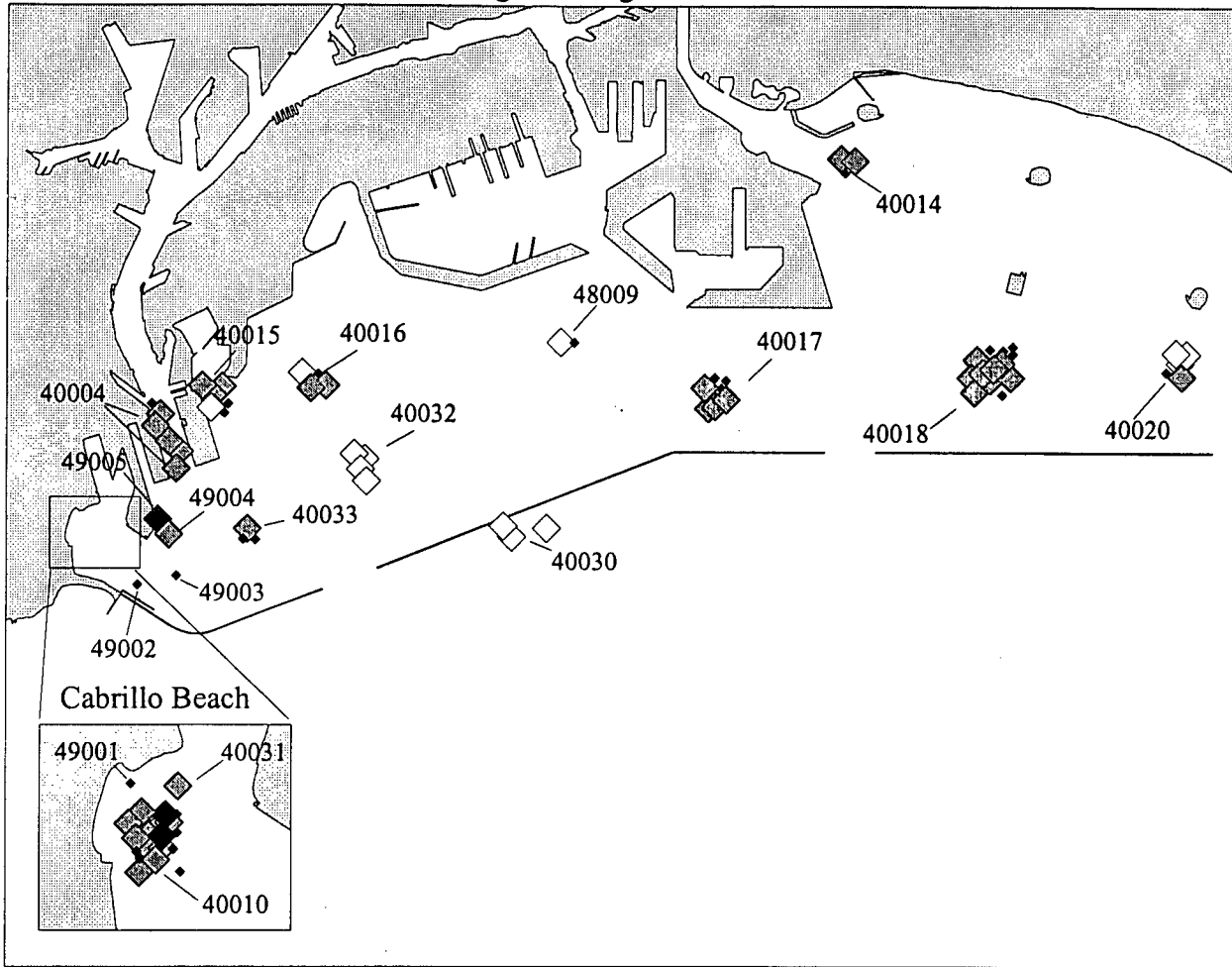
Table 35 continued. Categorization of Los Angeles Region Lagoon stations based on tissue chemistry analysis of field collected fish. Quotient value are derived from ratio of measured concentrations to US EPA screening values for Total DDT and PCBs (refer to Table 34).

Station Number	Station Name	IDORG	Fish Species	TTL DDT	TTL DDT Quot.	TTL PCB	TTL PCB Quot.	EPA Exceeds
Category 3 - Stations where field collected animals had elevated tissue concentrations								
44016.0	Mugu Lagoon	283	Topsmelt	15.98	0.053	5.024	0.502	0
44016.0	Mugu Lagoon	284	Shiner Surfperch	133.53	0.445	17.126	1.713	1

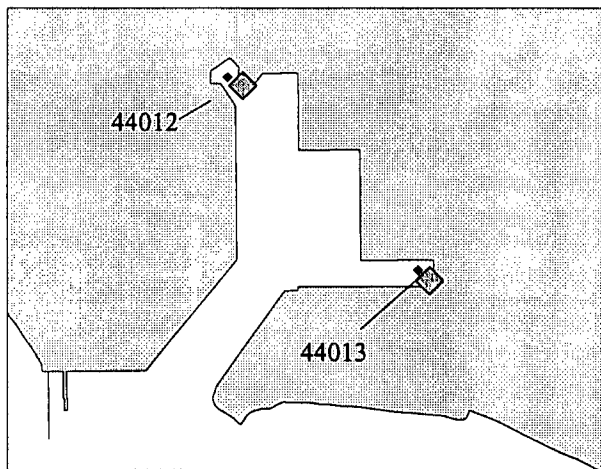


**Figure 10 .** Number of Industrial Harbor station samples exceeding either the ERM or ERL sediment quality guidelines. (Total DDT was compared to the Swartz *et al.* sediment effect concentration, 100 ug/g OC. \* no ERL exceedances were calculated for Total DDT or Dieldrin; see text for details).

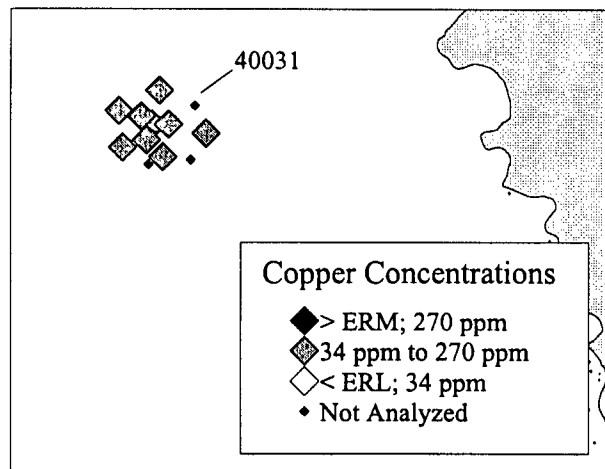
Outer Los Angeles/Long Beach Harbor Stations



Port Hueneme



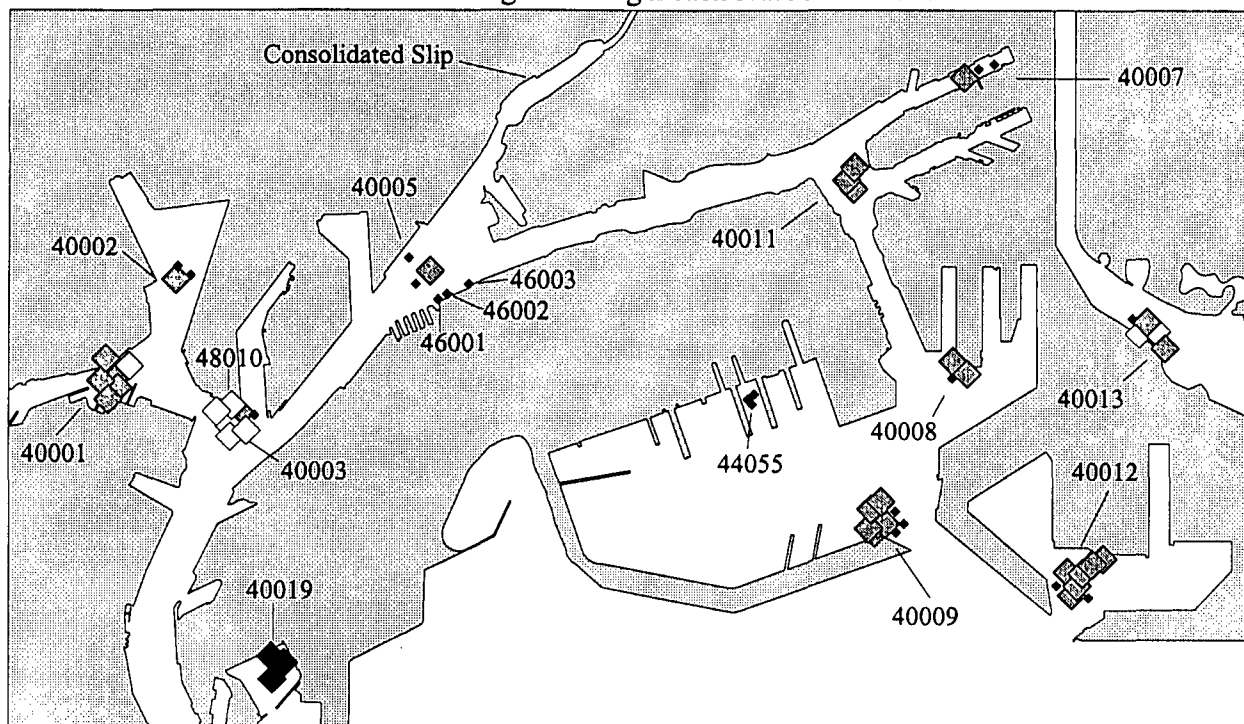
Palos Verdes



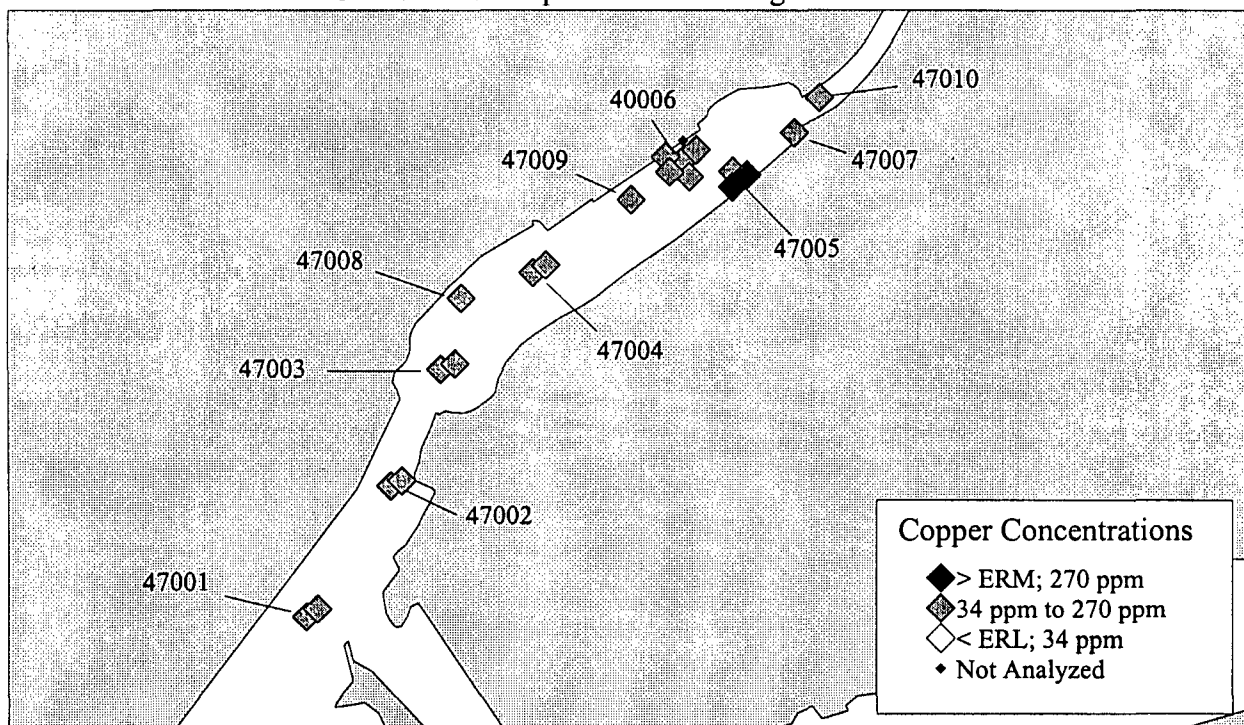
Figures 11a, 11b, and 11c. Distribution of sediment samples in Outer Los Angeles and Long Beach Harbor (a), Port Hueneme (b), and Palos Verdes (c) exceeding the ERM for Copper.



### Inner Los Angeles/Long Beach Harbor Stations

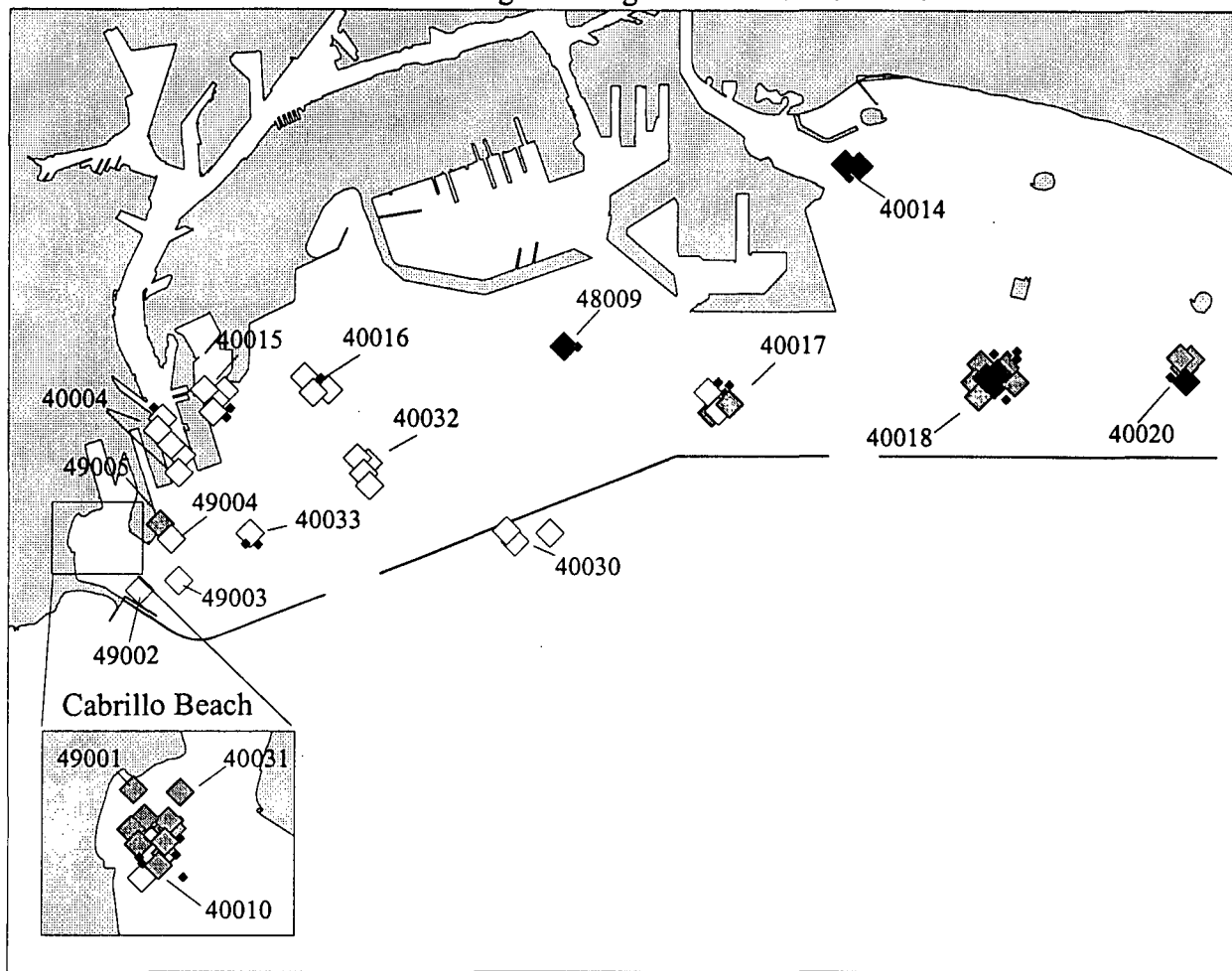


### Consolidated Slip of Inner Los Angeles Harbor

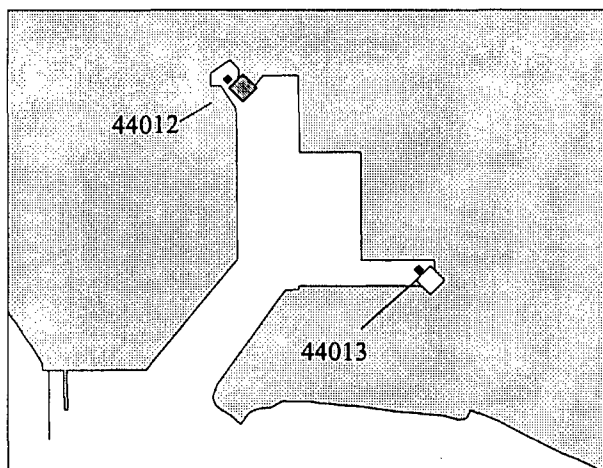


Figures 12a and 12b. Distribution of sediment samples in Inner Los Angeles and Long Beach Harbor (a) and Consolidated Slip (b) exceeding the ERM for Copper.

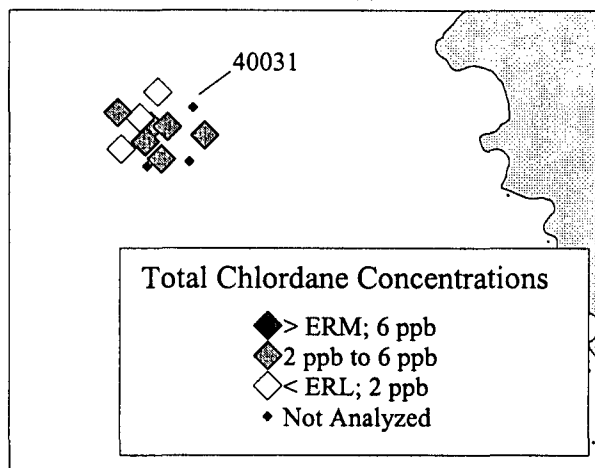
### Outer Los Angeles/Long Beach Harbor Stations



### Port Hueneme

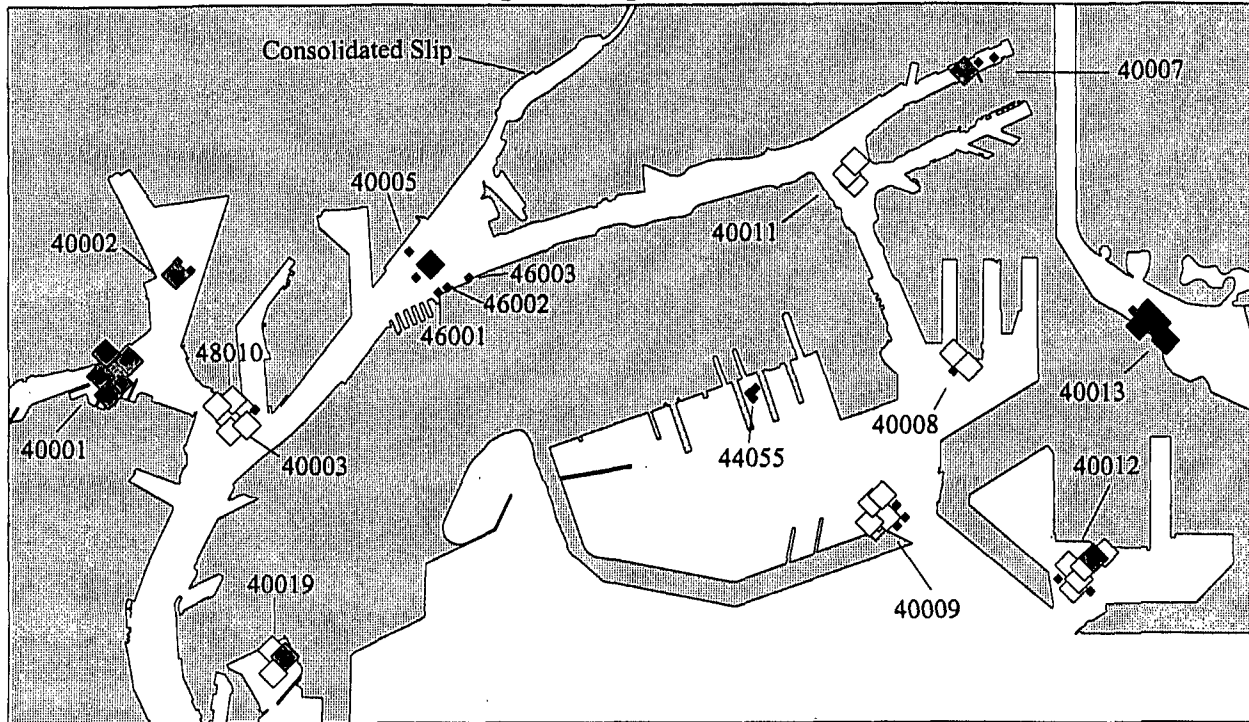


### Palos Verdes

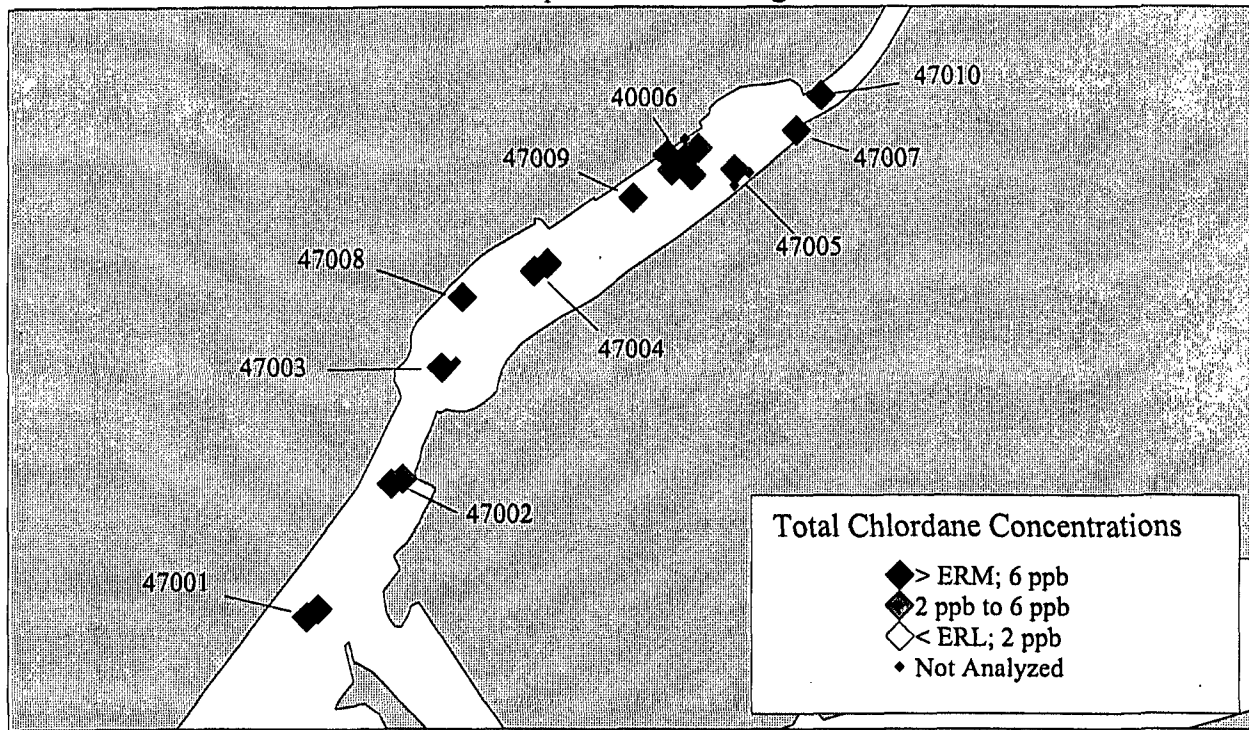


Figures 13a, 13b, and 13c. Distribution of sediment samples in Outer Los Angeles and Long Beach Harbor (a), Port Hueneme (b), and Palos Verdes (c) exceeding the ERM for Total Chlordane.

Inner Los Angeles/Long Beach Harbor Stations

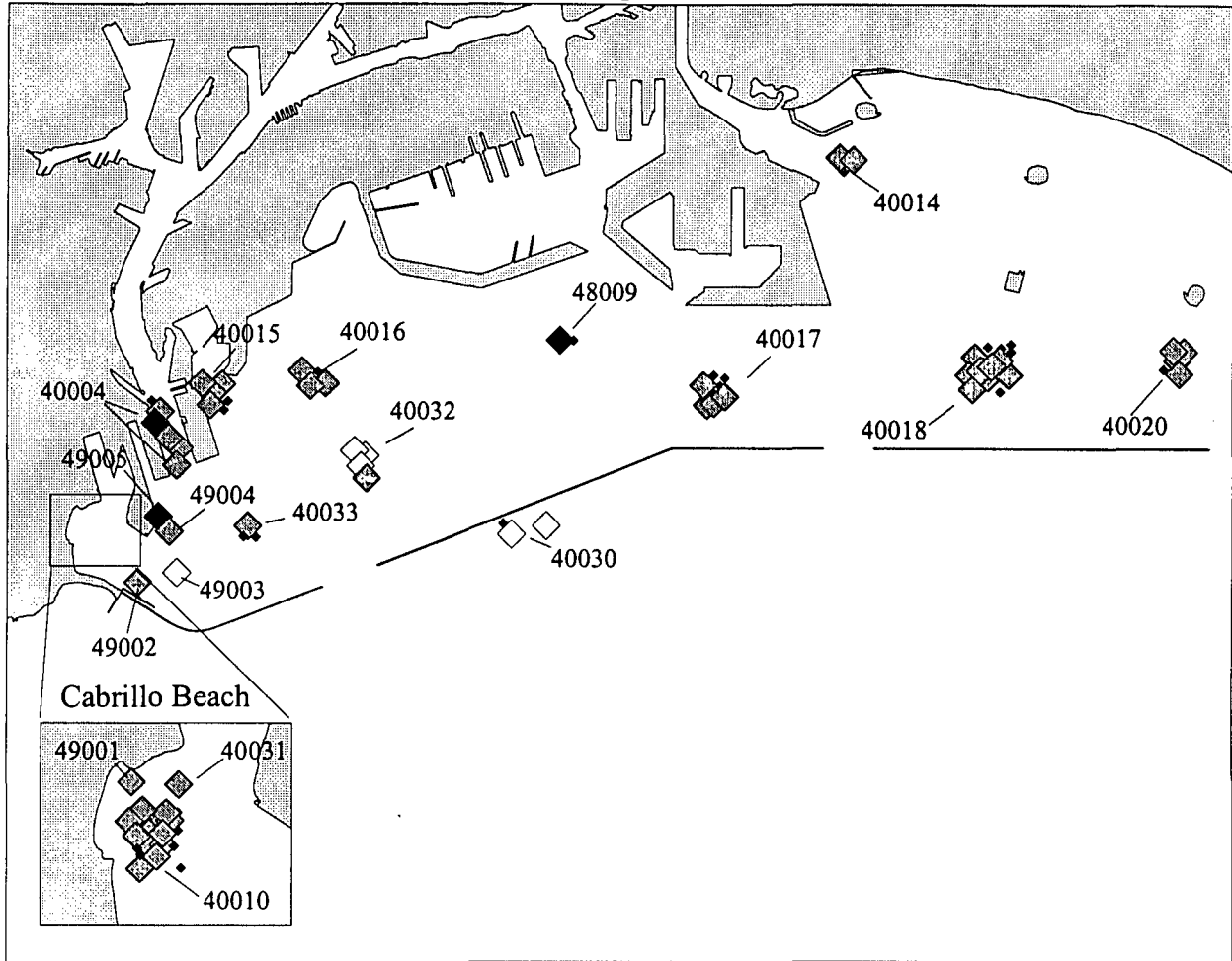


Consolidated Slip of Inner Los Angeles Harbor

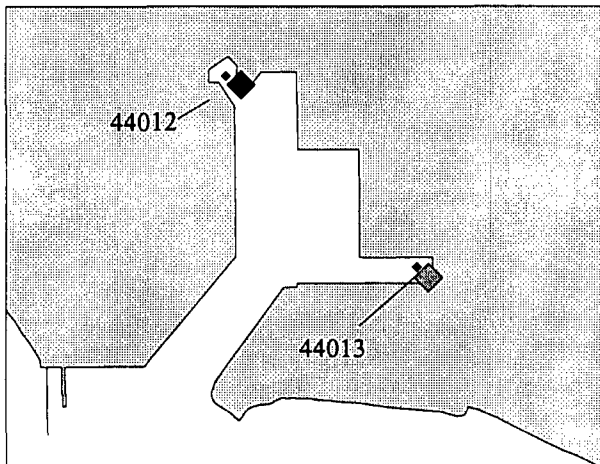


Figures 14a and 14b. Distribution of sediment samples in Inner Los Angeles and Long Beach Harbor (a), and Consolidated Slip (b), exceeding the ERM for Total Chlordane.

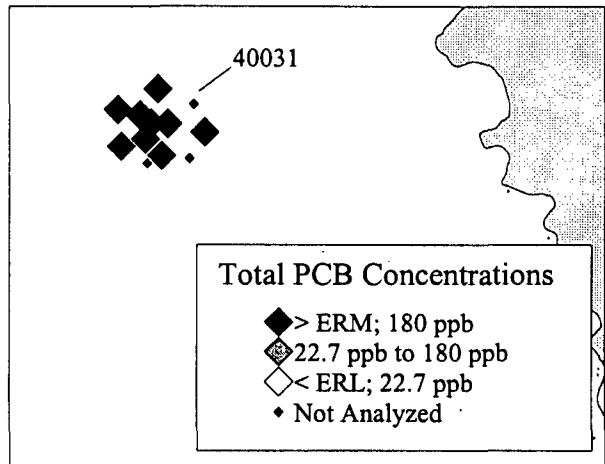
Outer Los Angeles/Long Beach Harbor Stations



Port Hueneme



Palos Verdes

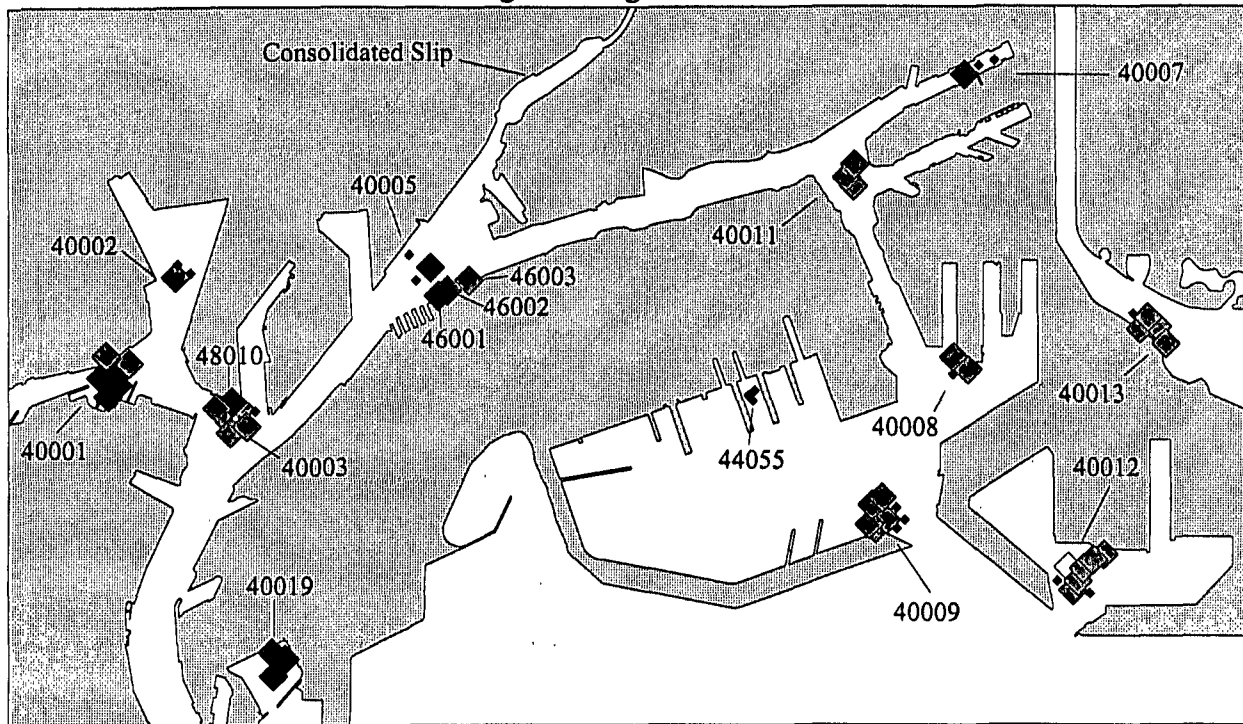


**Total PCB Concentrations**

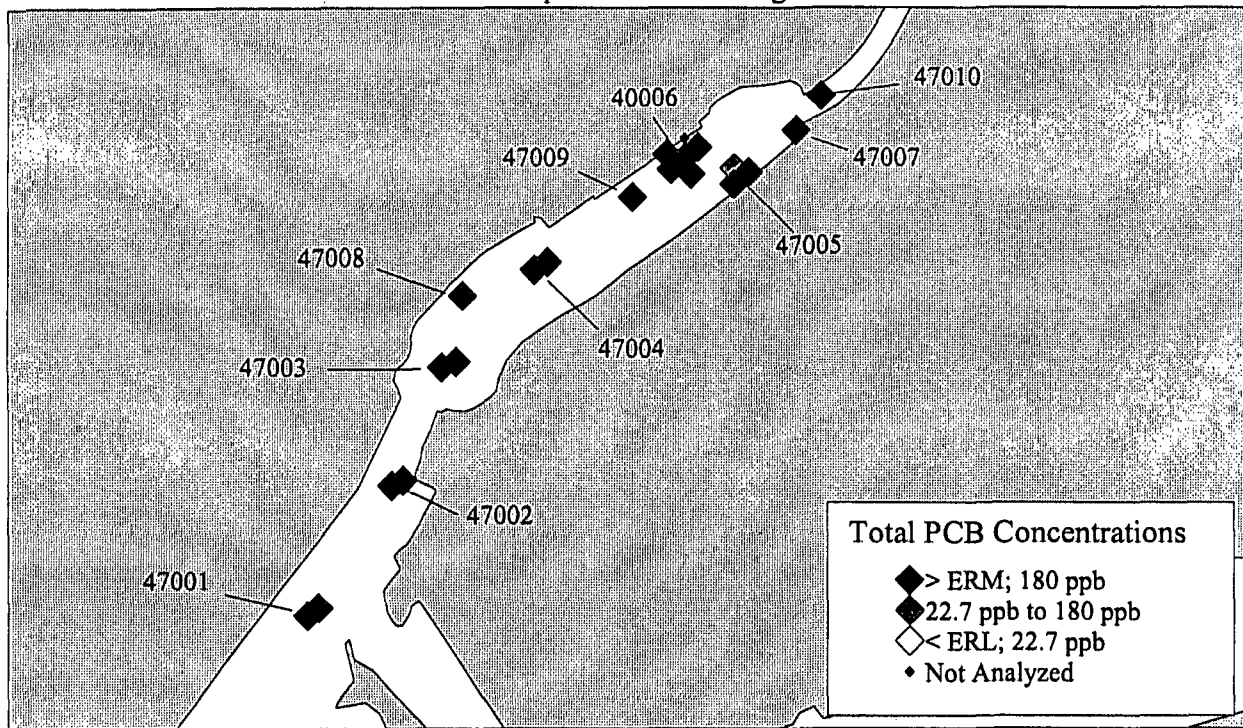
- ◆ > ERM; 180 ppb
- ◆ 22.7 ppb to 180 ppb
- ◇ < ERL; 22.7 ppb
- Not Analyzed

Figures 15a, 15b, and 15c. Distribution of sediment samples in Outer Los Angeles and Long Beach Harbor (a), Port Hueneme (b), and Palos Verdes (c) exceeding the ERM for Total PCB.

Inner Los Angeles/Long Beach Harbor Stations

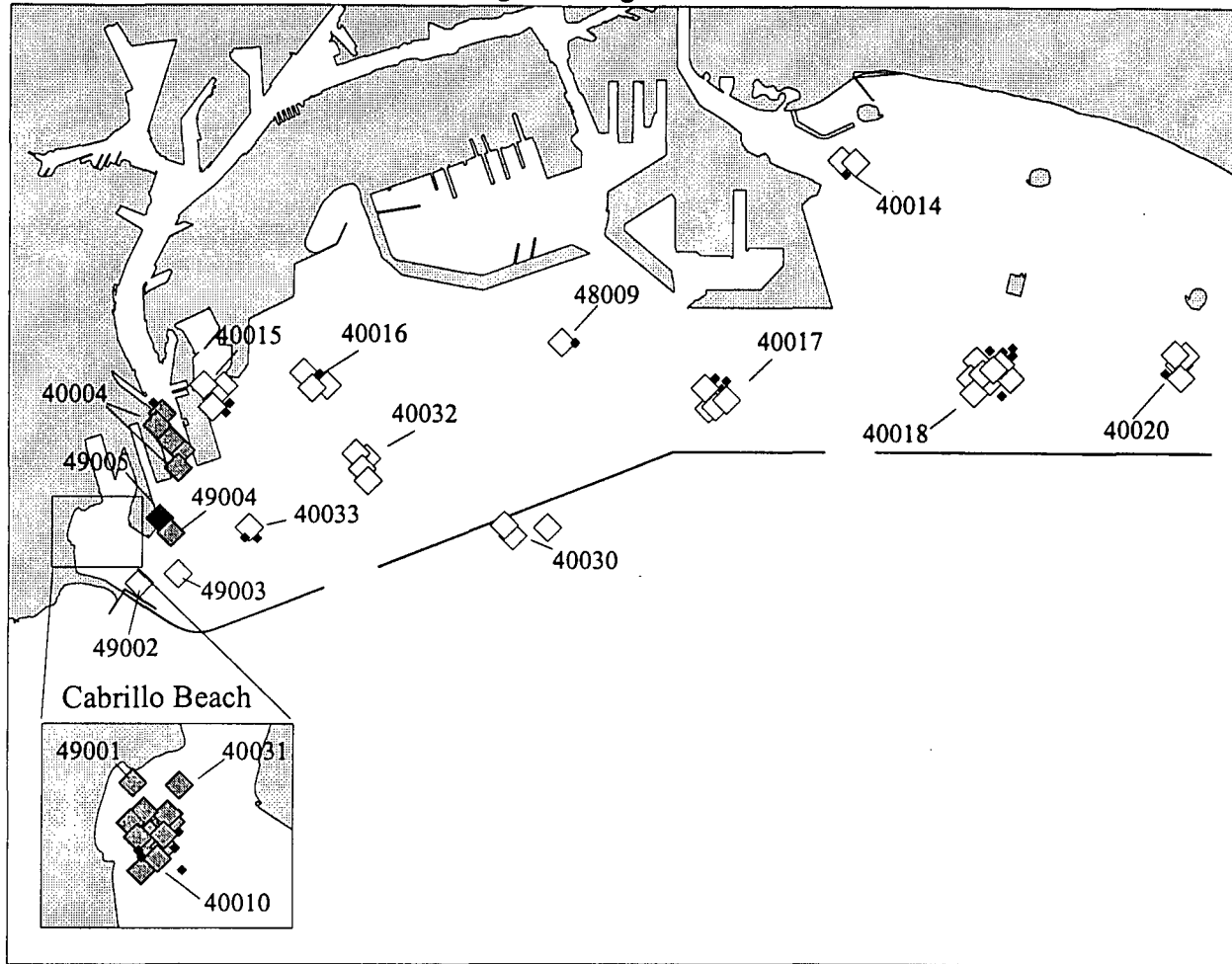


Consolidated Slip of Inner Los Angeles Harbor

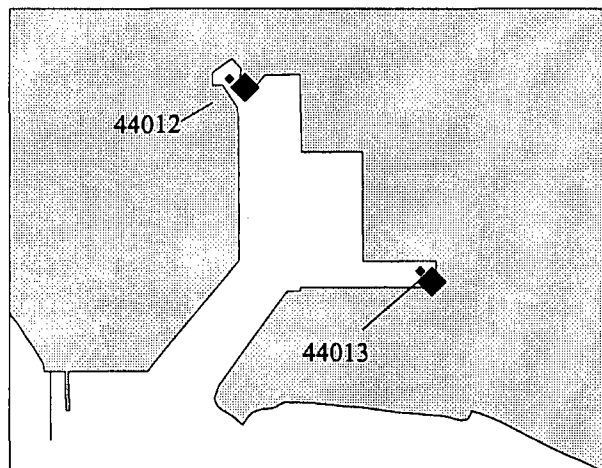


Figures 16a and 16b. Distribution of sediment samples in Inner Los Angeles and Long Beach Harbor (a), and Consolidated Slip (b), exceeding the ERM for Total PCB.

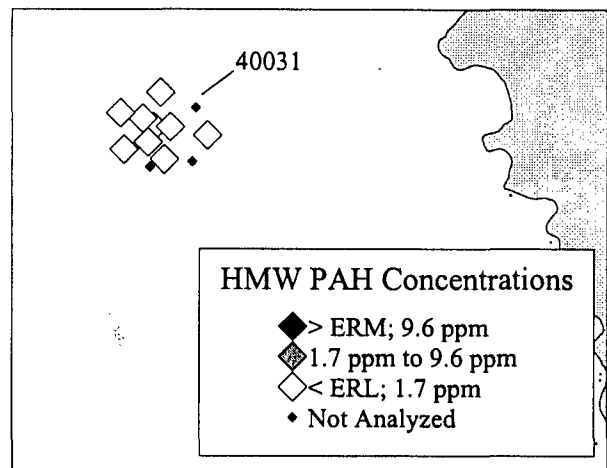
Outer Los Angeles/Long Beach Harbor Stations



Port Hueneme

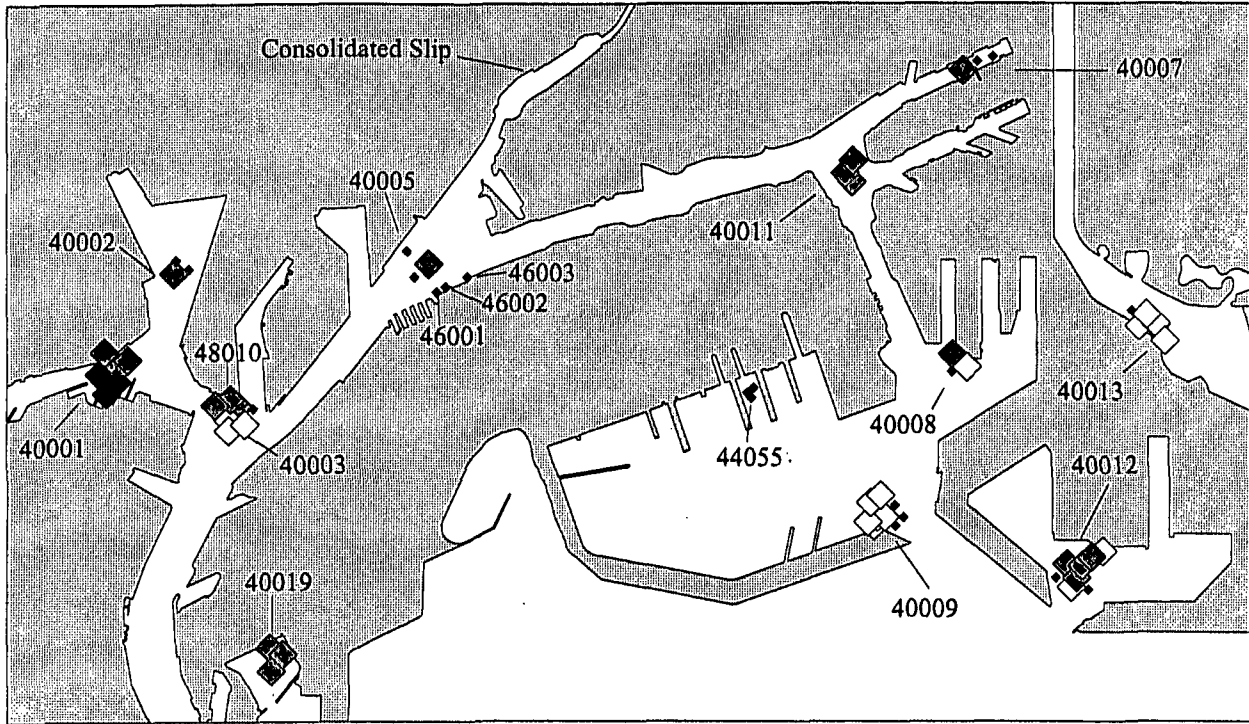


Palos Verdes

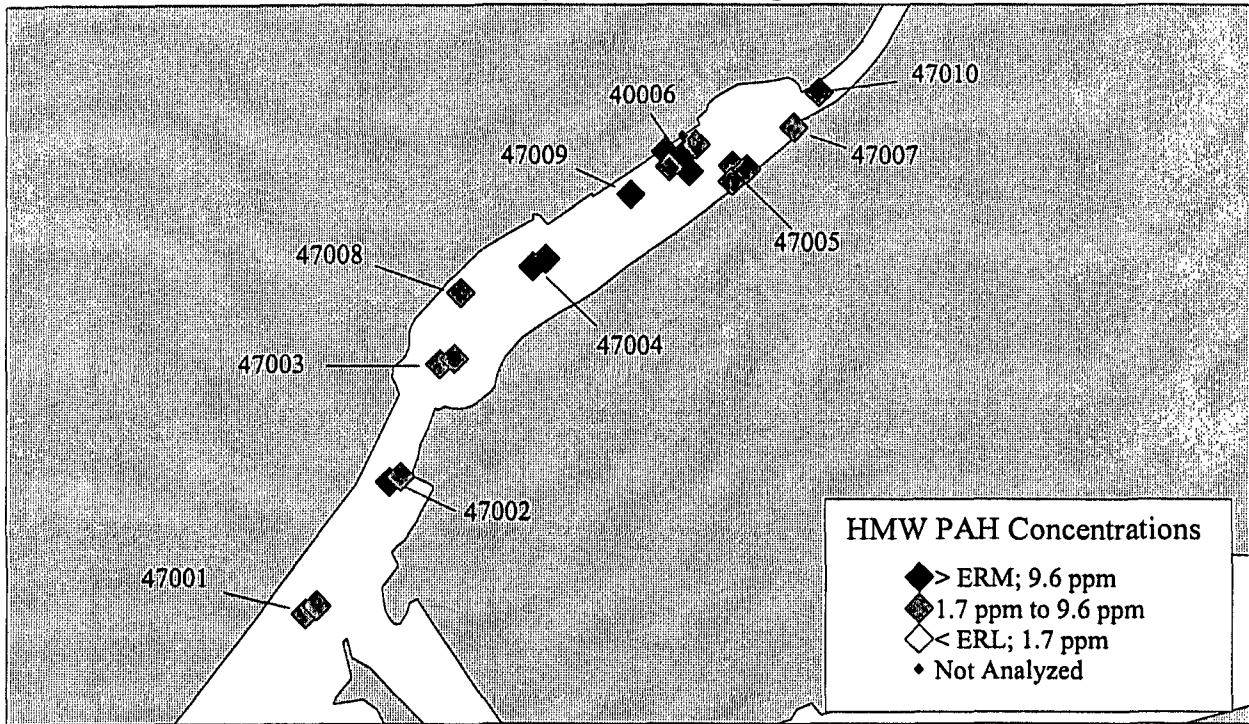


Figures 17a, 17b, and 17c. Distribution of sediment samples in Outer Los Angeles and Long Beach Harbor (a), Port Huéneme (b), and Palos Verdes (c) exceeding the ERM for High Molecular Weight PAH.

Inner Los Angeles/Long Beach Harbor Stations

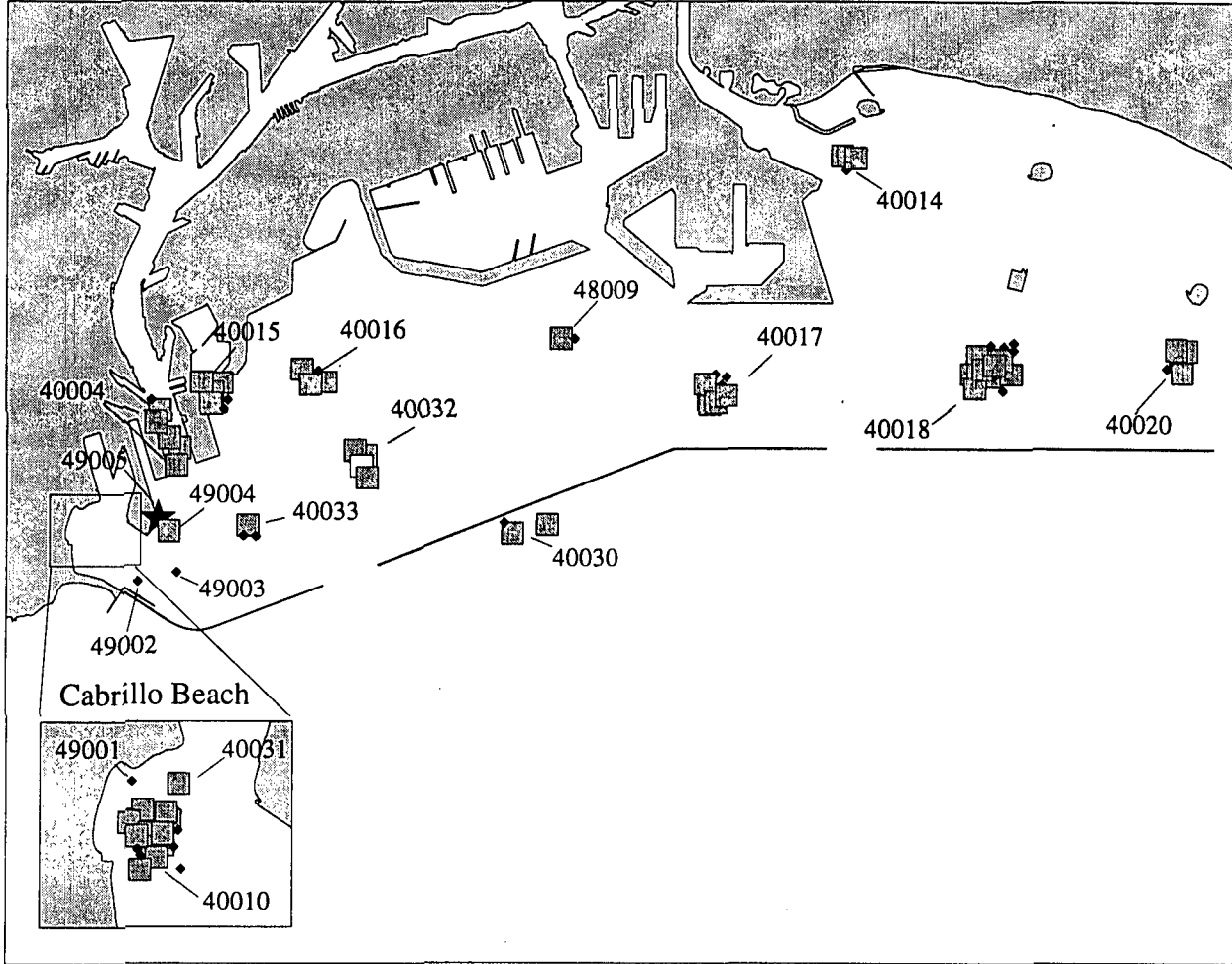


Consolidated Slip of Inner Los Angeles Harbor

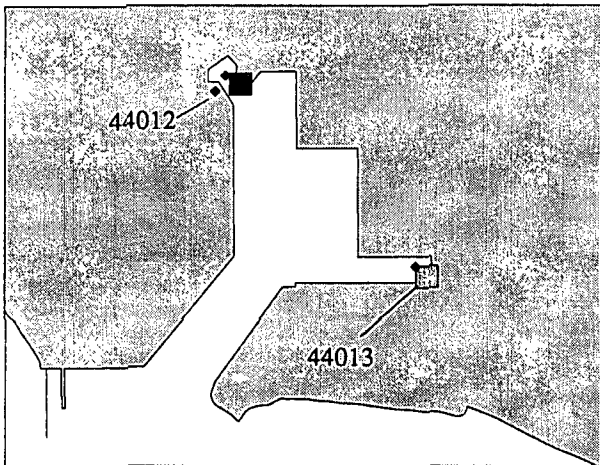


Figures 18a and 18b. Distribution of sediment samples in Inner Los Angeles and Long Beach Harbor (a), and Consolidated Slip (b), exceeding the ERM for High Molecular Weight PAH.

Outer Los Angeles/Long Beach Harbor Stations



Port Hueneme



Palos Verdes

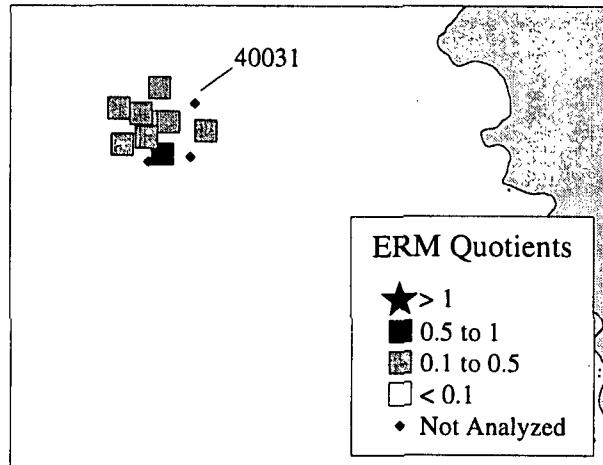
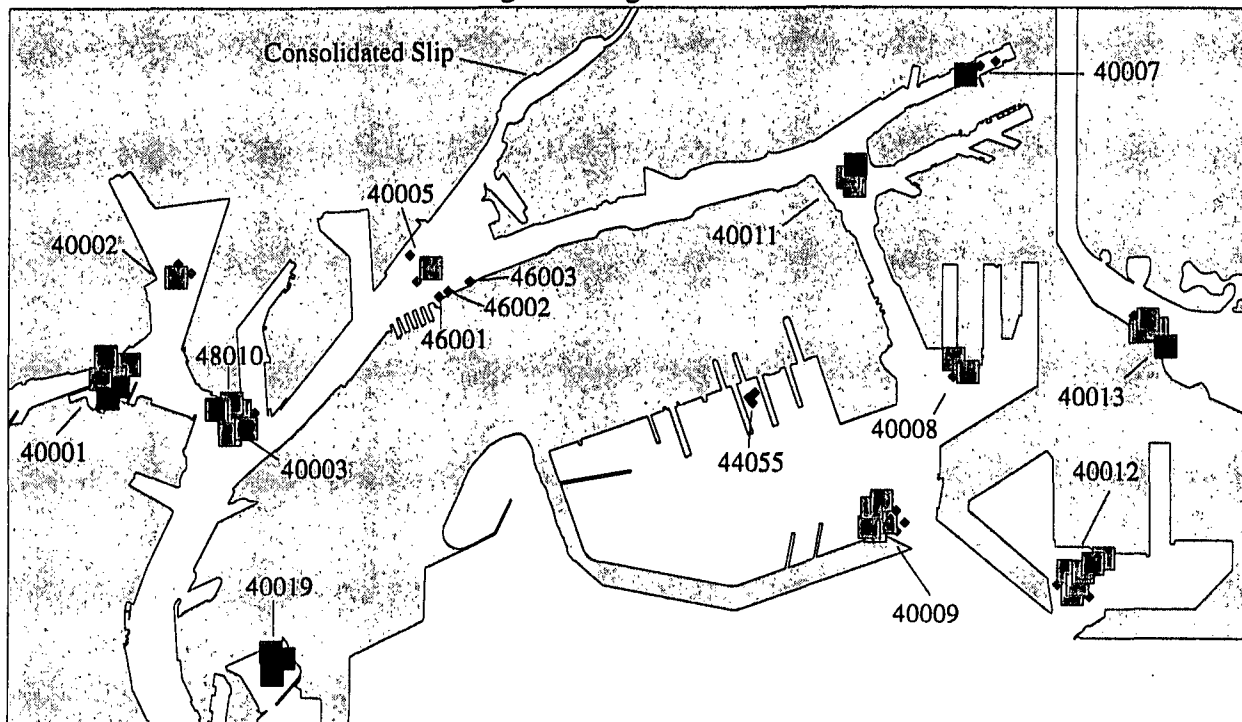


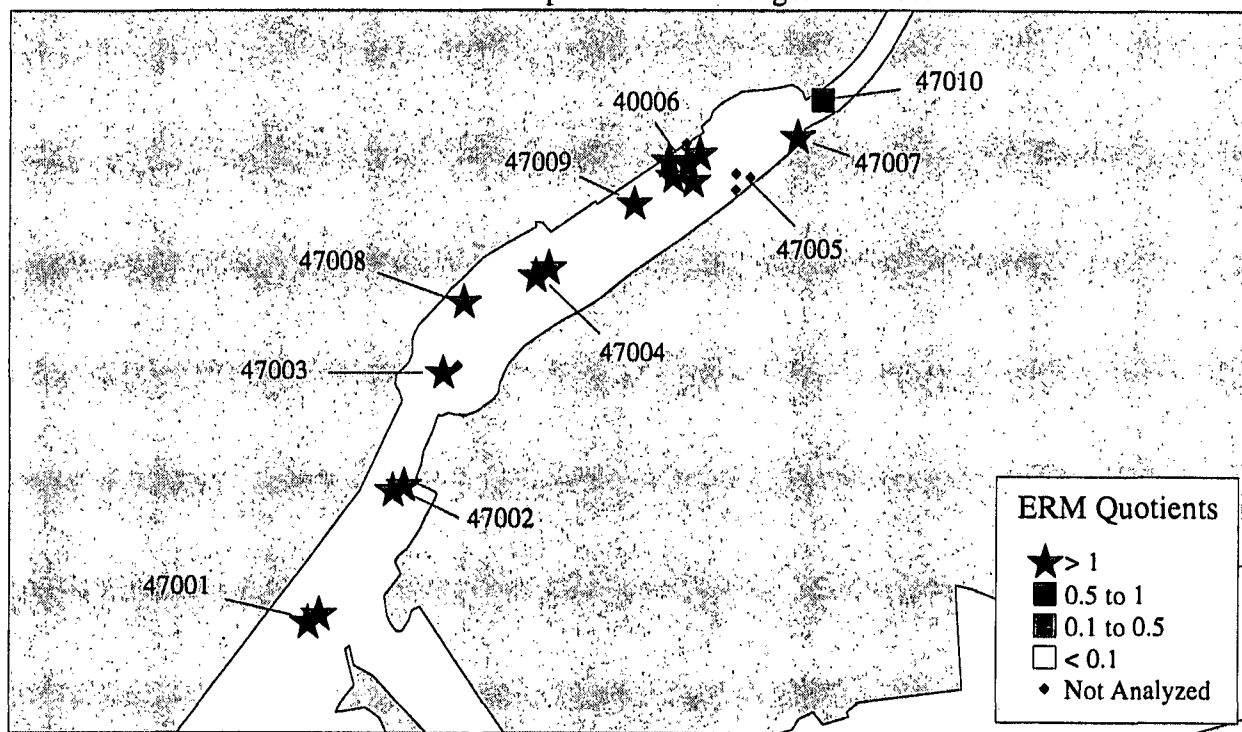
Figure 19a, 19b, and 19c. ERM Quotient values at Outer Los Angeles and Long Beach Harbor (a), Port Hueneme (b), and Palos Verdes (c), Sampling Stations.



### Inner Los Angeles/Long Beach Harbor Stations

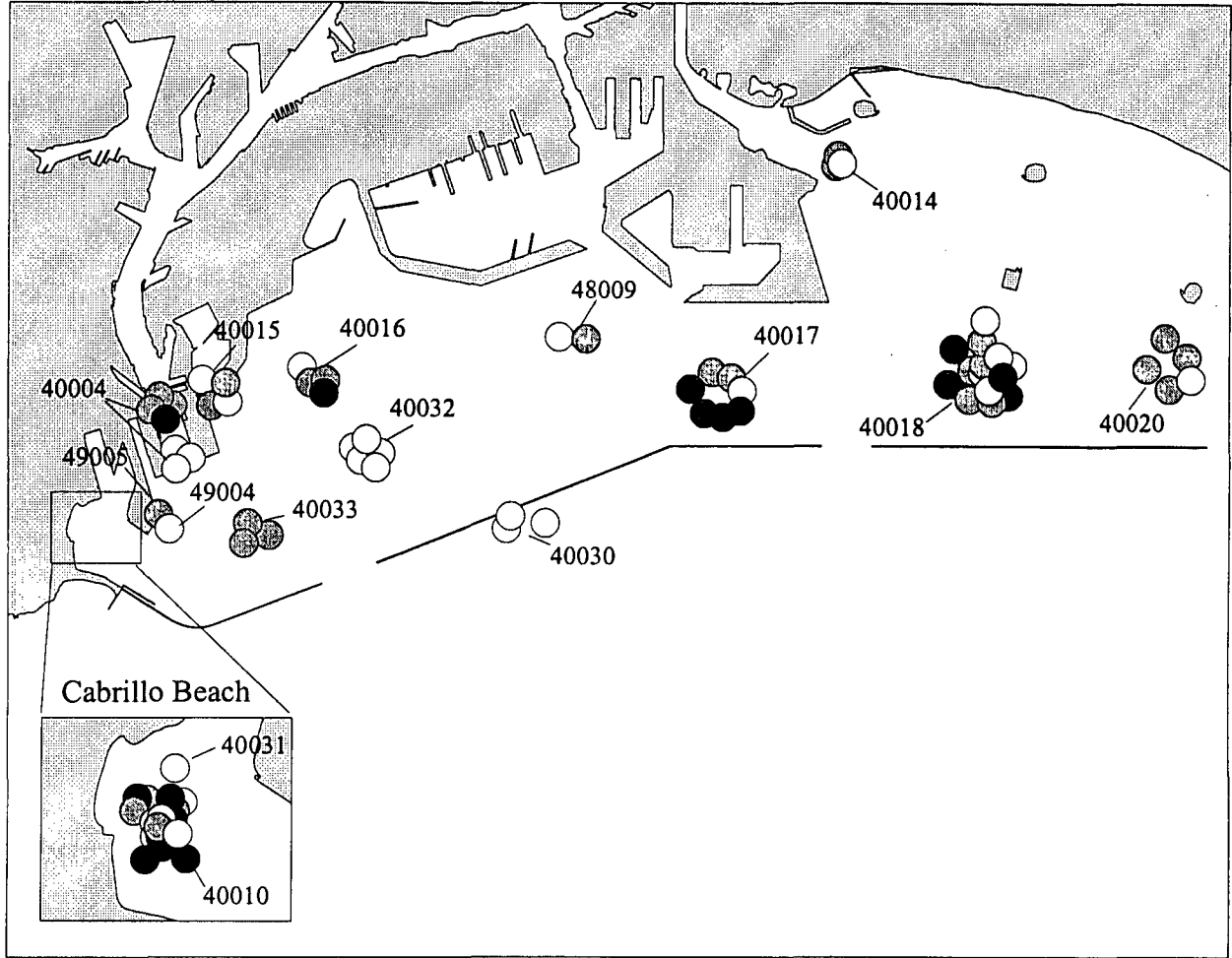


### Consolidated Slip of Inner Los Angeles Harbor

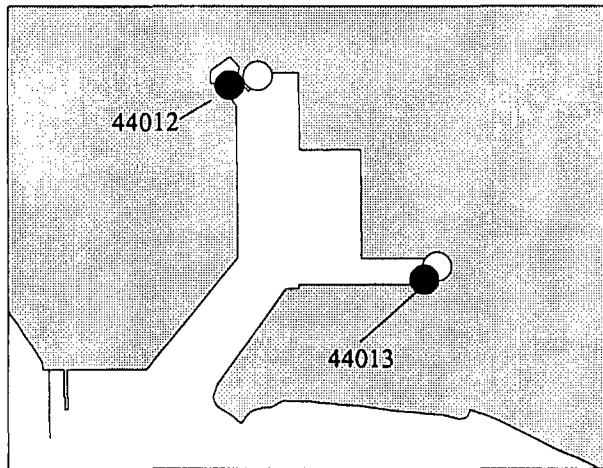


Figures 20a and 20b. ERM Quotient values at Inner Los Angeles and Long Beach Harbor (a), and Consolidated Slip (b), Sampling Stations.

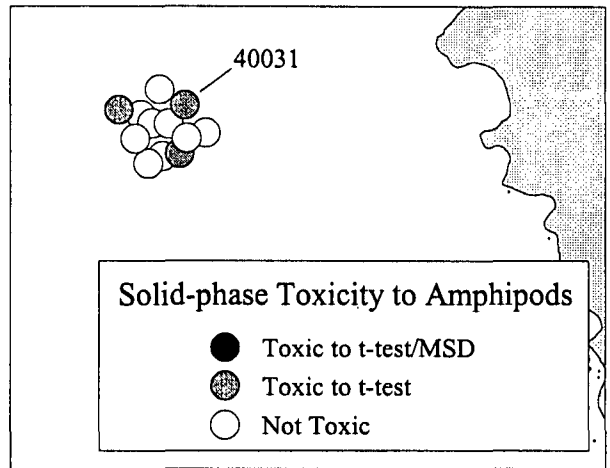
Outer Los Angeles/Long Beach Harbor Stations



Port Hueneme

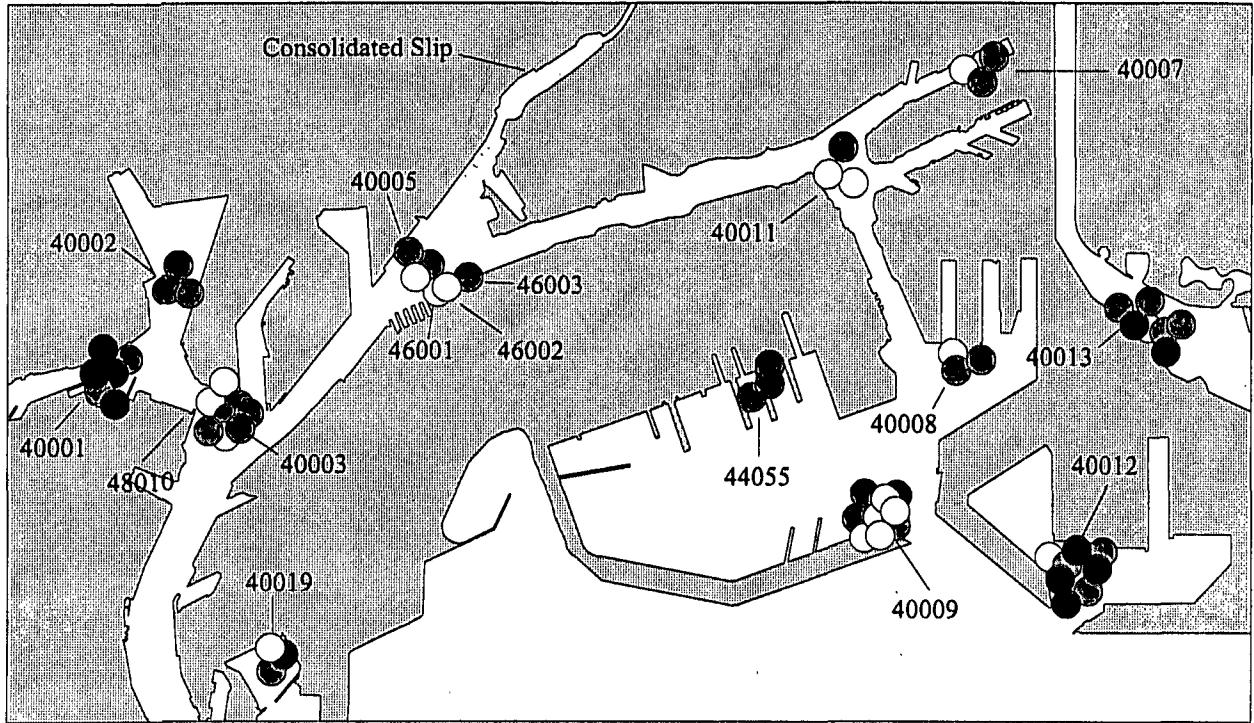


Palos Verdes

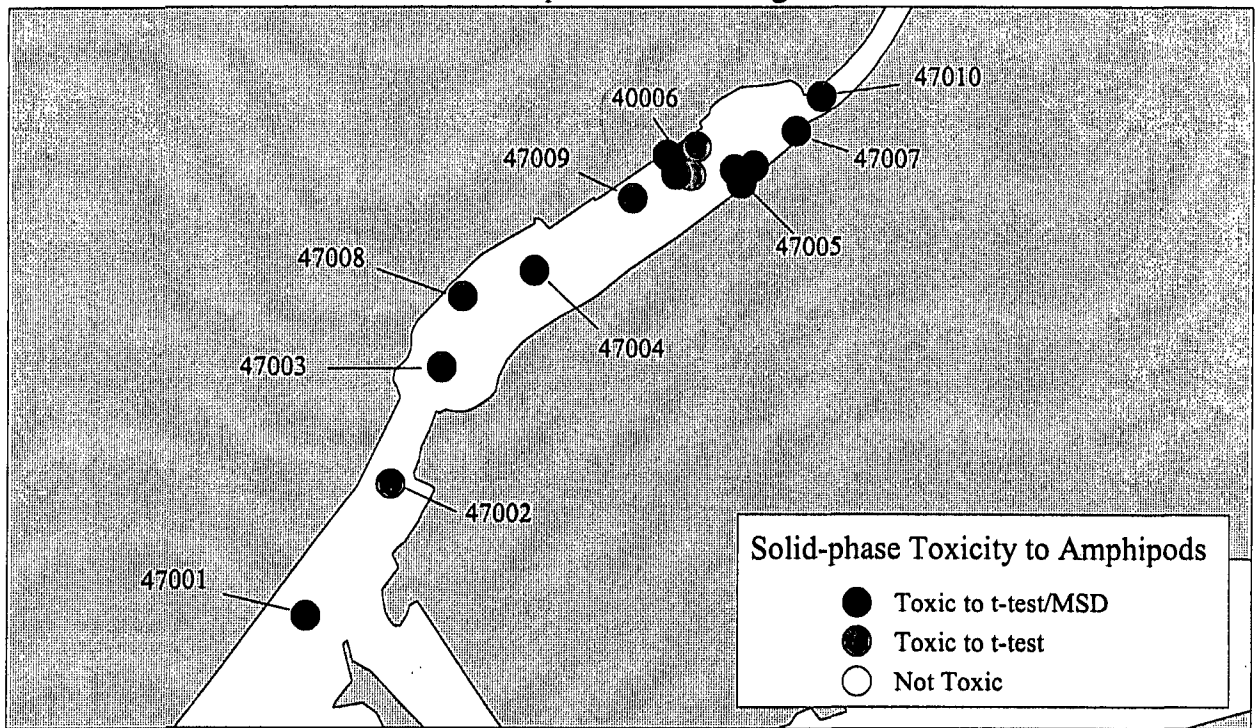


Figures 21a, 21b, and 21c. Toxicity of Sediment Samples in Outer Los Angeles and Long Beach Harbor (a), Port Hueneme (b), and Palos Verdes (c).

Inner Los Angeles/Long Beach Harbor Stations

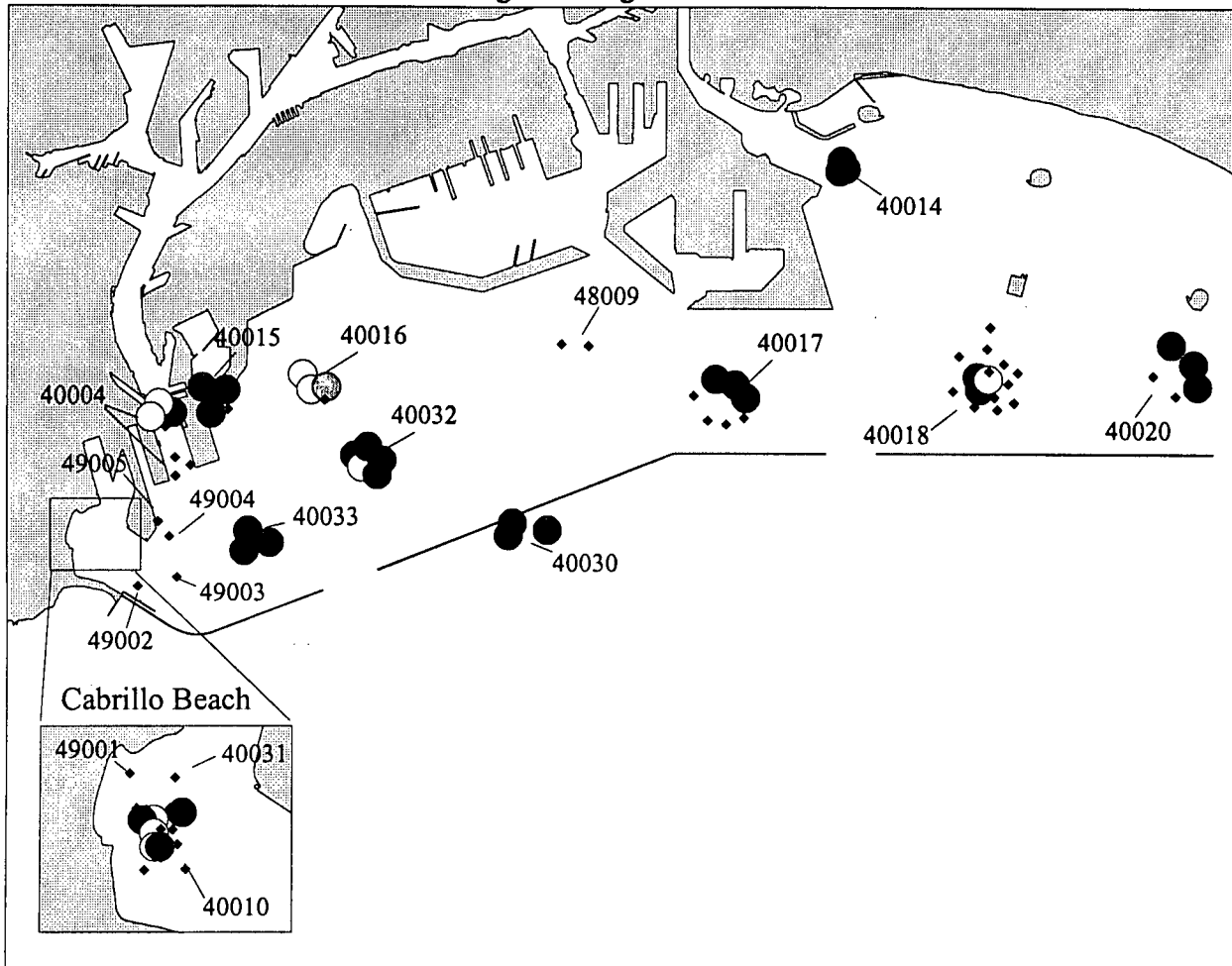


Consolidated Slip of Inner Los Angeles Harbor

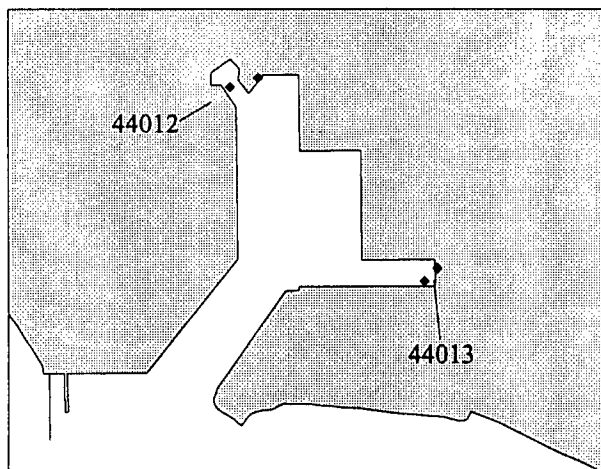


Figures 22a and 22b. Toxicity of Sediment Samples in Inner Los Angeles and Long Beach Harbor (a), and Consolidated Slip (b).

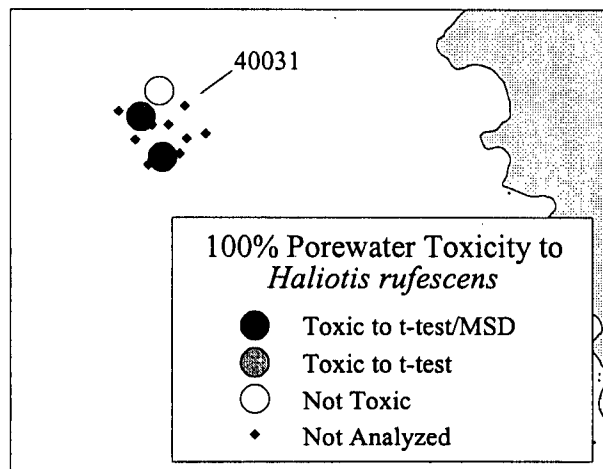
Outer Los Angeles/Long Beach Harbor Stations



Port Hueneme

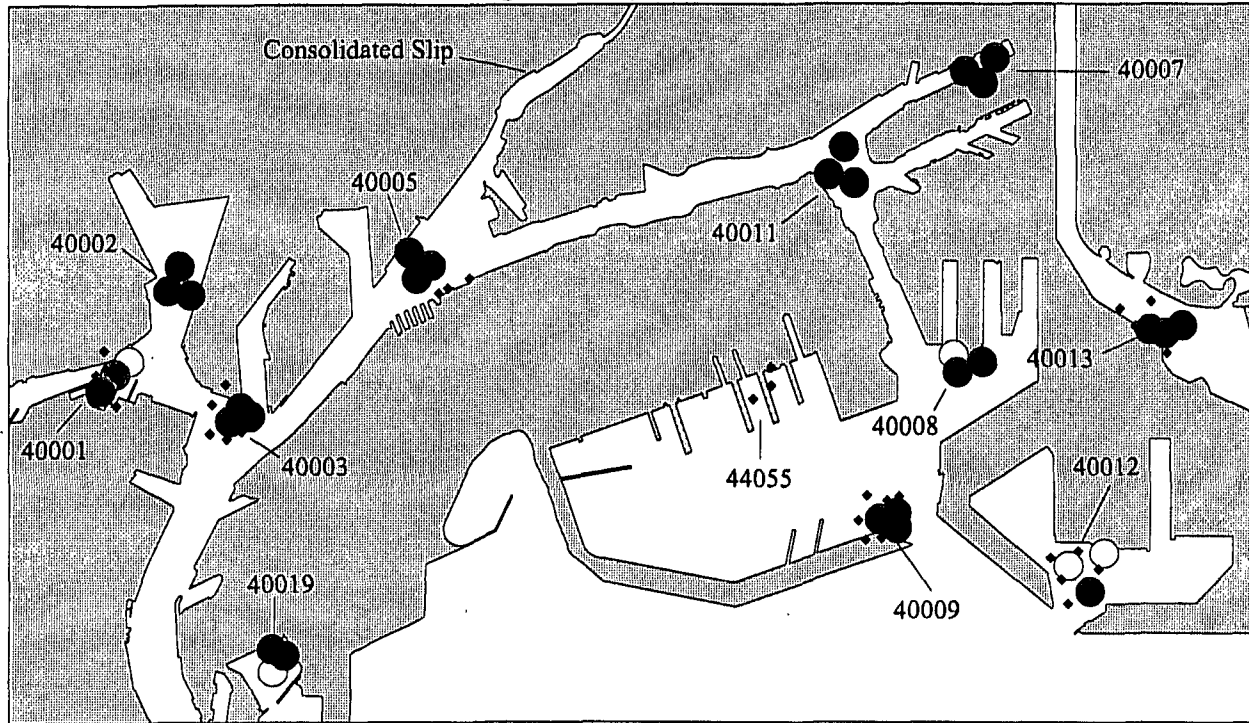


Palos Verdes

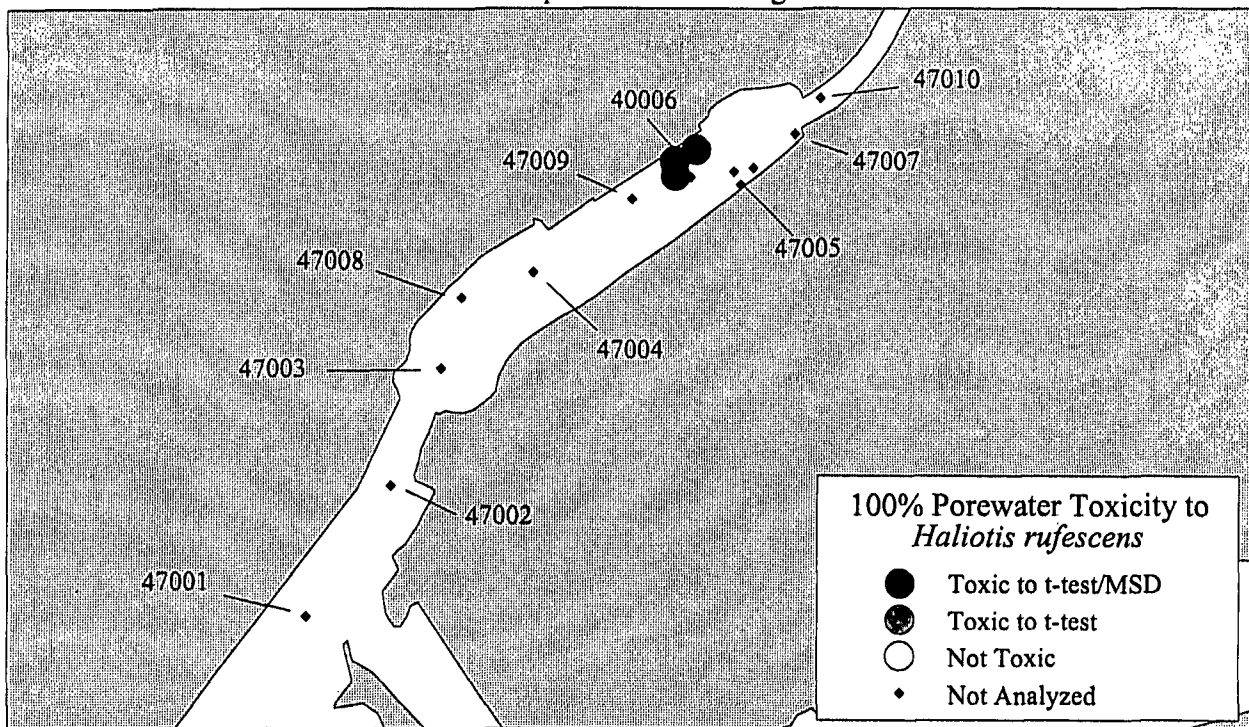


Figures 23a, 23b, and 23c. Toxicity of Porewater Samples in Outer Los Angeles and Long Beach Harbor (a), Port Hueneme (b), and Palos Verdes (c).

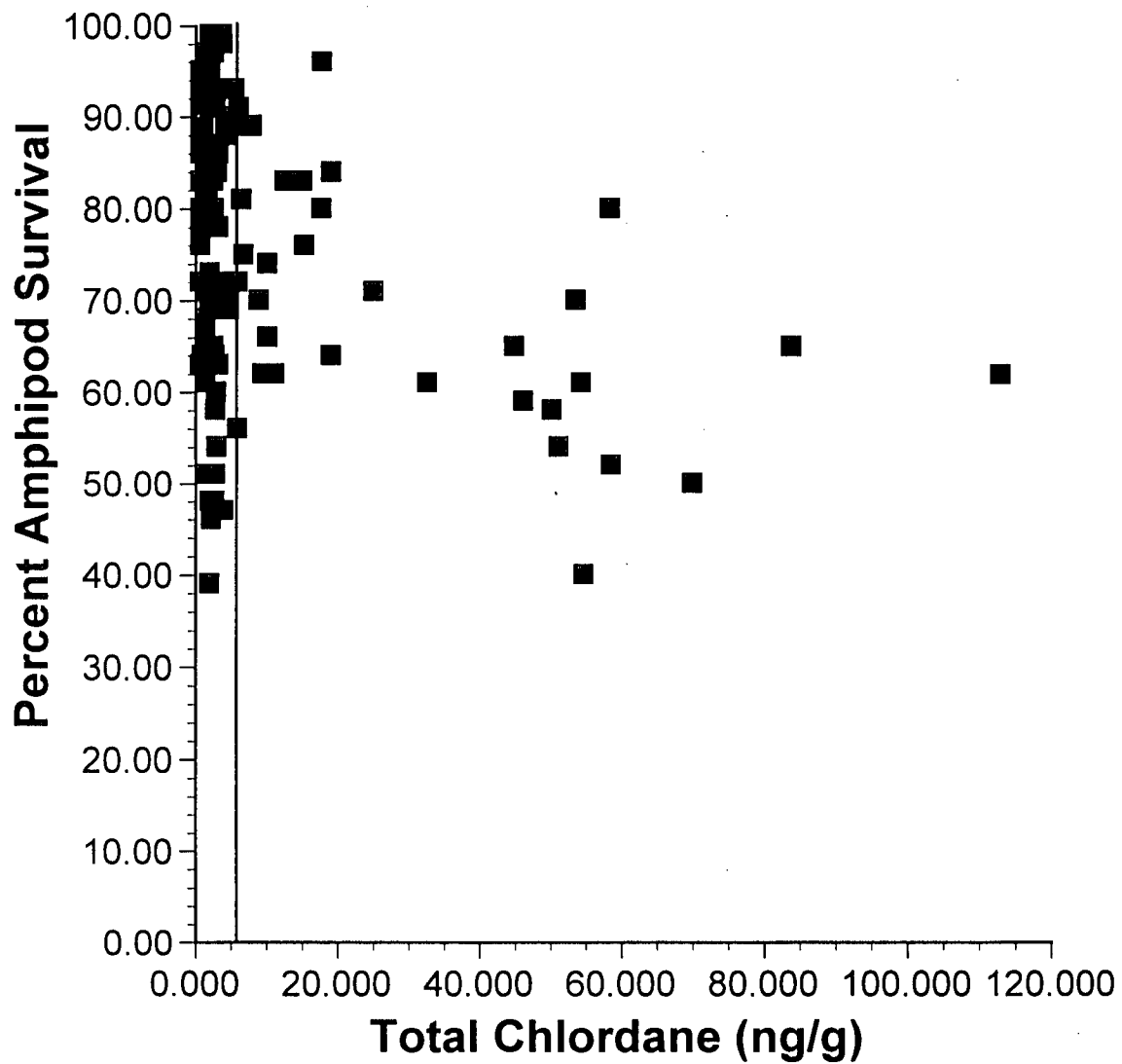
Inner Los Angeles/Long Beach Harbor Stations



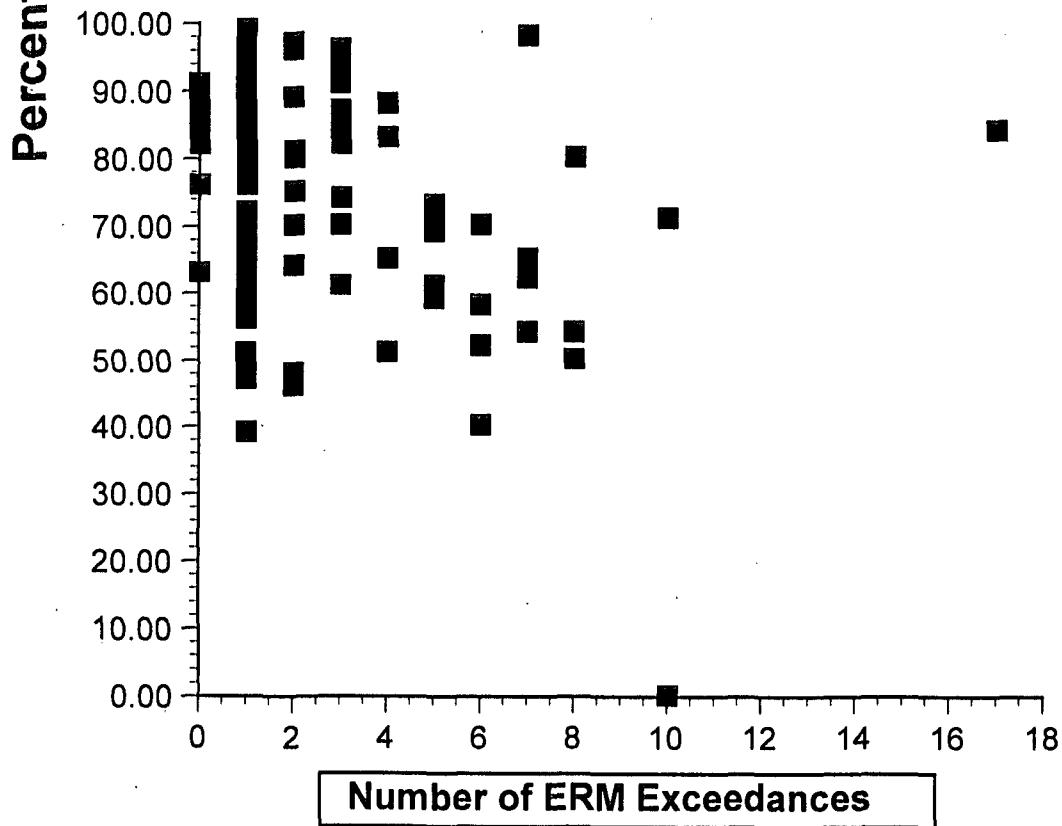
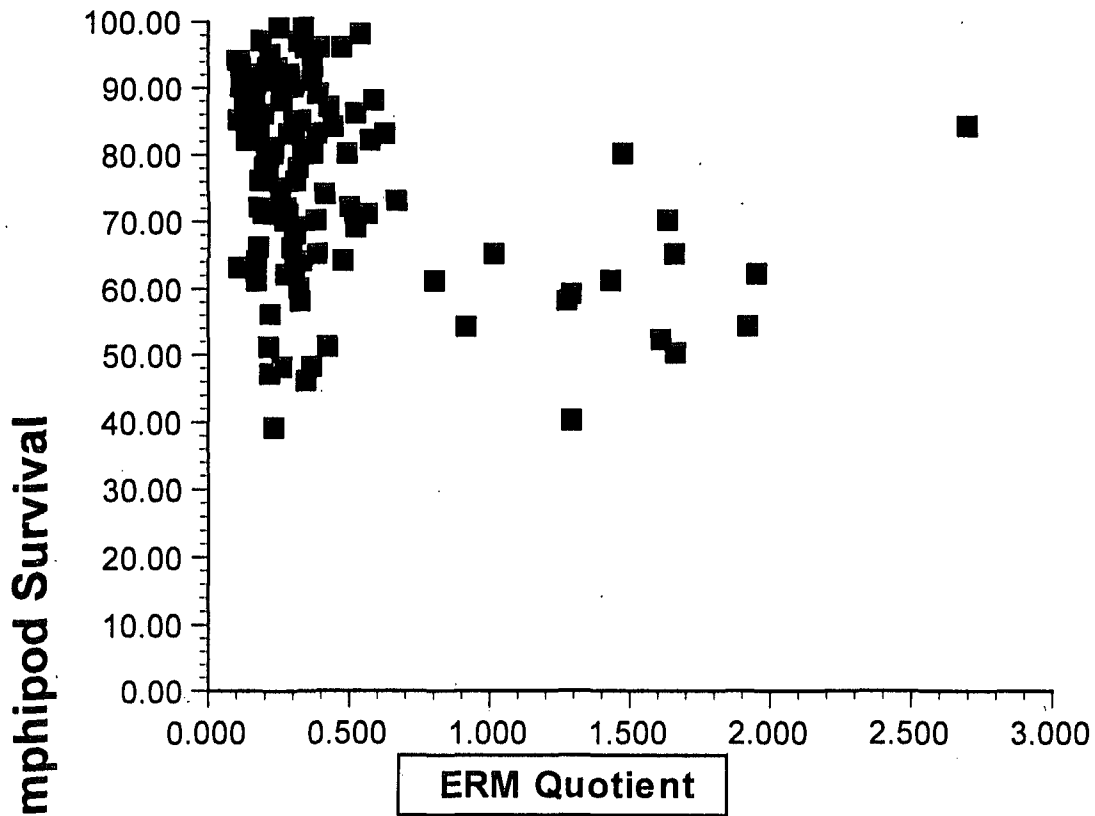
Consolidated Slip of Inner Los Angeles Harbor



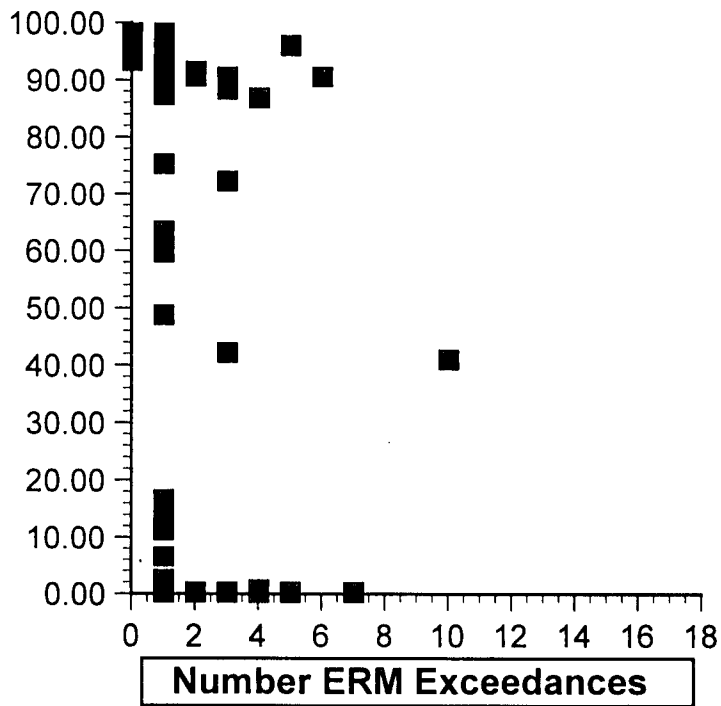
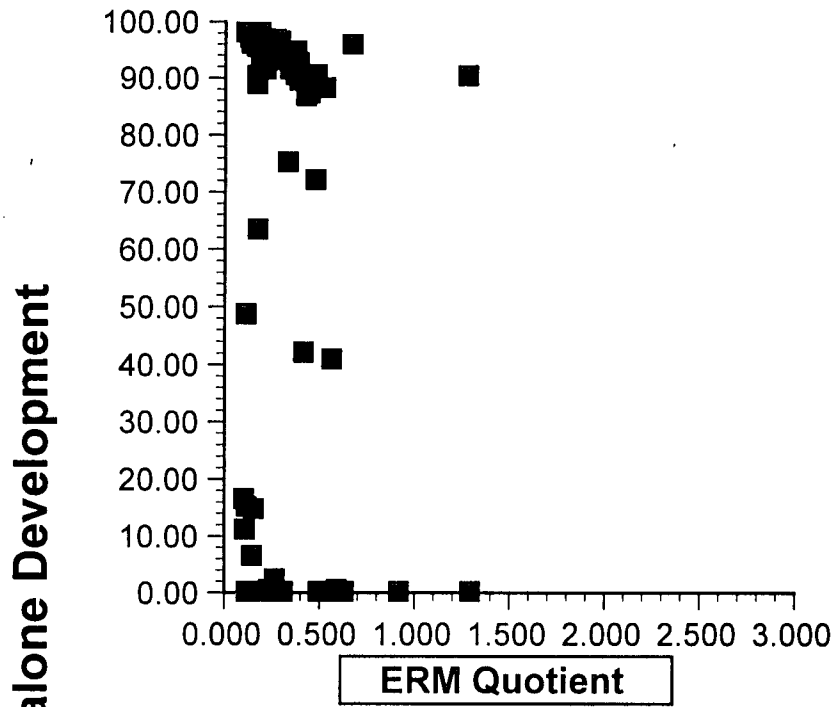
Figures 24a and 24b. Toxicity of Porewater Samples in Inner Los Angeles and Long Beach Harbor (a), and Consolidated Slip (b).



**Figure 25.** Amphipod survival at Industrial Harbor stations in relation to Total Chlordane concentrations. Vertical line indicates ERM value.

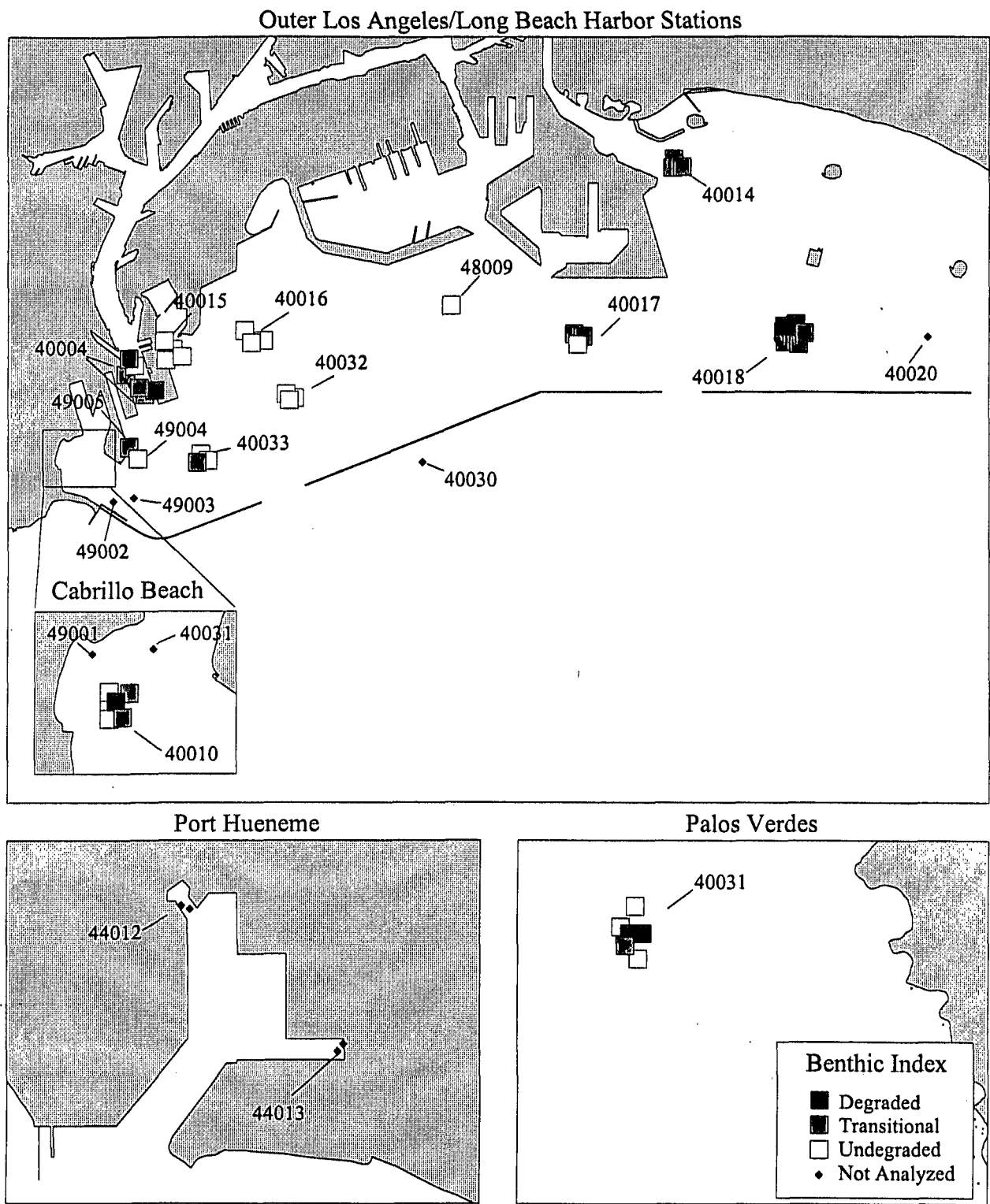


**Figure 26.** Amphipod survival at Industrial Harbor stations in relation to average ERM Quotient and Number of ERM Exceedances.



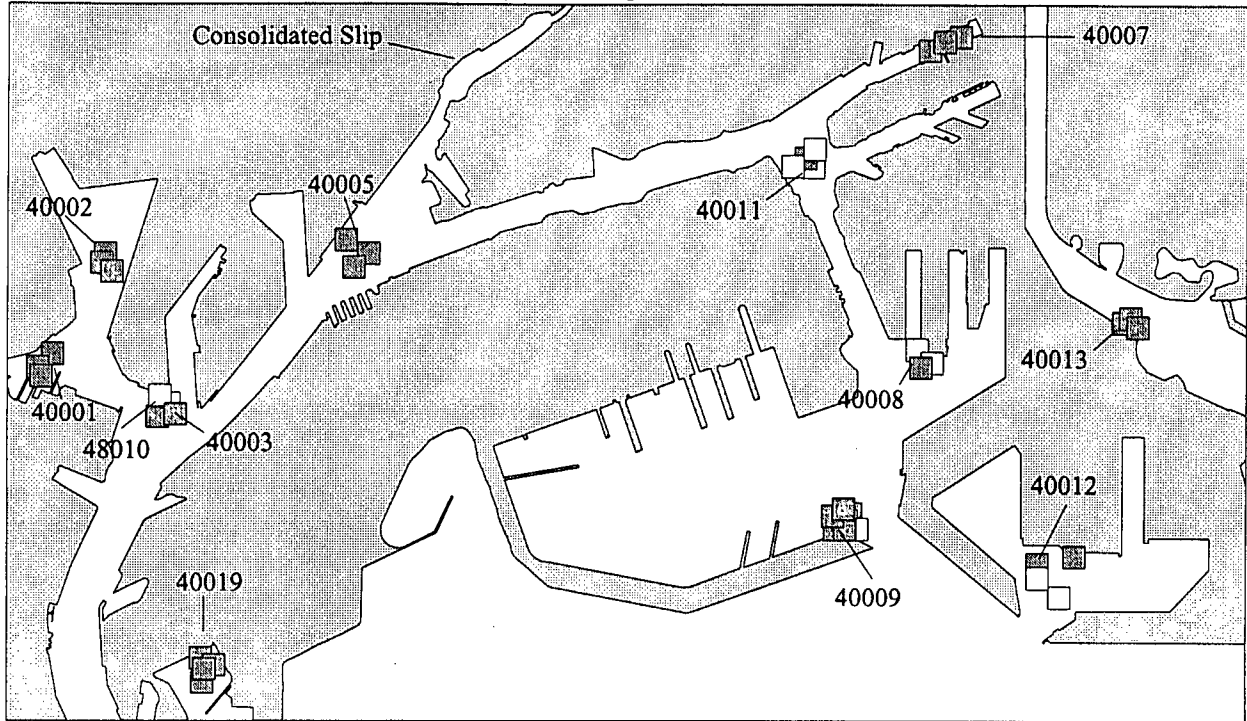
**Figure 27.** Relationship between abalone development in 50% pore water concentration, average ERM Quotient, and Number of ERM Exceedances at Industrial Harbor stations.



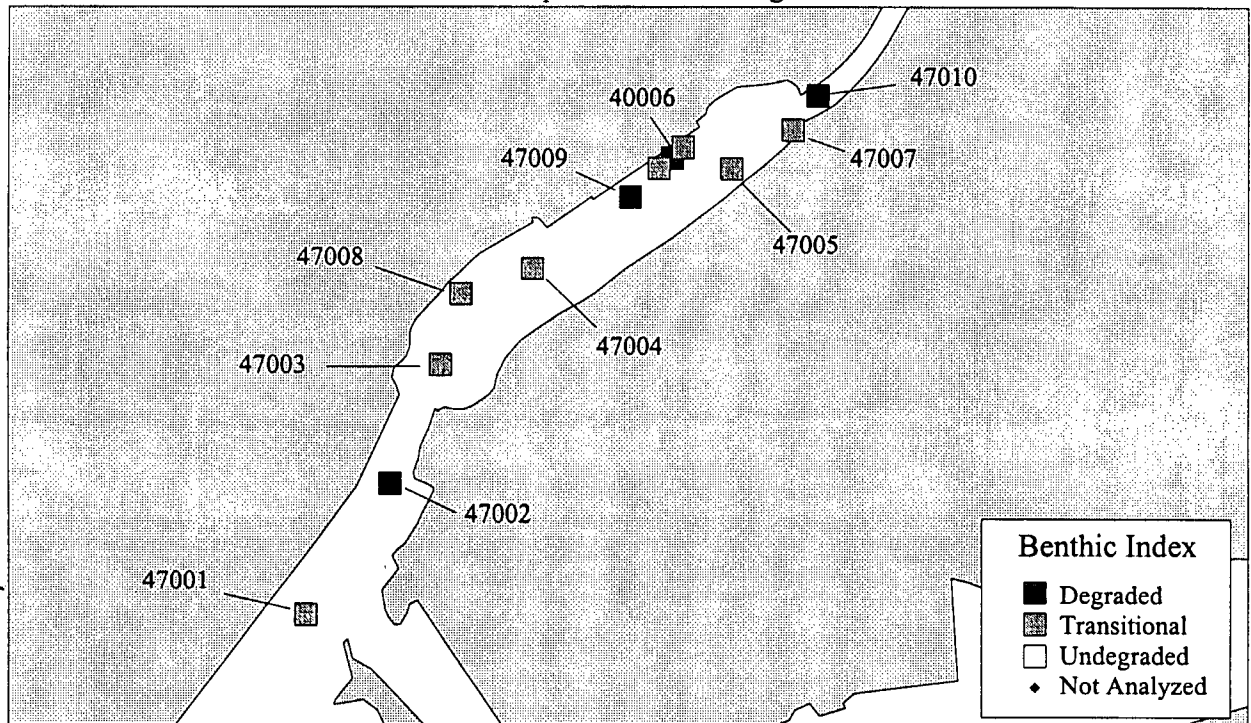


Figures 28a, 28b, and 28c. Distribution of Stations in Outer Los Angeles and Long Beach Harbor (a), Port Hueneme (b), and Palos Verdes (c), Demonstrating Benthic Community Structure.

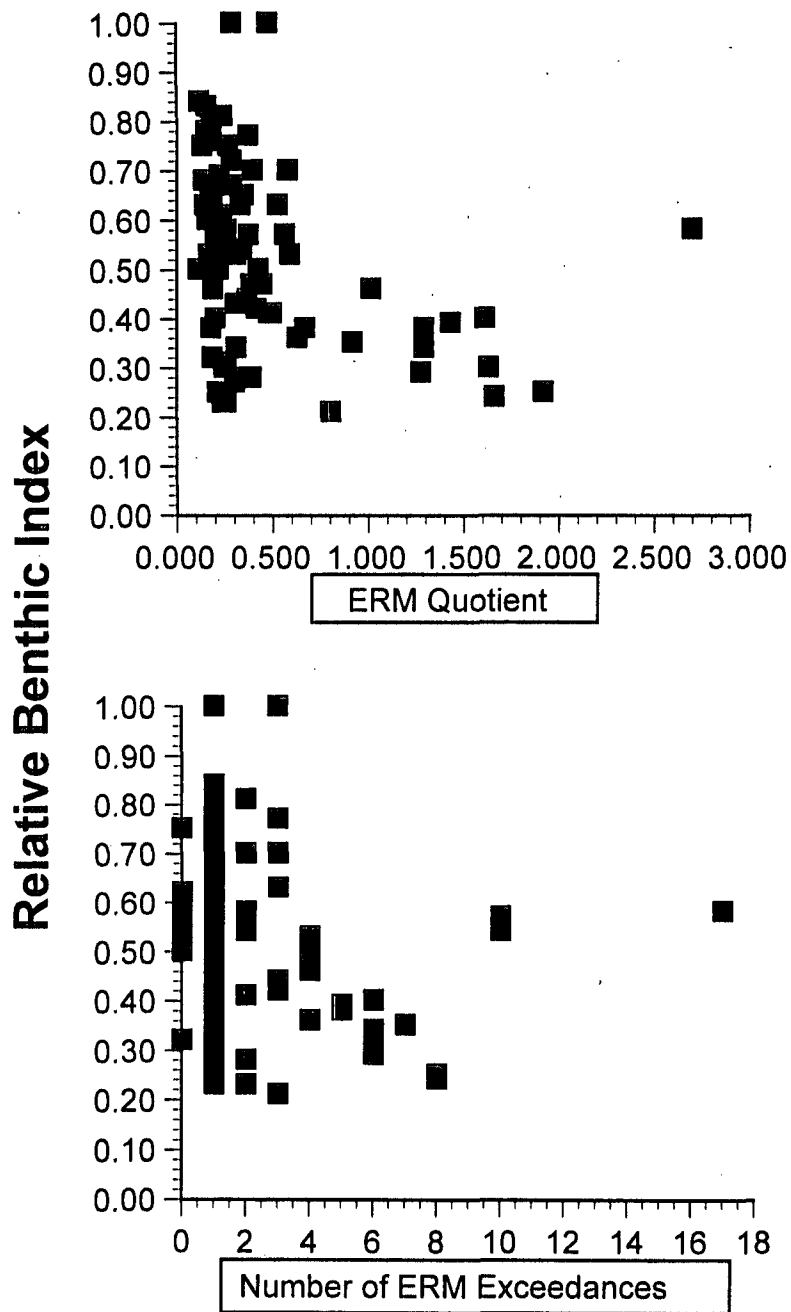
### Inner Los Angeles/Long Beach Harbor Stations



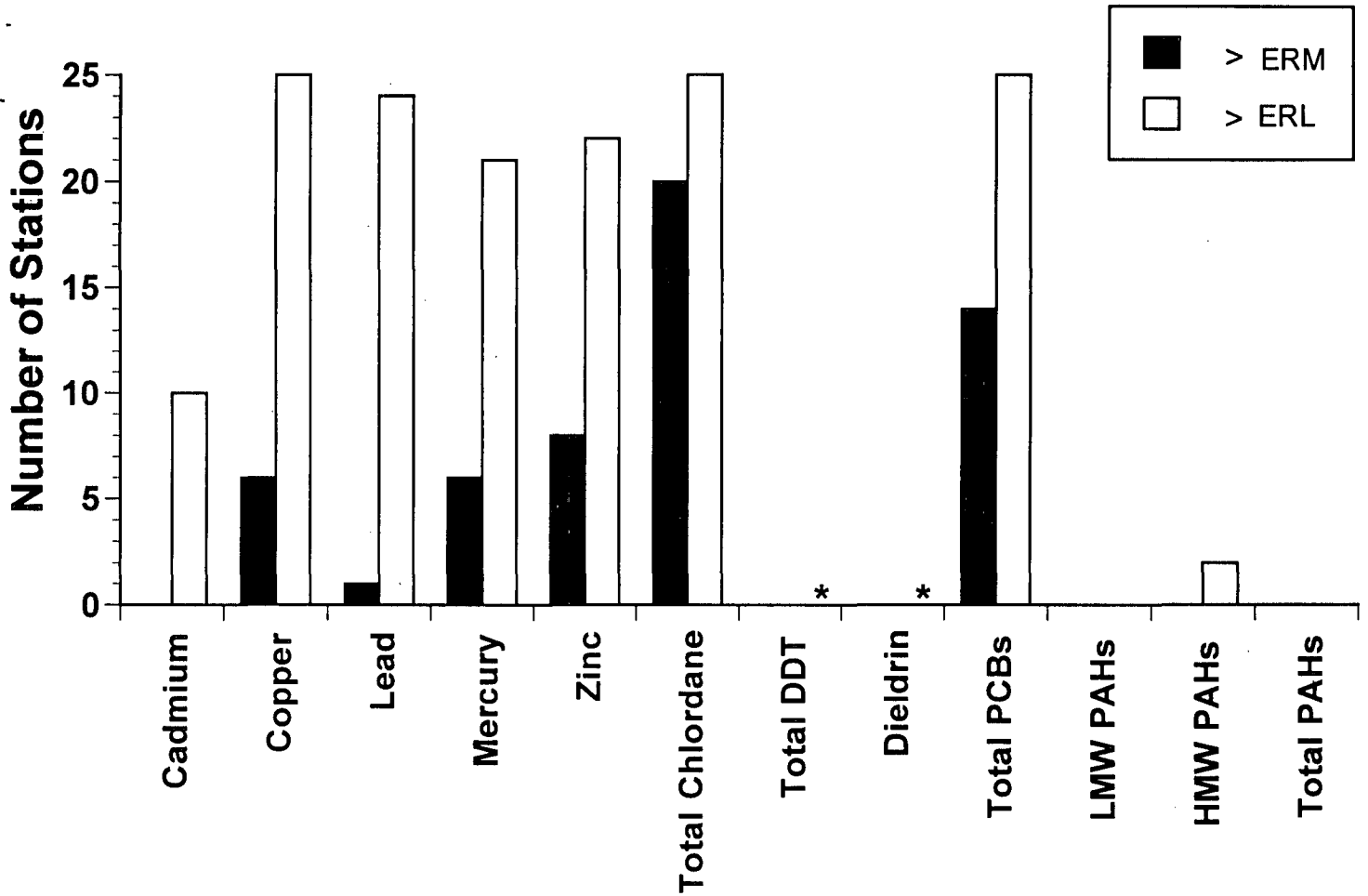
### Consolidated Slip of Inner Los Angeles Harbor



Figures 29a and 29b. Distribution of Stations in Inner Los Angeles and Long Beach Harbor (a), and Consolidated Slip (b), Demonstrating Benthic Community Structure.

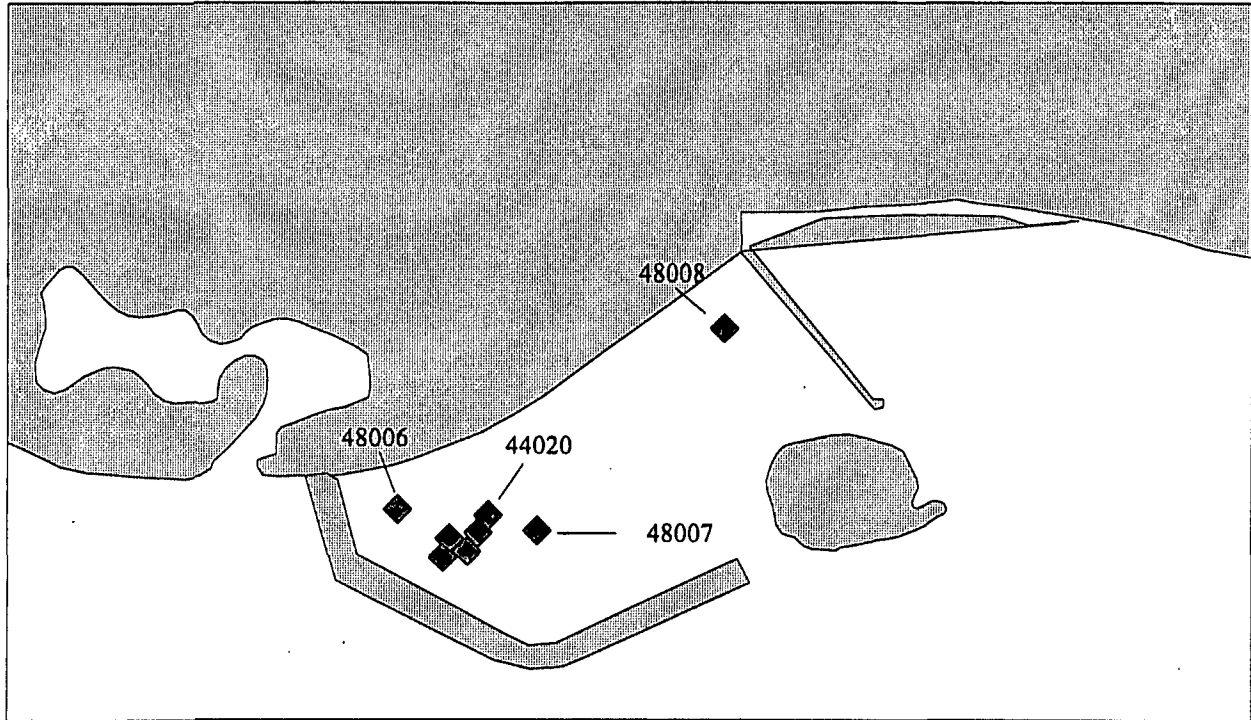


**Figure 30.** Relative Benthic Index at Industrial Harbor stations in relation to ERM Quotient and Number of ERM Exceedances

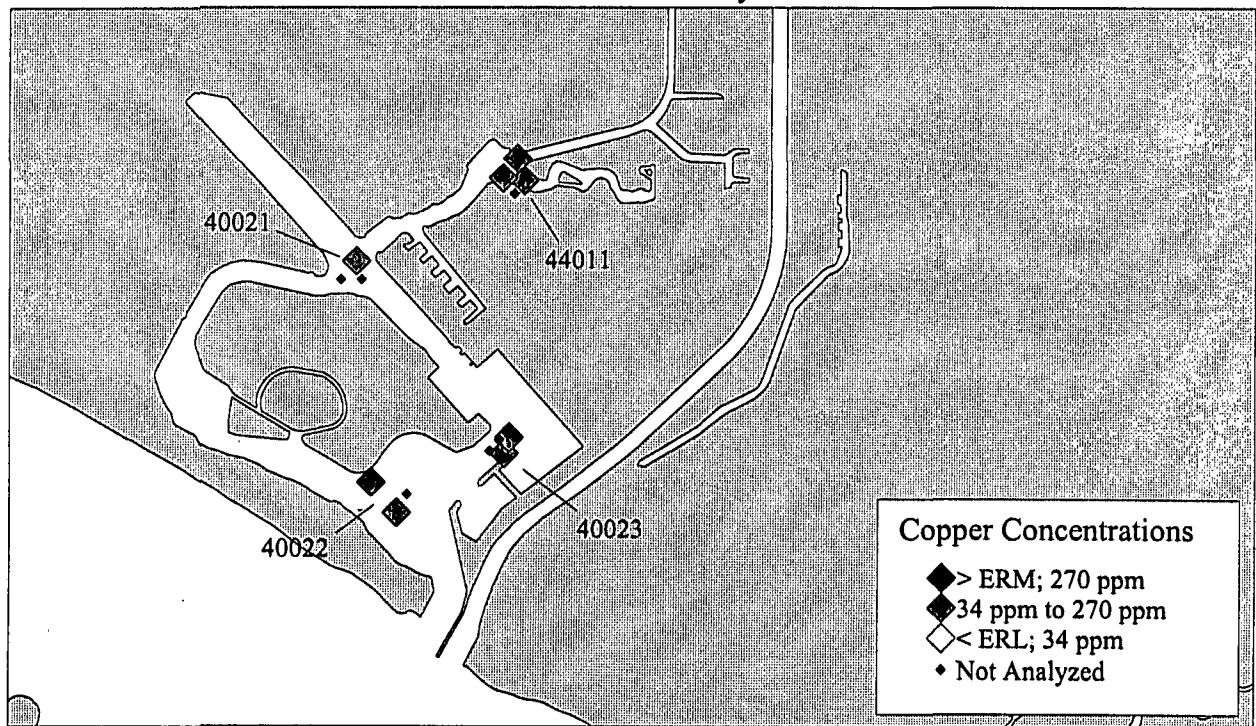


**Figure 31 .** Number of Marina station samples exceeding either the ERM or ERL sediment quality guidelines. (Total DDT was compared to the Swartz *et al.* sediment effect concentration, 100 ug/g OC. \* no ERL exceedances were calculated for Total DDT or Dieldrin; see text for details).

### Shoreline Marina

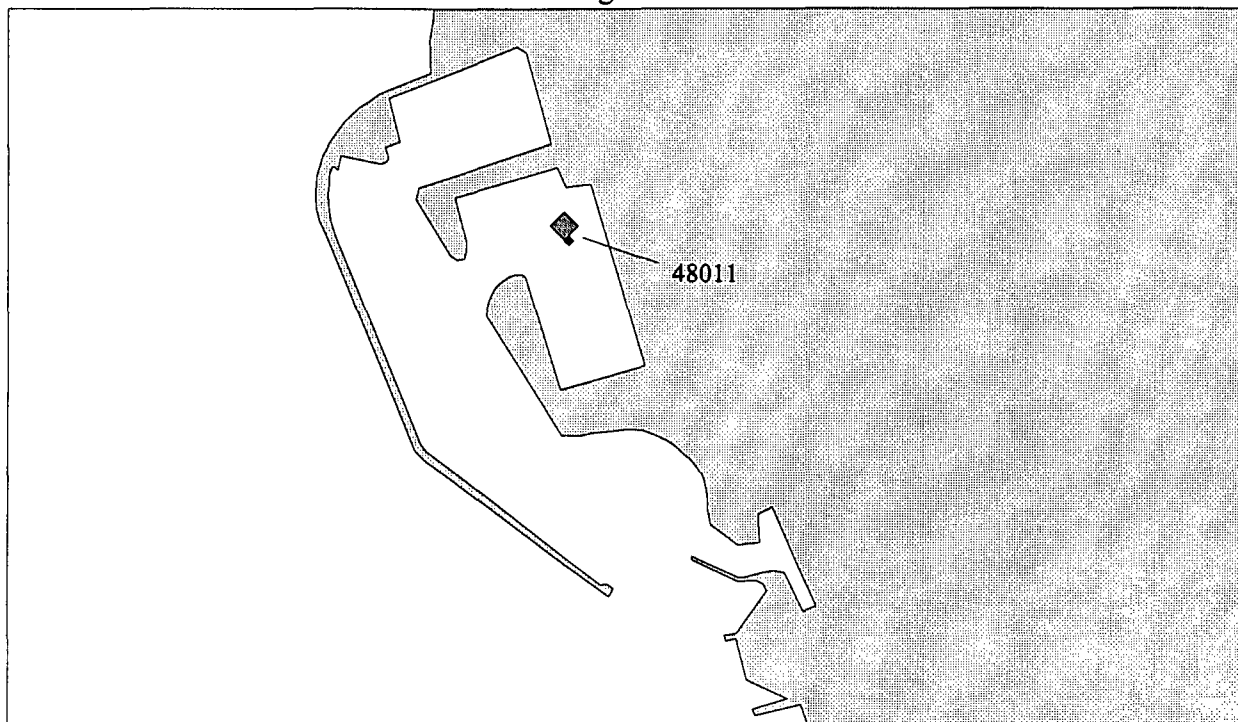


### Los Alamitos Bay

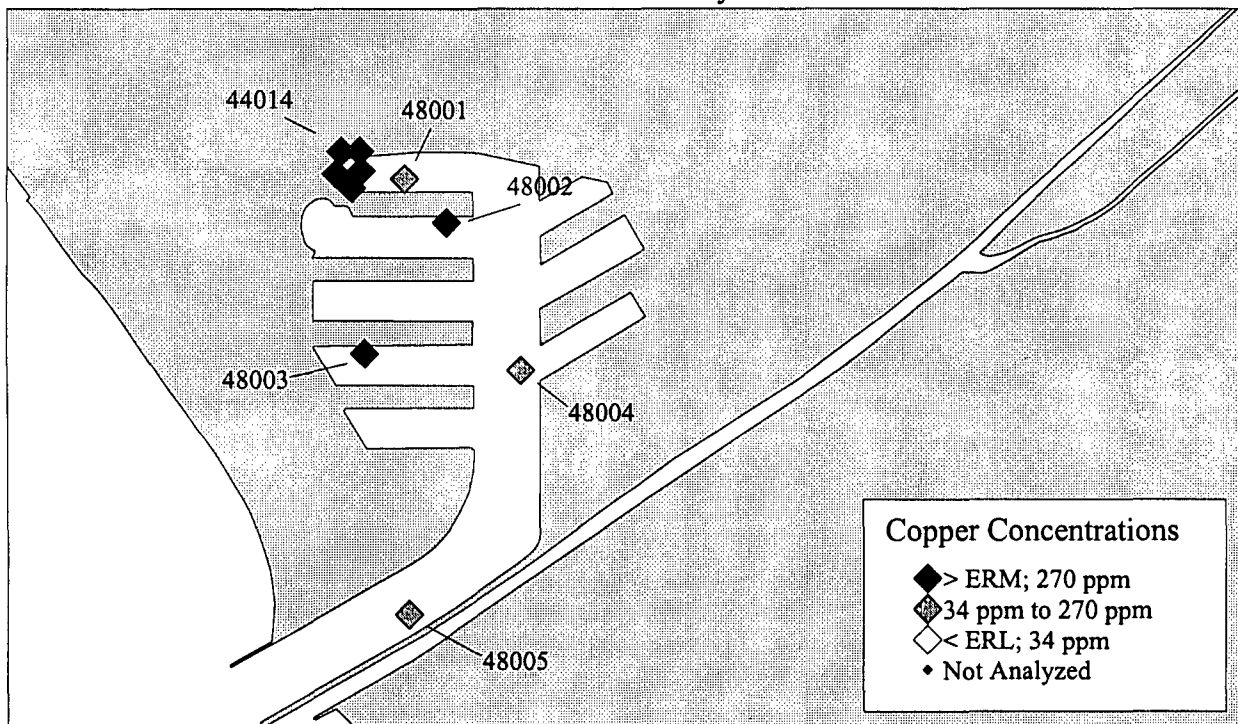


Figures 32a and 32b. Distribution of samples in Shoreline Marina (a), and Los Alamitos Bay (b), exceeding the ERM for Copper.

### King Harbor



### Marina Del Rey



Figures 33a and 33b. Distribution of samples in King Harbor (a), and Marina Del Rey (b), exceeding the ERM for Copper.

# Channel Islands Harbor

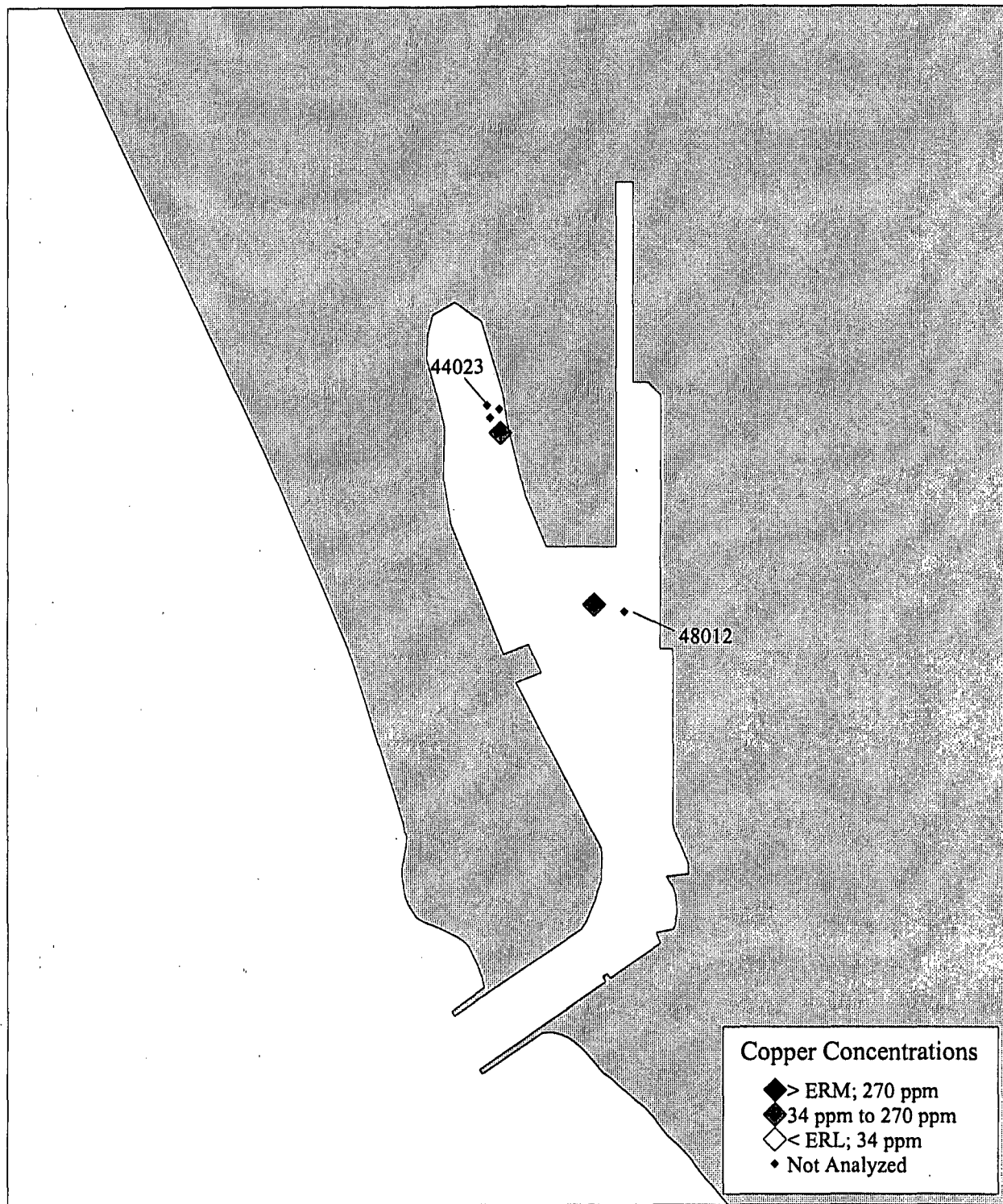
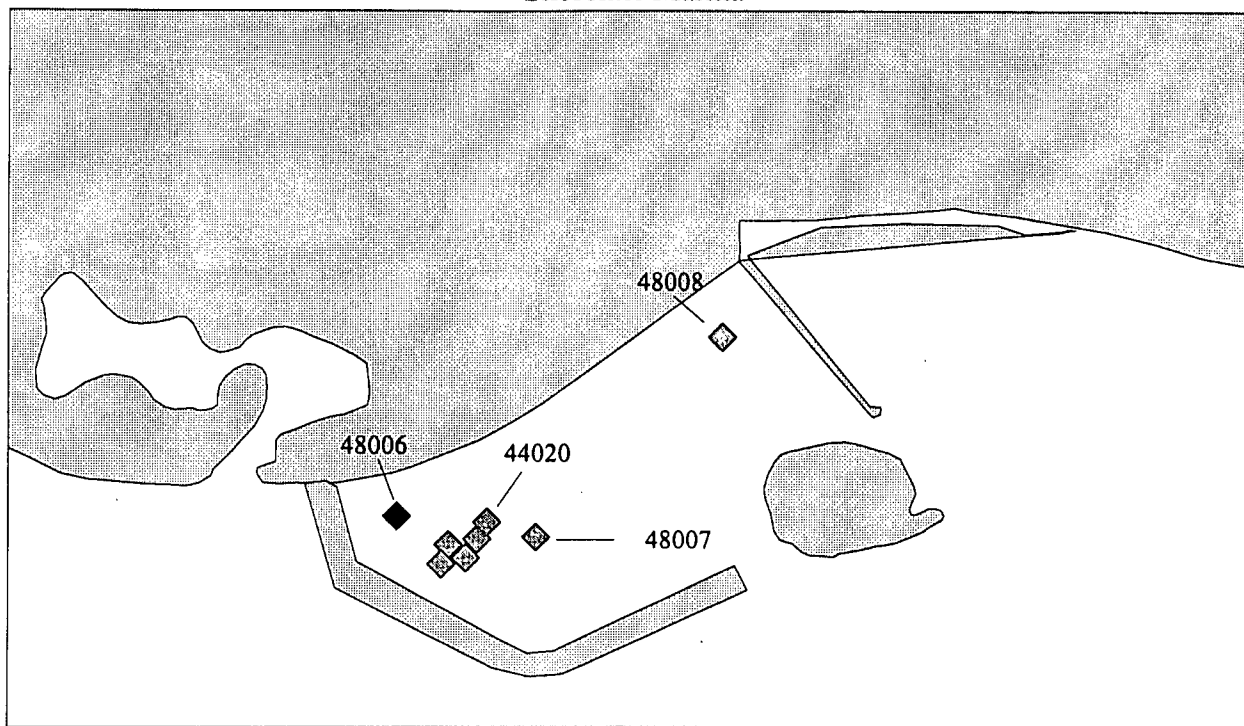
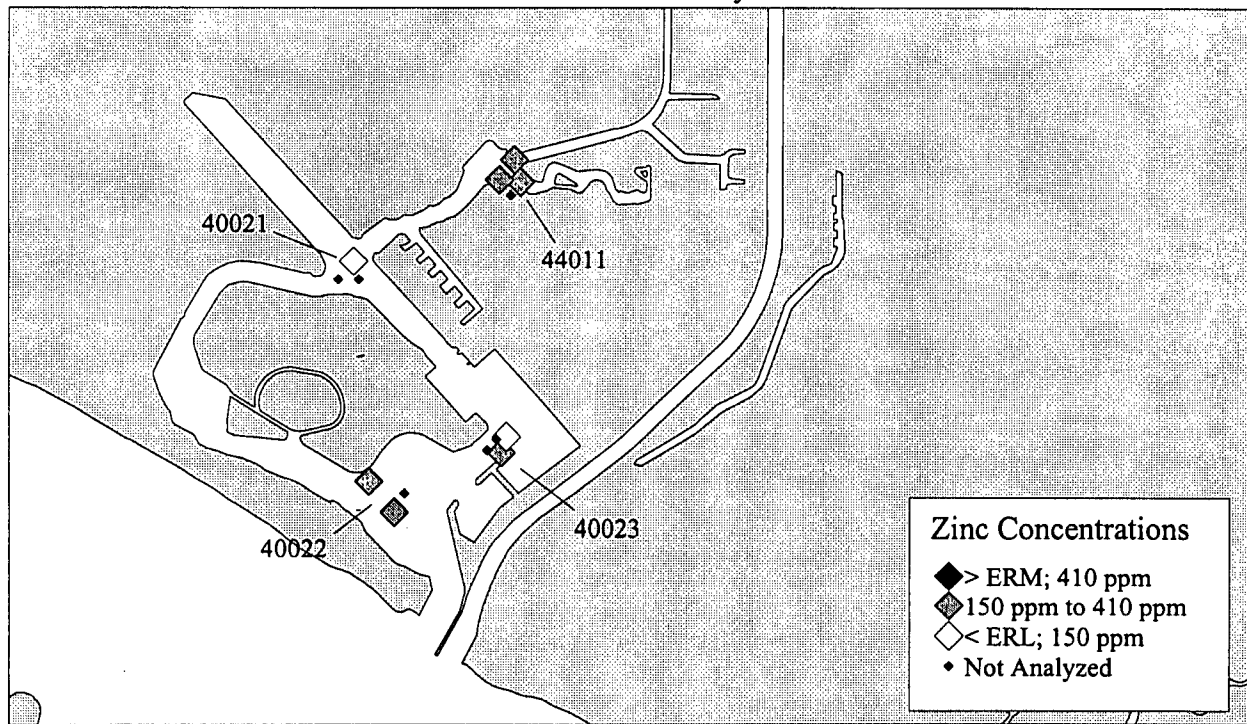


Figure 34. Distribution of samples in Channel Islands Harbor exceeding the ERM for Copper.

### Shoreline Marina



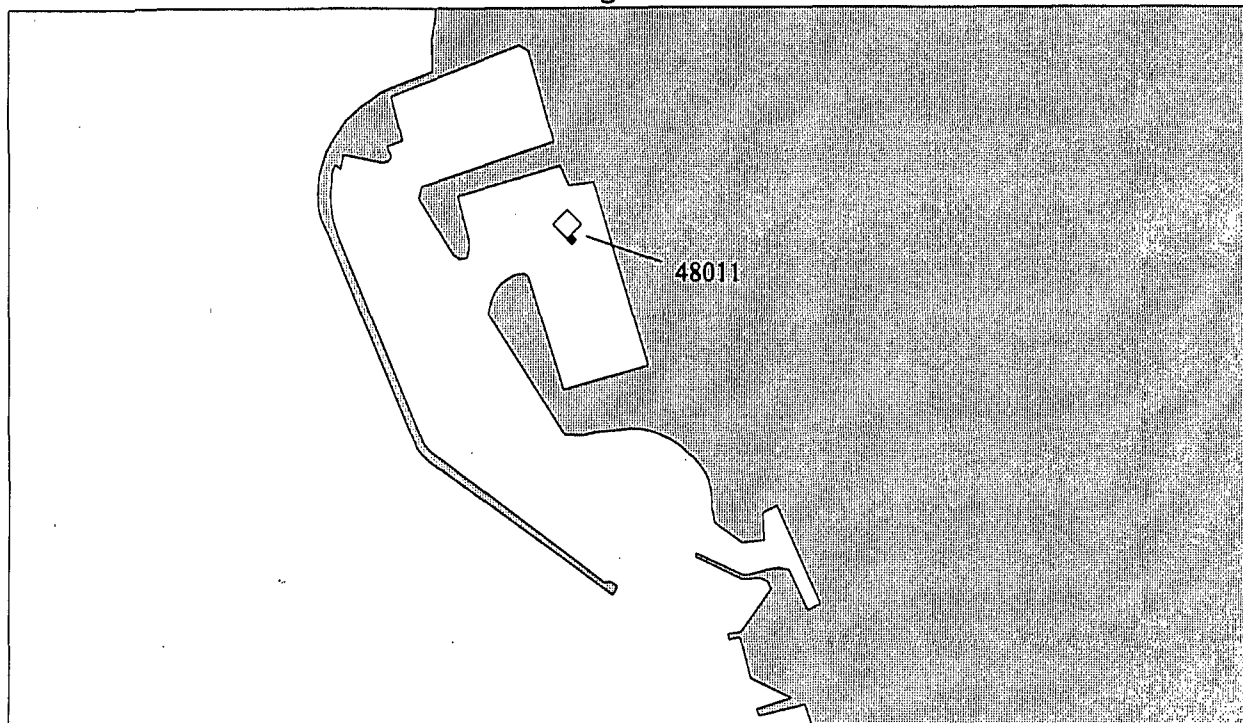
### Los Alamitos Bay



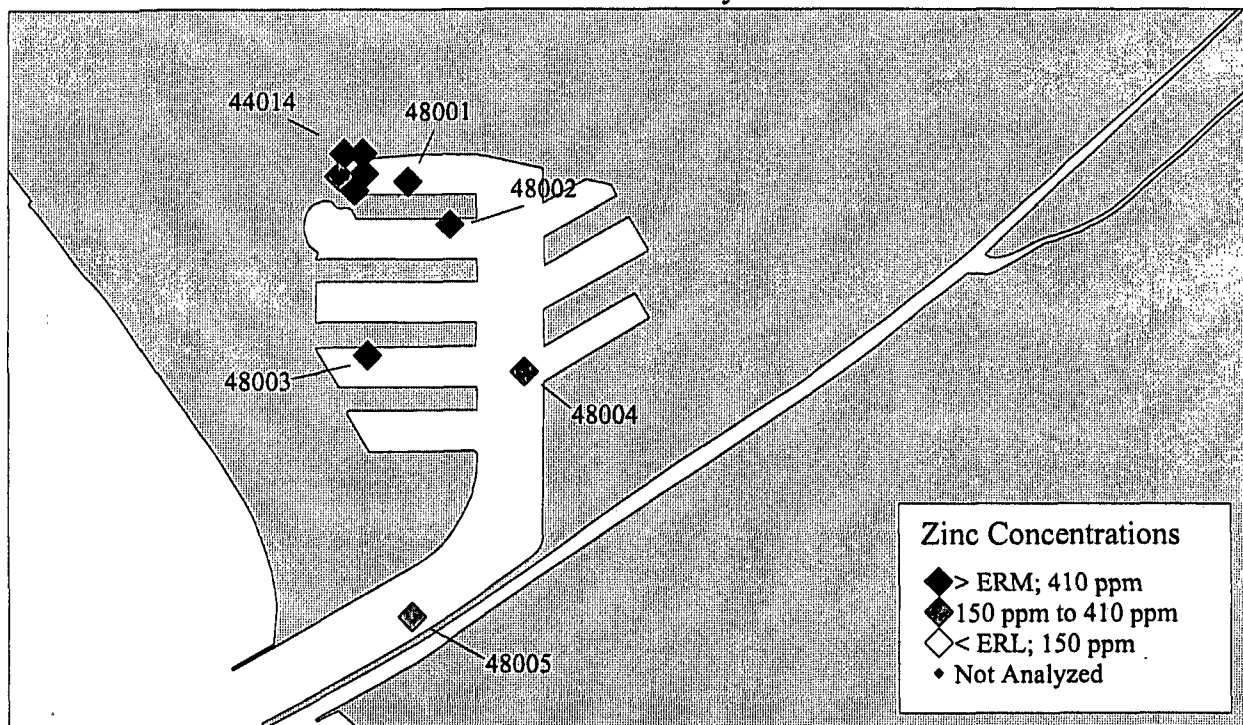
Figures 35a and 35b. Distribution of samples in Shoreline Marina (a), and Los Alamitos Bay (b), exceeding the ERM for Zinc



### King Harbor



### Marina Del Rey



Figures 36a and 36b. Distribution of samples in King Harbor (a), and Marina Del Rey (b), exceeding the ERM for Zinc

Channel Islands Harbor

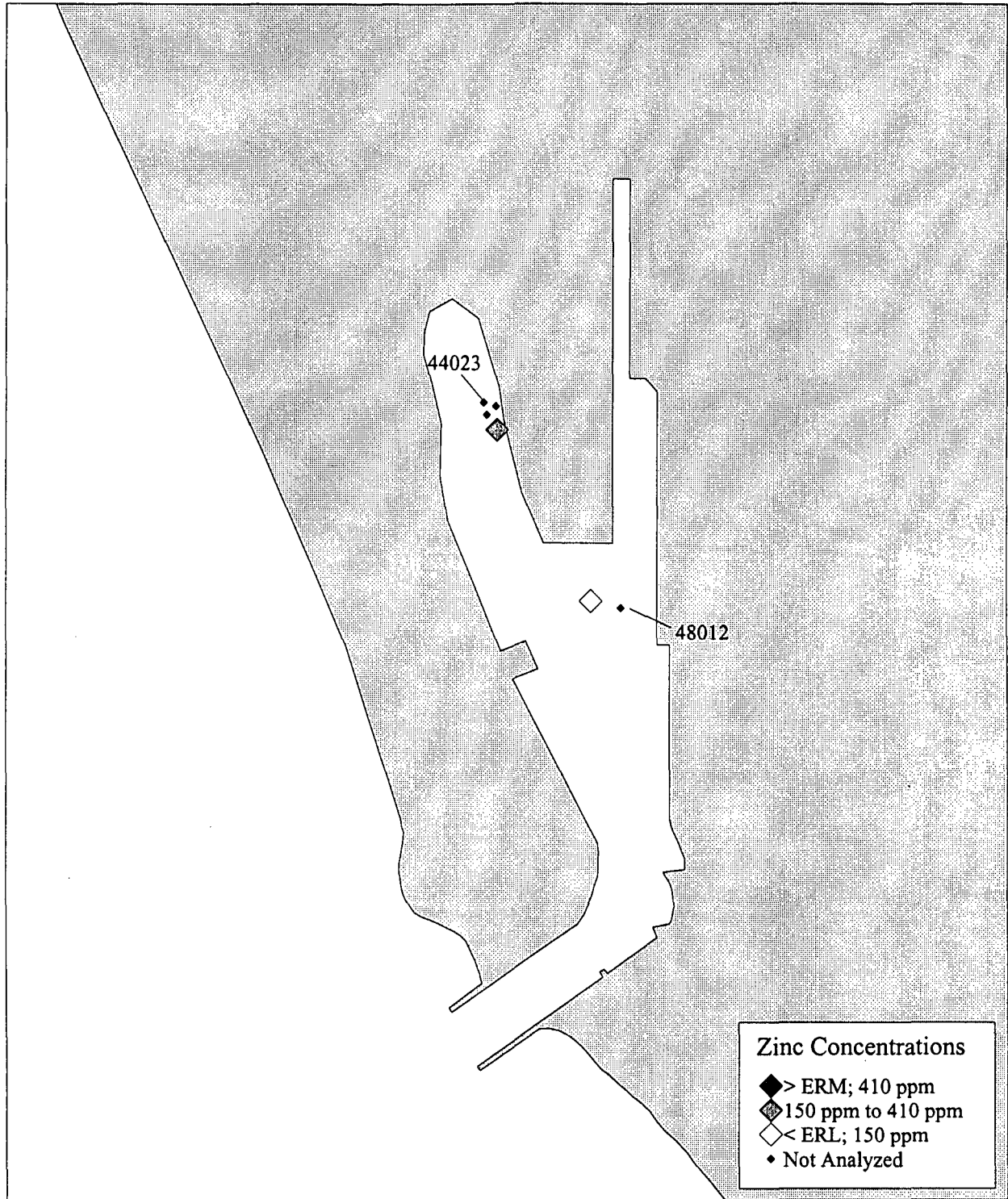
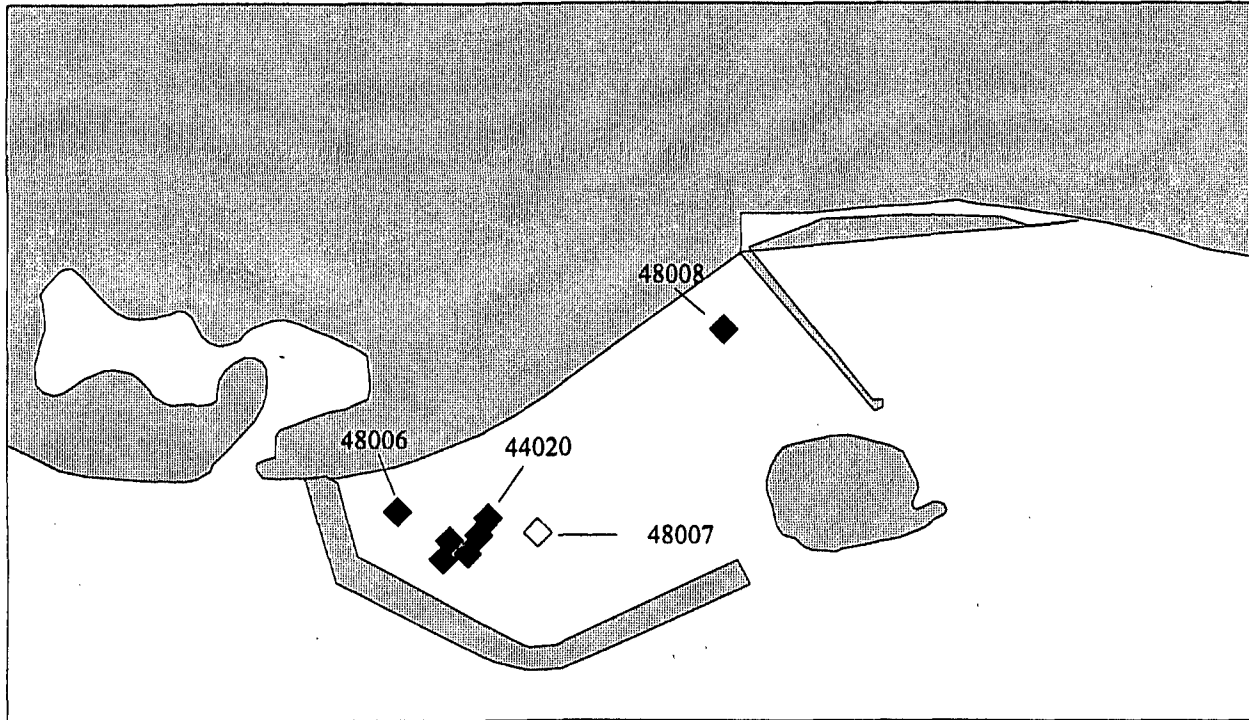
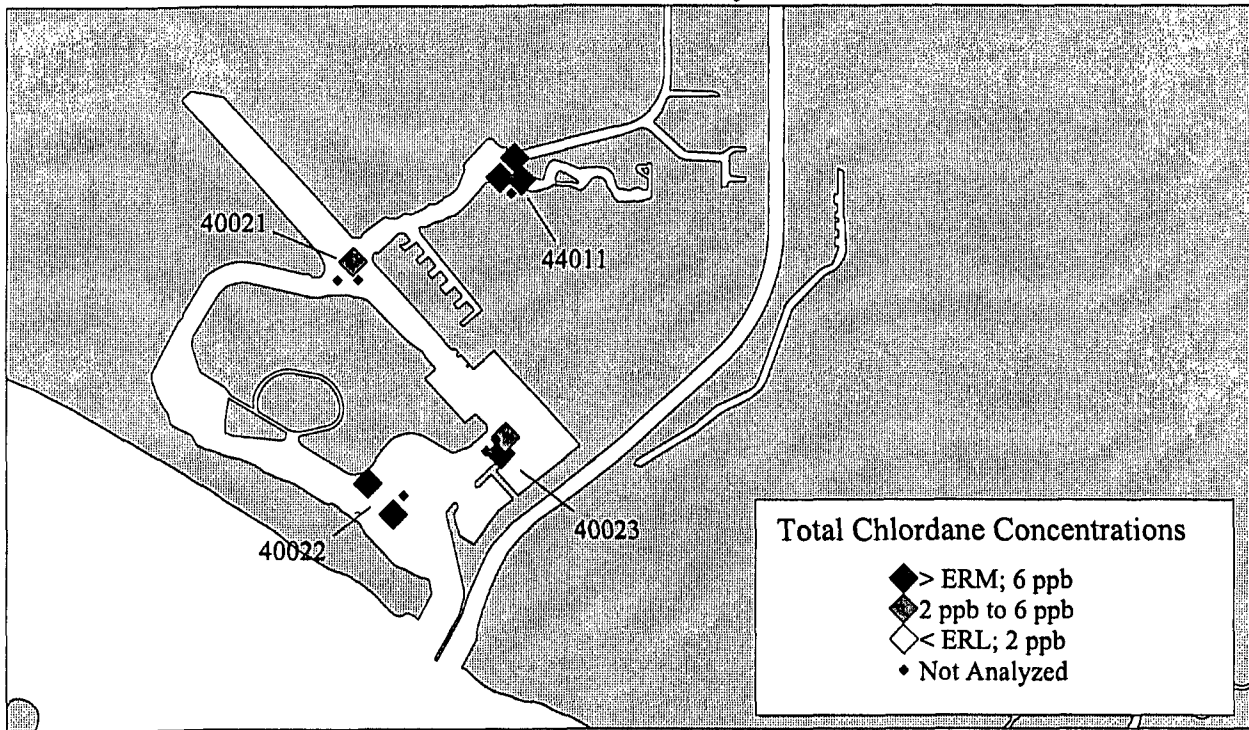


Figure 37. Distribution of samples in Channel Islands Harbor exceeding the ERM for Zinc.

### Shoreline Marina

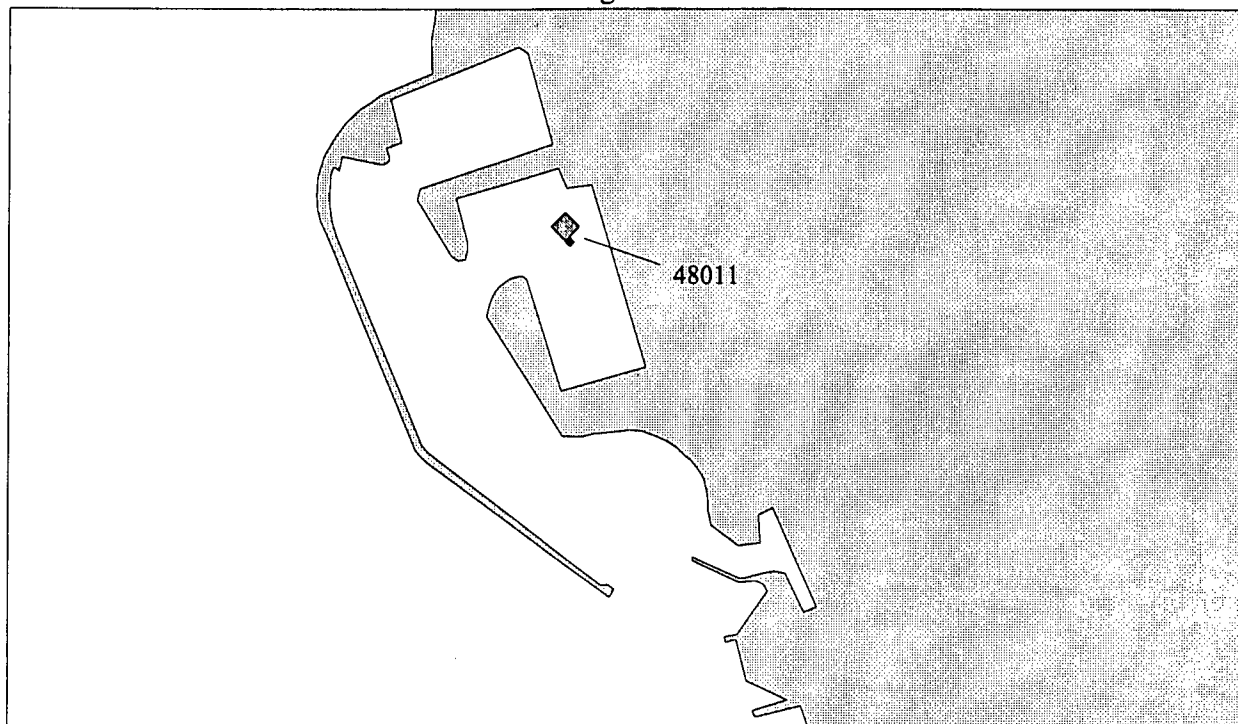


### Los Alamitos Bay

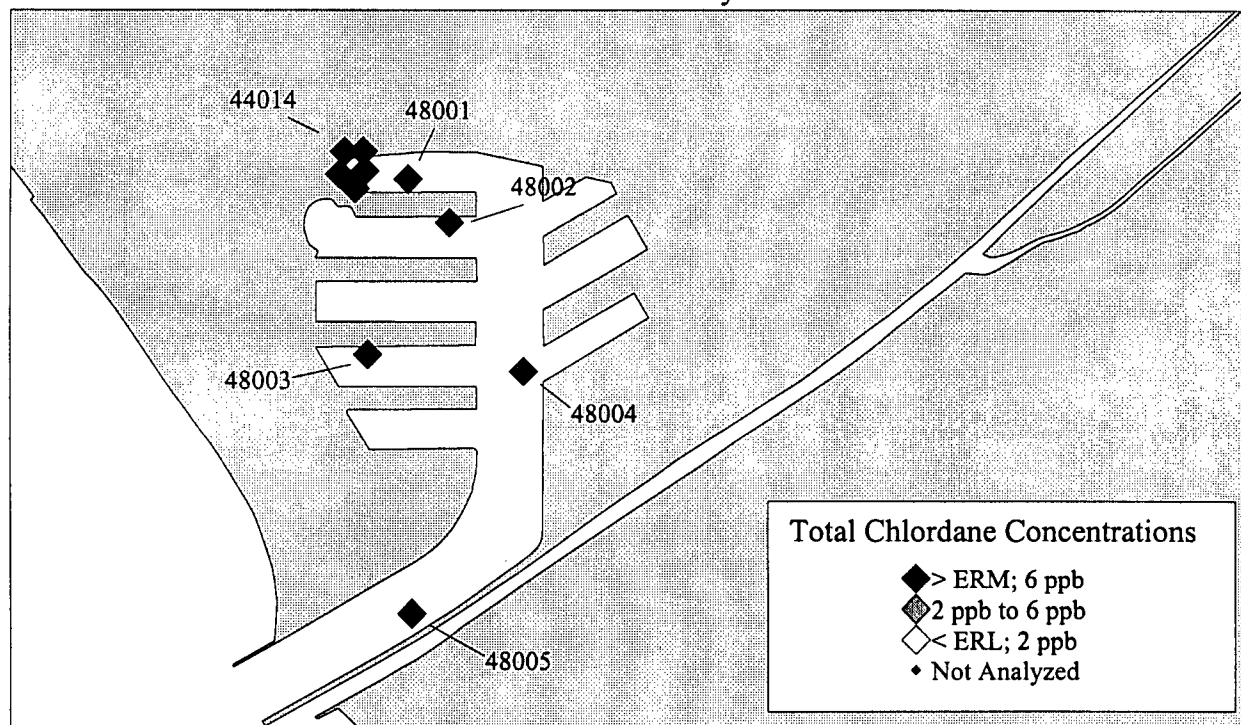


Figures 38a and 38b. Distribution of samples in Shoreline Marina (a), and Los Alamitos Bay (b), exceeding the ERM for Total Chlordane.

### King Harbor



### Marina Del Rey



Figures 39a and 39b. Distribution of samples in King Harbor (a), and Marina Del Rey (b), exceeding the ERM for Total Chlordane.

Channel Islands Harbor

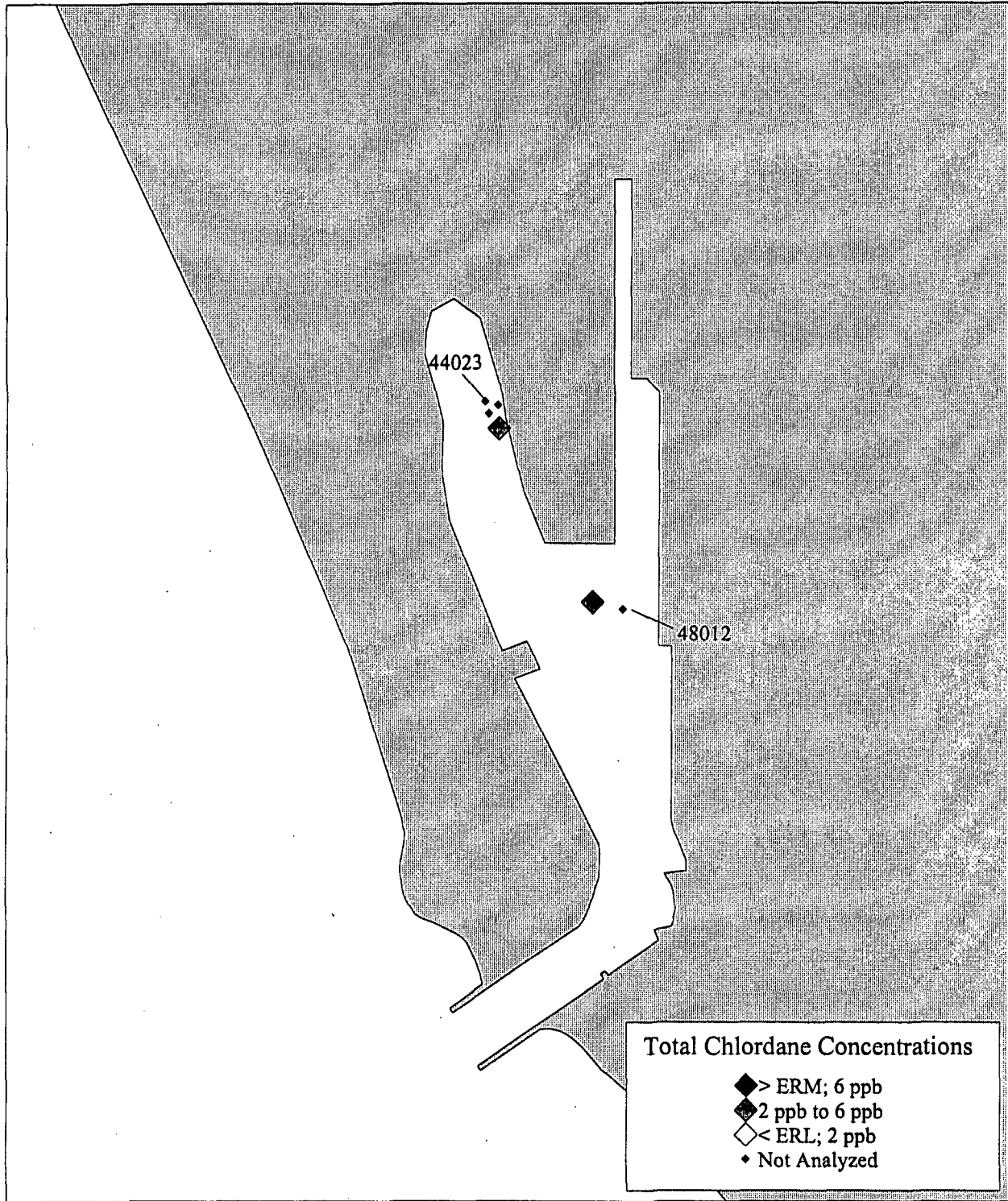
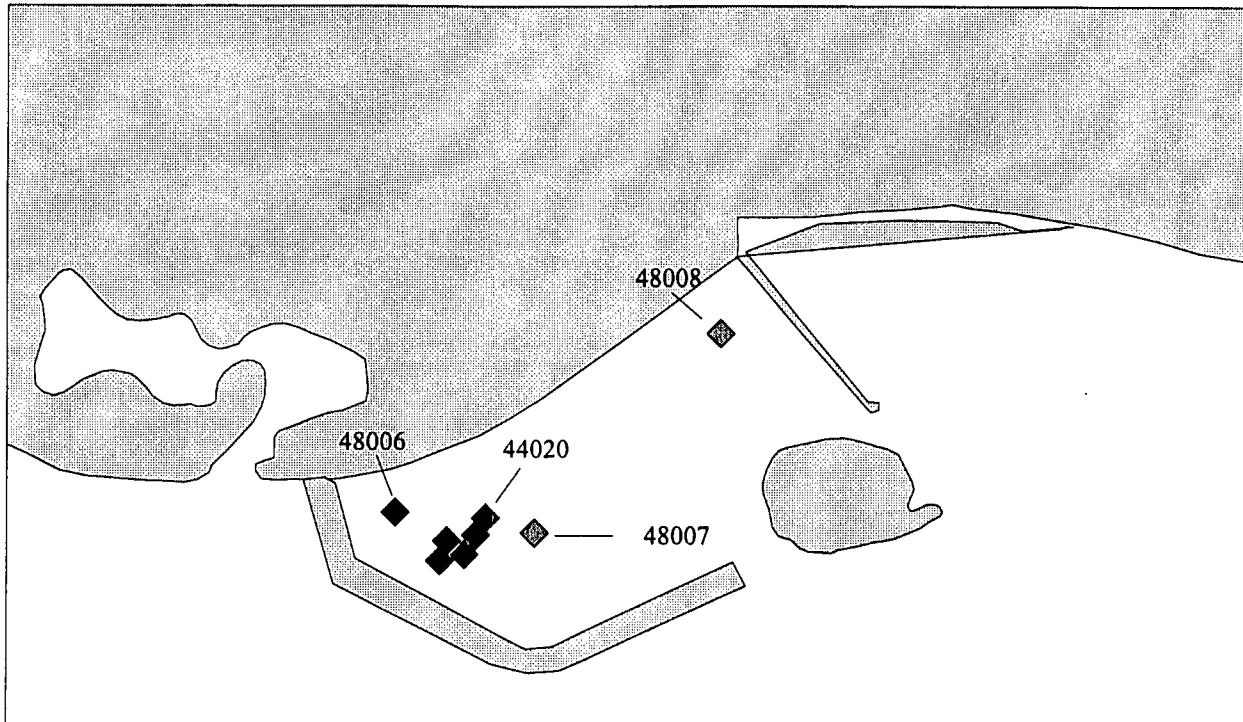
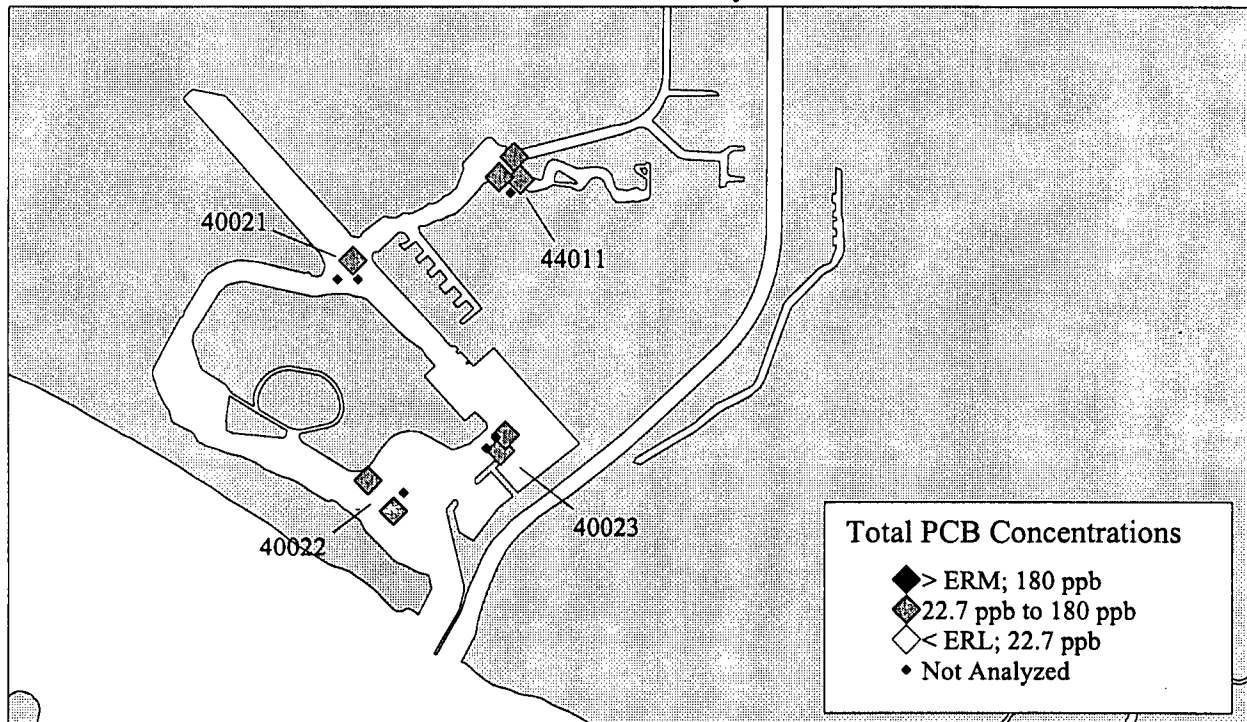


Figure 40. Distribution of samples in Channel Islands Harbor exceeding the ERM for Total Chlordane.

### Shoreline Marina

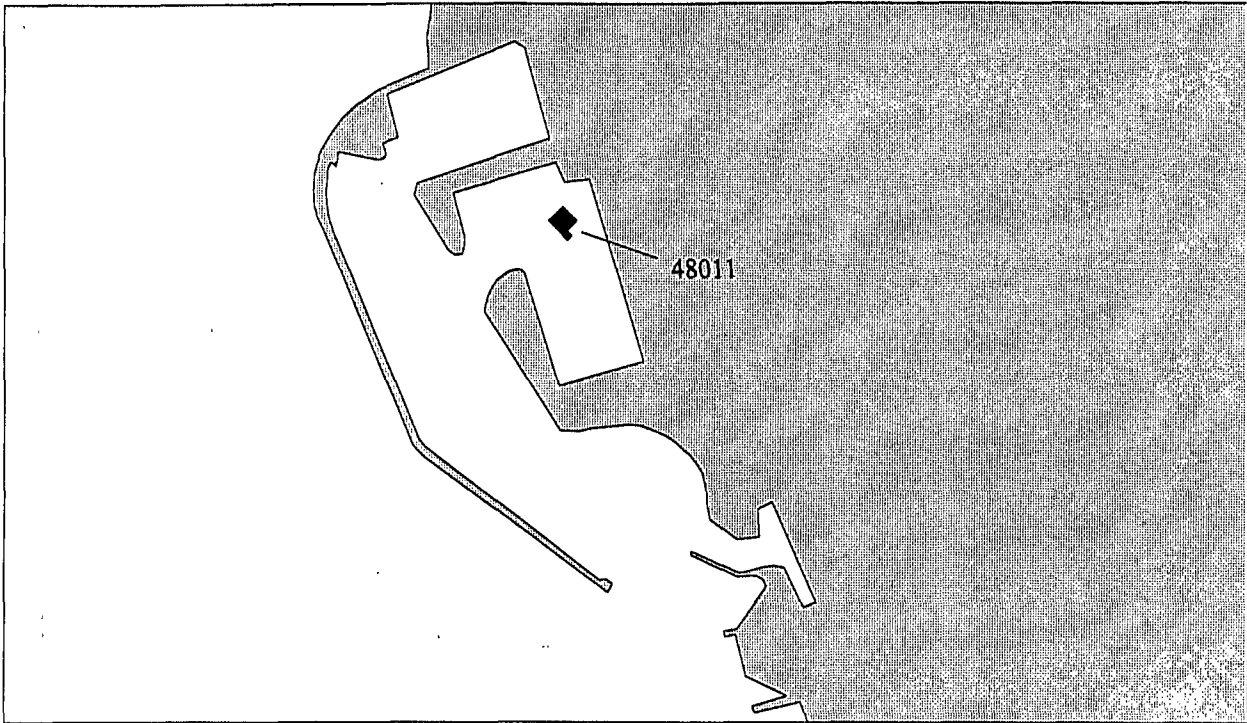


### Los Alamitos Bay

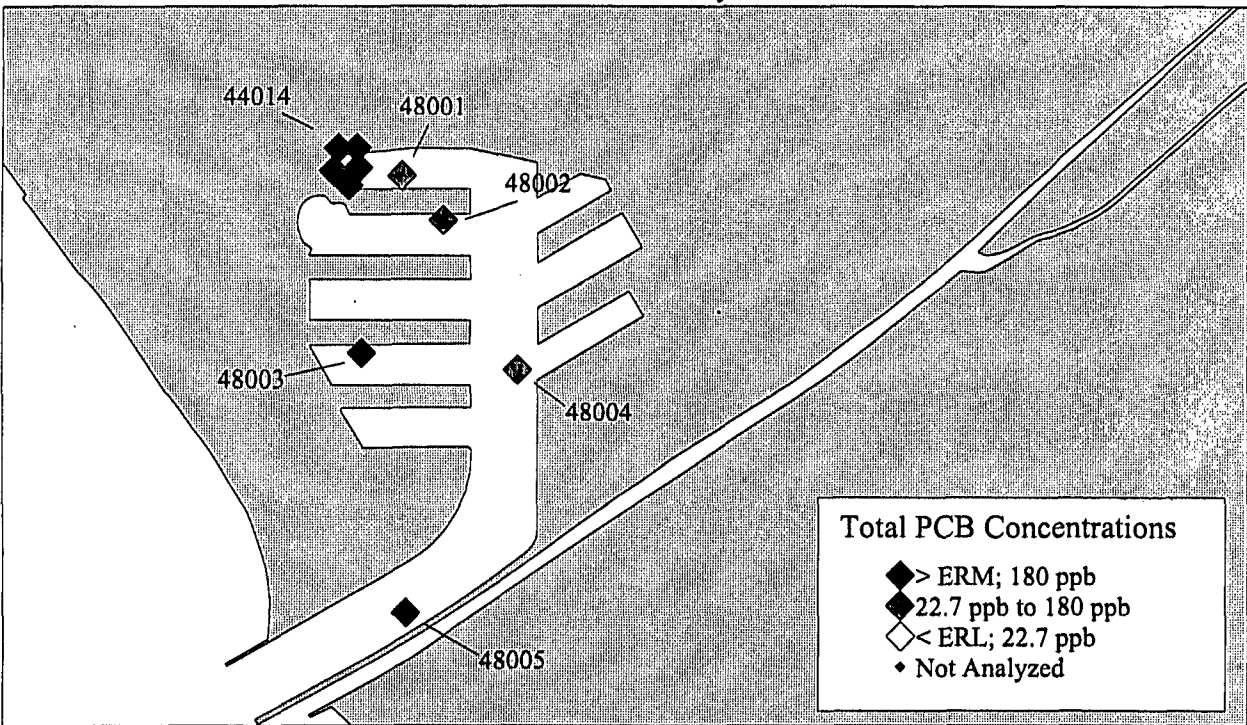


Figures 41a and 41b. Distribution of samples in Shoreline Marina (a), and Los Alamitos Bay (b), exceeding the ERM for Total PCB.

### King Harbor

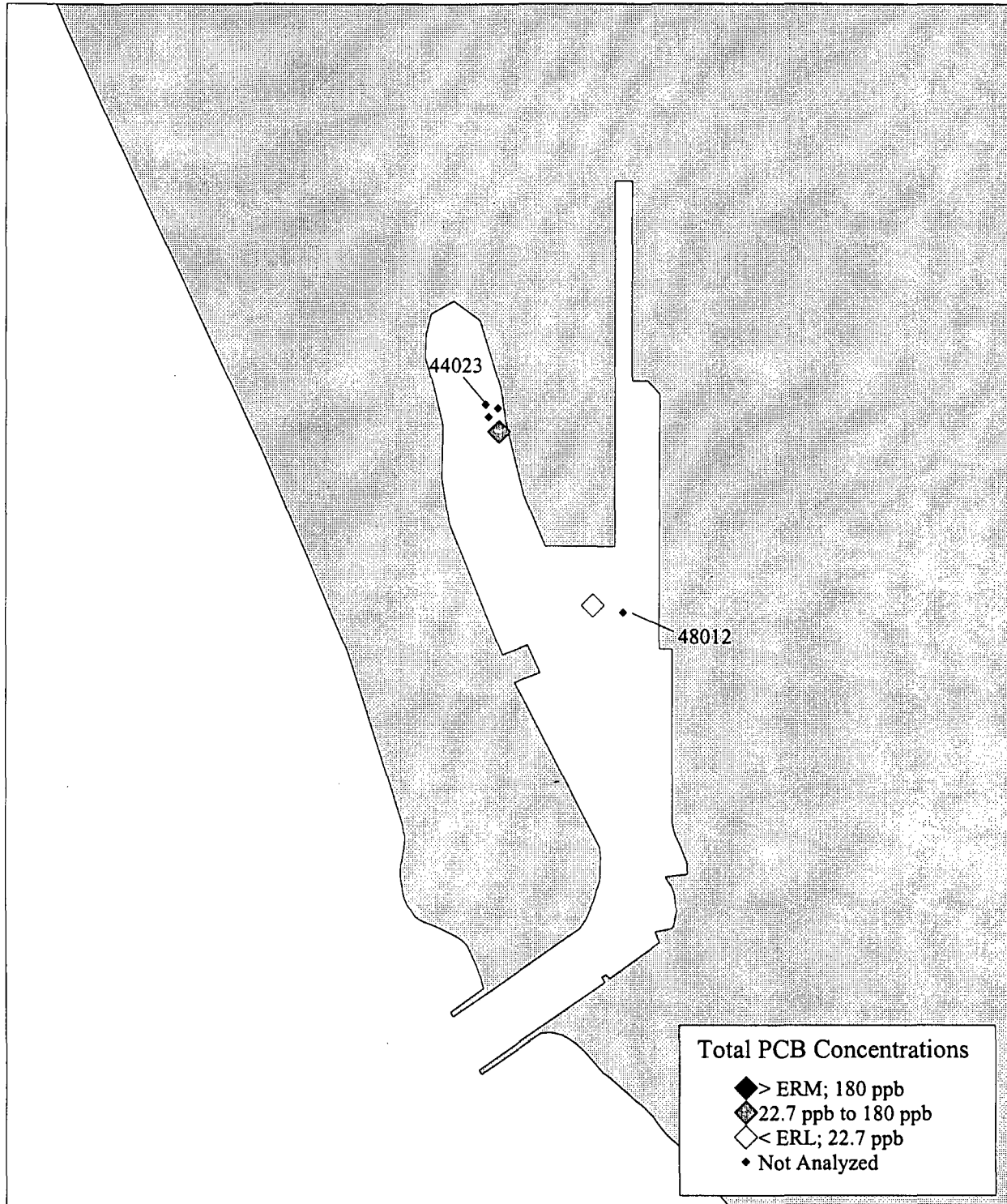


### Marina Del Rey



Figures 42a and 42b. Distribution of samples in King Harbor (a), and Marina Del Rey (b), exceeding the ERM for Total PCB.

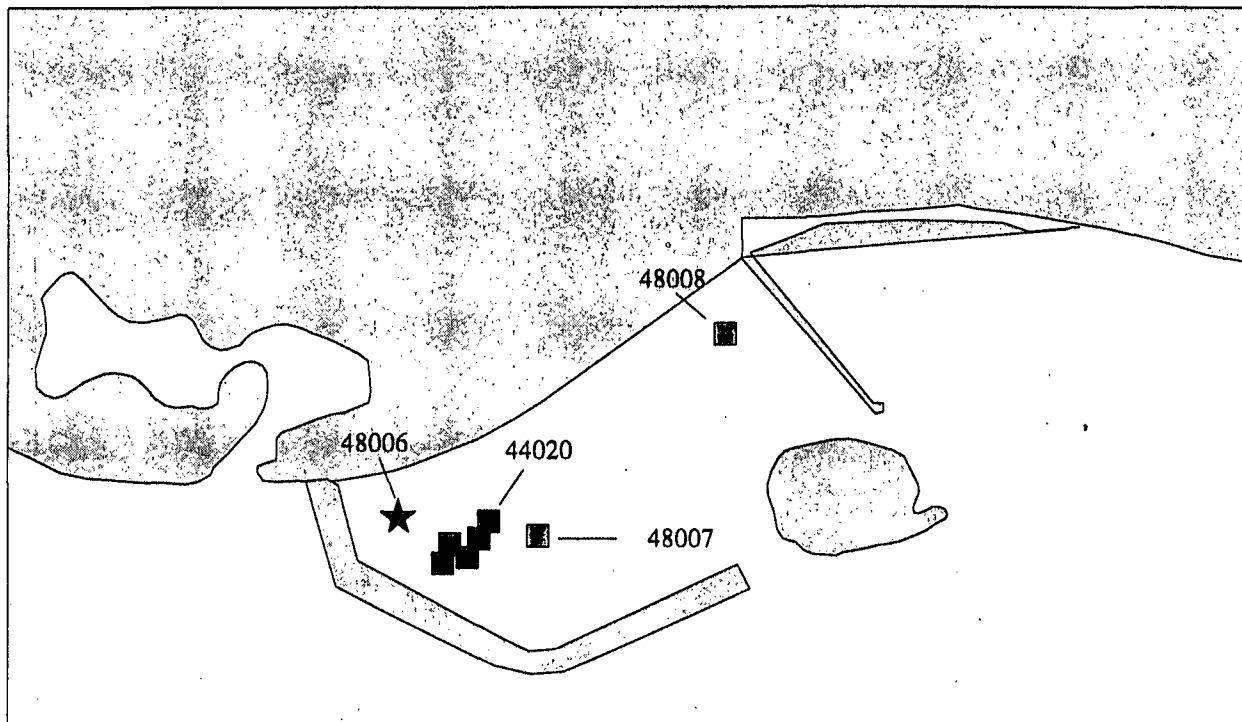
Channel Islands Harbor



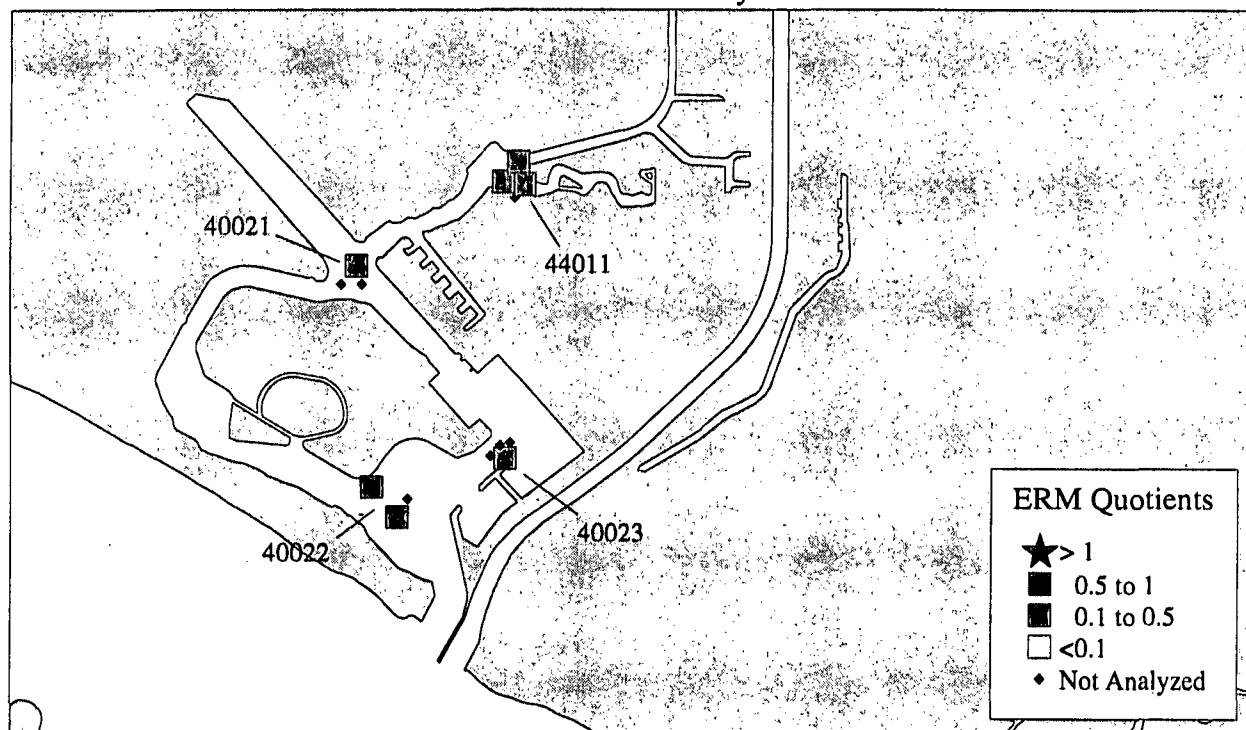
Figures 43. Distribution of samples in Channel Islands Harbor exceeding the ERM for Total PCB.



### Shoreline Marina

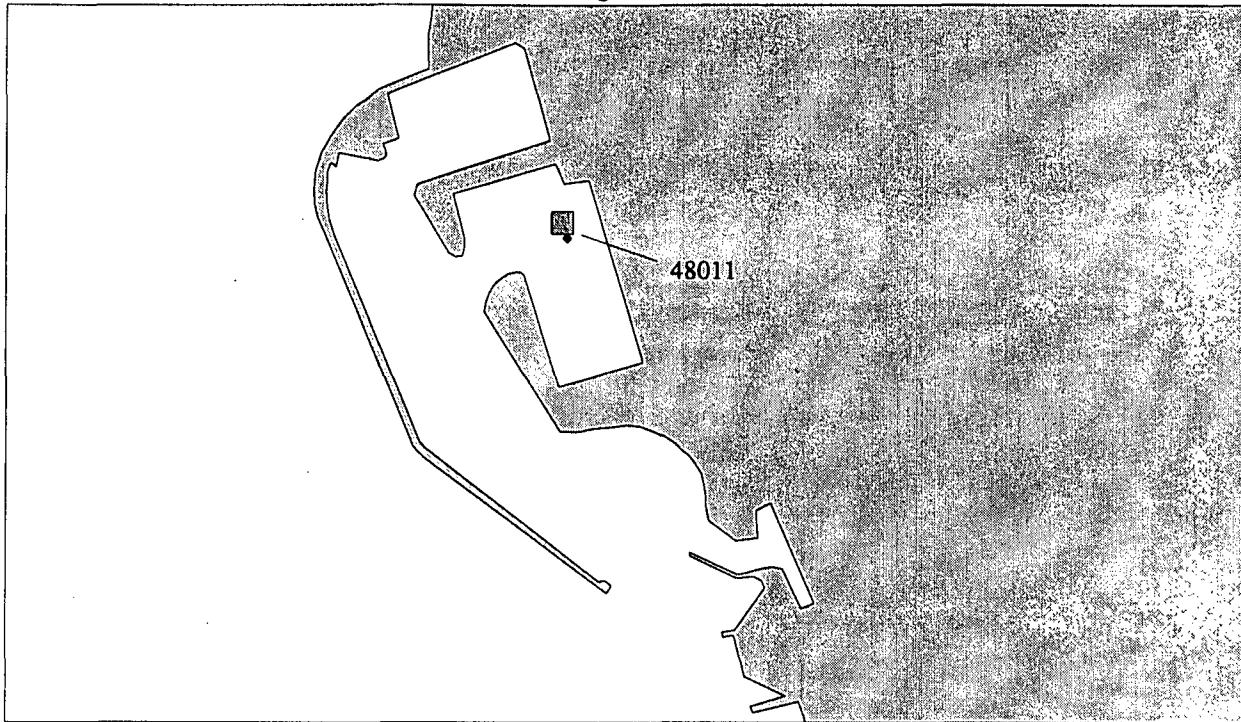


### Los Alamitos Bay

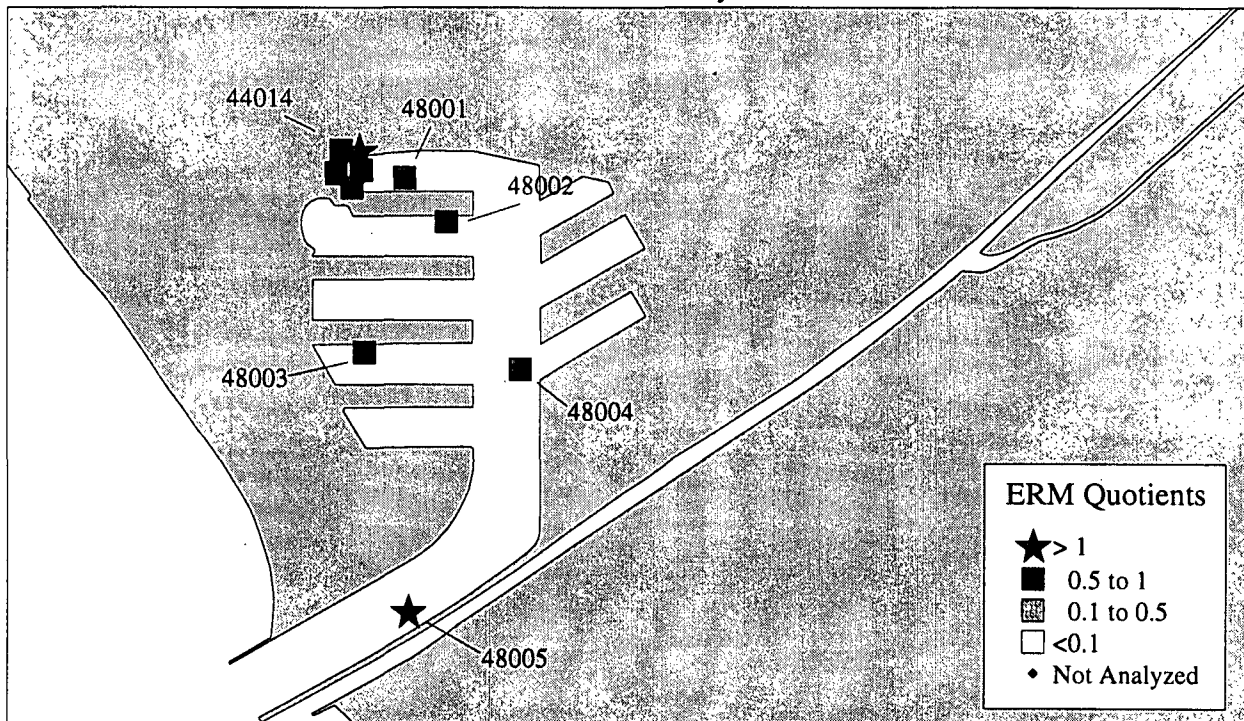


Figures 44a and 44b. ERM Quotient values at Shoreline Marina (a), and Los Alamitos Bay (b), Sampling Stations.

King Harbor



Marina Del Rey



Figures 45a and 45b. ERM Quotient values at King Harbor (a), and Marina Del Rey (b), Sampling Stations.

Channel Islands Harbor

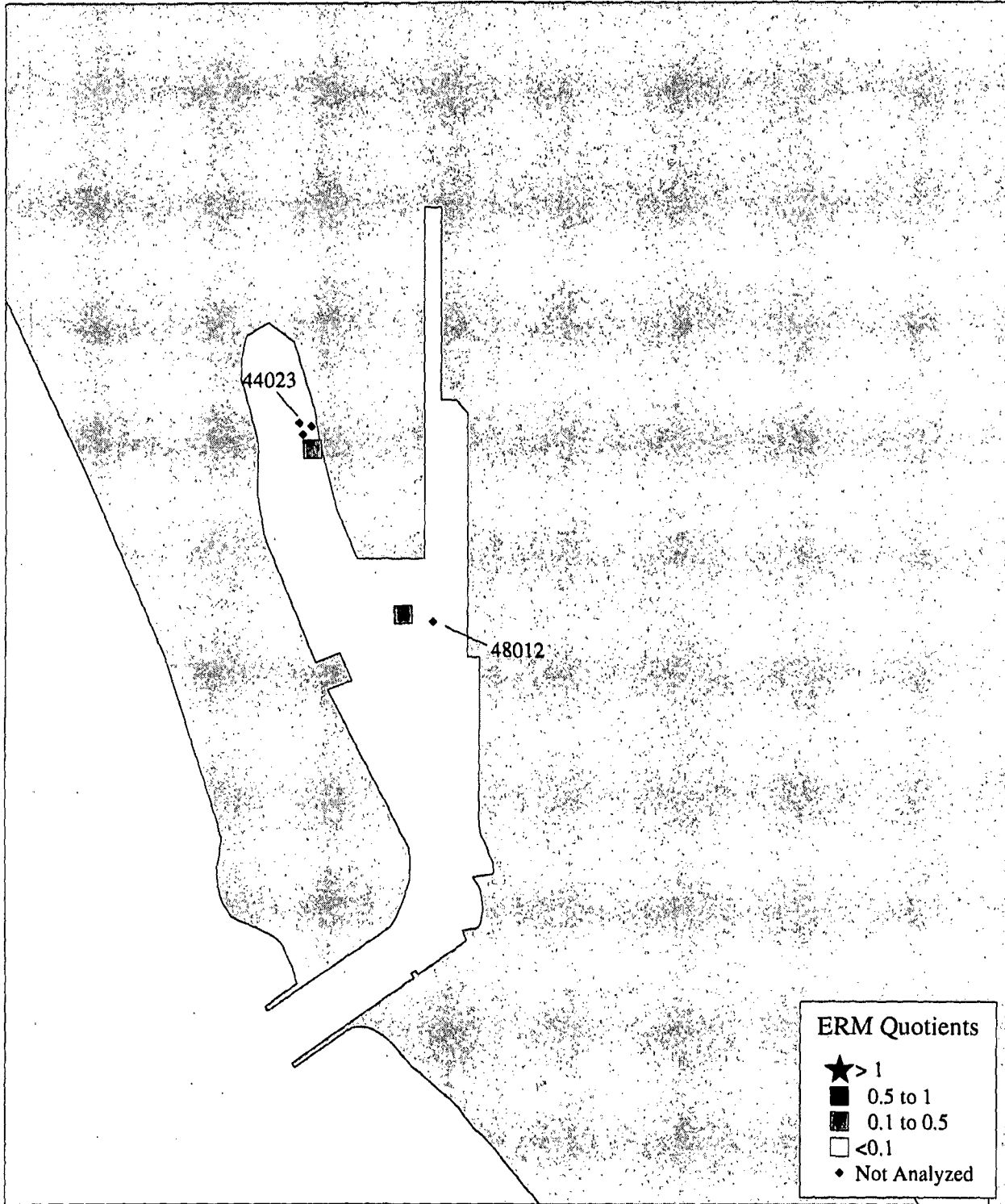
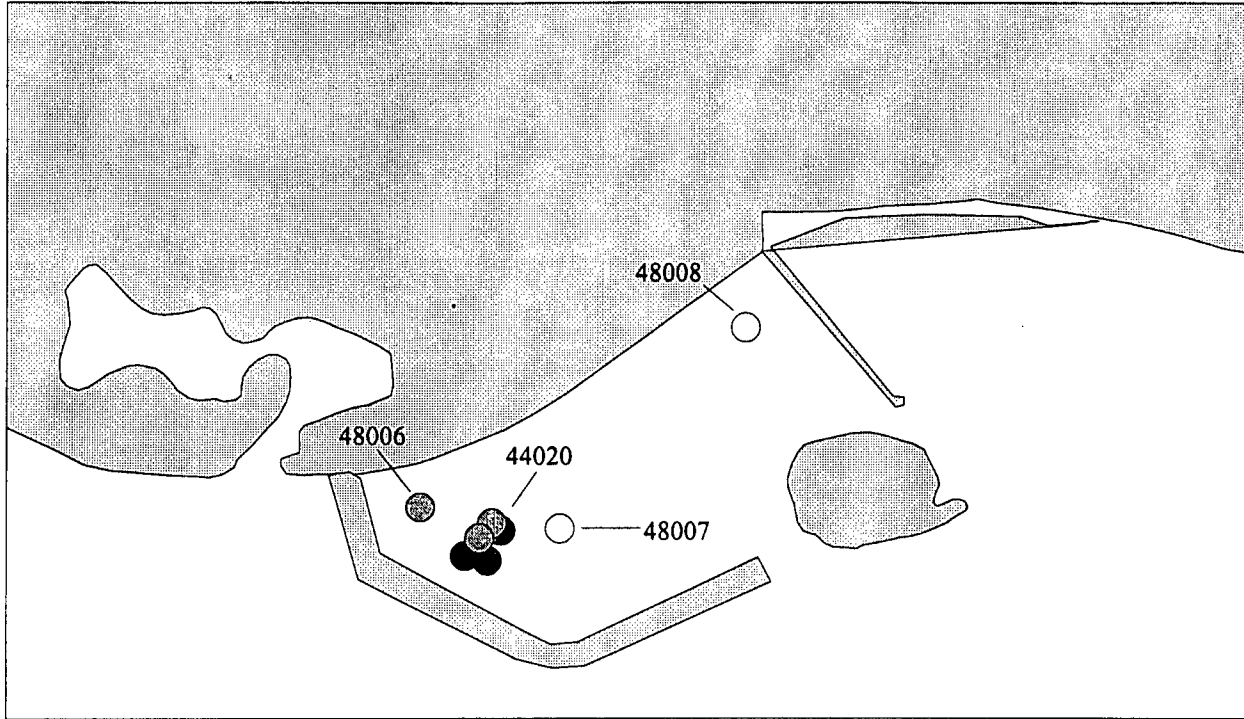
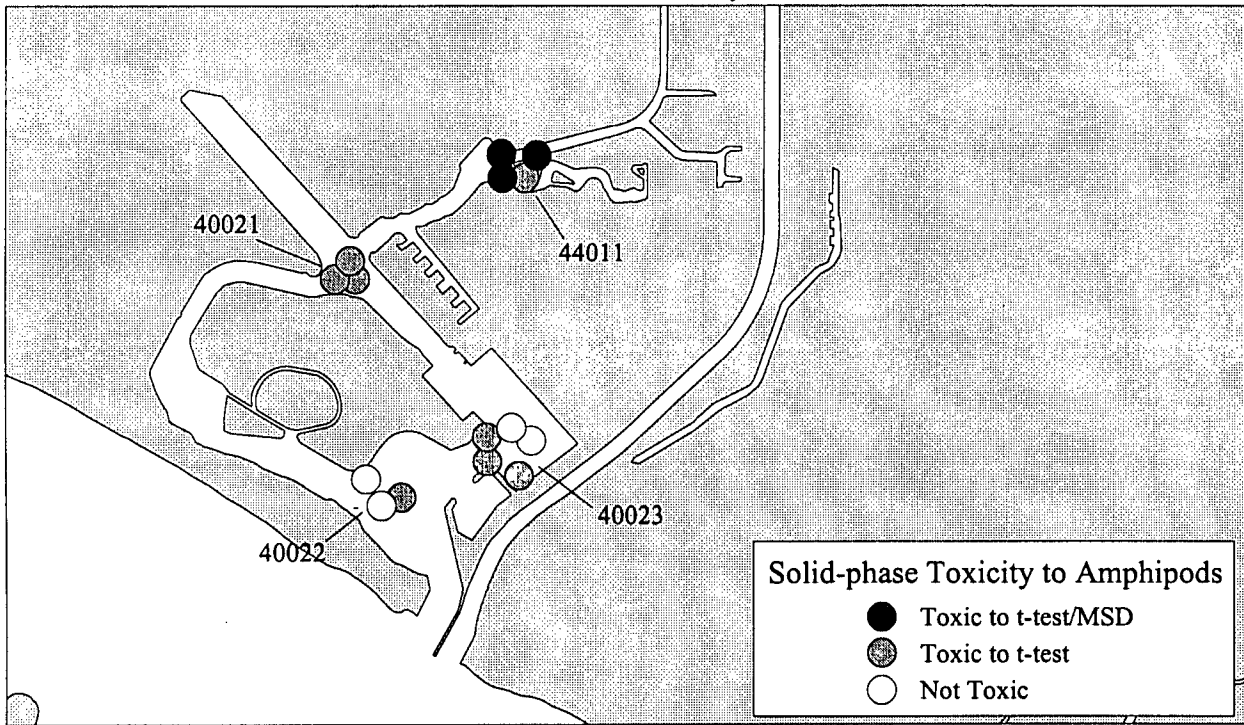


Figure 46. ERM Quotient values at Channel Islands Harbor Sampling Stations.

### Shoreline Marina

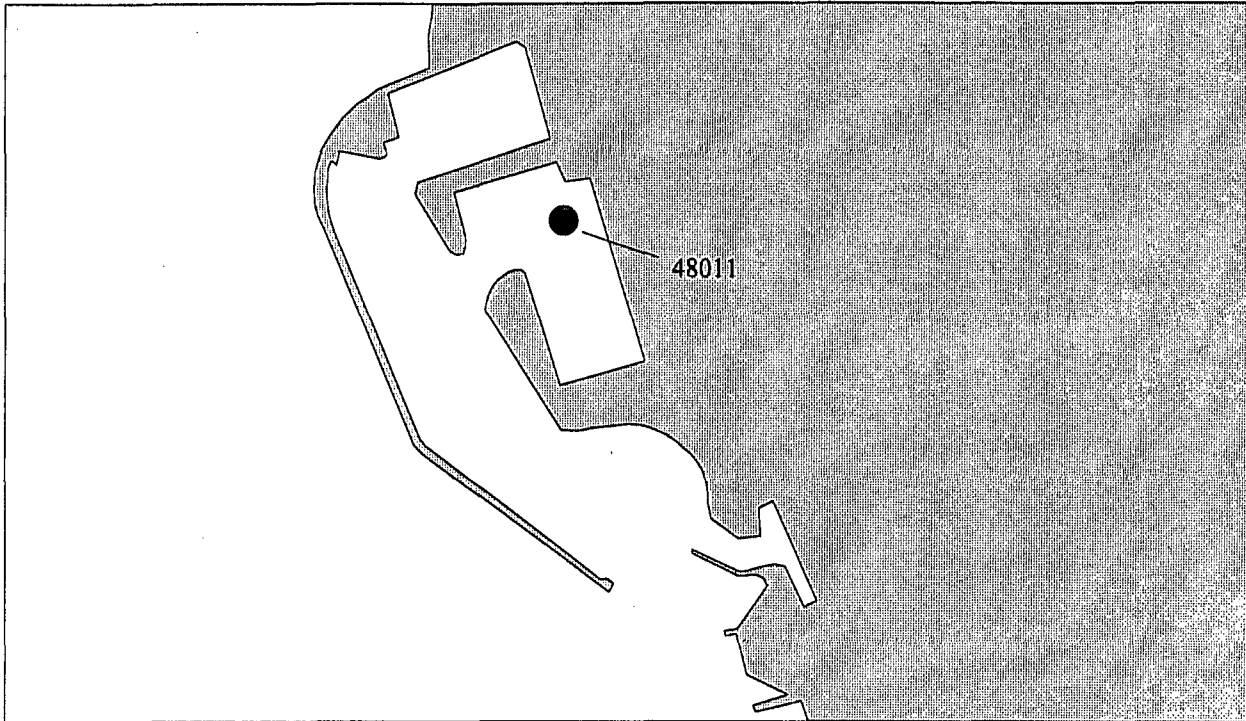


### Los Alamitos Bay

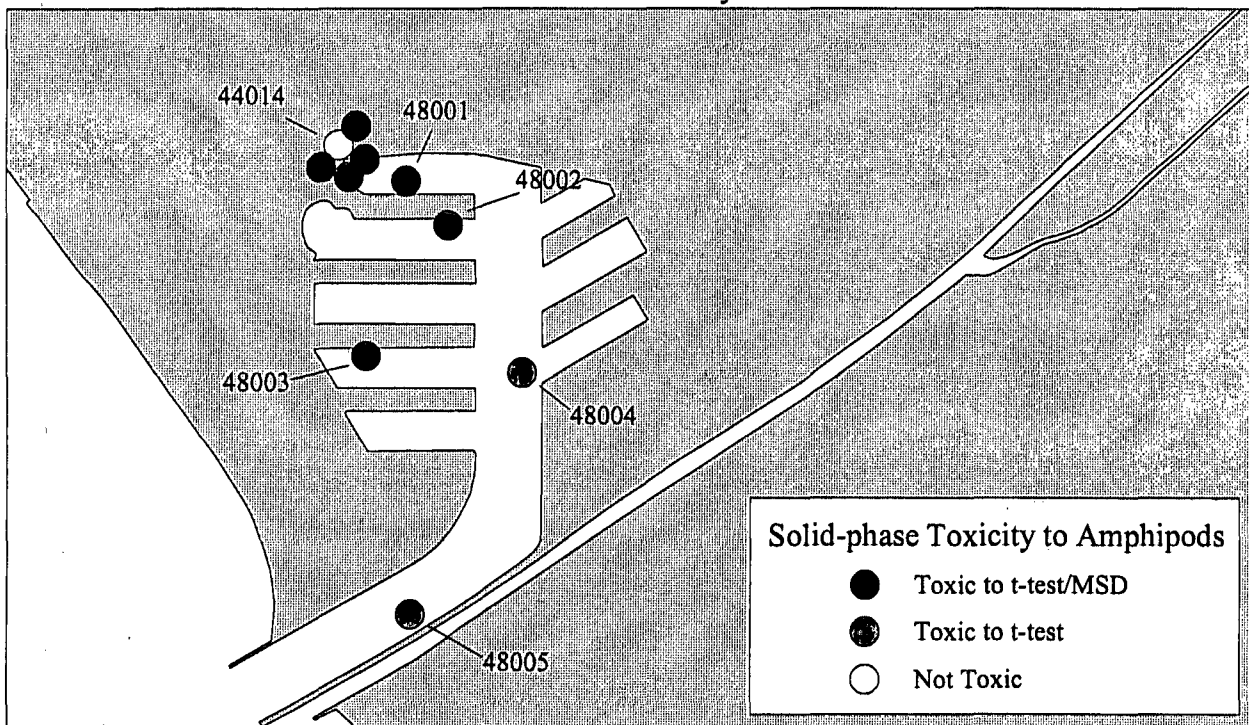


Figures 47a and 47b. Toxicity of Sediment Samples in Shoreline Marina (a), and Los Alamitos Bay (b).

### King Harbor

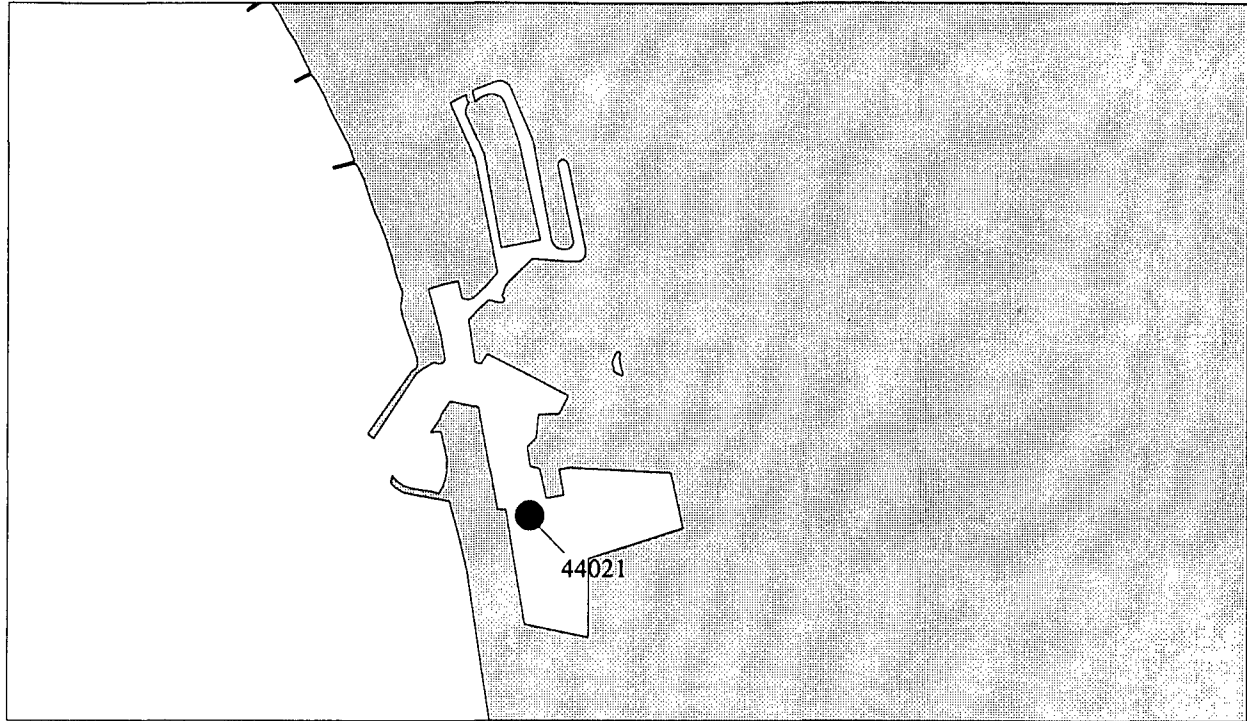


### Marina Del Rey

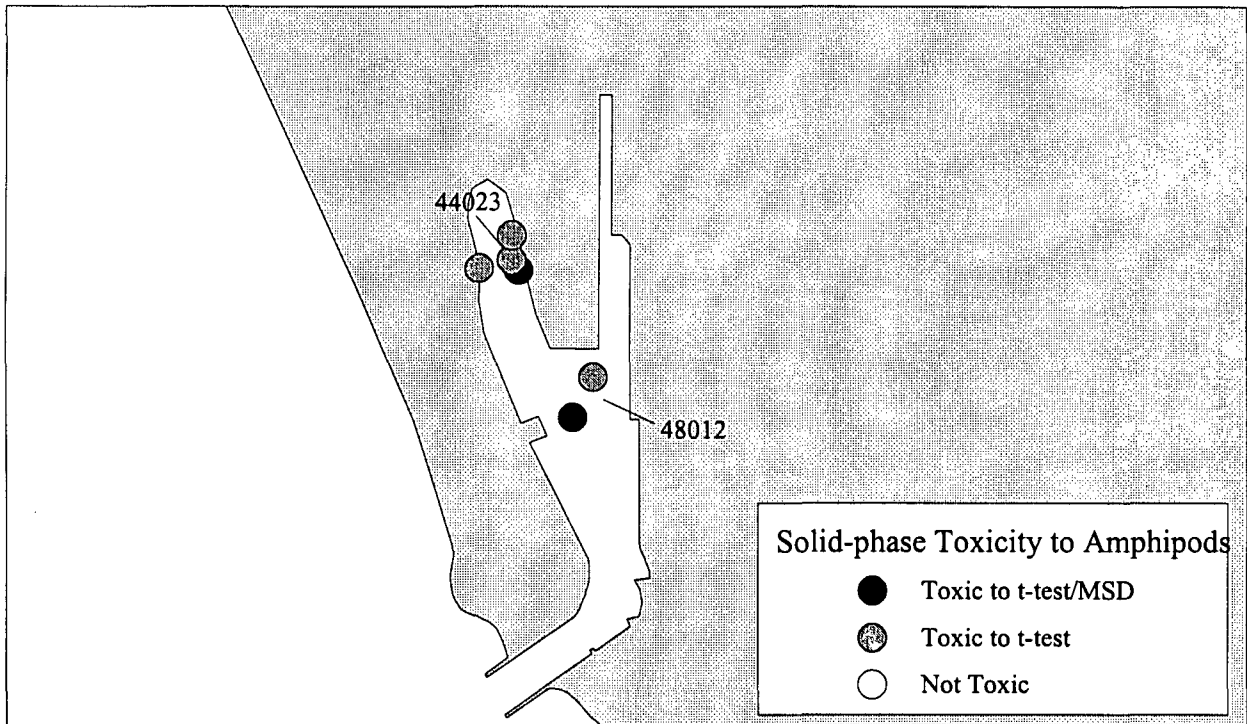


Figures 48a and 48b. Toxicity of Sediment Samples in King Harbor (a), and Marina Del Rey (b).

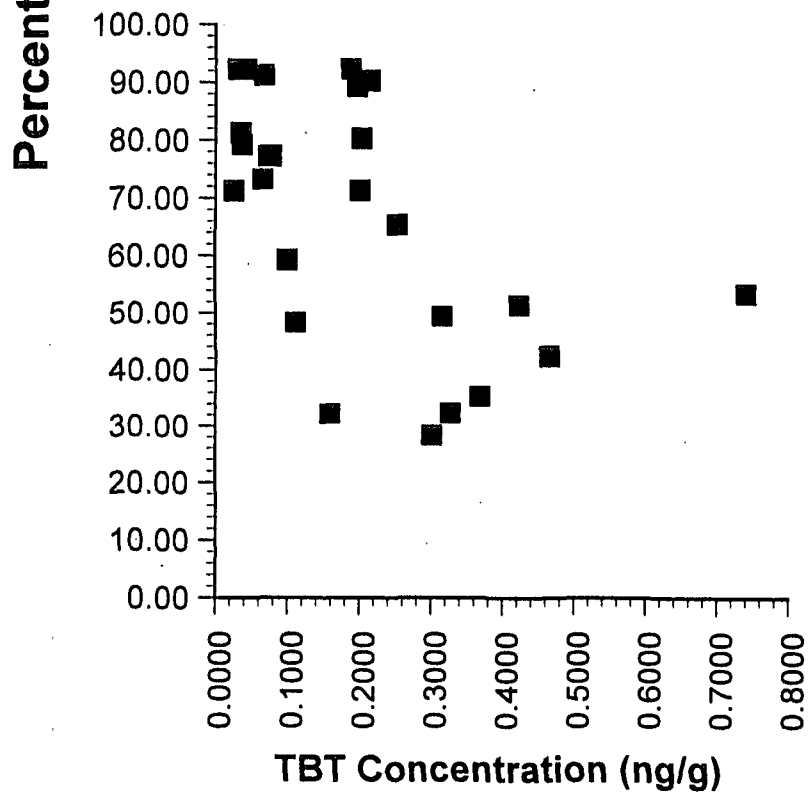
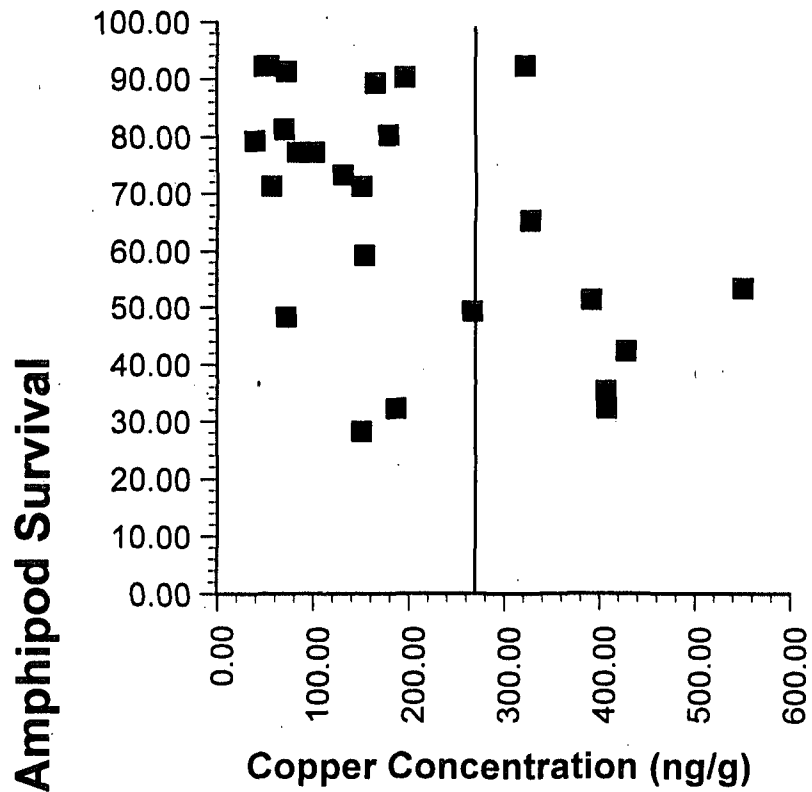
Ventura Marina



Channel Islands Harbor

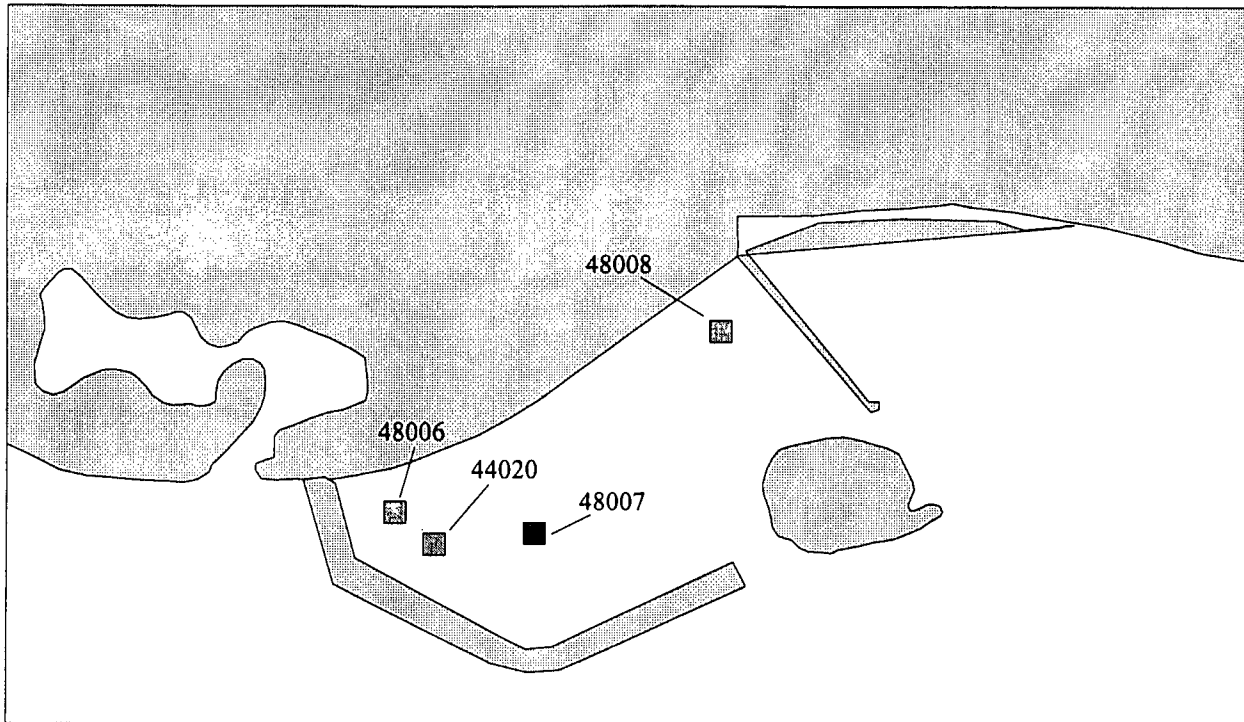


Figures 49a and 49b. Toxicity of Sediment Samples in Ventura Harbor (a), and Channel Islands Harbor (b).

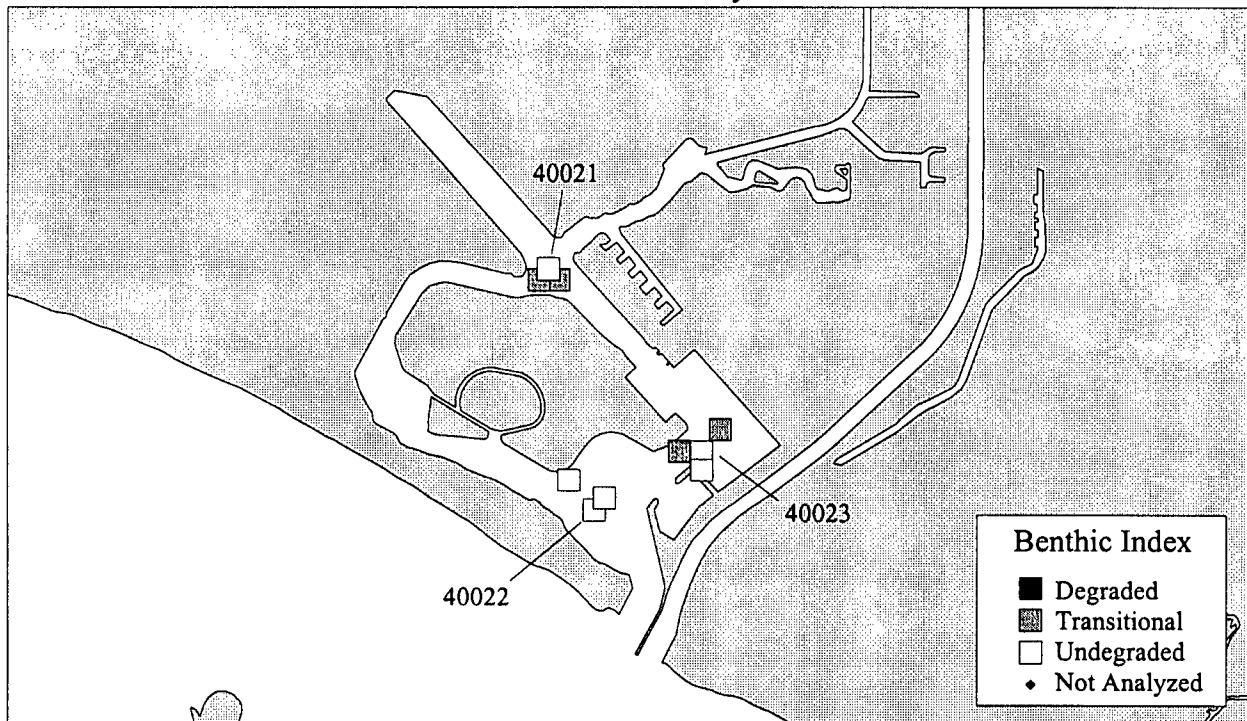


**Figure 50.** Amphipod survival at Marina stations in relation to copper and TBT concentrations. Vertical line indicates ERM value for copper.

### Shoreline Marina



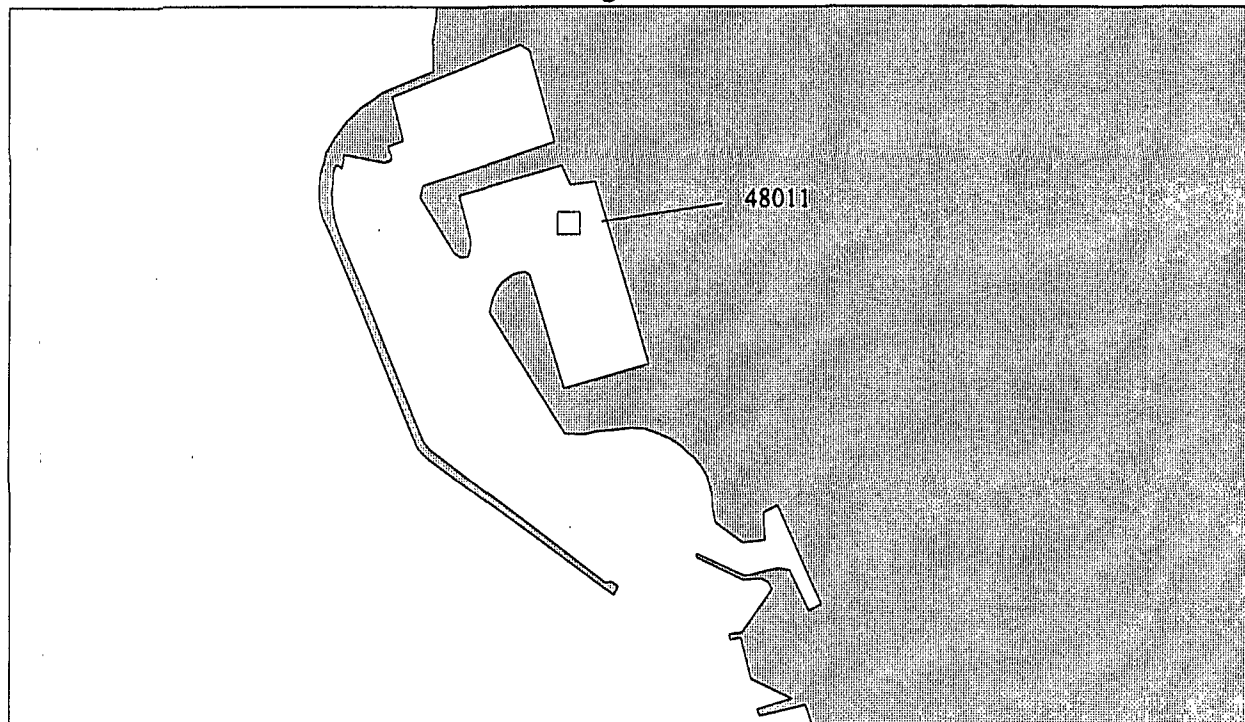
### Los Alamitos Bay



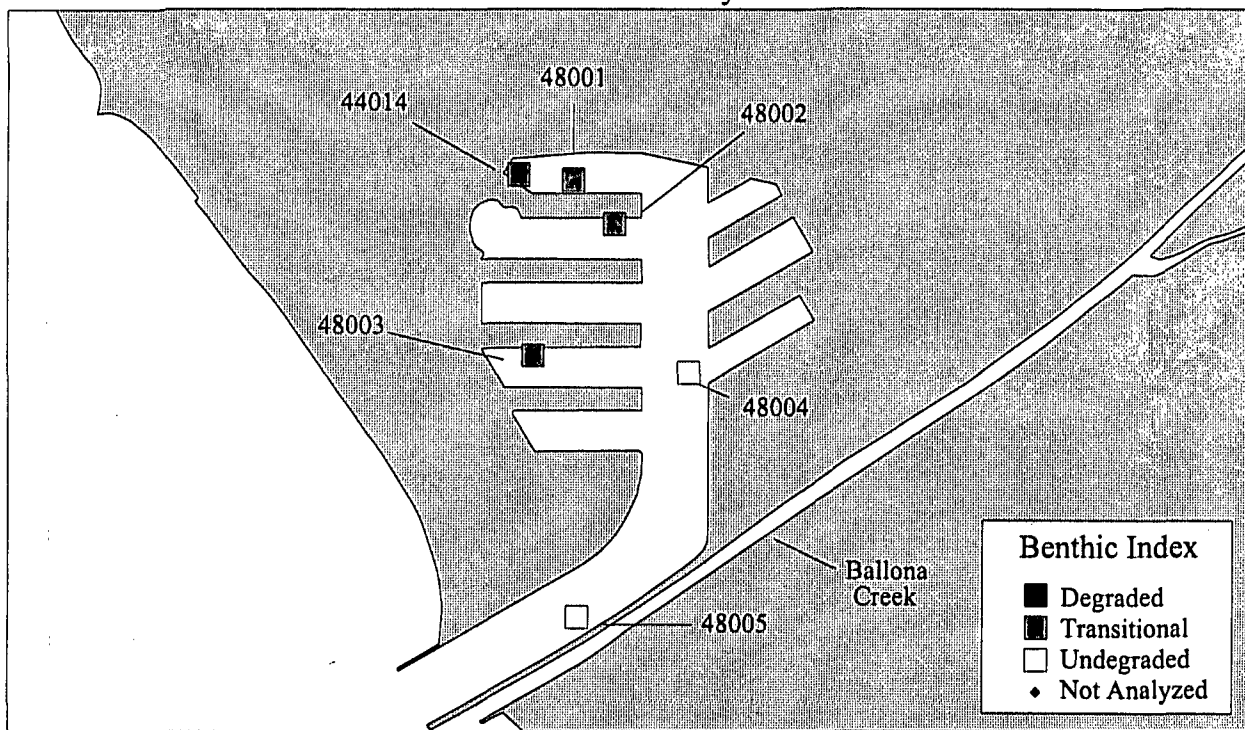
Figures 51a and 51b. Distribution of Stations in Shoreline Marina (a), and Los Alamitos Bay (b), Demonstrating Benthic Community Structure.



### King Harbor

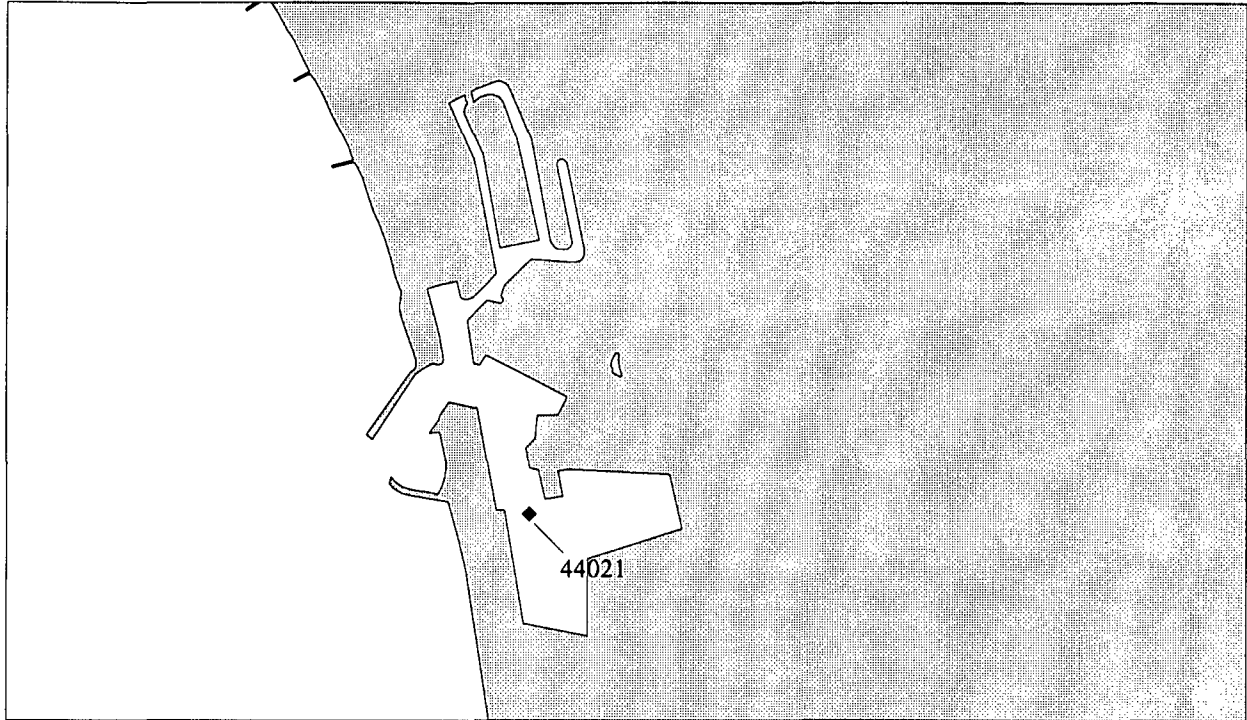


### Marina Del Rey

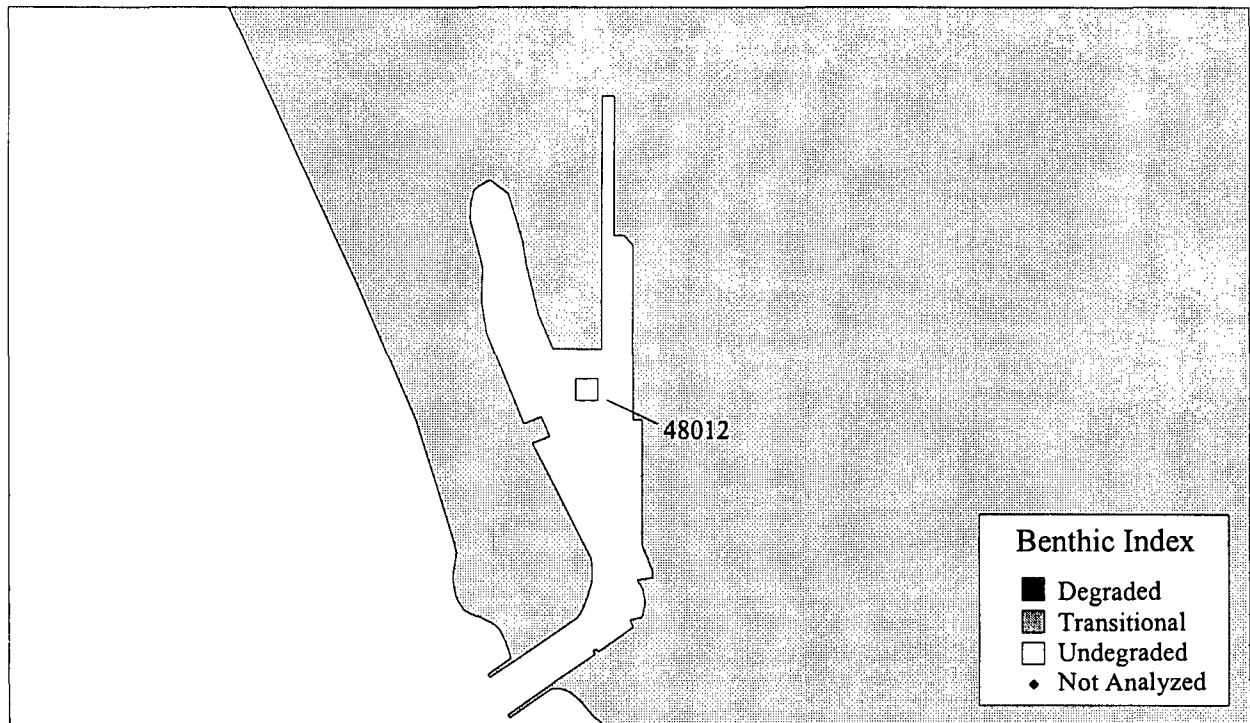


Figures 52a and 52b. Distribution of Stations in King Harbor (a), and Marina Del Rey (b), Demonstrating Benthic Community Structure.

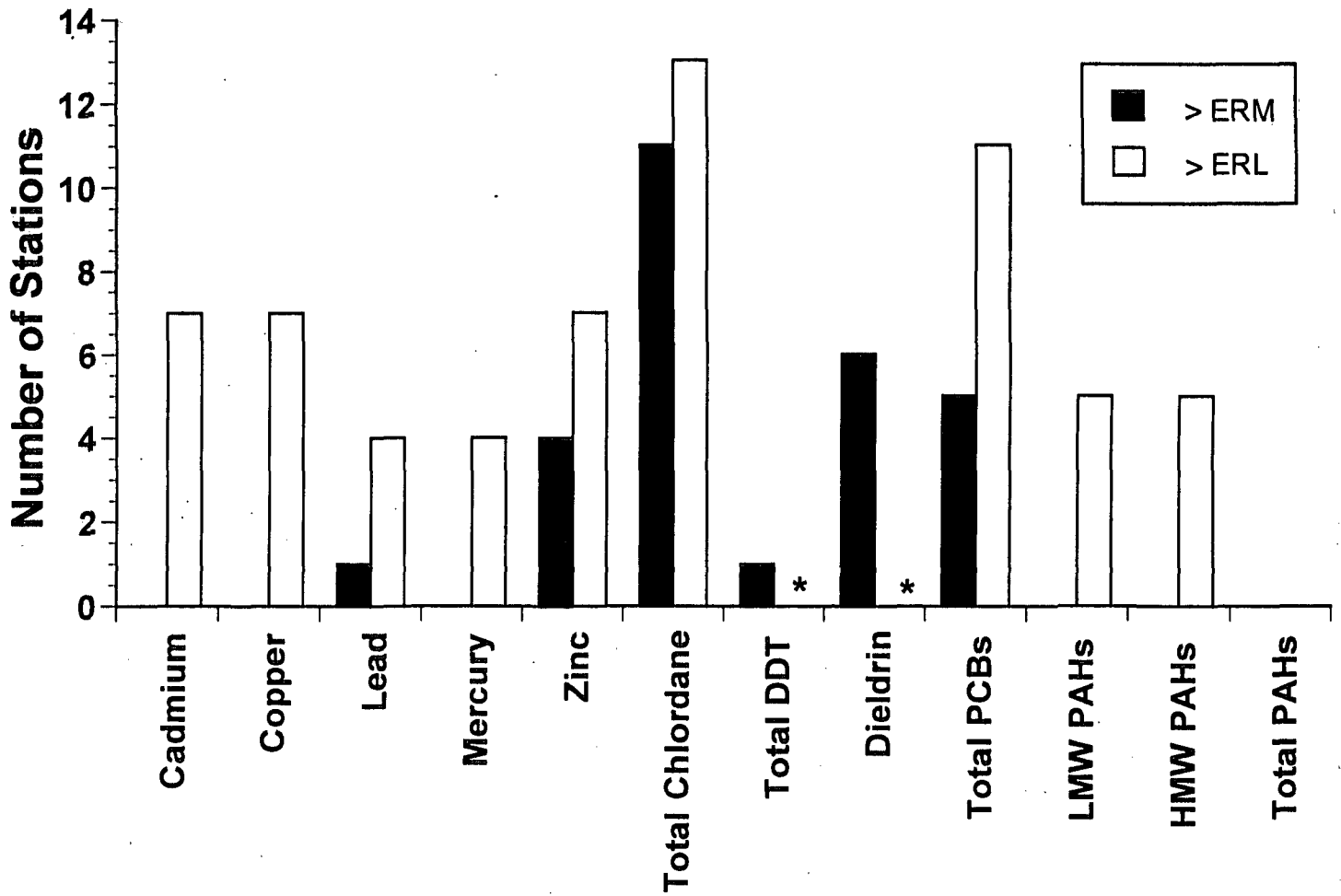
Ventura Marina



Channel Islands Harbor

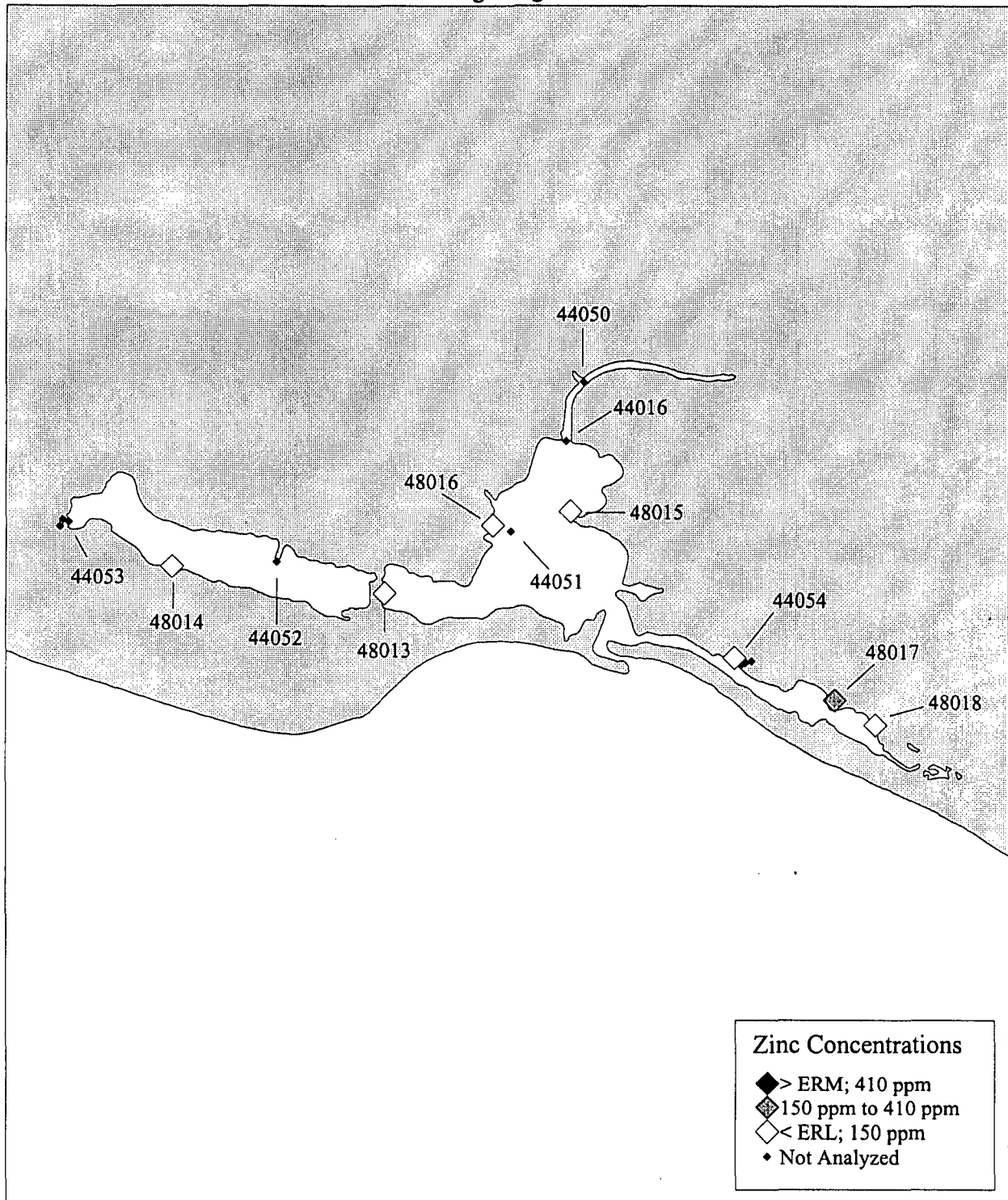


Figures 53a and 53b. Distribution of Stations in Ventura Harbor (a), and Channel Islands Harbor (b), Demonstrating Benthic Community Structure.



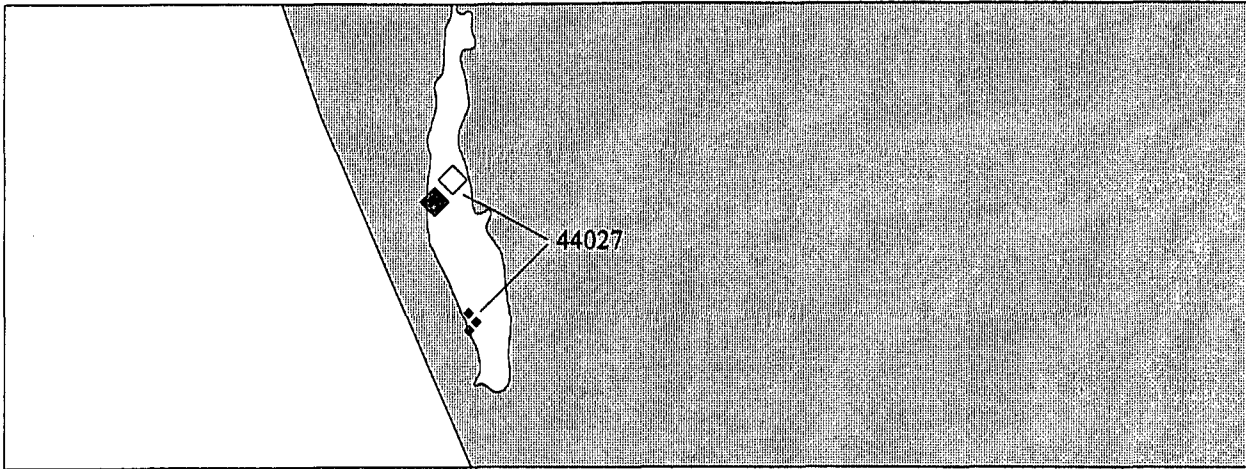
**Figure 54 .** Number of Lagoon station samples exceeding either the ERM or ERL sediment quality guidelines. (Total DDT was compared to the Swartz *et al.* sediment effect concentration, 100 ug/g OC. \* no ERL exceedances were calculated for Total DDT or Dieldrin; see text for details).

# Mugu Lagoon

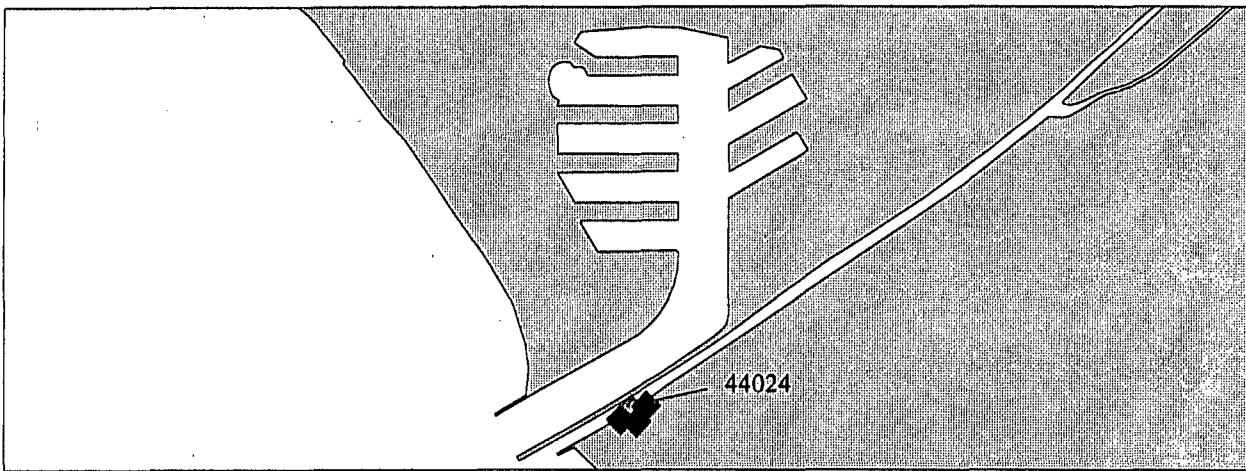


Figures 55. Distribution of samples in Mugu Lagoon exceeding the ERM for Zinc.

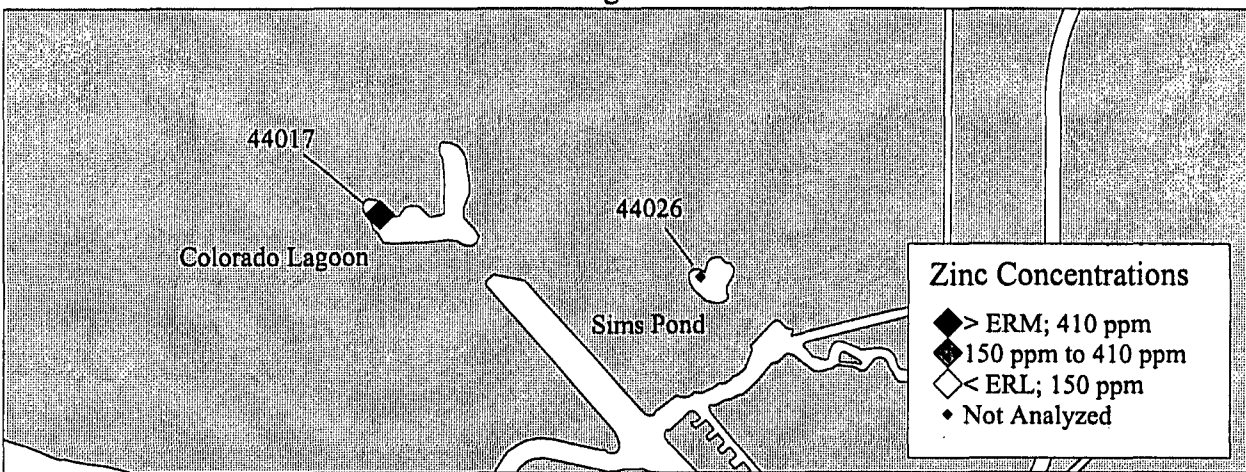
McGrath Lake



Ballona Creek



Colorado Lagoon/Sims Pond



Figures 56a, 56b, and 56c. Distribution of samples in McGrath Lake (a), Ballona Creek (b), and Colorado Lagoon/Sims Pond (c), exceeding the ERM for Zinc.

# Mugu Lagoon

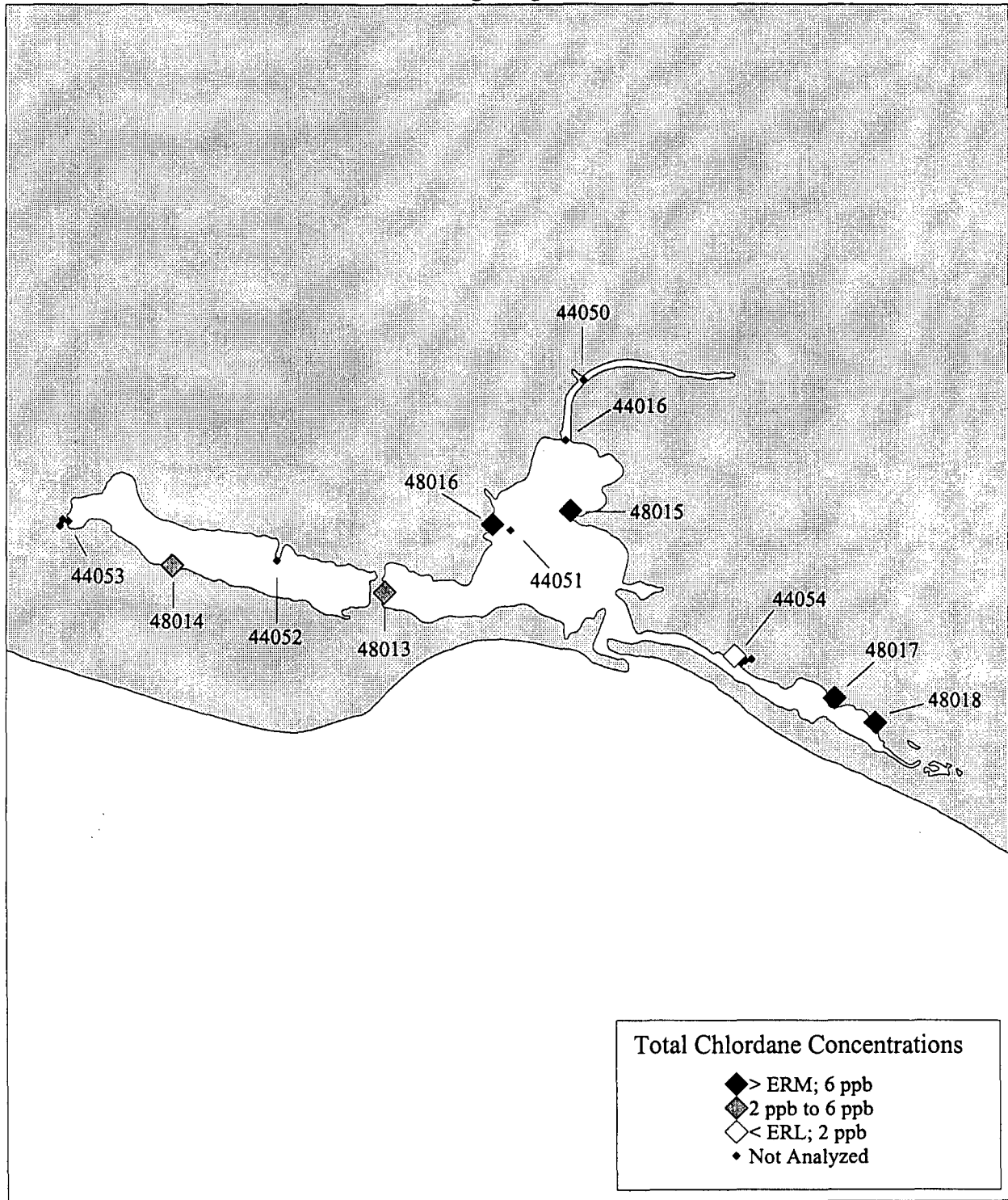
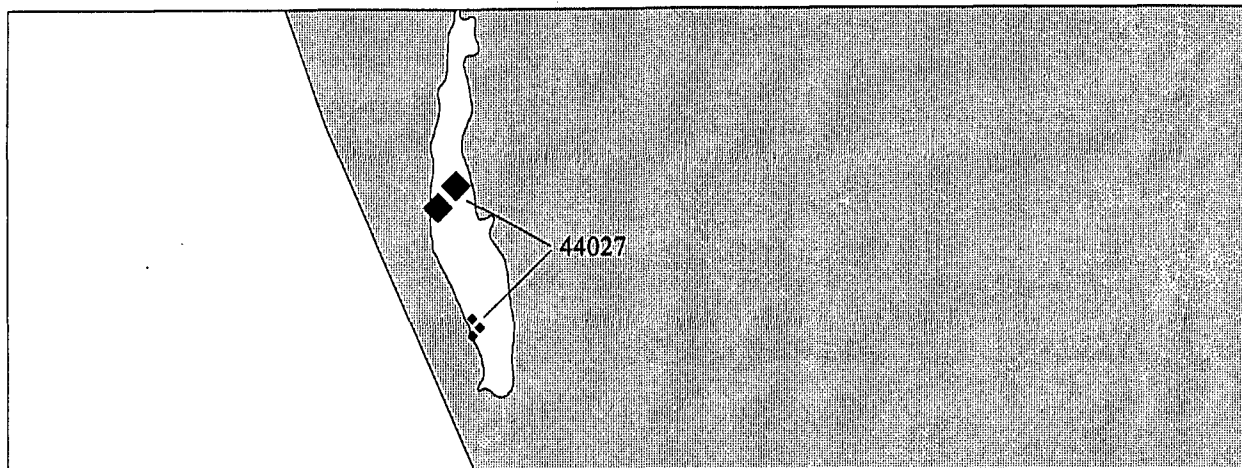
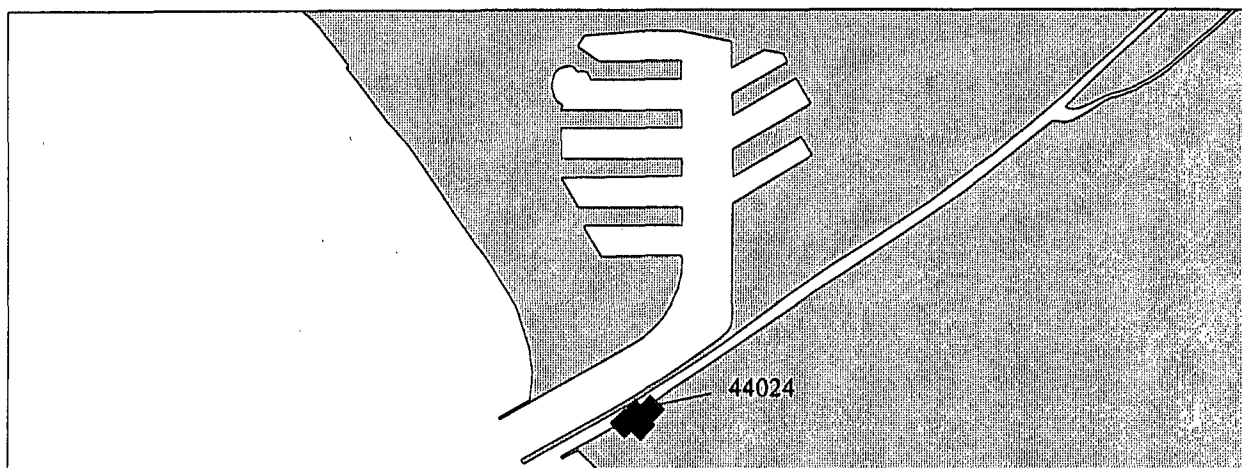


Figure 57. Distribution of samples in Mugu Lagoon exceeding the ERM for Total Chlordane.

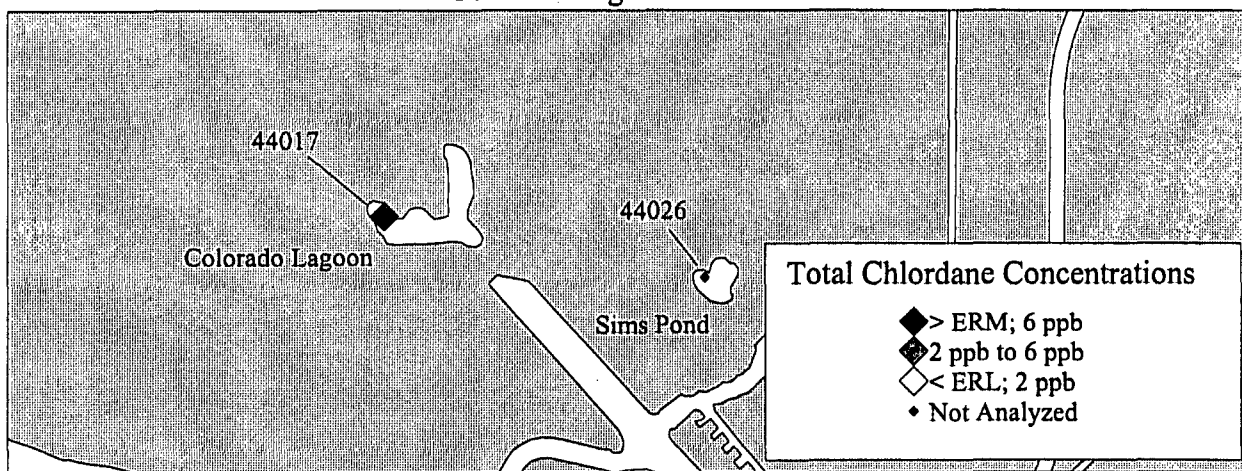
McGrath Lake



Ballona Creek



Colorado Lagoon/Sims Pond



Figures 58a, 58b, and 58c. Distribution of samples in McGrath Lake (a), Ballona Creek (b), and Colorado Lagoon/Sims Pond (c), exceeding the ERM for Total Chlordane.

# Mugu Lagoon

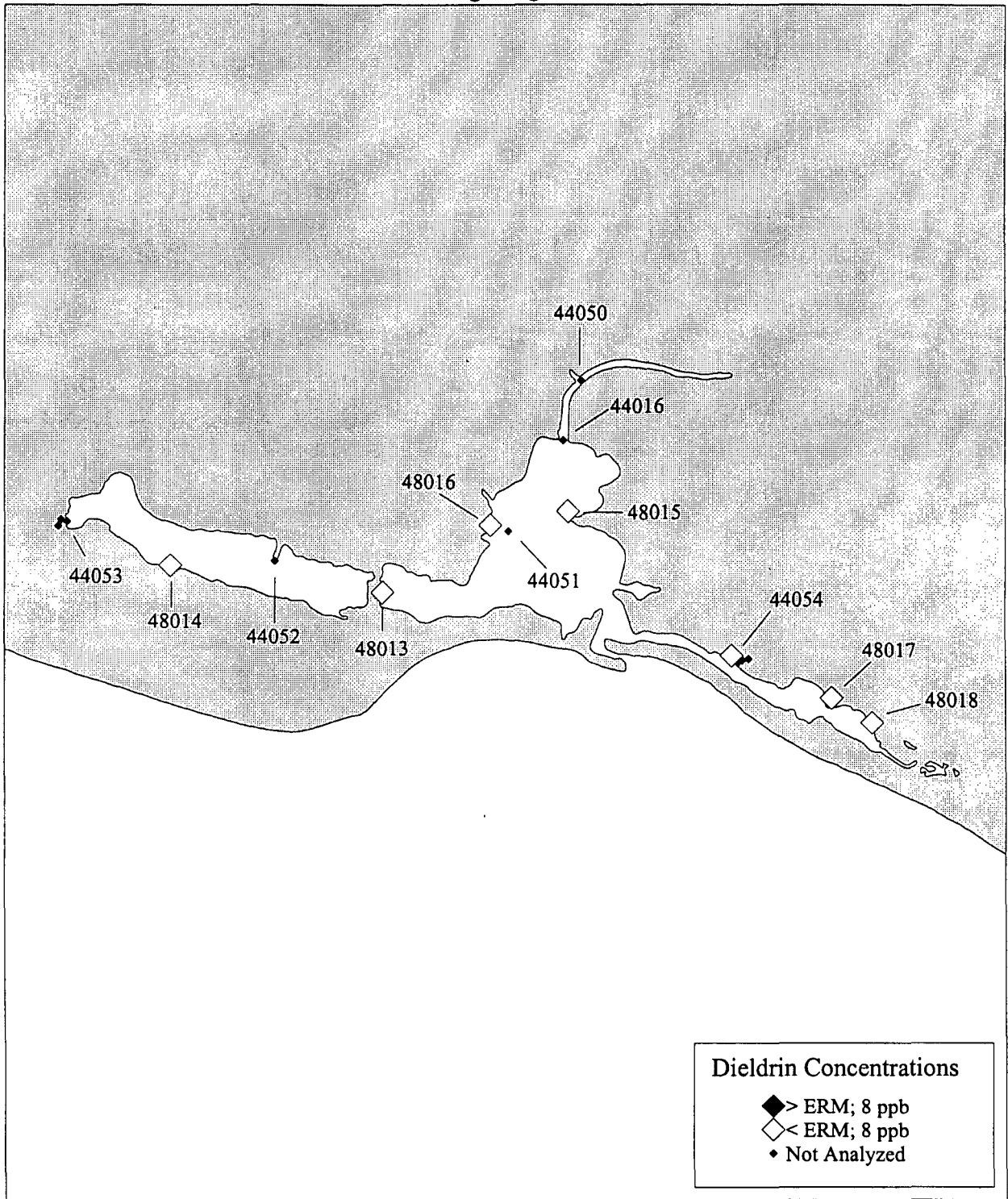
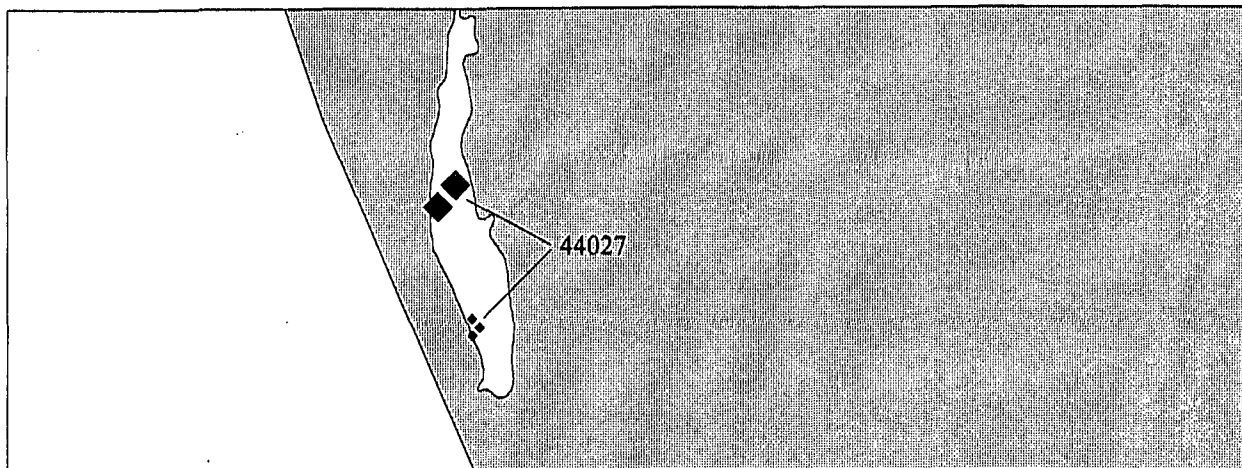


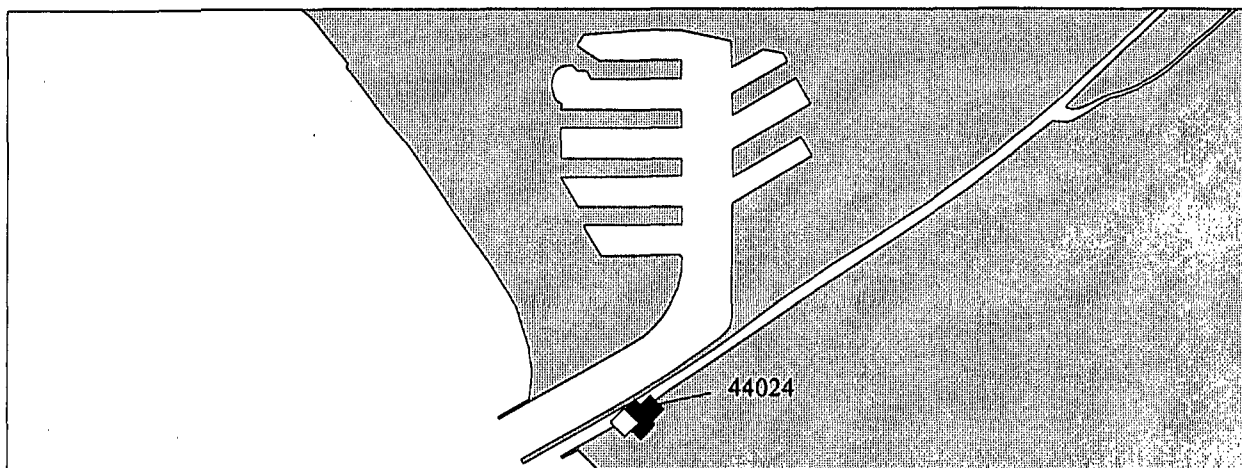
Figure 59. Distribution of samples in Mugu Lagoon exceeding the ERM for Dieldrin.



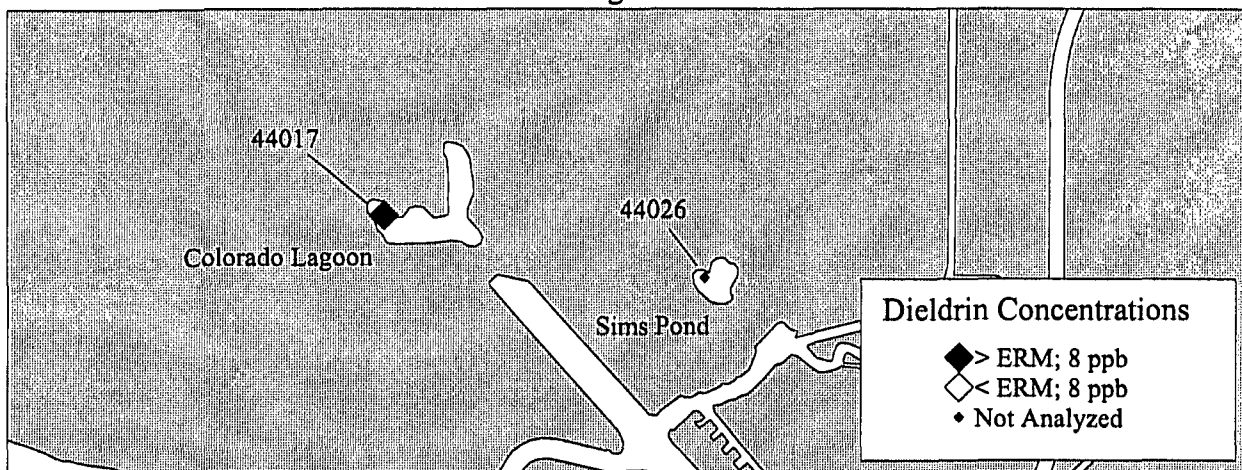
McGrath Lake



Ballona Creek



Colorado Lagoon/Sims Pond



Figures 60a, 60b, and 60c. Distribution of samples in McGrath Lake (a), Ballona Creek (b), and Colorado Lagoon/Sims Pond (c), exceeding the ERM for Dieldrin.

# Mugu Lagoon

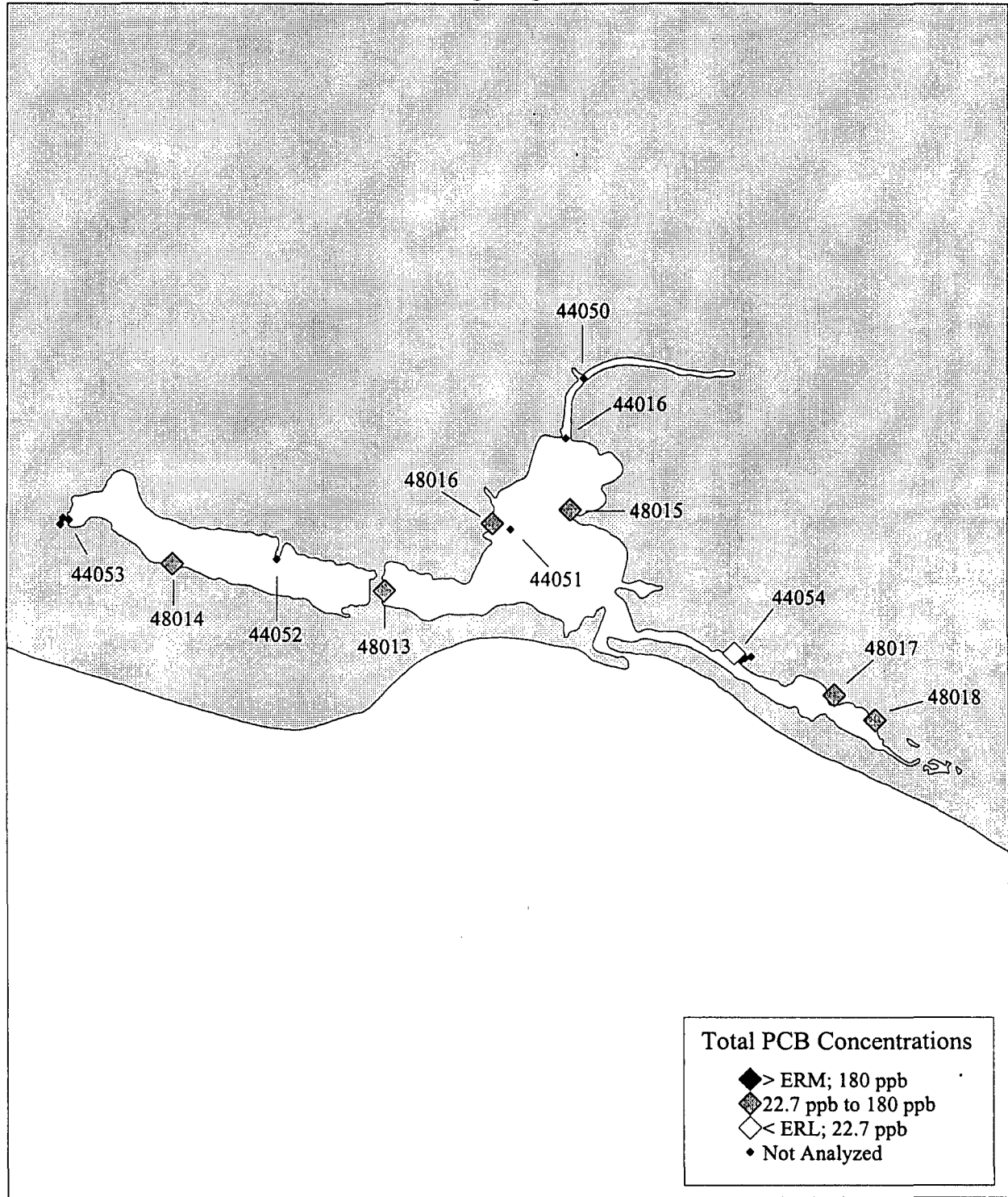
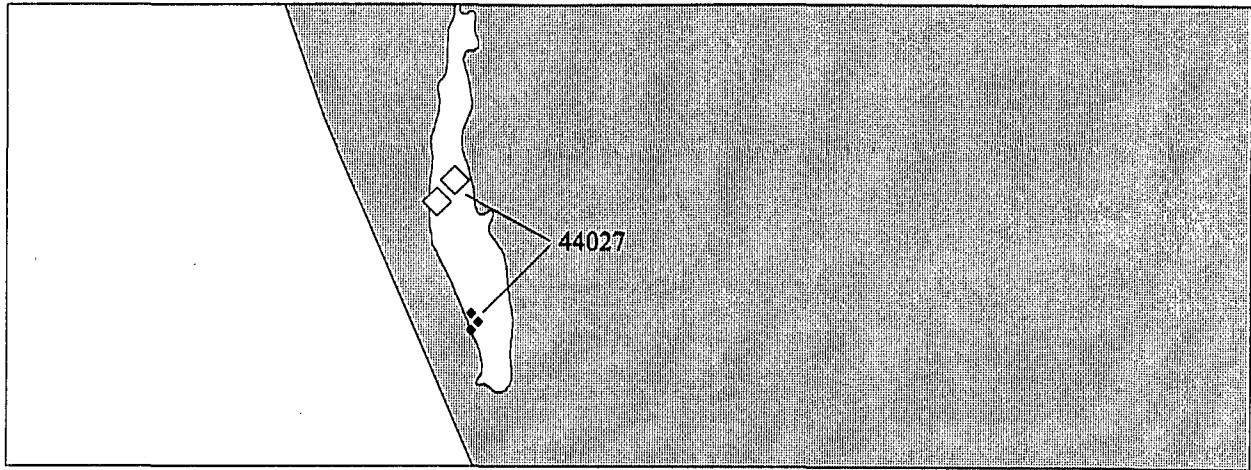
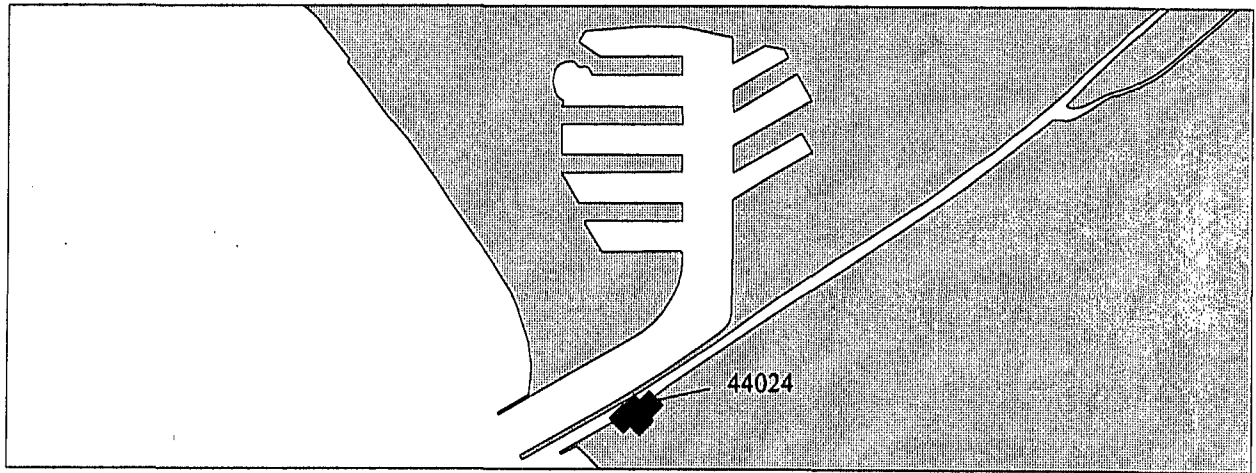


Figure 61. Distribution of samples in Mugu Lagoon exceeding the ERM for Total PCB.

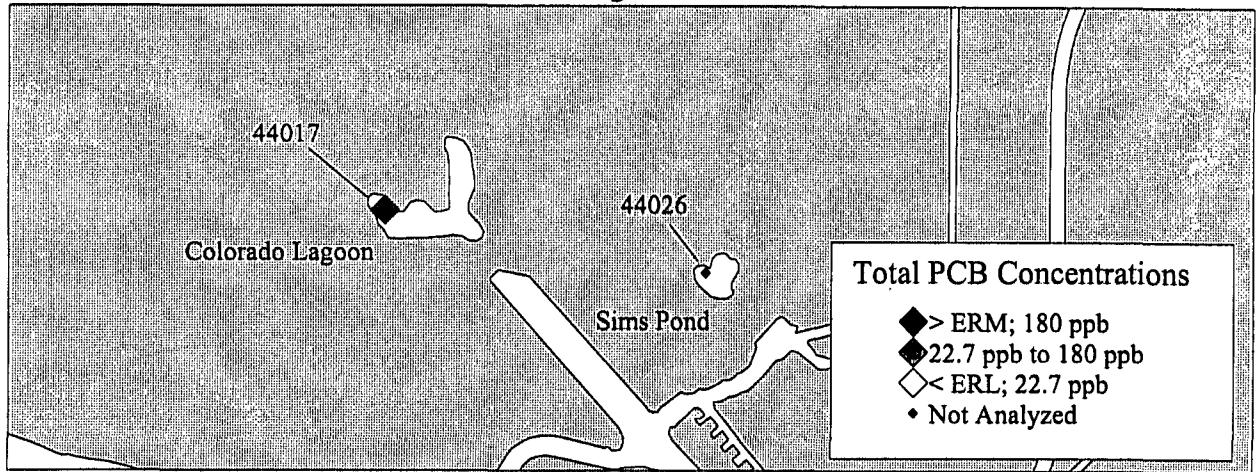
McGrath Lake



Ballona Creek



Colorado Lagoon/Sims Pond



Figures 62a, 62b, and 62c. Distribution of samples in McGrath Lake (a), Ballona Creek (b), and Colorado Lagoon/Sims Pond (c), exceeding the ERM for Total PCB.

# Mugu Lagoon

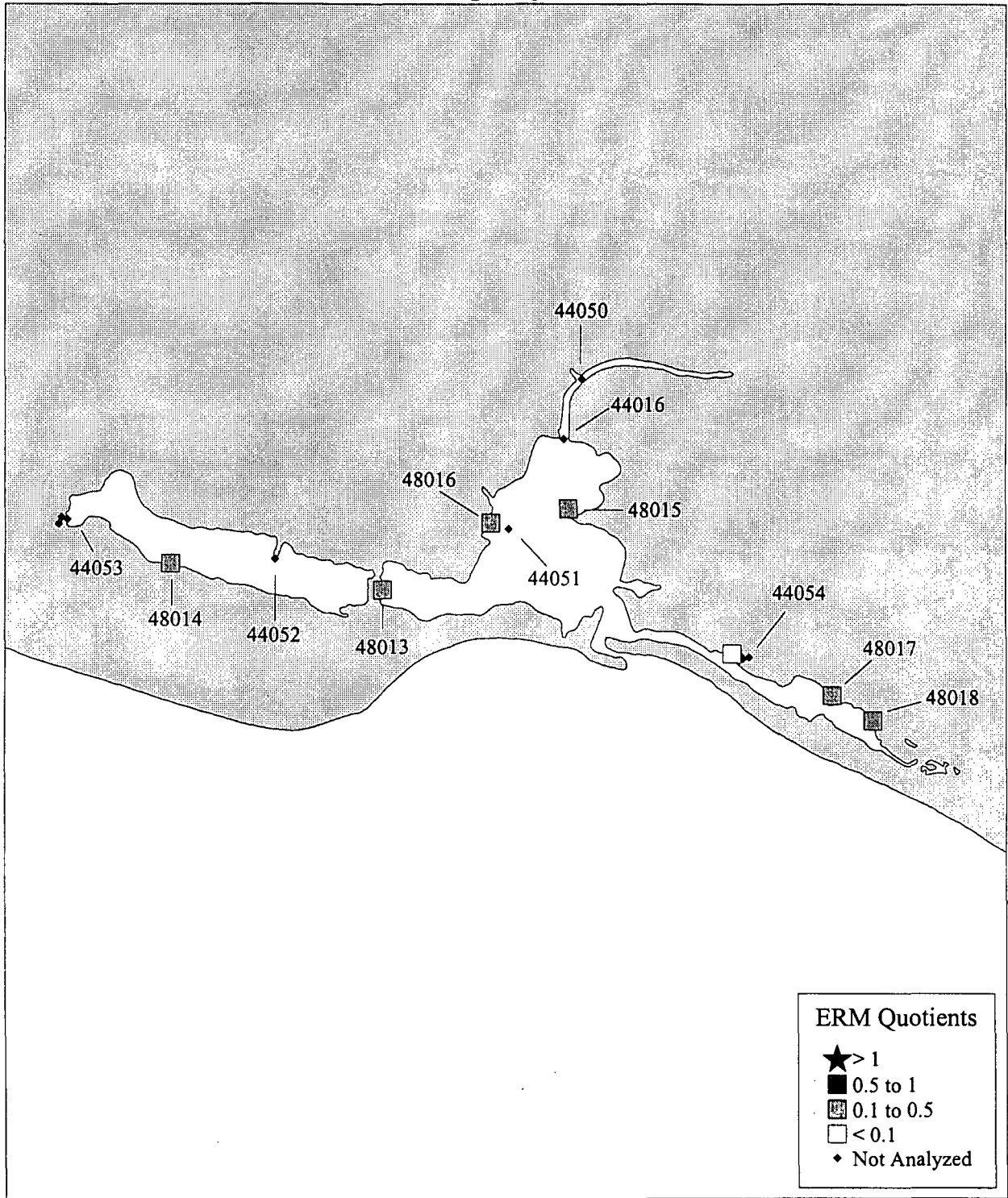
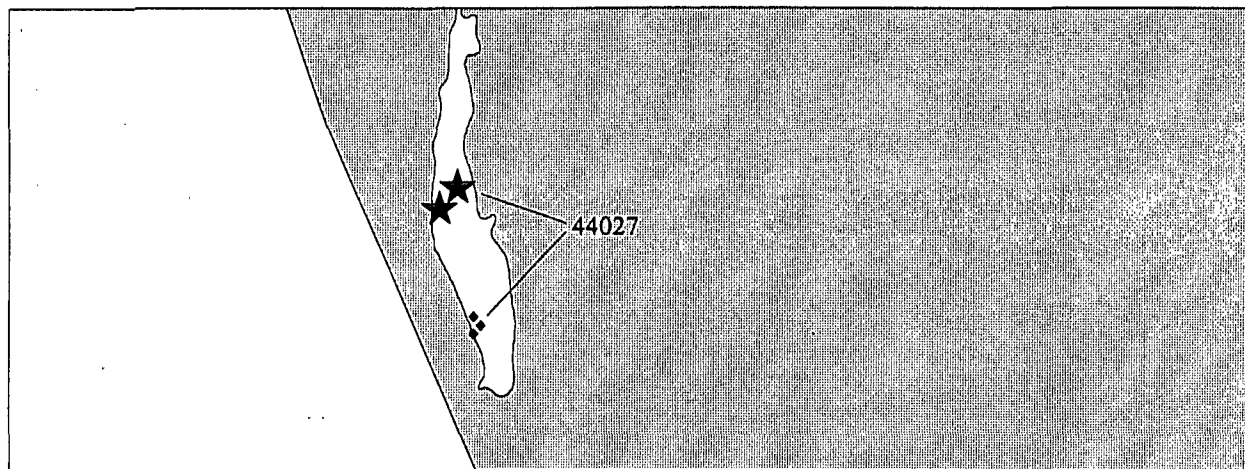
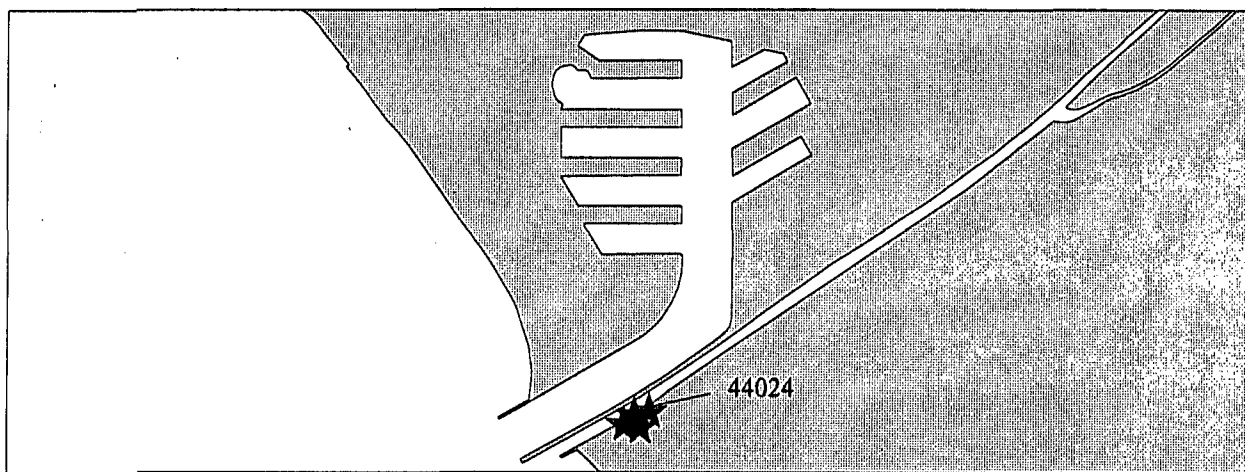


Figure 63. ERM values at Mugu Lagoon Sampling Stations.

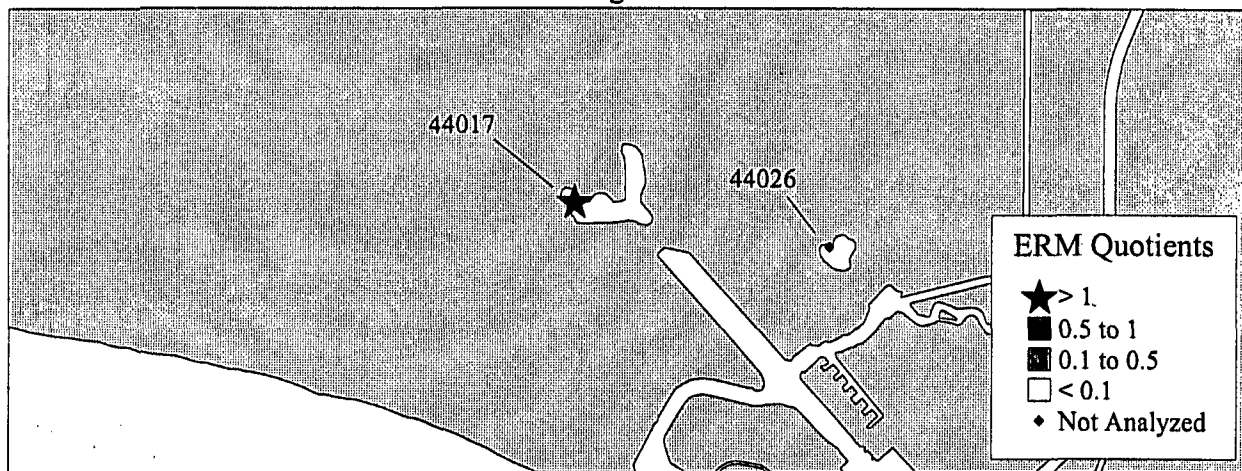
McGrath Lake



Ballona Creek



Colorado Lagoon/Sims Pond



Figures 64a, 64b, and 64c. ERM values at McGrath Lake (a), Ballona Creek (b), and Colorado Lagoon/Sims Pond (c), Sampling Stations.

# Mugu Lagoon

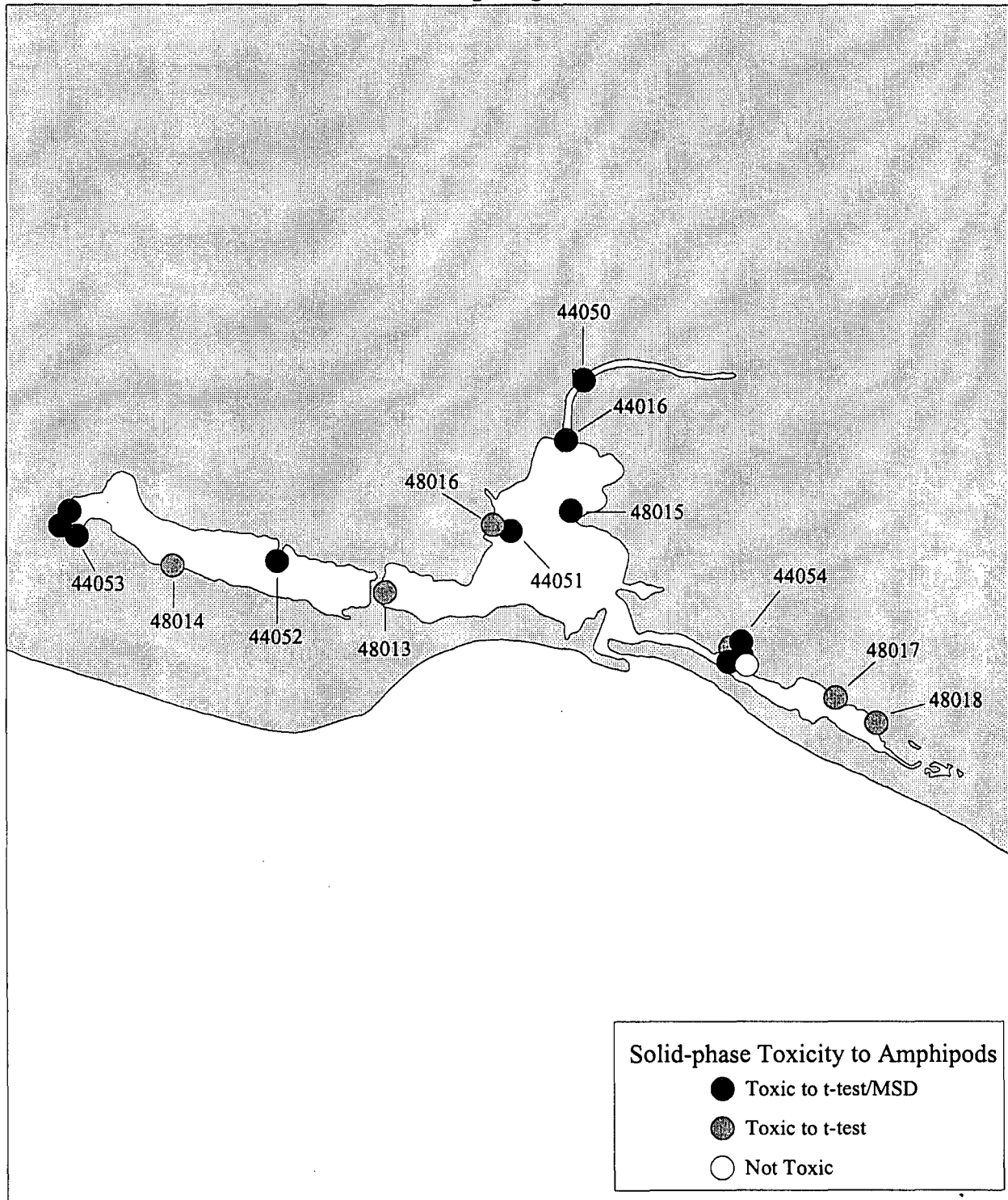
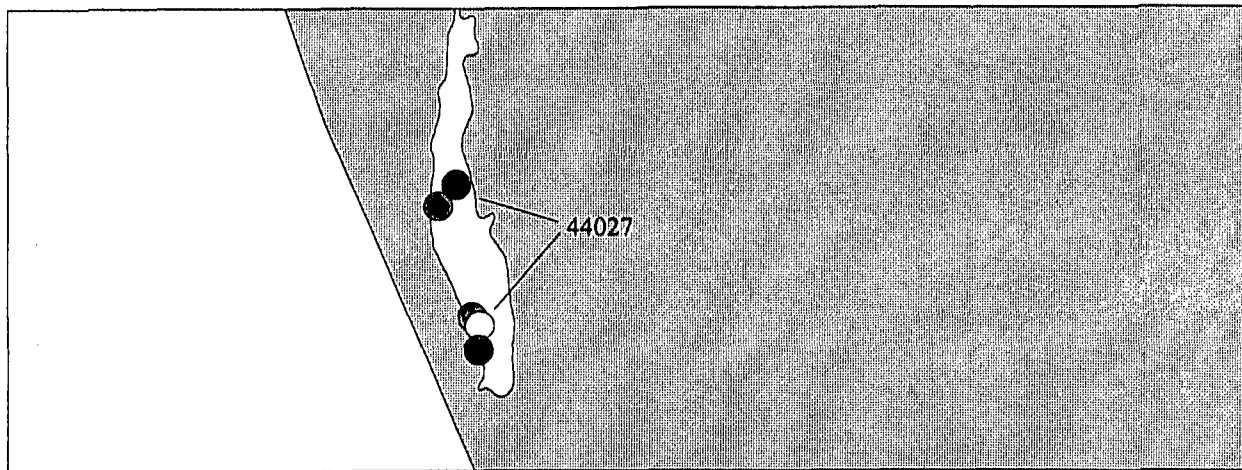
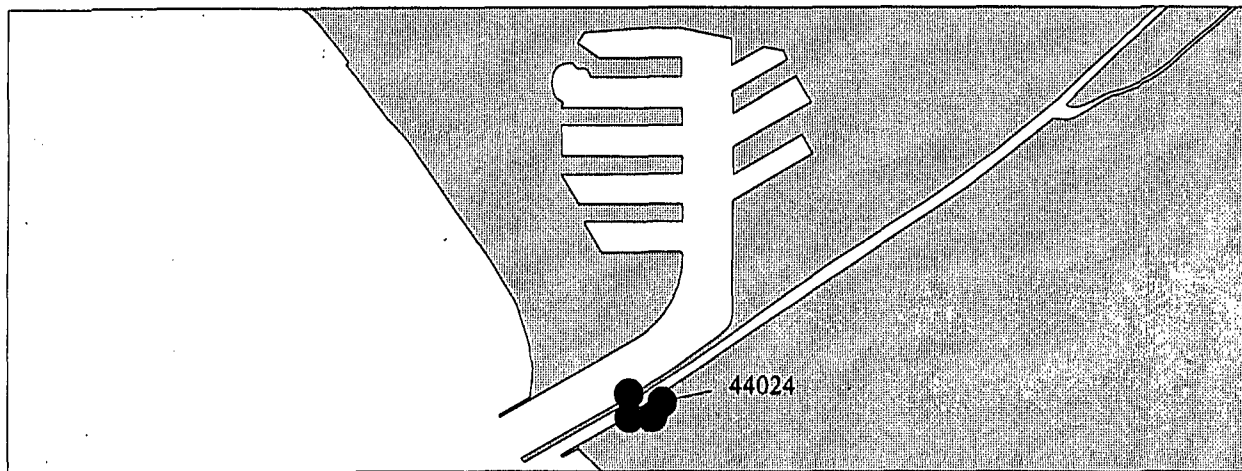


Figure 65. Toxicity of Sediment Samples in Mugu Lagoon.

McGrath Lake



Ballona Creek



Colorado Lagoon/Sims Pond

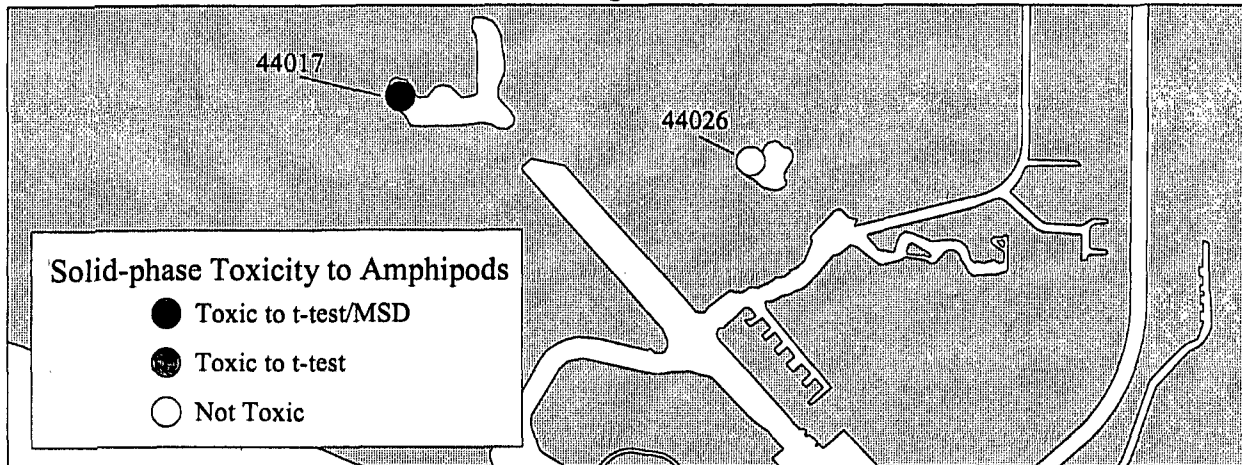
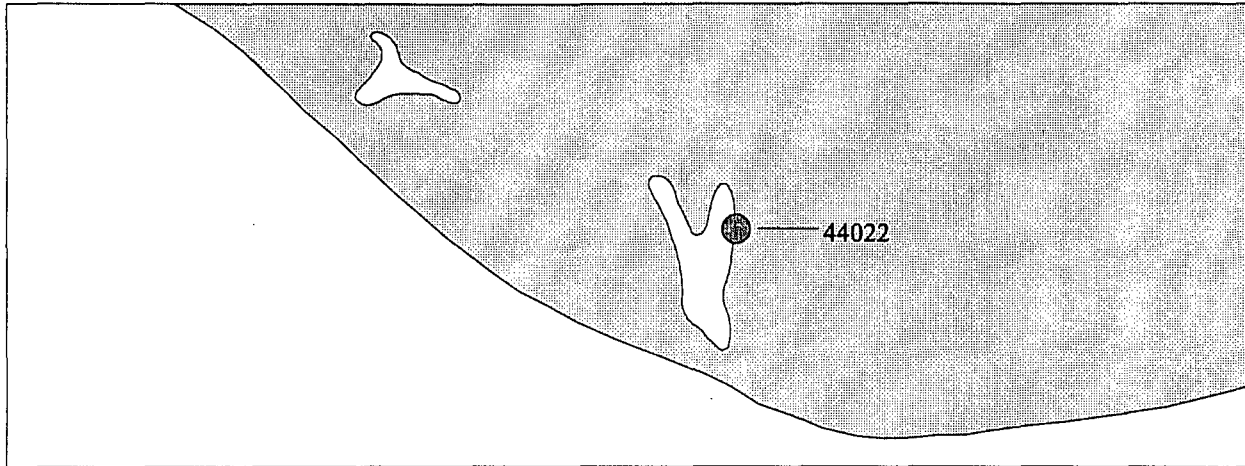
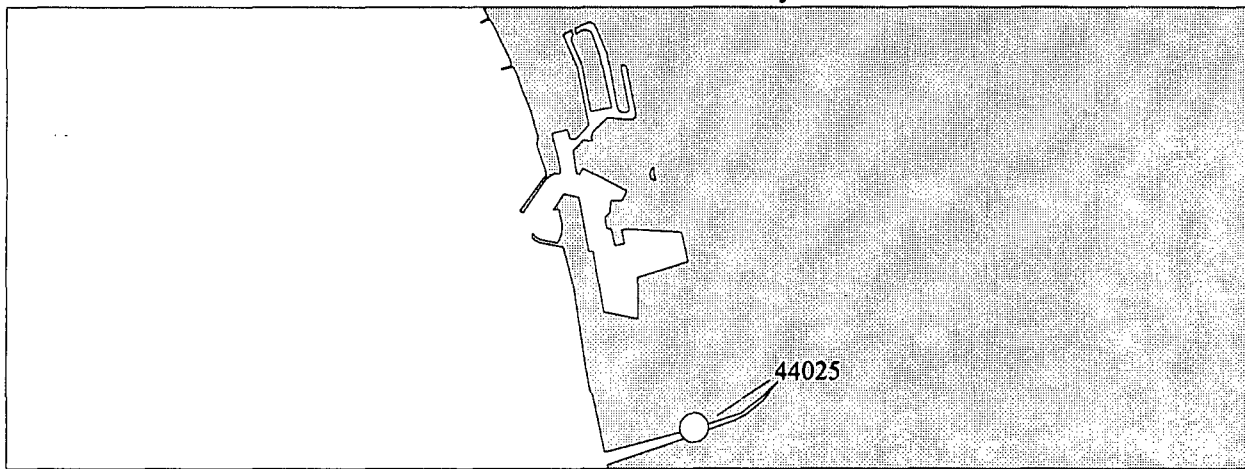


Figure 66a, 66b, and 66c. Toxicity of Sediment Samples in McGrath Lake (a), Ballona Creek (b), and Colorado Lagoon/Sims Pond (c).

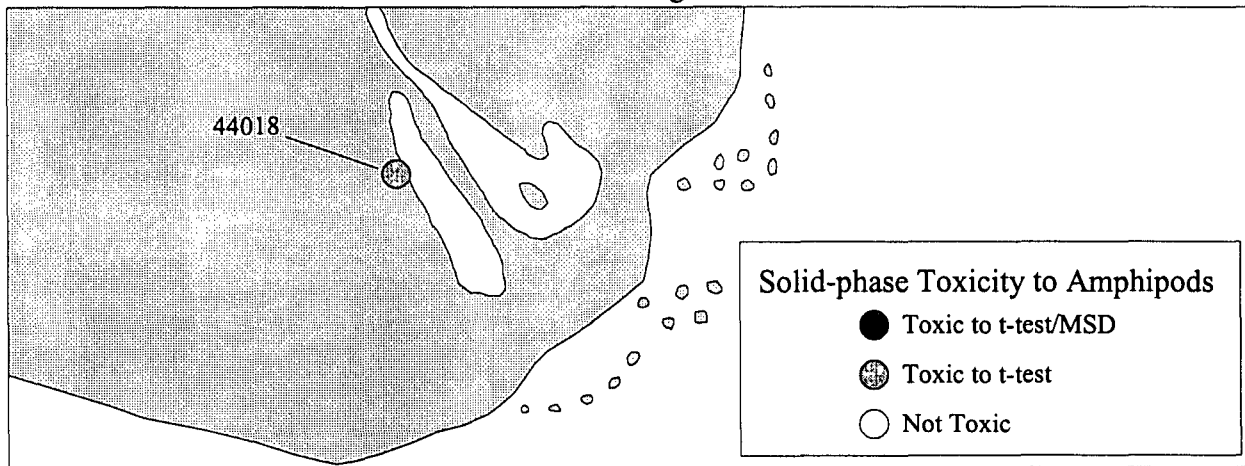
Ventura River Estuary



Santa Clara River Estuary

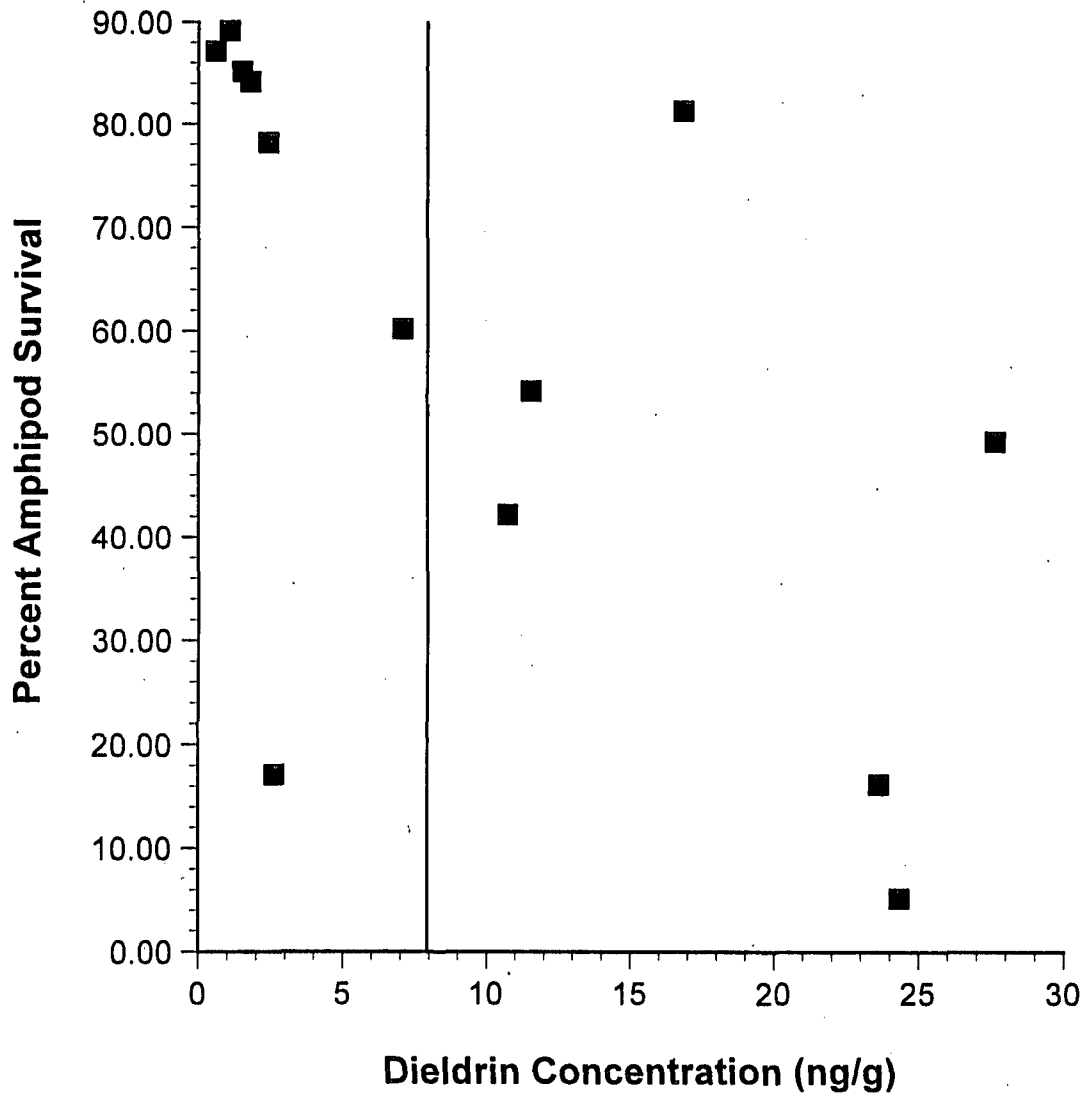


Malibu Lagoon



Figures 67a, 67b, and 67c. Toxicity of Sediment Samples in Ventura River Estuary (a), Santa Clara River Estuary (b), and Malibu Lagoon (c).





**Figure 68.** Amphipod survival at Lagoon stations in relation to Dieldrin concentrations. Vertical line indicates ERM guideline value.

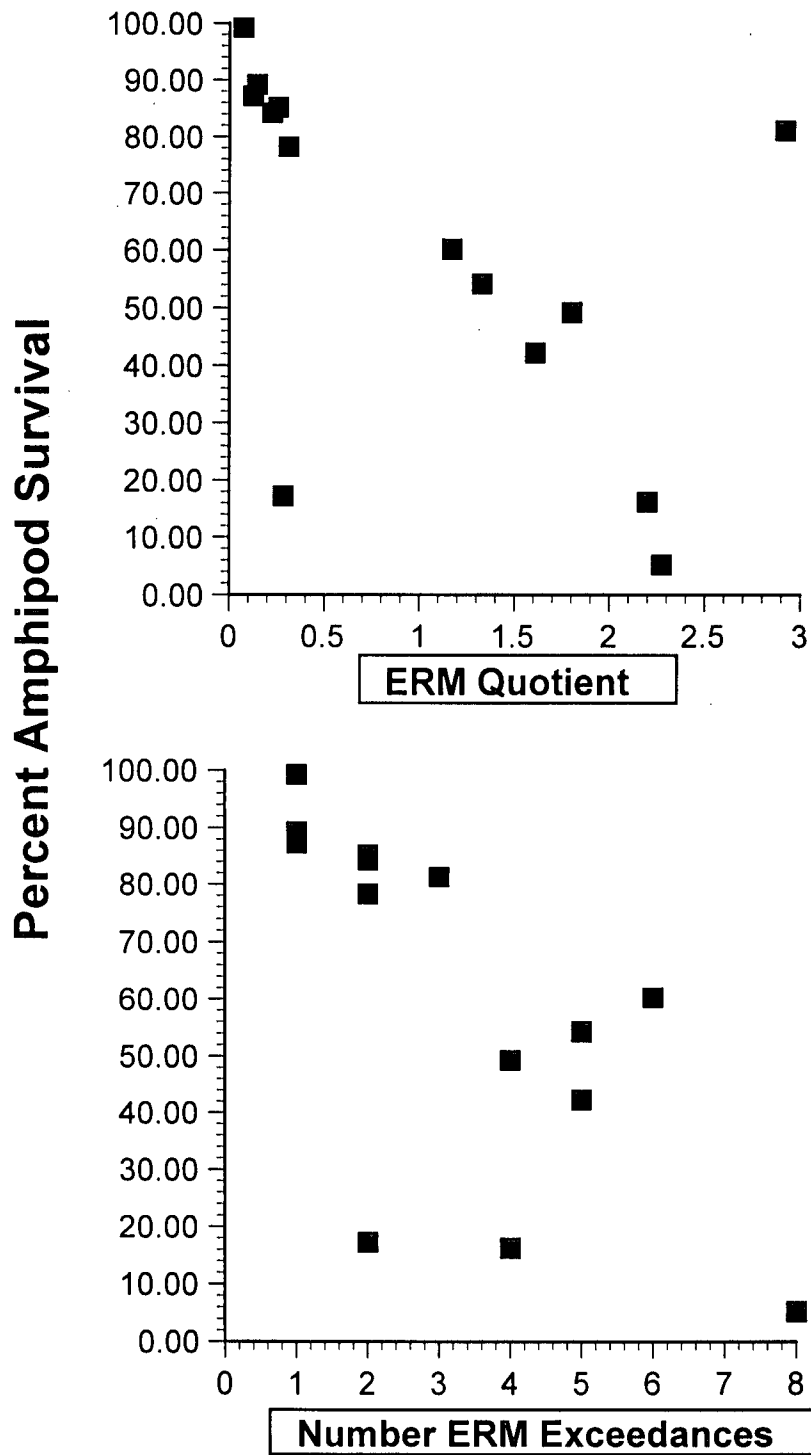


Figure 69 . Amphipod survival at Lagoon stations in relation to average ERM Quotient and Number of ERM Exceedances.

# Mugu Lagoon

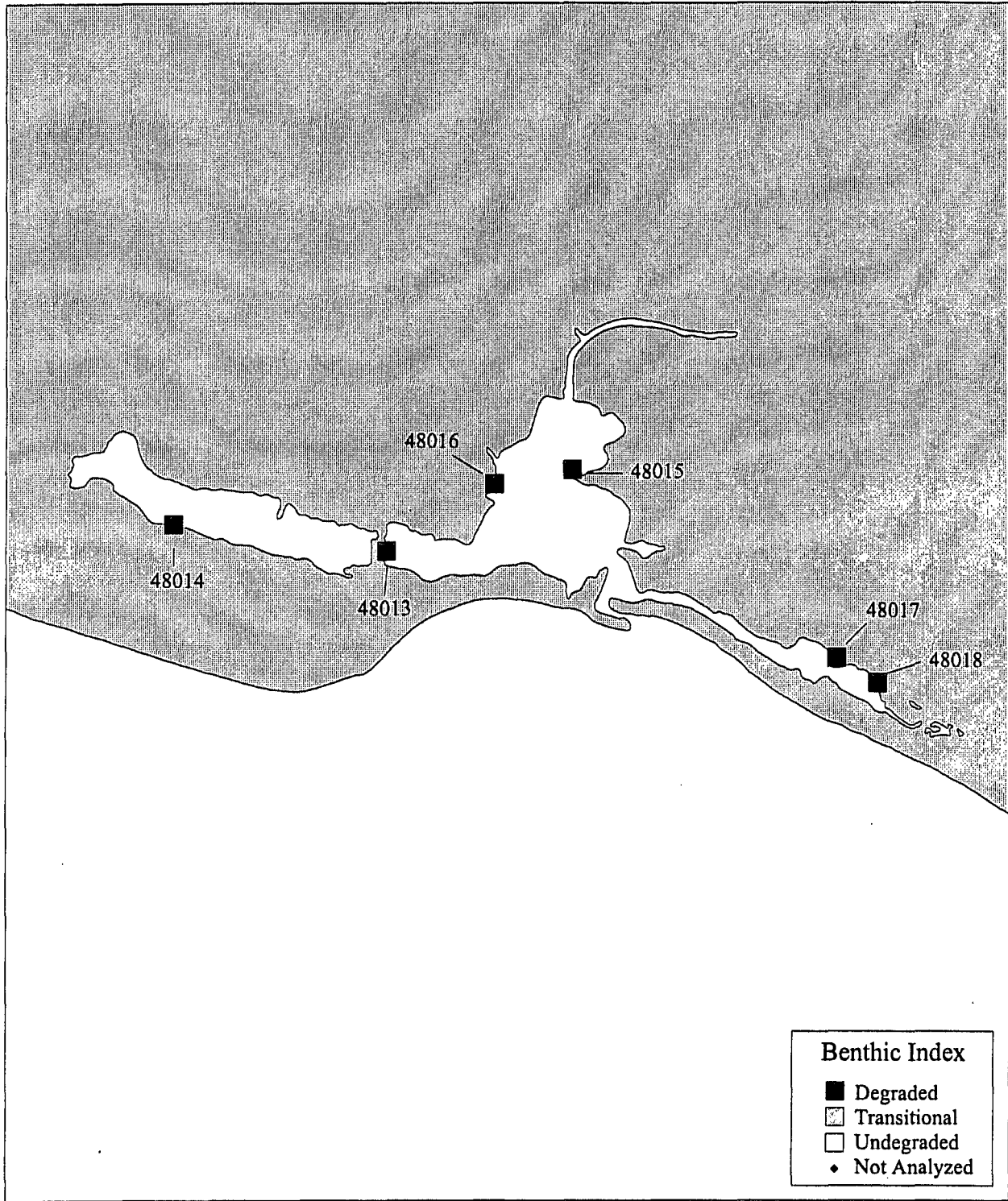


Figure 70. Distribution of Stations in Mugu Lagoon Demonstrating Benthic Community Structure.