

DWR-1388

Final

2011 Georgiana Slough Non-Physical Barrier Performance Evaluation Project Report



Prepared by:



California Department
of Water Resources

September 5, 2012

Final
2011 Georgiana Slough Non-Physical Barrier
Performance Evaluation Project Report



Prepared by:



California Department of Water Resources
1416 9th Street
Sacramento, CA 94236-001
Contact: Ryan Reeves
916.653.6868

September 5, 2012

State of California
Edmund G. Brown Jr., Governor

Natural Resources Agency
John Laird, Secretary for Resources

Department of Water Resources
Mark W. Cowin, Director

Dale Hoffman-Floerke,
Chief Deputy Director

Kasey Schimke
Asst. Director Legislative Affairs

Nancy Vogel
Asst. Director of Public Affairs

Cathy Crothers
Chief Counsel

Gary Bardini
Deputy Director

Kathie Kishaba
Deputy Director

John Pacheco
Deputy Director

Russ Stein
Acting Deputy Director

Carl Torgersen
Acting Deputy Director

Bay-Delta Office

Katherine F. Kelly Chief

South Delta Branch

Mark A. Holderman Branch Chief, South Delta Branch

This report was prepared under the supervision of

Jacob McQuirk Chief, Temporary Barriers and Lower San Joaquin

Ryan Reeves Senior Water Resources Engineer

Prepared by AECOM

ACKNOWLEDGMENTS

The following individuals, agencies, and organizations contributed to the 2011 Georgiana Slough Non-Physical Barrier Project.¹

Principal Investigator

Charles Hanson, Ph.D. Hanson Environmental, Inc.

Key Report Contributors

Ryan Reeves	California Department of Water Resources
Jacob McQuirk	California Department of Water Resources
Khalid Ameri	California Department of Water Resources
Russell Perry, Ph.D.	U.S. Geological Survey
Jason Romine, Ph.D.	U.S. Geological Survey
Theresa Liedtke	U.S. Geological Survey
Jon Bureau	U.S. Geological Survey
Aaron Blake	U.S. Geological Survey
Chris Fitzer	AECOM Technical Services, Inc.
Natalie Smith	AECOM Technical Services, Inc.
Steve Pagliughi	AECOM Technical Services, Inc.
Sam Johnston	Hydroacoustic Technologies, Inc.
Kevin Kumagai	Hydroacoustic Technologies, Inc.
Kenneth Cash	Normandeau Associates, Inc.

Project Collaborators

California Department of Water Resources	Project Sponsor, Lead Project Manager/Implementing Agency, Data Analysis, and Report Contribution and Review
U.S. Bureau of Reclamation	Field Implementation, Data Analysis, and Report Contribution
U.S. Geological Survey	Field Implementation, Data Analysis, and Report Contribution
AECOM Technical Services, Inc.	Consultant Team Project Manager, Field Implementation, Data Analysis, and Report Contribution
Hydroacoustic Technologies, Inc.	Field Implementation, Data Analysis, and Report Contribution
Hanson Environmental, Inc.	Co-Principal Investigator, Field Implementation, Data Analysis, and Report Contribution
Normandeau Associates, Inc.	Field Implementation, Data Analysis, and Report Contribution
Marcus Bole and Associates	Field Implementation Support
Professional Aquaculture Services	Field Implementation Support

Additional Acknowledgments

The project team would also like to acknowledge and thank the many people who provided valuable input on the project study plan, construction support, field support, data analysis, report review, and document production. These individuals and organizations include: Bill McLaughlin, Colin Hanley, and John Personeni at DWR, Noah Adams and several other staff with the USGS Columbia River Research Laboratory, and Cal Neva, C.S. Marine, and Big Valley Divers for providing barrier construction and maintenance support. We would also like to thank the U.S. Fish and Wildlife Service's Coleman National Fish Hatchery and California – Nevada Fish Health Center for providing the late fall–run Chinook salmon used in the study and laboratory facilities for the tag retention and fish health evaluation, and the California Department of Fish and Game's American River Fish Hatchery/Fish Health Laboratory for providing fish and facilities for training purposes.

¹ Any use of trade, firm, or product names is for descriptive purposes only and does not imply endorsement by the U.S. Government.

Project Report Reviews

The 2011 Georgiana Slough Non-Physical Barrier Performance Evaluation Project Report went through several review processes prior to finalization. These include:

- ▶ Project team / contributor review, including review by staff from California Department of Water Resources, U.S. Geological Survey, AECOM, Hanson Environmental, Inc., Hydroacoustic Technologies, Inc., and Normandeau Associates, Inc.
(February 2012)
- ▶ Fisheries agency review, including review by National Marine Fisheries Service and U.S. Fish and Wildlife Service.
(March through May 2012)
- ▶ U.S. Geological Survey peer review of contributions.
(July 2012)
- ▶ Final review by California Department of Water Resources, Bay-Delta Office.
(August 2012)

TABLE OF CONTENTS

Section	Page
ACRONYMS AND OTHER ABBREVIATIONS	VI
EXECUTIVE SUMMARY	ES-1
ES.1 Introduction	ES-1
ES.2 Study Purpose, Objectives, and Overview	ES-3
ES.3 Study Results and Findings	ES-8
ES.4 Study Conclusions	ES-10
ES.5 Recommendations and Future Directions	ES-11
1 INTRODUCTION.....	1-1
1.1 Background	1-1
1.1 Study Purpose, Objectives, and Overview	1-3
2 STUDY APPROACH AND METHODS.....	2-1
2.1 Overview of Experimental Design	2-1
2.2 Hypothesis Testing	2-3
2.3 Statistical Basis and Fish Sample Sizes for the Experimental Design	2-6
2.4 Experiment Implementation	2-7
2.5 Monitoring and Data Collection.....	2-29
2.6 Experimental Barrier Operations.....	2-32
2.7 Statistical Analysis of Barrier Efficiency and Variables Affecting Fish Fates	2-33
3 RESULTS AND DISCUSSION	3-1
3.1 Environmental Conditions.....	3-1
3.2 Fish Transport, Tagging, and Release	3-2
3.3 Barrier Operations	3-4
3.4 Barrier Deterrence, Protection, and Overall Efficiency	3-4
3.5 Generalized Linear Model.....	3-15
3.6 Survival and Route Entrainment Probabilities	3-30
3.7 Predation.....	3-31
4 SUMMARY OF FINDINGS AND CONCLUSIONS	4-1
4.1 Study Findings.....	4-1
4.2 Study Conclusions.....	4-3
5 RECOMMENDATIONS AND FUTURE DIRECTIONS.....	5-1
6 REFERENCES	6-1

Appendices

A	2011 GSNPB Acoustic Tag System Data Collection Plan
B	2011 GSNPB Fish Transport, Tagging, and Release Standard Operating Procedures
C	2011 GSNPB Acoustic Doppler Current Profiler Data Processing and Water Velocity Modeling
D	2011 GSNPB Summary of Fish Transport Conditions
E	2011 GSNPB Summary of Predator Detections within the Array

Figures

ES-1	Delta Migration Pathways	ES-2
ES-2	Location of 2011 Georgiana Slough Non-Physical Barrier Study	ES-5
ES-3	Conceptual Layout of the Georgiana Slough Non-Physical Barrier Components	ES-6
ES-4	Overview of the 2011 Georgiana Slough Non-Physical Barrier Study Area	ES-7
1-1	Delta Migration Pathways	1-2
1-2	Location of 2011 Georgiana Slough Non-Physical Barrier Study	1-5
1-3	Conceptual Design of the BAFF used at Georgiana Slough	1-6
2-1	Overview of the 2011 Georgiana Slough Non-Physical Barrier Study Area	2-2
2-2	2011 Non-Physical Barrier Layout Plan and Profile	2-9
2-3	Components of the BAFF System Installed at Georgiana Slough	2-11
2-4	Flow Velocity Components in Front of an Angled Fish Barrier	2-14
2-5	Hydrophone Array and other Data Collection Instrument Locations.....	2-20
2-6	Representative Photograph of a Tower Mount.....	2-21
2-7	Representative Photograph of a “Pound-In” Mount.....	2-22
2-8	Representative Photograph of a “Dock” Mount.....	2-23
2-9	Representative Photograph of Fish Holding Containers Tethered to Dock System.....	2-25
2-10	Representative Photograph of Fish Tagging	2-27
2-11a	Fish Fate Determination Schematic (Array Events).....	2-34
2-11b	Fish Fate Determination Schematic (Predation Events).....	2-35
2-12	The Streamwise and Cross-Stream Coordinate System in Relation to the Sacramento River and Georgiana Slough.....	2-37
2-13	Mark-Recapture Model Schematic Used to Estimate Survival, Route Entrainment, and Detection Probabilities.....	2-39
3-1	Distribution of Deterrence Efficiency for BAFF On/Off Operations.....	3-7
3-2	Relative Contribution of the BAFF Operations to Overall Efficiency	3-11
3-3	The Relative Contribution of the BAFF Operations to Overall Efficiency Under Different Light Conditions	3-12
3-4	The Relative Contribution of the BAFF Operations to Overall Efficiency Under Different Velocity Conditions	3-13
3-5	Two-Dimensional Tracks of Chinook Salmon Smolts in the Sacramento River	3-14
3-6	Pathway of an Acoustically Tagged Chinook Salmon Appearing to Pass Under the BAFF Framework into Georgiana Slough	3-14
3-7	River Discharge and BAFF Treatment at Time of Detection within the Array	3-16
3-8	Receiver Operating Curve Showing True and False Positive Rates of Classifying Fish to Georgiana Slough.....	3-18
3-9	Effect of the Interaction between Discharge Entering the River Junction (Q) and Cross-Stream Position of Acoustically Tagged Chinook Salmon (X)	3-20
3-10	Effect of Cross-Stream Position of Juvenile Salmon on Probability of Entrainment into Georgiana Slough under Different Discharges	3-21
3-11	Effect of Discharge on Probability of Entrainment into Georgiana Slough for Fish at Different Cross- Stream Locations	3-21
3-12	Effect of Streakline Position on Probability of Entrainment into Georgiana Slough for Fish at Different Cross-Stream Locations (X)	3-22
3-13	Probability of Entrainment into Georgiana Slough as a Function of Cross-stream Position for BAFF Off and BAFF On.....	3-22
3-14	Probability of Entrainment into Georgiana Slough as a Function Cross-Stream Position during Day and Night	3-23
3-15	Effect of Cross-Stream Position on Probability of Entrainment into Georgiana Slough during the Day	3-24

3-16	Effect of Cross-Stream Position on Probability of Entrainment into Georgiana Slough during the Night.....	3-25
3-17	Comparison of the Mean Estimated Probabilities from the Best-fit Logistic Regression Model to the Observed Fraction of Fish Entering Georgiana Slough.....	3-28
3-18	Date and Water Temperature for each Predation Event of an Acoustically Tagged Chinook Salmon Smolt during the 2011 Study.....	3-34
3-19	Movements of Tagged Predators in the Array.....	3-35
3-20	Movements of a Striped Bass during Change in BAFF Operations (Off to On).....	3-36

Tables

2-1	Design Angle Parameters for a Barrier Capable of Deflecting Juvenile Chinook Salmon	2-15
2-2	Discharge and Water Quality Stations in Close Proximity to the GSNPB Project Study Area	2-30
2-3	Parameter Definitions for the Mark-Recapture Model.....	2-40
2-4	Detection History Frequencies Used in the Mark-Recapture Model to Estimate Survival, Detection, and Route-Entrainment Probabilities	2-40
3-1	Summary of Weather Conditions during 2011 Study Implementation	3-1
3-2	Summary of Hydrologic and Water Quality Conditions during 2011 Study Implementation	3-3
3-3	2011 Georgiana Slough Study BAFF Operation.....	3-5
3-4	Summary of Acoustic Tagged Salmon Samples Encountering the BAFF during On/Off Operations at Low (< 5.4 lux) and High (≥ 5.4 lux) Light Levels.....	3-6
3-5	Summary of Acoustic Tagged Salmon Samples Encountering the BAFF during On/Off Operations at Low (< 0.25 m/s) and High (≥ 0.25 m/s) Across-Barrier Velocities.....	3-6
3-6	Comparison of BAFF On/Off Treatments for Three Response Metrics: Deterrence Efficiency, Protection Efficiency, and Overall Efficiency.....	3-7
3-7	Comparisons of Deterrence, Protection, and Overall Efficiencies with BAFF On/Off Treatments under Low (< 5.4 lux) and High (≥ 5.4 lux) Light Levels.....	3-8
3-8	Comparisons of Deterrence, Protection, and Overall Efficiencies with BAFF On/Off Treatments under Low (< 0.25 m/s) and High (≥ 0.25 m/s) Across-Barrier Water Velocities.....	3-9
3-9	Comparison of Deterrence, Protection, and Overall Efficiencies for BAFF On and BAFF Potentially Impaired.....	3-10
3-10	Comparison of Deterrence, Protection, and Overall Efficiencies for BAFF On and BAFF Potentially Impaired (Pooled) versus BAFF Off	3-11
3-11	Comparisons of Deterrence, Protection, and Overall Efficiencies with BAFF On and BAFF Potentially Impaired Pooled versus BAFF Off Operations under Low (< 5.4 lux) and High (≥ 5.4 lux) Light Levels.....	3-12
3-12	Comparisons of Deterrence, Protection, and Overall Efficiencies for BAFF On and BAFF Potentially Impaired Pooled versus BAFF Off Treatments under Low (< 0.25 m/s) and High (≥ 0.25 m/s) Across-Barrier Water Velocities	3-13
3-13	Model Selection Results for Logistic Regression Expressing the Probability of Fish Entering Georgiana Slough as a Function of Covariates	3-16
3-14	Parameter Estimates for the Best-Fit Model	3-19
3-15	Summary of Covariates Used in Logistic Regression, the Observed Fraction of Fish Entering Georgiana Slough, and the Mean Predicted Probability of Entering Georgiana Slough by Categories of Discharge, Time of Day, and BAFF Operation	3-27
3-16	Estimates of Detection Probabilities and Standard Errors for All Telemetry Stations.....	3-30
3-17	Survival and Route Entrainment Probabilities for BAFF On/Off Operations.....	3-31
3-18	Acoustically Tagged Chinook Salmon Smolt Predation Summary for BAFF On/Off Operations.....	3-32

ACRONYMS AND OTHER ABBREVIATIONS

°C	degrees Celsius
μPa	Micropascal
μS/cm	microsiemens per centimeter
2D	two-dimensional
3D	three-dimensional
ADCP	acoustic Doppler current profiler
AIC	Akaike's Information Criterion
ATR	Acoustic Tag Receiver
ATS	Acoustic Tag Tracking System
AUC	area under the receiver operating curve
BAFF	Bio-Acoustic Fish Fence
BIC	Bayesian Information Criterion
BL/s	body lengths per second
BO	<i>2009 Biological and Conference Opinion for the Long-Term Operations of the Central Valley Project and State Water Project</i>
cfs	cubic feet per second
CI	confidence interval
CVP	Central Valley Project
dB	decibel
dBht	decibel hearing threshold
DCC	Delta Cross Channel
Delta	Sacramento–San Joaquin Delta
DIDSON	dual-frequency identification sonar
DPM	Delta Passage Model
DWR	California Department of Water Resources
ESA	federal Endangered Species Act
GLM	General Linear Model
GPS	global positioning system
GSNPB	Georgiana Slough Non-Physical Barrier
HIML	high intensity modulated light
HOR	Head of Old River
IBM	Individual-Based Model
kHz	kilohertz
km	kilometer

kph	kilometers per hour
m	meter
mm	millimeter
m/s	meters per second
NLL	negative log-likelihood
NMFS	National Marine Fisheries Service
NTU	nephelometric turbidity unit
PIT	Passive Integrated Transponder
RAT	Raw Acoustic Tag
Reclamation	U.S. Bureau of Reclamation
ROC	receiver operating curve
RPA	Reasonable and Prudent Alternative
SE	Standard Error
SWP	State Water Project
TAT	Tracked Acoustic Tag
USGS	U.S. Geological Survey

This page intentionally left blank.

EXECUTIVE SUMMARY

ES.1 INTRODUCTION

The Sacramento River and its tributaries support populations of anadromous fish species including winter-run, spring-run, fall-run, and late fall–run Chinook salmon (*Oncorhynchus tshawytscha*); and steelhead (*O. mykiss*). Several of these species are listed as threatened or endangered under the California Endangered Species Act (CESA), federal Endangered Species Act (ESA), or both. These species spawn and rear in Sacramento River tributaries; adults use the mainstem Sacramento River for primarily upstream migration and juveniles use it for downstream migration. Juvenile Chinook salmon and steelhead migrate through the lower river during winter and spring. During their downstream migration, juvenile salmonids encounter alternative pathways, such as Sutter and Steamboat Sloughs, the Sacramento–San Joaquin Delta (Delta), Delta Cross Channel (DCC), and Georgiana Slough. Likewise, sturgeon juveniles migrate downstream in the Sacramento River basin to the Delta, utilizing the distributary channels to rear within and migrate through the system.

Georgiana Slough is a natural channel that allows water and fish to move into the interior Delta. Previous studies have demonstrated that juvenile Chinook salmon experience greater mortality when migrating into Georgiana Slough than those juveniles that continue to migrate downstream in the Sacramento River (Perry 2010). Movement and/or diversion of these fish into the interior and south Delta increases the likelihood of losses through predation, entrainment into non-project Delta diversions, and mortality associated with the State Water Project (SWP) and Central Valley Project (CVP) pumping facilities in the south Delta (Perry 2010; NMFS 2009). Figure ES-1 shows the migration pathways in the lower Sacramento River and Delta for outmigrating anadromous salmonids, and the location of the DCC, and the SWP and CVP pumping facilities in the south Delta.

Passage of juvenile salmonids from the Sacramento River into the interior Delta through the DCC can be reduced through seasonal closure of the radial gates (February through May); however, no similar protection is available to reduce the movement of juvenile salmonids from the Sacramento River into the interior Delta through Georgiana Slough. Flows into Georgiana Slough improve water quality and flushing in the interior Delta and free access encourages use by recreational boaters. Because of these benefits, alternatives to the installation of a physical barrier (i.e. radial gates), are being investigated.

Under the ESA, the National Marine Fisheries Service (NMFS) issued the 2009 *Biological and Conference Opinion for the Long-Term Operations of the Central Valley Project and State Water Project* (BO) for Chinook salmon and other listed anadromous fish species (NMFS 2009). Reasonable and Prudent Alternative (RPA) Action IV.1.3 of the BO requires the California Department of Water Resources (DWR) and the U.S. Bureau of Reclamation (Reclamation) to consider engineering solutions to reduce the diversion of juvenile salmonids from the Sacramento River into the interior and south Delta. DWR implemented the 2011 Georgiana Slough Non-Physical Barrier (GSNPB) Study to test the effectiveness of using a non-physical barrier, referred to as a behavioral Bio-Acoustic Fish Fence (BAFF), that combines three stimuli to deter juvenile Chinook salmon from entering Georgiana Slough: sound, high-intensity modulated light (previously known as stroboscopic light), and a bubble curtain. This report presents the results of the experimental tests conducted in 2011.

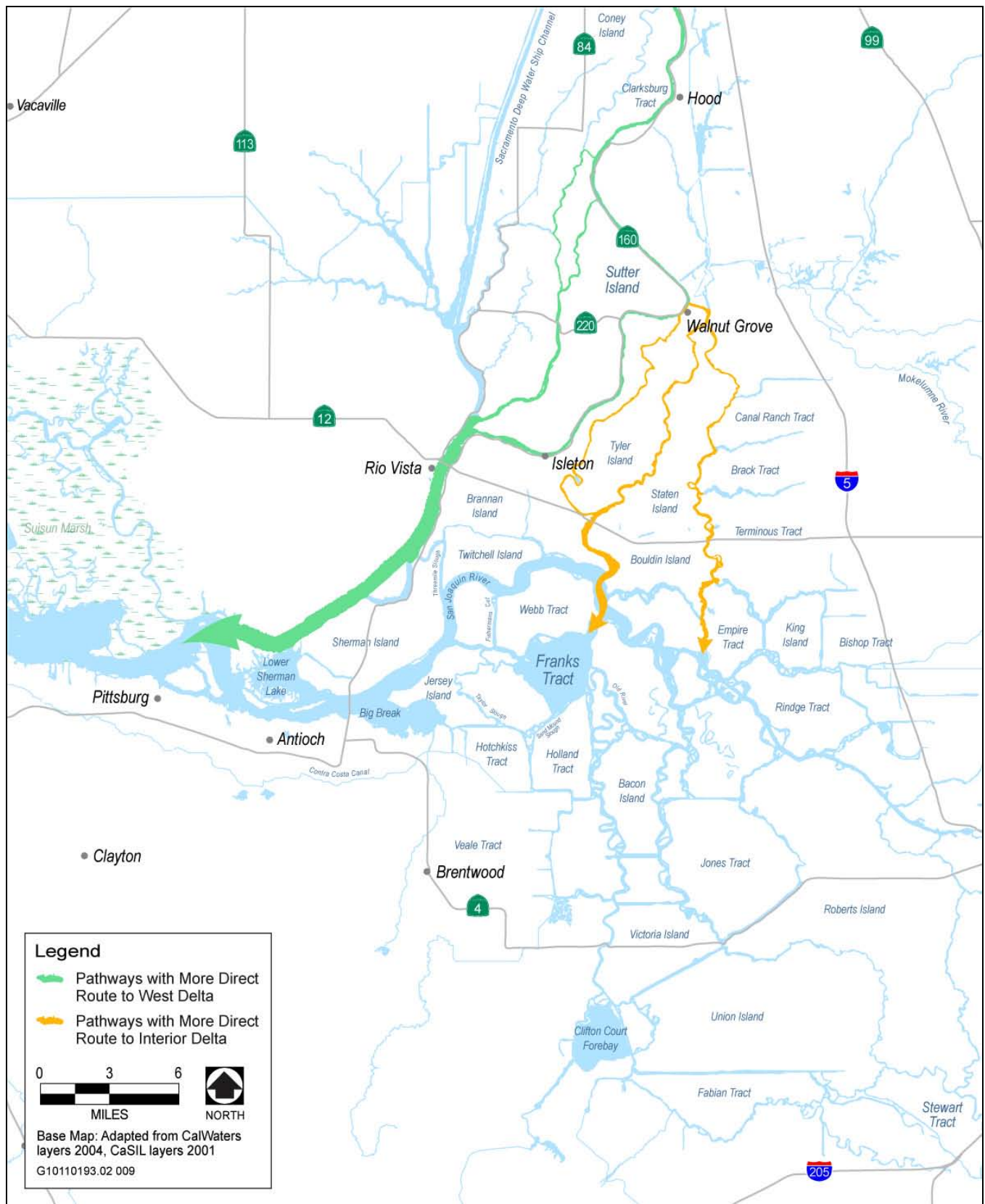

Source: AECOM 2011

Figure ES-1 Delta Migration Pathways

ES.2 STUDY PURPOSE, OBJECTIVES, AND OVERVIEW

The purpose of the 2011 GSNPB Study was to test the effectiveness of a BAFF in preventing outmigrating juvenile Chinook salmon from entering Georgiana Slough.

The objectives of the 2011 GSNPB Study were to:

- ▶ estimate the effectiveness of the BAFF in successfully deterring juvenile Chinook salmon from entering Georgiana Slough and encouraging them to continue their migration downstream in the Sacramento River (deterrence, protection, and overall efficiency of the barrier);
- ▶ determine the relative contribution of various factors influencing smolt entrainment into Georgiana Slough, such as the status of the BAFF (On or Off), water velocity, ambient light, and location of fish within the channel cross section in the Sacramento River; and
- ▶ observe the behavior, movements, and response of predatory fish such as striped bass near the BAFF and obtain estimates of predation on juvenile salmon and the survival of salmon passing through the study area.

The experimental tests conducted as part of the 2011 GSNPB Study provided data to support the feasibility study and field testing required under RPA Action IV.1.3 of the NMFS BO. The GSNPB study was designed to assist (1) DWR and Reclamation in meeting required actions for SWP and CVP compliance with ESA and the NMFS BO, and (2) with informing decision-making and adaptive management of the NMFS BO RPA actions, which could contribute to reducing adverse impacts on ESA-listed anadromous salmonids associated with long-term SWP and CVP operations.

The basic concept of the 2011 GSNPB Study was to (1) release hatchery-raised juvenile late fall–run Chinook salmon surgically implanted with acoustic tags programmed with unique codes into the Sacramento River upstream of Georgiana Slough; (2) use a monitoring system to track the downstream path of each tagged fish; and (3) compare the proportion of tagged salmon entering the test area that successfully migrated downstream in the Sacramento River when the non-physical barrier was on with the proportion of salmon that successfully migrated downstream in the Sacramento River when the barrier was off.

The 2011 GSNPB Study featured an experimental design that used acoustically tagged juvenile Chinook salmon to test the response of fish encountering the divergence between the Sacramento River and Georgiana Slough, both when the non-physical barrier was on and when the barrier was off. The overall goal of implementing a non-physical barrier at this location was to reduce the migration of juvenile salmon into the central Delta through Georgiana Slough, where their likelihood of survival is decreased and their potential vulnerability to entrainment into the SWP and CVP south Delta export facilities is increased. The 2011 experimental tests included the following components:

- ▶ 1,500 acoustically tagged juvenile late fall–run Chinook salmon produced at the Coleman National Fish Hatchery were released into the Sacramento River upstream of Georgiana Slough, and their downstream migrations past the non-physical barrier and divergence with Georgiana Slough were monitored.
- ▶ Fish were released from March 15, 2011 to May 16, 2011. This period is during the outmigration of all four runs: fall-run, late fall-run, winter-run, and spring-run Chinook salmon (Vogel and Marine 1991).

- ▶ Releases into the Sacramento River were made approximately 8.9 kilometers upstream of the non-physical barrier to allow the fish time to adjust to the river conditions and disperse into the channel before encountering the Georgiana Slough divergence.
- ▶ Passage of tagged salmon in the immediate area and downstream of the barrier in the Sacramento River and Georgiana Slough were monitored both when the barrier was on and when it was off.
- ▶ Multiple hydrophones were installed in the Sacramento River immediately upstream, downstream, and adjacent to the barrier to monitor tagged fish as they encountered and responded to the barrier. These hydrophones were referred to as the array at the barrier. Additional hydrophones, referred to as the peripheral hydrophones, were installed to detect tagged fish outside of the area of the barrier.
- ▶ Predatory fish, including striped bass (*Morone saxatilis*), were also tagged and monitored to study the behavior and movement patterns of predatory fish in response to environmental conditions, including the presence of juvenile Chinook salmon, and the potential for salmon predation by the tagged predatory fish, in association with operations of the non-physical barrier.

Figure ES-2 shows the location of the barrier and Figure ES-3 shows a conceptual layout of the non-physical barrier components. Figure ES-4 provides an overview of the study area, including the release location for tagged late fall–run Chinook salmon, the barrier’s orientation, and the locations of acoustic tag detection and monitoring systems, referred to as the peripheral hydrophones and array.

Based on the results of acoustic monitoring, the following evaluation metrics of barrier efficiency were compared between BAFF On and BAFF Off conditions:

- ▶ *deterrence efficiency*, the proportion of tagged juvenile Chinook salmon encountering the barrier that were deterred from entering Georgiana Slough and instead proceeded down the Sacramento River;
- ▶ *protection efficiency*, the proportion of tagged juvenile Chinook salmon that were not eaten and passed downstream of the barrier in the Sacramento River;
- ▶ *overall efficiency*, the proportion of tagged juvenile Chinook salmon that entered the test area immediately upstream of the barrier that subsequently were detected successfully migrating downstream in the Sacramento River, accounting for losses of fish migrating into Georgiana Slough and predation losses in the area adjacent to the barrier;
- ▶ *survival probabilities*, model predictions of fish survival from one location to another based on route selection and other factors; and
- ▶ *route entrainment probabilities*, model predictions of fish entrainment from the Sacramento River into Georgiana Slough based on cross-sectional position in the channel, velocities, light conditions, and other factors.

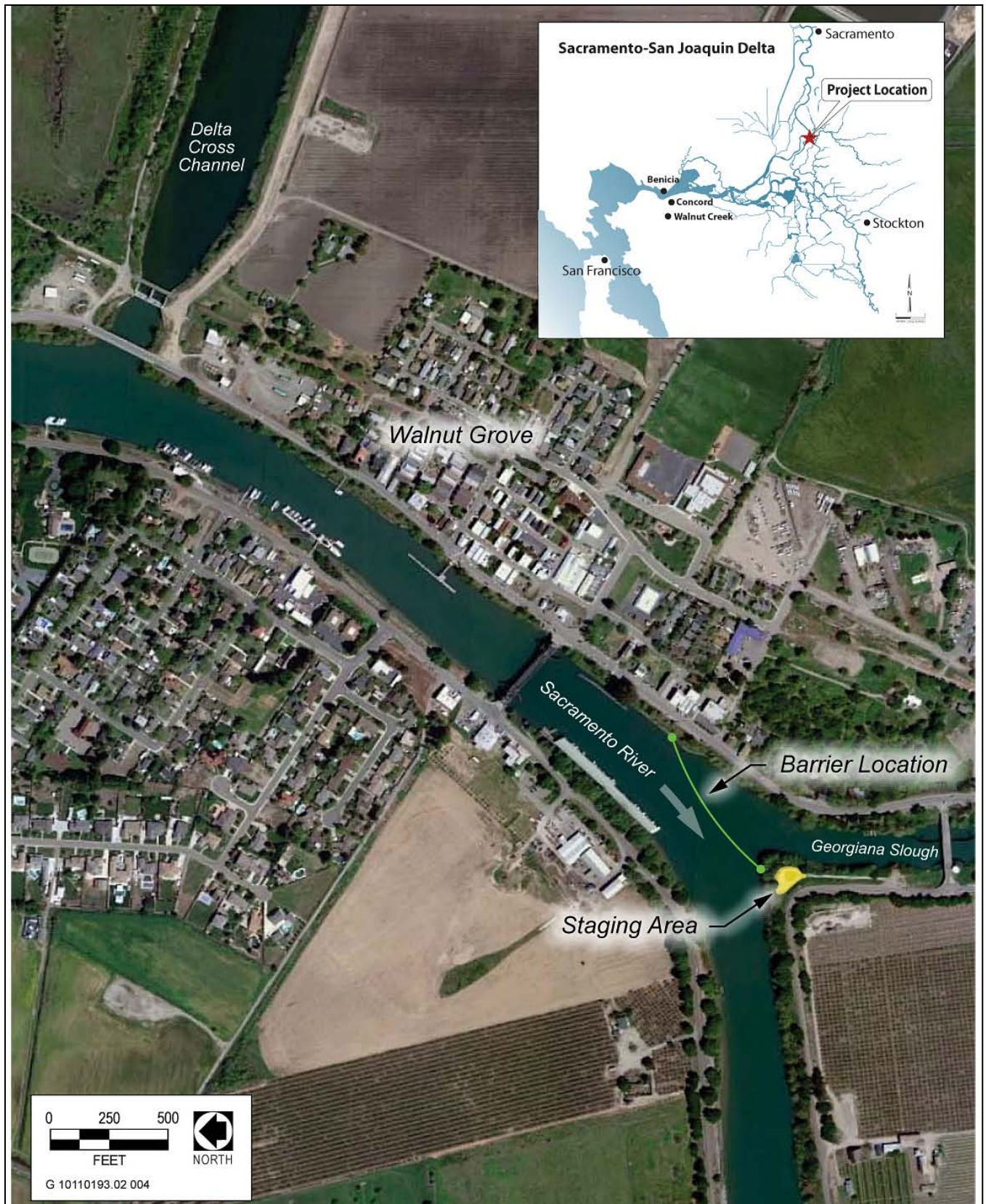

Source: Data provided by California Department of Water Resources and adapted by AECOM in 2011

Figure ES-2 Location of 2011 Georgiana Slough Non-Physical Barrier Study

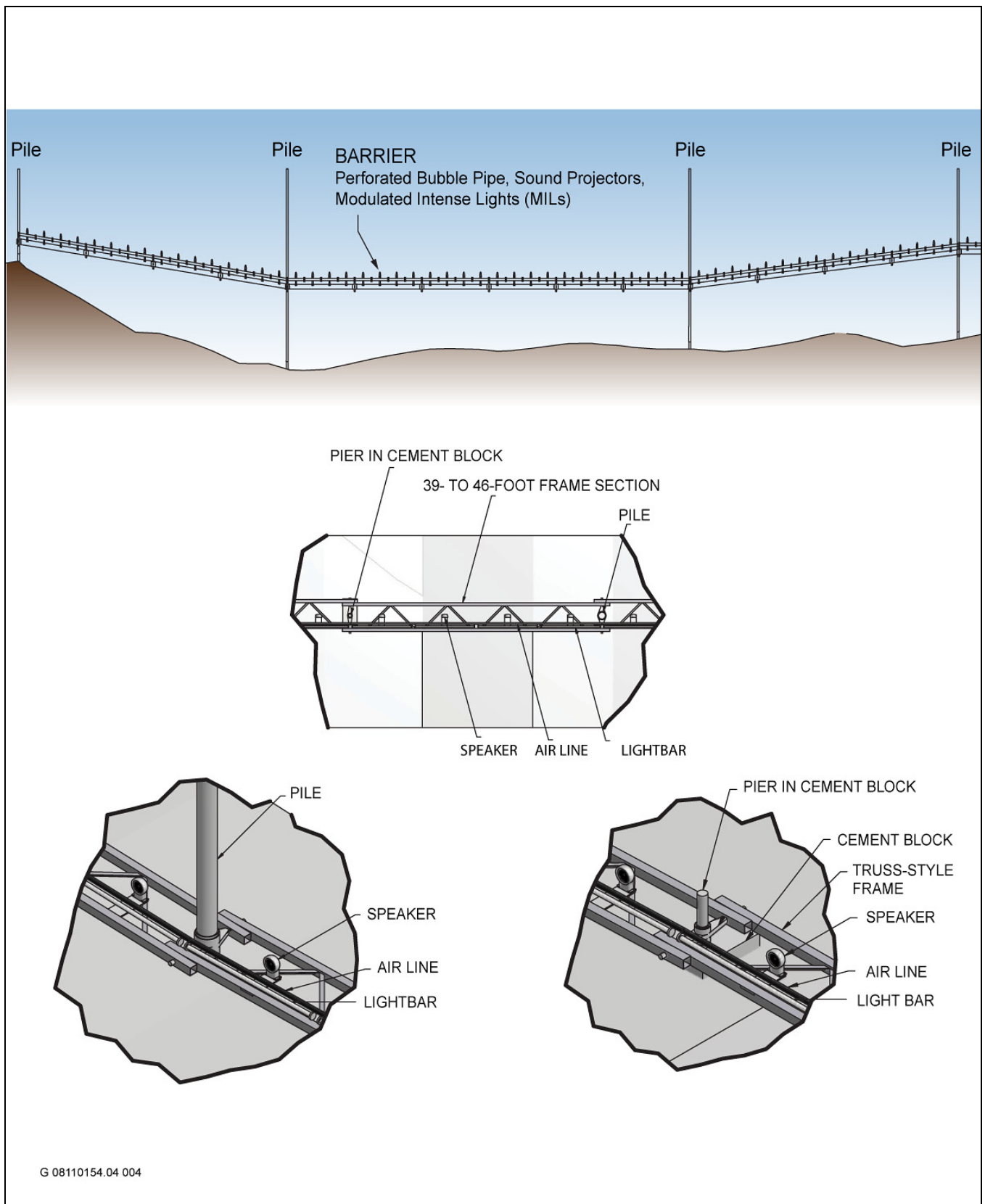

Source: Data provided by Fish Guidance Systems and adapted by AECOM in 2010

Figure ES-3 Conceptual Layout of the Georgiana Slough Non-Physical Barrier Components

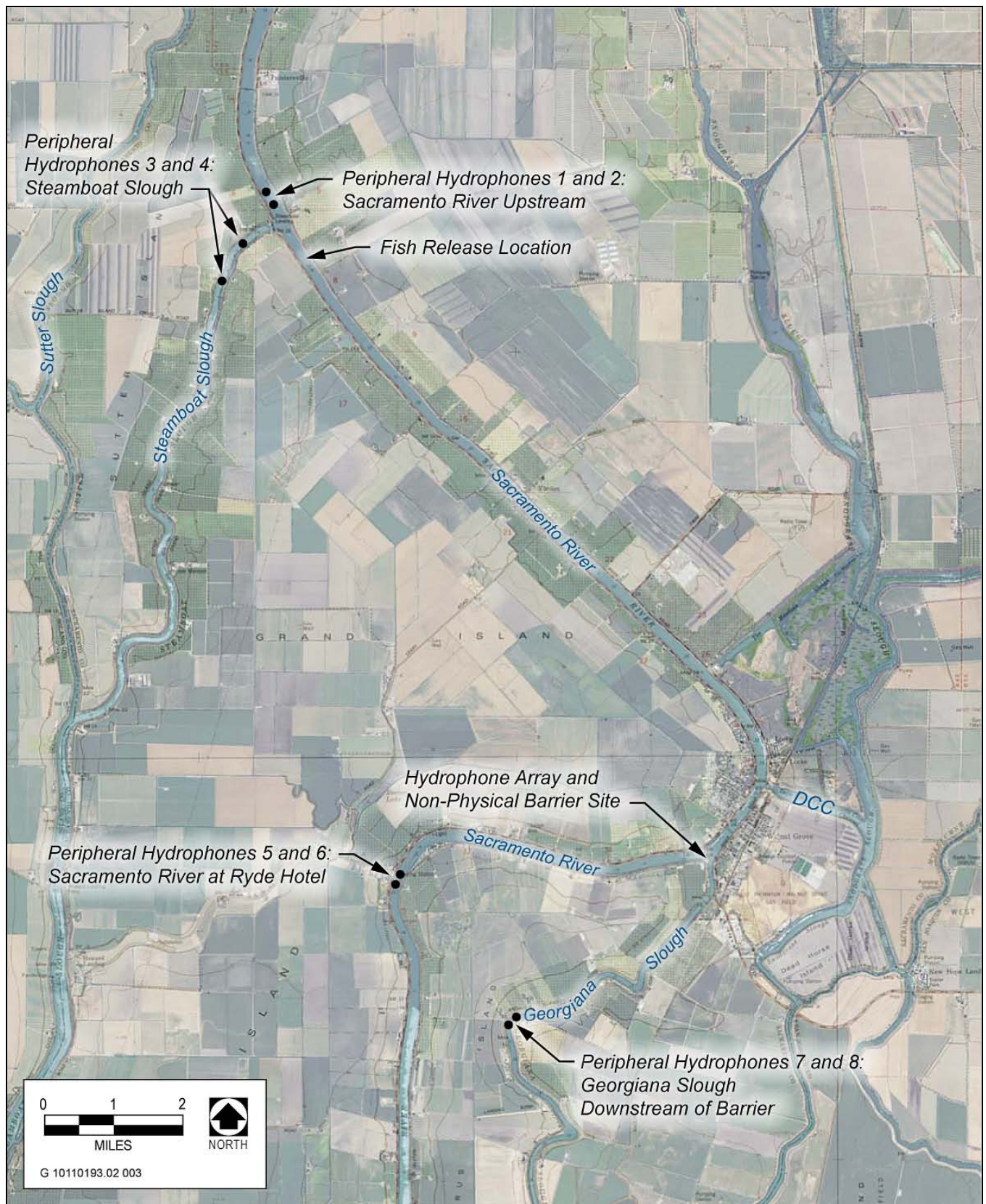

Source: Data provided by California Department of Water Resources and adapted by AECOM in 2011

Figure ES-4 Overview of the 2011 Georgiana Slough Non-Physical Barrier Study Area

ES.3 STUDY RESULTS AND FINDINGS

The results and findings of the 2011 GSNPB tests are summarized below.

ES.3.1 OVERALL EFFICIENCY AND ENTRAINMENT PROBABILITY

- ▶ During the 2011 study period, the non-physical barrier reduced the percentage of salmon smolts passing into Georgiana Slough from 22.1% (BAFF Off) to 7.4% (BAFF On), a reduction of approximately two-thirds of the fish that would have been entrained. This improvement produced an overall efficiency rate of 90.8%; that is, 90.8% of fish that entered the area when the BAFF was on exited by continuing down the Sacramento River.
- ▶ Three metrics of BAFF performance—deterrence, protection, and overall efficiency—were estimated from the results of the 2011 studies to compare passage of juvenile salmon into Georgiana Slough when the BAFF was on and when it was off. Based on all three metrics, barrier efficiency was significantly higher when the BAFF was on relative to periods when the BAFF was off.
- ▶ Based on the similarity between estimates of protection and overall efficiency, the effects of predation on juvenile salmon in the study area were low. It is hypothesized that high flows in the Sacramento River and corresponding increased water velocities and turbidity levels may have contributed to the relatively low level of predation on juvenile salmon estimated during the 2011 tests.

ES.3.2 INFLUENCES OF VELOCITY, LIGHT, AND CROSS-SECTIONAL POSITIONS

- ▶ All statistical results were significant for deterrence, protection, and overall efficiency when comparing results under varying light and/or velocity conditions. However, analysis using the General Linear Model (GLM) found that river discharge, which was found to be highly correlated with velocity, may have a more important role than light and that high discharge may be an important predictor of fish behavioral response to the BAFF and entrainment into Georgiana Slough. This finding warrants further study under lower Sacramento River flows than those observed in 2011.
- ▶ Under high river flows (approximately 43,000 to 45,000 cubic feet per second [cfs] river flow entering the river junction at Georgiana Slough), the BAFF consistently reduced probability of entrainment into Georgiana Slough. This is supported by analyses conducted as part of the hypothesis-testing statistical analysis (reflected in Table 3-12). It shows a 30.4 percentage points improvement in overall efficiency was calculated when the BAFF was on versus off during periods of high across-barrier velocities (flows passing through the BAFF at ≥ 0.25 meter per second [m/s]), whereas a much smaller improvement in efficiency (8.1 percentage points) was calculated during periods of lower across-barrier velocities (< 0.25 m/s).
- ▶ Conversely, when considering the cross-sectional position of a fish entering the array, high and low discharges had the opposite effect. For example, during periods of high river discharge, the BAFF was less effective for fish located close to the east side of the river channel (downstream river left). The reason for this finding is likely that a fish cannot behaviorally respond to the BAFF and swim away from it fast enough to avoid being swept across the barrier and into Georgiana Slough. Under the GLM, the location of a fish in the

cross section was the most important driver of an individual fish's probability of entrainment into Georgiana Slough at higher discharges.

- ▶ Although varying light conditions did not appear to affect salmon entrainment into Georgiana Slough or BAFF efficiency results, turbidity levels were relatively high during the study period; average turbidity at the test site was 19.5 nephelometric turbidity units (NTUs). Such high turbidity likely muted the BAFF's light intensity and limited the use of visual cues for juvenile salmon to navigate the BAFF during the daytime. This muting may possibly have led to similar performance between daytime and nighttime tests. Furthermore, laboratory studies have shown that Chinook salmon deterrence efficiency declines when turbidity is increased from 10 to 30 NTUs (Reclamation, unpublished data).

ES.3.3 PREDATION

- ▶ Estimated predation of tagged smolts in the array was low (3.5% of total study fish), based on examination of fish tracking.
- ▶ The low predation rate is supported by analyses conducted as part of the hypothesis testing that showed similar protection and overall efficiency rates under both BAFF On and BAFF Off conditions. Additionally, survival estimates for juvenile tagged salmon observed in both Georgiana Slough and the Sacramento River were similar and not significantly different under BAFF On and BAFF Off test conditions.
- ▶ The relatively high discharges in the Sacramento River likely reduced predation risk for juvenile salmon, as evidenced by the close similarity in protection and overall efficiencies. Several hypotheses explain this result including:
 - increased smolt transport velocities reduced the rate of predator-prey encounters;
 - increased turbidity reduced the rate of predator-prey encounters and reduced the predators' capture probability of the smolts; and
 - reduced water temperatures resulted in an energetic advantage to Chinook salmon over temperate piscivores (e.g., striped bass and smallmouth bass).
- ▶ Predators were located primarily near the river margin (evidenced by the vast majority of acoustically tracked predator movements near the river margin compared to mid-channel observations), which reduced the rate of encounters with salmon smolts that tended to migrate closer to the center of the channel. The Wet Water Year (DWR 2011) and the high discharges of 2011 may have provided a different bioenergetic landscape than would lower discharges in a different year; predators may not have found it profitable to hold position or patrol the mid-channel portions of the river. Consequently, it is important to test the BAFF's operations in a low flow year.
- ▶ It has been hypothesized that a non-physical barrier such as the BAFF may attract predatory fish, thus increasing predation mortality for juvenile salmonids. To examine this hypothesis, predation rates were estimated for areas within 5 meters of the BAFF and compared to predation rates farther from the BAFF within the Sacramento River. Predation data showed that one predation event occurred within 5 meters of the BAFF versus 48 events within the larger array area. These results do not support the hypothesis that the

BAFF increases predation mortality for juvenile salmon in the immediate vicinity of the non-physical barrier. Also, these results may differ in different water years: with lower discharges and reduced velocity there may be a change in the locations and incidence rate of predation events.

- ▶ Predation data showed that most (65%) predation events occurred when the BAFF was off, possibly because predators were startled by the BAFF when it was on. These findings could also be linked to observed differences between BAFF On versus BAFF Off modes in the survival analyses. For example, of the relatively small proportion of fish that entered Georgiana Slough when the BAFF was off and never arrived at the downstream hydrophones, 75% were classified as having been eaten within the hydrophone array downstream of the BAFF.

It is important to note that if the BAFF is used as a long-term management tool, predators could become conditioned to the BAFF On mode and may prey on salmon to a greater extent than under experimental operational conditions (BAFF On/BAFF Off). In addition, the habitat selected by and movement patterns of predators in the Sacramento River adjacent to the BAFF may vary within and among years in response to factors such as river flow and velocities, water temperatures, and recreational harvest. These factors, in combination with possible conditioning to BAFF operations, could result in different predation rates than those observed during the 2011 study.

ES.4 STUDY CONCLUSIONS

The results of the 2011 tests showed that BAFF On operations resulted in significant increases in deterrence, protection, and overall efficiency for juvenile salmon; that is, fewer of the tagged salmon migrated into Georgiana Slough when the BAFF was on than when it was off. For example, a two-thirds reduction in entrainment into Georgiana Slough was accomplished with BAFF On compared to BAFF Off. Variation in light levels did not significantly affect the deterrence, protection, and overall efficiency in 2011; however, there was some indication that the behavior and movement patterns of juvenile salmon were influenced by the high river flows that occurred in spring 2011. However, at high (≥ 0.25 m/s) and low (<0.25 m/s) across-barrier velocities, BAFF On operations resulted in statistically significant increases in deterrence, protection, and overall efficiency for juvenile salmon.

Predation rates were relatively low, and there was no evidence that BAFF operations were attracting predators to the area or increasing predation on juvenile salmon. The tests were conducted under high river flow conditions and may not reflect BAFF deterrence, protection, and overall efficiency when river flows and across-barrier velocities are lower.

The 2011 BAFF operations reduced the entrainment of juvenile salmon from the Sacramento River into Georgiana Slough; therefore, it is expected that the BAFF would increase survival rates of juvenile salmon migrating downstream in the Sacramento River. Study results represent the response of juvenile Chinook salmon smolts and do not necessarily reflect the response of juvenile steelhead to BAFF operations. The high flows and testing limited to juvenile Chinook salmon support the recommendation that the BAFF undergo further testing in 2012 to reflect a range of river flow conditions and evaluate BAFF effects on both juvenile Chinook salmon and steelhead.

ES.5 RECOMMENDATIONS AND FUTURE DIRECTIONS

The 2011 GSNPB experimental evaluation concluded that the BAFF improved juvenile Chinook salmon deterrence, protection, and overall efficiency during both night and day conditions, and at low and high velocities during the relatively high river flows that occurred during the study. It is recommended that an additional deployment be conducted in 2012 as part of the continuing evaluation of the BAFF effectiveness at deterring juvenile salmon from entering Georgiana Slough.

Additional tests under a range of hydrologic conditions in the Sacramento River, including lower river discharges and more extensive tidal influence, compared to 2011, will further benefit the evaluation of BAFF operations and other factors such as predation on juvenile Chinook salmon. Further investigations should also be conducted regarding the biological significance of improved guidance on the overall survival and population dynamics of various Chinook salmon metapopulations including winter-run, spring-run, fall-run, and late fall-run salmon. Extending the study to include steelhead would also be desirable. One potential analytical method that could be used to assess the biological benefits of BAFF operations on salmon survival and abundance would be the use of the Delta Passage Model (DPM) modified to account for overall protection efficiency of the BAFF at Georgiana Slough. Results of the DPM analyses could also be used along with lifecycle population models of Sacramento River salmon populations (e.g., IOS and OBAN) to assess potential population-level benefits of improved juvenile salmon survival on subsequent ocean abundance and escapement of adult salmon.

It is recommended that an Individual-Based Model (IBM) that predicts deterrence efficiency be developed. An IBM would allow a mechanistic understanding of the deterrence at the Georgiana Slough BAFF. The IBM preferably should be validated at another site before it is applied at Georgiana Slough. A validation at another site with late-fall run Chinook salmon would allow the fish behavioral decision rules to be tested independently and would provide a more rigorous and reliable approach. A validated IBM could be used to assess the likely deterrence efficiency of a BAFF deployment at other locations identified in the NMFS BO RPA Action IV.1.3 (i.e., Turner Cut, Columbia Cut) in the Delta. Assessments would need to be completed by summer/fall of 2014 to be included in the final recommendations to NMFS that are due by March 30, 2015 in a final report. An IBM analysis could identify locations where deterrence efficiency might be expected to be low, and an IBM analysis could be conducted at a fraction of the cost of a field deployment. Therefore, IBM development represents a very efficient economical approach to evaluation of the BAFF at other locations in the Delta.

Lifecycle population, DPM, and IBM modeling could be used to assess the effectiveness of BAFF operations on reducing the risk of incidental take of juvenile salmonids at the south Delta export facilities. Modeling would also allow an assessment of the BAFF's contributions to increasing juvenile salmon survival during emigration from the Sacramento River, and the population benefits of improved guidance and reduced mortality on juvenile salmon. Finally, modeling could determine if the BAFF might contribute, and to what extent, to increased adult abundance and species protection.

This page intentionally left blank.

1 INTRODUCTION

1.1 BACKGROUND

The Sacramento River and its tributaries support populations of anadromous fish species including, winter-run, spring-run, fall-run, and late fall–run Chinook salmon (*Oncorhynchus tshawytscha*); and steelhead (*O. mykiss*). Several of these species are listed as threatened or endangered under the California Endangered Species Act, federal Endangered Species Act (ESA), or both. Adult salmon and steelhead primarily use the Sacramento River as a migration corridor to access spawning grounds in the upper Sacramento River and its tributaries. Juvenile Chinook salmon and steelhead migrate downstream through the lower river during winter and spring. During their downstream migration, juvenile salmonids encounter alternative pathways, such as Sutter and Steamboat Sloughs, the Delta Cross Channel (DCC), and Georgiana Slough.

Results of experimental survival studies have demonstrated substantially higher mortality rates for juvenile salmon that migrate into the interior Sacramento–San Joaquin Delta (Delta) using an alternative pathway than for those that remain in the Sacramento River (Brandes and McLain 2001; Perry 2010). Studies of juvenile Chinook salmon migration have shown losses (i.e., mortality) of approximately 65% of the outmigrating fish that are diverted from the mainstream Sacramento River into the waterways of the central and south Delta (Perry 2010). Movement and/or diversion of these fish into the interior and south Delta increases the likelihood of losses through predation, entrainment into non-project Delta diversions, and mortality associated with the State Water Project (SWP) and Central Valley Project (CVP) pumping facilities in the south Delta (Perry 2010; NMFS 2009). Figure 1-1 shows the migration pathways in the Delta for outmigrating anadromous salmonids, and the location of the DCC, and the SWP and CVP pumping facilities in the south Delta.

Passage of juvenile salmonids from the Sacramento River into the interior Delta through the DCC can be reduced through seasonal closure of the radial gates (mid-December through May). No similar protection is available to reduce the movement of juvenile salmonids from the Sacramento River into the interior Delta through Georgiana Slough. When closed, the radial gates create a physical barrier to flows, fish and boats. Flows into Georgiana Slough improve water quality and flushing in the interior Delta and unrestricted access encourages use by recreational boaters. Because of these benefits, alternatives to a physical barrier, are being investigated. To reduce the movement of juvenile salmon into Georgiana Slough and thereby improve their survival rate and abundance, consideration has been given to using a non-physical barrier at the diversion between the Sacramento River and Georgiana Slough. In 1994, several experiments were conducted to evaluate the potential effectiveness of an acoustic barrier (underwater sound) in preventing migrating juvenile salmon from entering the slough. A Kodiak trawl was used in the Sacramento River and Georgiana Slough when the barrier was on and when it was off to capture juvenile Chinook salmon, and the relative numbers of salmon captured were used to quantify the efficiency of the barrier in guiding juvenile fish. Overall, the barrier guidance efficiency averaged 57% (95% confidence interval [CI] 47–65%) and was statistically significant ($p < 0.001$) (SLDMWA and Hanson 1996). Guidance efficiency was found to be greater during ebb tide (62%) than during flood tide (51%) and greater during the daytime than at night. Because the guidance efficiency observed in the 1994 tests was less than the 95% level of performance assumed for a physical barrier, testing of the acoustic barrier was discontinued.

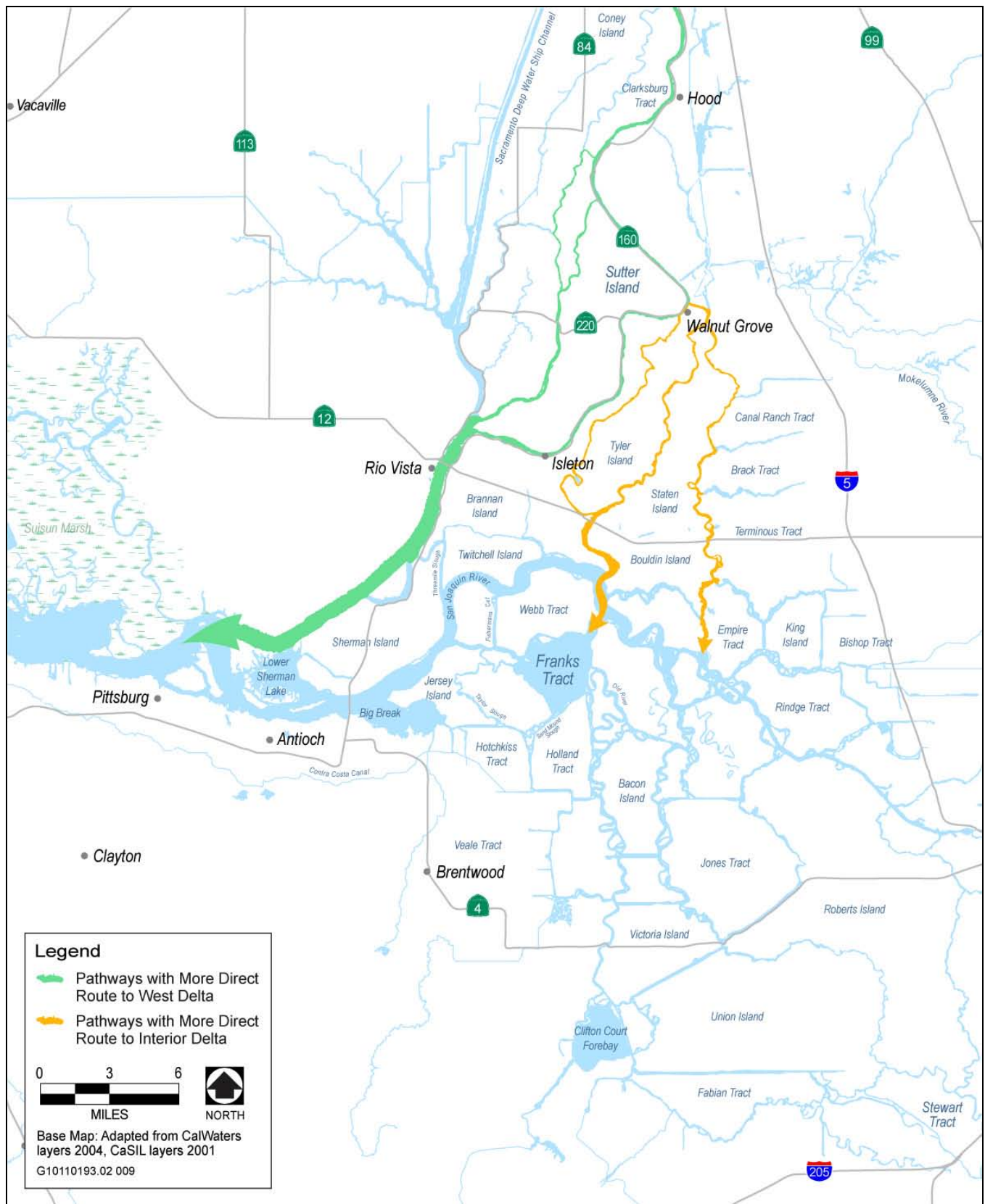

Source: AECOM 2011

Figure 1-1 Delta Migration Pathways

Since the acoustic barrier tests were conducted, substantial research and development have been directed toward improving the effectiveness of non-physical barriers in guiding juvenile salmon and other fish. Testing has led Fish Guidance Systems of Southampton, United Kingdom, to develop a non-physical barrier, referred to as a behavioral Bio-Acoustic Fish Fence (BAFF), that combines three stimuli to deter the movement of smolts: sound, high intensity modulated light (HIML) (previously known as stroboscopic light), and a air bubble curtain. Testing of the BAFF in Europe has produced promising results for fish guidance.

In 2009, the BAFF was tested in the San Joaquin River to determine its efficiency in guiding juvenile Chinook salmon migrating downstream where they encounter the Head of Old River (HOR) (Bowen et al. 2009). The testing results showed that a statistically significant proportion of juvenile Chinook salmon was deterred from entering Old River (81% deterrence rate). Predation losses, however, were observed to be high both upstream and in the vicinity of the barrier. The results of similar tests conducted in spring 2010 (Bowen and Bark 2010) showed that deterrence efficiency increased from approximately 5% when the barrier was off to 23% when the barrier was on. Protection efficiency (i.e., the change in the proportion of juvenile Chinook salmon that survive predation and pass downstream of the HOR when the barrier is on, compared to when the barrier is off) increased from 26% when the barrier was off to 43% when the barrier was on during the 2010 tests. The results of these tests indicated that the BAFF showed promise as a barrier that could provide significant positive guidance of juvenile Chinook salmon.

Under the federal ESA, the National Marine Fisheries Service (NMFS) issued the 2009 *Biological and Conference Opinion for the Long-Term Operations of the Central Valley Project and State Water Project* (BO) for Chinook salmon and other listed anadromous fish (NMFS 2009). Reasonable and Prudent Alternative (RPA) Action IV.1.3 of the BO requires the California Department of Water Resources (DWR) and U.S. Bureau of Reclamation (Reclamation) to consider engineering solutions to reduce the diversion of juvenile salmonids from the Sacramento River into the interior and south Delta. Based on past test results showing the effectiveness of the BAFF, DWR implemented the 2011 Georgiana Slough Non-Physical Barrier (GSNPB) Study to test the effectiveness of using a BAFF to prevent outmigrating juvenile Chinook salmon from entering Georgiana Slough.

1.1 STUDY PURPOSE, OBJECTIVES, AND OVERVIEW

The purpose of the 2011 GSNPB Study was to test the effectiveness of a BAFF in preventing outmigrating juvenile Chinook salmon produced at the Coleman National Fish Hatchery from entering Georgiana Slough.

The objectives of the 2011 GSNPB Study were to:

- ▶ estimate the effectiveness of the BAFF in successfully deterring juvenile Chinook salmon from entering Georgiana Slough and encouraging them to continue their migration downstream in the Sacramento River (deterrence, protection, and overall efficiency of the barrier);
- ▶ determine the relative contribution of various factors, such as the status of the BAFF (on or off), water velocity, ambient light, and location of fish within the channel cross section in the Sacramento River; and;
- ▶ observe the behavior, movements, and response of predatory fish such as striped bass near the BAFF and obtain estimates of predation on juvenile salmon and the survival of salmon passing through the study area.

The experimental tests conducted as part of the 2011 GSNPB Study provided data to support the feasibility study and field testing required under RPA Action IV.1.3 of the NMFS BO. The GSNPB study was designed to assist (1) DWR and Reclamation in meeting required actions for SWP and CVP compliance with ESA and the NMFS BO, and (2) with informing decision-making and adaptive management of the NMFS BO RPA actions, which could contribute to reducing adverse impacts on ESA-listed anadromous salmonids associated with long-term SWP and CVP operations.

The experimental design of the 2011 tests involved releasing juvenile late fall–run Chinook salmon sourced from the Coleman National Fish Hatchery with acoustic tags, each with a unique code, into the Sacramento River immediately downstream of Steamboat Slough, approximately 8.9 kilometers (km) upstream of Georgiana Slough. The tests used a non-physical barrier (i.e., the BAFF) and other means to determine the proportion of tagged salmon that entered the test area and successfully migrated downstream in the Sacramento River when the barrier was on, and the proportion that migrated into Georgiana Slough when the barrier was off. Figure 1-2 shows the study location and Figure 1-3 shows the conceptual design of the BAFF used at Georgiana Slough.

As part of the 2011 tests, striped bass (*Morone saxatilis*) and other predatory fish were also tagged and monitored to determine the behavior and movement patterns of predatory fish in response to environmental conditions including the presence of juvenile Chinook salmon, and the potential for salmon predation by the tagged predatory fish, in association with operations of the non-physical barrier.

The basic experimental design was developed to provide information on the behavioral response of juvenile Chinook salmon encountering the non-physical barrier over a range of environmental conditions (e.g., tidal conditions, day and night, Sacramento River flows, rate of flow entering Georgiana Slough). This information was valuable in determining the barrier's overall effectiveness across a range of conditions and provided a technical foundation for future refinements to the design and installation of a non-physical barrier to prevent outmigrating juvenile Chinook salmon from entering Georgiana Slough. The statistical power of the experimental design was maximized through the use of continuous monitoring of flow velocity and day/night conditions immediately upstream of the barrier location to record and document the range of conditions that were likely to affect the movement and fate of tagged salmon entering the test area. Results of the 2011 tests provided the basis for statistical models that can be used to evaluate how various factors (e.g., barrier on/off operations, variation in Sacramento River flows and water velocities, tidal conditions, daytime/nighttime [light] conditions, and fish length) influence the barrier's deterrence, protection, and overall efficiency in improving protection of listed salmonids in the Sacramento River watershed. The test results provide a strong technical basis for assessing the performance of the non-physical barrier as a method to improve the survival of juvenile salmonids migrating downstream in the Sacramento River, as well as a statistical basis for further refining and optimizing the experimental design of any subsequent tests.

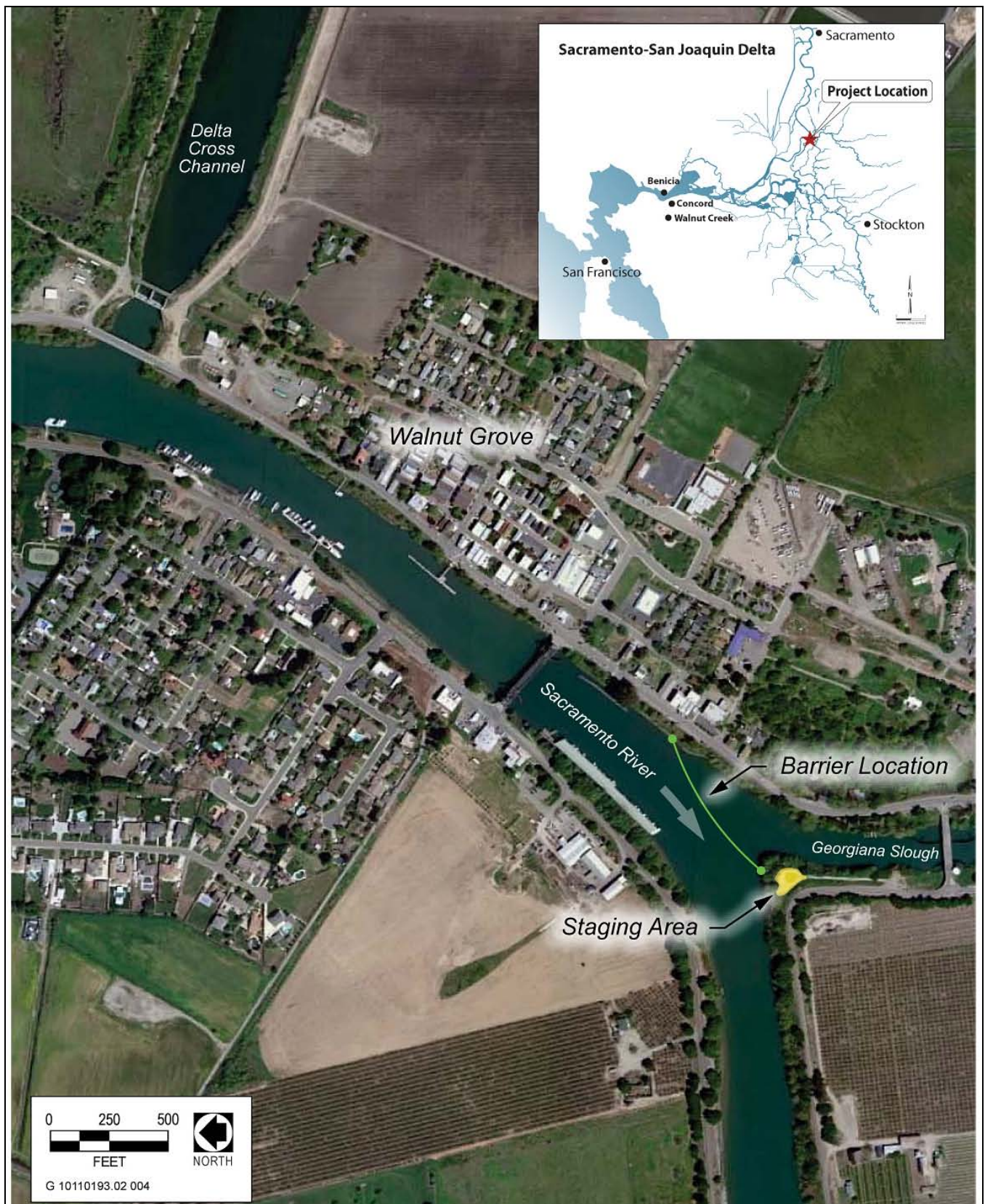

Source: Data provided by California Department of Water Resources and adapted by AECOM in 2011

Figure 1-2 Location of 2011 Georgiana Slough Non-Physical Barrier Study

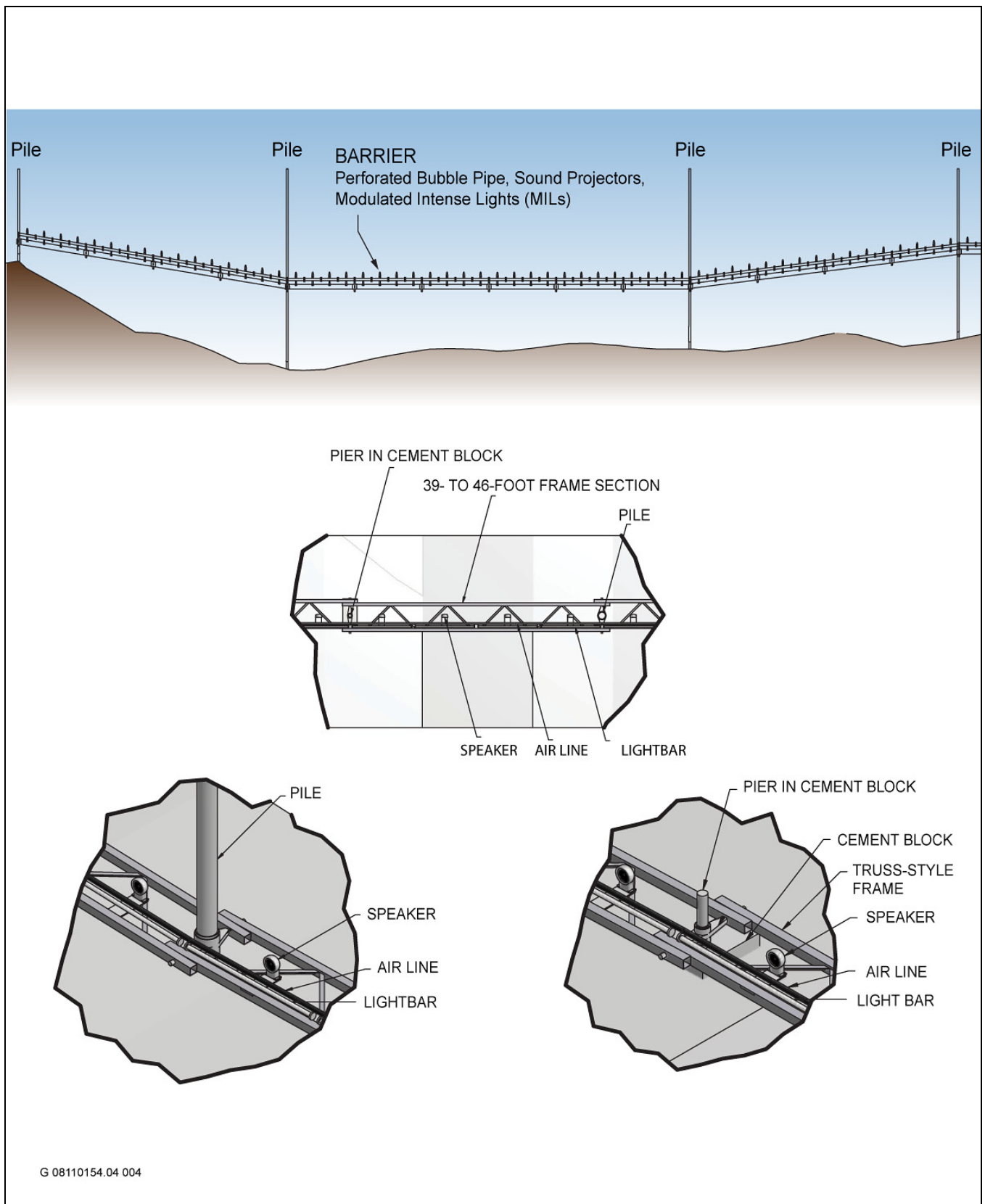

Source: Data provided by Fish Guidance Systems and adapted by AECOM in 2011

Figure 1-3 Conceptual Design of the BAFF used at Georgiana Slough

2 STUDY APPROACH AND METHODS

2.1 OVERVIEW OF EXPERIMENTAL DESIGN

The basic concept of the 2011 GSNPB Study was to release hatchery-raised juvenile late fall–run Chinook salmon, surgically implanted with acoustic tags with unique codes, into the Sacramento River immediately downstream of Steamboat Slough, approximately 8.9 km upstream of Georgiana Slough; then compare the proportion of tagged salmon entering the test area that successfully migrated downstream in the Sacramento River when a non-physical barrier was on with the proportion of salmon that migrated into Georgiana Slough when the barrier was off. The experimental design for the study tested the response of fish encountering the divergence between the Sacramento River and Georgiana Slough, both when the barrier was on and when the barrier was off. The overall goal of implementing a barrier at this location is to reduce the migration of juvenile salmon into the central Delta through Georgiana Slough, where they are less likely to survive and their potential vulnerability to entrainment into the SWP and CVP south Delta export facilities is greater.

The 2011 experimental tests included the following components:

- ▶ 1,500 acoustically tagged late fall–run Chinook salmon produced at the Coleman National Fish Hatchery were released into the Sacramento River, and their downstream migration past the non-physical barrier and divergence with Georgiana Slough was monitored.
- ▶ Fish were released from March 15, 2011 to May 16, 2011, during a period of important migratory movement for salmonid smolts.
- ▶ Releases into the Sacramento River were made approximately 8.9 km upstream of the non-physical barrier to allow the fish time to adjust to the river conditions and disperse into the channel before encountering the Georgiana Slough divergence.
- ▶ Passage of tagged salmon was monitored in the immediate area and downstream of the barrier in the Sacramento River and Georgiana Slough both when the barrier was on and when it was off.
- ▶ Multiple hydrophones were installed in the Sacramento River immediately upstream, downstream, and adjacent to the barrier to monitor tagged fish as they encountered and responded to the barrier. These hydrophones were referred to as the array at the barrier. The array at the barrier allowed for three-dimensional positioning of tags; the pathway of a tag, over or under the BAFF, was determined for each tag. Additional hydrophones, referred to as the peripheral hydrophones, were installed to detect tagged fish outside of the area of the barrier.

Figure 2-1 provides an overview of the study area, including the release location for tagged late fall–run Chinook salmon, the barrier’s orientation, and the locations of acoustic tag detection and monitoring systems, referred to as the peripheral hydrophones and array.

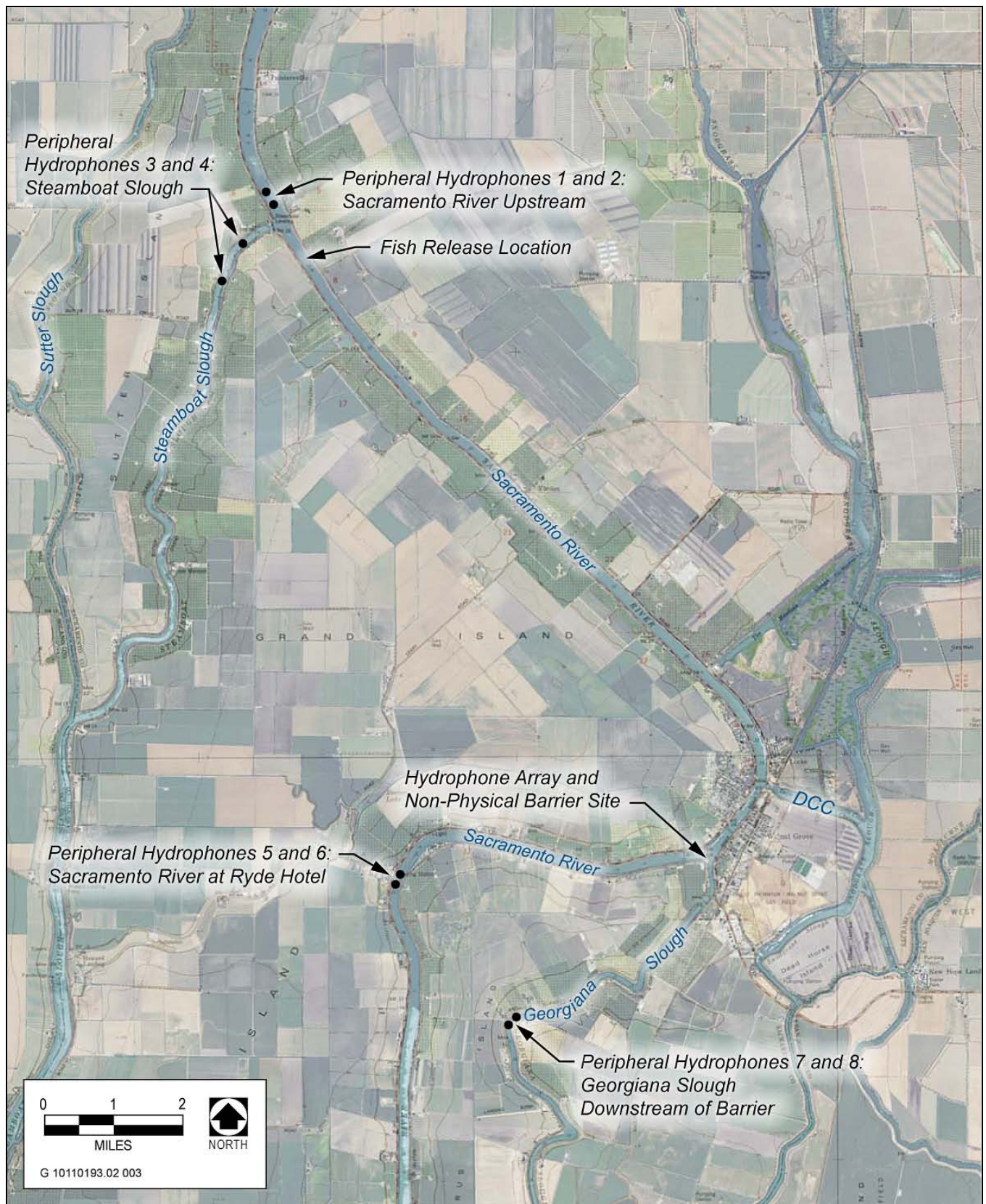

Source: Data provided by California Department of Water Resources and adapted by AECOM in 2011

Figure 2-1 Overview of the 2011 Georgiana Slough Non-Physical Barrier Study Area

Based on the results of acoustic monitoring, the following evaluation metrics of barrier efficiency were compared between barrier-on and barrier-off conditions:

- ▶ *deterrence efficiency*, the proportion of tagged juvenile Chinook salmon encountering the barrier that were deterred from entering Georgiana Slough and instead proceeded down the Sacramento River;
- ▶ *protection efficiency*, the proportion of tagged juvenile Chinook salmon that survived predation and passed downstream of the barrier in the Sacramento River;
- ▶ *overall efficiency*, the proportion of tagged juvenile Chinook salmon that entered the test area immediately upstream of the barrier that subsequently were detected successfully migrating downstream in the Sacramento River, accounting for losses of fish migrating into Georgiana Slough and predation losses in the area where the array is located adjacent to the barrier (Figure 2-1);
- ▶ *survival probabilities*, model predictions of fish survival from one location to another based on route selection and other factors; and
- ▶ *route entrainment probabilities*, model predictions of fish entrainment from the Sacramento River into Georgiana Slough based on cross-sectional position in the channel, velocities, light conditions, and other factors.

2.2 HYPOTHESIS TESTING

As previously summarized, the experimental design for the 2011 GSNPB Study was designed to test the non-physical barrier's deterrence efficiency, protection efficiency, and overall efficiency. The hypotheses related to each of these evaluation metrics of barrier efficiency are described below.

2.2.1 DETERRENCE EFFICIENCY

Determining the efficiency of the barrier in deterring Chinook salmon from entering Georgiana Slough was a key study objective. To determine deterrence efficiency, the change in the proportion of tagged Chinook salmon migrating downstream in the Sacramento River when the barrier was on was compared to the proportion migrating downstream in the river when the barrier was off.

The following *null hypothesis* was tested for the deterrence efficiency of the barrier:

H₁₀: There is no statistically significant difference in the proportion of tagged juvenile Chinook salmon that is deterred from entering Georgiana Slough upon approach within 80 meters (m) of the non-physical barrier when the barrier is on compared to when the barrier is off.

The following *alternative hypothesis* was tested for the barrier's deterrence efficiency:

H_{1A}: There is a statistically significant increase (increase in deterrence efficiency) in the proportion of juvenile Chinook salmon that is deterred from entering Georgiana Slough upon approach within 80 m of the non-physical barrier when the barrier is on compared to when the barrier is off.

The barrier's deterrence efficiency was calculated as:

$$D = B / (B + C)$$

where:

D = deterrence efficiency,

B = the number of fish deterred by the barrier (i.e., approaching within 80 m of the barrier and visibly changing direction by making a directed movement away from the BAFF), and

C = the number of fish undeterred by the barrier.

2.2.2 PROTECTION EFFICIENCY

Determining whether operation of the non-physical barrier increased the proportion of juvenile Chinook salmon that took the Sacramento River pathway rather than the Georgiana Slough pathway was a second key study objective. A second metric, protection efficiency, describes the incidence of juvenile Chinook salmon successfully migrating downstream in the Sacramento River, as measured by the proportion of tagged salmon detected migrating to a location beyond approximately 3.2 km downstream of the barrier location (relative to the total number of Chinook salmon migrating down the river and Georgiana Slough combined). The downstream monitoring locations (one each in the Sacramento River and Georgiana Slough downstream of the array) were selected a sufficient distance downstream to ensure that a juvenile salmon was completely out of the barrier's potential area of influence and free from any associated increased risk of predation mortality associated with the BAFF. Additionally, the downstream monitoring locations represent a distance of greater than one tidal excursion from the barrier.

The following *null hypothesis* was tested for the protection efficiency of the barrier:

H_{2o}: There is no statistically significant difference in the proportion of tagged juvenile Chinook salmon that move down the Sacramento River 3.2 km when the non-physical barrier is on compared to when the barrier is off.

The following *alternative hypothesis* was tested for the barrier's protection efficiency:

H_{2A}: There is a statistically significant increase in the proportion of juvenile Chinook salmon that migrate 3.2 km down the Sacramento River pathway when the barrier is on compared to periods when the barrier is off.

The barrier's protection efficiency was calculated as:

$$P = F / (F + G)$$

where:

P = protection efficiency,

F = the number of smolts that pass the downstream (3.2 km) Sacramento River tag detector (i.e., Hydrophones 5 and 6), and

G = the number of smolts that pass the downstream (3.2 km) Georgiana Slough tag detector (i.e., Hydrophones 7 and 8).

All tags that were implanted in juvenile Chinook salmon but were determined to have been eaten in the experimental area were not included in the calculation of protection efficiency. Thus, protection efficiency is a measure of the proportion of only juvenile Chinook salmon moving downstream in the Sacramento River as opposed to Georgiana Slough.

2.2.3 OVERALL EFFICIENCY

Based on monitoring results that showed the numbers of tagged juvenile Chinook salmon entering the experimental area and those that were subsequently detected successfully migrating downstream in the Sacramento River, hypotheses were tested to determine whether there was a significant difference in the overall proportion of tagged salmon that successfully migrated downstream in the river when the barrier was on relative to periods when the barrier was off.

The following *null hypothesis* was tested for the overall efficiency of the barrier:

H3₀: There is no statistically significant difference in the proportion of tagged juvenile Chinook salmon that have been released upstream of the barrier and successfully migrate downstream in the Sacramento River when the barrier is on compared to when the barrier is off.

The following *alternative hypothesis* was tested for the barrier's overall efficiency:

H3_A: There is a statistically significant increase (increase in overall efficiency) in the proportion of juvenile Chinook salmon that are deterred from migrating into Georgiana Slough and successfully survive to migrate downstream in the Sacramento River when the barrier is on compared to when the barrier is off.

The barrier's overall efficiency was calculated as:

$$O = F/E$$

where:

O = overall efficiency,

F = the number of smolts that pass the downstream Sacramento River tag detector (i.e., Hydrophones 5 and 6), and

E = the number of smolts that enter the experimental area (i.e., move past the area close to the DCC at which the array near the divergence begins to detect tagged smolts).

All tagged fish that moved 3.2 km downstream in the Sacramento River were included in the calculation of overall efficiency. To account for predation mortality on juvenile salmon, protection efficiency can be calculated to account for only those acoustic tag tracks that were characterized as not having been eaten by a predator. As a result, comparing protection efficiency versus overall efficiency provides an indicator of predation effects on BAFF efficiency. This may include tags from salmon that were preyed upon by untagged predators after they left the barrier array.

2.3 STATISTICAL BASIS AND FISH SAMPLE SIZES FOR THE EXPERIMENTAL DESIGN

Data were analyzed for this study using two principal statistical approaches. In the first approach, hypothesis testing, hypotheses were explicitly stated *a priori* (not based on prior studies), critical alpha values were described, and the division of the study into analytical conditions was outlined. For the second approach, generalized linear modeling (GLM) was used to examine the importance of barrier operation (relative to other independent variables) in influencing Chinook salmon smolts to continue down the Sacramento River instead of being entrained into Georgiana Slough or being preyed upon within the study area.

There is evidence to suggest that the movement and fate of juvenile salmon outmigrants are affected by a minimum of three generalized variables: day/night phase, Sacramento River discharge, and tidal phase (Blake and Horn 2006; Horn and Blake 2004; Perry 2010). Flow and day/night phase are important drivers; ultimately, however, changing flows, tides, and day/night cycles produce varying combinations of light, velocity, and velocity direction incident to the barrier. The effectiveness of the barrier (deterrence, protection, and overall efficiency) was tested in different combinations, using categories of light levels and water velocities. Light levels were measured underwater. The water velocity variables consisted of along-barrier velocity, cross-barrier velocity, and upstream secondary circulation (and its influence on fish position), along with a normalized combination of these variables. Results of the independent variables (light and velocity) were partitioned into two categories based on statistical and biological considerations.

A single “sample” was a period of time during which none of the following changed: (1) BAFF On/Off state, (2) light did not cross a threshold level, and (3) velocity did not cross a threshold level. All tagged fish that passed the BAFF during a single sample period were used to calculate deterrence, protection, and overall efficiency for that sample. Null hypotheses H_{1_0} , H_{2_0} , and H_{3_0} (described above in Section 2.2, “Hypothesis Testing”) were tested without dividing the samples into light-velocity combinations: that is all samples were combined into simple BAFF On versus BAFF Off comparisons.

The null hypotheses (H_{1_0} , H_{2_0} , and H_{3_0}) (described above in Section 2.2, “Hypothesis Testing”) were also tested at each of the unique combinations of light and velocity resulting from the categories described above. All samples were categorized into a light and velocity categories. Then for each light category, the three null hypotheses, H_{1_0} , H_{2_0} , and H_{3_0} , were tested. And, for each velocity category, the three null hypotheses, H_{1_0} , H_{2_0} , and H_{3_0} , were tested. In addition to this univariate hypothesis testing approach, an exploratory approach based on combining multiple independent variables in a GLM was also used, similar to the approach used by Perry (2010). Two years of the HOR study conducted by DWR have suggested that several variables not included in the hypothesis testing framework described above may influence fish behavior and barrier effectiveness. Ultimately, the GLM analysis was directed toward answering the question: After accounting for other independent variables, does the operation of the barrier significantly increase the probability of a tagged fish passing down the Sacramento River as opposed to Georgiana Slough? The GLM provides insight into the relative importance of different independent variables (including barrier operation) in influencing passage of tagged fish down the Sacramento River. Descriptions of the estimation and statistical testing methods used for hypothesis testing and GLM are provided in Section 2.7, “Statistical Analysis of Barrier Efficiency and Variables Affecting Fish Fates.”

To ensure sufficient statistical power to achieve the study's purpose, it was necessary to consider the number of fish that would need to encounter the barrier when off and on over the range of light and velocity conditions expected during the study. For the 2011 GSNPB Study, it was not known how many test fish might be consumed by predators within the test area or before reaching the test area. Releases of tagged late fall-run Chinook salmon smolts modeled by Perry (2010) suggested that approximately 88% to 93% of fish survived passage from immediately downstream of Steamboat Slough to immediately upstream of the DCC. However, these fish were released at river mile 57 (approximately 37 km upstream of Steamboat Slough) and may have had more time to acclimate to riverine conditions than fish released just below the divergence with Steamboat Slough, as proposed in the 2011 GSNPB Study. Based on the results of prior tests in the Sacramento River (Perry 2010), it was estimated that mortality in the reach between Steamboat Slough and the GSNPB would be less than 10%. Assuming release of a total of 1,500 tagged salmon over the total test period and less than 10% in-river mortality upstream of the barrier, a minimum of 1,350 tagged salmon were expected to enter the test area.

During the entire test period, it was desirable to expose approximately half of the test fish to the barrier when it was on and half when the barrier was off. Based on this premise, it was proposed that barrier operation be switched every 25-hour tidal cycle and that small groups of fish be released every 3 hours for the 45-day test period. By operating the barrier in an on/off mode based on the 25-hour tidal cycle, tagged fish were exposed to a full range of tidal and diurnal conditions over the test period.

Releases were implemented every 3 hours to expose tagged fish to a full suite of different times of the day and night and different tidal conditions over the March–May release period. With this schedule, approximately four tagged salmon were released into the Sacramento River every 3 hours at a location approximately 8.9 km upstream of the barrier to allow the fish time to adjust to river conditions and distribute within the river channel, while reducing the losses of tagged salmon to upstream predation and migration of tagged salmon into alternative migration pathways provided by Sutter and Steamboat Sloughs.

The experimental design was strengthened by the use of continuous monitoring of flow velocity and day/night conditions immediately upstream of the barrier location to record and document the range of conditions likely to affect the movement and fate of tagged salmon entering the test area. Results of the 2011 tests, combined with results from future tests (where possible), will provide the basis for statistical models that can evaluate how various factors (e.g., BAFF On/Off operations; variation in Sacramento River flows, tidal conditions, day/night conditions) influence the GSNPB's deterrence, protection, and overall efficiency in improving protection for listed salmonids produced in the Sacramento River watershed. The test results will provide a strong technical basis for assessing the performance of the GSNPB as a method for improving survival of juvenile salmonids emigrating from the Sacramento River, as well as a statistical basis for further refining and optimizing the experimental design of any subsequent tests and/or evaluations.

2.4 EXPERIMENT IMPLEMENTATION

2.4.1 NON-PHYSICAL BARRIER

Installation of the non-physical barrier began in mid-February 2011. The configuration of the barrier is shown on Figure 2-2. The configuration is similar in design to the barrier tested in the lower San Joaquin River at HOR in 2009 and 2010, and its experimental design builds on the results of the investigations of the HOR barrier. The barrier includes several fish deterrence technologies, including the use of an air bubble curtain, HIMLs, and

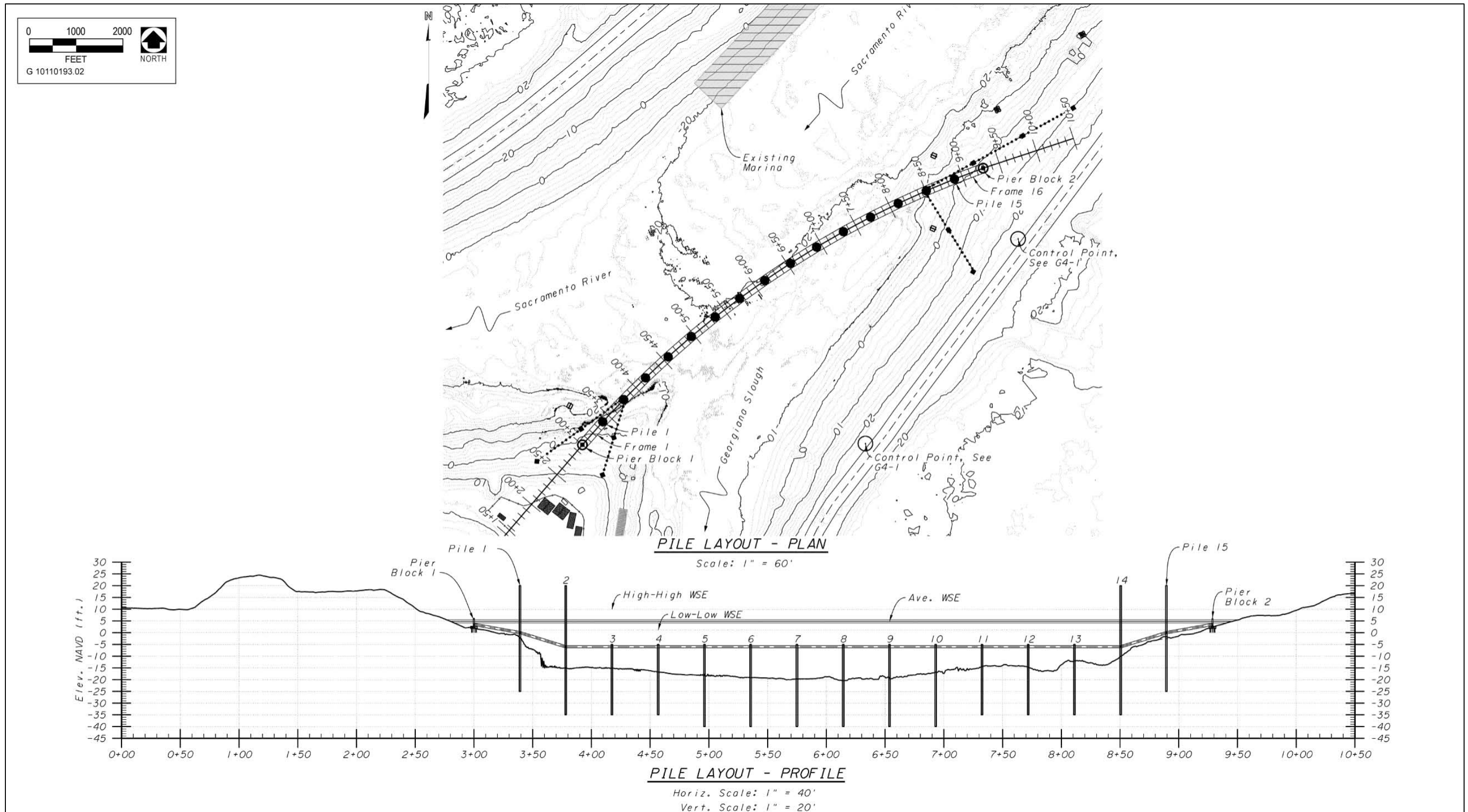

Source: Data provided by California Department of Water Resources and adapted by AECOM in 2011

Figure 2-2 2011 Non-Physical Barrier Layout Plan and Profile

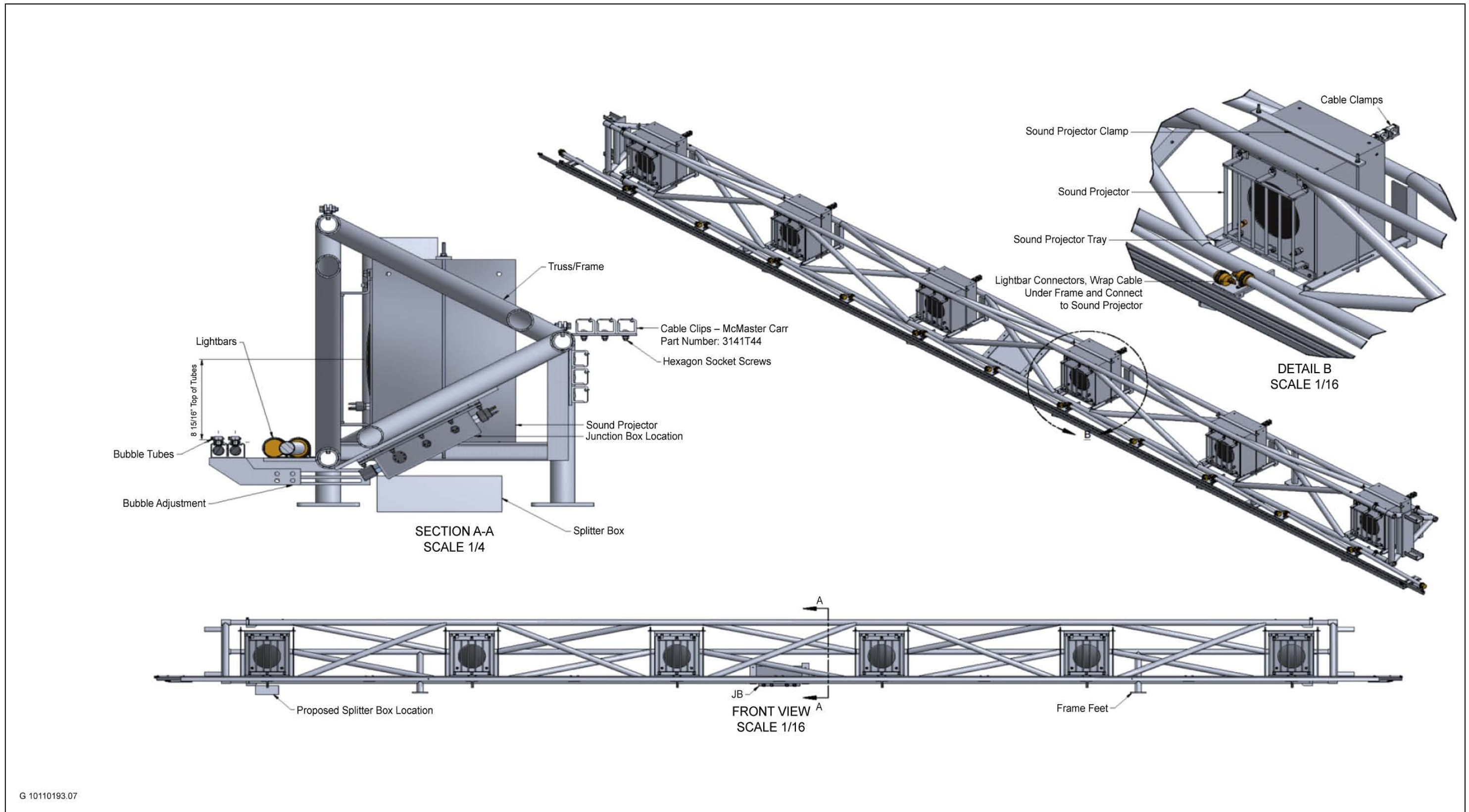

Source: Data provided by Fish Guidance Systems and adapted by AECOM in 2011

Figure 2-3 Components of the BAFF System Installed at Georgiana Slough

Bubble Curtain

The primary function of the bubble curtain is to contain the sound generated by the Sound Projectors. Using a unique principle patented by Fish Guidance Systems, the sound was encapsulated within the bubble curtain, allowing a precise linear wall of sound to be developed. The bubble curtain was generated by passing compressed air (~0.2 bar pressure) into a perforated rubber pipe running along the front of the barrier. Air flow rate was typically around 2.0 liters per second per 1 m length of barrier. The alignment of the bubble curtain determined the guidance line of fish, enabling them to be directed toward the Sacramento River. The trapping of the sound signal within the air curtain prevented saturation of the experimental area with sound.

High Intensity Modulated Lights

Fish Guidance Systems Linear HIML Arrays were used to generate the visual stimulus. The HIMLs are light-emitting, diode-powered devices that create white light, rapidly flashing on and off, providing a light beam that was aligned to project onto the rising bubble curtain. This served to reflect the beam and improved visibility from the direction of approaching fish. The light signal was controlled by the SILAS System Control Unit, with two HIML Bars being connected to each FGS MkIII 30-600 Sound Projector. The light signal for the system was also controlled by the SILAS System Control Unit, via the FGS MkIII 30-600 Sound Projectors. The light was generated by the HIML Bars, which have a minimum output of 847.44 lux (lux is the unit of luminance) at 1 m.

CIVIL INFRASTRUCTURE

The barrier was 192 m long and comprised of 16 frames, each 12 m long. Each frame comprised 6 FGS MkIII 30-600 Sound Projectors, spaced 2 m apart, 12 HIML Bars running along the entire length of the frame, a single FGS Underwater Power and Communication Hub, and two lengths of perforated bubble pipe (Figure 2-3). The bubble pipe was positioned along each frame below and upstream of the sound projectors. The HIMLs were powered from an “accumulator” positioned on each frame section. A mounting plate was attached to the support tray to house the accumulators. The junction of each frame section was able to pivot with the adjacent section, and where needed each frame section was supported at either end with a piling or support column to a pier block. The frame sections could be adjusted vertically at the pile attachments to adjust for the uneven river bed contour. The sections were positioned along the barrier line such that as much of the barrier as possible would be at a depth where the high tide bubble curtain was less than 3.6 m. In the main portion of the channel, this was approximately 3.6 m from the channel bottom. The top of the frame sections was designed to be at least 2.4 m from the average low tide water surface elevation. Formed, streamlined concrete pier blocks were used closer to the shore in shallower water to ensure the system remained in alignment.

Barrier Alignment

The flow orientation of the barrier reflected a relatively shallow angle to allow fish to be deterred and minimize the effects of the river’s hydrodynamic forces. Bowen and Bark (2010) suggested that such influences can reduce deterrence efficiency, based on the relatively steep barrier angle and higher flows at HOR in 2010. The barrier was positioned with the aim of deflecting fish passing down the Sacramento River away from the entrance to Georgiana Slough, allowing them to continue their migration along the Sacramento River. The downstream end of the barrier was terminated just upstream of a scour hole that is present just below the divergence of the Sacramento River and Georgiana Slough.

The alignment, and in particular the angle-to-flow of the river, was a critical element of barrier design. The general principle of angled barrier design, as is used for example in louver screen arrangements, requires that flow meets the barrier at a small acute angle such that fish would need to make a relatively small angular turn in order to be guided along the face of the barrier. This arrangement also ensured that fish require a relatively low sustained swimming speed to avoid passing through the barrier (Rainey 1985; Turnpenny and O’Keeffe 2005). The swimming direction requiring the lowest escape speed is at 90 degrees to the line of the barrier and thus the design should ensure that this velocity component is kept below the maximum sustainable swimming speed of the fish over the range of river flows for which the barrier is designed to work. Figure 2-4 shows the relevant velocity components for an angled fish barrier.

The main channel velocity is denoted Ua . The velocity perpendicular to the barrier face is the fish’s escape velocity, Ue . For a barrier angle ϕ , this is calculated as:

$$Ue = Ua \sin \phi$$

The sweeping velocity, Us , is the component parallel to the barrier face. This is used to calculate the time taken for the fish to traverse the screen from any given point, when swimming at velocity Ue . It is calculated as:

$$Us = Ua \cos \phi$$

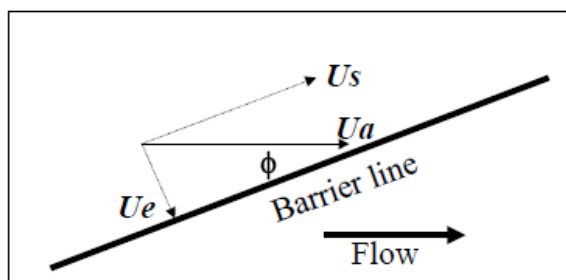

Note: Ua is the channel velocity, Ue is the fish escape velocity, and Us is the sweeping velocity component along the face of the barrier (Turnpenny and O’Keeffe 2005).

Figure 2-4 Flow Velocity Components in Front of an Angled Fish Barrier

The swimming ability of juvenile Chinook salmon was determined by Swanson, Young, and Cech (2004), who reported a sustained swimming speed of 3.4 body lengths per second (BL/s). The minimum size of Chinook salmon used in the design calculation was 60 millimeters (mm), and the maximum design river velocity was 0.5 meter per second (m/s). Table 2-1 shows the derivation of the barrier angle for these design parameters, which gave a barrier angle to flow of 24 degrees. On that basis, the maximum approach velocity perpendicular to the barrier was calculated to be 0.203 m/s (within the design discharge range). It should be noted that use of sustained swimming speed values in this calculation provides a margin of safety, as fish can develop significantly higher prolonged and burst speeds for short periods (Beamish 1978). The margin of safety was built into the maximum design approach velocity perpendicular to the barrier, so for a threshold, a slightly higher value was chosen, 0.25 m/s, to categorize low and high velocities. For the samples of deterrence, protection and overall efficiency, the definition of “high” velocities used was greater than or equal to 0.25 m/s and “low” velocities were less than 0.25 m/s.

**Table 2-1
Design Angle Parameters for a Barrier Capable of Deflecting Juvenile Chinook Salmon**

Attribute		Value		
Minimum size of fish		60 mm		
Sustained swimming speed		3.4 BL/s		
Swimming speed (prolonged)		0.204 m/s		
Maximum design channel velocity		0.5 m/s		
Required barrier angle		24 degrees		
		Angle		
Escape velocity	SIN	24	0.41	0.203 m/s
Sweeping velocity	COS	24	0.91	0.457 m/s

2.4.2 ACOUSTIC TAG SYSTEM OVERVIEW

Fish movements were monitored with an acoustic tracking system. The project incorporated an HTI Acoustic Tag Tracking System (ATS), which uses a fixed array of underwater hydrophones to track movements of fish implanted with acoustic tags. As fish approached the array, the transmitted signal from each tag was detected and the arrival time recorded at several hydrophones. The differences in tag signal arrival times at each hydrophone were used to calculate a three-dimensional (3D) position. The ATS includes the following hardware and software components:

- ▶ A tag programmer that activates and programs the tag.
- ▶ Acoustic tags each transmitting a pulse of sound at regular intervals.
- ▶ Hydrophones that function like underwater microphones, listening within a defined volume of water.
- ▶ Cables connecting hydrophones to tag receivers.
- ▶ Tag receivers connected to a computer that receives the tag signal from the hydrophones, conditions the signal and using specialized software, outputs the data into a format that can be stored in data files.

ACOUSTIC TAGS

All tags used in this study operated at 307 kilohertz (kHz) frequency and were encapsulated with a non-reactive, inert, low toxicity resin compound. The tags utilized “pulse-rate encoding” which provided increased detection range, improved the signal-to-noise ratio and pulse-arrival resolution, and decreased position variability when compared to other types of acoustic tags (Ehrenberg and Steig 2003). Pulse-rate encoding uses the interval between each transmission to detect and identify the tag. Each tag was programmed with a unique pulse-rate to track movements of individual tagged fish.

The pulse-rate is measured from the leading edge of one pulse to the leading edge of the next pulse in sequence. By using slightly different pulse-rates, tags can be individually identified. The timing of the start of each transmission is precisely controlled by a microprocessor within the tag. Each tag was programmed to have its own tag period to uniquely identify between tags. Test tag periods ranged between 2.003 and 3.474 seconds with beacon tag intervals of 9.997–10.263 seconds. The amount of time that the tag actively transmits is the pulse length (or pulse duration). For this study, the transmit pulse length was 3.0 milliseconds.

In addition to the tag period, the HTI tag double-pulse mode or “subcode” option can be used to increase the number of unique tag ID codes available. Using this tag coding option, each tag is programmed with a defined primary tag period, and also with a defined secondary transmit signal, called the subcode. This subcode defines a precise elapsed time period between the primary and secondary tag transmissions. There are 31 different subcodes possible for each tag period, resulting in over 100,000 total unique tag ID codes. There were eleven subcodes used for the 2011 GSNPB study.

HYDROPHONES

A total of 28 hydrophones were installed for this study (includes array and peripheral) and several more were used for pre-release tag testing operations. The Model 590 hydrophones operate at 307 kHz and include a low-noise preamplifier and temperature sensor. Hydrophone directional coverage was approximately 330 degrees, with equivalent sensitivity in all directions except for a 30 degree limited sensitivity cone directly behind the hydrophone where the cable is attached. The hydrophone sensor element tip is encapsulated in specially treated rubber to ensure long term reliability with acoustic impedance close to that of water. The hydrophone and connector housing are made of corrosion resistant aluminum-bronze alloy. Cables were twisted pair wire and double shielded for noise reduction. Individual cable lengths ranged from approximately 15 to 150 m.

The hydrophone preamplifier circuit provides signal conditioning and background noise filtering for transmission over long cable lengths and in acoustically noisy environments. A calibration circuit in the preamplifier provides a method for field testing hydrophone operation and is used to measure the signal time delays between hydrophones in the array. The Model 590 hydrophones include temperature sensors to measure water temperature variations and its affect on the velocity of the signal in water.

To measure signal time delays, the calibration circuit for each hydrophone is set to transmit (“ping”) while all other hydrophones are set to receive. This procedure was repeated for all hydrophones in the array. Data from each hydrophone are processed to measure the time delay and water temperature from each hydrophone. Accurate measurement of signal time delays between hydrophones provides the position data to locate the array in UTM or Lat/Lon coordinates and provides the resolution necessary for sub-meter 3D positioning.

Acoustic Tag Receiver

Two HTI Model 290 Acoustic Tag Receivers (ATRs) were used to monitor at the GSNPB. The ATR is designed to receive up to 16 separate channels; one channel is assigned to each hydrophone. Each ATR is connected to a personal computer used to analyze and store the acoustic data. The two ATRs were synchronized utilizing an internal global positioning system (GPS) in each of the receivers. An individual raw data file is created for each sample hour. Filters in the ATR are set to identify the acoustic tag sound pulse and discriminate tags from the ambient background noise.

When the tag signal is received by the ATR, a series of signal processing steps are completed. The envelope detector receives the signal and outputs the positive “envelope” with the carrier frequency removed. This detected echo envelope is then digitized at a rate of 12 kHz. A real-time adaptive noise threshold is set based on a 1 second window of the background noise level for each hydrophone independently which is updated every 0.083 msec. The pulse width of each pulse that exceeds a predetermined threshold is measured at the -3, -6, and -12 dB points and the pulse peak amplitude is located and measured.

The ATR pulse measurements are reported for each single echo from each hydrophone and written to Raw Acoustic Tag files (*.RAT) using the AcousticTag program. Each *.RAT file contains header information for data acquisition settings followed by the raw echo data. Each raw echo data file contains all acoustic signals detected during the time period, including signals from tagged fish as well as some additional unfiltered acoustic noise.

Software – MarkTags and AcousticTag

Two separate programs are used to process acoustic tag data; AcousticTag and MarkTags. AcousticTag is used initially to both acquire data from the ATR and store it in raw acoustic echoes files. MarkTags reads the raw acoustic echo files, identifies tag signals and create acoustic tag files. These acoustic tag files are used again in AcousticTag to position the tags in 3D space.

AcousticTag acquires data and stores it in *.RAT files. It is important to note that these raw echoes are not associated with any specific Tag ID or spatial positioning. Depending on the project site and environmental conditions, many echoes found within these files are not tag data but derived from secondary sources (i.e. ambient noise, multipath). Thus, the first important phase of post processing is to select the acoustic echoes that have been received directly from tags, and to assign the unique Tag ID to these echoes.

The echo selection process is completed in the MarkTags program. The procedure for isolating the signals from a given tag follows from the method used for displaying the signals themselves. Each vertical scan in the plot shows the detected arrivals in the time window equal to the pulse-rate encoding of a particular tag (Ehrenberg and Steig 2003). In this example, only signals from the tag programmed with this 1100 ms period will fall along the straight line. The results of the tag selection process completed in MarkTags is written to Tracked Acoustic Tag files (*.TAT file). These files contain the individual raw acoustic echoes which have been assigned a Tag ID but no spatial positioning has yet been assigned. AcousticTag performs the triangulation calculations and provides a database of point locations for each fish.

Tag Programmer

The TagProgrammer application sets the individual settings when programming a tag.

Hydrophone Placement Geometry and Position Calculation

Detection on one hydrophone confirms the presence of an acoustic tag, but to be accurately positioned in three-dimensions a tag must be detected on at least four hydrophones. Three-dimensional tag coordinates with sub-meter accuracy are achieved using hydrophones located in known positions, at different vertical planes and within direct line of sight of the tag. As an acoustic tag passed through the four beams, the difference in the arrival time of each pulse was used to triangulate the location of the tag. In this way, a swimming path for each tagged fish could be mapped and presented in a 3D display.

The principle that is used for determining acoustic tag positions is the same principle that accurately determines positions using a GPS. The acoustic tag transmits a signal which is received by at least four hydrophones. By knowing the positions of the four hydrophones and measuring the relative signal arrival times at the hydrophones, the locations of the tagged fish can be estimated. In particular, if h_{ix}, h_{iy}, h_{iz} specify the x,y,z location of the i^{th} hydrophone and let F_x, F_y, F_z specify the unknown x,y,z locations of the tagged fish.

Then the travel time from the tagged fish to the i^{th} hydrophone, t_i is given by:

$$t_i = \frac{1}{c} \sqrt{(h_{ix} - F_x)^2 + (h_{iy} - F_y)^2 + (h_{iz} - F_z)^2}$$

where: c is the velocity of sound.

Unfortunately, the absolute travel time cannot be directly measured. However the differences between the arrival times of the signal at the various hydrophones ($t_i - t_j$) can be measured as given by:

$$t_i - t_j = \frac{1}{c} \left[\sqrt{(h_{ix} - F_x)^2 + (h_{iy} - F_y)^2 + (h_{iz} - F_z)^2} - \sqrt{(h_{jx} - F_x)^2 + (h_{jy} - F_y)^2 + (h_{jz} - F_z)^2} \right]$$

For four hydrophones, there are three such distinct signal arrival time difference equations. The system of nonlinear equations is determined by solving the tagged fish coordinates, F_x, F_y, F_z such that the mean squared difference between the measured (left side of the equation above) and calculated time differences (right side of the equation above) are minimized. Additional information on the acoustic tag system can be found in Appendix A.

2.4.3 MONITORING EQUIPMENT DEPLOYMENT

Monitoring equipment was deployed in February 2011. Deployment activities commenced with installation of hydrophones and all other in-water components. Model 590 hydrophones were installed on bottom or surface mounts designed for the environmental and flow conditions at each location. The different configurations used for bottom- and surface-mounting configurations are discussed below. Cables attached to the hydrophones were twisted pair wire and double-shielded for noise reduction, and ranged in length from 15 to 152 m. Hydrophone cables were paired with tensioned aircraft cable to increase cable stiffness and strength.

Multiple hydrophones were installed in the Sacramento River immediately upstream, downstream, and adjacent to the barrier to monitor tagged fish as they encountered and responded to the barrier. These hydrophones were referred to as the array at the barrier. Additional hydrophones, referred to as the peripheral hydrophones, were installed to detect tagged fish outside of the area of the barrier. Each of the peripheral hydrophones was combined with autonomous data loggers and operated independently using air card modems for communication access and remote data downloading.

The array hydrophones, peripheral hydrophones, and cable assemblies were deployed and tested before implementation of the 2011 GSNPB Study. All equipment was bench tested and calibrated before installation. Hydrophones were installed and cables were routed to electronic equipment housed in secure, climate-controlled structures supplied with 110-volt AC power located on shore.

Hydrophones were positioned as part of barrier deployment and monitored on-site for use in documenting the response of tagged salmon and tagged predatory fish to the barrier when it was either on or off. This monitoring system allowed on-site, real-time detection and monitoring of movement by tagged fish into and through the test area. The system was maintained throughout the testing period.

HYDROPHONE ARRAY AT THE NON-PHYSICAL BARRIER

The hydrophone array was installed near the non-physical barrier. Hydrophones were positioned on both the Sacramento River side and the Georgiana Slough side of the non-physical barrier. Hydrophones were placed such that high-quality two-dimensional (2D) tracks could be obtained throughout this reach.

Hydrophones were deployed in the array using several types of mounting hardware discussed below. The precise location of hydrophones in the array was measured in-situ using a GPS unit and the procedure for calculating hydrophone placement geometry and positioning known as the “ping-around.” The effective range of detection and overlap of hydrophones in the array was also examined in-situ by actively moving a transmitting tag throughout the array and verifying consistent detection and positioning of the tag (termed the “tag drag” procedure).

Hydrophone array locations are presented on Figure 2-5.

Bottom-Mounted Hydrophones

Several hydrophones in the array and peripheral sites were deployed on the river bottom. The type of bottom mount used was dependent on flow velocities and the position of the hydrophone relative to the shore. The two types of bottom mounts that were used are described below and shown on Figures 2-6 and 2-7.

Tower Mount Bottom-Mount Configuration

Tower mounts are large, heavy river mounts used to minimize hydrophone movement after positioning (Figure 2-6). These types of mounts were used in offshore areas or other areas of high flow.

Near-Shore (“Pound-In”) Bottom-Mount Configuration

The “pound-in” mounts were used to mount hydrophones near shore (Figure 2-7).

Bottom-Mount Deployment Methods

Hydrophones were attached to bracket plates bolted to the mount frame. Cables were attached to the hydrophones and secured to the mount frame with cable ties. Offshore tower mounts were deployed from a boat using a winch (Figure 2-6). Near-shore pound-in mounts were also deployed from a boat.

Surface-Mounted Hydrophones

Surface-mounted hydrophones were attached to existing underwater structures such as docks and pilings. Dock mounts were used and attached to underwater structures where available (Figure 2-8).

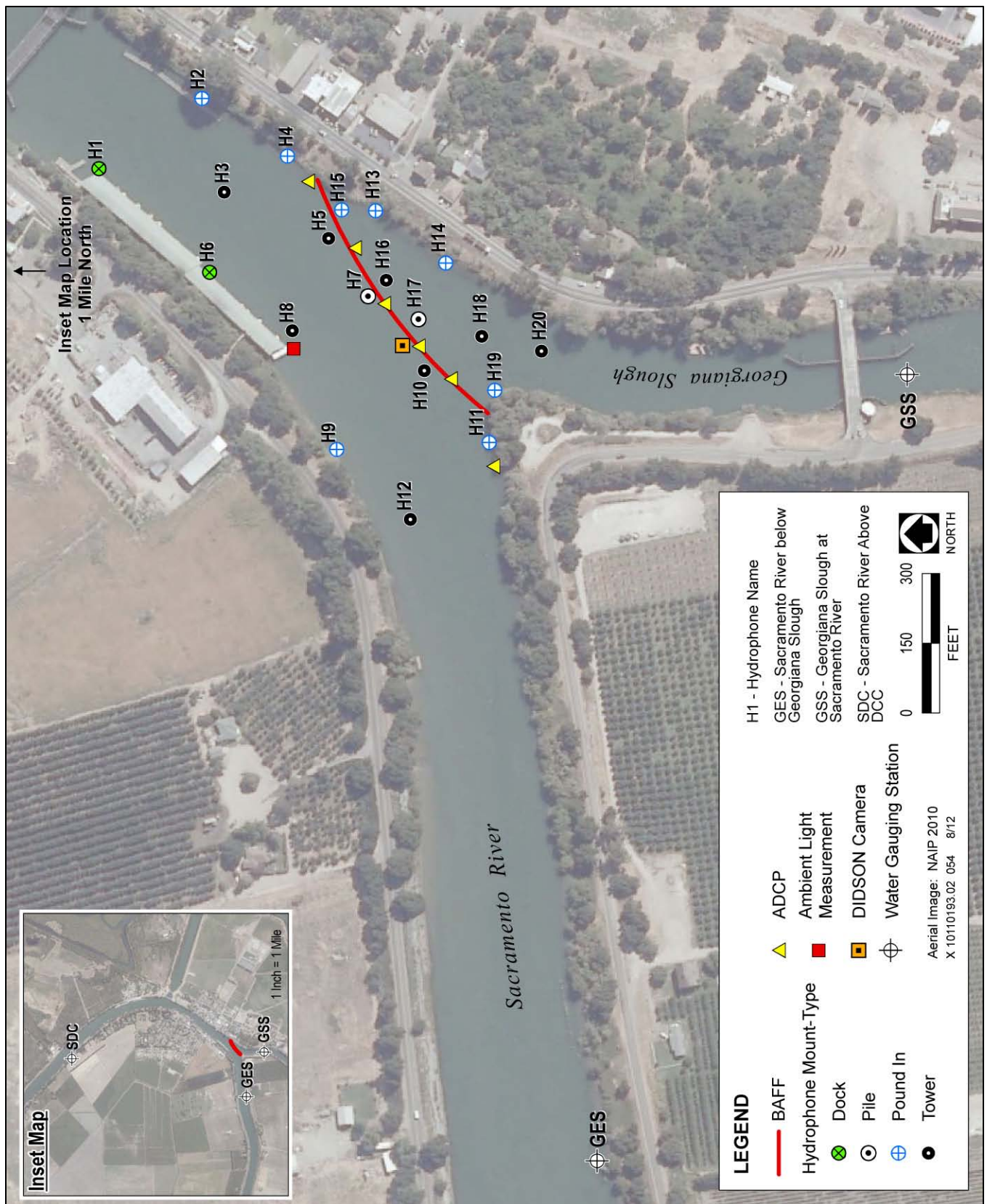

Source: Data provided by HTI, USGS, and DWR and adapted by AECOM in 2011

Figure 2-5 Hydrophone Array and other Data Collection Instrument Locations



Source: HTI

Figure 2-6 Representative Photograph of a Tower Mount



Source: HTI

Figure 2-7 Representative Photograph of a “Pound-In” Mount



Source: HTI

Figure 2-8 Representative Photograph of a “Dock” Mount

Receiver Locations

Receivers for the array at the barrier were housed in secure, climate-controlled facilities supplied with 110-volt AC power located in the data collection trailer at the staging area and in a houseboat moored at Dagmar’s Marina (on the opposite side of the Sacramento River from the barrier; see Figure 2-5).

PERIPHERAL HYDROPHONES

Peripheral hydrophones were attached to self-contained receivers that could be remotely accessed by way of cell modems and an Internet-based file upload and storage system. Receivers for the peripheral hydrophones were housed in secure structures supplied with 12-volt DC power from deep-cycle batteries. Batteries were charged with solar panels or 120-volt AC battery chargers where available. Figure 2-1 shows the locations of the peripheral hydrophone sites.

An automated data downloading and storage system for the peripheral hydrophone sites was set up, operated, and maintained during the duration of the tests.

2.4.4 FISH AND FISH TAGGING

Juvenile late fall–run Chinook salmon produced at the U.S. Fish and Wildlife Service Coleman National Fish Hatchery was the species used in the 2011 GSNPB Study. Ration level and holding conditions within the hatchery before tagging were managed, to the extent possible, to produce fish ranging in size from 110 to 140 mm fork length during the study period. This late fall-run size range is larger than fall-run, winter-run and spring-run individuals that are also migrating passed the Georgiana Slough divergence at this time of year (Vogel and Marine 1991).

TRANSPORT TO RELEASE SITE AND HOLDING

Groups of Chinook salmon were loaded into a transport truck tank that housed three 75-liter perforated fish containers with sufficient volume to achieve an appropriate loading density, based on accepted hatchery transport guidelines for the transport of hatchery-produced juvenile Chinook salmon. Provision of rations to test fish ceased on the day before transport to preserve the fishes' ability to cope with transport stress, as well as subsequent handling and surgeries. Approximately 40 fish (32 experimental fish for release plus 10 surplus fish to accommodate fish condition and size issues) spread across the three perforated containers were transported to the release site every day. The transport truck tank was filled with water from the hatchery. The fish were placed in three perforated containers, which were loaded into the transport tank. After the fish were loaded into the transport truck tank, the water was aerated using oxygen supplied through fine bubble diffusers. Water temperature and dissolved oxygen concentrations in the transport tank were monitored, and non-iodized salt was added to achieve a working concentration of 5-7 parts per thousand to reduce osmotic stresses.

After transfer from the hatchery to the tagging location, the 75-liter containers were lifted from the transport truck tank. The containers were partially dewatered, and then were placed in sleeves (non-perforated containers) to maintain the remaining water volume inside. The sleeved containers were then carried from the truck to the boat. If the water temperature in the containers was more than 2 degrees Celsius (°C) different from the ambient water temperature in the Sacramento River at the transfer site, river water was added to the containers to temper the water temperature at a rate of approximately 5°C per hour until the containers' water temperature was within 2°C of the ambient water temperature in the river at the transfer site. After the initial temperature adjustment, the containers were attached to a floating frame and placed in the Sacramento River supported by a dock platform, which was attached to a houseboat. Sacramento River water flowed freely through each container. The containers were tethered to a dock system attached to the houseboat (Figure 2-9) and held for 18–24 hours to allow the fish to further adjust to Sacramento River conditions and recover from handling and transport stresses before being tagged. Water temperature and dissolved oxygen adjacent to the containers was monitored regularly. A description of standard operating procedure for fish transports is provided in Appendix B.

TAGGING SCHEDULE

In total, 43 tag groups typically consisting of 32–33 juvenile late fall–run Chinook salmon were surgically implanted with acoustic tags. Fish were tagged daily beginning on March 14, after the barrier and monitoring equipment had been installed. Tagging and release operations took place at a houseboat moored near the release site. Half of a daily tag group (typically 16–17 fish) was tagged in the morning (between approximately 8 a.m. and 10 a.m.) and the other half was tagged in the afternoon (3–5 p.m.). This schedule reduced the variability associated with the time between tagging and release. Data were recorded so that the transport, tagging, and holding timelines for each fish were available and these variables could be incorporated into subsequent data analyses.

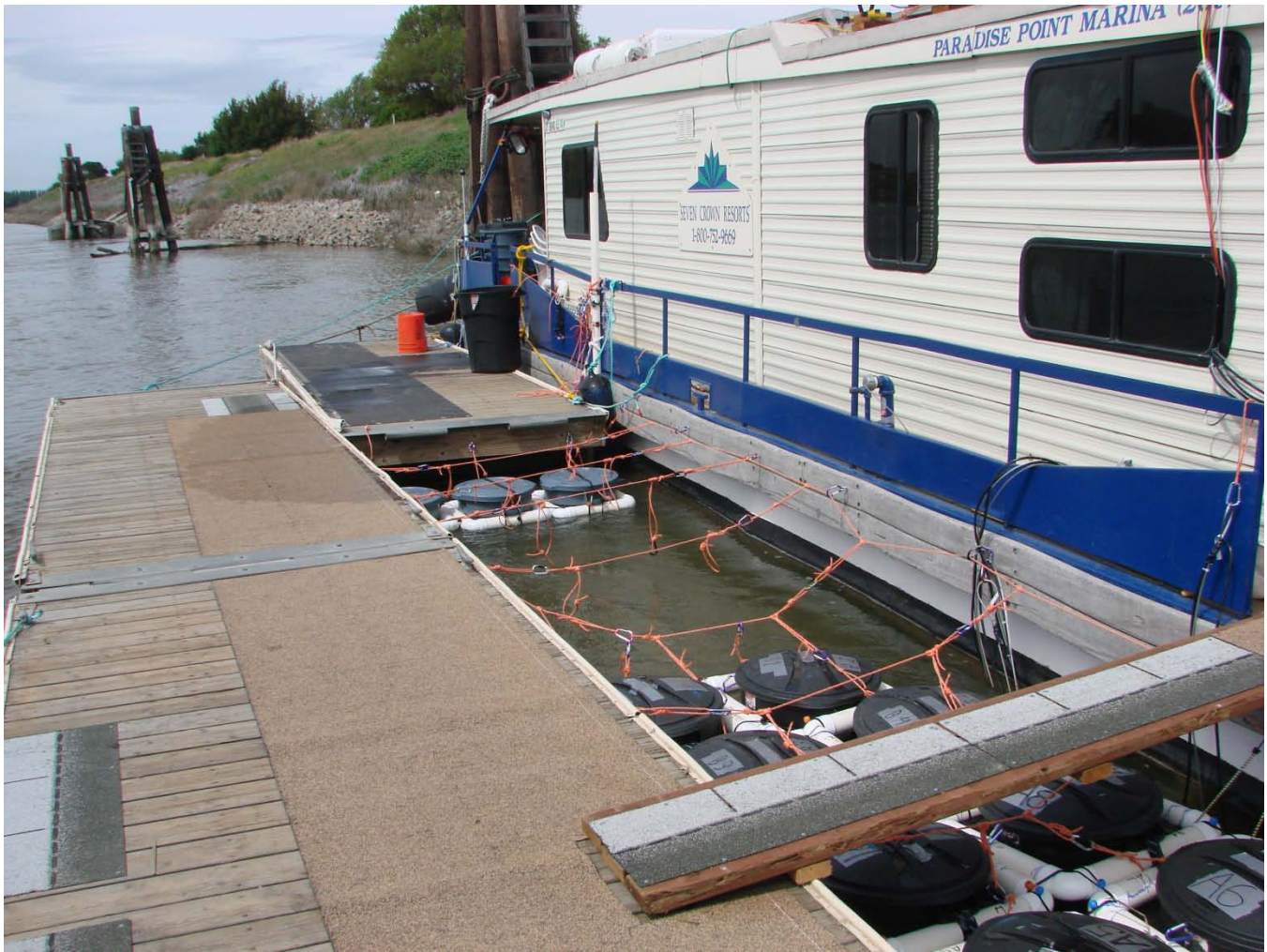

Source: AECOM

Figure 2-9 Representative Photograph of Fish Holding Containers Tethered to Dock System

SELECTION OF ACOUSTIC TAGS

Juvenile Chinook salmon within the size range of 110–140 mm fork length were acoustically tagged using HTI Model 795Lm microacoustic tags. The tags have a typical battery life of approximately 15 days and transmit a unique acoustic signal at a rate of one pulse every 2–4 seconds. They have a dry weight of 0.67 gram. Based on the estimated weight of the juvenile salmon (10–15 grams), the tag represents approximately 3.5% of the body weight of the fish. The tags are within the 5% “rule of thumb” for acoustic tagging studies performed using larger juvenile Chinook salmon (Adams et al. 1998).

Before surgeries were conducted, tags for each subgroup were activated and programmed. Passive Integrated Transponder (PIT) tags were coded to correspond to the HTI acoustic tags to speed up the process of checking and tracking the tag code separately, as necessary.

SURGICAL IMPLANTS

Juvenile Chinook salmon were surgically implanted with acoustic tags near the release site upstream of the barrier. Fish handling, holding, and tagging procedures followed the guidance outlined in Liedtke and Wargo-Rub (in press). Fish were held for 18–24 hours after transport and before tagging to allow them to recover from the stress of transport and handling. Surgical procedures adhered to aseptic technique recommendations such as the use of medical-grade exam gloves and disinfection of instruments and tagging equipment. Before the surgery, each juvenile salmon was placed in an anesthetic solution (i.e., 50–70 milligrams per liter Tricaine methanesulfonate [MS-222] buffered with sodium bicarbonate) until it no longer responded to stimuli. The time in anesthesia was monitored for each fish and did not exceed 5 minutes. Once anesthetized, the fish was weighed and measured before being placed ventral side up on a V-shaped foam trough (surgical platform). While on the surgical platform, the gills were perfused using a maintenance solution of buffered MS-222 that was kept in an elevated bucket and gravity fed via plastic tubing into the fish's mouth. The flow rate and anesthesia dosage were adjusted based on the ventilation rate observed for a given fish. Fish with obvious deformities or significant (>20% per side) scale loss were not selected for tagging. Surgical procedures followed the methods developed and refined by the U.S. Geological Survey (USGS) for juvenile salmon (Adams et al. 1998; Martinelli et al. 1998). The incision was made anterior of the pelvic girdle, 2–3 mm lateral to the mid-ventral line using a microsurgical blade. The incision was only long enough to allow insertion of the transmitter without tearing the surrounding tissue (just slightly longer than the diameter of the transmitter). The acoustic transmitter and PIT tag, which were previously disinfected in Chlorhexidine diacetate (Nolvasan) and rinsed, were then inserted into the body cavity via the incision. The incision was closed using two simple interrupted sutures with Vicryl+, 5/0 absorbable suture material (Figure 2-10). Once the incision was closed, fish were transferred to a recovery container with dissolved oxygen levels at 120% to 130% saturation. Fish remained in this oxygen-rich environment until they fully recovered from anesthesia and were responsive to stimuli (typically about 10–15 minutes). A description of standard operating procedure for surgical implants is provided in Appendix B.

POSTSURGERY HOLDING AND RECOVERY

After recovering from anesthesia, tagged fish were transferred (without netting) from the recovery container into a post-tag holding and release container (e.g., a 120-liter perforated garbage can) by lowering the recovery container into the holding container and allowing the fish to be passively moved. Typically, four to five fish (the subrelease group) were placed into a single container. The containers were supported by sealed polyvinyl chloride pipe floating frames so that the upper quarter of the container was above the water. This approach ensured that the container lids were properly secured to prevent fish from escaping, and provided tagged fish access to the air-water interface so that they could reestablish neutral buoyancy before being released (Liedtke and Wargo-Rub, in press). Once inside the holding container, the fish were not handled again before release. Immediately before release, each group of tagged fish was visually observed (while still in the water), and any mortality would have been documented and moribund fish would have also be removed and euthanized. Tags from any fish removed from the experimental population would have been recovered and evaluated for possible reuse.

Fish remained in the release container for 18–30 hours after tagging and then were released into the river at the predefined release schedule.

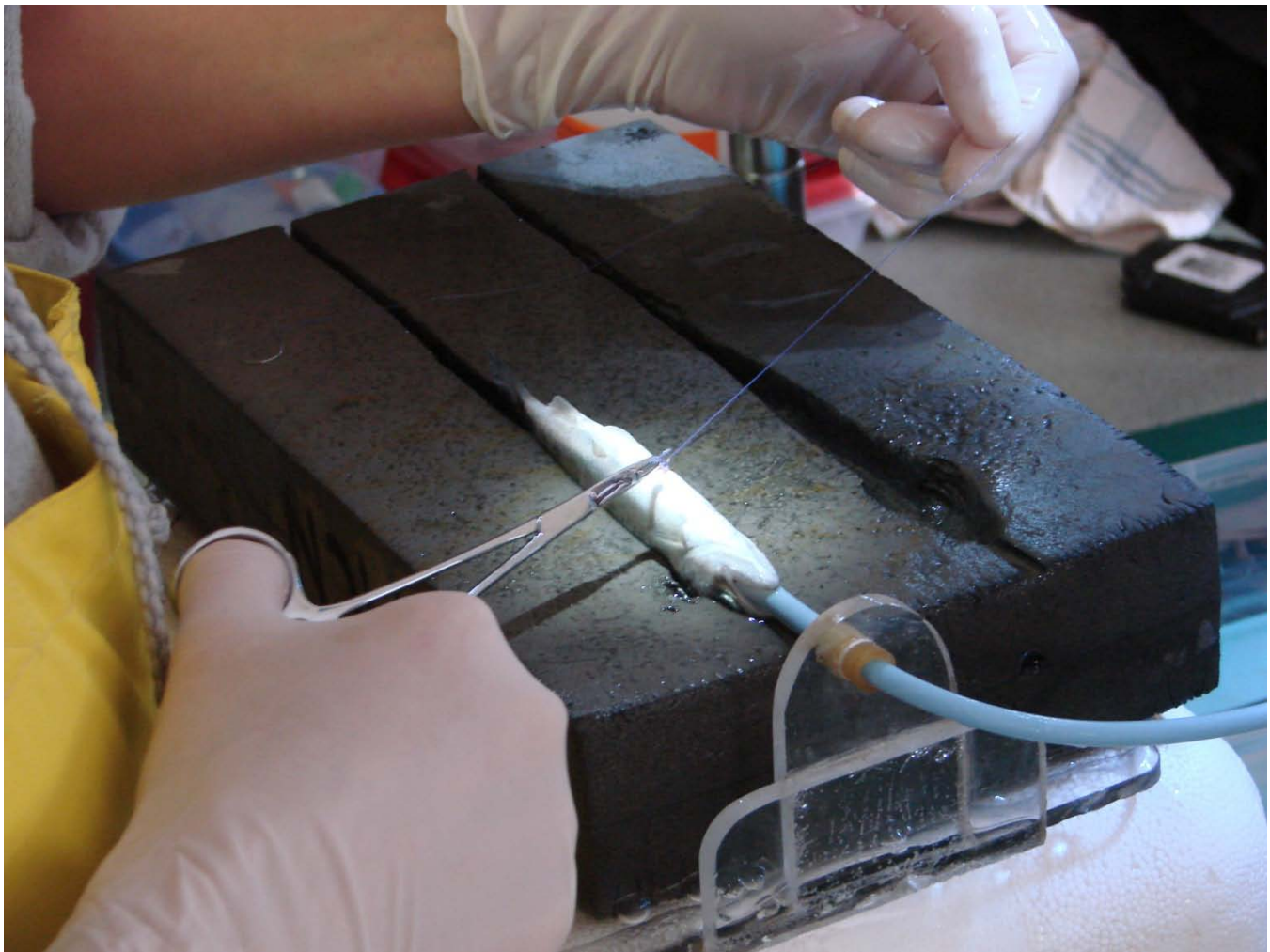

Source: AECOM

Figure 2-10 Representative Photograph of Fish Tagging

TAG RETENTION AND FISH HEALTH STUDIES

Multiple groups of surplus Chinook salmon were tagged with dummy tags during the study to evaluate their general condition after 48 hours, complete physiological tests, and evaluate post-tagging mortality and tag shedding within 30 days of tagging. Dummy-tagged fish followed protocols similar to those of live-tagged fish until release.

2.4.5 FISH RELEASES

This section provides a description of procedures employed during fish releases.

POSTSURGERY HOLDING AND OBSERVATION

As stated previously, subgroups typically consisting of four to five tagged salmon were held in perforated containers for 18–30 hours before release. Observations were made of fish showing signs of stress, infection, lethargic behavior, and/or poor health or fitness. Individual fish not appearing healthy and fully recovered from handling and transport were removed from the experimental population before release.

TAG VERIFICATION

Before each fish release, an acoustic hydrophone was used to log and document the acoustic tag codes.

EXPERIMENTAL RELEASES

A variety of factors may affect the behavior of juvenile salmon released into the Sacramento River upstream of the divergence with Georgiana Slough. Among these factors are river flows and tidal hydrodynamics that vary in the reach throughout the day in response to ebb and flood tidal conditions and the magnitude of Sacramento River flows. The migratory behavior of juvenile salmon has also been observed to vary depending on day and night conditions. To help control for several of these factors, tagged salmon were released in continuous increments throughout the test period. Small subgroups of approximately four to five tagged salmon were released at one location (mid-channel) every 3 hours over the duration of the test period. The effective continuous release of tagged fish at 3-hour intervals allowed fish releases to occur during both the day and night under both flood and ebb tidal conditions. Tagged salmon were released into the river near the water surface by allowing them to volitionally escape from post-tag holding containers. A description of standard operating procedure for fish releases is provided in Appendix B.

2.4.6 PREDATOR FISH TAGGING AND MONITORING

Predatory fish were also tagged and monitored to determine their behavior and movement patterns and potential predation of tagged juvenile Chinook salmon in association with the non-physical barrier operations. Several predatory fish species are known to reside year-round in the Sacramento River and Georgiana Slough near the study area: striped bass, smallmouth bass (*Micropterus dolomieu*), largemouth bass (*M. salmoides*), spotted bass (*M. punctulatus*), Sacramento pikeminnow (*Ptychocheilus grandis*), and white catfish (*Ameiurus catus*). Previous field studies have shown evidence of predation on juvenile salmonids in the Delta, including predation at the non-physical barrier in the lower San Joaquin River at HOR (Nobriga and Feyrer 2007; Hanson 2009).

Predatory fish were captured via hook and line using cut bait and artificial lures. Circle hooks were used during bait fishing to minimize hooking injuries. Sampling was confined to a 1.6-km radius from the divergence of Georgiana Slough and the Sacramento River. All tagged predatory fish were released in the immediate barrier area regardless of capture location. All predatory fish of sufficient size to effectively prey on the experimental juvenile Chinook salmon were considered eligible for tagging.

Sampling for predatory fish occurred from fixed locations (e.g., docks and the riverbank) and from fishing boats. Hooks were removed carefully immediately after capture and fish were placed in well-aerated live wells filled with cool water. A temporary tagging station was assembled in a location that was considered reasonable (e.g., stable and providing shade) on each sample date. Captured predatory fish were transported to the tagging station in a 19-liter bucket of water and placed in a large container of aerated water and an anesthetic solution of MS-222. Once sedated, fish were placed on their backs in a moist, sponge-like cradle (surgical platform) to provide protection during the brief surgical procedure. Aerated water with a maintenance solution of MS-222 was delivered to the gills during surgery. HTI Model 795Lg microacoustic tags with a typical tag life of approximately 90–130 days were inserted at a point below the lateral line and just posterior of the pelvic fins. After the surgical procedure, fish were placed in large, well-aerated containers of fresh, cool water for recovery. Fish were observed carefully during recovery and released only after exhibiting normal behavior (i.e., all fins moving and fish capable

of maintaining an upright position in the water column). Tagged predators were monitored using the acoustic detection and monitoring network established as part of the experimental program.

Sampling and tagging occurred throughout the study period to account for the loss of tagged fish migrating outside of the study area. Sampling through time also ensured that data were gathered from and representative of predator behavior and movement patterns characteristic of the full range of environmental conditions that occurred during the study period. In total, 50 predatory fish were captured and acoustically tagged during the study.

2.5 MONITORING AND DATA COLLECTION

This section describes monitoring and data collection procedures.

2.5.1 ENVIRONMENTAL CONDITIONS MONITORING

Several variables were monitored during the experiment to document environmental and other conditions that could influence the ultimate fate of the study fish. Each of these variables is discussed separately below.

CLIMATE AND WEATHER

California Irrigation Management Information System collects and manages data on general weather conditions (i.e., temperature, precipitation, wind, and solar radiation) throughout California. A weather station is located at Twitchell Island (near Rio Vista, approximately 19 km southwest of Walnut Grove). Data collected over the study period were downloaded from the Twitchell Island station to represent climate and weather conditions over the study period.

SACRAMENTO RIVER AND GEORGIANA SLOUGH HYDROLOGY AND WATER QUALITY

USGS maintains a network of flow monitoring and water quality gauges in the Sacramento River and Georgiana Slough. A gauge is located on the Sacramento River upstream of Walnut Grove (station SDC/WGA), in the Sacramento River below Georgiana Slough (station GES/WGB), and within Georgiana Slough (station GSS/GS) (Figure 2-5). Data from these monitoring locations were used to characterize the hydrologic and water quality conditions at the study site throughout the test period. Information concerning each station is shown in Table 2-2. Hydrologic and water quality data were downloaded on October 21, 2011, from California Data Exchange Center (DWR 2011). Stage, discharge, temperature, turbidity, and conductivity data at 15-minute intervals were collected for the period from March 1, 2011, through May 31, 2011.

HYDRODYNAMICS

In addition, USGS conducted more detailed velocity and current measurements near the barrier to characterize the hydraulic conditions experienced by juvenile salmon as they responded to the barrier. The flow and localized water velocity measurements also allowed analysis of the relationship between movement of individual tagged salmon within the area adjacent to the barrier in response to tidal currents and the relative proportion of flow entering Georgiana Slough and passing downstream in the Sacramento River during periods when each tagged fish is encountering the barrier.

**Table 2-2
Discharge and Water Quality Stations in Close Proximity to the GSNPB Project Study Area**

Attribute	Station Code		
	SDC/WGA	GES/WGB	GSS /GS
River Basin	Sacramento River	Sacramento River	Sacramento River
Hydrologic Area	Sacramento River	Sacramento River	Sacramento River
County	Sacramento	Sacramento	Sacramento
Nearby City	Walnut Grove	Walnut Grove	Walnut Grove
Operator	USGS	USGS	USGS
Elevation	10 feet	10 feet	10 feet
Latitude	38.257000°N	38.238900 N	38.237000 N
Longitude	121.518000°W	121.523400 W	121.518000 W
Full Name	Sacramento River Above DCC (Above Georgiana Slough)	Sacramento River Below Georgiana Slough	Georgiana Slough at Sacramento River

Deployment and Processing Summary

In order to document the water velocities along the face of the barrier the USGS deployed upwards looking acoustic Doppler current profilers (ADCPs) at intervals about 10 m upstream of the barrier. Upwards-looking ADCPs were chosen because they could make the type of high-frequency, continuous measurements throughout the study period required to support sufficient temporal averaging to remove the variance caused by low-frequency turbulence in the study area. Additionally, upwards looking ADCPs can measure velocities in any direction in a horizontal 2D plane without the bin (i.e., depth cell) mapping considerations of horizontal ADCPs. Four ADCPs were initially deployed along the face of the barrier. Unfortunately, the sudden increase in velocities and resulting bed-mobilization caused by the leading edge of the flood wave resulted in cable failure for all of the instruments. As a result, the ADCPs were recovered, and two were redeployed for the second half of the study. These ADCPs were configured with adequate battery capacity and internal memory capacity to operate self-contained to manage the risk of premature cable failure, and operated without any down-time during the second half of the study.

All of the ADCPs were deployed to collect data continuously for 10 minutes, and then record a single average for each 10-minute period. The ADCPs were configured to collect an average for every 1 m vertical bin above the instrument. During the binary-numeric processing steps described above the upper meter of data was often removed due to surface-induced bias, so the effective upper bin measurement was about 1 m below the surface at all times.

After the ADCPs were recovered, the data stored internally had to be converted from RDI's binary data format into numeric values, then geo-referenced, rotated into earth coordinates, heading/declination corrected, and attributed to the correct ADCP position (since several instruments were deployed in more than one location).

A total of 32 data fields representing different velocity and hydraulic attributes were populated. Data for each of the fields were then selected to correspond to time when tagged Chinook salmon were present in the array. Additional information on ADCP data processing and water velocity modeling can be found in Appendix C.

UNDERWATER LIGHT LEVELS

Continuous ambient light measurements were collected between March 18 and April 4, 2011, and between April 11 and May 16, 2011, at the houseboat stationed at Dagmar's Marina (Figure 2-5). The ambient light levels were collected to serve as representations of background light conditions occurring in the Sacramento River near the BAFF. Measurements were taken at a fixed 1 m depth below the water surface using a LI-COR LI-192SA light sensor and recorded using a LI-1400 data logger. Data were recorded in photosynthetic photon flux units and then manually converted to lux. Data values greater than 5.4 lux were considered to represent light conditions, whereas data with values less than 5.4 lux were representative of dark conditions.

BATHYMETRIC DATA

Bathymetric data were collected multiple times to map and record conditions on the river bed during the study period. The frequency of bathymetric data collection was based on the variability and magnitude of flows during the study period, which could affect sediment transport and deposition processes.

2.5.2 BARRIER OPERATION MEASUREMENTS

Several variables were measured during the experiment to document conditions associated with barrier operation, which could influence the effectiveness of the barrier. Each of these variables is discussed separately below.

UNDERWATER SOUND

Short-term sound measurements were collected at a total of eight locations at variable depths and distances from the BAFF. Measurements were taken while the BAFF was on during daylight and night conditions on May 5, 2011 and May 11, 2011 respectively. Short-term underwater noise levels were measured using a Larson Davis Laboratories Model 831 precision integrating sound level meter with a Reson TC4013 omnidirectional hydrophone. The sound level meter was calibrated before and after use with a G.R.A.S. Pistonphone Type 42AF to ensure that the measurements would be accurate. The sound meter and hydrophone were attached to a weighted bracket and lowered into the water from a boat. Measurements were taken at depths below the water surface, ranging from 3 to 15 m, and distances from the BAFF ranging from 0 to 563 m. An acoustical tag was fixed to the hydrophone to assist in recording the position at which measurements were taken in relation to the BAFF. A tape measure was also used to assist with determining the depth of measurements.

UNDERWATER LIGHT

Short-term light measurements were collected at a total of eight locations at variable depths and distances from the BAFF. Measurements were taken while the BAFF was on during daylight and night conditions on May 5, 2011 and May 11, 2011 respectively. Light was measured using a LI-COR LI-192SA light sensor and recorded using a LI-1400 data logger. The light meter was attached to the end of a Reson TC4013 omnidirectional hydrophone, sound rod, and weighted bracket, and lowered into the water from a boat. Measurements were taken at depths below the water surface, ranging from 3 to 15 m, and distances from the BAFF ranging from 0 to 563 m.

An acoustical tag was fixed to the hydrophone to assist in recording the position at which measurements were taken in relation to the BAFF. A tape measure was also used to assist with determining the depth of measurements. Light measurements were recorded as 15-second averages over a period of 1 to 2 minutes at each depth interval. Data were recorded in photosynthetic photon flux units and then manually converted to lux.

BUBBLE CURTAIN

The non-physical barrier bubble curtain was monitored through daily checks of air pressure and flow (at the valve manifold feeding the air to the diffuser) and through visual inspections during the study period.

2.5.3 ACOUSTIC TAG DETECTION/MONITORING

As part of the barrier tests, a 3D monitoring system, comprised of multiple hydrophones located in the river immediately upstream, downstream, and adjacent to the barrier, was deployed and operated to monitor 3D fine-scale movement of tagged fish as they encountered and responded to the barrier (Figure 2-5). The upstream detection range of the array was in the Walnut Grove Bridge, allowing determination of the movement of tagged smolts into the experimental area. Acoustic detectors were positioned as part of the deployment of the barrier, and monitored on-site, for use in documenting the response of tagged salmon and tagged predatory fish to the barrier when it is on or when it is off. The hydrophone monitoring system also allowed on-site real-time detection and monitoring of movement by tagged fish into and through the test area. A detailed description of acoustic tag detection and monitoring is provided in the project data collection plan (see Appendix A).

2.5.4 DIDSON OBSERVATIONS

A dual-frequency identification sonar (DIDSON) camera was used to observe fish behavior immediately adjacent to the barrier. At the start of the study (March 15, 2011), a DIDSON camera was temporarily installed on the dock at the south end of the BAFF while technical issues were resolved with the mounting bracket for the planned installation. The temporary DIDSON was removed on March 16 before sampling procedures were finalized due to high debris loads in the river. The mounting bracket and DIDSON camera were ready for installation on March 17, but high flows prevented divers from entering the water until April 16. The DIDSON was mounted on a pile located approximately 4.5 m upstream of the BAFF and 1.2 m above the river bed (Figure 2-5). During automated sampling, the DIDSON was aimed downstream toward the BAFF and 13 degrees upward from horizontal to view juvenile fish response to BAFF operations. Starting April 23, automated sampling occurred 3 hours before and 3 hours after changes in BAFF operations.

2.6 EXPERIMENTAL BARRIER OPERATIONS

The experimental design for the barrier tests was based on a comparison of the responses of tagged juvenile salmon that migrate downstream in the Sacramento River and encounter the divergence with Georgiana Slough either when the barrier is on or when the barrier is off over a range of Sacramento River discharge, tidal, and diel conditions. The selection of a starting barrier setting (on or off) was chosen arbitrarily; the experiment began with the barrier in the “off” mode. Thereafter, the barrier was switched approximately every 25 hours on the minimum low tide. Switching the barrier operation approximately every 25 hours on the minimum low tide resulted in BAFF On and BAFF Off conditions over a range of light and tidal cycles; two full tidal cycles were completed every 25 hours.

2.7 STATISTICAL ANALYSIS OF BARRIER EFFICIENCY AND VARIABLES AFFECTING FISH FATES

2.7.1 FISH FATE DETERMINATION

To determine the fate of study fish, hydrophones were deployed to detect fish movement. MarkTag software was then used to build spatially referenced fish tracks, which were in turn, were displayed in EonFusion software for visual inspection and analysis of fish movement patterns and route selection. Fish tracks were systematically reviewed by the project team over a week-long conference, referred to as the Fish Fate Conference. For all fish tracks, fish “fates” were determined for a total of seven different possible “events.” The “events” were grouped into categories of entering the array, exiting the array, and predation. Each fate was assigned a fate code that was entered into a spreadsheet for further analysis. A schematic showing the categories of events, events, and fates (with fate codes) used during the conference is provided on Figures 2-11a and 2-11b.

2.7.2 BARRIER DETERRENCE, PROTECTION, AND OVERALL EFFICIENCY

To determine the fate of study fish and test the three stated hypotheses, hydrophones were deployed to analyze fish movement and route selection. Two hydrophones were installed in Georgiana Slough approximately 3.2 km downstream of the divergence (Figure 2-1), another two hydrophones were installed in the Sacramento River approximately 3.2 km downstream of the divergence (near the Ryde Hotel), and an array with multiple hydrophones (Figure 2-5) was installed near the barrier to detect telemetered Chinook salmon smolts in the vicinity of the barrier. The various hydrophones allowed for an assessment of the movement of tagged smolts past several locations:

1. Sacramento River—upstream of divergence and the barrier (close to the Walnut Grove Bridge, where the array at the divergence begins to detect tagged smolts),
2. Sacramento River—downstream of the divergence and the barrier (peripheral hydrophones 5 and 6 on Figure 2-1), and
3. Georgiana Slough—downstream of the divergence and the barrier (peripheral hydrophones 7 and 8 on Figure 2-1).

The calculation for barrier *deterrence efficiency* is provided under Section 2.2.1, “Deterrence Efficiency,” above. This calculation is based on whether or not a fish was deterred by the barrier, based on fish tracks.

The second evaluation metric used in the experimental protocol is the *protection efficiency*, which includes consideration of the pathways (i.e., Sacramento River or Georgiana Slough) taken by juvenile salmon when the barrier is on or off. The potential fate of a juvenile salmon entering the experimental area included:

- ▶ being eaten by a predator (determined by the tag exhibiting a predator-like trace);
- ▶ successfully migrating downstream in the Sacramento River, as determined by detection at the downstream acoustic monitor;

Fish Fate Determination Schematic

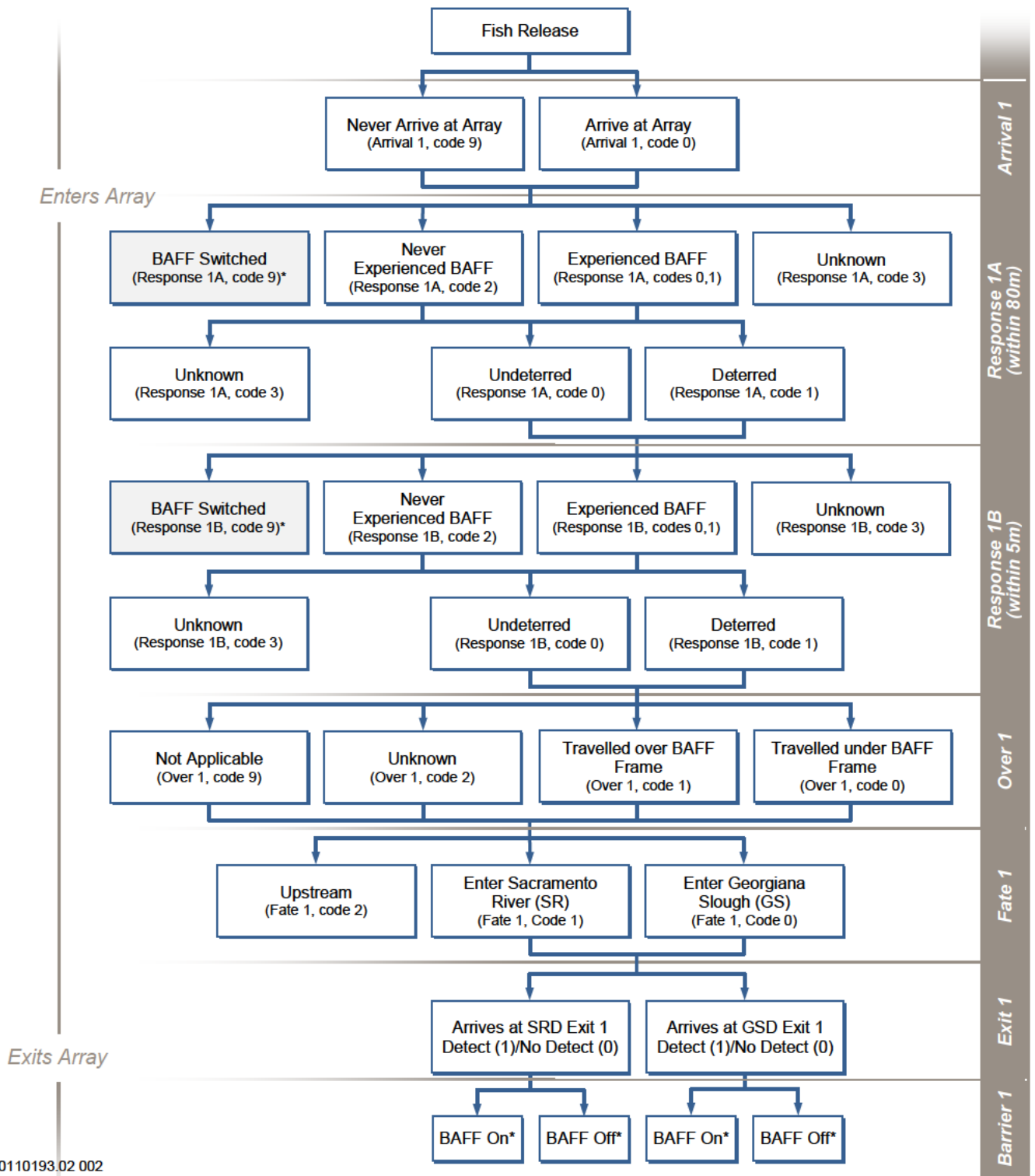

10110193.02 002

* Determined following the fish fate conference.

Figure 2-11a Fish Fate Determination Schematic (Array Events)

Fish Fate Determination Schematic

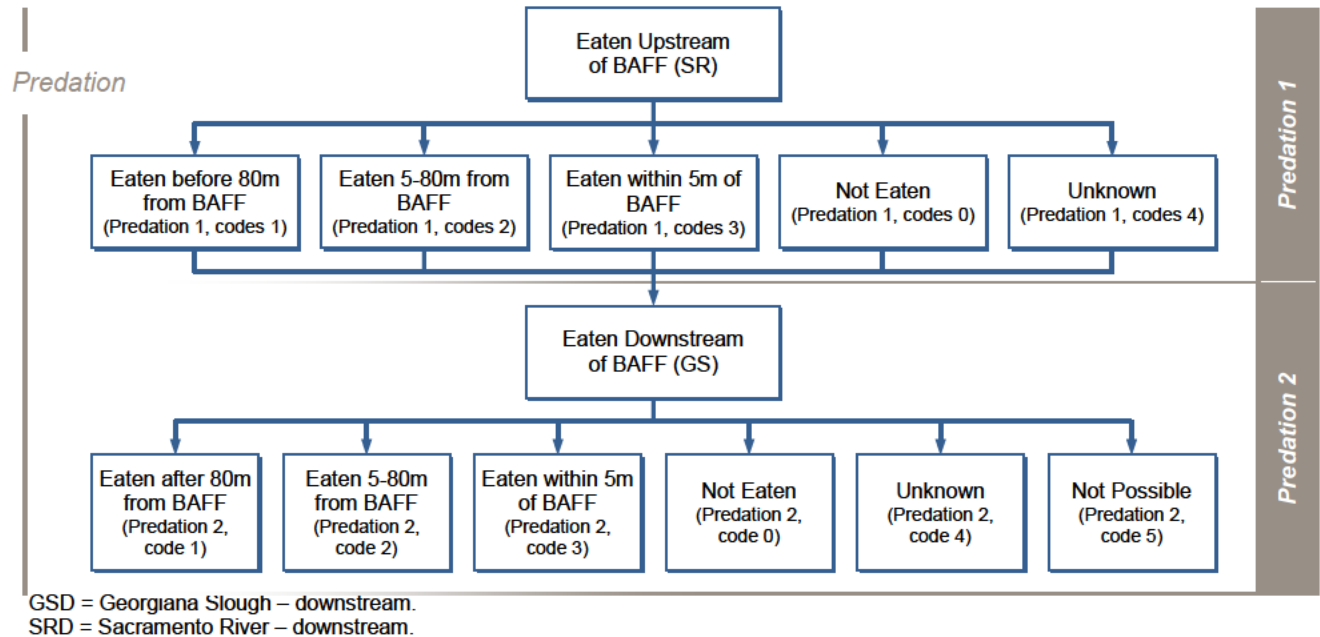

10110193.02 005

Figure 2-11b Fish Fate Determination Schematic (Predation Events)

- ▶ migrating downstream into Georgiana Slough, as determined by detection of the acoustic monitor located downstream in Georgiana Slough; or
- ▶ unknown (insufficient information to determine fate).
- ▶ The calculation for barrier *protection efficiency* is provided under Section 2.2.2, “Protection Efficiency,” above.
- ▶ Only fish that had not been preyed upon were included in the calculation of protection efficiency. To account for both deterrence and potential predation in the barrier vicinity, the final evaluation metric considered was overall efficiency. This is the proportion of fish entering the experimental area that successfully reach the downstream Sacramento River site. The calculation for barrier *overall efficiency* is provided under Section 2.2.3, “Overall Efficiency,” above.

Based on the deterrence, protection, and overall efficiency estimates during tests when the barrier is on and when the barrier is off, comparative results were tested for statistical significance. First, the data were tested for the assumptions of parametric statistics: (1) independence of observations, (2) homogeneity of variance, and (3) normality. Second, if the data met these three criteria, analysis of variance (ANOVA) tests were conducted for BAFF On versus BAFF Off and for the unique combinations of light and velocity outlined in Section 2.3, “Statistical Basis and Fish Sample Sizes for the Experimental Design.” Third, if the data do not meet the assumptions of parametric statistics, nonparametric techniques were used (e.g., a Kruskal-Wallis test).

2.7.3 GENERALIZED LINEAR MODELING OF TAGGED FISH FATES

The first 2 years of the HOR study have suggested that a number of variables that are not included in the hypothesis testing framework described above may influence barrier effectiveness (Bowen et al. 2009; Bowen and Bark 2010). To account for these variables, a supplemental analysis was conducted that predicted the probability of a tagged Chinook salmon smolt reaching Sacramento River – Downstream or Georgiana Slough – Downstream or being eaten by a predator. Ultimately, this analysis was directed towards answering the question: After accounting for other variables, does the operation of the GSNPB significantly increase the probability of a tagged fish being protected (i.e., reaching Sacramento River – Downstream)? The analysis consisted of a GLM with a binomial distribution and logit link function, similar to the technique used by Perry (2010) to predict entrainment probability into the DCC and Georgiana Slough from the Sacramento River.

For this part of the analysis, the fate of each fish, F_i , was modeled as a Bernoulli random variable where $F_i = 1$ for fish entering Georgiana Slough and $F_i = 0$ for fish remaining in the Sacramento River. Migration routes used by each fish were determined based on whether 2D tracks exited the array via the Sacramento River or Georgiana Slough. The probability of entrainment into Georgiana Slough, $\pi_{G,i}$, was modeled as a function of individual covariates using generalized linear models in the R statistical platform (R Development Core Team 2011). The logit link function, which models $\ln(\pi_{G,i}/(1-\pi_{G,i}))$ as linear function of covariates, was used. Entrainment probability for each individual is then expressed as a function of covariates using the inverse logit function:

$$\pi_{G,i} = \frac{\exp(\beta_0 + \beta_1 Y_{1,i}, \dots, \beta_n Y_{n,i})}{1 + \exp(\beta_0 + \beta_1 Y_{1,i}, \dots, \beta_n Y_{n,i})} \quad (1)$$

where: $Y_{1,i}, \dots, Y_{n,i}$ are the values of n covariates for the i th fish, β_0 is the intercept, and β_1, \dots, β_n are slope coefficients for the n covariates.

Five covariates were considered for inclusion in candidate models: operation of the BAFF (B ; on = 1, off = 0), time of day (D ; day = 1, night = 0), discharge entering the river junction (Q , $\text{ft}^3/\text{s} \cdot 1000$), cross-stream position (X) which is the location of tagged fish in the channel cross-section, and the location of the critical streakline in the channel cross section (S). Turbidity and water velocity upstream of the BAFF were also considered, but both were highly correlated with discharge ($r = 0.89$ for turbidity; $r = 0.97$ for velocity) and were therefore excluded from the analysis. The cross-stream position of each fish was measured using its nearest 2D position to a cross section aligned with the upstream end of the BAFF (Figure 2-12). All other individual covariates were based on the time at which fish were closest to the BAFF. The critical streakline estimates the cross-stream location that divides the river channel into water parcels entering either Georgiana Slough or the Sacramento River: $Q_S + Q_G$

$$S = W \left(\frac{Q_G}{Q_S + Q_G} \right) - 37.5 \quad (2)$$

where: W is the width of the channel (144.8 m) and Q_G and Q_S is discharge of Georgiana Slough and the Sacramento River, respectively, measured downstream of the river junction.

This equation makes the simplifying assumption of a rectangular channel and uniform velocity distribution. Both S and X were offset by 37.5 m to set the origin to the outer-most position of the BAFF (Figure 2-12). Thus, for

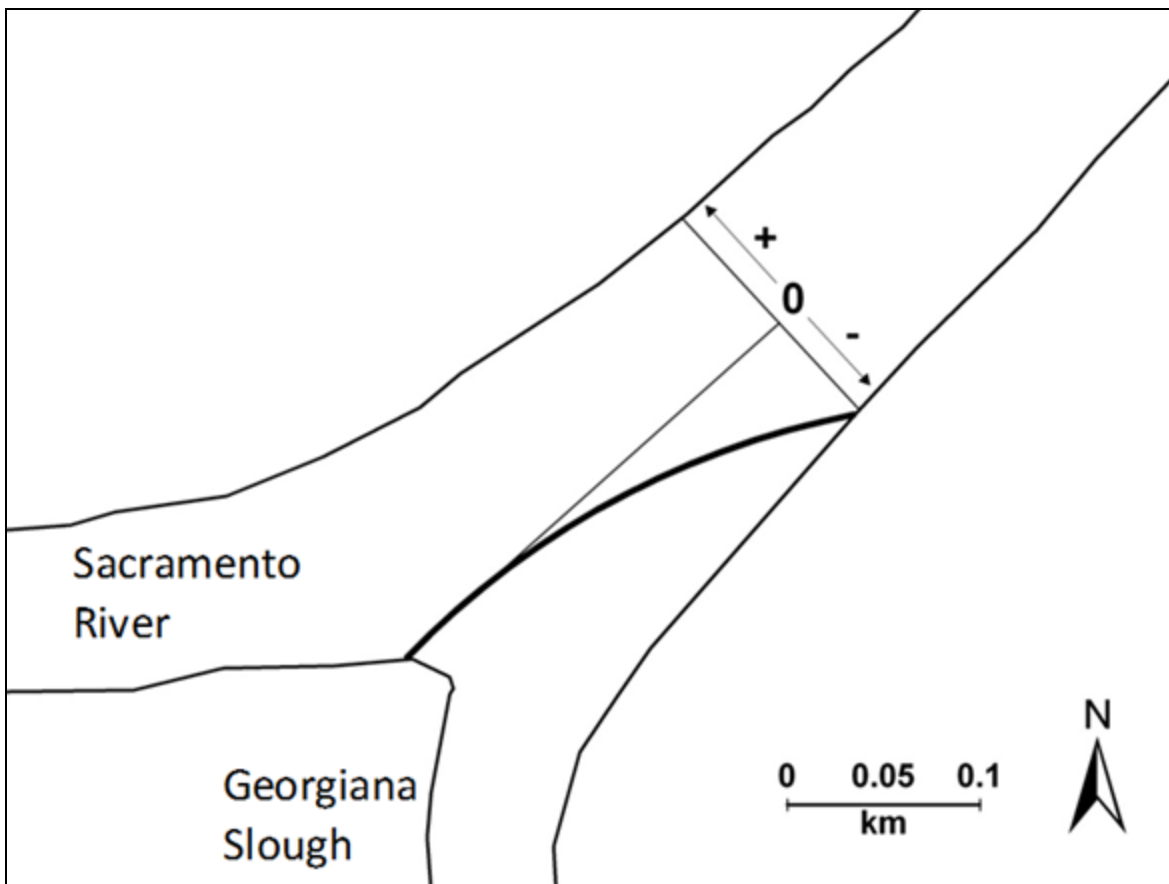

Note: The heavy solid line shows the location of the BAFF in the river junction and thin lines show the streamwise (parallel to mean velocity vectors) and cross-stream (perpendicular to mean velocity vectors) coordinate system. Zero indicates the origin with positive cross-stream coordinates indicating locations to the Sacramento River side of the BAFF and negative cross-stream coordinates to the Georgiana Slough side of the BAFF.

Figure 2-12 The Streamwise and Cross-Stream Coordinate System in Relation to the Sacramento River and Georgiana Slough

$X < 0$, fish were located to the Georgiana Slough side of the BAFF in river channel just upstream of the junction and for $X > 0$, fish were located toward the Sacramento River side of the BAFF in the river channel just upstream of the junction. Likewise, for $S < 0$, the critical streakline intersects the BAFF, but for $S > 0$ the streakline extends into the Sacramento River beyond the BAFF. Similarly, $X < S$ indicates that fish were located in the parcel of water likely to enter Georgiana Slough, whereas $X > S$ indicates fish were more likely to remain in the Sacramento River.

The model selection process consisted of fitting alternative models to the data, ranking the models based on an information criterion, and then using the best fit model for inference. The Bayesian Information Criterion (BIC) was used for model selection because BIC tends to be more conservative (i.e., selects simpler models) than other model selection criteria (e.g., Likelihood Ratio Test or Akaike's Information Criterion (AIC)) when sample size is relatively large (Ward 2008). Both AIC and BIC seek to identify the most parsimonious model by trading off goodness of fit, measured by the maximized log-likelihood of a given model, with a penalty term based on the number of parameters used to fit the model. These information criteria differ only in the penalty term for the number of parameters. For AIC, the penalty term is $2k$, and for BIC the penalty term is $k \cdot \ln(n)$, where k is the

number of parameters and n is the sample size. Models with lower BIC are considered more parsimonious models. Differences of < 3 BIC units were interpreted between models (ΔBIC) as models that explain the data equally well.

To identify the best model, series of main-effects models were fit and two-way interactions (i.e., products of variables) were added to the best-fit main effects model. All possible main-effects models formed were fit using the five predictor variables, resulting in 32 models. Biologically reasonable two-way interactions were then added to the main-effects model that was selected on the basis of BIC differences among models. Interaction terms assessed whether the effectiveness of the BAFF varied with time of day (D), cross-stream location of fish (X), and discharge (Q). The model with the lowest BIC value in the set of models was then selected as the best-fit model explaining variation in migration routing of juvenile salmon. To assess the relative importance of each variable, the difference in BIC of each model (ΔBIC) relative to lowest-BIC model was calculated within groups of models of similar complexity. Models were loosely grouped according the number of variables in each model.

Model fit was assessed according to the data using both quantitative and descriptive techniques. To check for systematic deviations of predicted from observed values, the Hosmer-Lemeshow goodness-of-fit test was performed (Hosmer and Lemeshow 2000). The area under the receiver operating curve (AUC) was also calculated to quantify how well the model predicts the fates of fish (Hosmer and Lemeshow 2000). The AUC is calculated as follows: if estimated probabilities of $\pi_{G,i}$ are greater than an arbitrary cutoff value of π_G , then the i th fish is assigned to Georgiana Slough. For a particular cutoff value, the actual route used by each fish is compared to the predicted route, and the false-positive and true-positive rate calculated. The receiver operating curve (ROC) plots the true-positive rate versus the false-positive rate for all possible cutoff values, and AUC is the area under this curve. An AUC of 0.5 indicates the model has no ability to predict the fish's migration route, whereas $\text{AUC} = 1$ indicates perfect classification ability. In practice, models with AUC between 0.8 and 0.9 are considered to have "excellent" discrimination ability and $\text{AUC} > 0.9$ is considered "outstanding" (Hosmer and Lemeshow 2000).

Results were presented from the best fit model in three ways. First, the parameter estimates (i.e., the slope coefficients) indicate whether each variable positively or negatively influenced entrainment into Georgiana Slough. To illustrate the effect of each variable on entrainment probability, the relationship between $\pi_{G,i}$ and each covariate were plotted while holding all other covariates constant. Second, to examine how covariates interacted to affect entrainment probabilities, the data set was divided into day and night, BAFF On and BAFF Off, and high- and low-flow periods (i.e., before and after April 5, 2011), resulting in eight strata. The relationship between predicted entrainment probabilities and mean values of covariates within each stratum was then examined. Last, the observed fraction of fish entrained into Georgiana Slough arises as a function of individual entrainment probabilities integrated across the conditions experienced by each fish as it passed through the river junction. Given estimated individual entrainment probabilities from the best fit model, the fraction of fish entering Georgiana Slough as the mean of individual entrainment probabilities during each stratum was estimated. Mean estimated entrainment probabilities to the observed fraction of fish entering Georgiana Slough were then compared to assess how well the best-fit model predicted entrainment at the population level.

2.7.4 SURVIVAL AND ROUTE ENTRAINMENT PROBABILITY ANALYSIS

A mark-recapture survival model was developed using telemetry stations at three locations: (1) the river junction of the Sacramento River and Georgiana Slough (array), (2) downstream of the BAFF in the Sacramento River

(peripheral hydrophone site), and (3) downstream of the BAFF in Georgiana Slough downstream of the BAFF (peripheral hydrophone site) (Figure 2-13).

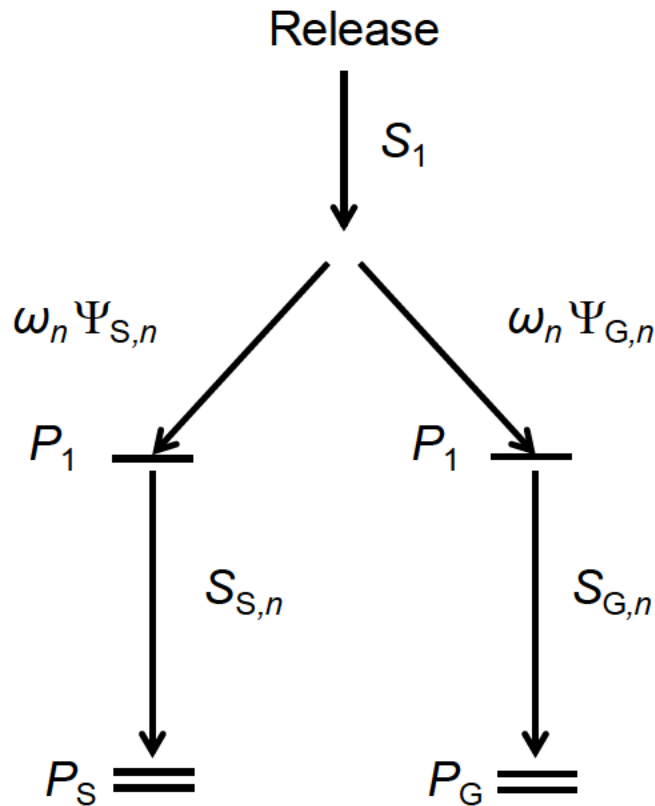

Note: A horizontal bars represents a telemetry location and two horizontal bars represent the peripheral hydrophones.

Figure 2-13 Mark-Recapture Model Schematic Used to Estimate Survival, Route Entrainment, and Detection Probabilities

The model was constructed using the methods of Perry et al. (2010) and estimated three sets of parameters: survival (S_{hi}), detection (P_i), and route entrainment probabilities (Ψ_h) (Table 2-3). Survival probabilities estimate the probability of surviving from location i to $i+1$ within each route (h). Detection probabilities estimate the tag being detected at a given location, conditional on the fish surviving with an operational transmitter. Route entrainment probabilities estimate the probability of a fish entering route h ; in this case, the probability of entering the Sacramento River (route “S”) or Georgiana Slough (route “G”). In addition, survival and route entrainment probabilities were estimated for BAFF On and BAFF Off treatments. This required inclusion of an additional parameter in the model, ω_n , which estimates the probability of fish arriving at the river junction during BAFF On (ω_{on}) and BAFF Off (ω_{off}) treatment periods.

The data for the model are comprised of observed counts of detection histories that define whether fish were detected at the array and/or peripheral hydrophones, the route of detection, and the BAFF treatment at the time fish were detected near the BAFF (Table 2-4). Each detection history has three detection codes. The first code simply indicates that fish were released upstream of the BAFF and is coded with a “1” for all fish. The second code indicates fish not detected in the array (“0”), fish that entered either the Sacramento River (“S”) or

Georgiana Slough (“G”), and the BAFF operation when fish were detected (“on,” “off”). Fish were assigned a route based on observing the final disposition of 2D tracks as determined at the “Fish Fate Conference.” The third

**Table 2-3
Parameter Definitions for the Mark-Recapture Model**

Parameter	Definition
S_1	Survival from release to array
$S_{S,n}$	Survival from array to Sacramento River peripheral hydrophones
$S_{G,n}$	Survival from array Georgiana Slough peripheral hydrophones
P_1	Detection probability of the array
P_S	Overall detection probability of the peripheral hydrophones in the Sacramento River
P_G	Overall detection probability of the peripheral hydrophones in Georgiana Slough
ω_{on}	Probability of arriving at the array with the BAFF on
$\Psi_{S,n}$	Probability of entering the Sacramento River BAFF conditional on BAFF status
$\Psi_{G,n}$	Probability of entering Georgiana Slough conditional on BAFF status

Note: The subscript “n” denotes parameters estimated separately for BAFF On and BAFF Off.

**Table 2-4
Detection History Frequencies Used in the Mark-Recapture Model to Estimate Survival, Detection, and Route-Entrainment Probabilities**

Model	Detection History Overall	Frequency
Overall model	<i>1 0 0</i>	65
	<i>1 0 S</i>	2
	<i>1 0 G</i>	0
	<i>1 Soff 0</i>	12
	<i>1 Soff S</i>	569
	<i>1 Son 0</i>	16
	<i>1 Son S</i>	620
	<i>1 Goff 0</i>	12
	<i>1 Goff G</i>	153
	<i>1 Gon 0</i>	2
<i>1 Gon G</i>	49	
Sacramento double array model	<i>S1 0</i>	1
	<i>0 S2</i>	98
	<i>S1 S2</i>	1092
Georgiana double array model	<i>G1 0</i>	0
	<i>0 G2</i>	1
	<i>G1 G2</i>	201

code indicates whether fish were detected at peripheral hydrophones downstream of the BAFF in the Sacramento River (“S”), Georgiana Slough (“G”), or at neither site (“0”). For example a fish that arrived in the array when the BAFF was on, exited the array via the Sacramento River, and was detected at downstream peripheral hydrophone exit site was coded as “1 Son S.” A fish that entered the array when the BAFF was off and entered Georgiana Slough but was not detected at the downstream peripheral hydrophone was coded as “1 Goff 0” (Table 2-4).

Fish classified as having been predated within the array needed to be assigned to one of the three reaches (i.e., either the release site to the array, or from the array to each of the downstream detection sites). Therefore, fish classified as having been eaten upstream of the BAFF were assigned to the upstream reach by coding them as “1 0 0.” Fish classified as having been predated downstream of the BAFF were coded either as “1 Son 0,” “1 Soff 0,” “1 Gon 0,” or “1 Goff 0,” depending on migration route and BAFF operation. Thus, fish predated upstream of the BAFF are incorporated into the estimate of S_1 , whereas fish eaten downstream of the BAFF are incorporated into the estimates of either S_S or S_G .

Detection probabilities at the downstream detection sites (P_S and P_G) were estimated by using detection data provided by two peripheral hydrophones that were implemented at each monitoring location. A mark-recapture model for peripheral hydrophones (described as double arrays) described by Skalski et al. (2002) allowed us to estimate detection probability for each detection location separately, and the overall detection probability of both peripheral hydrophone locations. Detection histories for the peripheral hydrophone locations are comprised of two codes indicating whether fish were detected by only one detection location, only the other detection location, or both detection locations (e.g., “G1 0,” “0 G2,” or “G1 G2”).

Model parameters were estimated via maximum likelihood using optimization routines in the software program USER (Lady et al. 2008). The standard error and profile likelihood 95% CIs were estimated for each parameter. Stations that had perfect detection histories were not estimable and assigned a value of 1. The reduced models were then fit with set parameters equal between BAFF On and BAFF Off to test whether Ψ_G , S_S , and S_G differed between treatments. These hypotheses were assessed using likelihood ratio tests.

This page intentionally left blank.

3 RESULTS AND DISCUSSION

3.1 ENVIRONMENTAL CONDITIONS

General environmental conditions that could potentially influence fish movement or the effectiveness of the BAFF, including weather, water quality, river stage and discharge, and ambient light, were monitored throughout the study period (March through May 2011). Results are presented in the following sections.

3.1.1 WEATHER CONDITIONS

Weather conditions in the study area are summarized in Table 3-1. Conditions were generally cool and wet. A total of 24 local storm events (15 in March and 7 in May) with measurable precipitation occurred during project implementation (CIMIS 2011). The coolest air temperatures and highest precipitation occurred in March. Slightly higher average air temperatures and lower rainfalls were reported in April than in May. Total precipitation in March was nearly twice the average March precipitation during the past 14 years (CIMIS 2011). Average daily low air temperatures ranged between -0.6 and 12.8 degrees Celsius (°C), while highs ranged from 9.4 to 27.2°C from March through May. Winds were predominantly from the west with average wind speeds of 12.2, 14.0, and 12.7 kilometers per hour in March, April, and May, respectively (Table 3-1). The average daily solar radiation recorded for March, April, and May was comparable to that recorded during those months over the past 14 years, with the exception of slightly lower solar radiation in March compared to the period of record. Additionally, solar radiation recorded in March was markedly less than that recorded in either April or May (Table 3-1).

**Table 3-1
Summary of Weather Conditions during 2011 Study Implementation**

Parameter	Unit	Month ¹		
		March	April	May
Air Temperature - Maximum Daily Average	°C	16.5	19.7	18.4
Air Temperature - Minimum Daily Average	°C	5.7	7.6	6.8
Air Temperature - Maximum Range	°C	9.4 to 26.7	13.9 to 27.2	9.4 to 27.2
Air Temperature - Minimum Range	°C	-0.6 to 9.4	-0.6 to 12.8	-0.6 to 12.8
Precipitation - Daily Average	mm	2.5	0.0	0.0
Precipitation - Monthly Total	mm	116.8	2.5	20.3
Wind Direction - Dominant	--	West	West	West
Wind speed - Daily Average	kph	12.2	14.0	12.7
Wind Speed - Monthly Range	kph	6.4 to 28.9	4.8 to 24.1	8.0 to 19.3
Solar Radiation - Daily Average	Ly	325.3	538.9	610.9
Relative Humidity - Average Maximum	%	96.1	88.3	85.5
Relative Humidity - Average Minimum	%	60.7	46.4	41.3

Notes:

¹Measurements were recorded at Twitchell Island Station, located near Rio Vista, approximately 19 kilometers southwest of Walnut Grove
 °C = degrees Celsius; kph = kilometers per hour; Ly = langley: a unit of energy distribution over area. It is used to measure solar radiation.
 mm = millimeters.

Source: Compiled by AECOM in 2011; CIMIS 2011

3.1.2 HYDROLOGIC CONDITIONS

Monthly hydrological conditions, including water quality parameters and river discharge and stage, are summarized in Table 3-2. Water quality data from the GES and GSS monitoring stations were evaluated. At the GES station, the minimum, maximum, and average water temperatures were 8.8°C, 17.5°C, and 12.9°C, respectively. At the GSS station, the minimum, maximum, and average water temperatures were 8.8°C, 16.5°C, and 12.9°C, respectively. Daily fluctuations at both stations generally were low throughout the study period, rarely exceeding 1°C and typically less than 1°C.

Turbidity at both stations was unstable and daily fluctuations generally were high during runoff events. At the GES station, the minimum, maximum, and average turbidities were 7.5, 1,356, and 24 NTUs, respectively. At the GSS station, the minimum, maximum, and average turbidities were 6.9, 62, and 19.6 NTUs, respectively. Daily conductivity fluctuations at each station generally were low. At the GES station, the minimum, maximum, and average specific conductivities were 5, 161, and 114 microsiemens per centimeter ($\mu\text{S}/\text{cm}$), respectively. At the GSS station, the minimum, maximum, and average specific conductivities were 79, 161, and 115 $\mu\text{S}/\text{cm}$, respectively. In the vicinity of the study area, Georgiana Slough flows ranged from 4,237 to 13,815 cfs and Sacramento River flows ranged from 8,638 to 37,466 cfs. Flows peaked in March and were the lowest in May. In April, the minimum daily flow was the highest during the study period. River stage ranged from 1.53 to 3.92 m in Georgiana Slough and from 1.55 to 3.93 m in the Sacramento River. The average daily change in the river stage during study implementation was approximately 0.43 m in Georgiana Slough at GES and approximately 0.42 m in the Sacramento River at GSS (DWR 2011).

3.2 FISH TRANSPORT, TAGGING, AND RELEASE

During the study period, late fall-run Chinook salmon were transported from Coleman National Fish Hatchery to the fish release site, where they were tagged and released over the duration of the study period. The fish were divided among a total of 43 transport groups. Transport conditions (e.g., water temperature, dissolved oxygen concentrations) for the fish are summarized in Appendix D.

The first release occurred on March 16 and the final release occurred on May 15. Smolts were released approximately 8.9 km upstream of the BAFF. Released groups arrived within the array on average approximately 8 hours after release. The upstream boundary of the array was approximately 120 m from the BAFF and was delineated by a straight line between hydrophones numbered H1 and H2 (Figure 2-5). The downstream boundary of the array on the Sacramento River was approximately 22 m from the BAFF and was delineated by a straight line between hydrophones numbered H12 and H11. The downstream boundary of the array on Georgiana Slough was approximately 20 m from the BAFF and was delineated by a straight line between hydrophones numbered H19 and H20.

Out of the 1,500 fish that were tagged and released, 1,467 arrived and were detected within the array (98%). The fates of the 33 individuals that did not arrive within the array are unknown. The average fork length of released smolts was 123.4 mm and ranged from 102 mm to 155 mm and there were no visually noted differences in smolt condition.

**Table 3-2
Summary of Hydrologic and Water Quality Conditions during 2011 Study Implementation**

Parameter	Measurement	Unit	March	April	May
Georgiana Slough at Sacramento River (GSS)					
Temperature	Minimum	°C	8.8	12.1	13.1
	Maximum		12.4	14.7	16.5
	Average		10.37	13.31	14.96
Turbidity	Minimum	NTU	11.7	10.9	6.9
	Maximum		62	32	23
	Average		27.46	19.87	11.53
Specific Conductivity	Minimum	µS/cm	79	94	94
	Maximum		161	146	130
	Average		117.84	120.55	106.85
River Stage	Minimum	m ¹	1.53	1.76	1.60
	Maximum		3.92	3.35	2.54
	Average		2.74	2.56	1.97
Discharge (Flow)	Minimum	cfs	4,579	5,163	4,237
	Maximum		13,815	11,990	6,938
	Average		9,451	8,618	5,411
Sacramento River Below Georgiana Slough (GES)					
Temperature	Minimum	°C	8.8	12.1	13.1
	Maximum		12.5	14.8	17.5
	Average		10.42	13.36	15.02
Turbidity	Minimum	NTU	11.6	11.7	7.5
	Maximum		133.5	227.3	1356
	Average		29.46	24.01	18.65
Specific Conductivity	Minimum	µS/cm	80	12	5
	Maximum		161	142	133
	Average		117.78	119.18	105.12
River Stage	Minimum	m ¹	1.55	1.77	1.62
	Maximum		3.93	3.36	2.56
	Average		2.76	2.57	1.99
Discharge (Flow)	Minimum	cfs	8,851	12,515	8,683
	Maximum		37,466	29,555	19,867
	Average		23,498	22,413	15,448
Notes:					
¹ NAV88 Datum					
°C = degrees Celsius; cfs = cubic feet per second; m = meter; NTU = nephelometric turbidity units; µS/cm = microsiemens per centimeter.					
Source: Compiled by AECOM in 2011; DWR 2011					

3.3 BARRIER OPERATIONS

BAFF On and BAFF Off operations are presented in Table 3-3. BAFF operations were consistent with the study plan with the following exceptions presented below.

On March 26, an air line delivering air to the barrier bubble diffuser was damaged, the study was suspended (including fish tagging and releases) until repairs could be made, and the study resumed on April 15 with the BAFF in the “on” mode.

On April 29, issues with the sound system (e. g., detection of low source sound levels) of the barrier were detected. A working group conference call took place with Fish Guidance Systems. It was determined that Speaker #5 on Frame 11 and Speaker #4 on Frame 12 were faulty and replaced by the divers on May 4. The BAFF was turned “off” on the morning of May 4 at 07:35, as scheduled, and was turned “on” May 5 at 08:11, as scheduled.

On May 8, the compressor feeding the air line shut down sometime between 00:00 and 02:00 due to fuel shortage. The fuel tank was subsequently re-filled and the BAFF resumed normal operations following the next “off” cycle.

3.4 BARRIER DETERRENCE, PROTECTION, AND OVERALL EFFICIENCY

The efficiency of the BAFF was tested by releasing acoustically tagged juvenile Chinook salmon at a location upstream of the BAFF and monitoring the migration pathway of each fish as it passed through the array when the BAFF was on versus when the BAFF was off. Based on acoustic tag tracking results for juvenile Chinook salmon that entered the array and encountered the BAFF, estimates were derived for deterrence efficiency, protection efficiency, and overall efficiency by comparing results for fish passing through the array when the BAFF was on and when the BAFF was off. A number of salmon were classified as eaten by predatory fish based on changes in the characteristics of the acoustic tag track (e.g., tracks of juvenile salmon passing through the array were typically unidirectional in a downstream pathway while tracks for salmon that had been eaten by a predator typically showed little movement or erratic pathways that typically included upstream movement and the vast majority of movements along the river margin). To account for predation mortality on juvenile salmon, protection efficiency was calculated to account for only those acoustic tag tracks that were characterized as not having been eaten by a predator. As a result, comparing protection efficiency versus overall efficiency provides an indicator of predation effects on BAFF efficiency.

The experimental design and data collection associated with the 2011 evaluation of the BAFF performance efficiency included (1) BAFF On versus BAFF Off when there was no evidence that BAFF operations had been potentially compromised by variation in the bubble curtain or other operations, (2) BAFF On versus BAFF Off under conditions of light (ambient light conditions were monitored during the study period and light conditions were defined as dark (low light < 5.4 lux) and light (high light \geq 5.4 lux) and, (3) BAFF On versus BAFF Off under conditions when water velocity passing through the BAFF was low and high.

The criterion used for characterizing light and dark ambient conditions (5.4 lux) was based on the work of Anderson et al. (1988). Anderson et al. (1988) provided Chinook avoidance reaction to strobe lights at between 0.1 and 5 $\mu\text{E m}^{-2} \text{s}^{-1}$. As a result, it was assumed that if the ambient light is greater than the upper threshold, then the ambient light may influence the BAFF’s ability to initiate a reaction to the high intensity modulated lights.

**Table 3-3
2011 Georgiana Slough Study BAFF Operation**

Date	BAFF On	BAFF Off	Duration (hours)
Thursday, March 17, 2011	18:45		22.75
Friday, March 18, 2011		17:30	
Saturday, March 19, 2011	18:15		25.50
Sunday, March 20, 2011		19:45	
Monday, March 21, 2011	21:30		24.75
Tuesday, March 22, 2011		22:15	
Wednesday, March 23, 2011	23:30		24.50
Thursday, March 24, 2011			
Friday, March 25, 2011		0:00	17.00
Saturday, March 26, 2011	0:30	17:30	
Friday, April 15, 2011	20:02		45.75
Saturday, April 16, 2011			
Sunday, April 17, 2011		17:39	24.5
Monday, April 18, 2011	20:00		
Tuesday, April 19, 2011		20:30	25.0
Wednesday, April 20, 2011	21:20		
Thursday, April 21, 2011		22:25	25.0
Friday, April 22, 2011	22:08		
Saturday, April 23, 2011		23:05	25.0
Monday, April 25, 2011	0:36		
Tuesday, April 26, 2011		1:45	25.75
Wednesday, April 27, 2011	3:05		
Thursday, April 28, 2011		4:52	24.25
Friday, April 29, 2011	6:19		
Saturday, April 30, 2011		6:40	23.75
Sunday, May 01, 2011	7:17		
Monday, May 02, 2011		7:00	23.0
Tuesday, May 03, 2011	6:34		
Wednesday, May 04, 2011		7:35	24.0
Thursday, May 05, 2011	8:11		
Friday, May 06, 2011		8:13	~15 to 17
Saturday, May 07, 2011	9:16		
Sunday, May 08, 2011		Between 0:00 and 2:00	
Monday, May 09, 2011	9:50		24.75
Tuesday, May 10, 2011		10:35	
Wednesday, May 11, 2011	11:40		26.25
Thursday, May 12, 2011		13:55	
Friday, May 13, 2011	14:30		25.0
Saturday, May 14, 2011		15:36	
Sunday, May 15, 2011	16:20		12.5
Monday, May 16, 2011		4:50 Air and 7:26 Light and Sound	

During the field study, observations were made routinely of BAFF operations. On several occasions, these observations suggested that the BAFF operations may have been impaired when an air nozzle became blocked and disrupted the continuity of the air bubble curtain or other operational issues. The experimental design and field observations allowed any potentially impaired BAFF operations to be identified and to allow statistical testing to determine whether or not deterrence, protection, and overall efficiency of the BAFF varied significantly between periods when the BAFF was on and operating routinely versus periods when operations of the BAFF may have been impaired.

A single “sample” was a period of time during which none of the following changed: (1) BAFF state, (2) light did not cross the threshold level (5.4 lux), and (3) velocity did not cross the threshold level (0.25 m/s). All tagged fish that passed through the array during a single sample period were used to calculate deterrence, protection, and overall efficiency for that sample. The sample sizes (N) for when the BAFF was off, when the BAFF was on, and when the BAFF was potentially impaired are summarized in Tables 3-4 and 3-5. A total of 1,378 Chinook passed closely enough to the BAFF (within 80 m) to be included in the samples. The number of fish (n) found in these samples ranged from two to 24. Based on results of these analyses, subsequent statistical analyses were performed to evaluate BAFF deterrence, protection, and overall efficiency over the range of environmental conditions that occurred during testing, as well as, stratified to assess BAFF efficiency as a function of ambient light levels and water velocities passing through the BAFF.

Light Level	BAFF Off (N)	BAFF On (N)	BAFF Potentially Impaired (N)
Low Light	62	42	13
High Light	49	35	15
Total	111	77	28

Across-Barrier Velocity Level	BAFF Off (N)	BAFF On (N)	BAFF Potentially Impaired (N)
Low Water Velocity	67	50	20
High Water Velocity	45	31	10
Total	112	81	30

The initial statistical testing focused on evaluating the hypotheses that there was no significant difference in deterrence, protection, and overall efficiency of the BAFF when it was on and when it was off. The initial comparison disregarded observations made when the BAFF was potentially impaired. Results of initial parametric statistical analysis showed that the basic assumptions of the parametric tests were not met and, therefore, the subsequent statistical analyses were based on non-parametric comparisons (Kruskal-Wallis Test). The first analysis was completed comparing deterrence efficiency, protection efficiency, and overall efficiency using observations when the BAFF was on (and fully functional) and off.

A significantly greater deterrence efficiency, protection efficiency, and overall efficiency was found with BAFF On than with BAFF Off (Table 3-6). The BAFF On operations resulted in consistently greater deterrence (21% improvement), protection (16% improvement), and overall efficiency (16% improvement) when compared to the BAFF Off condition. This result showed there was a statistically measurable difference in BAFF performance when in the on condition compared to the off condition (see Table 3-6; P-value of less than 0.5 or 0.1 is said to be statistically significant). The distribution of deterrence efficiency for BAFF On and BAFF Off shows a great deal of overlap in range (Figure 3-1), but the difference between the two samples was still statistically significant (see Table 3-6). The ability to detect a statistically significant response to BAFF operations was the result, in part, of the relatively large sample size monitored as part of the 2011 tests.

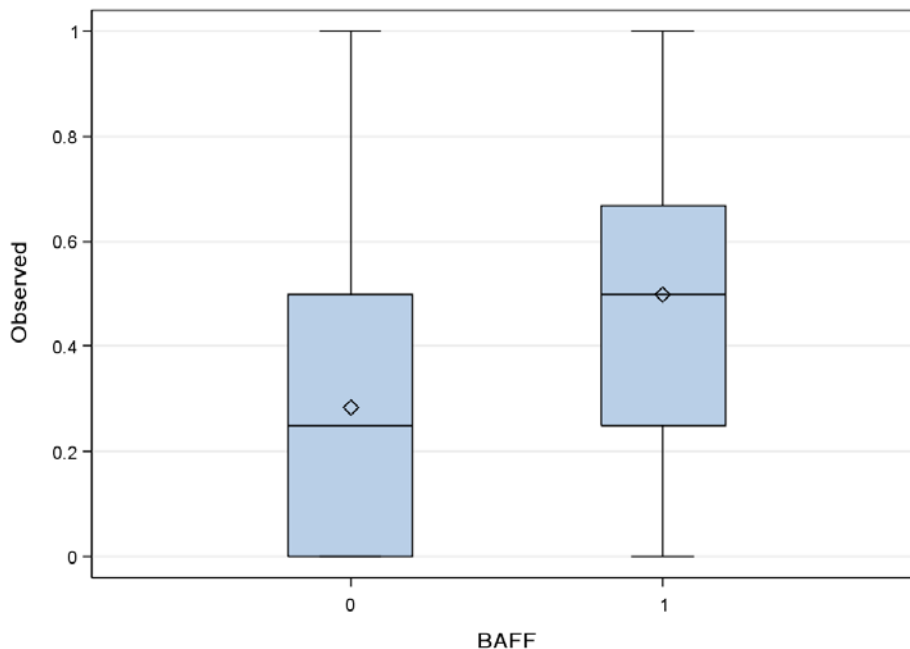

Note: DE = deterrence efficiency. Potentially impaired BAFF observations were not included. BAFF On is represented as 1 and BAFF Off is represented as 0. The lower line in the blue box represents the 25th percentile of observations while the upper line represents the 75th percentile. The lower whisker represents the 10th percentile and the upper whisker represents the 90th percentile.

Figure 3-1 Distribution of Deterrence Efficiency for BAFF On/Off Operations

Comparison Metrics	BAFF On Mean	BAFF Off Mean	Percentage Point Change in Efficiency	Kruskal-Wallis X ²	P-value
Deterrence Efficiency	0.498	0.285	21.3	22.235	<0.0001
Protection Efficiency	0.887	0.727	16.0	23.874	<0.0001
Overall Efficiency	0.891	0.734	15.7	24.339	<0.0001

The numerators of protection and overall efficiency include all tags placed in Chinook salmon that reached the downstream Sacramento River downstream tag detectors (see Figure 2-1: Hydrophones 5 and 6). It is possible that some Chinook salmon passed by the BAFF at a distance of more than 80 m and were included in the numerators of protection and overall efficiency. However, protection and overall efficiency are designed to indicate the total number of salmonid smolts passing by Georgiana Slough and remaining in the Sacramento River. Deterrence efficiency provided the contribution of the BAFF's operation (through deterrence) to the overall efficiency.

The influence of fish, passing greater than 80 m from the BAFF, on protection and overall efficiency was also investigated. It was estimated that this scenario could possibly have occurred for a total of 36 tags. The inclusion of these fish would increase the protection and overall efficiency values; however, the effect of this increase would be minor because a total of 1,378 tags were used for the hypotheses testing. It should be emphasized that overall efficiency included these fish because this metric, overall efficiency, is intended to show the total number of fish that move successfully through the Sacramento River/Georgiana Slough area.

After it was determined that deterrence efficiency with BAFF Off was significantly less than with BAFF On, the influence of light on deterrence efficiency was investigated. Light conditions were divided into two categories: dark (< 5.4 lux) and light (≥ 5.4 lux). Deterrence efficiency was compared for conditions when the BAFF was off and when the BAFF was on for observations obtained during dark. During dark periods, deterrence efficiency was found to be significantly less with BAFF Off compared to BAFF On (Table 3-7). Similarly, comparisons of deterrence efficiency when the BAFF was off and when the BAFF was on for observations made in the light were made. Similar to observations obtained in the dark, deterrence efficiency was found to be significantly less with BAFF Off compared to BAFF On (Table 3-7). Under all of the light conditions observed during the 2011 tests, BAFF guidance efficiency was improved when the BAFF was on when compared to the off condition. Protection and overall efficiency also improved when the BAFF was on under both low and high light conditions (Table 3-7).

Comparison Metrics	BAFF On Mean	BAFF Off Mean	Percentage Point Change in Efficiency	Kruskal-Wallis X^2	P-value
Deterrence Efficiency – Low Light	0.448	0.229	21.9	15.707	<0.0001
Deterrence Efficiency – High Light	0.556	0.356	20.0	7.872	0.0050
Protection Efficiency – Low Light	0.900	0.713	18.7	14.306	0.0002
Protection Efficiency – High Light	0.871	0.744	12.7	9.865	0.0017
Overall Efficiency – Low Light	0.903	0.721	18.2	15.013	<0.0001
Overall Efficiency – High Light	0.877	0.751	12.6	9.592	0.0020

When across-barrier velocity was < 0.25 m/s, deterrence efficiency was significantly lower when the BAFF was off compared to when the BAFF was on (Table 3-8). Similarly, when across-barrier velocity was ≥ 0.25 m/s, deterrence efficiency was significantly lower when the BAFF was off compared to when the BAFF was on (Table 3-8). The same pattern was observed for protection and overall efficiencies; both protection and overall efficiencies improved significantly when the BAFF was on compared to the off condition. The overall efficiency

**Table 3-8
Comparisons of Deterrence, Protection, and Overall Efficiencies with BAFF On/Off Treatments under Low (< 0.25 m/s) and High (≥ 0.25 m/s) Across-Barrier Water Velocities**

Comparison Metrics	BAFF On Mean	BAFF Off Mean	Percentage Point Change in Efficiency	Kruskal-Wallis X ²	P-value
Deterrence Efficiency - Low Velocity	0.523	0.356	16.7	9.860	0.0017
Deterrence Efficiency - High Velocity	0.459	0.180	27.9	13.122	0.0003
Protection Efficiency - Low Velocity	0.974	0.897	7.7	14.135	0.0002
Protection Efficiency - High Velocity	0.758	0.478	28.0	17.094	<0.0001
Overall Efficiency - Low Velocity	0.977	0.896	8.1	15.285	<0.0001
Overall Efficiency - High Velocity	0.765	0.496	26.9	16.877	<0.0001

of 0.977 (97.7% efficiency) when the BAFF was on under low velocity conditions (Table 3-8) is among the highest levels of overall efficiency for juvenile salmonids detected for BAFF operations conducted in the world to date. For example, the highest overall efficiencies ever recorded are 92.7% observed in BAFF tests on the River Leven (Cumbria, United Kingdom) (Turnpenny and O’Keefe 2005), 97.7% in one trial in Ragitata River (Central South Island Region, New Zealand) (Webb 2011), and 80% on the River Frome (Dorset, United Kingdom) (Beaumont, pers. comm., 2011).

Deterrence, protection, and overall efficiencies were all significantly improved over a wide range of ambient light and water velocity conditions, when the BAFF was on compared to the off condition. Deterrence, protection and overall efficiencies of the BAFF were significantly lower with BAFF Off compared to BAFF On for all light and water velocity conditions (Tables 3-7 and 3-8). Thus, it may be concluded that the BAFF improved deterrence, protection, and overall efficiencies both during day and night conditions, as well as under both low and high water velocities.

The 2011 study was characterized by relatively high discharges in the Sacramento River throughout the BAFF testing period. It was hypothesized that efficiency of the BAFF may have been reduced under high river flow conditions as a result of high velocities, which could hinder the behavioral response and reaction time for juvenile salmon encountering the BAFF. Even under the unusually high flow conditions encountered in 2011, the BAFF consistently improved deterrence, protection, and overall efficiencies and reduced the numbers of juvenile salmon passing from the Sacramento River into Georgiana Slough when the BAFF was on.

Potential impairments to BAFF routine operations were evaluated statistically by comparing deterrence, protection, and overall efficiencies of the BAFF during periods when the BAFF was on and operating routinely and during periods when BAFF operations were potentially compromised. Results of these analyses detected no statistically significant difference between operations for any measure of BAFF efficiency (Table 3-9). The percentage point changes in deterrence, protection, and overall efficiencies were less than 10% with the deterrence, protection, and overall efficiency estimates during the period when BAFF operations were potentially compromised being greater than estimates when BAFF operations were not potentially compromised. Because no significant difference was found, results were subsequently pooled for use in statistical analyses for observations of juvenile Chinook salmon passage during periods when the BAFF was operating routinely and when BAFF operations were potentially compromised.

**Table 3-9
Comparison of Deterrence, Protection, and Overall Efficiencies for BAFF On and BAFF Potentially Impaired**

Comparison Metrics	BAFF On Mean	BAFF Impaired Mean	Percentage Point Change in Efficiency	Kruskal-Wallis X ²	P-value
Deterrence	0.498	0.522	2.4	0.234	0.6283
Protection	0.887	0.954	6.7	0.874	0.3498
Overall	0.891	0.953	6.2	0.655	0.4184

For the grouped data, significantly greater deterrence, protection, and overall efficiencies were found when the BAFF was on (fully functional and potentially impaired pooled) compared to periods when the BAFF was off (Table 3-10). In addition, the BAFF On only observations and the pooled BAFF On and Potentially Impaired observations produced extremely high overall efficiencies near 90% and the contribution of the BAFF operation to that was about 21 percentage points (Figure 3-2). The contribution of the BAFF operation to overall efficiency is determined by the difference between deterrence efficiencies with BAFF On and BAFF Off (Figure 3-2, Tables 3-6 and 3-10).

The change in deterrence efficiency shows the improvement in deterrence when the BAFF is on compared to off. So, the change in deterrence efficiency is the observable effect on fish behavior in response to the BAFF. The change in deterrence efficiency is the BAFF's contribution to overall efficiency, the total proportion of tags that continued down the Sacramento River (Figure 3-2). If all smolts that were eaten in the vicinity of Georgiana Slough are removed from overall efficiency, these "smolt-only" observations were used to calculate protection efficiency. If protection and overall efficiency are very similar it may be concluded that the effect of predation was very slight. This is, in fact, the case (Table 3-10); the effect of predation seems very slight. If predation was high, and smolts migrate through while the predators tend to remain in the experimental area, then protection and overall efficiency would be very different.

Using the pooled data, deterrence, protection, and overall efficiencies were compared for BAFF Off versus BAFF On for observations obtained during dark periods (ambient light < 5.4 lux). All three response variables were significantly lower with BAFF Off compared to BAFF On (Table 3-11). The three response variables were also compared at BAFF Off to BAFF On for observations made during light periods (ambient light ≥ 5.4 lux). Similar to observations obtained in the dark, deterrence, protection, and overall efficiencies were found to be significantly lower when the BAFF was off compared to periods when the BAFF was on (Table 3-11). For each light level, the contribution of the BAFF operations to overall efficiency can be seen graphically (see Figure 3-3) in both low and high light conditions, 91% of smolts pass down the Sacramento River and the change in deterrence efficiency, caused by BAFF operations, contributes about 21 percentage points of that.

When across-barrier velocity was < 0.25 m/s, deterrence, protection, and overall efficiencies were significantly lower when the BAFF was off compared to periods when the BAFF was fully functional or potentially impaired (Table 3-12). Similarly, when across-barrier velocity was ≥ 0.25 m/s, deterrence, protection, and overall efficiencies were significantly lower when the BAFF was off compared to periods when the BAFF was fully functional or potentially impaired (Table 3-12). For each velocity level, the contribution of the BAFF operations to overall efficiency can be seen graphically (Figure 3-4): however, unlike the contributions made during different

**Table 3-10
Comparison of Deterrence, Protection, and Overall Efficiencies for BAFF On and BAFF Potentially Impaired (Pooled) versus BAFF Off**

Comparison Metrics	Pooled BAFF On Mean	BAFF Off Mean	Percentage Point Change in Efficiency	Kruskal-Wallis X ²	P-value
Deterrence	0.504	0.285	21.9	28.816	<0.0001
Protection	0.905	0.727	17.8	34.394	<0.0001
Overall	0.908	0.734	17.4	34.746	<0.0001

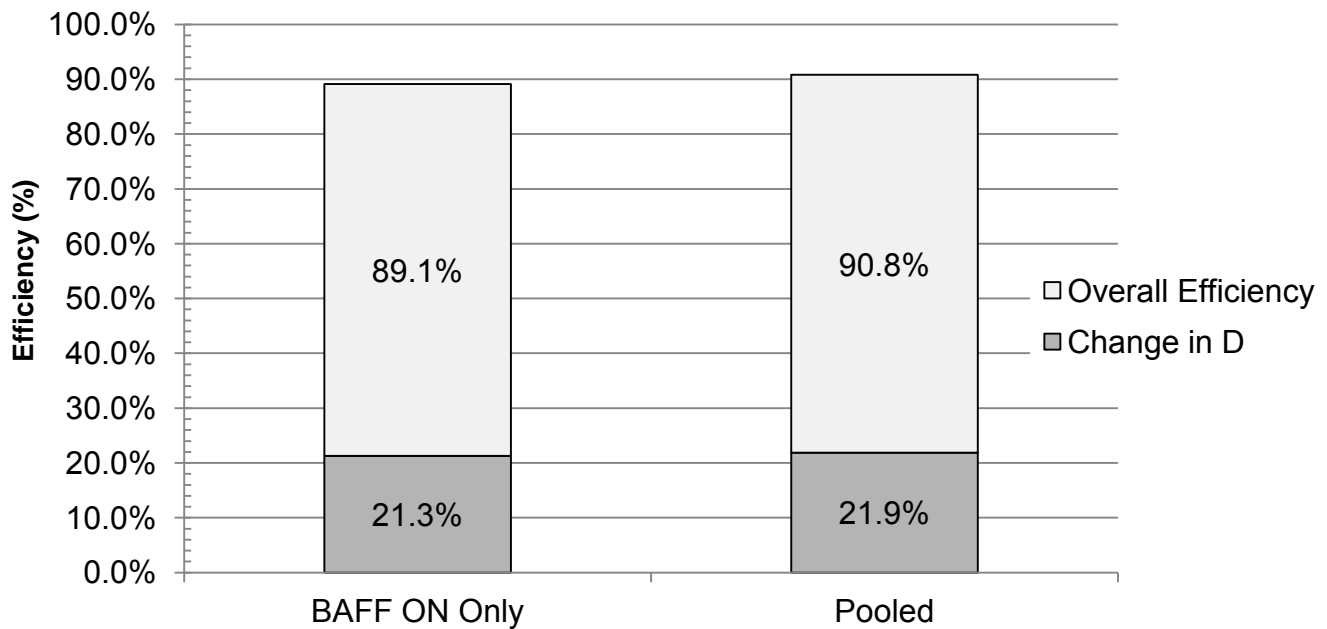

Note: The Change in Deterrence Efficiency (D) is the difference in deterrence efficiency between BAFF On and BAFF Off. "Pooled" are the BAFF On observations and the BAFF Potentially Impaired observations pooled.

Figure 3-2 Relative Contribution of the BAFF Operations to Overall Efficiency

Table 3-11 Comparisons of Deterrence, Protection, and Overall Efficiencies with BAFF On and BAFF Potentially Impaired Pooled versus BAFF Off Operations under Low (< 5.4 lux) and High (≥ 5.4 lux) Light Levels					
Comparison Metric	Pooled BAFF On Mean	BAFF Off Mean	Percentage Point Change in Efficiency	Kruskal-Wallis X2	P-value
Deterrence Efficiency – Low Light	0.439	0.229	21.0	17.963	0.0001
Deterrence Efficiency – High Light	0.576	0.356	22.0	12.260	0.0022
Protection Efficiency – Low Light	0.907	0.713	19.4	17.927	<0.0001
Protection Efficiency – High Light	0.903	0.744	15.9	16.649	<0.0001
Overall Efficiency – Low Light	0.909	0.721	18.8	18.584	<0.0001
Overall Efficiency – High Light	0.906	0.751	15.5	16.211	<0.0001

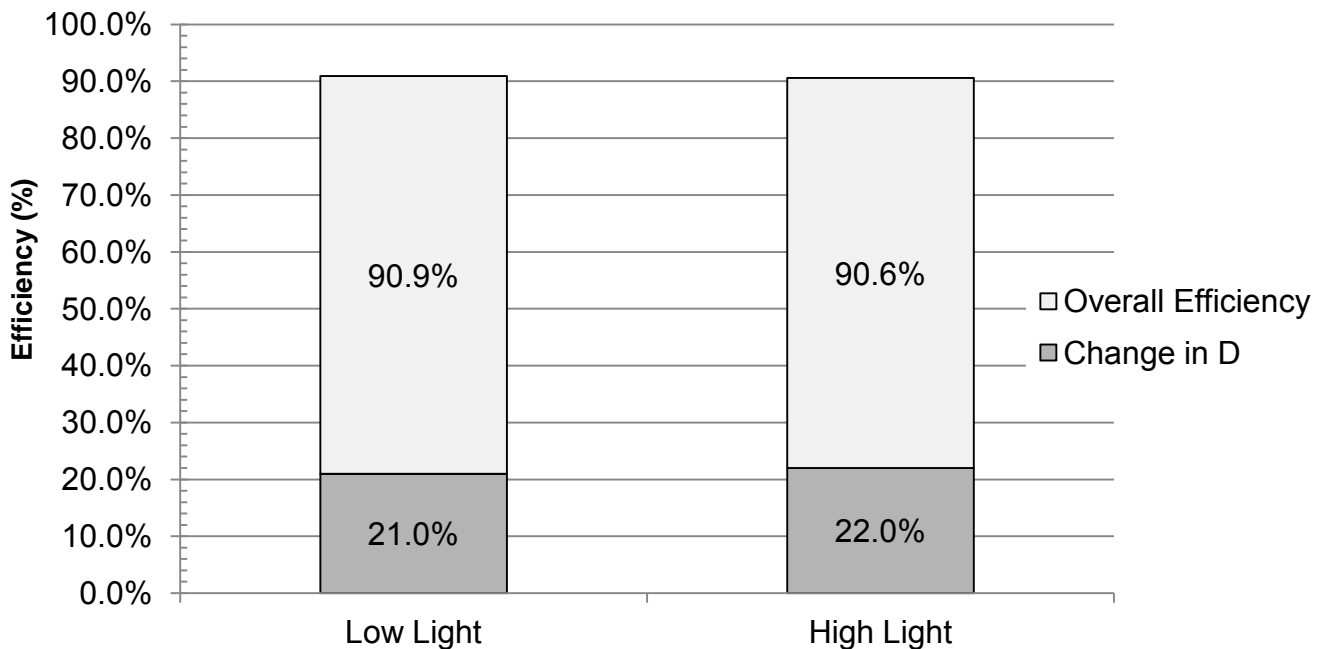

Note: The Change in Deterrence Efficiency (D) is the difference in deterrence efficiency between BAFF On and BAFF Off.

Figure 3-3 Relative Contribution of the BAFF Operations to Overall Efficiency Under Different Light Conditions

Table 3-12
Comparisons of Deterrence, Protection, and Overall Efficiencies for BAFF On and BAFF Potentially Impaired Pooled versus BAFF Off Treatments under Low (< 0.25 m/s) and High (≥ 0.25 m/s) Across-Barrier Water Velocities

Comparison Metric	Pooled BAFF On Mean	BAFF Off Mean	Percentage Point Change in Efficiency	Kruskal-Wallis X ²	P-value
Deterrence Efficiency - Low Velocity	0.518	0.356	16.2	12.941	0.0003
Deterrence Efficiency - High Velocity	0.482	0.180	30.2	15.384	<0.0001
Protection Efficiency - Low Velocity	0.975	0.897	7.8	18.346	<0.0001
Protection Efficiency - High Velocity	0.795	0.478	31.7	25.862	<0.0001
Overall Efficiency - Low Velocity	0.977	0.896	8.1	19.447	<0.0001
Overall Efficiency - High Velocity	0.800	0.496	30.4	25.604	<0.0001

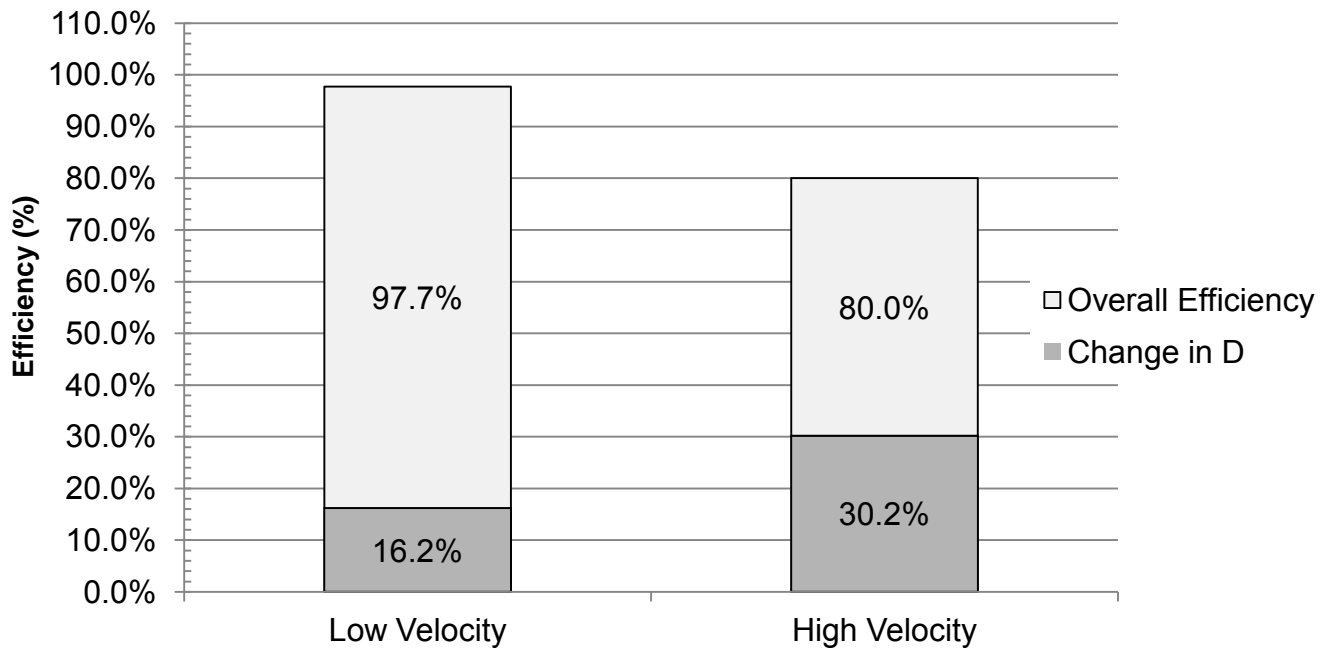

Note: The change in Deterrence Efficiency (D) is the difference in deterrence efficiency between BAFF On and BAFF Off.

Figure 3-4 **Relative Contribution of the BAFF Operations to Overall Efficiency Under Different Velocity Conditions**

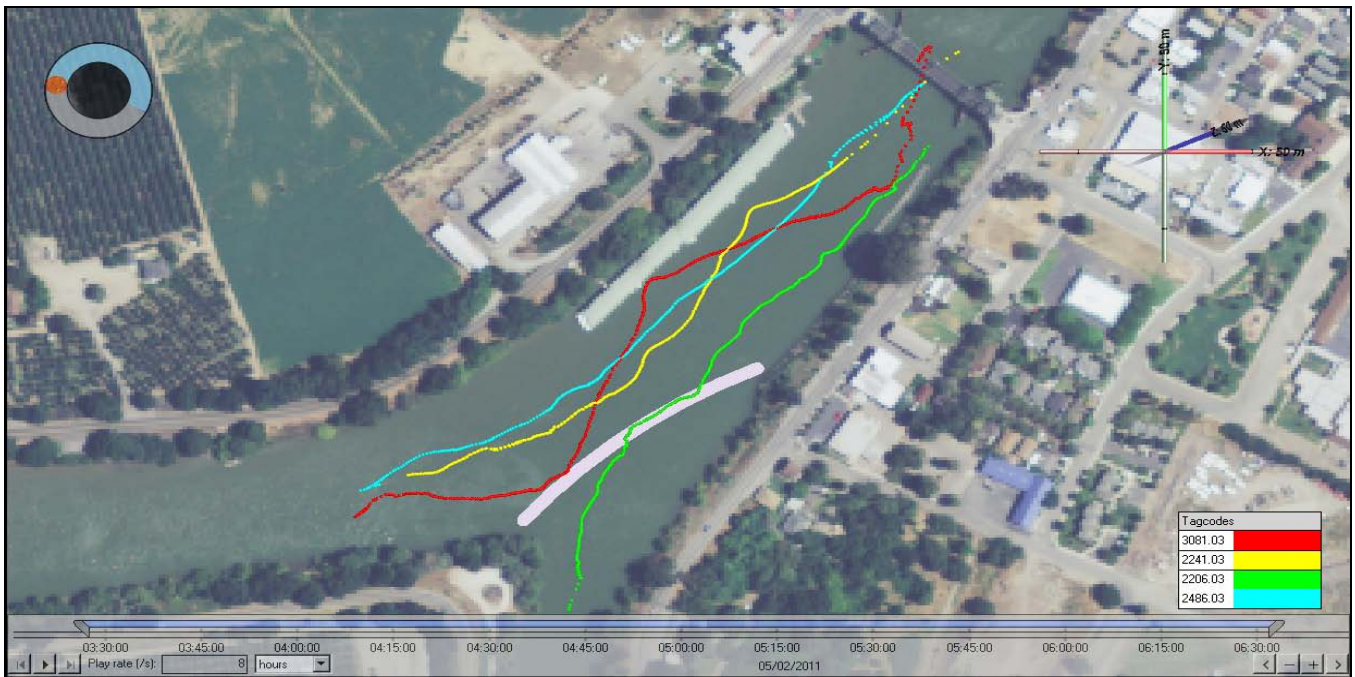

Notes: All four smolts were released May 2, 2011 at 00:00 hours. All four tracks passed by the divergence of the Sacramento River and Georgiana Slough on May 2, 2011 between 03:17 and 03:44 hours. 2206.03 was undeterred and entered Georgiana Slough. 3081.03 and 2241.03 were deterred into the Sacramento River. 2486.03 was determined to be undeterred because it made no movement away from the BAFF.

Figure 3-5 Two-Dimensional Tracks of Chinook Salmon Smolts in the Sacramento River

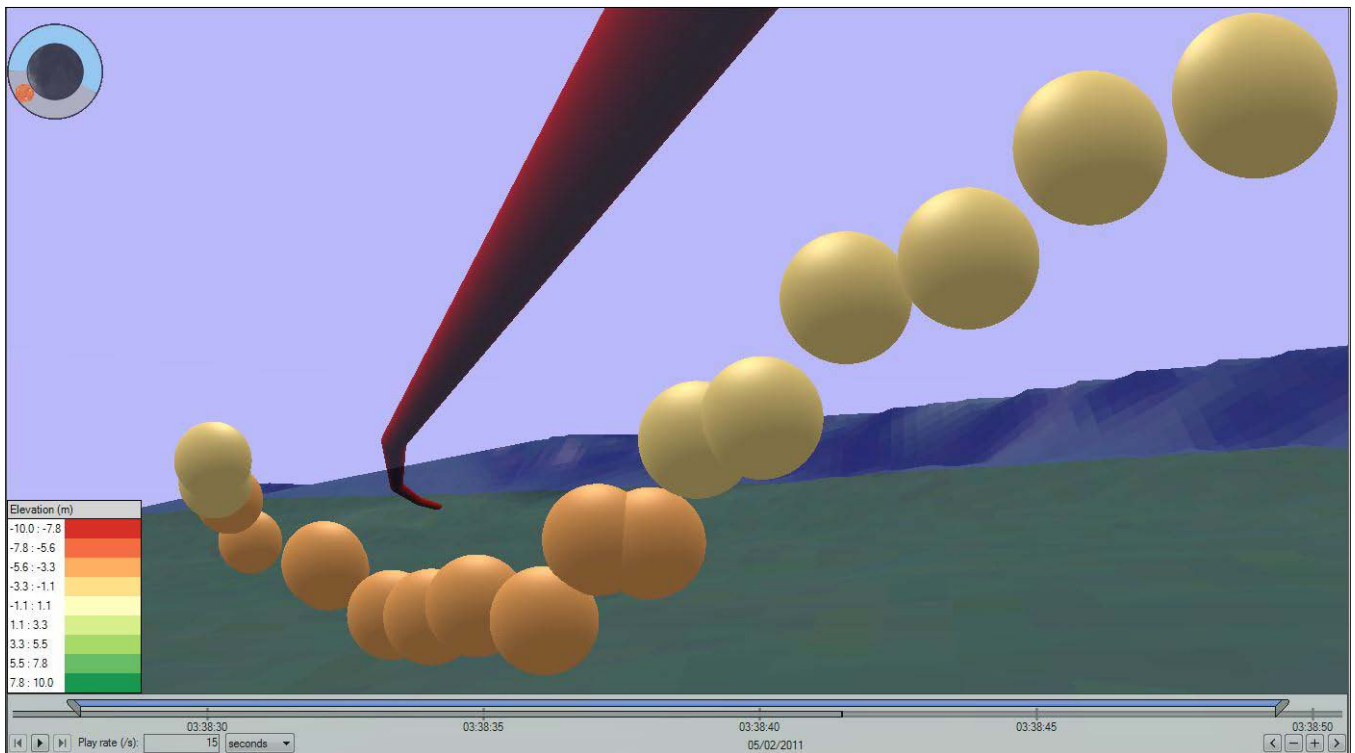

Notes: Point of view is from underneath the BAFF looking upstream: red curve represents the BAFF framework, spheres represent positions of the tagged Chinook smolt, sphere color represents the elevation relative to sea level.

Figure 3-6 Pathway of an Acoustically Tagged Chinook Salmon Appearing to Pass Under the BAFF Framework into Georgiana Slough

light periods, contributions vary between low and high velocity conditions. Under high velocity conditions, a smaller percentage of smolts pass down the Sacramento River and the change in deterrence efficiency (D), caused by BAFF operations, contributes a larger percentage compared to low velocity conditions. These results suggest that the BAFF contributed a greater proportion of smolts to the Sacramento River when the probability of entrainment into Georgiana Slough was increased.

Detailed 2D mapping of each tagged juvenile salmon as it migrated downstream in the Sacramento River and encountered the divergence with Georgiana Slough and the BAFF (Figure 3-5) provided a basis for examining individual fish responses to factors such as the distance from the BAFF and water velocity. When appropriate, 3D tracking allowed an assessment of the tag's location (depth) within the water column. Figure 3-6 shows an example of results of a 3D map of an acoustically tagged juvenile salmon that appears to have passed under the frame of the BAFF and migrated into Georgiana Slough. Although few fish appear to have passed under the BAFF, these monitoring results provide insight into the response of individual fish to the system and help evaluate results from other aspects of the study. Analyses of these variables will be valuable in assessing and refining the future BAFF configuration and operations. In addition, these analyses provide a foundation for extrapolating information from the Georgiana Slough tests to develop additional design criteria for BAFF deployments at other locations. During the 2011 study, the ability of the 3D tag monitoring system to determine the location of a tagged salmon in the water column relative to the configuration of the BAFF was limited (approximately 3 m vertical accuracy in tag location). It is recommended that future studies using the 3D tag monitoring system be refined to provide better vertical resolution in determining the location of tagged fish in the water column to further improve results of subsequent monitoring efforts. Furthermore, other methods to resolve whether a smolt passed over or under the BAFF infrastructure should be investigated. For example, paired low and high hydrophones on a fixed structure might allow discrimination of smolt path relative to the BAFF infrastructure.

3.5 GENERALIZED LINEAR MODEL

RIVER CONDITIONS AND BAFF OPERATION

Over the course of the study between March 16 and May 15, 2011, river flow entering the river junction at Georgiana Slough receded from about 50,000 to 13,000 cfs (Figure 3-7). The experiment began during a “High Flow” period but was postponed in late March until flows receded in order to assess the effect of the BAFF over a range of discharge (Figure 3-7). When the experiment was restarted, the “Low Flow” period began. Of the 1,500 fish released, 86 fish were excluded from the analysis due to mortality upstream of the river junction or fish being classified as eaten within the array, resulting in 1,414 fish available for analysis. Overall, 7.7% of the fish were entrained into Georgiana Slough when the BAFF was on, while 22.3% entered Georgiana Slough when the BAFF was off.

MODEL SELECTION

Model selection results suggested that cross-stream position (X), followed by BAFF operation (B) had the largest influence on entrainment into Georgiana Slough, but all variables affected migration routing to some extent. Among single-variable models, cross-stream location of fish (X) had the lowest BIC value, followed by BAFF operation (B), streakline (S), river discharge (Q), and time of day (D ; Table 3-13). The second-best univariate model had a within-group $\Delta\text{BIC} > 300$, indicating that the location of fish in the cross-section was the primary factor driving migration routing. Among two-variable models, the lowest BIC model included both X and B ,

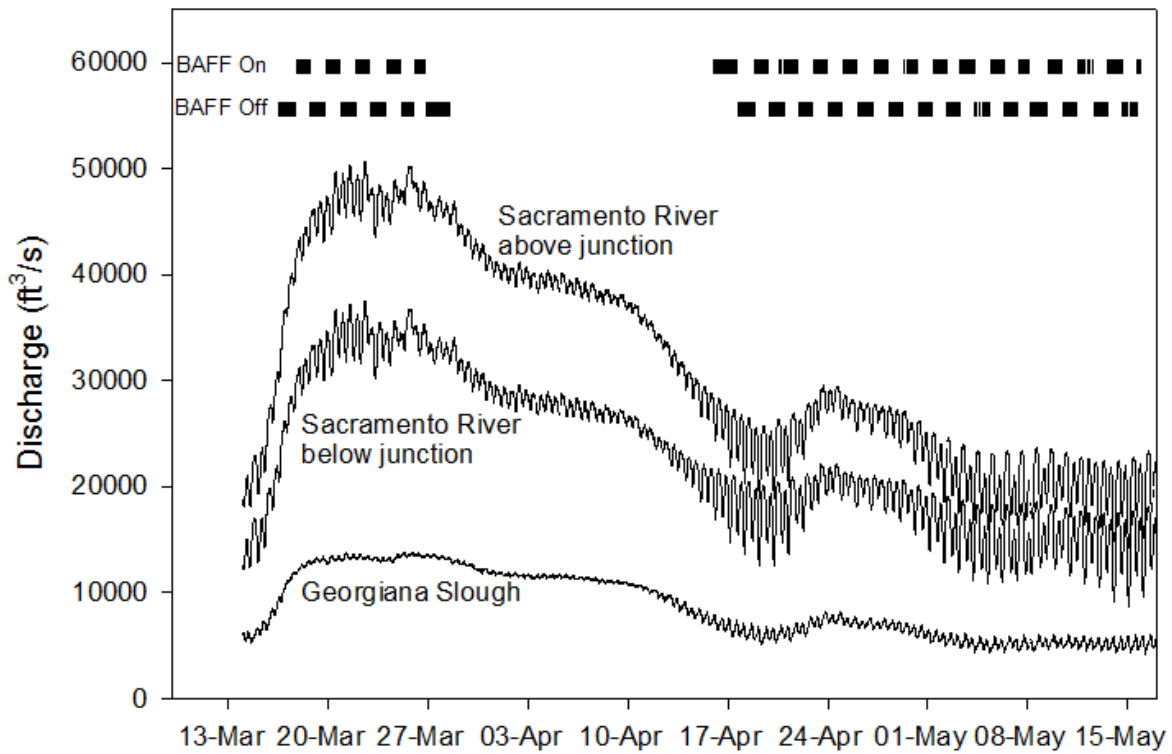

Source: USGS unpublished data 2011.

Figure 3-7 River Discharge and BAFF Treatment at Time of Detection within the Array

Model	Group	Number of Variables	NLL	BIC	Group ΔBIC	Overall ΔBIC
$D+B+S+Q+X+Q*X+B*Q$	1	7	321.8	701.7	5.2	5.2
$D+B+S+Q+X+Q*X$		6	322.9	696.5	0	0
$D+B+S+Q+X+Q*B$			337.7	726.2	29.7	29.7
$D+B+S+Q+X+D*B$			340.4	731.5	35	35
$D+B+S+Q+X+B*X$			342.1	734.9	38.4	38.4
$D+B+S+Q+X$	2	5	342.1	727.8	2.3	31.2
$B+S+Q+X$		4	344.6	725.5	0	28.9
$D+B+Q+X$			348.2	732.8	7.3	36.2
$D+B+S+X$			352.7	741.8	16.3	45.2
$D+S+Q+X$			372.8	781.8	56.3	85.3
$D+B+S+Q$			552.4	1141	415.5	444.5
$B+Q+X$	3	3	353.8	736.6	0	40.1
$B+S+X$			354.7	738.5	1.9	42
$D+B+X$			363	755.1	18.5	58.6

**Table 3-13
Model Selection Results for Logistic Regression Expressing the Probability of Fish Entering Georgiana Slough as a Function of Covariates**

Model	Group	Number of Variables	NLL	BIC	Group Δ BIC	Overall Δ BIC
<i>S+Q+X</i>			375.4	779.9	43.2	83.3
<i>D+Q+X</i>			380.5	790	53.4	93.5
<i>D+S+X</i>			385.3	799.5	62.9	103
<i>B+S+Q</i>			552.4	1133.8	397.2	437.3
<i>D+B+S</i>			556.3	1141.6	405	445.1
<i>D+B+Q</i>			560.2	1149.5	412.8	452.9
<i>D+S+Q</i>			582.7	1194.4	457.8	497.9
<i>B+X</i>	4	2	368.8	759.3	0	62.7
<i>Q+X</i>			386.7	795.2	35.9	98.7
<i>S+X</i>			387.3	796.3	37.1	99.8
<i>D+X</i>			397.9	817.5	58.2	120.9
<i>B+S</i>			556.3	1134.4	375.2	437.9
<i>B+Q</i>			561	1143.8	384.5	447.3
<i>D+B</i>			567.6	1157	397.8	460.5
<i>S+Q</i>			582.7	1187.2	428	490.7
<i>D+S</i>			588.1	1198.1	438.8	501.5
<i>D+Q</i>			592.1	1206	446.7	509.5
<i>X</i>	5	1	403.9	822.3	0	125.8
<i>B</i>			568.7	1151.9	329.6	455.4
<i>S</i>			588.1	1190.8	368.5	494.3
<i>Q</i>			592.9	1200.3	378	503.7
<i>D</i>			601.7	1217.9	395.6	521.4
Intercept only		0	602.7	1212.7	390.4	516.2

Notes:
NLL = negative log-likelihood, BIC = Bayesian Information Criterion, and Δ BIC is the difference in BIC of each model relative to the lowest BIC model (either within groups of models or over all models).

supporting the hypothesis that the BAFF affected migration routing (Table 3-13). For the more complex models, the BIC rankings followed the ranking of simpler models. For example, among three-variable models, *X* appeared in the top six models and *B* appeared in the top three models. Among all main-effects models, the model with the lowest-BIC model value included *X*, *B*, *Q*, and *S*, followed closely by the model with all five variables (Δ BIC = 2.3; Table 3-13). Although time of day (*D*) was excluded from the most parsimonious main-effects model, *D* in the model was chosen in order to evaluate interaction terms involving *D*.

Among models with interaction terms, a $Q*X$ interaction was strongly supported, having a BIC that was 31.2 units lower than the five-variable main-effects model, while adding a $B*Q$ interaction slightly reduced BIC relative to the main effects model ($\Delta BIC = 1.6$). Neither a $B*D$ interaction nor a $B*X$ interaction was supported, as evidenced by BIC for these models being larger than the BIC for the five-variable main effects model (Table 3-13). Given these findings, a model that included both $Q*X$ and $B*Q$ was also assessed, but the BIC of this model was 5.2 units greater than the model with only the $Q*X$ interaction. Based on these findings, the model with all five covariates and a $Q*X$ interaction was selected for inference, which had the lowest BIC value over all models.

Goodness-of-fit diagnostics showed no evidence of lack-of-fit and indicated that the model predicted the fates of individuals well. The Hosmer-Lemeshow goodness-of-fit test was not significant ($\hat{C} = 13.0$, $df = 17$, $P = 0.734$). The AUC was 0.928 indicating that the model had excellent ability to predict fates of individuals. For example, a cutoff of π_G (probability of entering Georgiana slough) > 0.2 correctly predicted 82% of the fish that entered Georgiana Slough (true positive rate) and incorrectly assigned only 18% of fish with a Sacramento River fate to Georgiana Slough (Figure 3-8).

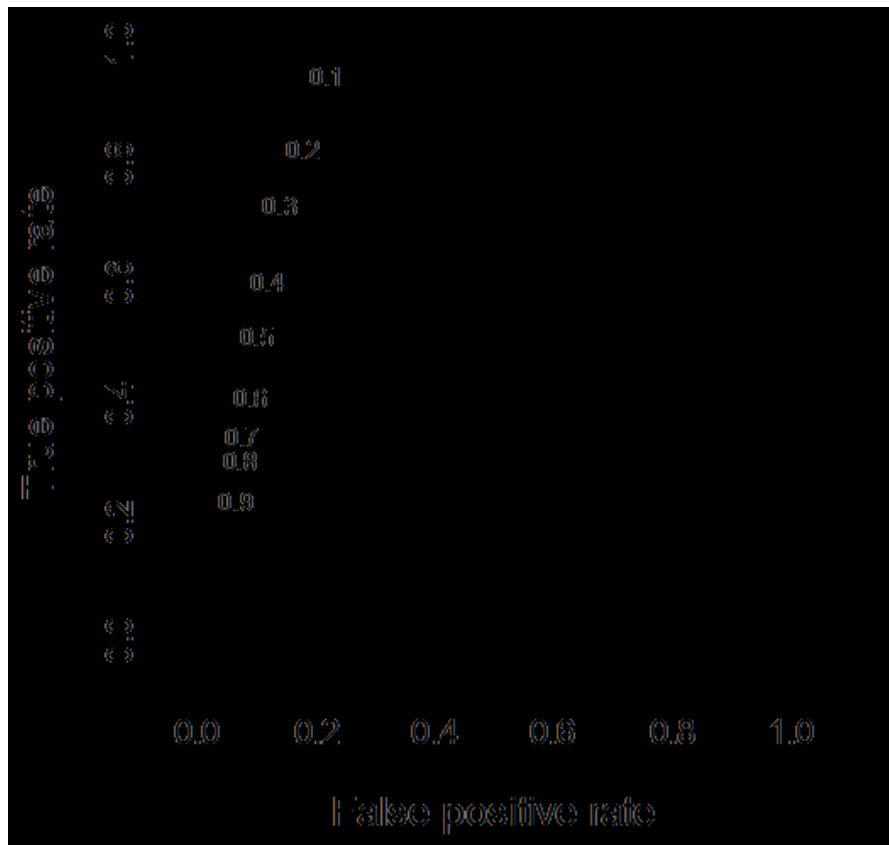

Notes: Results are based on cutoff values of π_G ranging from zero to one (shown as labeled data points). The 45° reference line shows the performance of a model with no ability to predict fates of individual fish.

Figure 3-8 Receiver Operating Curve Showing True and False Positive Rates of Classifying Fish to Georgiana Slough

EFFECTS OF COVARIATES ON ENTRAINMENT PROBABILITY

Due to the interaction between Q and X , the effect of cross-stream position on $\pi_{G,i}$ depended on river discharge. The slope for cross-stream position was negative at all values of discharge (Figure 3-9[A]) indicating that $\pi_{G,i}$ decreased moving from the Georgiana Slough side of the river channel to the Sacramento River side of the channel (Figure 3-10). However, the magnitude of the slope for X increased (i.e., becomes more negative) with flow, indicating that higher flows increase the gradient of $\pi_{G,i}$ across the river channel. For example, at high flows $\pi_{G,i}$ transitions sharply from near zero at $X = 20$ m to near one at $X = -20$ m, whereas this transition is more gradual at lower flows (Figure 3-10). Likewise, the slope for Q decreases as X increases, but the slope switches from positive to negative at about $X = 10$ m (Figure 3-9[B]). Therefore, $\pi_{G,i}$ increases with flow for fish located on the Georgiana Slough side of the channel, but decreases with flow for fish located on the Sacramento River side of the channel (Figure 3-11).

Parameter estimates indicate the effect of the other covariates on the probability of fish entering Georgiana Slough. The slope estimate for streakline (S) was positive, indicating that as the streakline moves in a positive direction (i.e., towards the Sacramento side of the river channel), the probability of fish entering Georgiana Slough increases (Table 3-14, Figure 3-12). For example, for fish located at $X = -10$ m, $\pi_{G,i}$ increases from about 0.6 to 0.9 at the mean observed discharge during night with the BAFF Off (Figure 3-12). The negative coefficient for B , where $B = 1$ is BAFF On, indicated that operation of the BAFF reduced the probability of fish entering Georgiana Slough (Table 3-14). At the mean observed discharge, entrainment probability for the BAFF On was up to 40 percentage points lower than for BAFF Off, depending on the cross-stream position of fish (Figure 3-13). Similarly, the negative coefficient for D , where $D = 1$ is day, showed that $\pi_{G,i}$ was lower during the day (Table 3-14). However, differences in entrainment probability between day and night were relatively small compared to the effect of other covariates (Figure 3-14).

Table 3-14
Parameter Estimates for the Best-Fit Model

Variable	Parameter Estimate	Standard Error	95% Confidence Interval
Intercept (Night, Off)	-2.104	0.361	-2.812, -1.397
D	-0.531	0.215	-0.951, -0.110
B	-1.700	0.232	-2.150, -1.242
S	0.082	0.024	0.035, 0.129
Q	0.068	0.013	0.043, 0.093
X	0.045	0.028	-0.010, 0.101
$Q*X$	-0.006	0.001	-0.008, -0.004

Notes:

Variables defined as follows: D = time of day (Day = 1, Night = 0), B = BAFF operation (On = 1, Off = 1), S = critical streakline, Q = discharge, and X = cross-stream position of fish. The reference group for the intercept is D = Night and B = off.

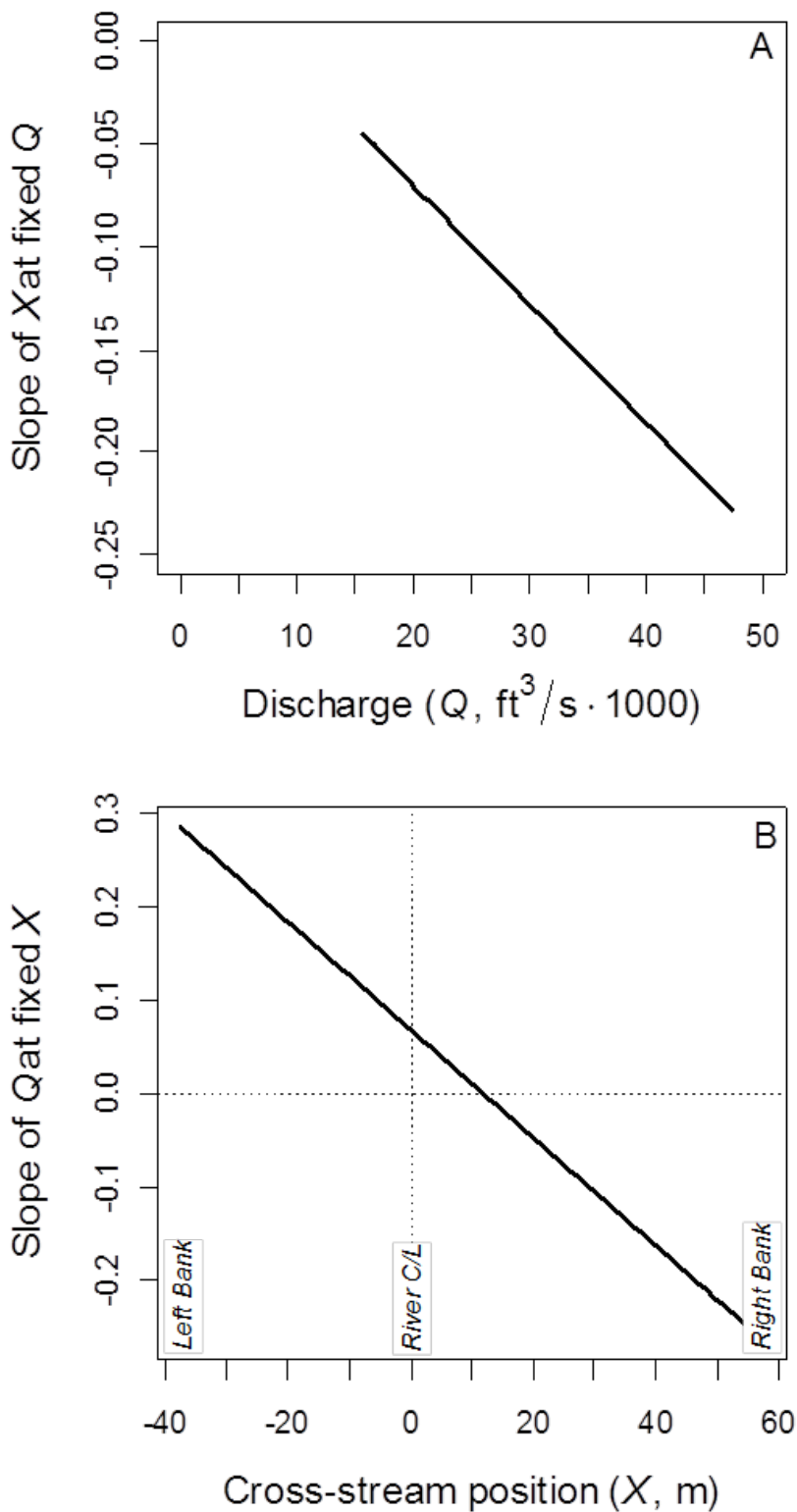

Note: Each panel shows the slope coefficient of one variable at fixed values of the other variable. Curves are plotted over the range of observed discharge and cross-stream positions.

Figure 3-9 Effect of the Interaction between Discharge Entering the River Junction (Q) and Cross-Stream Position of Acoustically Tagged Chinook Salmon (X)

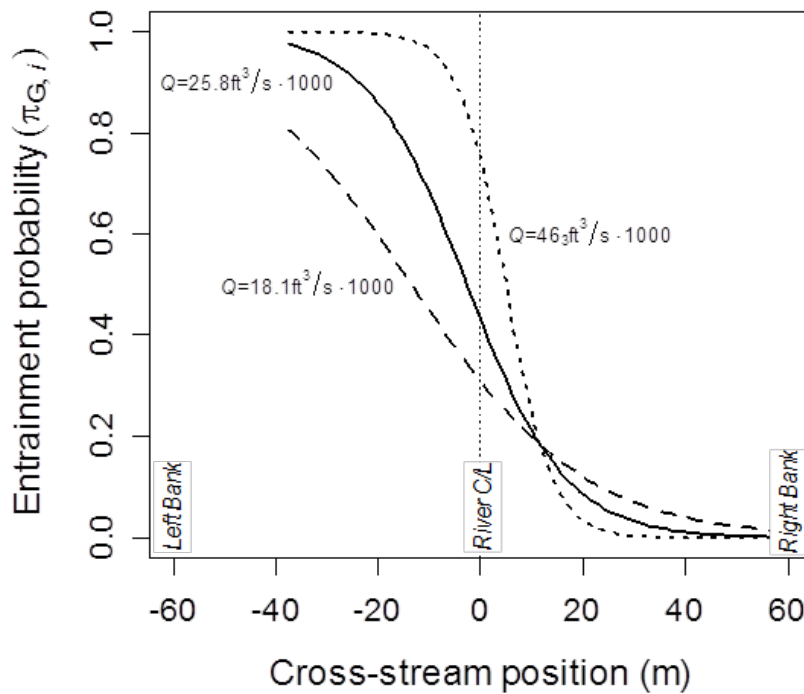

Notes: Effect of cross-stream position (X) of acoustically tagged juvenile salmon on probability of entrainment into Georgiana Slough at the 5th (dashed line), 50th (solid line), and 95th (dotted line) percentiles of discharge. Curves are plotted over the observed range of cross-stream positions for night with BAFF Off at the mean streakline of 0.88 meter.

Figure 3-10 Effect of Cross-Stream Position of Juvenile Salmon on Probability of Entrainment into Georgiana Slough under Different Discharges

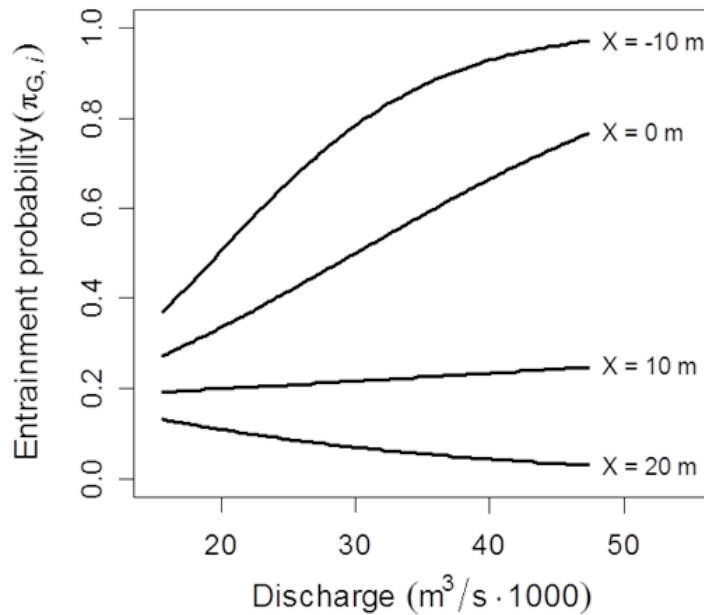

Note: Curves are plotted over the range of observed discharge for night with the BAFF Off at the mean streakline of 0.88 m.

Figure 3-11 Effect of Discharge on Probability of Entrainment into Georgiana Slough for Fish at Different Cross-Stream Locations

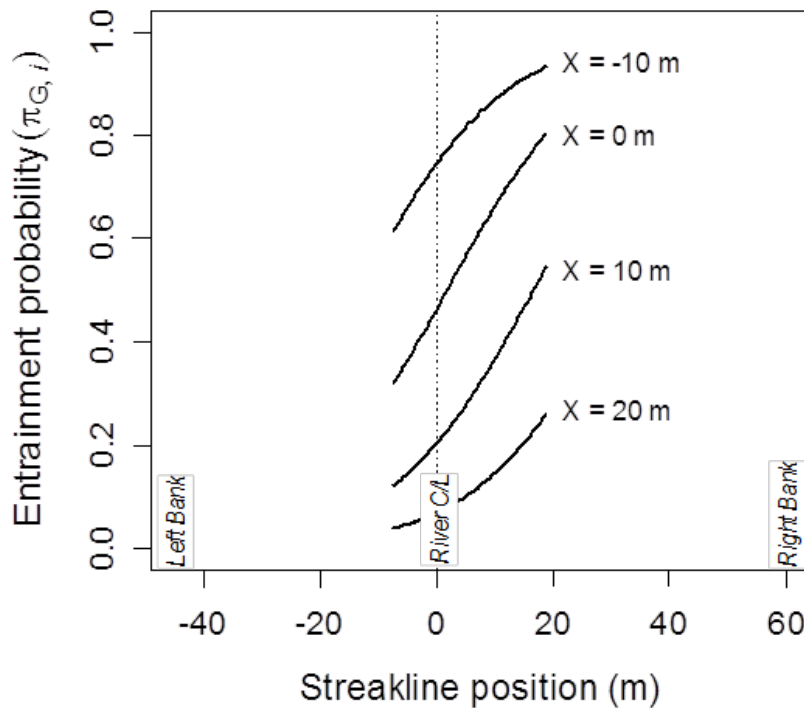

Note: Curves are plotted over the range of observed streakline positions for night with the BAFF Off at the mean discharge of 28.9 cfs-1000.

Figure 3-12 Effect of Streakline Position on Probability of Entrainment into Georgiana Slough for Fish at Different Cross-Stream Locations (X)

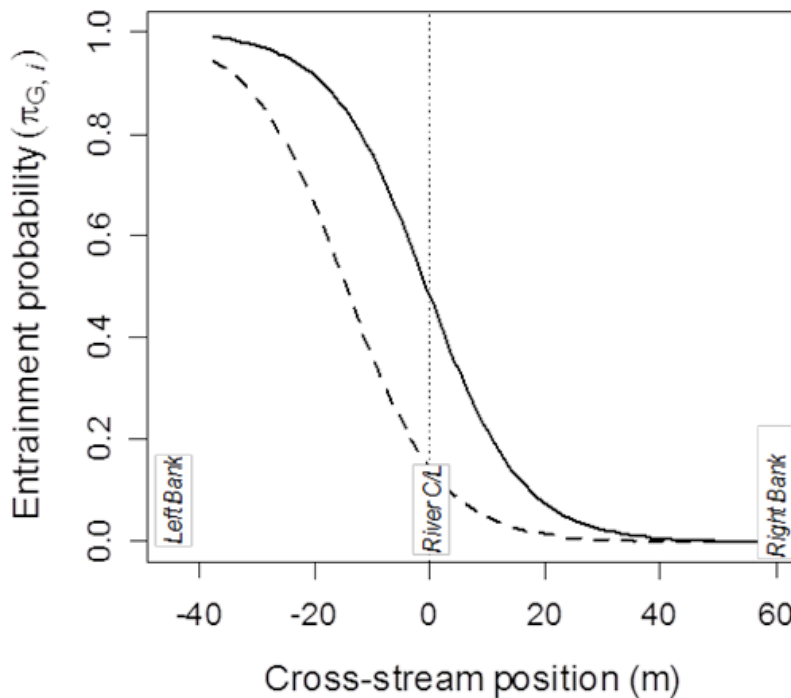

Notes: Curves are plotted over the range of observed cross-stream positions for night at the mean discharge of 28.9 cfs-1000 and the mean streakline of 0.88 m. BAFF Off is represented as a solid line and BAFF On is represented as a dashed line.

Figure 3-13 Probability of Entrainment into Georgiana Slough as a Function of Cross-stream Position for BAFF Off and BAFF On

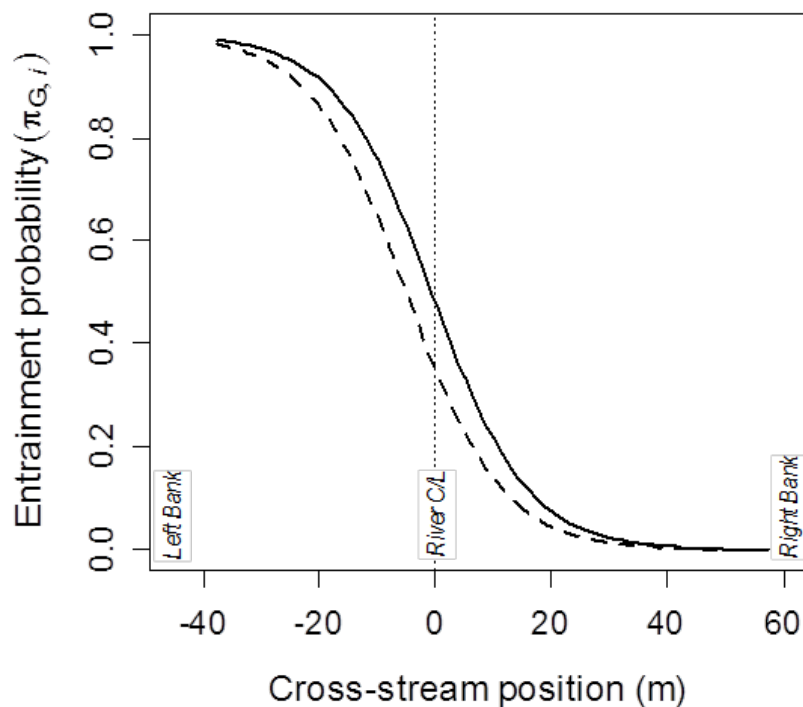

Notes: Curves are plotted over the range of observed cross-stream positions for BAFF off at the mean discharge of 28.9 ft³/s-1000 and the mean streakline of 0.88 m. Day is represented as a dashed line and night is represented as a solid line.

Figure 3-14 Probability of Entrainment into Georgiana Slough as a Function Cross-Stream Position during Day and Night

ENTRAINMENT PROBABILITIES DURING LOW- AND HIGH-FLOW PERIODS

Because covariates other than discharge differed between low- and high-flow periods (i.e., before and after April 5, 2011; see Figure 3-7), examining the predicted entrainment probability for different strata takes into account the simultaneous effect of covariates (Table 3-14).

First, regardless of the effect of any covariate, fish on the Sacramento River side of the channel had a low probability of entering Georgiana Slough (Figures 3-15[A] and 3-16[A]). For example, the probability of entrainment into Georgiana Slough was less than 0.20 for $X > 10$ m for all groups (Figures 3-15[A] and 3-16[A]). Given the cross-stream distribution of fish approaching the river junction, >60% of fish were located at $X > 10$ m, indicating that the majority of fish were unlikely to enter Georgiana Slough (Figures 3-15[C] and 3-16[C]). These findings also suggest that the BAFF had little influence on fish located at $X > 10$ m. For example, for $X > 10$ m, the difference in predicted entrainment probability between BAFF On and BAFF Off was < 0.10 (Figures 3-15[B] and 3-16[B]).

In contrast, for fish located at $X < 10$ m, $\pi_{G,i}$ increased rapidly approaching Georgiana Slough and depended on river discharge and BAFF operation. As cross-stream position decreased (i.e., moving towards Georgiana Slough), entrainment for the high-flow period increased more rapidly than for low flows, approaching unity at $X < -15$ m (Figures 3-15[A] and 3-16[A]). These findings reveal that BAFF operation had little effect on entrainment probability at $X < -15$ m during high flows. However, during low-flow periods, $\pi_{G,i}$ for BAFF On

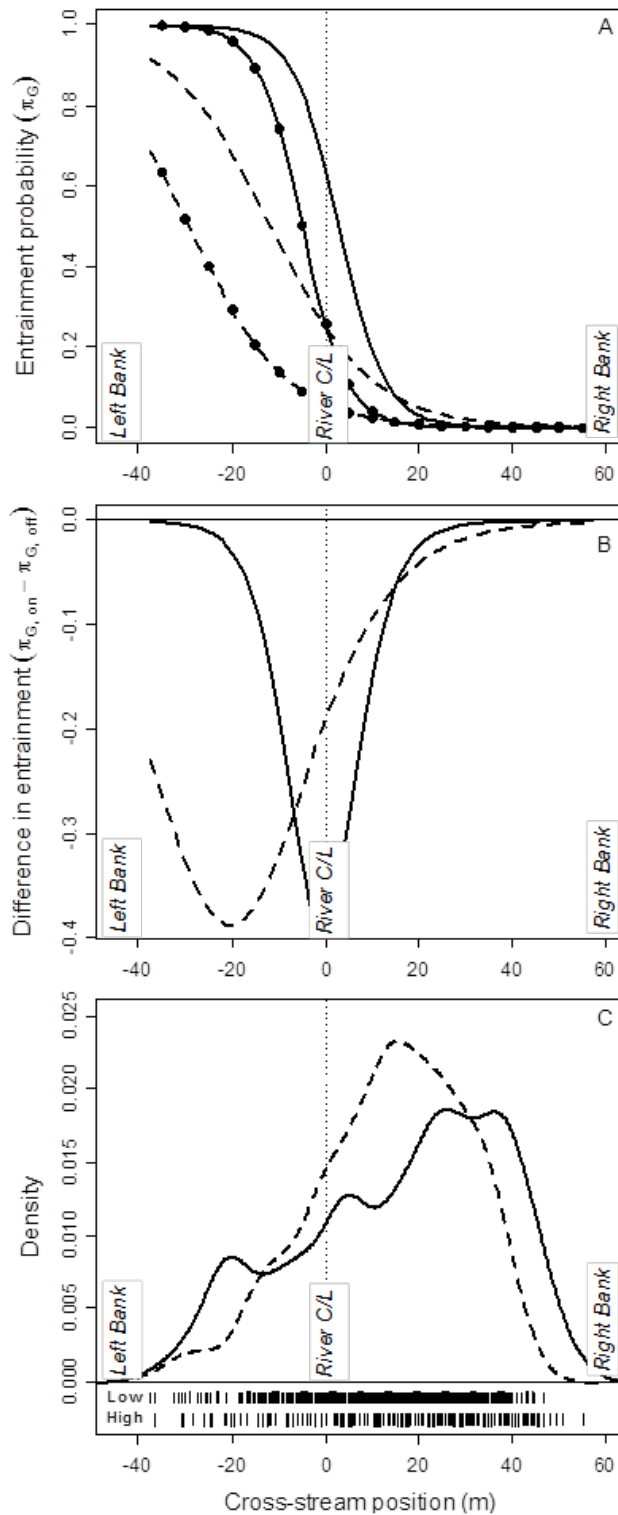

Notes: (A) presents the estimated probability of entrainment during the day for high- and low-flow periods (solid and dashed lines respectively) for BAFF On (lines with circles) and BAFF Off (line without symbols), (B) represents the difference in estimated entrainment between BAFF On and BAFF Off, and (C) represents the cross-sectional distribution of fish. In (A), curves were plotted based mean values of discharge and streakline given in Table 3-15. In (C), the distribution was based on a kernel density estimator and the rug plot shows observed cross-stream positions of fish for high- and low-flow periods.

Figure 3-15 Effect of Cross-Stream Position on Probability of Entrainment into Georgiana Slough during the Day

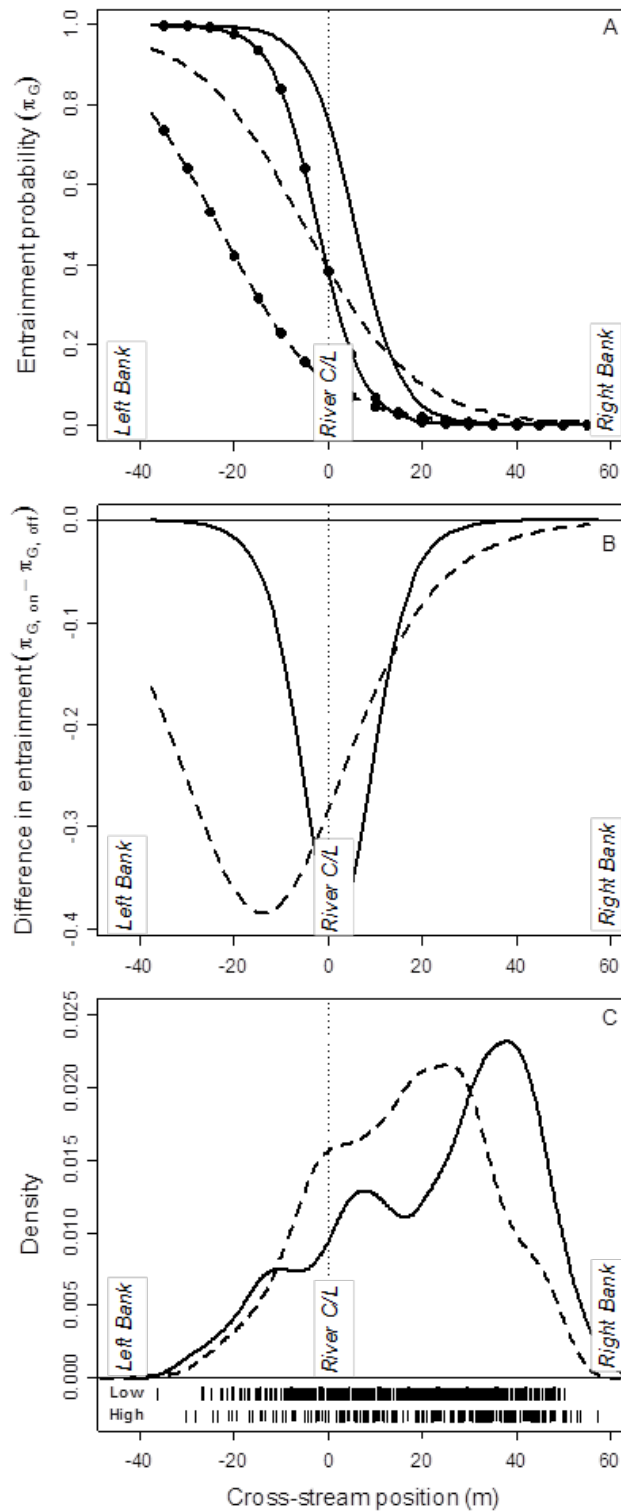

Notes: (A) presents the probability of entrainment into Georgiana Slough during night for high- and low-flow periods (solid and dashed lines respectively) for BAFF On (lines with circles) and BAFF Off (line without symbols), (B) the difference in estimated entrainment between BAFF On and BAFF Off, and (C) the cross-sectional distribution of fish. In (A), curves were plotted based mean values of discharge and streakline given in Table 3-15. In (C), the distribution was based on a kernel density estimator and the rug plot shows observed cross-stream positions of fish for high- and low-flow periods.

Figure 3-16 Effect of Cross-Stream Position on Probability of Entrainment into Georgiana Slough during the Night

remained considerably lower than for BAFF Off over the range of $X < 10$ m (Figures 3-15[A] and 3-16[A]). This last finding suggests that further studies of the BAFF in low-flow periods would be valuable.

The probability that a smolt will be entrained into Georgiana Slough was greater during high flow periods than during low flow periods (Figure 3-15[A] and 3-16[A]). These findings were supported in the overall efficiencies reported for high velocities (80%) in Figure 3-5. But Figure 3-8 suggests that BAFF operations play an even more important role when there are high velocity conditions. For example, when discharge is high, the effect of the BAFF contributes more than one-third of the fish that continue down the Sacramento. However, when flow is low and velocities are low, the BAFF contributes less than one-fifth of the fish continuing down the Sacramento. In effect, the BAFF constrains the losses due to high velocity by increasing the relative proportion of smolts contributed to those continuing down the Sacramento River.

The findings indicate that the spatial zone of influence of the BAFF varied with discharge entering the river junction. Under both high and low flows, operation of the BAFF reduced the probability of fish being entrained into Georgiana Slough by up to 40 percentage points (Figures 3-15[B] and 3-16[B]). However, during the low-flow period, the BAFF reduced the probability of entrainment by > 10 percentage points over a 55 m section of the cross-channel (from about $X = -40$ m to $X = 15$ m; Figures 3-15[B] and 3-16[B]). In comparison, under high flows, this same reduction in $\pi_{G,i}$ occurred over a 30-m section of channel (from about $X = -15$ m to $X = 15$ m; Figures 3-15[B] and 3-16[B]).

ESTIMATING ENTRAINMENT INTO GEORGIANA SLOUGH

The observed fraction of fish entering Georgiana Slough varied considerably among strata from 0.017 to 0.295 (Table 3-15). The model helps to explain the factors driving this variation. The mean estimated entrainment probability over individuals estimates the fraction of fish entering Georgiana Slough by integrating individual entrainment probabilities over the conditions experienced by each fish. The mean entrainment probabilities were found to closely match the observed fraction of fish entering Georgiana Slough, indicating that the model captured the influence of covariates on entrainment at the population level (Table 3-15, Figure 3-17). With the BAFF on, observed entrainment for the high-flow period was 8.4 and 11.7 percentage points less than with the BAFF off (for day and night respectively), whereas during the low-flow period, entrainment was 17.6 and 14.3 percentage points lower (Table 3-15). These results are consistent with the finding that high flows increased entrainment probabilities on the Georgiana Slough side of the river channel and reduced the spatial zone of influence of the BAFF.

Covariates other than river flow and BAFF operation also varied among strata and influenced entrainment probabilities. For example, during high-flow periods, both the mean streakline and mean of the cross-stream fish distribution were shifted towards the Sacramento River, relative to the low-flow period (Table 3-15). However, the cross-stream distribution for the group with the highest entrainment (high flow, day, BAFF Off) was shifted more towards the Georgiana Slough side of the channel (Table 3-15). For this group, 33% of the fish were located to the Georgiana Slough side of the streakline compared to 17-23% for the other high-flow groups. Thus, the interaction between location of the streakline and cross-stream distribution of fish, combined with the effect of BAFF Off and high flow, acted to increase individual entrainment probabilities resulting in a high fraction of fish being entrained into Georgiana Slough. In contrast, the lowest observed and predicted entrainment occurred during the day for the low-flow period with the BAFF On (Table 3-15). For this group, although the distribution of fish was shifted towards the Georgiana Slough side of the channel (relative to other groups), the streakline was

also shifted considerably towards Georgiana Slough (Table 3-15). For this group, only 18% of fish were located to the Georgiana Slough side of the streakline, compared to 18-26% of the other low-flow groups. These factors, combined with the effect of low flow and operation of the BAFF, led to a low fraction being entrained into Georgiana Slough. The analysis illustrates how multiple factors interacted to influence the fraction of fish entrained into Georgiana Slough.

Discharge Level	Time of Day	BAFF Operation	Discharge (Q, ft ³ /s · 1000)	Streakline (S, m)	Cross-stream Position (X, m)	N	Number Entering Georgiana Slough	Fraction Entering Georgiana Slough	$\hat{\pi}_G$
High	Day	On	44.6 (1.2)	3.0 (1.6)	19.9 (19.9)	71	15	0.211 (0.048)	0.149 (0.034)
		Off	43.0 (4.0)	3.6 (1.7)	13.5 (22.4)	105	31	0.295 (0.045)	0.322 (0.039)
	Night	On	44.6 (1.1)	3.6 (1.5)	22.9 (20.7)	71	9	0.127 (0.040)	0.150 (0.037)
		Off	43.6 (2.6)	3.9 (1.3)	21.4 (20.4)	119	29	0.244 (0.039)	0.262 (0.034)
Low	Day	On	24.3 (3.1)	-1.3 (3.8)	14.3 (16.4)	301	5	0.017 (0.007)	0.047 (0.005)
		Off	23.9 (3.2)	-1.0 (4.1)	12.9 (16.7)	290	56	0.193 (0.023)	0.167 (0.012)
	Night	On	23.4 (3.4)	1.2 (4.8)	17.8 (17.0)	243	21	0.086 (0.018)	0.060 (0.006)
		Off	22.8 (3.5)	1.5 (4.6)	14.2 (17.2)	214	49	0.229 (0.029)	0.241 (0.016)

Notes:
Summary of covariates used in logistic regression, the observed fraction of fish entering Georgiana Slough, and the mean predicted probability of entering Georgiana Slough ($\hat{\pi}_G$) stratified into categories of discharge level, time of day, and BAFF operation. Values represent the mean (SD) for Q, S, and X, and the mean (SE) for $\hat{\pi}_G$ and the fraction entering Georgiana Slough. N is the total number of fish observed in each strata. For $\hat{\pi}_G$, the standard error is based on variance in $\hat{\pi}_G$ among individual fish whereas standard error is based on the binomial distribution for the observed fraction of fish entering Georgiana Slough.

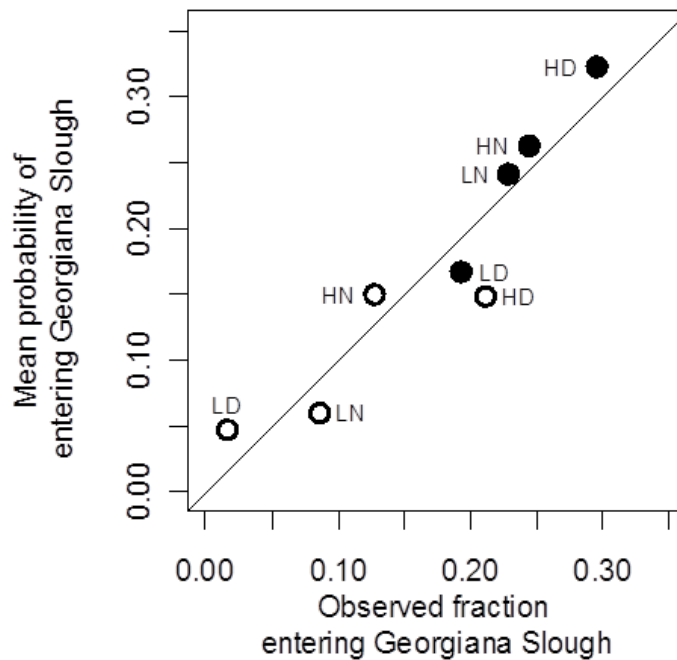

Notes: Points represent data stratified by BAFF On (open circles) and BAFF Off (filled circles) for day and night during high- and low-flow periods (see Table 3-15). The reference line shows where mean probabilities equal observed fractions. Data labels indicate high-flow (H) or low-flow (L) and day (D) or night (N) groups. Diagonal line has a slope of 1.

Figure 3-17 Comparison of the Mean Estimated Probabilities from the Best-fit Logistic Regression Model to the Observed Fraction of Fish Entering Georgiana Slough

To use the BAFF as a management tool requires understanding its effectiveness under a range of environmental conditions. Although the analysis quantified the effect of the BAFF at river discharge ranging from 20,000 to 50,000 cfs, discharge entering this river junction is often considerably lower than observed during this study. At discharges below about 10,000 cfs entering the junction, hydrodynamics change considerably because tidal fluctuations cause the river to reverse direction on flood tides. Under these conditions, up to 50% of fish passing this river junction can be entrained into Georgiana Slough (Perry 2010), substantially higher than observed during this study. Entrainment is likely higher under these conditions because fish may pass by Georgiana Slough safely when the river is flowing downstream, only to be advected back upstream on the flood tide and ultimately entrained into Georgiana Slough. Thus, under low-flow conditions when the river reverses direction, the BAFF needs to reduce entrainment probabilities of fish approaching Georgiana Slough from both the upstream and downstream direction. It is difficult to infer BAFF performance under these conditions, but the findings provide some insight into the expected change in individual entrainment probabilities. Because velocities approaching the BAFF declined with discharge, it may be expected that the BAFF would further reduce individual entrainment probabilities of fish at a particular cross-stream location when discharge is lower than observed in the study. However, on the transition from ebb to flood tide, water is funneled into Georgiana Slough simultaneously from both the upstream and downstream directions. Under these conditions, all fish passing the junction will have a high probability of entering Georgiana Slough. Therefore, what remains to be seen is how the cross-stream distribution of fish changes with flow, how multiple encounters with the BAFF affect an individual's total probability of entrainment, and how these processes integrate across tidal cycles to drive the fraction of the population entrained into Georgiana Slough.

Not surprisingly, fish location in the cross-section was the most important driver of an individual's probability of entrainment into Georgiana Slough. Common sense dictates that fish along the Sacramento River shoreline will remain in the Sacramento River, and fish along the shoreline entering Georgiana Slough will enter that channel. However, including cross-stream position in the analysis revealed where in the cross-section fish became vulnerable to entrainment into Georgiana Slough and where the BAFF reduced, or failed to reduce, an individual's probability of entrainment. This approach allowed us to identify that the BAFF failed to substantially reduce entrainment probabilities of fish closest to the Georgiana Slough shoreline during the high-flow period (i.e., fish located between $X = -37.5$ m and $X = -15$ m). Cross-stream position was also critical for understanding how the cross-sectional distribution of fish drives overall entrainment by dictating the fraction of the population likely to come into contact with the BAFF or likely to enter Georgiana Slough. Such insights are critical for understanding how the BAFF affects individual entrainment probabilities and subsequently, overall entrainment.

The findings show how an integrated, multi-sensory non-physical barrier was able to reduce, but not eliminate, entrainment into Georgiana Slough. Coutant (2001) makes a strong argument that behavioral guidance devices are likely to be most effective when different technologies are used in concert and tailored to a specific application. Along these lines, it was hypothesized that entrainment into Georgiana Slough could be further reduced by altering the cross-stream distribution of fish just upstream of the river junction (or just downstream for reverse flows). Relatively simple guidance structures, such as a shallow-draft floating boom, could be used to shift the cross-stream distribution towards the Sacramento River side of the channel. For example, a floating log boom at Lower Granite Dam on the Snake River was successful at guiding migrating juvenile salmon towards a surface passage structure (Plumb et al. 1999). Given that entrainment probability dropped rapidly to zero at $X > 10$ m (Figures 3-15[A] and 3-16[A]), the findings suggest that a small shift in the cross-stream distribution could have a large effect on the fraction of fish entering Georgiana Slough. To gain insights about the potential effectiveness of using such guidance devices in tandem with the BAFF, the model could be used to simulate how altering the cross stream distribution affects total entrainment, with and without the BAFF (at least under the range of flows observed during the study). It should be noted that such a structure may also provide holding cover for predatory fishes and in turn increase mortality in the area near the solid structure.

Although the BAFF succeeded in reducing entrainment into Georgiana Slough, success of the BAFF as a management tool needs to be considered in the context of improving survival of the population migrating through the Delta. The consequence of migrating through a given route must be measured to the point at which different routes converge, i.e., to Chipps Island. The BAFF experiment was implemented under the hypothesis that reducing entrainment into interior Delta increases population-level survival by shifting fish from a low-survival to a high-survival migration route. However, it was not possible to quantify the magnitude of change in survival realized by operation of the BAFF because survival was measured over only a few kilometers downstream of the river junction. Furthermore, if the BAFF substantially alters the abundance of juvenile salmon among migration routes, then predator distributions may also shift among routes in response to prey abundance. Future studies should quantify survival through the Delta during operation of the BAFF to better understand how within-route survival and overall survival changes in response to altering migration routing of juvenile salmon.

Although the day/night effect was included in the model, it did not explain much of the data variation. Furthermore, the interaction between BAFF operation and time of day was not supported by model selection criteria, suggesting that the BAFF performed equally well during day and night periods. In contrast, Welton et al. (2002) found that the BAFF was much more effective at deterring juvenile Atlantic salmon (*Salmo salar*) at night

as opposed to during the day. They attributed the difference in performance to the ability of fish to navigate through the bubble curtain using visual cues during the day, which were unavailable at night. During the Georgiana Slough study, average turbidity was 19.48 NTUs. Such high turbidity likely limited the use of visual cues to navigate the bubble curtain during daytime, possibly leading to similar performance between day and night.

The GLM analysis has shown that the BAFF was effective at reducing entrainment into Georgiana Slough during high- and low-flow conditions (see Figure 3-7). However, the BAFF was less effective at higher flows for fish located close to the Georgiana Slough side of the river channel. The mechanism behind this finding is likely the inability of a fish to alter its course away from the BAFF before being swept across the barrier and into Georgiana Slough. Given typical burst swimming speeds of smolts (~1.5 m/s or 10 BL/s) (Swanson et al. 2004) relative to water velocities approaching the BAFF, escape vectors may have been physically unattainable at high flows. Therefore, fish may have tried to avoid the BAFF, but were unable to do so and were entrained into Georgiana Slough.

3.6 SURVIVAL AND ROUTE ENTRAINMENT PROBABILITIES

Only site A1 missed an appreciable number of fish (Table 2-4), leading to near perfect detection probabilities for most sites (Table 3-16). Nearly equal proportions of fish arrived at the array during BAFF On and BAFF Off treatments ($\omega_{on} = 0.48$). The probability of entering Georgiana Slough (Ψ_G) was 0.074 with the BAFF On and 0.221 with the BAFF Off. A likelihood ratio test indicated that $\Psi_{G,on}$ was significantly lower than $\Psi_{G,off}$ ($X^2 = 63.04, P < 0.0001$). Survival through the study area was high during the study, and estimates of all survival probabilities were >0.95 with the exception of $S_{G,off}$, which was 0.927 (Table 3-17). Survival from the exit of the array to the Sacramento River peripheral hydrophones (S_S) differed little between BAFF Off and BAFF On ($X^2 = 0.285, P = 0.594$; Table 3-17). Although the estimate of $S_{G,off}$ was lower than $S_{G,on}$, these survival probabilities were not significantly different ($X^2 = 0.801, P = 0.371$; Table 3-17).

Table 3-16
Estimates of Detection Probabilities and Standard Errors for All Telemetry Stations

Station	Detection Probability	Standard Error
<i>PI</i>	0.999	0.001
<i>PA</i>	0.999	<0.001
<i>PA1</i>	0.918	0.008
<i>PA2</i>	0.999	0.001
<i>PD</i>	1.000	NA
<i>PD1</i>	0.995	0.005
<i>PD2</i>	1.000	NA

Notes:

PS and PG are the overall detection probabilities calculated from estimates of each detection location detection probability (PS1, PS2 and PG1, PG2, respectively). Estimates with NA for the standard error indicate that the detection probability was set to 1.0 because all fish were detected.

**Table 3-17
Survival and Route Entrainment Probabilities for BAFF On/Off Operations**

BAFF Operation	Reach/Route	Survival Probability ($S_{h,n}$)		Route Entrainment Probability ($\Psi_{h,n}$)	
		Estimate (SE)	95% CI	Estimate (SE)	95% CI
NA	Release to Array	0.957 (0.005)	0.946,0.966	NA	
On	Sacramento River	0.975 (0.006)	0.961,0.985	0.926 (0.010)	0.905, 0.944
Off		0.979 (0.006)	0.966,0.989	0.779 (0.015)	0.747, 0.806
On	Georgiana Slough	0.961 (0.027)	0.884,0.993	0.074 (0.010)	0.056, 0.095
Off		0.927 (0.020)	0.881,0.960	0.221 (0.015)	0.192, 0.251

Notes:

Survival was estimated from the release site to the array, and from the start line of the array to peripheral hydrophones located in either the Sacramento River or Georgiana Slough. Confidence intervals (CIs) were estimated with profile likelihood methods. SE = Standard Error

Strong evidence that operation of the BAFF influenced route entrainment was found during the study. With the BAFF On, a lower fraction of fish entered Georgiana Slough. Survival during the study was similar among reaches and treatments, with the exception of fish entering Georgiana Slough when the BAFF was off. With the BAFF Off, survival in Georgiana Slough was 3.4 percentage points less than when the BAFF was on, but these estimates were not statistically different. Nonetheless, this observation merits discussion of potential mechanisms that may have caused such differences in survival. It is possible that the physical structure of the BAFF provided sufficient cover for structure-oriented ambush predators such as smallmouth bass. The 2D tracks of tagged fish provided some support for this hypothesis. Of the fish that entered Georgiana Slough with the BAFF Off and never arrived at the downstream peripheral hydrophones (detection history “1 Goff 0,” Table 2-4), 75% were classified as having been eaten in the array downstream of the BAFF. In the “on” position, the BAFF may have deterred predators from aggregating around the structure, thus reducing the number of predation events near the BAFF. This is one potential explanation for the lower survival downstream of the BAFF when the BAFF was off although the statistical evidence also suggests that the difference in survival could have arisen due to random chance alone. Perhaps future studies will provide a sufficient body of evidence to determine whether the physical structure of the BAFF influences mortality of fish entering Georgiana Slough.

3.7 PREDATION

Predation on juvenile Chinook salmon at the HOR has been identified as an important factor affecting the survival of fish in the Delta (Bowen 2009; Bowen 2010). Results of the 2011 GSNPB study showed evidence that juvenile salmon were at risk of predation. A number of the tagged salmon showed signs of having been preyed on in the Sacramento River within the study area. Predators in the area included, but were not limited to, striped bass, smallmouth bass, and Sacramento pikeminnow. The predation component of the 2011 study included the evaluation of predation on acoustically tagged Chinook salmon and the evaluation of acoustically tagged predators. Each is summarized below.

PREDATION ON ACOUSTICALLY TAGGED CHINOOK SALMON

As discussed above, 1,467 of the total number (1,500) of acoustically tagged and released Chinook salmon smolts arrived and were detected within the experimental area (98%). The fates of the 33 smolts that did not arrive within the experimental area are unknown. The fates of 55 of the 1,467 smolts detected within the experimental area were classified as predation events (3.7% predation rate). Thirty-two smolts were preyed upon upstream of the BAFF (58%) and 23 were preyed upon downstream of the BAFF (42%). The average fork length of smolts eaten was 120.7 mm and ranged from 106 mm to 151 mm.

Predation Dates and Times

Predation dates and times were available for 52 predation events. Predation occurred during all study months and all times of day and night. However, there was a positive correlation between day of year and predation frequency and more events occurred during daylight than at night. Eight % (4) of predation events occurred in March, 31% (16) in April, and 61% (32) in May. Sixty three % (33) of predation events occurred during daylight (defined as the time period between 0600 and 1800) and 37% (19) occurred during nighttime.

Predation and BAFF Operation Condition

BAFF operation alternated from BAFF On to BAFF Off conditions at approximately 25-hour intervals during the study period. Table 3-18 summarizes predation events for each condition. Barrier condition was available for 49 predation events. Seventeen (35%) predation events occurred during the BAFF On condition and 32 (65%) predation events occurred during the BAFF Off condition. Of those that occurred during BAFF On conditions, nine occurred upstream of the BAFF and eight occurred downstream of the BAFF. Of those that occurred during BAFF Off conditions, 19 occurred upstream of the BAFF and 13 occurred downstream of the BAFF. During the BAFF On condition, nine predation events occurred at a distance of >80 m from the BAFF, seven occurred between 5-80 m, and one occurred <5 m. During the BAFF Off condition, 17 predation events occurred at a distance of >80 m from the BAFF, 15 occurred between 5-80 m, and zero occurred <5 m.

BAFF Operation	Predation Location	Distance from BAFF			Total
		>80 m	5-80 m	<5 m	
BAFF On	Upstream	6	3	0	9
	Downstream	3	4	1	8
BAFF Off	Upstream	13	6	0	19
	Downstream	4	9	0	13
Total		26	22	1	49

One of the concerns for projects using a combination of deterrence structures and features to influence route selection by fish is incidental contribution to increased predation. Many predators use underwater hard structures for refugia and for ambush sites. Installation of a physical deterrence structure, in this case a network of piles and scaffolding, has the potential to increase predation of target species by providing velocity refugia and ambush

sites potentially creating an area of predator concentration. In addition, many speculate the deterrence features often used in combination with physical structures, in this case strobe lights, air bubble curtain, and sound waves, have the potential to increase predation of target species, especially over time. The theory is the deterrence features temporarily disorient target fish which negatively affects predator avoidance behavior thus increasing the capture probability. The limited predation event data for the 2011 GSNPB Study suggest the BAFF and its associated features may not increase predation of emigrating Chinook salmon smolts within the vicinity of the barrier. The highest number of predation events occurred during barrier off conditions and at the greatest measured distance in relation to the barrier (>80 m). Only one acoustically tagged smolt was eaten close to the barrier (<5 m).

Predators use both artificial (e.g., barrier, docks) and natural (e.g., scour holes, large woody debris, rock piles) instream structures for ambush habitat and velocity refugia. All of these habitats are available to predators within the study area, and it is highly likely that these features attract and hold numbers of predators. It is uncertain if the barrier increased the number of predators or predation within the study area. In addition, it is uncertain if the barrier re-positioned predators within the study area. Many predators show avoidance behavior toward loud noises and other unnatural disturbances. The data suggest the deterrence features of the barrier may deter predators. The fewest predation events occurred during barrier on conditions and there was a positive correlation between number of predation events and distance from barrier.

Predation and Water Temperature

Water temperature was available for all 55 predation events. Dates and water temperatures for each predation event is shown on Figure 3-18. Water temperatures at the GES and GSS water quality stations (Figure 2-5) were very similar. At the GES station, the minimum, maximum, and average water temperature was 8.8°C, 17.5°C, and 12.9°C, respectively. At the GSS station, the minimum, maximum, and average water temperature was 8.8°C, 16.5°C, and 12.9°C, respectively. Daily fluctuations at both stations generally were low throughout the study period, rarely exceeding 1°C and typically less than 1°C. Most predation events (94%) occurred at water temperatures between 13.3°C and 15.6°C and during the second half of the study period. Predation frequency was positively correlated with water temperature.

Water temperature is an important physical habitat parameter for all Chinook salmon life stages because salmon are poikilothermic. Water temperatures outside of optimal ranges can disrupt physiological processes, cause stress, and cause abnormal behavioral patterns. Water temperature influences many aspects of the life history of juvenile salmon including susceptibility to predation. Thermal stress loading occurs when water temperatures are outside suitable ranges which, by itself, can cause immediate or delayed mortalities (Brett 1952). Available literature suggests water temperatures $\leq 17.2^{\circ}\text{C}$ allow salmon smolts to exhibit normal feeding, behavioral, and physiological responses. Water temperature very rarely exceeded 17.2°C within the study area during the study time period (exceedance occurred during a brief 30 minute period at the GES water quality station). No direct mortality may be attributable to thermal stress. However, higher temperatures could have affected Chinook smolt swimming capacity as temperatures rose over the course of the study period. Water temperatures also have the potential to influence predator species. Known predator species in the area are generally considered cool and warm water species. As temperatures warmed during the study period, these species likely became more active, increasing predation activity.

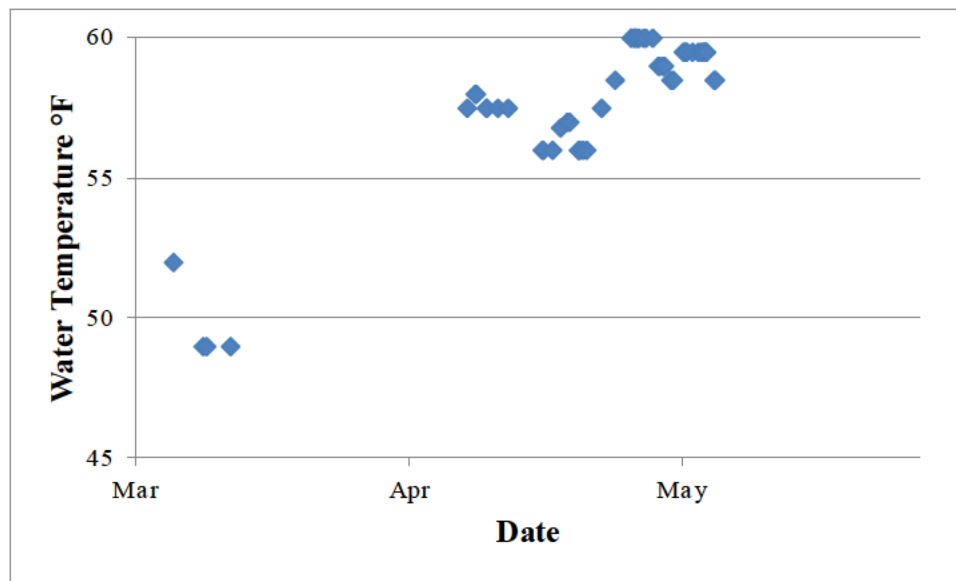

Figure 3-18 Date and Water Temperature for each Predation Event of an Acoustically Tagged Chinook Salmon Smolt during the 2011 Study

ACOUSTICALLY TAGGED PREDATORS

Over the duration of the study period, a total of 50 predators were captured within 1.6 km of the BAFF, implanted with acoustic tags, and released. The tagged predators consisted of 37 striped bass, 12 smallmouth bass, and one Sacramento pikeminnow. Forty-two tagged predators were detected within the array during the study period. Detections consisted of 35 striped bass, 6 smallmouth bass, and 1 Sacramento pikeminnow. Predator detections within the array are summarized in Appendix E. The table shows the approximate total time each predator was detected in the array, and lists the likely entry and exit routes for each discrete paired entry/exit event. Entry and exit routes were based on subjective interpretation of the geometry of the hydrophones responsible for each detection event.

Tagged predators exhibited high variation in movement behavior and patterns within and through the array. The vast majority of first detections, or first entries into the array, were consistent with the date and time of release (most of the tagged predators were released in the study area shortly after surgical implantation). Twenty-six individuals were detected in the array on one discrete paired entry/exit event, 11 were detected on two discrete paired entry/exit events, three were detected on three discrete paired entry/exit events, one was detected on four discrete paired entry/exit events, and one was detected on five discrete paired entry/exit events.

Twenty-one striped bass were detected in the array on one discrete paired entry/exit event, 11 were detected on two discrete paired entry/exit events, two were detected on three discrete paired entry/exit events, and one was detected on five discrete paired entry/exit events. Four smallmouth bass were detected in the array on one discrete paired entry/exit event, one was detected on three discrete paired entry/exit events, and one was detected on four discrete paired entry/exit events. One Sacramento pikeminnow was captured, tagged, and released at point of capture approximately 1.6 km downstream of the array in the Sacramento River. Approximately 14 days after release, it was detected in the array for 4 minutes before exiting. The entry and exit route was downstream in the Sacramento River. A subsample of predator tracks can be found on Figure 3-19. It was clear from the predator 2D

track analysis that the vast majority of predator movements were along the river margins. In addition, when a fish moved into the main river channel away from the margin (e.g., fish 3327.31 on Figure 3-19), it did not tend to hold position. Instead, most movements in the open channel were movements across the river; seldom was a fish observed holding position in the open channel of the river.

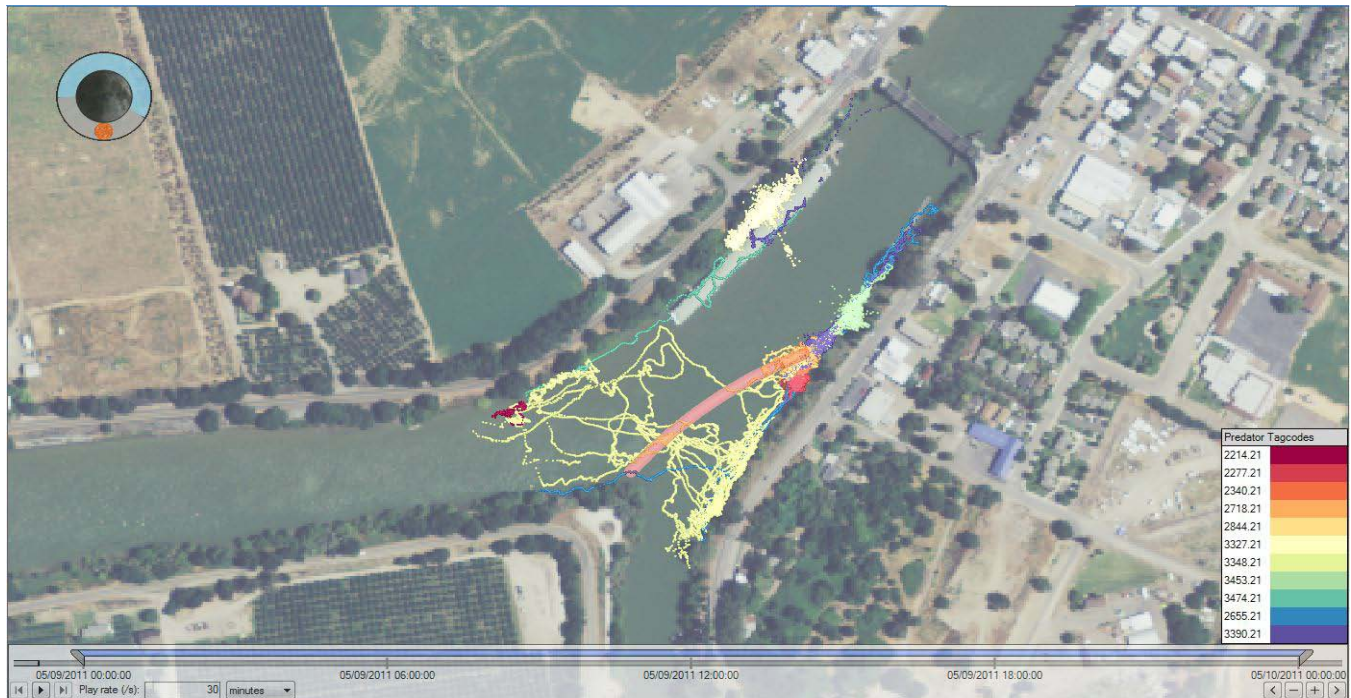

Notes: Tag data are for May 9, 2011. All tracks depicted here are smallmouth bass except: (1) 2214.21 was a Sacramento p keminnow and (2) 3348.21 was a striped bass.

Figure 3-19 Movements of Tagged Predators in the Array

Forty-six of the 50 tagged predators were released within the array and four of the tagged predators were released at point of capture between 0.8 and 1.6 km downstream of the array in the Sacramento River. Six of the 46 tagged predators released in the array were never detected (13%) and they consisted of two striped bass and four smallmouth bass.

PREDATION SUMMARY

Estimated predation of tagged smolts in the array was low (3.5% of total study fish), based on examination of tag tracking. The low predation rate is supported by analyses conducted as part of the hypothesis testing that showed similar protection and overall efficiency rates under both BAFF On and BAFF Off conditions. Additionally, survival estimates for juvenile tagged salmon observed in both Georgiana Slough and the Sacramento River were similar under BAFF On and BAFF Off test conditions.

The relatively high discharges in the Sacramento River likely reduced predation risk for juvenile salmon, as evidenced by the close similarity in protection and overall efficiencies. Several hypotheses explain this result:

- ▶ Increased smolt transport velocities reduced the rate of predator-prey encounters.

- ▶ Increased turbidity reduced the rate of predator-prey encounters and reduced the predators' capture probability of the smolts.
- ▶ Reduced water temperatures conveyed an energetic advantage to Chinook salmon over temperate piscivores (e.g., striped bass and smallmouth bass).

Predators were located primarily near the river margin (evidenced by the vast majority of acoustically-tracked predator movements near the river margin), which reduced the rate of encounters with salmon smolts that tended to migrate closer to the center of the channel.

It has been hypothesized that a non-physical barrier such as the BAFF may attract predatory fish, thus increasing predation mortality for juvenile salmonids. To examine this hypothesis, predation rates were estimated for areas within 5 m of the BAFF and compared to predation rates farther from the BAFF within the Sacramento River. Predation data showed that one predation event occurred within 5 m of the BAFF versus 48 events within the larger array area. These results do not support the hypothesis that the BAFF increases predation mortality for juvenile salmon in the immediate vicinity of the barrier.

Predation data showed that most (65%) predation events occurred when the BAFF was off, possibly because predators were startled by the BAFF when it was on (Figure 3-20). These findings could also be linked to observed differences between BAFF On versus BAFF Off conditions in the survival analyses. For example, of the relatively small proportion of fish that entered Georgiana Slough when the BAFF was off and never arrived at the downstream hydrophones, 75% were classified as having been eaten within the array downstream of the BAFF.



Notes: Striped bass (3138.21) was tagged and released April 15, 2011 at 11:39 hours. It moved to the BAFF and remained there for 07:55 hours. Then at 19:57 hours the bubble screen was started and at 19:57, 3128.21 moved across the river away from the BAFF. By 20:02 hours the sound projectors and modulated intense lights were also started.

Figure 3-20 Movements of a Striped Bass during Change in BAFF Operations (Off to On)

It is important to note that if the BAFF is used as a long-term management tool, predators could become conditioned to the BAFF On operation and may prey on salmon to a greater extent than under experimental operational conditions (BAFF On/BAFF Off). In addition, the habitat selected by and movement patterns of predators in the Sacramento River adjacent to the BAFF may vary within and among years in response to factors such as river flow and velocities, water temperatures, and recreational harvest. These factors, in combination with possible conditioning to BAFF operations, could result in different predation rates than those observed during the 2011 study.

This page intentionally left blank.

4 SUMMARY OF FINDINGS AND CONCLUSIONS

4.1 STUDY FINDINGS

The results and findings of the 2011 GSNPB tests are summarized below.

4.1.1 OVERALL EFFICIENCY AND ENTRAINMENT PROBABILITY

- ▶ During the 2011 study period, the non-physical barrier reduced the percentage of salmon smolts passing into Georgiana Slough from 22.1% (BAFF Off) to 7.4% (BAFF On), a reduction of approximately two-thirds of the fish that would have been entrained. This improvement produced an overall efficiency rate of 90.8%; that is, 90.8% of fish that entered the area when the BAFF was on exited by continuing down the Sacramento River.
- ▶ Three metrics of BAFF performance—deterrence, protection, and overall efficiency—were estimated from the results of the 2011 studies to compare passage of juvenile salmon into Georgiana Slough when the BAFF was on and when it was off. Based on all three metrics, barrier efficiency was significantly higher when the BAFF was on relative to periods when the BAFF was off.
- ▶ Based on the similarity between estimates of protection and overall efficiency, the effects of predation on juvenile salmon in the study area were low. It is hypothesized that high flows in the Sacramento River and corresponding increased water velocities and turbidity levels may have contributed to the relatively low level of predation on juvenile salmon estimated during the 2011 tests.

4.1.2 INFLUENCES OF VELOCITY, LIGHT, AND CROSS-SECTIONAL POSITIONS

- ▶ All statistical results were significant for deterrence, protection, and overall efficiency when comparing results under varying light and/or velocity conditions. However, analysis using the General Linear Model (GLM) found that river discharge, which was found to be highly correlated with velocity, may have a more important role than light and that high discharge may be an important predictor of fish behavioral response to the BAFF and entrainment into Georgiana Slough. This finding warrants further study under lower Sacramento River flows than those observed in 2011.
- ▶ Under high river flows (approximately 43,000 to 45,000 cubic feet per second [cfs] river flow entering the river junction at Georgiana Slough), the BAFF consistently reduced probability of entrainment into Georgiana Slough. This is supported by analyses conducted as part of the hypothesis-testing statistical analysis (reflected in Table 3-12). It shows a 30.4 percentage point improvement in overall efficiency was calculated when the BAFF was on versus off during periods of high across-barrier velocities (flows passing through the BAFF at ≥ 0.25 meter per second [m/s]), whereas a much smaller improvement in efficiency (8.1 percentage points) was calculated during periods of lower across-barrier velocities (< 0.25 m/s). However, because protection efficiency and overall efficiency were so high at across-barrier velocities categorized as low when the BAFF was off (see Table 3-12), there was little opportunity for “BAFF On” operations to improve efficiency.
- ▶ Conversely, when considering the cross-sectional position of a fish entering the array, high and low discharges had the opposite effect. For example, during periods of high river discharge, the BAFF was less

effective for fish located close to the east side of the river channel (downstream river left). The reason for this finding is likely that a fish cannot behaviorally respond to the BAFF and swim away from it fast enough to avoid being swept across the barrier and into Georgiana Slough. Under the GLM, the location of a fish in the cross section was the most important driver of an individual fish's probability of entrainment into Georgiana Slough at higher discharges.

- ▶ Although varying light conditions did not appear to affect salmon entrainment into Georgiana Slough or BAFF efficiency results, turbidity levels were relatively high during the study period; average turbidity at the test site was 19.5 nephelometric turbidity units (NTUs). Such high turbidity likely muted the BAFF's light intensity and limited the use of visual cues for juvenile salmon to navigate the BAFF during the daytime. This muting may possibly have led to similar performance between daytime and nighttime tests. Furthermore, laboratory studies have shown that Chinook salmon deterrence efficiency declines when turbidity is increased from 10 to 30 NTUs (Reclamation, unpublished data).

4.1.3 PREDATION

- ▶ Estimated predation of tagged smolts in the array was low (3.5% of total study fish), based on examination of tag tracking.
- ▶ The low predation rate is supported by analyses conducted as part of the hypothesis testing that showed similar protection and overall efficiency rates under both BAFF On and BAFF Off conditions (Table 3-10). Additionally, survival estimates for juvenile tagged salmon observed in both Georgiana Slough and the Sacramento River were similar (and not significantly different, $p > 0.05$) under BAFF On and BAFF Off test conditions (Table 3-17).
- ▶ The relatively high discharges in the Sacramento River likely reduced predation risk for juvenile salmon, as evidenced by the close similarity in protection and overall efficiencies. Several hypotheses explain this result:
 - Increased smolt transport velocities reduced the rate of predator-prey encounters.
 - Increased turbidity reduced the rate of predator-prey encounters and reduced the predators' capture probability of the smolts.
 - Reduced water temperatures conveyed an energetic advantage to Chinook salmon over temperate piscivores (e.g., striped bass and smallmouth bass).
 - Predators were located primarily near the river margin (evidenced by the vast majority of acoustically-tracked predator movements near the river margin), which reduced the rate of encounters with salmon smolts that tended to migrate closer to the center of the channel.
- ▶ It has been hypothesized that a non-physical barrier such as the BAFF may attract predatory fish, thus increasing predation mortality for juvenile salmonids. To examine this hypothesis, predation rates were estimated for areas within 5 m of the BAFF and compared to predation rates farther from the BAFF within the Sacramento River. Predation data showed that one predation event occurred within 5 m of the BAFF versus 48 events within the larger array area. These results do not support the hypothesis that the BAFF increases predation mortality for juvenile salmon in the immediate vicinity of the barrier.

- ▶ Predation data showed that most (65%) predation events occurred when the BAFF was off, possibly because predators were startled by the BAFF when it was on. These findings could also be linked to observed differences between BAFF On versus BAFF Off conditions in the survival analyses. For example, of the relatively small proportion of fish that entered Georgiana Slough when the BAFF was off and never arrived at the downstream hydrophones, 75% were classified as having been eaten within the array downstream of the BAFF.

It is important to note that if the BAFF is used as a long-term management tool, predators could become conditioned to the BAFF On operation and may prey on salmon to a greater extent than under experimental operational conditions (BAFF On/BAFF Off). In addition, the habitat selected by and movement patterns of predators in the Sacramento River adjacent to the BAFF may vary within and among years in response to factors such as river flow and velocities, water temperatures, and recreational harvest. These factors, in combination with possible conditioning to BAFF operations, could result in different predation rates than those observed during the 2011 study.

4.2 STUDY CONCLUSIONS

Overall, the analyses performed under the hypothesis testing, survival analysis, and GLM produced results that did not conflict and generally supported one another. The results of the tests showed that BAFF On operations resulted in significant increases in deterrence, protection, and overall efficiency for juvenile salmon; that is, fewer of the tagged salmon migrated into Georgiana Slough when the BAFF was on than when it was off. Variation in light levels did not significantly affect the deterrence, protection, and overall efficiency; however, there was some indication that the behavior and movement patterns of juvenile salmon were influenced by the high river flows that occurred in spring 2011. However, at high (≥ 0.25 m/s) and low (<0.25 m/s) across-barrier velocities, BAFF On operations resulted in significant increases in deterrence, protection, and overall efficiency for juvenile salmon.

Predation rates were relatively low in 2011, and there was no evidence that BAFF operations were attracting predators to the area or increasing predation on juvenile salmon. The 2011 tests were conducted under high river flow conditions and may not reflect BAFF deterrence, protection, and overall efficiency when river flows and across-barrier velocities are lower.

It was concluded that BAFF operations reduced the entrainment of juvenile salmon from the Sacramento River into Georgiana Slough; therefore, it is expected that the BAFF would increase survival rates of juvenile salmon migrating downstream in the Sacramento River. Study results represent the response of juvenile Chinook salmon smolts and do not necessarily reflect the response of juvenile steelhead to BAFF operations. High flows in 2011 and testing limited to juvenile Chinook salmon support the recommendation that the BAFF undergo further testing in 2012 to reflect a range of river flow conditions and evaluate BAFF effects on both juvenile Chinook salmon and steelhead.

This page intentionally left blank.

5 RECOMMENDATIONS AND FUTURE DIRECTIONS

The 2011 GSNPB experimental evaluation concluded that the BAFF provided improved deterrence, protection, and overall efficiency during both night and day conditions, and at the categories of low and high (< and >0.25m/s) across-barrier velocities observed during the study period. These results are the same whether the BAFF's potentially compromised data are included or not.

The potential effects that BAFF operations may or may not have on predator fish behavior is not well understood. The data presented in this report does not specifically address questions related to predator behavior in the vicinity of the Georgiana Slough divergence with and without the barrier structure in place. Additional studies or analysis of existing predator behavior data should be conducted to better understand and evaluate the potential relationship between the barrier structure, BAFF operations, and predator behavior. Specifically, further analysis and possibly additional data collection is required to understand if the BAFF changes predatory fish densities or predation efficiency.

It is recommended that an additional deployment be conducted in 2012 as part of the continuing evaluation of the BAFF effectiveness at deterring juvenile salmon from entering Georgiana Slough and to better understand the influence of the BAFF on predator behavior. Additional tests under a range of hydrologic conditions in the Sacramento River, including lower river discharges compared to 2011, will further benefit the evaluation of BAFF operations and other factors such as predation on juvenile Chinook salmon. Further investigations should also be conducted regarding the biological significance of improved guidance on the overall survival and population dynamics of various Chinook salmon metapopulations including winter-run, spring-run, fall-run, and late fall-run salmon. Extending the study to include steelhead would also be desirable. One potential analytical method that could be used to assess the biological benefits of BAFF operations on salmon survival and abundance would be the use of the Delta Passage Model (DPM) modified to account for overall protection efficiency of the BAFF at Georgiana Slough. Results of the DPM analyses could also be used in context with lifecycle population models of Sacramento River salmon populations (IOS and OBAN) to assess potential population-level benefits of improved juvenile salmon survival on subsequent ocean abundance and escapement of adult salmon.

It is recommended that an Individual-Based Model (IBM) that predicts deterrence efficiency be developed. An IBM would allow a mechanistic understanding of the deterrence at the Georgiana Slough BAFF. The IBM preferably should be validated at another site before it is applied at Georgiana Slough. A validation at another site with late-fall run Chinook salmon would allow the fish behavioral decision rules to be tested independently and would provide a more rigorous and reliable approach. A validated IBM could be used to assess the likely deterrence efficiency of a BAFF deployment at Turner Cut or Columbia Cut in the Delta. An IBM analysis could identify locations where deterrence efficiency might be expected to be low, and an IBM analysis could be conducted at a fraction of the cost of a field deployment. Therefore, IBM development represents a very efficient economical approach to evaluation of the BAFF at other locations in the Delta.

Lifecycle population, DPM, and IBM modeling could be used to assess the effectiveness of BAFF operations on reducing the risk of incidental take of juvenile salmonids at the south Delta export facilities. Modeling would also allow an assessment of the BAFF's contributions to increasing juvenile salmon survival during emigration from the Sacramento River, and the population benefits of improved guidance and reduced mortality on juvenile salmon. Finally, modeling could determine if the BAFF might contribute, and to what extent, to increased adult abundance and species protection.

This page intentionally left blank.

6 REFERENCES

- Adams, N. S., D. W. Rondorf, S. D. Evans, and J. E. Kelly. 1998. Effects of Surgically and Gastrically Implanted Radio Transmitters on Growth and Feeding Behavior of Juvenile Chinook Salmon. *Transactions of the American Fisheries Society* 127:128–136.
- Anderson, J. J., K. J. Puckett, and R. S. Nemeth. 1988. *Studies on the Effect of Behavior on Fish Guidance Efficiency at Rocky Reach Dam: Avoidance to Strobe Light and Other Stimuli*. Final Report for Chelan County Public Utility District No. 1. Fisheries Research Institute FRI-UW-8801. Seattle: University of Washington.
- Beamish, F. W. H. 1978. Swimming Capacity. In *Fish Physiology*, Volume VII, ed. W. H. Hoar and D. J. Randall, 101–187. New York: Academic Press.
- Beaumont, William. Game & Wildlife Conservation Trust, Wareham, Dorset, United Kingdom. 2011—e-mail to Andy Turnpenny, Fish Guidance Systems, Southampton, Hampshire County, United Kingdom.
- Blake, A., and M. Horn. 2006. *Acoustic Tracking of Juvenile Chinook Salmon Movement in the Vicinity of Georgiana Slough, Sacramento River, California – 2003 Study Results*. Draft report. Sacramento, CA: U.S. Geological Survey.
- U.S. Bureau of Reclamation. 2008. Unpublished data. U.S. Bureau of Reclamation Laboratory Results. Denver, CO: Denver Hydraulic Laboratory.
- Bowen, M. D., S. Hiebert, C. Hueth, and V. Maisonneuve. 2009. *2009 Effectiveness of a Non-Physical Fish Barrier at the Divergence of the Old and San Joaquin Rivers (CA)*. Technical Memorandum 86-68290-09-05. Denver, CO: U.S. Bureau of Reclamation.
- Bowen, M. D., and R. Bark. 2010. *2010 Effectiveness of a Non-Physical Fish Barrier at the Divergence of the Old and San Joaquin Rivers (CA)*. Technical Memorandum 86-68290-10-07. Denver, CO: U.S. Bureau of Reclamation.
- Brandes, P. L., and J. S. McLain. 2001. Juvenile Chinook Salmon Abundance, Distribution, and Survival in the Sacramento–San Joaquin Estuary. In *Contributions to the Biology of Central Valley Salmonids*, Fish Bulletin 179, Volume 2, ed. R. L. Brown, 39–136. Sacramento: California Department of Fish and Game.
- Brett, J. R. 1952. Temperature Tolerance in Young Pacific Salmon, Genus *Oncorhynchus*. *Journal of the Fisheries Research Board of Canada* 9:265-323.
- California Department of Water Resources. 2011. California Data Exchange Center. Available online: <http://cdec.water.ca.gov/cgi-progs/iudir/WSIHIST>.
- California Irrigation Management Information System. 2011. Statewide Integrated Pest Management Program, 2011. California Weather Data for CIMIS Station 140, Twitchell Island. University of California, Department of Agriculture and Natural Resources. Davis, CA.

CIMIS. *See* California Irrigation Management Information System.

Coutant, C. C. 2001. Integrated, Multi-Sensory, Behavioral Guidance Systems for Fish Diversions. In *Behavioral Technologies for Fish Guidance*, ed. C. C. Coutant, 105–114. American Fisheries Society, Symposium 26, Bethesda, MD.

DWR. *See* California Department of Water Resources.

Ehrenberg, J. E., and T. W. Steig. 2003. Improved Techniques for Studying the Temporal and Spatial Behavior of Fish in a Fixed Location. *ICES Journal of Marine Science* 60:700–706.

Hanson, C. H. 2009. *Striped Bass Predation on Listed Fish within the Bay Delta Estuary and Tributary Rivers*. Expert report in *Coalition for a Sustainable Delta et al. v. McCamman*.

Horn, M. J., and A. Blake. 2004 (February). *Acoustic Tracking of Juvenile Chinook Salmon Movement in the Vicinity of the Delta Cross Channel. 2001 Study Results*. USBR Technical Memorandum No. 8220-04-04. Denver, CO: Technical Service Center.

Hosmer, D. W., and S. Lemeshow. 2000. *Applied Logistic Regression*. New York: John Wiley and Sons.

Lady, J. M., P. Westhagen, and J. R. Skalski. 2008. *USER 4: User Specified Estimation Routine*. School of Aquatic and Fishery Sciences, University of Washington.
Available: <http://www.cbr.washington.edu/paramest/user/>.

Liedtke, T. L., and A. M. Wargo-Rub. In press. Techniques for Telemetry Transmitter Attachment and Evaluation of transmitter Effects on Fish Performance. In *Telemetry Techniques*, ed. N. Adams, J. Beeman, and J. Eiler. Bethesda, MD: American Fisheries Society.

Martinelli, T. L., H. C. Hansel, and R. S. Shively. 1998. Growth and Physiological Responses to Surgical and Gastric Radio Transmitter Implantation Techniques in Subyearling Chinook Salmon (*Oncorhynchus tshawytscha*). *Hydrobiologia* 371/372:79–87.

National Marine Fisheries Service. 2009 (June 4). *Biological Opinion and Conference Opinion on the Long-Term Operations of the Central Valley Project and State Water Project*. Long Beach, CA: Southwest Regional Office.

NMFS. *See* National Marine Fisheries Service.

Nobriga, M. L., and F. Feyrer. 2007. Shallow-Water Piscivore-Prey Dynamics in California's Sacramento–San Joaquin Delta. *San Francisco Estuary and Watershed Science* 5(2): Article 4.

Perry, R. W. 2010. *Survival and Migration Dynamics of Juvenile Chinook Salmon (Oncorhynchus tshawytscha) in the Sacramento–San Joaquin River Delta*. Ph.D. dissertation. University of Washington. Seattle, WA.

- Perry, R.W., J.R. Skalski, P.L. Brandes, P.T. Sandstrom, A.P. Klimley, A. Ammann & B. MacFarlane. 2010. Estimating Survival and Migration Route Probabilities of Juvenile Chinook Salmon in the Sacramento-San Joaquin River Delta. *North American Journal of Fisheries Management* 30: 142-156.
- Plumb, J.M., N.S. Adams, and D.W. Rondorf. 1999. *Behavior of juvenile Chinook salmon and steelhead relative to the log boom at Lower Granite Dam*. U.S. Army Corps of Engineers, Portland, OR.
- R Development Core Team. 2011. R: A Language and Environment for Statistical Computing. R Foundation for Statistical Computing. Vienna, Austria.
- Rainey, W. S. 1985. *Considerations in the Design of Juvenile Bypass Systems*. In Proceedings of the Symposium on Small Hydropower and Fisheries, May 1–3, 1985, Aurora, CO, 261–268. Bethesda, MD: American Fisheries Society.
- San Luis & Delta-Mendota Water Authority and C. H. Hanson. 1996 (May). *Georgiana Slough Acoustic Barrier Applied Research Project: Results of 1994 Phase II Field Tests*. Technical Report 44. Interagency Ecological Program for the San Francisco Bay/Delta Estuary. Prepared for California Department of Water Resources and U.S. Bureau of Reclamation.
- Skalski, J. R., R. Townsend, J. Lady, A. E. Giorgi, J. R. Stevenson, and R. D. McDonald. 2002. Estimating Route-Specific Passage and Survival Probabilities at a Hydroelectric Project from Smolt Radiotelemetry Studies. *Canadian Journal of Fisheries and Aquatic Sciences* 59:1385–1393.
- SLDMWA and Hanson. See San Luis & Delta-Mendota Water Authority and C. H. Hanson.
- Swanson, C., P. S. Young, and J. J. Cech, Jr. 2004. Swimming in Two-Vector Flows: Performance and Behavior of Juvenile Chinook Salmon Near a Simulated Screened Water Diversion. *Transactions of the American Fisheries Society* 133:265–278.
- Turnpenny, A. W. H., and N. O'Keeffe. 2005. *Screening for Intake and Outfalls: A Best Practice Guide*. Science Report SC030231. Environment Agency (UK). Bristol, UK.
- Vogel, D.A. and K.R. Marine. 1991. *Central Valley Project: Guide to upper Sacramento River Chinook salmon life history*. Prepared for U.S. Bureau of Reclamation. Prepared by CH2M HILL. Redding, CA.
- Ward, E. J. 2008. A Review and Comparison of Four Commonly Used Bayesian and Maximum Likelihood Model Selection Tools. *Ecological Modeling* 211:1–10.
- Webb, M. 2011. *Rangitata Diversion Race Bio-Acoustic Fish Fence Progress Report, 2010/11 Season*. Central South Island Fish and Game Report. Temuka, NZ.
- Welton, J. S., W. R. C. Beaumont, and R. T. Clarke. 2002. The Efficacy of Air, Sound and Acoustic Bubble Screens in Deflecting Atlantic Salmon, *Salmo salar* L., Smolts in the River Frome, UK. *Fisheries Management and Ecology* 9:11–18.

This page intentionally left blank.

APPENDIX A

2011 GSNPB Acoustic Tag System Data Collection Plan



2011 GEORGIANA SLOUGH NON-PHYSICAL BARRIER STUDY
ACOUSTIC TAG SYSTEM DATA COLLECTION

Draft Final Report

HTI Project 3129

Prepared for

California Department of Water Resources
1416 Ninth St, Room 252-35
P.O. Box 942836
Sacramento, CA 94236-0001

Prepared by

Hydroacoustic Technology, Inc.
715 NE Northlake Way
Seattle, WA 98105
(206) 633-3383
consulting@htisonar.com

September 30, 2011

TABLE OF CONTENTS

	<u>page</u>
1.0 INTRODUCTION	1
1.1 Study Area Description	1
2.0 Objectives.....	5
3.0 METHODS.....	5
3.1 Acoustic Tag System Overview.....	5
3.2 System Components	5
3.3 System Deployment and Array Design	12
3.4 Data Collection/Back-up Procedures	18
3.5 System Testing Procedures	19
4.0 REFERENCES	23
Appendix A Hydrophone number, location, depth, mount type and time and date deployed at the GSNPB, 2011.	A1
Appendix B Summary of Releases during the GSNPB Study, 2011.....	B1
Appendix C Release sheets for each tag release during the GSNPB Study, 2011.....	C1
Appendix D GSNPB operation during Spring 2011.....	D1
Appendix E Response to Comments from DWR	E1

LIST OF FIGURES

	<u>page</u>
Figure 1. Location of Non-Physical Barrier (NPB) installed in the Sacramento River at the divergence of the Georgiana Slough, 2011 (From: California Department of Water Resources. 2011).....	2
Figure 2. Basic components of the Non-Physical Barrier (NPB) installed at Georgiana Slough, 2011. (Adapted from Bowen and Bark 2010).....	3
Figure 3. Schematic of components of the NBP installed on frame and attached to piling (From: California Department of Water Resources, 2011).....	4
Figure 4. Pulse-rate interval also referred to as the “Tag Period” or “ping” rate is the interval between each tag transmission.	6
Figure 5. Tag Pulse Length is the amount of time the tag transmits its pulse. The interval between transmissions is the tag period.	6
Figure 6. Example graphic from the data collection program showing the primary (tag period) and secondary (subcode) transmit signal returns from a <i>Model 795 Acoustic Tag</i>	7
Figure 7. Acoustic Tag Receiver signal processing procedures.	9
Figure 8. An echogram of detected signals using time window 1100ms (vertical scale) shown in <i>MarkTags</i>	11
Figure 9. Positioning of an acoustic tag in three dimensions with a four-hydrophone array.....	11
Figure 10. Location of hydrophones as deployed at Georgiana Slough NPB 2011.....	13
Figure 11. Hydrophone cables ready for deployment.	14
Figure 12. Example of the “Pound In” mount used for deployment of hydrophones H2, H4, H11,, H13, H14, H15, and H19 at the GSNPB, 2011.....	15
Figure 13. Example of the “Tower” mount used for deployment of hydrophones H3, H5, H8, H10, H12, H16, H18 and H20 at the GSNPB, 2011.	16
Figure 14. Example of the “Dock” mount used for the Hydrophones H1, and H6 at the GSNPB, 2011.	17
Figure 15. Example of the modified railroad tie mounts used for the at the autonomous data logger sites upstream and downstream of the main hydrophone array at the GSNPB, 2011.	18
Figure 16. Results of a "ping-around" test in <i>MarkTags</i> program.	20
Figure 17. <i>MarkTags</i> marked signals (yellow) received from a transmitting hydrophone, included in the ping around analysis.	21

LIST OF TABLES

	<u>page</u>
Table 1. Acoustic tags used for the GSNPB study in 2011.....	6
Table 2. Acoustic tag subcodes used for Chinook and predators at GSNPB study, 2011.	7

1.0 INTRODUCTION

The Sacramento River Delta is a complex network of natural and man-made channels connecting the Sacramento River with San Francisco Bay (Nichols et al 1986). The decline of Chinook salmon (*Oncorhynchus tshawytscha*) stocks emigrating from its tributaries are likely attributable to the cumulative effect of a number of anthropogenic and natural changes in the Delta. Efforts to protect and restore salmon stocks are guided by scientific findings outlined in the June 2009, National Marine Fisheries Service (NMFS) Biological Opinion (BO) on the operation of the State Water Project (SWP) and Central Valley Project (CVP).

The NMFS BO recognized that operations at the CVP/SWP jeopardize populations of several federally listed species, including Chinook salmon. Recent studies have indicated that operations at the CVP/SWP can affect juvenile Chinook salmon migration rates, vulnerability to predation, feeding success growth rates and overall survival (Perry et al 2011). Studies using hydroacoustic sampling indicated that juvenile Chinook salmon migrating downstream in the Sacramento River have an increased potential for entering the interior Delta via the Georgiana Slough and other pathways. (Horn and Blake 2003). A solution to redirect migratory paths and/or redistribute river flow to limit the likelihood of entering Georgiana Slough was developed.

Based on preliminary results from studies of a non-physical barrier (NPB) installed to keep chinook salmon from entering the Old River (Bowen et al. 2009, Bowen and Bark 2010), a similar configuration to prevent emigrating juvenile salmonids from entering Georgiana Slough was installed. The Georgiana Slough Non-Physical Barrier (GSNPB) is intended to protect out-migrating salmon smolts by keeping them in the Sacramento River and preventing them from entering the central and south Delta with the goal of increasing the survival rate of salmon as they move through the Sacramento River to San Francisco Bay.

1.1 Study Area Description

Hydroacoustic Technology Inc. (HTI), in cooperation with AECOM and California Department of Water Resources (DWR), installed and monitored a fish tracking system at the NPB located in the Sacramento River at the divergence of the Georgiana Slough near the town of Walnut Grove, CA (Figure 1). The GSNPB was similar to one installed previously at Old River in 2010 (Bowen and Bark, 2010). Designed by Fish Guidance Systems and also called the "Bio-Acoustic Fish Fence", it is an alternative to a solid barrier that allows free flow of water and does not obstruct boat traffic (Fish Guidance Systems). The GSNPB components included sound projectors, an air bubble curtain, and strobe lights (Figure 2). The air bubble curtain constrains the sound signal to create a more well defined sound source that was used to guide fish (Fish Guidance Systems). The GSNPB was attached to pilings and installation completed by March 14, 2011 (Figure 3).

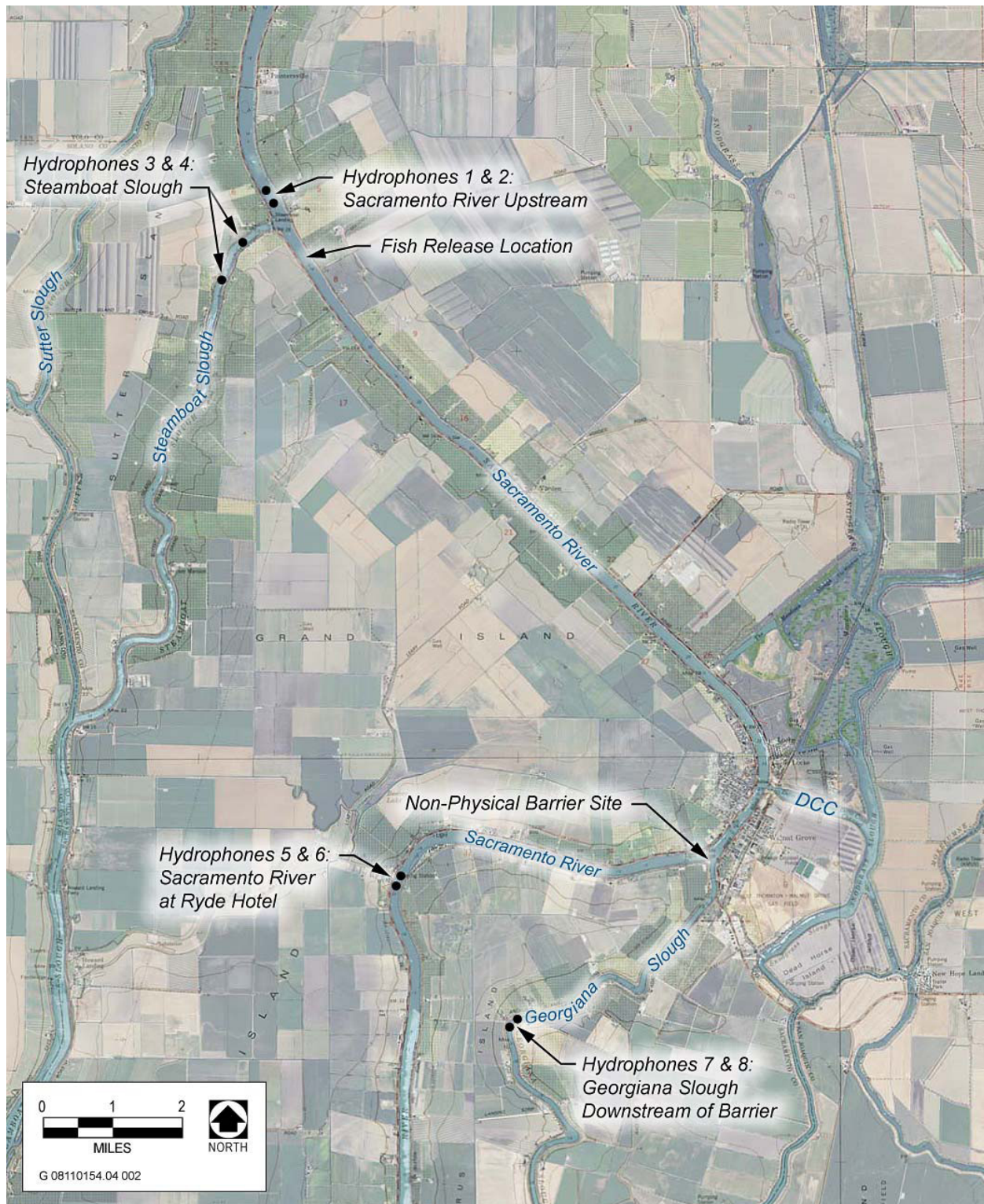

Figure 1. Location of Non-Physical Barrier (NPB) installed in the Sacramento River at the divergence of the Georgiana Slough, 2011 (From: California Department of Water Resources. 2011).

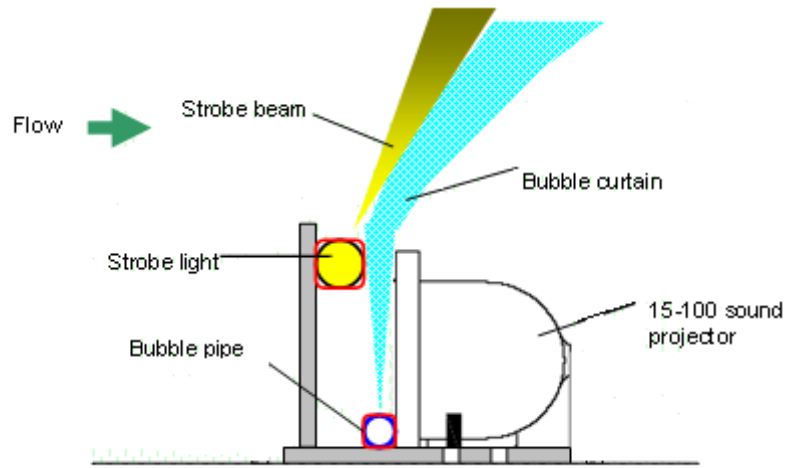
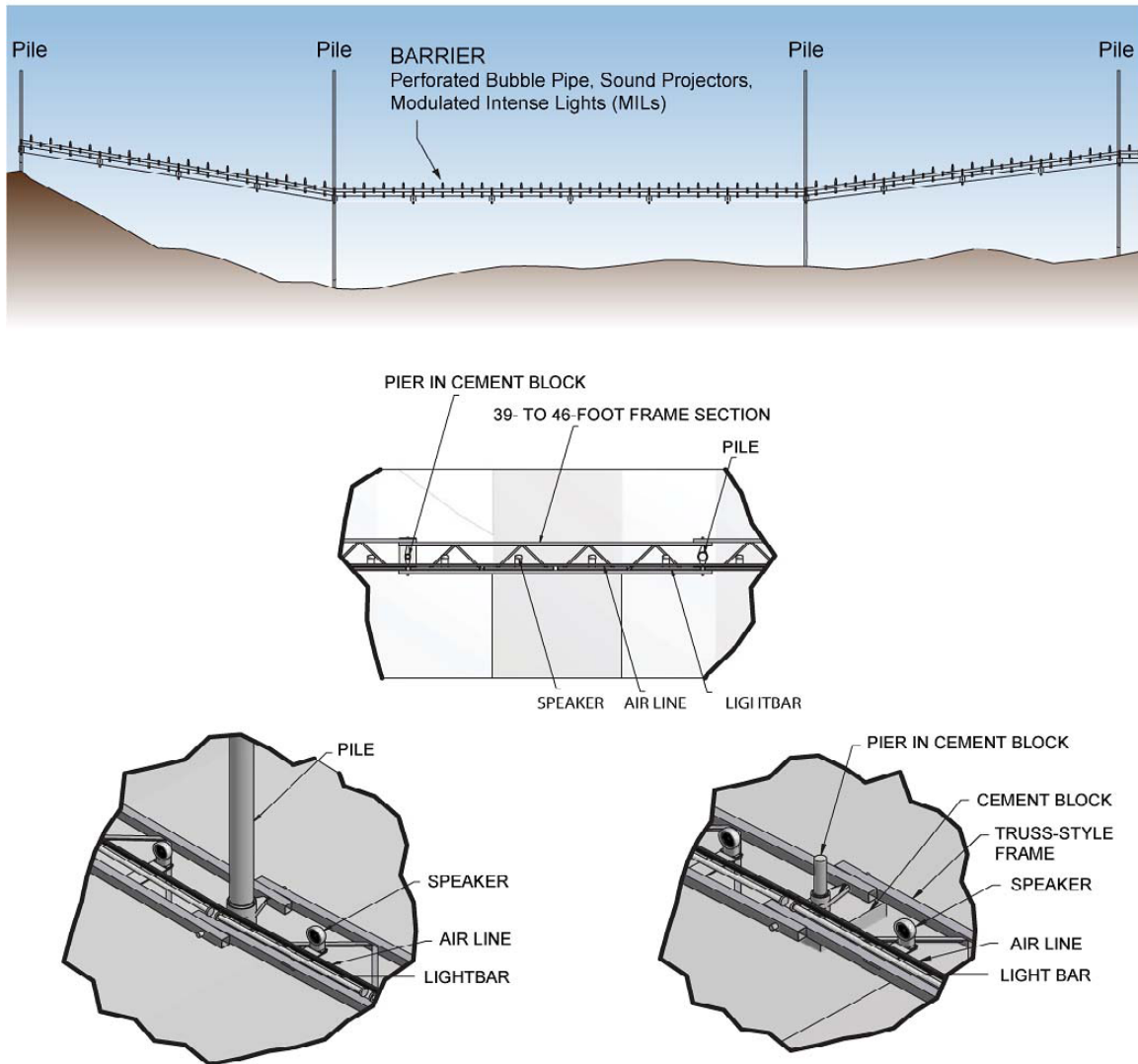

Figure 2. Basic components of the Non-Physical Barrier (NPB) installed at Georgiana Slough, 2011. (Adapted from Bowen and Bark 2010).



G 09110154.04 004

Figure 3. Schematic of components of the NBP installed on frame and attached to piling (From: California Department of Water Resources, 2011).

2.0 OBJECTIVES

The component of this project that comprises the acoustic tag system data collection have the following objectives:

- Documentation of release of 1,500 acoustically tagged late fall–run Chinook salmon into the Sacramento River
- Monitoring of acoustically tagged late fall-run Chinook during their downstream migration past the non-physical barrier and divergence with Georgiana Slough.

3.0 METHODS

3.1 Acoustic Tag System Overview

Acoustic tag tracking was performed using the system developed by Hydroacoustic Technology, Inc. (HTI), Seattle, Washington. The HTI Acoustic Tag Tracking System (ATS) uses a fixed array of underwater hydrophones to track movements of fish implanted with acoustic tags. As fish approached the study area, the transmitted signal from each tag was detected and the arrival time recorded at several hydrophones. The differences in tag signal arrival times at each hydrophone were used to calculate a three-dimensional position. The ATS includes the following hardware and software components:

- A tag programmer that activates and programs the tag.
- Acoustic tags each transmitting a pulse of sound at regular intervals.
- Hydrophones that function like underwater microphones, listening within a defined volume of water.
- Cables connecting hydrophones to tag receivers.
- Tag receivers connected to a computer that receives the tag signal from the hydrophones, conditions the signal and using specialized software, outputs the data into a format that can be stored in data files.

3.2 System Components

Acoustic Tags

All tags used in this study operated at 307 kHz frequency and were encapsulated with a non-reactive, inert, low toxicity resin compound. The tags utilized “pulse-rate encoding” which provided increased detection range, improved the signal-to-noise ratio and pulse-arrival resolution, and decreased position variability when compared to other types of acoustic tags (Ehrenberg and Steig 2003). Pulse-rate encoding uses the interval between each transmission to detect and identify the tag (Figure 4). Each tag was programmed with a unique pulse-rate to track movements of individual tagged fish.

The pulse-rate is measured from the leading edge of one pulse to the leading edge of the next pulse in sequence. By using slightly different pulse-rates, tags can be individually identified. The timing of the start of each transmission is precisely controlled by a microprocessor within the tag. Each tag was programmed to have its own tag period to uniquely identify between tags. Test tag periods ranged between 2.003-3.474 s with beacon tag intervals of 9.997-10.263 s. The amount of time that the tag actively transmits is the pulse length (or pulse duration) (Figure 5). For this study, the transmit pulse length was 3.0 ms.

Table 1. Acoustic tags used for the GSNPB study in 2011.

Model Number	Diameter (mm)	Length (mm)	Weight in Air (gm)	Used for sampling
795Lm	6.8	16.5	0.65	Juvenile Chinook
795LE	9.0	21	1.5	Predator
795G	11	25	4.5	Predator

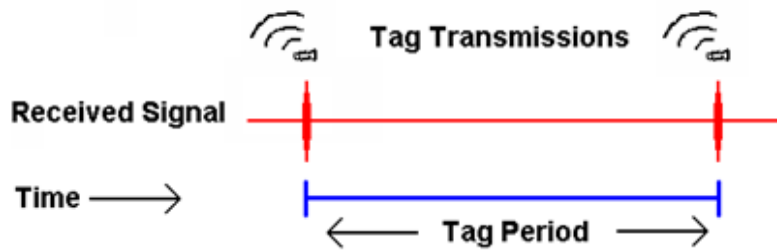

Figure 4. Pulse-rate interval also referred to as the “Tag Period” or “ping” rate is the interval between each tag transmission.

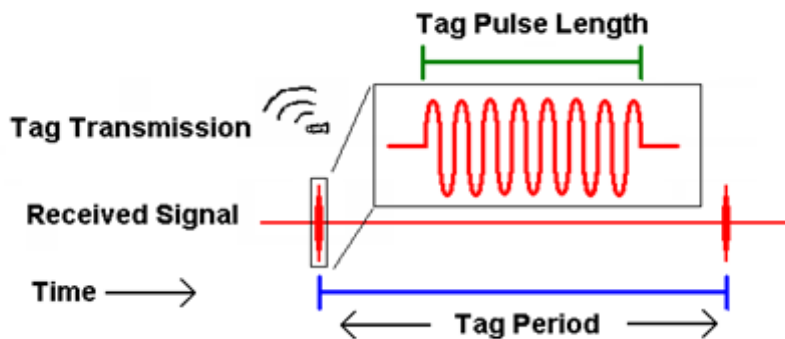

Figure 5. Tag Pulse Length is the amount of time the tag transmits its pulse. The interval between transmissions is the tag period.

In addition to the tag period, the HTI tag double-pulse mode or “subcode” option can be used to increase the number of unique tag ID codes available. Using this tag coding option, each tag is programmed with a defined primary tag period, and also with a defined secondary transmit signal, called the subcode. This subcode defines a precise elapsed time period between the primary and secondary tag transmissions (Figure 6). There are 31 different subcodes possible for each tag period, resulting in over 100,000 total unique tag ID codes. There were eleven subcodes used for the GSNPB study in 2011 (Table 2).

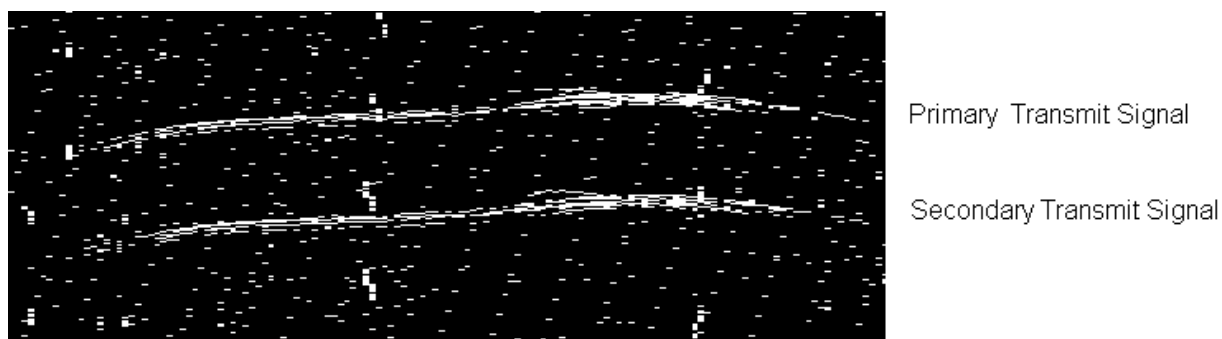

Figure 6. Example graphic from the data collection program showing the primary (tag period) and secondary (subcode) transmit signal returns from a *Model 795 Acoustic Tag*.

Table 2. Acoustic tag subcodes used for Chinook and predators at GSNPB study, 2011.

Subcodes	Release	Start date	End date
9	GS001-GS040	3/16 0900h	3/21 0600h
30	GS041-GS080	3/21 0900h	3/26 0600h
14	GS0081-GS108	3/26 0900h	4/17 0600h
23	GS109-GS132	4/17 0900h	4/20 0600h
17	GS133-GS156	4/20 0900h	4/23 0600h
27	GS157-GS188	4/23 0900h	4/27 0600h
3	GS189-GS228	4/27 0900h	5/2 0600h
5	GS229-GS268	5/2 0900h	5/7 0600h
25	GS269-GS300	5/7 0900h	5/11 0600h
19	GS301-GS336	5/11 0900h	5/15 1800h
21	Predators		

Hydrophones

A total of twenty-eight hydrophones were installed for this study and several more were used for pre-release tag testing operations. The *Model 590* hydrophones operate at 307 kHz and include a low-noise preamplifier and temperature sensor. Hydrophone directional coverage was approximately 330 degrees, with equivalent sensitivity in all directions except for a 30 degree limited sensitivity cone directly behind the hydrophone where the cable is attached. The hydrophone sensor element tip is encapsulated in specially treated rubber to ensure long term reliability with acoustic impedance close to that of water. The hydrophone and connector housing are made of corrosion resistant aluminum-bronze alloy. Cables were

twisted pair wire and double shielded for noise reduction. Individual cable lengths ranged from 50 ft to 500 ft.

The hydrophone preamplifier circuit provides signal conditioning and background noise filtering for transmission over long cable lengths and in acoustically noisy environments. A calibration circuit in the preamplifier provides a method for field testing hydrophone operation and is used to measure the signal time delays between hydrophones in the array. The *Model 590* hydrophones include temperature sensors to measure water temperature variations and its affect on the velocity of the signal in water.

To measure signal time delays, the calibration circuit for each hydrophone is set to transmit ("ping") while all other hydrophones are set to receive. This procedure is repeated for all hydrophones in the array. Data from each hydrophone are processed to measure the time delay and water temperature from each hydrophone. Accurate measurement of signal time delays between hydrophones will provide the position data to locate the array in UTM or Lat/Lon coordinates and provides the resolution necessary for sub-meter three-dimensional positioning.

Acoustic Tag Receiver

Two HTI *Model 290 Acoustic Tag Receivers (ATR)* were used to monitor at the GSNPB. The ATR is designed to receive up to 16 separate channels; one channel is assigned to each hydrophone. Each ATR is connected to a personal computer used to analyze and store the acoustic data. The two ATR's were synchronized utilizing an internal GPS in each of the receivers. An individual raw data file is created for each sample hour. Filters in the acoustic tag receiver are set to identify the acoustic tag sound pulse and discriminate tags from the ambient background noise.

When the tag signal is received by the ATR, a series of signal processing steps are completed (Figure 7). The envelope detector receives the signal and outputs the positive "envelope" with the carrier frequency removed. This detected echo envelope is then digitized at a rate of 12 kHz. A real-time adaptive noise threshold is set based on a 1 second window of the background noise level for each hydrophone independently which is updated every 0.083 msec. The pulse width of each pulse that exceeds a predetermined threshold is measured at the -3, -6, and -12 dB points and the pulse peak amplitude is located and measured.

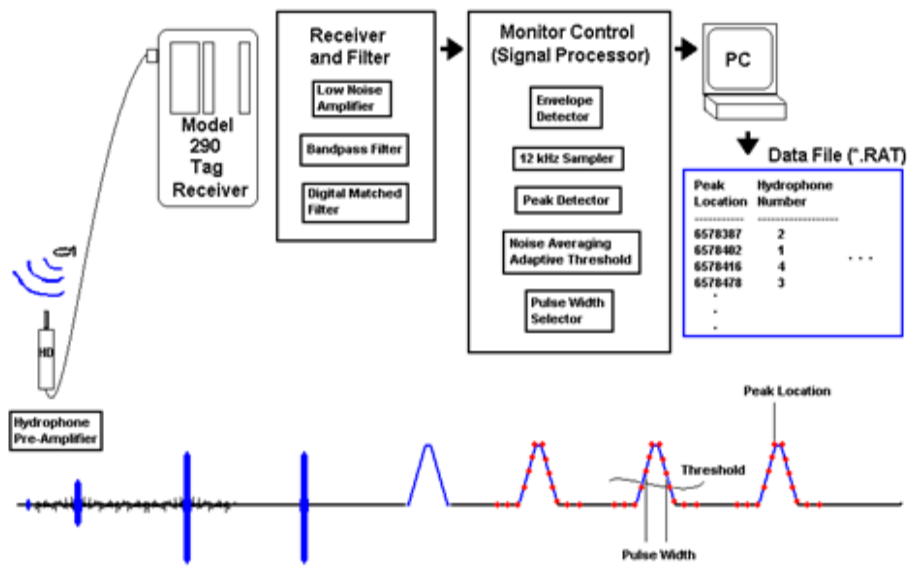

Figure 7. Acoustic Tag Receiver signal processing procedures.

The ATR pulse measurements are reported for each single echo from each hydrophone and written to Raw Acoustic Tag files (*.RAT) using the AcousticTag program. Each *.RAT file contains header information for data acquisition settings followed by the raw echo data. Each raw echo data file contains all acoustic signals detected during the time period, including signals from tagged fish as well as some additional unfiltered acoustic noise.

Software – MarkTags and AcousticTag

Two separate programs are used to process acoustic tag data; AcousticTag and MarkTags. AcousticTag is used initially to both acquire data from the ATR and store it in raw acoustic echoes files. MarkTags reads the raw acoustic echo files, identifies tag signals and create acoustic tag files. These acoustic tag files are used again in AcousticTag to position the tags in three-dimensional space.

AcousticTag acquires data and stores it in *.RAT files. It is important to note that these raw echoes are not associated with any specific Tag ID or spatial positioning. Depending on the project site and environmental conditions, many echoes found within these files are not tag data but derived from secondary sources (i.e. ambient noise, multipath). Thus, the first important phase of post processing is to select the acoustic echoes that have been received directly from tags, and to assign the unique Tag ID to these echoes.

The echo selection process is completed in the MarkTags program (Figure 8). The procedure for isolating the signals from a given tag follows from the method used for displaying the signals themselves. Each vertical scan in the plot shows the detected arrivals in the time window equal to the pulse-rate encoding of a particular tag (Ehrenberg and Steig 2003). In this example, only signals from the tag programmed with this 1100 ms period will fall along the straight line. The results of the tag selection process completed in MarkTags is written to tracked acoustic tag files (*.TAT file). These files contain the individual raw acoustic echoes which have been assigned a Tag ID but no spatial positioning has yet been assigned. AcousticTag performs the triangulation calculations and provides a database of point locations for each fish.

Tag Programmer

The TagProgrammer application sets the individual settings when programming a tag.

Hydrophone Placement Geometry and Position Calculation

Detection on one hydrophone confirms the presence of an acoustic tag, but to be accurately positioned in three-dimensions a tag must be detected on at least four hydrophones (Figure 9). Three-dimensional tag coordinates with sub-meter accuracy are achieved using hydrophones located in known positions, at different vertical planes and within direct line of sight of the tag. As an acoustic tag passed through the four beams, the difference in the arrival time of each pulse was used to triangulate the exact location of the tag. In this way, a swimming path for each tagged fish could be mapped and presented in a three-dimensional display.

The principle that is used for determining acoustic tag positions is the same principle that accurately determines positions using the Global Position Satellites (GPS). The acoustic tag transmits a signal which is received by at least four hydrophones. By knowing the positions of the four hydrophones and measuring the relative signal arrival times at the hydrophones, the locations of the tagged fish can be estimated. In particular, if h_{ix}, h_{iy}, h_{iz} specify the x,y,z location of the i^{th} hydrophone and let F_x, F_y, F_z specify the unknown x,y,z locations of the tagged fish.

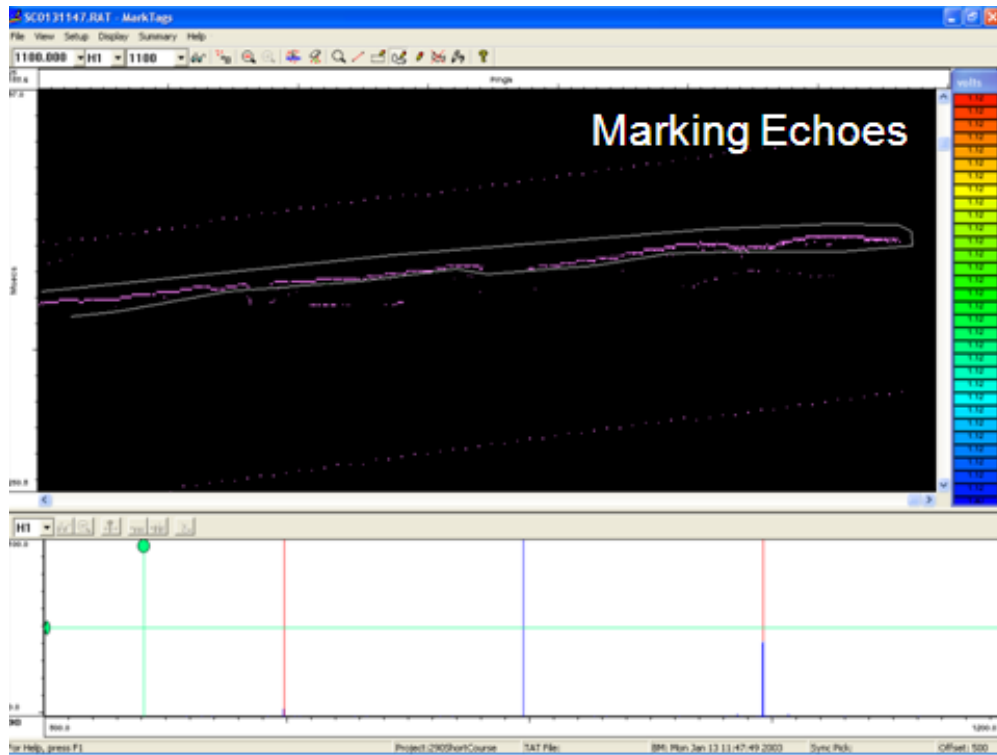

Figure 8. An echogram of detected signals using time window 1100ms (vertical scale) shown in MarkTags.

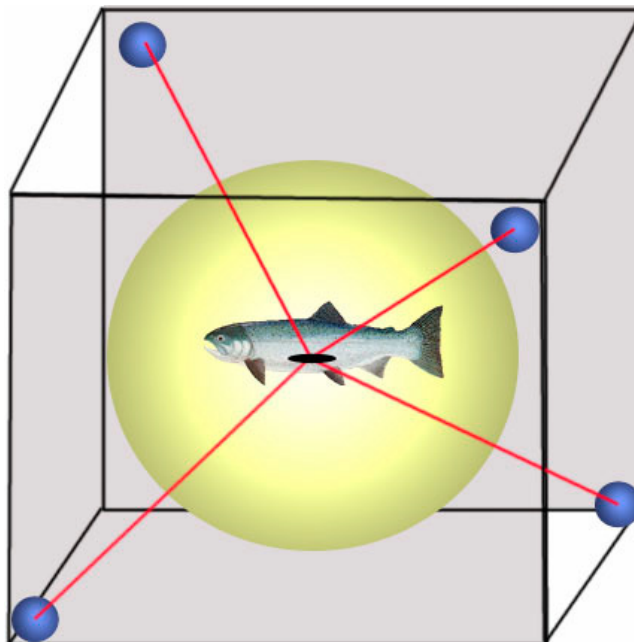

Figure 9. Positioning of an acoustic tag in three dimensions with a four-hydrophone array.

Then the travel time from the tagged fish to the i^{th} hydrophone, t_i is given by

$$t_i = \frac{1}{c} \sqrt{(h_{ix} - F_x)^2 + (h_{iy} - F_y)^2 + (h_{iz} - F_z)^2}$$

where c is the velocity of sound. Unfortunately the absolute travel time cannot be directly measured. However the differences between the arrival times of the signal at the various hydrophones ($t_i - t_j$) can be measured as given by

$$t_i - t_j = \frac{1}{c} \left[\sqrt{(h_{ix} - F_x)^2 + (h_{iy} - F_y)^2 + (h_{iz} - F_z)^2} - \sqrt{(h_{jx} - F_x)^2 + (h_{jy} - F_y)^2 + (h_{jz} - F_z)^2} \right]$$

For four hydrophones, there are three such distinct signal arrival time difference equations. The system of nonlinear equations is determined by solving the tagged fish coordinates, F_x, F_y, F_z such that the mean squared difference between the measured (left side of the equation above) and calculated time differences (right side of the equation above) are minimized.

3.3 System Deployment and Array Design

A twenty node array of hydrophones was installed at the non-physical barrier site (Figure 10). Eight additional hydrophones were installed upstream and downstream of the non-physical barrier site. The four upstream hydrophones included two hydrophones in Steamboat Slough and two in the Sacramento River above the divergence of Steamboat Slough. The four downstream hydrophones included two hydrophones in the Sacramento River near the Ryde Hotel and two in Georgiana Slough downstream of the barrier (see Figure 1). The installation of all hydrophones at the GSNPB site was completed by March 12, 2011. Hydrophones were positioned to assure optimal coverage as fish passed through the vicinity of the GSNPB.

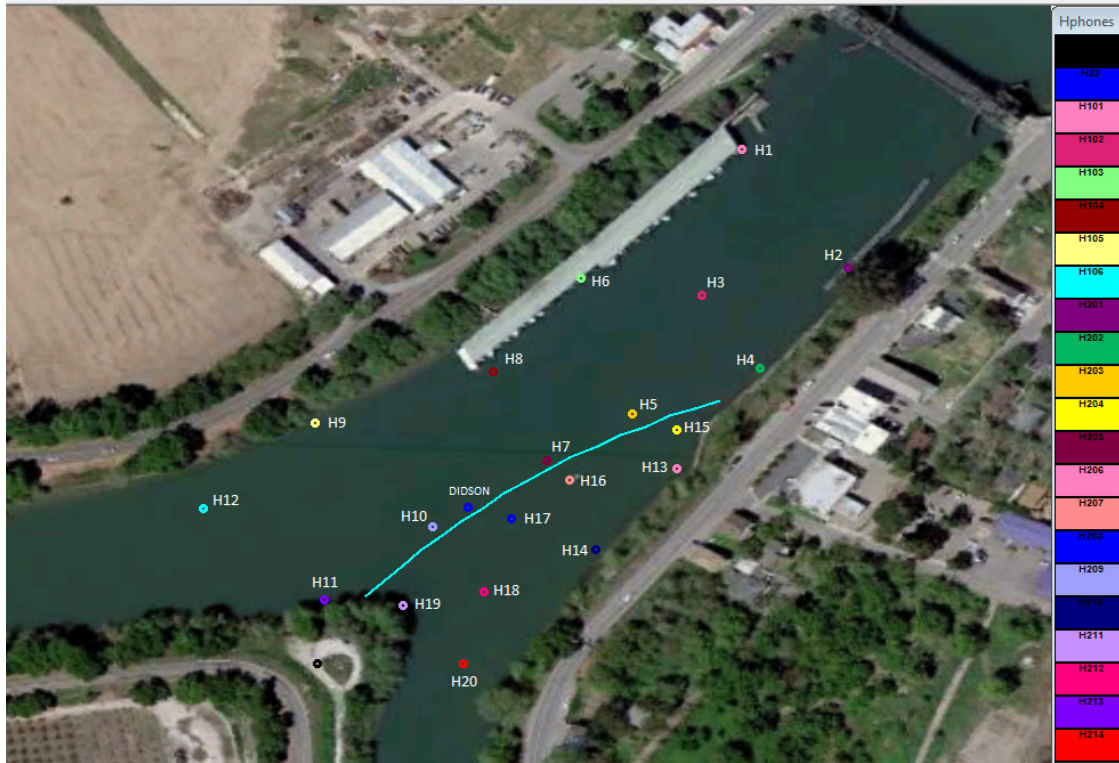

Figure 10. Location of hydrophones as deployed at Georgiana Slough NPB 2011.

Deployment Overview

HTI in coordination with DWR, USGS, USBR and Normandeau Associates Environmental Consultants (NAEC) completed system deployment and testing in February and March 2011. All equipment was bench tested and calibrated prior to installation. Hydrophones were deployed and cables were routed to the electronic equipment housed in secure, climate-controlled structures supplied with 110 VAC power located on either shore of the Sacramento River near the divergence of Georgiana Slough.

The *Model 590 Hydrophones* were positioned to detect tagged fish at the GSNPB. A total of twenty hydrophones were installed in the vicinity of the non-physical barrier, twelve hydrophones positioned on the Sacramento River side of the GSNPB and eight hydrophones positioned downstream of the GSNPB on the Georgiana Slough side of the GSNPB with hydrophone depths ranging from elevation -8.091m to 1.572m (Figure 10 and Appendix A). Individual hydrophone cables were paired with tensioned aircraft cable to increase cable stiffness and strength (Figure 11).

The additional eight hydrophones positioned to detect tagged fish outside of the area of the non-physical barrier were installed during this same time period. Each of these hydrophones were combined with autonomous data loggers and were operated independently using air card modems for communication access and remote data downloading. These sites were operated and maintained by USGS personnel.



Figure 11. Hydrophone cables ready for deployment.

Hydrophones were deployed adjacent to the GSNPB using several types of mounting brackets (Figures 12-15). The “pound in” type mounts were used for mounting hydrophones near shore at locations H2, H4, H11, H13, H14, H15, and H19 (see Appendix A and Figures 10 and 12). The “Tower” mounts were heavier large river mounts used to minimize hydrophone movement after positioning. The “Tower” mounts were used for mounting hydrophones H3, H5, H8, H10, H12, H16, H18 and H20 (see Appendix A and Figures 10 and 13). The “dock” mounts were used and attached to underwater structures where available (Figure 14). Mounts fabricated with railroad ties were not used in the array at the GSNPB but were used at the data logger sites located both up and downstream (see Figure 1) from the GSNPB (Figure 15). The precise location of hydrophones in the array was examined in-situ using the hydrophone placement geometry and position calculation procedure known as the “ping-around”. The effective range of detection and overlap of hydrophones in the array was also examined in-situ by actively moving a transmitting tag throughout the array and verifying consistent detection and positioning of the tag (termed the “tag drag” procedure). Both the “ping-around” and the “tag drag” procedures and results along with the analyzed data will be presented as part of the project final report.



Figure 12. Example of the “Pound In” mount used for deployment of hydrophones H2, H4, H11, H13, H14, H15, and H19 at the GSNPB, 2011.



Figure 13. Example of the "Tower" mount used for deployment of hydrophones H3, H5, H8, H10, H12, H16, H18 and H20 at the GSNPB, 2011.



Figure 14. Example of the “Dock” mount used for the Hydrophones H1, and H6 at the GSNPB, 2011.



Figure 15. Example of the modified railroad tie mounts used for the at the autonomous data logger sites upstream and downstream of the main hydrophone array at the GSNPB, 2011.

3.4 Data Collection/Back-up Procedures

Data collection for the acoustic tag tracking system at the GSNPB began March 16, 2011 at 0900 h. This system was maintained throughout the duration of the study. A summary of dates and times for each tag release is presented in Appendix B. Release sheets documenting each fish tag activation, programming, surgery, release parameters and additional comments for the duration of the study are also provided (Appendix C).

The tag coding and activation procedure was developed and maintained throughout the study for both chinook and predatory species. Tags were activated and programmed at the the staging area temporary office near the GSNPB. Tag activation and programming was conducted using the HTI *Model 490-LP Tag Programmer*. Tags were delivered within 8 hours of activation to the fish release barge. An experienced technician verified tag codes and operation prior to fish release.

Experienced technicians were on-site 24h/d throughout the duration of the study. Additionally, at least one HTI staff scientist was on-site for a minimum of 18h/d monitoring data acquisition and analysis activities. These staff scientists were in direct communication and worked under the supervision of a senior-level HTI scientist throughout the duration of the monitoring activities. In addition, the supervising senior-level HTI scientists were on-site no less than 8 hours in a 48-hour period during the field data collection period to review and participate in the ongoing data collection and processing efforts.

In addition to monitoring the acoustic tag tracking system at the GSNPB, HTI helped to maintain and troubleshoot the remotely operated peripheral hydrophone/data logger sites. Additional monitoring of the GSNPB operational parameters were completed each day it was operating. The GSNPB was operated

on an approximately 25h “on” and 25h “off” cycle (Appendix D). The GSNPB was shut down for the period March 27 through April 15 for repair.

Daily data acquisition activities included merging data files from the two acoustic tag receiver systems. A primary check through each merged hourly file to isolate and identify tag codes and subcodes was completed. Tags identified during this process were either manually tracked or auto-tracked depending on the noise levels present within the data file. The entire dataset was backed up daily to a pair of identical external hard drives on alternating days. The full data set was reviewed by experienced HTI data technicians, and this processed data set will serve as the basis for the final analyses presented in the Project Report.

3.5 System Testing Procedures

Each sampling site has its own unique characteristics that affect underwater sound propagation. These characteristics include acoustic noise interference, underwater structures, floating debris, water density differences and bathymetry, among others. This section describes the testing procedures including ambient noise measurements, hydrophone placement and positioning using the “ping-around” and in-situ tag testing (the “tag drag”). Tests conducted to measure the precise location of hydrophones in the array were completed throughout the monitoring period at the GSNPB. In addition “tag drag” tests to measure the effective range of detection and overlap of hydrophones in the array were also completed. Both the “ping-around” and the “tag drag” results will be reported with the analyzed tag tracking data in the final report.

Ambient Noise Measurement

Quantifying the acoustic noise interference provides the basis for setting the individual hydrophone receiver gains to maximize detection ranges without impacting individual fish detectability. This is an iterative process, involving recording and evaluating the amplitude of background noise levels under a series of amplification steps. The objective of this evaluation is to set the receiver gain to the lowest value that achieves total coverage over the sampling array, yet minimizes echoes from background noise. At the conclusion of these measurements, the acoustic tag receiver gains were set to the appropriate levels.

Periodic evaluations of background noise and system gain settings continued throughout the study period, based on ongoing review of the data files. If the environmental conditions at the site changed, system gain adjustments were made to optimize sampling coverage and resolution. Other acoustic monitoring devices located in the immediate vicinity, such as Acoustic Doppler Current Profilers (ADCP's) and the operation of other systems can create underwater noise.

Hydrophone Placement Geometry and Positioning

The accuracy of each tagged fish position depends on accurate estimation of the location of the hydrophones in the array. To describe the hydrophone locations in two-dimensional space a Cartesian coordinate system (X, Y) with equivalent units of distance in each plane is used. Latitude and longitude measurements are based on a polar coordinate system and the units of distance are not equivalent in the X and Y planes (except at the equator). The most convenient coordinate system to use for acoustic tag monitoring applications is the UTM grid system (Universal Transverse Mercator), which expresses the X and Y coordinates in meters. The UTM grid system is also supported and used in most GIS systems. For these reasons, all hydrophone locations are referenced using UTM coordinates. Determining hydrophone locations is a two step process that begins with measuring hydrophone GPS coordinates and then using hydrophone generated signal delays to improve the accuracy of those original measurements.

A high-quality GPS supplied by DWR was used to measure the UTM coordinates for each hydrophone in the array. The X, Y coordinates were expressed in meters and located on a standardized UTM grid.

Several measurements were made for each hydrophone deployment and the mean value defined the location during the initial installation (see Appendix A). The absolute UTM coordinate positions for each hydrophone were verified and further refined using the “ping-around” technique.

The “ping-around” procedure was used to measure absolute hydrophone locations at the GSNPB. During the ping-around test, the calibration circuit in one hydrophone is enabled to transmit a series of “pings” in the same way that an acoustic tag “pings”. While one hydrophone “pings” or transmits, all other hydrophones are receiving (Figure 16). The time difference between the transmit signal on one hydrophone and the signal arrival at each of the other hydrophones is a measure of the signal time delay between the transmitting and receiving pair of hydrophones. This procedure is repeated in an iterative process for all hydrophones in the array, providing multiple signal time delay measurements between each pair of hydrophones under the same environmental conditions.

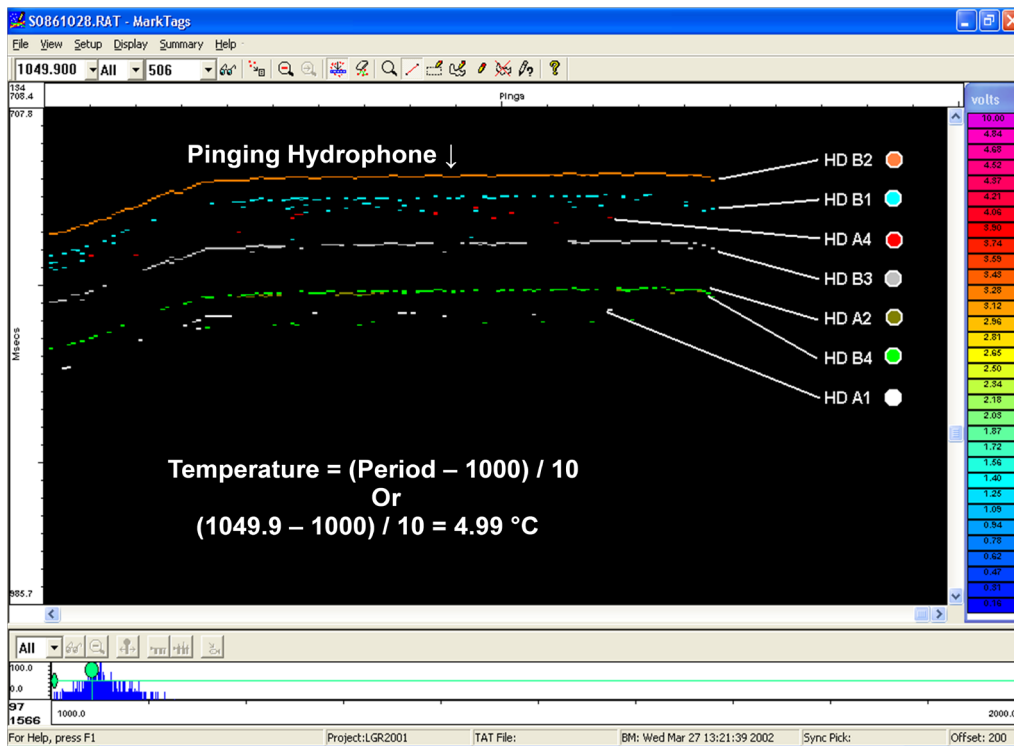

Figure 16. Results of a "ping-around" test in *MarkTags* program.

The *AcousticTag* program collected ping-around data automatically each week for the GSNPB array. The raw acoustic data file (*.RAT) are manually marked using the *MarkTags* program. Data from each hydrophone is analyzed to measure the water temperature and the signal time delays. For each pinging hydrophone, only the set of linear returns indicating constant temperature are marked and included for analysis (Figure 17).

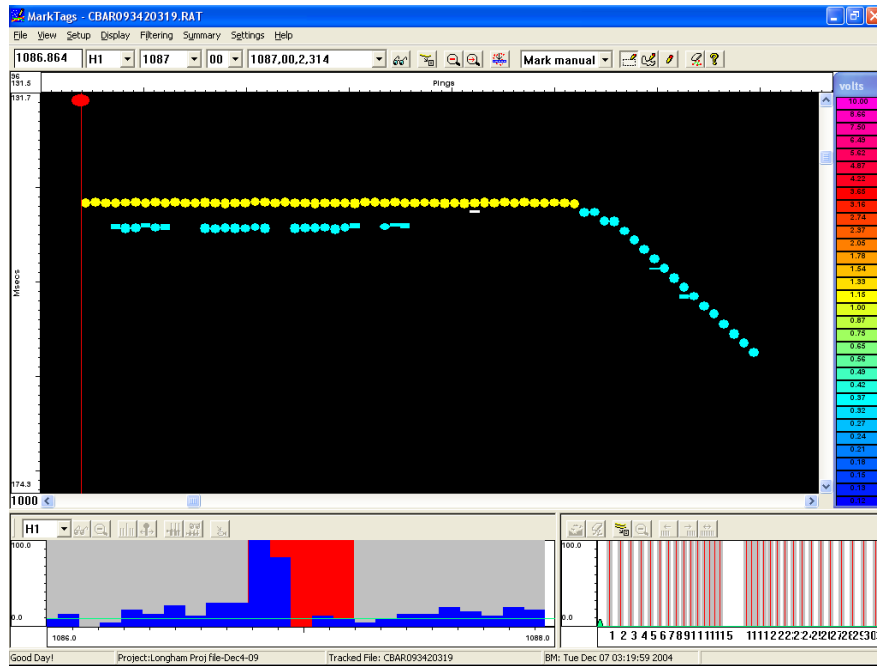

Figure 17. *MarkTags* marked signals (yellow) received from a transmitting hydrophone, included in the ping around analysis.

The location of each hydrophone is calculated by minimizing the mean squared differences between the GPS measurements and the temperature-corrected signal delays. Comparison of hydrophone positions measured by GPS and modified by the “ping-around” position adjustments will be completed and presented with the analyzed tag data in the final project report.

In-Situ Tag Testing

The size and shape of the overall detection area is affected by the interaction of the hydrophone directivity, tag signal characteristics, and the surrounding environment. Factors affecting hydrophone signal detection include hydrophone receiver gain, directivity pattern, spacing, and array geometry (spatial relationship of hydrophones). Factors affecting the energy transmitted by the tags include the programmed tag pulse width and the source level. Environmental factors that can affect tag detection range and resolution include ambient background acoustic noise levels, large amounts of entrained air, and bathymetric variability that blocks line of sight signal transmission between hydrophones. Determination of the optimum acoustic tag sampling parameters for a given site is an iterative process that considers all of these factors.

The extent of the hydrophone array detection area and the ability to accurately position tagged fish within it was examined using in-situ test tags collected during sampling. This process involved transiting the sample area with a deployed transmitting tag, called the “tag drag” procedure. As the name implies, one or more active acoustic tags were located and moved within and beyond the hydrophone array. A GPS

unit on the boat was used to log vessel position over time. The acoustic tag system data files were reviewed to verify the ability to obtain consistent tag returns on three or more hydrophones over the areas surrounding the GSNPB, verifying the desired overlap of individual hydrophone detection areas and overall system performance before the study period.

4.0 REFERENCES

- Adams N. S., D. W. Rondorf, S. D. Evans, and J. E. Kelly. 1998a. Effects of surgically and gastrically implanted radio transmitters on growth and feeding behavior of juvenile Chinook salmon. *Trans. Am. Fish. Soc.* 127:128-136.
- Bowen, M.D. and R. Bark. 2010. 2010 Effectiveness of a Non-Physical Fish Barrier at the Divergence of the Old and San Joaquin Rivers (CA). Technical Memorandum 86-68290-10-07. U.S. Bureau of Reclamation, Denver, CO.
- Bowen, M. D., Hiebert, S., Hueth, C., and V. Maisonneuve. 2009. *2009 Effectiveness of a Non-Physical Fish Barrier at the Divergence of the Old and San Joaquin Rivers (CA)*. Technical Memorandum 86-68290-09-05. U.S. Bureau of Reclamation, Denver, CO.
- California Department of Water Resources. 2011. Experimental Design and Study Plan for the 2011 Georgiana Slough Non-Physical Barrier Performance Evaluation. Dated February 2, 2011.
- Ehrenberg, J.E. and T.W. Steig. 2003. Improved techniques for studying the temporal and spatial behavior of fish in a fixed location. *ICES J of Mar. Sci.*, 60: 700-706.
- Fish Guidance Systems (FGS) Ltd. BAFF System. Retrieved in June, 2011. , <http://www.fish-guide.com/>
- Horn, M.J., and Blake, A. 2003. Acoustic tracking of juvenile Chinook salmon movement in the vicinity of the Delta Cross Channel. 2001 study results. USBR Technical Memorandum No. 8220-04-04.
- National Marine Fisheries Service (NMFS). 2009. *Biological Opinion and Conference Opinion on the Long-term Operations of the Central Valley Project and State Water Project*. NMFS, Southwest Region. June 4, 2009.
- Perry, R. W. 2010. *Survival and Migration Dynamics of Juvenile Chinook Salmon (Oncorhynchus tshawytscha) in the Sacramento-San Joaquin River Delta*. A dissertation submitted in partial fulfillment of the requirements for the degree of Doctor of Philosophy, University of Washington.

APPENDIX A

HYDROPHONE NUMBER, LOCATION (COLUMN NORTH(M) AND EAST(M)), DEPTH (ELEV(M))
MOUNT TYPE (DESCRIPTION) AND TIME AND DATE DEPLOYED AT THE GSNPB, 2011. HORIZ
DATUM: UTM 10 (NORTH) VERT. DATUM: NAV88 (GEOID03).

Hydrophone number, location (column NORTH(M) and EAST(M)), depth (ELEV(M)) mount type (DESCRIPTION) and time and date deployed at the GSNPB, 2011. Horiz Datum: UTM 10 (North) Vert. Datum: NAV88 (GEOID03).

HYDROPHONE	NORTH (M)	EAST (M)	ELEV (M)	DESCRIPTION	TIME	DATE
H1	4233679.520	629873.670	1.572	HYDRO 1 (DOCK)	11:45:25	3/7/2011
H2	4233611.946	629919.774	-0.352	HYDRO 2 (POUND IN)	14:48:12	2/28/2011
H3	4233597.267	629858.303	-8.091	HYDRO 3 (TOWER)	12:02:32	2/28/2011
H4	4233555.867	629882.018	1.116	HYDRO 4 (POUND IN)	15:55:57	2/28/2011
H5	4233528.941	629828.087	-4.907	HYDRO 5 (TOWER)	12:12:41	3/9/2011
H6	4233606.914	629805.787	1.520	HYDRO 6 (DOCK)	11:53:17	3/7/2011
H7	4233497.020	629792.250	-1.219	HYDRO 7 (PILE)	---	---
H8	4233552.705	629767.548	-6.404	HYDRO 8 (TOWER)	14:40:53	2/28/2011
H9	4233523.598	629689.608	0.637	HYDRO 9 (POUND IN)	11:30:56	2/28/2011
H10	4233466.144	629741.255	-4.624	HYDRO 10 (TOWER)	17:10:26	3/9/2011
H11	4233423.639	629694.205	0.068	HYDRO 11 (POUND IN)	12:00:27	3/7/2011
H12	4233475.305	629643.757	-2.054	HYDRO 12 (TOWER)	16:02:40	2/28/2011
H13	4233498.128	629846.219	0.847	HYDRO 13 (POUND IN)	10:30:53	3/4/2011
H14	4233452.150	629811.838	0.593	HYDRO 14 (POUND IN)	11:25:46	3/4/2011
H15	4233520.319	629846.799	-1.477	HYDRO 15 (POUND IN)	11:04:18	3/7/2011
H16	4233491.161	629800.652	-3.179	HYDRO 16 (TOWER)	13:51:59	3/4/2011
H17	4233467.490	629754.470	-1.219	HYDRO 17 (PILE)	---	---
H18	4233428.529	629763.924	-3.196	HYDRO 18 (TOWER)	11:57:18	3/4/2011
H19	4233419.911	629728.515	0.554	HYDRO 19 (POUND IN)	13:54:48	3/7/2011
H20	4233389.287	629754.146	-4.931	HYDRO 20 (TOWER)	10:52:38	3/4/2011

APPENDIX B

SUMMARY OF RELEASE NUMBER, TAG PROGRAMMING DATE, DELIVERY/SURGERY DATE, RELEASE DATE AND TIME AND NUMBER OF TAGS RELEASED FOR EACH RELEASE DURING THE GSNPB STUDY, 2011.

Release	Program date	Delivery/Surgery Date	Release Date	Release Hour	# tags released
GS001	14-Mar	15-Mar	16-Mar	9:00	3
GS002	14-Mar	15-Mar	16-Mar	12:00	4
GS003	14-Mar	15-Mar	16-Mar	15:00	4
GS004	14-Mar	15-Mar	16-Mar	18:00	4
GS005	14-Mar	15-Mar	16-Mar	21:00	4
GS006	14-Mar	15-Mar	17-Mar	0:00	4
GS007	14-Mar	15-Mar	17-Mar	3:00	4
GS008	14-Mar	15-Mar	17-Mar	6:00	4
GS009	15-Mar	16-Mar	17-Mar	9:00	4
GS010	15-Mar	16-Mar	17-Mar	12:00	4
GS011	15-Mar	16-Mar	17-Mar	15:00	4
GS012	15-Mar	16-Mar	17-Mar	18:00	4
GS013	15-Mar	16-Mar	17-Mar	21:00	4
GS014	15-Mar	16-Mar	18-Mar	0:00	4
GS015	15-Mar	16-Mar	18-Mar	3:00	4
GS016	15-Mar	16-Mar	18-Mar	6:00	4
GS017	16-Mar	17-Mar	18-Mar	9:00	4
GS018	16-Mar	17-Mar	18-Mar	12:00	4
GS019	16-Mar	17-Mar	18-Mar	15:00	4
GS020	16-Mar	17-Mar	18-Mar	18:00	4
GS021	16-Mar	17-Mar	18-Mar	21:00	4
GS022	16-Mar	17-Mar	19-Mar	0:00	4
GS023	16-Mar	17-Mar	19-Mar	3:00	4
GS024	16-Mar	17-Mar	19-Mar	6:00	4
GS025	17-Mar	18-Mar	19-Mar	9:00	5
GS026	17-Mar	18-Mar	19-Mar	12:00	4
GS027	17-Mar	18-Mar	19-Mar	15:00	4
GS028	17-Mar	18-Mar	19-Mar	18:00	4
GS029	17-Mar	18-Mar	19-Mar	21:00	4
GS030	17-Mar	18-Mar	20-Mar	0:00	4
GS031	17-Mar	18-Mar	20-Mar	3:00	4
GS032	17-Mar	18-Mar	20-Mar	6:00	4
GS033	18-Mar	19-Mar	20-Mar	9:00	4
GS034	18-Mar	19-Mar	20-Mar	12:00	4
GS035	18-Mar	19-Mar	20-Mar	15:00	4
GS036	18-Mar	19-Mar	20-Mar	18:00	4
GS037	18-Mar	19-Mar	20-Mar	21:00	4
GS038	18-Mar	19-Mar	21-Mar	0:00	4
GS039	18-Mar	19-Mar	21-Mar	3:00	4
GS040	18-Mar	19-Mar	21-Mar	6:00	4
GS041	19-Mar	20-Mar	21-Mar	9:00	4
GS042	19-Mar	20-Mar	21-Mar	12:00	4
GS043	19-Mar	20-Mar	21-Mar	15:00	4
GS044	19-Mar	20-Mar	21-Mar	18:00	4
GS045	19-Mar	20-Mar	21-Mar	21:00	4
GS046	19-Mar	20-Mar	22-Mar	0:00	4

Release	Program date	Delivery/Surgery Date	Release Date	Release Hour	# tags released
GS047	19-Mar	20-Mar	22-Mar	3:00	4
GS048	19-Mar	20-Mar	22-Mar	6:00	4
GS049	20-Mar	21-Mar	22-Mar	9:00	4
GS050	20-Mar	21-Mar	22-Mar	12:00	4
GS051	20-Mar	21-Mar	22-Mar	15:00	4
GS052	20-Mar	21-Mar	22-Mar	18:00	4
GS053	20-Mar	21-Mar	22-Mar	21:00	4
GS054	20-Mar	21-Mar	23-Mar	0:00	4
GS055	20-Mar	21-Mar	23-Mar	3:00	4
GS056	20-Mar	21-Mar	23-Mar	6:00	4
GS057	21-Mar	22-Mar	23-Mar	9:00	4
GS058	21-Mar	22-Mar	23-Mar	12:00	4
GS059	21-Mar	22-Mar	23-Mar	15:00	4
GS060	21-Mar	22-Mar	23-Mar	18:00	4
GS061	21-Mar	22-Mar	23-Mar	21:00	4
GS062	21-Mar	22-Mar	24-Mar	0:00	4
GS063	21-Mar	22-Mar	24-Mar	3:00	4
GS064	21-Mar	22-Mar	24-Mar	6:00	4
GS065	22-Mar	23-Mar	24-Mar	9:00	4
GS066	22-Mar	23-Mar	24-Mar	12:00	3
GS067	22-Mar	23-Mar	24-Mar	15:00	4
GS068	22-Mar	23-Mar	24-Mar	18:00	4
GS069	22-Mar	23-Mar	24-Mar	21:00	4
GS070	22-Mar	23-Mar	25-Mar	0:00	4
GS071	22-Mar	23-Mar	25-Mar	3:00	3
GS072	22-Mar	23-Mar	25-Mar	6:00	4
GS073	23-Mar	24-Mar	25-Mar	9:00	4
GS074	23-Mar	24-Mar	25-Mar	12:00	4
GS075	23-Mar	24-Mar	25-Mar	15:00	4
GS076	23-Mar	24-Mar	25-Mar	18:00	4
GS077	23-Mar	24-Mar	25-Mar	21:00	4
GS078	23-Mar	24-Mar	26-Mar	0:00	4
GS079	23-Mar	24-Mar	26-Mar	3:00	4
GS080	23-Mar	24-Mar	26-Mar	6:00	4
GS081	24-Mar	25-Mar	26-Mar	9:00	4
GS082	24-Mar	25-Mar	26-Mar	12:00	4
GS083	24-Mar	25-Mar	26-Mar	15:00	4
GS084	24-Mar	25-Mar	26-Mar	18:00	4
GS085	24-Mar	25-Mar	26-Mar	21:00	3
GS086	24-Mar	25-Mar	27-Mar	0:00	4
GS087	24-Mar	25-Mar	27-Mar	3:00	4
GS088	24-Mar	25-Mar	27-Mar	6:00	4
GS089	25-Mar	26-Mar	27-Mar	9:00	4
GS090	25-Mar	26-Mar	27-Mar	12:00	4
GS091	25-Mar	26-Mar	27-Mar	15:00	4
GS092	25-Mar	26-Mar	27-Mar	18:00	4

Release	Program date	Delivery/Surgery Date	Release Date	Release Hour	# tags released
GS093	25-Mar	26-Mar	27-Mar	21:00	4
GS094	25-Mar	26-Mar	28-Mar	0:00	4
GS095	25-Mar	26-Mar	28-Mar	3:00	4
GS096	25-Mar	26-Mar	28-Mar	6:00	4
	tag releases suspended 3/28-4/15 2011				
GS097	13-Apr	14-Apr	15-Apr	21:00	7
GS098	13-Apr	14-Apr	16-Apr	0:00	6
GS099	13-Apr	14-Apr	16-Apr	3:00	6
GS100	13-Apr	14-Apr	16-Apr	6:00	6
GS101	14-Apr	15-Apr	16-Apr	9:00	7
GS102	14-Apr	15-Apr	16-Apr	12:00	6
GS103	14-Apr	15-Apr	16-Apr	15:00	6
GS104	14-Apr	15-Apr	16-Apr	18:00	6
GS105	14-Apr	15-Apr	16-Apr	21:00	6
GS106	14-Apr	15-Apr	17-Apr	0:00	6
GS107	14-Apr	15-Apr	17-Apr	3:00	6
GS108	14-Apr	15-Apr	17-Apr	6:00	6
GS109	15-Apr	16-Apr	17-Apr	9:00	5
GS110	15-Apr	16-Apr	17-Apr	12:00	6
GS111	15-Apr	16-Apr	17-Apr	15:00	6
GS112	15-Apr	16-Apr	17-Apr	18:00	6
GS113	15-Apr	16-Apr	17-Apr	21:00	7
GS114	15-Apr	16-Apr	18-Apr	0:00	6
GS115	15-Apr	16-Apr	18-Apr	3:00	6
GS116	15-Apr	16-Apr	18-Apr	6:00	6
GS117	16-Apr	17-Apr	18-Apr	9:00	6
GS118	16-Apr	17-Apr	18-Apr	12:00	6
GS119	16-Apr	17-Apr	18-Apr	15:00	6
GS120	16-Apr	17-Apr	18-Apr	18:00	6
GS121	16-Apr	17-Apr	18-Apr	21:00	6
GS122	16-Apr	17-Apr	19-Apr	0:00	7
GS123	16-Apr	17-Apr	19-Apr	3:00	6
GS124	16-Apr	17-Apr	19-Apr	6:00	6
GS125	17-Apr	18-Apr	19-Apr	9:00	6
GS126	17-Apr	18-Apr	19-Apr	12:00	7
GS127	17-Apr	18-Apr	19-Apr	15:00	6
GS128	17-Apr	18-Apr	19-Apr	18:00	6
GS129	17-Apr	18-Apr	19-Apr	21:00	6
GS130	17-Apr	18-Apr	20-Apr	0:00	6
GS131	17-Apr	18-Apr	20-Apr	3:00	7
GS132	17-Apr	18-Apr	20-Apr	6:00	6
GS133	18-Apr	19-Apr	20-Apr	9:00	6
GS134	18-Apr	19-Apr	20-Apr	12:00	6
GS135	18-Apr	19-Apr	20-Apr	15:00	7
GS136	18-Apr	19-Apr	20-Apr	18:00	6
GS137	18-Apr	19-Apr	20-Apr	21:00	6

Release	Program date	Delivery/Surgery Date	Release Date	Release Hour	# tags released
GS138	18-Apr	19-Apr	21-Apr	0:00	6
GS139	18-Apr	19-Apr	21-Apr	3:00	6
GS140	18-Apr	19-Apr	21-Apr	6:00	6
GS141	19-Apr	20-Apr	21-Apr	9:00	7
GS142	19-Apr	20-Apr	21-Apr	12:00	6
GS143	19-Apr	20-Apr	21-Apr	15:00	6
GS144	19-Apr	20-Apr	21-Apr	18:00	6
GS145	19-Apr	20-Apr	21-Apr	21:00	6
GS146	19-Apr	20-Apr	22-Apr	0:00	6
GS147	19-Apr	20-Apr	22-Apr	3:00	6
GS148	19-Apr	20-Apr	22-Apr	6:00	7
GS149	20-Apr	21-Apr	22-Apr	9:00	6
GS150	20-Apr	21-Apr	22-Apr	12:00	5
GS151	20-Apr	21-Apr	22-Apr	15:00	6
GS152	20-Apr	21-Apr	22-Apr	18:00	7
GS153	20-Apr	21-Apr	22-Apr	21:00	6
GS154	20-Apr	21-Apr	23-Apr	0:00	7
GS155	20-Apr	21-Apr	23-Apr	3:00	6
GS156	20-Apr	21-Apr	23-Apr	6:00	6
GS157	21-Apr	22-Apr	23-Apr	9:00	5
GS158	21-Apr	22-Apr	23-Apr	12:00	4
GS159	21-Apr	22-Apr	23-Apr	15:00	4
GS160	21-Apr	22-Apr	23-Apr	18:00	5
GS161	21-Apr	22-Apr	23-Apr	21:00	4
GS162	21-Apr	22-Apr	24-Apr	0:00	4
GS163	21-Apr	22-Apr	24-Apr	3:00	5
GS164	21-Apr	22-Apr	24-Apr	6:00	4
GS165	22-Apr	23-Apr	24-Apr	9:00	6
GS166	22-Apr	23-Apr	24-Apr	12:00	6
GS167	22-Apr	23-Apr	24-Apr	15:00	7
GS168	22-Apr	23-Apr	24-Apr	18:00	7
GS169	22-Apr	23-Apr	24-Apr	21:00	6
GS170	22-Apr	23-Apr	25-Apr	0:00	6
GS171	22-Apr	23-Apr	25-Apr	3:00	6
GS172	22-Apr	23-Apr	25-Apr	6:00	7
GS173	23-Apr	24-Apr	25-Apr	9:00	5
GS174	23-Apr	24-Apr	25-Apr	12:00	4
GS175	23-Apr	24-Apr	25-Apr	15:00	5
GS176	23-Apr	24-Apr	25-Apr	18:00	5
GS177	23-Apr	24-Apr	25-Apr	21:00	5
GS178	23-Apr	24-Apr	26-Apr	0:00	4
GS179	23-Apr	24-Apr	26-Apr	3:00	5
GS180	23-Apr	24-Apr	26-Apr	6:00	4
GS181	24-Apr	25-Apr	26-Apr	9:00	4
GS182	24-Apr	25-Apr	26-Apr	12:00	4
GS183	24-Apr	25-Apr	26-Apr	15:00	4

Release	Program date	Delivery/Surgery Date	Release Date	Release Hour	# tags released
GS184	24-Apr	25-Apr	26-Apr	18:00	4
GS185	24-Apr	25-Apr	26-Apr	21:00	4
GS186	24-Apr	25-Apr	27-Apr	0:00	4
GS187	24-Apr	25-Apr	27-Apr	3:00	4
GS188	24-Apr	25-Apr	27-Apr	6:00	4
GS189	25-Apr	26-Apr	27-Apr	9:00	4
GS190	25-Apr	26-Apr	27-Apr	12:00	4
GS191	25-Apr	26-Apr	27-Apr	15:00	4
GS192	25-Apr	26-Apr	27-Apr	18:00	4
GS193	25-Apr	26-Apr	27-Apr	21:00	4
GS194	25-Apr	26-Apr	28-Apr	0:00	4
GS195	25-Apr	26-Apr	28-Apr	3:00	4
GS196	25-Apr	26-Apr	28-Apr	6:00	4
GS197	26-Apr	27-Apr	28-Apr	9:00	4
GS198	26-Apr	27-Apr	28-Apr	12:00	4
GS199	26-Apr	27-Apr	28-Apr	15:00	4
GS200	26-Apr	27-Apr	28-Apr	18:00	4
GS201	26-Apr	27-Apr	28-Apr	21:00	4
GS202	26-Apr	27-Apr	29-Apr	0:00	4
GS203	26-Apr	27-Apr	29-Apr	3:00	4
GS204	26-Apr	27-Apr	29-Apr	6:00	4
GS205	27-Apr	28-Apr	29-Apr	9:00	5
GS206	27-Apr	28-Apr	29-Apr	12:00	4
GS207	27-Apr	28-Apr	29-Apr	15:00	4
GS208	27-Apr	28-Apr	29-Apr	18:00	4
GS209	27-Apr	28-Apr	29-Apr	21:00	4
GS210	27-Apr	28-Apr	30-Apr	0:00	5
GS211	27-Apr	28-Apr	30-Apr	3:00	4
GS212	27-Apr	28-Apr	30-Apr	6:00	4
GS213	28-Apr	29-Apr	30-Apr	9:00	4
GS214	28-Apr	29-Apr	30-Apr	12:00	5
GS215	28-Apr	29-Apr	30-Apr	15:00	4
GS216	28-Apr	29-Apr	30-Apr	18:00	4
GS217	28-Apr	29-Apr	30-Apr	21:00	4
GS218	28-Apr	29-Apr	1-May	0:00	3
GS219	28-Apr	29-Apr	1-May	3:00	4
GS220	28-Apr	29-Apr	1-May	6:00	4
GS221	29-Apr	30-Apr	1-May	9:00	4
GS222	29-Apr	30-Apr	1-May	12:00	4
GS223	29-Apr	30-Apr	1-May	15:00	4
GS224	29-Apr	30-Apr	1-May	18:00	4
GS225	29-Apr	30-Apr	1-May	21:00	4
GS226	29-Apr	30-Apr	2-May	0:00	4
GS227	29-Apr	30-Apr	2-May	3:00	4
GS228	29-Apr	30-Apr	2-May	6:00	4
GS229	30-Apr	1-May	2-May	9:00	4

Release	Program date	Delivery/Surgery Date	Release Date	Release Hour	# tags released
GS230	30-Apr	1-May	2-May	12:00	4
GS231	30-Apr	1-May	2-May	15:00	4
GS232	30-Apr	1-May	2-May	18:00	4
GS233	30-Apr	1-May	2-May	21:00	3
GS234	30-Apr	1-May	3-May	0:00	3
GS235	30-Apr	1-May	3-May	3:00	3
GS236	30-Apr	1-May	3-May	6:00	2
GS237	1-May	2-May	3-May	9:00	3
GS238	1-May	2-May	3-May	12:00	4
GS239	1-May	2-May	3-May	15:00	4
GS240	1-May	2-May	3-May	18:00	4
GS241	1-May	2-May	3-May	21:00	4
GS242	1-May	2-May	4-May	0:00	4
GS243	1-May	2-May	4-May	3:00	4
GS244	1-May	2-May	4-May	6:00	4
GS245	2-May	3-May	4-May	9:00	4
GS246	2-May	3-May	4-May	12:00	4
GS247	2-May	3-May	4-May	15:00	4
GS248	2-May	3-May	4-May	18:00	4
GS249	2-May	3-May	4-May	21:00	4
GS250	2-May	3-May	5-May	0:00	4
GS251	2-May	3-May	5-May	3:00	4
GS252	2-May	3-May	5-May	6:00	4
GS253	3-May	4-May	5-May	9:00	4
GS254	3-May	4-May	5-May	12:00	4
GS255	3-May	4-May	5-May	15:00	4
GS256	3-May	4-May	5-May	18:00	4
GS257	3-May	4-May	5-May	21:00	4
GS258	3-May	4-May	6-May	0:00	4
GS259	3-May	4-May	6-May	3:00	4
GS260	3-May	4-May	6-May	6:00	4
GS261	4-May	5-May	6-May	9:00	4
GS262	4-May	5-May	6-May	12:00	4
GS263	4-May	5-May	6-May	15:00	4
GS264	4-May	5-May	6-May	18:00	4
GS265	4-May	5-May	6-May	21:00	4
GS266	4-May	5-May	7-May	0:00	4
GS267	4-May	5-May	7-May	3:00	4
GS268	4-May	5-May	7-May	6:00	4
GS269	5-May	6-May	7-May	9:00	4
GS270	5-May	6-May	7-May	12:00	4
GS271	5-May	6-May	7-May	15:00	4
GS272	5-May	6-May	7-May	18:00	4
GS273	5-May	6-May	7-May	21:00	5
GS274	5-May	6-May	8-May	0:00	5
GS275	5-May	6-May	8-May	3:00	4

Release	Program date	Delivery/Surgery Date	Release Date	Release Hour	# tags released
GS276	5-May	6-May	8-May	6:00	3
GS277	6-May	7-May	8-May	9:00	4
GS278	6-May	7-May	8-May	12:00	4
GS279	6-May	7-May	8-May	15:00	4
GS280	6-May	7-May	8-May	18:00	4
GS281	6-May	7-May	8-May	21:00	4
GS282	6-May	7-May	9-May	0:00	4
GS283	6-May	7-May	9-May	3:00	4
GS284	6-May	7-May	9-May	6:00	4
GS285	7-May	8-May	9-May	9:00	4
GS286	7-May	8-May	9-May	12:00	4
GS287	7-May	8-May	9-May	15:00	4
GS288	7-May	8-May	9-May	18:00	4
GS289	7-May	8-May	9-May	21:00	4
GS290	7-May	8-May	10-May	0:00	5
GS291	7-May	8-May	10-May	3:00	4
GS292	7-May	8-May	10-May	6:00	5
GS293	8-May	9-May	10-May	9:00	4
GS294	8-May	9-May	10-May	12:00	4
GS295	8-May	9-May	10-May	15:00	3
GS296	8-May	9-May	10-May	18:00	4
GS297	8-May	9-May	10-May	21:00	4
GS298	8-May	9-May	11-May	0:00	4
GS299	8-May	9-May	11-May	3:00	4
GS300	8-May	9-May	11-May	6:00	4
GS301	9-May	10-May	11-May	9:00	4
GS302	9-May	10-May	11-May	12:00	4
GS303	9-May	10-May	11-May	15:00	4
GS304	9-May	10-May	11-May	18:00	4
GS305	9-May	10-May	11-May	21:00	3
GS306	9-May	10-May	12-May	0:00	4
GS307	9-May	10-May	12-May	3:00	5
GS308	9-May	10-May	12-May	6:00	5
GS309	10-May	11-May	12-May	9:00	4
GS310	10-May	11-May	12-May	12:00	4
GS311	10-May	11-May	12-May	15:00	4
GS312	10-May	11-May	12-May	18:00	3
GS313	10-May	11-May	12-May	21:00	4
GS314	10-May	11-May	13-May	0:00	4
GS315	10-May	11-May	13-May	3:00	4
GS316	10-May	11-May	13-May	6:00	4
GS317	11-May	12-May	13-May	9:00	4
GS318	11-May	12-May	13-May	12:00	4
GS319	11-May	12-May	13-May	15:00	4
GS320	11-May	12-May	13-May	18:00	4
GS321	11-May	12-May	13-May	21:00	4

Release	Program date	Delivery/Surgery Date	Release Date	Release Hour	# tags released
GS322	11-May	12-May	14-May	0:00	4
GS323	11-May	12-May	14-May	3:00	4
GS324	11-May	12-May	14-May	6:00	5
GS325	12-May	13-May	14-May	9:00	5
GS326	12-May	13-May	14-May	12:00	5
GS327	12-May	13-May	14-May	15:00	4
GS328	12-May	13-May	14-May	18:00	4
GS329	12-May	13-May	14-May	21:00	4
GS330	12-May	13-May	15-May	0:00	4
GS331	12-May	13-May	15-May	3:00	4
GS332	12-May	13-May	15-May	6:00	4
GS333	13-May	14-May	15-May	9:00	4
GS334	13-May	14-May	15-May	12:00	5
GS335	13-May	14-May	15-May	15:00	5
GS336	13-May	14-May	15-May	18:00	5

APPENDIX C

RELEASE SHEETS FOR EACH TAG RELEASE DURING THE GSNPB STUDY, 2011.

To obtain a copy of release sheets for the 2011 GSNPB Study, please contact:

Ryan Reeves
Senior Engineer
California Department of Water Resources
Bay-Delta Office, South Delta Management
1416 9th Street, Room 215-20A
Sacramento, CA 95814

APPENDIX D

GSNPB operation during Spring 2011.

Date	julian	HOUR																						
		0	1	2	3	4	5	6	7	8	9	10	11	12	13	14	15	16	17	18	19	20	21	22
17-Mar	76	off	off	off	off	off	off	off	off	off	off	off	off	off	off	off	off	off	1845	on	on	on	on	on
18-Mar	77	on	on	on	on	on	on	on	on	on	on	on	on	on	on	on	on	on	1730	off	off	off	off	off
19-Mar	78	off	off	off	off	off	off	off	off	off	off	off	off	off	off	off	off	off	1815	on	on	on	on	on
20-Mar	79	on	on	on	on	on	on	on	on	on	on	on	on	on	on	on	on	on	1945	off	off	off	off	off
21-Mar	80	off	off	off	off	off	off	off	off	off	off	off	off	off	off	off	off	off	off	off	2130	on	on	
22-Mar	81	on	on	on	on	on	on	on	on	on	on	on	on	on	on	on	on	on	on	on	on	on	2215	off
23-Mar	82	off	off	off	off	off	off	off	off	off	off	off	off	off	off	off	off	off	off	off	off	off	off	2330
24-Mar	83	on	on	on	on	on	on	on	on	on	1058	?	1232	on	on	on	on	on	on	on	on	on	on	2354
25-Mar	84	off	off	off	off	off	off	off	off	off	off	off	off	off	off	off	off	off	off	off	off	off	off	off
26-Mar	85	30	on	on	on	on	on	on	on	830	on	on	on	on	on	on	on	1730	off	off	off	off	off	off
27-Mar	86	off	off	off	off	off	off	off	off	off	off	off	off	off	off	off	off	off	off	off	off	off	off	off
28-Mar	87	BAFF OFF UNTIL April 15, 2002hr																						
29-Mar	88																							
14-Apr	104																							
15-Apr	105	off	off	off	off	off	off	off	off	off	off	off	off	off	off	off	off	off	off	off	2002	on	on	on
16-Apr	106	on	on	on	on	on	on	on	on	on	on	on	on	on	on	on	on	on	on	on	on	on	on	on
17-Apr	107	on	on	on	on	on	on	on	on	on	on	on	on	on	on	on	on	1739	off	off	off	off	off	off
18-Apr	108	off	off	off	off	off	off	off	off	off	off	off	off	off	off	off	off	off	off	off	2000	on	on	on
19-Apr	109	on	on	on	on	on	on	on	on	on	on	on	on	on	on	on	on	on	on	on	2030			
20-Apr	110	off	off	off	off	off	off	off	off	off	off	off	off	off	off	off	off	off	off	off	off	2120	on	on
21-Apr	111	on	on	on	on	on	on	on	on	on	on	on	on	on	on	on	on	on	on	on	on	on	2225	
22-Apr	112	off	off	off	off	off	off	off	off	off	off	off	off	off	off	off	off	off	off	off	off	off	2208	on
23-Apr	113	on	on	on	on	on	on	on	on	on	on	on	on	on	on	on	on	on	on	on	on	on	on	2305
24-Apr	114	off	off	off	off	off	off	off	off	off	off	off	off	off	off	off	off	off	off	off	off	off	off	off
25-Apr	115	36	on	on	on	on	on	on	on	on	on	on	on	on	on	on	on	on	on	on	on	on	on	on
26-Apr	116	1	145	off	off	off	off	off	off	off	off	off	off	off	off	off	off	off	off	off	off	off	off	off
27-Apr	117	off	off	off	305	on	on	on	on	on	on	on	on	on	on	on	on	on	on	on	on	on	on	on
28-Apr	118	on	on	on	on	452	off	off	off	off	off	off	off	off	off	off	off	off	off	off	off	off	off	off
29-Apr	119	off	off	off	off	off	619	on	on	on	1020	on	on	on	on	on	on	on	on	on	on	on	on	on
30-Apr	120	on	on	on	on	on	640	off	off	off	off	off	off	off	off	off	off	off	off	off	off	off	off	off
1-May	121	off	off	off	off	off	off	717	on	on	on	on	on	on	on	on	on	on	on	on	on	on	on	on
2-May	122	on	on	on	on	on	on	700	off	off	off	off	off	off	off	off	off	off	off	off	off	off	off	off
3-May	123	off	off	off	off	off	634	on	on	on	on	on	on	on	on	on	on	on	on	on	on	on	on	on
4-May	124	on	on	on	on	on	on	735	off	off	off	off	off	off	off	off	off	off	off	off	off	off	off	off
5-May	125	off	off	off	off	off	off	811	on	on	on	on	on	on	on	on	on	on	on	on	on	on	on	on
6-May	126	on	on	on	on	on	on	813	off	off	off	off	off	off	off	off	off	off	off	off	off	off	off	off
7-May	127	off	off	off	off	off	off	916	on	on	on	on	on	on	on	on	on	on	on	on	on	on	on	on
8-May	128	no fuel	off	330	off	off	off	off	off	off	off	off	off	off	off	off	off	off	off	off	off	off	off	off
9-May	129	off	off	off	off	off	off	off	off	950	on	on	on	on	on	on	on	on	on	on	on	on	on	on
10-May	130	on	on	on	on	on	on	on	on	on	1035	off	off	off	off	off	off	off	off	off	off	off	off	off
11-May	131	off	off	off	off	off	off	off	off	935	1043	1140	on	on	on	on	on	on	on	on	on	on	on	on
12-May	132	on	on	on	on	on	on	on	on	on	on	on	on	1355	off	off	off	off	off	off	off	off	off	off
13-May	133	off	off	off	off	off	off	off	off	off	off	off	off	1430	on	on	on	on	on	on	on	on	on	on
14-May	134	on	on	on	on	on	on	on	on	on	on	on	on	on	on	1536	off	off	off	off	off	off	off	off
15-May	135	off	off	off	off	off	off	off	off	off	off	off	off	off	off	1620	1715	on	on	on	on	on	on	on
16-May	136	on	on	on	on	450 air		726 FGS																
OFF =	off																							
ON =	on	numbers in cells indicate times recorded for condition change																						
		notes from log sheets and log book indicate potential problem with BAFF operation																						

APPENDIX E

Response to Comments from DWR.

Response to Comments on Draft Report:

Acoustic Tag System Data Collection at the Non-Physical Barrier at Georgiana Slough in 2011 Draft Report dated June 17, 2011

1. Revise report name to:

2011 Georgiana Slough Non-Physical Barrier Study
Acoustic Tag System Data Collection

2. Page 1 paragraph 2: Replace “were likely to put at risk” with “jeopardize populations of”
3. Page 1 paragraph 4: Comment [r1]: Recommend deleting this paragraph here, but including it in a report transmittal memo.

Response: Removed paragraph 4.

4. Page 1 paragraph 5 Comment [r2]: Is this supposed to be a personal communication reference? Please use a standard format.

Response: This is a reference to a website citation included in the reference list. Revised citation to standard format.

5. Page 1 Section 1.1 Study Area Description paragraph 1: Replace “The air bubble curtain enclosed the sound signal to create a wall of sound that was used to guide fish (Fish Guidance Systems).” With “The air bubble curtain constrains the sound signal to create a more well defined sound source that was used to guide fish (Fish Guidance Systems).”

6. Page 2 Figure 1 Comment [K.A3]: Hydrophone location are missing or not at the correct locations.

1. Two hydrophones were placed upstream of steamboat slough on sac river
2. Two hydrophones were placed at steamboat slough
3. There wasn't any hydrophone upstream of DCC

Response: Revised figure inserted.

7. Page 4 Figure 3 Comment [r4]: I think the project study plan should be referenced here not FGS.

Response: Reference changed to the Study Plan

8. Page 5 Section 2.0 paragraph 1 Comment [K.A5]: The objective of what component? It's confusing. Need more than just few lines Refer to project study plan for objectives.

Response: This report was submitted as fulfilment of the HTI Task 2, item 1 Draft Data Collection Report called for in the AECOM Scope of Work. It was not intended as the draft of the final project report. This report contains materials and methods implemented for collecting, processing and storing the 3-D tracking data and fish release data. This data collection information and the final analysis of acoustic data will be included in the Draft and Final Project Report entitled “2011 Effectiveness of a Non-Physical Fish Barrier at the Divergence of the Sacramento River and Georgiana Slough (CA)”.

Replace with:

The component of this project that comprises the acoustic tag system data collection have the following objectives:

- Documentation of release of 1,500 acoustically tagged late fall–run Chinook salmon into the Sacramento River
- Monitoring of acoustically tagged late fall-run Chinook during their downstream migration past the non-physical barrier and divergence with Georgiana Slough.

9. Page 6 Table 1 Format change: Not Italic for Acoustic tag Model numbers.

Response: no italics

10. Page 6 Table 1 Comment [K.A6]: What's CH? Chinook.

Response: Replace CH with Juvenile Chinook (CH)

11. Page 7 paragraph 1 Comment [r7]: What about the peripheral sites? The hydrophone array and peripheral hydrophones are discussed in Section 3.3 System Deployment and Array Design

Response:

A total of twenty-eight hydrophones were installed for this study and several more were used for pre-release tag testing operations.

12. Page 7 paragraph 1 Comment [r8]: What about the 50 footers?

Response: Individual cable lengths ranged from 50 ft to 500 ft.

13. Page 11 Section 3.3 System Deployment and Array Design Comment [K.A9]: Combine this with "Hydrophones" which is on page 7. There is no need to have a separated heading for the same subject matter. Response: Section 3.2 System Components discusses the general operation and function of each of the components of the acoustic tagging system. The hydrophone discussion is provided to explain hydrophone specifications, operation and function. The purpose of Section 3.3 System Deployment and Array Design is to discuss the application of the system components for this study.

Replace with:

3.3 System Deployment and Array Design

A twenty node array of hydrophones was installed at the non-physical barrier site (Figure 10). Eight additional hydrophones were installed upstream and downstream of the non-physical barrier site. The four upstream hydrophones included two hydrophones in Steamboat Slough and two in the Sacramento River above the divergence of Steamboat Slough. The four downstream hydrophones included two hydrophones in the Sacramento River near the Ryde Hotel and two in Georgiana Slough downstream of the barrier (see Figure 1). The installation of all hydrophones at the GSNPB site was completed by March 12, 2011. Hydrophones were positioned to assure optimal coverage as fish passed through the vicinity of the GSNPB.

14. Page 12 paragraph 1 insert USGS, USBR

15. Page 12 paragraph 1 Comment [K.A11]: Is NAEC stand for Normandeu Associates, Inc? If yes then spell it out.

Replace with: HTI in coordination with DWR, USGS, USBR and Normandeu Associates Environmental Consultants (NAEC) completed system deployment and testing in February and March 2011.

16. Page 12 paragraph 2 Comment [K.A12]: Combine this with the previous heading "Deployment Overview"

Replace with: removed Heading "Hydrophone Deployment"

17. Page 12 paragraph 2 Comment [r13]: What about the peripheral sites?

Replace with: Add additional paragraph:

The additional eight hydrophones positioned to detect tagged fish outside of the area of the non-physical barrier were installed during this same time period. Each of these hydrophones combined with autonomous data loggers and were operated independently using air card modems for communication access and remote data downloading. These sites were operated

and maintained by USGS personnel.

18. Page 12 paragraph 3 replace ...results will be reported with the analyzed data under separate cover with ...results along with the analyzed data will be presented as part of the final report.

19. Page 14 Table 3 Comment [K.A14]: I think this table should be in the appendix not in the main report.

Response: Moved Table 3 to:

Appendix A. Hydrophone number, location (column NORTH(M) and EAST(M)), depth (ELEV(M)) mount type (DESCRIPTION) and time and date deployed at the GSNPB, 2011. Horiz Datum: UTM 10 (North) Vert. Datum: NAV88 (GEOID03).

Appendix A Summary of Release Number, Tag Programming date, Delivery/Surgery Date, Release Date and Time and Number of tags released for each release during the GSNPB Study, 2011, moved to Appendix B

Appendix B Release sheets for each tag release during the GSNPB Study, 2011, moved to Appendix C.

20. Page 17 paragraph 2 Replaced: "Tags were activated and programmed at the the offices at staging area near the GSNPB." With: "Tags were activated and programmed at the the staging area temporary office near the GSNPB."

21. Page 17 paragraph 2 Comment [r15]" Model? Replaced HTI tag programmer with HTI *Model 490-LP Tag Programmer*

22. Page 19 Table 4 Comment [r16]: The purpose of this table is unclear to me in this context. Wouldn't "off" and "on" convey the same information and be easier to understand?

Response: Replaced "1" with "on" and replace blank cell with "off".

23. Page 19 table 4 Comment [K.A17]: Move this table to the appendix.

Response: Moved Table 4 to Appendix D.

24. Page 20 Section 3.5 System testing Procedures para 1. Comment [r18]: Let's just say final report.

Response: Replace "under separate cover" to "in the final report"

25. Page 23 Comment [K.A19]: Ryan: There is no discussion about the peripheral sites. Is that part of another report? Yes I think peripheral node data collection should be included as well.

Response: As a result of other comments (i.e. [r7], [r13] above) we have included data collection at the peripheral sites.

26. Page 24 citation #5 Comment [r20]: Please use a standard reference format.

Response: Replaced citation with standard citation format when referencing a web site location.

APPENDIX B

2011 GSNPB Fish Transport, Tagging, and Release Standard
Operating Procedures

Field Standard Operating Procedure

Fish Transport Procedures for the GSNPB Study

PURPOSE: To provide guidelines and standard protocols for the transport and care of juvenile salmon between Coleman National Fish Hatchery and the tagging location at a houseboat in the Sacramento River for the Georgiana Slough non-physical barrier (GSNPB) study.

AREA OF APPLICABILITY: All staff involved in the transport of juvenile salmon for the GSNPB study.

REFERENCES:

Kelsch, S. W., and B. Shields. 1996. Care and Handling of Sampled Organisms. Fisheries Techniques, 2nd edition. American Fisheries Society 121-155.

MATERIALS NEEDED:

- Insulated transport containers
- Oxygen delivery system (cylinder, regulator, airline, air diffusers)
- Redundant oxygen delivery system supplies
- Thermometer
- YSI dissolved oxygen (DO) meter
- Salinity meter
- Datasheets and writing tools

PROCEDURES:

1) Loading Fish at Coleman National Fish Hatchery

- A. Coordinate as needed with appropriate hatchery staff prior to loading fish.
- B. Follow all hatchery security and disinfection procedures. Transport containers used to hold fish for this study will be exposed to Sacramento River water and will require disinfection prior to taking them onto the hatchery grounds.
- C. Ensure that redundant oxygen delivery supplies are on-board and are ready to be put into use without significant delay.
- D. Fill the transport tank with water just before loading begins in order to prevent warming of the water. When local air temperatures have been high, fill the transport tank and then drain it to allow it to cool. Re-fill the tank again just before loading.
- E. Add non-iodized salt to the transport container in appropriate volume to give a working concentration of 5-7 ppt. Ensure that the salt is well-mixed prior to loading fish.

- F. The number of fish needed for transport will vary somewhat through the study period and will be in the range of 30-40 fish. Coordinate with Hanson Environmental or AECOM to finalize the requested number of fish for a given transport effort.
- G. Fish to be transported must be counted individually and accurately. Estimates of fish numbers will not be sufficient. If needed, lightly anesthetize fish in MS-222 (estimated dose of 40-50 mg/L) to allow them to be more easily handled. If MS-222 is used, ensure that fish recover from anesthesia prior to loading and record the amount used on the transport datasheet.
- H. The total number of fish planned for transport should be divided, in approximately equal proportions, into transport containers to separate the fish planned for the AM and PM tagging sessions.
- I. Configure the oxygen delivery system to achieve oxygen saturation (100% DO) rather than to achieve super-saturation (>100% DO). Elevated DO levels can cause injury to fish (gas bubble trauma) over hours of exposure and should be avoided. Acceptable DO levels during fish transport are between **80% and 110% DO**. Levels outside of this range require system adjustment to bring the DO level back into the acceptable range.
- J. Immediately prior to departure measure the water temperature, DO, and salinity in the transport tank or the individual transport containers. Record the time and data on the "Daily Fish Transport Log".
- K. Choose the most direct travel route possible to shorten the transport time. In addition, give consideration to a smooth transport process in terms of road condition (gravel roads and roads in poor condition give a rough ride to the transported fish).

2) Transport between Coleman and Steamboat Slough

- A. Study fish are held approximately 24 h prior to tagging and approximately 24 h after tagging. Fish held before tagging (hereafter referred to as "source fish") are held in 20 gallon containers of 16-20 fish each. Fish held after tagging (hereafter referred to as "tagged fish") are held in 32 gallon containers that hold individual release groups of 4 fish each.
- B. Plan a stop approximately half way through the transport to measure and record water quality. If the DO levels are outside of the acceptable range (80 – 100%), make adjustments to the oxygen delivery system. If the DO level is less than 60% or more than 150%, plan to make an additional stop to check DO levels approximately 1 h further into the transport (or about ¼ of the transport distance).
- C. Water temperature may rise significantly during transport. No matter how high the water temperature climbs during a given transport effort, do not add commercially-produced ice to the tank as it may contain chlorine, which will be lethal to fish in a closed system. If water temperature increases are a recurring issue, we will make adjustments to the protocol and add ice made from distilled water or water from Coleman National Fish Hatchery. Communicate with Hanson Environmental or AECOM to discuss suggested changes to the transport protocol to address water temperature issues.
- D. As you approach the delivery location (within about 30 min), contact the tagging operation so that they have time to move the transport boat into position to meet the truck. This coordination step is critical so that the boat is in position when the truck arrives. The goal is to get fish established on Sacramento River water as quickly as possible after they are delivered. Make every effort to avoid any transport or delivery delays.

1. Any anticipated delivery delays must be relayed to the tagging operation. The delivery of fish is the first step in the tagging operation and its timing begins the cascade of events that follow. If the delivery of fish is delayed the tagging and release operations may need to be delayed as well to maintain constant treatment across all the release groups.
2. Anticipated delivery time at Steamboat Slough is noon. If delivery will be accomplished by 2:30 pm, no changes are required to the tag and release operations.
3. If delivery will be delayed past 2:30 pm, changes will have to be made to the tag and release operations. Coordinate closely with the tag operation during an anticipated delivery delay so that the procedures that rely on fish delivery can be adjusted accordingly.

3) Arrival at Delivery Location and Transfer of Care

- A. Immediately upon arrival at the delivery location measure and record the water temperature, salinity and DO levels in the transport tank or individual transport containers. Record findings on the "Daily Fish Transport Log".
- B. The goal is to establish fish on circulating Sacramento River water as quickly as possible after delivery.
- C. Transfer control of the "Daily Fish Transport Log" to the curator staff that arrived at the delivery location by boat. They will record the water temperature of the Sacramento River and refine the procedures for the transfer of fish from the transport tank to the Sacramento River. The curator crew will take the lead with this activity, assisted by the transport crew.
 1. The water temperature of the transport containers and the water temperature of the river will be compared before any fish transfers are made.
 2. If the difference in water temperature between the river and the transport containers is $\leq 2^{\circ}\text{C}$, transfer fish from the truck to the boat for transport to the houseboat.
 3. If the difference in water temperature exceeds 2°C , the transfer must be done using tempering.
 - I. Changes in water temperature exceeding 2°C require tempering (Kelsch and Shields 1996). "Tempering" means "to bring to a suitable state by mixing in or adding a usually liquid ingredient". Therefore, prior to exposing fish to a new water source the fish holding temperature and the temperature of the new water source need to be measured to ensure that the difference between the two water sources is $\leq 2^{\circ}\text{C}$.
 - II. If the temperature difference is $> 2^{\circ}\text{C}$ then water in the container holding fish should be tempered at a rate of $0.5^{\circ}\text{C}/15$ min until the temperature difference between the two water sources is $\leq 2^{\circ}\text{C}$. New source water should be added in small amounts multiple times over 15 min to gradually change the temperature by 0.5°C . Once the temperature difference between the two water sources is $\leq 2^{\circ}\text{C}$ fish can be transferred to the new water source.
 - III. If tempering is conducted, record it on the "Daily Fish Transport Log"
- D. Support the curator crews as they work to transfer fish from the truck to the transport boat. This effort is done without netting by partially de-watering the transport containers to decrease the volume of water they contain, and then carrying them from the truck to the transport boat. Be careful to lift the containers safely to avoid injuries to personnel and handle them carefully to avoid stressing the study fish.

- E. On the boat the transport containers will be put inside of non-perforated transport containers (“liners”) that match the style of the perforated transport containers. Use of the liners will allow the full volume of the container will be filled with river water, giving a better transport experience.
- F. Before the truck departs the delivery location, communicate with the tagging operation to determine the number of fish required for the next transport effort. In addition, on some occasions you may be asked to transport fish tissue samples or live fish from Steamboat Slough back to Coleman National Fish Hatchery. This coordination step will ensure that all appropriate transfers are made prior to the departure of the transport truck.

4) Communication and Contingency Plans

- A. Fish delivery needs will likely change as the study progresses. You will receive regular communication from Hanson Environmental and AECOM providing updated fish transport needs. Regular contact between the transport and tagging operations is required for smooth operations.
- B. Please alert the curator (boat) crew or the tagging operation of changing conditions at Coleman and through the transport process. Examples include sick or dying fish in the holding raceway at Coleman, low numbers of fish in the raceway, or transport processes that need improvement.
- C. The YSI DO meter used during the transport process requires regular service. The membrane on the DO probe needs to be changed to ensure proper meter calibration and accurate DO readings. The tagging and release operations also use DO meters and have a staff member that can change members and standardize meter calibration. Coordinate with the tagging operation to arrange the loan of an alternate meter while the primary transport meter is serviced.
 - 1. The meter should be serviced immediately if it is not performing well (the DO reading will not stabilize, or the readings do not make sense).
 - 2. The meter should have the membrane replaced at least 3 times during the course of the 45 day study, even if it has no performance issues.
- D. Regularly check to be sure the redundant oxygen delivery systems are on-board the transport truck, and are ready to be activated to support fish transport. Be sure a spare oxygen cylinder is on-board the truck and has sufficient cylinder pressure to be used in the event of failure of the primary system.
- E. Mechanical issues may arise that delay the scheduled fish delivery. Some latitude is allowed for fish delivery timing (see 1D under Fish Transport from Coleman under Steamboat Slough). If mechanical issues delay delivery beyond the latitude allowed, contact the tagging operation and keep them informed of delivery status. Monitor fish condition regularly during the delay to ensure the best possible water quality conditions for fish.

APPROVED BY: _____ **DATE** _____
QUALITY ASSURANCE OFFICER

SUPPORTED BY: _____ **DATE** _____
STAFF USING THESE PROCEDURES

Field Standard Operating Procedure

Surgical Tag Implantation Procedures Used for the GSNPB Study

RECOMMENDED CITATION INFORMATION: This SOP was adapted from USGS Columbia River Research Laboratory's standard operating procedures for juvenile salmonids and should not be used for other studies without written permission from USGS-CRRL.

PURPOSE: To provide guidelines and standard protocols for surgical transmitter implantation of juvenile salmonids for the Georgiana Slough Non-physical barrier (GSPB) study.

AREA OF APPLICABILITY: All staff involved in surgical tagging procedures for the GSNPB study.

REFERENCES:

Adams, N.S., Rondorf, D.W., Evans, S.D., Kelly, J.E. 1998. Effects of Surgically and Gastrically Implanted Radio Transmitters on Growth and Feeding Behavior of Juvenile Chinook Salmon. Transactions of the American Fisheries Society 127:128-136.

Kelsch, S. W., and B. Shields. 1996. Care and Handling of Sampled Organisms. Fisheries Techniques, 2nd edition. American Fisheries Society 121-155.

Martinelli, T.L., H.C. Hansel, and R. S. Shively. 1998. Growth and physiological responses to surgical and gastric radio transmitter implantation techniques in subyearling Chinook salmon. Hydrobiologia 371/372: 79-87.

Summerfelt, R. C. and L. S. Smith. 1990. Anesthesia, surgery, and related techniques. Pages 213-272 in C. B. Schreck and P. B. Moyle, editors. Methods for fish biology. American Fisheries Society, Bethesda, Maryland.

MATERIALS NEEDED:

- Thermometer
- YSI 55 dissolved oxygen (DO) meter
- Acoustic tags and acoustic tag programming equipment
- Chlorhexidine solution (30mL/L D-H₂O)
- Distilled or de-ionized water (D-H₂O)
- Tricaine methanesulfonate (MS-222; 100g/L),
- Sodium bicarbonate solution (buffer; 100g/L)
- Stress coat - stock concentration and 25% solution (250mL/L D-H₂O)
- Disinfectant solution (70% ETOH or Vircon Aquatic)

- 19 L bucket(s) marked at 10 L and clearly labeled 'Anesthesia'
- 19 L perforated recovery buckets (7 L holding capacity)
- 19 L bucket clearly labeled 'Reject' for fish not selected for tagging procedures
- Two gravity feed containers marked at 10 L, and connected by rubber tubing with in-line shut-off valves (one labeled 'anesthesia' and one labeled 'freshwater')
- Syringes (10 mL) for measuring anesthetic, buffer, and stress coat
- Oxygen delivery system (cylinder, regulator, airline, air diffusers)
- Dip nets
- Nitrile gloves
- Scale measuring to the nearest 0.1 g
- Large plastic weigh boats
- Measuring board with ruler to the nearest millimeter
- Surgical platform (tray with foam pad and groove cut)
- Trays for holding solutions used to disinfect surgical tools
- Needle drivers
- Forceps
- Scalpel handle and blades
- Sutures (Vicryl plus size: 5-0 and 4-0) with an RB-1 needle
- Spray bottles for disinfectant solution
- Timer(s)
- Sharps container
- Datasheets and writing tools

PROCEDURES:

1) Collection and Pre-Tag Holding

- A. The pre-tag holding period begins once the fish are placed in holding containers at the tagging location. Prior to tag implantation, the pre-tag holding period should be 18-36 h. Food should be withheld during the pre-tagging holding period.
- B. Record the collection date and time on each pre-tag holding container.
- C. Ensure good holding conditions for pre-tag fish containers. Use a submersible pump or river flow-through water to provide appropriate water exchange. Monitor and record water quality regularly throughout the pre-tag holding period to ensure optimal conditions.

2) Fish Size Criteria

- A. Size of fish tagged is dependent on the type of tag being used. A maximum tag weight to body weight ratio of 5% is used to calculate minimum fish size.
- B. Transmitters for the GSNPB study will weigh 0.67 g in air. To meet a maximum tag weight to body weight ratio of 5% study fish must weigh at least 13 g (estimated corresponding FL of about 105 mm)

3) Pre-Tag Preparations

- A. Environmental conditions
 - i. Dissolved oxygen (DO): will be measured as percent saturation in a pre- and post-tag holding tank or raceway during each tag session.
 1. Measurements will be taken using a YSI model 55 DO meter
 2. DO concentrations in pre- and post-tag holding tanks should be between 80% and 130% saturation.
 - ii. Temperature: will be measured in °C in a pre- and post-tag holding tank during each tag session.
 1. Changes in water temperature exceeding 2°C require tempering (Kelsch and Shields 1996). "Tempering" means "to bring to a suitable state by mixing in or

adding a usually liquid ingredient". Therefore, prior to exposing fish to a new water source the fish holding temperature and the temperature of the new water source need to be measured to ensure that the difference between the two water sources is $\leq 2^{\circ}\text{C}$. If the temperature difference is $> 2^{\circ}\text{C}$ then water in the container holding fish should be tempered at a rate of $0.5^{\circ}\text{C}/15$ min until the temperature difference between the two water sources is $\leq 2^{\circ}\text{C}$. New source water should be added in small amounts multiple times over 15 min to gradually change the temperature by 0.5°C . Once the temperature difference between the two water sources is $\leq 2^{\circ}\text{C}$ fish can be transferred to the new water source.

B. Setup of equipment

- i. Tags should be programmed and prepared for implantation.
- ii. Disinfect all tags in chlorhexidine solution (minimum contact time of 20 minutes) and **thoroughly** rinse in distilled or de-ionized water using at least a double rinse. Position disinfected tags near the surgery table and do not handle them without gloved hands or the use of instruments.
- iii. Prepare surgical table and equipment for use.
- iv. Setup measuring board and scale
 1. Ensure the scale is functioning properly. Scales should be calibrated at the start of the study, checked each week for accuracy, and recalibrated as necessary.
 2. Put approximately 1-2 mL of diluted stress coat on the weigh boat and the measuring board.

C. Recovery buckets must be filled with river water and supplied with oxygen just prior to tagging. The concentration of DO in recovery buckets should be between 120 and 150% saturation.

D. Administration of anesthetic: The effectiveness of MS-222 as an anesthetic varies with factors such as temperature, fish density, and individual sensitivity. Adjustments of the anesthesia concentration should be based on the amount of time it takes for a fish to lose equilibrium (induction time).

- i. Fill the anesthesia bucket with 10 L of river water. As a suggestion for a starting concentration, add 7 mL (1 mL= 1 cc) of MS-222 stock solution. This will yield an anesthetic concentration of 70 mg/L. Base the daily starting concentration on fish responses during the tagging operation in previous days.
- ii. Fill both gravity feed containers with 10 L of river water. Add 2 mL of MS-222 stock solution to the container marked anesthesia. This will yield an anesthetic concentration of 20 mg/L. Add nothing to the other gravity feed container so that it can supply fresh water during surgeries.
- iii. For each mL of MS-222 added to ANY container, add the same amount of bicarbonate solution (buffer).
- iv. Water in all containers (anesthesia and gravity feed) should be changed regularly to minimize dilution of anesthesia water and temperature changes and to ensure you do not run out of water during a procedure.
- v. Add a small amount of diluted stress coat for each liter of water in the anesthesia, gravity feed, and recovery containers to protect fish from loss/damage to the slime layer.
- vi. Containers should be filled and prepared just prior to tagging to avoid temperature changes.

4) **Implantation of tags**

A. Anesthetizing fish

- i. Net one fish from the pre-tag holding source and place directly into an anesthesia bucket. Secure the lid as soon as the fish is in the bucket. Start a timer to keep track of how long a fish has been in the anesthesia bucket.
 1. Time of sedation for a fish should normally be 2 - 4 minutes, with an average time of about 3 minutes. If loss of equilibrium takes less than 1 min or greater than 5 min, reject that fish. If after sedating a few fish, they are consistently losing equilibrium in more or less time than typical, adjust the concentration of the anesthetic (up or down) in 0.5 ml increments of stock MS-222 solution.

2. Remove the lid after one minute to observe the fish for loss of equilibrium. Once the fish loses equilibrium, visually screen the fish for tags, fin clips, fungus, disease, descaling, bloated abdomen, discharge of milt, or any obvious abnormalities. Make sure to keep the fish submerged during this examination. Relay any information to the data recorder.
 - a. Due to anticipated low levels of ATPase in precocious males, and their corresponding low likelihood to show typical migration behavior, we are omitting precocious males from this study.
3. Keep the fish in the water for an additional 30 - 60 sec after it has lost equilibrium.
4. Rejects - If the fish is unacceptable for tagging, place the fish in the bucket labeled Rejects, and relay the information to the data recorder.

- ii. Any fish exposed to the initial anesthesia concentration (prior to being removed for weighing and measuring) for more than 5 min will be rejected due to the risk of excessively deep anesthesia and reduced likelihood of successful recovery.

B. Recording fish length and weight

- i. Transfer the fish to the scale and weigh the fish to the nearest 0.1 g.
- ii. Transfer the fish to the measuring board and measure the fork length to the nearest millimeter (mm).
- iii. Data must be vocally relayed to the data recorder. The data recorder should then record this information on the appropriate datasheet and repeat numbers back to avoid any miscommunication.
- iv. Any fish that is dropped on the floor during this process must be rejected. A fish dropped on the table during surgery may still be tagged. If a fish is dropped on the floor after it is tagged, remove the tag and reject the fish.

C. Surgery

- i. Place the fish on the surgery table ventral side up. Anesthesia should be administered through the gravity feed tubing as soon as the fish is on the surgery table. The tubing must be placed just inside the mouth so the water flows across the gills. If the flow is too low, the fish will flare its opercula and become agitated. Adjust the flow so that the gilling rate of the fish is steady. Use the in-line valve to control the flow of anesthesia, fresh water, or a mixture of both. Start the procedure with a constant flow of anesthesia and monitor the condition of the fish. Near the conclusion of the procedure, switch the gravity feed to fresh water to encourage more shallow levels of anesthesia in preparation for recovery.
- ii. Using a scalpel, make an incision, approximately 5 mm in length (dependent on tag size), about 3 mm away from and parallel to the mid-ventral line. Start your incision a few millimeters in front of the pelvic girdle, approximately 20% of the distance from the base of the pelvic fins to the base of the pectoral fins, and draw the blade toward the head of the fish. (For example, in Figure 1, the distance between the base of the pelvic and pectoral fins is ~45 mm, so the incision should start ~9 mm in front of the base of the pelvic fins.) The incision should be just deep enough to penetrate the peritoneum (the thin membrane separating the gut cavity from the musculature), avoiding the internal organs. The spleen is generally near the incision point, so pay close attention to the depth of the incision. Refer to Figure 1 for location of internal organs and Figure 2 for placement of incision. Avoid getting anesthesia water in the incision as river water is a source of pathogens.

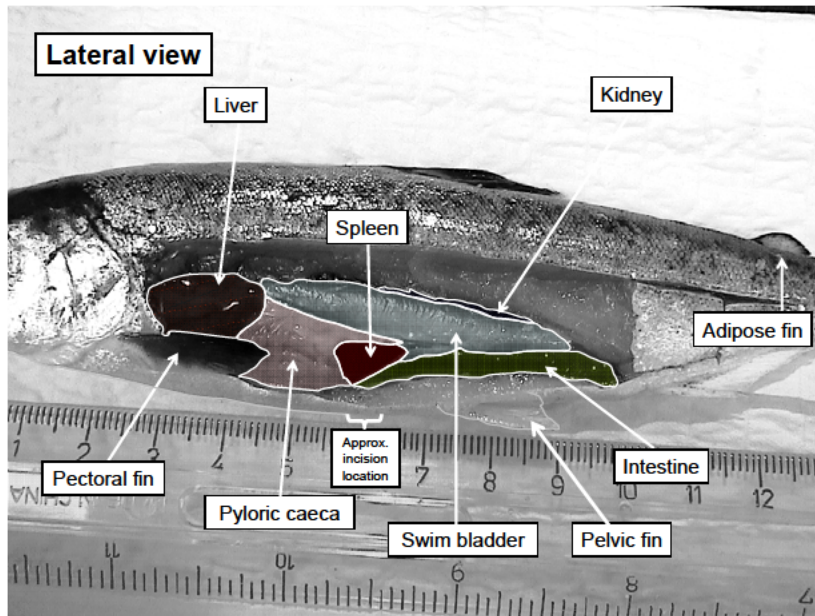

Figure 1. Lateral view of a juvenile salmonid, showing the location of internal organs.

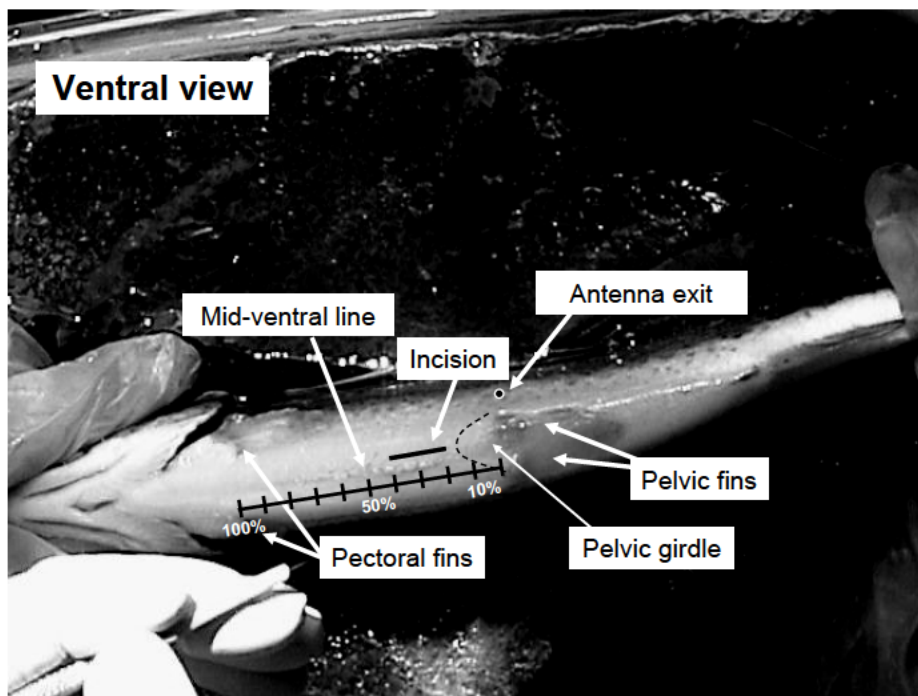

Figure 2. Ventral view of a juvenile salmonid, showing the location external organs and proper placement of incision and antenna exit (if applicable).

1. There is no exact specification for what size scalpel blade to use for each fish. The general recommendation is to use a 5 mm blade for hatchery steelhead, which typically weigh more than ~50.0 g, and a 3 mm blade for smaller fish, such as yearling and subyearling Chinook salmon that typically weigh less than ~50.0 g.
 2. One scalpel blade can be used on about seven fish before it becomes dull. If the blade is pulling roughly or making jagged incisions, it needs to be changed.
 3. Use forceps to open the incision to ensure you did not damage any internal organs or cause excessive bleeding. If you observe damage or think you damaged an organ, do not implant the tag, and reject that fish. Excessive bleeding indicates likely organ damage and should be noted on the datasheet if the surgery continues.
- iii. Gently push the tag into the body cavity, and position it so that it lies directly under the incision. This positioning will provide a barrier between the suture needle and internal organs. Through time the tag location will naturally move posterior in the fish.
- iv. Begin suturing the incision. Two or three interrupted stitches are used to close the incision, depending on the size of the tag and incision.
1. To make a stitch, lock the needle (at the end of the suture) in the needle drivers so the needle point faces you. Enter the outside edge of the incision on the side farthest from you and exit through the other edge of the incision, pulling the suture perpendicular through the two edges. The needle should enter and exit the skin as close to the edge of the incision as possible without tearing the skin (~ 2 mm from edge of incision). Pull the needle and suture through the skin to leave a tag end of about 2 - 3 cm of suture material protruding from the needle entrance location, then release the needle from the needle drivers. With your non-dominant hand, grasp the long end of the suture material (usually with thumb and forefinger) at or below the needle, and make two forward wraps (i.e., away from your body) around the tip of the needle driver, which should be held in your dominant hand. With the two wraps still around the needle driver, grasp the short tag end of suture material with the needle driver and tighten the stitch by pulling the wraps off the needle driver and pulling both ends of suture material perpendicular to the incision. On the first knot, the dominant hand holding the needle driver should pull toward your body and the non-dominant hand should pull away from your body. Tighten the suture lightly, just so the edges of the incision meet, but do not overlap, pucker, or bulge the edges of the incision. The second knot is the same as the first, but in reverse order. On the second knot, grasp the long end of suture material with your non-dominant hand, make two reverse wraps (i.e., toward you body) around the end of the needle driver, grasp the short end of suture with the needle driver, and tighten the stitch. This time, the knot should be tightened by pulling your dominant hand (holding the needle drivers) away from you and your non-dominant hand toward you. The second knot can be slightly tighter than the first, again taking care not to overlap, pucker, or bulge the edges of the incision. The third knot is a repeat of the first and should be tightened snug to prevent the stitch from coming loose. This completes one knot. Cut the suture with the needle drivers, leaving ends approximately 3-5 mm in length.
 2. There is no exact specification for what size suture to use. Generally, 4-0 suture is used for hatchery steelhead, which typically weigh greater than ~50.0 g. For fish weighing less than ~50.0 g, such as yearling and subyearling Chinook salmon, 5-0 suture is used.
 3. Generally, a good time to switch the in-line valve on the gravity feed buckets to river water is just prior to starting the last knot. This initiates recovery from anesthesia as early as possible. However, if the opercular rate appears to be inadequate, set the gravity feed system to provide all fresh water as soon as possible. If the fish is too active to finish the surgery safely do not switch to fresh water, but maintain sedation.

4. If the incision is too long to close with two stitches, it is acceptable to add a 3rd suture knot. Relay this information to the data recorder.
 5. Each individual suture (one packet) can be used on 2-4 fish. Disinfect the suture material and the attached suture needle in the sanitizing solution used for instruments.
- v. Transfer the fish from the surgery table directly to a labeled recovery bucket. If a direct transfer is not possible, use a container filled with river water to make the transfer.
 - vi. Between surgeries, the surgeon should replace the tools that were just used into the disinfectant bath. Each surgeon will have at least three (3) sets of surgical instruments to rotate through to ensure that tools get a thorough soaking in disinfectant for between uses (10 min minimum contact time with disinfectant). Once disinfected in chlorhexidine solution, rinse the tools thoroughly with distilled or de-ionized water and ensure that the scalpel blade and suture are ready to use on the next fish. Organic debris in the disinfectant bath reduces its effectiveness, so be sure to change the bath regularly. If necessary, replace the scalpel blade.
 - vii. When all fish in a recovery bucket have spent a minimum of 10 minutes in the bucket (exposed to high DO concentration) and gained equilibrium, transfer the bucket to the post-tag holding container (tank or raceway that has a constant flow of river water).

5) Post-tag holding

- A. Following the tagging procedures fish should be held for 18-40 h prior to release and the start of study monitoring. The post-tag holding period begins when the last fish of the tagging session has been secured in the holding container.
- B. The post-tag holding period must be consistent across the different tag sessions and release groups. If the tagging operation is not completed by the scheduled time, the release timing must be adjusted to accommodate the minimum post-tag holding period.

6) Cleanup at the end of the tagging session

- A. Spray all work surfaces (tagging platform, counter tops, scales, and measuring boards) with disinfectant (Vircon Aquatic).
- B. Scrub needle drivers, forceps, and scissors with a small brush to remove large pieces of organic debris. Pay special attention to the grooves and notches in the instruments where tissue can collect.
- C. Soak all surgical instruments in chlorhexidine solution for at least 30 minutes, rinse in distilled or de-ionized water solution, and thoroughly dry to prevent rusting.
- D. Buckets should be rinsed thoroughly with untreated river water and placed upside down to dry. In addition, all buckets need to be cleaned weekly.

APPROVED BY: _____ **DATE** _____
QUALITY ASSURANCE OFFICER

SUPPORTED BY: _____ **DATE** _____
STAFF USING THESE PROCEDURES

Field Standard Operating Procedure

Curator Procedures for the GSNPB Study

PURPOSE: To provide guidelines and standard protocols for the monitoring and care of juvenile salmon held both before and after surgical transmitter implantation for the Georgiana Slough non-physical barrier (GSPNB) study.

AREA OF APPLICABILITY: All staff involved in juvenile salmon fish monitoring (curation) for the GSNPB study.

REFERENCES:

Kelsch, S. W., and B. Shields. 1996. Care and Handling of Sampled Organisms. Fisheries Techniques, 2nd edition. American Fisheries Society 121-155.

MATERIALS NEEDED:

- Digital Thermometer
- YSI 55 dissolved oxygen (DO) meter
- Datasheets and writing tools
- Covered clipboard for use during boat operations
- Dedicated timepiece for recording release times
- Datasheets

PROCEDURES:

1) Fish Delivery and Transfer

- A. Juvenile salmon will be delivered daily from Coleman National Fish Hatchery. Fish will be delivered by truck to the Steamboat Slough Marina parking lot. The anticipated time of arrival for daily deliveries is approximately noon but exact timing will be coordinated daily with the delivery personnel.
- B. The number of fish delivered will vary somewhat with study needs, and will be in the range of 30-40 fish. The total number of fish will be divided, in approximately equal proportions, into two transport containers to separate the fish planned for the AM and PM tagging sessions.
- C. Plan to have the transport boat at the marina at noon to be ready to receive delivered fish. Request a call from the transport crew as they approach the marina. The transport boat should always be in position when the truck arrives so the fish can be transferred to curator care and established on Sacramento River water.

- D. As soon as the transport truck arrives, measure and record the water temperature and DO of the river near the transport boat. This information will determine the procedures needed for transferring fish.
- E. Transfer the control of the “Daily Fish Transport Log” from the truck transport crew to the curator crew and record the river water temperature and DO (measured in previous step). This datasheet will document the water conditions during the fish transfer and will be kept on the houseboat.
- F. Measure and record the water temperature and DO of all transport containers and record on the “Daily Fish Transport Log”.
- i. Compare the water temperature of the transport containers to the water temperature of the river before any fish transfers are made.
 - ii. If the difference in water temperature between the river and the transport containers is $\leq 2^{\circ}\text{C}$, transfer fish from the truck to the boat for transport to the houseboat.
 - iii. If the difference in water temperature exceeds 2°C , the transfer must be done using tempering.
 1. Changes in water temperature exceeding 2°C require tempering (Kelsch and Shields 1996). “Tempering” means “to bring to a suitable state by mixing in or adding a usually liquid ingredient”. Therefore, prior to exposing fish to a new water source the fish holding temperature and the temperature of the new water source need to be measured to ensure that the difference between the two water sources is $\leq 2^{\circ}\text{C}$.
 2. If the temperature difference is $> 2^{\circ}\text{C}$ then water in the container holding fish should be tempered at a rate of $0.5^{\circ}\text{C}/15$ min until the temperature difference between the two water sources is $\leq 2^{\circ}\text{C}$. New source water should be added in small amounts multiple times over 15 min to gradually change the temperature by 0.5°C . Once the temperature difference between the two water sources is $\leq 2^{\circ}\text{C}$ fish can be transferred to the new water source.
 3. If tempering is conducted, record it on the “Daily Fish Transport Log”
- G. Transfer fish from the truck to the boat without netting by partially de-watering the transport containers to decrease the volume of water they contain, and then carrying them from the truck to the boat. Be careful to lift the containers safely to avoid injuries to personnel and handle them carefully to avoid stressing the study fish.
- H. Prepare the boat to receive the study fish by setting up non-perforated transport containers (“liners”) that match the style of the perforated transport containers. The perforated containers will be set inside the liners and the full volume of the container will be filled with river water.
1. Do not fill the liners with river water until there is confirmation that water temperatures have been compared and that no tempering is required.
 2. Do not fill the liners with river water until just before the transport containers are to be moved from the truck so that water temperature will not increase in the liner.
- I. Tempering, if needed, can be conducted at the marina, immediately after delivery, or at the houseboat, following transport.
1. To temper at the marina, mix Sacramento River water and transport water until the difference is less than 2°C . Place the transport containers into the liners on the boat, fill the liners with river water, and commence transport.
 2. To temper at the houseboat, do not add river water to the transport container. Carry the transport containers to the boat, and secure them in the EMPTY liners. The fish will be held in a smaller volume of water so immediate transport is

required. Upon arrival at the houseboat, mix Sacramento River water and transport water until the difference is less than 2°C.

- J. During the boat transit from the marina to the houseboat, operate the boat for the smoothest possible ride for the study fish. Avoid aggressive turns and high-speed operations that may create bounce.
- K. Upon arrival at the houseboat, de-water the transport containers and lift them out of the boat onto the docks near the houseboat. Remove the perforated cans from the liners and immerse the liners in the river. Maintain the position of the lids during these transfers to avoid stress to fish and the risk of fish jumping out of the container.
- L. Label in-river holding containers with the number of fish in each and the time the containers were immersed in the river. Report the stocking time on the "Daily Fish Transport Log." This stocking time will be used to calculate the pre-tag holding time for fish tagging operations.
- M. File the "Daily Fish Transport Log" in the appropriate binder on the houseboat.
- N. Late arrival of transport truck procedures: The anticipated delivery time for Coleman fish is noon. The timing of the fish delivery is critical in that it influences the timing of the tag and release operations for the following days. The time of importance is not the time the truck arrives at the dock, but when the fish are positioned at the houseboat and secured. In the event that the transport truck is delayed for less than 2.5 hours (delivery of fish by 2:30 pm), and fish are secured at the houseboat by 3 pm, no changes to the schedule need to be made. If delivery will be after 2:30 pm, (and fish will be secured after 3 pm) the pre-tag holding time will be shortened and the tagging operations the following day will need to be delayed a corresponding amount of time to ensure that fish are held for a minimum of 18 h before tagging starts. See the tag timing operations summary for further details.

2) Fish Curation Procedures

- A. Study fish are held approximately 24 h prior to tagging and approximately 24 h after tagging. Fish held before tagging (hereafter referred to as "source fish") are held in 20 gallon containers (typically 3 containers). Fish held after tagging (hereafter referred to as "tagged fish") are held in 32 gallon containers that hold individual release groups of 4 fish each. At any point in time there will be several containers of fish secured to the docks near the houseboat.
- B. Water quality monitoring will be conducted in and around the source fish and tagged fish holding containers, but not within the containers. The lids of the containers are secured to prevent fish loss and we want to minimize disturbance. The containers are perforated so that they exchange water with the river, so recording water quality near the containers will represent the water quality within the containers.
- C. Water temperature and DO will be recorded regularly (every 2 hours) while fish are held at the houseboat. A single reading will be used to represent all the containers unless they are held at significant distances from each other (i.e., some off the back of the houseboat and some off the front).
 - 1. Use the "Curator Water Quality Monitoring Log" to record water quality.
 - 2. Log water quality approximately every 2 hours, around the clock.
 - 3. Keep the monitoring log based on date and time, not based on release number or release group since several release groups will always be present.

4. When a log is complete, photocopy it for back-up, and file the original and copy in the appropriate binders.

3) Fish Release Procedures

- A. Fish releases will be conducted daily at 9 am, 12 pm, 3 pm, 6 pm, 9 pm, 12 am, 3 am, and 6 am. These are target release times, and there is some leeway to allow for logistics. Make every attempt to release fish at these times or within 10 min after the target release time.
- B. Fish releases will be conducted by boat, in the middle of the Sacramento River channel (approximately equal distance from both shorelines), nearby the houseboat.
- C. Approximately 45 min prior to a scheduled release, reference the appropriate tag-release datasheet to determine which tagged fish container holds the fish that need to be released.
 1. Partially remove the lid of the container and insert a hydrophone to monitor for transmitter function prior to release.
 2. Complete the tag code-out log with the time the hydrophone was moved, the container ID and your initials. Call the HTI trailer to confirm the code out was completed.
 3. Remove the hydrophone (and complete the code-out log) prior to the scheduled release time. Be sure to remove the hydrophone before the turn of the hour to ensure proper data logging (e.g., if the scheduled release time is 3:00 am, move the hydrophone into the appropriate container at 2:15 am and remove it by 2:55 am)
- D. Approximately 10 min prior to the scheduled release time remove the lid of the container and conduct a visual exam of the fish. Containers will typically hold 4 tagged fish each. If your inspection reveals less than 4 fish or more than 4 fish, examine the tag-release datasheet to confirm the number of fish that were tagged. Resolve any discrepancies.
 1. The visual exam should include a count of the fish in the container, a general review of fish condition, and a clear visualization of the bottom of the container to determine if any tags have been shed from the fish.
 2. Night operations will require the use of a headlamp to conduct the visual exam.
- E. If the exam reveals dead or moribund fish, remove the fish from the container. Kill moribund fish using high dose MS-222 or other lethal means. Use the PIT tag reader to determine the fish ID. Reference the tag-release datasheet and record "mort" in the release comment field.
 1. Remove the acoustic tag and PIT tag from the fish, rinse them, and put them into the "MORT/RECYCLE TAG" box. Keep tags from multiple dead fish separate.
 2. Place the dead fish in a plastic bag with a label showing the release date and hour. Place the bag in the freezer of the houseboat refrigerator.
 2. Complete the "Mortality – Tag Recycle Record" sheet.
- F. Approximately 5 min prior to the scheduled release time move the container from its holding position to the boat (or bring the boat to the holding position). Attach a tether line from the container to the boat and slowly motor the container to the release location mid-channel. Alternately the can may be partially de-watered and lifted into the boat for transport to the release location. Take care to transfer the container gently so as to reduce disturbance and stress to the fish.
- G. At the scheduled release time, remove the lid from the container; use the PVC frame to tip the container so that tagged fish can volitionally swim out of the container into the river. If the can was lifted into the boat for transport, lift the can into the river, remove the lid, and tip the top of the can to allow fish to volitionally swim out of the container.

- H. Use the provided time piece to record the release time on the tag-release datasheet.
- I. In the event of a mechanical failure of the release boat, make attempts to enact repairs and/or activate an alternate release boat as quickly as possible. Every effort should be made to execute the release of tagged fish as near as possible to the scheduled release time. Continue efforts to make a delayed release, up to 30 minutes prior to the next scheduled release time (that is, work on repairs, etc. for 2.5 h). As a last resort, release the tagged fish with the next scheduled release group.

4) Fish Tagging Operations

- A. Fish tagging operations will be conducted daily. Tagging staff will arrive at the houseboat at approximately 8:00 am and will conduct two tagging sessions. The first session will be from 8:00 am until approximately 12:00 pm, and the second will be from approximately 2:00 pm until 5:00 pm. As you are available, please assist the taggers and assistants during these periods. The tagging staff can provide specific guidance on how you can assist the tagging operation.
- B. Source fish containers (held in-river since delivery) will be moved to the houseboat deck prior to the tagging operation. Once in position a pump system will be used to supply a constant flow of river water to the container. While the source fish container is on the deck of the houseboat the water quality in the container must be monitored to ensure that it is comparable to the river conditions (which are being logged regularly). Visually monitor the container for evidence that the pump is fully operational and good water exchange is occurring. Resolve any deficiencies you observe.
- C. At the completion of the PM tagging session check with the tagging operation to see if there are untagged (surplus) fish that need to be released to the river.
 - 1. Confirm that the tagging operation is complete and that no additional fish are needed.
 - 2. Develop a plan to release surplus fish as soon as reasonable, but not concurrently with tagged fish (e.g., release fish at 5 pm, but not 6 pm). Separate the release of surplus fish from a scheduled release time by at least 30 min).
 - 3. Continue use of the pump system or return fish to the river to maintain water quality while fish are waiting for release.

5) Maintenance of Fish Holding Containers

- A. Monitor all fish holding containers for the presence of lids and lid securing hardware. Repair or replace lids or hardware as needed.
- B. Monitor all fish holding containers for proper labels. Repair or replace as needed.
- C. Keep containers clear of debris or growth by rotating stock to provide some drying time. As needed, use a brush to clean the inside of containers to ensure adequate water exchange.

APPROVED BY: _____ **DATE** _____
QUALITY ASSURANCE OFFICER

SUPPORTED BY: _____ **DATE** _____
STAFF USING THESE PROCEDURES

APPENDIX C

2011 GSNPB Acoustic Doppler Current Profiler Data Processing and
Water Velocity Modeling

Appendix C: 2011 GSNPB Acoustic Doppler Current Profiler data processing and water velocity modeling.

Instrument Deployment and Operation

In order to document the water velocities along the face of the barrier the USGS deployed upwards looking Acoustic Doppler Current Profiler's (ADCPs) at intervals about 10 meters upstream of the barrier. Upwards looking ADCPs were chosen because they could make the type of high frequency, continuous measurements throughout the study period required to support sufficient temporal averaging to remove the variance caused by low-frequency turbulence in the study area. Additionally, upwards looking ADCPs can measure velocities in any direction in a horizontal 2d plane without the bin-mapping considerations of horizontal profilers. 4 ADCPs were initially deployed along the face of the barrier, with the ADCP locations shown in Figure 1 are labeled 1-4 in order from downstream to upstream. Unfortunately, the sudden increase in velocities and resulting bed-mobilization caused by the leading edge of the flood wave resulted in cable failure for all of the instruments. As a result, the ADCPs were recovered, and two were redeployed for the second half of the study. These ADCP locations are labeled location 5 and 6, again numbered in order from downstream to upstream. These ADCPs were configured with adequate battery capacity and internal memory capacity to operate self-contained to manage the risk of premature cable failure, and operated without any down-time during the second half of the study.

All of the ADCPs were deployed to collect data continuously for 10 minutes, and then record a single ensemble average for each 10 minute ensemble. The ADCPs were configured to collect an ensemble average for every 1 meter vertical bin above the instrument. During the binary-numeric processing steps the upper meter of data was often removed due to surface-induced bias, so the effective upper bin measurement was about 1 meter below the surface at all times.

After the ADCPs were recovered, the data stored internally had to be converted from RDI's binary data format into numeric values, then geo-referenced, rotated into earth coordinates, heading/declination corrected, and attributed to the correct ADCP position (since several instruments were deployed in more than one location). This process is described below.

ADCP Data Processing

Converting from RDI Binary Format to Geo-referenced Numeric Data

All conversions from binary to numeric data along with geo-referencing and basis transformations were accomplished using a custom suit of labview software developed by Aaron Blake and Mike Simpson from the California Water Science Center. The details of this process are beyond the scope of this document.

Declination and heading offsets

Starting Declination

All ADCPs were programmed with a starting declination of 14.41 degrees. Current models accessed @ <http://www.ngdc.noaa.gov/geomagmodels/struts/calcDeclination> show a declination in the Walnut Grove area of 14.2 degrees. As a result, all deployments EXCEPT deployment 2 were processed with a heading offset (implemented in the labview binary processing software) of -0.27 degrees.

ADCP2 Declination Correction

Based on plots and animations, USGS staff determined that the ADCP compass for deployment 2 appeared to have been affected by the presence of a nearby steel piling. As a result, a correction factor was computed by comparing the average original vector heading for deployment 2 to the averaged corrected vector headings for the rest of the instruments. For this correction each deployment was given a ADCP Location number that was a surrogate for location along a streamline moving downstream in the junction.

Figure 2 shows the mean 2d vector heading for all deployments as a function of ADCP Location Number, with the uncorrected heading for ADCP2 shown in blue. Based on this curve, a heading correction of 6.81 degrees was calculated, and implemented by entering +6.81 degrees as the declination correction in the binary processing software. The post correction curve is shown in Figure 3.

ADCP angle and velocity distributions; filtering of bad data

It was evident from animations of the unfiltered data that many of the ADCPs had periods of bad data, likely due to partial burial under sand waves. Angle and 2D velocity magnitude distributions were computed for all ADCPs, and filter parameters were developed to remove obviously bad data periods. Acceptable data ranges were chosen as follows:

- 200 < Heading < 240
- Magnitude (speed) > .4 m/s

Figures documenting the uncorrected velocity heading and magnitude distributions can be found at:

<https://sites.google.com/site/dwrdisco2011/home/2011-study/hydrodynamic-data-collection/adcp-data-processing-page>

Figures 4-9 show 2D vector heading and velocity magnitude distributions for ADCPs 1-6 post filtering and heading correction. These distributions are indicative of the velocity data used for all subsequent analysis. Note that ADCPs 1-4 show bi-modal distributions that are the result of their being deployed before and during the peak flow event. The lower velocity mode is indicative of normal winter flows, and the high velocity mode represents peak flow/bank full conditions. ADCPs 5 & 6 were deployed after the peak flow event and are uni-modal.

The final processed ADCP .csv files can be downloaded from:

http://www.sfbaydelta.org/GSBarrier/private/2010/Velocity/ADCP_CSV_Files/

These files include all declination/heading corrections, but they also include bad data values. Bad values were filtered out in Matlab using the acceptable magnitude and heading ranges given above.

ADCP Outages and Fish Arrival Times

Due to equipment failures, the study was effectively separated into an early and a late replicate. During the early replicate 4 ADCPs were deployed in advance of fish releases. Unfortunately, the high flow event caused cable failures that eventually resulted in all of the ADCPs failing before fish releases were concluded. During the late replicate the ADCPs were deployed to rely on internal batteries and storage, and they were able to function regardless of cable integrity; these ADCPs (5 & 6) were able to collect continuous 10 minute ensembles for the entire time that fish were released during the late replicate.

Figure 10 shows ADCP operation periods along with fish arrival times at the barrier, and a normalized mean velocity signal for reference. The time of each good ADCP 10 minute ensemble is shown in black, the time when each unique tag code was closest to the barrier is shown as a red line, and the blue line is a normalized downstream velocity signal from an upstream side-looking ADCP (Deckhands Marina).

As the figure indicates, there are times during the early replicate when velocity values for each fish need to be estimated from predictive relationships since the velocities were not measured directly.

Developing Models for ADCP Velocity components

Model development and signals used

As a result of the need to estimate water velocities during ADCP failures in the early replicated, regression models were developed to predict 2d surface velocities at each ADCP location as a function of flow and velocity signals acquired by HADCPs (Channel Masters) located upstream. For each ADCP location U and V velocity components were modeled independently. The signals used as independent variables are listed below:

1. gsFQ - The fraction of flow entering the Georgiana Slough junction area that passes down georgiana slough, calculated as $(gs+wgb)/gs$, where gs and wgb flow measurements from stations run by the usgs. gsFQ is a fraction from 0-1.
2. dhU - The downstream velocity magnitude measured @ Deckhands marina upstream of the study site. m/s.
3. dhV - The cross-channel velocity magnitude measured @ Deckhands marina upstream of the study site. m/s.
4. wgb - The cross-channel averaged mean velocity @ the usgs wgb flow station downstream of the study site on the Sacramento River.
5. gs - The cross-channel averaged mean velocity @ the usgs wgb flow station downstream of the study site on the Georgiana Slough.
6. gsFQ2
7. dhU2
8. dhV2
9. wgb2
10. gs2
11. gsFQ3
12. dhU3
13. dhV3
14. wgb3
15. gs3

The signal components based on USGS flow station measurements were collected as 15 minute average values, signals based on the Dechkands side looking ADCP were collected as 10 minute average values, and the upward looking ADCP values were collected as 10 minute

averages. For the regression modeling, all independent signals were first interpolated to a common 15 minute time step, the 15 minute time series were used to develop regression models, and then the regression models were used to estimate velocity values for the time that each fish was nearest to the barrier based on times from the location spreadsheet.

For the regression, the ADCP observation values that were used to drive the models were computed as the average of the upper two bin values for each velocity component (u and v). By fitting against the average of the upper two bins the regression is essentially predicting the average 2d velocity of the upper 3-4 meters of the water column. Past studies on juvenile outmigrants in the North Delta (Blake and Horn, [2004,2006](#)) suggest that most outmigrating juvenile salmon are in the upper 3 meters of the water column, and initial analysis of the tracking data from this study indicate a similar trend.

Using the Matlab step-wise regression tool, it was found that the first three independent signals could explain most of the variance in the ADCP velocity observations, however, including all 15 independent signals in the regression improved the heteroscedasticity of the model, especially at higher velocities. As a result, all 15 signals were included in the final regression models for each ADCP's U and V component. **It is important to note that models are likely "over fit", and contain a significant number of non-linear terms; as a result these models should only be applied within the range of independent signal values encompassed by the periods of each ADCPs operation. In other words, these models are valid for interpolation, but not extrapolation.**

After the initial model fit was obtained, outliers were identified as residuals that were located more than N stand deviations from the residual mean. For ADCPs 1,3,4,5,6 a value of N=3 was used, for ADCP 2 a value of N=1.3 was used, due to the larger number of bad velocity measurements present in the ADCP2 record (Due to partial burial by sandwaves). Outliers were removed from the U and V signals used for the model fit, and the model regression was performed again to improve fit. The model performance discussed below is the performance of the second round of modeling, with outliers removed.

Model performance

Figures 11 - 16 show model performance for each ADCP location with outliers removed. In general, model performance was quite good, the R2 value for each velocity component model was above 0.979, most were on the order of .99, and heteroscedasticity was fairly good, though models for ADCPs located lower in the junction (closer to the study trailers) exhibited increased and slightly biased error at extreme velocity values. The model for ADCP 2 had the largest number of outliers removed; analysis of the acoustic backscatter intensity and pitch-roll data from this ADCP suggest that this instrument was constantly being buried by sandwaves, and as a result, there are a number of clearly bad values that were not filtered out by the bulk filter parameters described above.

Given the tight model fits, and the probability that all of the ADCP measurement records include some data that is biased (or completely bad) due to partial burial and/or the extremely high concentrations of suspended sediment present in the turbulent boundary layer, the modeled velocity components were used to for fitting velocities for each fish position/time in the position spreadsheet, rather than using a mix of modeled and measured velocities. Using modeled velocity components for each fish also increases consistency, as the alternative would be to use a fuzzy-logic approach to choosing between

direct interpolation from nearby ADCP measurements and model measurements as a function of quasi-arbitrary data gap parameters. Given the number of regression parameters the model coefficients are not given, but are available upon request.

Simplified Regression Models With Only Linear Terms

As stated above, most of the variance in the U and V velocity components for each ADCP was explained by simple regression models that used the first three linear terms included in the full model (gsFQ,dhU,dhV). In order to provide simple, robust regression models for velocity that will better support extrapolation, the regression modeling process was repeated as described above, but using a different series of independent variables that allow users to predict velocity values using linear combinations of USGS gauge data based on the independent variables are described below.

1. gsFQ - this can be calculated as $(gsFlow/(gsFlow+wgbFlow))$, these terms are the flow (discharge) values from the USGS GS and WGB flow stations
2. wga - Mean cross sectional averaged velocity from the WGB (Walnut Grove Below) usgs gauge
3. wgb - Mean cross sectional averaged velocity from the GS (Georgiana Slough) usgs gauge

Note that gsFQ is computed using flow (discharge), and wga and wgb are the mean cross sectional velocity values, not the flow (discharge) values.

The equations for these regression models, as well as figures indicating model performance can be found at:

<https://sites.google.com/site/dwrdisco2011/home/2011-study/hydrodynamic-data-collection/adcp-data-processing-page>

The data required for these models can be downloaded from either CDEC or the USGS:

1. GS - http://waterdata.usgs.gov/nwis/inventory?agency_code=USGS&site_no=11447903
2. WGB - http://waterdata.usgs.gov/nwis/inventory?agency_code=USGS&site_no=11447905
3. WGA - http://waterdata.usgs.gov/nwis/inventory?agency_code=USGS&site_no=11447890

ADCP position locations corresponding to modeled velocity values

For reference, the locations of each of these ADCPs is as follows (UTM, NAD83, meters):

1. 629729 m East, 4233450 m North
2. 629768 m East, 4233487 m North
3. 629793 m East, 4233505 m North
4. 629822 m East 4233529 m North
5. 629752 m East 4233468 m North
6. 629784 m East 4233498 m North

Determining water velocity value for each fish position

Figure 17 shows the locations given in the positions spreadsheet as the point where each fish was closest to the barrier, along with the barrier location and ADCP Locations. Given that almost all of these positions were not located on a streamline between ADCPs, and given the long distance from the ADCPs and the barrier of most of these positions, it is not valid to interpolate a velocity for the locations given in the position spreadsheet. Instead, the distance from each ADCP was computed for each fish position, and these distances were used to drive an inverse-distance-squared average of all the relevant ADCP velocity estimates (generated using the above regression models) yielding a single velocity value for each fish position. For fish arriving during the "early replicate" (<DOY 90) modeled values for ADCPs 1 through 4 were averaged, and for fish arriving during the late replicate modeled values for ADCPs 5 and 6 were averaged.

This average was implemented with the following Matlab code, contained in *InterpolateADCPDateToFish.m* :

```
p=2;
%calculate the distance from the fish to Each ADCP Location
dists=sqrt(((locs(:,1)-fish(f,3)).^2)+((locs(:,2)-fish(f,4)).^2));
weights=dists.^p;
weights=1./weights;

%if it is the early replicate, give the ADCPs 5 and 6 no weight
if fish(f,2)<90
    weights(5:6)=0;
else
    weights(1:4)=0;
end

%now calculate the modeled u and v components
theseUs=[fitVals(f,1);fitVals(f,3);fitVals(f,5);fitVals(f,7);fitVals(f,9);fitVals(f,11)];
theseVs=[fitVals(f,2);fitVals(f,4);fitVals(f,6);fitVals(f,8);fitVals(f,10);fitVals(f,12)];
fitU=sum(theseUs.*weights)/sum(weights);
fitV=sum(theseVs.*weights)/sum(weights);
```

Change of basis to calculate streamline and cross-streamline coordinates.

Description of change-of-basis process

In order to investigate the effects of cross-sectional location on fish entrainment, a new coordinate system was developed so that locations within the study area could be expressed in terms of down-stream and cross-stream components, and a change of basis matrix was calculated to allow for the conversion of any point in the study area to this new coordinate system.

The new coordinate system is referred to as "barrier-mid", and is a fully orthogonal basis for R3 that obeys all standard right-hand-rule conventions; the barrier-mid \hat{j} axis points downstream along the mean streamline from the axes origin, and the systems \hat{i} axis points across stream normal to the mean streamline from the axes origin, with the positive direction moving towards Dagmar's landing (the northwest side of the Sacramento River). The mean streamline that formed the reference for this new coordinate basis was calculated as the average of all velocity components from all of the fish times in the spreadsheet. This mean streamline provides enough information to calculate the \hat{i} and \hat{j} axes components, but an axes origin point is needed to complete the transformation. The goal of this process was to compute an origin point such that 0 on the \hat{j} axes would be even (along the mean streamline) with the upstream edge of the barrier, as defined by the location of pier block 2, and the zero on the \hat{i} axes should be located such that 0 was at the cross-stream most point on the barrier.

To find the desired origin, a basis called barrier-0 was computed using the mean streamline as the streamline direction, and the location of Pier Block 2 as the basis origin. An interpolated barrier curve (interpolating the shape of the barrier onto a curve with points every 1/2 meter along the barrier length) was computed and its coordinates were converted into barrier-0 coordinates. The location of the point on the barrier with the greatest \hat{i} value in barrier-0 coordinates was found, and this location was used to compute the barrier-0 coordinates of the point with the same \hat{i} value, but with a \hat{j} value of 0 (even with Pier Block 2). This coordinate was then multiplied by the inverted change of basis matrix to find the appropriate utm coordinates for the barrier-mid axes origin.

After this process was completed, preliminary tracking results obtained from HTI were loaded, and the tracks for all fish were converted into barrier-mid coordinates. The location with the lowest absolute value

of the jhat component was found, and the ihat and jhat values for this point were reported in the covariate spreadsheet in columns 21 (ihat) and 22 (jhat).

Figure 18 shows the barrier-mid coordinate system axes used to compute the along-stream, and the cross-stream coordinates reported in the variable spreadsheet. The documentation and pseudocode required to reproduce the barrier-mid coordinate system can be found at:

<https://sites.google.com/site/dwrdisco2011/home/2011-study/hydrodynamic-data-collection/adcp-data-processing-page>

Covariate Spreadsheet

The most current version of the covariate spreadsheet can be downloaded as a csv file from google docs [here](#). It can also be viewed as a google docs spreadsheet [here](#)

Data Fields

Data fields (columns) listed in order (left to right).

1. Tag code (code+subcode/100)
2. DOY value when fish was closest to barrier (0.0 hrs on Jan 1 is DOY=0.0)
3. Easting when fish was closest to barrier (m, NAD 83)
4. Northing when fish was closest to barrier (m, NAD 83)
5. Elevation, all are zero, only 2d was considered
6. Nearest ADCP number, these numbers correspond to the numbers in the ADCP operation time figure
7. Distance to nearest ADCP, m
8. Interpolated water velocity u component, m/s
9. interpolated water velocity v component, m/s
10. interpolated water velocity heading (compass heading, see above)
11. interpolated water velocity magnitude m/s
12. Barrier-mid x value for fish position, m. See figure and above
13. Barrier mid y value for fish position, m. See figure and above
14. Interpolated water velocity downstream component as defined by the Barrier-mid y axis. Positive is downstream towards the ocean.
15. Interpolated water velocity cross-stream component as defined by the Barrier-mid x axis. Positive is towards Dagmars
16. Distance to the nearest point on the barrier, m
17. Heading of the barrier itself @ the nearest point on the barrier, heading angle.
18. Along-Barrier water velocity component, @ the nearest point on the barrier, m/s. Positive is moving progressively along the barrier
19. Across-Barrier water velocity component, @ the nearest point on the barrier, m/s. Positive is moving across the barrier, negative is moving away from the barrier
20. Distance along barrier from top (pair block 2) to the nearest point on the barrier. meters
21. Barrier-mid x value for fish location closest to pair block 2, derived from preliminary fish tracks. If there was no fish track found this is NaN. Positive is cross-stream away from the barrier, negative is cross-stream towards the barrier, 0 is cross-stream location of the most cross-stream portion of the barrier. See figure
22. Barrier-mid y value for fish location closest to pair block 2, derived from preliminary fish tracks. If there was no fish track found this is NaN. Positive is down-stream of pair block 2. Negative is up-stream of pair block 2, 0 is cross-stream from pair block 2. See figure
23. Normalization based on column 21,14,and 15. Basically a measure of where the fish started, where it was advected, and where it could swim, measured in cross-stream coordinates
24. Fraction of junction flow entering Georgiana Slough. 0 to 1.

25. Deckhands marina horizontal ADCP downstream velocity component, m/s, positive is downstream.
26. Deckhands marina horizontal ADCP cross-stream velocity component, m/s, positive is towards the east bank (Georgiana Slough side of the river).
27. WGA (flow station in the Sacramento River 1km upstream of the junction) mean cross-sectional velocity magnitude, m/s. Positive is downstream
28. WGA discharge, cfs, positive is downstream
29. WGB (flow station in the Sacramento River downstream of the junction) mean cross-sectional velocity magnitude, m/s. Positive is downstream
30. WGB discharge, cfs, positive is downstream
31. GS (flow station in the Georgiana Slough downstream of the junction) mean cross-sectional velocity magnitude, m/s. Positive is downstream
32. GS discharge, cfs, positive is downstream

Software Listing

The matlab code used to perform the data processing and the interpolation can be found at:

<https://sites.google.com/site/dwrdisco2011/home/2011-study/hydrodynamic-data-collection/adcp-data-processing-page>

List of figures contained in the ADCP data processing appendix

Figure 1 - ADCP Deployment Locations

Figure 2 - Average ADCP vector headings pre-correction

Figure 3 - Average ADCP vector headings post-correction

Figure 4 - ADCP 1 Filtered velocity heading and magnitude distributions.

Figure 5 - ADCP 2 Filtered velocity heading and magnitude distributions.

Figure 6 - ADCP 3 Filtered velocity heading and magnitude distributions.

Figure 7 - ADCP 4 Filtered velocity heading and magnitude distributions.

Figure 8 - ADCP 5 Filtered velocity heading and magnitude distributions.

Figure 9 - ADCP 6 Filtered velocity heading and magnitude distributions.

Figure 10 – ADCP operation periods and fish release periods shown with Sacramento River discharge.

Figure 11 - Performance of regression model predicting water velocities at ADCP 1

Figure 12 - Performance of regression model predicting water velocities at ADCP 2

Figure 13 - Performance of regression model predicting water velocities at ADCP 3

Figure 14 - Performance of regression model predicting water velocities at ADCP 4

Figure 15 - Performance of regression model predicting water velocities at ADCP 5

Figure 16 - Performance of regression model predicting water velocities at ADCP 6

Figure 17 - location of each fish was determined to be closest to the barrier, based on data from the Locations Spreadsheet

Figure 18 - Barrier-mid coordinate system used to compute along-stream and cross-stream coordinates for each fish's nearest position.

Figure 1 - ADCP Deployment Locations

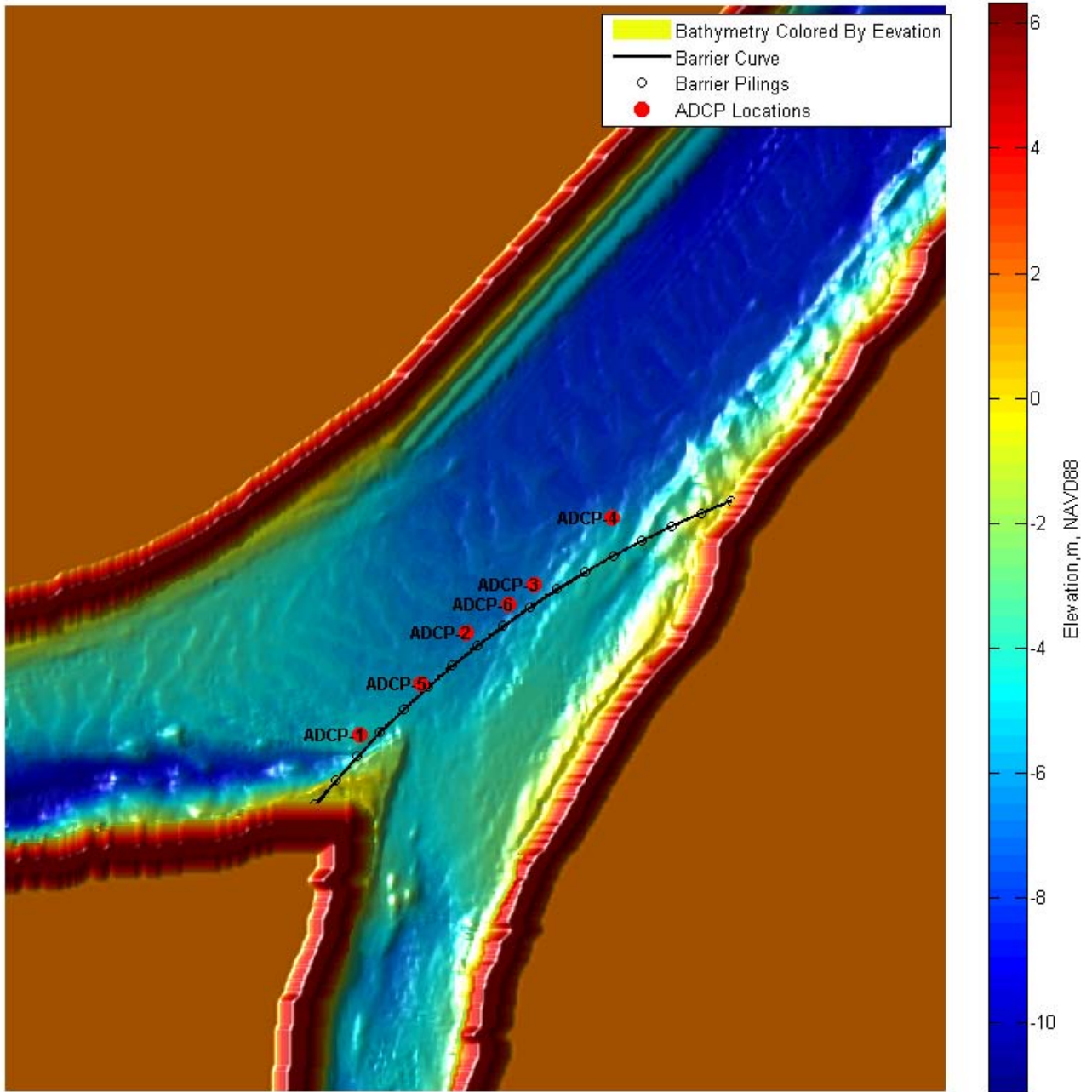

Figure 2 - Average ADCP vector headings pre-correction

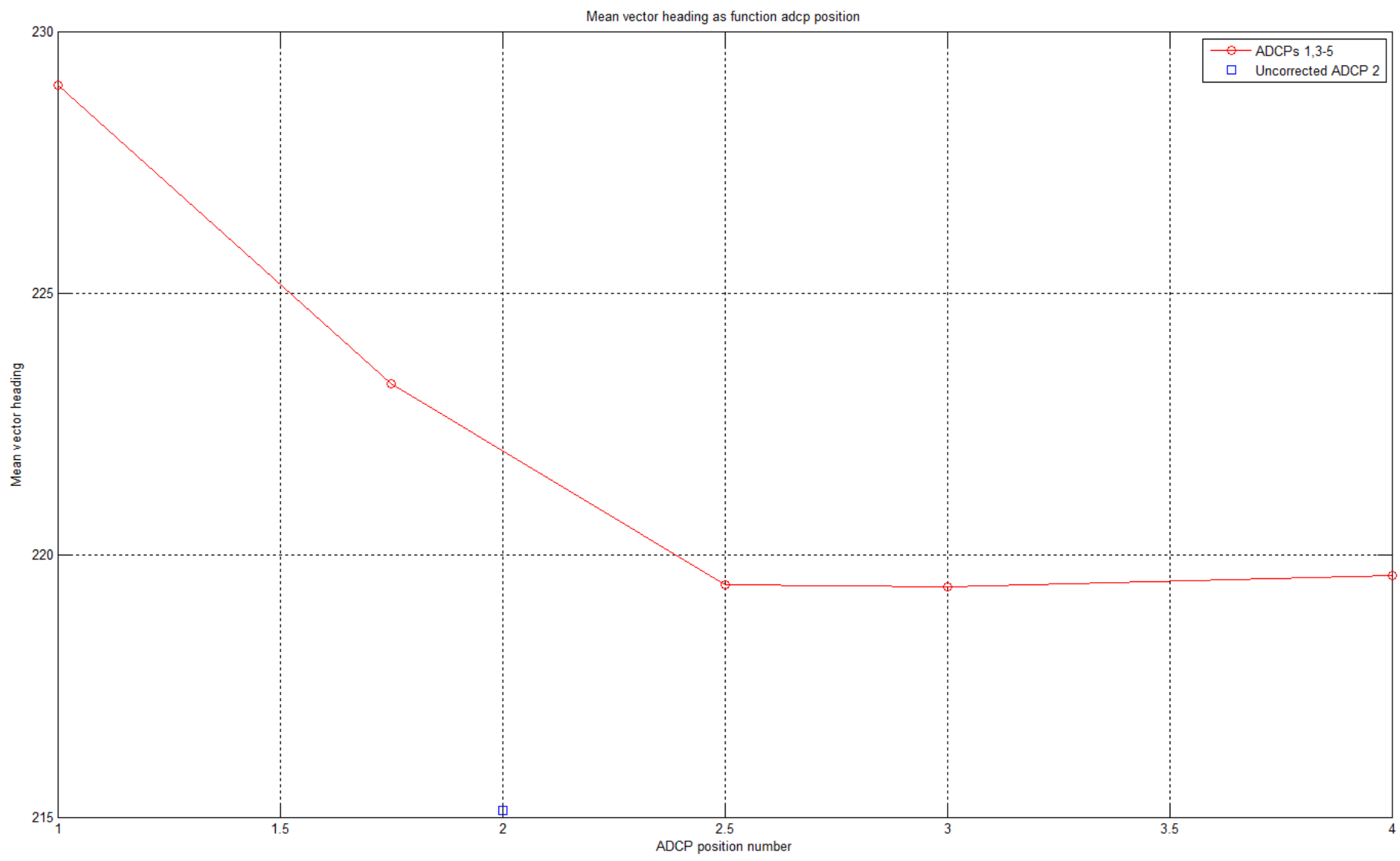

Figure 3 - Average ADCP vector headings post correction

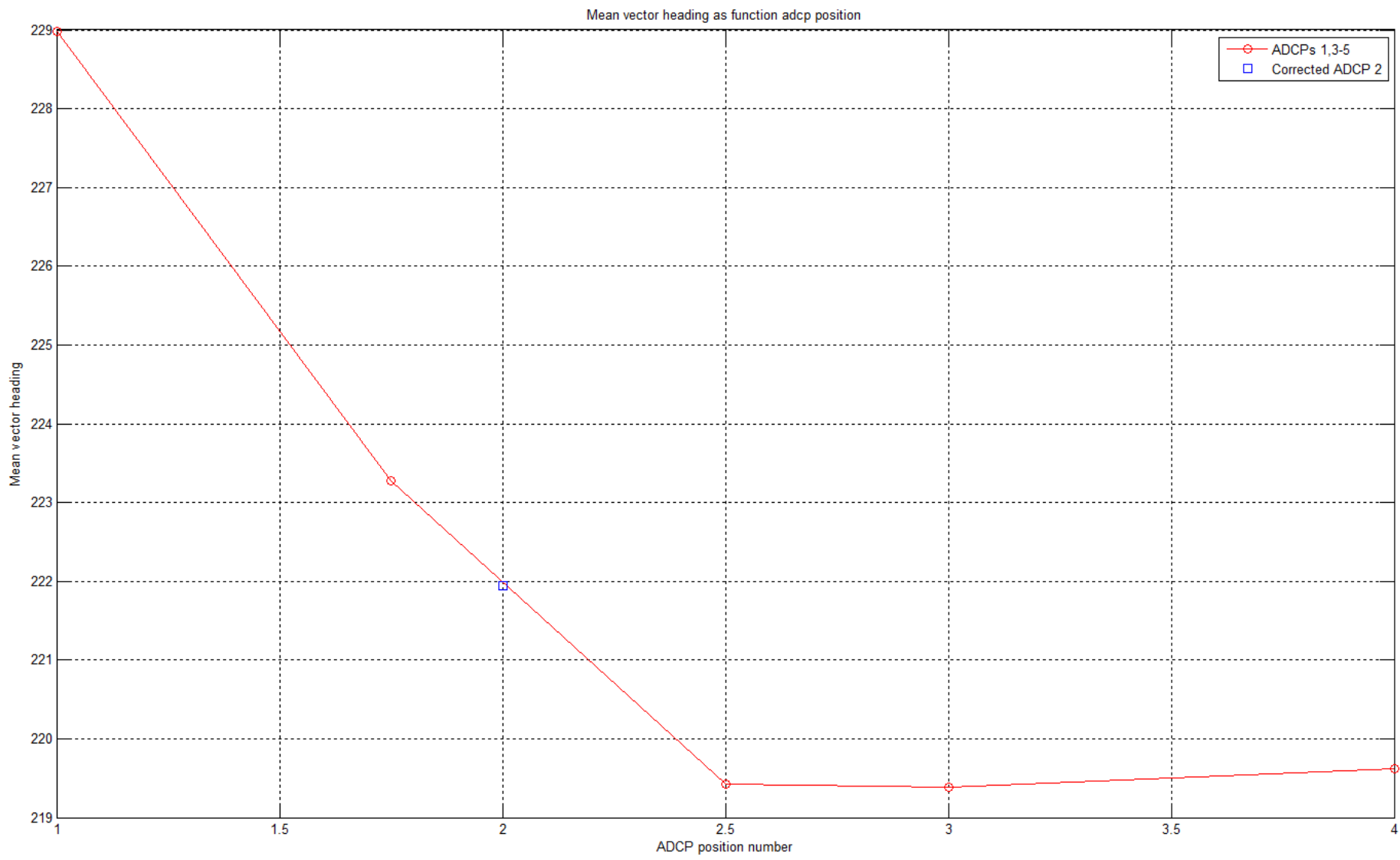

Figure 4 - ADCP 1 Filtered velocity heading and magnitude distributions.

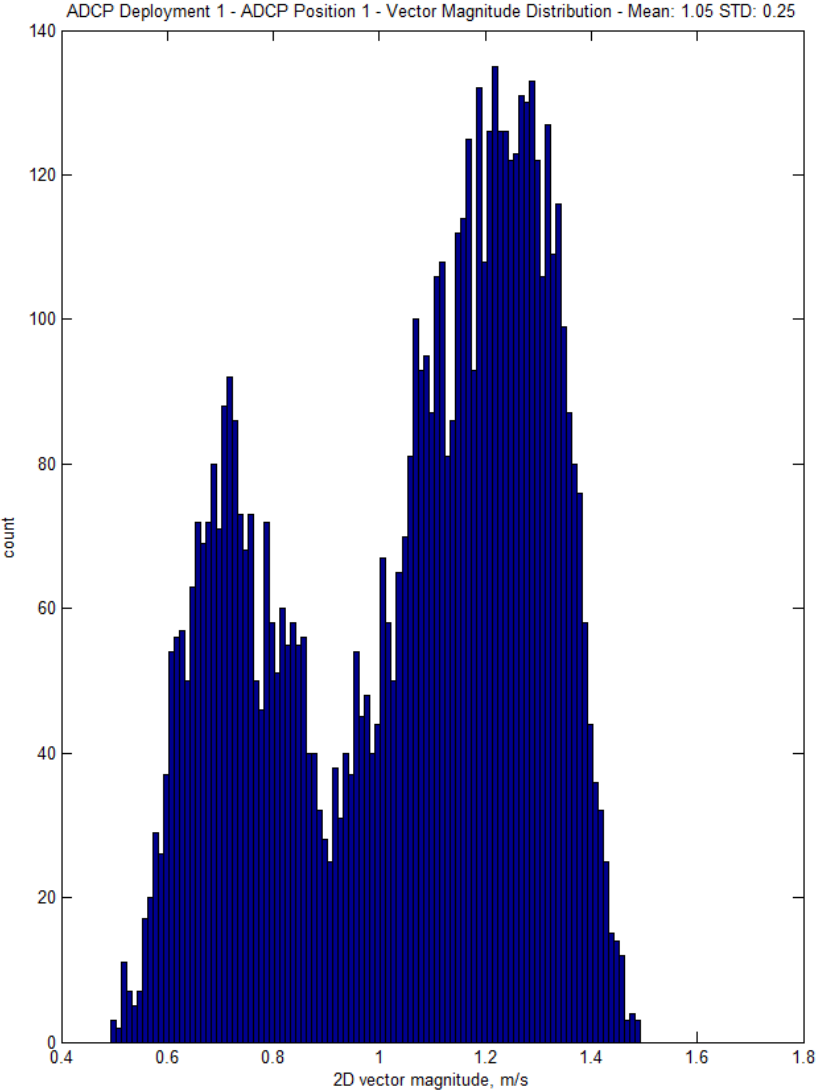
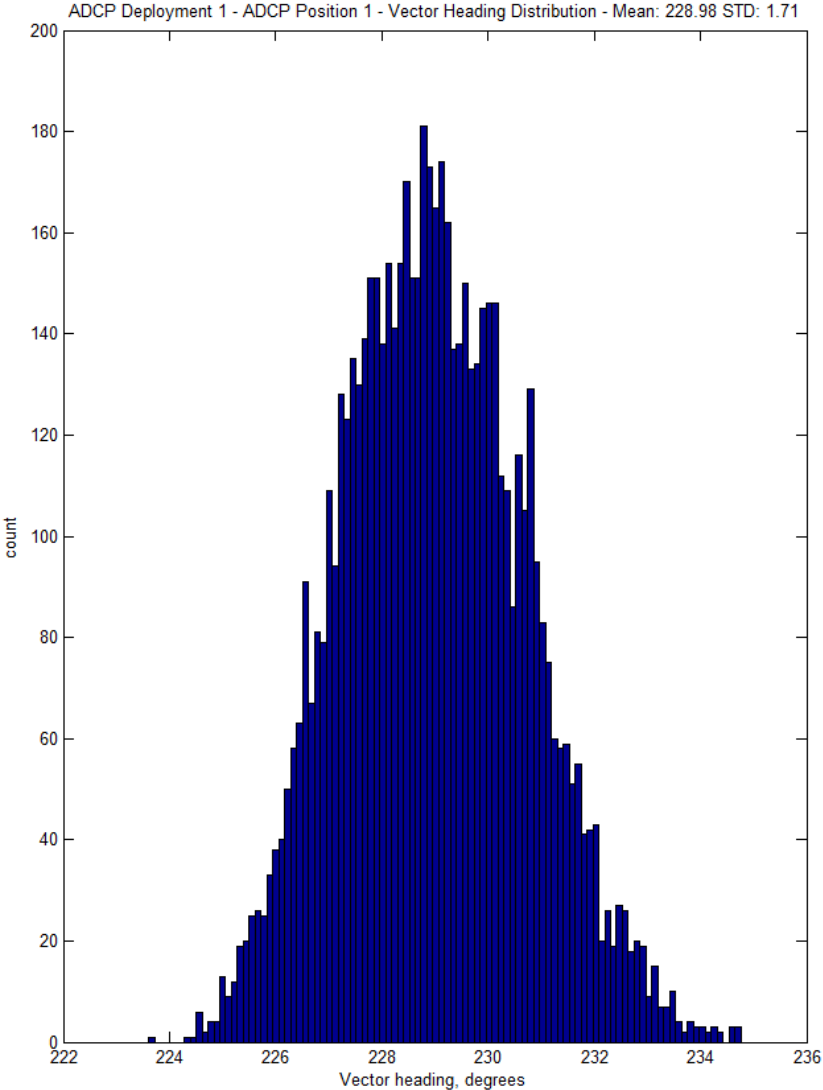

Figure 5 - ADCP 2 Filtered velocity heading and magnitude distributions.

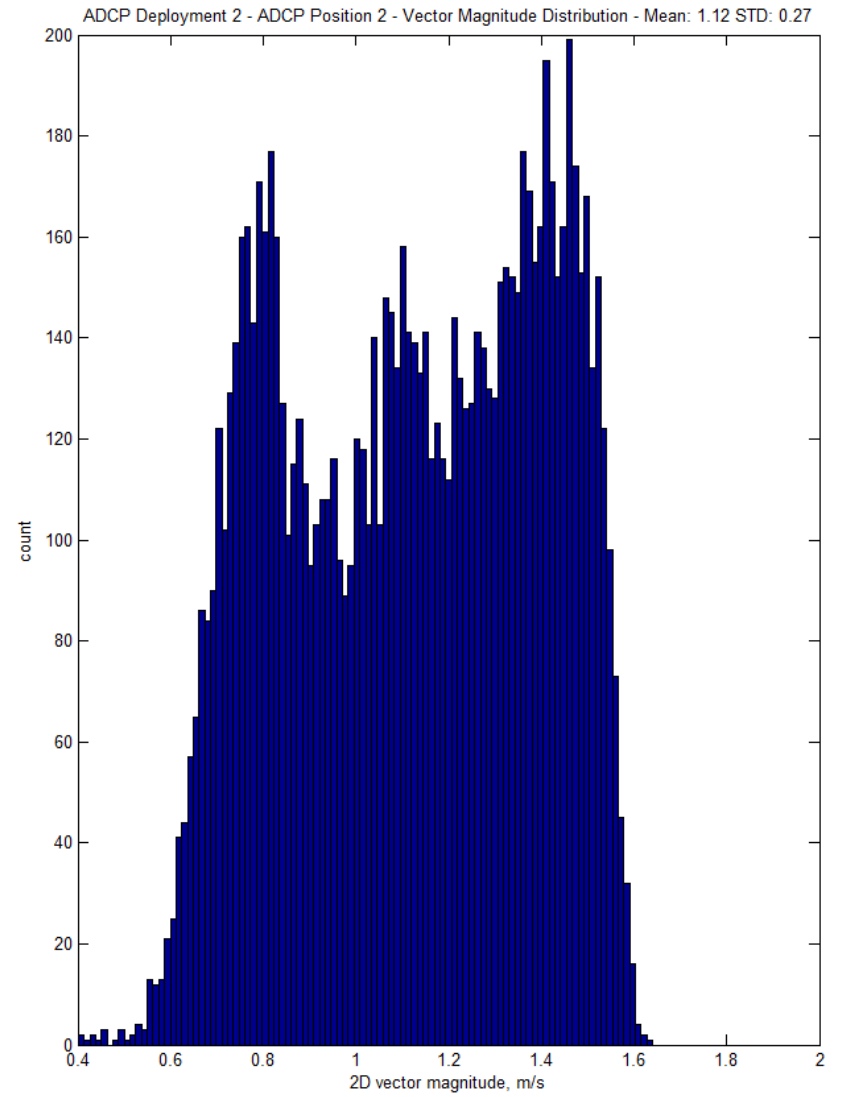
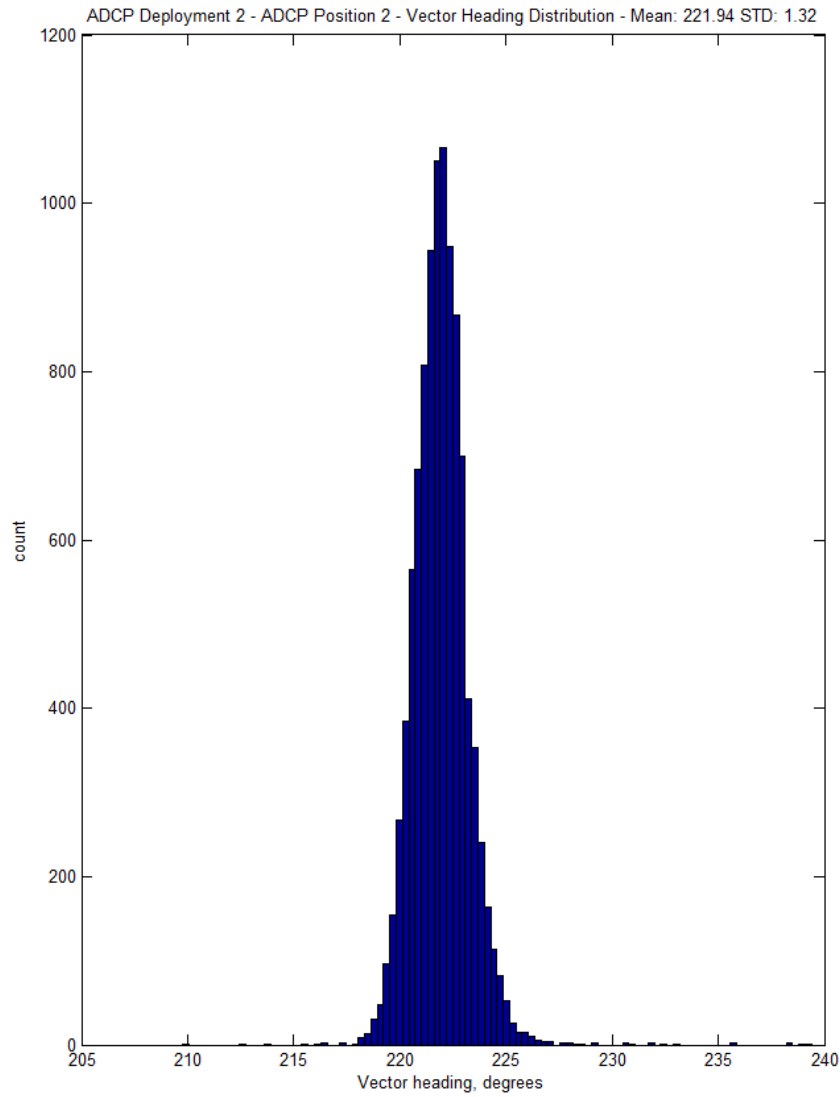

Figure 6 - ADCP 3 Filtered velocity heading and magnitude distributions.

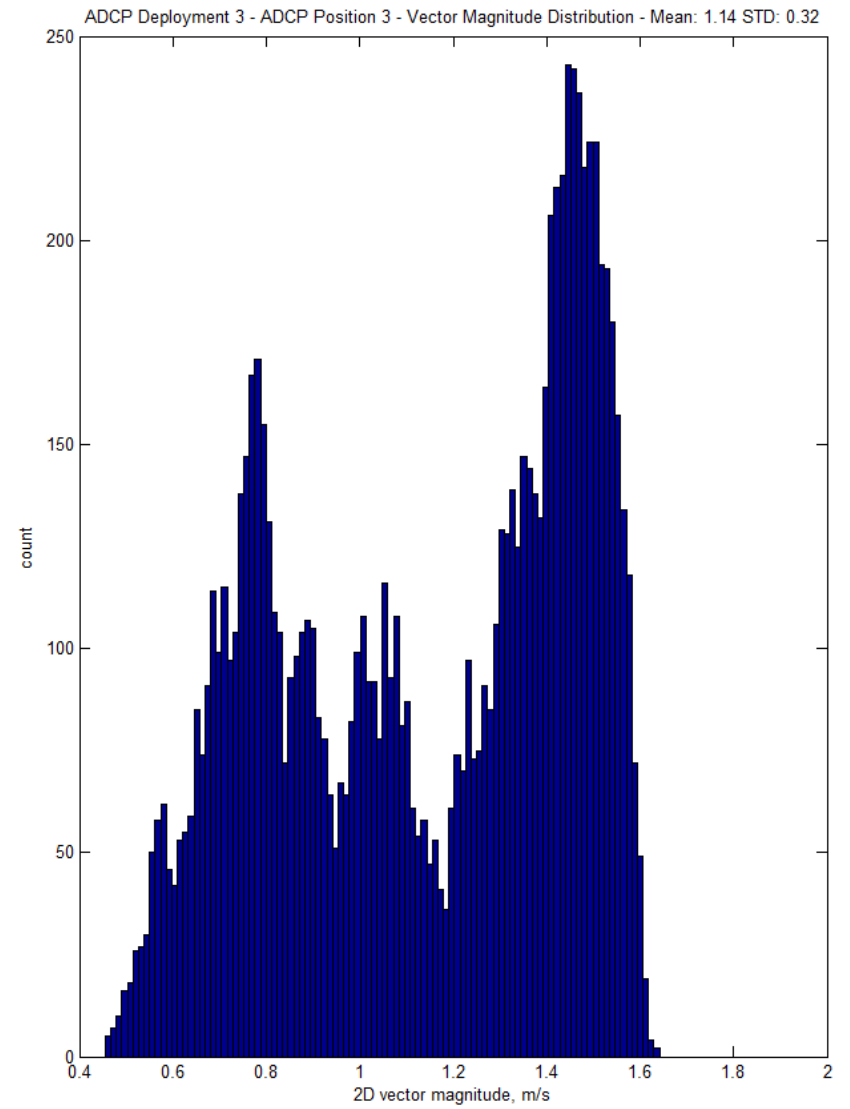
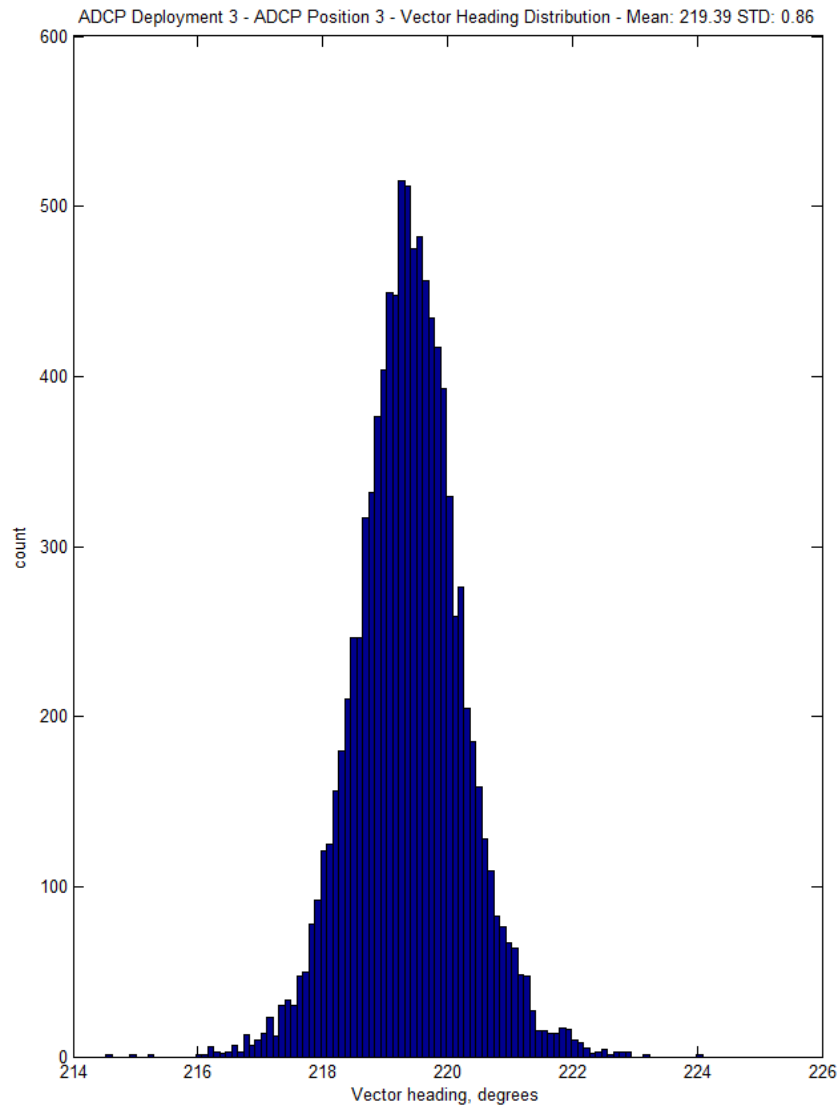

Figure 7 - ADCP 4 Filtered velocity heading and magnitude distributions.

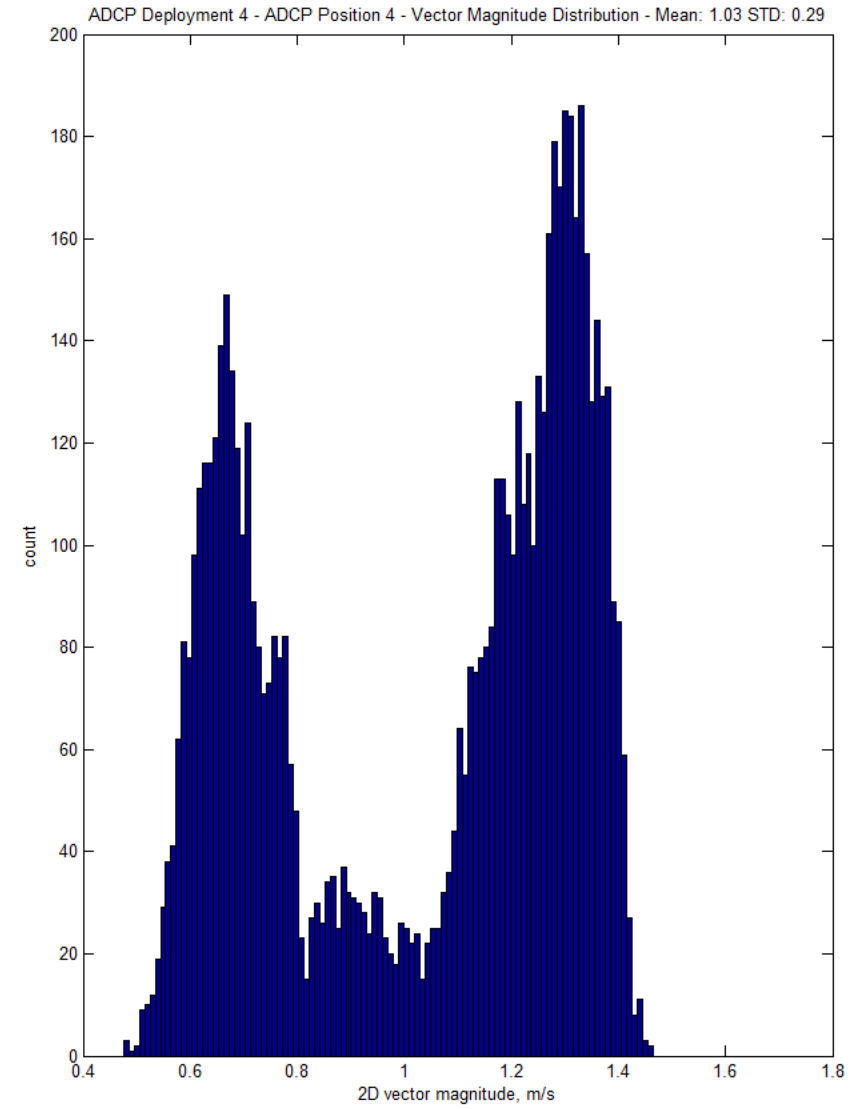
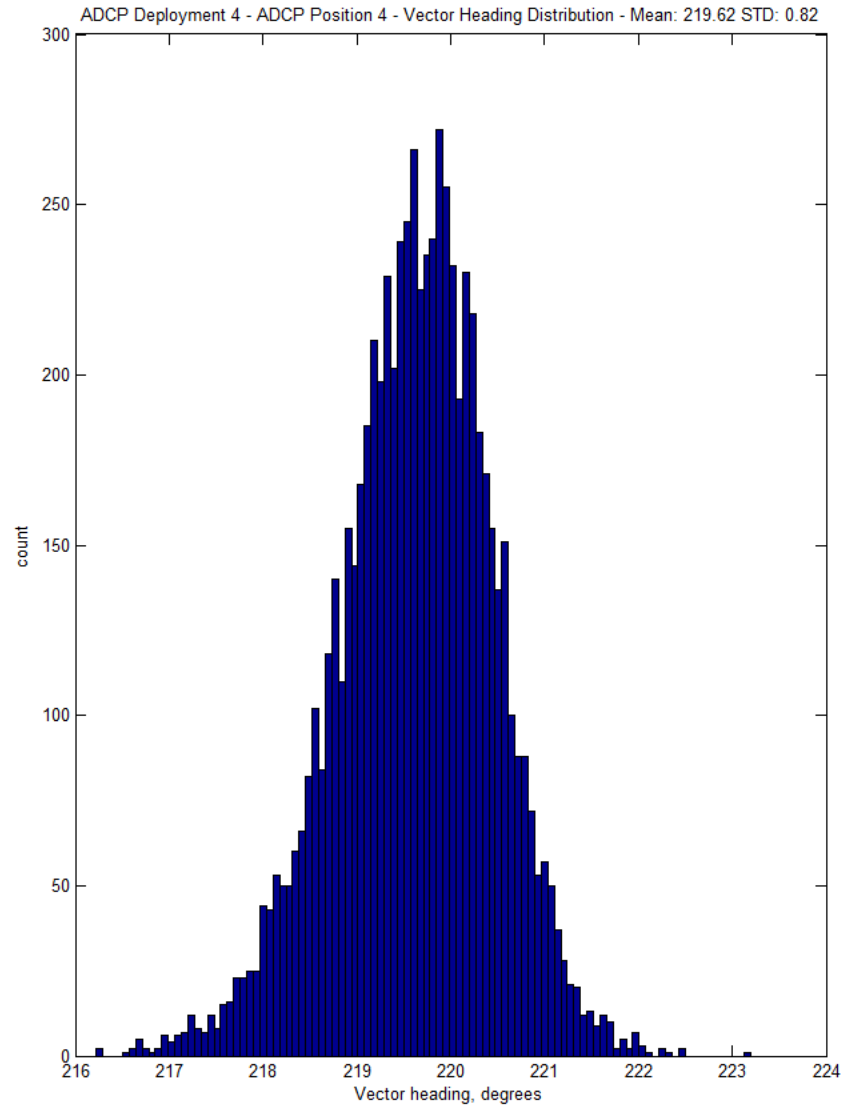

Figure 8 - ADCP 5 Filtered velocity heading and magnitude distributions.

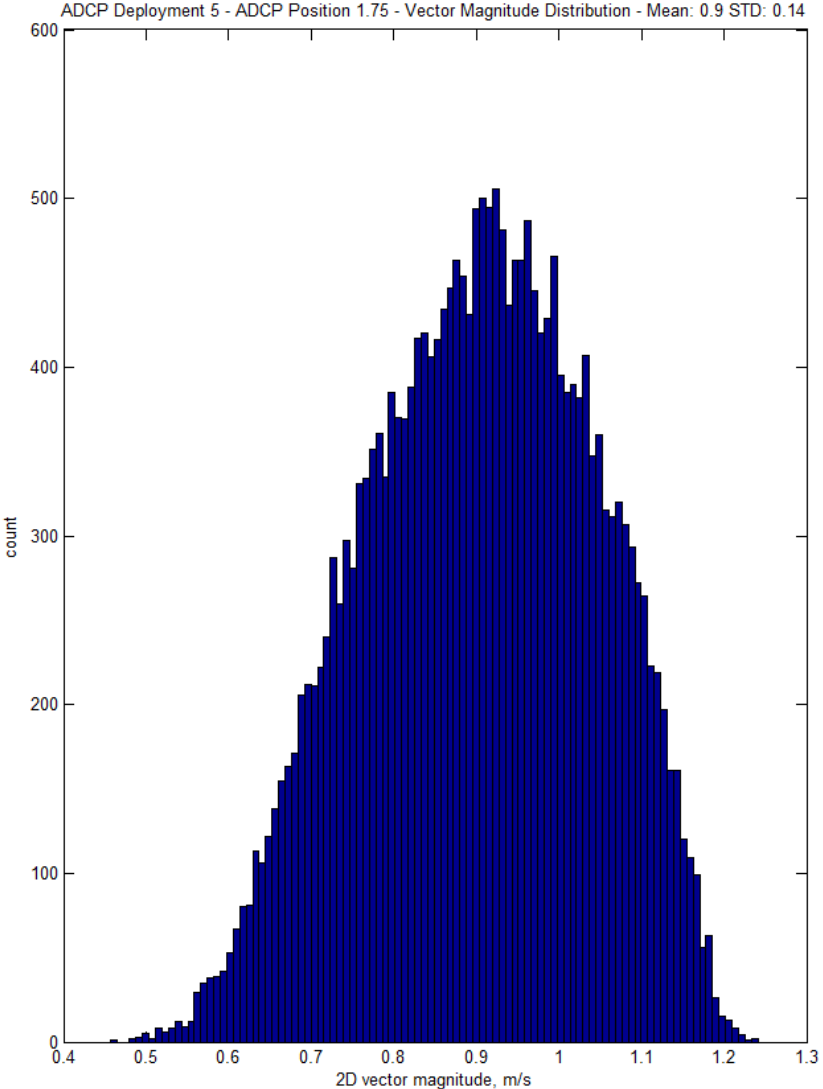
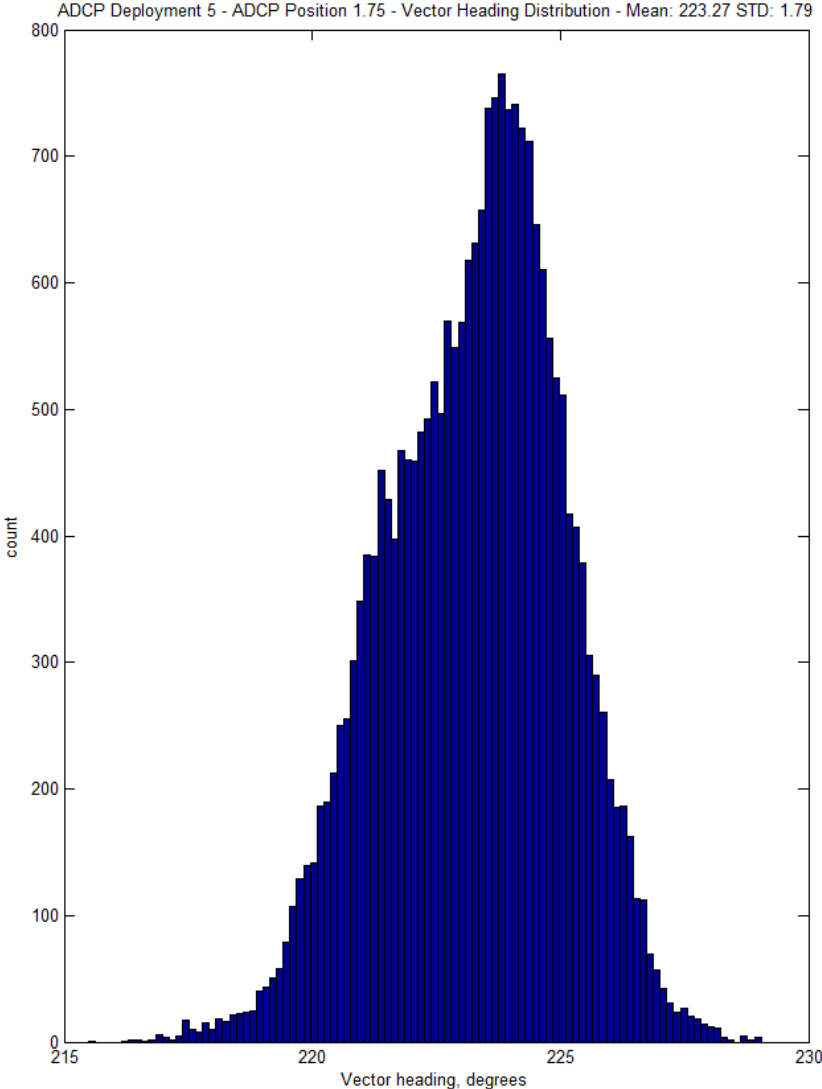

Figure 9 - ADCP 6 Filtered velocity heading and magnitude distributions.

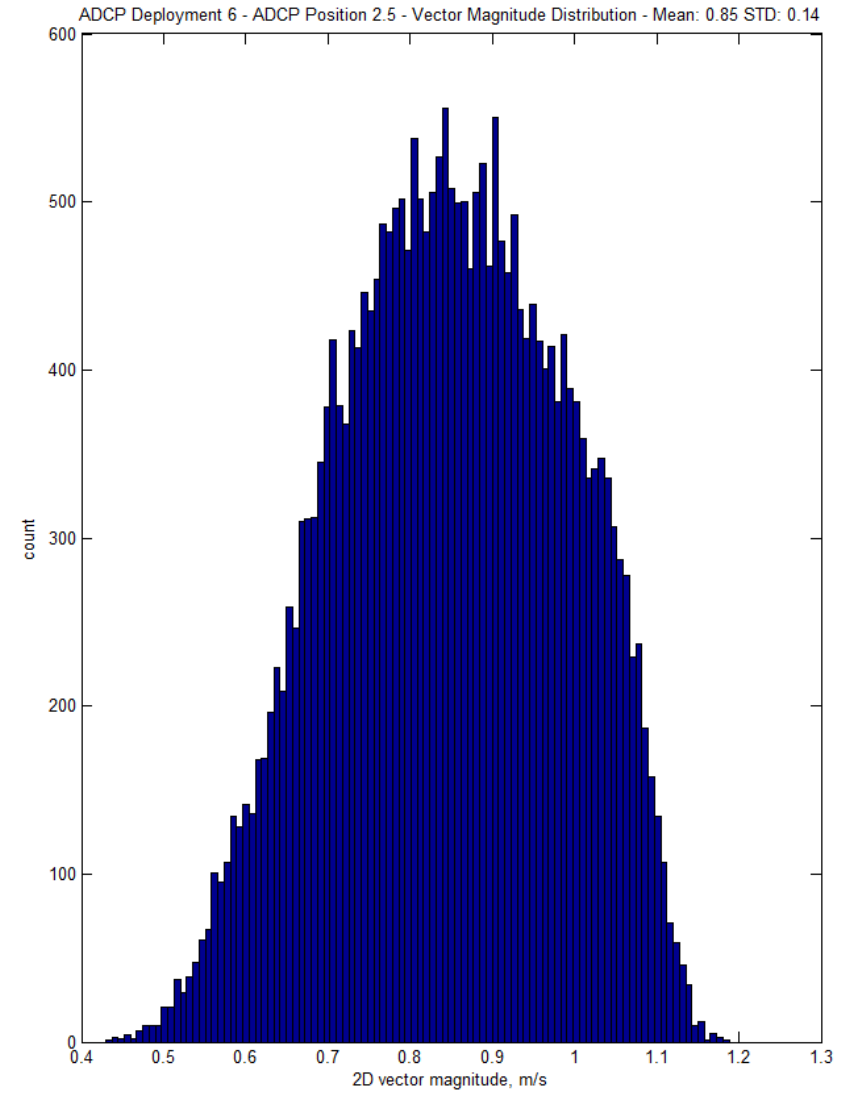
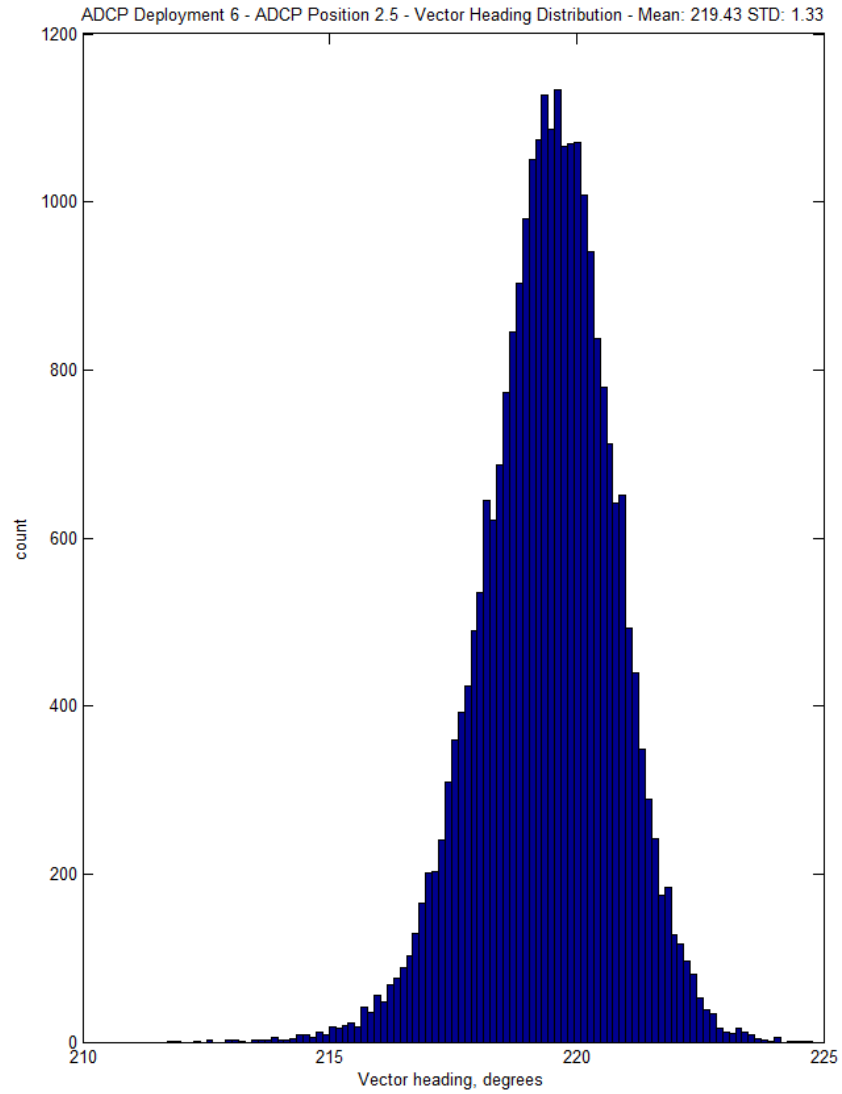

Figure 10 – ADCP operation periods and fish release periods shown with Sacramento River discharge.

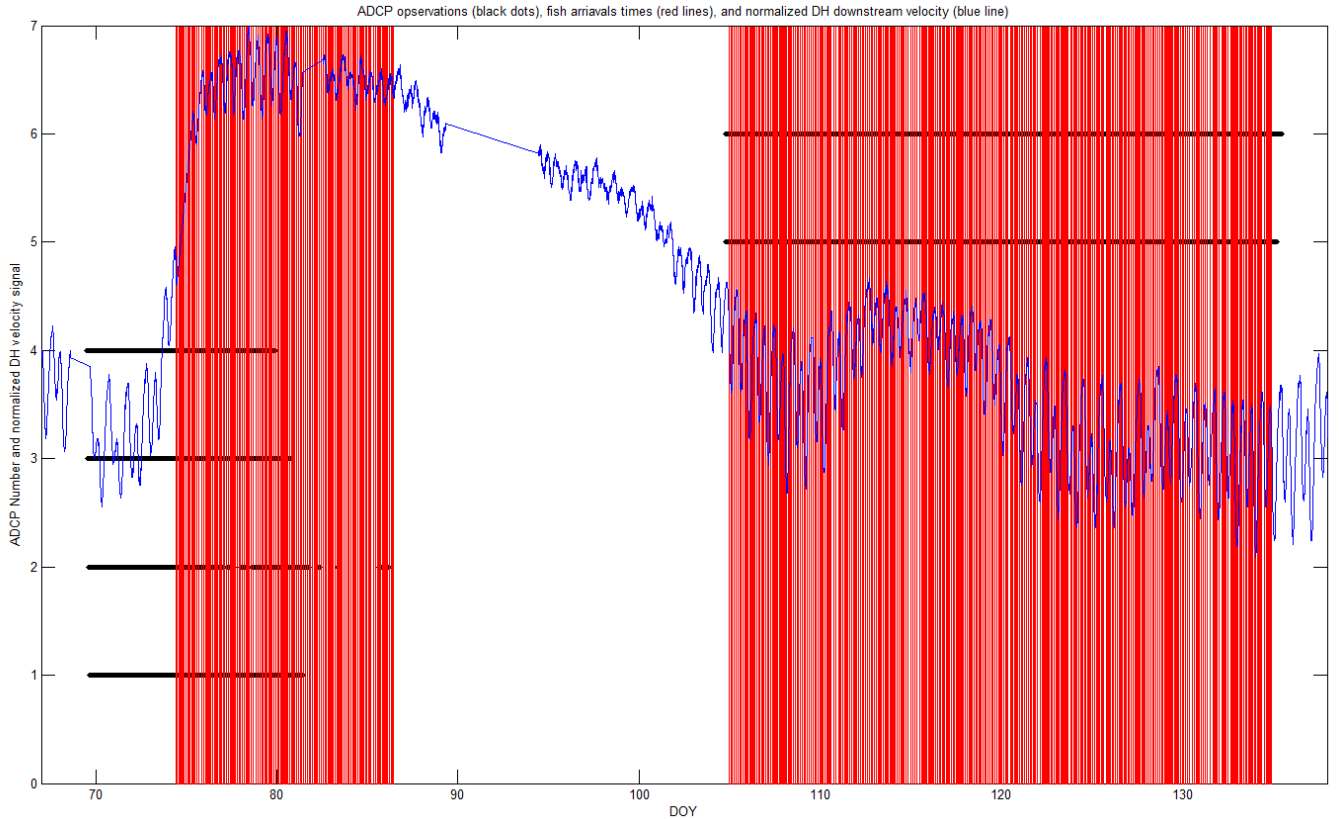

Figure showing Sacramento River discharge during the 2011 Barrier study, along with the ADCP operation times and fish arrival times. Vertical red lines indicate the arrival time of fish in the study area, and the horizontal black lines indicate periods when each ADCP was operational. The vertical axis on the left indicates the ADCP location number while the blue line shows the normalized plot of Sacramento River discharge during the study. Discharge the normalized to fit on the same axis as ADCP number.

Figure 11 - Performance of regression model predicting water velocities at ADCP 1

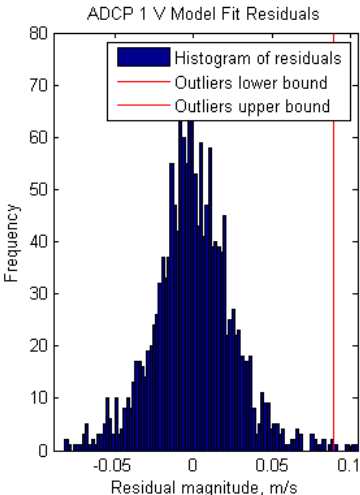
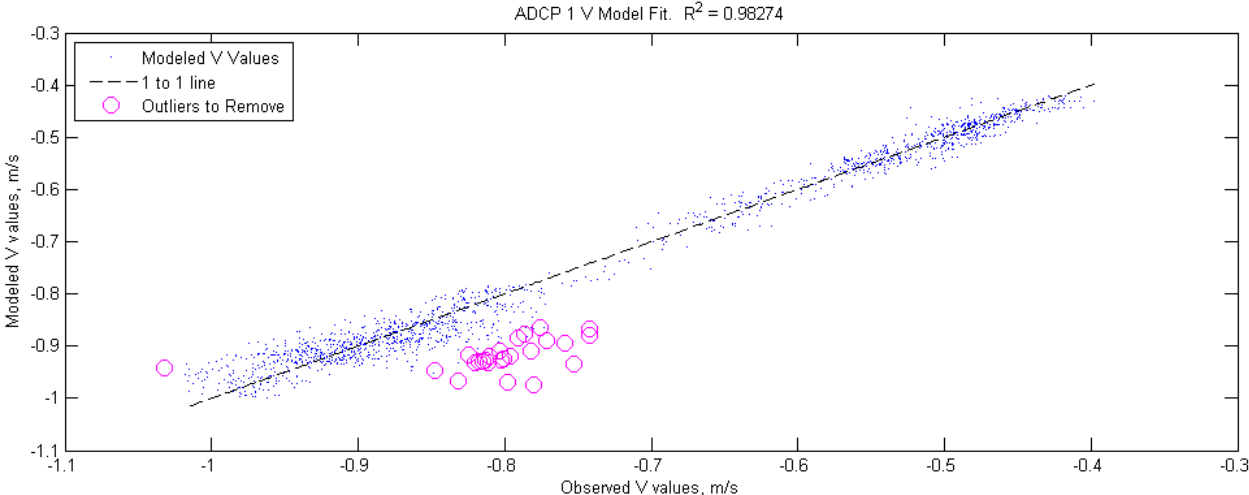
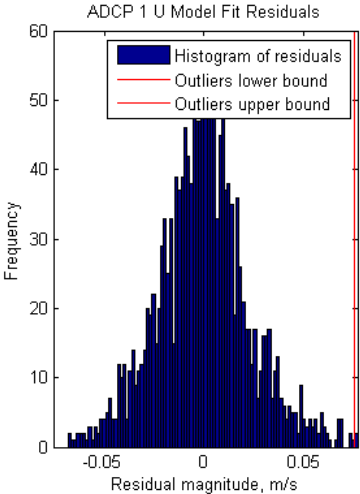
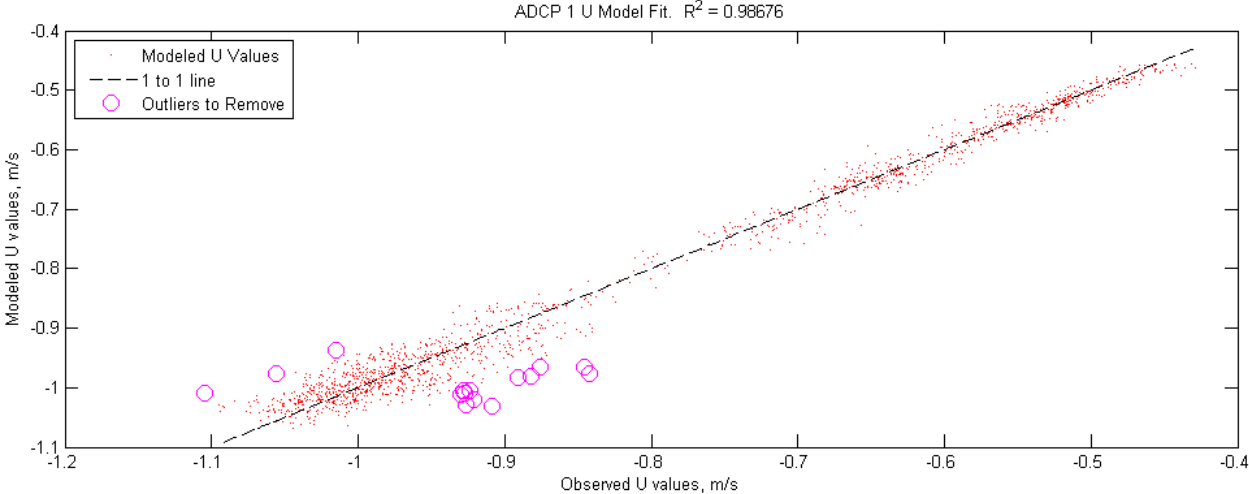

Figure 12 - Performance of regression model predicting water velocities at ADCP 2

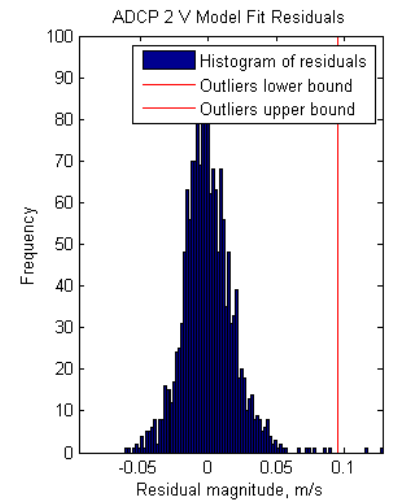
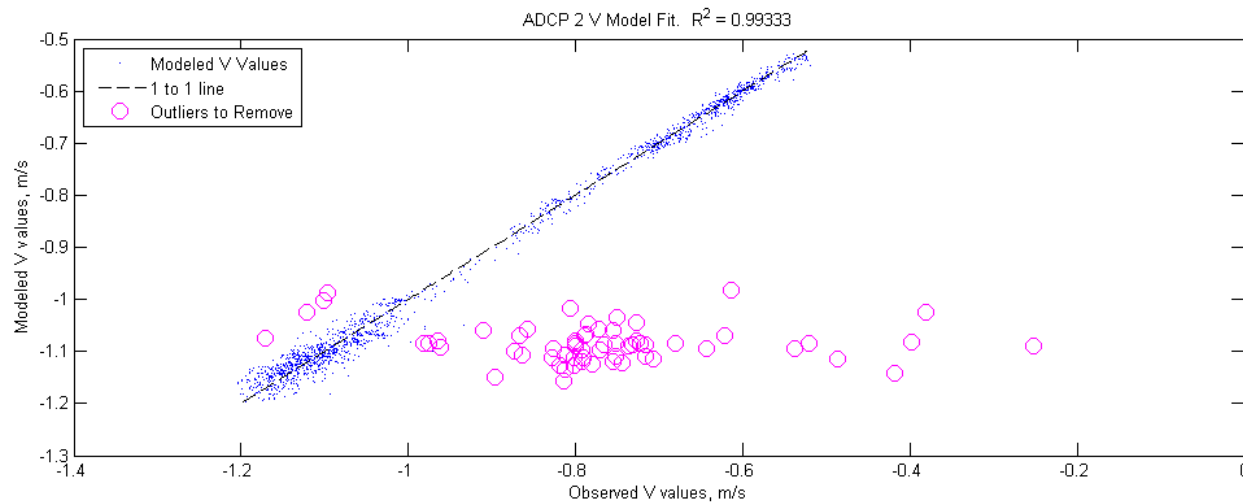
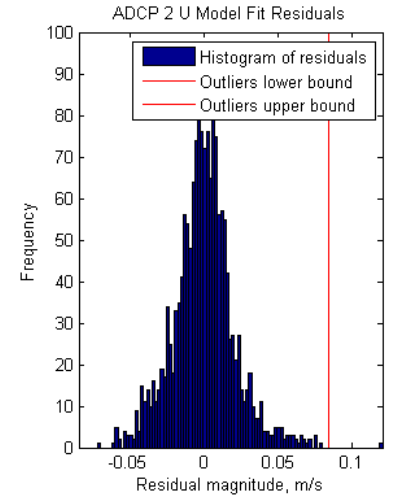
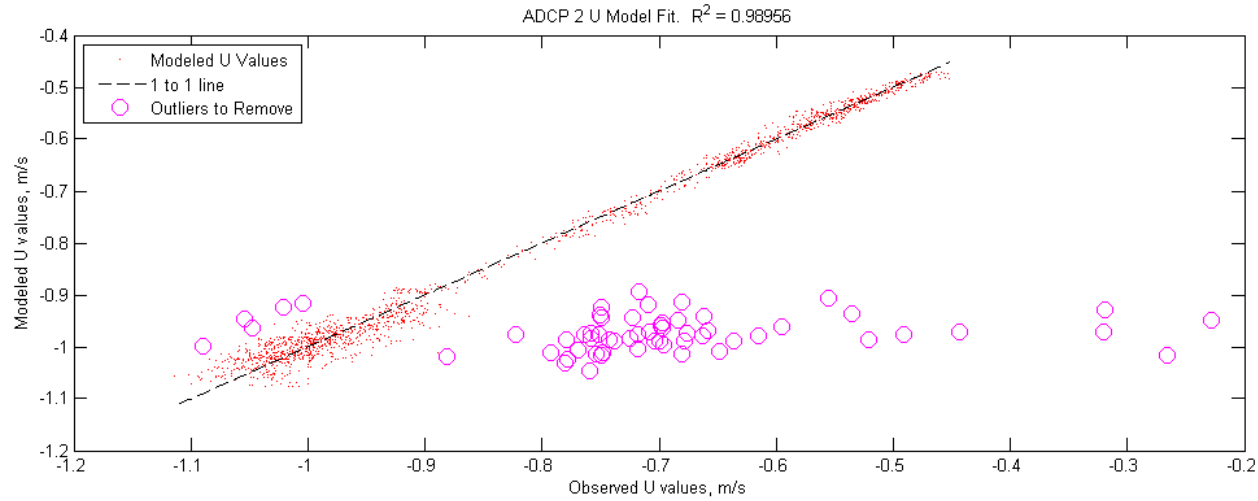

Figure 13 - Performance of regression model predicting water velocities at ADCP 3

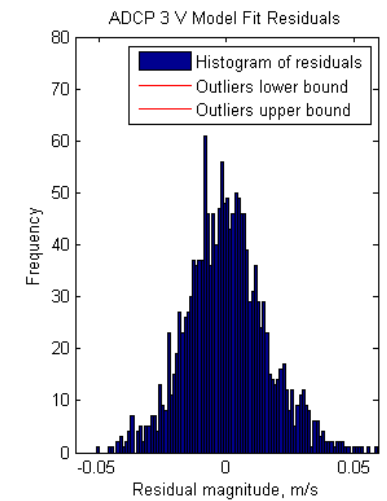
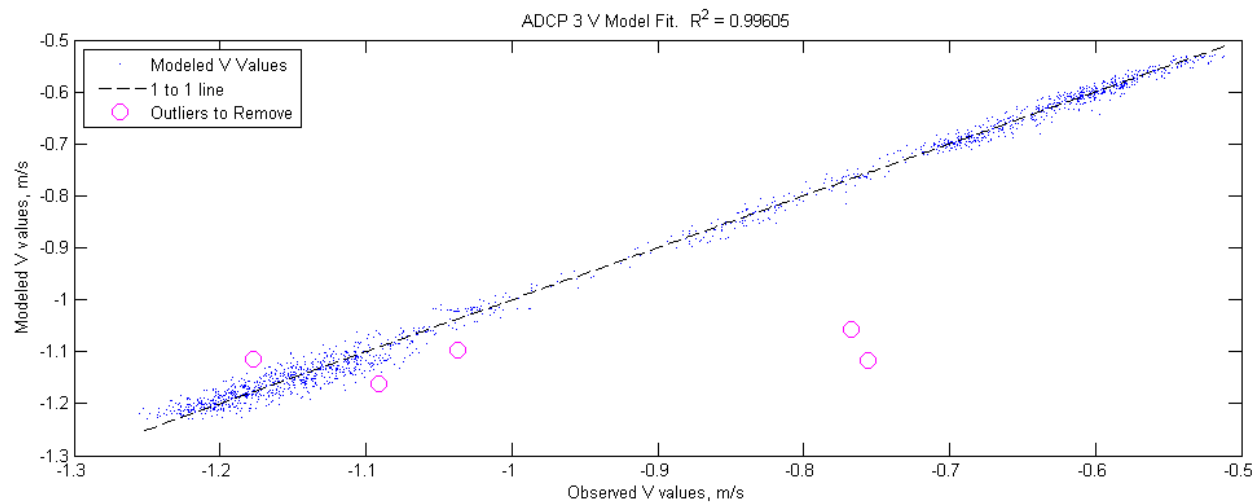
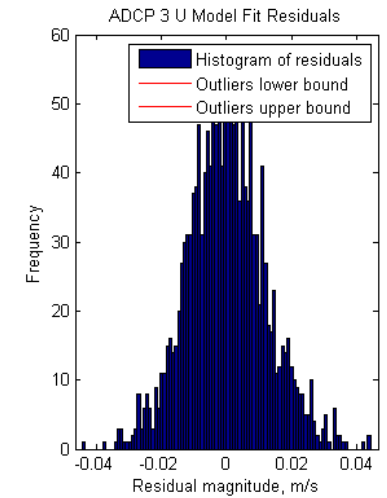
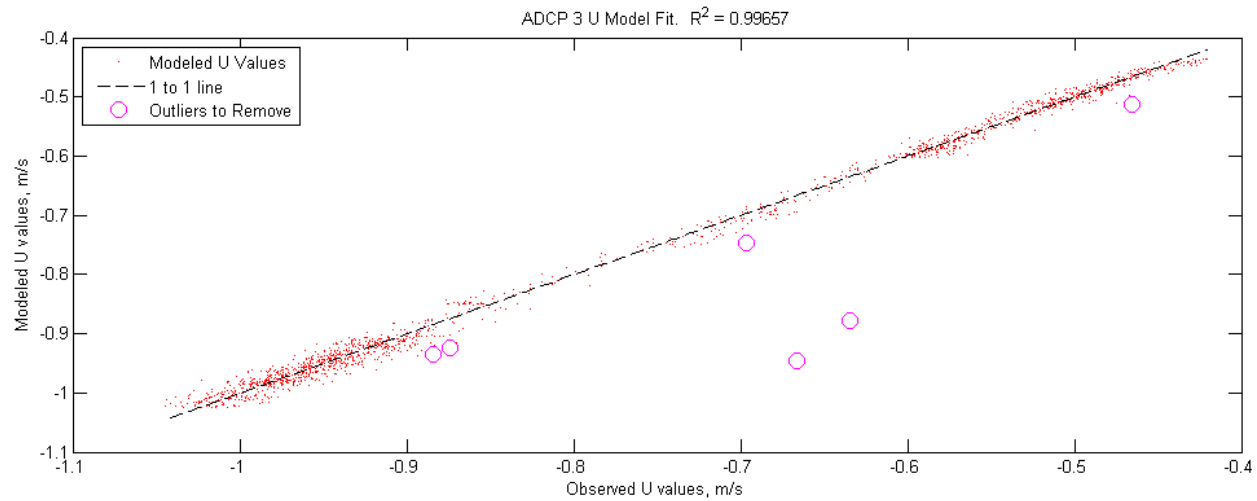

Figure 14 - Performance of regression model predicting water velocities at ADCP 4

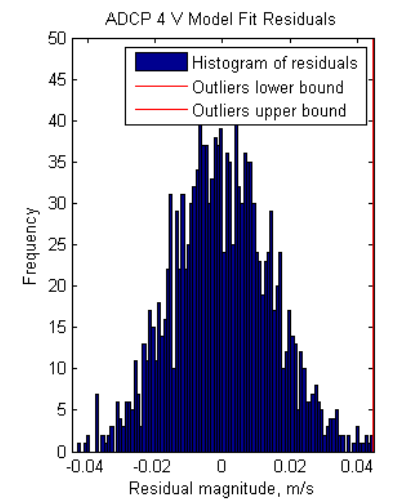
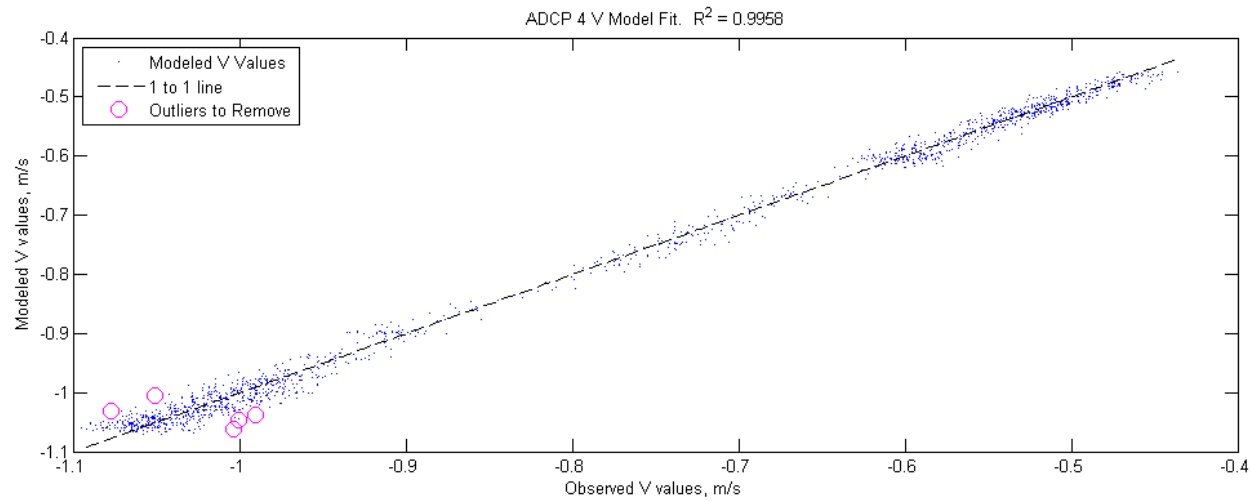
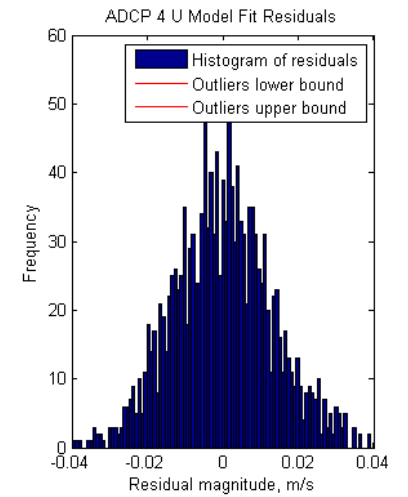
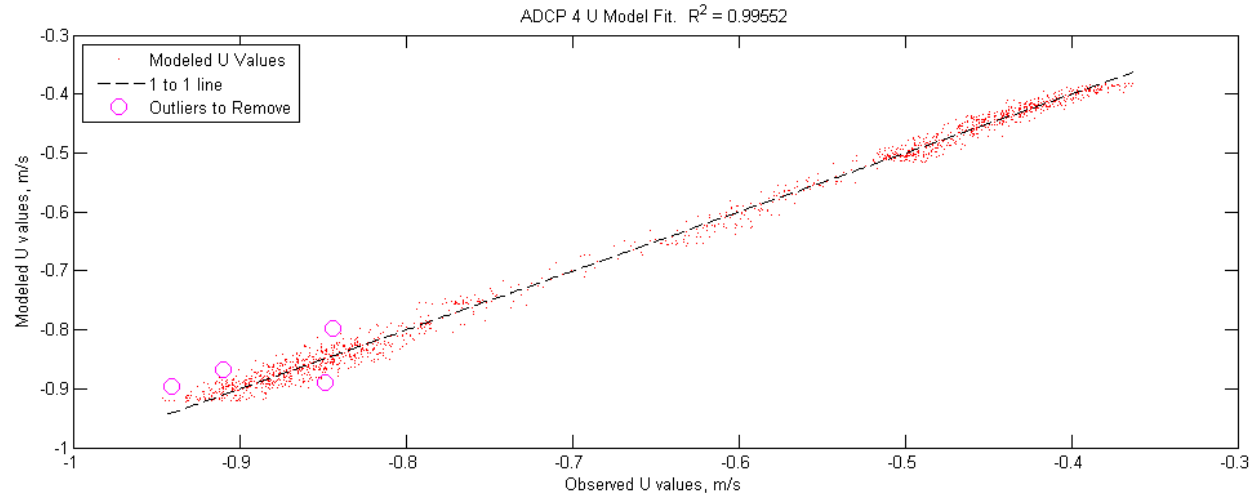

Figure 15 - Performance of regression model predicting water velocities at ADCP 5

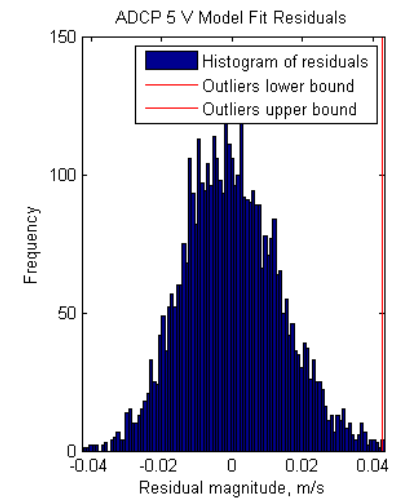
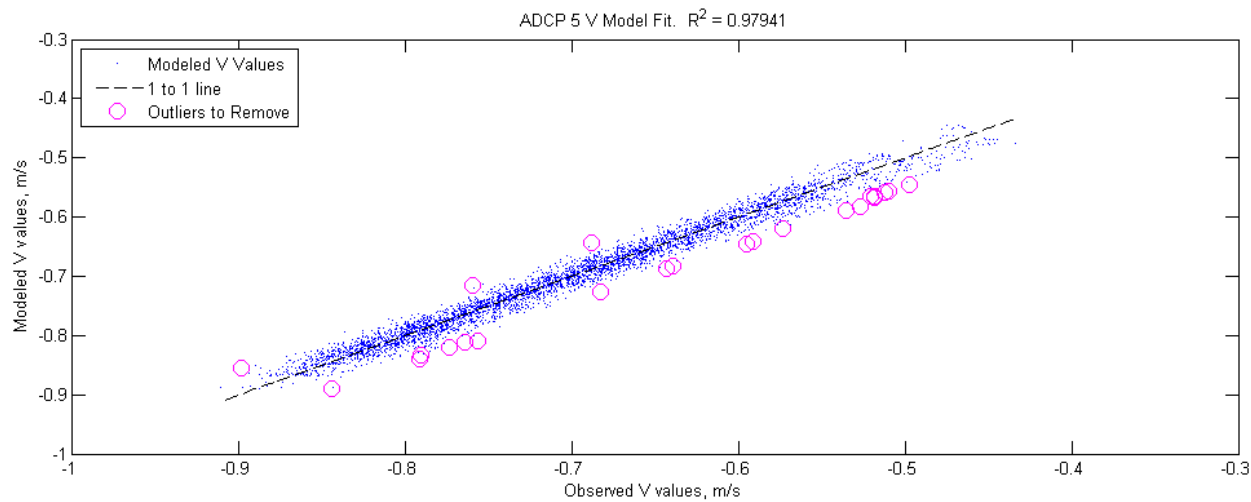
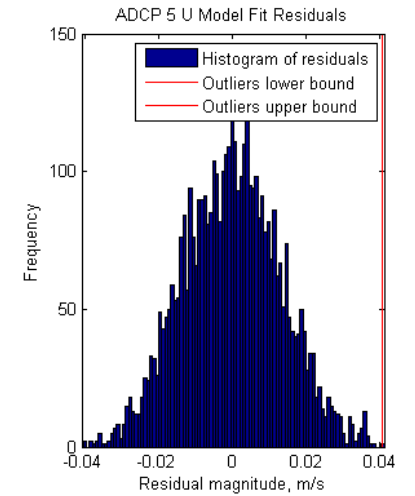
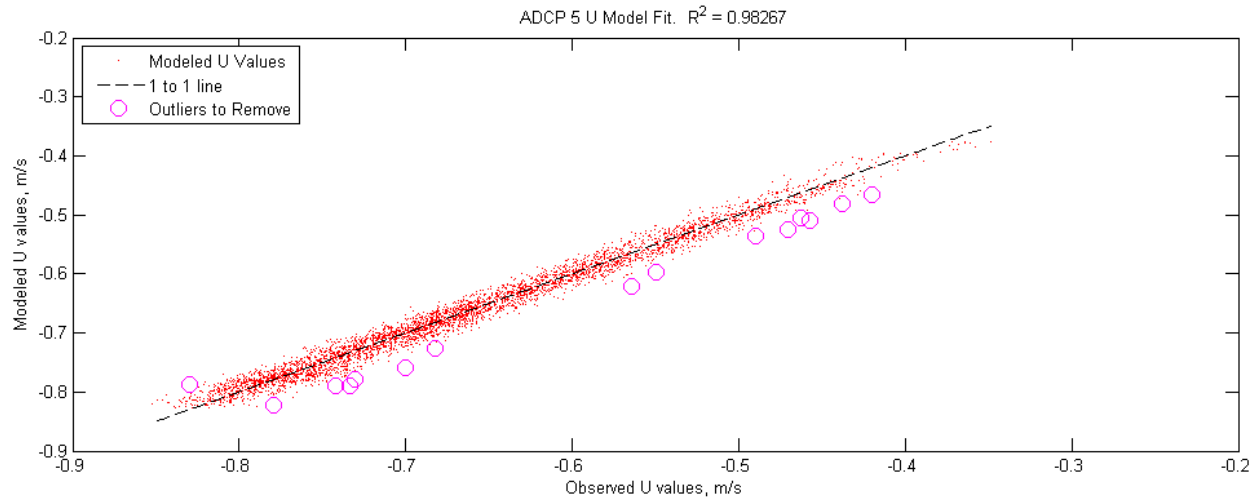

Figure 16 - Performance of regression model predicting water velocities at ADCP 6

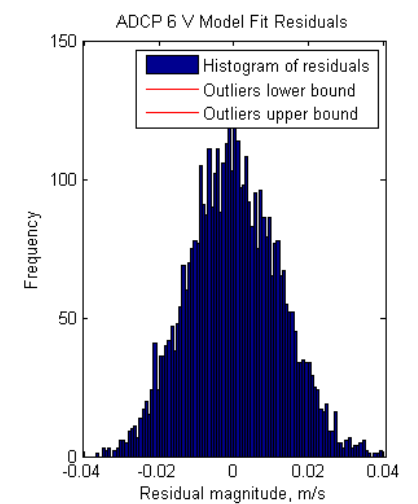
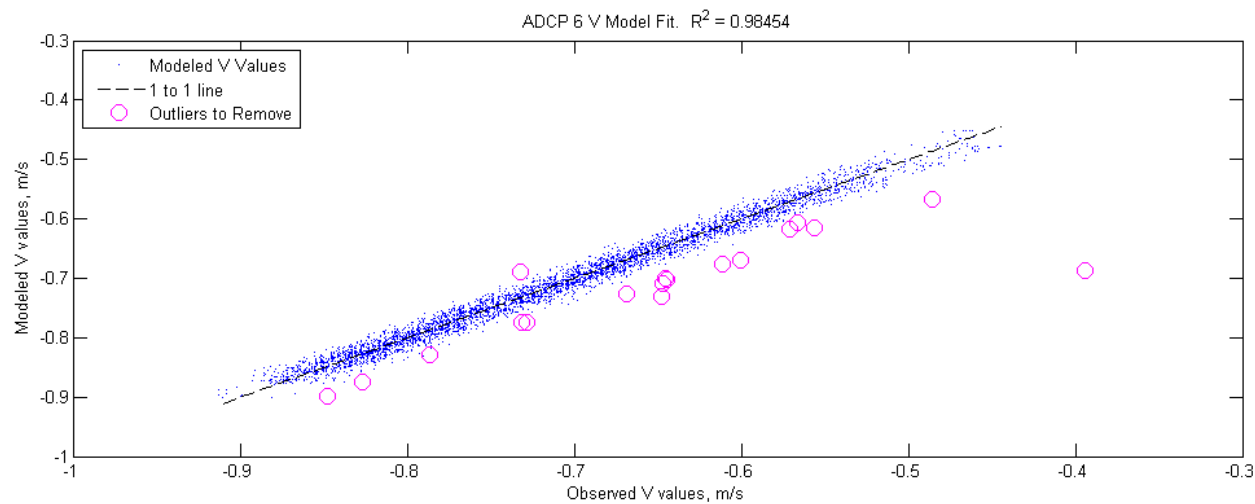
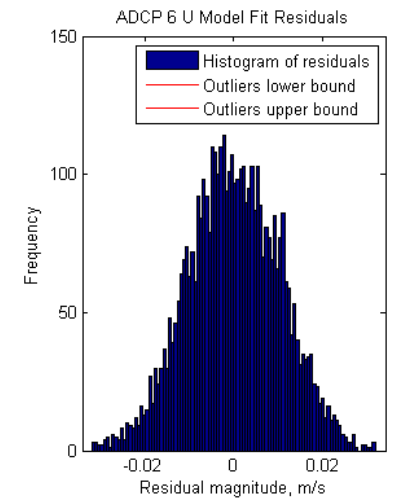
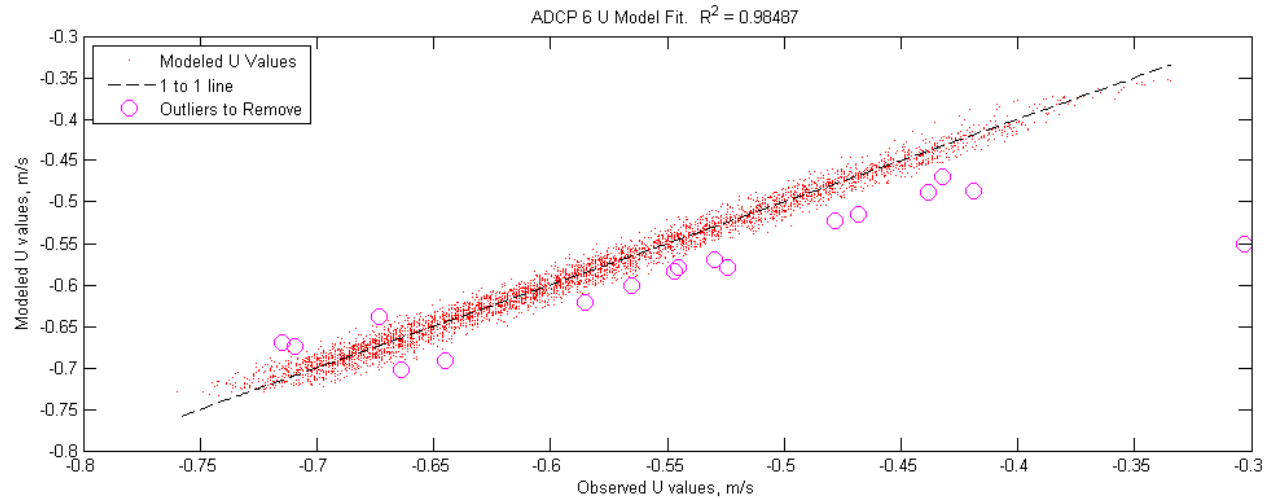

Figure 17 - location of each fish was determined to be closest to the barrier, based on data from the Locations Spreadsheet

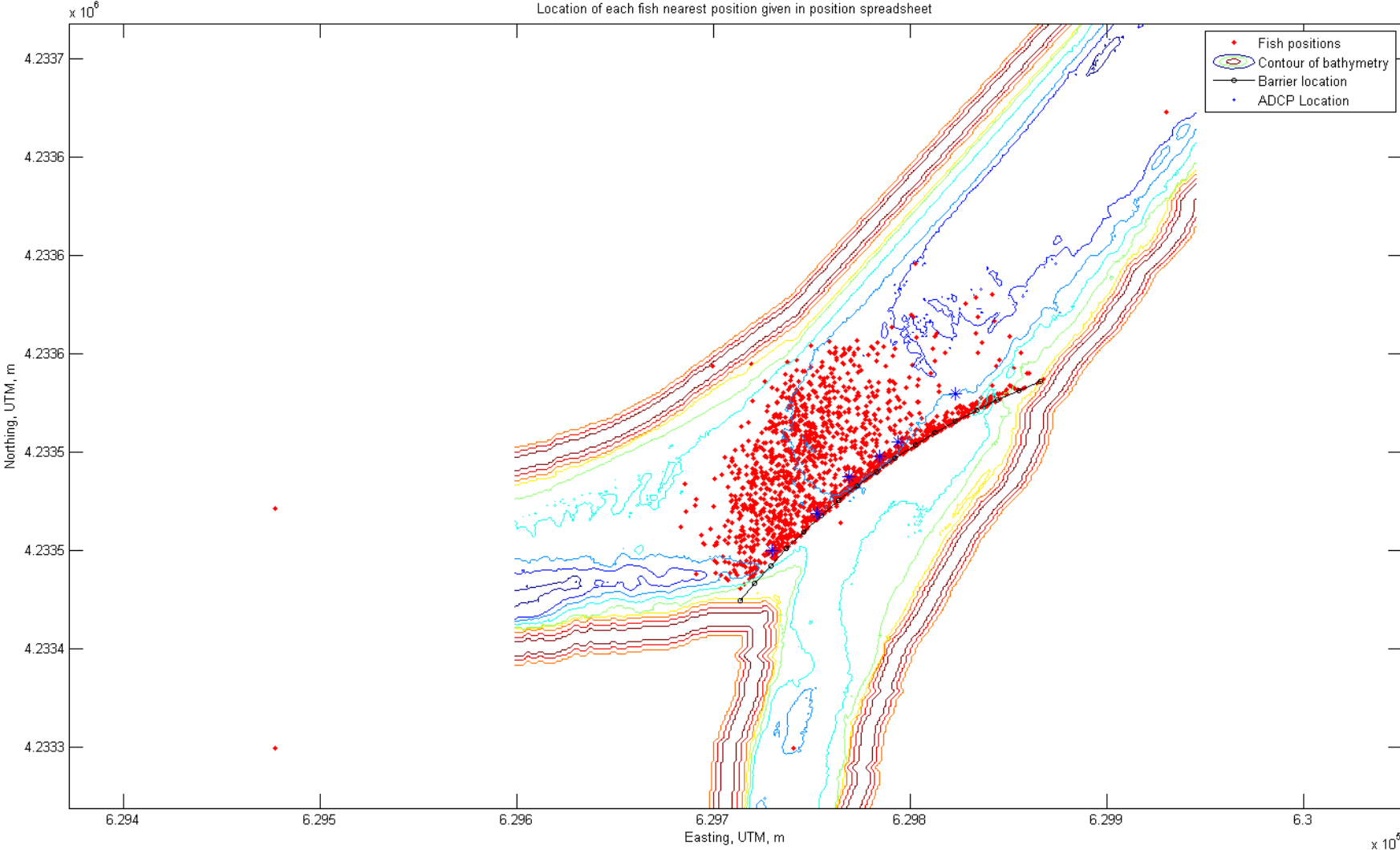
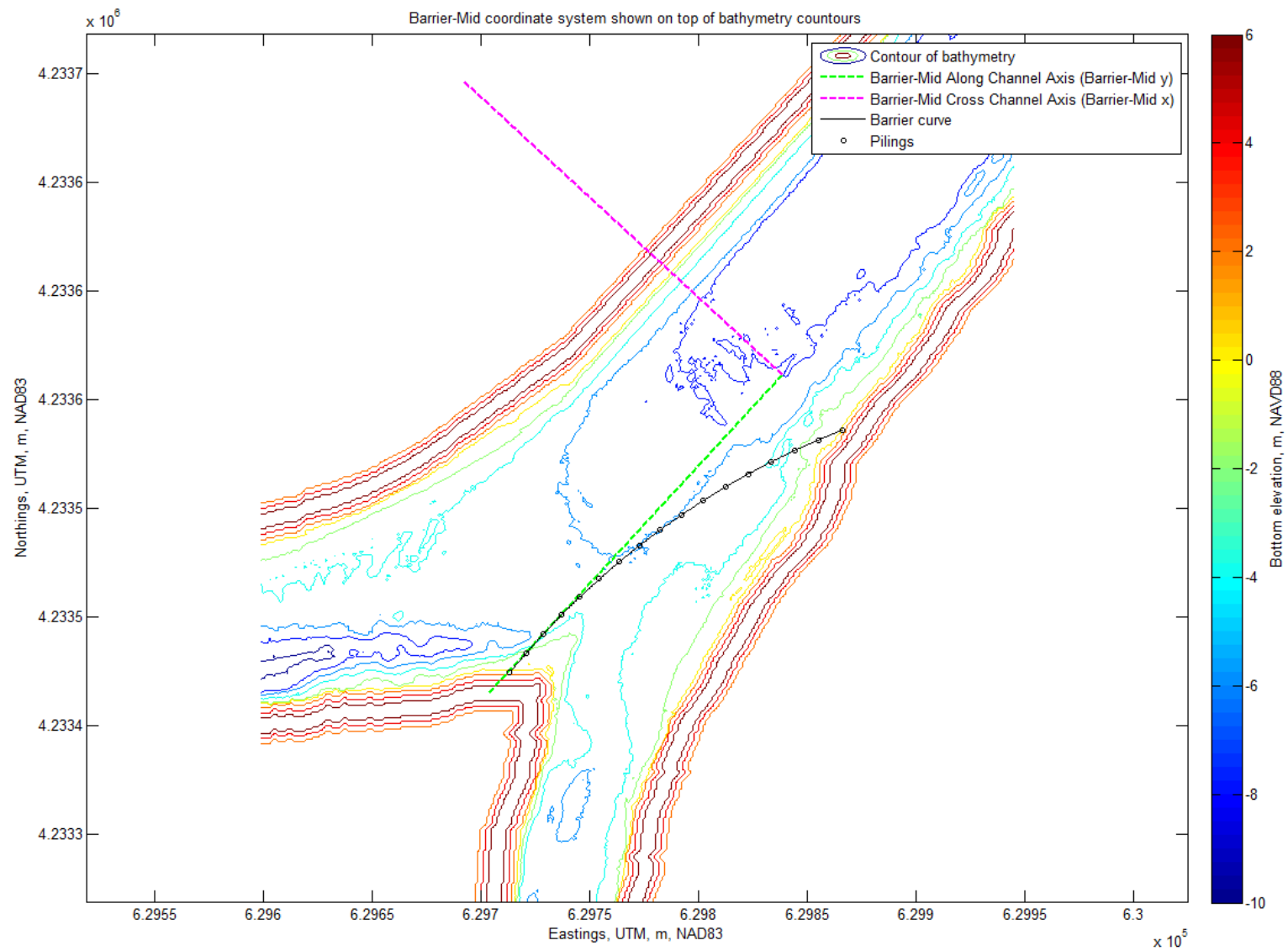

Figure 18 - Barrier-mid coordinate system used to compute along-stream and cross-stream coordinates for each fish's nearest position.



APPENDIX D

2011 GSNPB Summary of Fish Transport Conditions

Table) -1. Summary of transport conditions for juvenile Chinook salmon between the Coleman National Hatchery and Sacramento River/Georgiana Slough fish holding and tagging facility (March 14 to May 13, 2011).

	Number of Juvenile Salmon Transport Events	Minimum Dissolved Oxygen Concentration (% Saturation)	Maximum Dissolved Oxygen Concentration (% Saturation)	Minimum Water Temperature (C)	Maximum Water Temperature (C)	Transport Time from Hatchery to River (Minutes)	Dissolved Oxygen Concentration in Sacramento River at Transfer (% Saturation)	Water Temperature in Sacramento River at Transfer (C)	Total Number of Salmon Tagged per Delivery	Number of Salmon Transported and Rejected from Tagging per Delivery
Number	43	43	43	43	43	40	43	43	41	41
Mean	-	106.4	128.8	11.6	12.3	207	97.8	13.0	35.5	2.4
Minimum	-	93.1	106.6	7.6	8.0	180	91.3	9.1	20	0
Maximum	-	122.1	154.0	15.5	16.3	232	112.3	15.9	52	9

APPENDIX E

2011 GSNPB Summary of Predator Detections within the Array

Table E-1 Summary of Tagged Predator Detections within the Array during the 2011 Georgiana Slough Non-Physical Barrier Project

TAG CODE	DATE TAGGED AND RELEASED	DATE(S) DETECTED IN STUDY AREA ARRAY	SPECIES	APPROXIMATE TIME DETECTED IN STUDY AREA ARRAY	COMMENTS
2067	27-Mar	28-Mar	Striped Bass	12 min	Entered from downstream in GS, exited heading downstream in GS
2130	27-Mar	28-Mar	Striped Bass	52 min	Entered from downstream in GS, exited heading upstream in SR
2193	31-Mar	31-Mar 2-Apr 24-Apr	Striped Bass	5 min, 26 min, 5 min	Detected near release dock immediately after release, exited heading downstream in GS; entered from downstream in GS, exited heading upstream in SR; entered from upstream in SR, exited heading downstream in SR
2256	31-Mar	31-Mar 1-Apr	Striped Bass	7 min, 22 min	Detected near release dock immediately after release, exited heading downstream in SR; entered from downstream in SR, exited heading upstream in SR
2319	31-Mar	31-Mar 2-Apr	Striped Bass	8 hr 28 min, 47 min	Detected near release dock immediately after release, exited heading downstream in GS; entered from downstream in GS, exited heading upstream in SR
2382	31-Mar	31-Mar	Striped Bass	55 min	Detected near release dock immediately after release, exited heading downstream in SR
2445	31-Mar	31-Mar	Striped Bass	25 min	Detected near release dock after release, exited heading upstream in SR
2508	31-Mar	31-Mar	Striped Bass	6 min	Detected near release dock after release, exited heading downstream in SR
2571	31-Mar	31-Mar 7-Apr	Striped Bass	6 min, 26 min	Detected near release dock immediately after release, exited heading downstream in SR; entered from downstream in SR, exited heading upstream in SR
2634	31-Mar	31-Mar 1-Apr	Striped Bass	25 min, 1 hr 3 min	Detected near release dock immediately after release, exited heading downstream in GS; entered from downstream in GS, exited heading upstream in SR
2697	31-Mar	31-Mar 2-Apr	Striped Bass	14 min, 13 min	Detected near release dock immediately after release, exit route inconclusive; entered from downstream in GS, exited heading upstream in SR

TAG CODE	DATE TAGGED AND RELEASED	DATE(S) DETECTED IN STUDY AREA ARRAY	SPECIES	APPROXIMATE TIME DETECTED IN STUDY AREA ARRAY	COMMENTS
2760	31-Mar	31-Mar 1-Apr 6-Apr	Striped Bass	11 min, 11 min, 5 min	Detected near release dock immediately after release, exited heading downstream in SR; entered from downstream in SR, exited heading upstream in SR; entered from upstream SR, exited heading downstream in SR
2823	31-Mar	31-Mar 6-Apr	Striped Bass	8 min, 30 min	Detected near release dock immediately after release, exit route inconclusive; entered from downstream in GS, exited heading upstream in SR
2886	31-Mar	31-Mar 7-Apr	Striped Bass	12 min, 12 min	Detected near release dock immediately after release, exited heading downstream in GS; entered from downstream in GS, exited heading upstream in SR
2949	31-Mar	11-Apr	Striped Bass	5 min	First detected in array approximately 11 days after release, entered from downstream in GS, exit route inconclusive
3012	31-Mar	31-Mar 2-Apr 8-Apr 9-Apr 19-Apr	Striped Bass	8 min, 15 min, 8 min, 24 min, 20 min	Detected near release dock immediately after release, exited heading downstream in GS; entered from downstream GS, exited heading upstream in SR; entered from upstream in SR, exited heading downstream in GS; entered from downstream GS, exited heading downstream in SR; entered from downstream GS, exited heading upstream SR
3075	15-Apr	15-Apr 16-Apr 17-Apr 22-Apr	Striped Bass	18 hr 3 min, 6 min	Detected near release dock immediately after release; from 4/15 through early 4/17 remained on the upstream boundary of array entering and exiting the array many times; on 4/22 entered array from upstream in SR and 7 minutes later exited heading downstream in SR
3138	15-Apr	15-Apr	Striped Bass	8 hr 37 min	Detected near release dock immediately after release, exited heading downstream in SR
3201	15-Apr	15-Apr 16-Apr 17-Apr	Striped Bass	30 hr 25 min, 18 min	Detected near release dock immediately after release on 4/15 and stayed through late 4/16 when it exited heading downstream in SR; entered on 4/17 from downstream SR, exited heading upstream in SR
3264	15-Apr	N/A	Striped Bass	N/A	Never detected in array
2025	22-Apr	N/A	Smallmouth Bass	N/A	Never detected in array; released at point of capture downstream of study area in SR

TAG CODE	DATE TAGGED AND RELEASED	DATE(S) DETECTED IN STUDY AREA ARRAY	SPECIES	APPROXIMATE TIME DETECTED IN STUDY AREA ARRAY	COMMENTS
2088	22-Apr	25-Apr	Striped Bass	19 min	Entered from downstream in SR, exited heading upstream in SR; released at point of capture downstream of study area in SR
2151	22-Apr	N/A	Smallmouth Bass	N/A	Never detected in array; released at point of capture downstream of study area in SR
2214	22-Apr	6-May	Sacramento Pikeminnow	4 min	Entered from downstream in SR, exited heading downstream in SR; released at point of capture downstream of study area in SR
2277	4-May	4-May 5-May 6-May	Smallmouth Bass	36 hr 37 min	Entered at release dock shortly after release and appeared to have stayed continuously in array although it was not detected continuously
2340	4-May	4-May 14-May 15-May	Smallmouth Bass	12 hr 46 min, 59 min, 59 min	Detected near release dock immediately after release and appeared to have stayed continuously in array although it was not detected continuously
3453	4-May	4-May 5-May	Smallmouth Bass	14 hr 59 min	First detected near release dock approximately 7 hours after release, exited heading upstream in SR
2403	5-May	N/A	Smallmouth Bass	N/A	Never detected in array
3327	5-May	N/A	Smallmouth Bass	N/A	Never detected in array
3390	5-May	N/A	Smallmouth Bass	N/A	Never detected in array
2466	5-May	5-May	Striped Bass	4 hr 9 min	Detected near release dock immediately after release, exited heading upstream in SR
2529	5-May	5-May	Striped Bass	10 min	Detected near release dock immediately after release, exited heading downstream in SR
2655	5-May	5-May 6-May 9-May 10-May	Smallmouth Bass	6 hr 46 min, 2 hr, 2 hr 1 min, 17 min	Detected near release dock immediately after release, exited heading upstream in SR; entered from upstream in SR, exited heading downstream in SR; entered from downstream in SR, exit route inconclusive; entry route inconclusive, exited heading downstream in SR
2718	5-May	5-May 6-May 7-May	Smallmouth Bass	52 hr	Detected near release dock immediately after release, exited heading upstream in SR
2844	5-May	N/A	Smallmouth Bass	N/A	Never detected in array
2970	5-May	5-May 6-May 7-May	Smallmouth Bass	52 hr 38 min	Detected near release dock immediately after release, exited heading upstream in SR

TAG CODE	DATE TAGGED AND RELEASED	DATE(S) DETECTED IN STUDY AREA ARRAY	SPECIES	APPROXIMATE TIME DETECTED IN STUDY AREA ARRAY	COMMENTS
3033	5-May	5-May	Striped Bass	11 min	Detected near release dock shortly after release, exited heading downstream in SR
3096	5-May	5-May	Striped Bass	2 min	Detected near release dock immediately after release, exited heading upstream in SR
3159	5-May	5-May	Striped Bass	58 min	Detected near release dock shortly after release, exited heading downstream in SR
3222	5-May	5-May 6-May	Striped Bass	25 hr 23 min	Detected near release dock shortly after release, exited heading upstream in SR
2046	5-May	5-May 6-May 7-May	Striped Bass	49 hr 19 min	Detected near release dock shortly after release and appeared to never leave the array
2109	5-May	5-May	Striped Bass	39 min	Detected near release dock immediately after release, exited heading downstream in SR
2172	6-May	6-May	Striped Bass	17 min	Detected near release dock shortly after release, exit route inconclusive
2235	6-May	6-May	Striped Bass	5 min	Detected downstream of release dock shortly after release, exited heading downstream in SR
2298	6-May	6-May	Striped Bass	5 min	Detected near release dock immediately after release, exit route inconclusive
2361	6-May	7-May	Striped Bass	17 min	Detected near release dock immediately after release, exited heading downstream in SR
3285	7-May	7-May 8-May	Striped Bass	6 hr 2 min 8 hr 35 min	Detected near release dock immediately after release, exited heading downstream in SR; entry route inconclusive, exited heading downstream in SR
3348	7-May	N/A	Striped Bass	N/A	Never detected in array
3411	7-May	7-May 8-May	Striped Bass	8 min, 6 min	Detected near release dock immediately after release, exited heading downstream in SR; entry route inconclusive, exited heading upstream in SR
3474	7-May	7-May	Striped Bass	7 min	Detected near release dock immediately after release, exited heading downstream in SR

Notes:

SR= Sacramento River, GS = Georgiana Slough